

AR039 NEUTRON ACER TENDL-2024 LIBRARY; T=293.6K

Principal cross sections

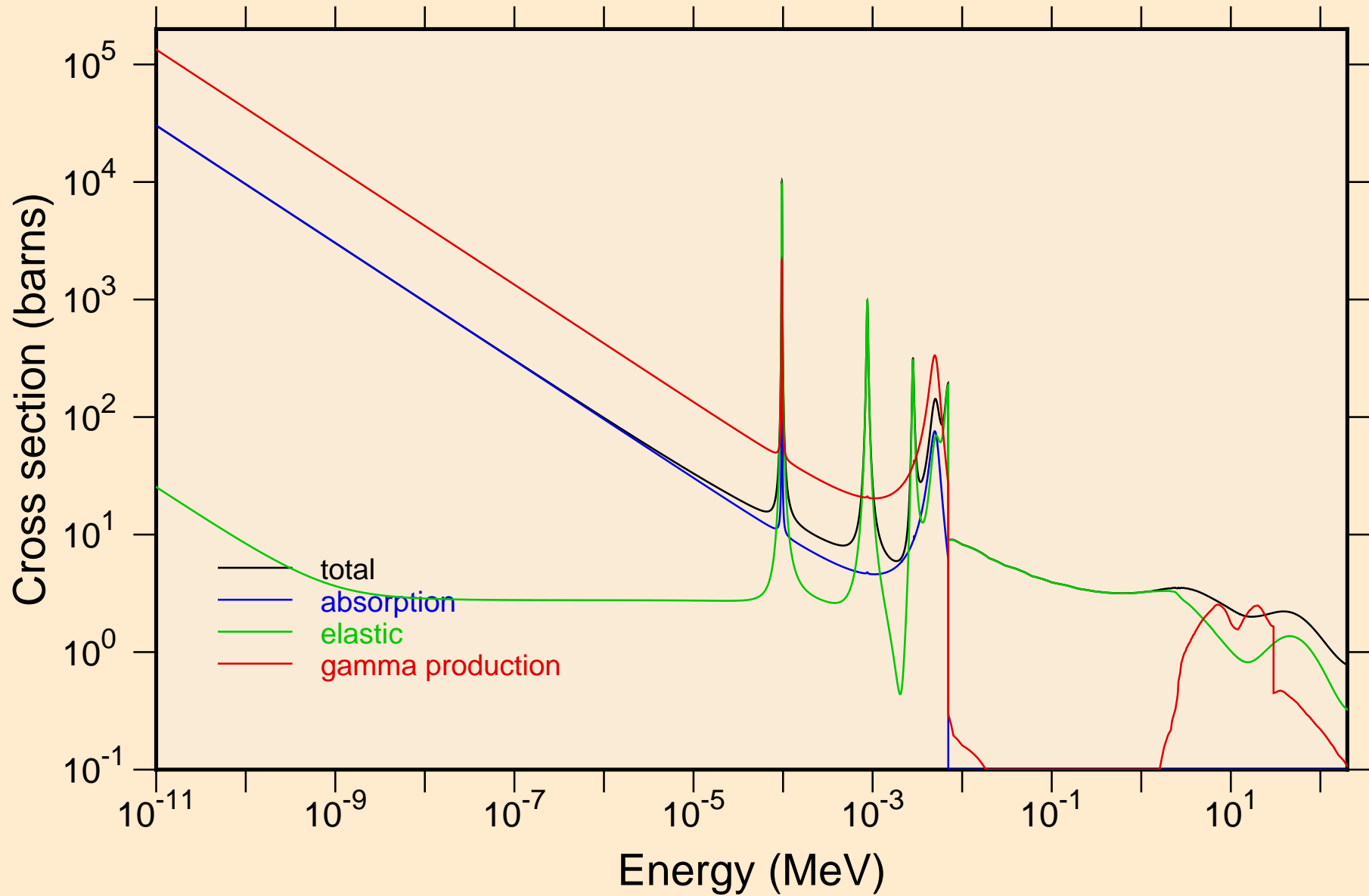

AR039 NEUTRON ACER TENDL-2024 LIBRARY; T=293.6K
resonance total cross section

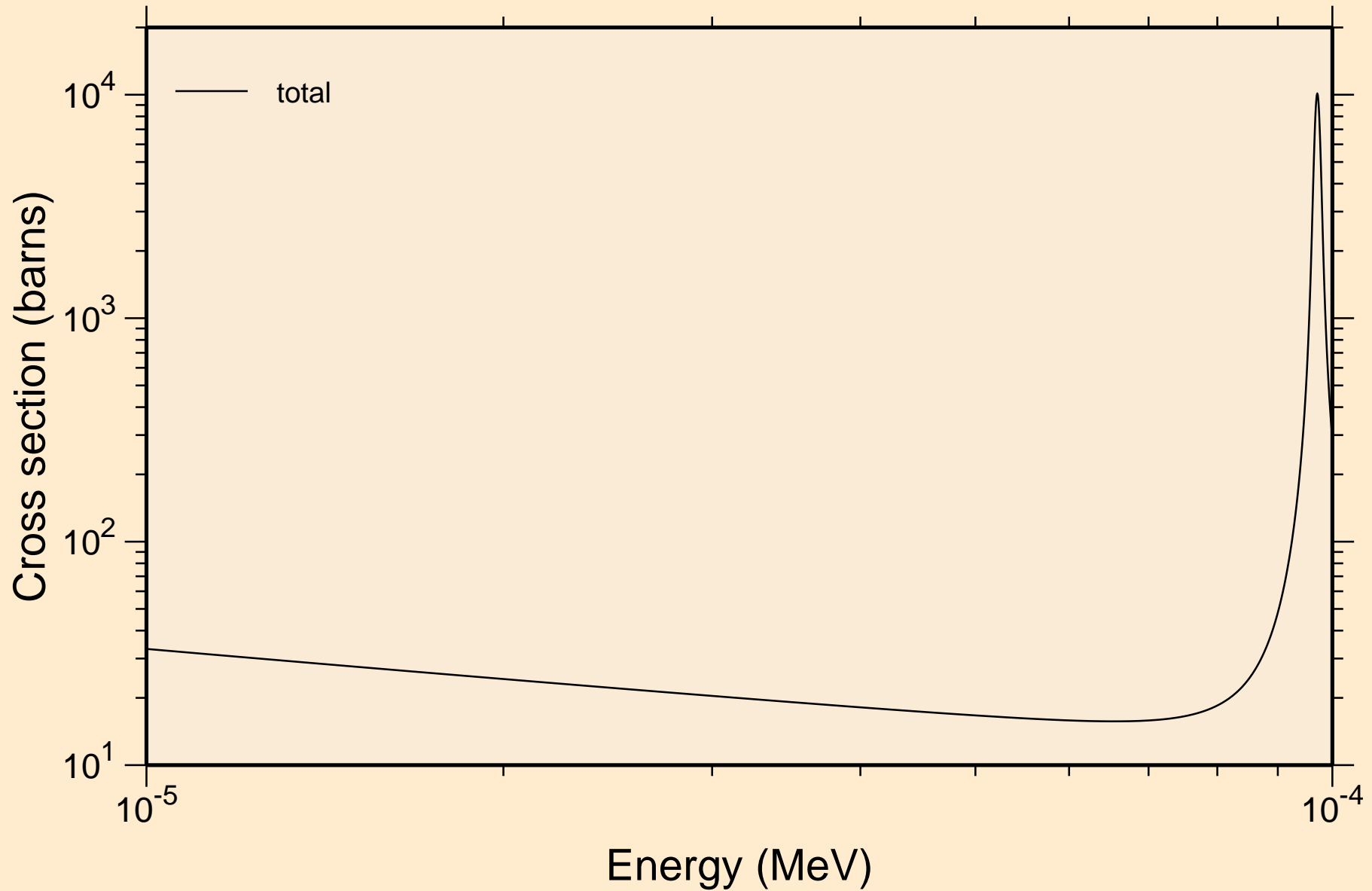

AR039 NEUTRON ACER TENDL-2024 LIBRARY; T=293.6K
resonance total cross section

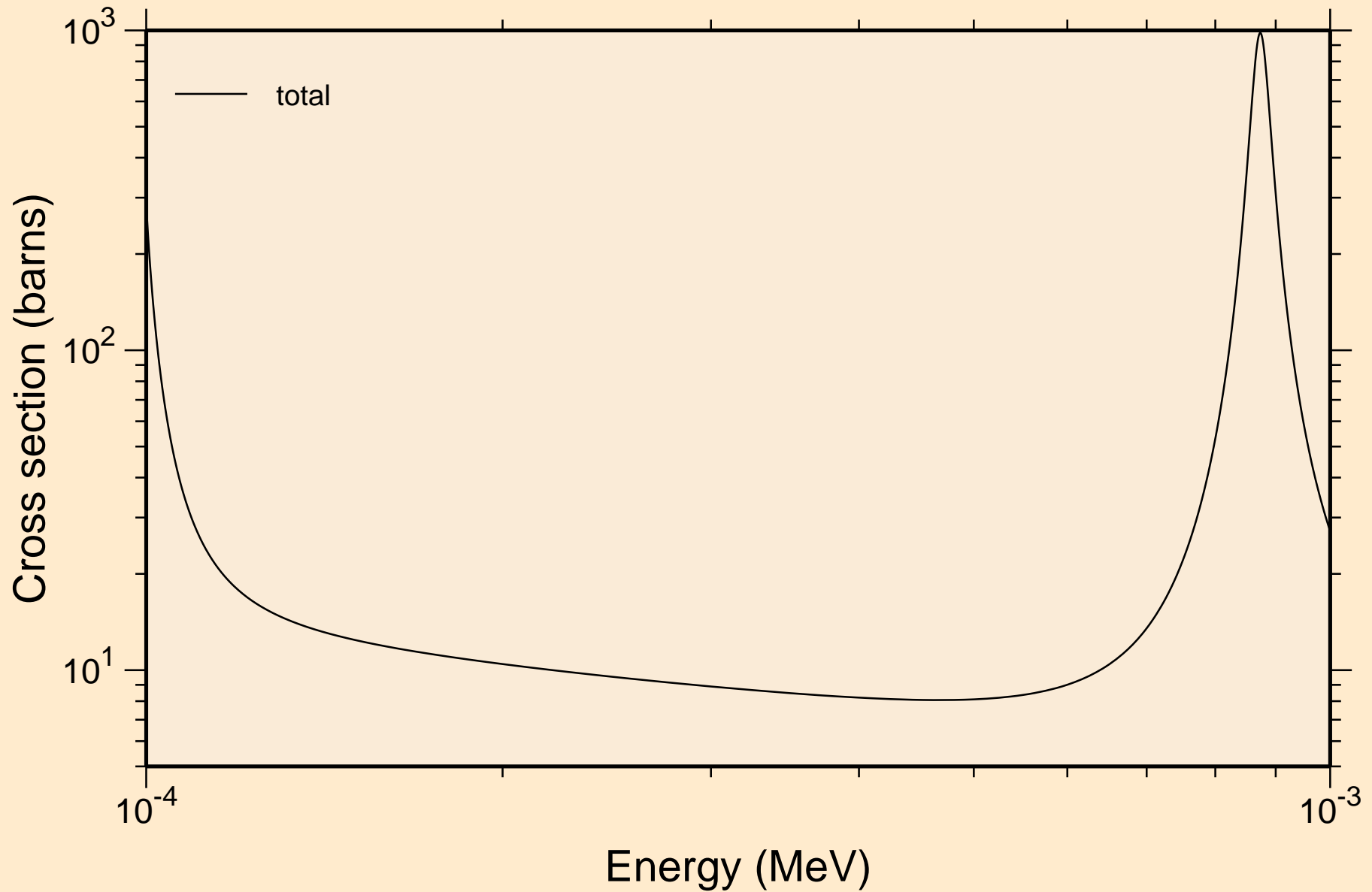

AR039 NEUTRON ACER TENDL-2024 LIBRARY; T=293.6K
resonance total cross section

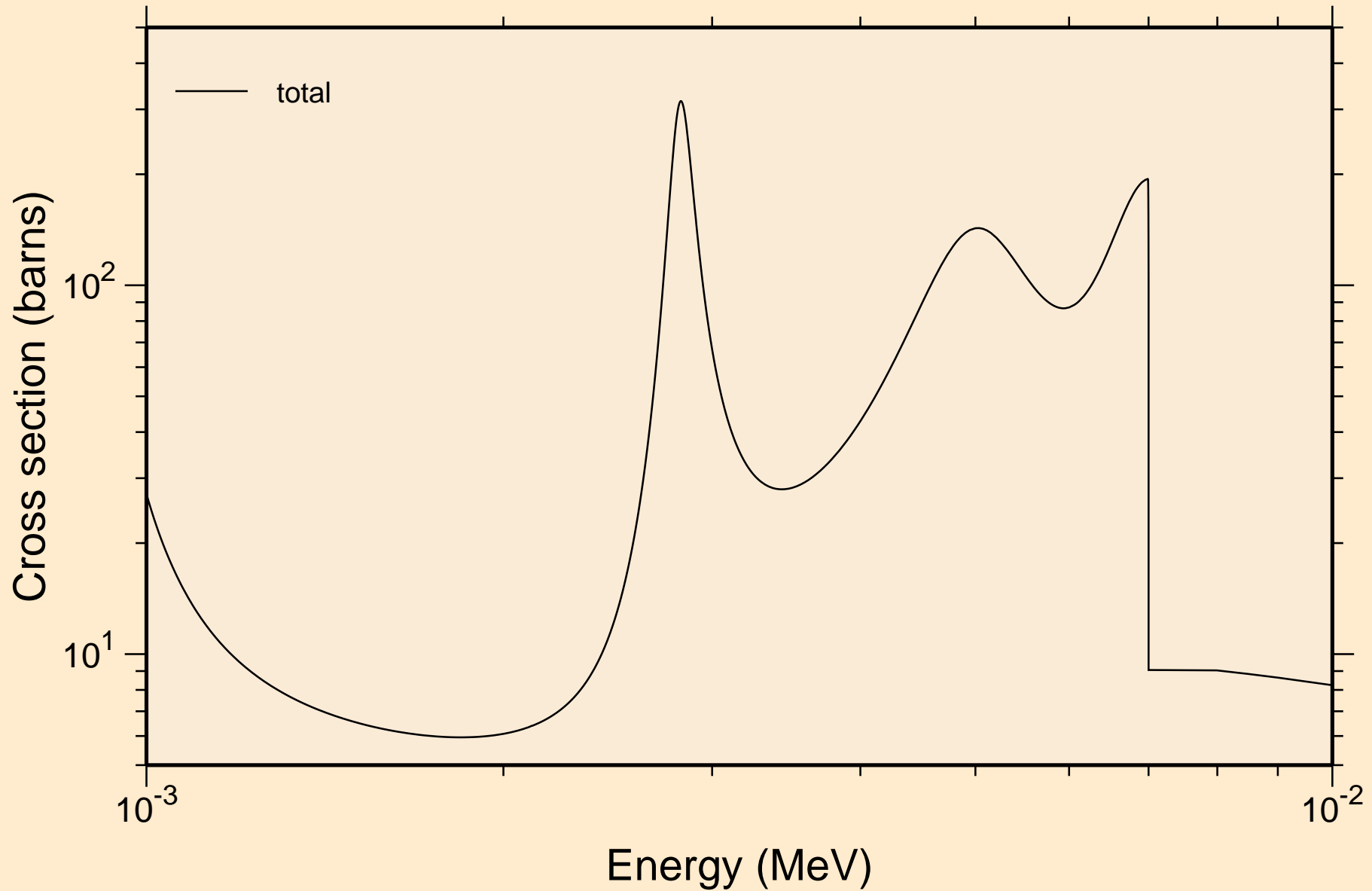

AR039 NEUTRON ACER TENDL-2024 LIBRARY; T=293.6K
resonance total cross section

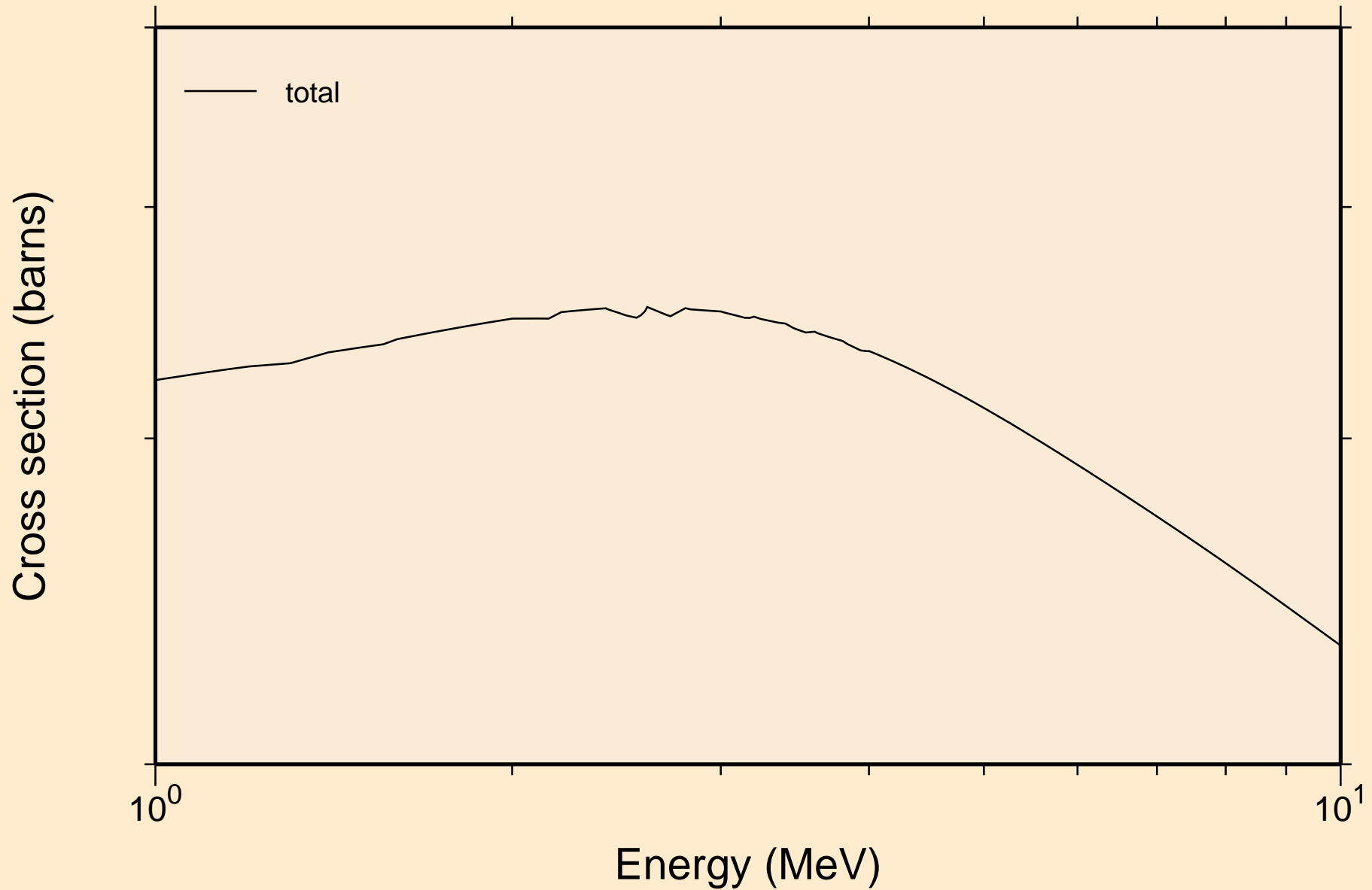

AR039 NEUTRON ACER TENDL-2024 LIBRARY; T=293.6K
resonance absorption cross sections

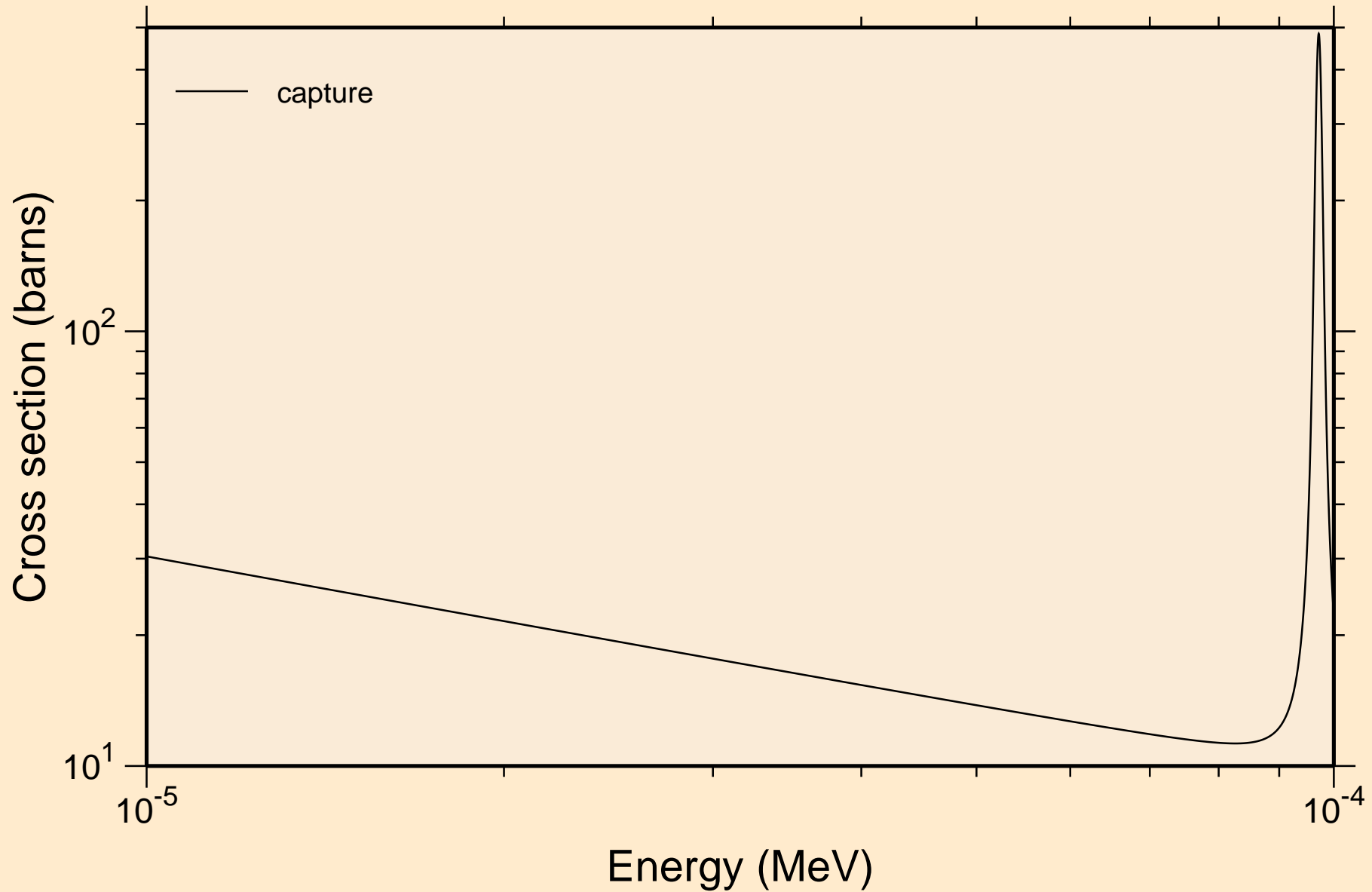

AR039 NEUTRON ACER TENDL-2024 LIBRARY; T=293.6K
resonance absorption cross sections

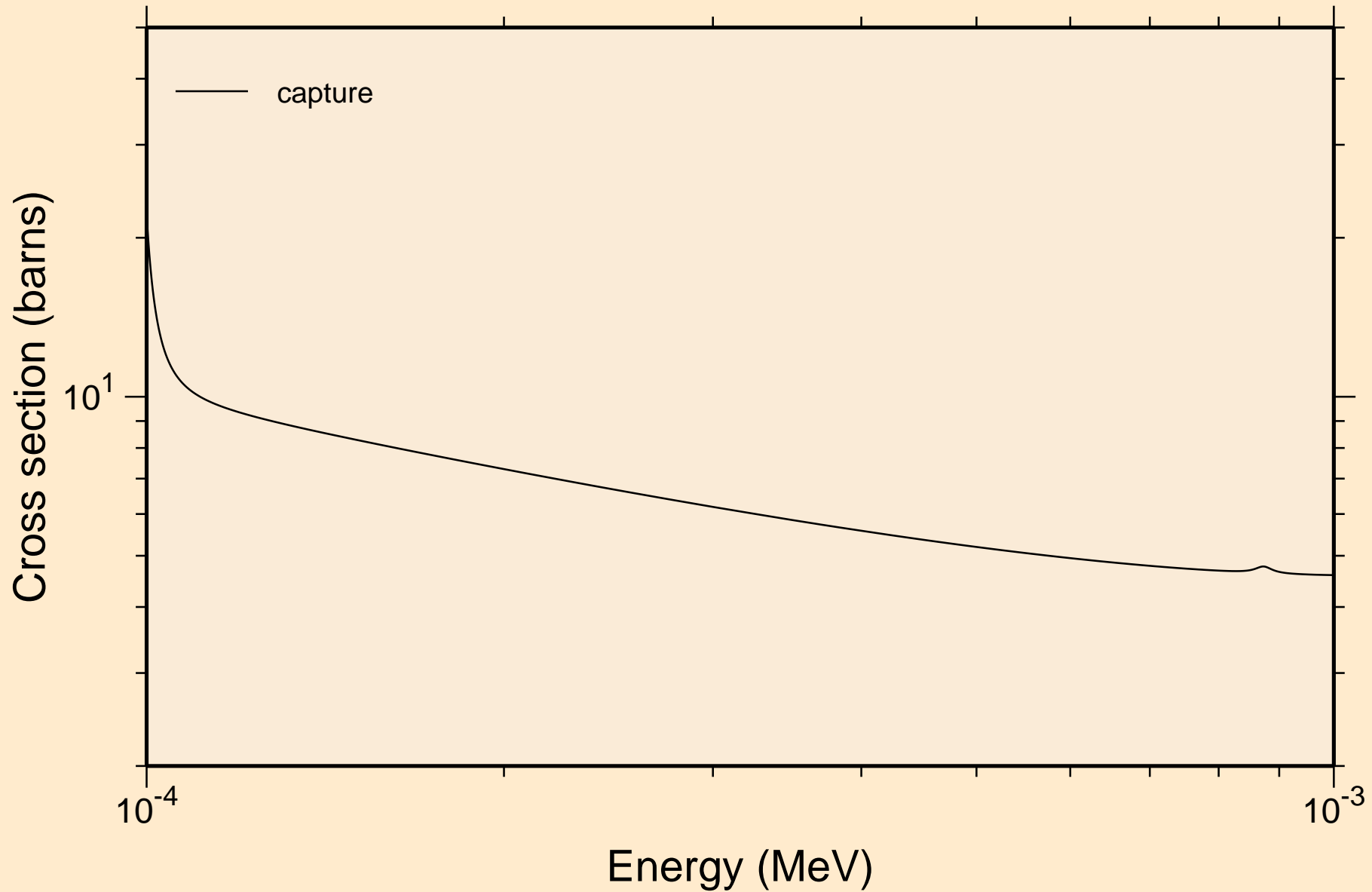

AR039 NEUTRON ACER TENDL-2024 LIBRARY; T=293.6K
resonance absorption cross sections

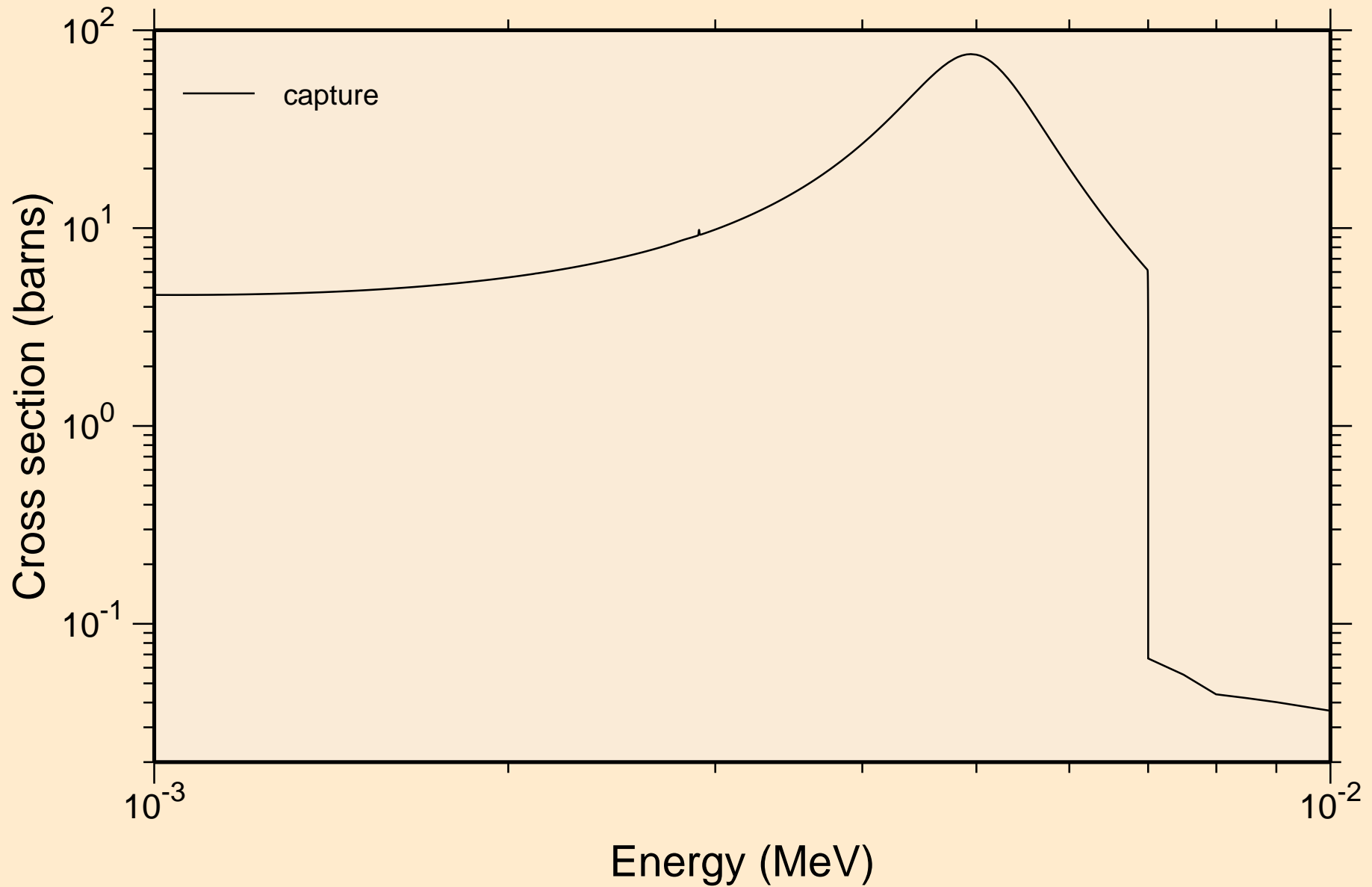

AR039 NEUTRON ACER TENDL-2024 LIBRARY; T=293.6K
resonance absorption cross sections

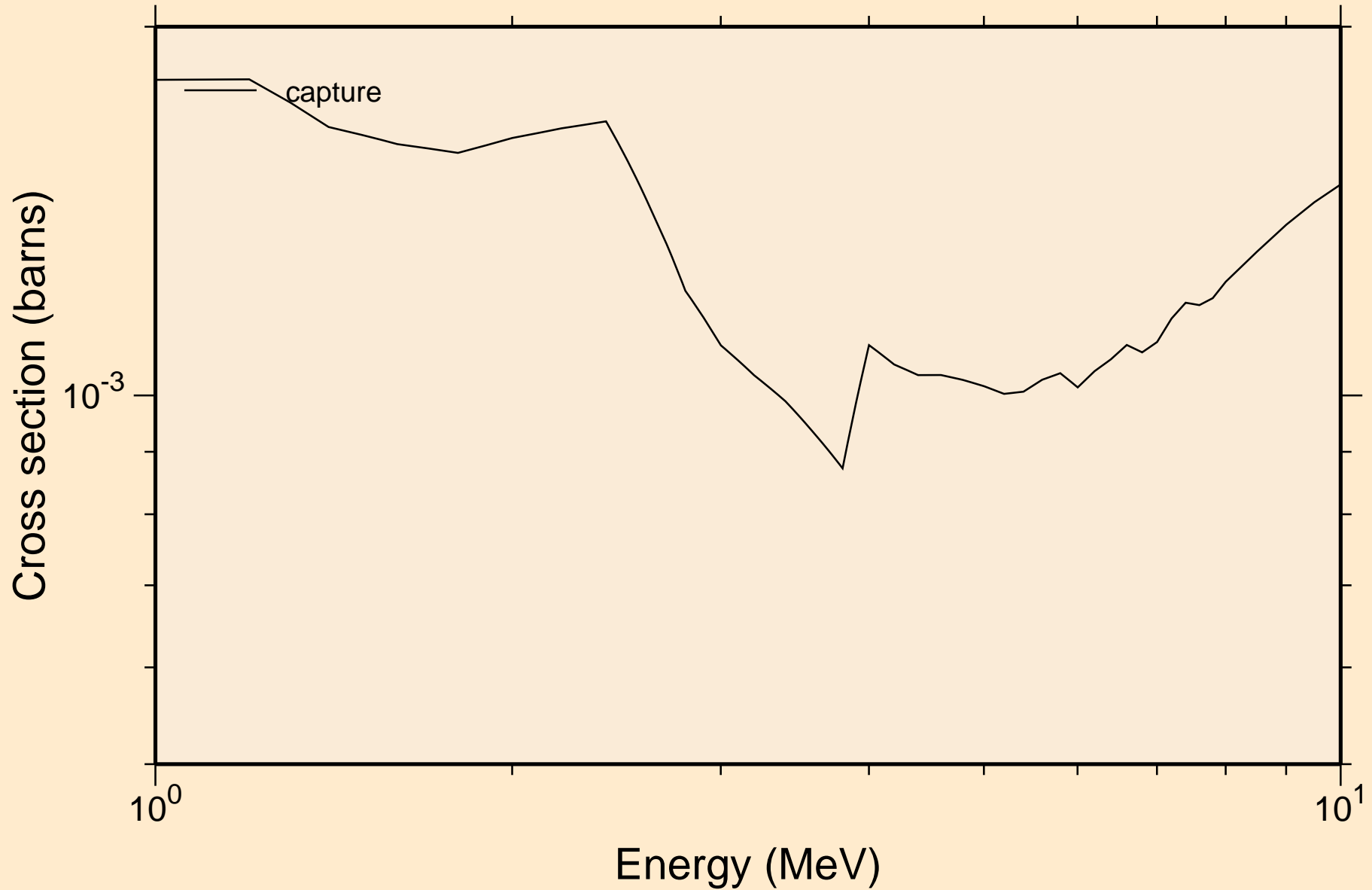

AR039 NEUTRON ACER TENDL-2024 LIBRARY; T=293.6K
Heating

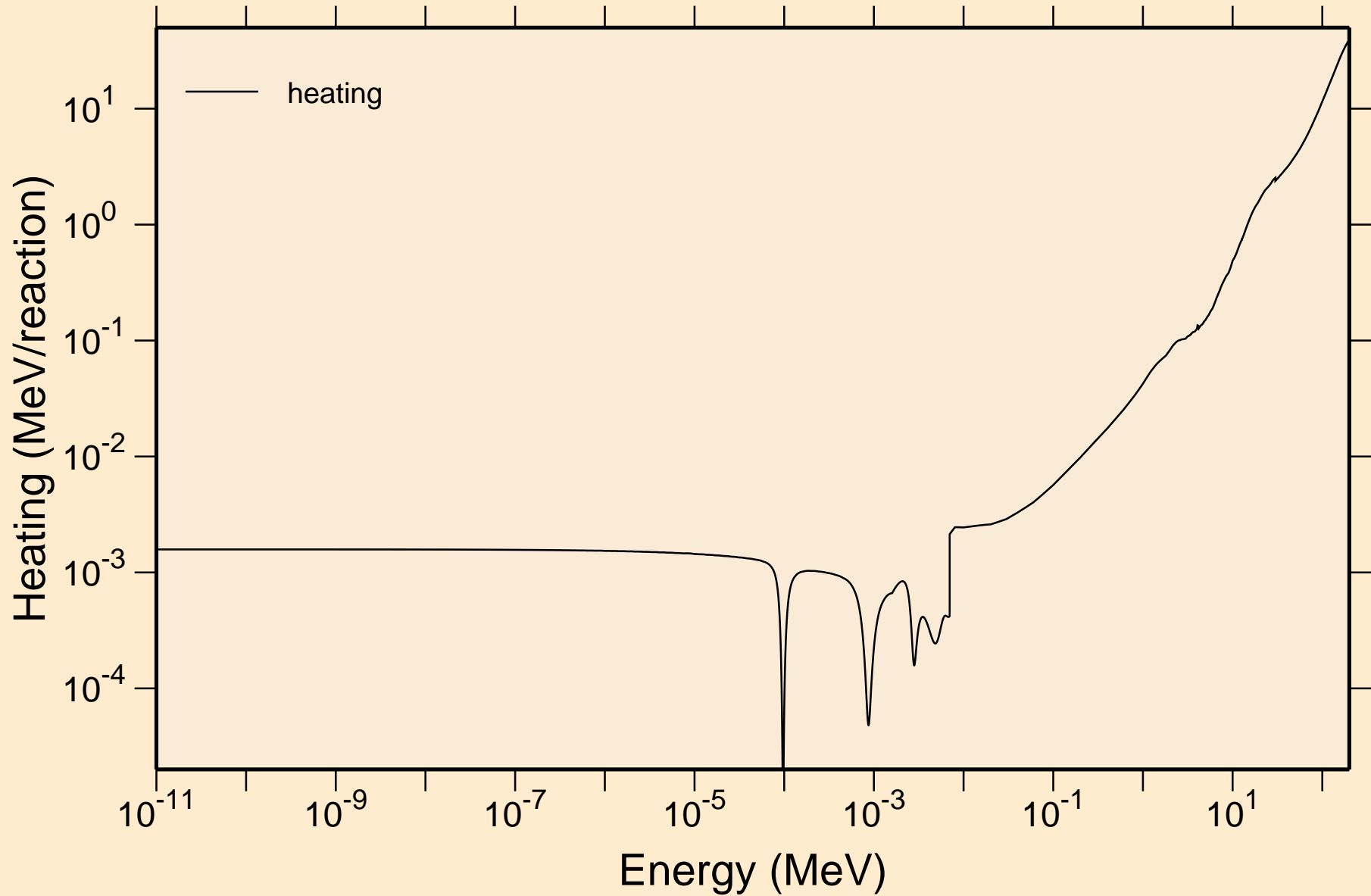

AR039 NEUTRON ACER TENDL-2024 LIBRARY; T=293.6K
Damage

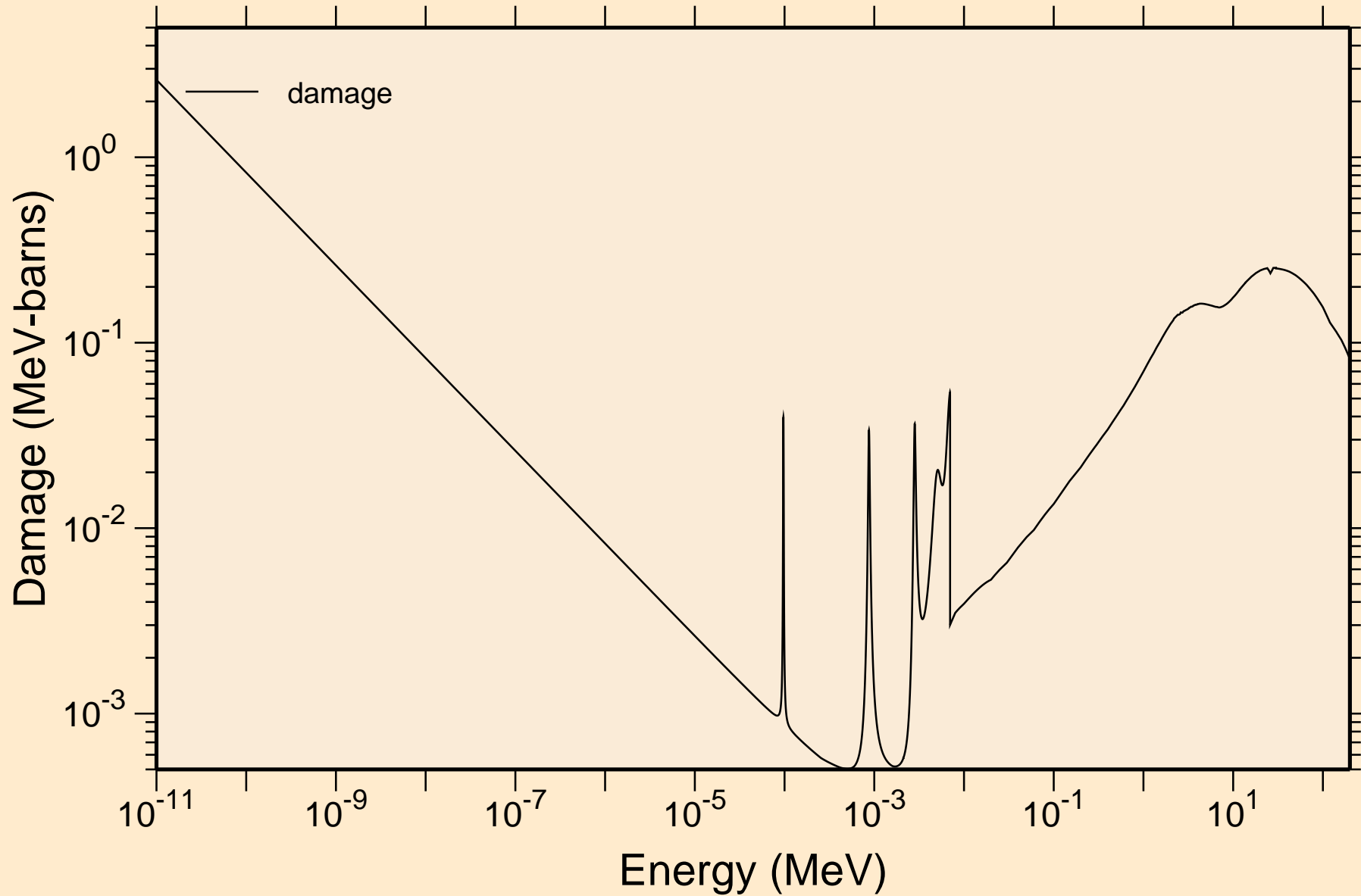

AR039 NEUTRON ACER TENDL-2024 LIBRARY; T=293.6K
Non-threshold reactions

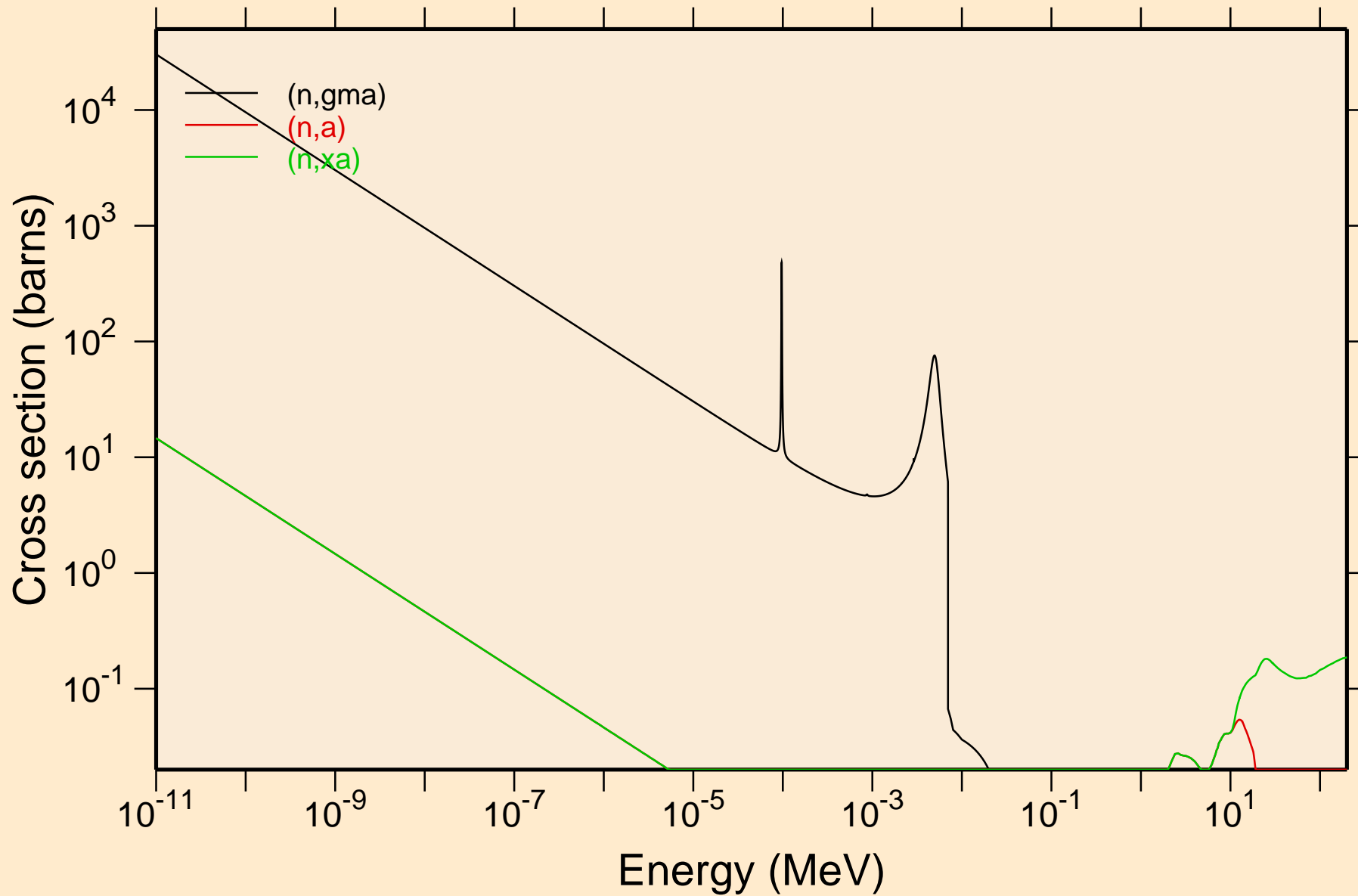

AR039 NEUTRON ACER TENDL-2024 LIBRARY; T=293.6K
Principal cross sections

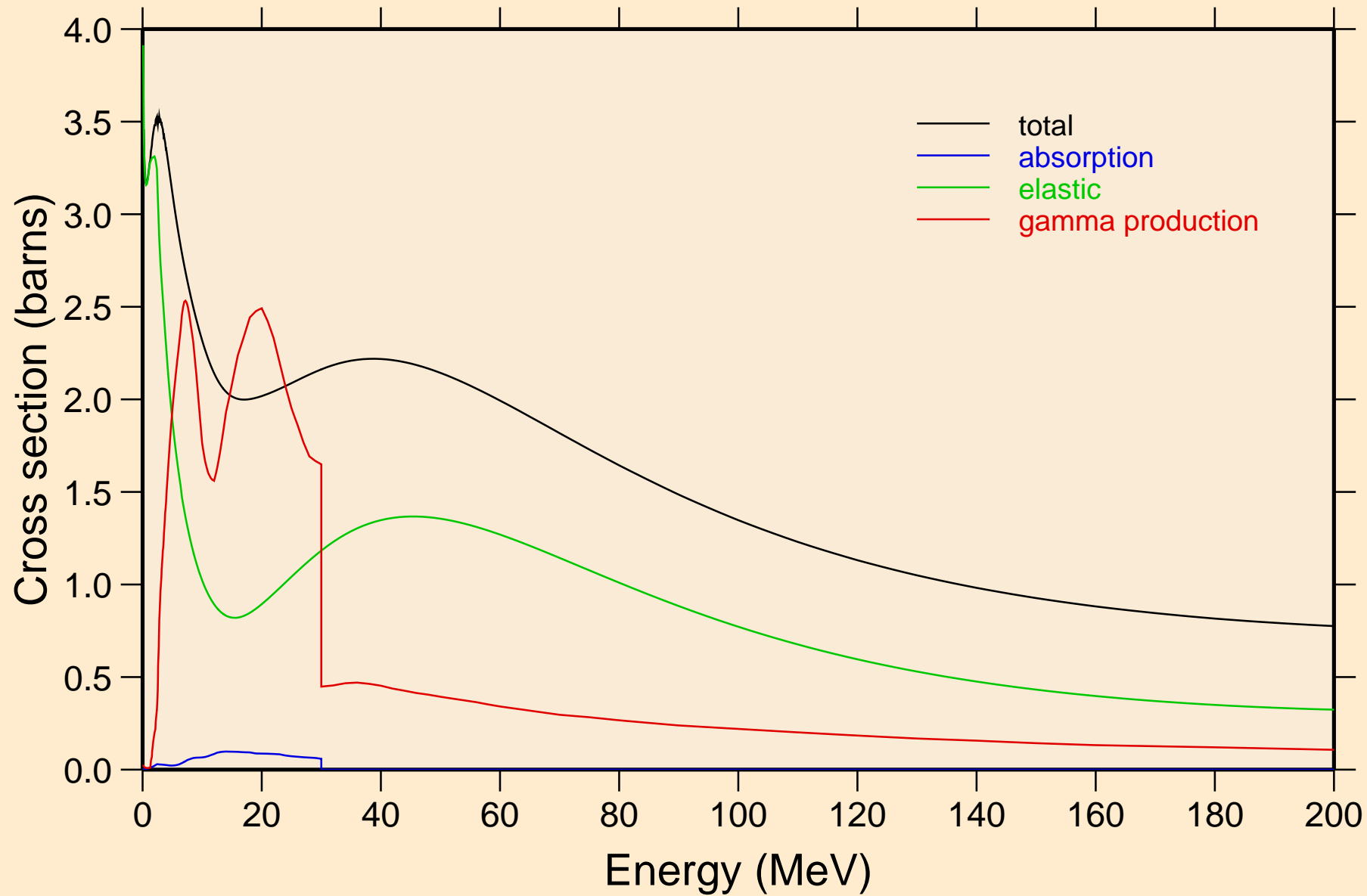

AR039 NEUTRON ACER TENDL-2024 LIBRARY; T=293.6K

Heating

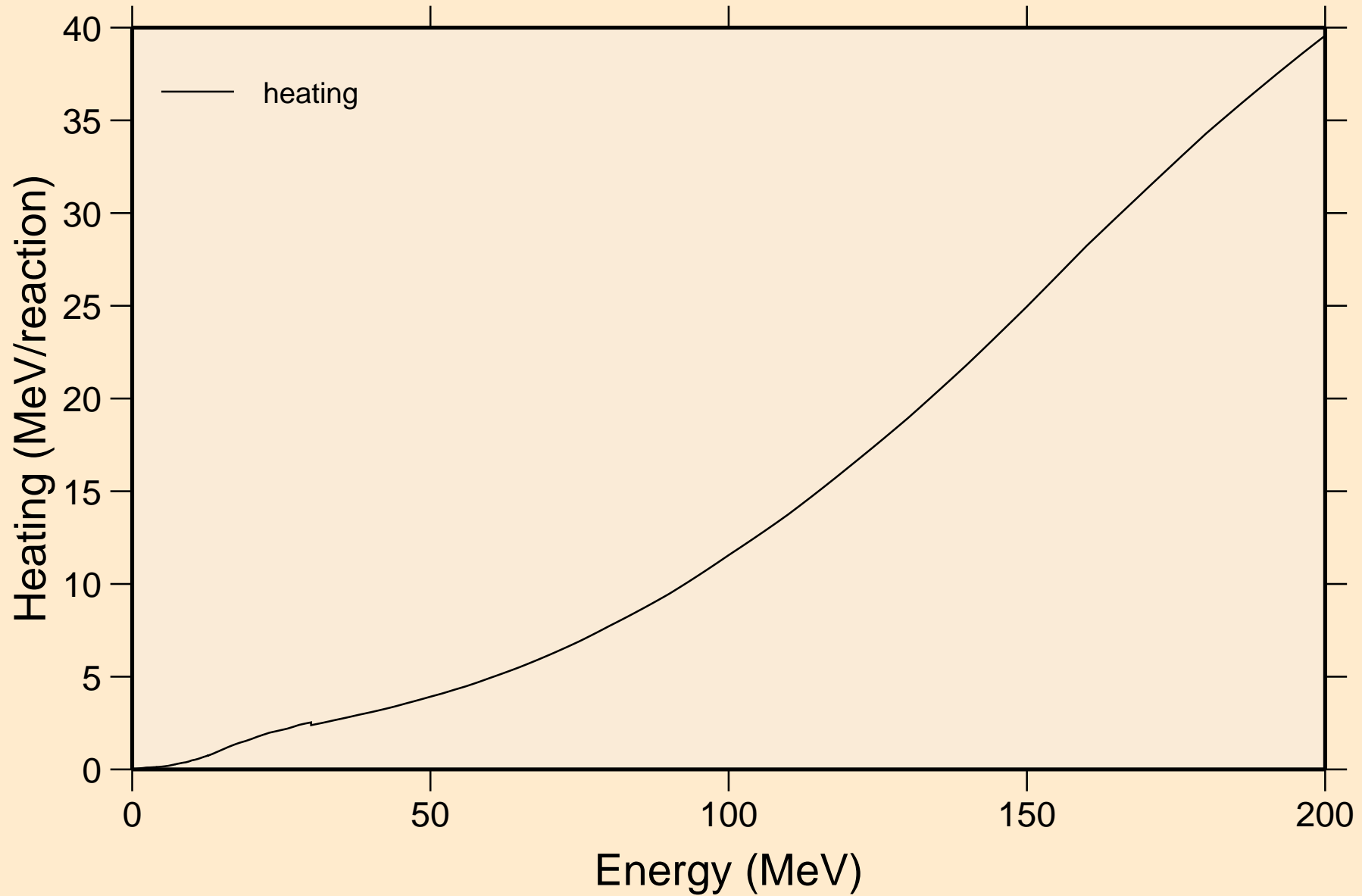

AR039 NEUTRON ACER TENDL-2024 LIBRARY; T=293.6K
Damage

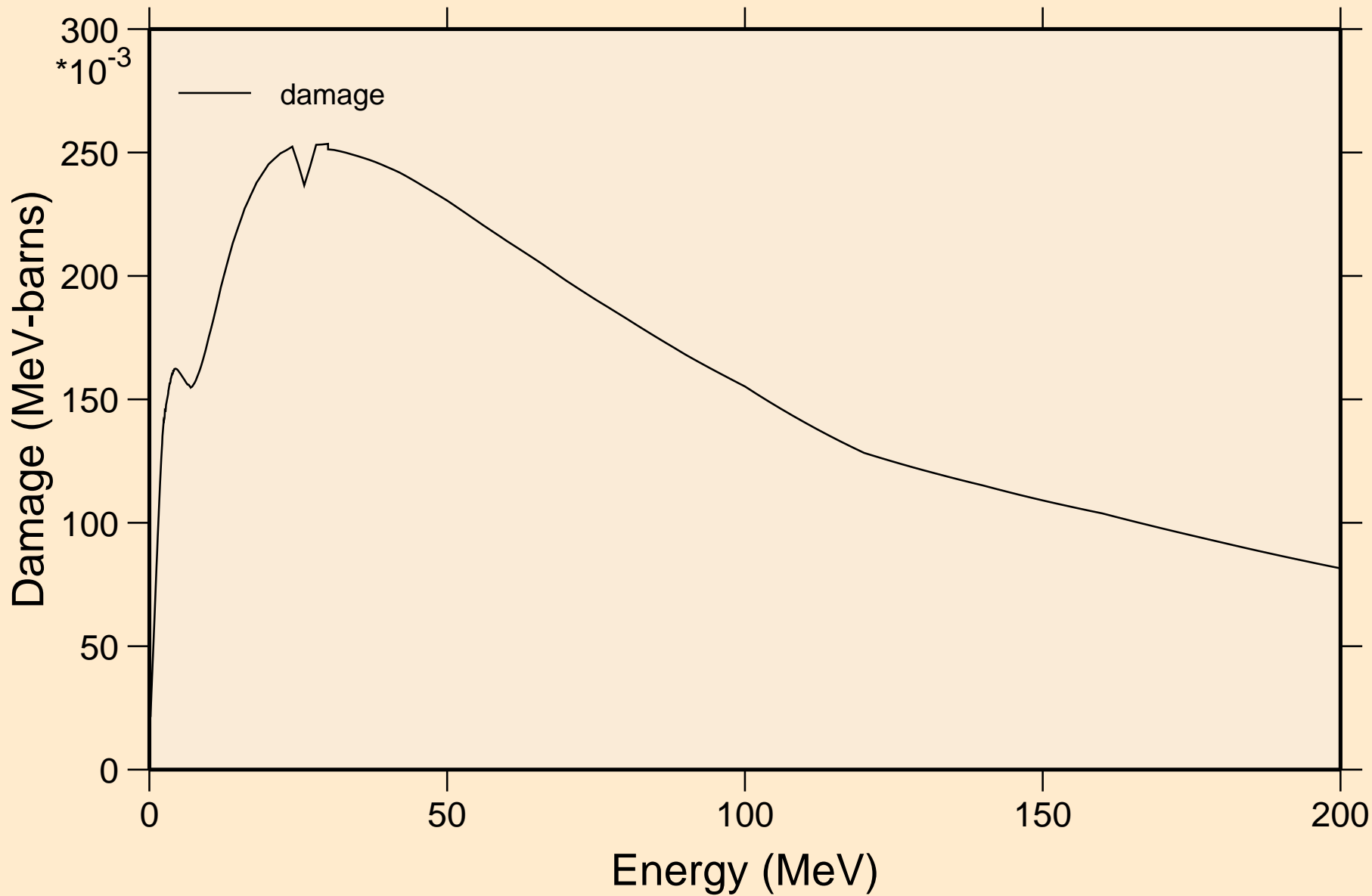

AR039 NEUTRON ACER TENDL-2024 LIBRARY; T=293.6K
Non-threshold reactions

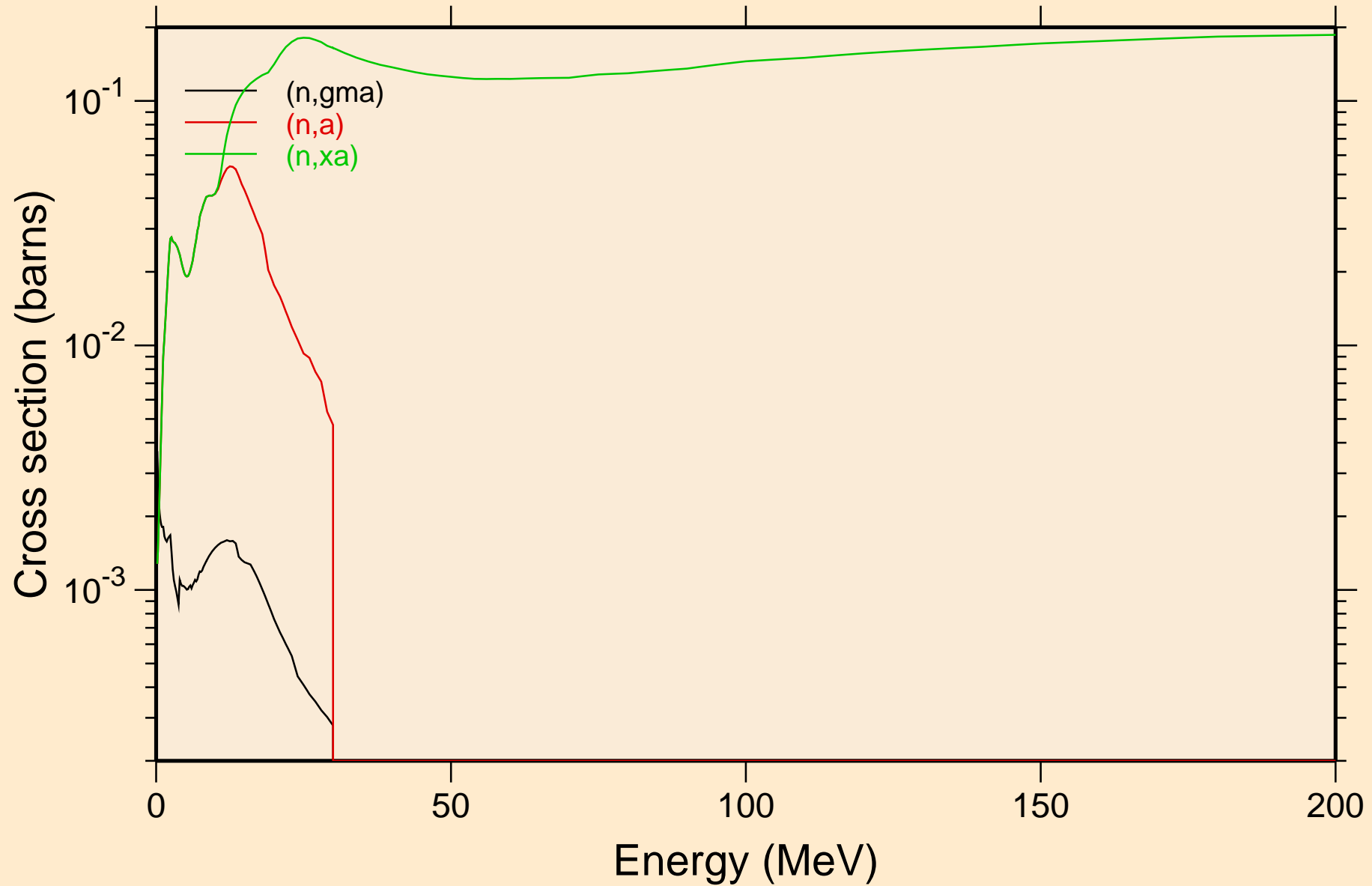

AR039 NEUTRON ACER TENDL-2024 LIBRARY; T=293.6K
Inelastic levels

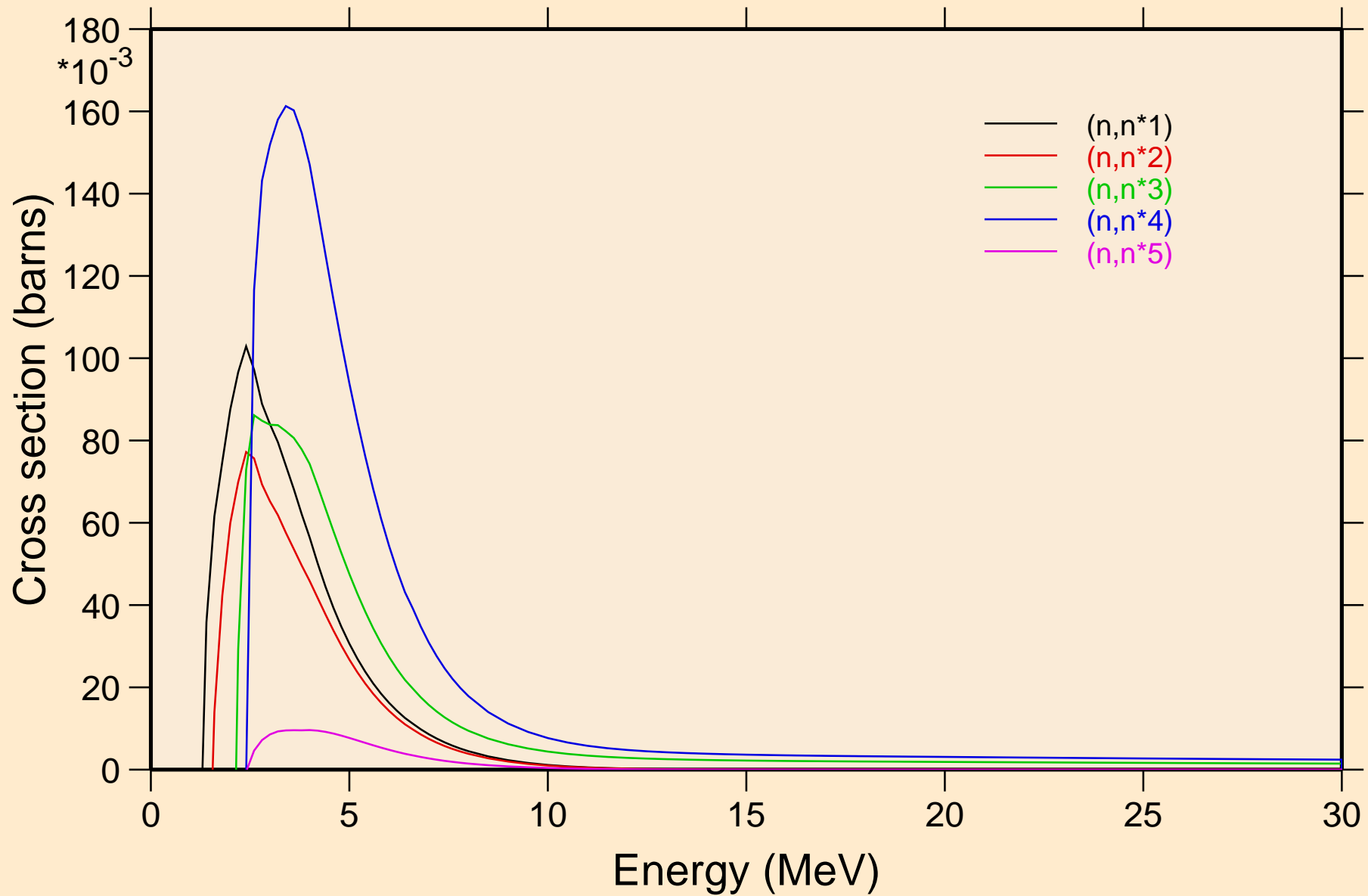

AR039 NEUTRON ACER TENDL-2024 LIBRARY; T=293.6K
Inelastic levels

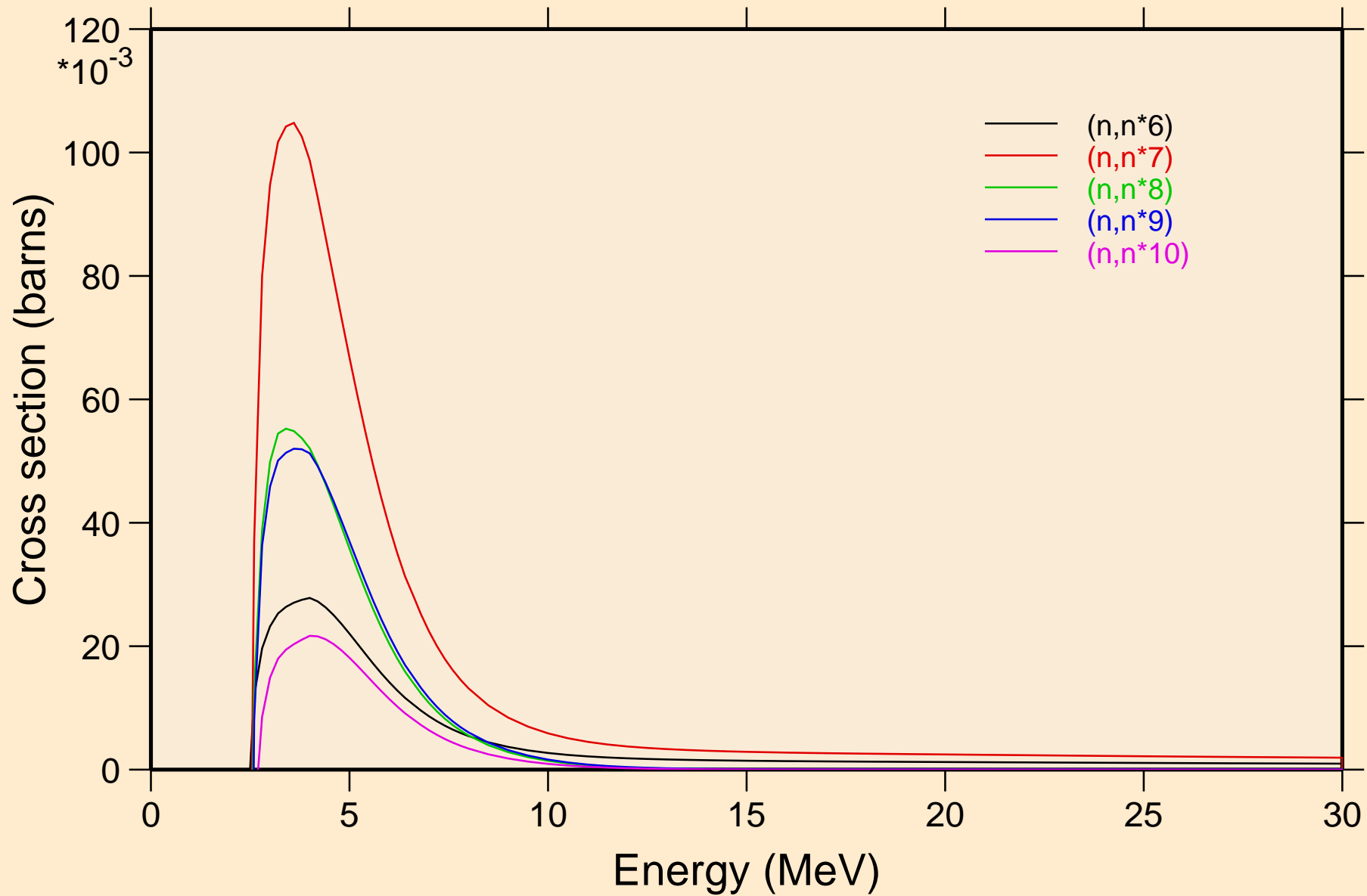

AR039 NEUTRON ACER TENDL-2024 LIBRARY; T=293.6K
Inelastic levels

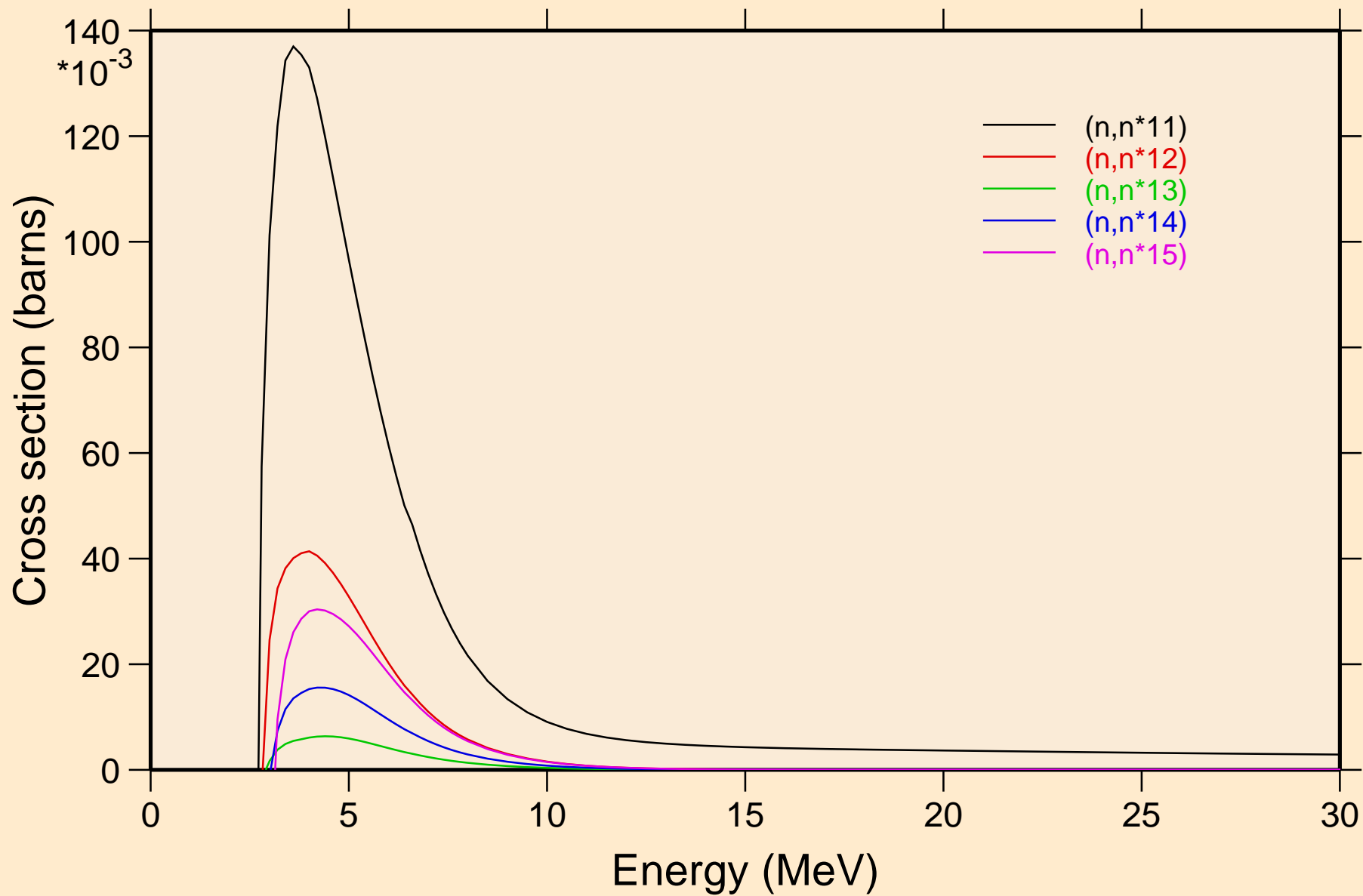

AR039 NEUTRON ACER TENDL-2024 LIBRARY; T=293.6K
Inelastic levels

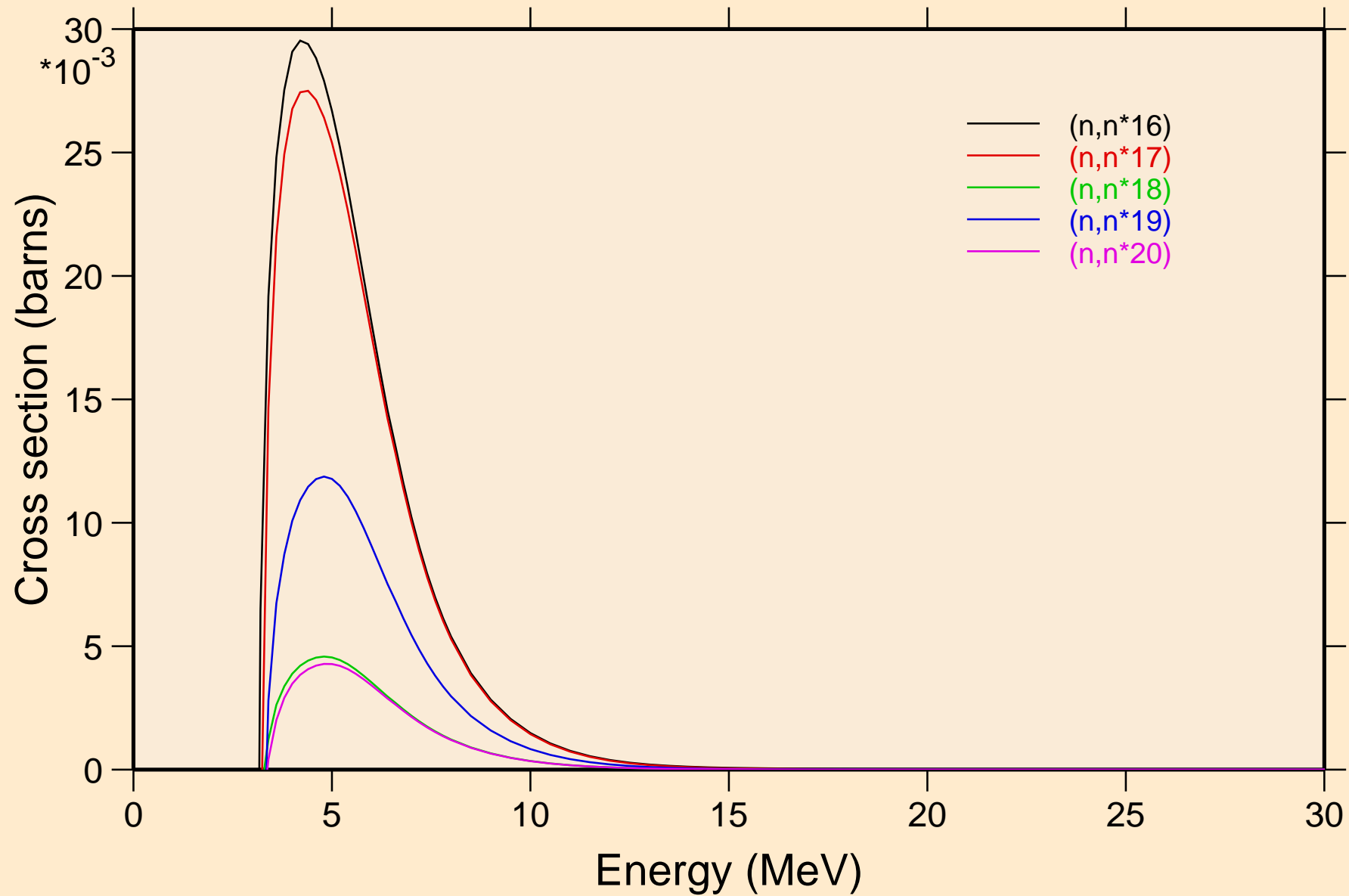

AR039 NEUTRON ACER TENDL-2024 LIBRARY; T=293.6K
Inelastic levels

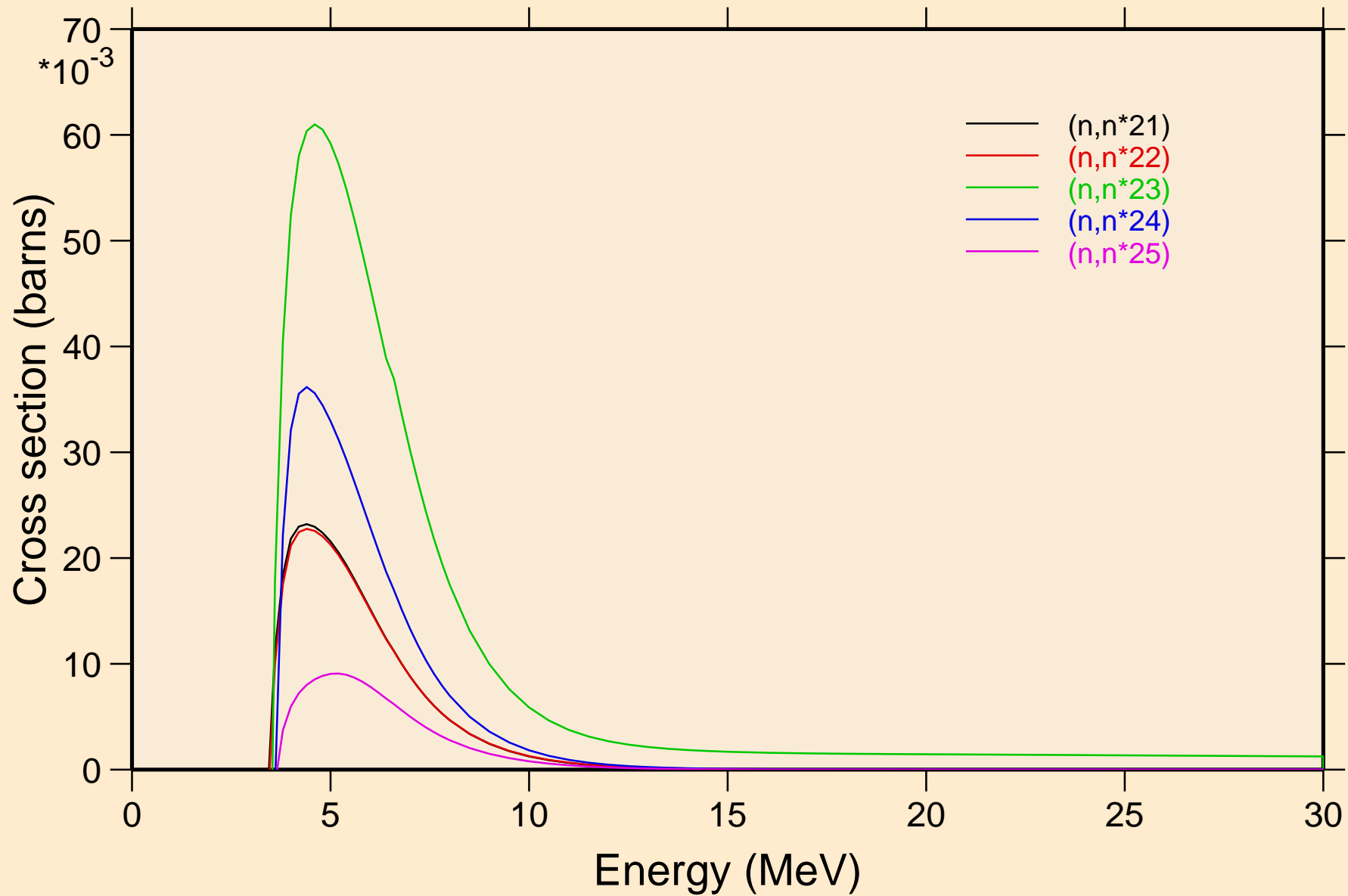

AR039 NEUTRON ACER TENDL-2024 LIBRARY; T=293.6K
Inelastic levels

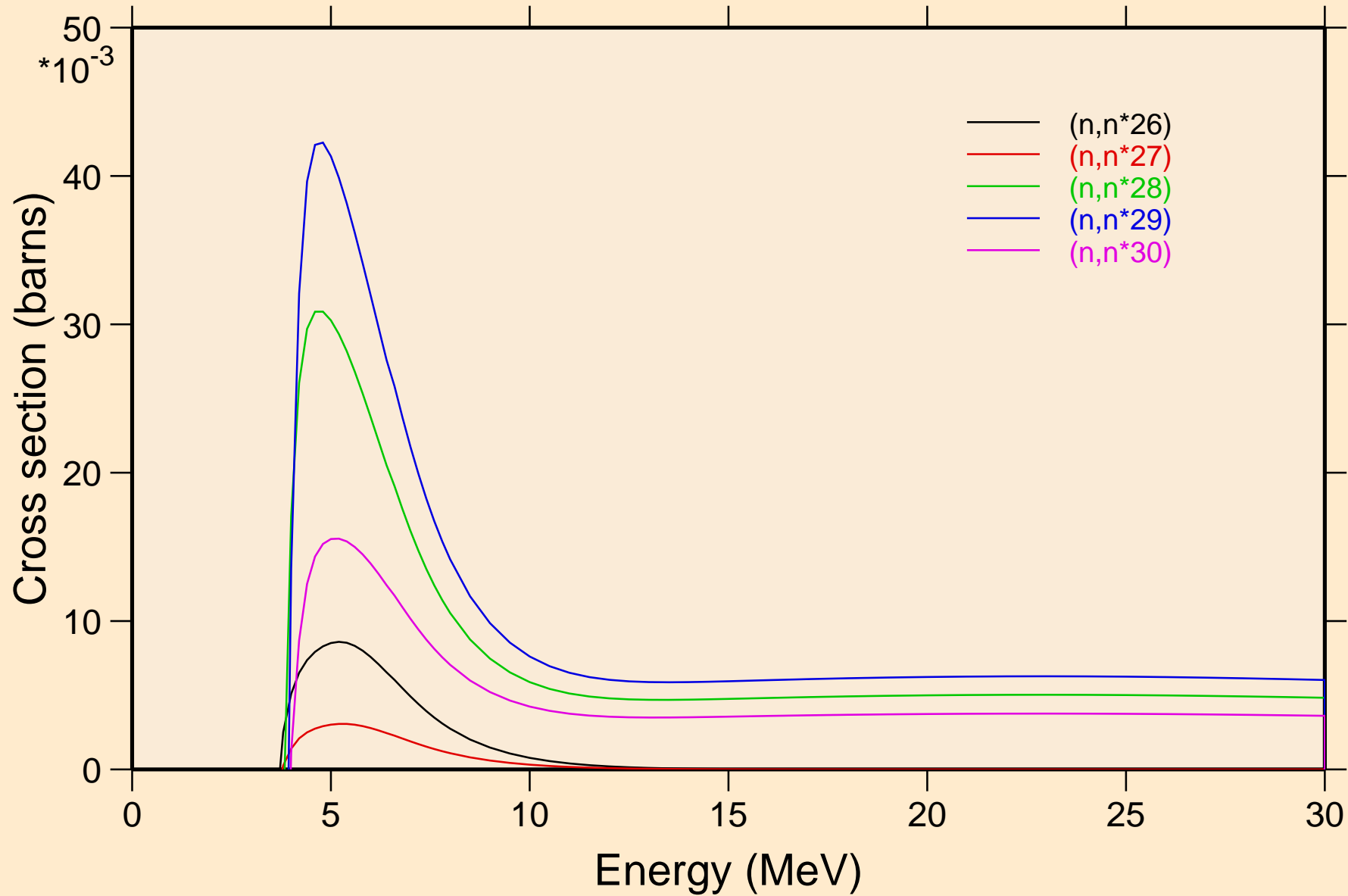

AR039 NEUTRON ACER TENDL-2024 LIBRARY; T=293.6K
Threshold reactions

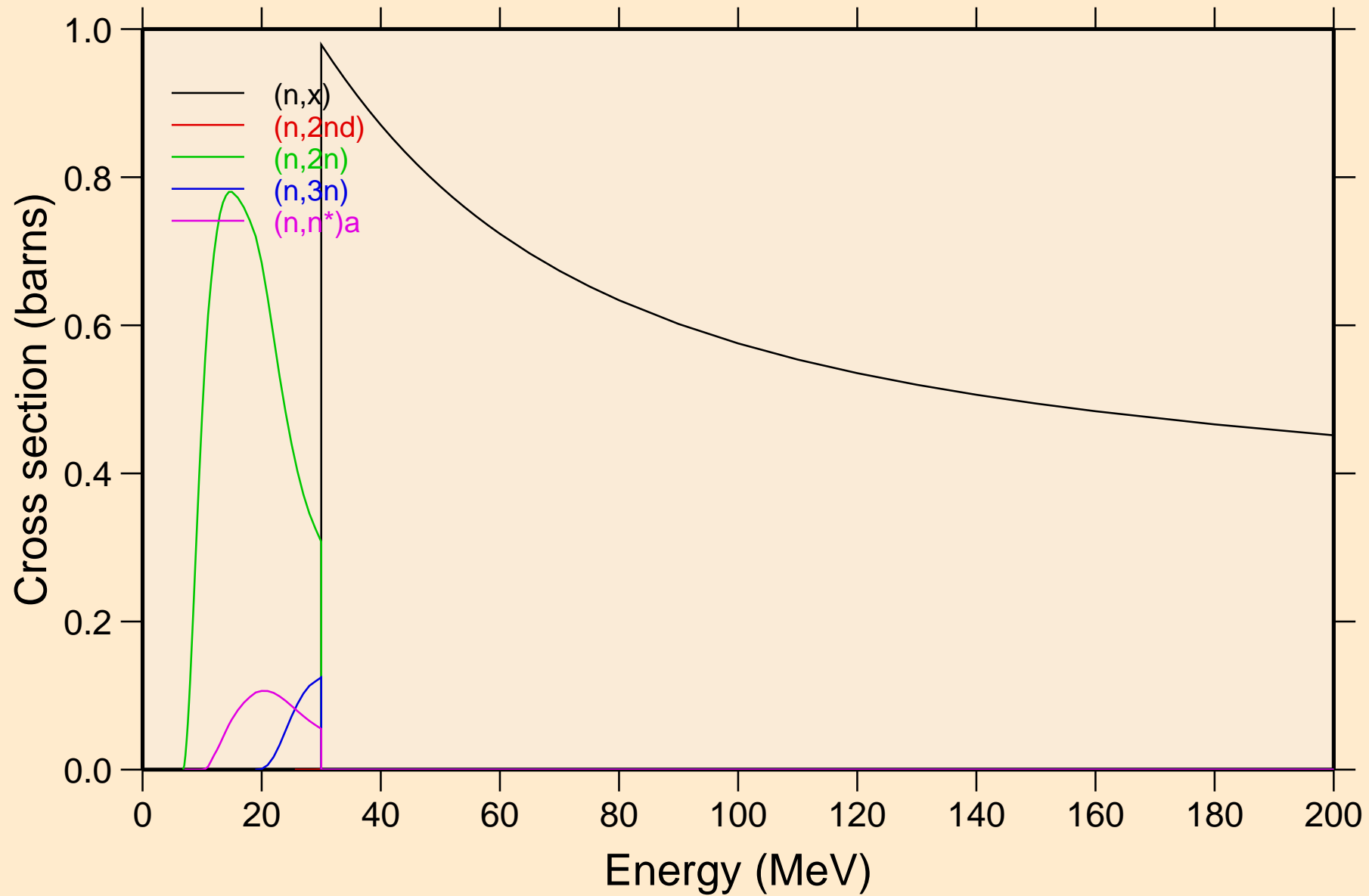

AR039 NEUTRON ACER TENDL-2024 LIBRARY; T=293.6K
Threshold reactions

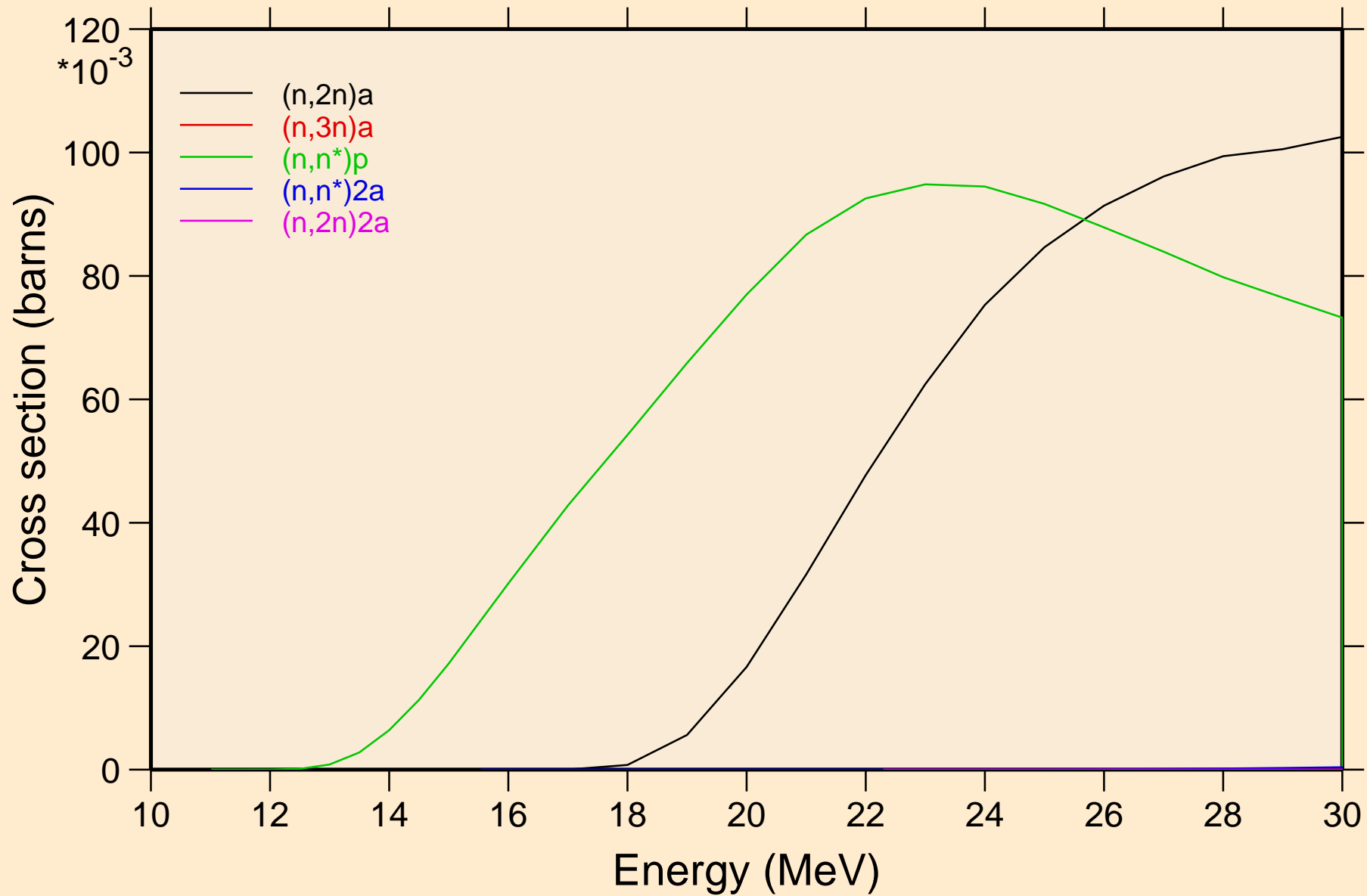

AR039 NEUTRON ACER TENDL-2024 LIBRARY; T=293.6K
Threshold reactions

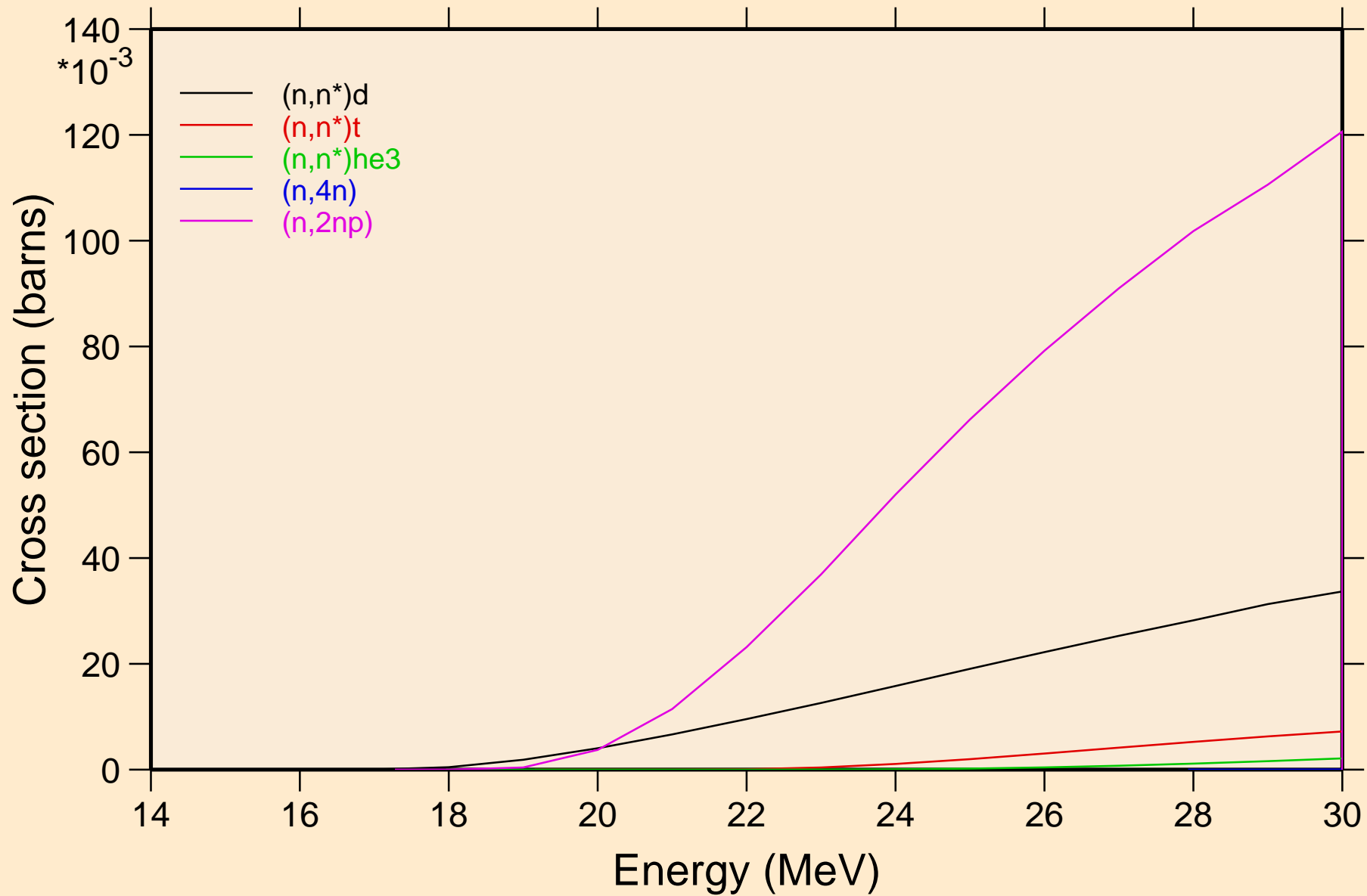

AR039 NEUTRON ACER TENDL-2024 LIBRARY; T=293.6K
Threshold reactions

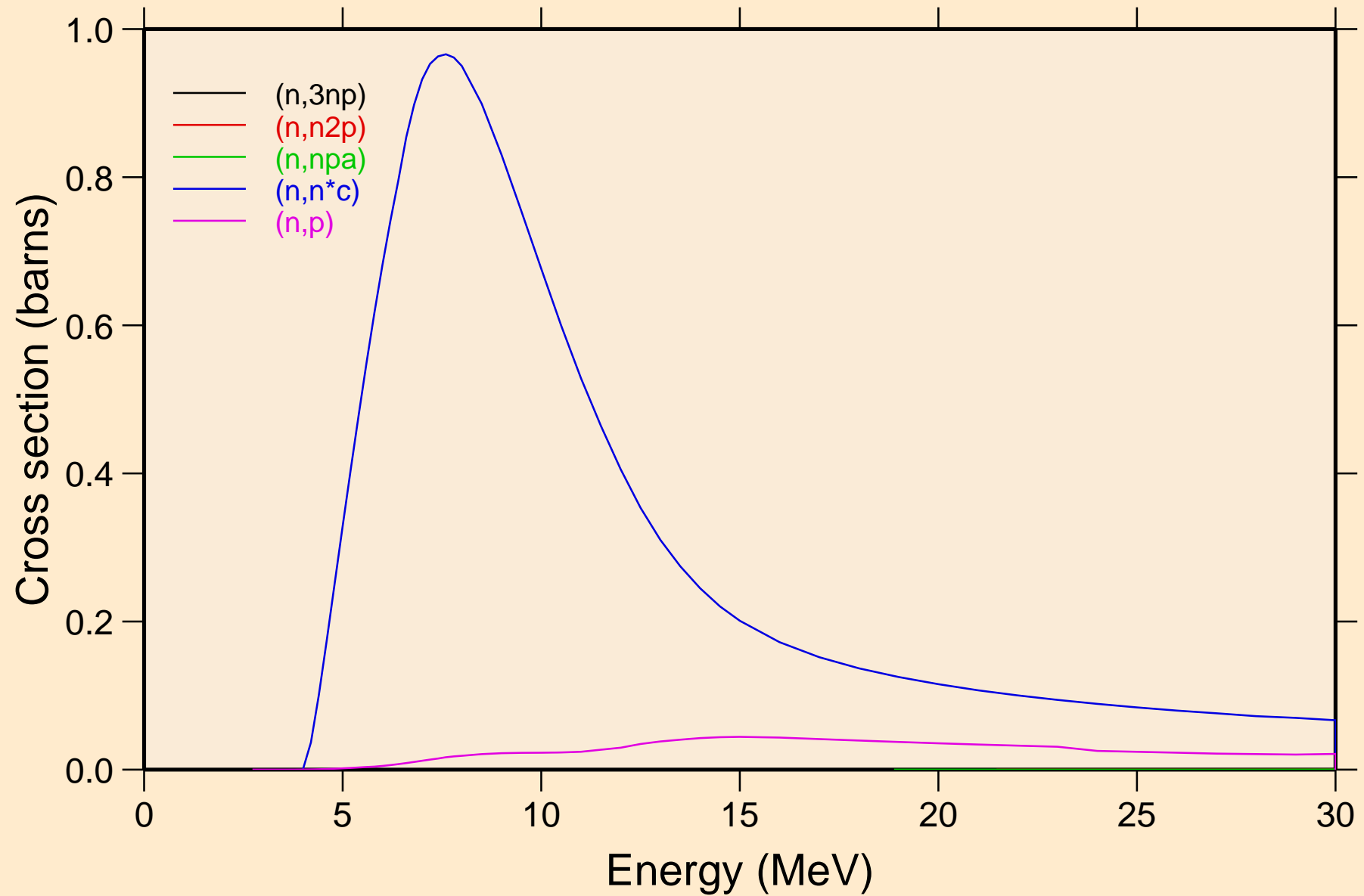

AR039 NEUTRON ACER TENDL-2024 LIBRARY; T=293.6K
Threshold reactions

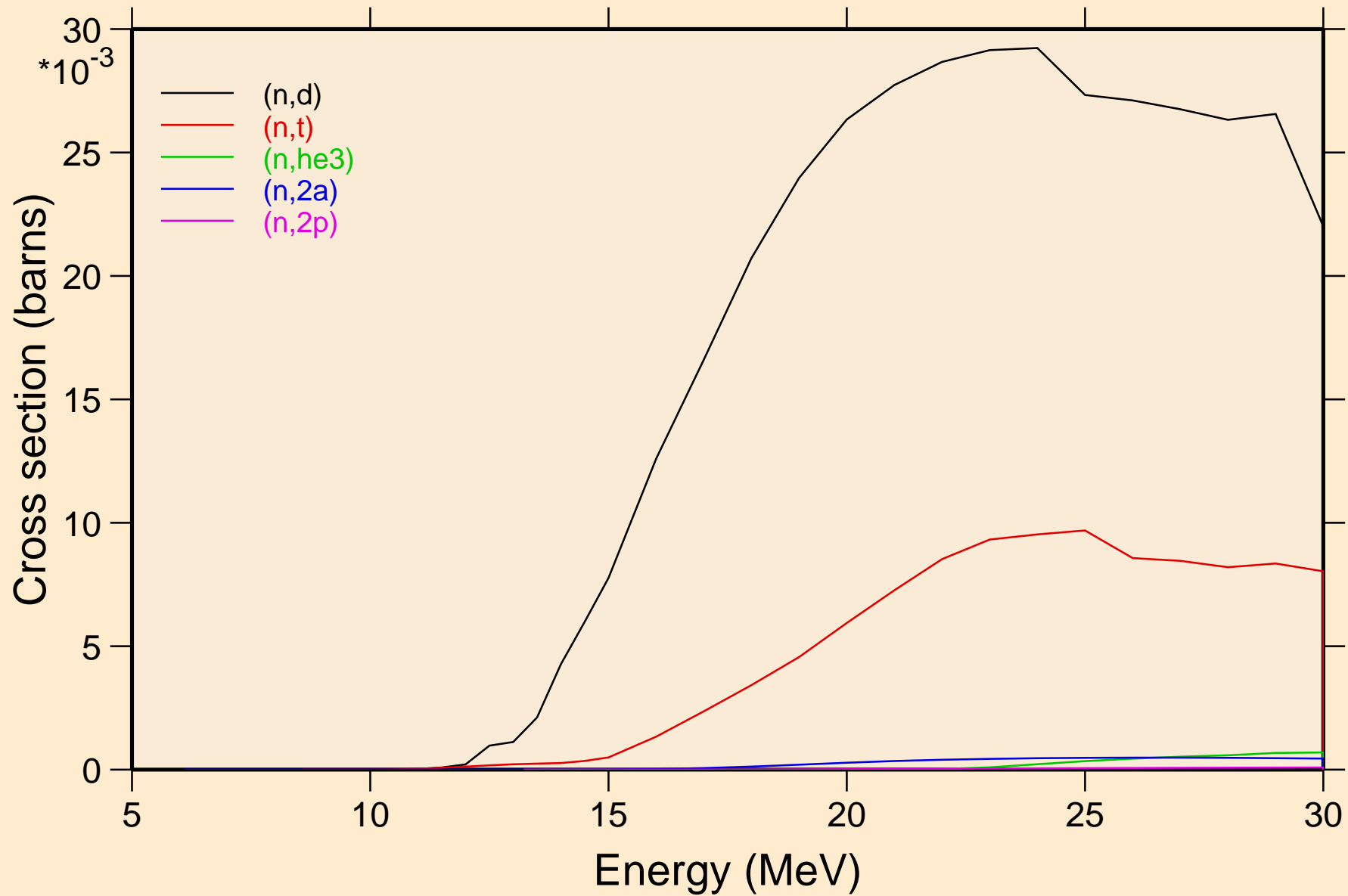

AR039 NEUTRON ACER TENDL-2024 LIBRARY; T=293.6K
Threshold reactions

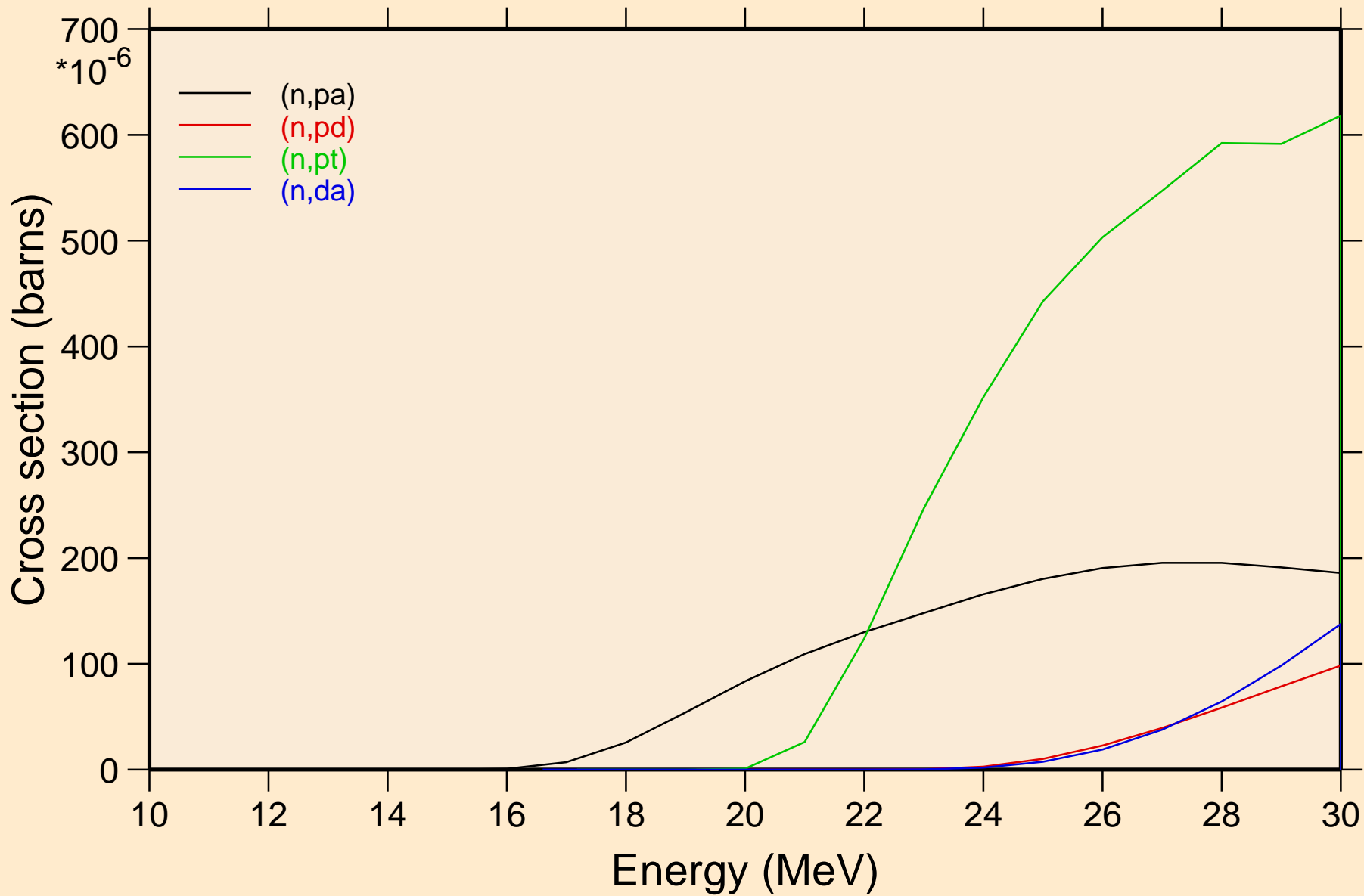

AR039 NEUTRON ACER TENDL-2024 LIBRARY; T=293.6K

Threshold reactions

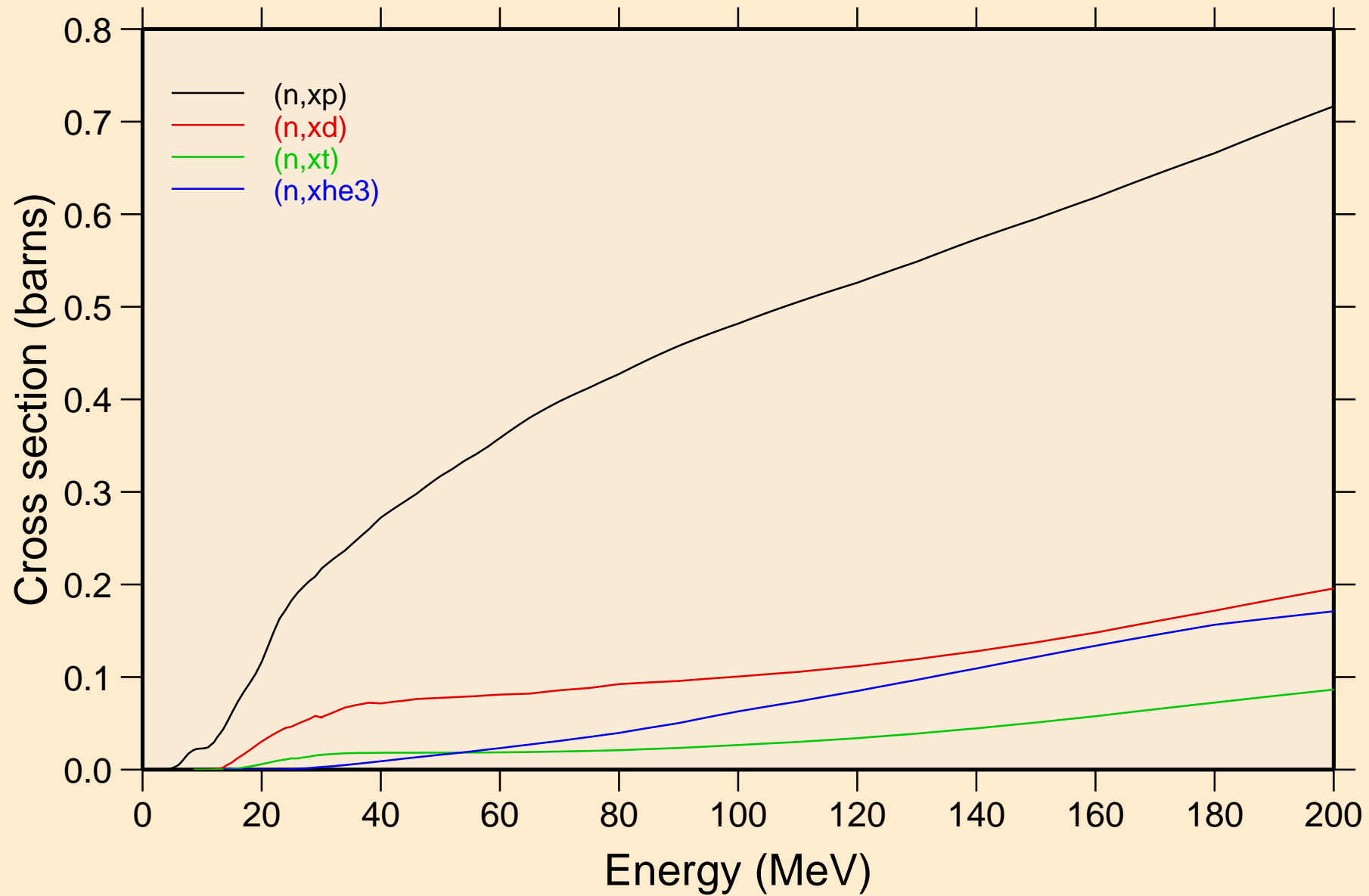

AR039 NEUTRON ACER TENDL-2024 LIBRARY; T=293.6K
angular distribution for elastic

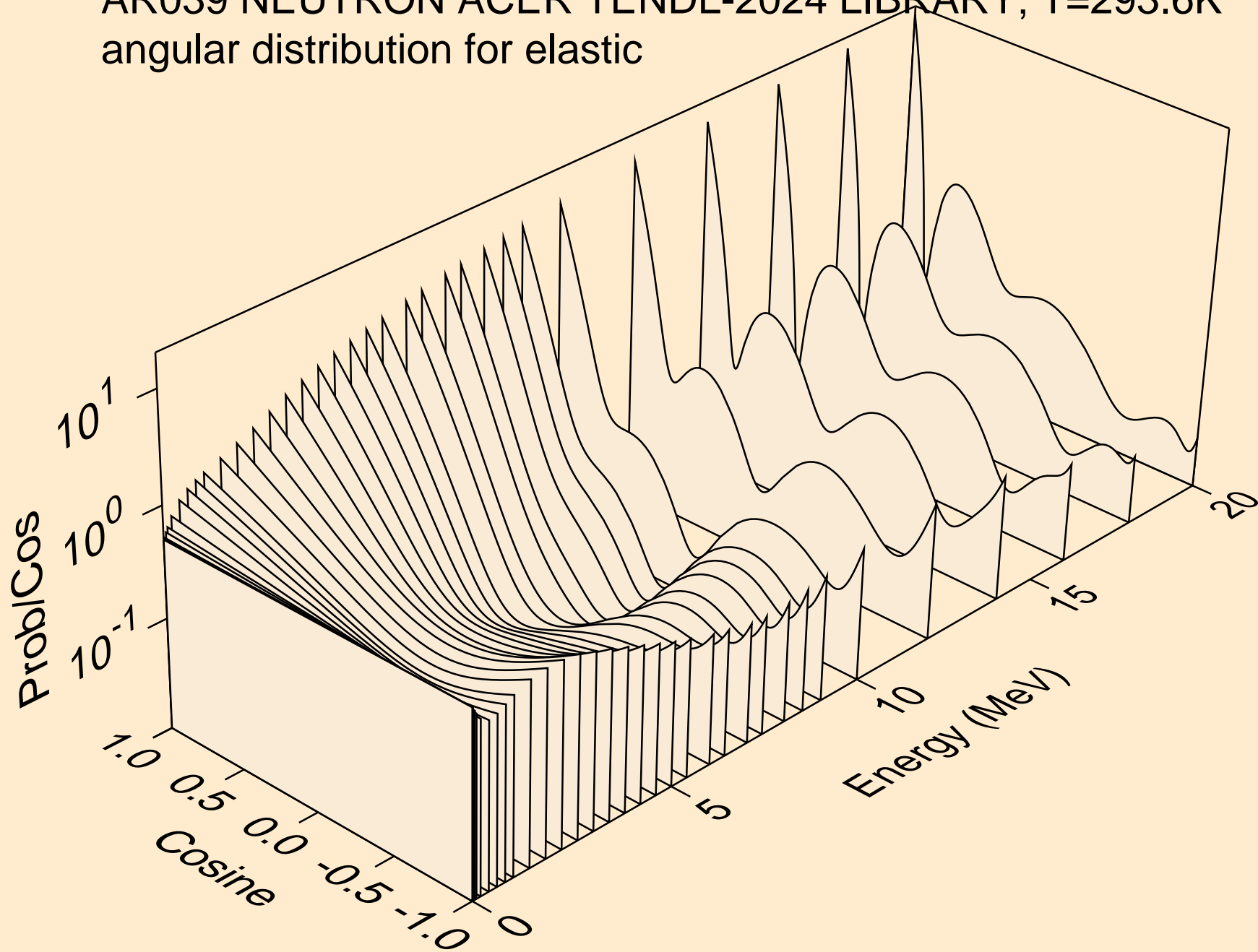

AR039 NEUTRON ACER TENDL-2024 LIBRARY; T=293.6K
angular distribution for elastic

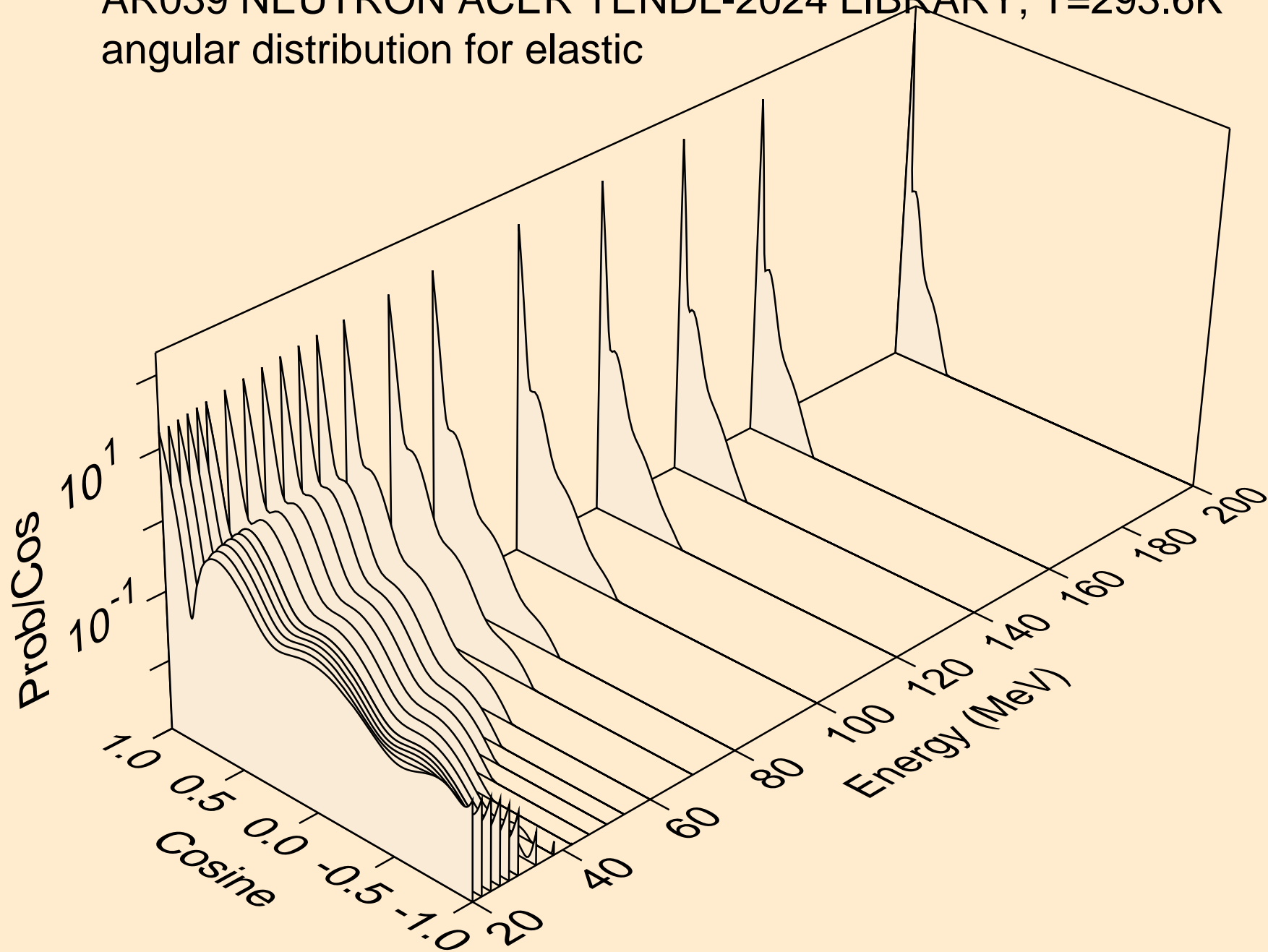

AR039 NEUTRON ACER TENDL-2024 LIBRARY; T=293.6K
angular distribution for (n,n*1)

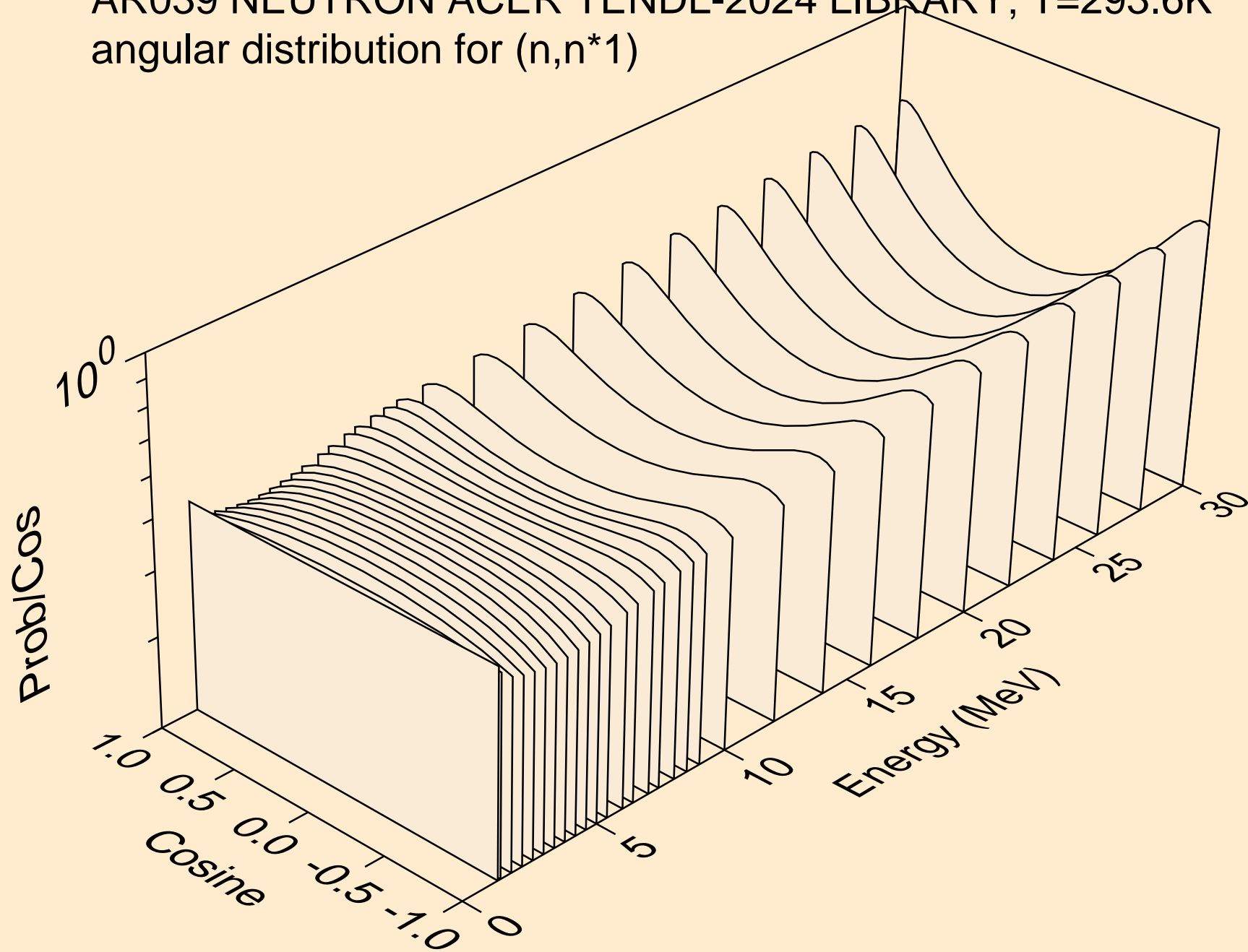

AR039 NEUTRON ACER TENDL-2024 LIBRARY; T=293.6K
angular distribution for (n,n*2)

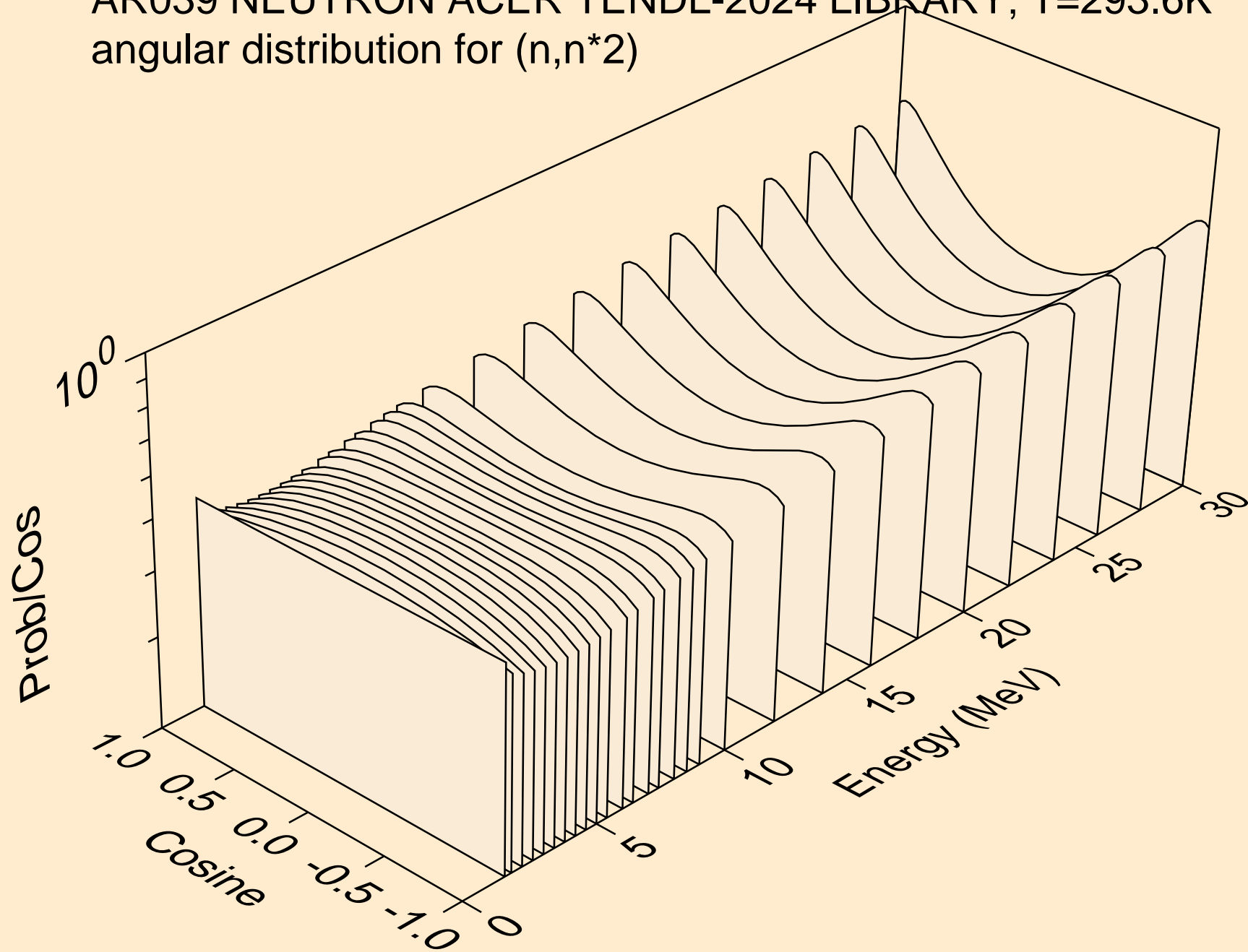

AR039 NEUTRON ACER TENDL-2024 LIBRARY; T=293.6K
angular distribution for (n,n*3)

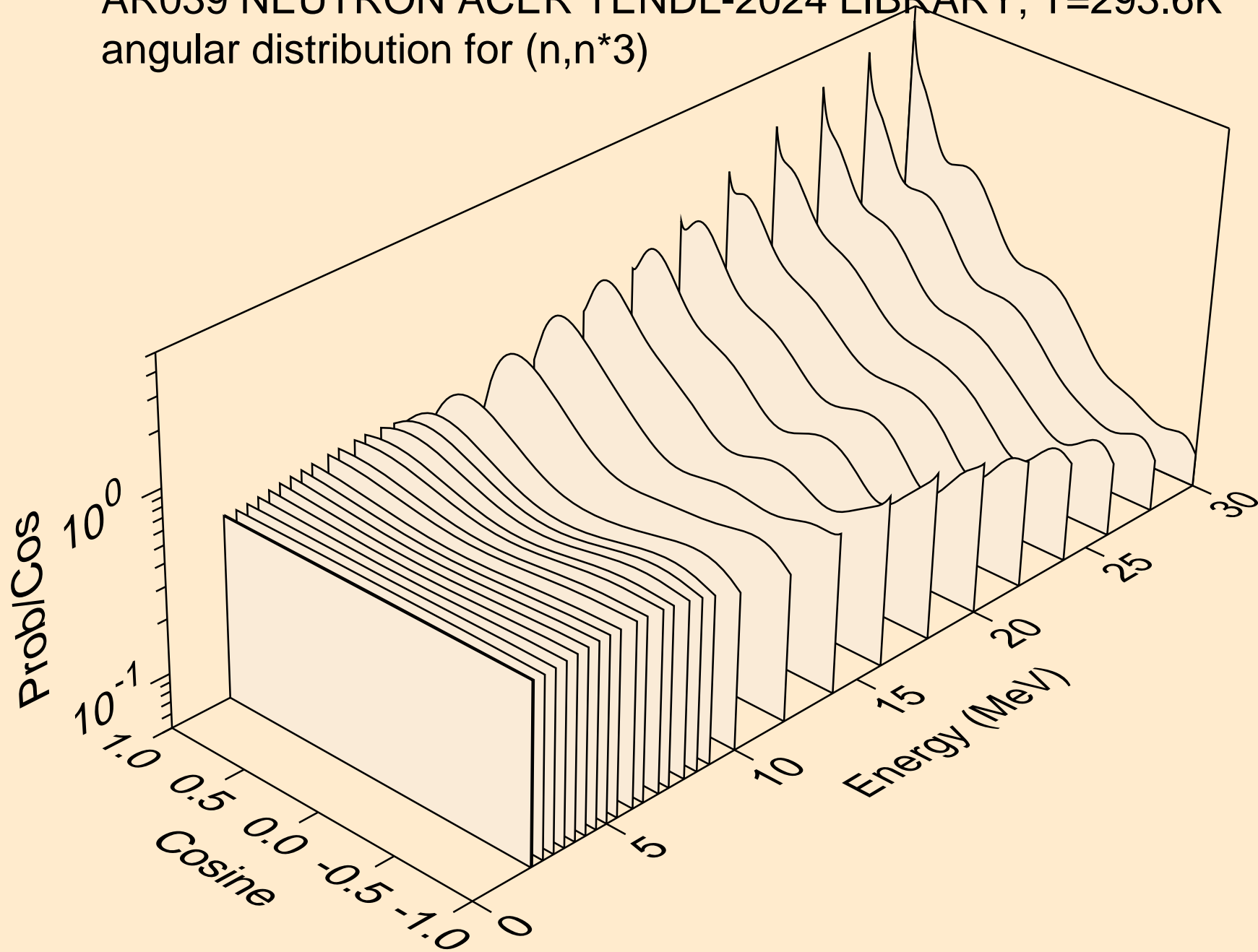

AR039 NEUTRON ACER TENDL-2024 LIBRARY; T=293.6K
angular distribution for (n,n*4)

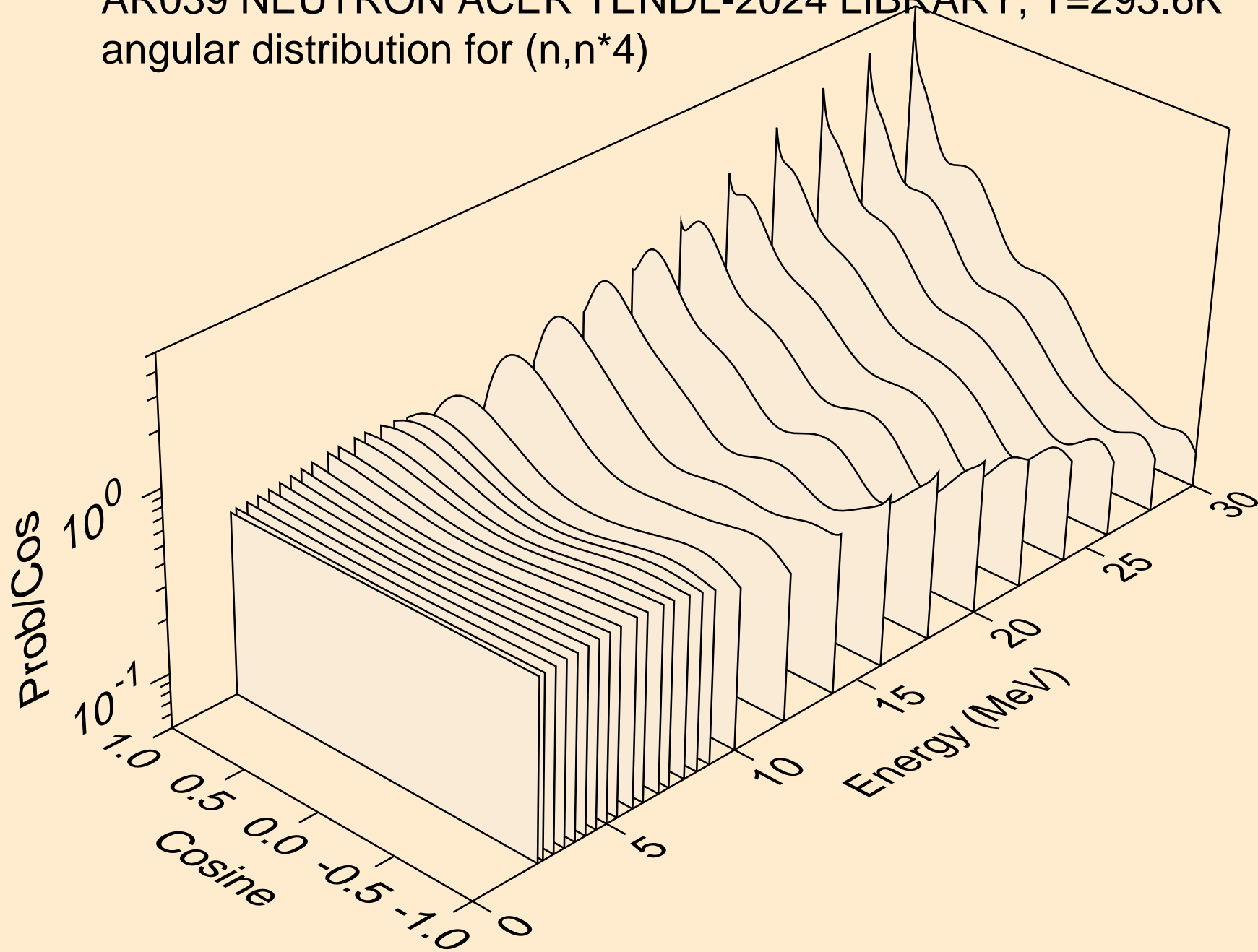

AR039 NEUTRON ACER TENDL-2024 LIBRARY; T=293.6K
angular distribution for (n,n*5)

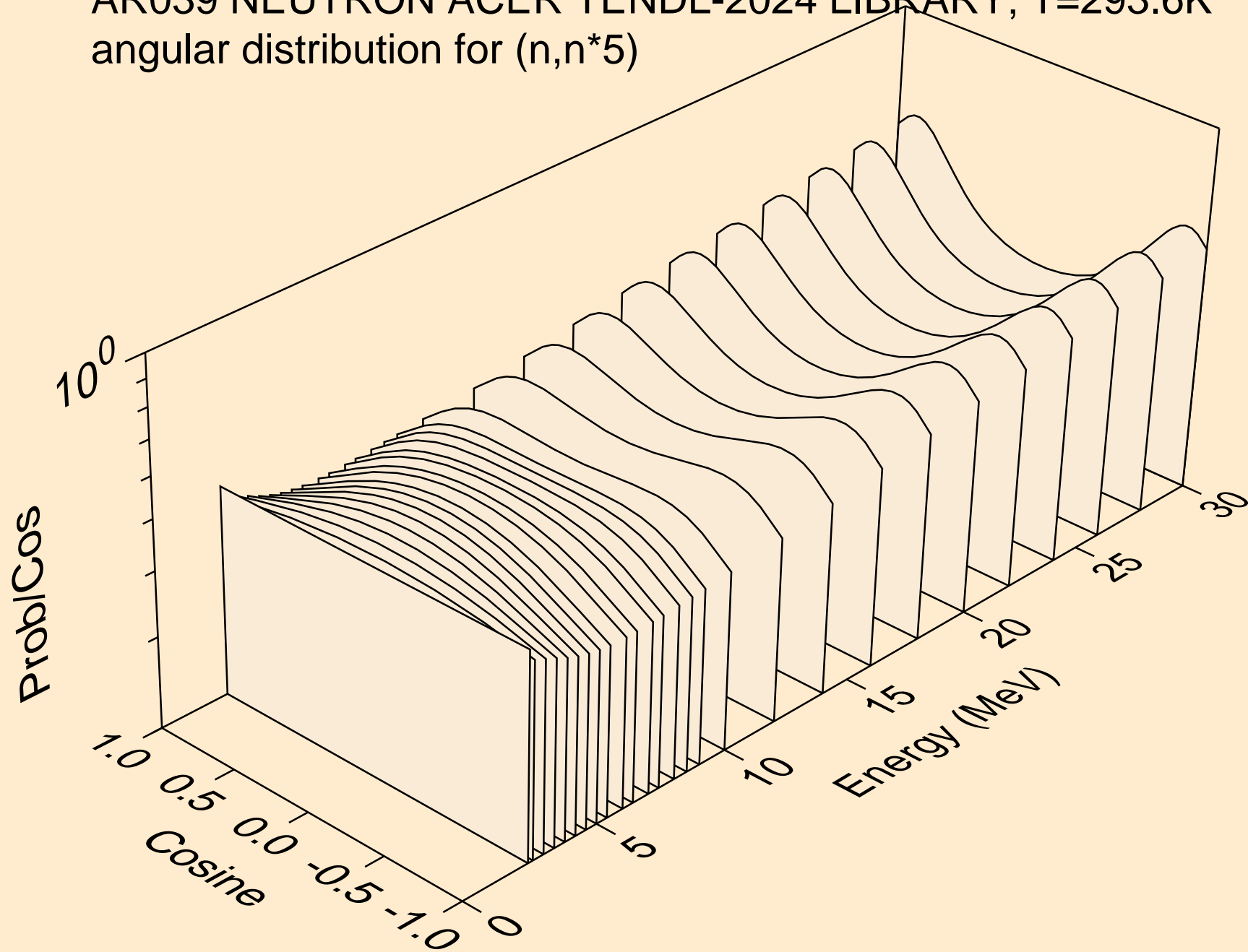

AR039 NEUTRON ACER TENDL-2024 LIBRARY; T=293.6K
angular distribution for (n,n*6)

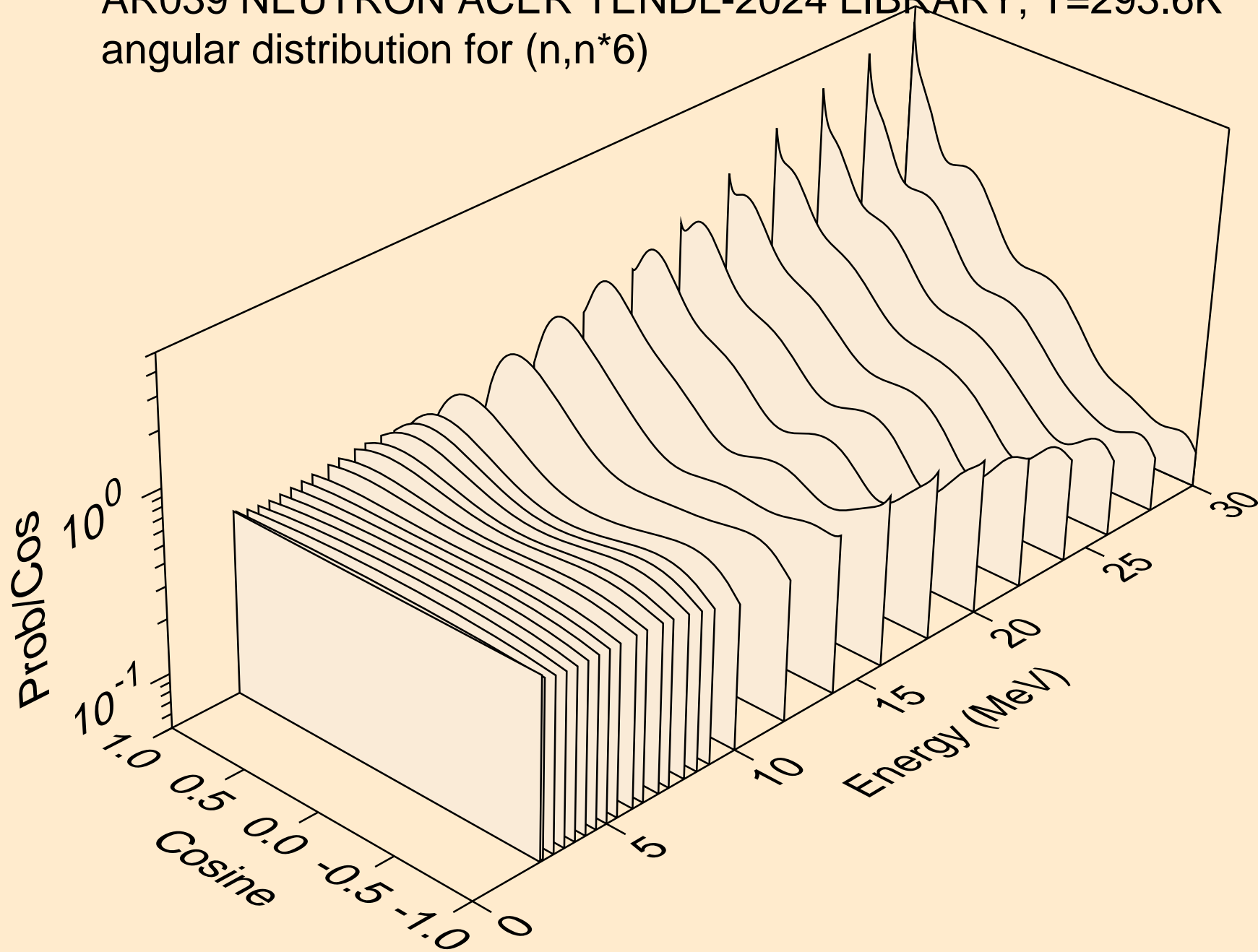

AR039 NEUTRON ACER TENDL-2024 LIBRARY; T=293.6K
angular distribution for (n,n*7)

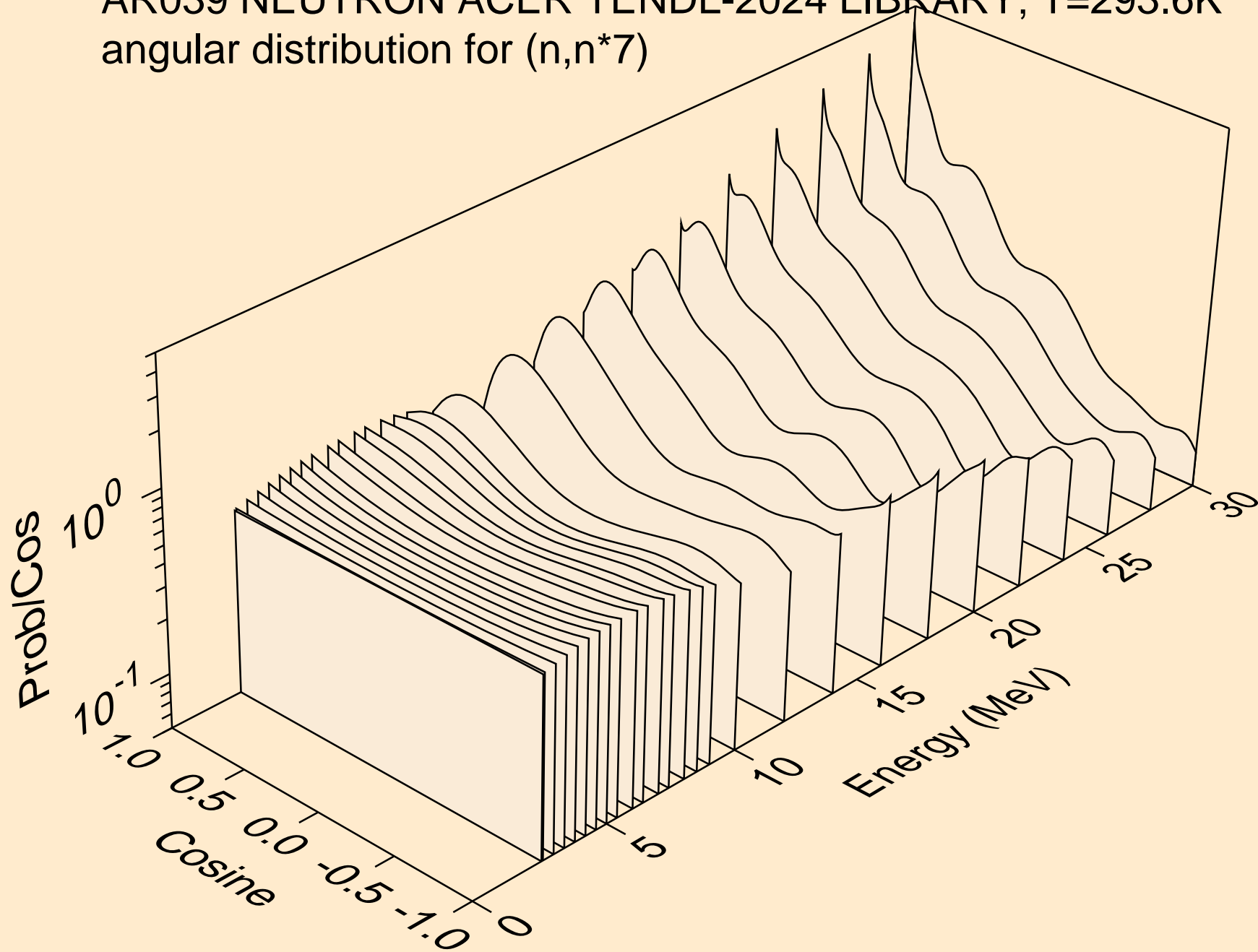

AR039 NEUTRON ACER TENDL-2024 LIBRARY; T=293.6K
angular distribution for (n,n*8)

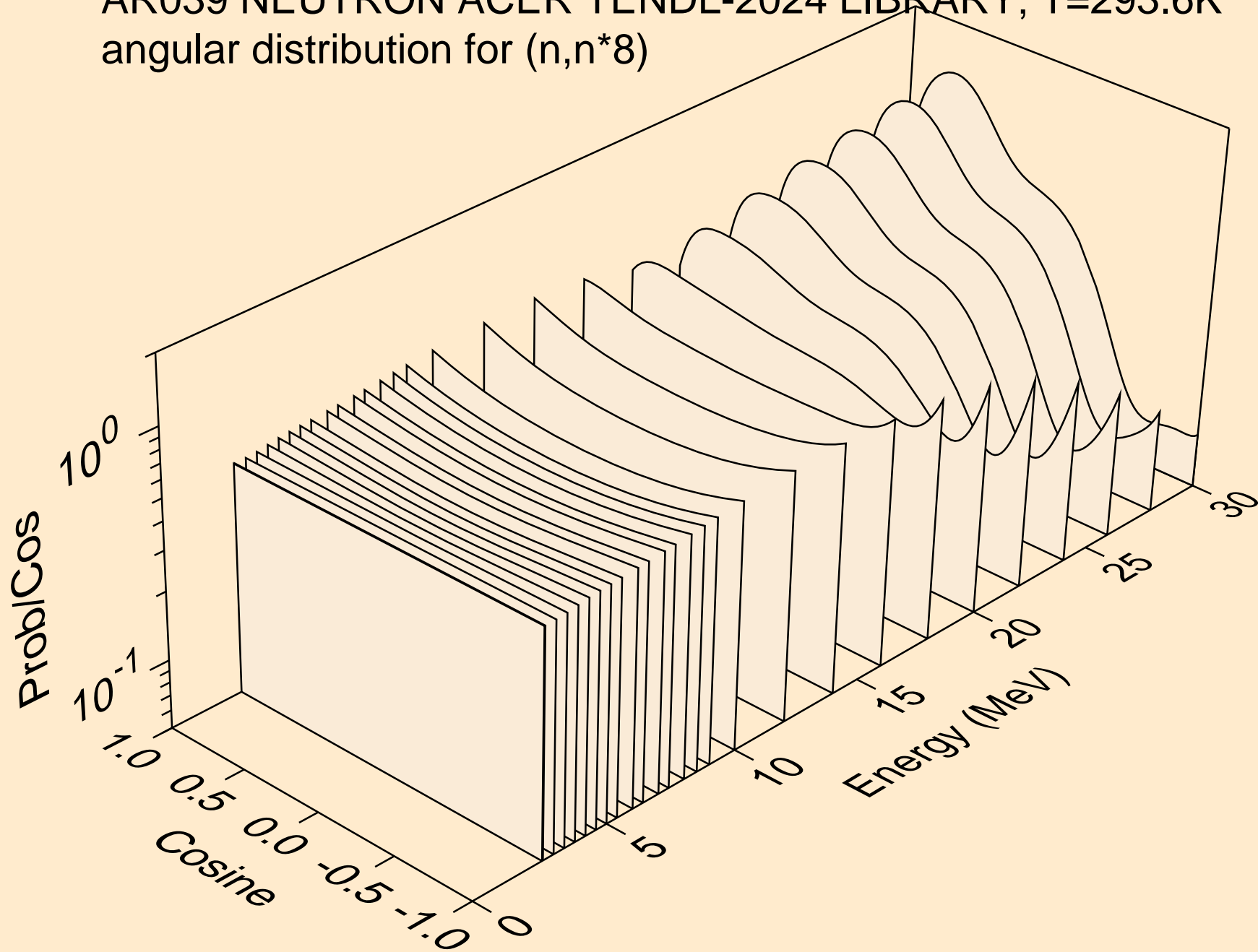

AR039 NEUTRON ACER TENDL-2024 LIBRARY; T=293.6K
angular distribution for (n,n*9)

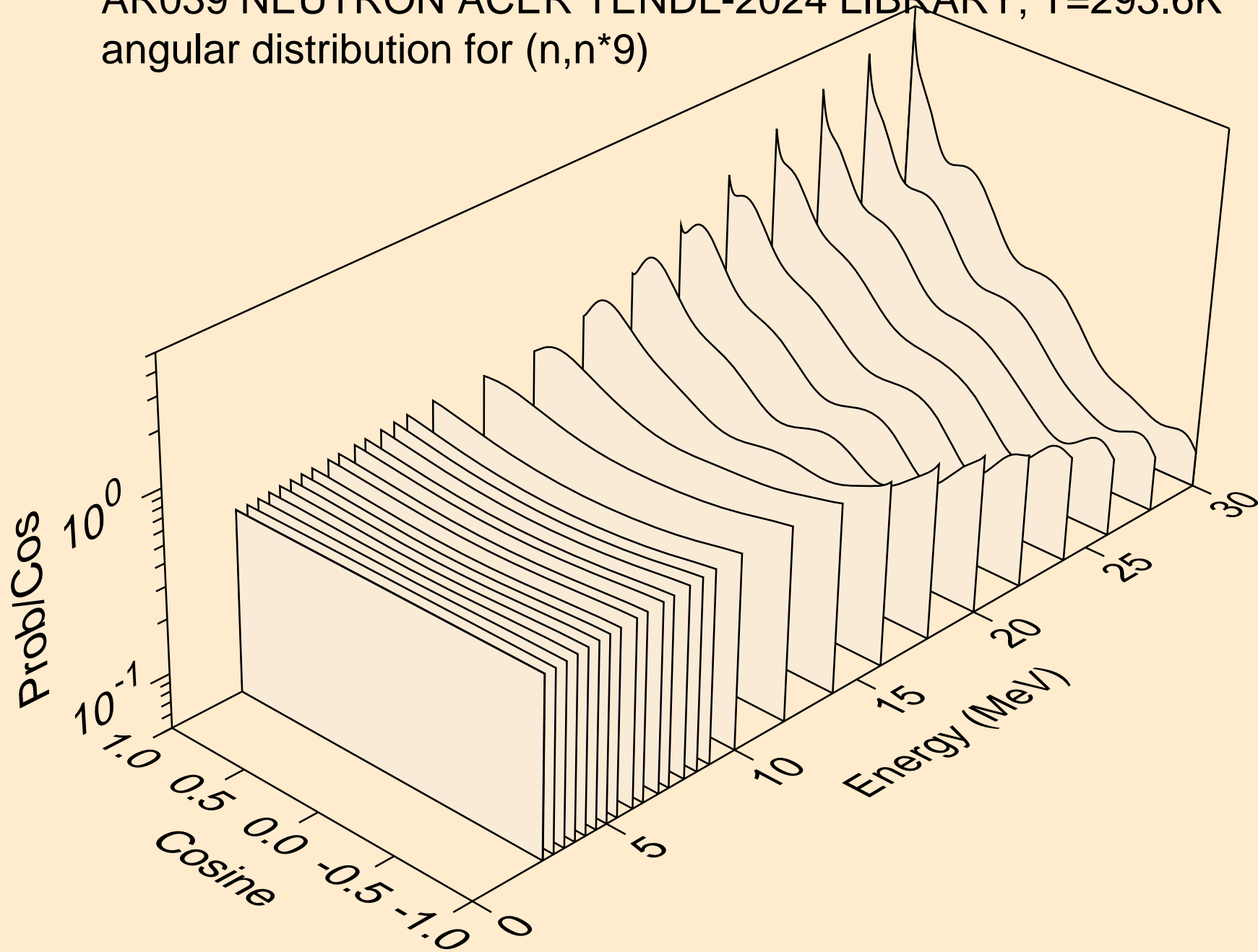

AR039 NEUTRON ACER TENDL-2024 LIBRARY; T=293.6K
angular distribution for (n,n*10)

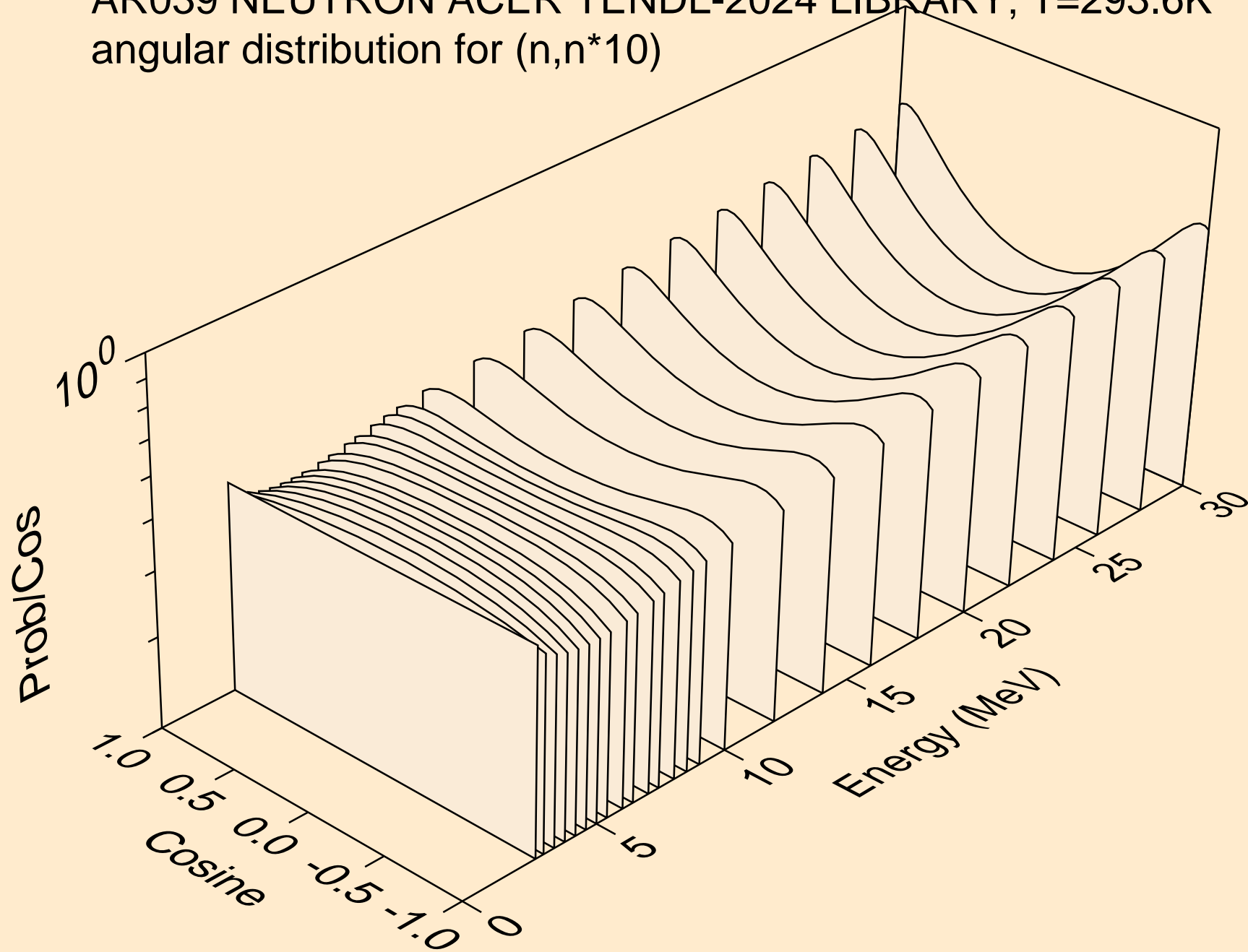

AR039 NEUTRON ACER TENDL-2024 LIBRARY; T=293.6K
angular distribution for (n,n*11)

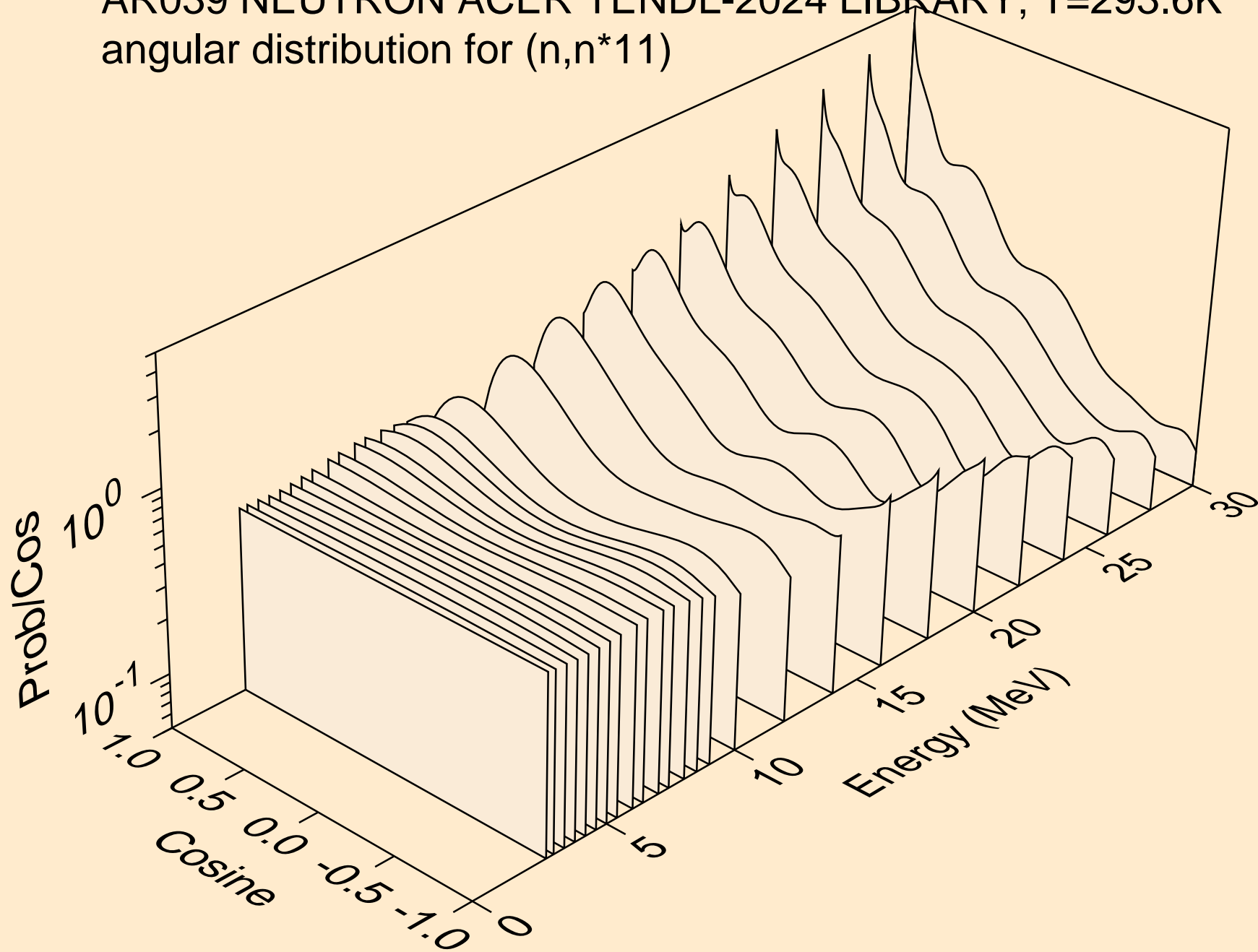

AR039 NEUTRON ACER TENDL-2024 LIBRARY; T=293.6K
angular distribution for (n,n*12)

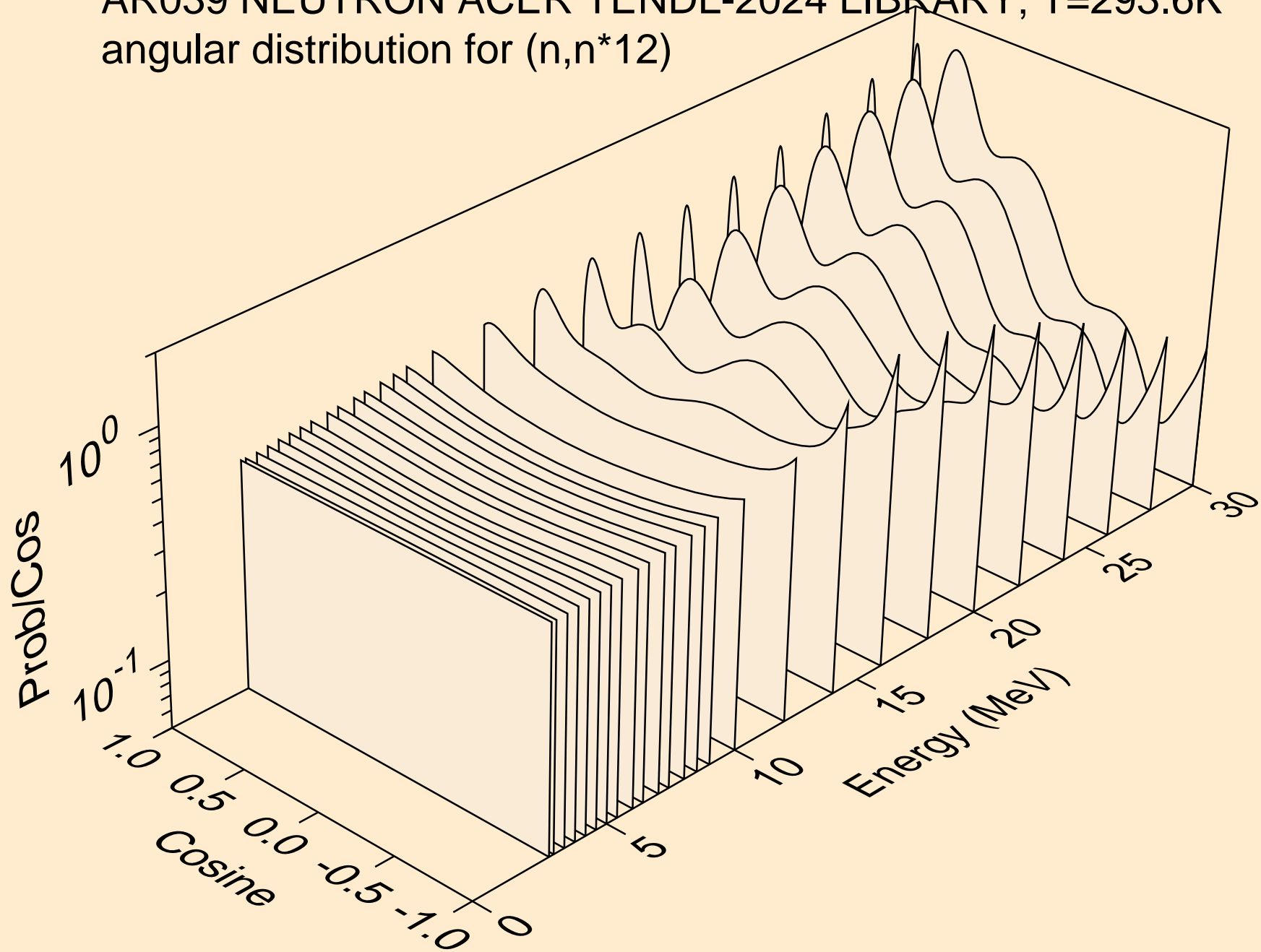

AR039 NEUTRON ACER TENDL-2024 LIBRARY; T=293.6K
angular distribution for (n,n*13)

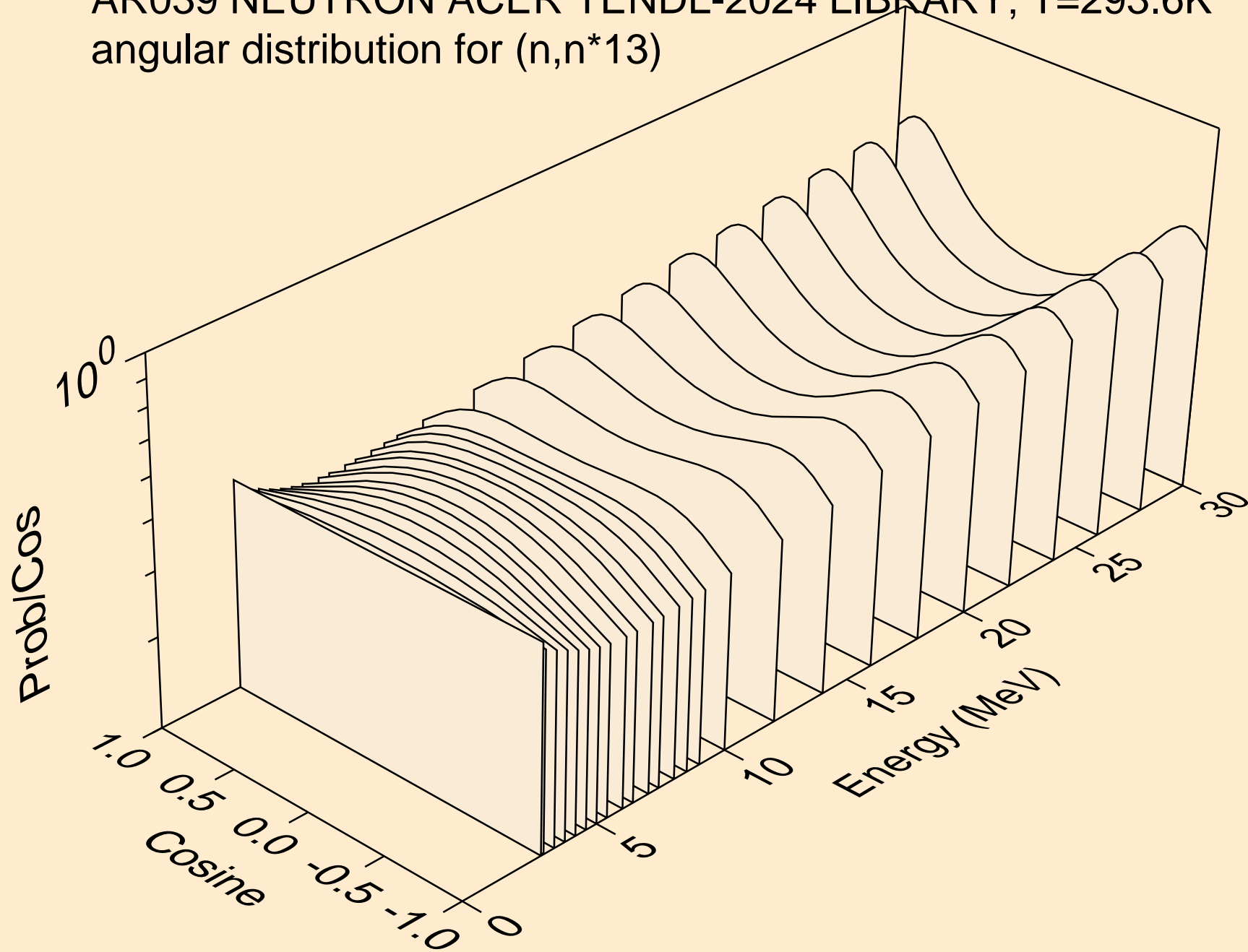

AR039 NEUTRON ACER TENDL-2024 LIBRARY; T=293.6K
angular distribution for (n,n*14)

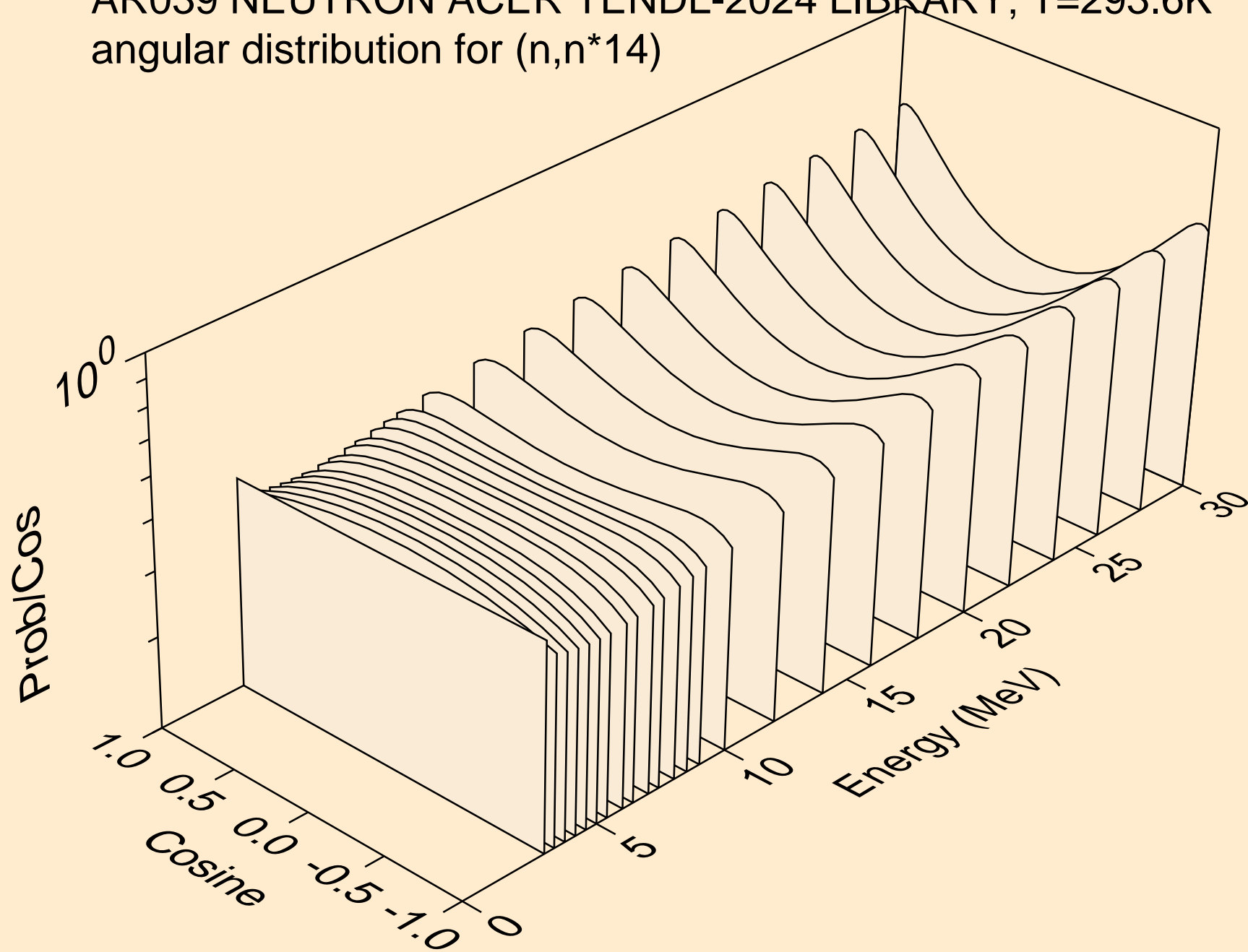

AR039 NEUTRON ACER TENDL-2024 LIBRARY; T=293.6K
angular distribution for (n,n*15)

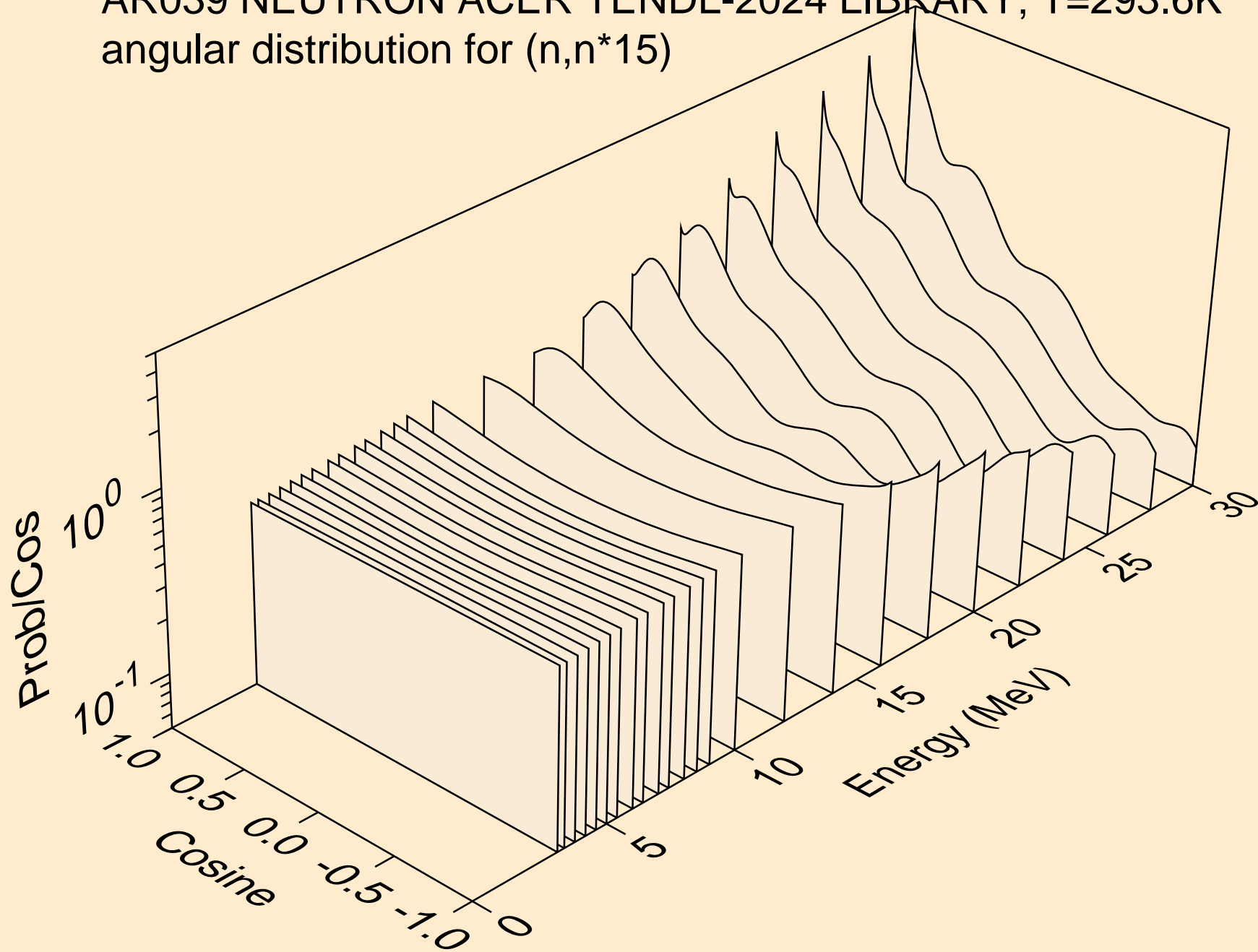

AR039 NEUTRON ACER TENDL-2024 LIBRARY; T=293.6K
angular distribution for (n,n*16)

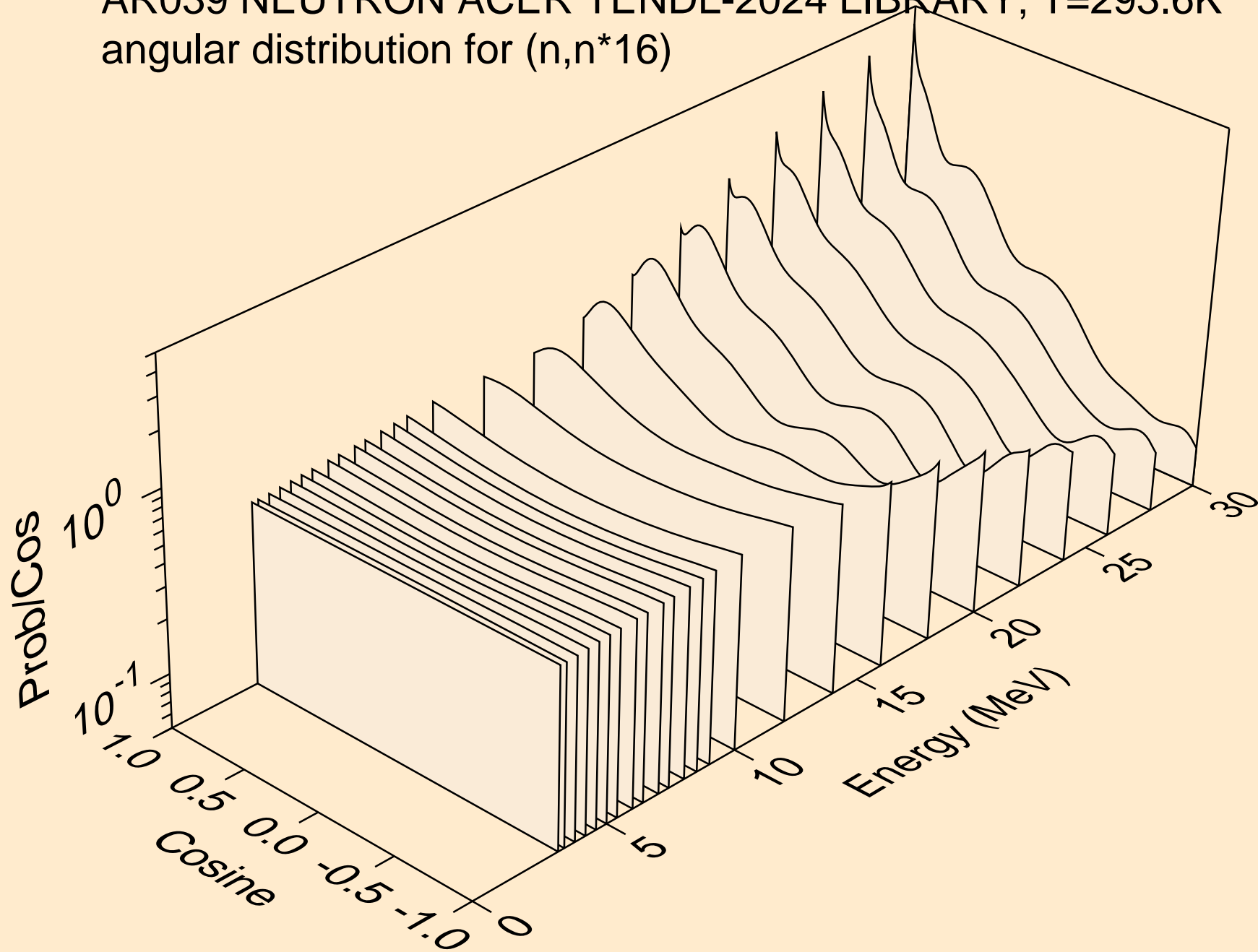

AR039 NEUTRON ACER TENDL-2024 LIBRARY; T=293.6K
angular distribution for (n,n*17)

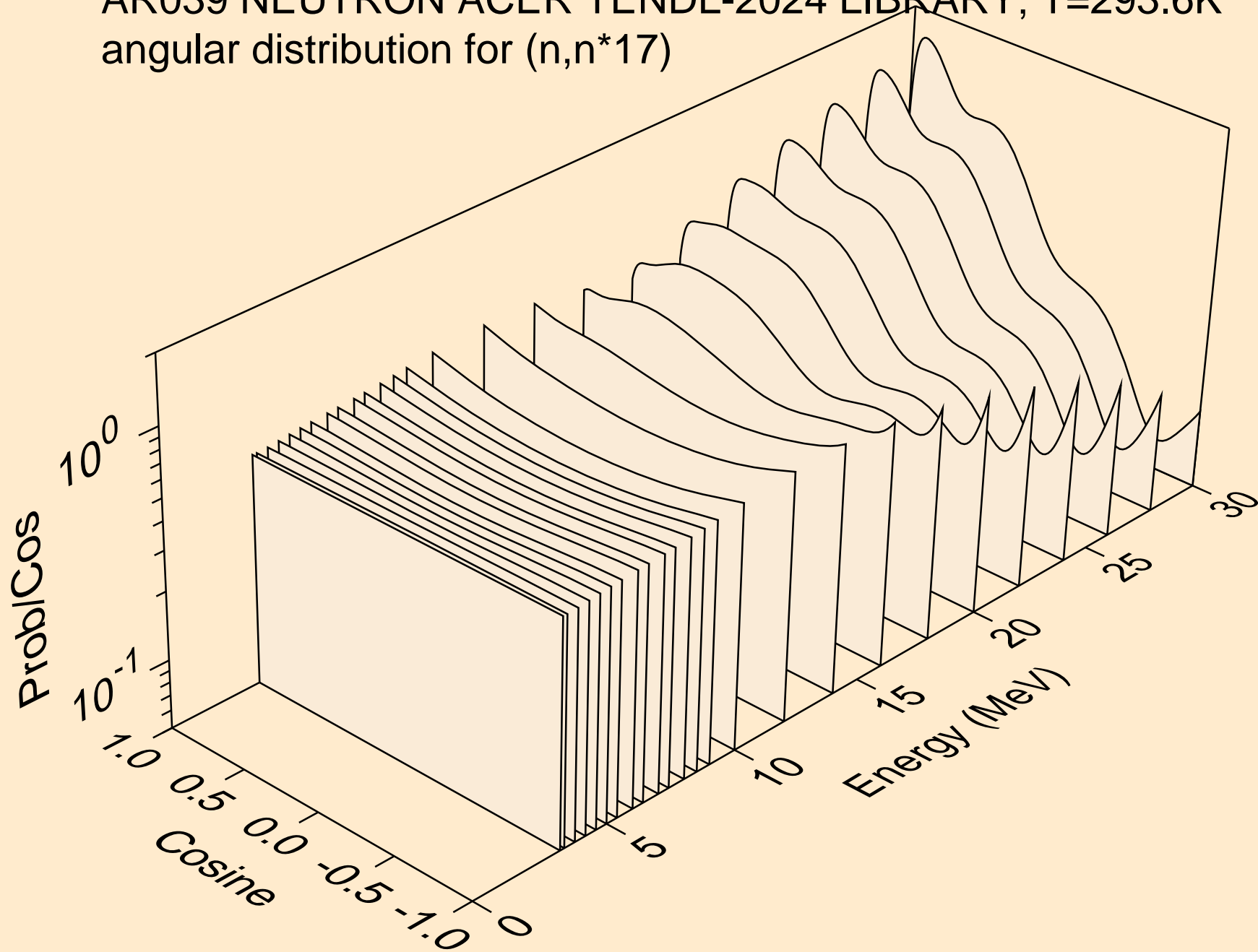

AR039 NEUTRON ACER TENDL-2024 LIBRARY; T=293.6K
angular distribution for (n,n*18)

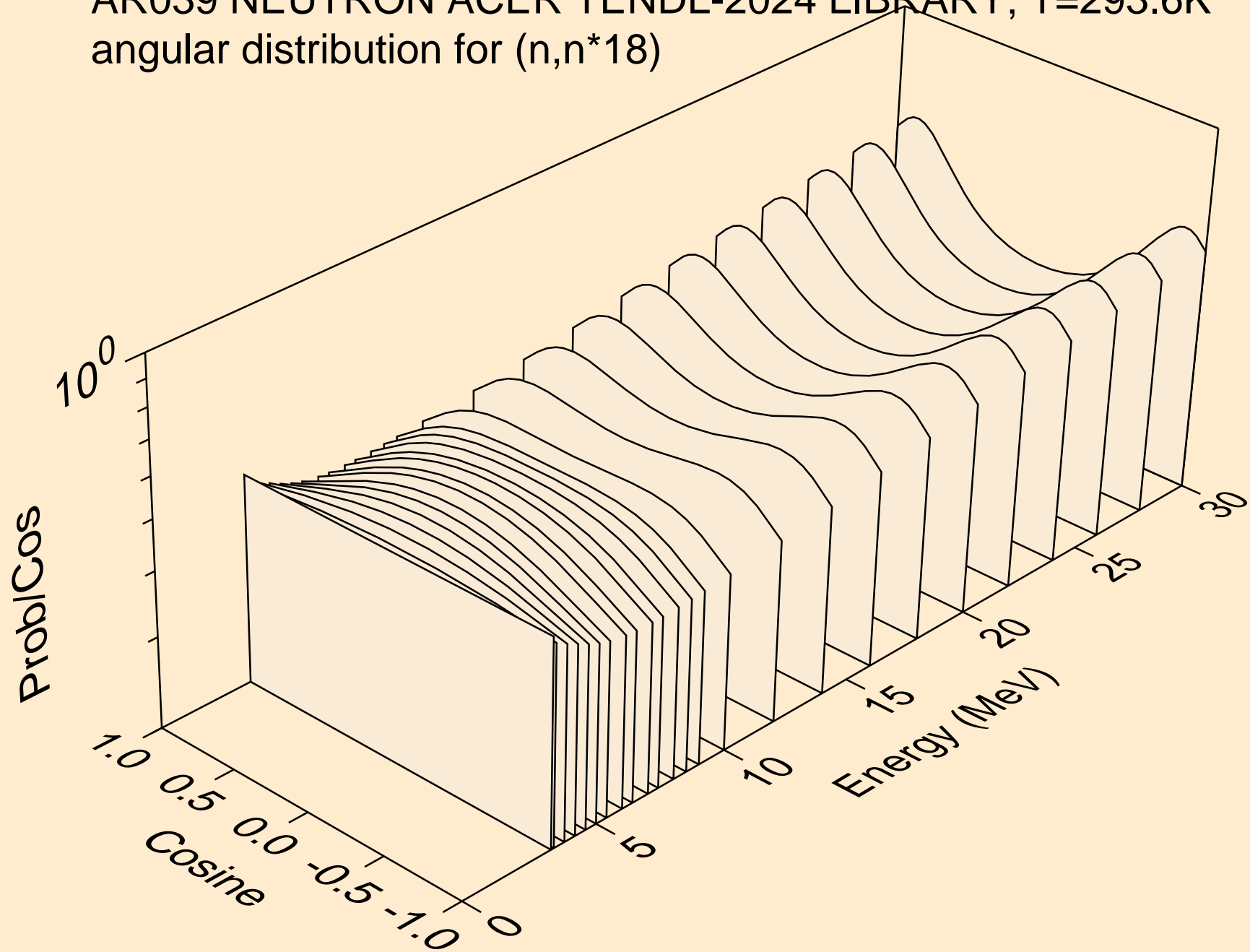

AR039 NEUTRON ACER TENDL-2024 LIBRARY; T=293.6K
angular distribution for (n,n*19)

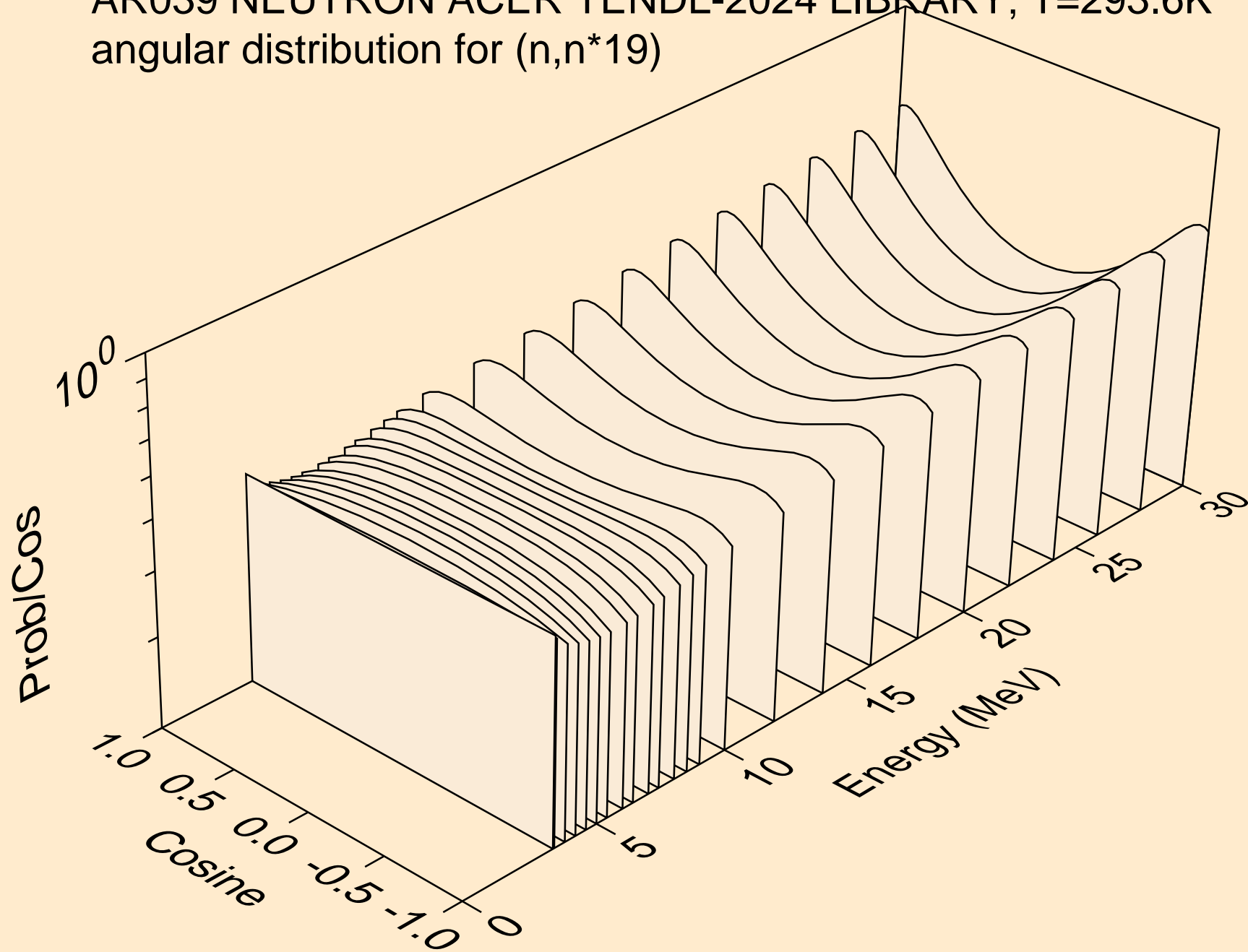

AR039 NEUTRON ACER TENDL-2024 LIBRARY; T=293.6K
angular distribution for (n,n*20)

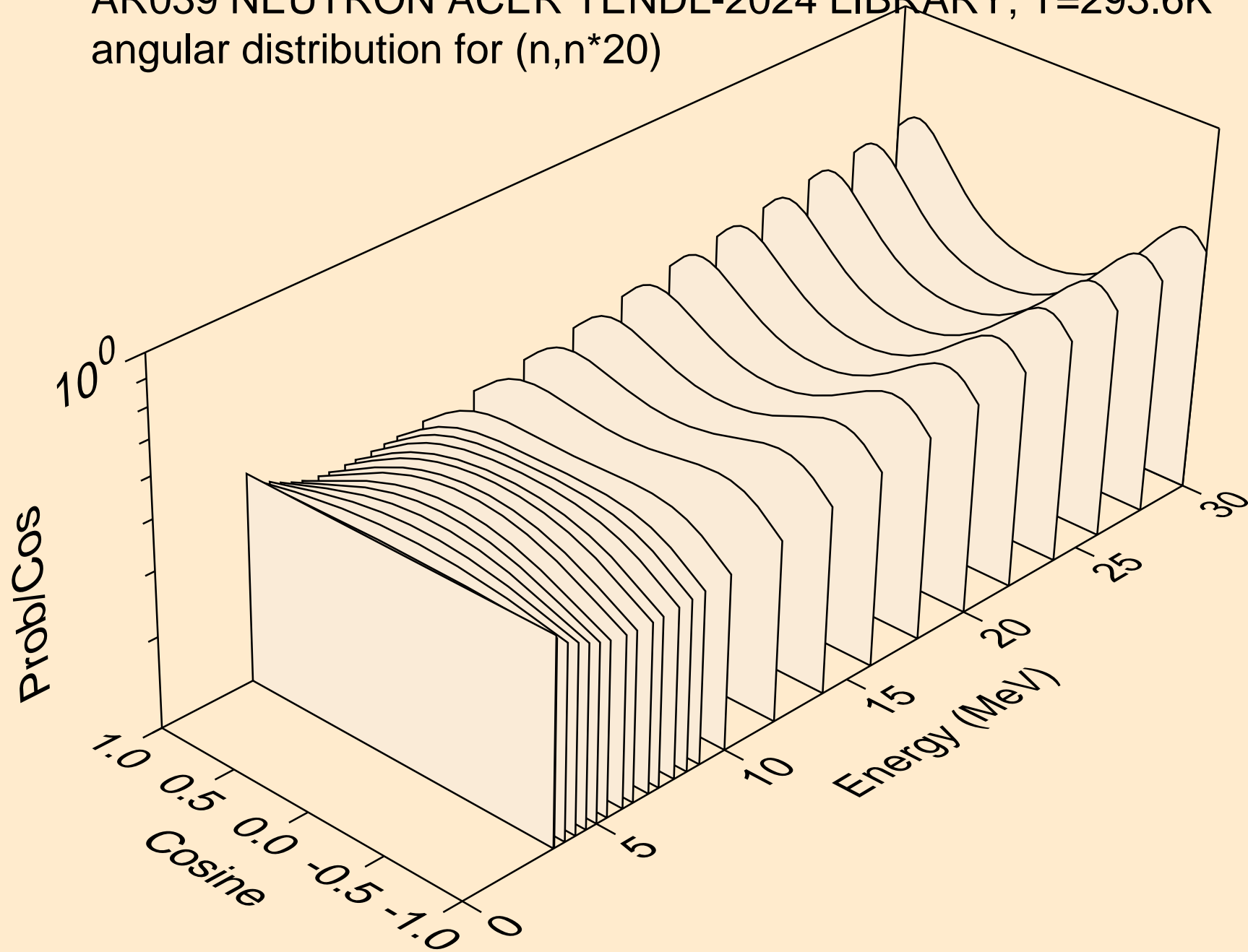

AR039 NEUTRON ACER TENDL-2024 LIBRARY; T=293.6K
angular distribution for (n,n*21)

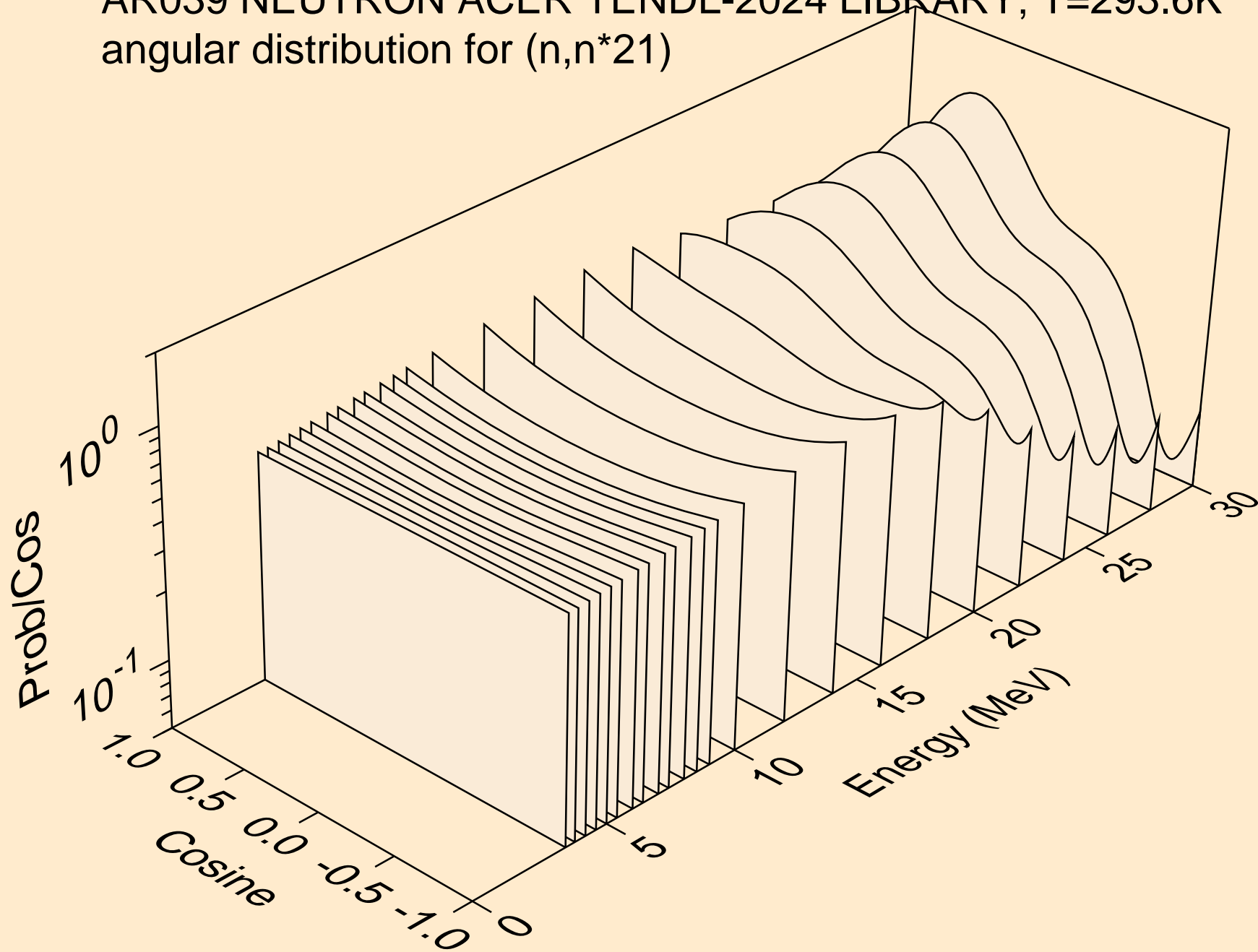

AR039 NEUTRON ACER TENDL-2024 LIBRARY; T=293.6K
angular distribution for (n,n*22)

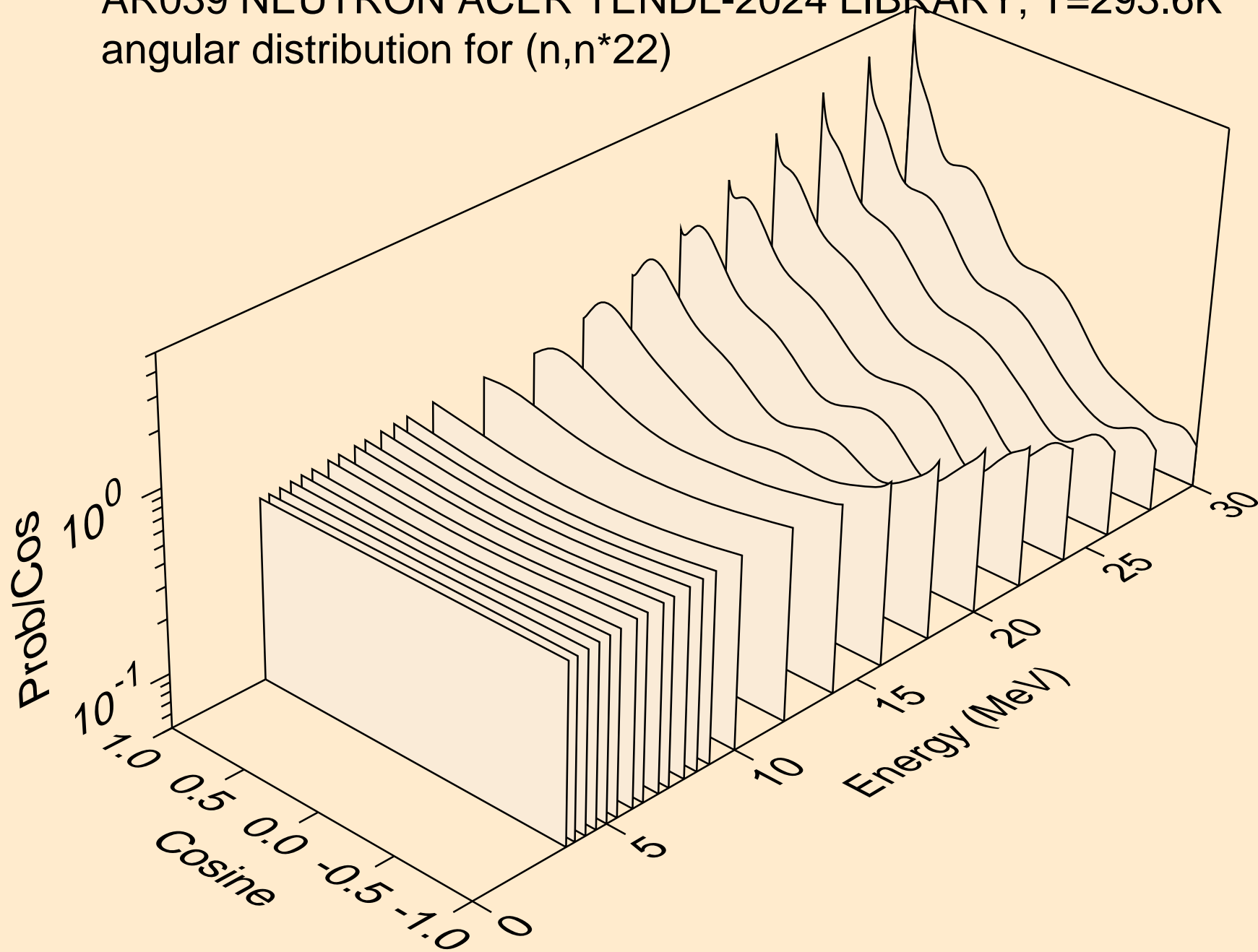

AR039 NEUTRON ACER TENDL-2024 LIBRARY; T=293.6K
angular distribution for (n,n*23)

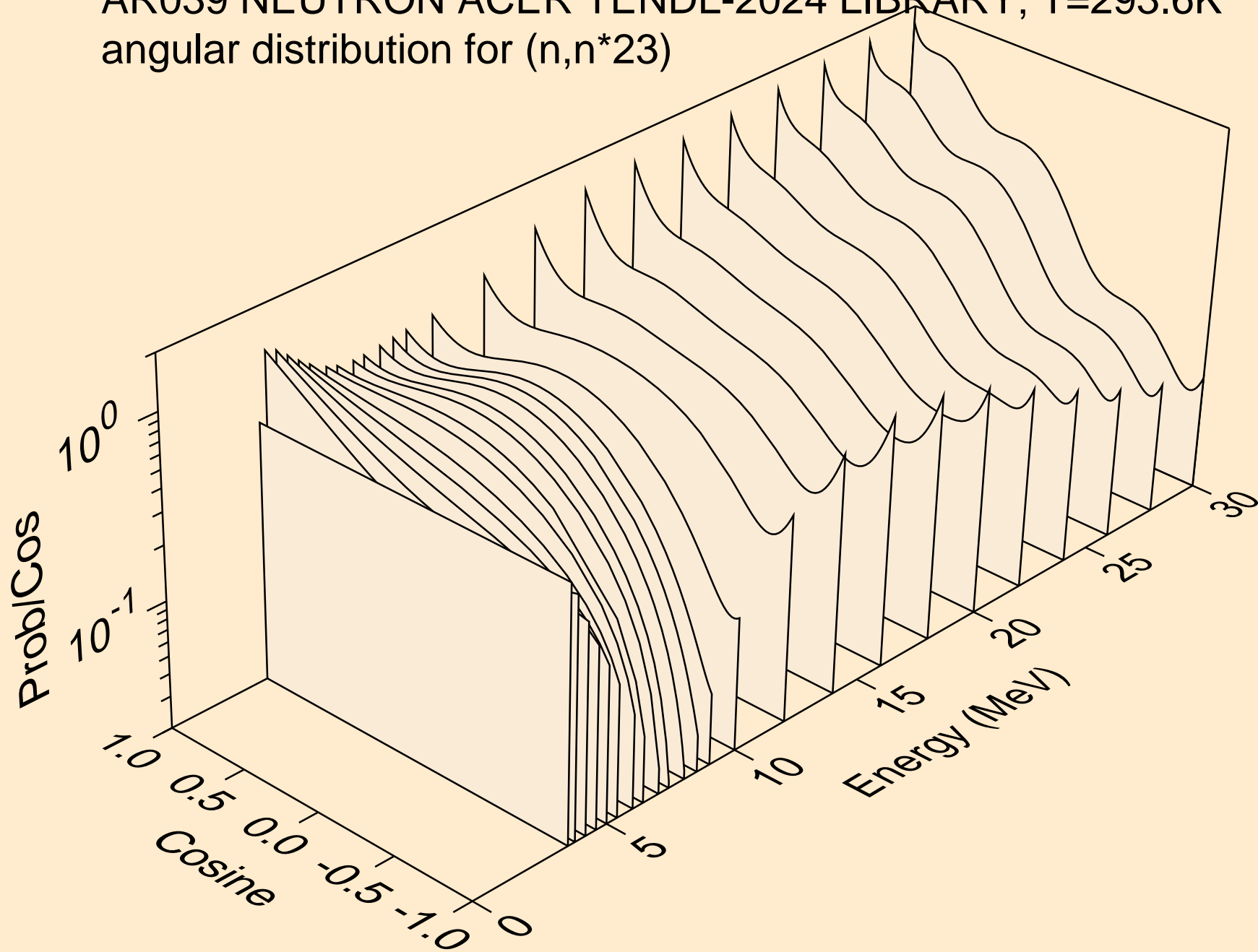

AR039 NEUTRON ACER TENDL-2024 LIBRARY; T=293.6K
angular distribution for (n,n*24)

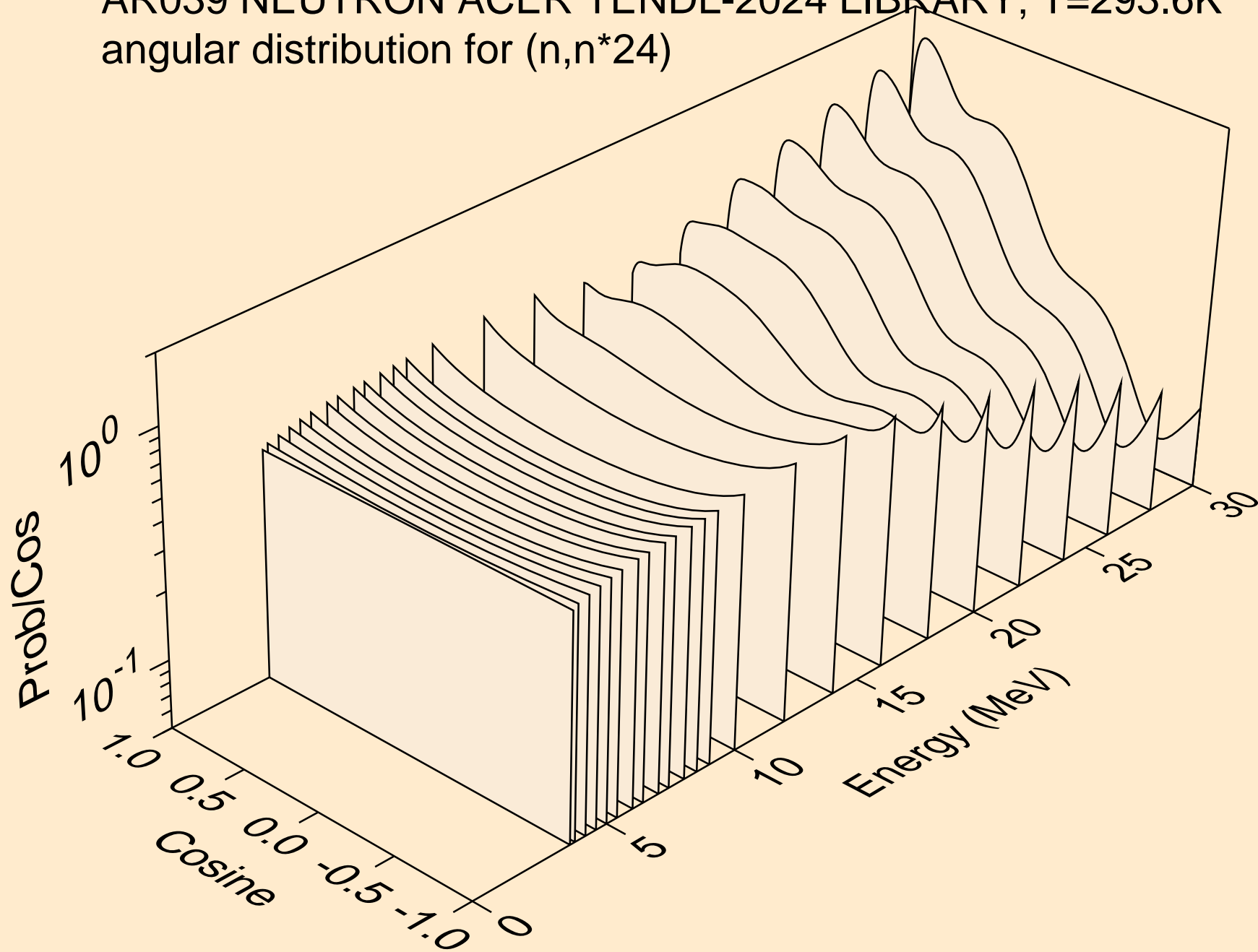

AR039 NEUTRON ACER TENDL-2024 LIBRARY; T=293.6K
angular distribution for (n,n*25)

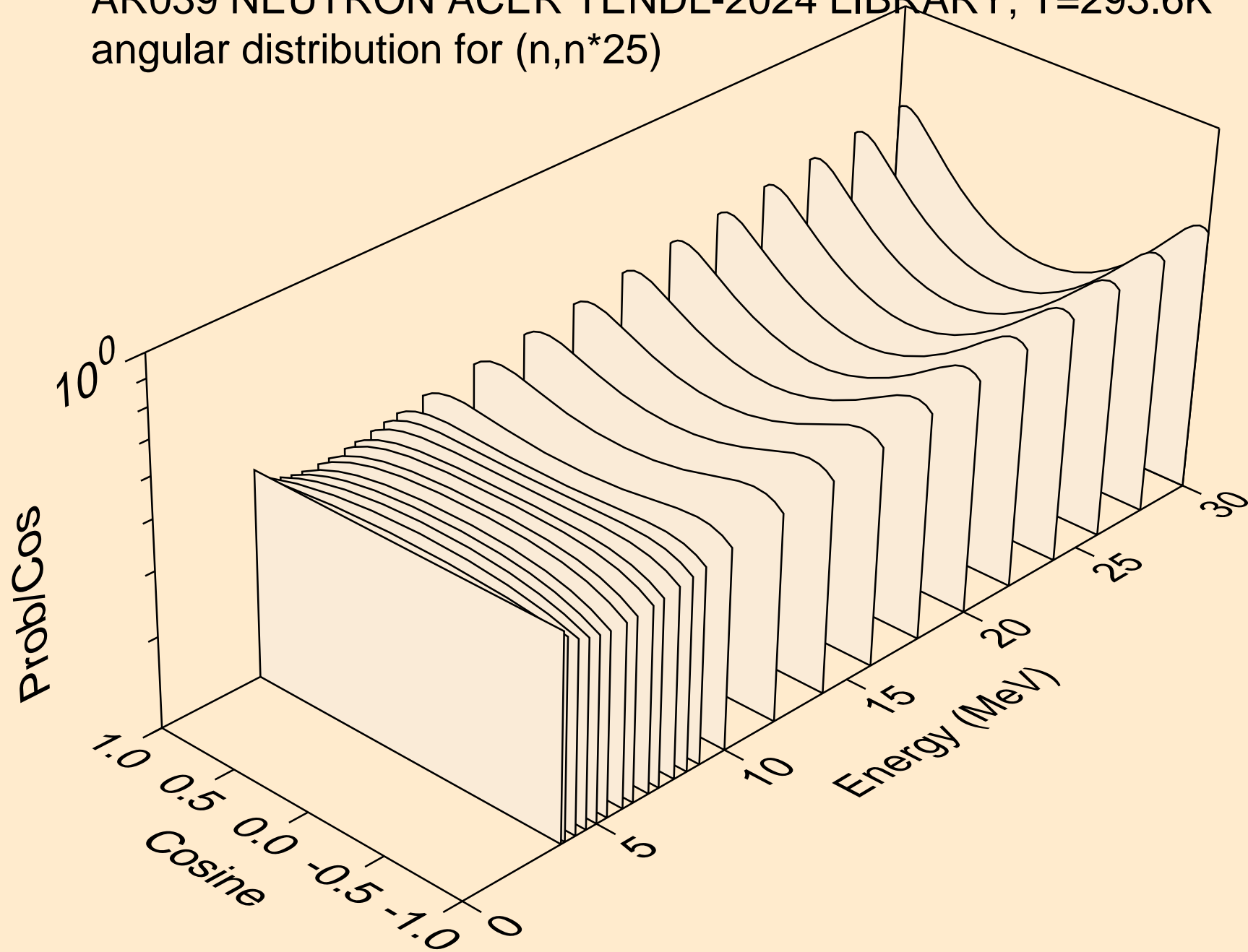

AR039 NEUTRON ACER TENDL-2024 LIBRARY; T=293.6K
angular distribution for (n,n*26)

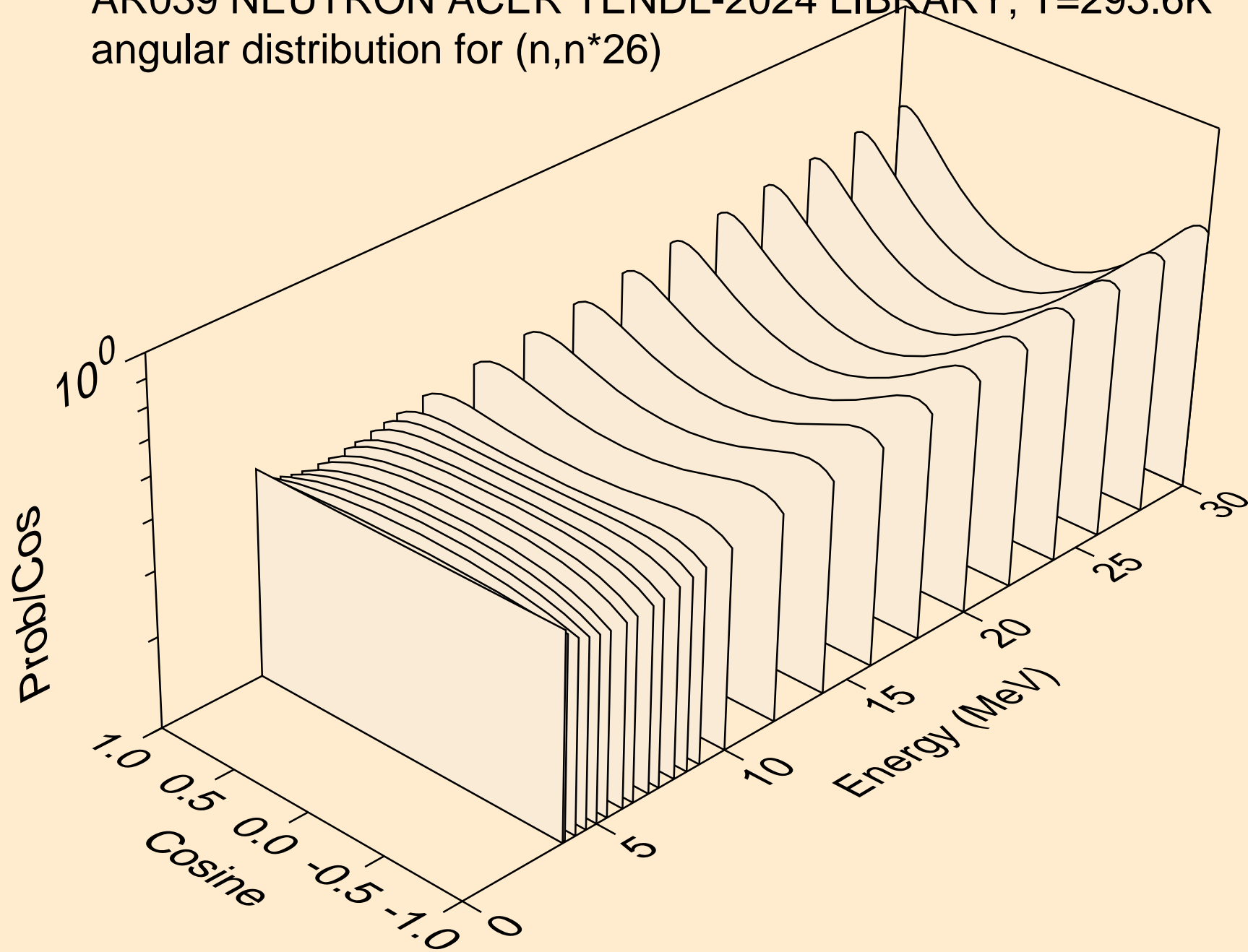

AR039 NEUTRON ACER TENDL-2024 LIBRARY; T=293.6K
angular distribution for (n,n*27)

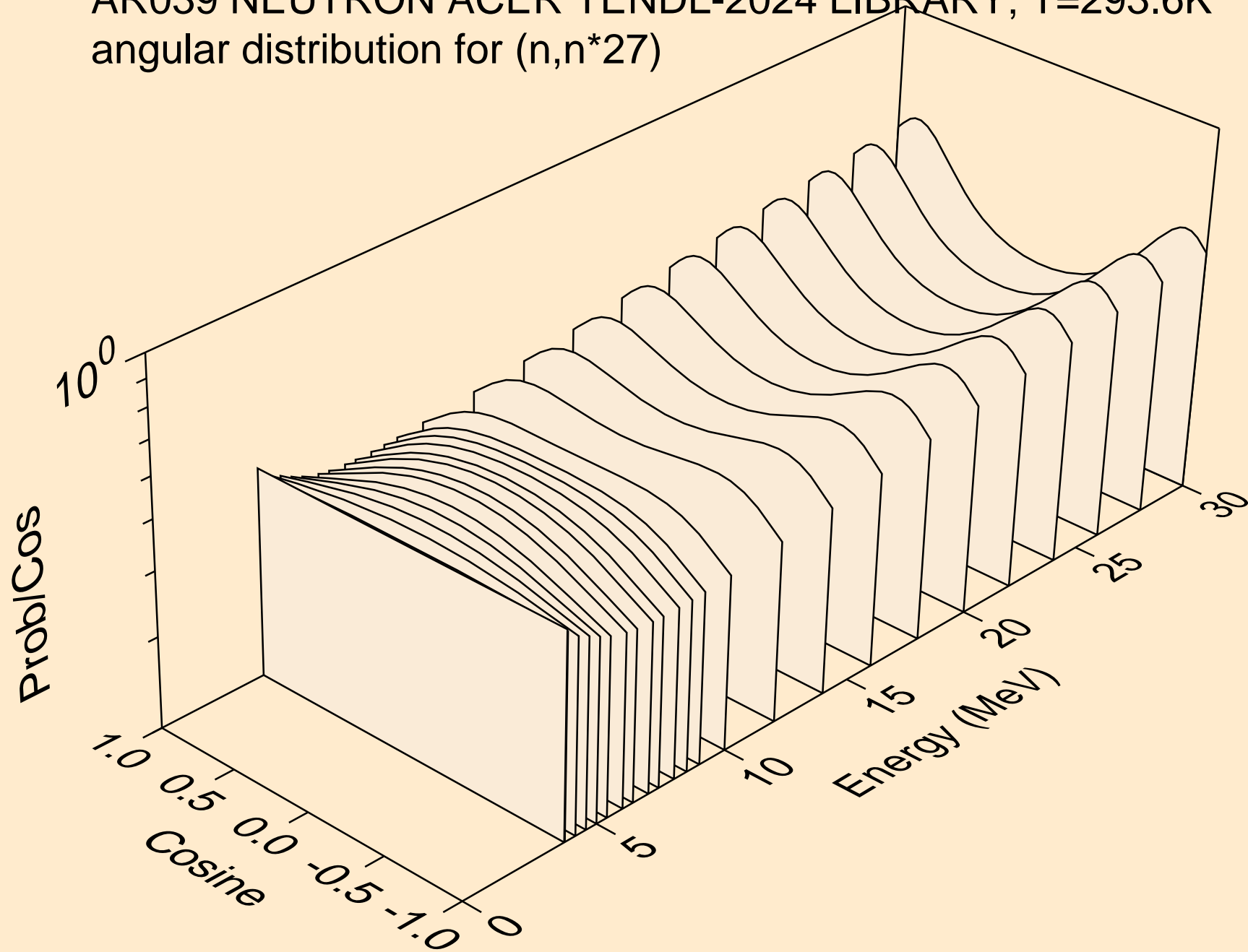

AR039 NEUTRON ACER TENDL-2024 LIBRARY; T=293.6K
angular distribution for (n,n*28)

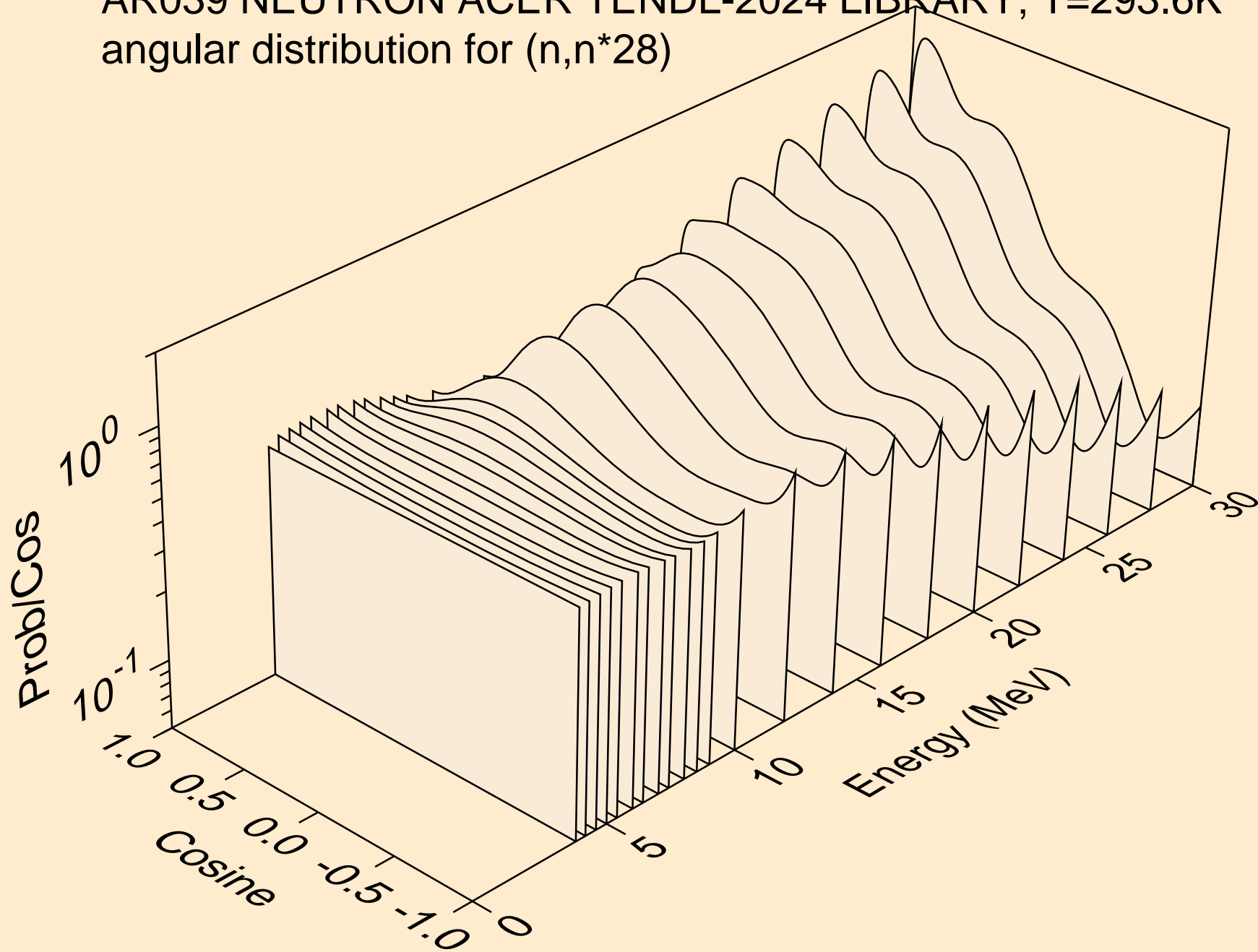

AR039 NEUTRON ACER TENDL-2024 LIBRARY; T=293.6K
angular distribution for (n,n*29)

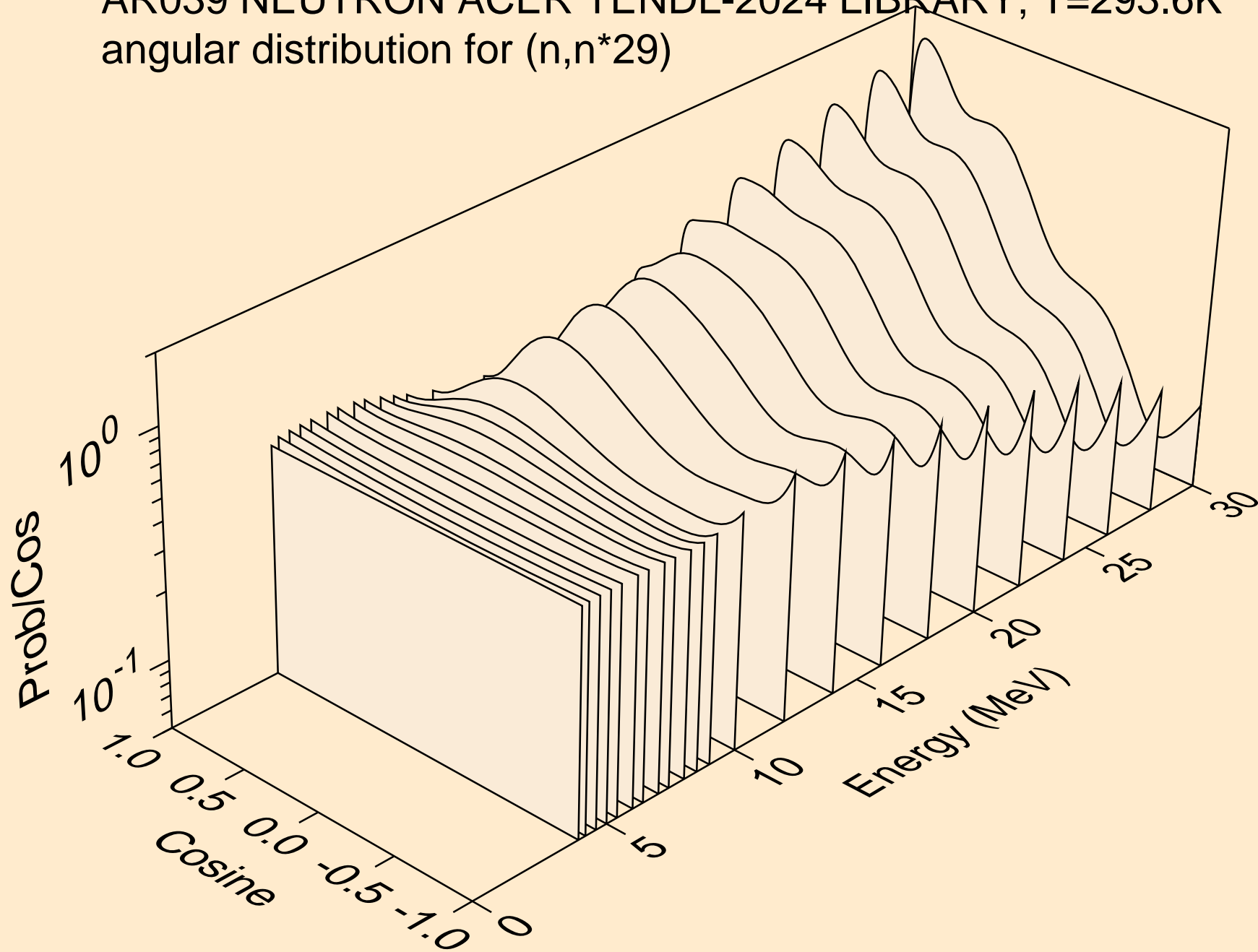

AR039 NEUTRON ACER TENDL-2024 LIBRARY; T=293.6K
angular distribution for (n,n*30)

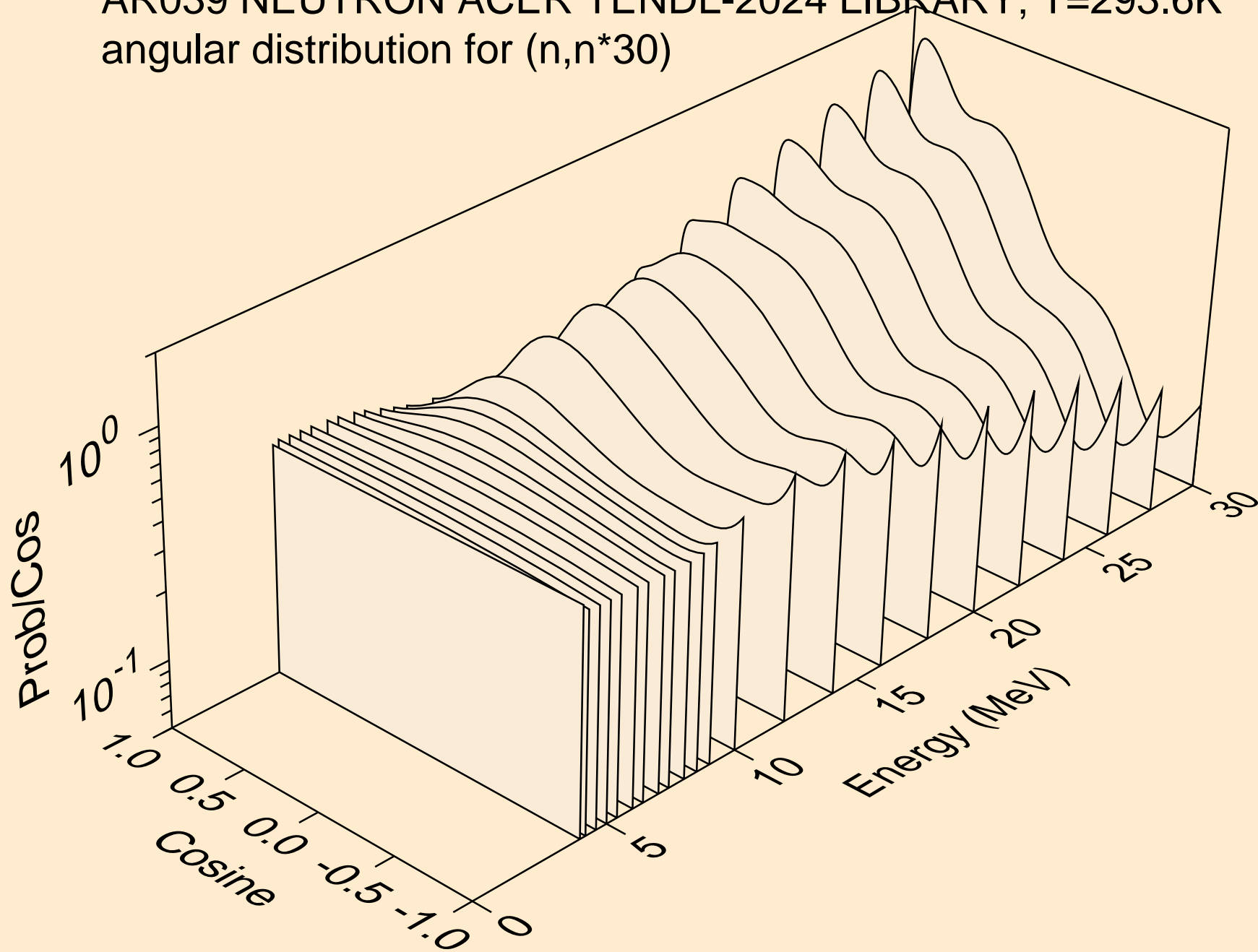

AR039 NEUTRON ACER TENDL-2024 LIBRARY; T=293.6K
Neutron emission for (n,x)

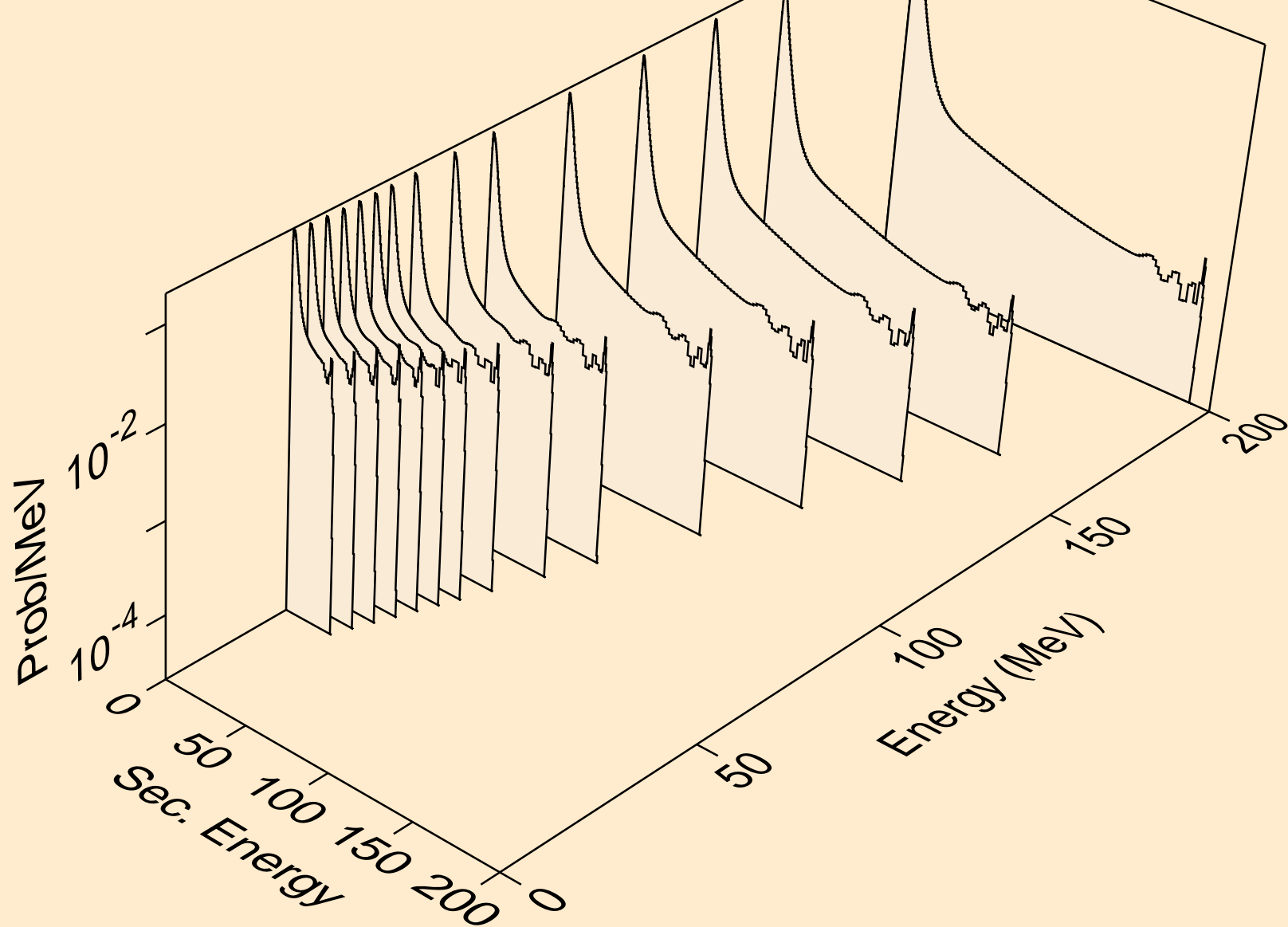

AR039 NEUTRON ACER TENDL-2024 LIBRARY; T=293.6K
Neutron emission for (n,2nd)

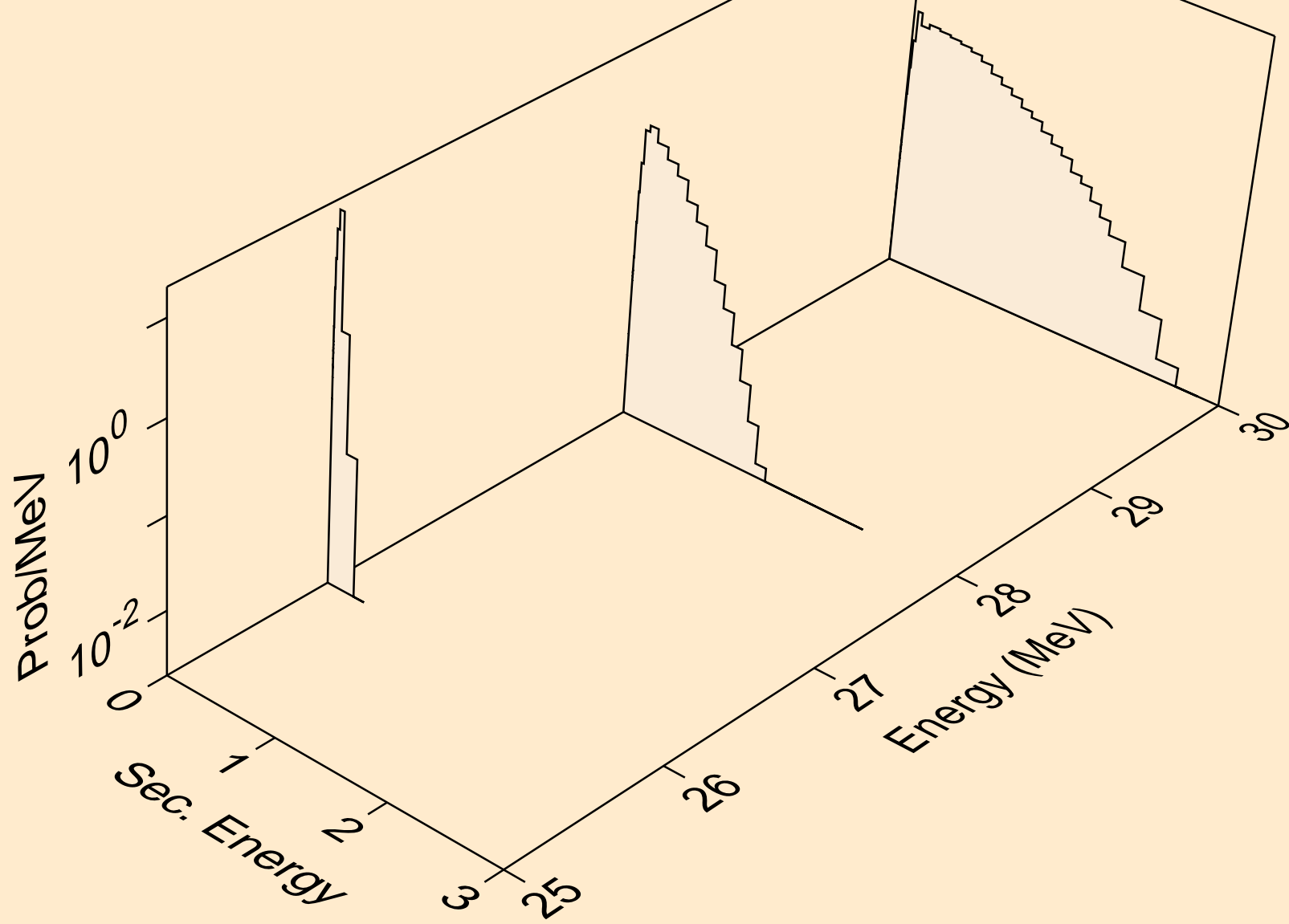

AR039 NEUTRON ACER TENDL-2024 LIBRARY; T=293.6K
Neutron emission for (n,2n)

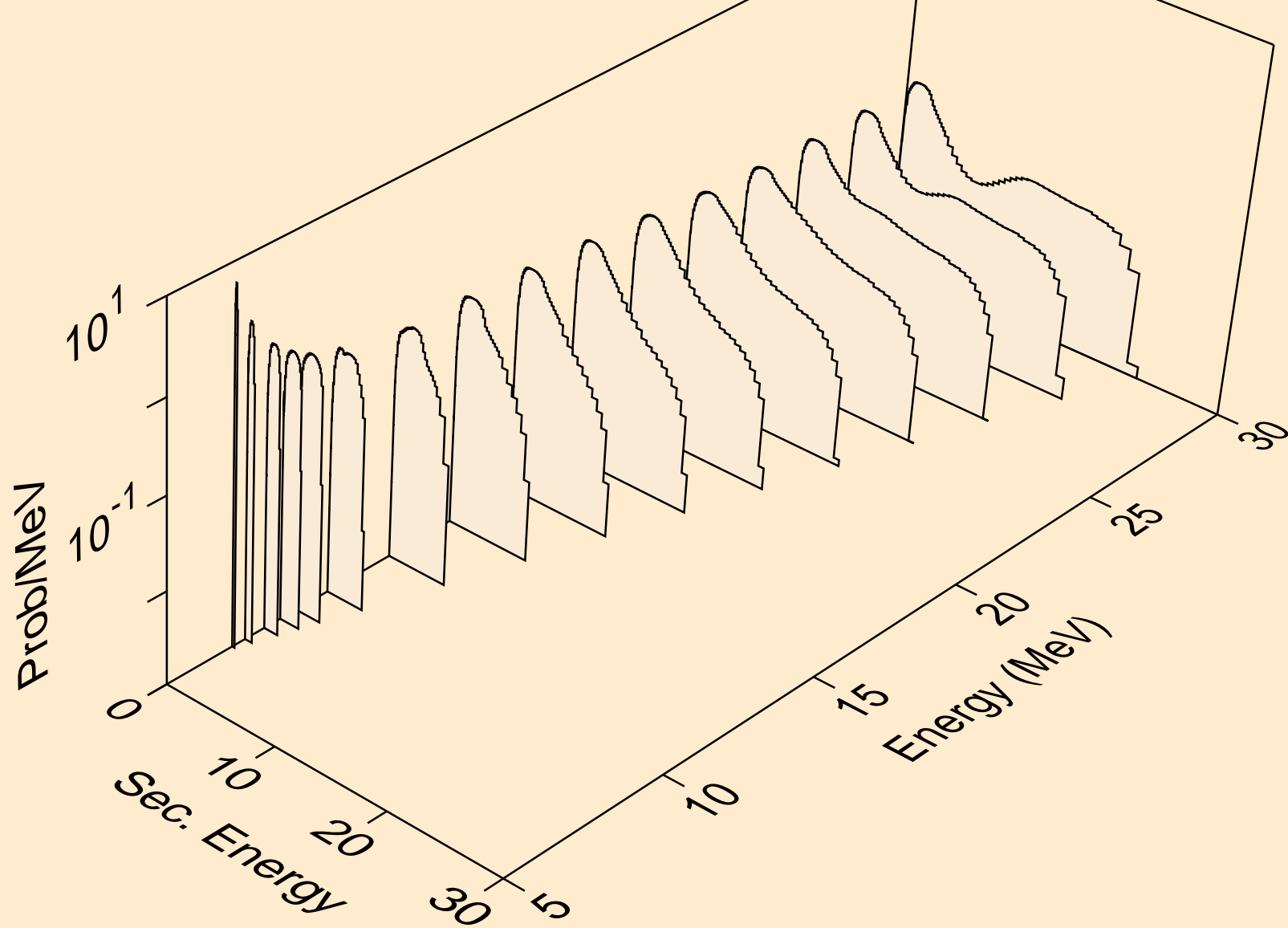

AR039 NEUTRON ACER TENDL-2024 LIBRARY; T=293.6K
Neutron emission for (n,3n)

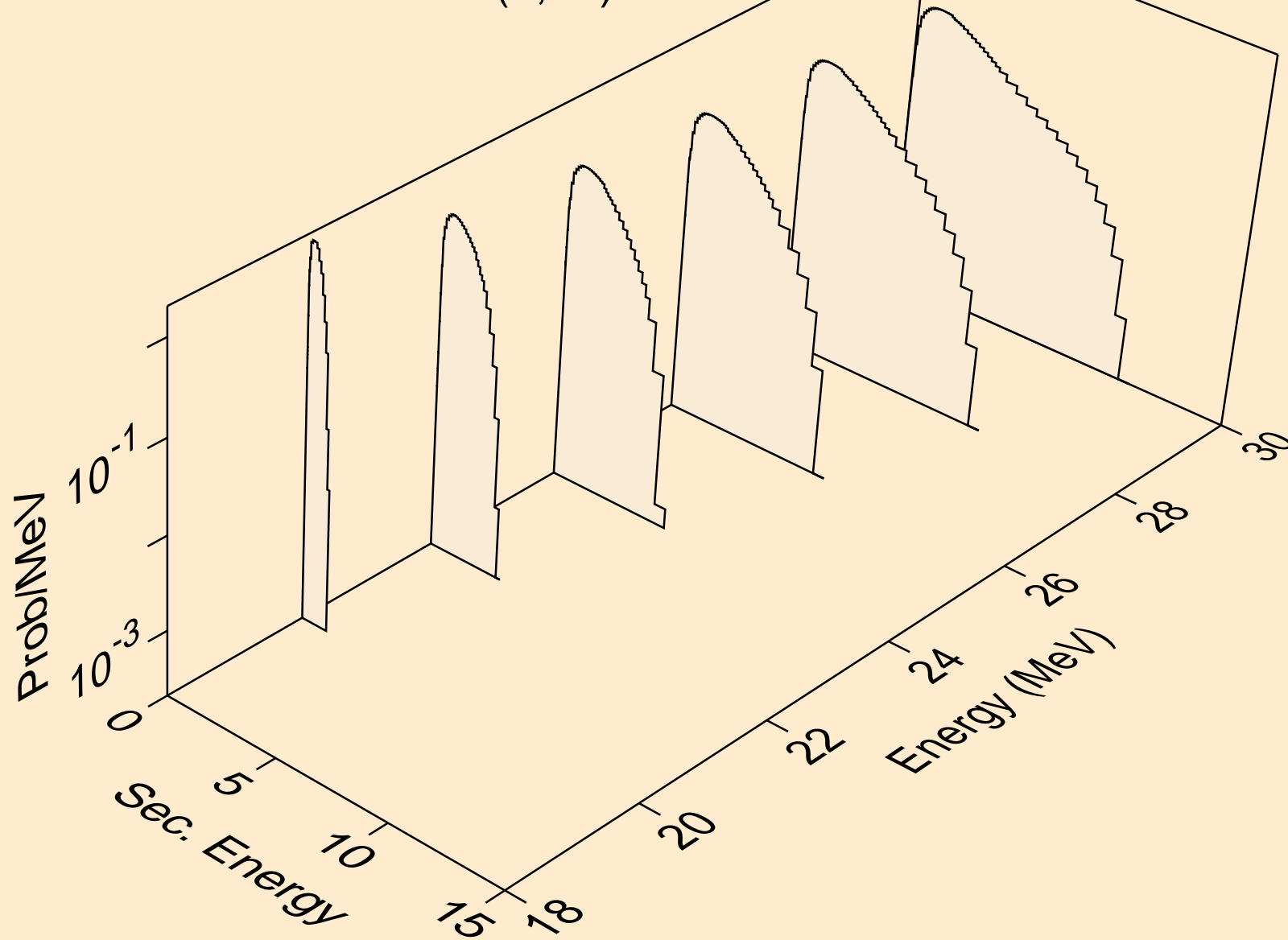

AR039 NEUTRON ACER TENDL-2024 LIBRARY; T=293.6K
Neutron emission for (n,n*)a

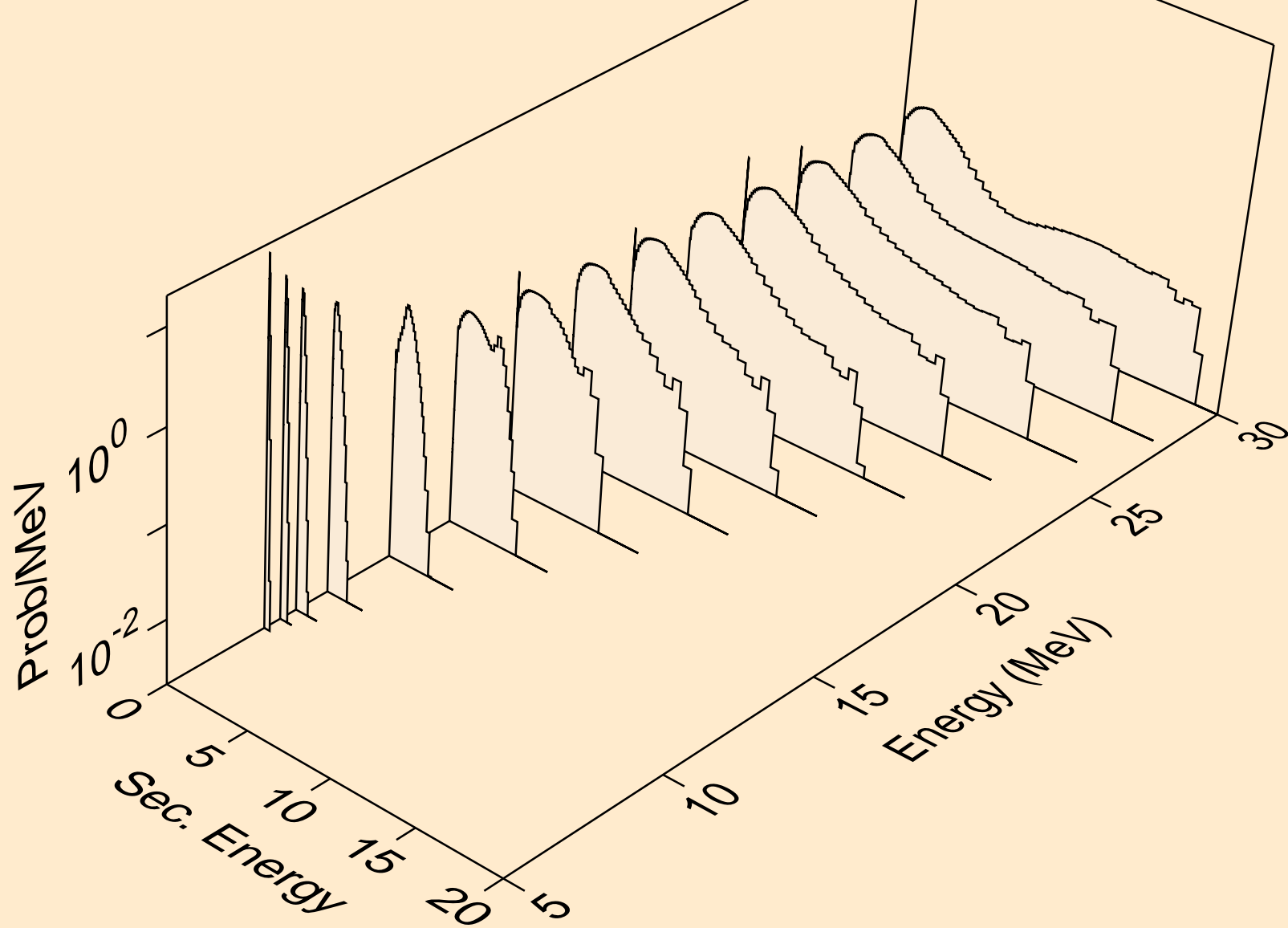

AR039 NEUTRON ACER TENDL-2024 LIBRARY; T=293.6K
Neutron emission for (n,2n)a

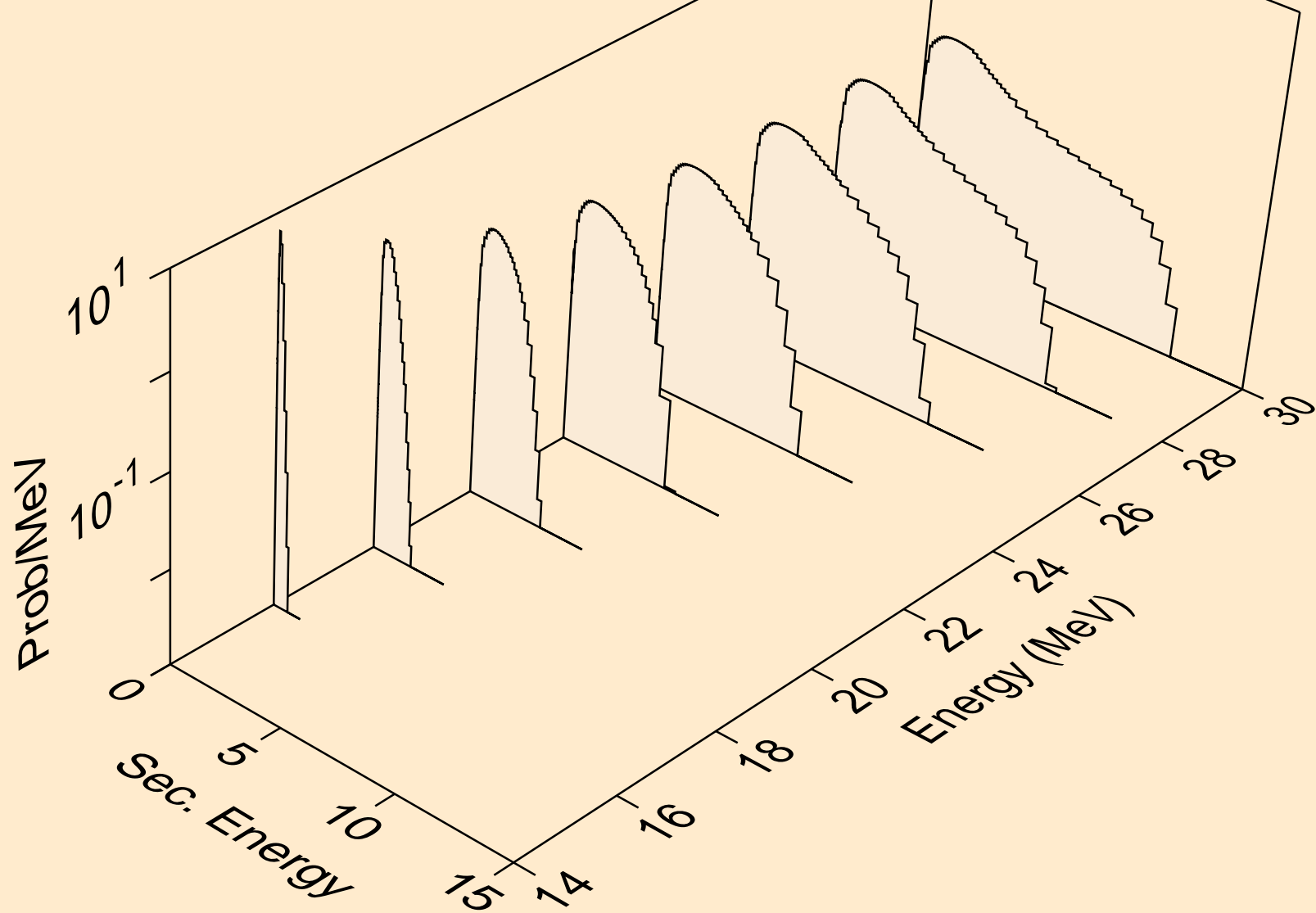

AR039 NEUTRON ACER TENDL-2024 LIBRARY; T=293.6K
Neutron emission for (n,3n)a

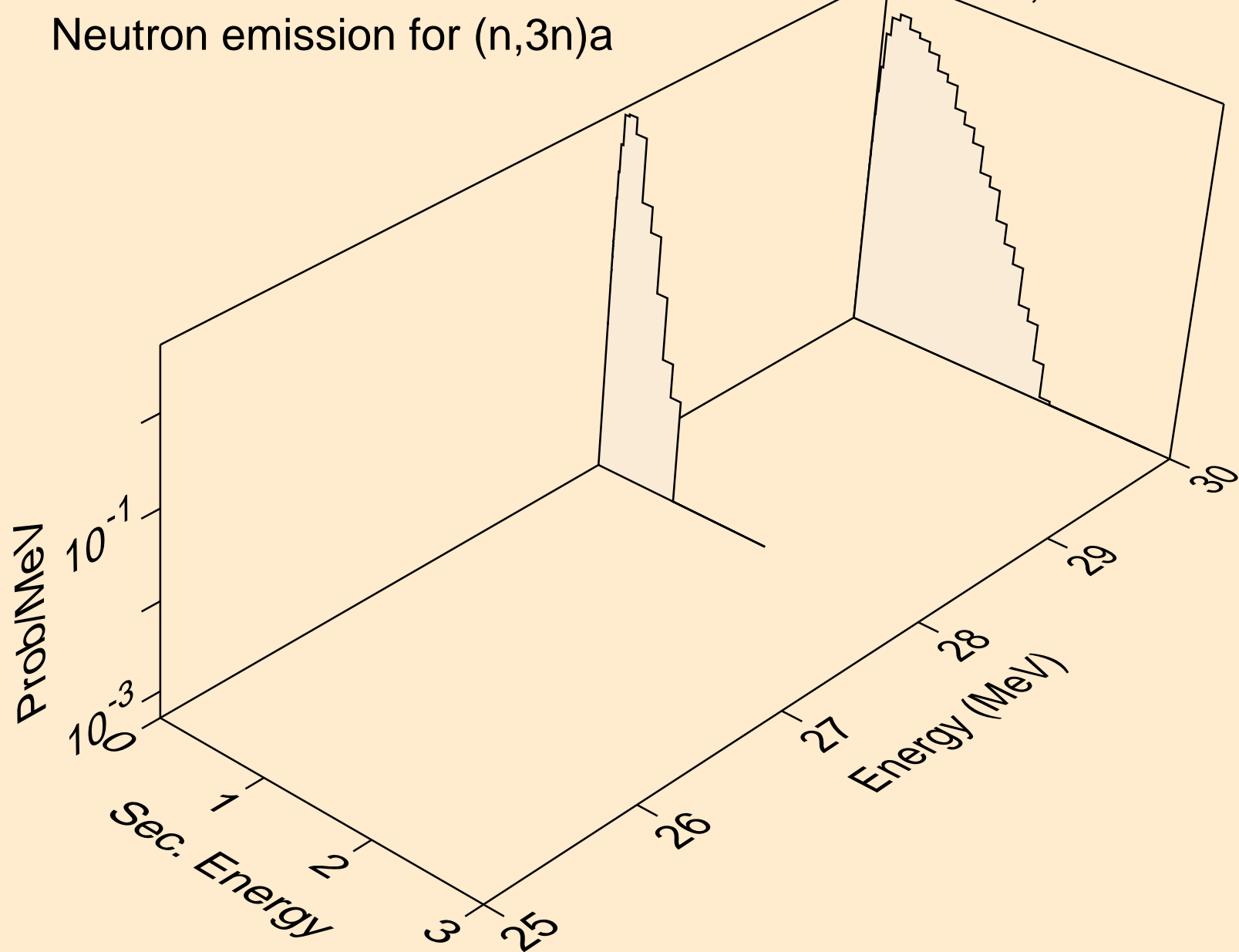

AR039 NEUTRON ACER TENDL-2024 LIBRARY; T=293.6K
Neutron emission for (n,n*)p

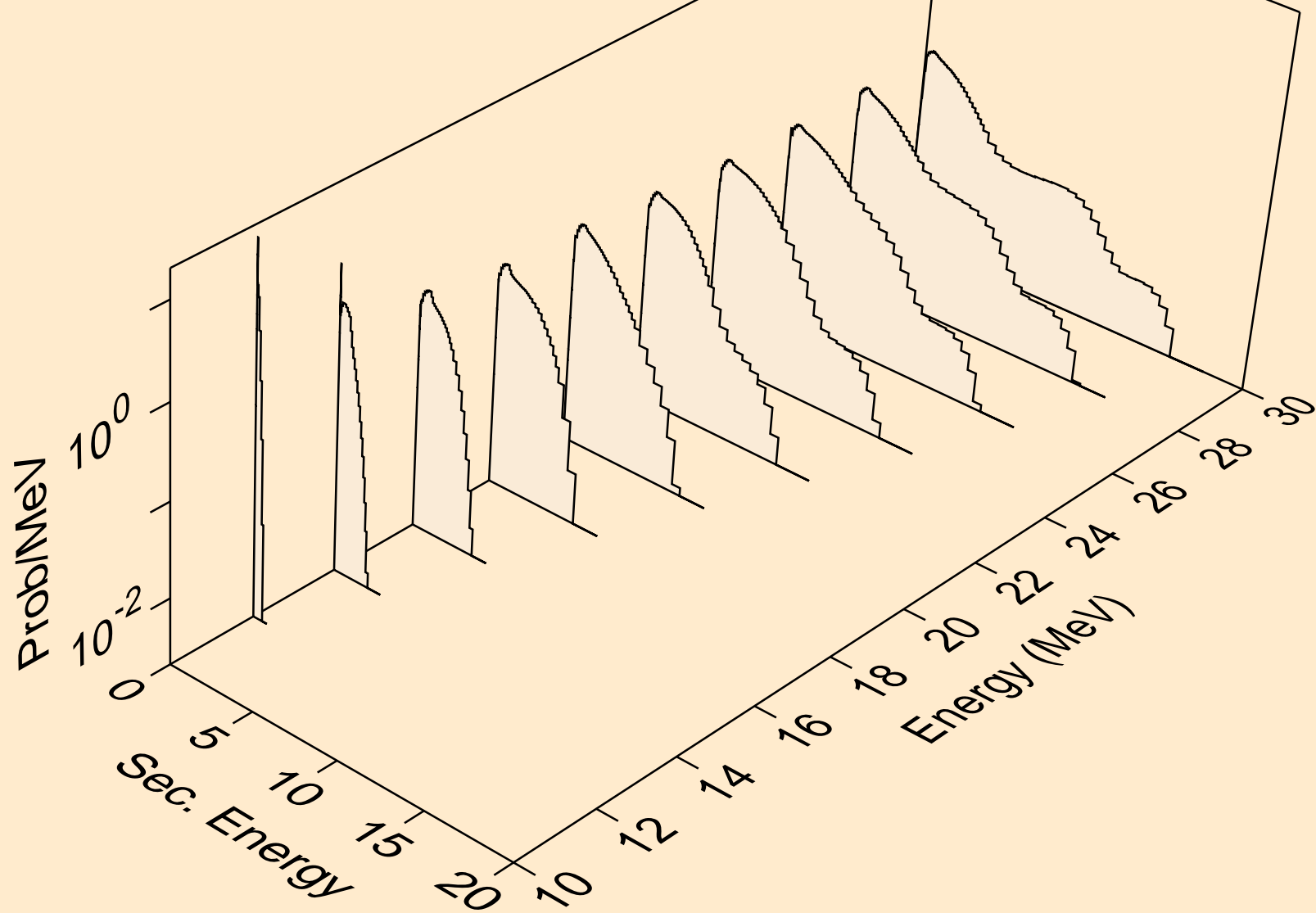

AR039 NEUTRON ACER TENDL-2024 LIBRARY; T=293.6K
Neutron emission for (n,n*)2a

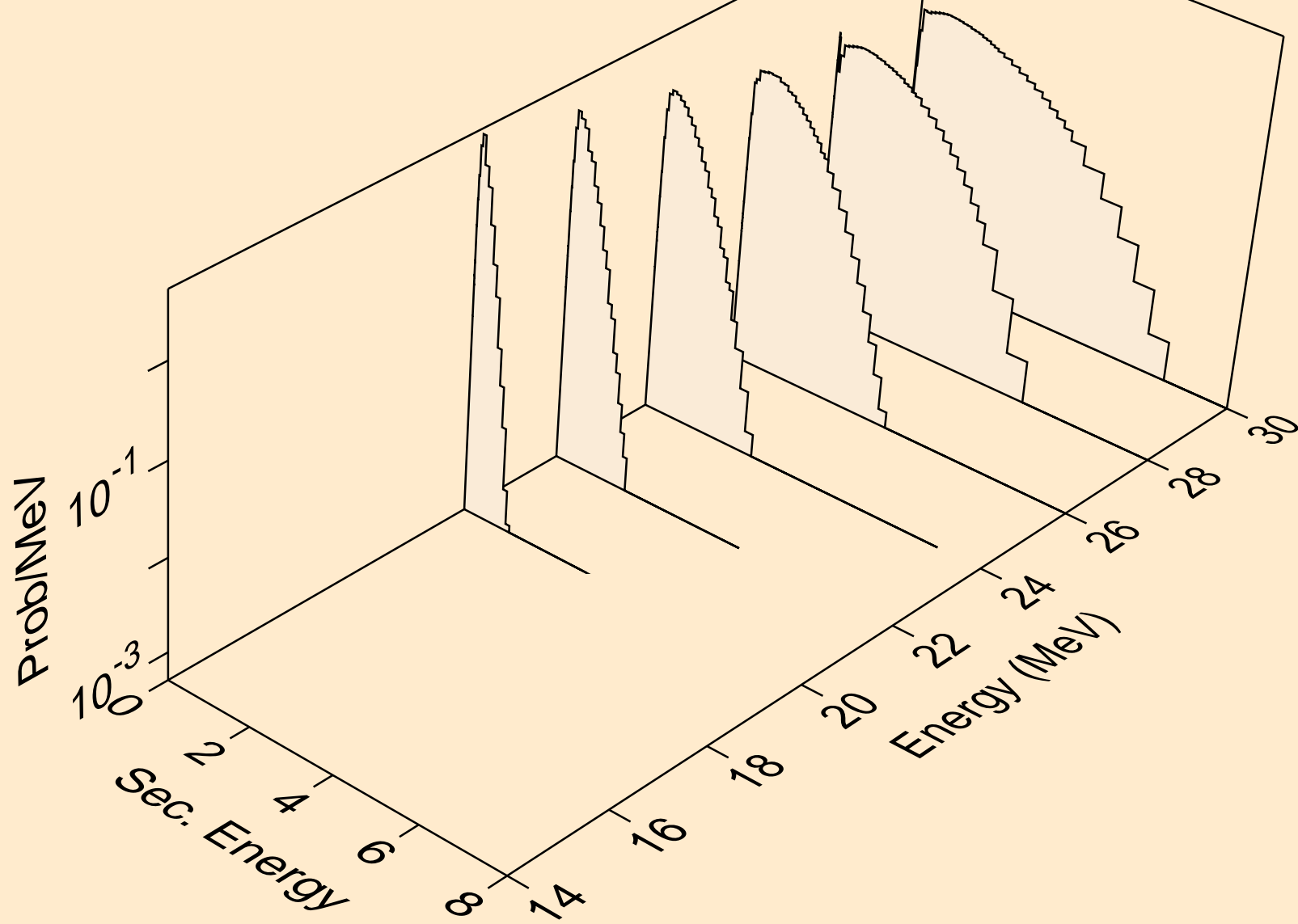

AR039 NEUTRON ACER TENDL-2024 LIBRARY; T=293.6K
Neutron emission for (n,2n)2a

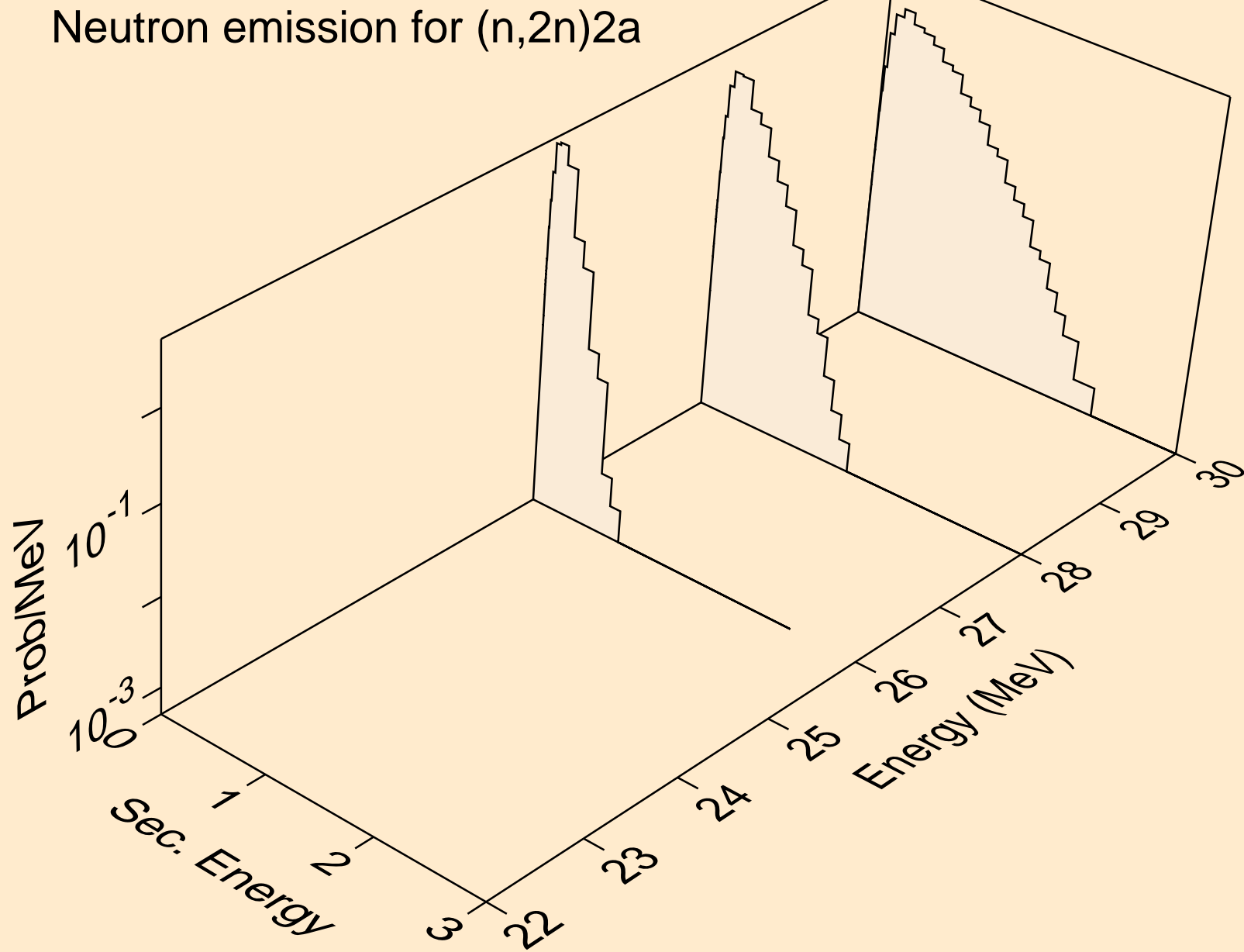

AR039 NEUTRON ACER TENDL-2024 LIBRARY; T=293.6K
Neutron emission for (n,n*)d

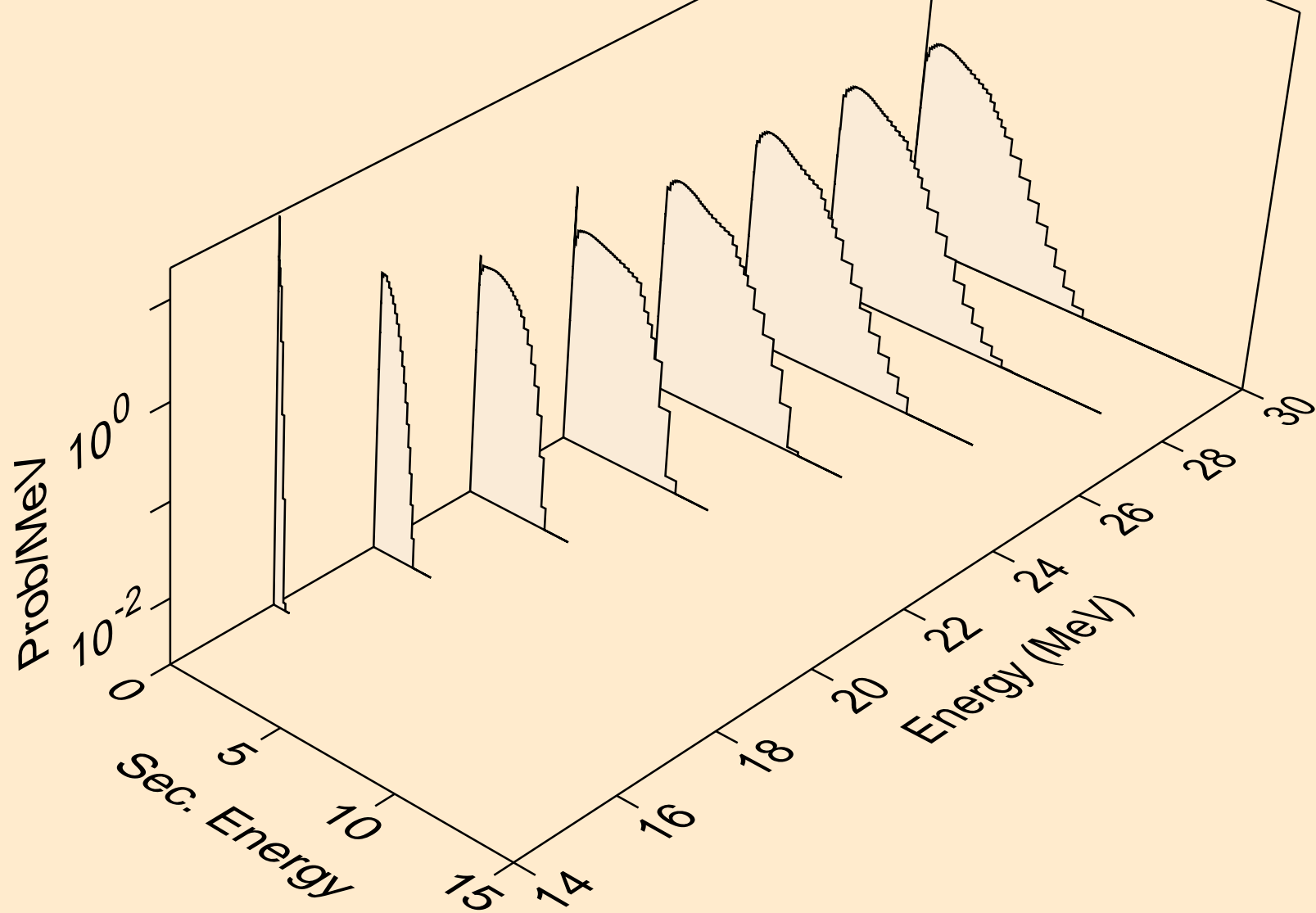

AR039 NEUTRON ACER TENDL-2024 LIBRARY; T=293.6K
Neutron emission for (n,n*)t

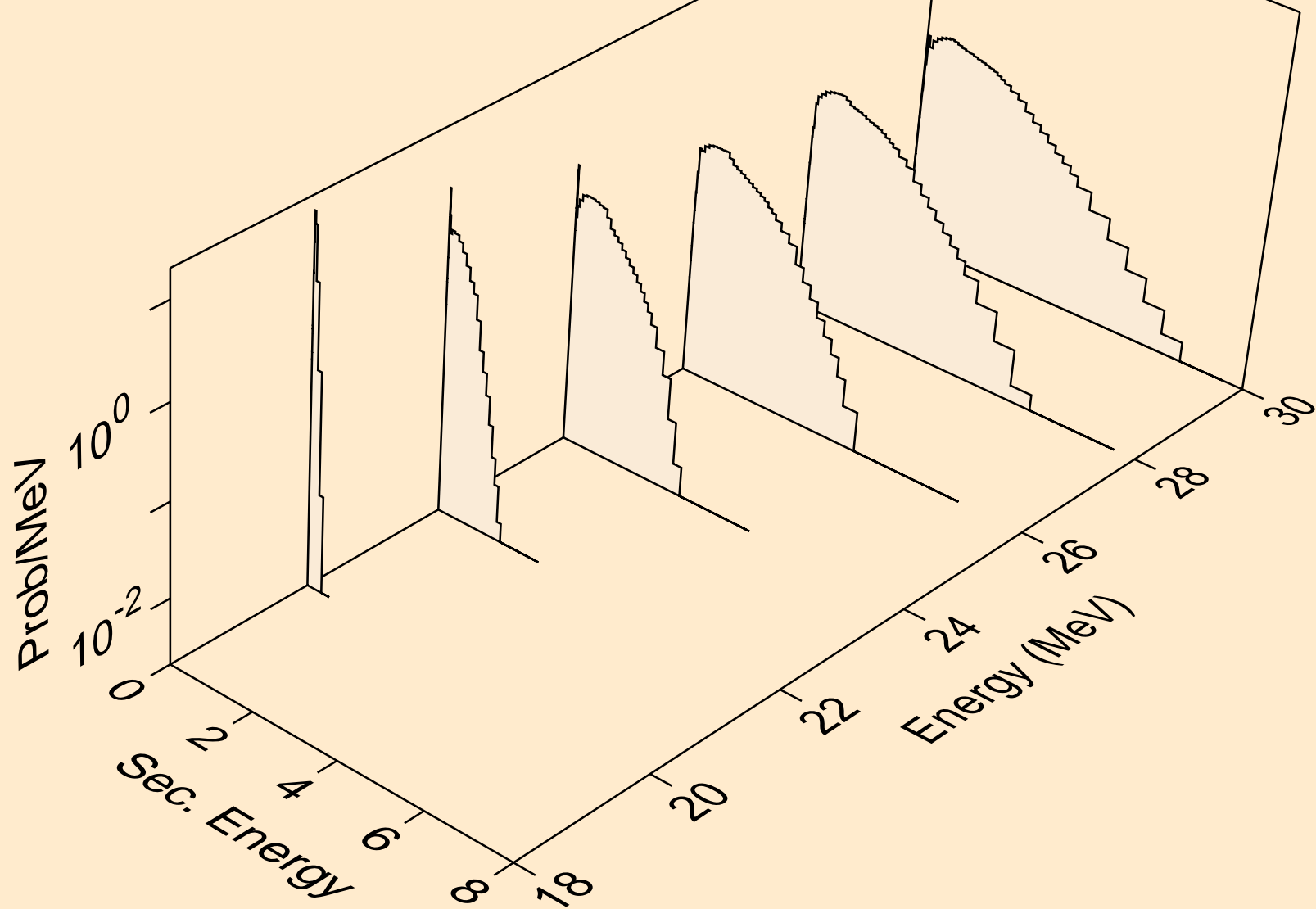

AR039 NEUTRON ACER TENDL-2024 LIBRARY; T=293.6K
Neutron emission for (n,n*)he3

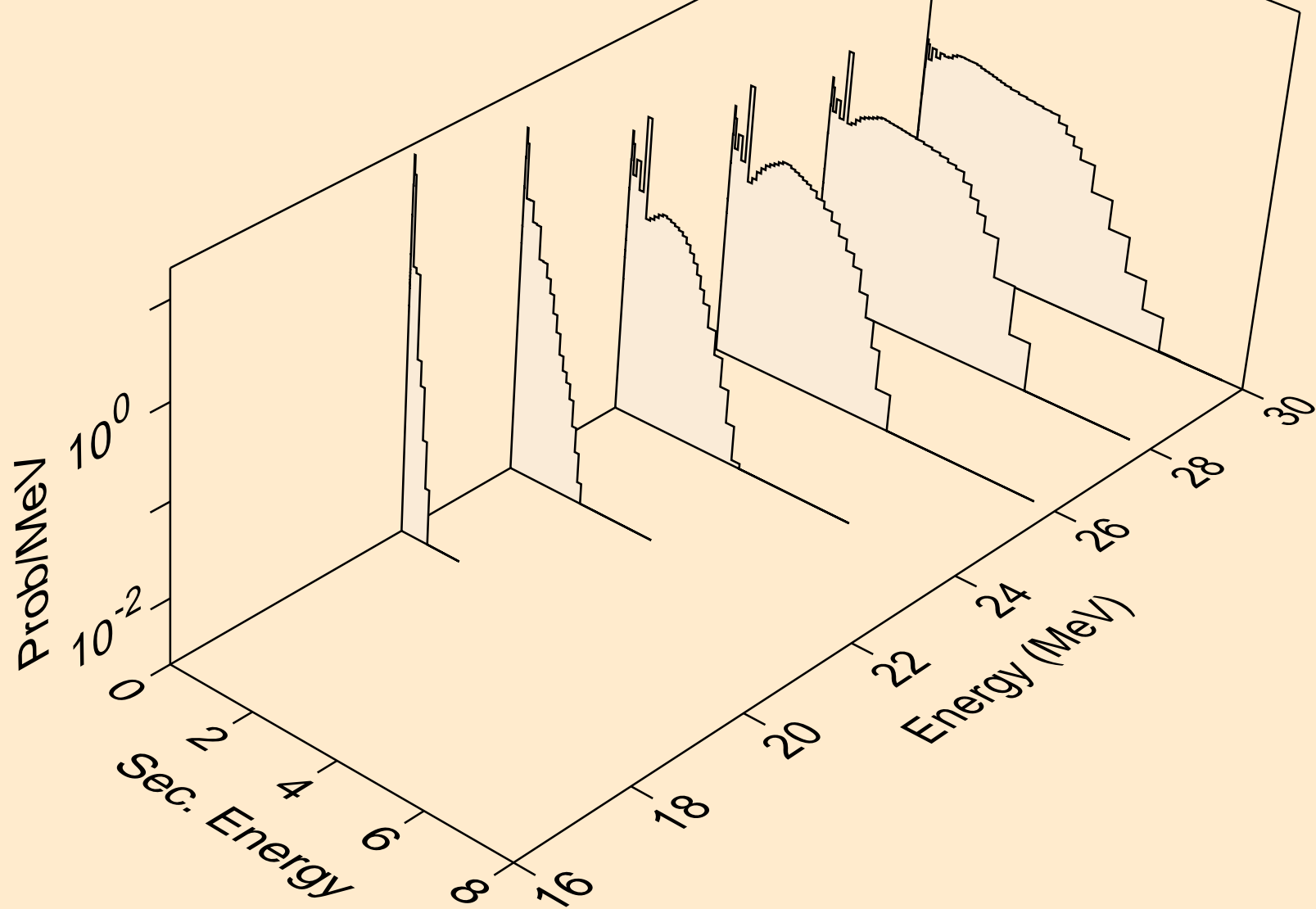

AR039 NEUTRON ACER TENDL-2024 LIBRARY; T=293.6K
Neutron emission for (n,4n)

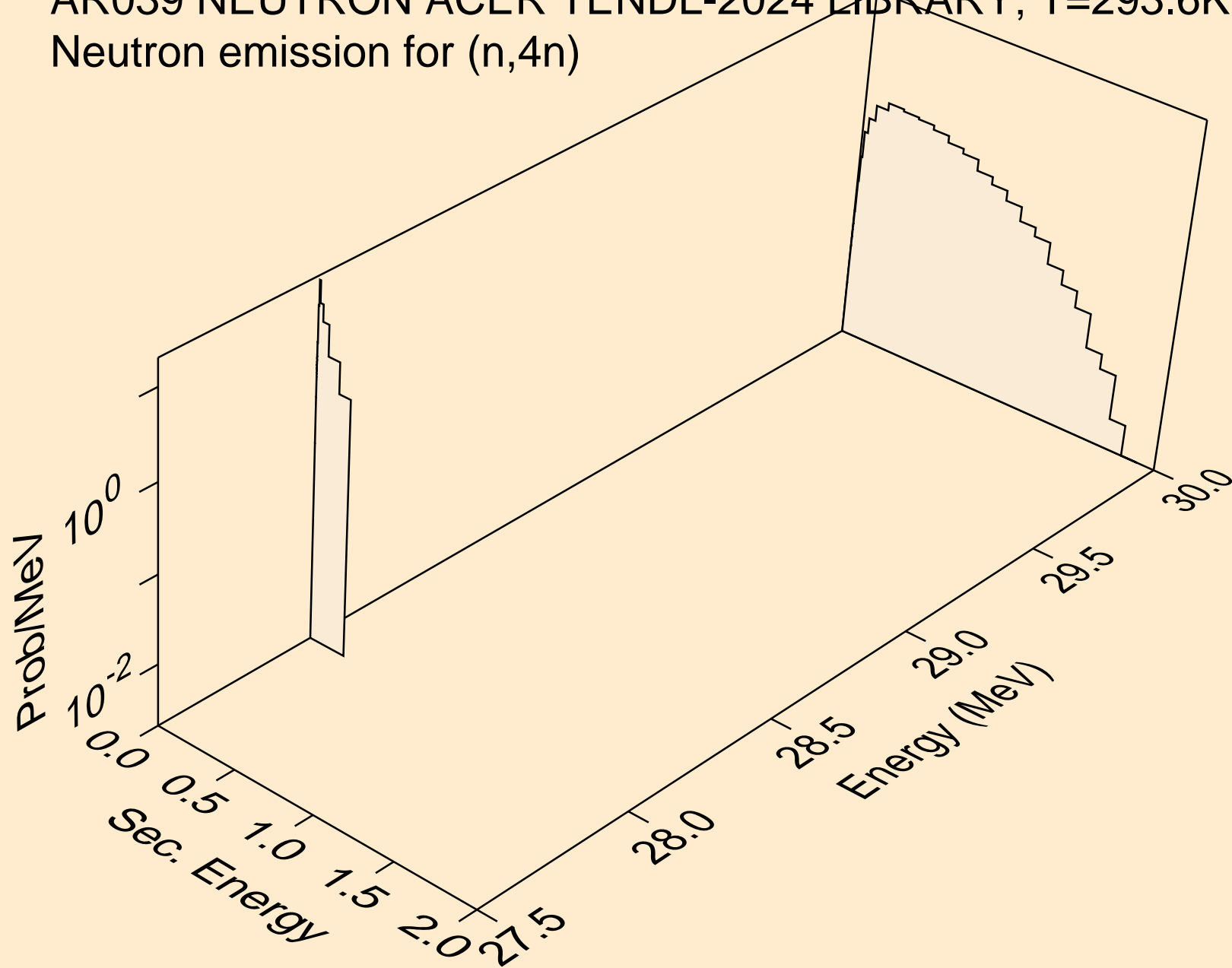

AR039 NEUTRON ACER TENDL-2024 LIBRARY; T=293.6K
Neutron emission for (n,2np)

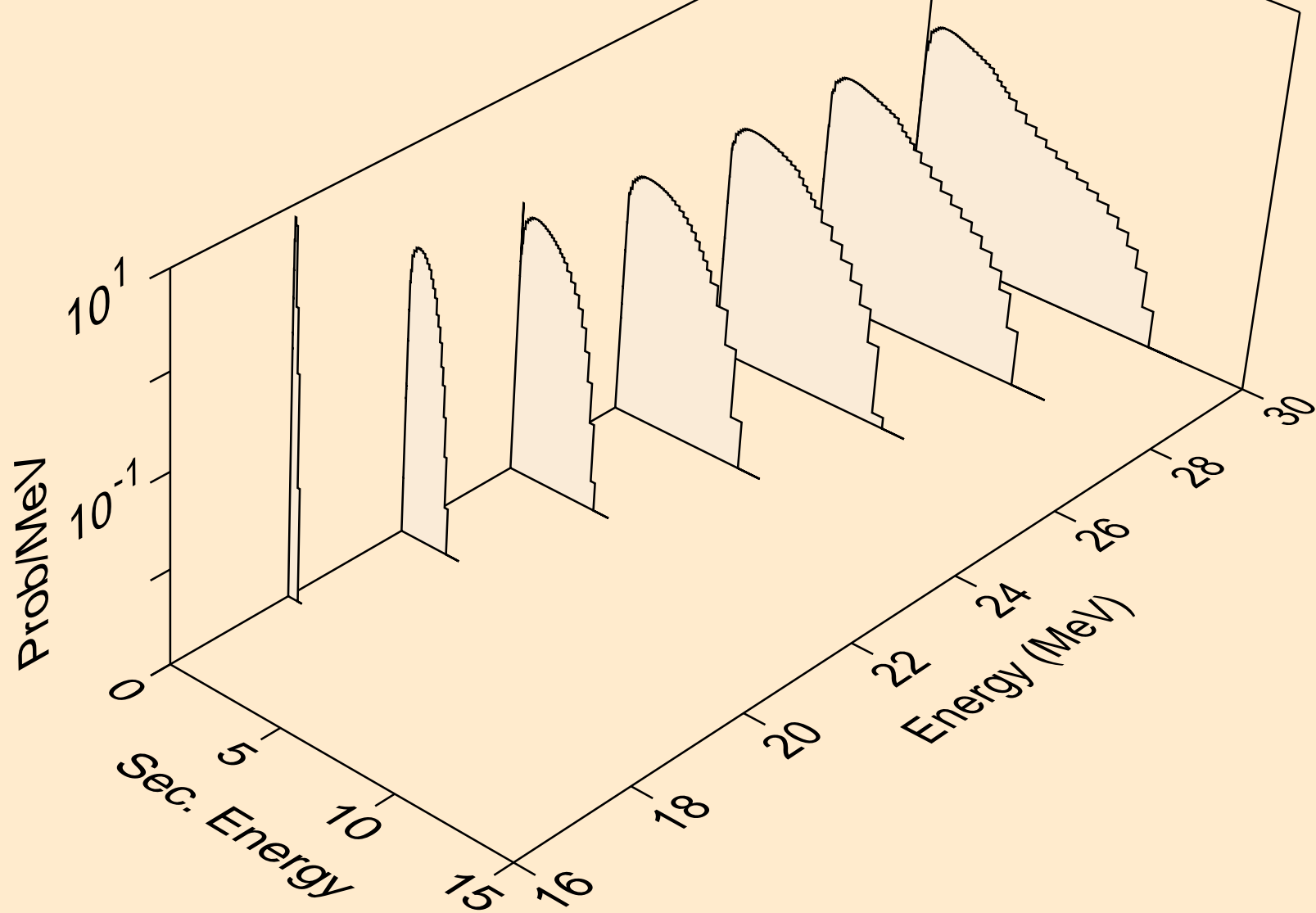

AR039 NEUTRON ACER TENDL-2024 LIBRARY; T=293.6K
Neutron emission for (n,3np)

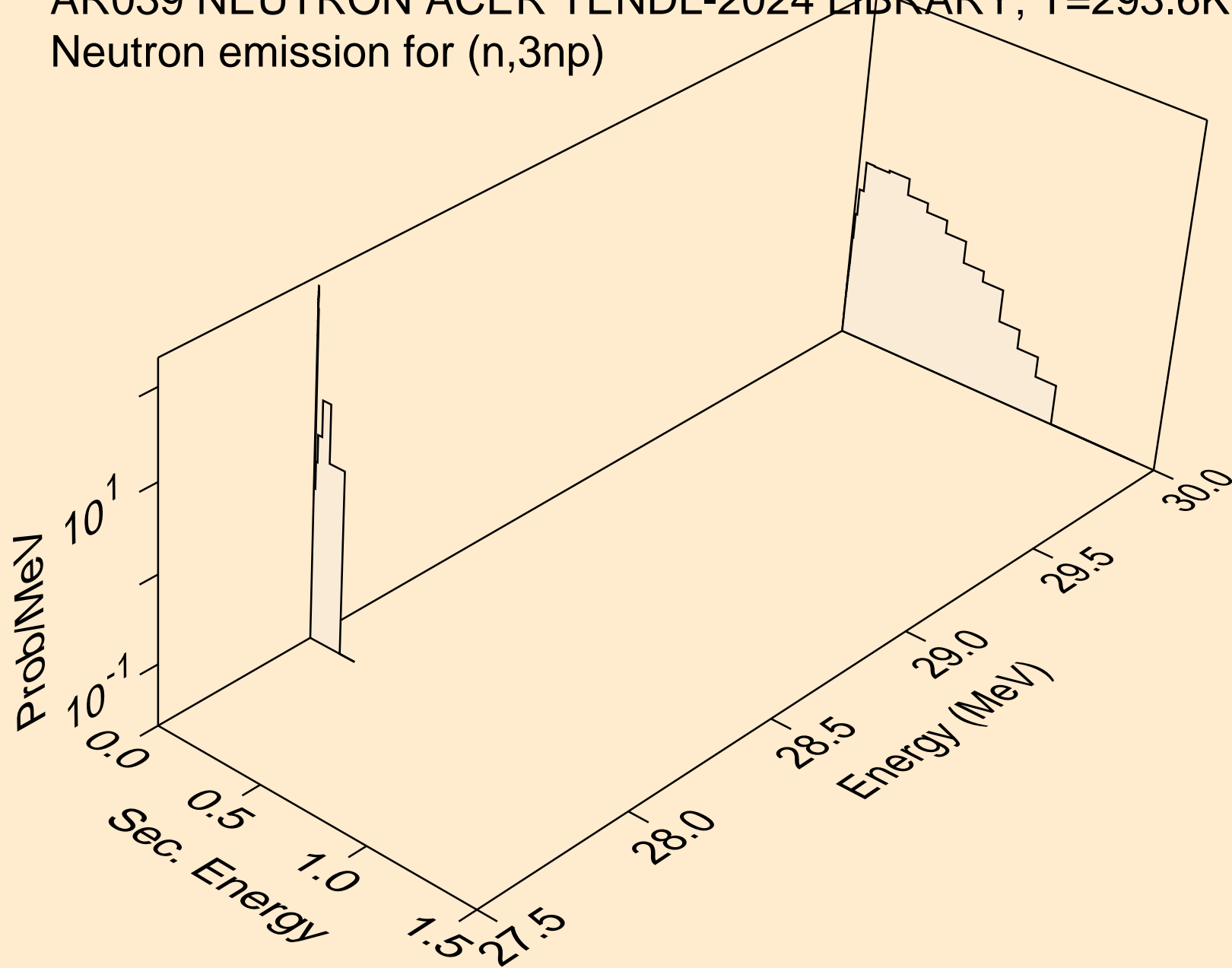

AR039 NEUTRON ACER TENDL-2024 LIBRARY; T=293.6K
Neutron emission for (n,n2p)

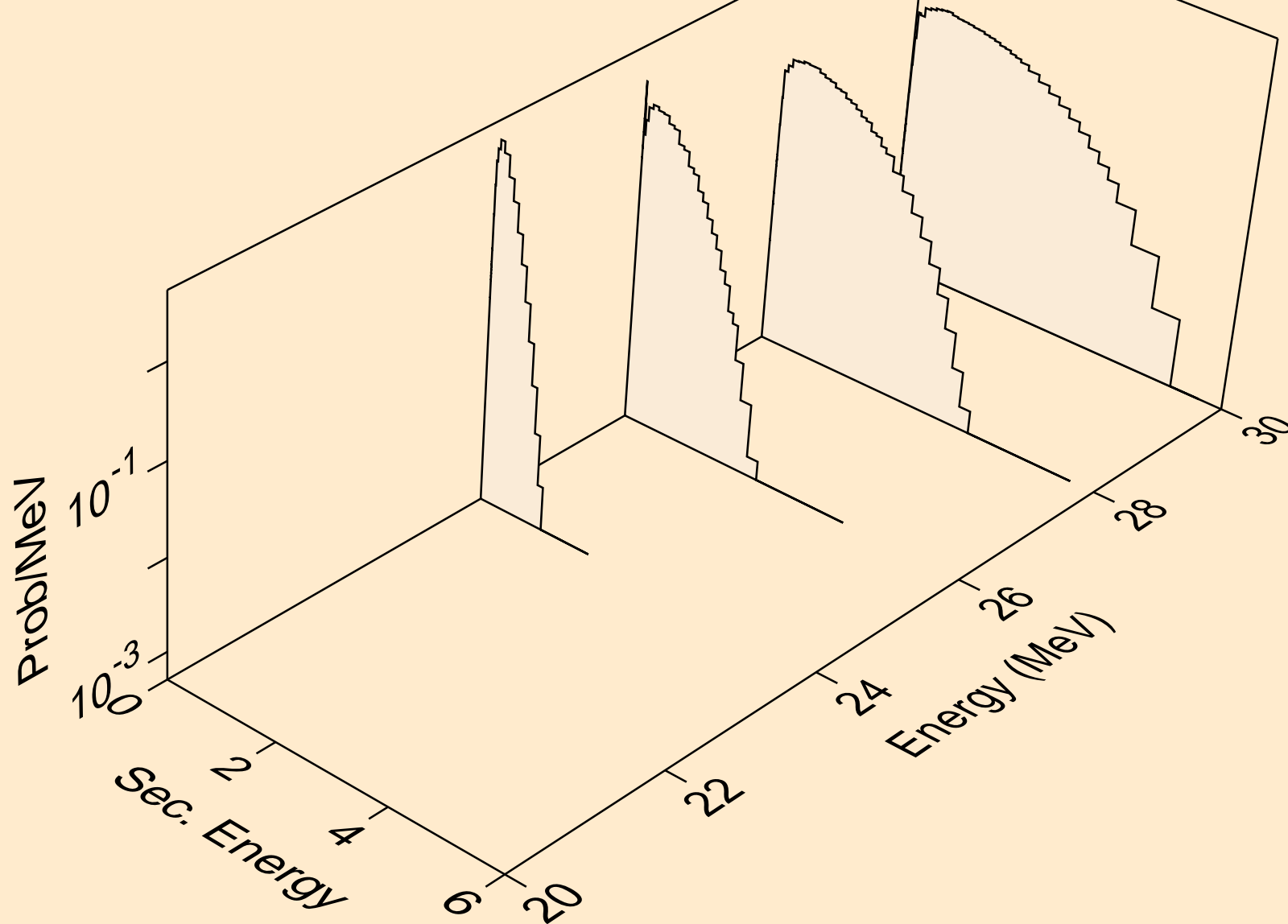

AR039 NEUTRON ACER TENDL-2024 LIBRARY; T=293.6K
Neutron emission for (n,npa)

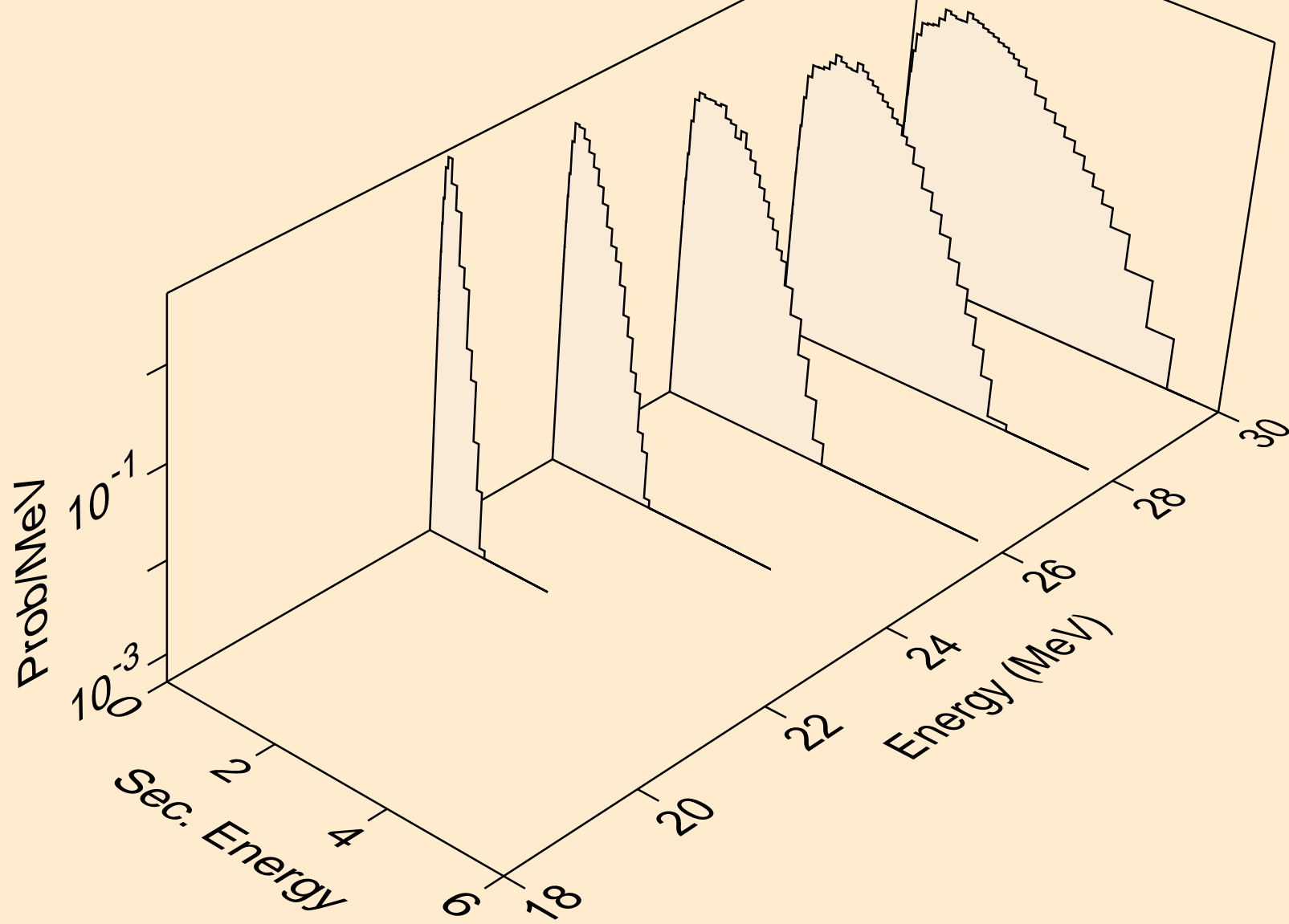

AR039 NEUTRON ACER TENDL-2024 LIBRARY; T=293.6K
Neutron emission for (n,n*c)

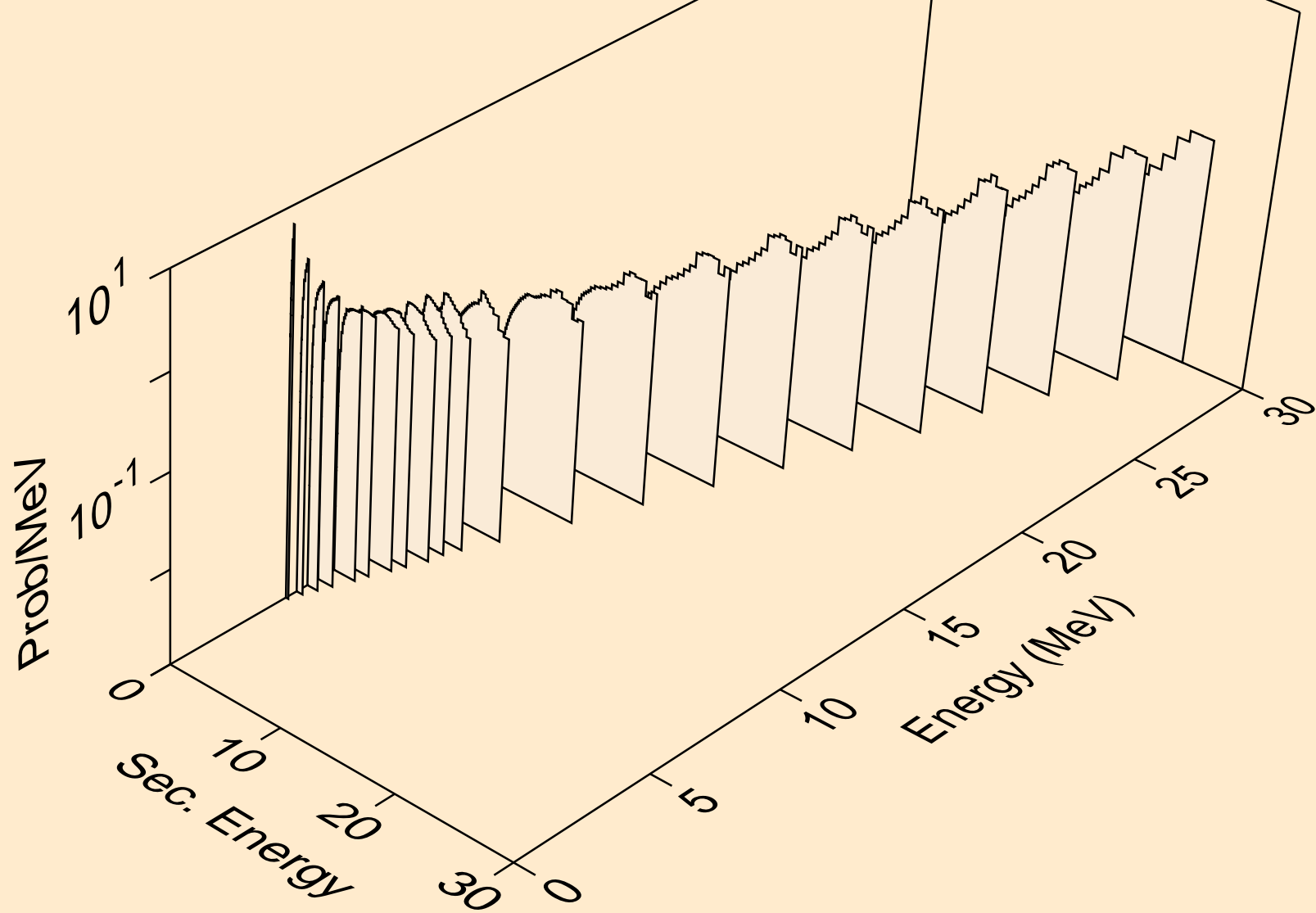

AR039 NEUTRON ACER TENDL-2024 LIBRARY; T=293.6K
Photon emission for (n,x)

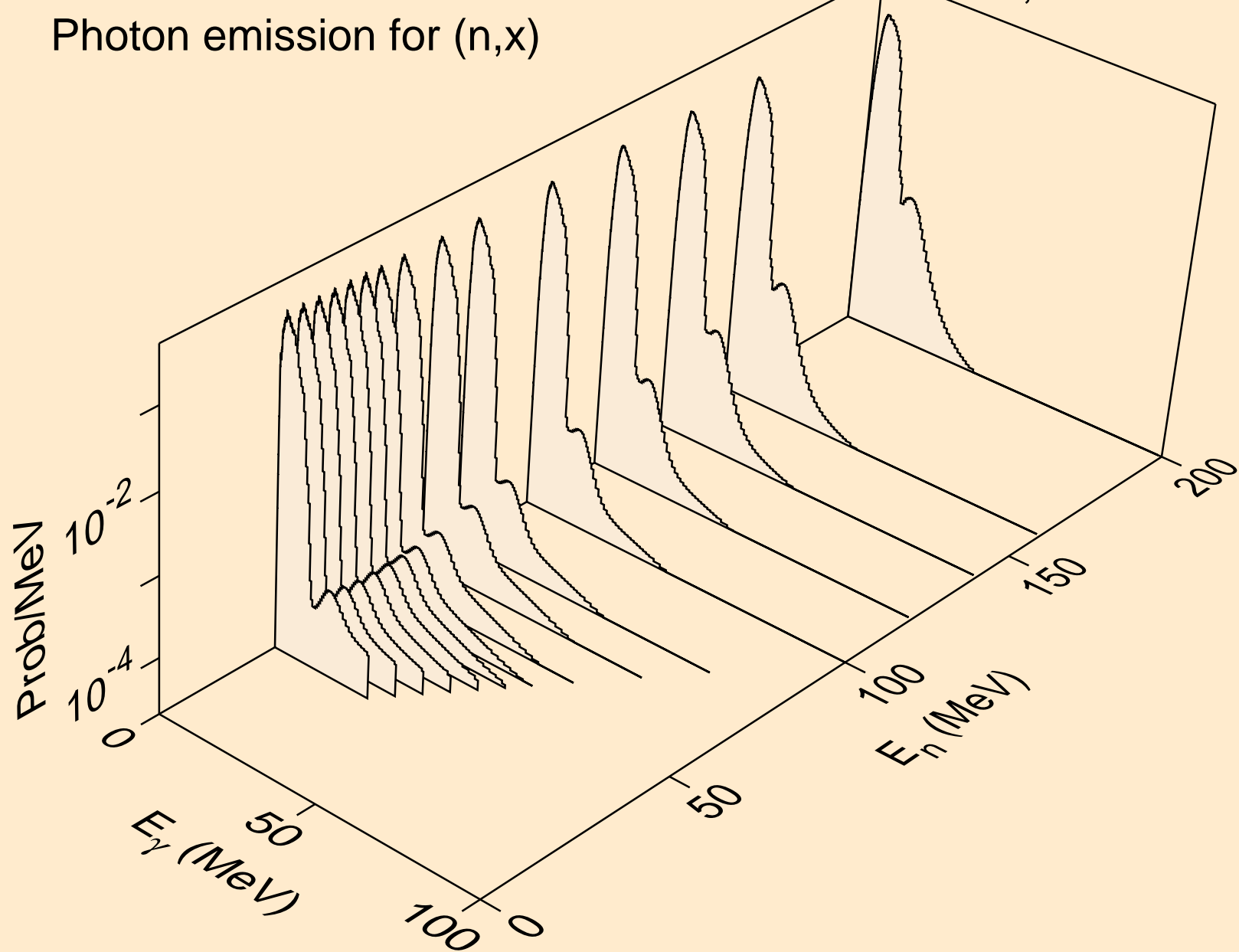

AR039 NEUTRON ACER TENDL-2024 LIBRARY; T=293.6K
Photon emission for (n,2nd)

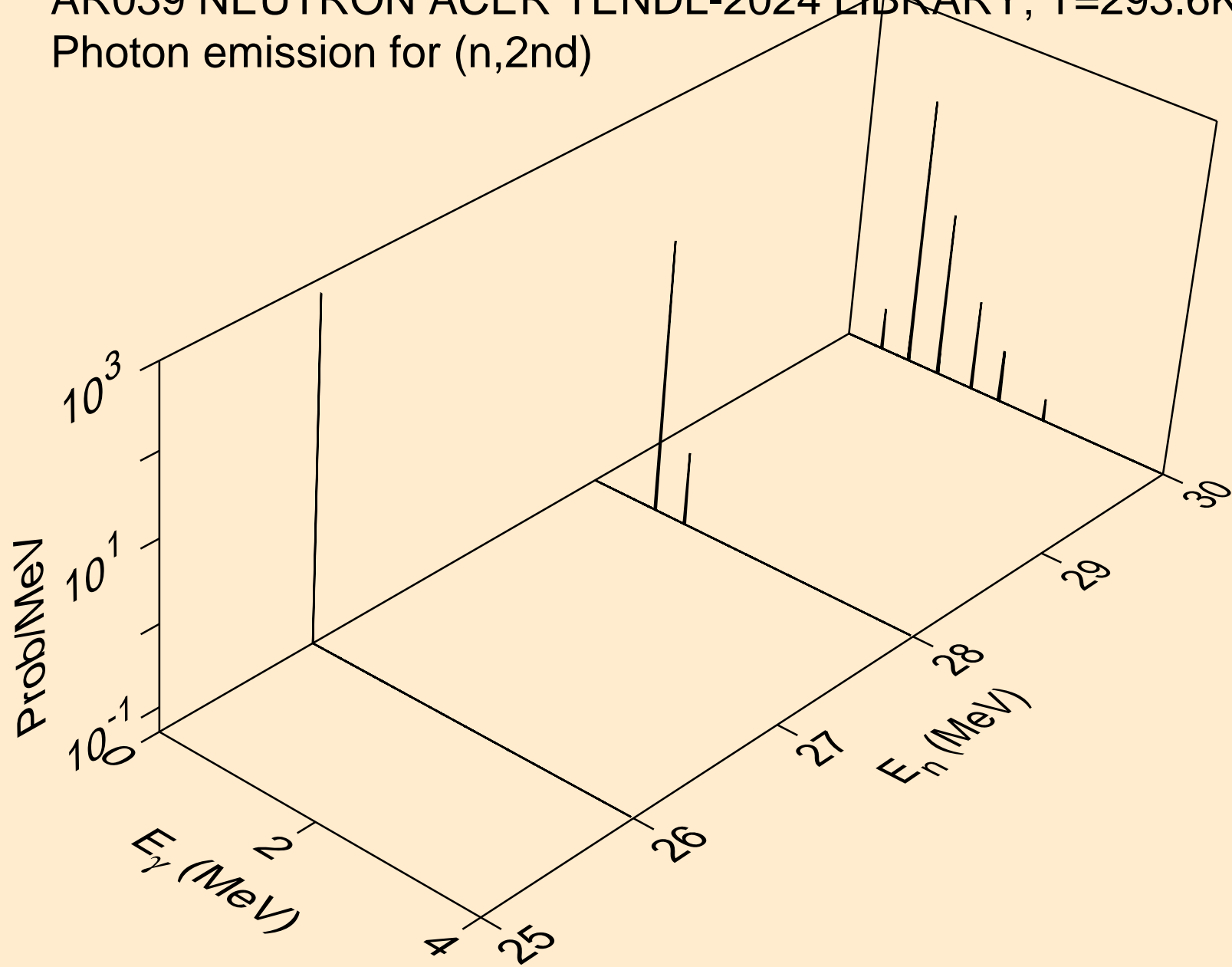

AR039 NEUTRON ACER TENDL-2024 LIBRARY; T=293.6K
Photon emission for (n,2n)

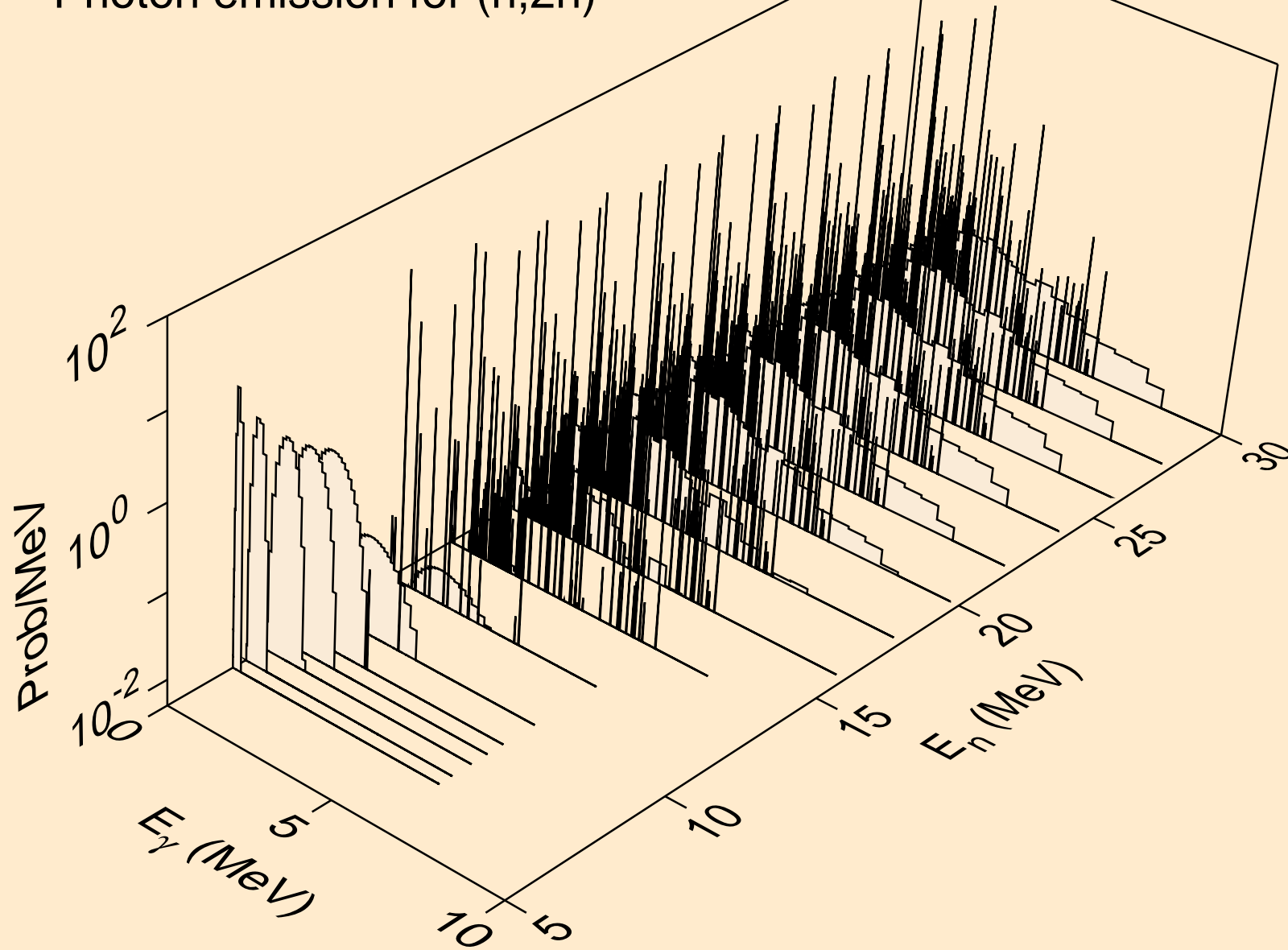

AR039 NEUTRON ACER TENDL-2024 LIBRARY; T=293.6K
Photon emission for (n,3n)

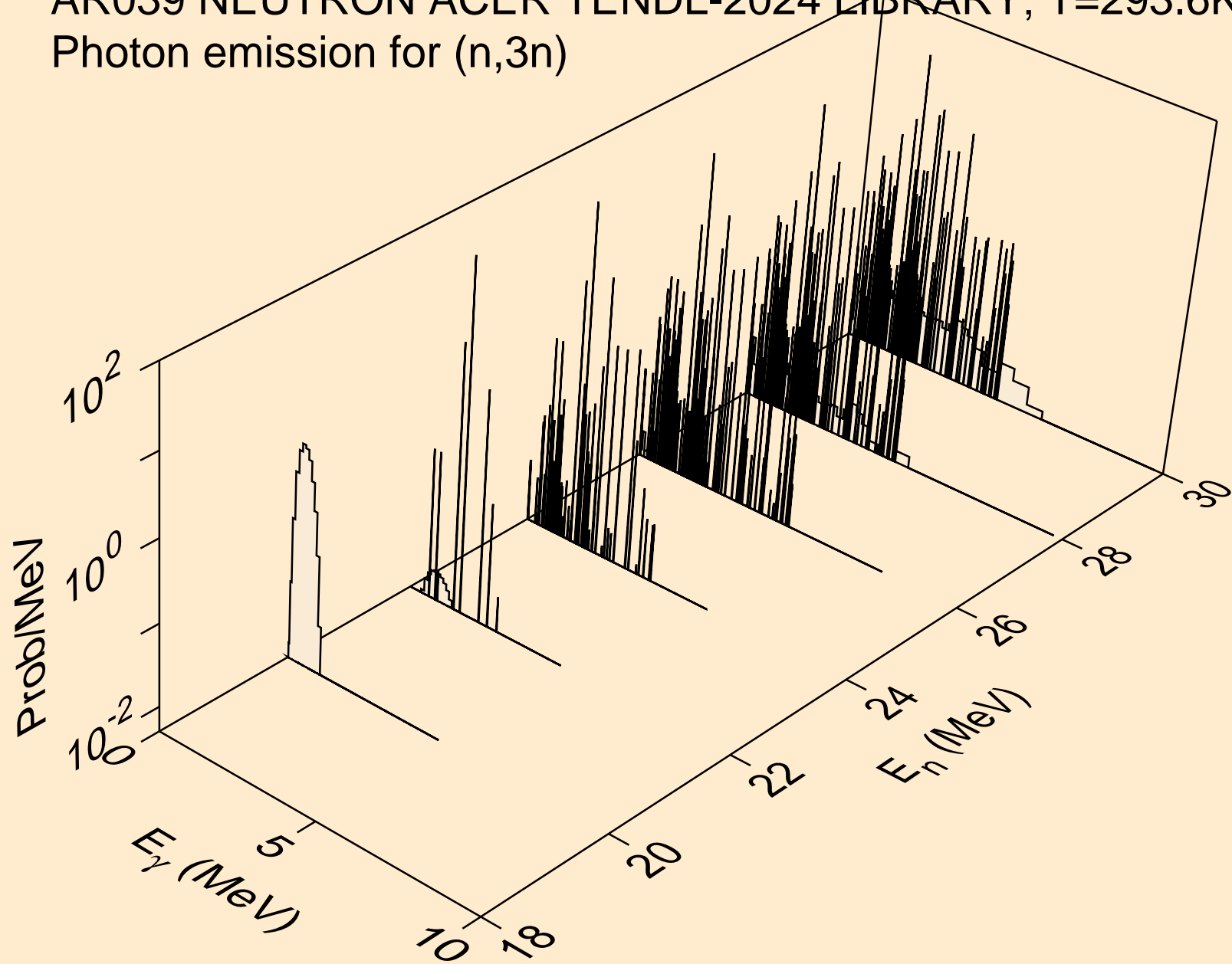

AR039 NEUTRON ACER TENDL-2024 LIBRARY; T=293.6K
Photon emission for (n,n*)a

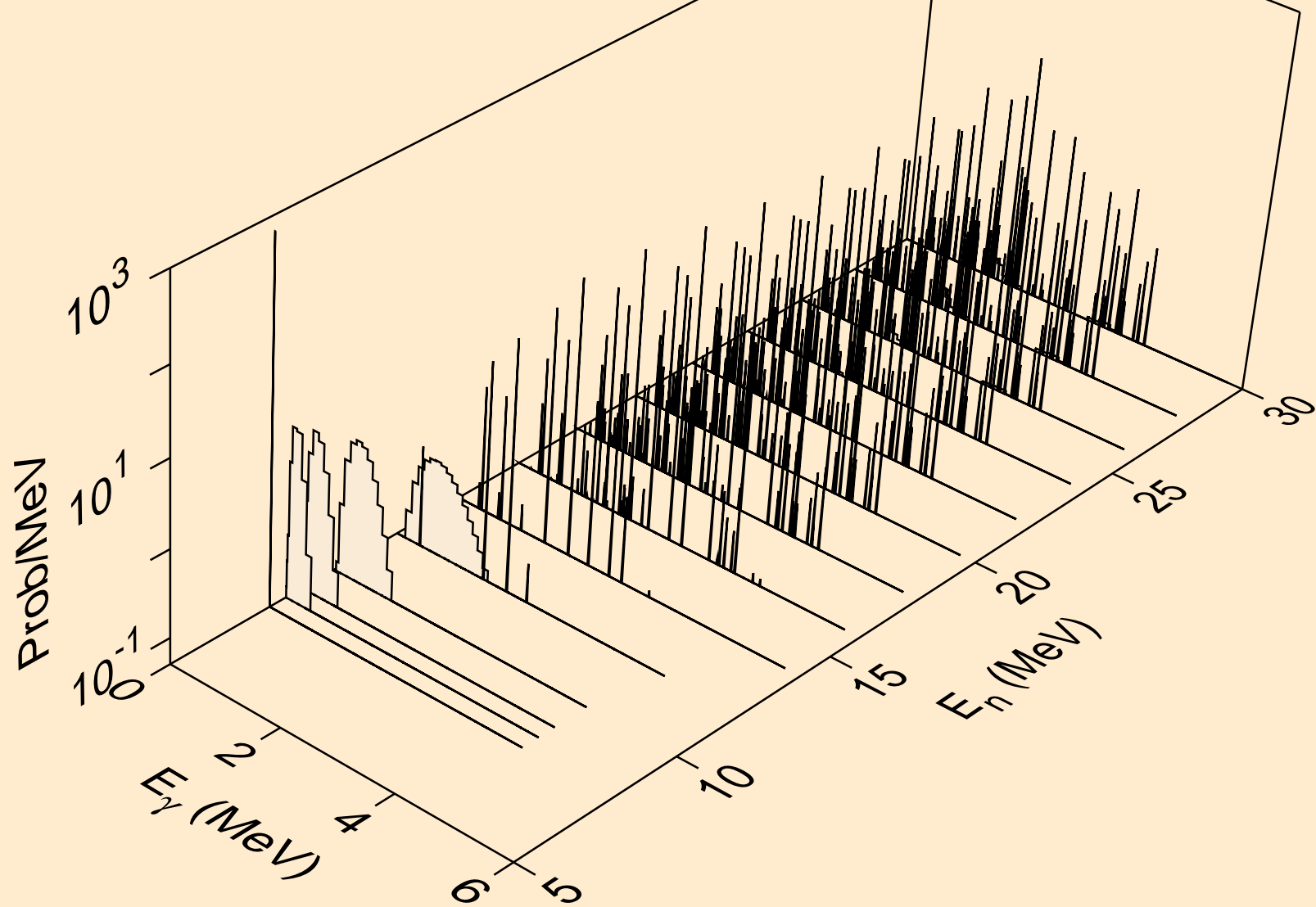

AR039 NEUTRON ACER TENDL-2024 LIBRARY; T=293.6K
Photon emission for (n,2n)a

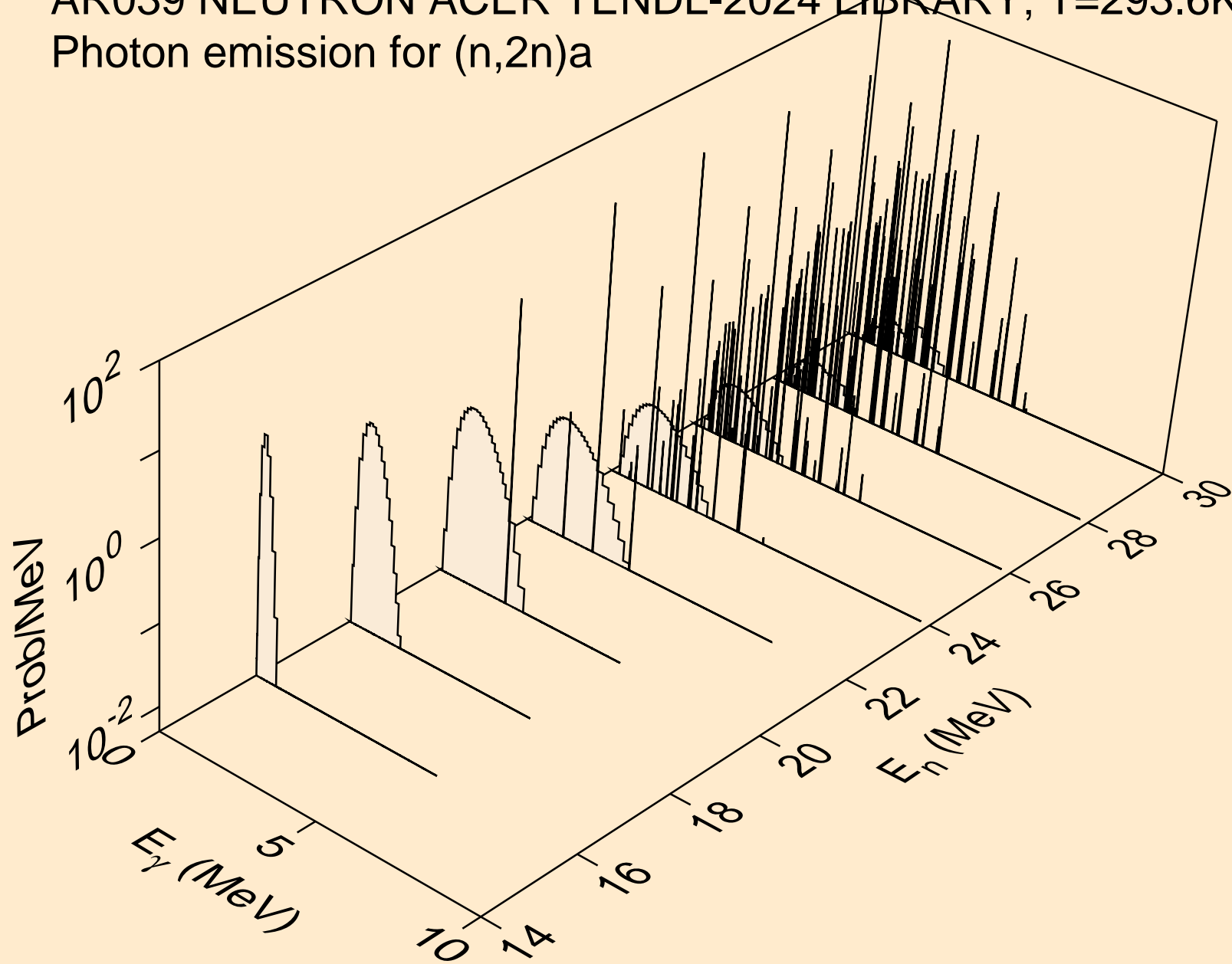

AR039 NEUTRON ACER TENDL-2024 LIBRARY; T=293.6K
Photon emission for (n,3n)a

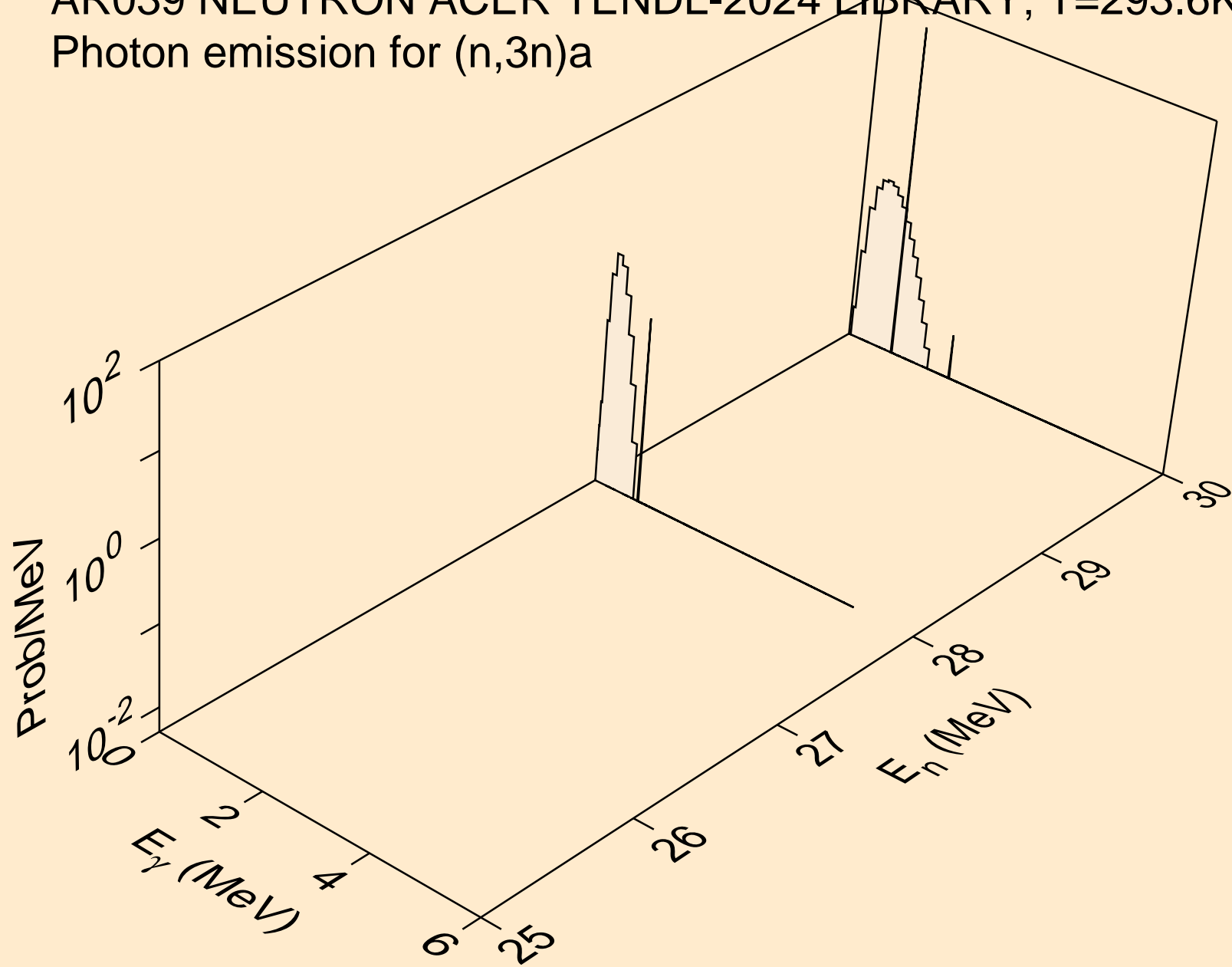

AR039 NEUTRON ACER TENDL-2024 LIBRARY; T=293.6K
Photon emission for (n,n*)p

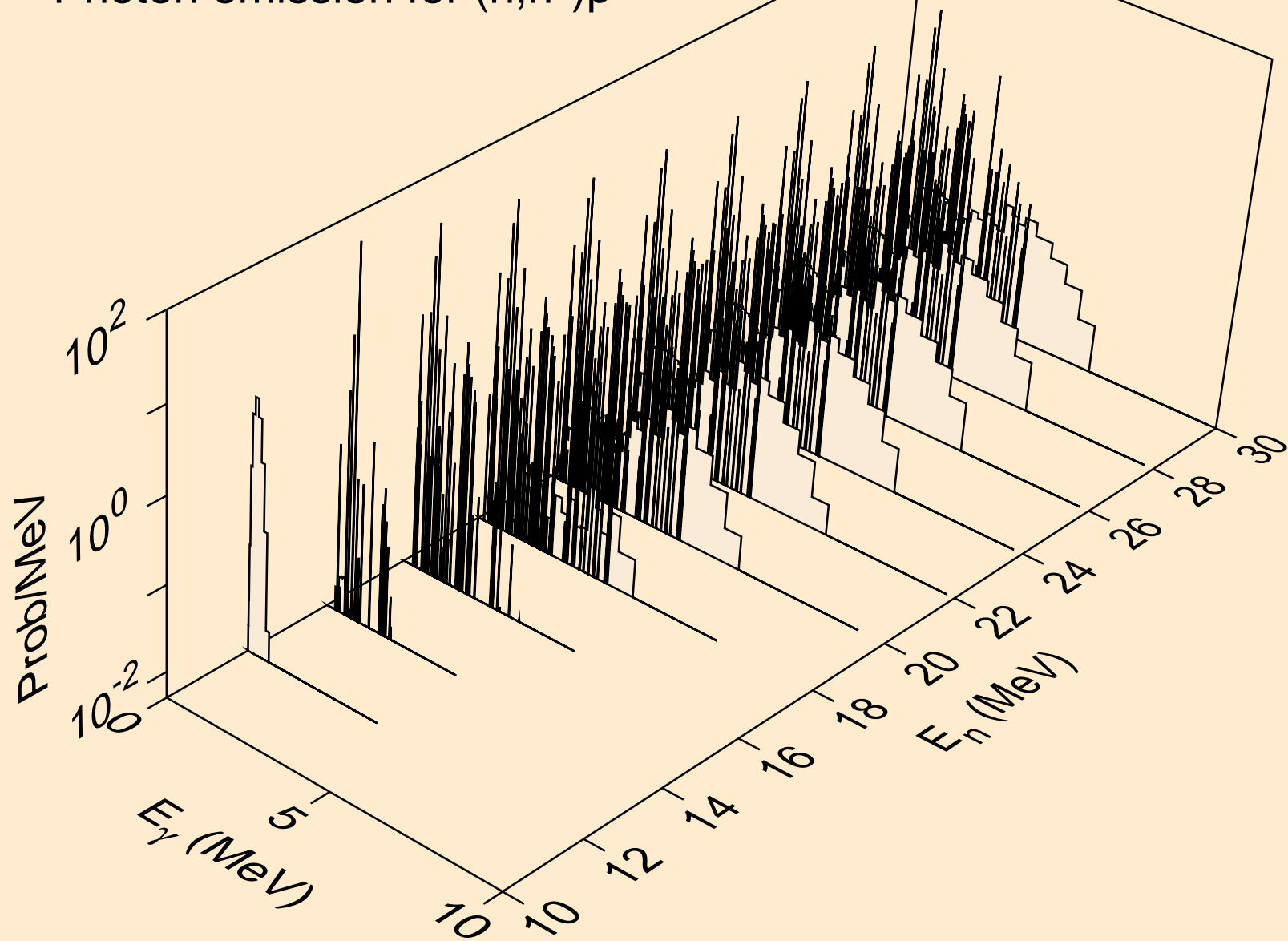

AR039 NEUTRON ACER TENDL-2024 LIBRARY; T=293.6K
Photon emission for (n,n*)2a

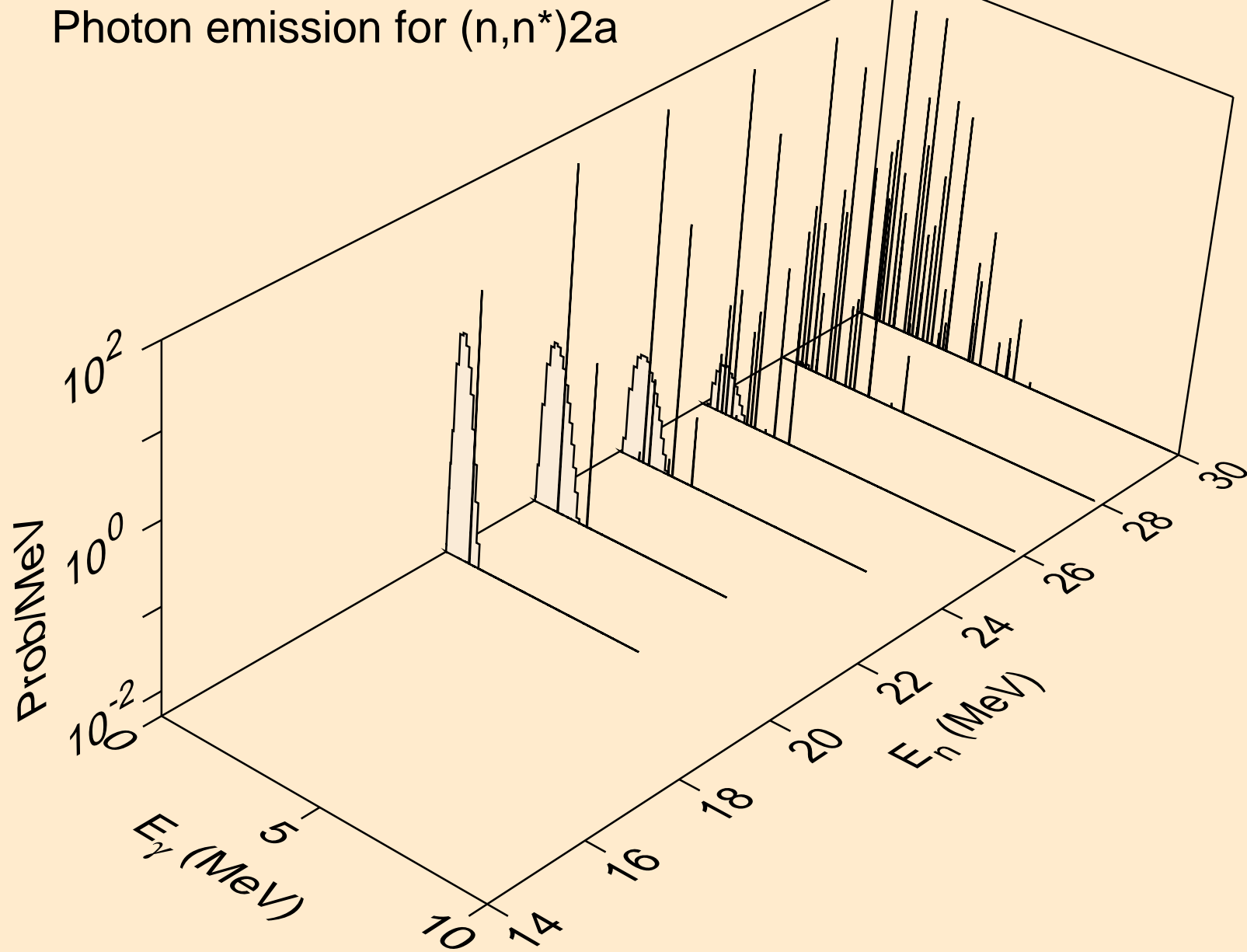

AR039 NEUTRON ACER TENDL-2024 LIBRARY; T=293.6K
Photon emission for (n,2n)2a

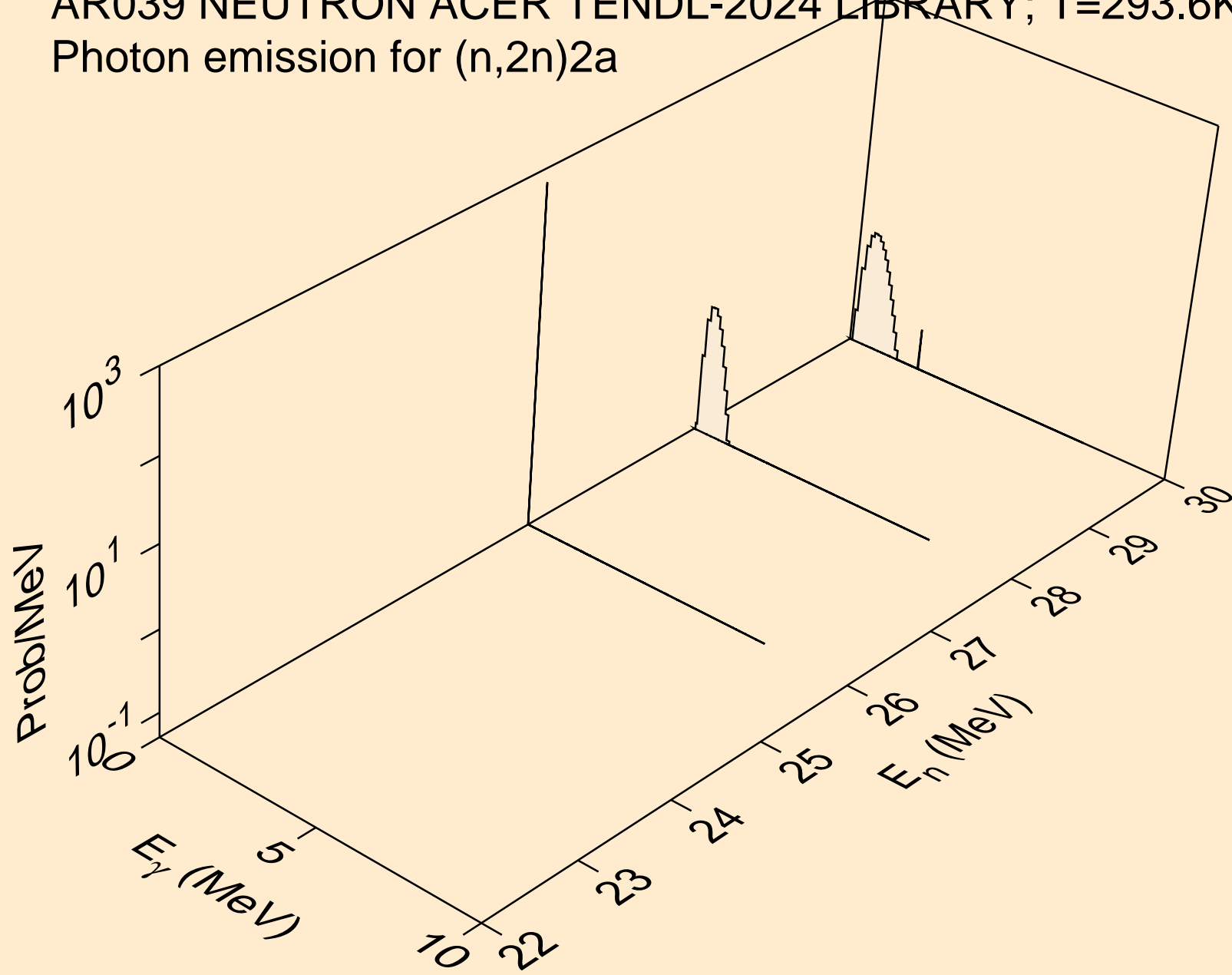

AR039 NEUTRON ACER TENDL-2024 LIBRARY; T=293.6K
Photon emission for (n,n*)d

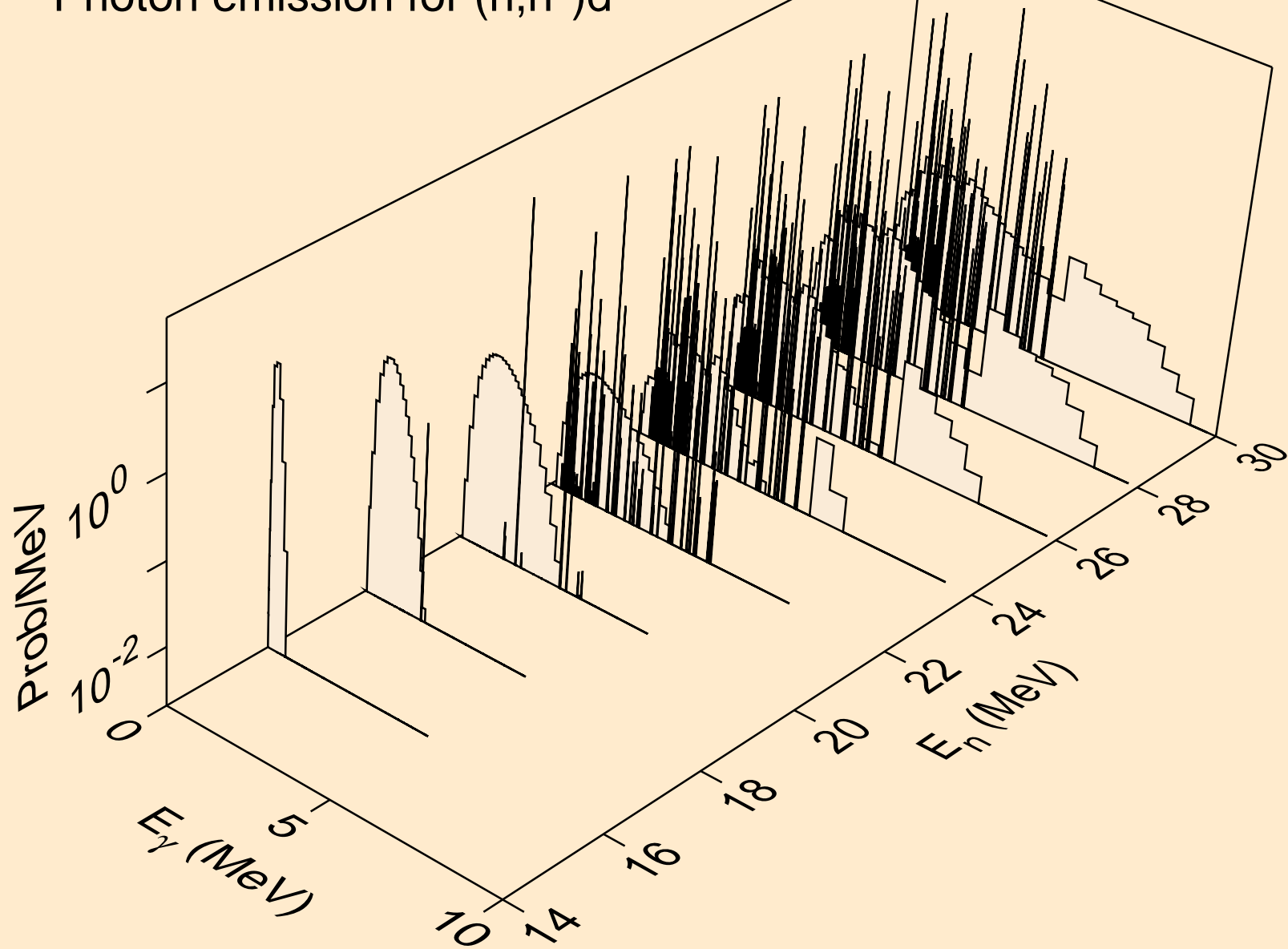

AR039 NEUTRON ACER TENDL-2024 LIBRARY; T=293.6K
Photon emission for (n,n*)t

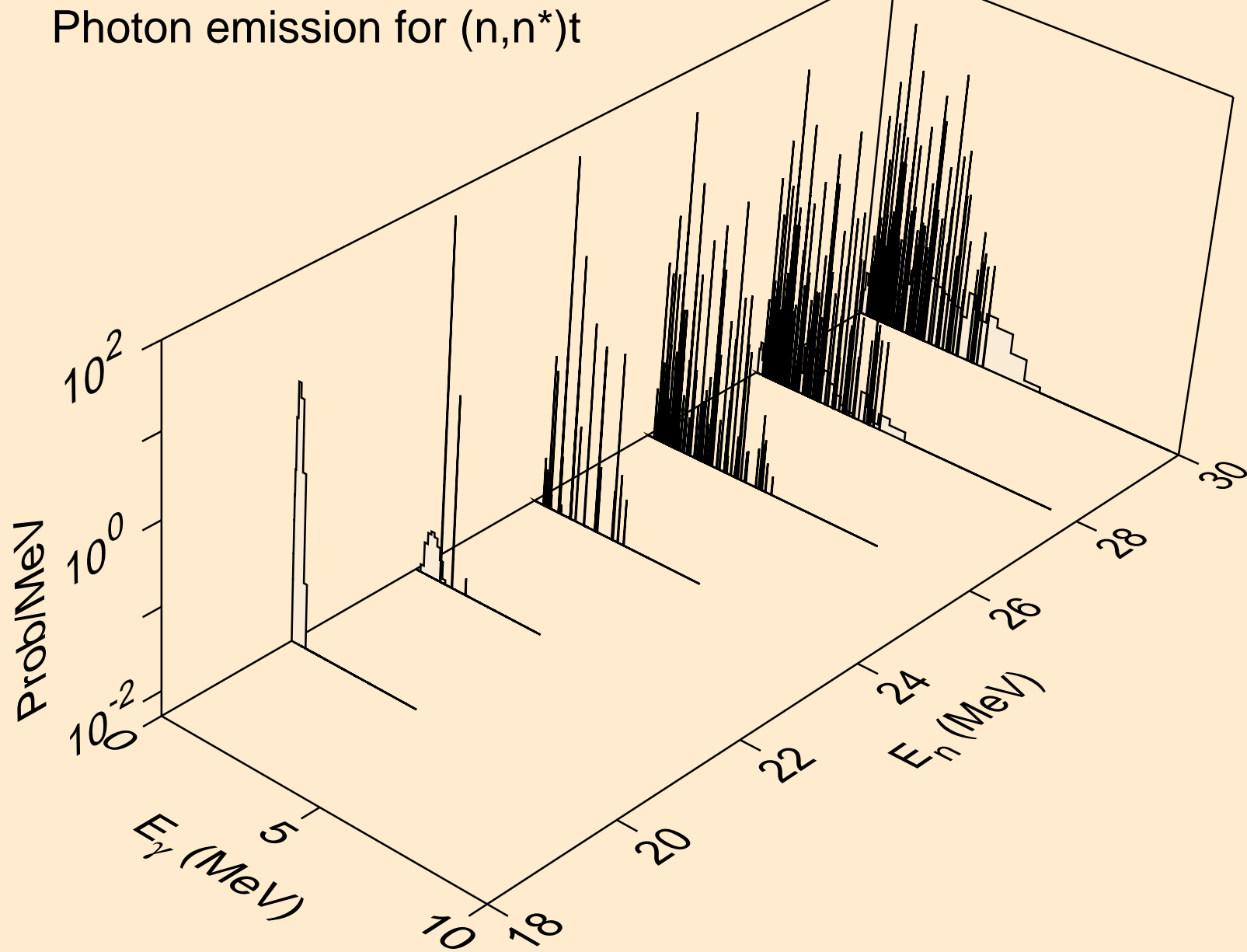

AR039 NEUTRON ACER TENDL-2024 LIBRARY; T=293.6K
Photon emission for (n,n*)he3

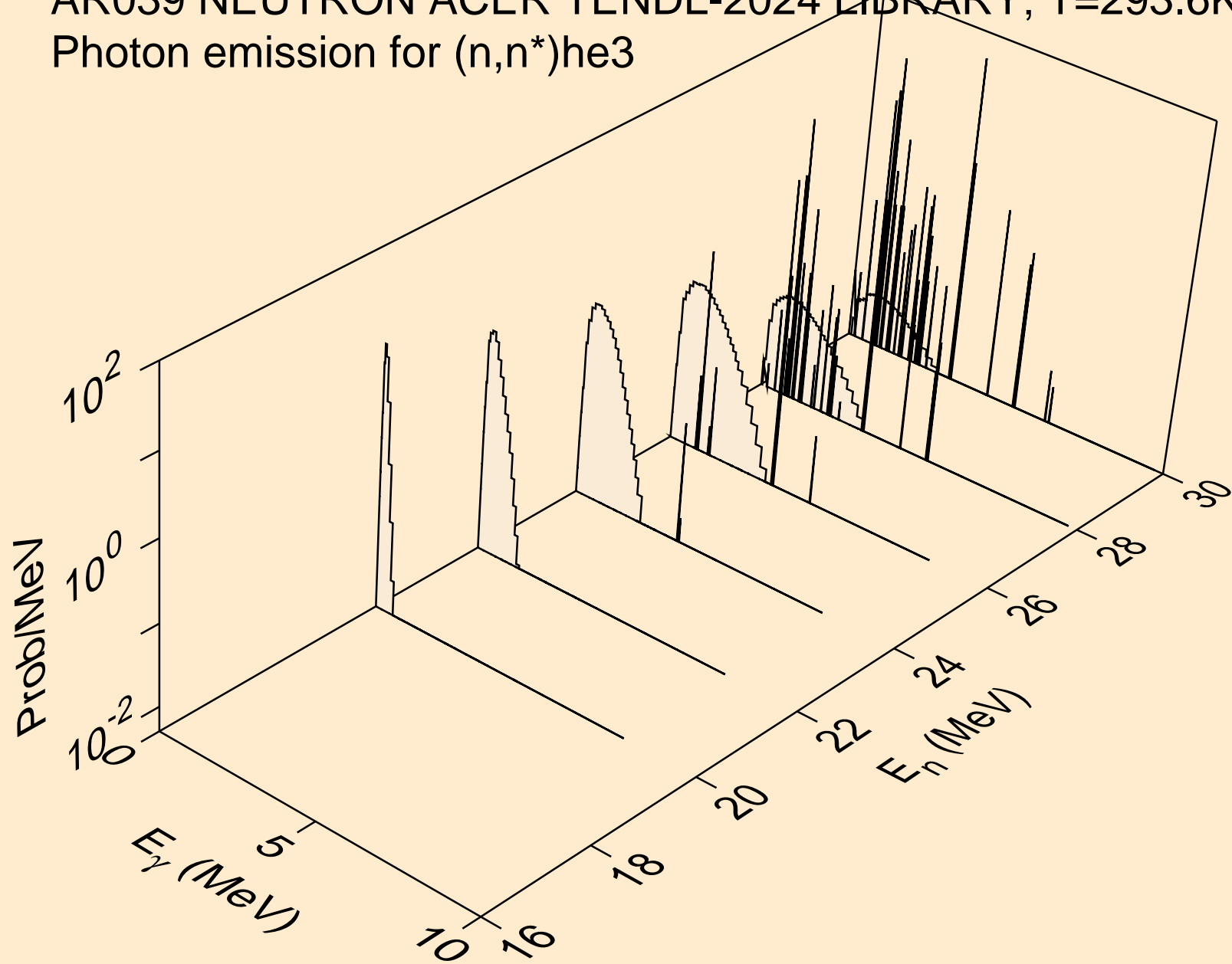

AR039 NEUTRON ACER TENDL-2024 LIBRARY; T=293.6K
Photon emission for (n,4n)

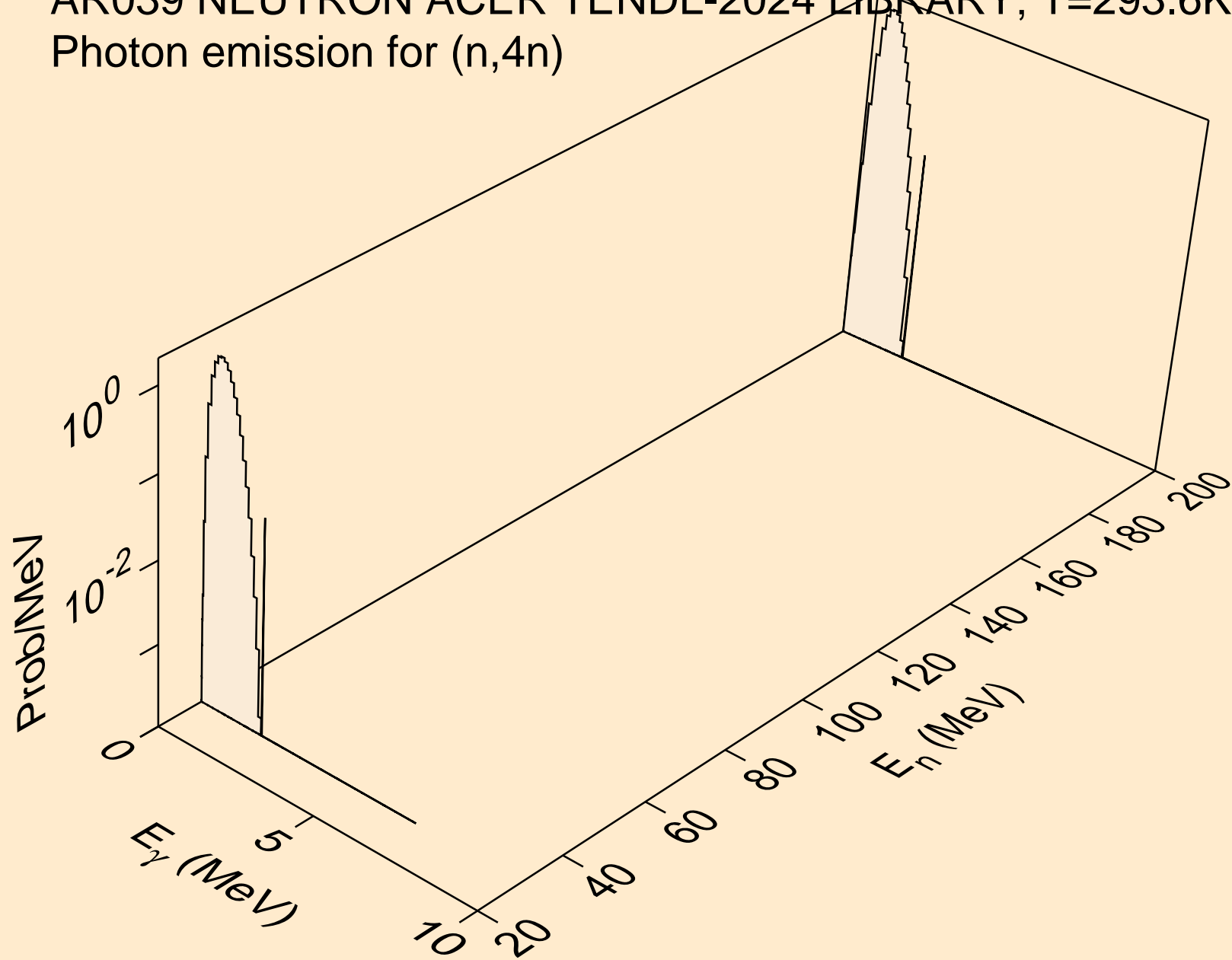

AR039 NEUTRON ACER TENDL-2024 LIBRARY; T=293.6K
Photon emission for (n,2np)

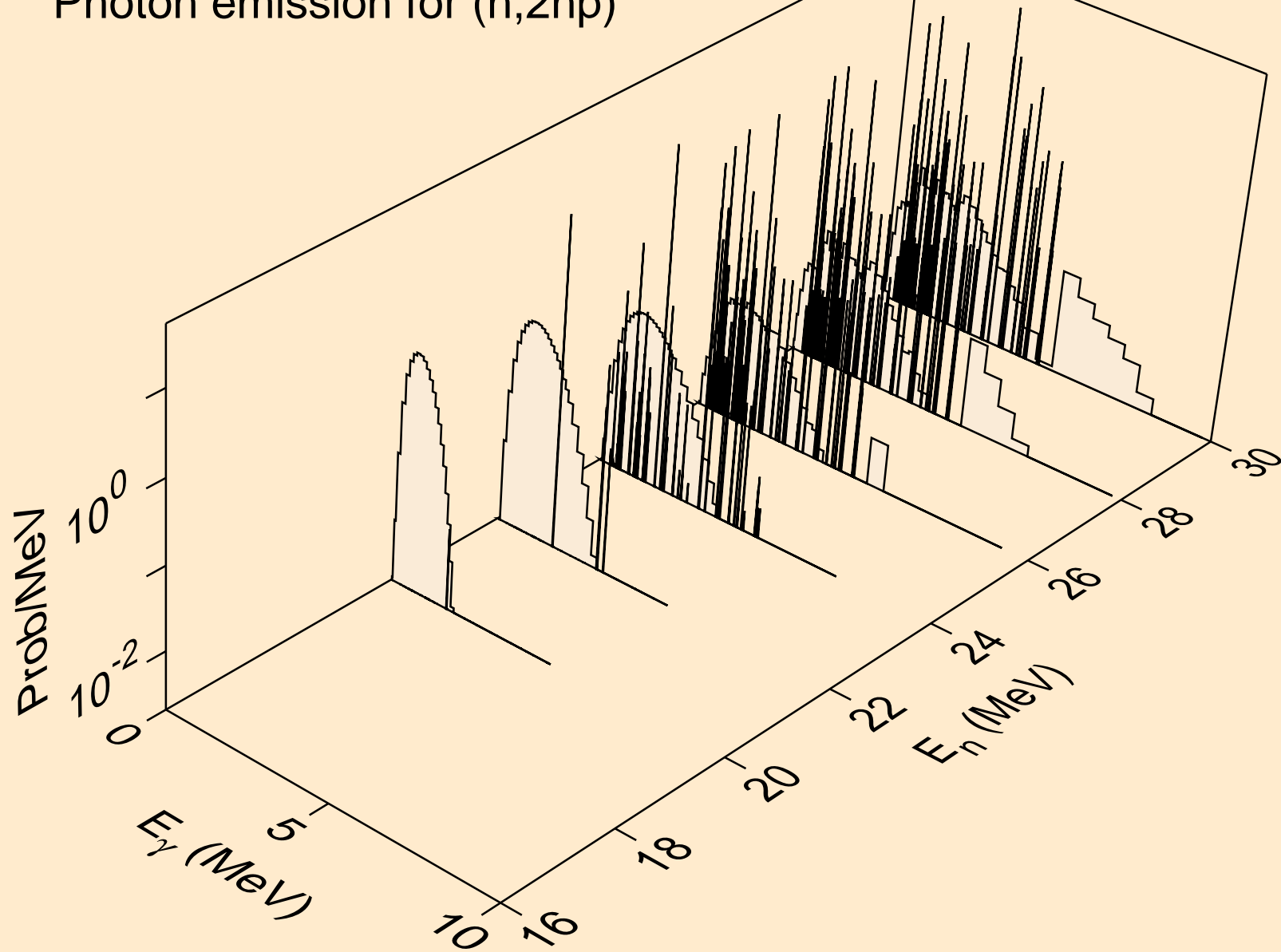

AR039 NEUTRON ACER TENDL-2024 LIBRARY; T=293.6K
Photon emission for (n,3np)

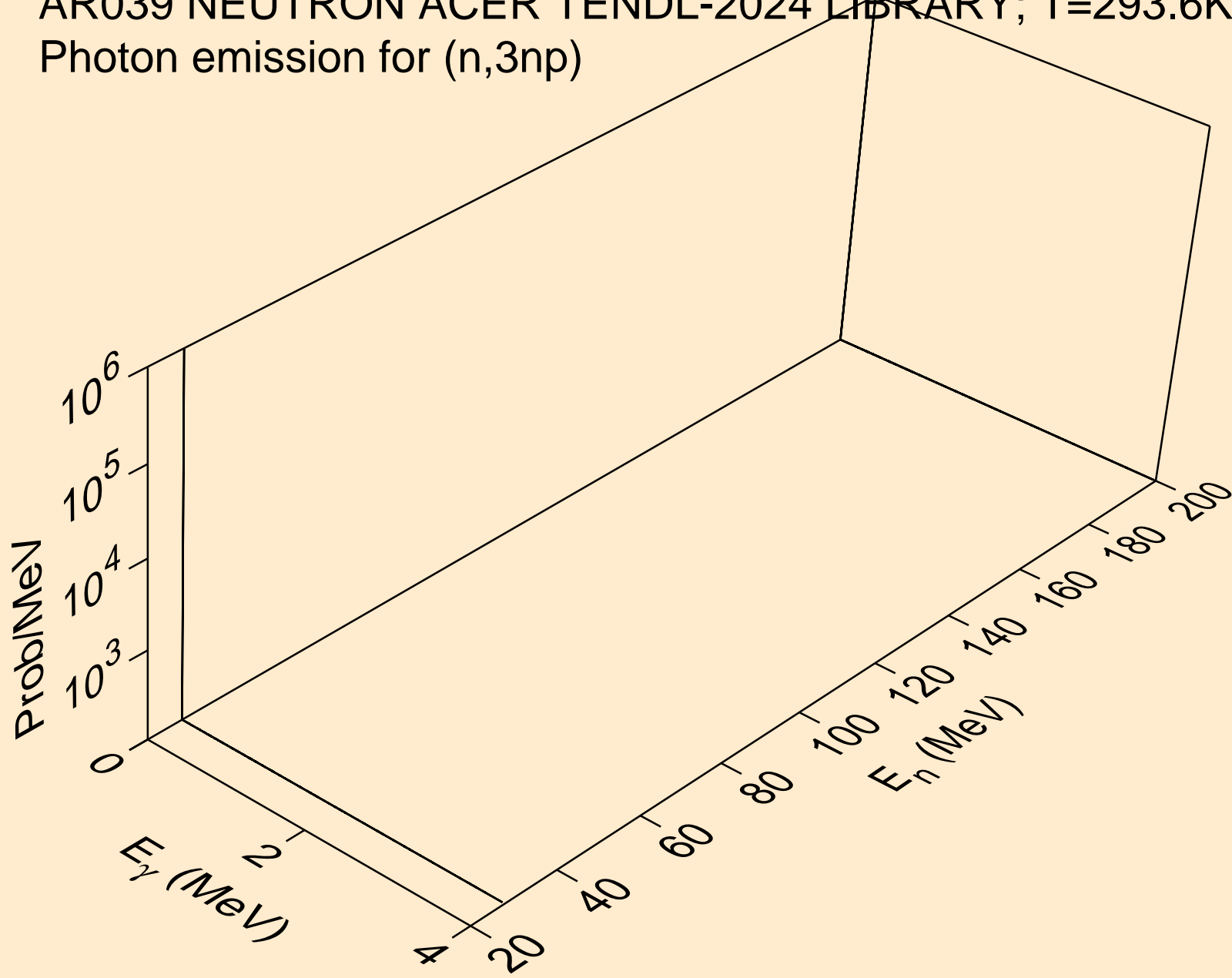

AR039 NEUTRON ACER TENDL-2024 LIBRARY; T=293.6K
Photon emission for (n,n2p)

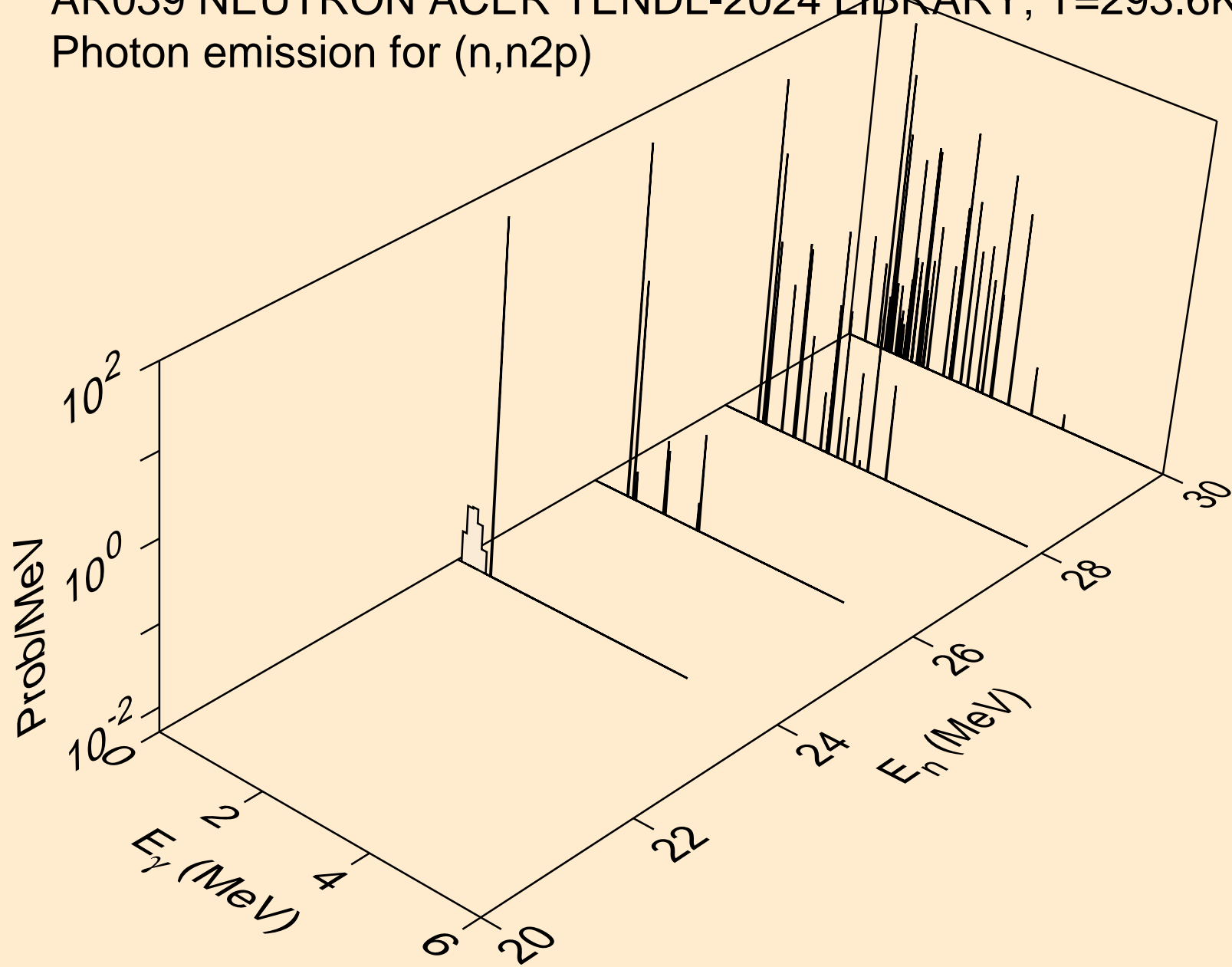

AR039 NEUTRON ACER TENDL-2024 LIBRARY; T=293.6K
Photon emission for (n,npa)

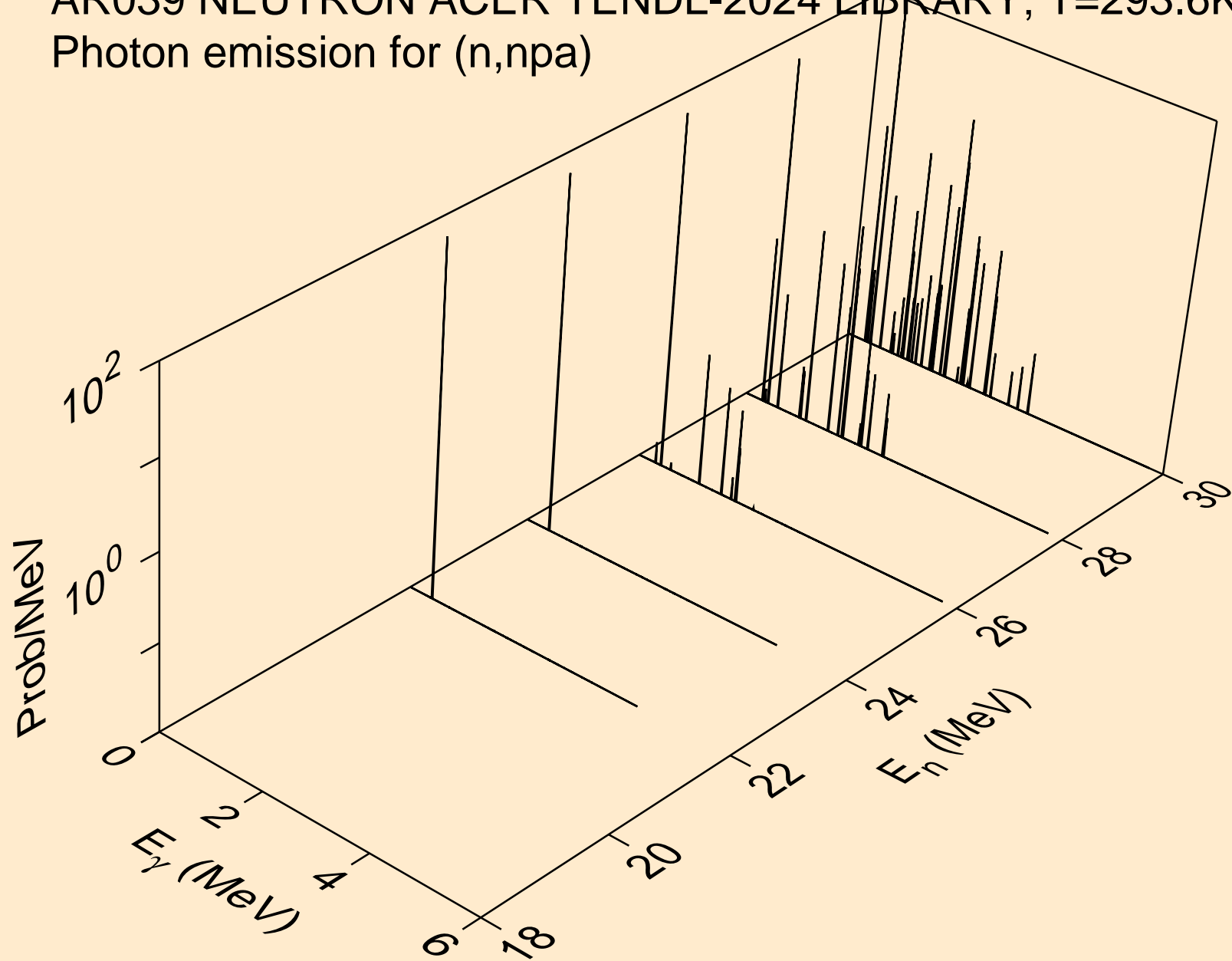

AR039 NEUTRON ACER TENDL-2024 LIBRARY; T=293.6K
Photon emission for (n,n*c)

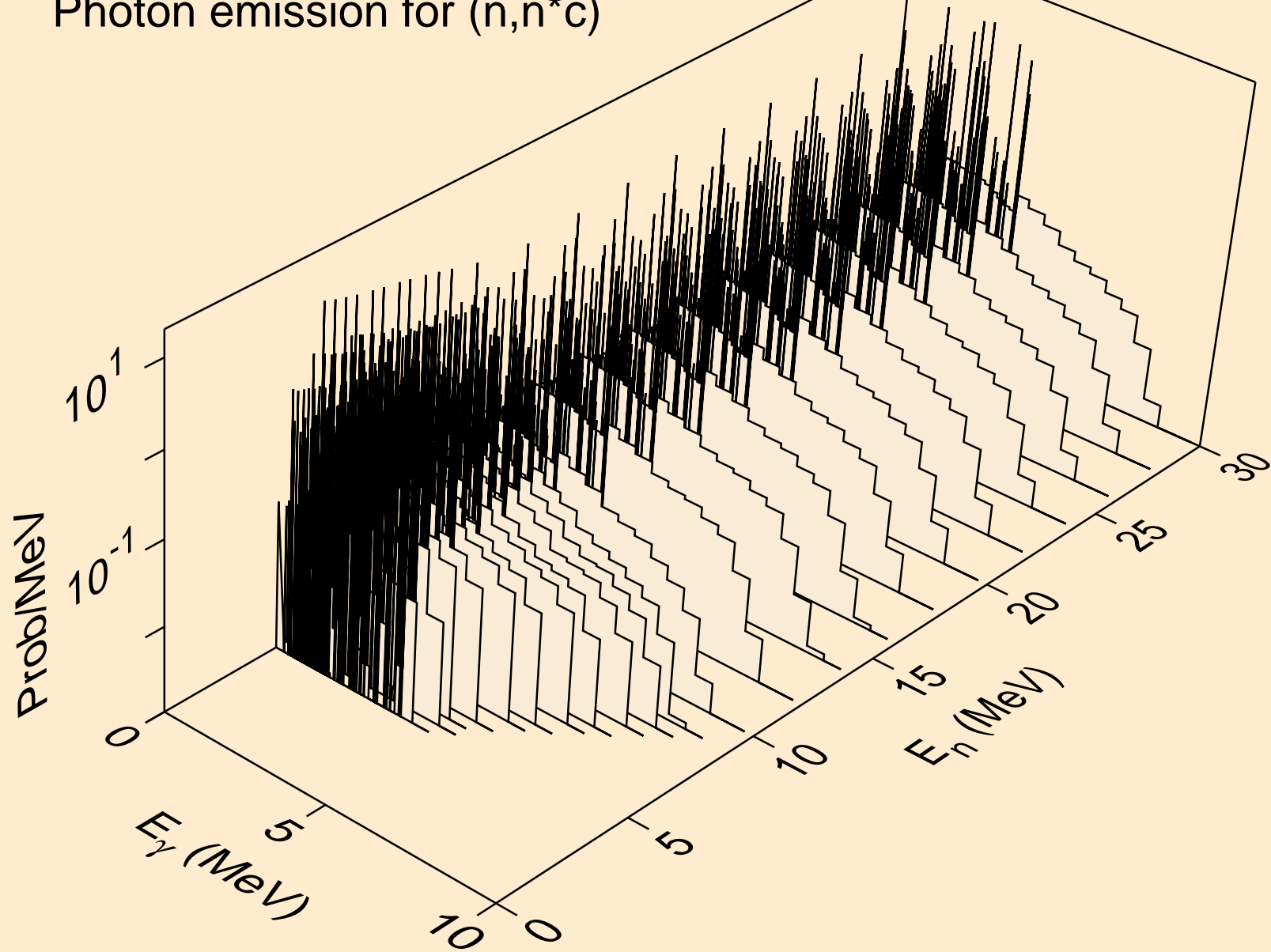

AR039 NEUTRON ACER TENDL-2024 LIBRARY; T=293.6K
Photon emission for (n,gma)

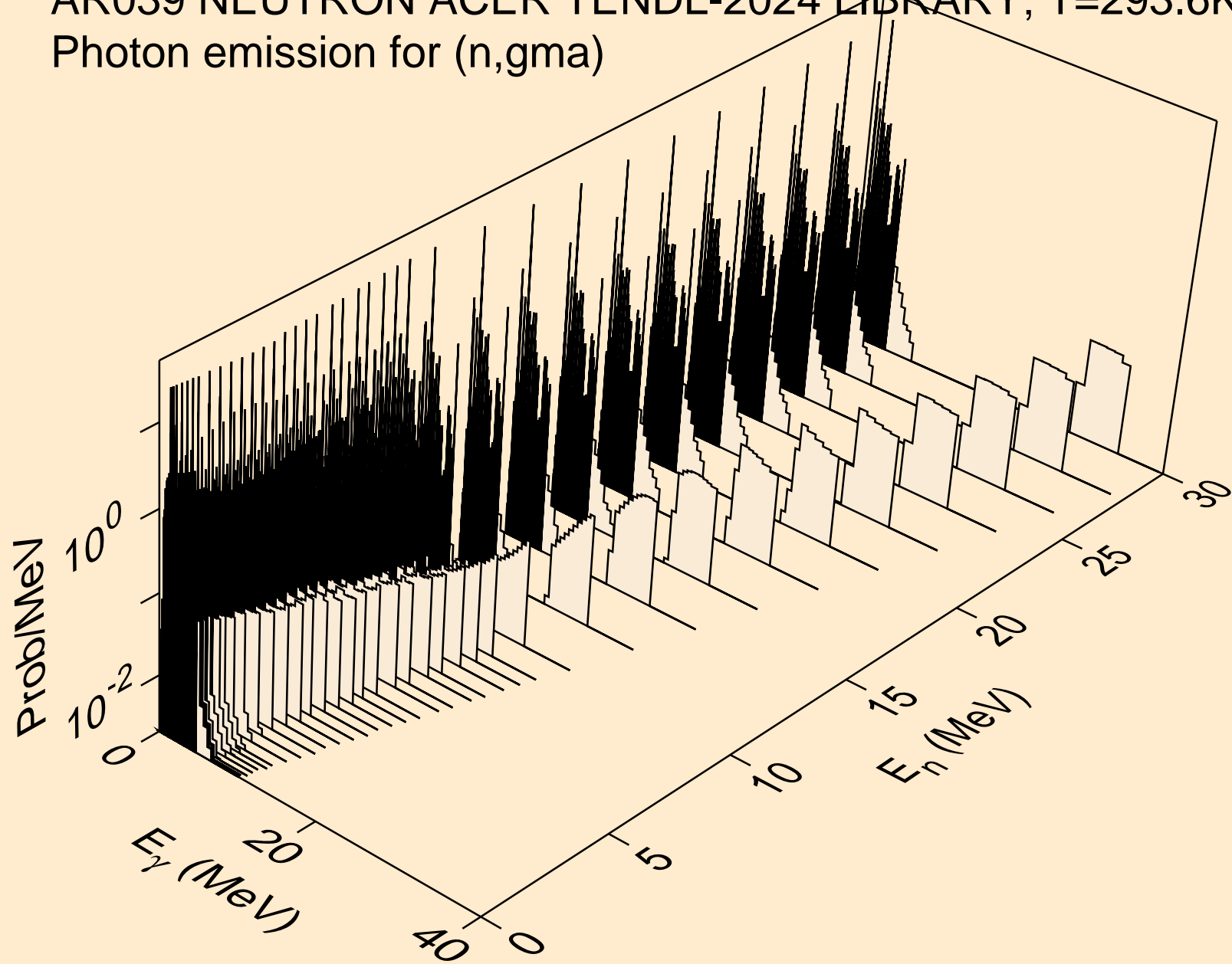

AR039 NEUTRON ACER TENDL-2024 LIBRARY; T=293.6K
Photon emission for (n,p)

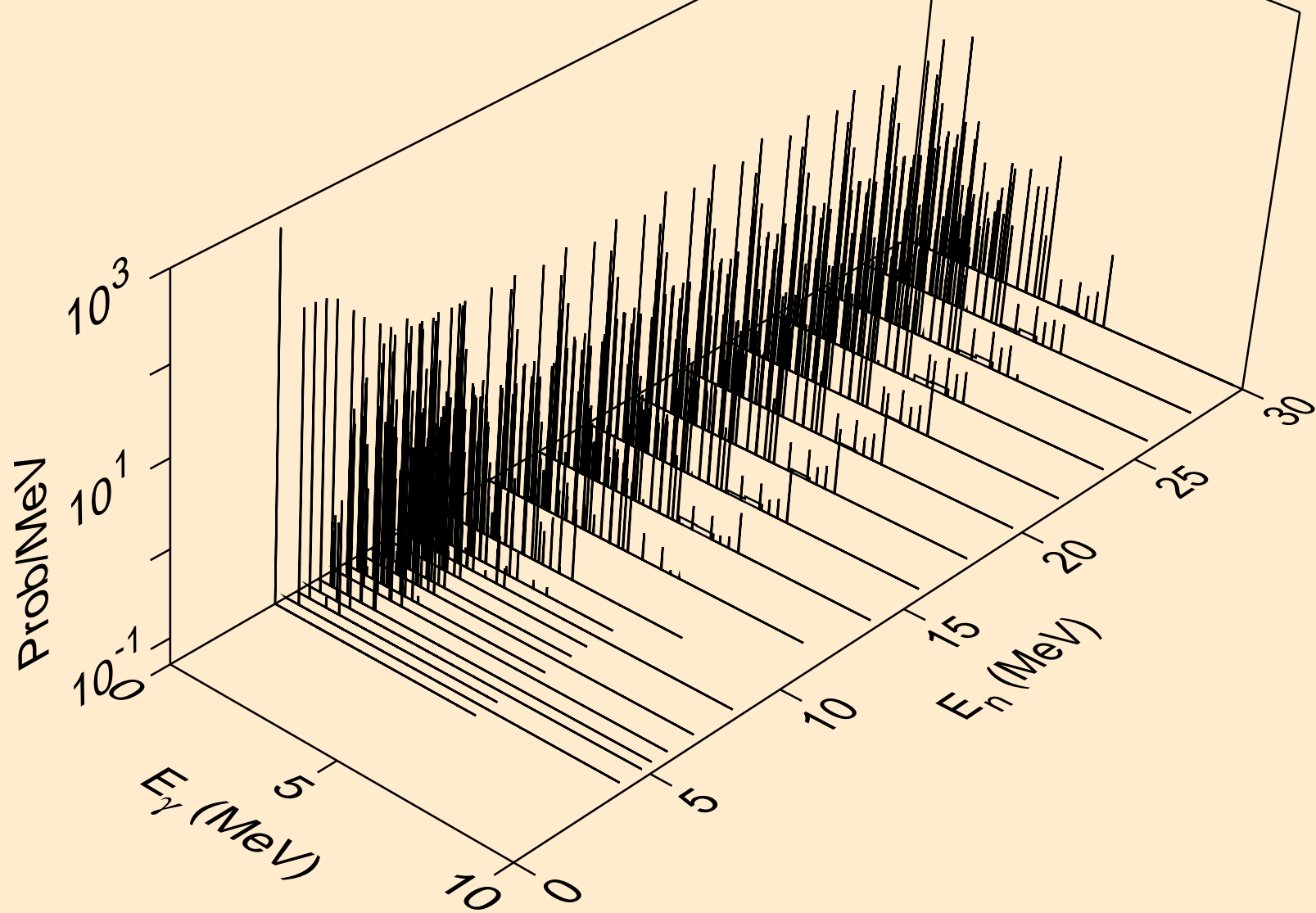

AR039 NEUTRON ACER TENDL-2024 LIBRARY; T=293.6K
Photon emission for (n,d)

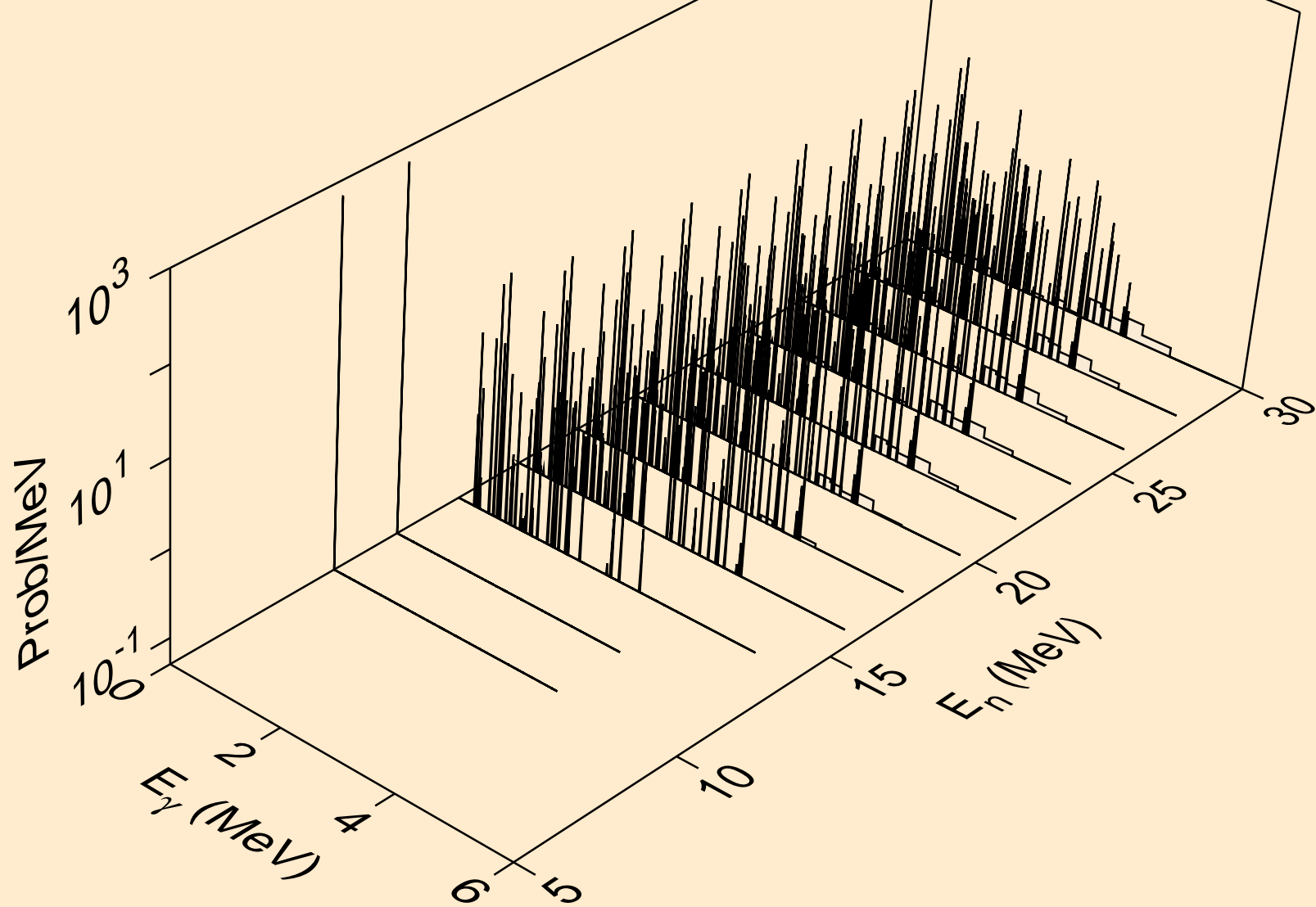

AR039 NEUTRON ACER TENDL-2024 LIBRARY; T=293.6K
Photon emission for (n,t)

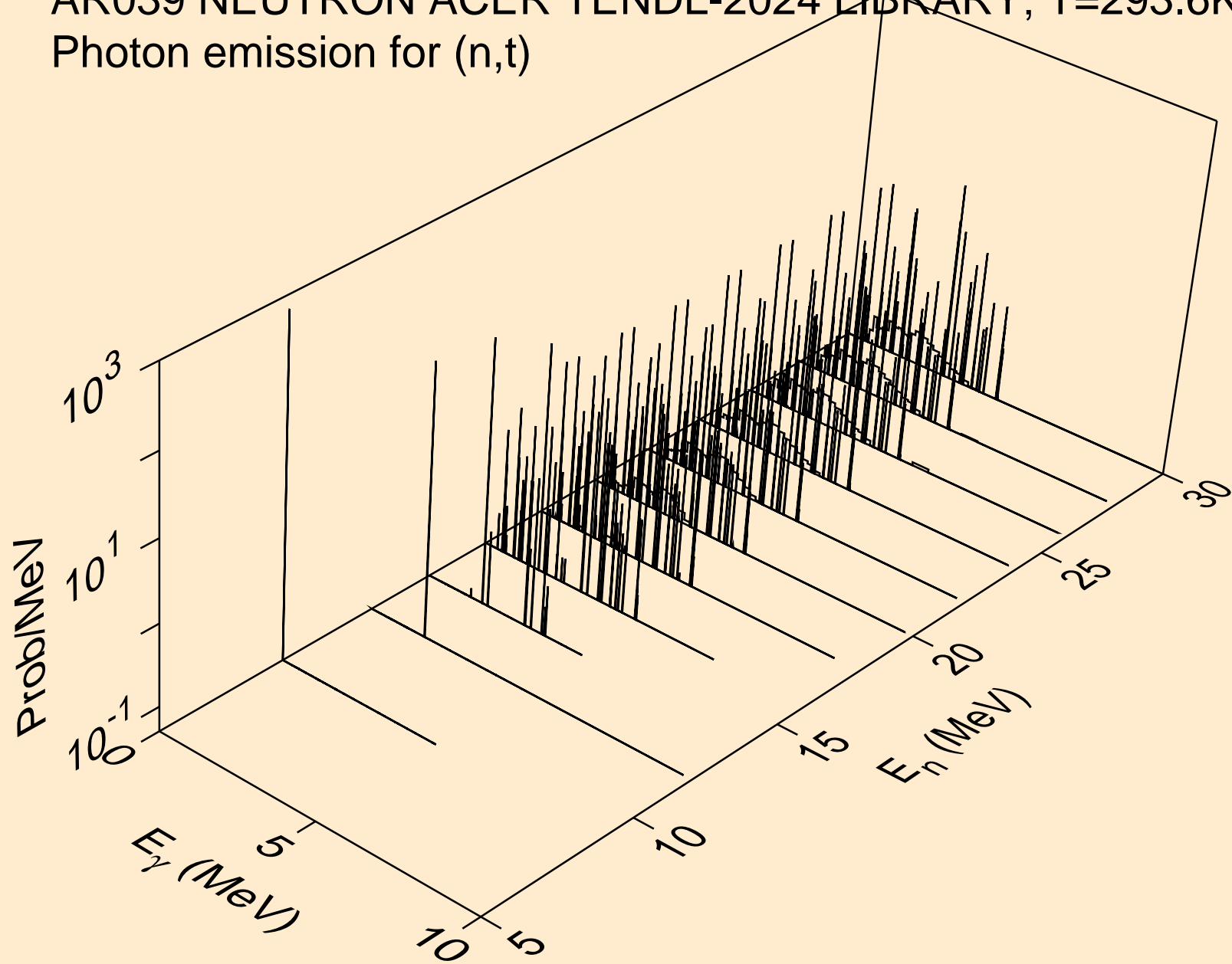

AR039 NEUTRON ACER TENDL-2024 LIBRARY; T=293.6K
Photon emission for (n,he3)

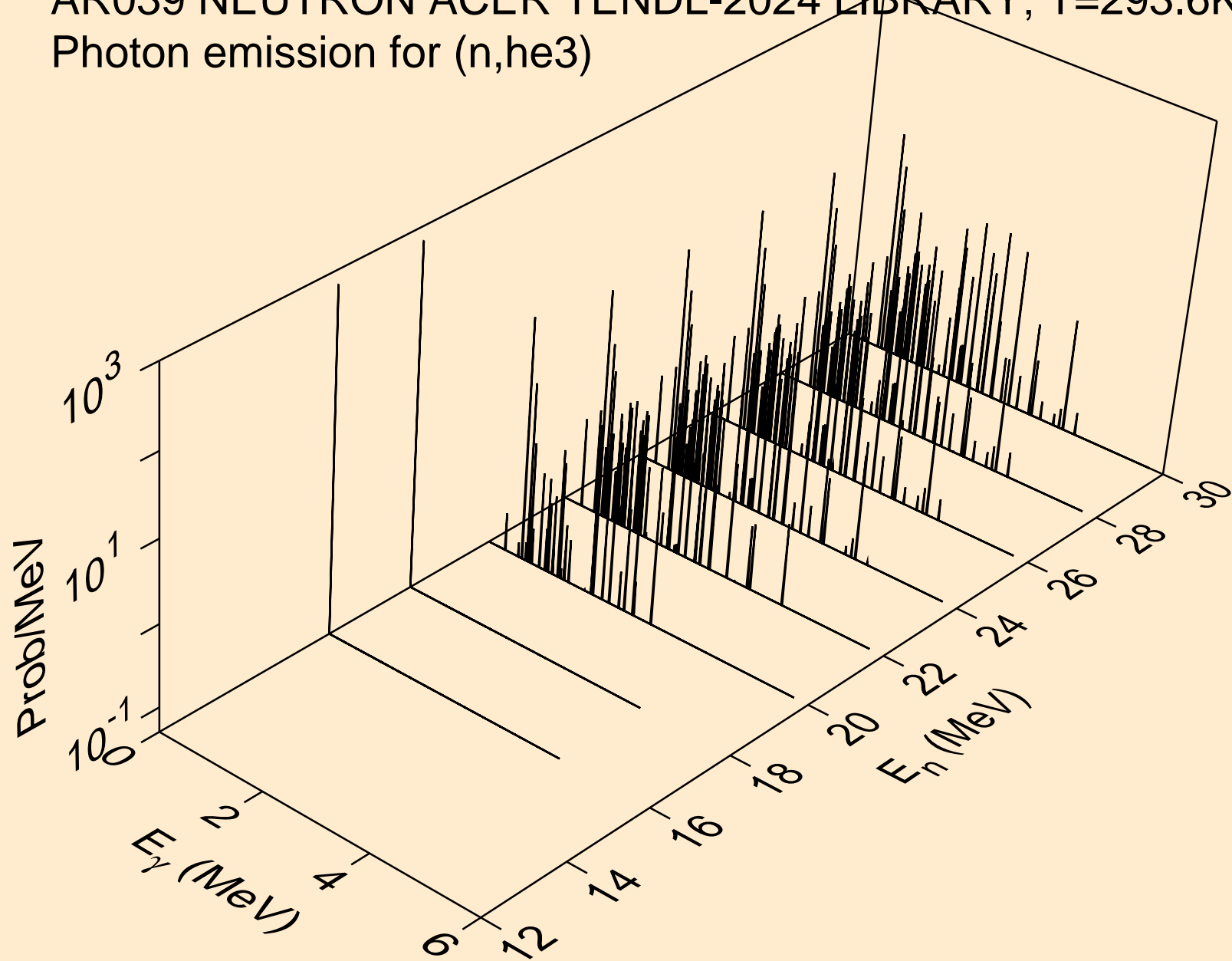

AR039 NEUTRON ACER TENDL-2024 LIBRARY; T=293.6K
Photon emission for (n,a)

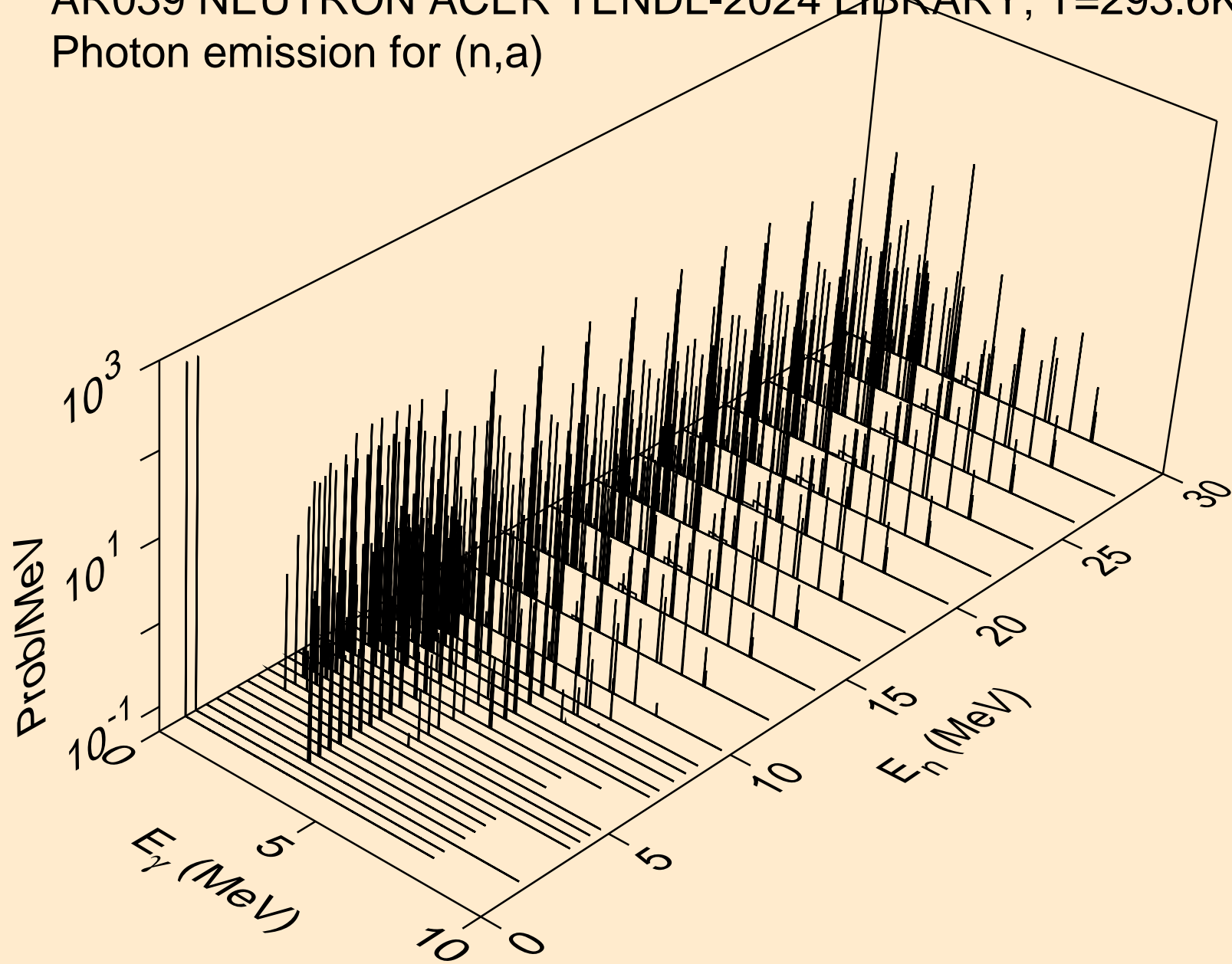

AR039 NEUTRON ACER TENDL-2024 LIBRARY; T=293.6K
Photon emission for (n,2a)

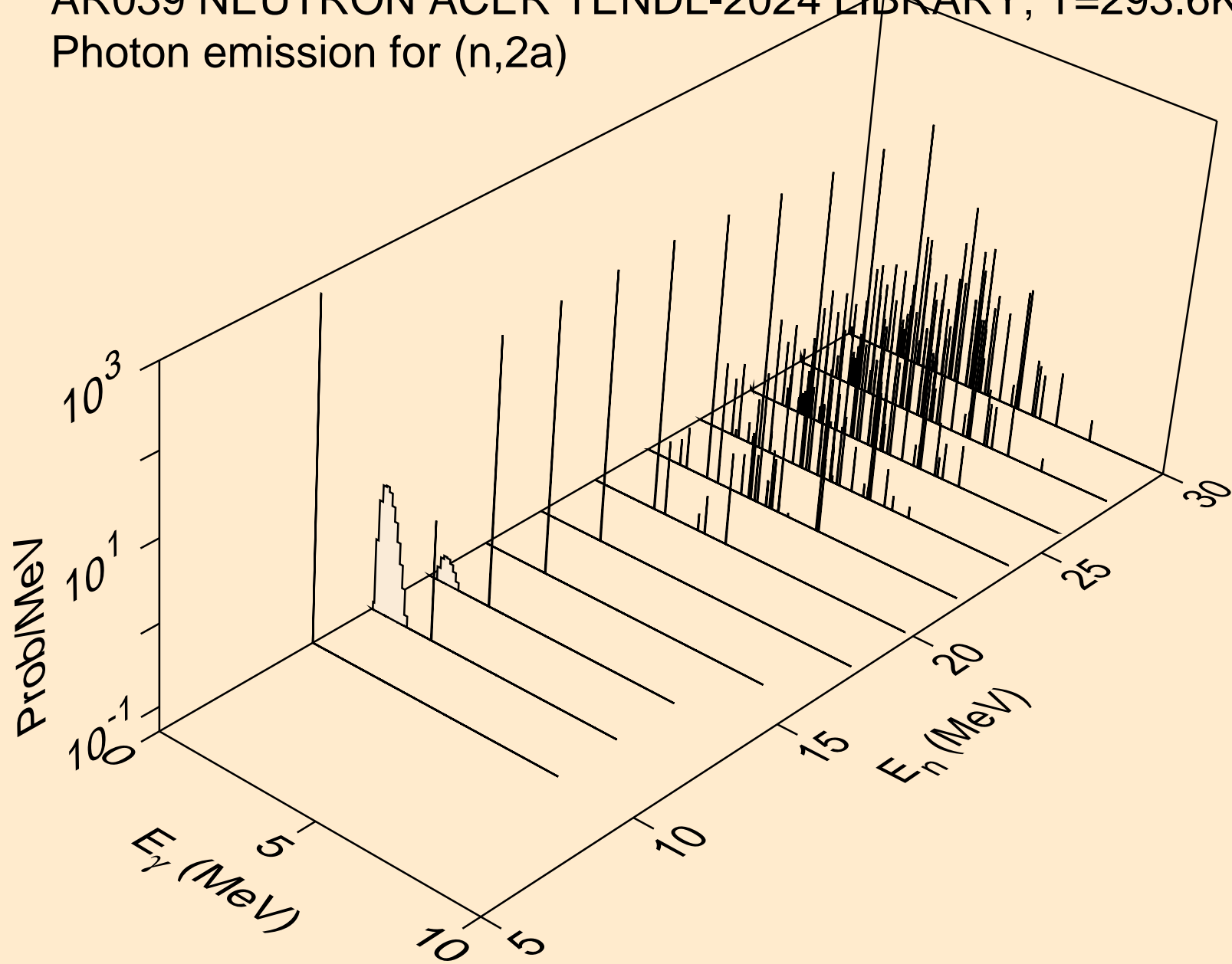

AR039 NEUTRON ACER TENDL-2024 LIBRARY; T=293.6K
Photon emission for (n,2p)

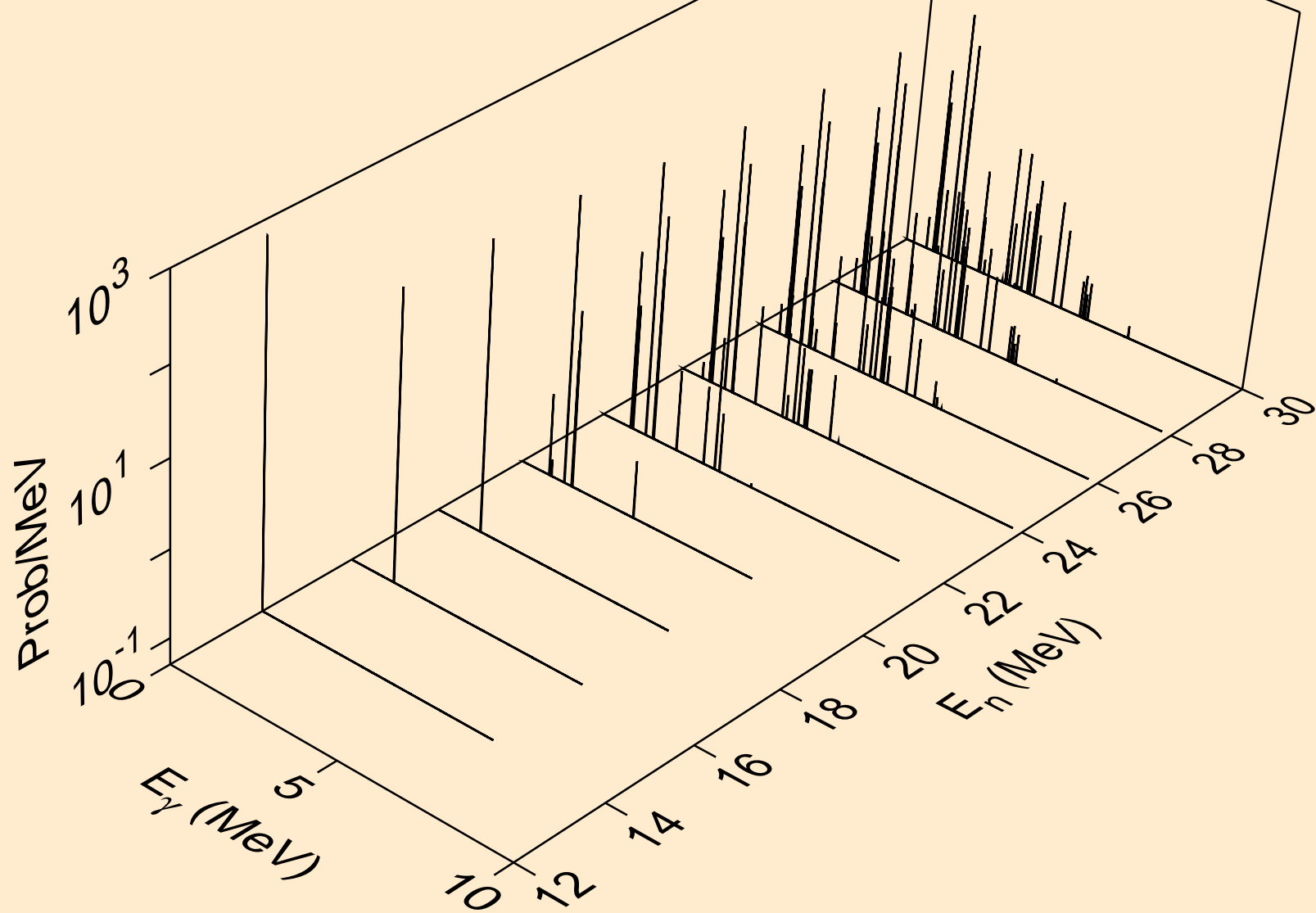

AR039 NEUTRON ACER TENDL-2024 LIBRARY; T=293.6K
Photon emission for (n,p)

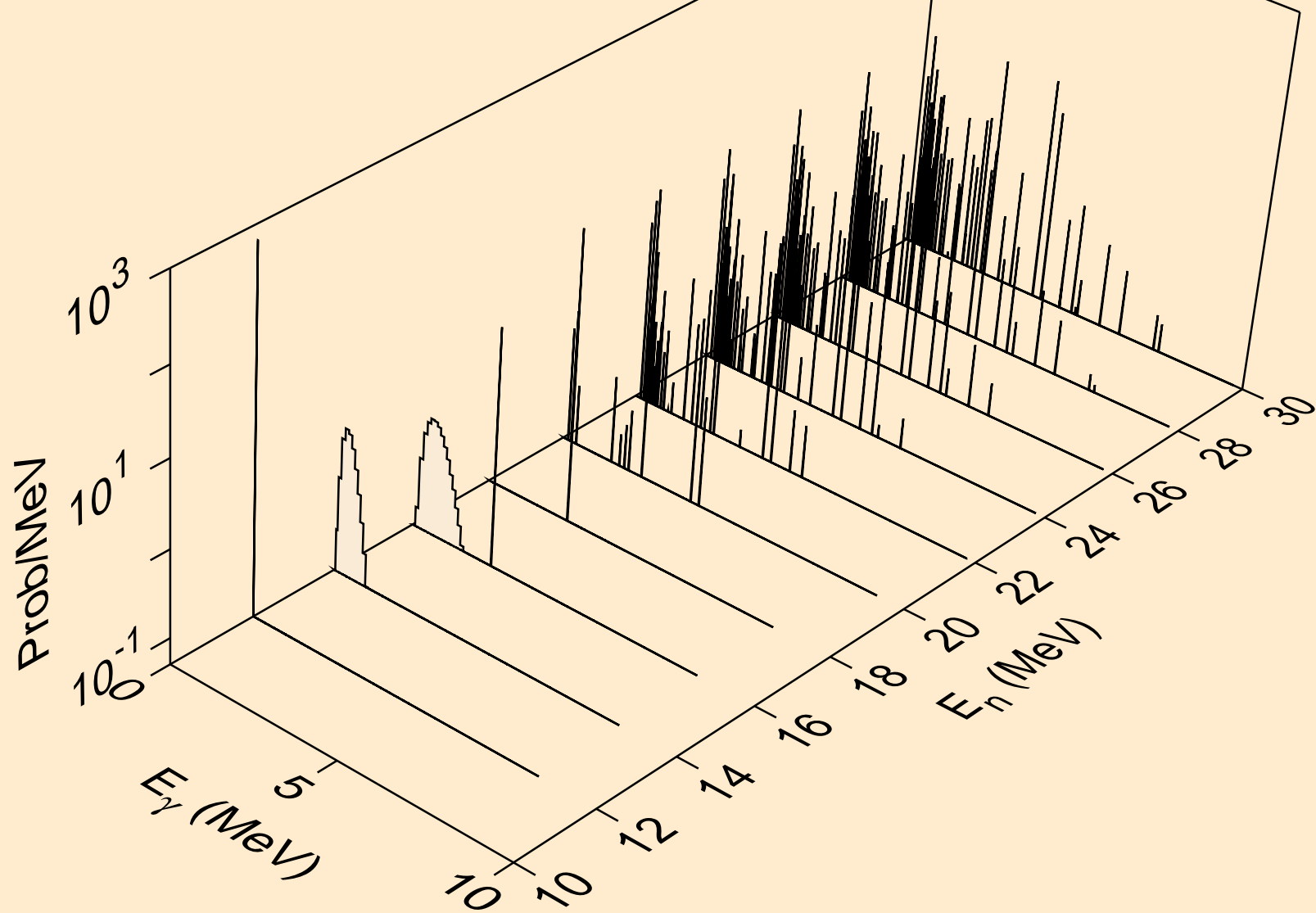

AR039 NEUTRON ACER TENDL-2024 LIBRARY; T=293.6K
Photon emission for (n,pd)

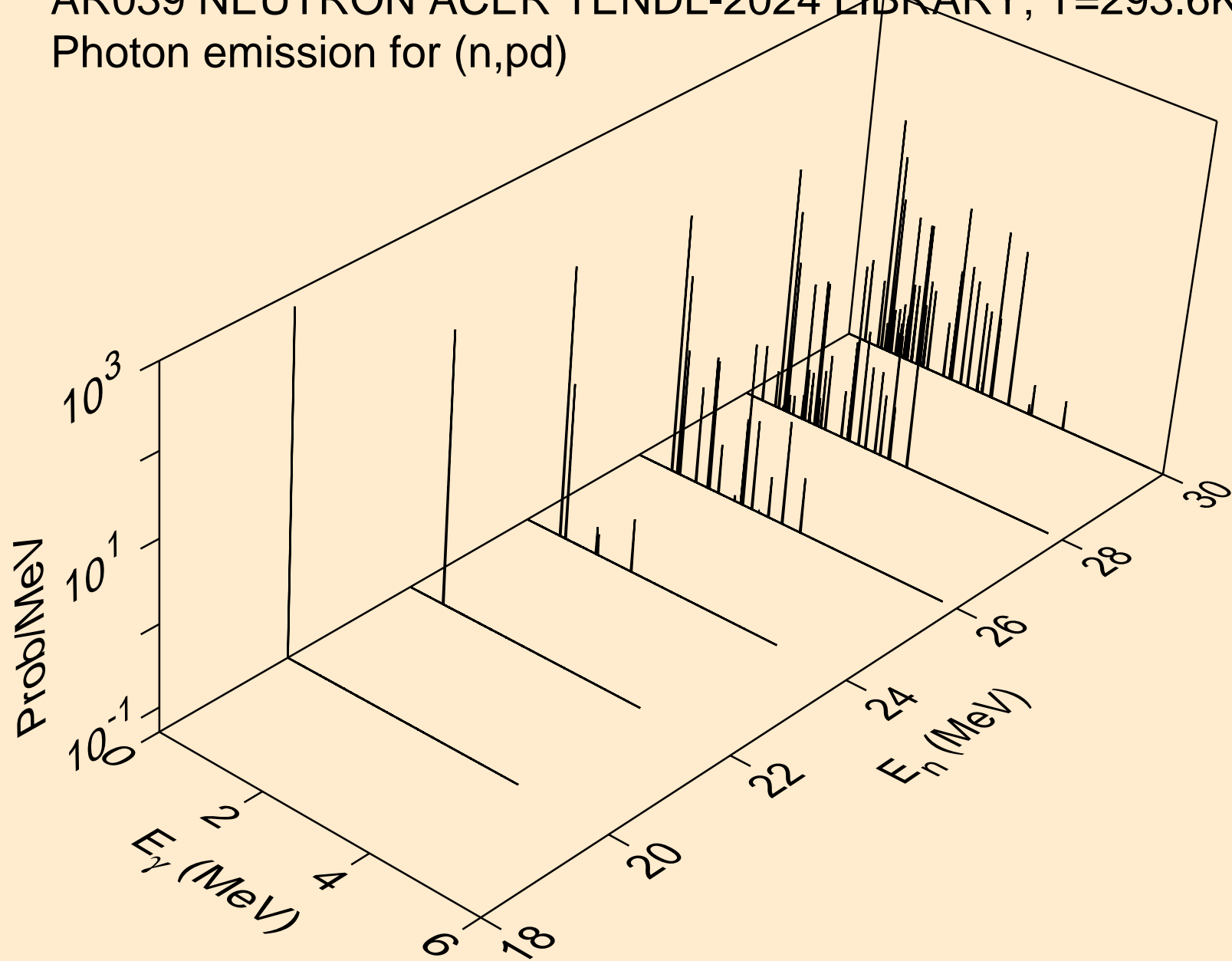

AR039 NEUTRON ACER TENDL-2024 LIBRARY; T=293.6K
Photon emission for (n,pt)

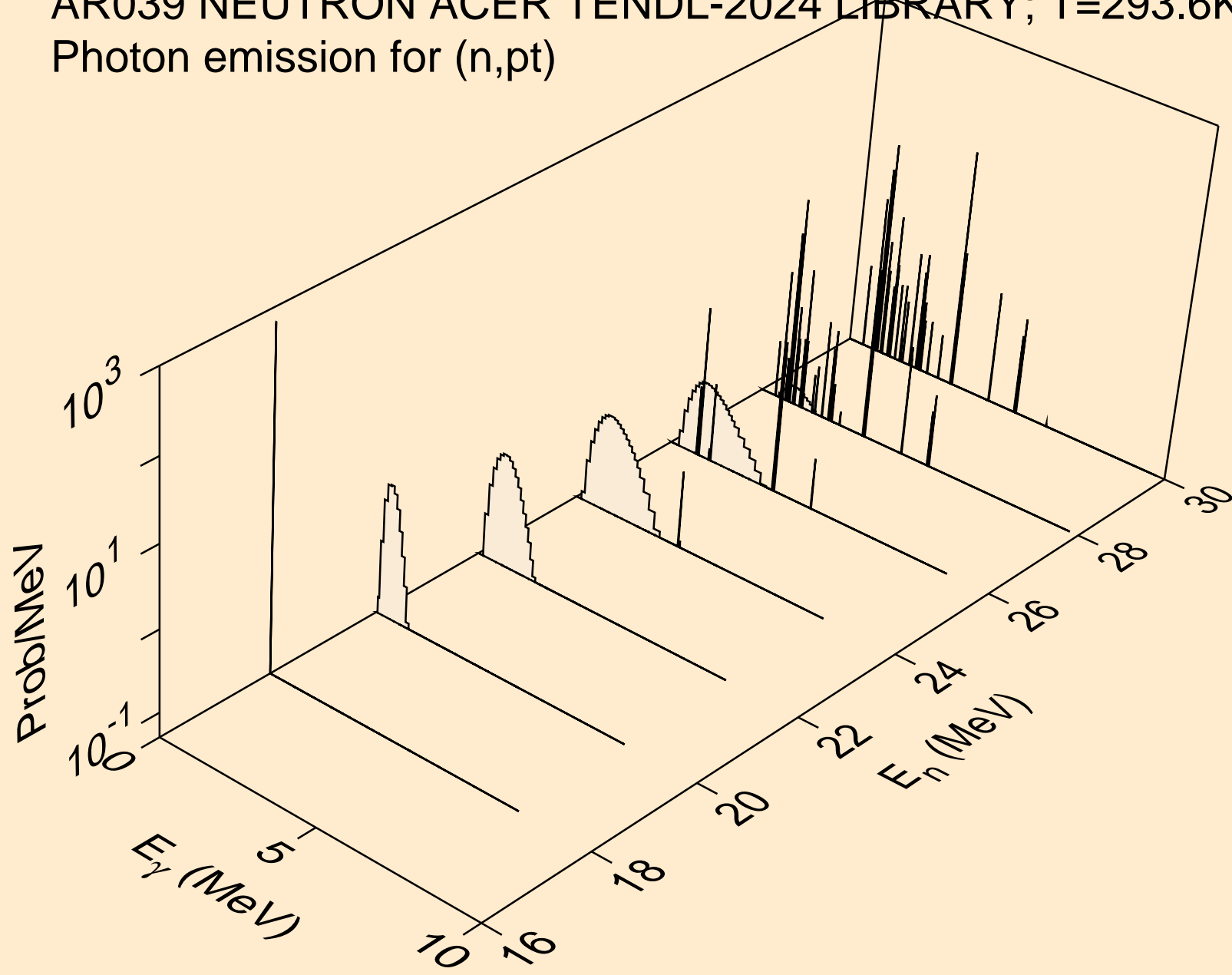

AR039 NEUTRON ACER TENDL-2024 LIBRARY; T=293.6K
Photon emission for (n,da)

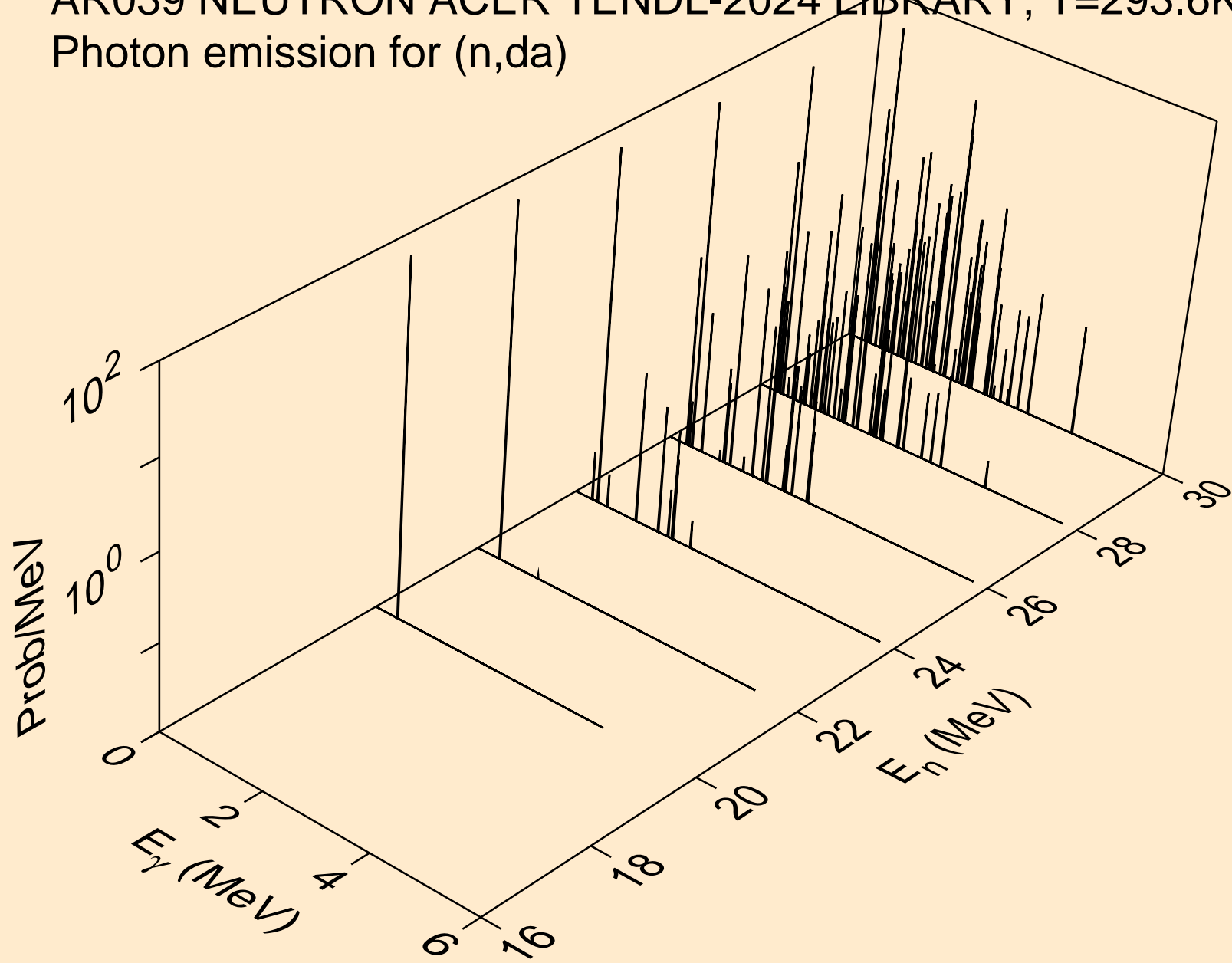

AR039 NEUTRON ACER TENDL-2024 LIBRARY; T=293.6K
thermal capture photon spectrum

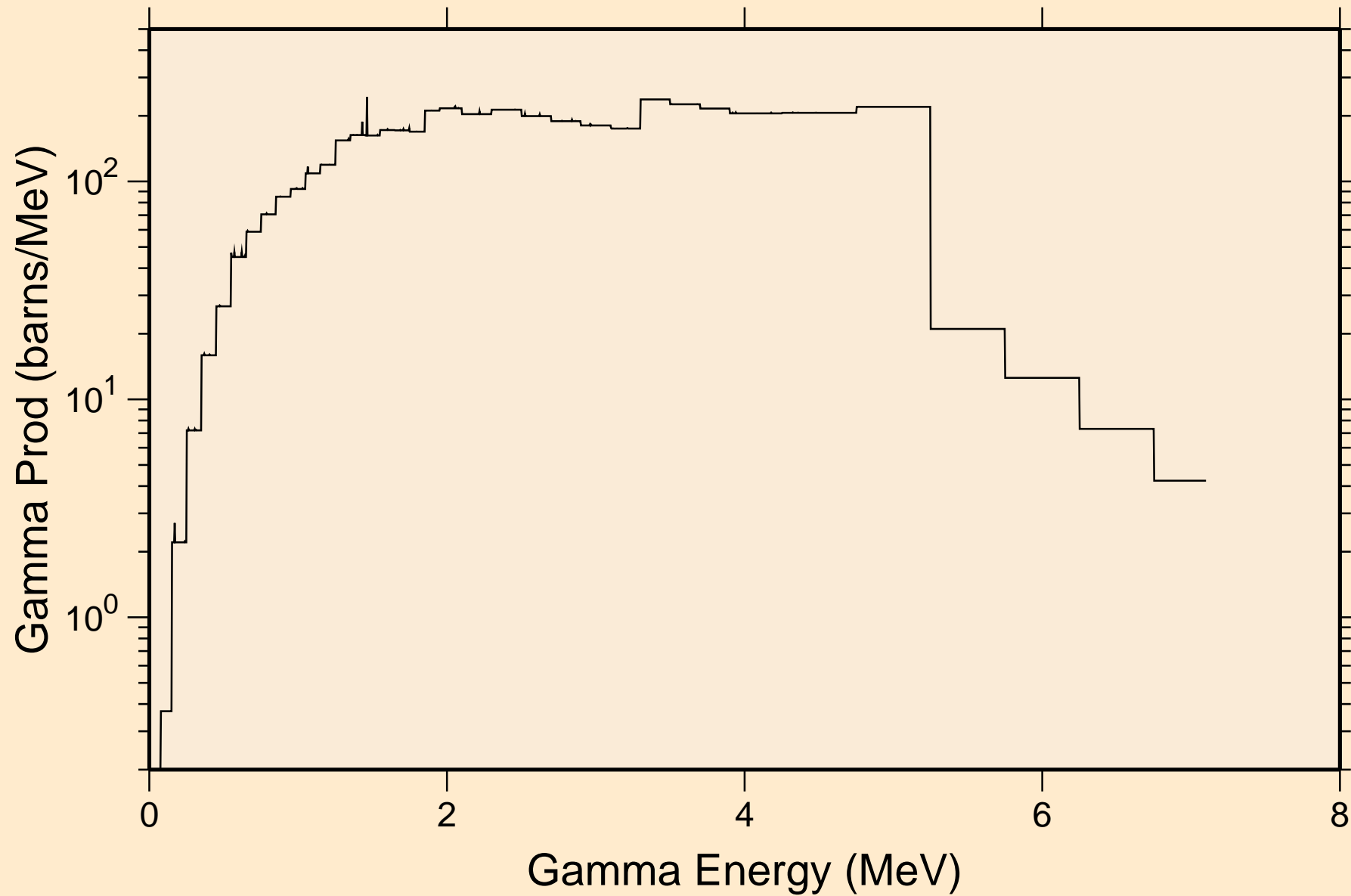

AR039 NEUTRON ACER TENDL-2024 LIBRARY; T=293.6K
14 MeV photon spectrum

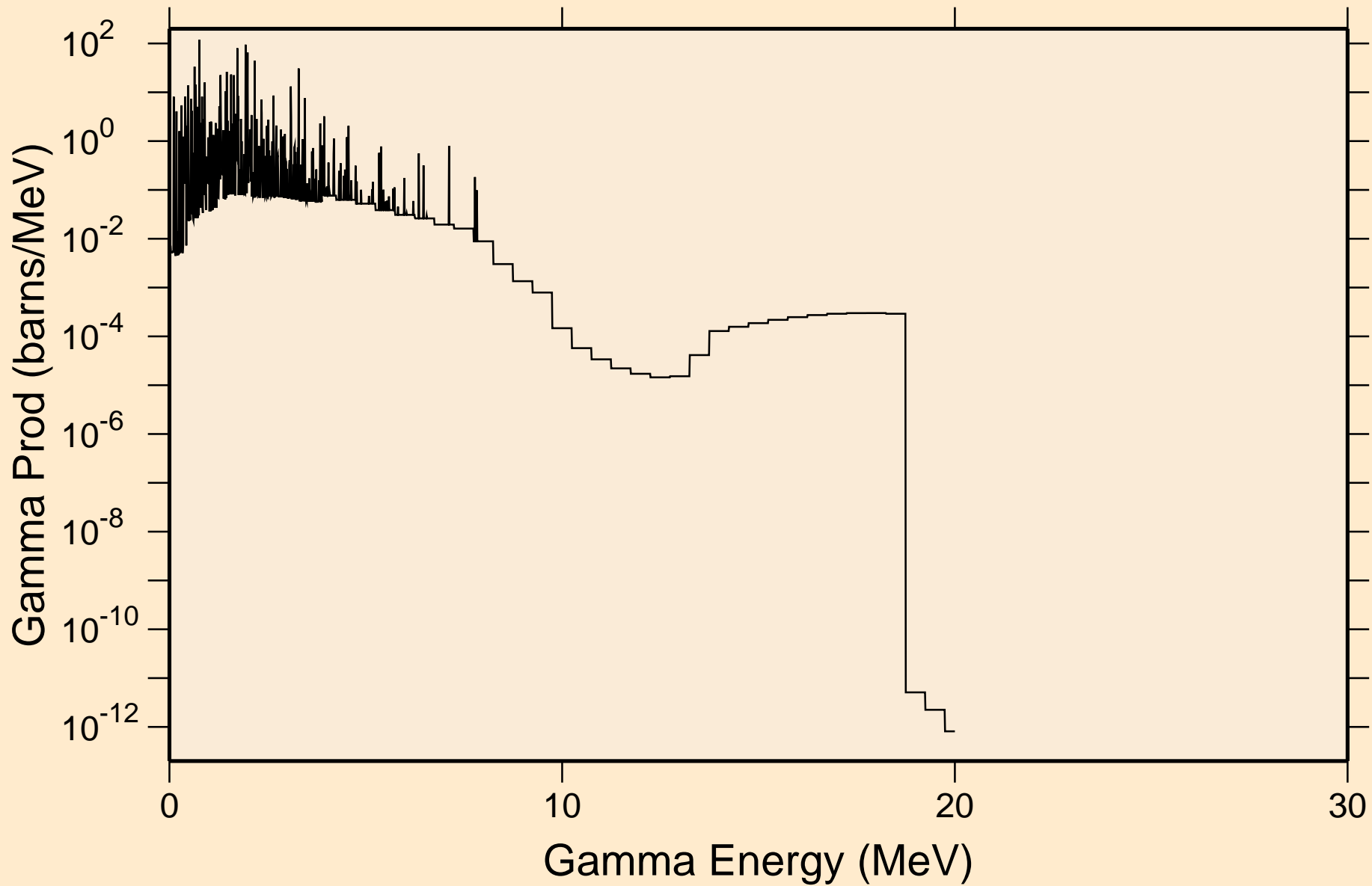

AR039 NEUTRON ACER TENDL-2024 LIBRARY; T=293.6K

Particle heating contributions

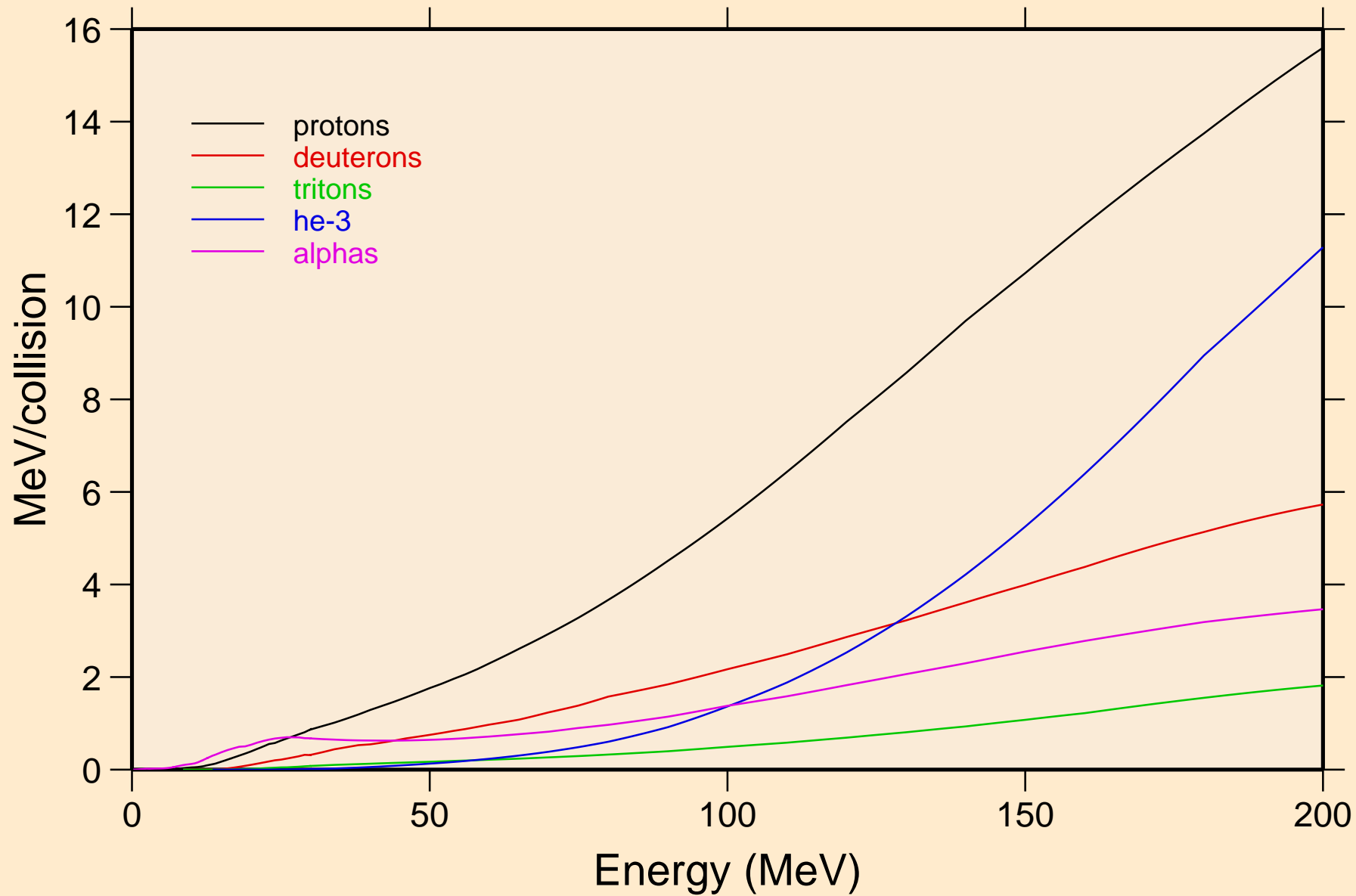

AR039 NEUTRON ACER TENDL-2024 LIBRARY; T=293.6K
Recoil Heating

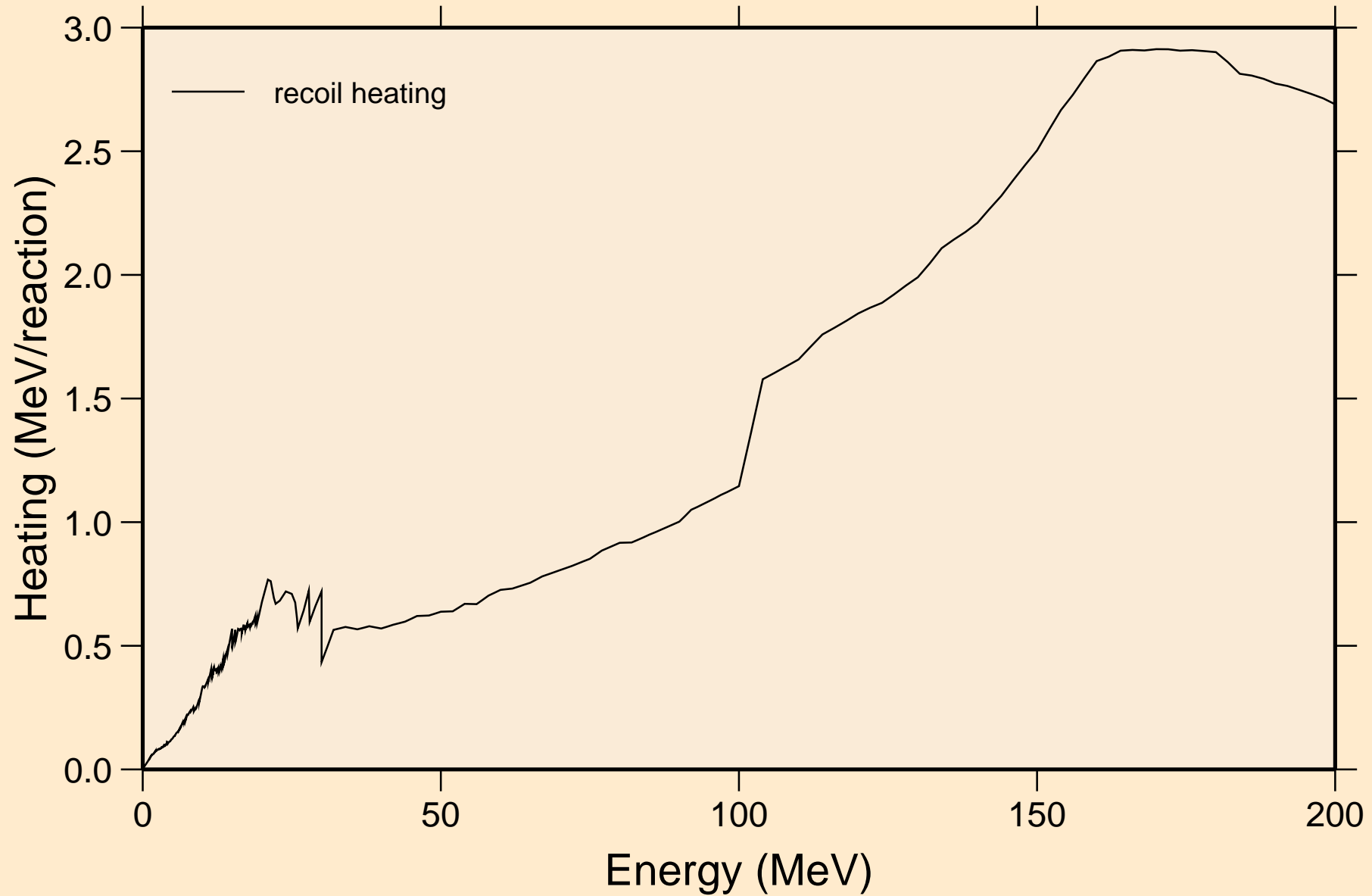

AR039 NEUTRON ACER TENDL-2024 LIBRARY; T=293.6K

Particle production cross sections

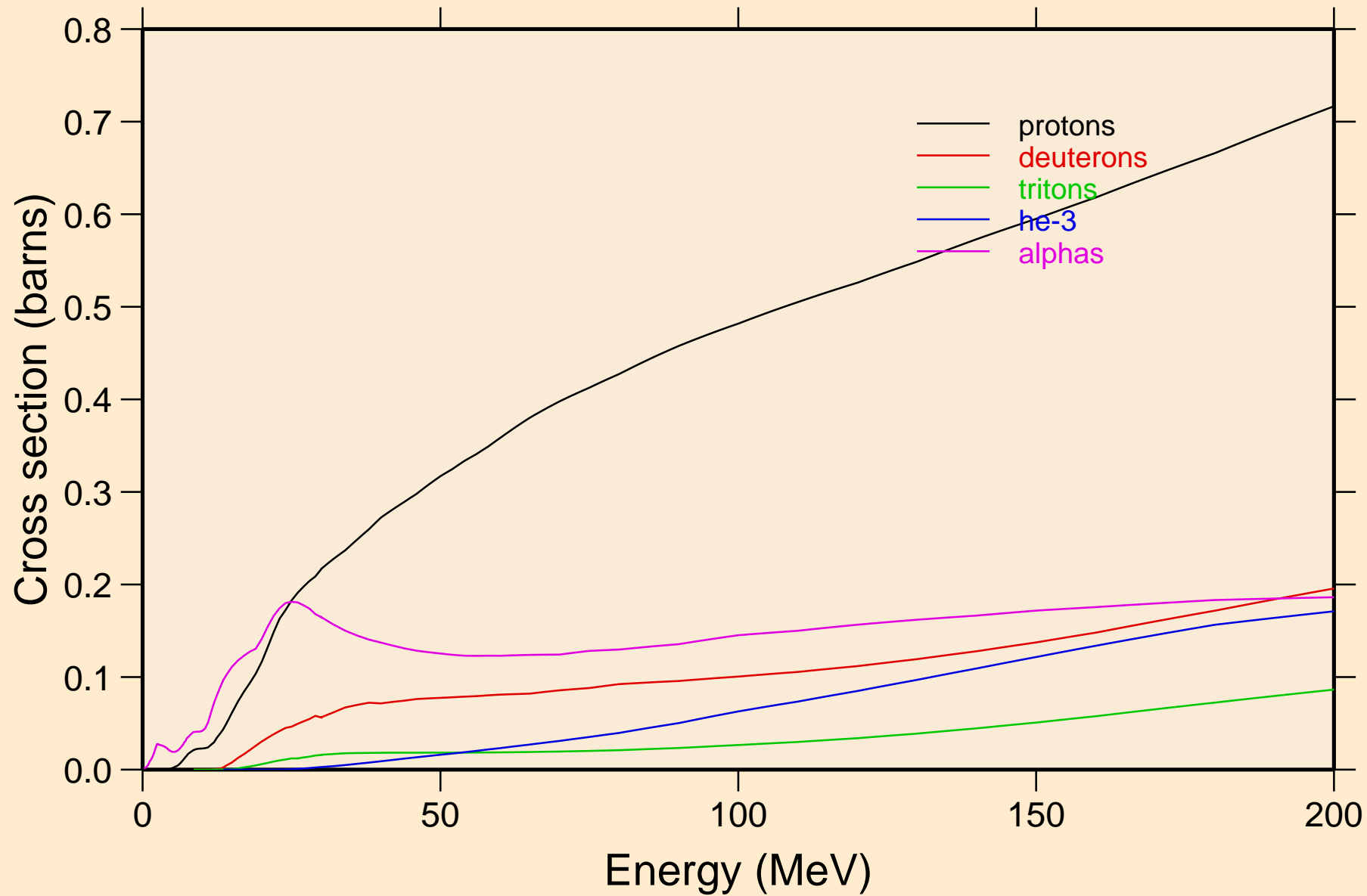

AR039 NEUTRON ACER TENDL-2024 LIBRARY; T=293.6K
protons from (n,x)

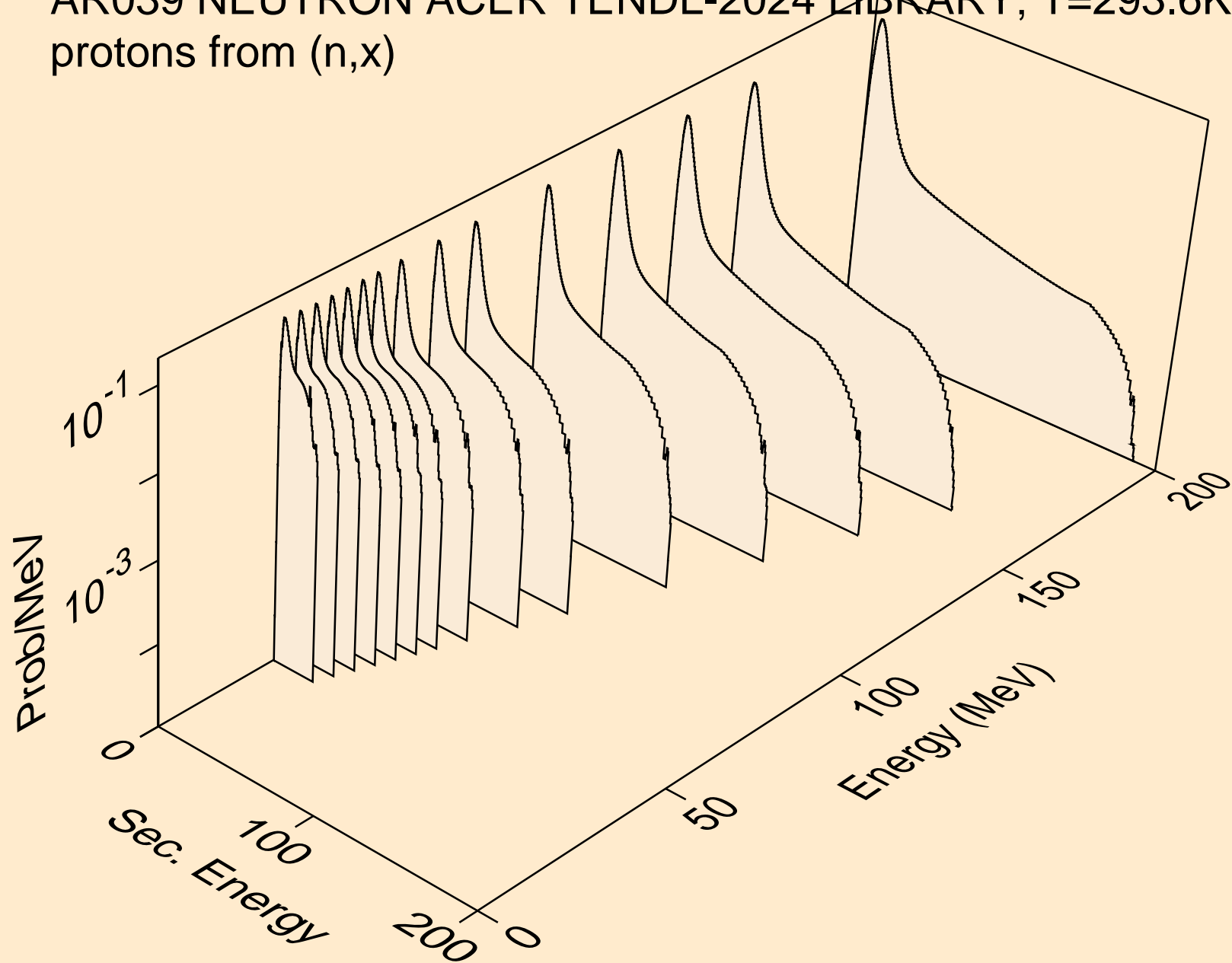

AR039 NEUTRON ACER TENDL-2024 LIBRARY; T=293.6K
protons from (n,n*)p

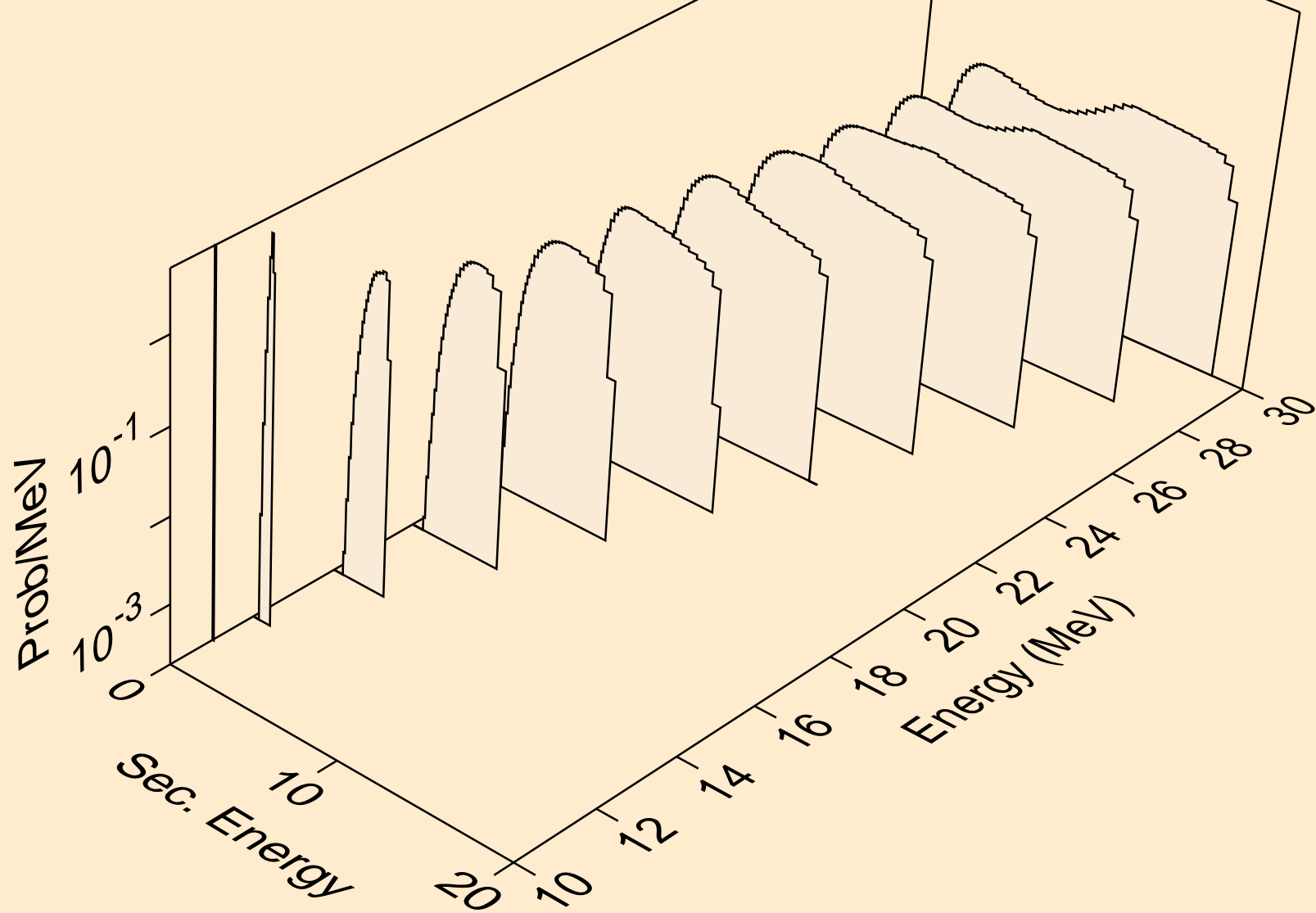

AR039 NEUTRON ACER TENDL-2024 LIBRARY; T=293.6K
protons from (n,2np)

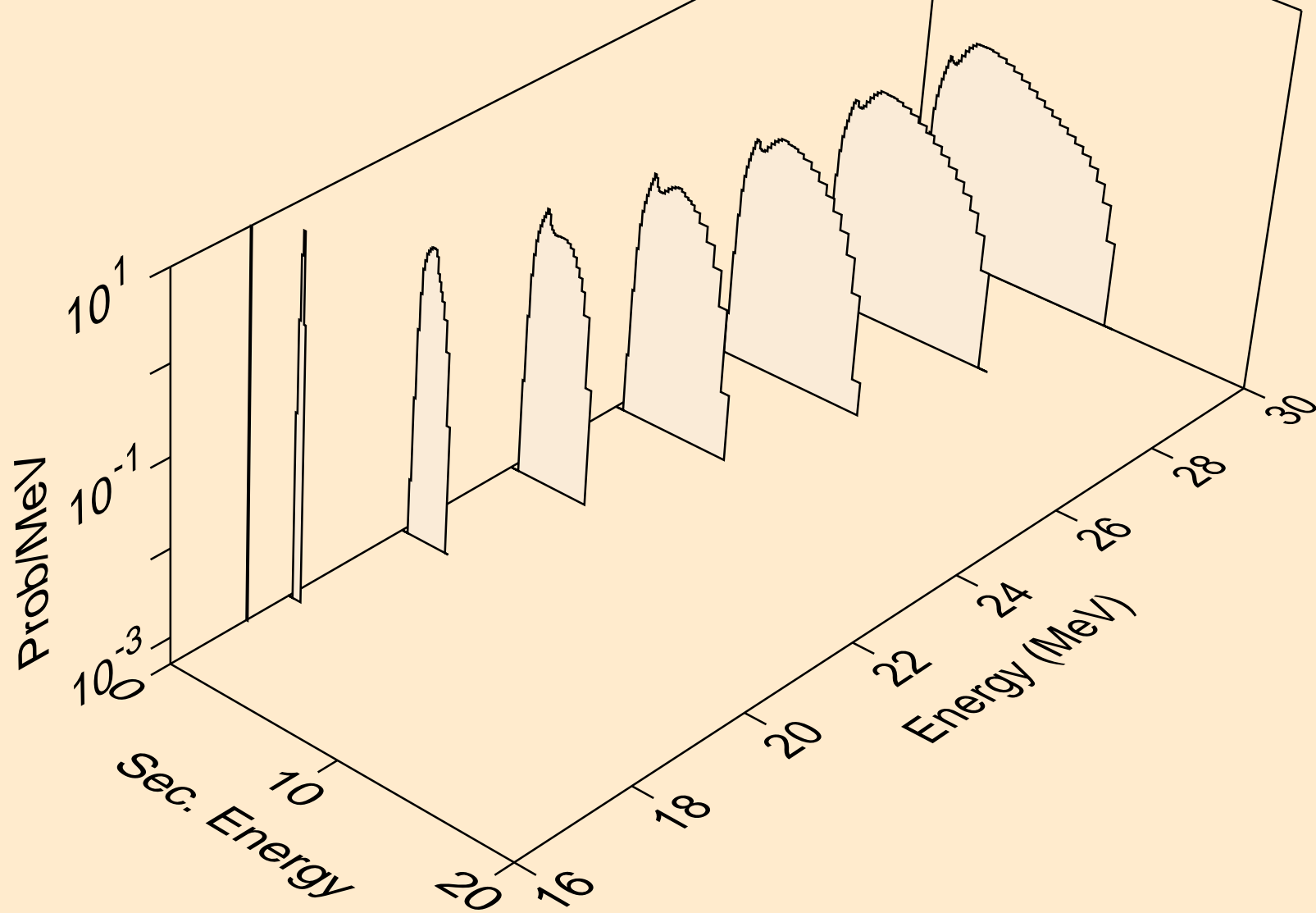

AR039 NEUTRON ACER TENDL-2024 LIBRARY; T=293.6K
protons from (n,3np)

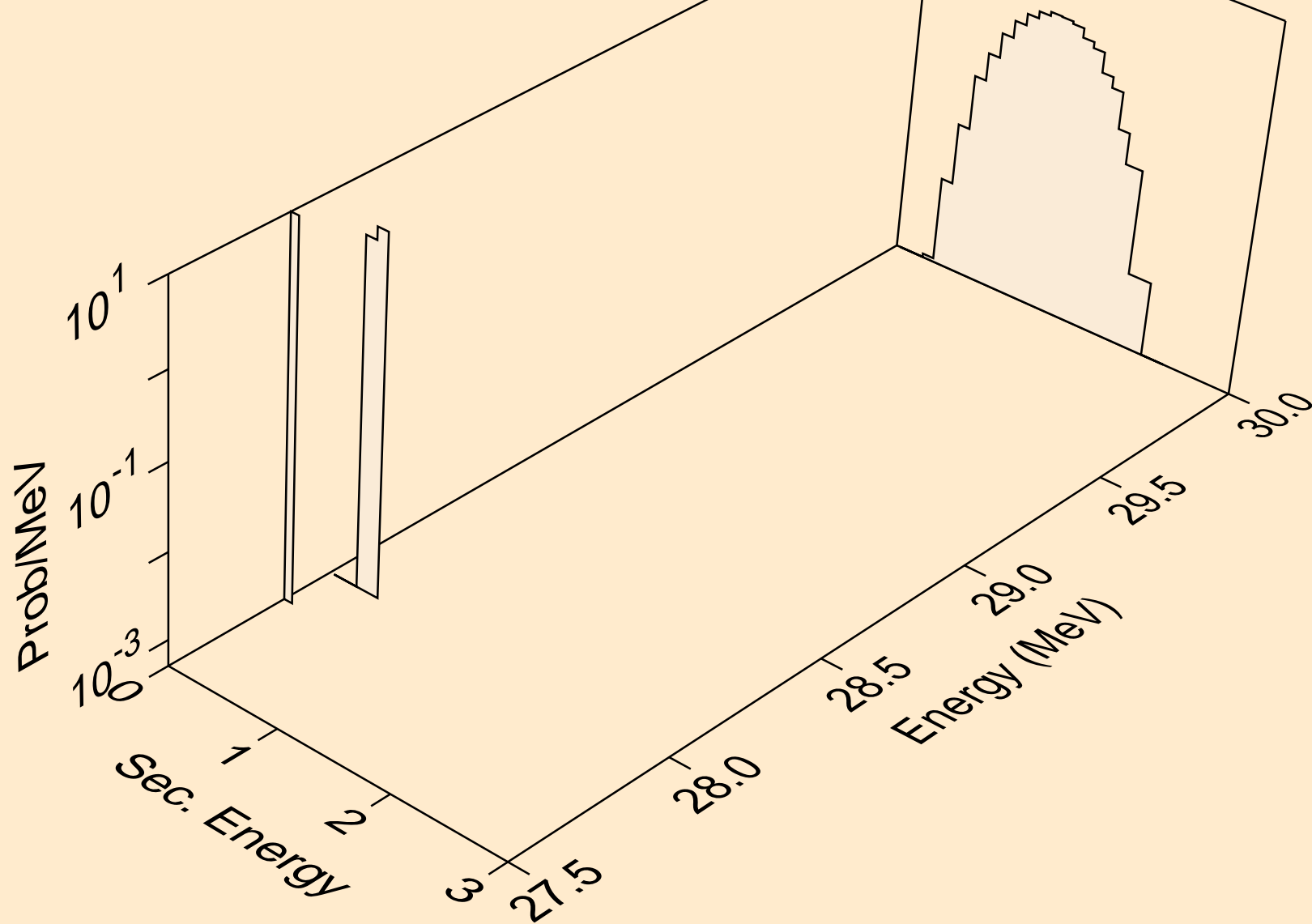

AR039 NEUTRON ACER TENDL-2024 LIBRARY; T=293.6K
protons from (n,n2p)

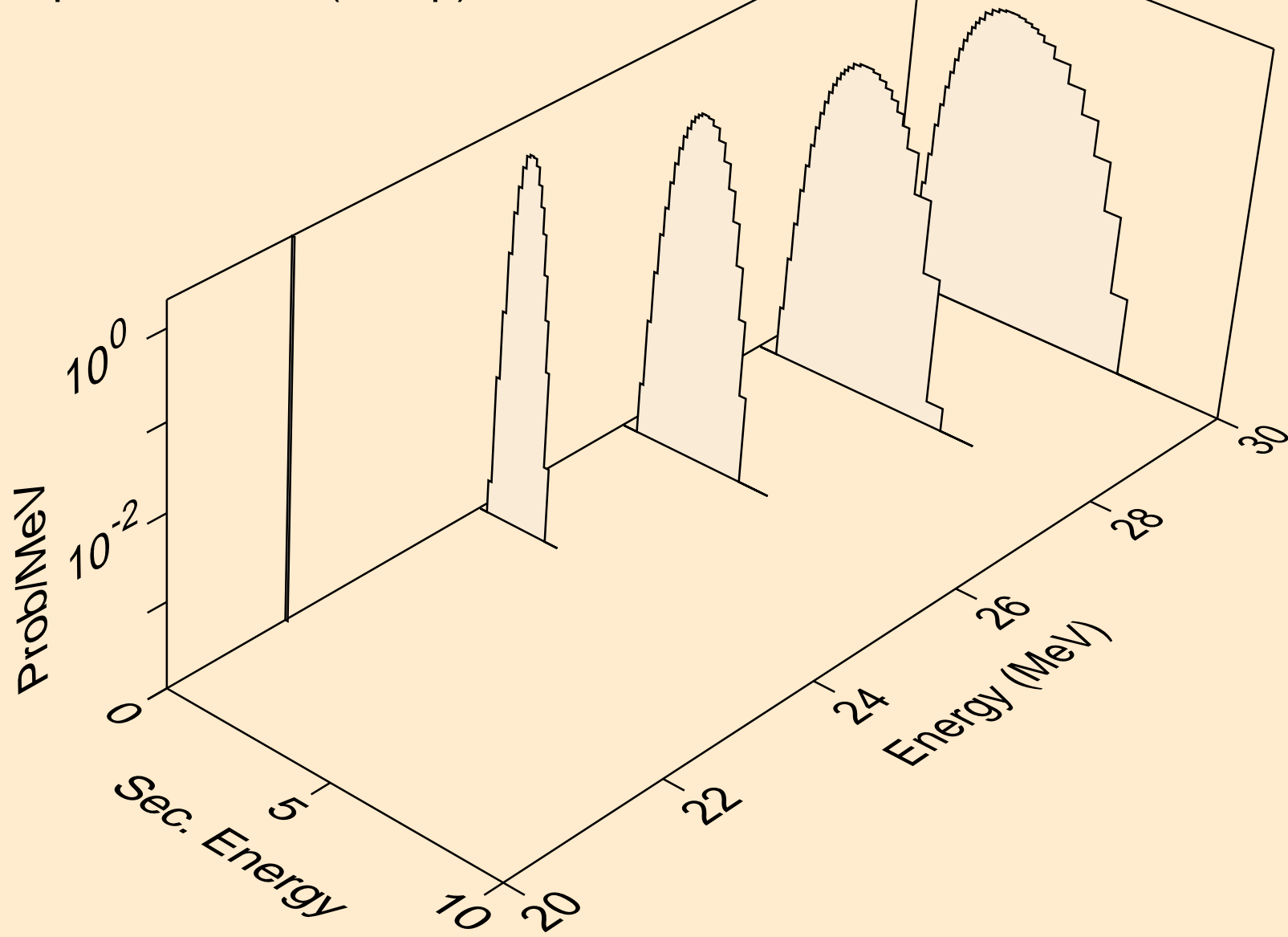

AR039 NEUTRON ACER TENDL-2024 LIBRARY; T=293.6K
protons from (n,npa)

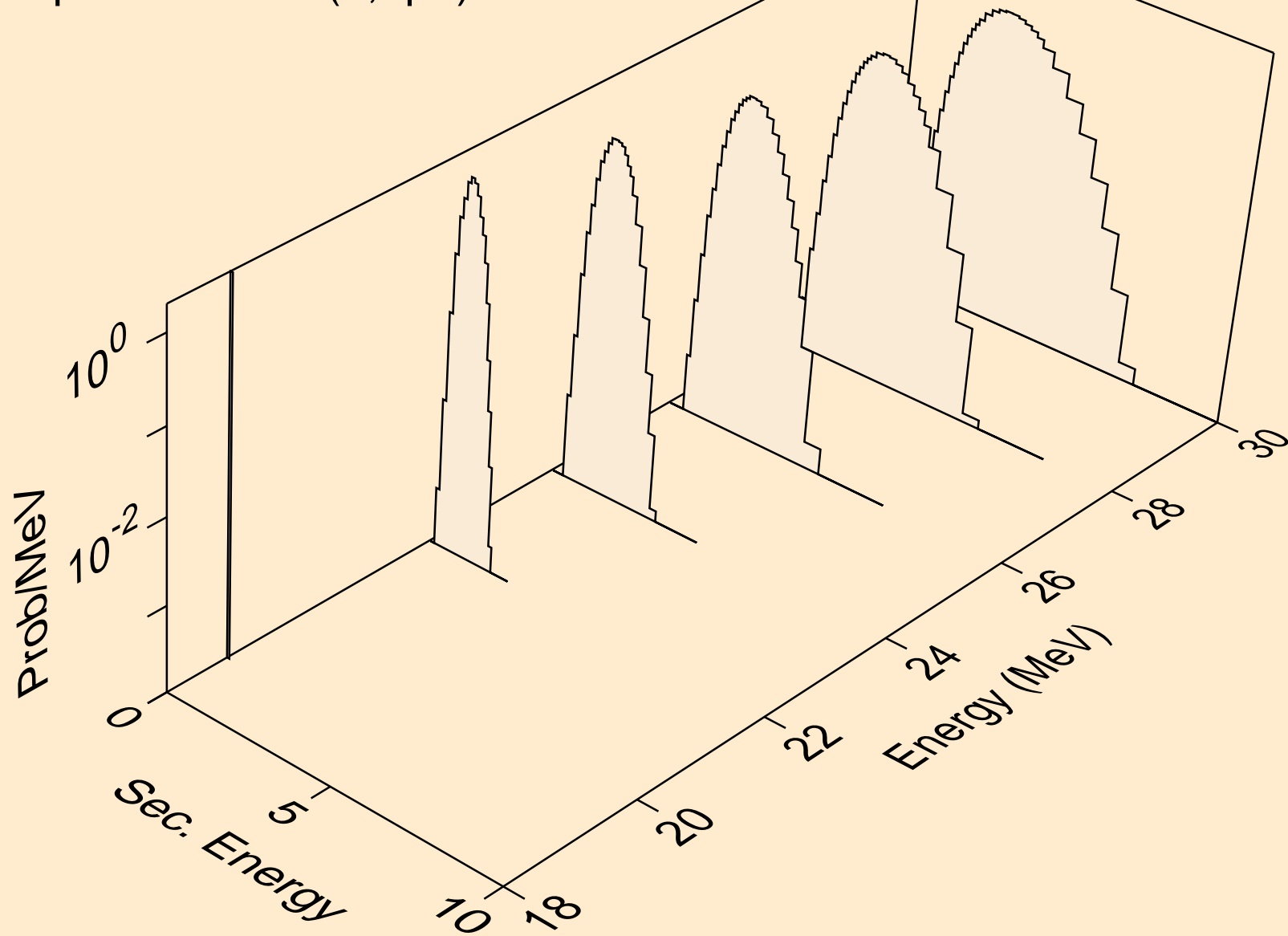

AR039 NEUTRON ACER TENDL-2024 LIBRARY; T=293.6K
protons from (n,p)

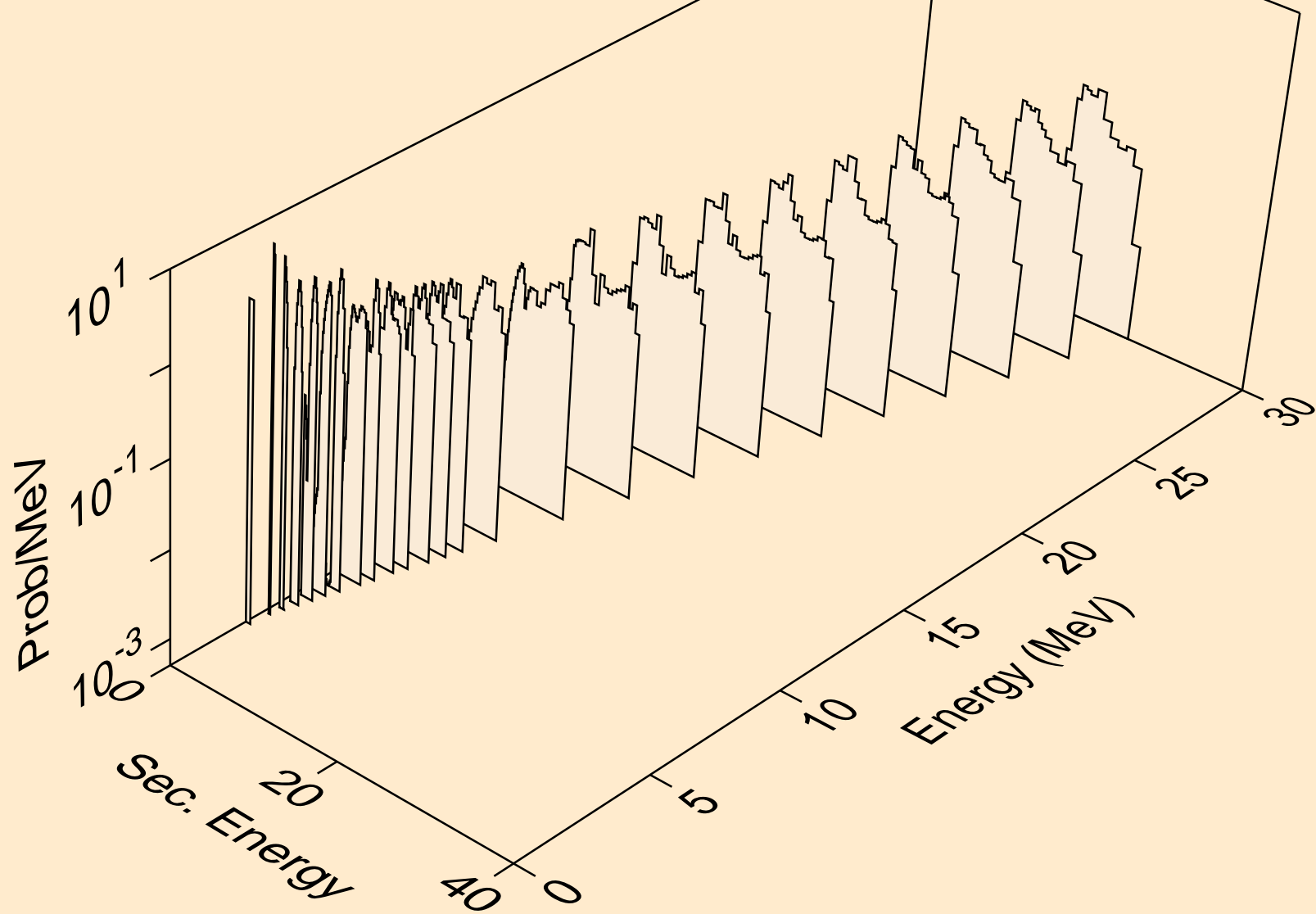

AR039 NEUTRON ACER TENDL-2024 LIBRARY; T=293.6K
protons from (n,2p)

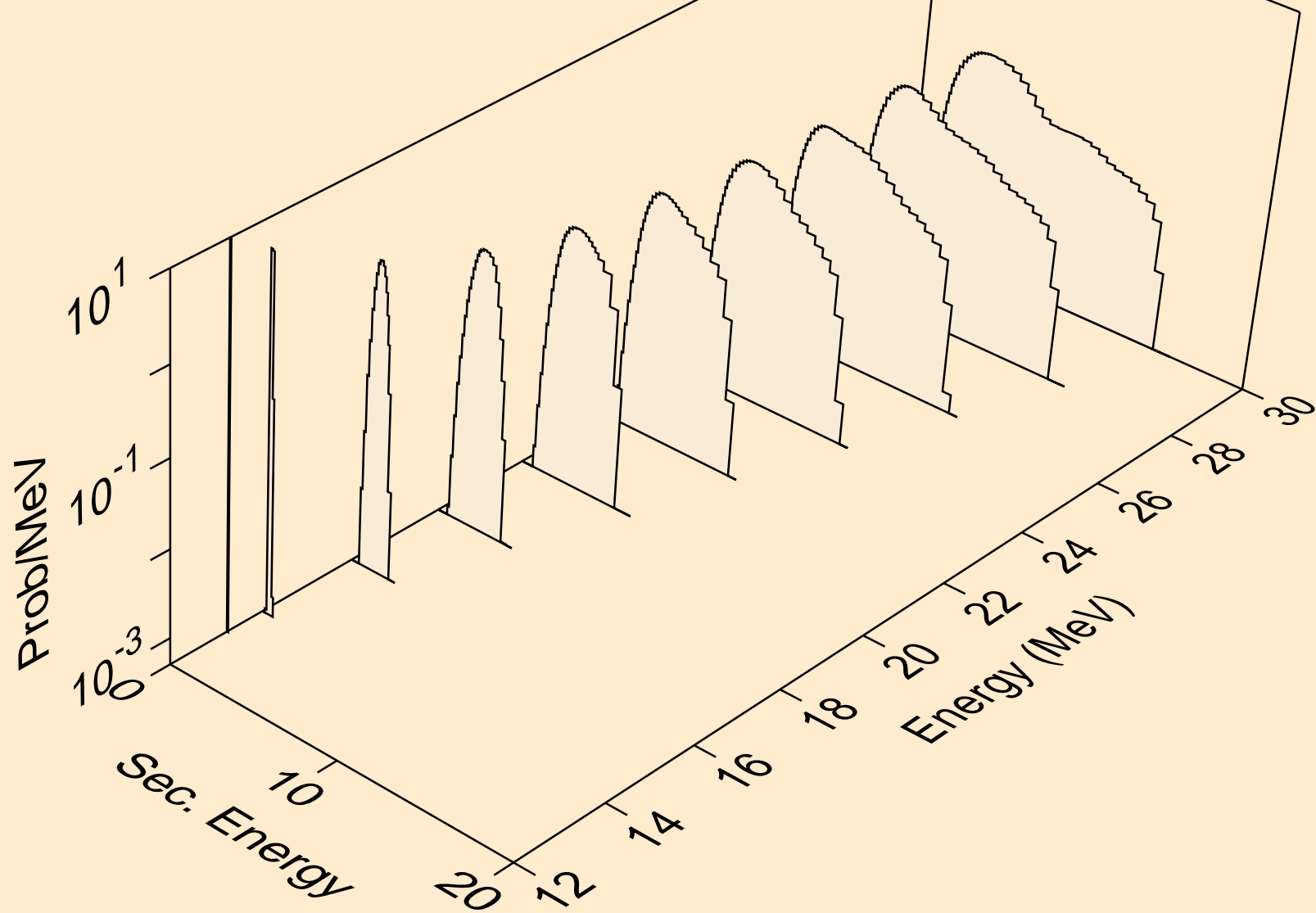

AR039 NEUTRON ACER TENDL-2024 LIBRARY; T=293.6K
protons from (n,p)

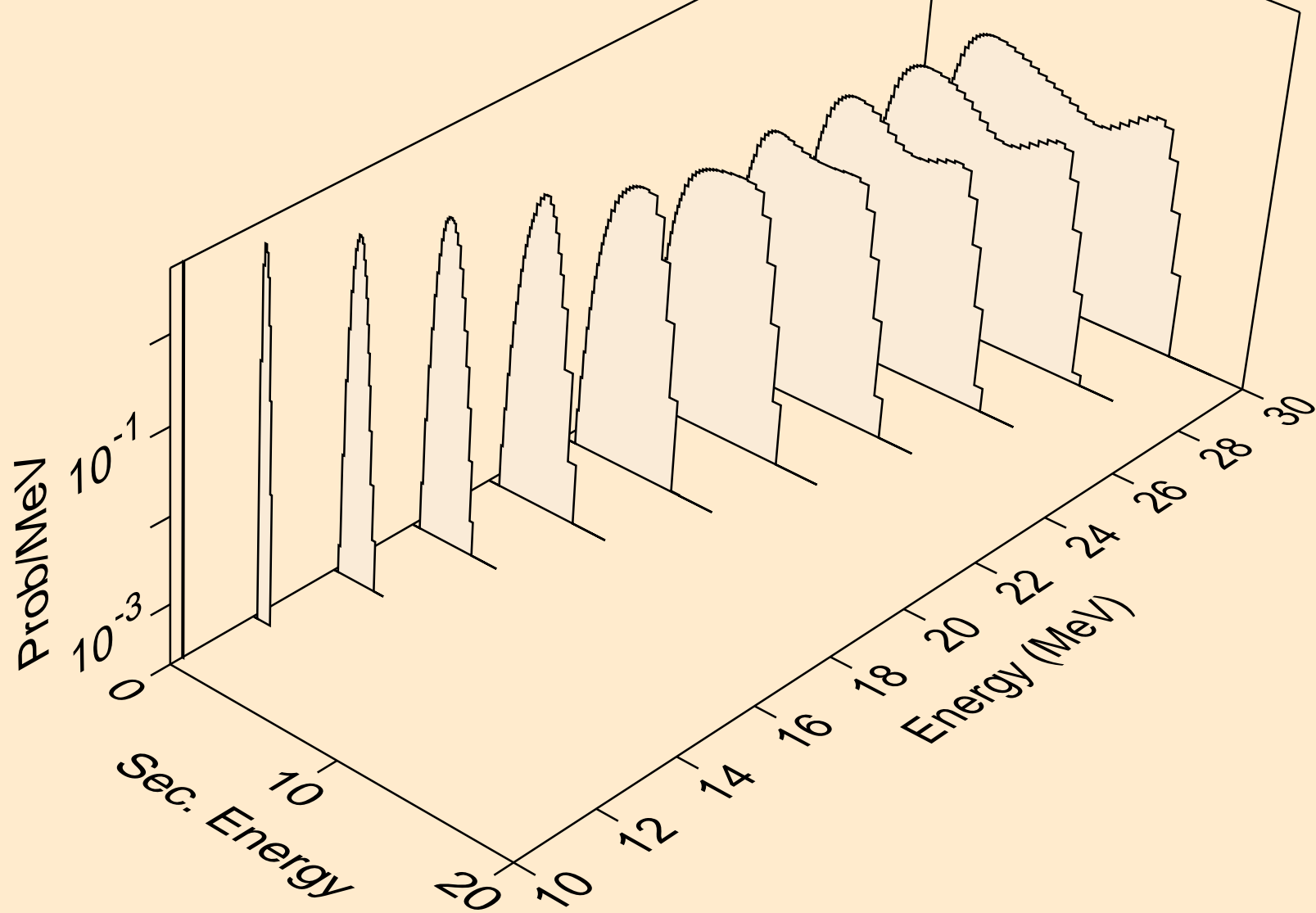

AR039 NEUTRON ACER TENDL-2024 LIBRARY; T=293.6K
protons from (n,pd)

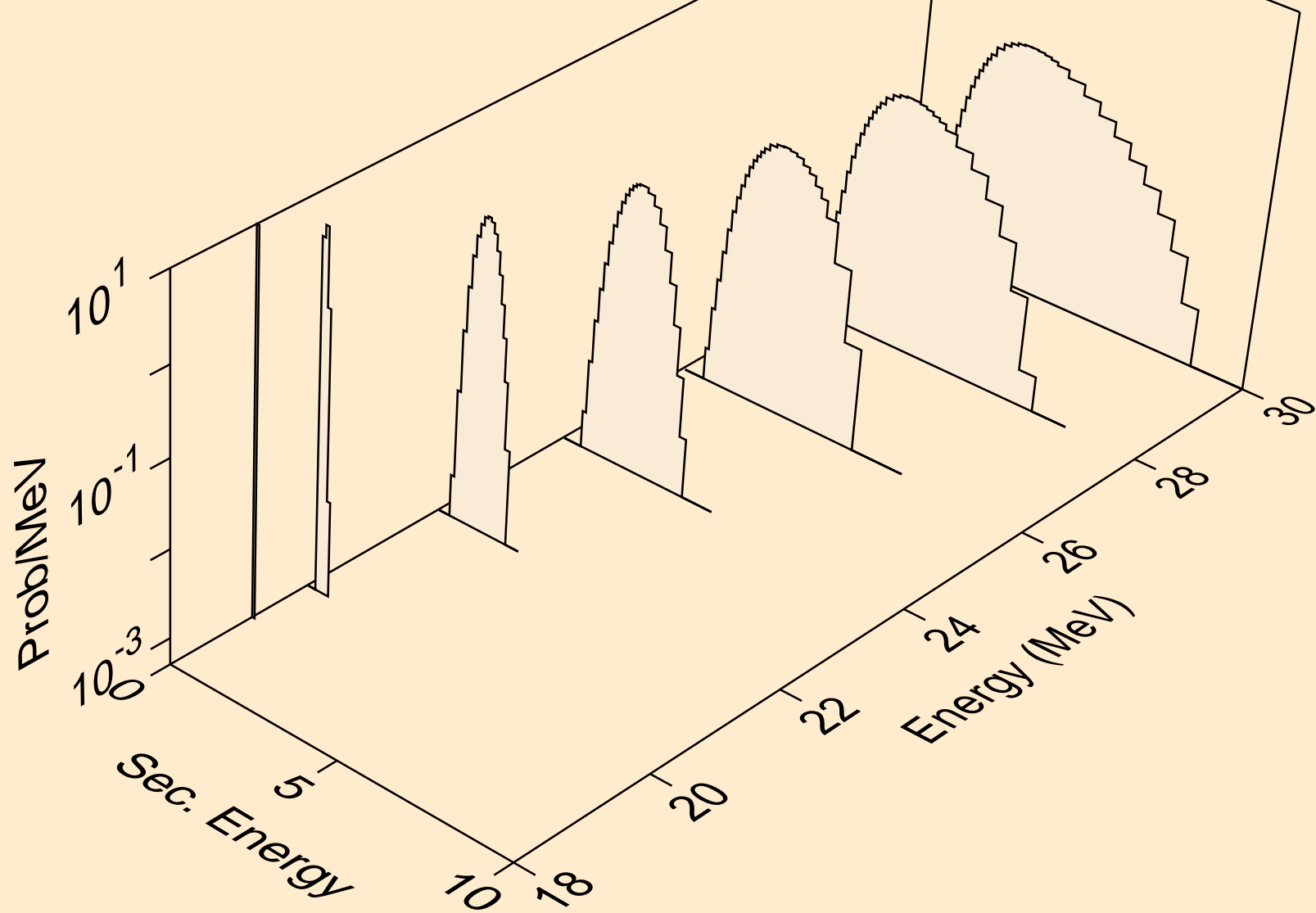

AR039 NEUTRON ACER TENDL-2024 LIBRARY; T=293.6K
protons from (n,pt)

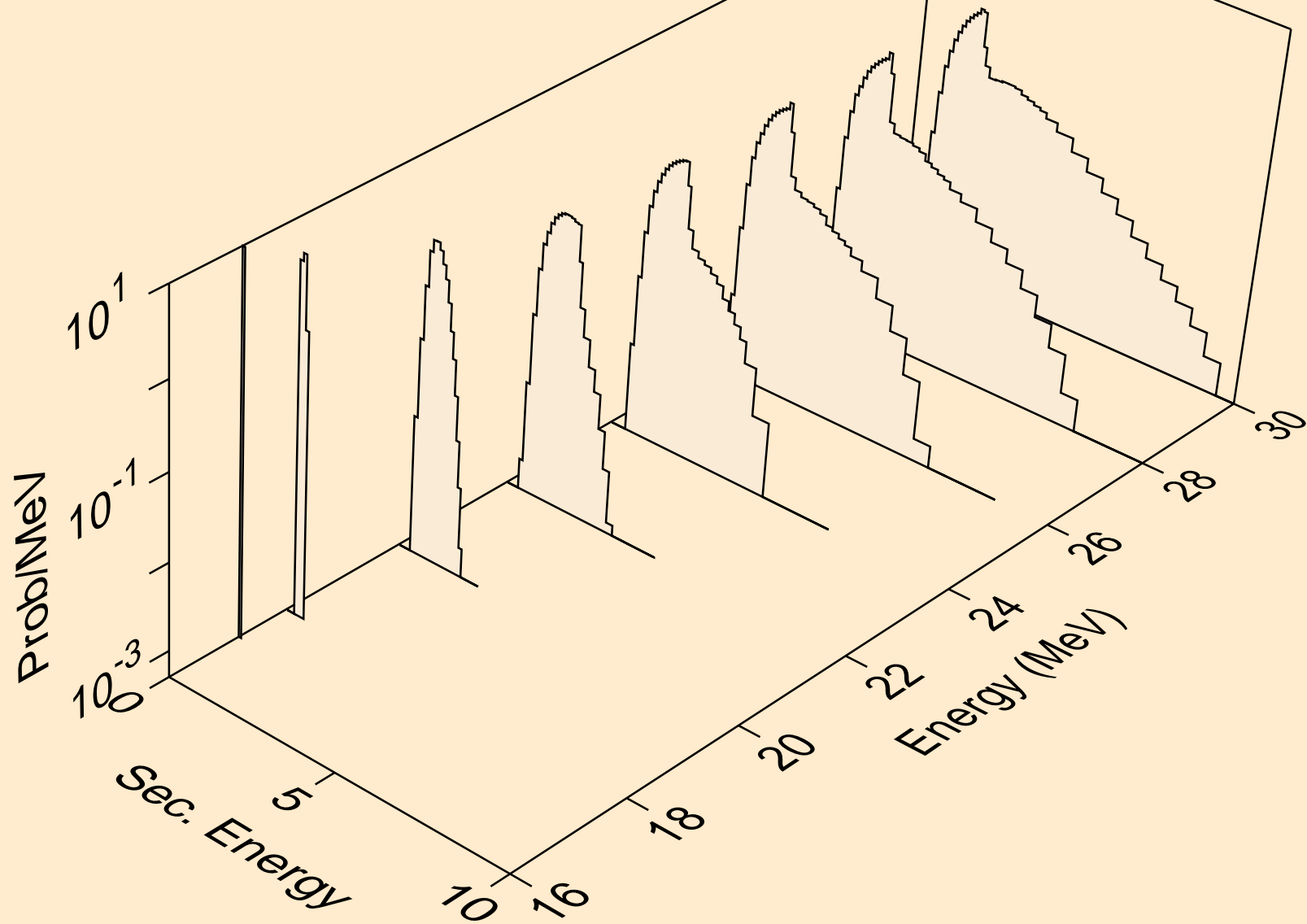

AR039 NEUTRON ACER TENDL-2024 LIBRARY; T=293.6K
deuterons from (n,x)

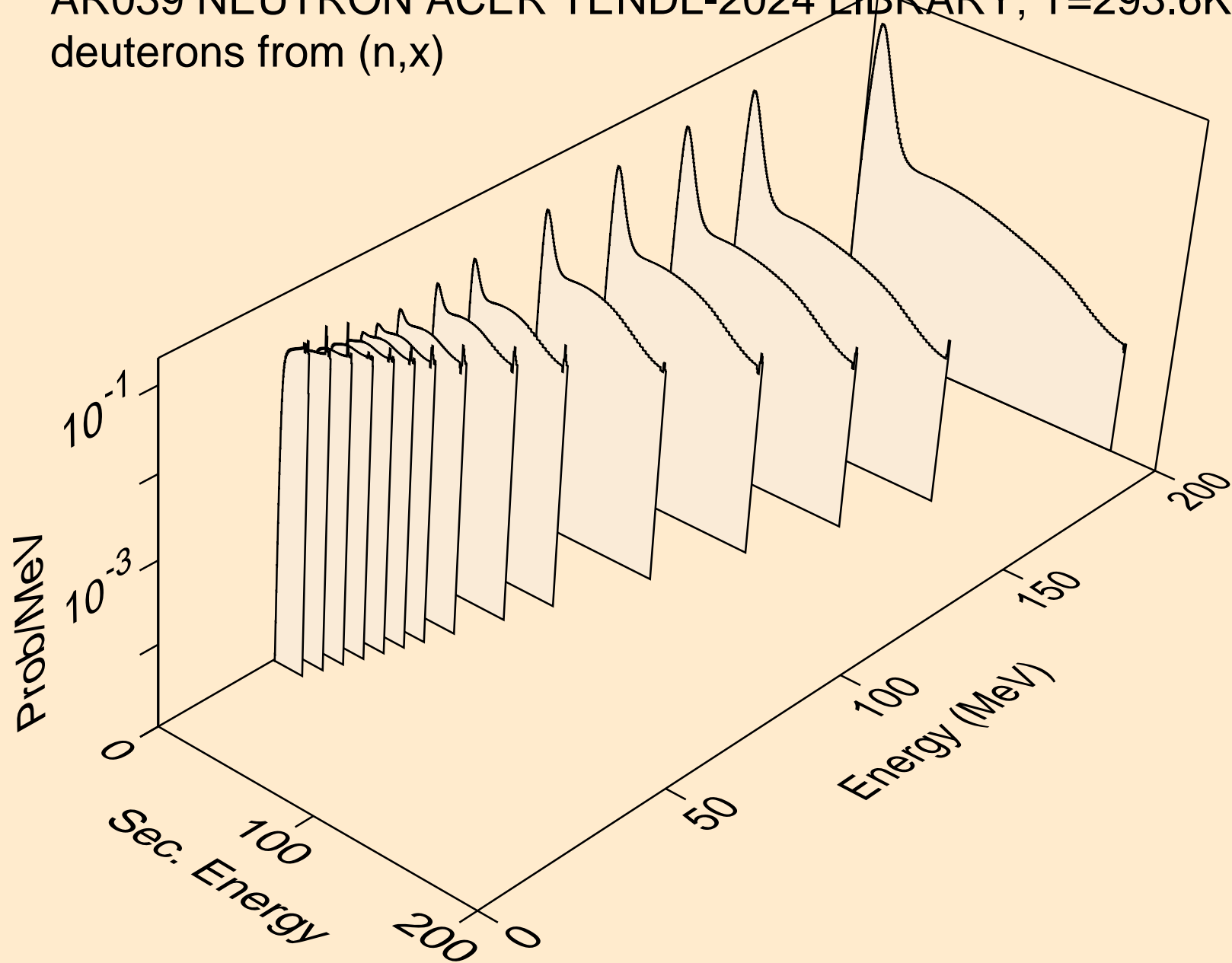

AR039 NEUTRON ACER TENDL-2024 LIBRARY; T=293.6K
deuterons from (n,2nd)

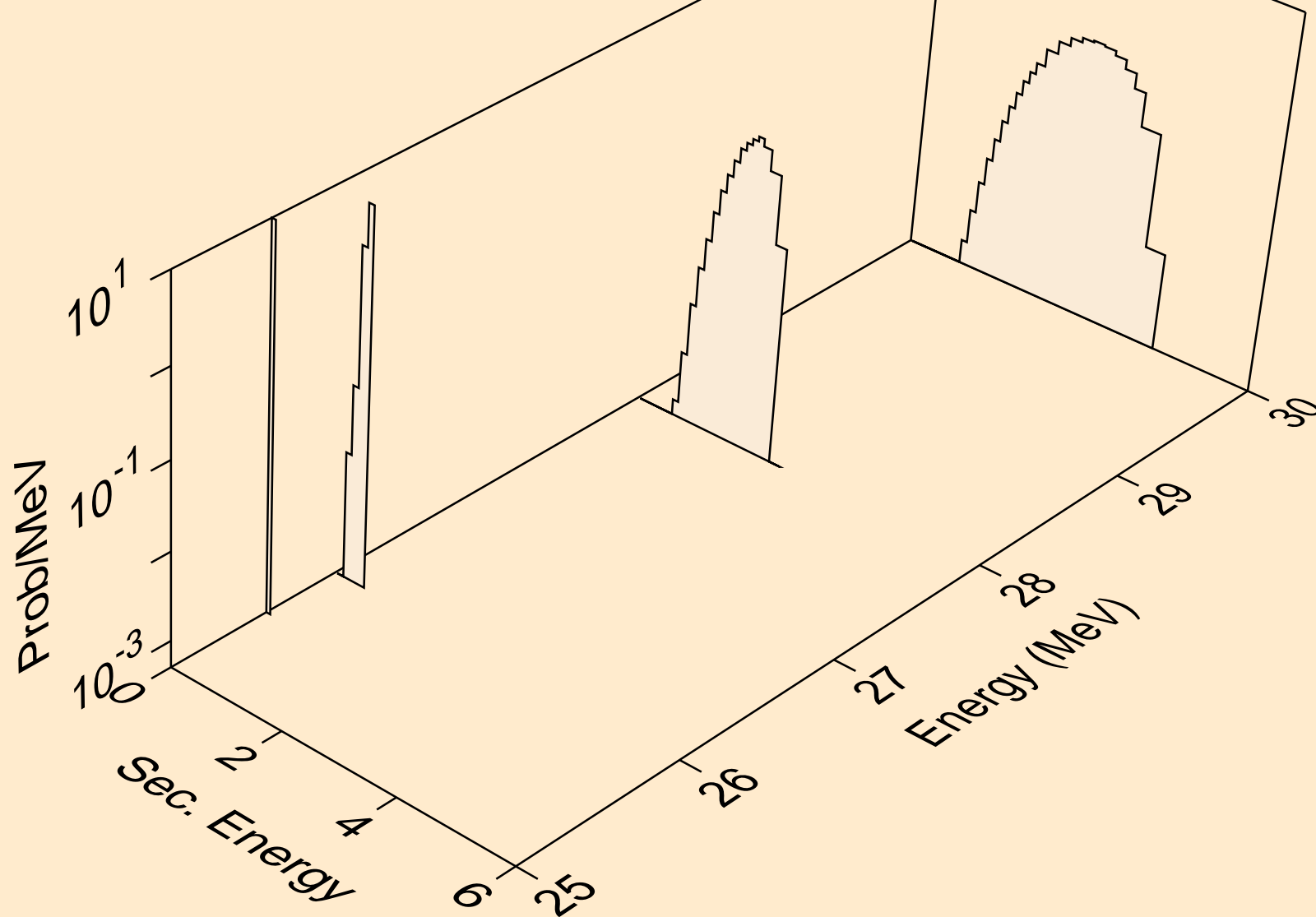

AR039 NEUTRON ACER TENDL-2024 LIBRARY; T=293.6K
deuterons from (n,n*)d

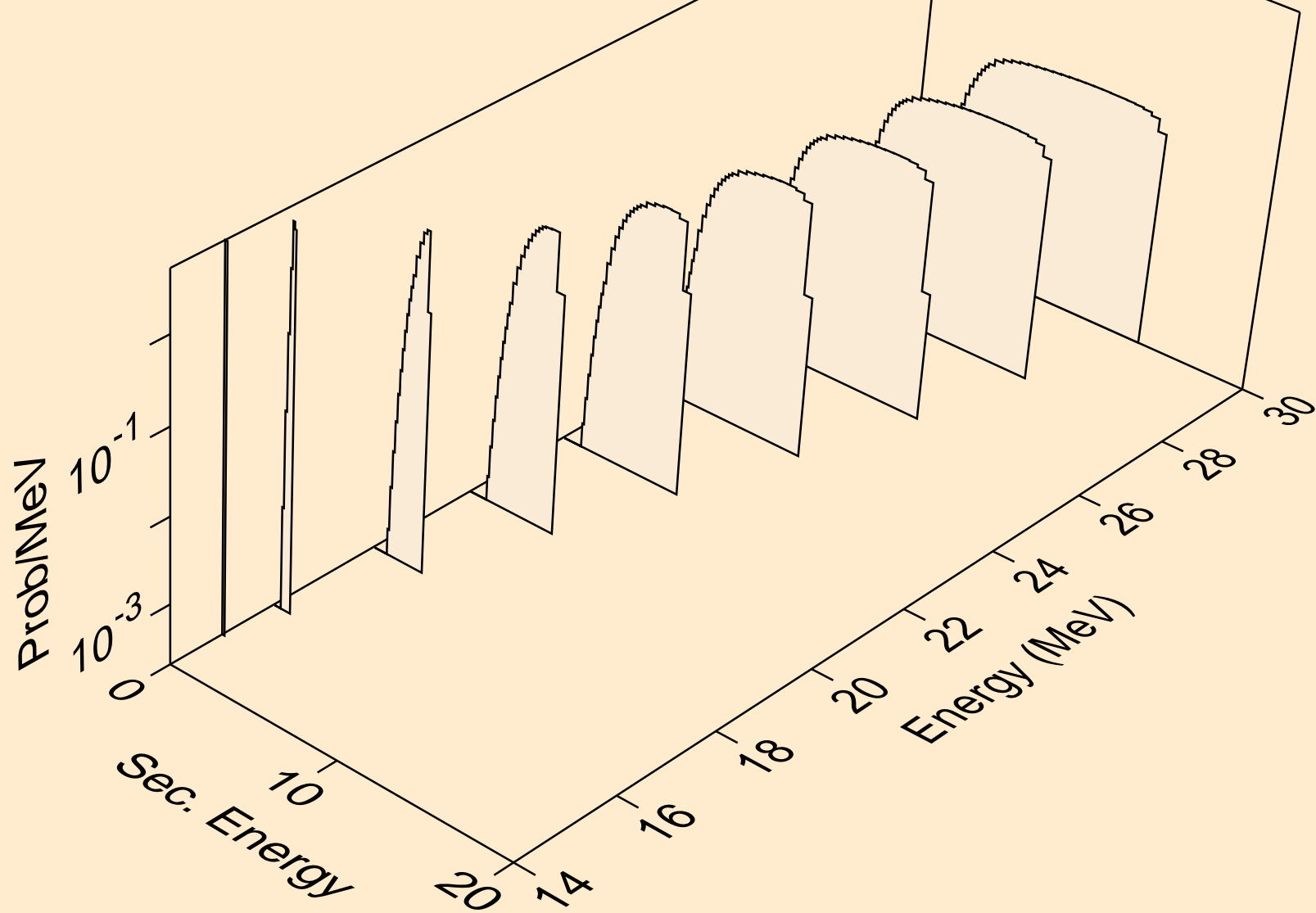

AR039 NEUTRON ACER TENDL-2024 LIBRARY; T=293.6K
deuterons from (n,d)

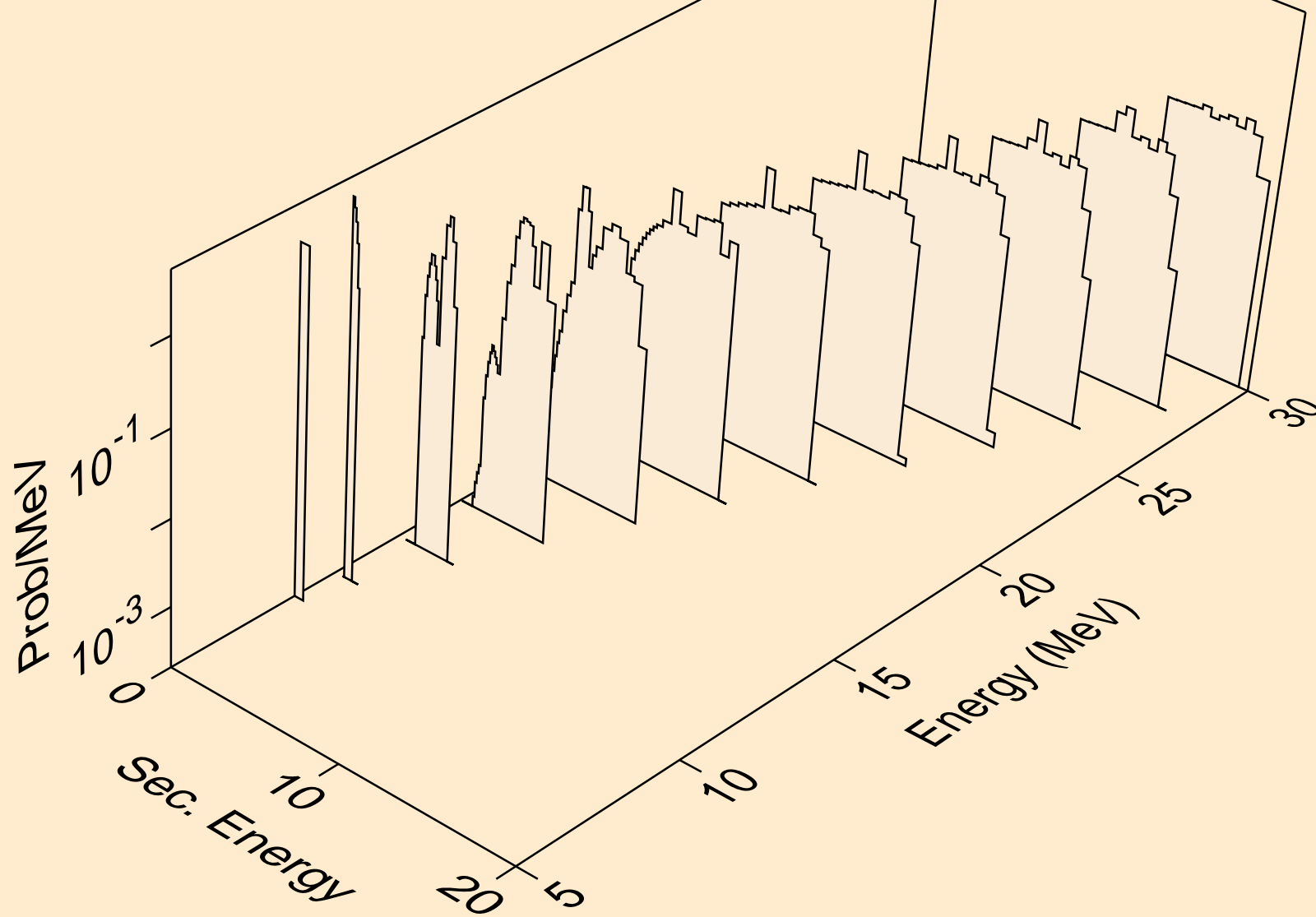

AR039 NEUTRON ACER TENDL-2024 LIBRARY; T=293.6K
deuterons from (n,pd)

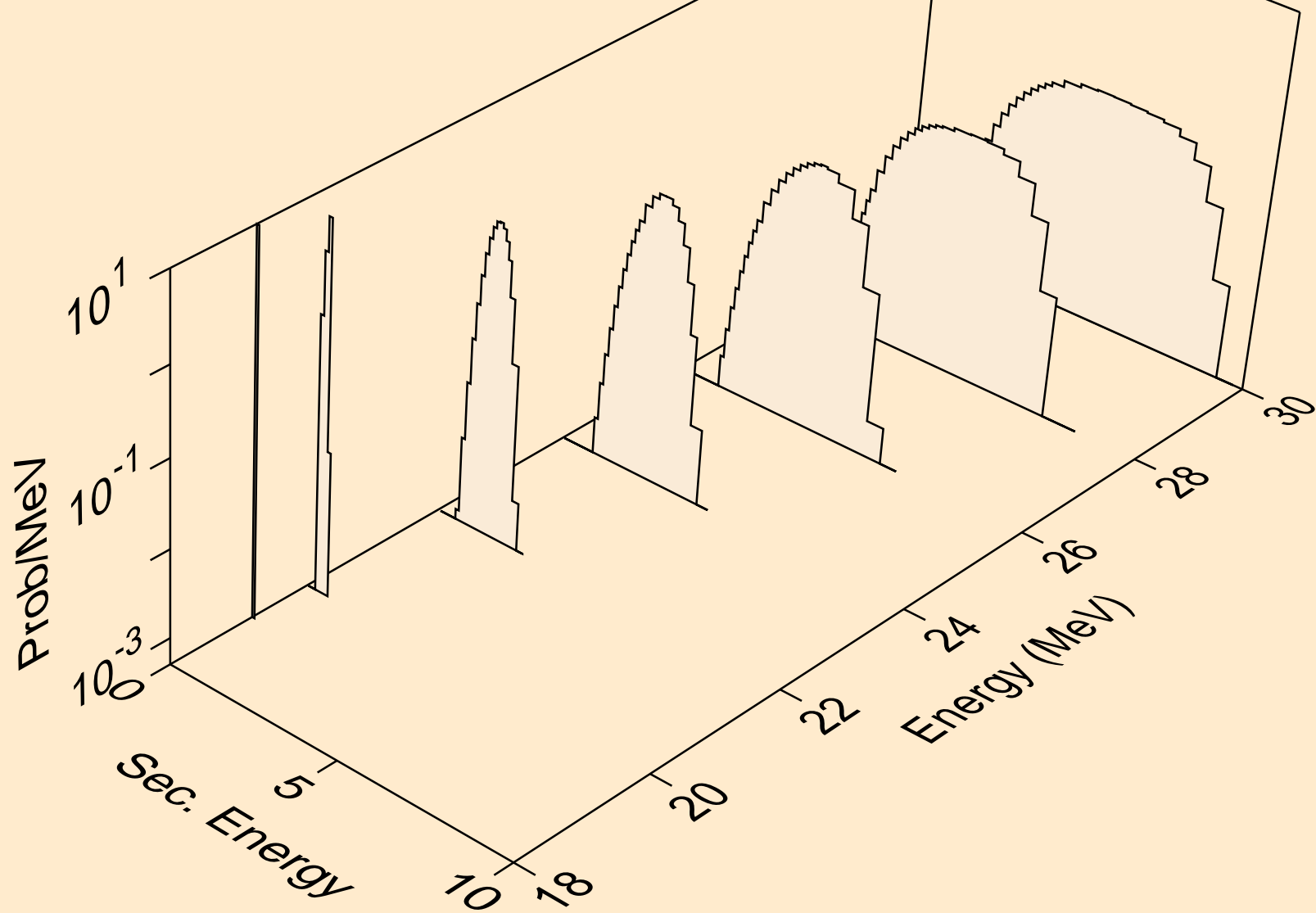

AR039 NEUTRON ACER TENDL-2024 LIBRARY; T=293.6K
deuterons from (n,da)

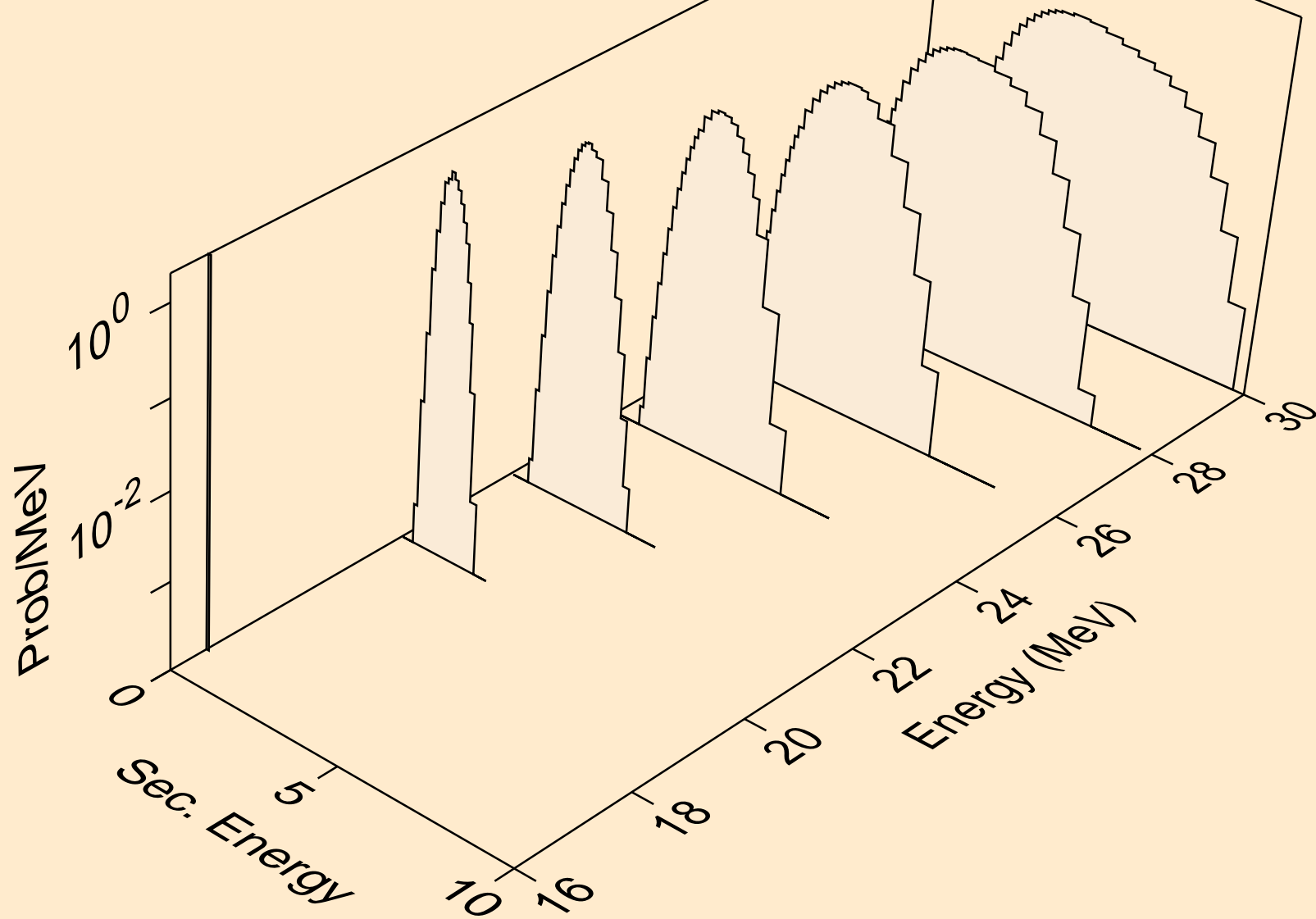

AR039 NEUTRON ACER TENDL-2024 LIBRARY; T=293.6K
tritons from (n,x)

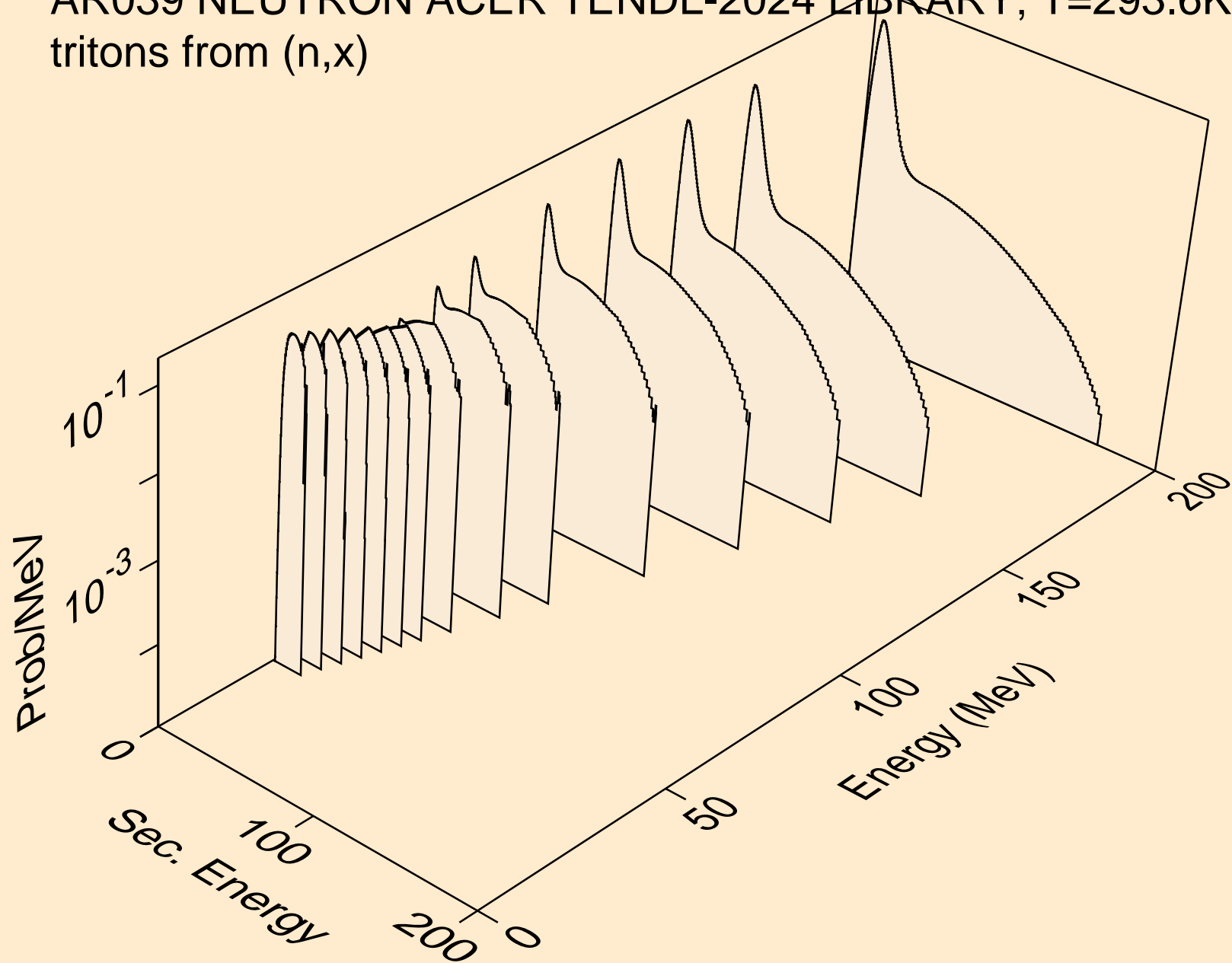

AR039 NEUTRON ACER TENDL-2024 LIBRARY; T=293.6K
tritons from (n,n*)t

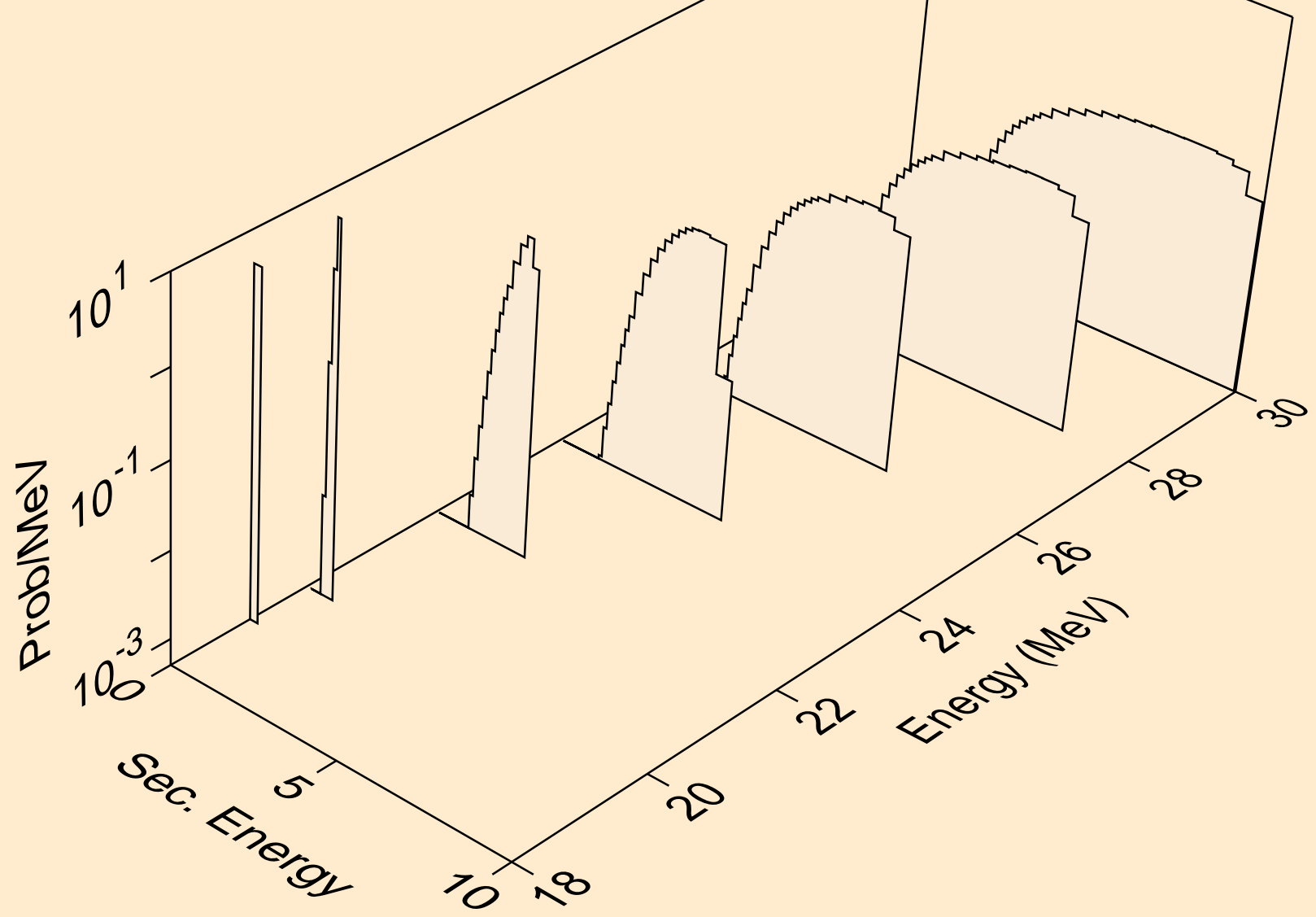

AR039 NEUTRON ACER TENDL-2024 LIBRARY; T=293.6K
tritons from (n,t)

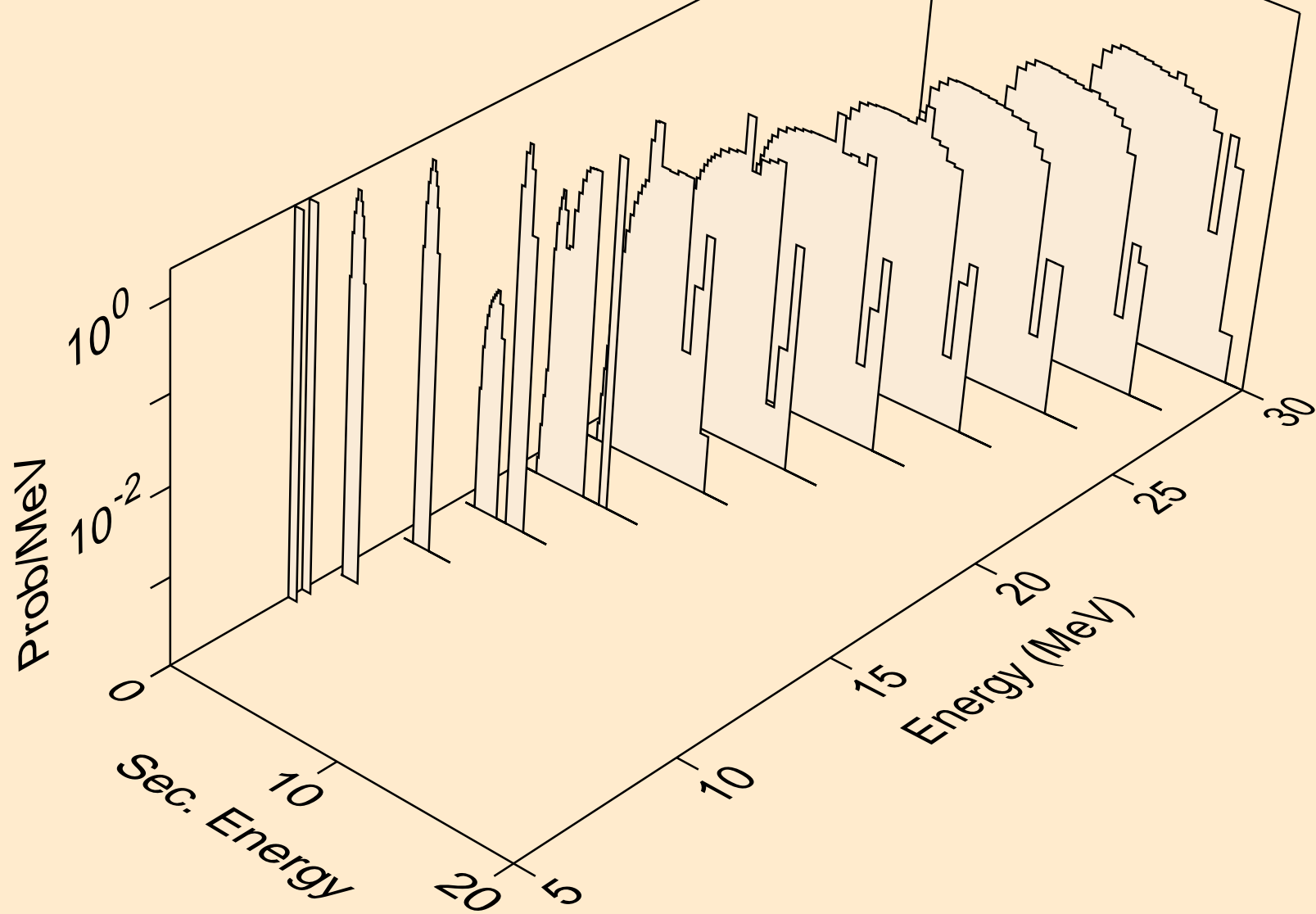

AR039 NEUTRON ACER TENDL-2024 LIBRARY; T=293.6K
tritons from (n,pt)

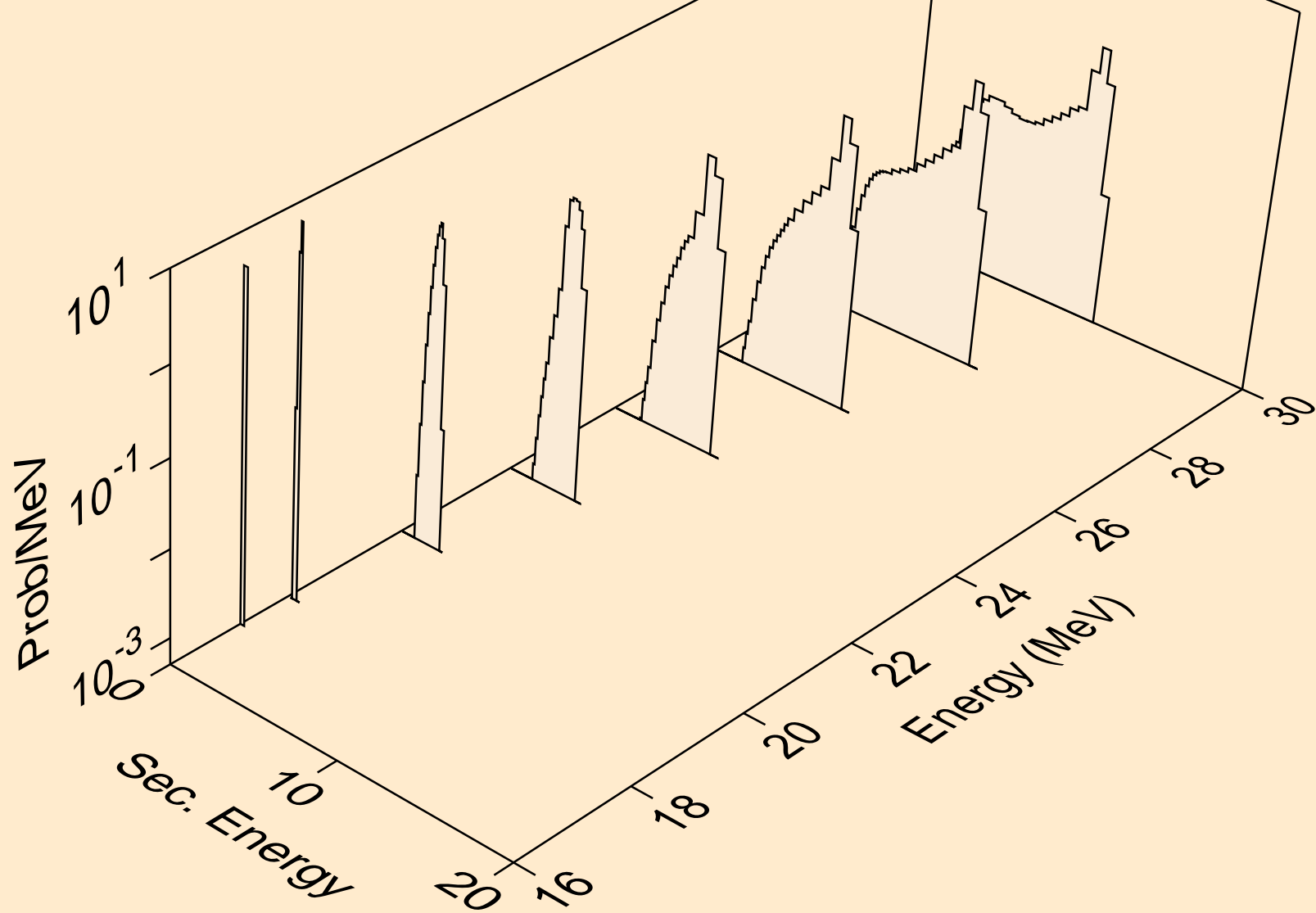

AR039 NEUTRON ACER TENDL-2024 LIBRARY; T=293.6K
he3s from (n,x)

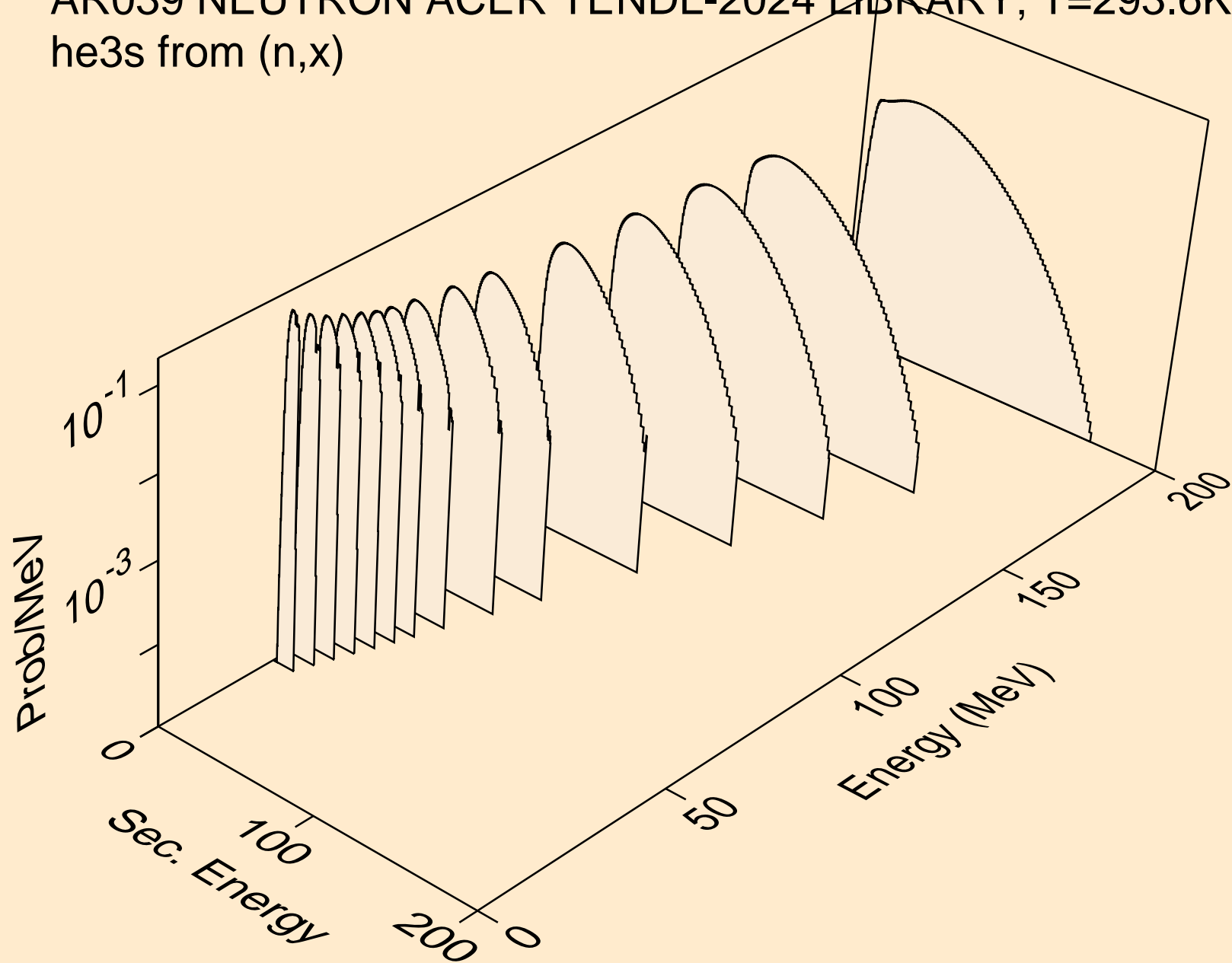

AR039 NEUTRON ACER TENDL-2024 LIBRARY; T=293.6K
he3s from (n,n*)he3

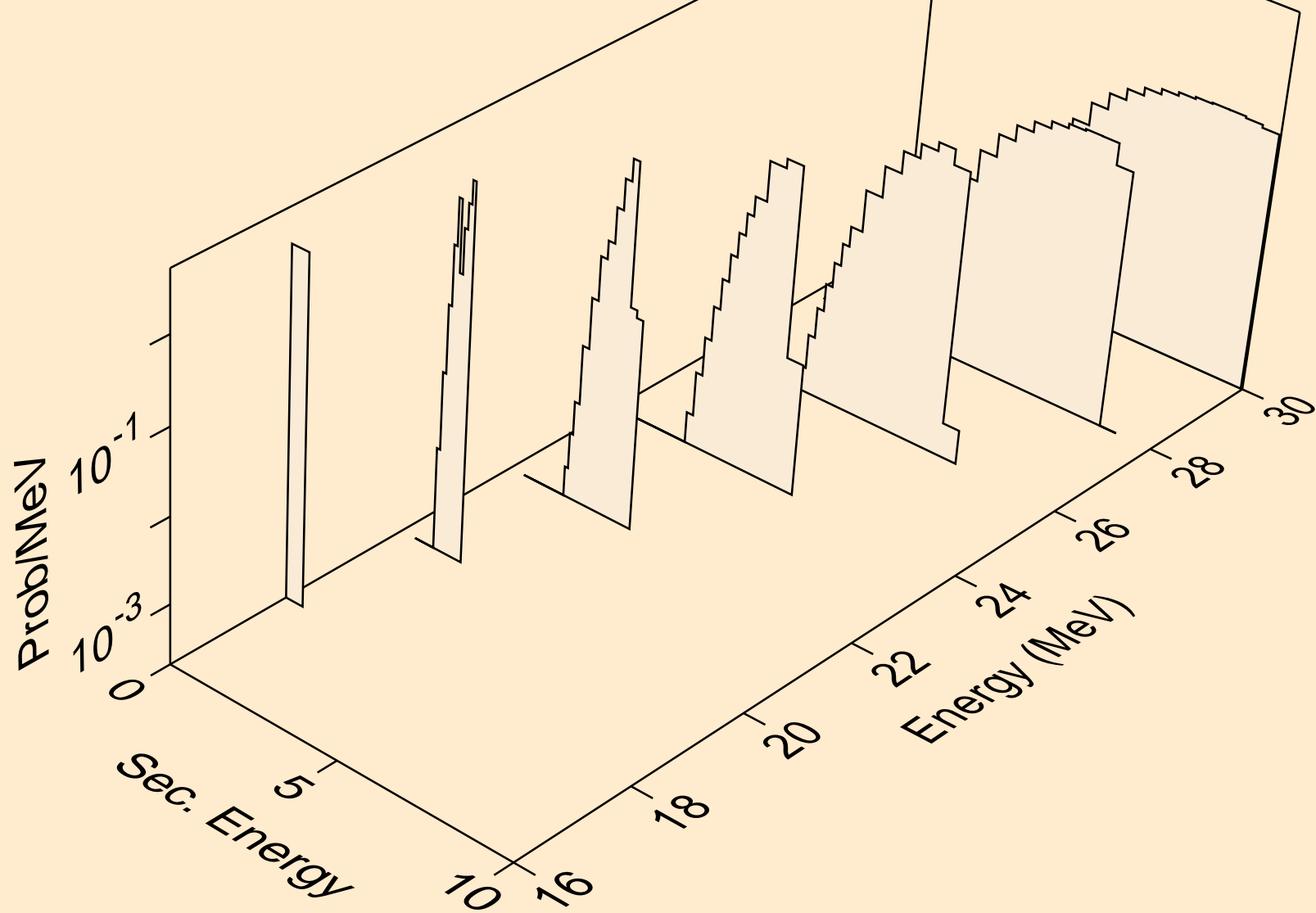

AR039 NEUTRON ACER TENDL-2024 LIBRARY; T=293.6K
he3s from (n,he3)

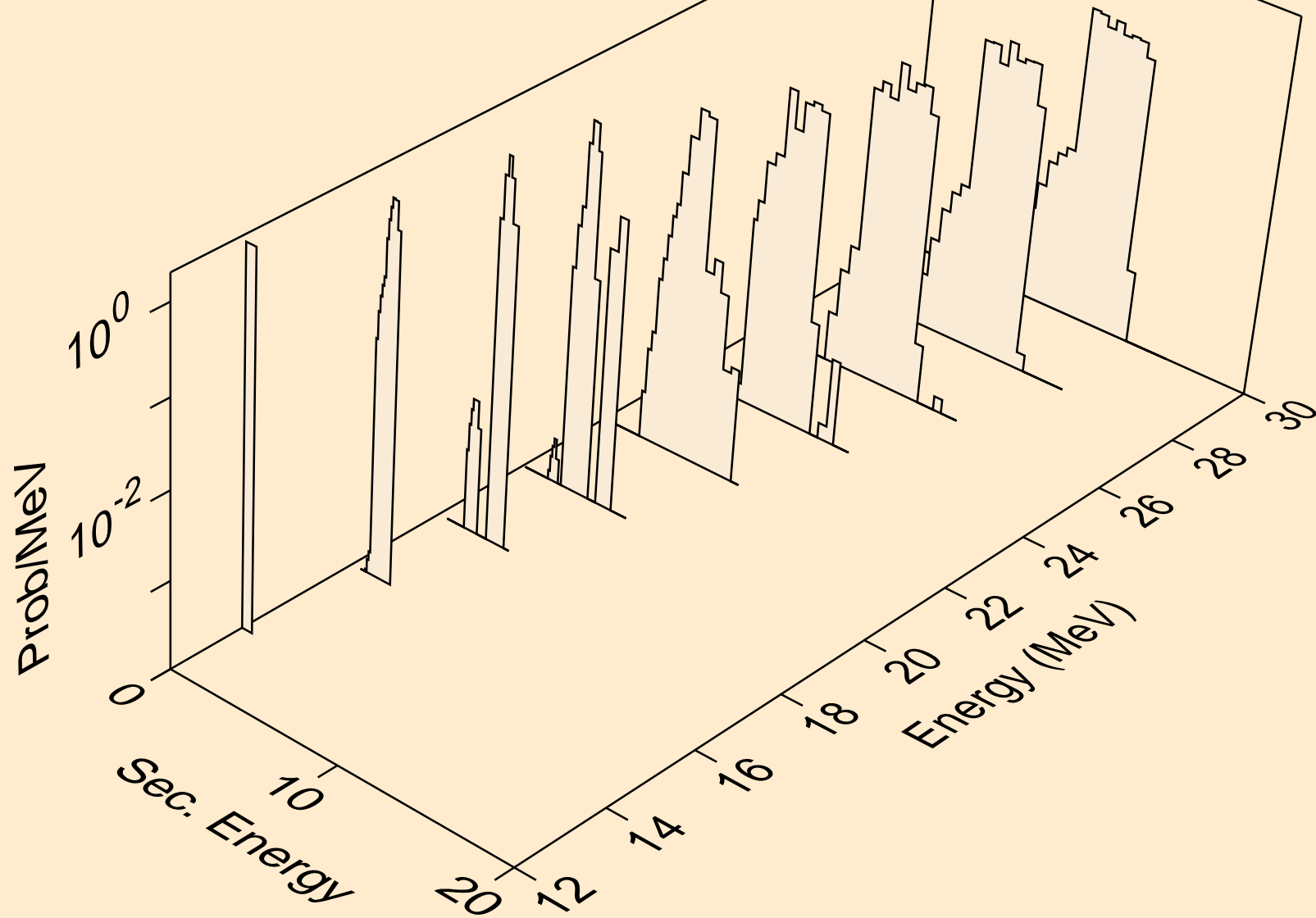

AR039 NEUTRON ACER TENDL-2024 LIBRARY; T=293.6K
alphas from (n,x)

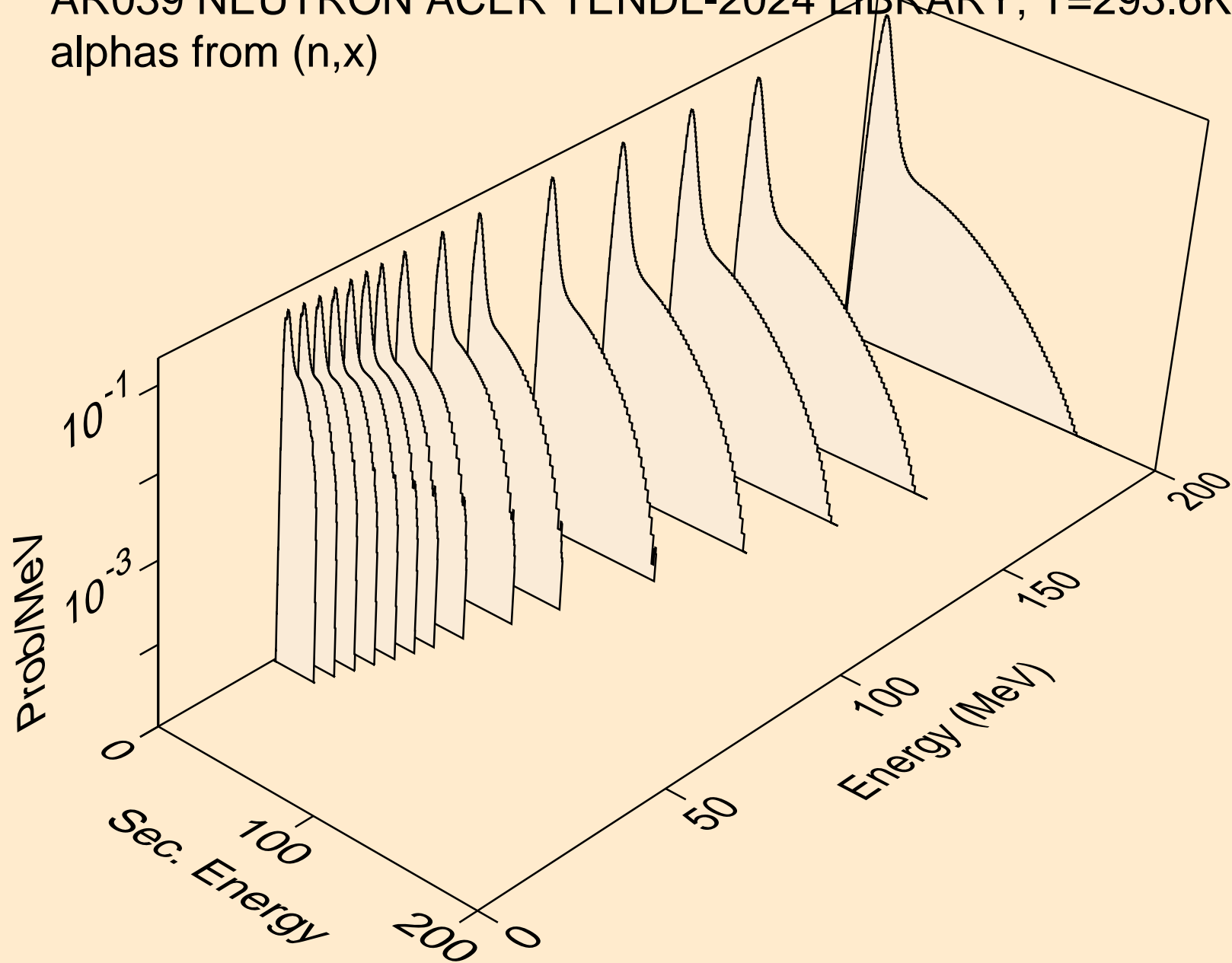

AR039 NEUTRON ACER TENDL-2024 LIBRARY; T=293.6K
alphas from (n,n*)a

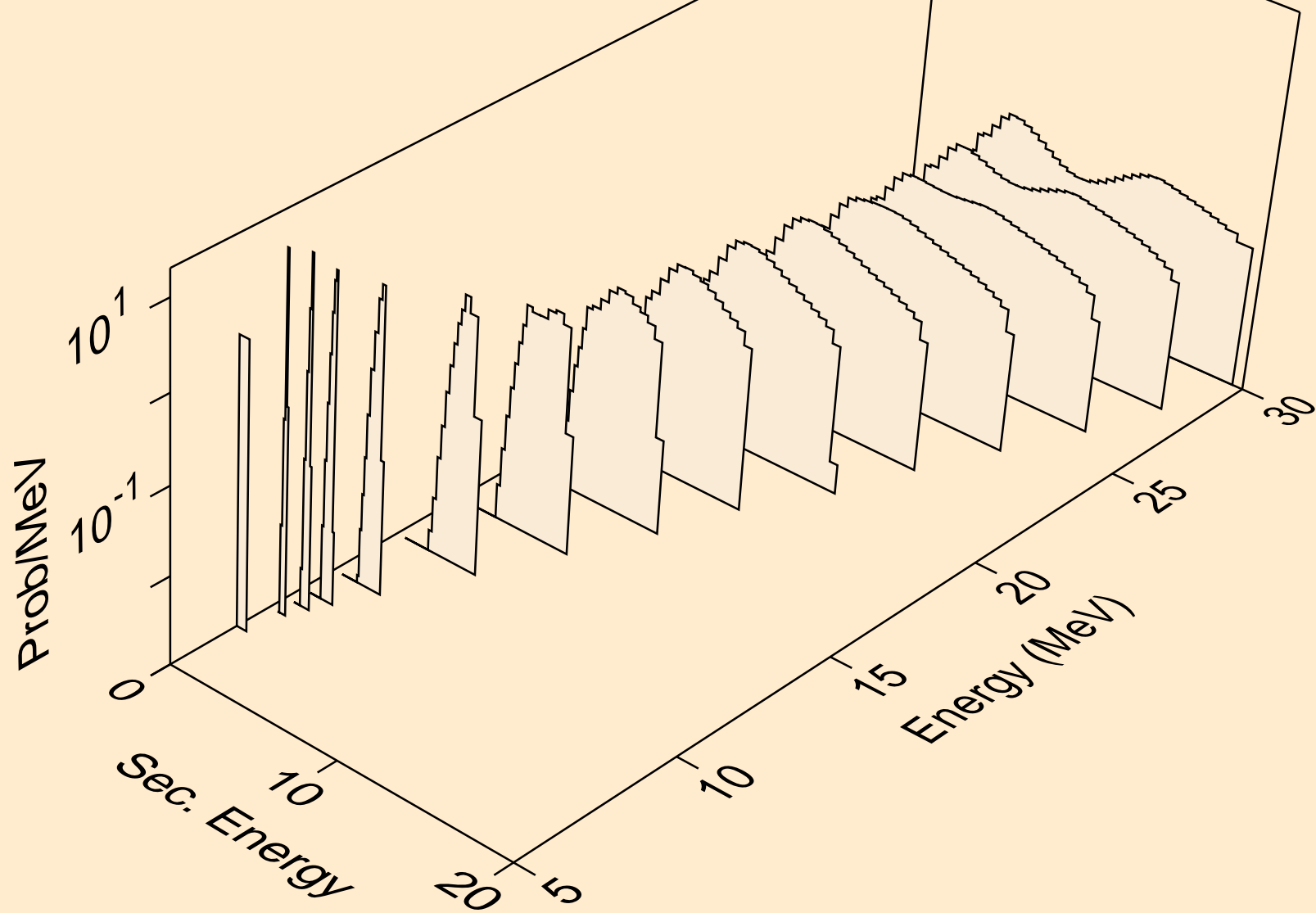

AR039 NEUTRON ACER TENDL-2024 LIBRARY; T=293.6K
alphas from (n,2n)a

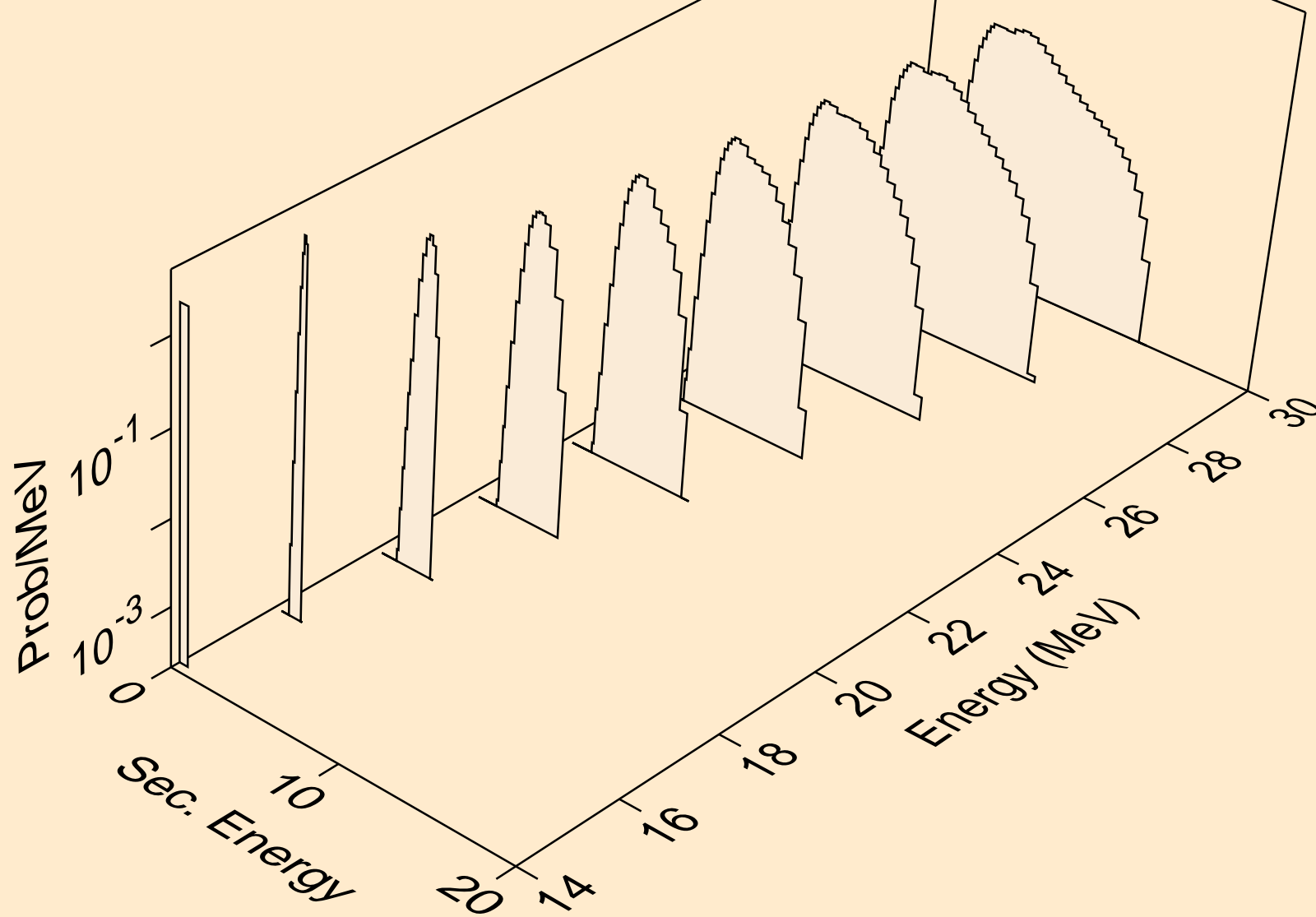

AR039 NEUTRON ACER TENDL-2024 LIBRARY; T=293.6K
alphas from (n,3n)a

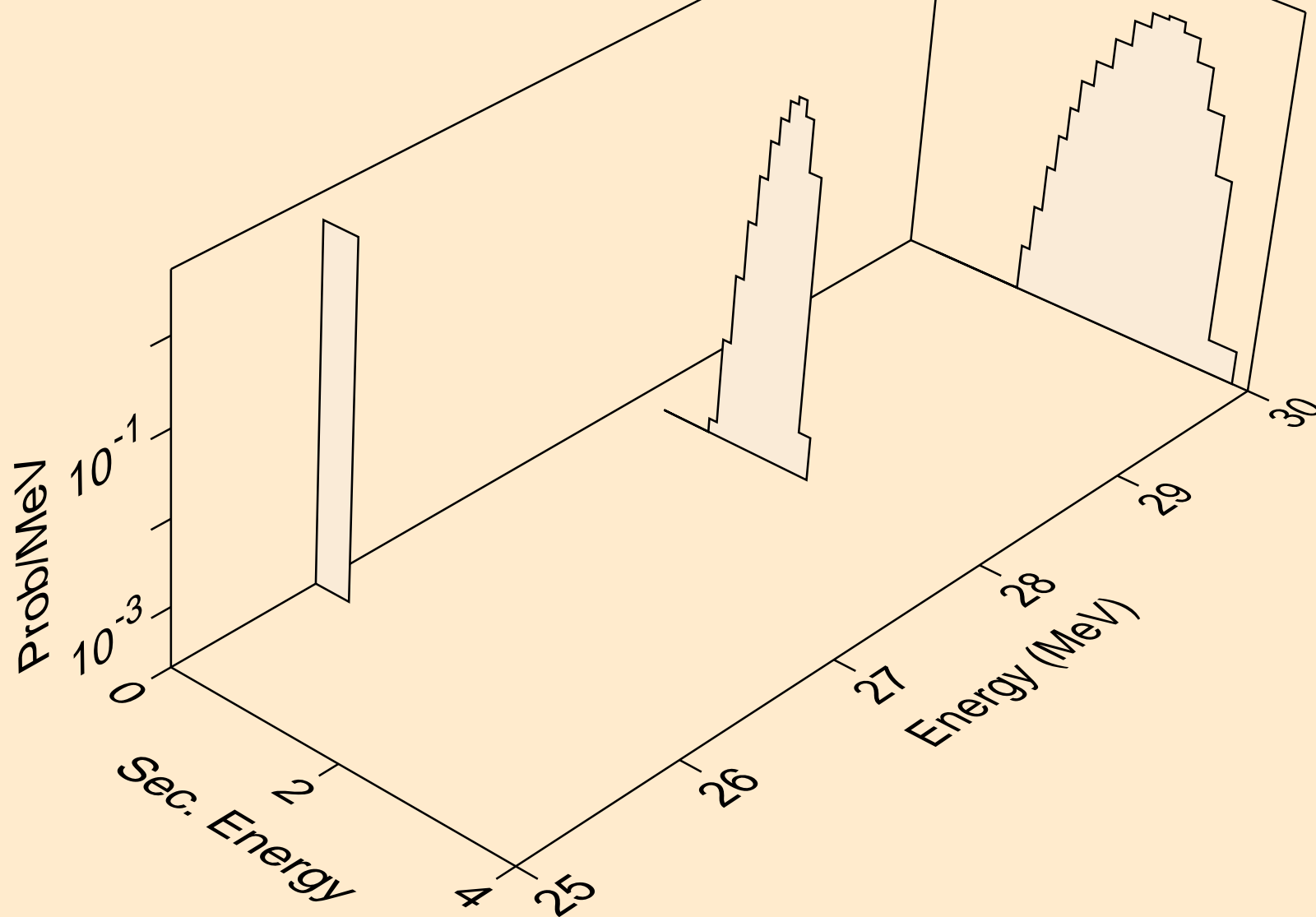

AR039 NEUTRON ACER TENDL-2024 LIBRARY; T=293.6K
alphas from (n,n*)2a

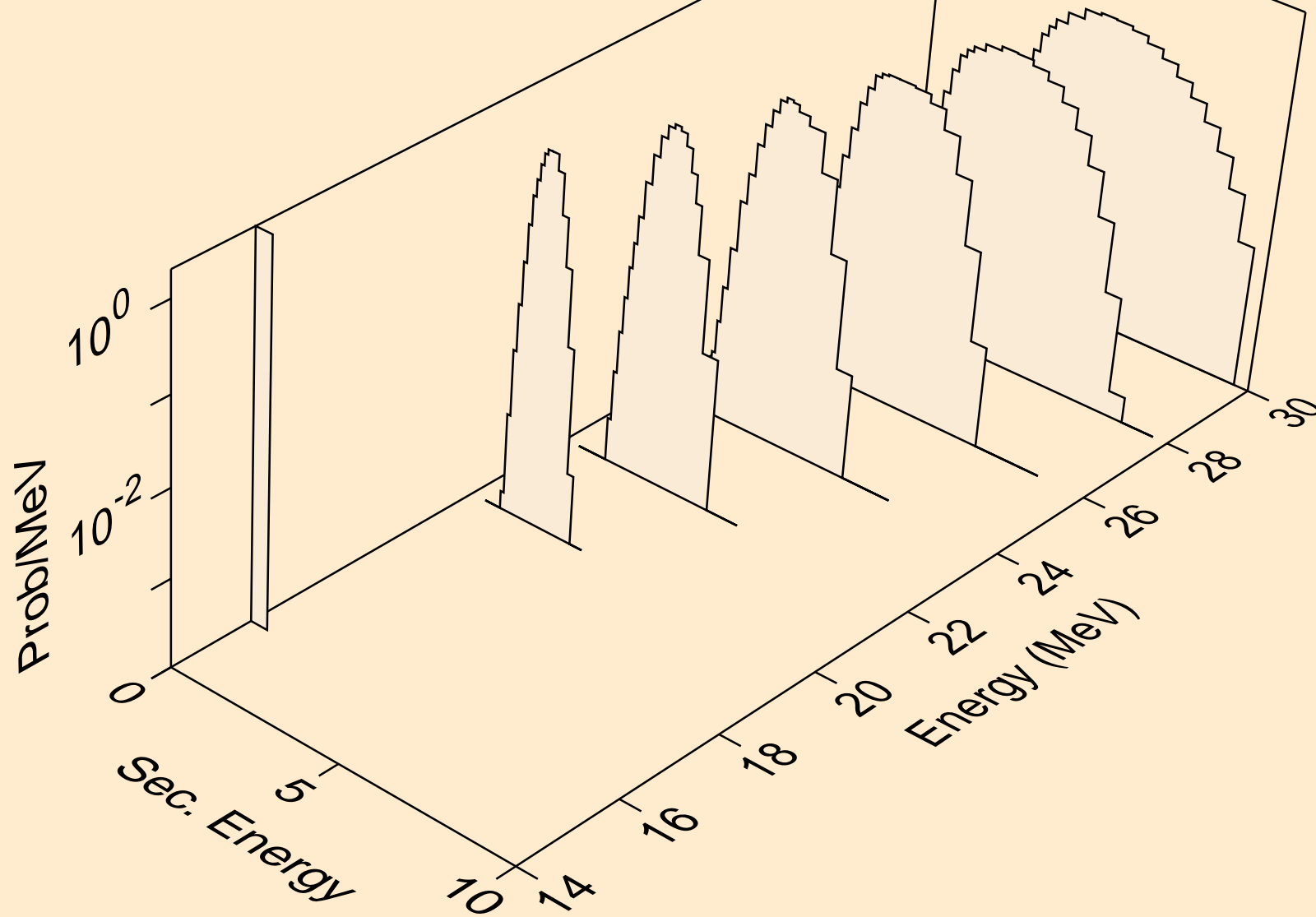

AR039 NEUTRON ACER TENDL-2024 LIBRARY; T=293.6K
alphas from (n,2n)2a

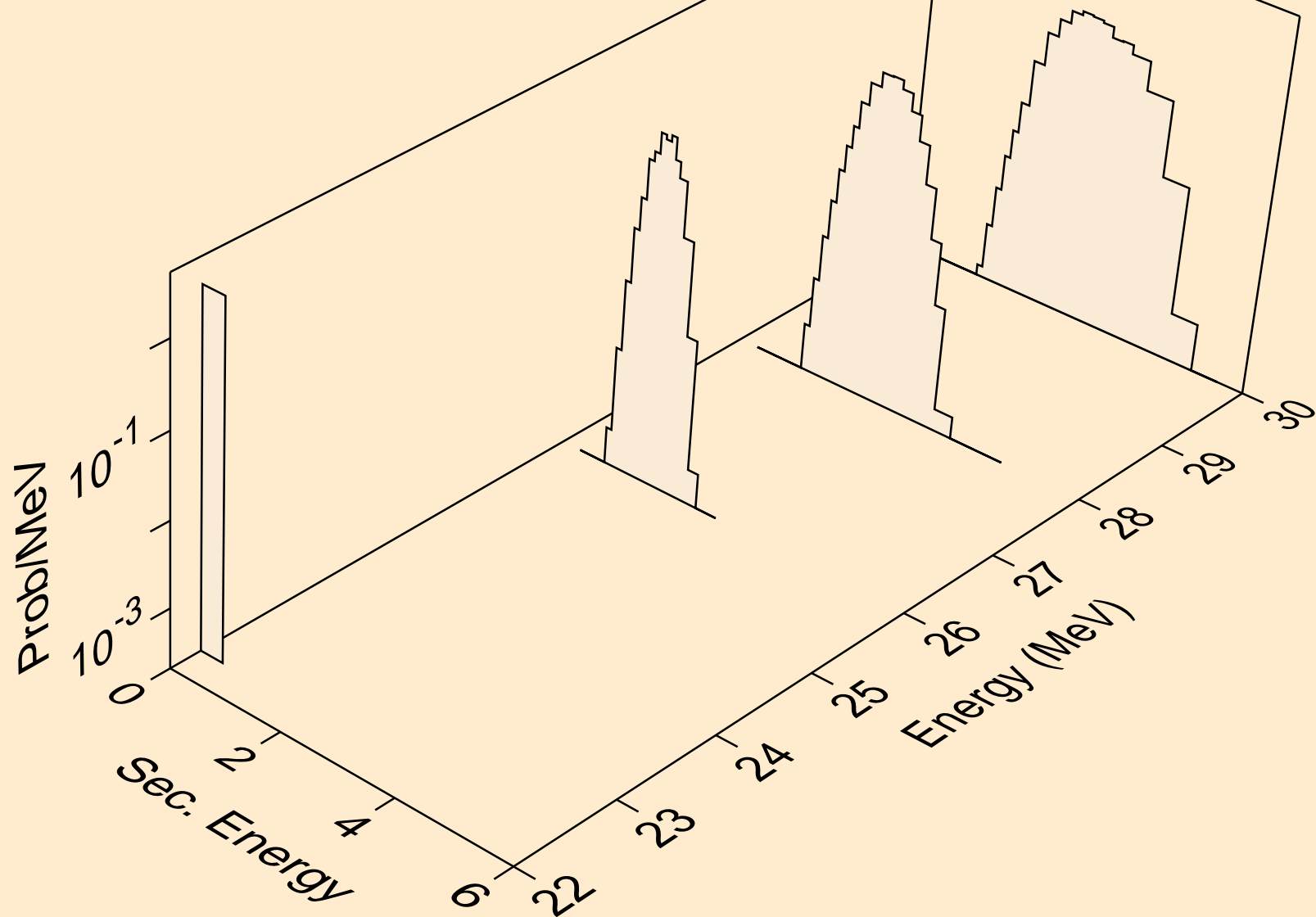

AR039 NEUTRON ACER TENDL-2024 LIBRARY; T=293.6K
alphas from (n,npa)

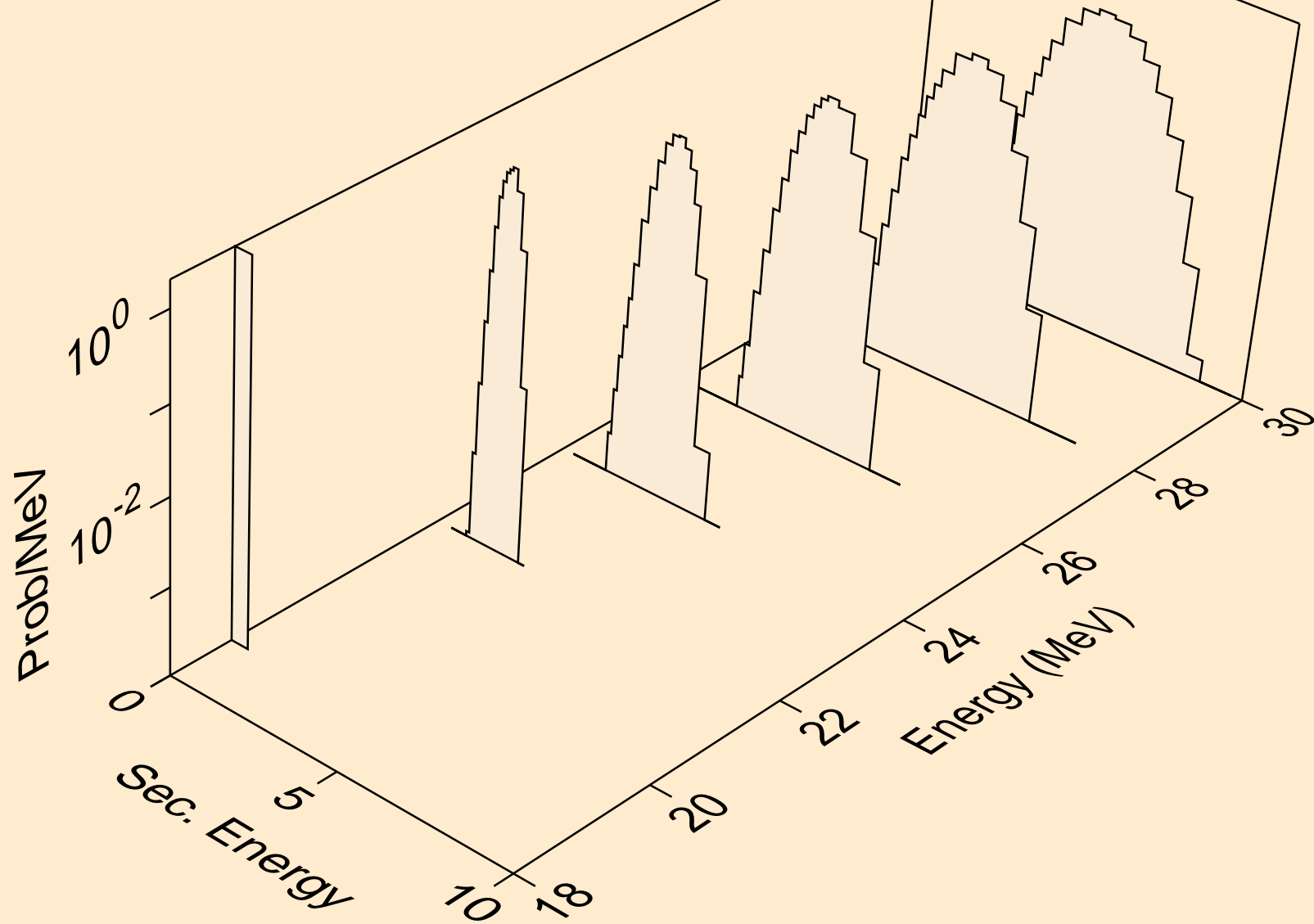

AR039 NEUTRON ACER TENDL-2024 LIBRARY; T=293.6K
alphas from (n,a)

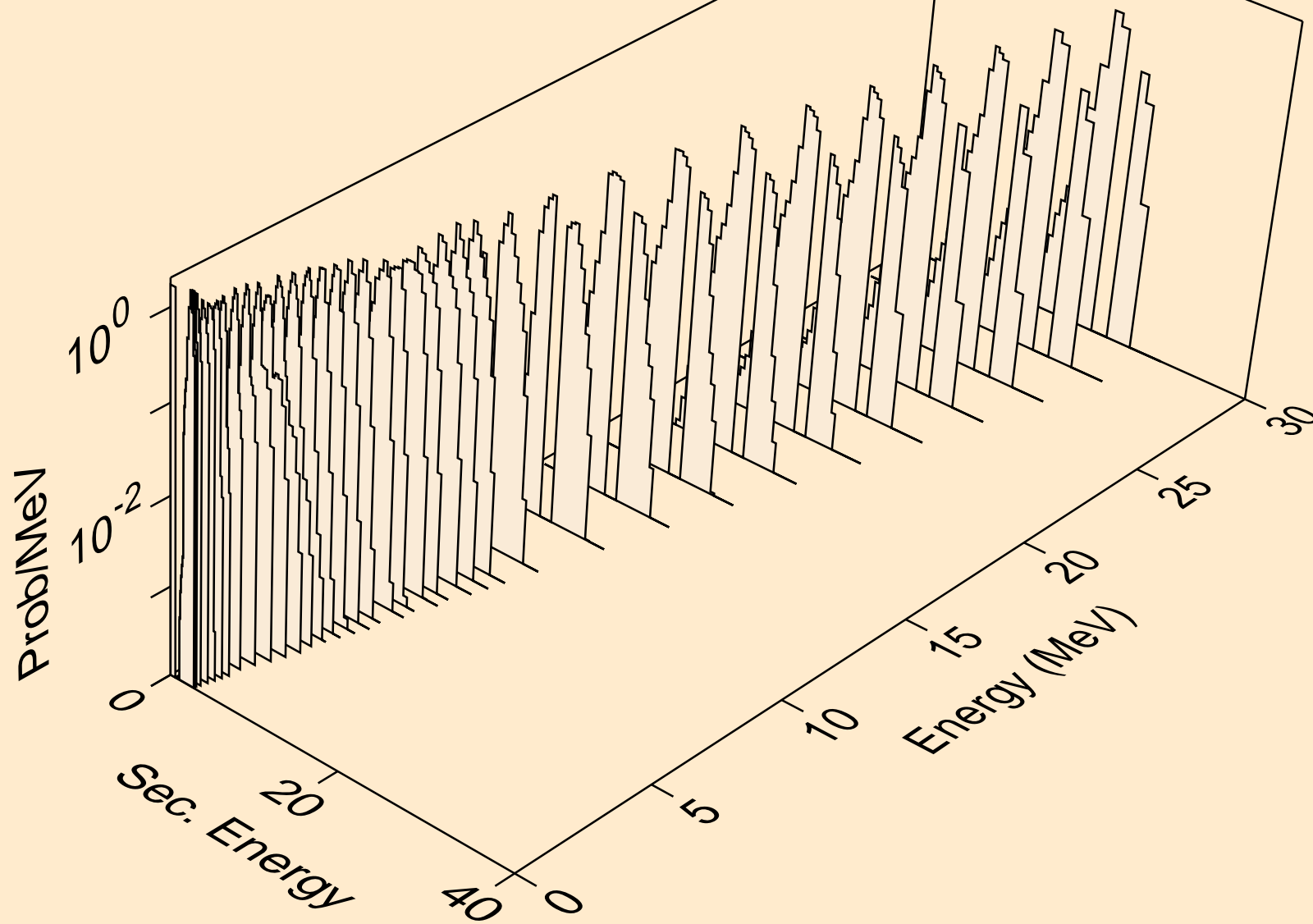

AR039 NEUTRON ACER TENDL-2024 LIBRARY; T=293.6K
alphas from (n,2a)

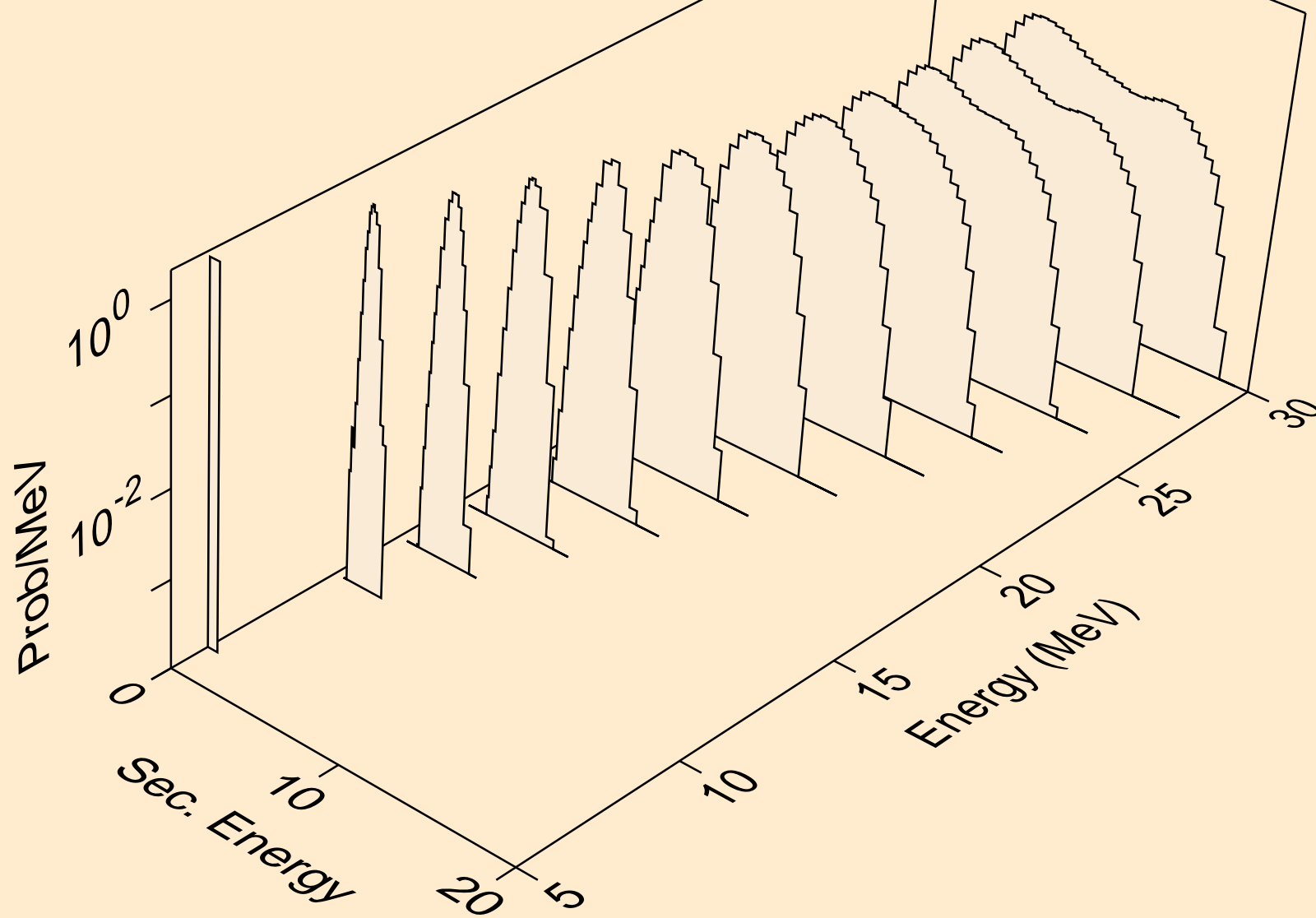

AR039 NEUTRON ACER TENDL-2024 LIBRARY; T=293.6K
alphas from (n,pa)

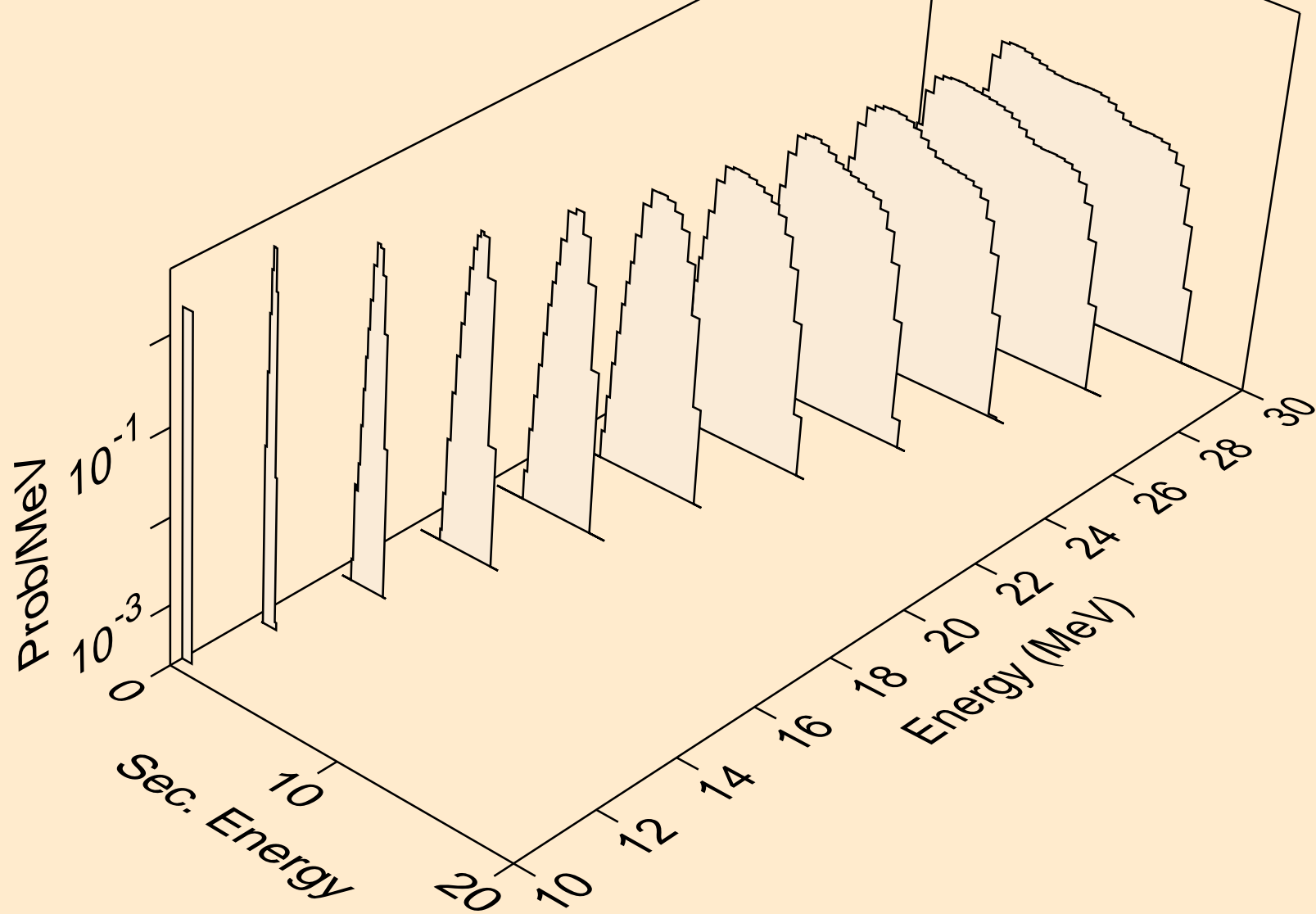

AR039 NEUTRON ACER TENDL-2024 LIBRARY; T=293.6K
alphas from (n,da)

