

AT200 NEUTRON ACER TENDL-2024 LIBRARY; T=293.6K  
Principal cross sections

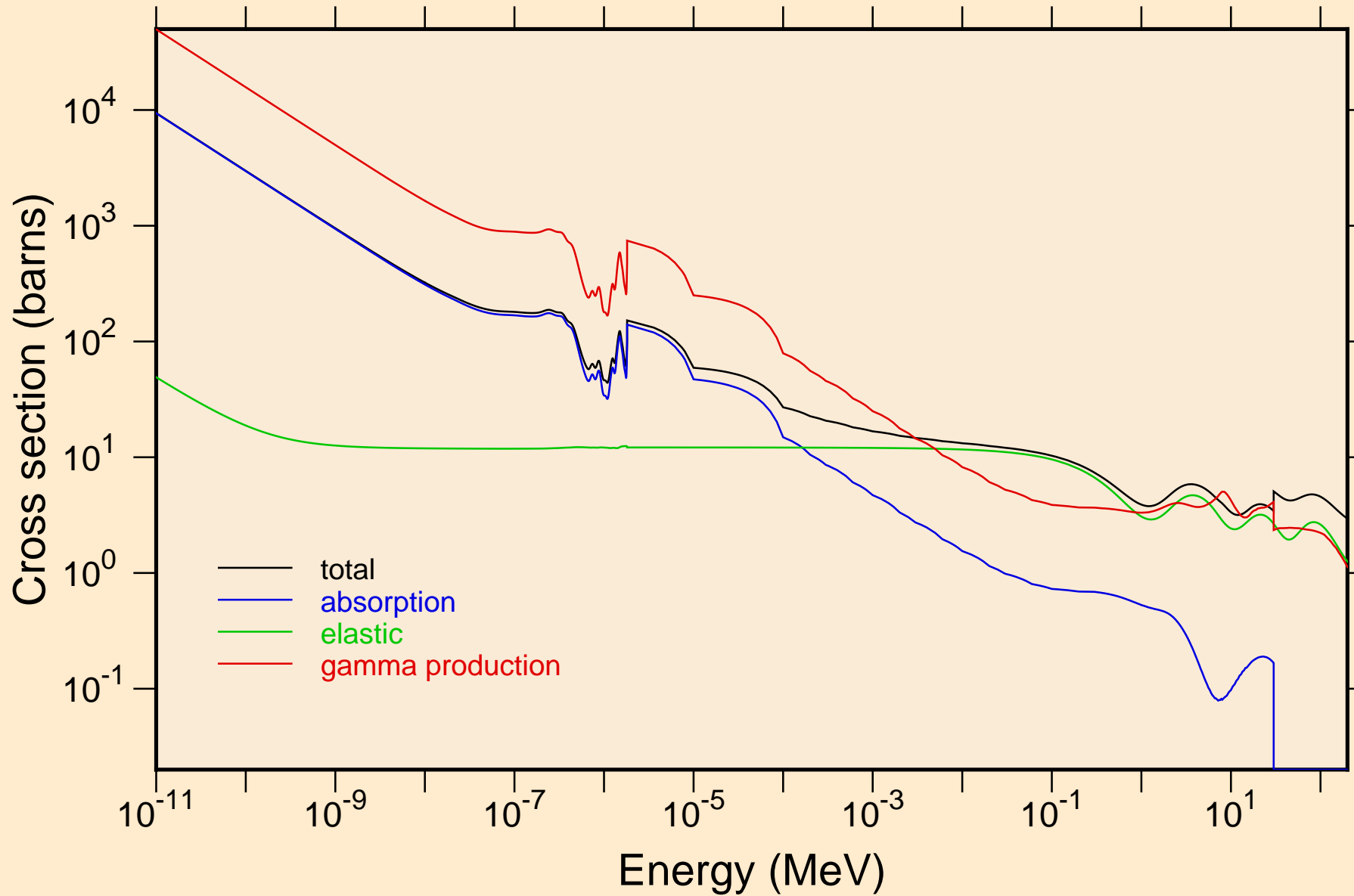

AT200 NEUTRON ACER TENDL-2024 LIBRARY; T=293.6K  
Heating

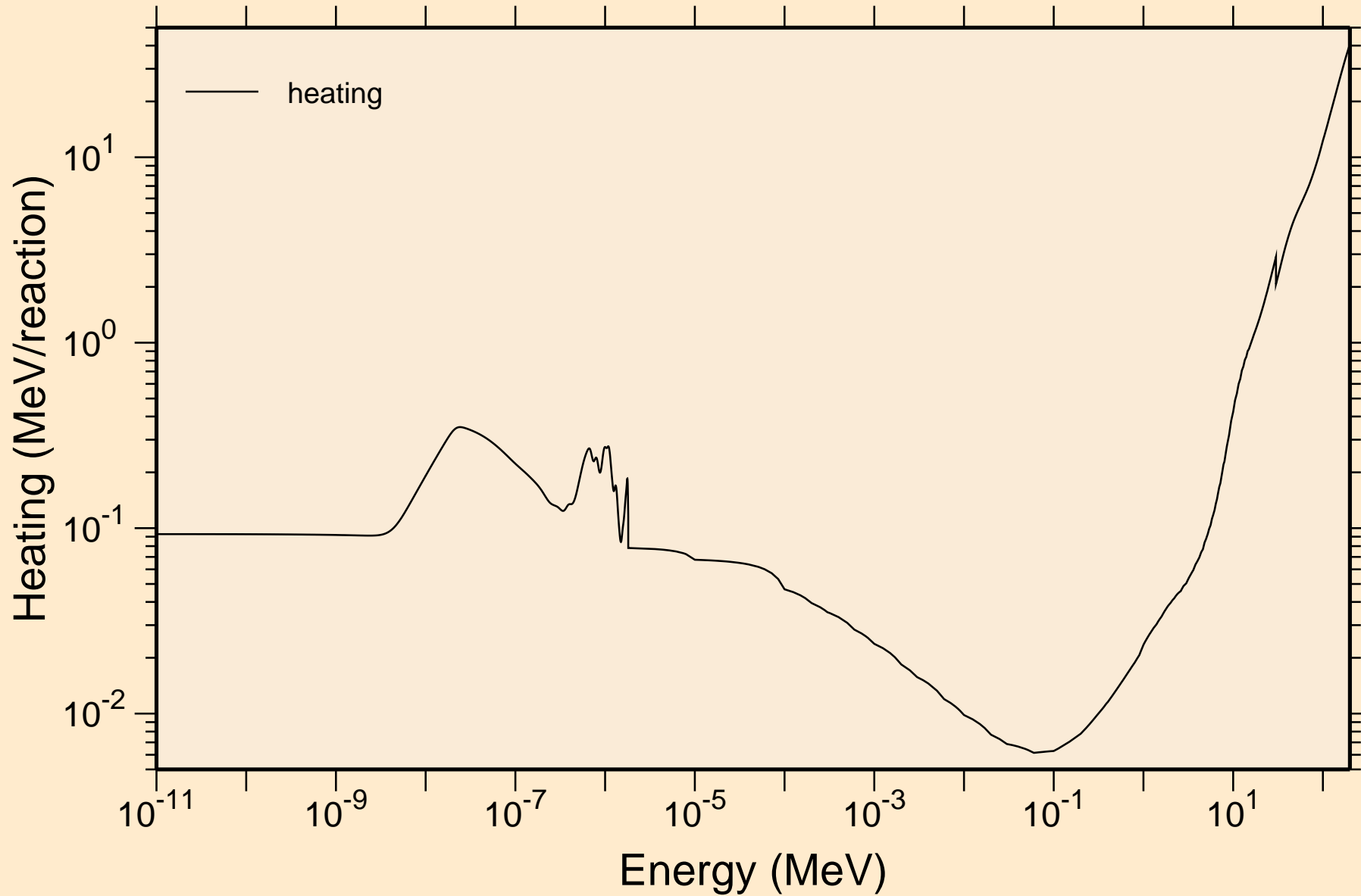

AT200 NEUTRON ACER TENDL-2024 LIBRARY; T=293.6K  
Damage

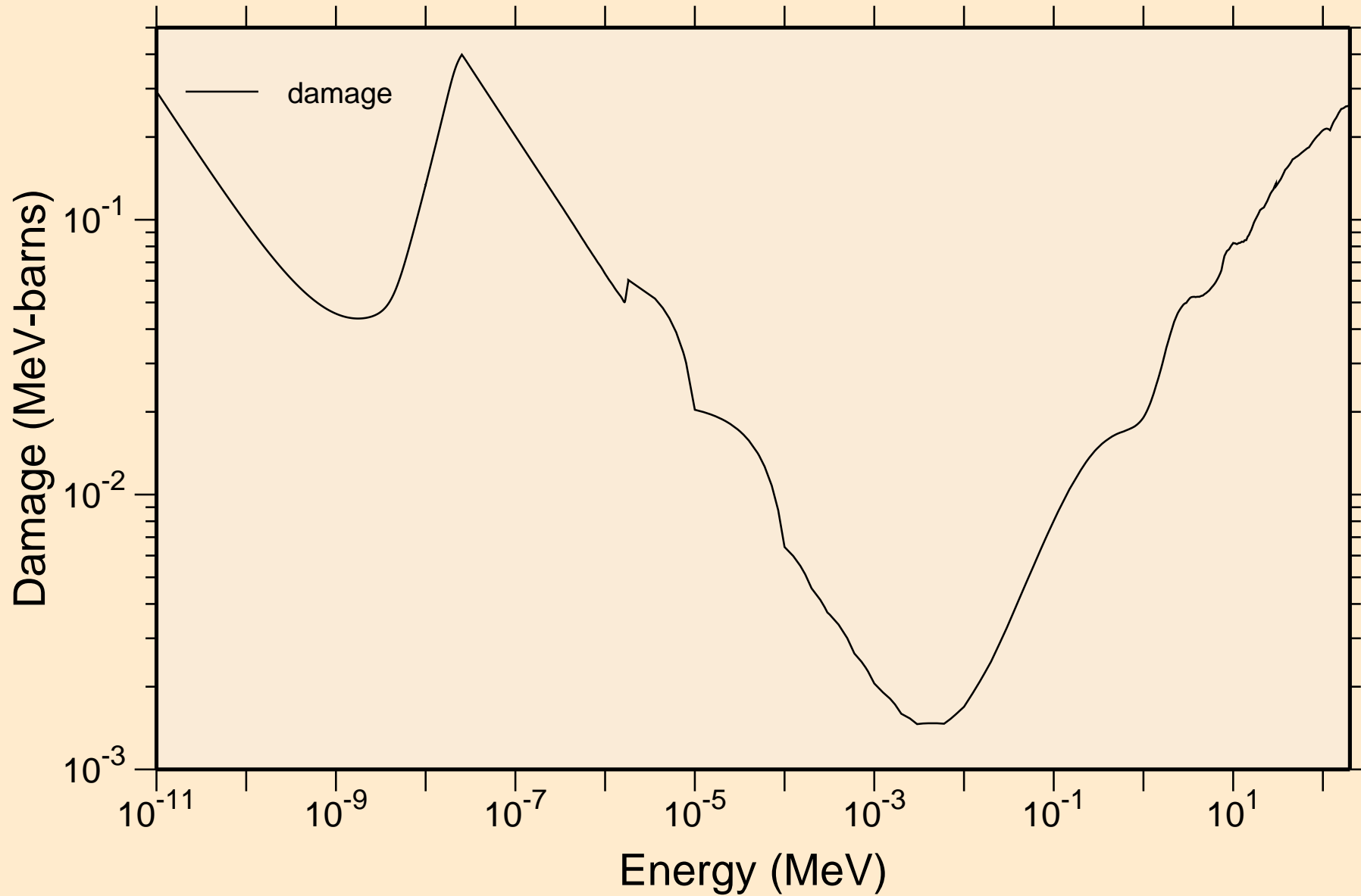

AT200 NEUTRON ACER TENDL-2024 LIBRARY; T=293.6K  
Non-threshold reactions

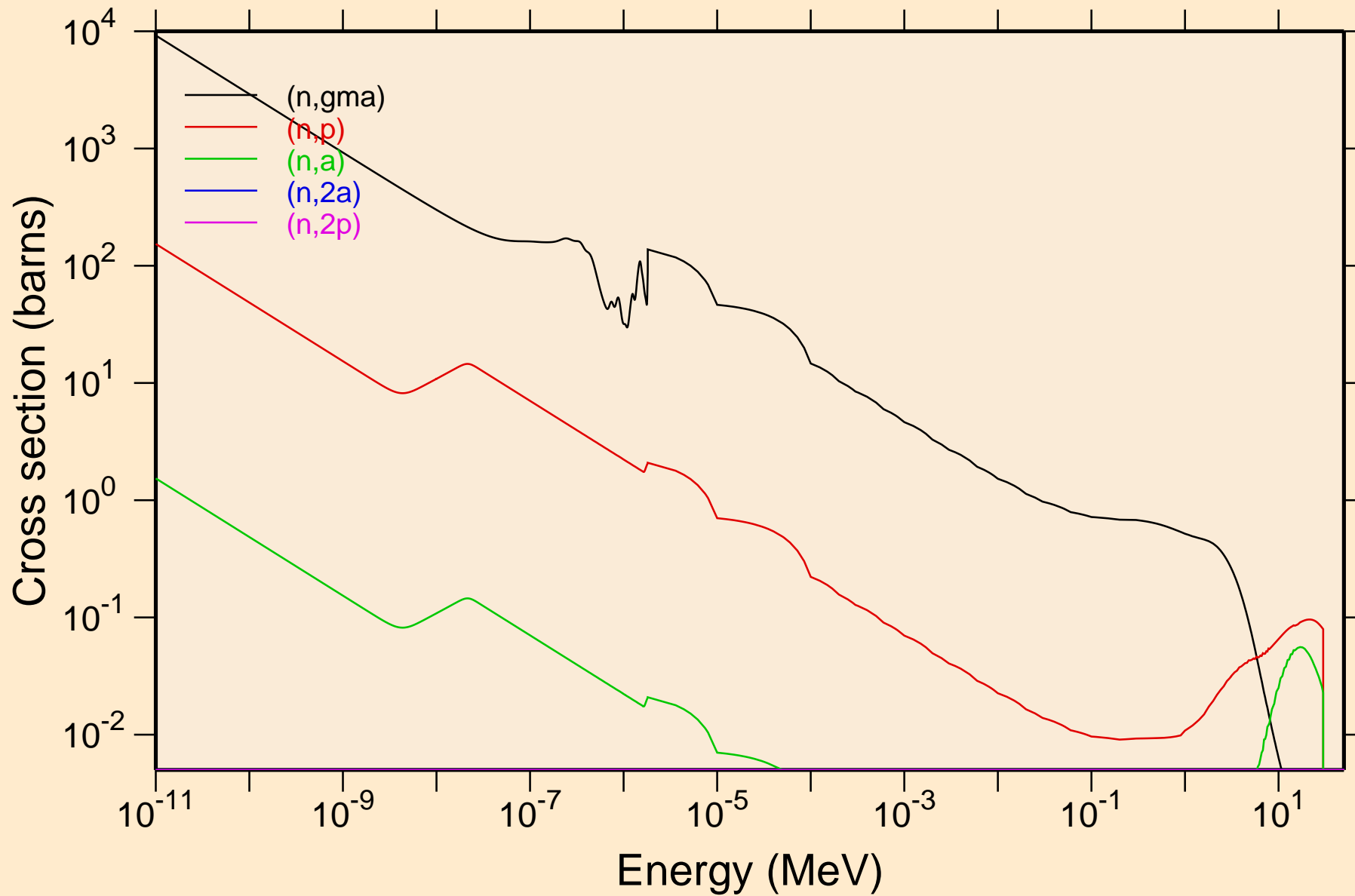

AT200 NEUTRON ACER TENDL-2024 LIBRARY; T=293.6K  
Non-threshold reactions

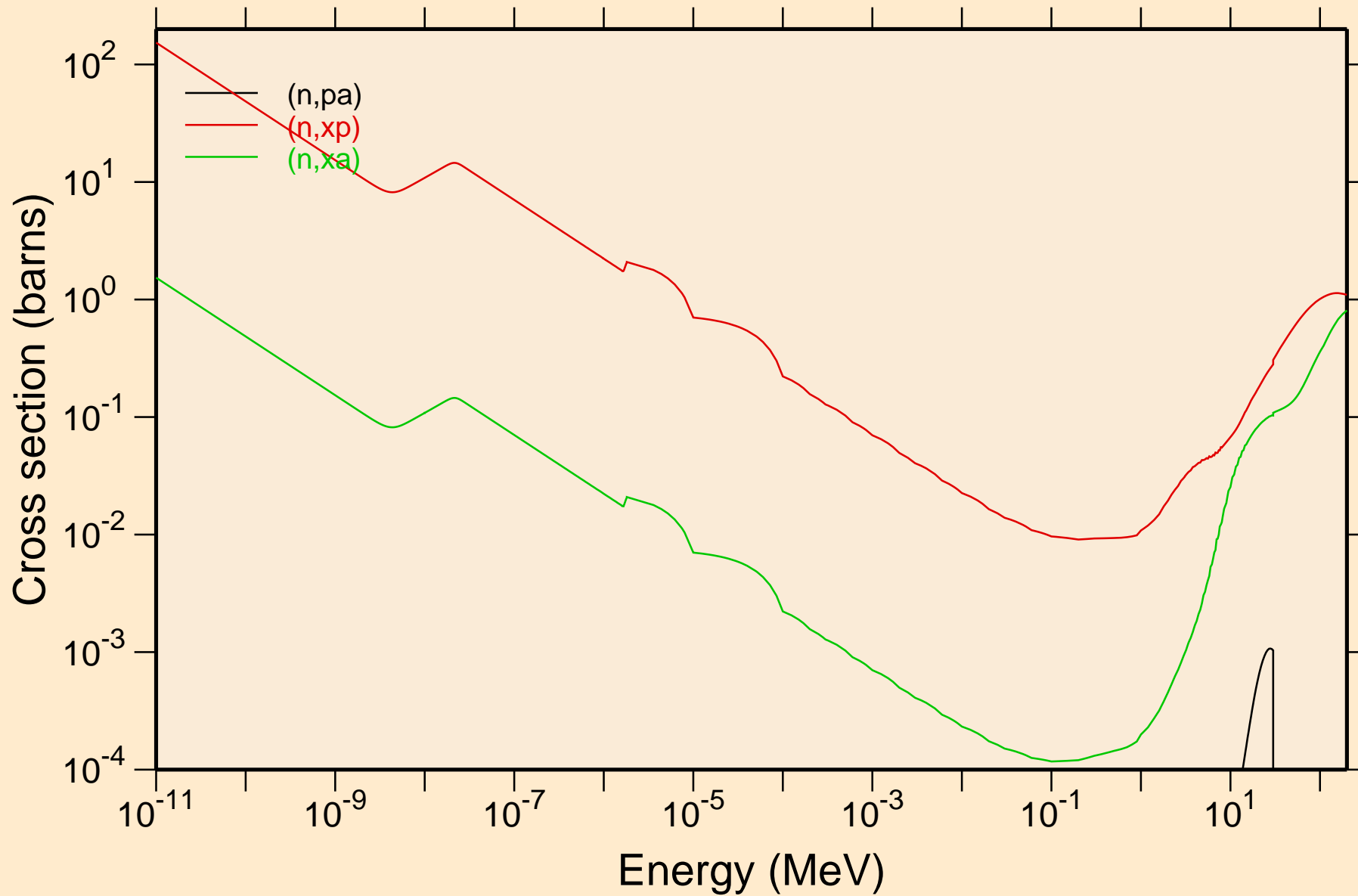

AT200 NEUTRON ACER TENDL-2024 LIBRARY; T=293.6K  
Principal cross sections

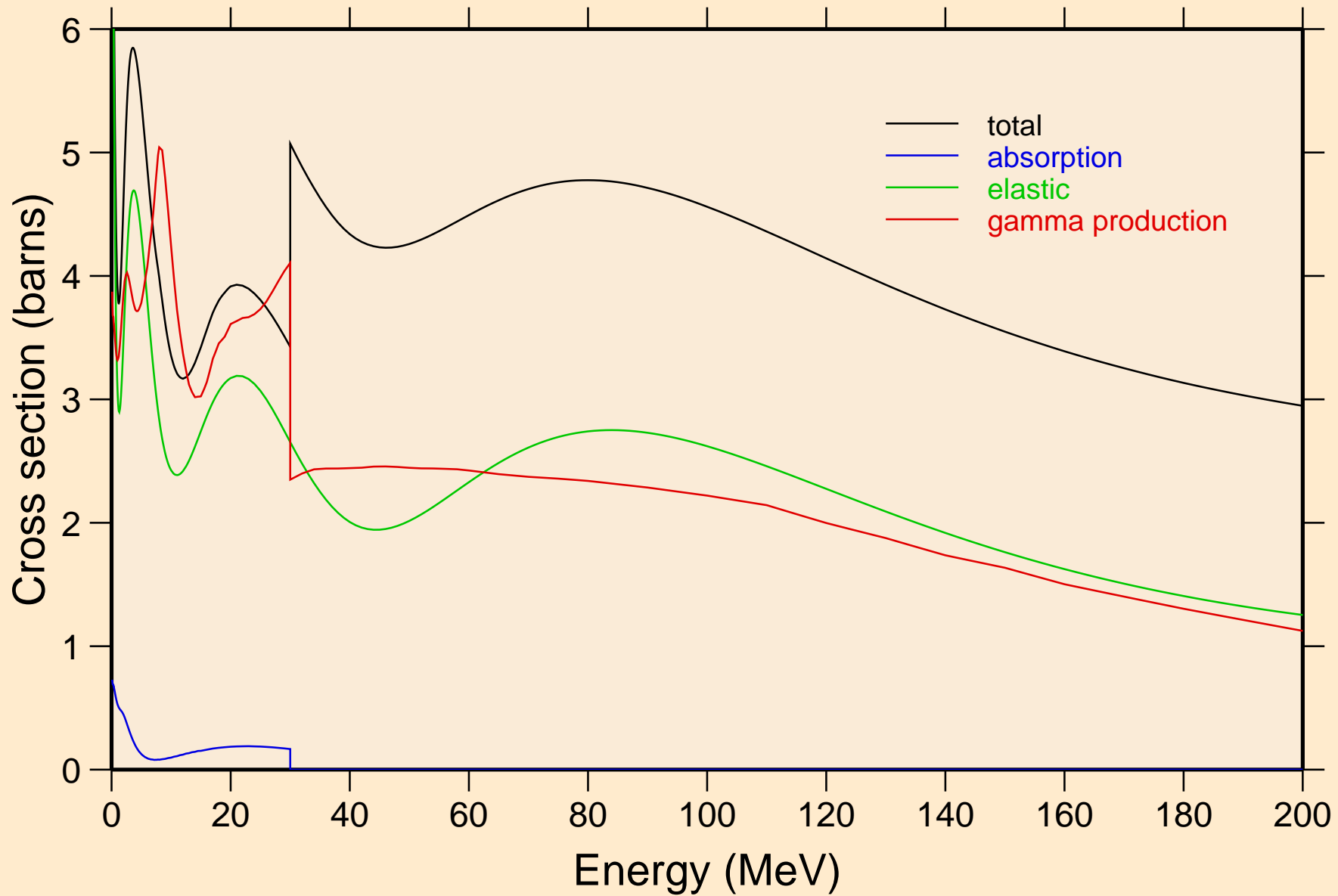

# AT200 NEUTRON ACER TENDL-2024 LIBRARY; T=293.6K

## Heating

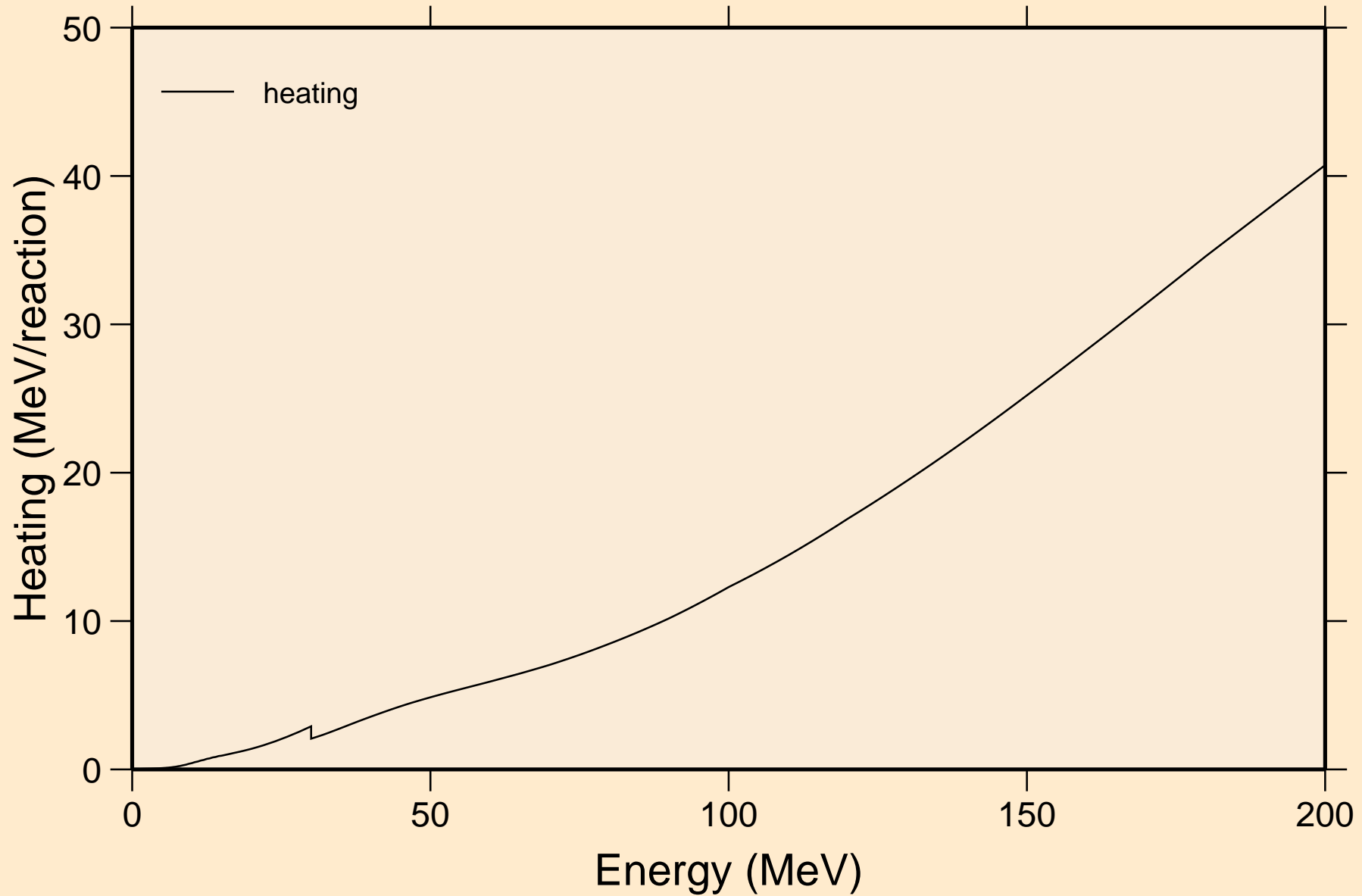

AT200 NEUTRON ACER TENDL-2024 LIBRARY; T=293.6K  
Damage

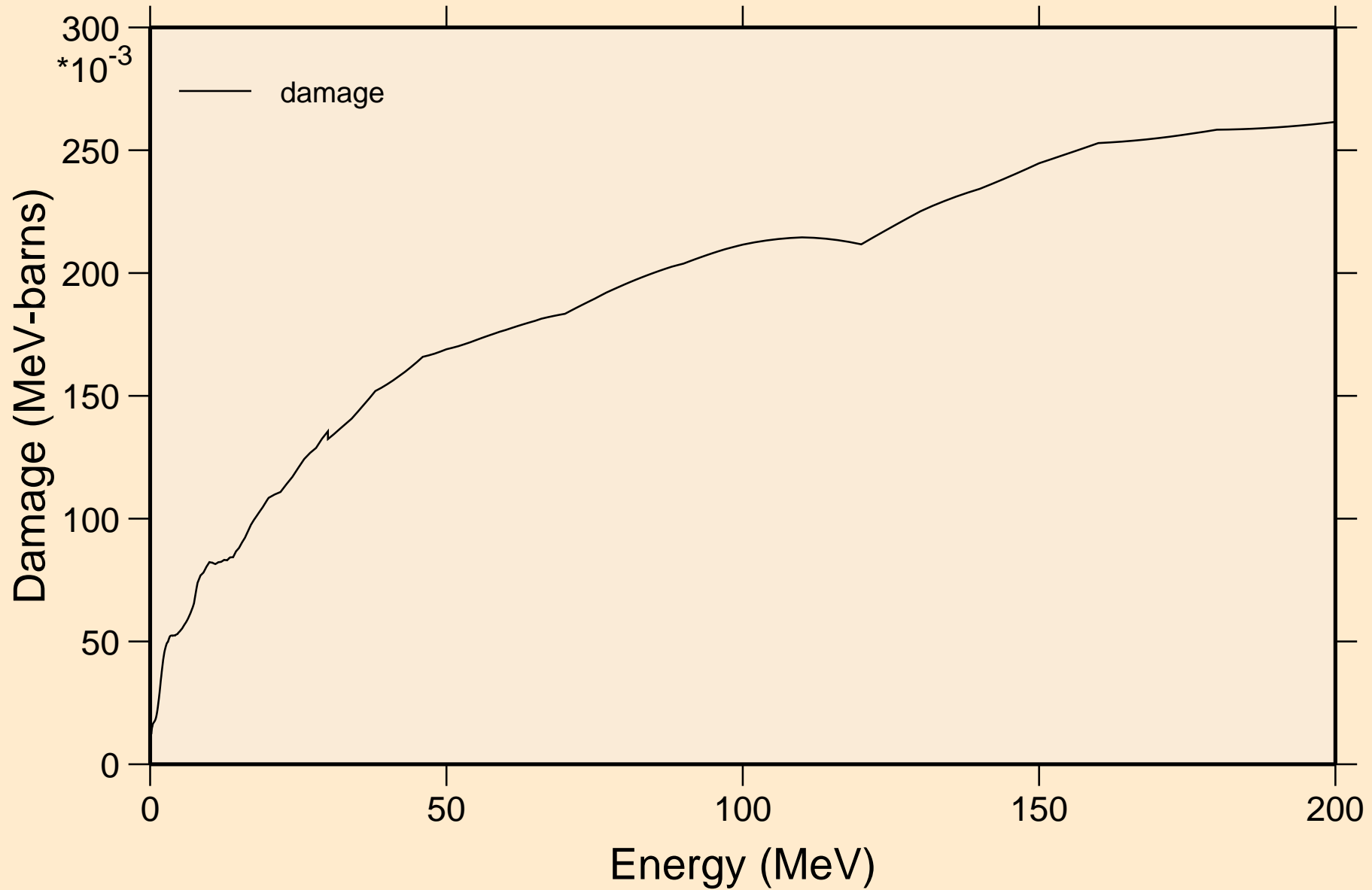

AT200 NEUTRON ACER TENDL-2024 LIBRARY; T=293.6K  
Non-threshold reactions

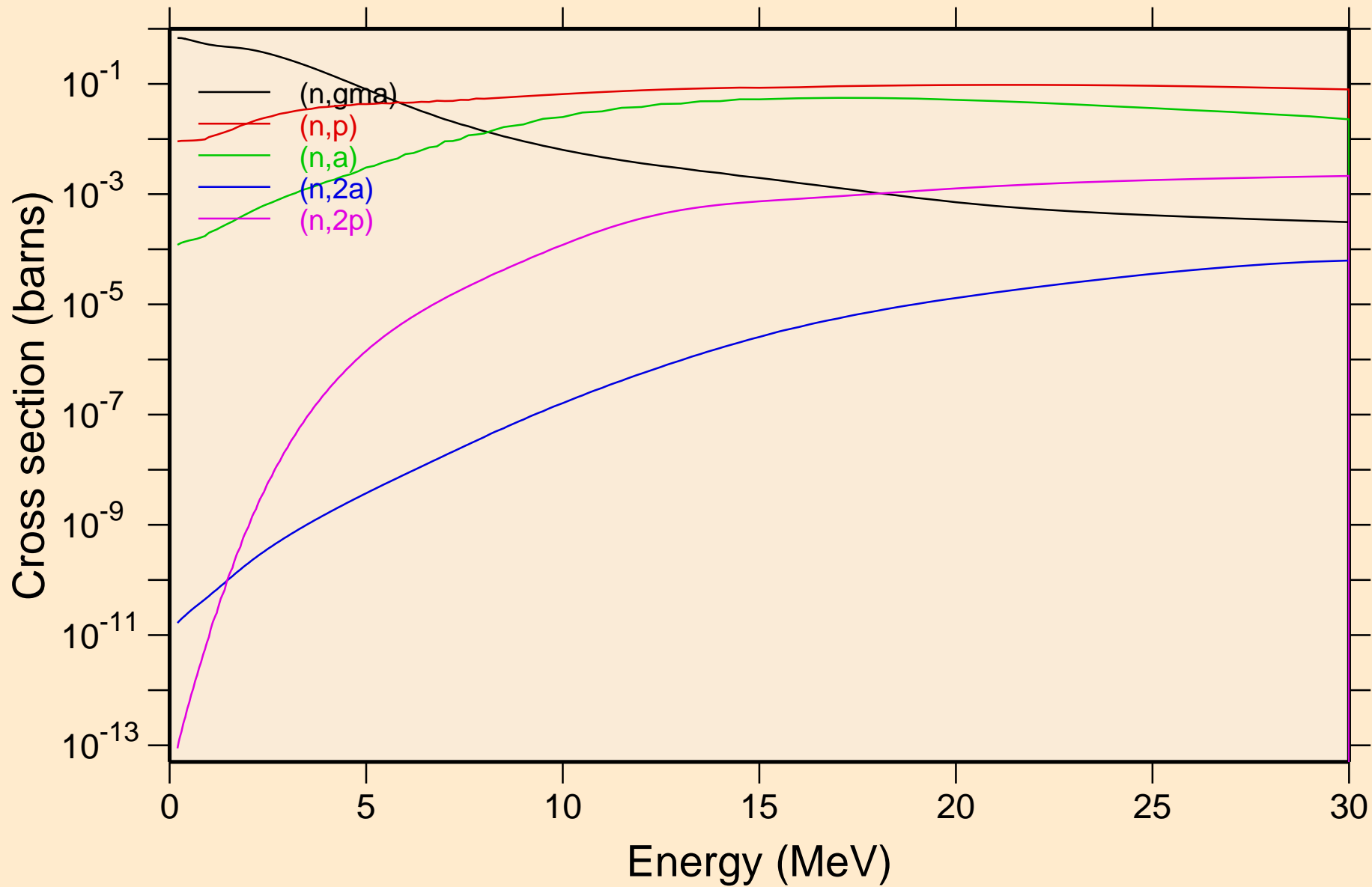

AT200 NEUTRON ACER TENDL-2024 LIBRARY; T=293.6K  
Non-threshold reactions

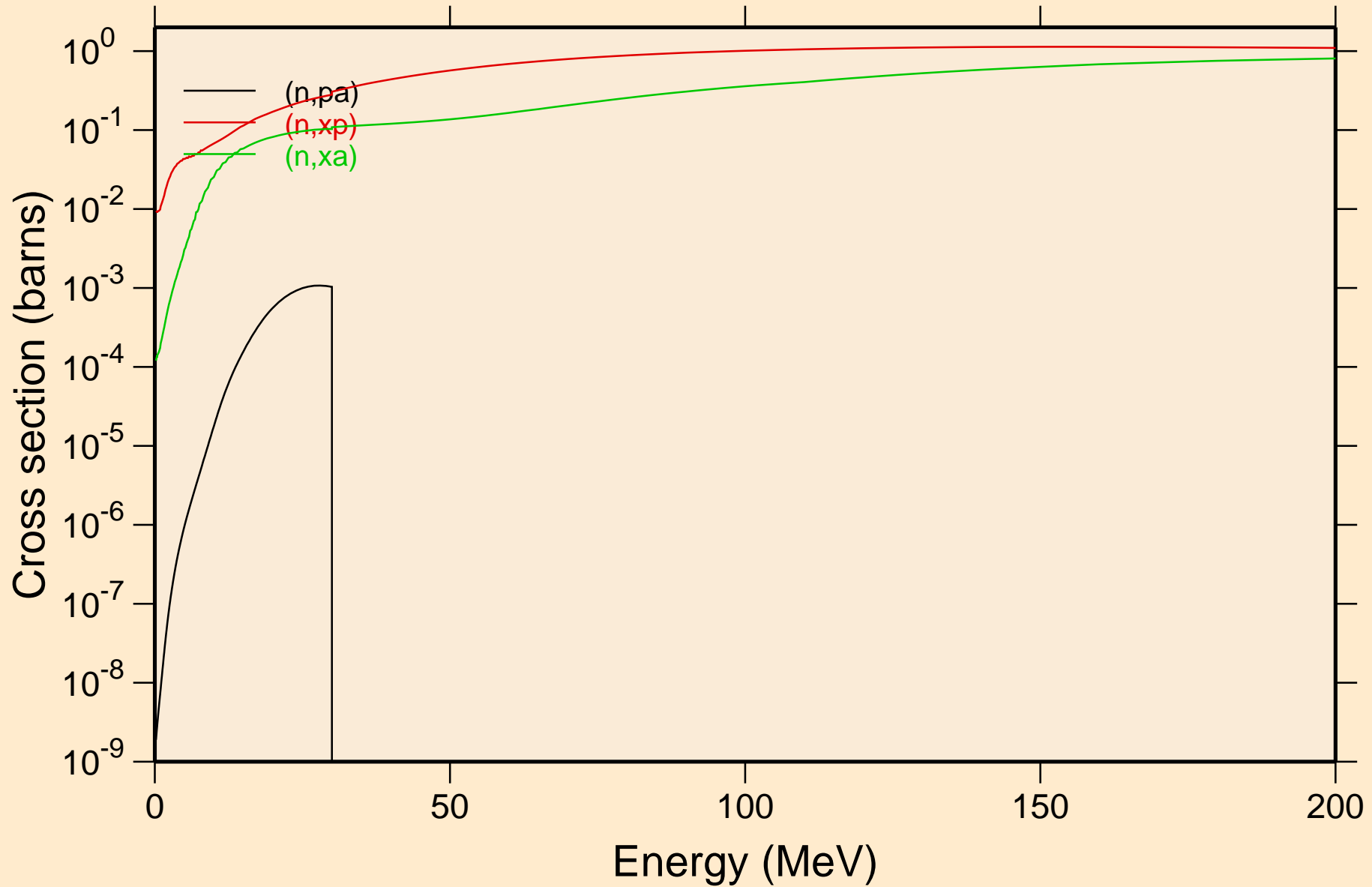

AT200 NEUTRON ACER TENDL-2024 LIBRARY; T=293.6K  
Inelastic levels

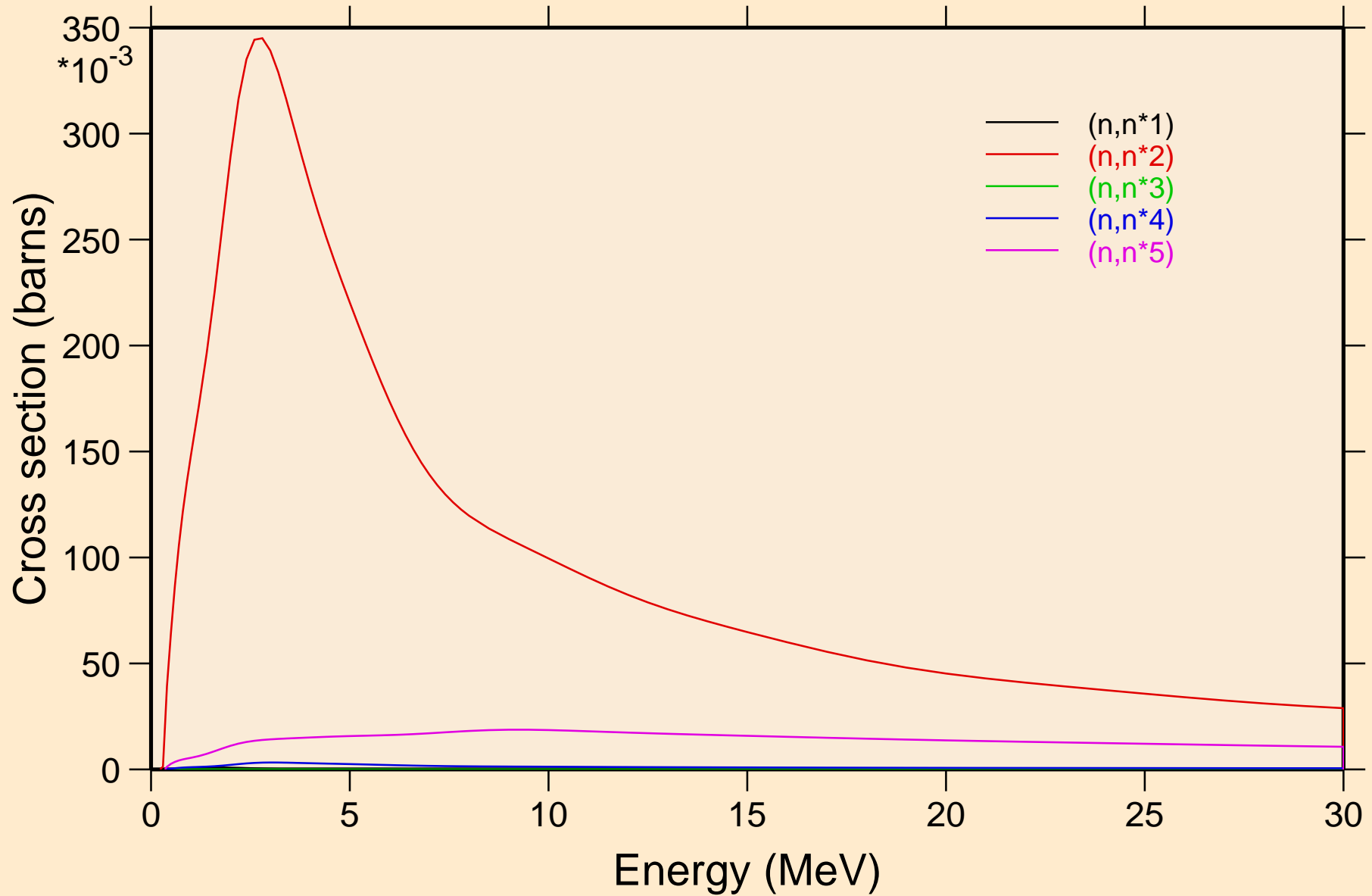

AT200 NEUTRON ACER TENDL-2024 LIBRARY; T=293.6K  
Inelastic levels

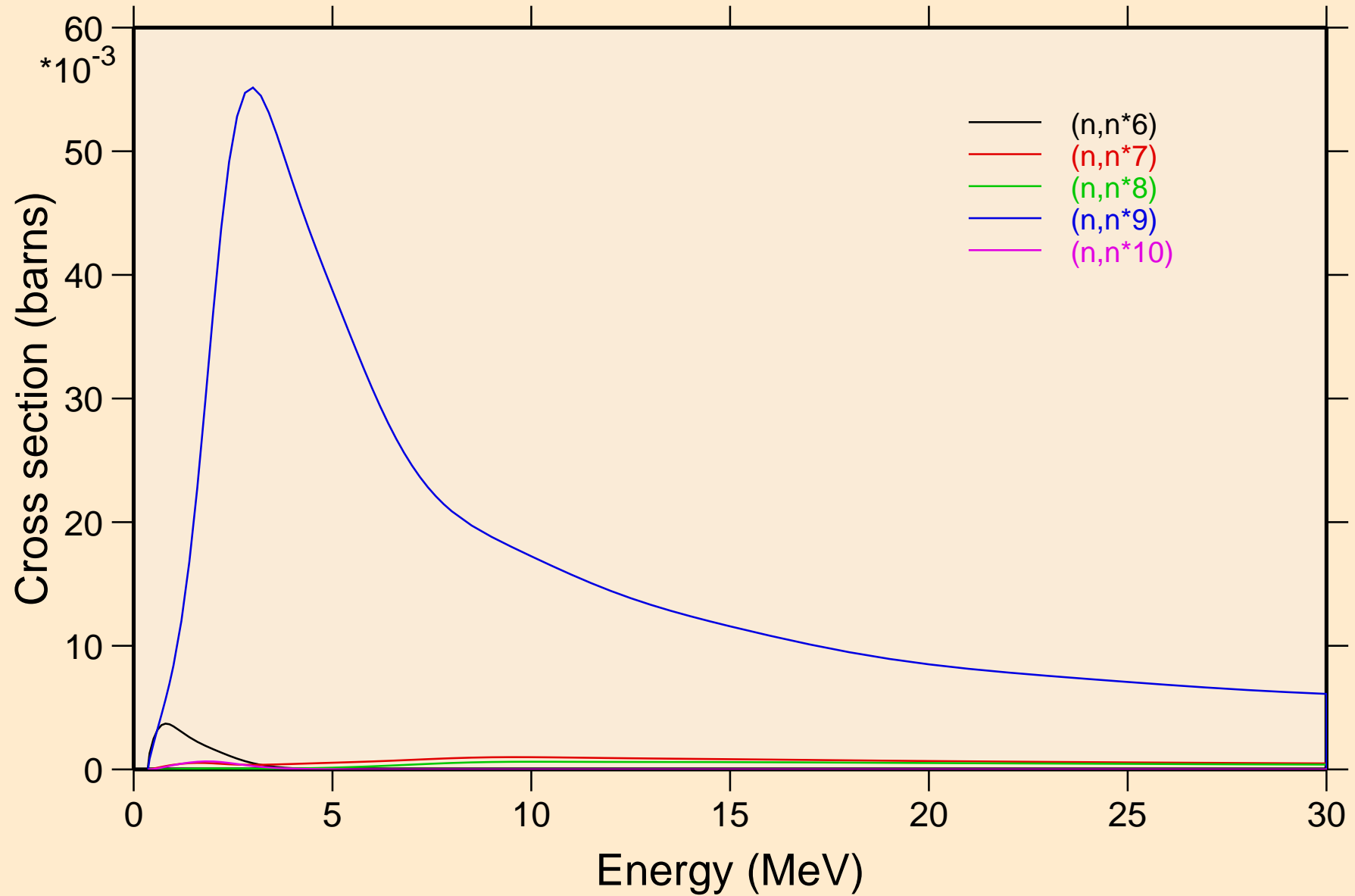

AT200 NEUTRON ACER TENDL-2024 LIBRARY; T=293.6K  
Inelastic levels

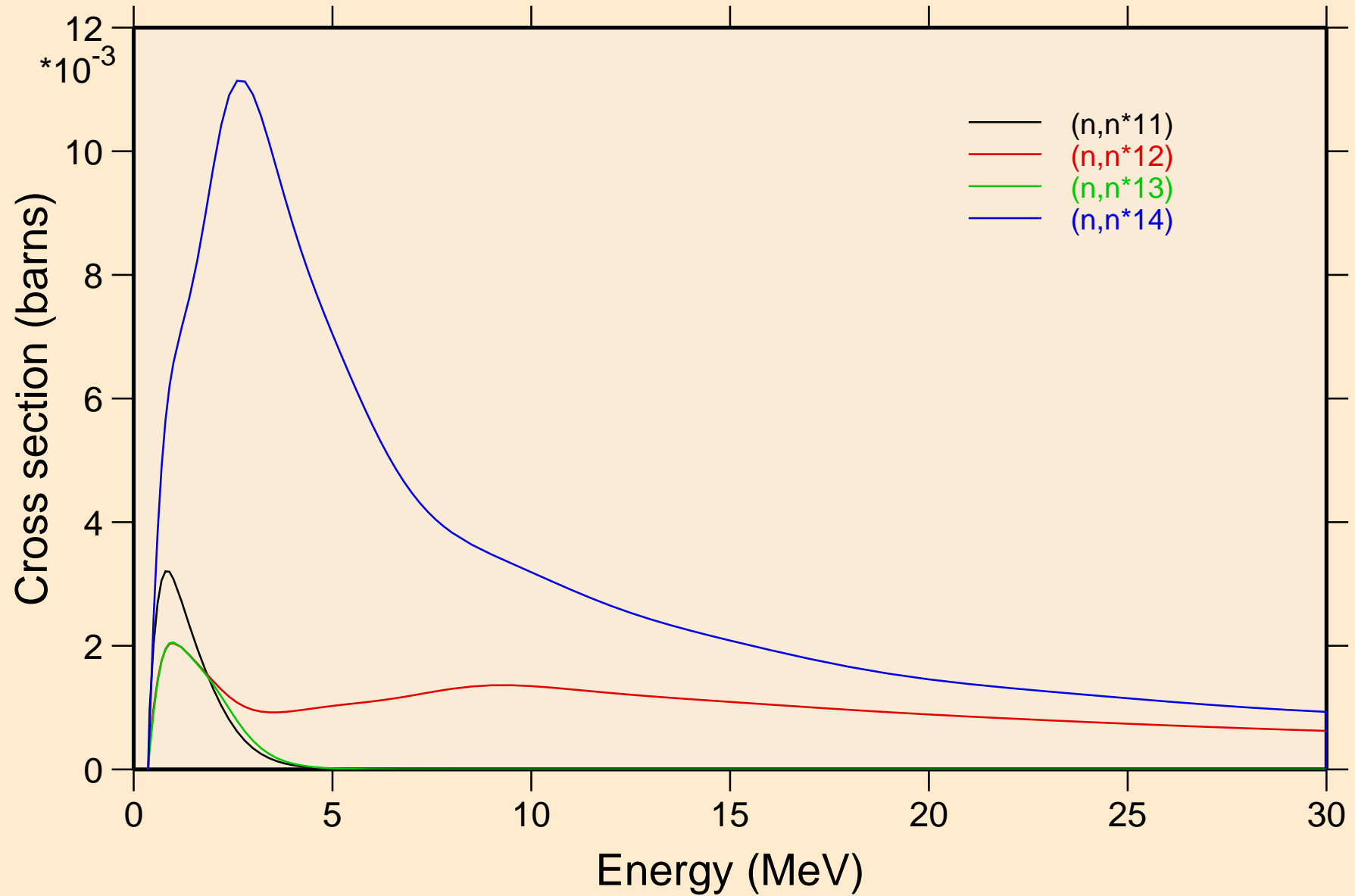

AT200 NEUTRON ACER TENDL-2024 LIBRARY; T=293.6K  
Threshold reactions

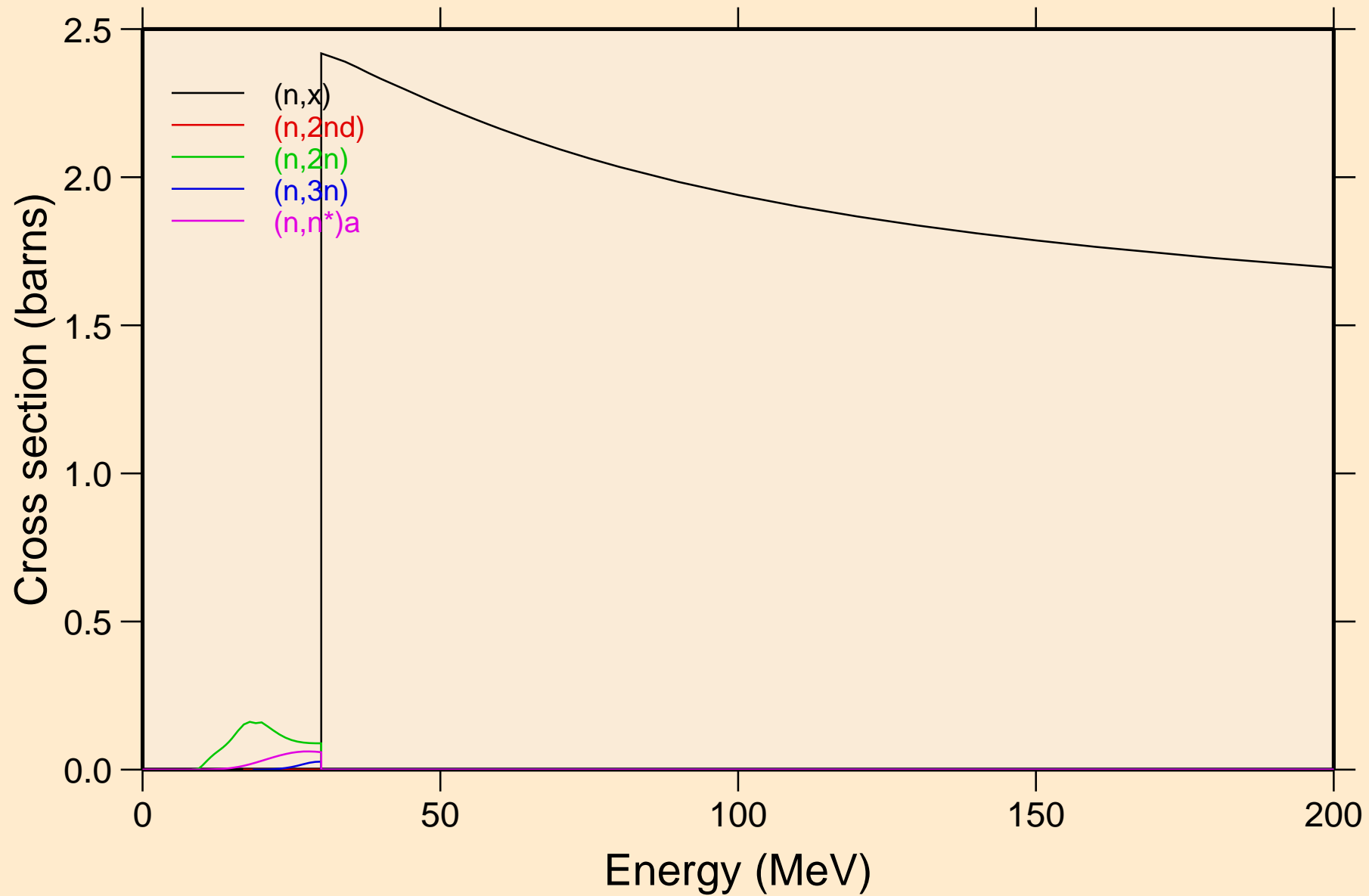

AT200 NEUTRON ACER TENDL-2024 LIBRARY; T=293.6K  
Threshold reactions

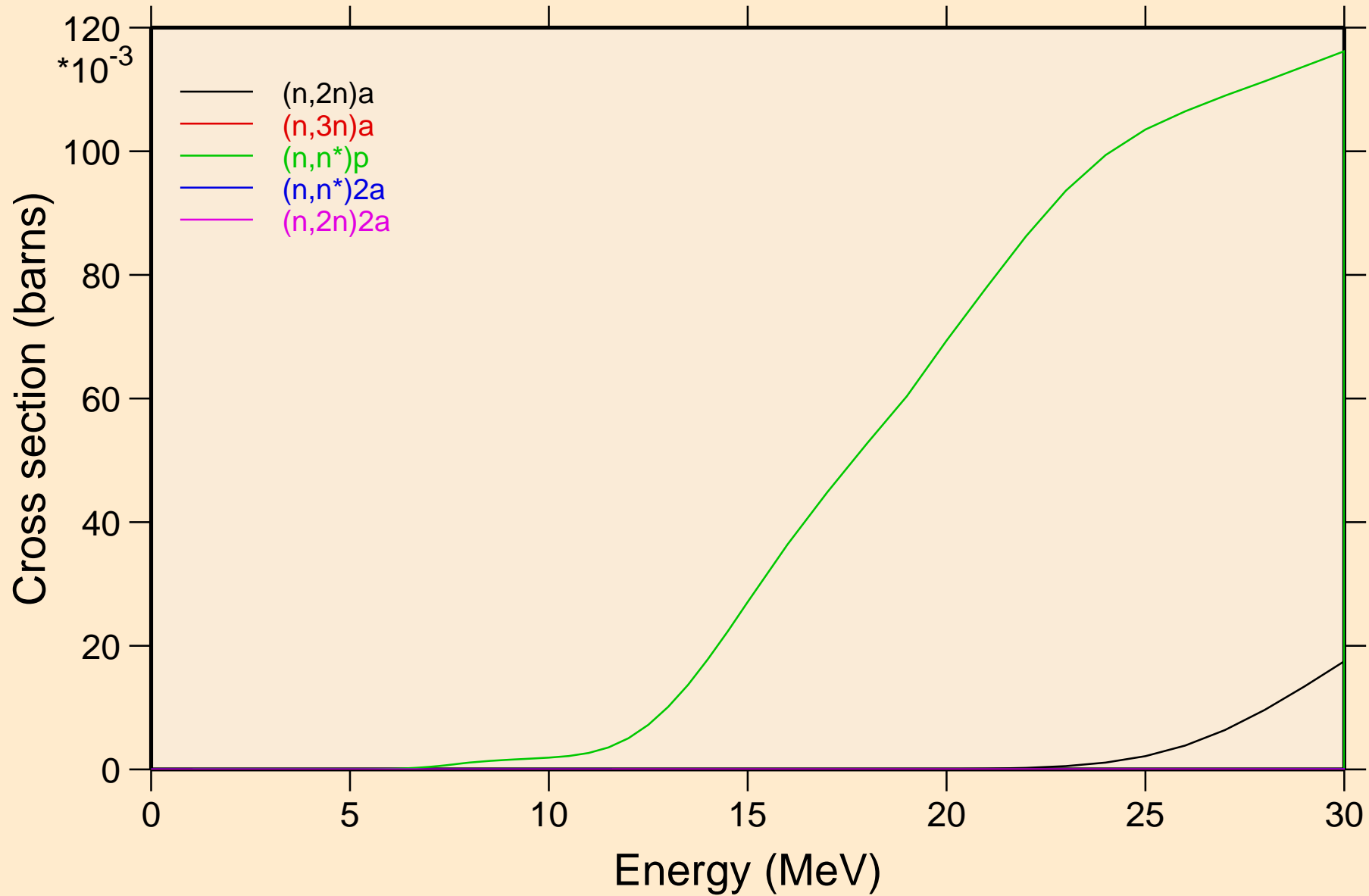

AT200 NEUTRON ACER TENDL-2024 LIBRARY; T=293.6K  
Threshold reactions

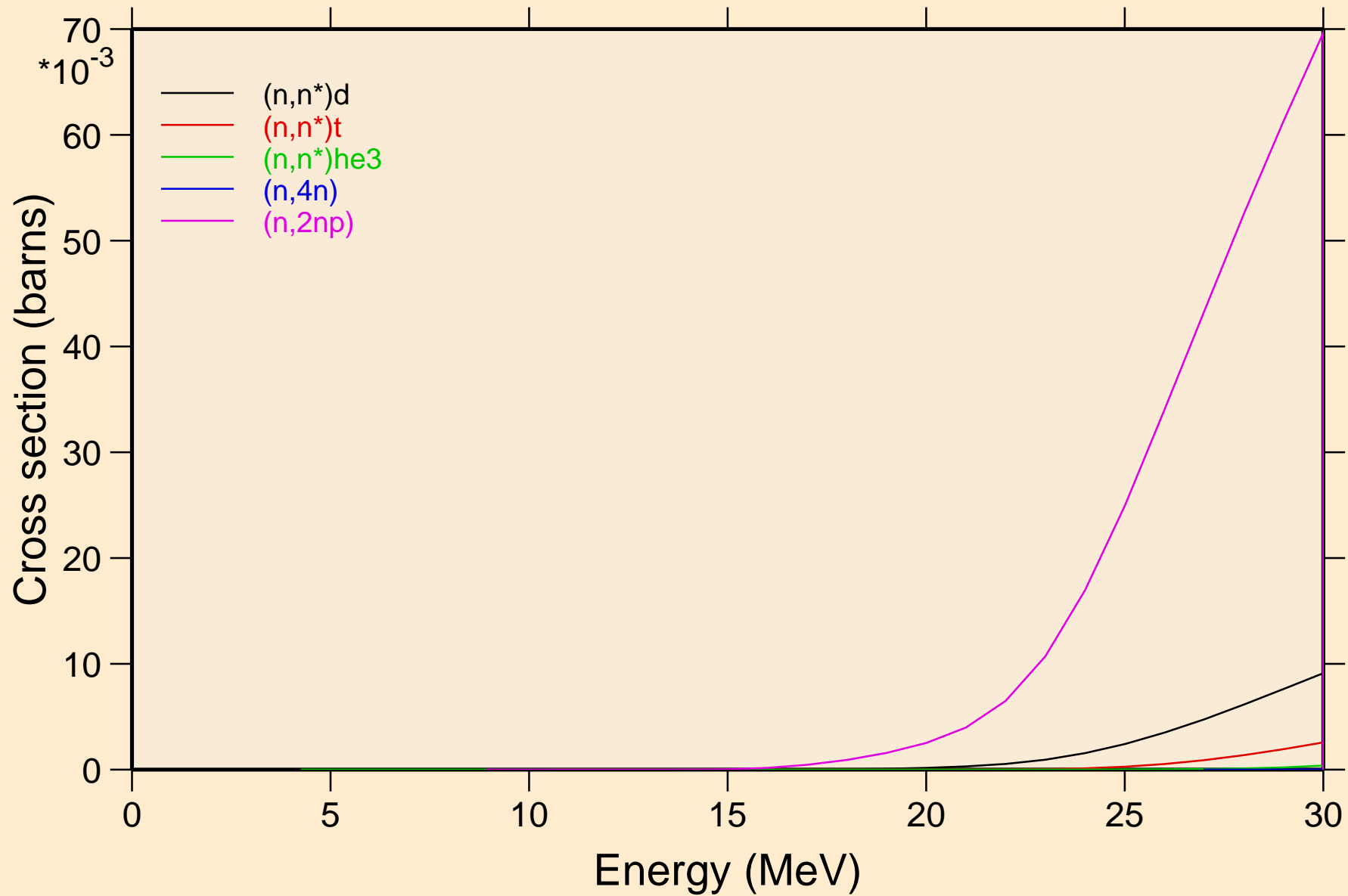

AT200 NEUTRON ACER TENDL-2024 LIBRARY; T=293.6K  
Threshold reactions

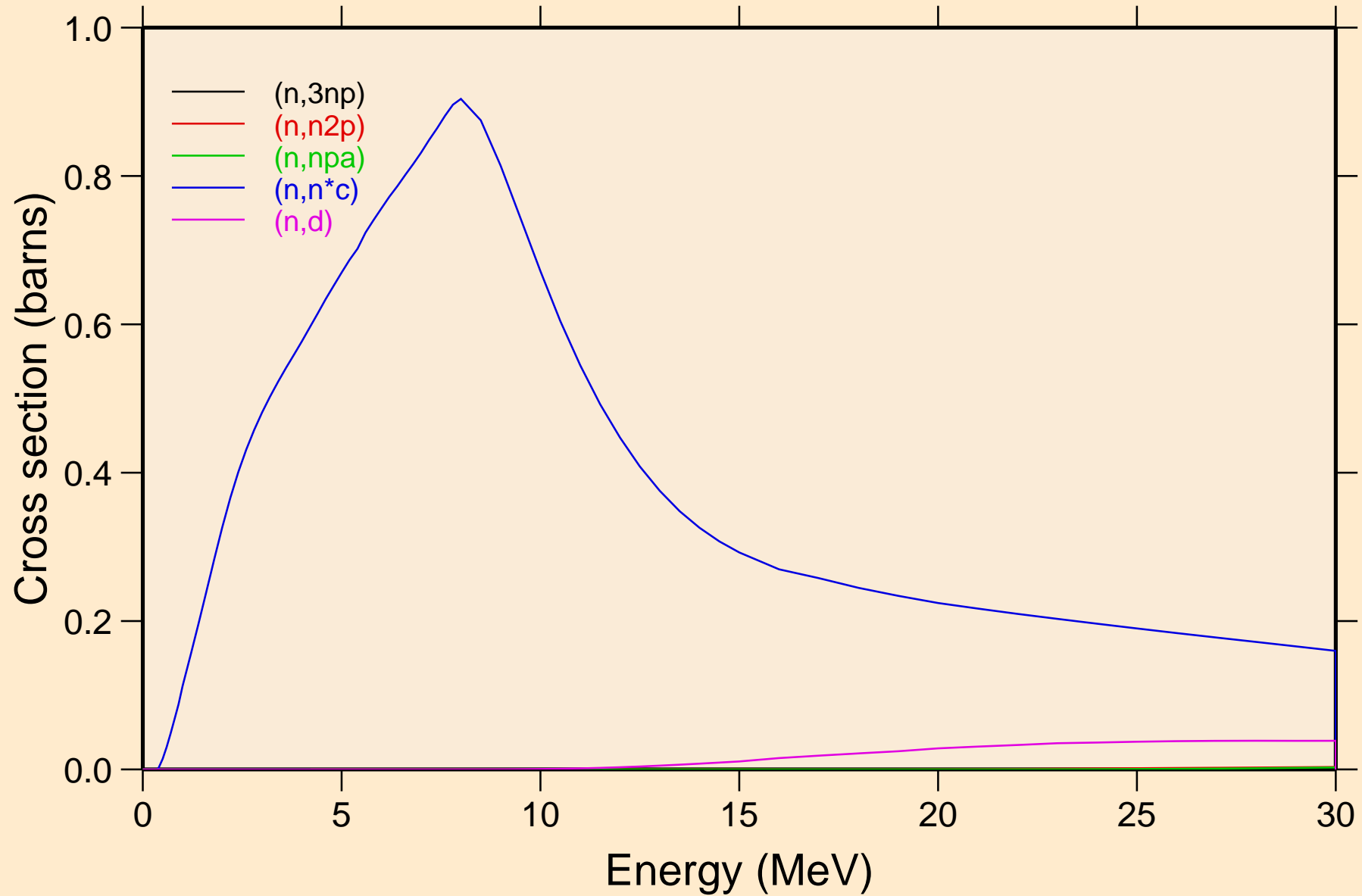

AT200 NEUTRON ACER TENDL-2024 LIBRARY; T=293.6K  
Threshold reactions

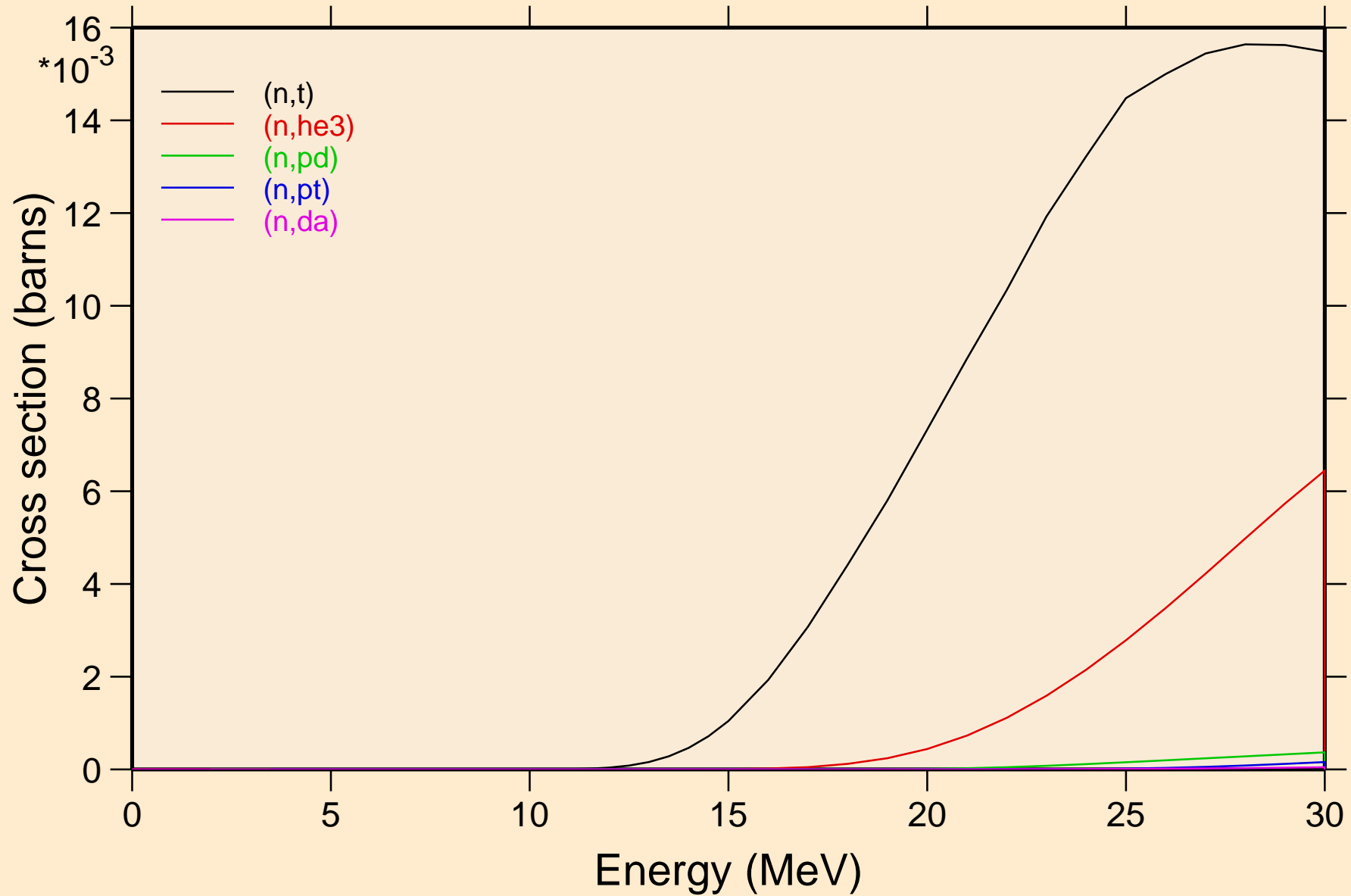

AT200 NEUTRON ACER TENDL-2024 LIBRARY; T=293.6K  
Threshold reactions

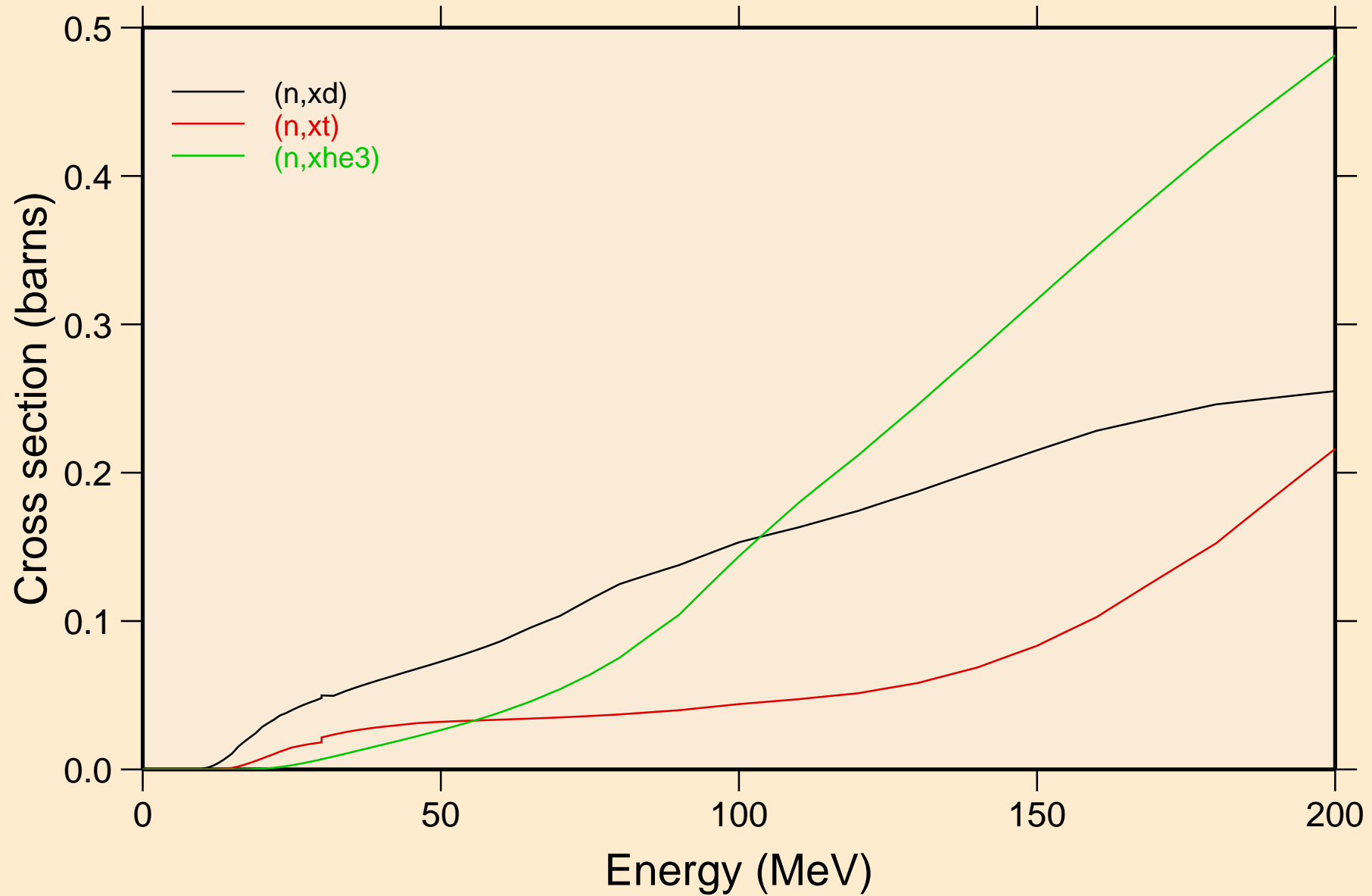

AT200 NEUTRON ACER TENDL-2024 LIBRARY; T=293.6K  
angular distribution for elastic

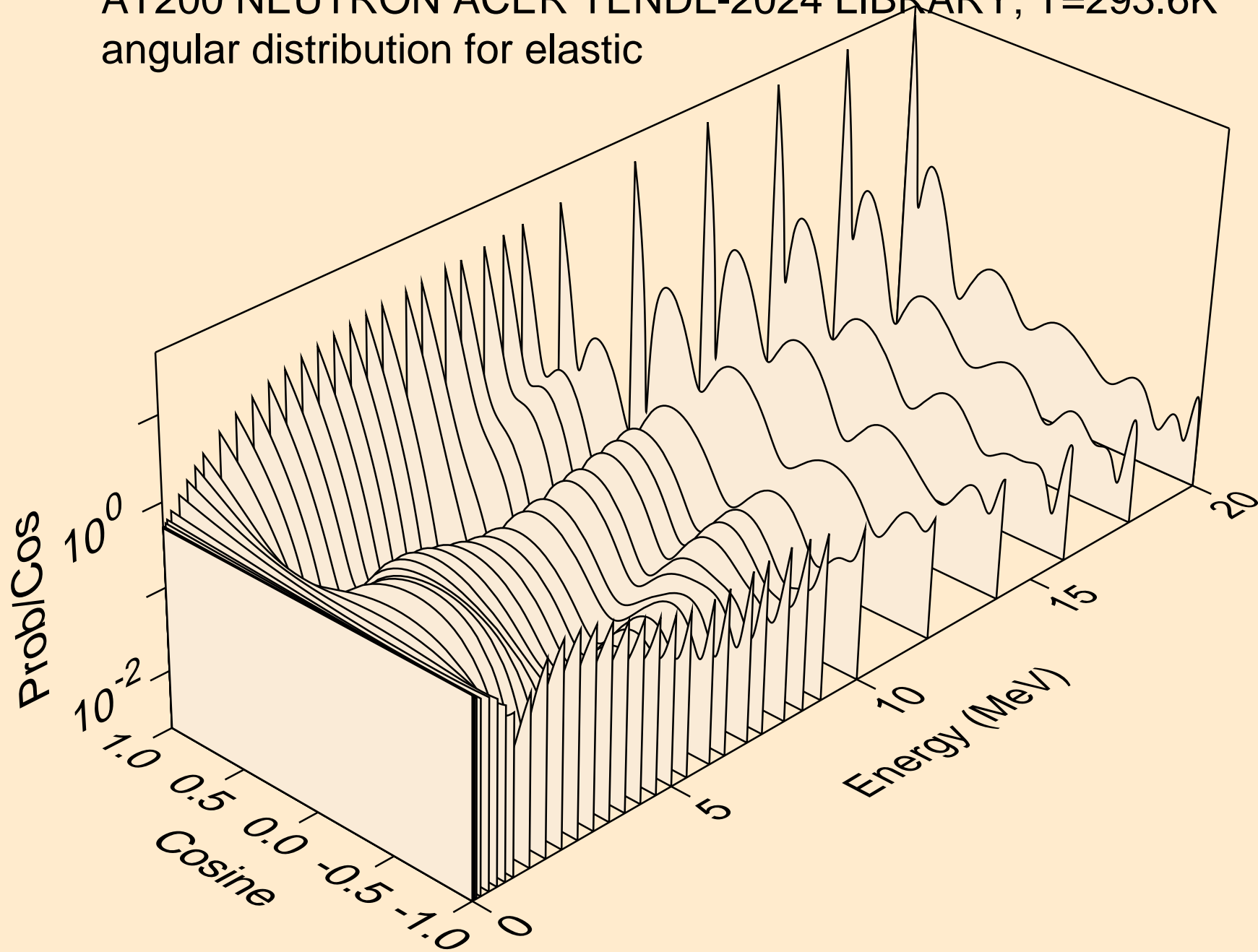

AT200 NEUTRON ACER TENDL-2024 LIBRARY; T=293.6K  
angular distribution for elastic

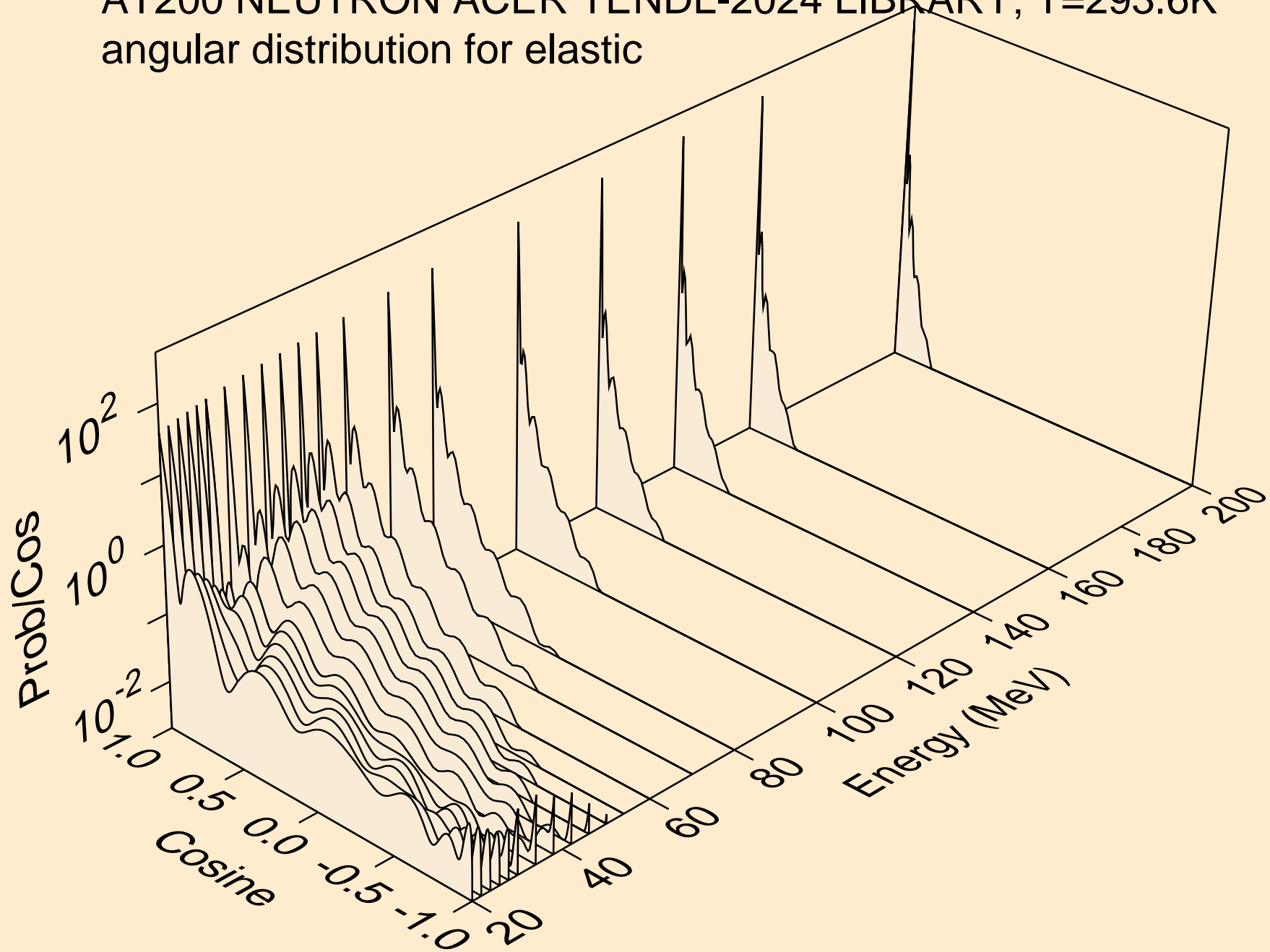

AT200 NEUTRON ACER TENDL-2024 LIBRARY; T=293.6K  
angular distribution for (n,n\*1)

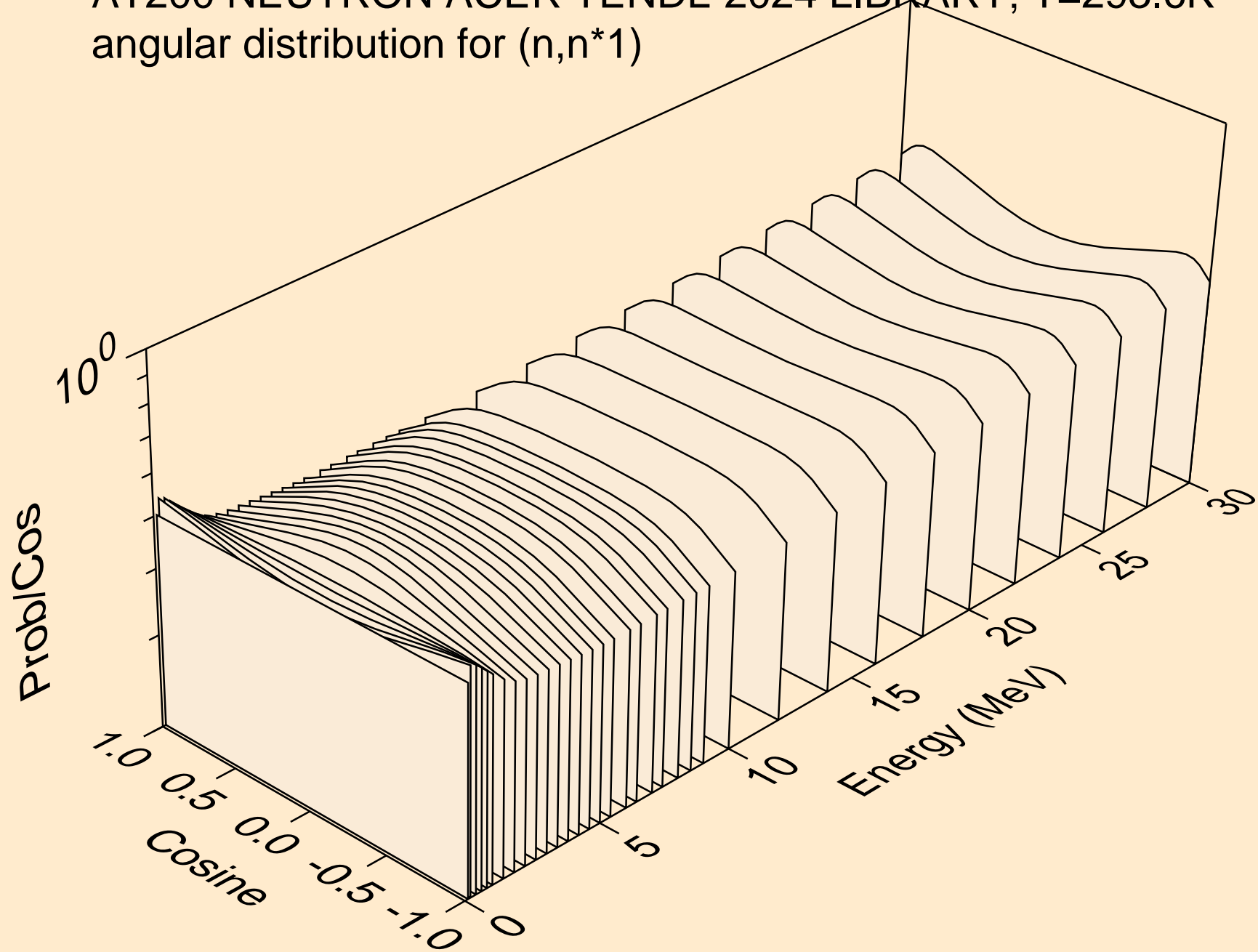

AT200 NEUTRON ACER TENDL-2024 LIBRARY; T=293.6K  
angular distribution for (n,n\*2)

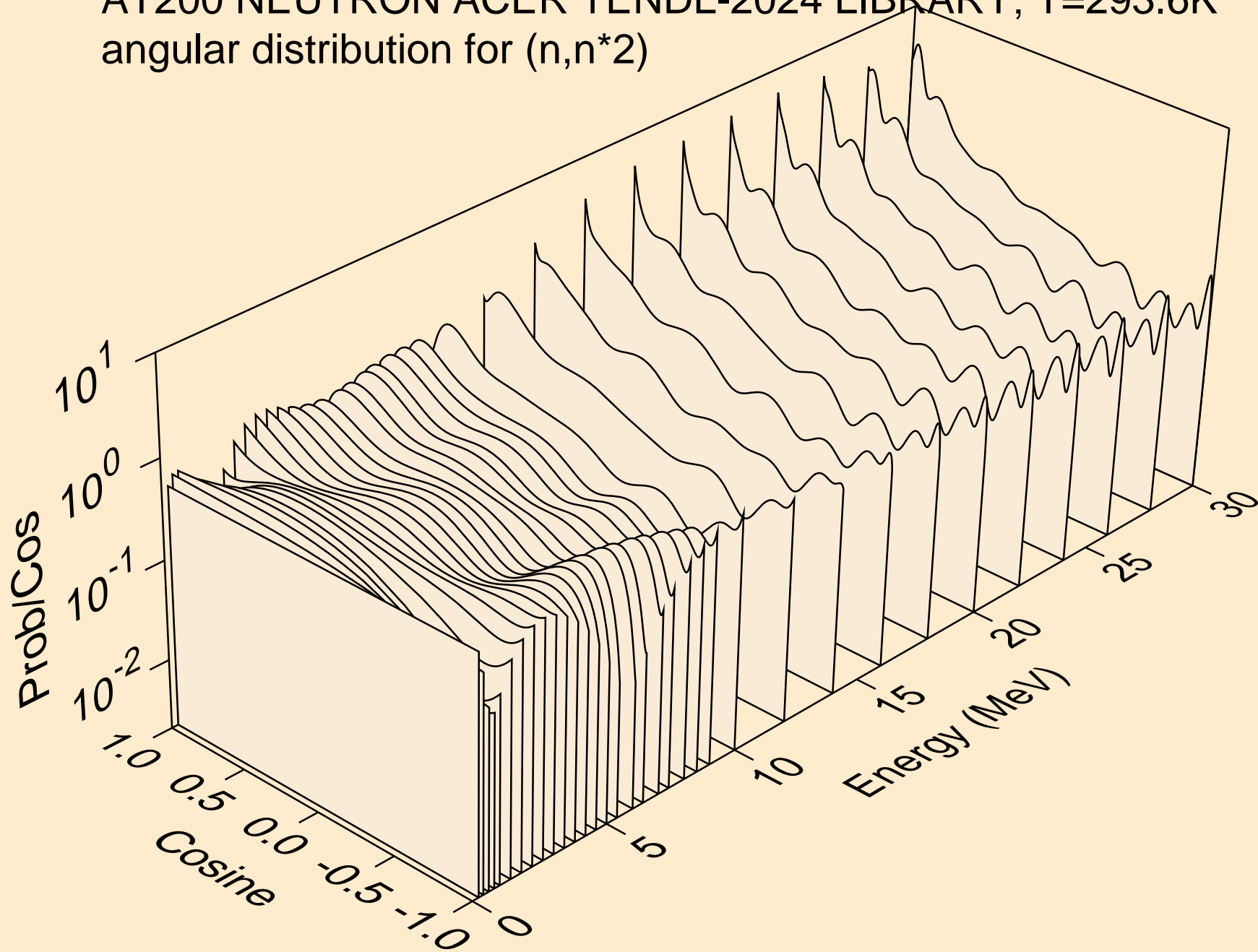

AT200 NEUTRON ACER TENDL-2024 LIBRARY; T=293.6K  
angular distribution for (n,n\*3)

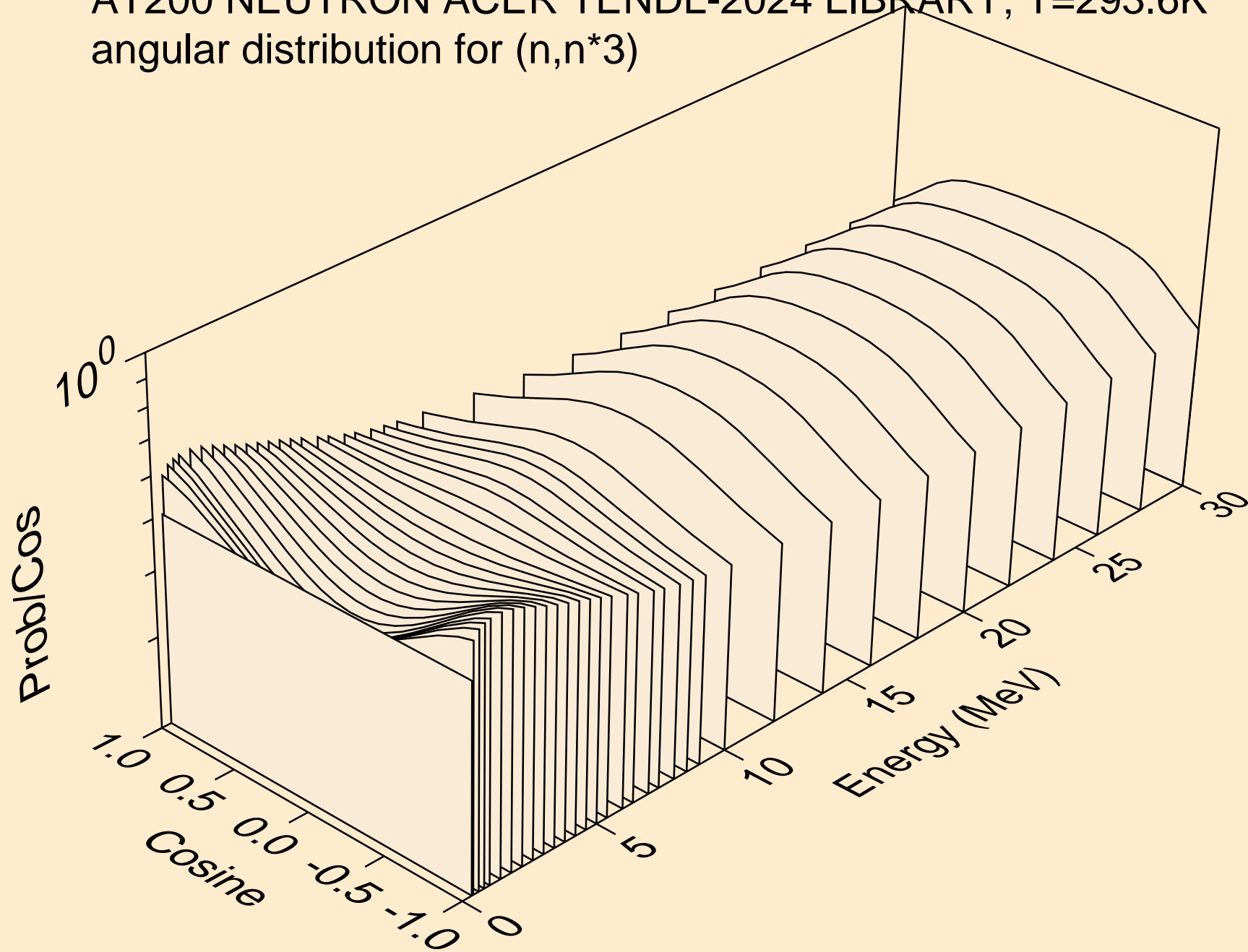

AT200 NEUTRON ACER TENDL-2024 LIBRARY; T=293.6K  
angular distribution for (n,n\*4)

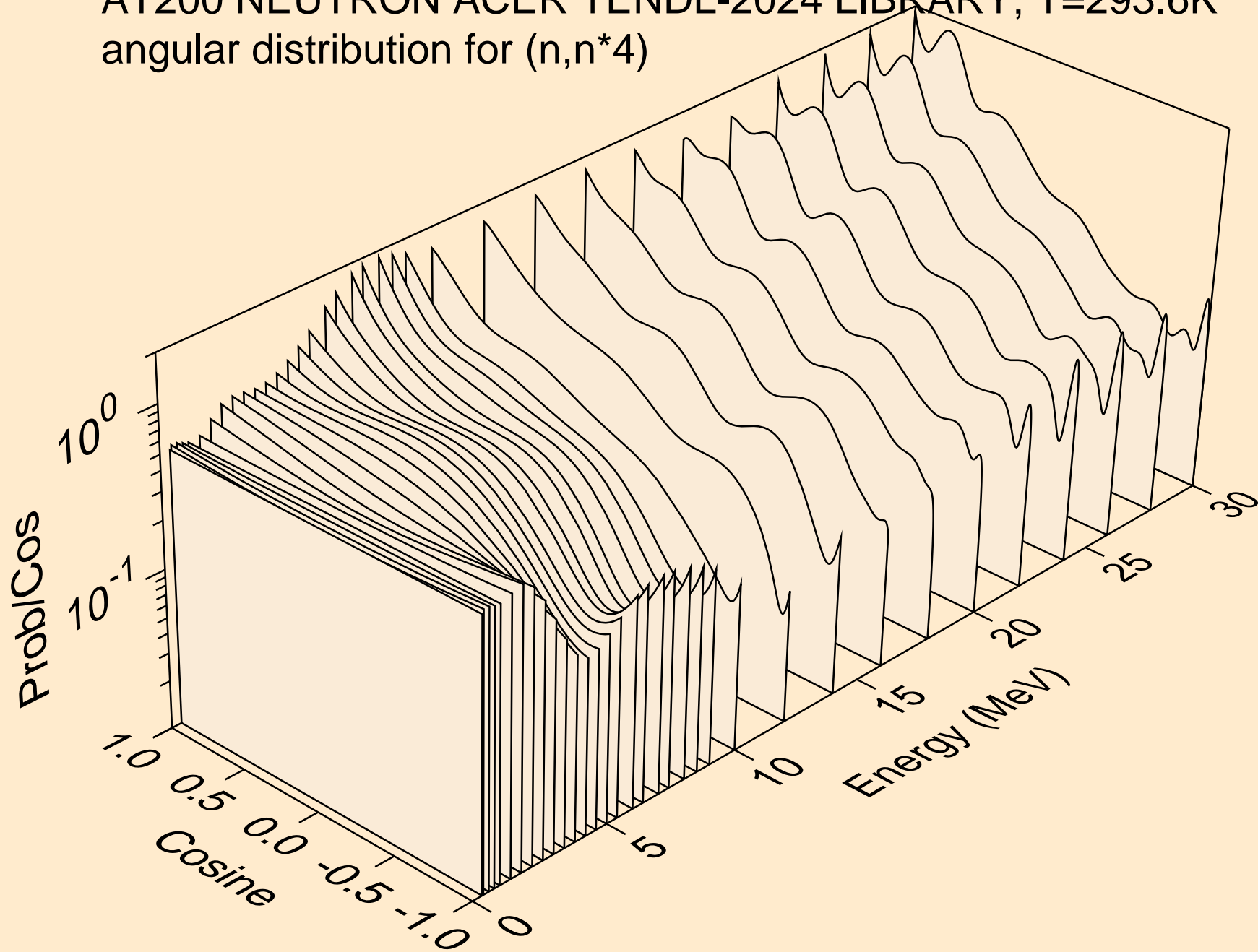

AT200 NEUTRON ACER TENDL-2024 LIBRARY; T=293.6K  
angular distribution for (n,n\*5)

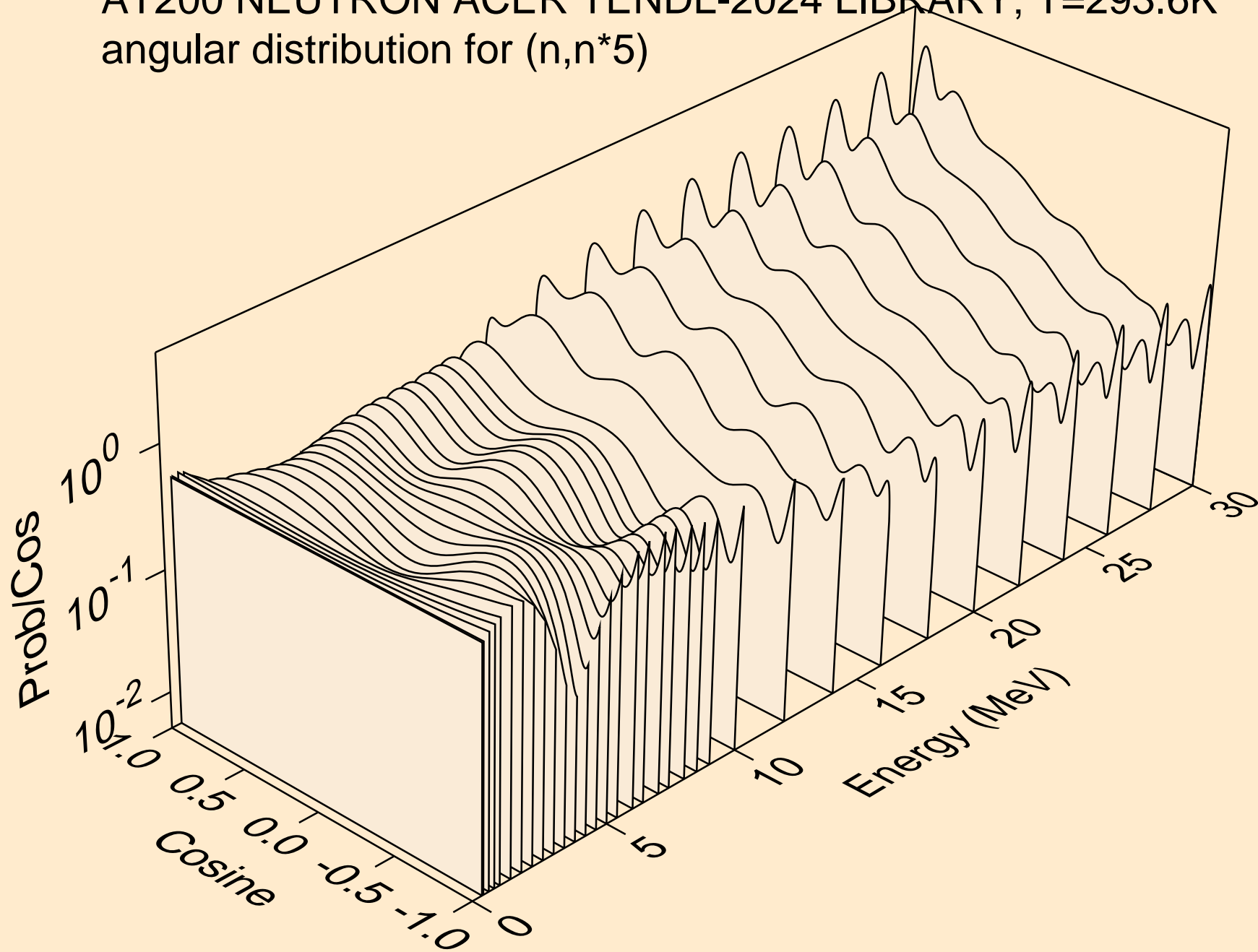

AT200 NEUTRON ACER TENDL-2024 LIBRARY; T=293.6K  
angular distribution for (n,n\*6)

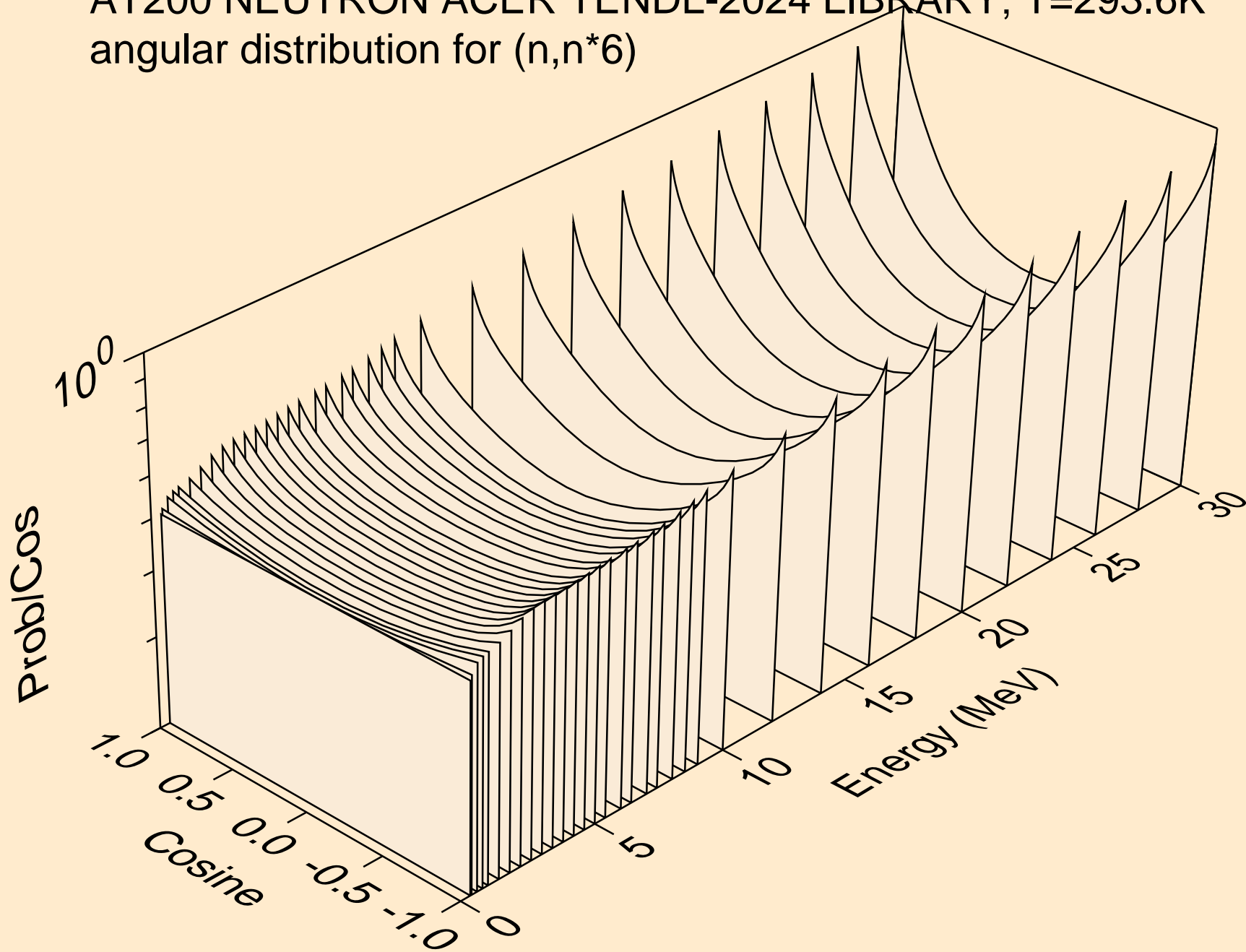

AT200 NEUTRON ACER TENDL-2024 LIBRARY; T=293.6K  
angular distribution for (n,n\*7)

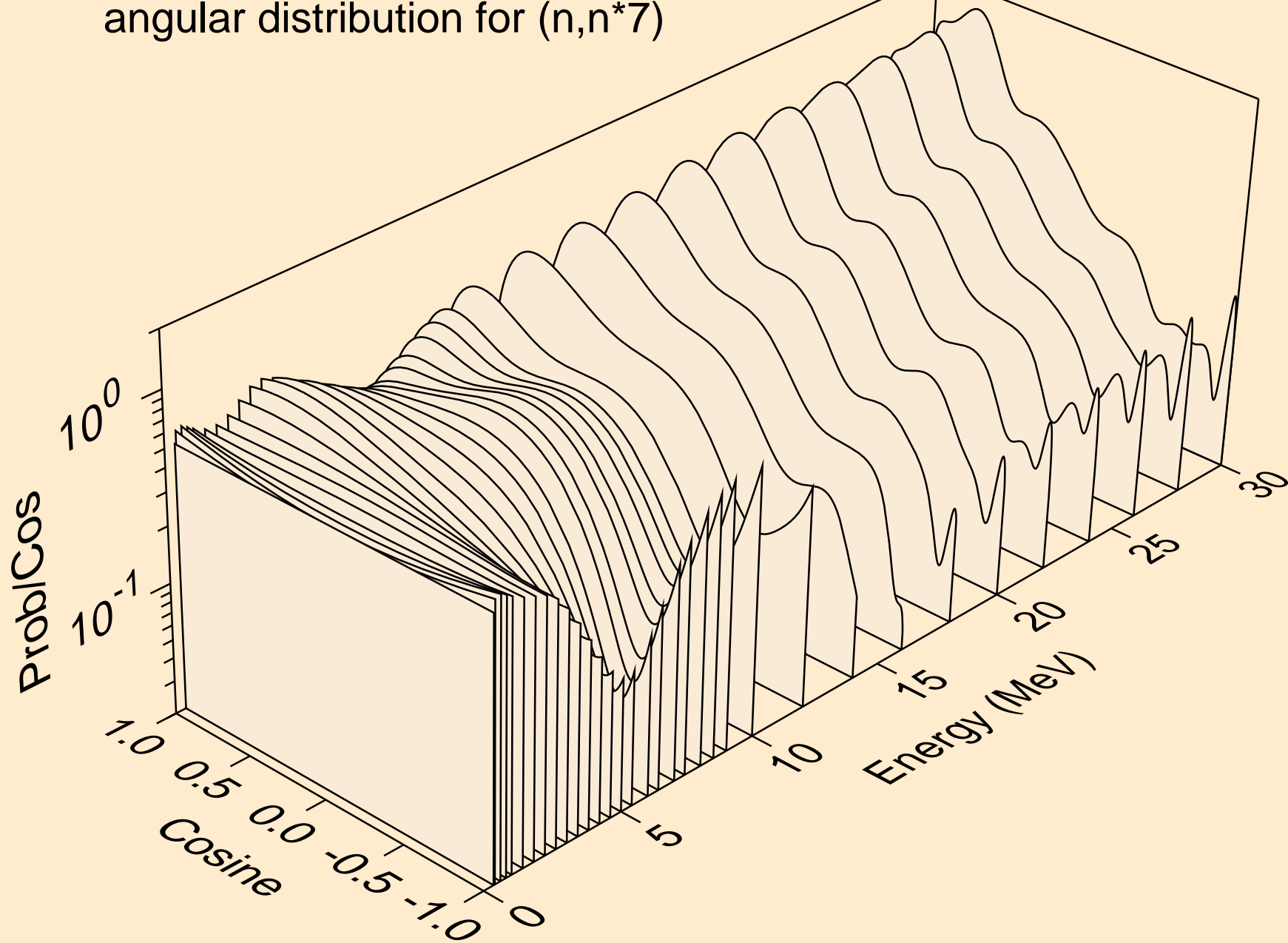

AT200 NEUTRON ACER TENDL-2024 LIBRARY; T=293.6K  
angular distribution for (n,n\*8)

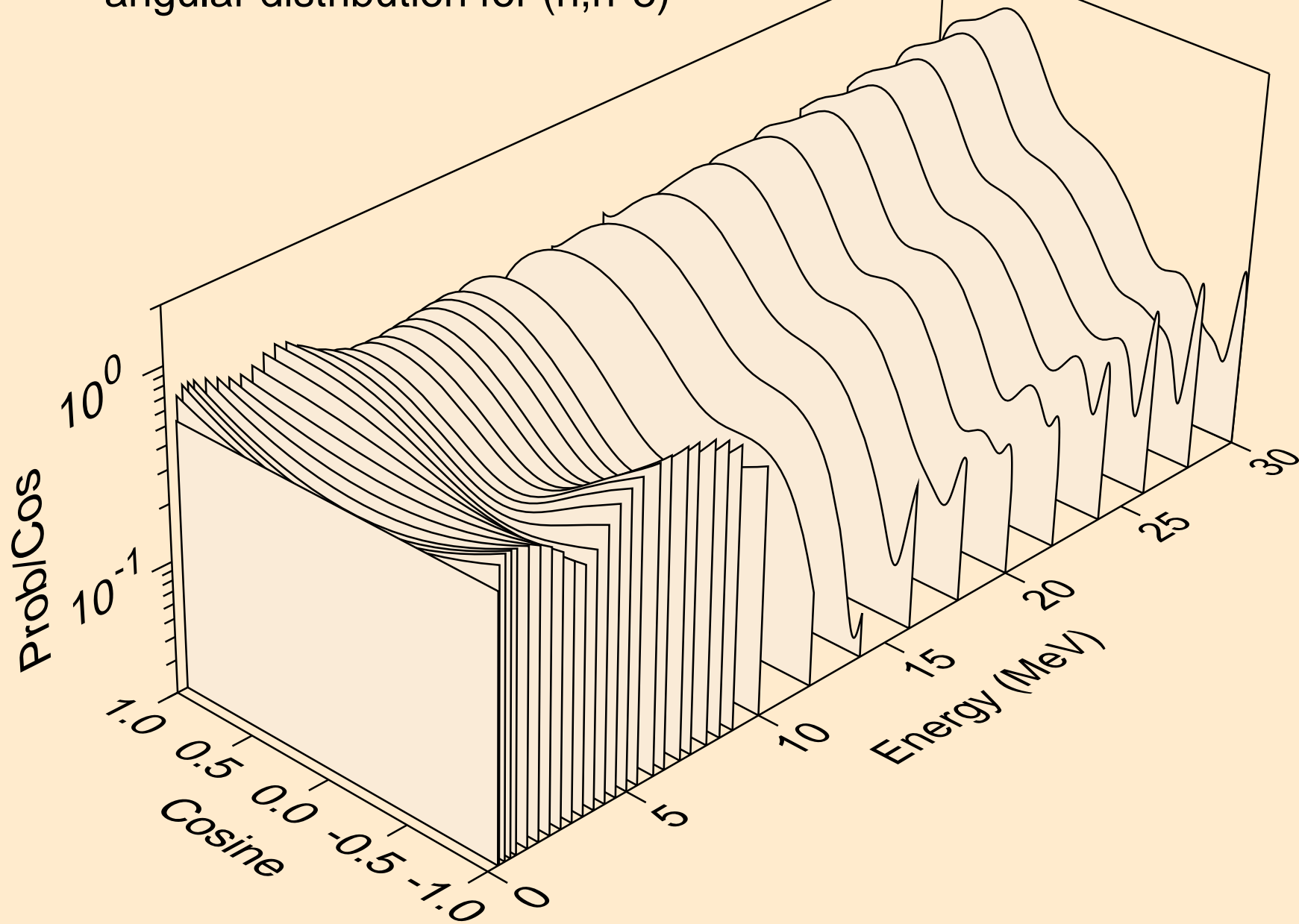

AT200 NEUTRON ACER TENDL-2024 LIBRARY; T=293.6K  
angular distribution for (n,n\*9)

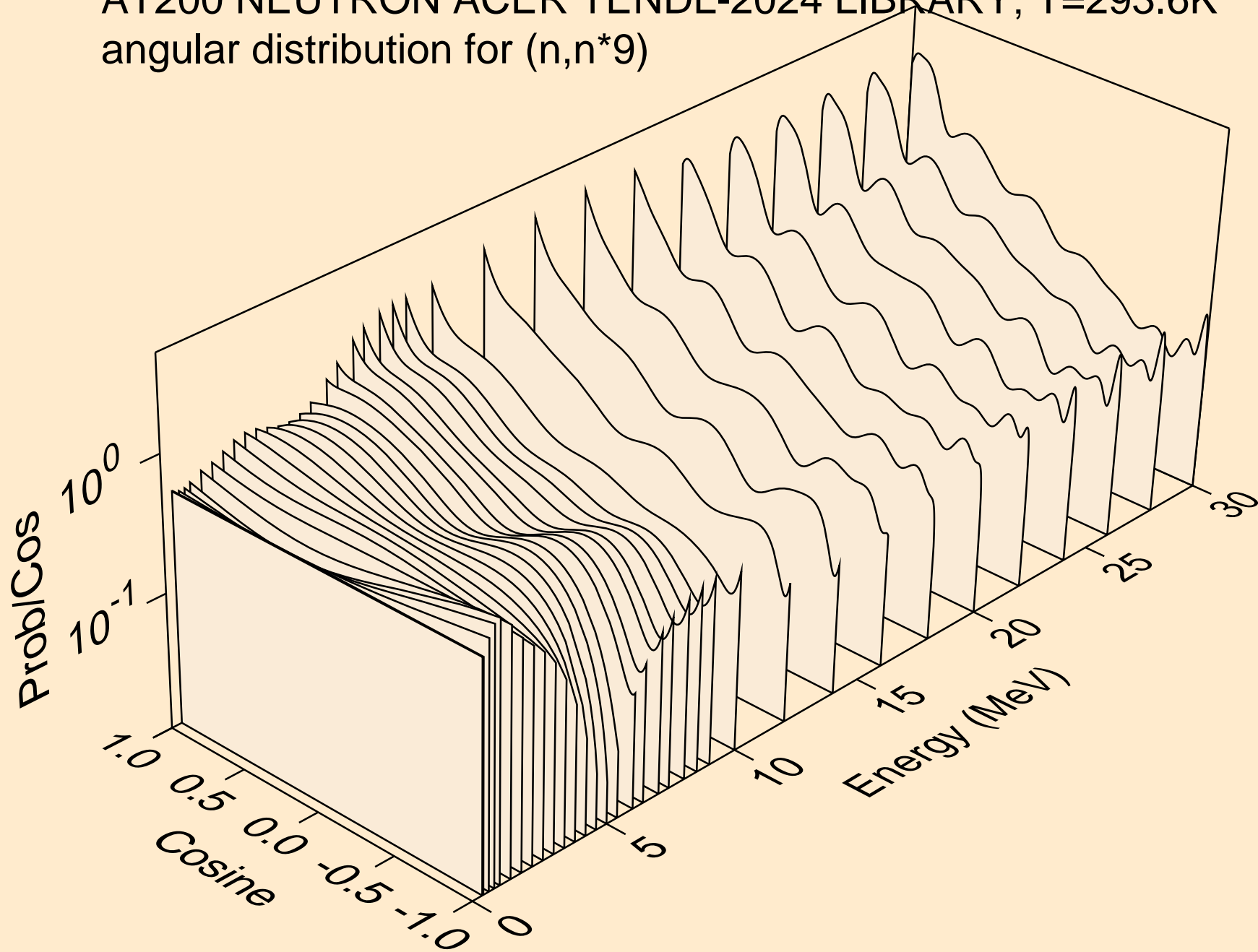

AT200 NEUTRON ACER TENDL-2024 LIBRARY; T=293.6K  
angular distribution for (n,n\*10)

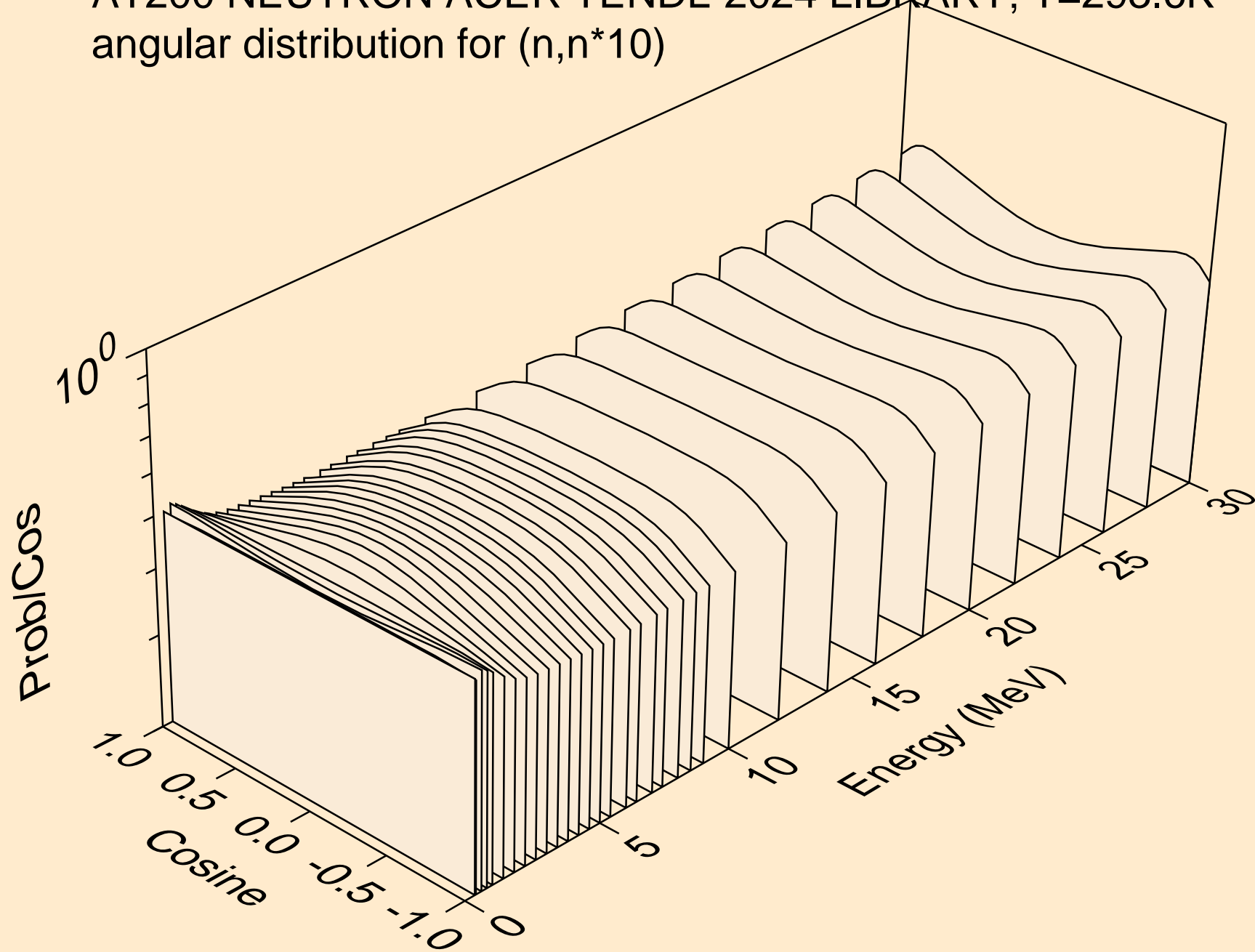

AT200 NEUTRON ACER TENDL-2024 LIBRARY; T=293.6K  
angular distribution for (n,n\*11)

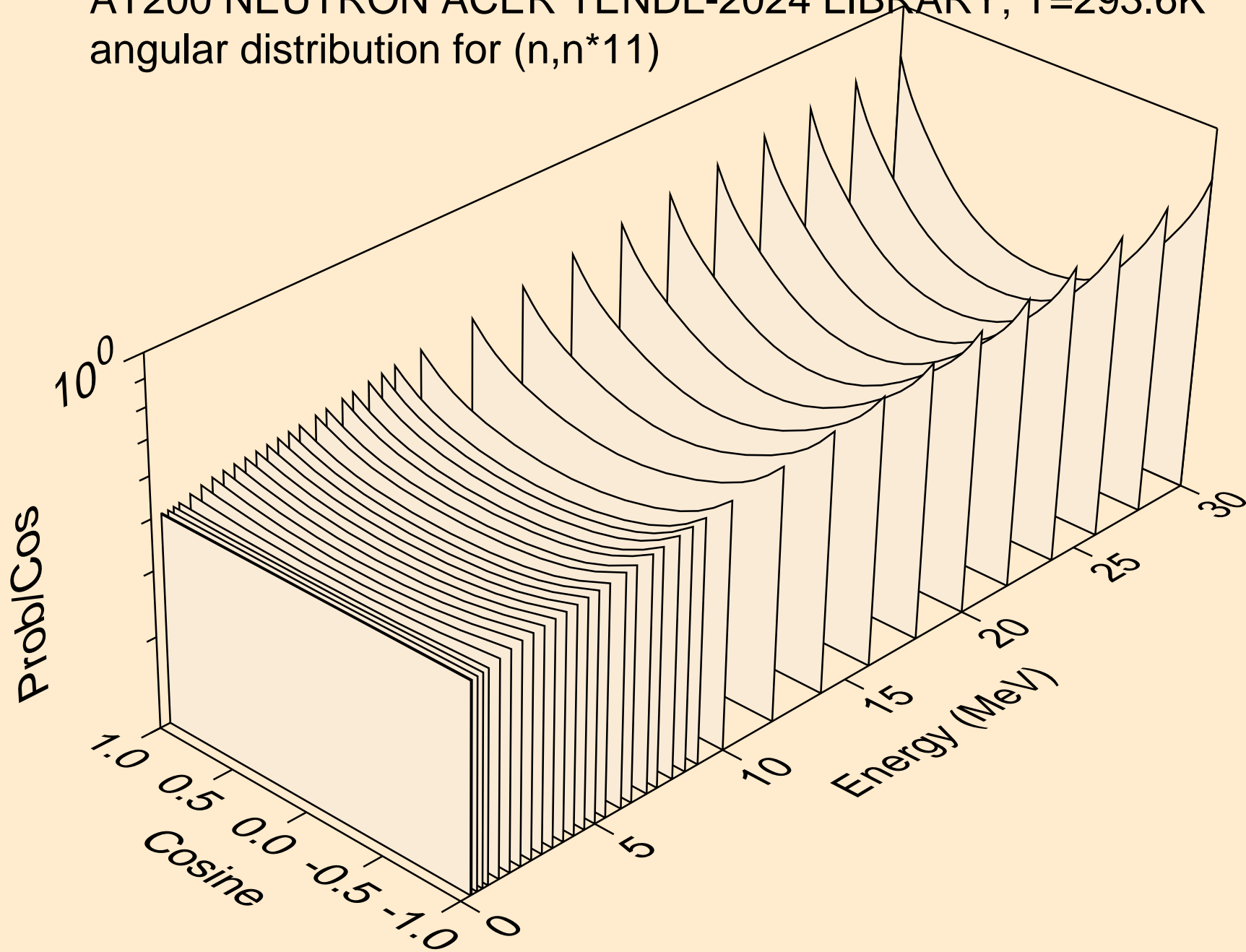

AT200 NEUTRON ACER TENDL-2024 LIBRARY; T=293.6K  
angular distribution for (n,n\*12)

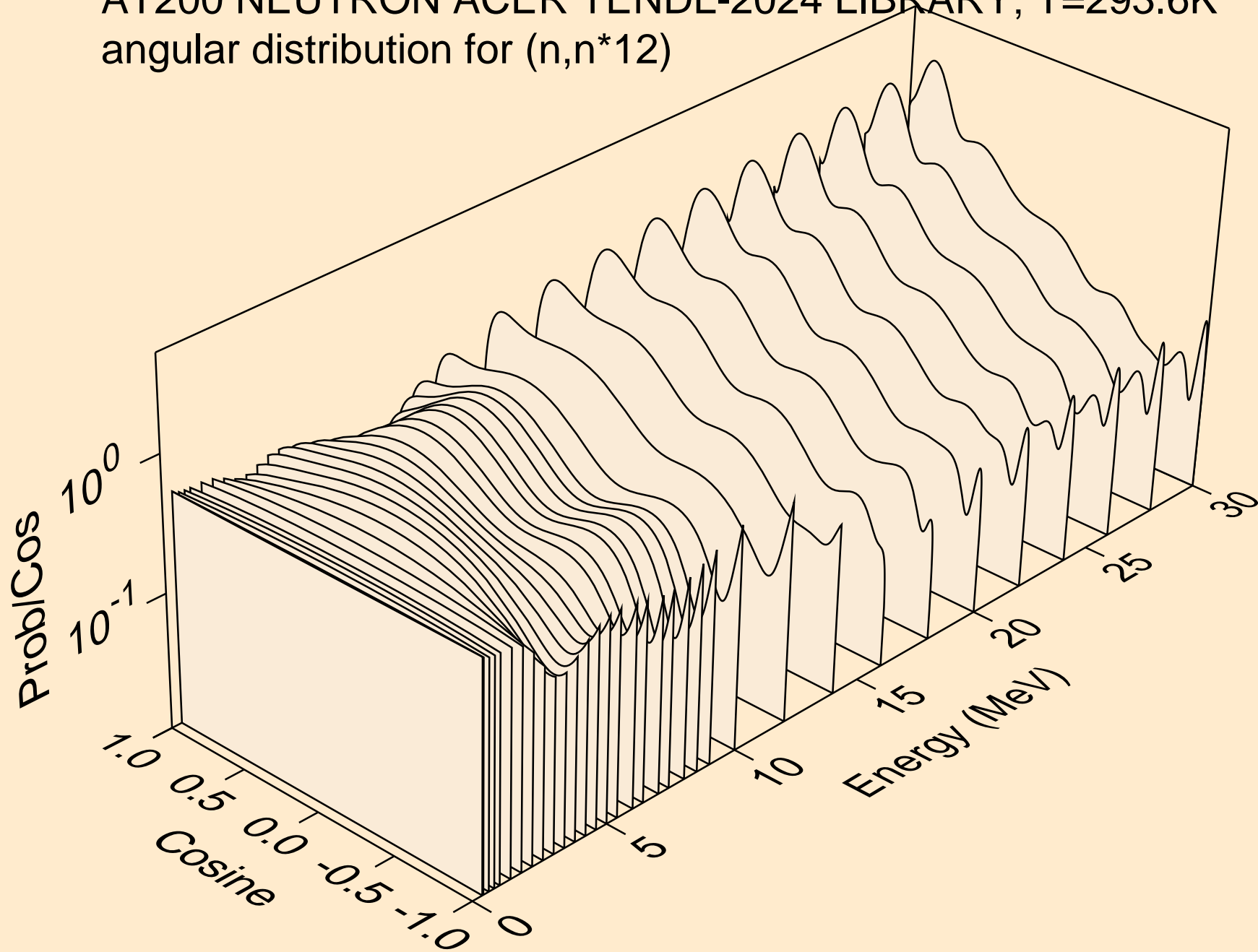

AT200 NEUTRON ACER TENDL-2024 LIBRARY; T=293.6K  
angular distribution for (n,n\*13)

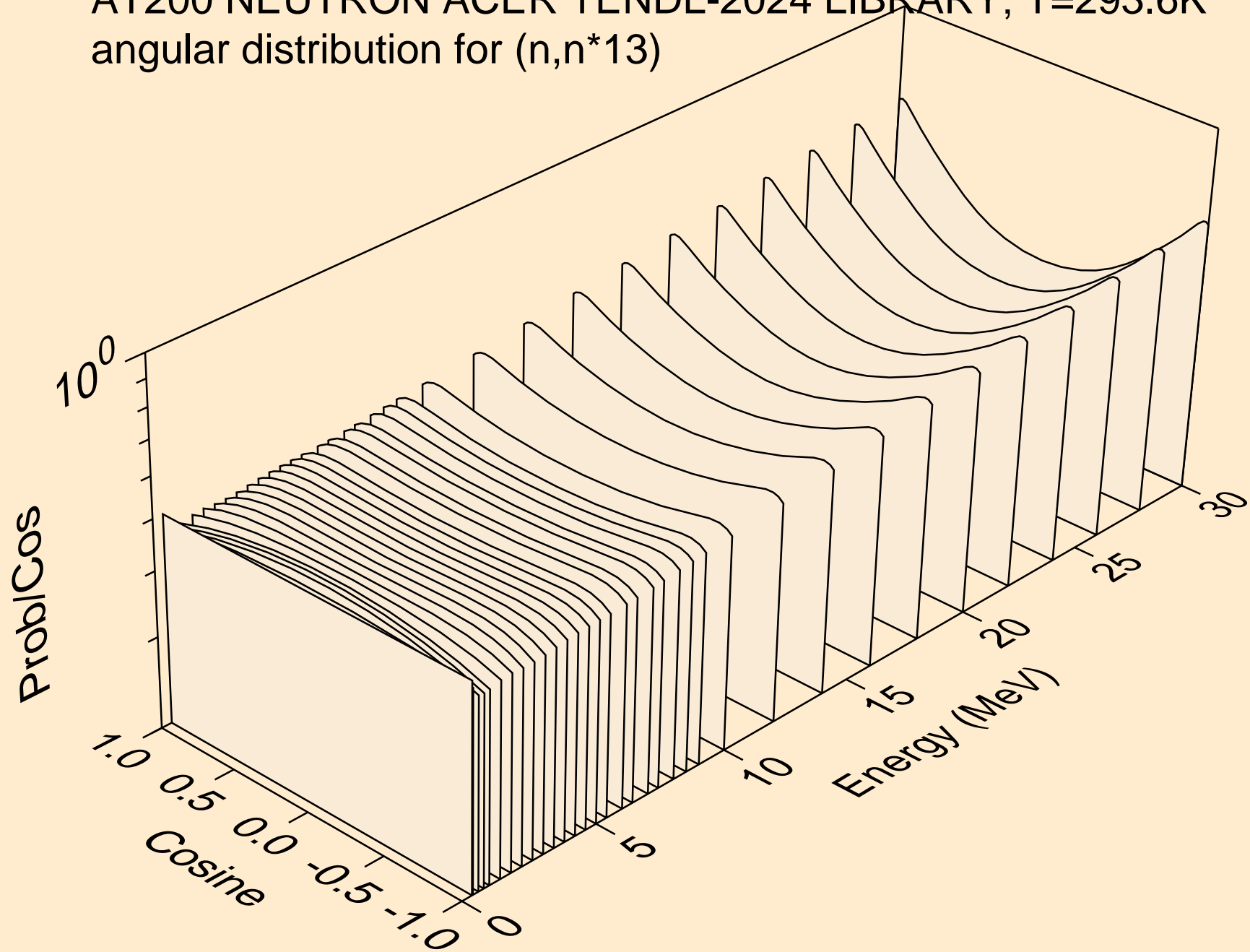

AT200 NEUTRON ACER TENDL-2024 LIBRARY; T=293.6K  
angular distribution for (n,n\*14)

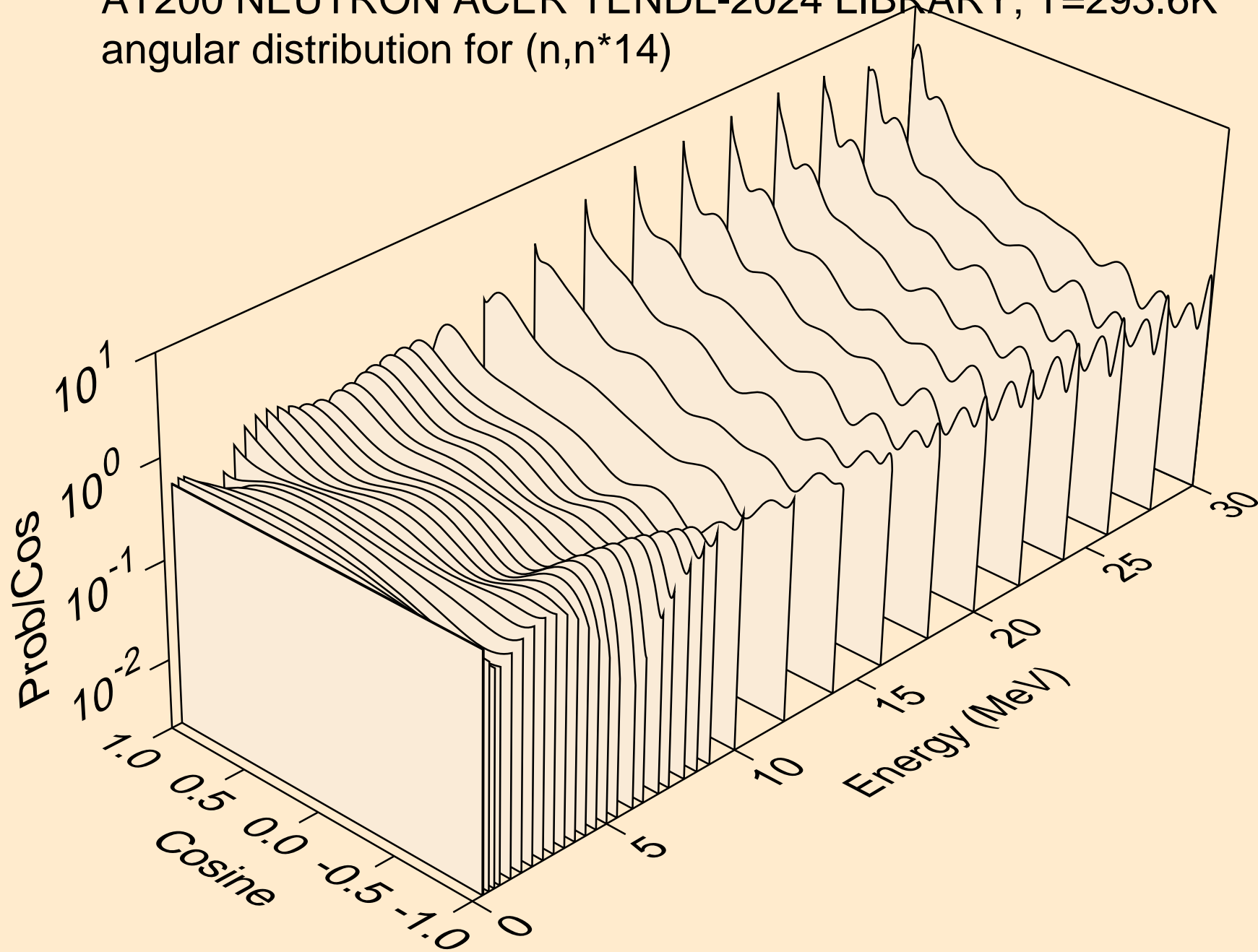

AT200 NEUTRON ACER TENDL-2024 LIBRARY; T=293.6K  
Neutron emission for (n,x)

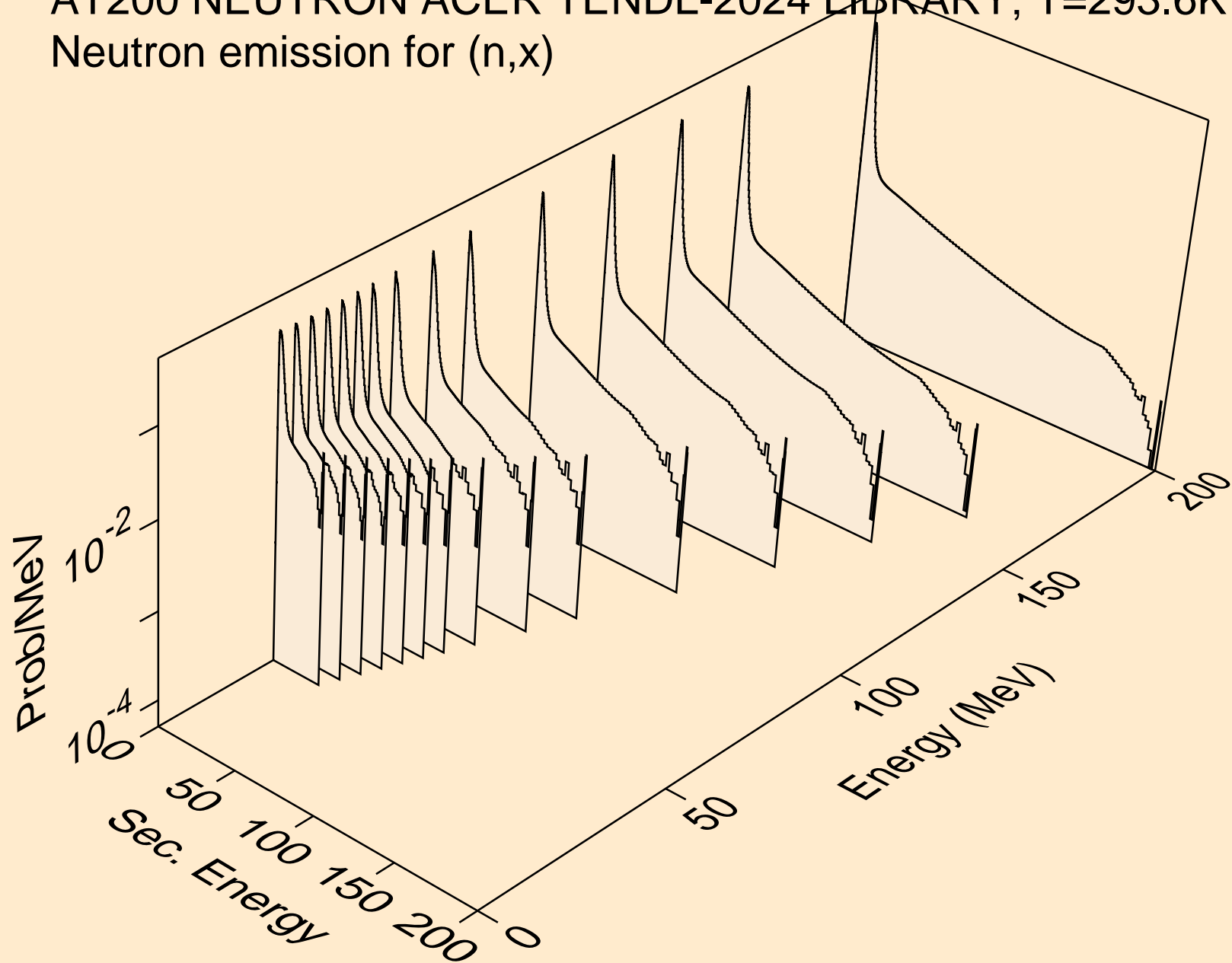

AT200 NEUTRON ACER TENDL-2024 LIBRARY; T=293.6K  
Neutron emission for (n,2nd)

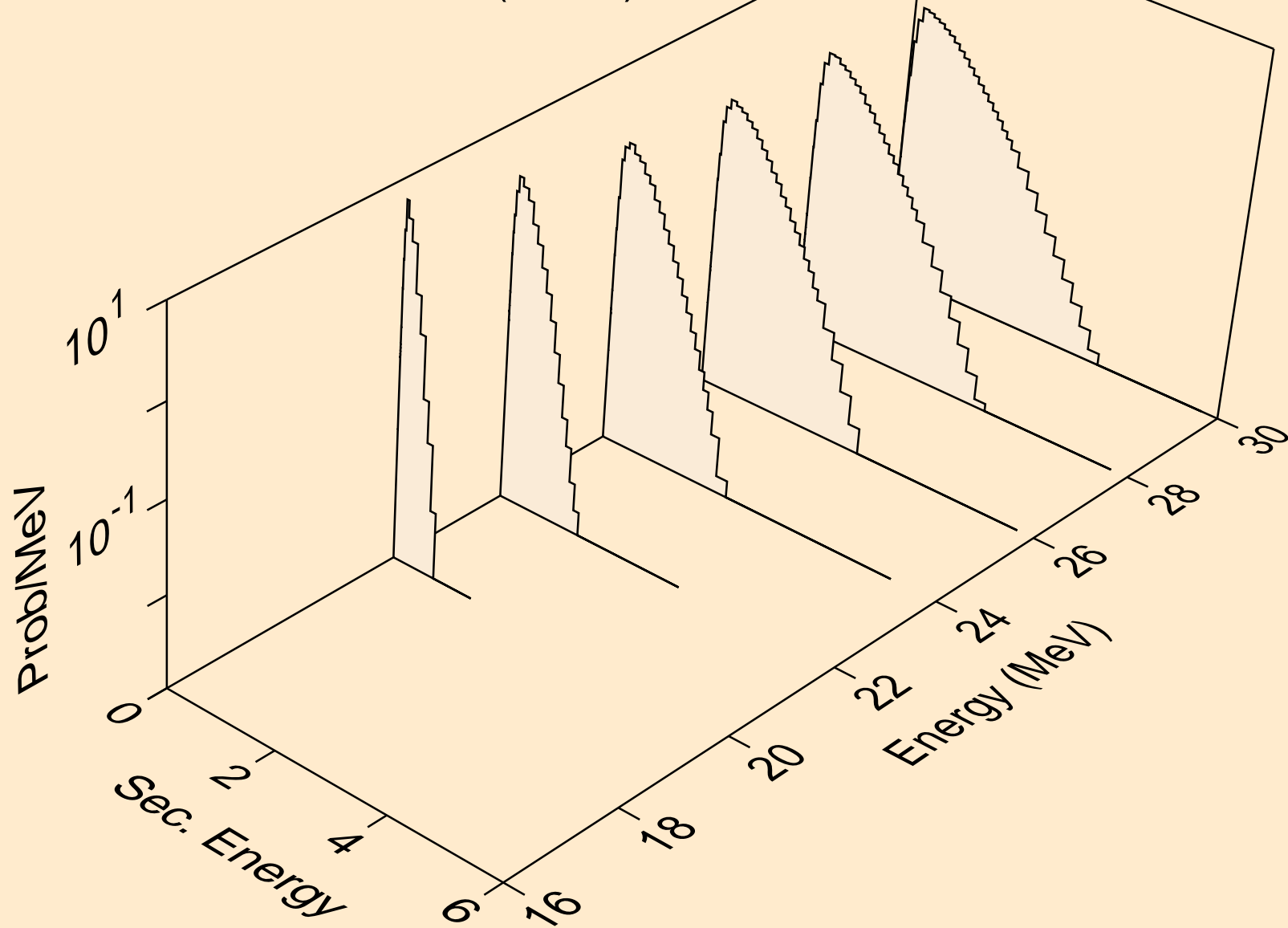

AT200 NEUTRON ACER TENDL-2024 LIBRARY; T=293.6K  
Neutron emission for (n,2n)

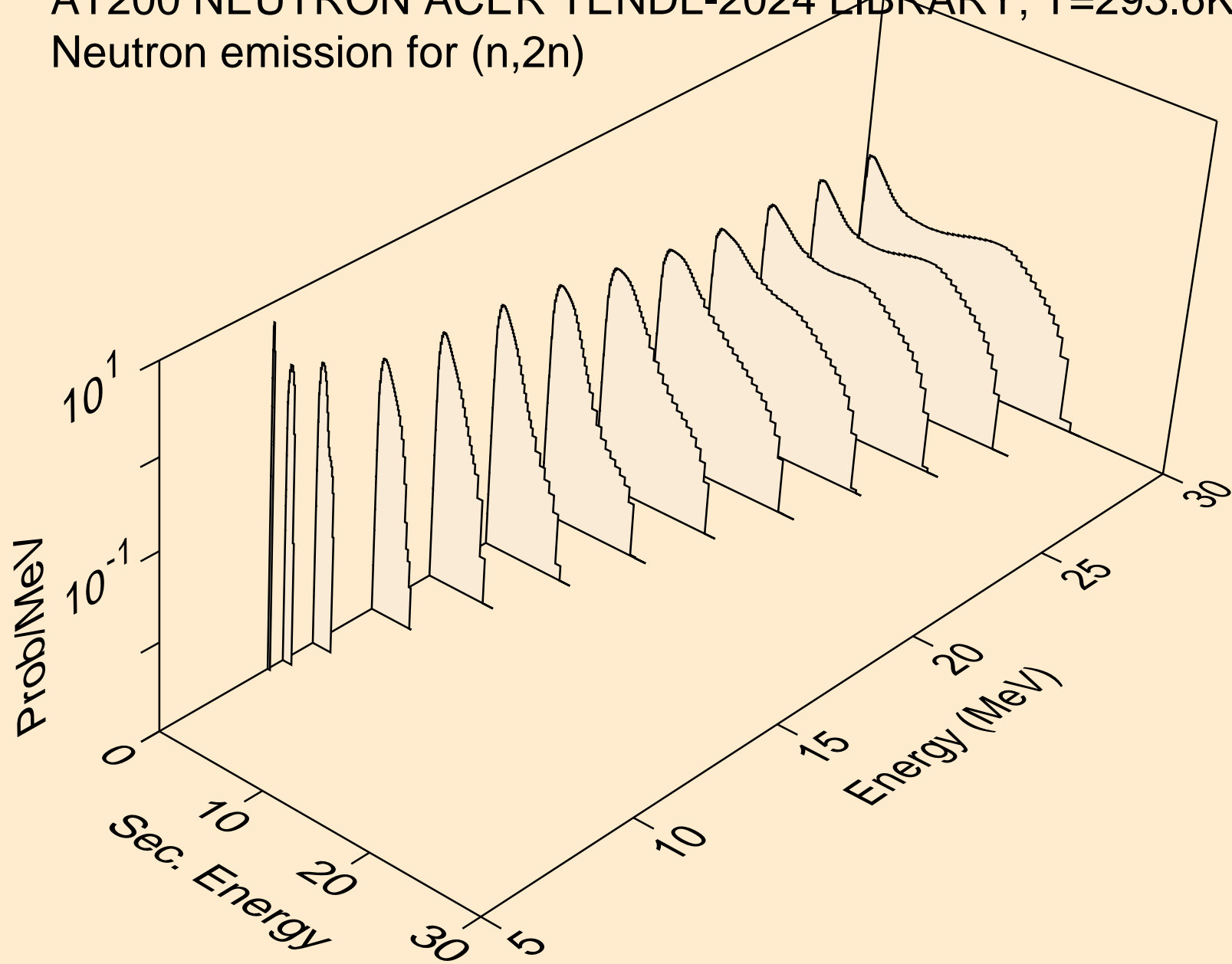

AT200 NEUTRON ACER TENDL-2024 LIBRARY; T=293.6K  
Neutron emission for (n,3n)

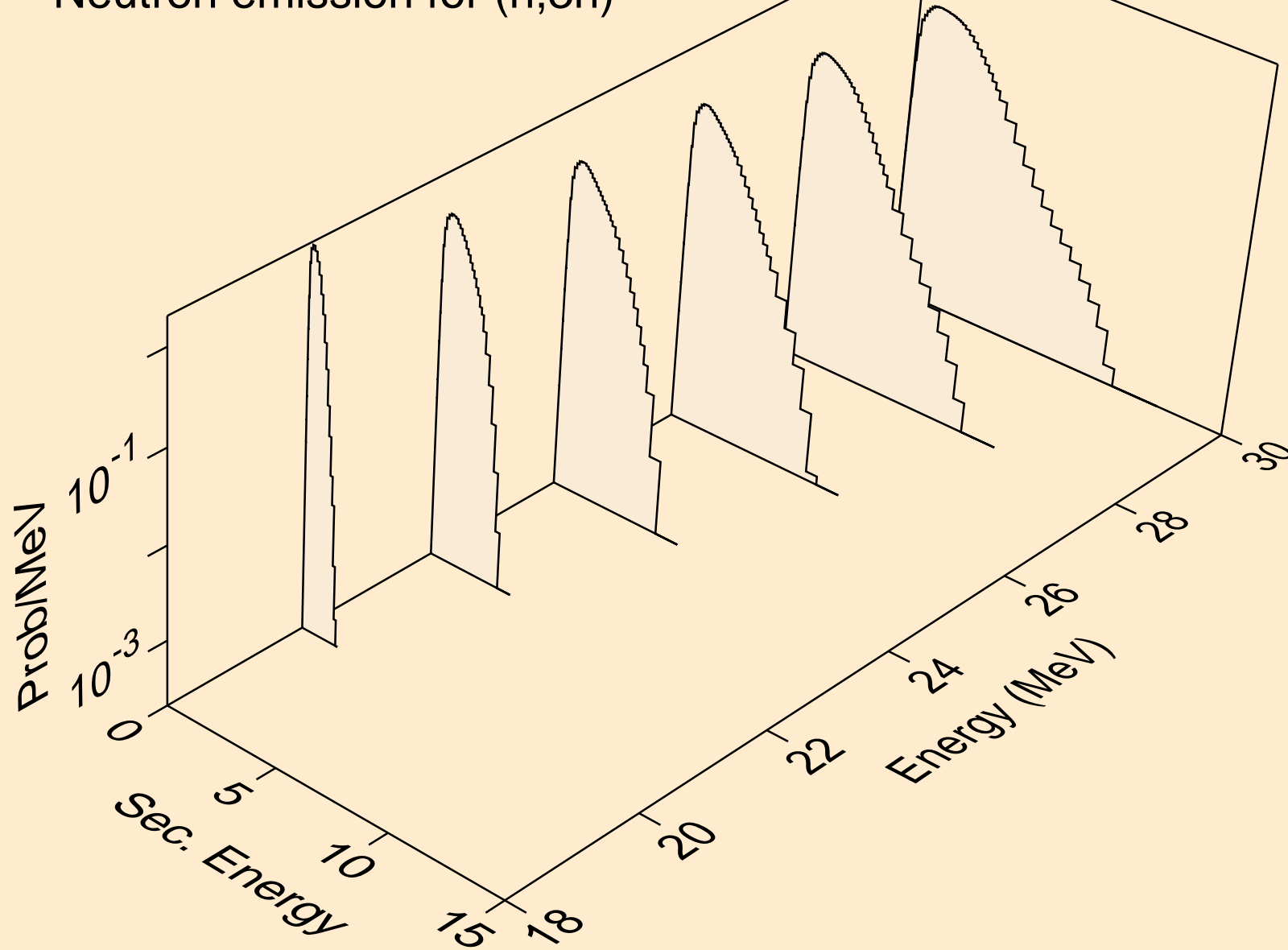

AT200 NEUTRON ACER TENDL-2024 LIBRARY; T=293.6K  
Neutron emission for (n,n\*)a

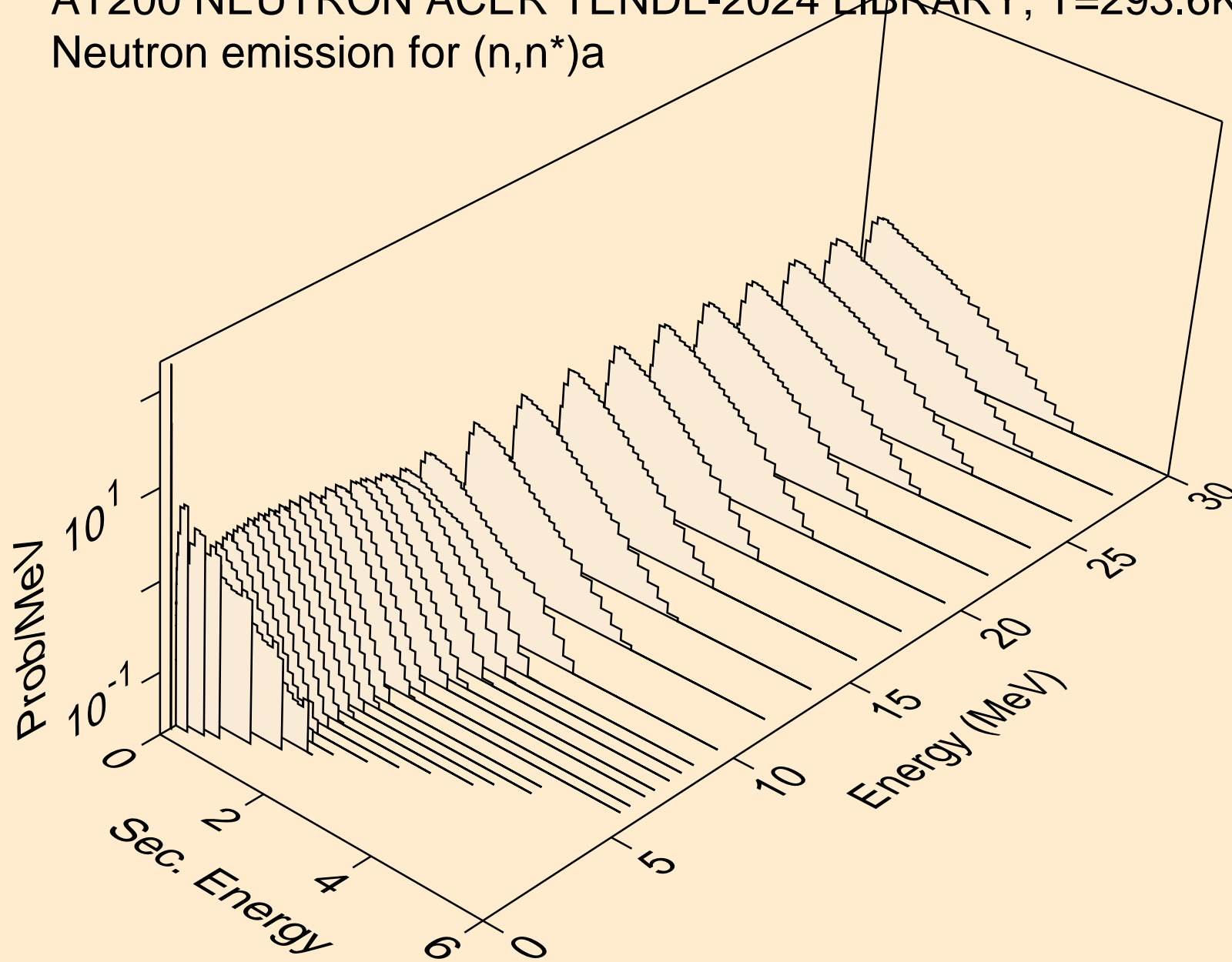

AT200 NEUTRON ACER TENDL-2024 LIBRARY; T=293.6K  
Neutron emission for (n,2n)a

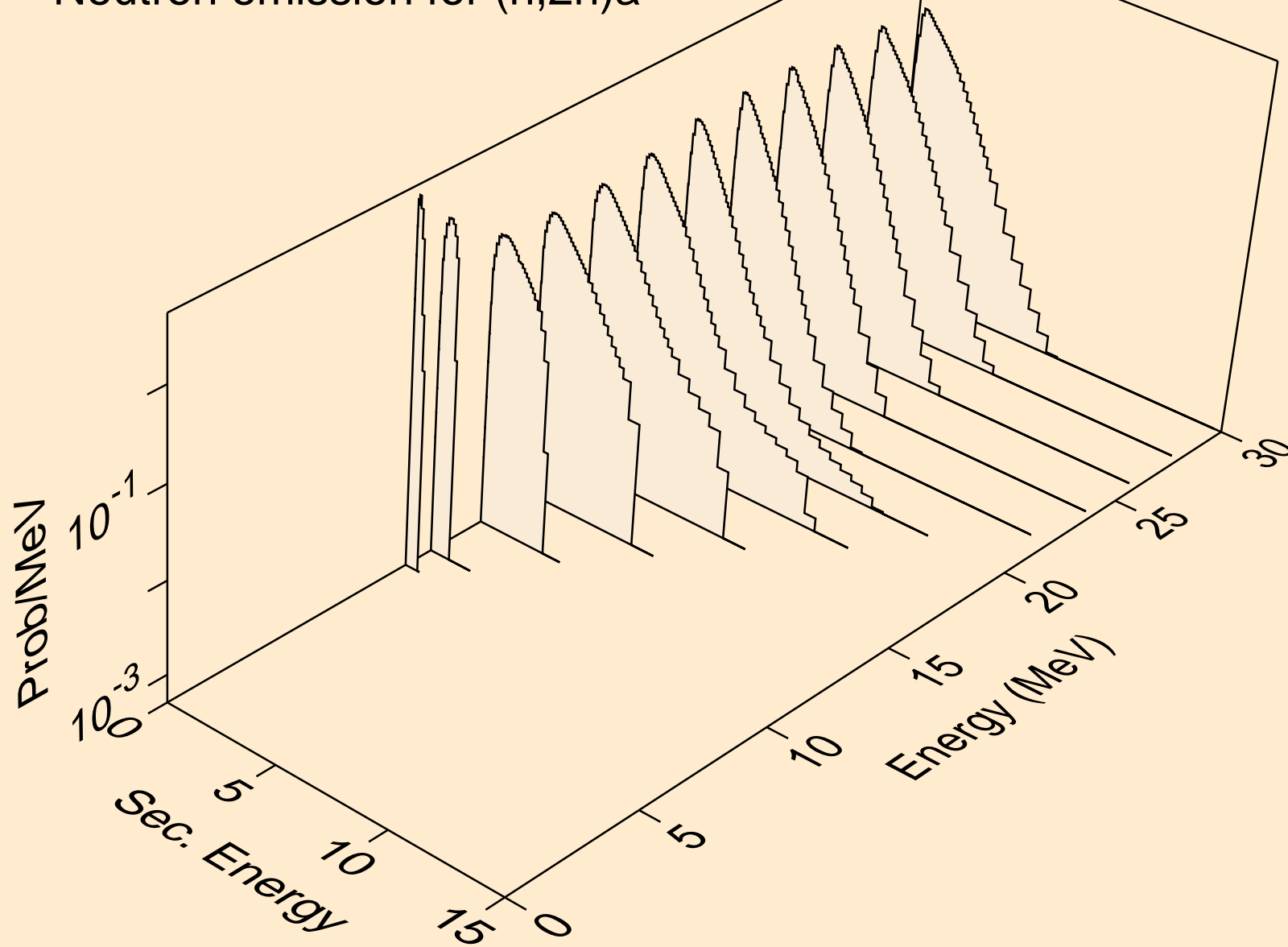

AT200 NEUTRON ACER TENDL-2024 LIBRARY; T=293.6K  
Neutron emission for (n,3n)a

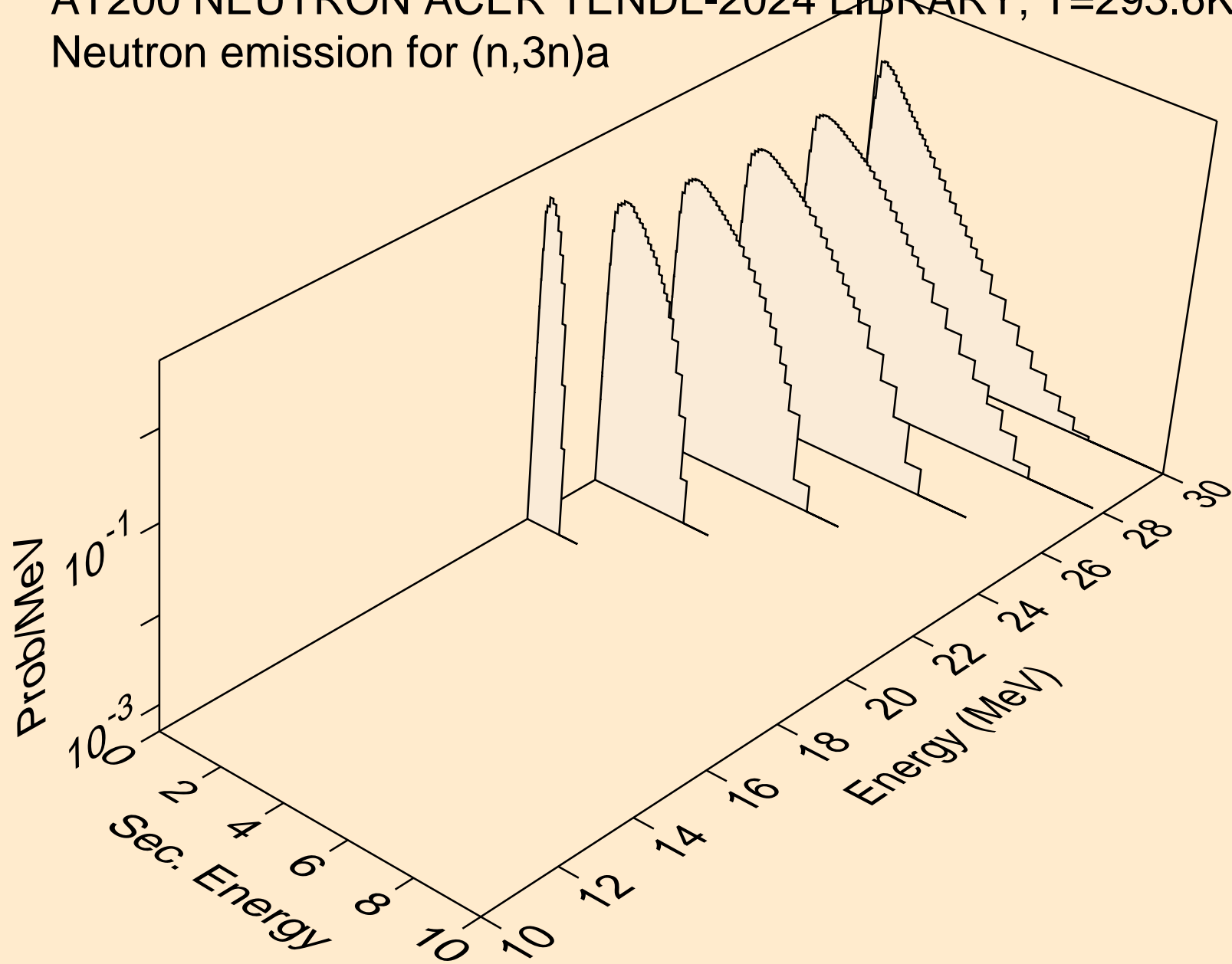

AT200 NEUTRON ACER TENDL-2024 LIBRARY; T=293.6K  
Neutron emission for (n,n\*)p

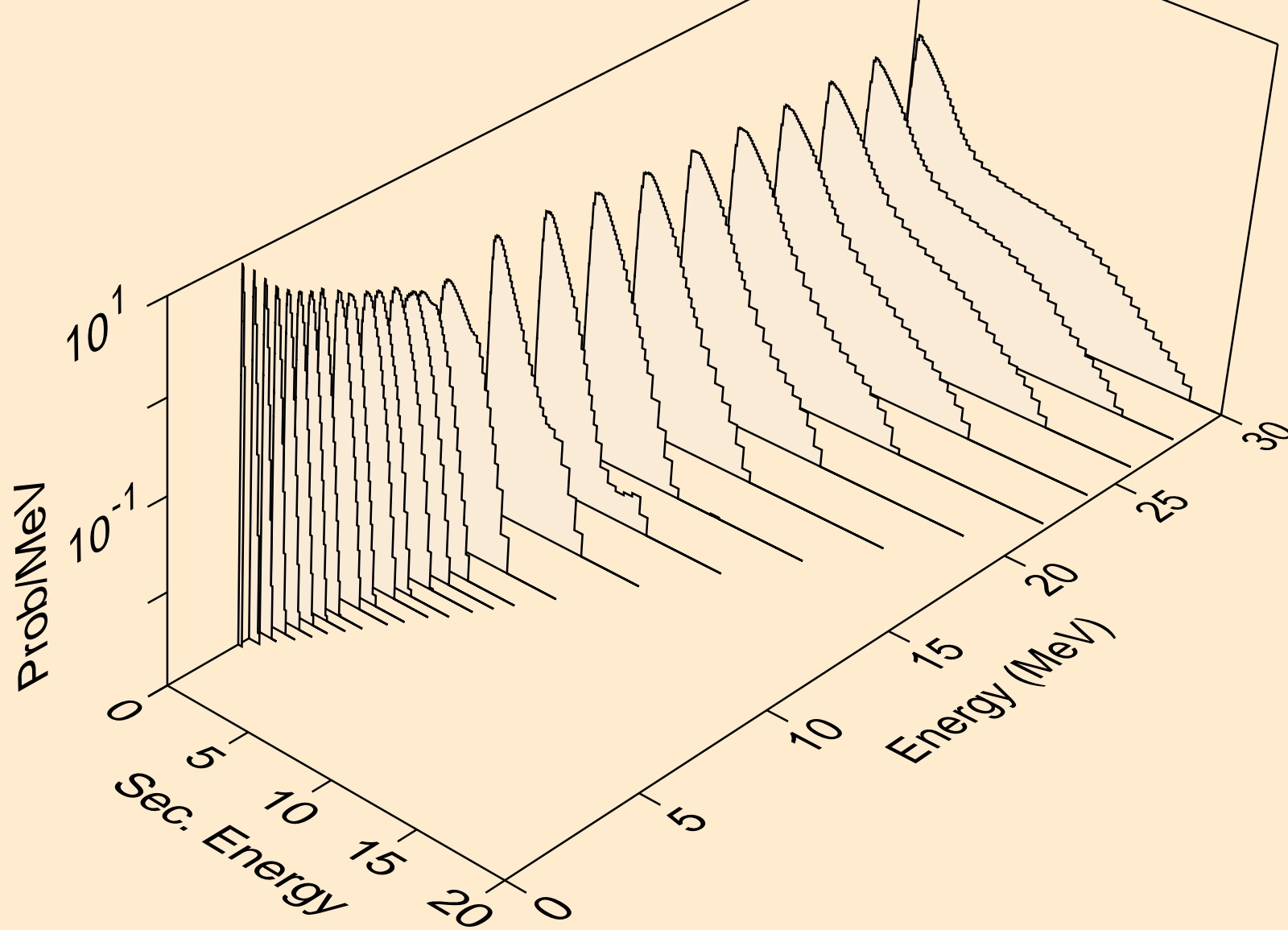

AT200 NEUTRON ACER TENDL-2024 LIBRARY; T=293.6K  
Neutron emission for (n,n\*)2a

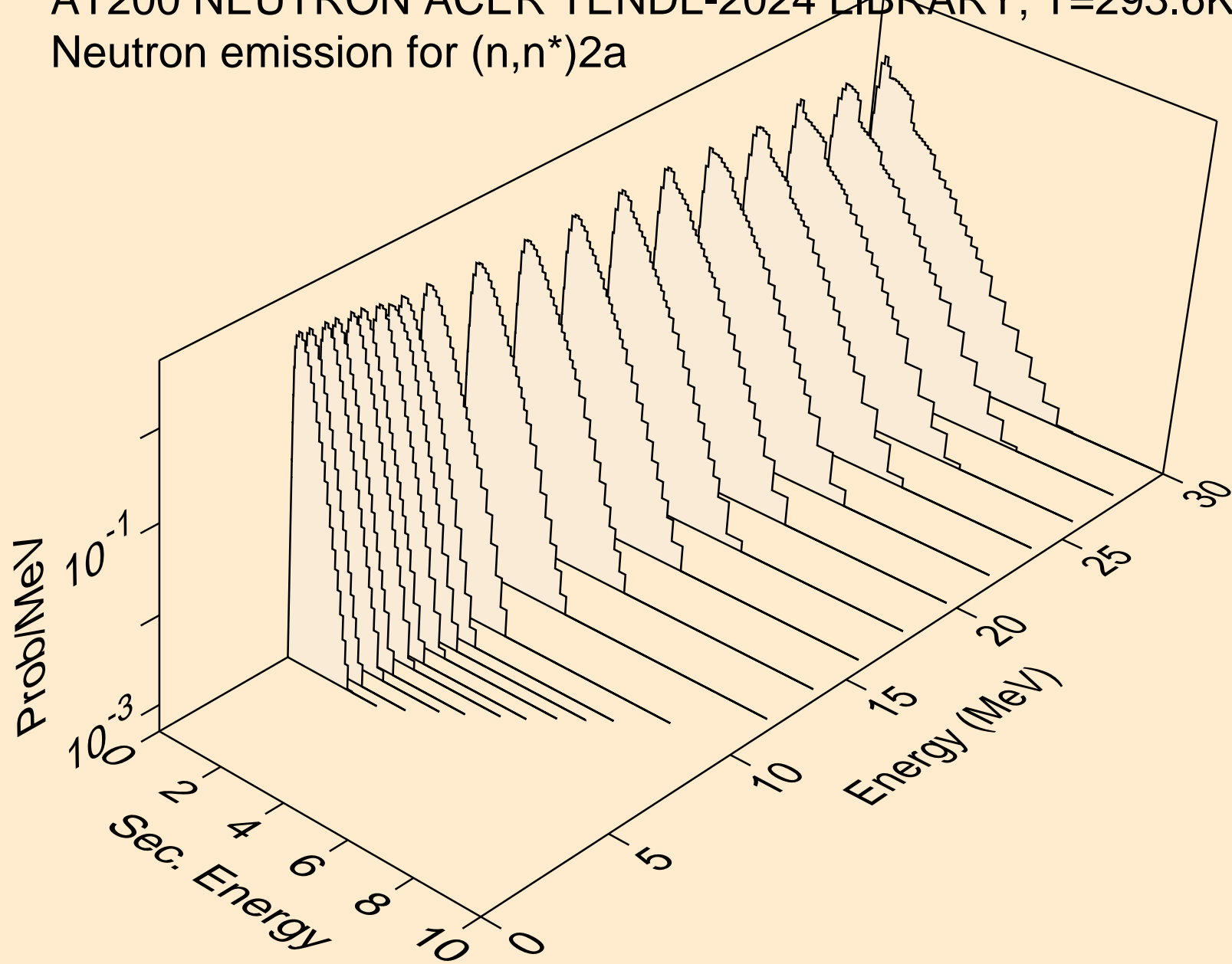

AT200 NEUTRON ACER TENDL-2024 LIBRARY; T=293.6K  
Neutron emission for (n,2n)2a

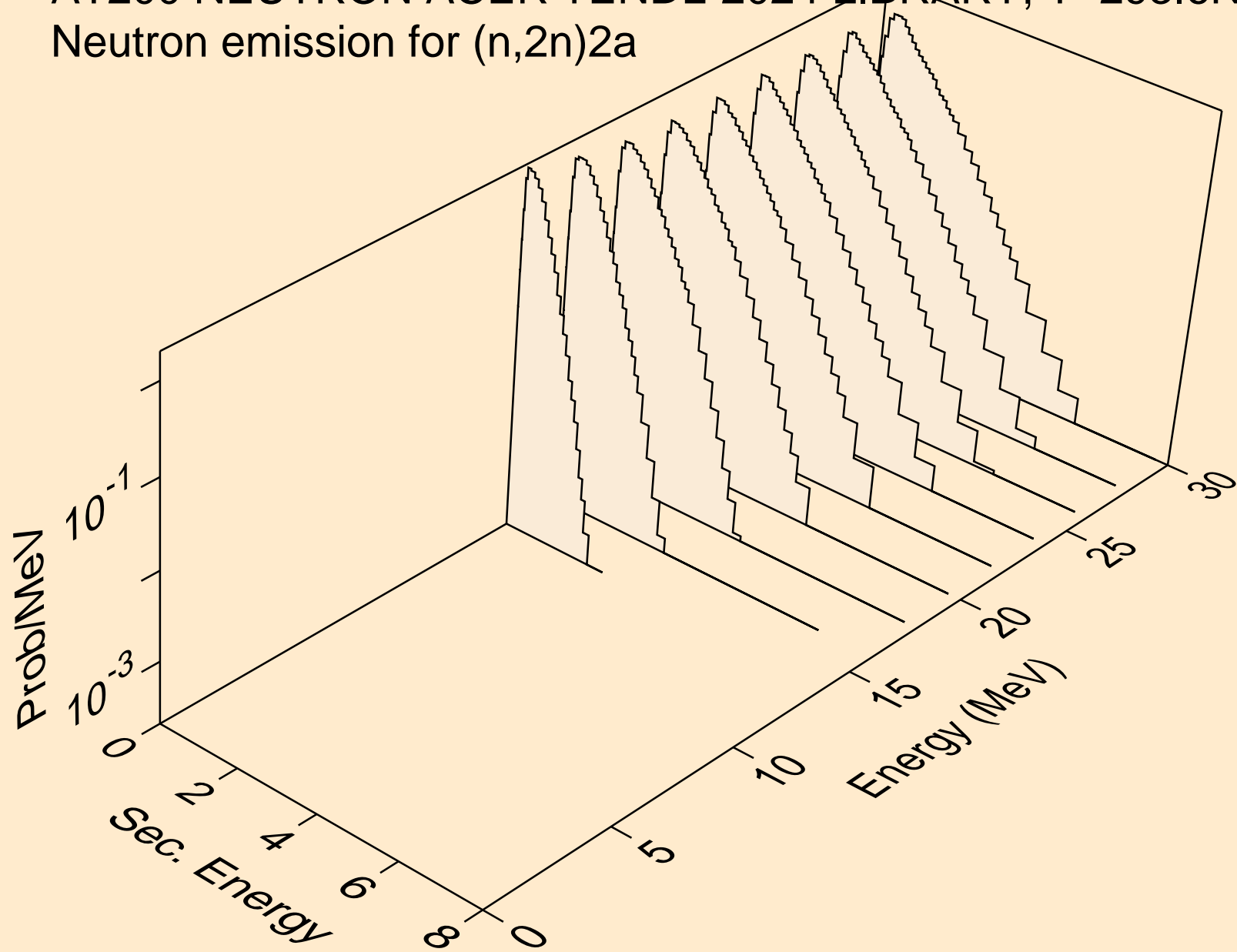

AT200 NEUTRON ACER TENDL-2024 LIBRARY; T=293.6K  
Neutron emission for (n,n\*)d

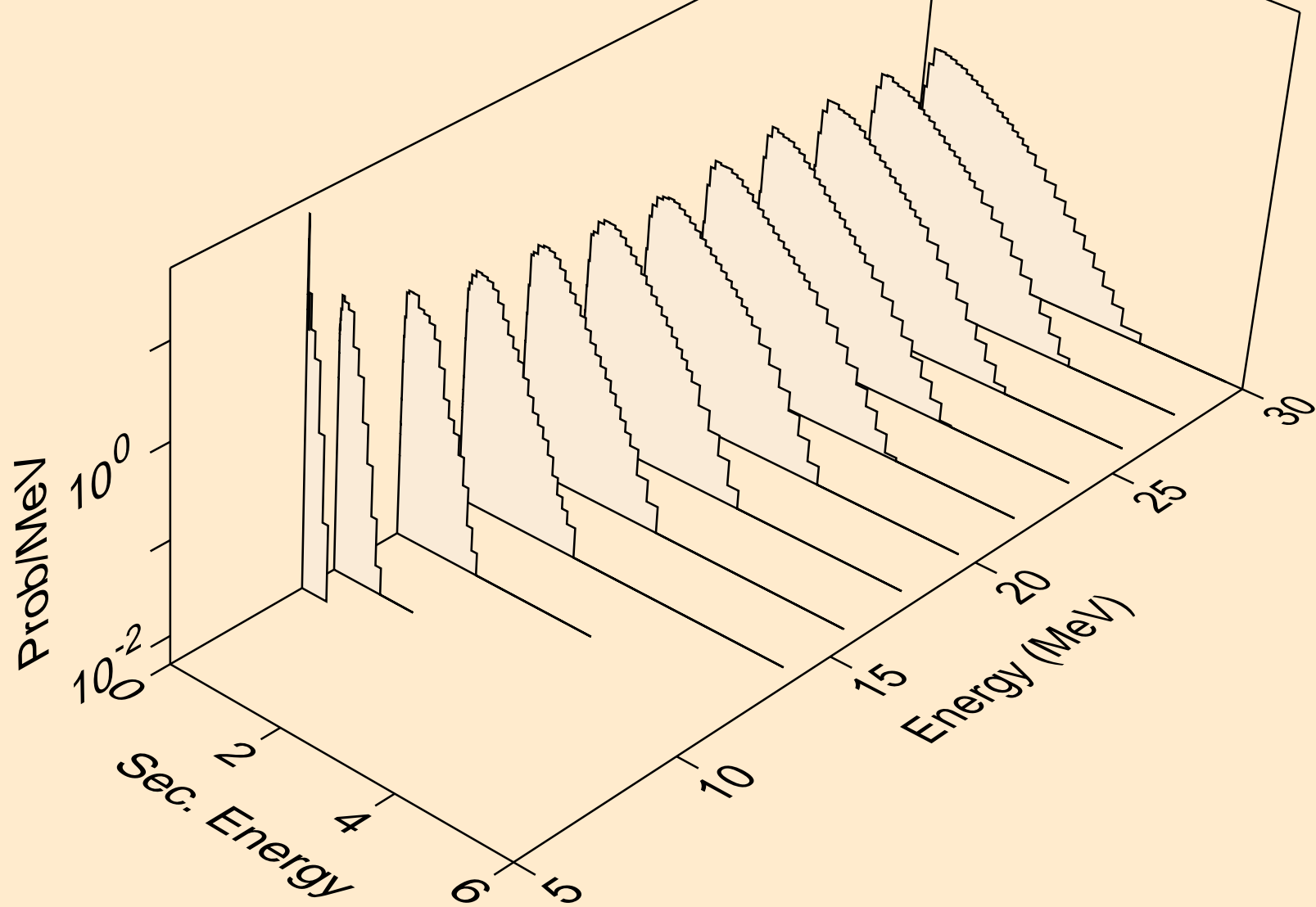

AT200 NEUTRON ACER TENDL-2024 LIBRARY; T=293.6K  
Neutron emission for (n,n\*)t

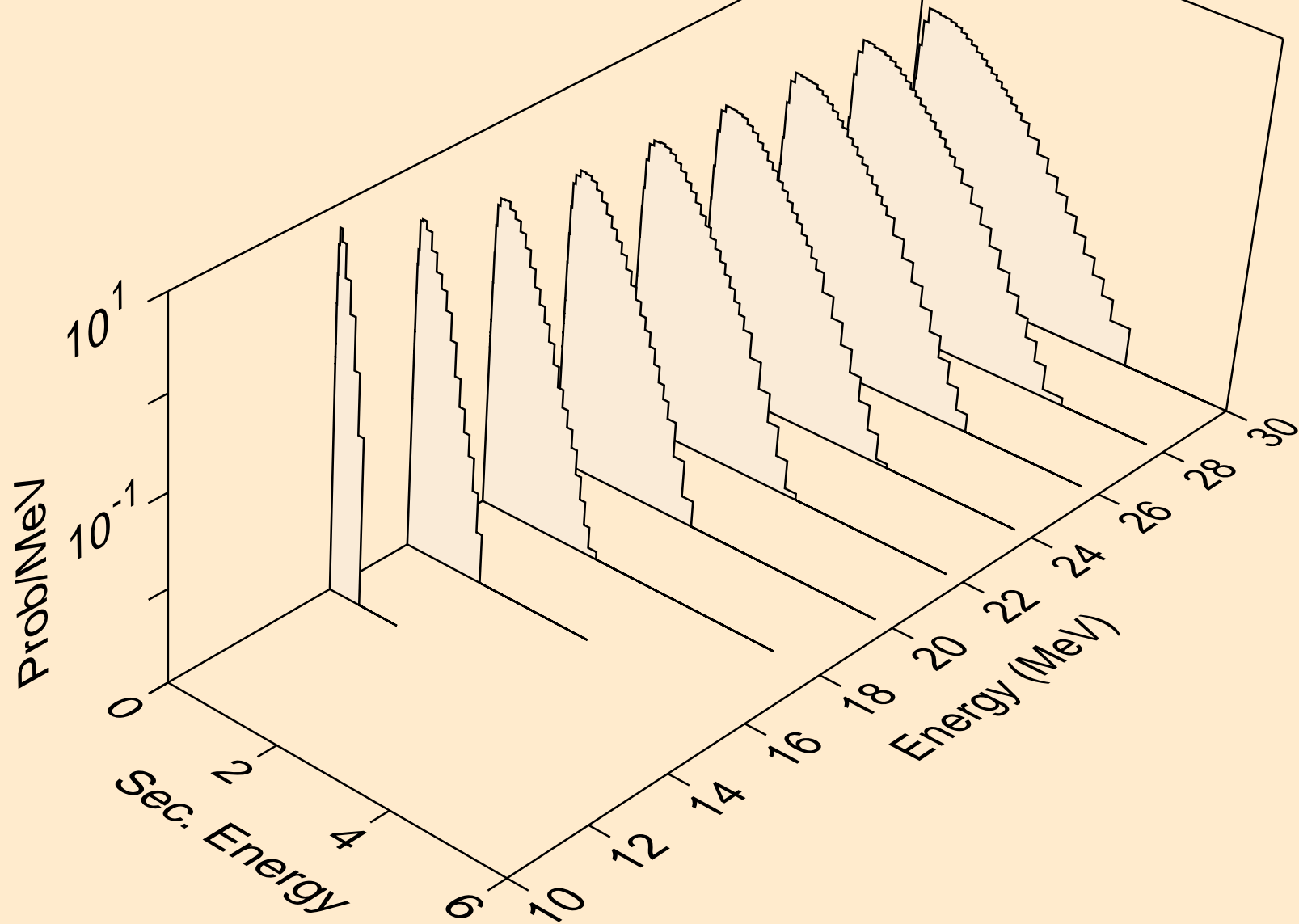

AT200 NEUTRON ACER TENDL-2024 LIBRARY; T=293.6K  
Neutron emission for (n,n\*)he3

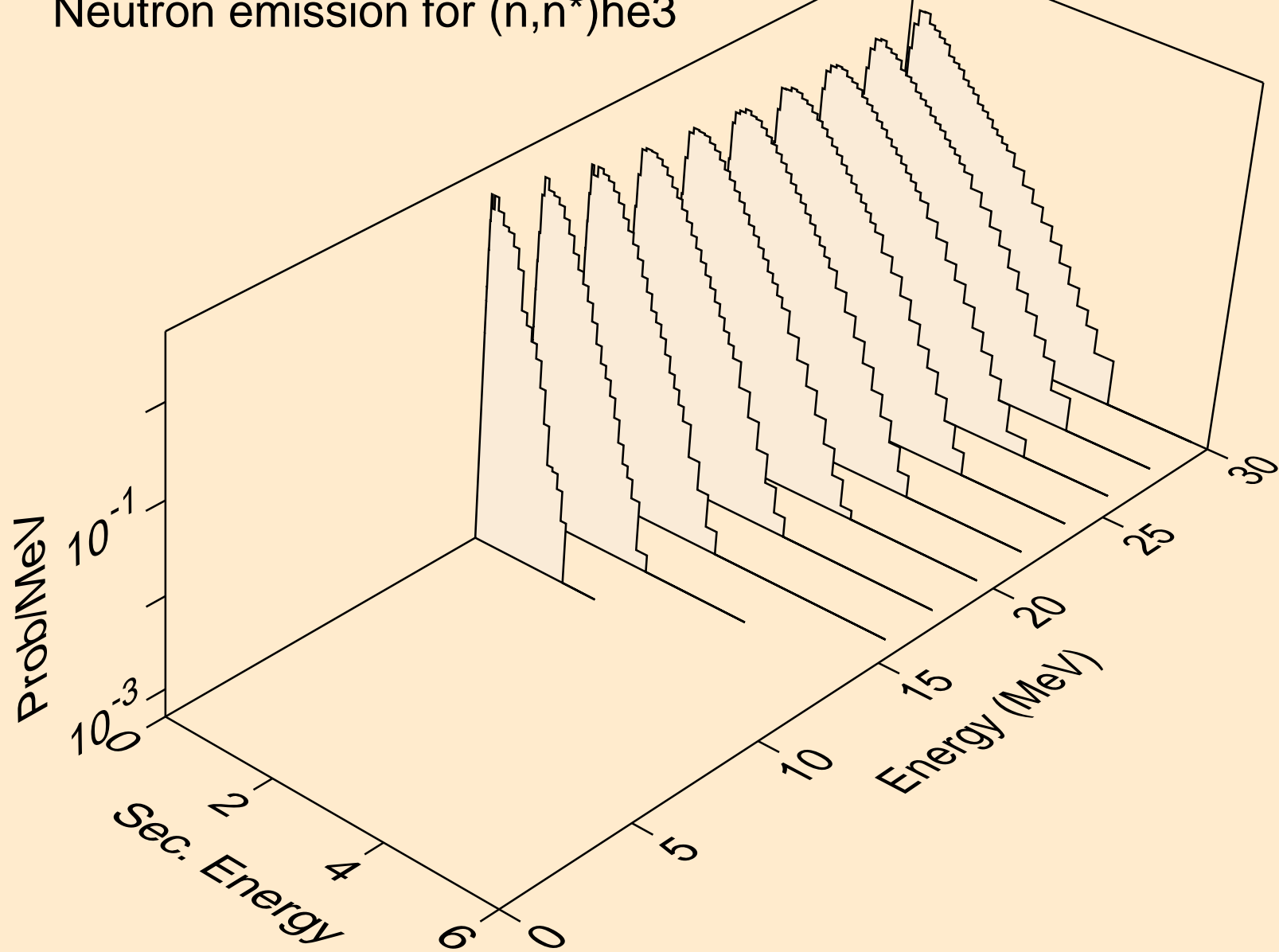

AT200 NEUTRON ACER TENDL-2024 LIBRARY; T=293.6K  
Neutron emission for (n,4n)

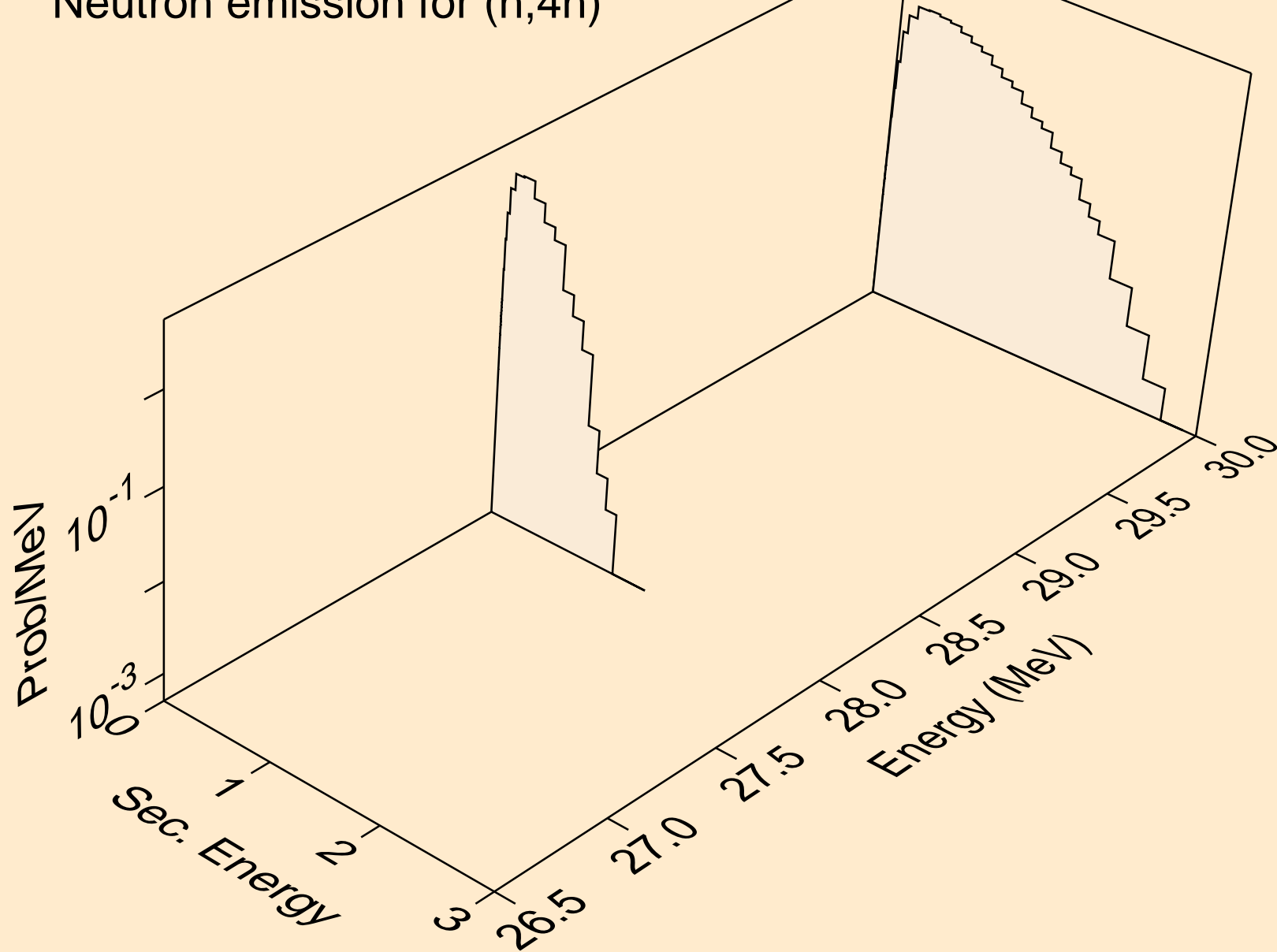

AT200 NEUTRON ACER TENDL-2024 LIBRARY; T=293.6K  
Neutron emission for (n,2np)

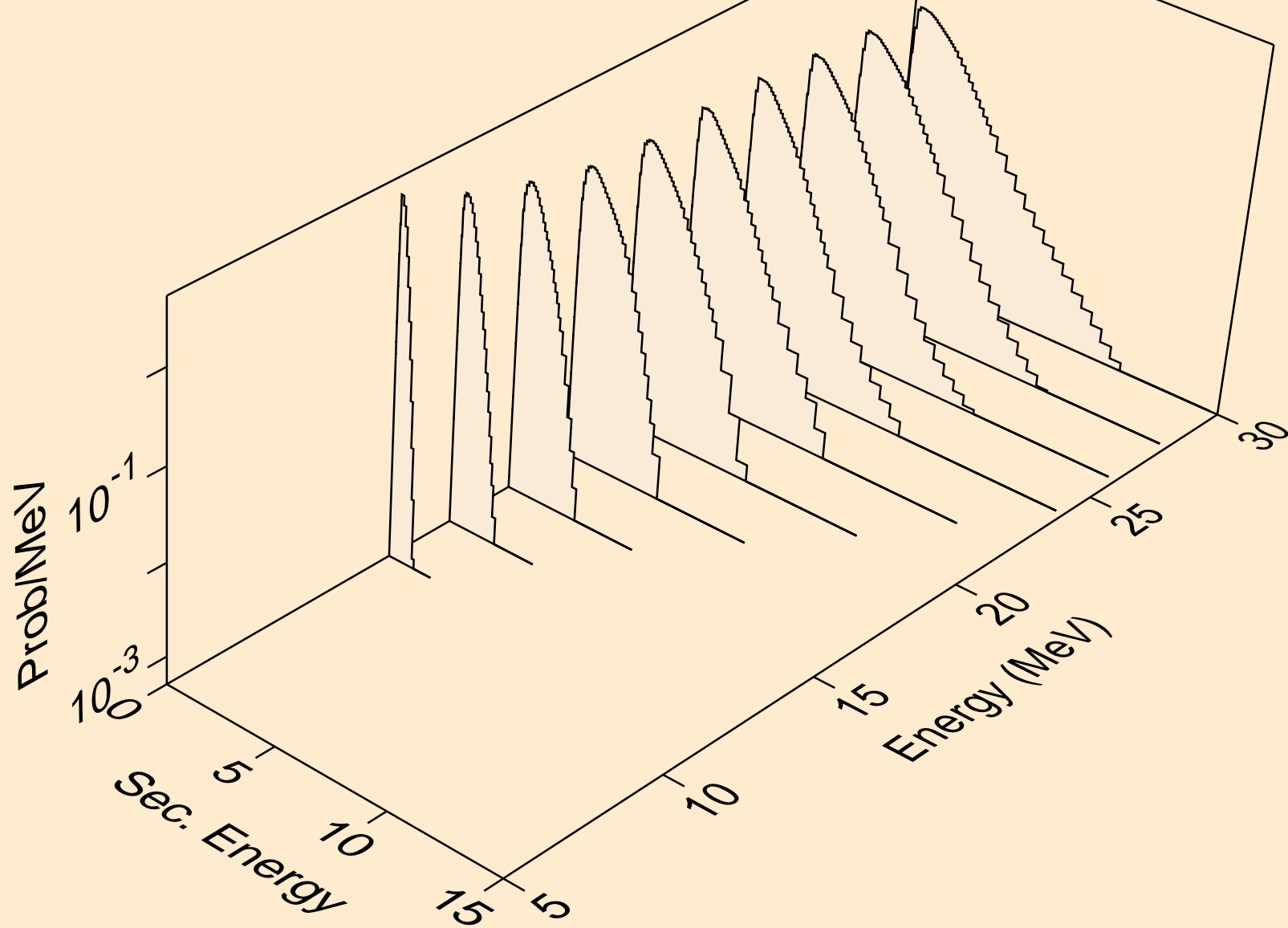

AT200 NEUTRON ACER TENDL-2024 LIBRARY; T=293.6K  
Neutron emission for (n,3np)

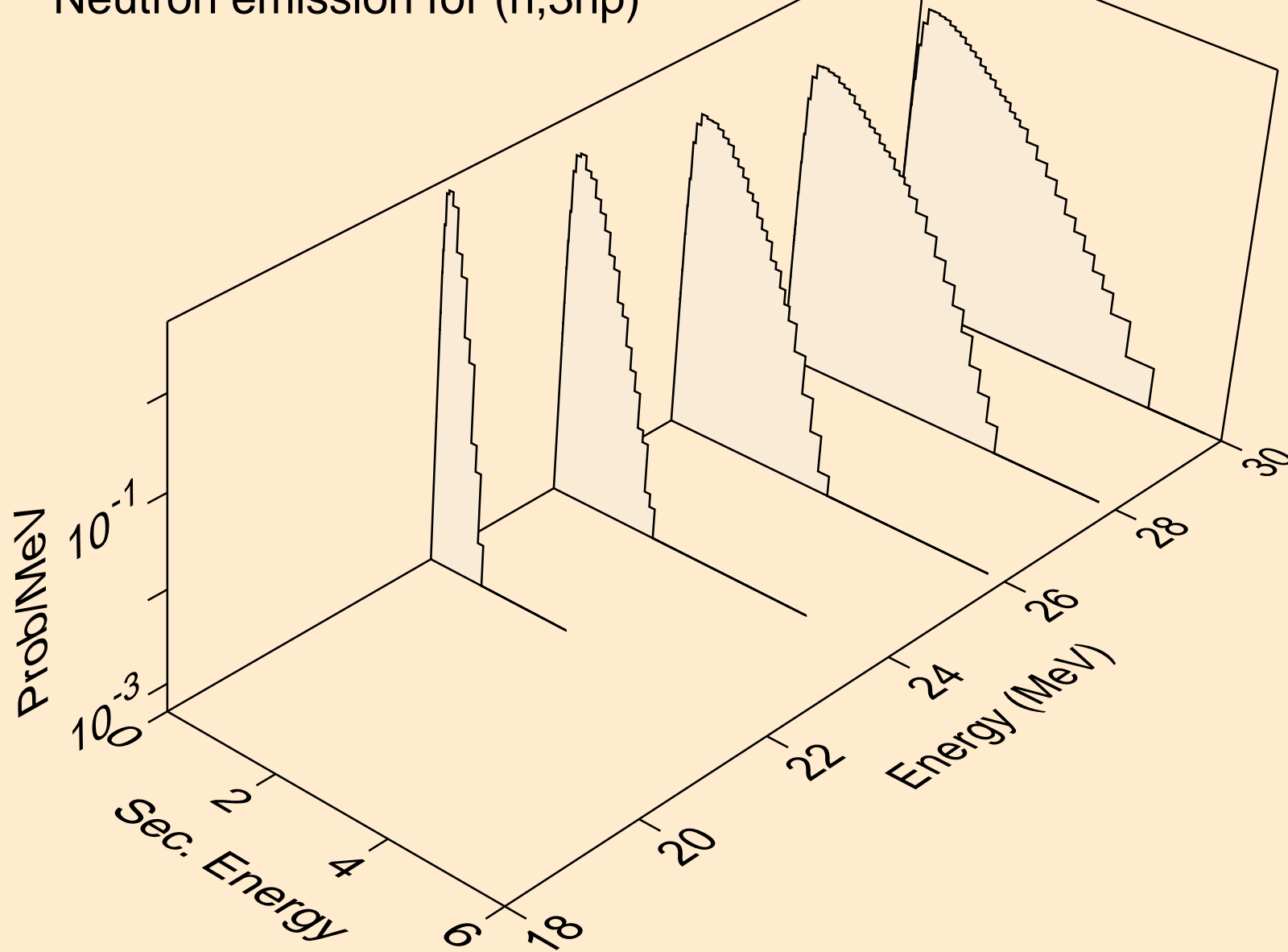

AT200 NEUTRON ACER TENDL-2024 LIBRARY; T=293.6K  
Neutron emission for (n,n2p)

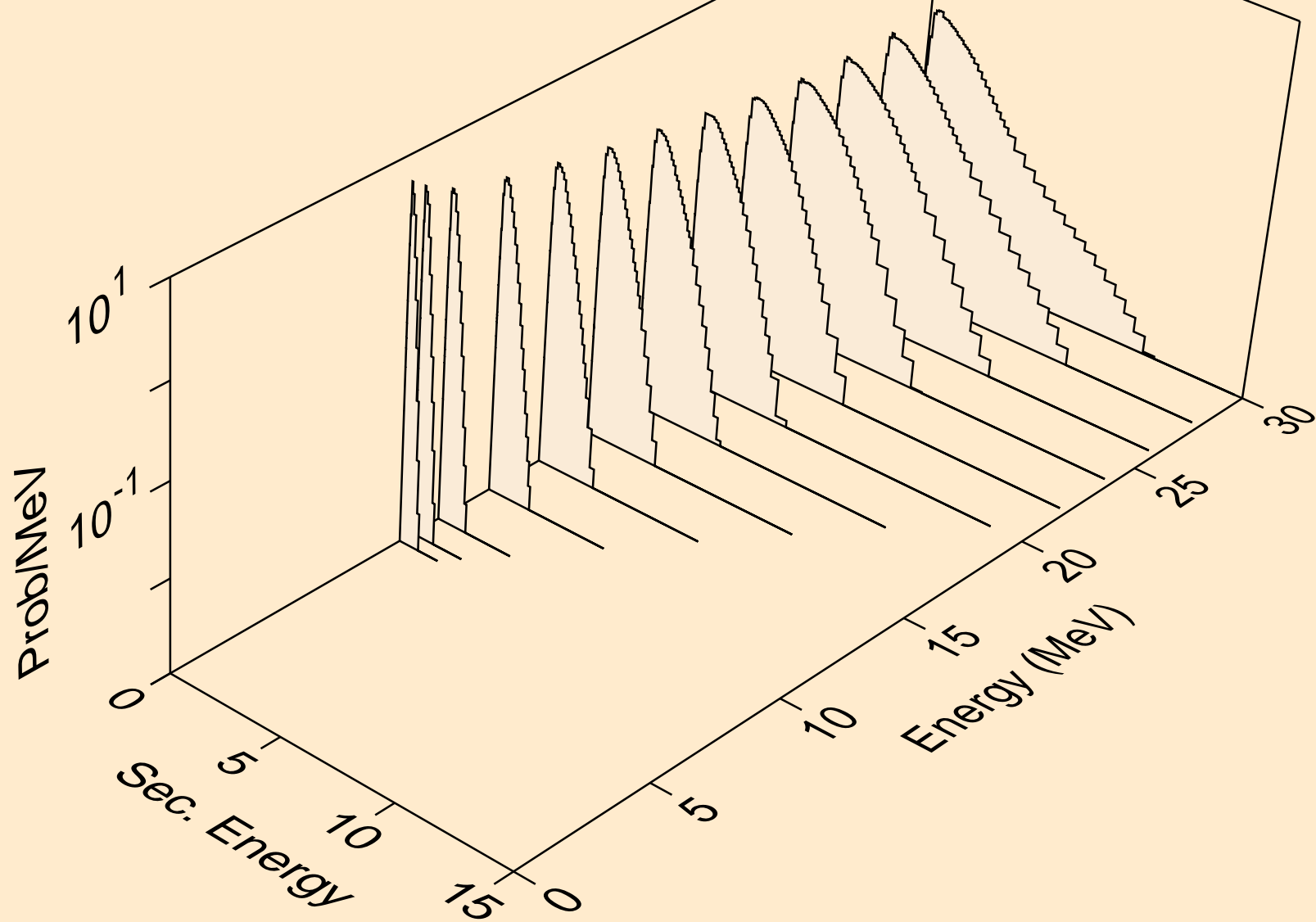

AT200 NEUTRON ACER TENDL-2024 LIBRARY; T=293.6K  
Neutron emission for (n,npa)

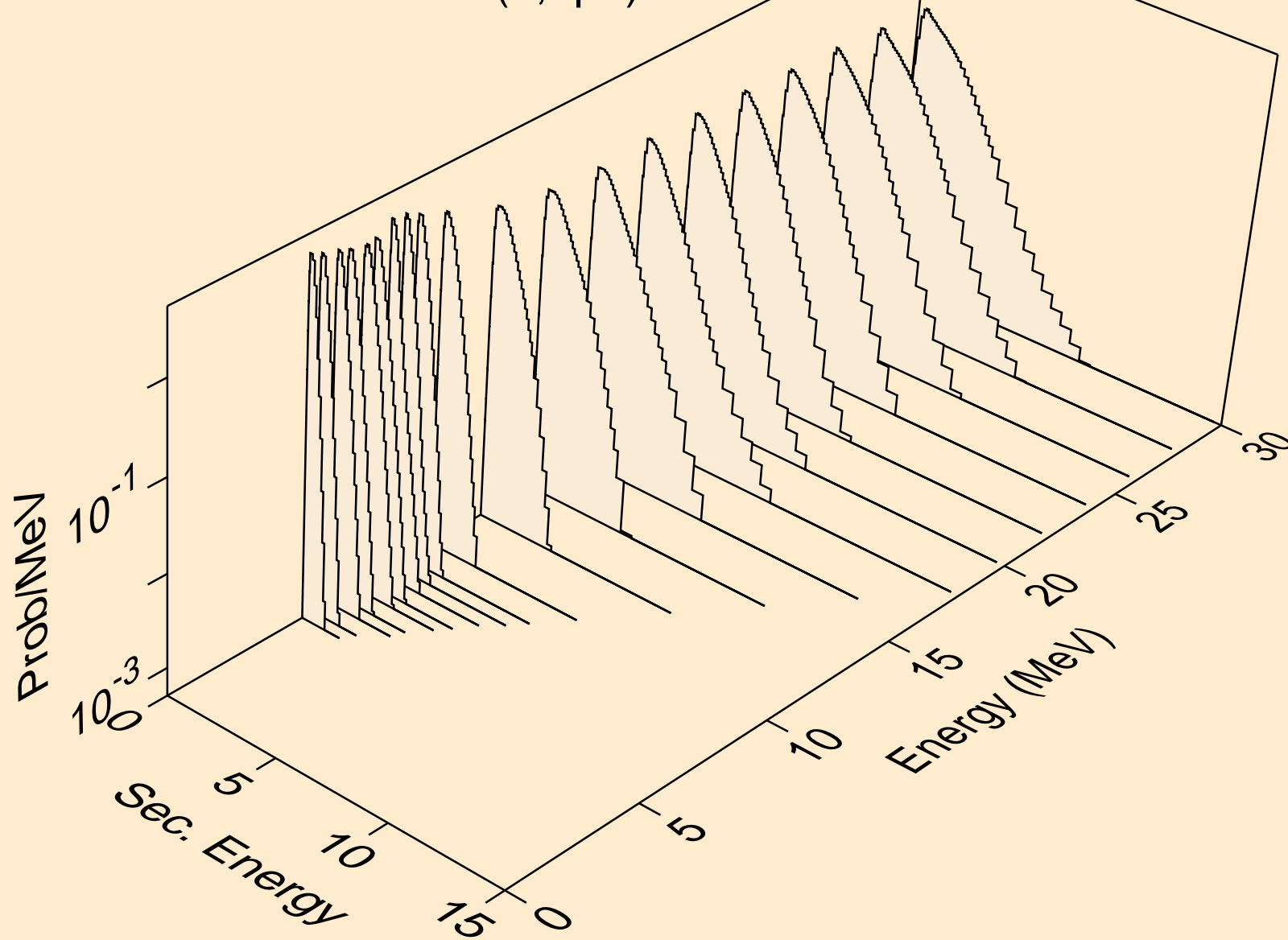

AT200 NEUTRON ACER TENDL-2024 LIBRARY; T=293.6K  
Neutron emission for (n,n\*c)

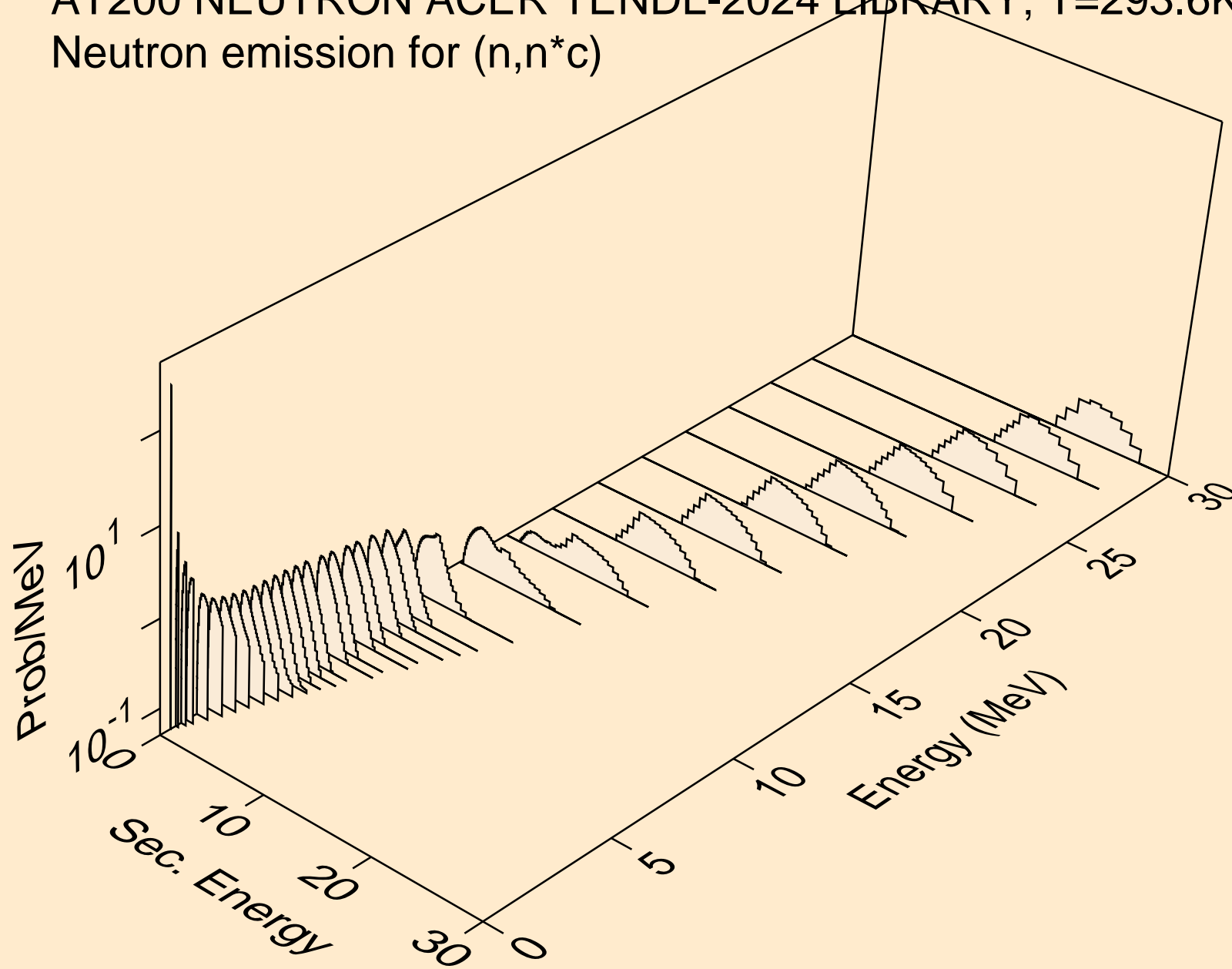

AT200 NEUTRON ACER TENDL-2024 LIBRARY; T=293.6K  
Photon emission for (n,x)

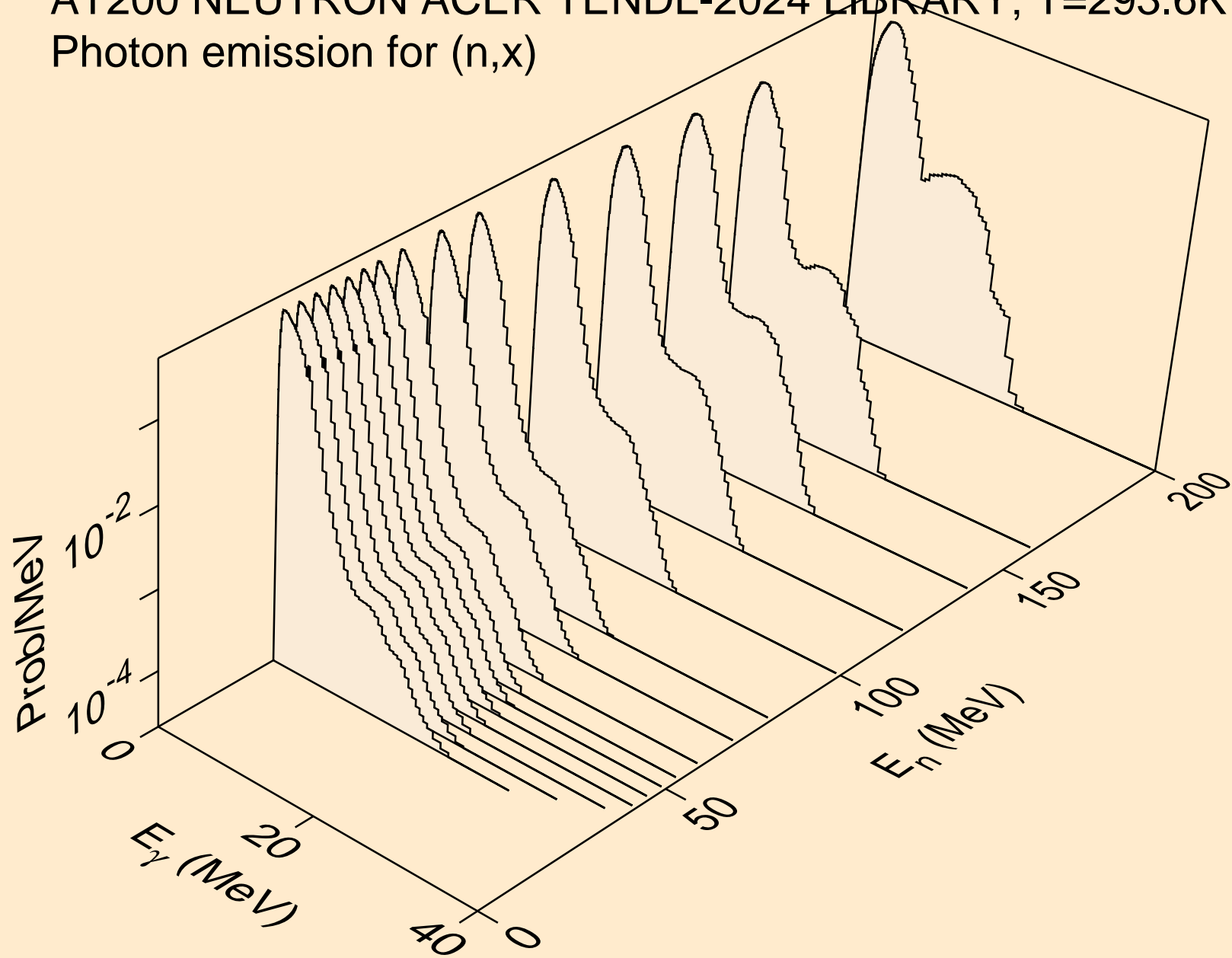

AT200 NEUTRON ACER TENDL-2024 LIBRARY; T=293.6K  
Photon emission for (n,2nd)

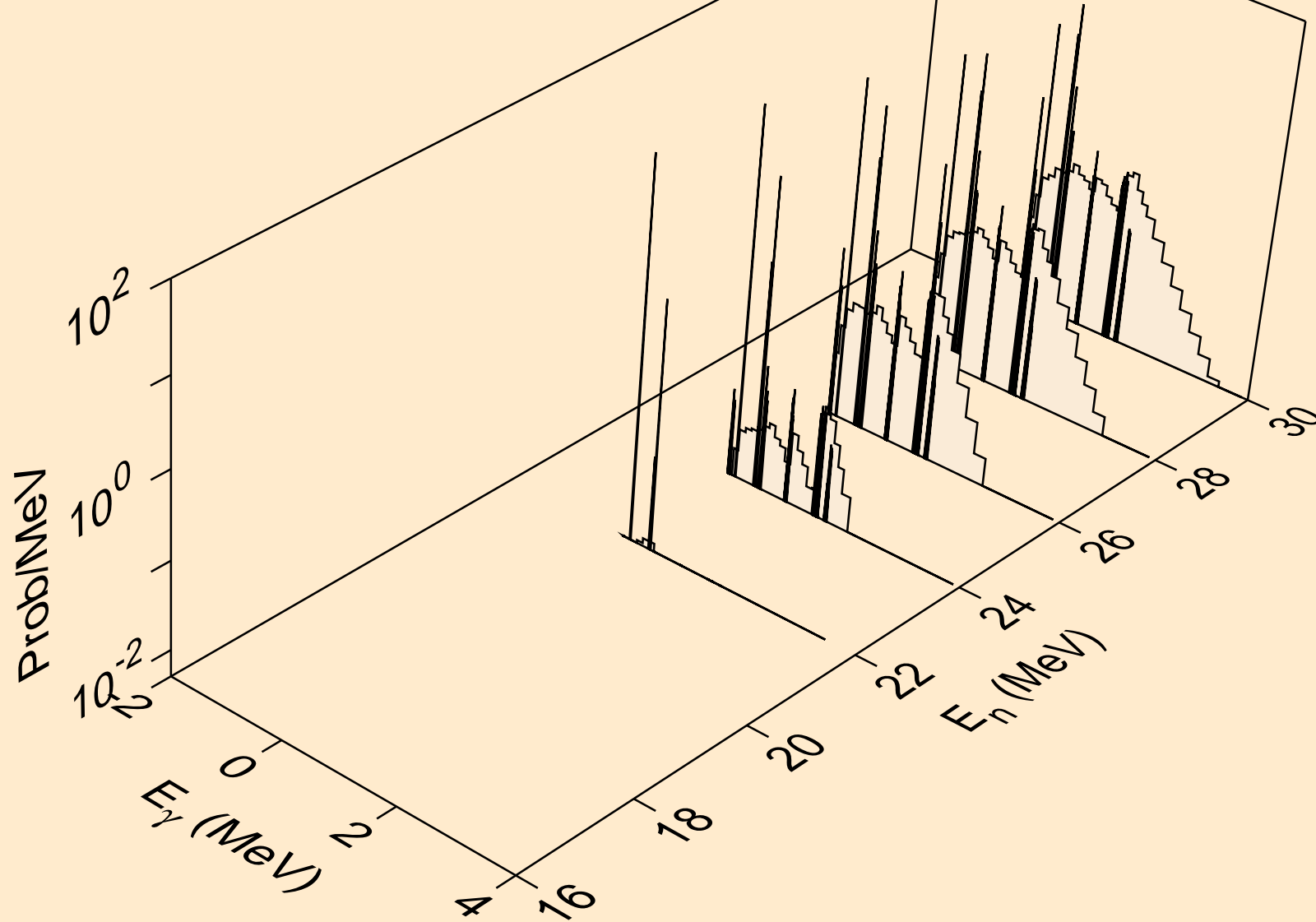

AT200 NEUTRON ACER TENDL-2024 LIBRARY; T=293.6K  
Photon emission for (n,2n)

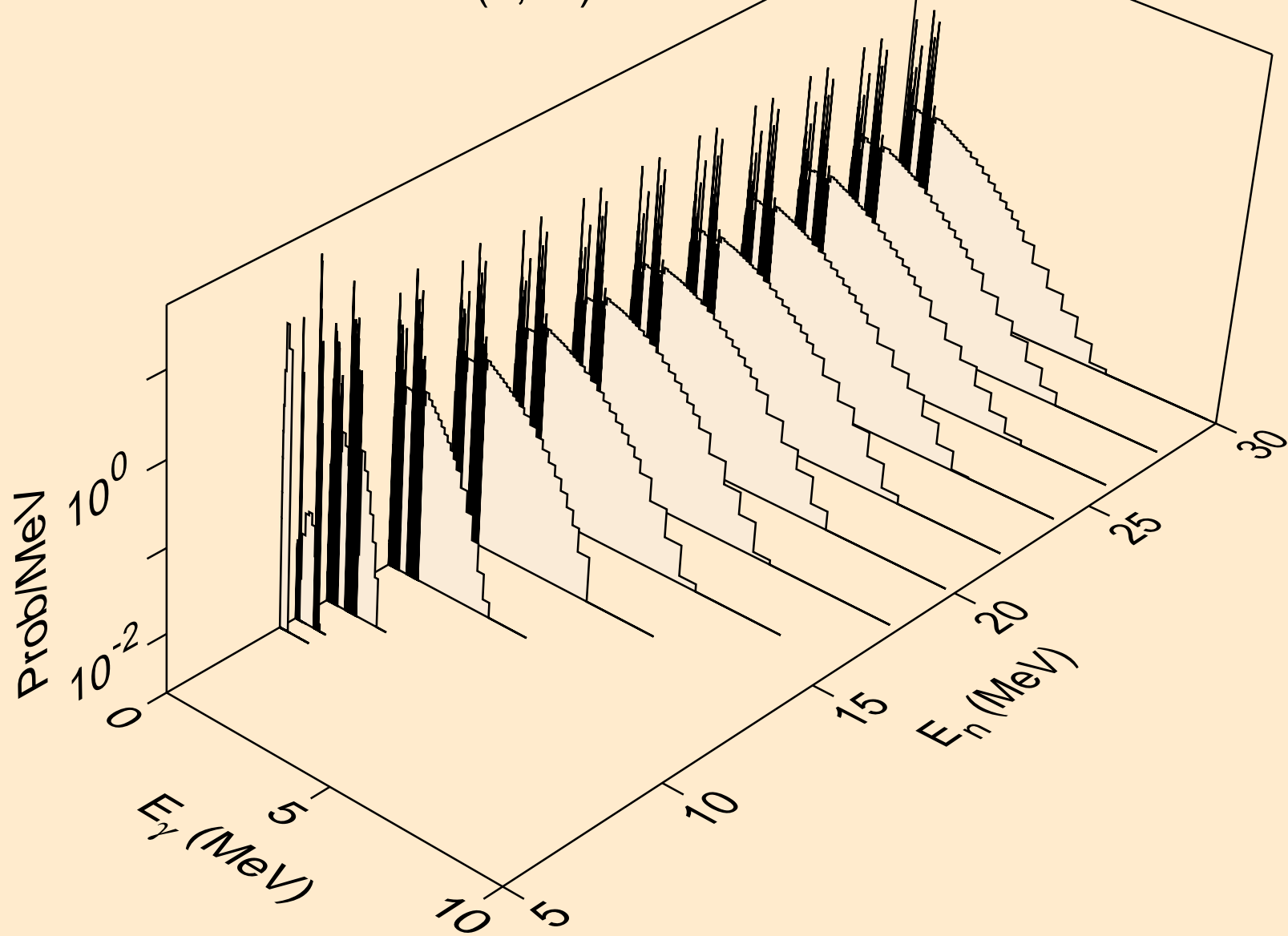

AT200 NEUTRON ACER TENDL-2024 LIBRARY; T=293.6K  
Photon emission for (n,3n)

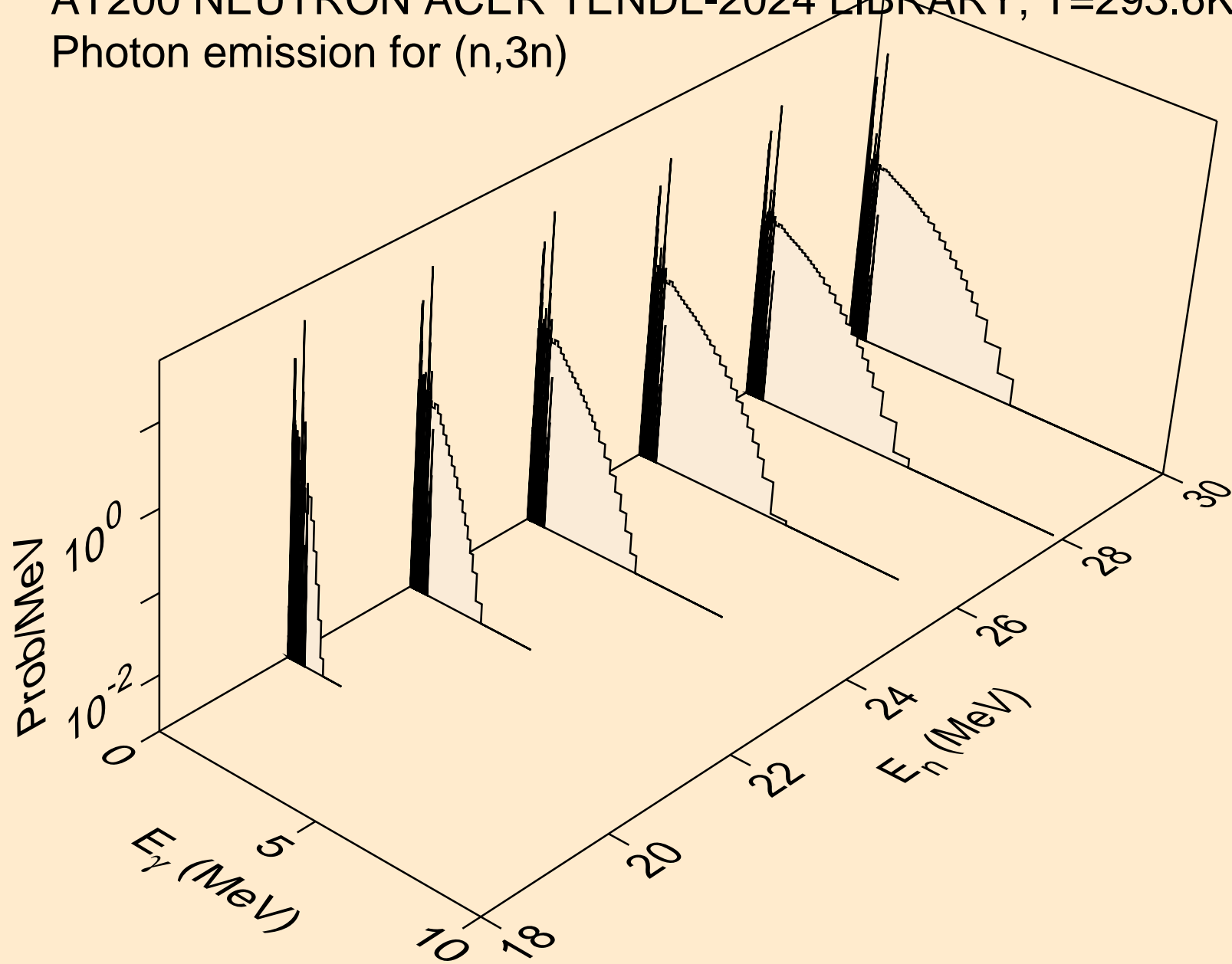

AT200 NEUTRON ACER TENDL-2024 LIBRARY; T=293.6K  
Photon emission for (n,n\*)a

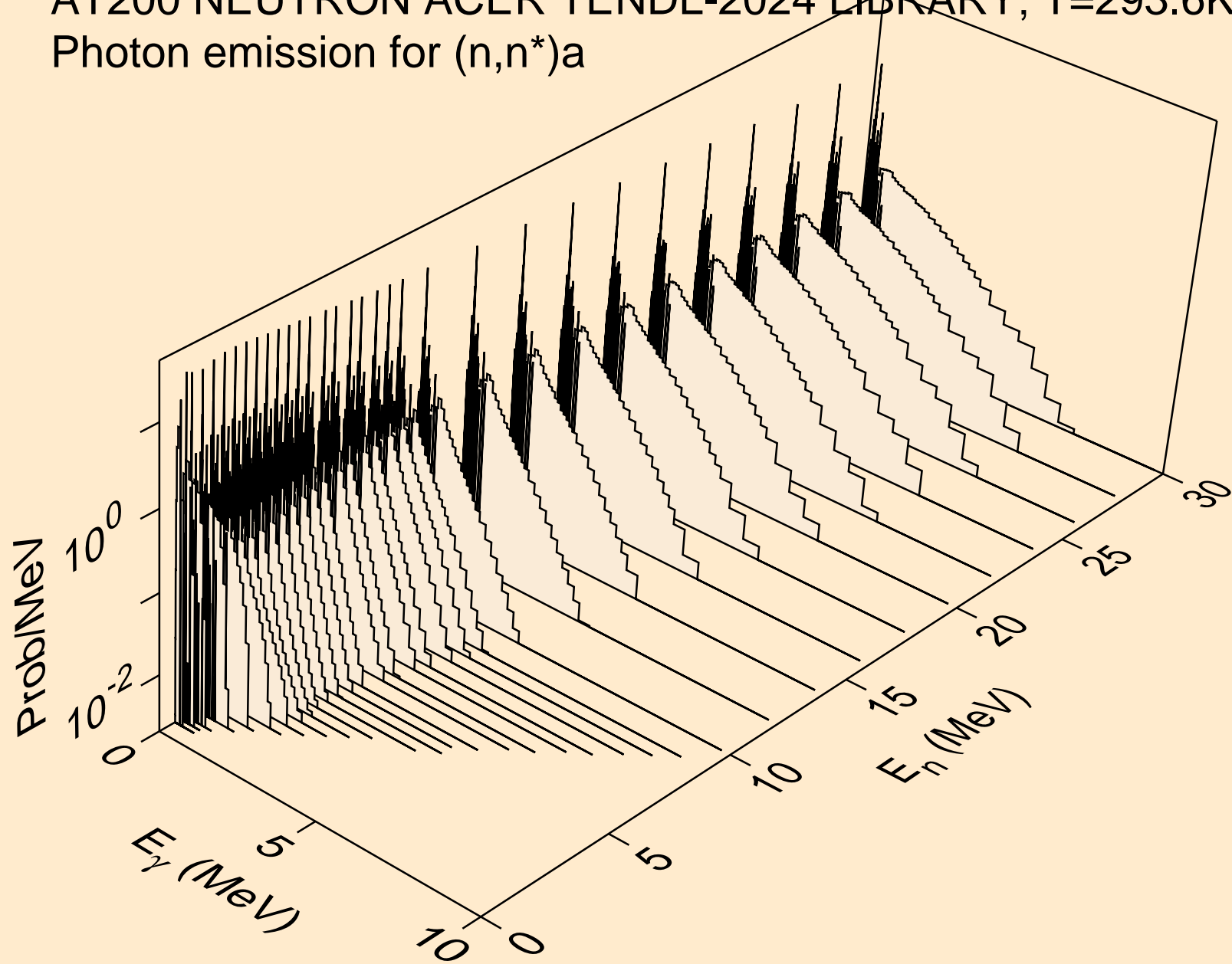

AT200 NEUTRON ACER TENDL-2024 LIBRARY; T=293.6K  
Photon emission for (n,2n)a

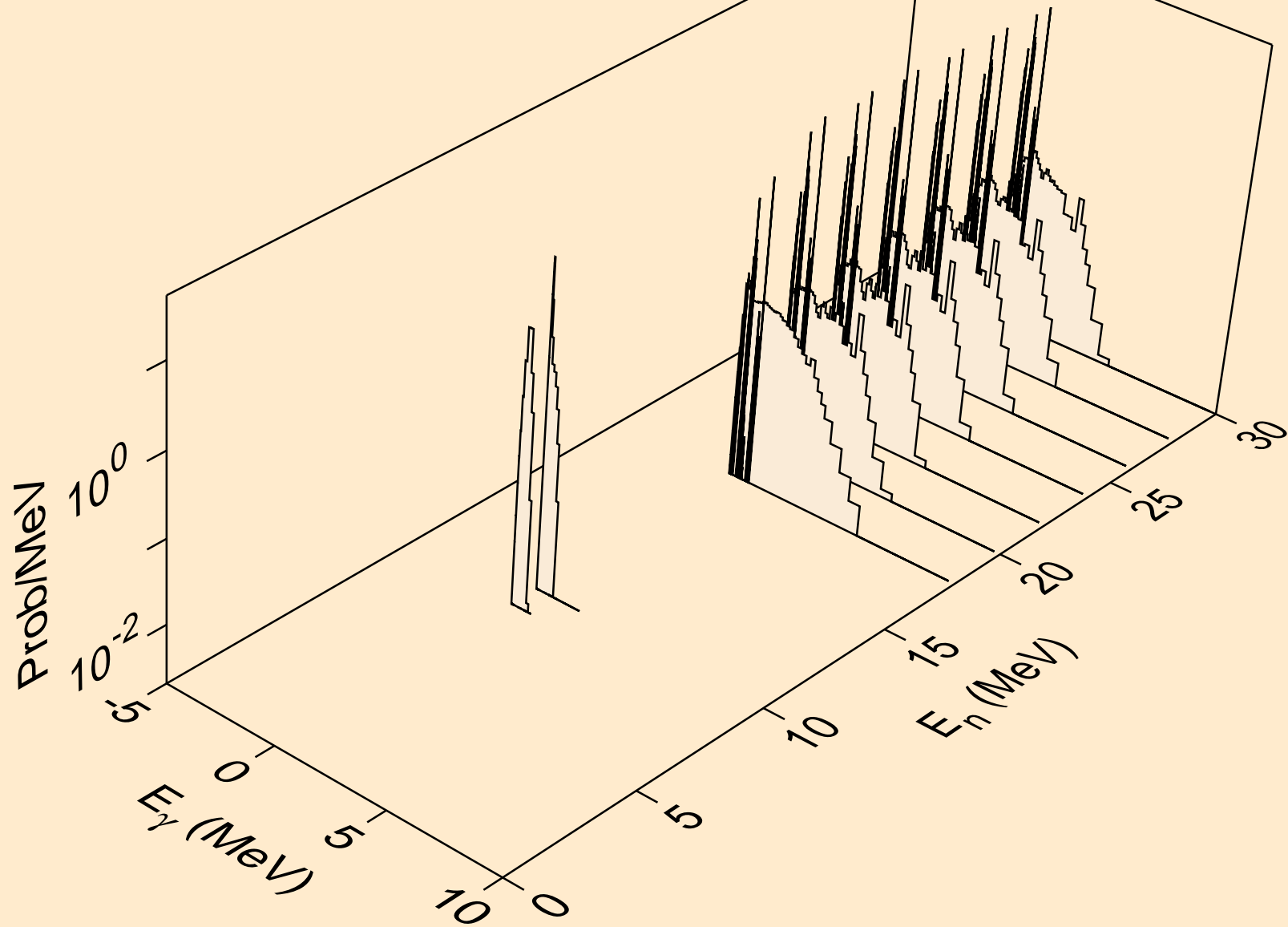

AT200 NEUTRON ACER TENDL-2024 LIBRARY; T=293.6K  
Photon emission for (n,3n)a

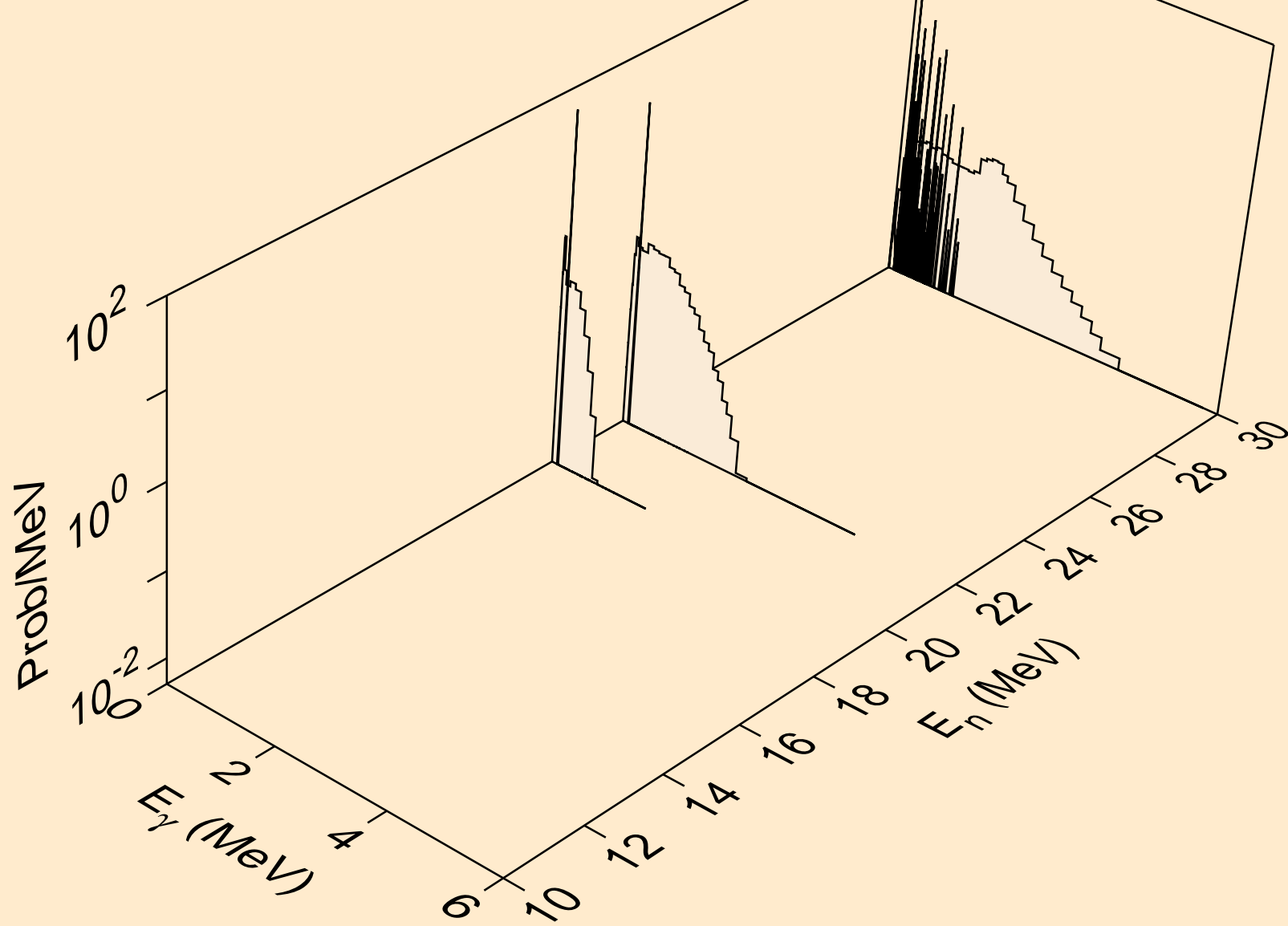

AT200 NEUTRON ACER TENDL-2024 LIBRARY; T=293.6K  
Photon emission for (n,n\*)p

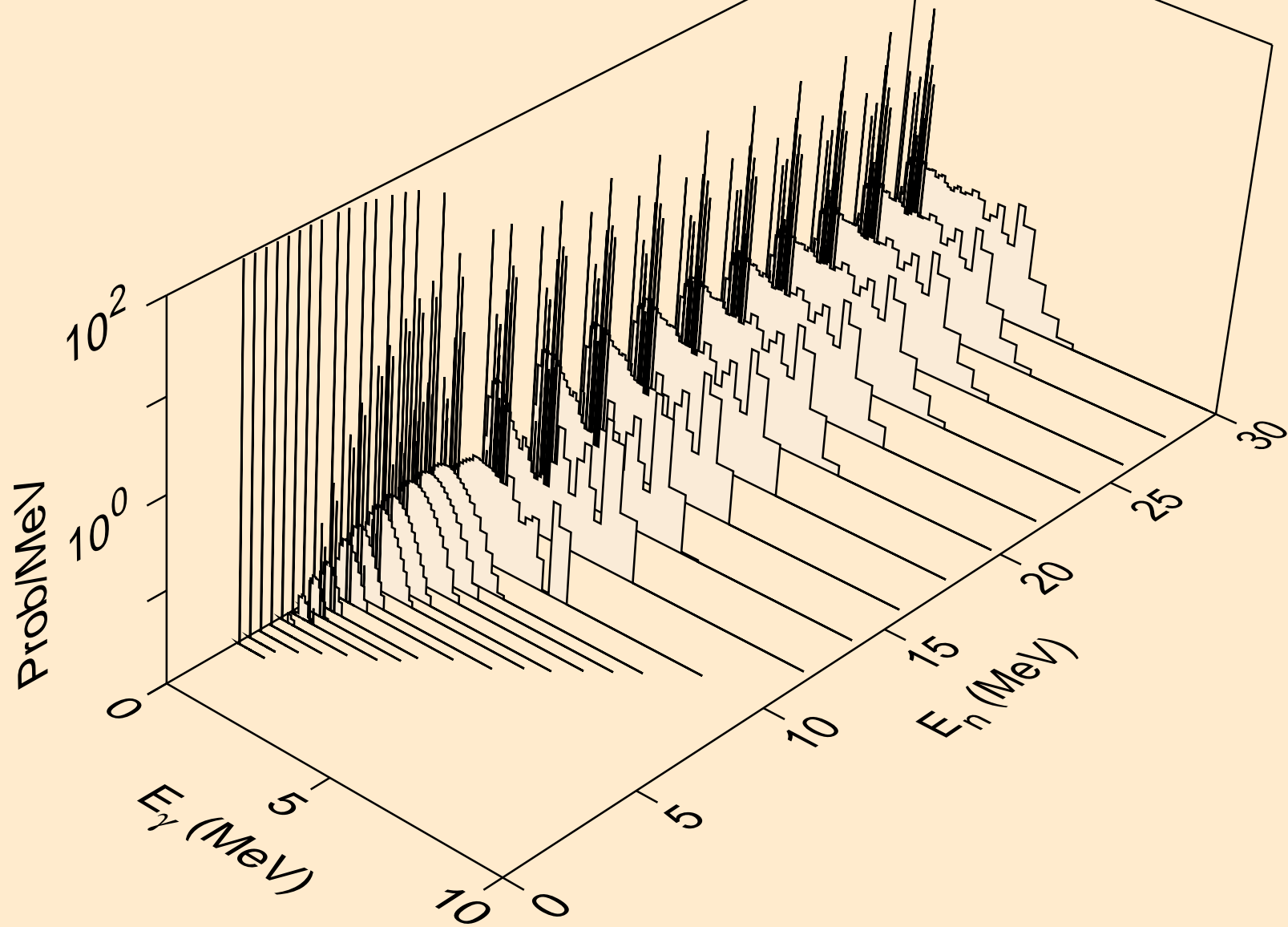

AT200 NEUTRON ACER TENDL-2024 LIBRARY; T=293.6K  
Photon emission for (n,n\*)2a

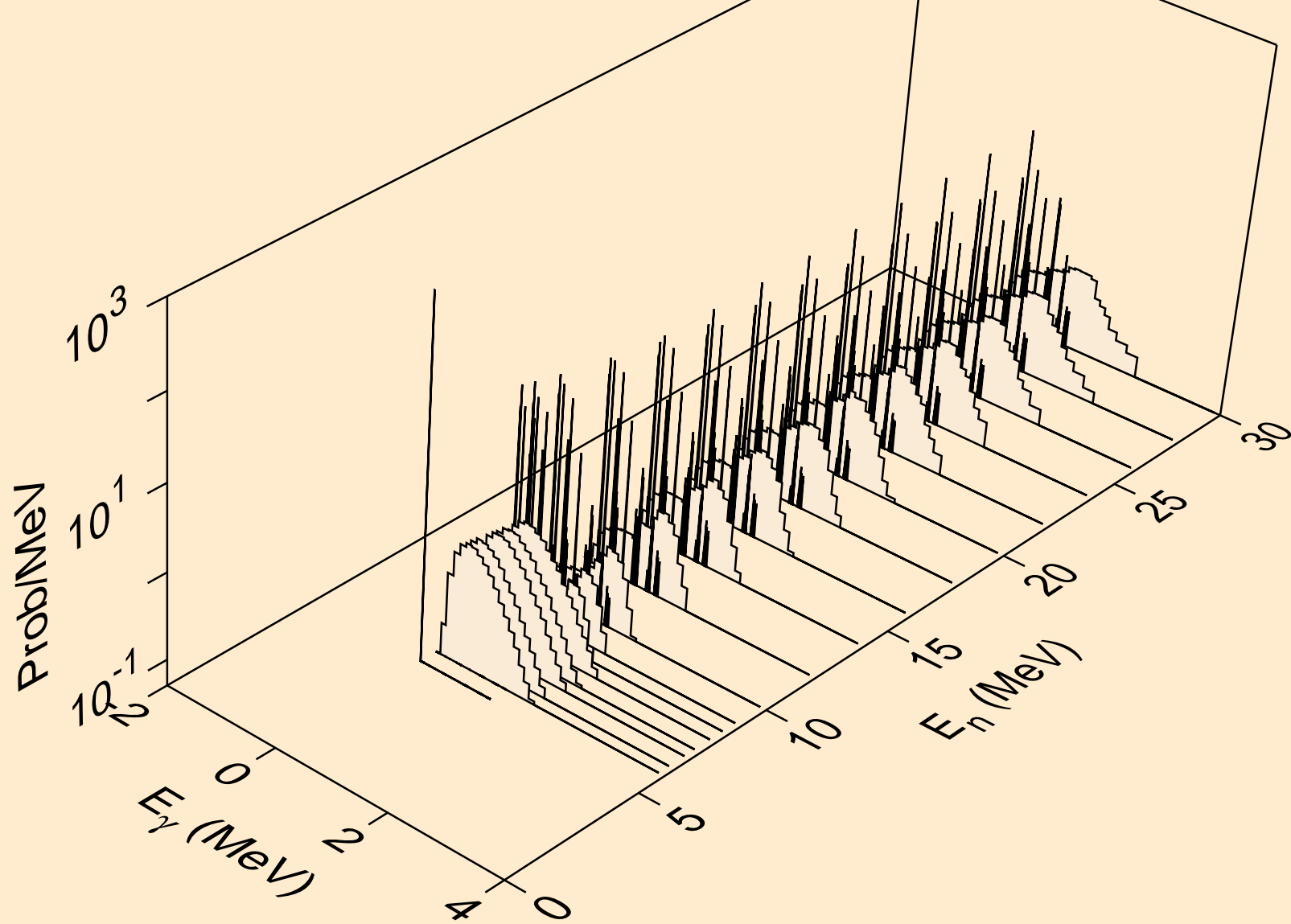

AT200 NEUTRON ACER TENDL-2024 LIBRARY; T=293.6K  
Photon emission for (n,2n)2a

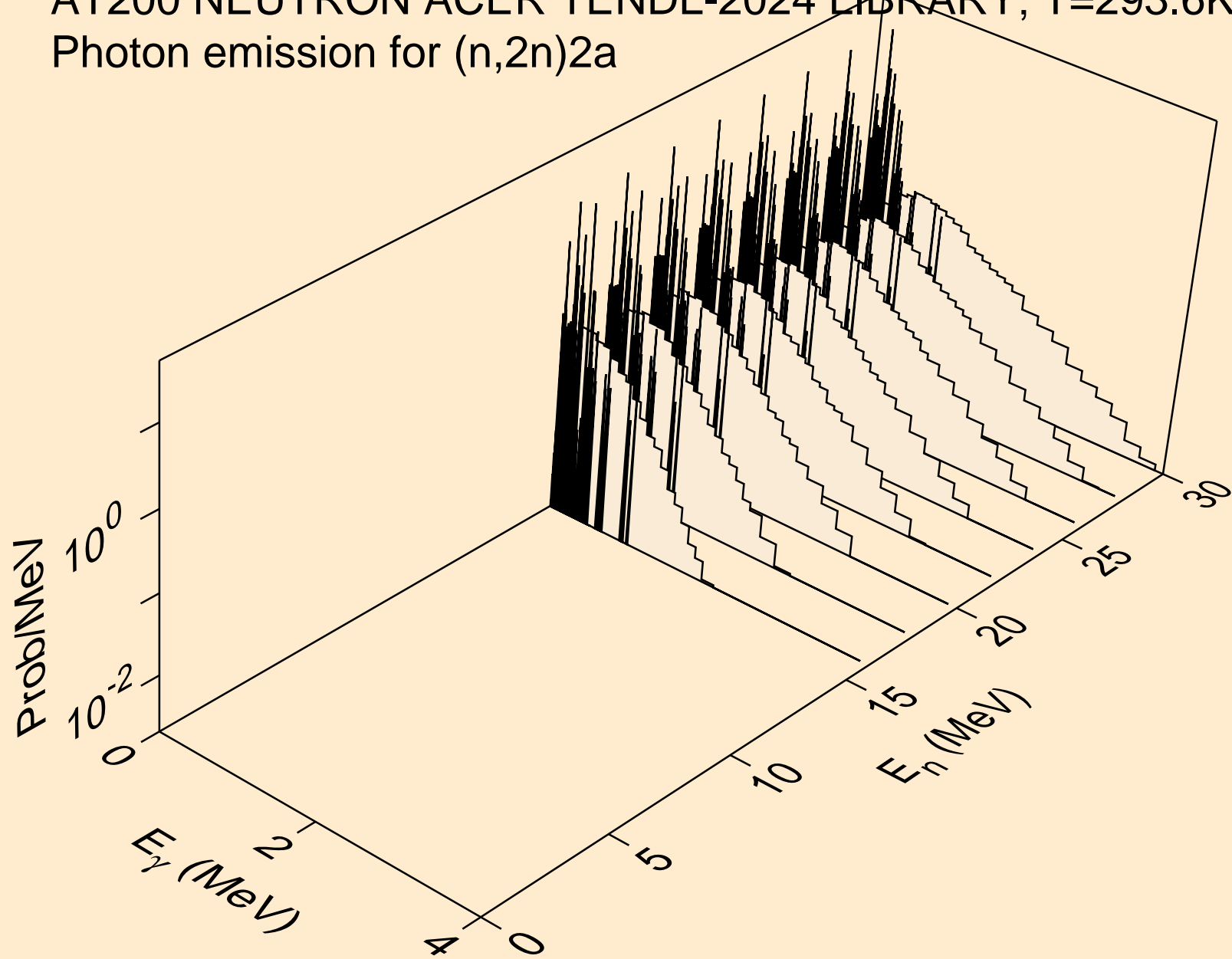

AT200 NEUTRON ACER TENDL-2024 LIBRARY; T=293.6K  
Photon emission for (n,n\*)d

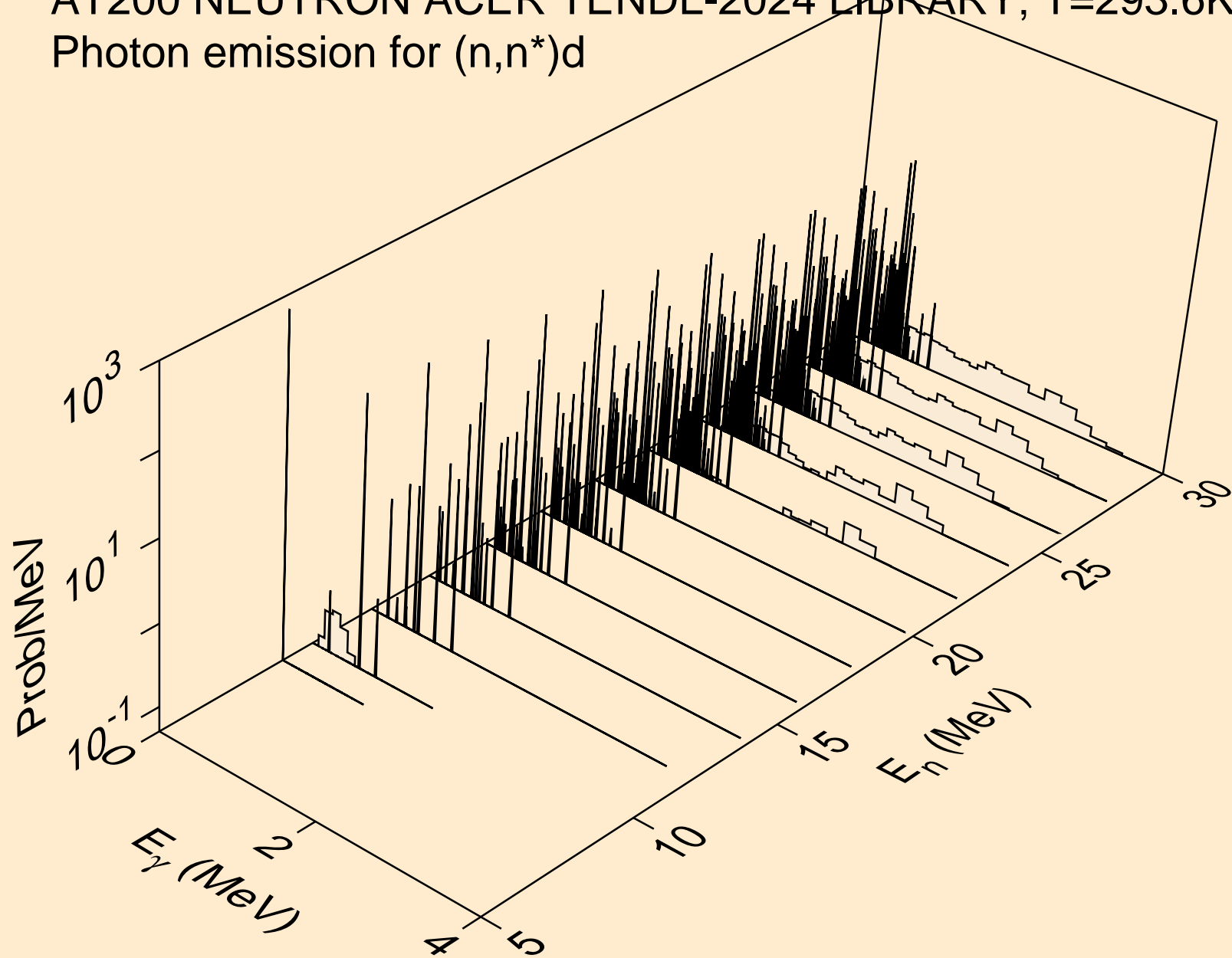

AT200 NEUTRON ACER TENDL-2024 LIBRARY; T=293.6K  
Photon emission for (n,n\*)t

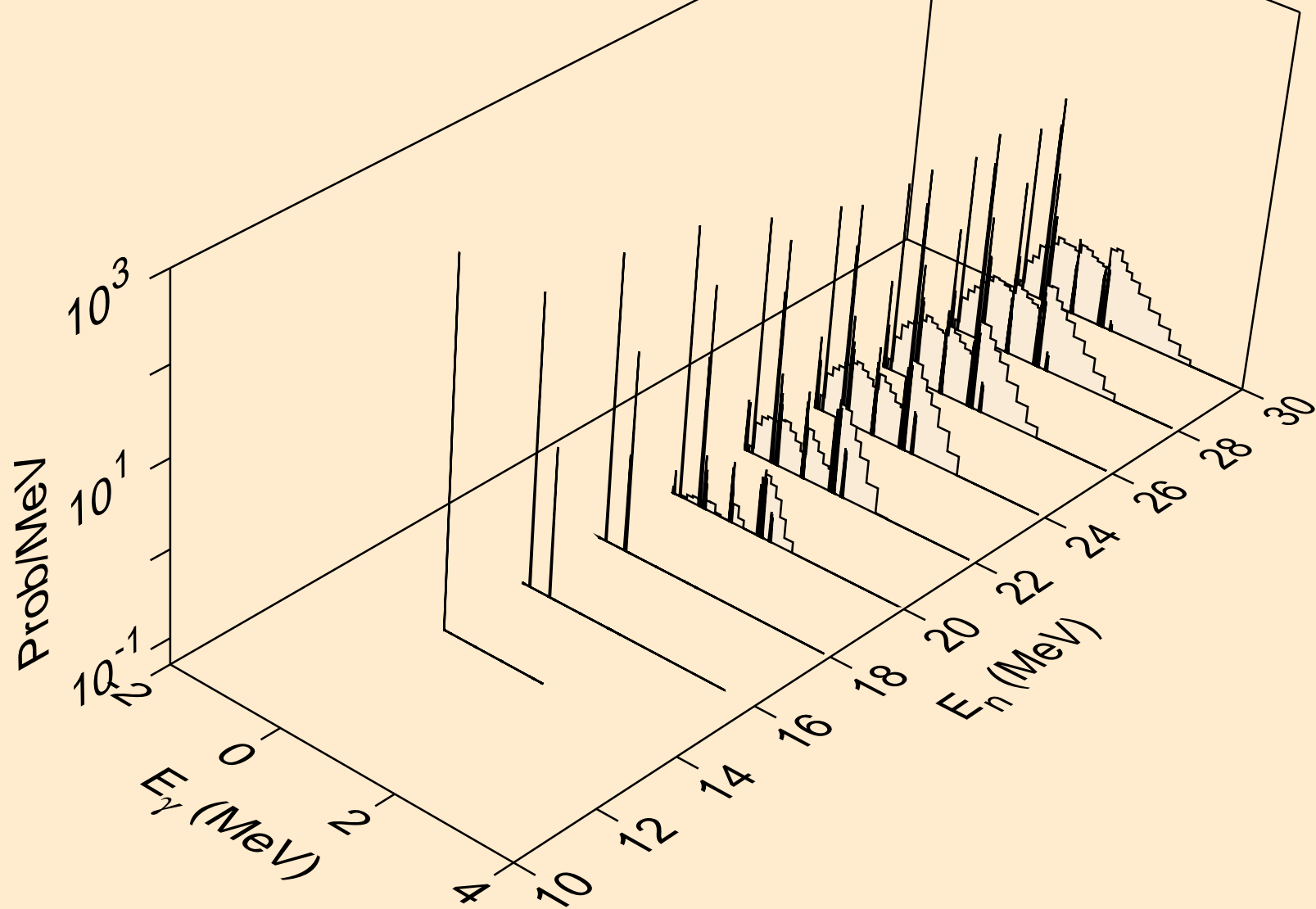

AT200 NEUTRON ACER TENDL-2024 LIBRARY; T=293.6K  
Photon emission for (n,n\*)he3

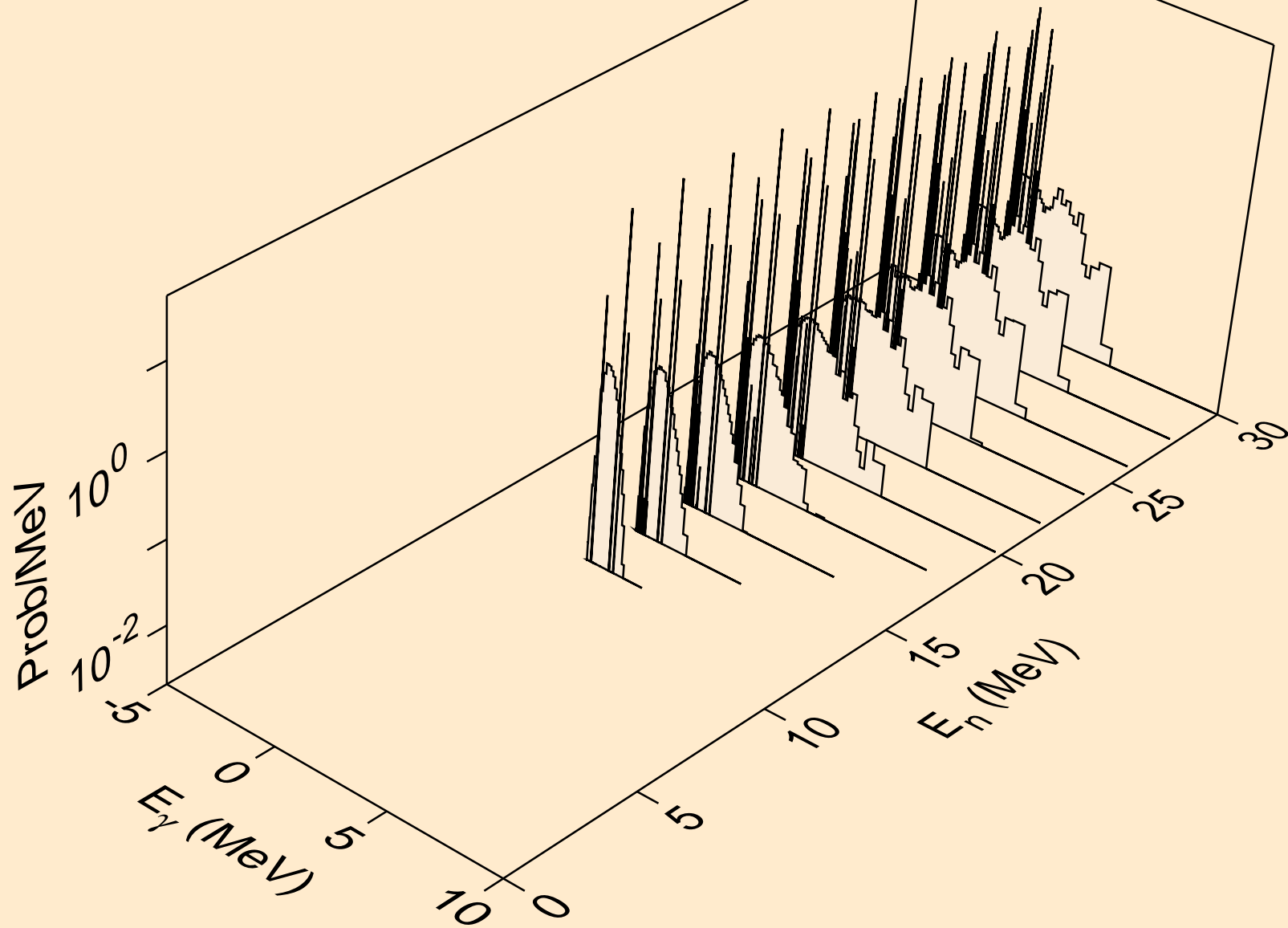

AT200 NEUTRON ACER TENDL-2024 LIBRARY; T=293.6K  
Photon emission for (n,4n)

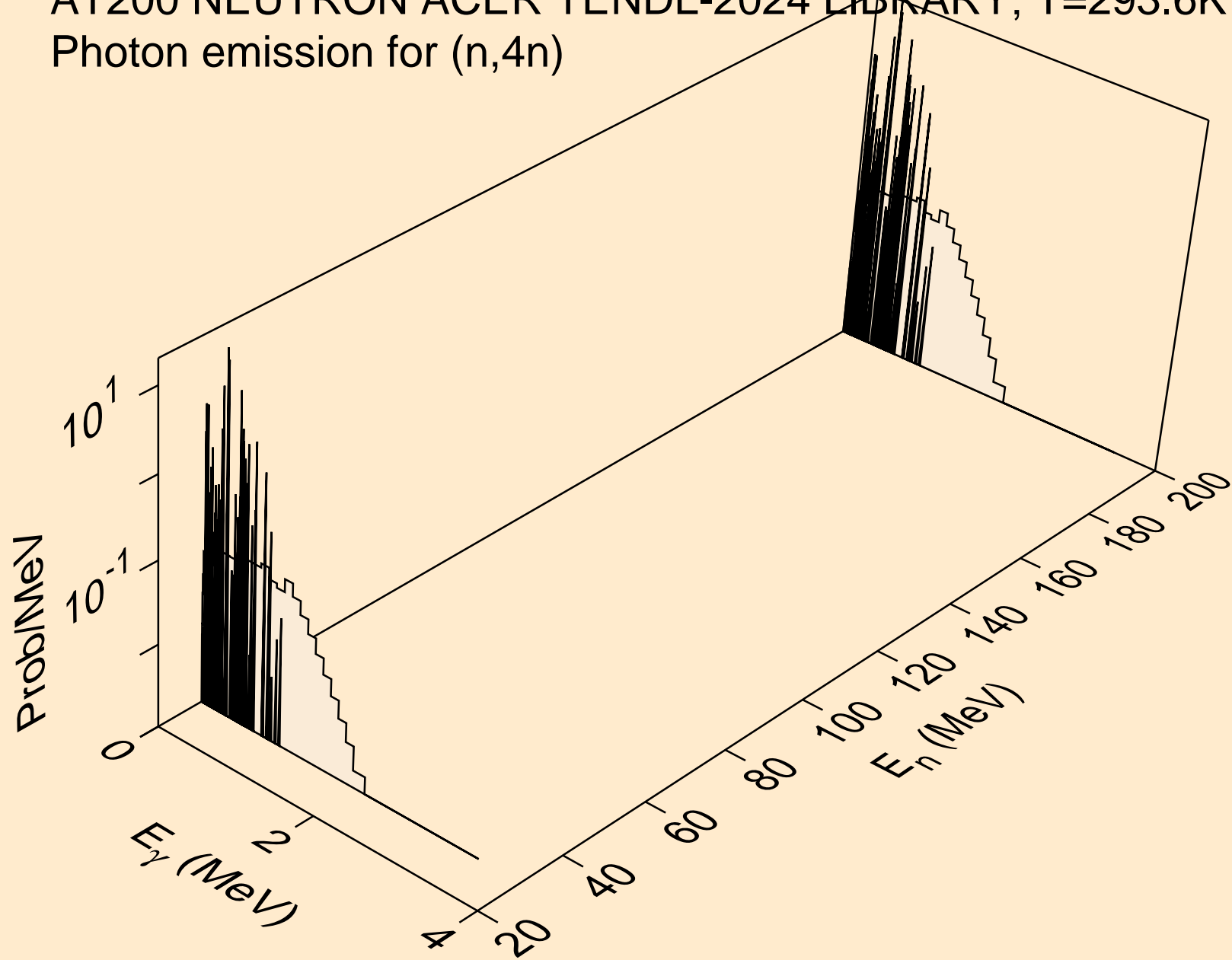

AT200 NEUTRON ACER TENDL-2024 LIBRARY; T=293.6K  
Photon emission for (n,2np)

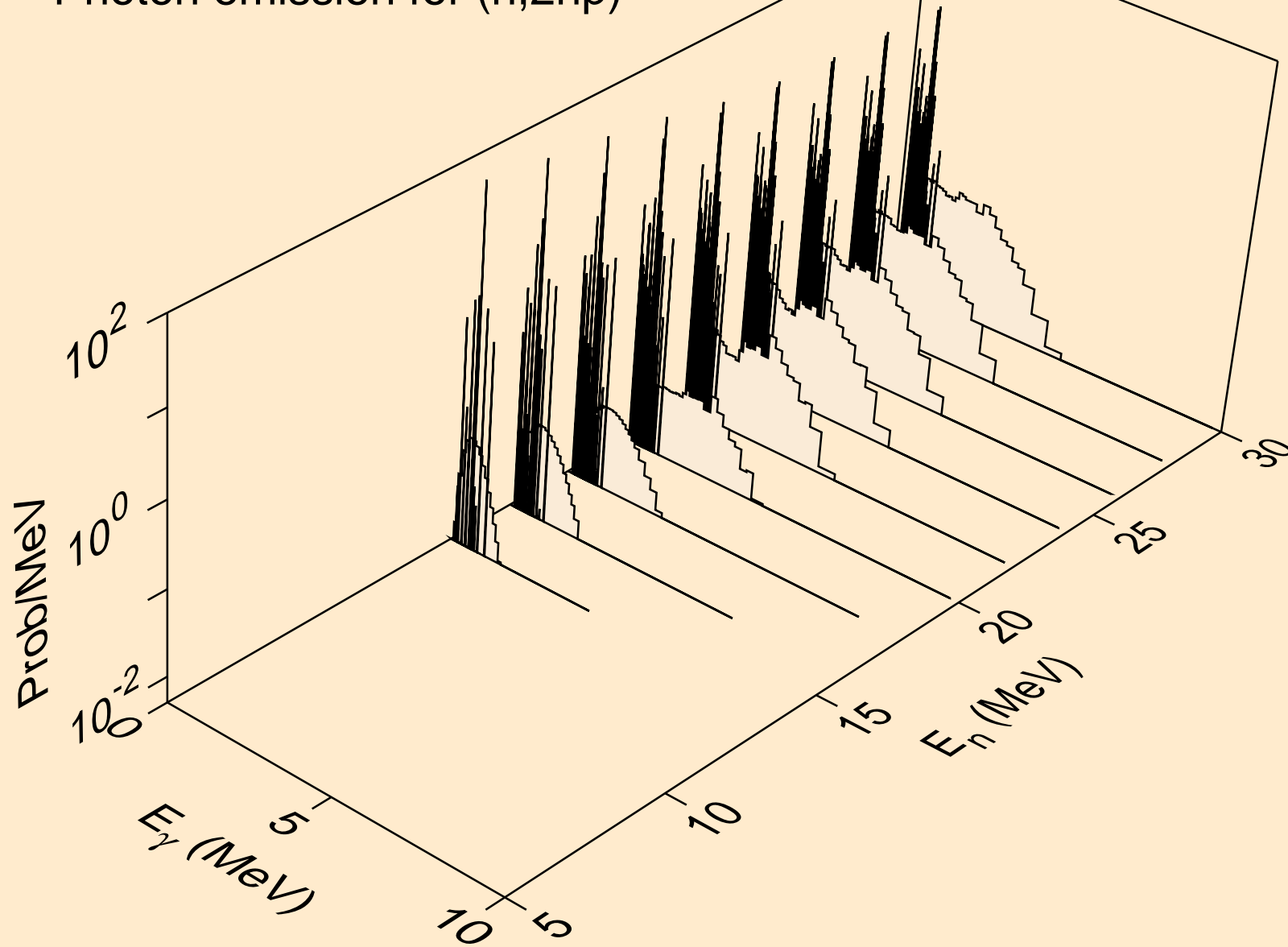

AT200 NEUTRON ACER TENDL-2024 LIBRARY; T=293.6K  
Photon emission for (n,3np)

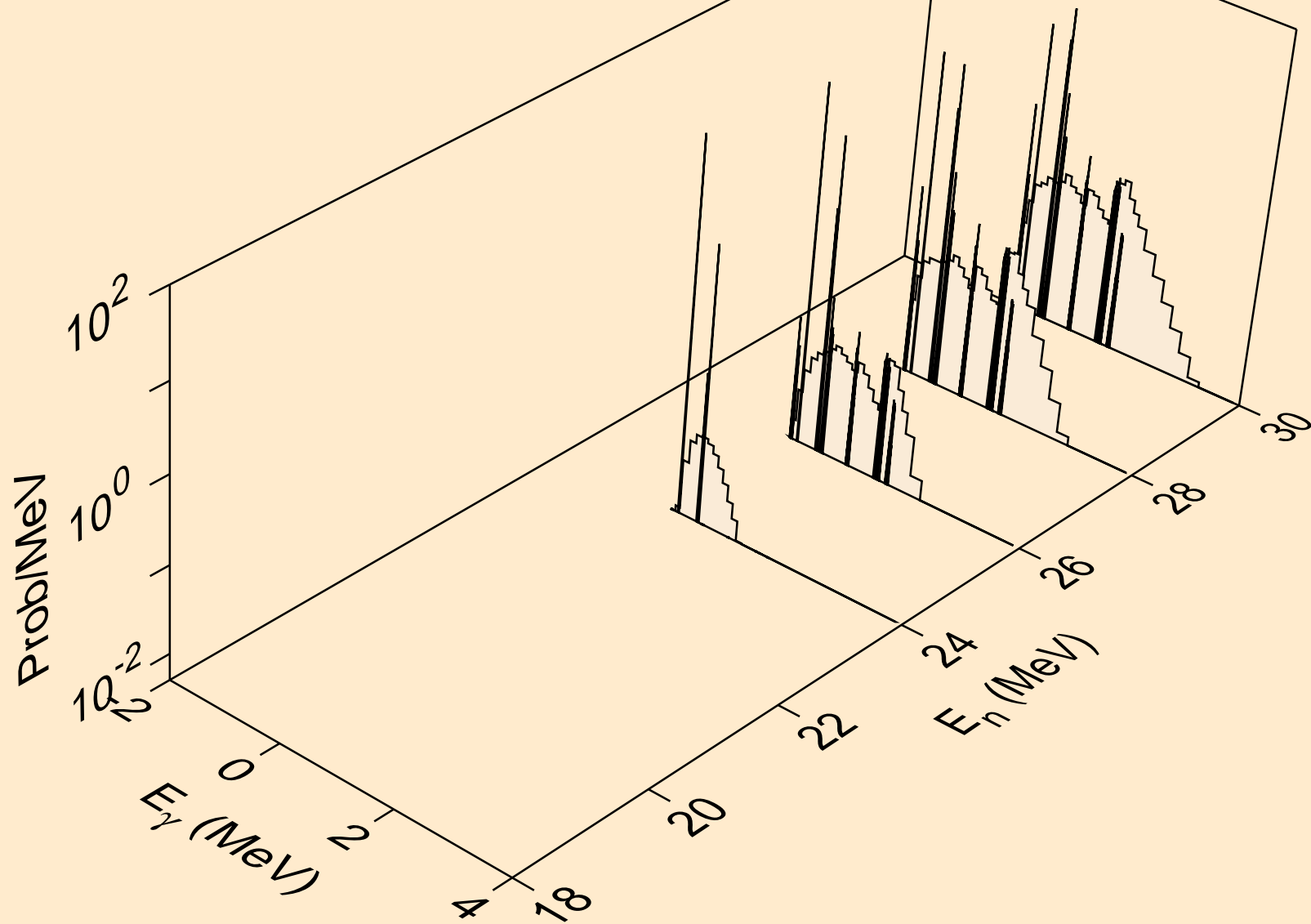

AT200 NEUTRON ACER TENDL-2024 LIBRARY; T=293.6K  
Photon emission for (n,n2p)

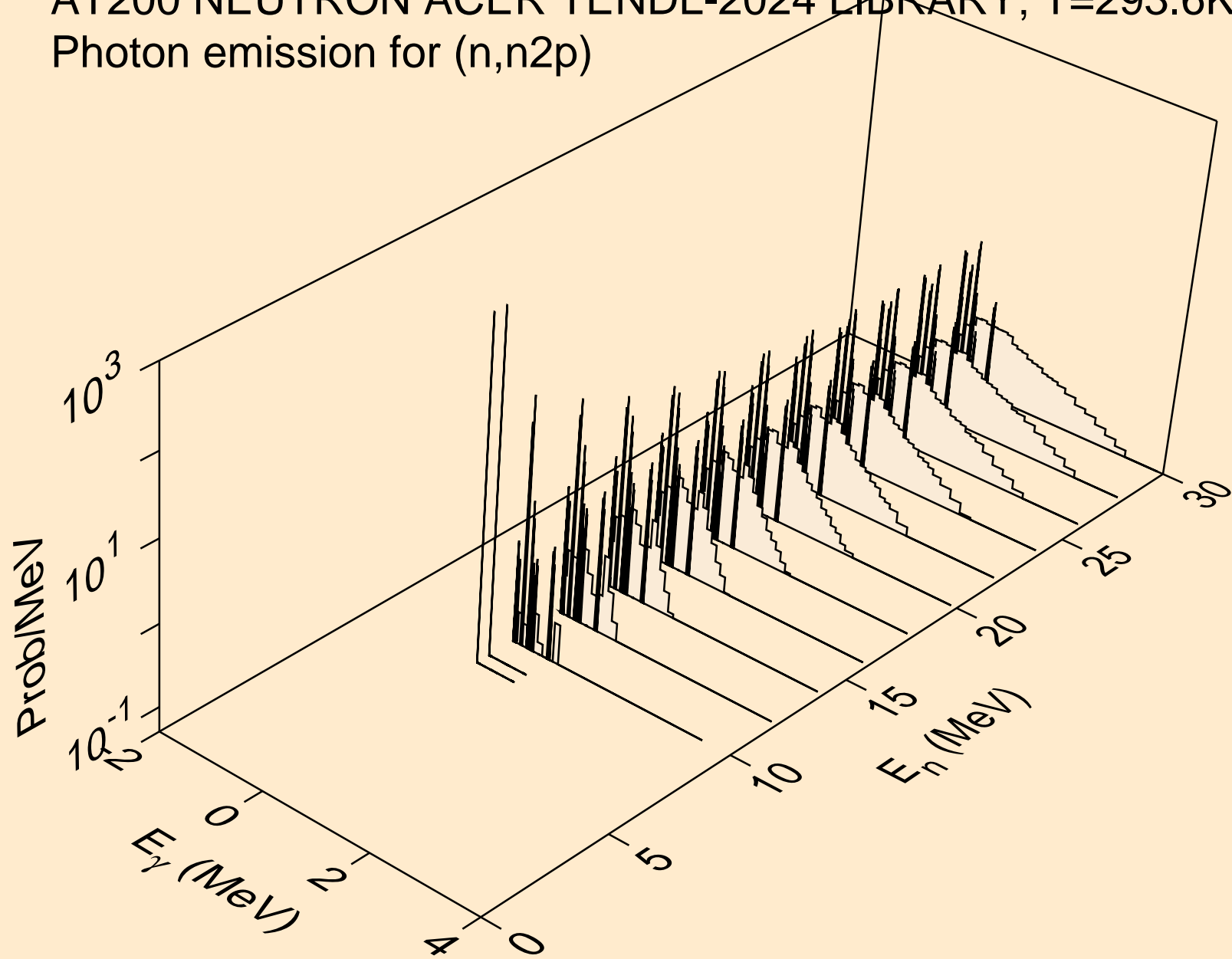

AT200 NEUTRON ACER TENDL-2024 LIBRARY; T=293.6K  
Photon emission for (n,npa)

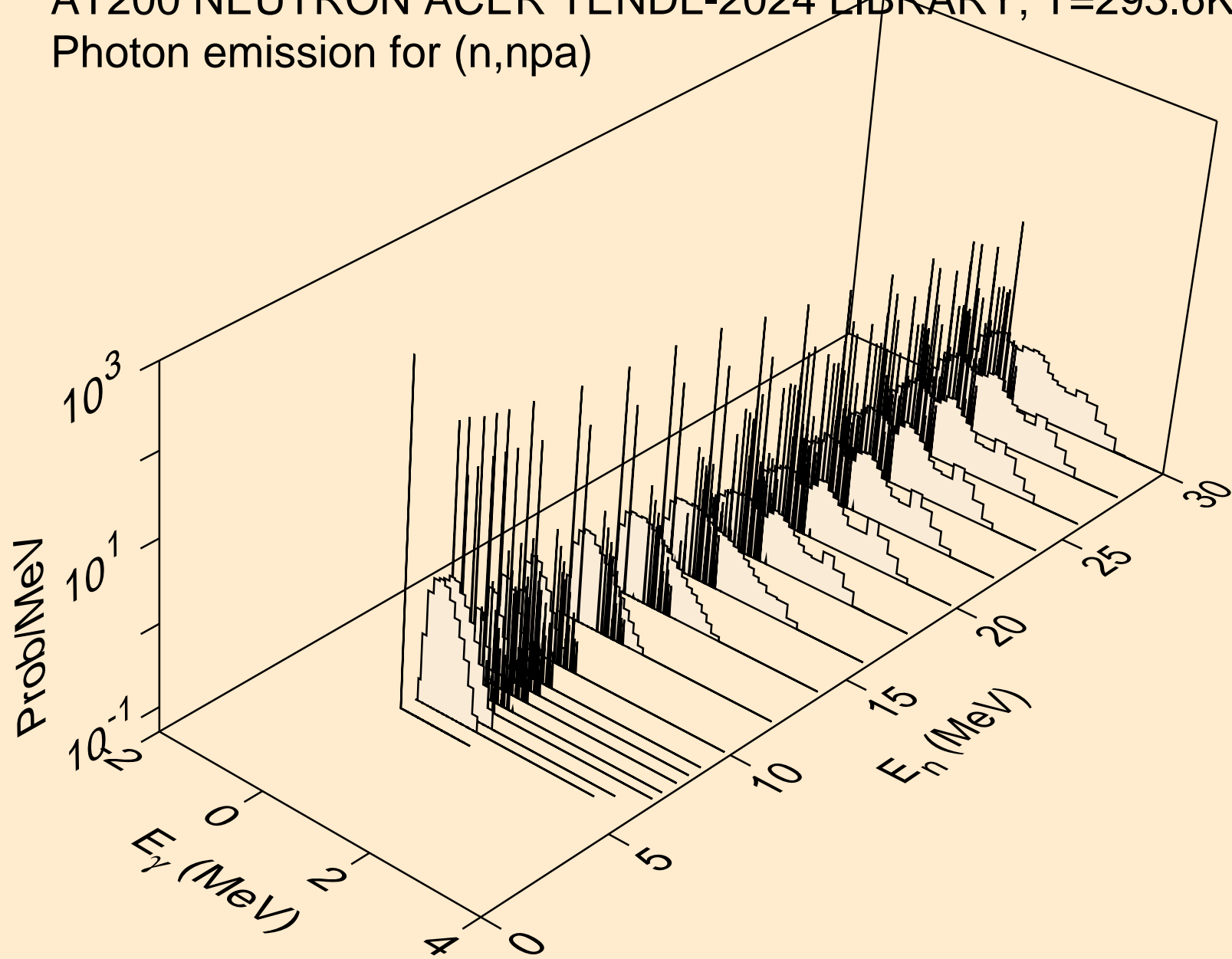

AT200 NEUTRON ACER TENDL-2024 LIBRARY; T=293.6K  
Photon emission for (n,n\*c)

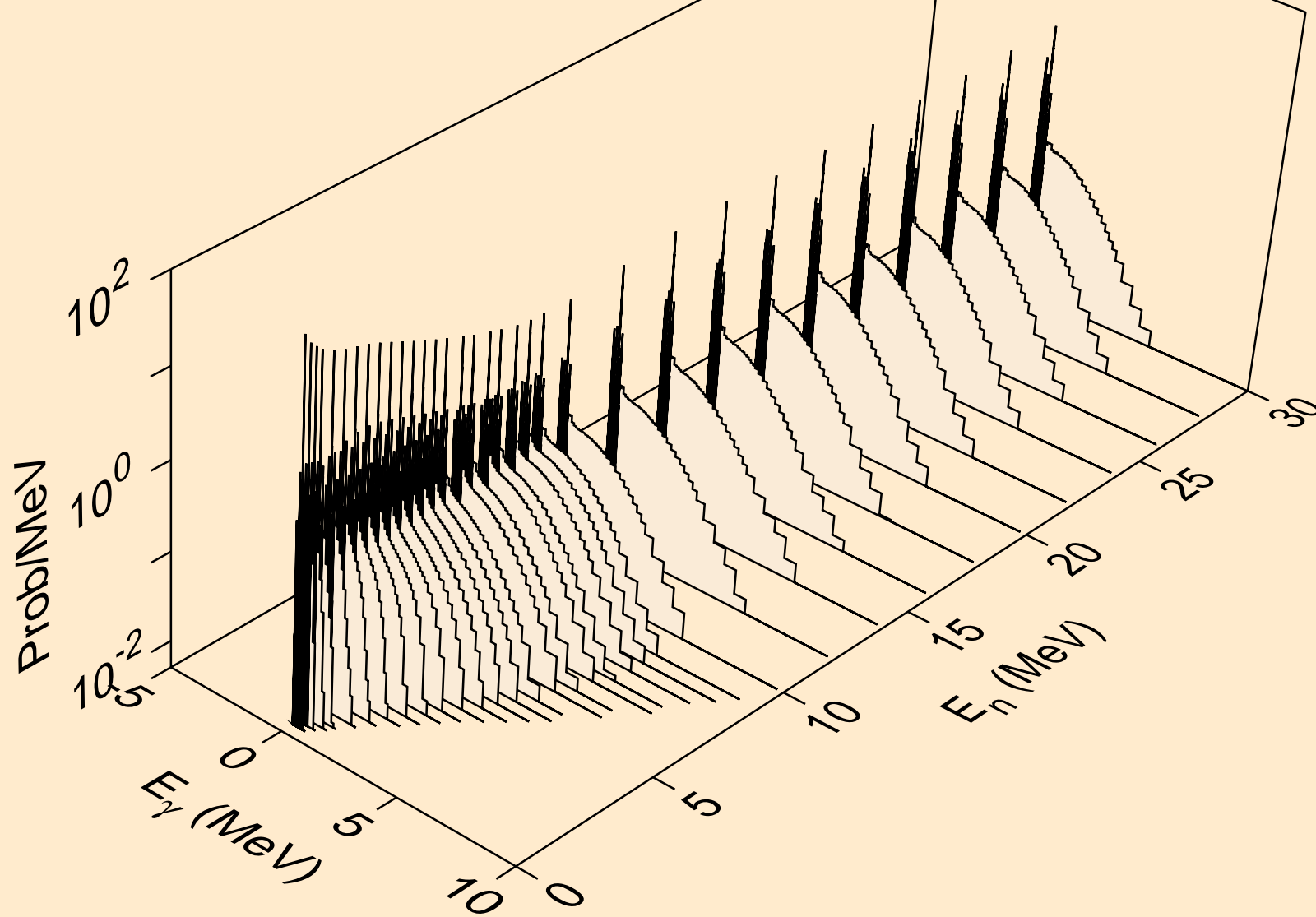

AT200 NEUTRON ACER TENDL-2024 LIBRARY; T=293.6K  
Photon emission for (n,gma)

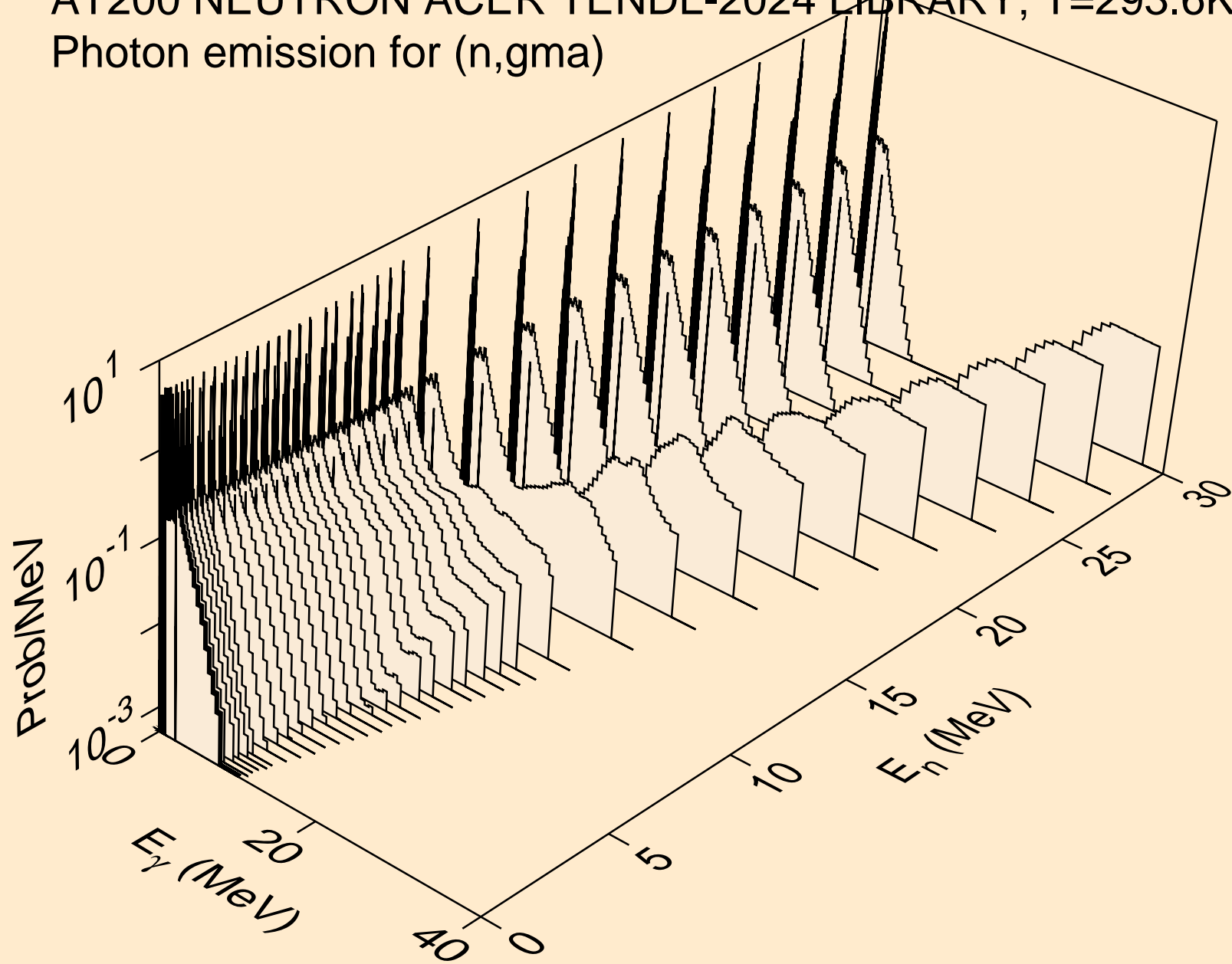

AT200 NEUTRON ACER TENDL-2024 LIBRARY; T=293.6K  
Photon emission for (n,p)

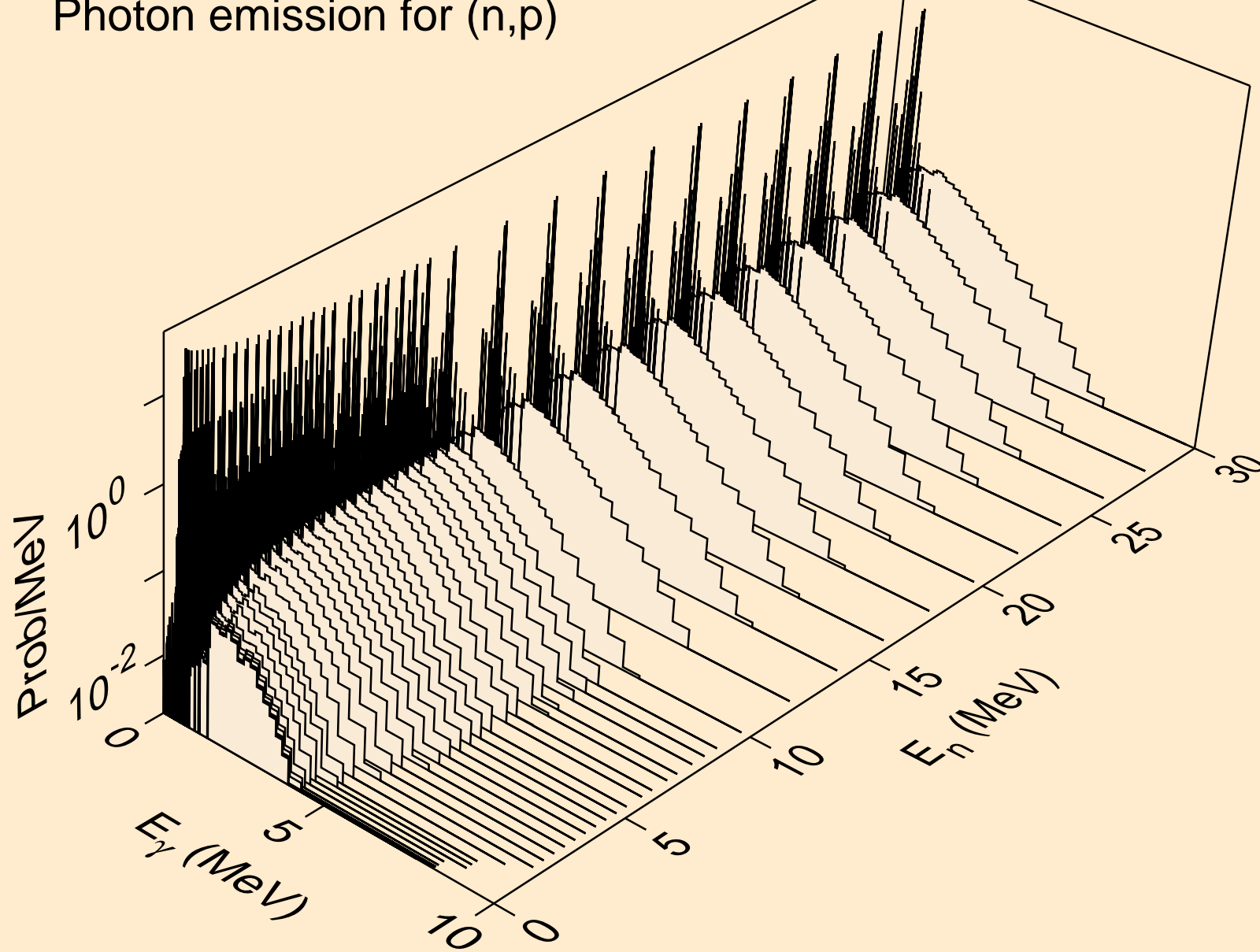

AT200 NEUTRON ACER TENDL-2024 LIBRARY; T=293.6K  
Photon emission for (n,d)

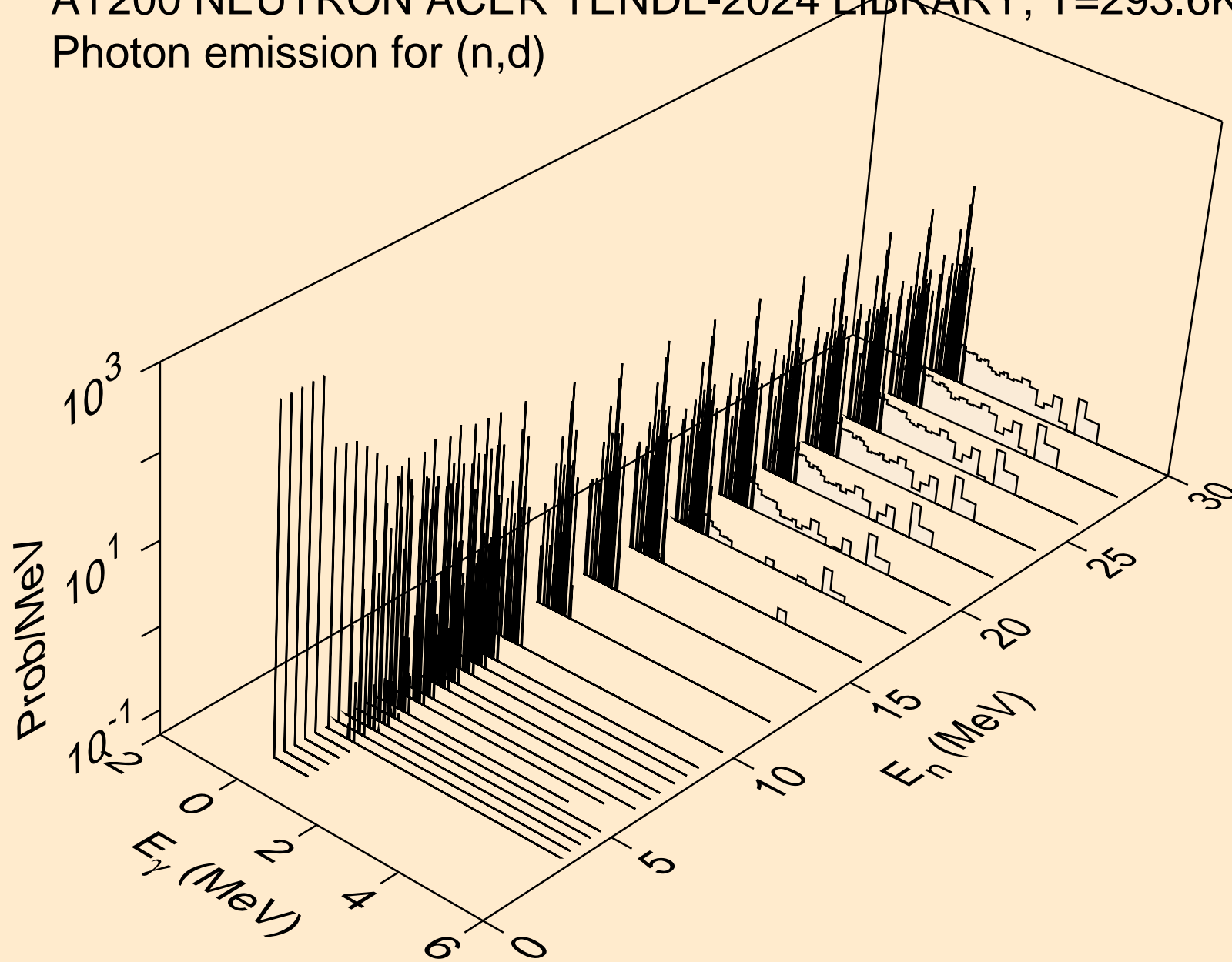

AT200 NEUTRON ACER TENDL-2024 LIBRARY; T=293.6K  
Photon emission for (n,t)

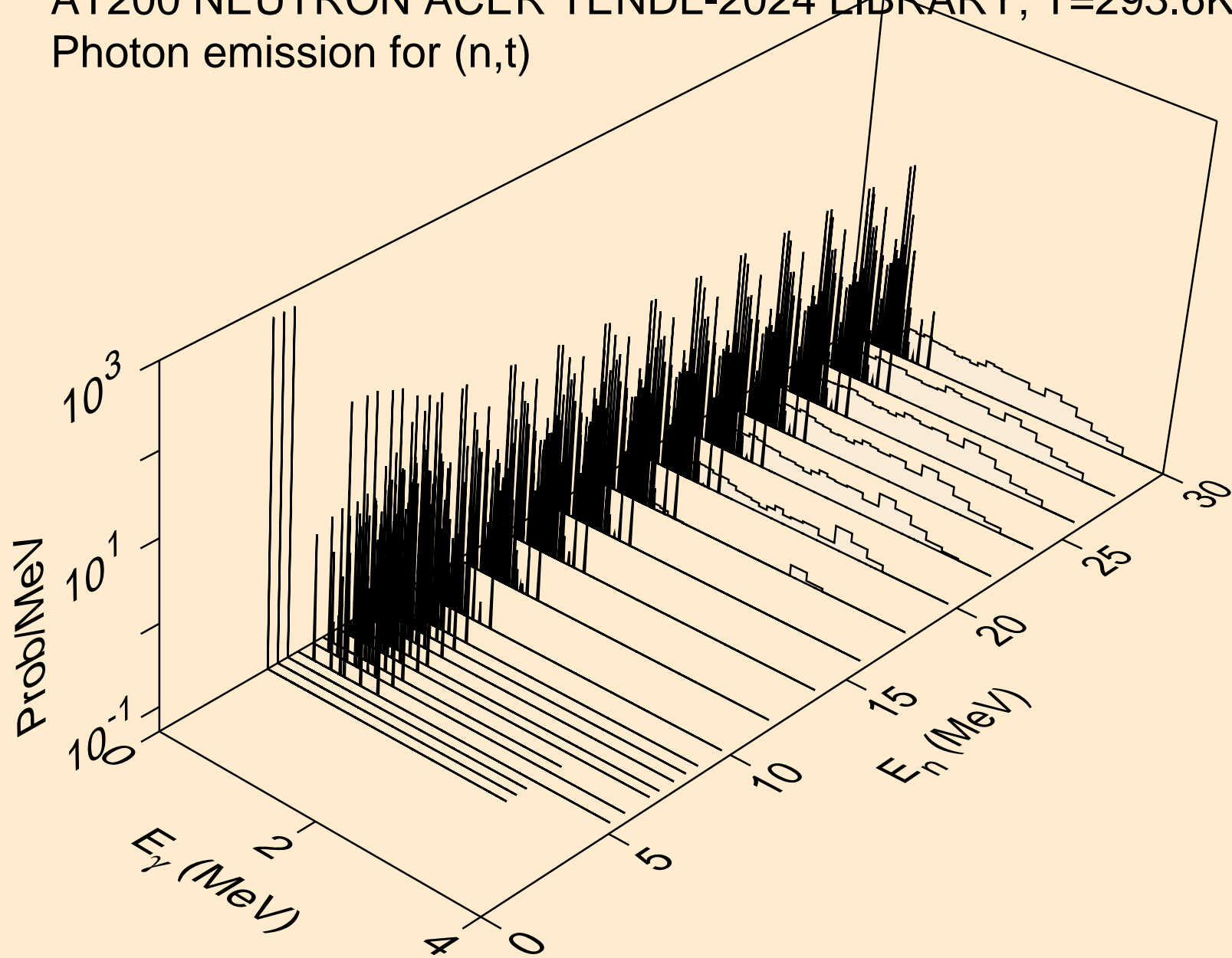

AT200 NEUTRON ACER TENDL-2024 LIBRARY; T=293.6K  
Photon emission for (n,he3)

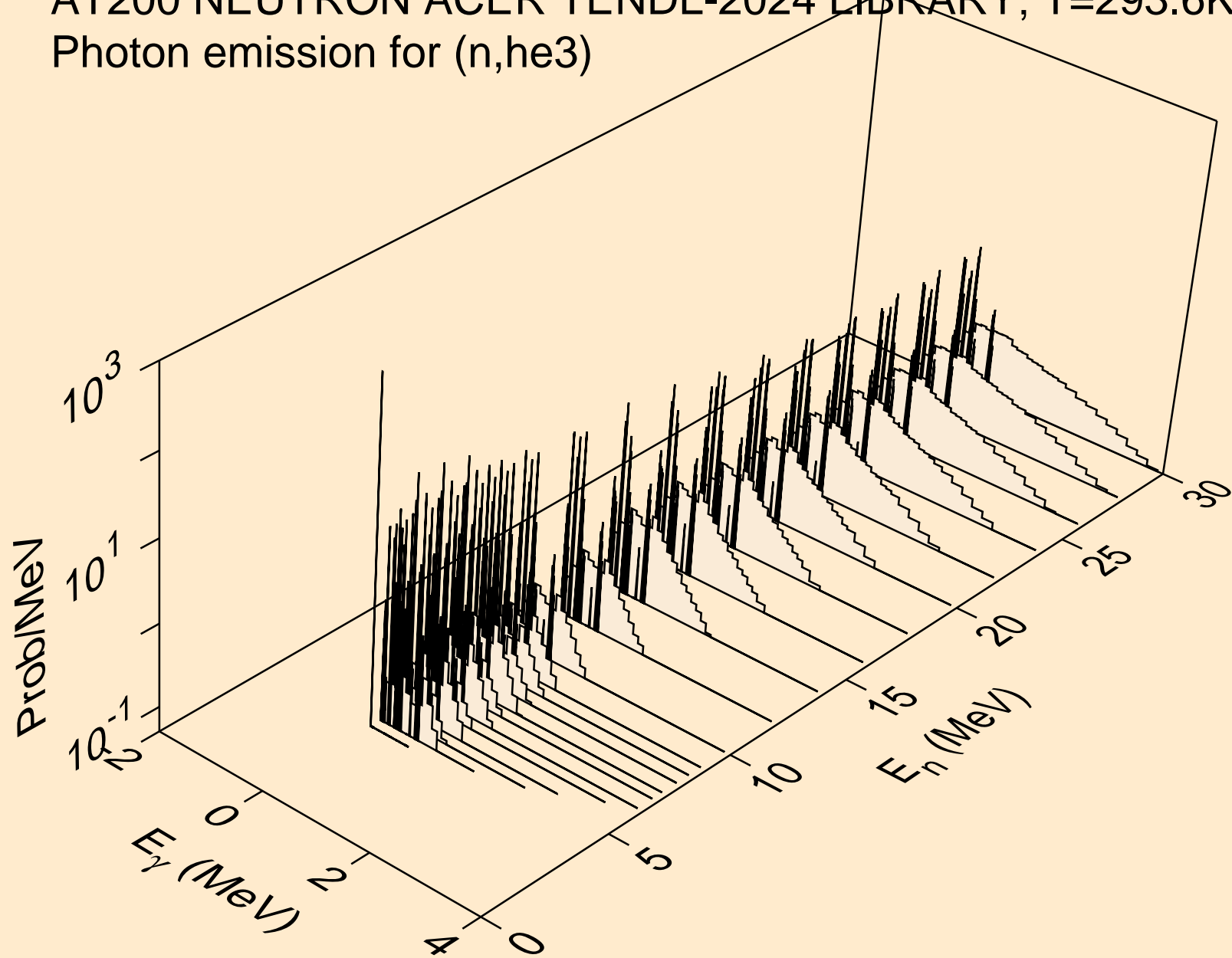

AT200 NEUTRON ACER TENDL-2024 LIBRARY; T=293.6K  
Photon emission for (n,a)

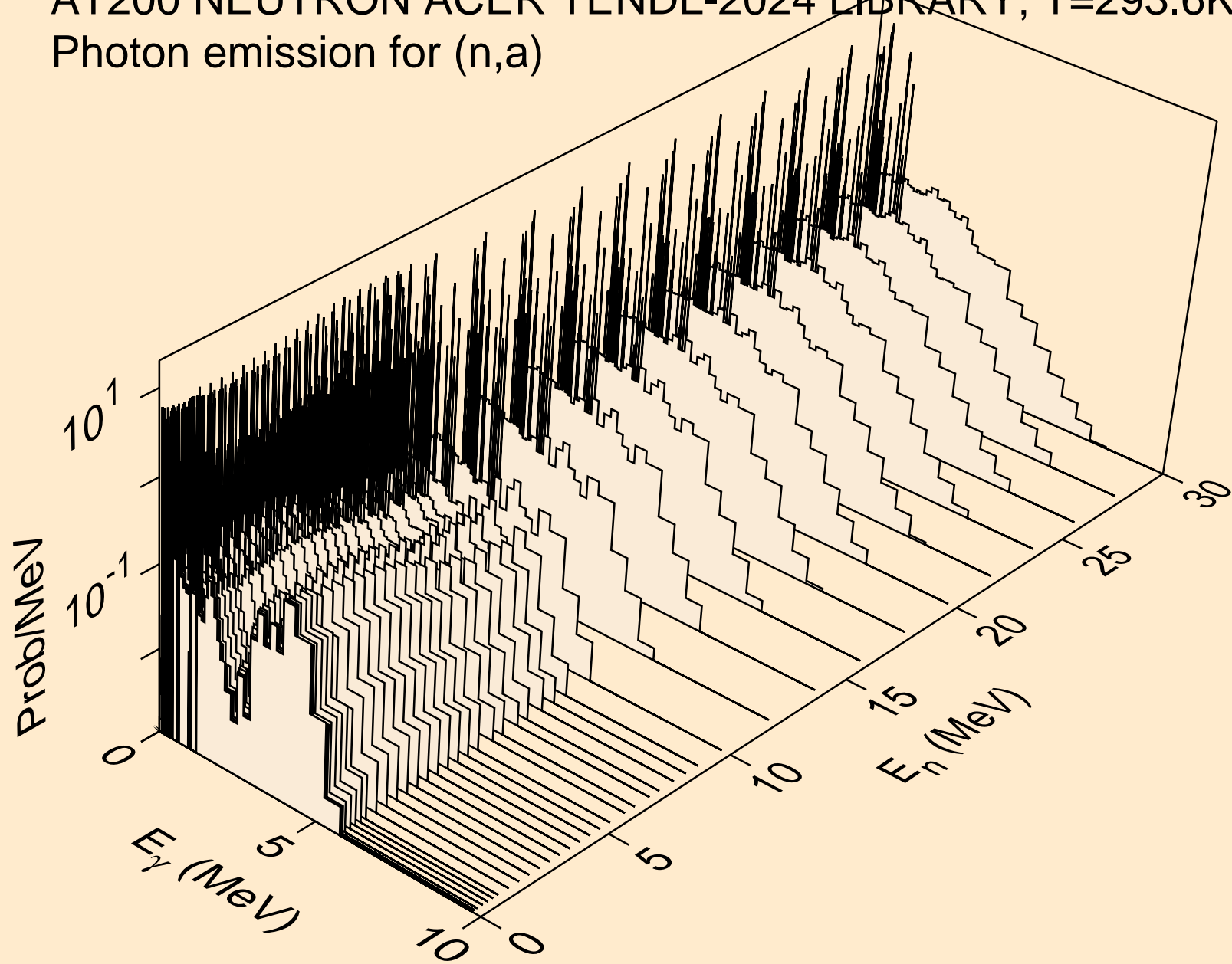

AT200 NEUTRON ACER TENDL-2024 LIBRARY; T=293.6K  
Photon emission for (n,2a)

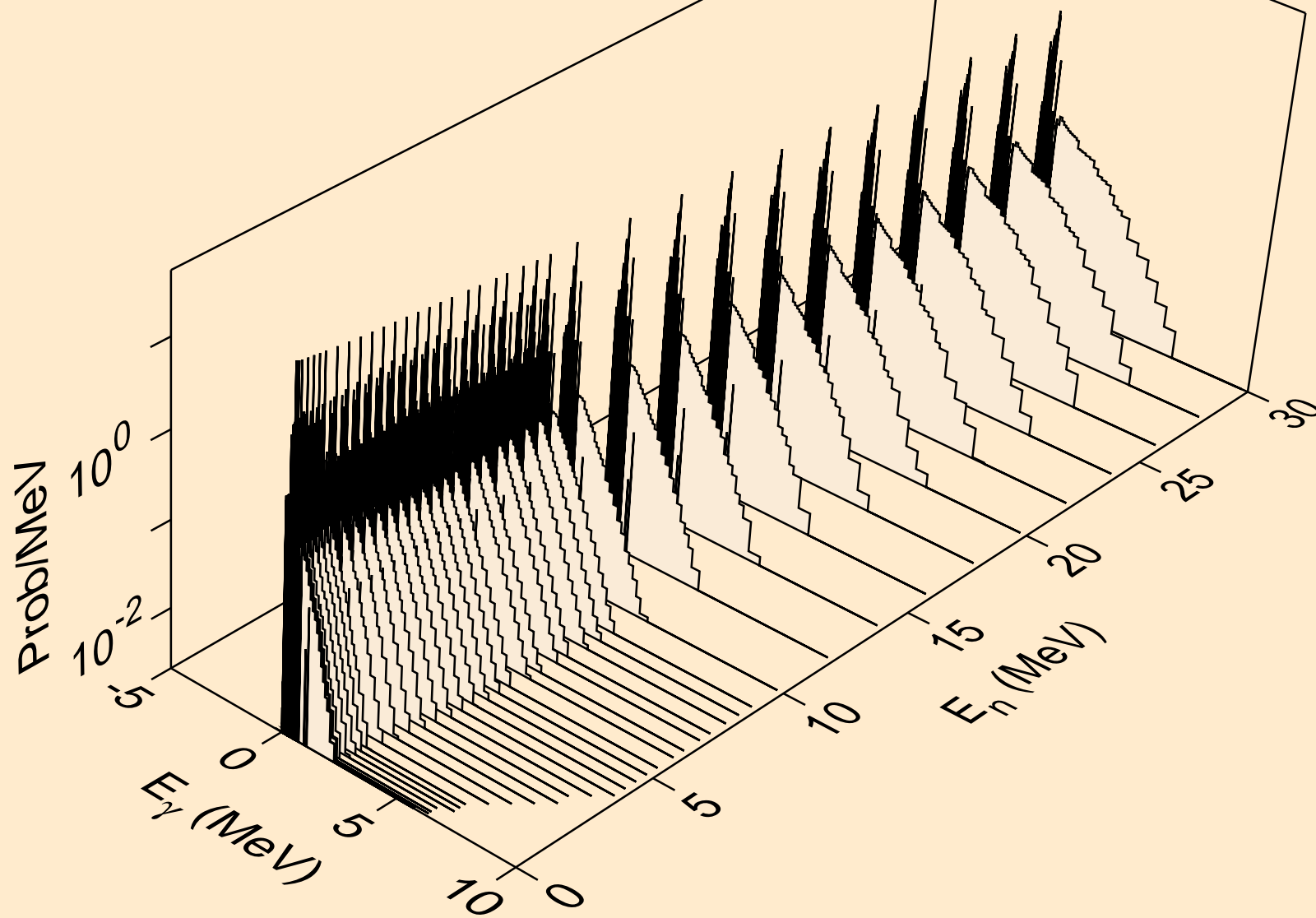

AT200 NEUTRON ACER TENDL-2024 LIBRARY; T=293.6K  
Photon emission for (n,2p)

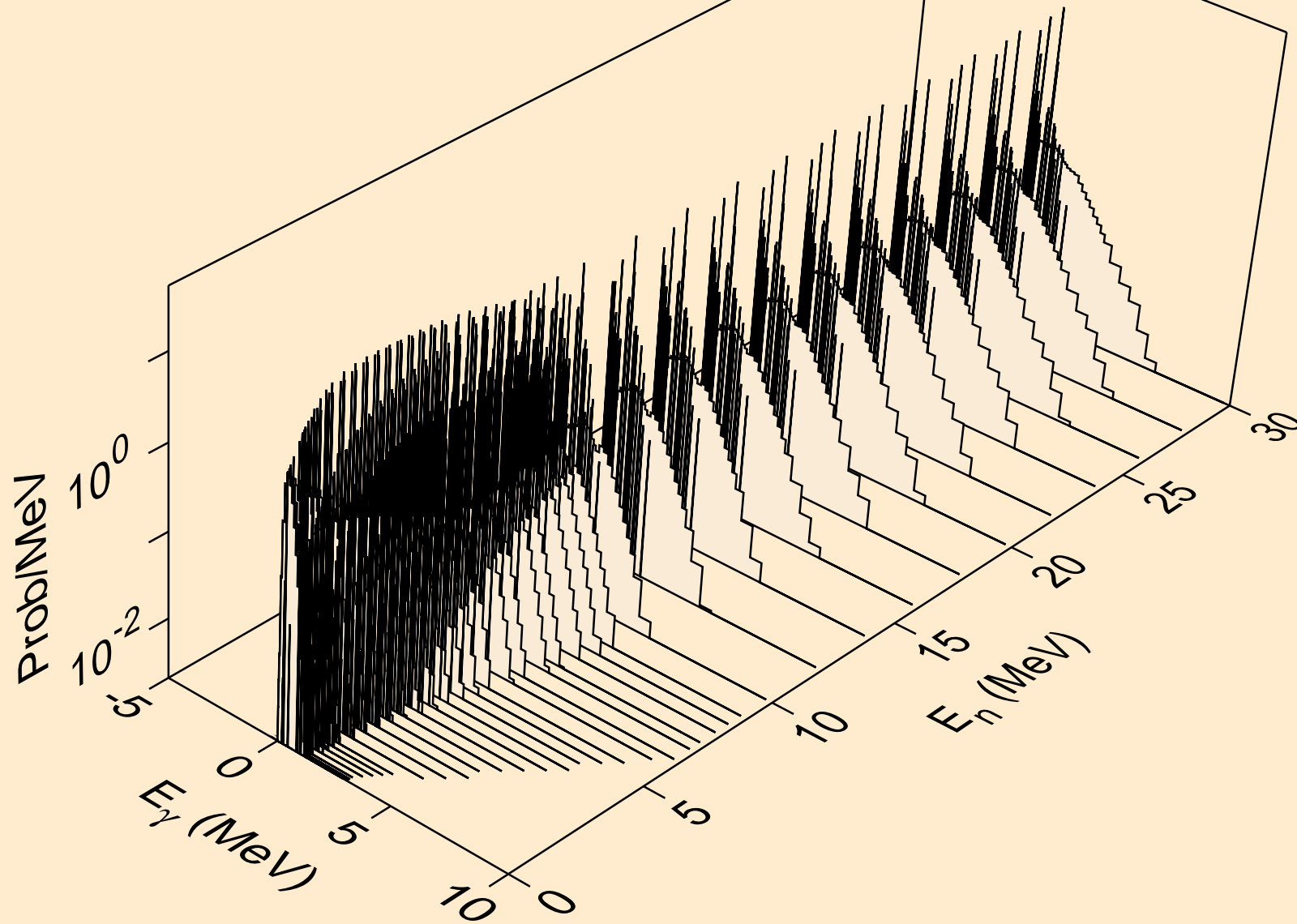

AT200 NEUTRON ACER TENDL-2024 LIBRARY; T=293.6K  
Photon emission for (n,p $\alpha$ )

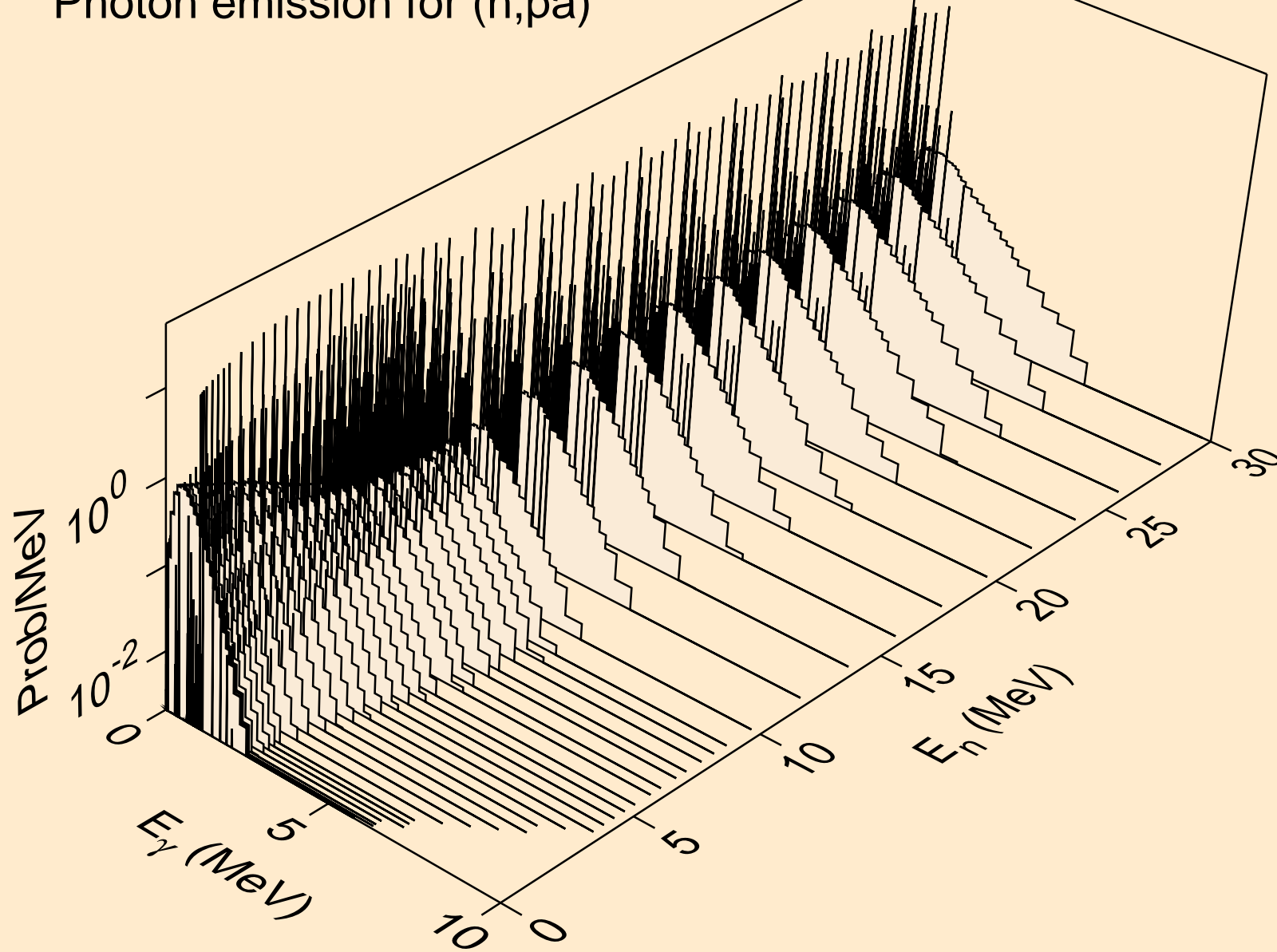

AT200 NEUTRON ACER TENDL-2024 LIBRARY; T=293.6K  
Photon emission for (n,pd)

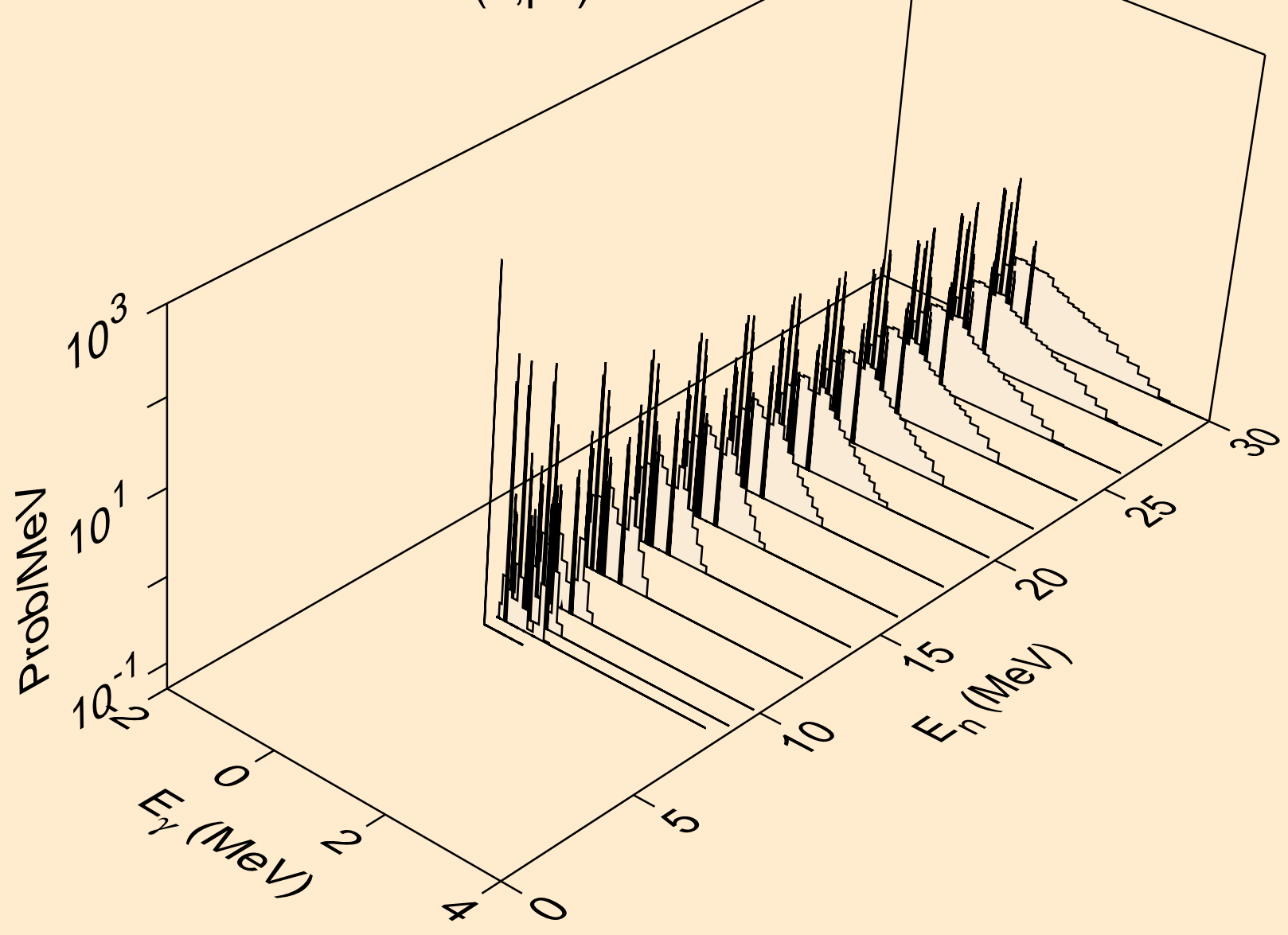

AT200 NEUTRON ACER TENDL-2024 LIBRARY; T=293.6K  
Photon emission for (n,pt)

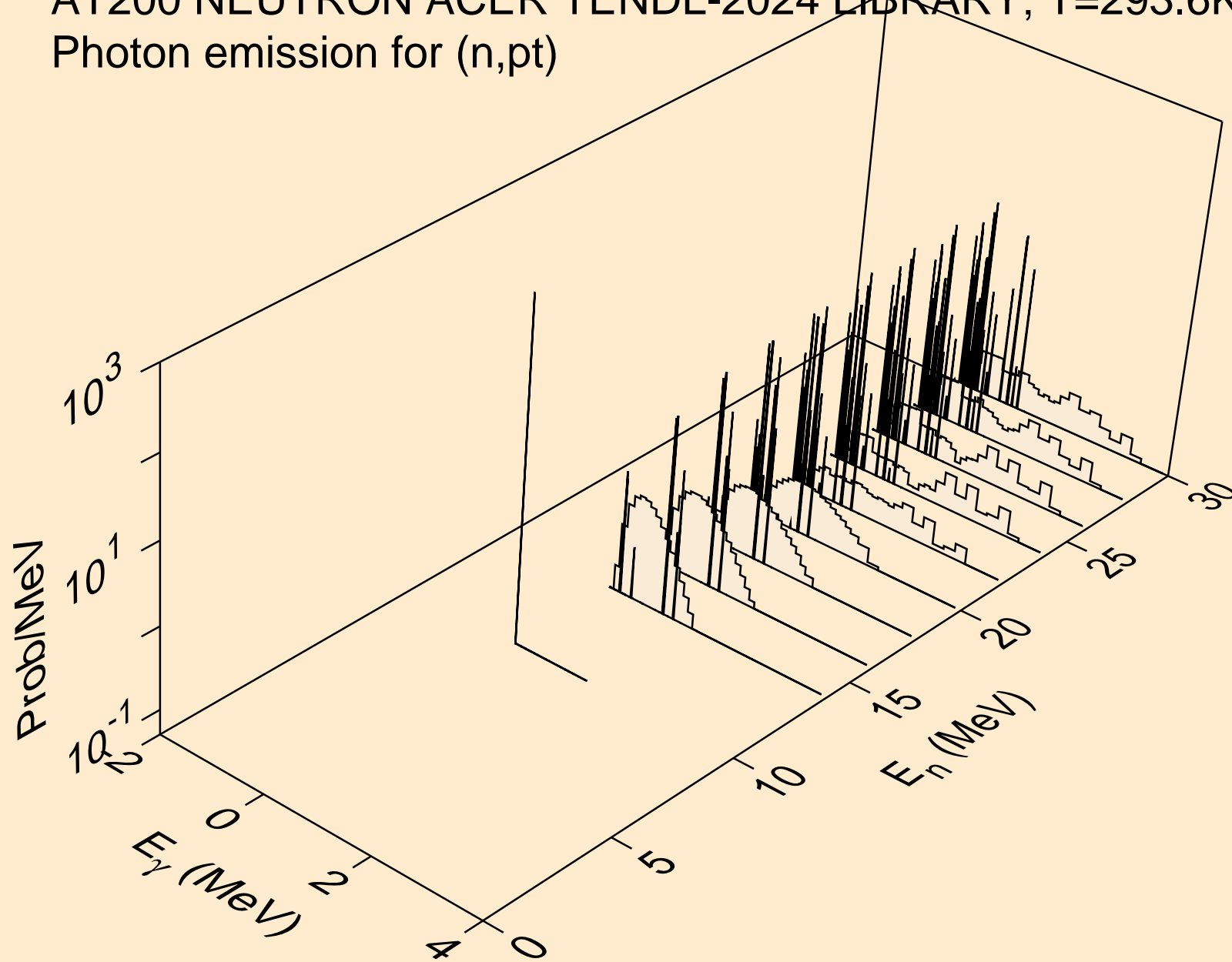

AT200 NEUTRON ACER TENDL-2024 LIBRARY; T=293.6K  
Photon emission for (n,da)

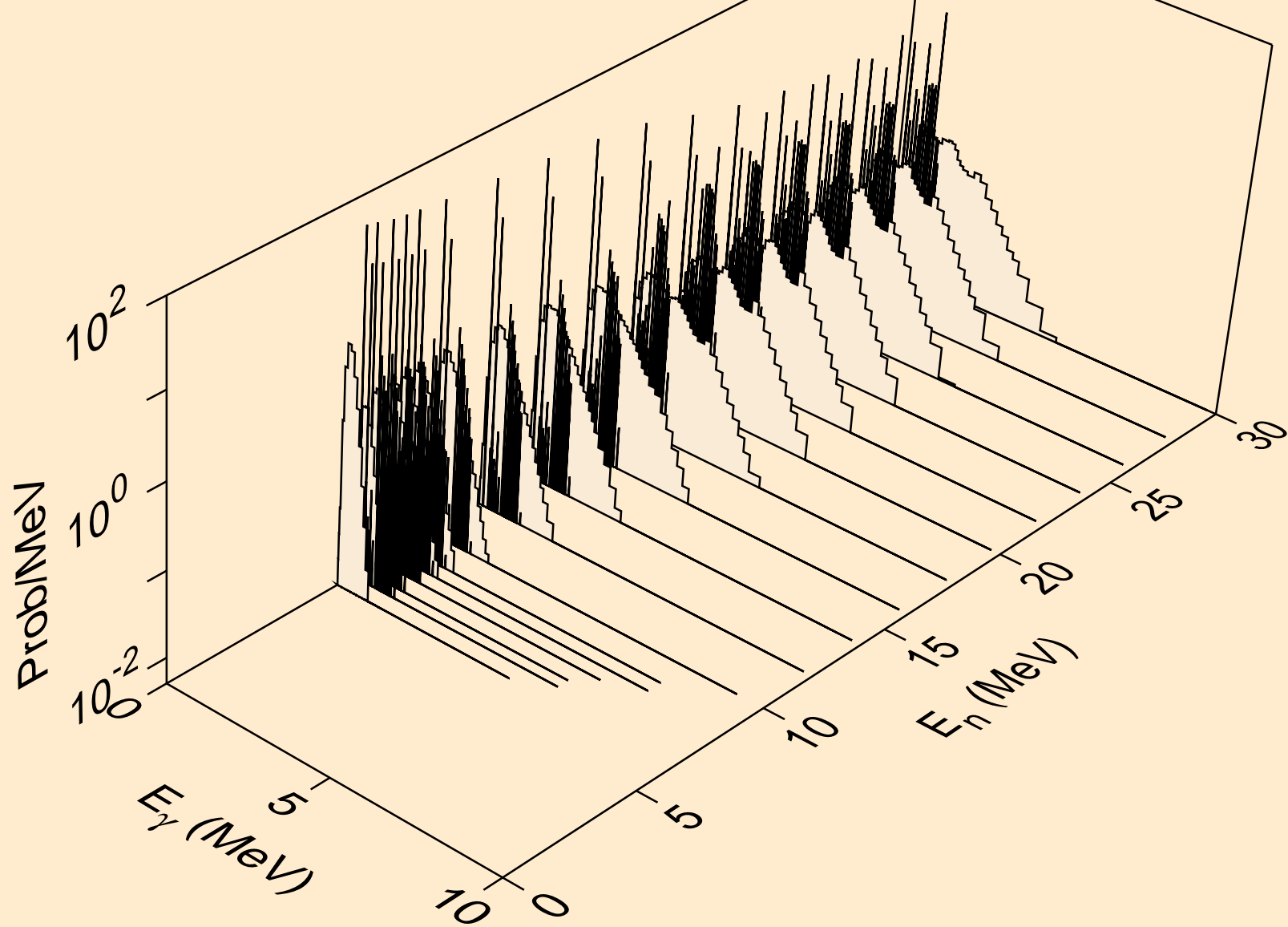

AT200 NEUTRON ACER TENDL-2024 LIBRARY; T=293.6K  
thermal capture photon spectrum

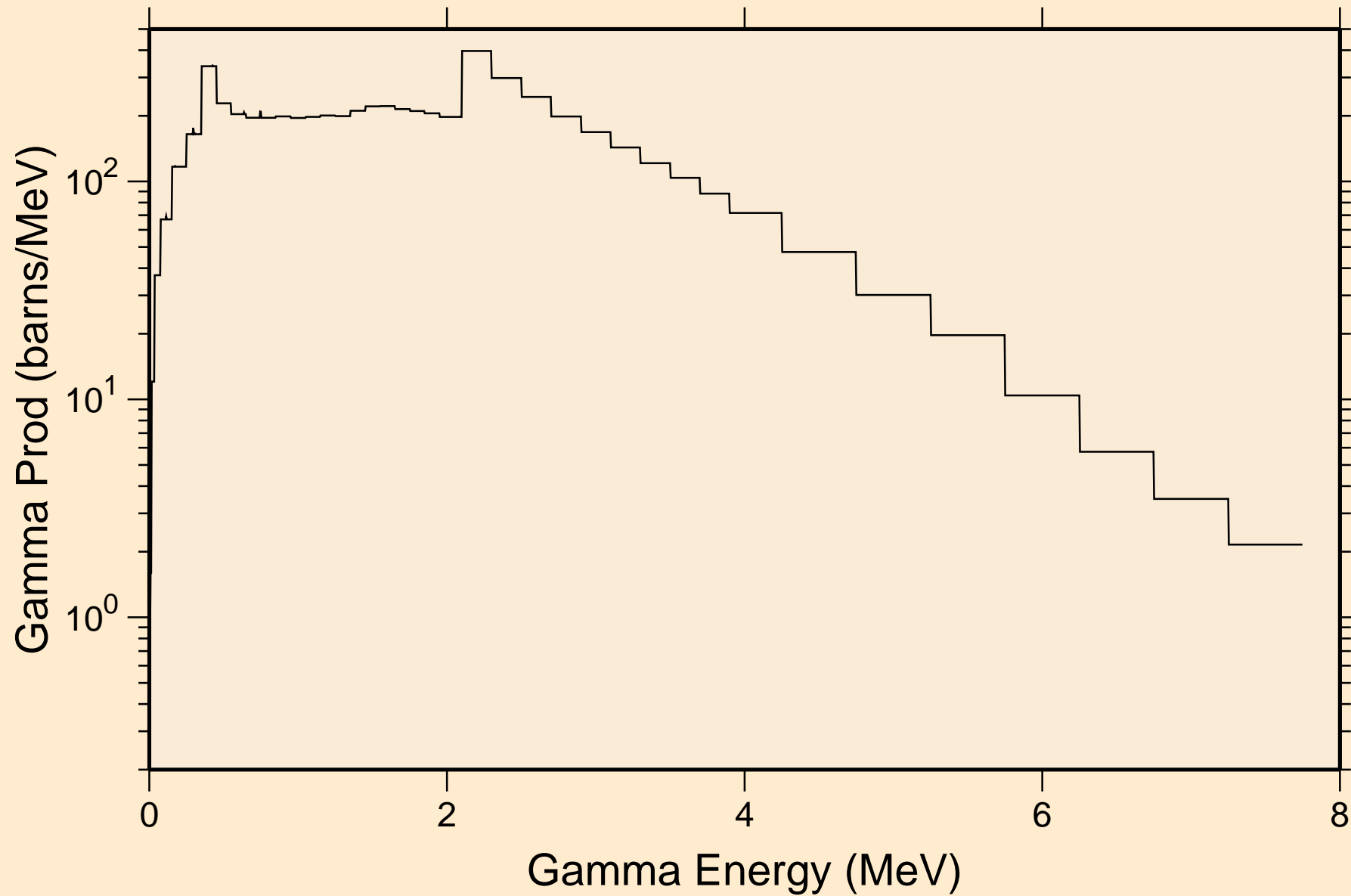

AT200 NEUTRON ACER TENDL-2024 LIBRARY; T=293.6K  
14 MeV photon spectrum

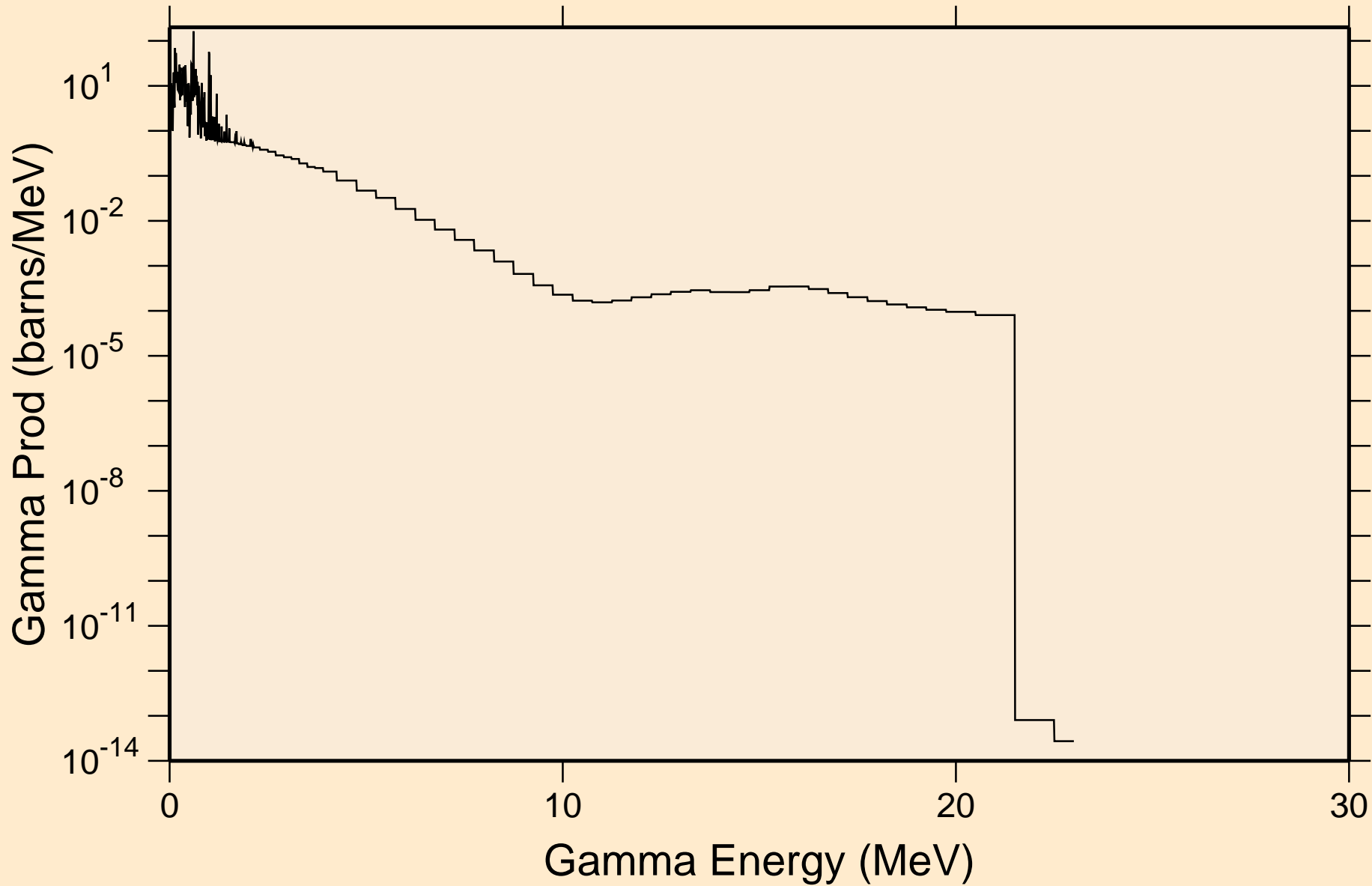

AT200 NEUTRON ACER TENDL-2024 LIBRARY; T=293.6K  
Particle heating contributions

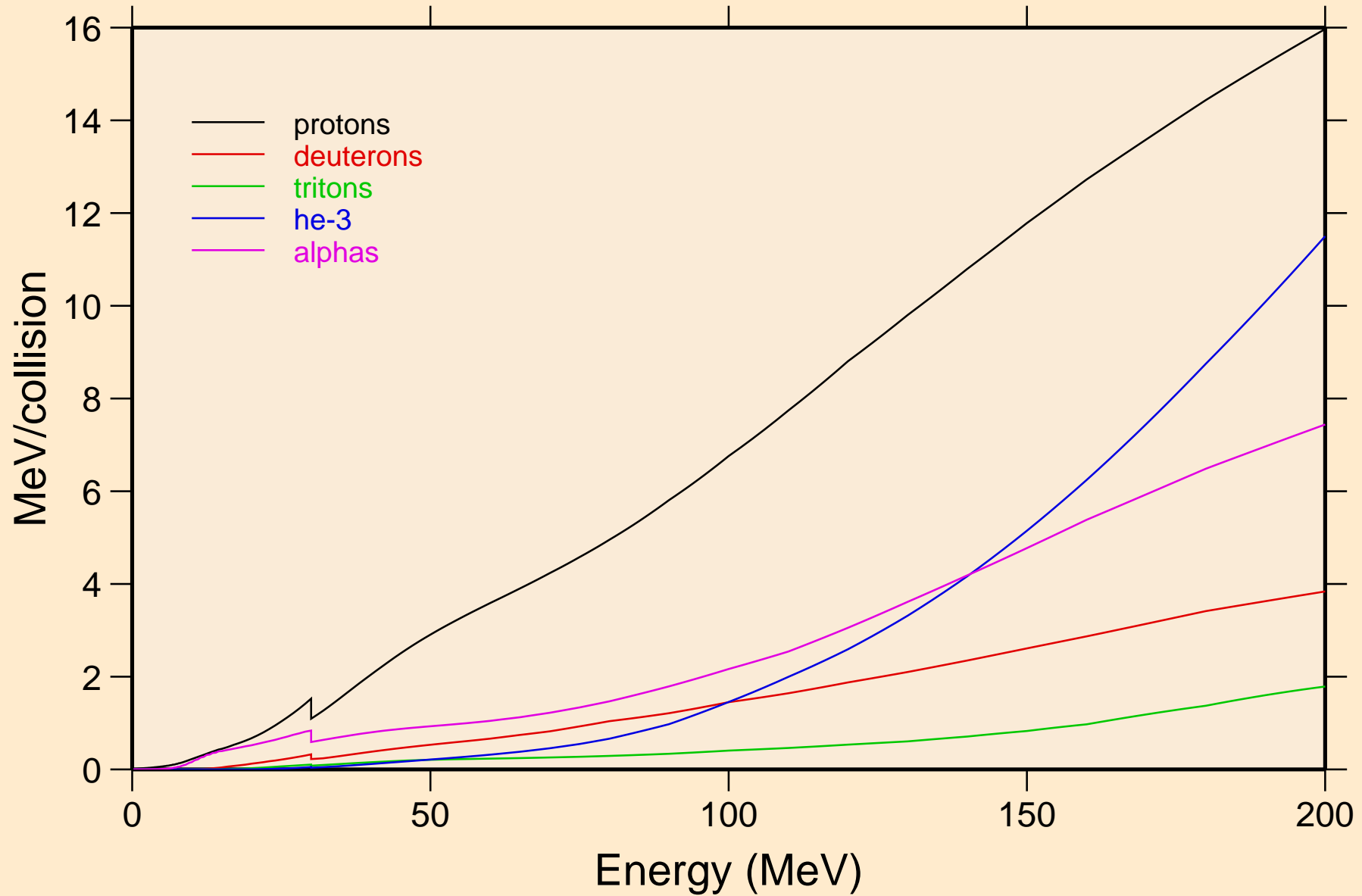

AT200 NEUTRON ACER TENDL-2024 LIBRARY; T=293.6K  
Recoil Heating

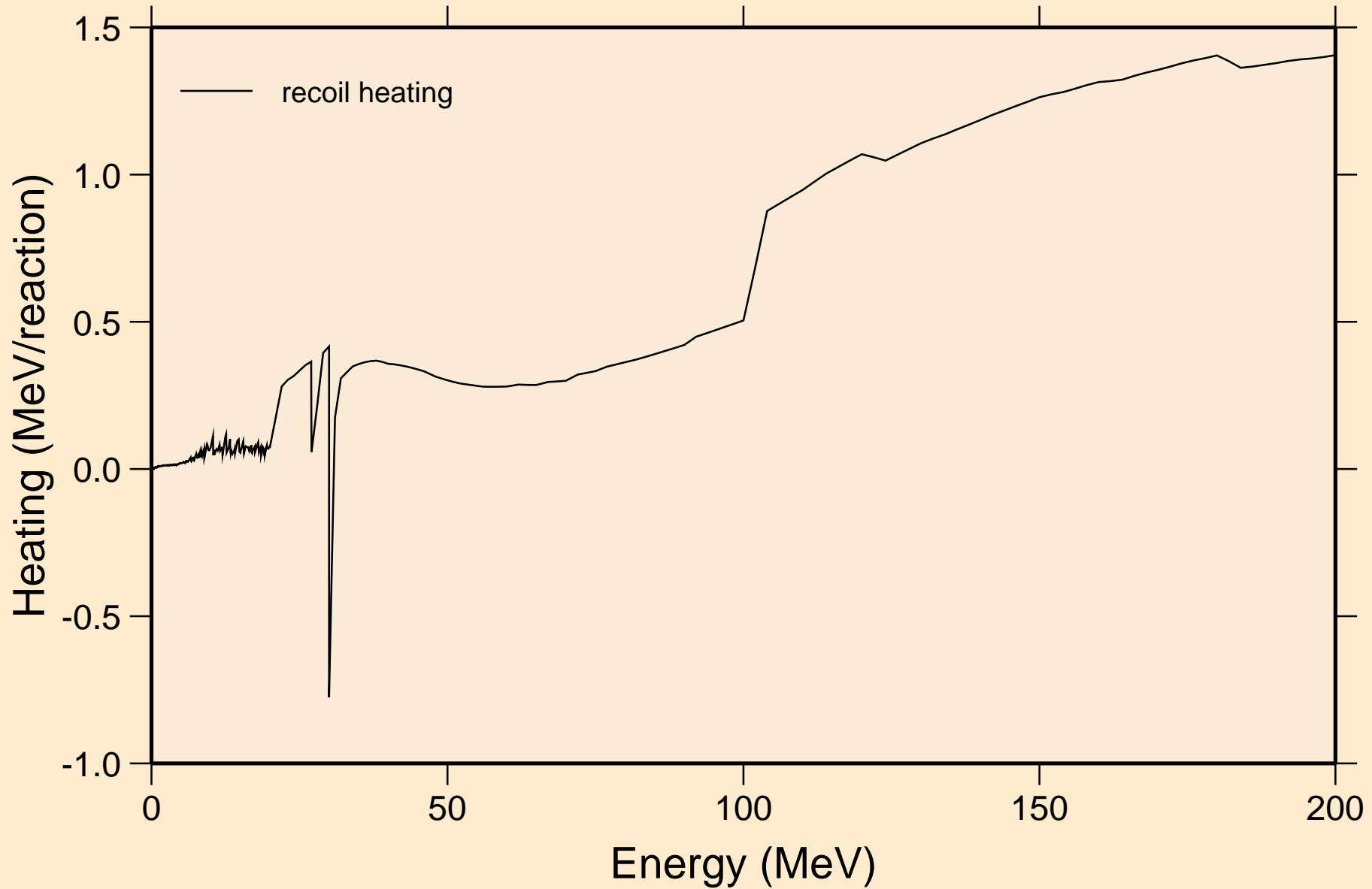

AT200 NEUTRON ACER TENDL-2024 LIBRARY; T=293.6K  
Particle production cross sections

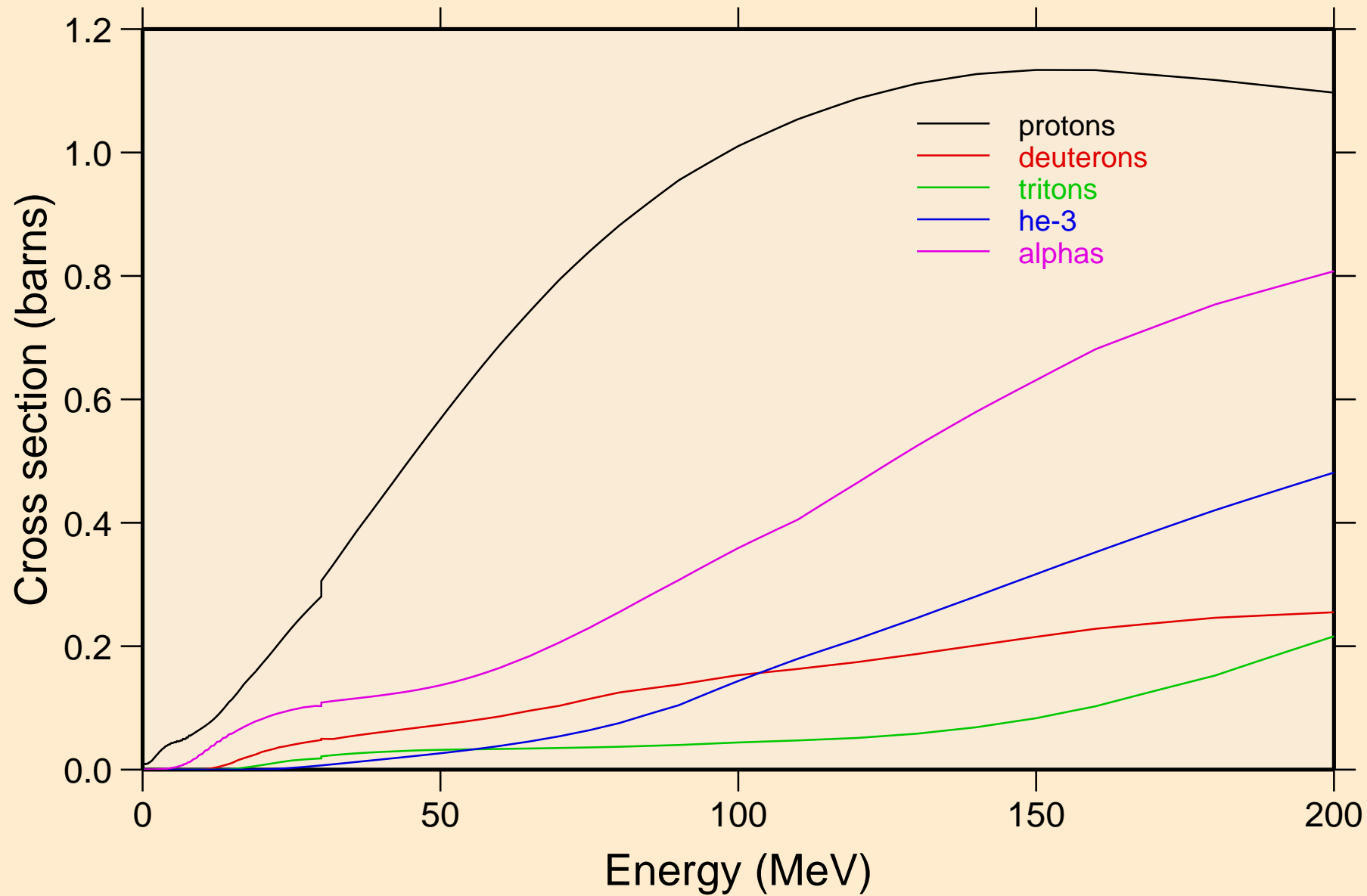

AT200 NEUTRON ACER TENDL-2024 LIBRARY; T=293.6K  
protons from (n,x)

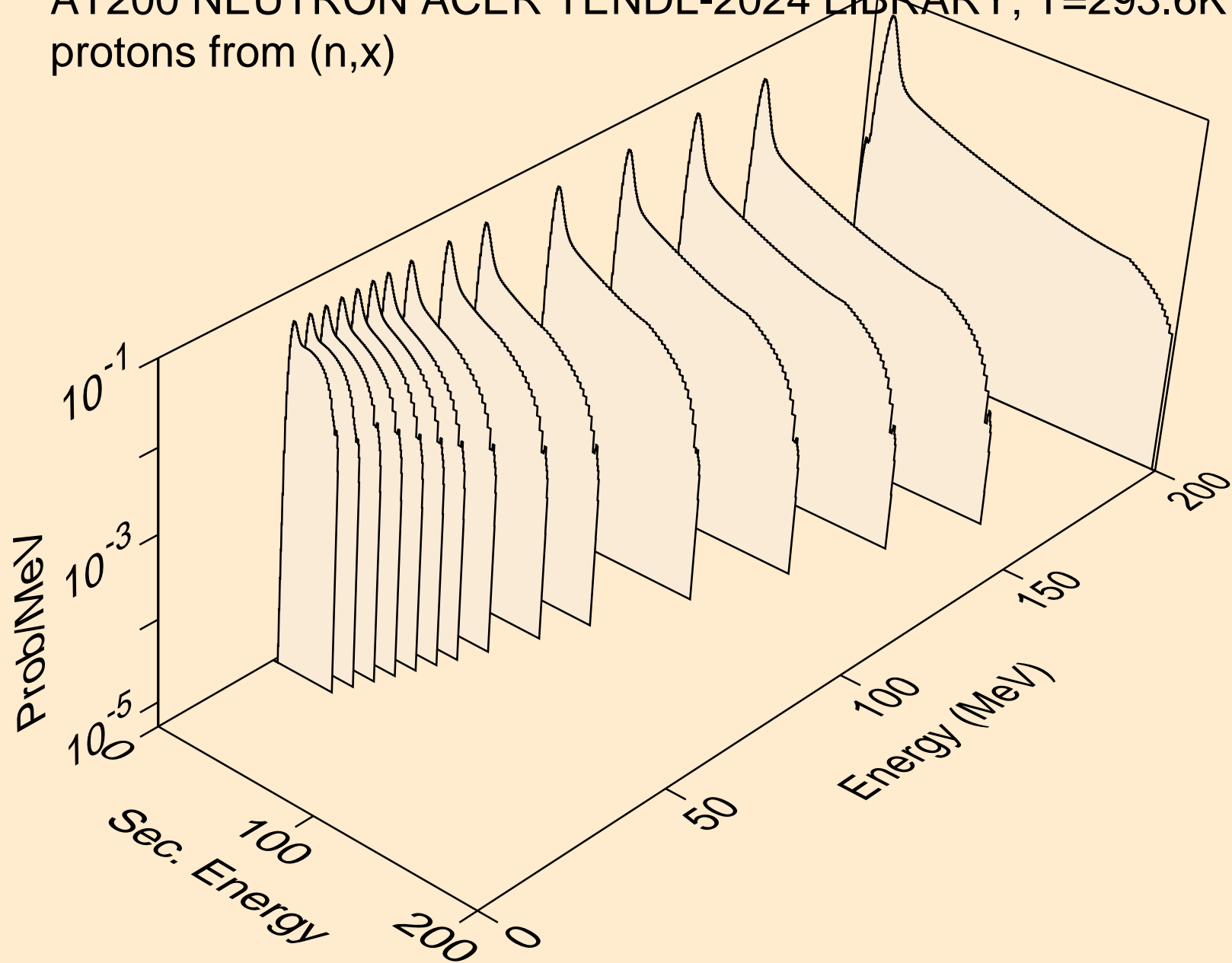

AT200 NEUTRON ACER TENDL-2024 LIBRARY; T=293.6K  
protons from (n,n\*)p

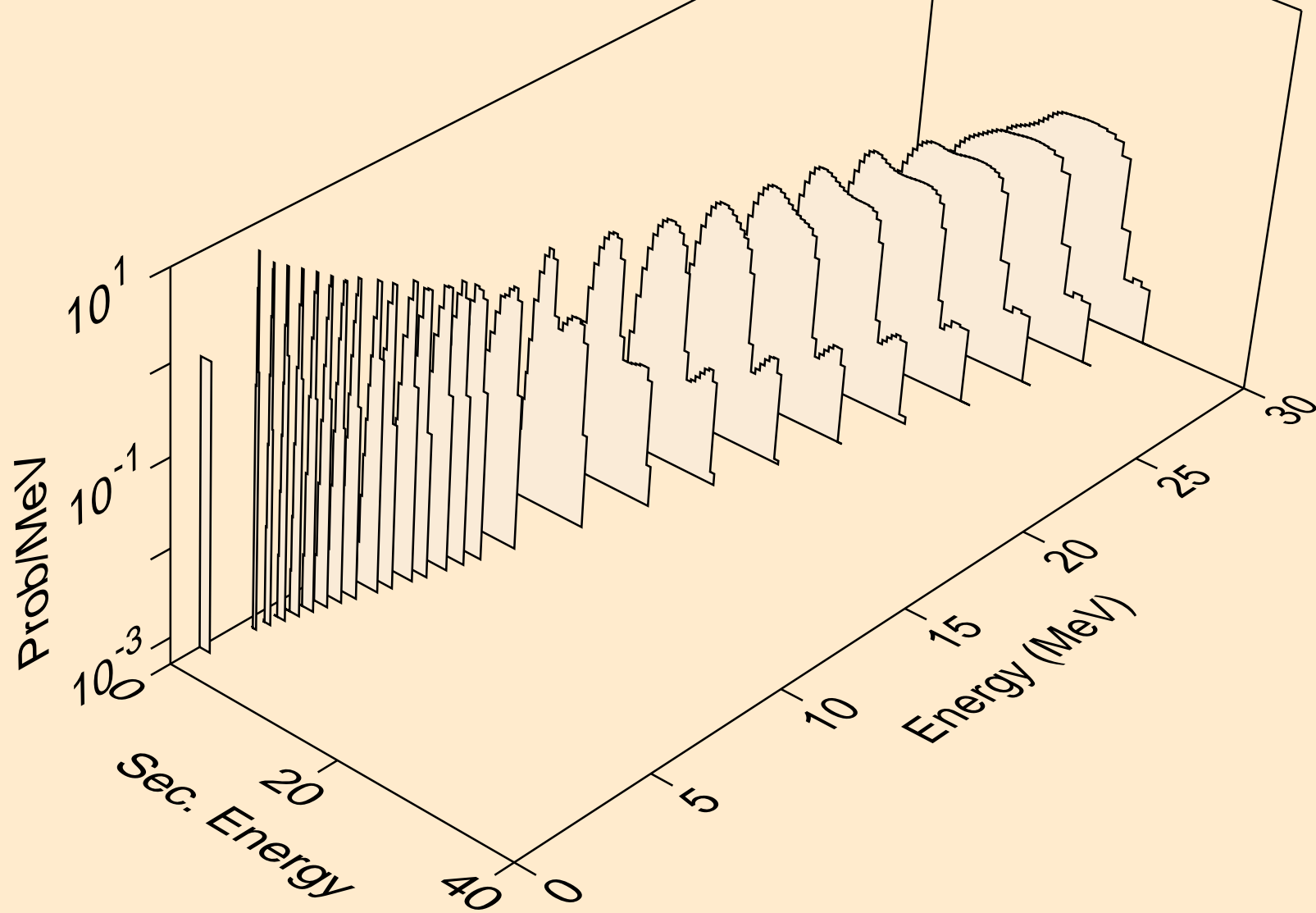

AT200 NEUTRON ACER TENDL-2024 LIBRARY; T=293.6K  
protons from (n,2np)

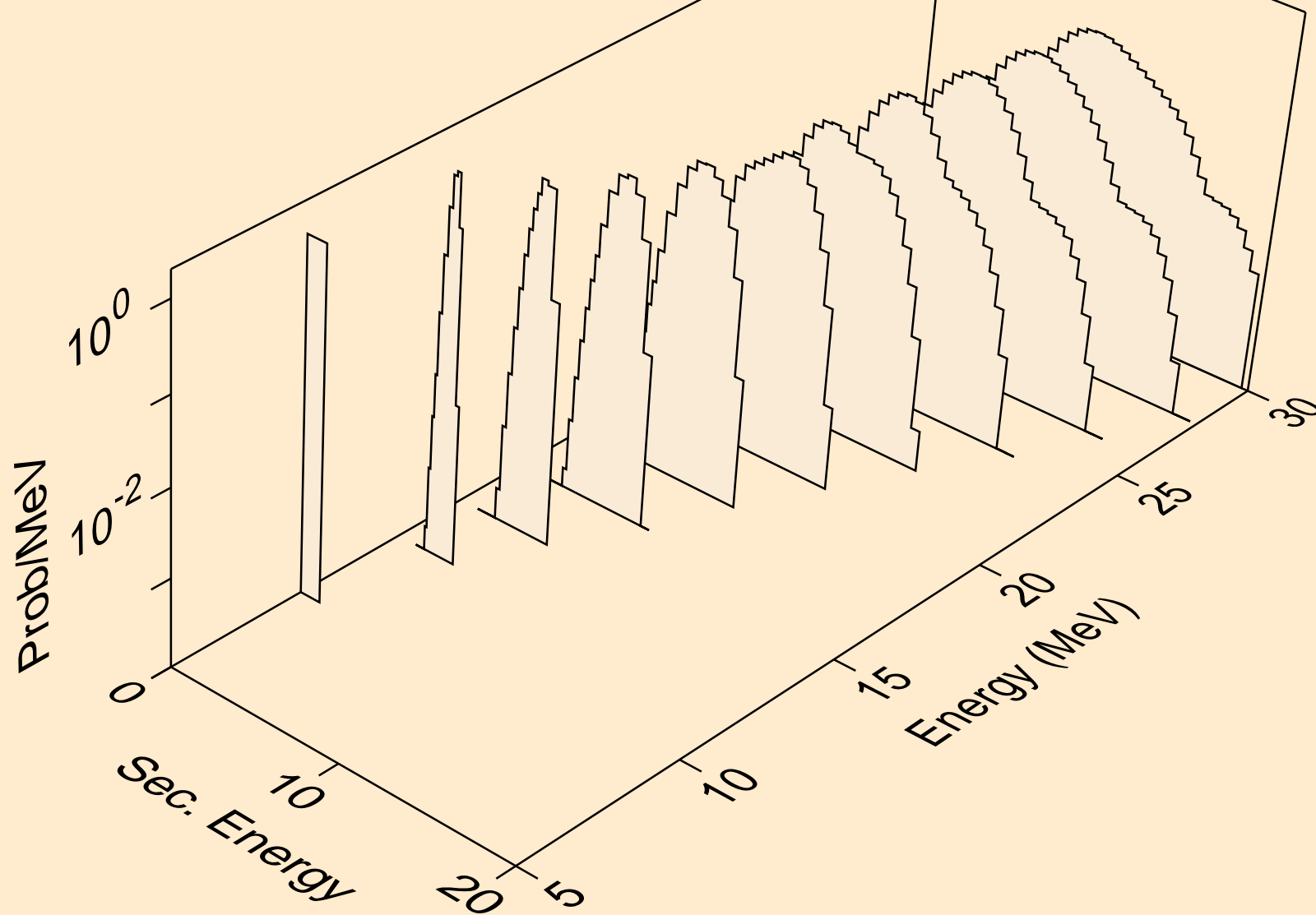

AT200 NEUTRON ACER TENDL-2024 LIBRARY; T=293.6K  
protons from (n,3np)

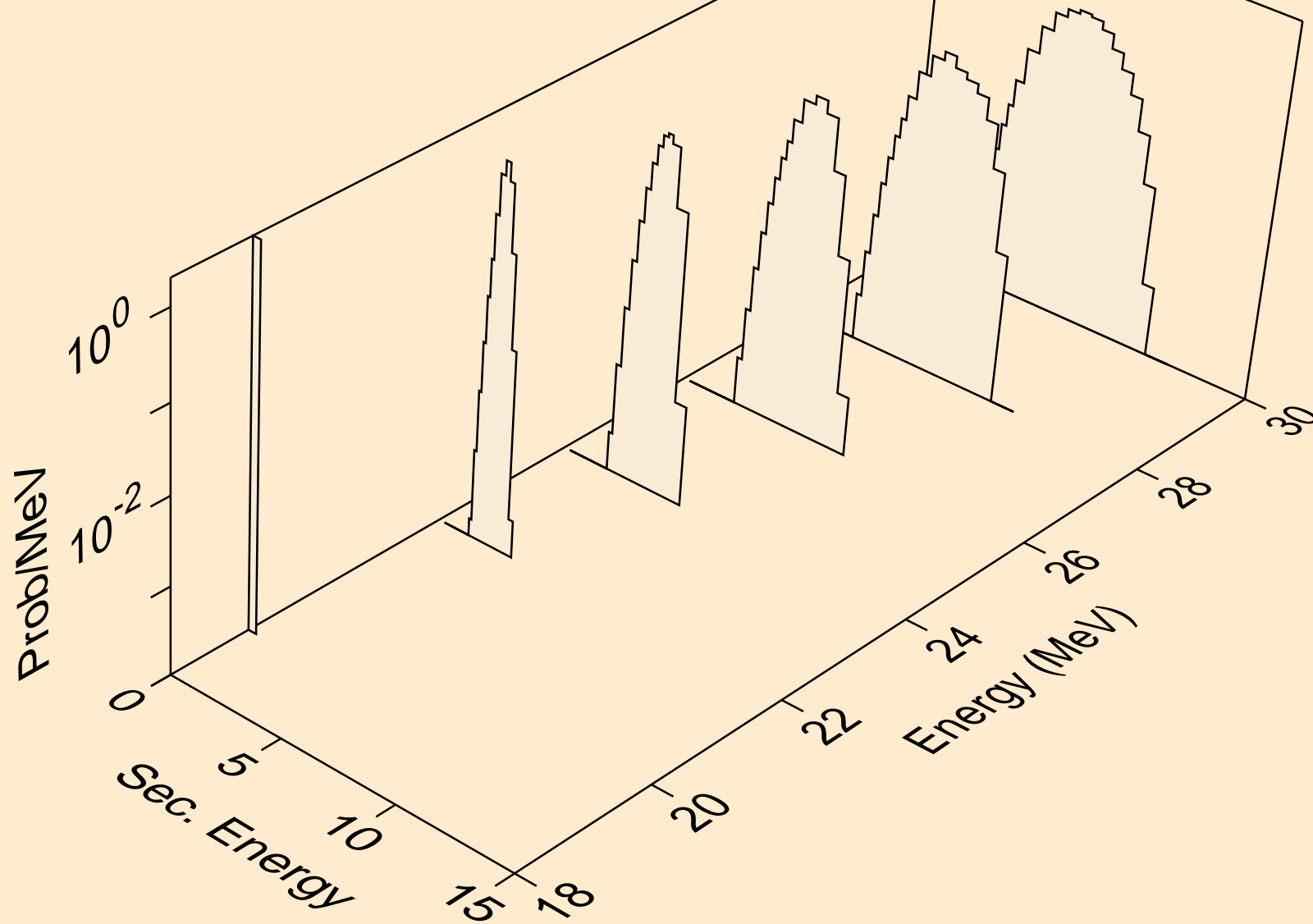

AT200 NEUTRON ACER TENDL-2024 LIBRARY; T=293.6K  
protons from (n,n2p)

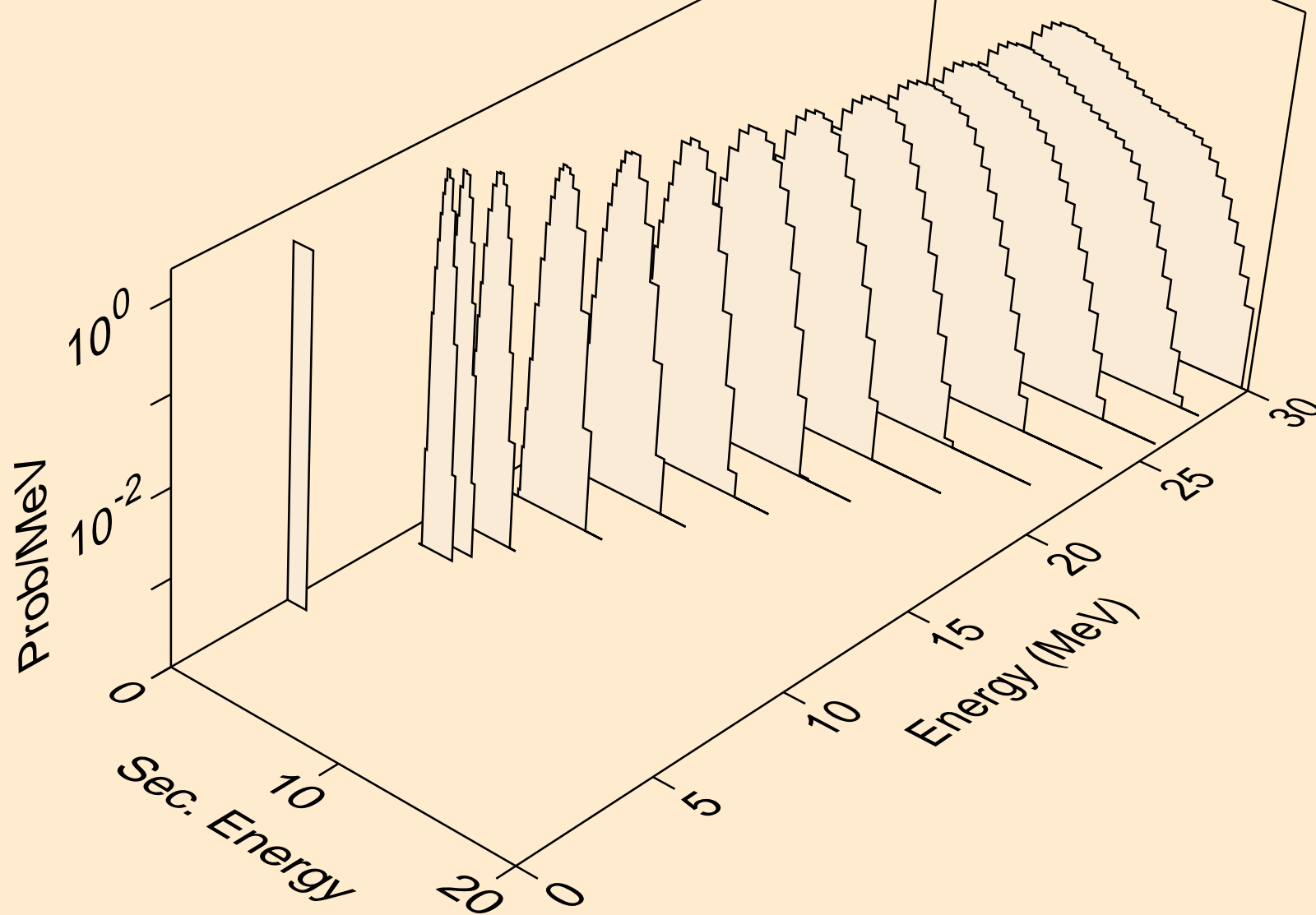

AT200 NEUTRON ACER TENDL-2024 LIBRARY; T=293.6K  
protons from (n,npa)

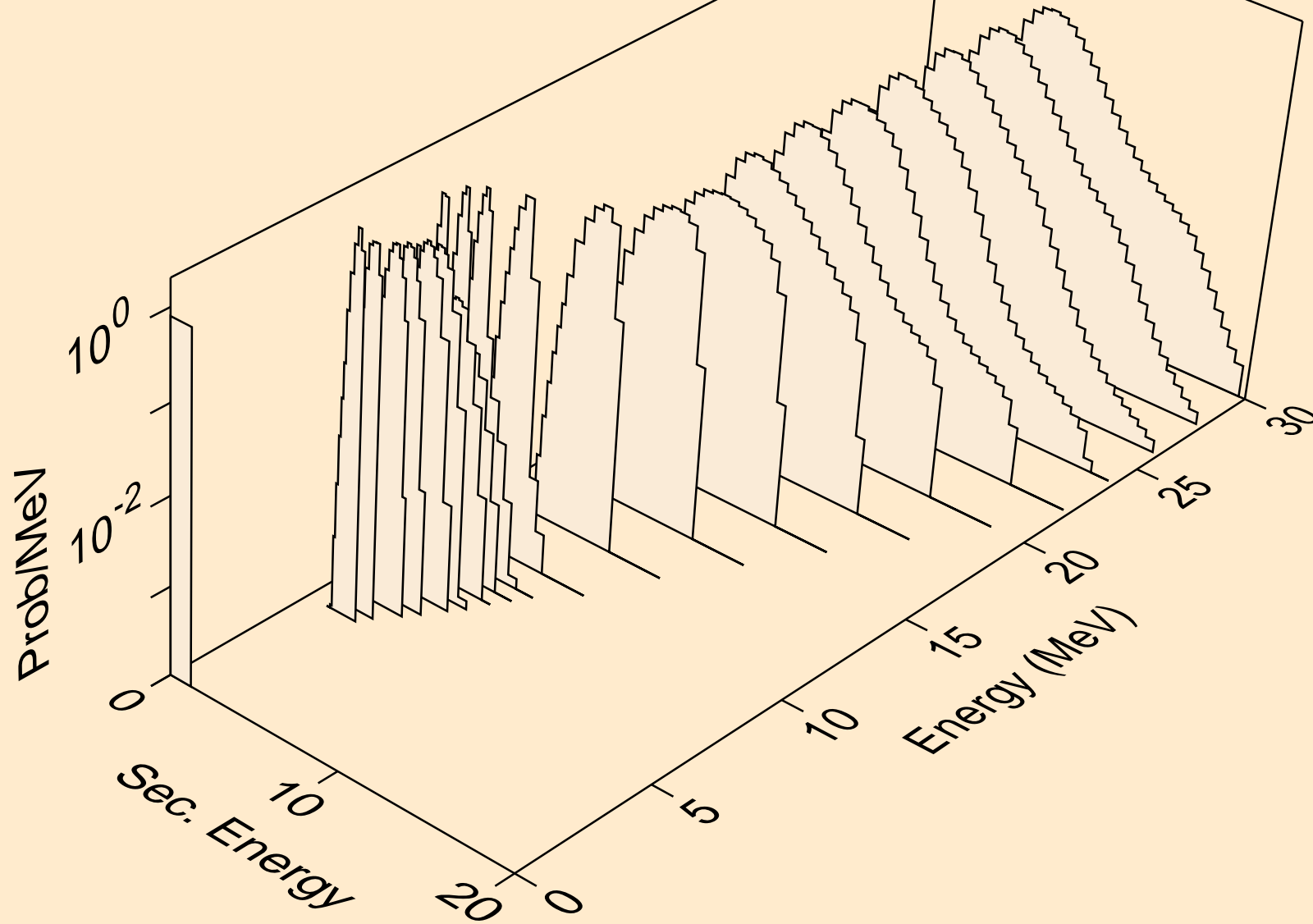

AT200 NEUTRON ACER TENDL-2024 LIBRARY; T=293.6K  
protons from (n,p)

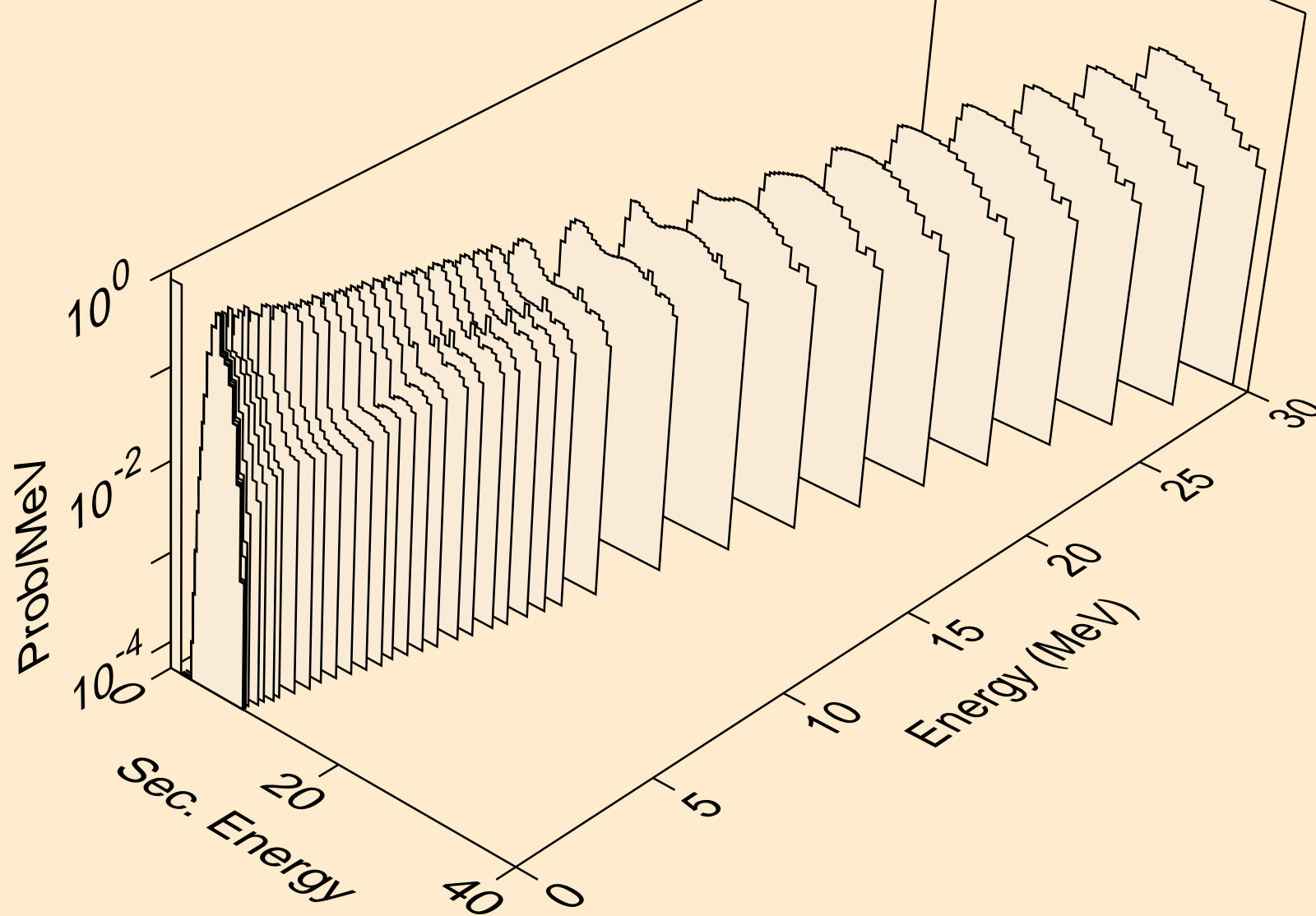

AT200 NEUTRON ACER TENDL-2024 LIBRARY; T=293.6K  
protons from (n,2p)

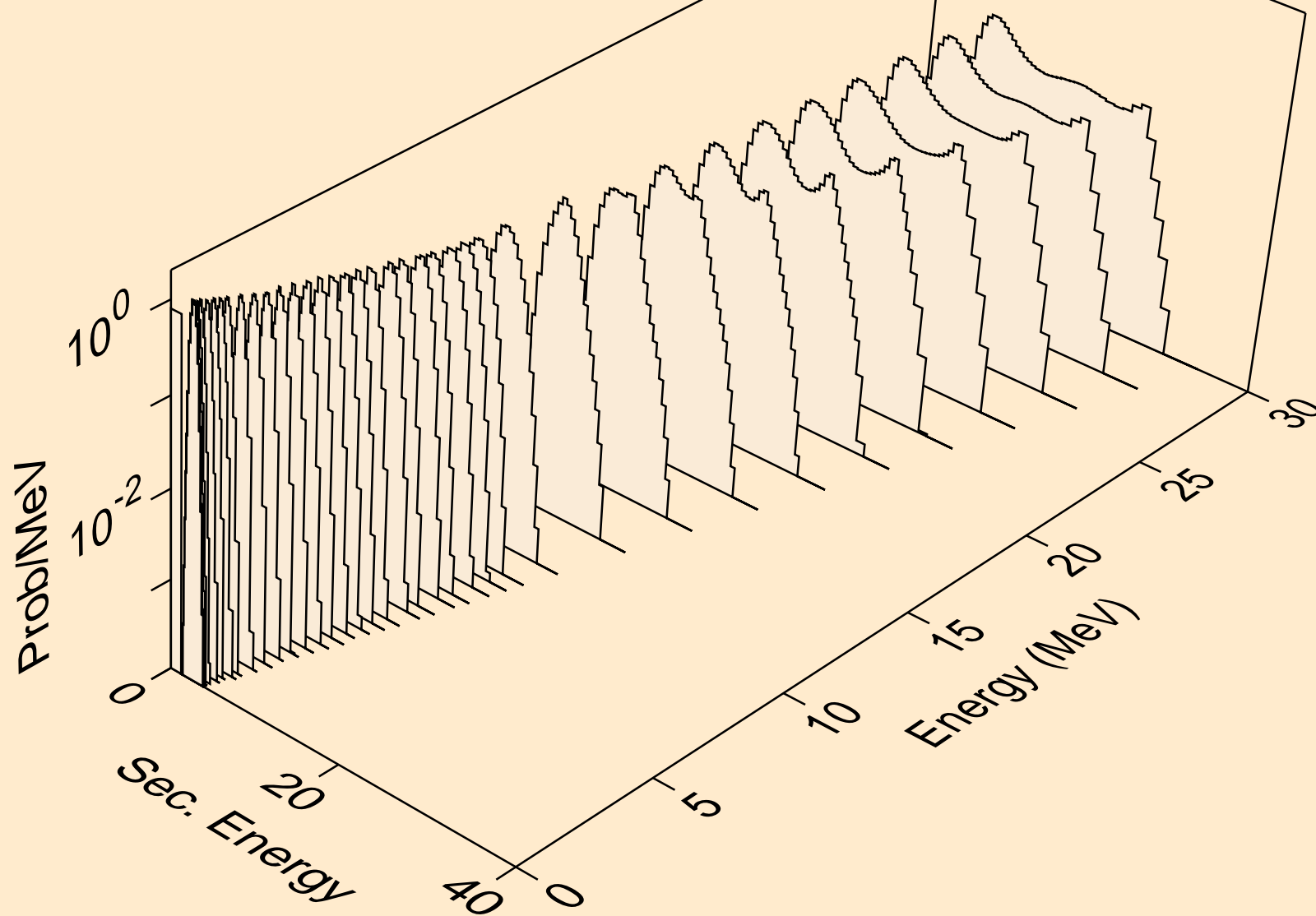

AT200 NEUTRON ACER TENDL-2024 LIBRARY; T=293.6K  
protons from (n,p)

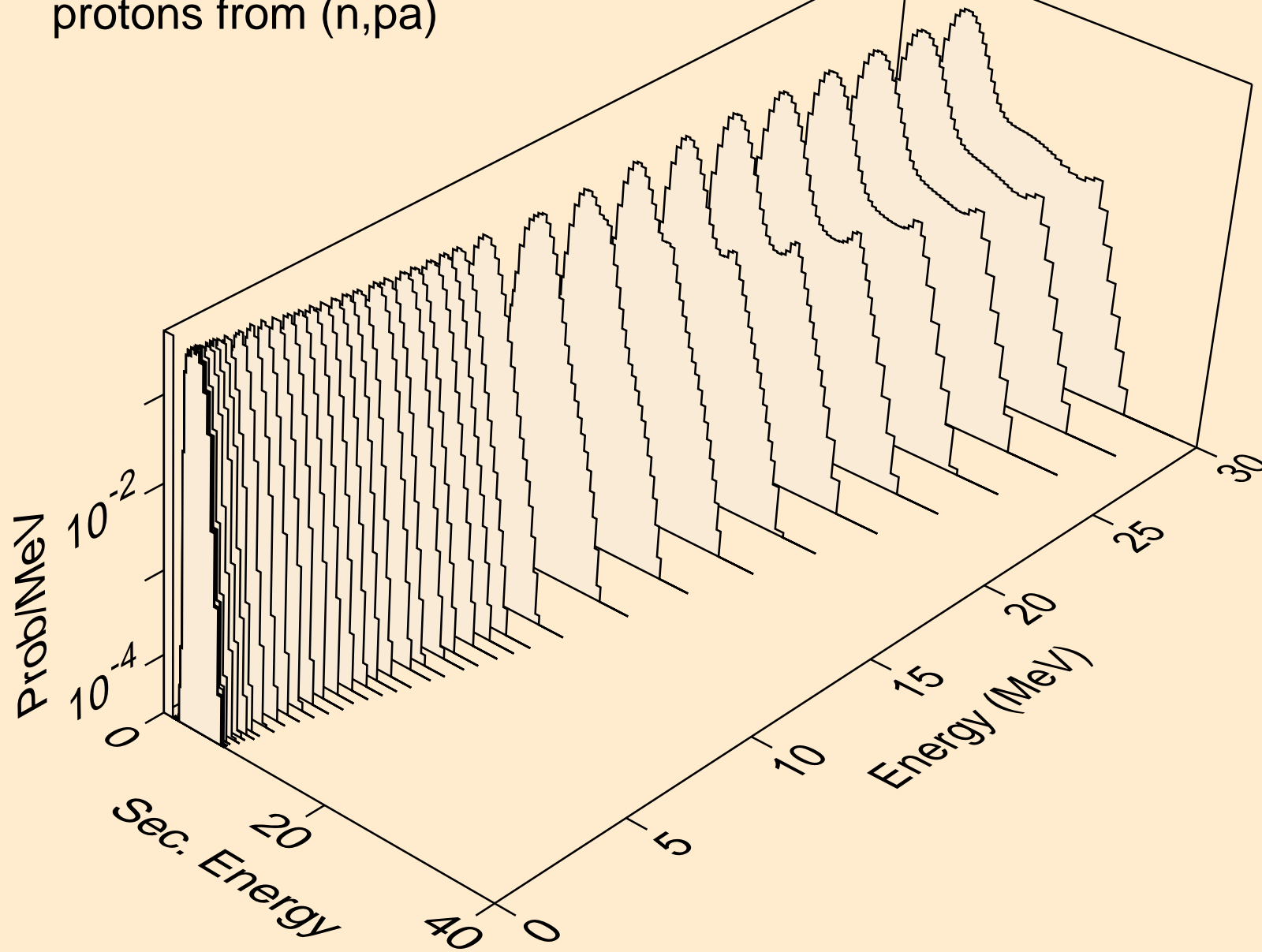

AT200 NEUTRON ACER TENDL-2024 LIBRARY; T=293.6K  
protons from (n,pd)

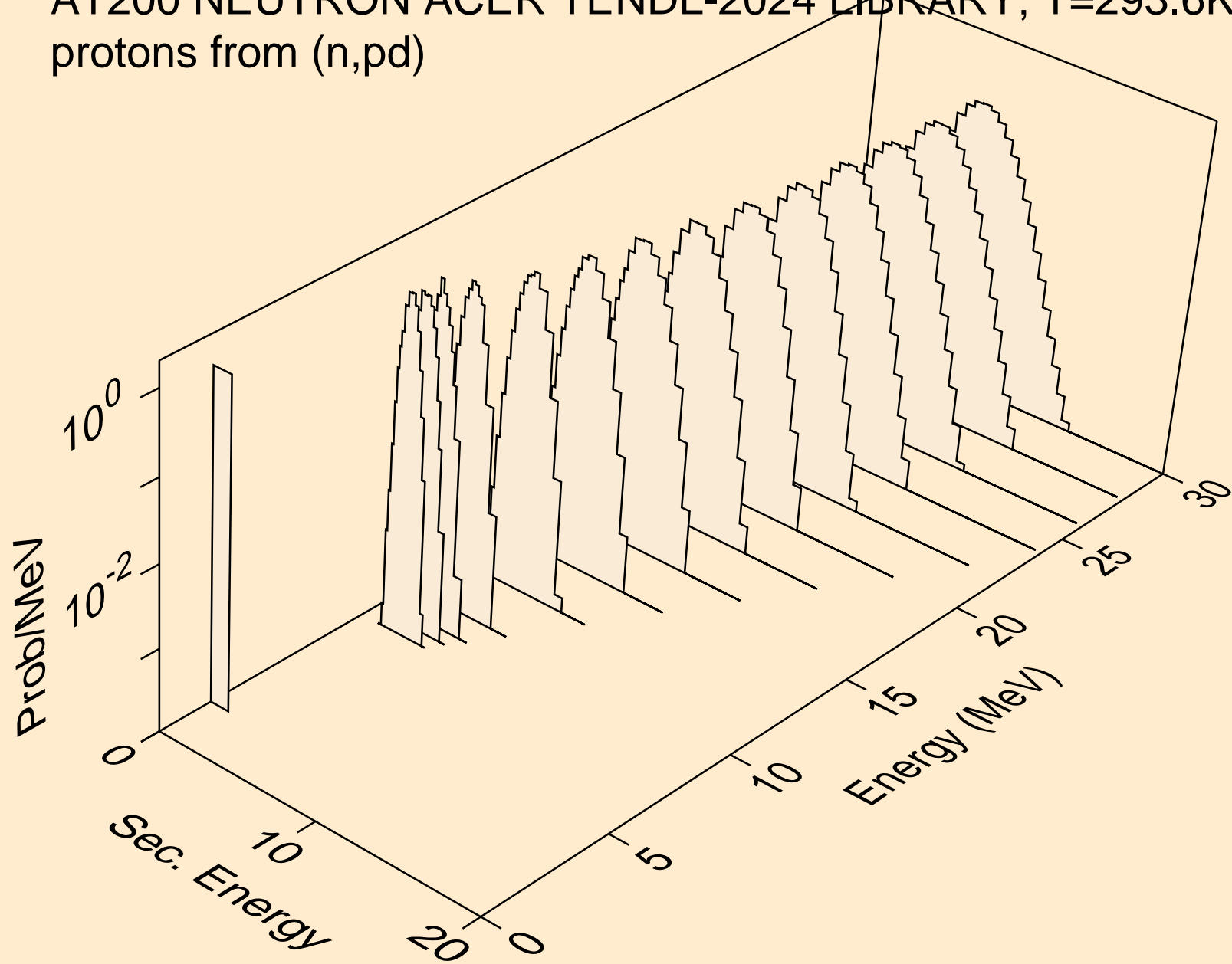

AT200 NEUTRON ACER TENDL-2024 LIBRARY; T=293.6K  
protons from (n,pt)

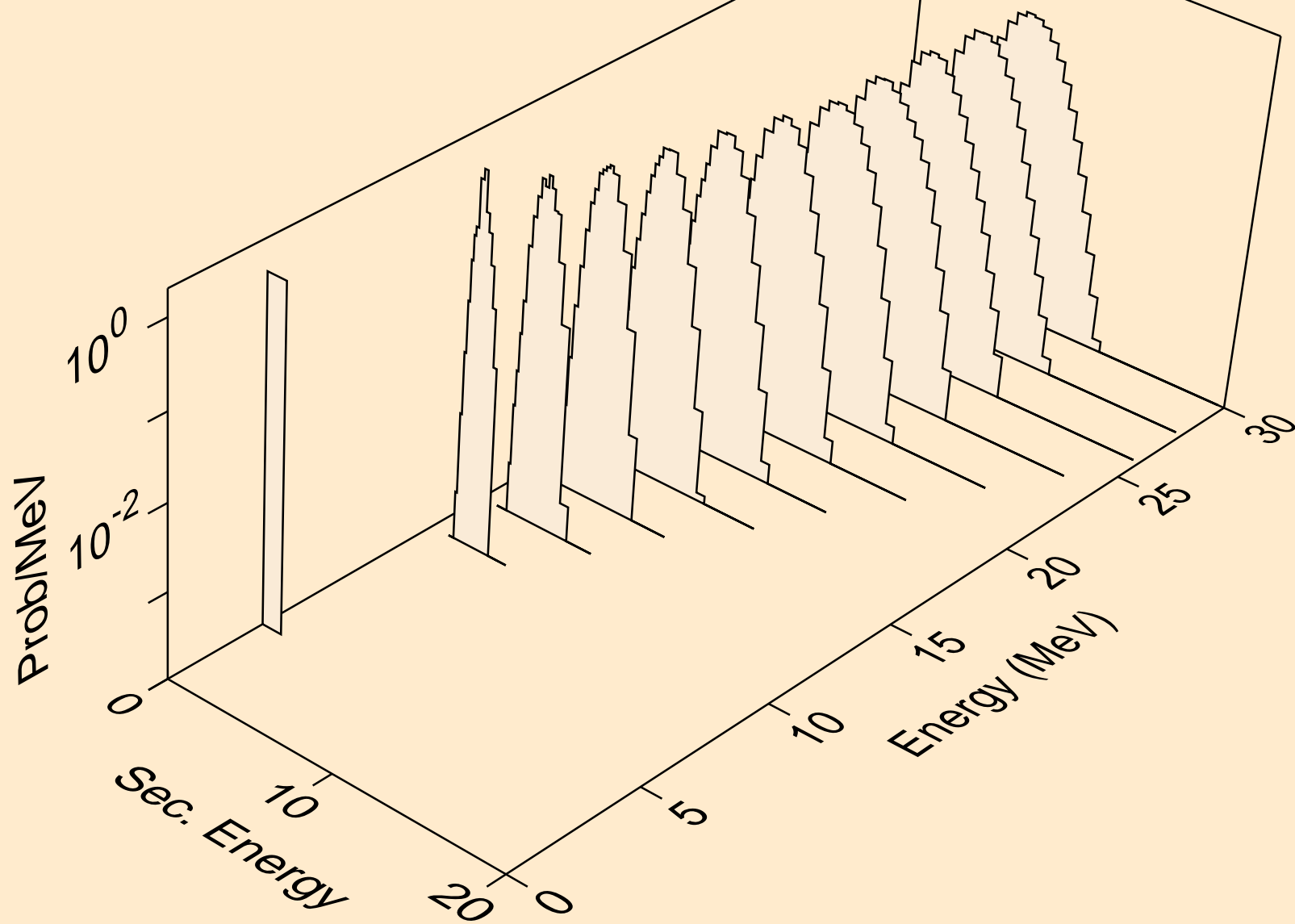

AT200 NEUTRON ACER TENDL-2024 LIBRARY; T=293.6K  
deuterons from (n,x)

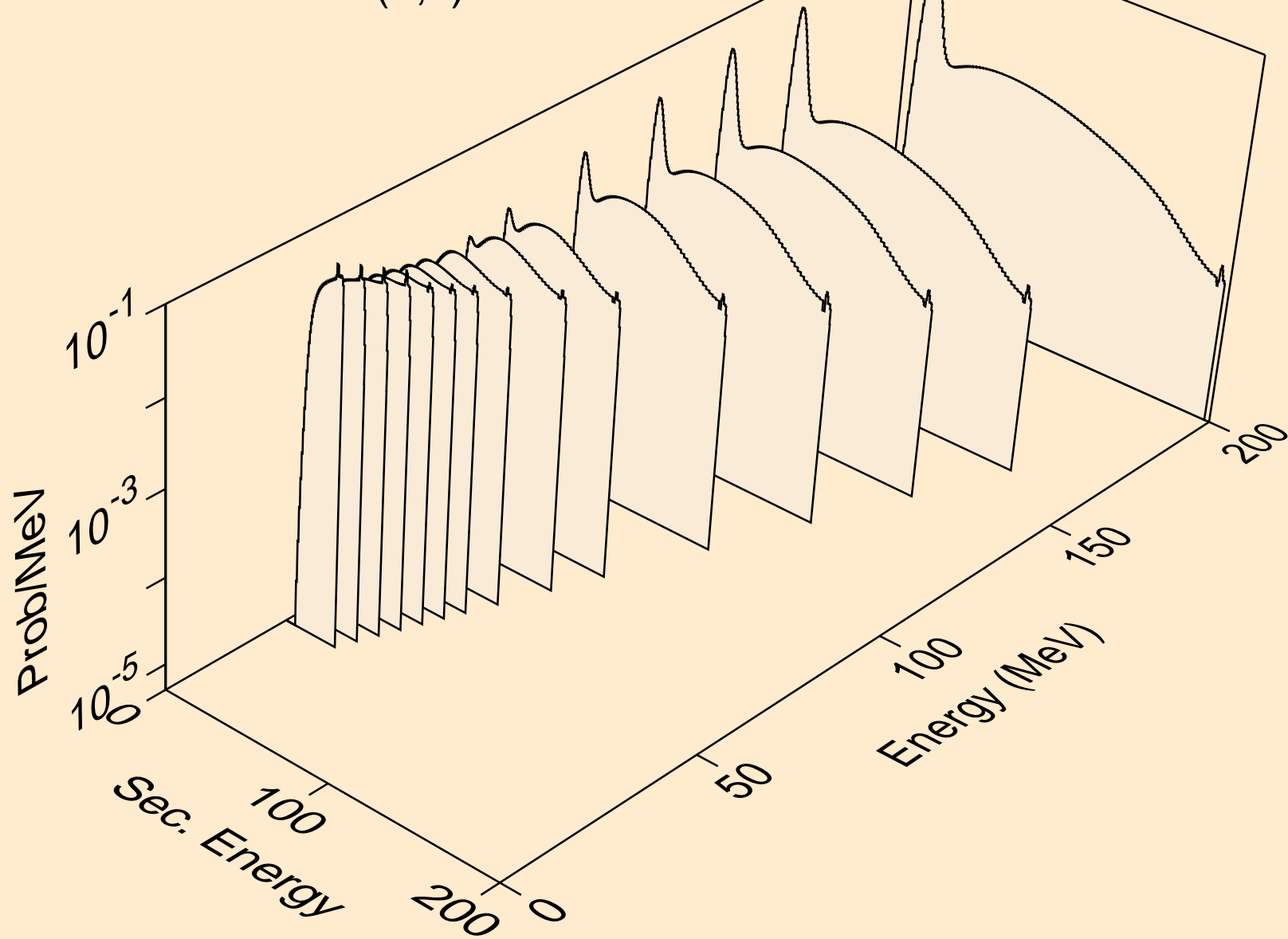

AT200 NEUTRON ACER TENDL-2024 LIBRARY; T=293.6K  
deuterons from (n,2nd)

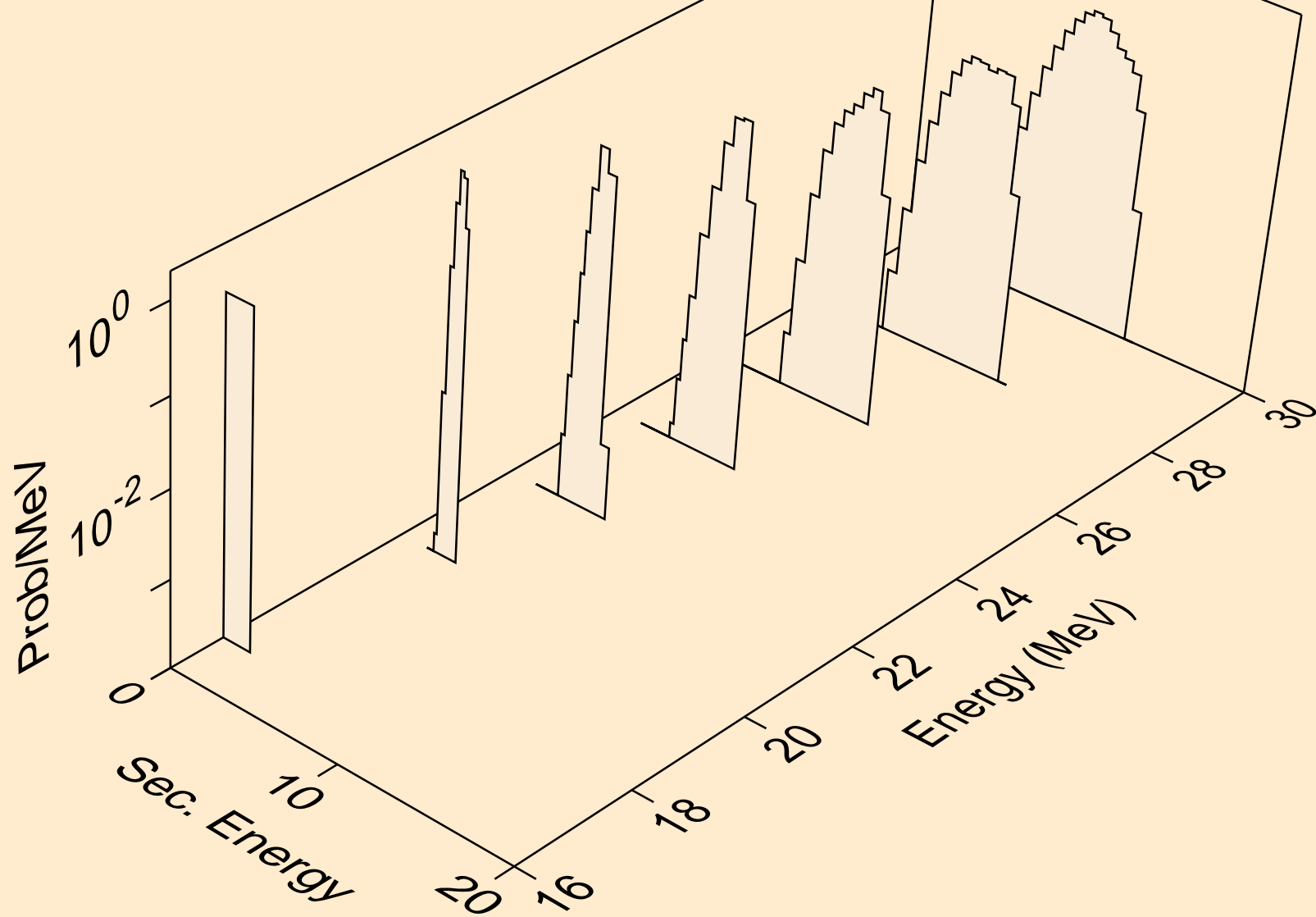

AT200 NEUTRON ACER TENDL-2024 LIBRARY; T=293.6K  
deuterons from (n,n\*)d

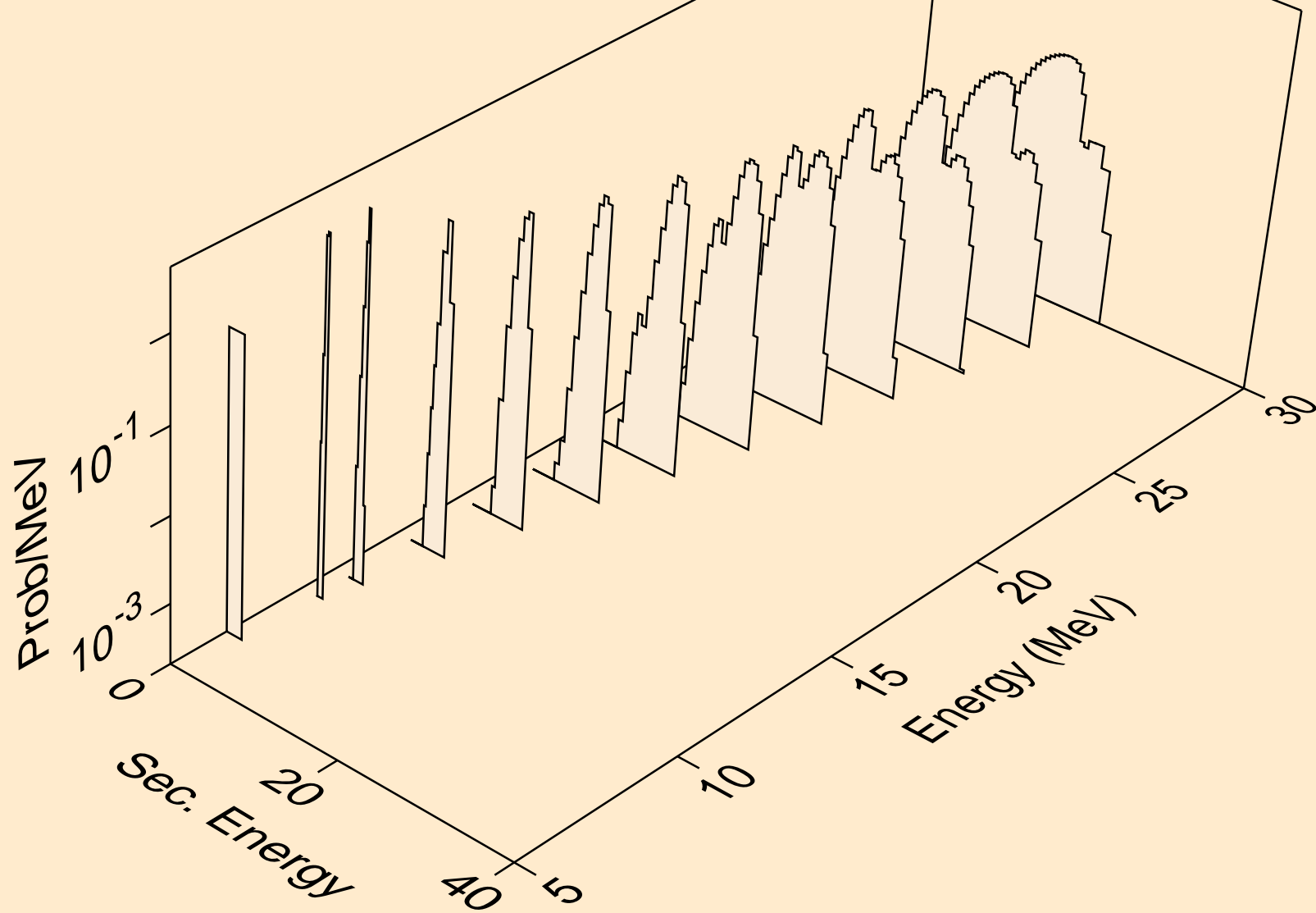

AT200 NEUTRON ACER TENDL-2024 LIBRARY; T=293.6K  
deuterons from (n,d)

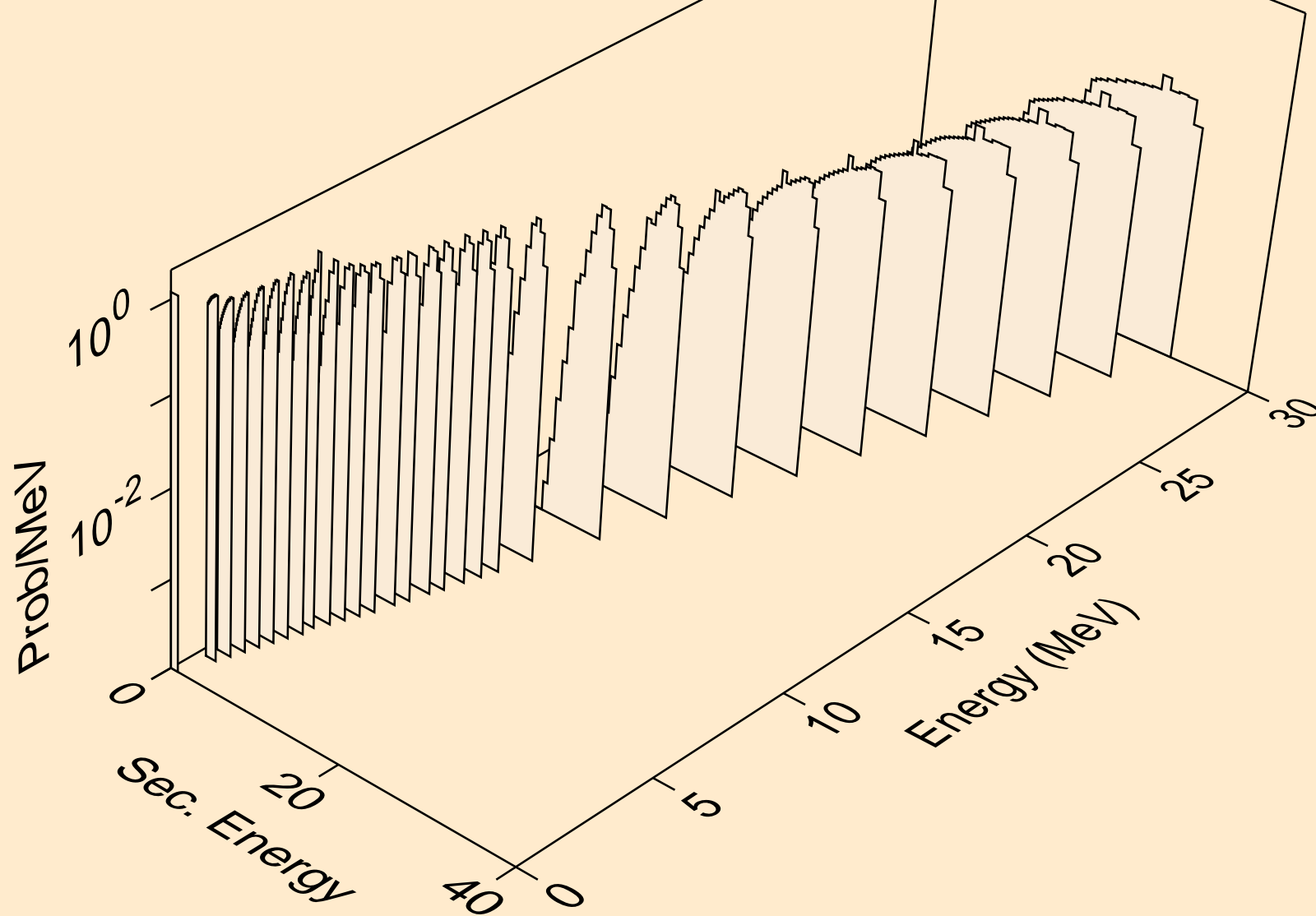

AT200 NEUTRON ACER TENDL-2024 LIBRARY; T=293.6K  
deuterons from (n,pd)

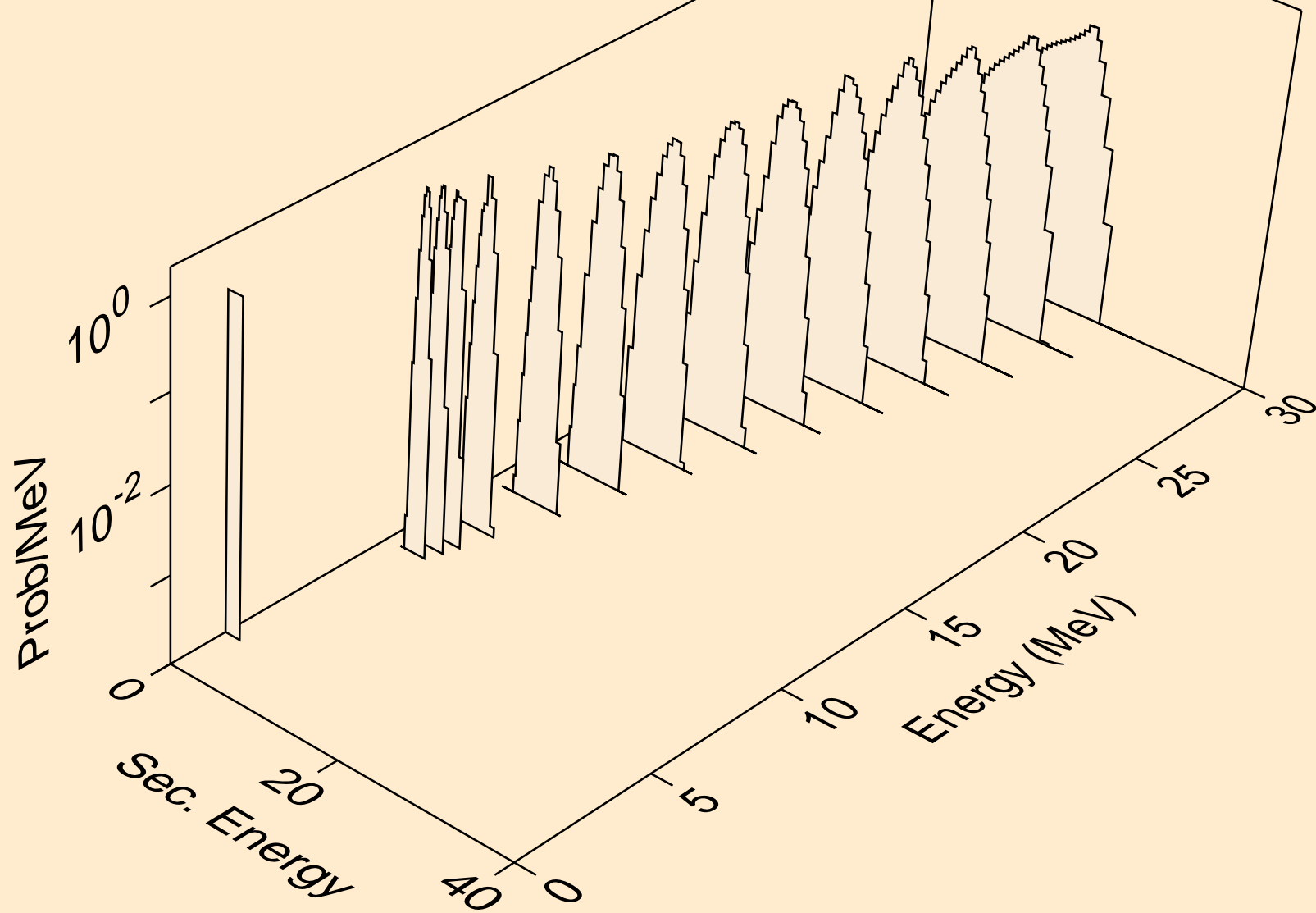

AT200 NEUTRON ACER TENDL-2024 LIBRARY; T=293.6K  
deuterons from (n,da)

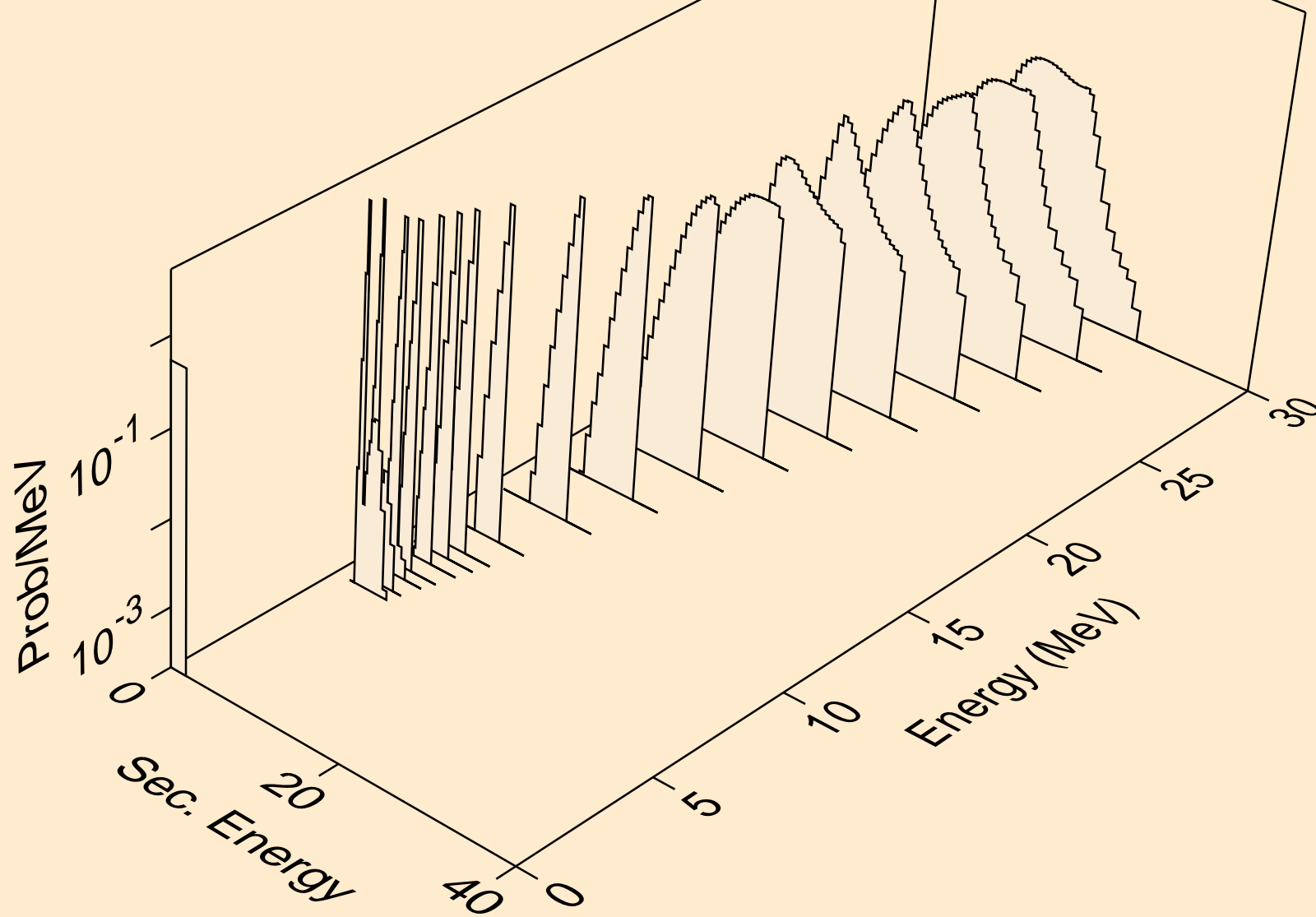

AT200 NEUTRON ACER TENDL-2024 LIBRARY; T=293.6K  
tritons from (n,x)

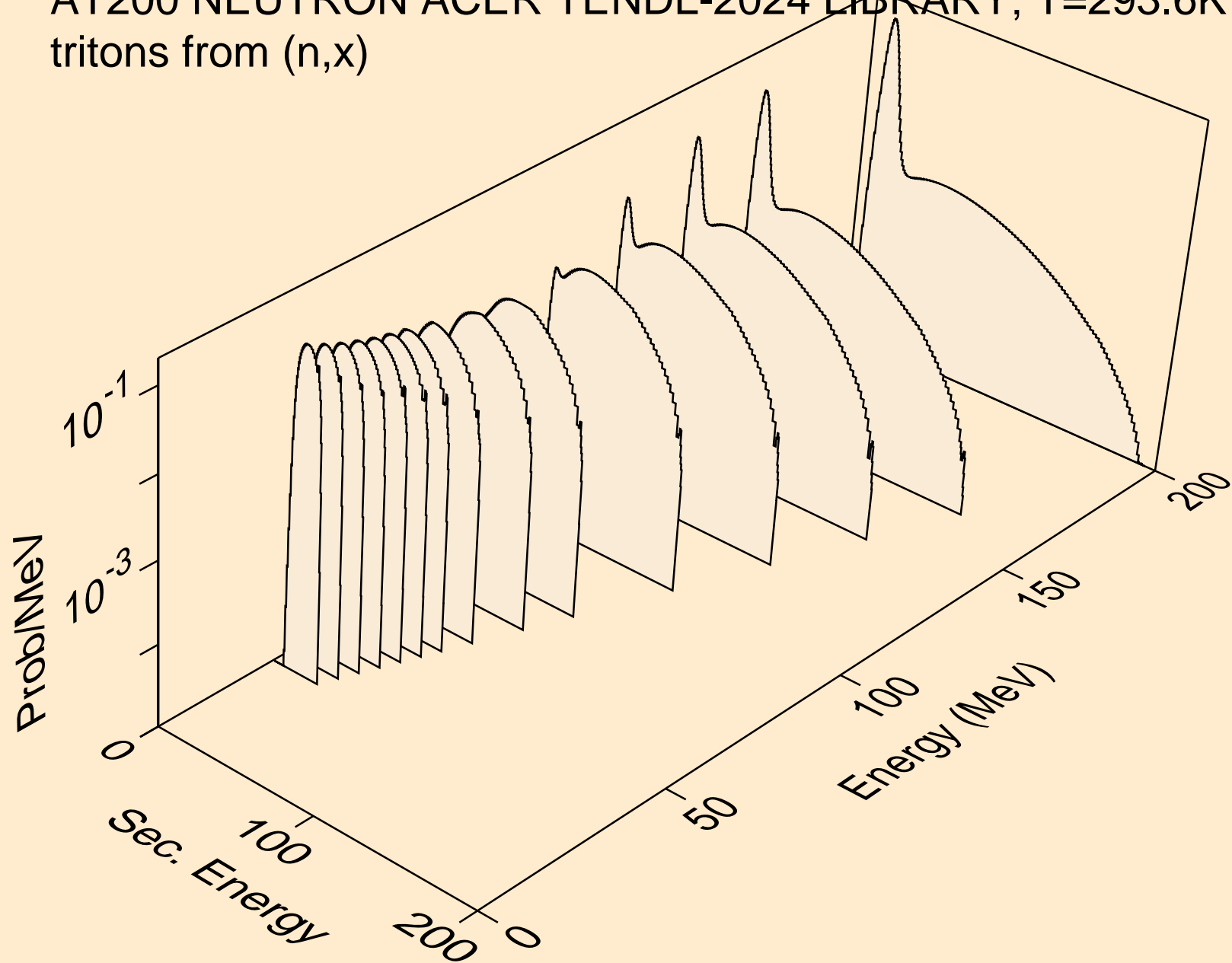

AT200 NEUTRON ACER TENDL-2024 LIBRARY; T=293.6K  
tritons from (n,n\*)t

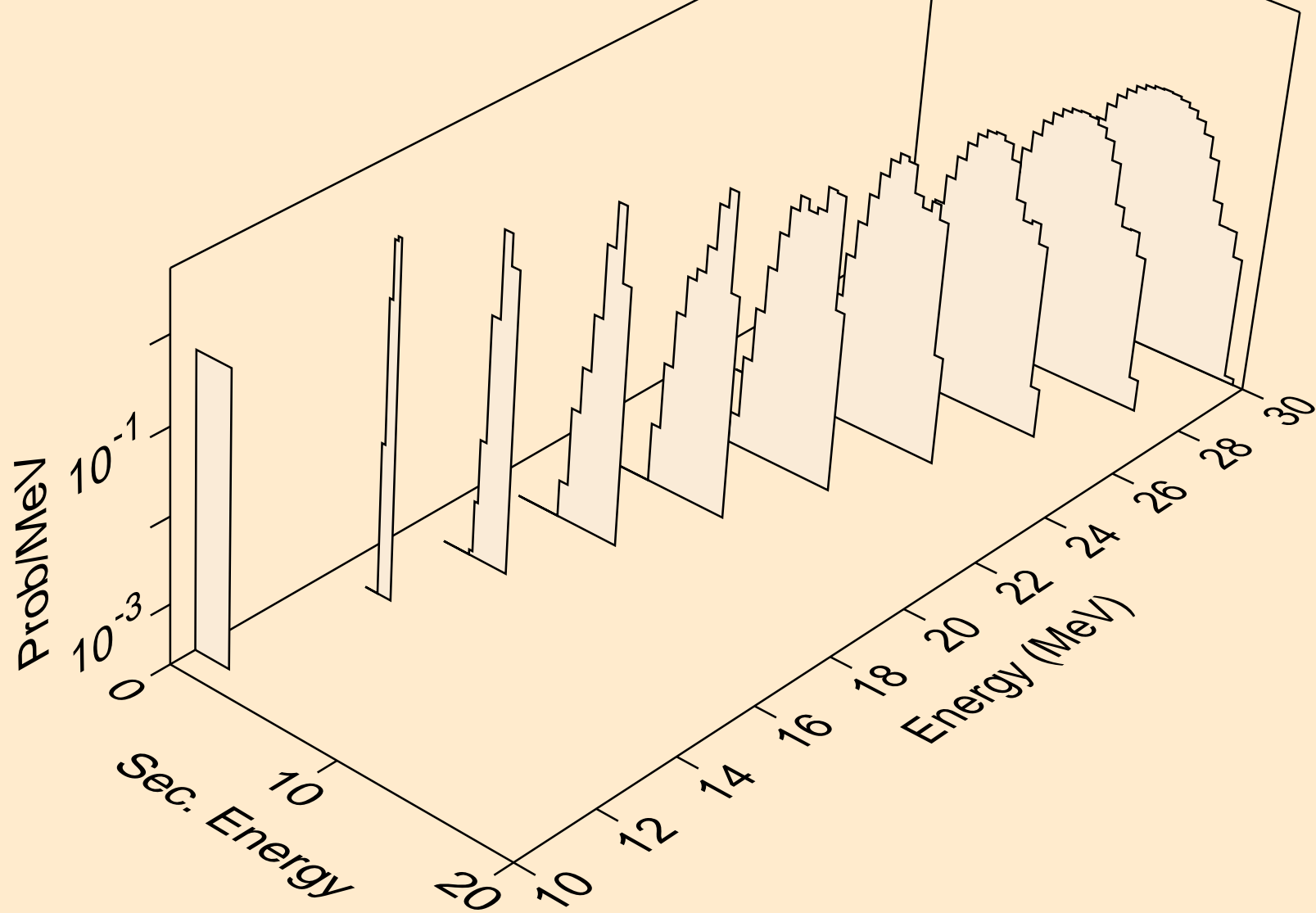

AT200 NEUTRON ACER TENDL-2024 LIBRARY; T=293.6K  
tritons from (n,t)

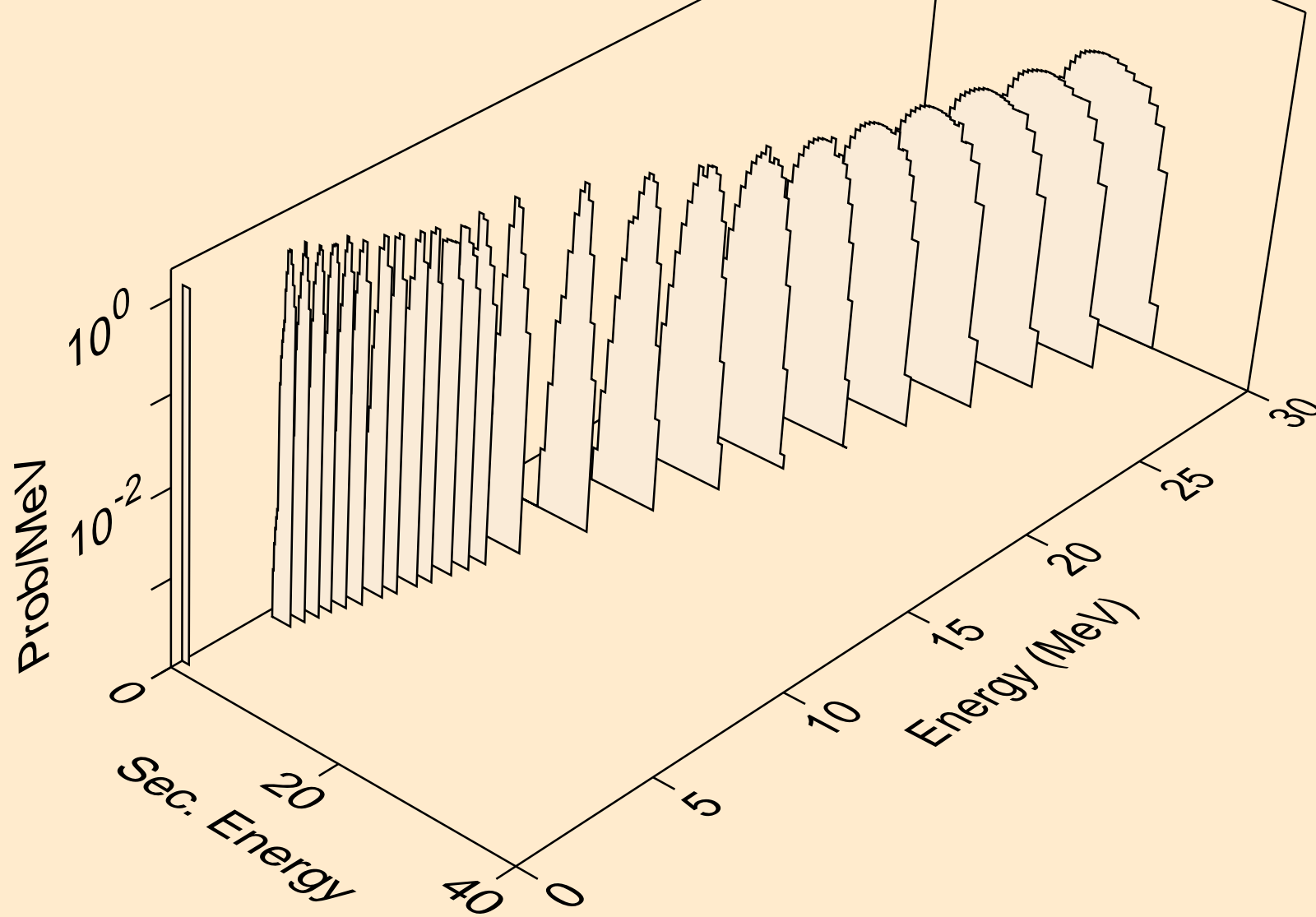

AT200 NEUTRON ACER TENDL-2024 LIBRARY; T=293.6K  
tritons from (n,pt)

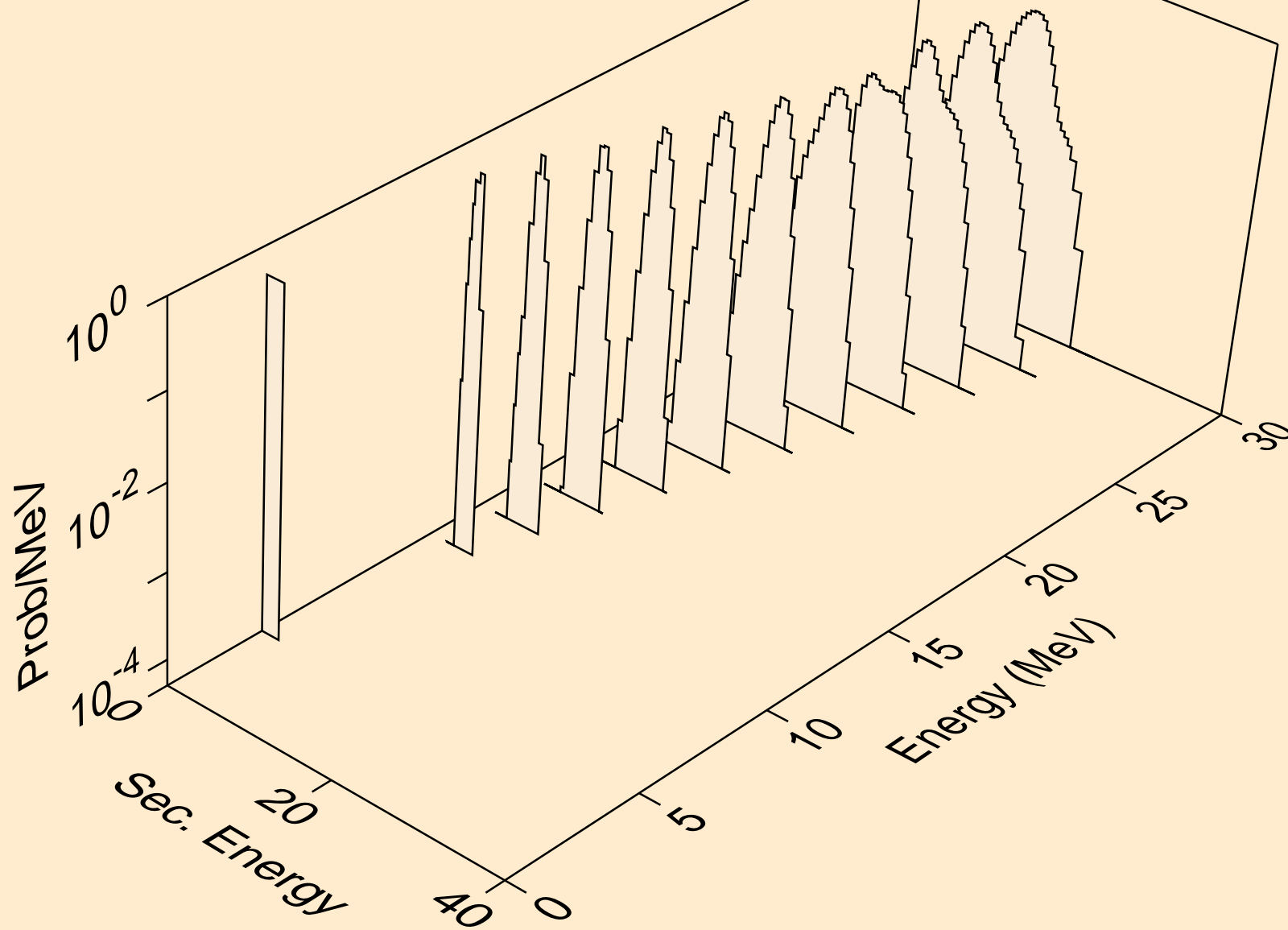

AT200 NEUTRON ACER TENDL-2024 LIBRARY; T=293.6K  
he3s from (n,x)

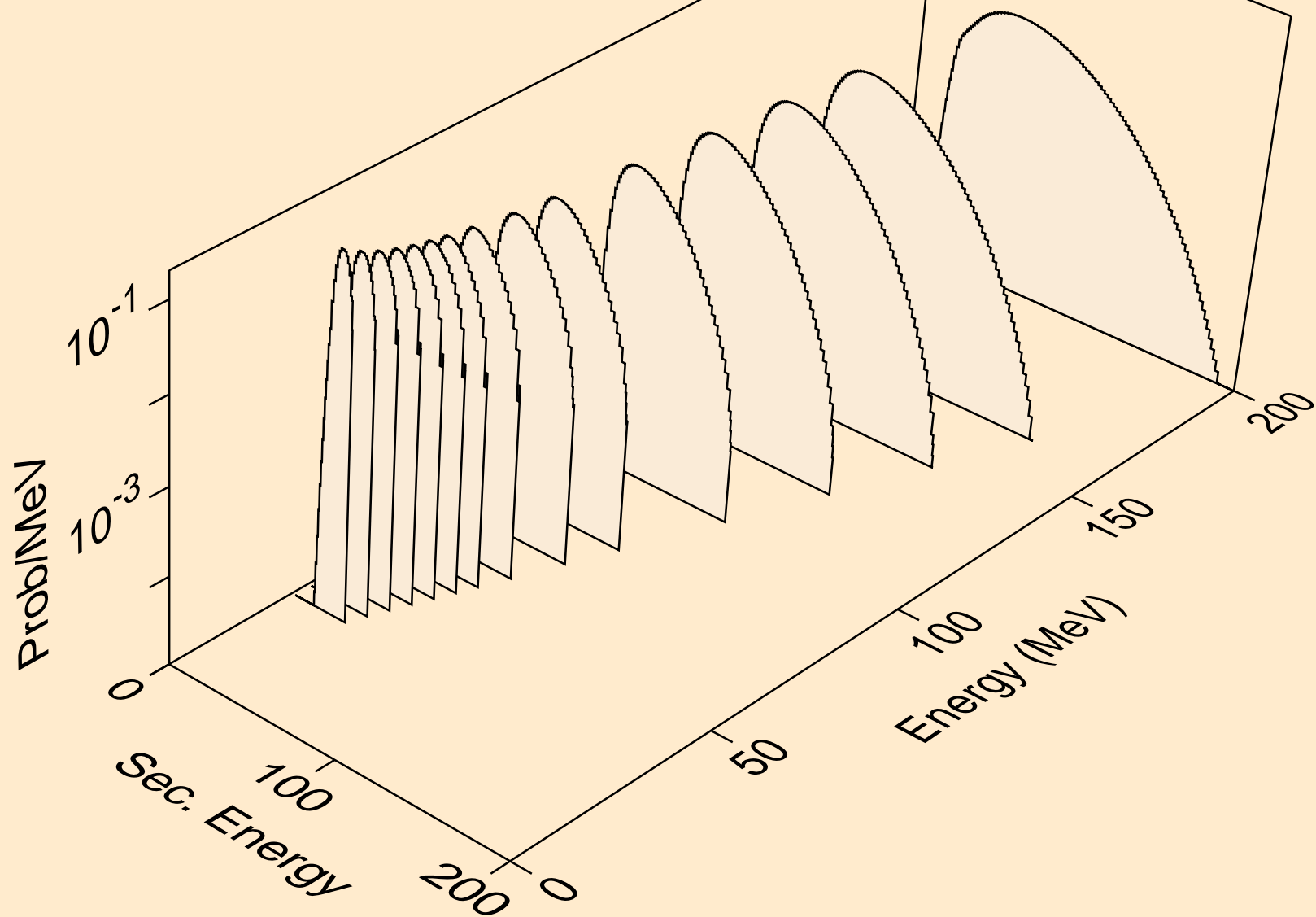

AT200 NEUTRON ACER TENDL-2024 LIBRARY; T=293.6K  
he3s from (n,n\*)he3

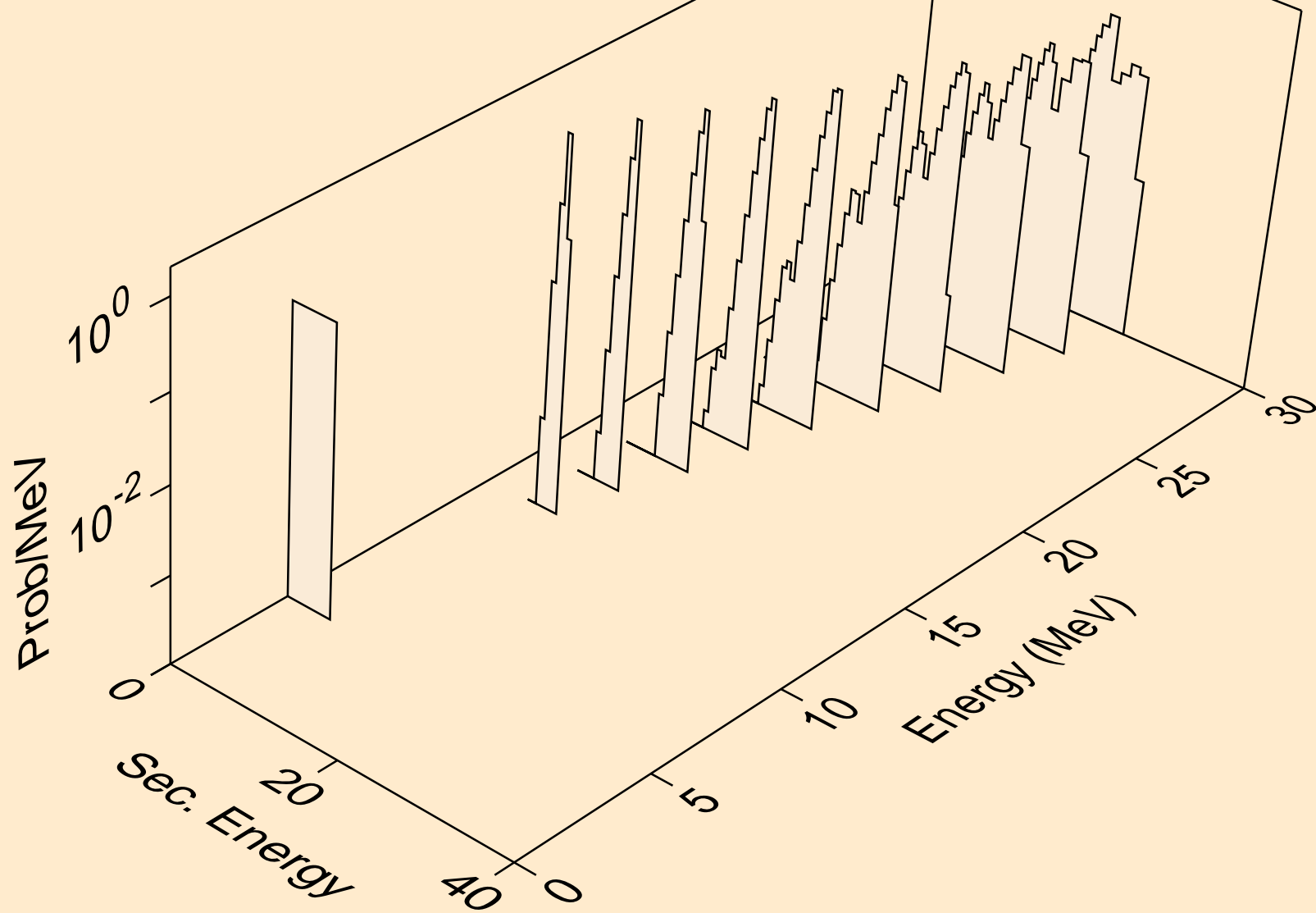

AT200 NEUTRON ACER TENDL-2024 LIBRARY; T=293.6K  
he3s from (n,he3)

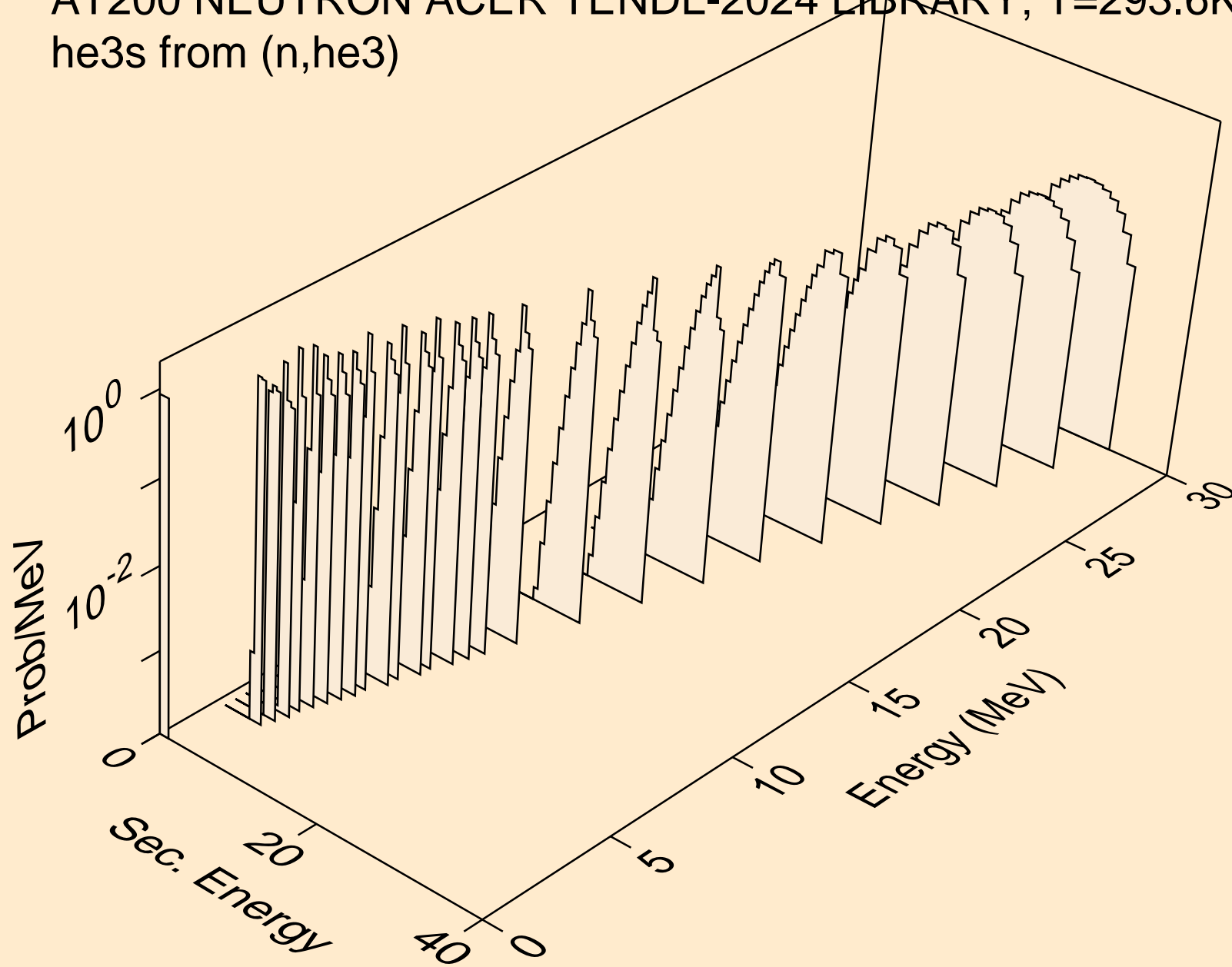

AT200 NEUTRON ACER TENDL-2024 LIBRARY; T=293.6K  
alphas from (n,x)

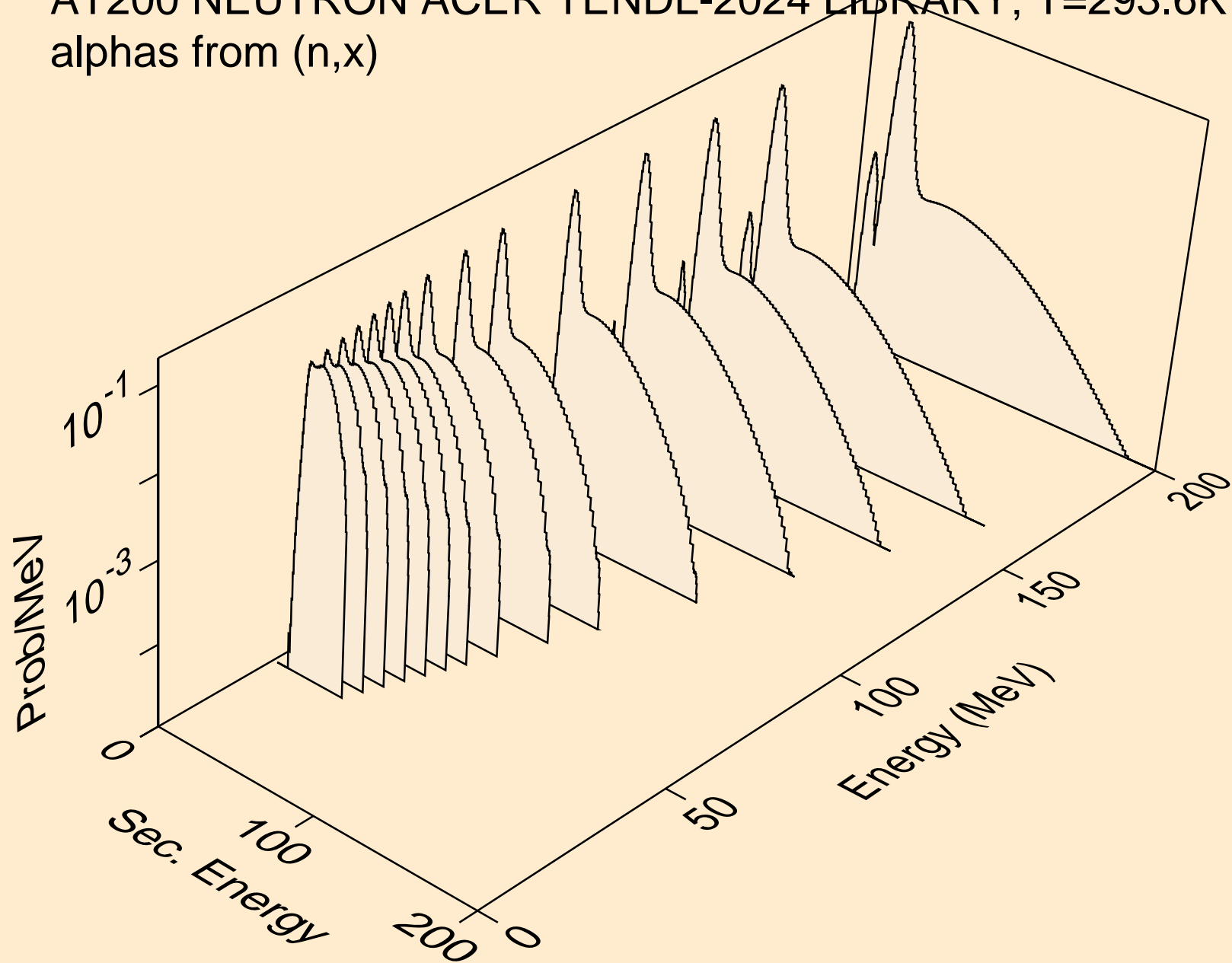

AT200 NEUTRON ACER TENDL-2024 LIBRARY; T=293.6K  
alphas from (n,n\*)a

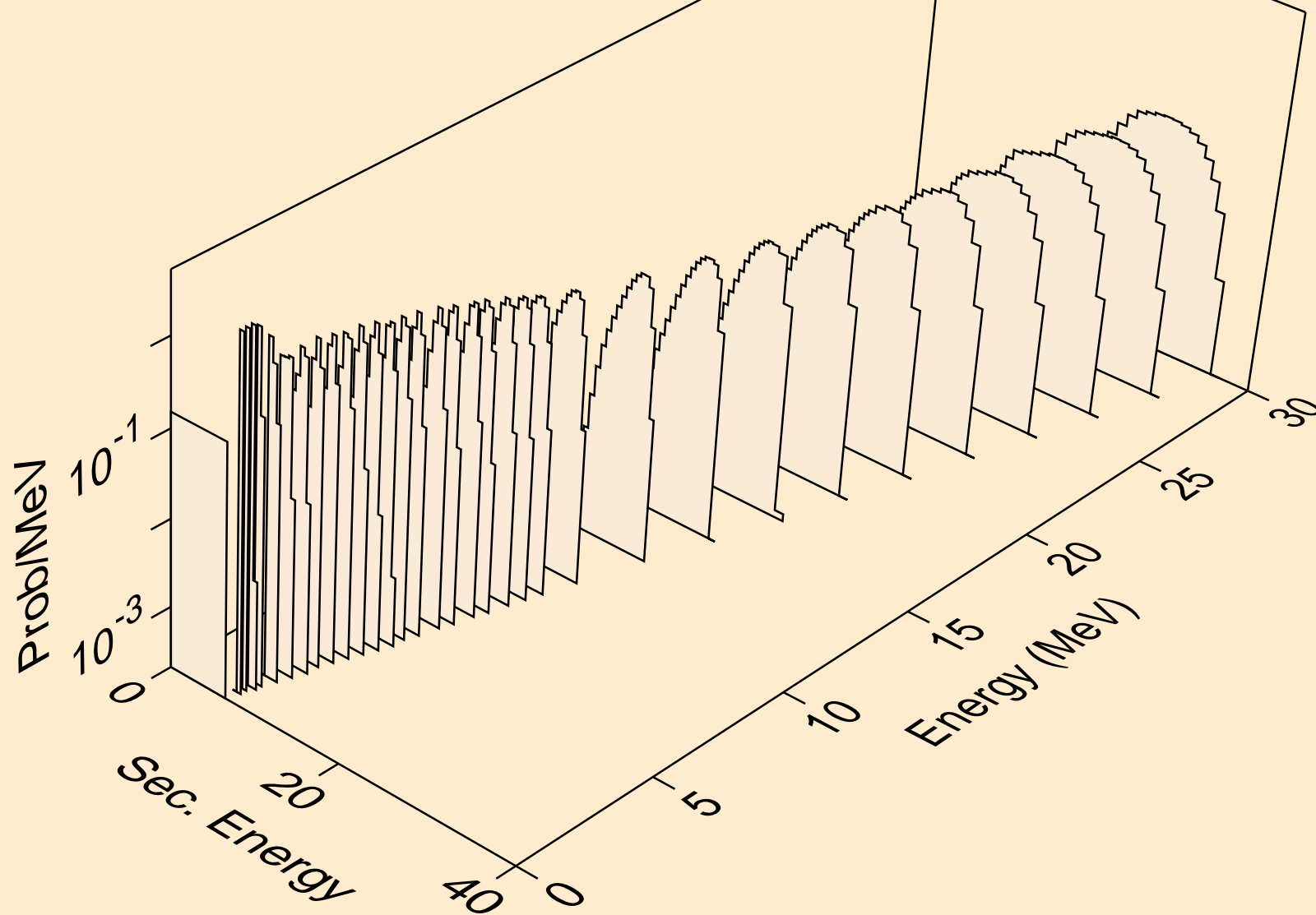

AT200 NEUTRON ACER TENDL-2024 LIBRARY; T=293.6K  
alphas from (n,2n)a

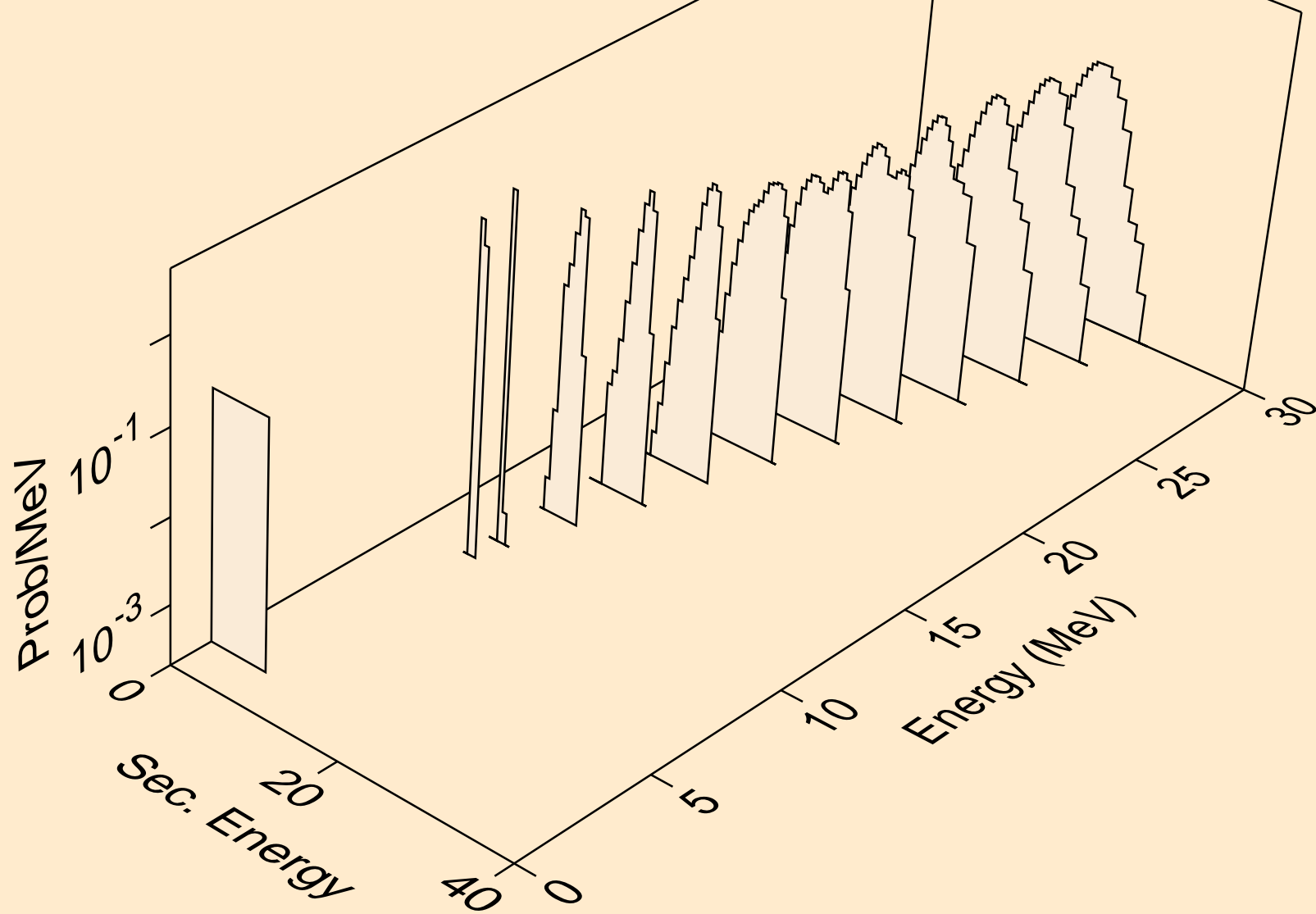

AT200 NEUTRON ACER TENDL-2024 LIBRARY; T=293.6K  
alphas from (n,3n)a

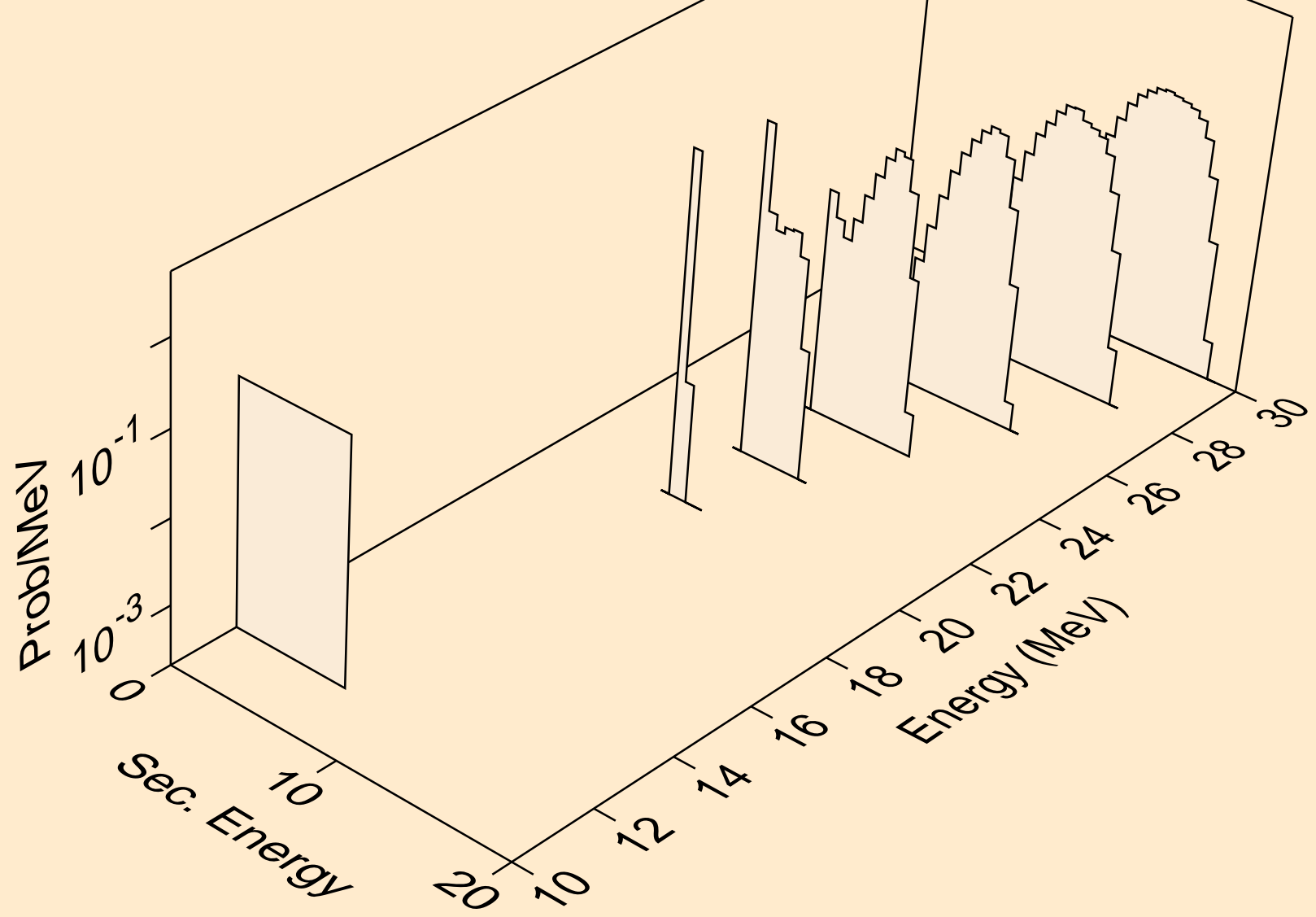

AT200 NEUTRON ACER TENDL-2024 LIBRARY; T=293.6K  
alphas from (n,n\*)2a

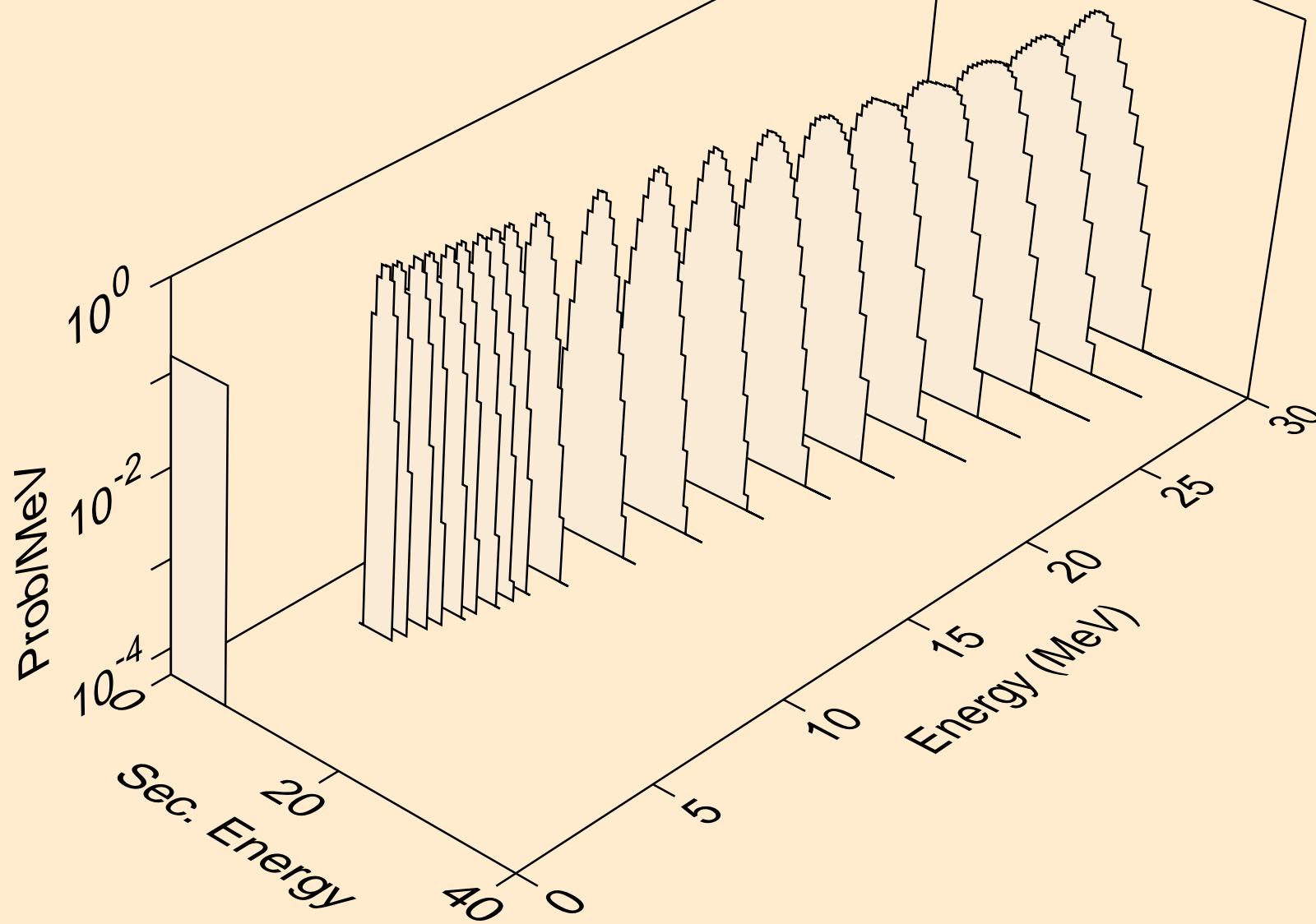

AT200 NEUTRON ACER TENDL-2024 LIBRARY; T=293.6K  
alphas from (n,2n)2a

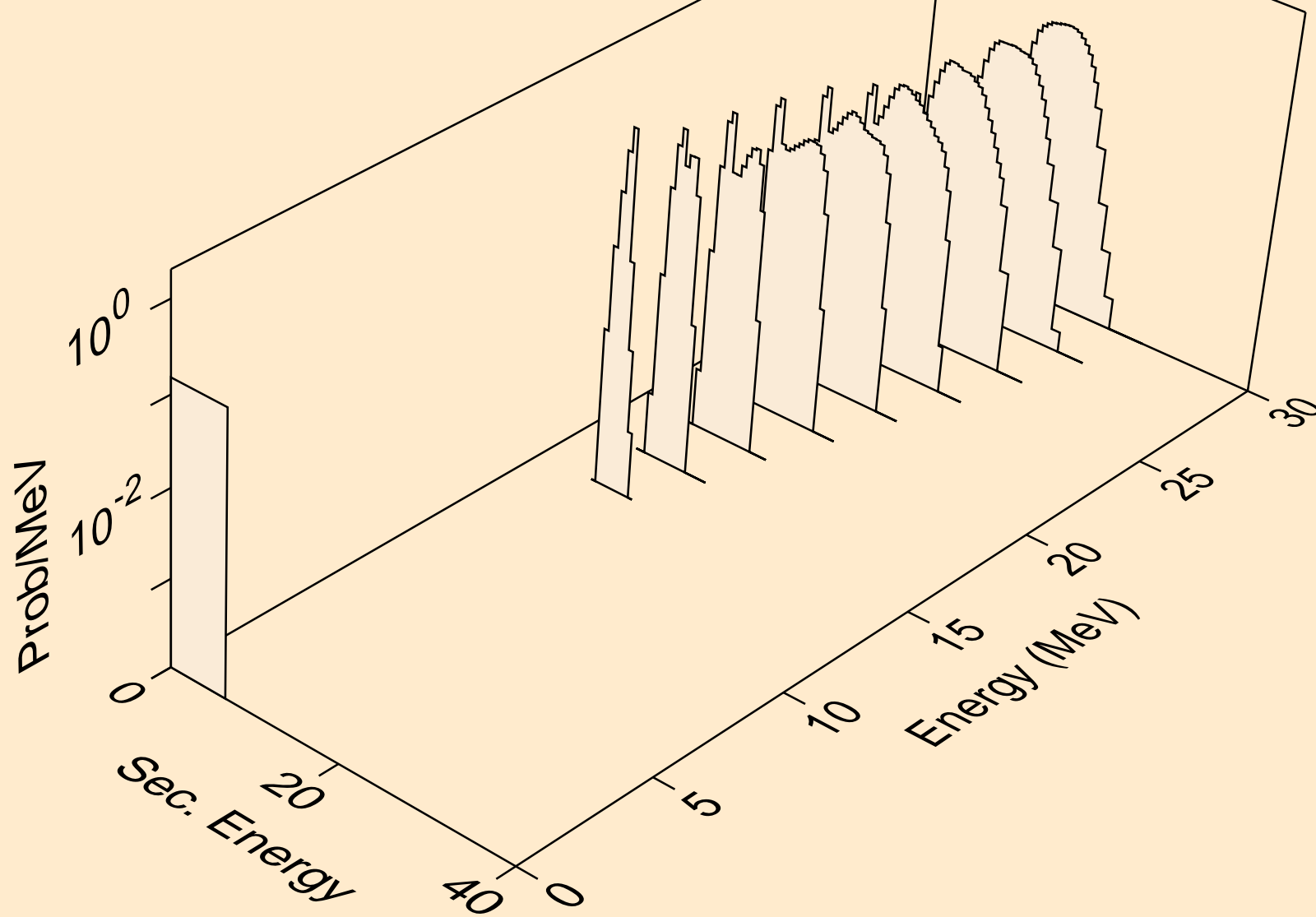

AT200 NEUTRON ACER TENDL-2024 LIBRARY; T=293.6K  
alphas from (n,npa)

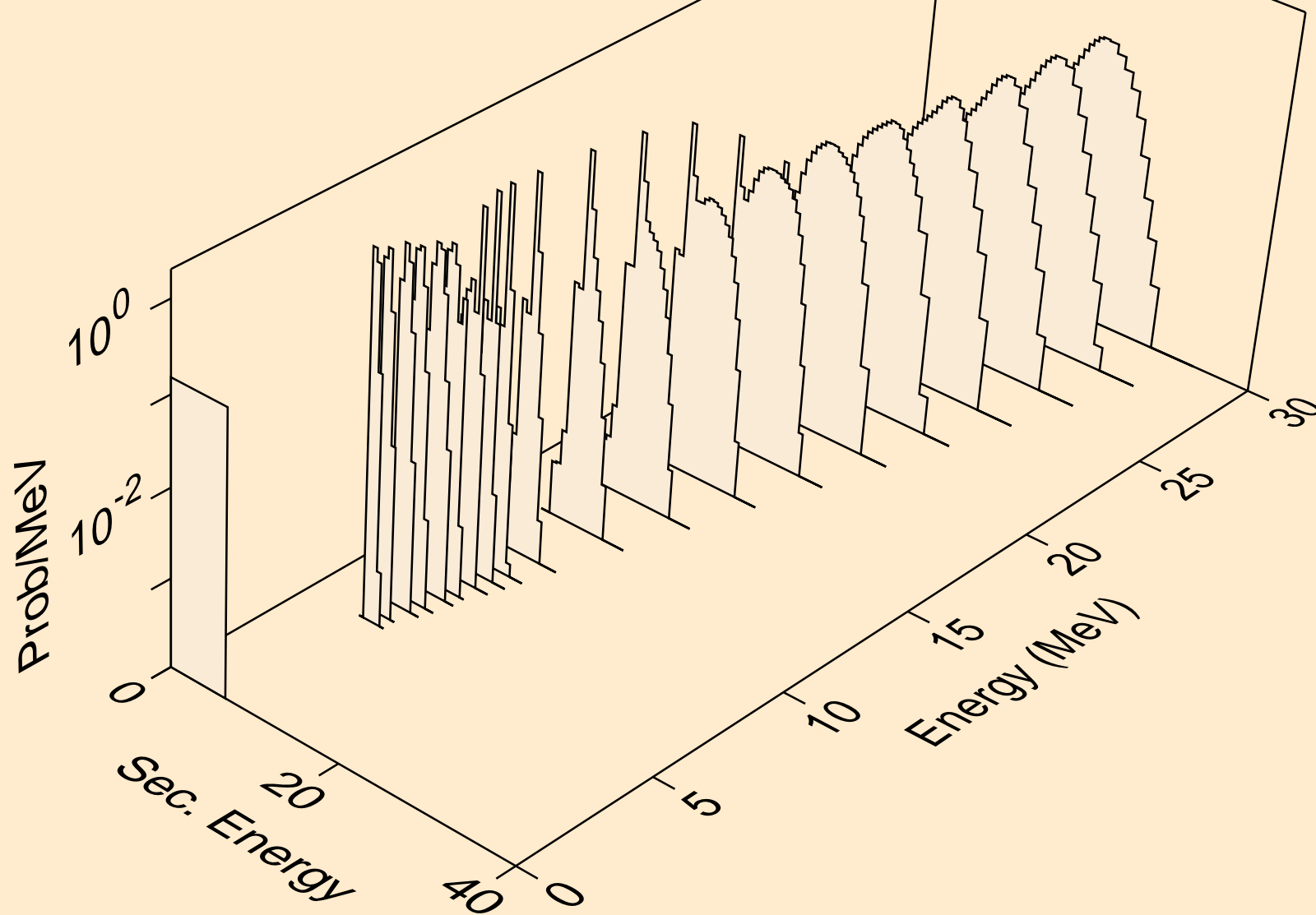

AT200 NEUTRON ACER TENDL-2024 LIBRARY; T=293.6K  
alphas from (n,a)

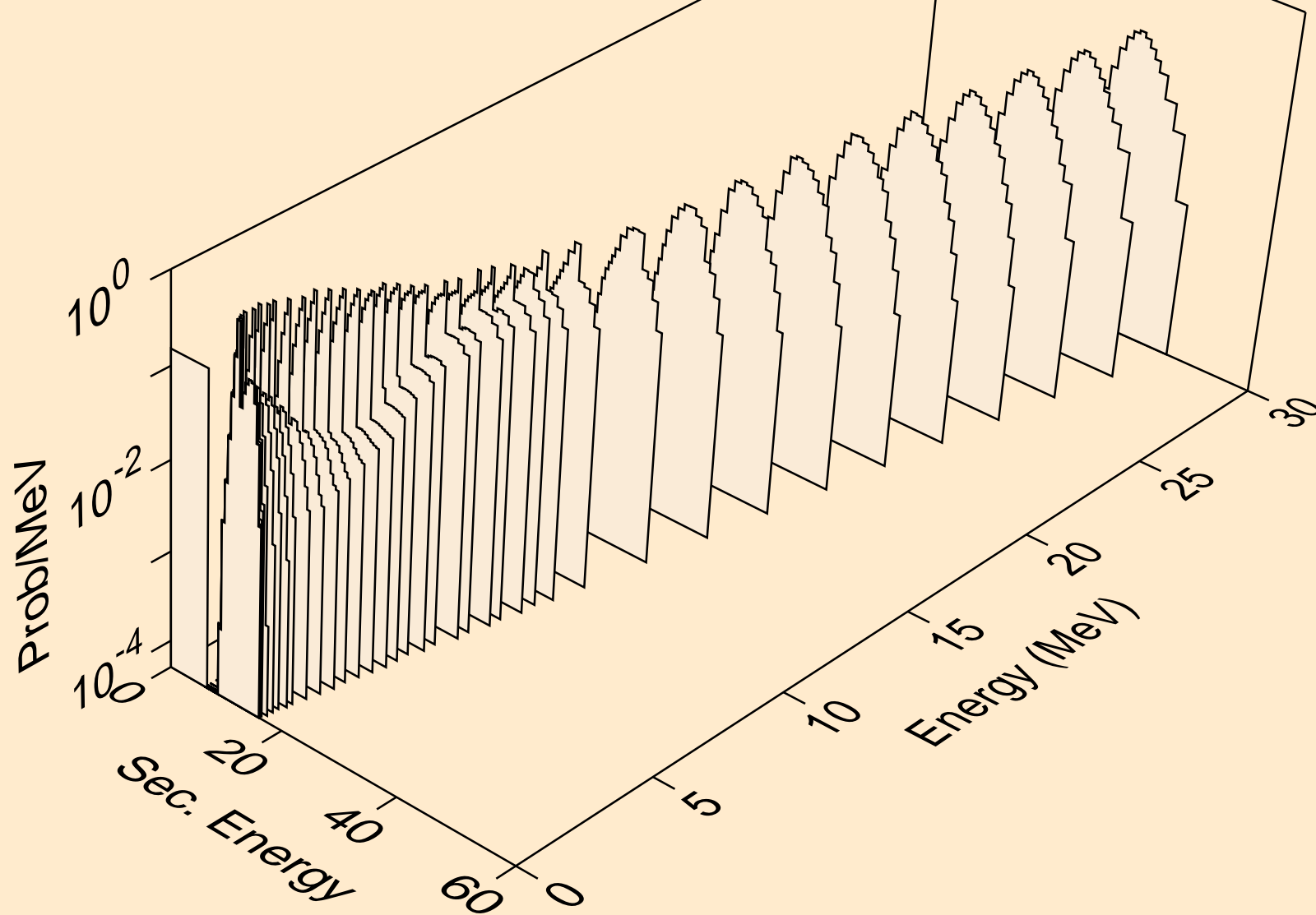

AT200 NEUTRON ACER TENDL-2024 LIBRARY; T=293.6K  
alphas from (n,2a)

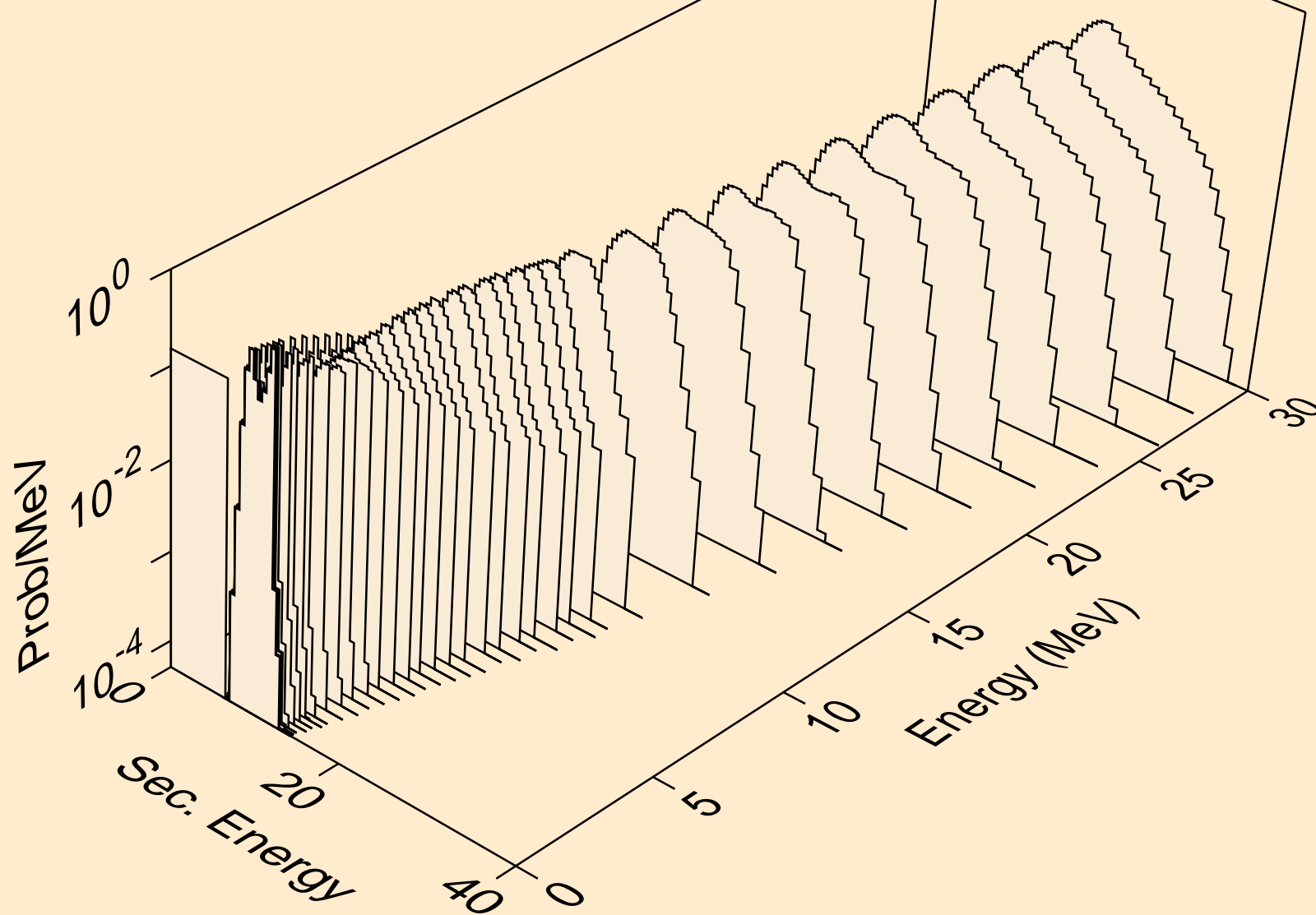

AT200 NEUTRON ACER TENDL-2024 LIBRARY; T=293.6K  
alphas from (n,pa)

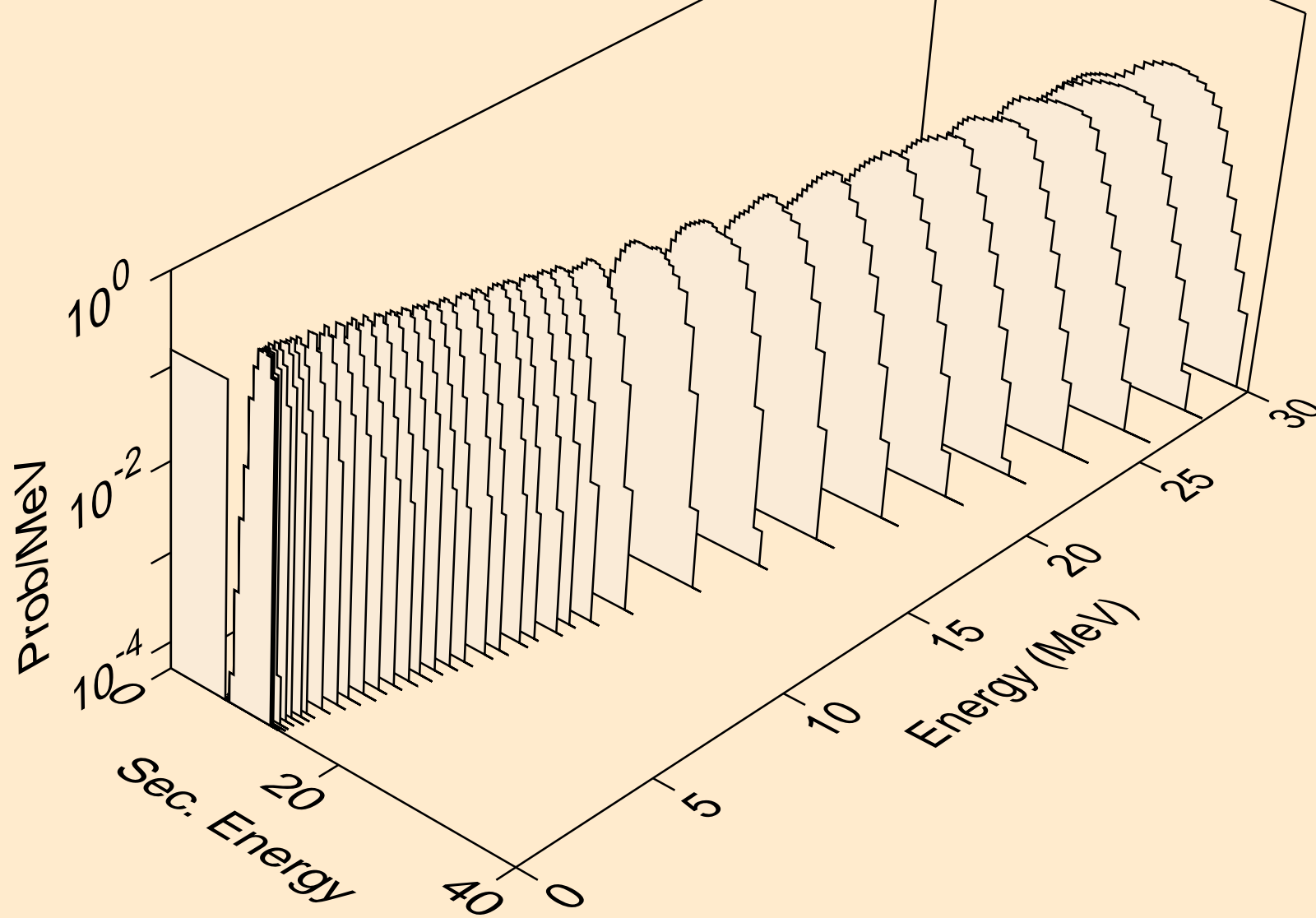

AT200 NEUTRON ACER TENDL-2024 LIBRARY; T=293.6K  
alphas from (n,da)

