

BA119 NEUTRON ACER TENDL-2024 LIBRARY; T=293.6K  
Principal cross sections

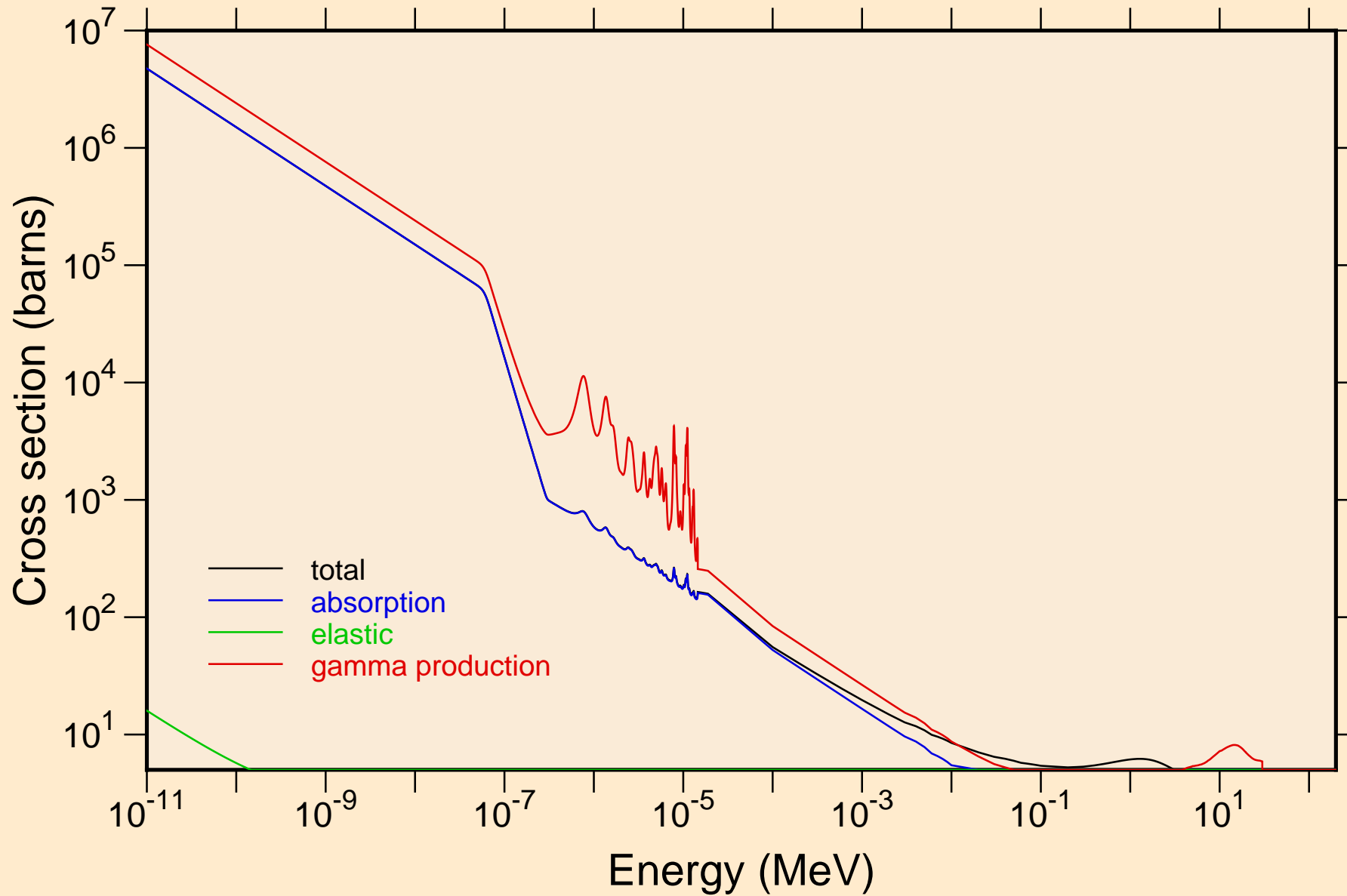

BA119 NEUTRON ACER TENDL-2024 LIBRARY; T=293.6K  
resonance total cross section

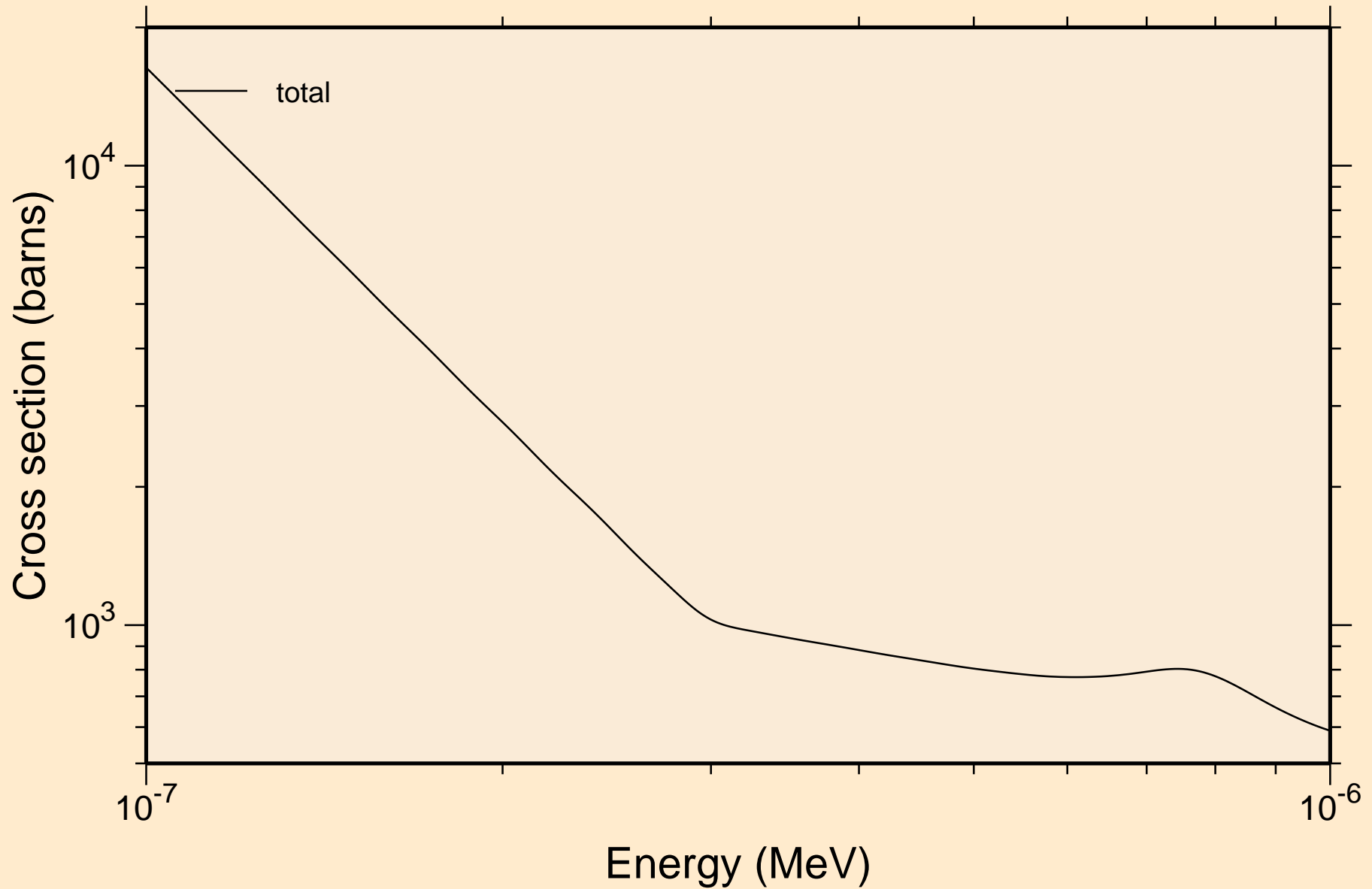

BA119 NEUTRON ACER TENDL-2024 LIBRARY; T=293.6K  
resonance total cross section

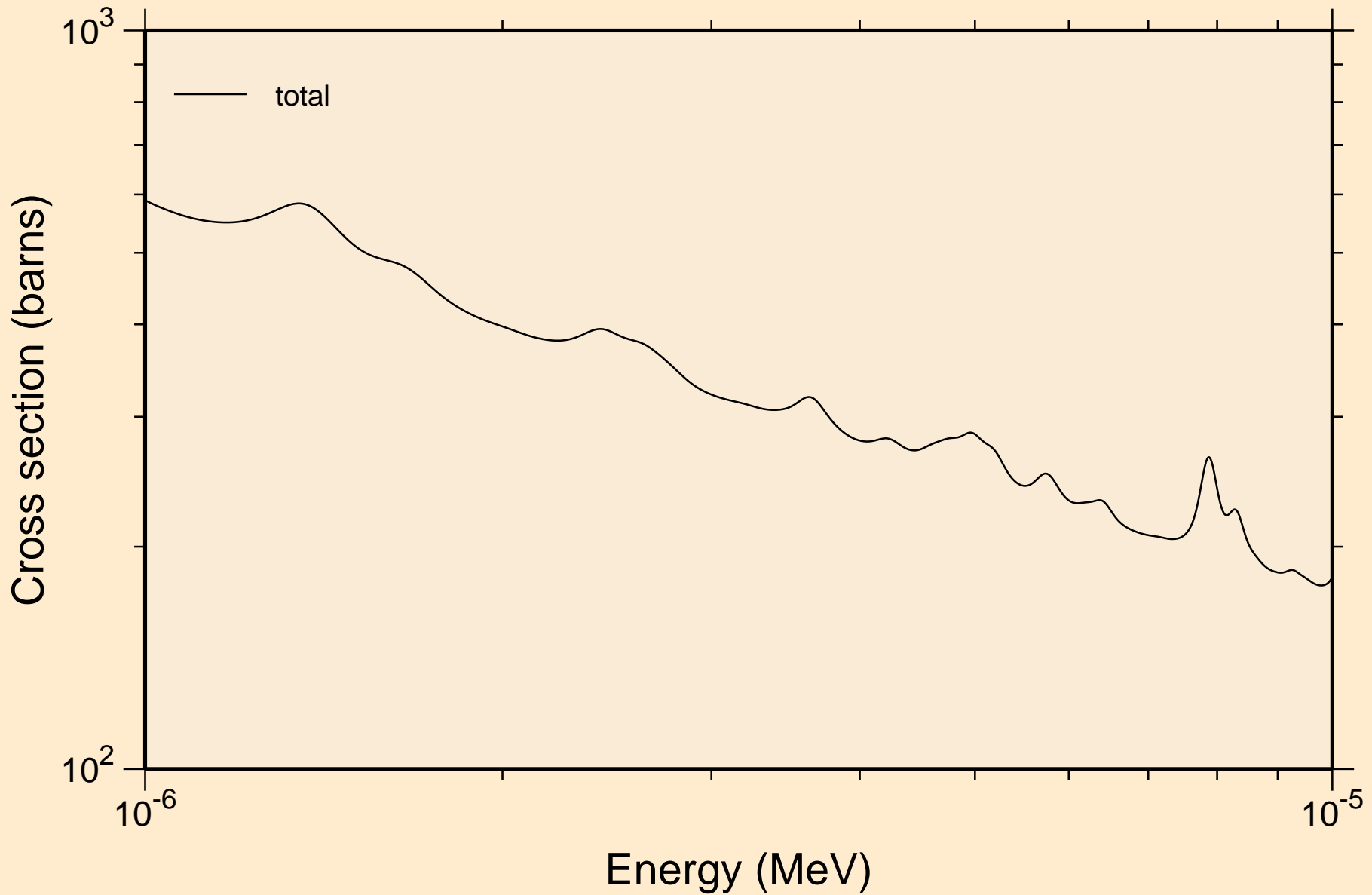

BA119 NEUTRON ACER TENDL-2024 LIBRARY; T=293.6K  
resonance total cross section

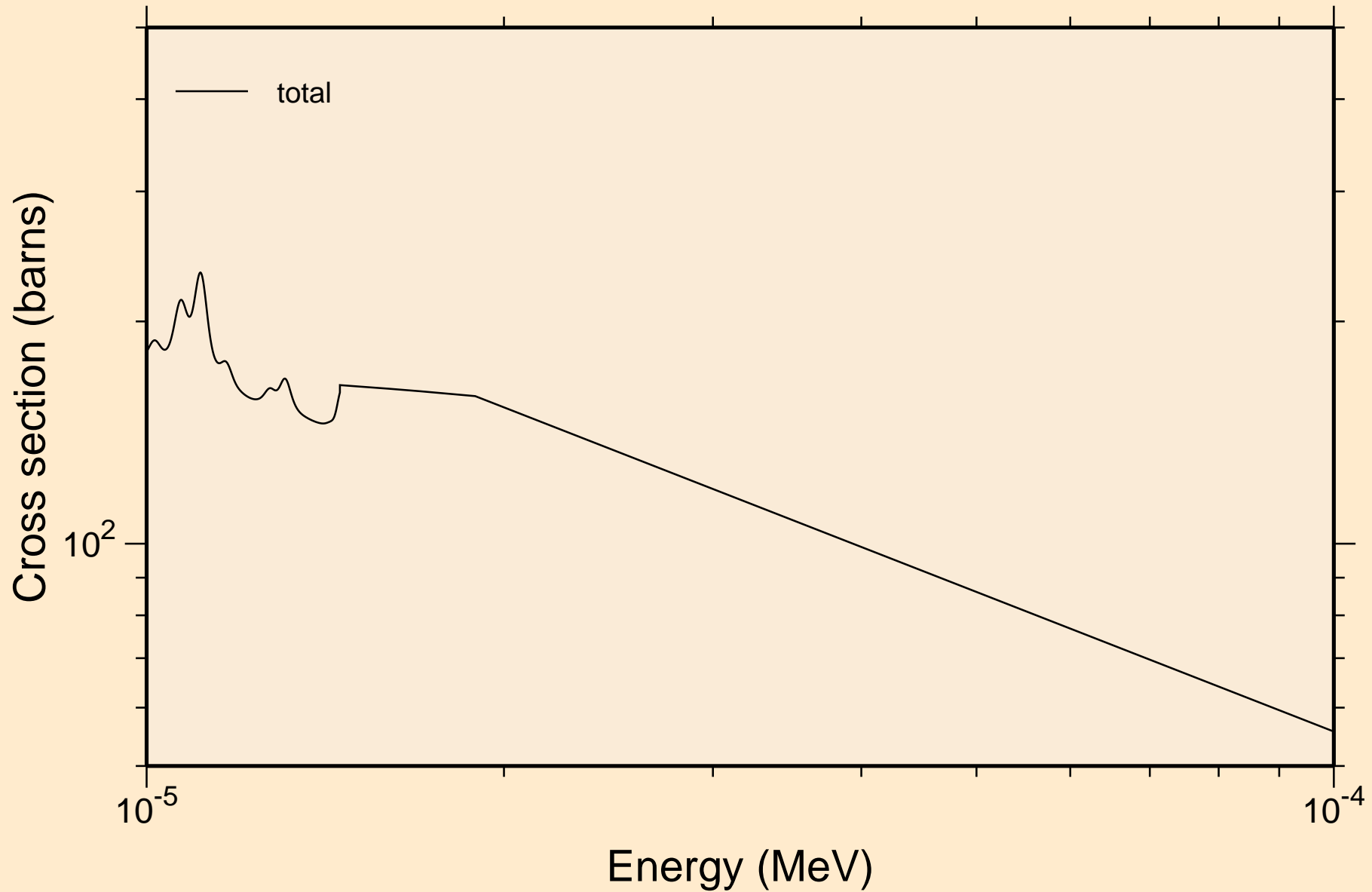

BA119 NEUTRON ACER TENDL-2024 LIBRARY; T=293.6K  
resonance total cross section

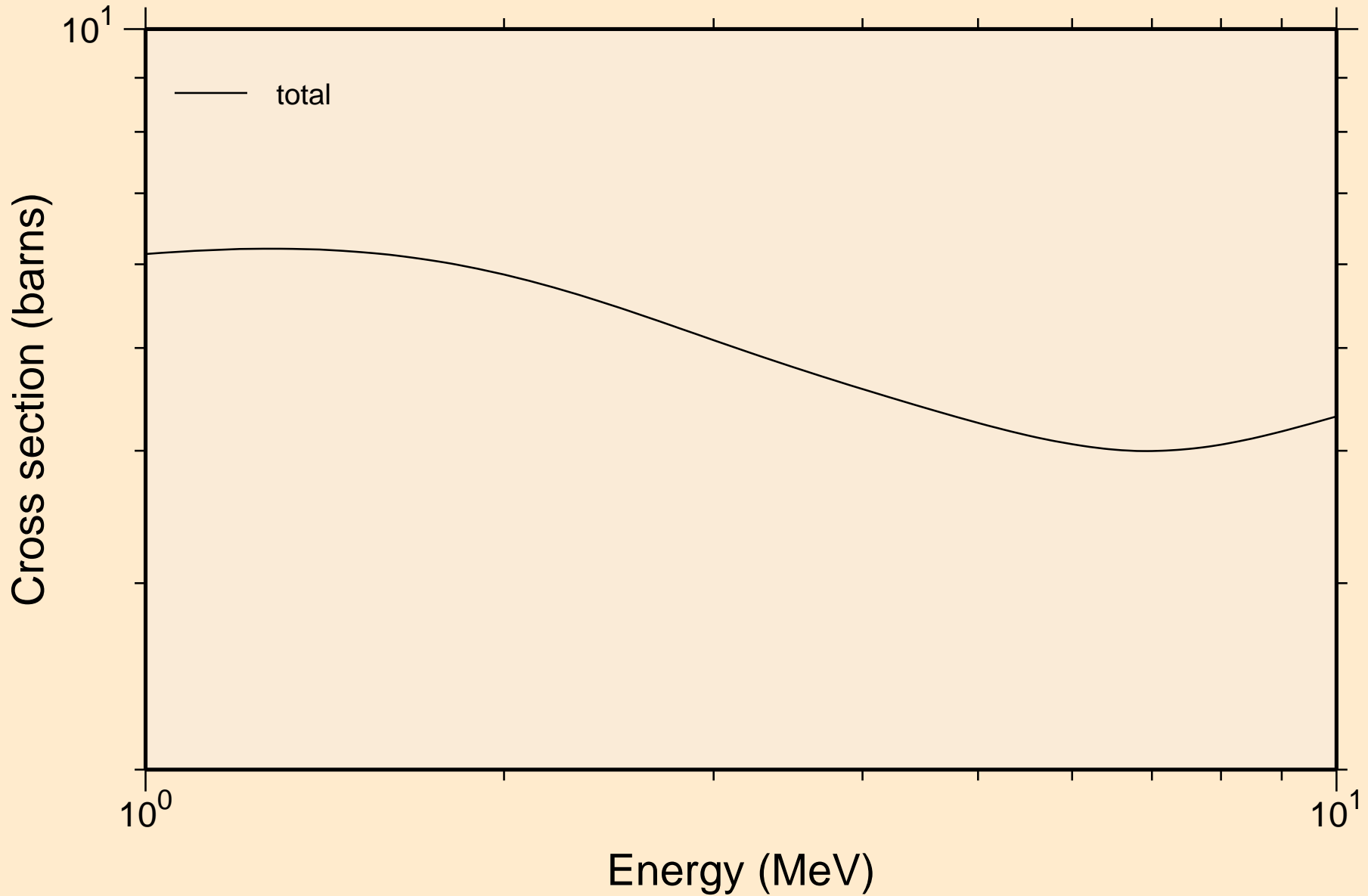

BA119 NEUTRON ACER TENDL-2024 LIBRARY; T=293.6K  
resonance absorption cross sections

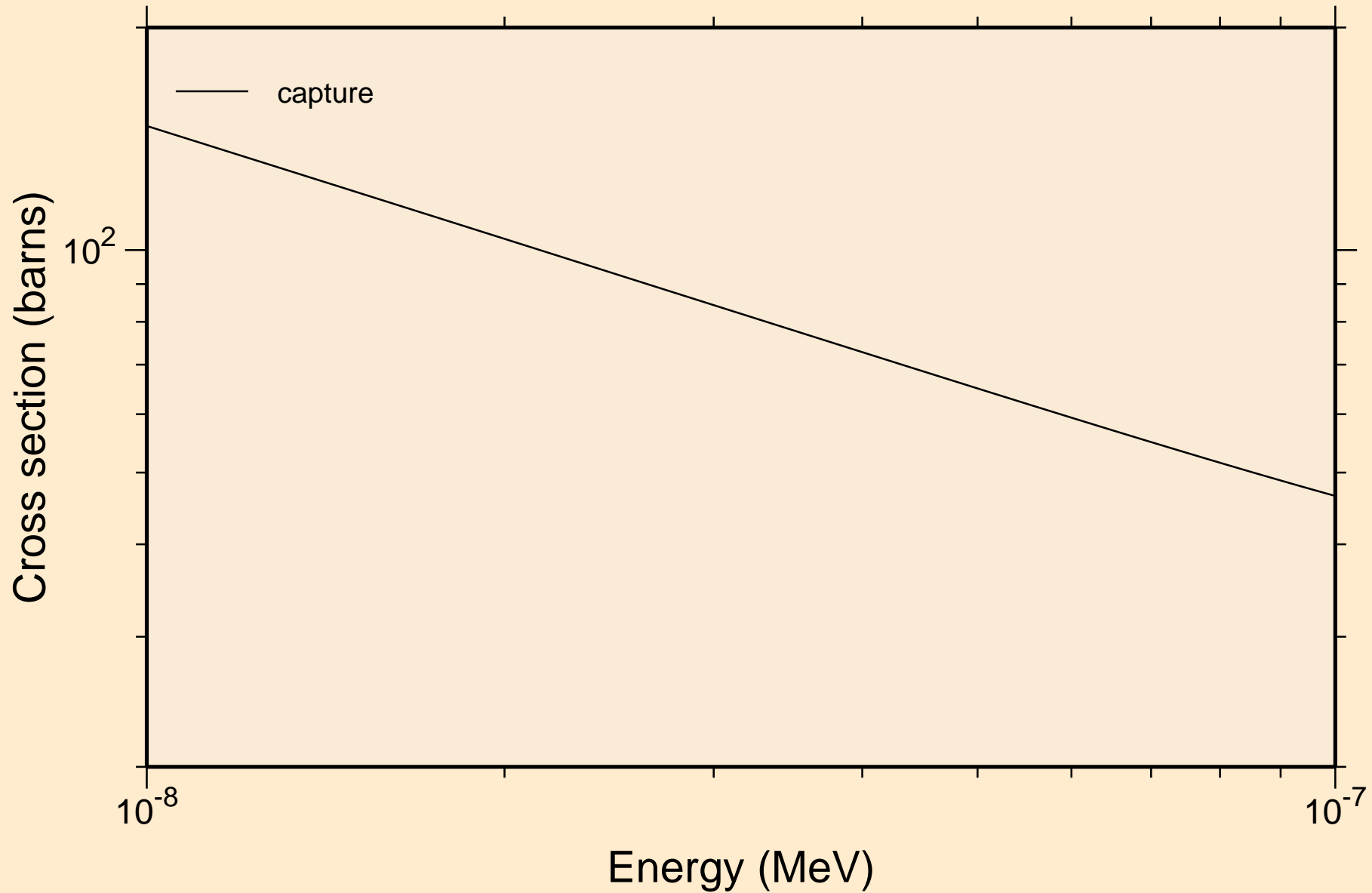

BA119 NEUTRON ACER TENDL-2024 LIBRARY; T=293.6K  
resonance absorption cross sections

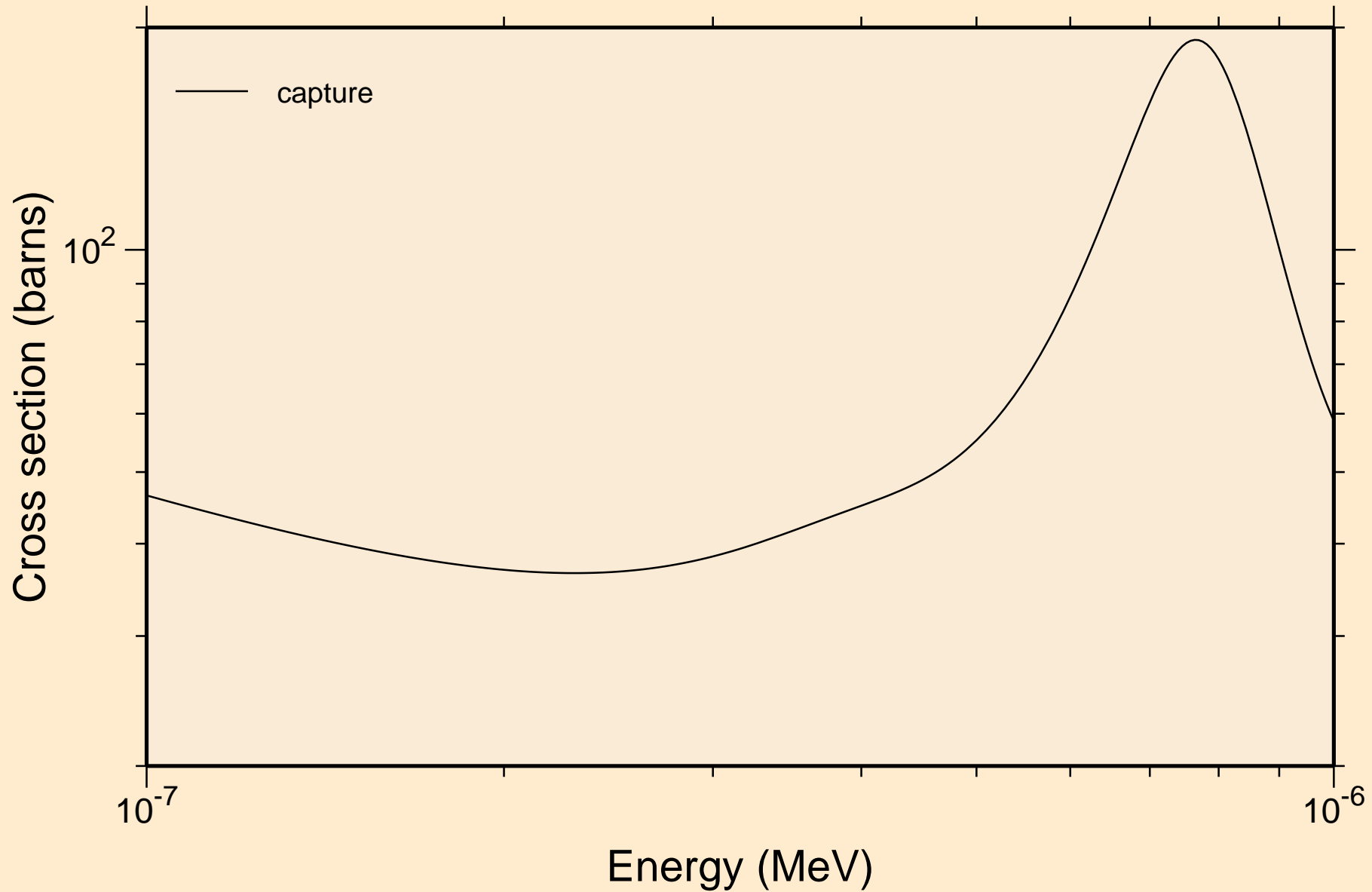

BA119 NEUTRON ACER TENDL-2024 LIBRARY; T=293.6K  
resonance absorption cross sections

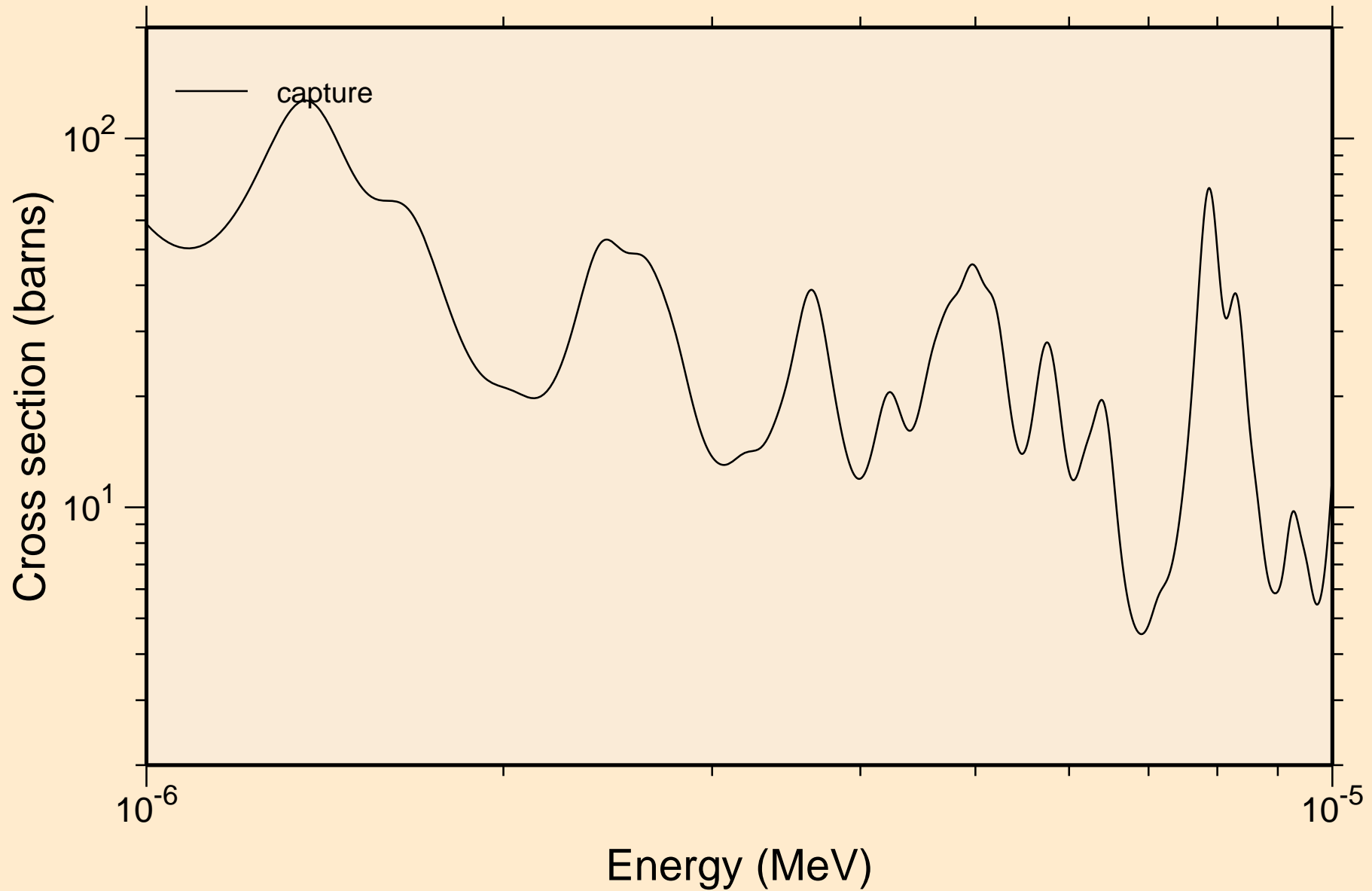

BA119 NEUTRON ACER TENDL-2024 LIBRARY; T=293.6K  
resonance absorption cross sections

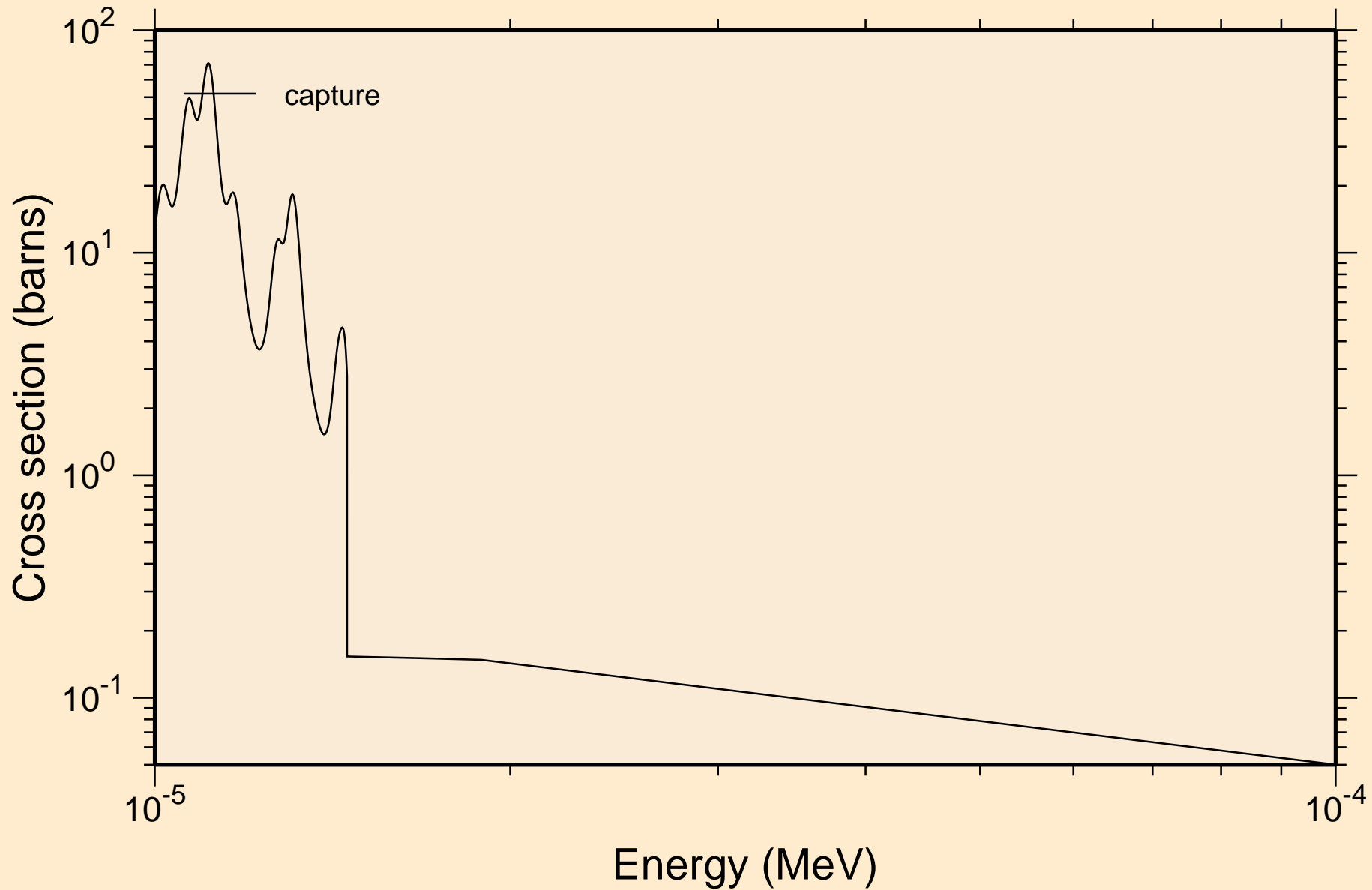

BA119 NEUTRON ACER TENDL-2024 LIBRARY; T=293.6K  
resonance absorption cross sections

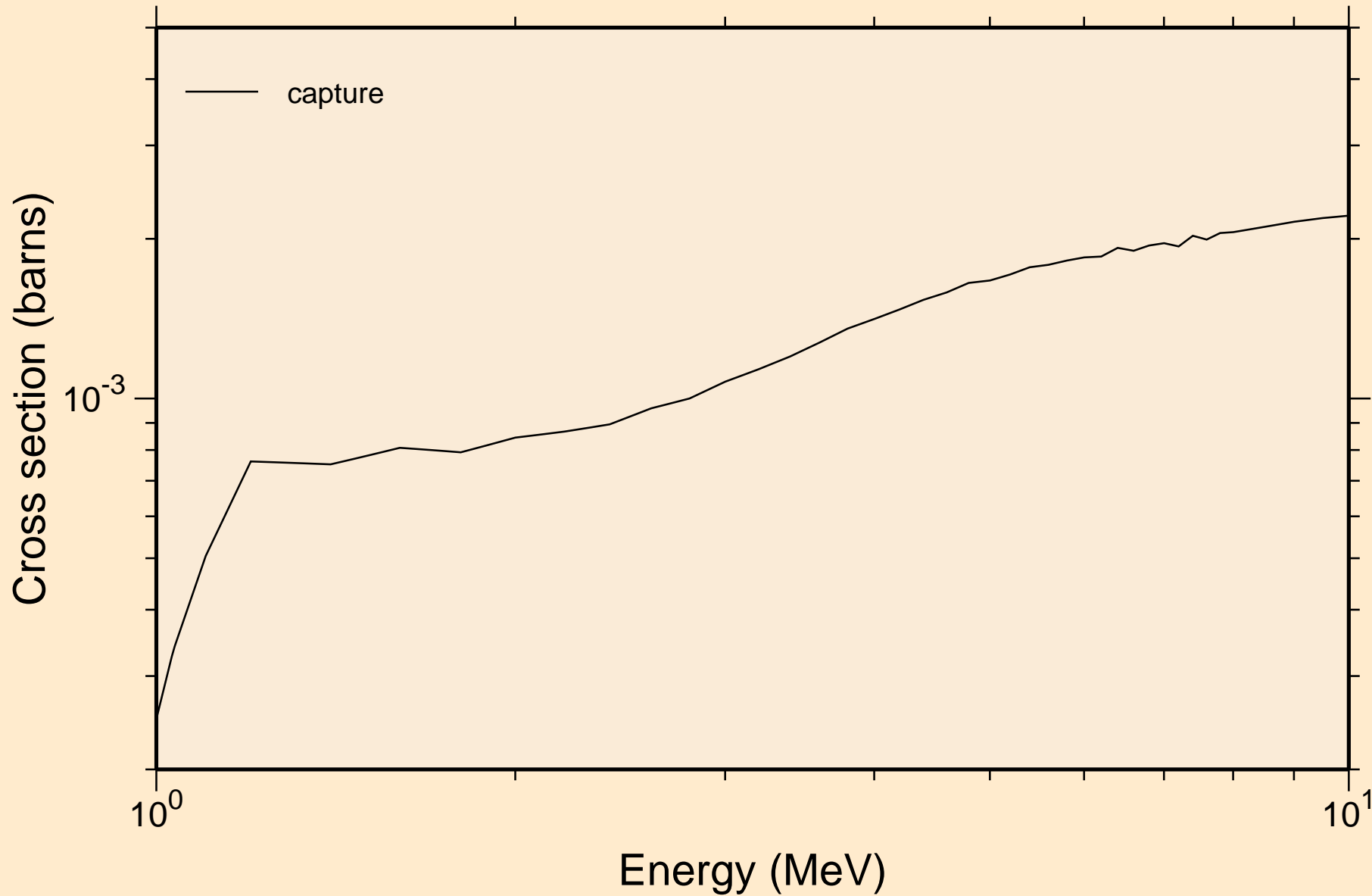

BA119 NEUTRON ACER TENDL-2024 LIBRARY; T=293.6K  
Heating

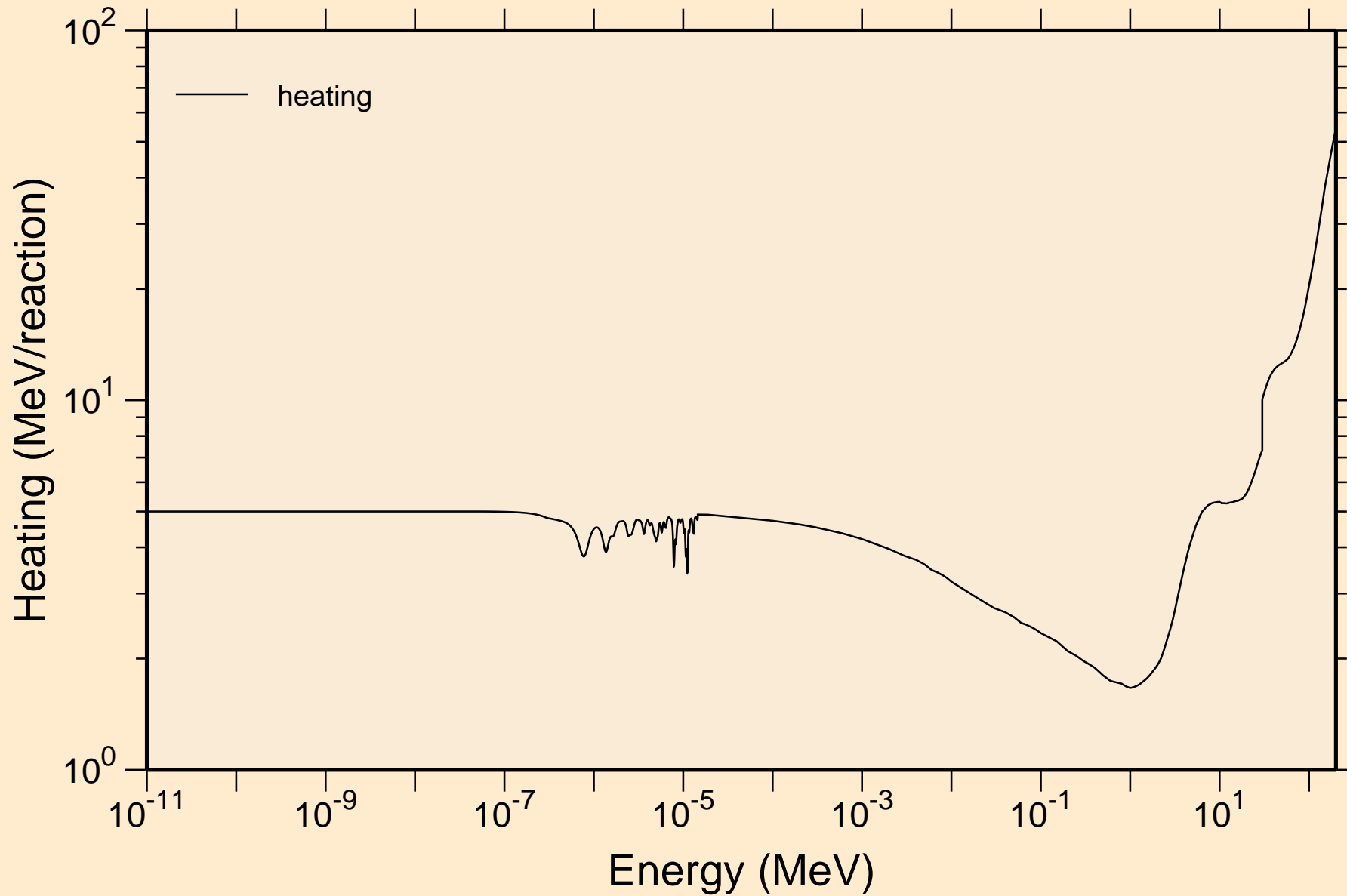

# BA119 NEUTRON ACER TENDL-2024 LIBRARY; T=293.6K

## Damage

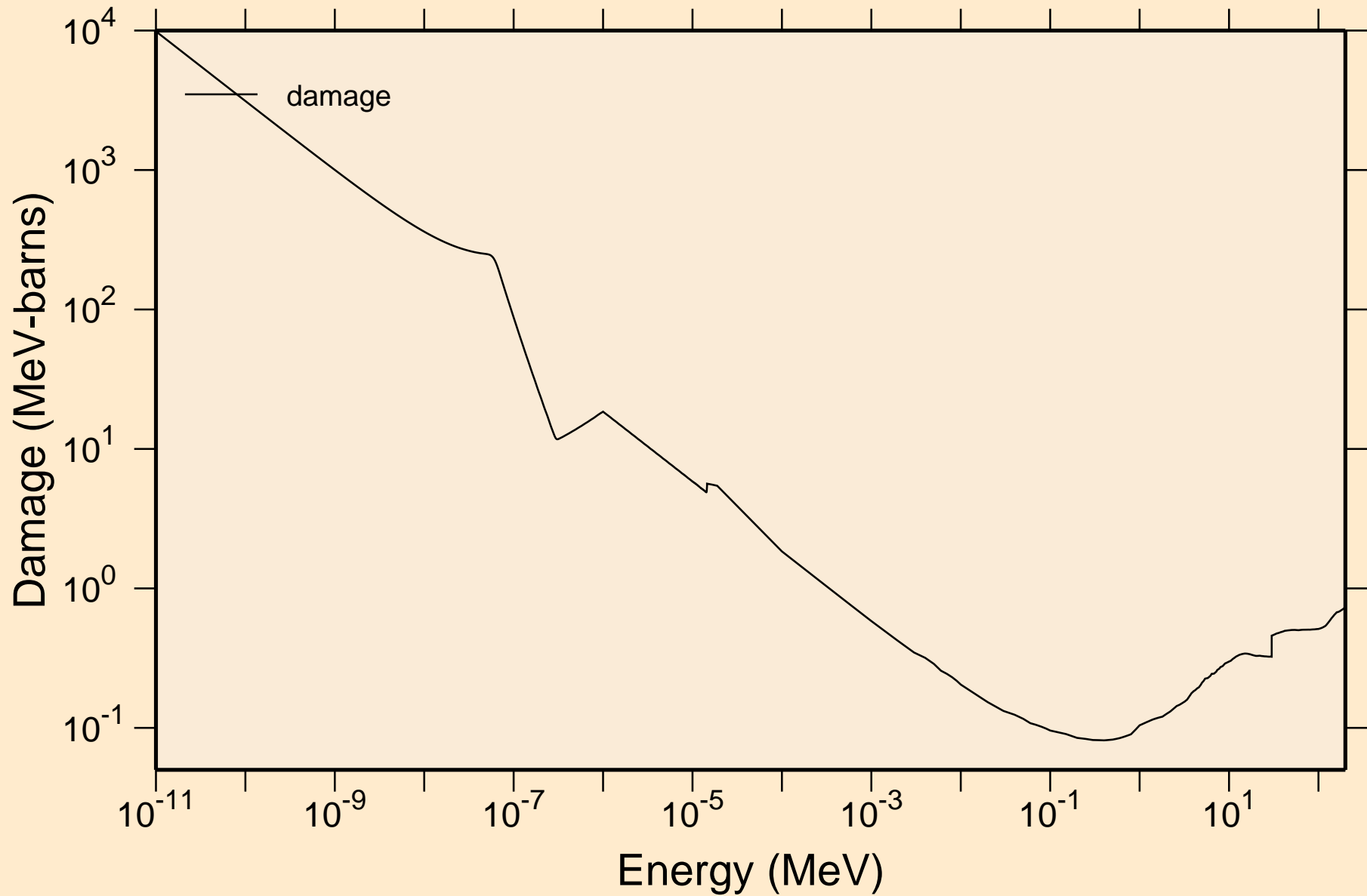

BA119 NEUTRON ACER TENDL-2024 LIBRARY; T=293.6K  
Non-threshold reactions

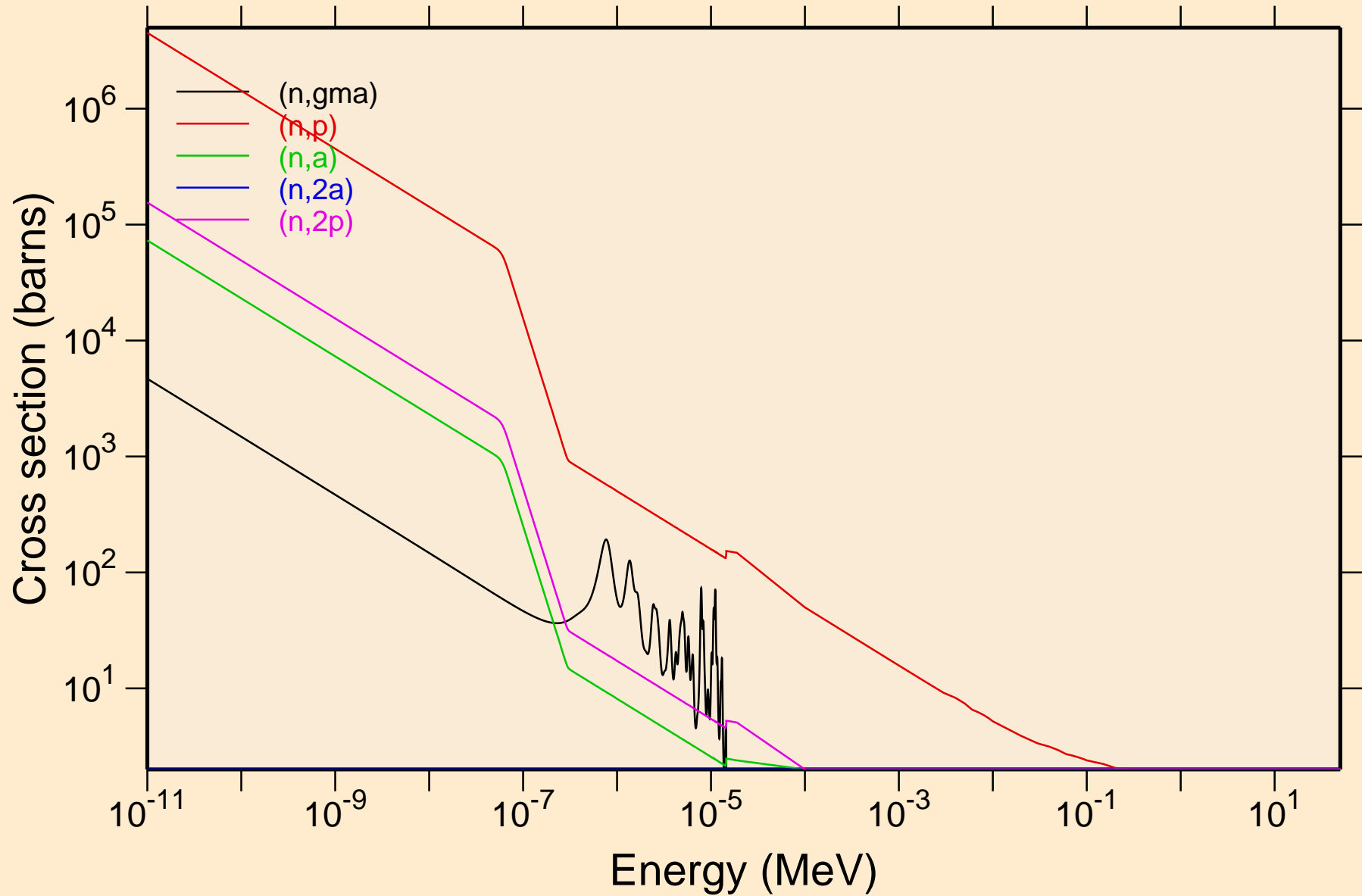

BA119 NEUTRON ACER TENDL-2024 LIBRARY; T=293.6K  
Non-threshold reactions

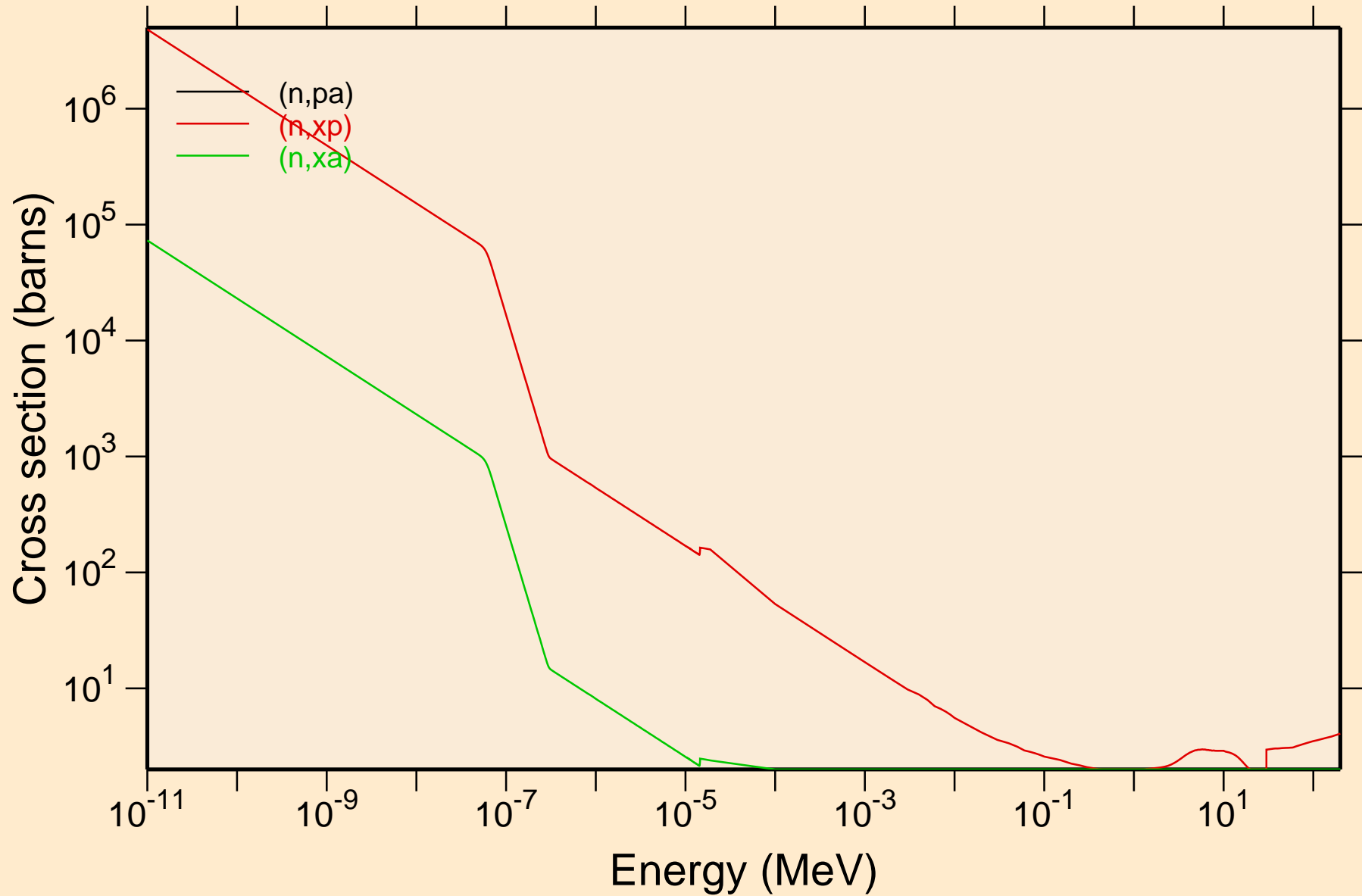

BA119 NEUTRON ACER TENDL-2024 LIBRARY; T=293.6K  
Principal cross sections

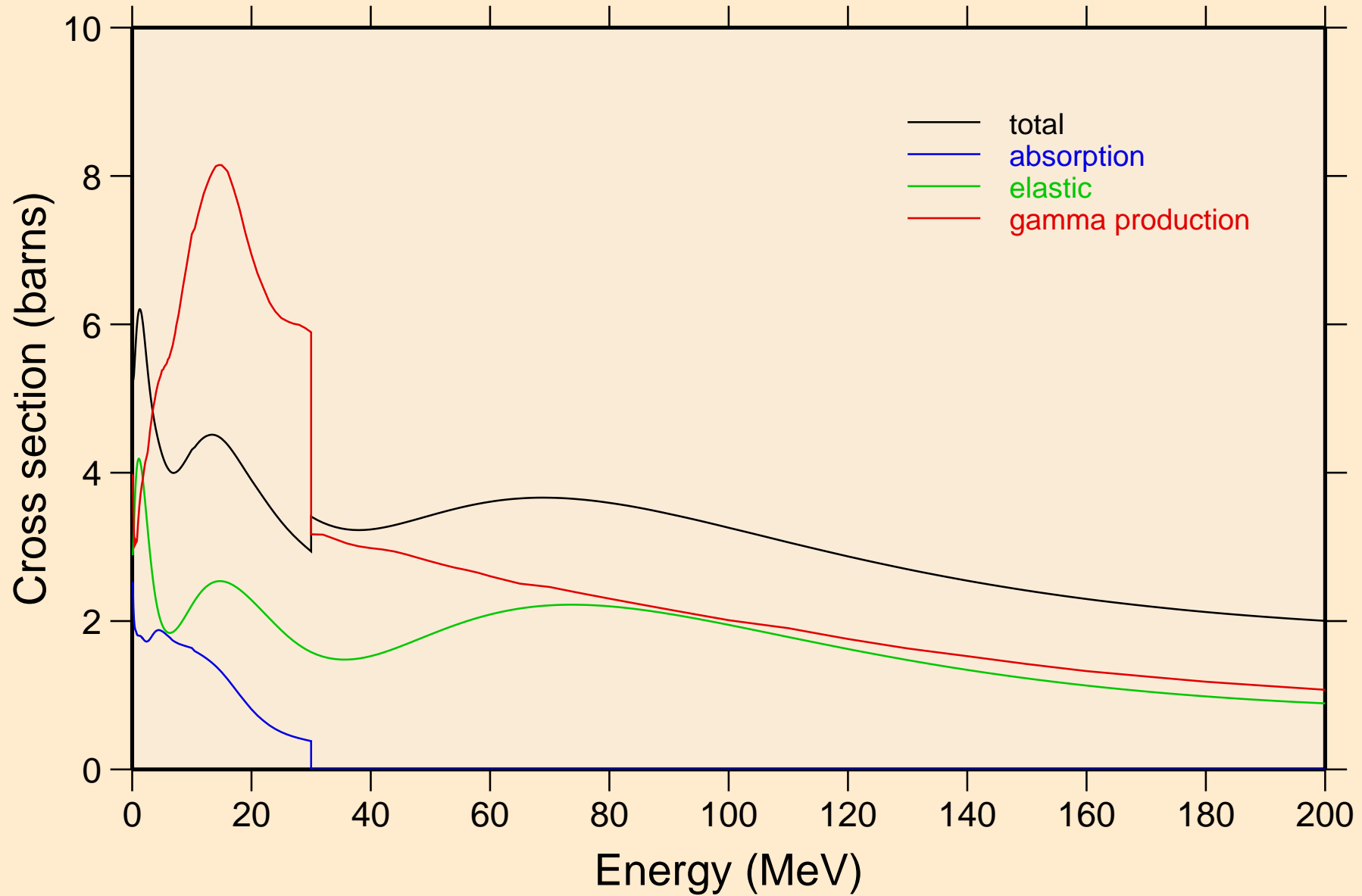

# BA119 NEUTRON ACER TENDL-2024 LIBRARY; T=293.6K

## Heating

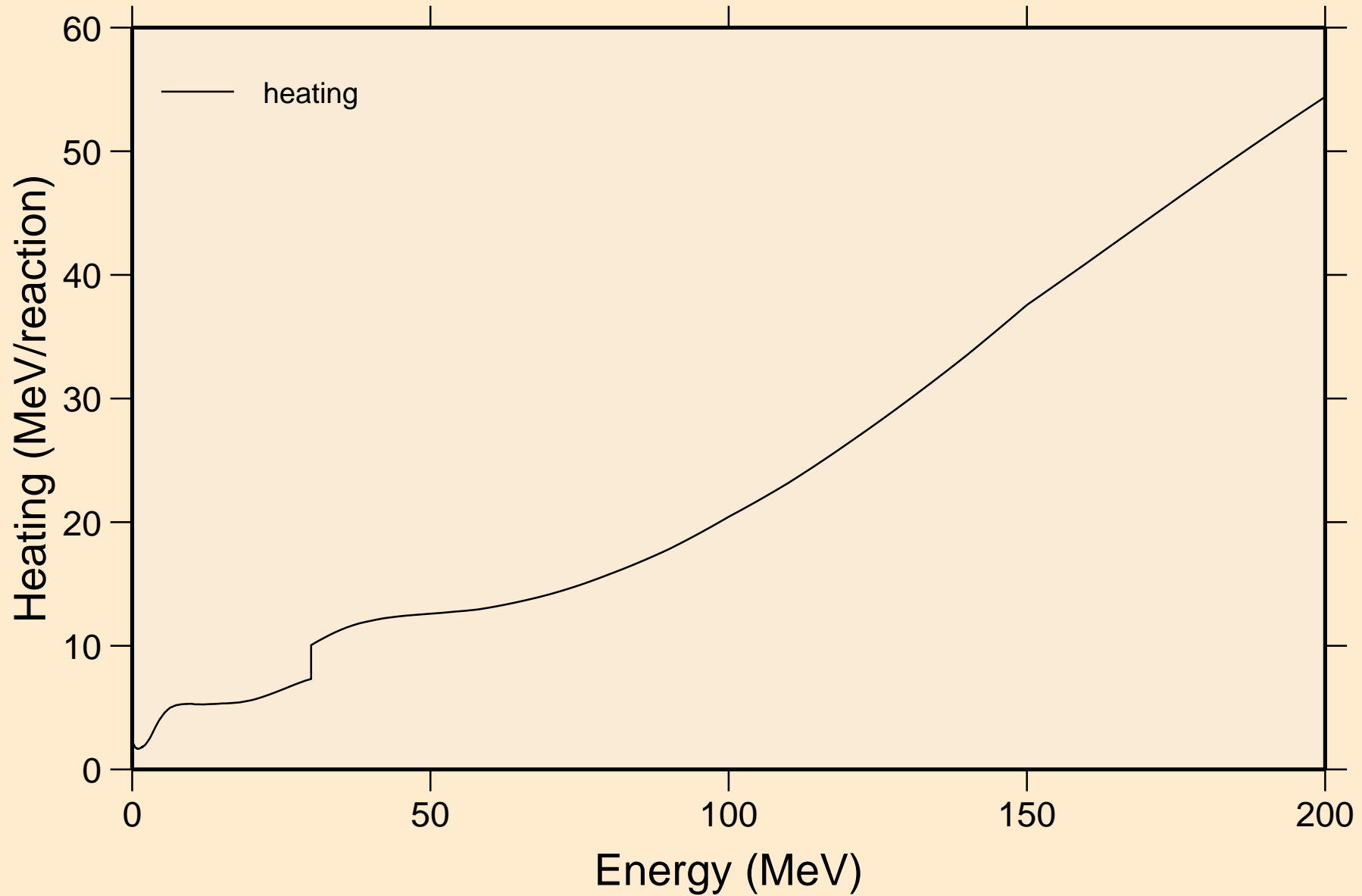

BA119 NEUTRON ACER TENDL-2024 LIBRARY; T=293.6K  
Damage

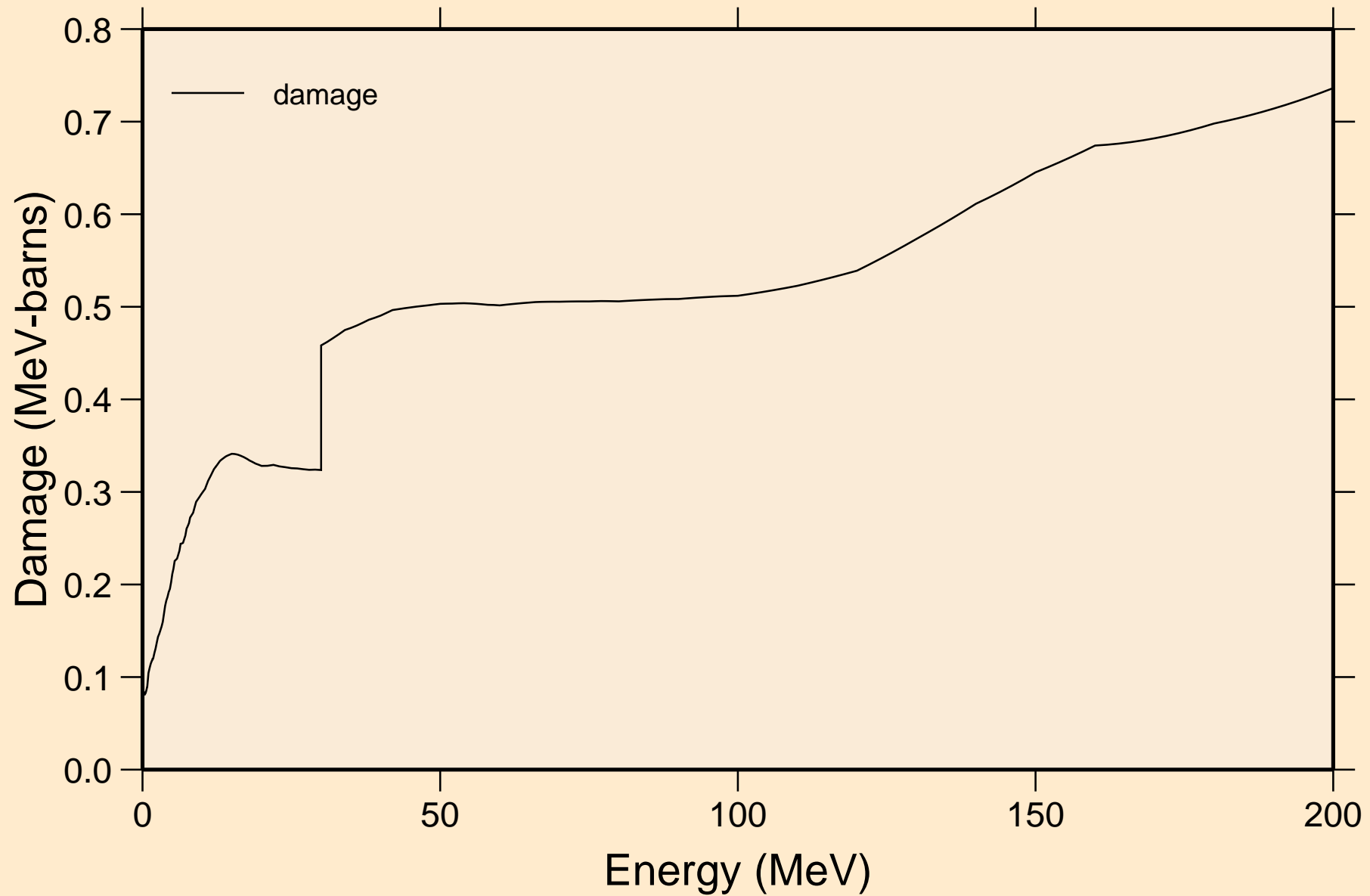

BA119 NEUTRON ACER TENDL-2024 LIBRARY; T=293.6K  
Non-threshold reactions

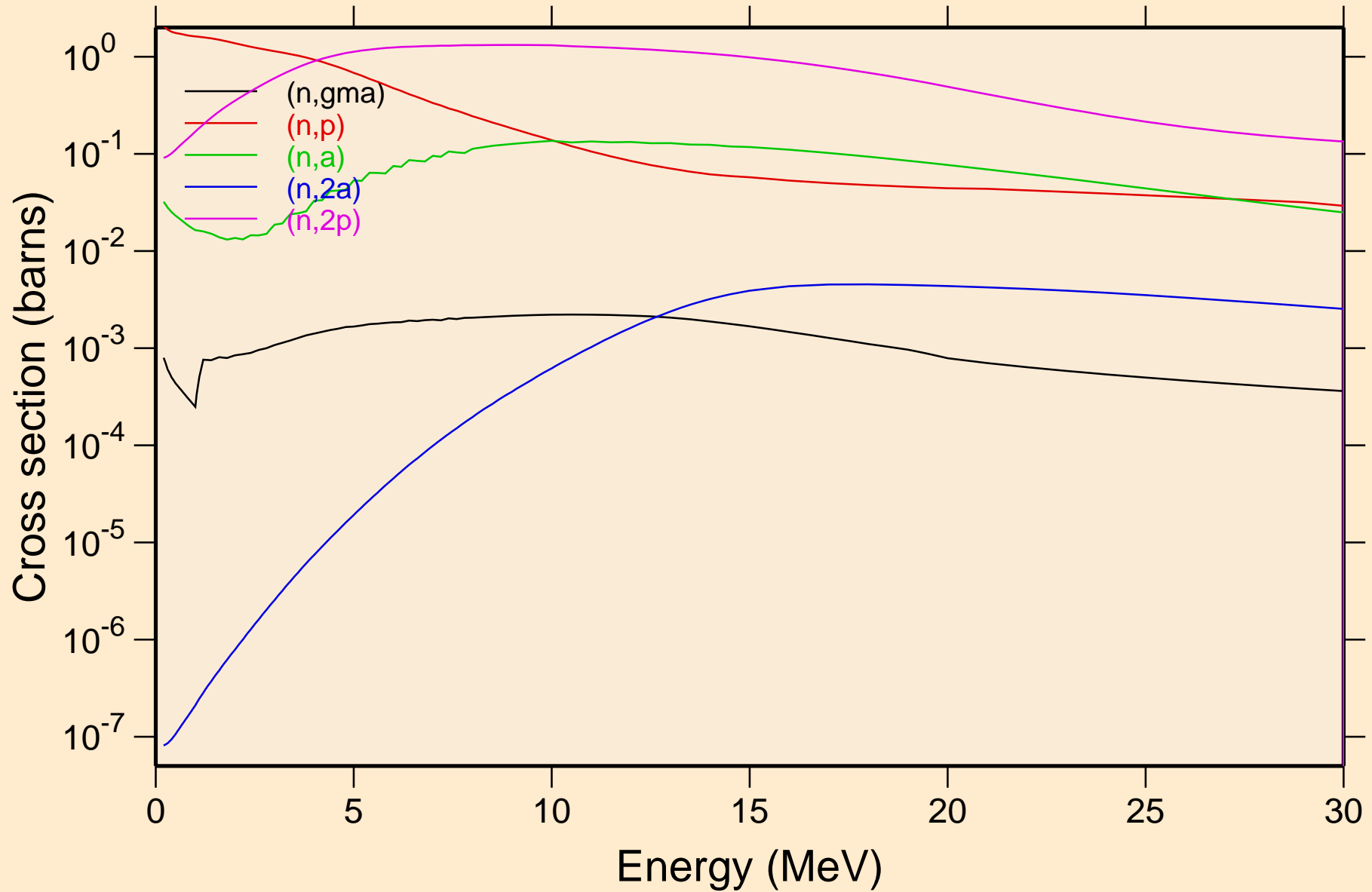

BA119 NEUTRON ACER TENDL-2024 LIBRARY; T=293.6K  
Non-threshold reactions

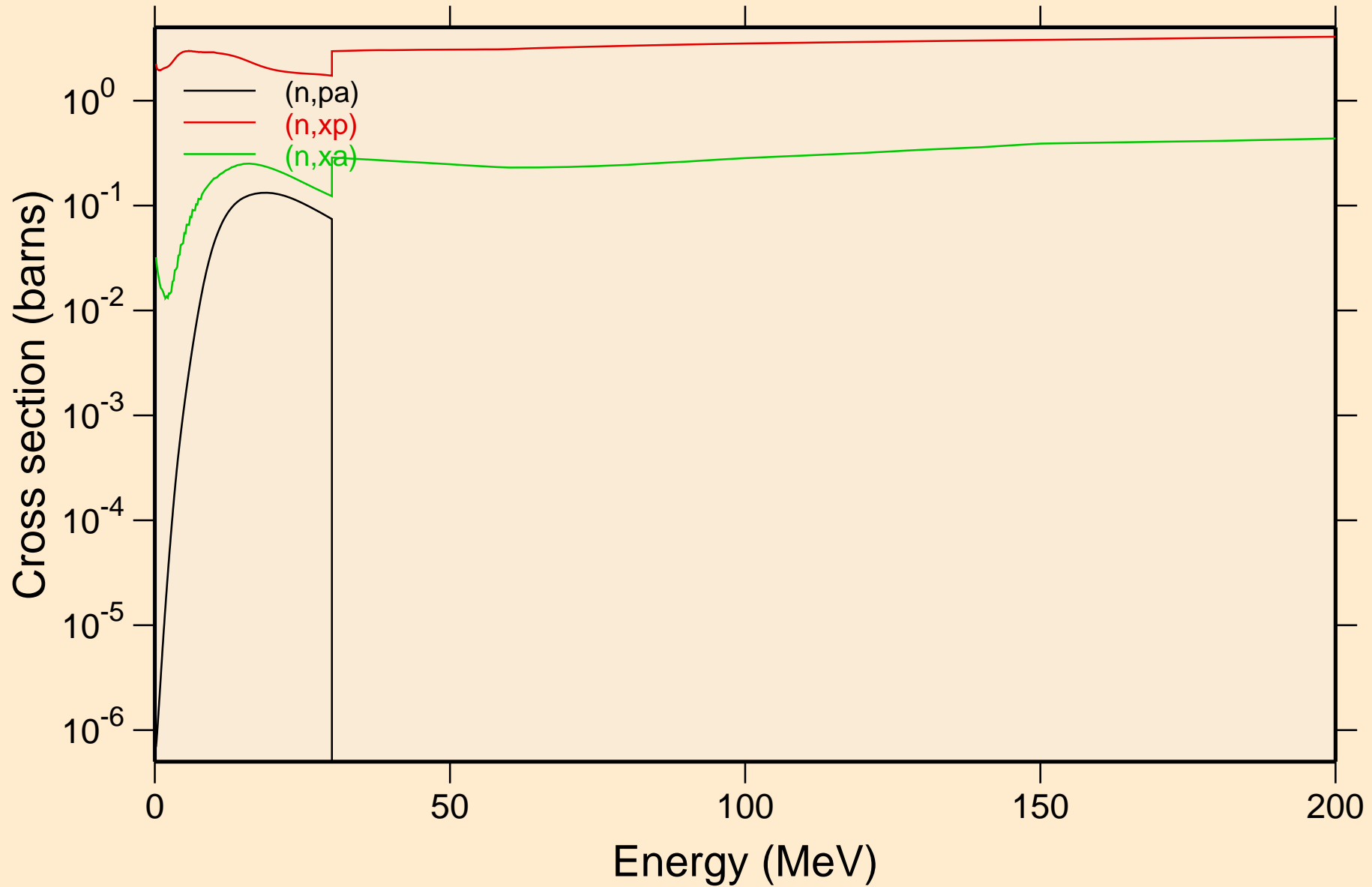

BA119 NEUTRON ACER TENDL-2024 LIBRARY; T=293.6K  
Inelastic levels

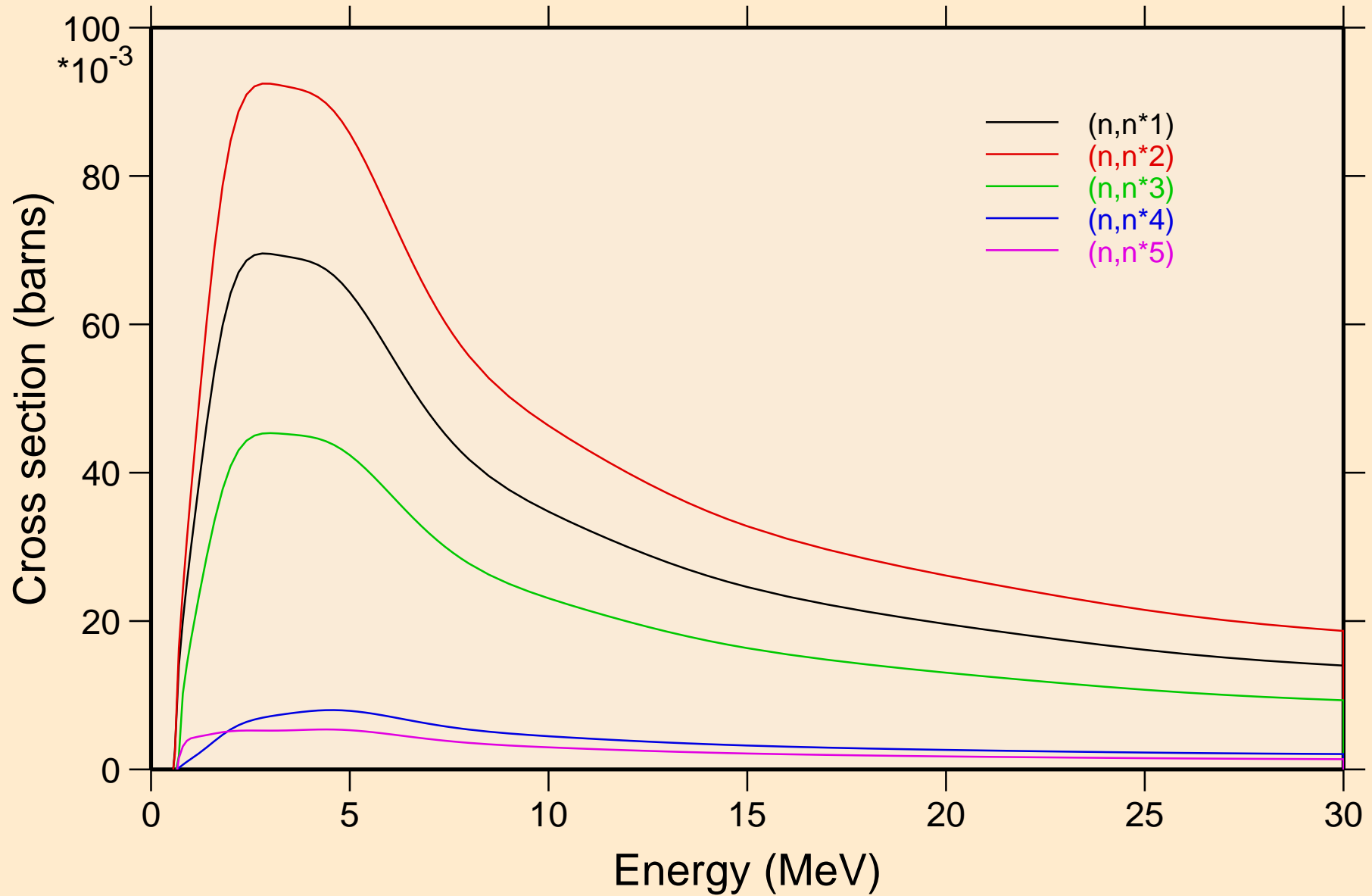

BA119 NEUTRON ACER TENDL-2024 LIBRARY; T=293.6K  
Inelastic levels

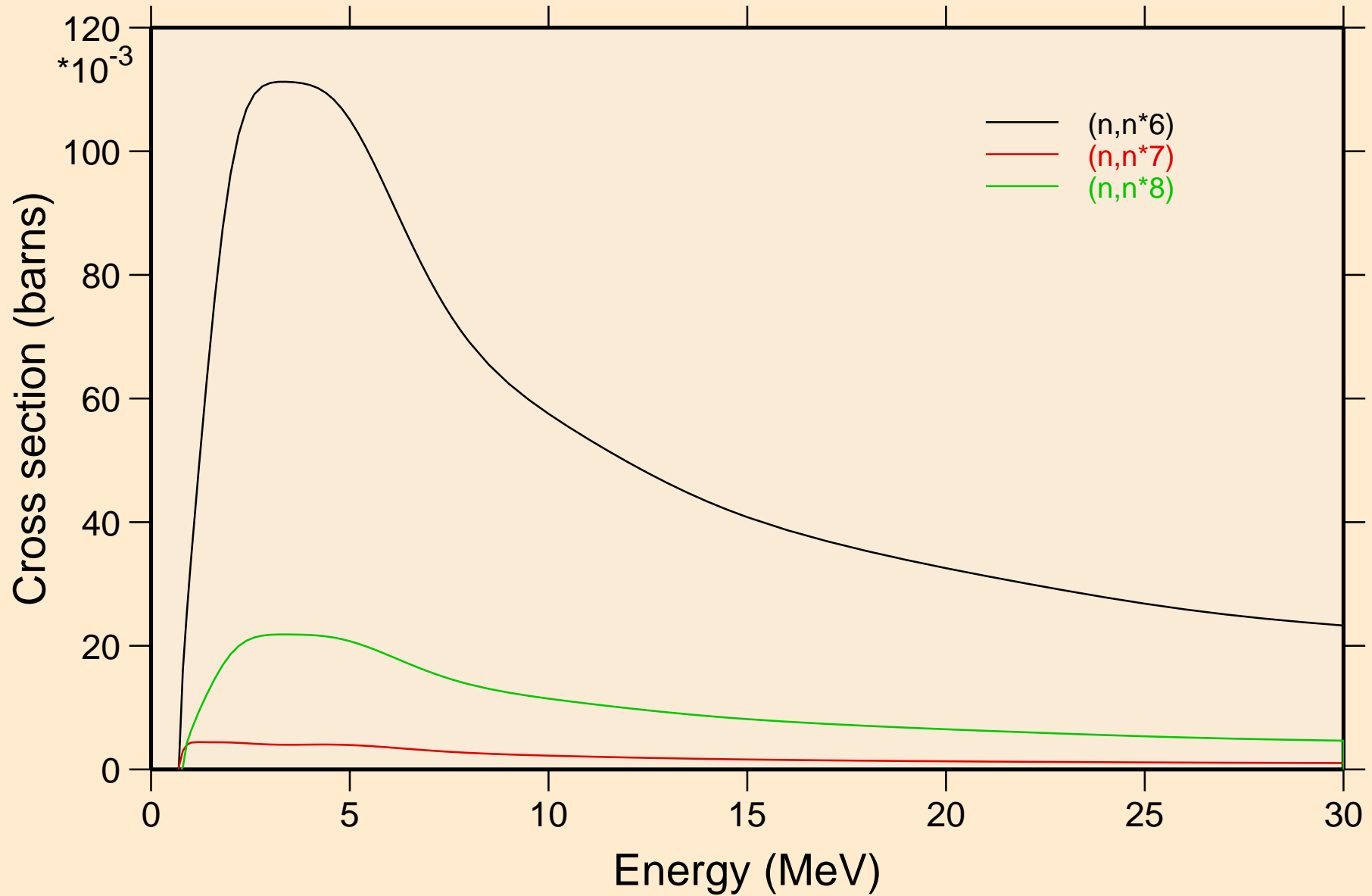

BA119 NEUTRON ACER TENDL-2024 LIBRARY; T=293.6K  
Threshold reactions

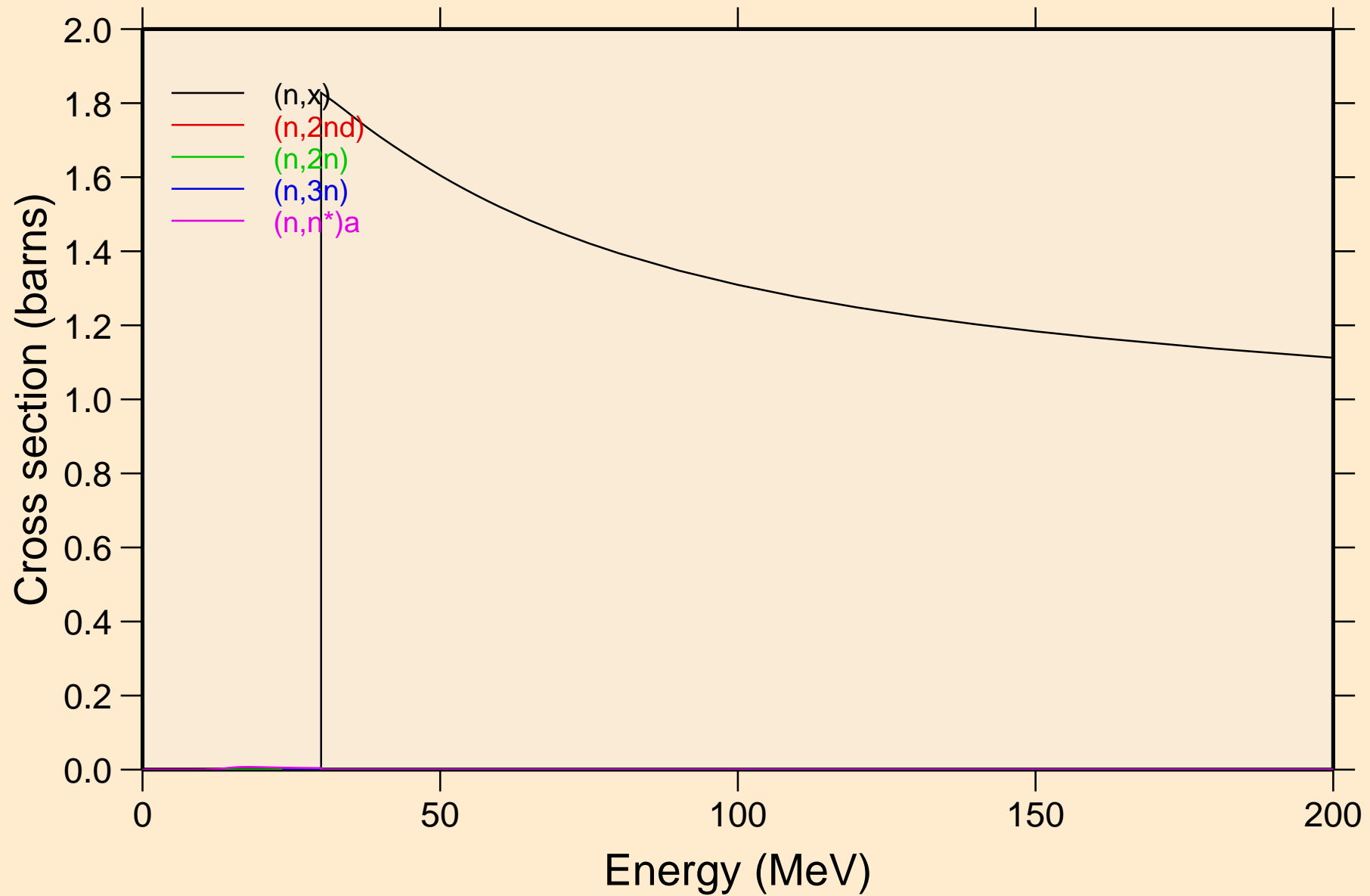

BA119 NEUTRON ACER TENDL-2024 LIBRARY; T=293.6K  
Threshold reactions

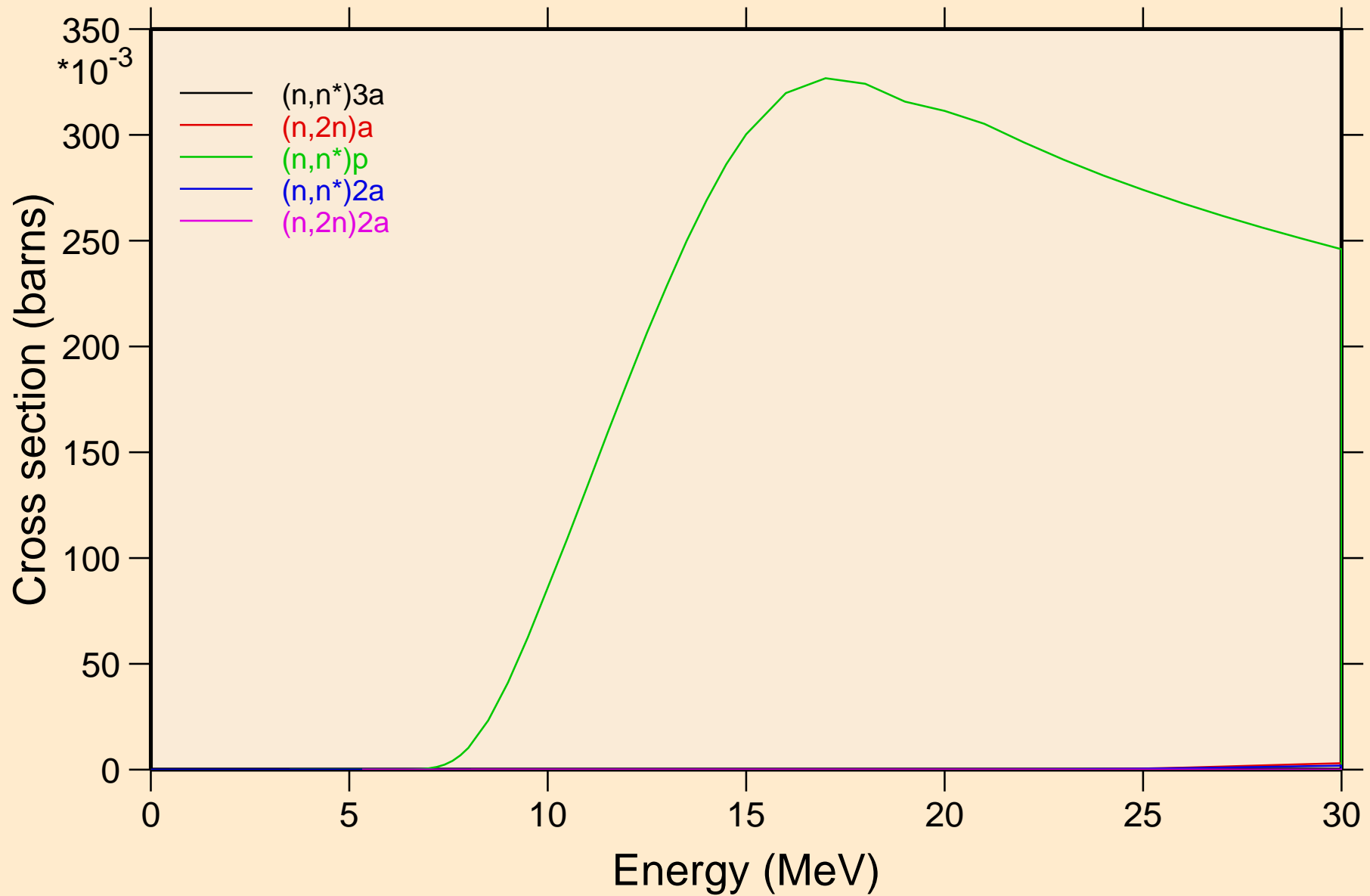

BA119 NEUTRON ACER TENDL-2024 LIBRARY; T=293.6K  
Threshold reactions

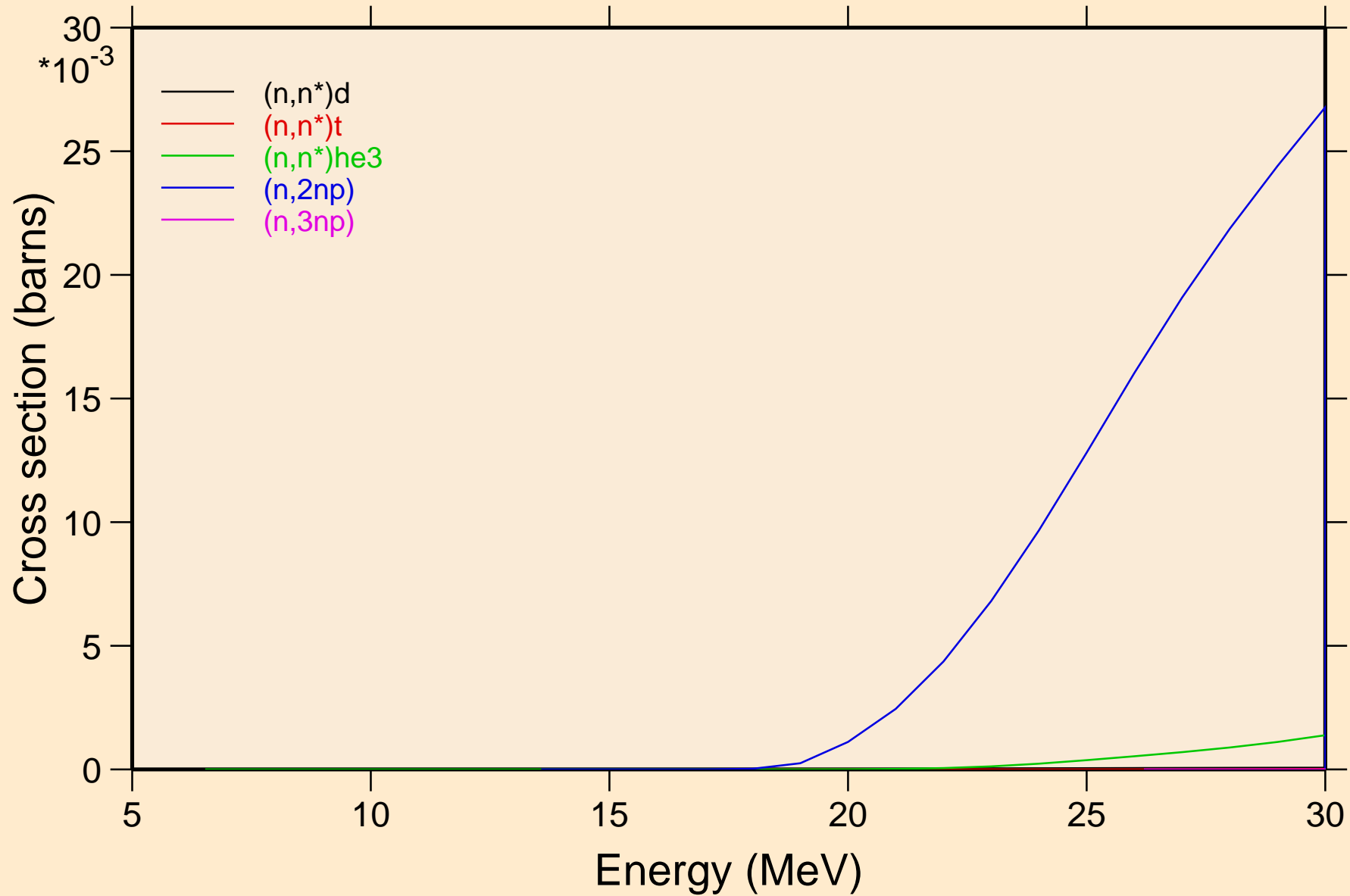

BA119 NEUTRON ACER TENDL-2024 LIBRARY; T=293.6K  
Threshold reactions

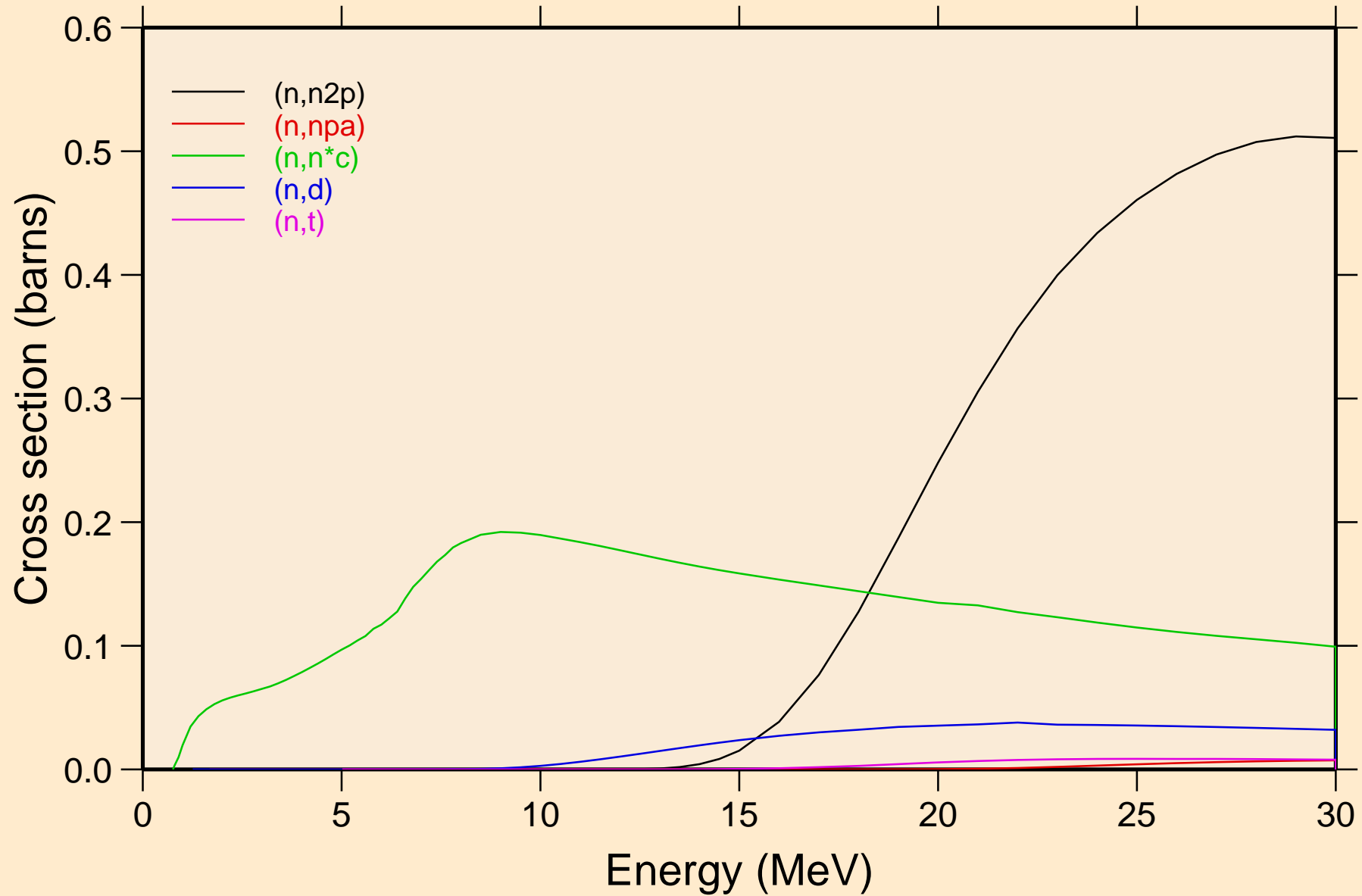

BA119 NEUTRON ACER TENDL-2024 LIBRARY; T=293.6K  
Threshold reactions

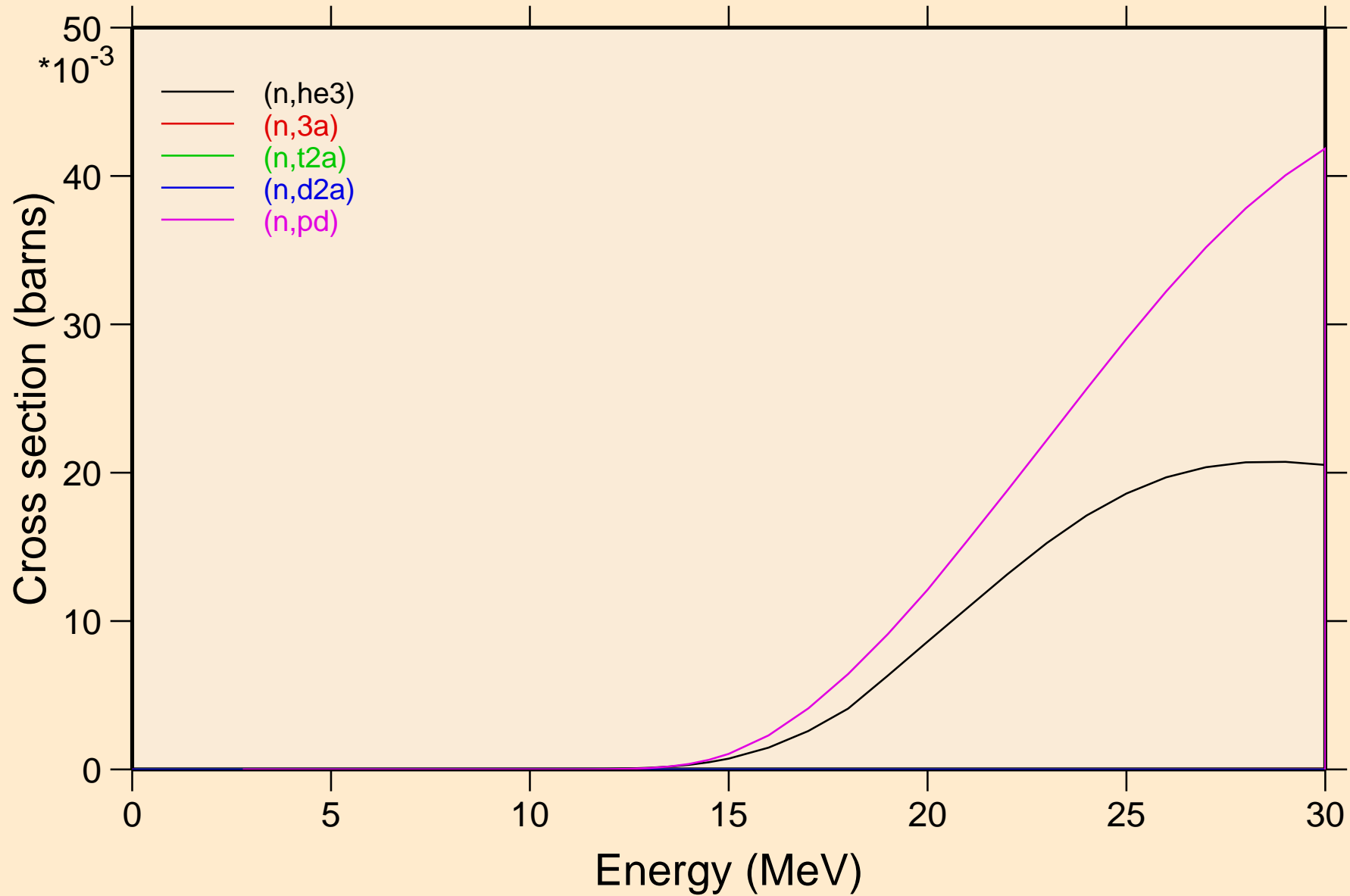

BA119 NEUTRON ACER TENDL-2024 LIBRARY; T=293.6K  
Threshold reactions

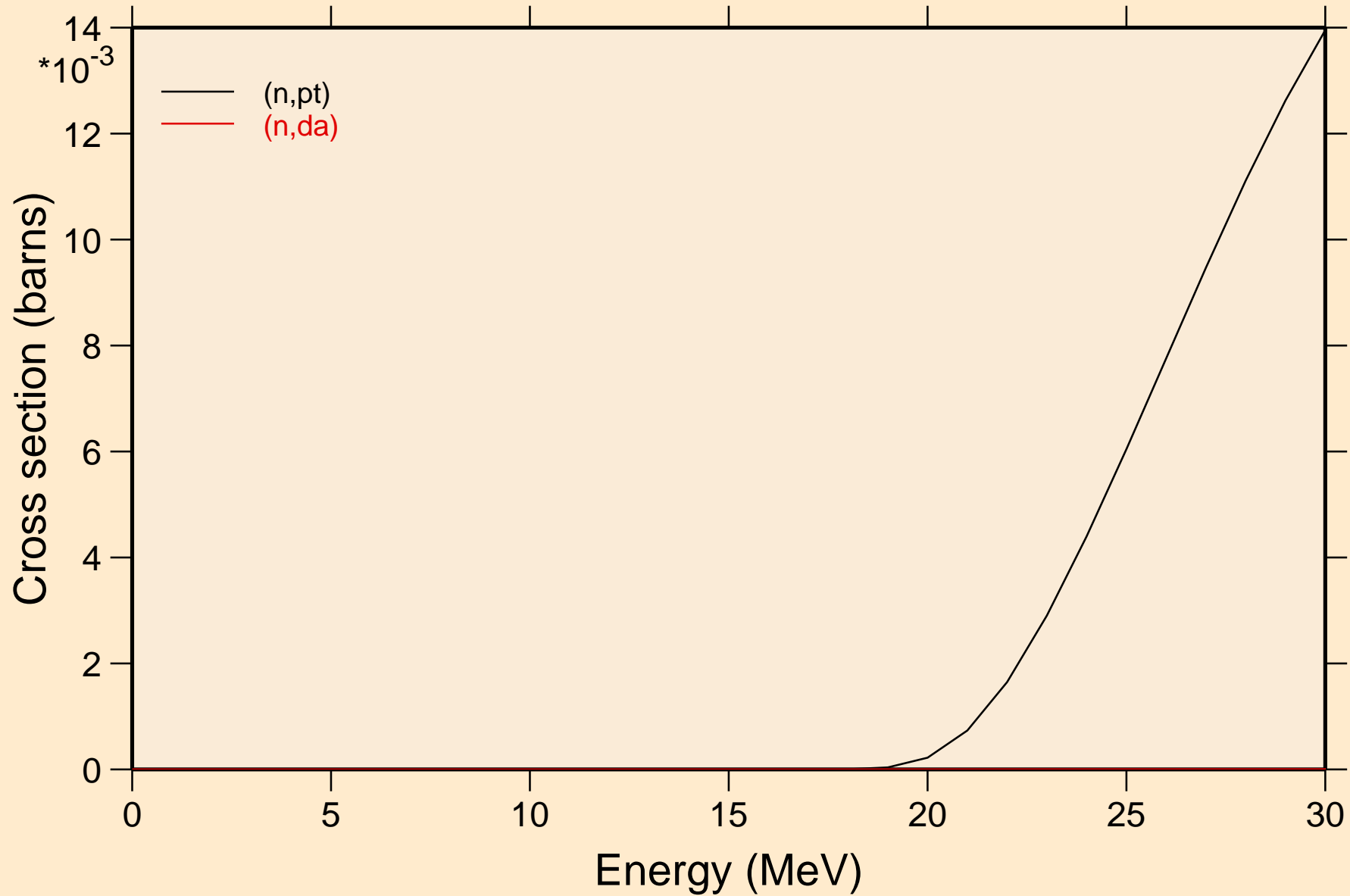

BA119 NEUTRON ACER TENDL-2024 LIBRARY; T=293.6K  
Threshold reactions

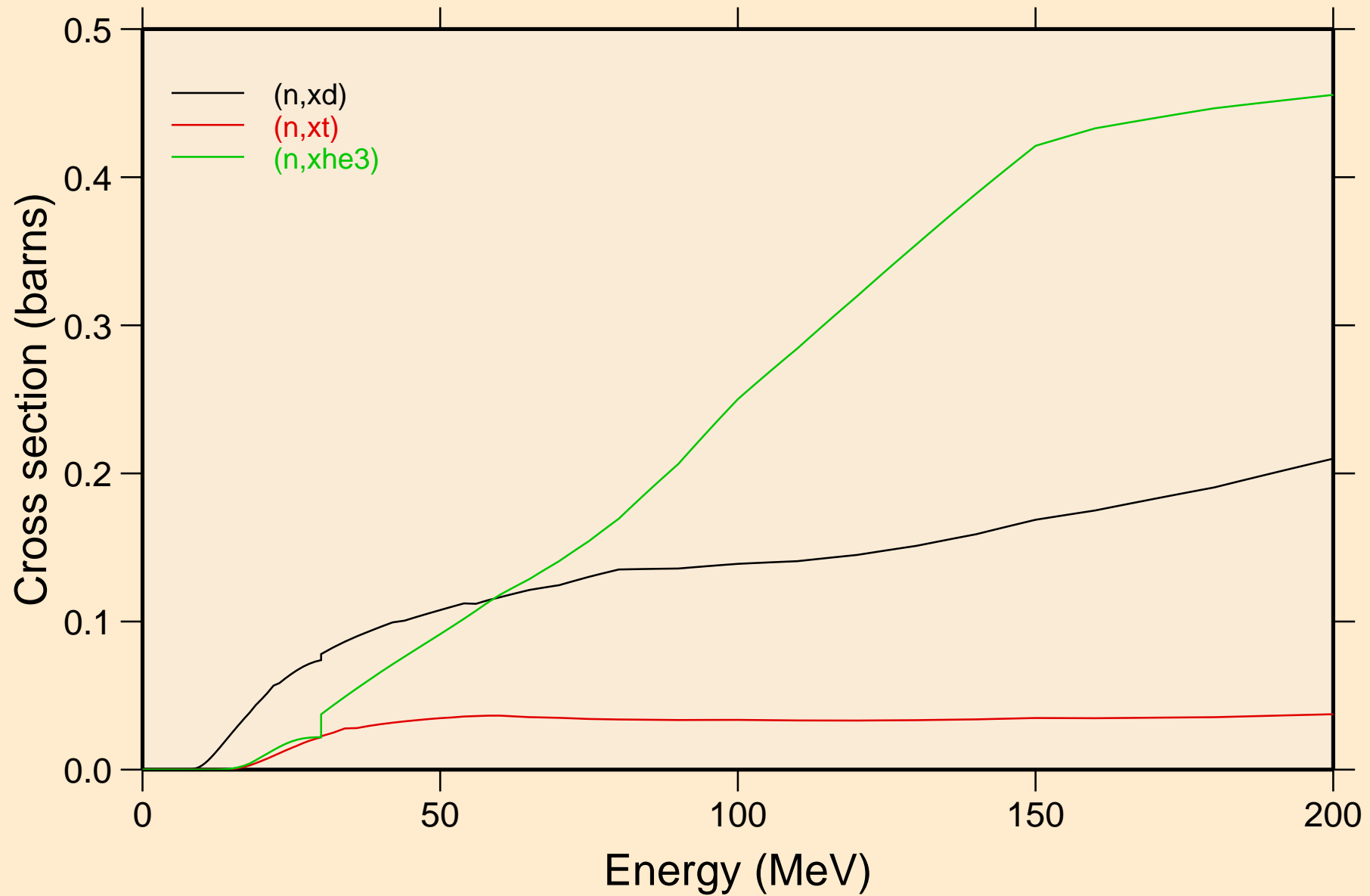

BA119 NEUTRON ACER TENDL-2024 LIBRARY; T=293.6K  
angular distribution for elastic

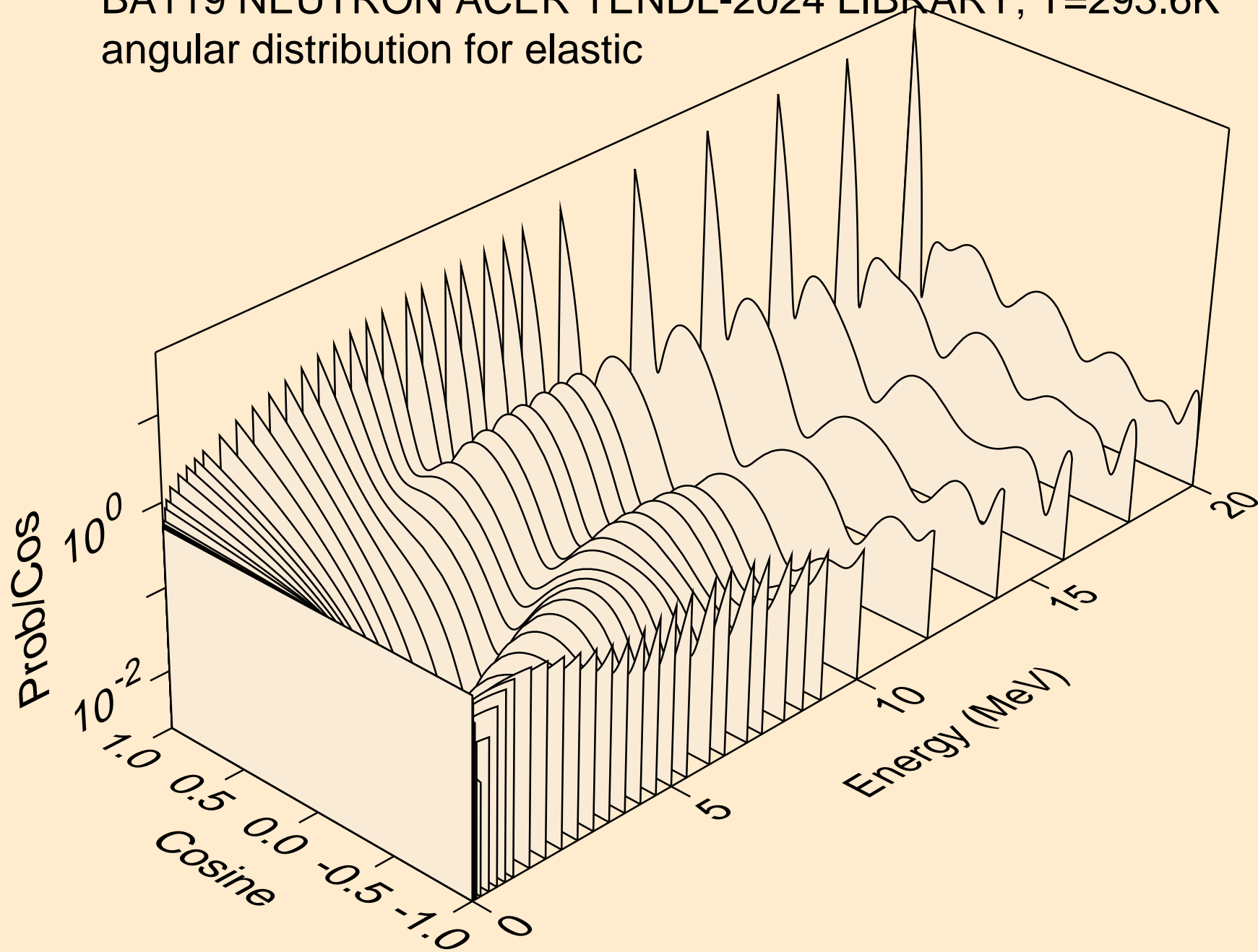

BA119 NEUTRON ACER TENDL-2024 LIBRARY; T=293.6K  
angular distribution for elastic

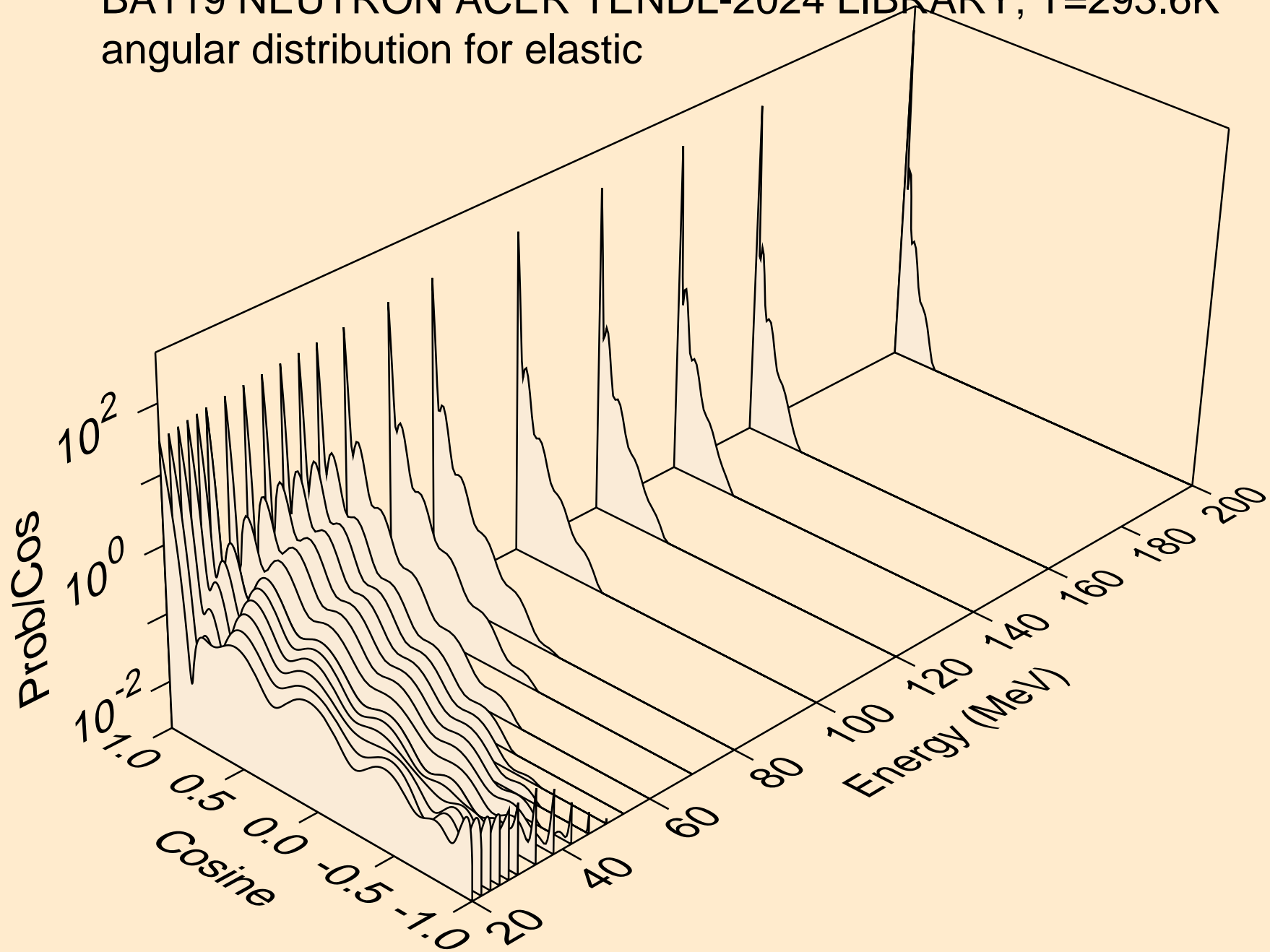

BA119 NEUTRON ACER TENDL-2024 LIBRARY; T=293.6K  
angular distribution for (n,n\*1)

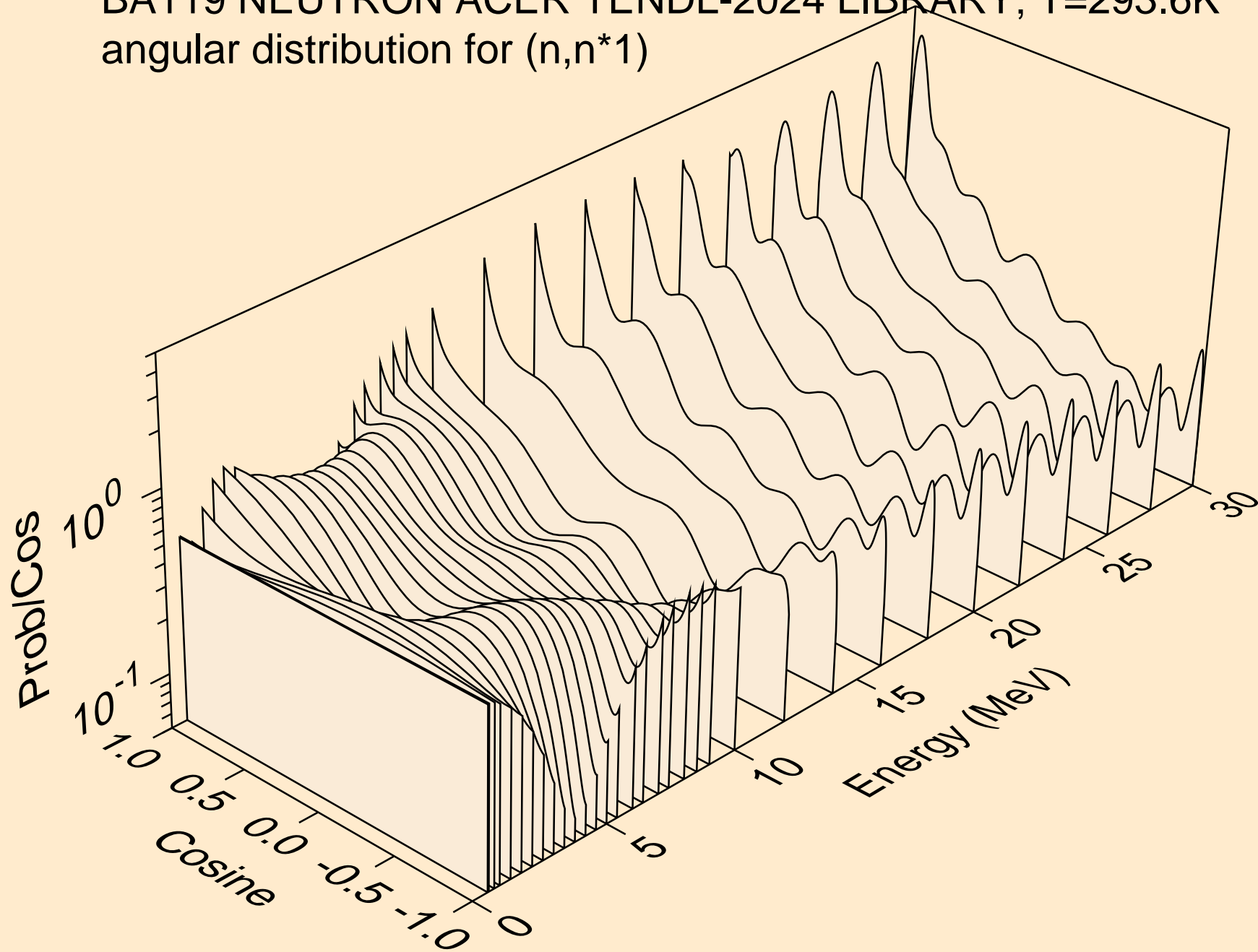

BA119 NEUTRON ACER TENDL-2024 LIBRARY; T=293.6K  
angular distribution for (n,n\*2)

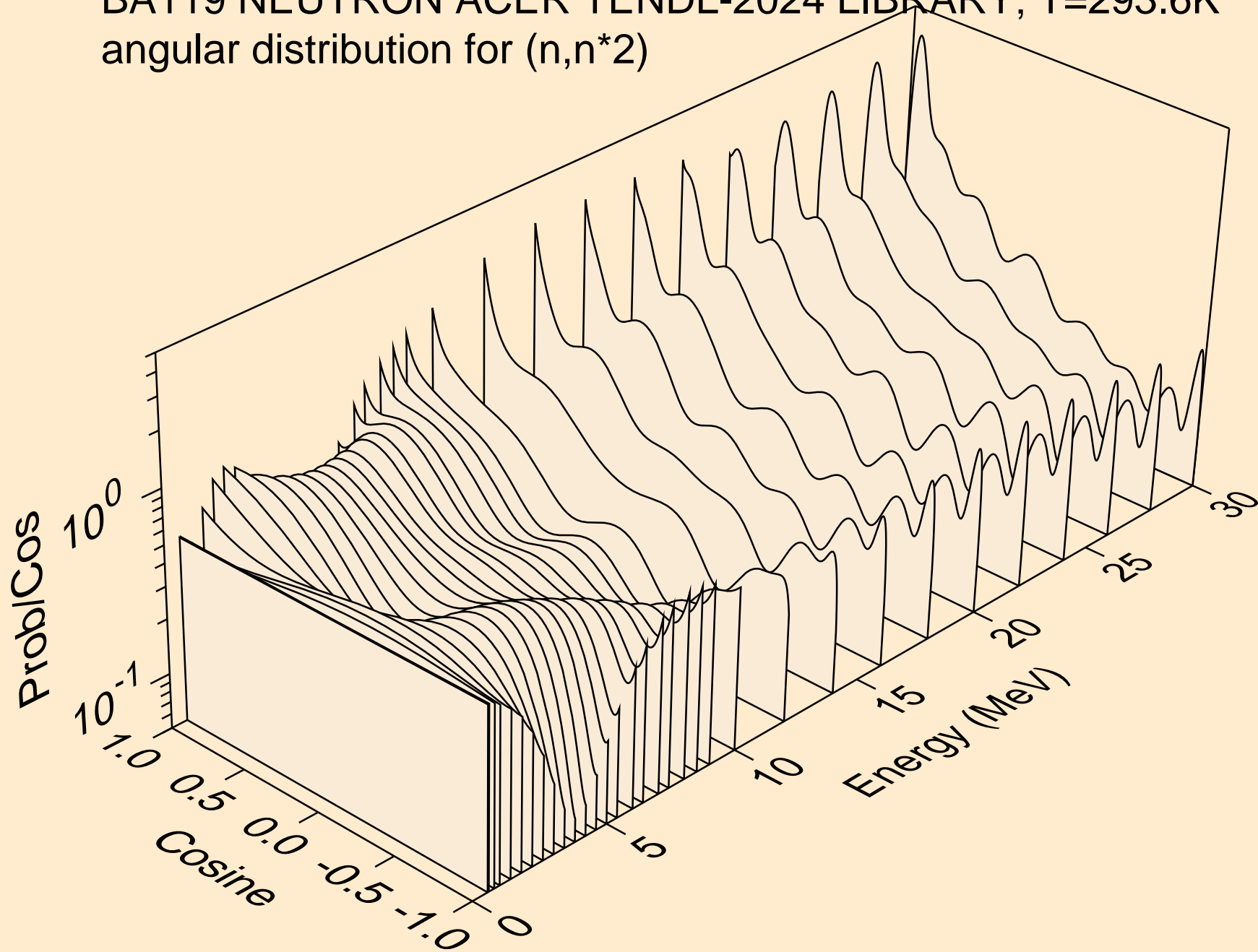

BA119 NEUTRON ACER TENDL-2024 LIBRARY; T=293.6K  
angular distribution for (n,n\*3)

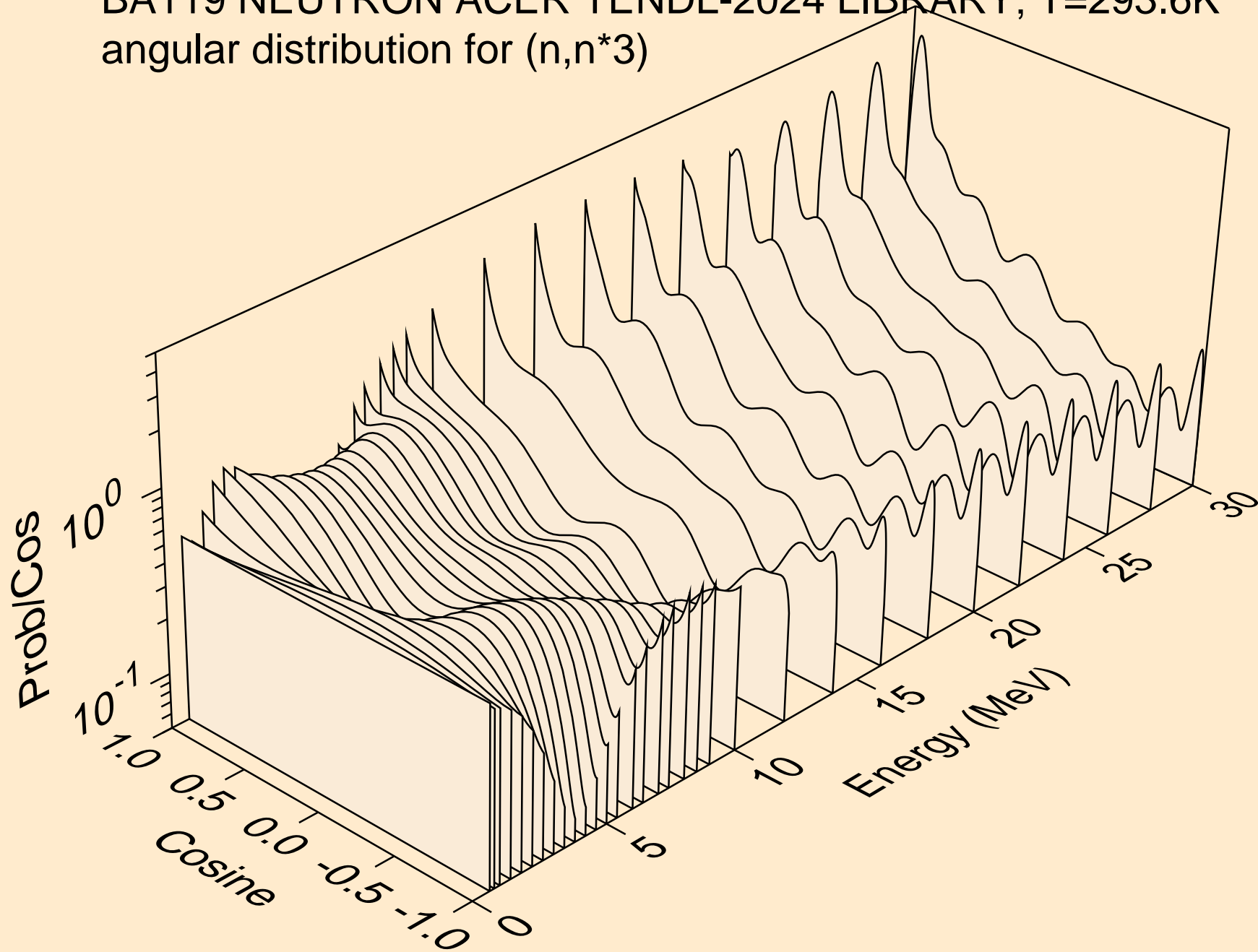

BA119 NEUTRON ACER TENDL-2024 LIBRARY; T=293.6K  
angular distribution for (n,n\*4)

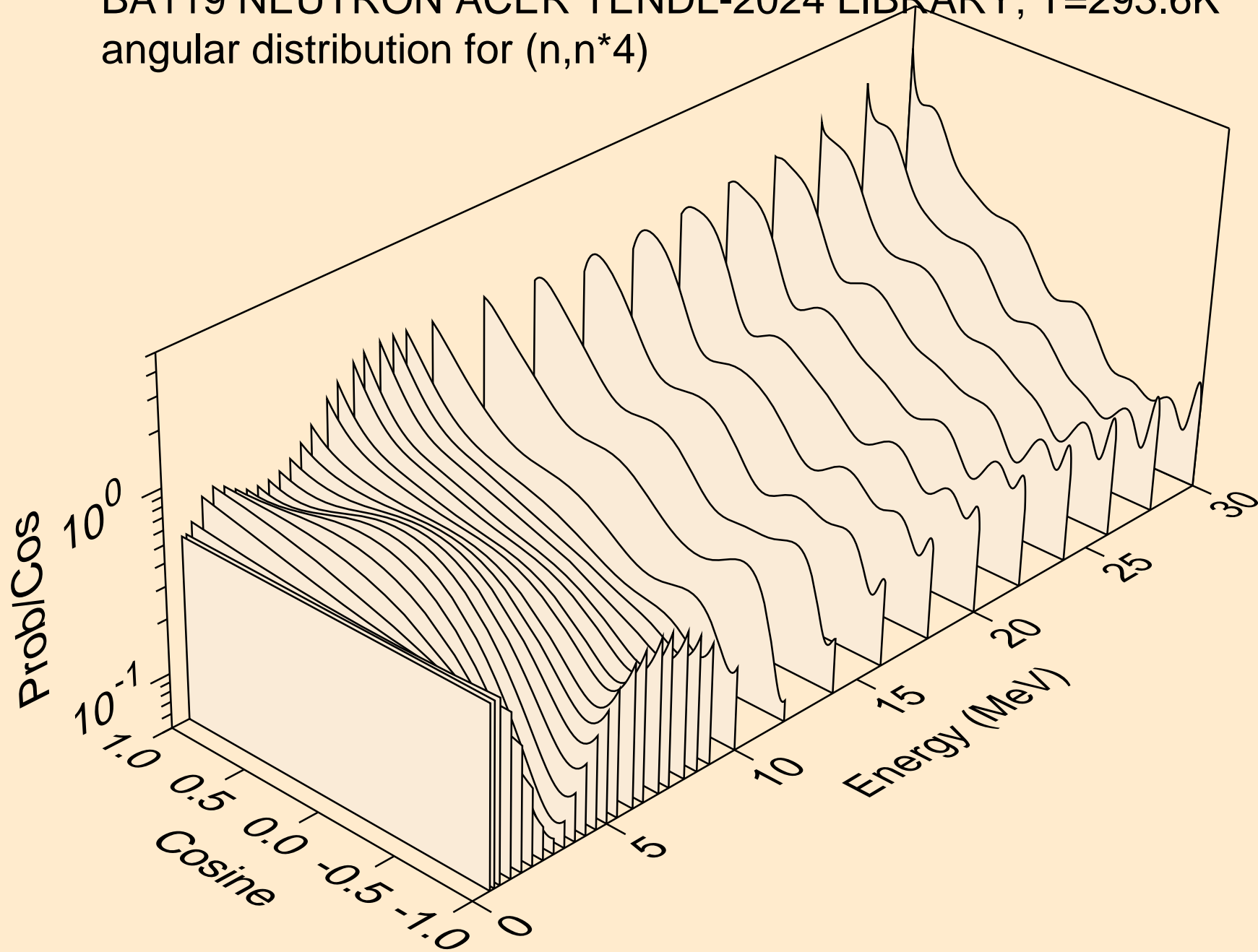

BA119 NEUTRON ACER TENDL-2024 LIBRARY; T=293.6K  
angular distribution for (n,n\*5)

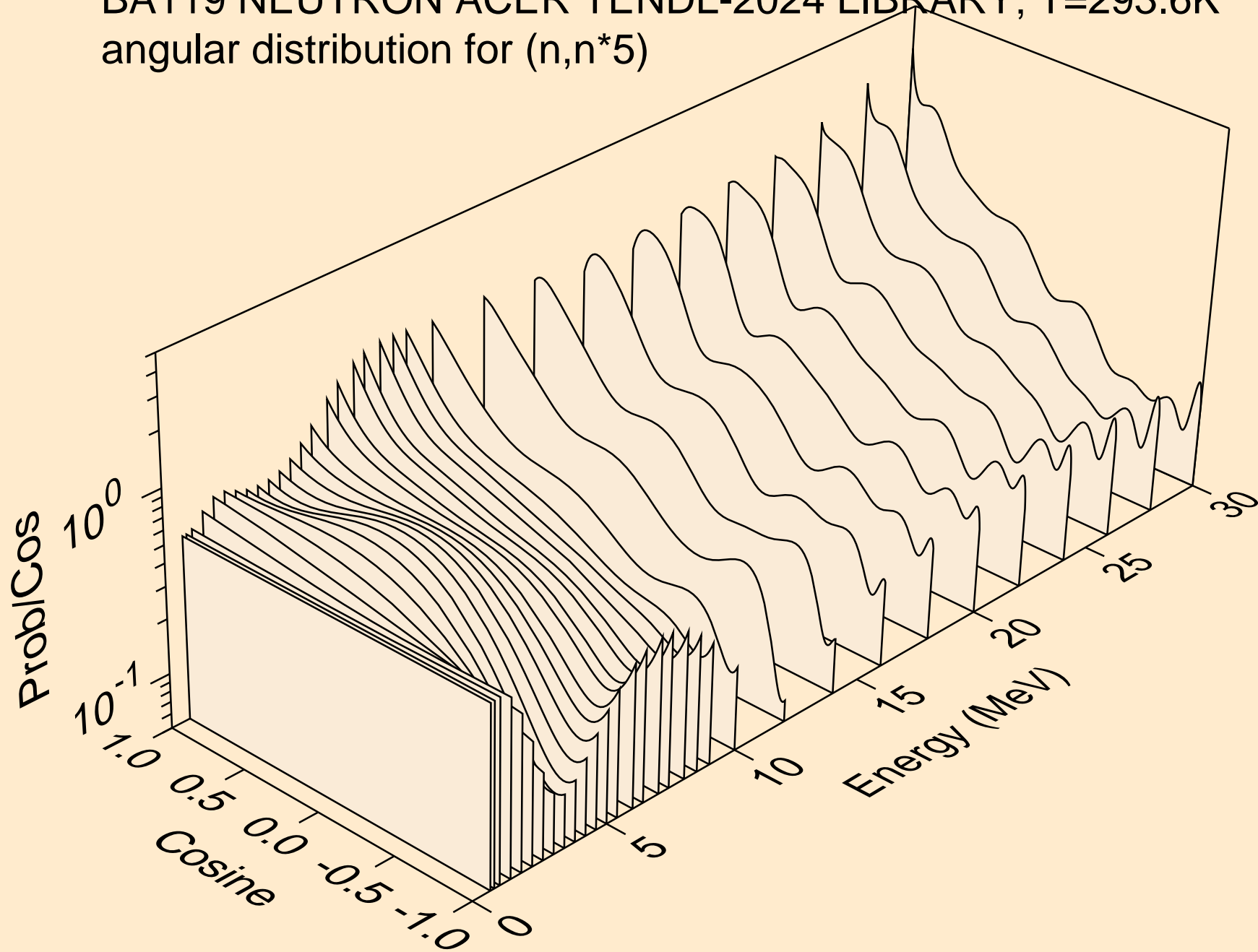

BA119 NEUTRON ACER TENDL-2024 LIBRARY; T=293.6K  
angular distribution for (n,n\*6)

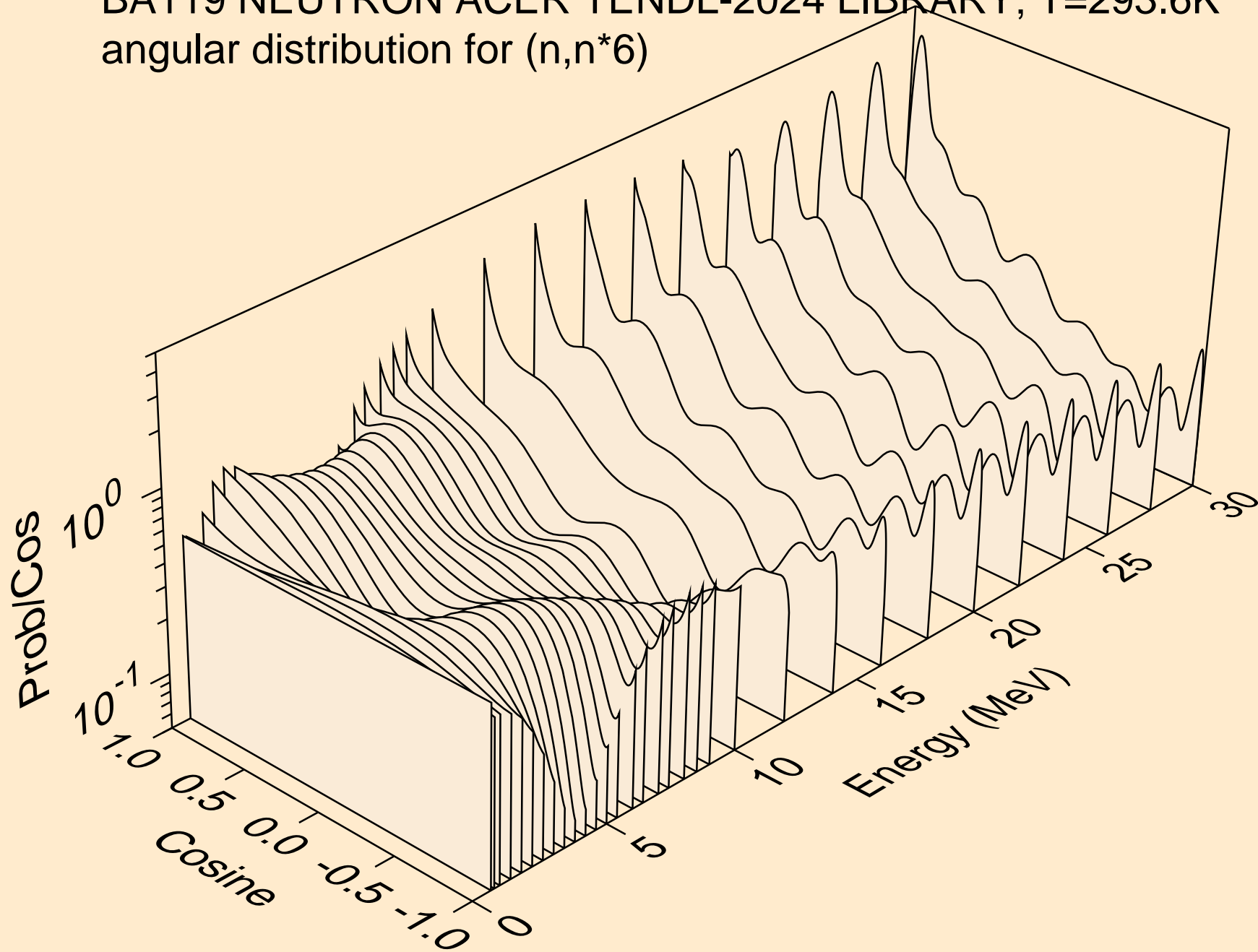

BA119 NEUTRON ACER TENDL-2024 LIBRARY; T=293.6K  
angular distribution for (n,n\*7)

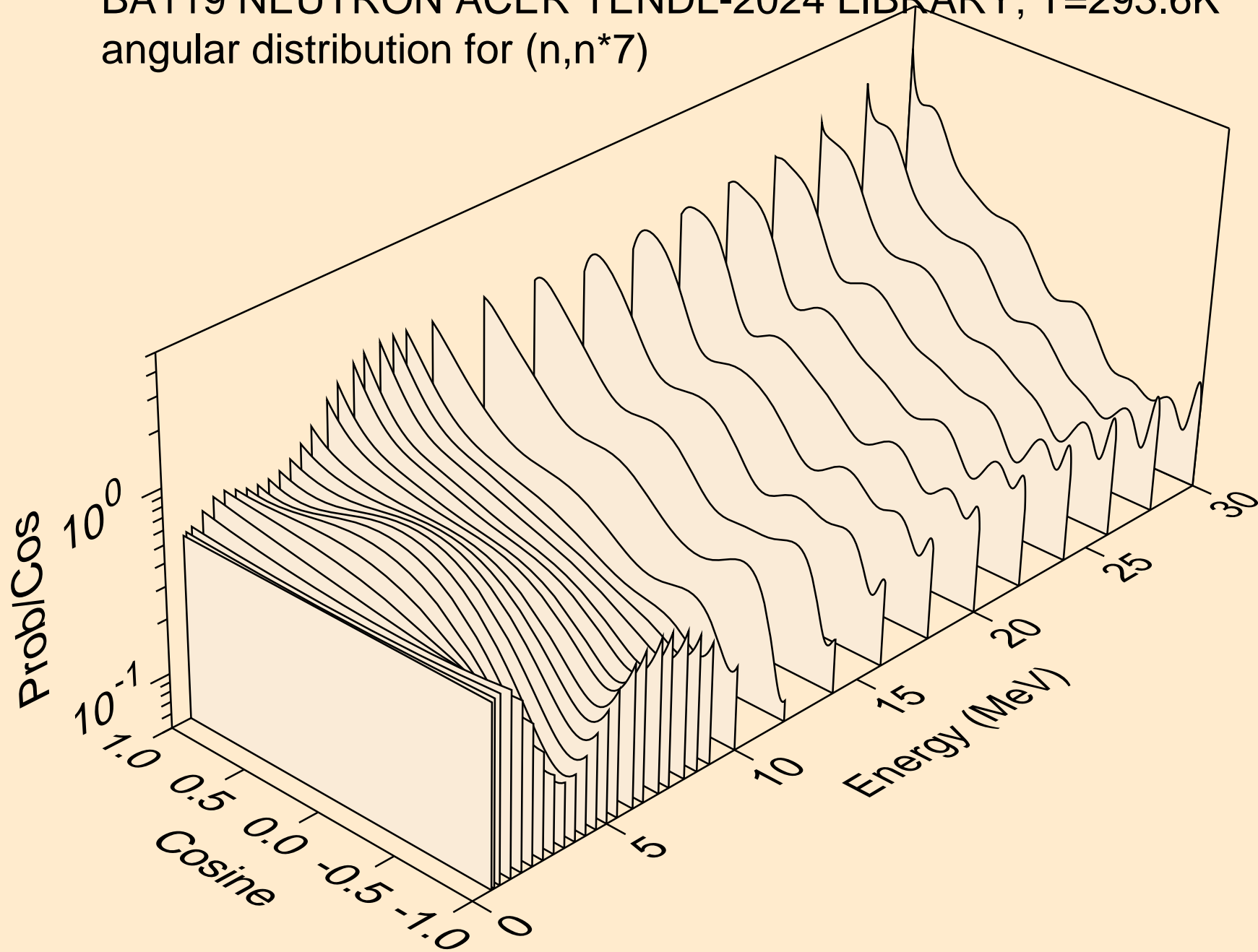

BA119 NEUTRON ACER TENDL-2024 LIBRARY; T=293.6K  
angular distribution for (n,n\*8)

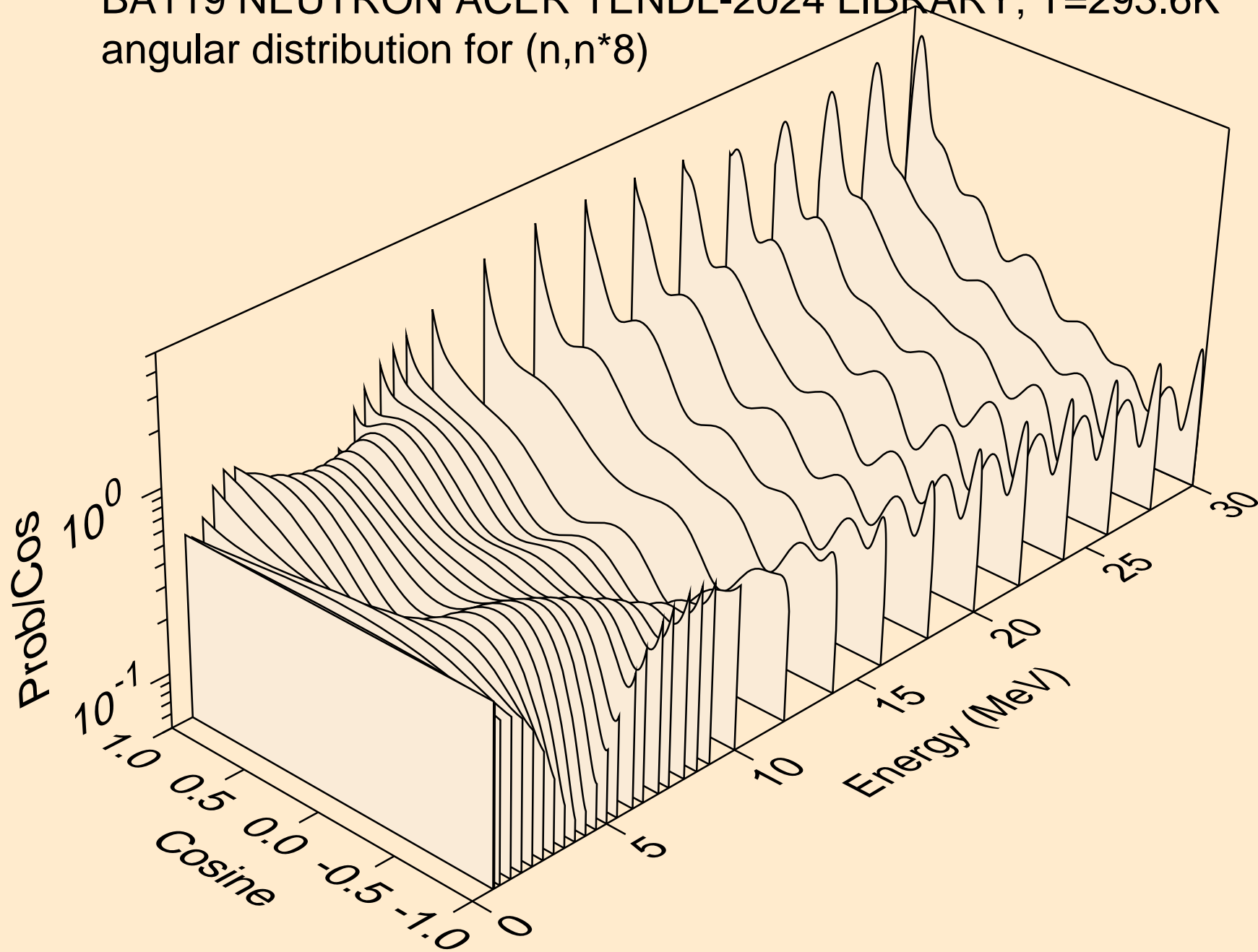

BA119 NEUTRON ACER TENDL-2024 LIBRARY; T=293.6K  
Neutron emission for (n,x)

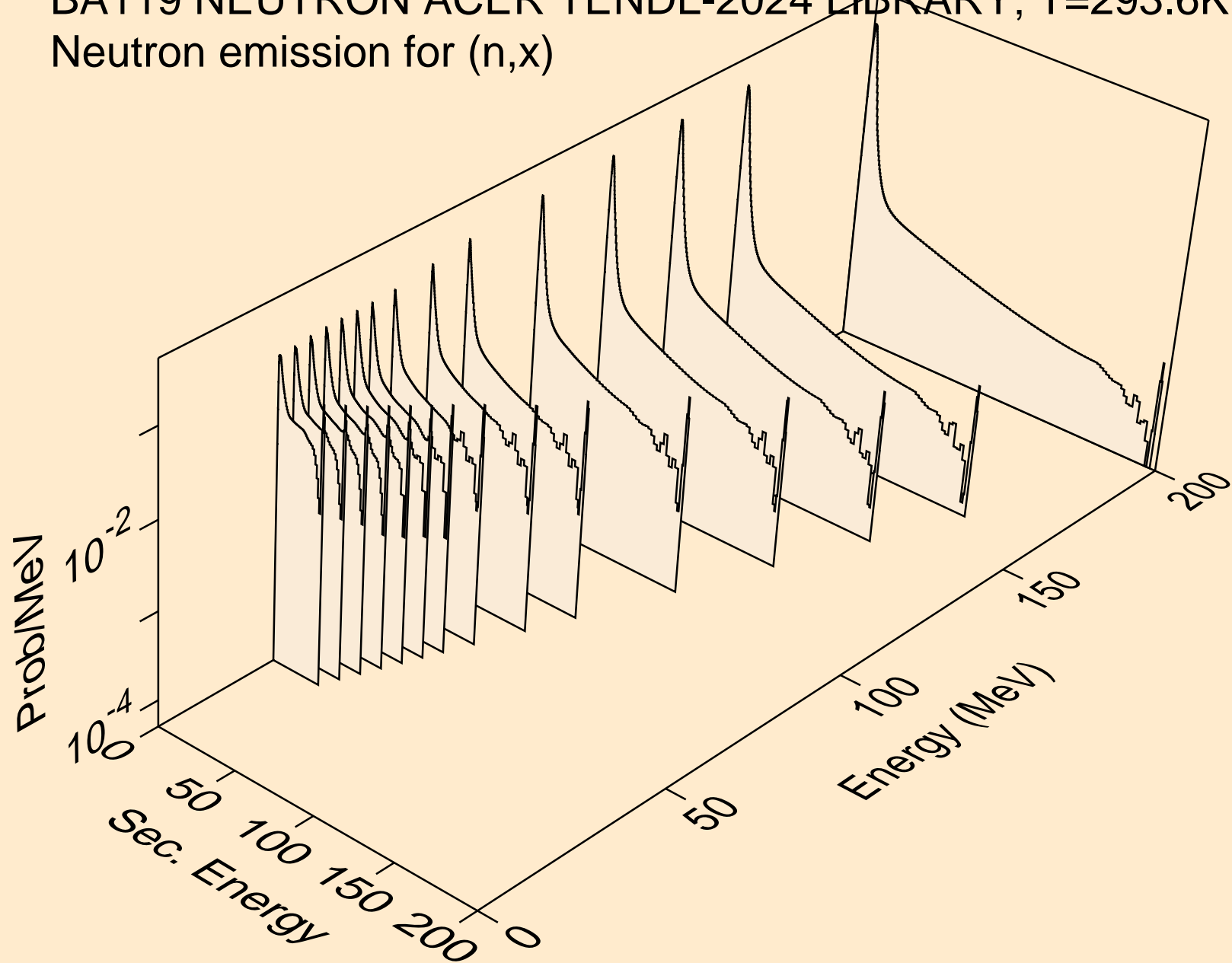

BA119 NEUTRON ACER TENDL-2024 LIBRARY; T=293.6K  
Neutron emission for (n,2nd)

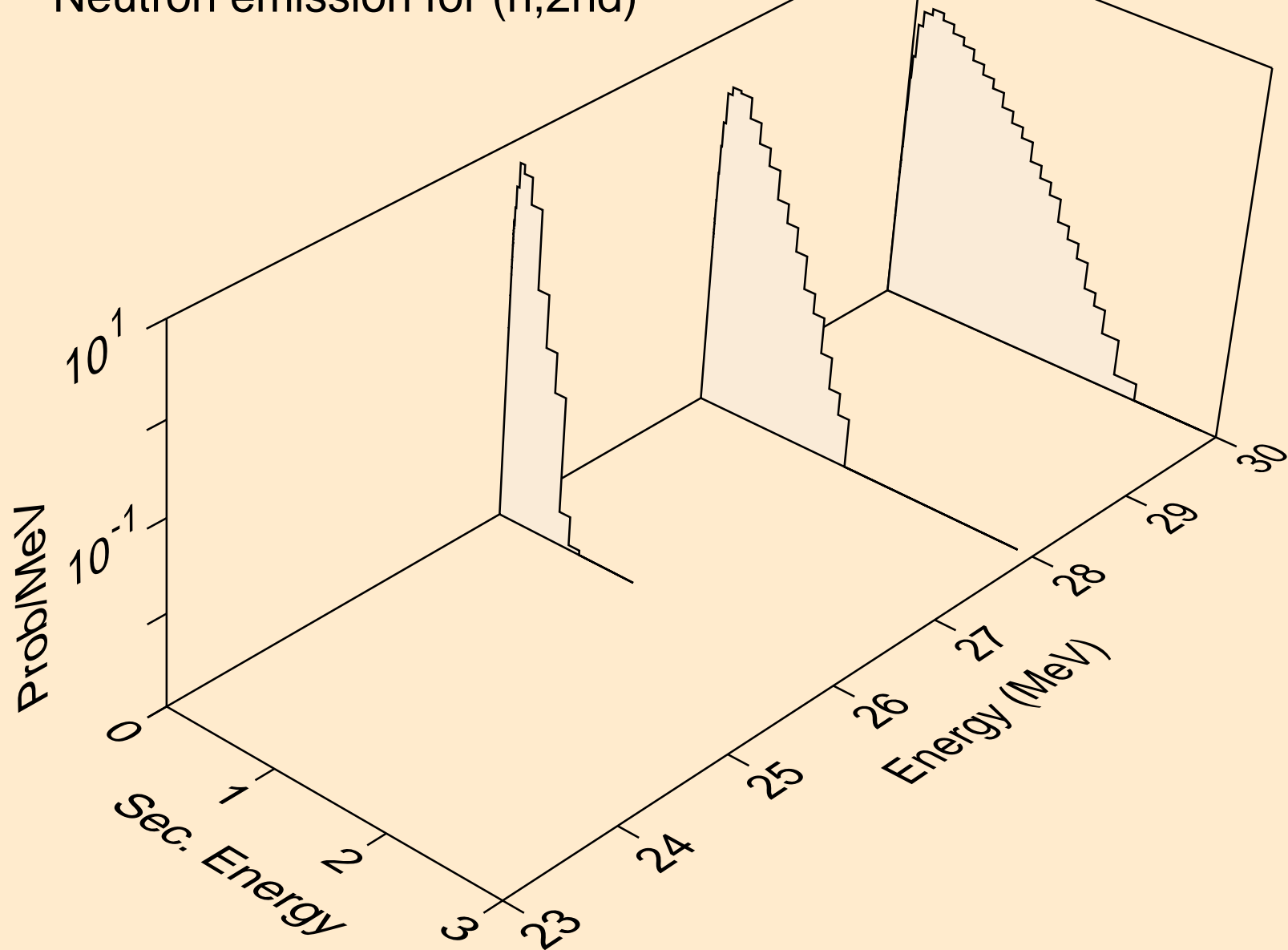

BA119 NEUTRON ACER TENDL-2024 LIBRARY; T=293.6K  
Neutron emission for (n,2n)

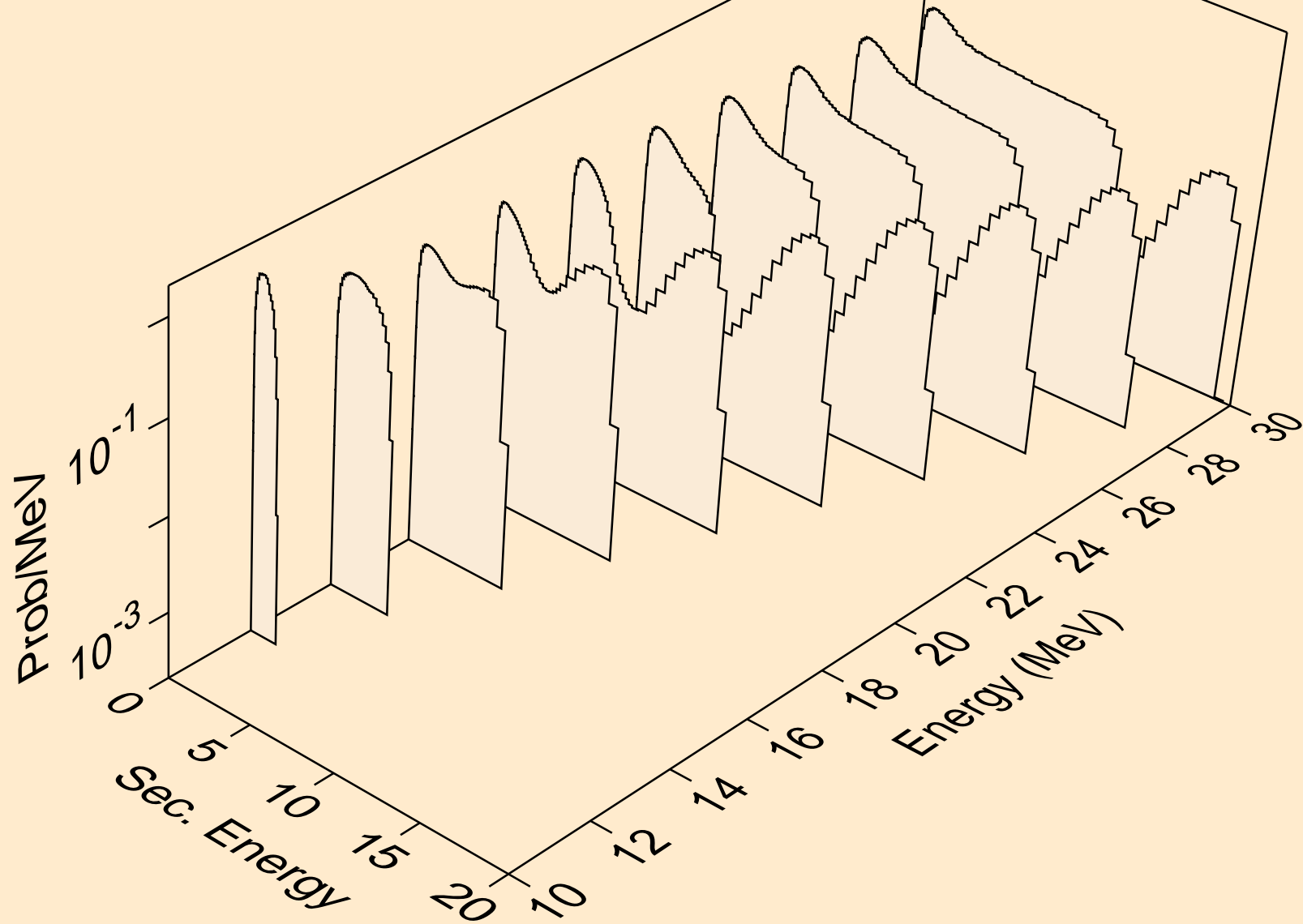

BA119 NEUTRON ACER TENDL-2024 LIBRARY; T=293.6K  
Neutron emission for (n,3n)

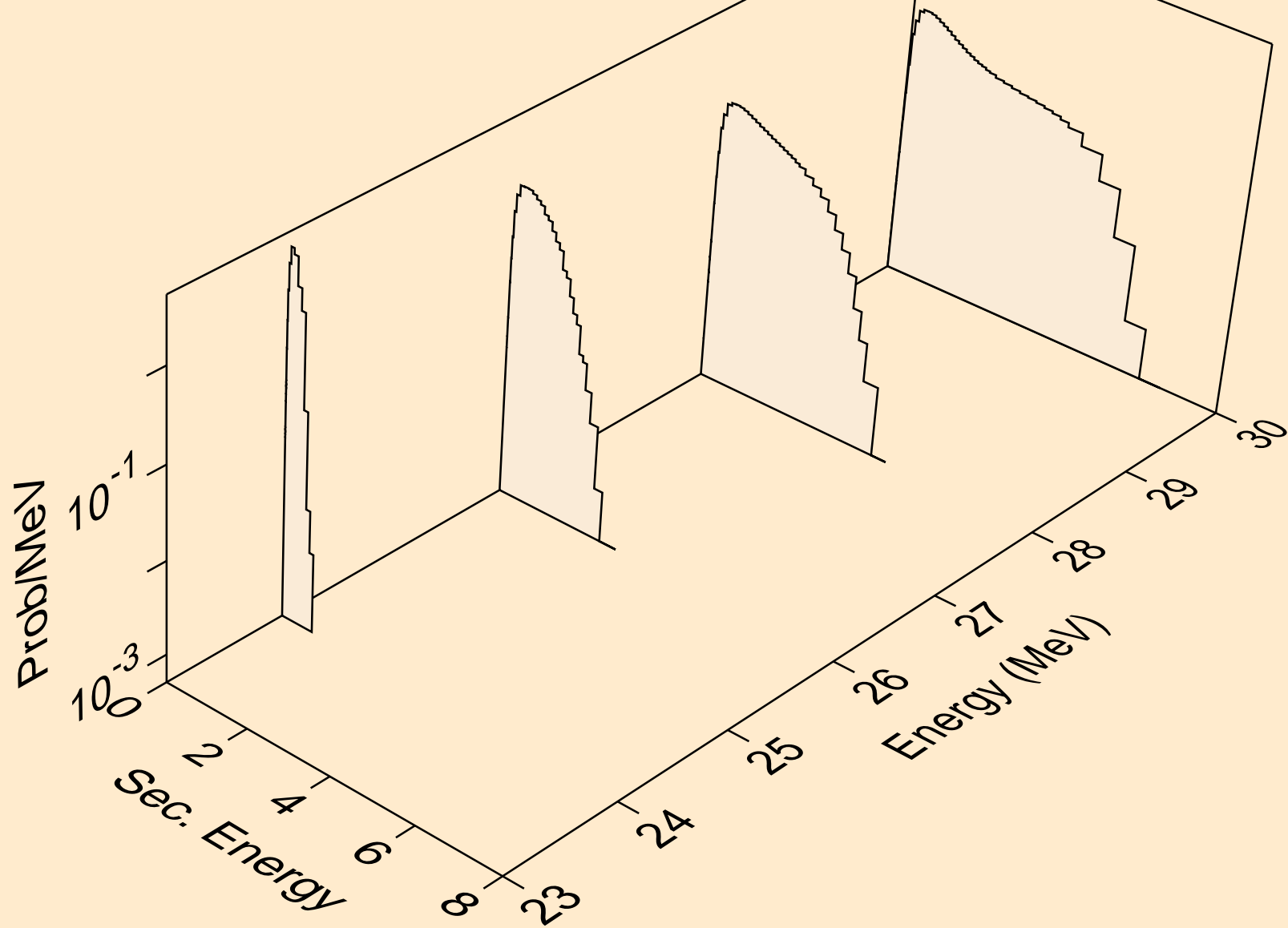

BA119 NEUTRON ACER TENDL-2024 LIBRARY; T=293.6K  
Neutron emission for (n,n\*)a

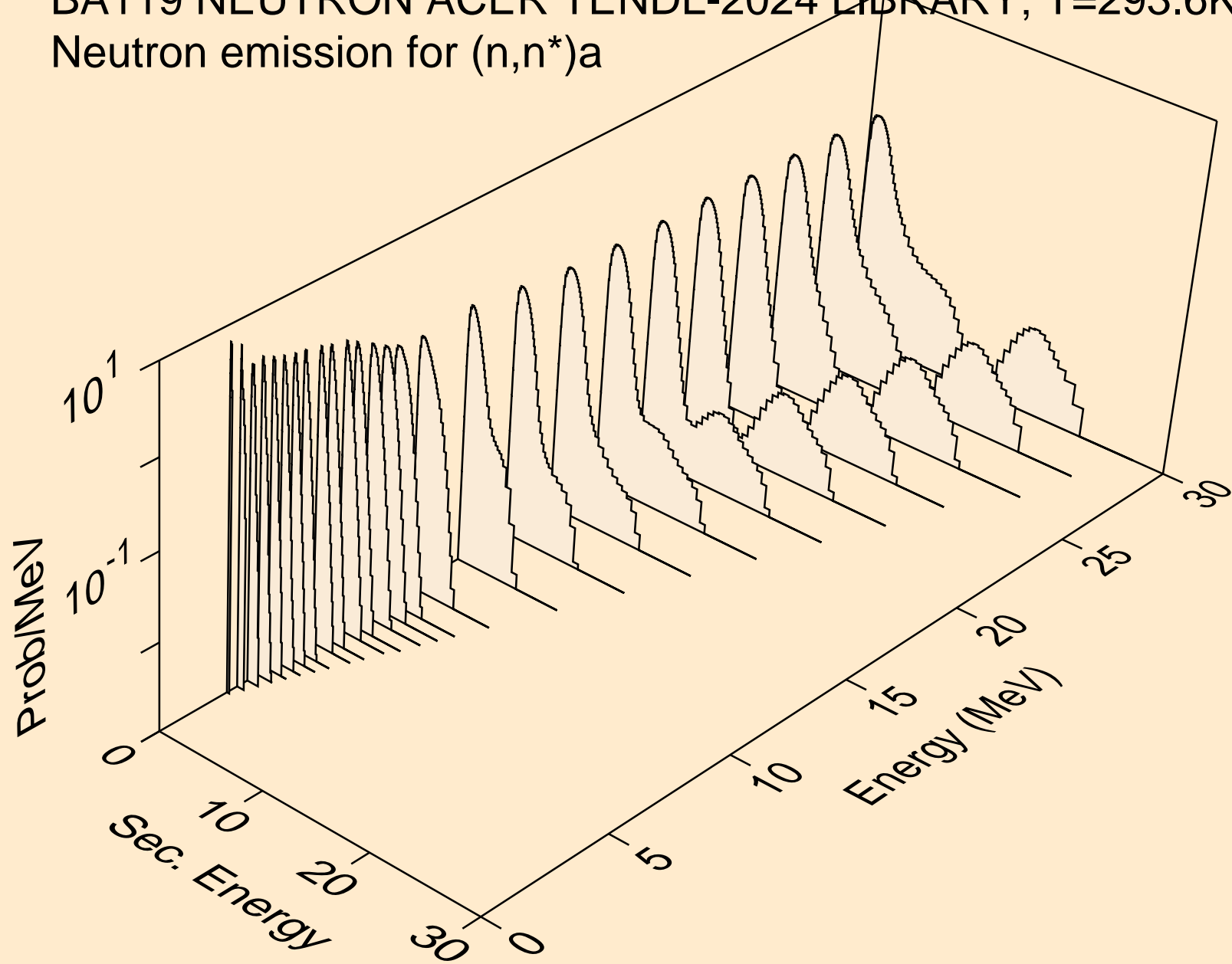

BA119 NEUTRON ACER TENDL-2024 LIBRARY; T=293.6K  
Neutron emission for (n,n\*)3a

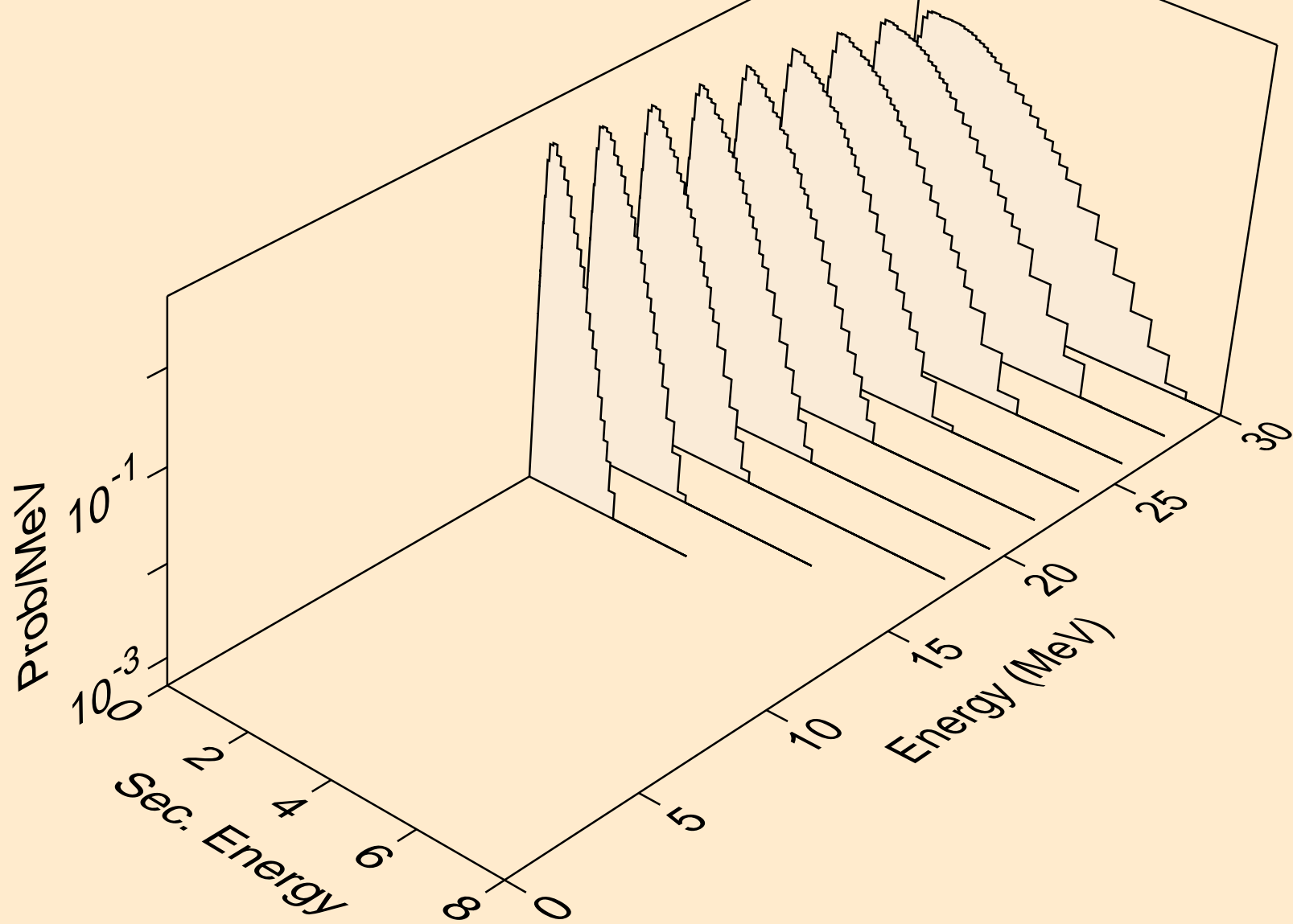

BA119 NEUTRON ACER TENDL-2024 LIBRARY; T=293.6K  
Neutron emission for (n,2n)<sub>a</sub>

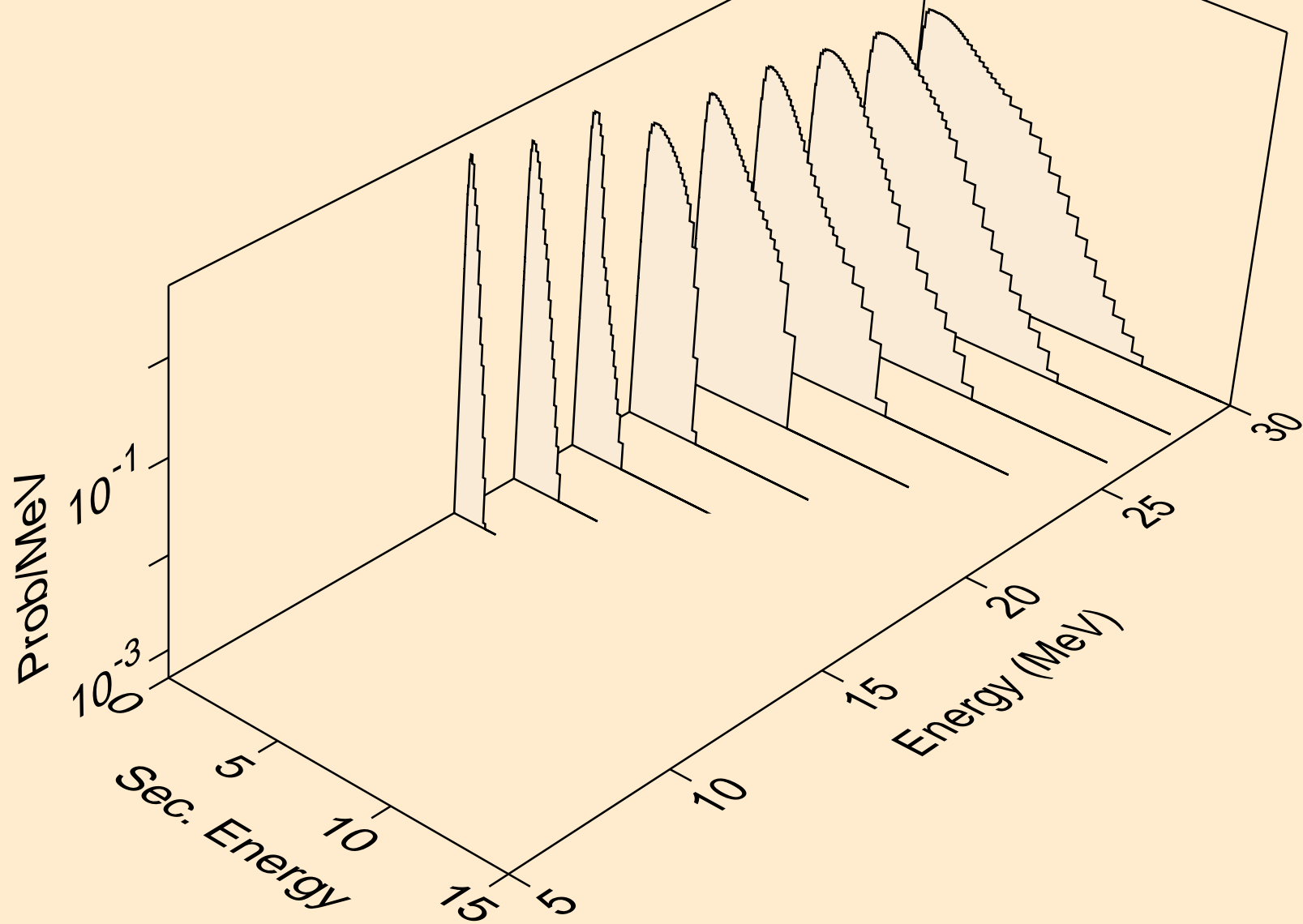

BA119 NEUTRON ACER TENDL-2024 LIBRARY; T=293.6K  
Neutron emission for (n,n\*)p

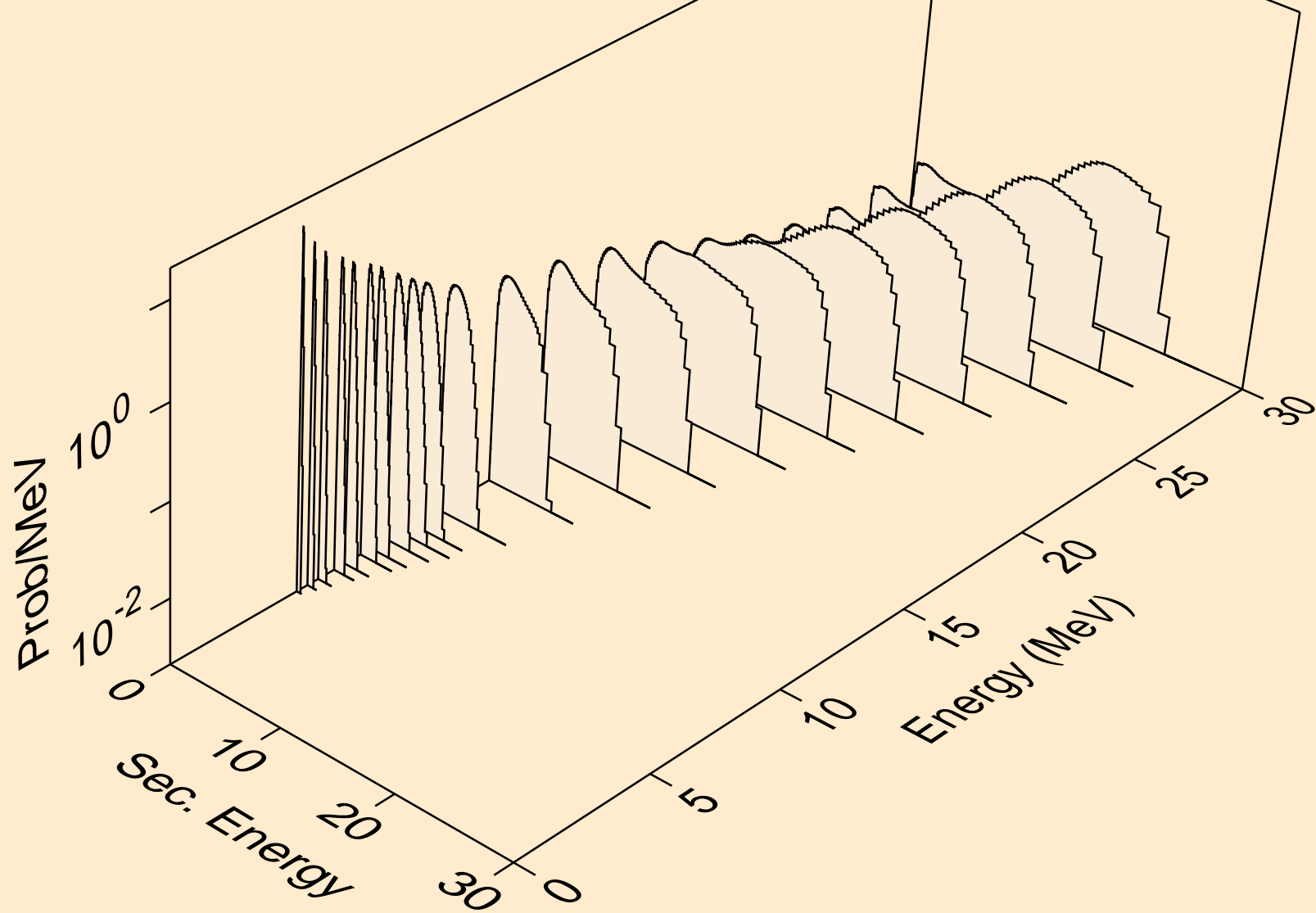

BA119 NEUTRON ACER TENDL-2024 LIBRARY; T=293.6K  
Neutron emission for (n,n\*)2a

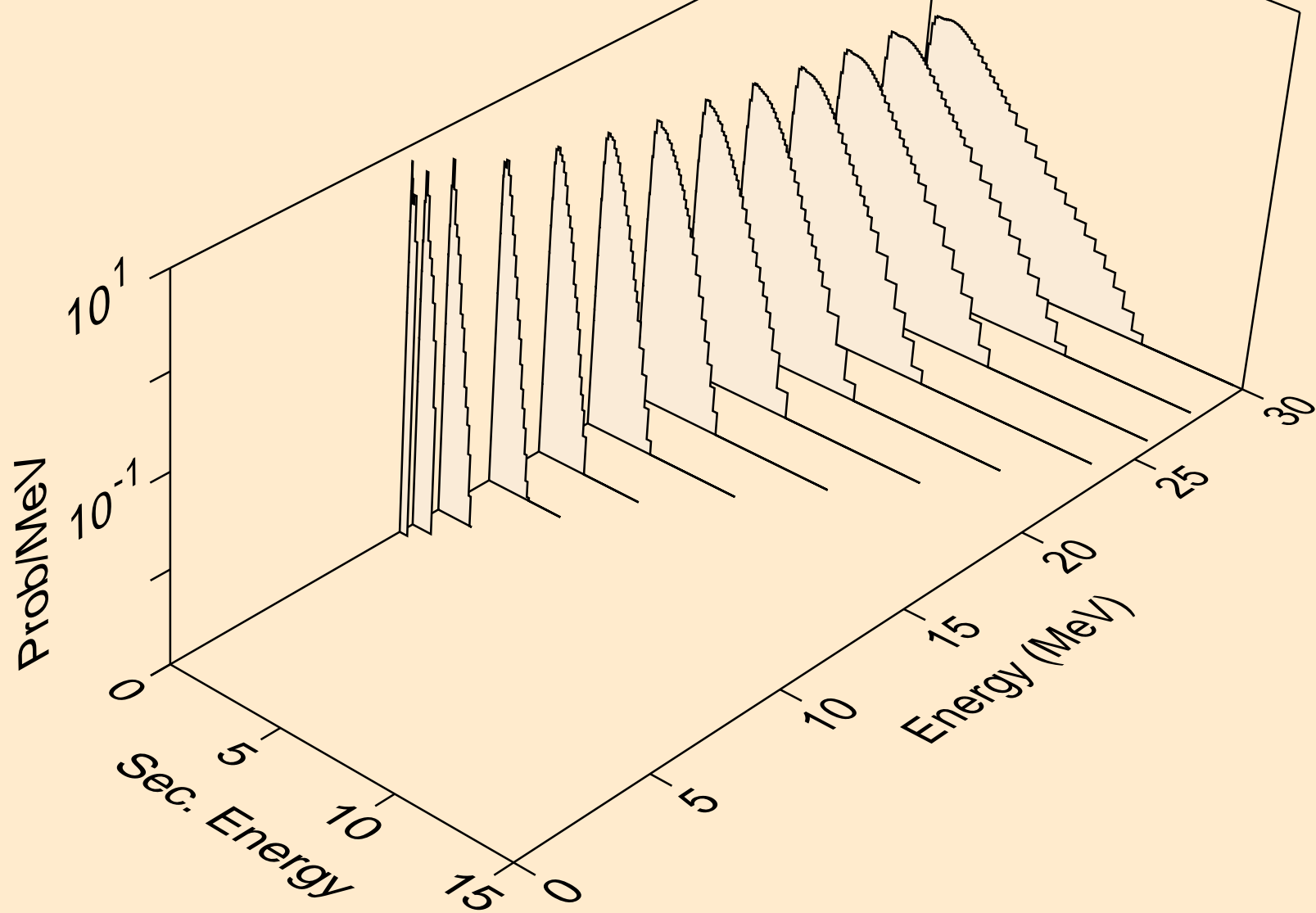

BA119 NEUTRON ACER TENDL-2024 LIBRARY; T=293.6K  
Neutron emission for (n,2n)2a

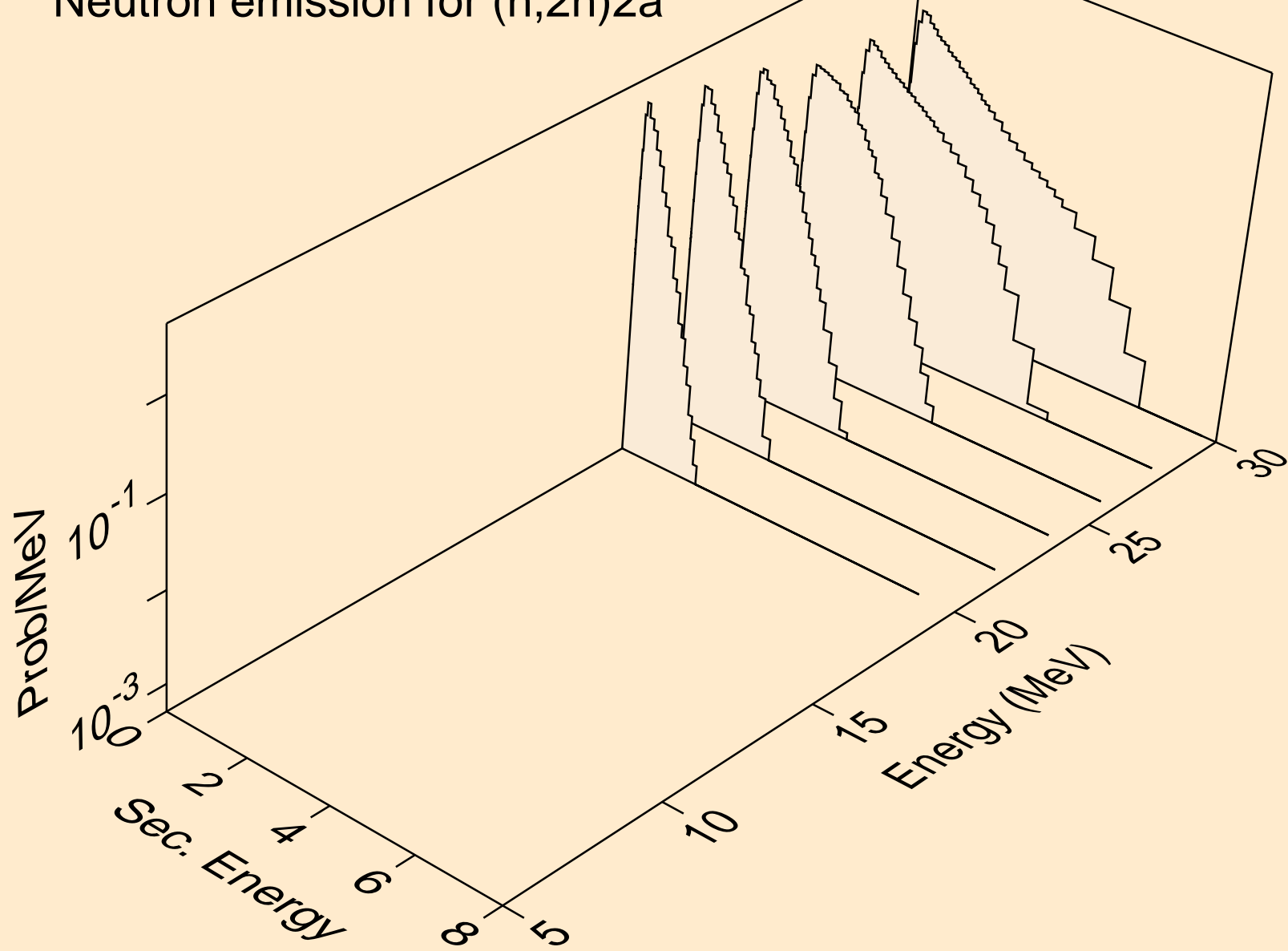

BA119 NEUTRON ACER TENDL-2024 LIBRARY; T=293.6K  
Neutron emission for (n,n\*)d

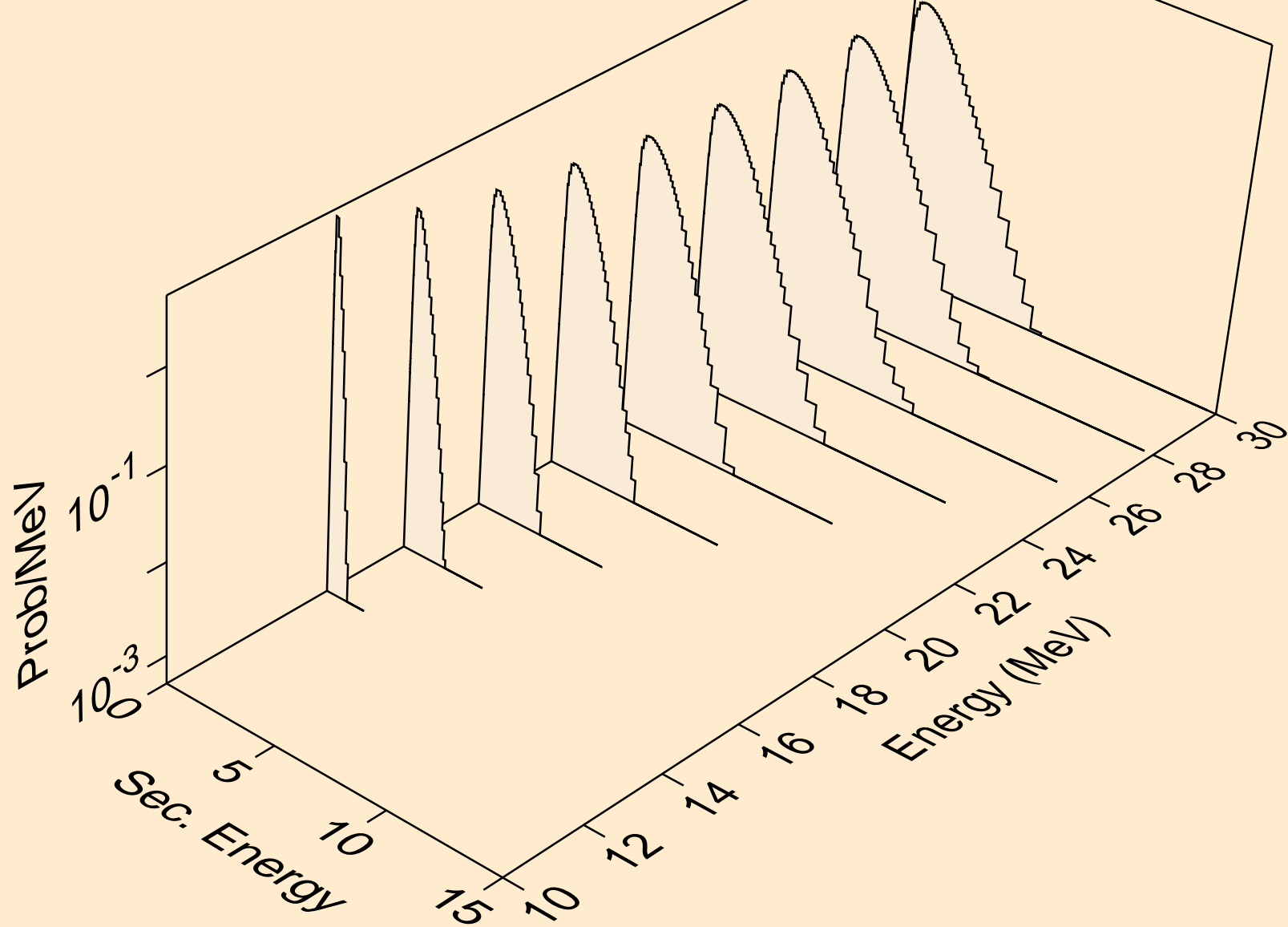

BA119 NEUTRON ACER TENDL-2024 LIBRARY; T=293.6K  
Neutron emission for (n,n\*)t

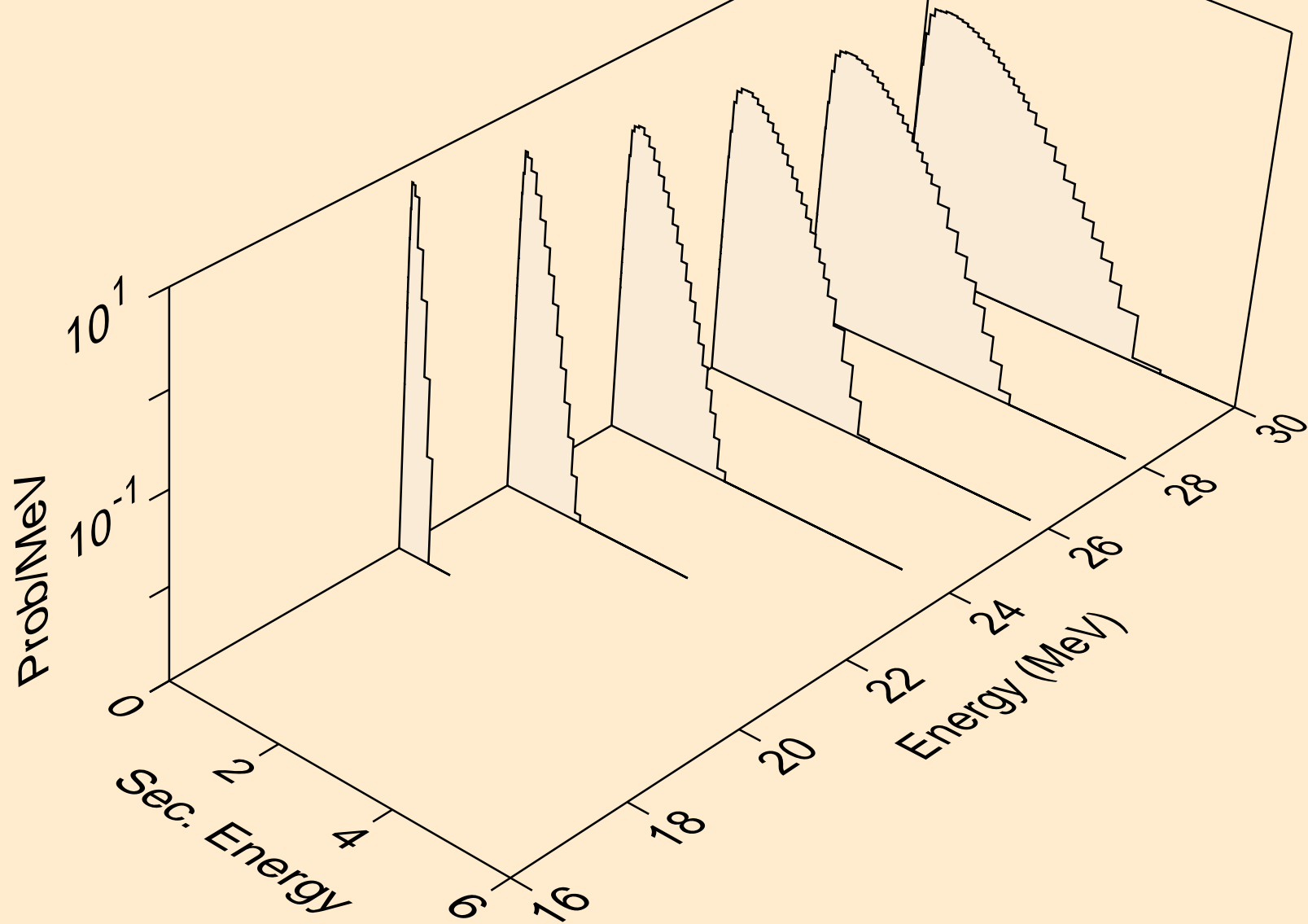

BA119 NEUTRON ACER TENDL-2024 LIBRARY; T=293.6K  
Neutron emission for (n,n\*)he3

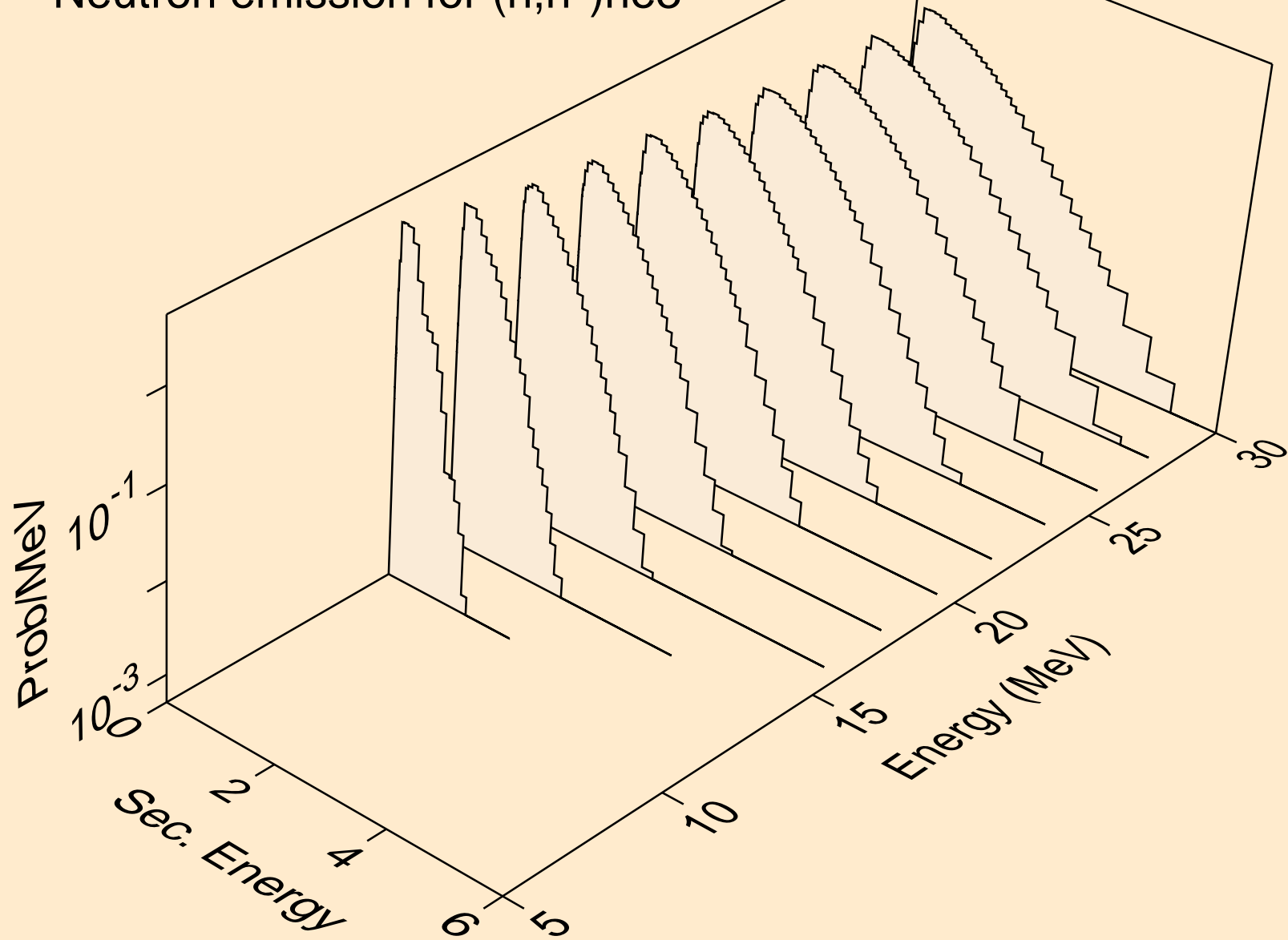

BA119 NEUTRON ACER TENDL-2024 LIBRARY; T=293.6K  
Neutron emission for (n,2np)

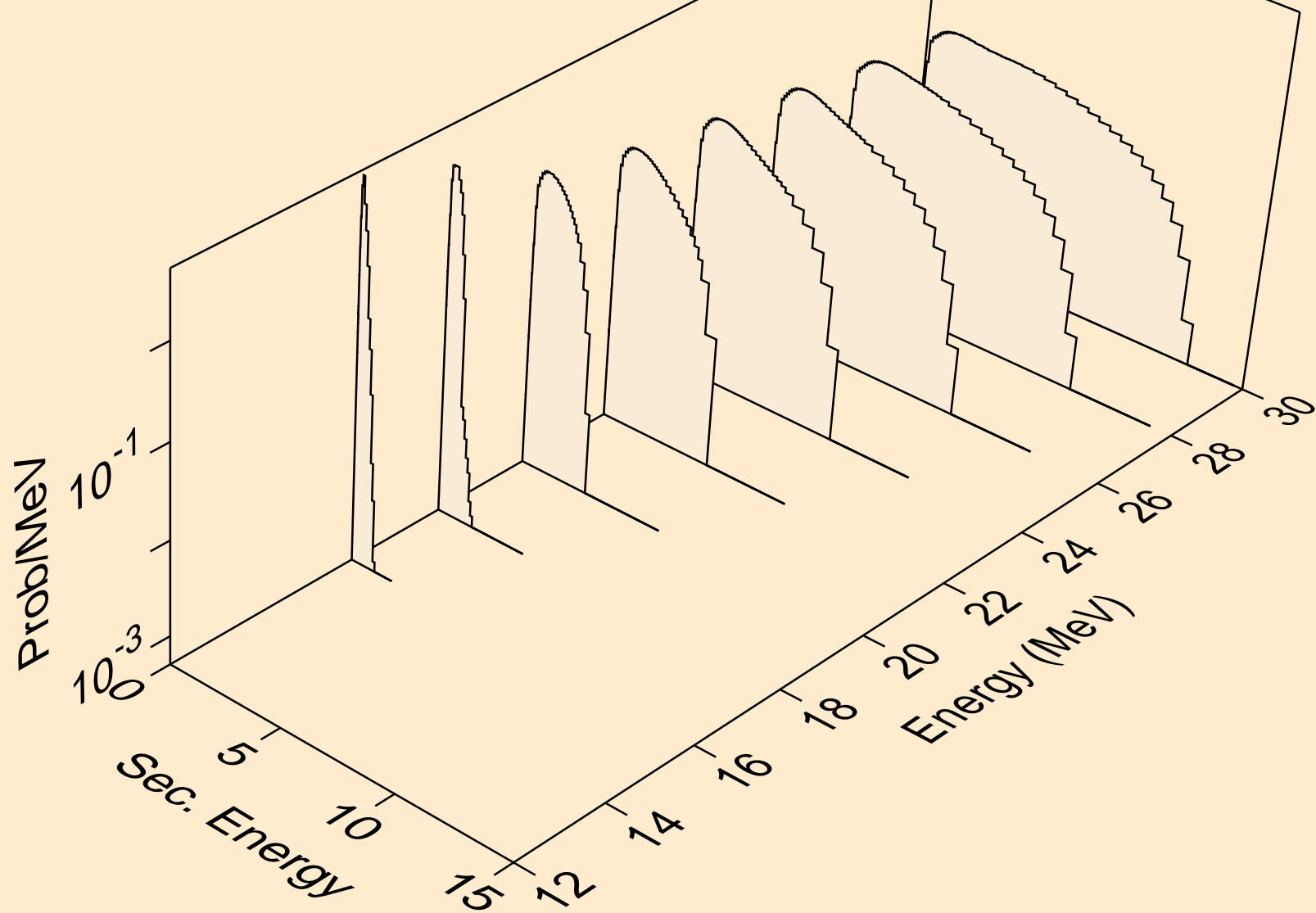

BA119 NEUTRON ACER TENDL-2024 LIBRARY; T=293.6K  
Neutron emission for (n,3np)

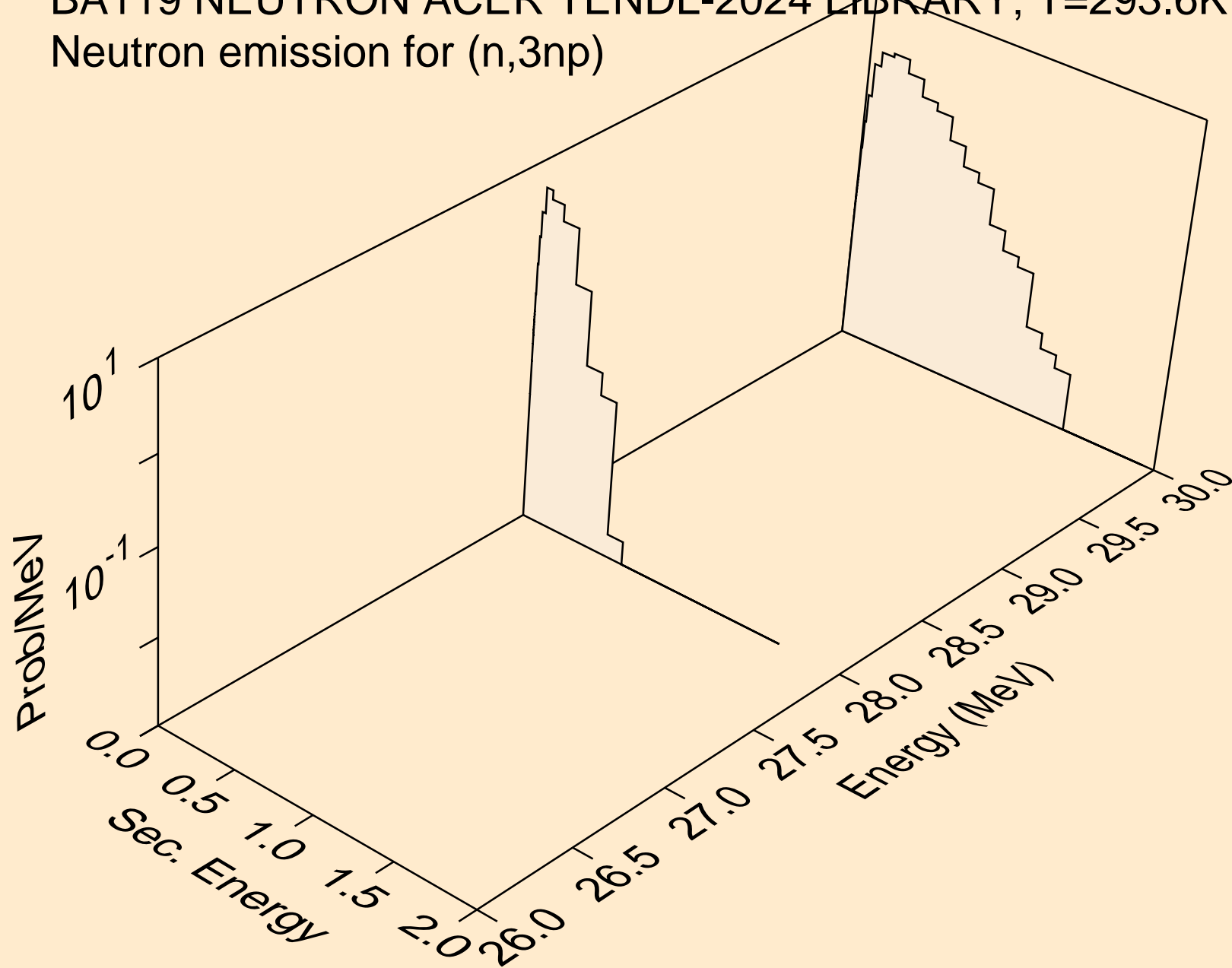

BA119 NEUTRON ACER TENDL-2024 LIBRARY; T=293.6K  
Neutron emission for (n,n2p)

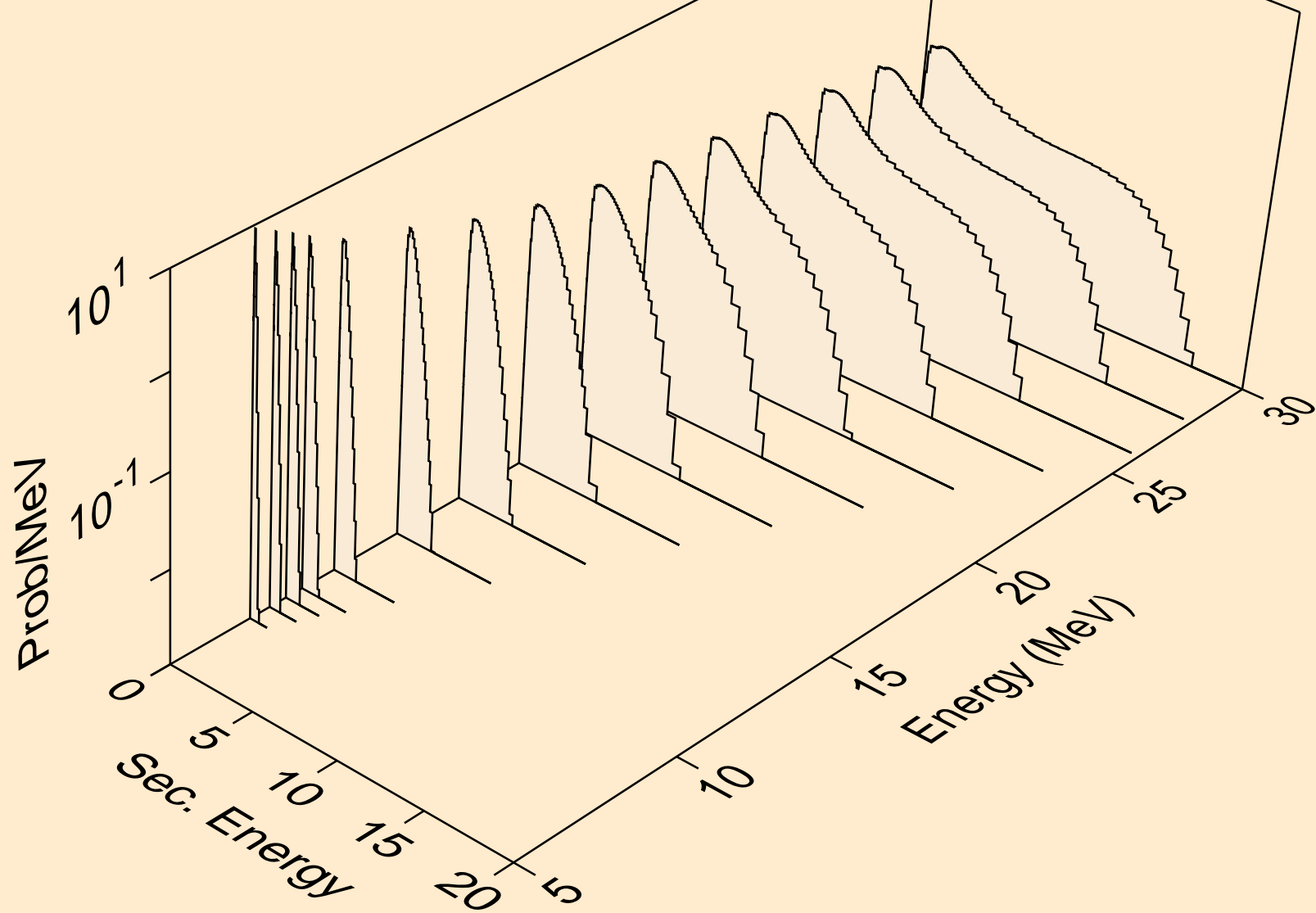

BA119 NEUTRON ACER TENDL-2024 LIBRARY; T=293.6K  
Neutron emission for (n,npa)

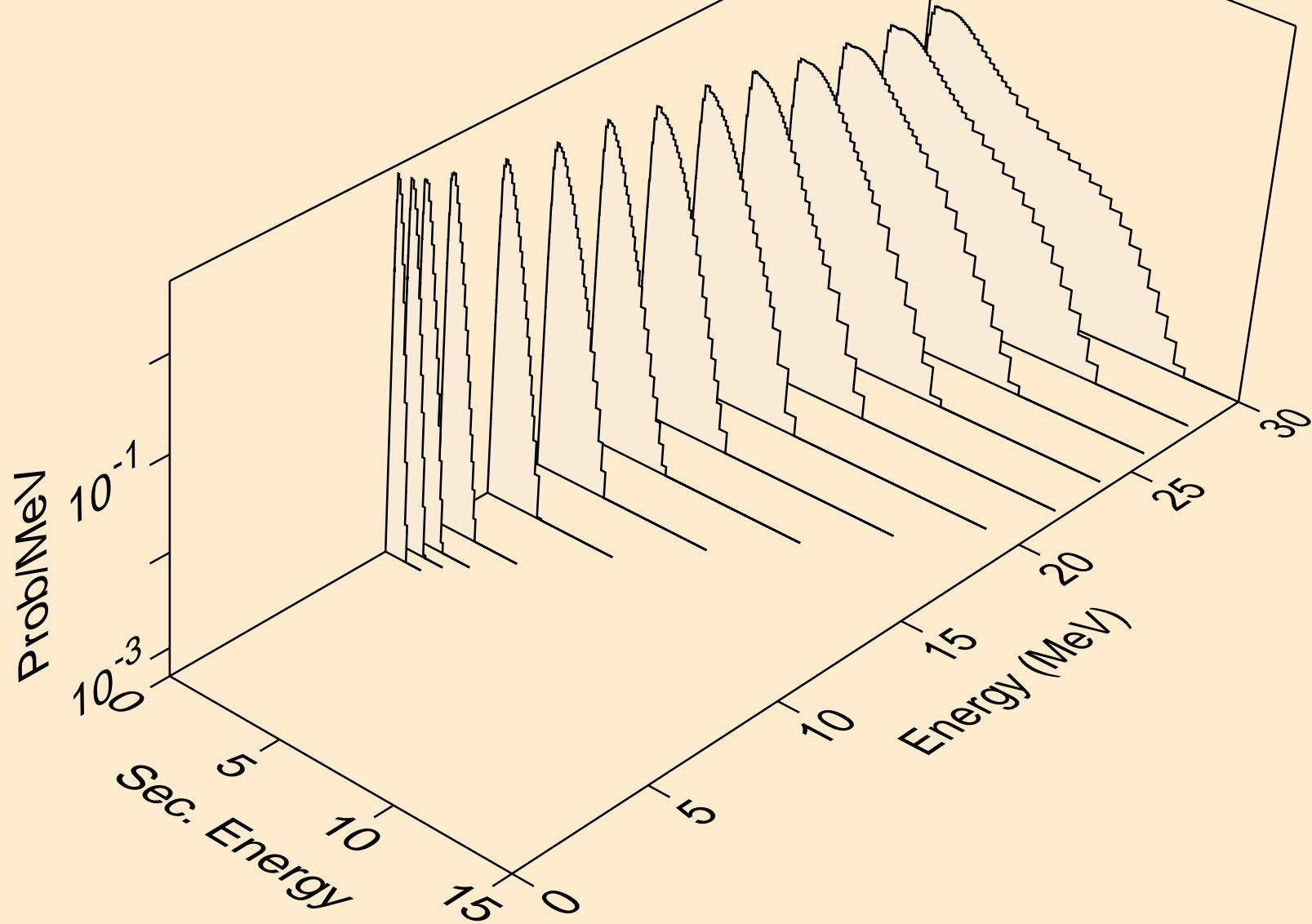

BA119 NEUTRON ACER TENDL-2024 LIBRARY; T=293.6K  
Neutron emission for (n,n\*c)

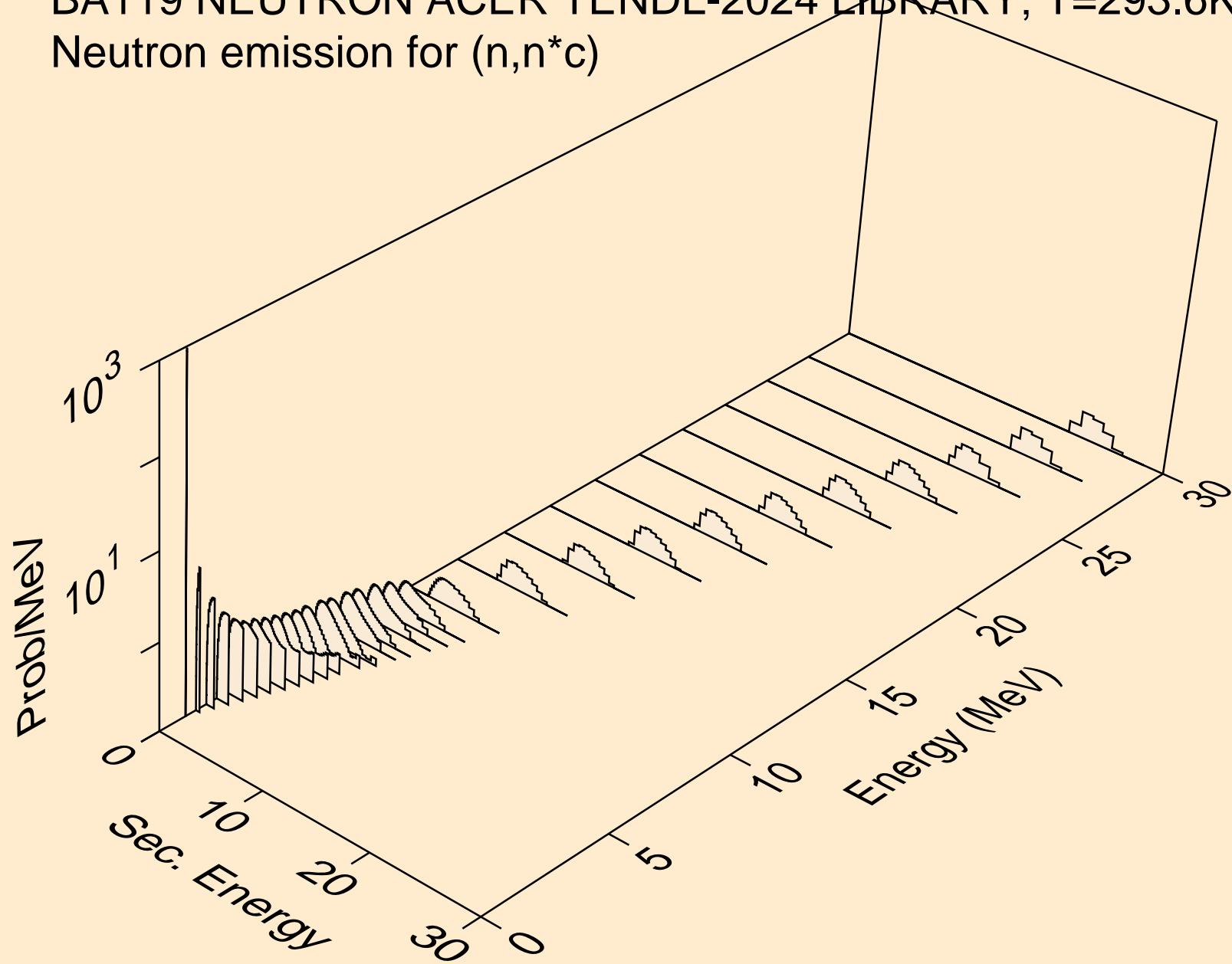

BA119 NEUTRON ACER TENDL-2024 LIBRARY; T=293.6K  
Photon emission for (n,x)

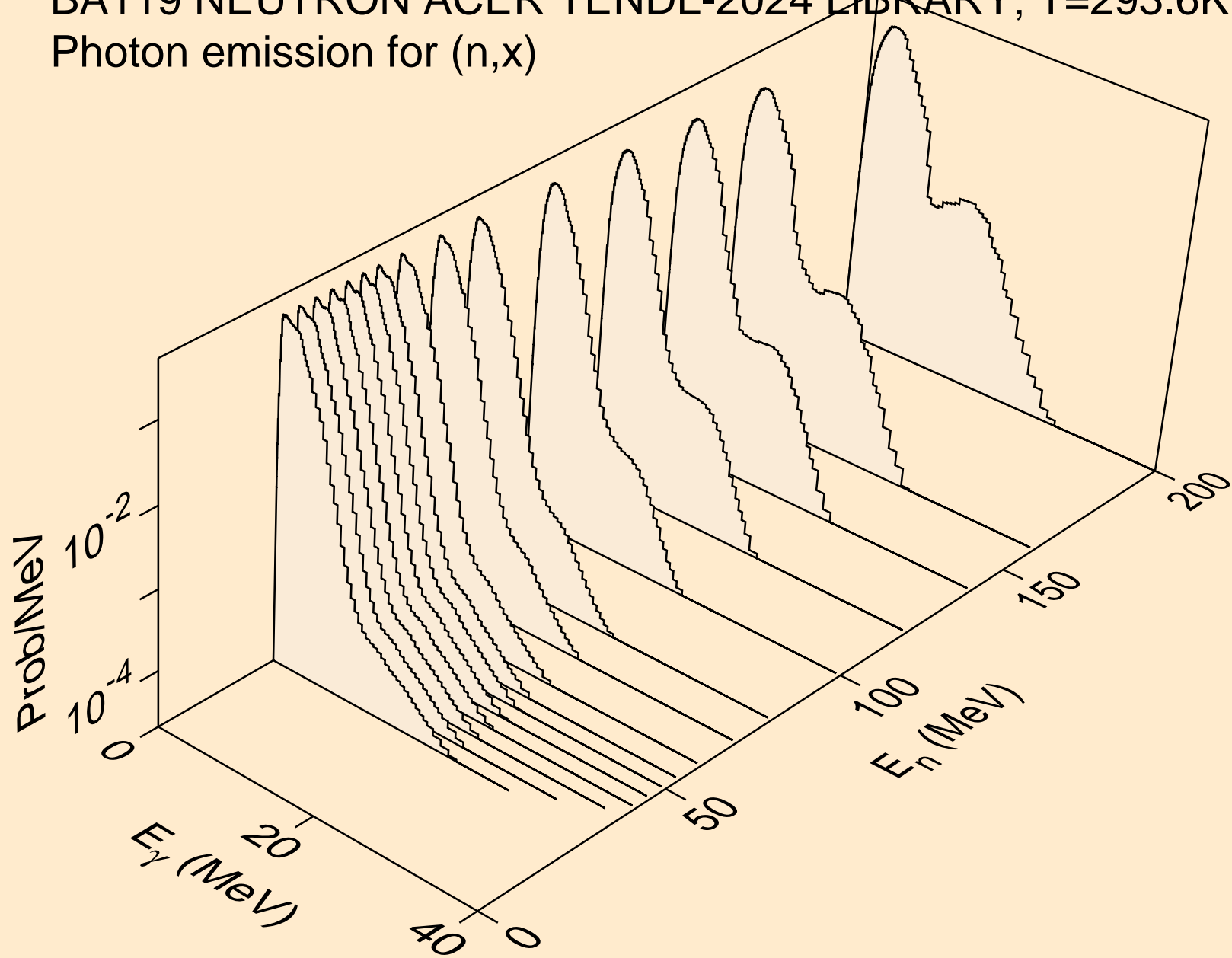

BA119 NEUTRON ACER TENDL-2024 LIBRARY; T=293.6K  
Photon emission for (n,2nd)

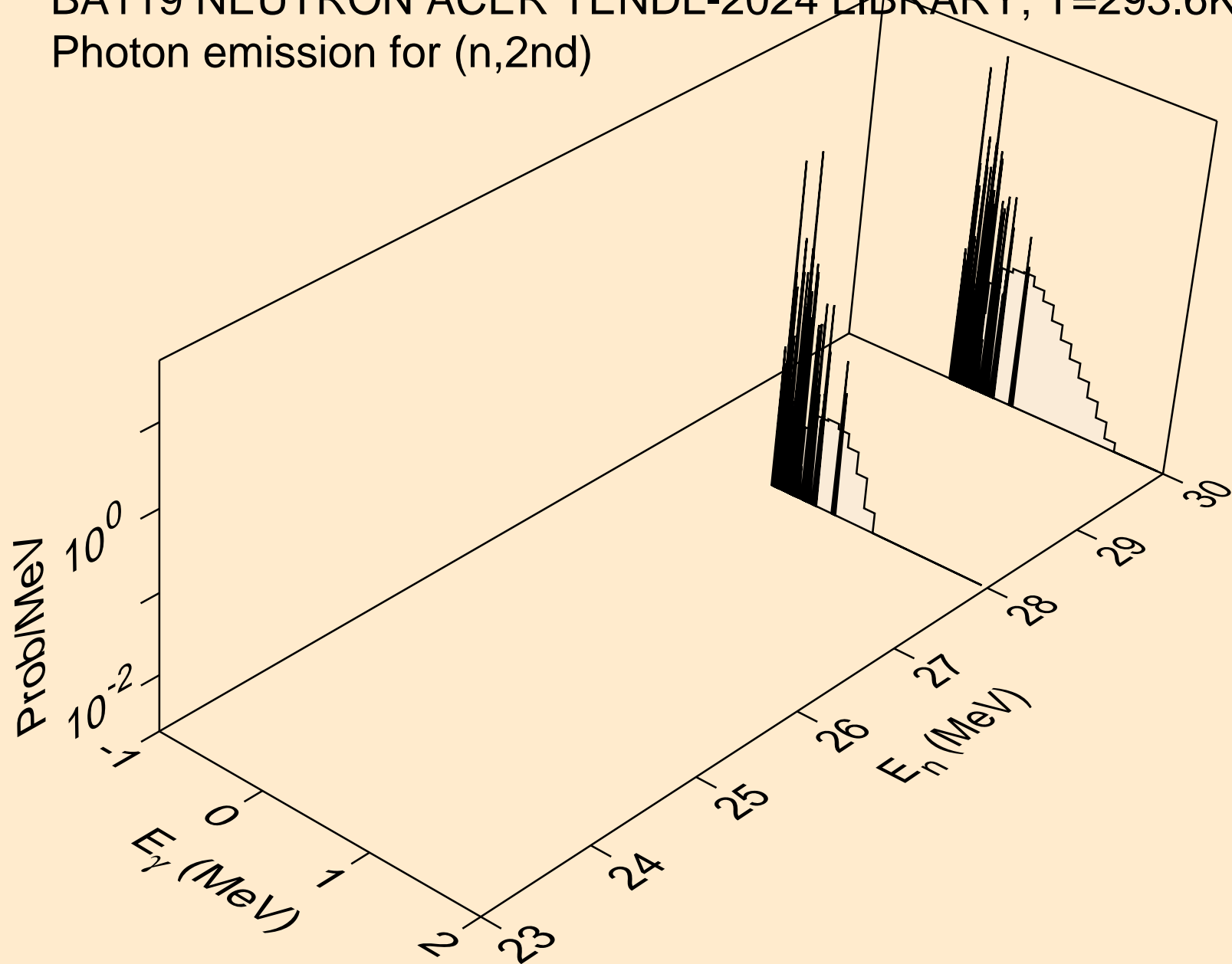

BA119 NEUTRON ACER TENDL-2024 LIBRARY; T=293.6K  
Photon emission for (n,2n)

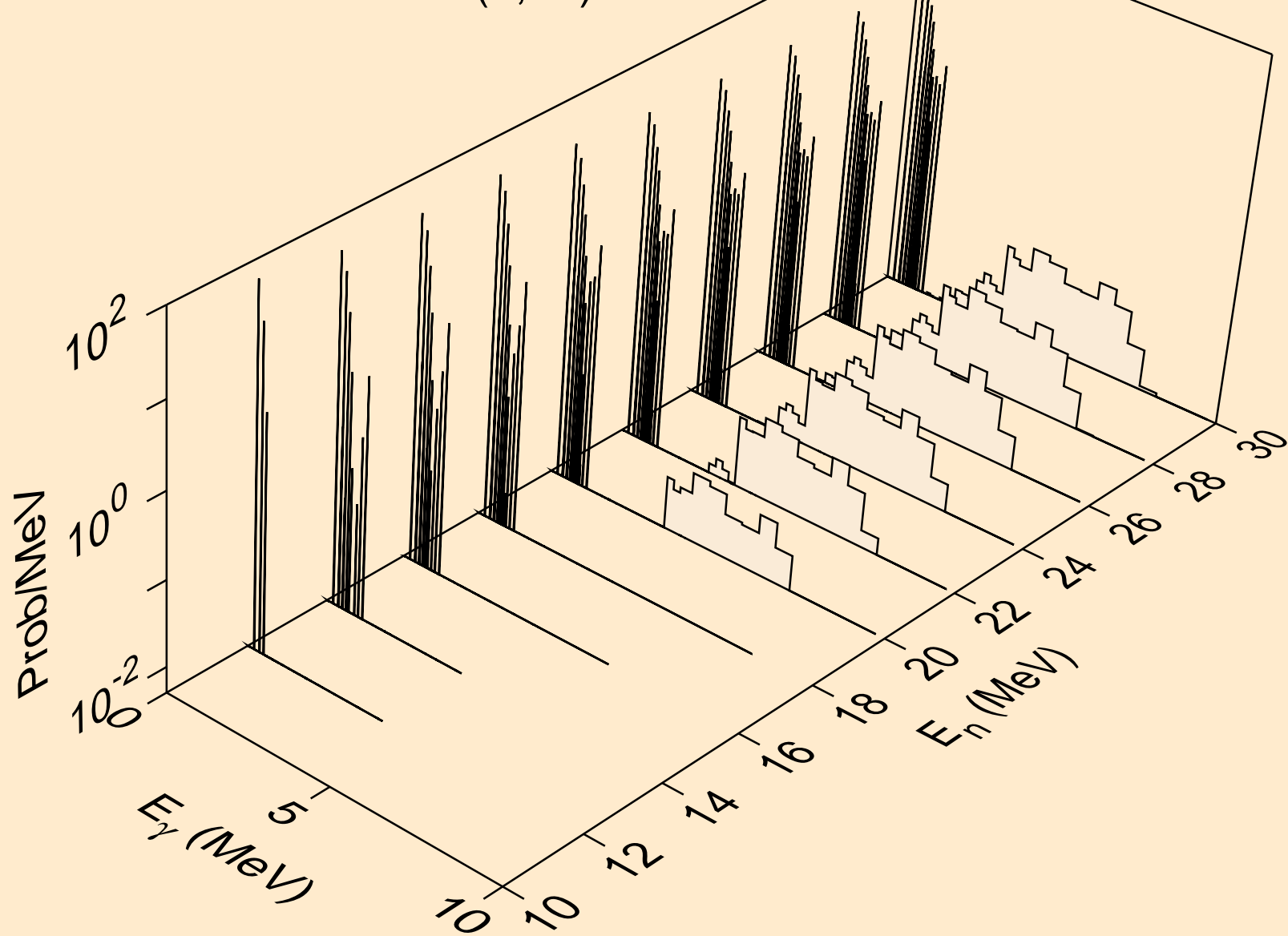

BA119 NEUTRON ACER TENDL-2024 LIBRARY; T=293.6K  
Photon emission for (n,3n)

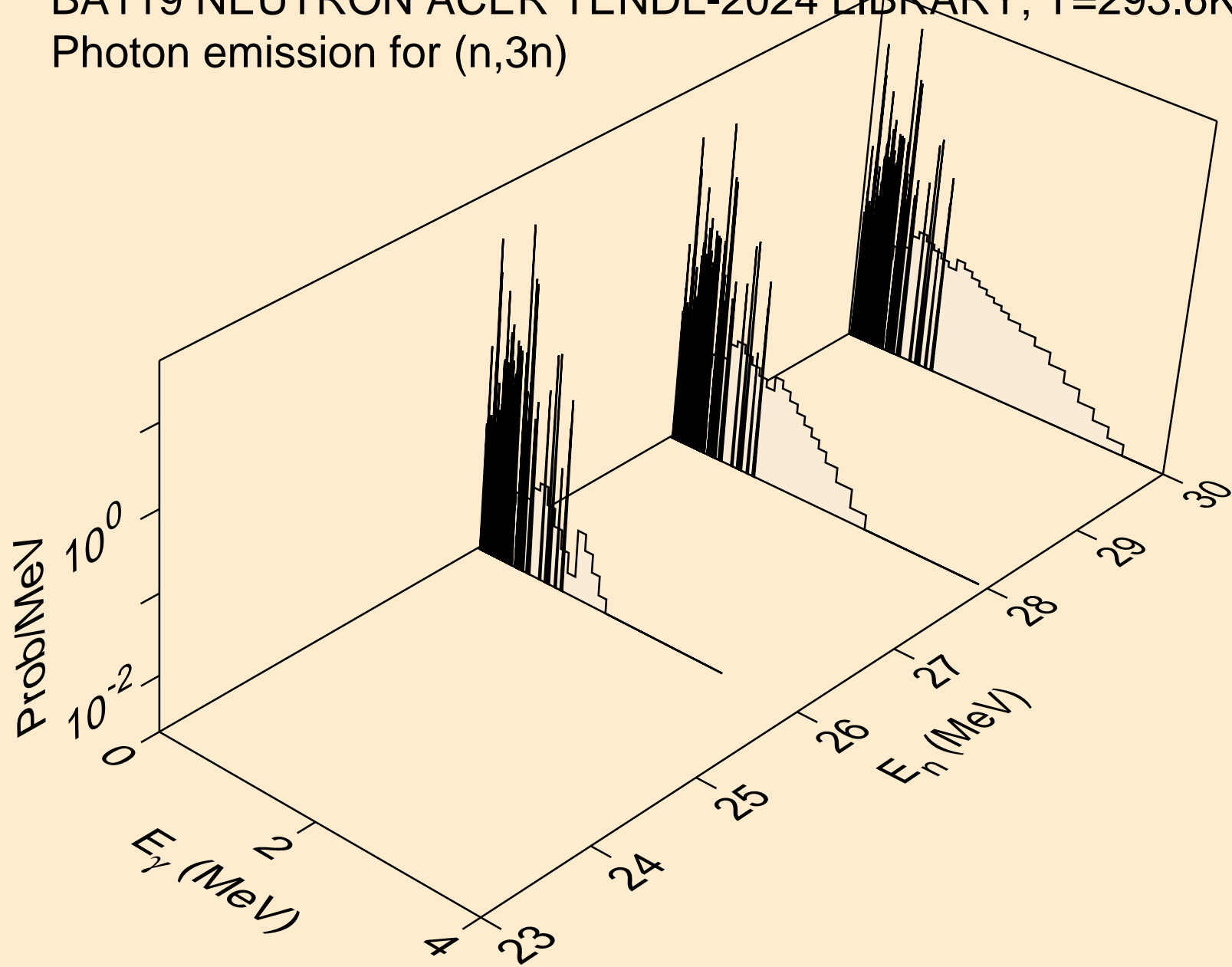

BA119 NEUTRON ACER TENDL-2024 LIBRARY; T=293.6K  
Photon emission for (n,n\*)a

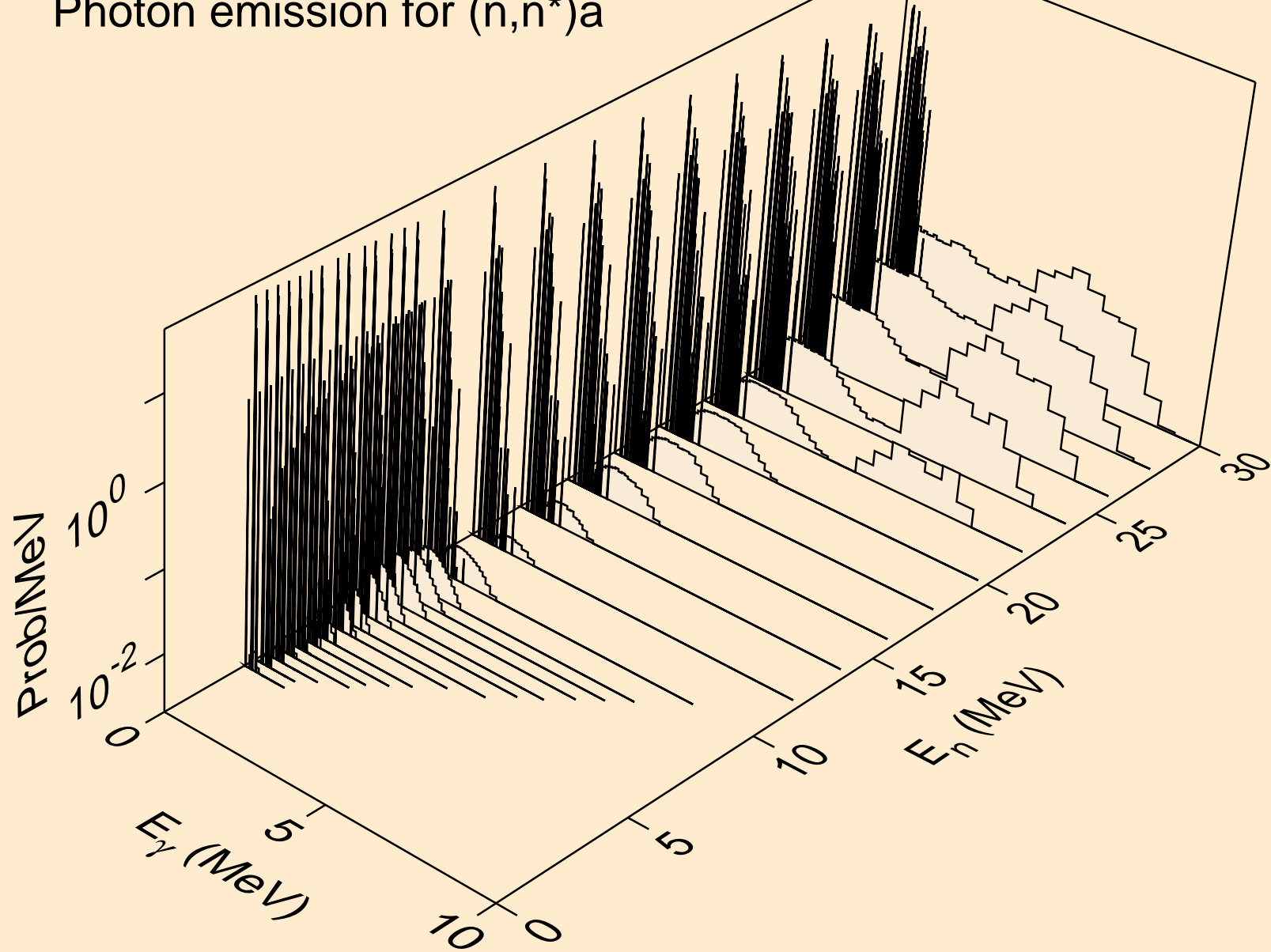

BA119 NEUTRON ACER TENDL-2024 LIBRARY; T=293.6K  
Photon emission for (n,n\*)3a

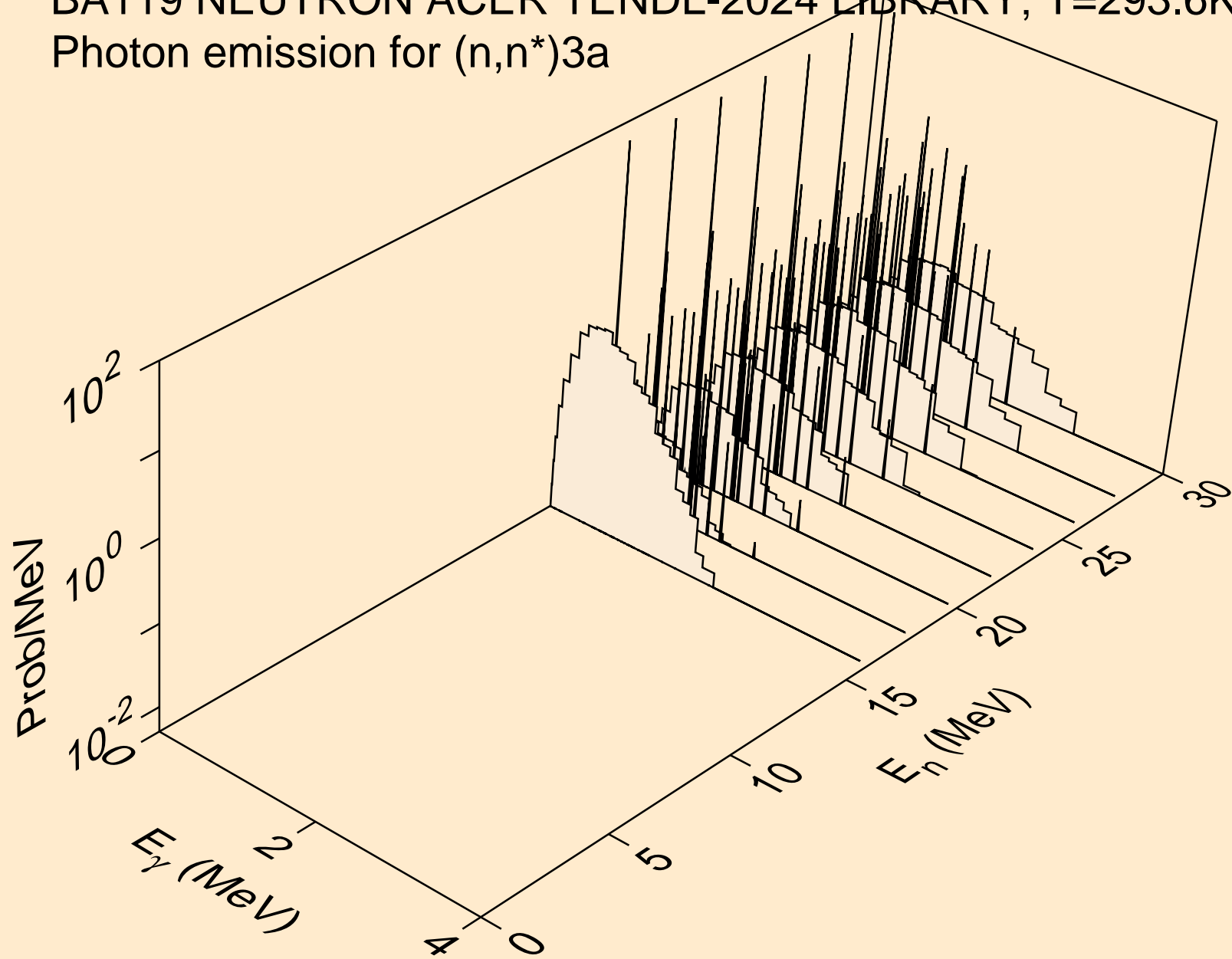

BA119 NEUTRON ACER TENDL-2024 LIBRARY; T=293.6K  
Photon emission for (n,2n)a

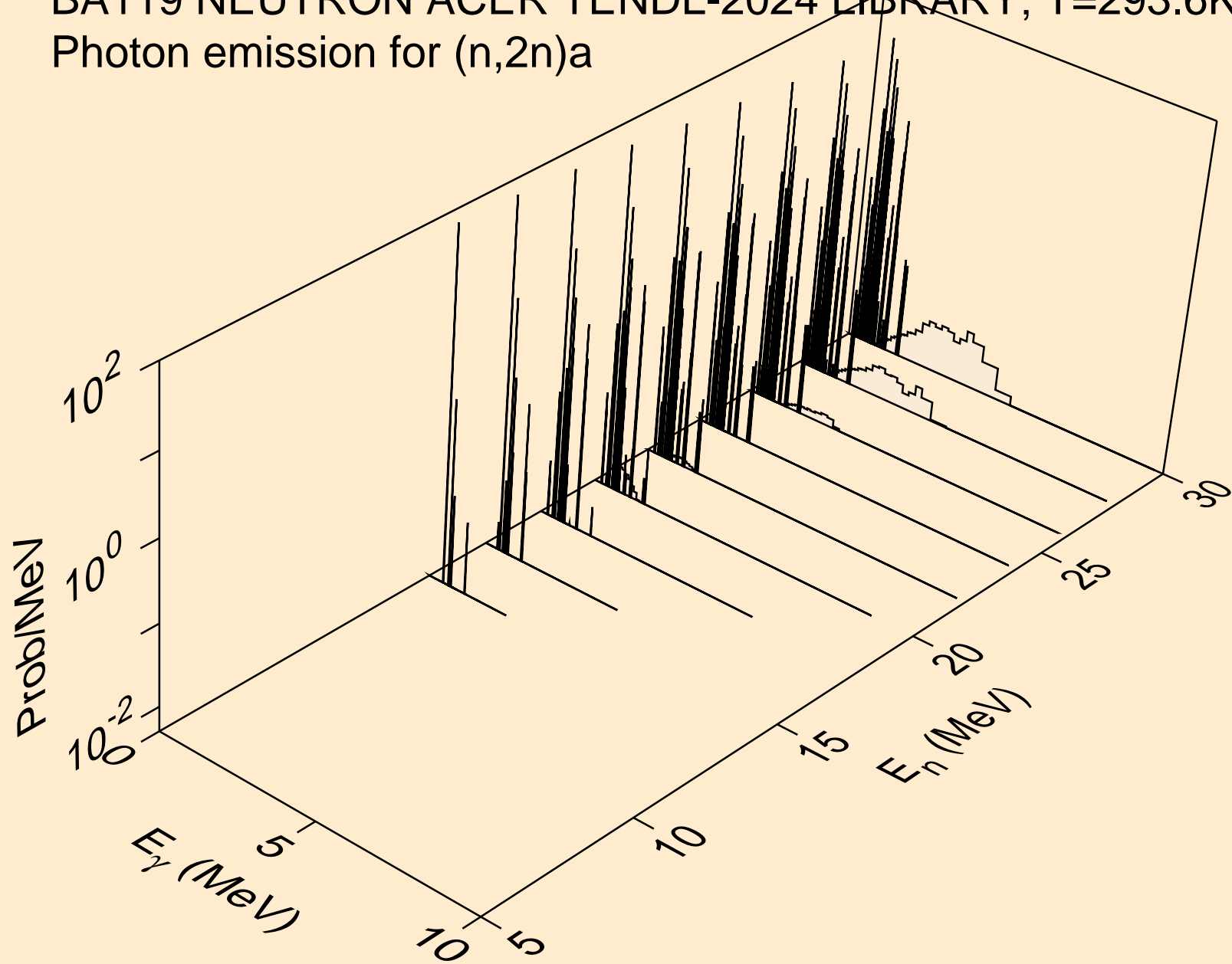

BA119 NEUTRON ACER TENDL-2024 LIBRARY; T=293.6K  
Photon emission for (n,n\*)p

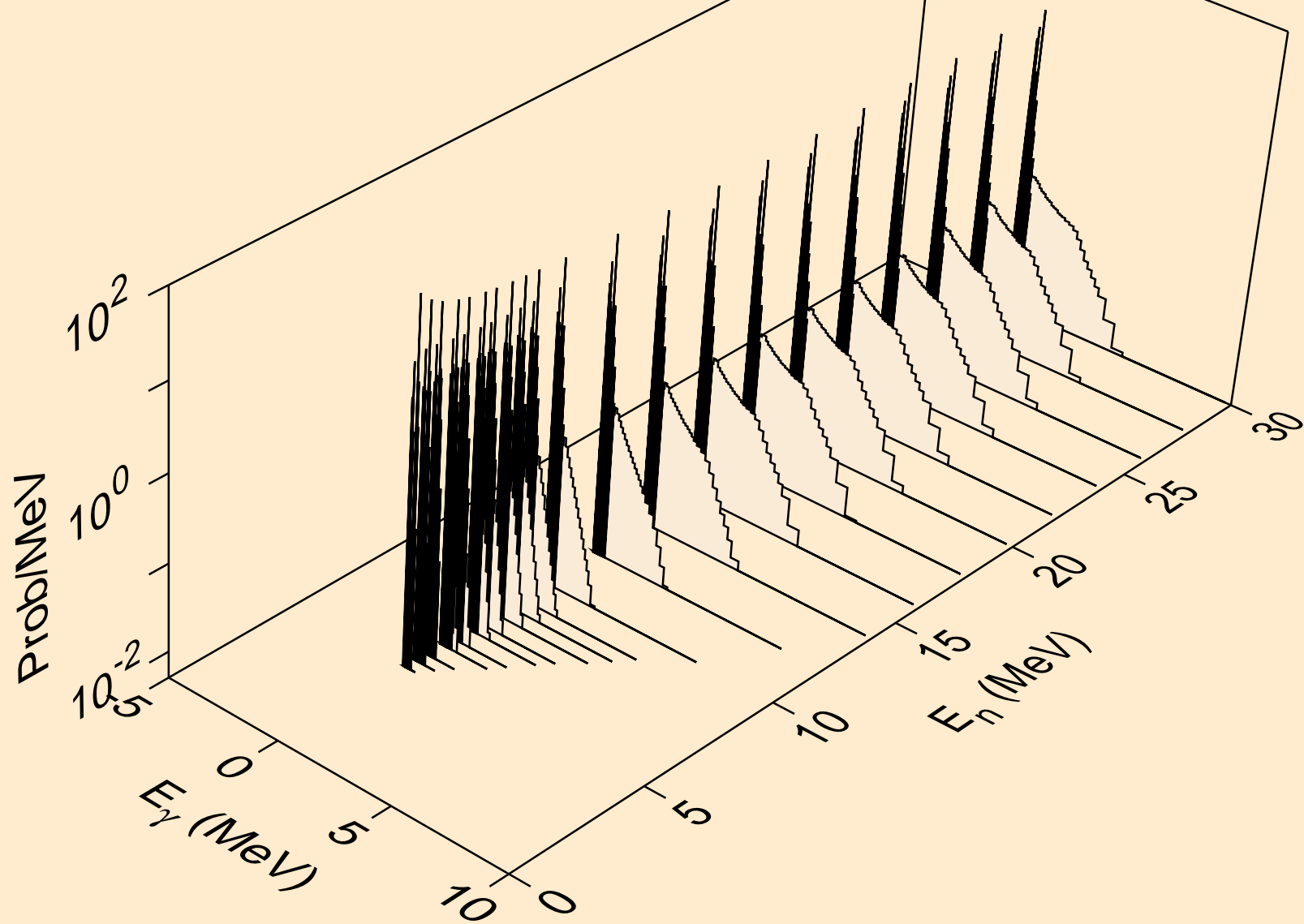

BA119 NEUTRON ACER TENDL-2024 LIBRARY; T=293.6K  
Photon emission for (n,n\*)2a

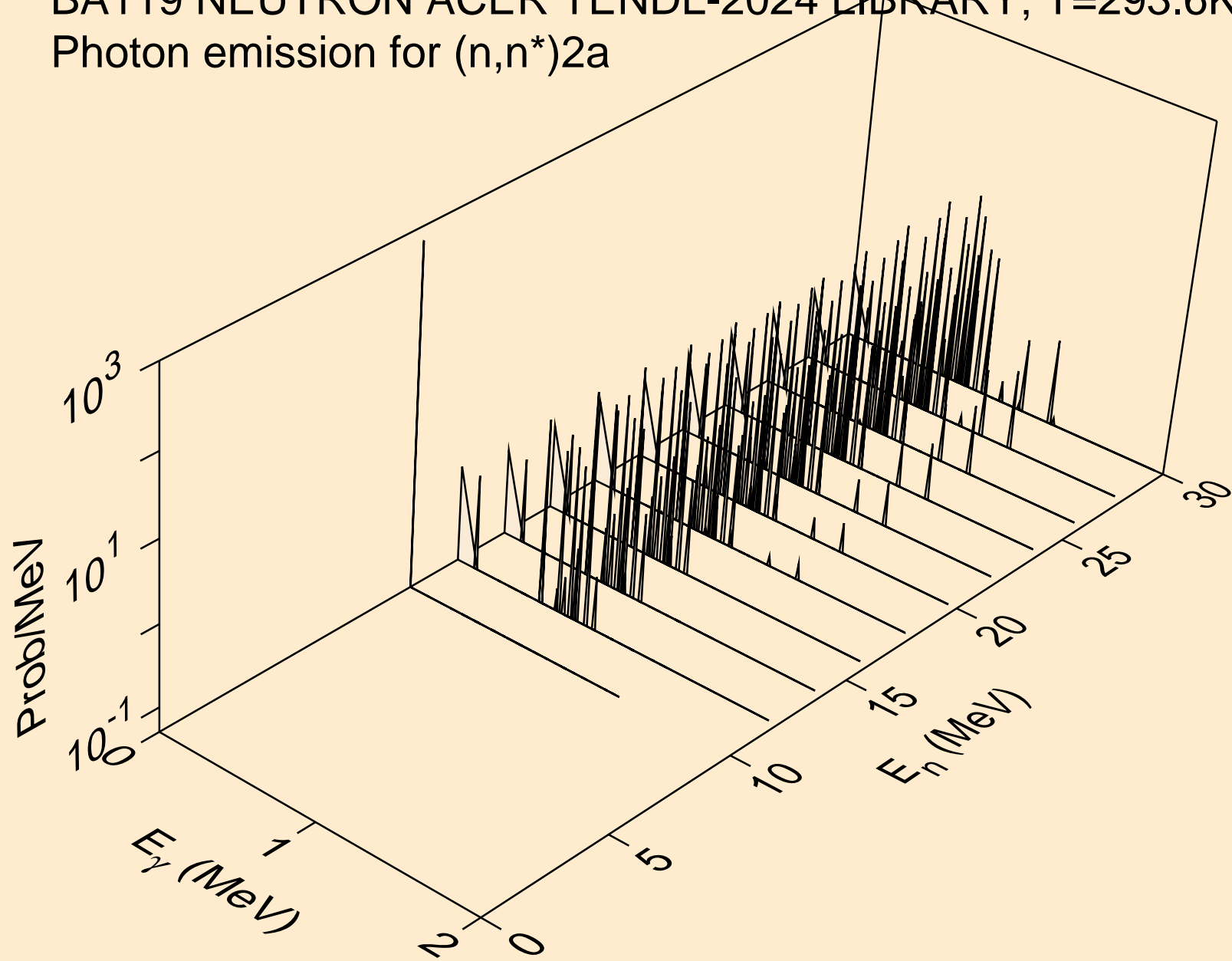

BA119 NEUTRON ACER TENDL-2024 LIBRARY; T=293.6K  
Photon emission for (n,2n)2a

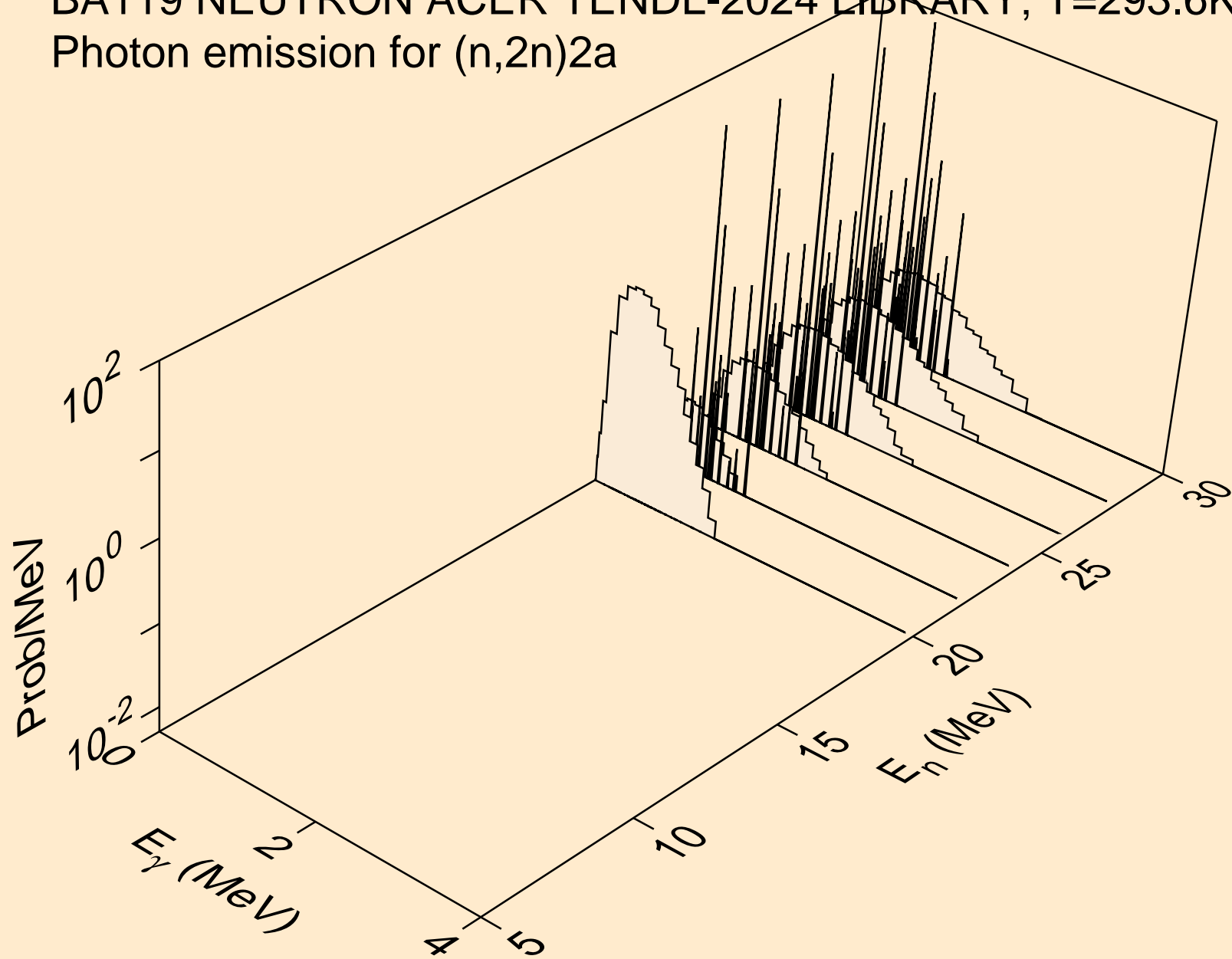

BA119 NEUTRON ACER TENDL-2024 LIBRARY; T=293.6K  
Photon emission for (n,n\*)d

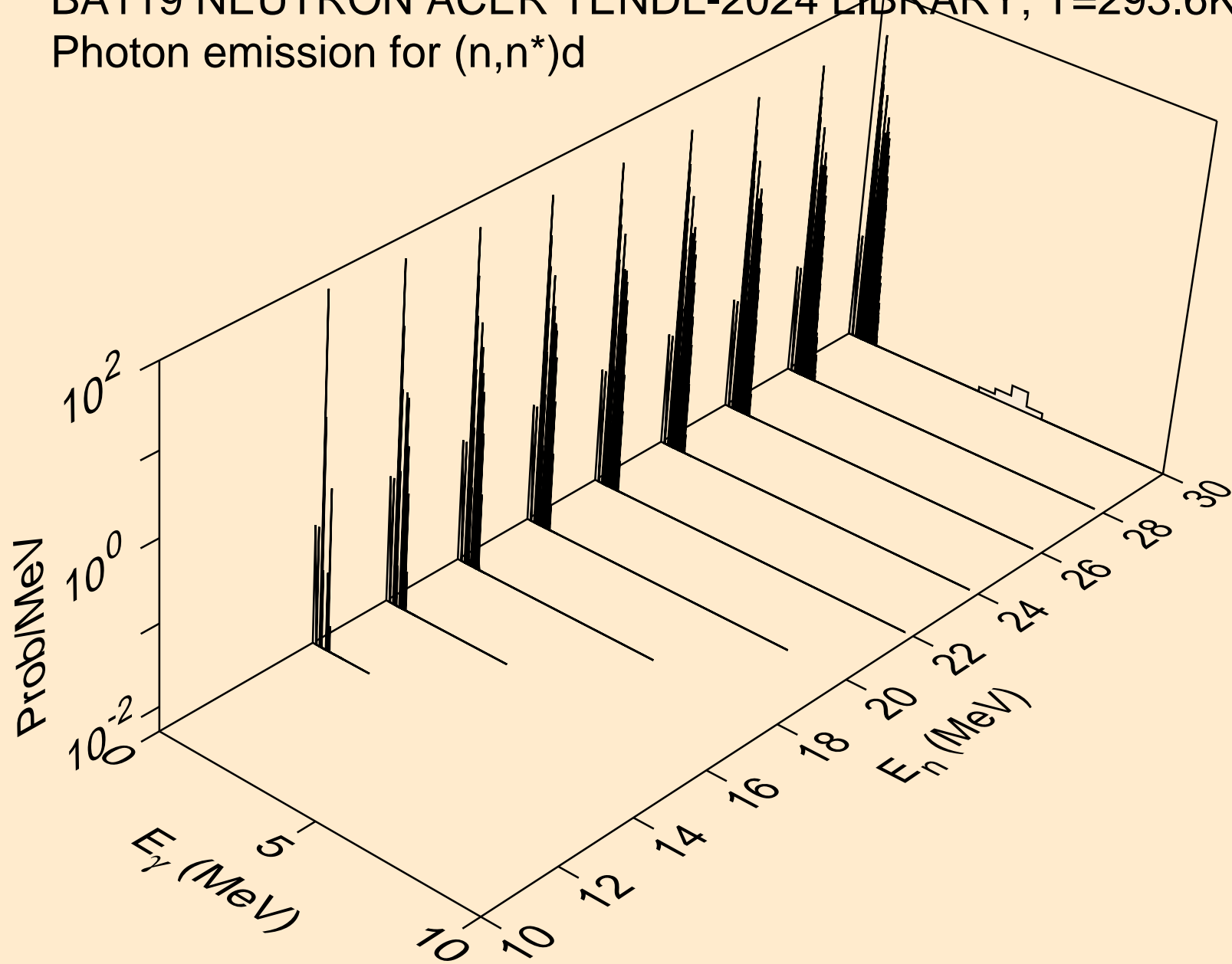

BA119 NEUTRON ACER TENDL-2024 LIBRARY; T=293.6K  
Photon emission for (n,n\*)t

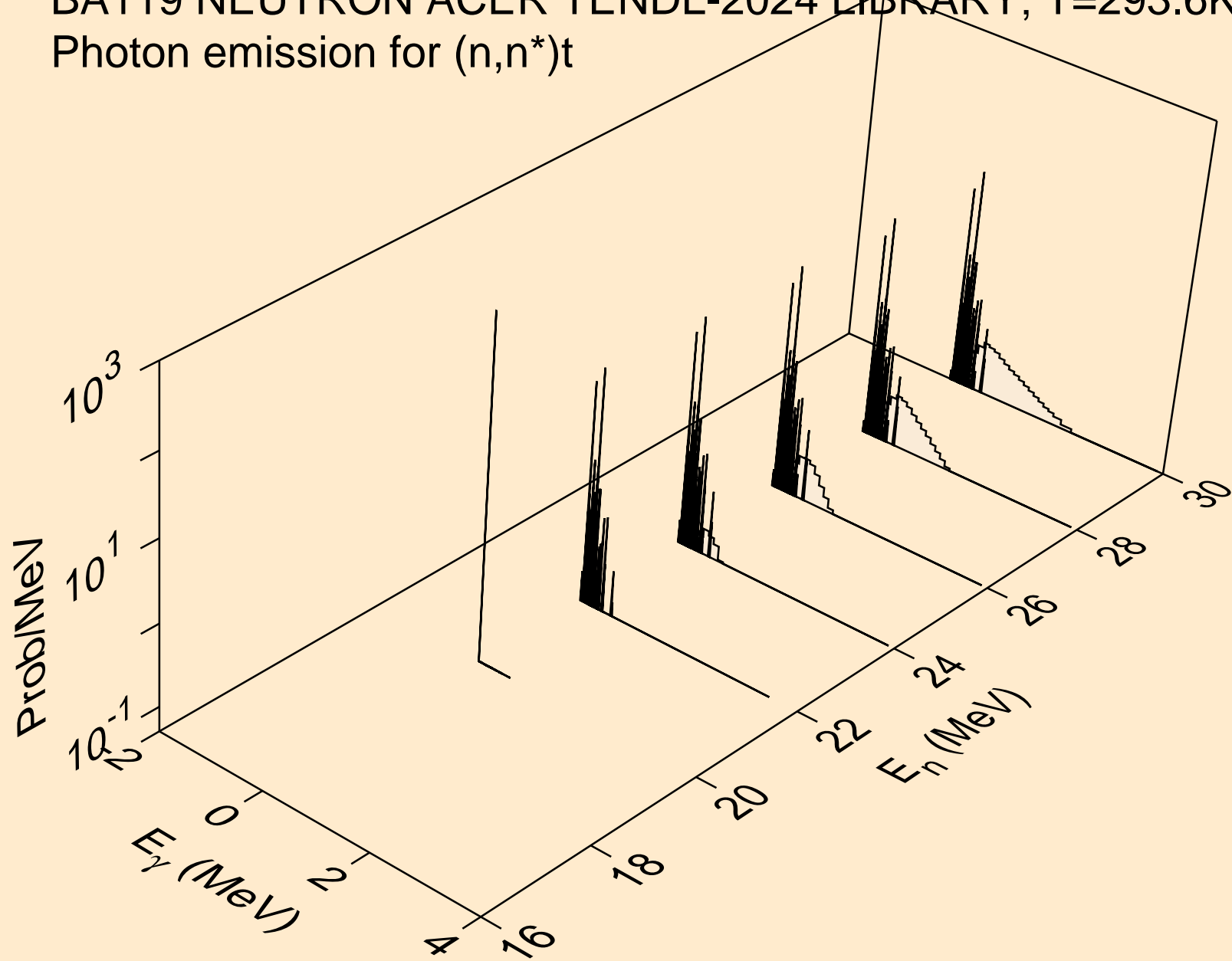

BA119 NEUTRON ACER TENDL-2024 LIBRARY; T=293.6K  
Photon emission for (n,n\*)he3

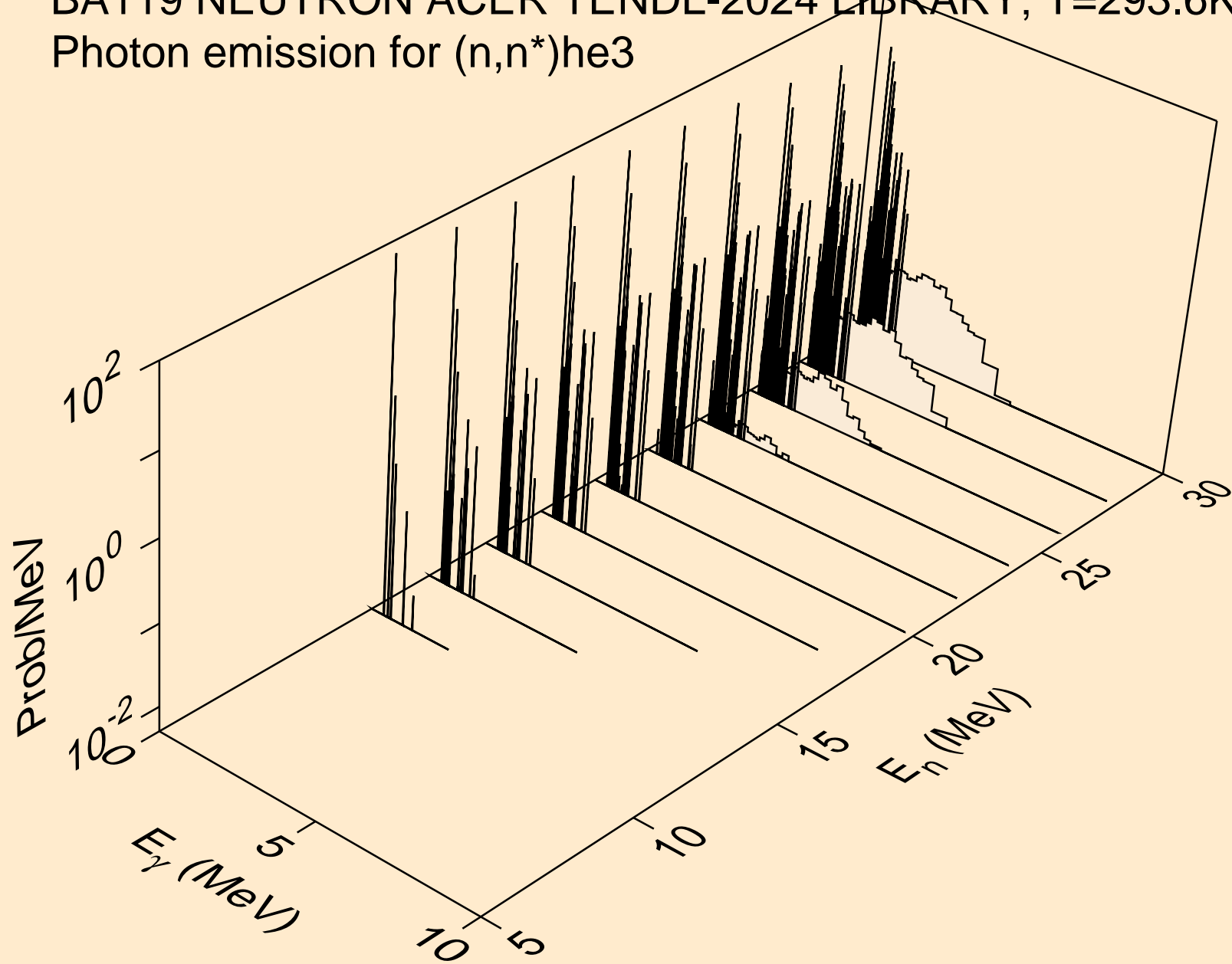

BA119 NEUTRON ACER TENDL-2024 LIBRARY; T=293.6K  
Photon emission for (n,2np)

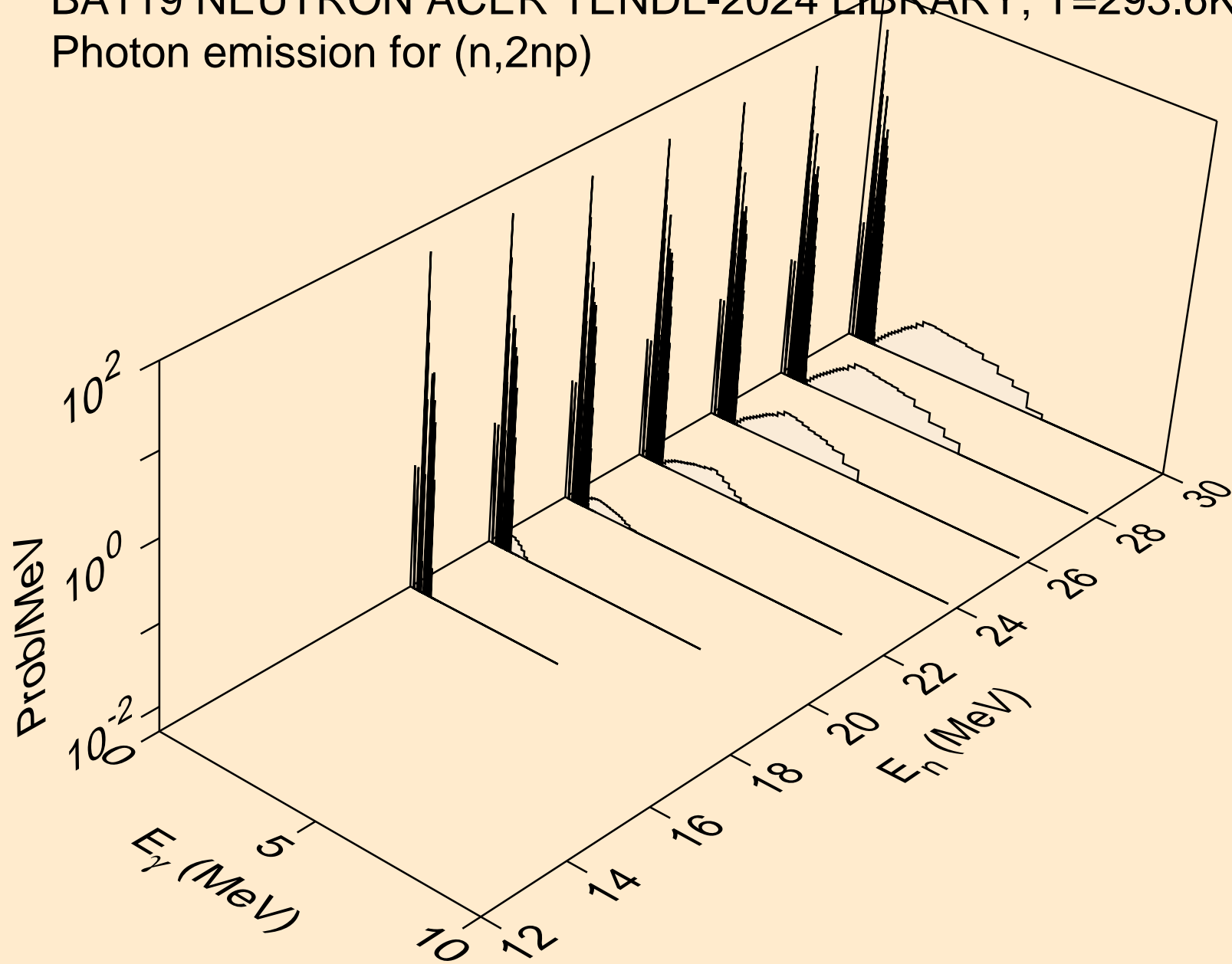

BA119 NEUTRON ACER TENDL-2024 LIBRARY; T=293.6K  
Photon emission for (n,3np)

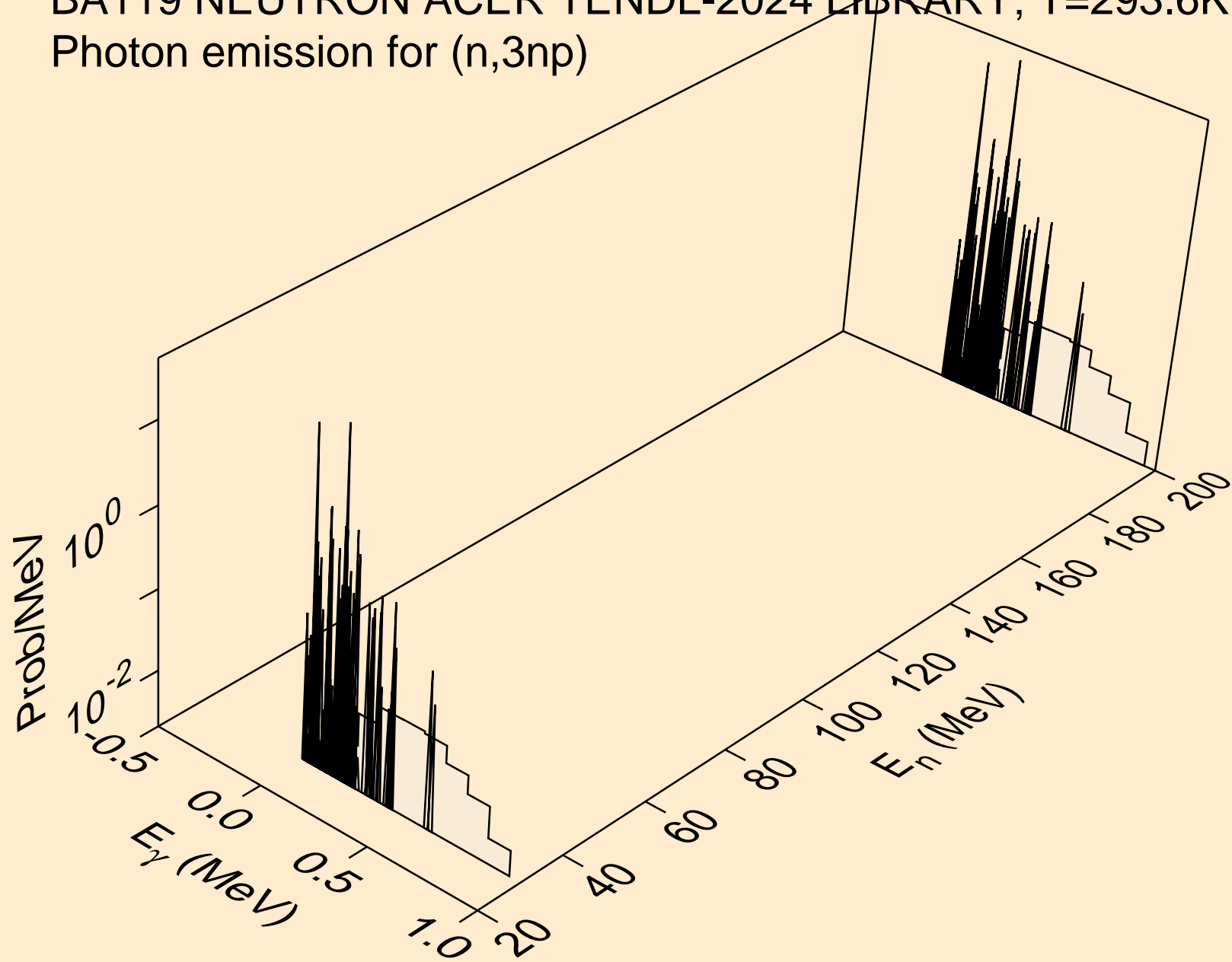

BA119 NEUTRON ACER TENDL-2024 LIBRARY; T=293.6K  
Photon emission for (n,n2p)

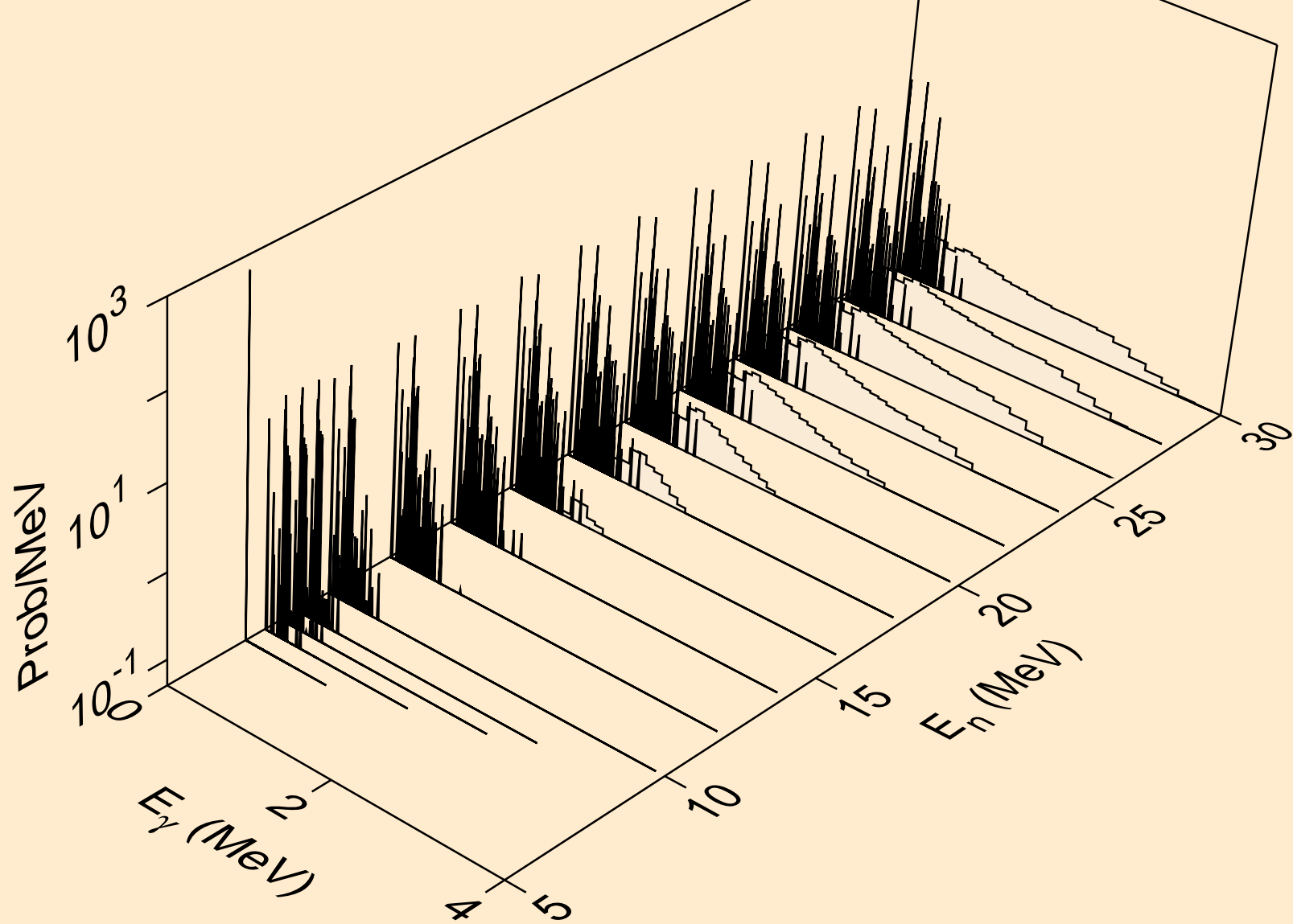

BA119 NEUTRON ACER TENDL-2024 LIBRARY; T=293.6K  
Photon emission for (n,npa)

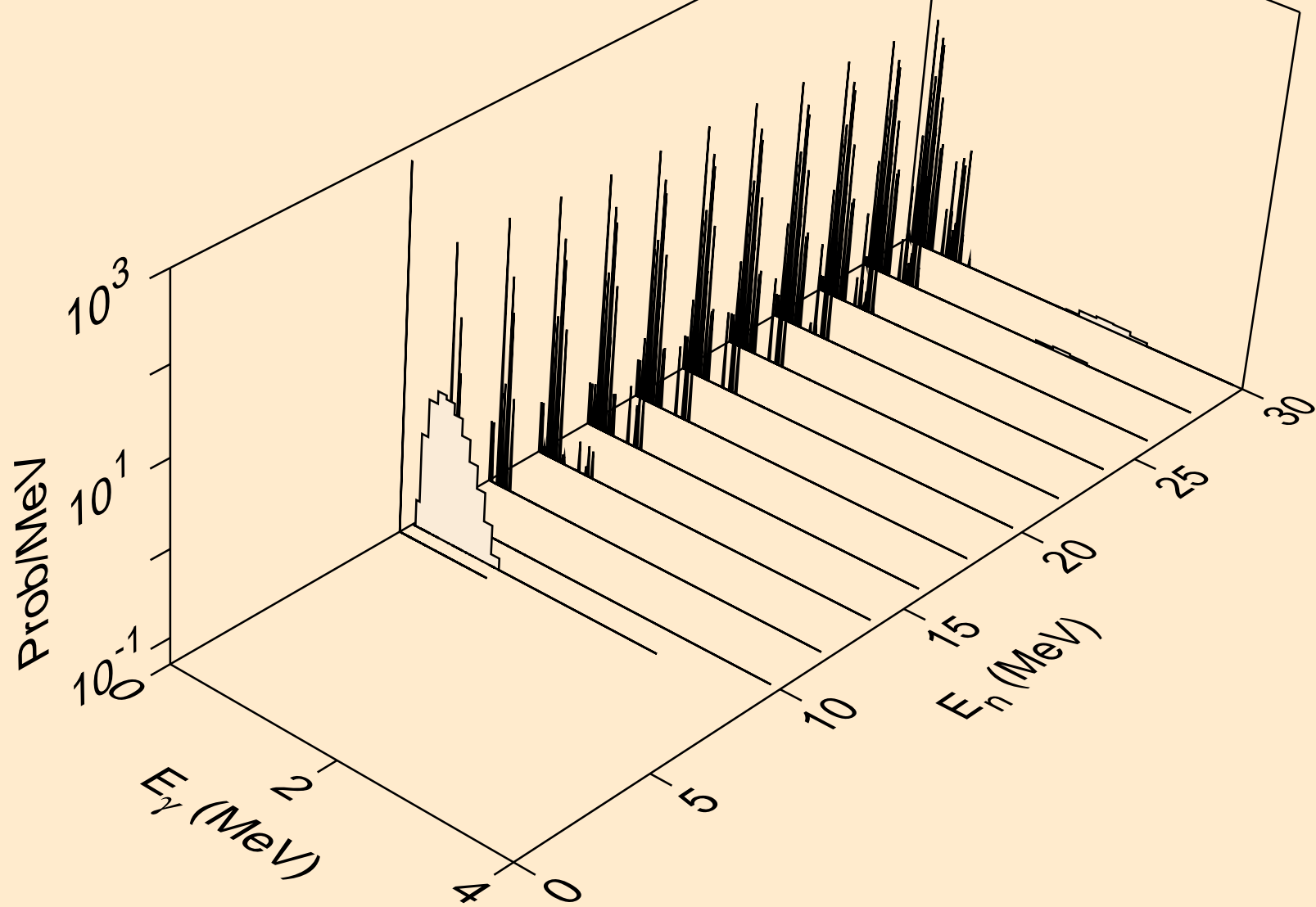

BA119 NEUTRON ACER TENDL-2024 LIBRARY; T=293.6K  
Photon emission for (n,n\*c)

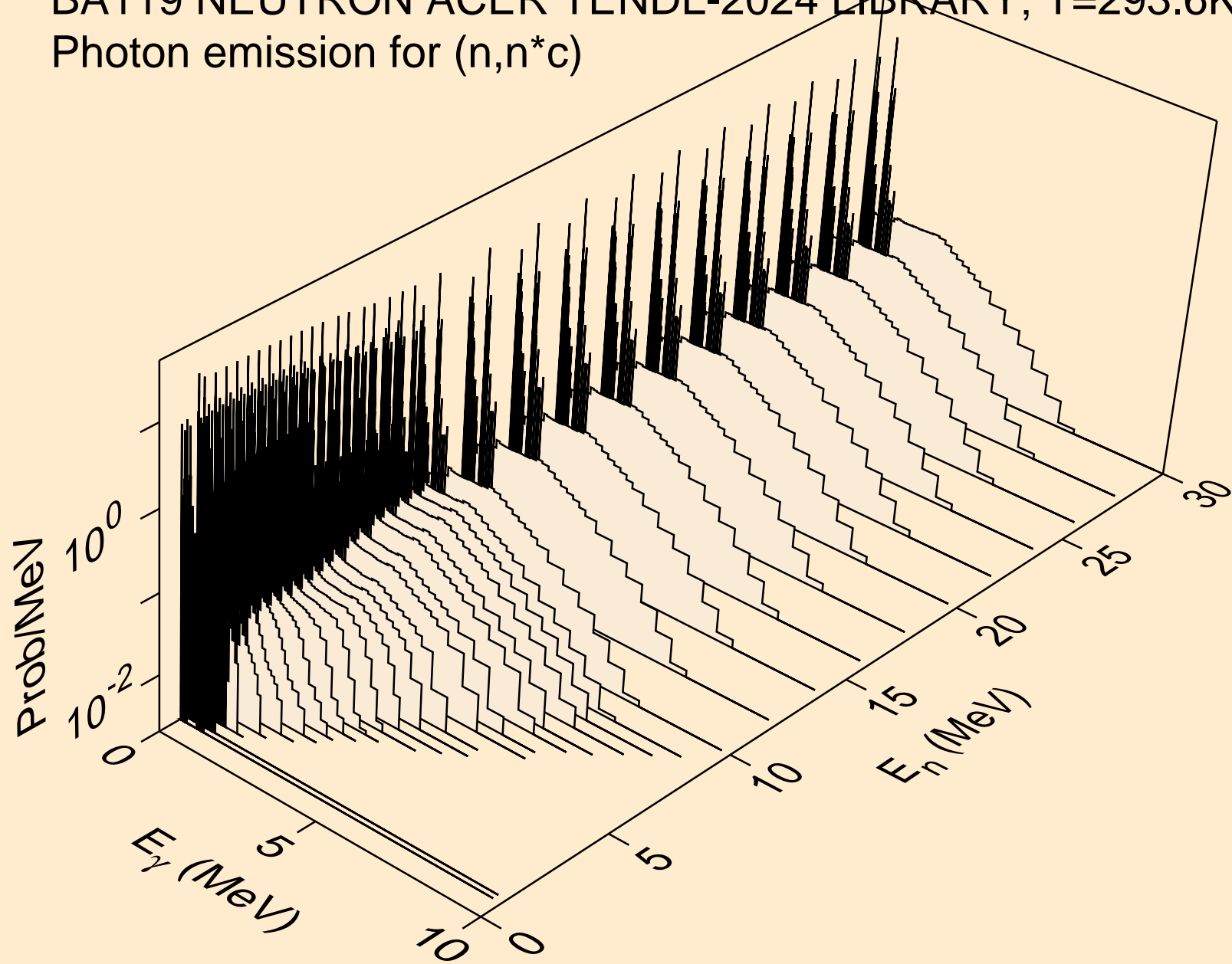

BA119 NEUTRON ACER TENDL-2024 LIBRARY; T=293.6K  
Photon emission for (n,gma)

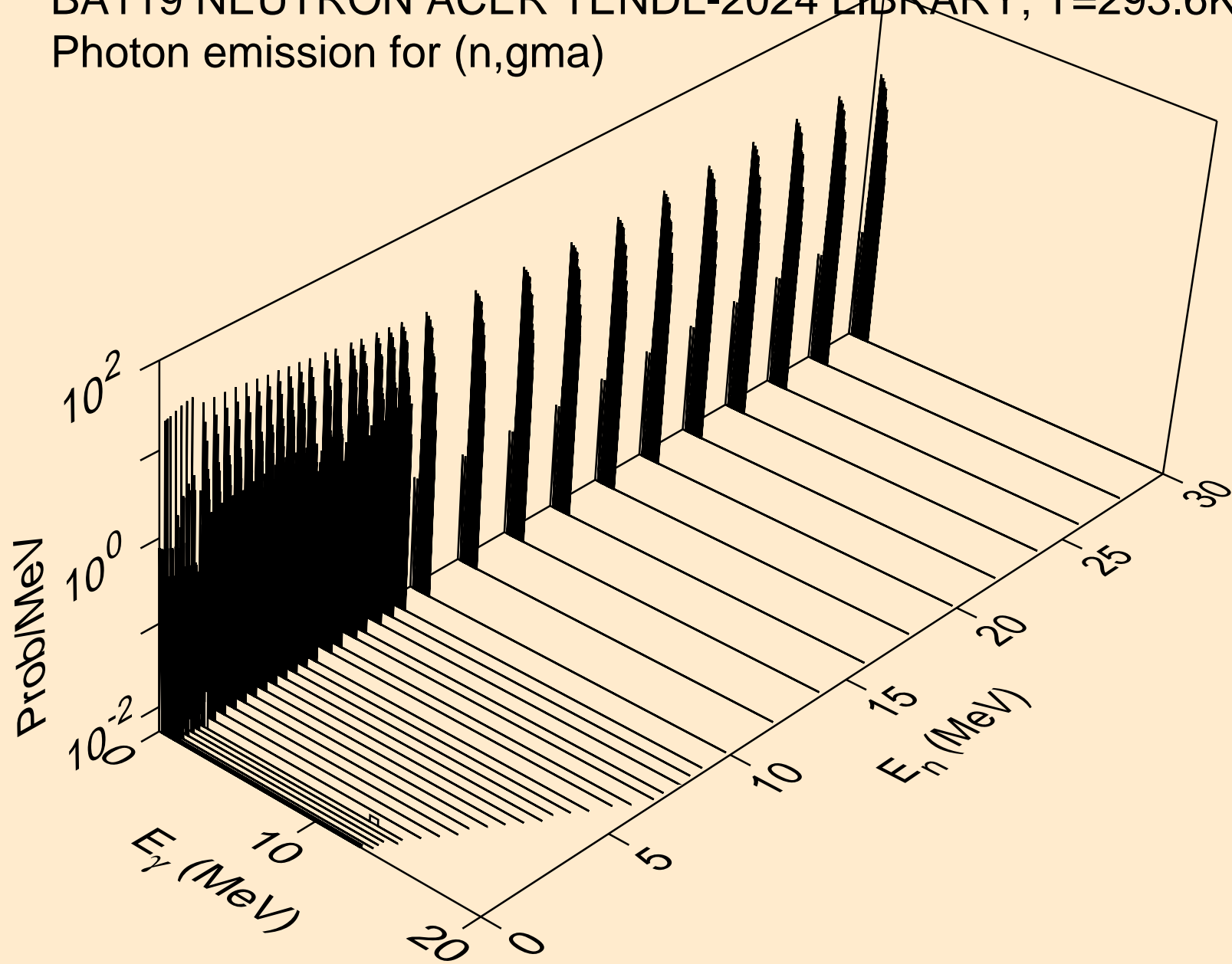

BA119 NEUTRON ACER TENDL-2024 LIBRARY; T=293.6K  
Photon emission for (n,p)

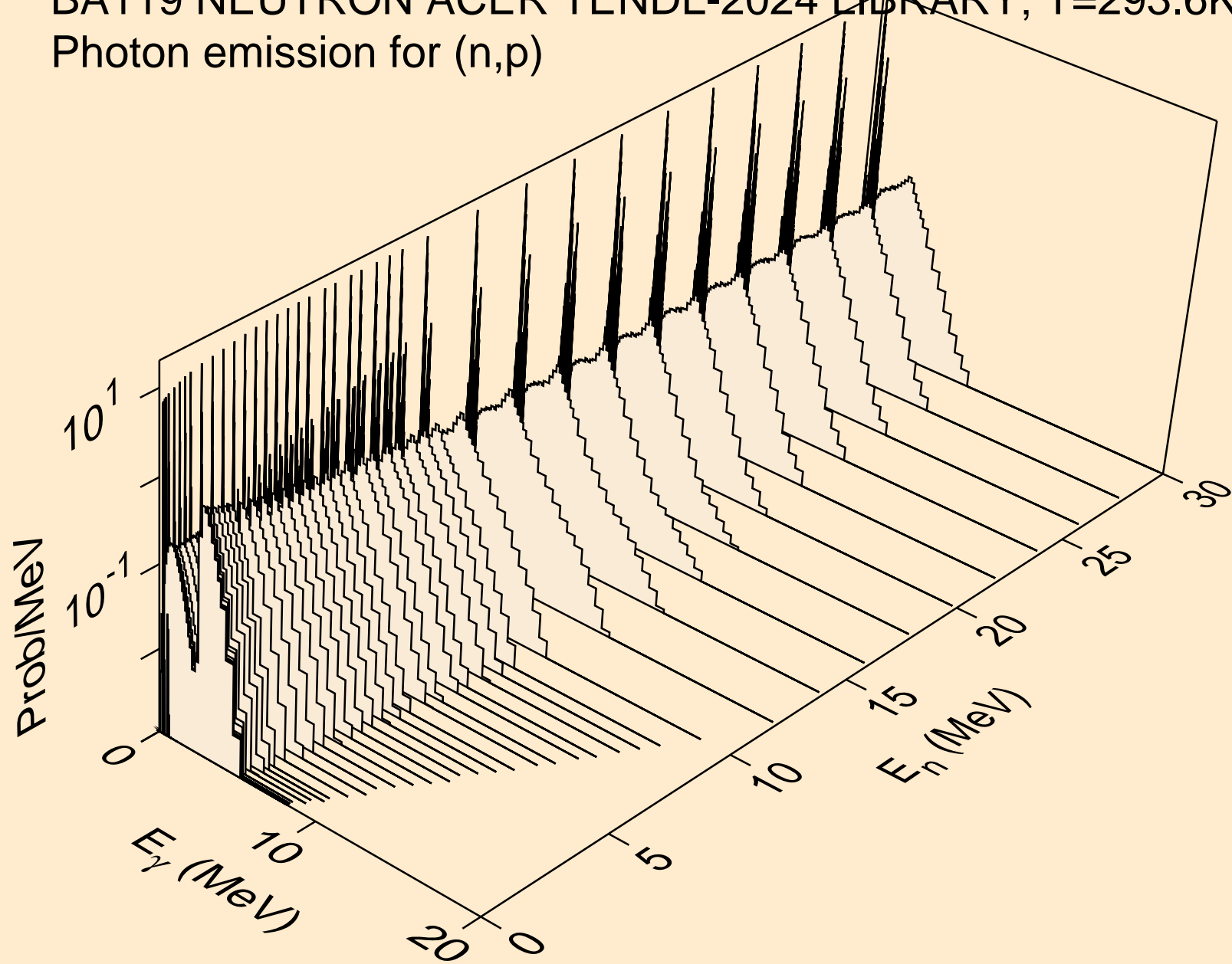

BA119 NEUTRON ACER TENDL-2024 LIBRARY; T=293.6K  
Photon emission for (n,d)

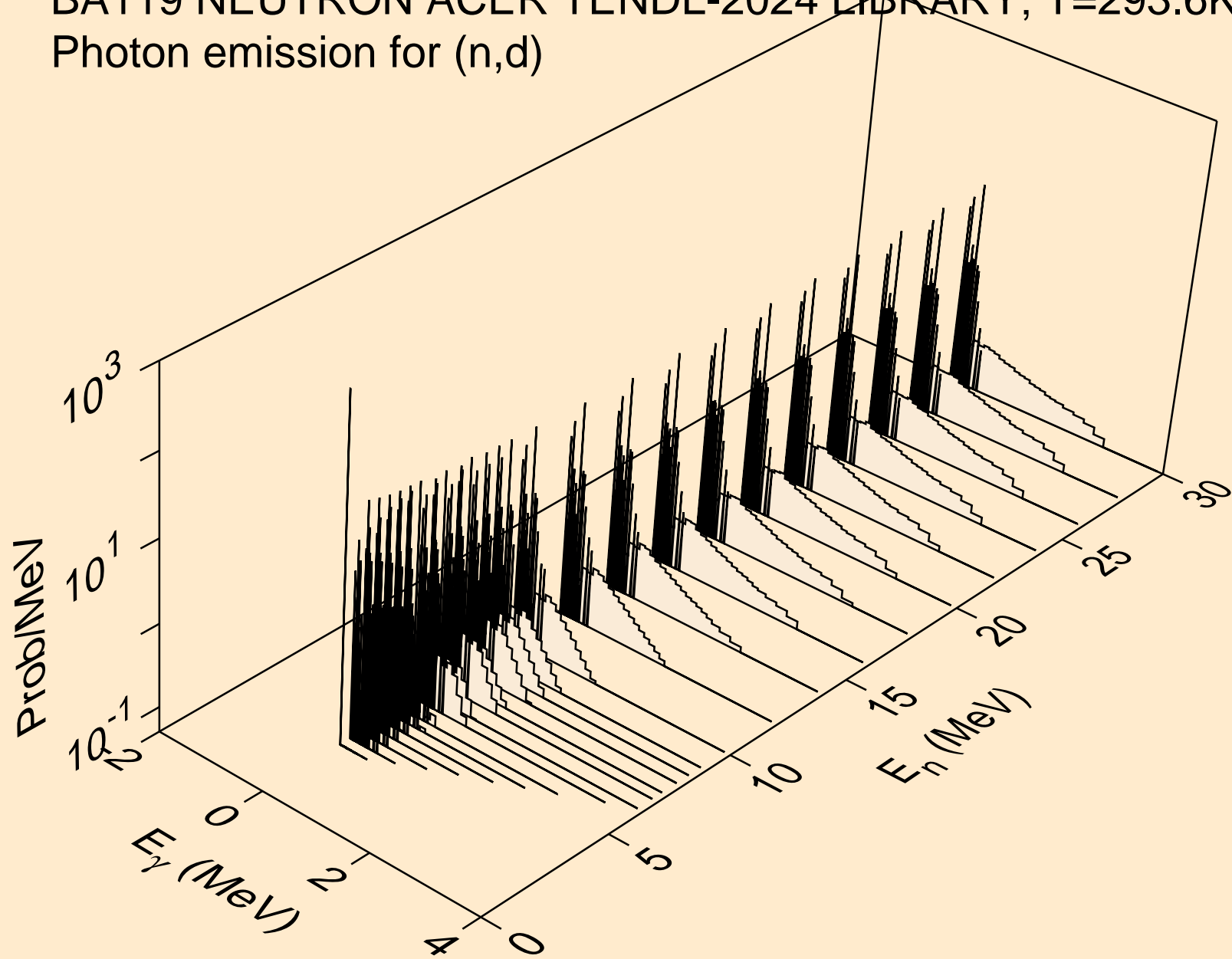

BA119 NEUTRON ACER TENDL-2024 LIBRARY; T=293.6K  
Photon emission for (n,t)

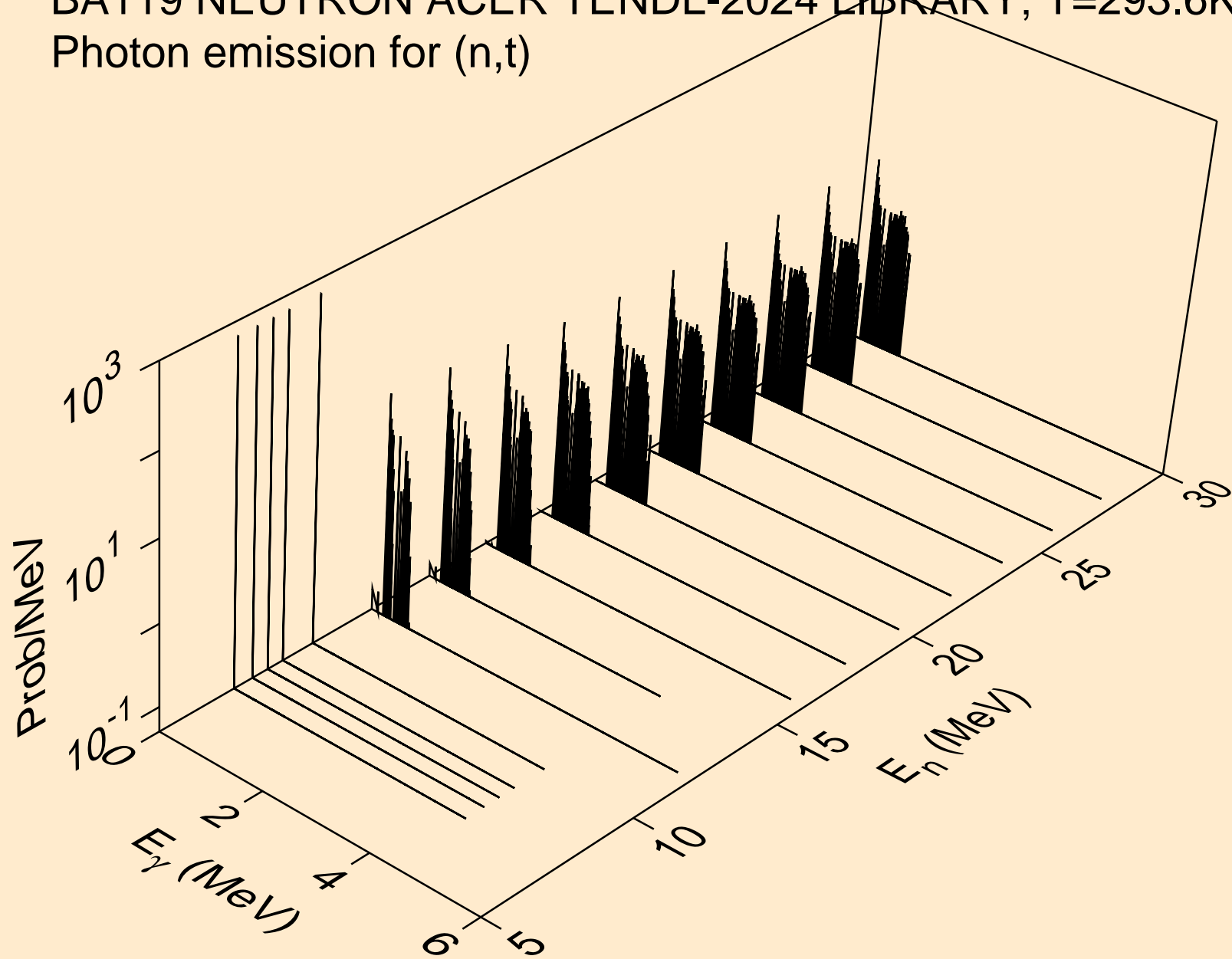

BA119 NEUTRON ACER TENDL-2024 LIBRARY; T=293.6K  
Photon emission for (n,he3)

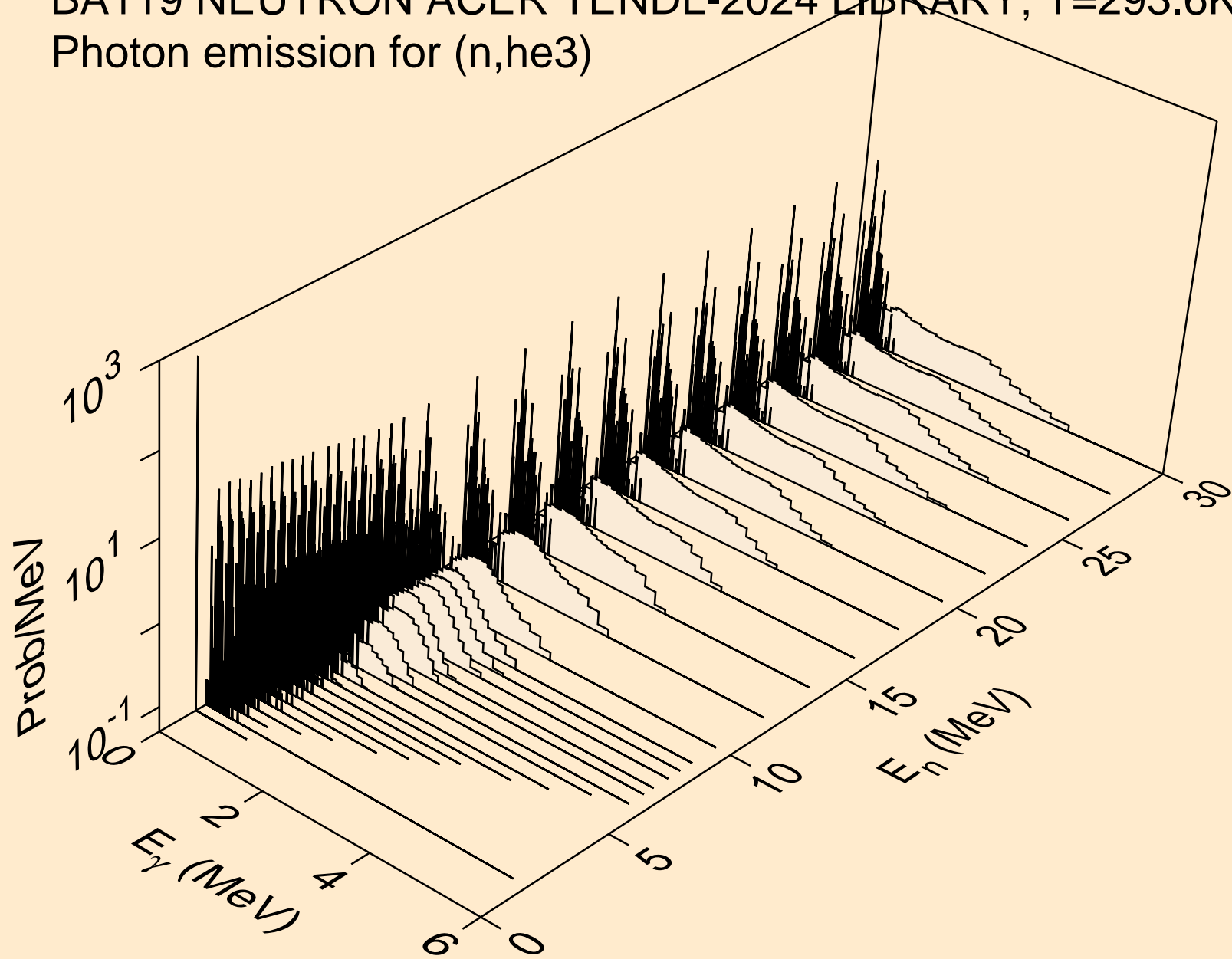

BA119 NEUTRON ACER TENDL-2024 LIBRARY; T=293.6K  
Photon emission for (n,a)

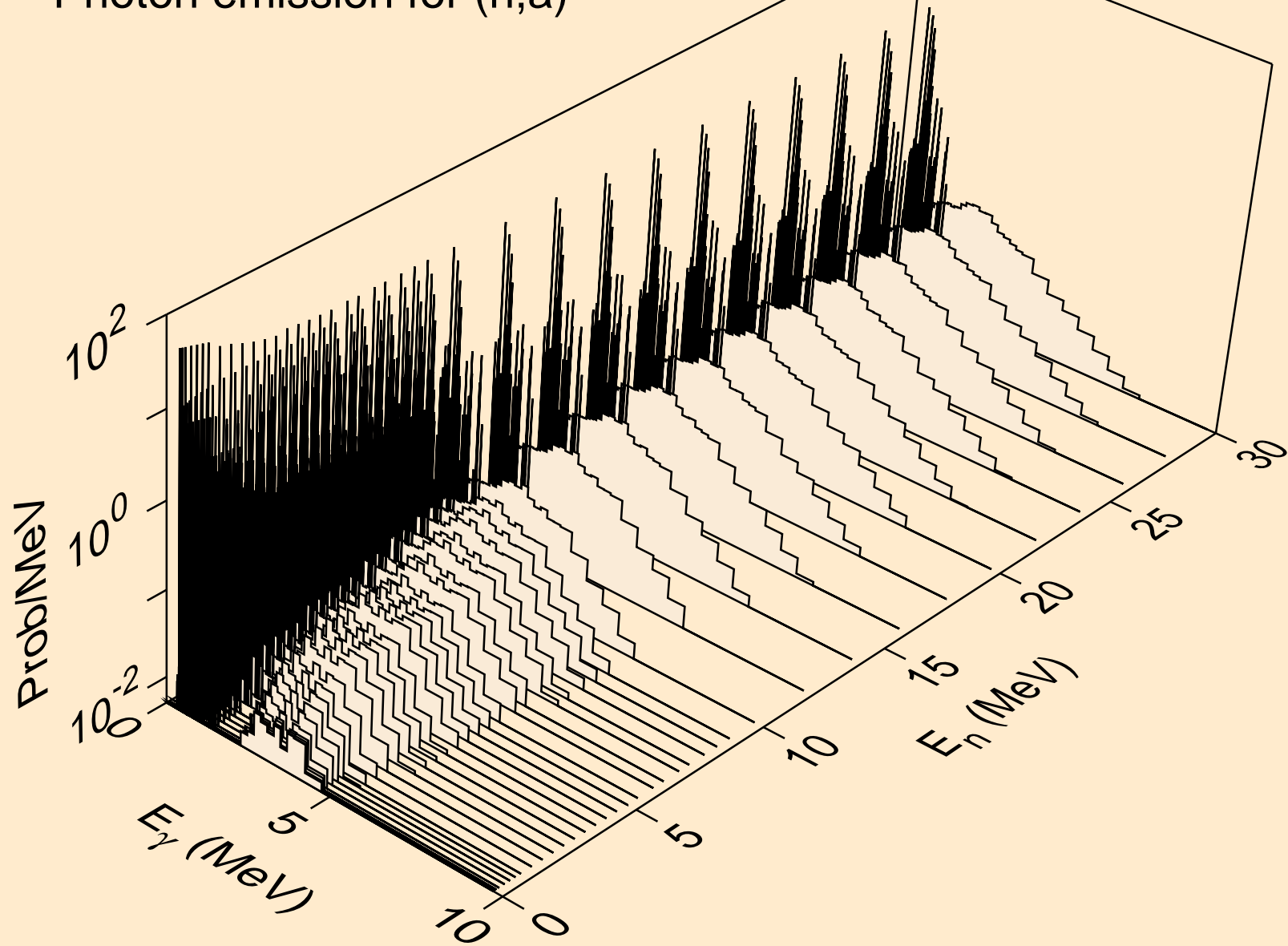

BA119 NEUTRON ACER TENDL-2024 LIBRARY; T=293.6K  
Photon emission for (n,2a)

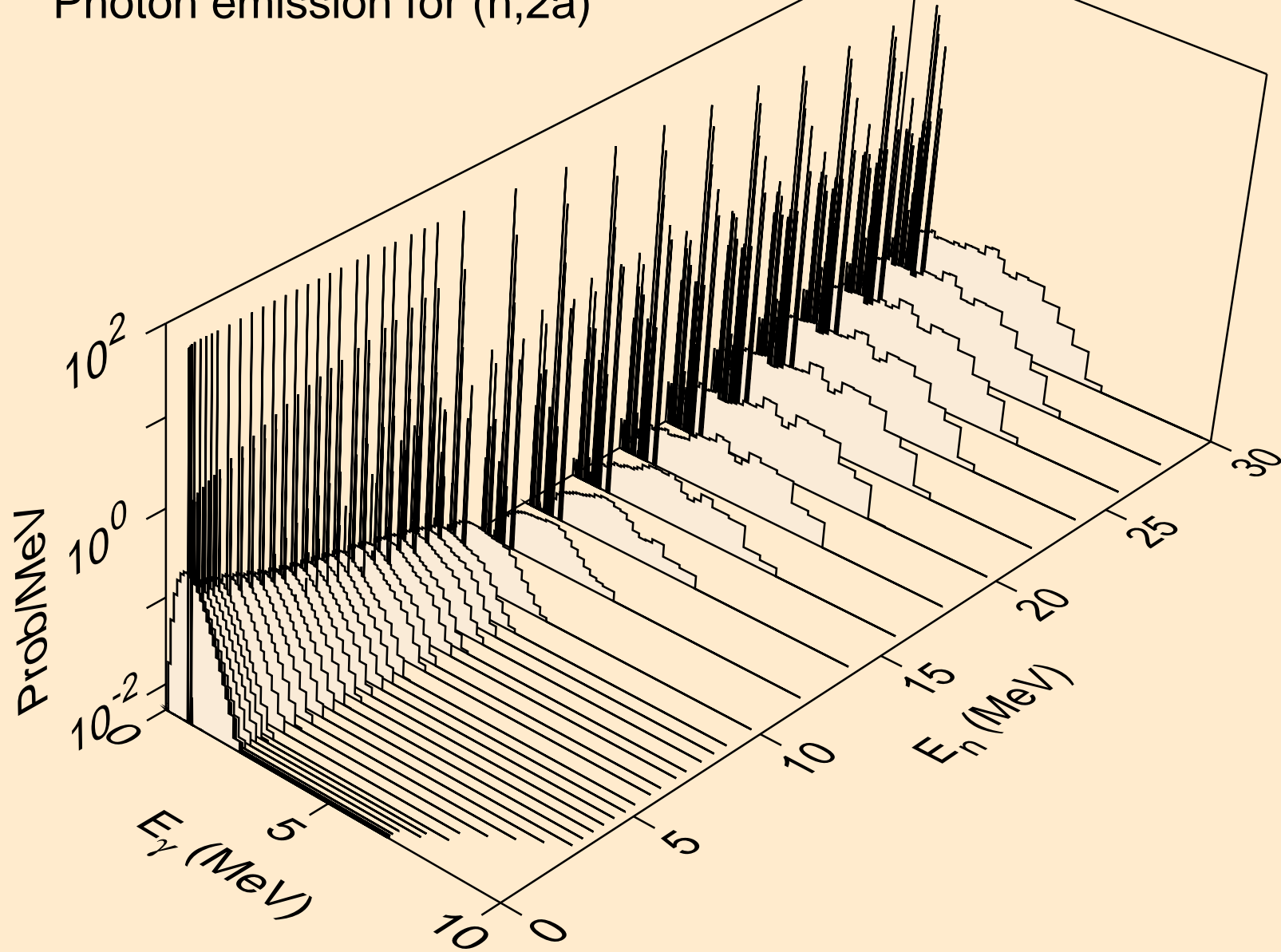

BA119 NEUTRON ACER TENDL-2024 LIBRARY; T=293.6K  
Photon emission for (n,3a)

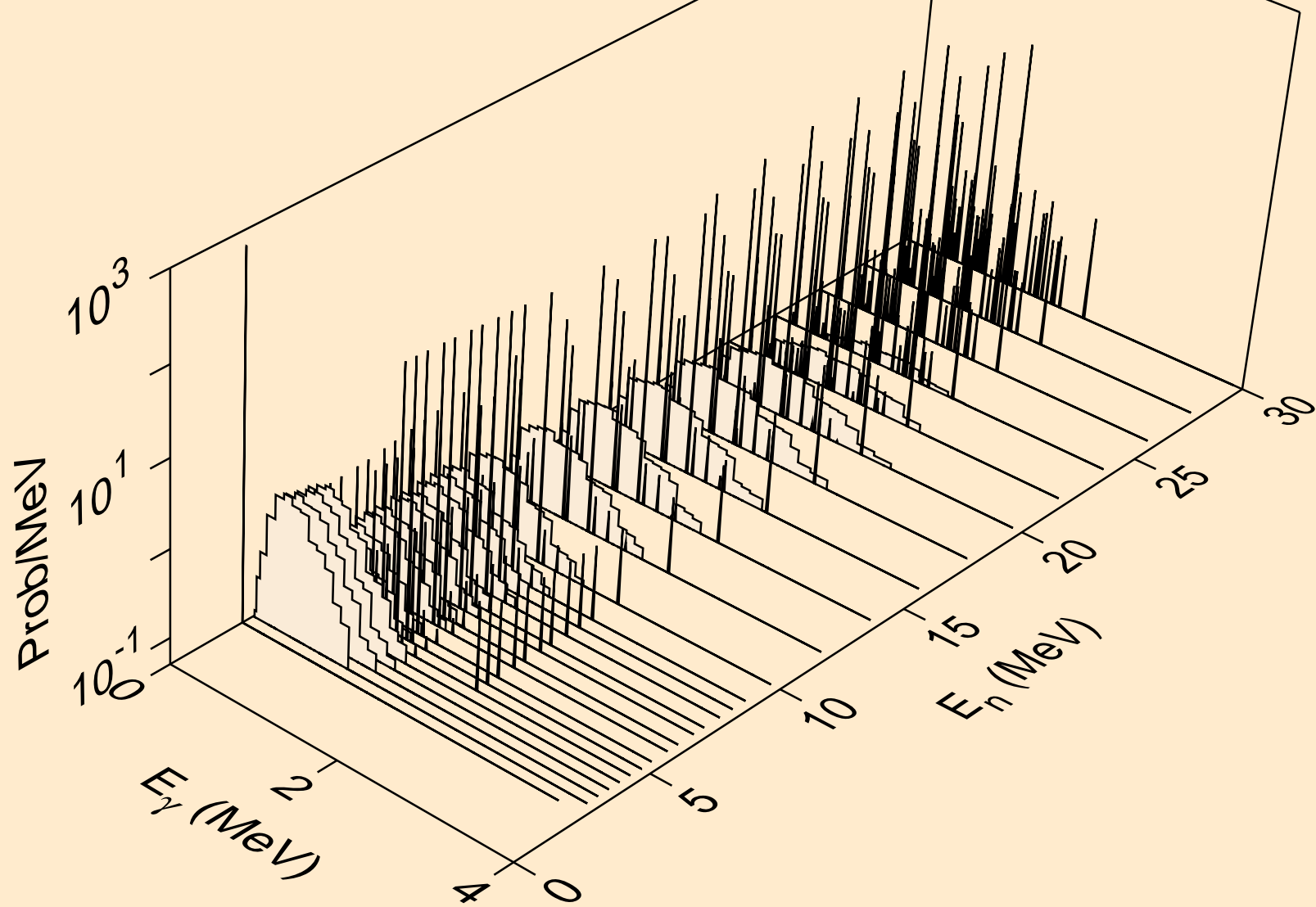

BA119 NEUTRON ACER TENDL-2024 LIBRARY; T=293.6K  
Photon emission for (n,2p)

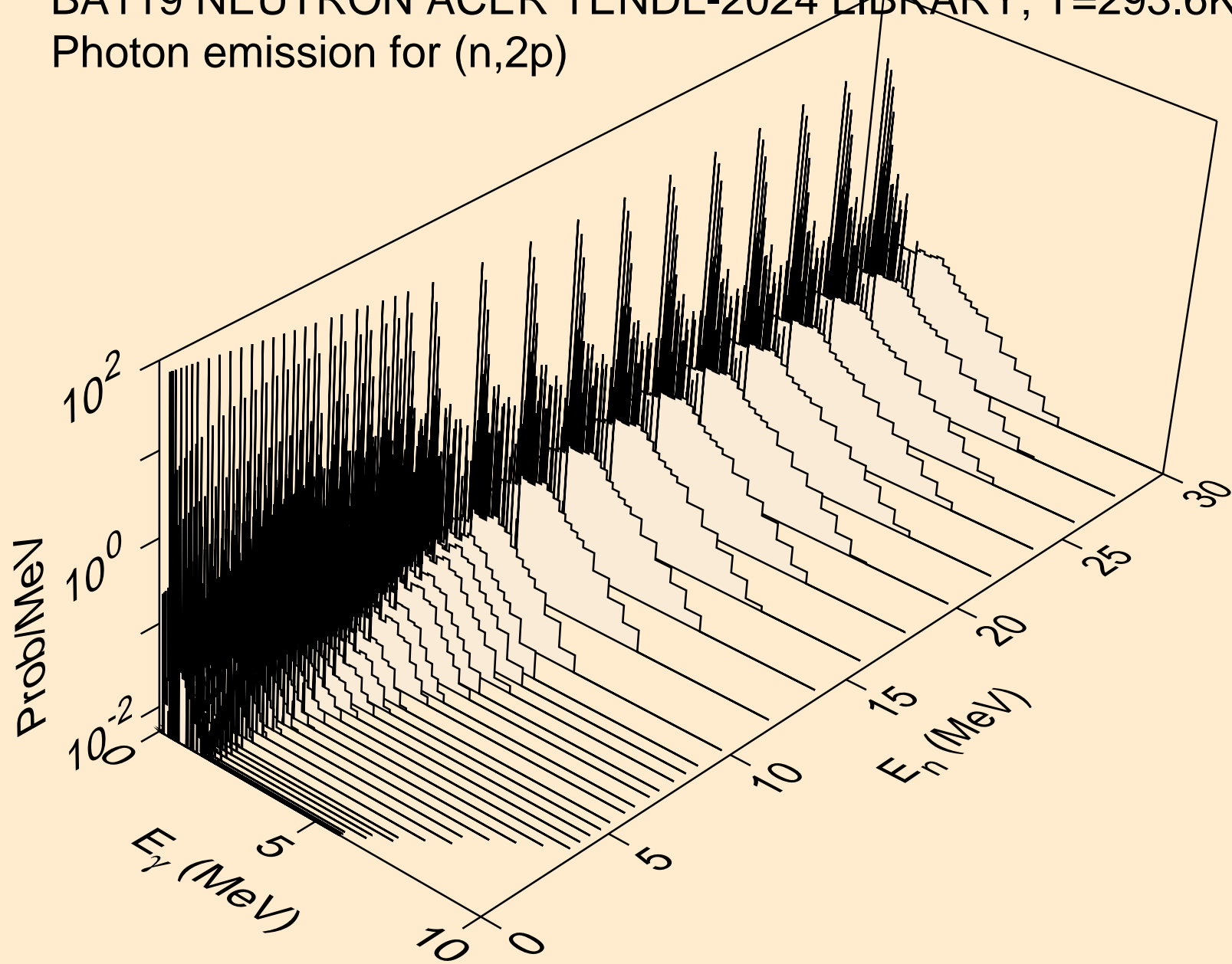

BA119 NEUTRON ACER TENDL-2024 LIBRARY; T=293.6K  
Photon emission for (n,p)

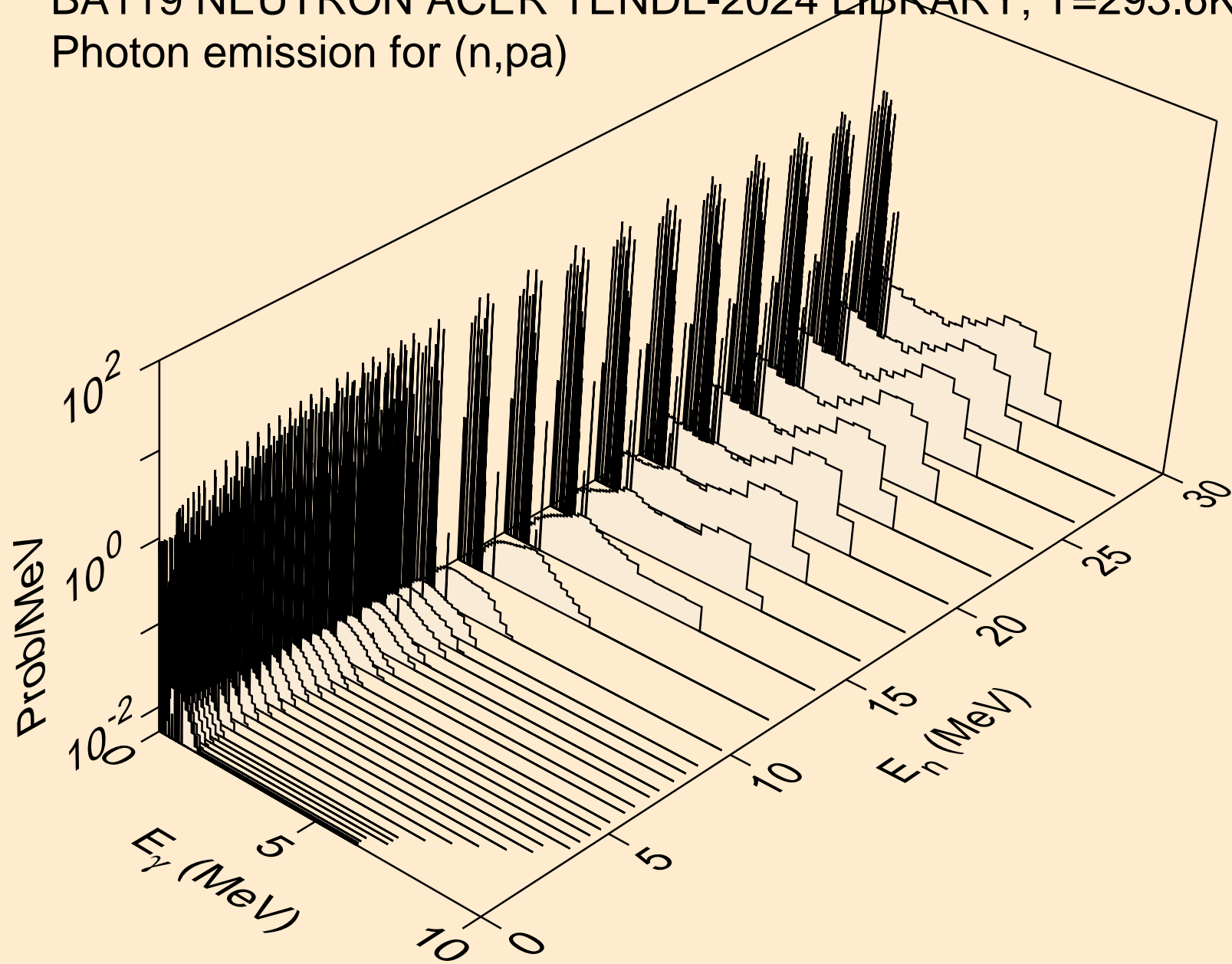

BA119 NEUTRON ACER TENDL-2024 LIBRARY; T=293.6K  
Photon emission for (n,t2a)

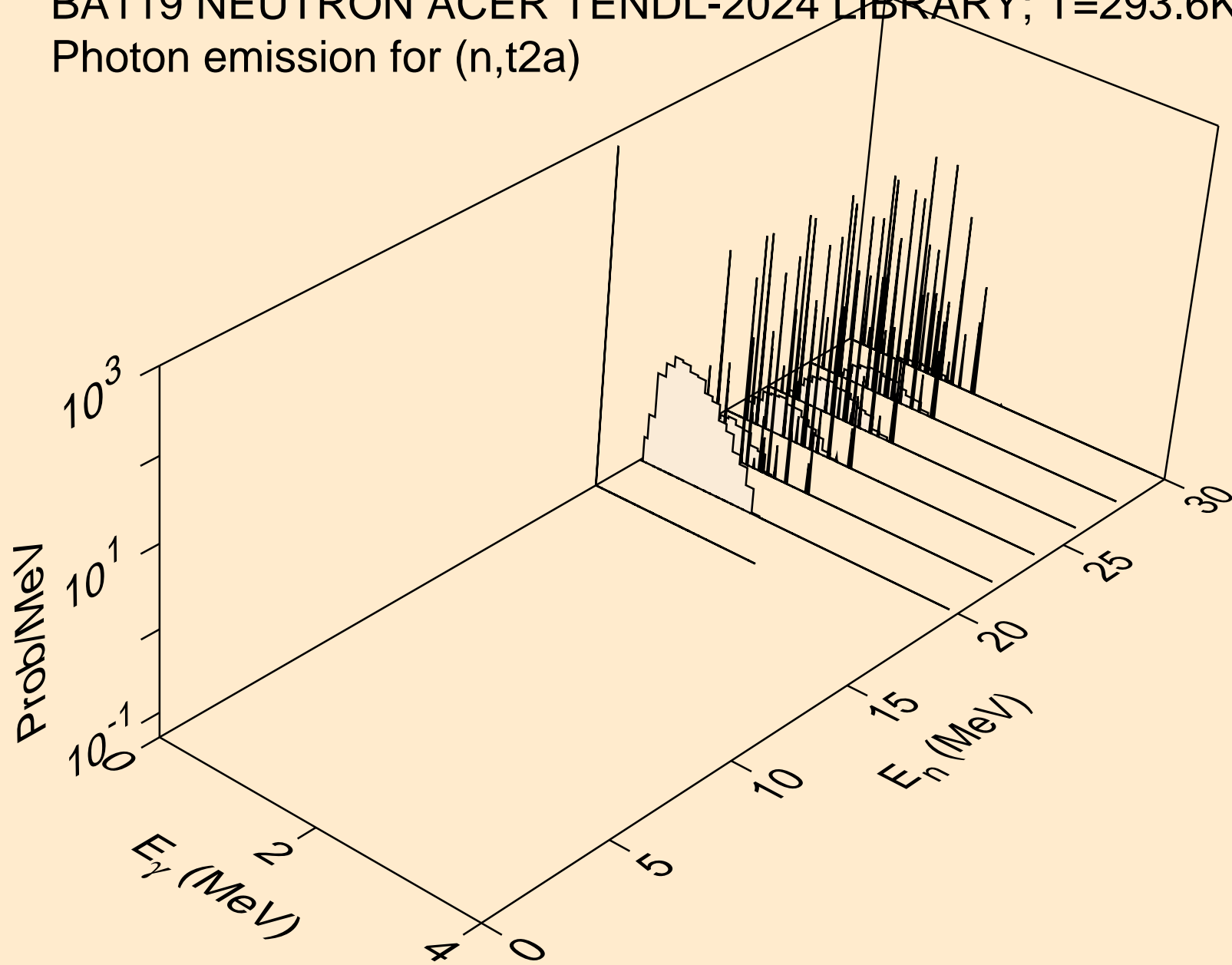

BA119 NEUTRON ACER TENDL-2024 LIBRARY; T=293.6K  
Photon emission for (n,d2a)

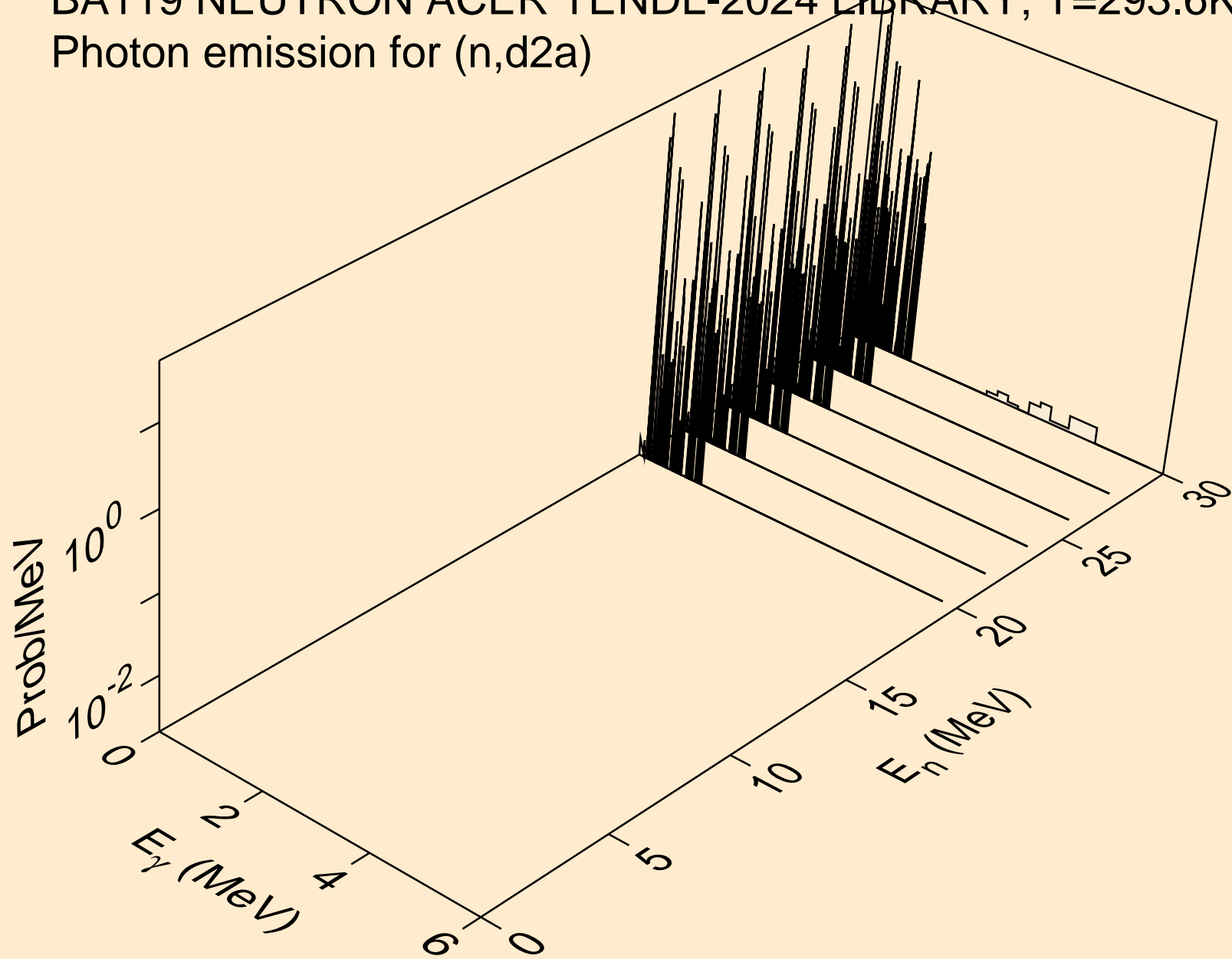

BA119 NEUTRON ACER TENDL-2024 LIBRARY; T=293.6K  
Photon emission for (n,pd)

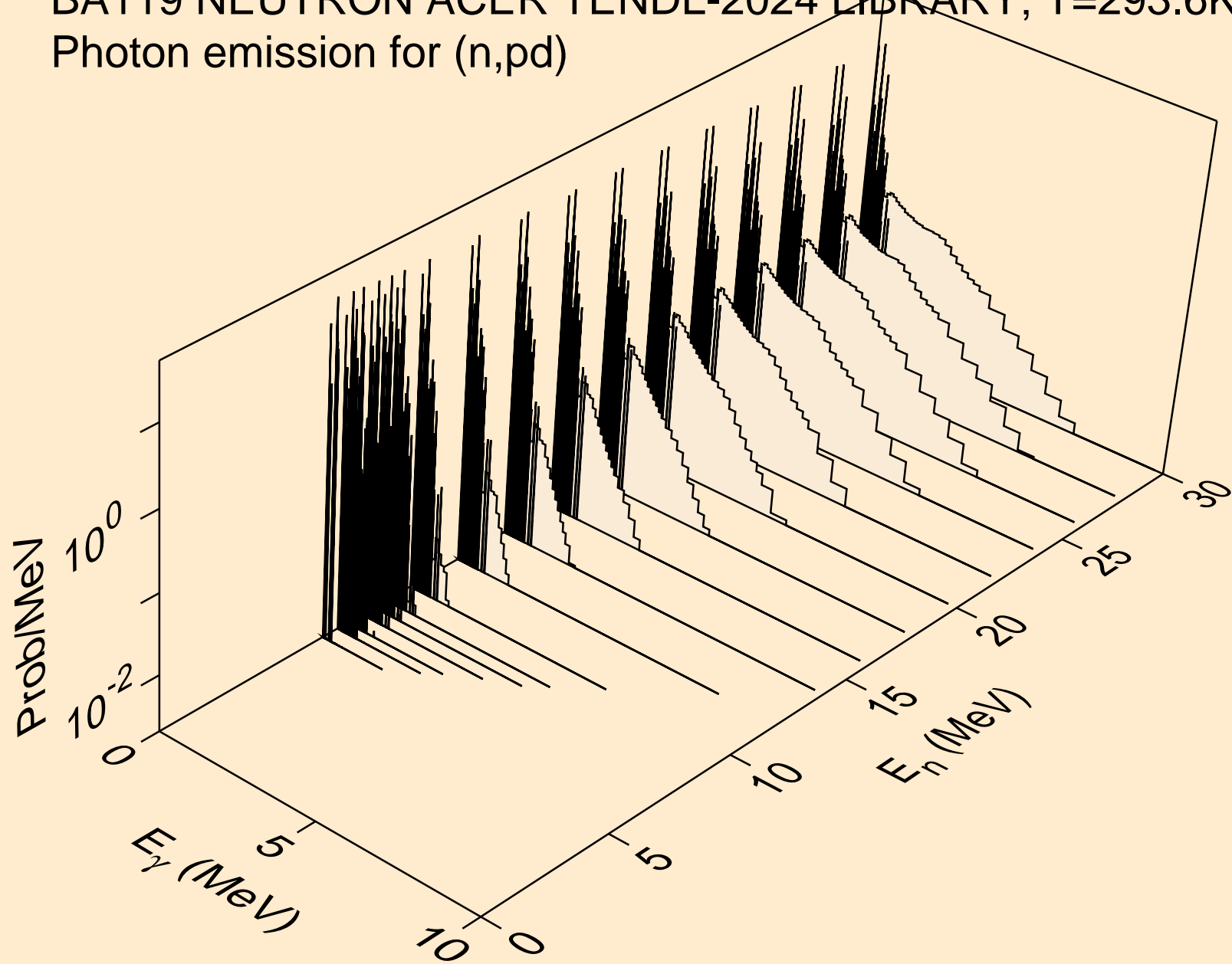

BA119 NEUTRON ACER TENDL-2024 LIBRARY; T=293.6K  
Photon emission for (n,pt)

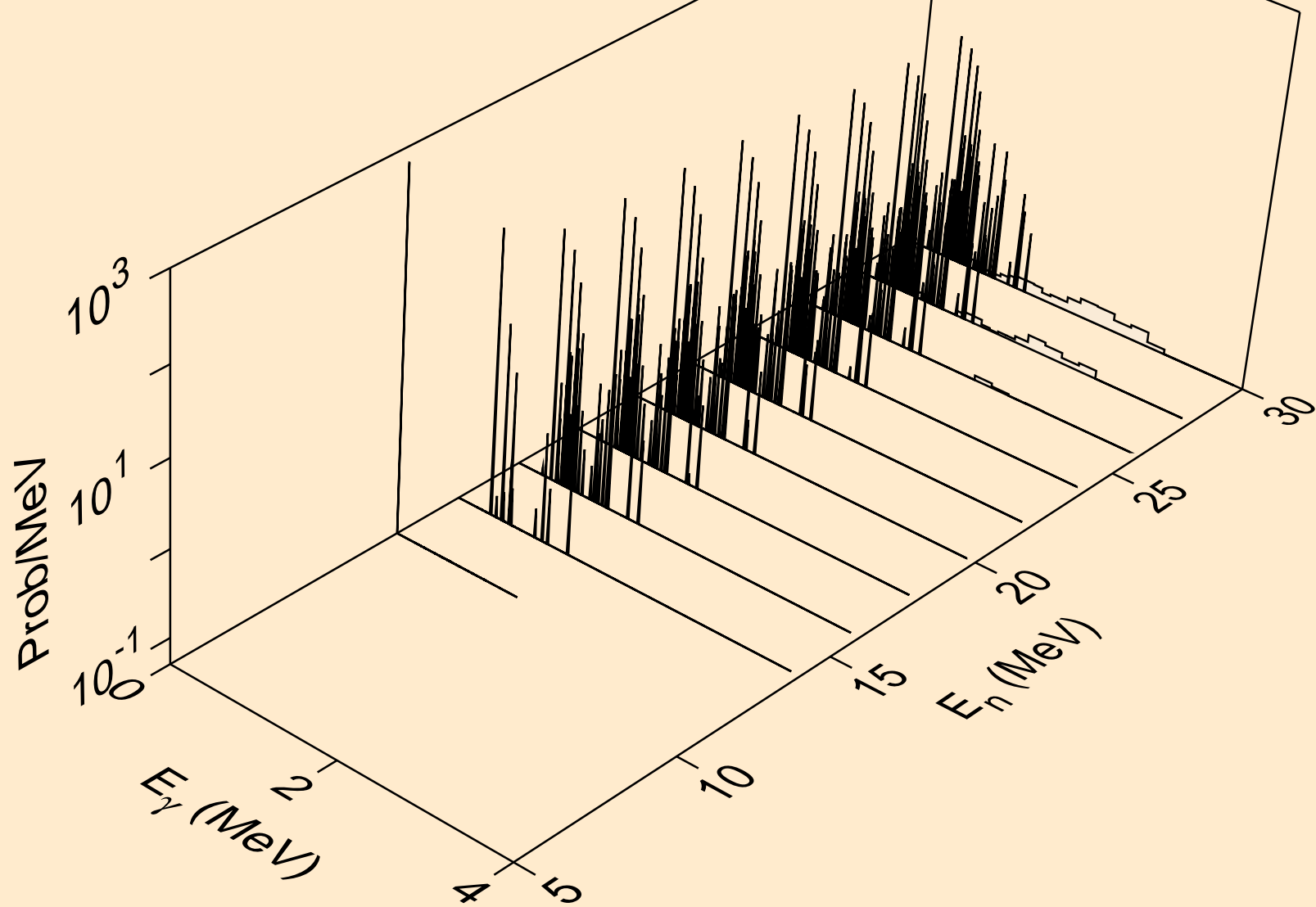

BA119 NEUTRON ACER TENDL-2024 LIBRARY; T=293.6K  
Photon emission for (n,da)

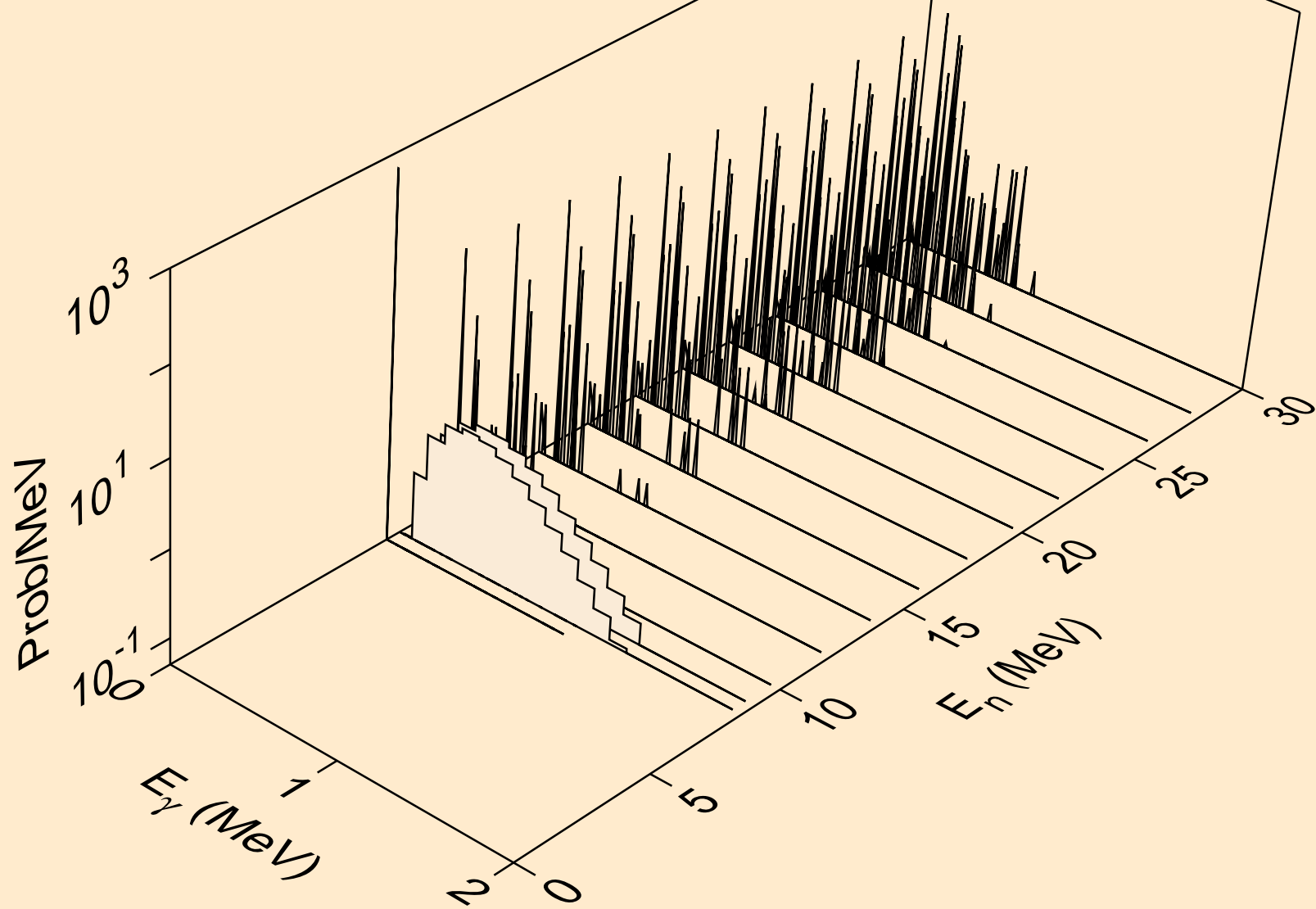

BA119 NEUTRON ACER TENDL-2024 LIBRARY; T=293.6K  
thermal capture photon spectrum

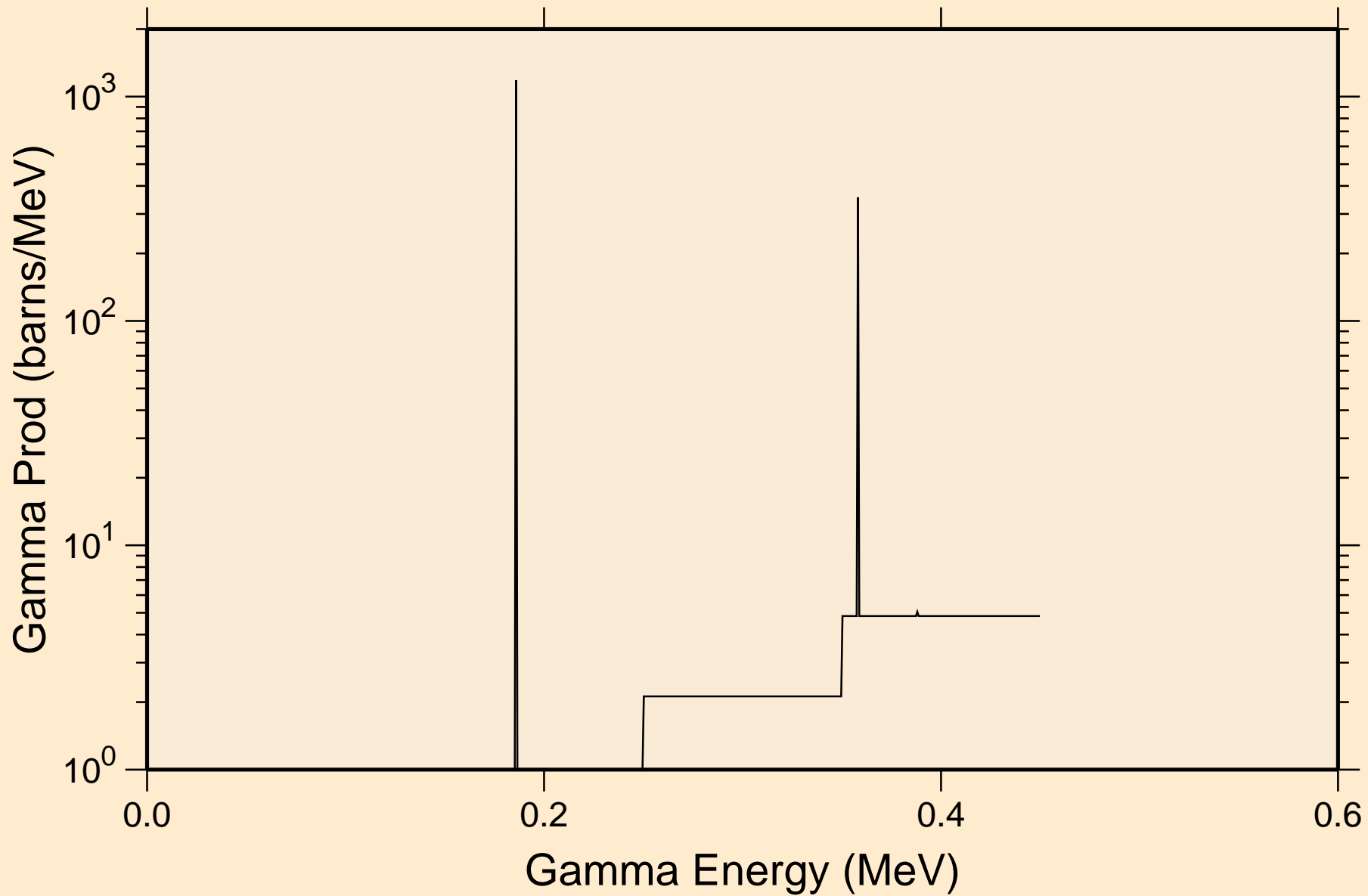

BA119 NEUTRON ACER TENDL-2024 LIBRARY; T=293.6K  
14 MeV photon spectrum

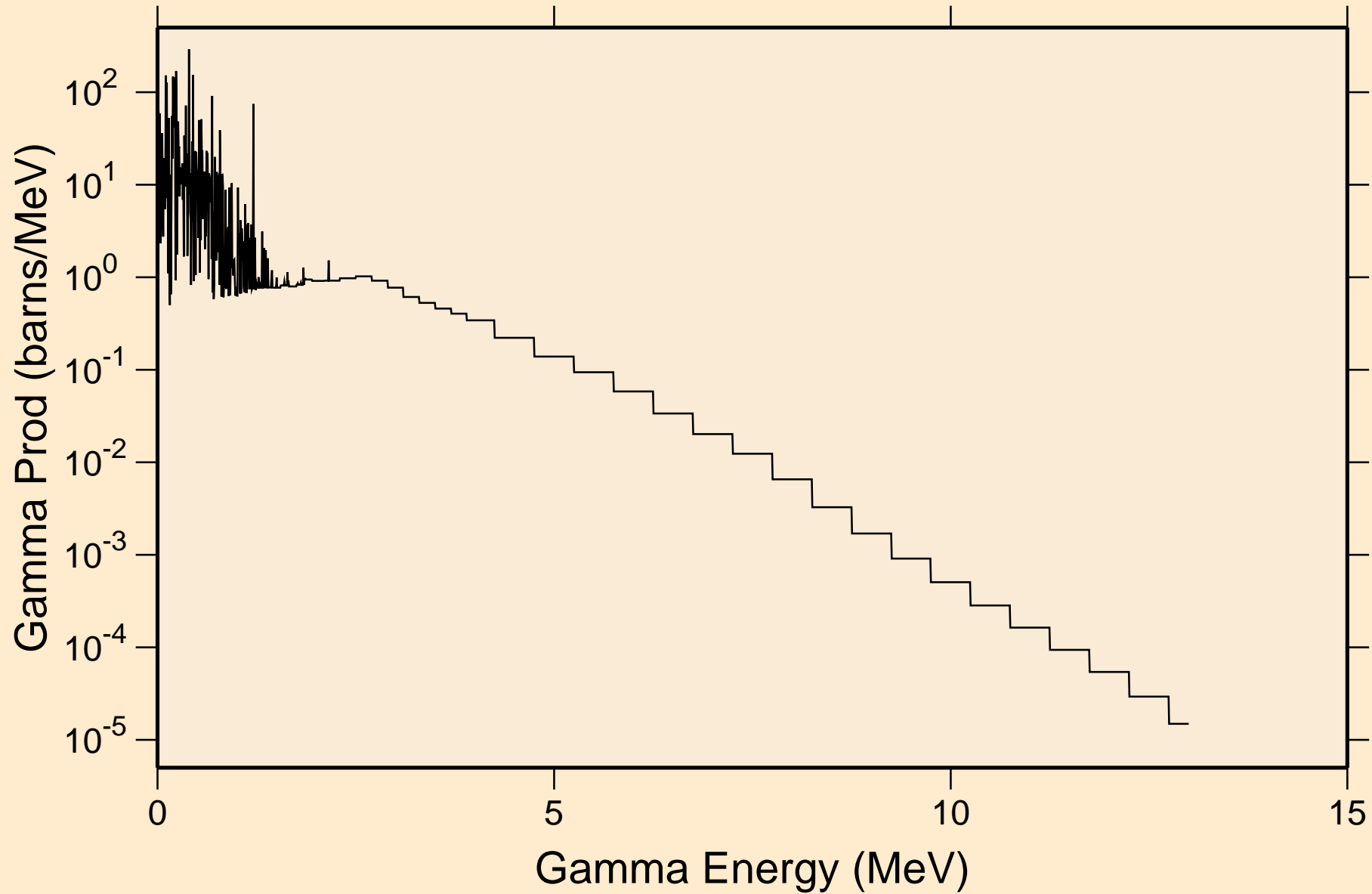

# BA119 NEUTRON ACER TENDL-2024 LIBRARY; T=293.6K

## Particle heating contributions

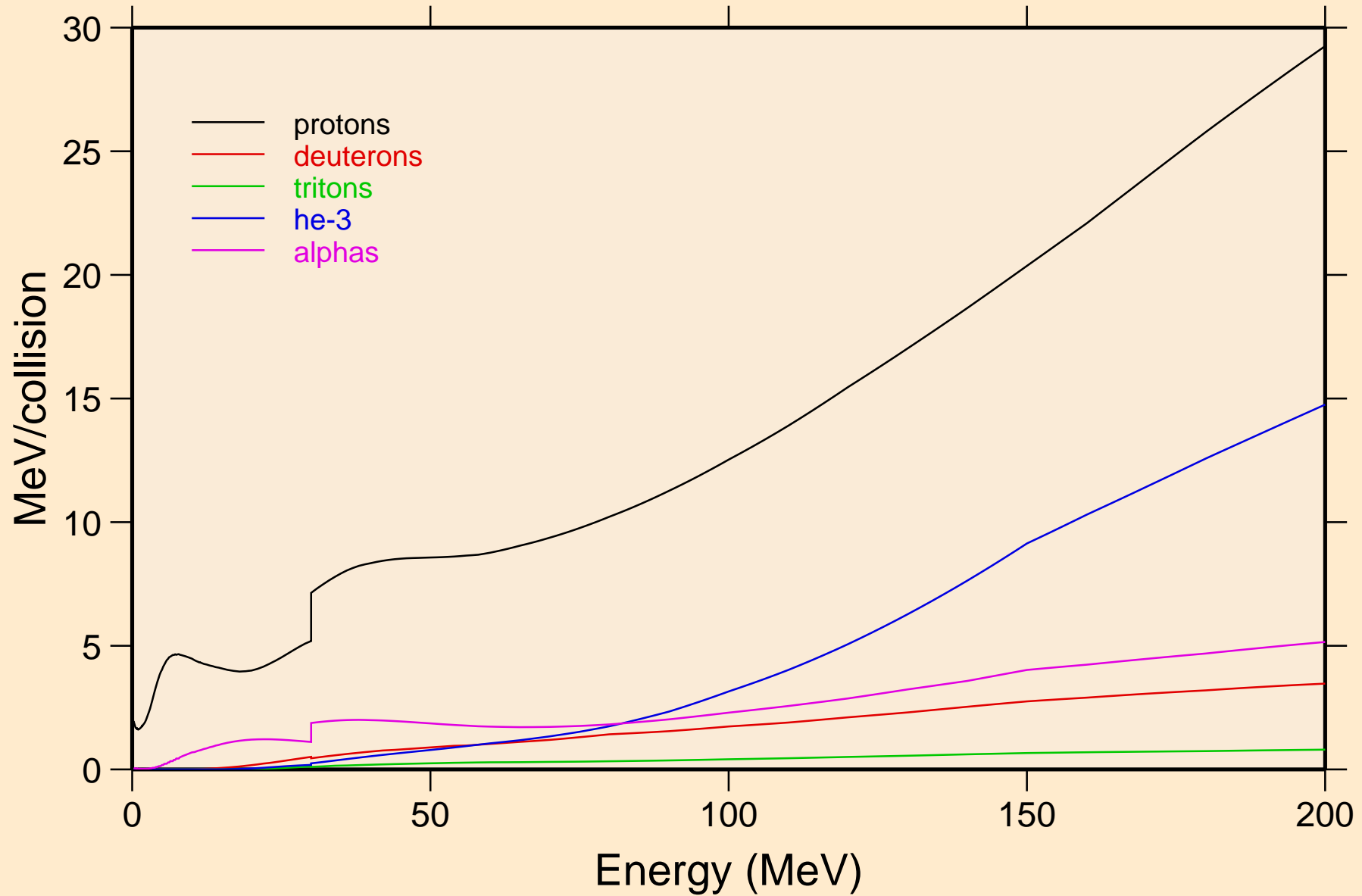

BA119 NEUTRON ACER TENDL-2024 LIBRARY; T=293.6K  
Recoil Heating

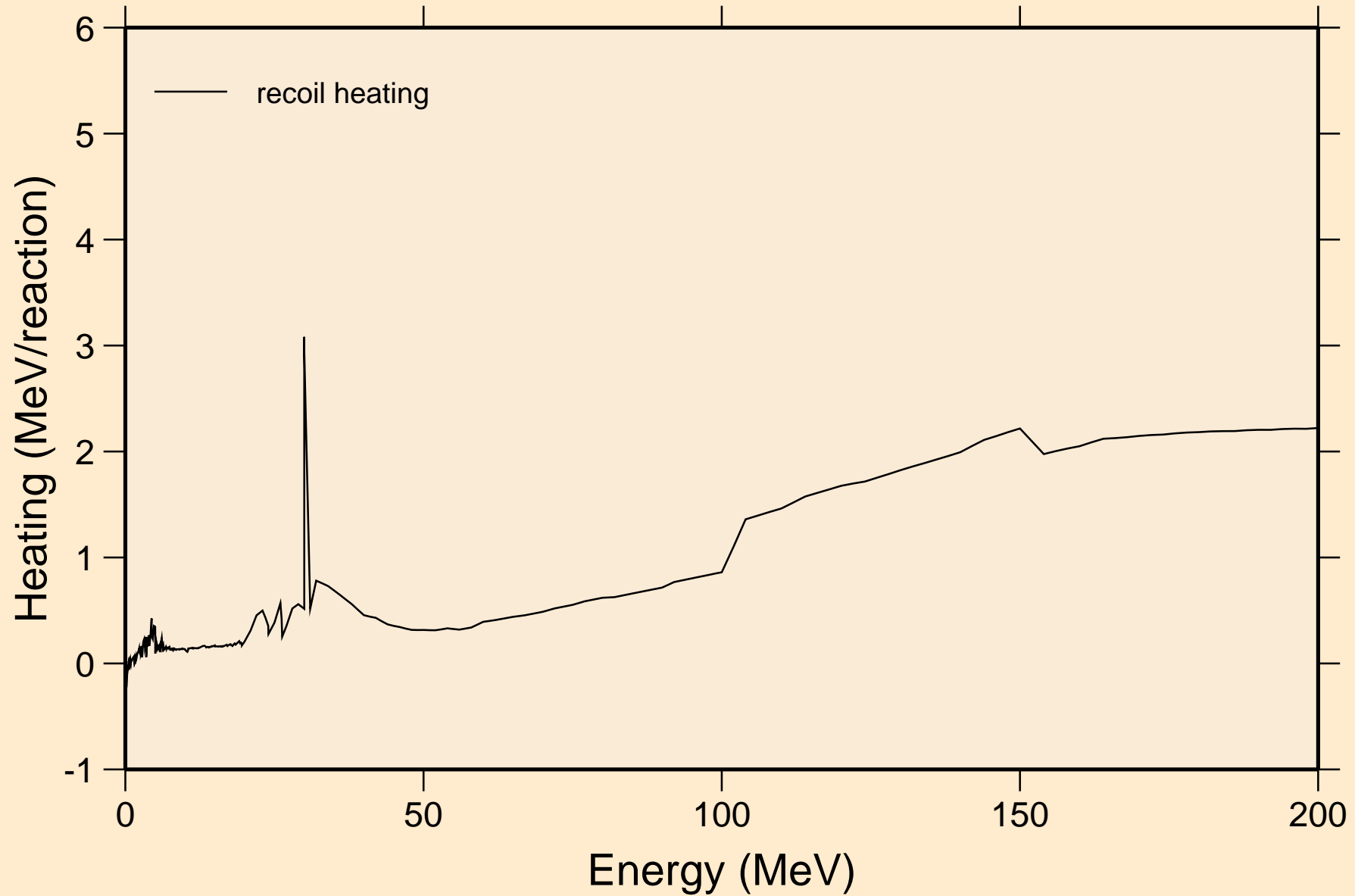

BA119 NEUTRON ACER TENDL-2024 LIBRARY; T=293.6K  
Particle production cross sections

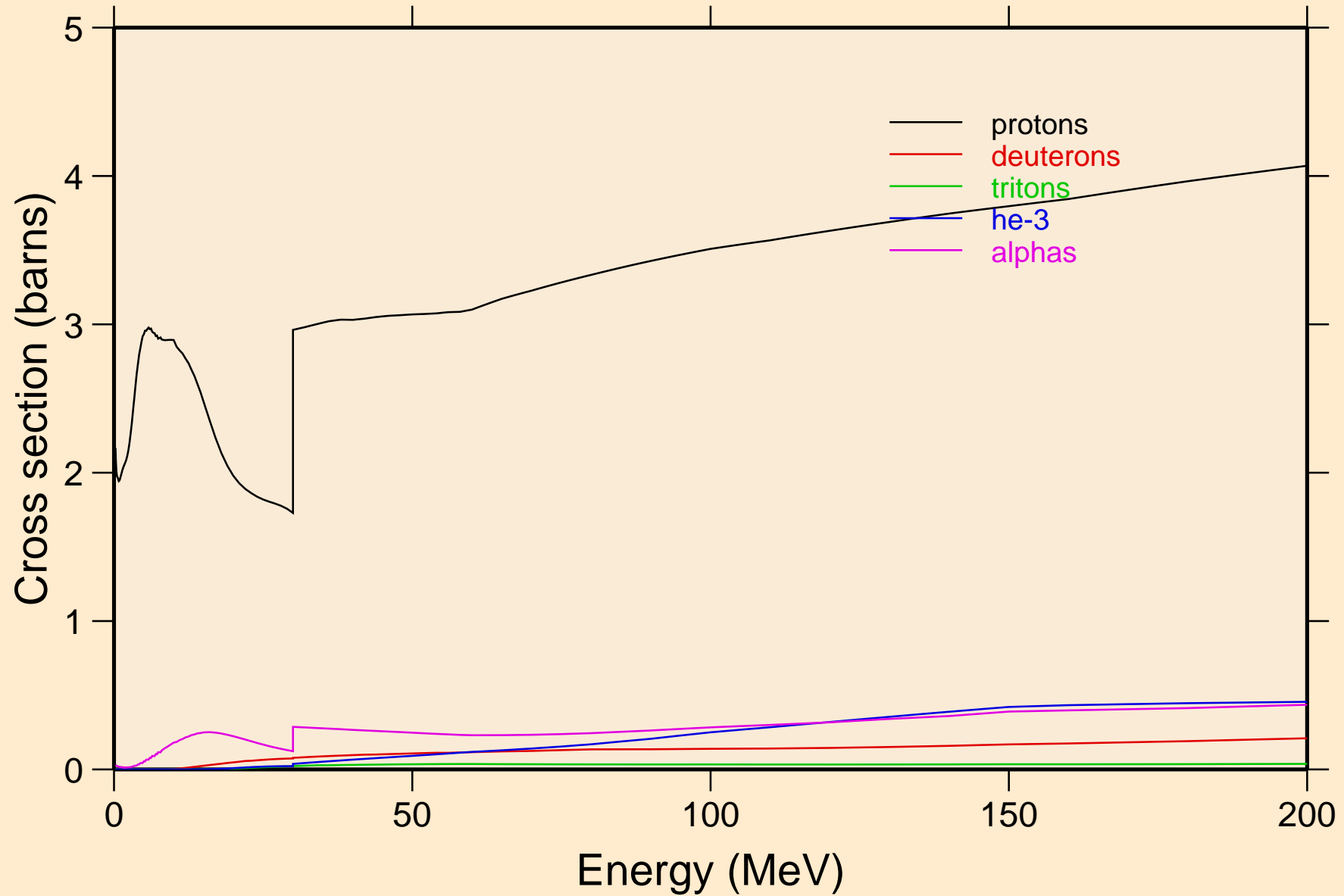

BA119 NEUTRON ACER TENDL-2024 LIBRARY; T=293.6K  
protons from (n,x)

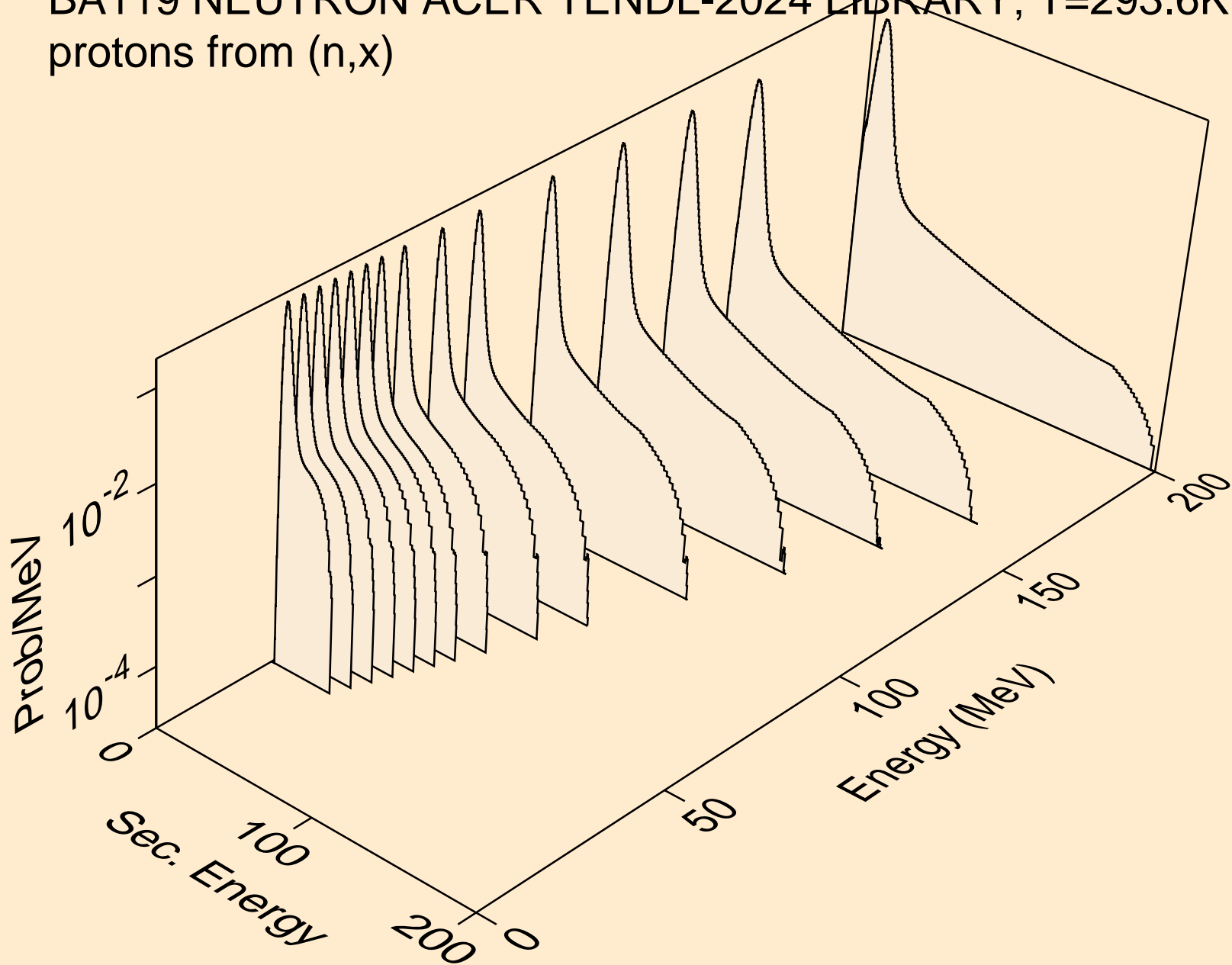

BA119 NEUTRON ACER TENDL-2024 LIBRARY; T=293.6K  
protons from (n,n\*)p

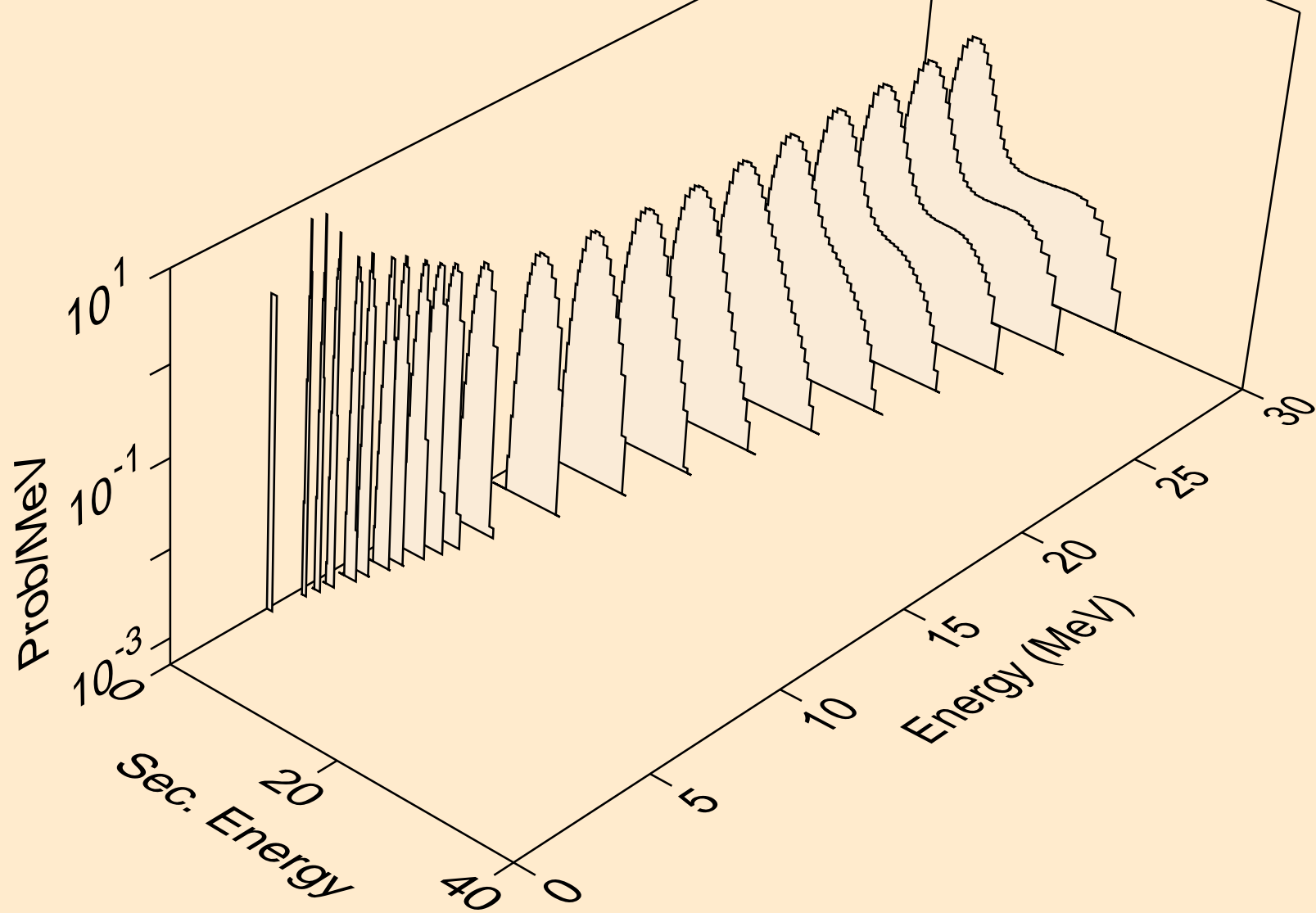

BA119 NEUTRON ACER TENDL-2024 LIBRARY; T=293.6K  
protons from (n,2np)

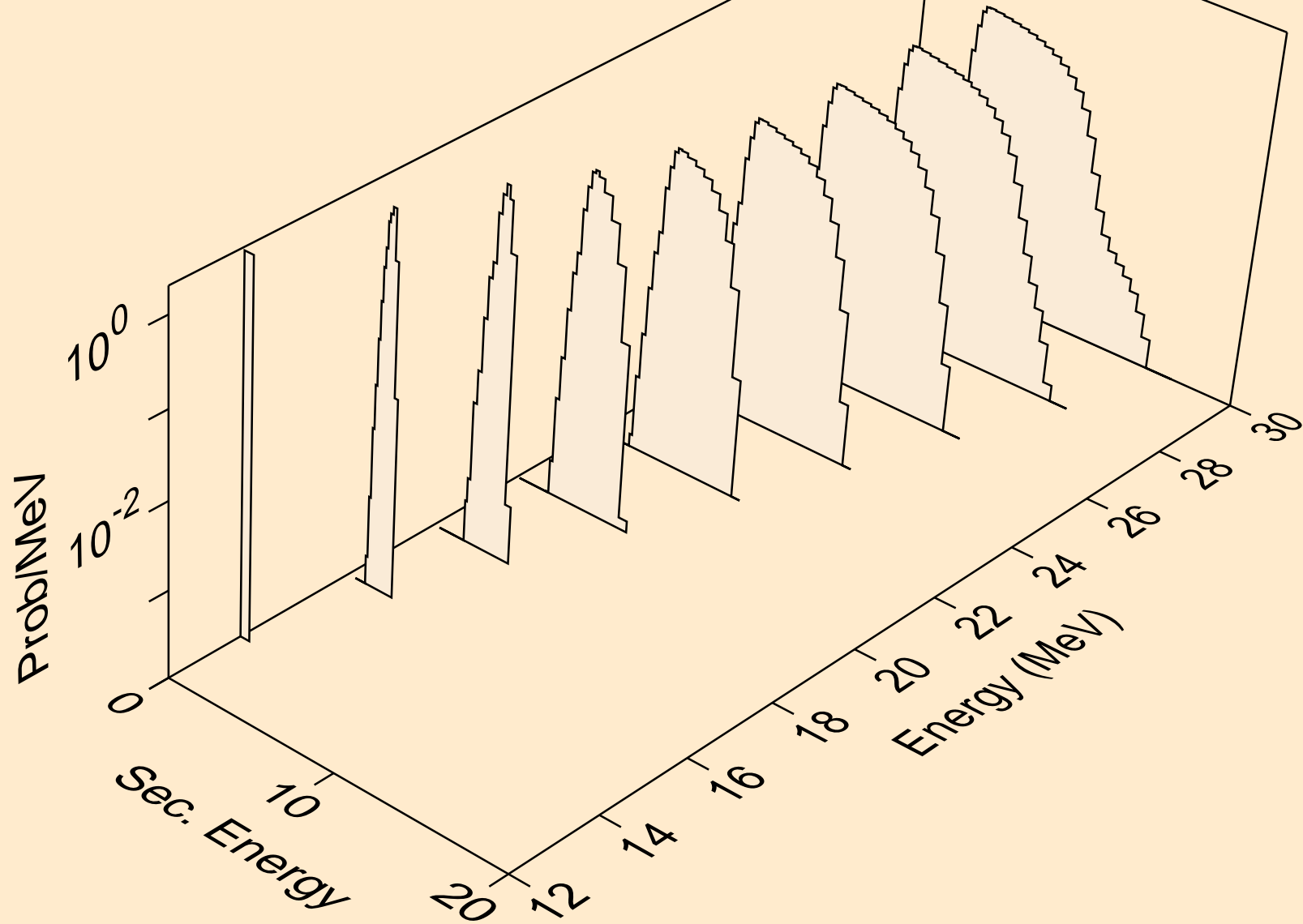

BA119 NEUTRON ACER TENDL-2024 LIBRARY; T=293.6K  
protons from (n,3np)

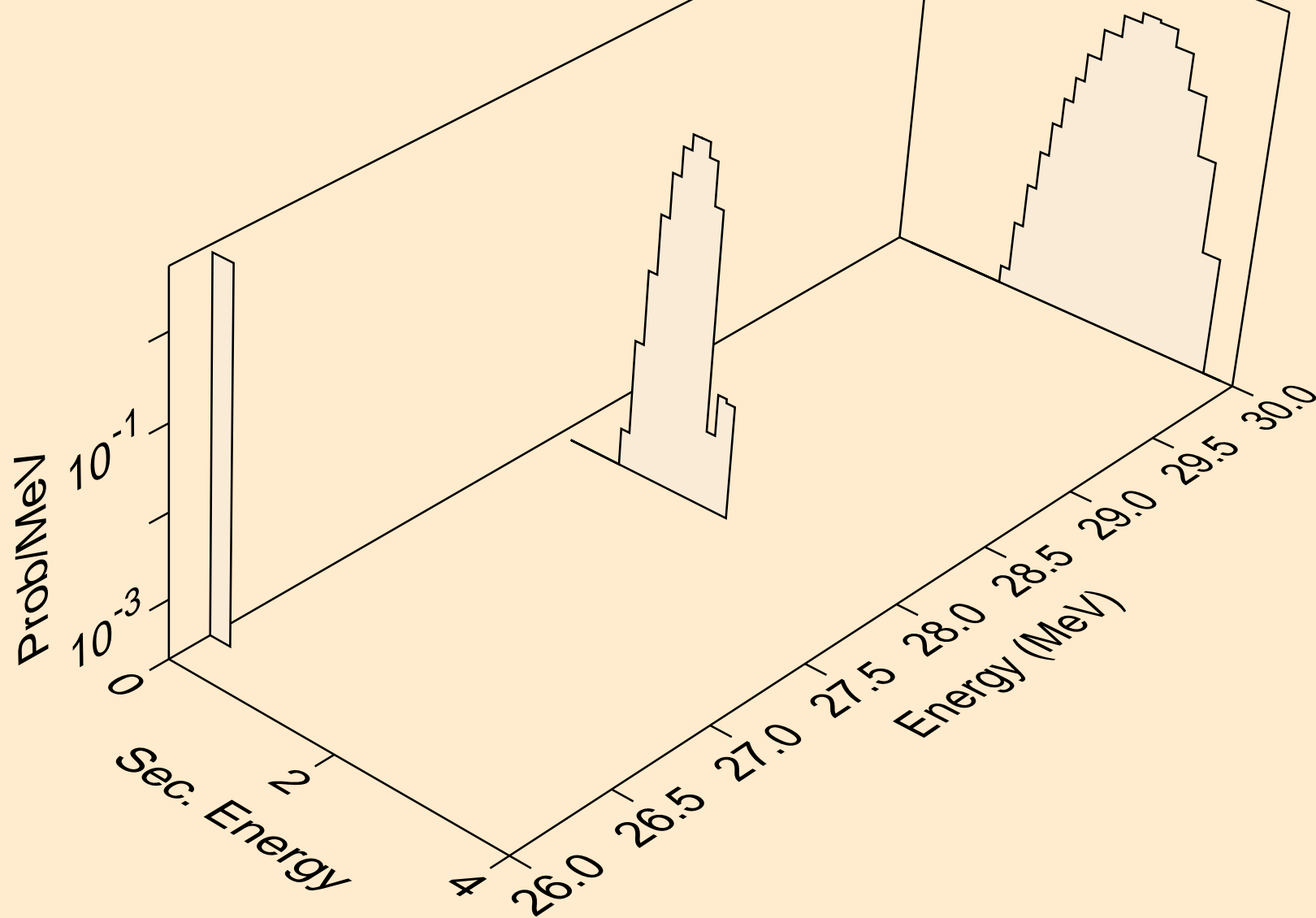

BA119 NEUTRON ACER TENDL-2024 LIBRARY; T=293.6K  
protons from (n,n2p)

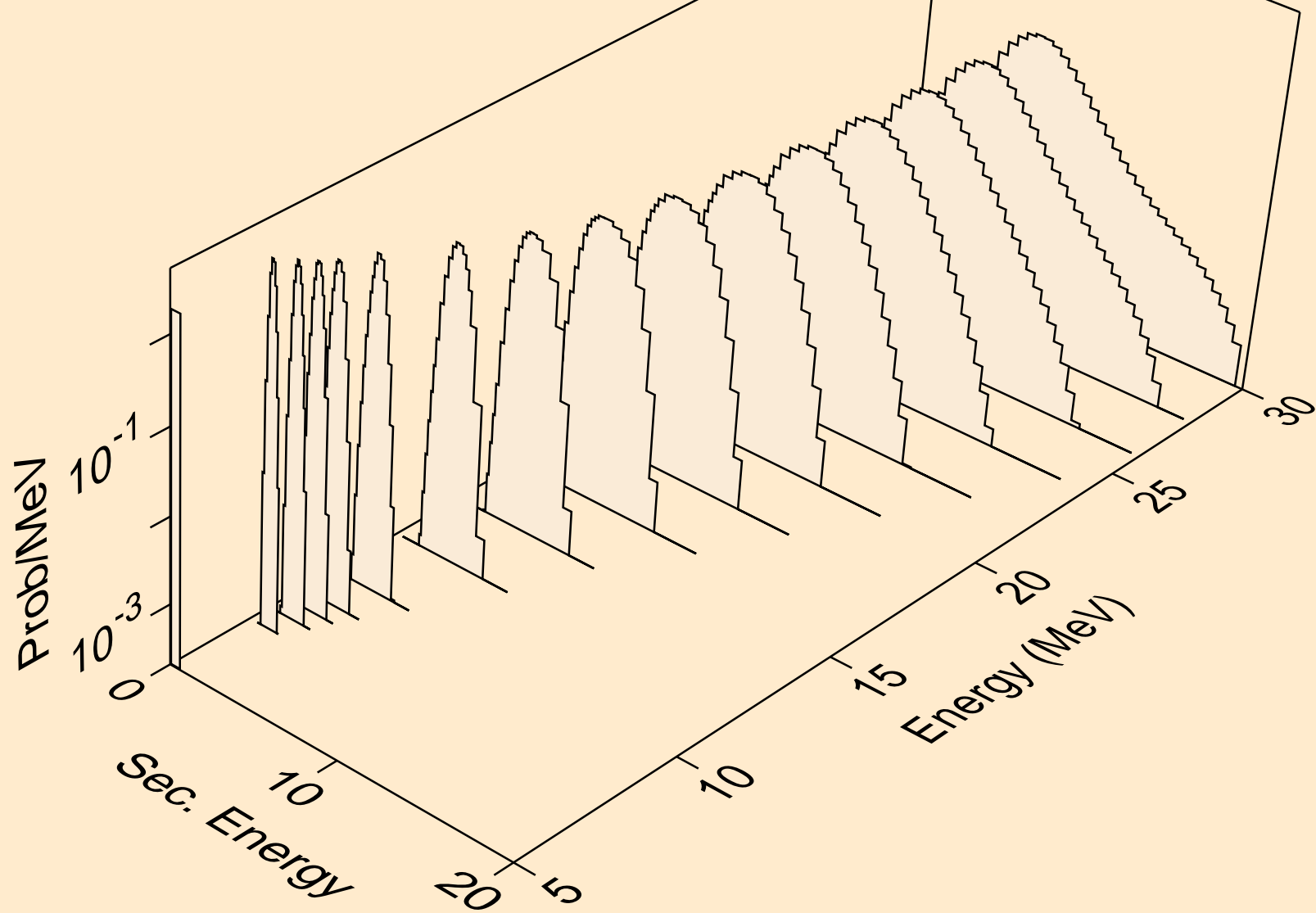

BA119 NEUTRON ACER TENDL-2024 LIBRARY; T=293.6K  
protons from (n,npa)

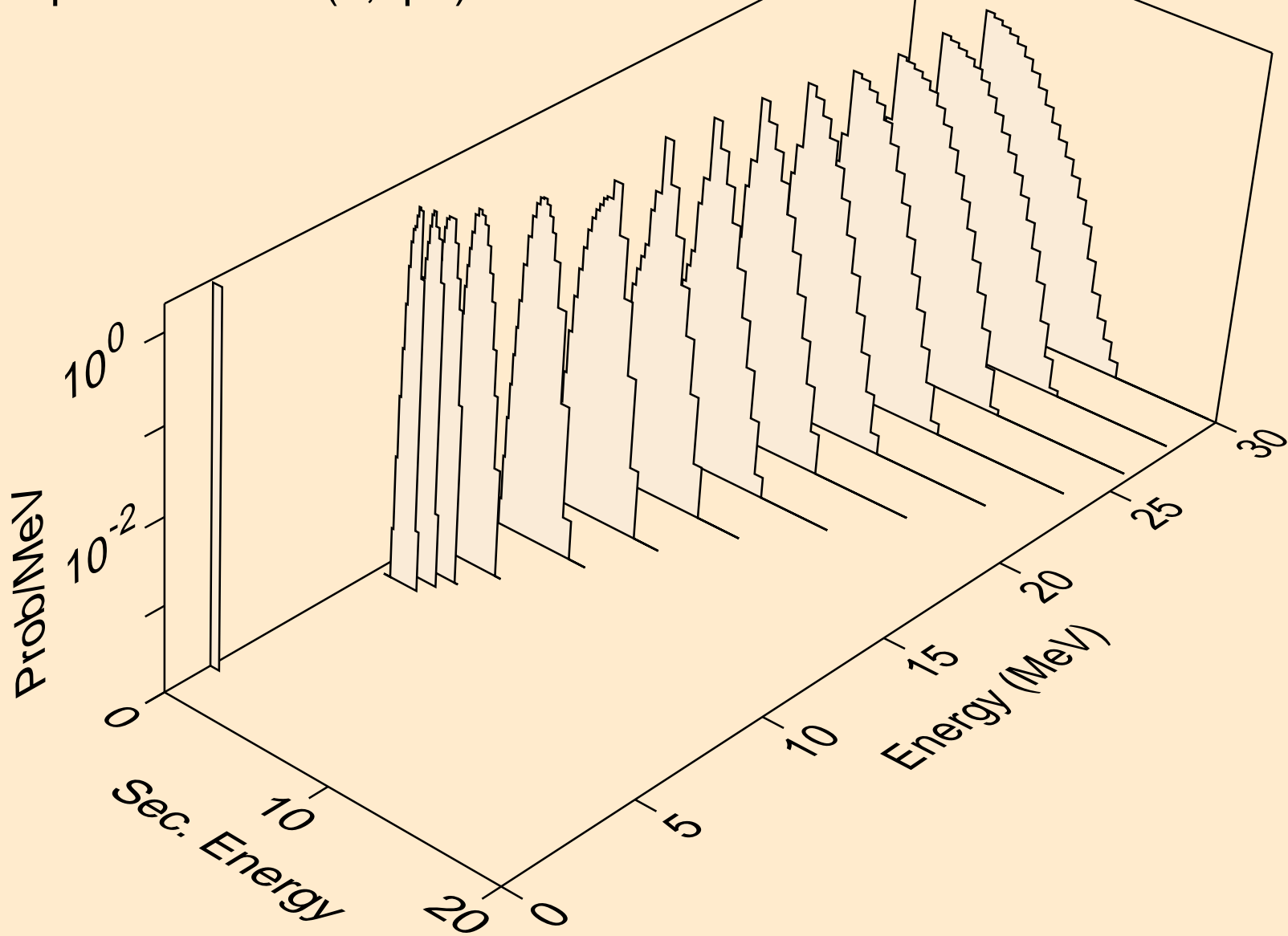

BA119 NEUTRON ACER TENDL-2024 LIBRARY; T=293.6K  
protons from (n,p)

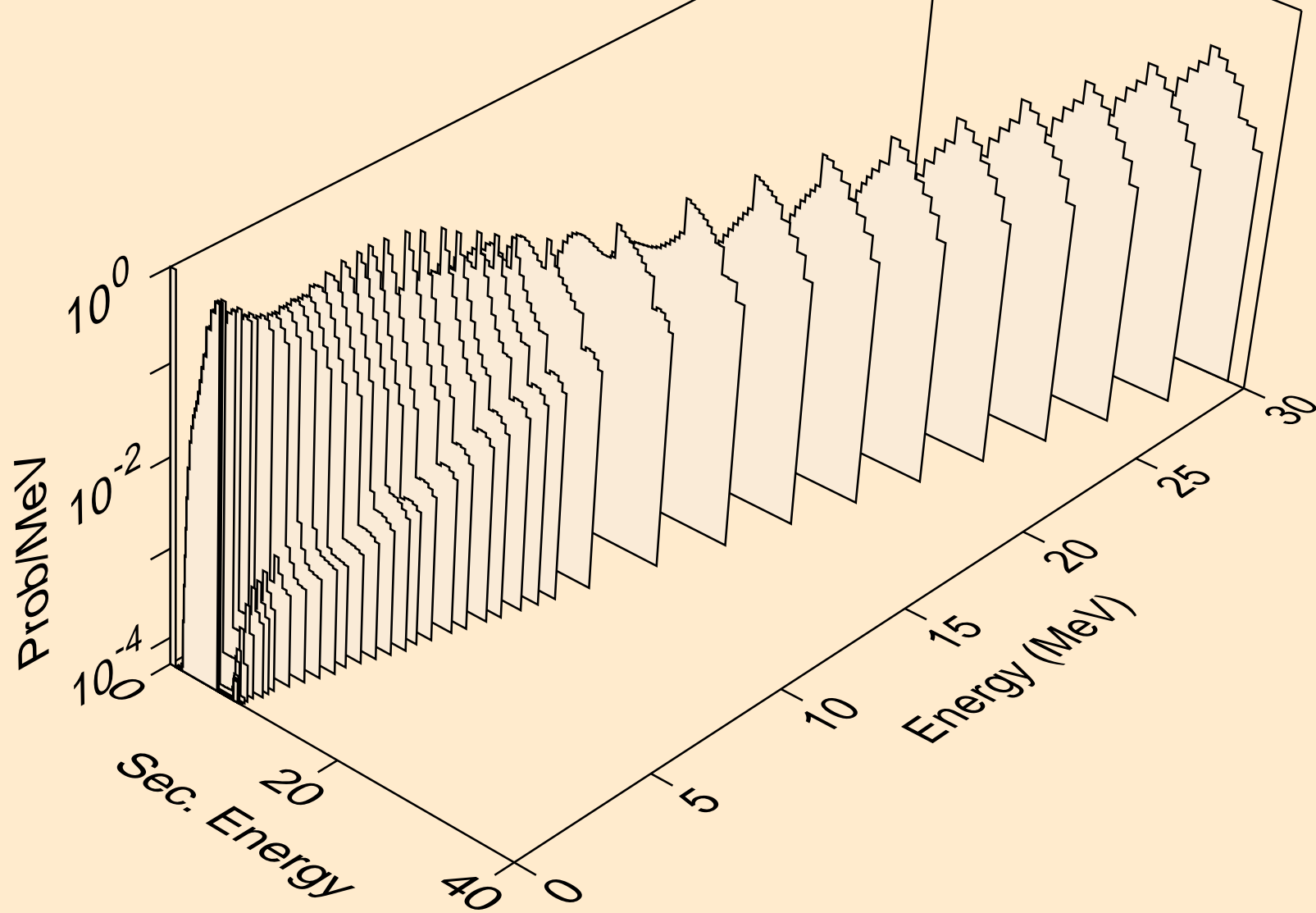

BA119 NEUTRON ACER TENDL-2024 LIBRARY; T=293.6K  
protons from (n,2p)

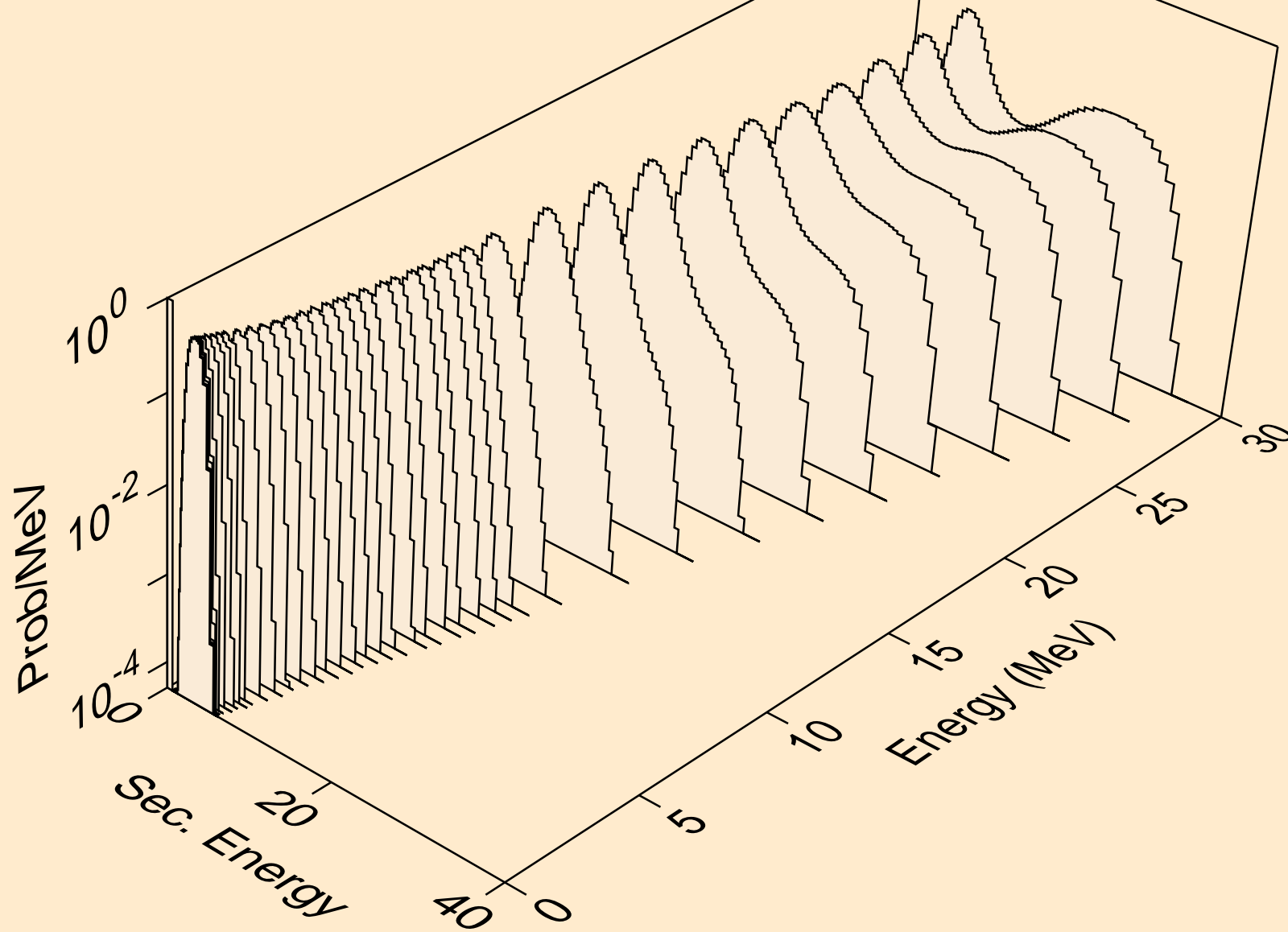

BA119 NEUTRON ACER TENDL-2024 LIBRARY; T=293.6K  
protons from (n,p)

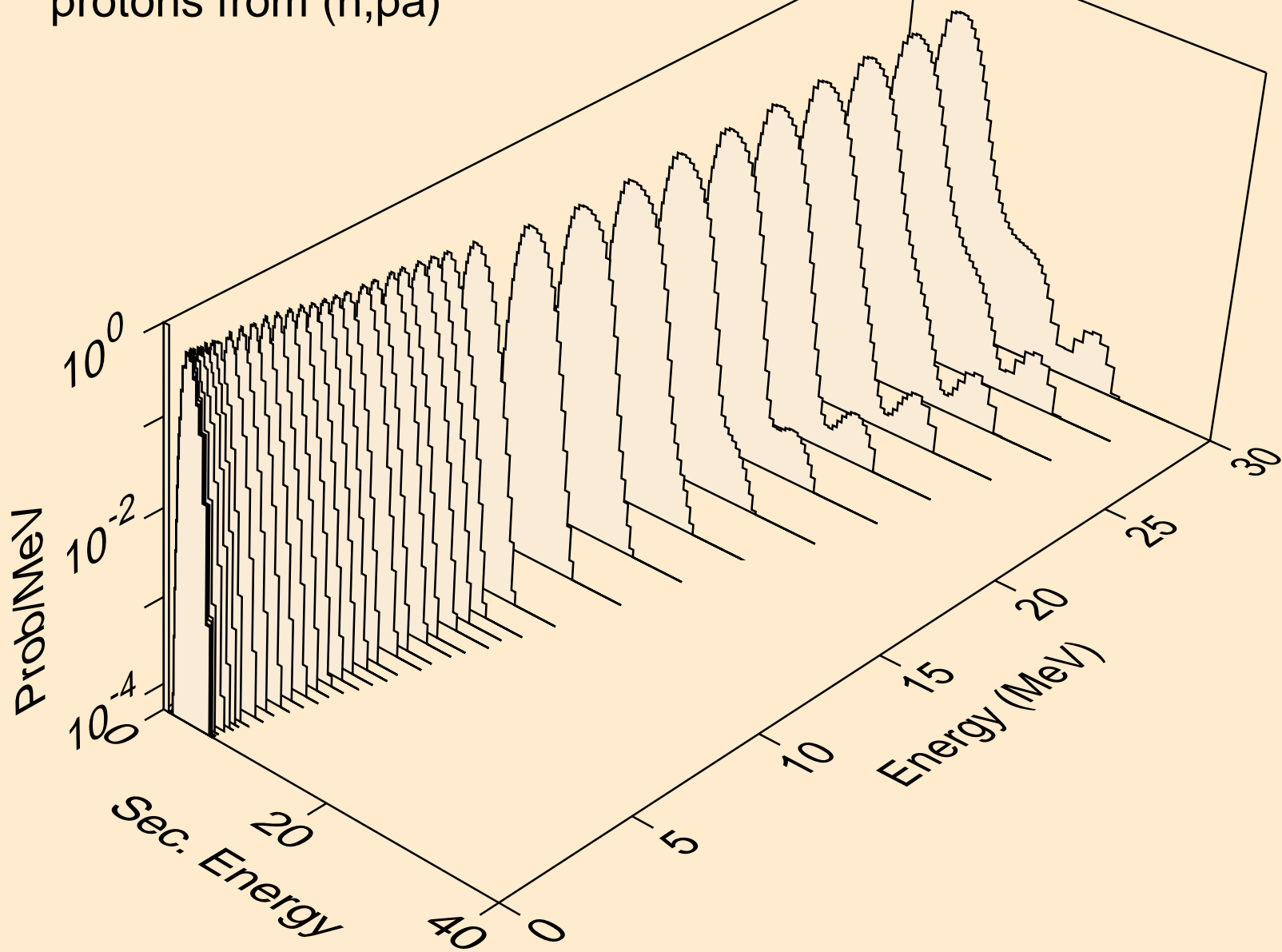

BA119 NEUTRON ACER TENDL-2024 LIBRARY; T=293.6K  
protons from (n,pd)

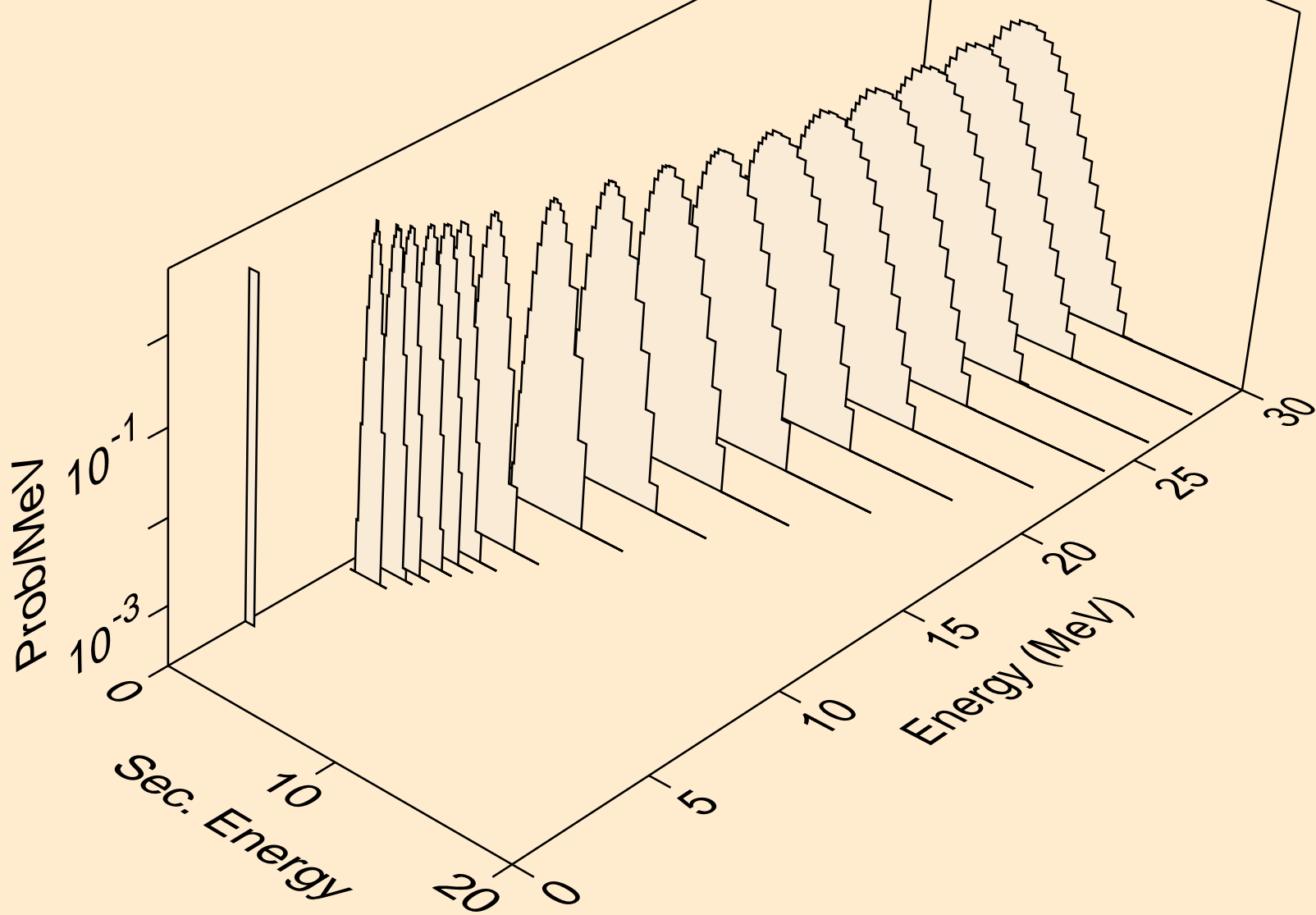

BA119 NEUTRON ACER TENDL-2024 LIBRARY; T=293.6K  
protons from (n,pt)

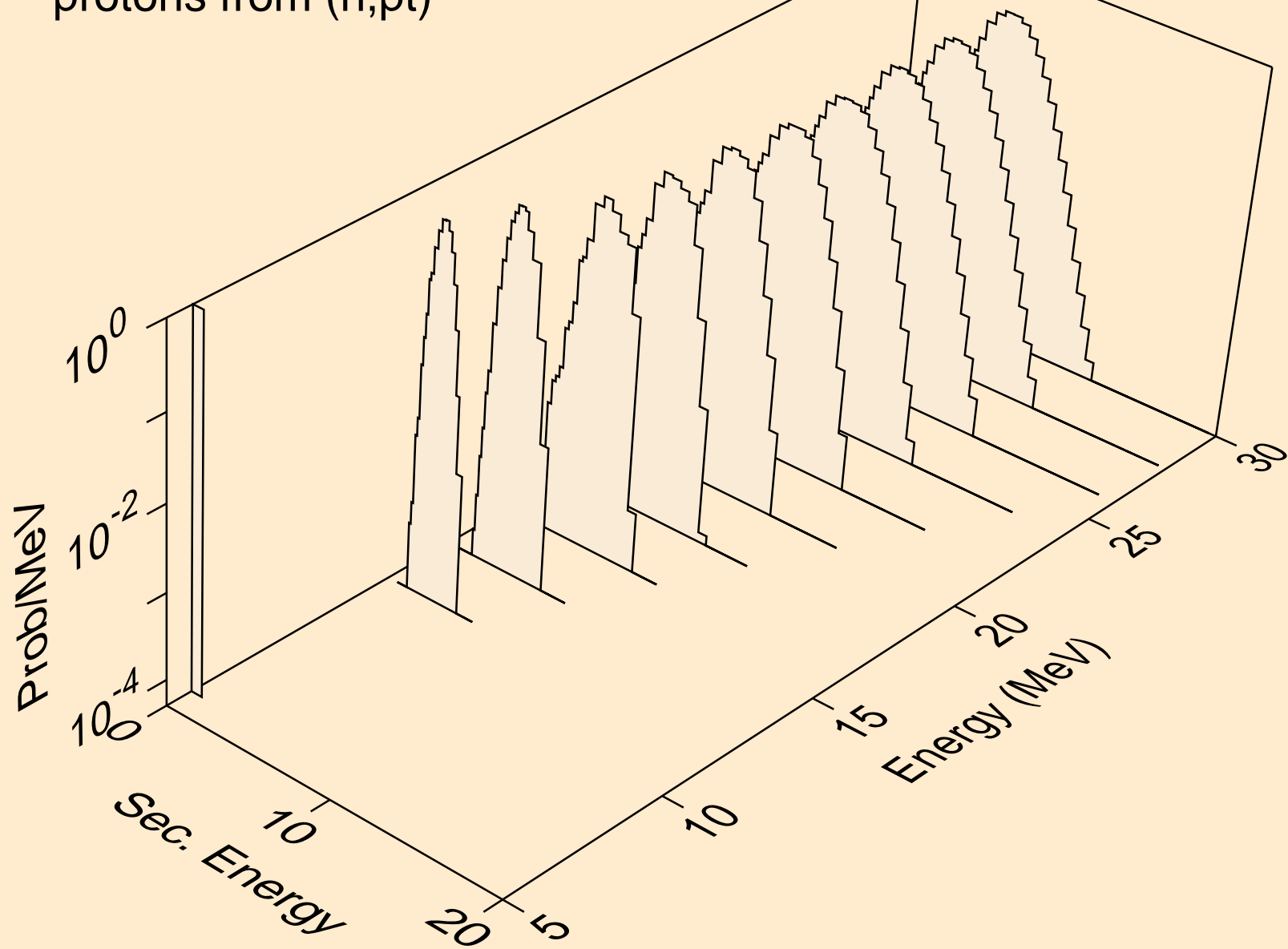

BA119 NEUTRON ACER TENDL-2024 LIBRARY; T=293.6K  
deuterons from (n,x)

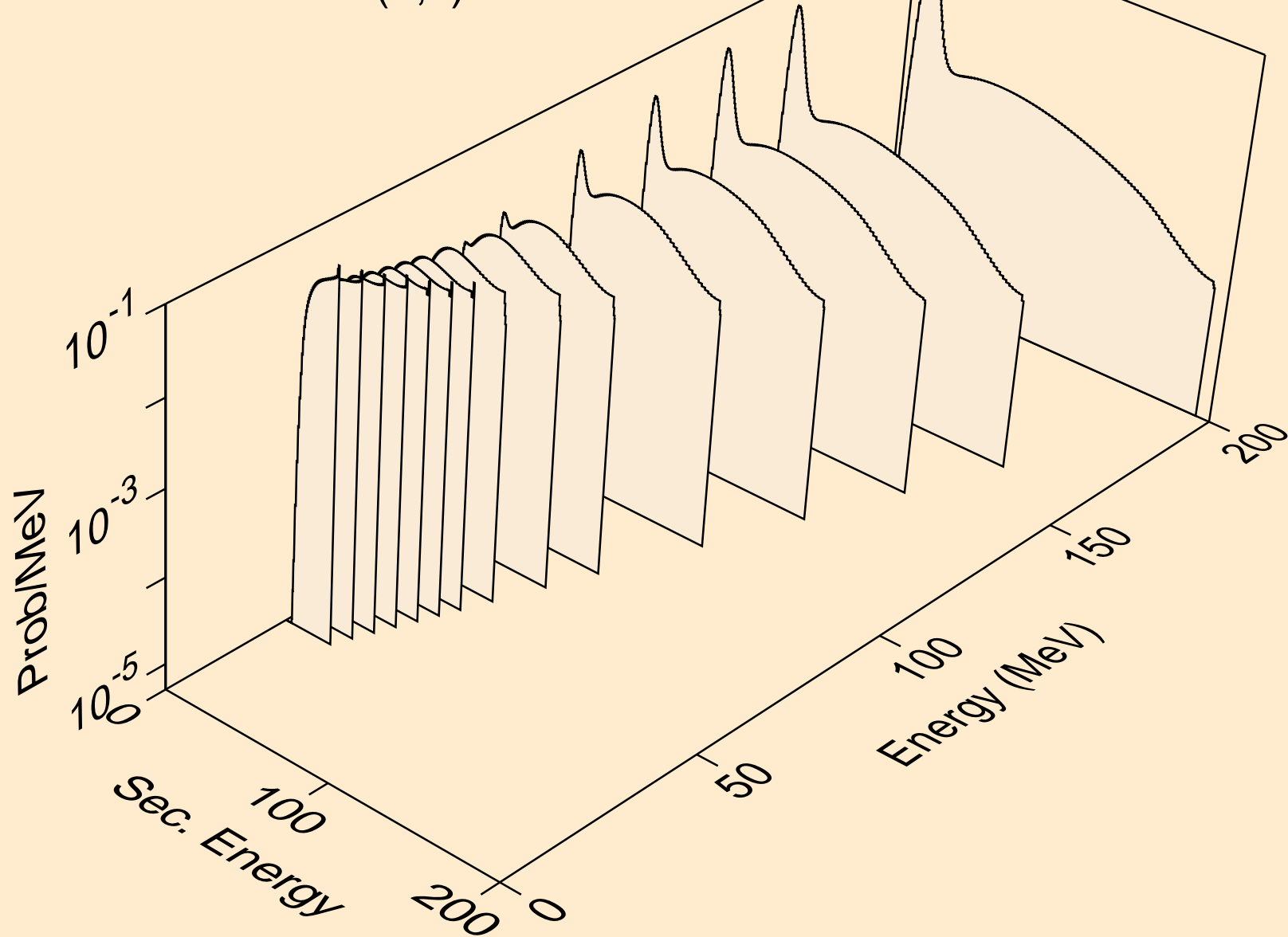

BA119 NEUTRON ACER TENDL-2024 LIBRARY; T=293.6K  
deuterons from (n,2nd)

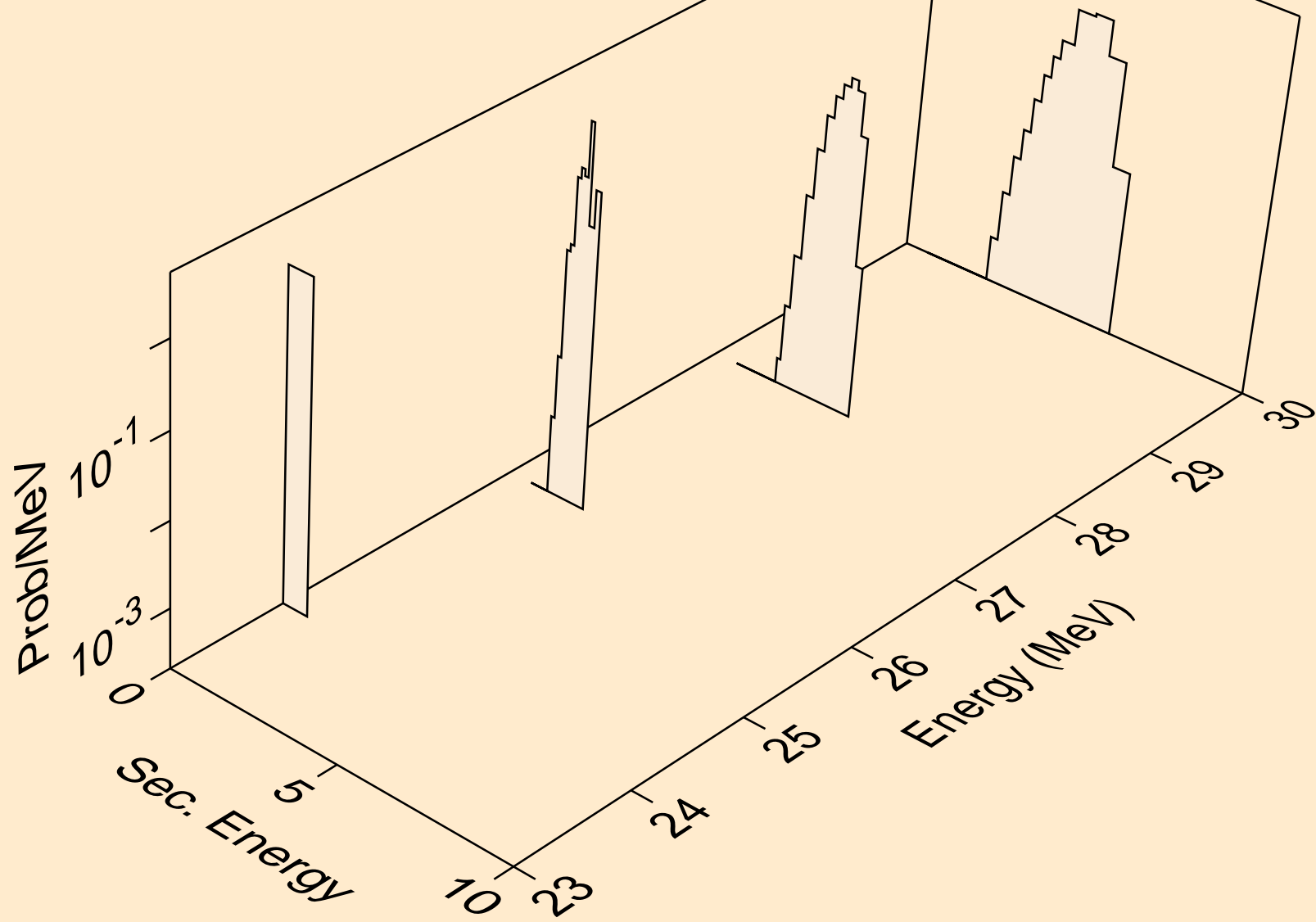

BA119 NEUTRON ACER TENDL-2024 LIBRARY; T=293.6K  
deuterons from (n,n\*)d

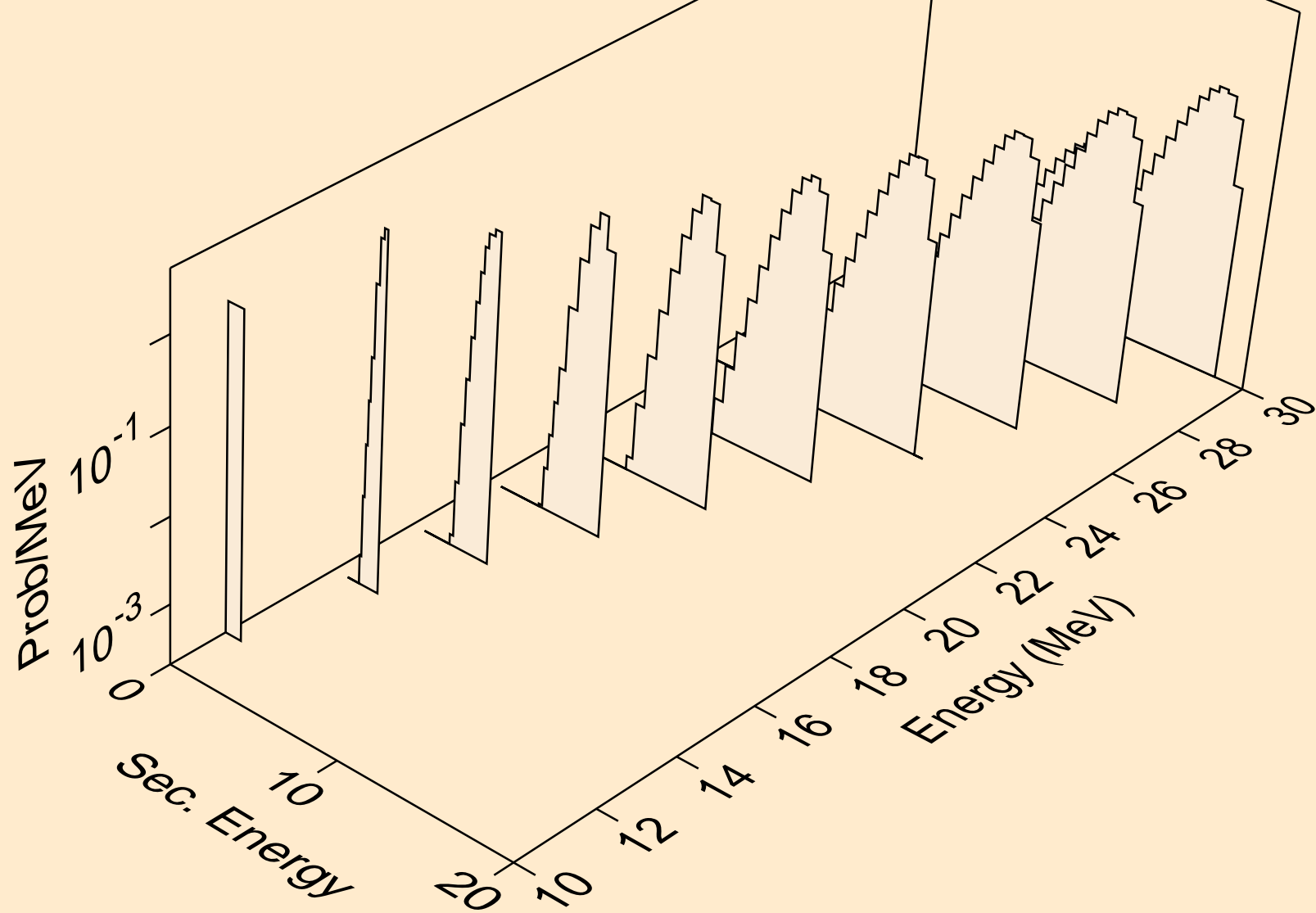

BA119 NEUTRON ACER TENDL-2024 LIBRARY; T=293.6K  
deuterons from (n,d)

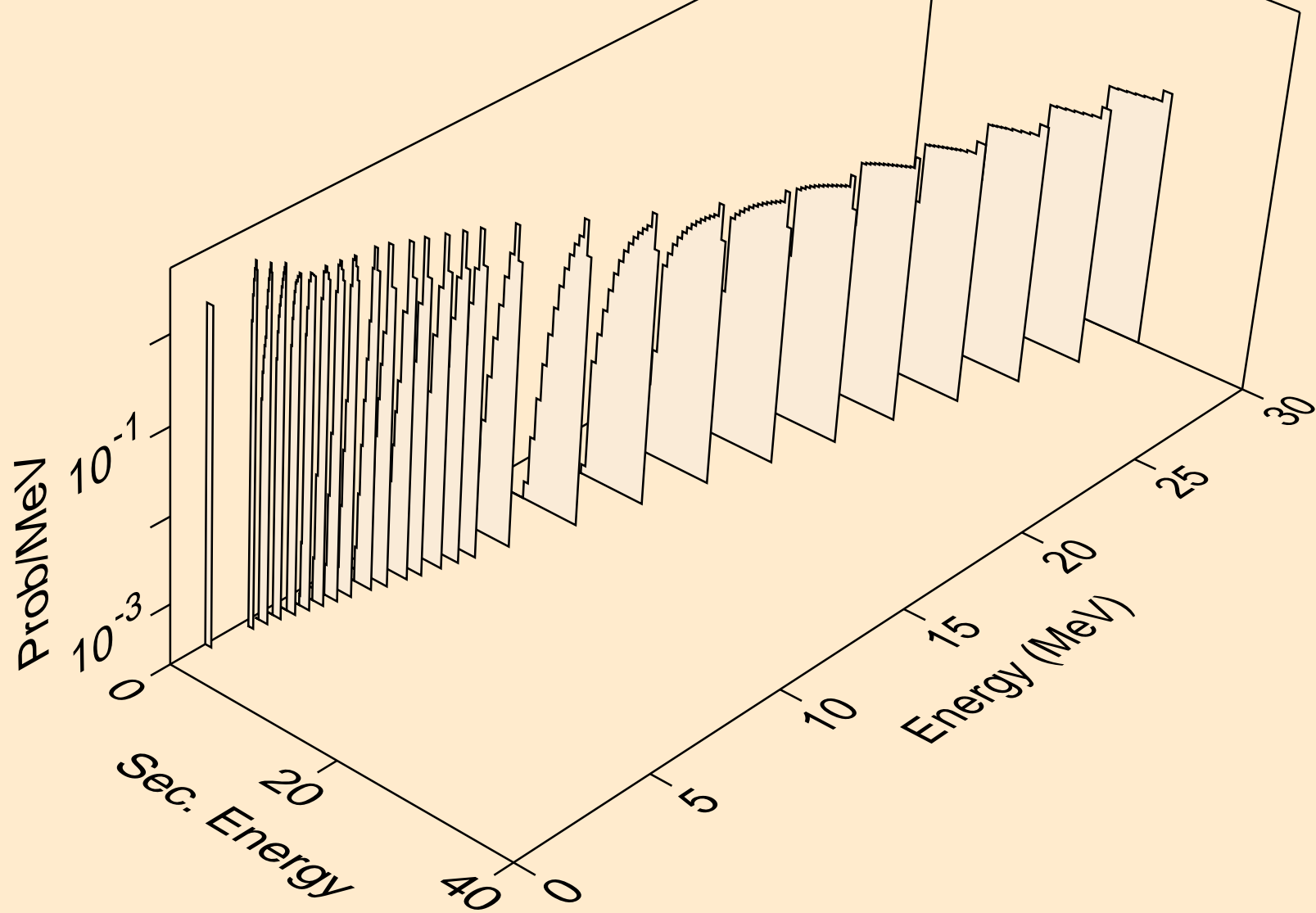

BA119 NEUTRON ACER TENDL-2024 LIBRARY; T=293.6K  
deuterons from (n,d2a)

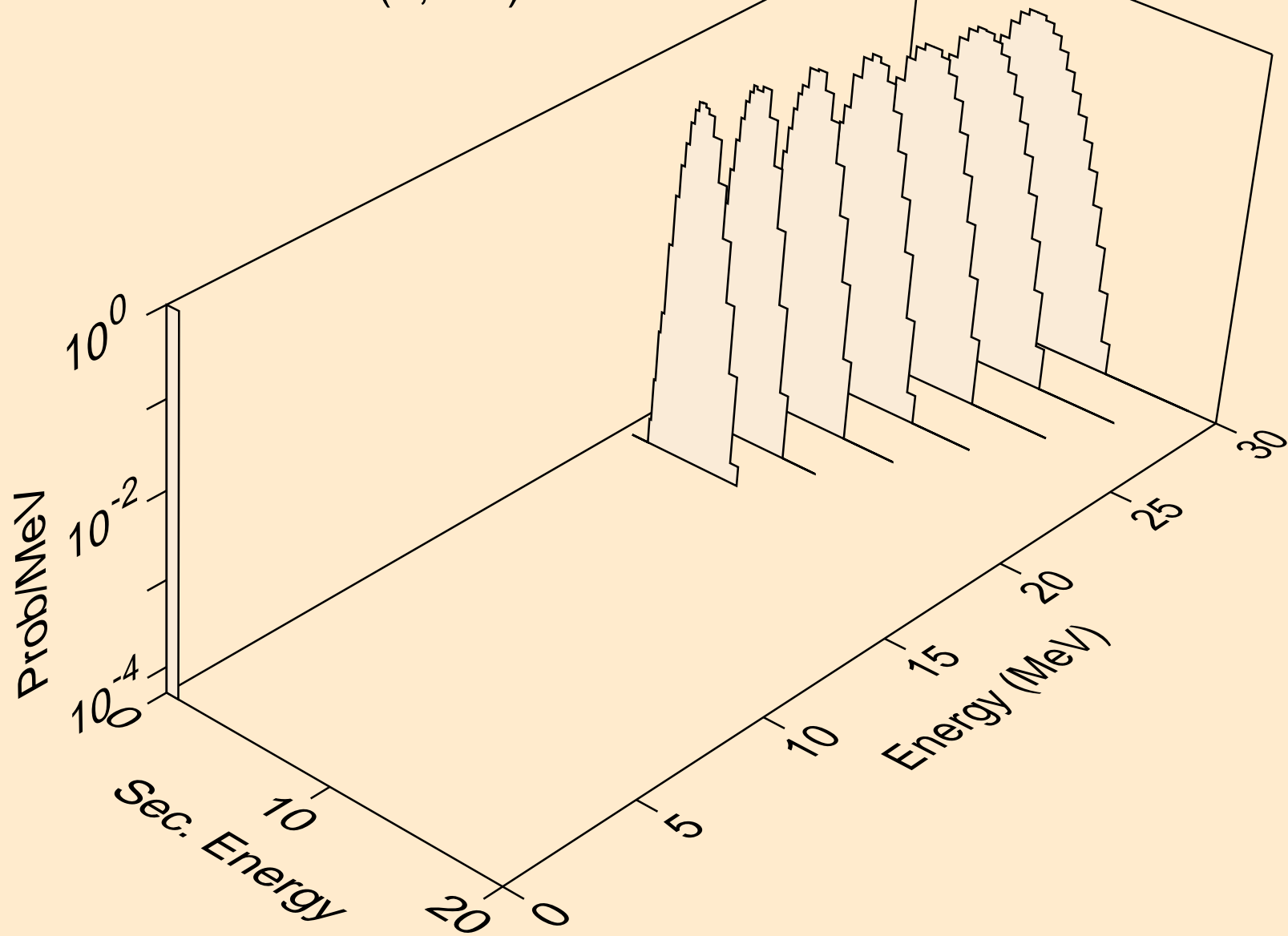

BA119 NEUTRON ACER TENDL-2024 LIBRARY; T=293.6K  
deuterons from (n,pd)

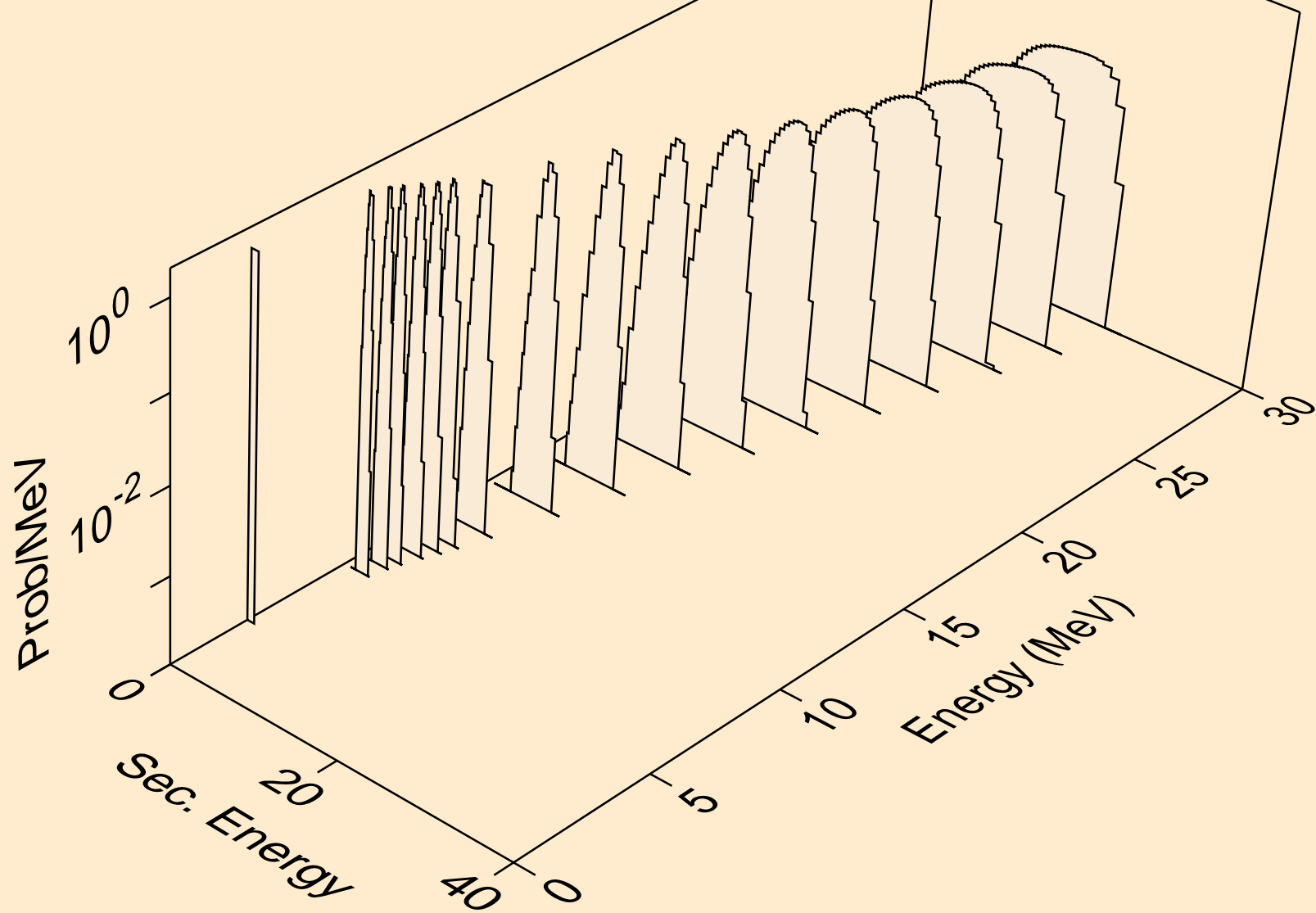

BA119 NEUTRON ACER TENDL-2024 LIBRARY; T=293.6K  
deuterons from (n,da)

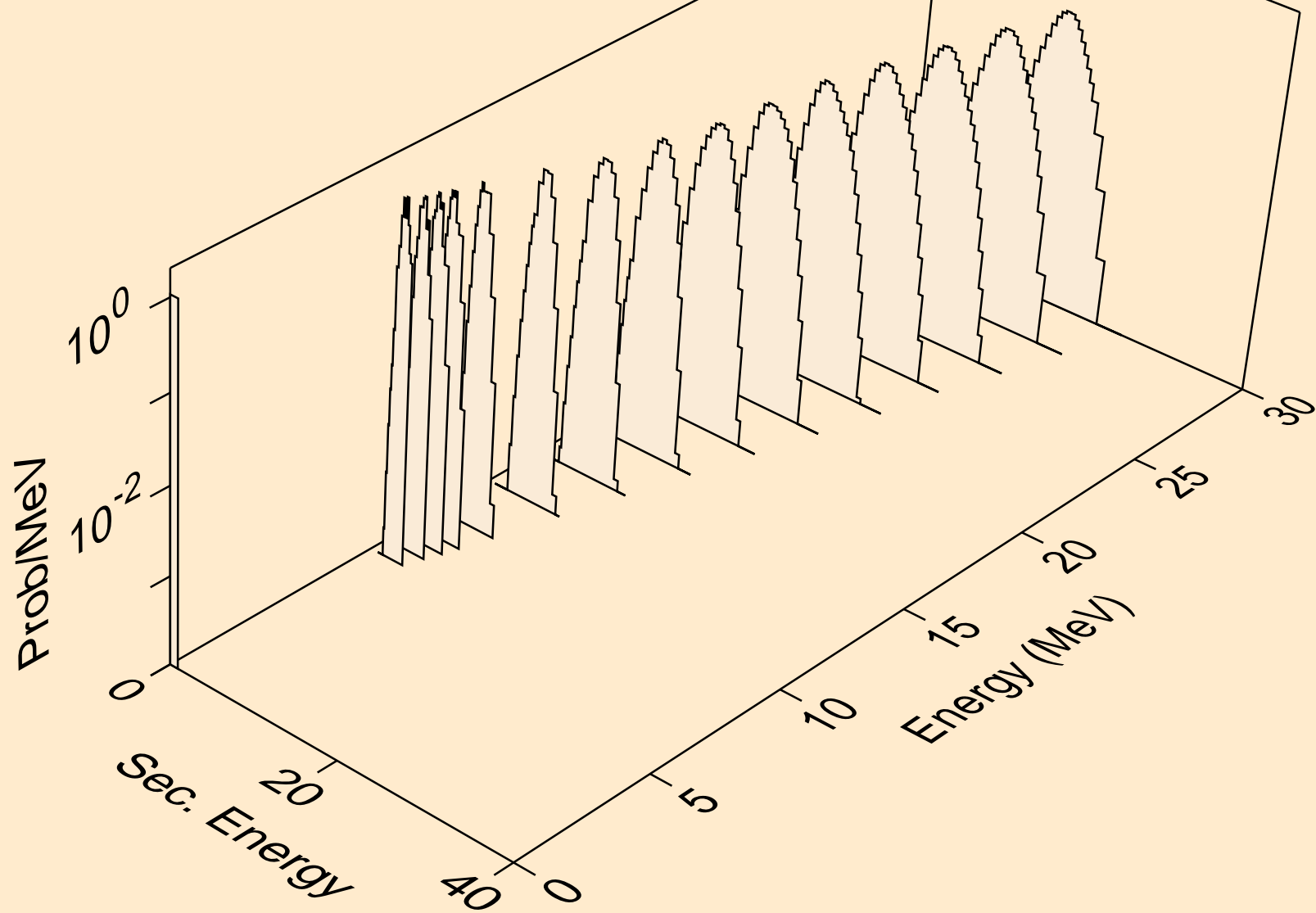

BA119 NEUTRON ACER TENDL-2024 LIBRARY; T=293.6K  
tritons from (n,x)

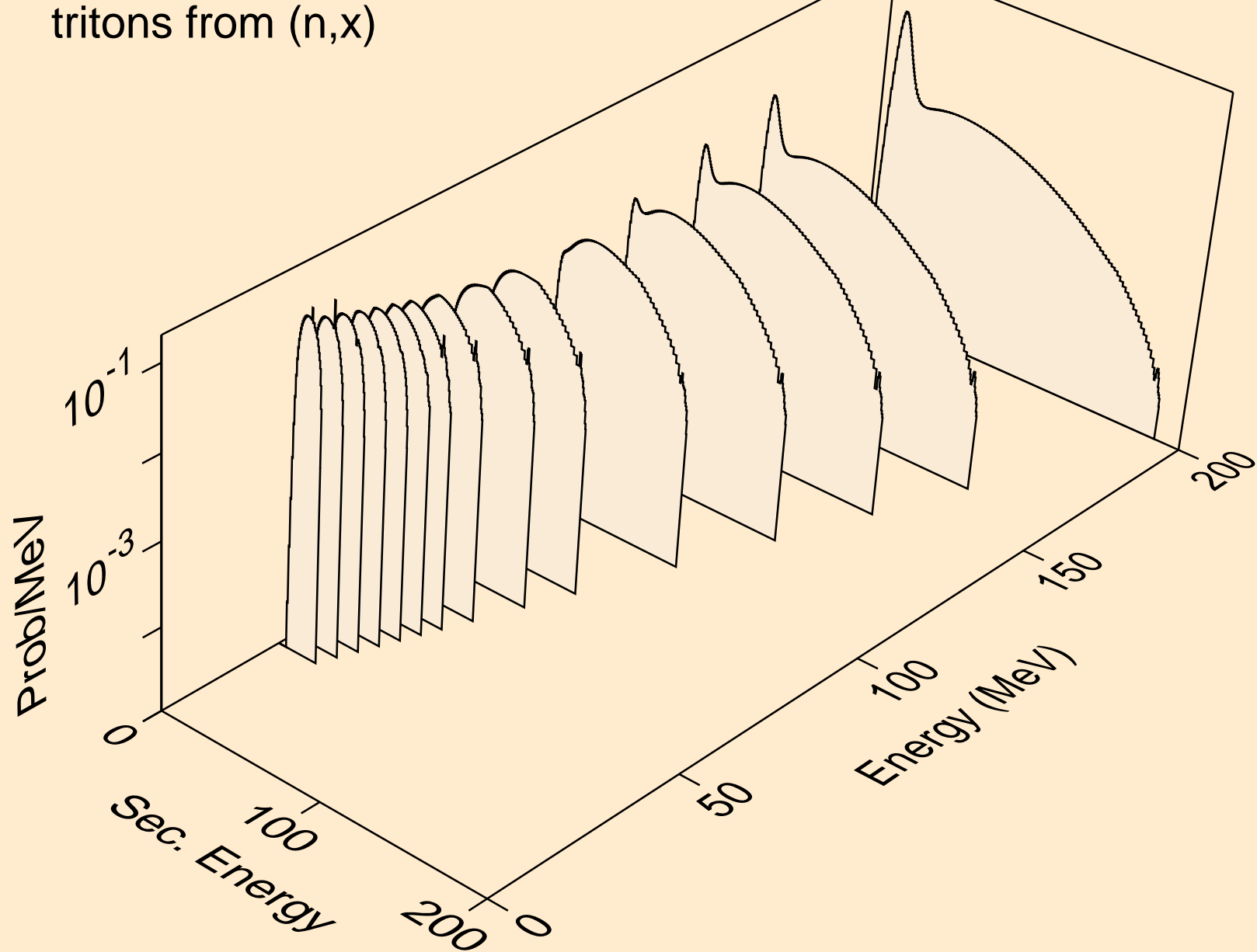

BA119 NEUTRON ACER TENDL-2024 LIBRARY; T=293.6K  
tritons from (n,n\*)t

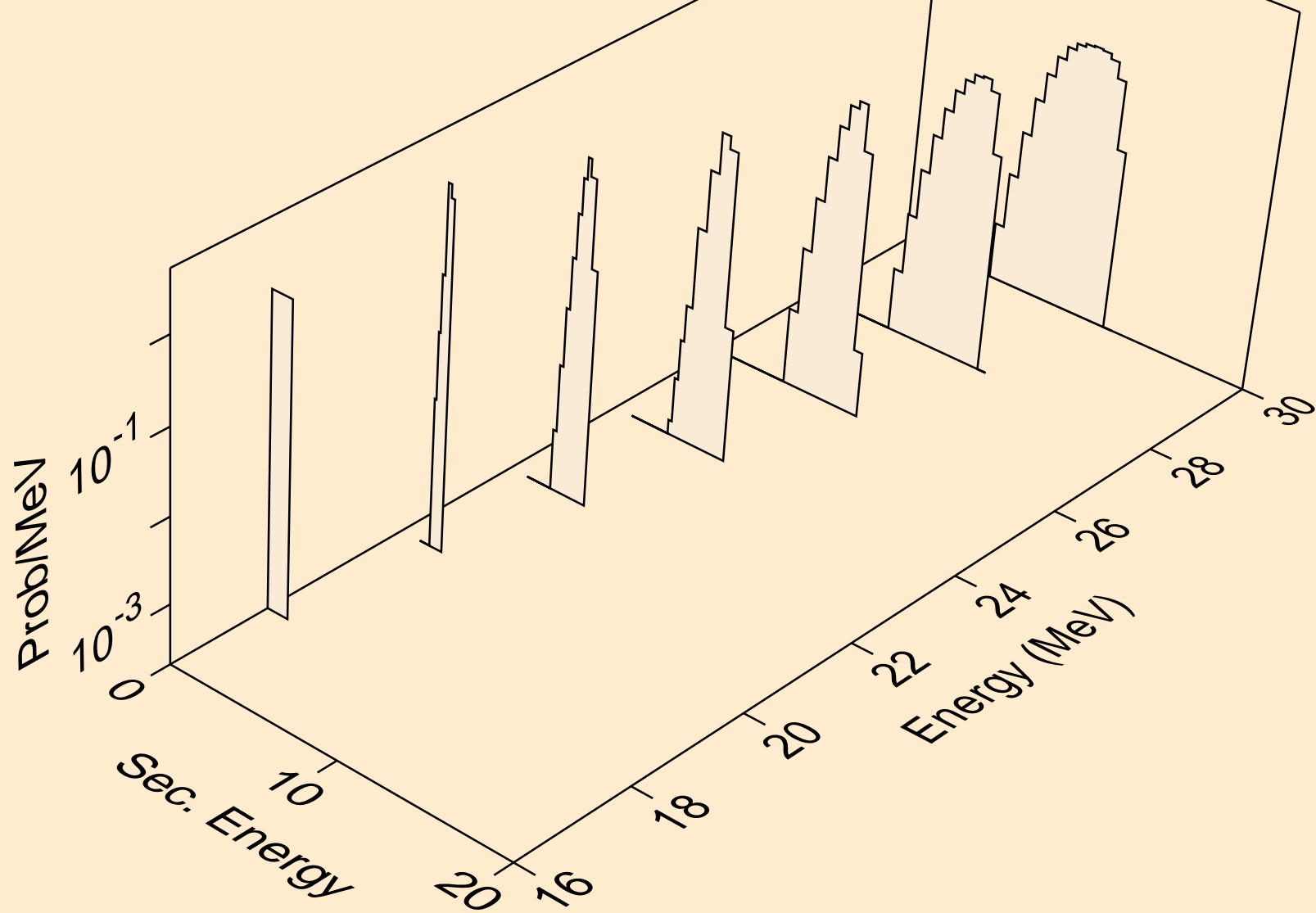

BA119 NEUTRON ACER TENDL-2024 LIBRARY; T=293.6K  
tritons from (n,t)

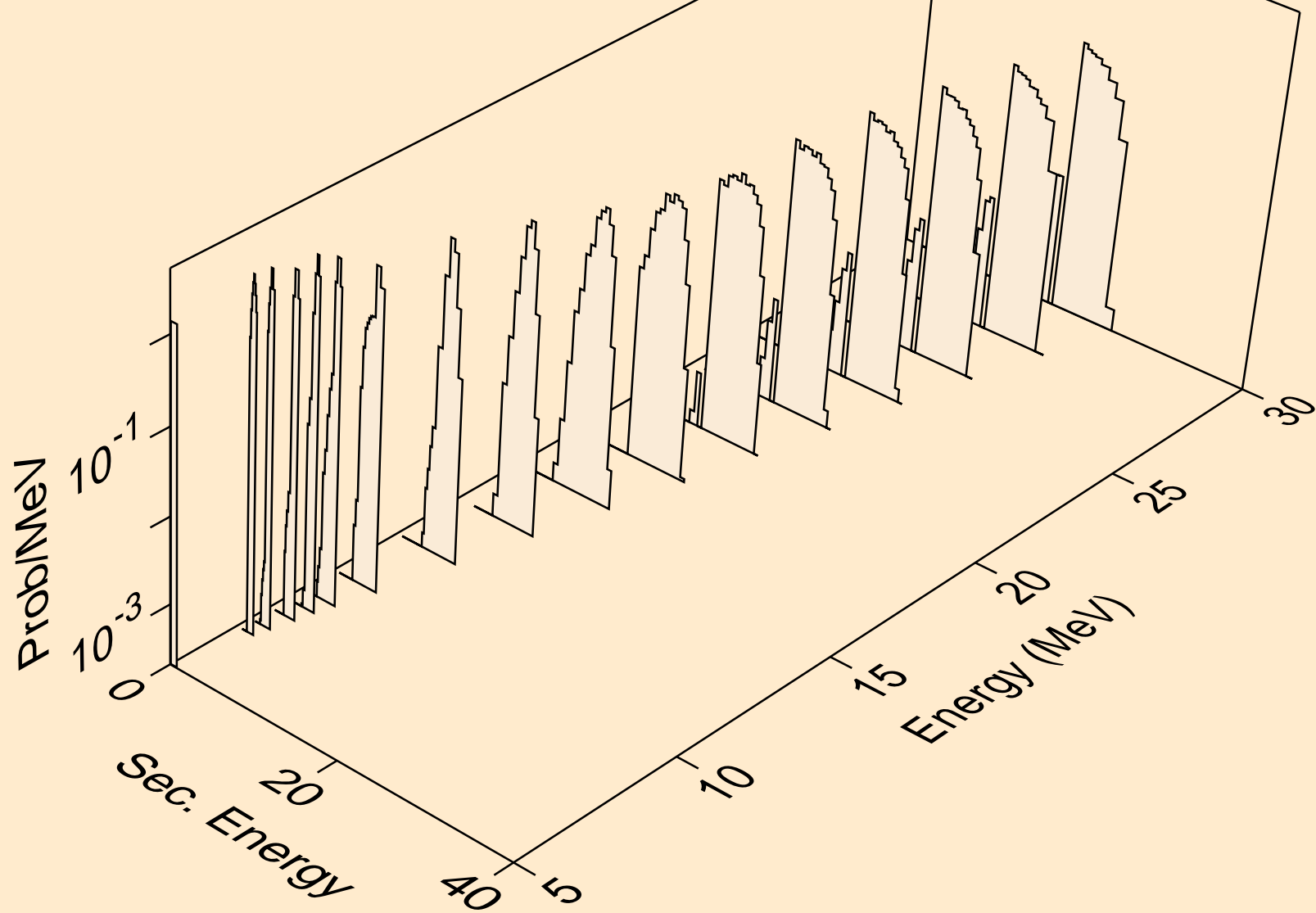

BA119 NEUTRON ACER TENDL-2024 LIBRARY; T=293.6K  
tritons from (n,t2a)

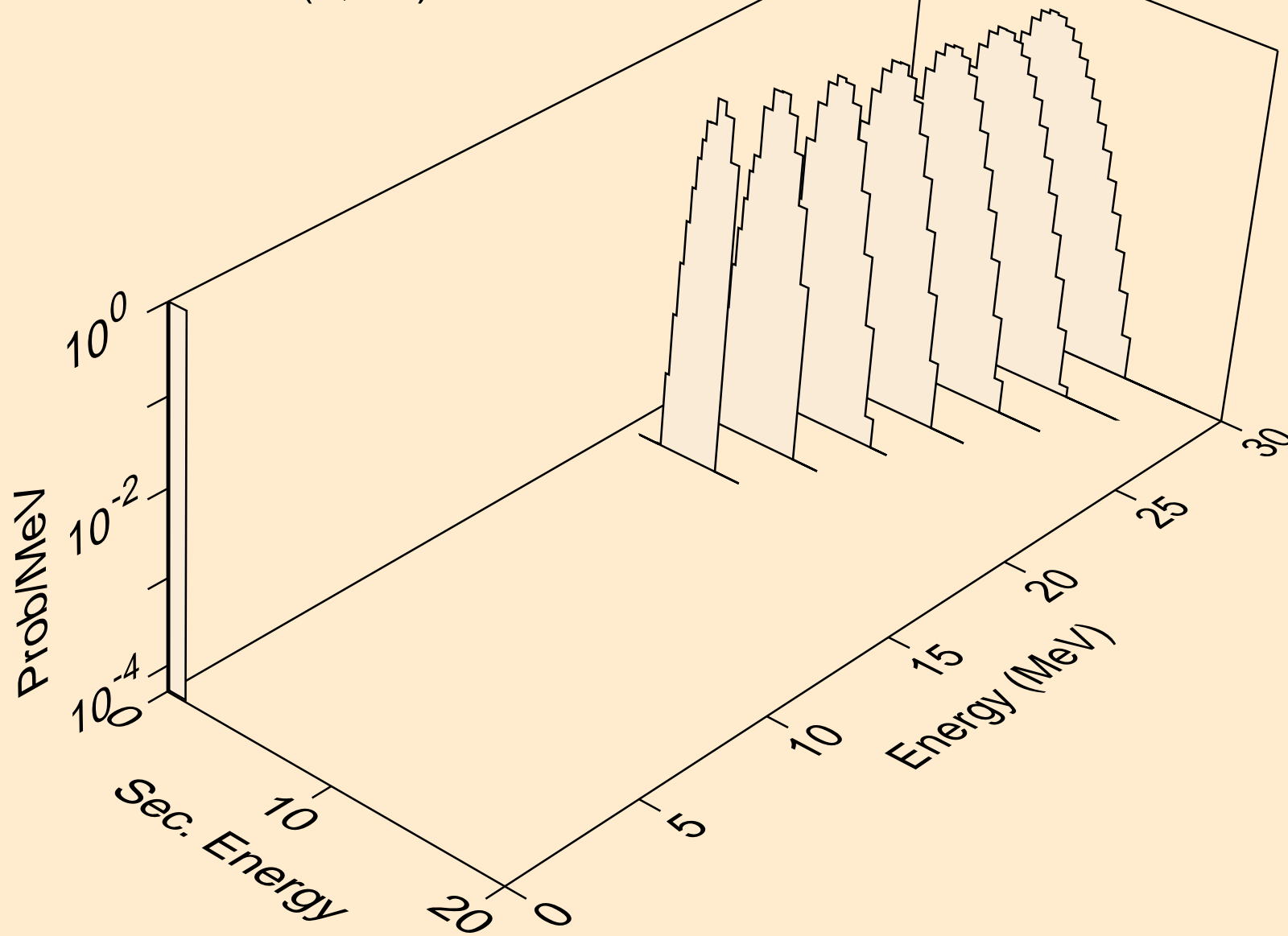

BA119 NEUTRON ACER TENDL-2024 LIBRARY; T=293.6K  
tritons from (n,pt)

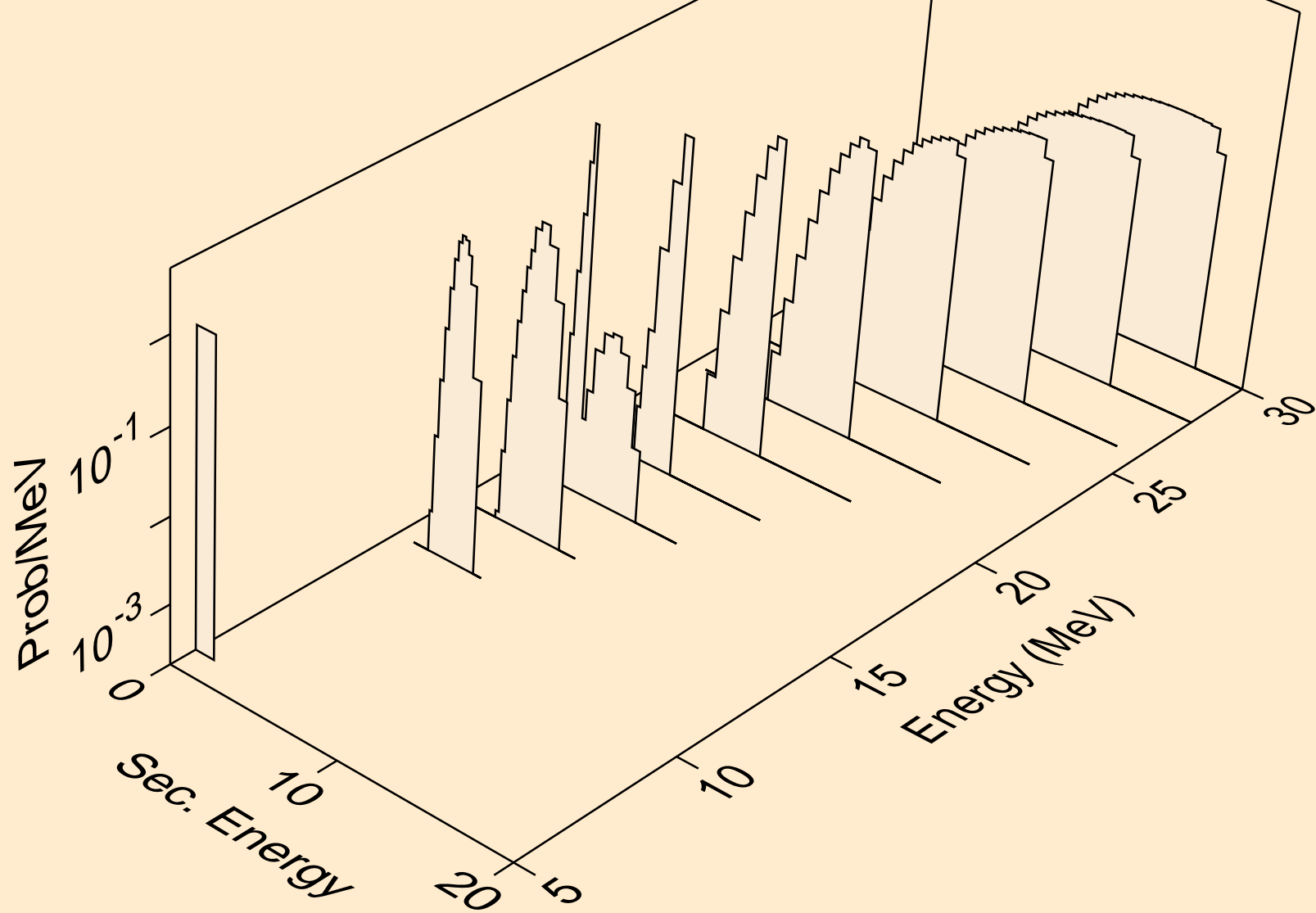

BA119 NEUTRON ACER TENDL-2024 LIBRARY; T=293.6K  
he3s from (n,x)

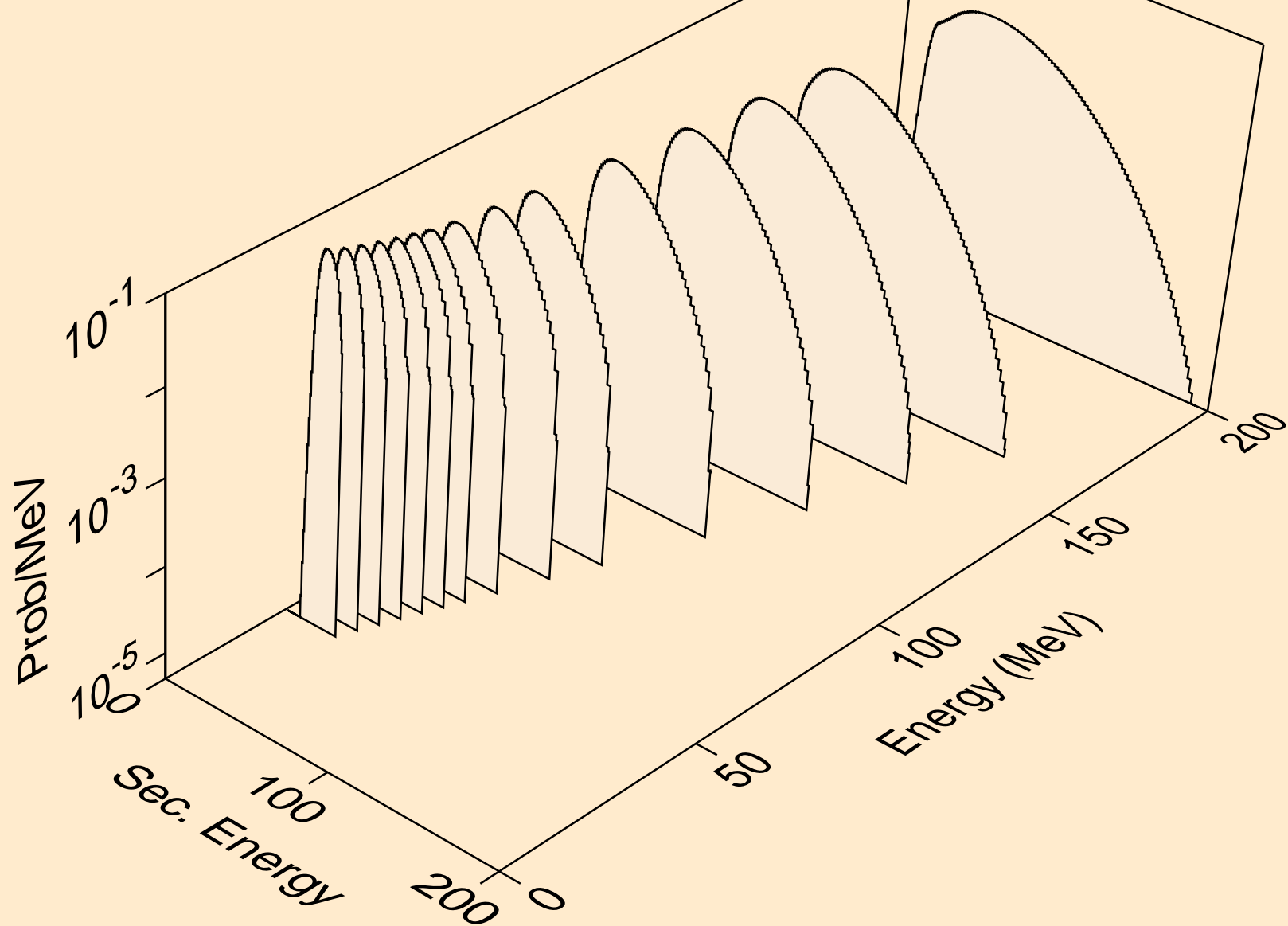

BA119 NEUTRON ACER TENDL-2024 LIBRARY; T=293.6K  
he3s from (n,n\*)he3

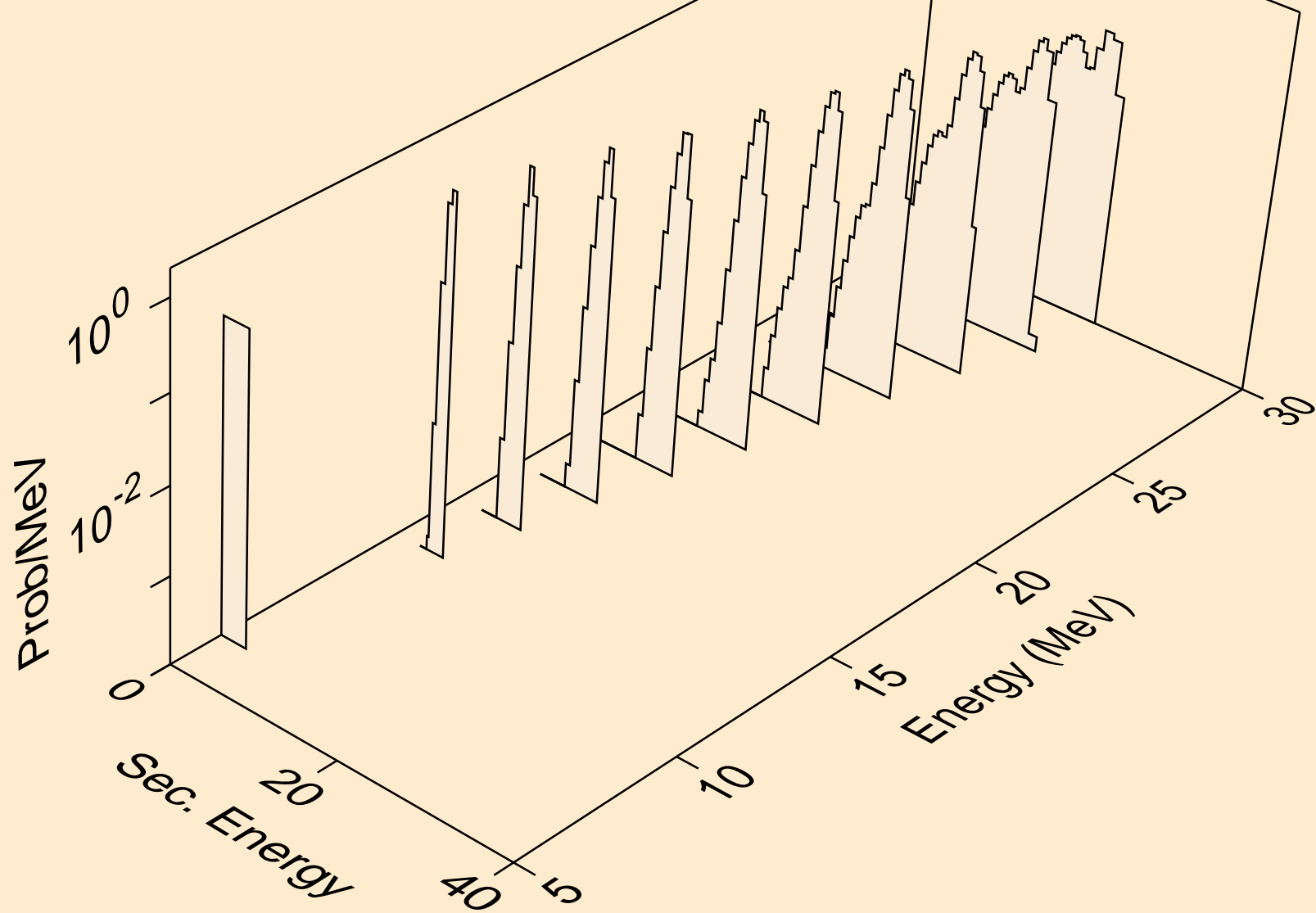

BA119 NEUTRON ACER TENDL-2024 LIBRARY; T=293.6K  
he3s from (n,he3)

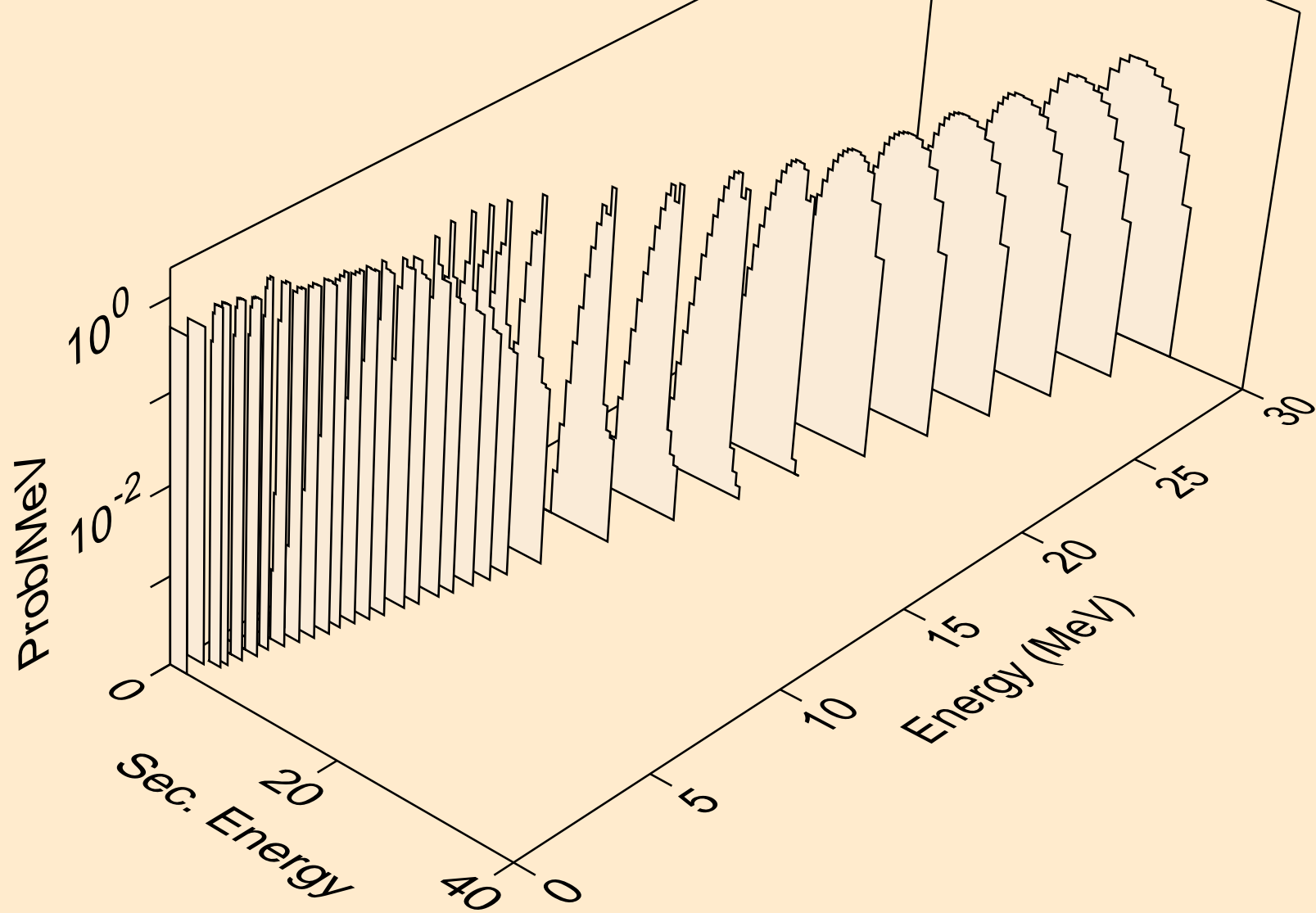

BA119 NEUTRON ACER TENDL-2024 LIBRARY; T=293.6K  
alphas from (n,x)

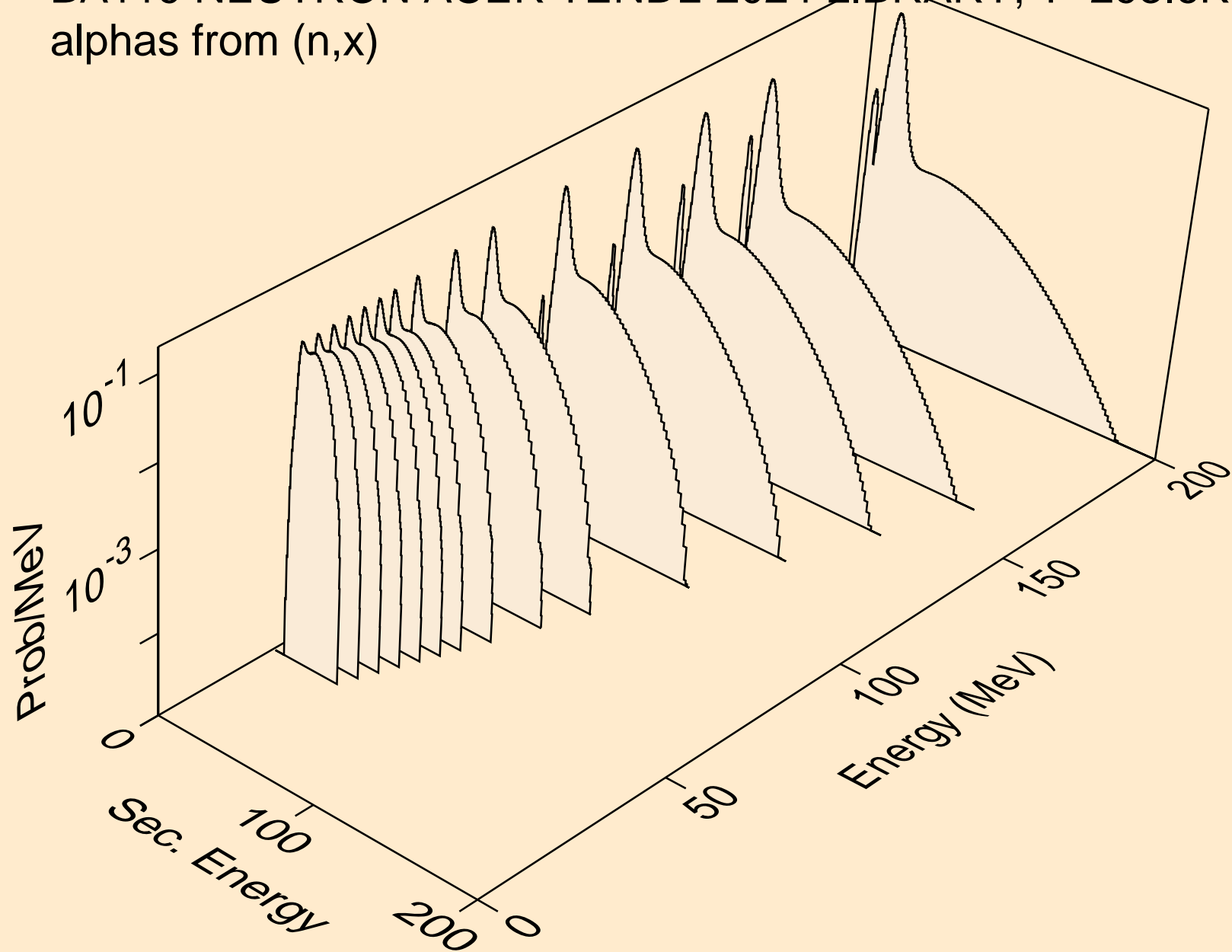

BA119 NEUTRON ACER TENDL-2024 LIBRARY; T=293.6K  
alphas from (n,n\*)a

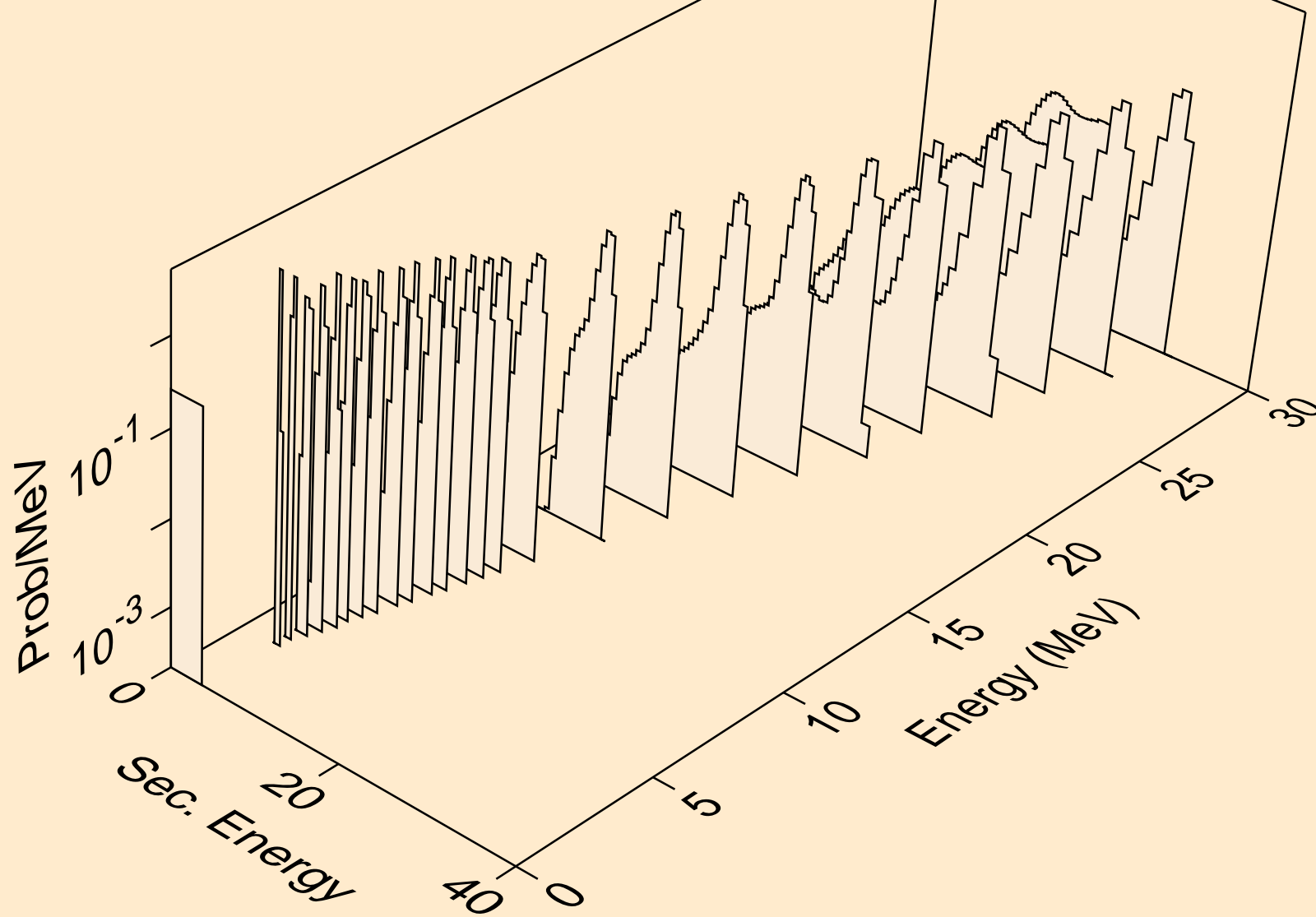

BA119 NEUTRON ACER TENDL-2024 LIBRARY; T=293.6K  
alphas from (n,n\*)3a

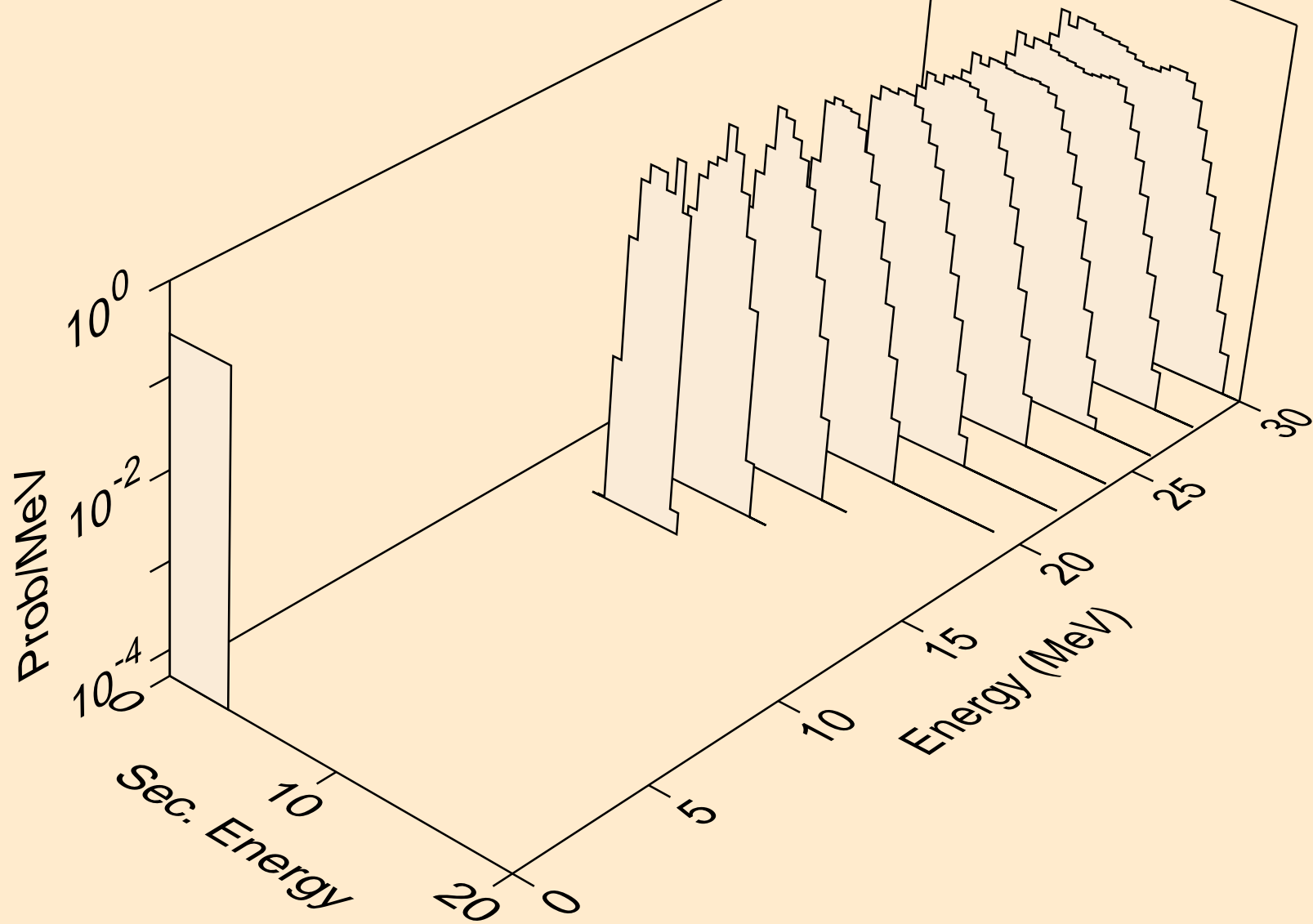

BA119 NEUTRON ACER TENDL-2024 LIBRARY; T=293.6K  
alphas from (n,2n)a

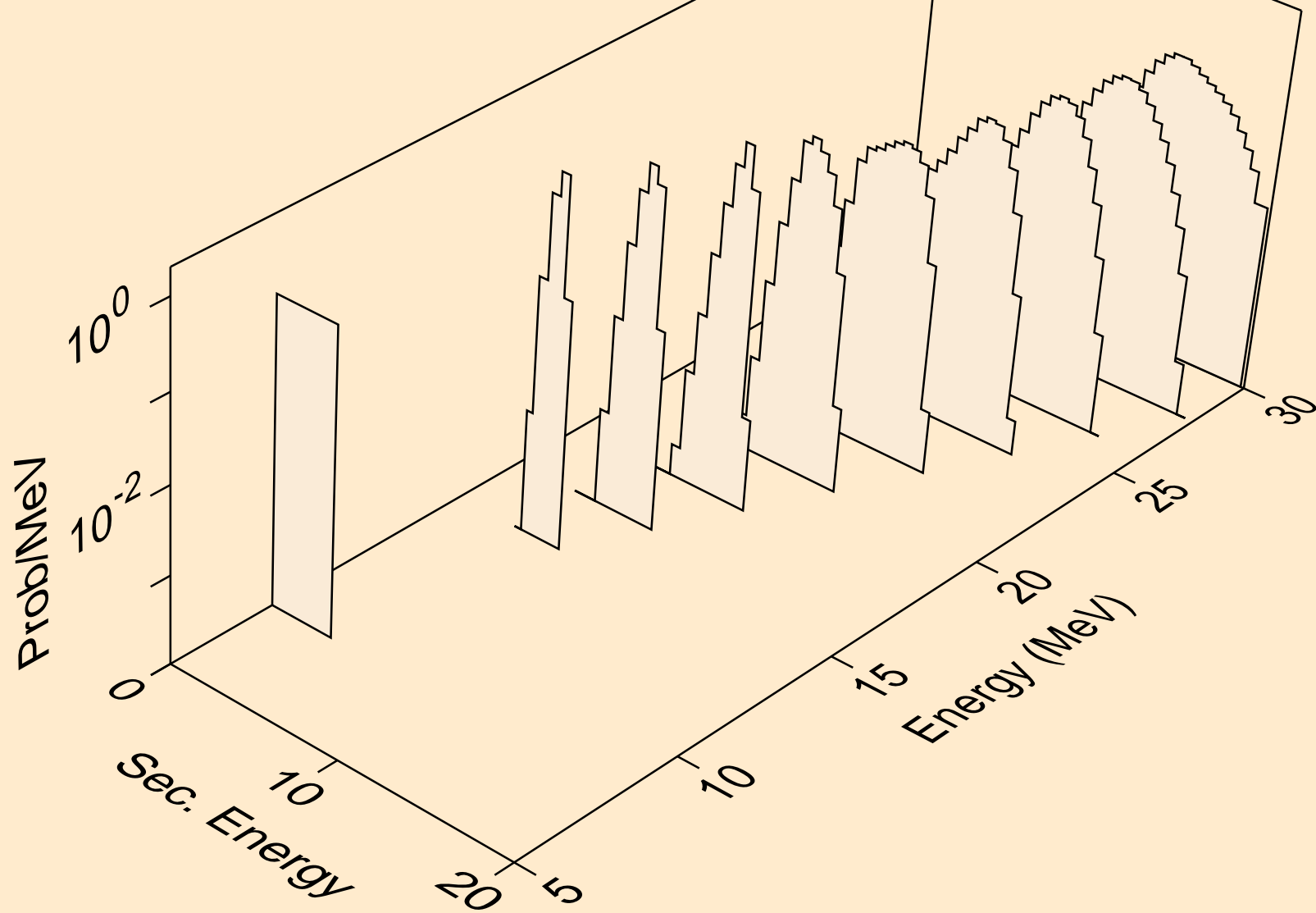

BA119 NEUTRON ACER TENDL-2024 LIBRARY; T=293.6K  
alphas from (n,n\*)2a

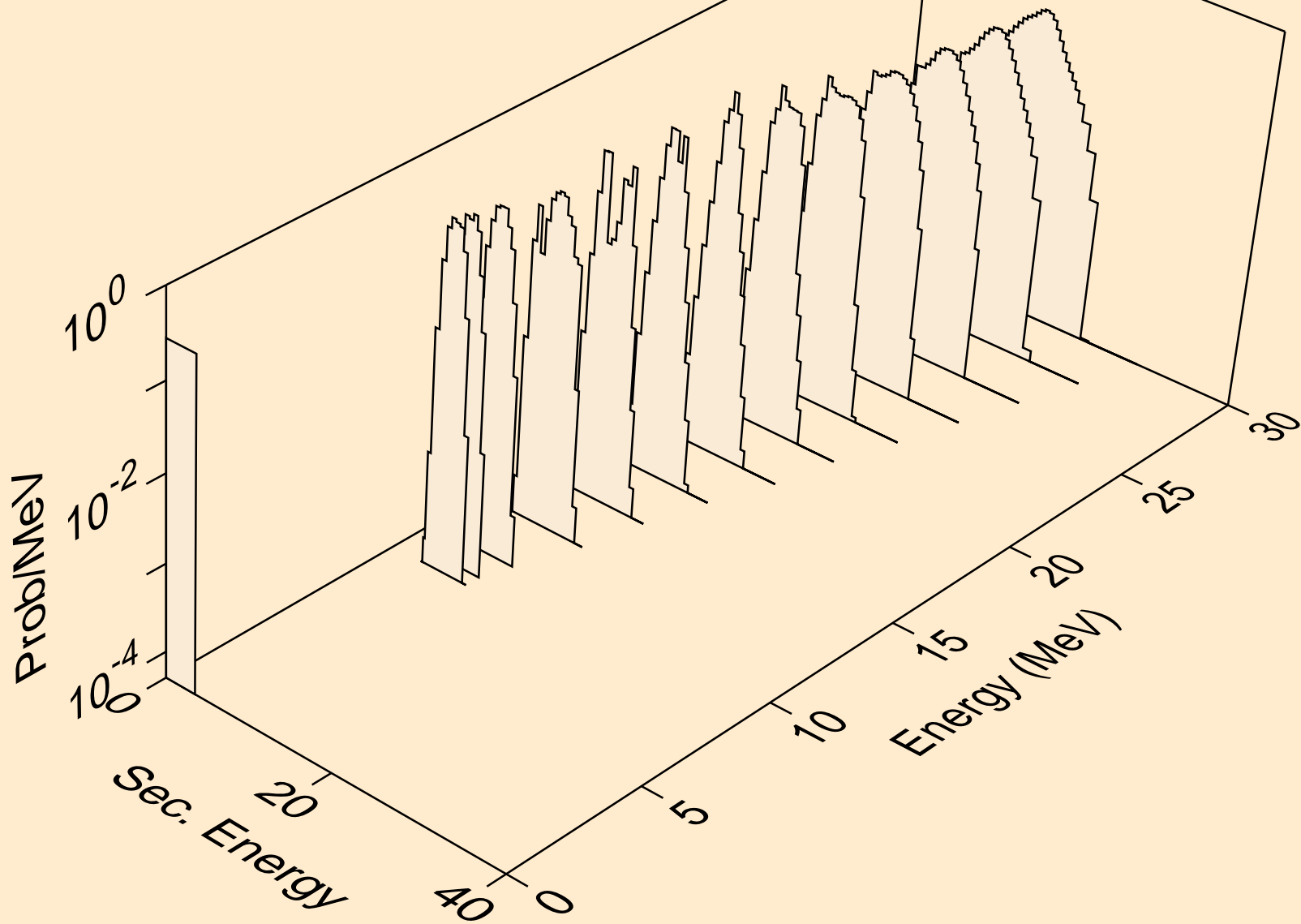

BA119 NEUTRON ACER TENDL-2024 LIBRARY; T=293.6K  
alphas from (n,2n)2a

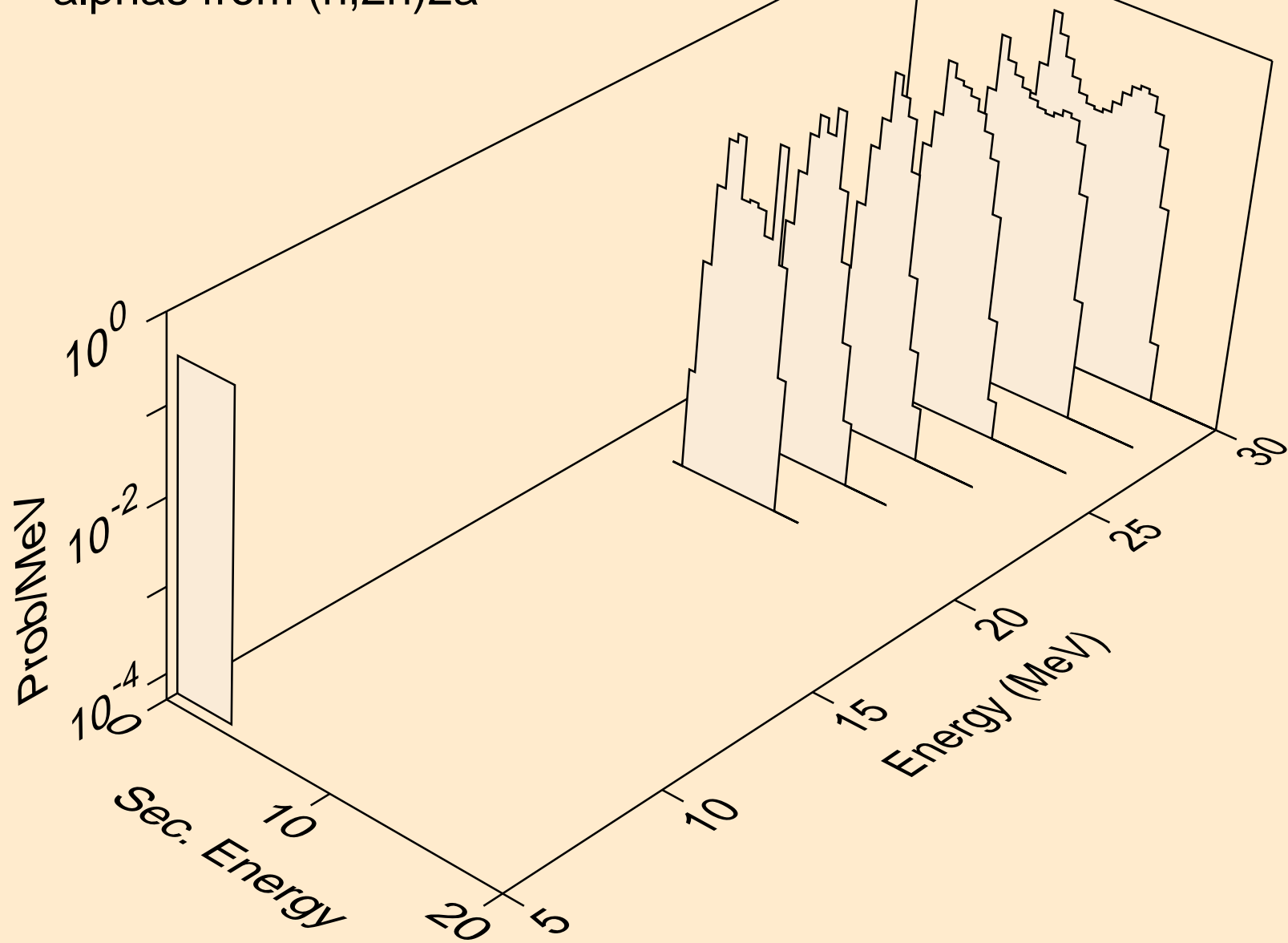

BA119 NEUTRON ACER TENDL-2024 LIBRARY; T=293.6K  
alphas from (n,npa)

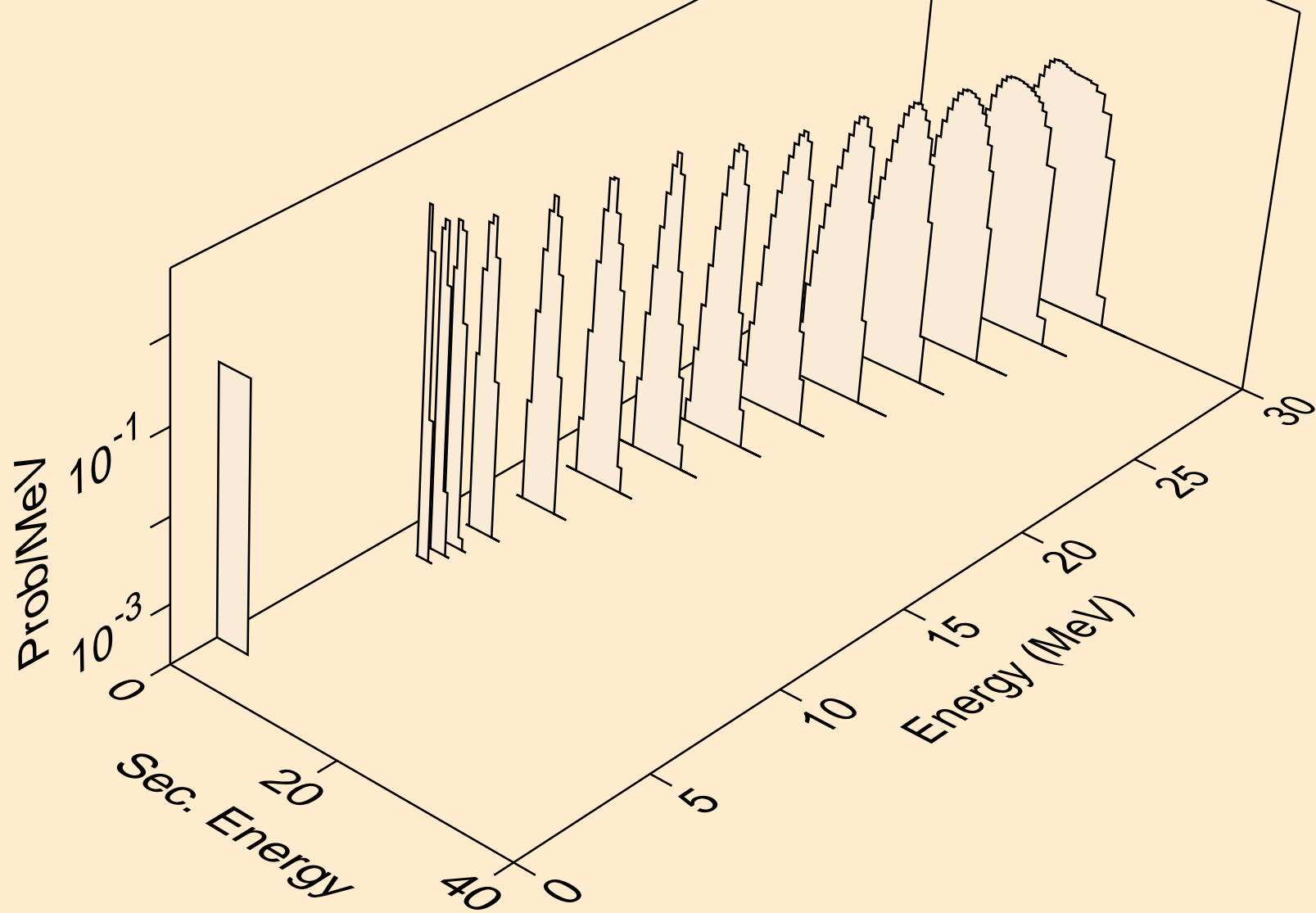

BA119 NEUTRON ACER TENDL-2024 LIBRARY; T=293.6K  
alphas from (n,a)

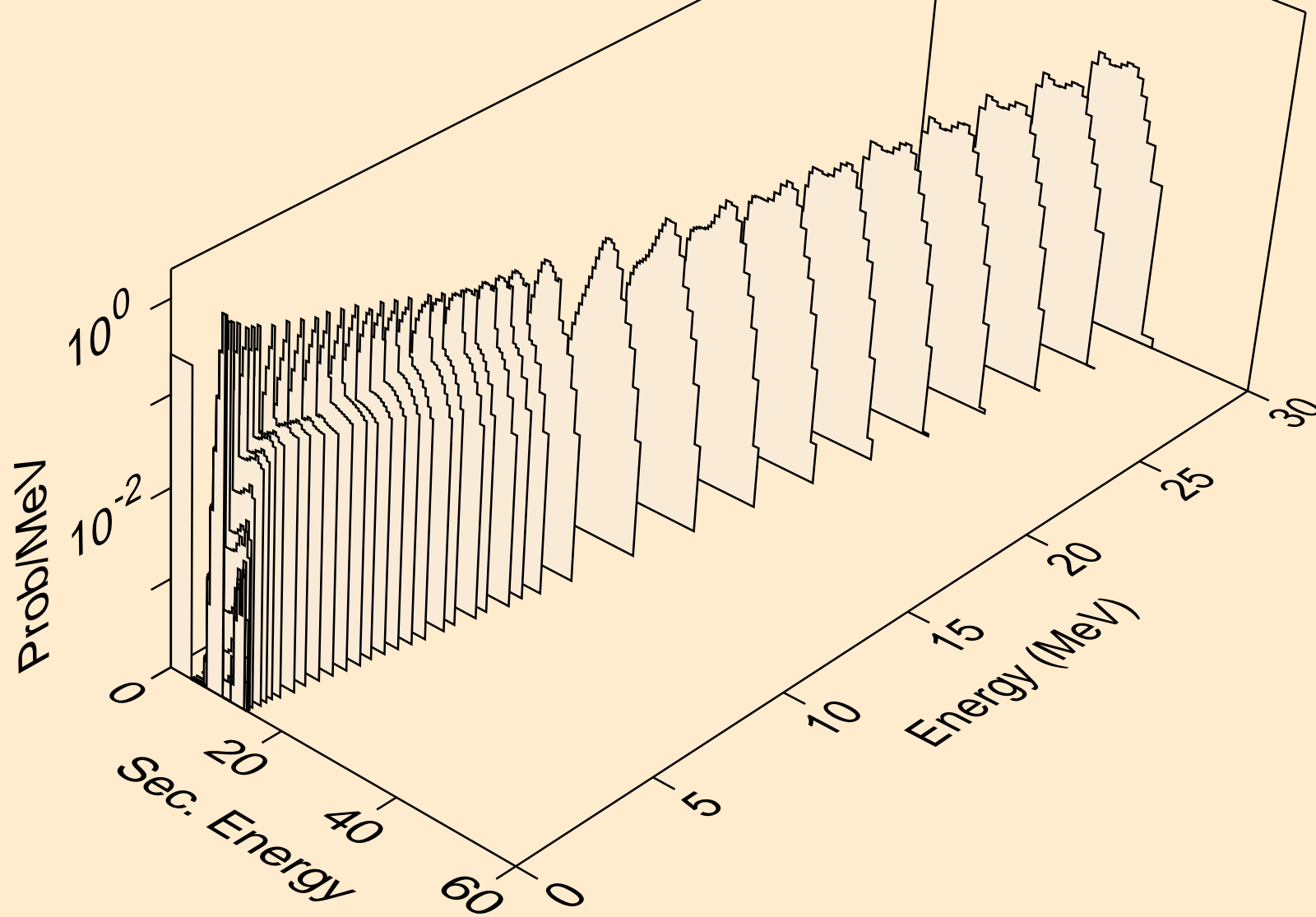

BA119 NEUTRON ACER TENDL-2024 LIBRARY; T=293.6K  
alphas from (n,2a)

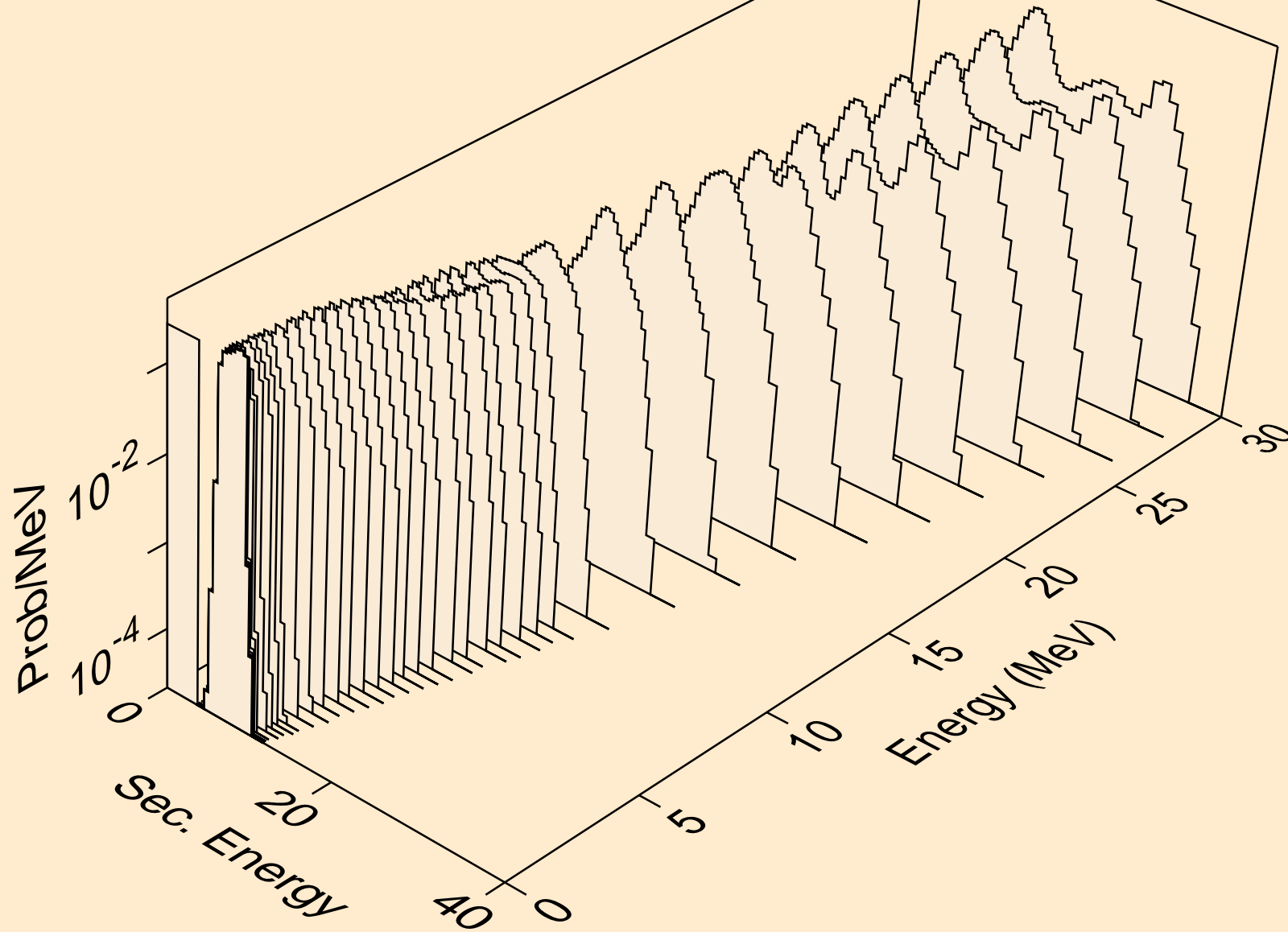

BA119 NEUTRON ACER TENDL-2024 LIBRARY; T=293.6K  
alphas from (n,3a)

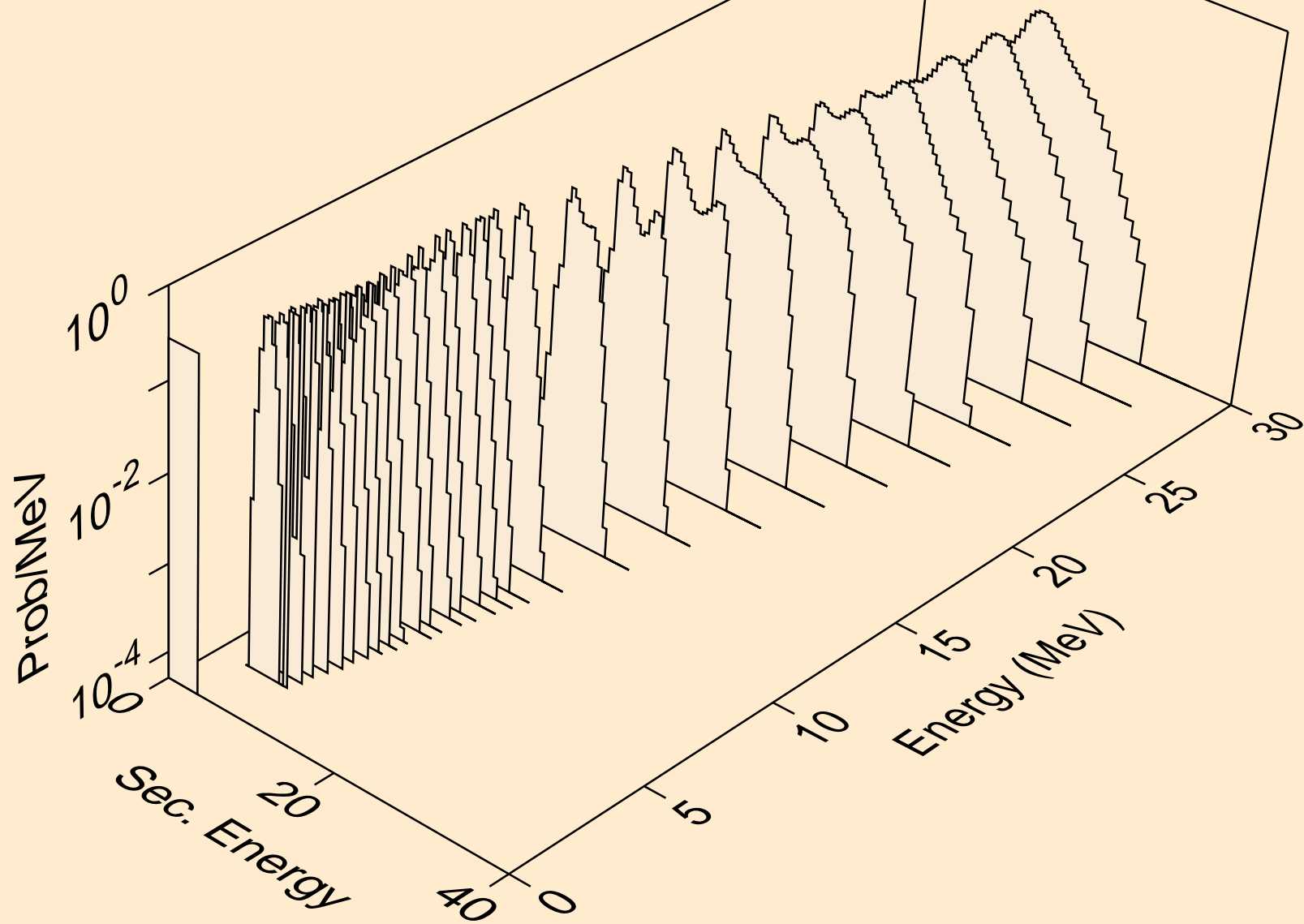

BA119 NEUTRON ACER TENDL-2024 LIBRARY; T=293.6K  
alphas from (n,pa)

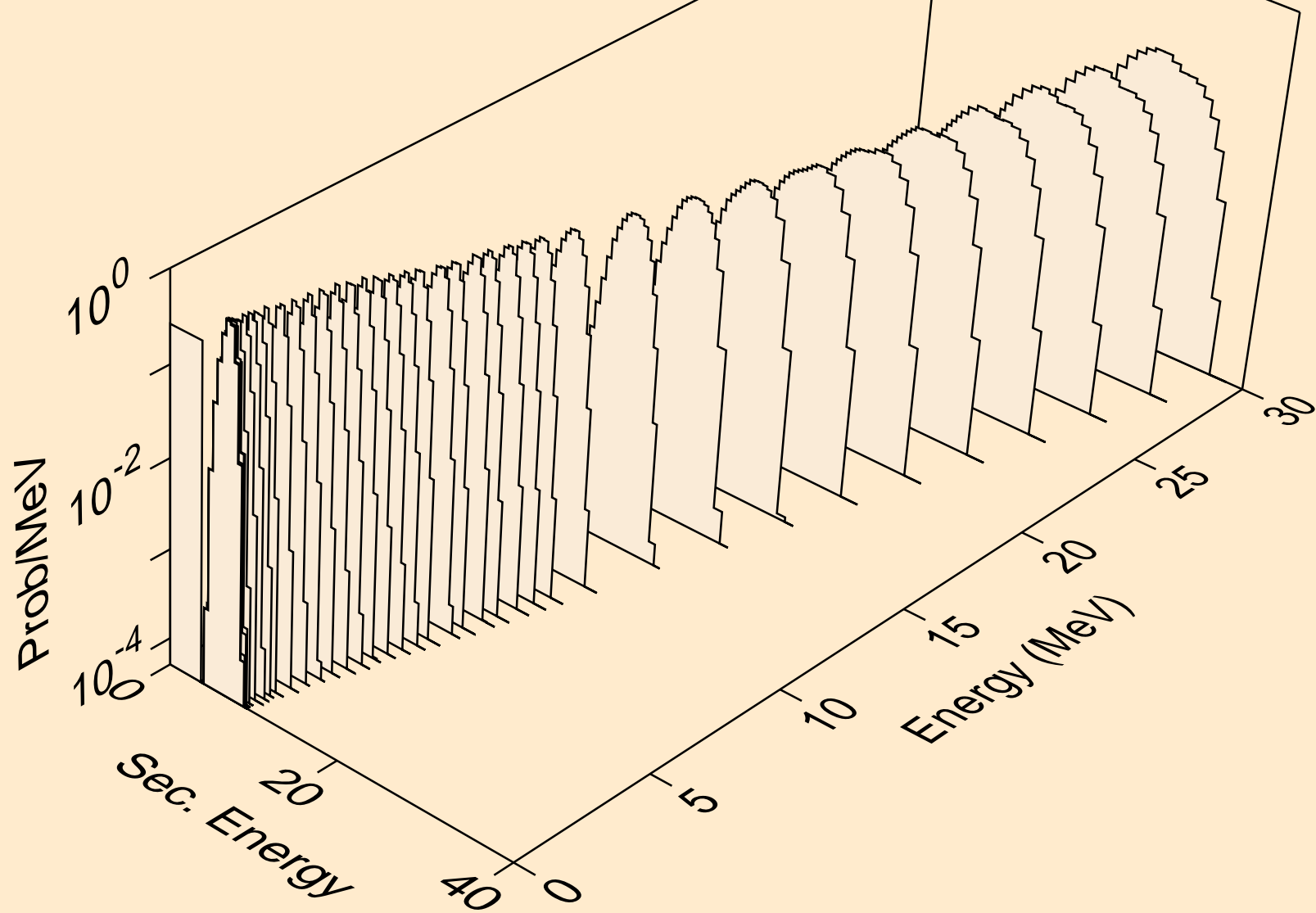

BA119 NEUTRON ACER TENDL-2024 LIBRARY; T=293.6K  
alphas from (n,t2a)

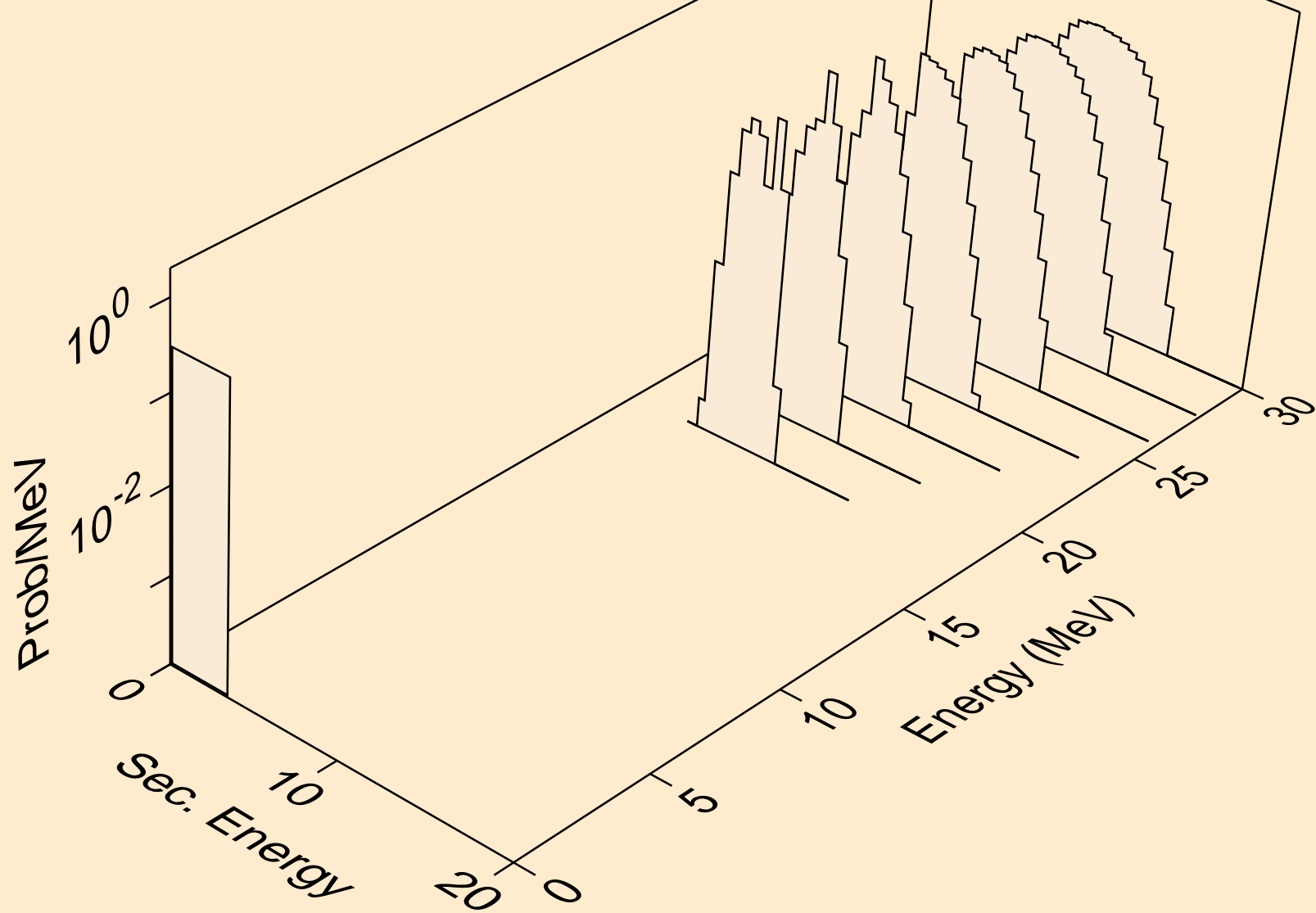

BA119 NEUTRON ACER TENDL-2024 LIBRARY; T=293.6K  
alphas from (n,d2a)

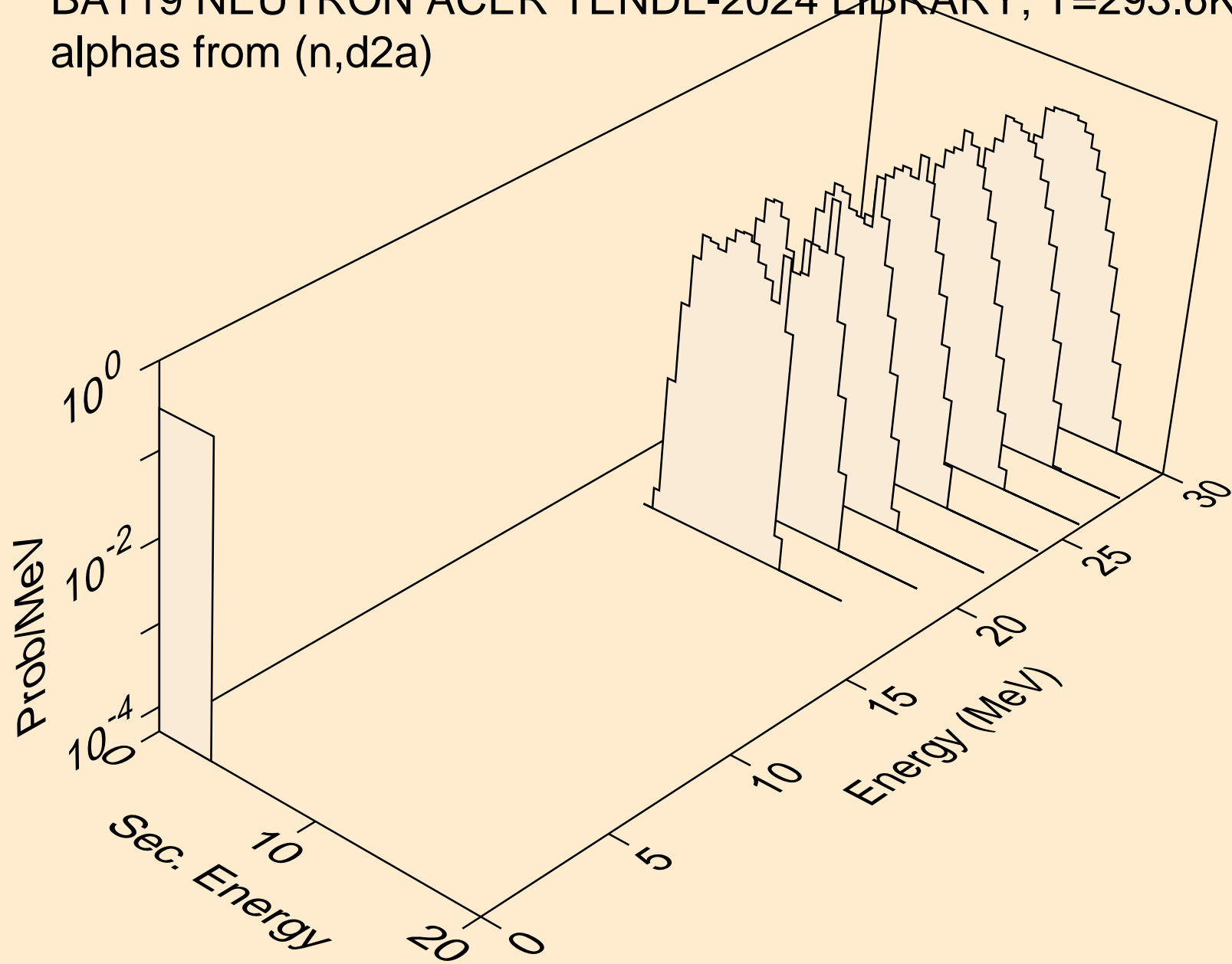

BA119 NEUTRON ACER TENDL-2024 LIBRARY; T=293.6K  
alphas from (n,da)

