

# BA123 NEUTRON ACER TENDL-2024 LIBRARY; T=293.6K

## Principal cross sections

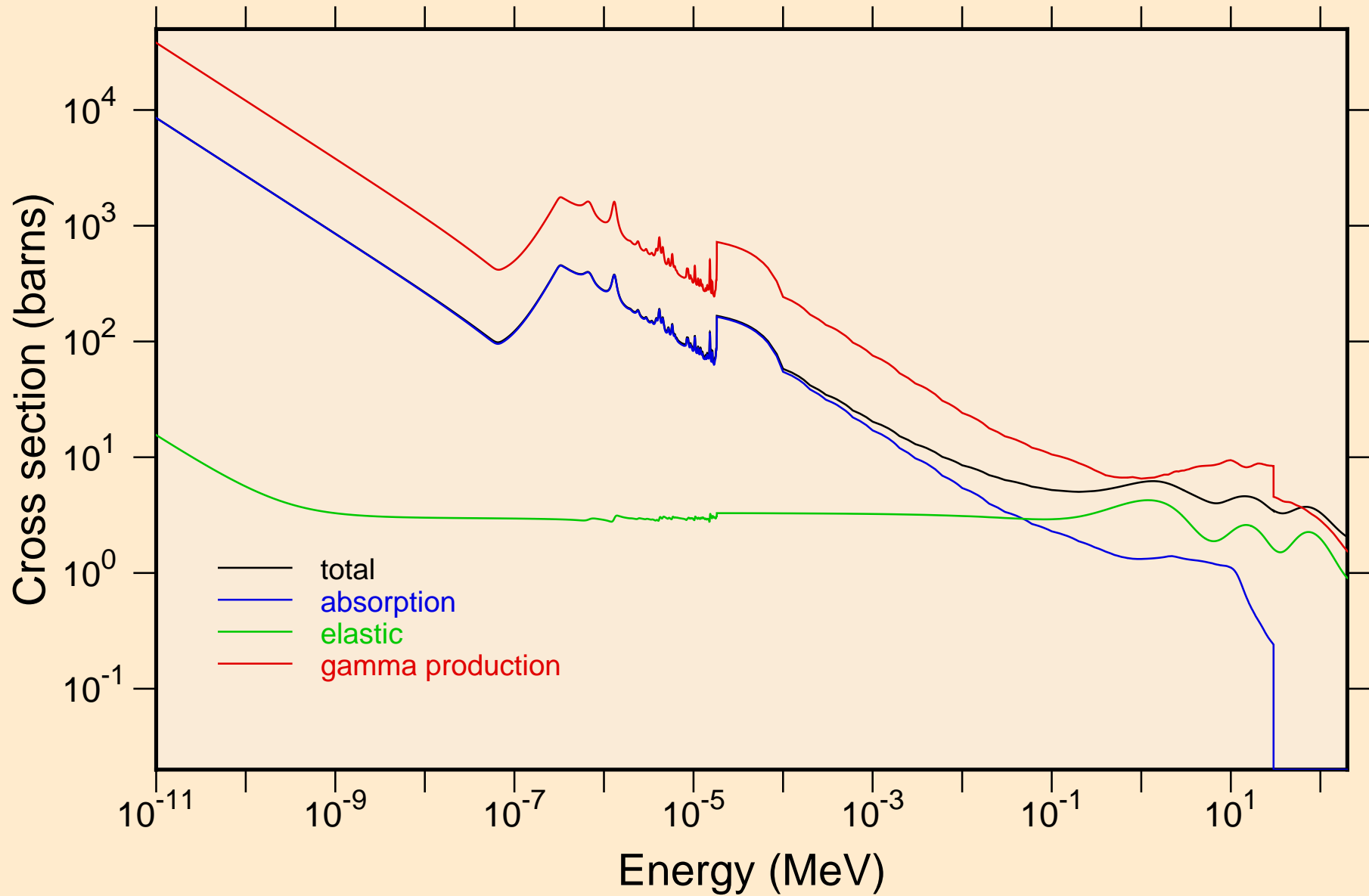

BA123 NEUTRON ACER TENDL-2024 LIBRARY; T=293.6K  
resonance total cross section

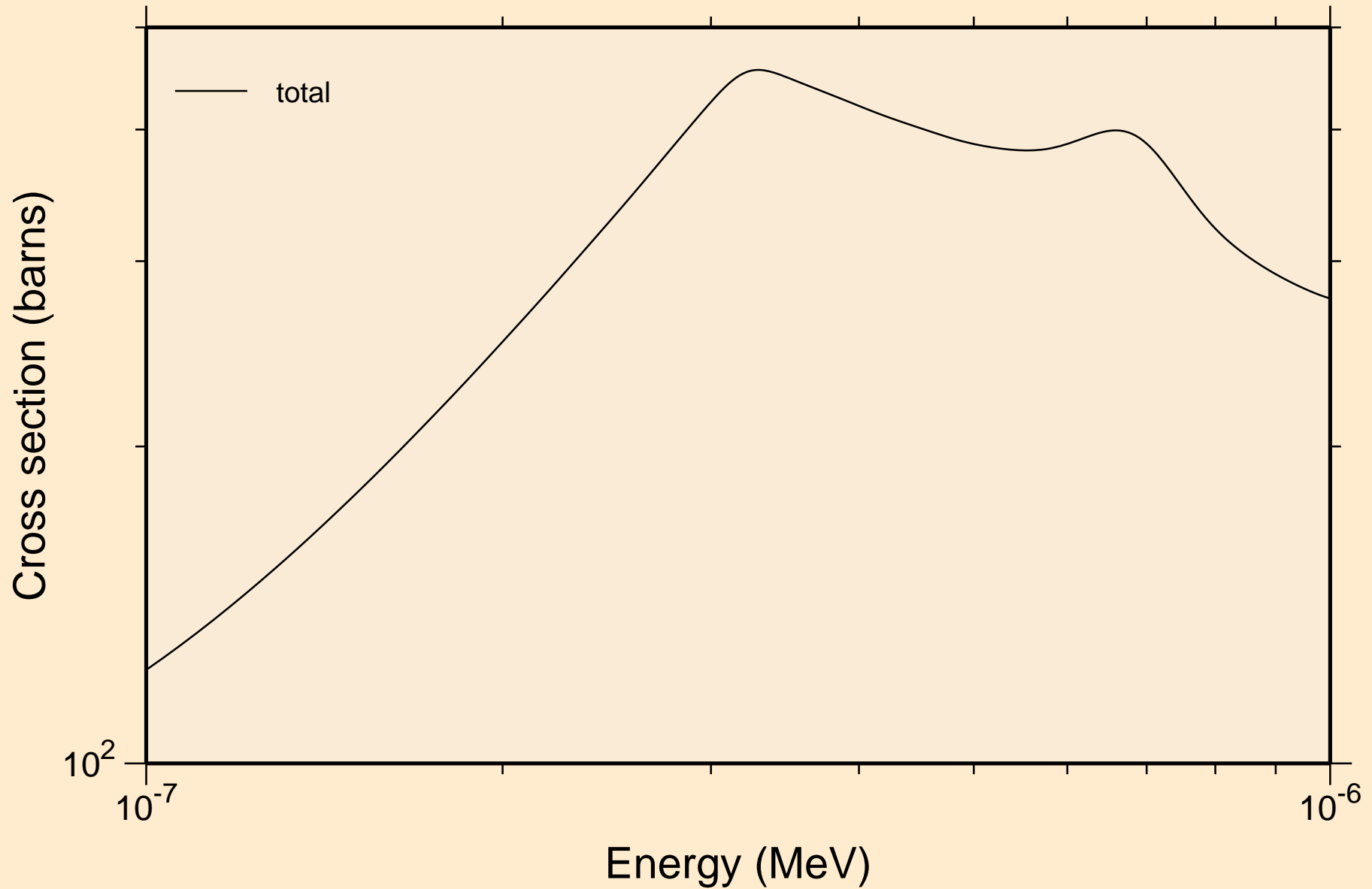

BA123 NEUTRON ACER TENDL-2024 LIBRARY; T=293.6K  
resonance total cross section

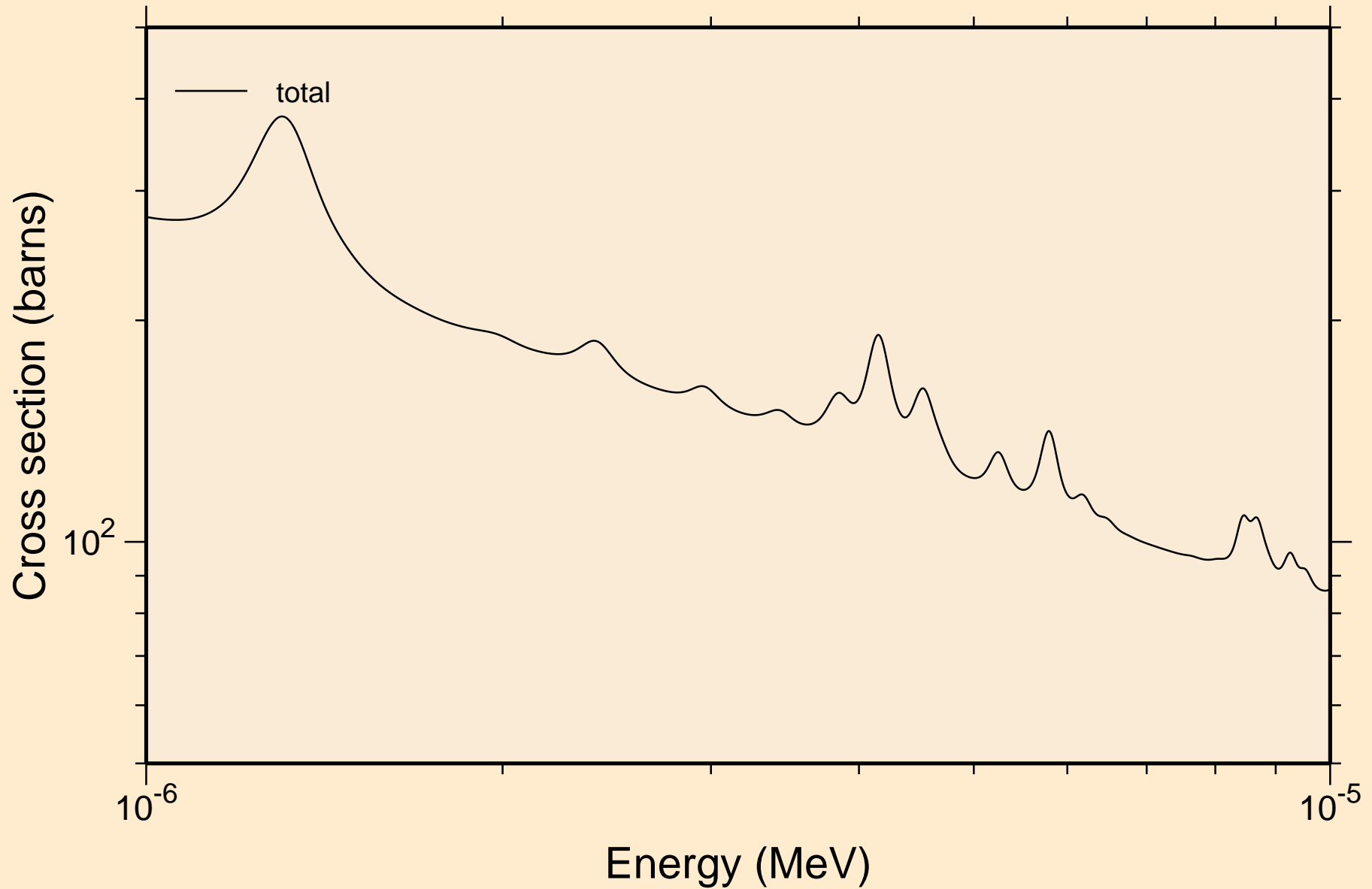

BA123 NEUTRON ACER TENDL-2024 LIBRARY; T=293.6K  
resonance total cross section

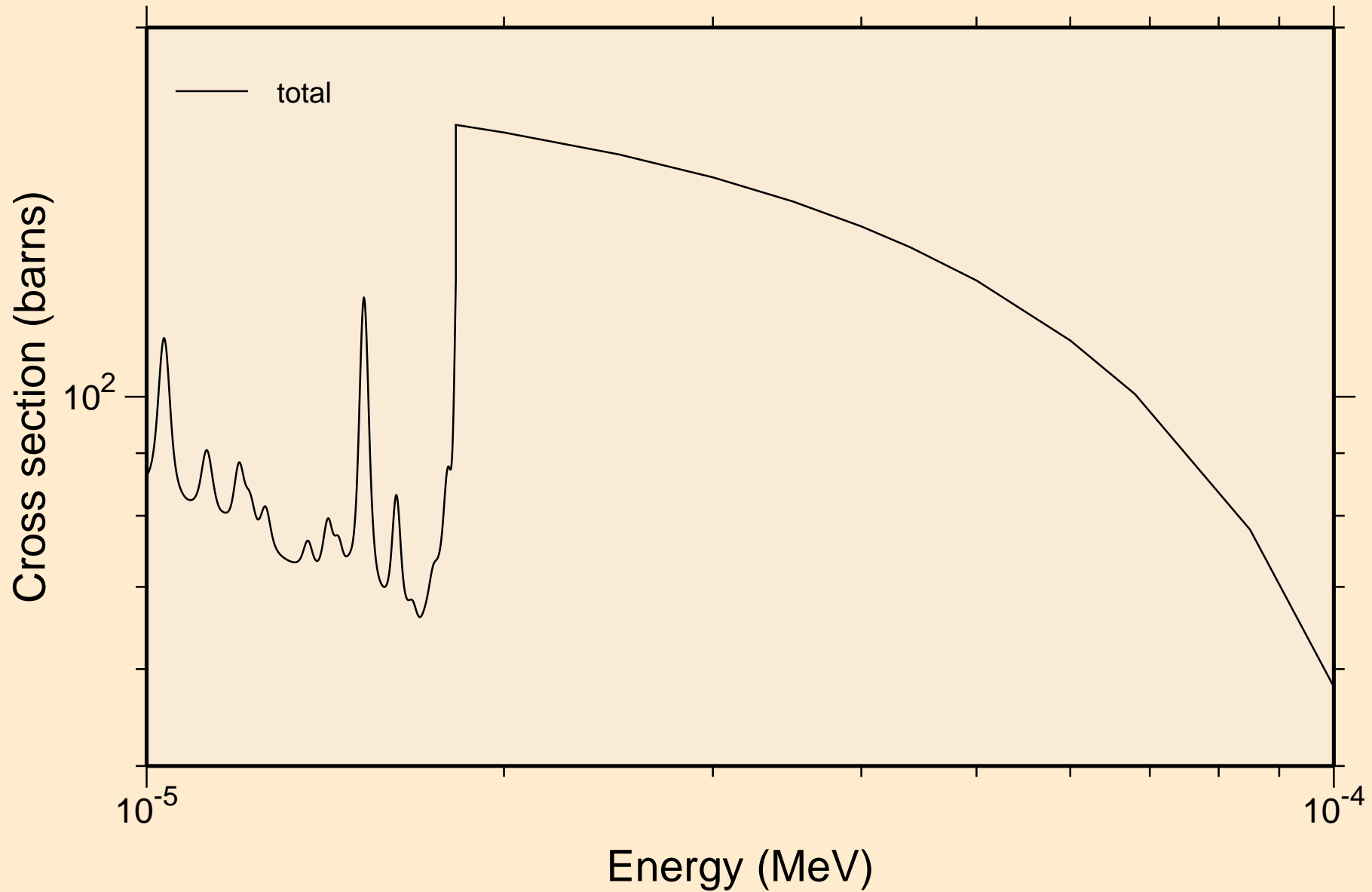

BA123 NEUTRON ACER TENDL-2024 LIBRARY; T=293.6K  
resonance total cross section

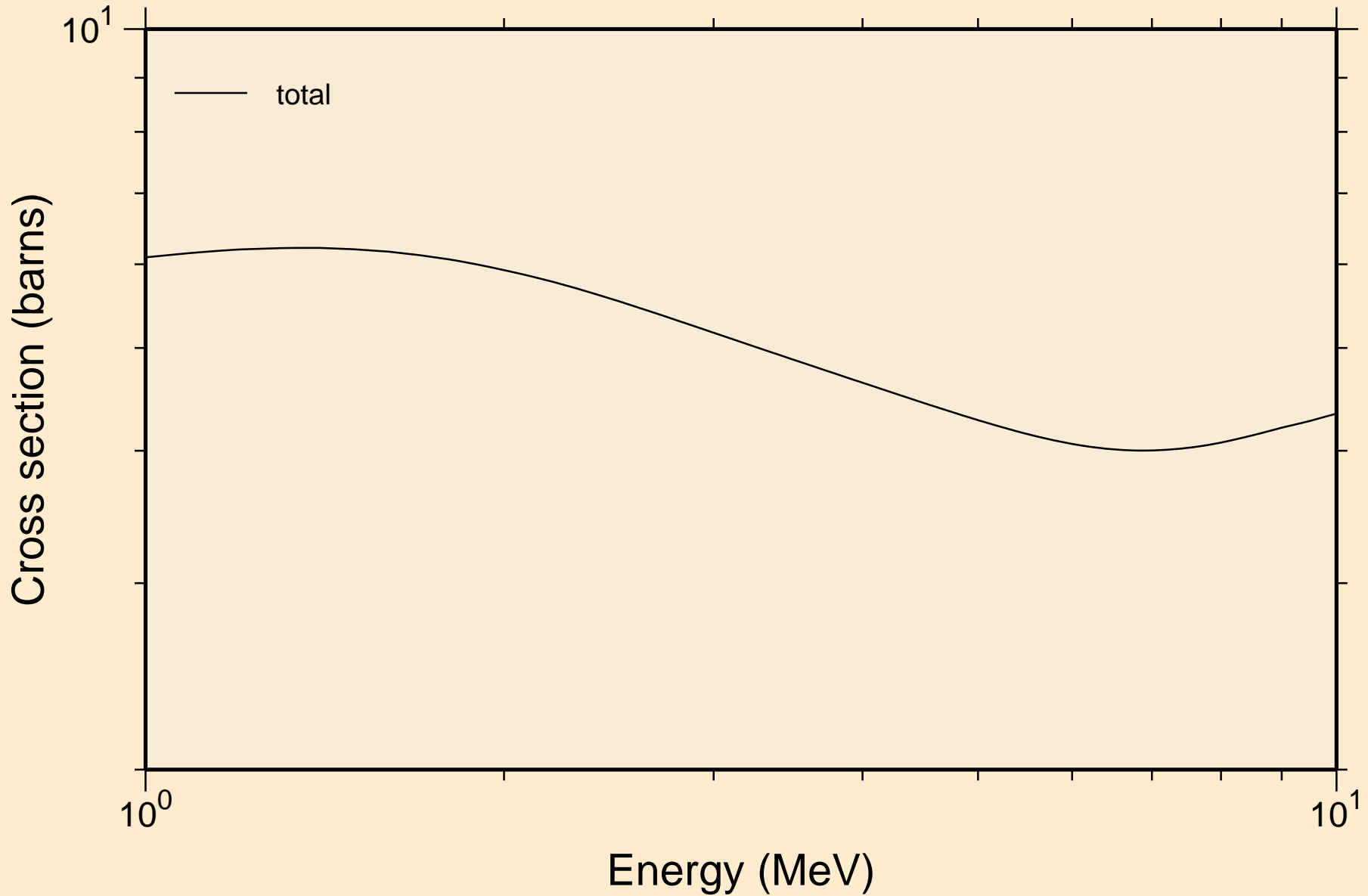

BA123 NEUTRON ACER TENDL-2024 LIBRARY; T=293.6K  
resonance absorption cross sections

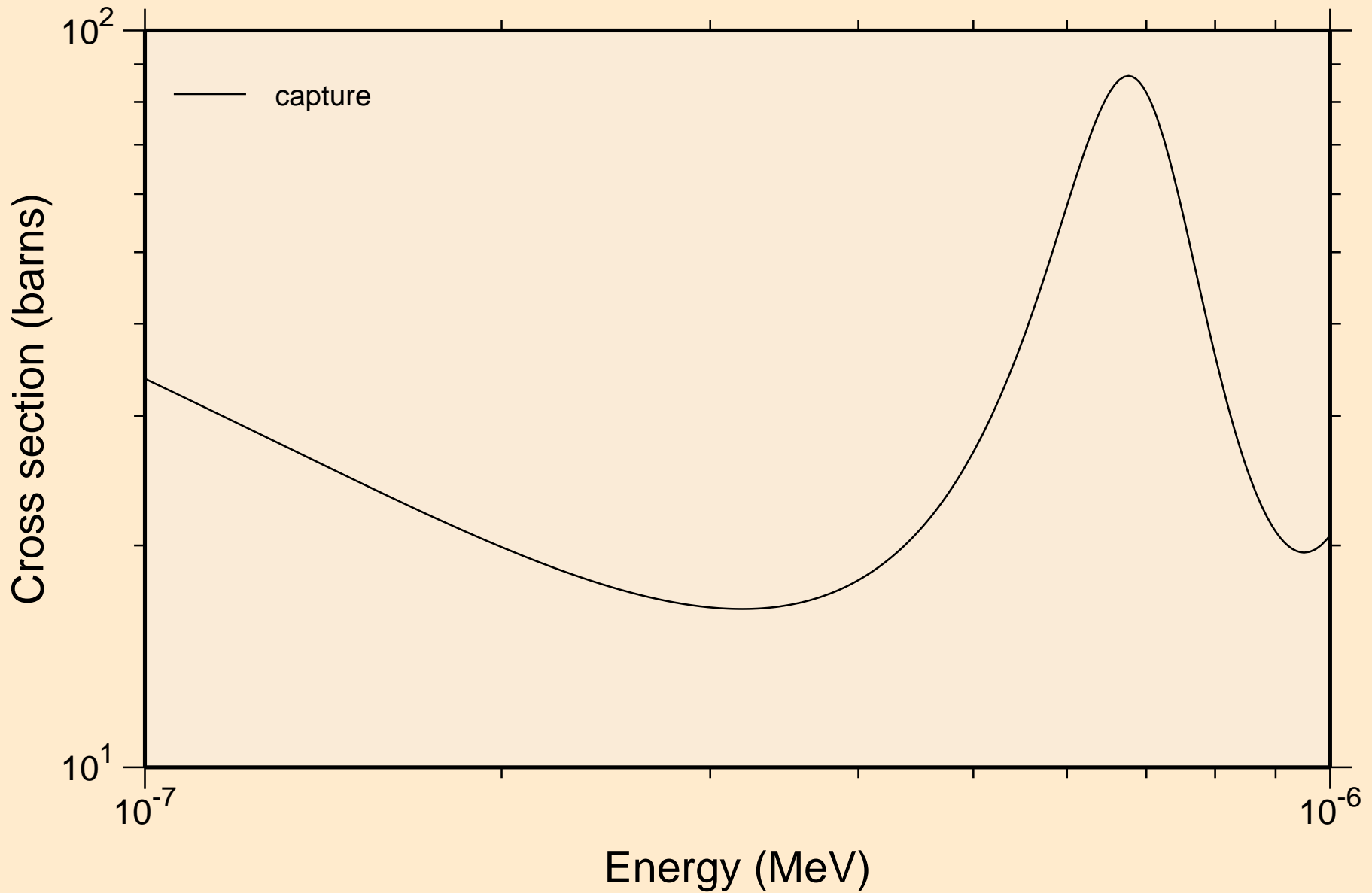

BA123 NEUTRON ACER TENDL-2024 LIBRARY; T=293.6K  
resonance absorption cross sections

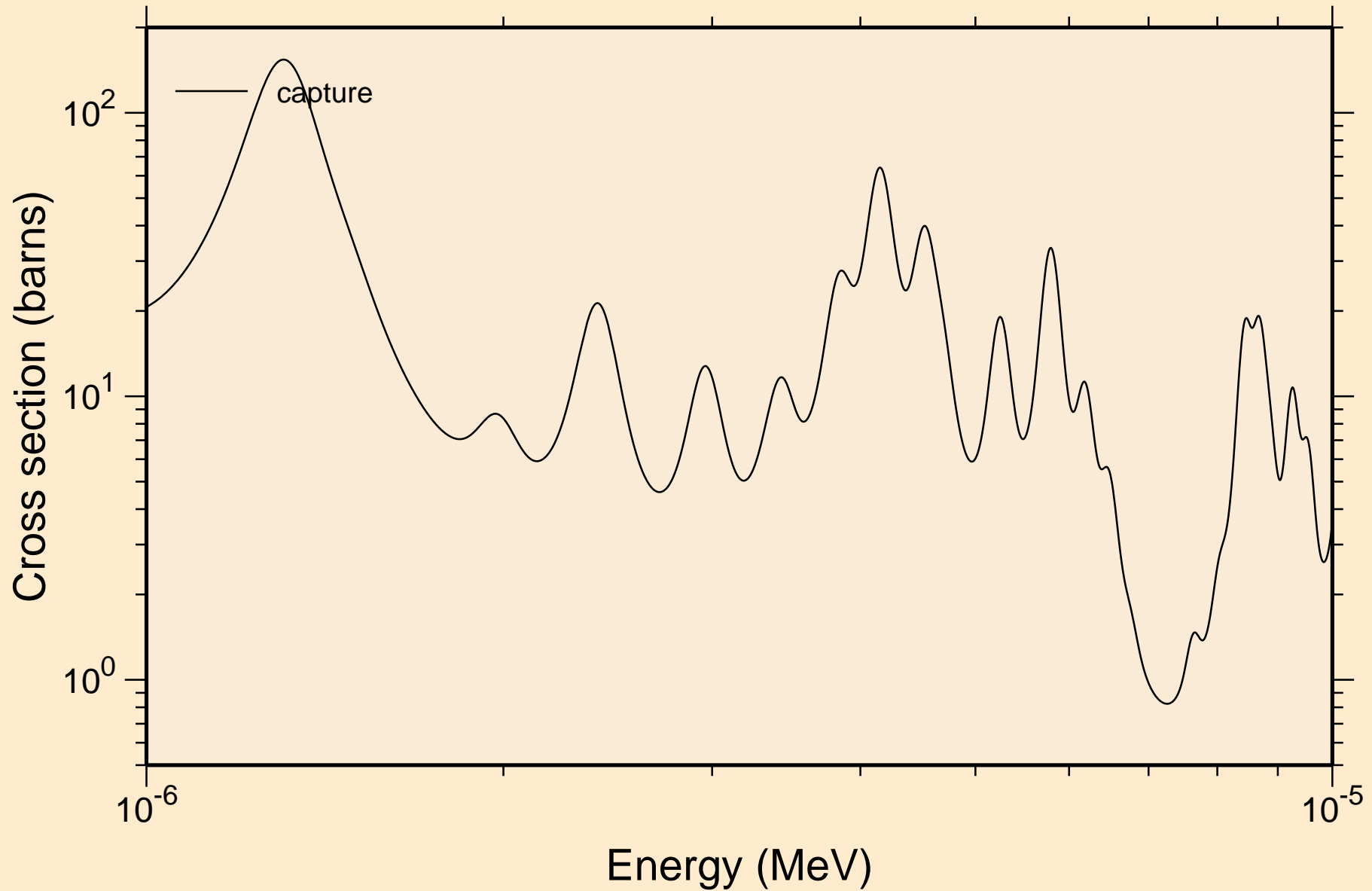

BA123 NEUTRON ACER TENDL-2024 LIBRARY; T=293.6K  
resonance absorption cross sections

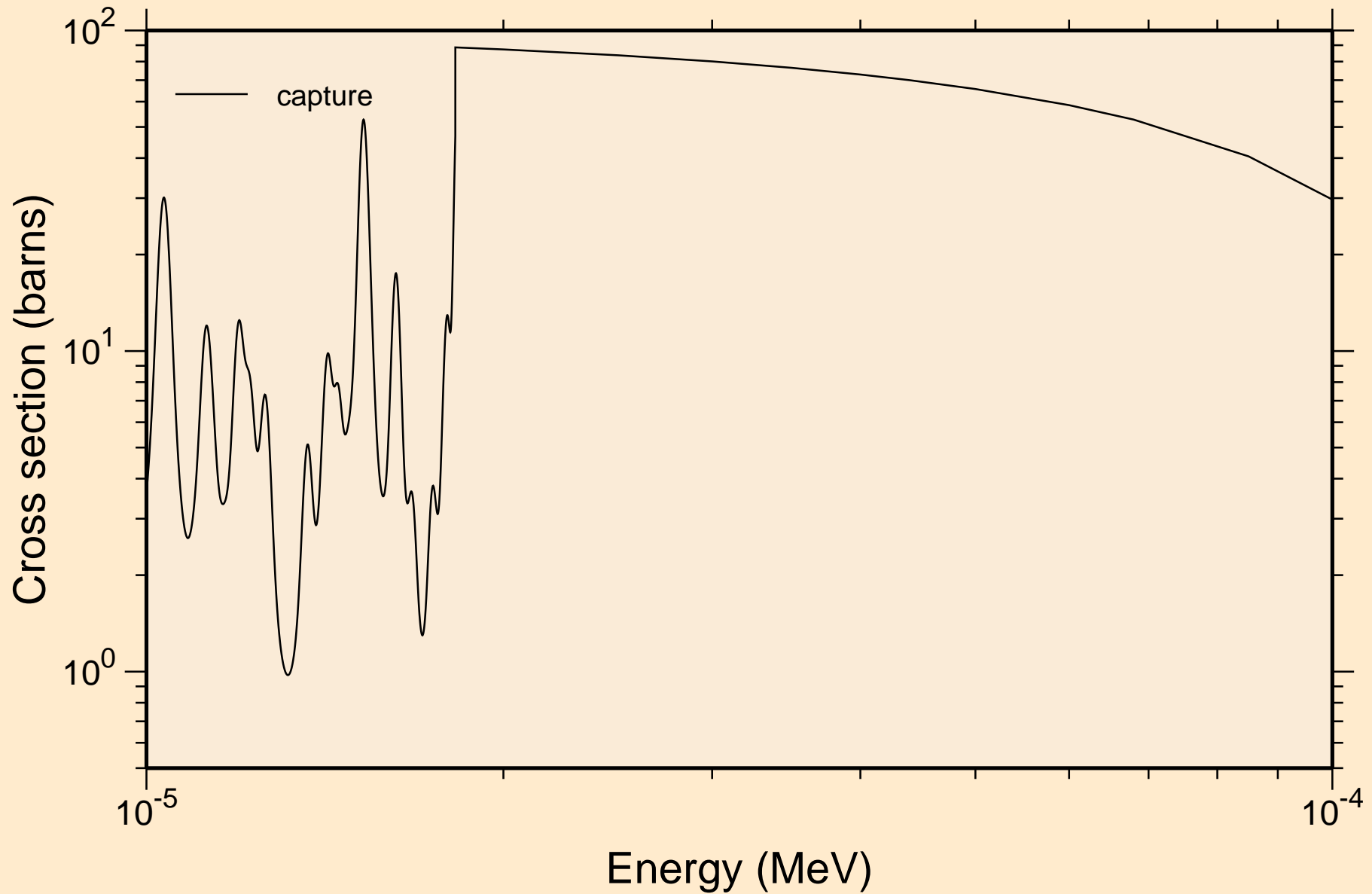

BA123 NEUTRON ACER TENDL-2024 LIBRARY; T=293.6K  
resonance absorption cross sections

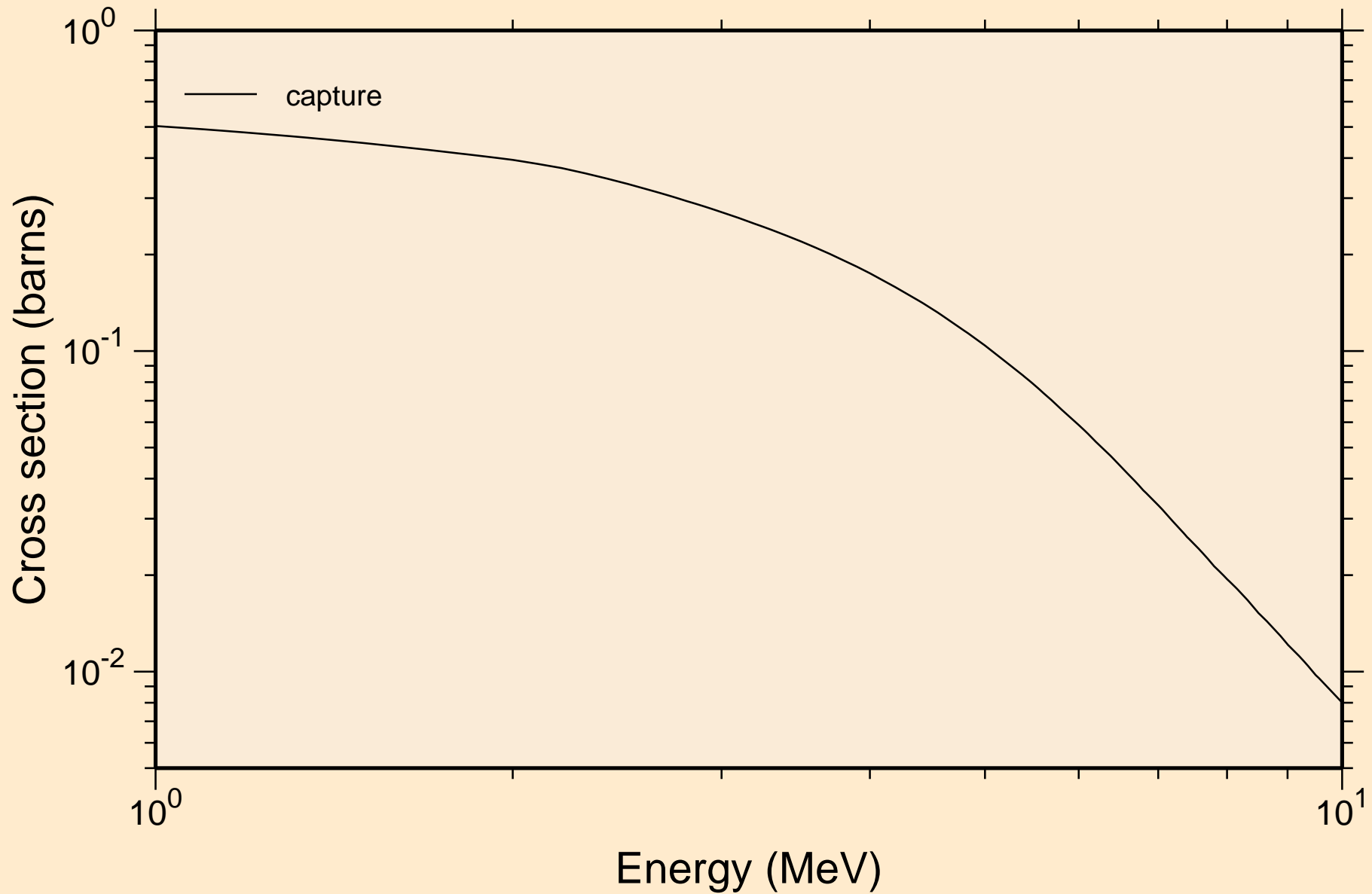

BA123 NEUTRON ACER TENDL-2024 LIBRARY; T=293.6K  
Heating

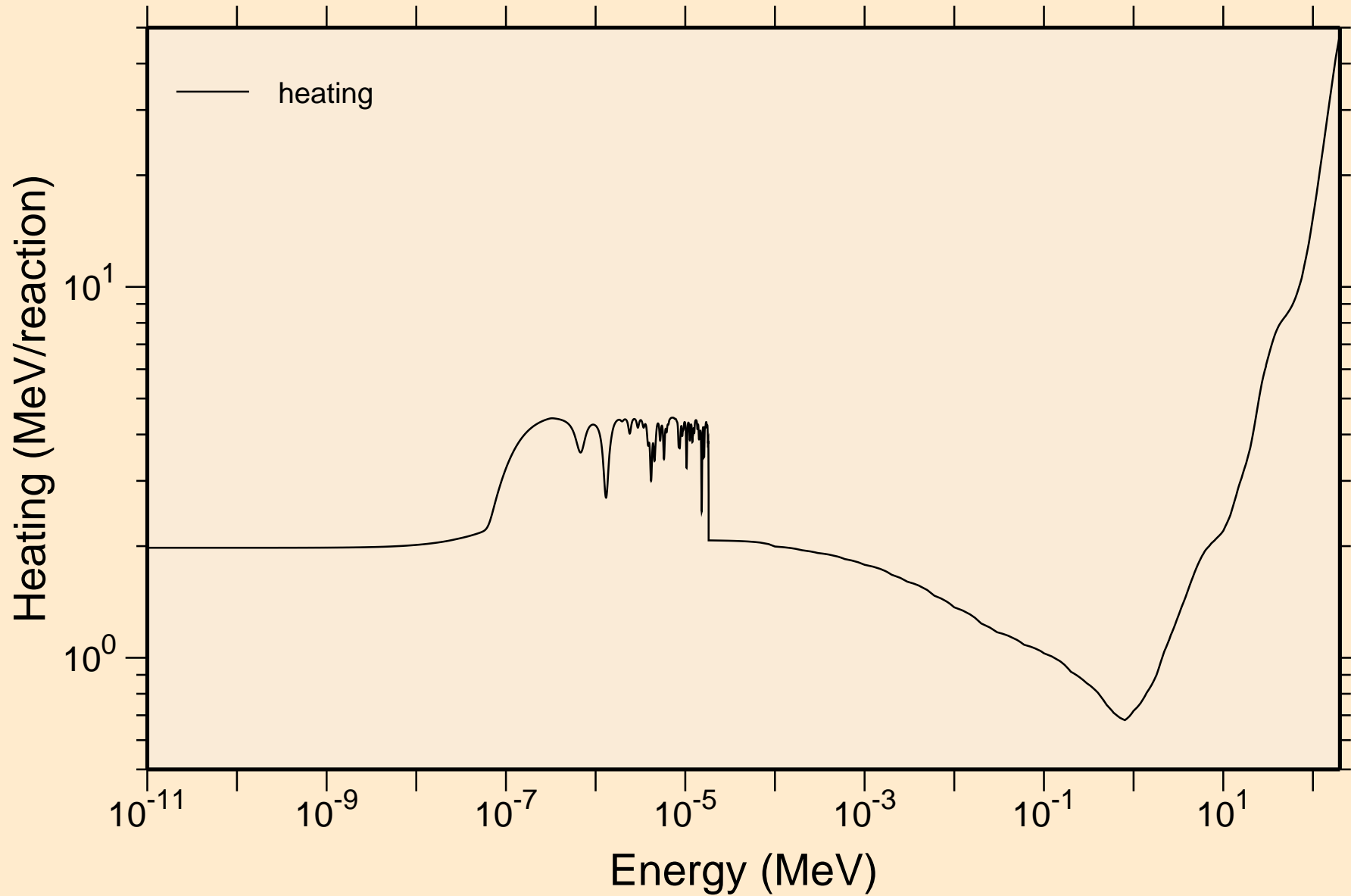

BA123 NEUTRON ACER TENDL-2024 LIBRARY; T=293.6K  
Damage

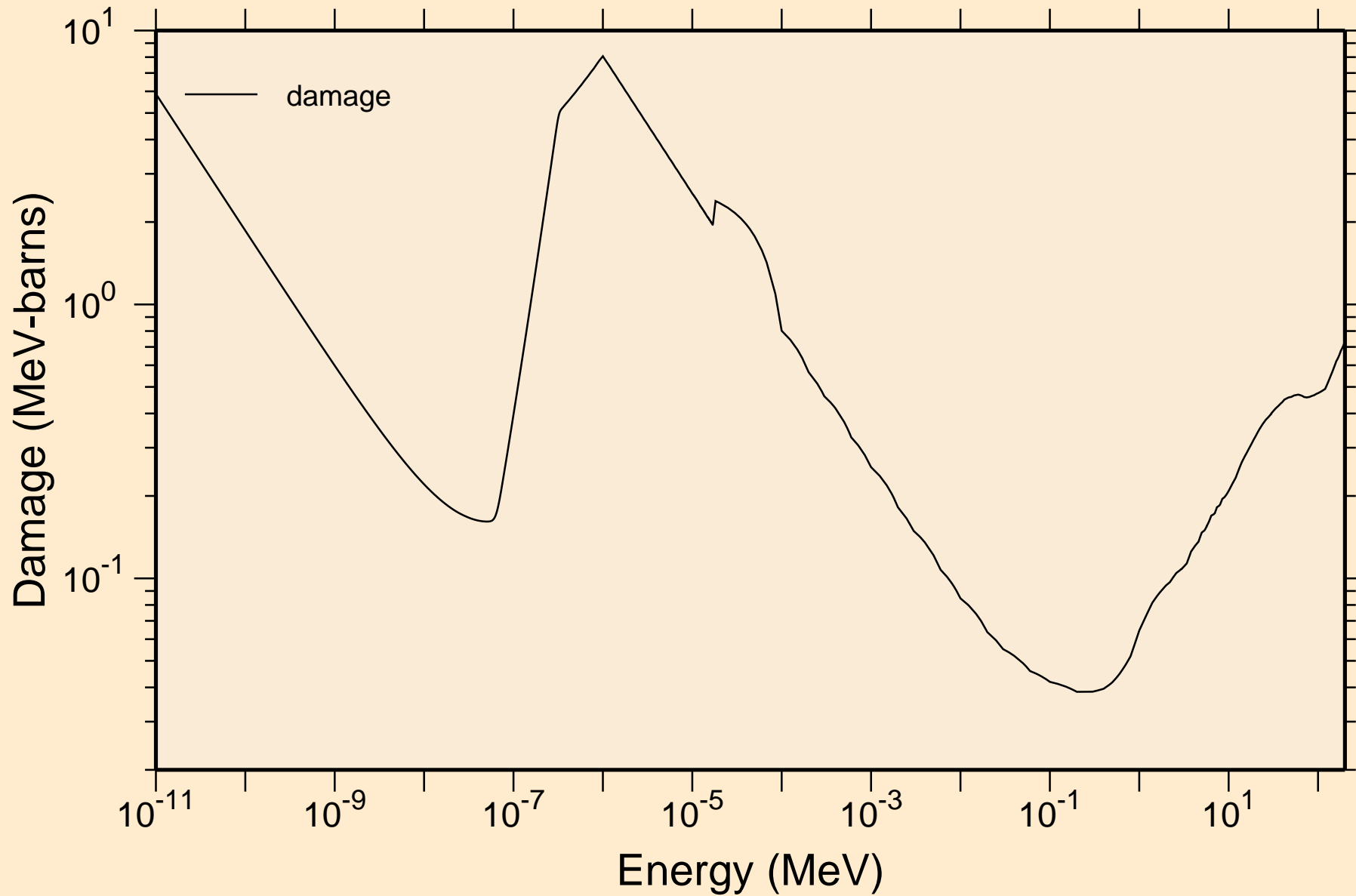

BA123 NEUTRON ACER TENDL-2024 LIBRARY; T=293.6K  
Non-threshold reactions

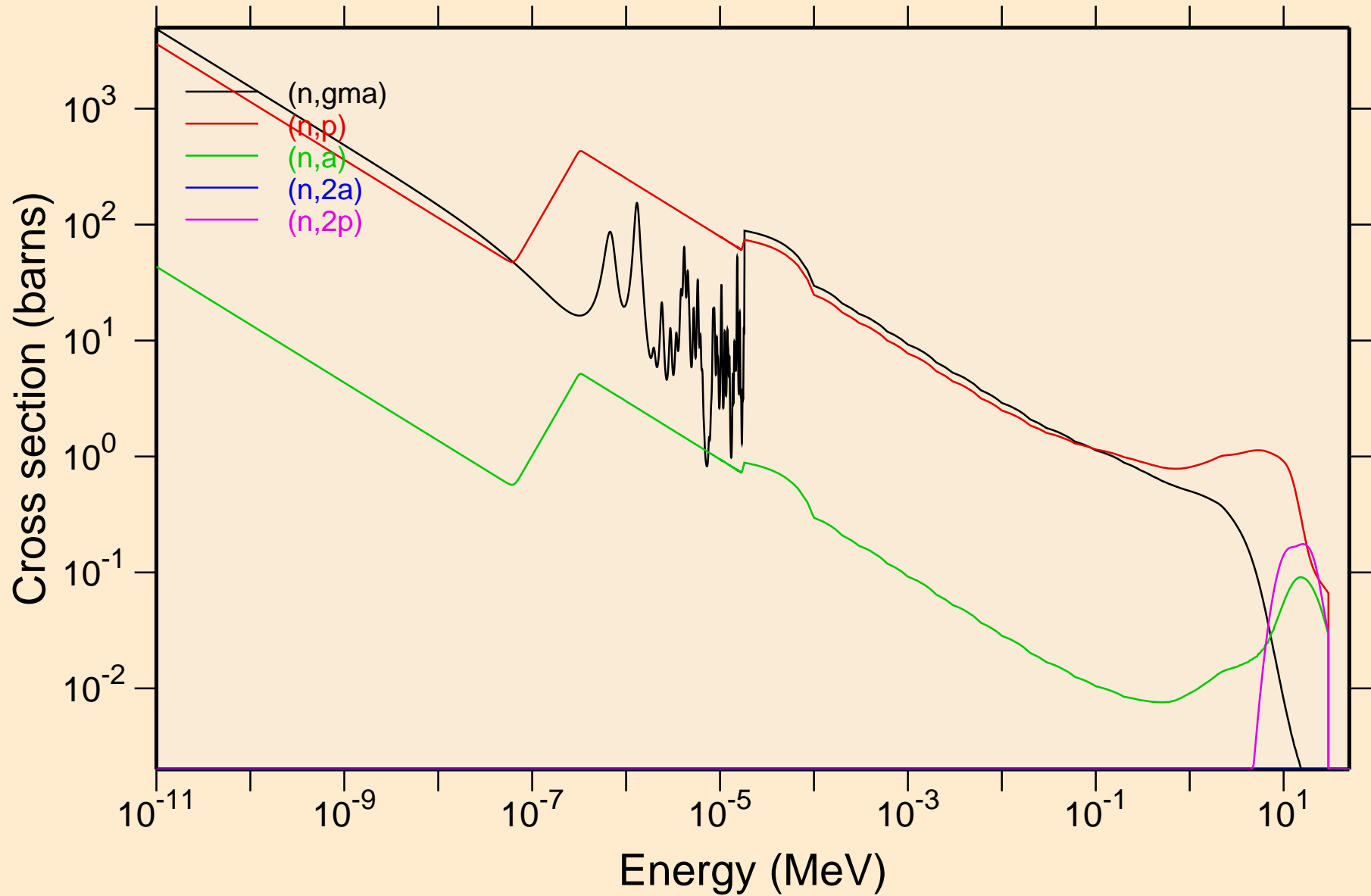

BA123 NEUTRON ACER TENDL-2024 LIBRARY; T=293.6K  
Non-threshold reactions

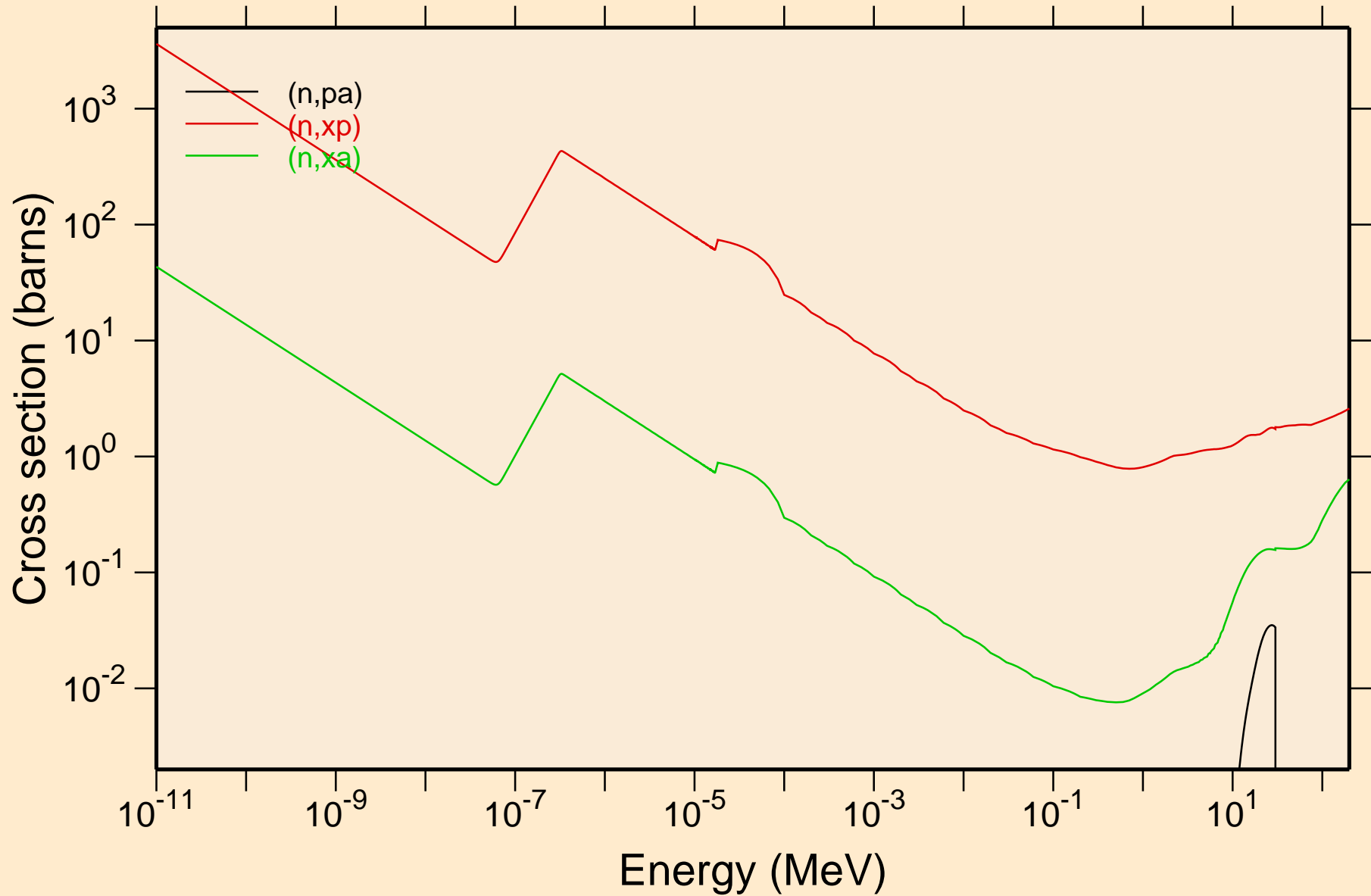

# BA123 NEUTRON ACER TENDL-2024 LIBRARY; T=293.6K

## Principal cross sections

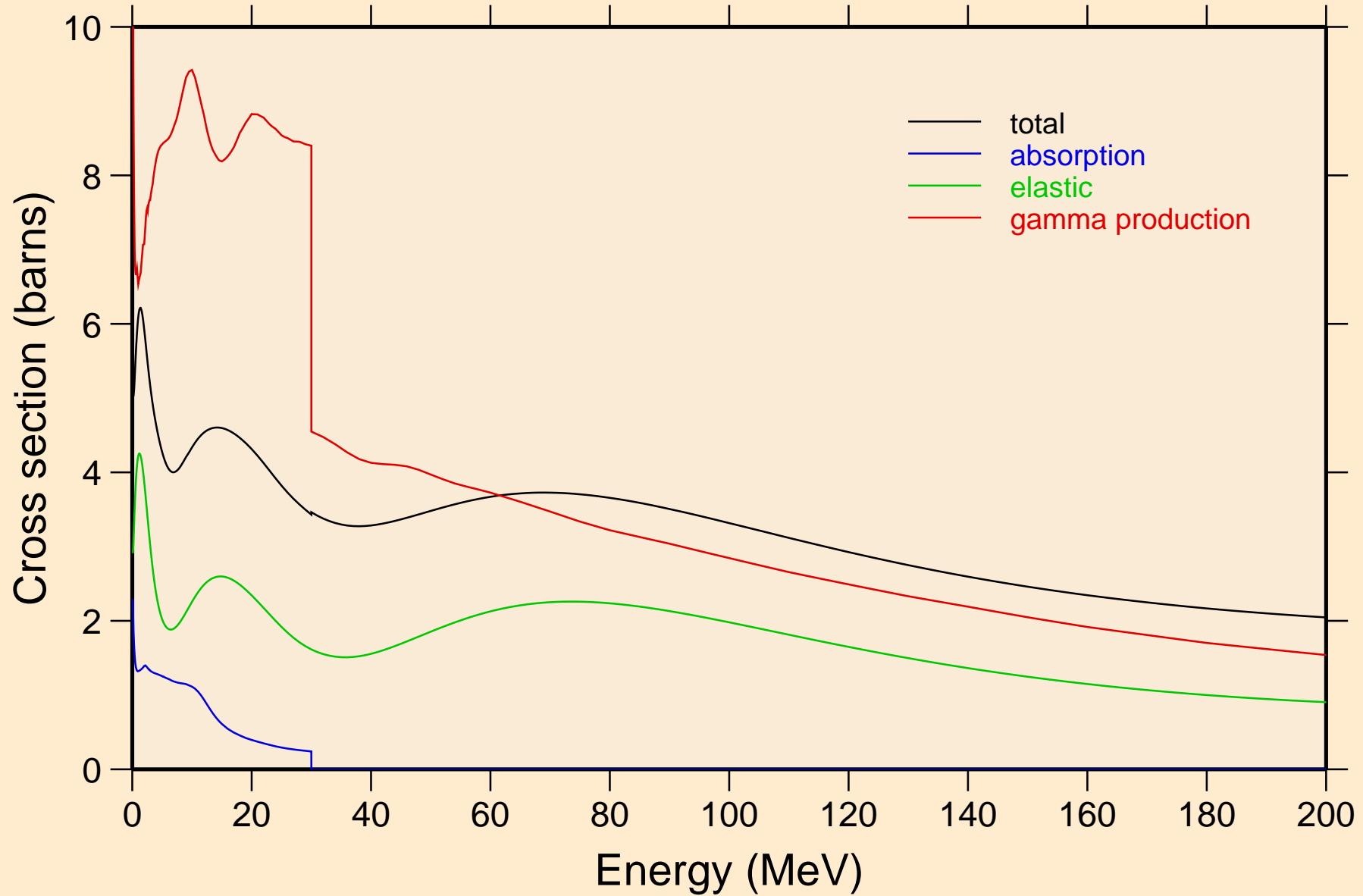

# BA123 NEUTRON ACER TENDL-2024 LIBRARY; T=293.6K

## Heating

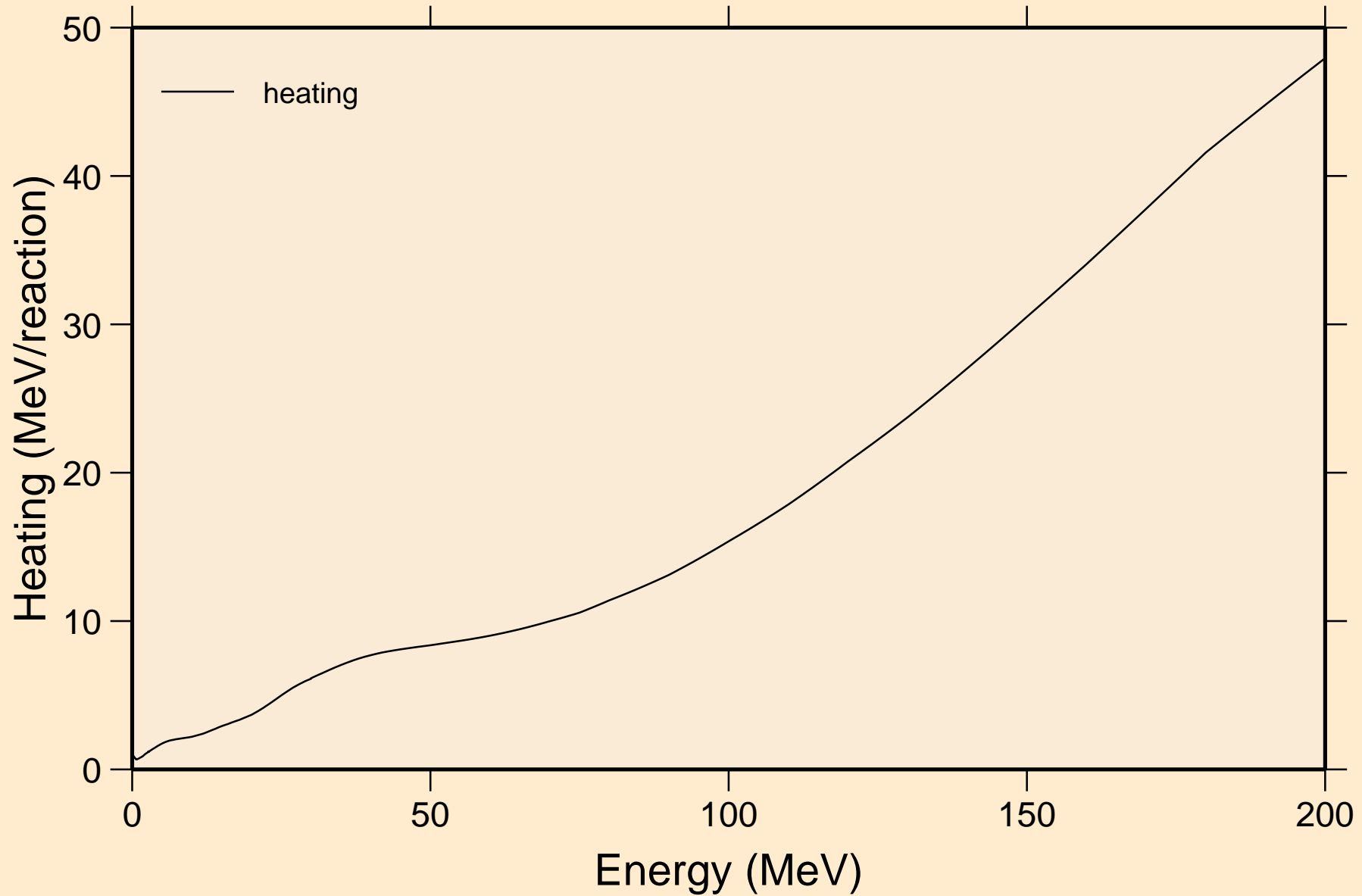

BA123 NEUTRON ACER TENDL-2024 LIBRARY; T=293.6K  
Damage

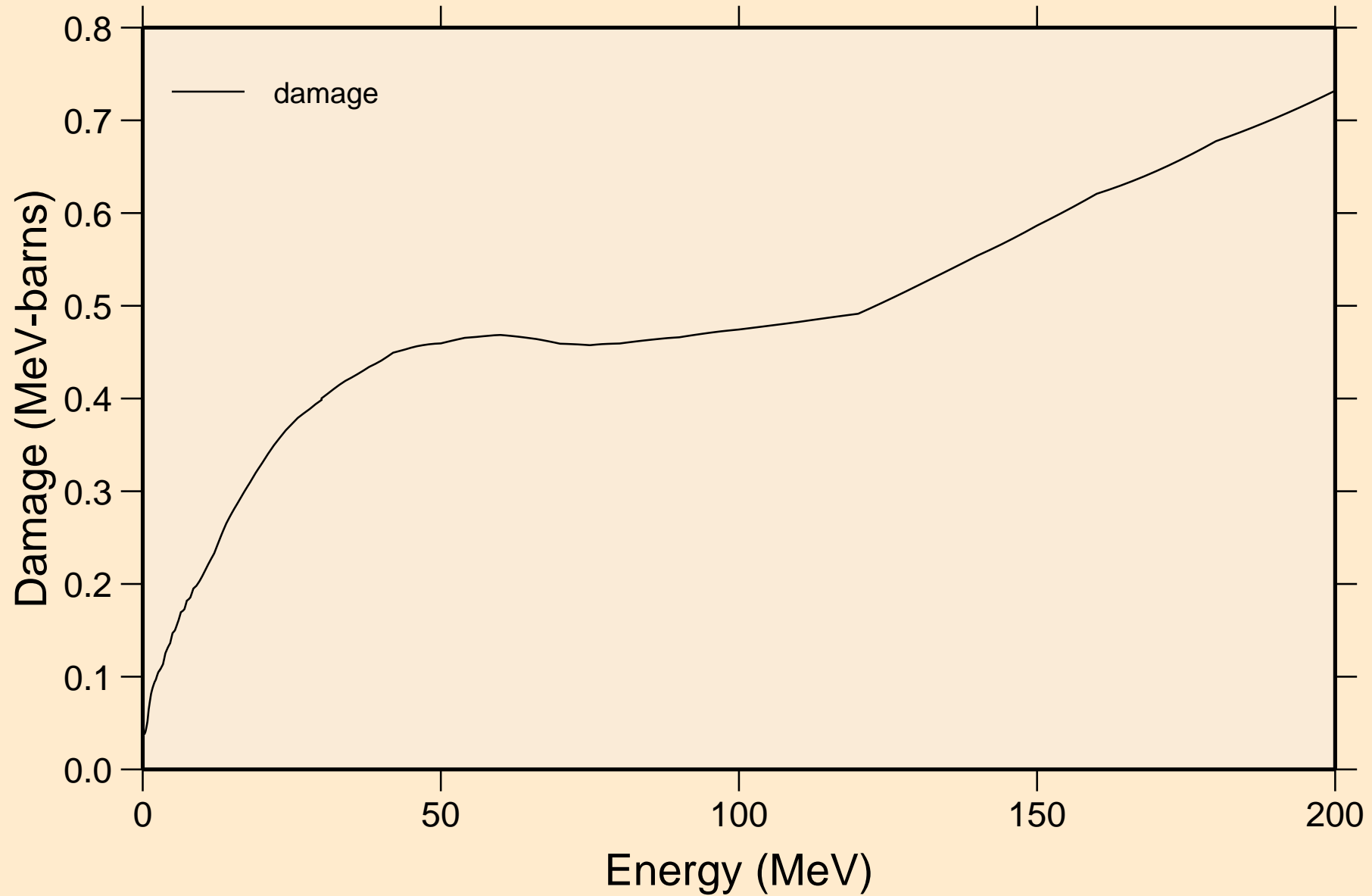

BA123 NEUTRON ACER TENDL-2024 LIBRARY; T=293.6K  
Non-threshold reactions

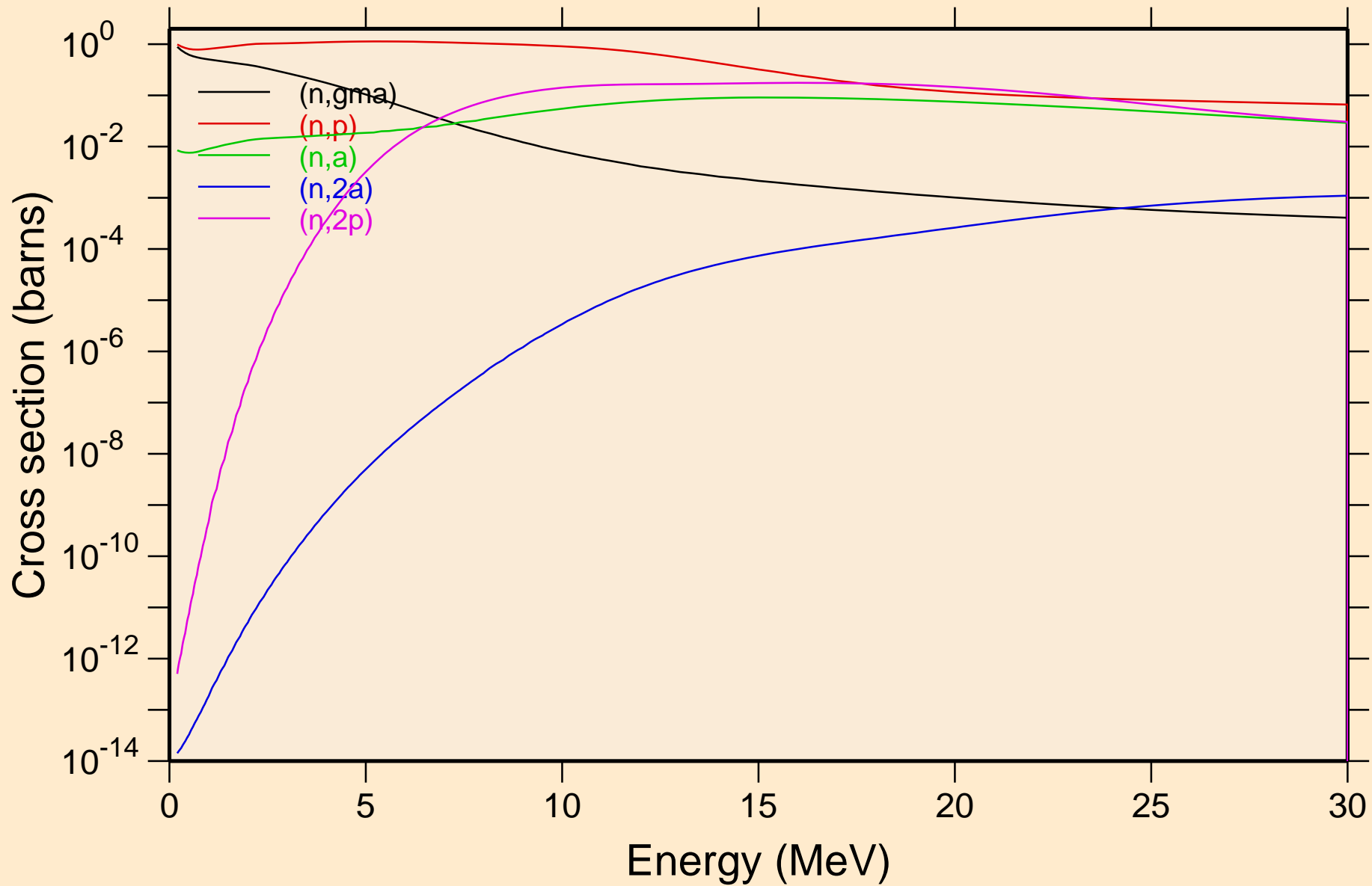

BA123 NEUTRON ACER TENDL-2024 LIBRARY; T=293.6K  
Non-threshold reactions

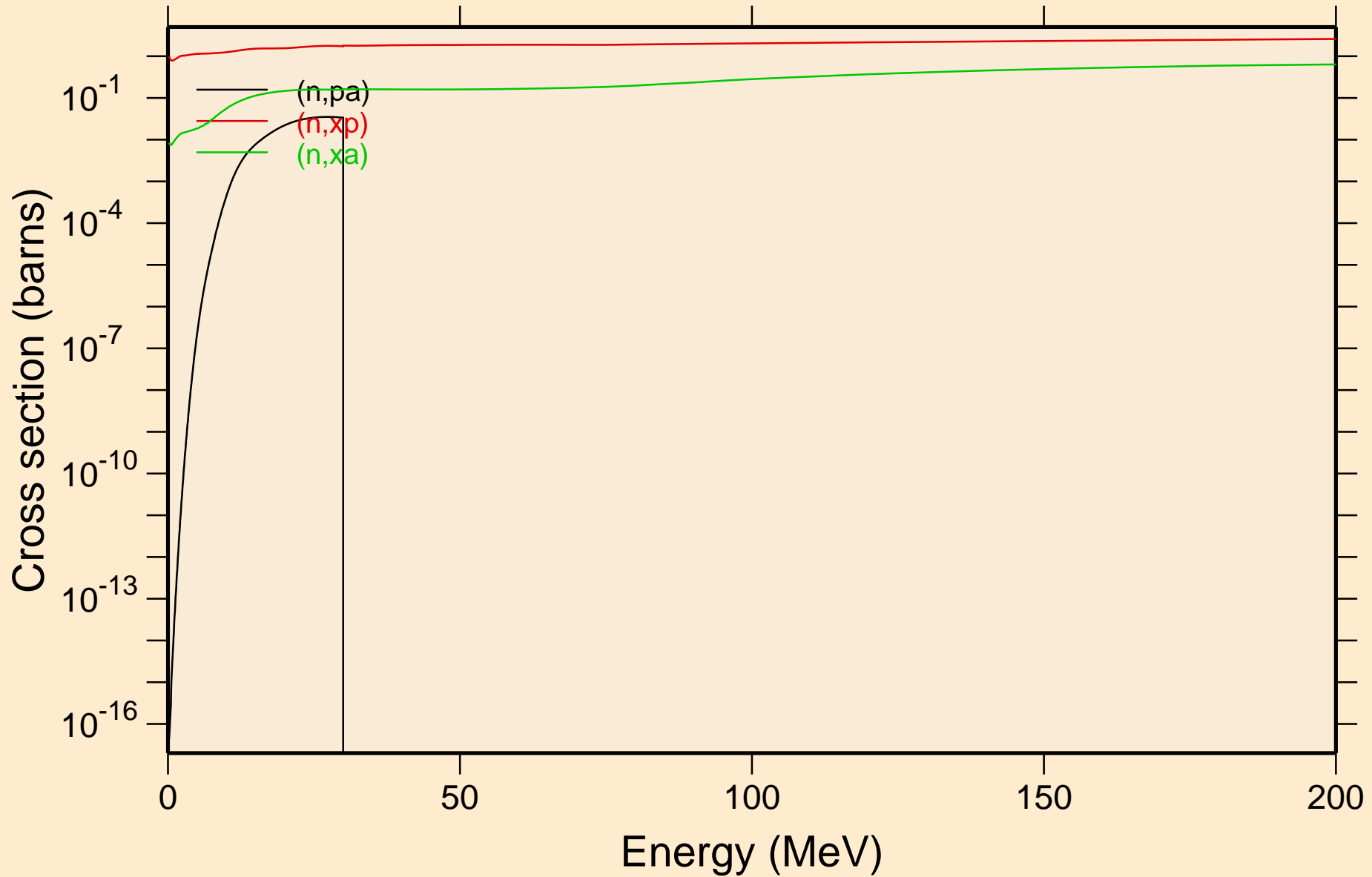

BA123 NEUTRON ACER TENDL-2024 LIBRARY; T=293.6K  
Inelastic levels

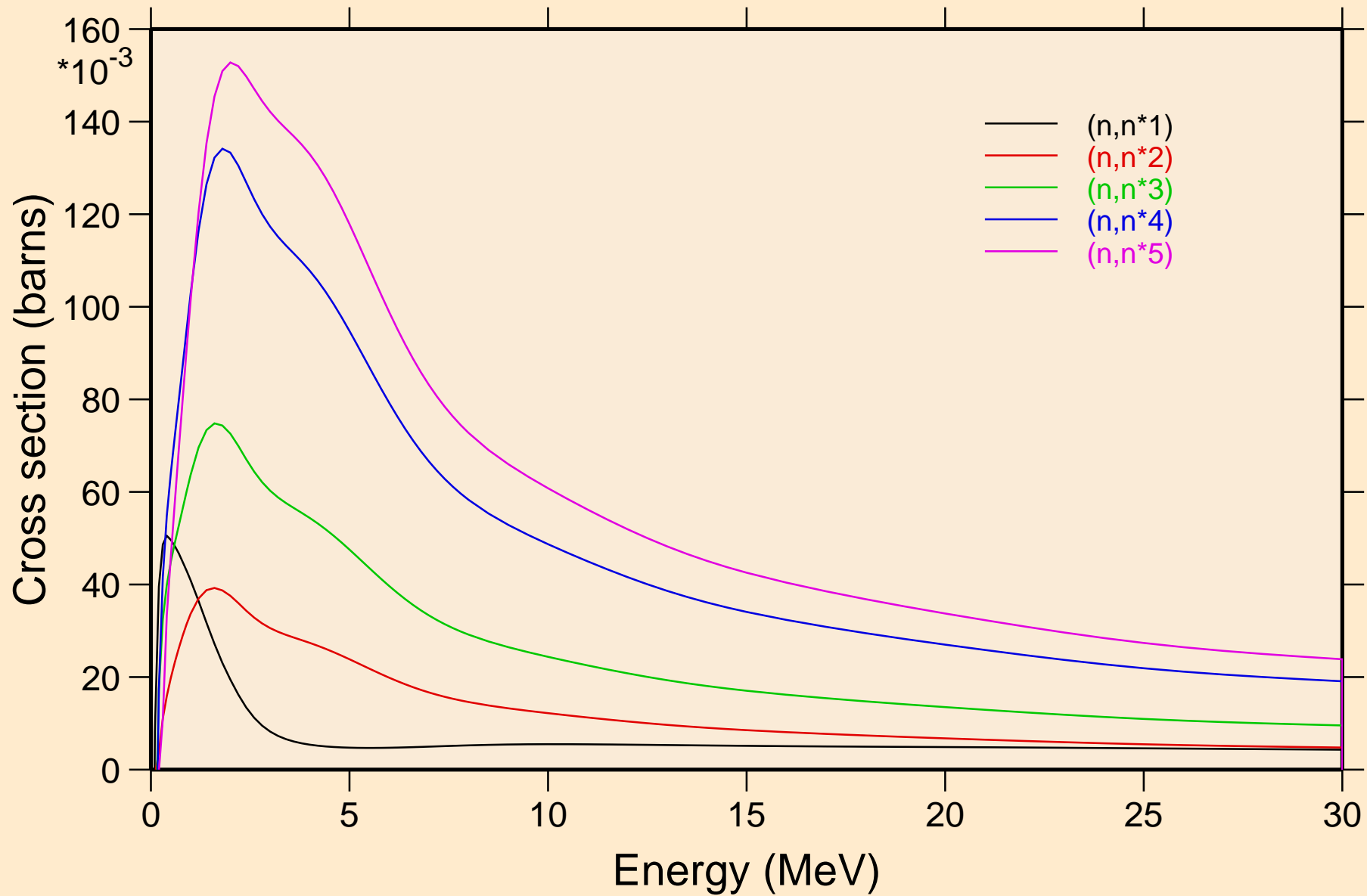

BA123 NEUTRON ACER TENDL-2024 LIBRARY; T=293.6K  
Inelastic levels

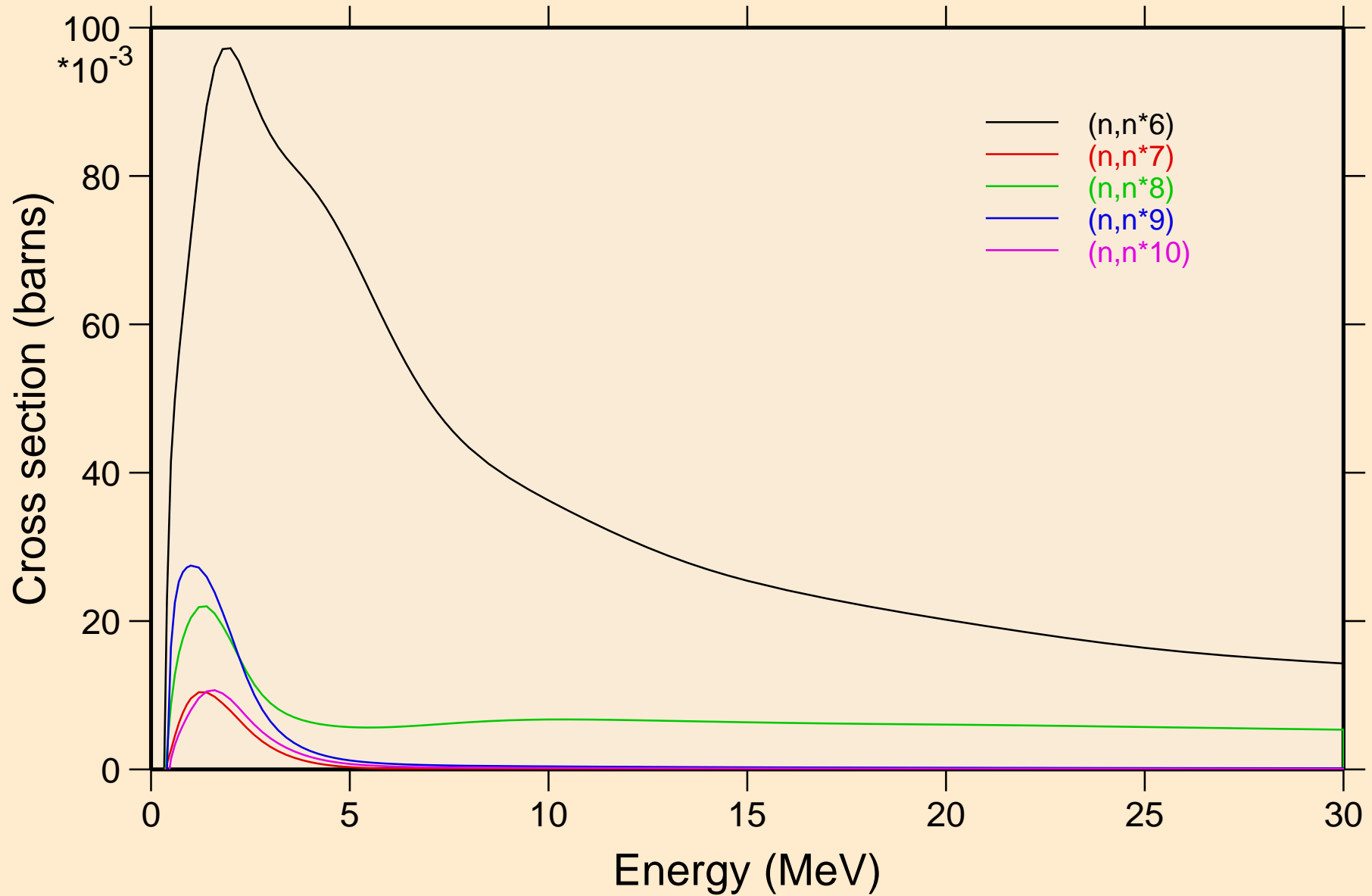

BA123 NEUTRON ACER TENDL-2024 LIBRARY; T=293.6K  
Inelastic levels

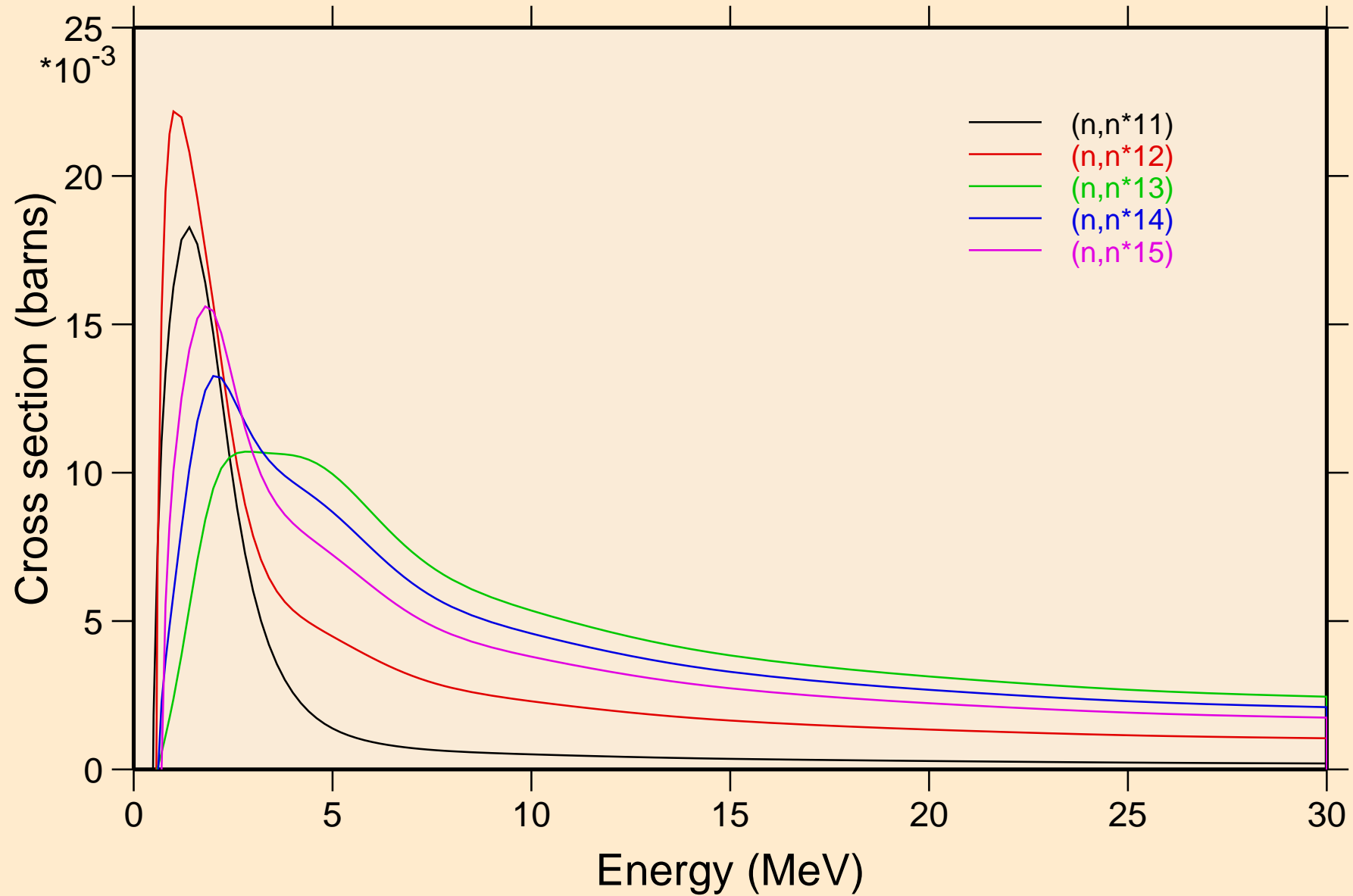

BA123 NEUTRON ACER TENDL-2024 LIBRARY; T=293.6K  
Threshold reactions

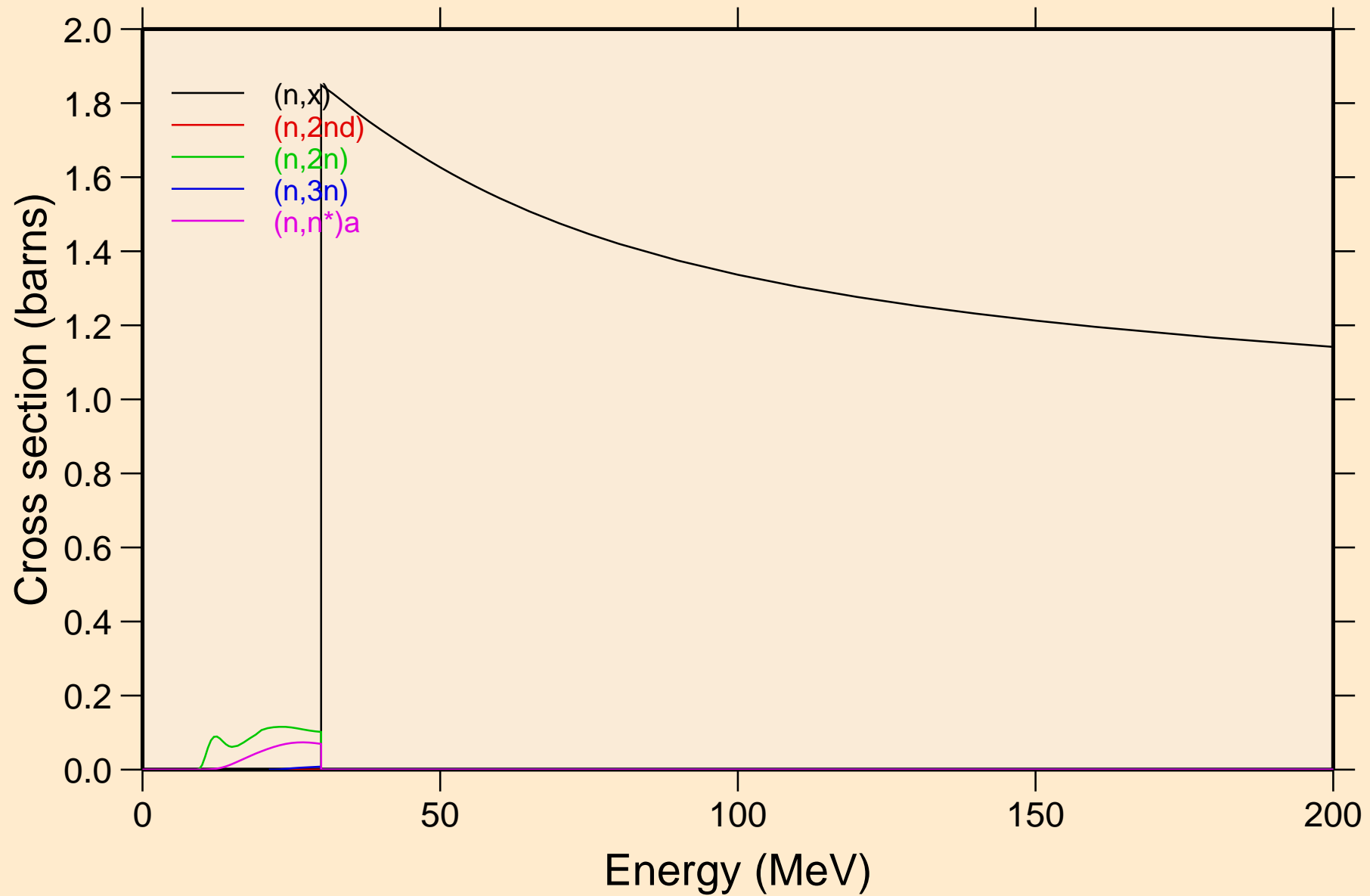

BA123 NEUTRON ACER TENDL-2024 LIBRARY; T=293.6K  
Threshold reactions

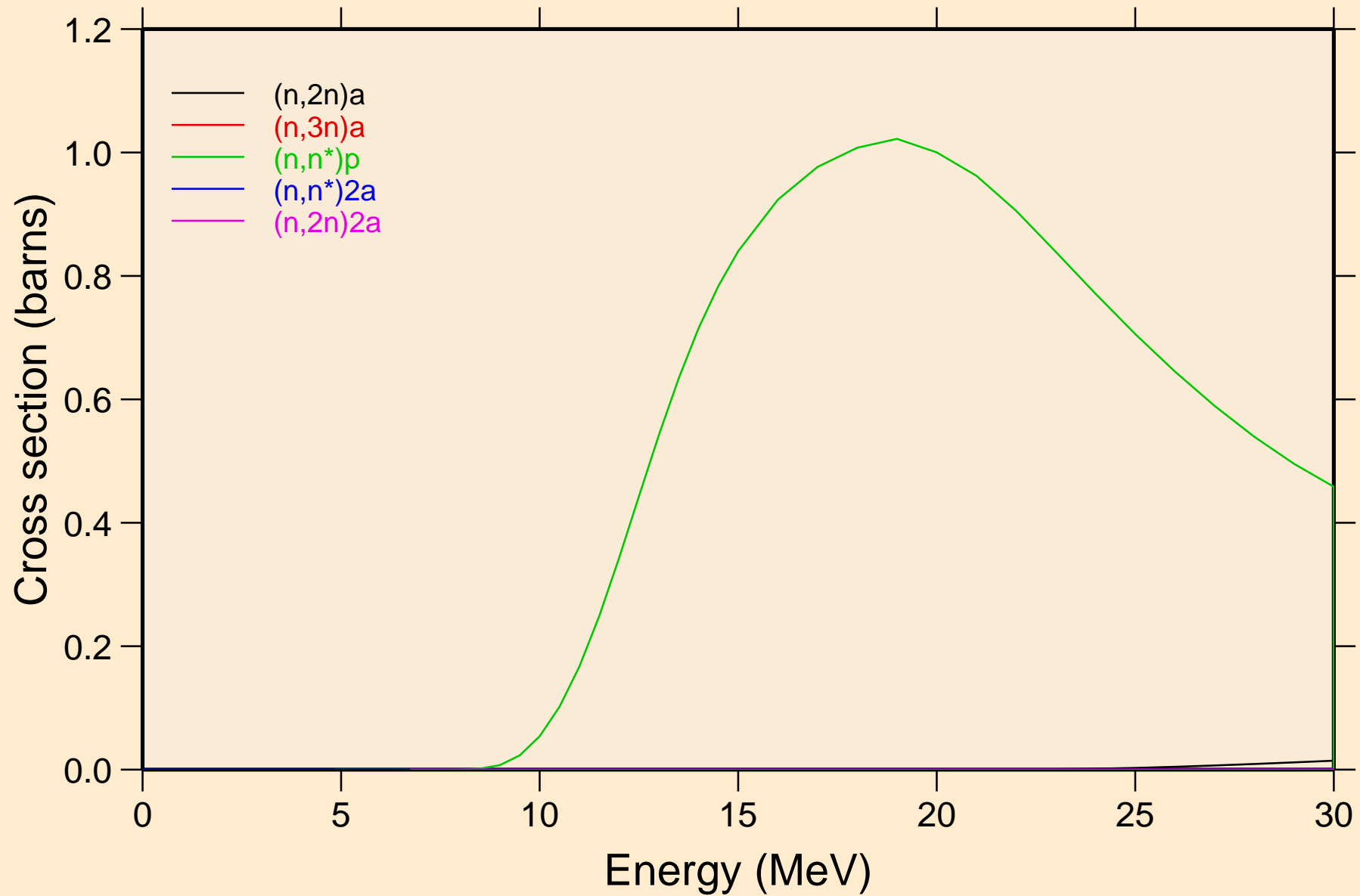

BA123 NEUTRON ACER TENDL-2024 LIBRARY; T=293.6K  
Threshold reactions

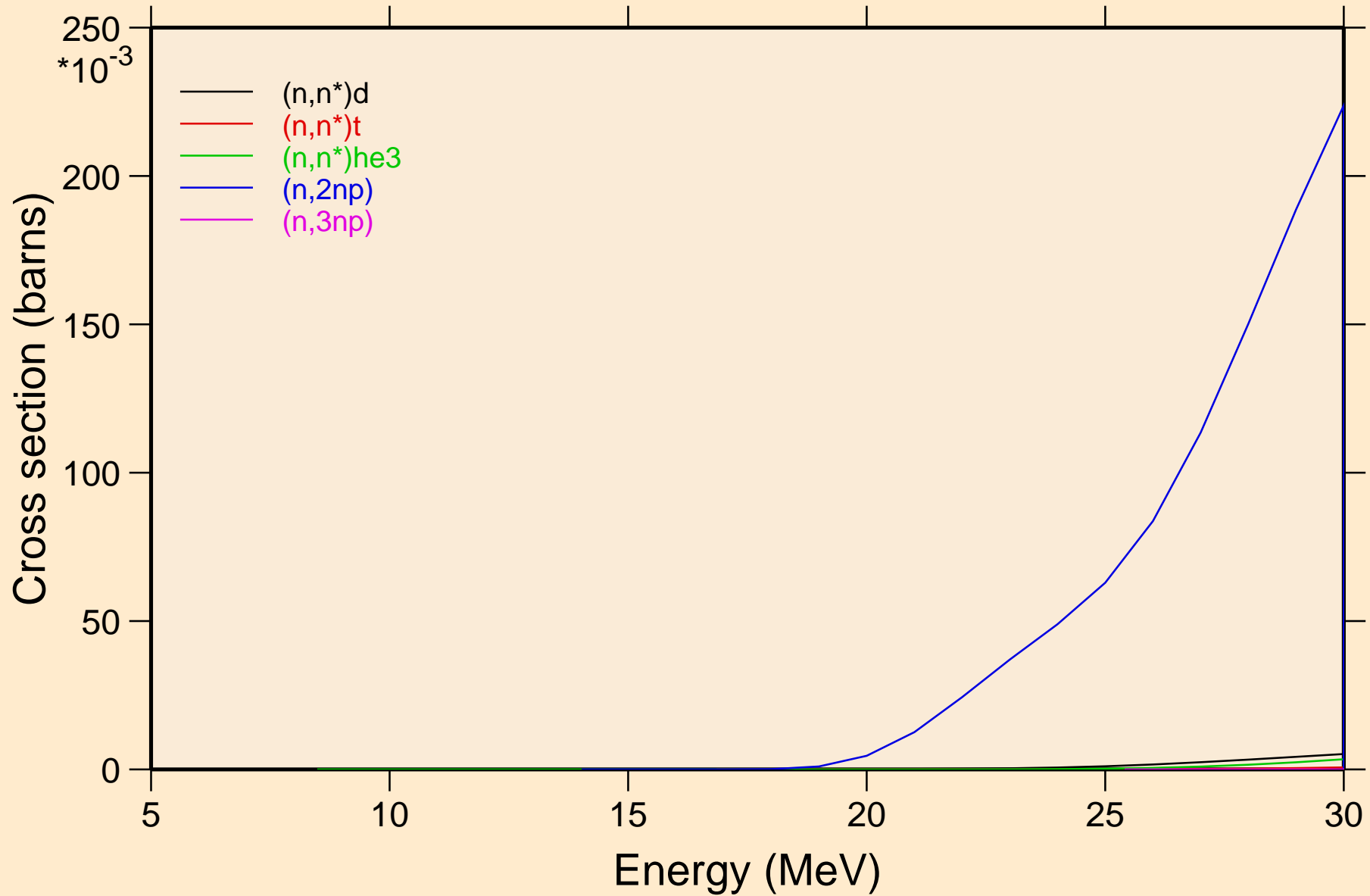

BA123 NEUTRON ACER TENDL-2024 LIBRARY; T=293.6K  
Threshold reactions

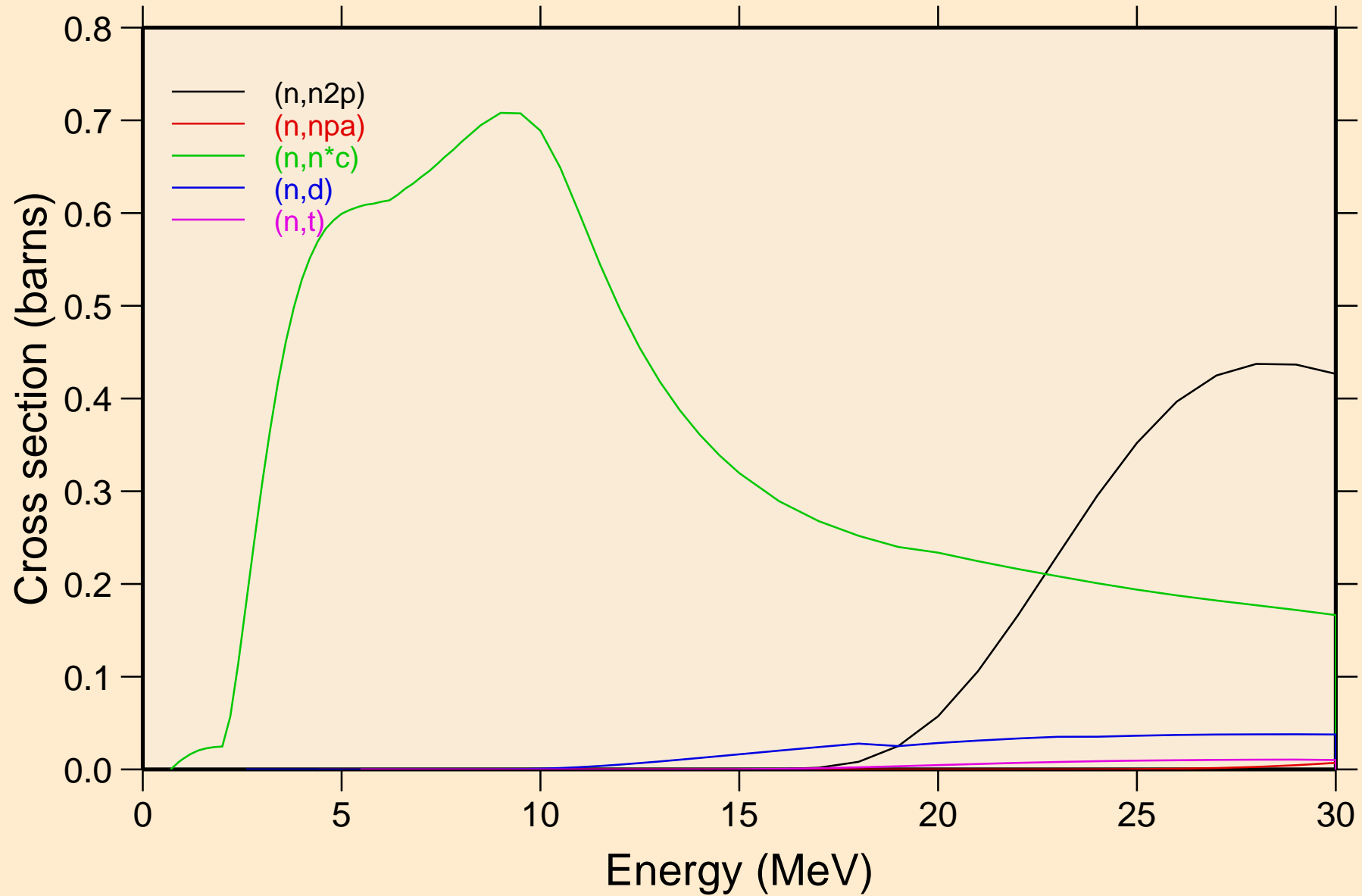

BA123 NEUTRON ACER TENDL-2024 LIBRARY; T=293.6K  
Threshold reactions

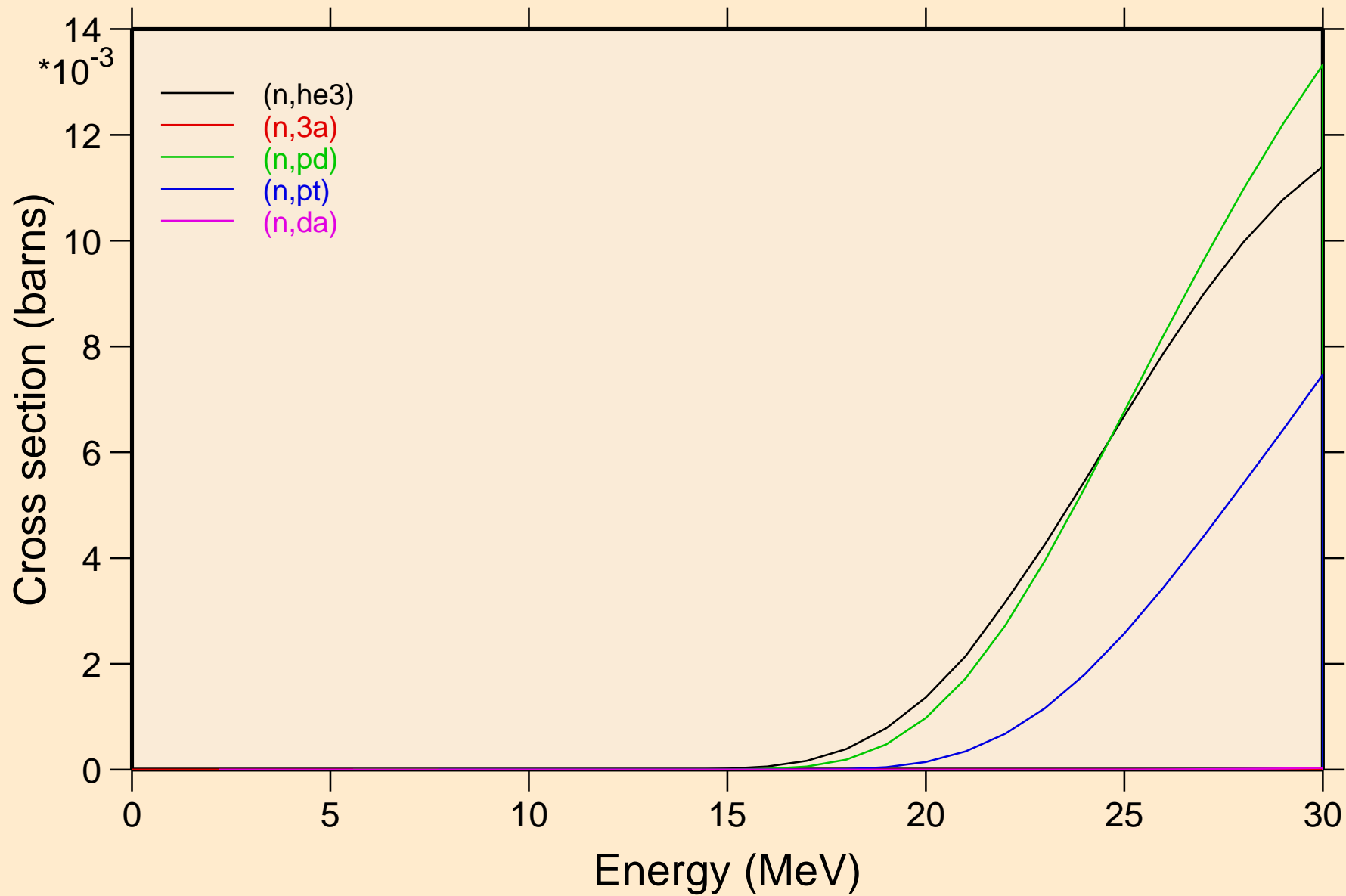

BA123 NEUTRON ACER TENDL-2024 LIBRARY; T=293.6K  
Threshold reactions

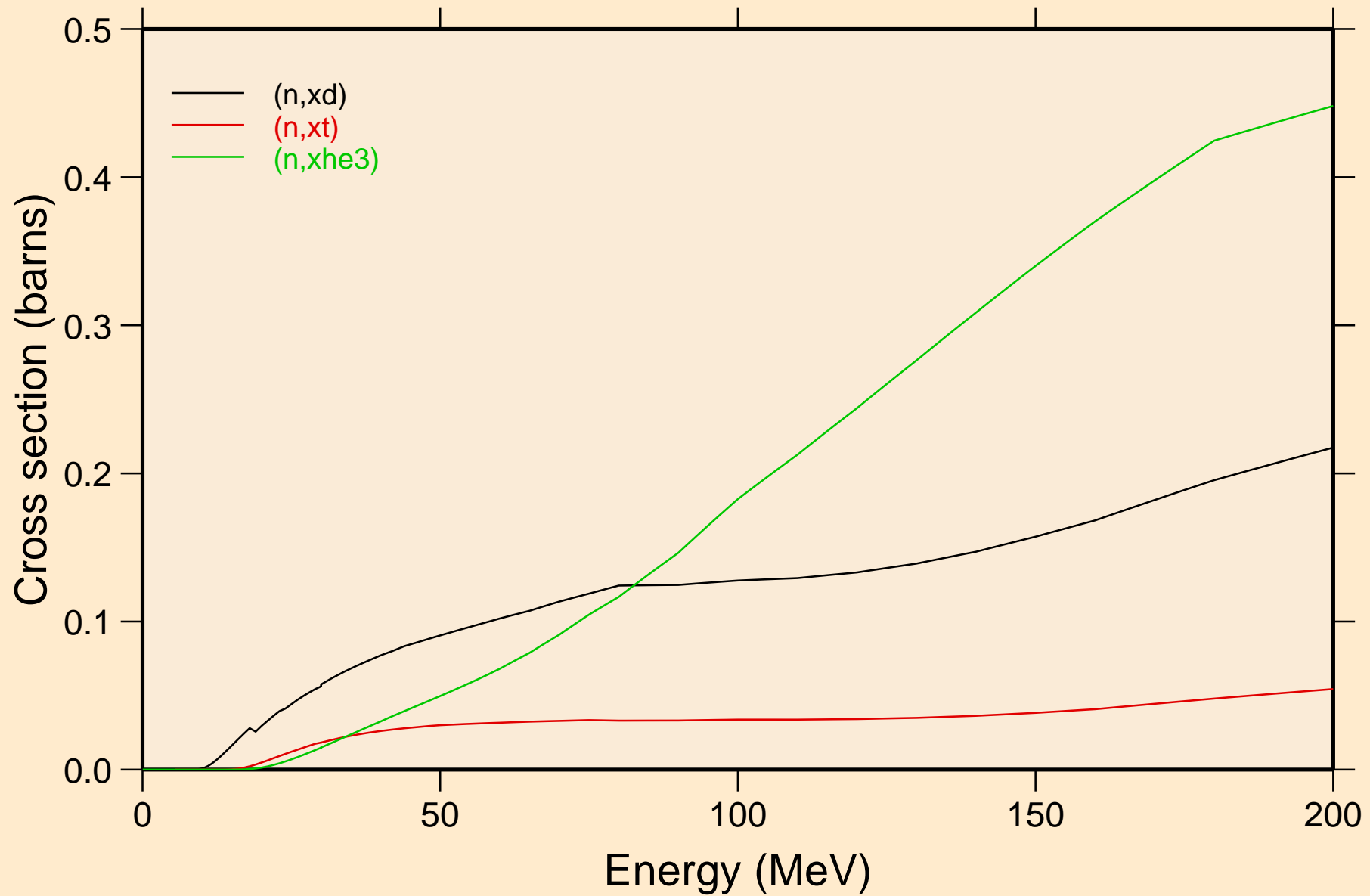

BA123 NEUTRON ACER TENDL-2024 LIBRARY; T=293.6K  
angular distribution for elastic

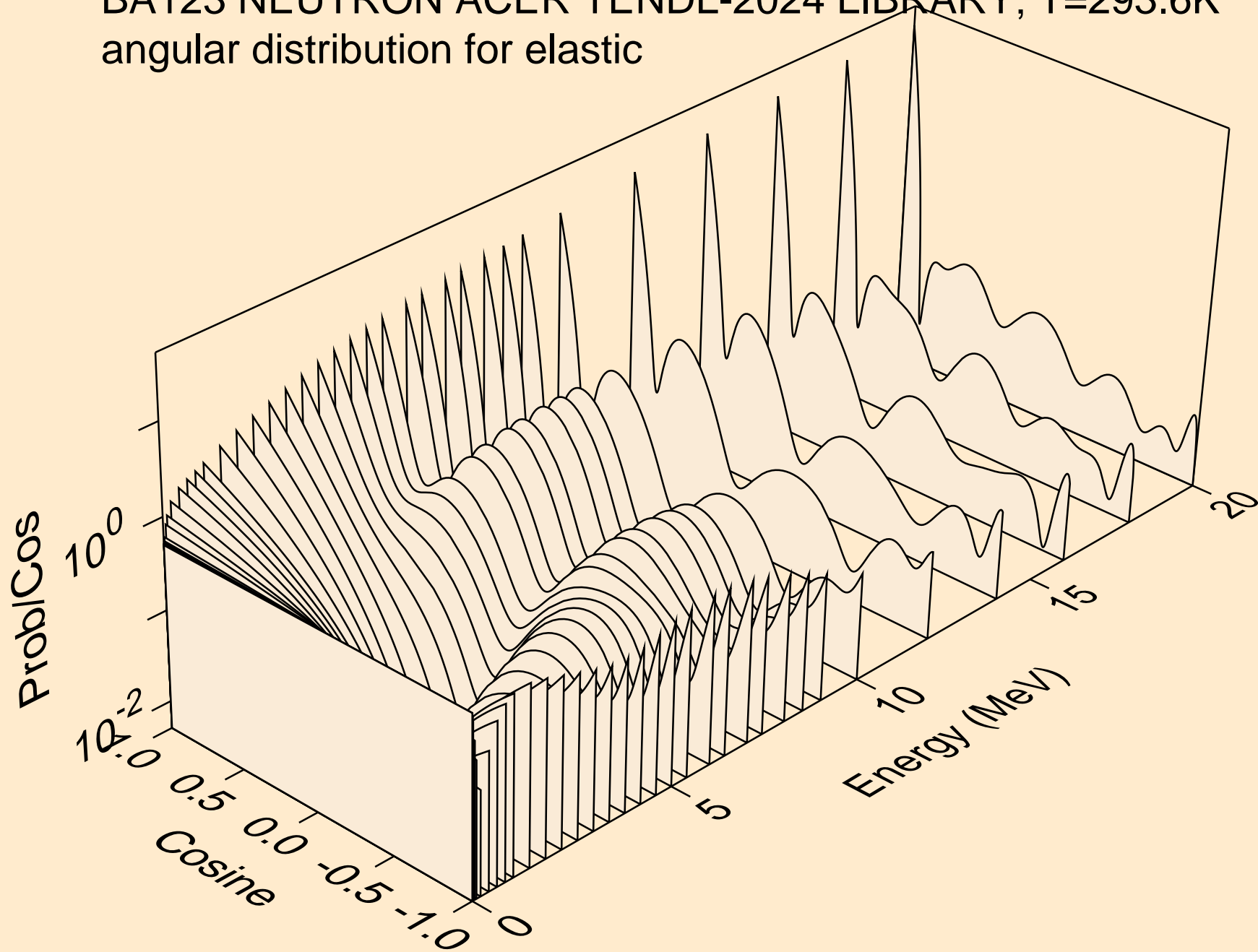

BA123 NEUTRON ACER TENDL-2024 LIBRARY; T=293.6K  
angular distribution for elastic

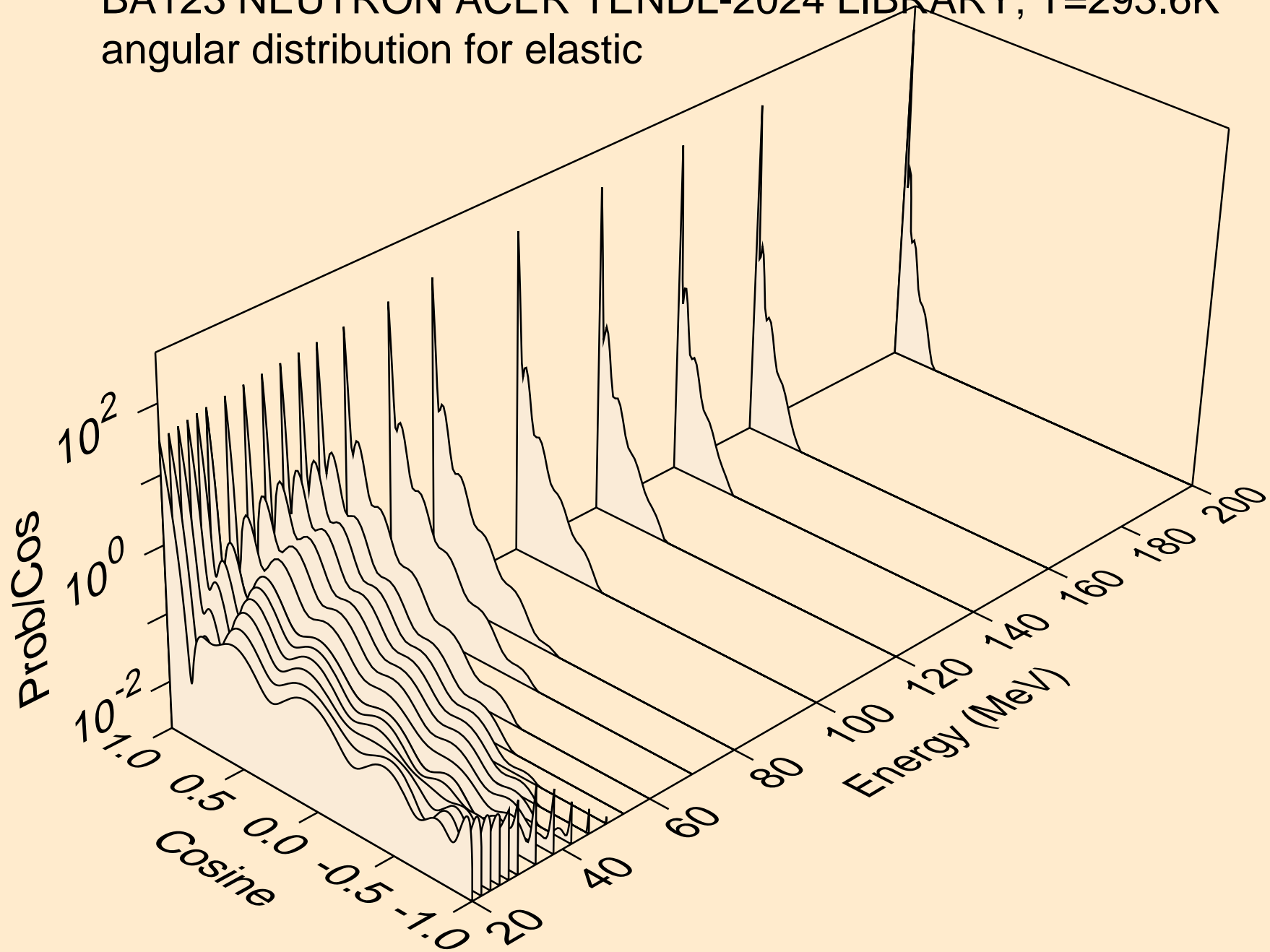

BA123 NEUTRON ACER TENDL-2024 LIBRARY; T=293.6K  
angular distribution for (n,n\*1)

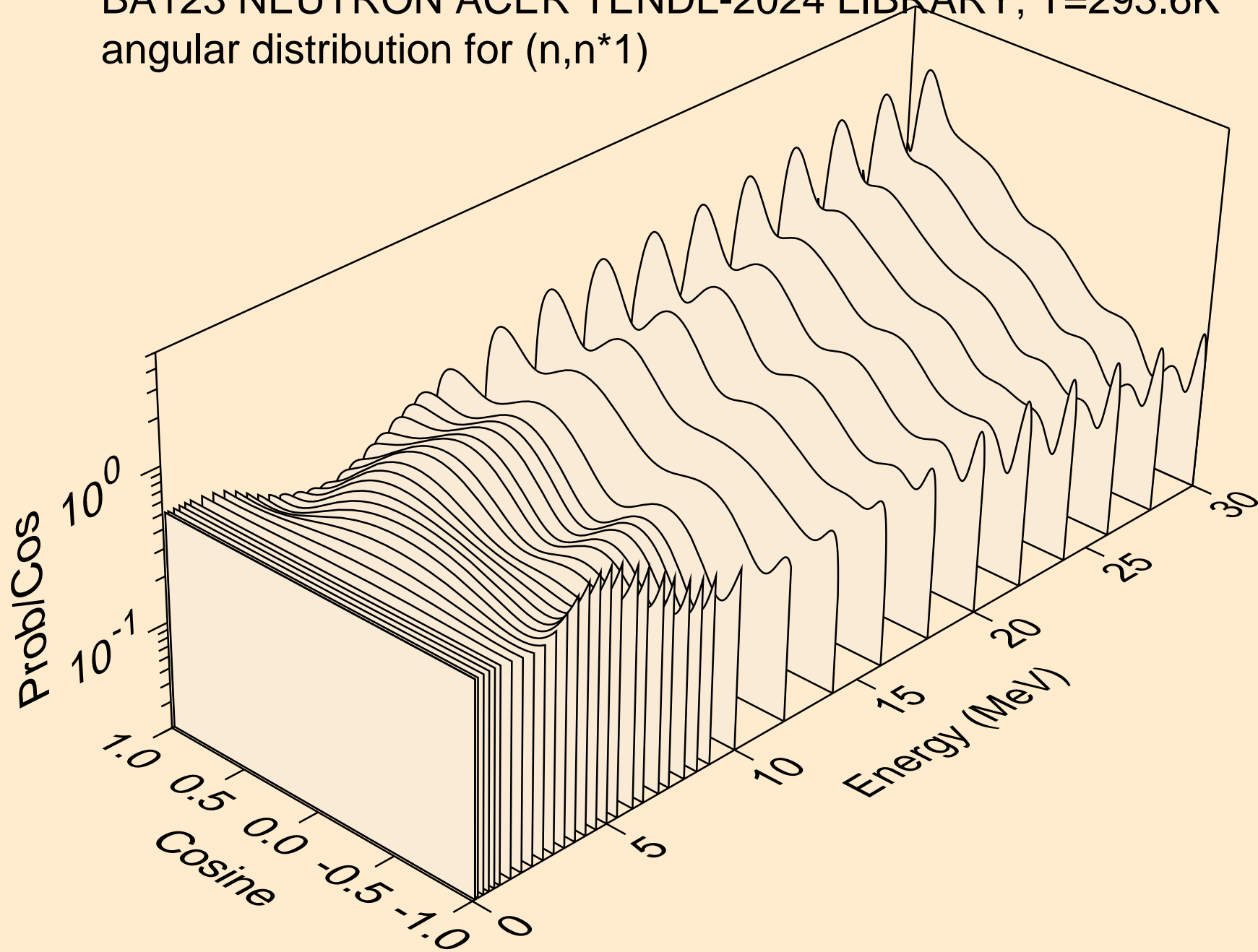

BA123 NEUTRON ACER TENDL-2024 LIBRARY; T=293.6K  
angular distribution for (n,n\*2)

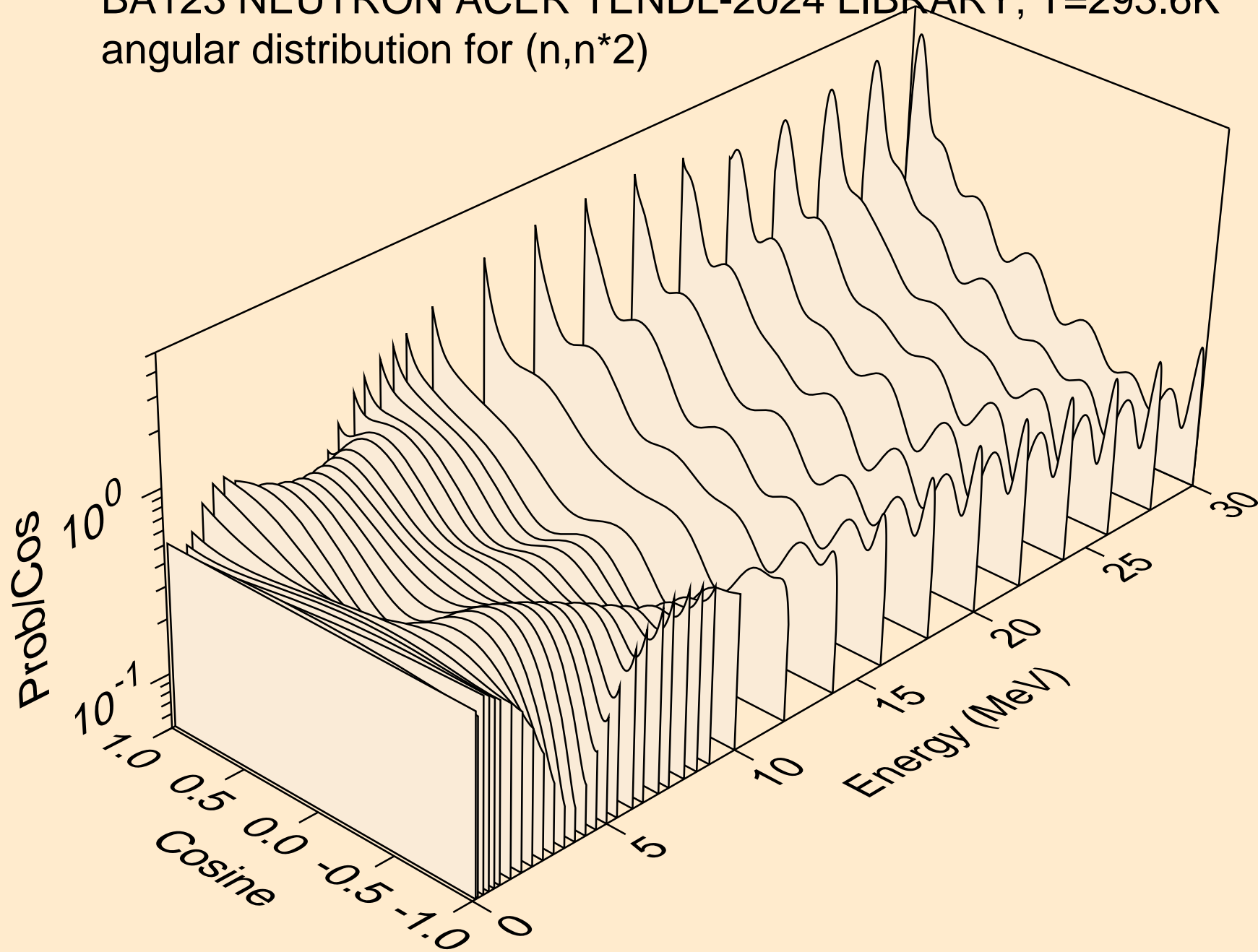

BA123 NEUTRON ACER TENDL-2024 LIBRARY; T=293.6K  
angular distribution for (n,n\*3)

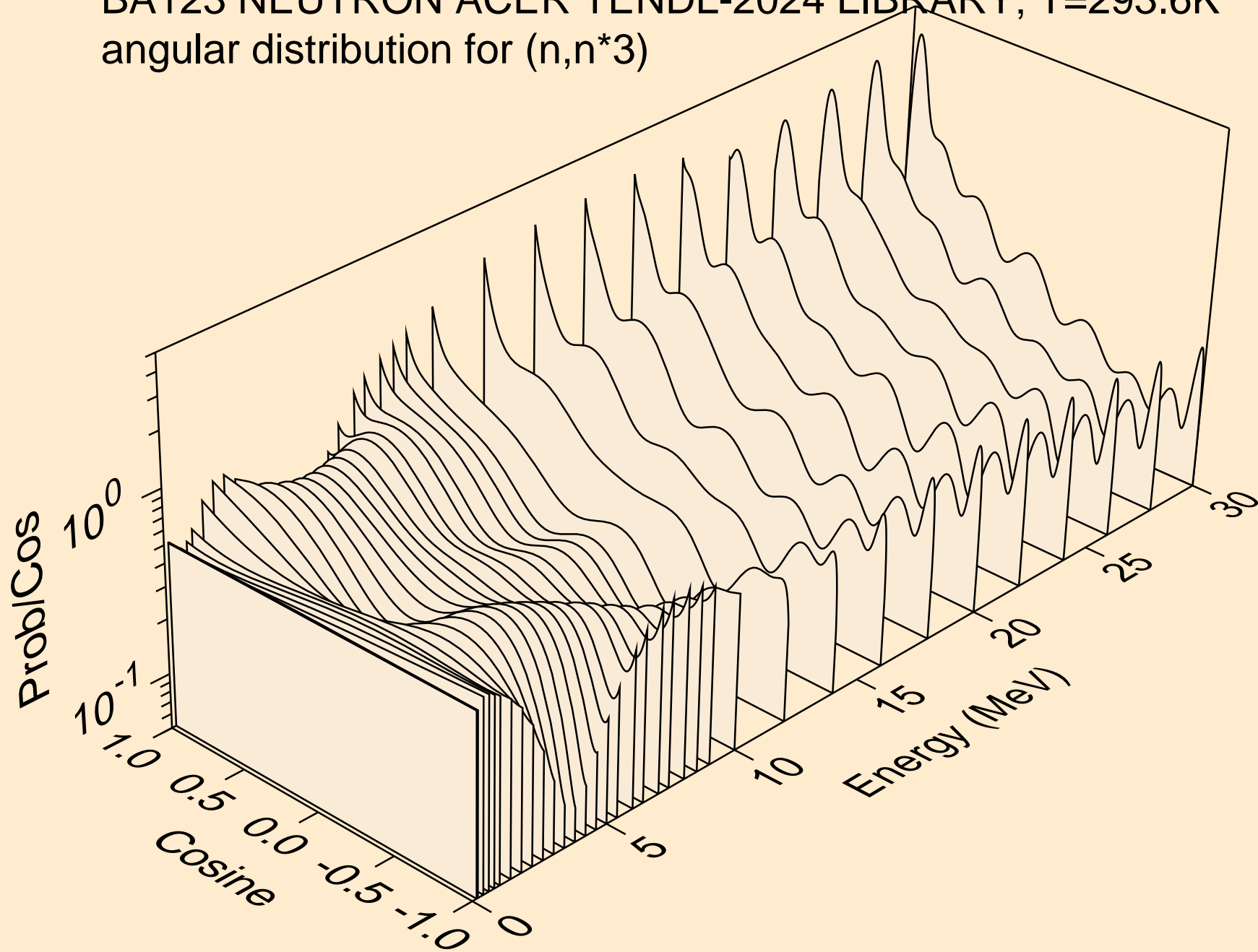

BA123 NEUTRON ACER TENDL-2024 LIBRARY; T=293.6K  
angular distribution for (n,n\*4)

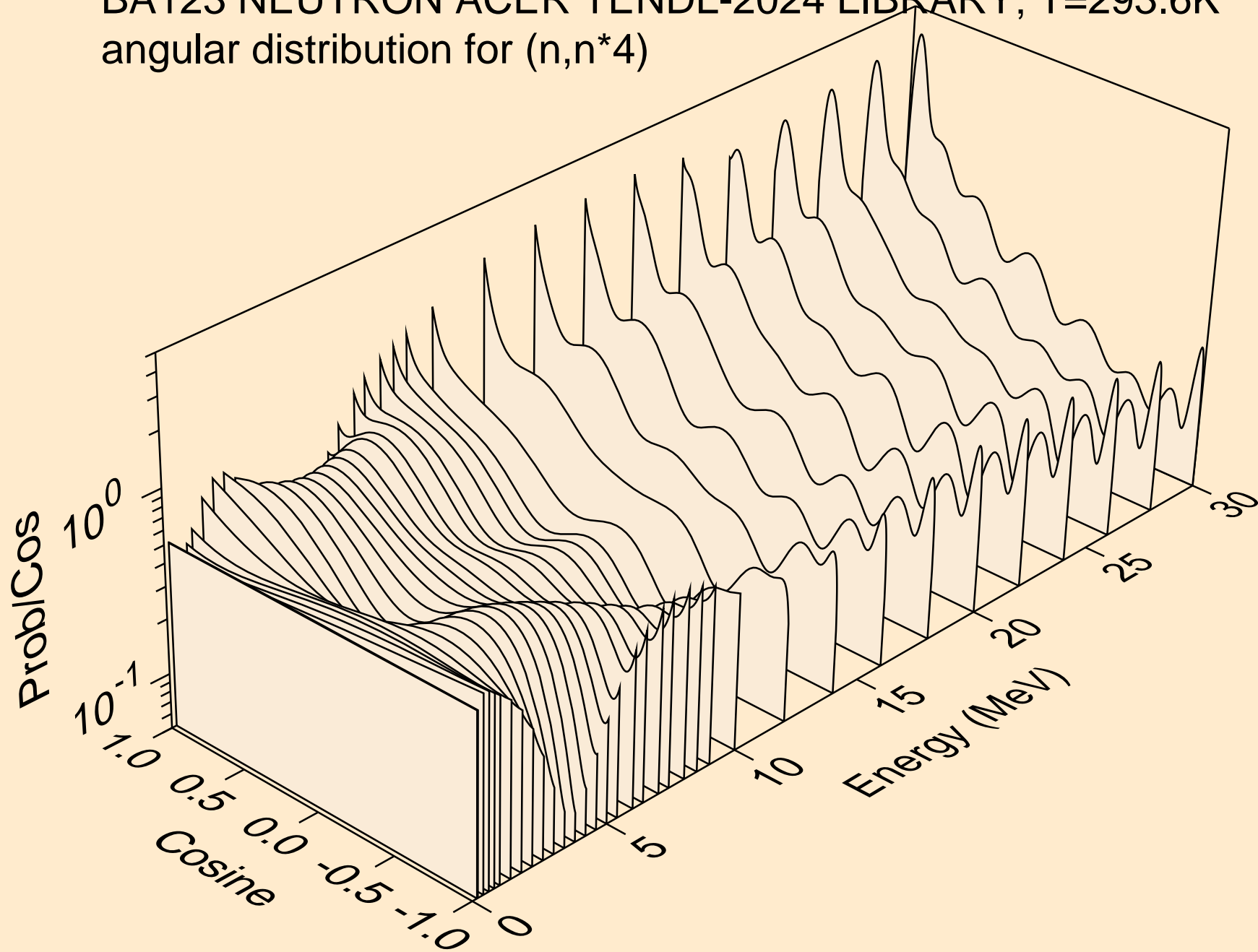

BA123 NEUTRON ACER TENDL-2024 LIBRARY; T=293.6K  
angular distribution for (n,n\*5)

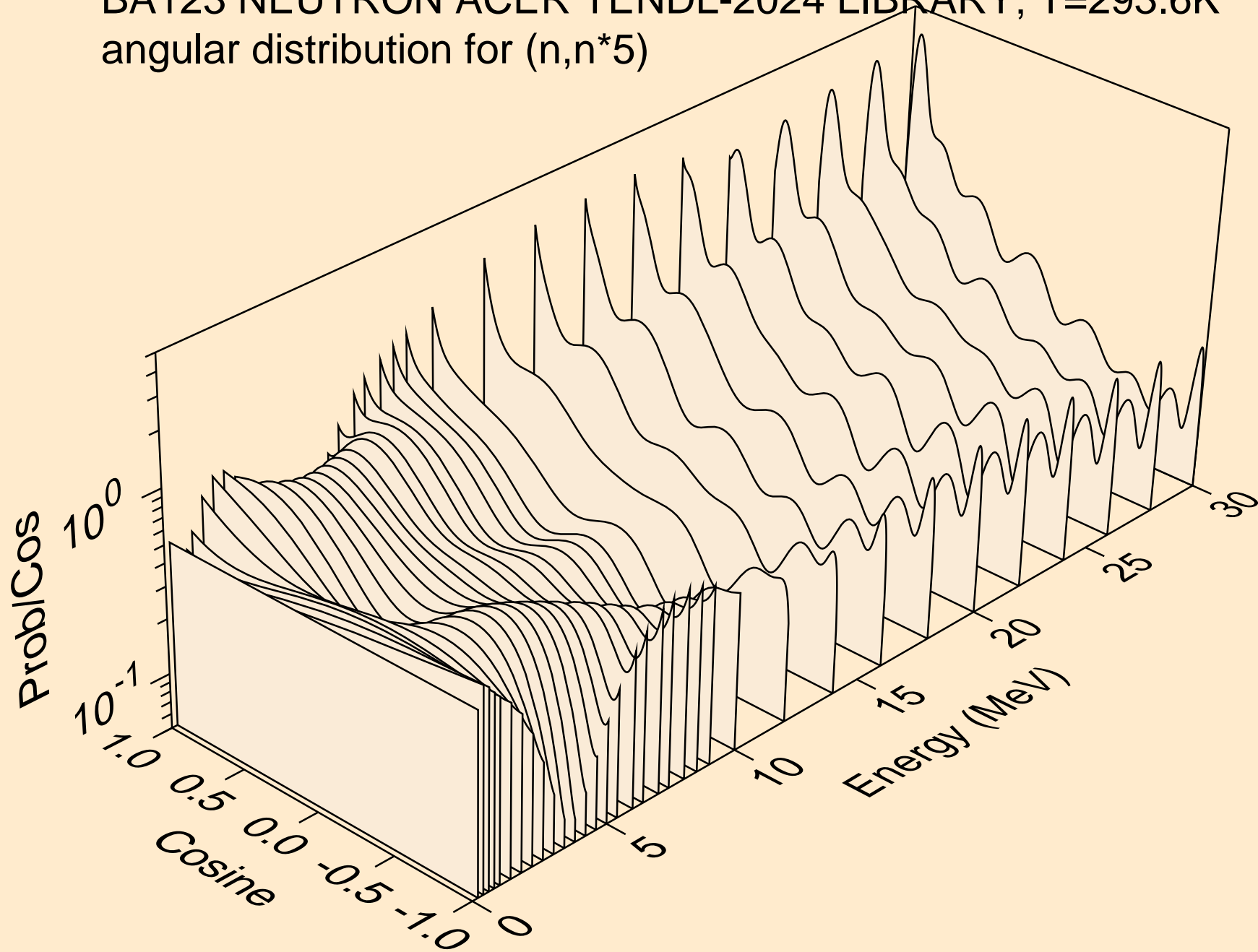

BA123 NEUTRON ACER TENDL-2024 LIBRARY; T=293.6K  
angular distribution for (n,n\*6)

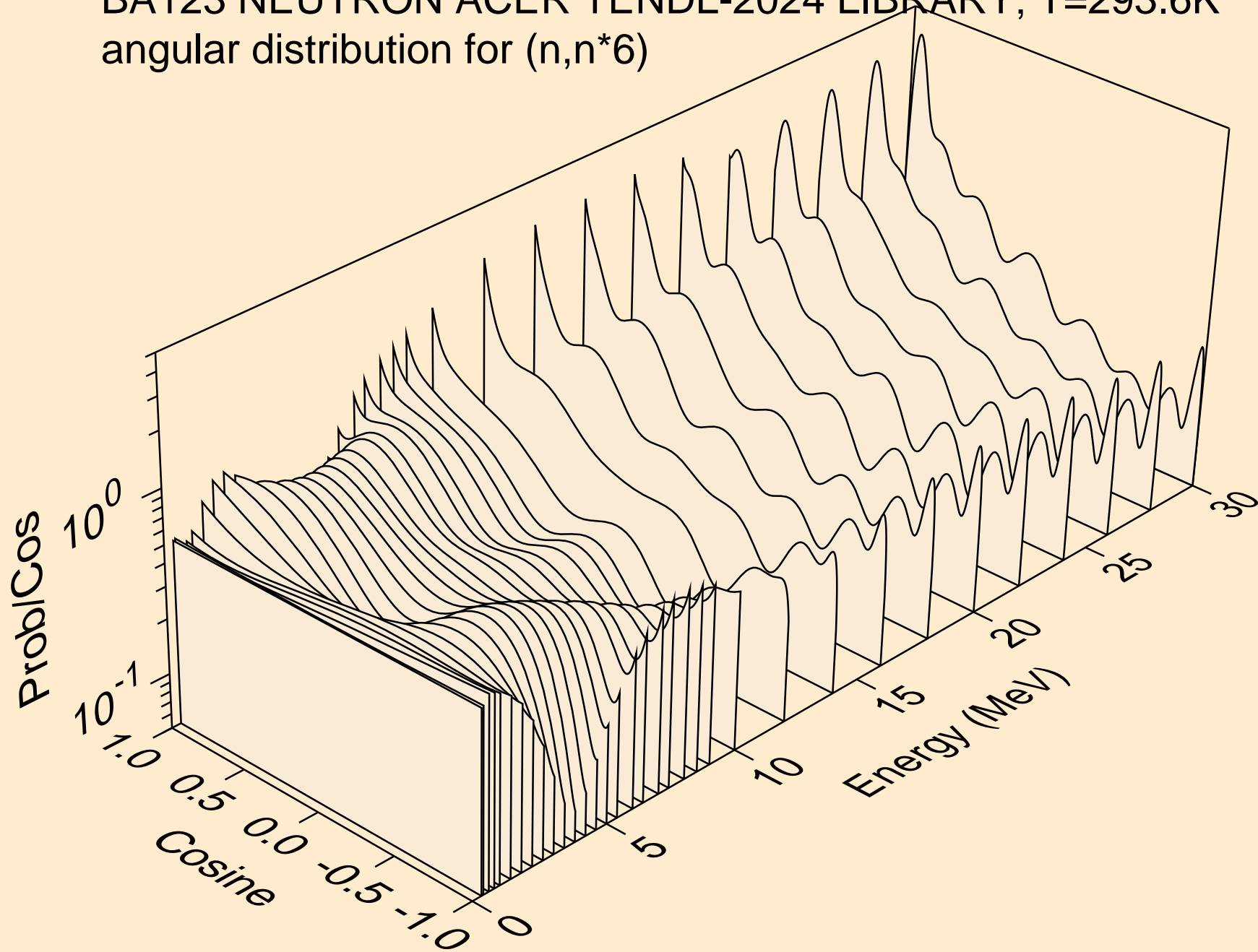

BA123 NEUTRON ACER TENDL-2024 LIBRARY; T=293.6K  
angular distribution for (n,n\*7)

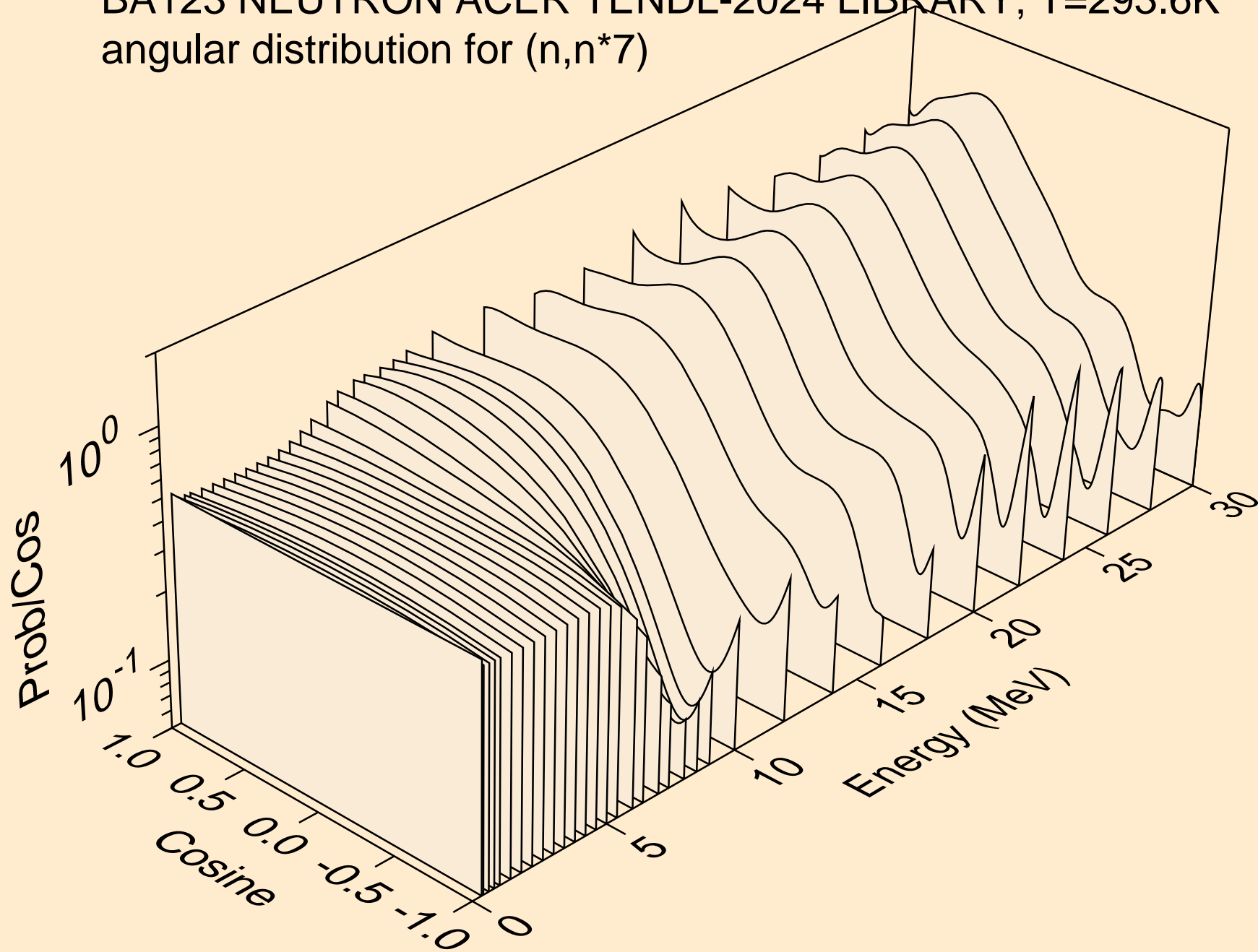

BA123 NEUTRON ACER TENDL-2024 LIBRARY; T=293.6K  
angular distribution for (n,n\*8)

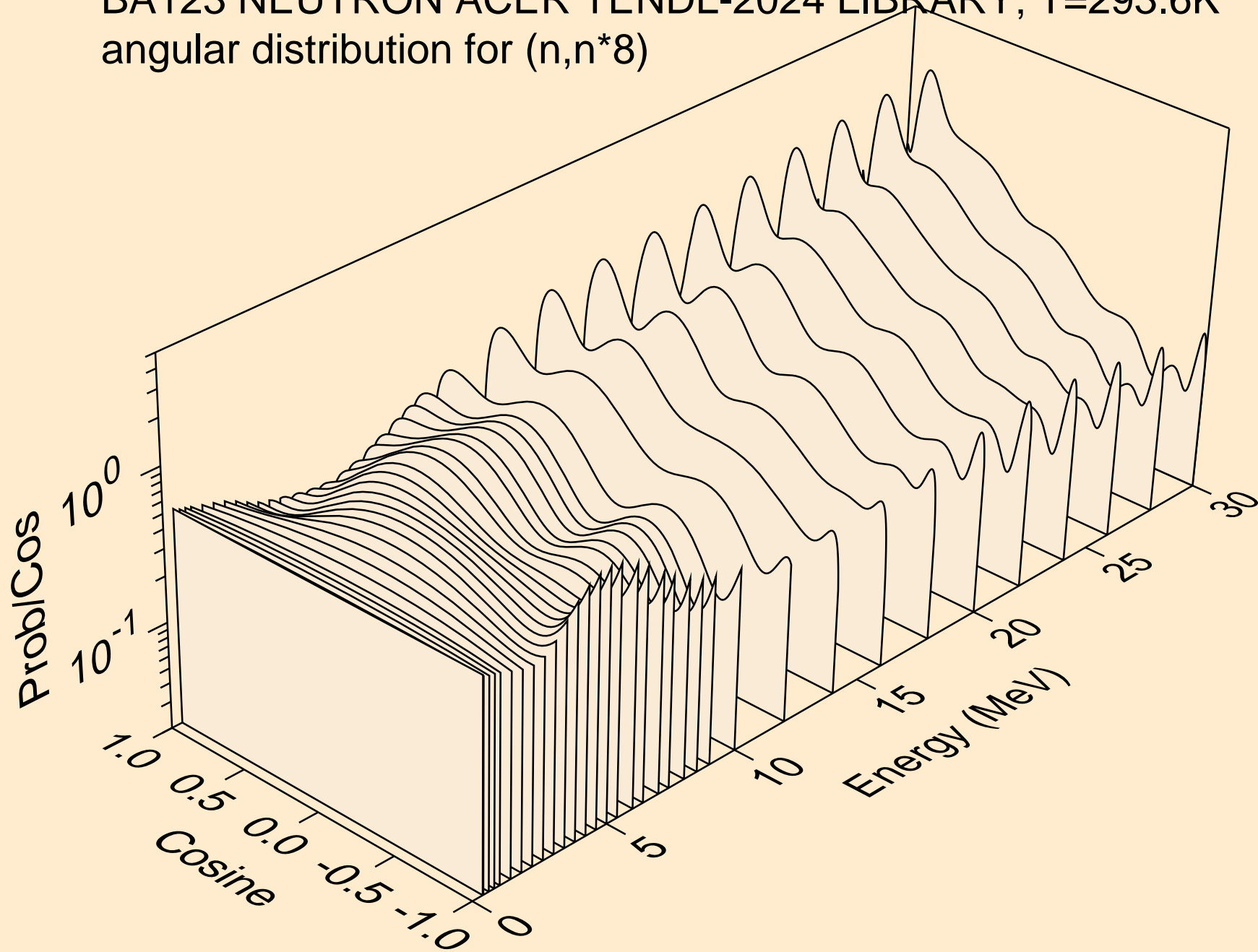

BA123 NEUTRON ACER TENDL-2024 LIBRARY; T=293.6K  
angular distribution for (n,n\*9)

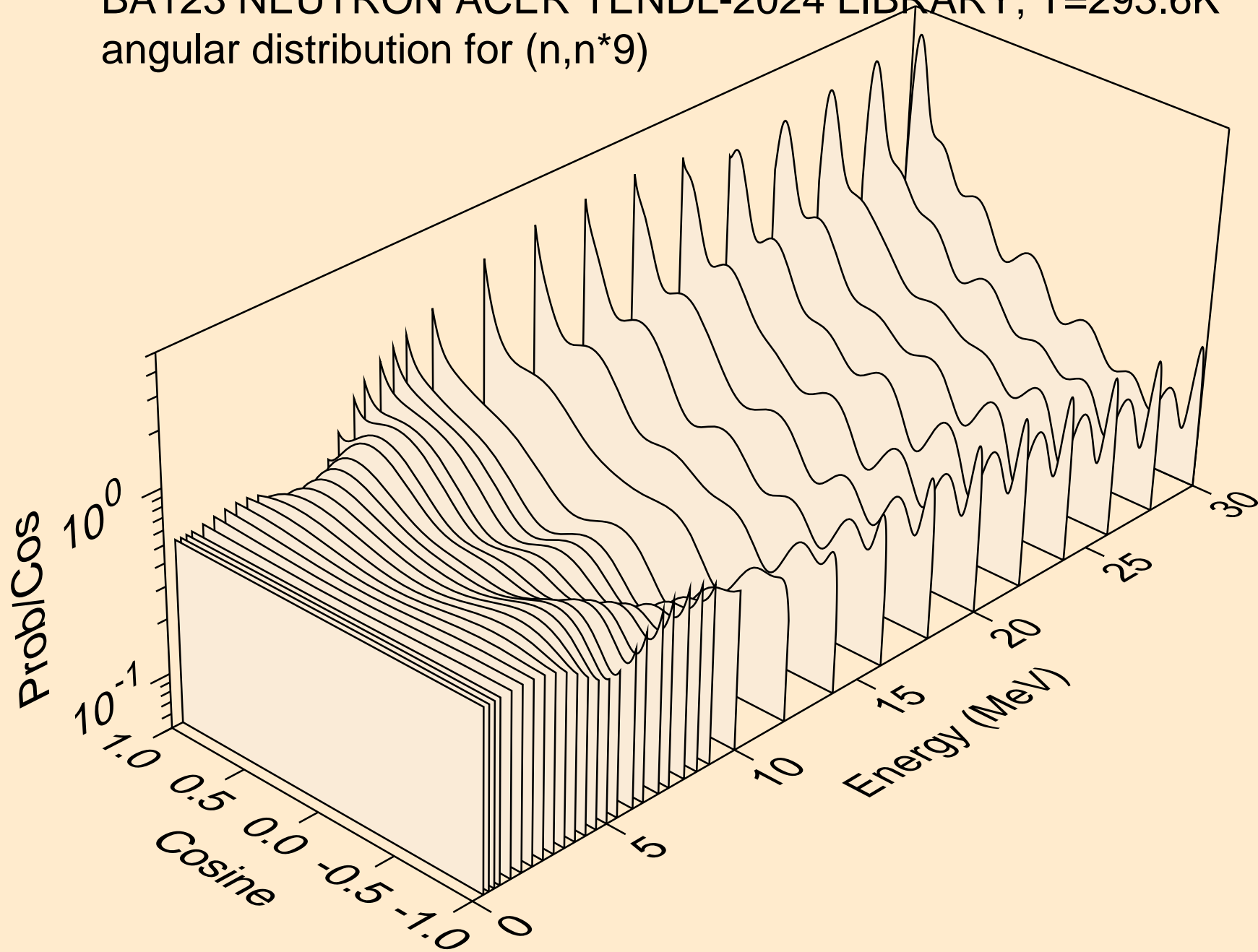

BA123 NEUTRON ACER TENDL-2024 LIBRARY; T=293.6K  
angular distribution for (n,n\*10)

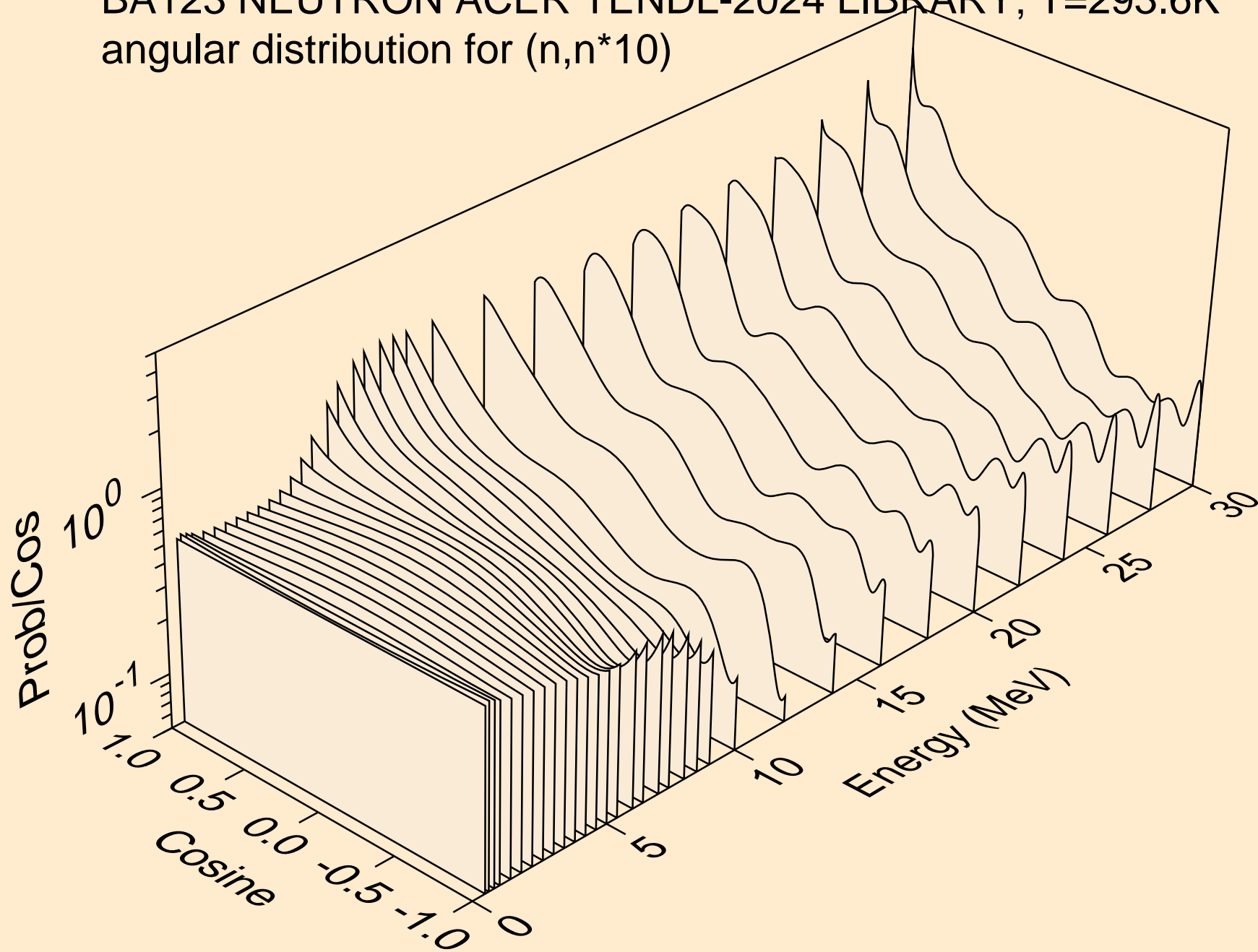

BA123 NEUTRON ACER TENDL-2024 LIBRARY; T=293.6K  
angular distribution for (n,n\*11)

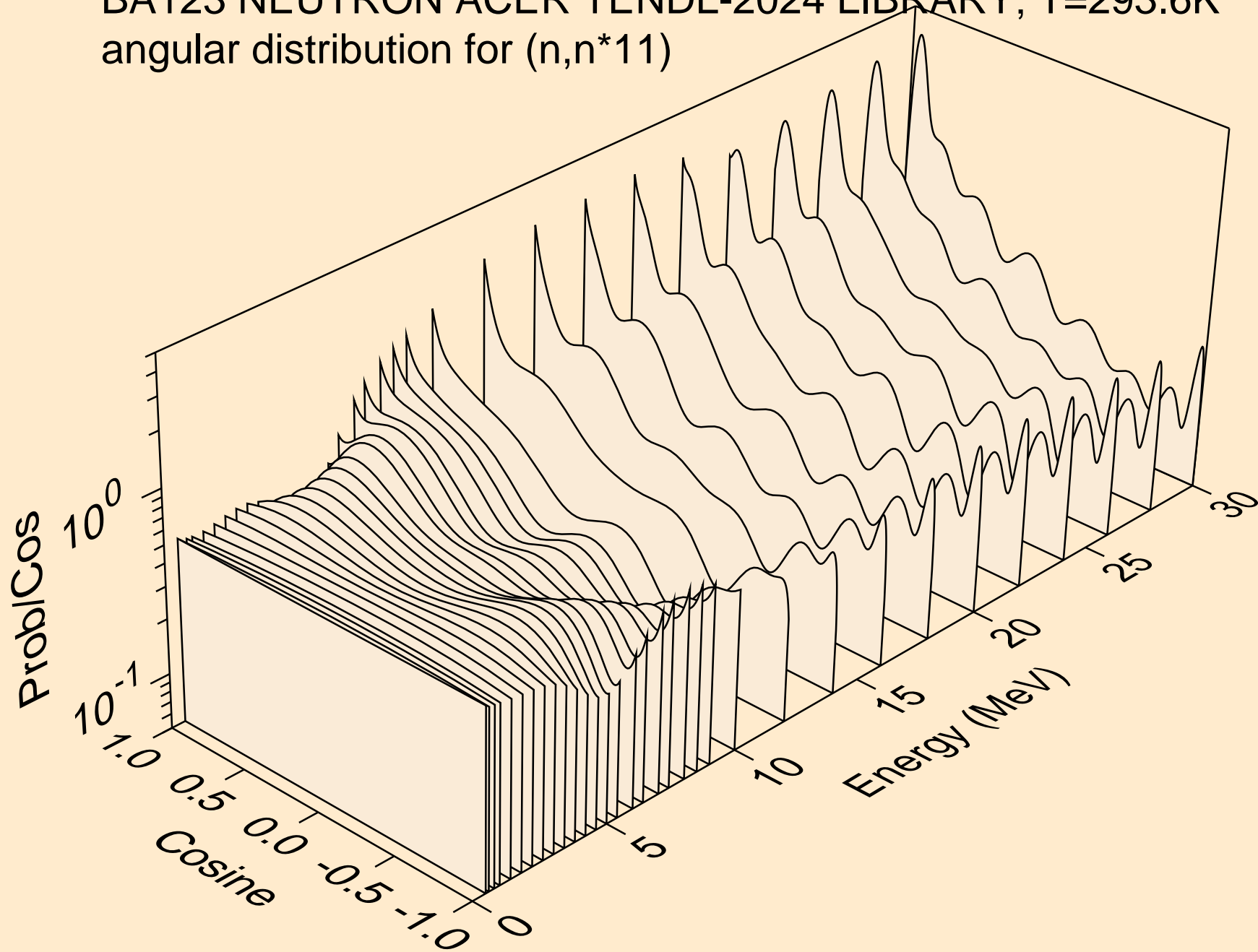

BA123 NEUTRON ACER TENDL-2024 LIBRARY; T=293.6K  
angular distribution for (n,n\*12)

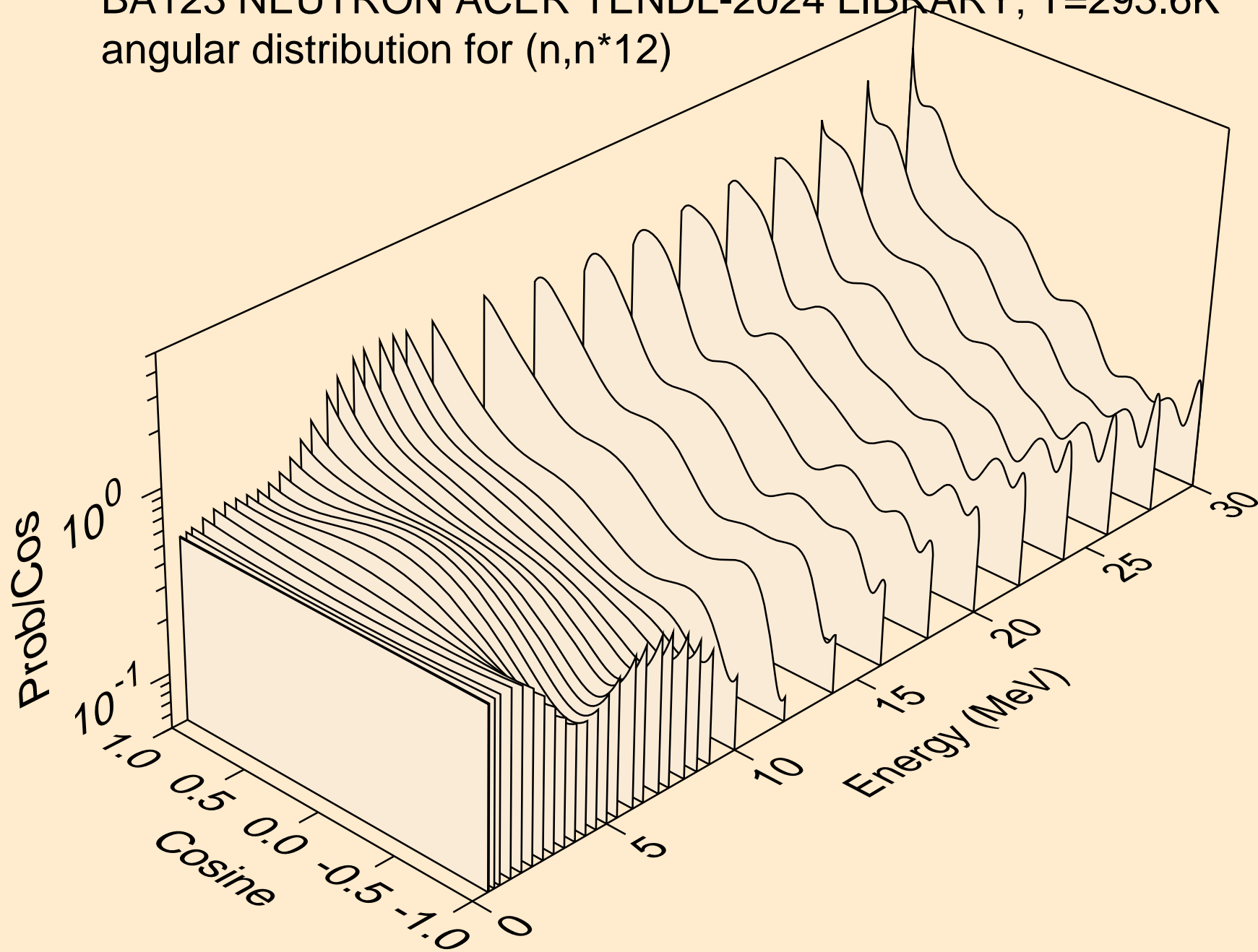

BA123 NEUTRON ACER TENDL-2024 LIBRARY; T=293.6K  
angular distribution for (n,n\*13)

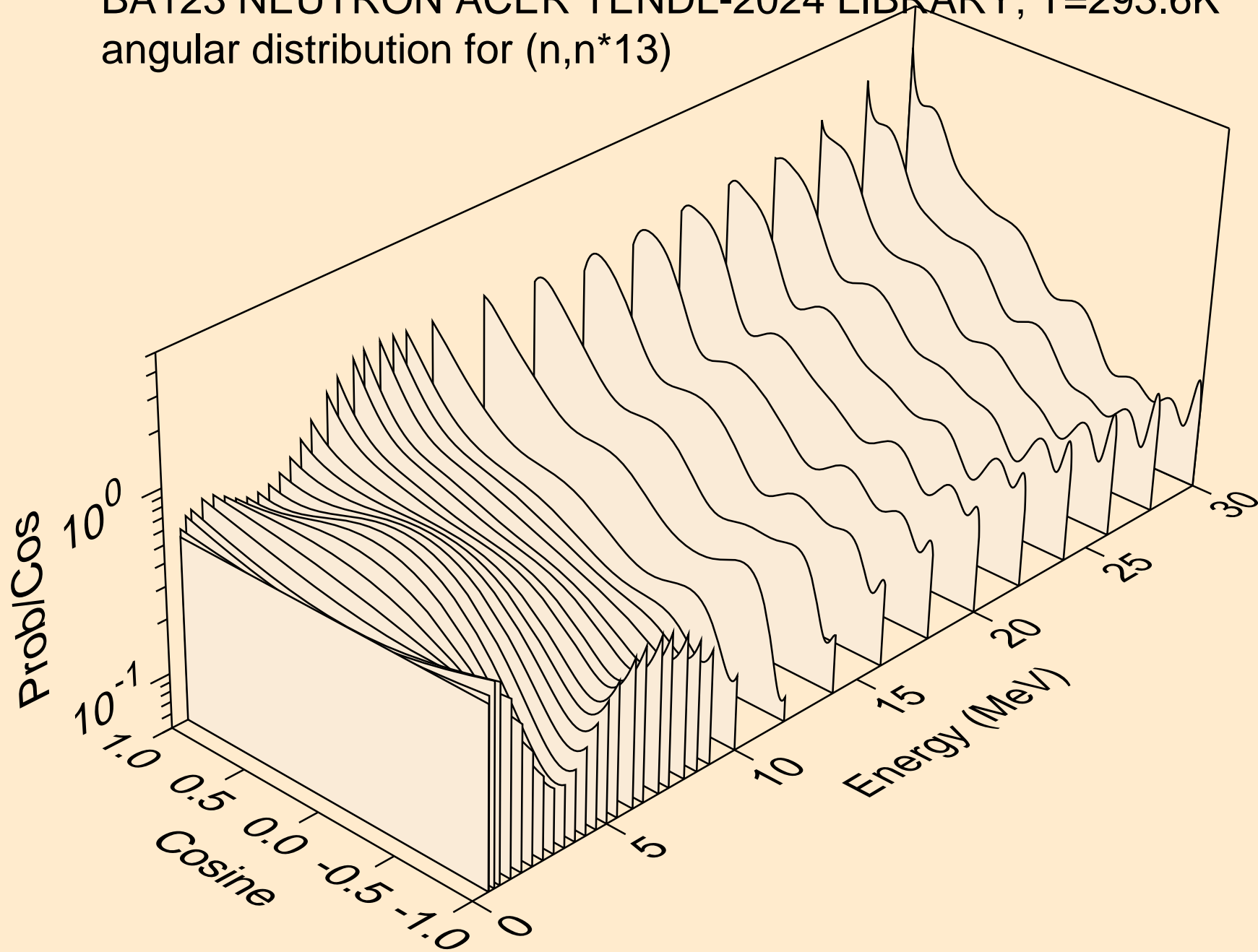

BA123 NEUTRON ACER TENDL-2024 LIBRARY; T=293.6K  
angular distribution for (n,n\*14)

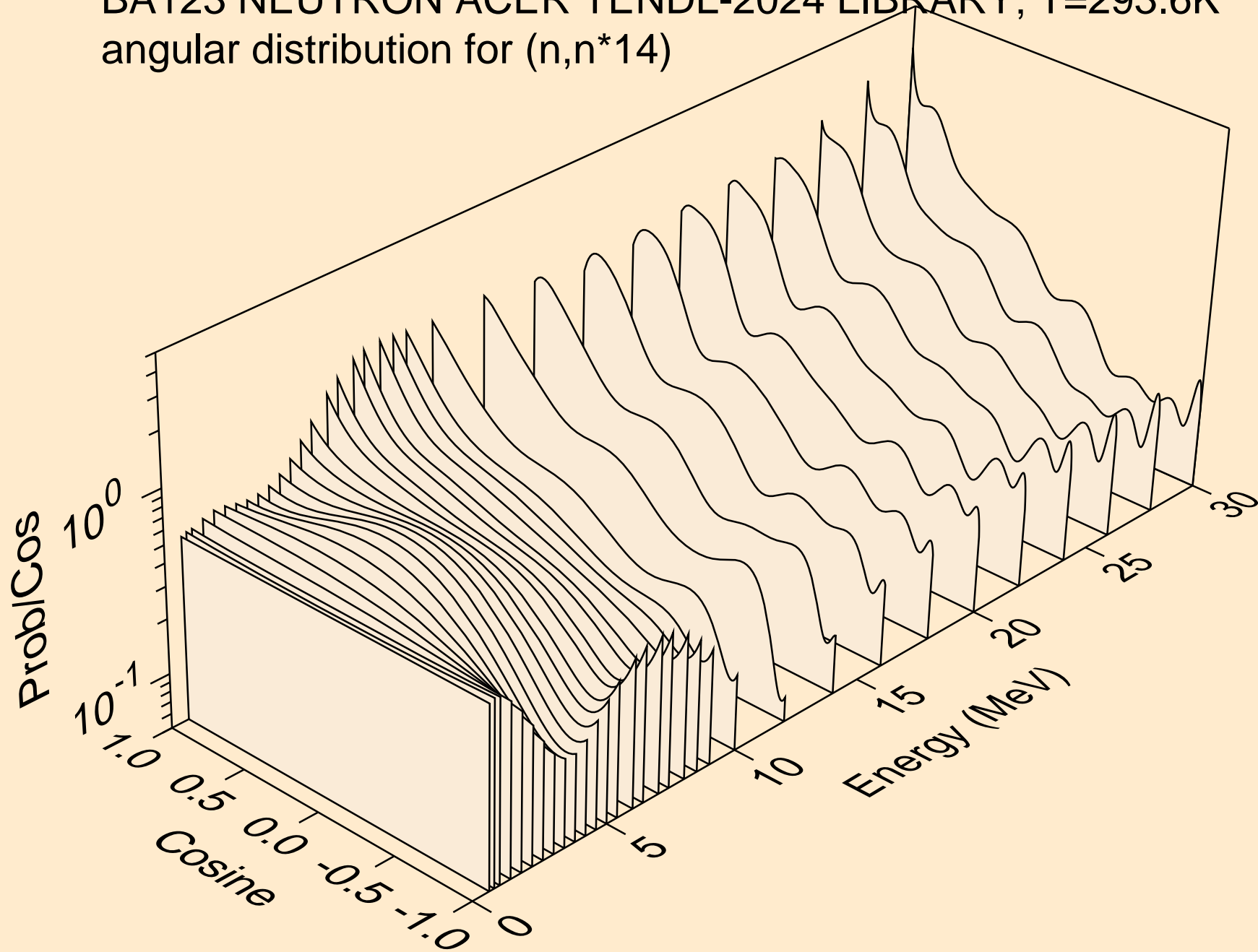

BA123 NEUTRON ACER TENDL-2024 LIBRARY; T=293.6K  
angular distribution for (n,n\*15)

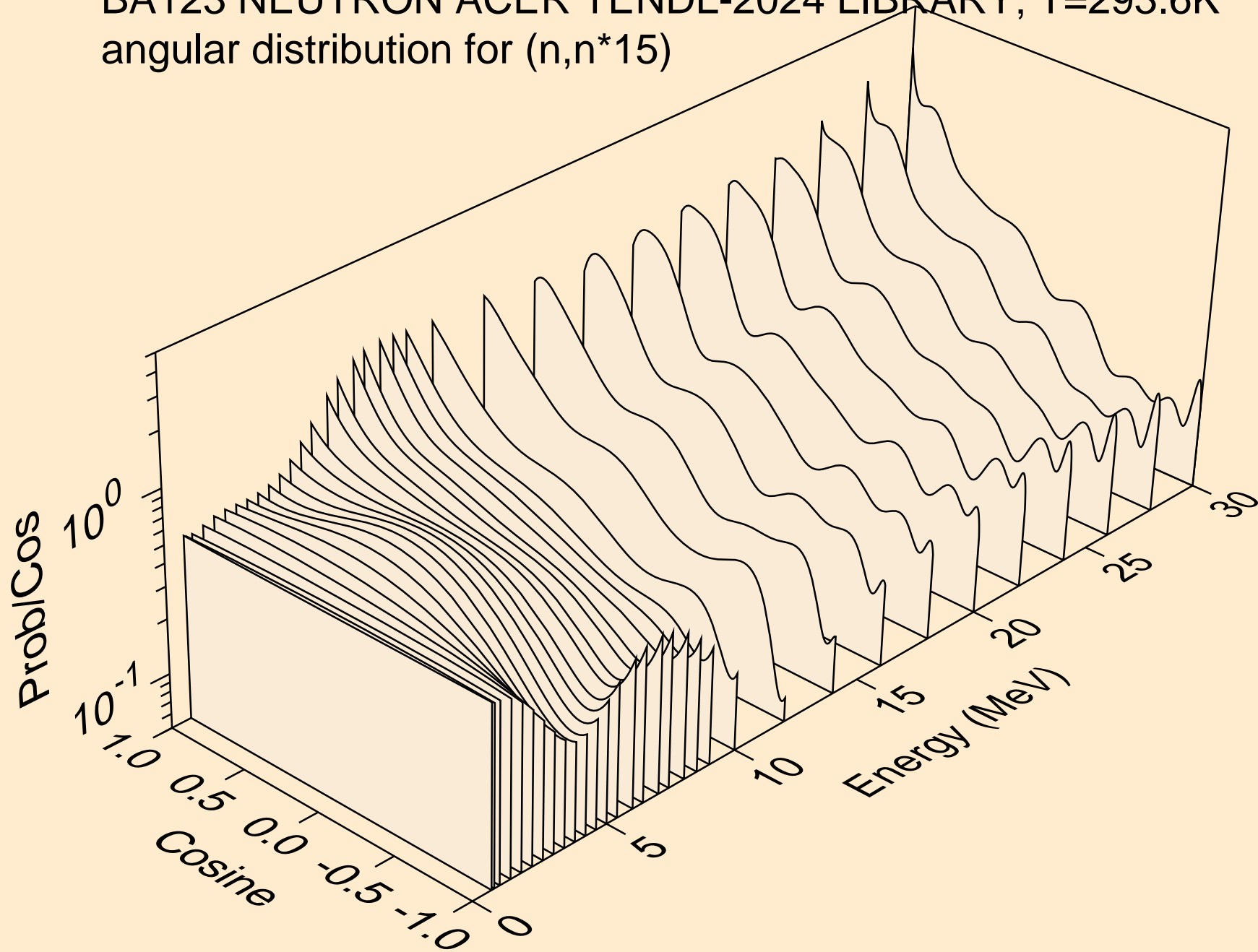

BA123 NEUTRON ACER TENDL-2024 LIBRARY; T=293.6K  
Neutron emission for (n,x)

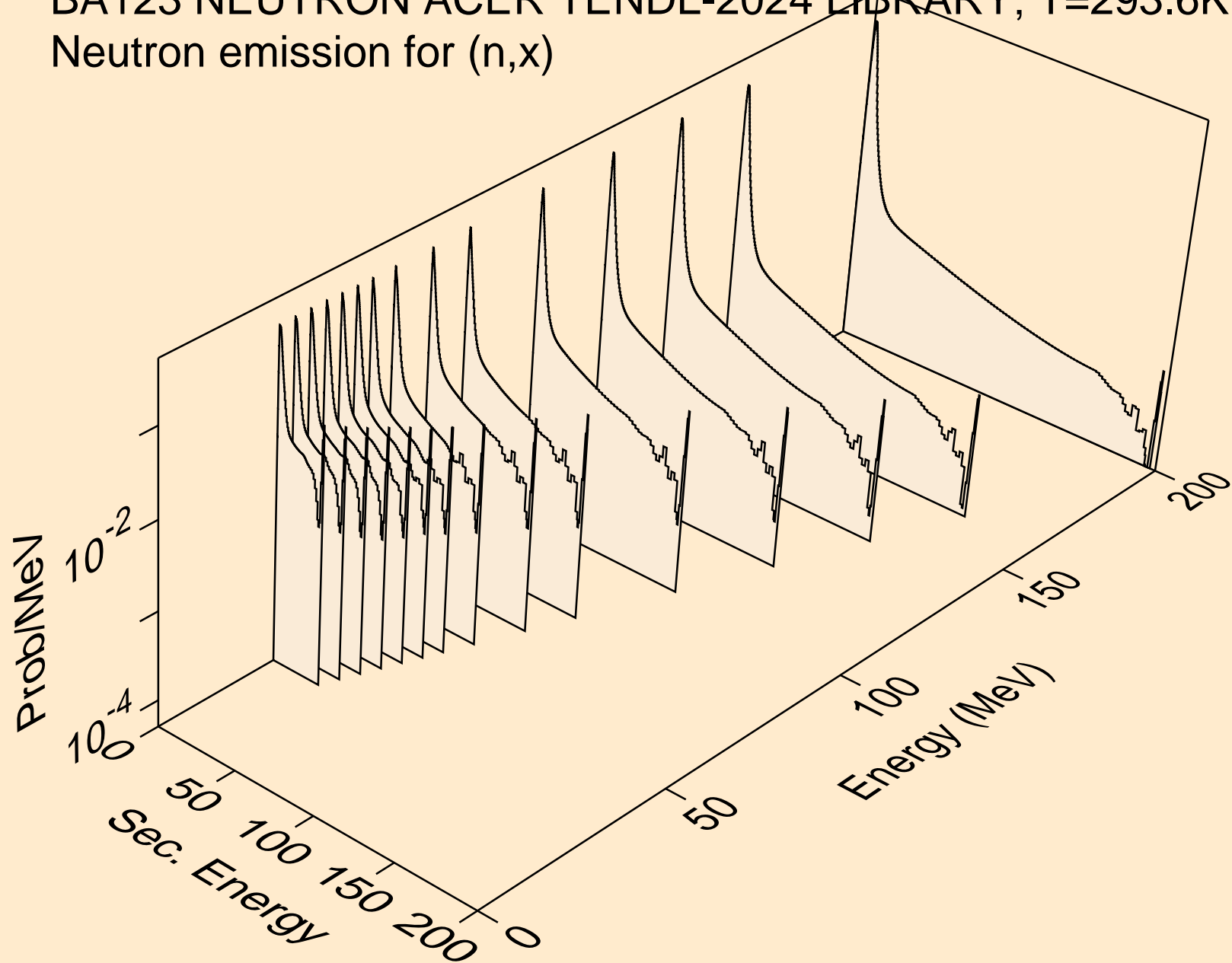

BA123 NEUTRON ACER TENDL-2024 LIBRARY; T=293.6K  
Neutron emission for (n,2nd)

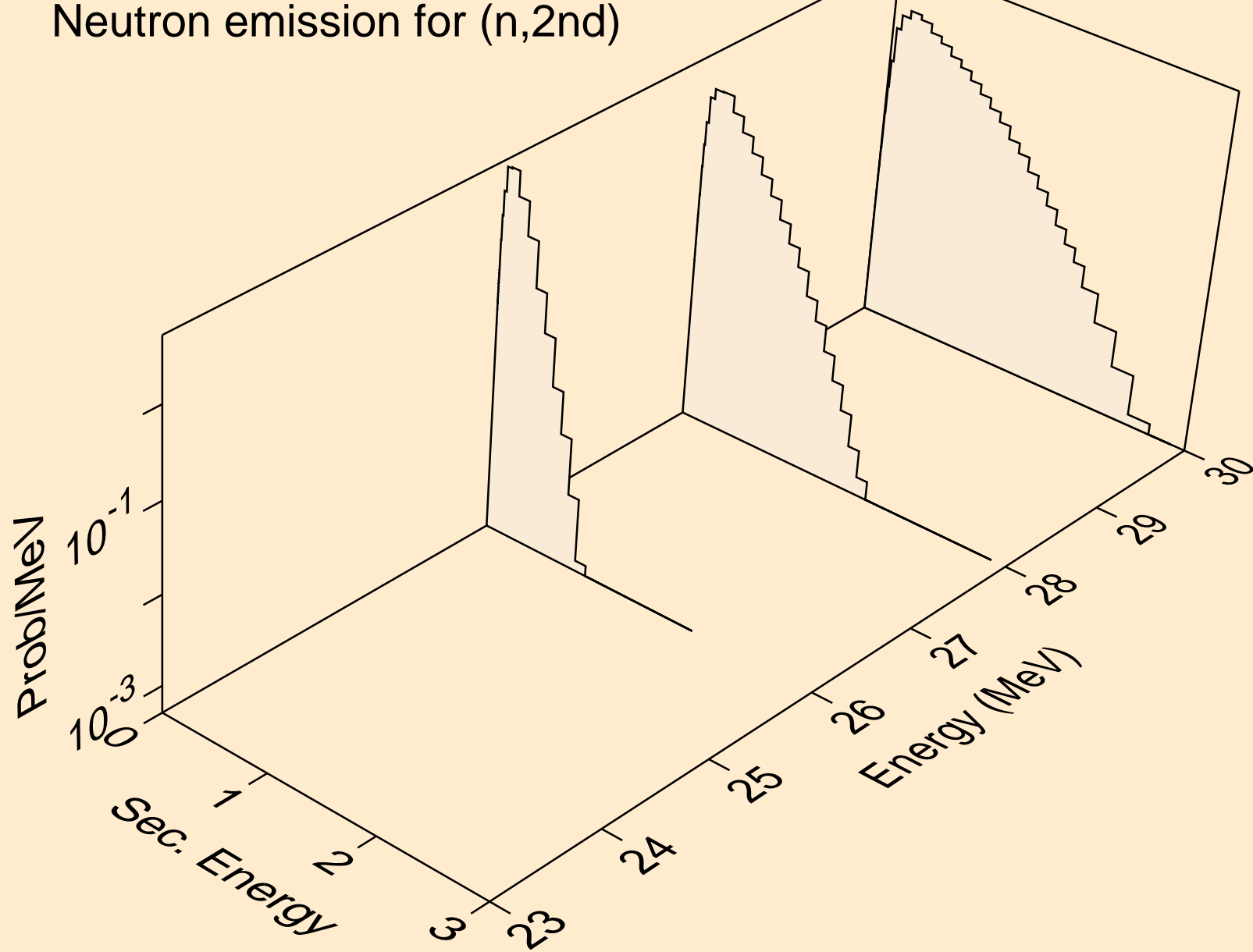

BA123 NEUTRON ACER TENDL-2024 LIBRARY; T=293.6K  
Neutron emission for (n,2n)

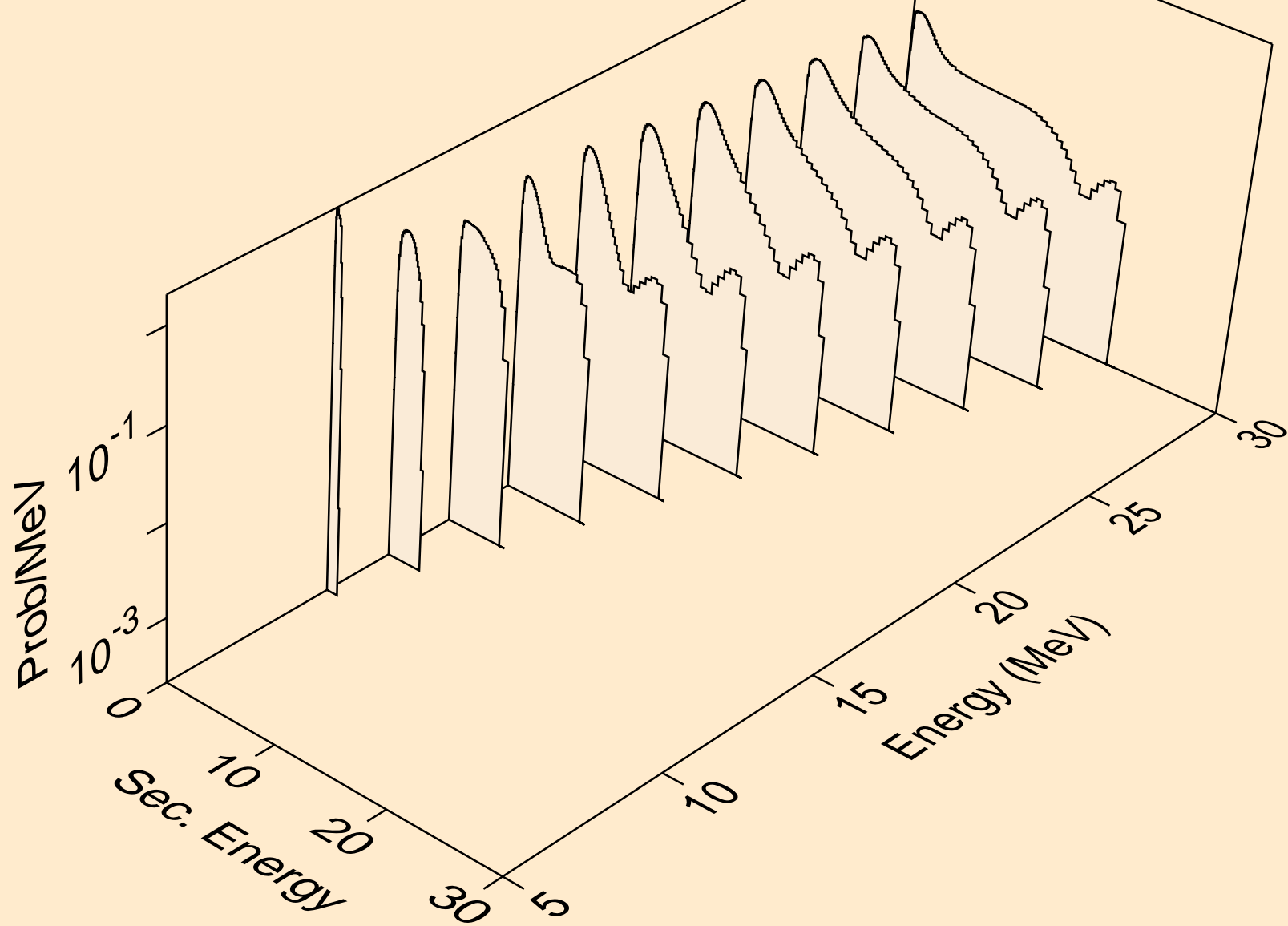

BA123 NEUTRON ACER TENDL-2024 LIBRARY; T=293.6K  
Neutron emission for (n,3n)

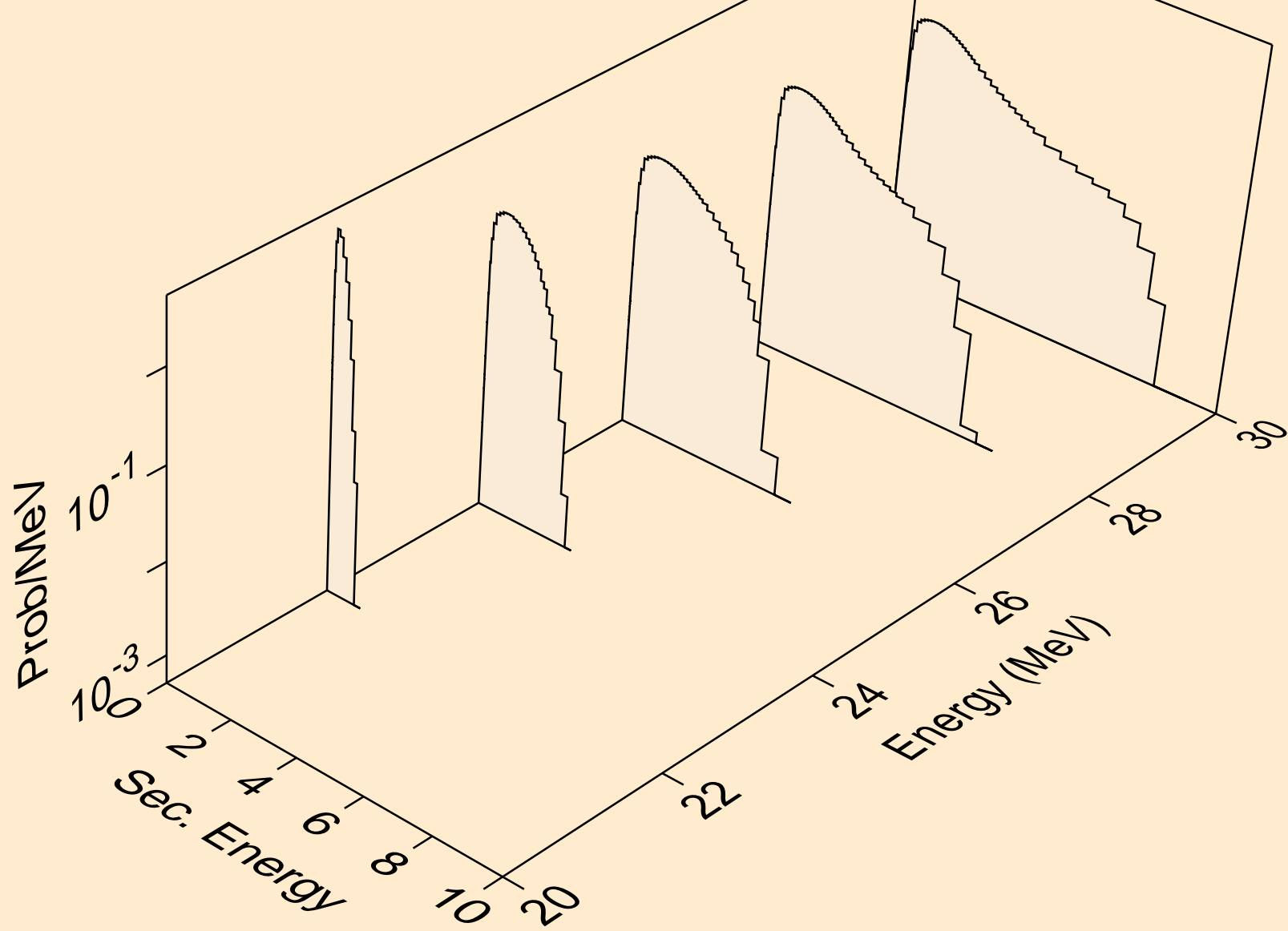

BA123 NEUTRON ACER TENDL-2024 LIBRARY; T=293.6K  
Neutron emission for (n,n\*)a

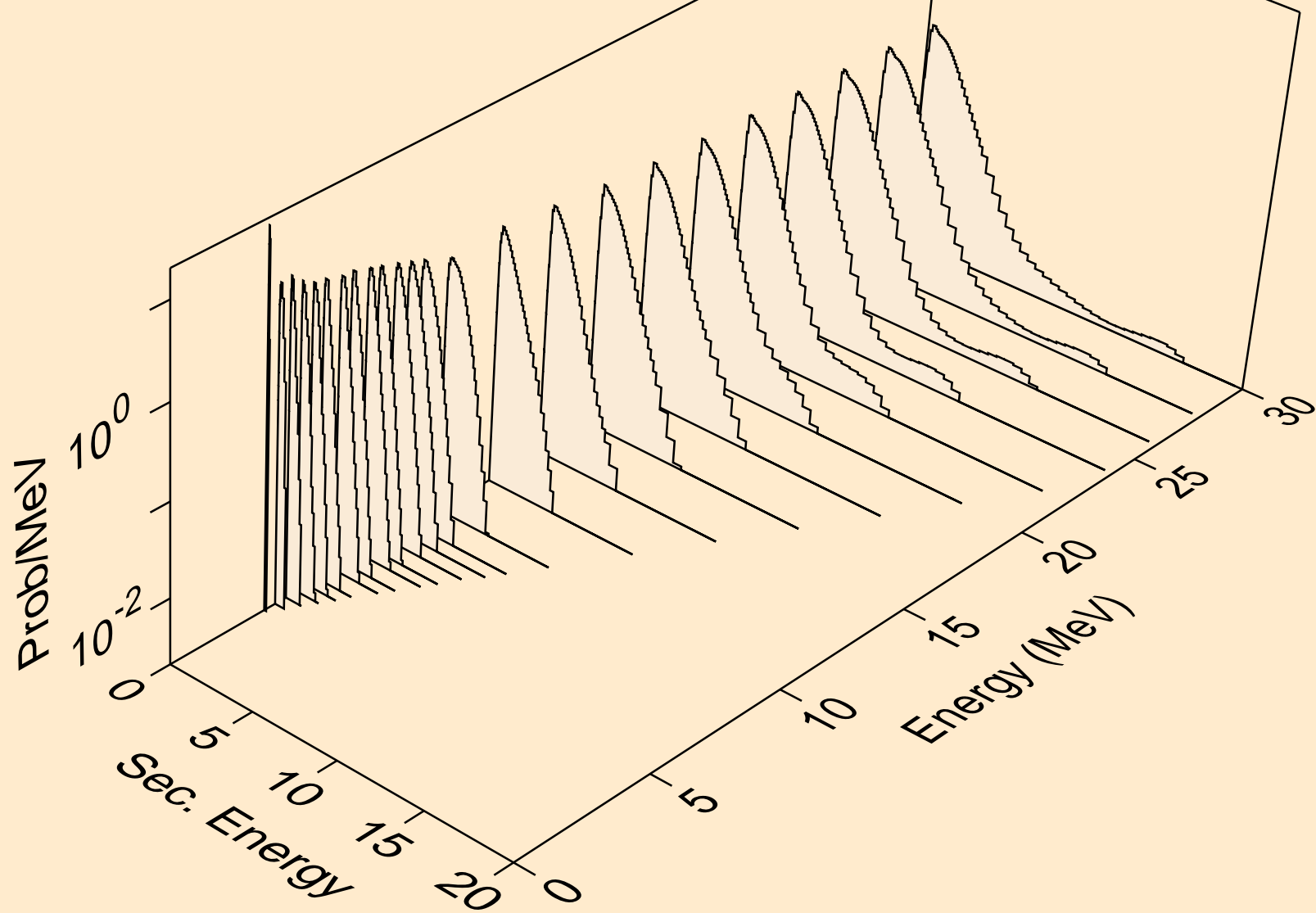

BA123 NEUTRON ACER TENDL-2024 LIBRARY; T=293.6K  
Neutron emission for (n,2n)<sub>a</sub>

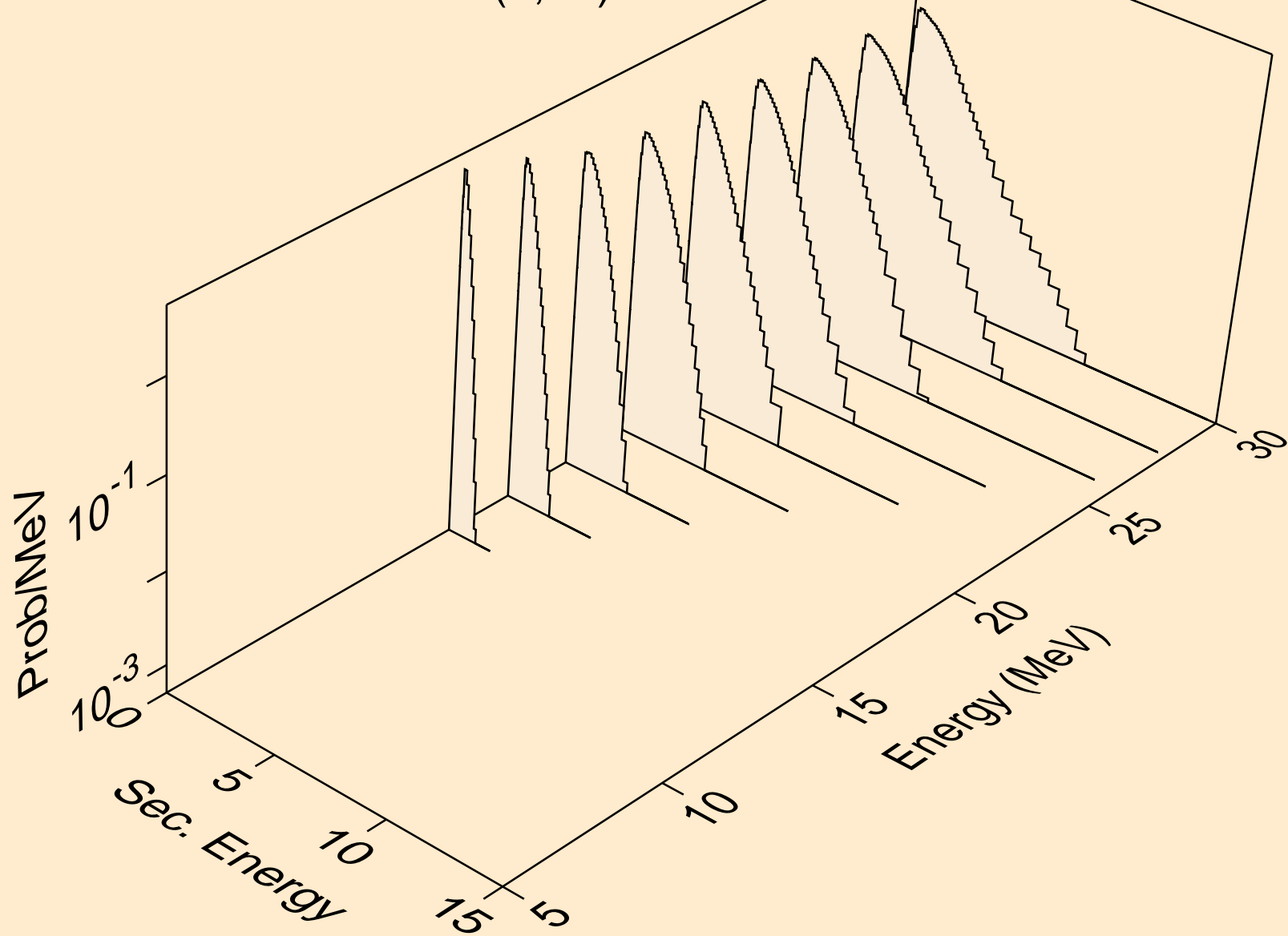

BA123 NEUTRON ACER TENDL-2024 LIBRARY; T=293.6K  
Neutron emission for (n,3n)a

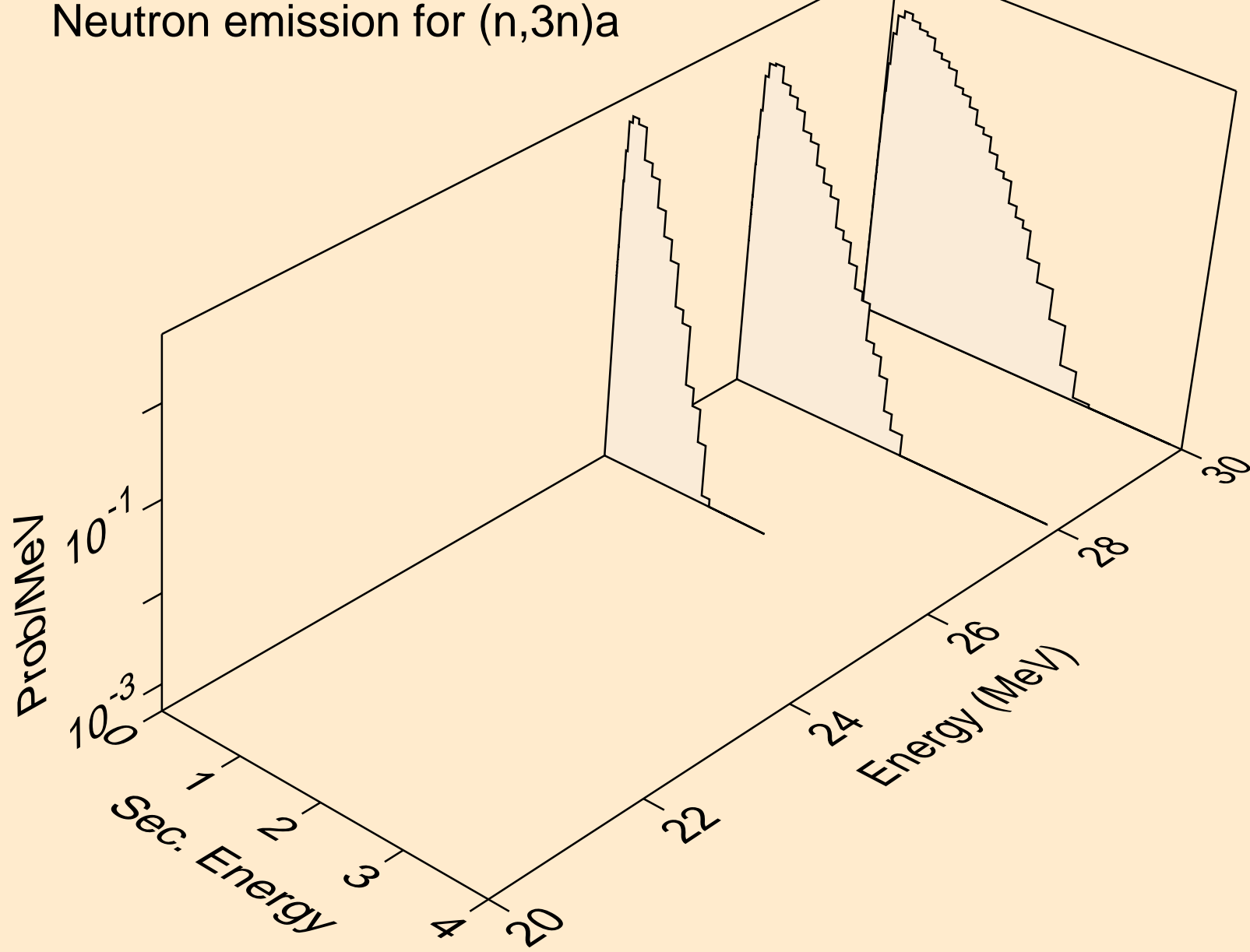

BA123 NEUTRON ACER TENDL-2024 LIBRARY; T=293.6K  
Neutron emission for (n,n\*)p

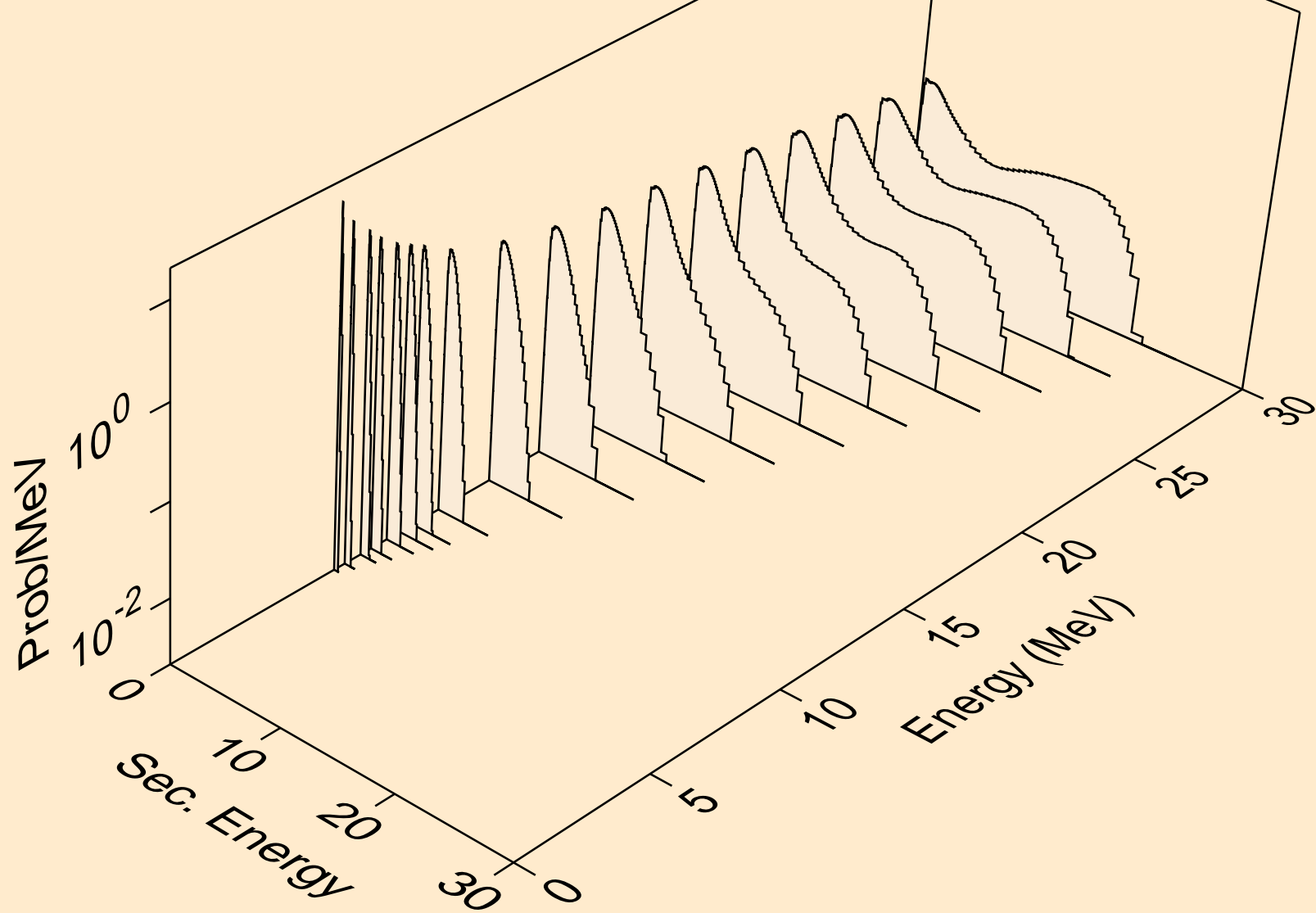

BA123 NEUTRON ACER TENDL-2024 LIBRARY; T=293.6K  
Neutron emission for (n,n\*)2a

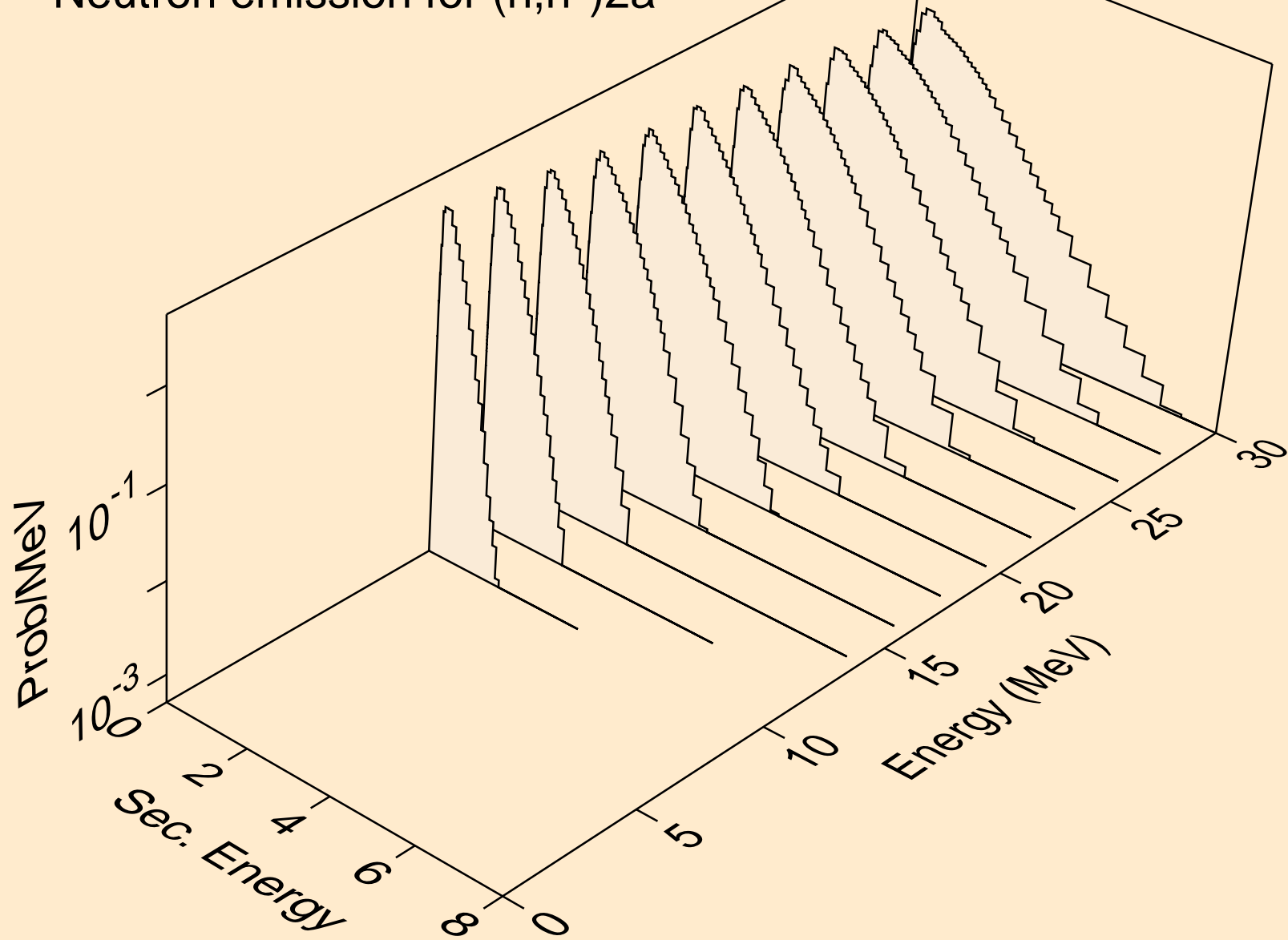

BA123 NEUTRON ACER TENDL-2024 LIBRARY; T=293.6K  
Neutron emission for (n,2n)2a

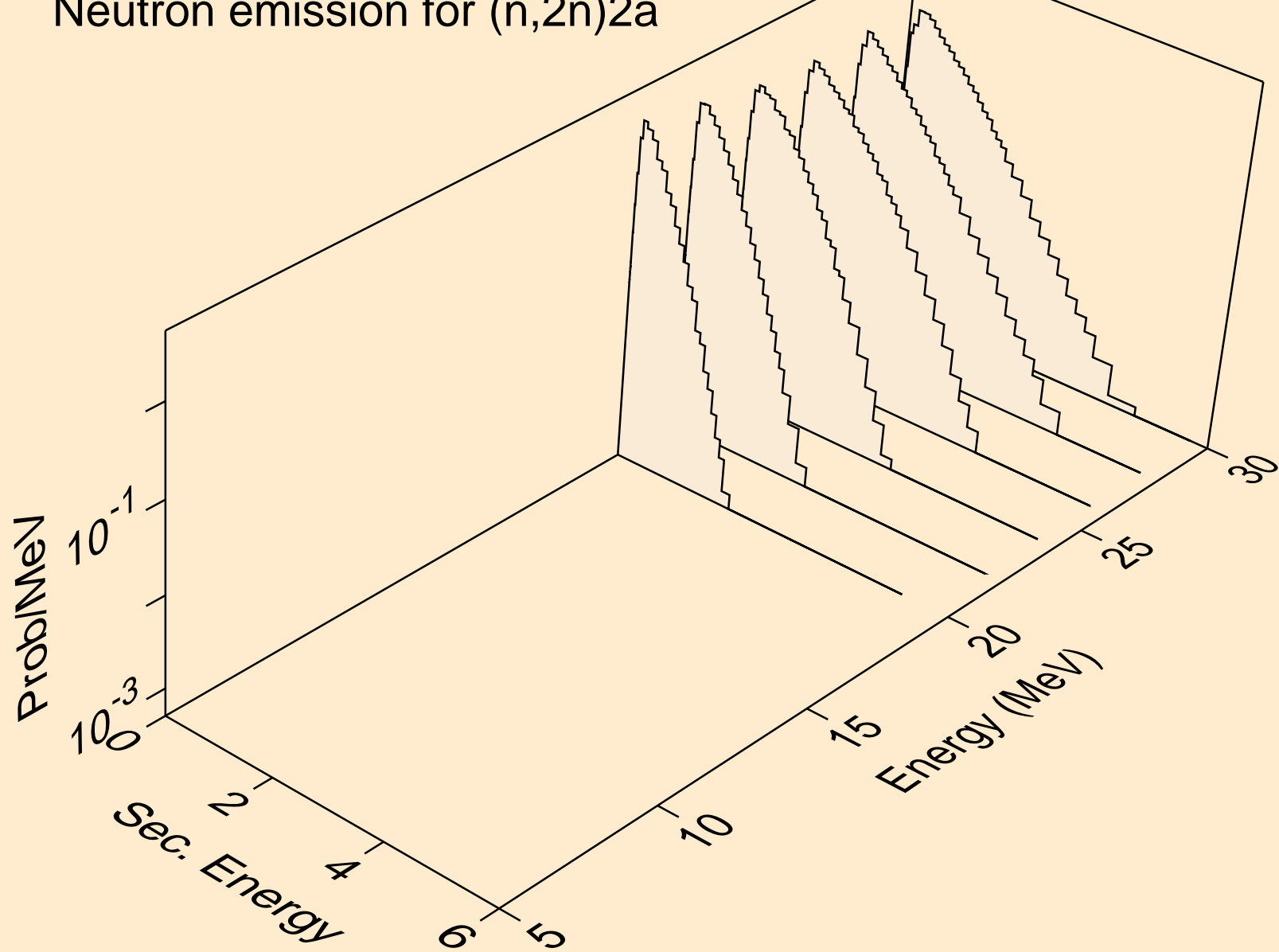

BA123 NEUTRON ACER TENDL-2024 LIBRARY; T=293.6K  
Neutron emission for (n,n\*)d

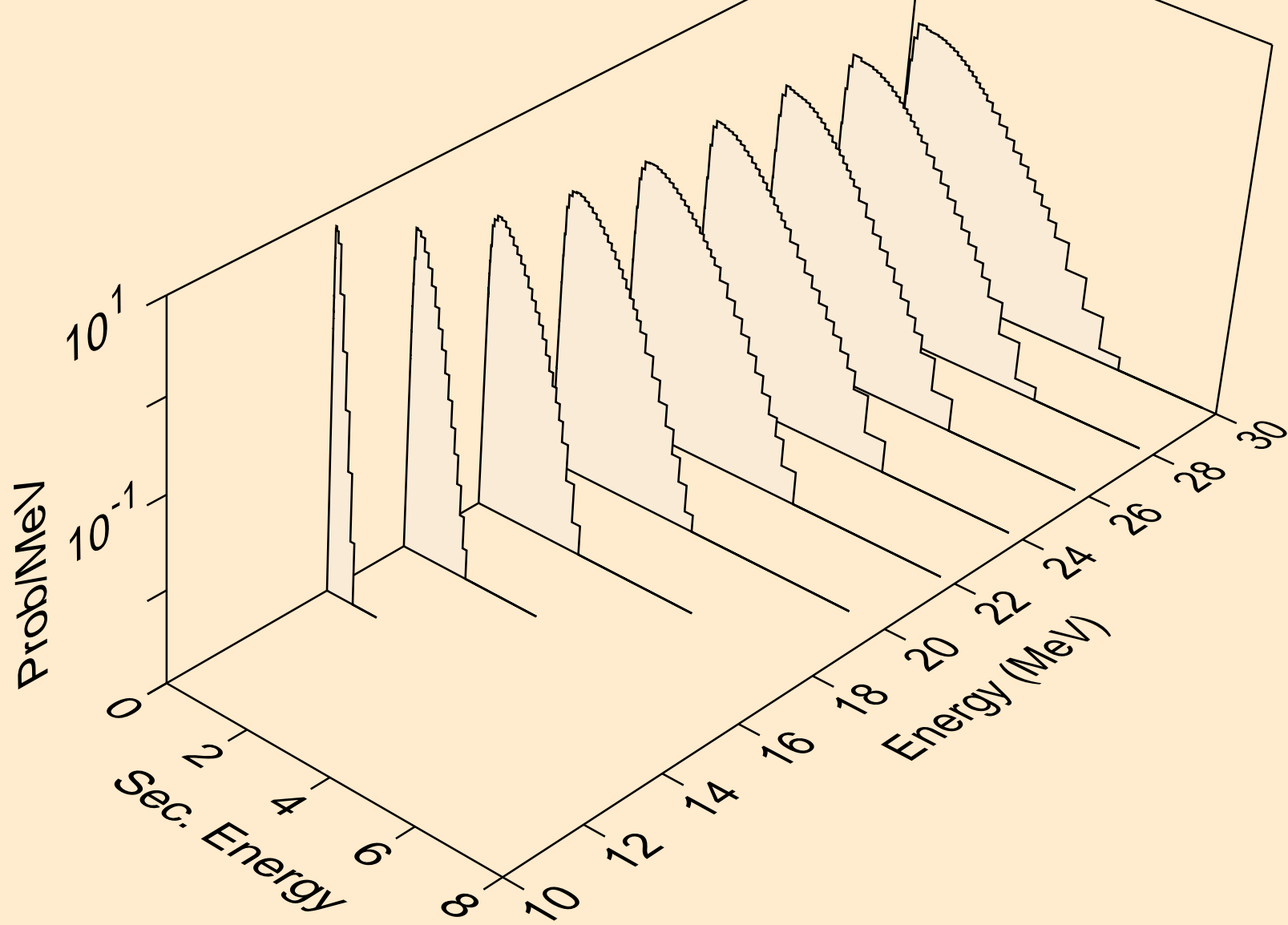

BA123 NEUTRON ACER TENDL-2024 LIBRARY; T=293.6K  
Neutron emission for (n,n\*)t

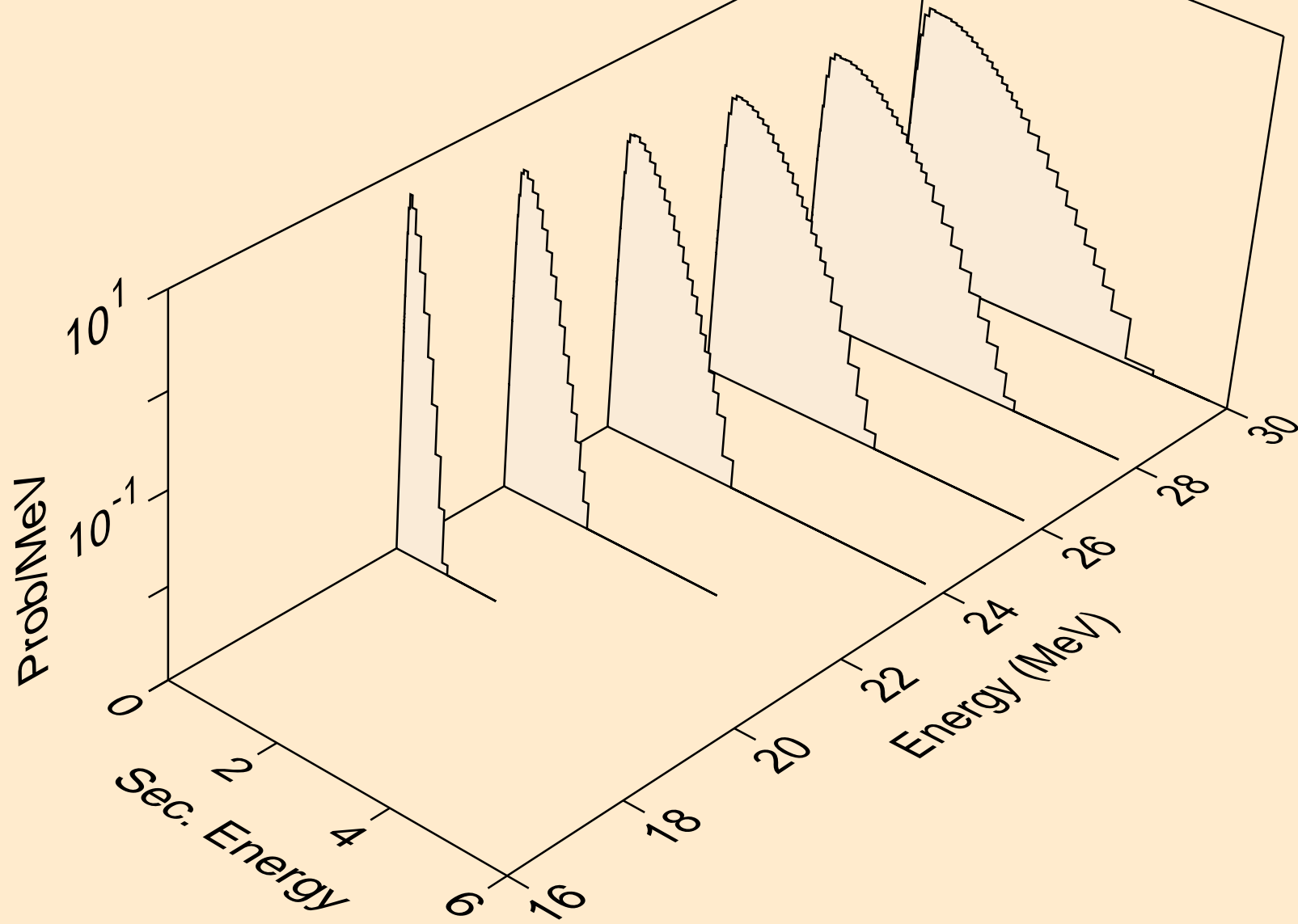

BA123 NEUTRON ACER TENDL-2024 LIBRARY; T=293.6K  
Neutron emission for (n,n\*)he3

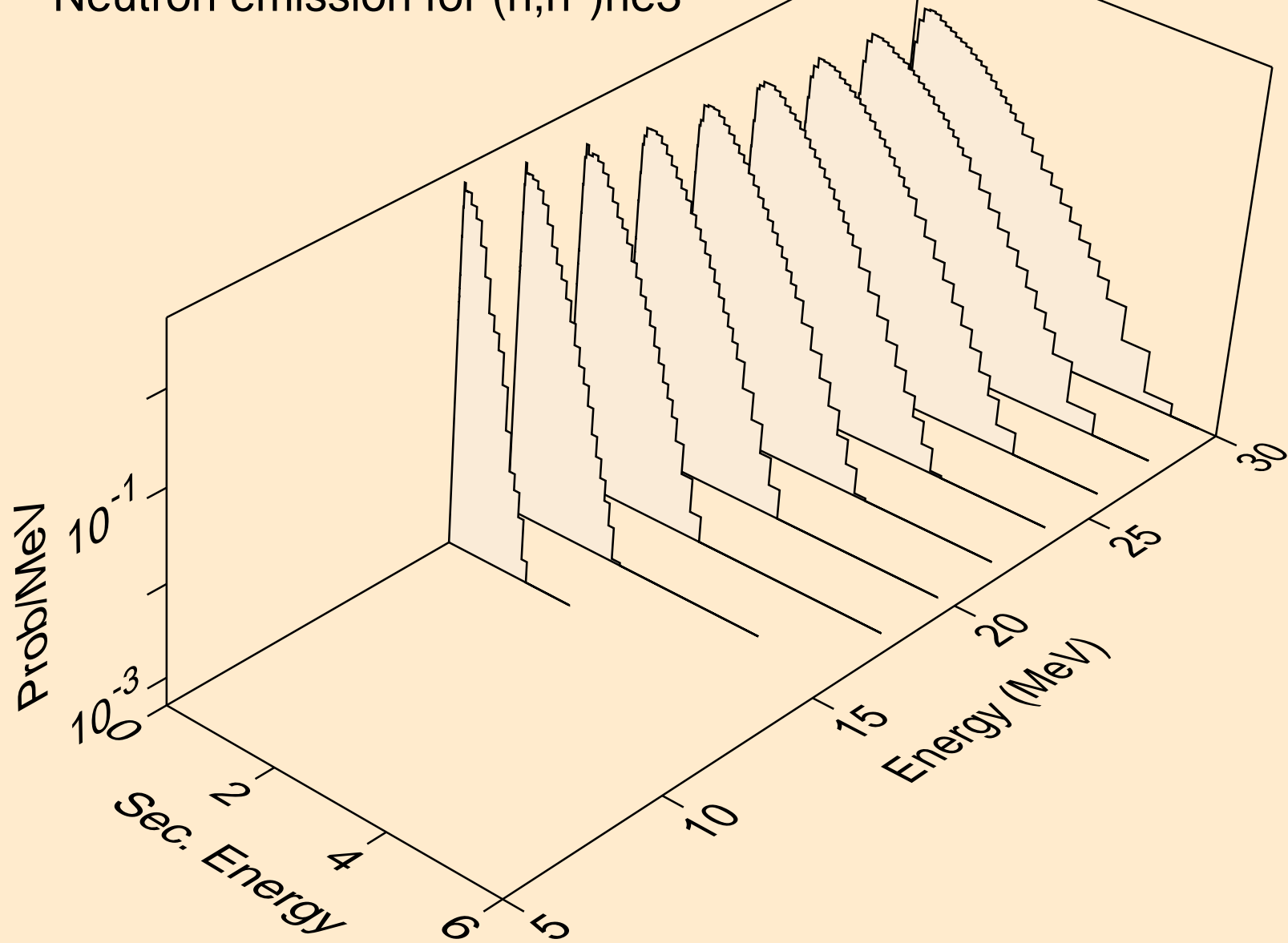

BA123 NEUTRON ACER TENDL-2024 LIBRARY; T=293.6K  
Neutron emission for (n,2np)

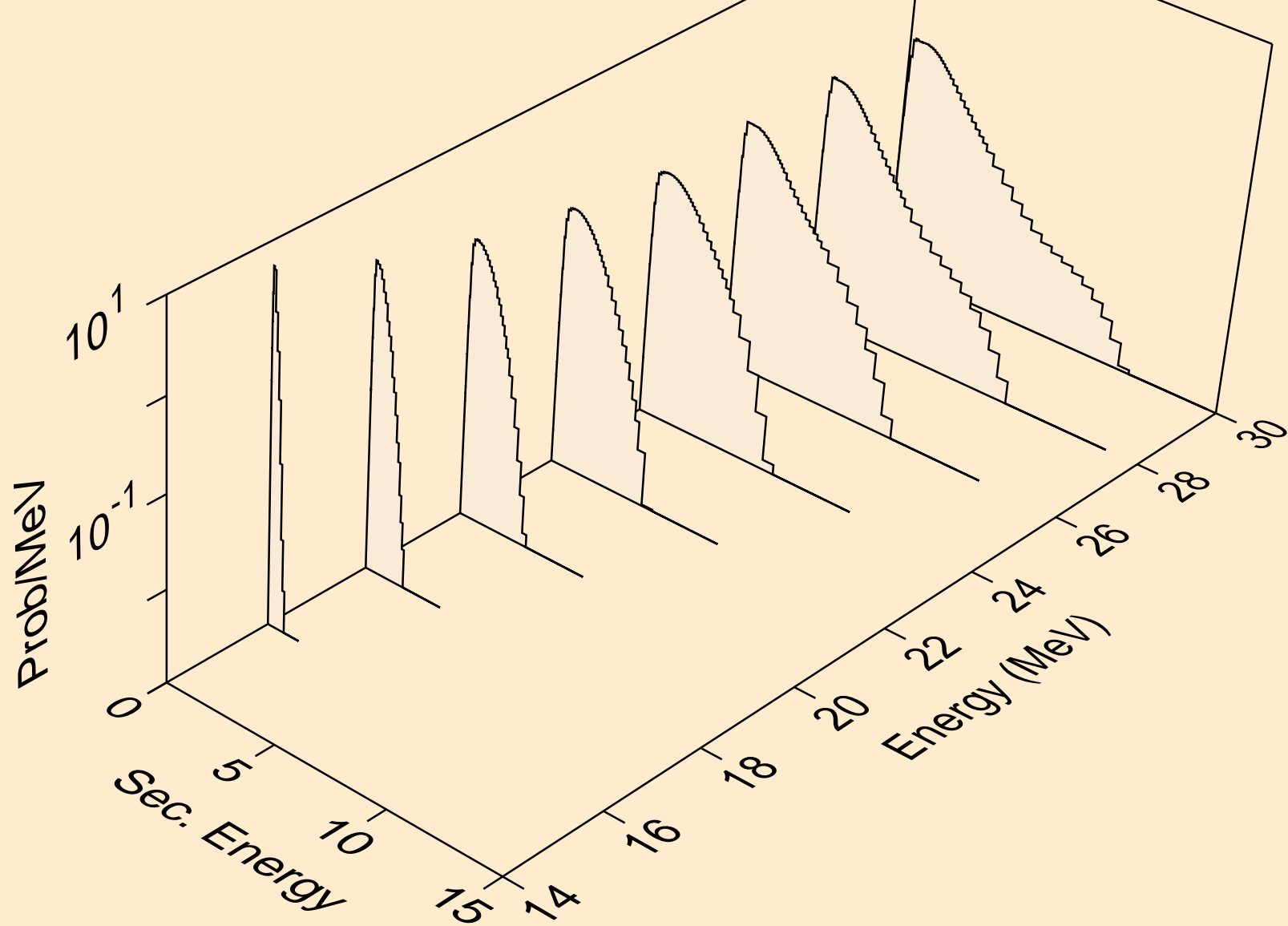

BA123 NEUTRON ACER TENDL-2024 LIBRARY; T=293.6K  
Neutron emission for (n,3np)

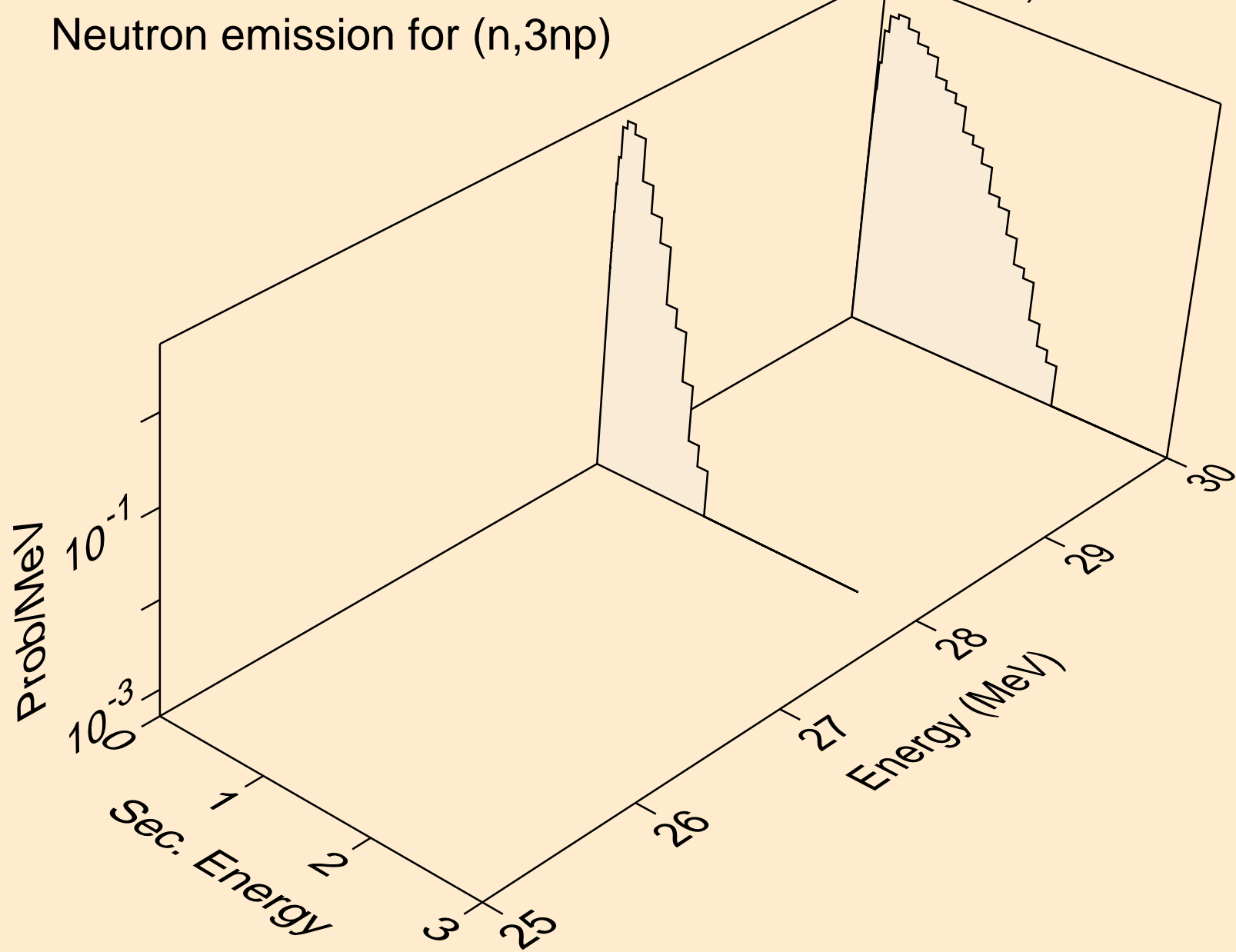

BA123 NEUTRON ACER TENDL-2024 LIBRARY; T=293.6K  
Neutron emission for (n,n2p)

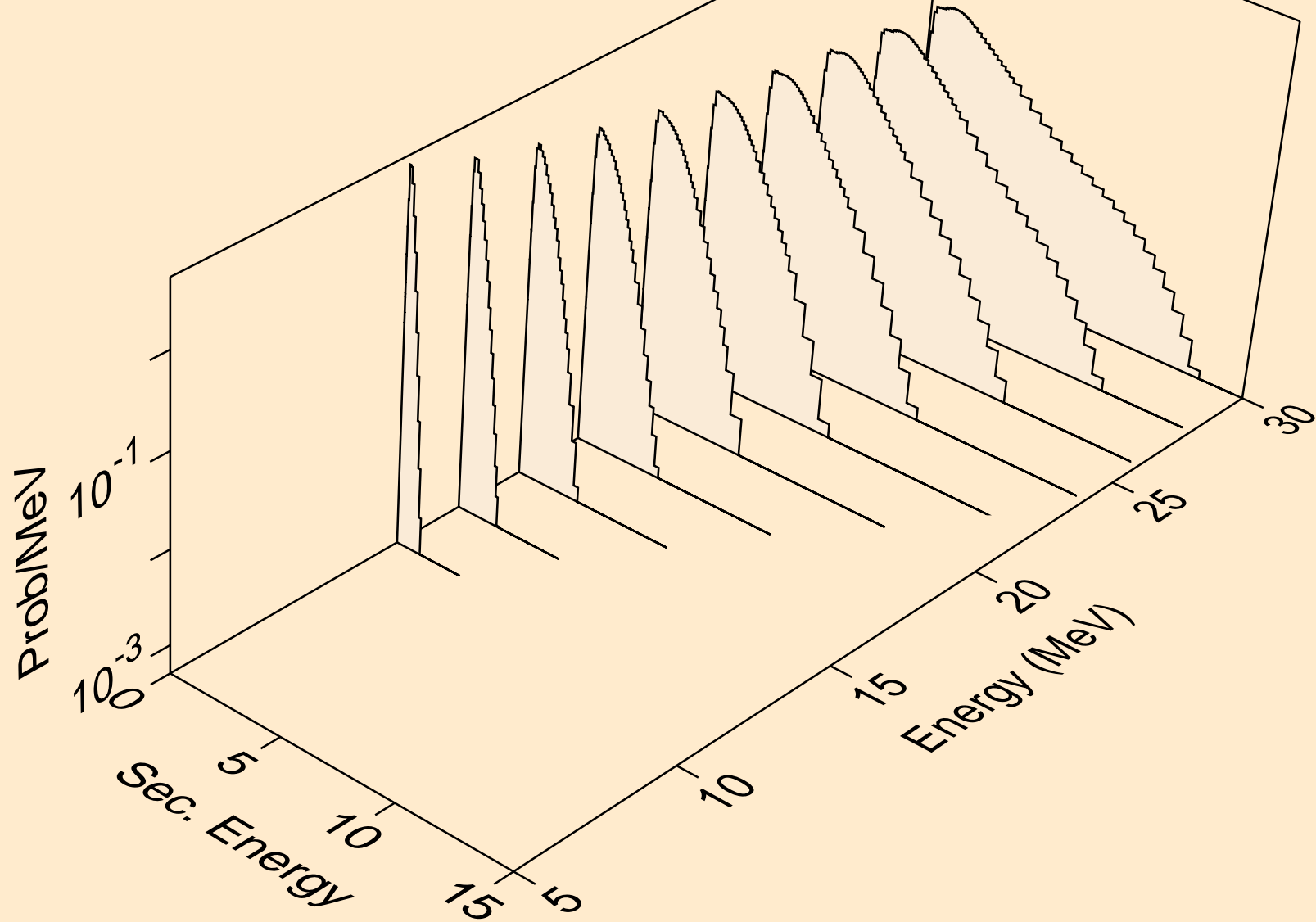

BA123 NEUTRON ACER TENDL-2024 LIBRARY; T=293.6K  
Neutron emission for (n,npa)

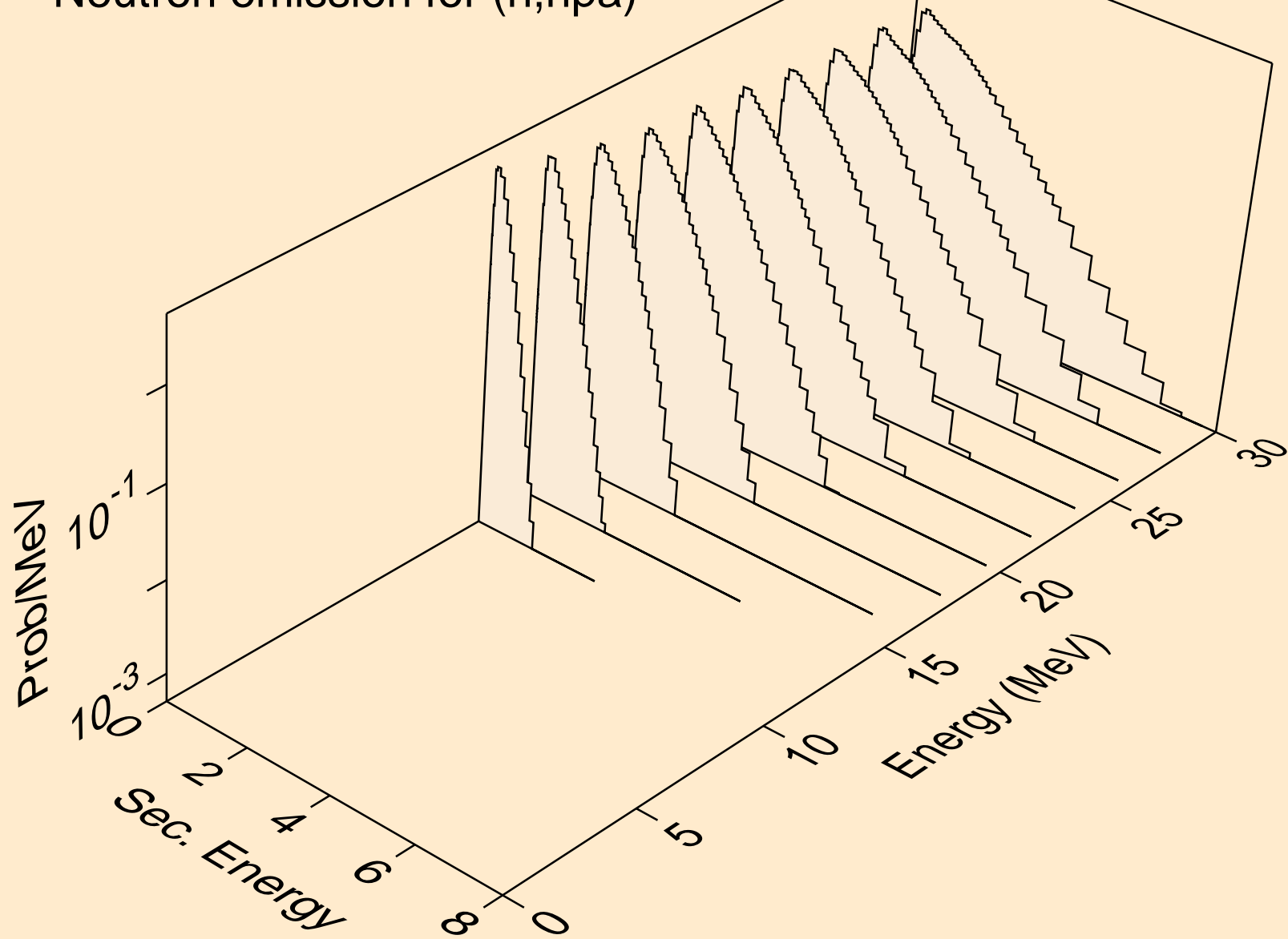

BA123 NEUTRON ACER TENDL-2024 LIBRARY; T=293.6K  
Neutron emission for (n,n\*c)

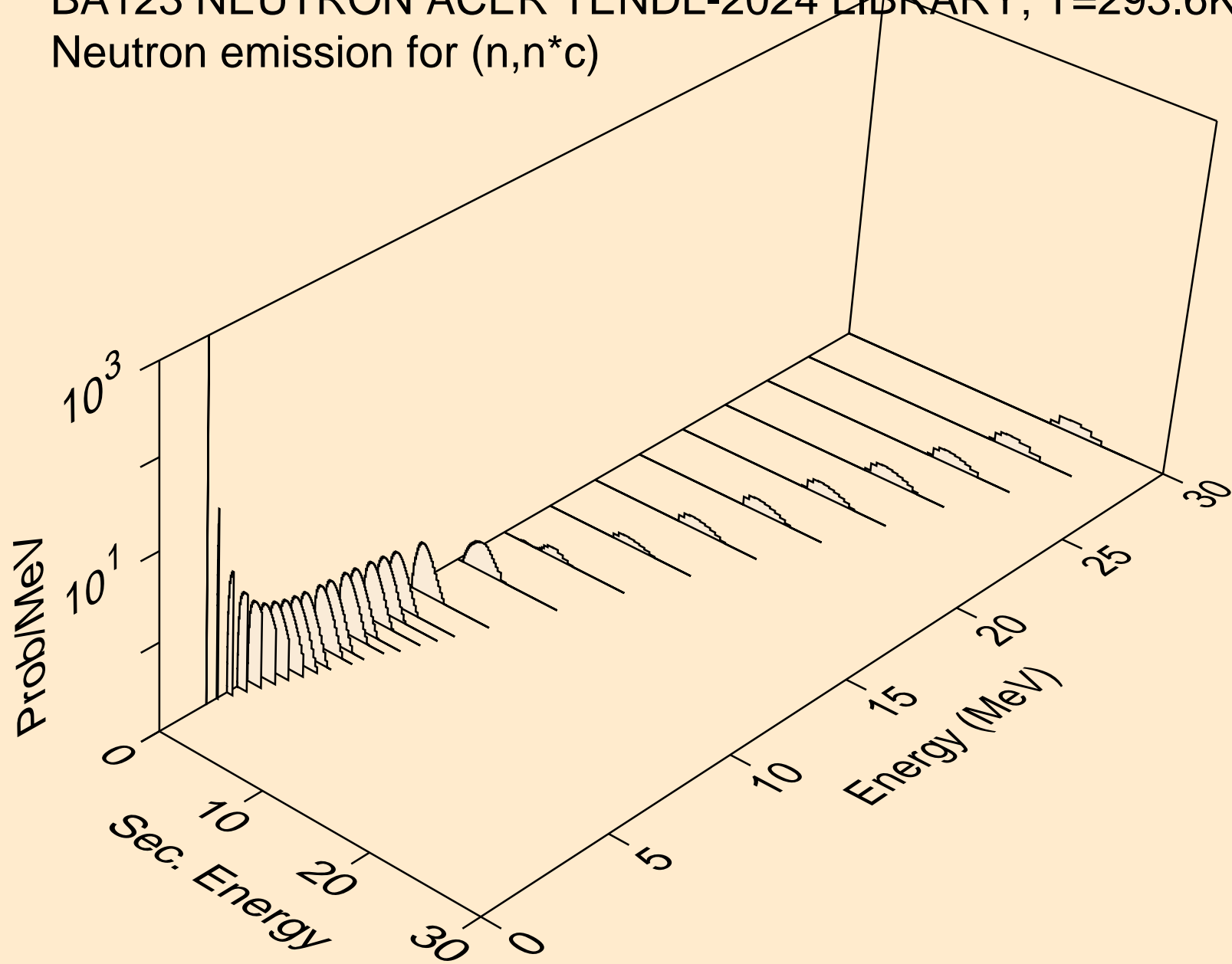

BA123 NEUTRON ACER TENDL-2024 LIBRARY; T=293.6K  
Photon emission for (n,x)

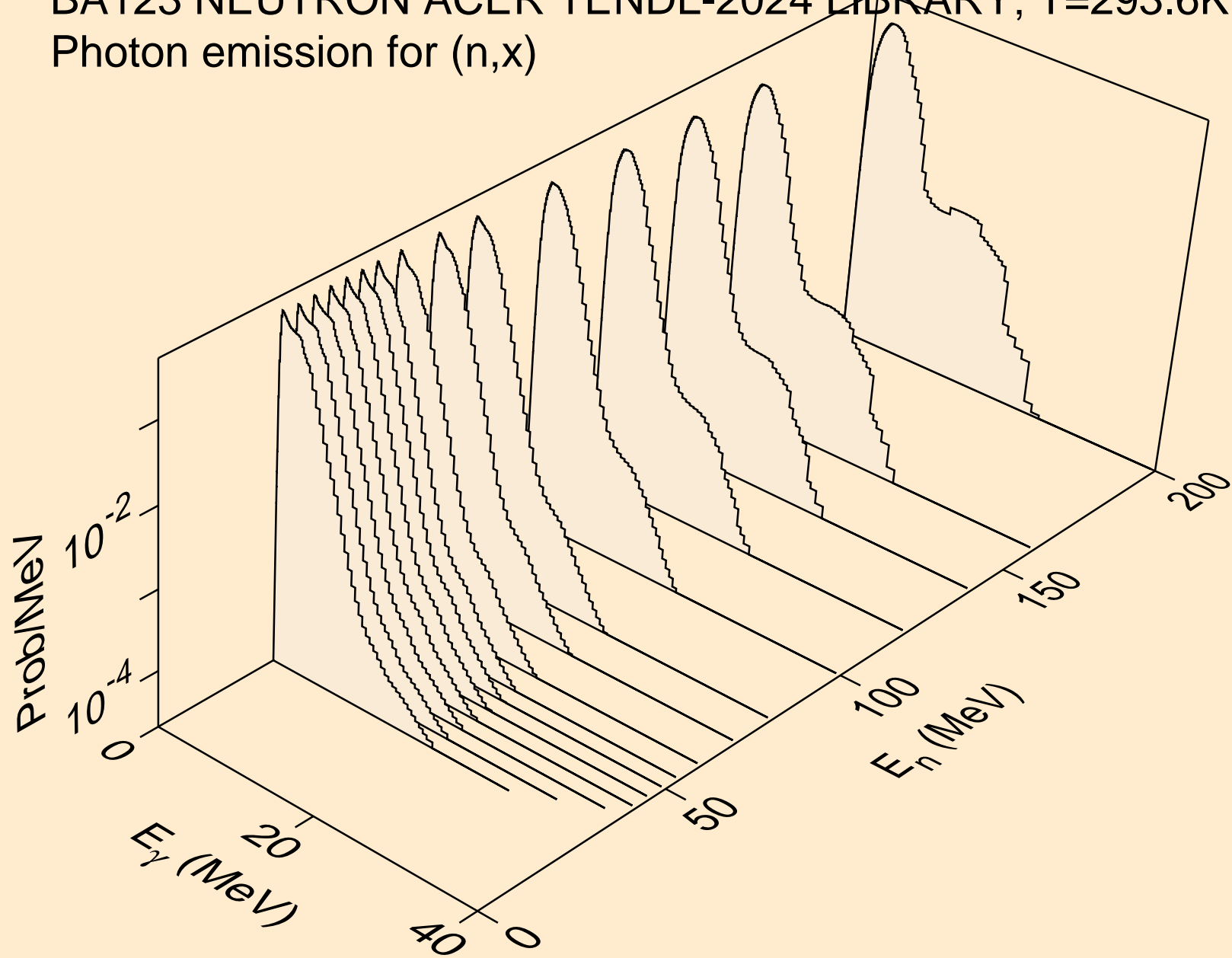

BA123 NEUTRON ACER TENDL-2024 LIBRARY; T=293.6K  
Photon emission for (n,2nd)

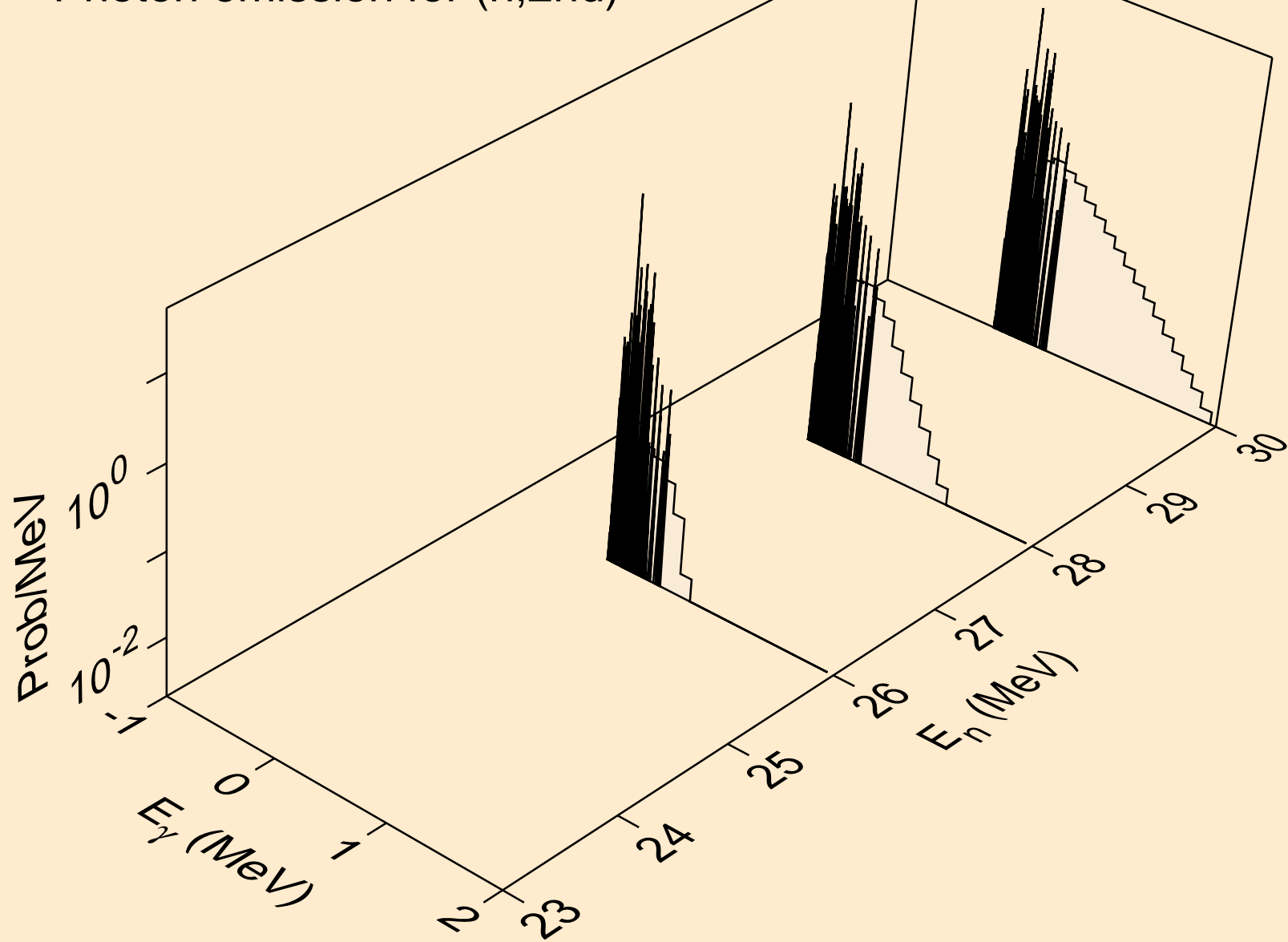

BA123 NEUTRON ACER TENDL-2024 LIBRARY; T=293.6K  
Photon emission for (n,2n)

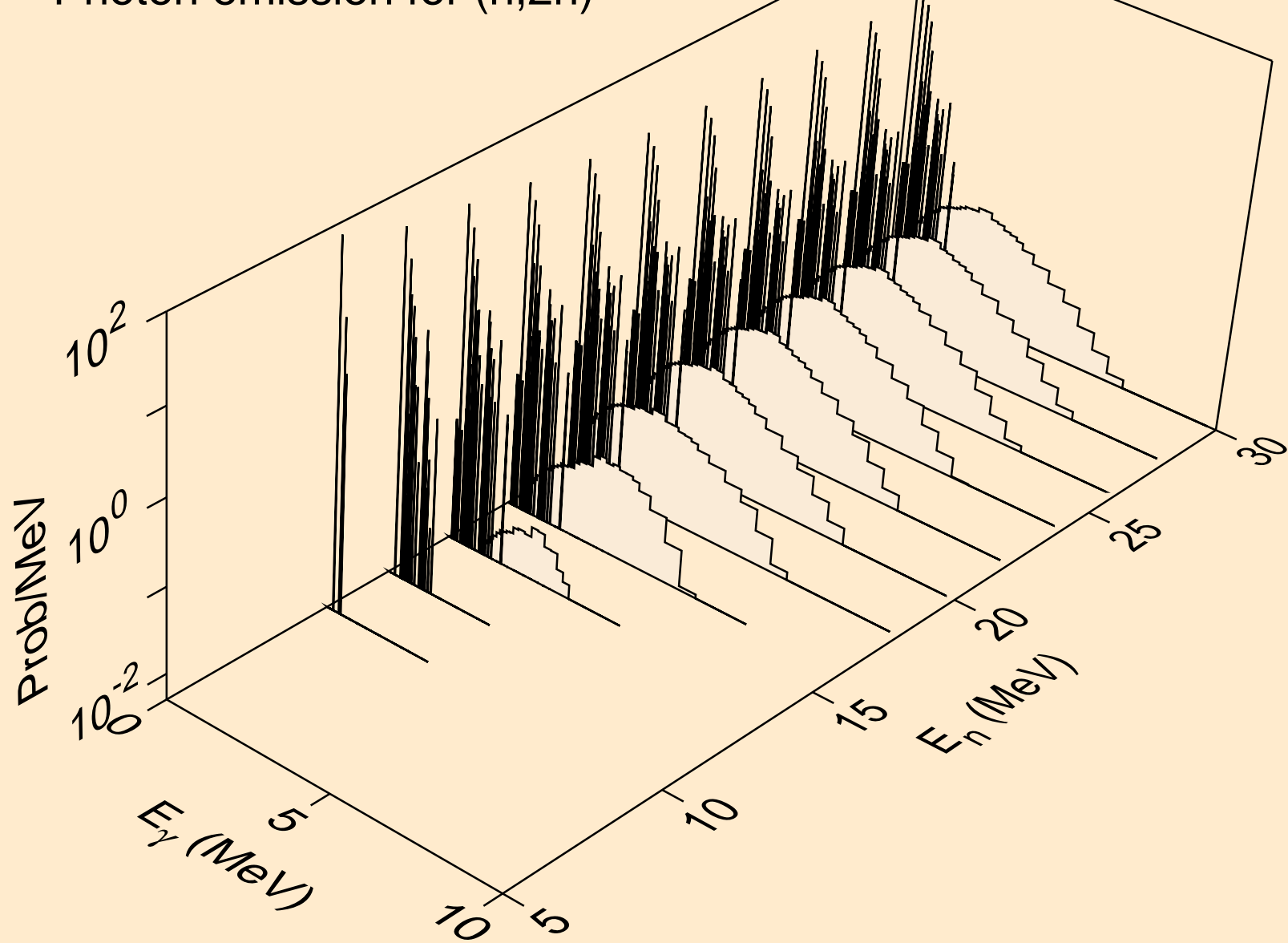

BA123 NEUTRON ACER TENDL-2024 LIBRARY; T=293.6K  
Photon emission for (n,3n)

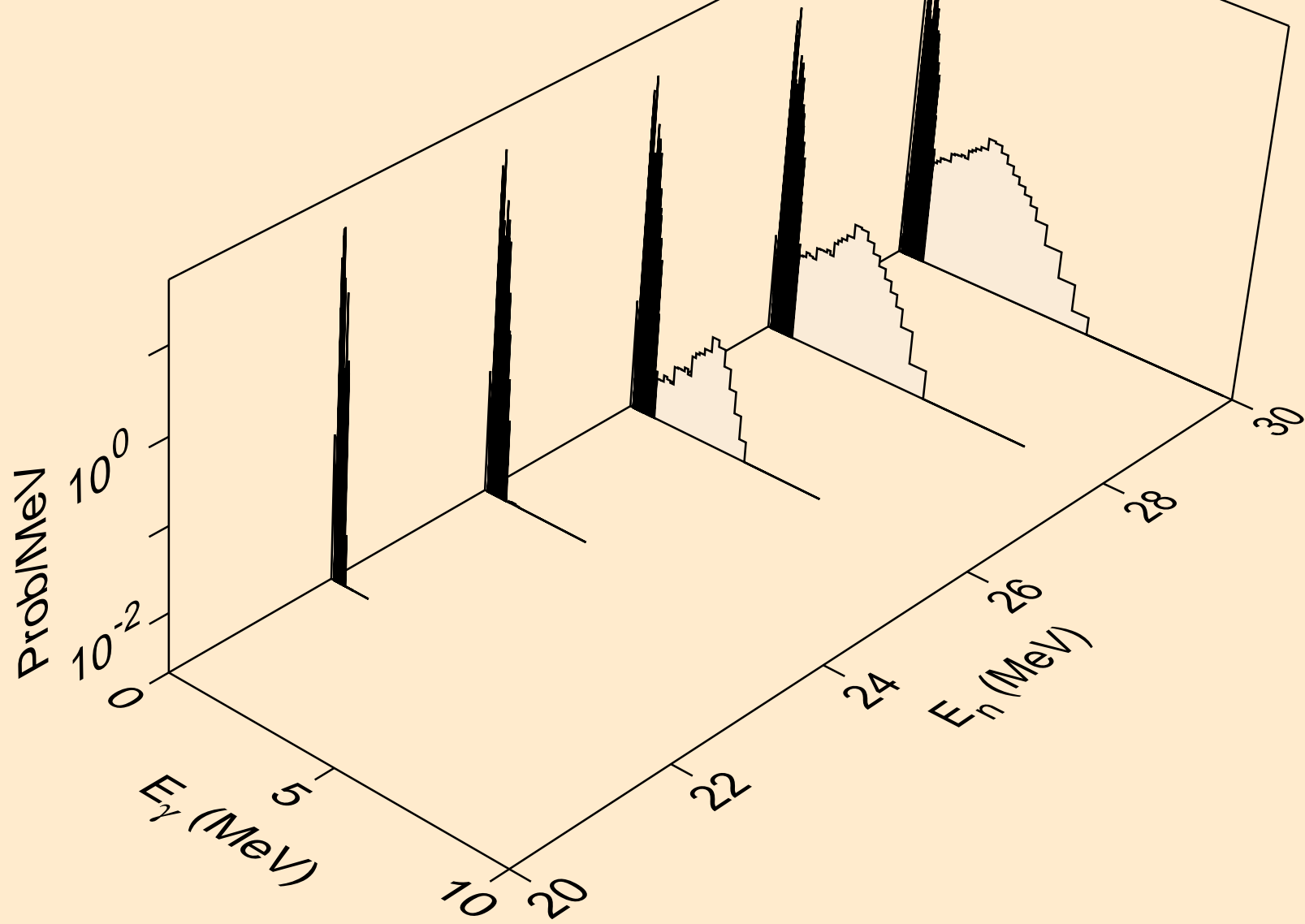

BA123 NEUTRON ACER TENDL-2024 LIBRARY; T=293.6K  
Photon emission for (n,n\*)a

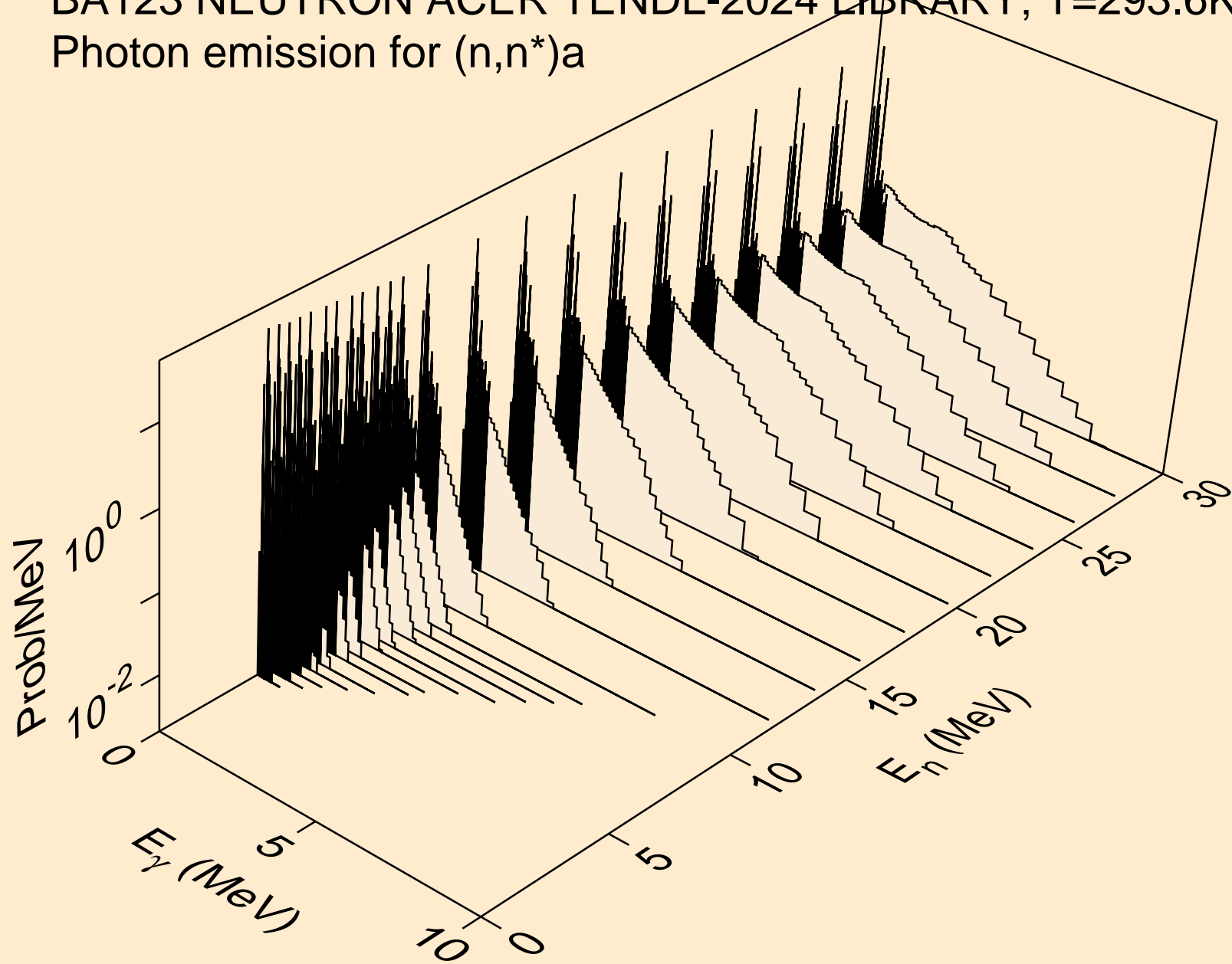

BA123 NEUTRON ACER TENDL-2024 LIBRARY; T=293.6K  
Photon emission for (n,2n)a

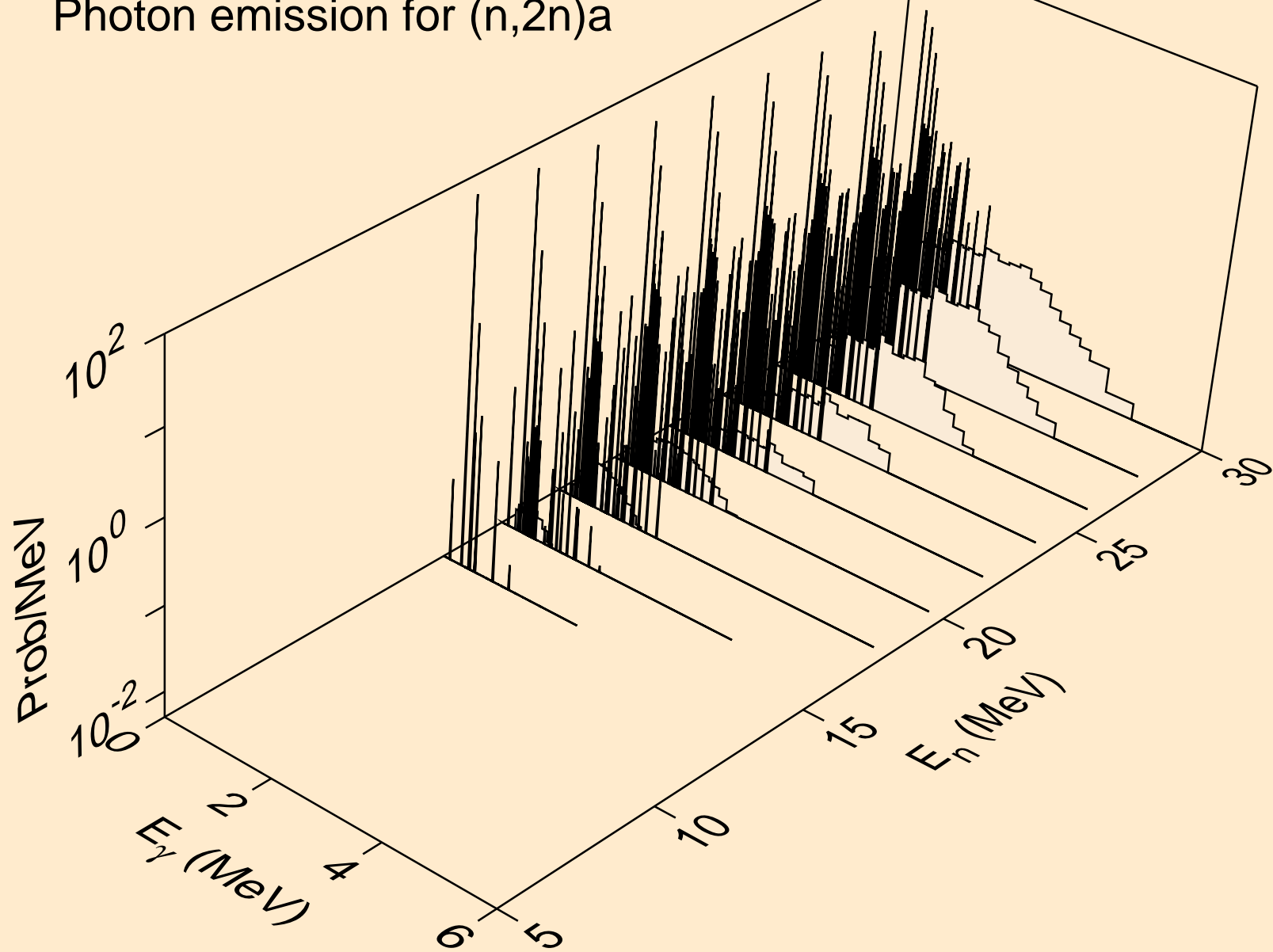

BA123 NEUTRON ACER TENDL-2024 LIBRARY; T=293.6K  
Photon emission for (n,3n)a

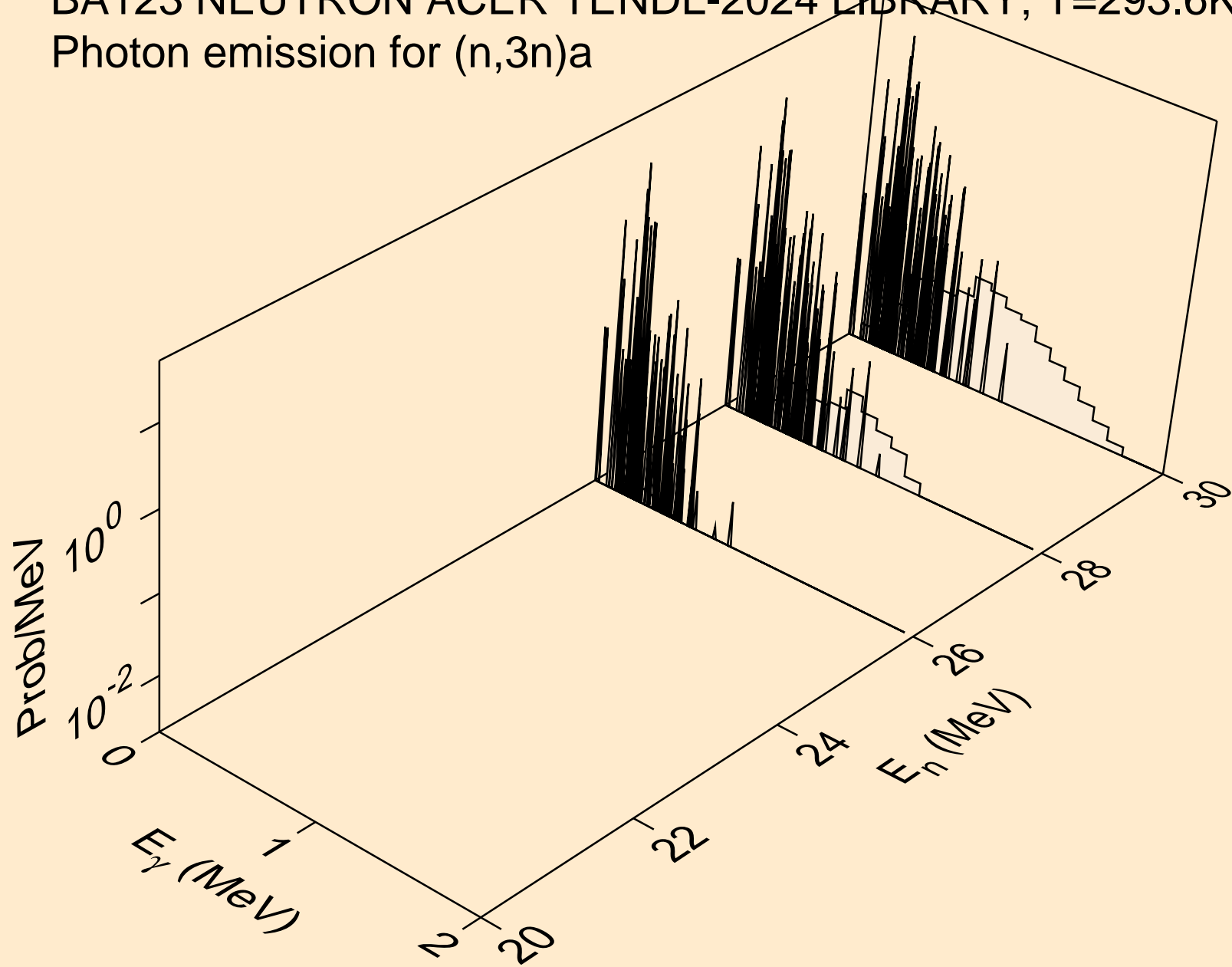

BA123 NEUTRON ACER TENDL-2024 LIBRARY; T=293.6K  
Photon emission for (n,n\*)p

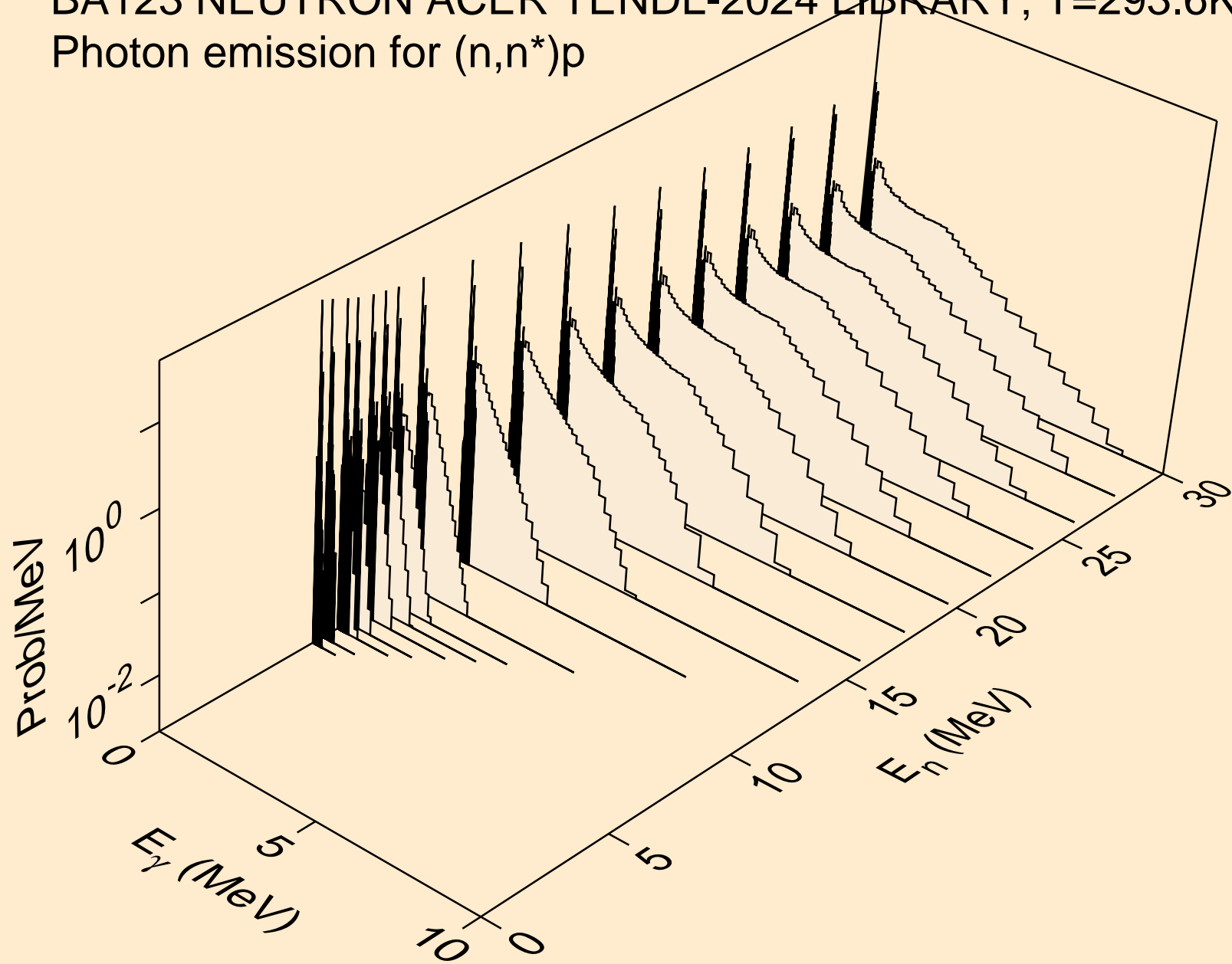

BA123 NEUTRON ACER TENDL-2024 LIBRARY; T=293.6K  
Photon emission for (n,n\*)2a

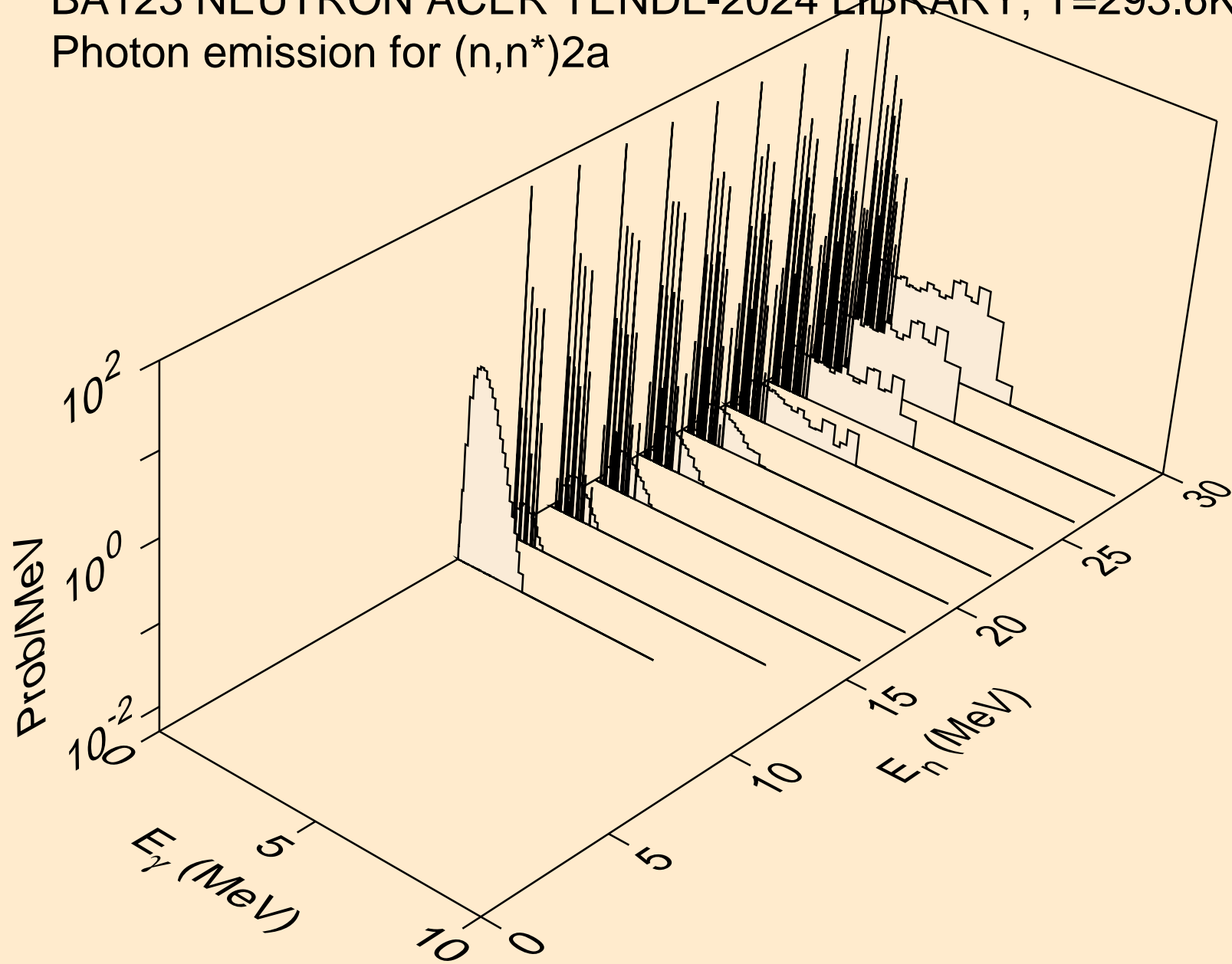

BA123 NEUTRON ACER TENDL-2024 LIBRARY; T=293.6K  
Photon emission for (n,2n)2a

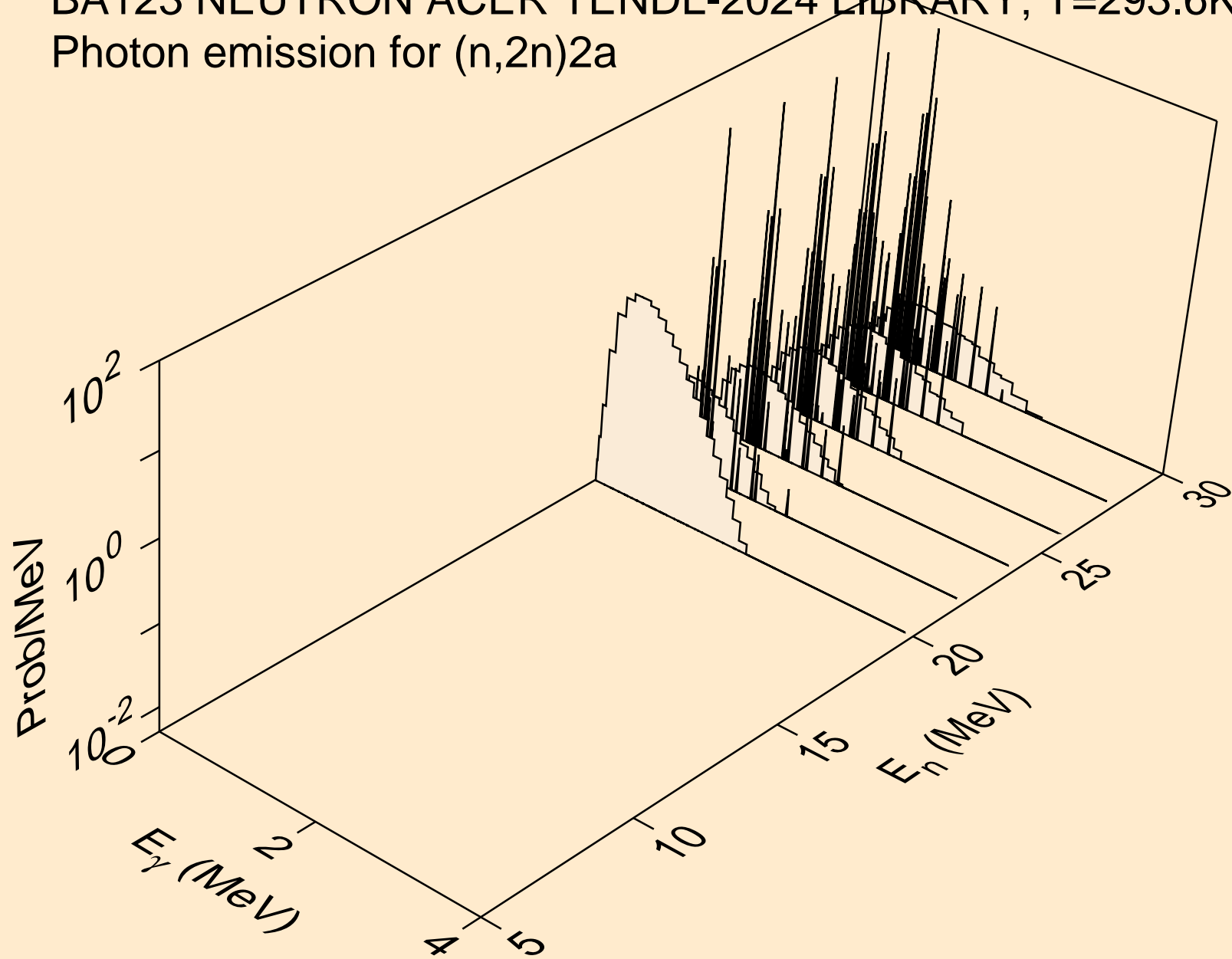

BA123 NEUTRON ACER TENDL-2024 LIBRARY; T=293.6K  
Photon emission for (n,n\*)d

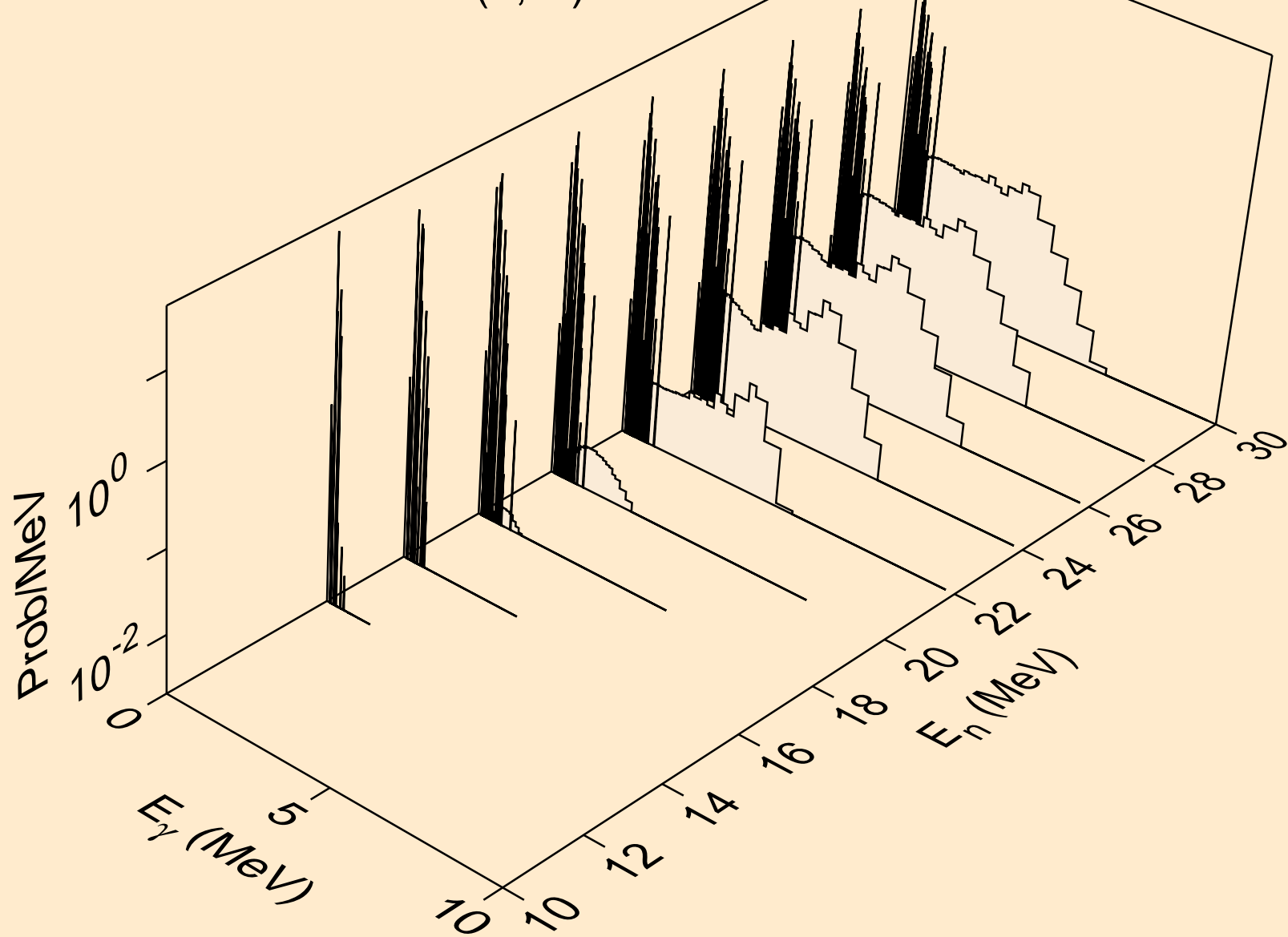

BA123 NEUTRON ACER TENDL-2024 LIBRARY; T=293.6K  
Photon emission for (n,n\*)t

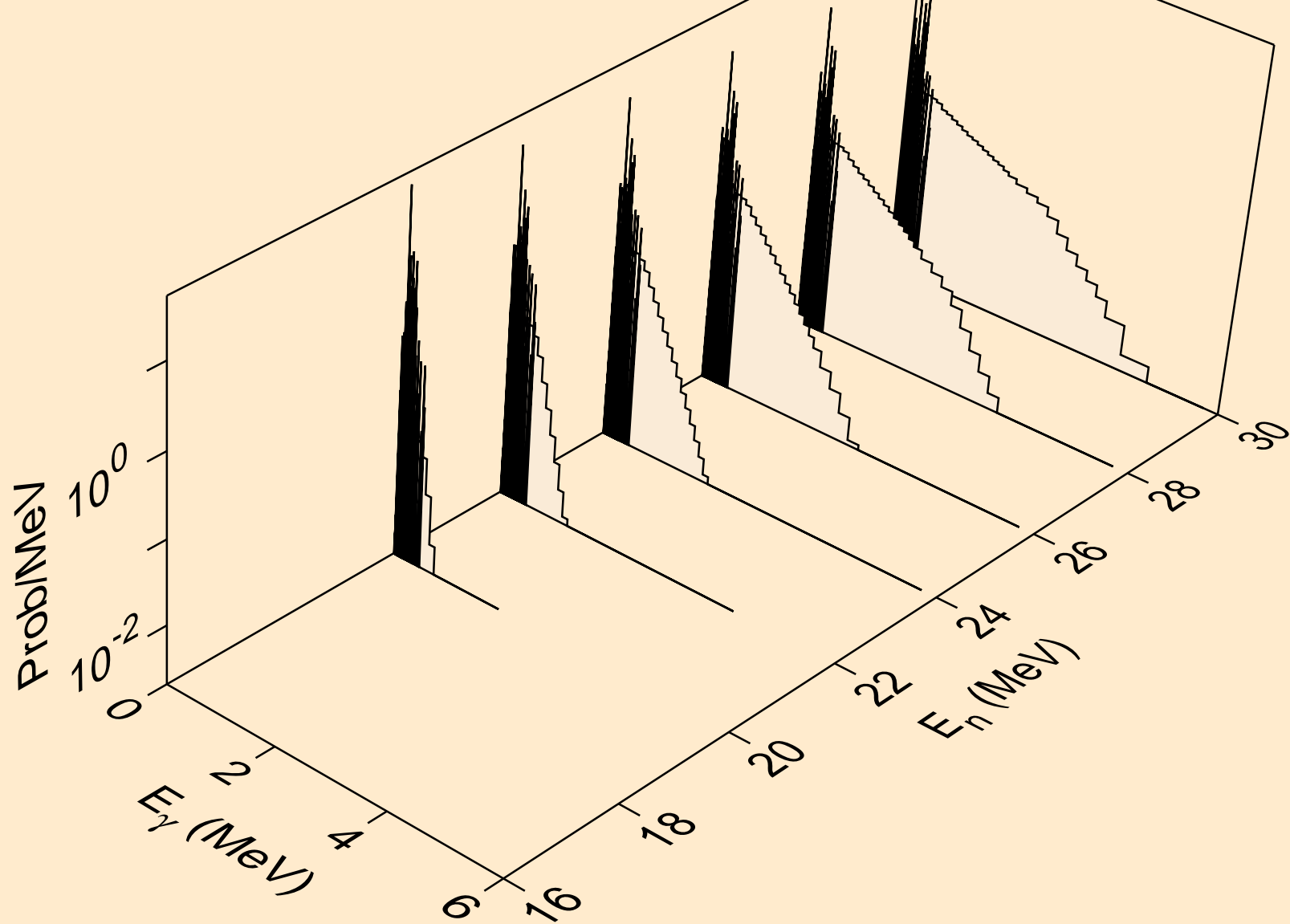

BA123 NEUTRON ACER TENDL-2024 LIBRARY; T=293.6K  
Photon emission for (n,n\*)he3

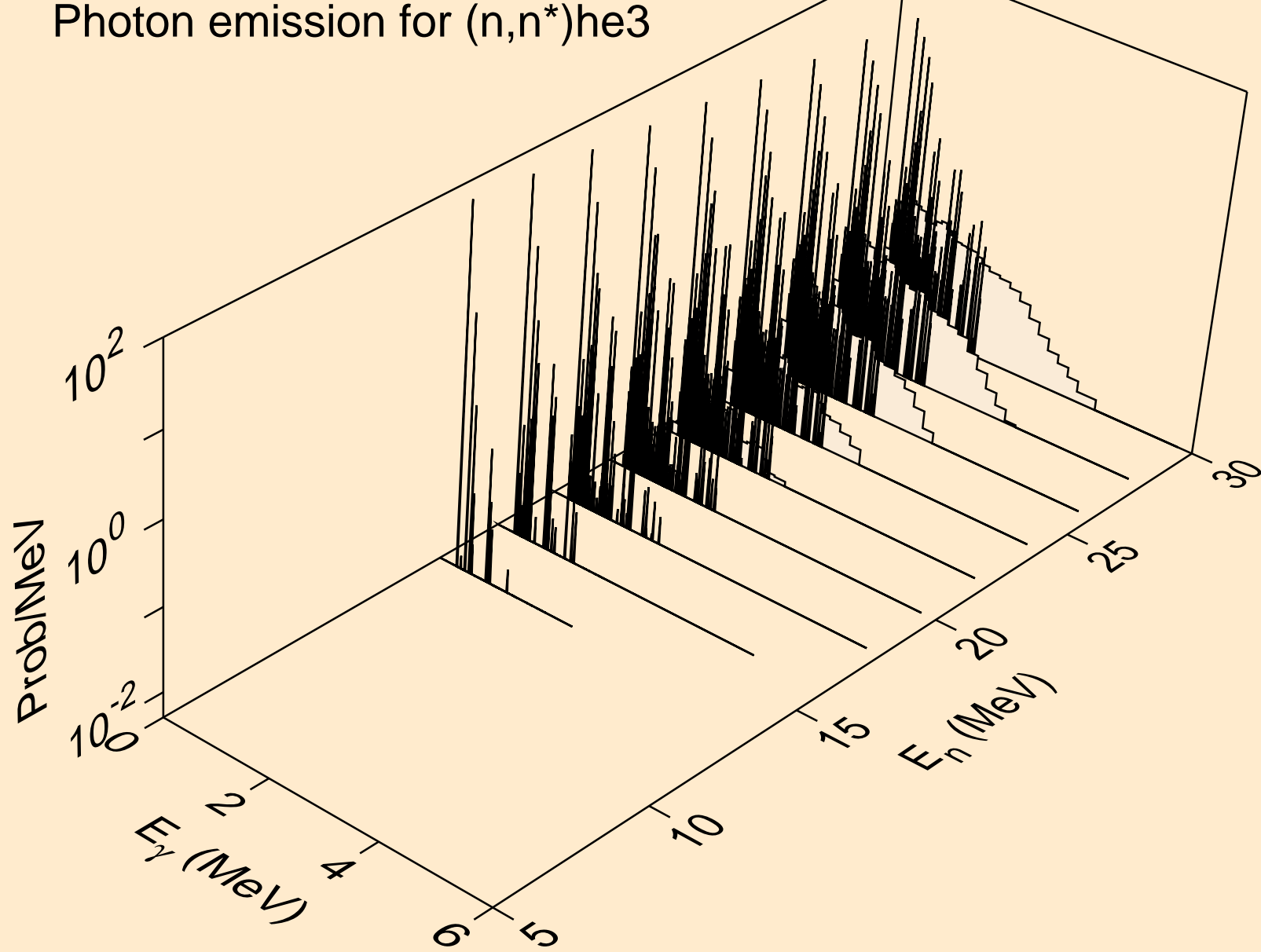

BA123 NEUTRON ACER TENDL-2024 LIBRARY; T=293.6K  
Photon emission for (n,2np)

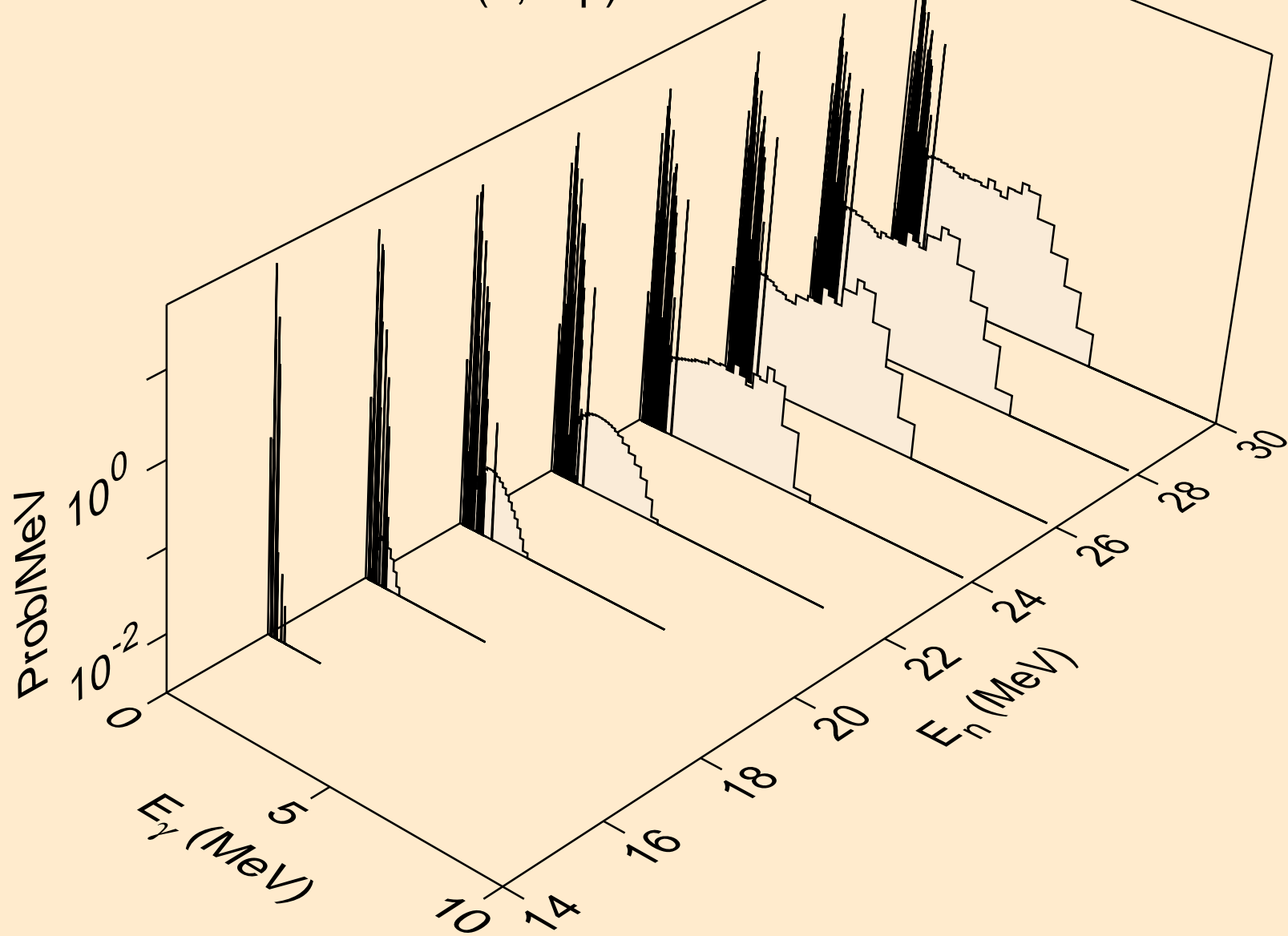

BA123 NEUTRON ACER TENDL-2024 LIBRARY; T=293.6K  
Photon emission for (n,3np)

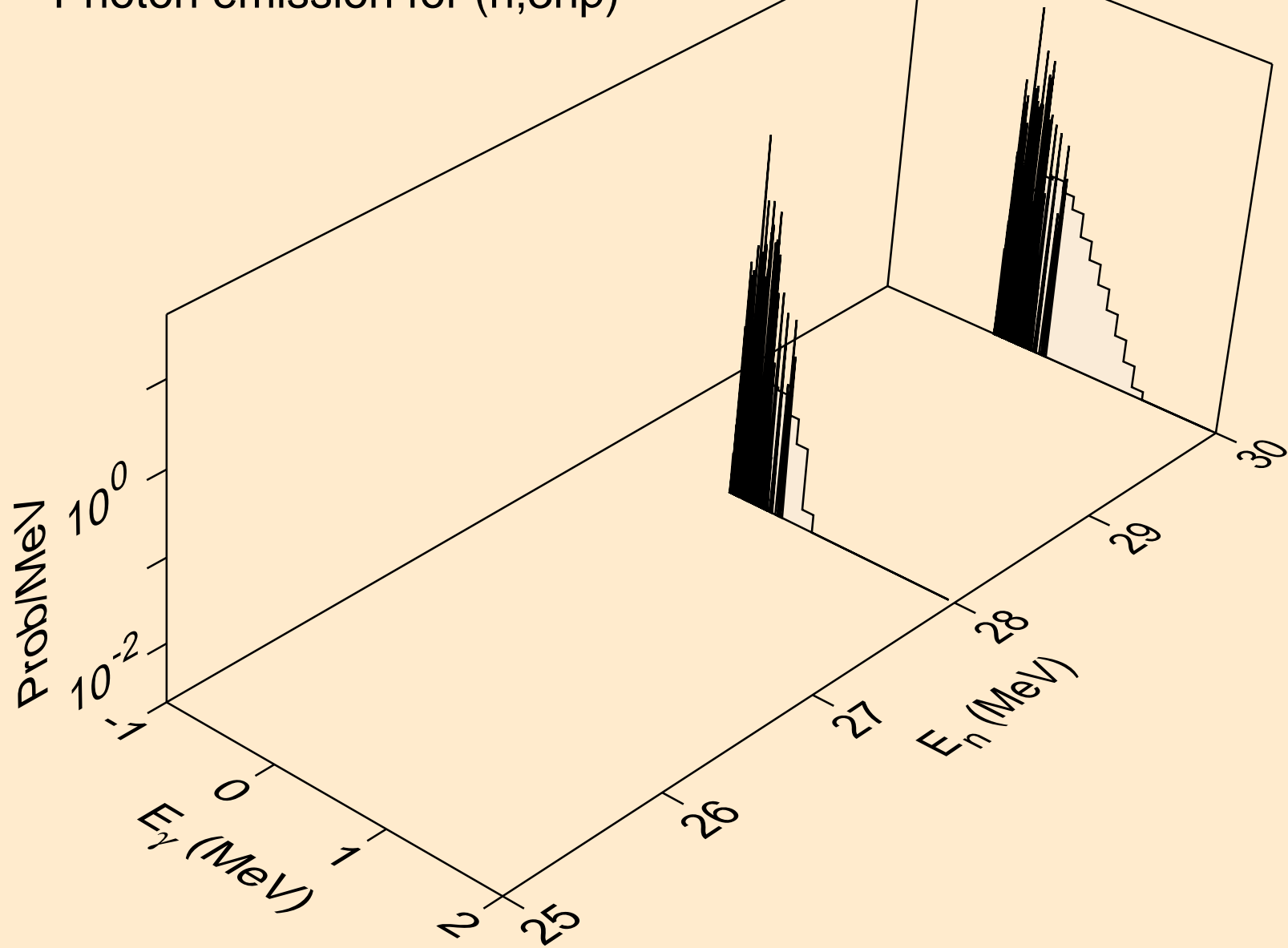

BA123 NEUTRON ACER TENDL-2024 LIBRARY; T=293.6K  
Photon emission for (n,n2p)

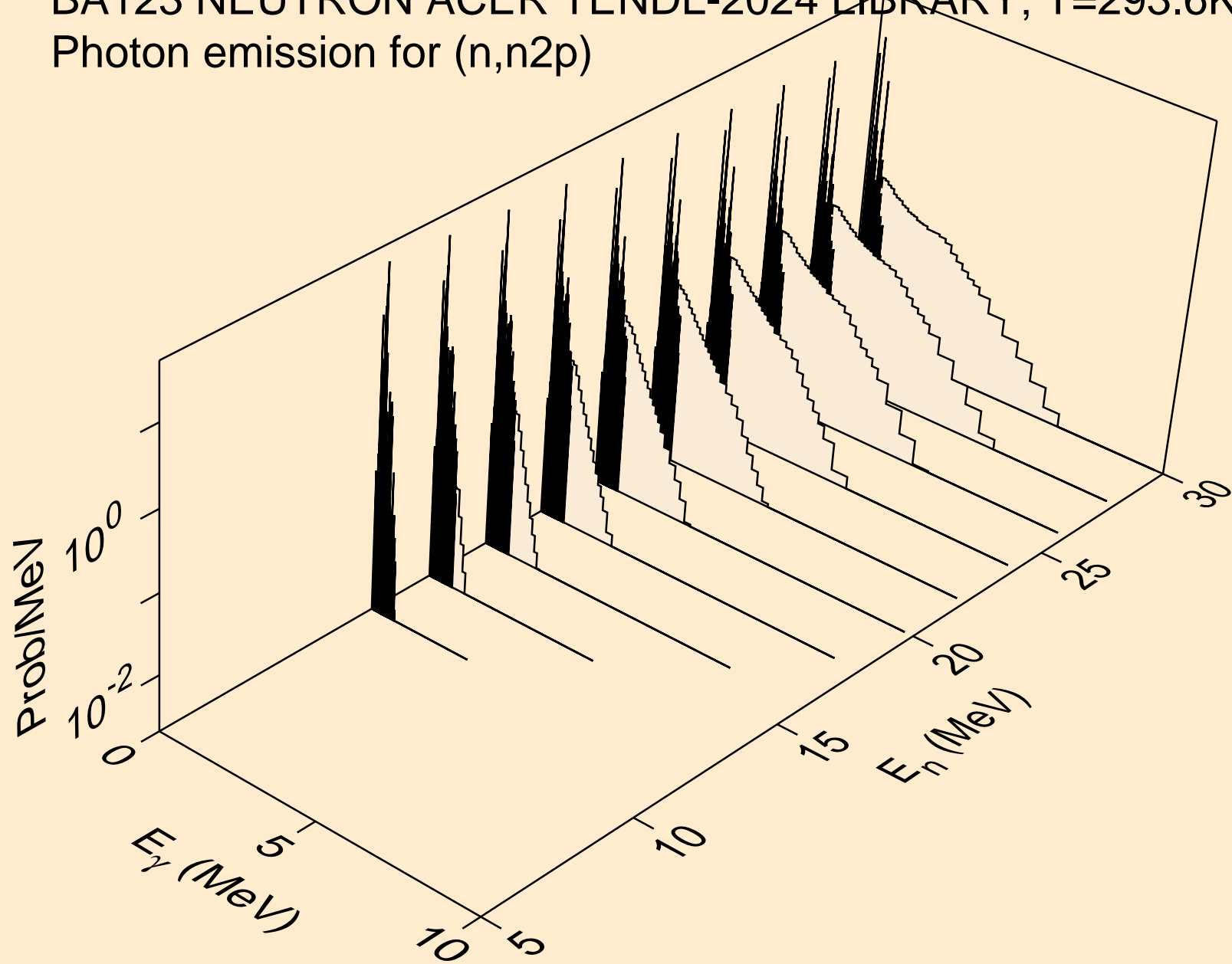

BA123 NEUTRON ACER TENDL-2024 LIBRARY; T=293.6K  
Photon emission for (n,npa)

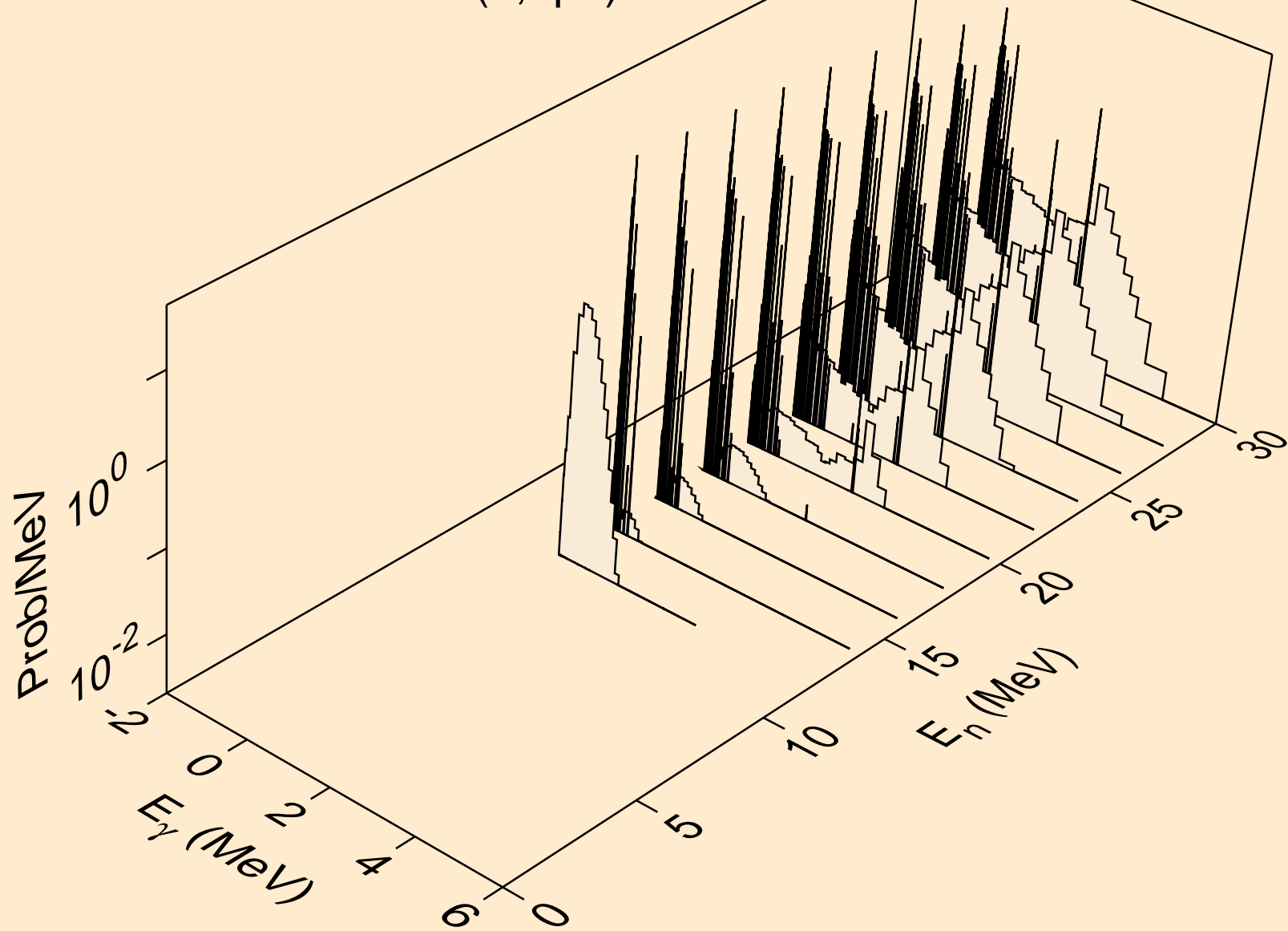

BA123 NEUTRON ACER TENDL-2024 LIBRARY; T=293.6K  
Photon emission for (n,n\*c)

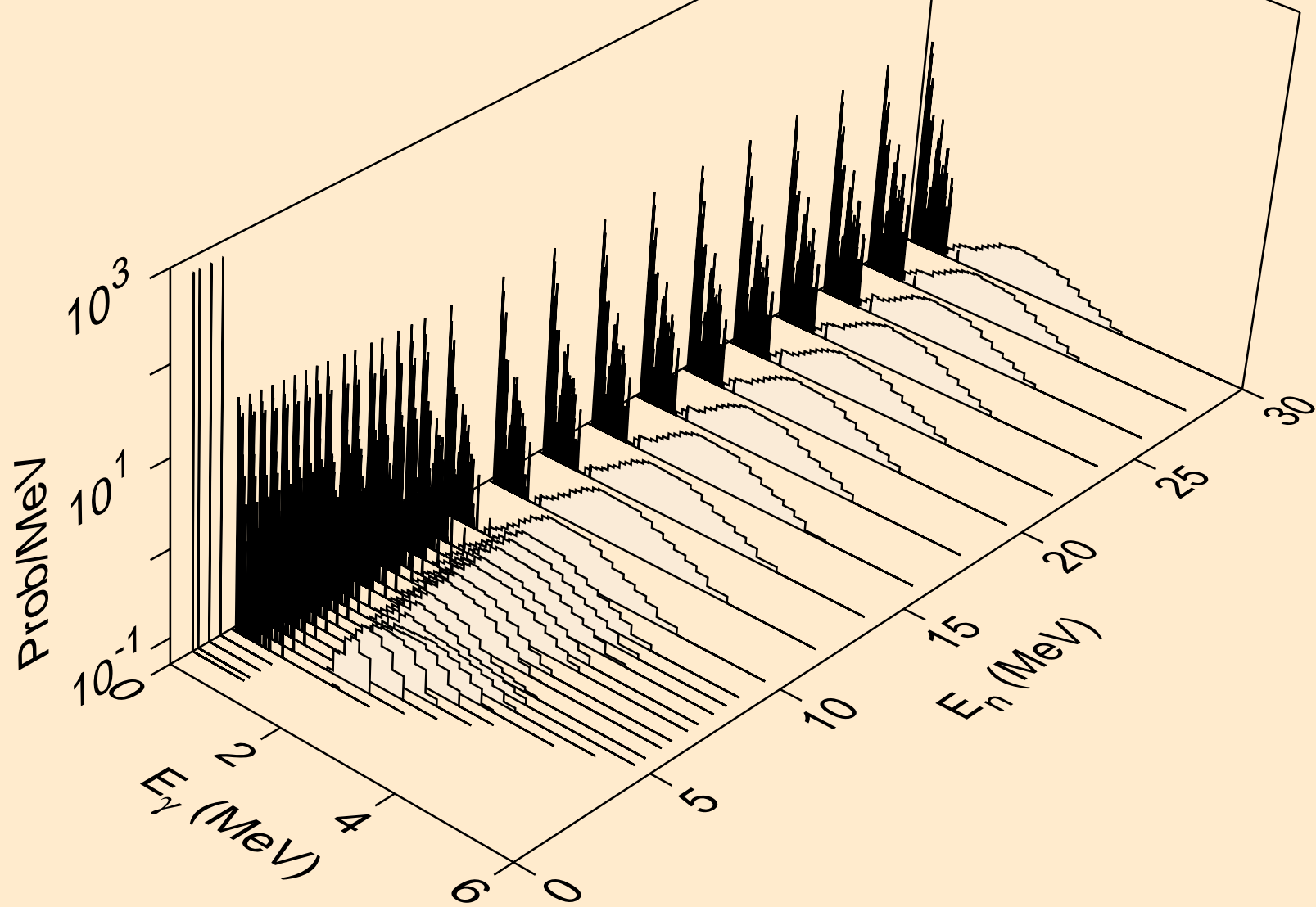

BA123 NEUTRON ACER TENDL-2024 LIBRARY; T=293.6K  
Photon emission for (n,gma)

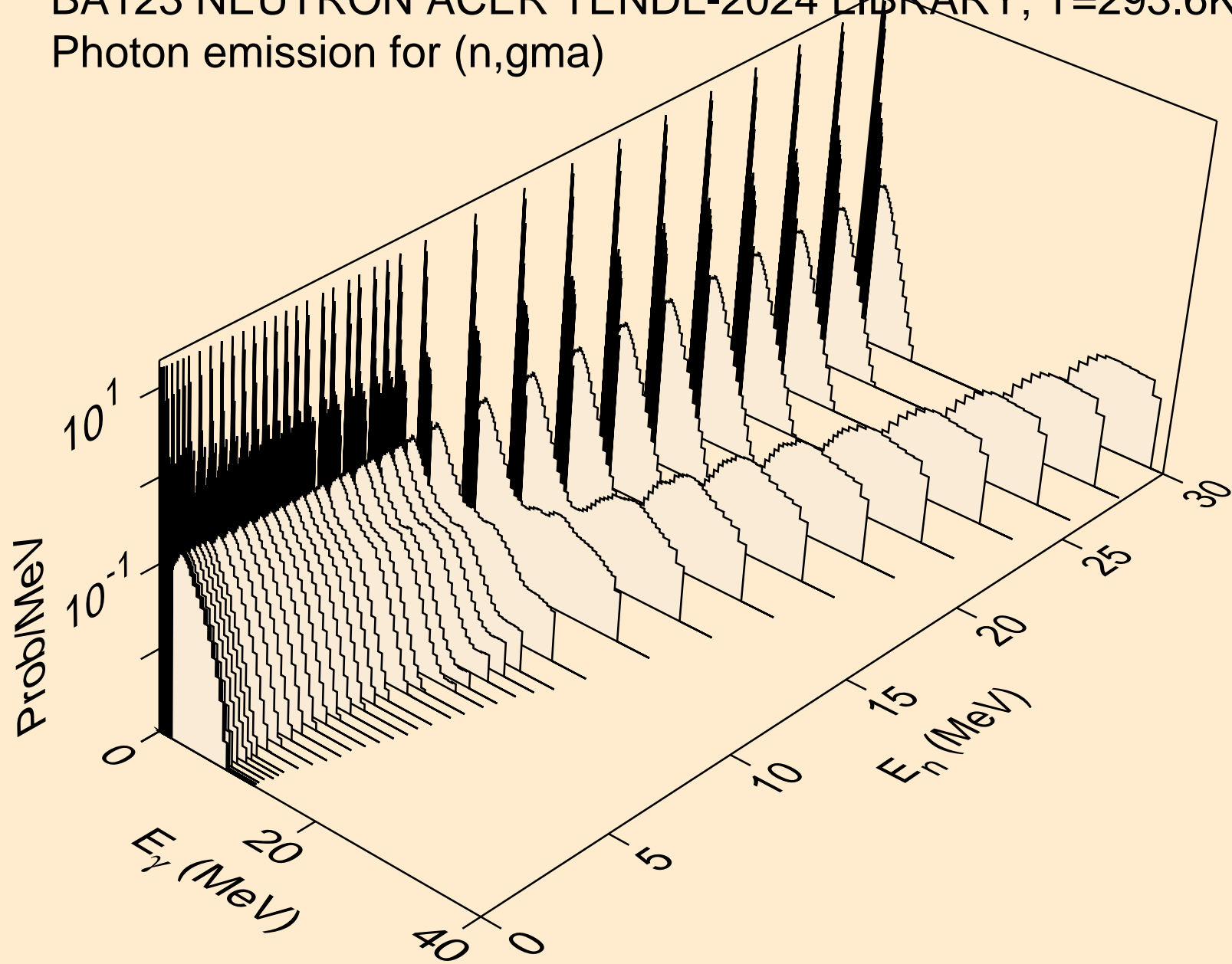

BA123 NEUTRON ACER TENDL-2024 LIBRARY; T=293.6K  
Photon emission for (n,p)

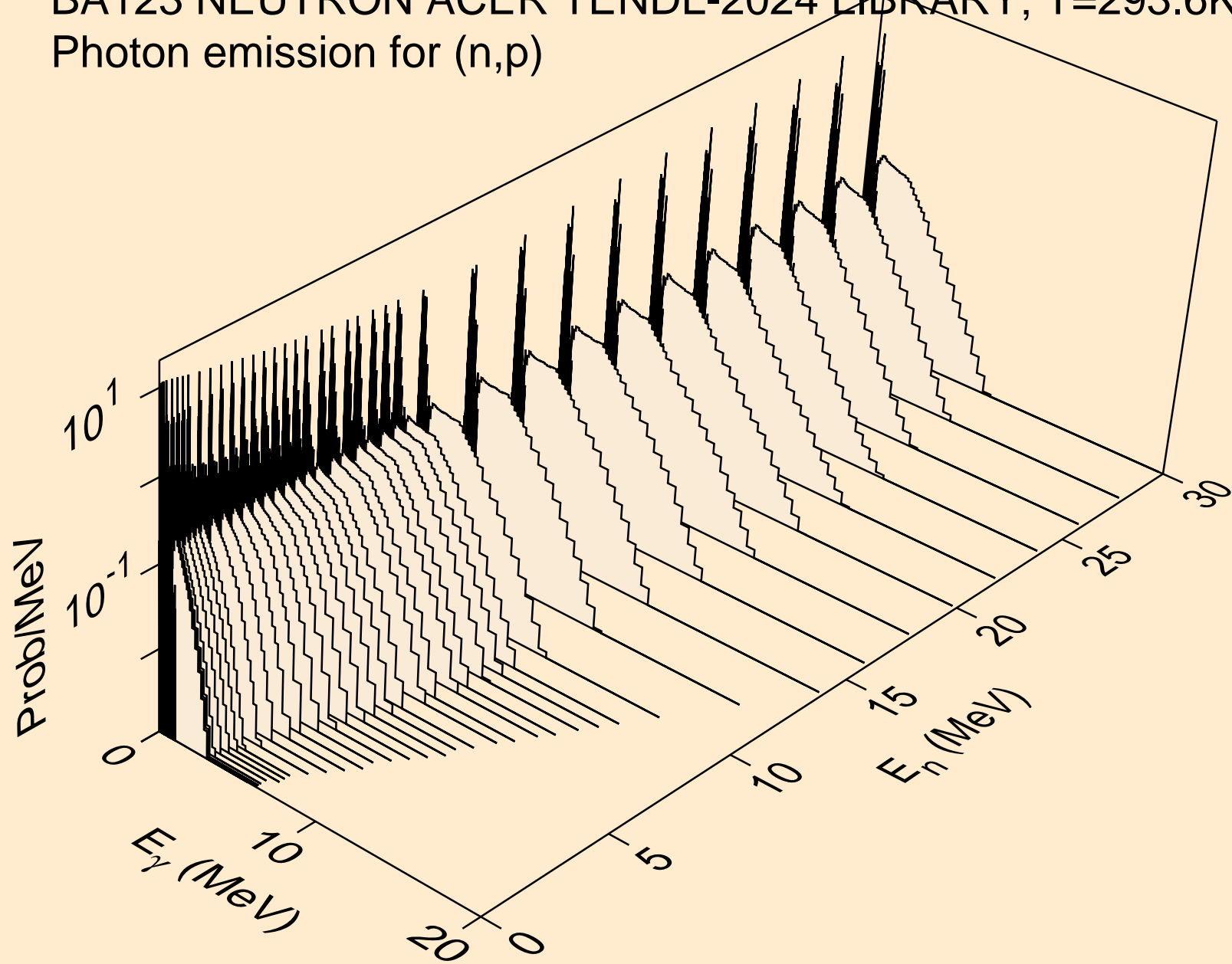

BA123 NEUTRON ACER TENDL-2024 LIBRARY; T=293.6K  
Photon emission for (n,d)

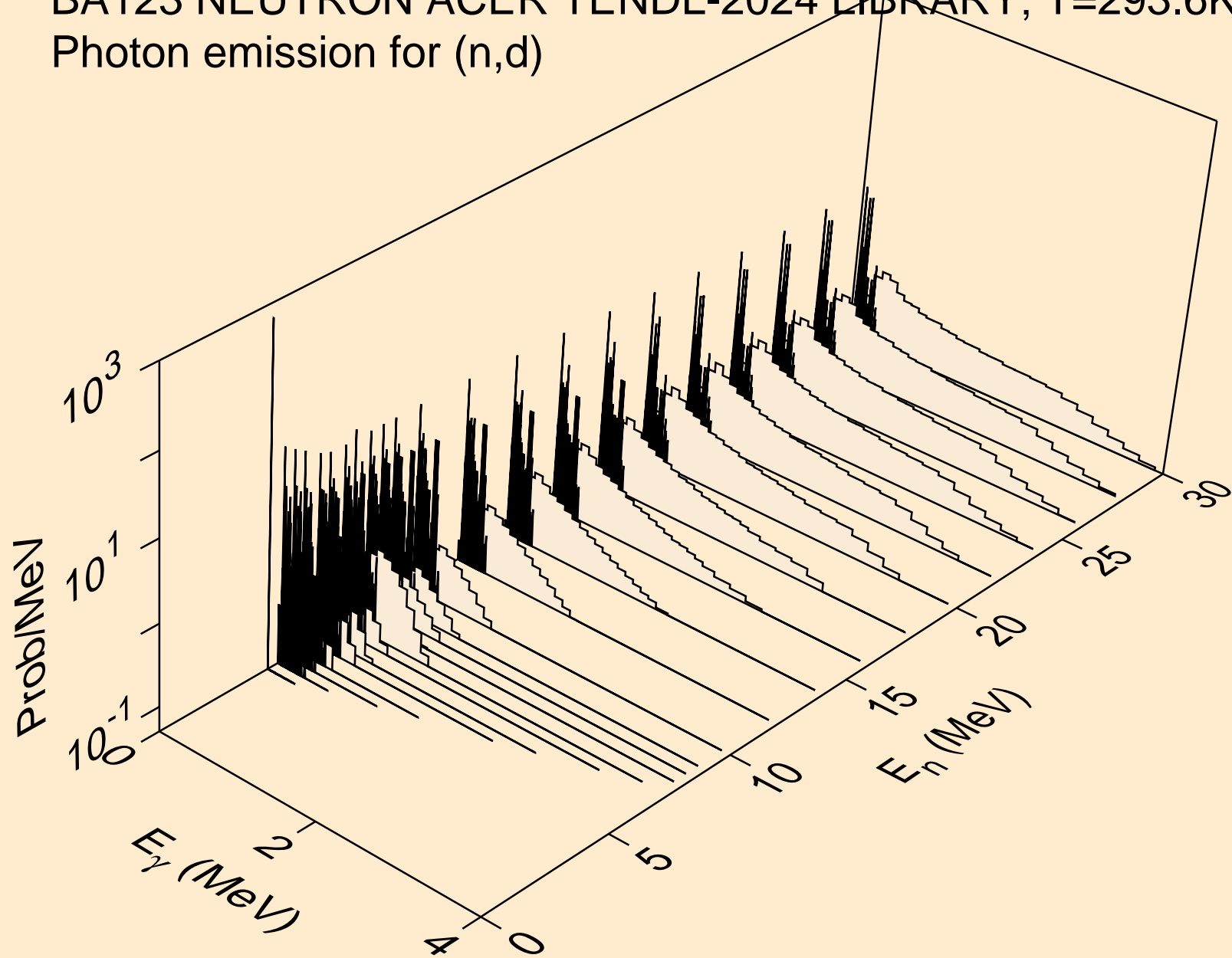

BA123 NEUTRON ACER TENDL-2024 LIBRARY; T=293.6K  
Photon emission for (n,t)

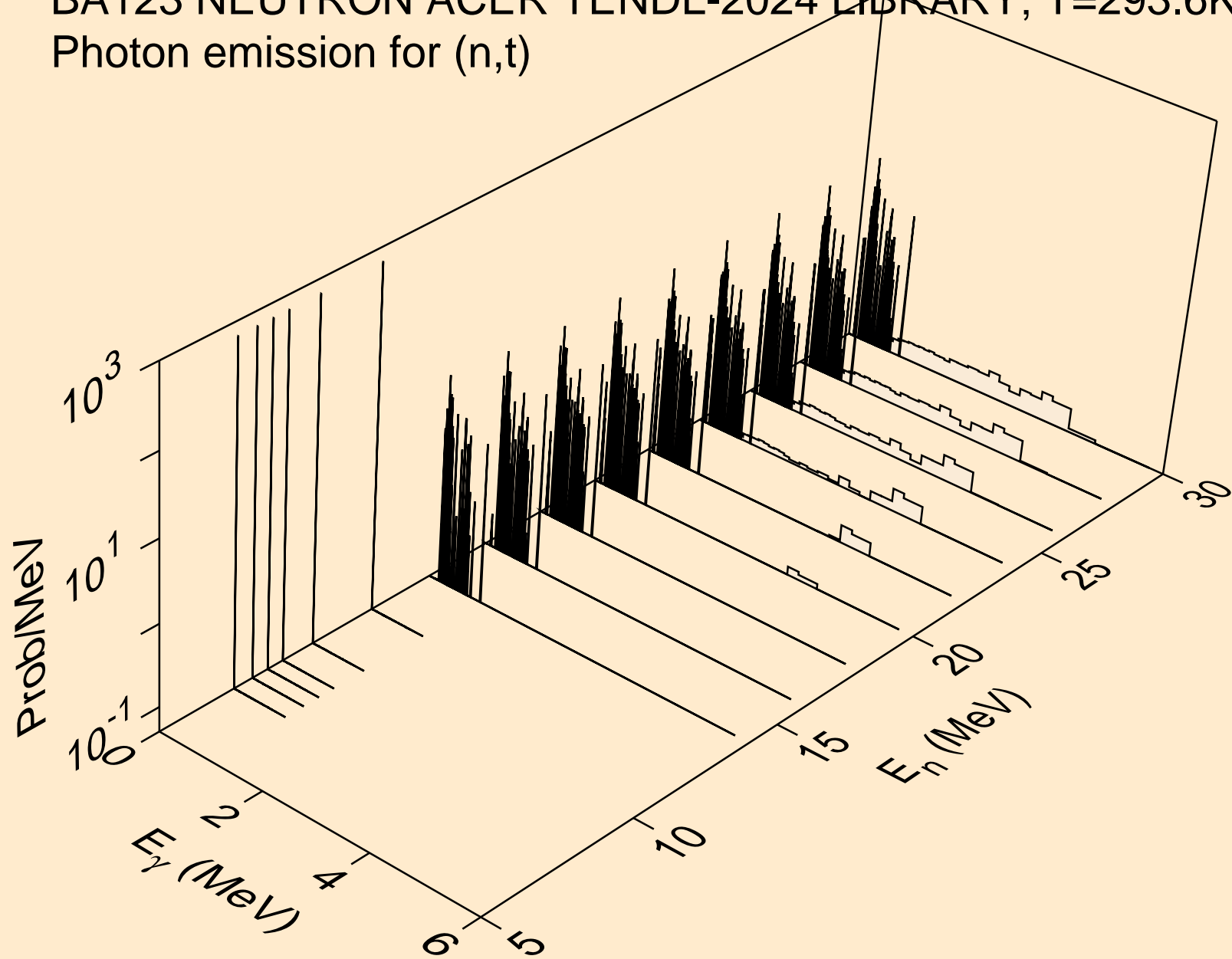

BA123 NEUTRON ACER TENDL-2024 LIBRARY; T=293.6K  
Photon emission for (n,he3)

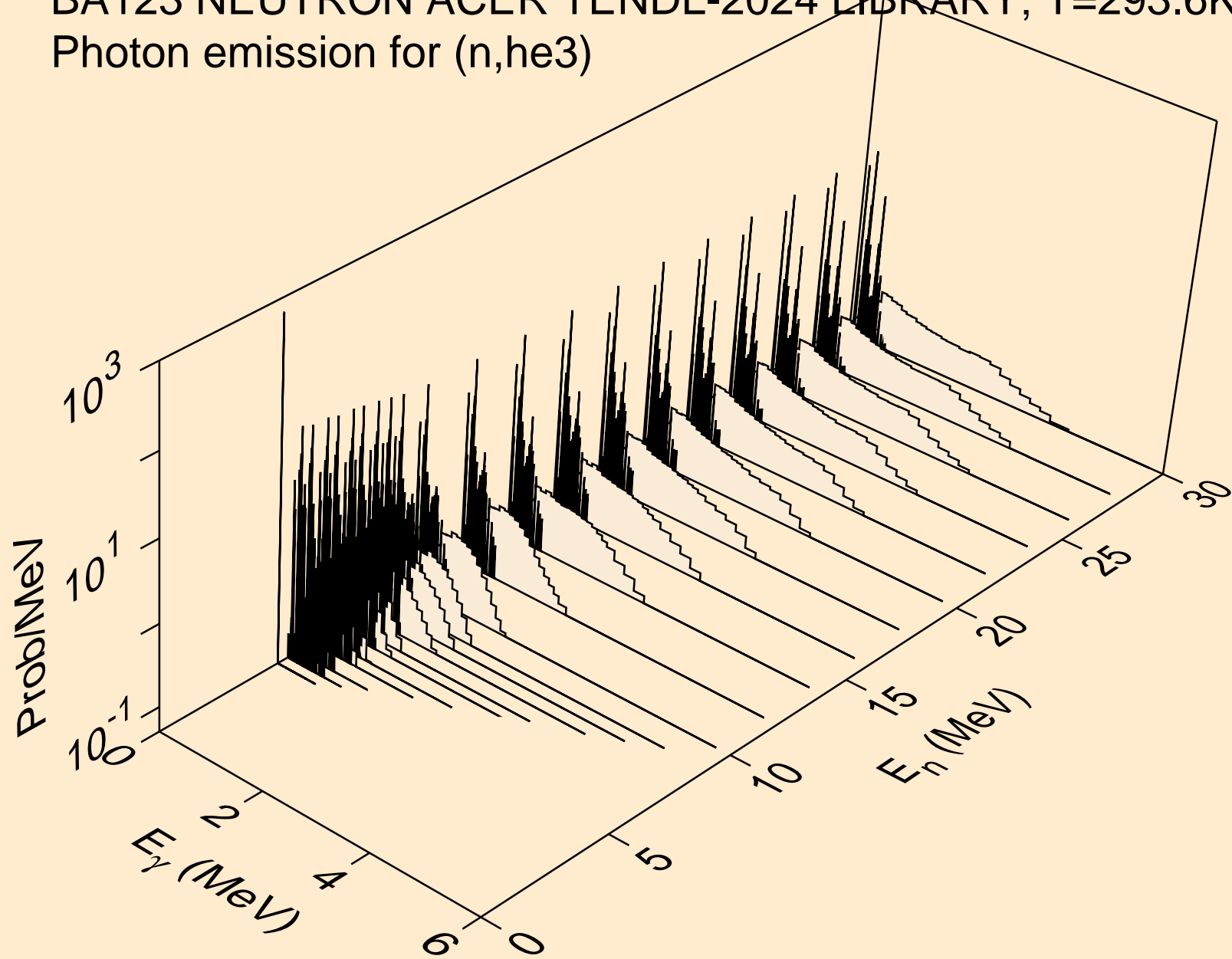

BA123 NEUTRON ACER TENDL-2024 LIBRARY; T=293.6K  
Photon emission for (n,a)

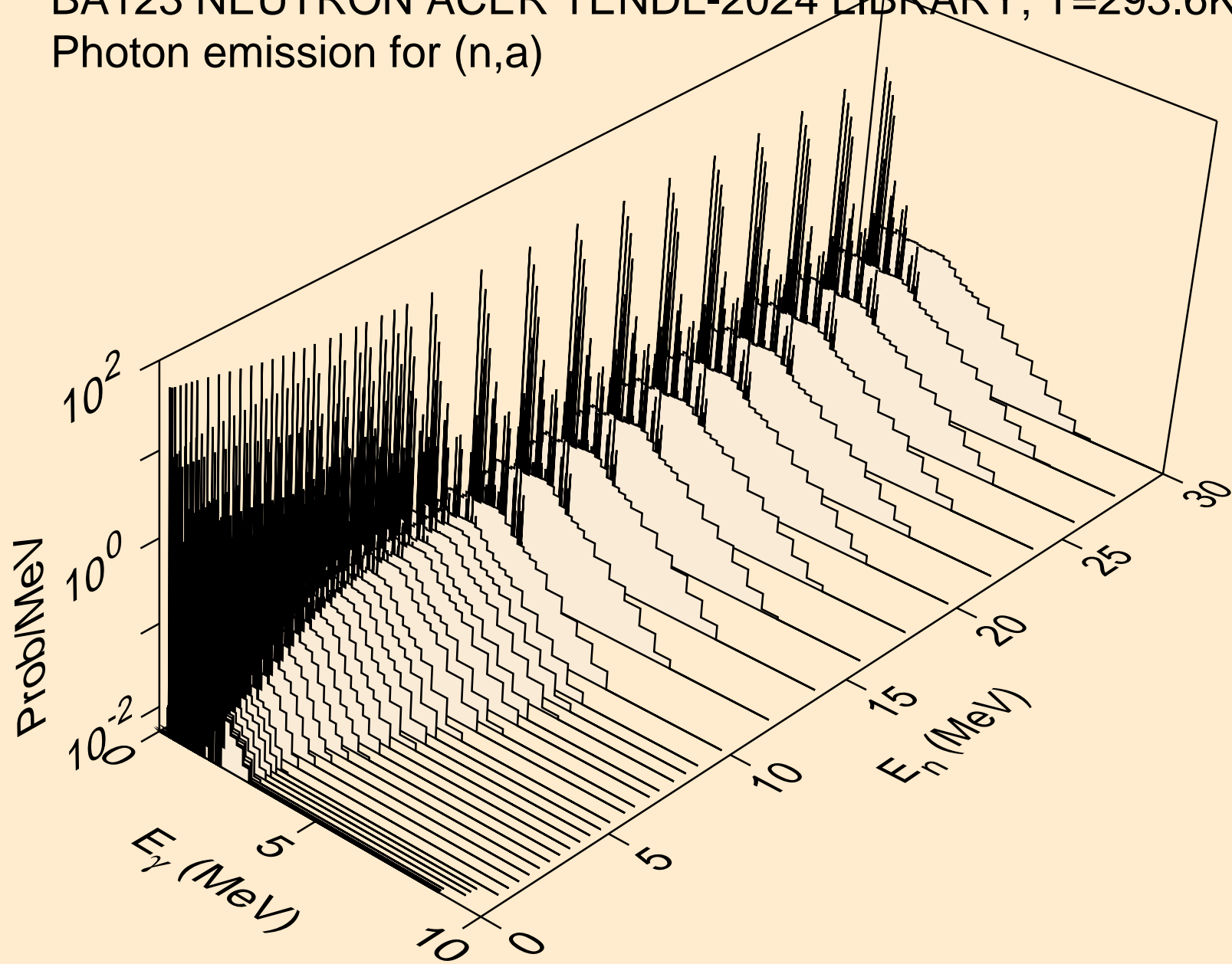

BA123 NEUTRON ACER TENDL-2024 LIBRARY; T=293.6K  
Photon emission for (n,2a)

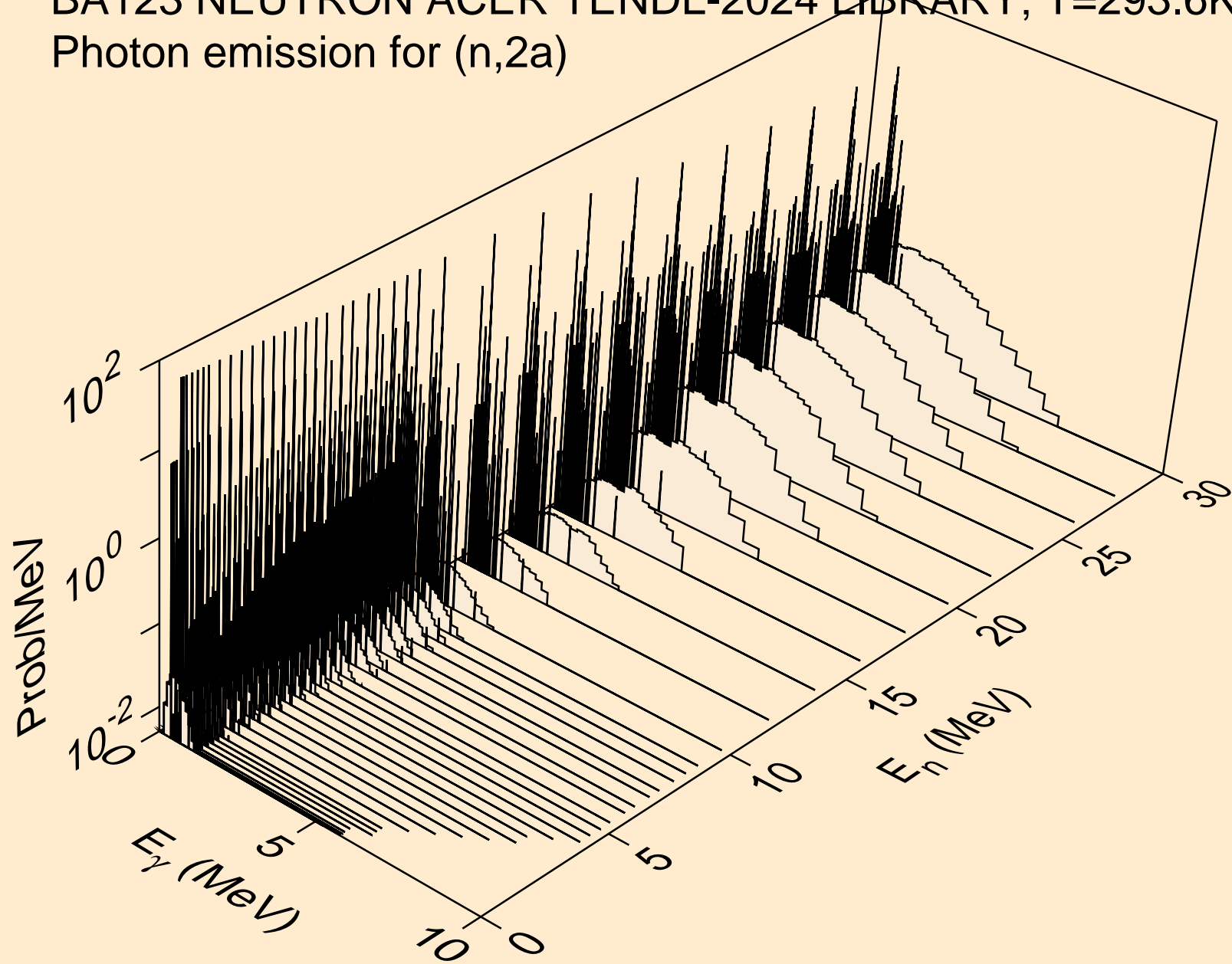

BA123 NEUTRON ACER TENDL-2024 LIBRARY; T=293.6K  
Photon emission for (n,3a)

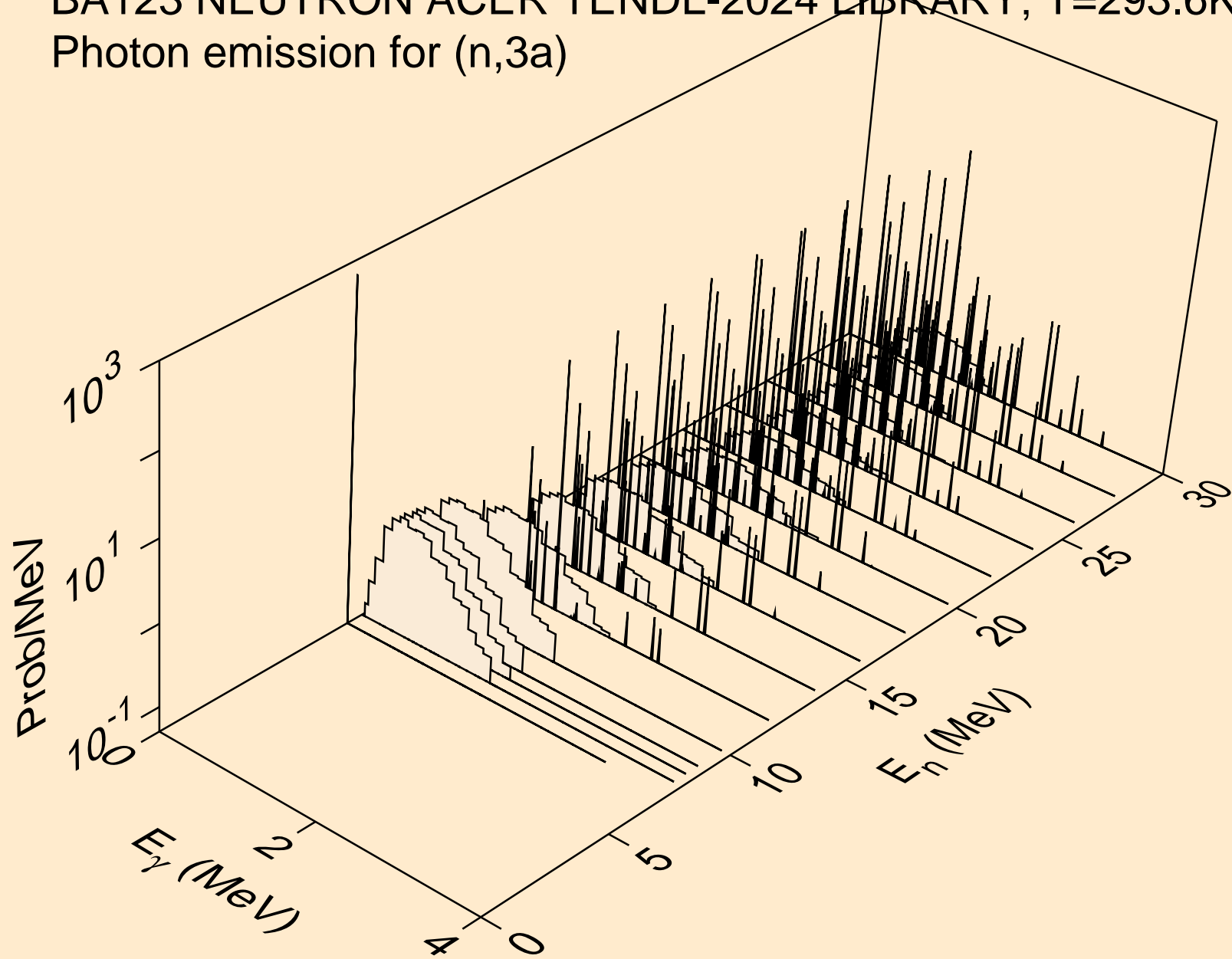

BA123 NEUTRON ACER TENDL-2024 LIBRARY; T=293.6K  
Photon emission for (n,2p)

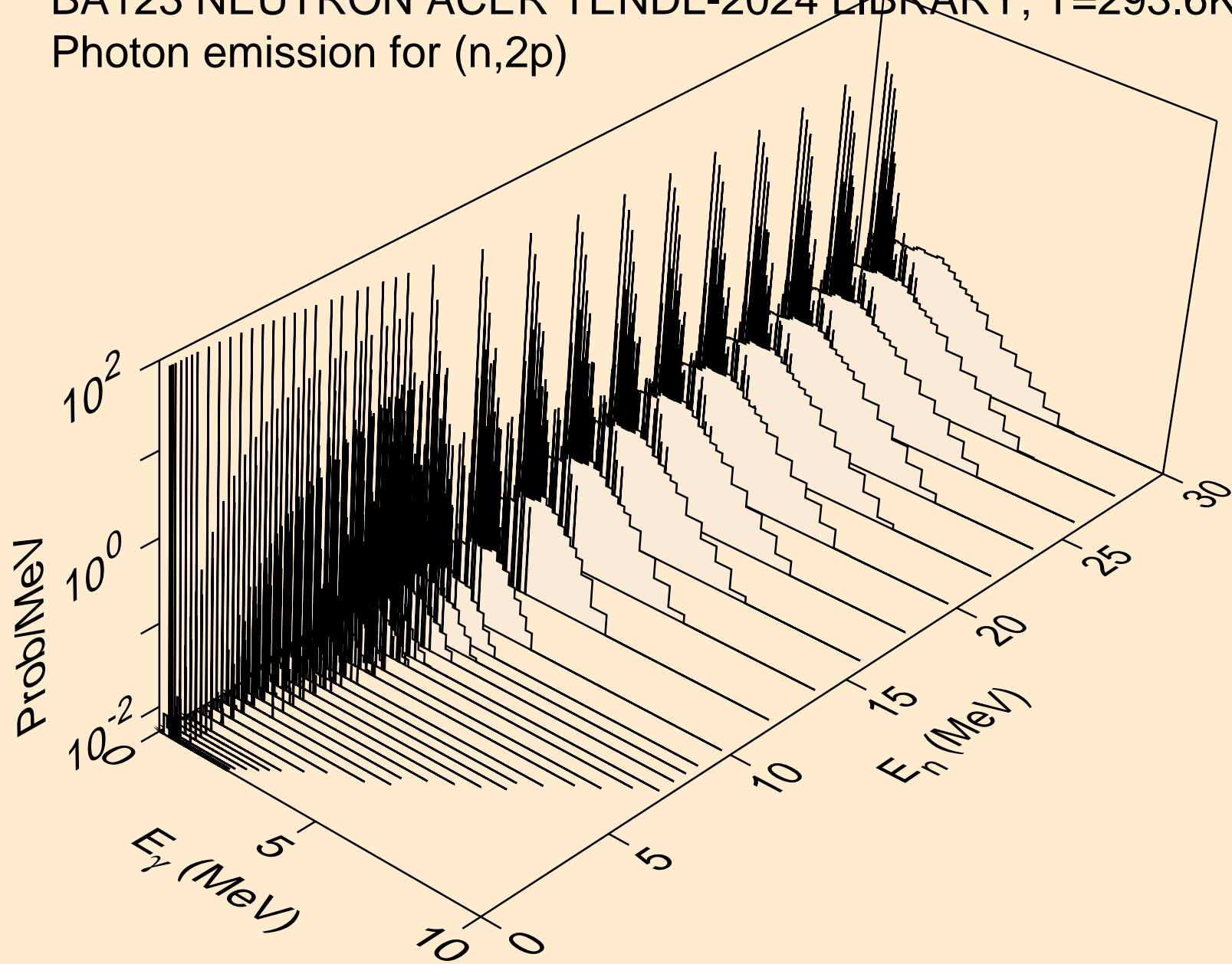

BA123 NEUTRON ACER TENDL-2024 LIBRARY; T=293.6K  
Photon emission for (n,p $\alpha$ )

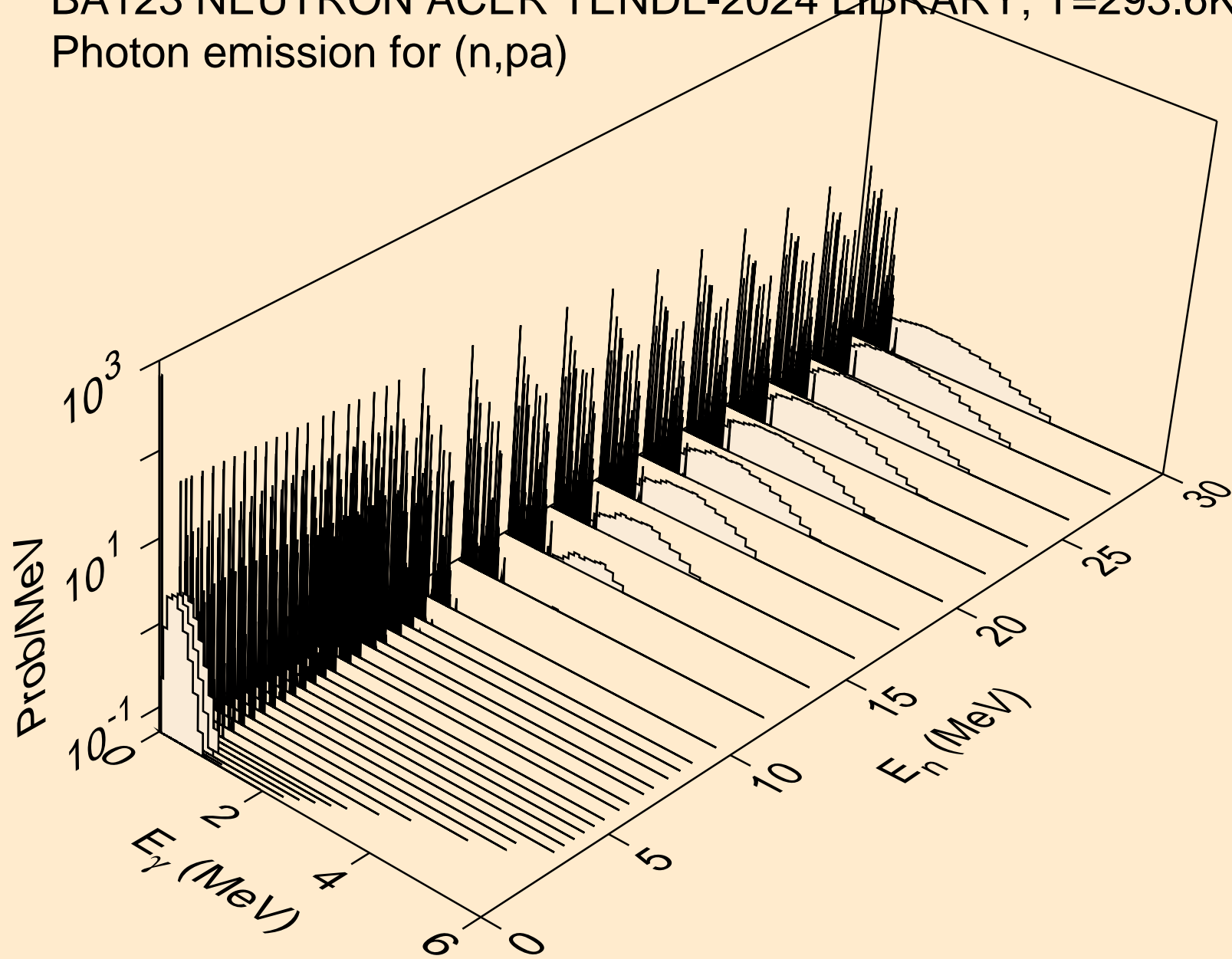

BA123 NEUTRON ACER TENDL-2024 LIBRARY; T=293.6K  
Photon emission for (n,pd)

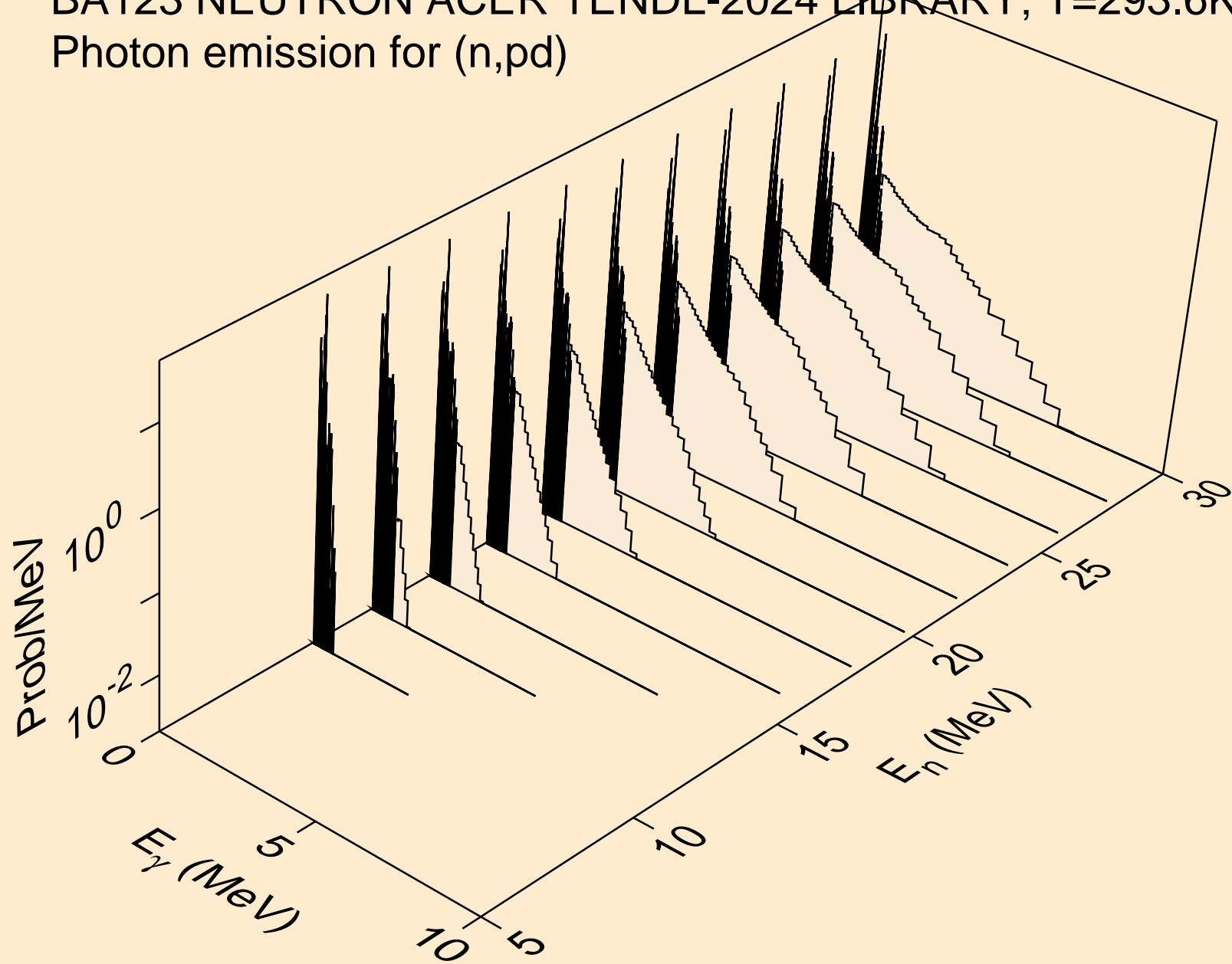

BA123 NEUTRON ACER TENDL-2024 LIBRARY; T=293.6K  
Photon emission for (n,pt)

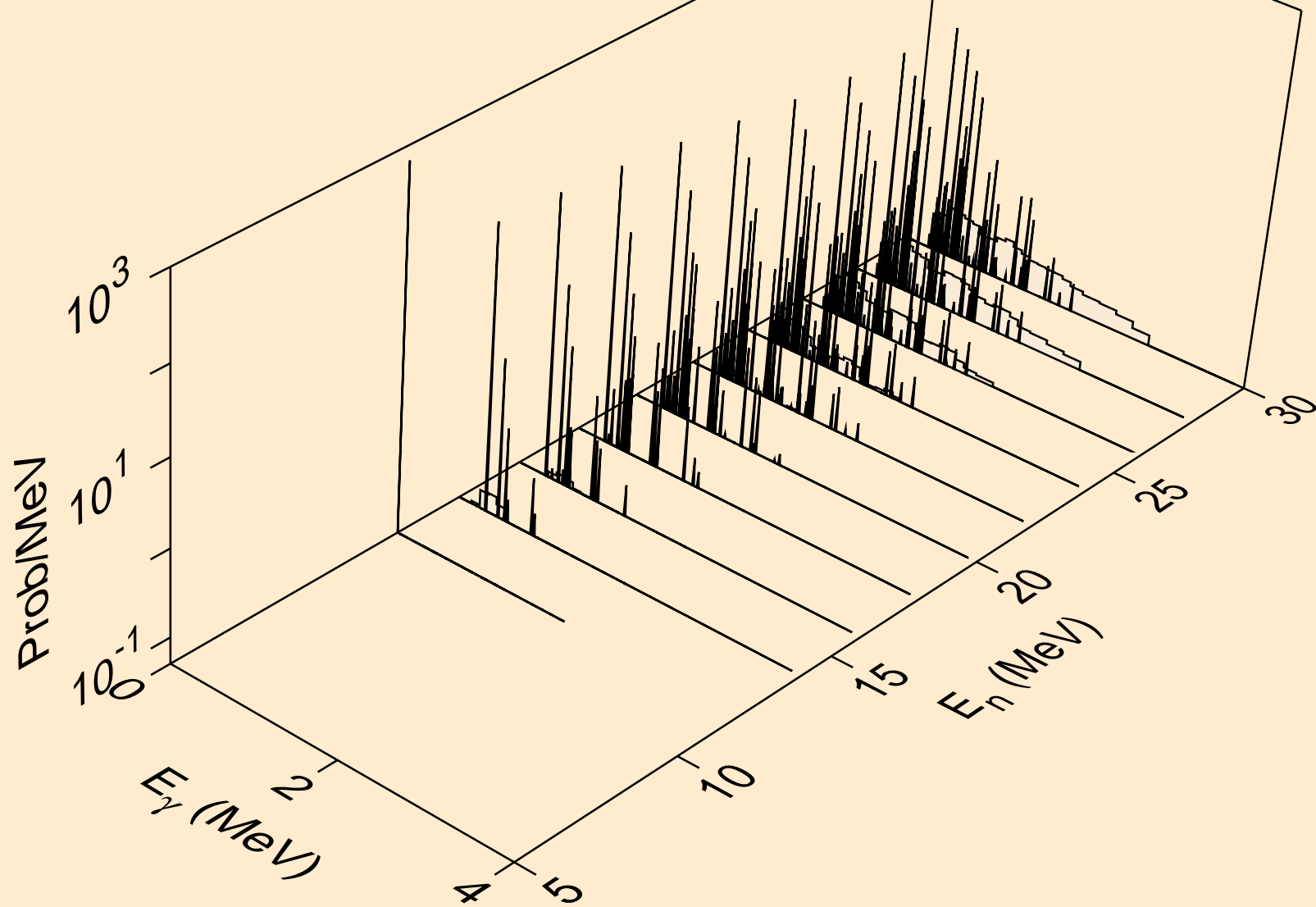

BA123 NEUTRON ACER TENDL-2024 LIBRARY; T=293.6K  
Photon emission for (n,da)

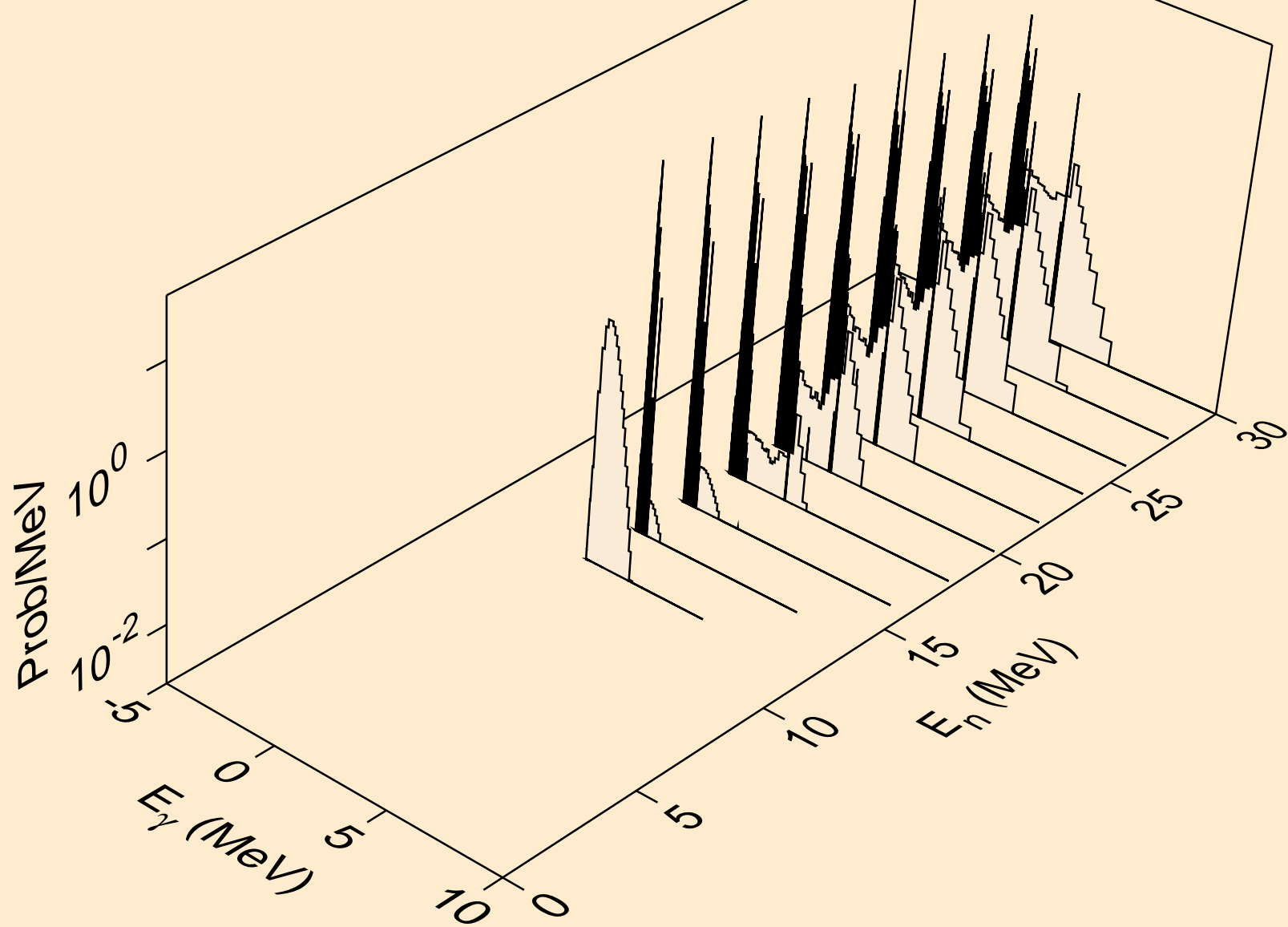

BA123 NEUTRON ACER TENDL-2024 LIBRARY; T=293.6K  
thermal capture photon spectrum

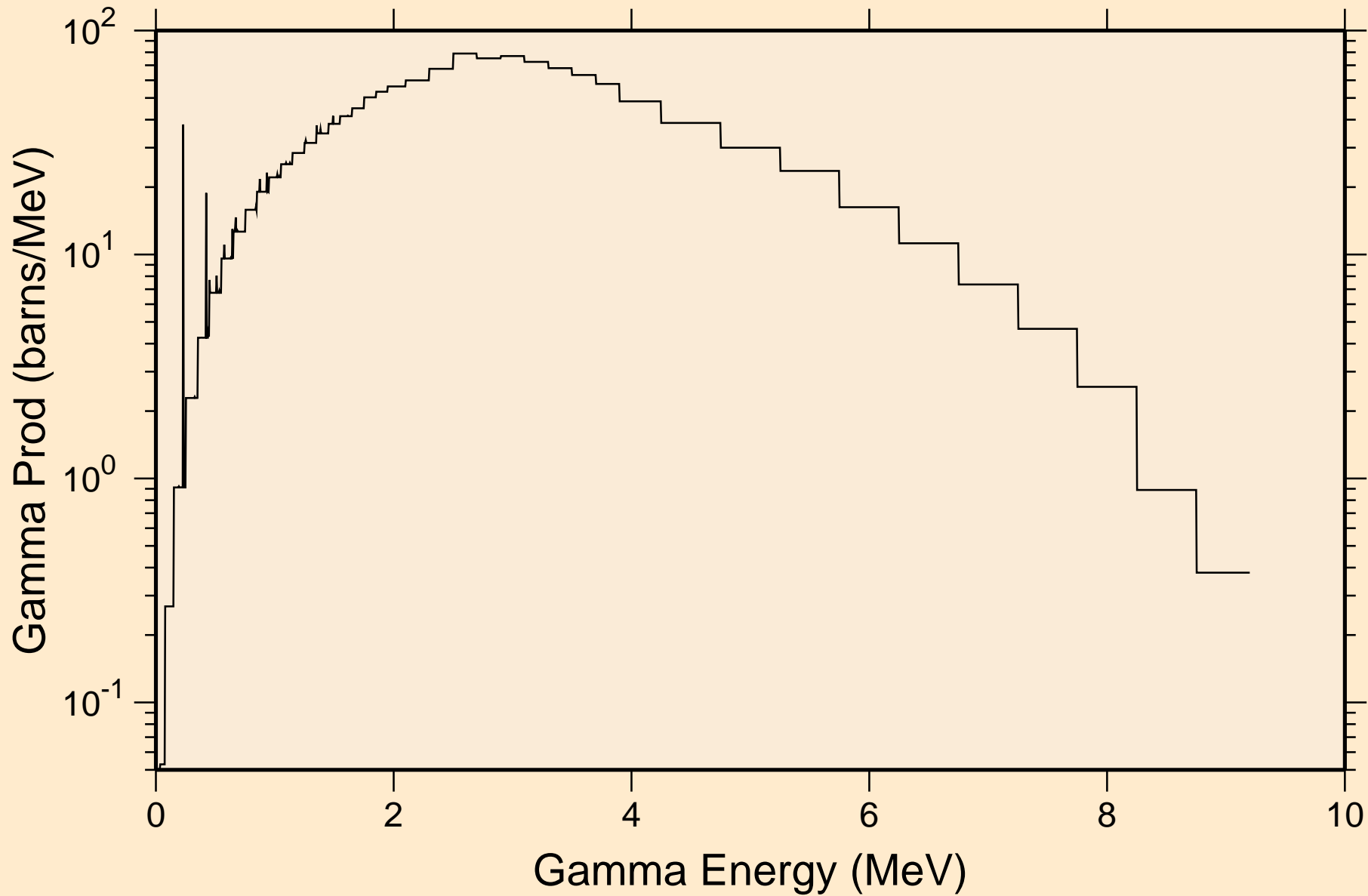

BA123 NEUTRON ACER TENDL-2024 LIBRARY; T=293.6K  
14 MeV photon spectrum

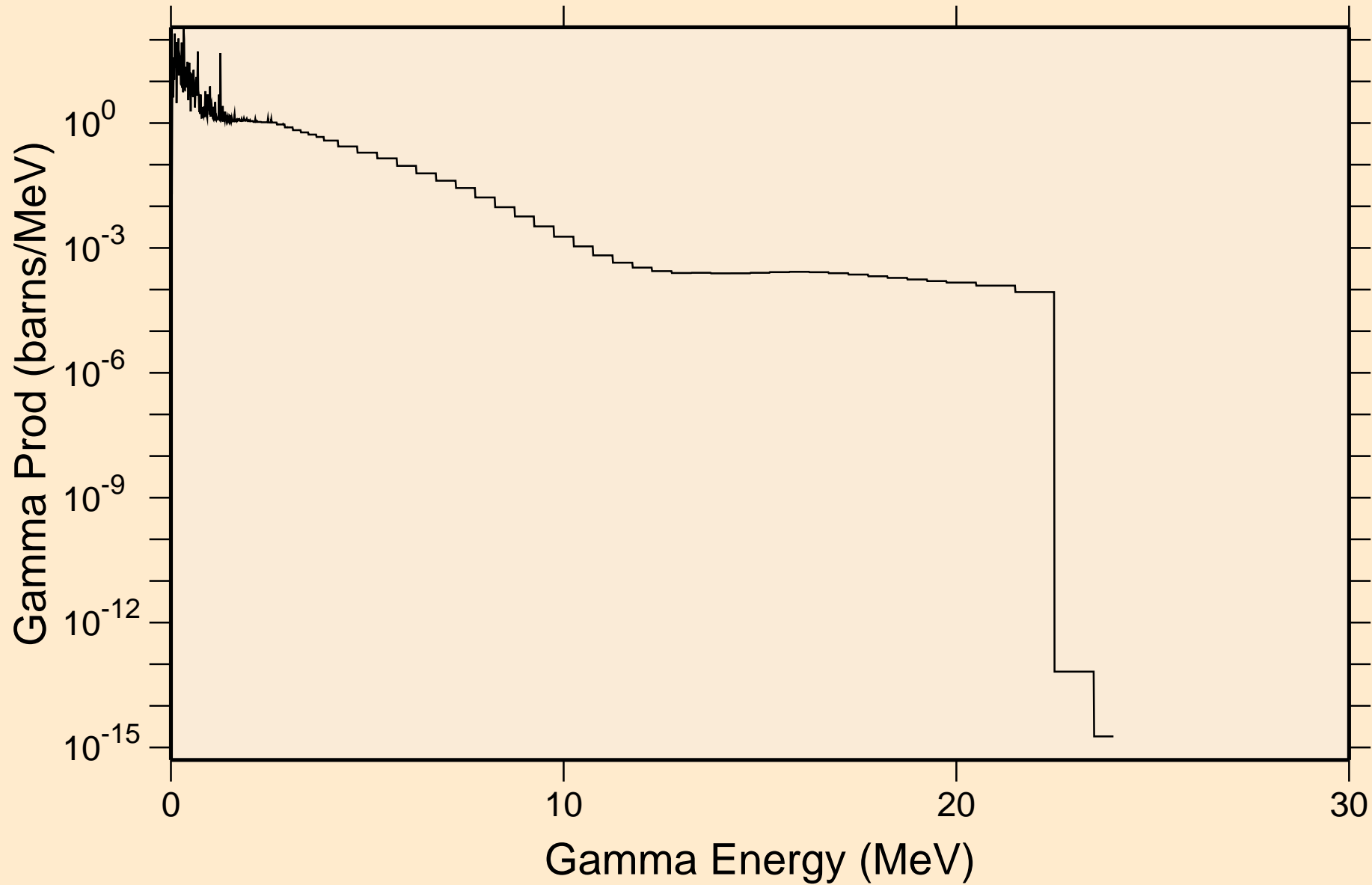

BA123 NEUTRON ACER TENDL-2024 LIBRARY; T=293.6K  
Particle heating contributions

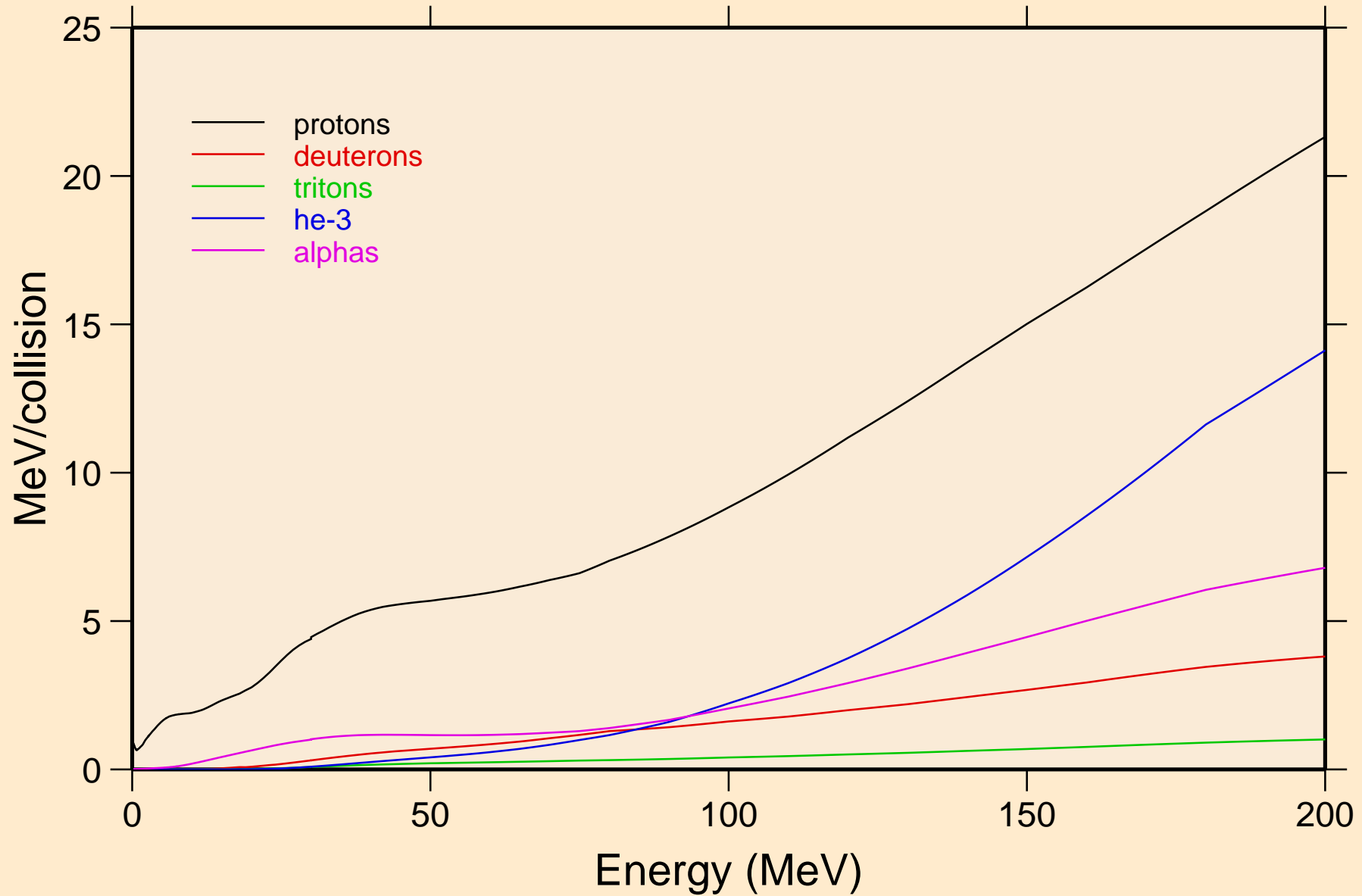

BA123 NEUTRON ACER TENDL-2024 LIBRARY; T=293.6K  
Recoil Heating

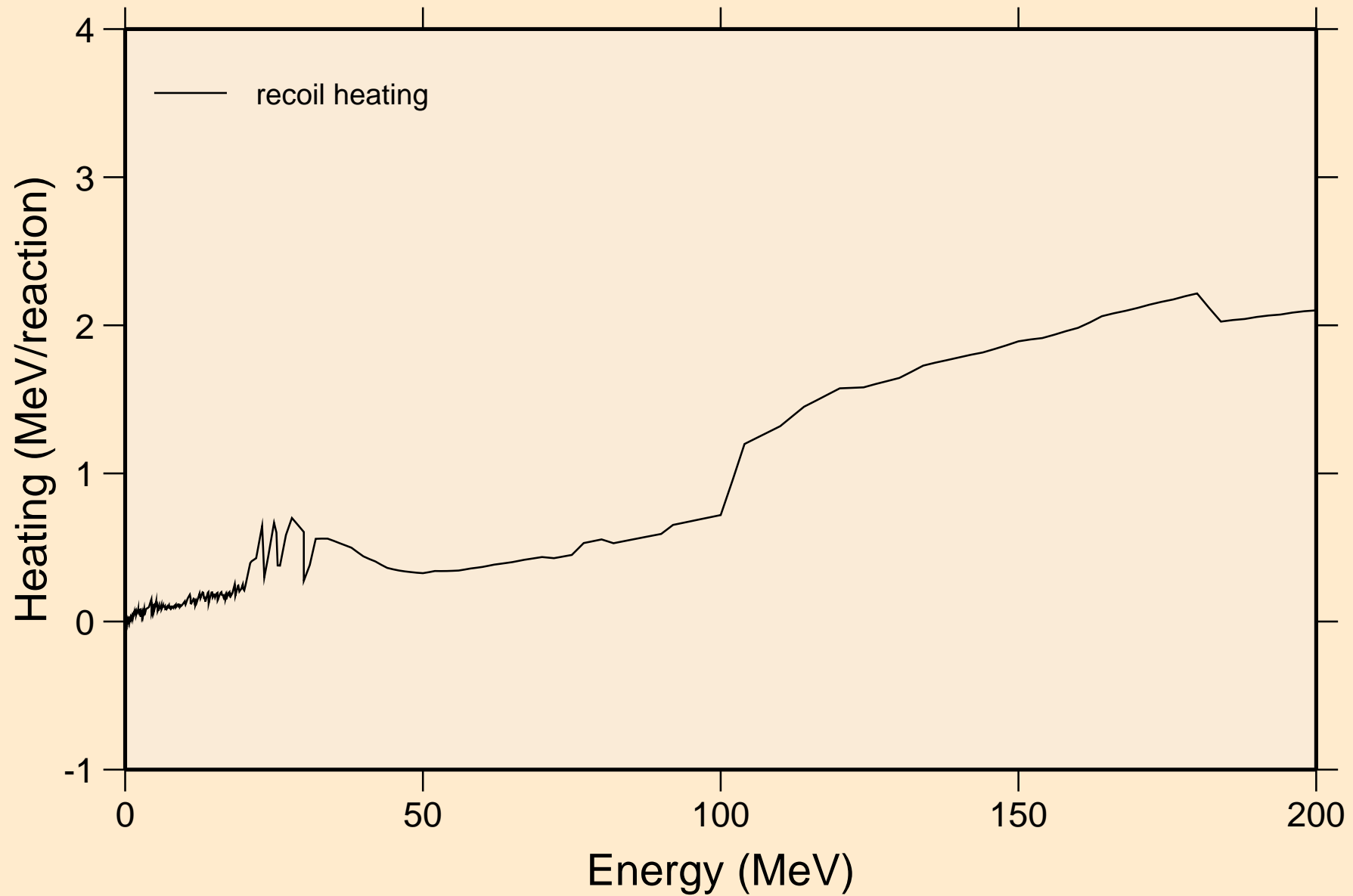

BA123 NEUTRON ACER TENDL-2024 LIBRARY; T=293.6K  
Particle production cross sections

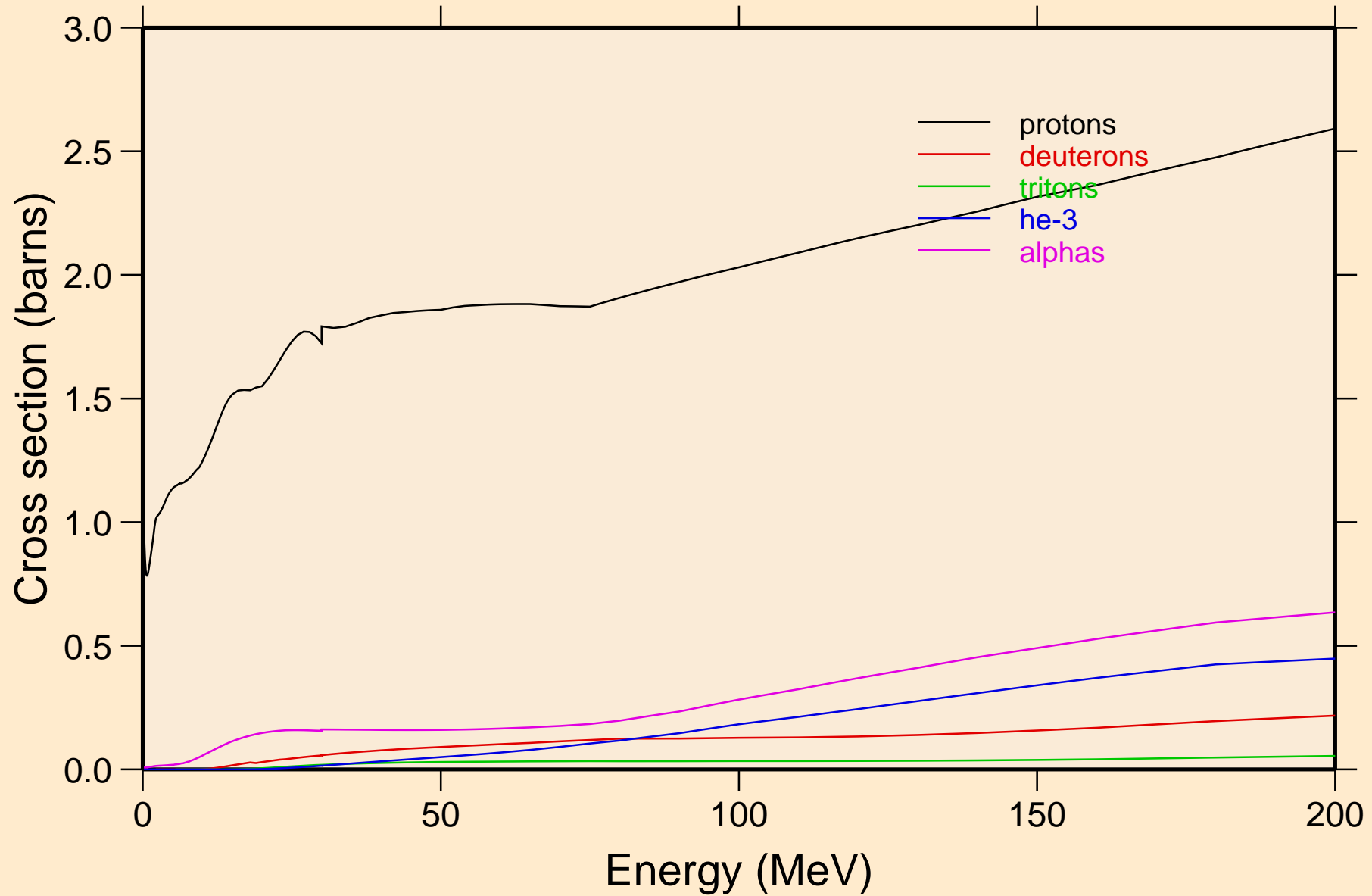

BA123 NEUTRON ACER TENDL-2024 LIBRARY; T=293.6K  
protons from (n,x)

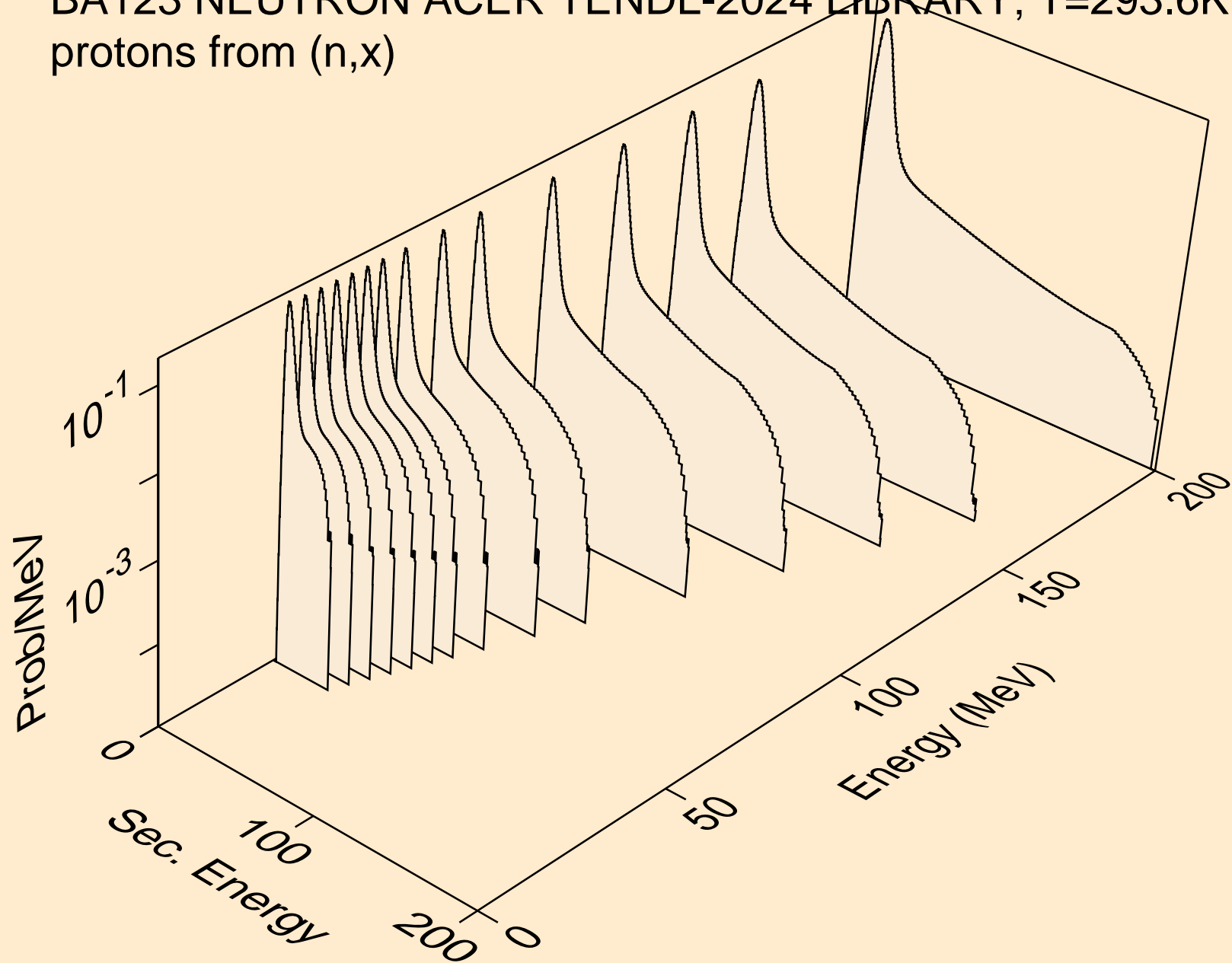

BA123 NEUTRON ACER TENDL-2024 LIBRARY; T=293.6K  
protons from (n,n\*)p

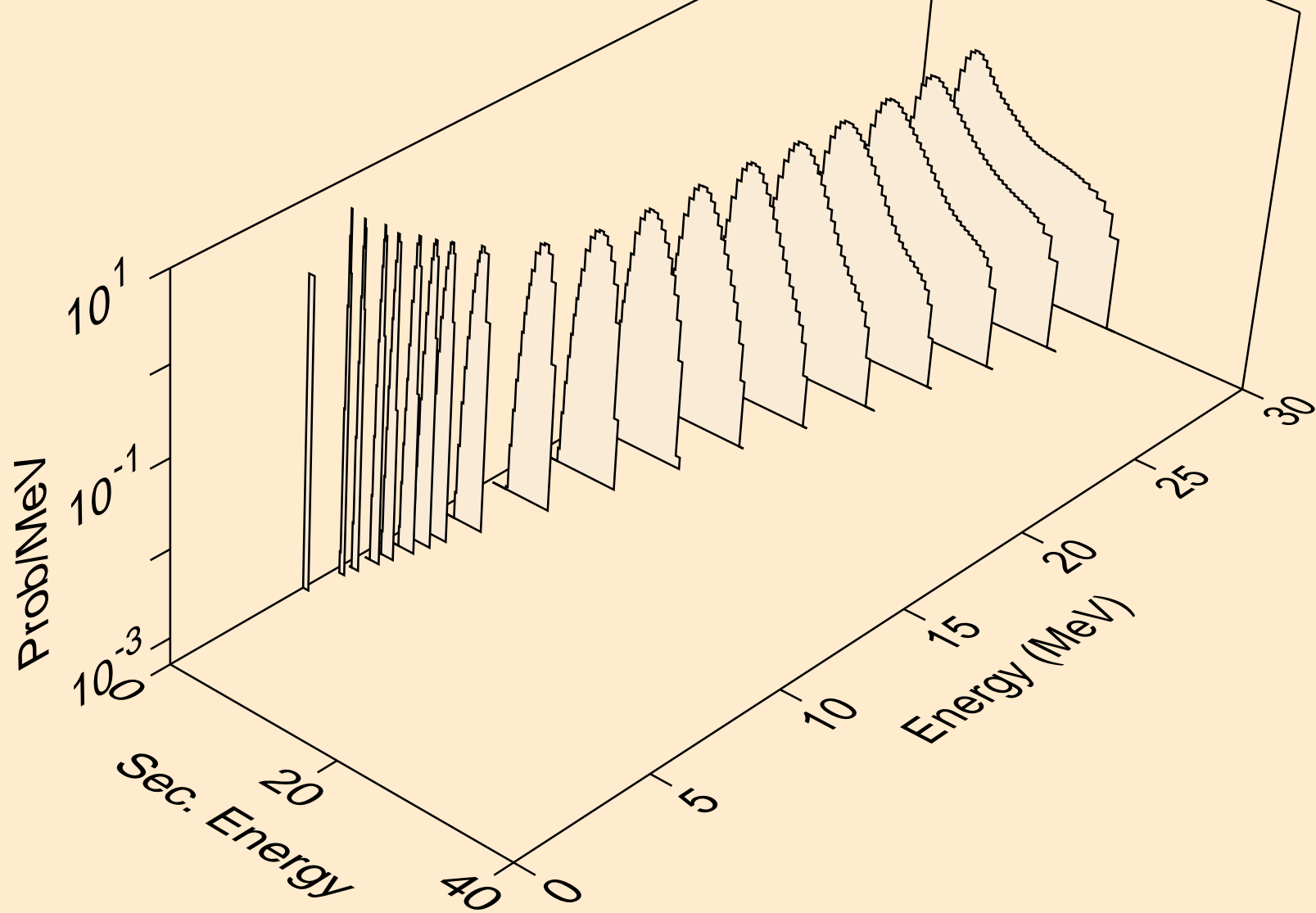

BA123 NEUTRON ACER TENDL-2024 LIBRARY; T=293.6K  
protons from (n,2np)

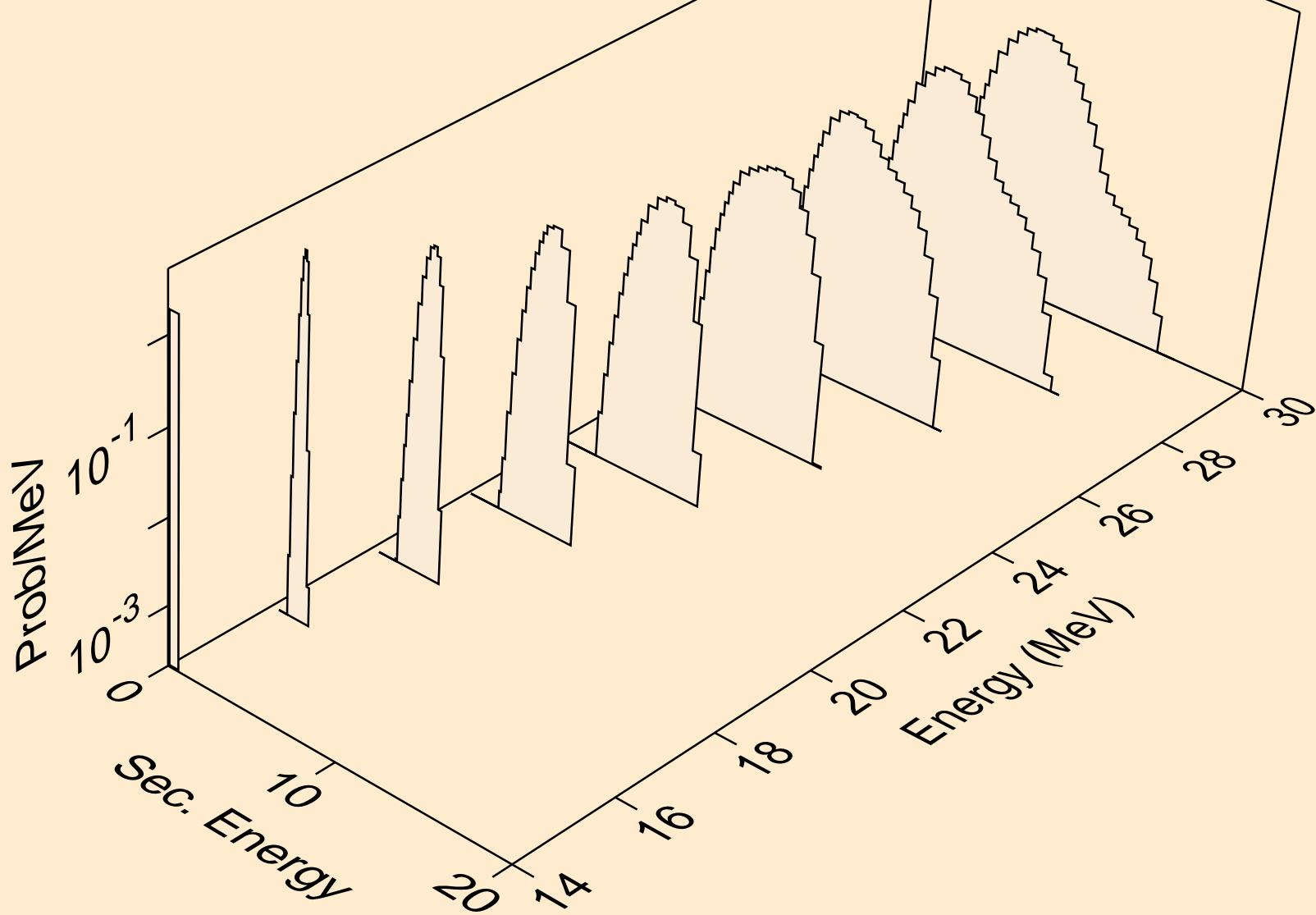

BA123 NEUTRON ACER TENDL-2024 LIBRARY; T=293.6K  
protons from (n,3np)

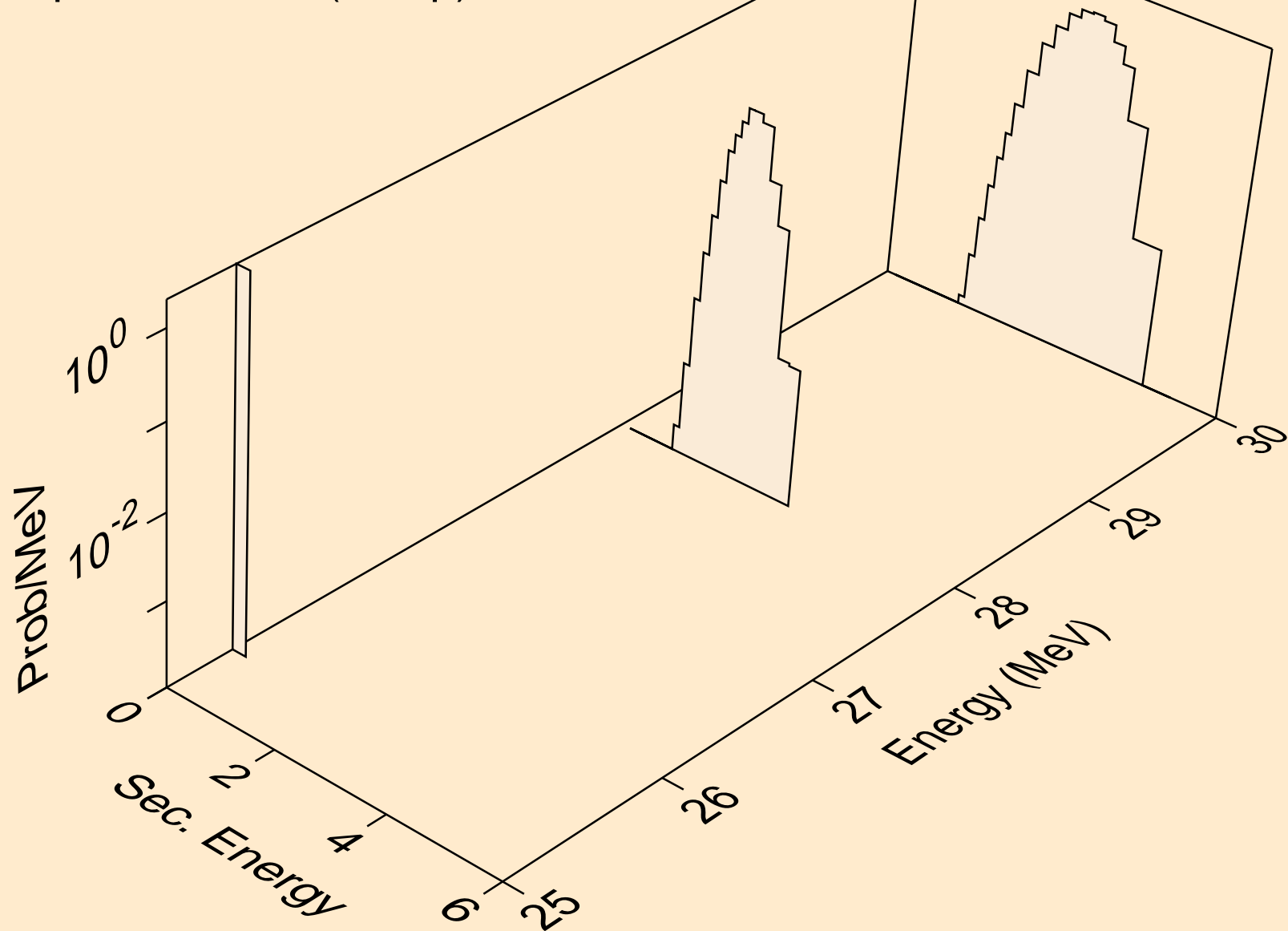

BA123 NEUTRON ACER TENDL-2024 LIBRARY; T=293.6K  
protons from (n,n2p)

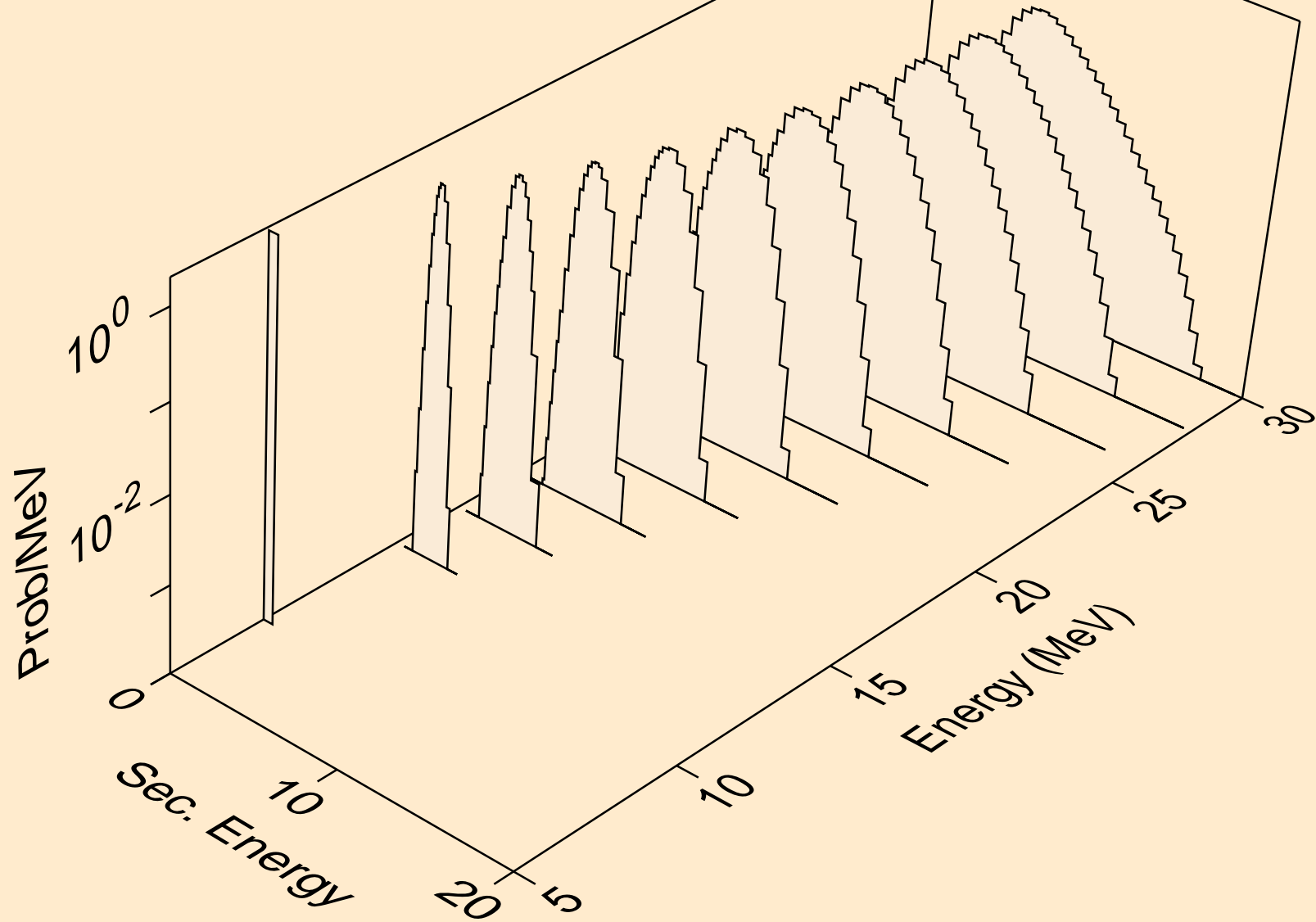

BA123 NEUTRON ACER TENDL-2024 LIBRARY; T=293.6K  
protons from (n,npa)

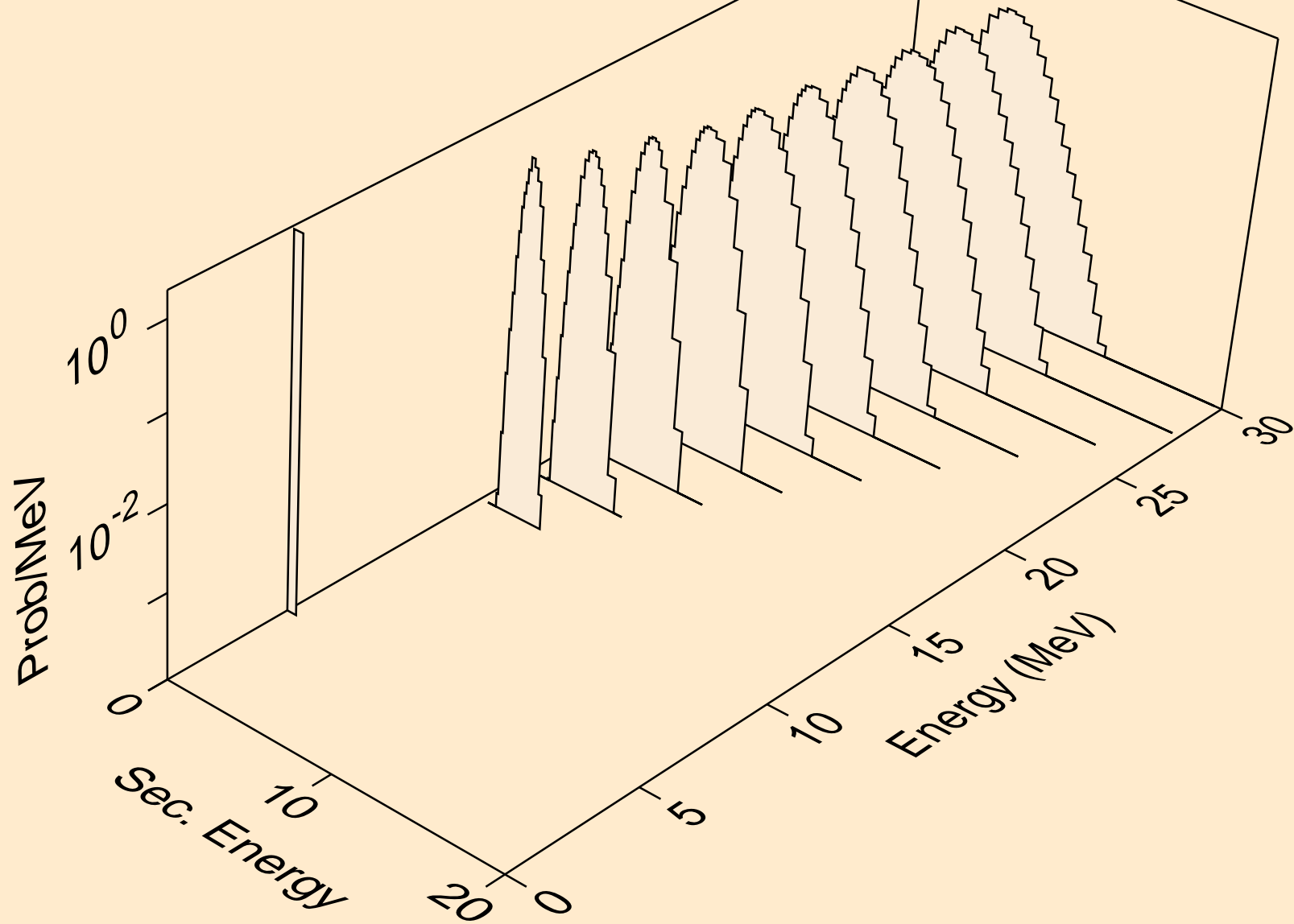

BA123 NEUTRON ACER TENDL-2024 LIBRARY; T=293.6K  
protons from (n,p)

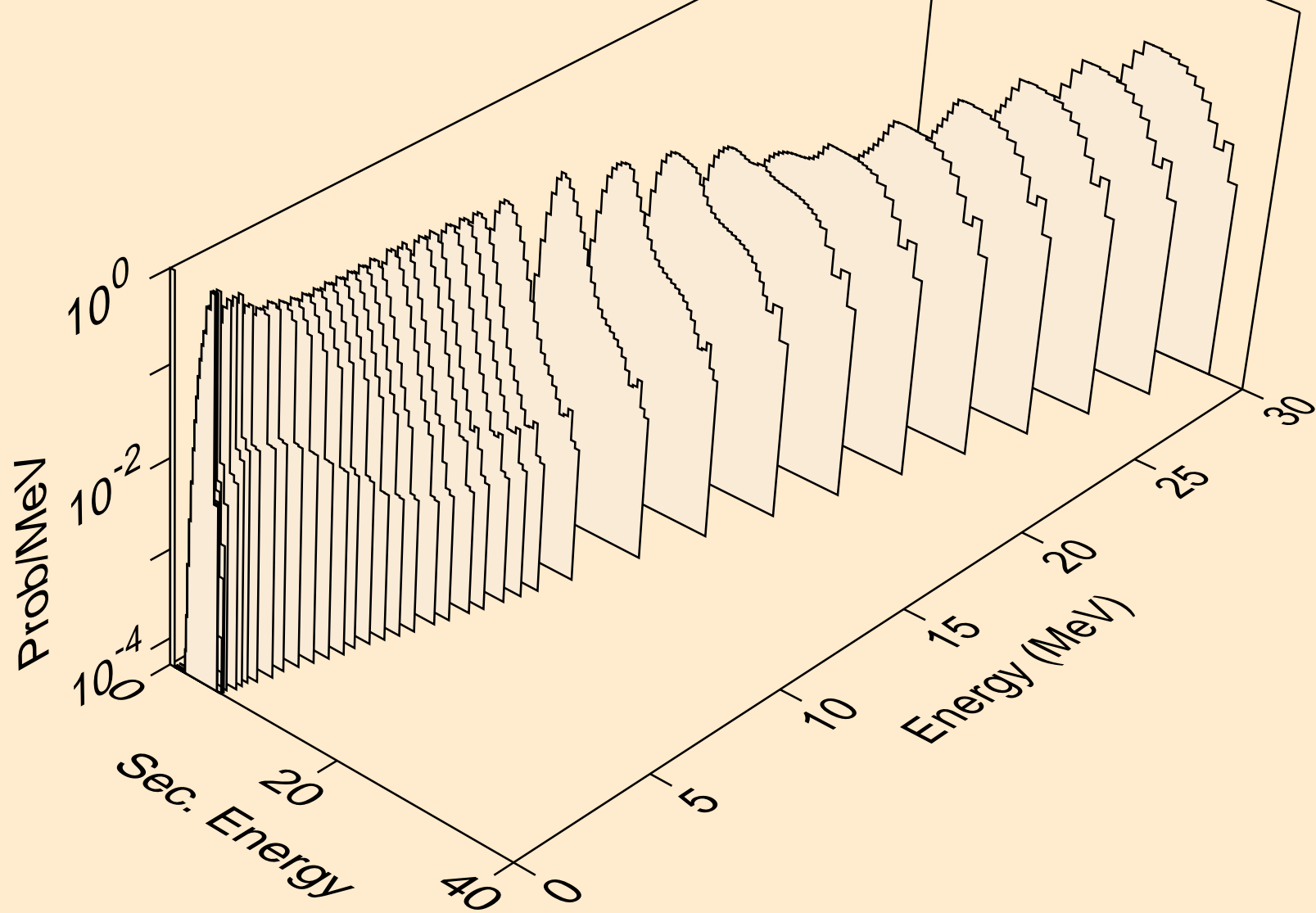

BA123 NEUTRON ACER TENDL-2024 LIBRARY; T=293.6K  
protons from (n,2p)

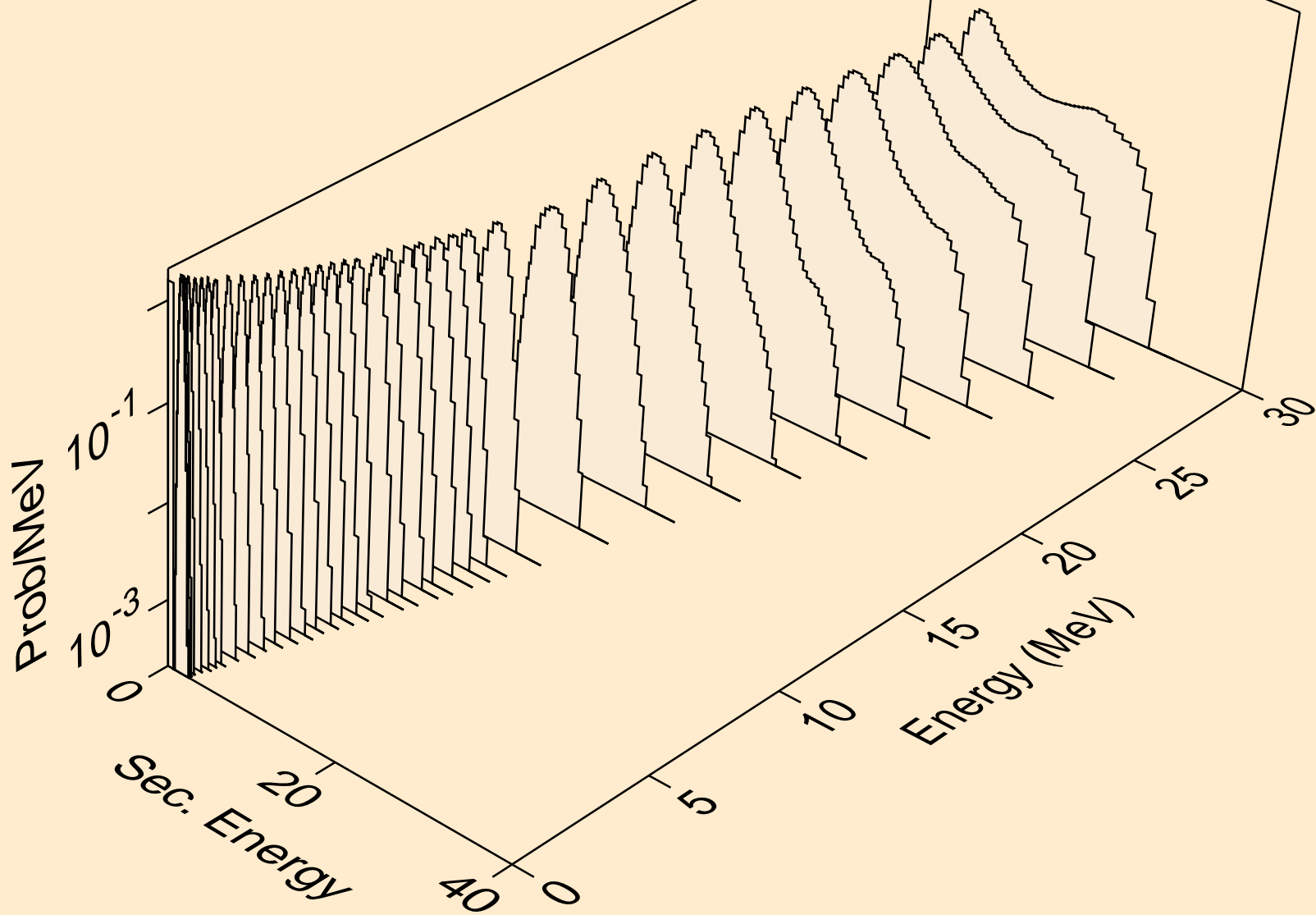

BA123 NEUTRON ACER TENDL-2024 LIBRARY; T=293.6K  
protons from (n,p)

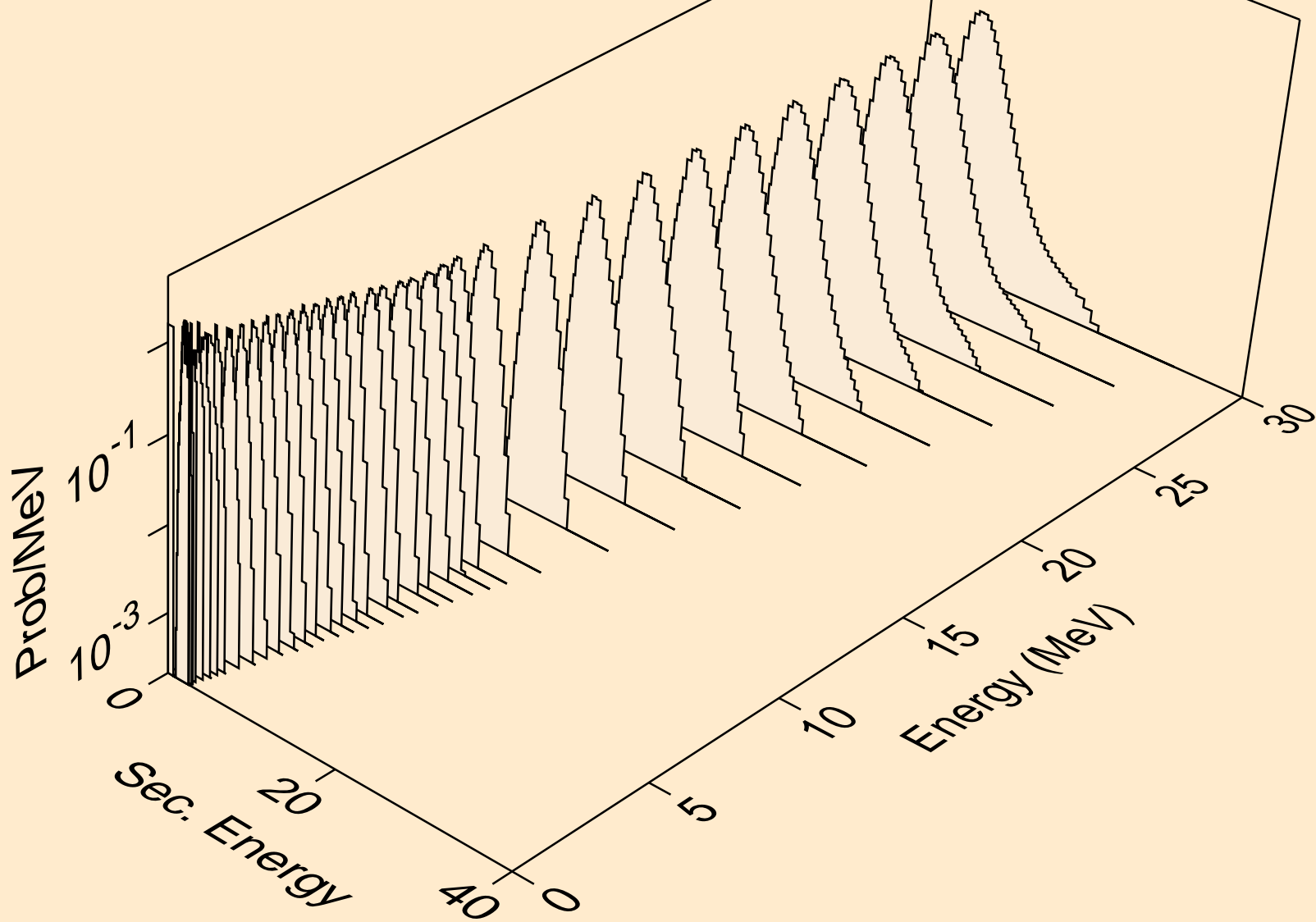

BA123 NEUTRON ACER TENDL-2024 LIBRARY; T=293.6K  
protons from (n,pd)

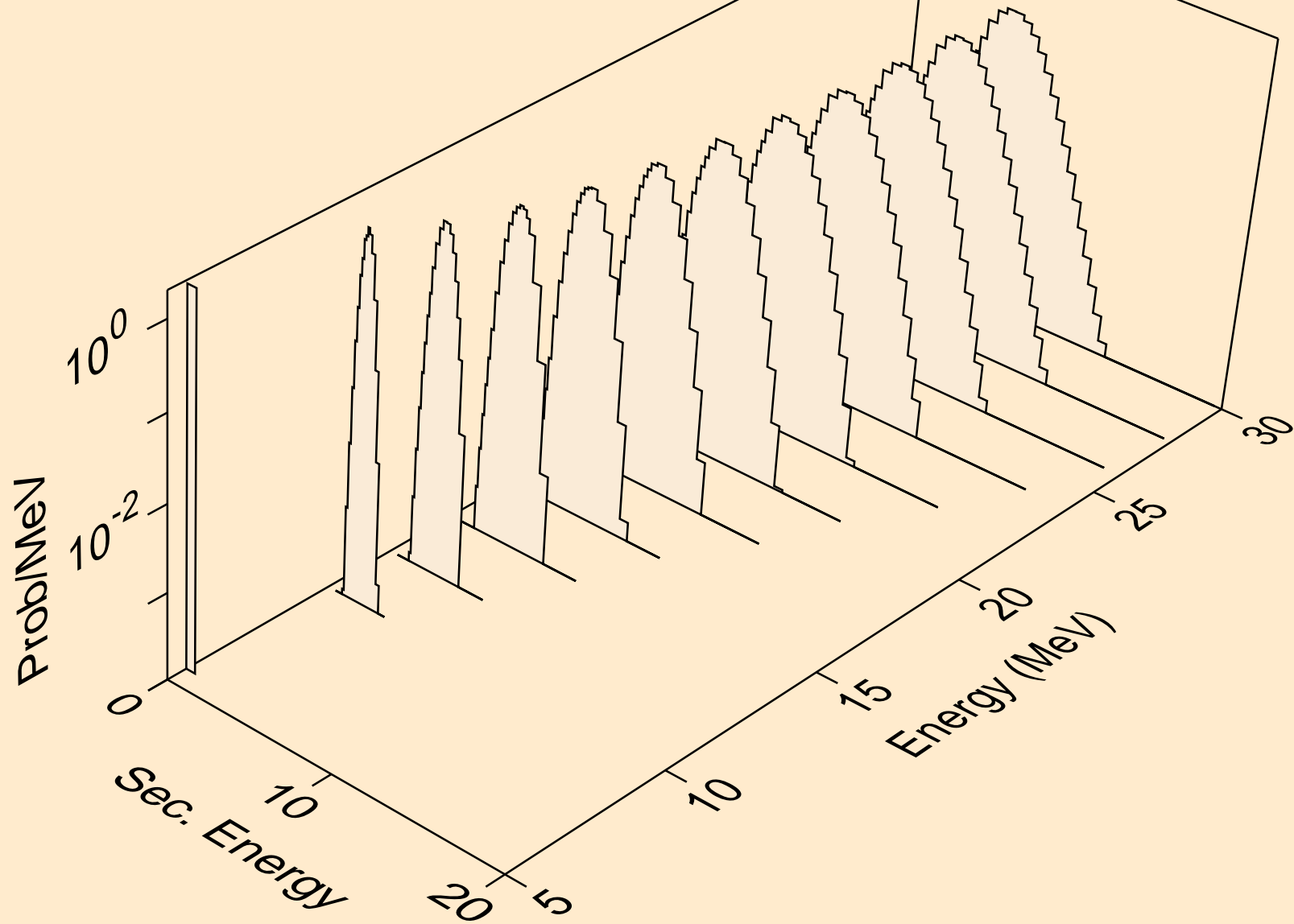

BA123 NEUTRON ACER TENDL-2024 LIBRARY; T=293.6K  
protons from (n,pt)

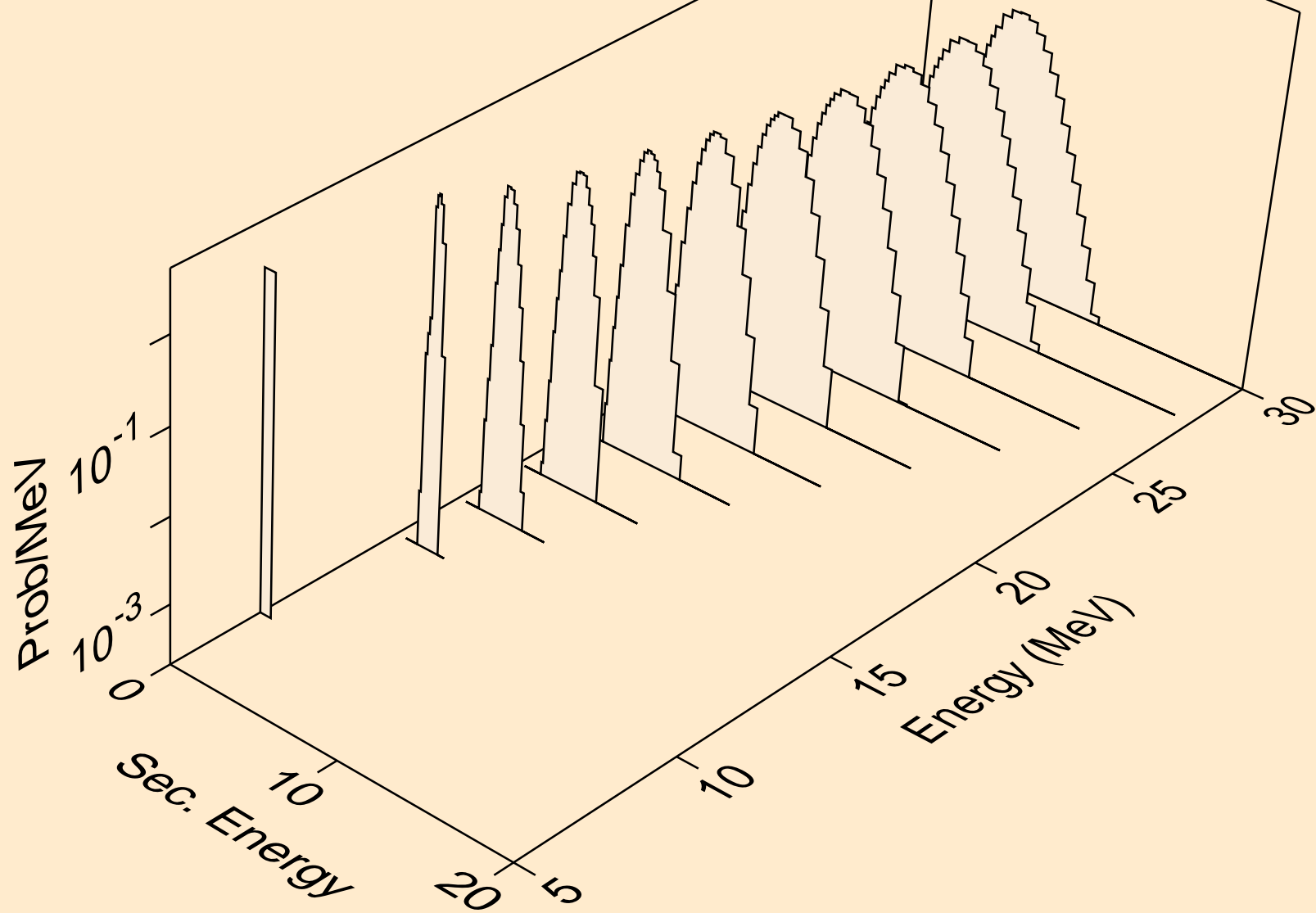

BA123 NEUTRON ACER TENDL-2024 LIBRARY; T=293.6K  
deuterons from (n,x)

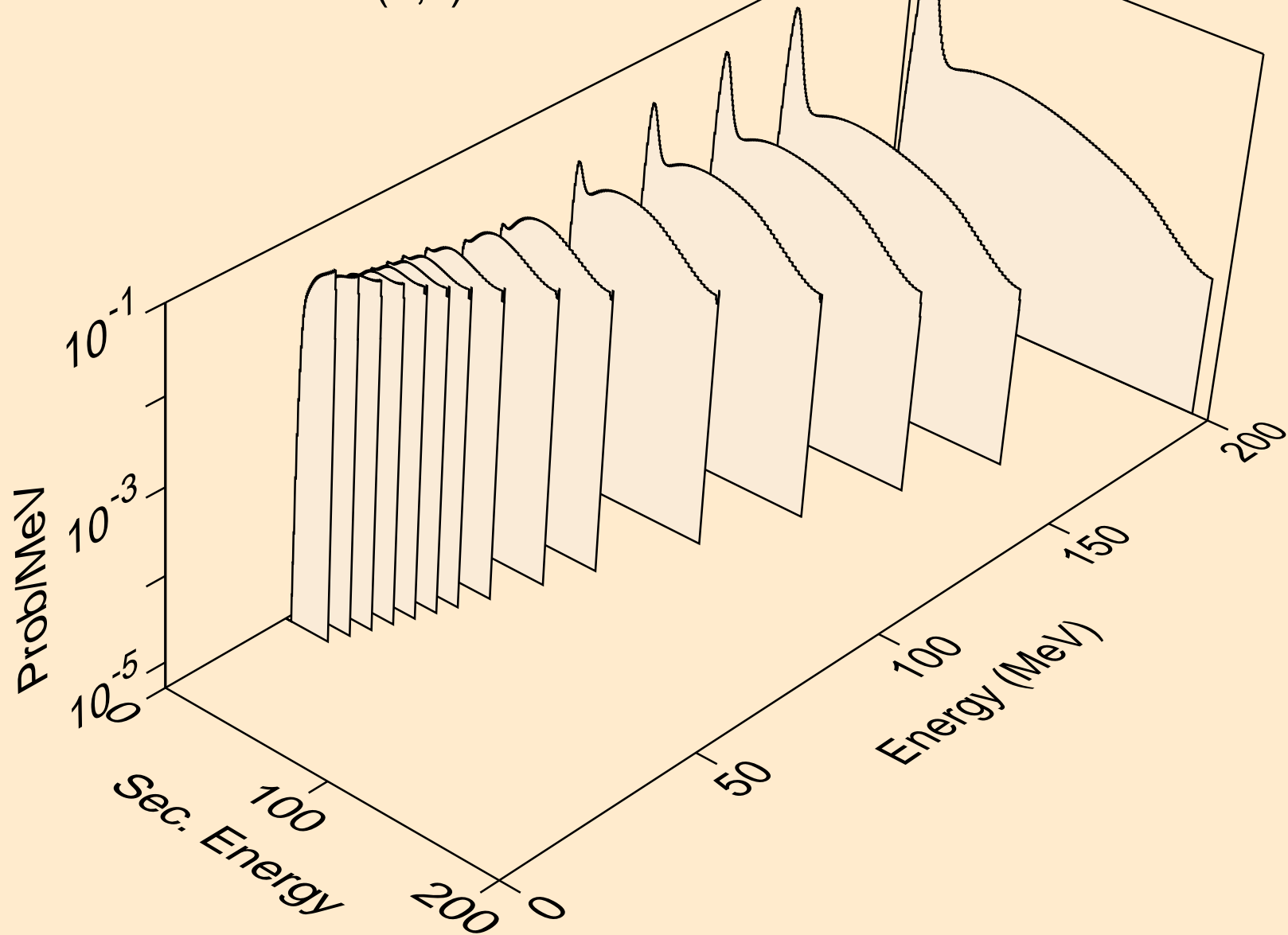

BA123 NEUTRON ACER TENDL-2024 LIBRARY; T=293.6K  
deuterons from (n,2nd)

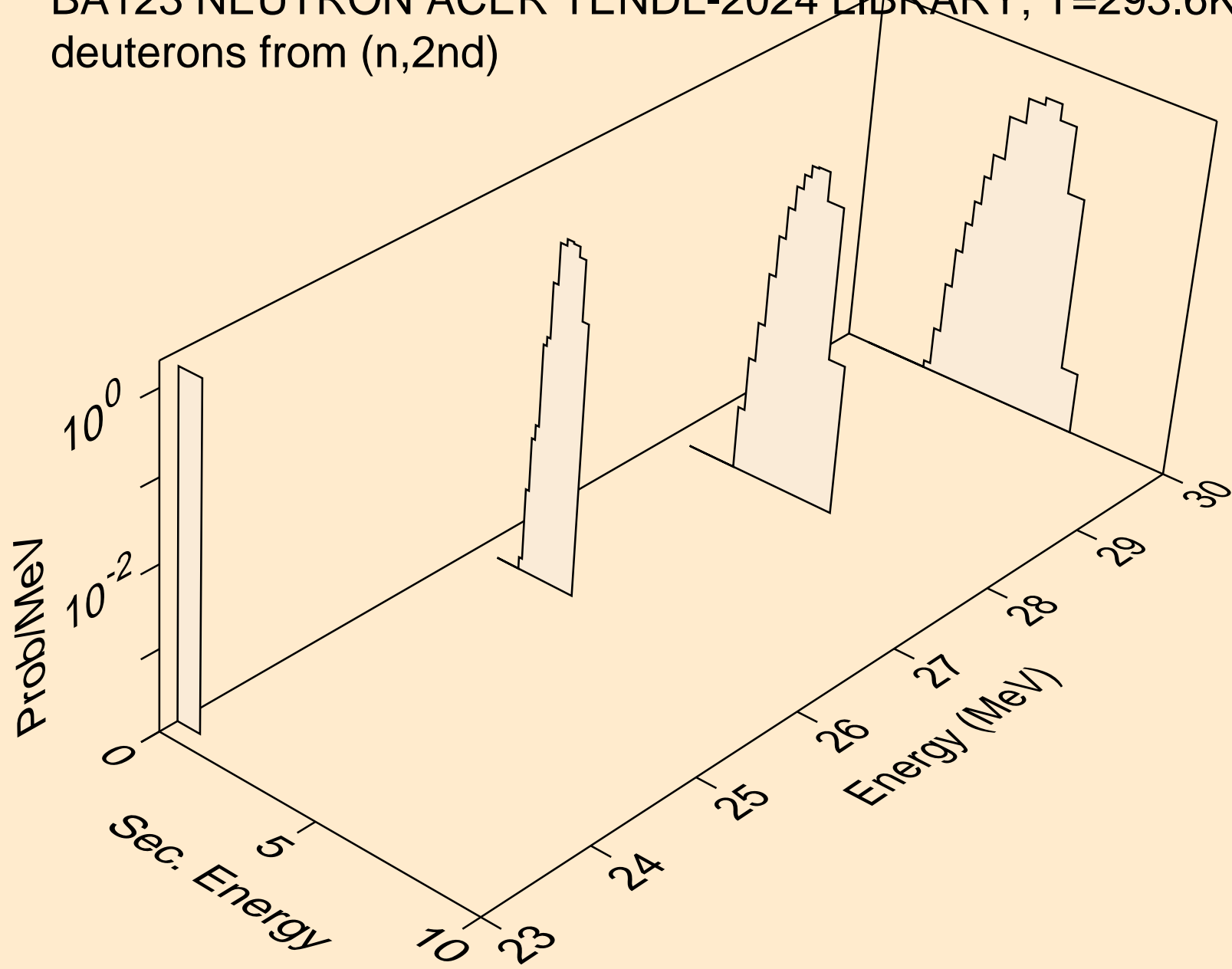

BA123 NEUTRON ACER TENDL-2024 LIBRARY; T=293.6K  
deuterons from (n,n\*)d

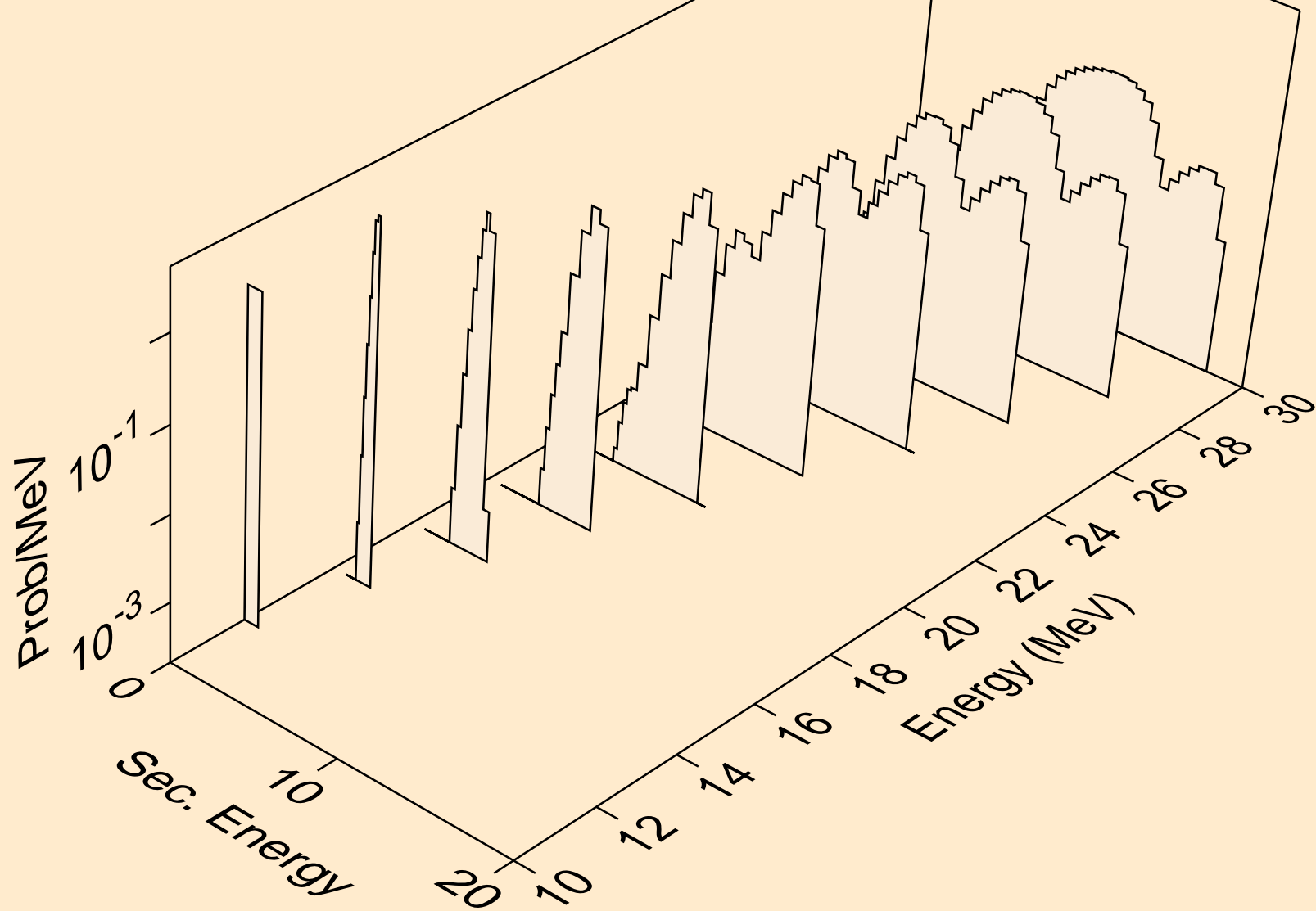

BA123 NEUTRON ACER TENDL-2024 LIBRARY; T=293.6K  
deuterons from (n,d)

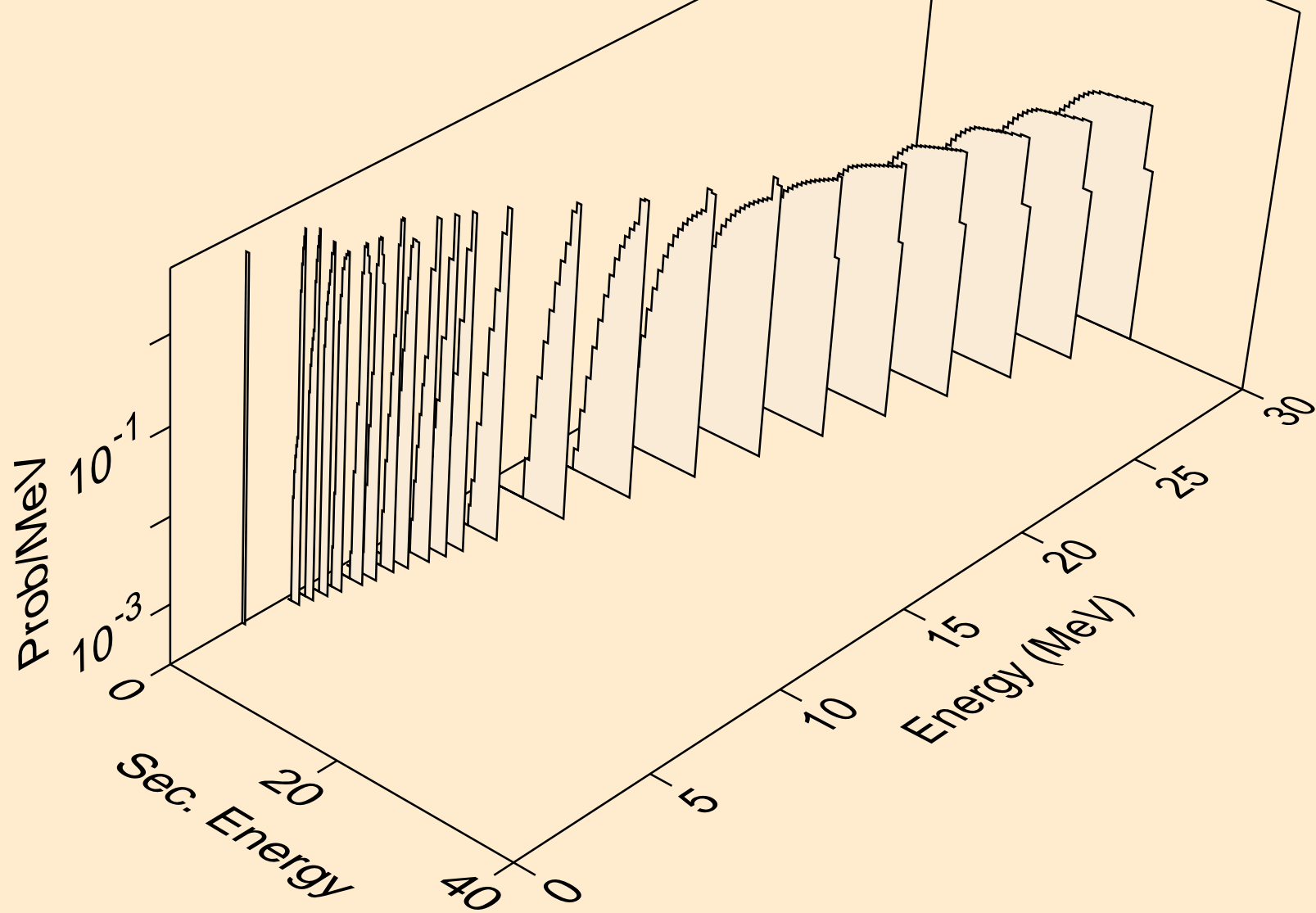

BA123 NEUTRON ACER TENDL-2024 LIBRARY; T=293.6K  
deuterons from (n,pd)

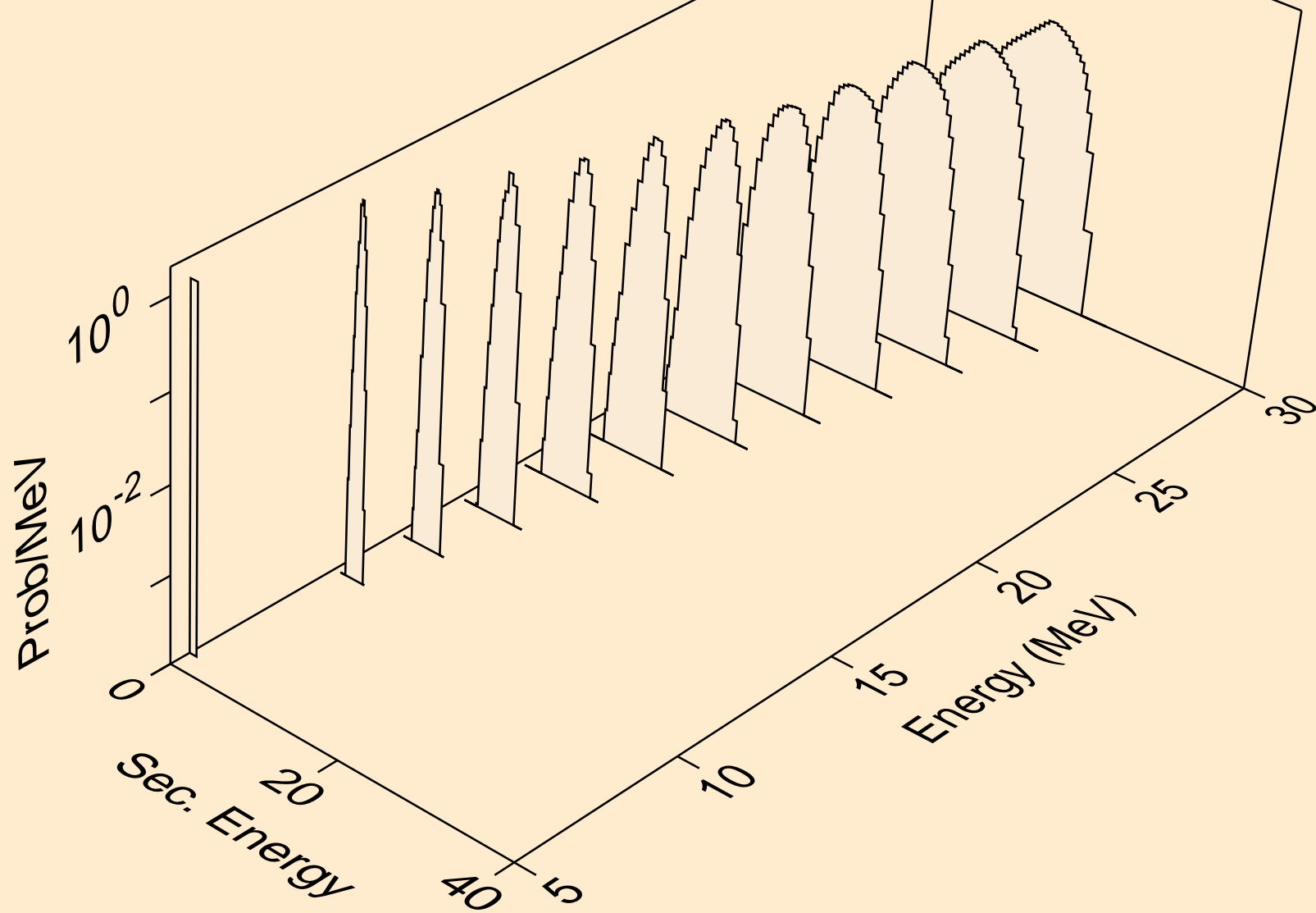

BA123 NEUTRON ACER TENDL-2024 LIBRARY; T=293.6K  
deuterons from (n,da)

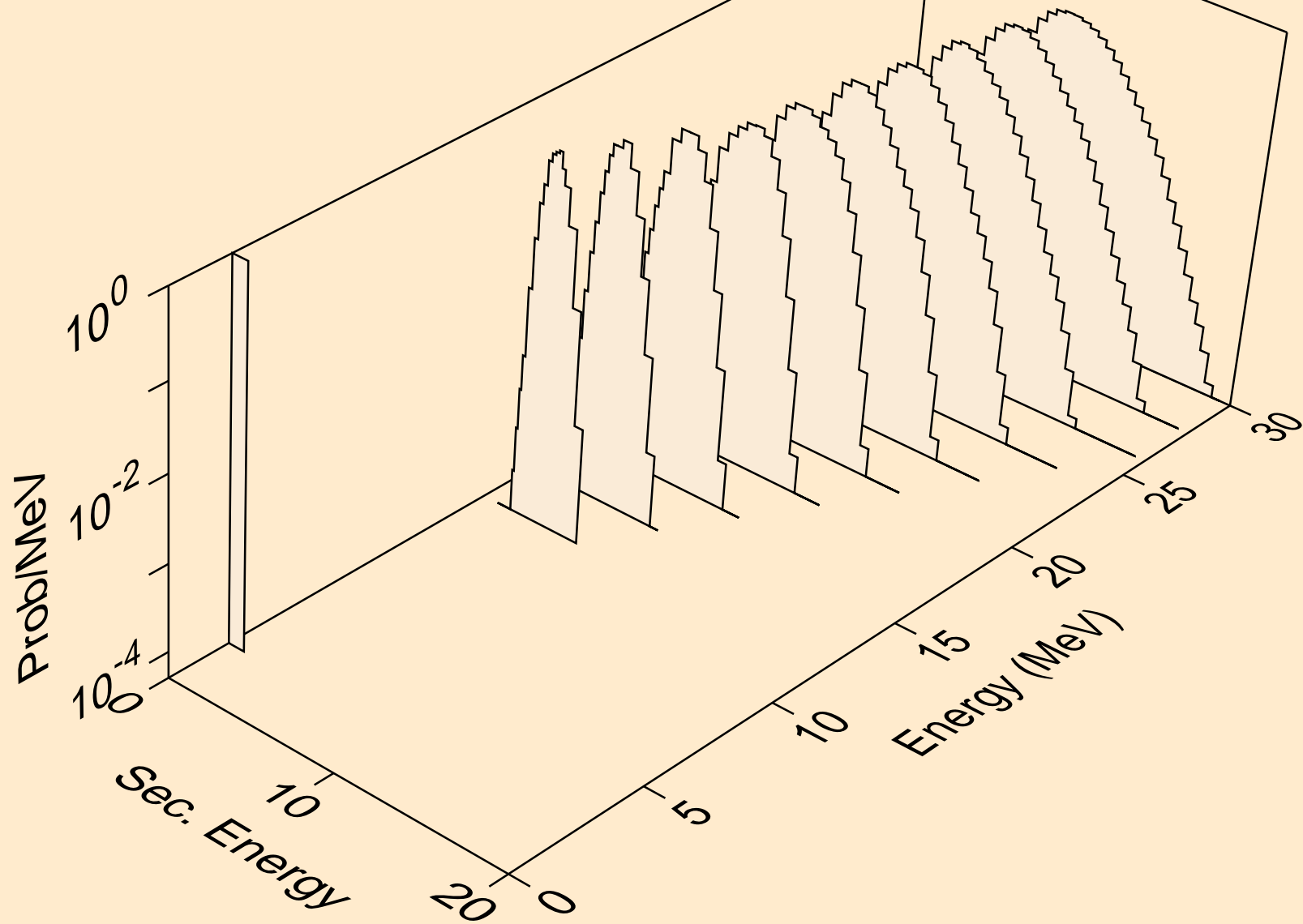

BA123 NEUTRON ACER TENDL-2024 LIBRARY; T=293.6K  
tritons from (n,x)

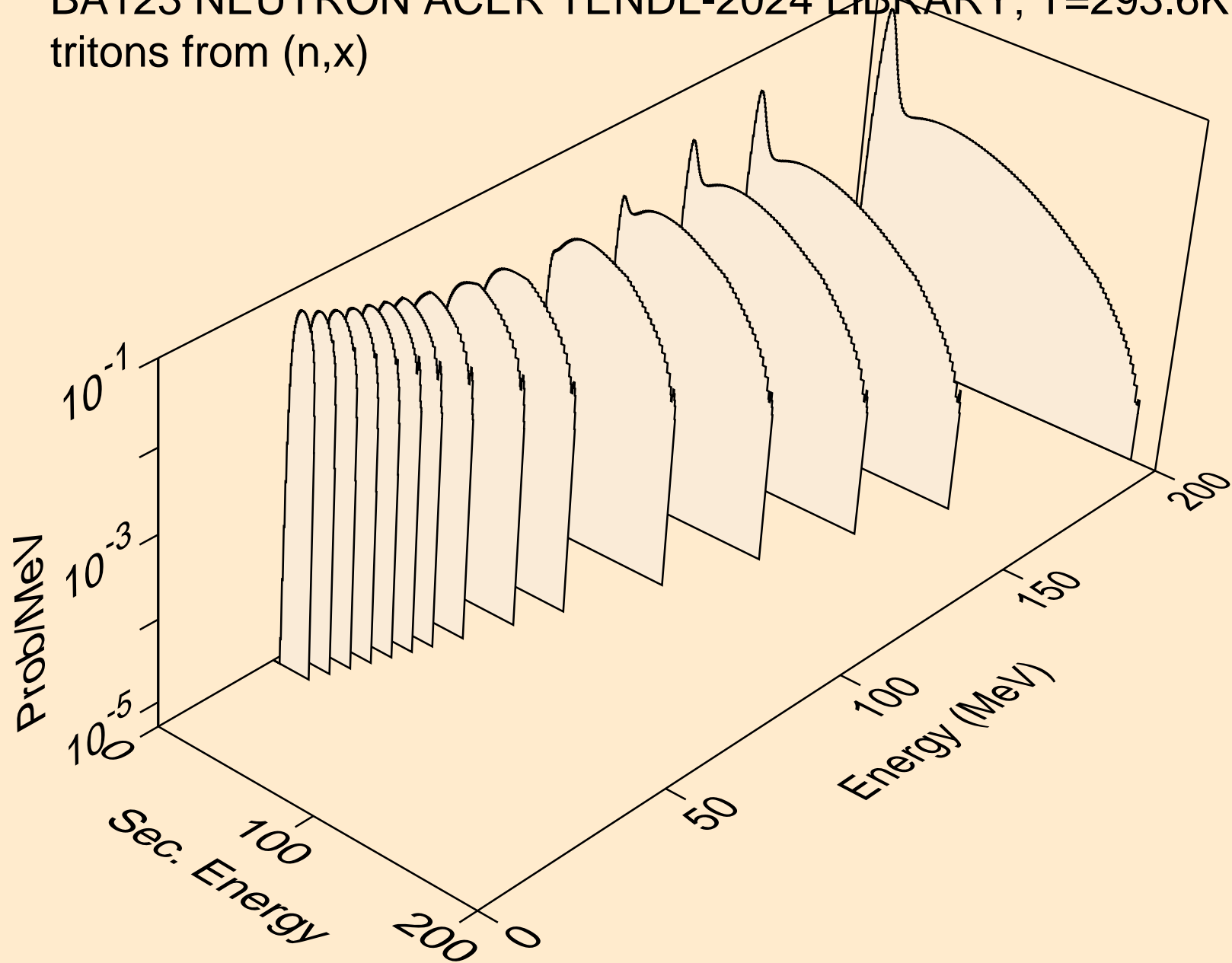

BA123 NEUTRON ACER TENDL-2024 LIBRARY; T=293.6K  
tritons from (n,n\*)t

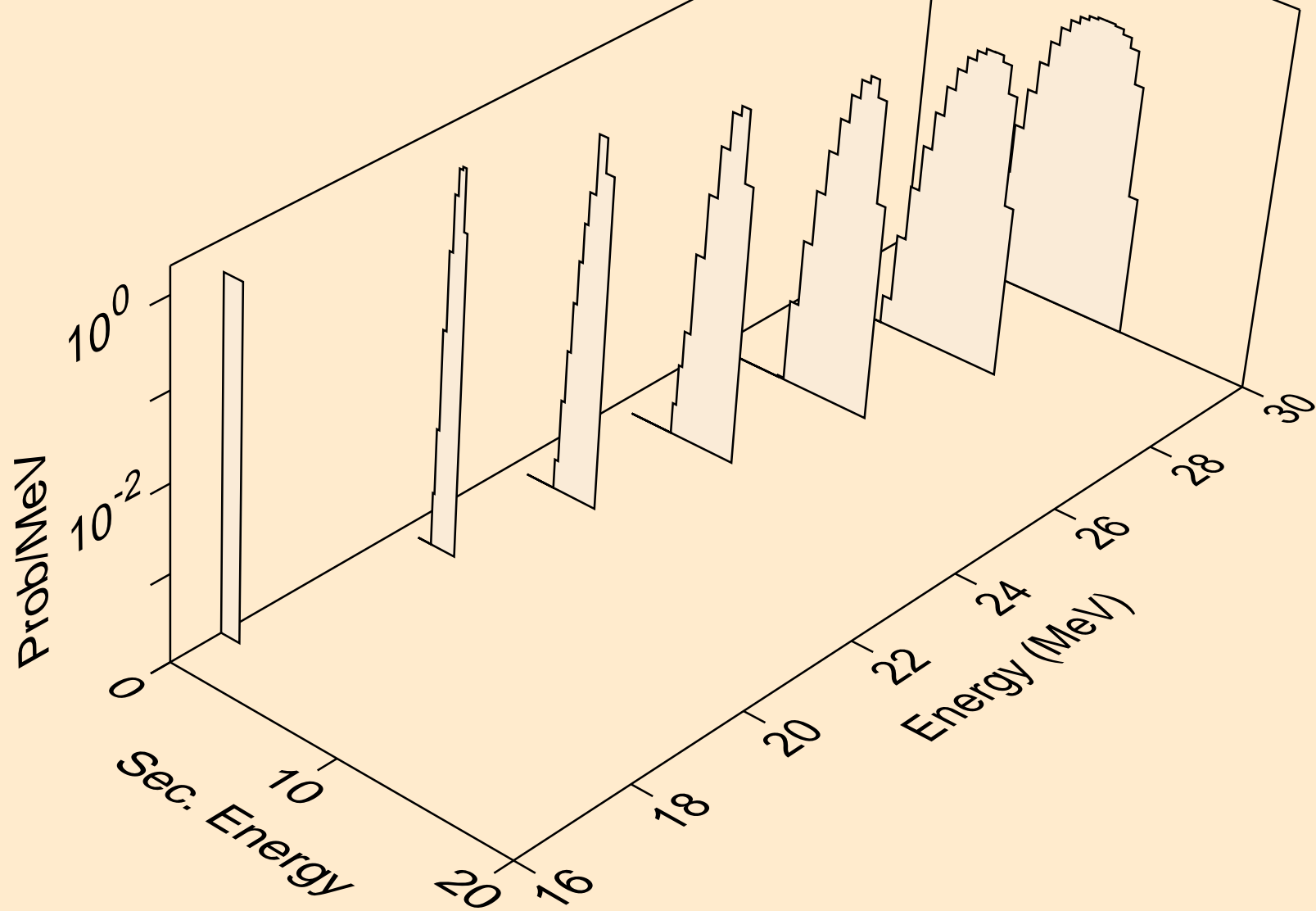

BA123 NEUTRON ACER TENDL-2024 LIBRARY; T=293.6K  
tritons from (n,t)

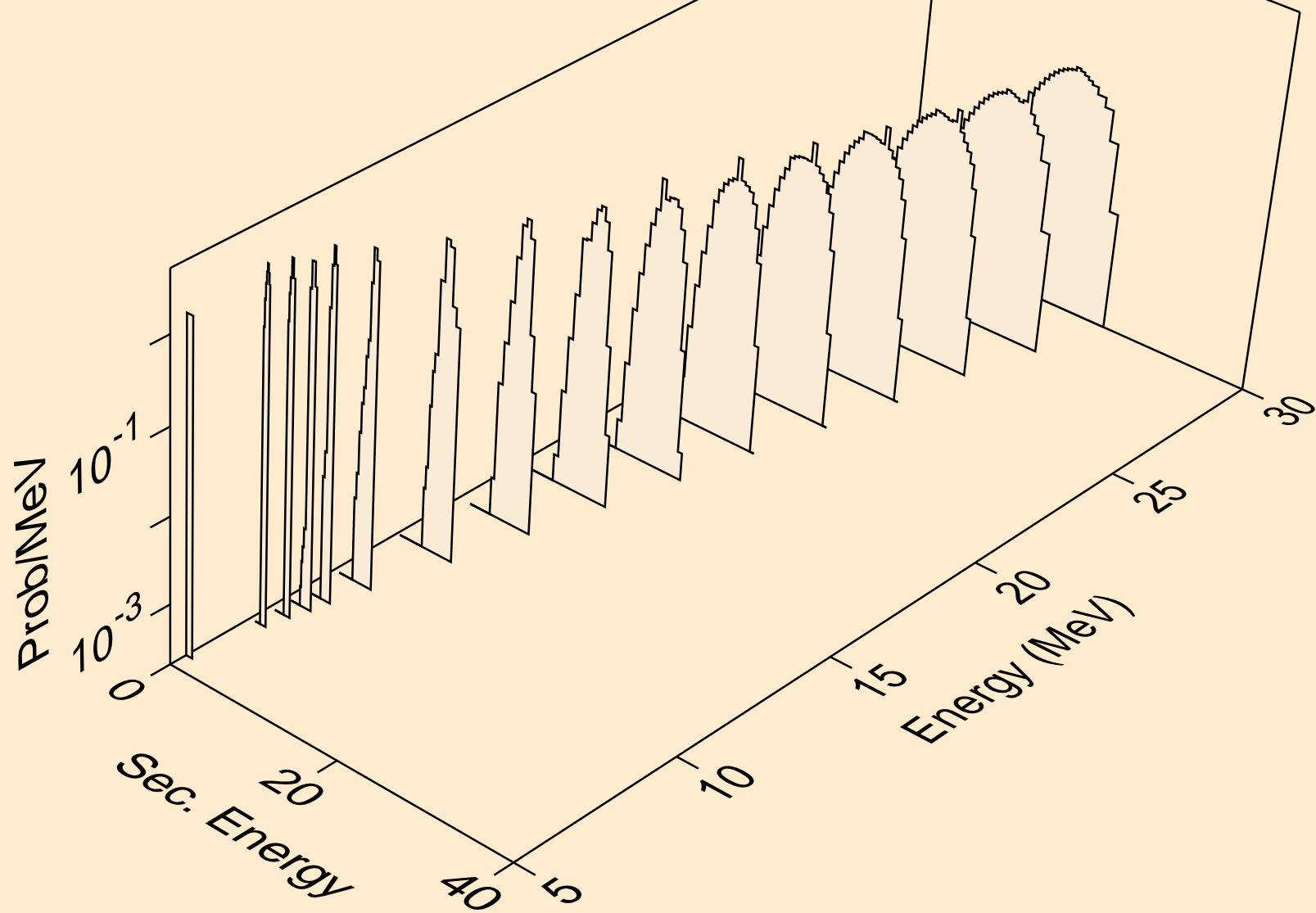

BA123 NEUTRON ACER TENDL-2024 LIBRARY; T=293.6K  
tritons from (n,pt)

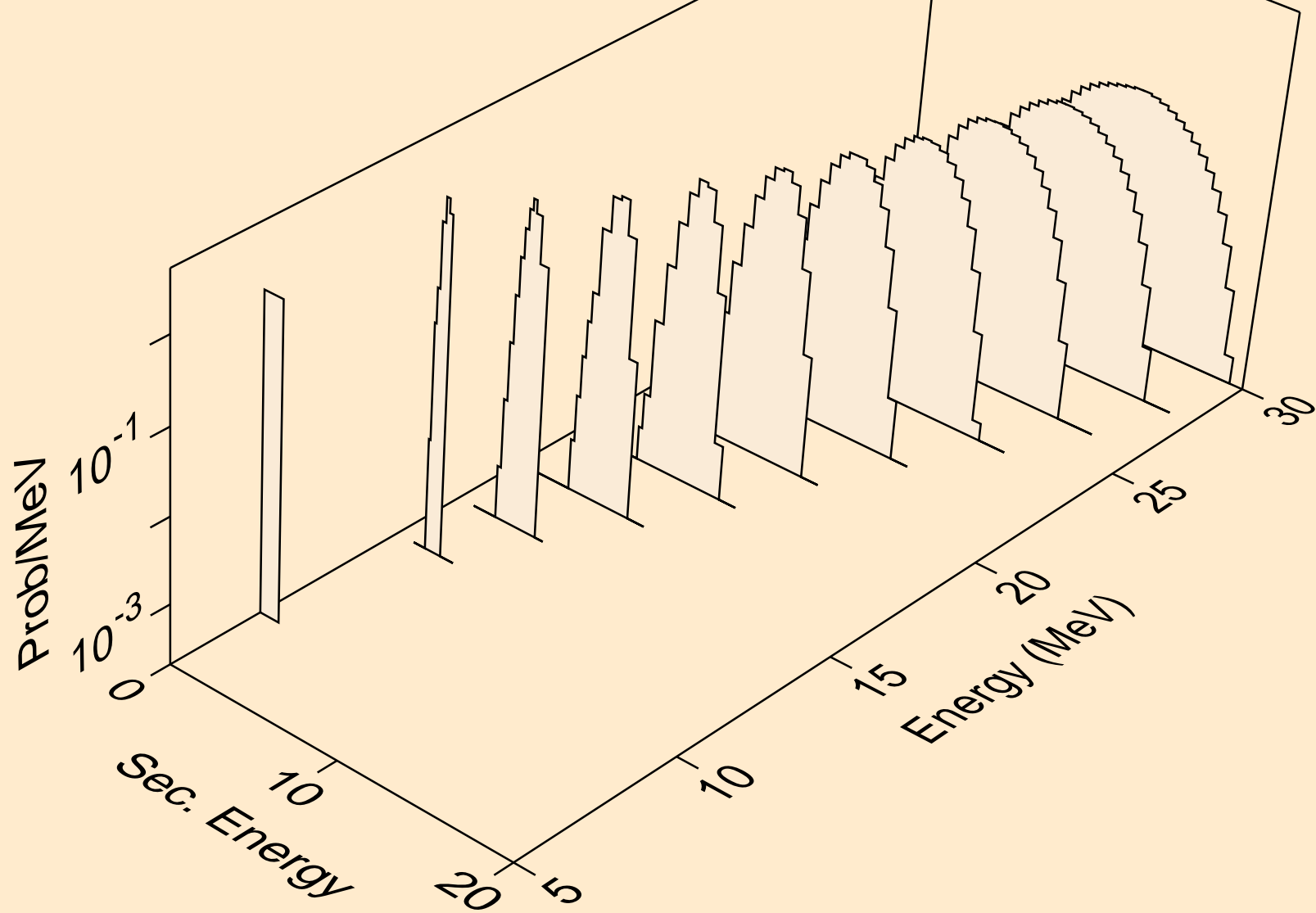

BA123 NEUTRON ACER TENDL-2024 LIBRARY; T=293.6K  
he3s from (n,x)

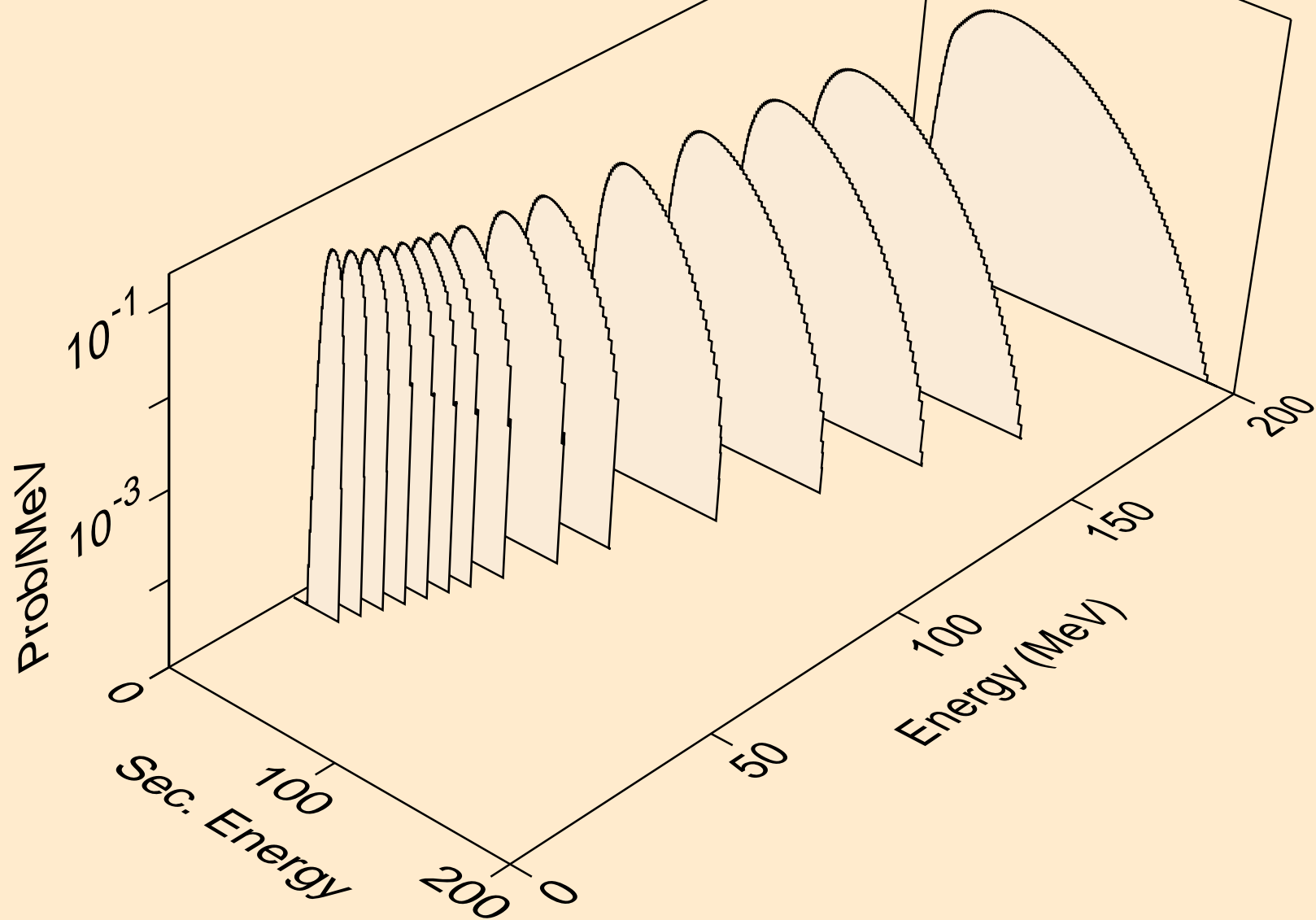

BA123 NEUTRON ACER TENDL-2024 LIBRARY; T=293.6K  
he3s from (n,n\*)he3

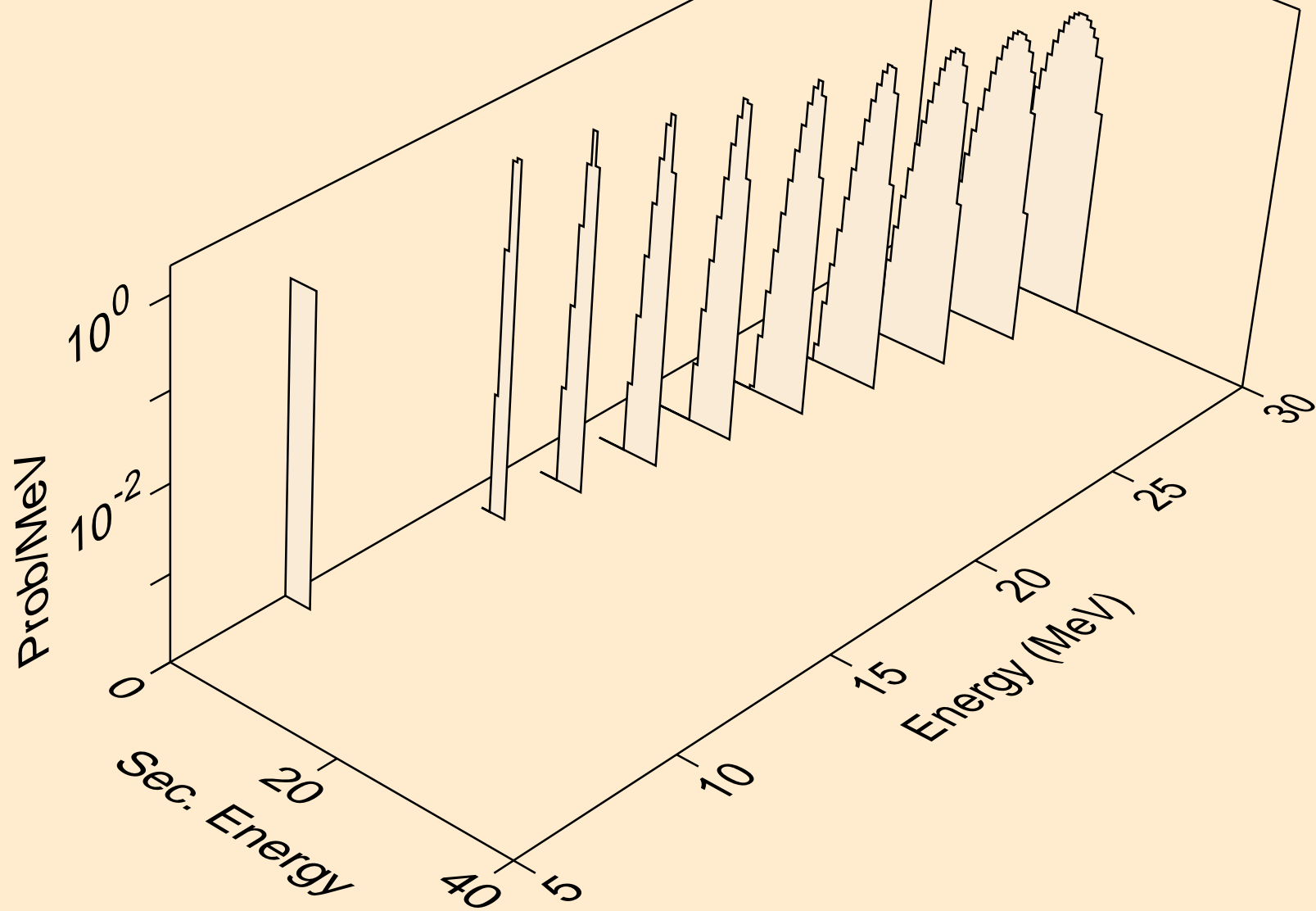

BA123 NEUTRON ACER TENDL-2024 LIBRARY; T=293.6K  
he3s from (n,he3)

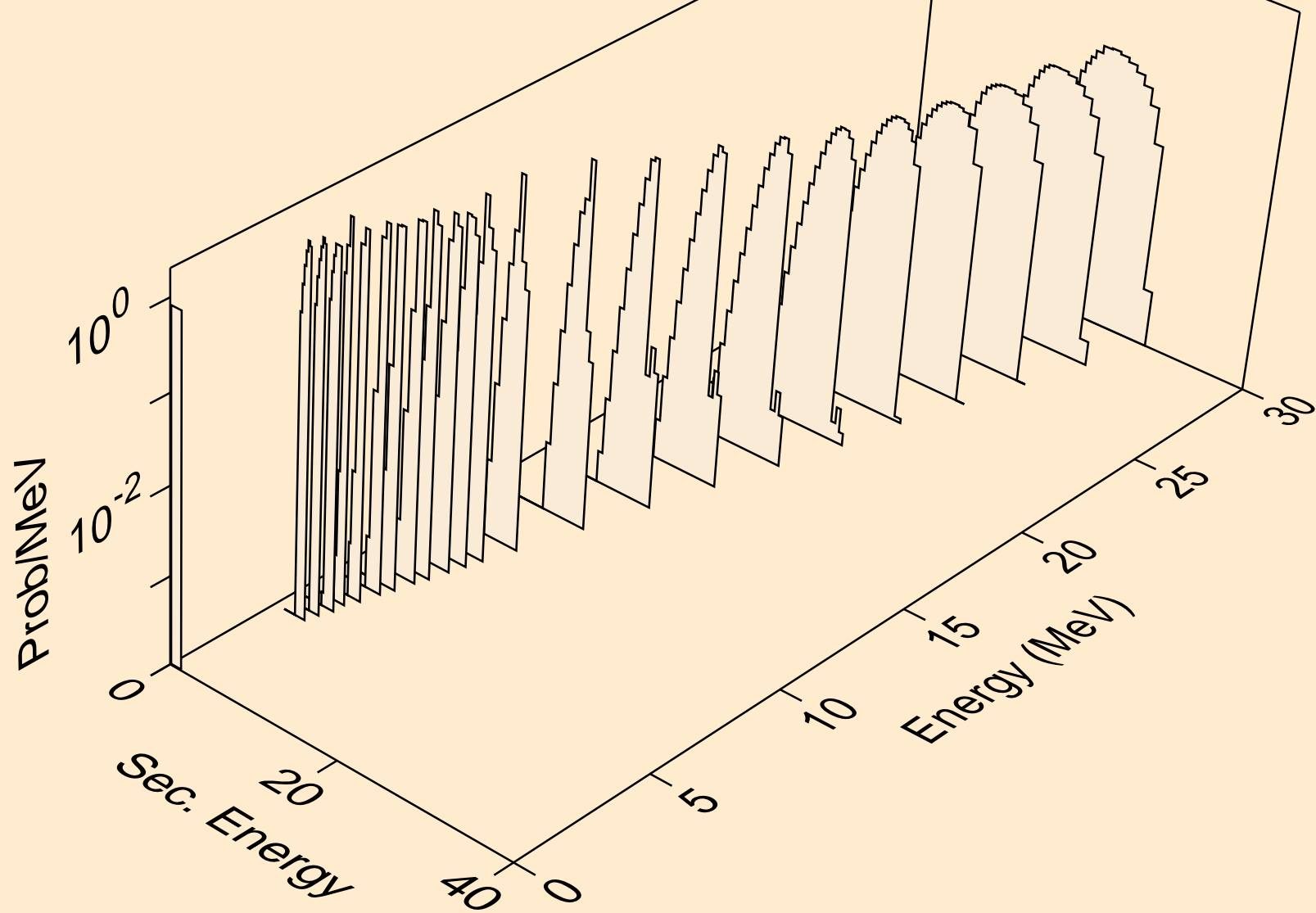

BA123 NEUTRON ACER TENDL-2024 LIBRARY; T=293.6K  
alphas from (n,x)

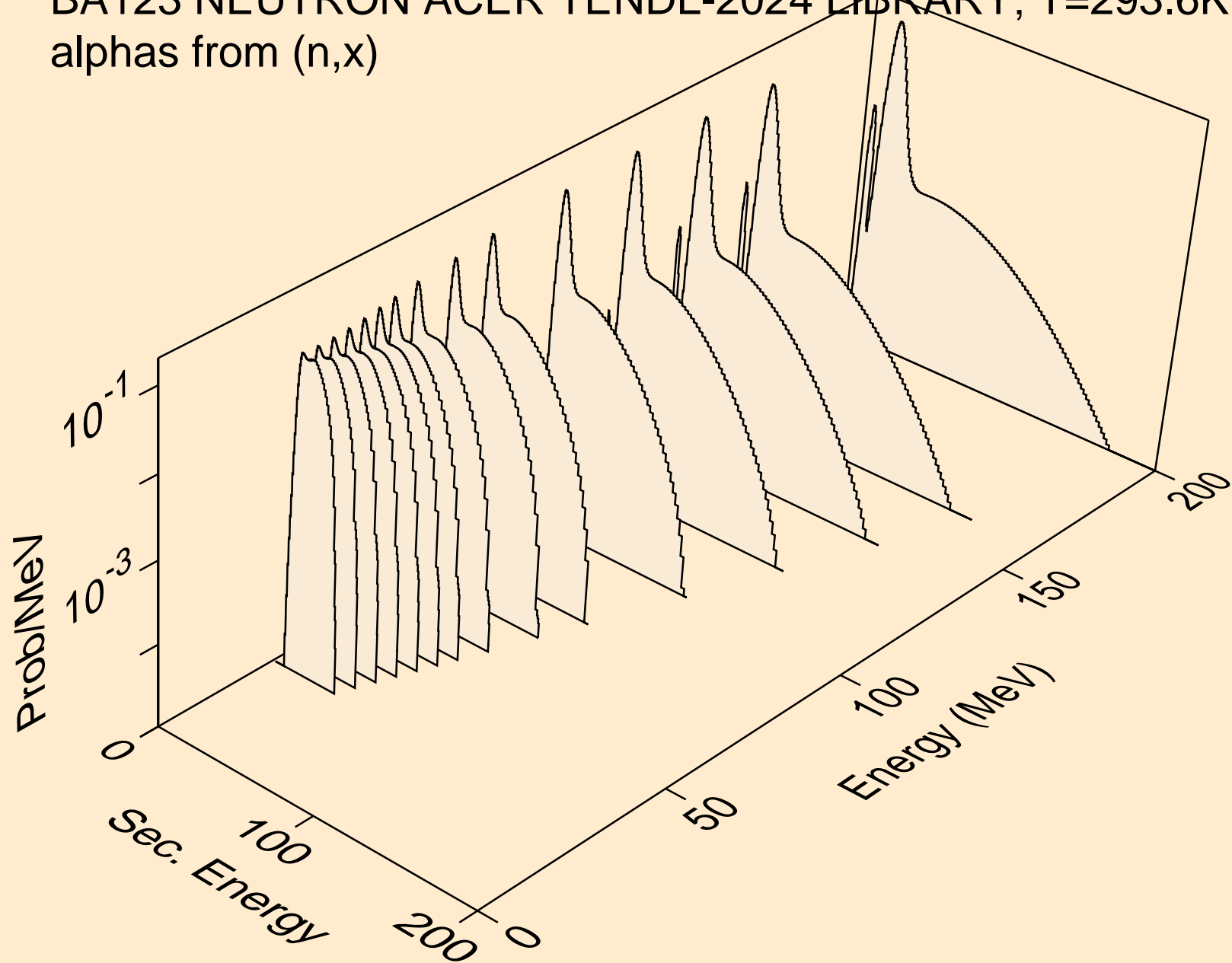

BA123 NEUTRON ACER TENDL-2024 LIBRARY; T=293.6K  
alphas from (n,n\*)a

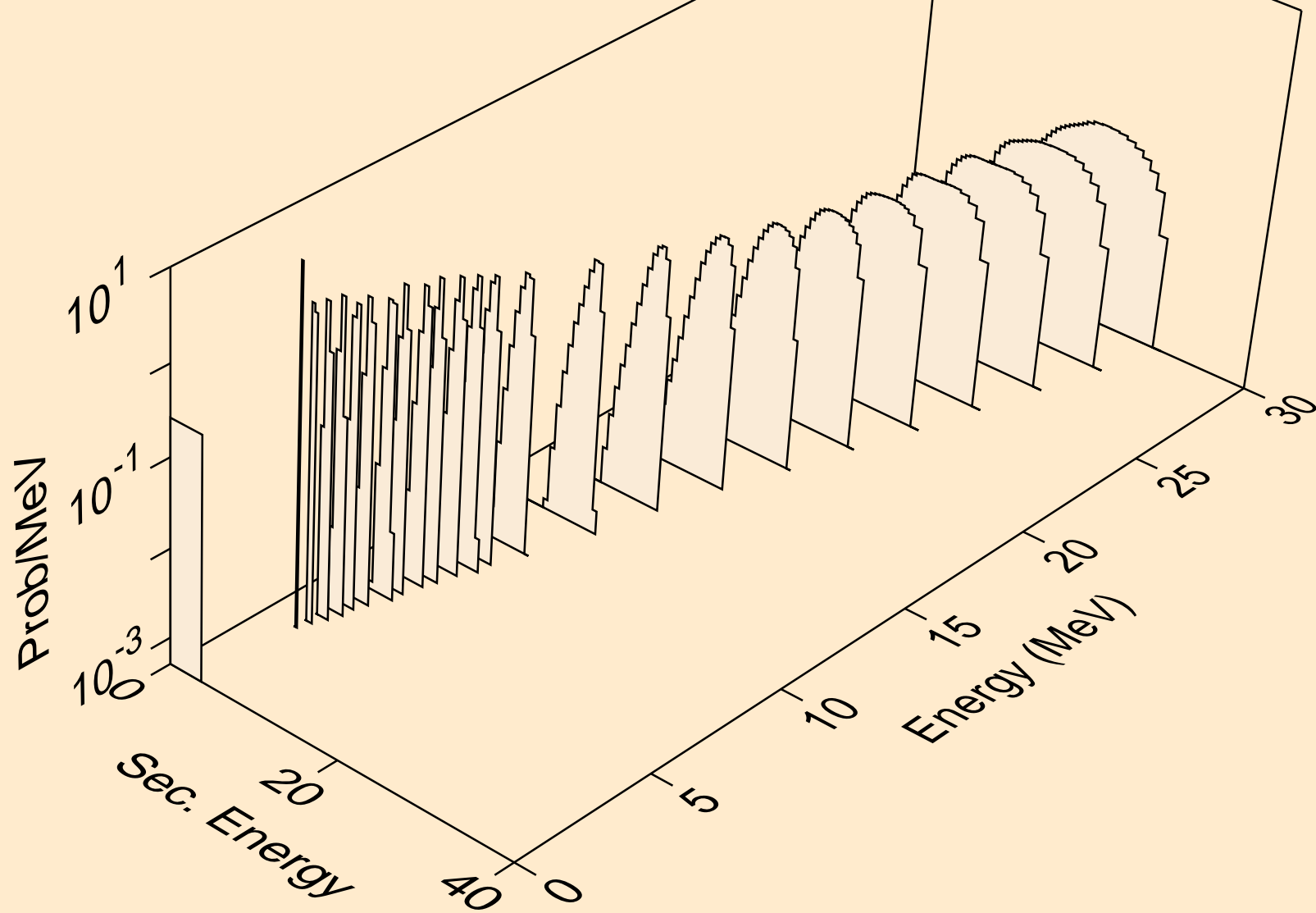

BA123 NEUTRON ACER TENDL-2024 LIBRARY; T=293.6K  
alphas from (n,2n)a

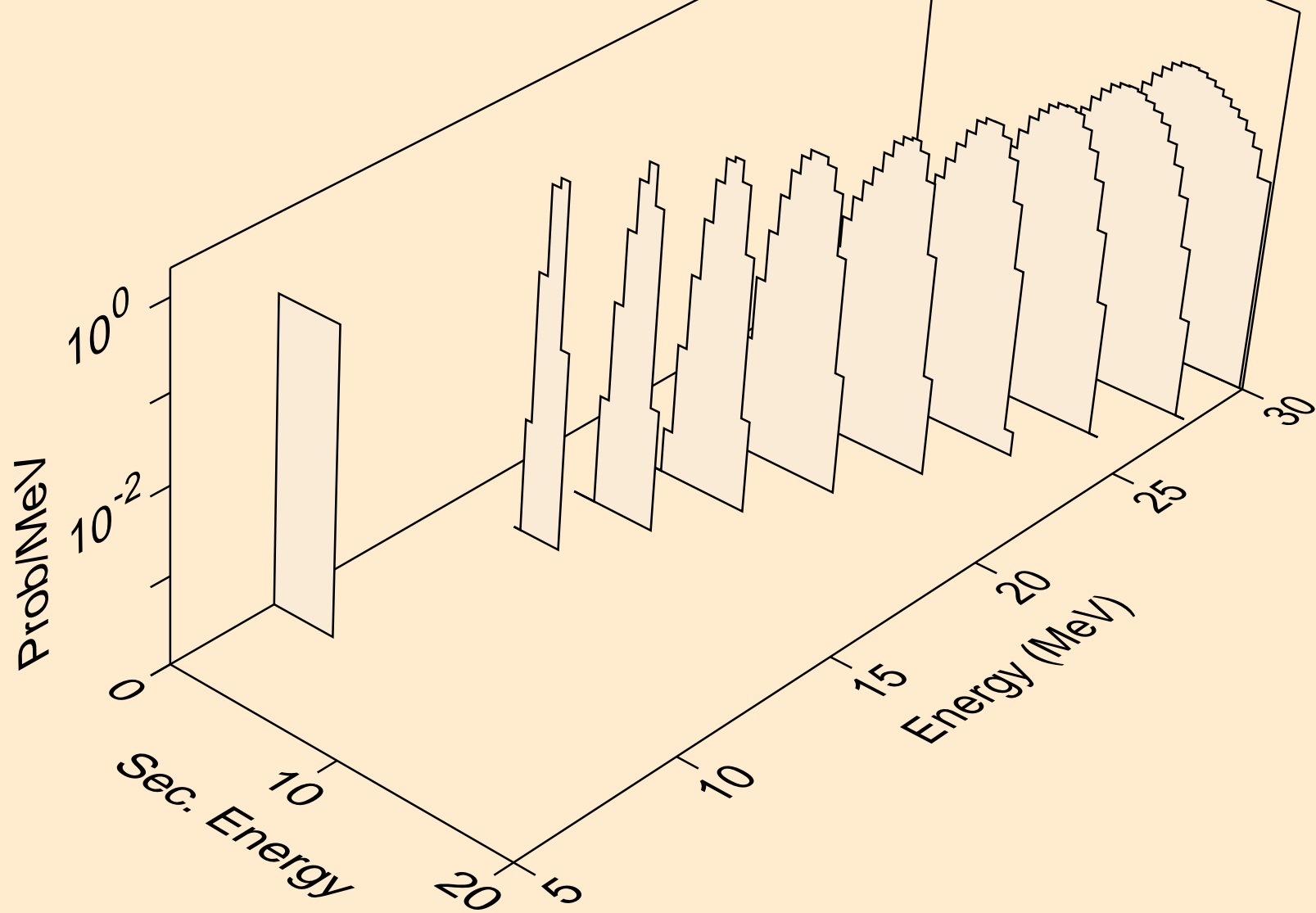

BA123 NEUTRON ACER TENDL-2024 LIBRARY; T=293.6K  
alphas from (n,3n)a

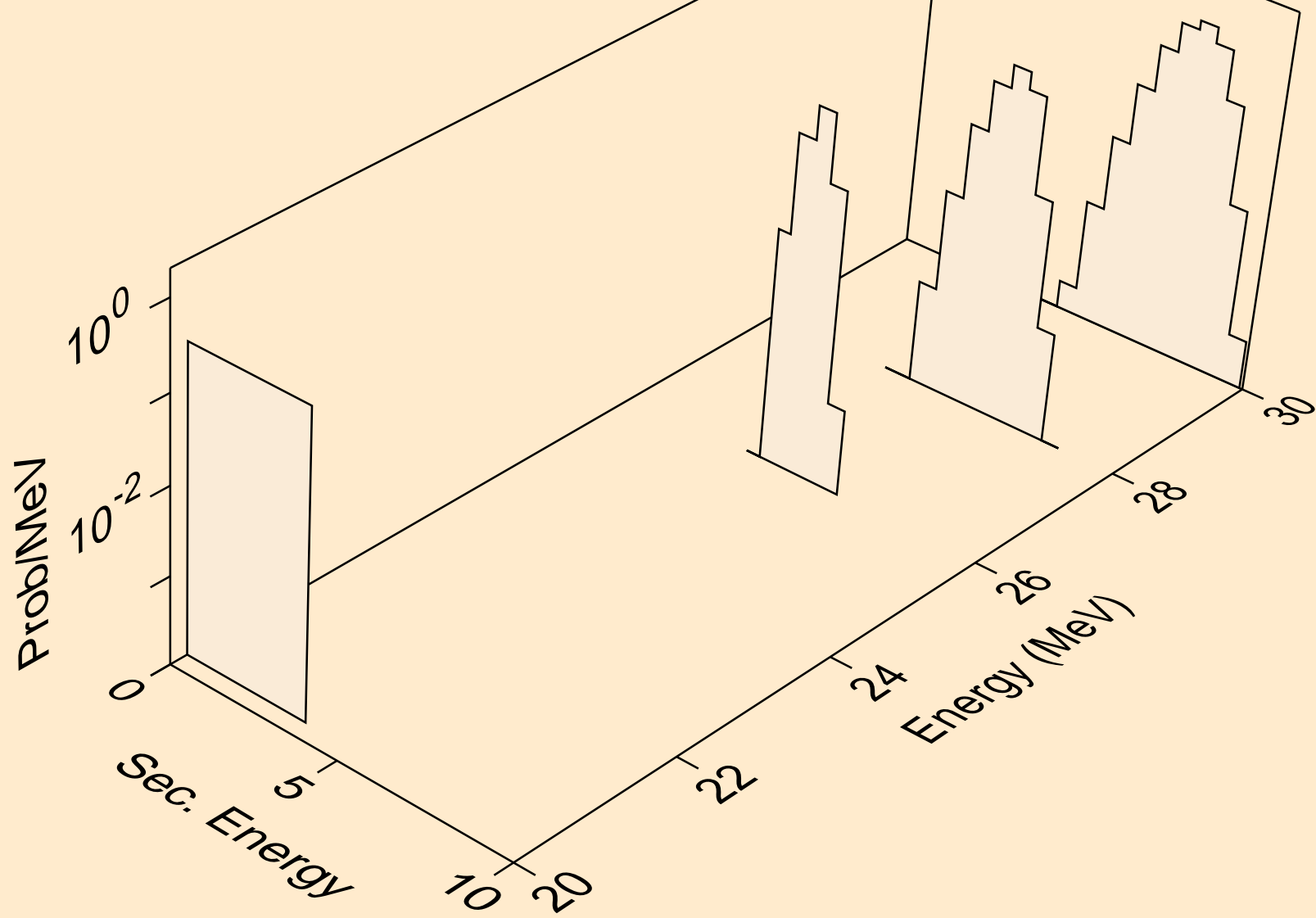

BA123 NEUTRON ACER TENDL-2024 LIBRARY; T=293.6K  
alphas from (n,n\*)2a

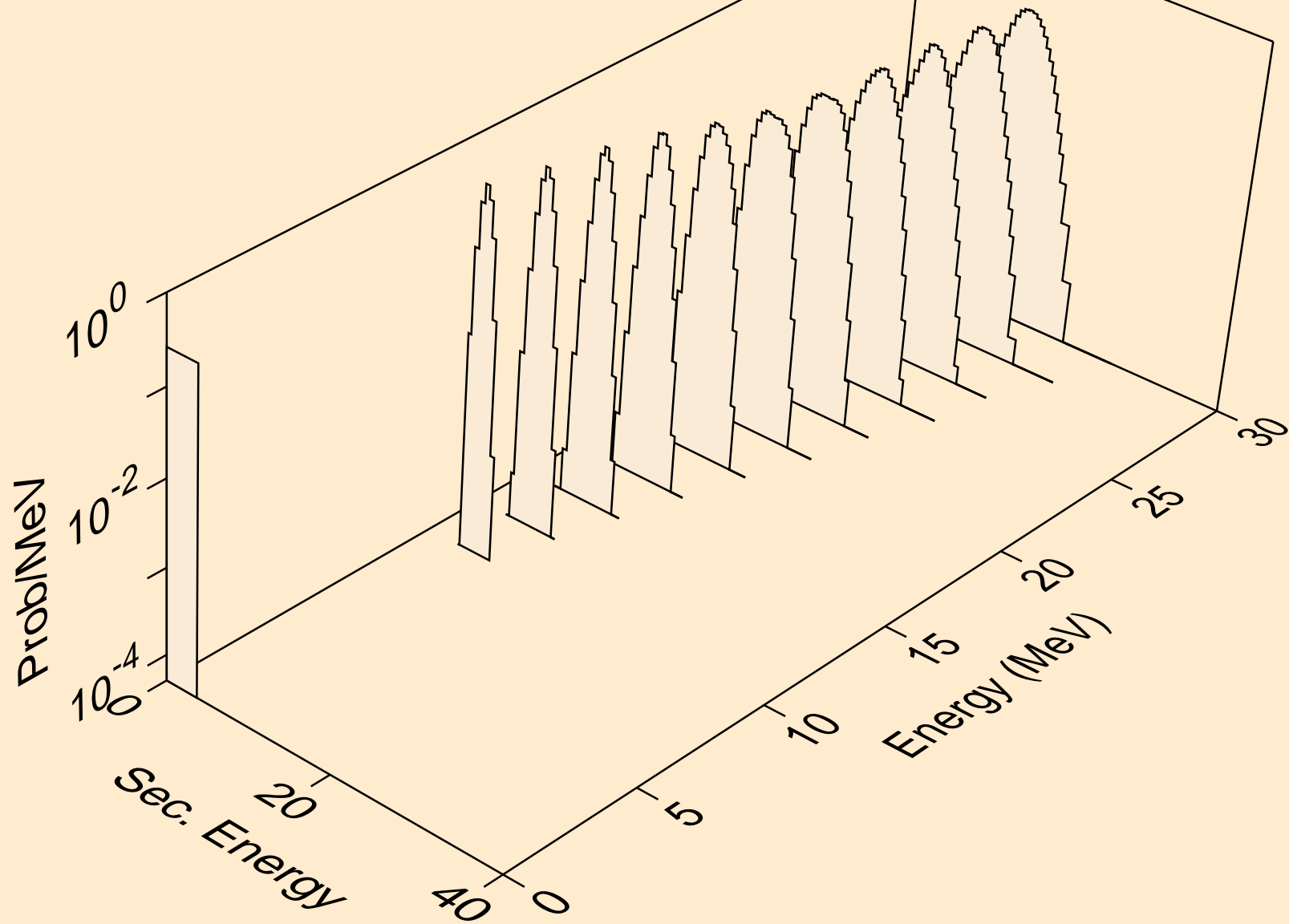

BA123 NEUTRON ACER TENDL-2024 LIBRARY; T=293.6K  
alphas from (n,2n)2a

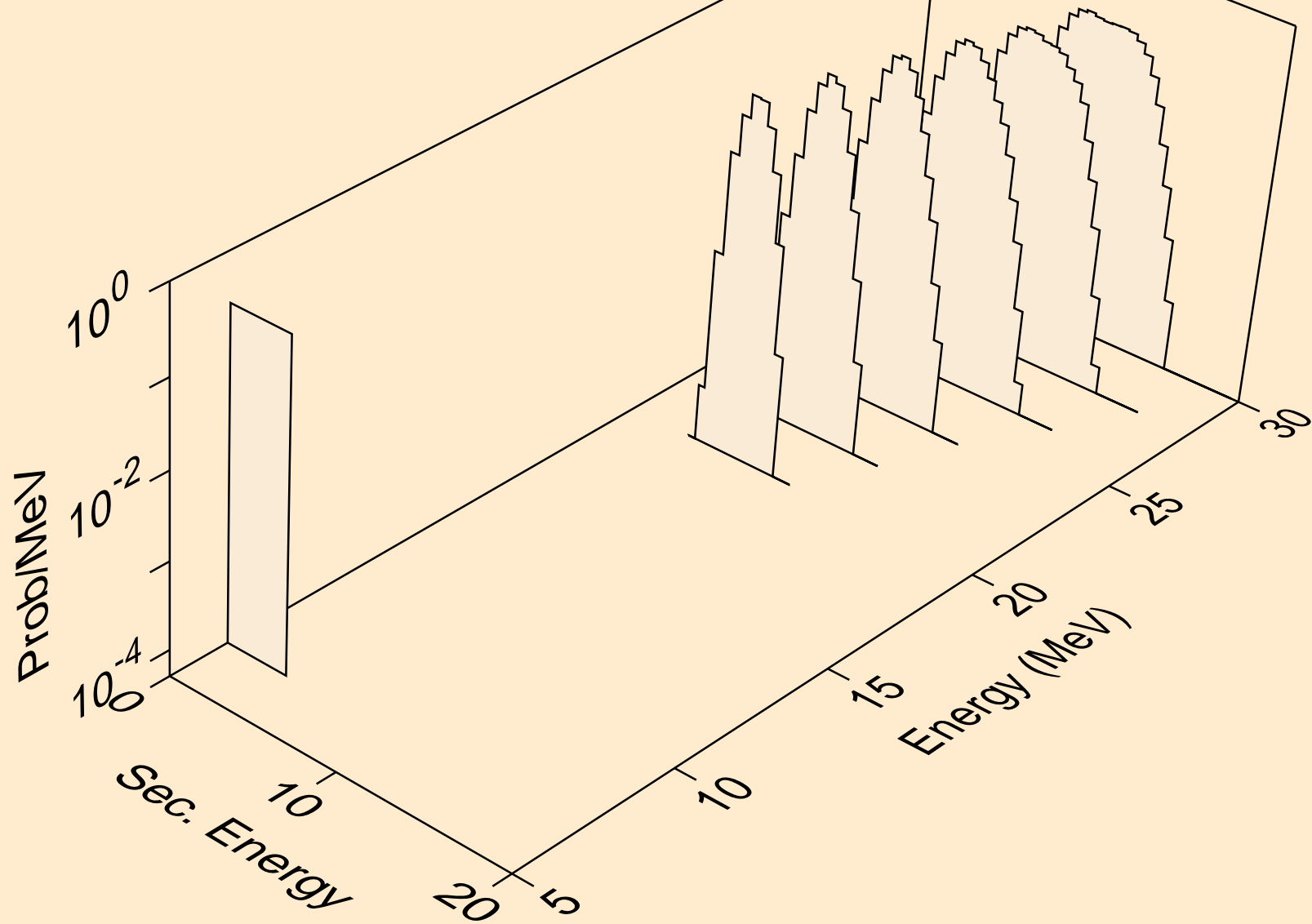

BA123 NEUTRON ACER TENDL-2024 LIBRARY; T=293.6K  
alphas from (n,npa)

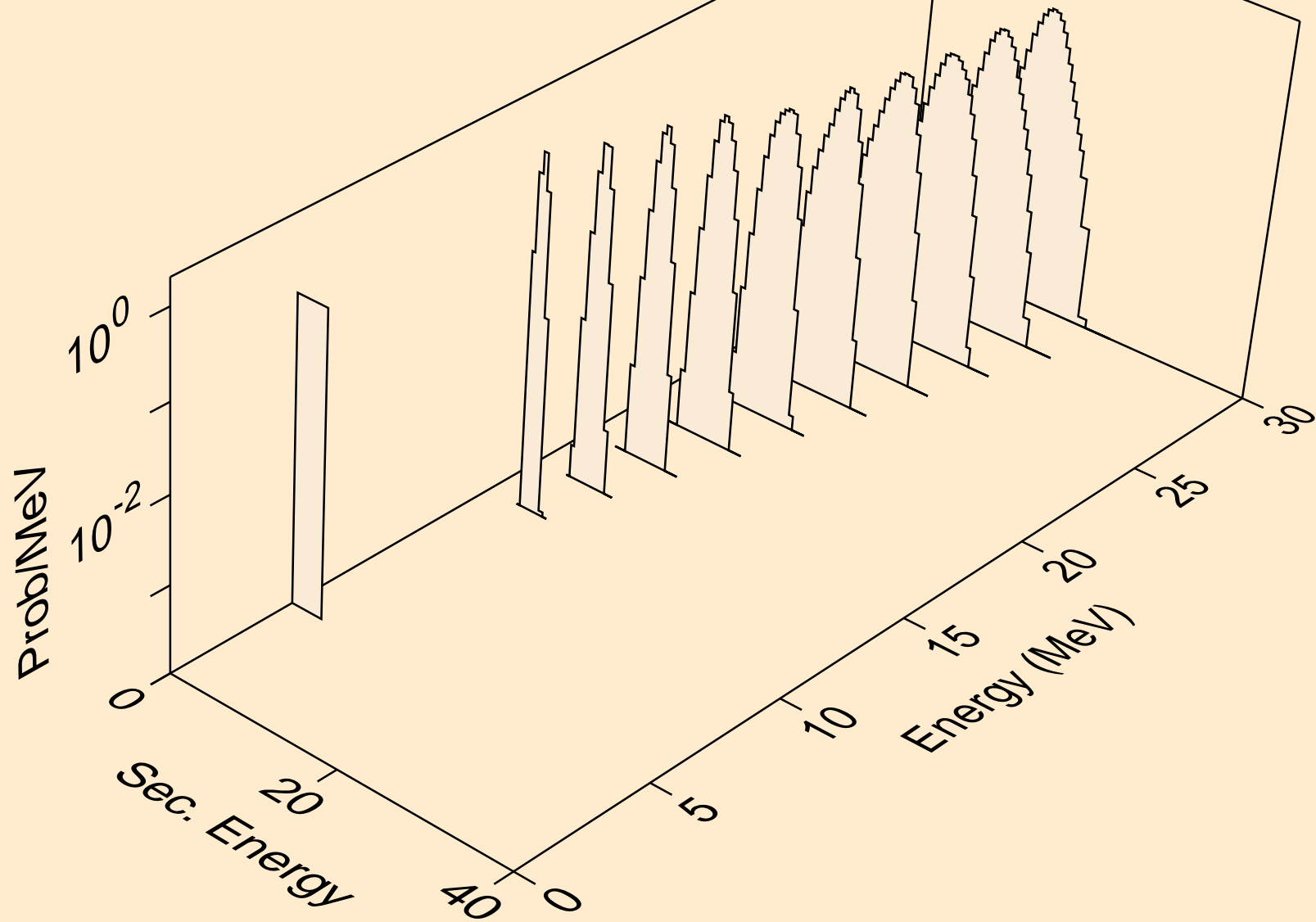

BA123 NEUTRON ACER TENDL-2024 LIBRARY; T=293.6K  
alphas from (n,a)

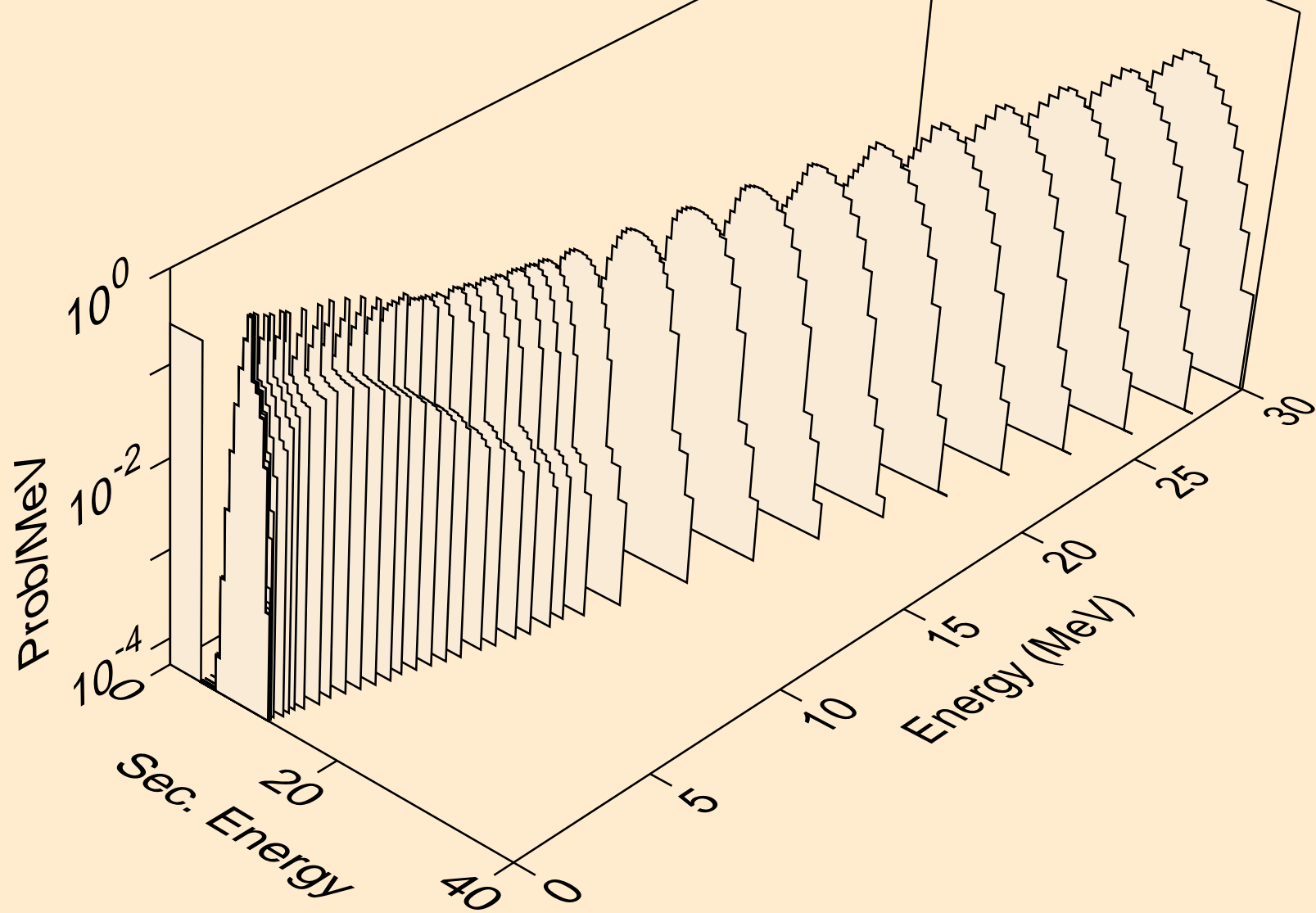

BA123 NEUTRON ACER TENDL-2024 LIBRARY; T=293.6K  
alphas from (n,2a)

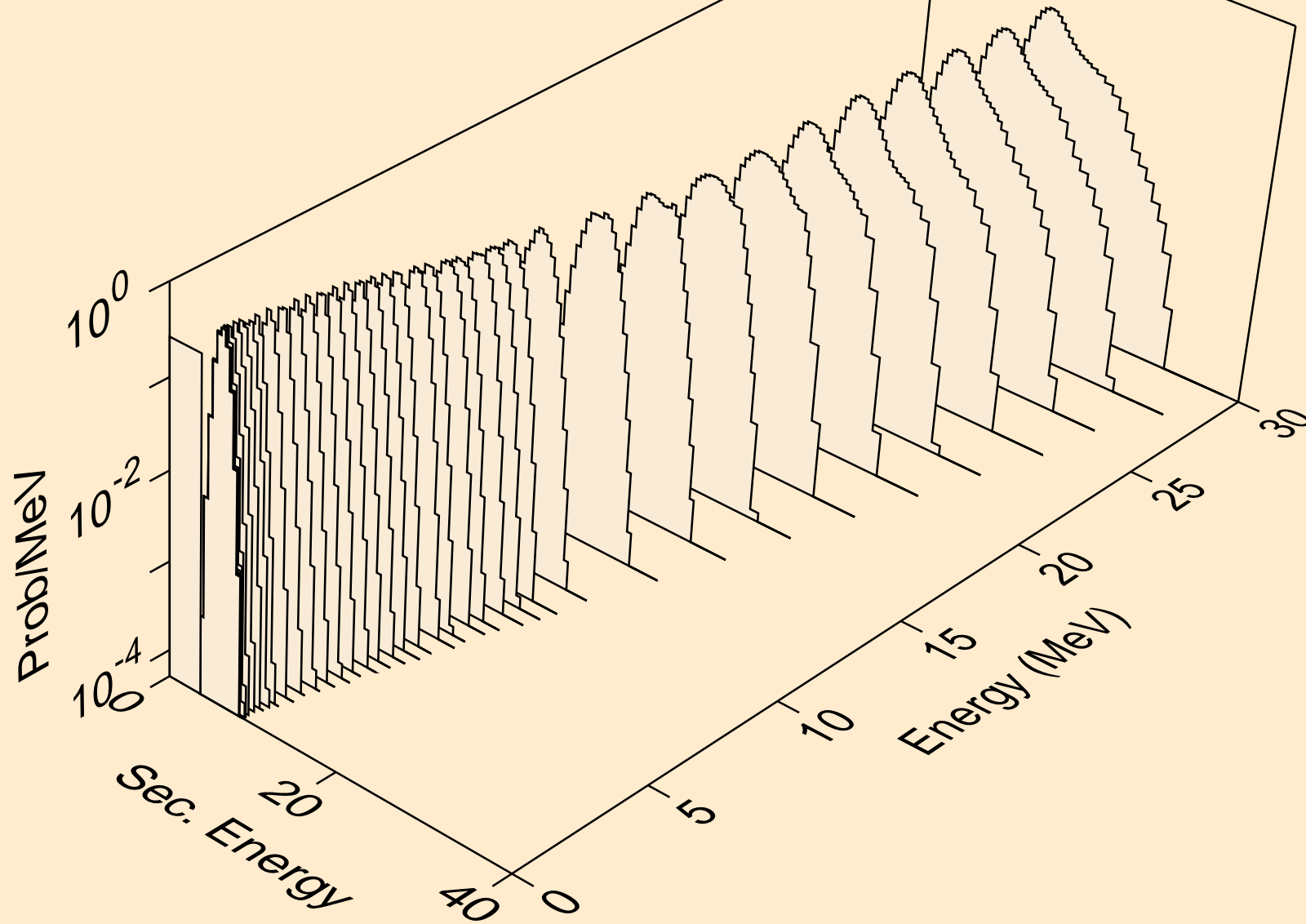

BA123 NEUTRON ACER TENDL-2024 LIBRARY; T=293.6K  
alphas from (n,3a)

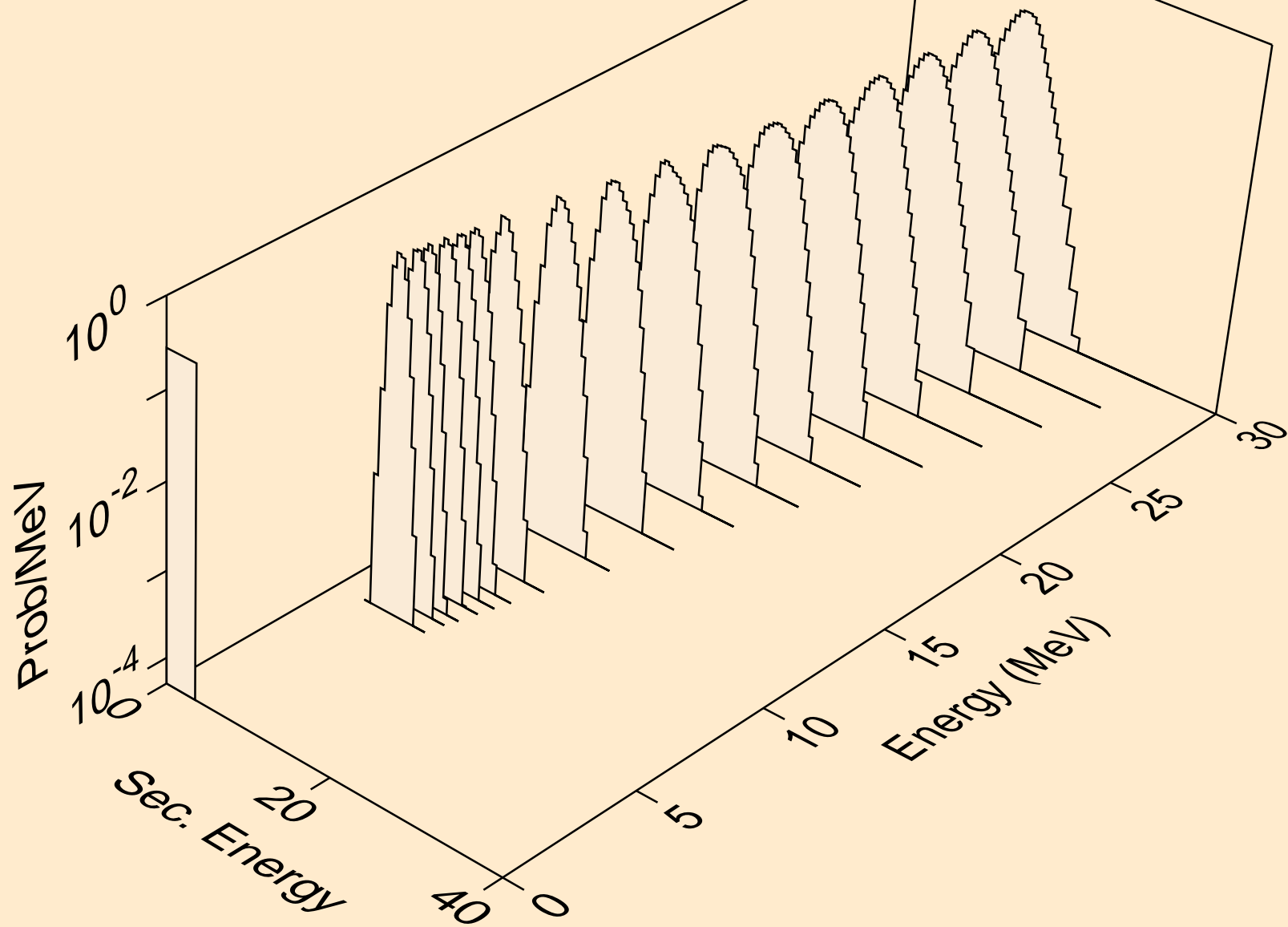

BA123 NEUTRON ACER TENDL-2024 LIBRARY; T=293.6K  
alphas from (n,pa)

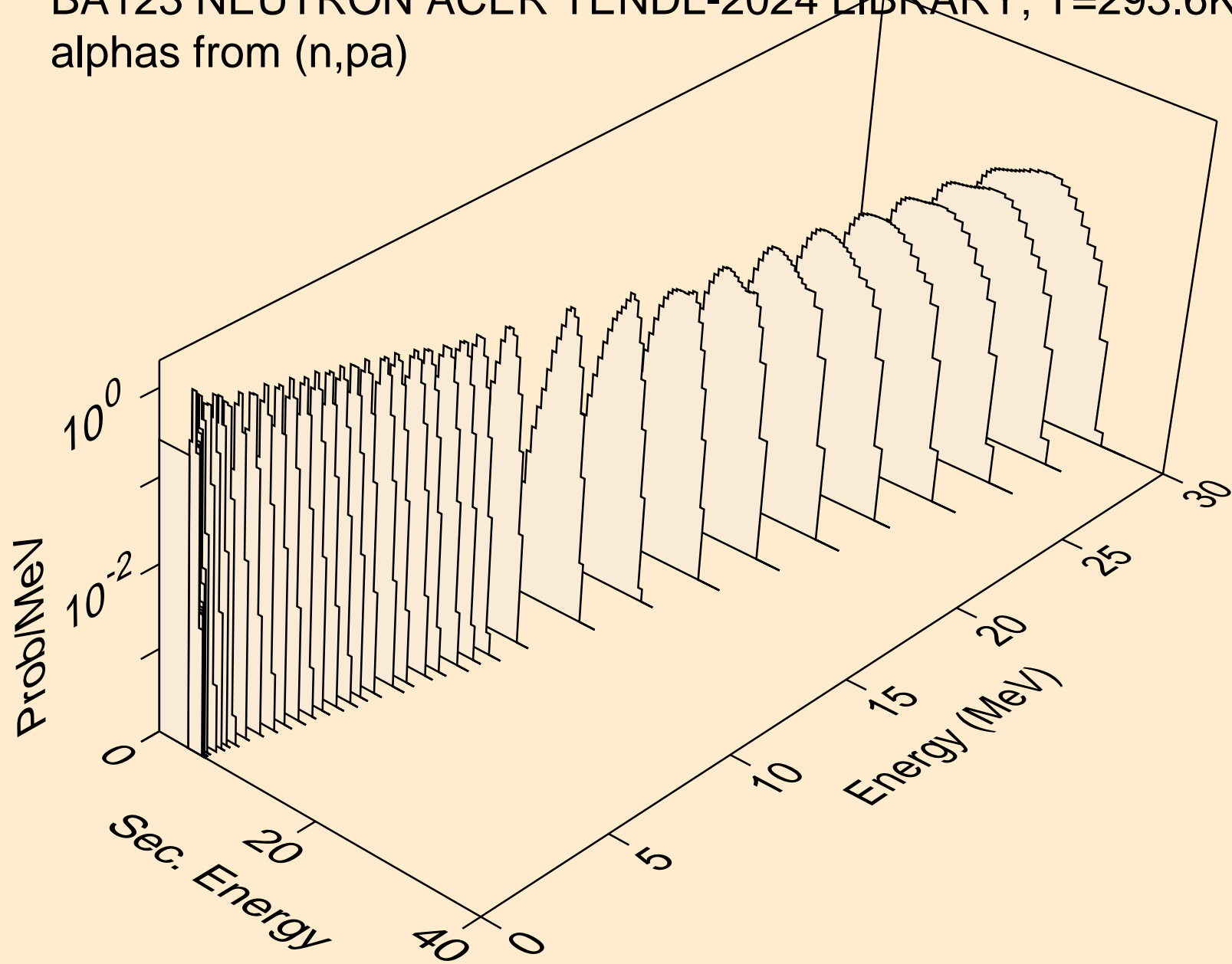

BA123 NEUTRON ACER TENDL-2024 LIBRARY; T=293.6K  
alphas from (n,da)

