

BA138 NEUTRON ACER TENDL-2024 LIBRARY; T=293.6K

Principal cross sections

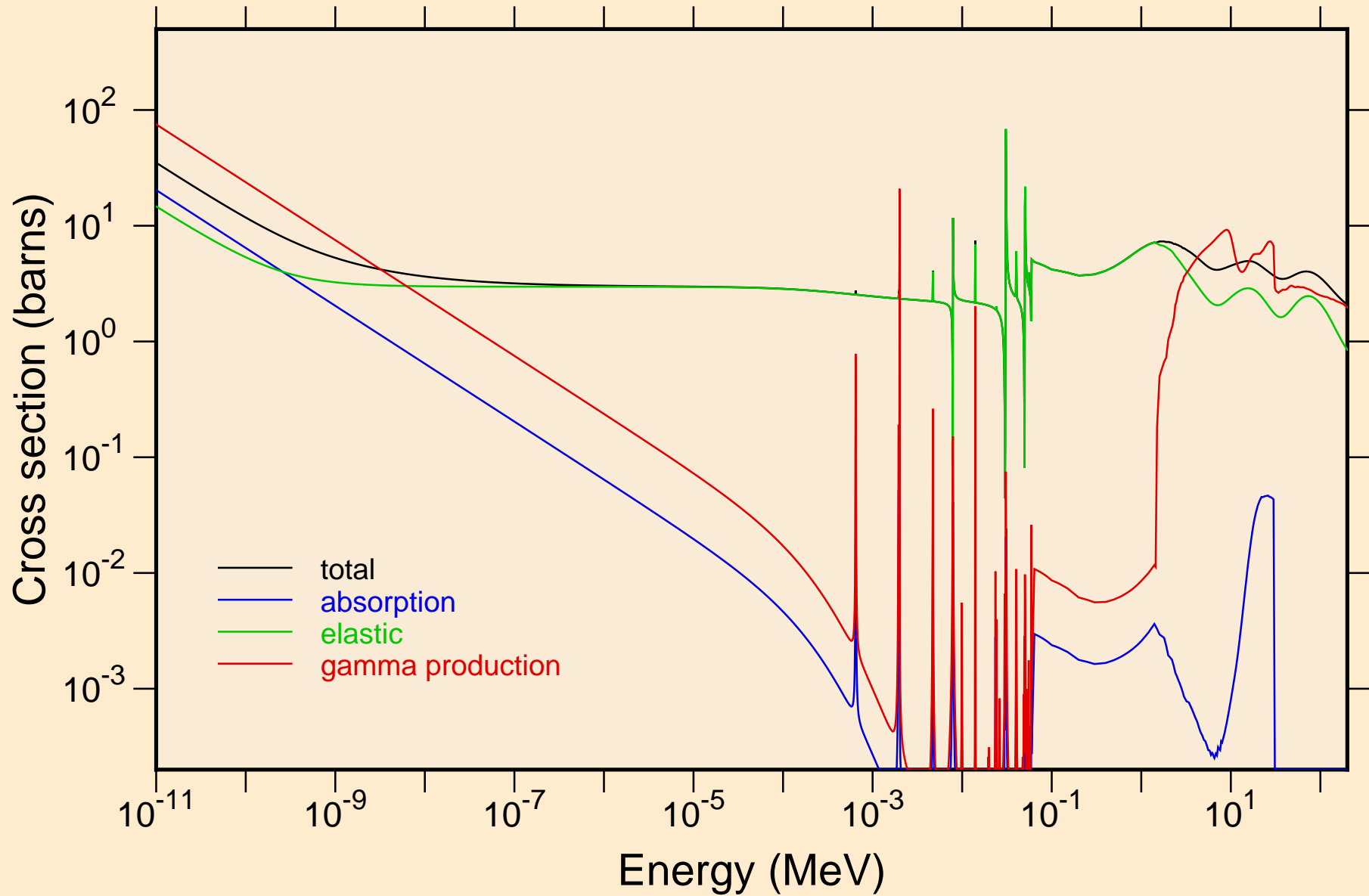

BA138 NEUTRON ACER TENDL-2024 LIBRARY; T=293.6K
resonance total cross section

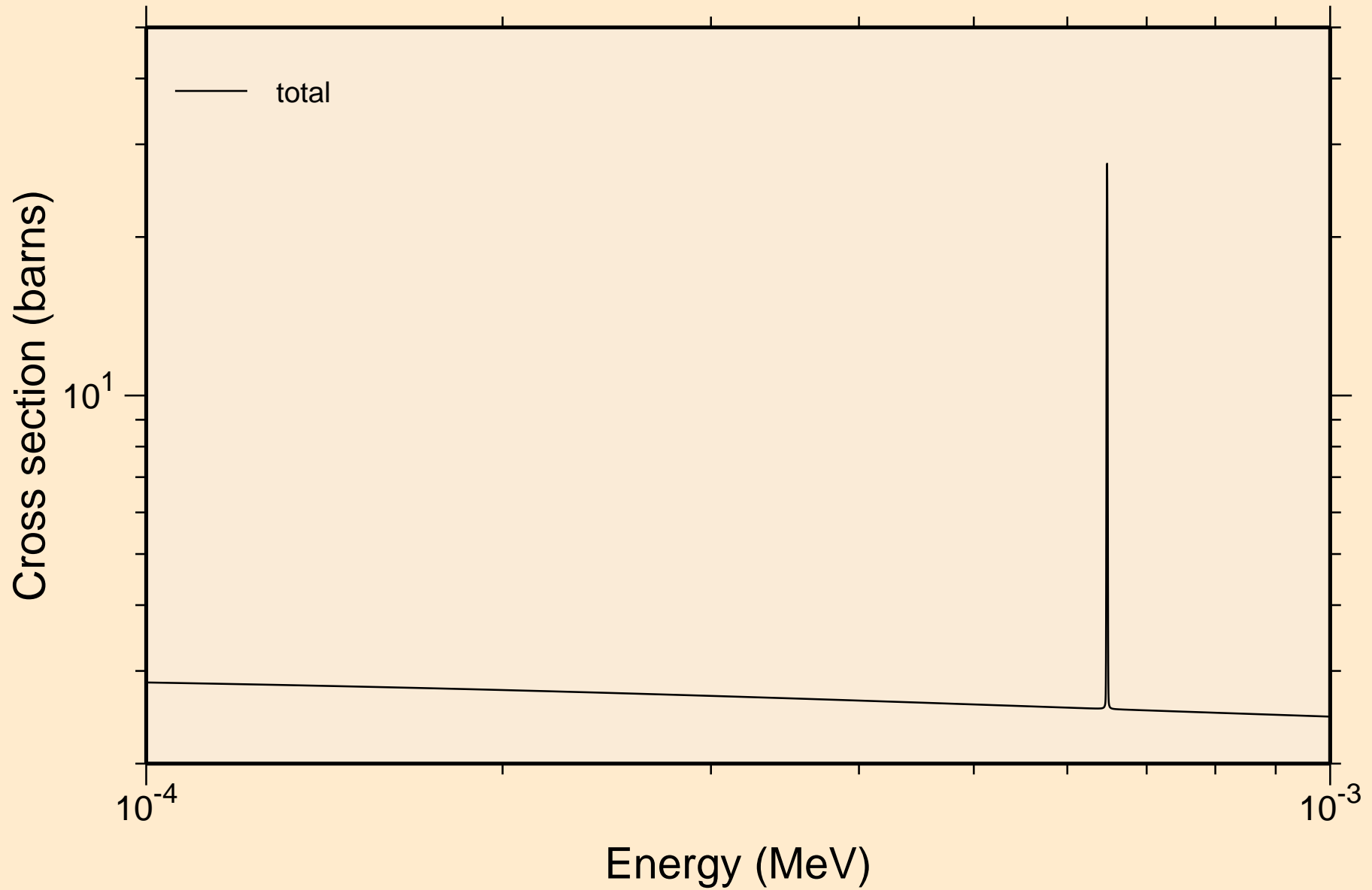

BA138 NEUTRON ACER TENDL-2024 LIBRARY; T=293.6K
resonance total cross section

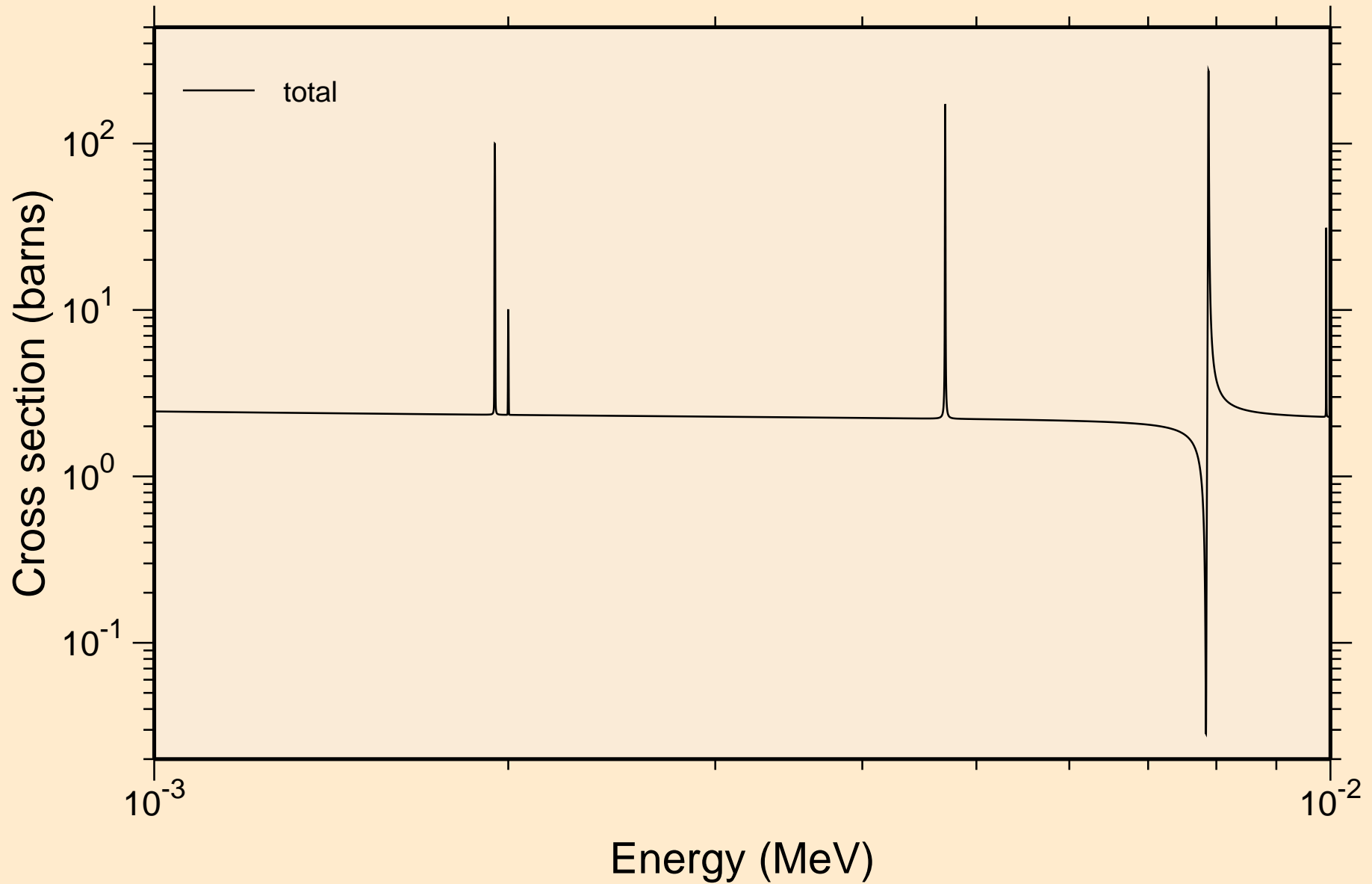

BA138 NEUTRON ACER TENDL-2024 LIBRARY; T=293.6K
resonance total cross section

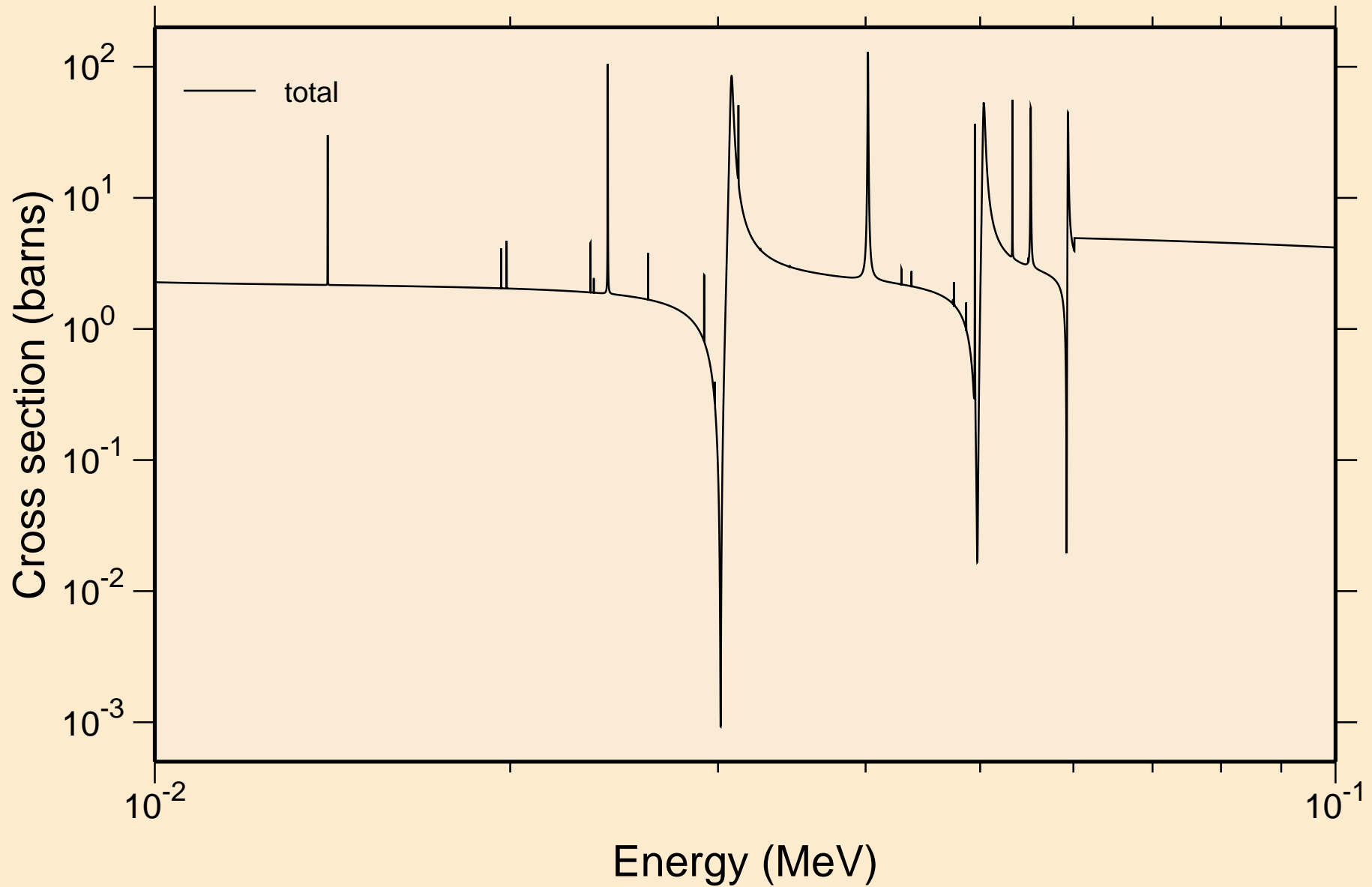

BA138 NEUTRON ACER TENDL-2024 LIBRARY; T=293.6K
resonance total cross section

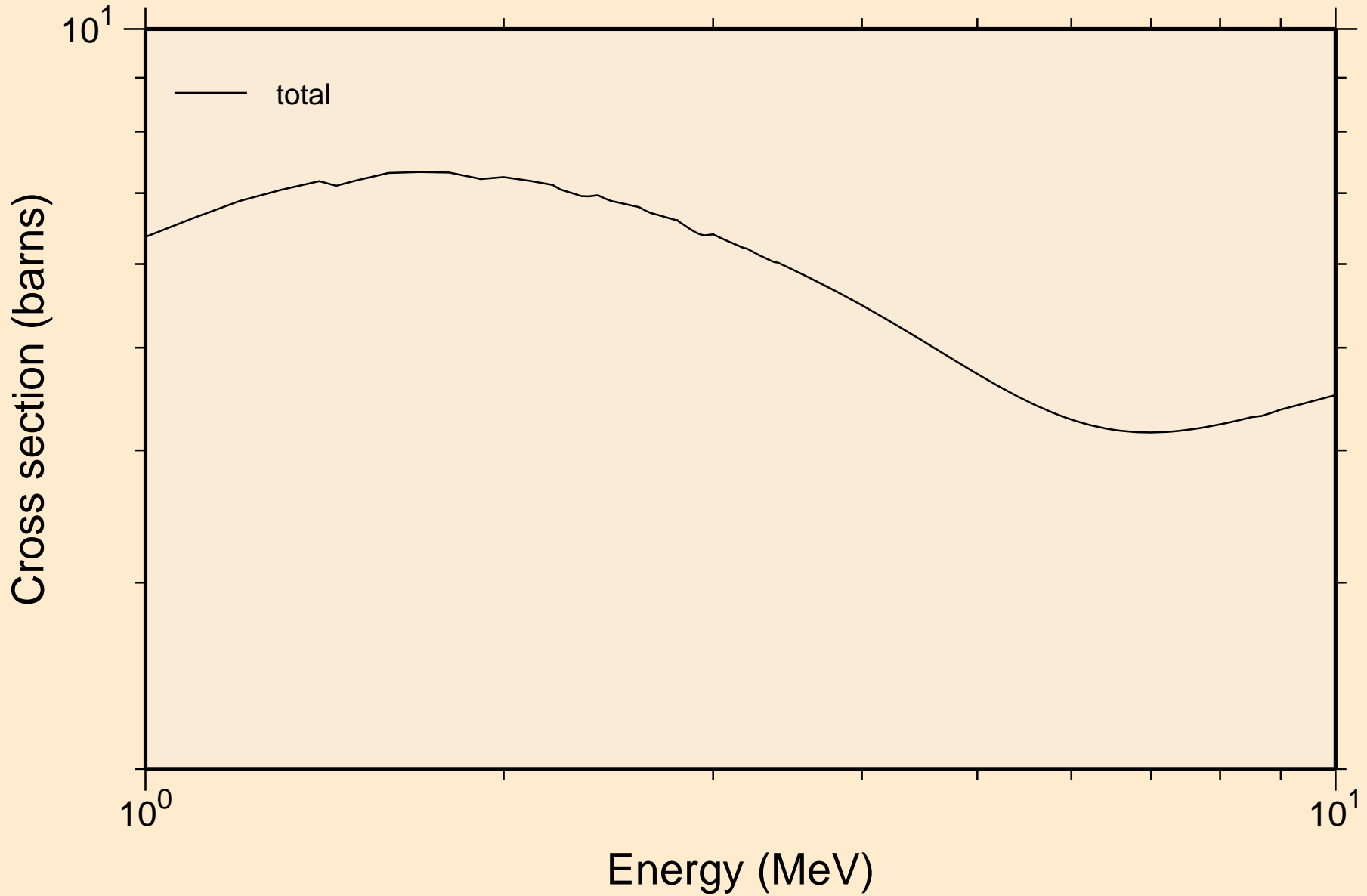

BA138 NEUTRON ACER TENDL-2024 LIBRARY; T=293.6K
resonance absorption cross sections

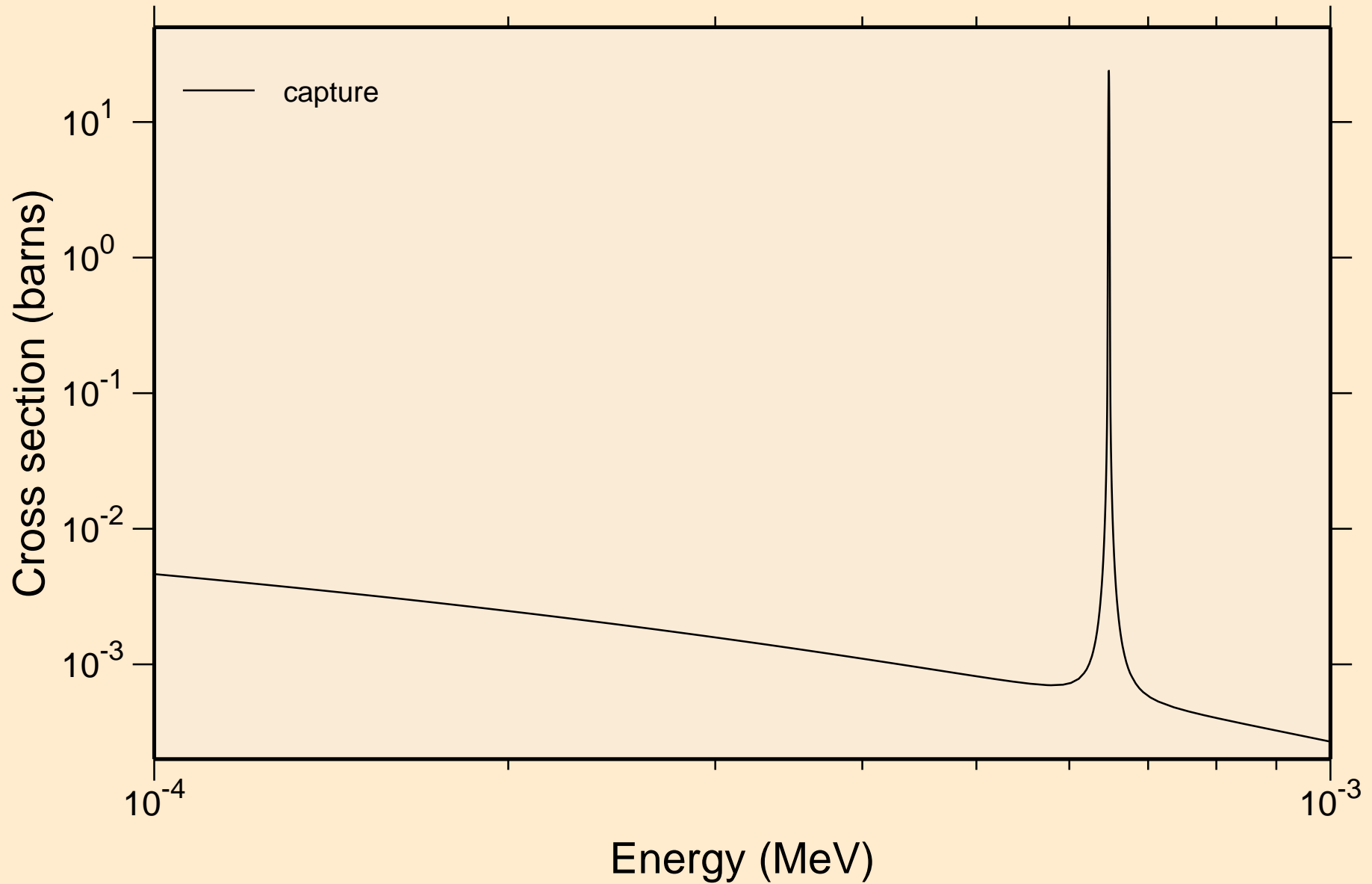

BA138 NEUTRON ACER TENDL-2024 LIBRARY; T=293.6K
resonance absorption cross sections

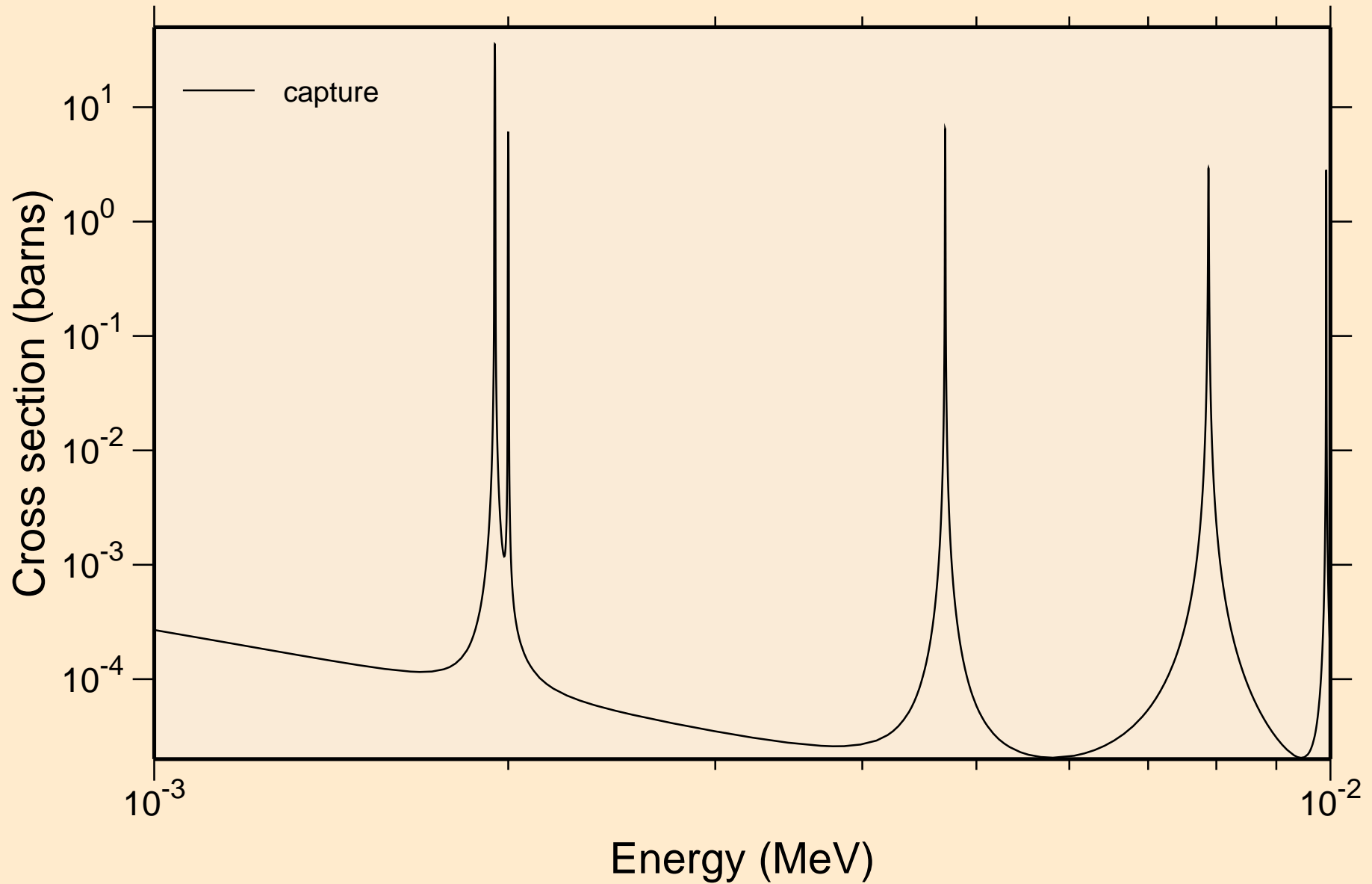

BA138 NEUTRON ACER TENDL-2024 LIBRARY; T=293.6K
resonance absorption cross sections

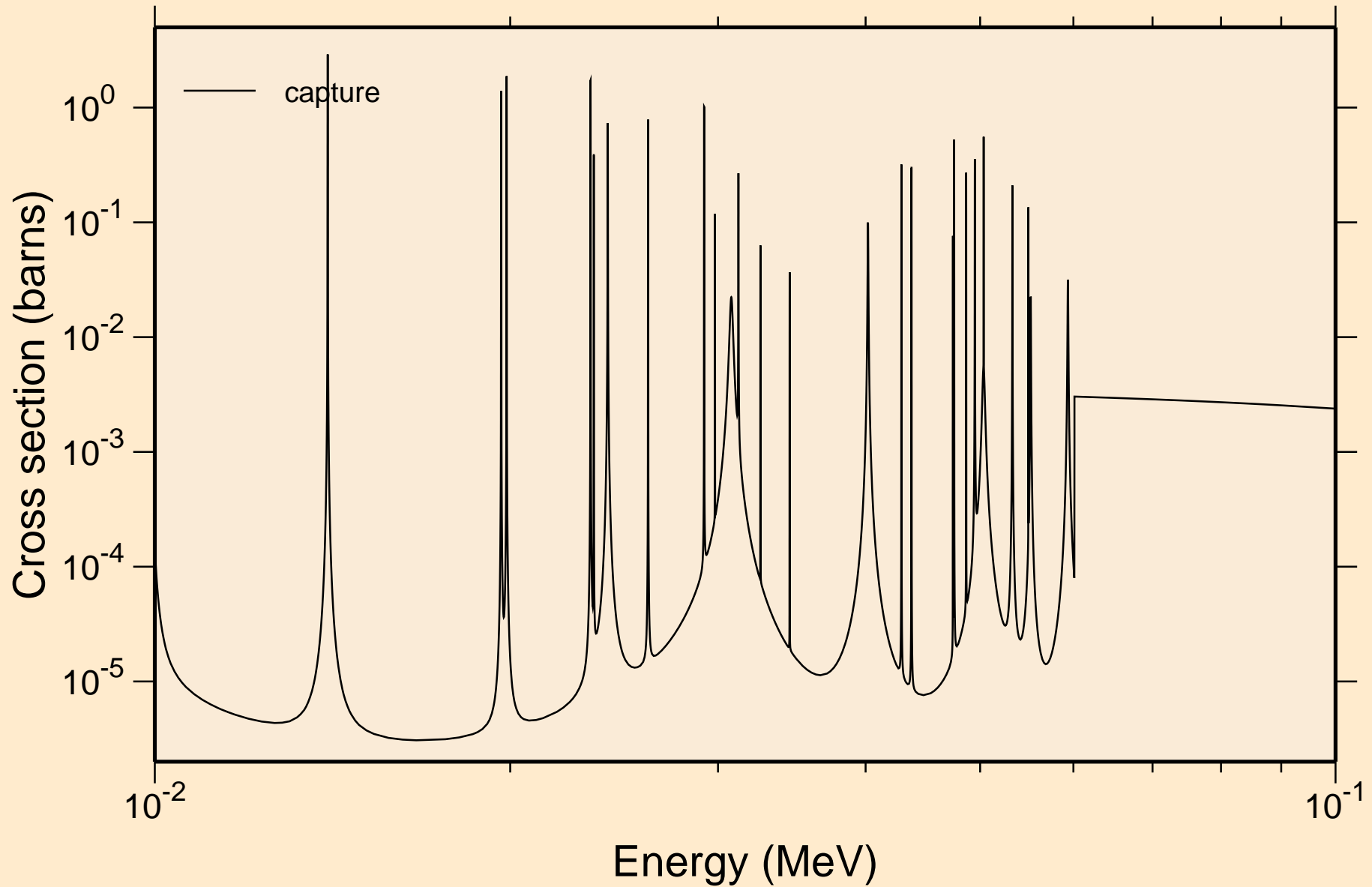

BA138 NEUTRON ACER TENDL-2024 LIBRARY; T=293.6K
resonance absorption cross sections

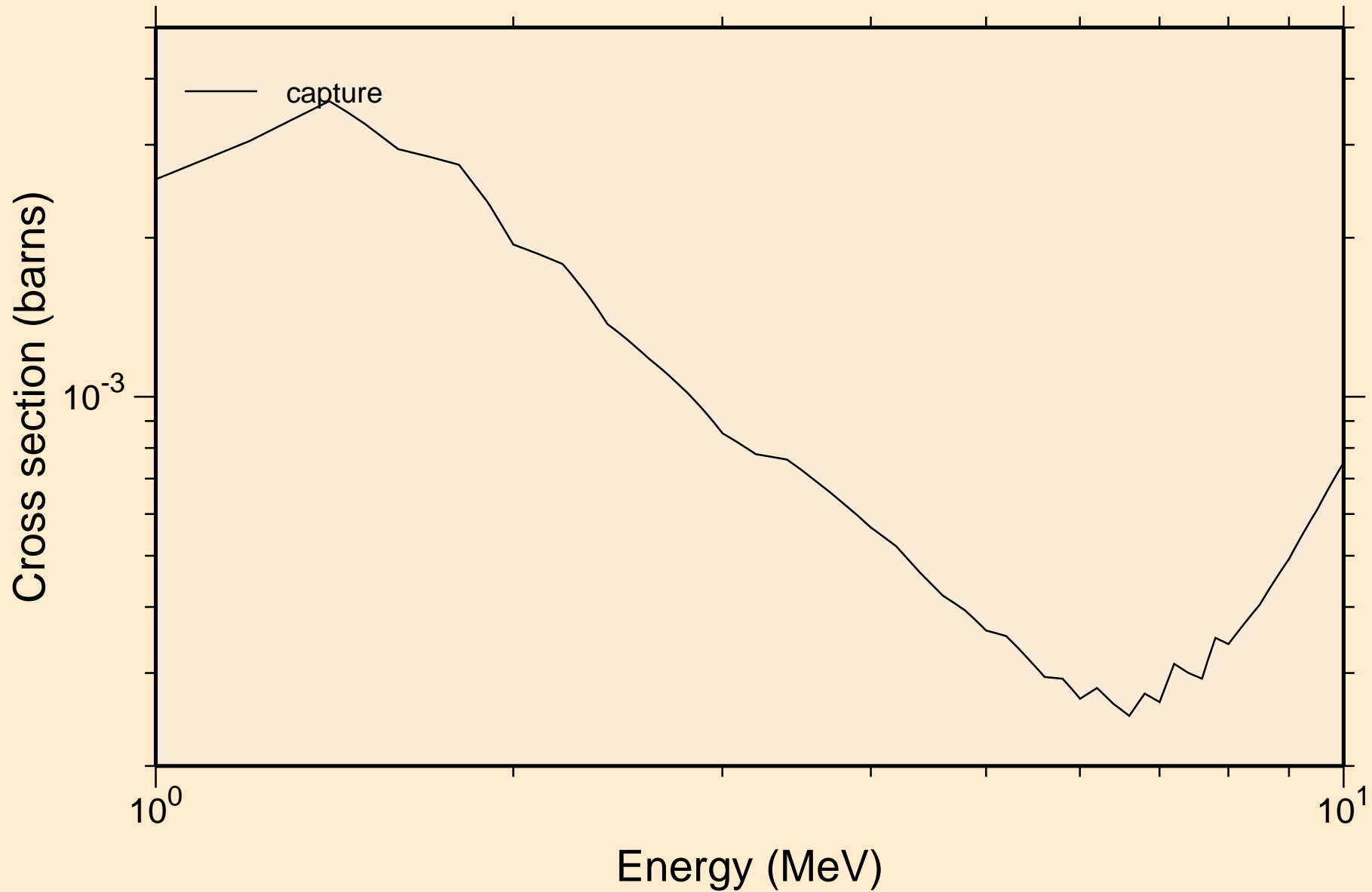

BA138 NEUTRON ACER TENDL-2024 LIBRARY; T=293.6K
Heating

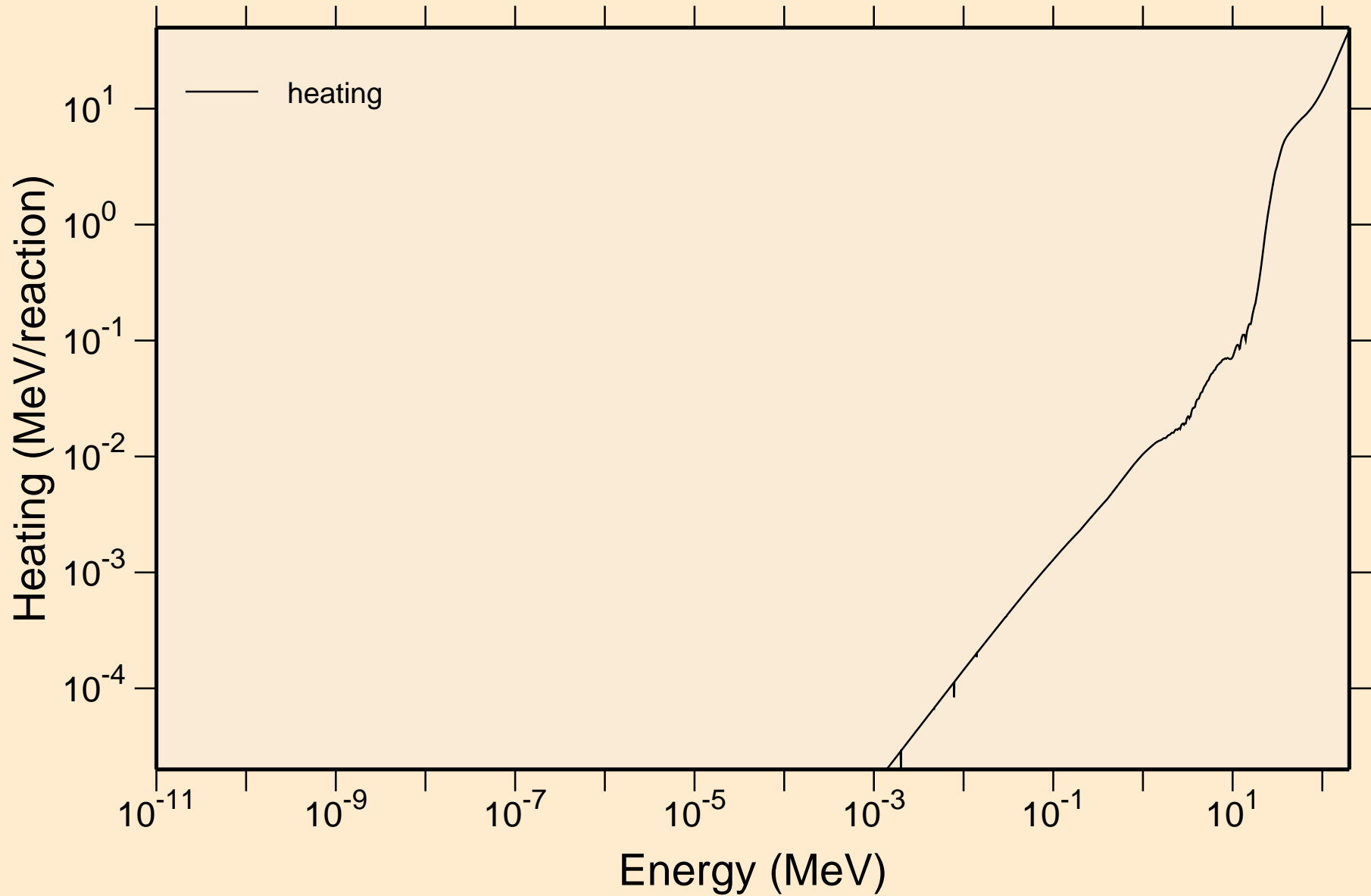

BA138 NEUTRON ACER TENDL-2024 LIBRARY; T=293.6K
Damage

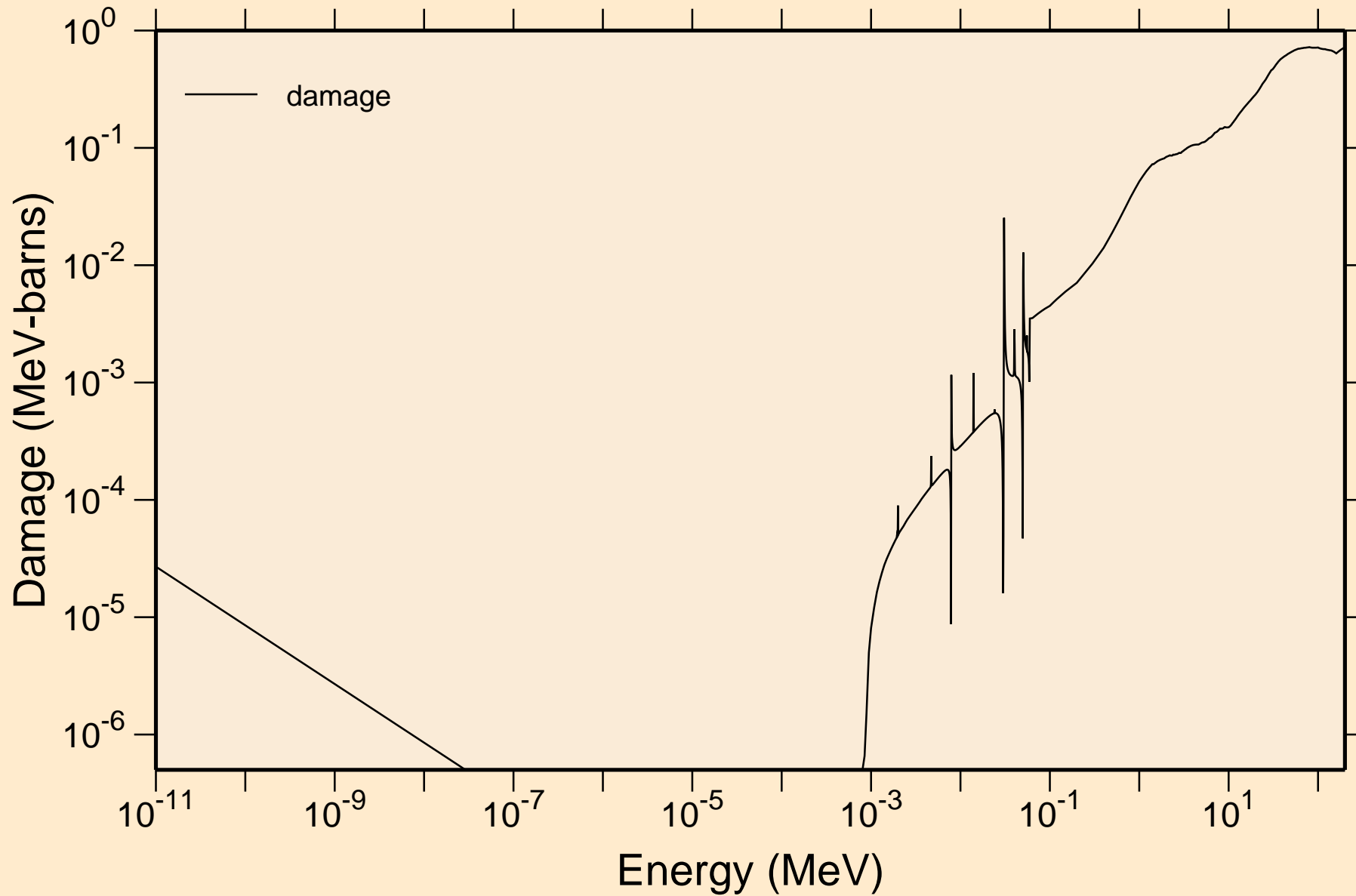

BA138 NEUTRON ACER TENDL-2024 LIBRARY; T=293.6K
Non-threshold reactions

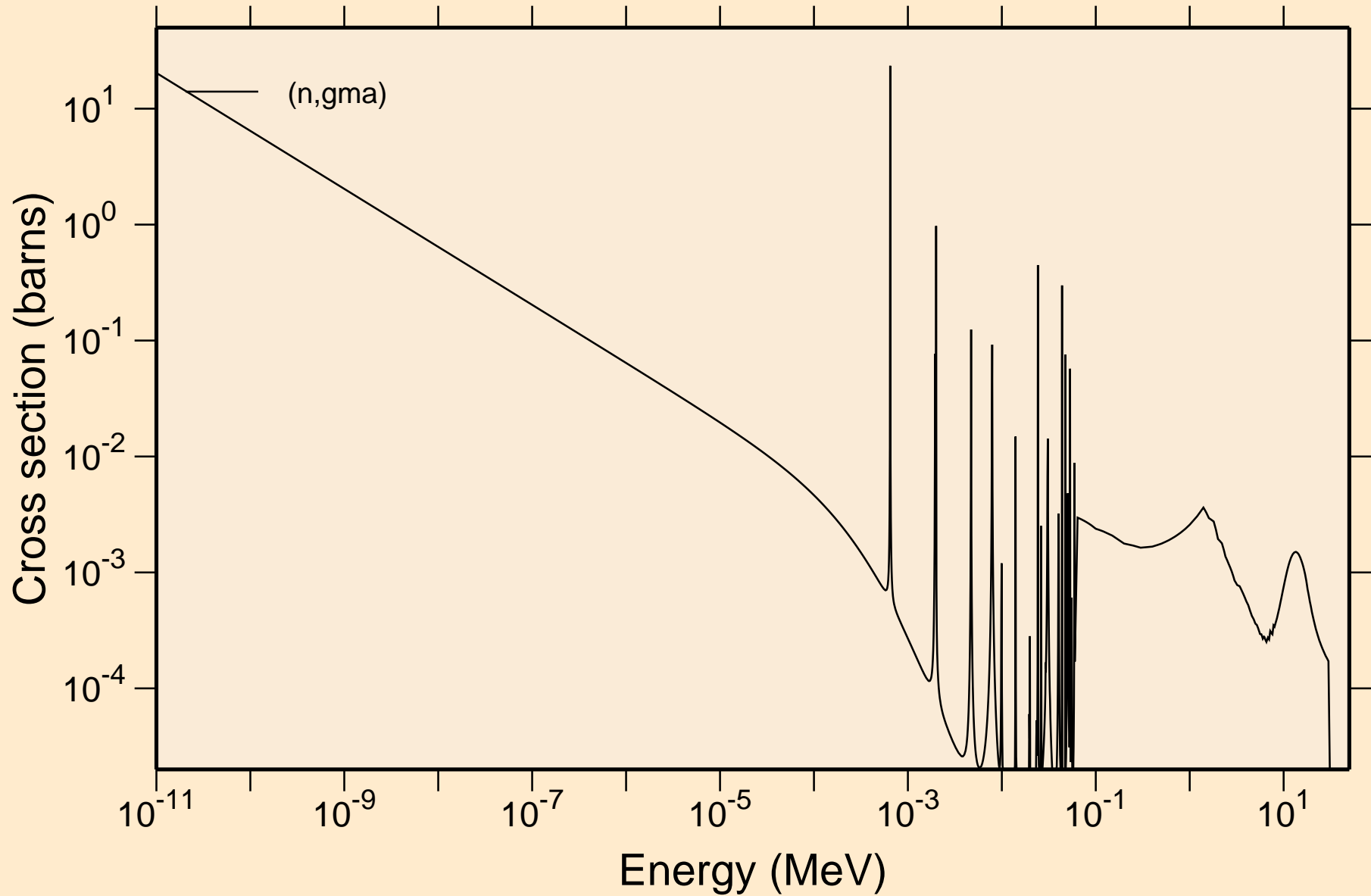

BA138 NEUTRON ACER TENDL-2024 LIBRARY; T=293.6K
Principal cross sections

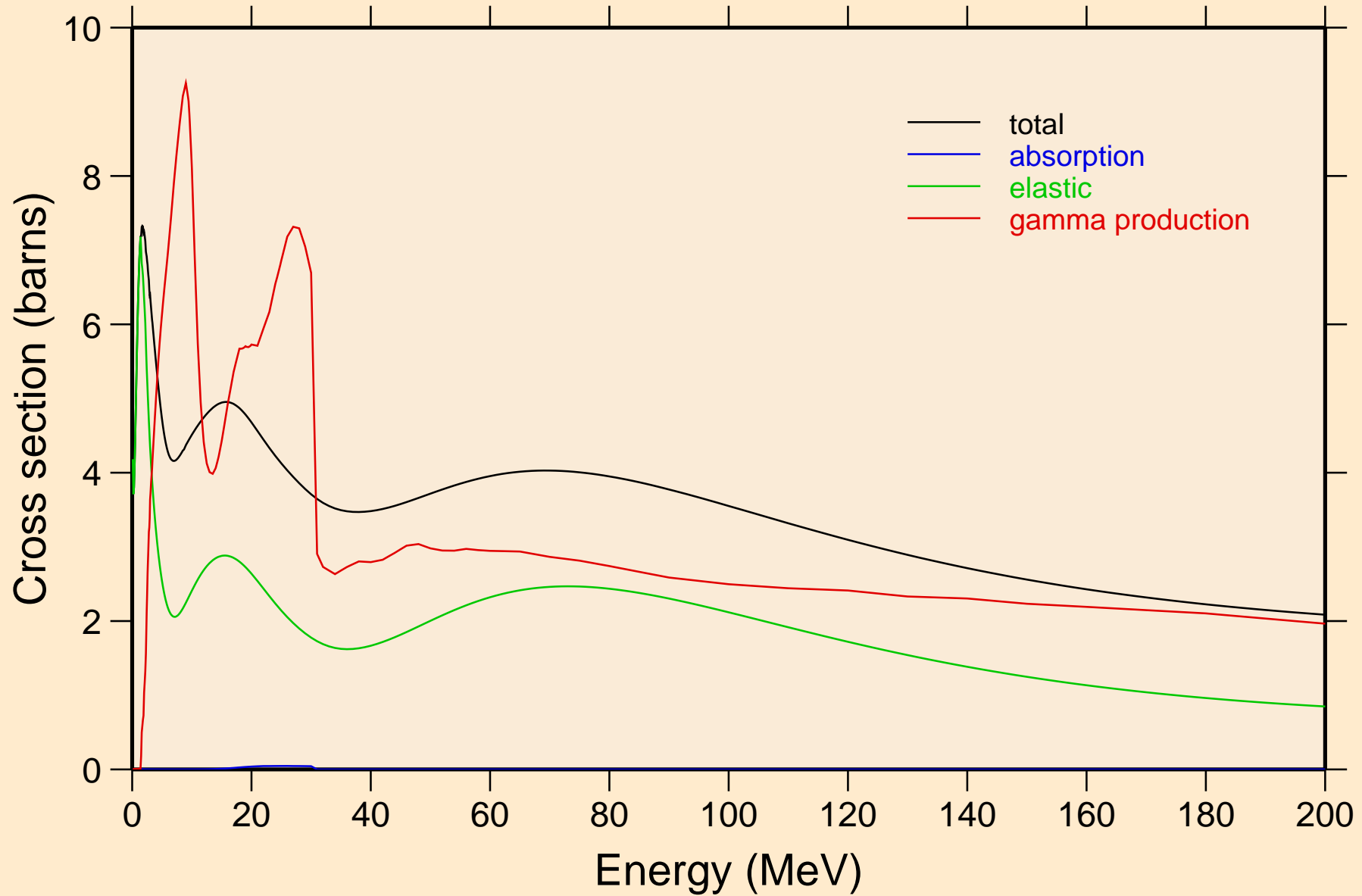

BA138 NEUTRON ACER TENDL-2024 LIBRARY; T=293.6K

Heating

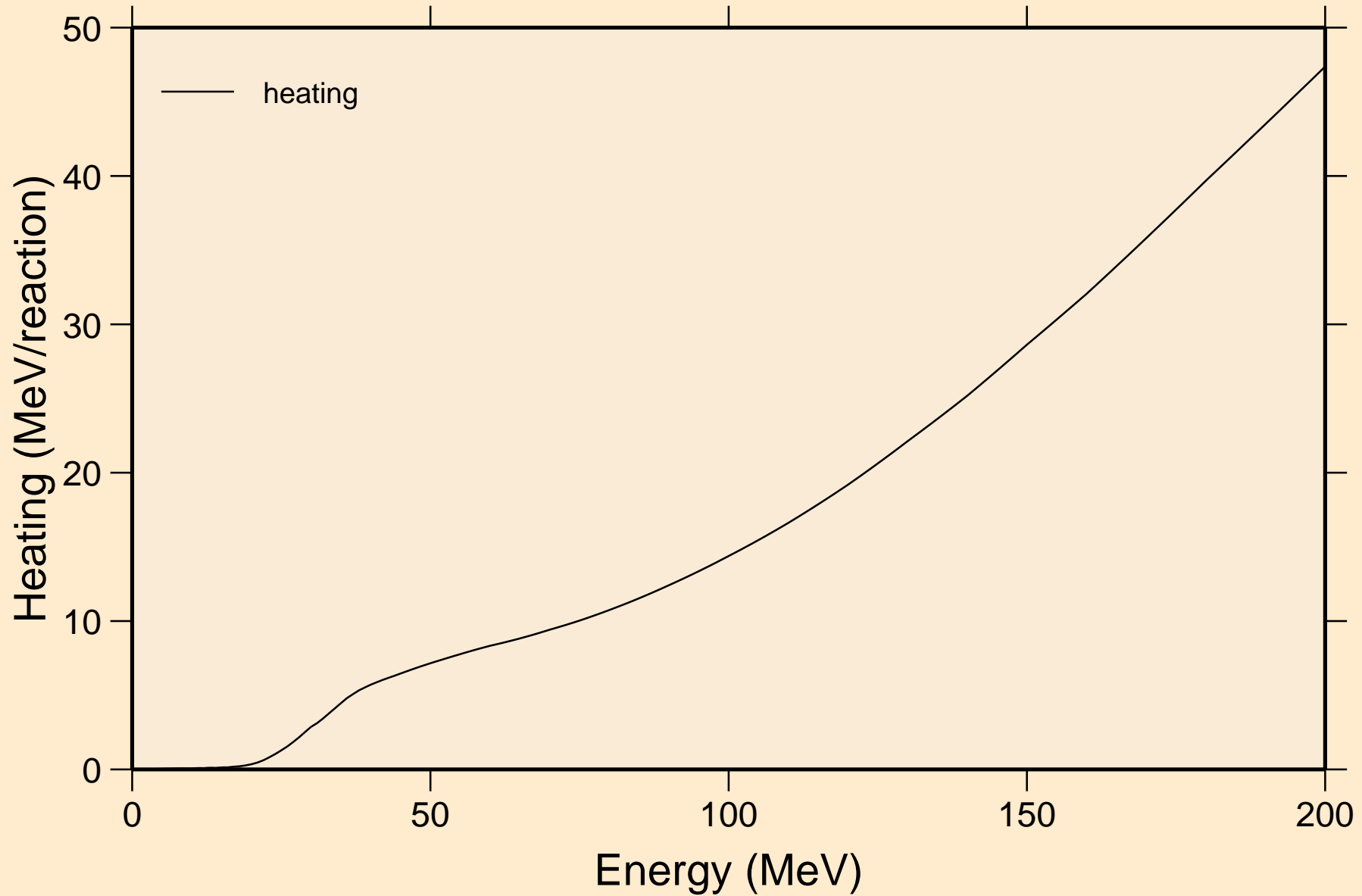

BA138 NEUTRON ACER TENDL-2024 LIBRARY; T=293.6K
Damage

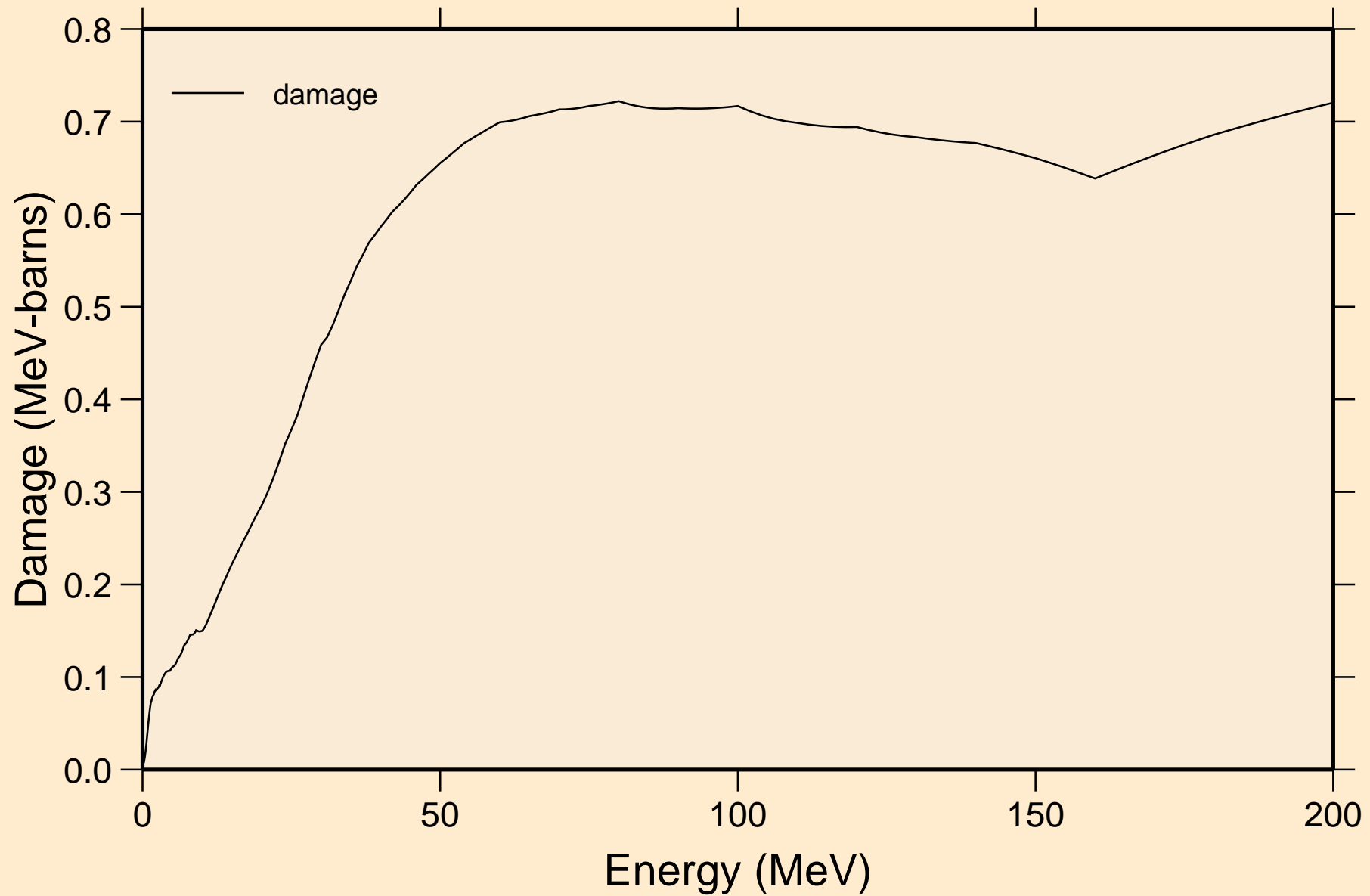

BA138 NEUTRON ACER TENDL-2024 LIBRARY; T=293.6K
Non-threshold reactions

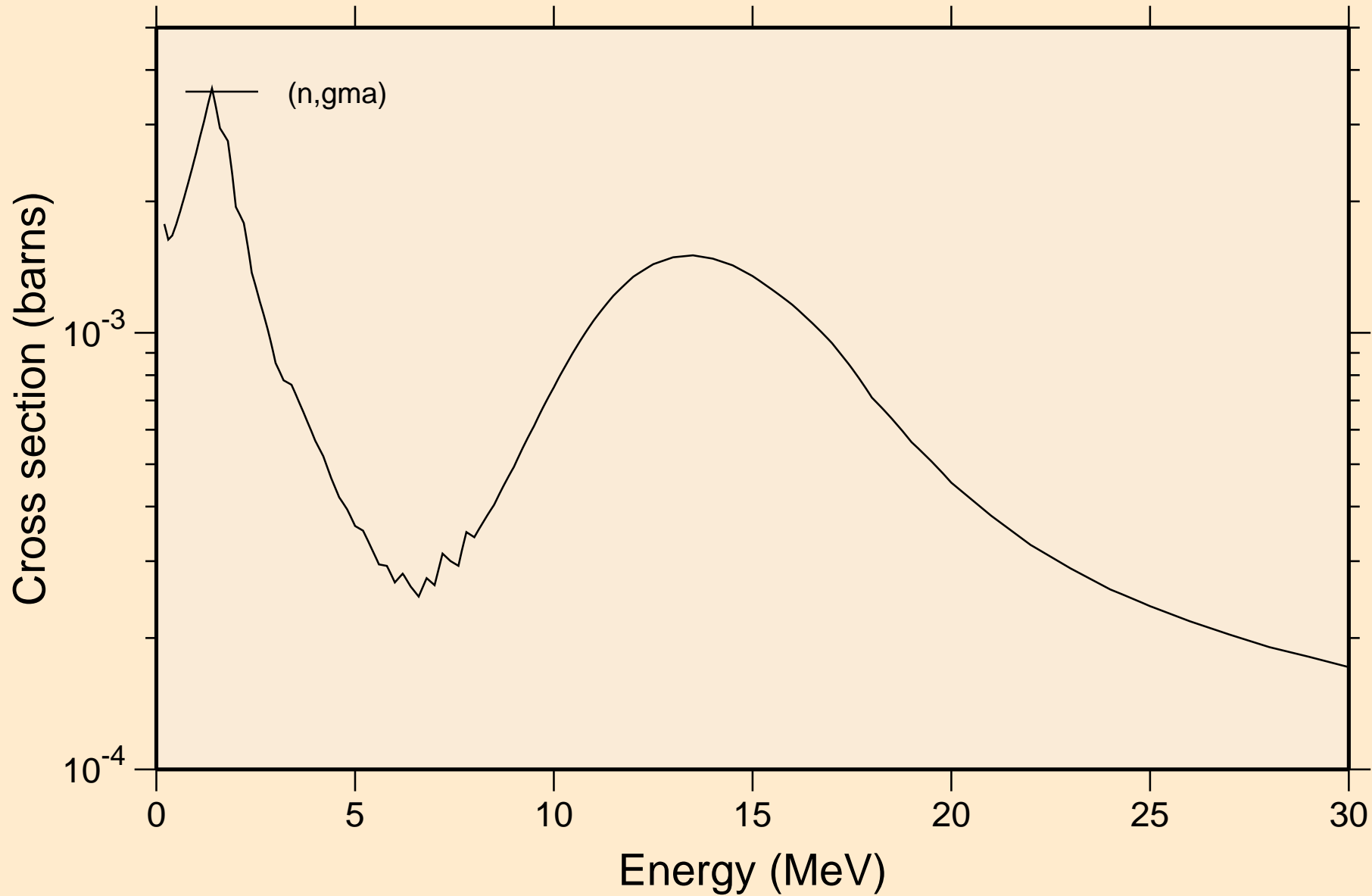

BA138 NEUTRON ACER TENDL-2024 LIBRARY; T=293.6K
Inelastic levels

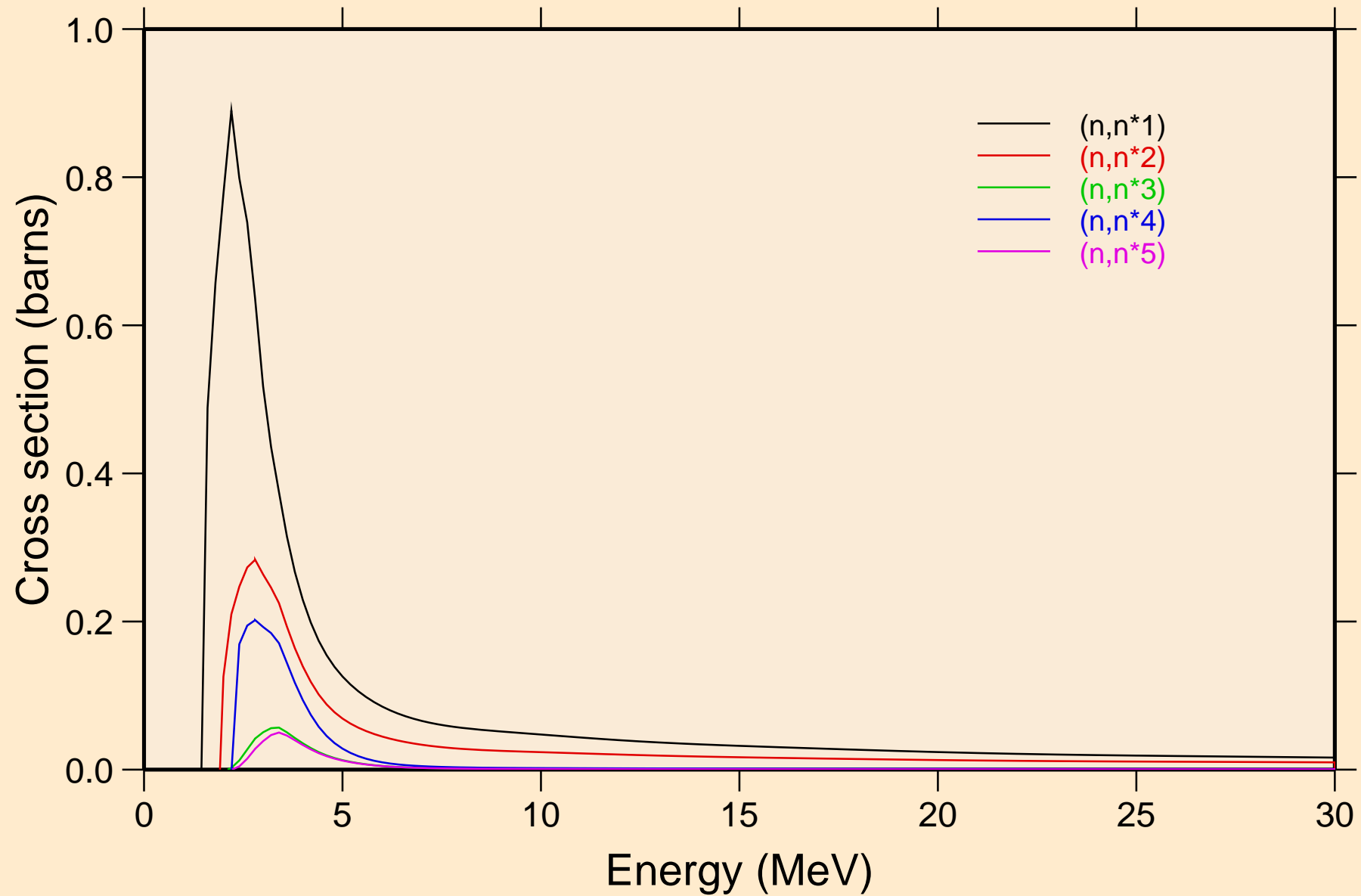

BA138 NEUTRON ACER TENDL-2024 LIBRARY; T=293.6K
Inelastic levels

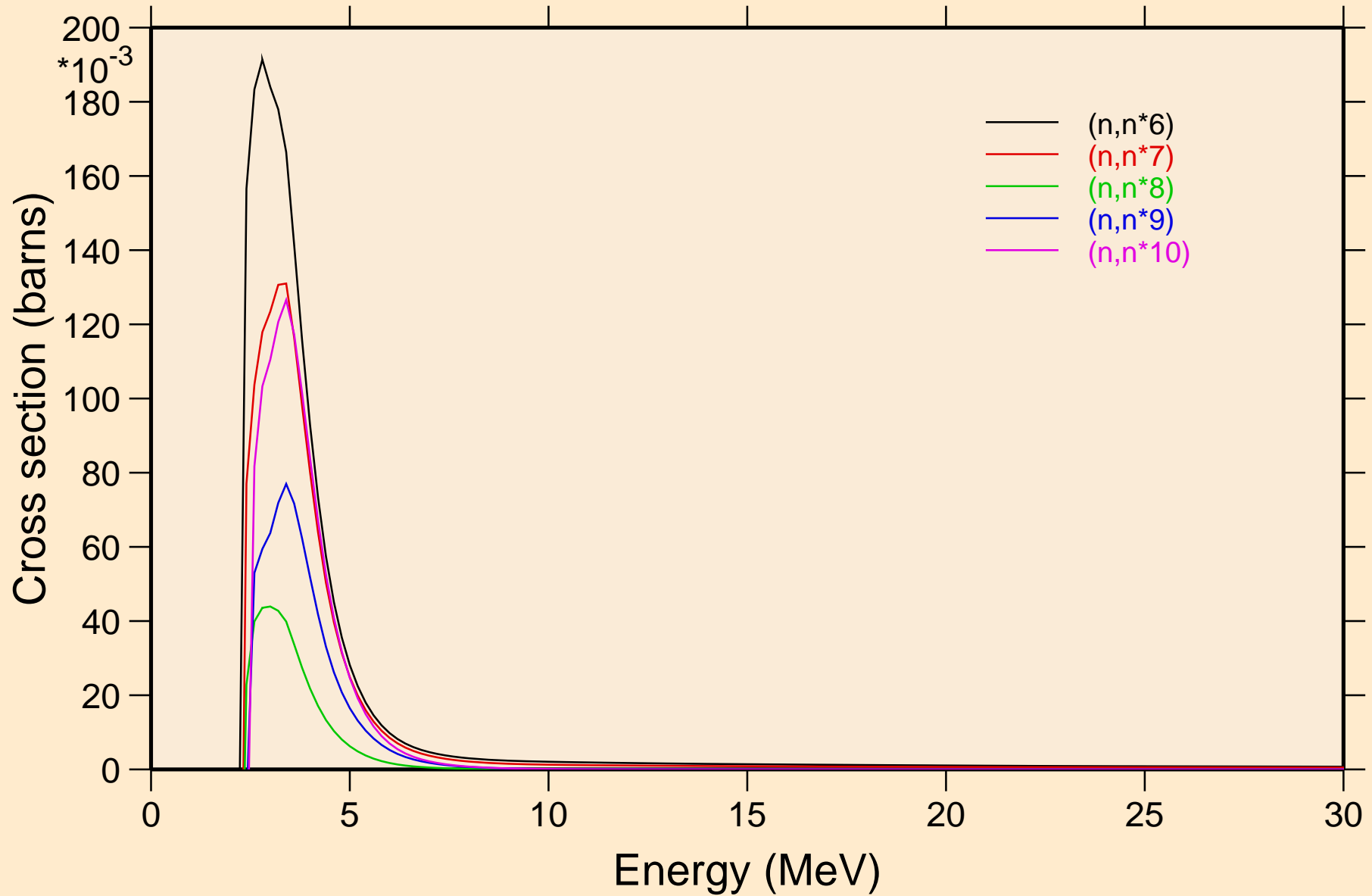

BA138 NEUTRON ACER TENDL-2024 LIBRARY; T=293.6K
Inelastic levels

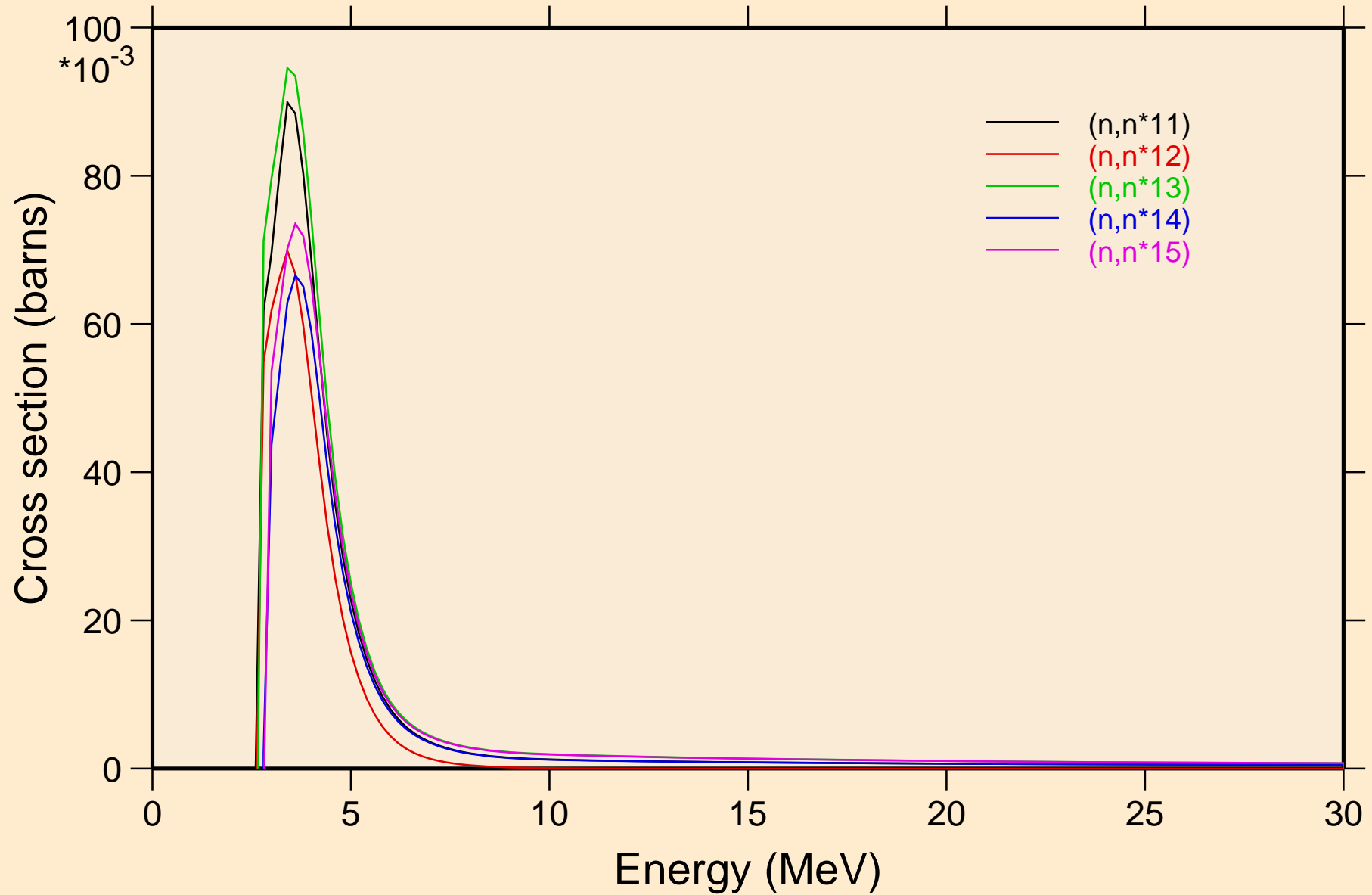

BA138 NEUTRON ACER TENDL-2024 LIBRARY; T=293.6K
Inelastic levels

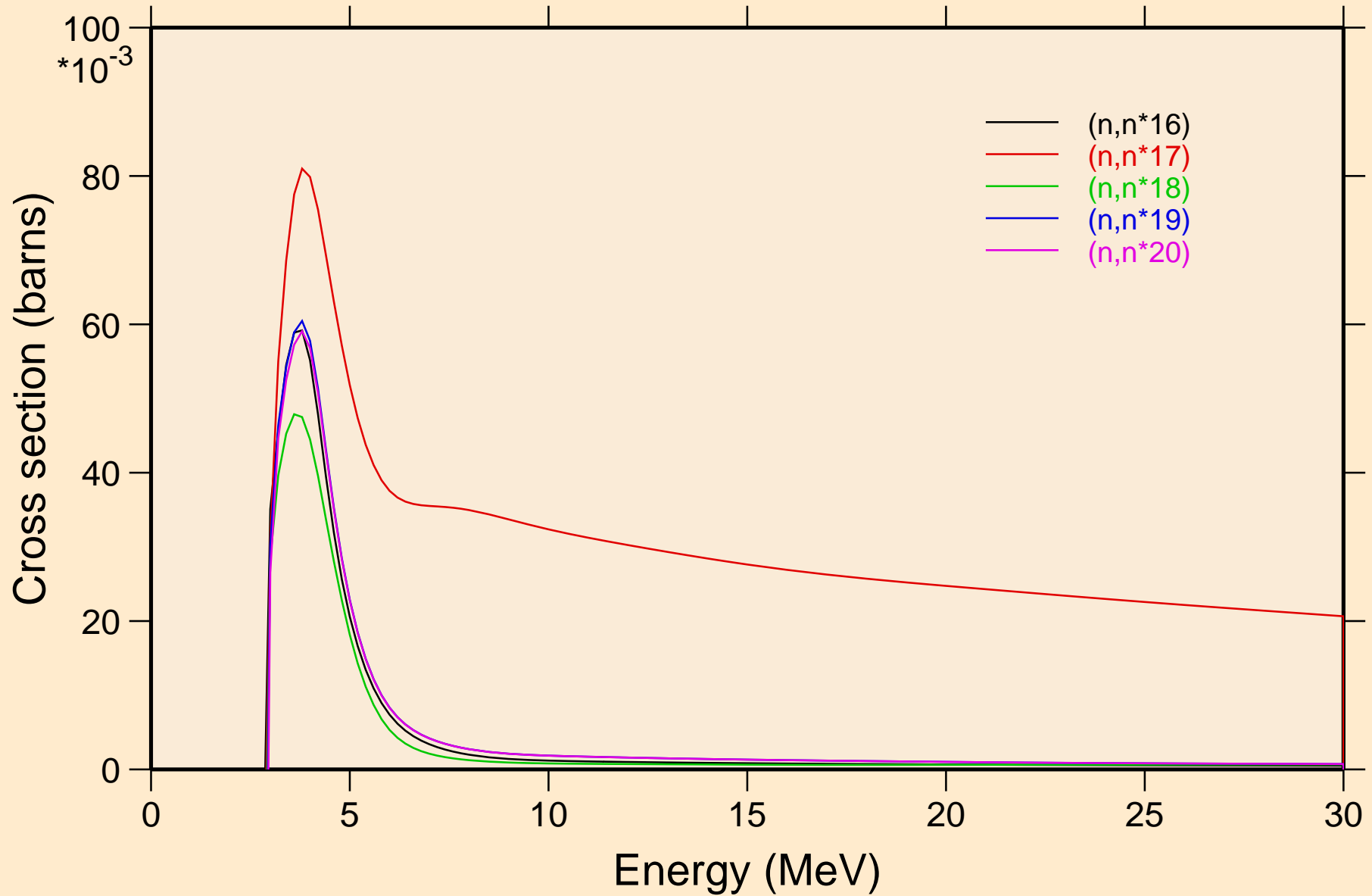

BA138 NEUTRON ACER TENDL-2024 LIBRARY; T=293.6K
Inelastic levels

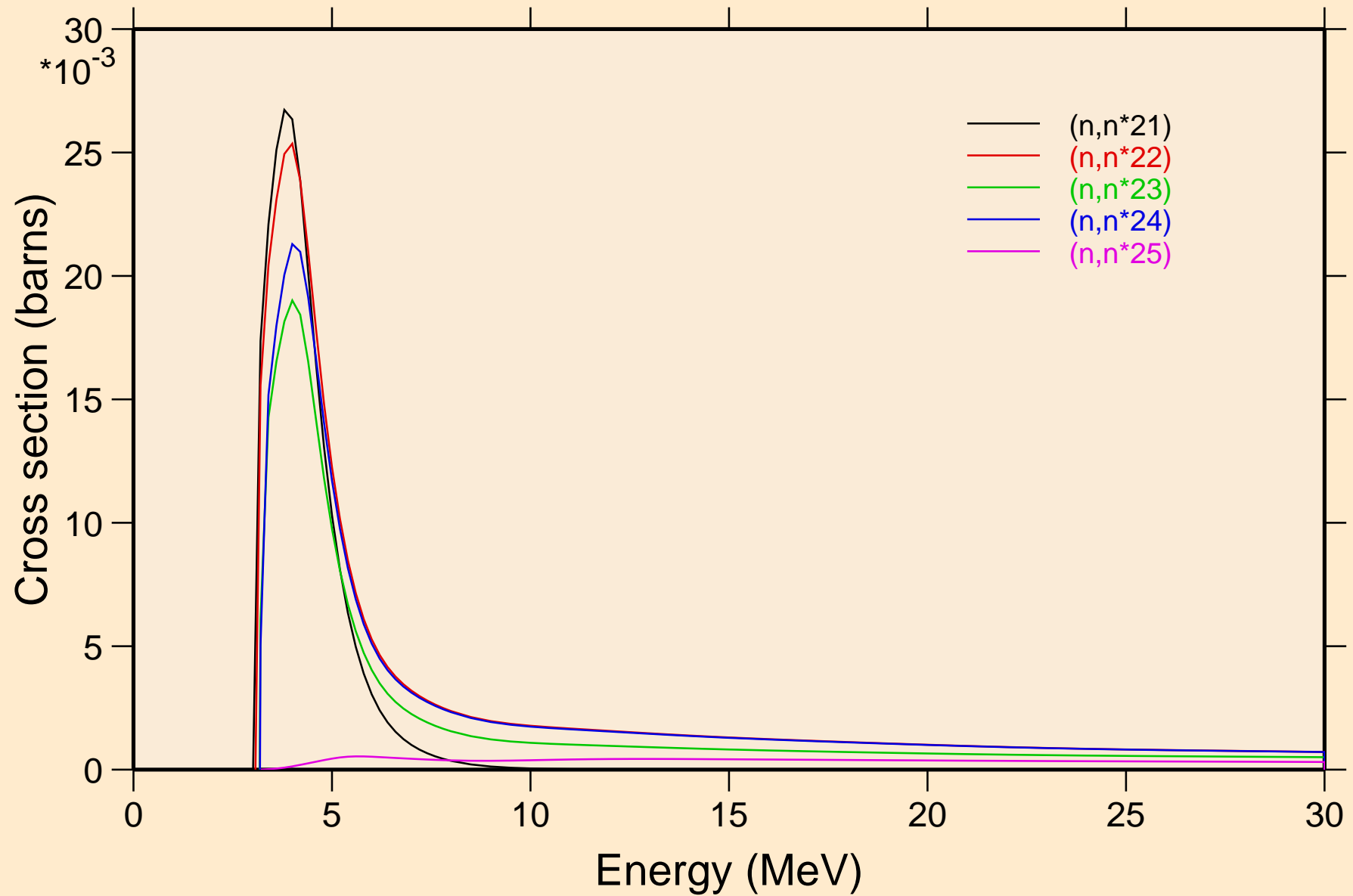

BA138 NEUTRON ACER TENDL-2024 LIBRARY; T=293.6K
Inelastic levels

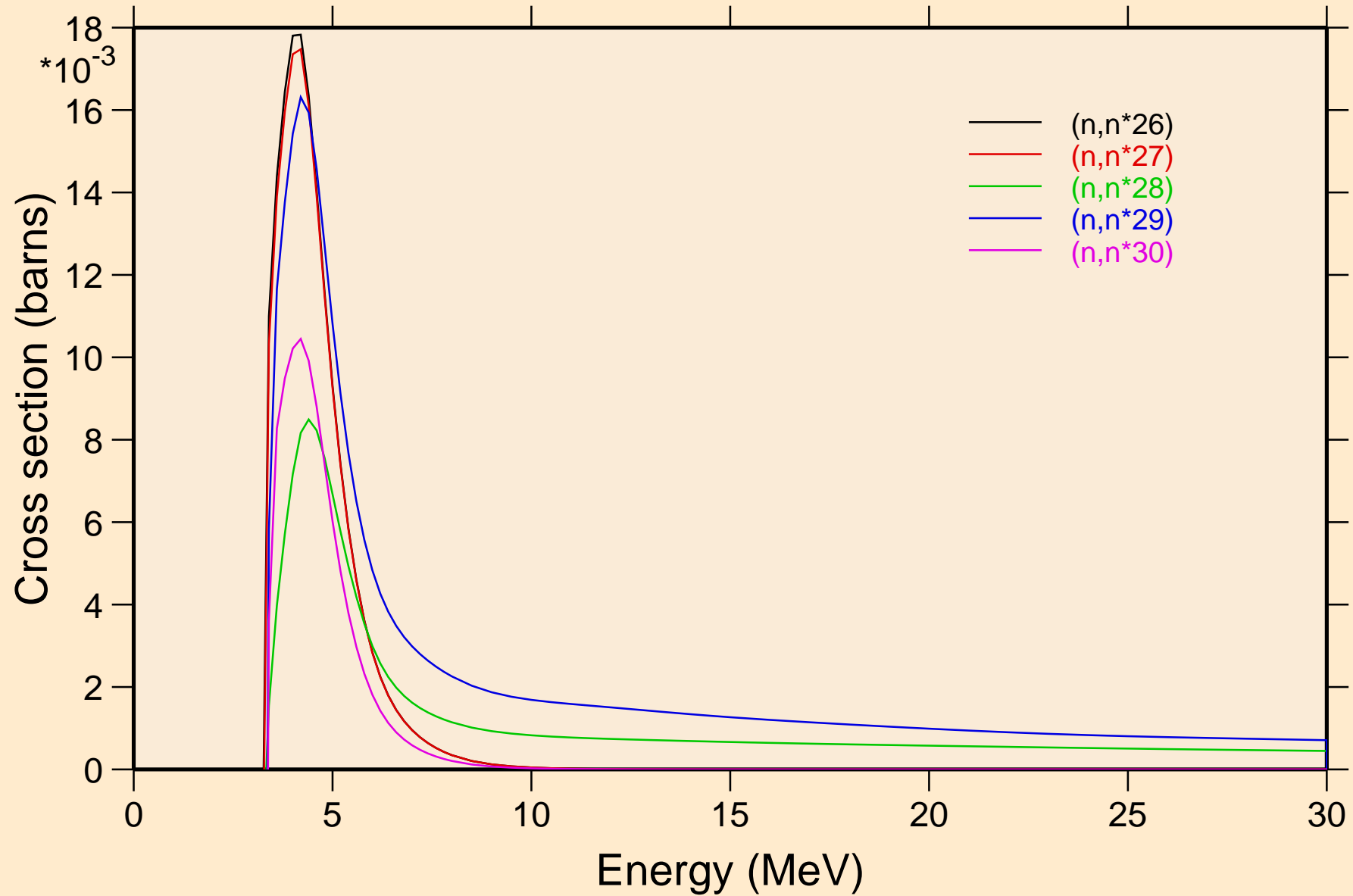

BA138 NEUTRON ACER TENDL-2024 LIBRARY; T=293.6K
Threshold reactions

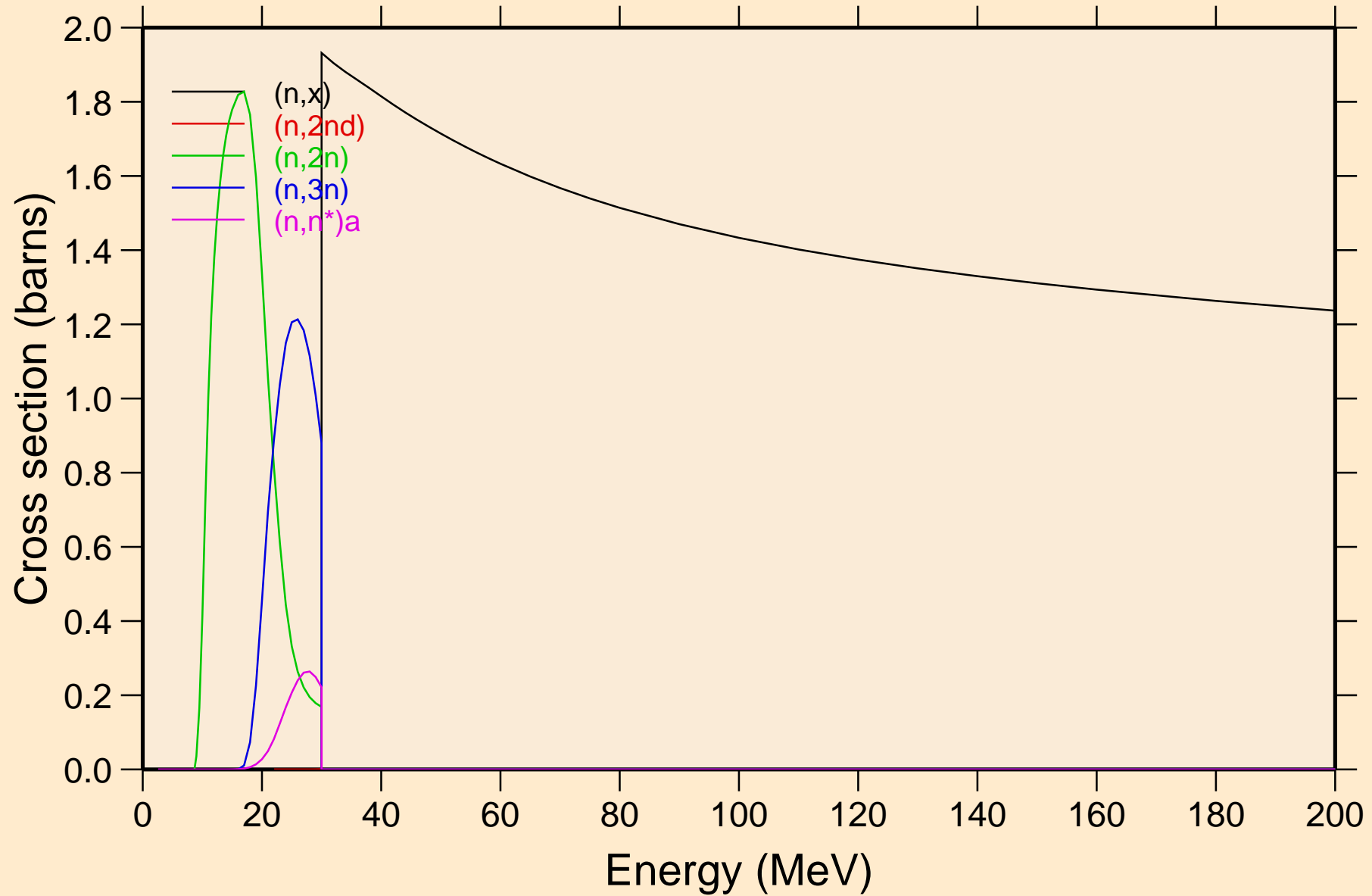

BA138 NEUTRON ACER TENDL-2024 LIBRARY; T=293.6K
Threshold reactions

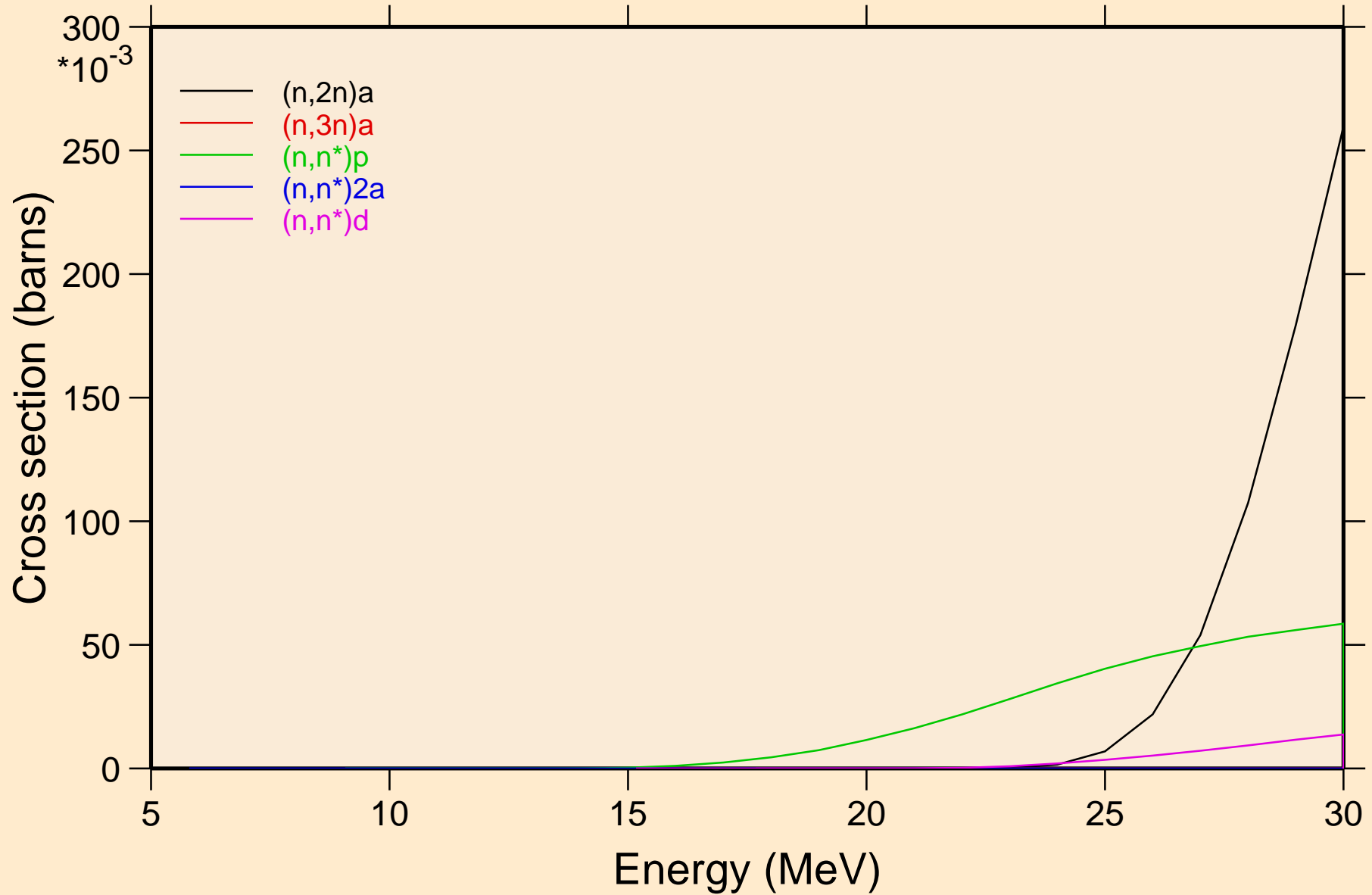

BA138 NEUTRON ACER TENDL-2024 LIBRARY; T=293.6K
Threshold reactions

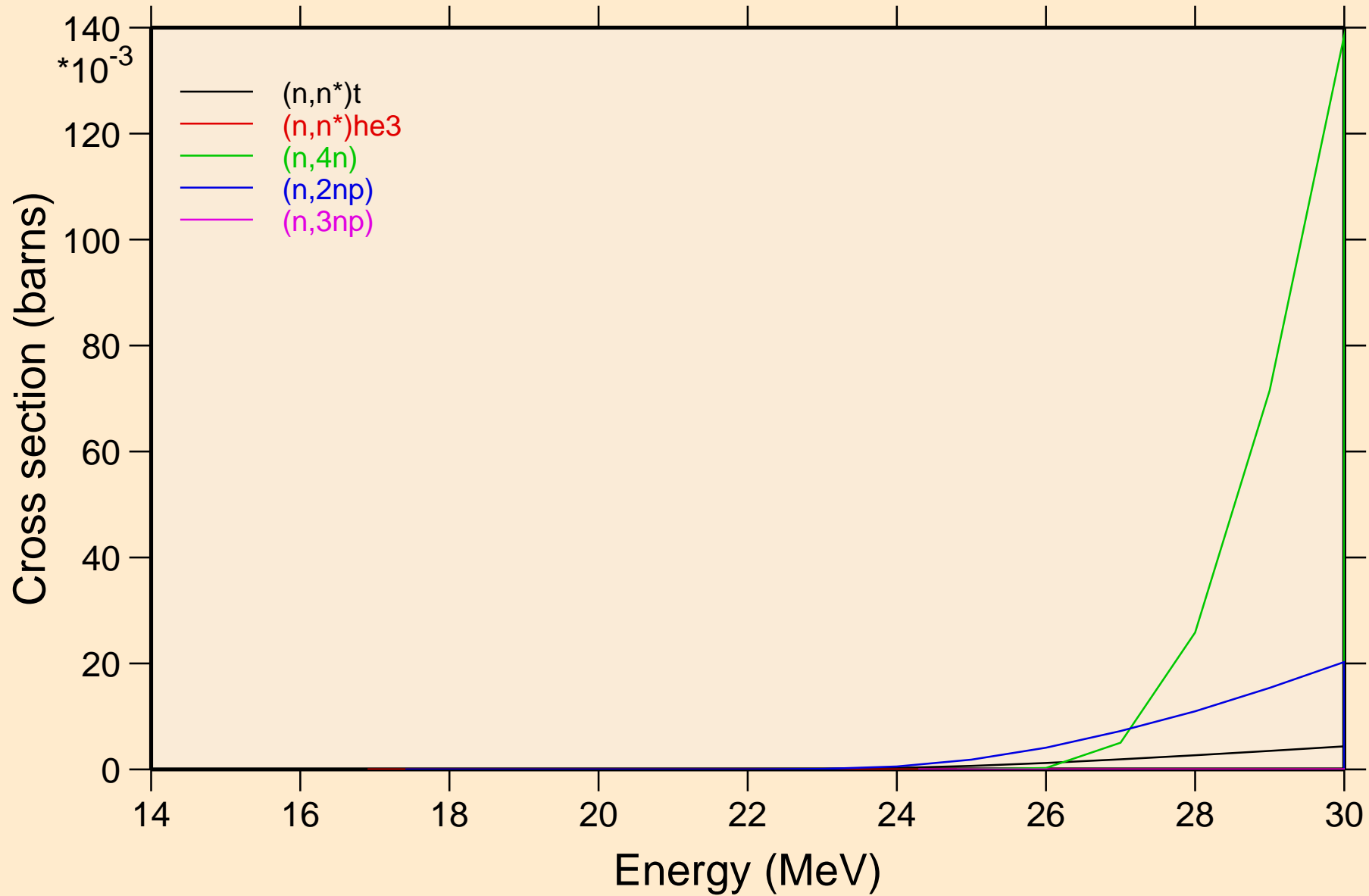

BA138 NEUTRON ACER TENDL-2024 LIBRARY; T=293.6K
Threshold reactions

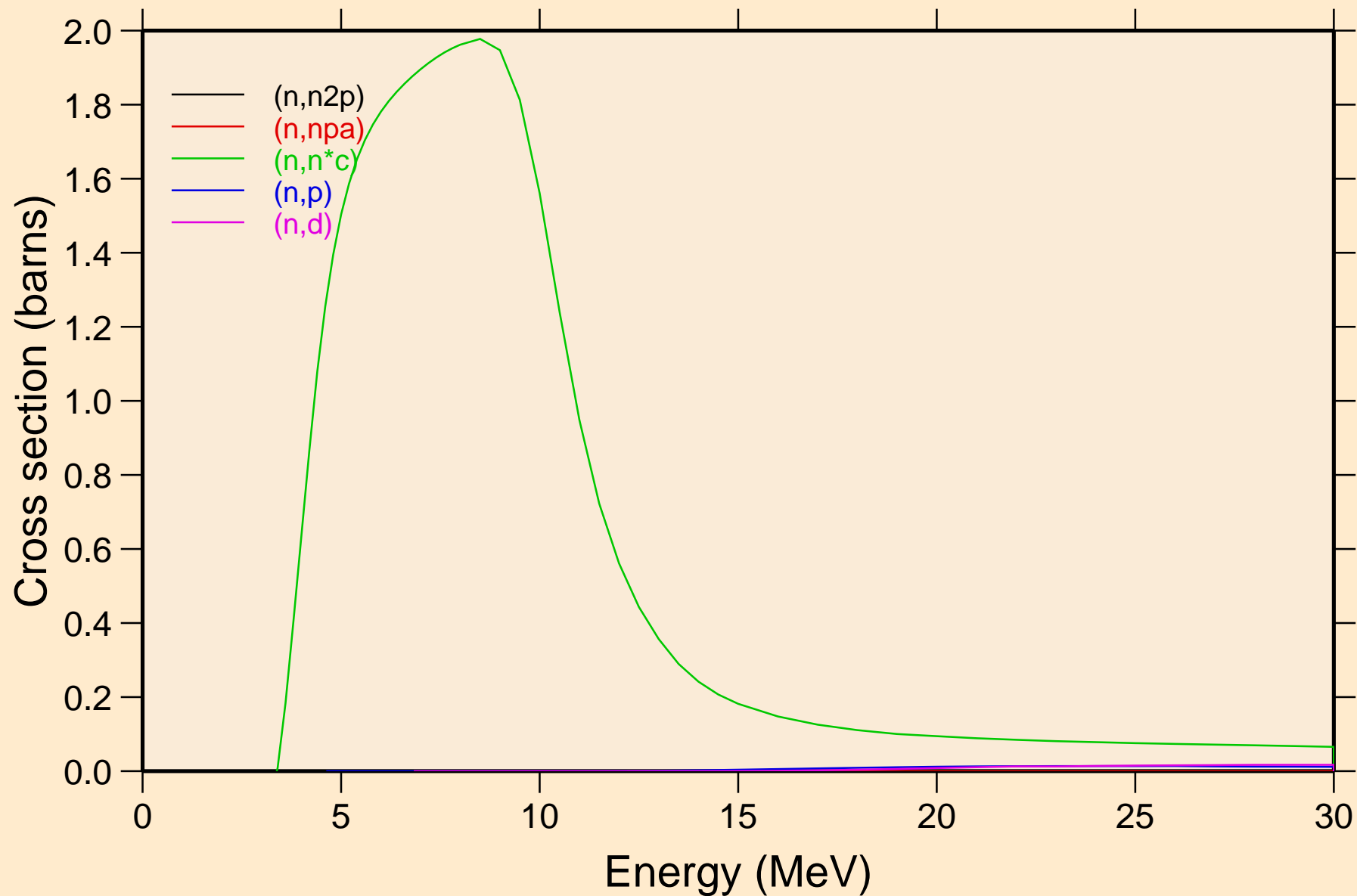

BA138 NEUTRON ACER TENDL-2024 LIBRARY; T=293.6K
Threshold reactions

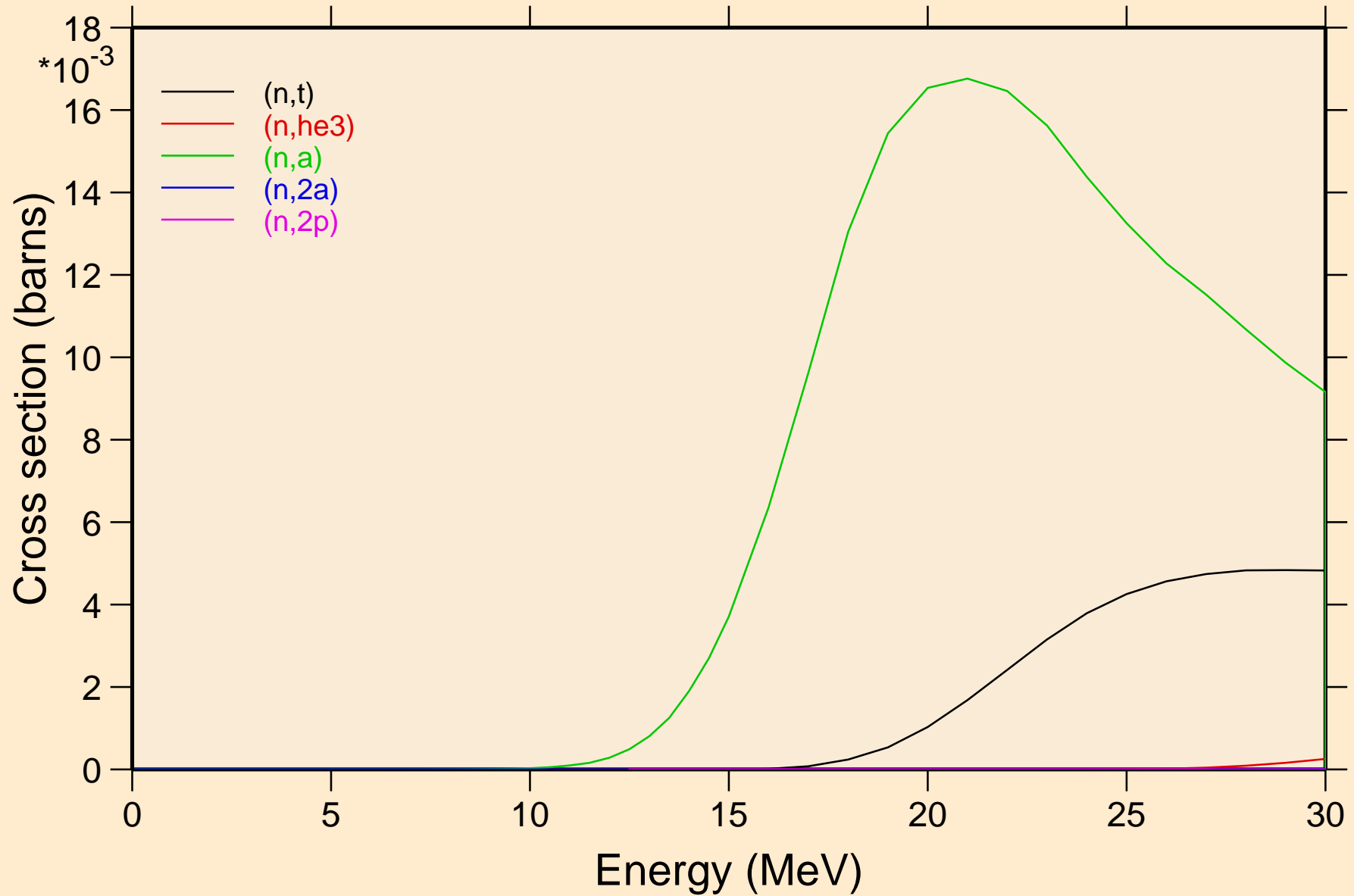

BA138 NEUTRON ACER TENDL-2024 LIBRARY; T=293.6K
Threshold reactions

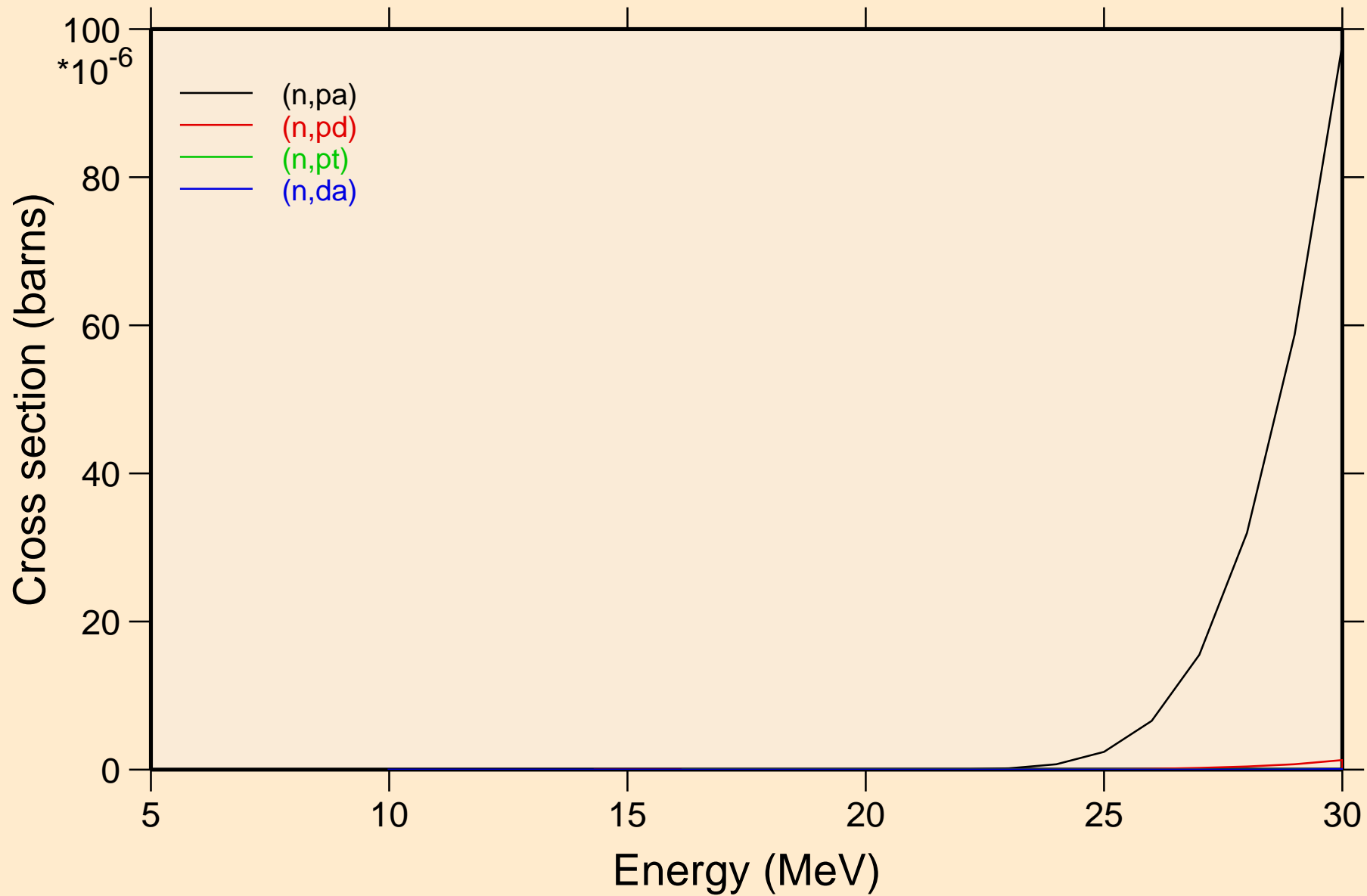

BA138 NEUTRON ACER TENDL-2024 LIBRARY; T=293.6K
Threshold reactions

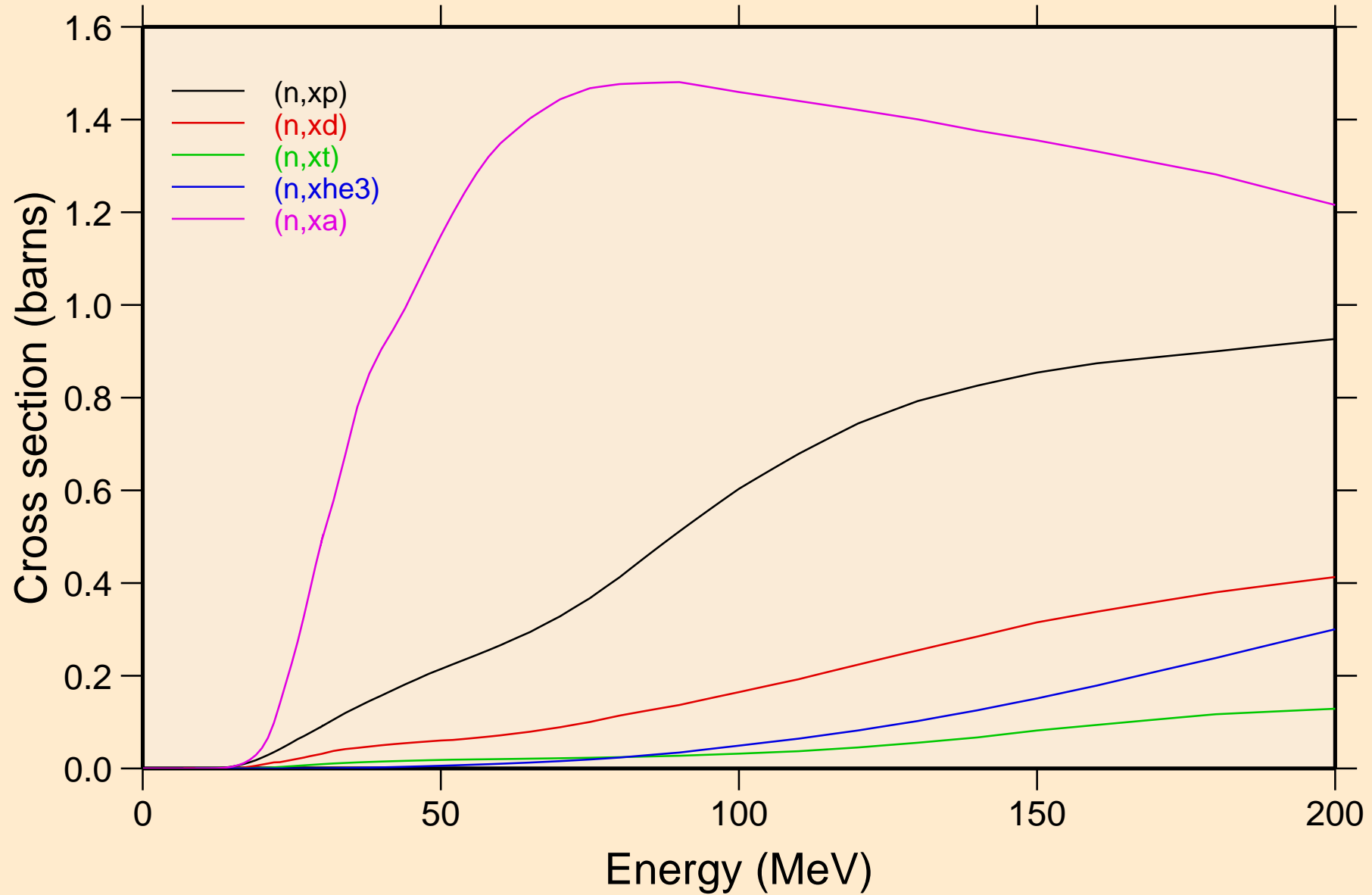

BA138 NEUTRON ACER TENDL-2024 LIBRARY; T=293.6K
angular distribution for elastic

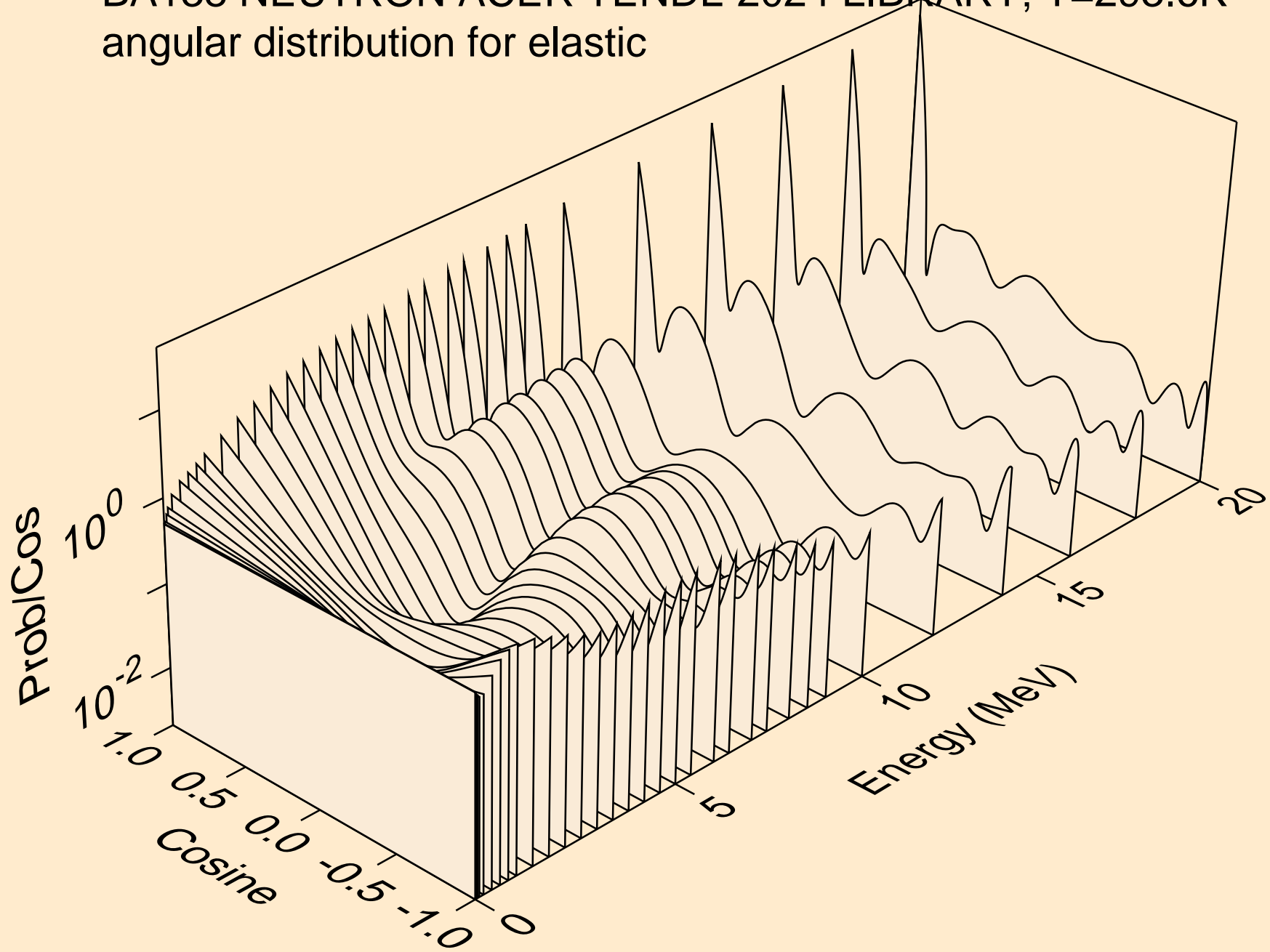

BA138 NEUTRON ACER TENDL-2024 LIBRARY; T=293.6K
angular distribution for elastic

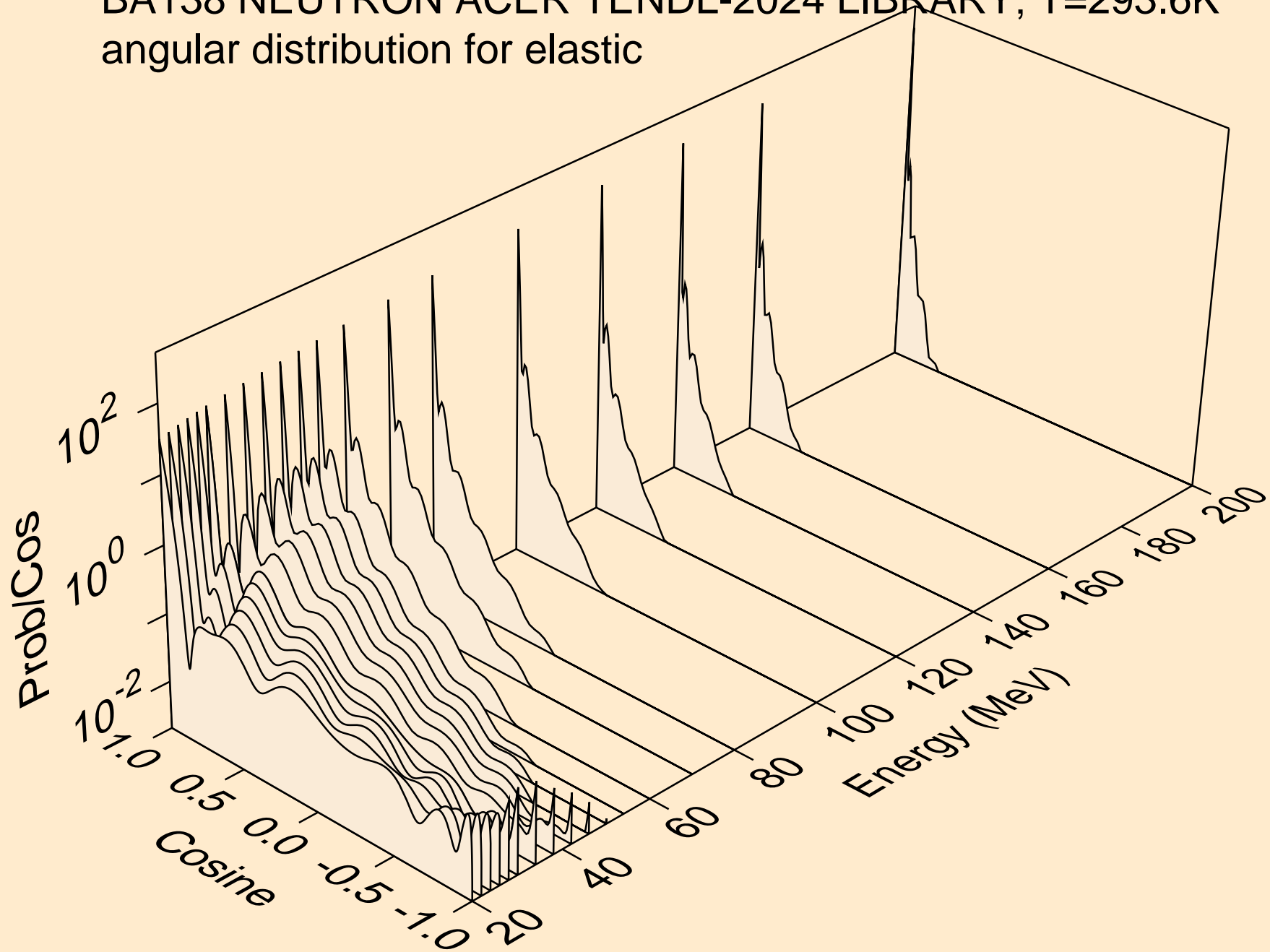

BA138 NEUTRON ACER TENDL-2024 LIBRARY; T=293.6K
angular distribution for (n,n*1)

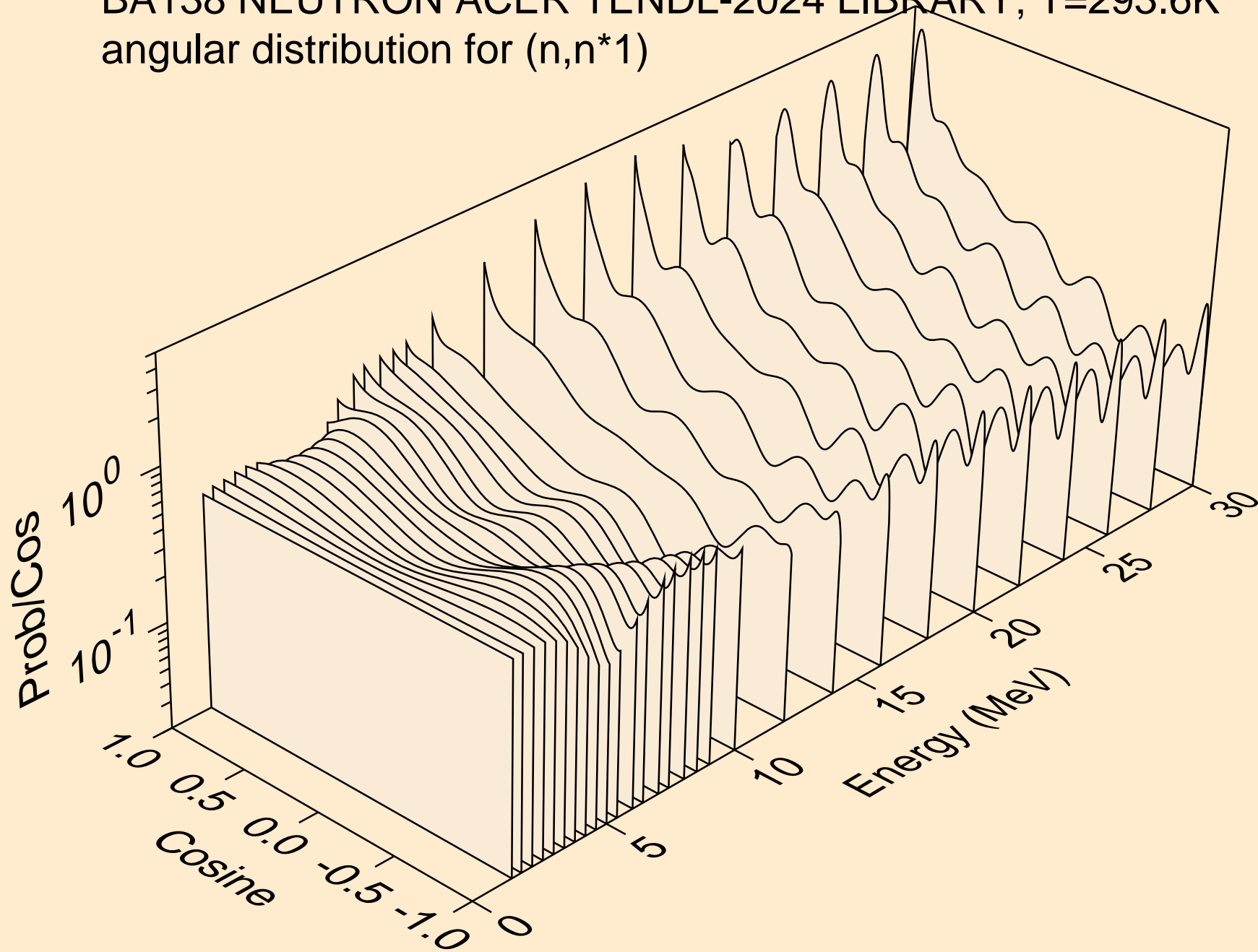

BA138 NEUTRON ACER TENDL-2024 LIBRARY; T=293.6K
angular distribution for (n,n*2)

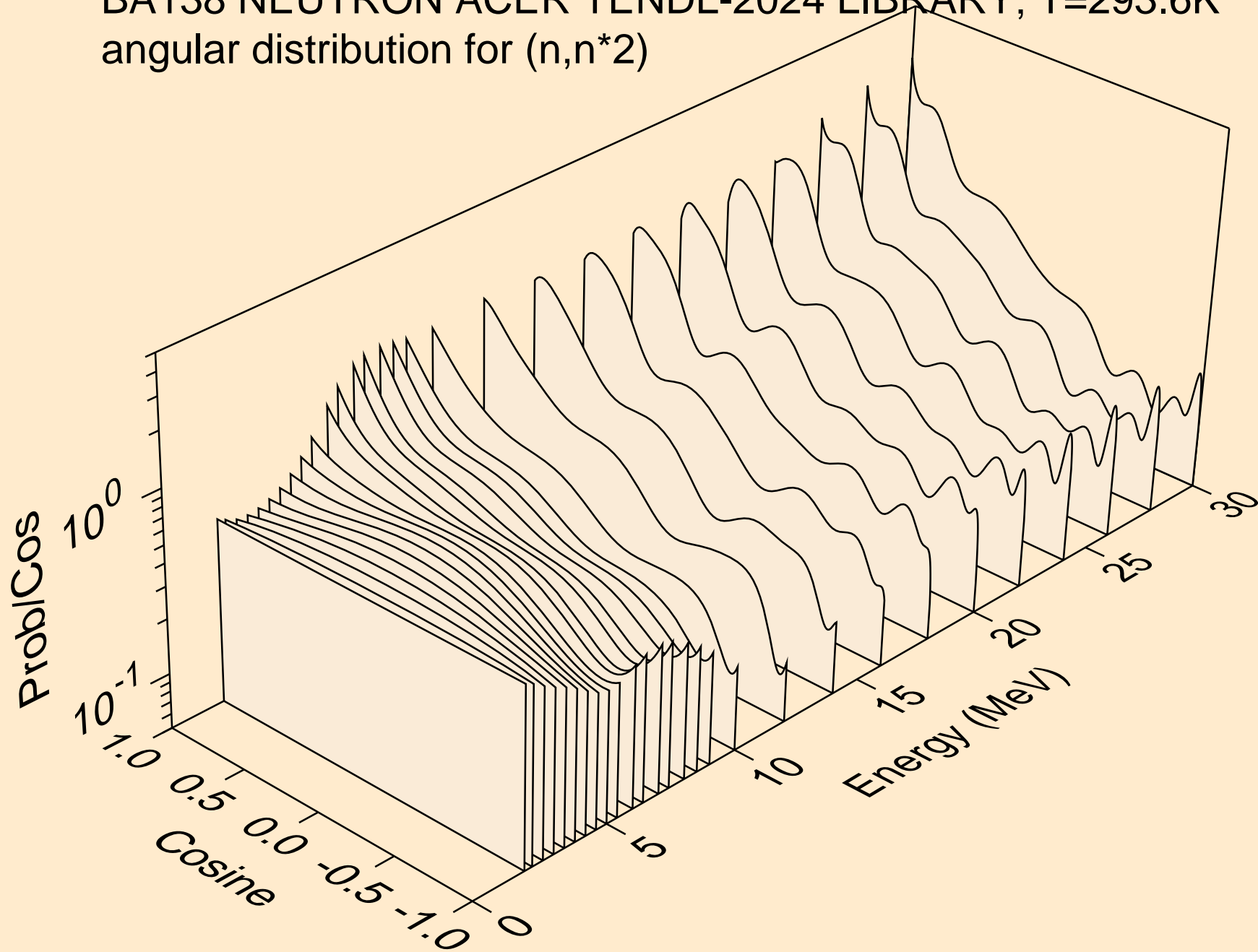

BA138 NEUTRON ACER TENDL-2024 LIBRARY; T=293.6K
angular distribution for (n,n*3)

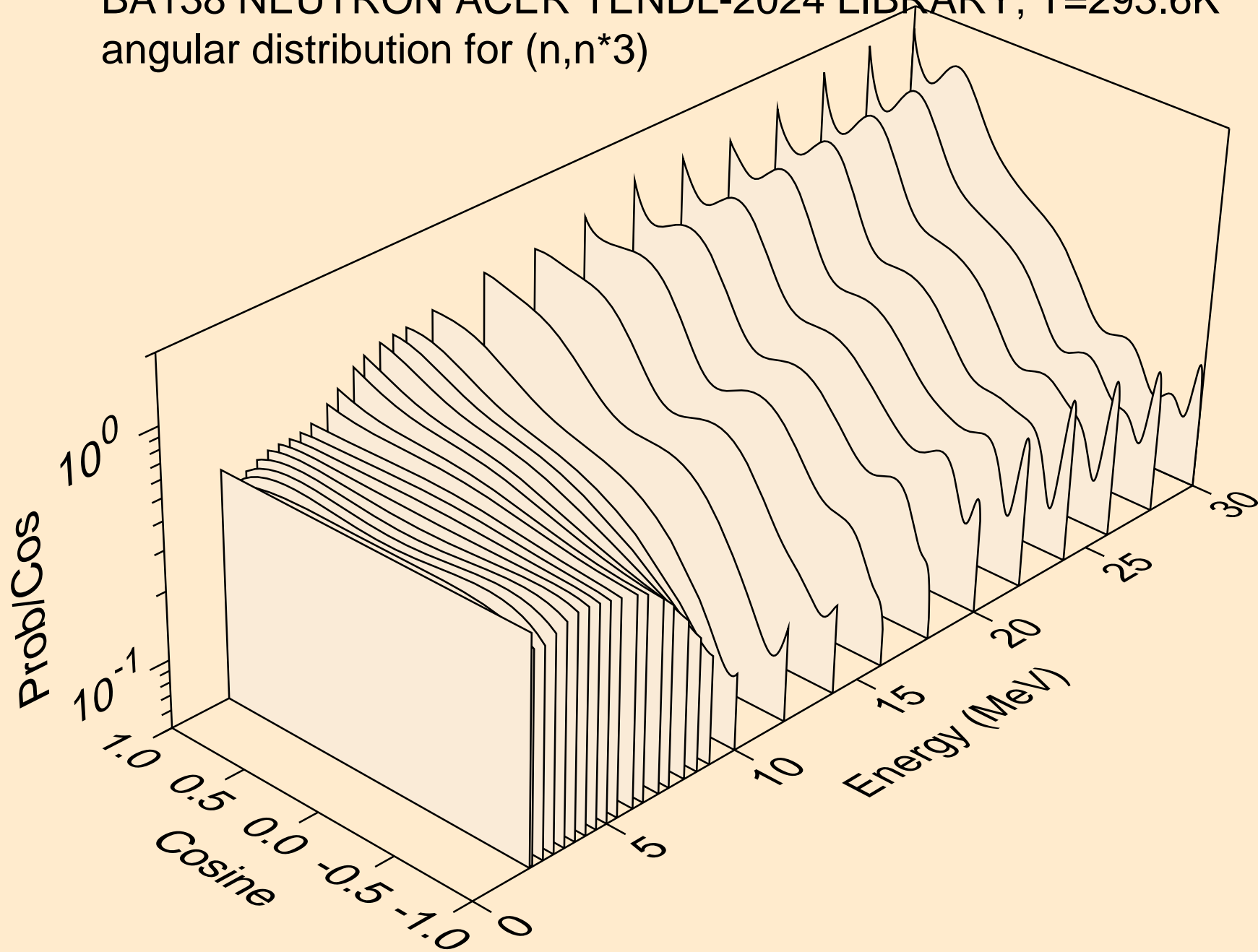

BA138 NEUTRON ACER TENDL-2024 LIBRARY; T=293.6K
angular distribution for (n,n*4)

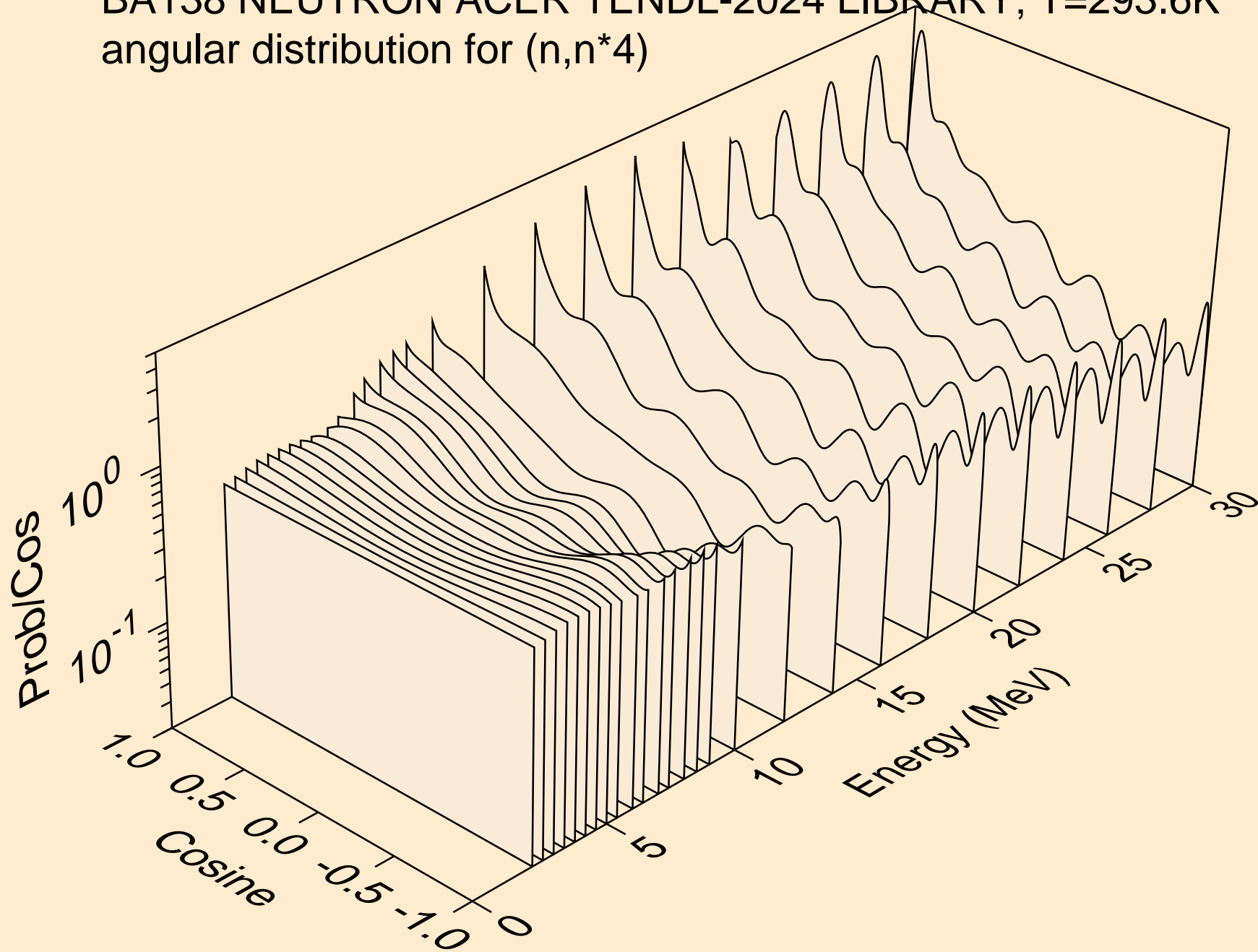

BA138 NEUTRON ACER TENDL-2024 LIBRARY; T=293.6K
angular distribution for (n,n*5)

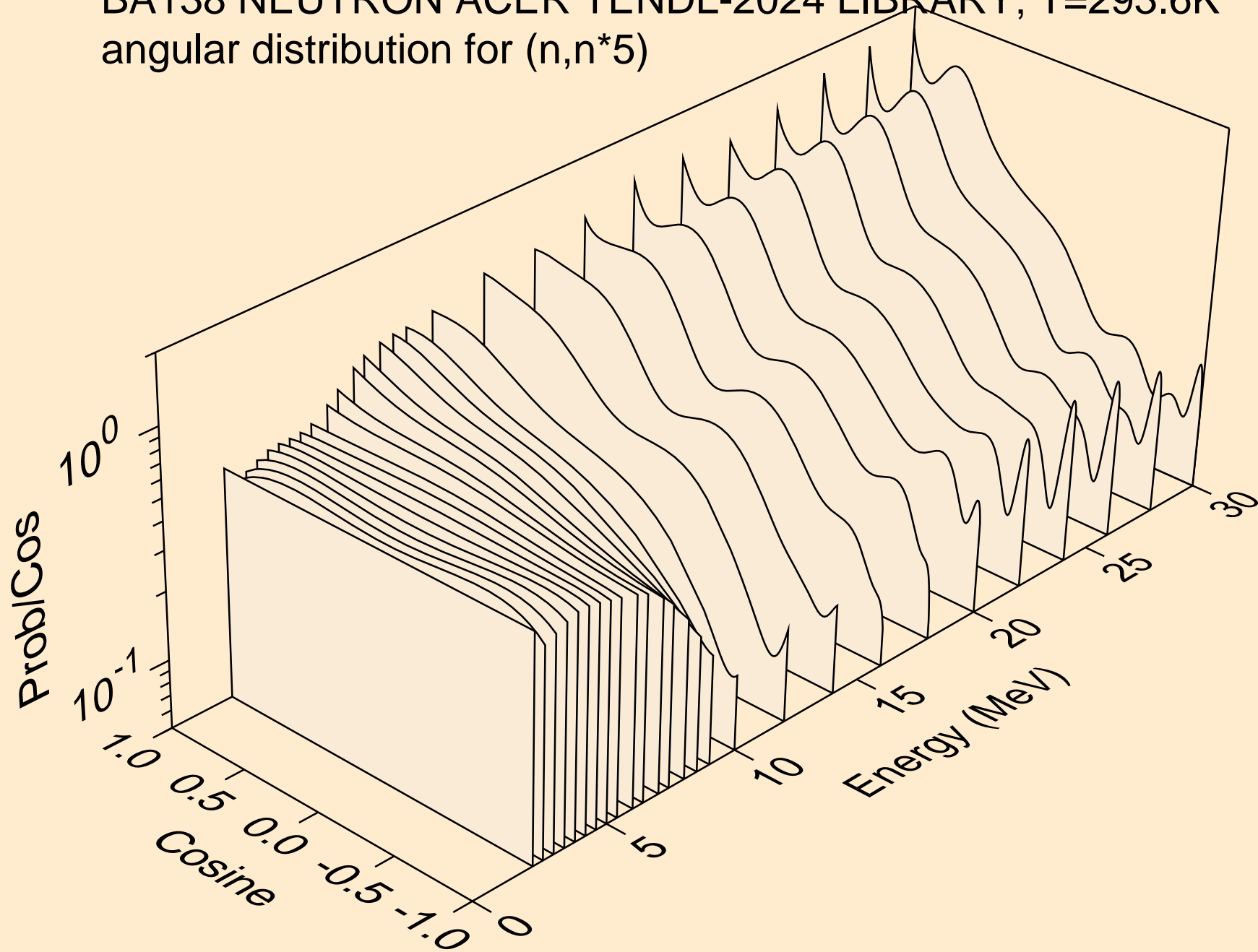

BA138 NEUTRON ACER TENDL-2024 LIBRARY; T=293.6K
angular distribution for (n,n*6)

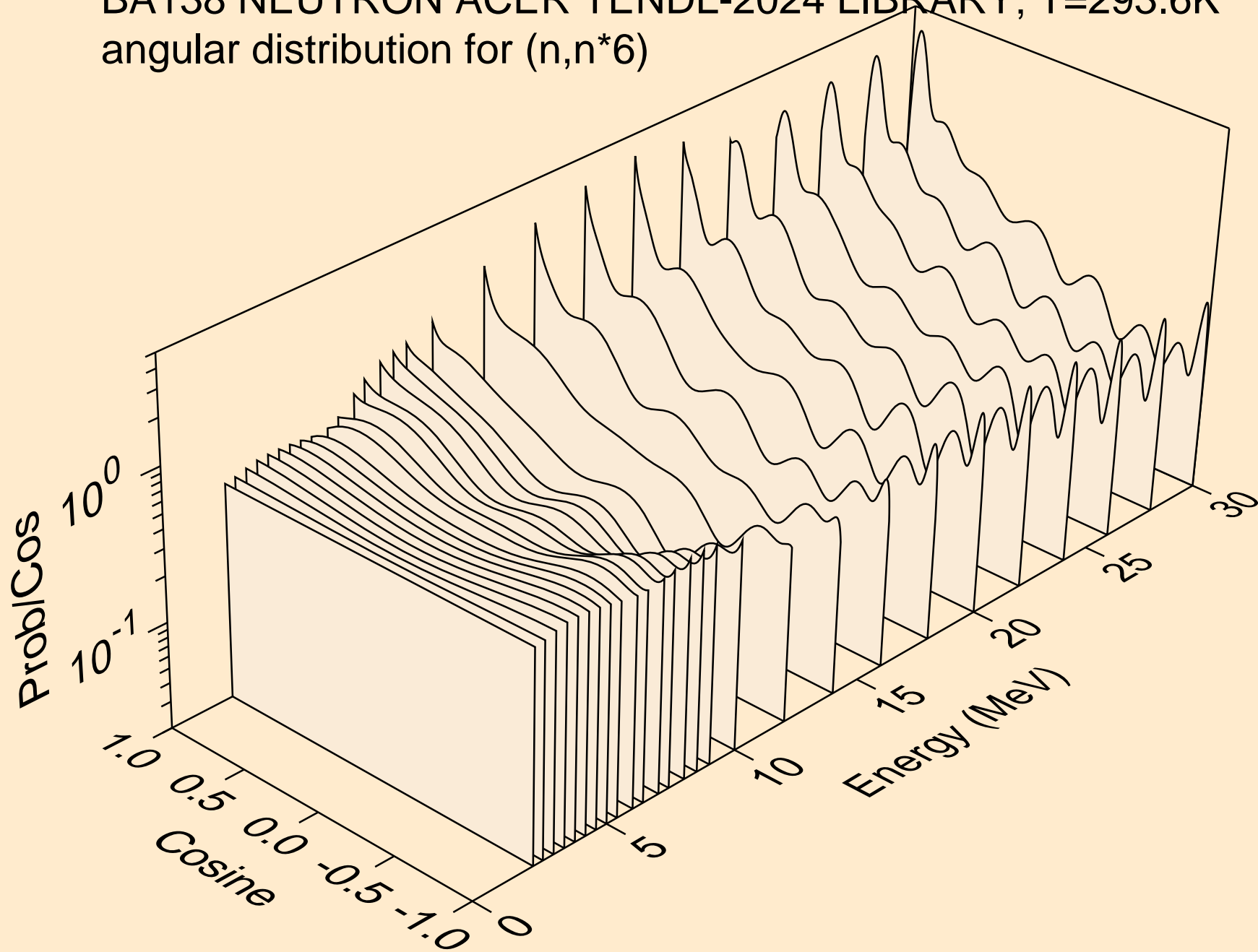

BA138 NEUTRON ACER TENDL-2024 LIBRARY; T=293.6K
angular distribution for (n,n*7)

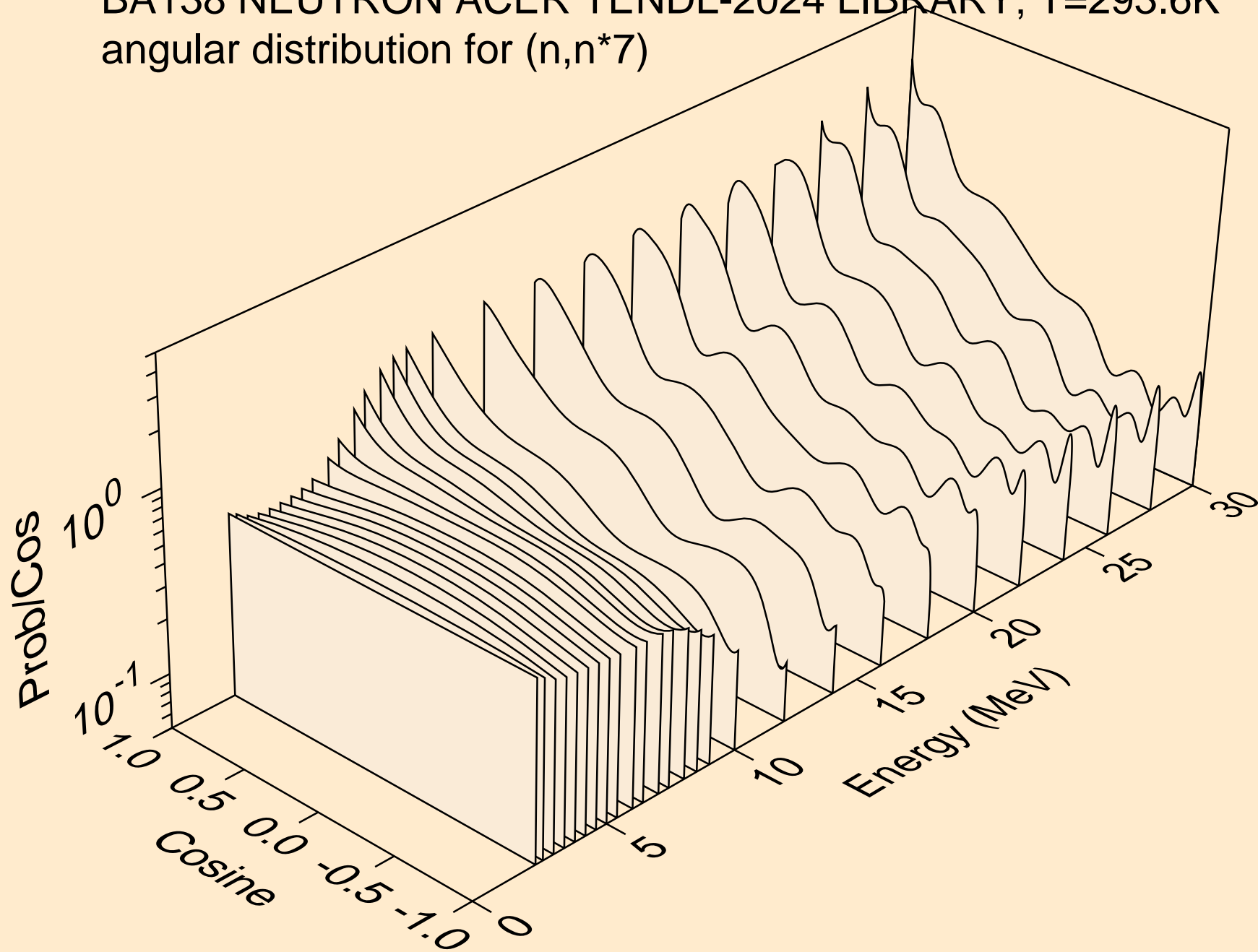

BA138 NEUTRON ACER TENDL-2024 LIBRARY; T=293.6K
angular distribution for (n,n*8)

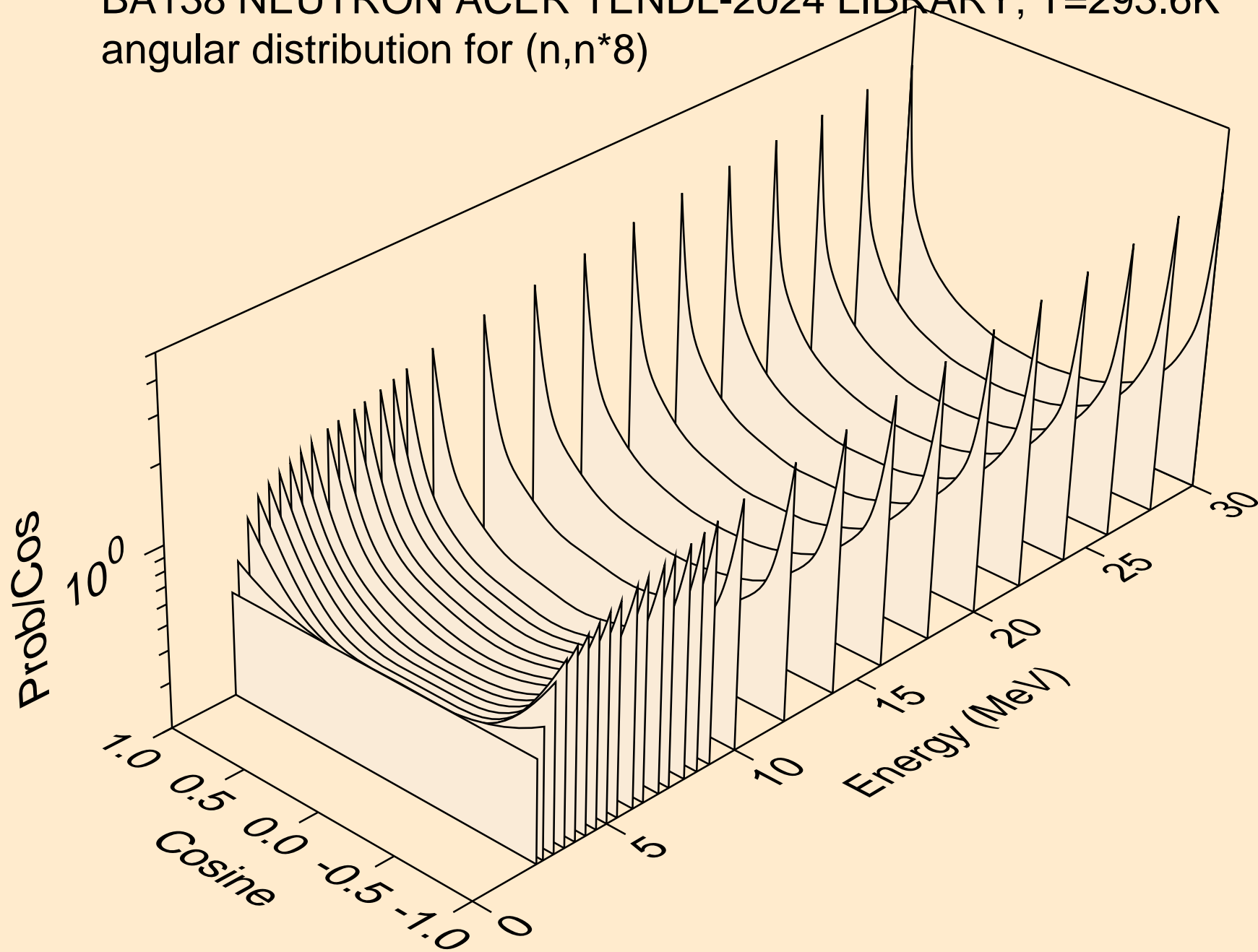

BA138 NEUTRON ACER TENDL-2024 LIBRARY; T=293.6K
angular distribution for (n,n*9)

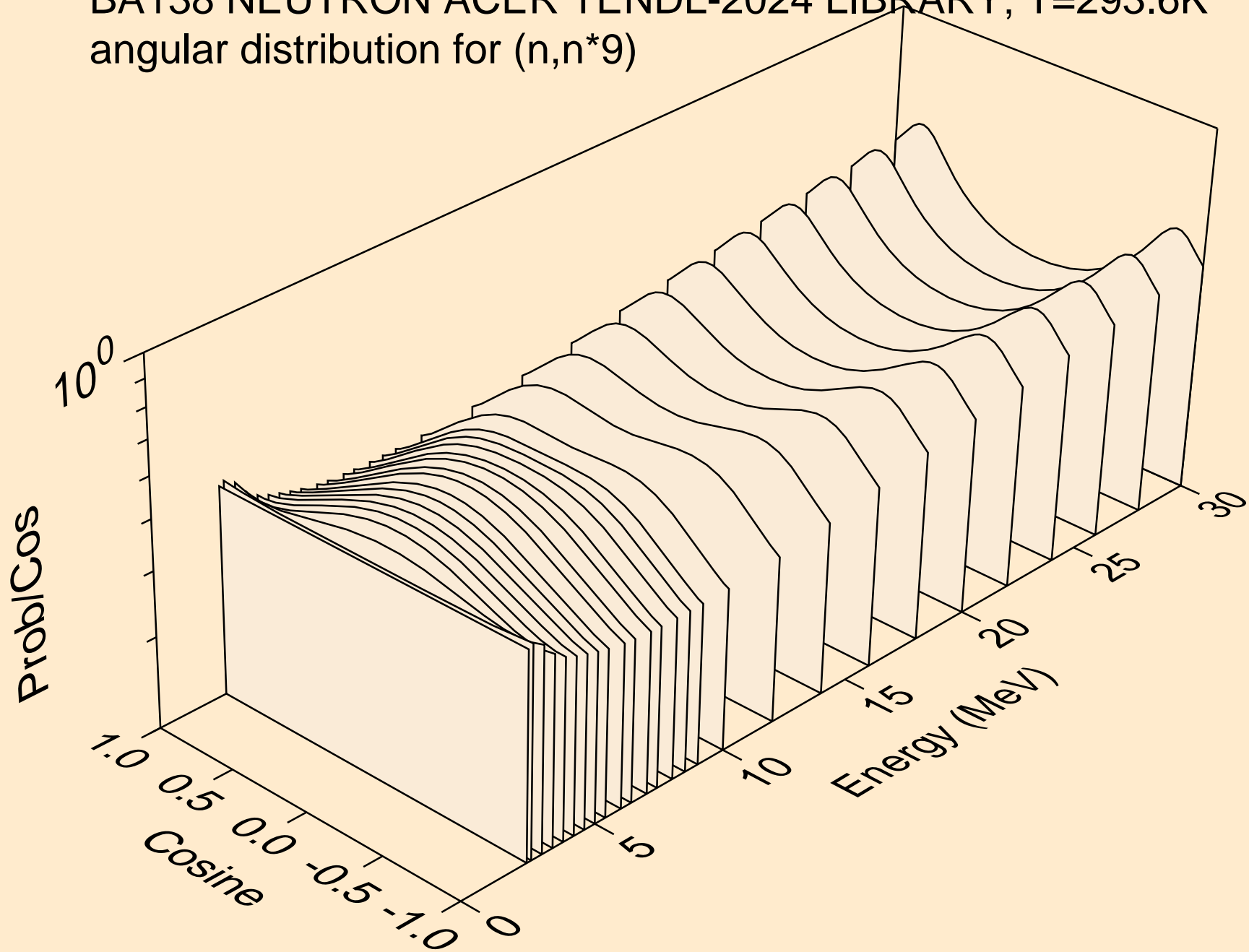

BA138 NEUTRON ACER TENDL-2024 LIBRARY; T=293.6K
angular distribution for (n,n*10)

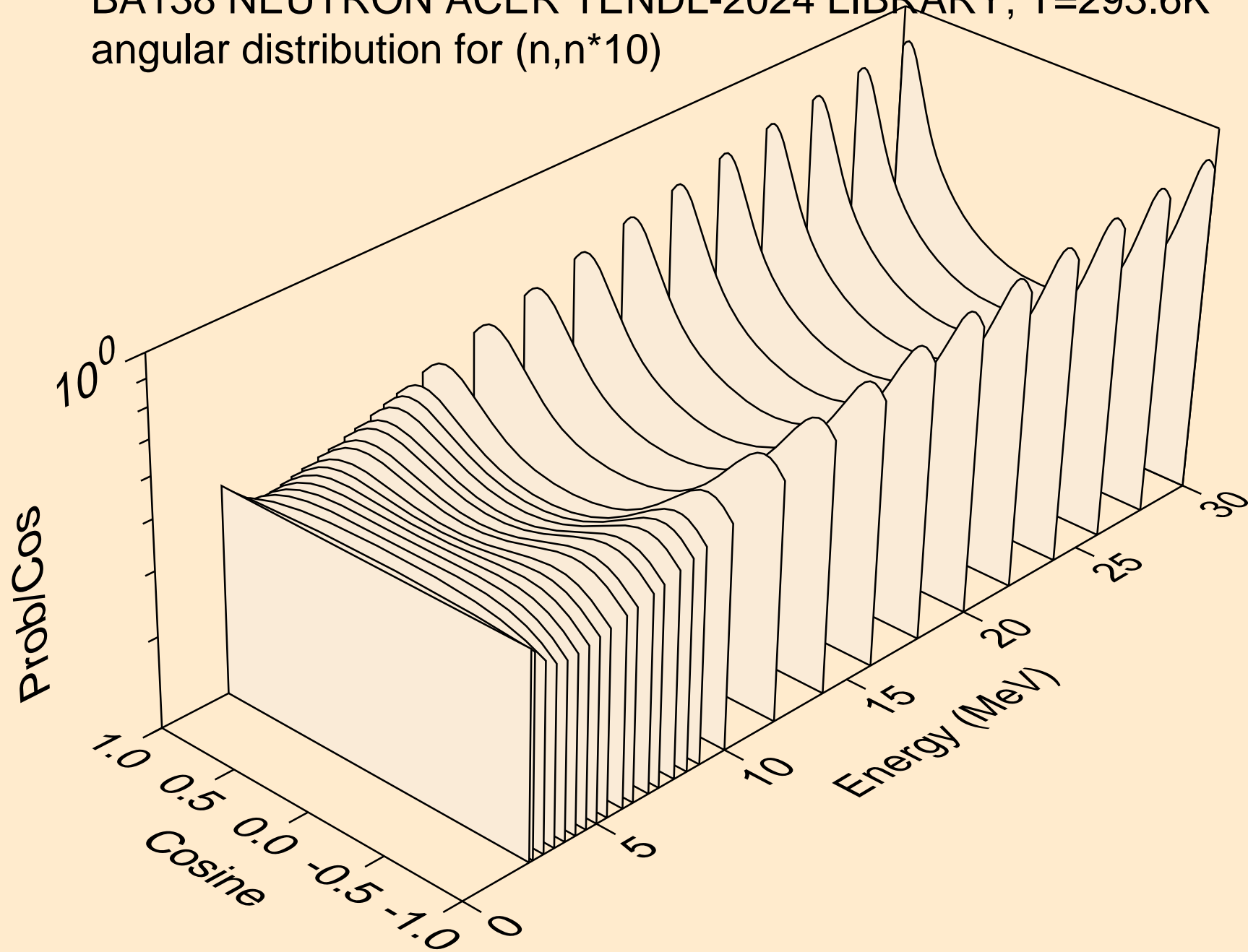

BA138 NEUTRON ACER TENDL-2024 LIBRARY; T=293.6K
angular distribution for (n,n*11)

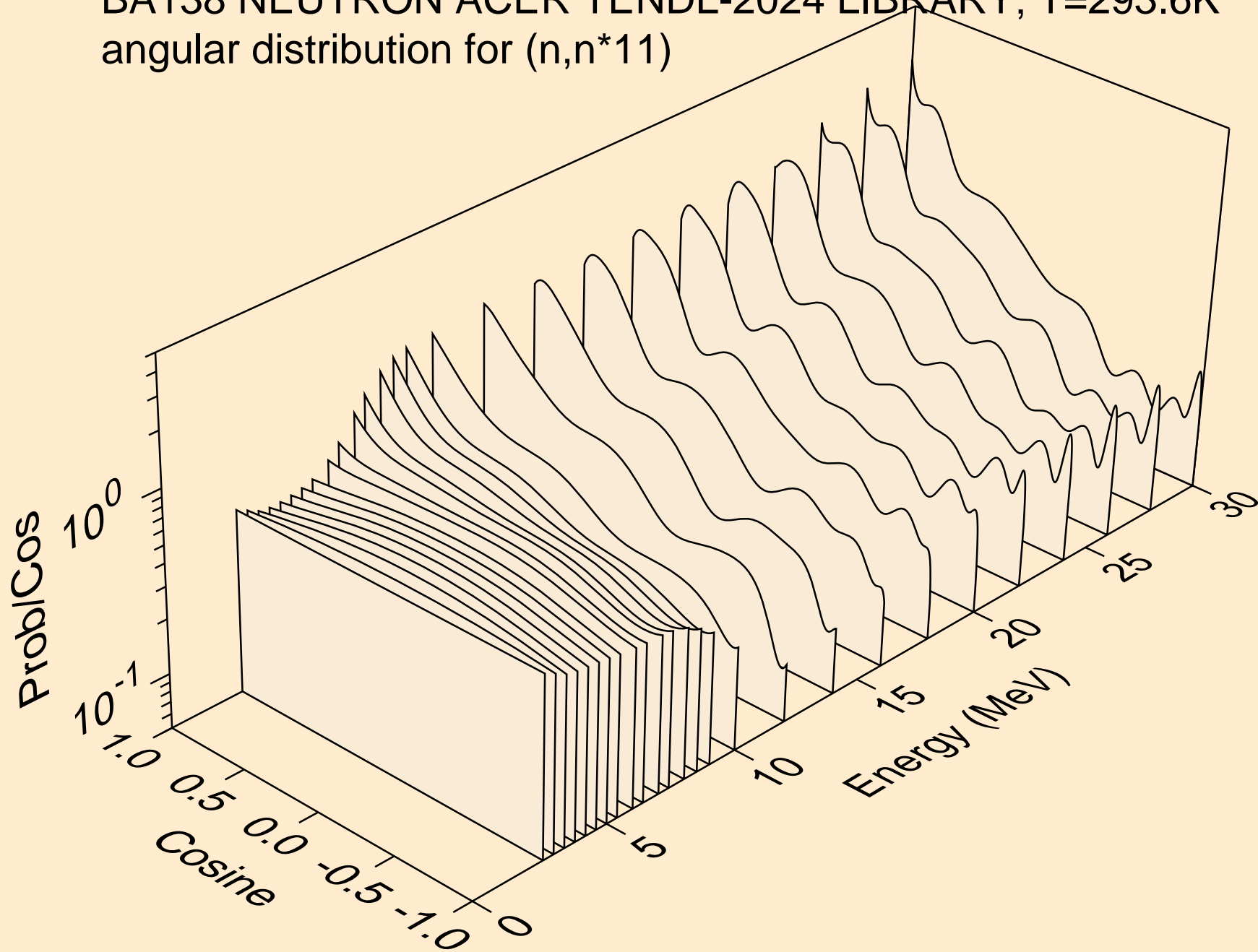

BA138 NEUTRON ACER TENDL-2024 LIBRARY; T=293.6K
angular distribution for (n,n*12)

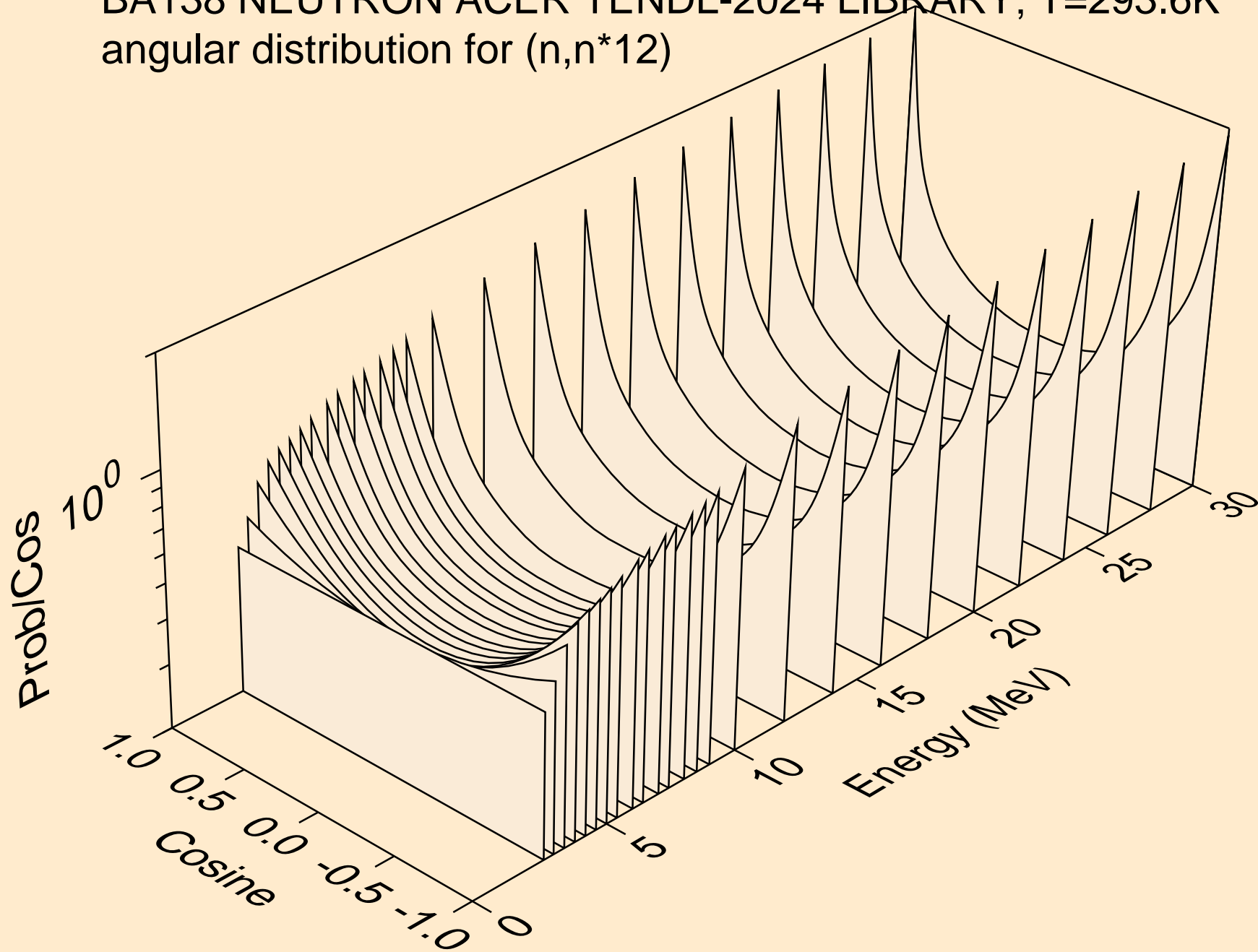

BA138 NEUTRON ACER TENDL-2024 LIBRARY; T=293.6K
angular distribution for (n,n*13)

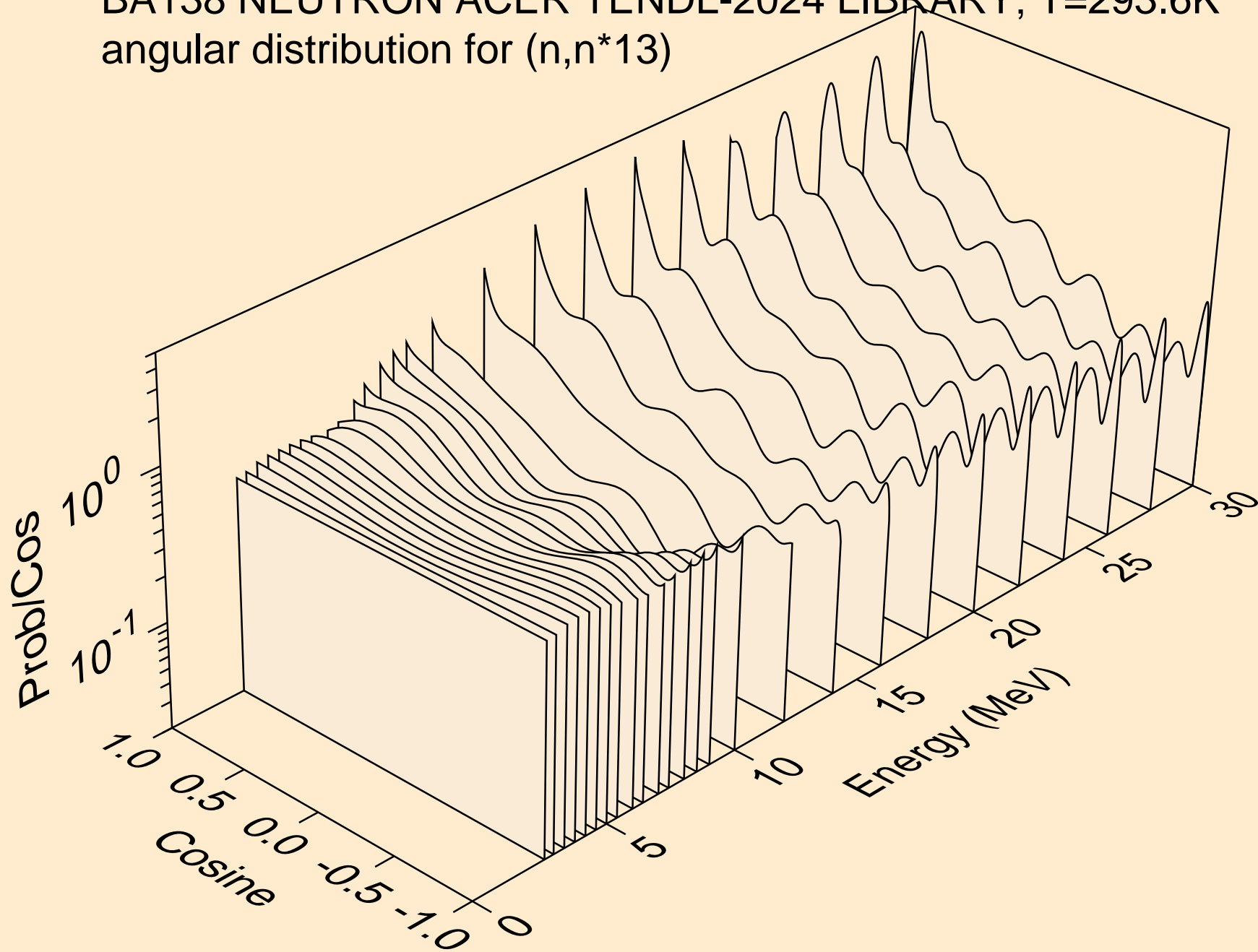

BA138 NEUTRON ACER TENDL-2024 LIBRARY; T=293.6K
angular distribution for (n,n*14)

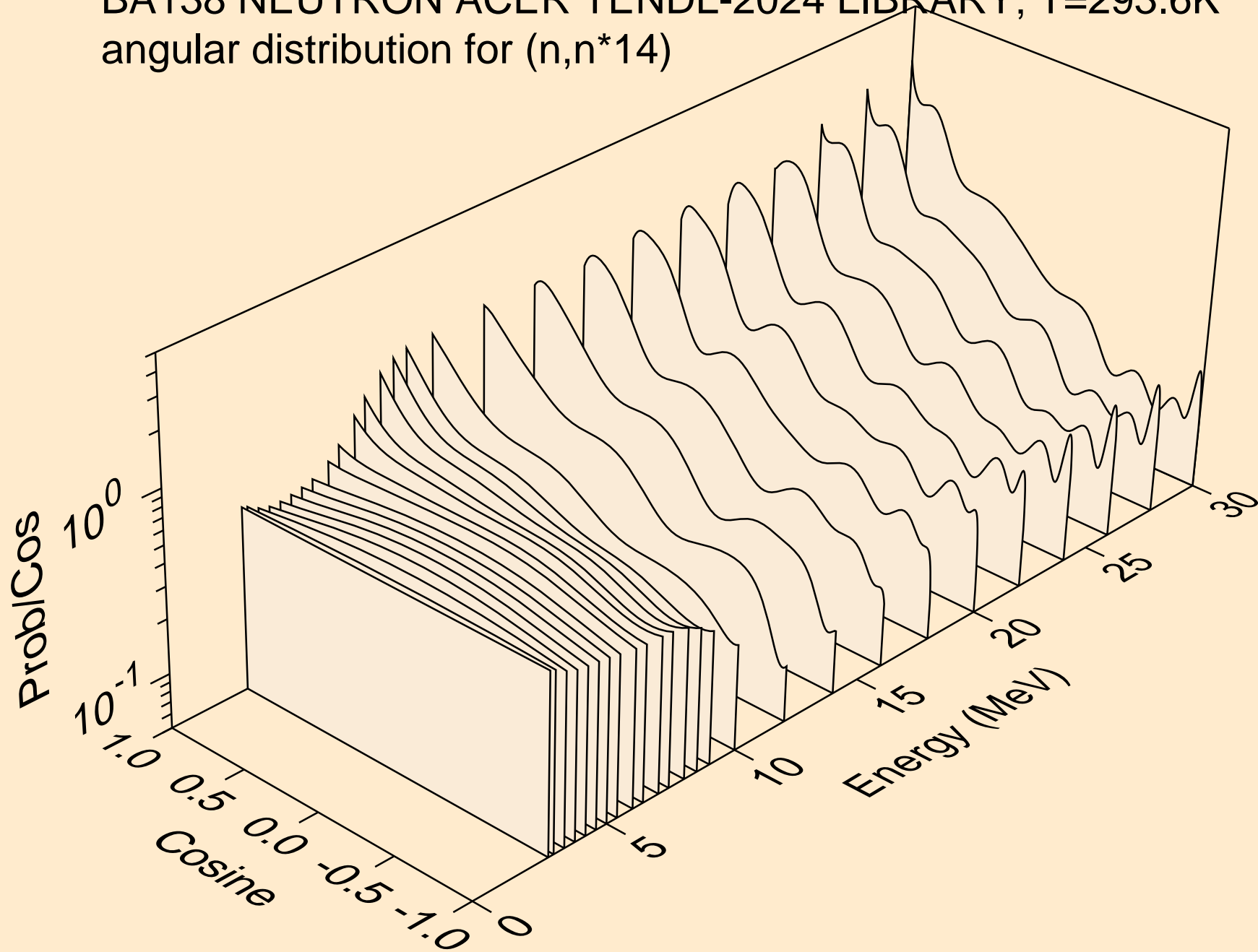

BA138 NEUTRON ACER TENDL-2024 LIBRARY; T=293.6K
angular distribution for (n,n*15)

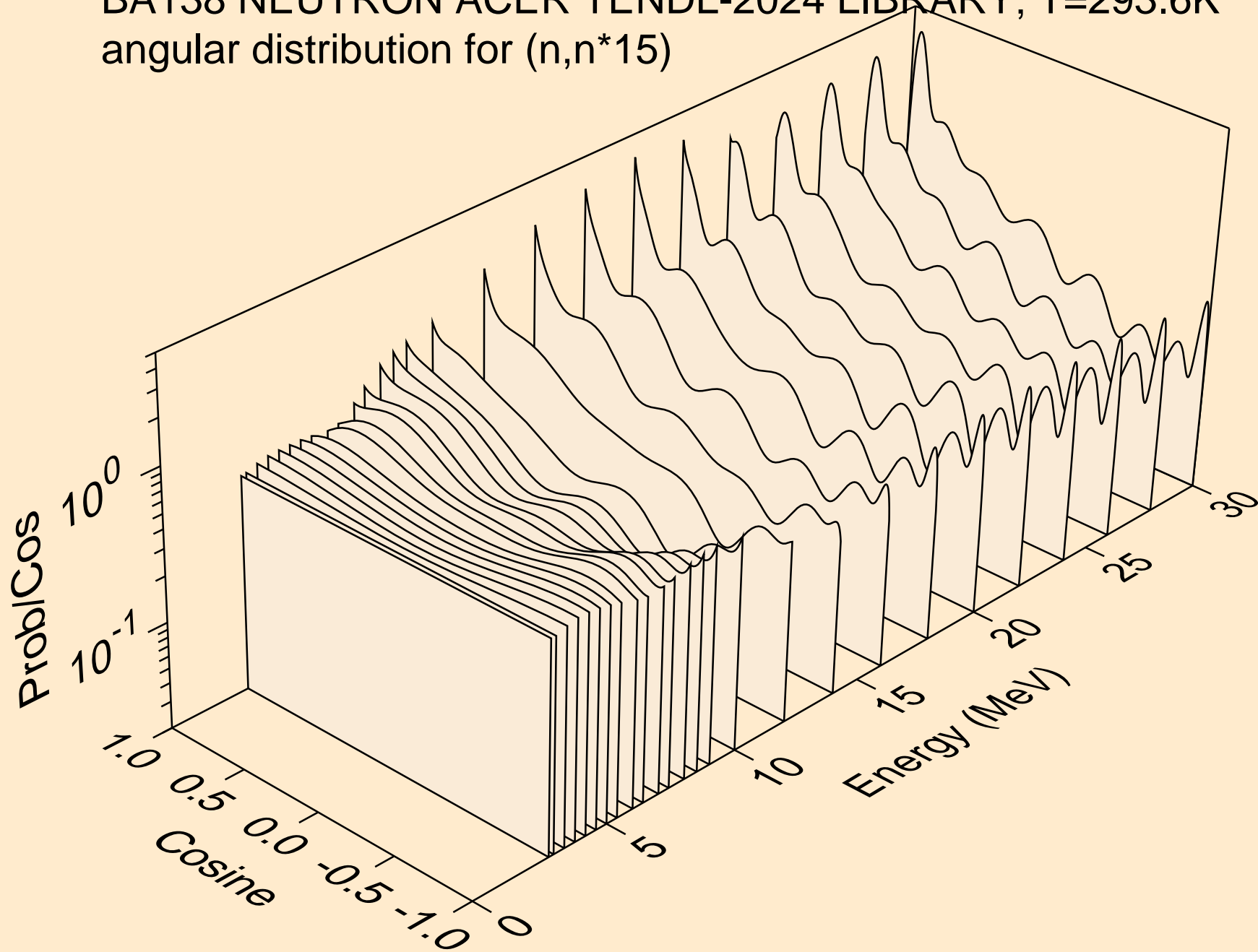

BA138 NEUTRON ACER TENDL-2024 LIBRARY; T=293.6K
angular distribution for (n,n*16)

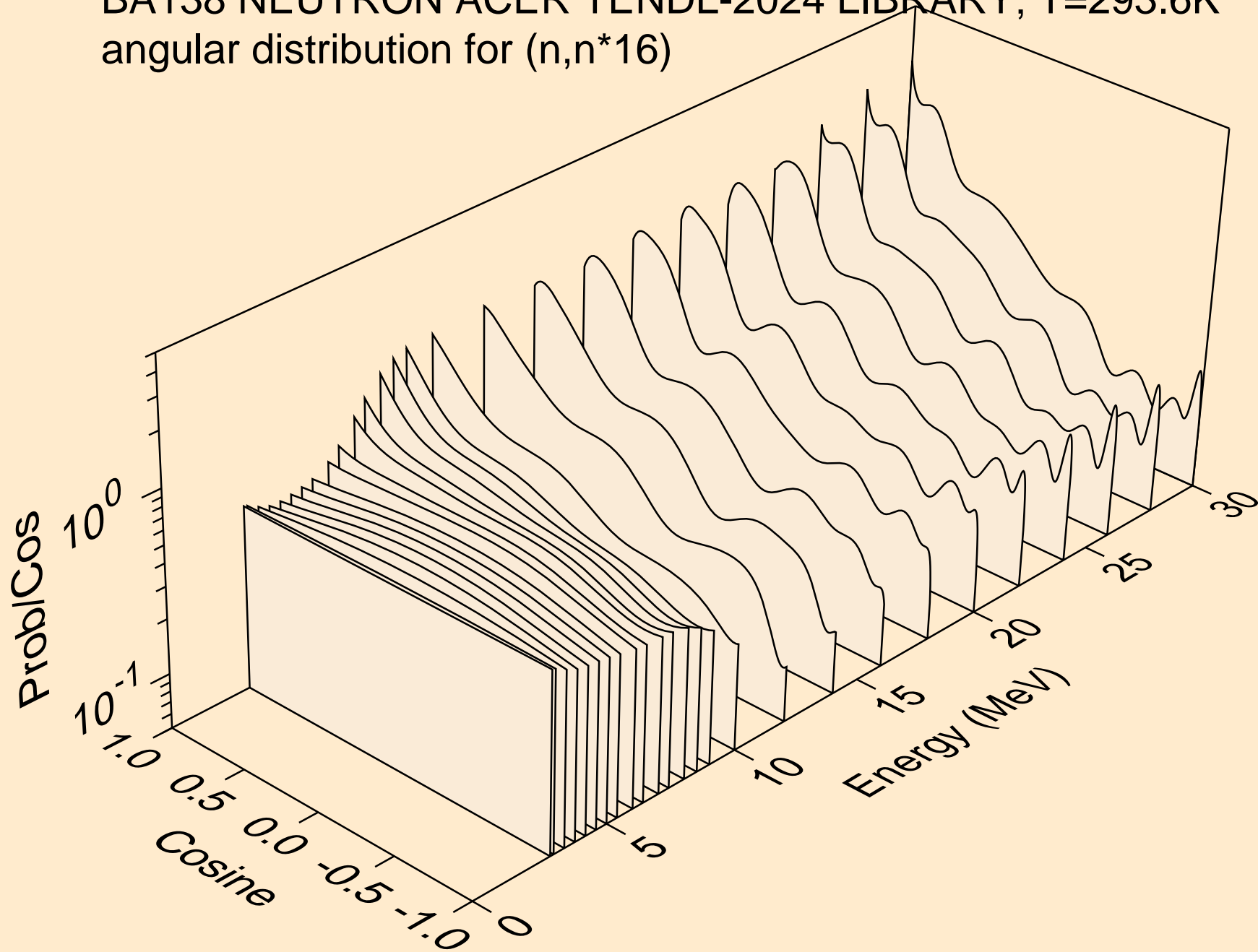

BA138 NEUTRON ACER TENDL-2024 LIBRARY; T=293.6K
angular distribution for (n,n*17)

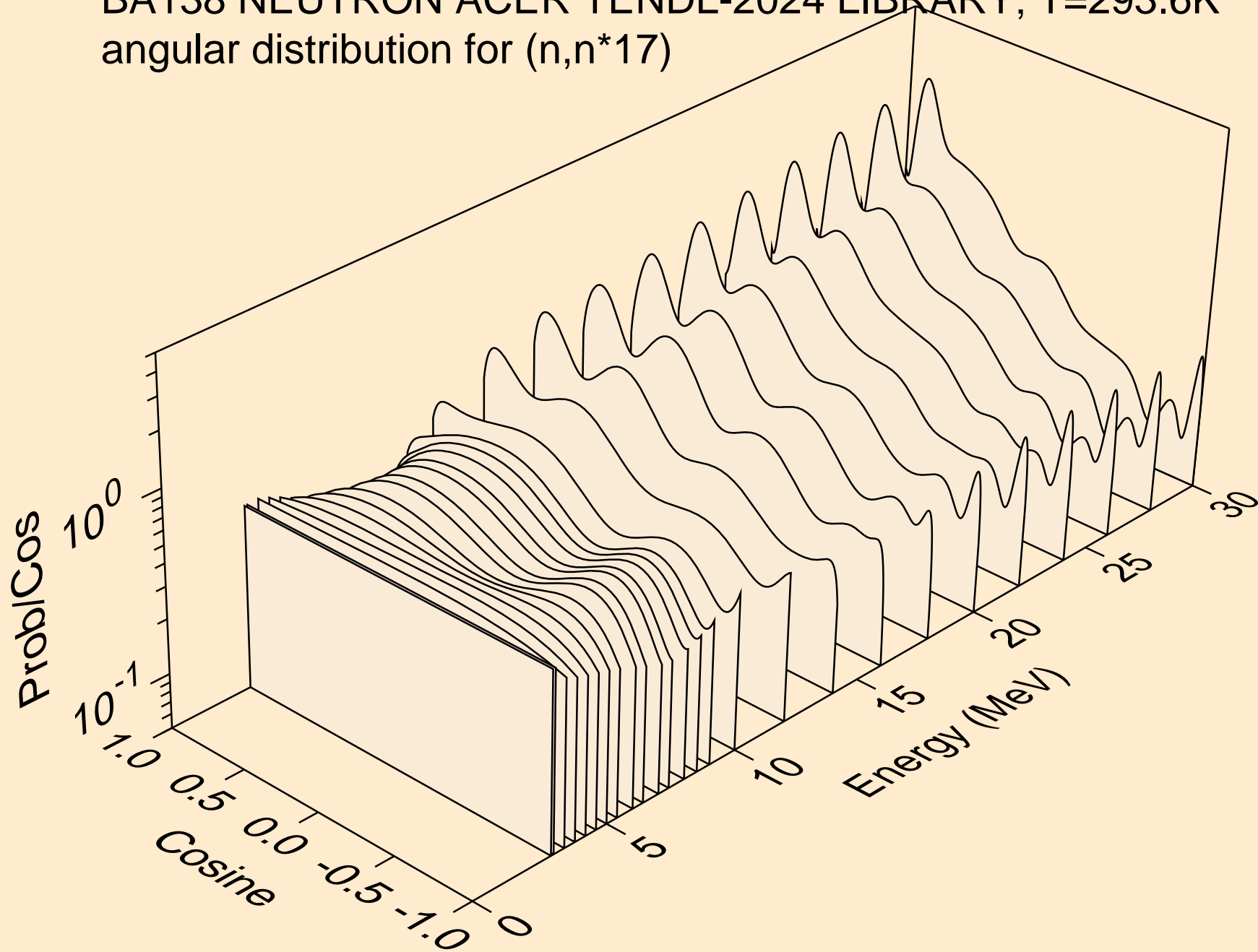

BA138 NEUTRON ACER TENDL-2024 LIBRARY; T=293.6K
angular distribution for (n,n*18)

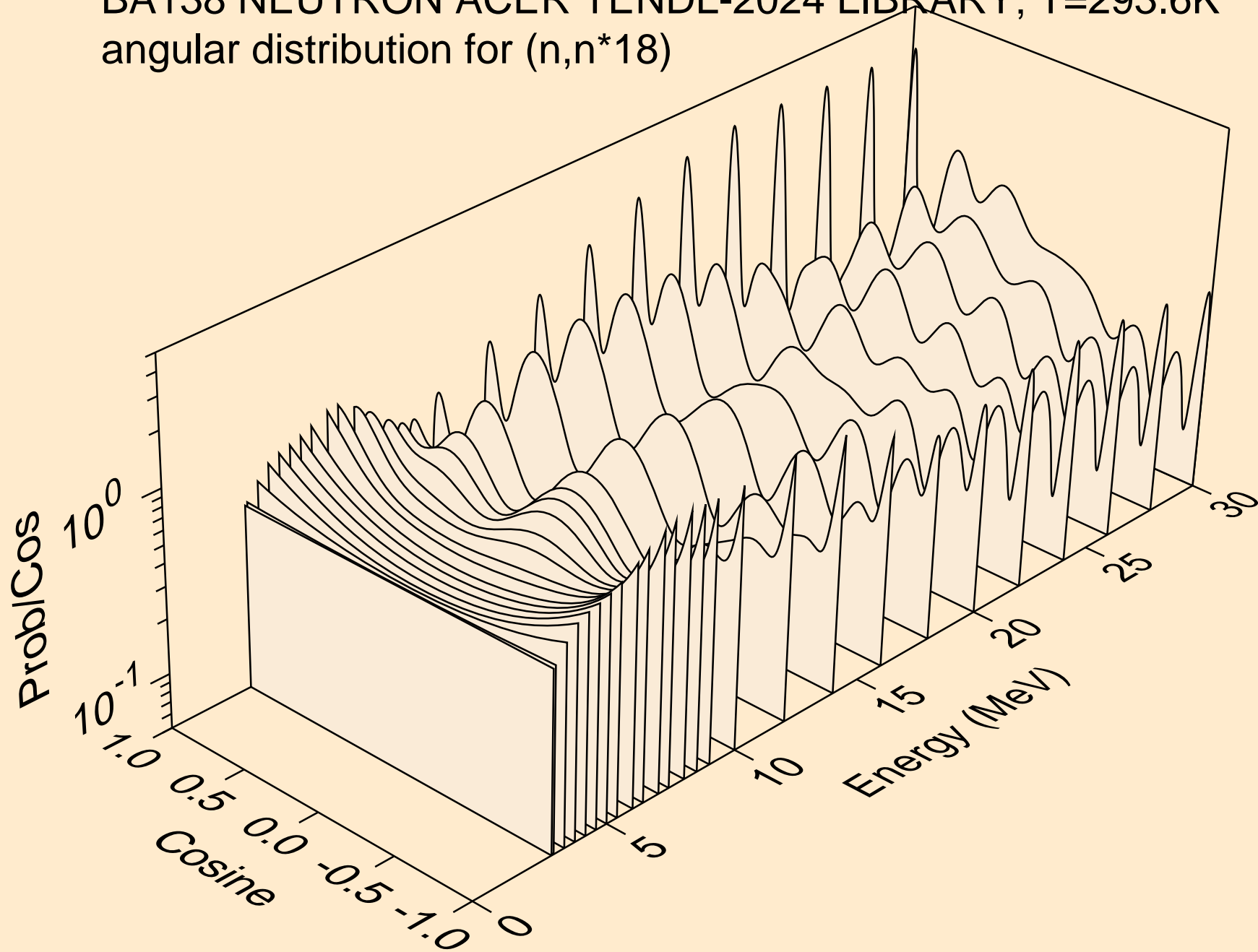

BA138 NEUTRON ACER TENDL-2024 LIBRARY; T=293.6K
angular distribution for (n,n*19)

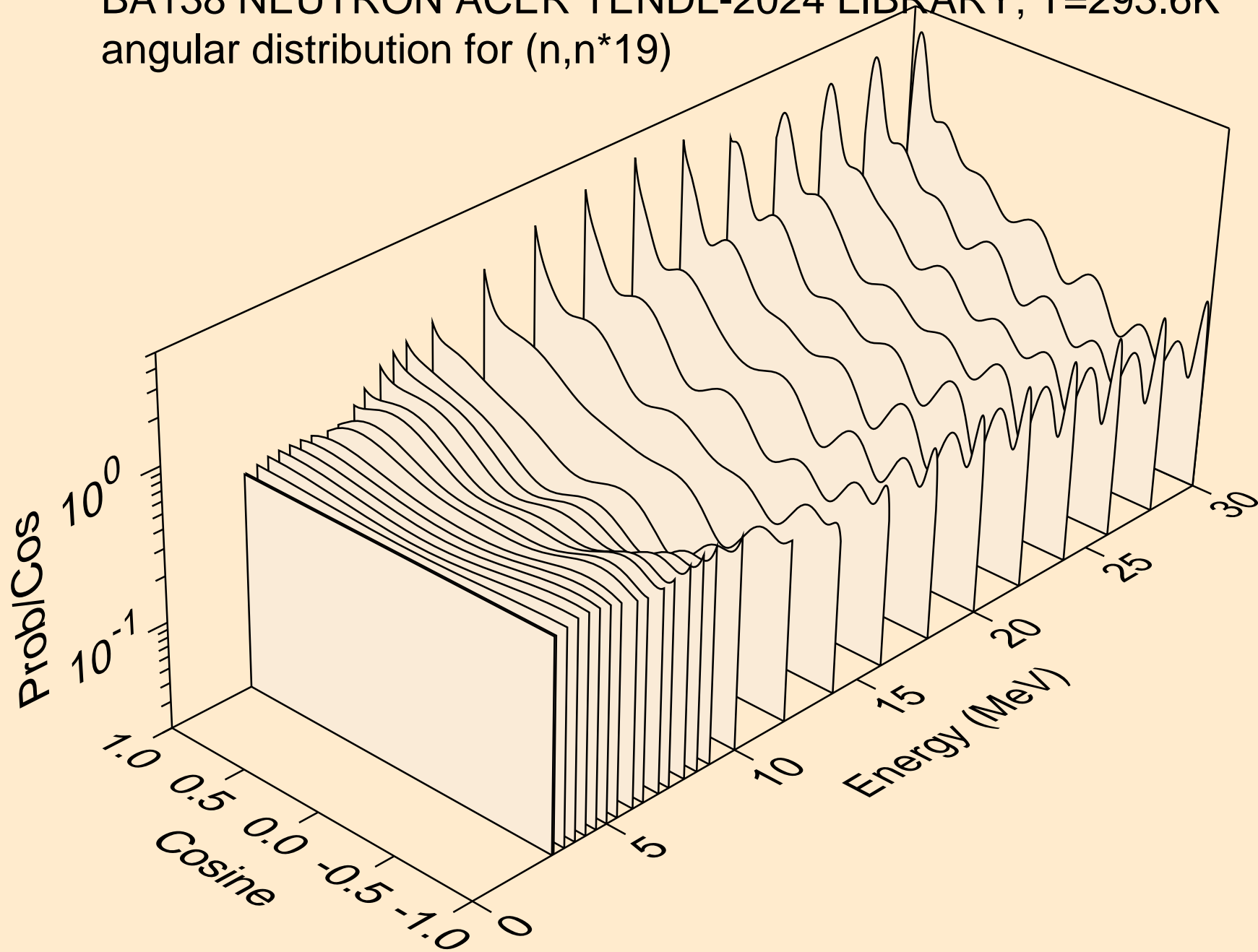

BA138 NEUTRON ACER TENDL-2024 LIBRARY; T=293.6K
angular distribution for (n,n*20)

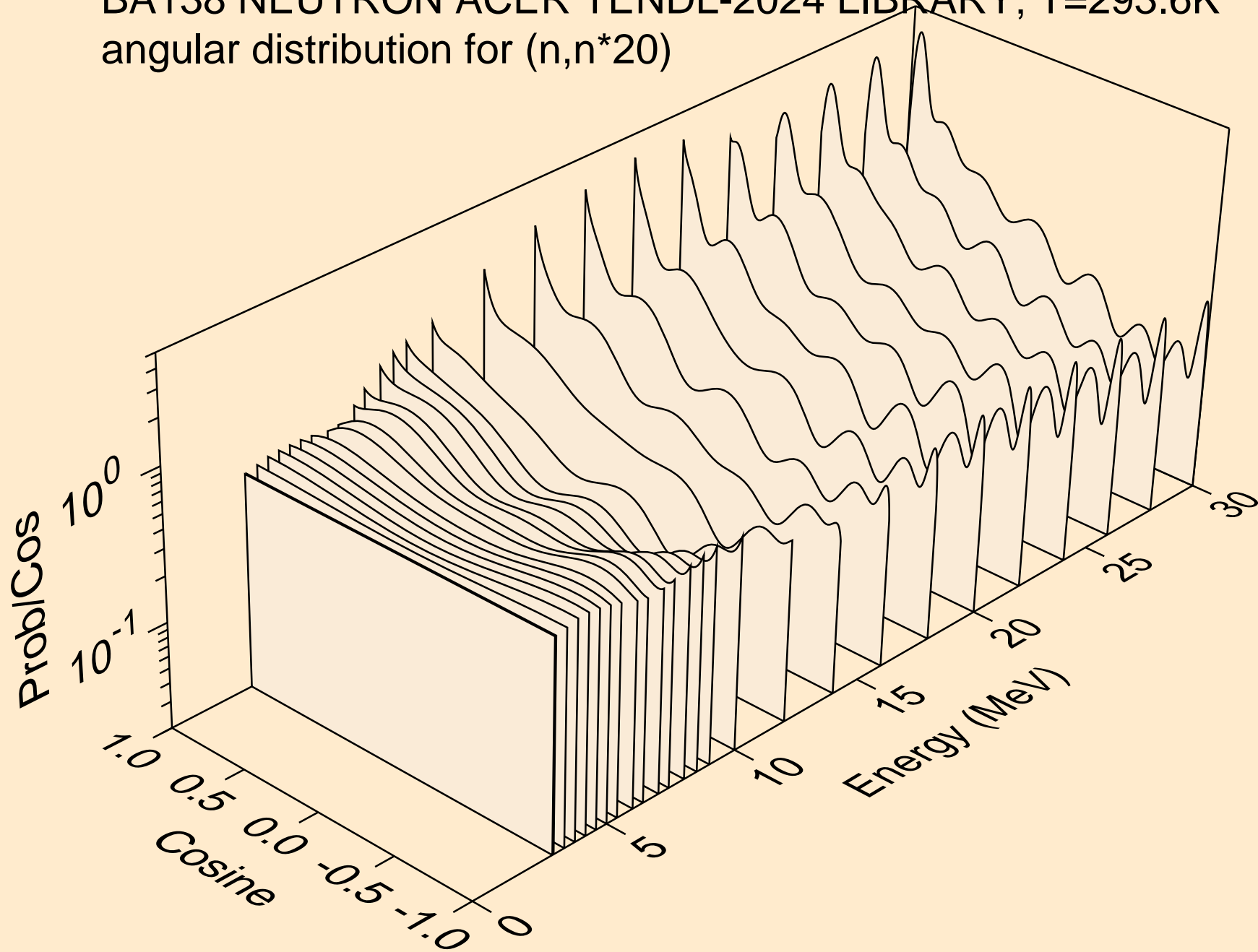

BA138 NEUTRON ACER TENDL-2024 LIBRARY; T=293.6K
angular distribution for (n,n*21)

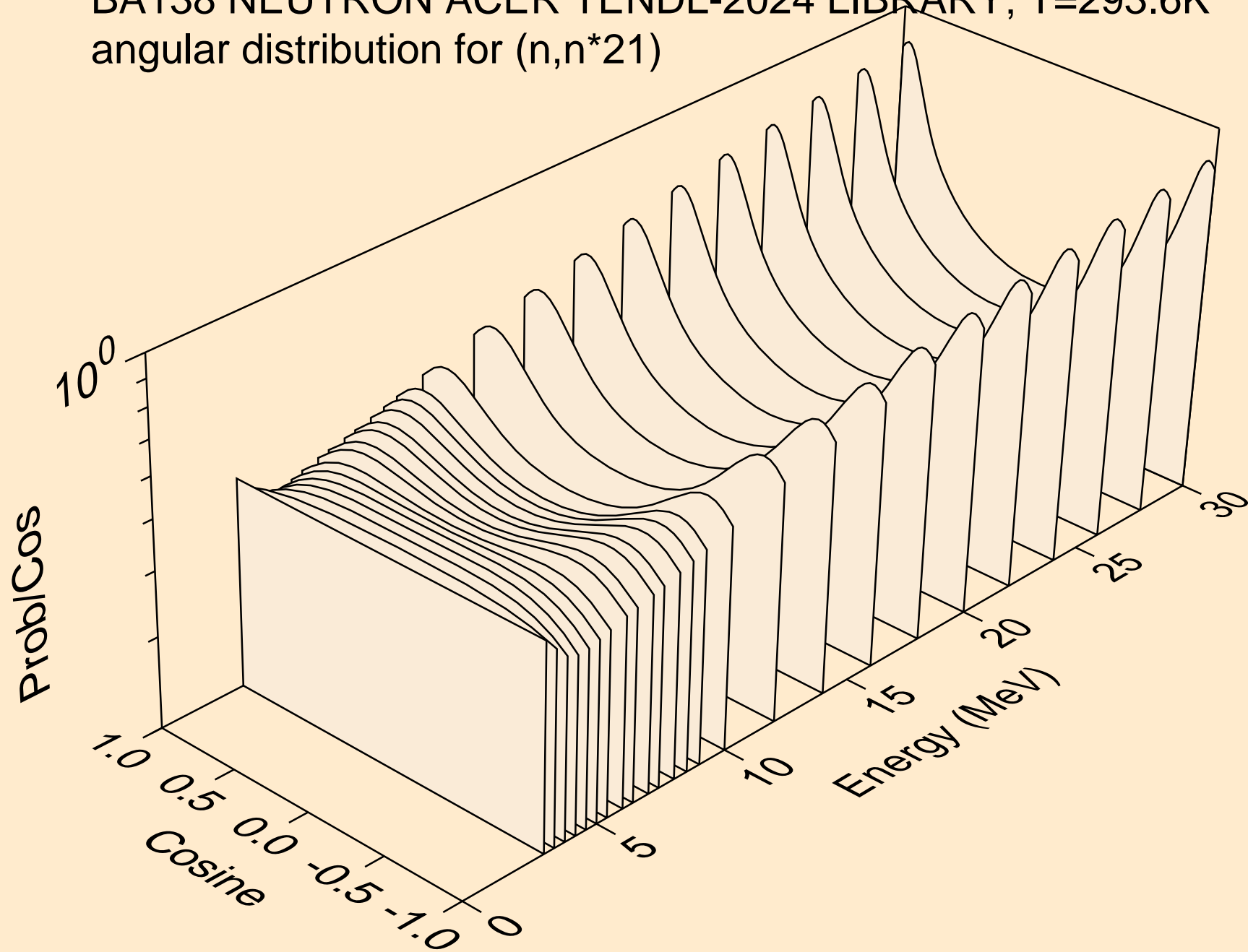

BA138 NEUTRON ACER TENDL-2024 LIBRARY; T=293.6K
angular distribution for (n,n*22)

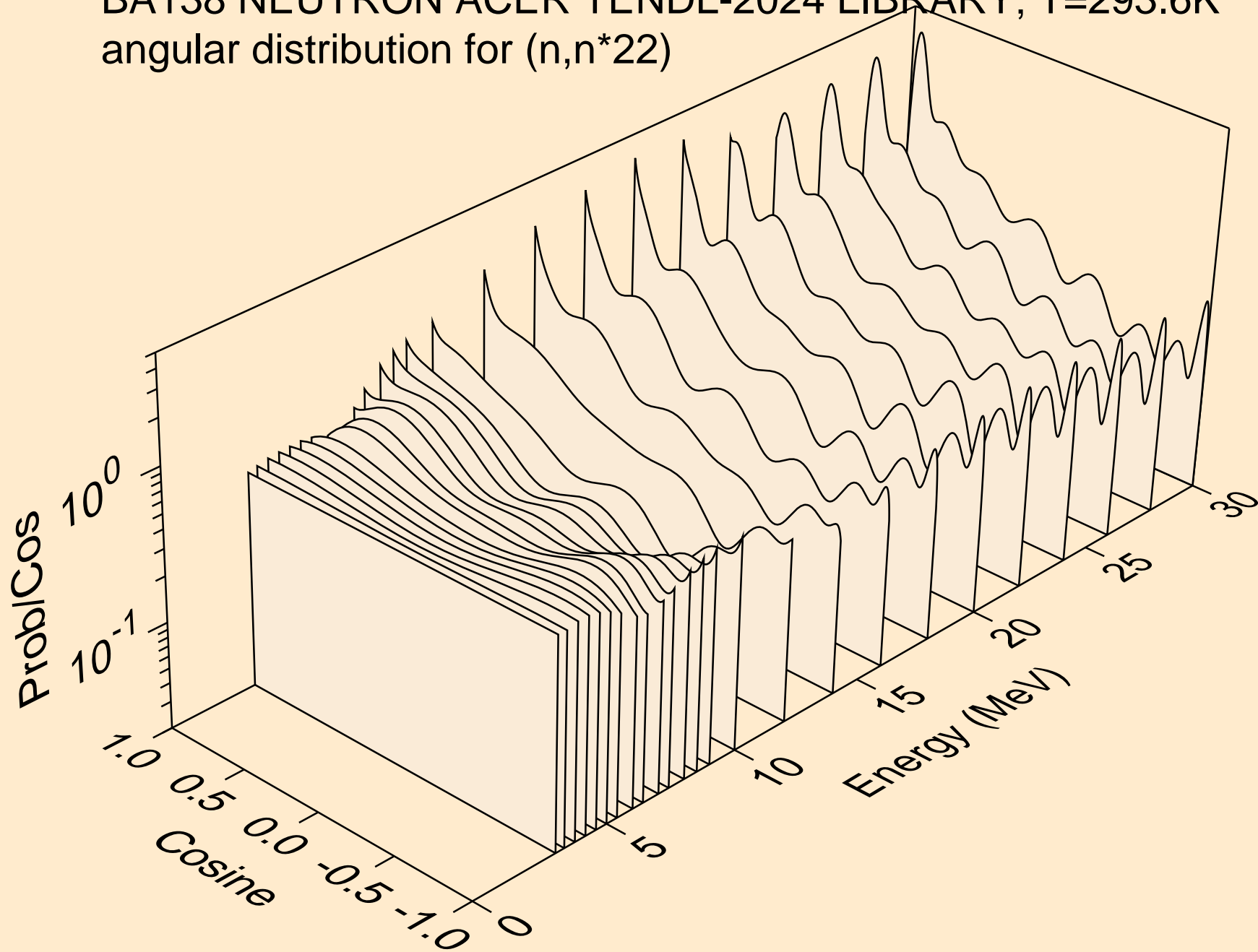

BA138 NEUTRON ACER TENDL-2024 LIBRARY; T=293.6K
angular distribution for (n,n*23)

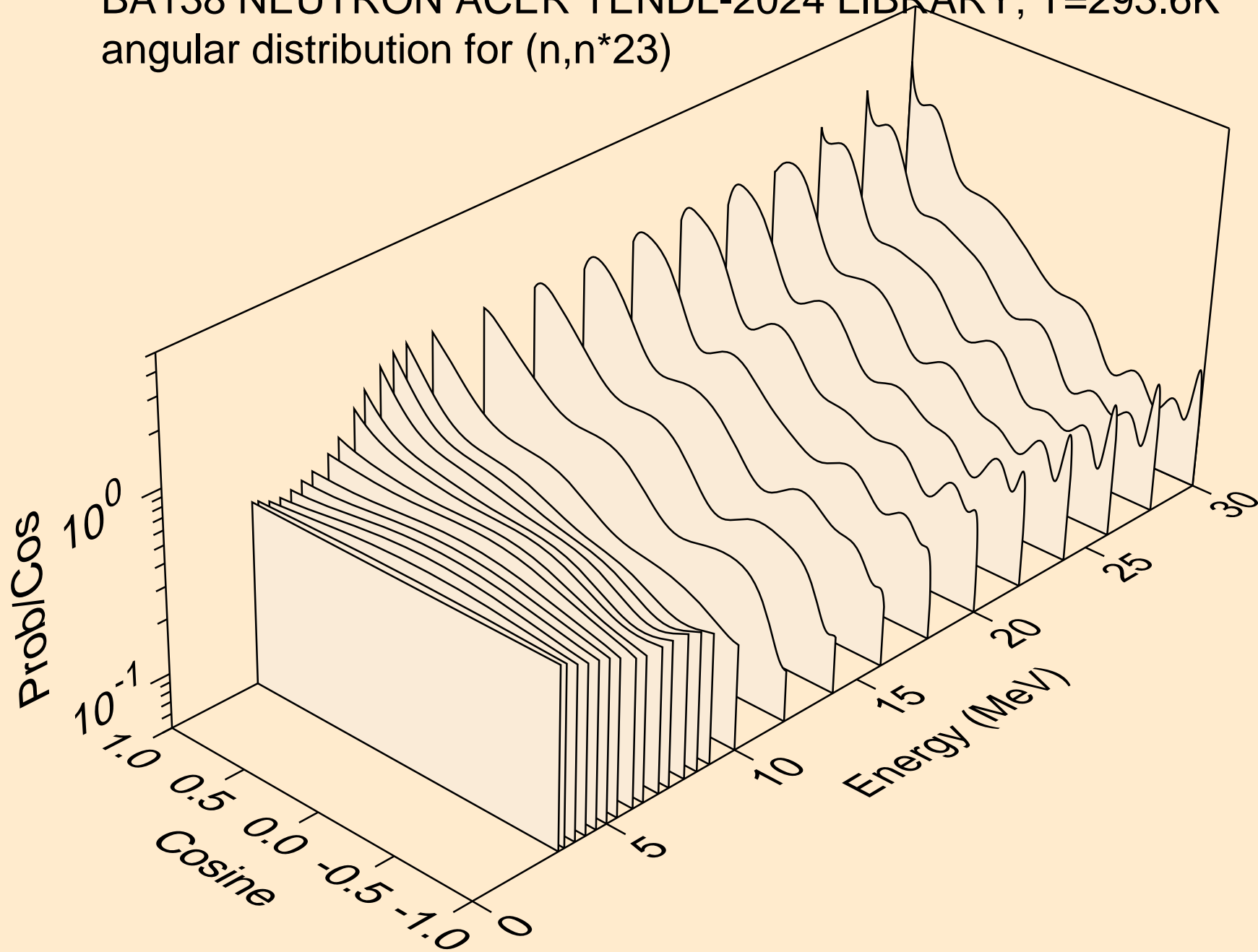

BA138 NEUTRON ACER TENDL-2024 LIBRARY; T=293.6K
angular distribution for (n,n*24)

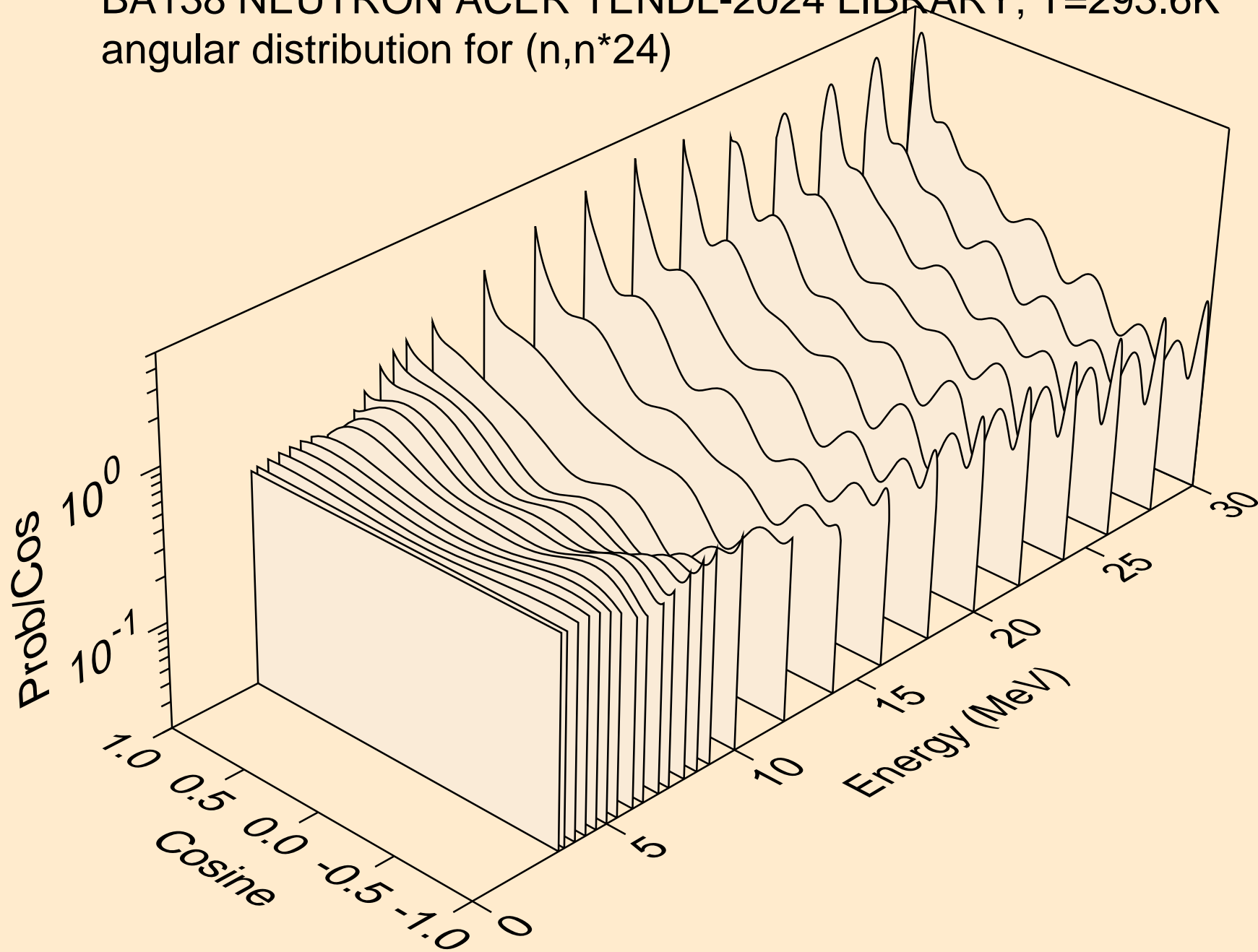

BA138 NEUTRON ACER TENDL-2024 LIBRARY; T=293.6K
angular distribution for (n,n*25)

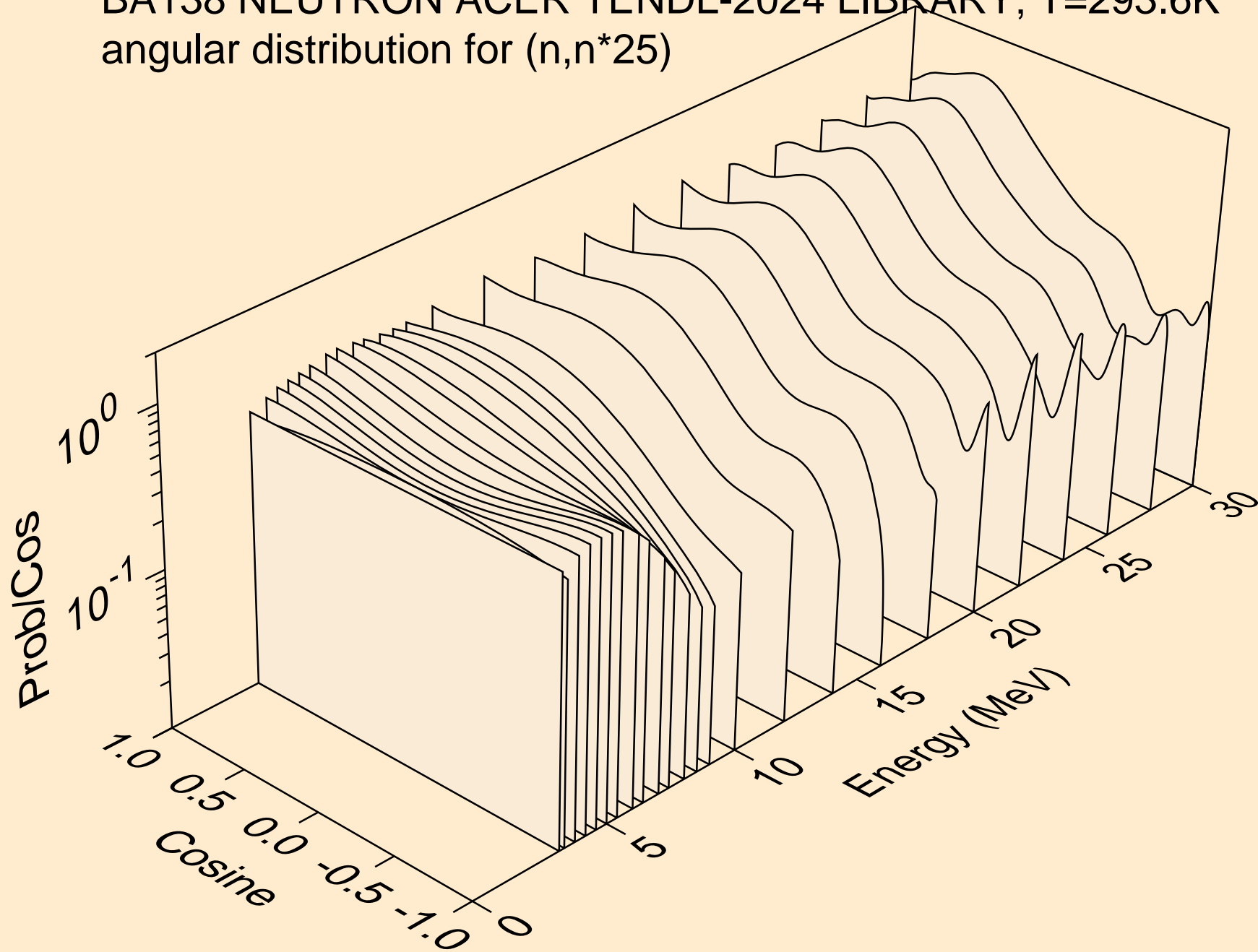

BA138 NEUTRON ACER TENDL-2024 LIBRARY; T=293.6K
angular distribution for (n,n*26)

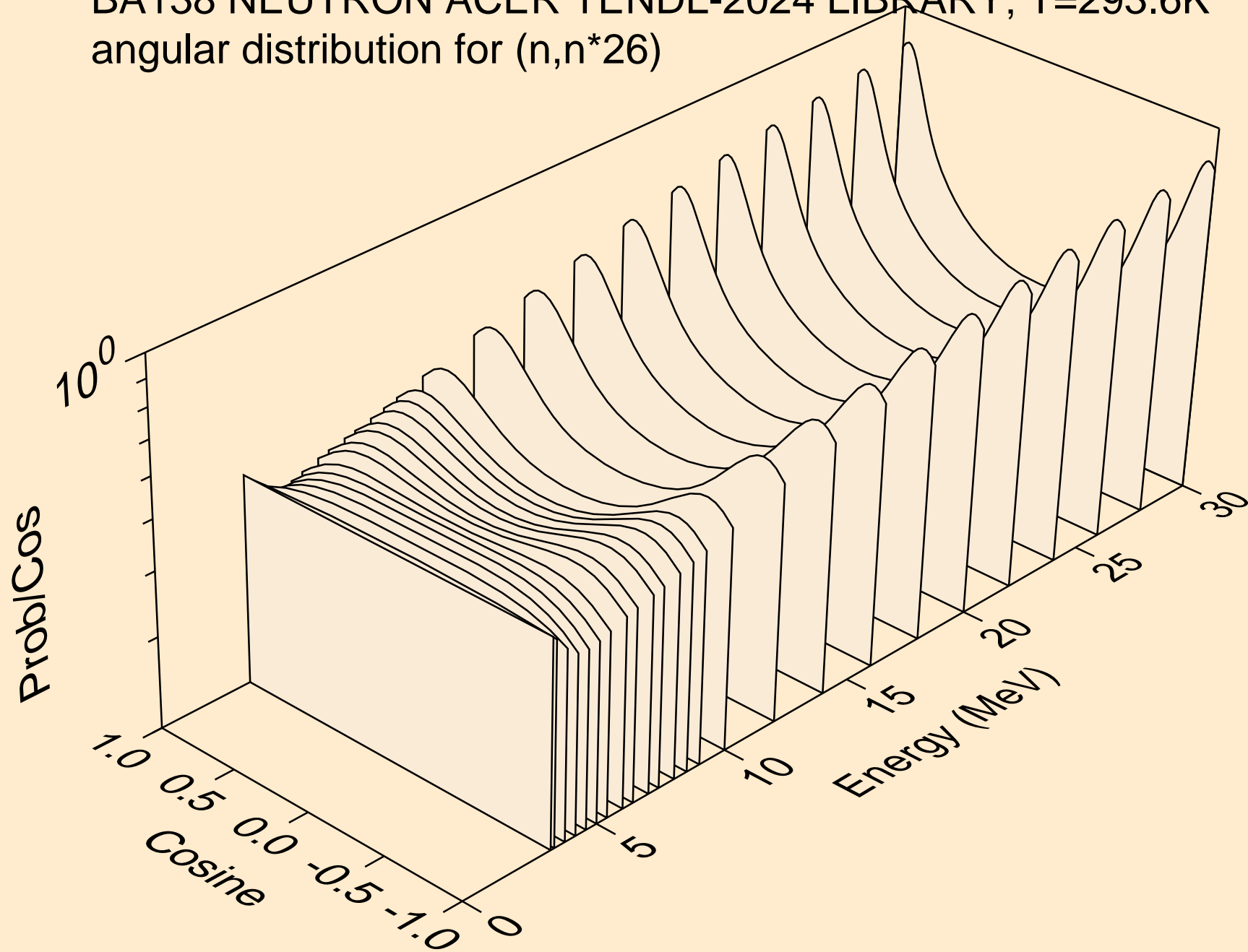

BA138 NEUTRON ACER TENDL-2024 LIBRARY; T=293.6K
angular distribution for (n,n*27)

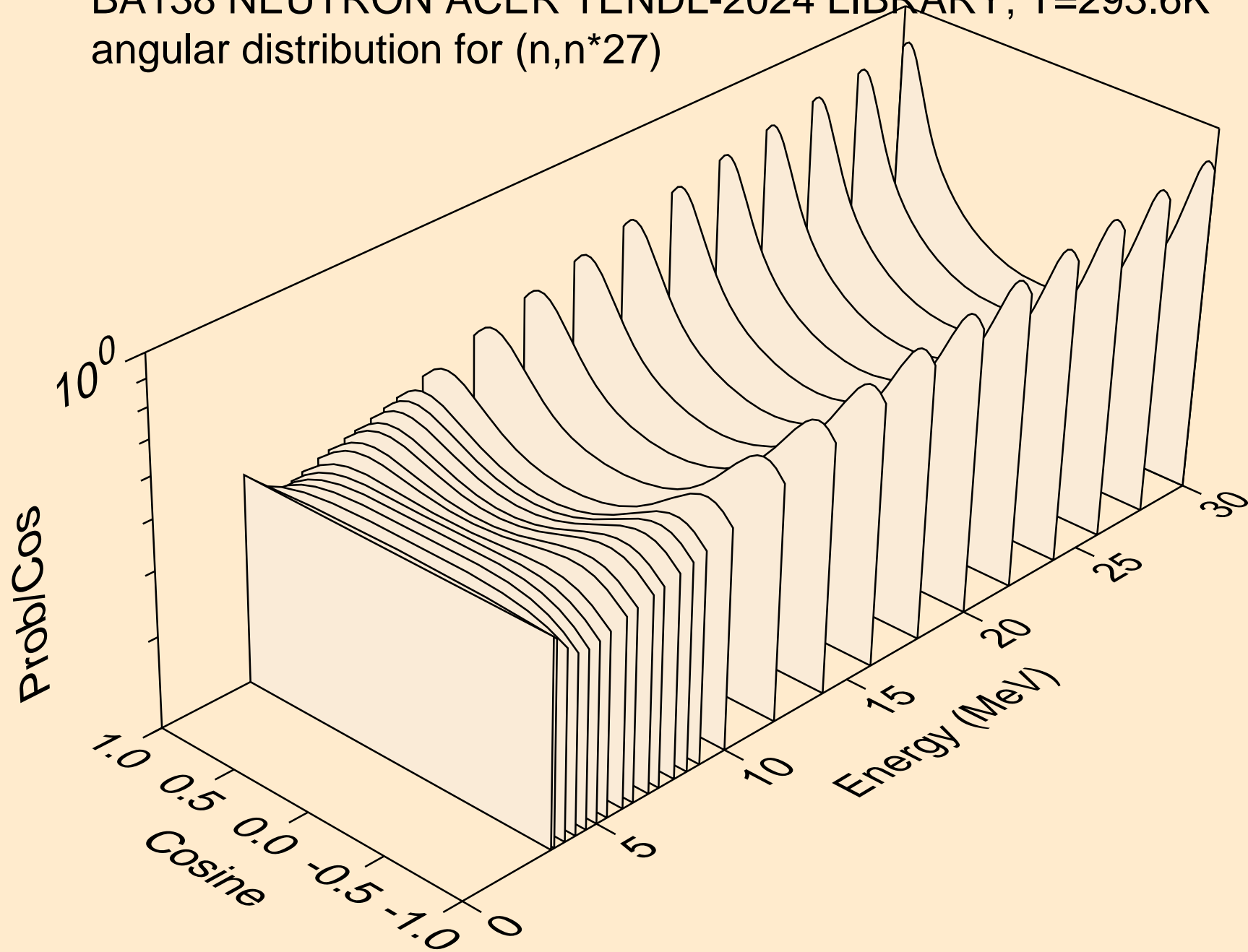

BA138 NEUTRON ACER TENDL-2024 LIBRARY; T=293.6K
angular distribution for (n,n*28)

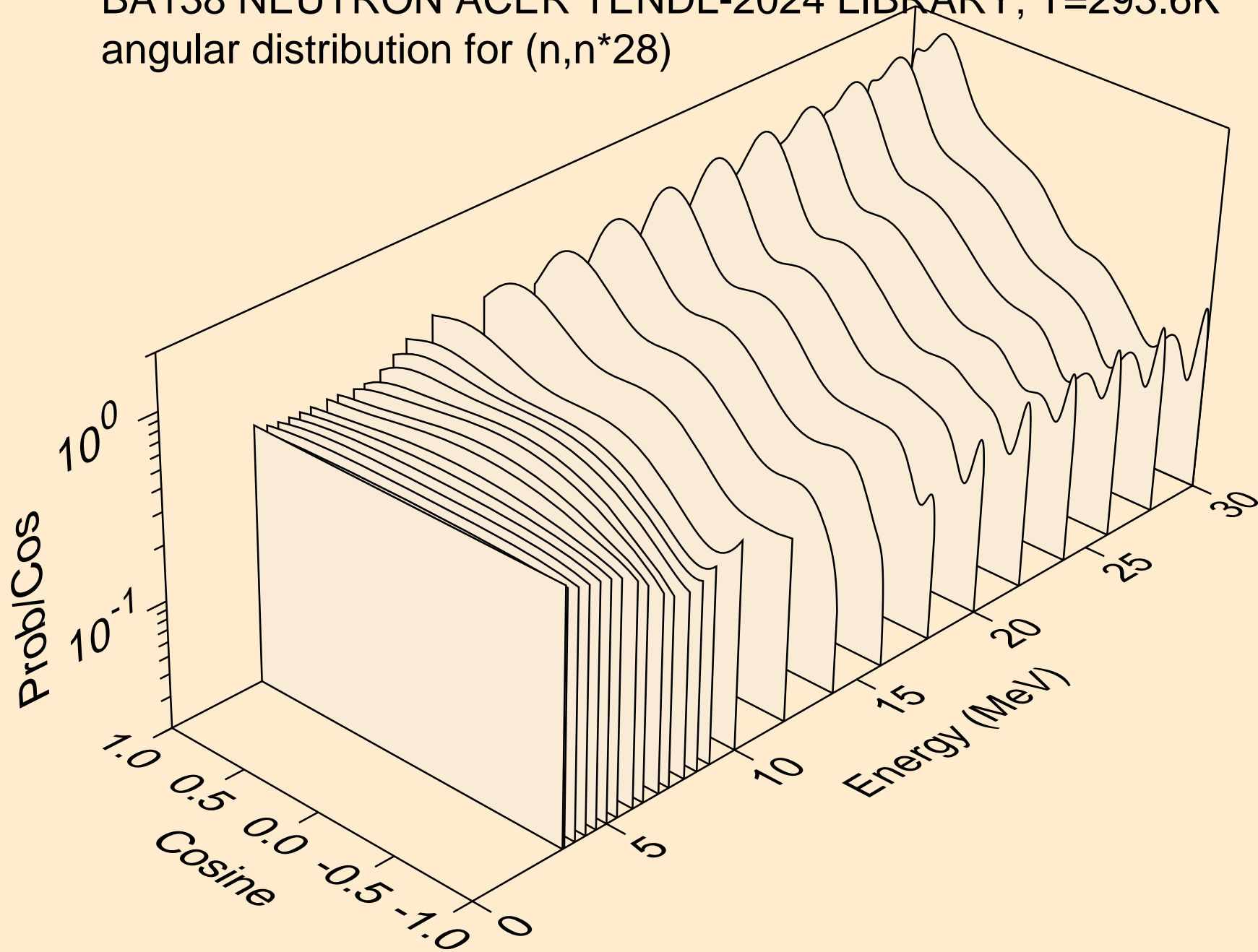

BA138 NEUTRON ACER TENDL-2024 LIBRARY; T=293.6K
angular distribution for (n,n*29)

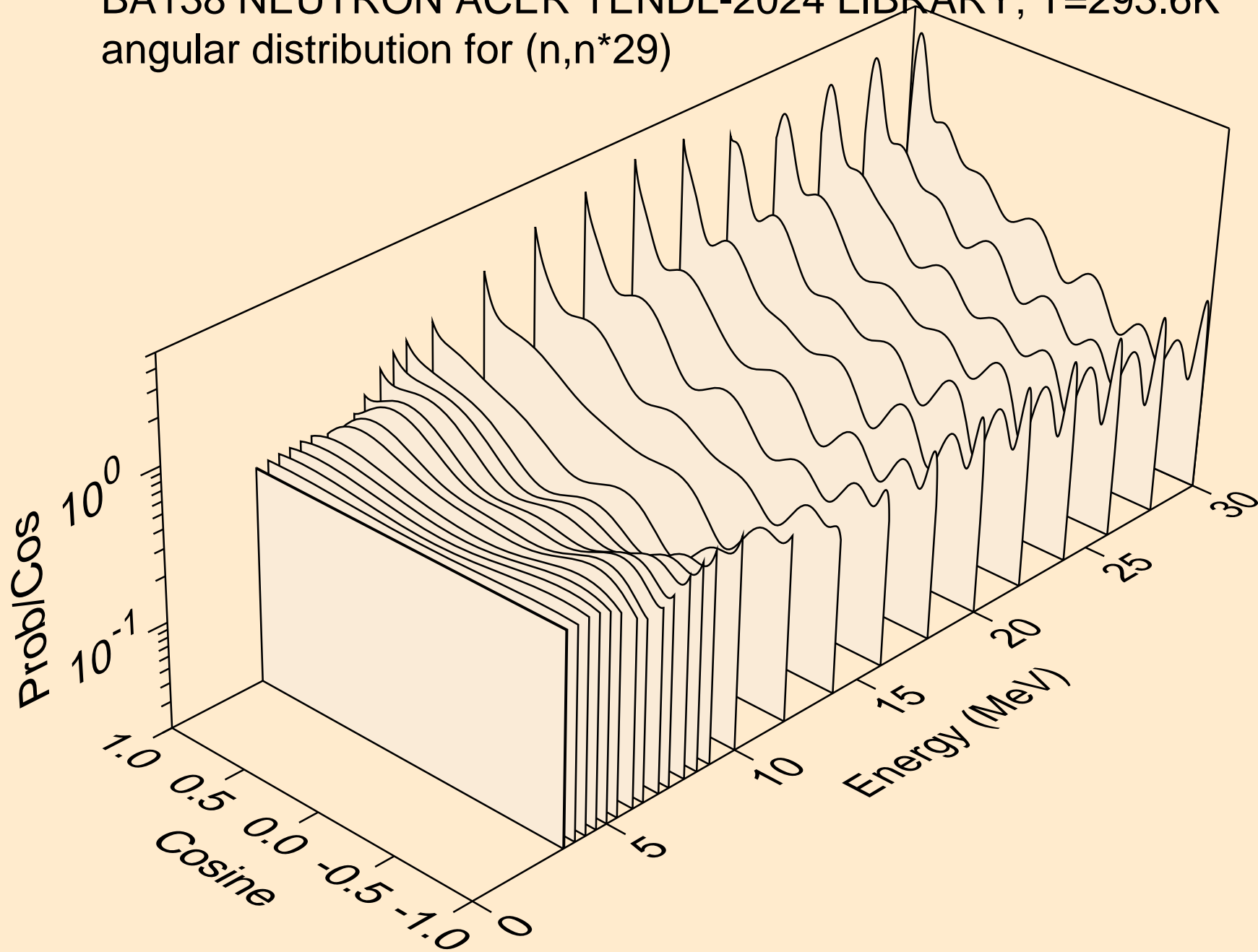

BA138 NEUTRON ACER TENDL-2024 LIBRARY; T=293.6K
angular distribution for (n,n*30)

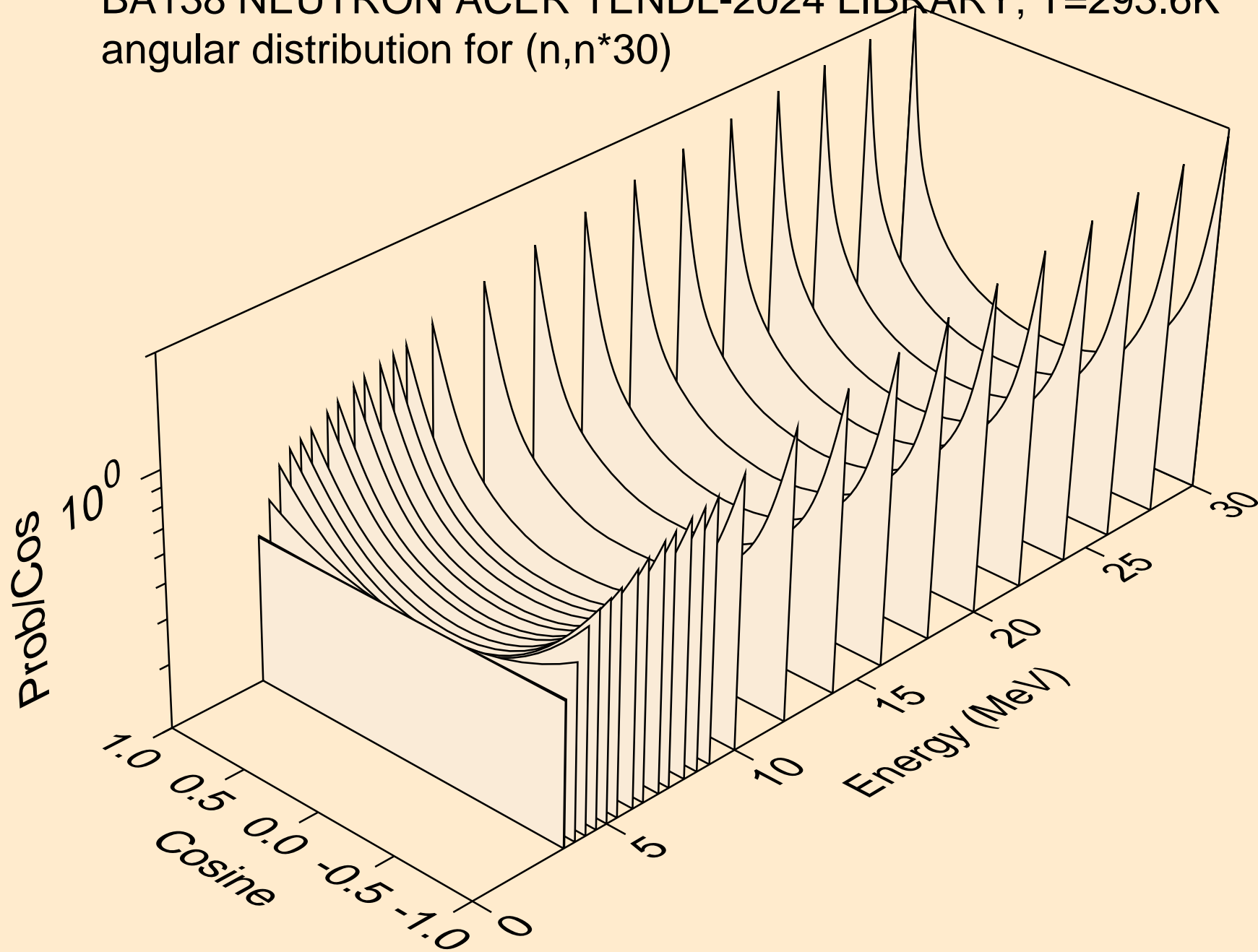

BA138 NEUTRON ACER TENDL-2024 LIBRARY; T=293.6K
Neutron emission for (n,x)

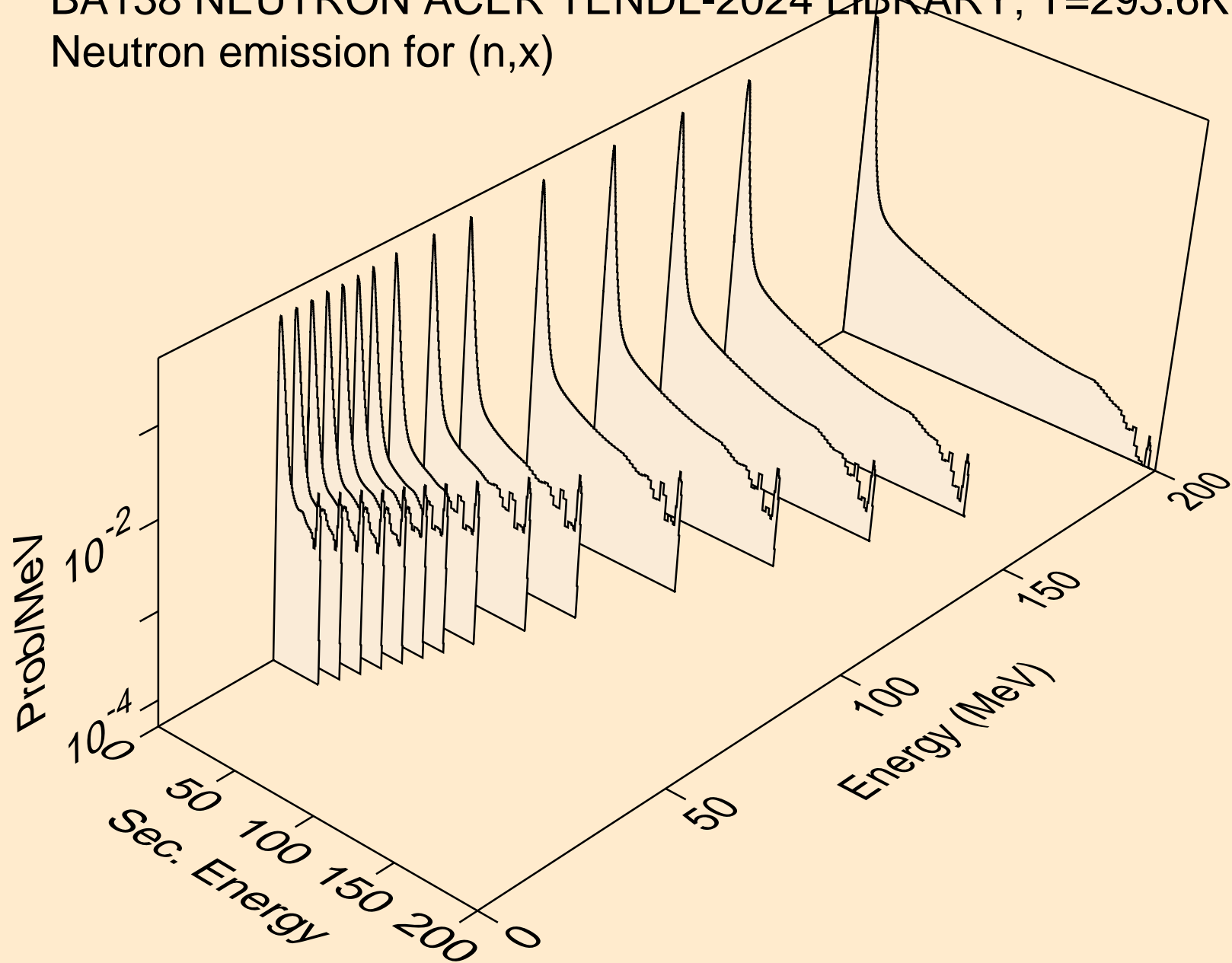

BA138 NEUTRON ACER TENDL-2024 LIBRARY; T=293.6K
Neutron emission for (n,2nd)

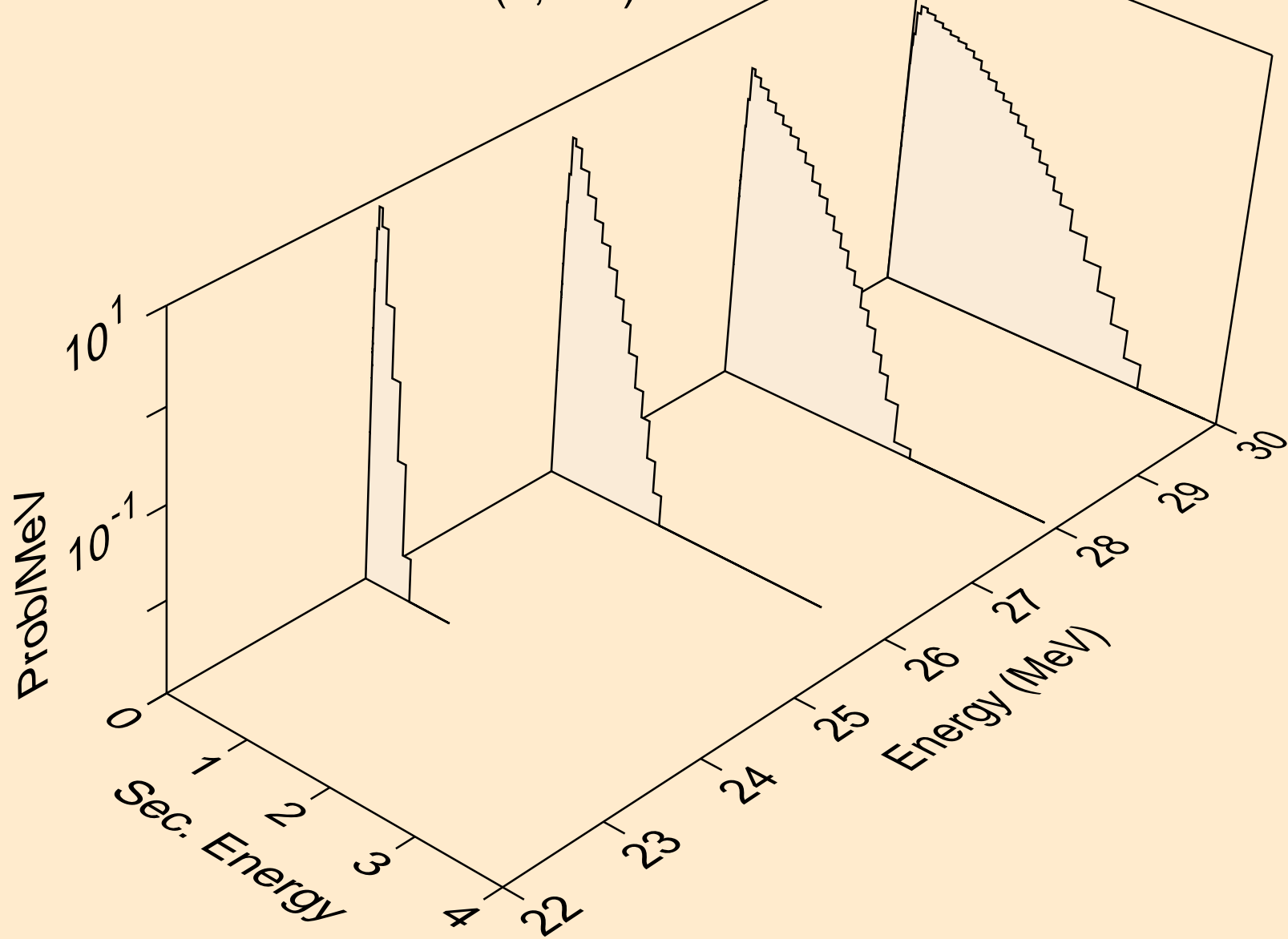

BA138 NEUTRON ACER TENDL-2024 LIBRARY; T=293.6K
Neutron emission for (n,2n)

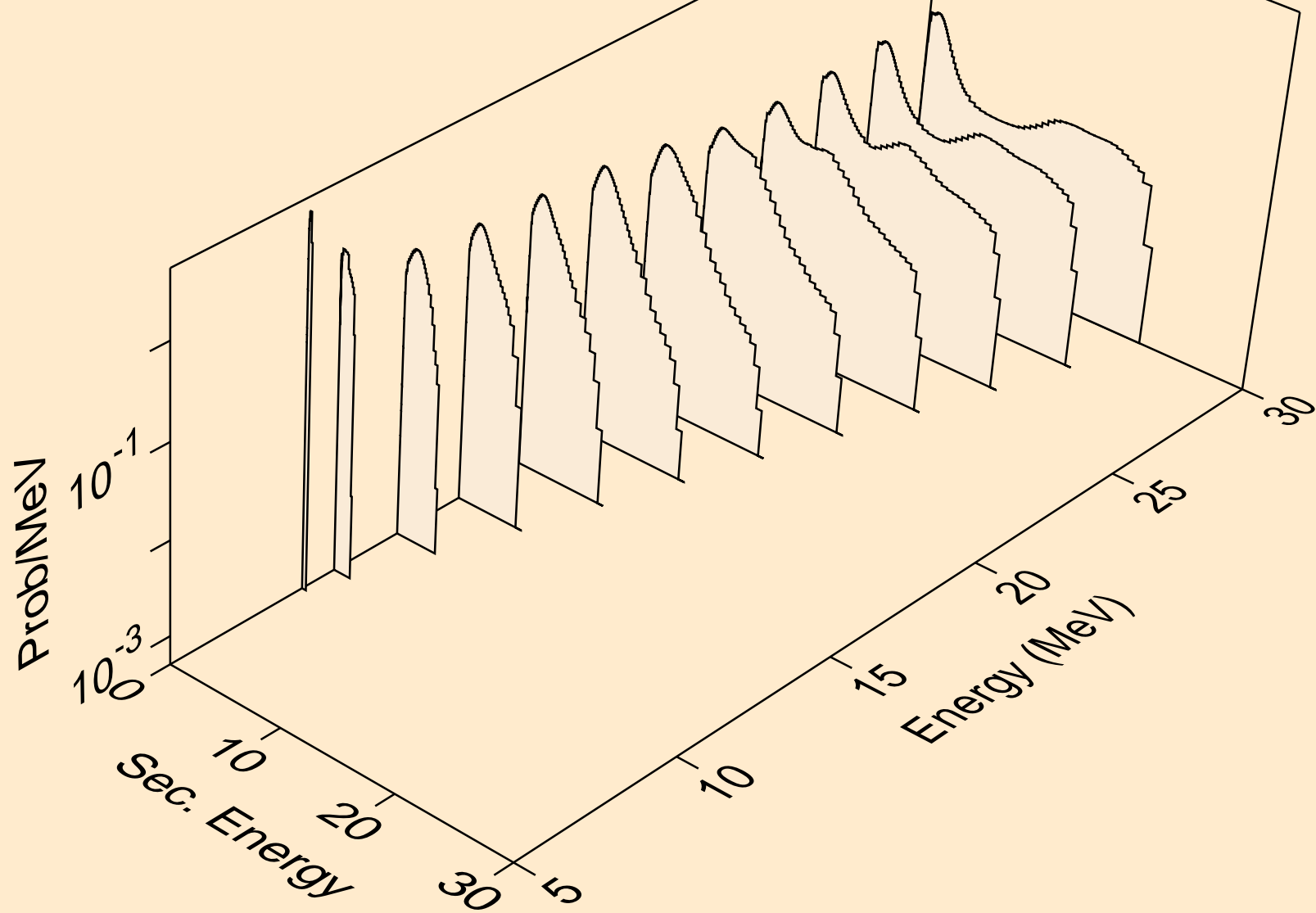

BA138 NEUTRON ACER TENDL-2024 LIBRARY; T=293.6K
Neutron emission for (n,3n)

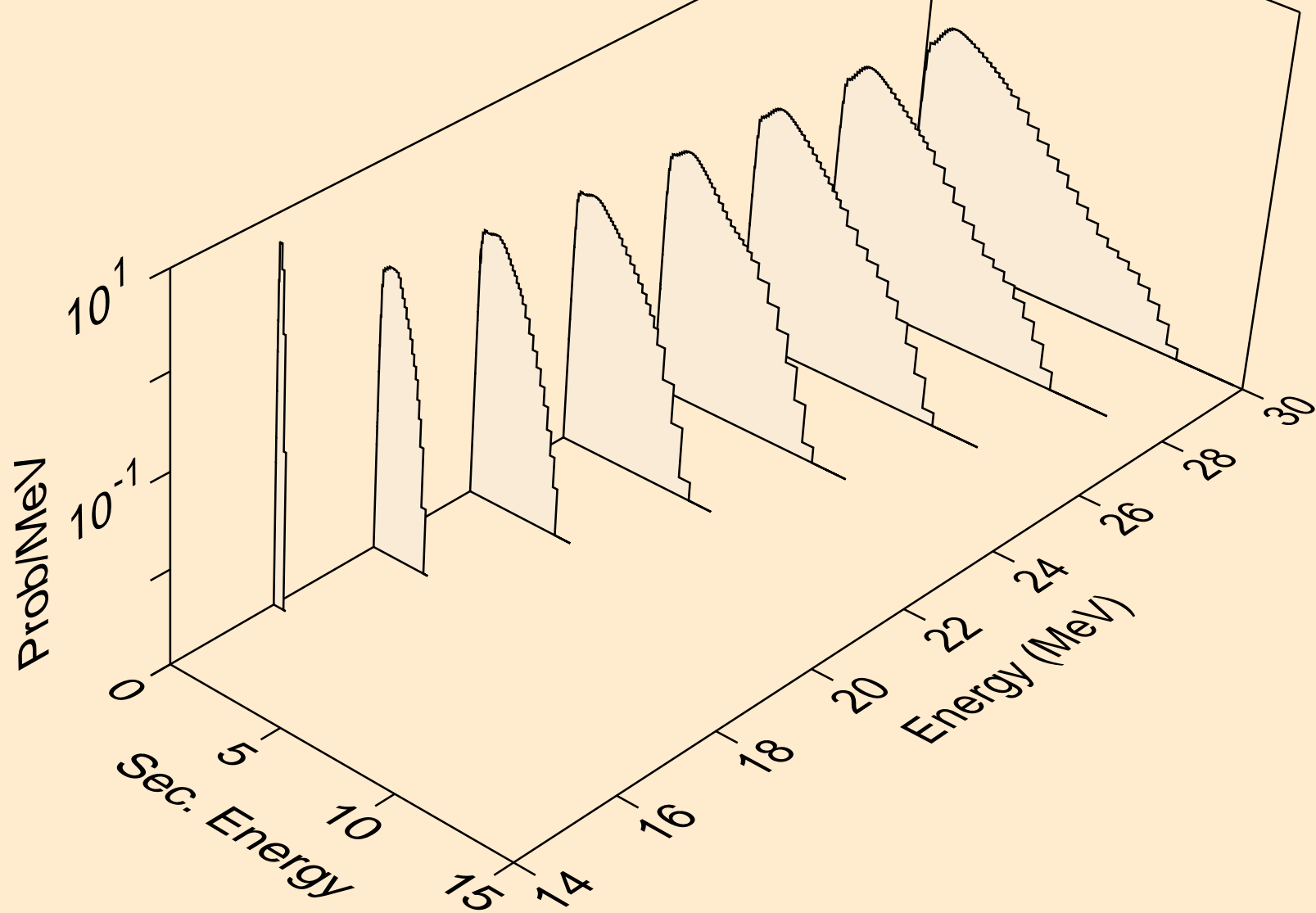

BA138 NEUTRON ACER TENDL-2024 LIBRARY; T=293.6K
Neutron emission for (n,n*)a

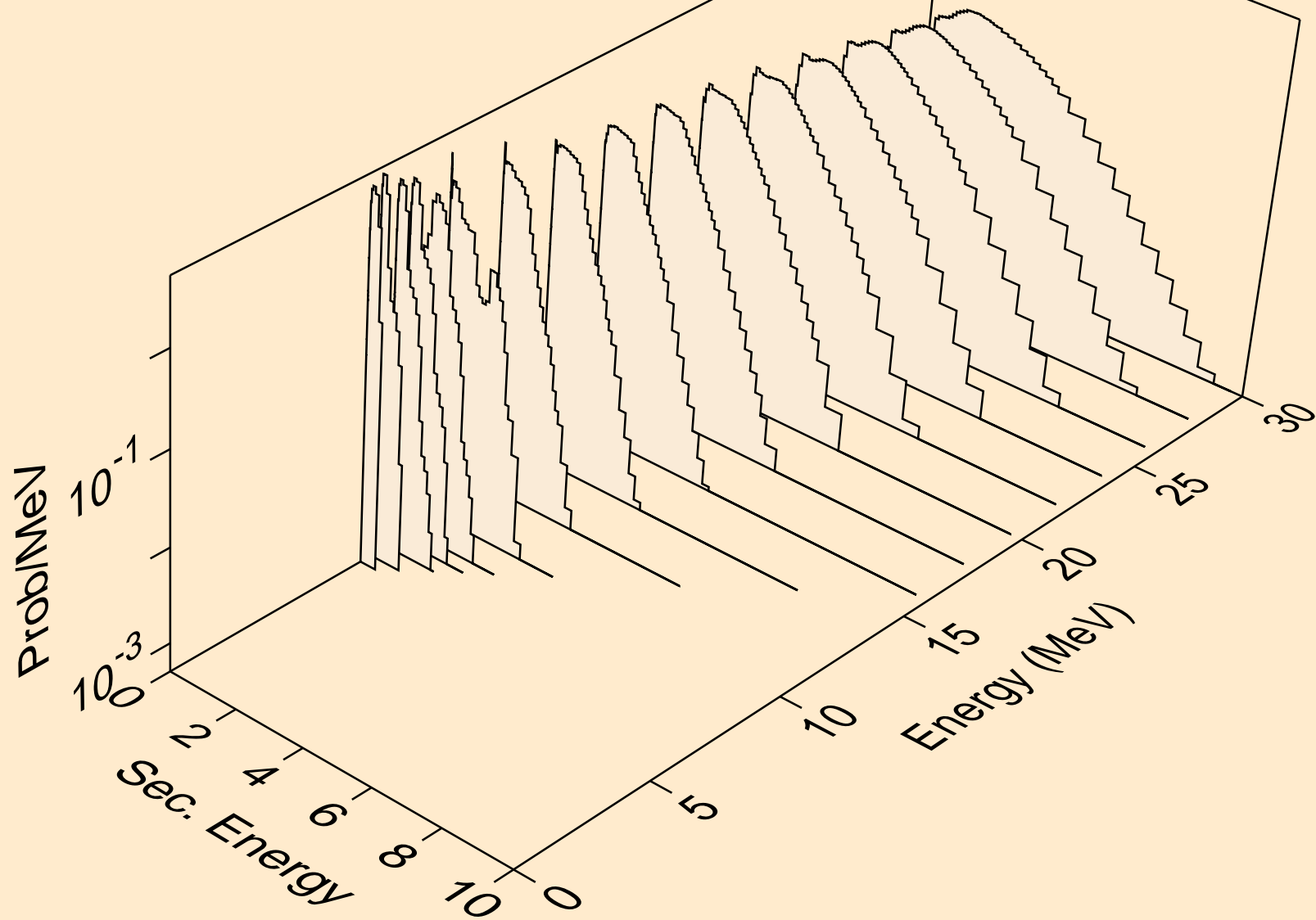

BA138 NEUTRON ACER TENDL-2024 LIBRARY; T=293.6K
Neutron emission for (n,2n)_a

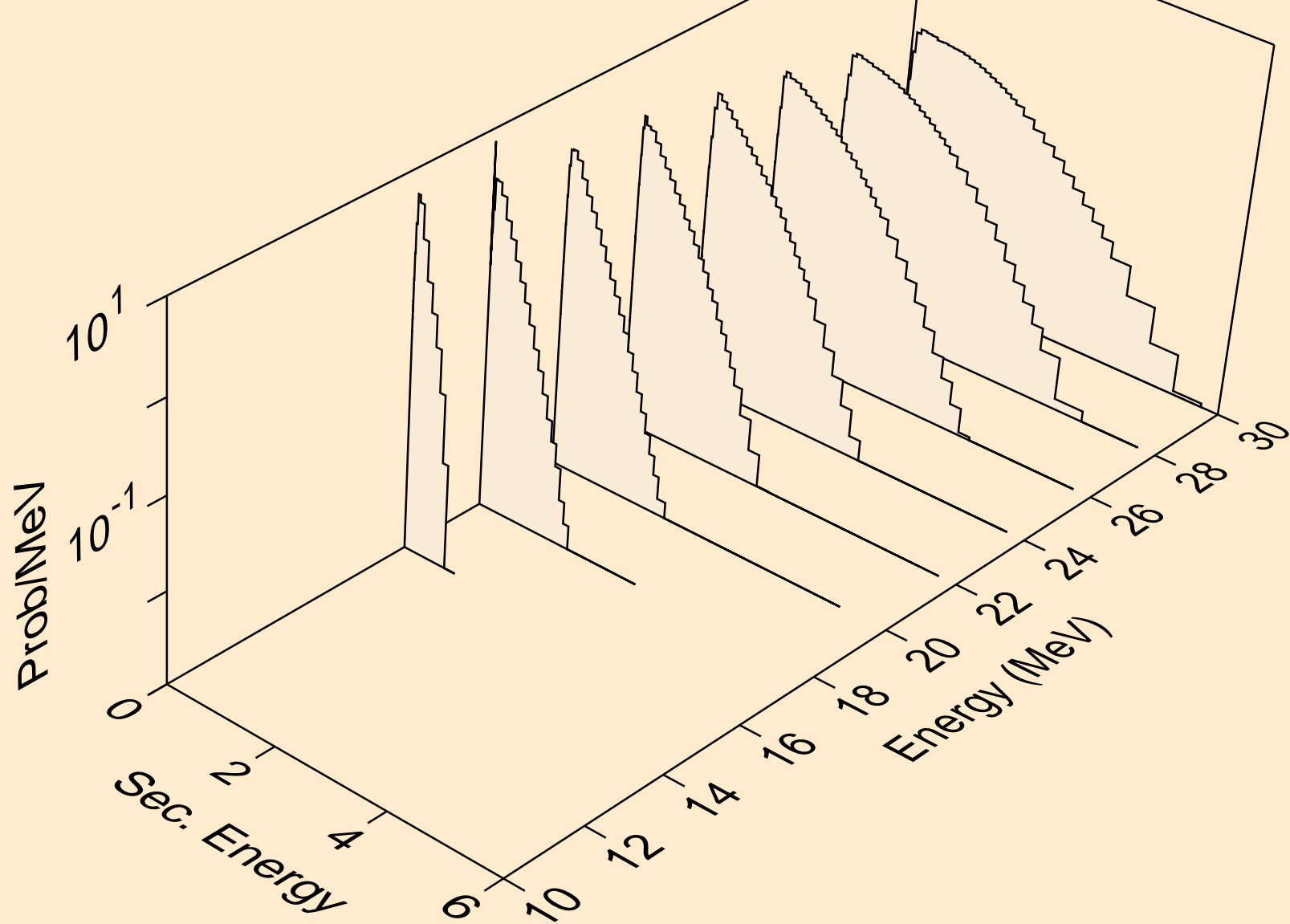

BA138 NEUTRON ACER TENDL-2024 LIBRARY; T=293.6K
Neutron emission for (n,3n)a

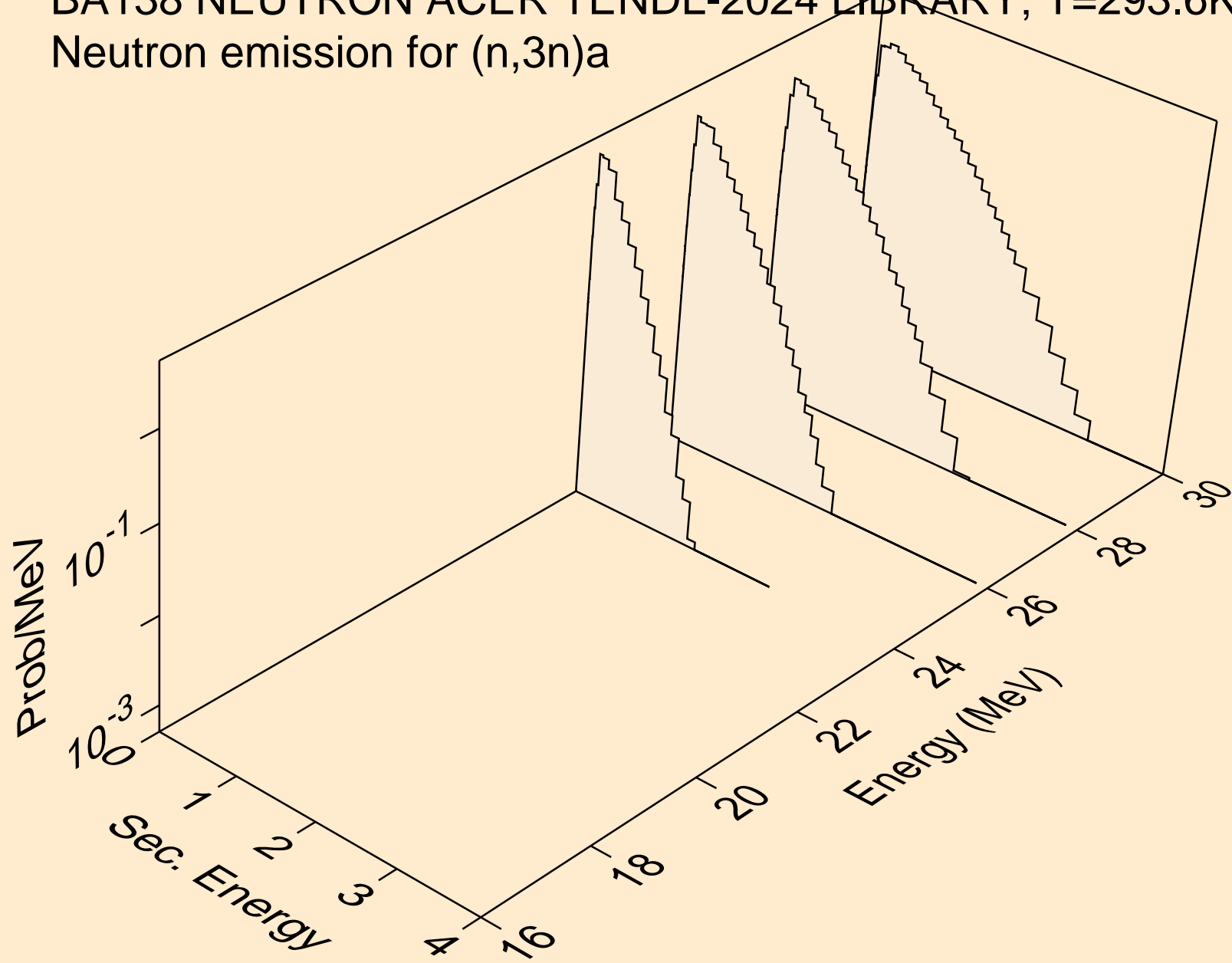

BA138 NEUTRON ACER TENDL-2024 LIBRARY; T=293.6K
Neutron emission for (n,n*)p

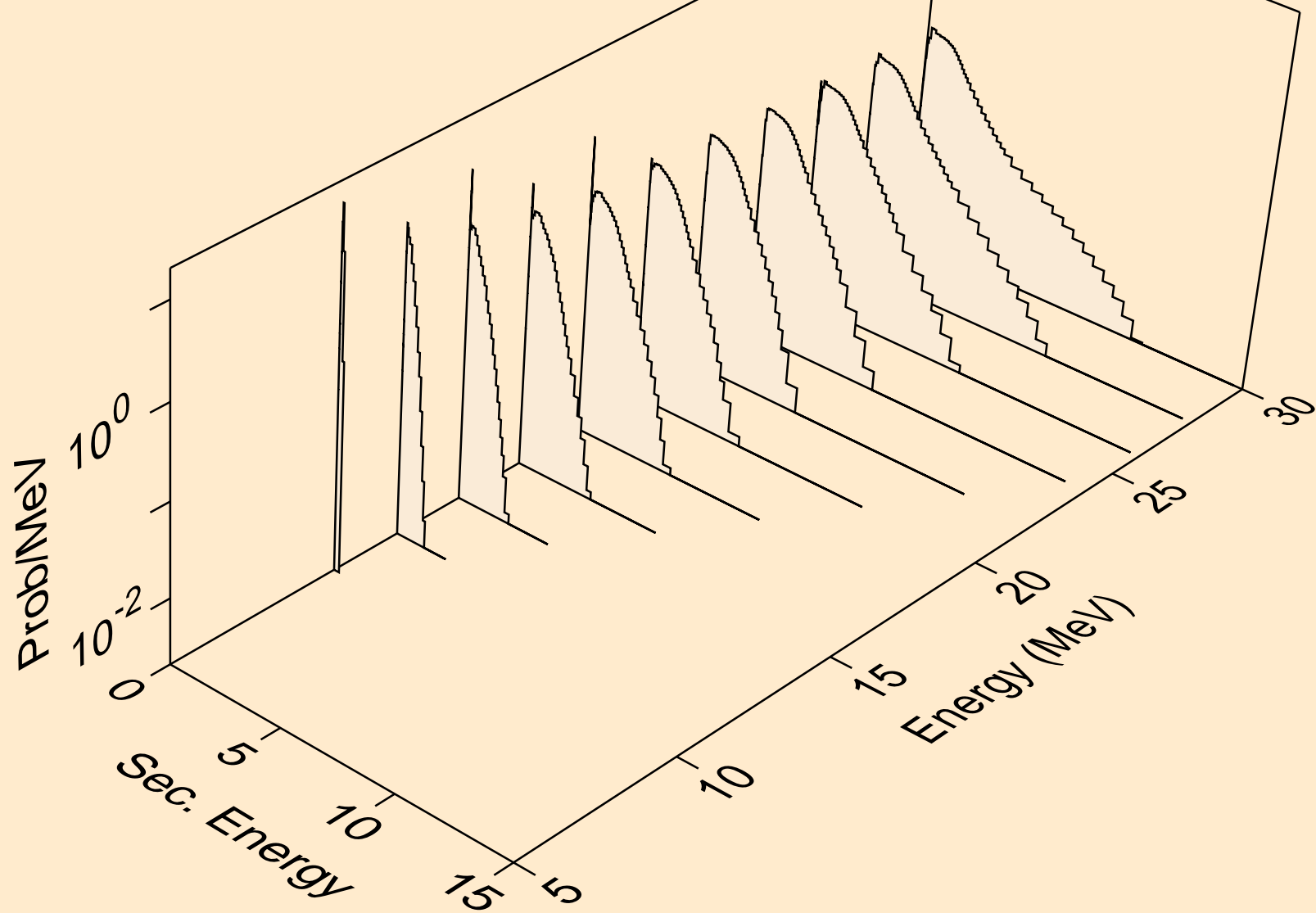

BA138 NEUTRON ACER TENDL-2024 LIBRARY; T=293.6K
Neutron emission for (n,n*)2a

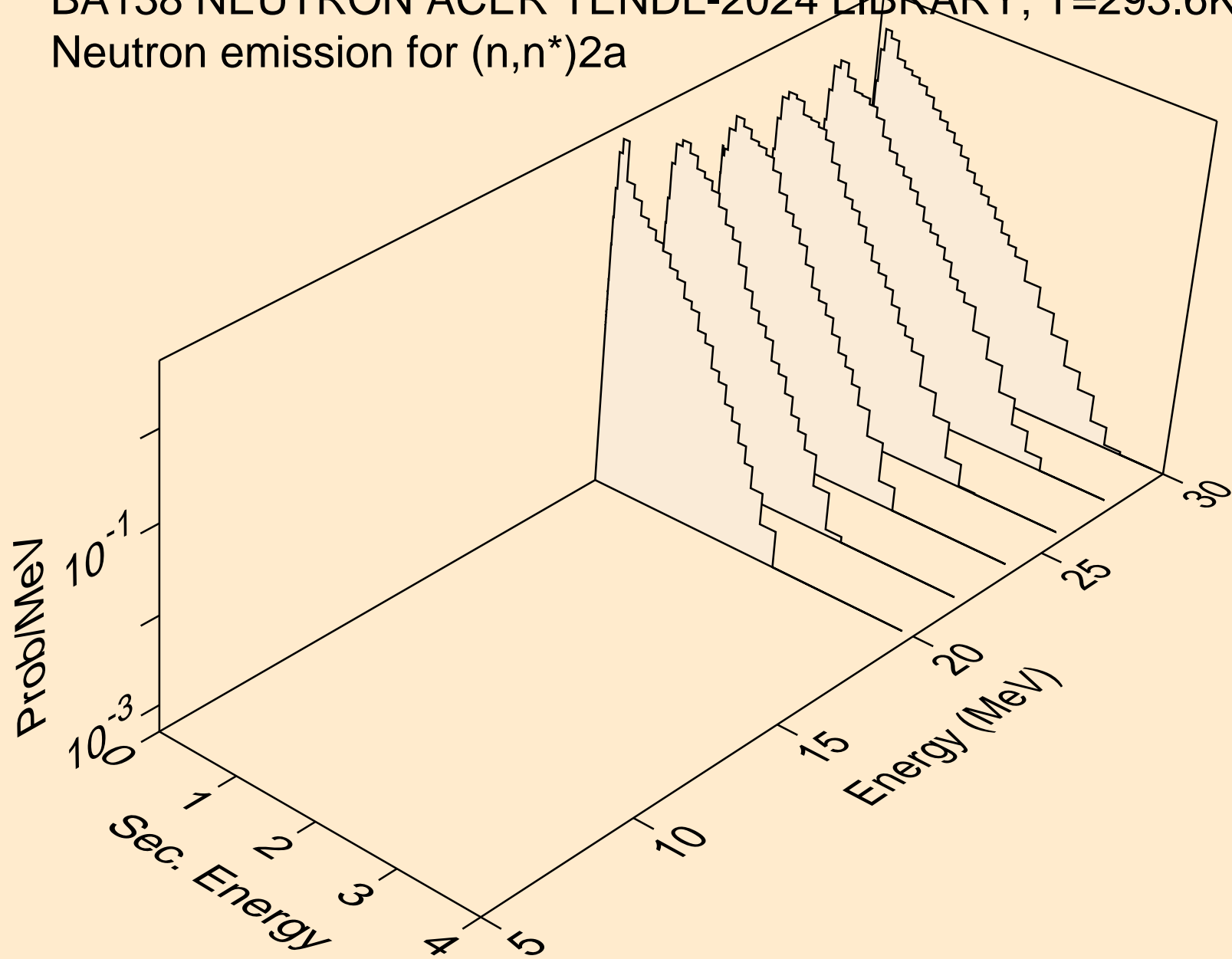

BA138 NEUTRON ACER TENDL-2024 LIBRARY; T=293.6K
Neutron emission for (n,n*)d

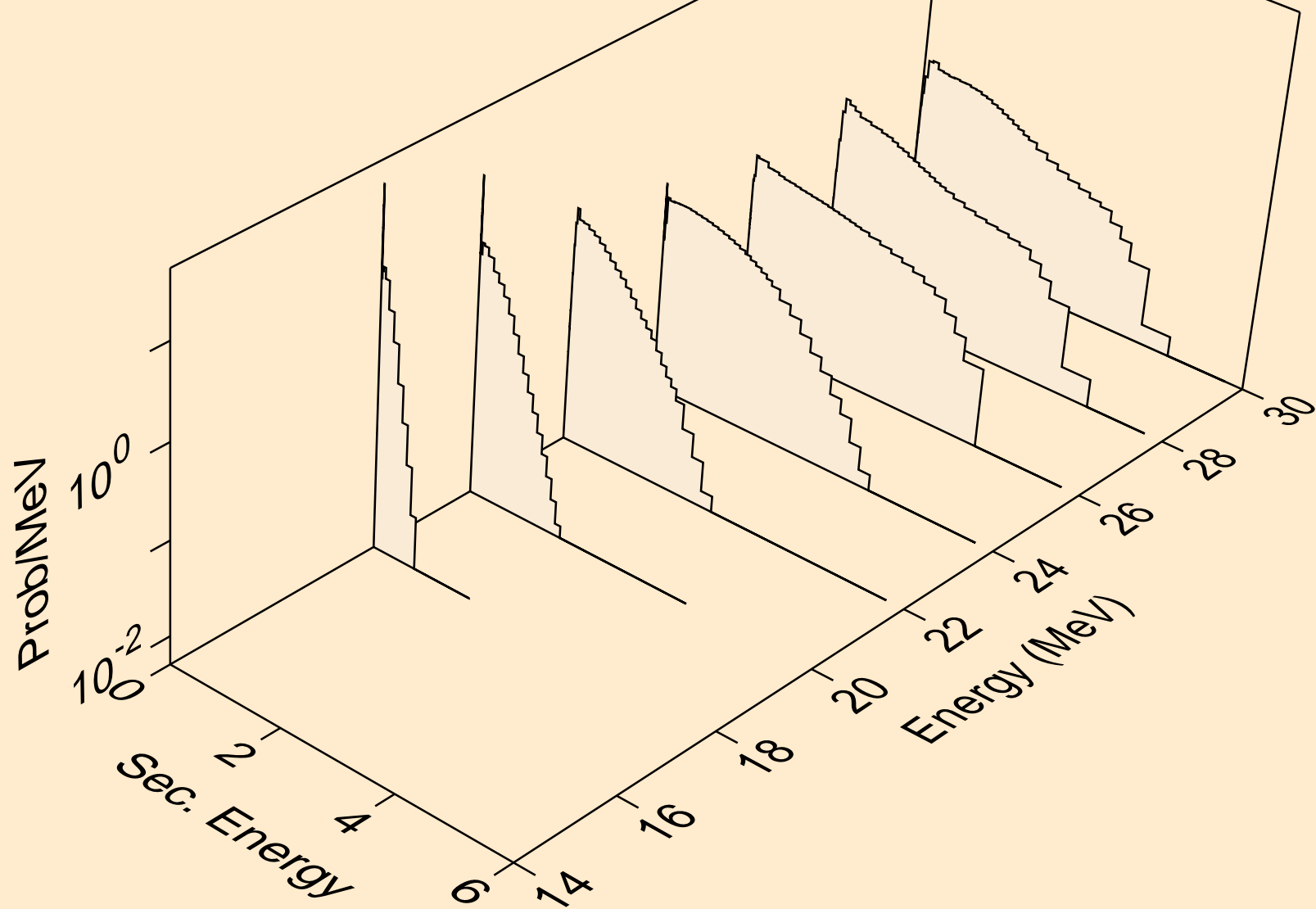

BA138 NEUTRON ACER TENDL-2024 LIBRARY; T=293.6K
Neutron emission for (n,n*)t

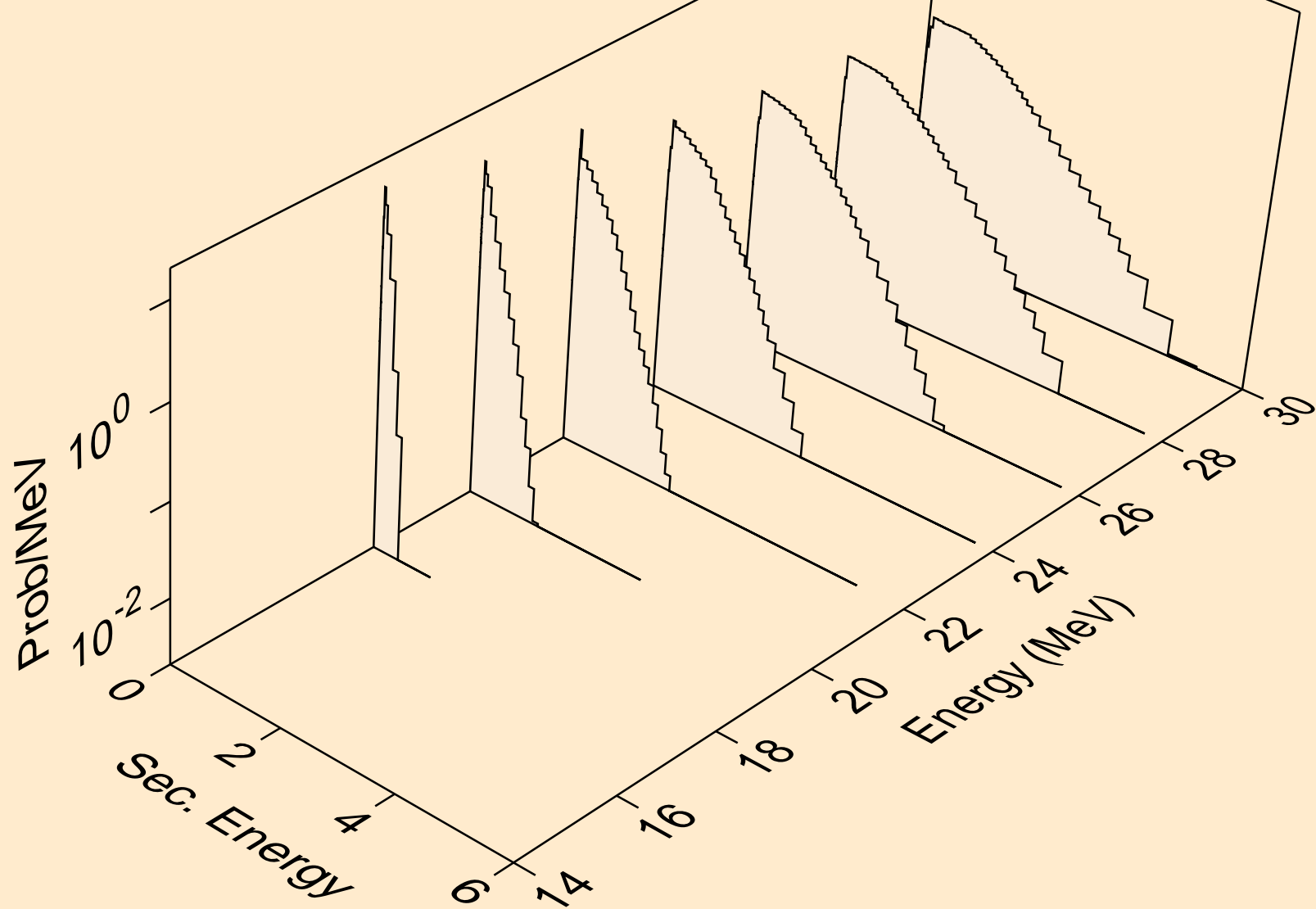

BA138 NEUTRON ACER TENDL-2024 LIBRARY; T=293.6K
Neutron emission for (n,n*)he3

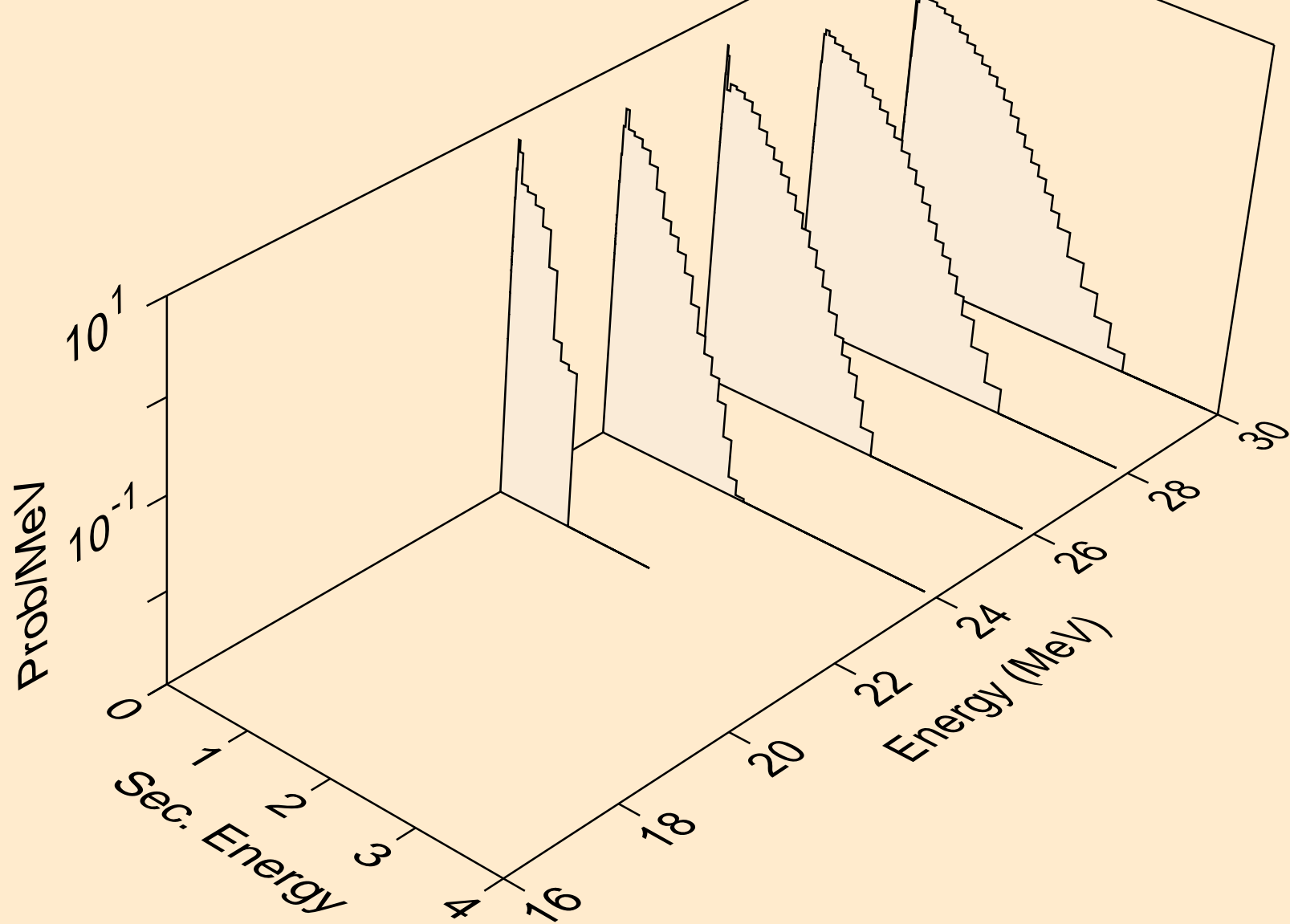

BA138 NEUTRON ACER TENDL-2024 LIBRARY; T=293.6K
Neutron emission for (n,4n)

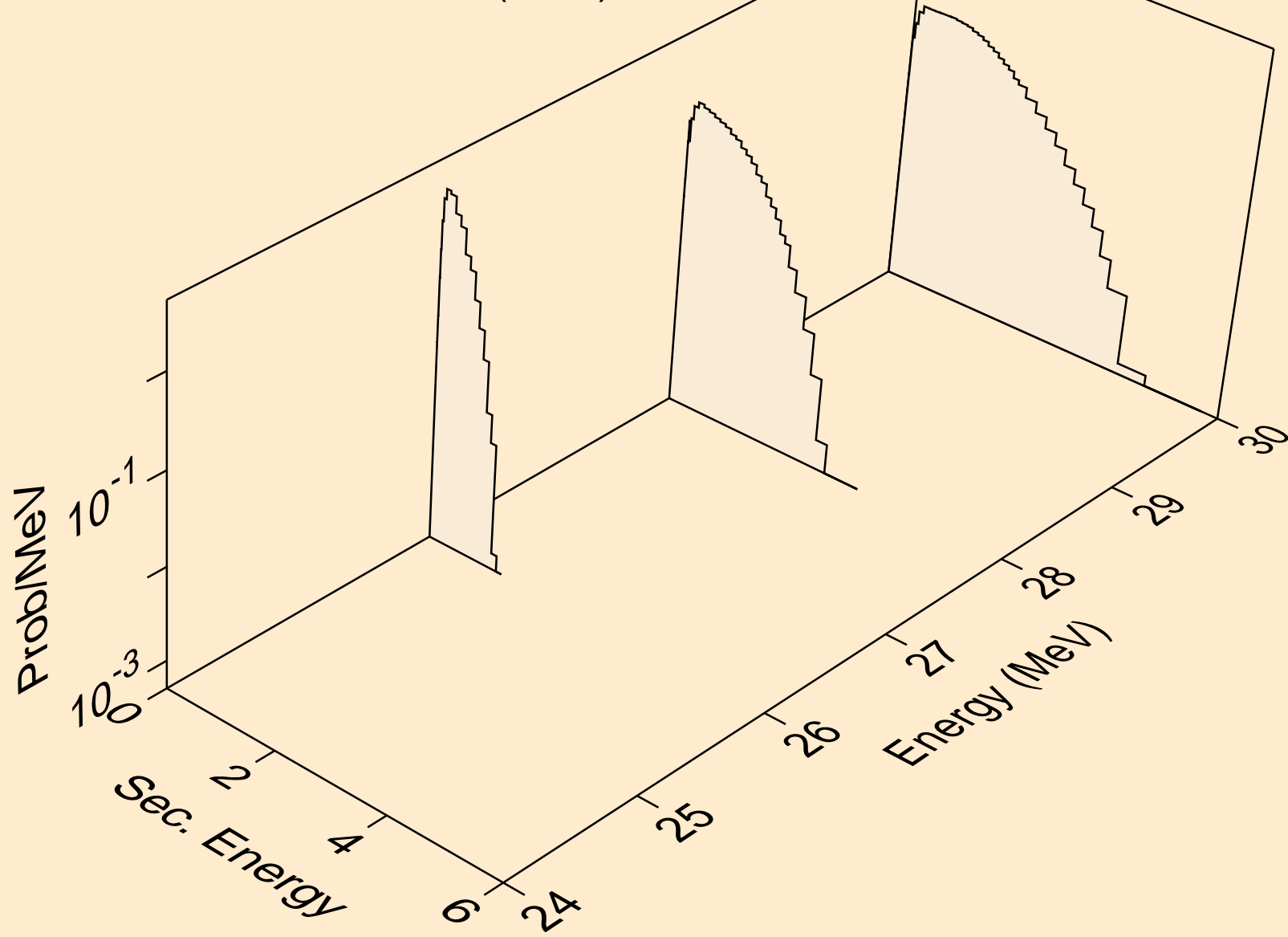

BA138 NEUTRON ACER TENDL-2024 LIBRARY; T=293.6K
Neutron emission for (n,2np)

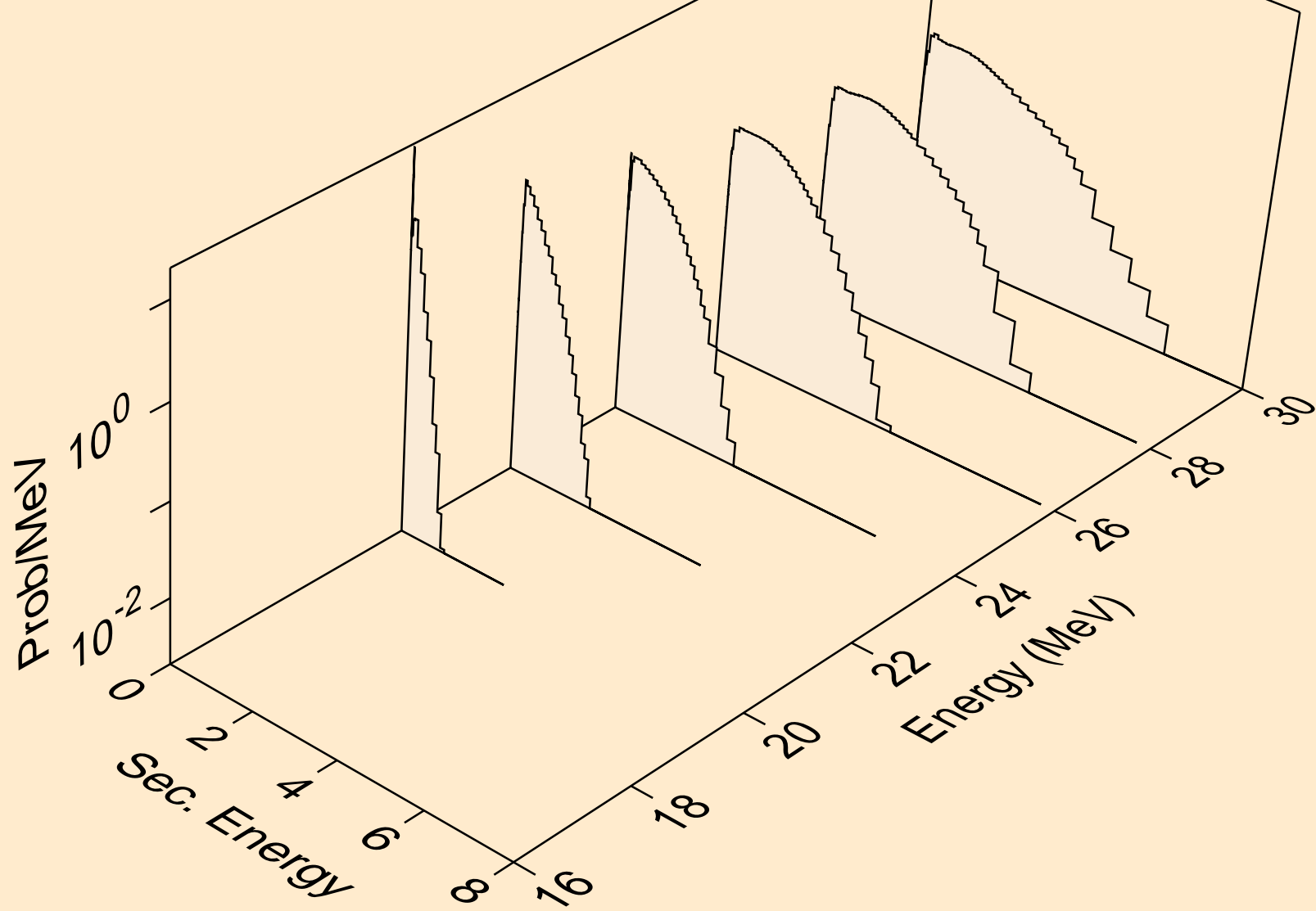

BA138 NEUTRON ACER TENDL-2024 LIBRARY; T=293.6K
Neutron emission for (n,3np)

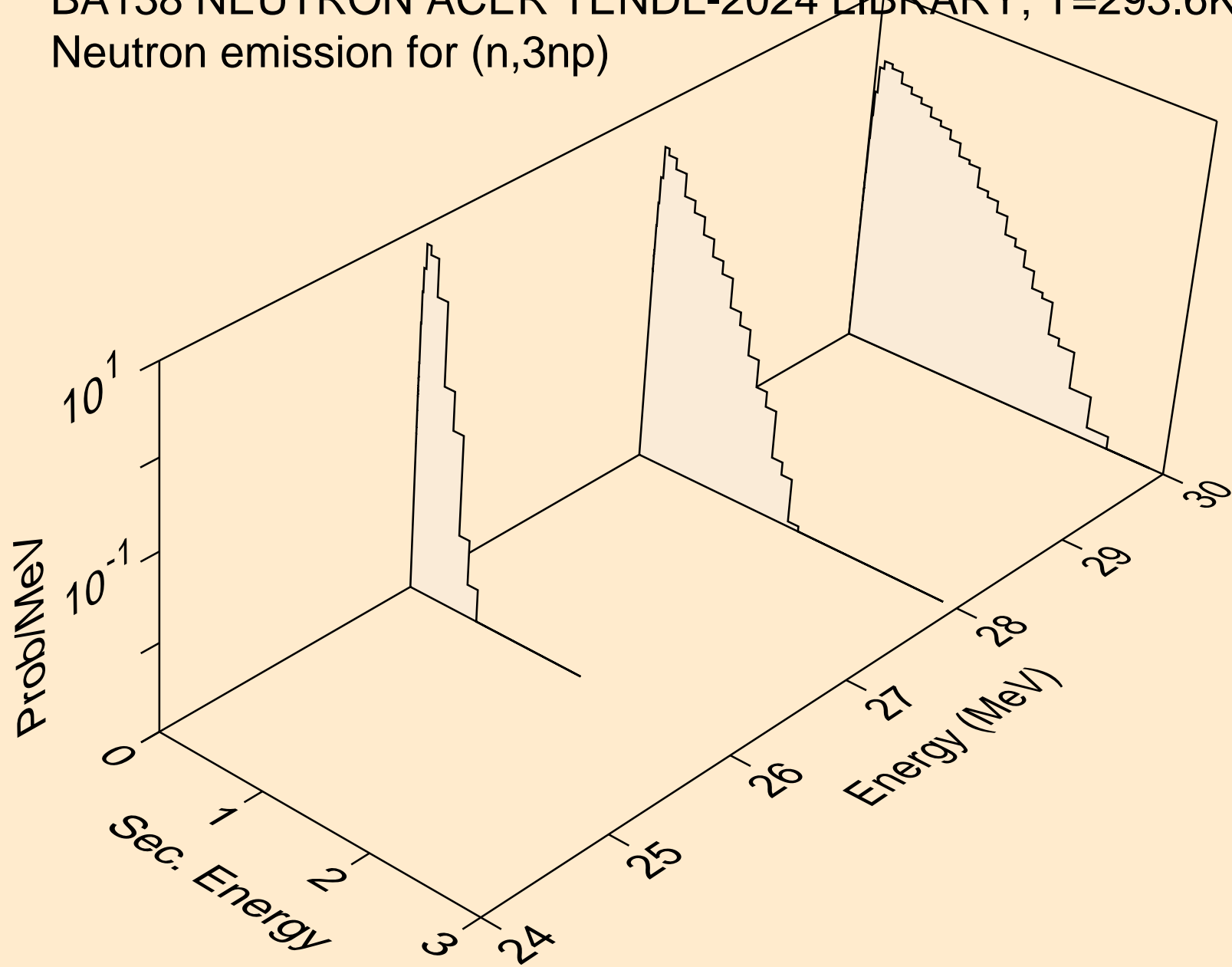

BA138 NEUTRON ACER TENDL-2024 LIBRARY; T=293.6K
Neutron emission for (n,n2p)

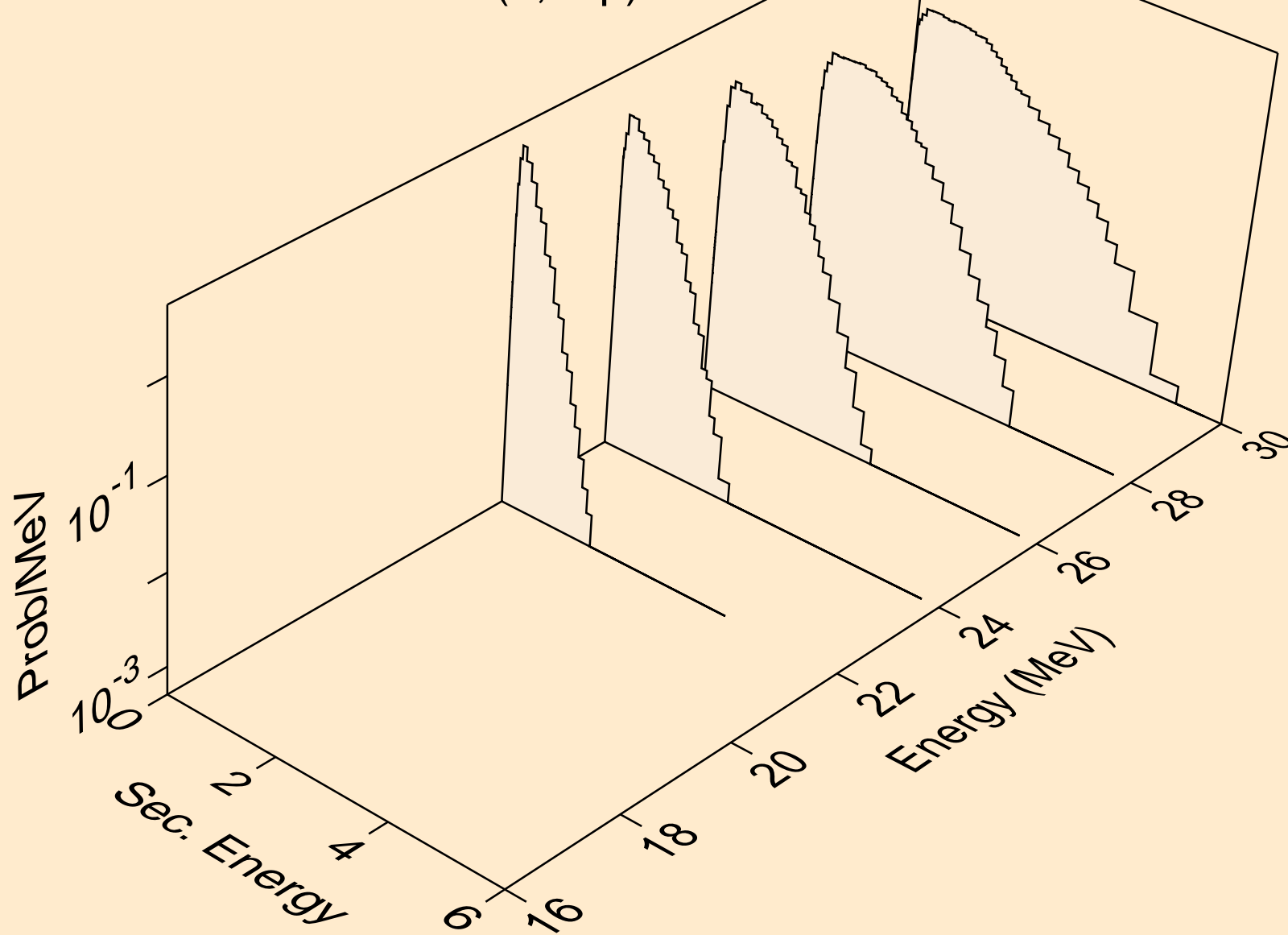

BA138 NEUTRON ACER TENDL-2024 LIBRARY; T=293.6K
Neutron emission for (n,npa)

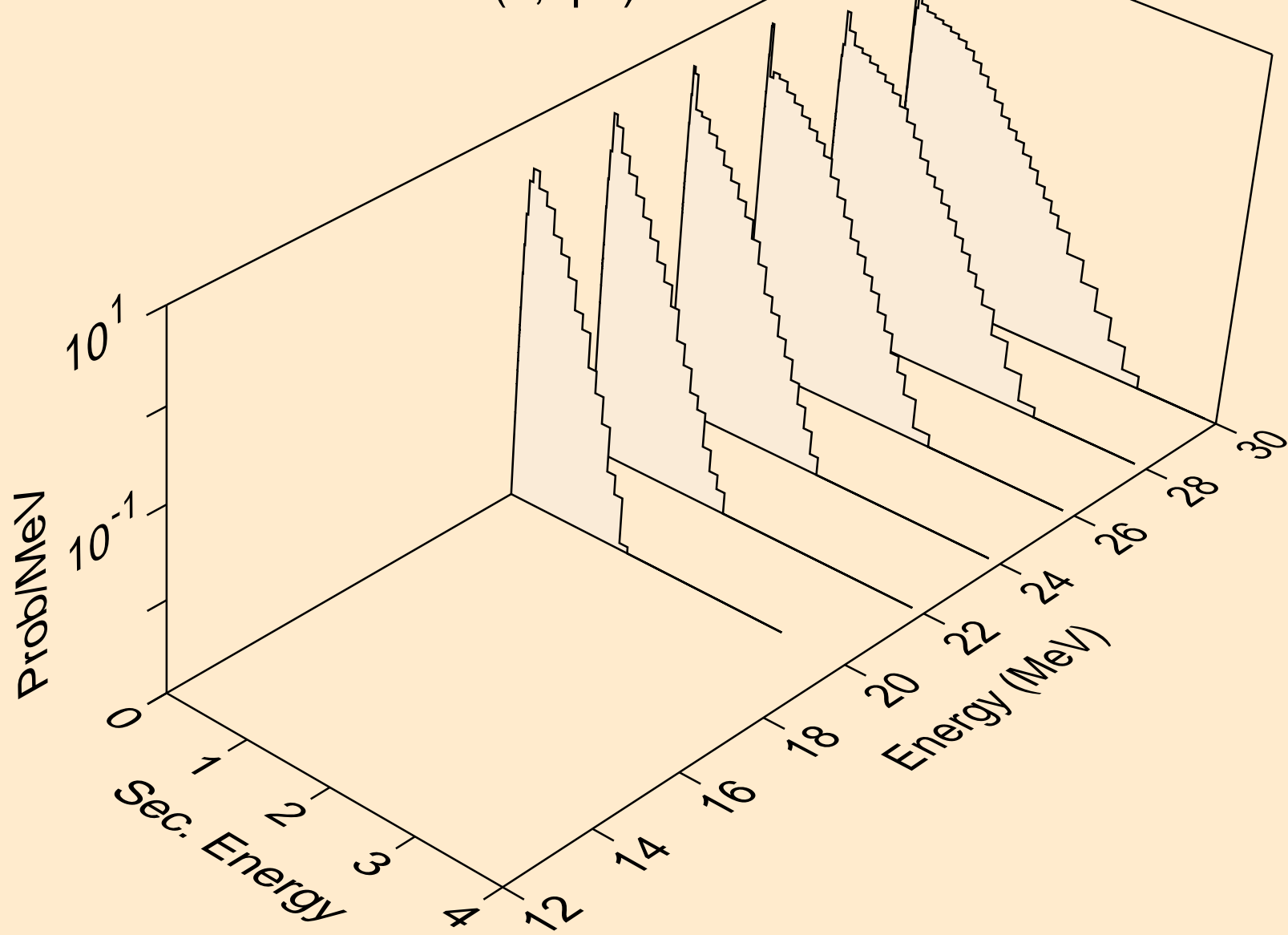

BA138 NEUTRON ACER TENDL-2024 LIBRARY; T=293.6K
Neutron emission for (n,n*c)

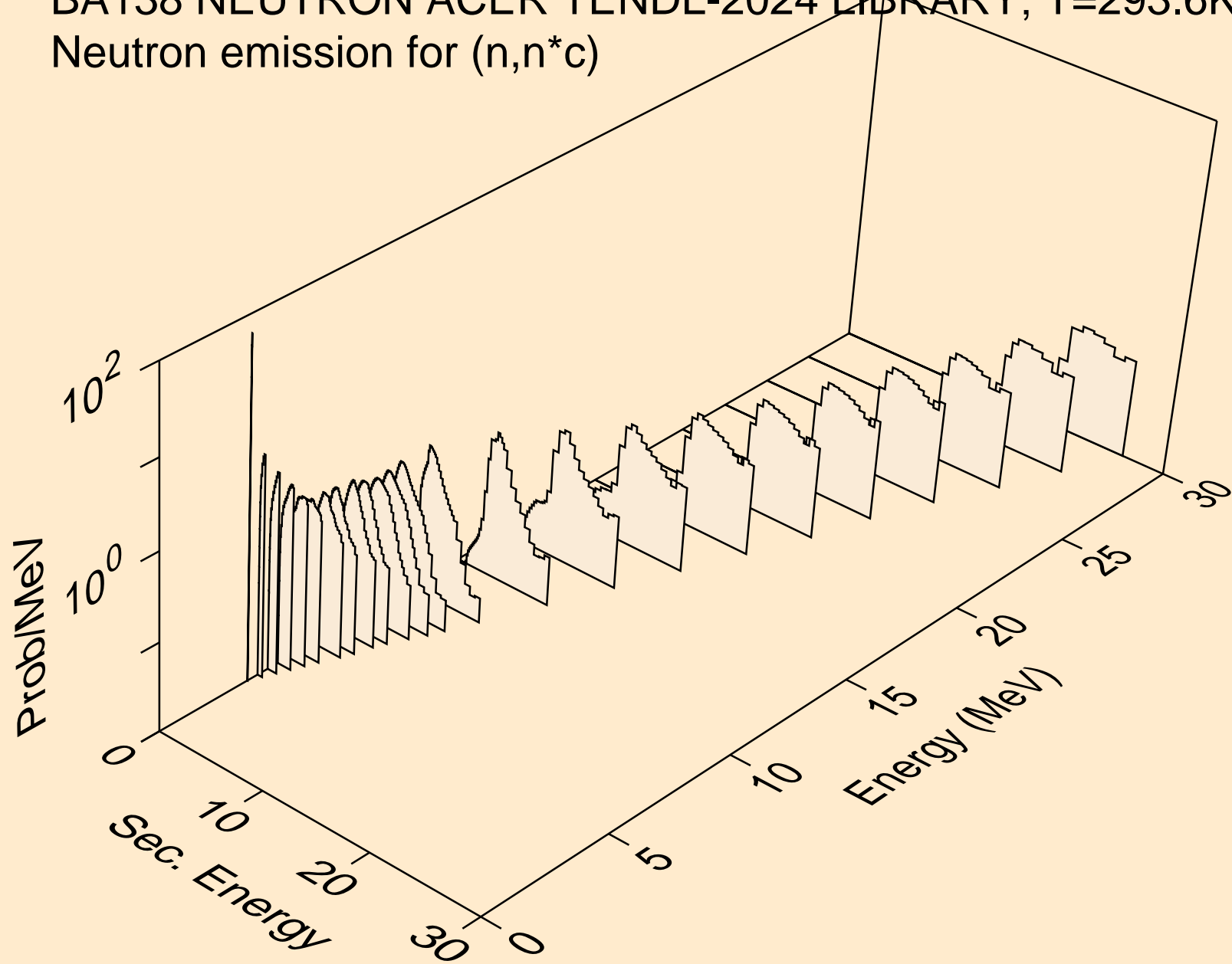

BA138 NEUTRON ACER TENDL-2024 LIBRARY; T=293.6K
Photon emission for (n,x)

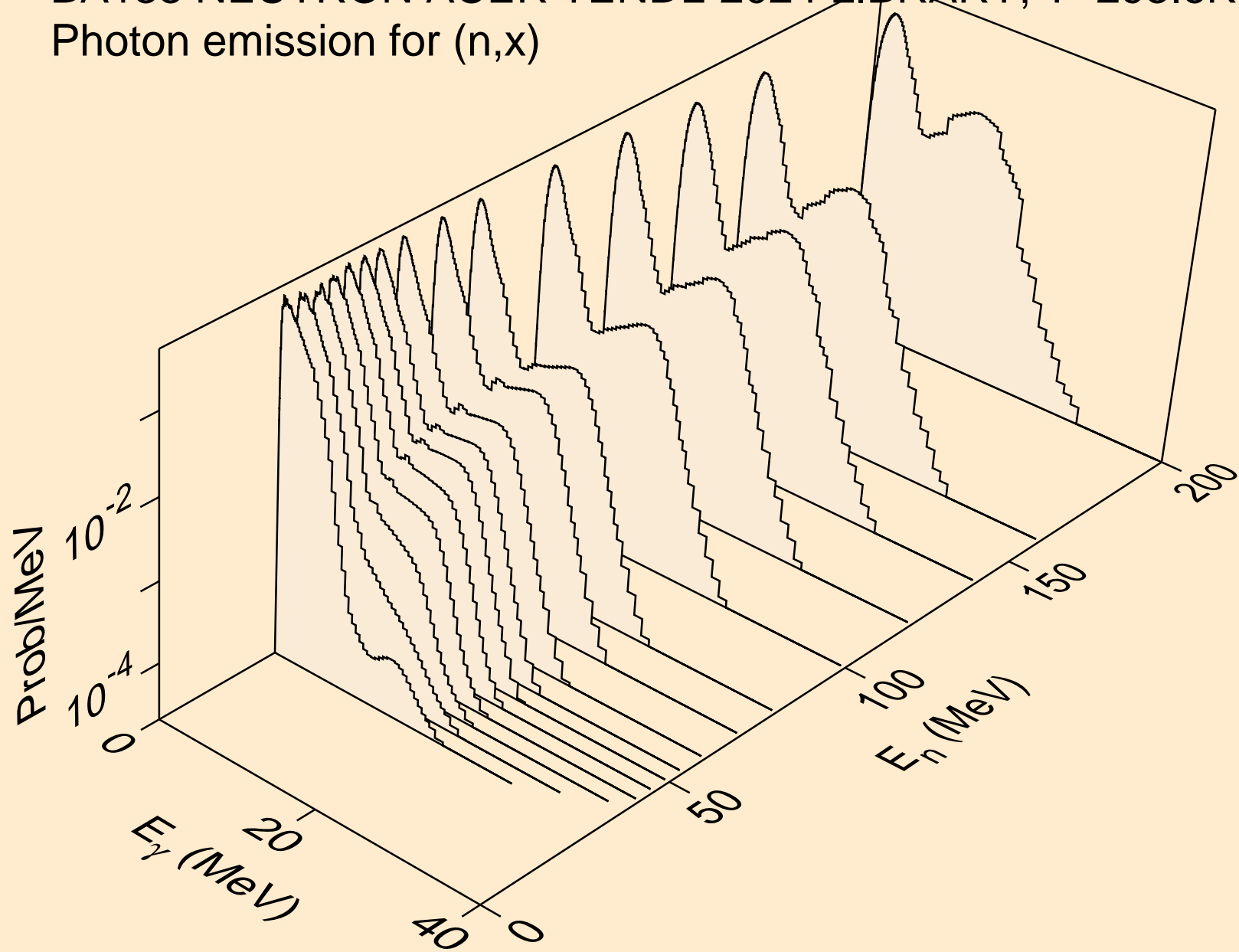

BA138 NEUTRON ACER TENDL-2024 LIBRARY; T=293.6K
Photon emission for (n,2nd)

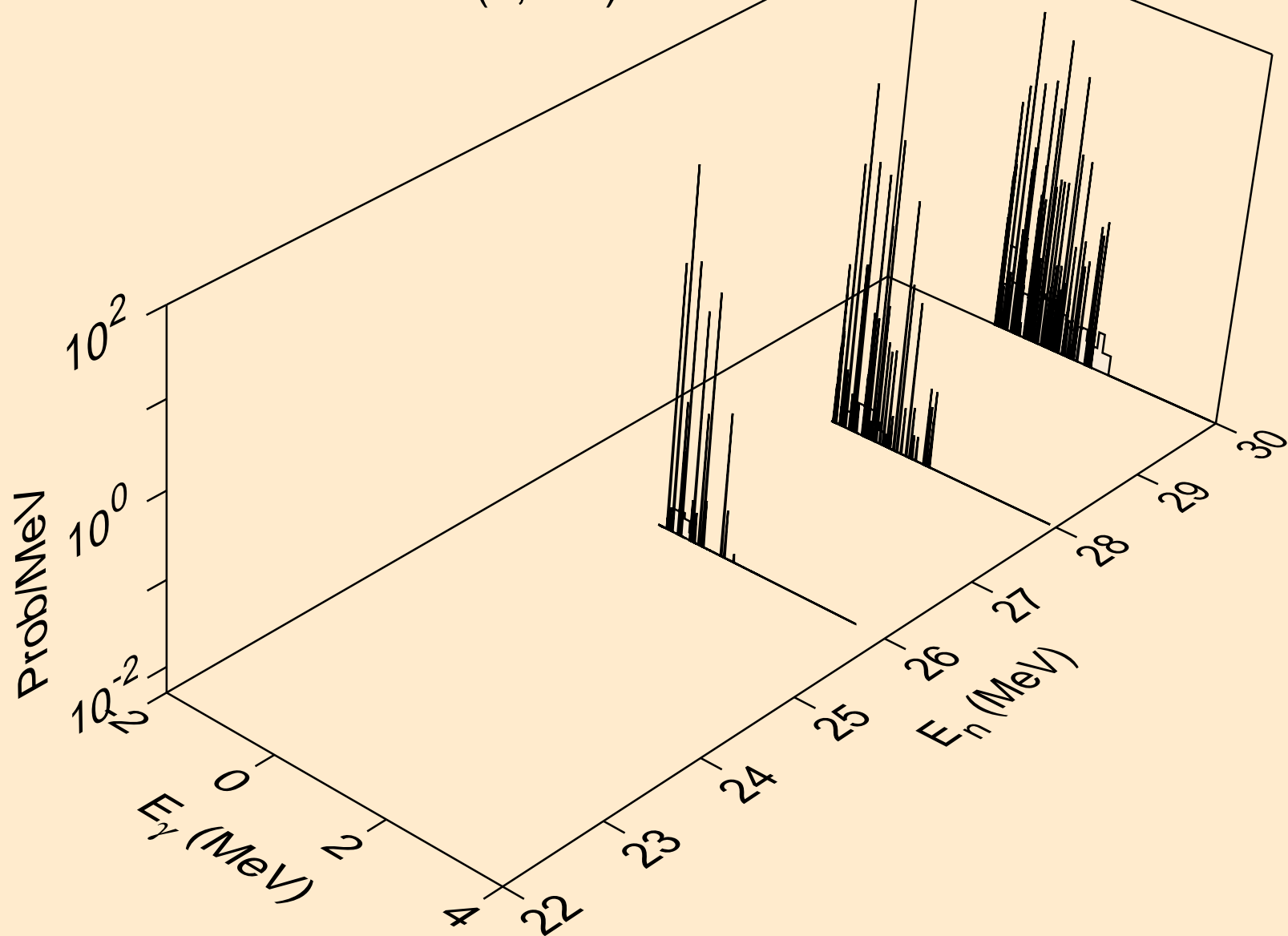

BA138 NEUTRON ACER TENDL-2024 LIBRARY; T=293.6K
Photon emission for (n,2n)

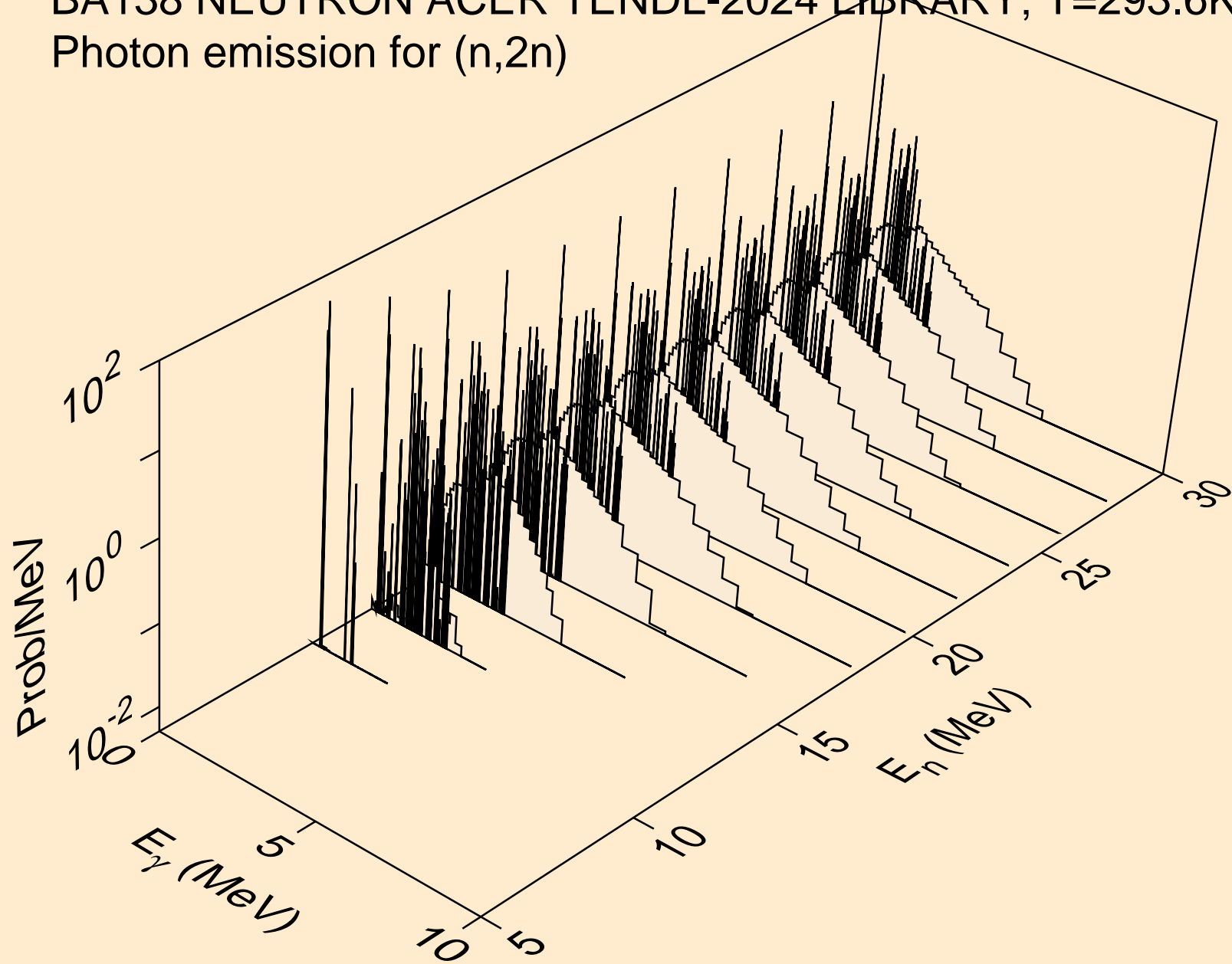

BA138 NEUTRON ACER TENDL-2024 LIBRARY; T=293.6K
Photon emission for (n,3n)

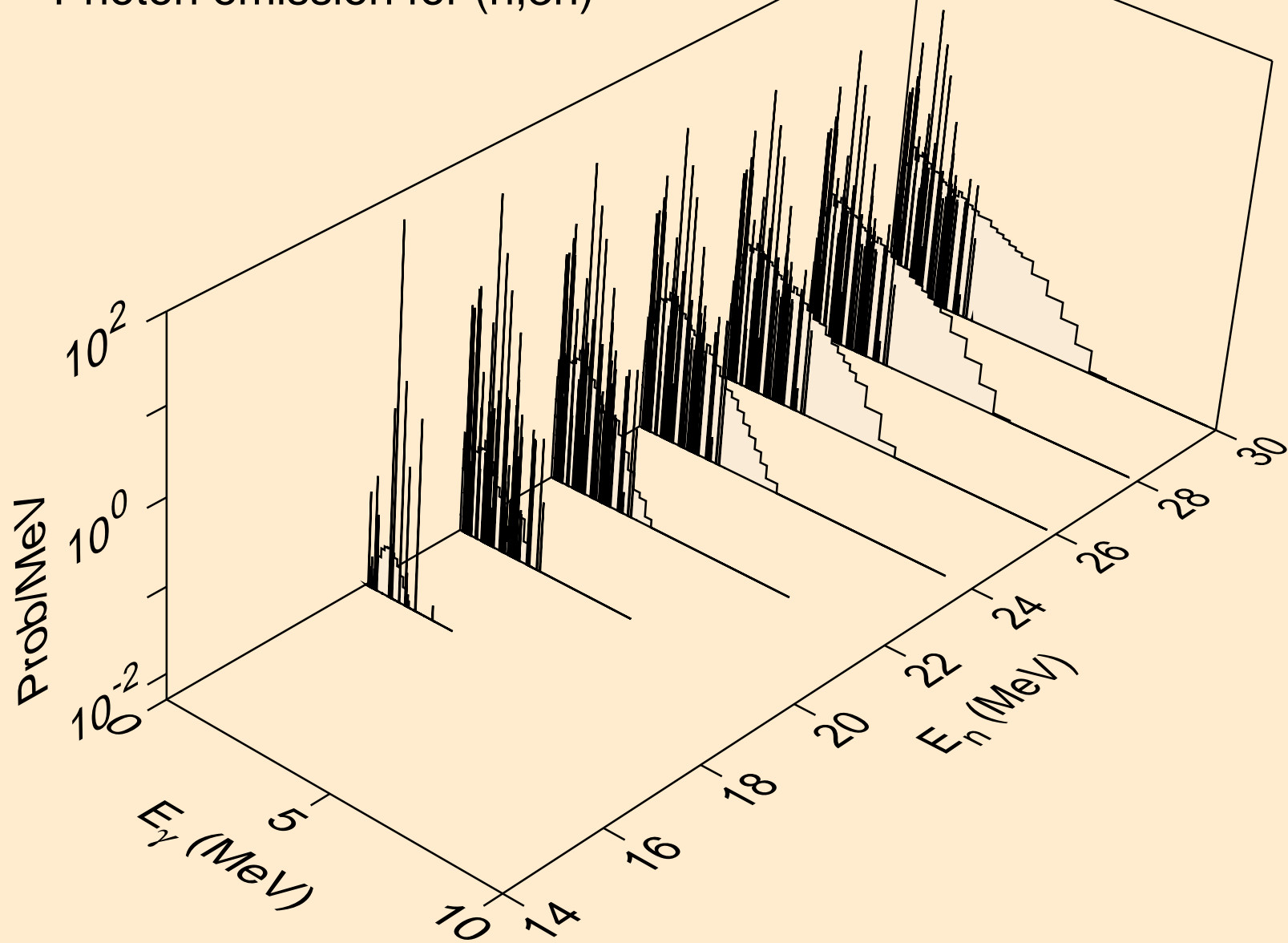

BA138 NEUTRON ACER TENDL-2024 LIBRARY; T=293.6K
Photon emission for (n,n*)a

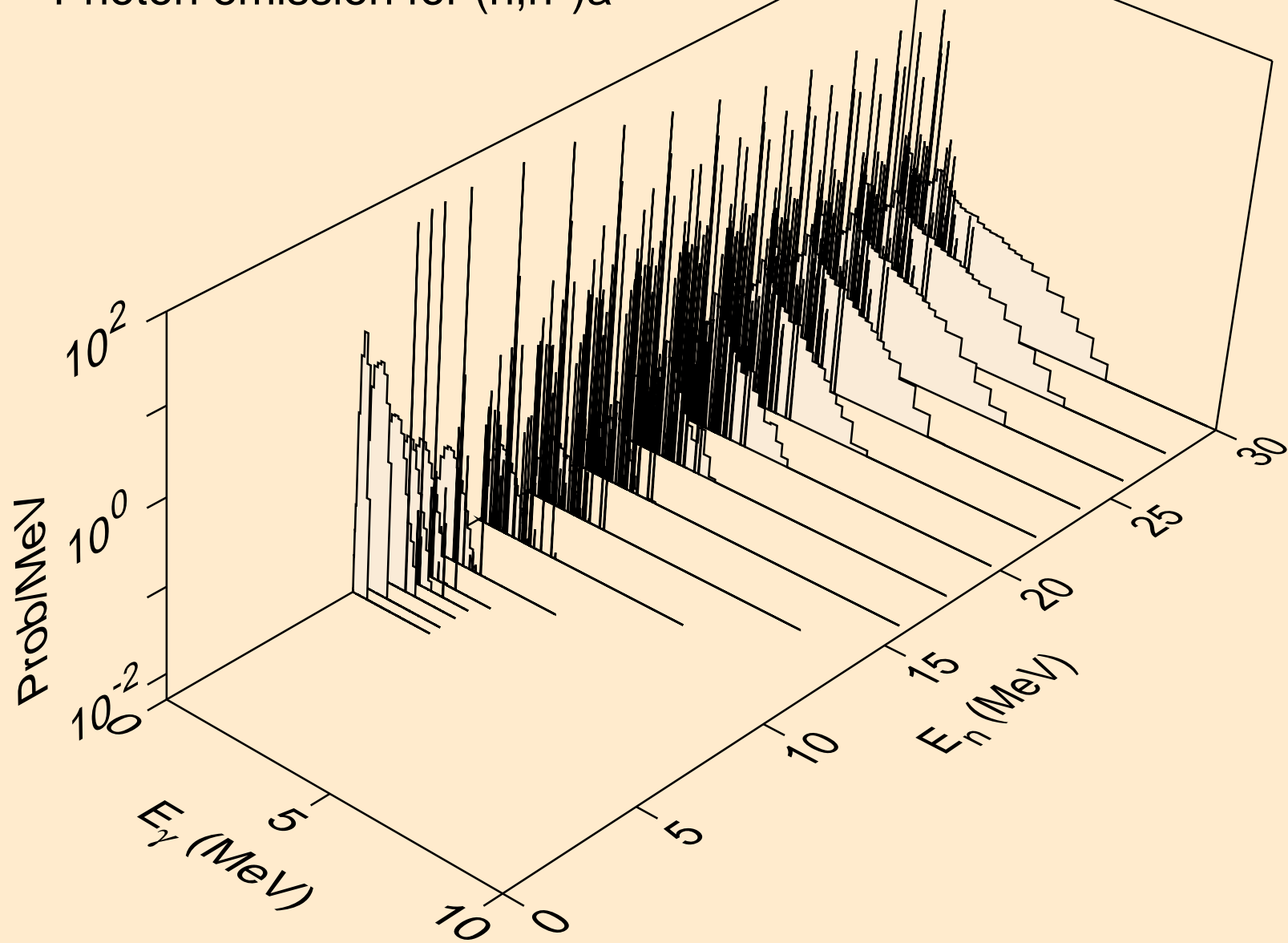

BA138 NEUTRON ACER TENDL-2024 LIBRARY; T=293.6K
Photon emission for (n,2n)a

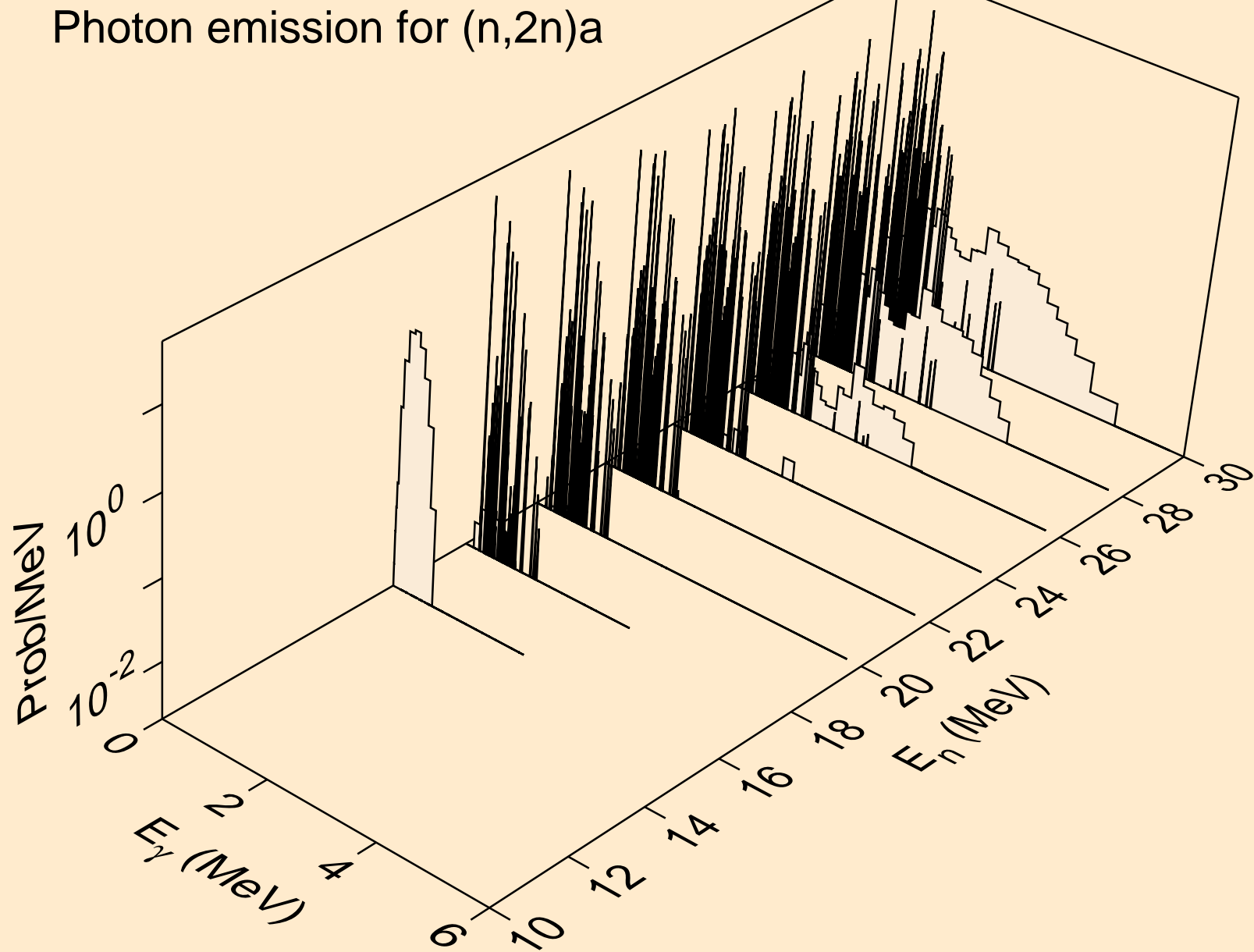

BA138 NEUTRON ACER TENDL-2024 LIBRARY; T=293.6K
Photon emission for (n,3n)a

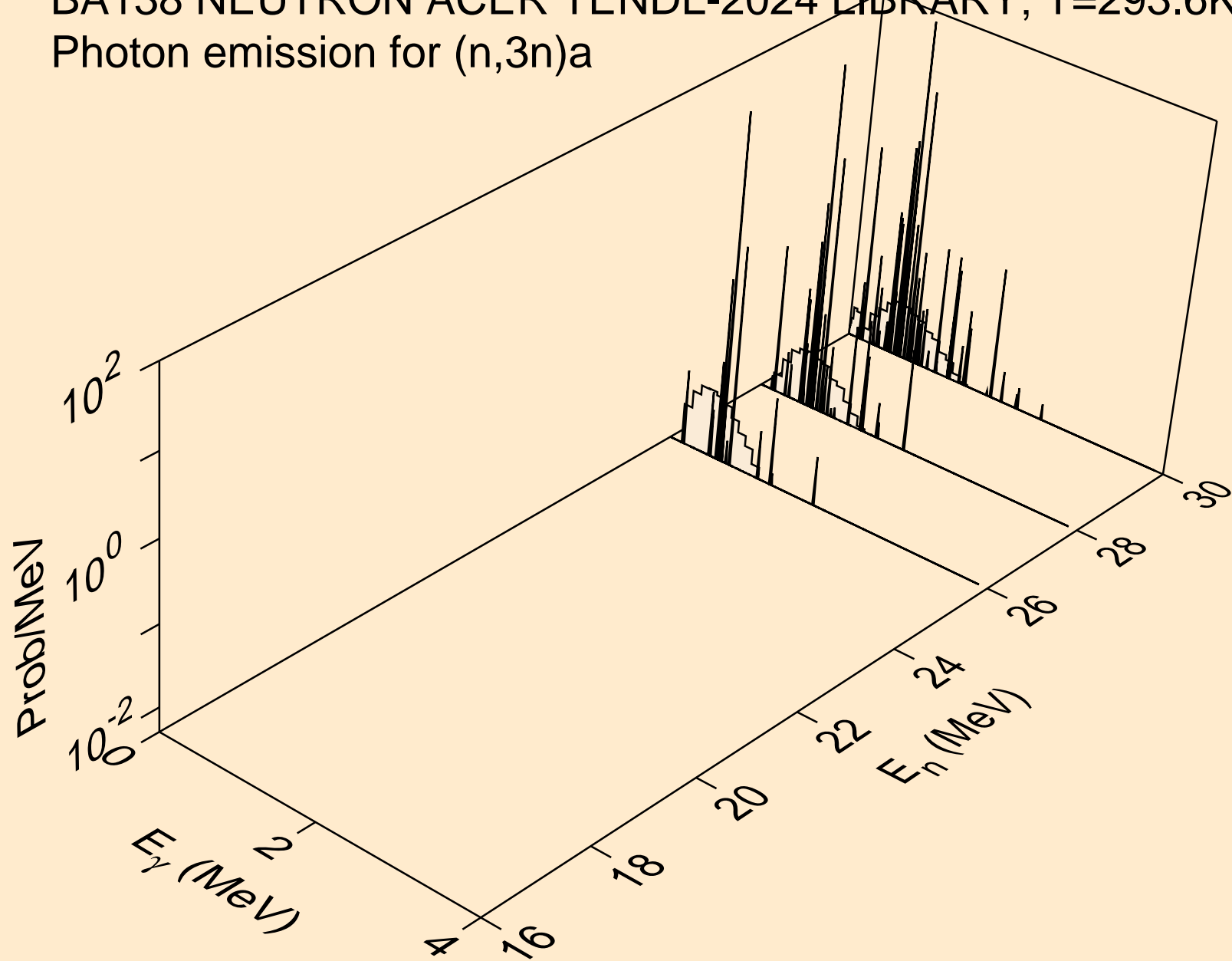

BA138 NEUTRON ACER TENDL-2024 LIBRARY; T=293.6K
Photon emission for (n,n*)p

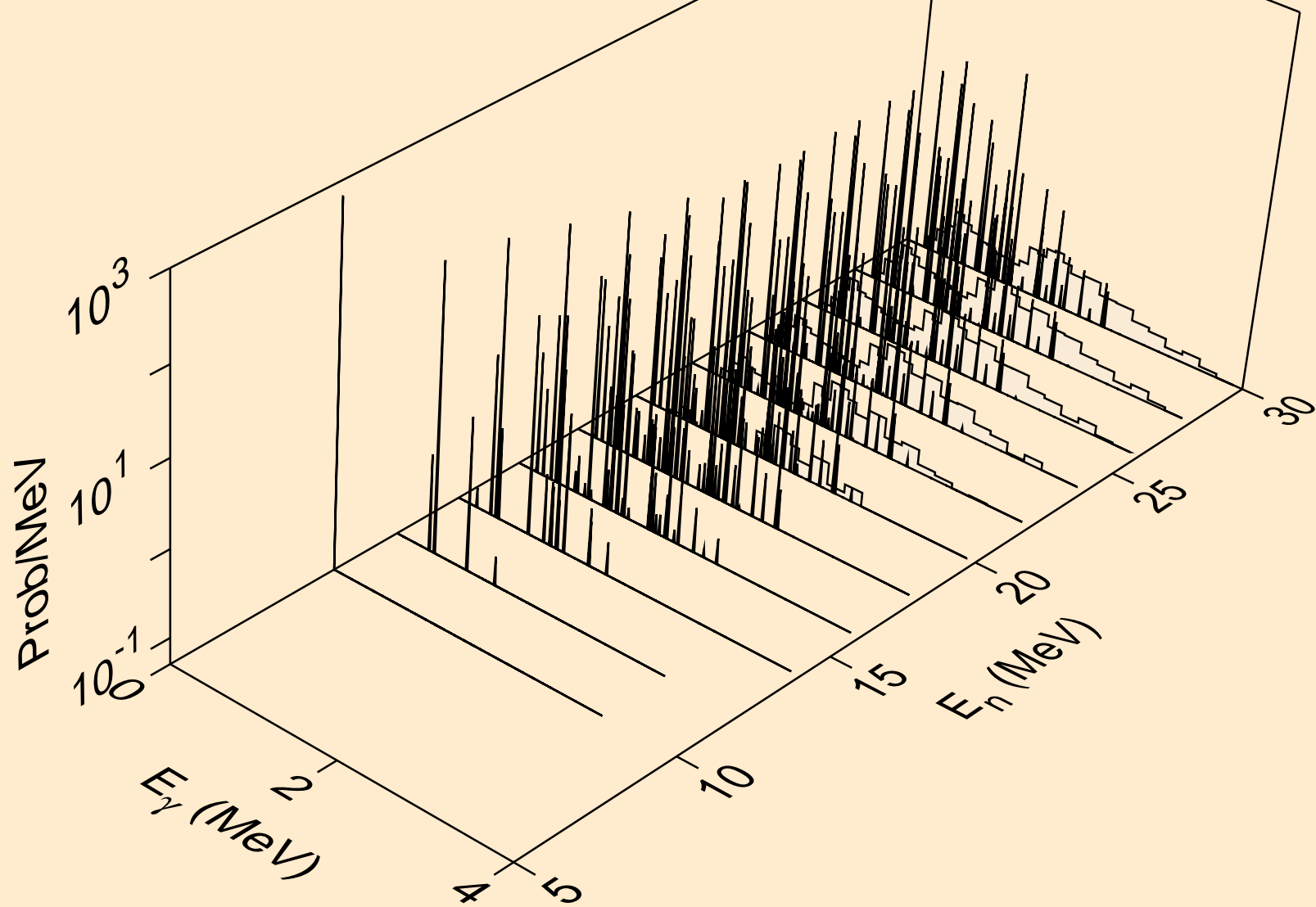

BA138 NEUTRON ACER TENDL-2024 LIBRARY; T=293.6K
Photon emission for (n,n*)2a

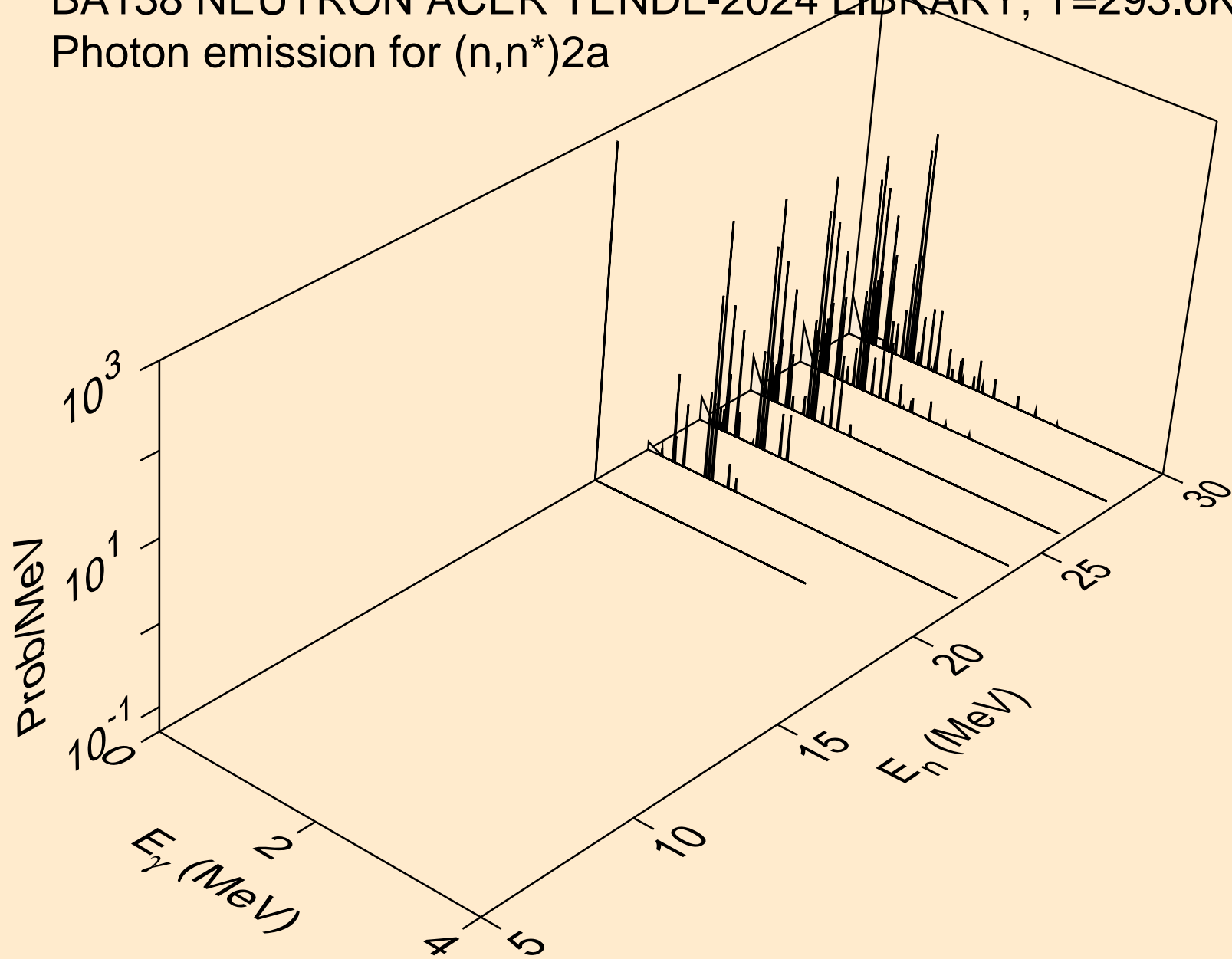

BA138 NEUTRON ACER TENDL-2024 LIBRARY; T=293.6K
Photon emission for (n,n*)d

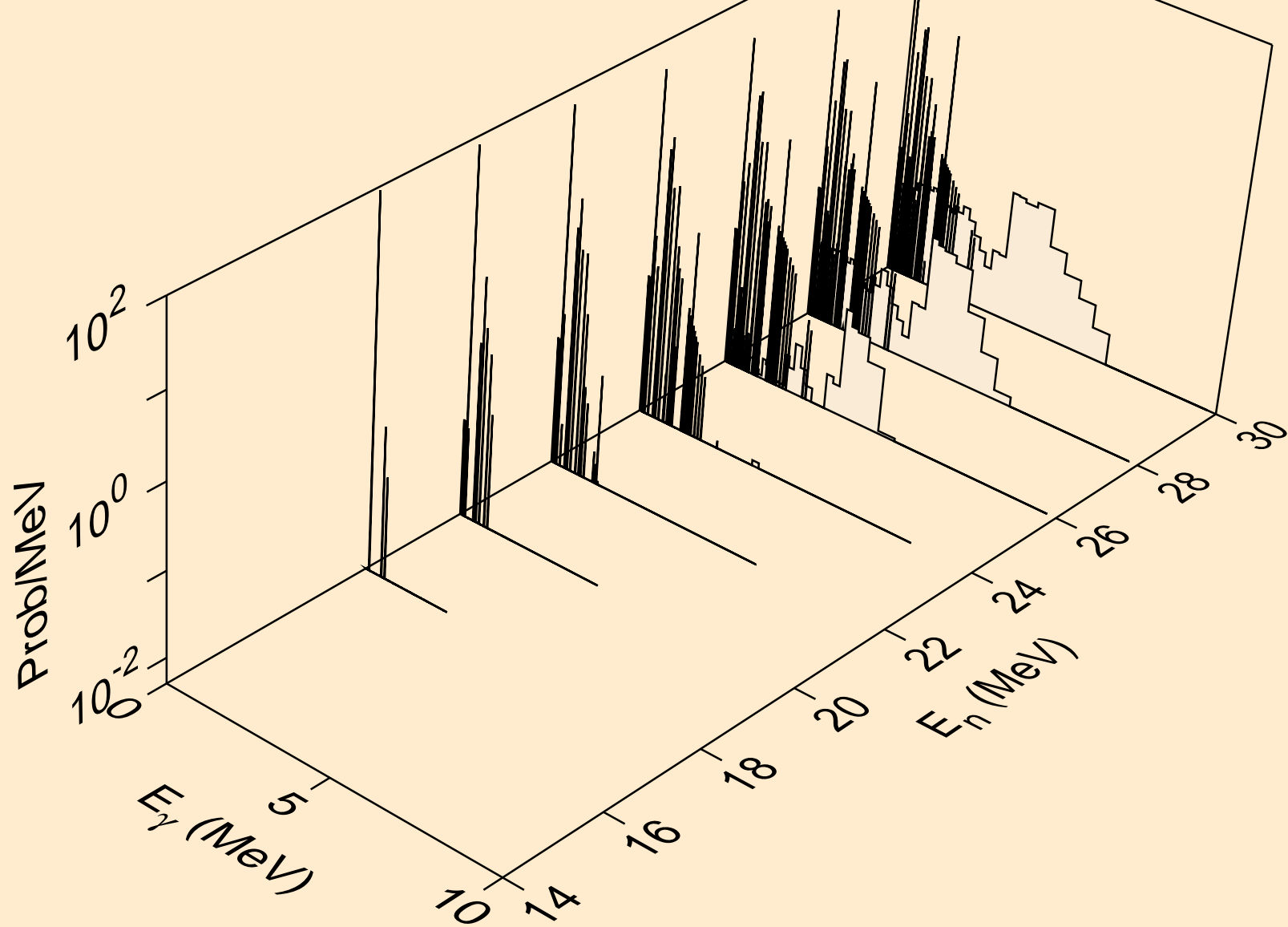

BA138 NEUTRON ACER TENDL-2024 LIBRARY; T=293.6K
Photon emission for (n,n*)t

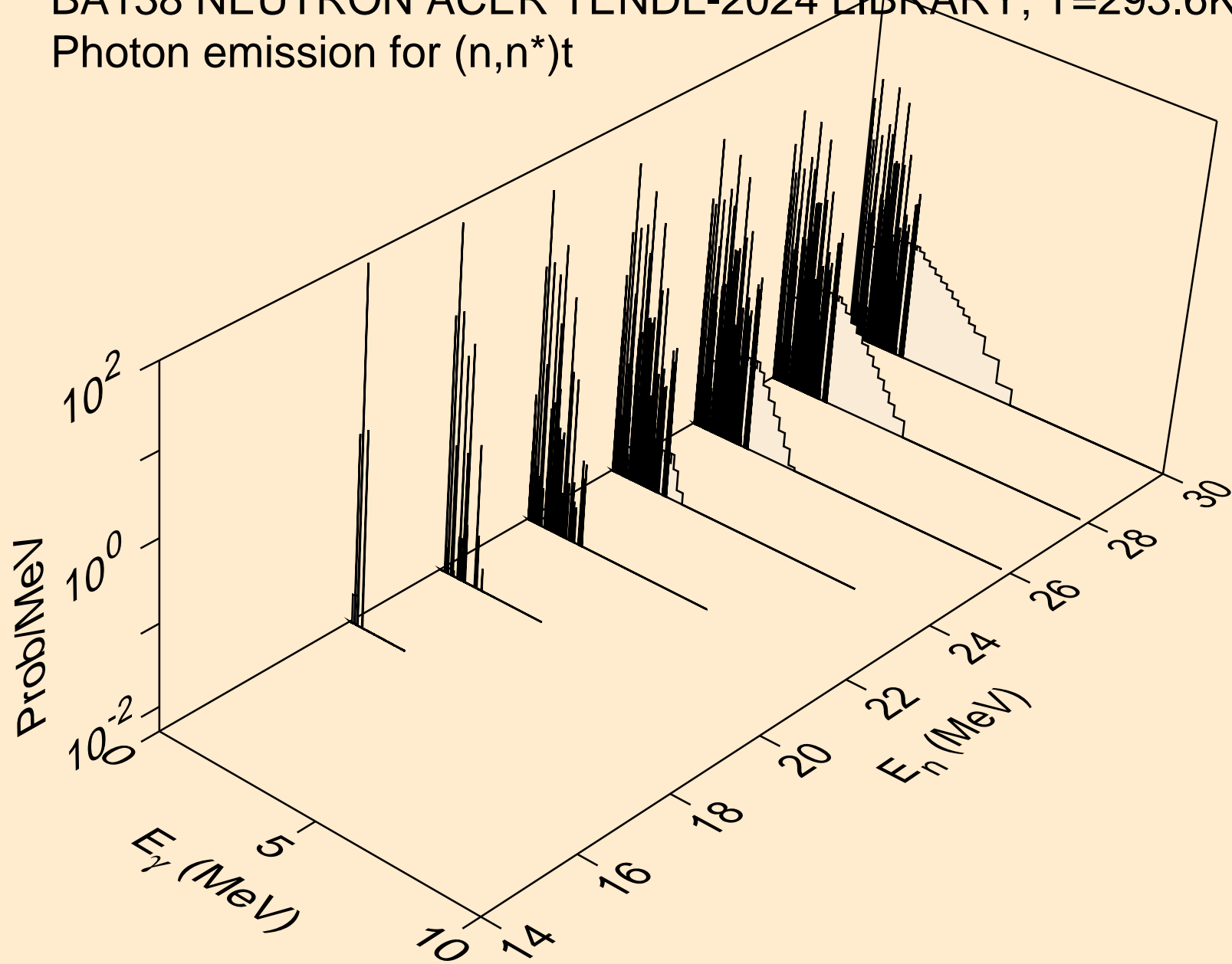

BA138 NEUTRON ACER TENDL-2024 LIBRARY; T=293.6K
Photon emission for (n,n*)he3

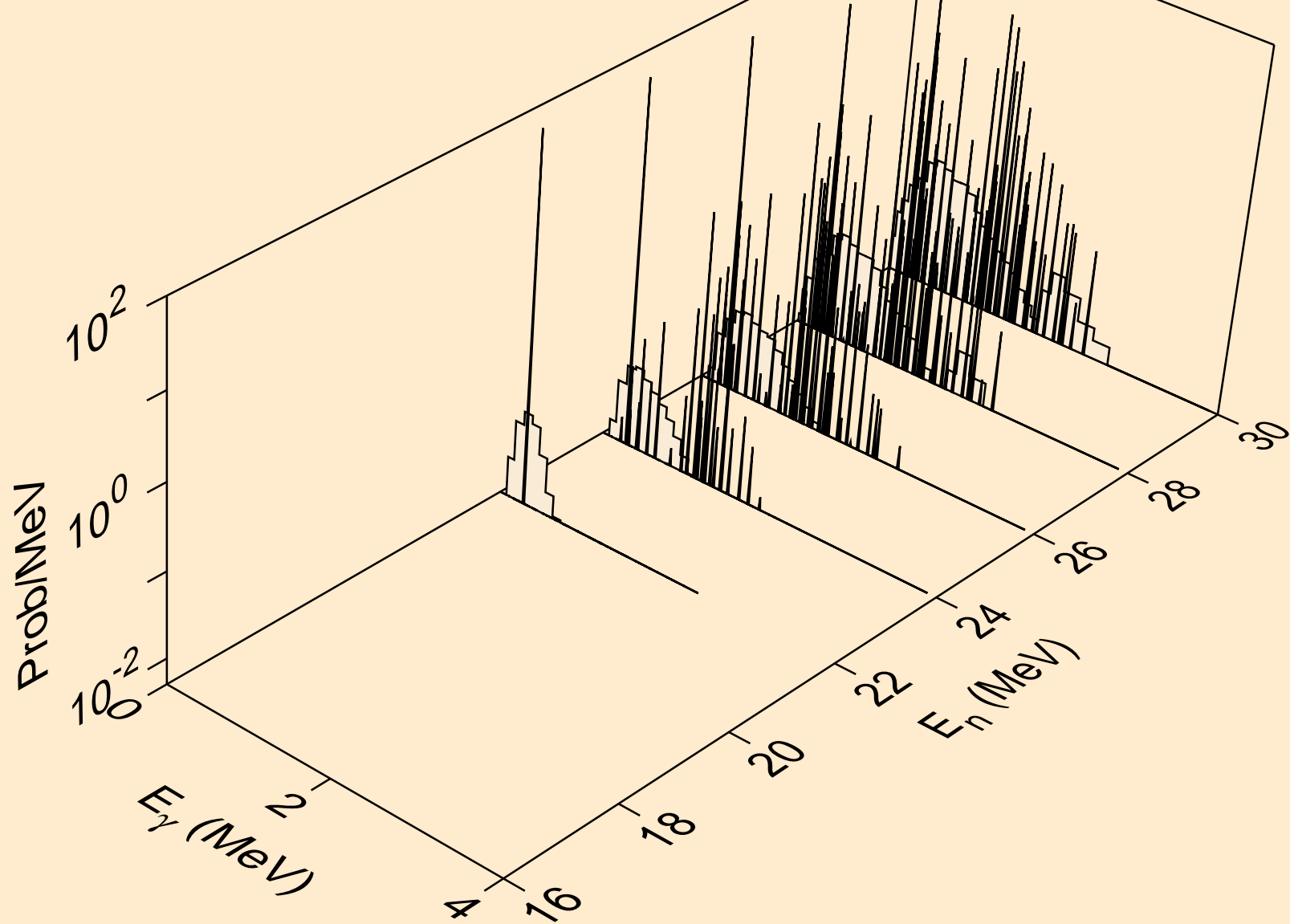

BA138 NEUTRON ACER TENDL-2024 LIBRARY; T=293.6K
Photon emission for (n,4n)

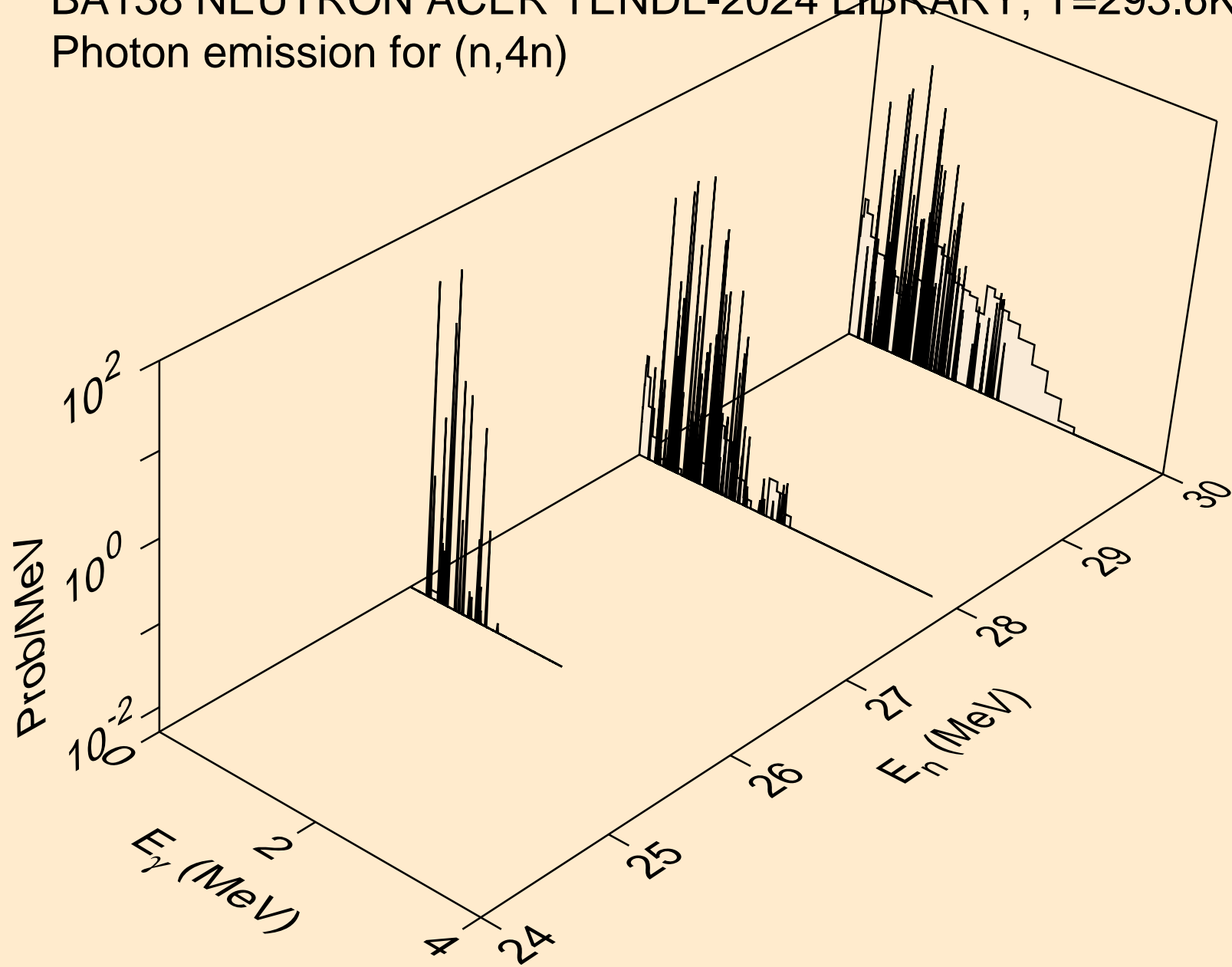

BA138 NEUTRON ACER TENDL-2024 LIBRARY; T=293.6K
Photon emission for (n,2np)

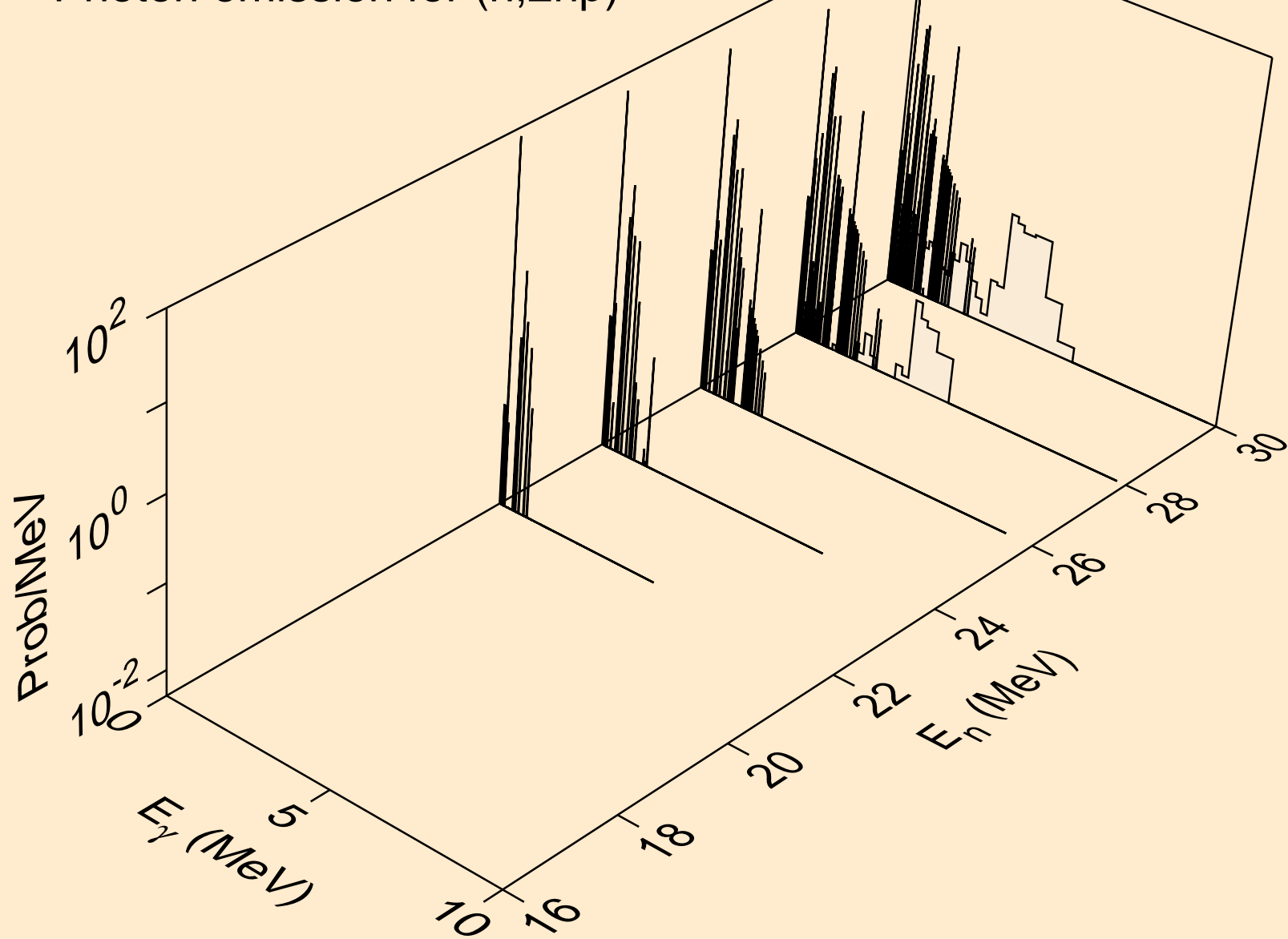

BA138 NEUTRON ACER TENDL-2024 LIBRARY; T=293.6K
Photon emission for (n,3np)

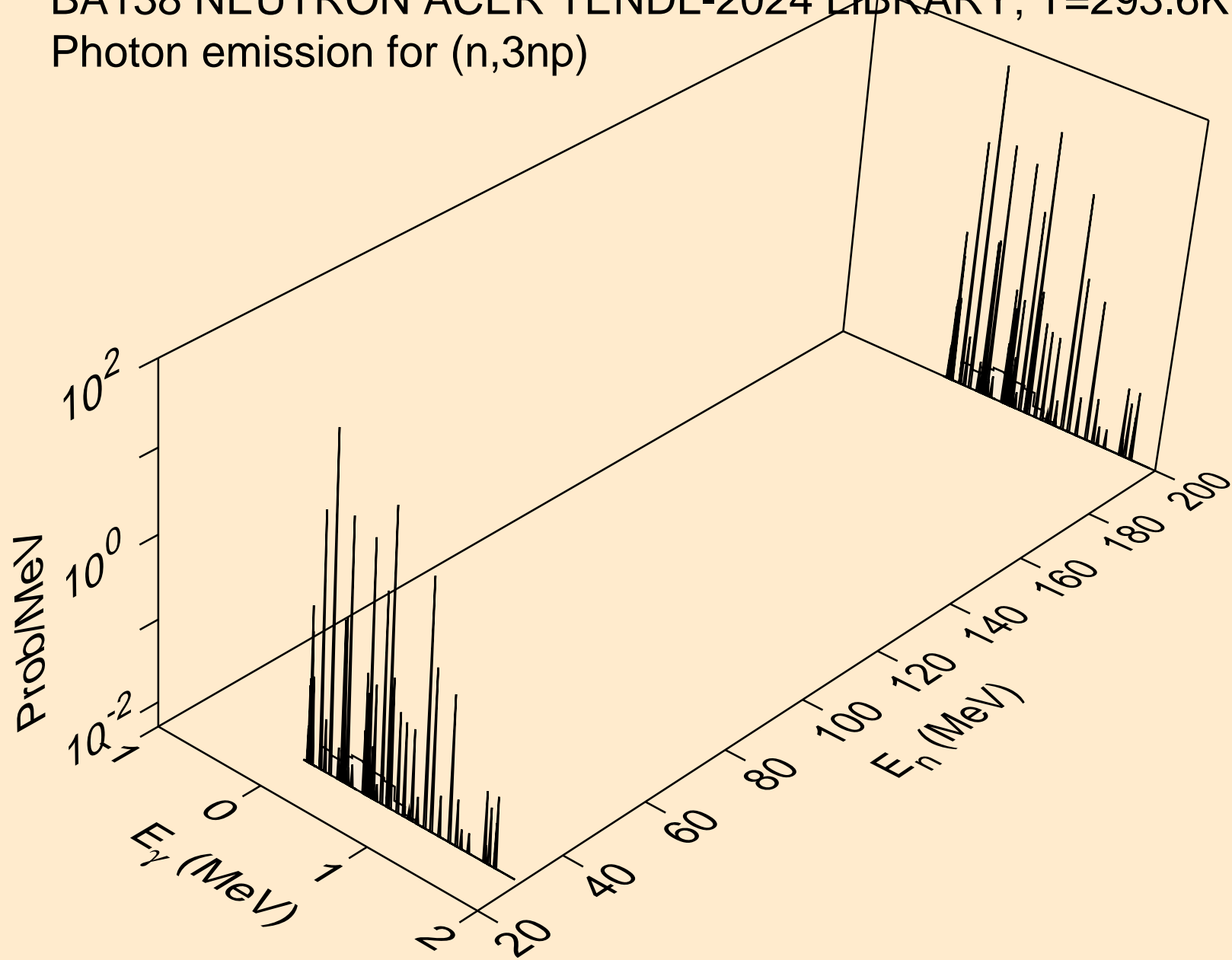

BA138 NEUTRON ACER TENDL-2024 LIBRARY; T=293.6K
Photon emission for (n,n2p)

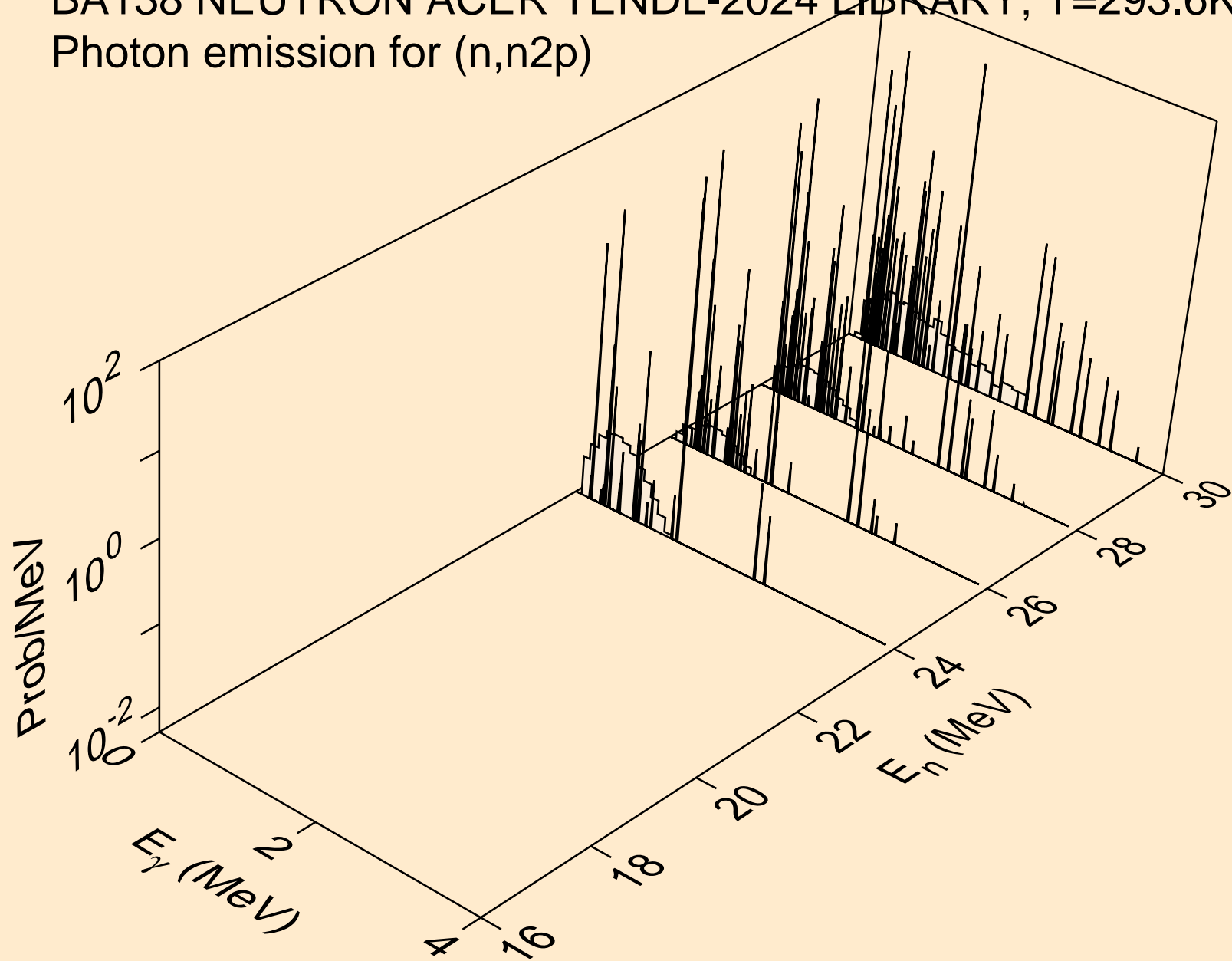

BA138 NEUTRON ACER TENDL-2024 LIBRARY; T=293.6K
Photon emission for (n,npa)

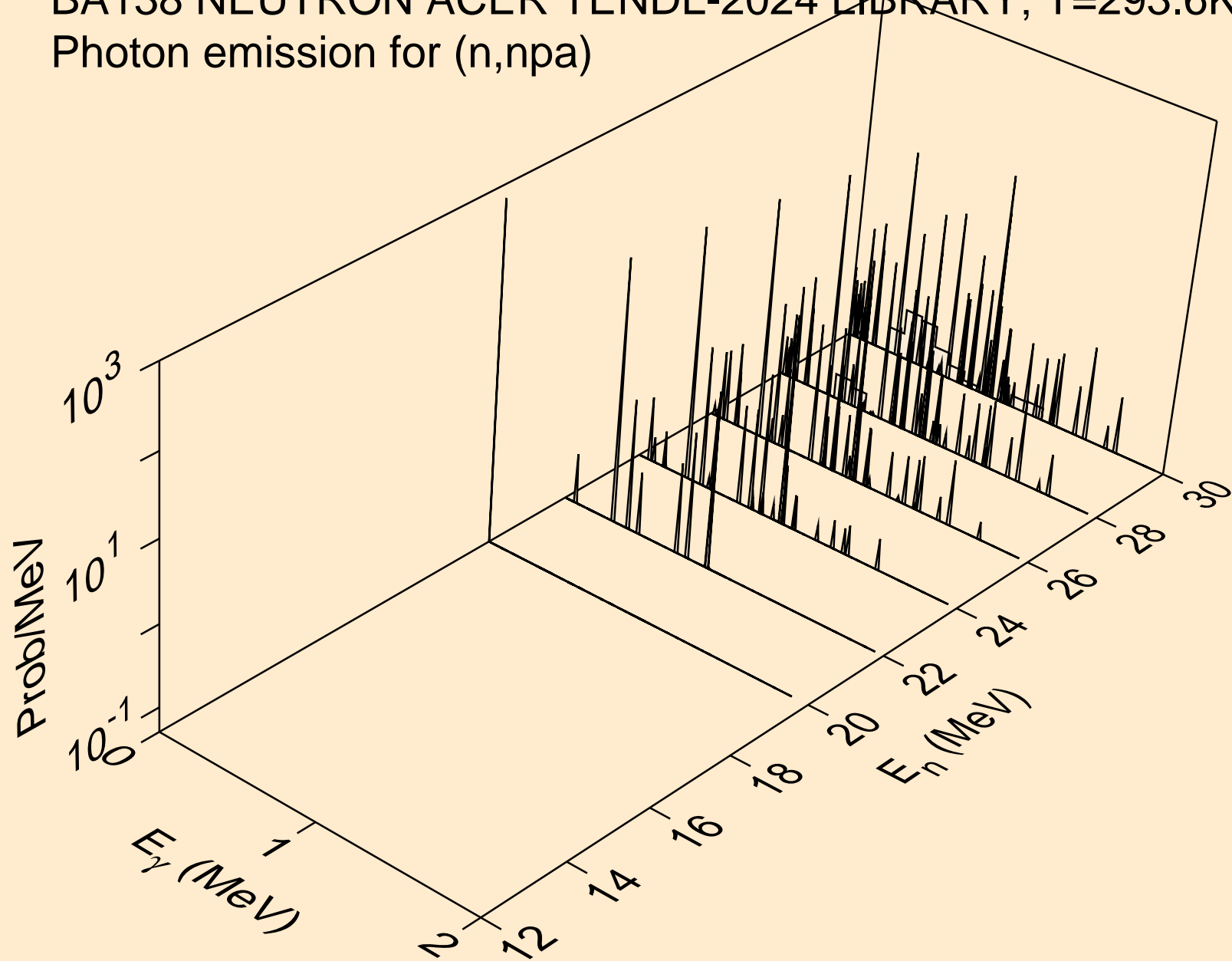

BA138 NEUTRON ACER TENDL-2024 LIBRARY; T=293.6K
Photon emission for (n,n*c)

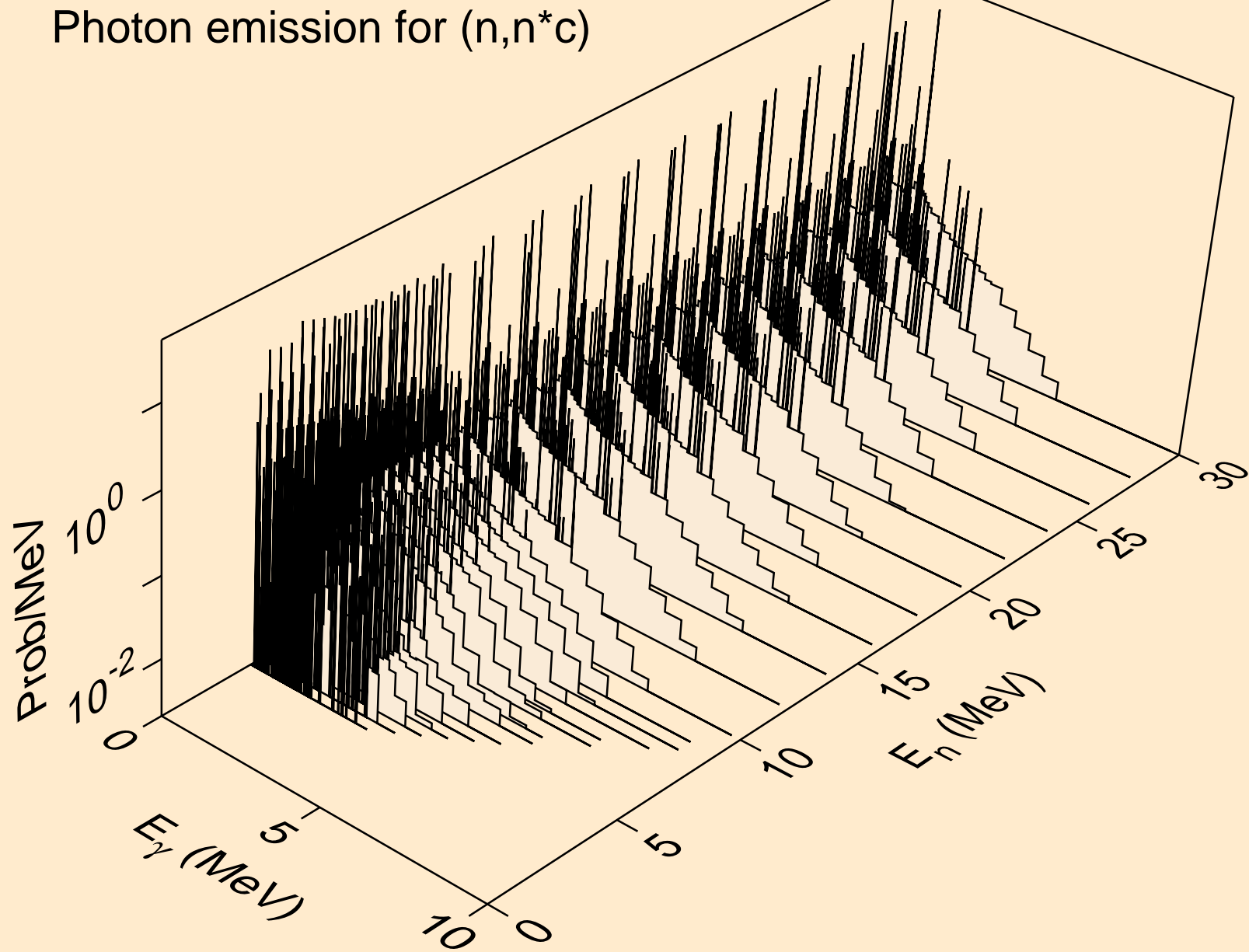

BA138 NEUTRON ACER TENDL-2024 LIBRARY; T=293.6K
Photon emission for (n,gma)

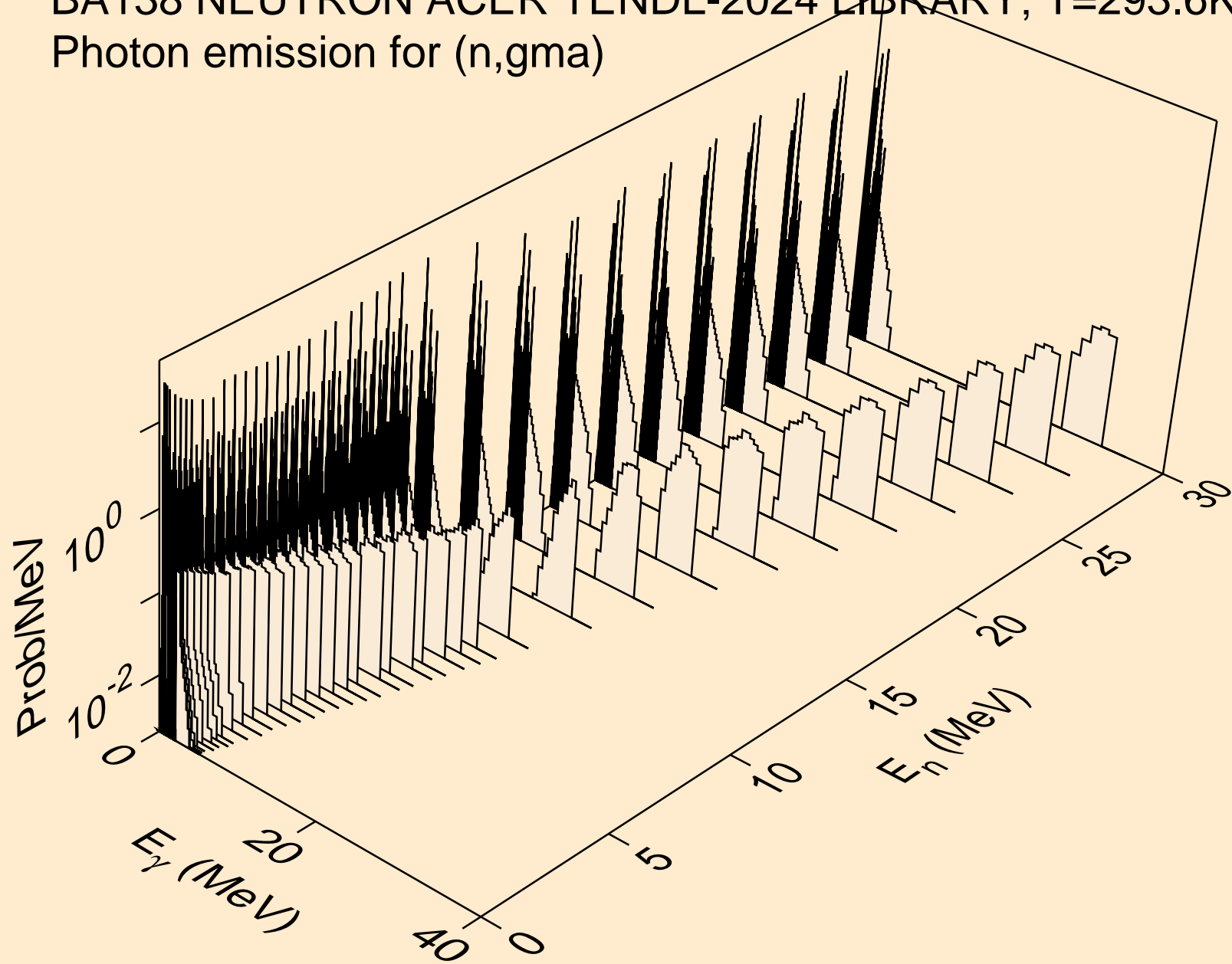

BA138 NEUTRON ACER TENDL-2024 LIBRARY; T=293.6K
Photon emission for (n,p)

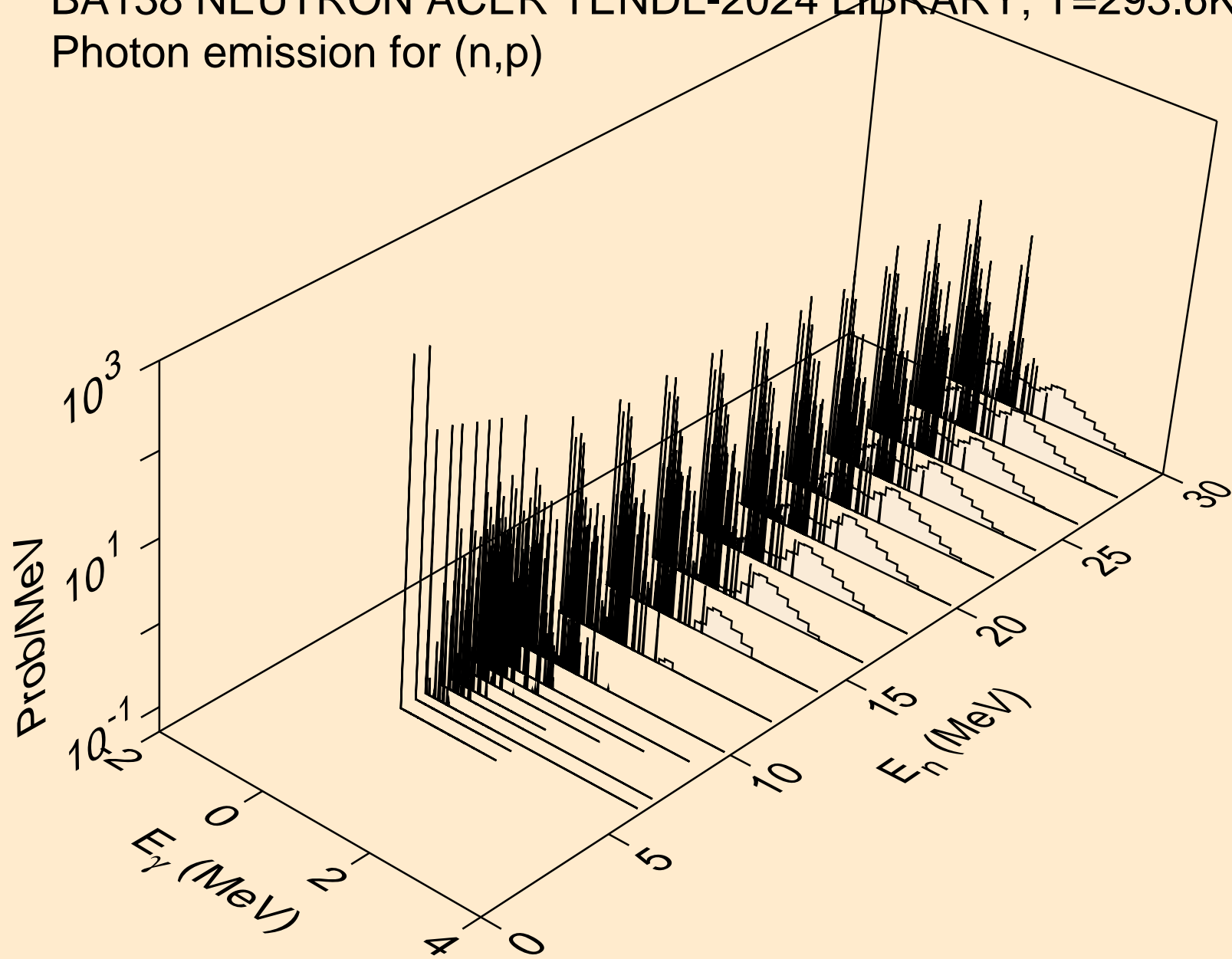

BA138 NEUTRON ACER TENDL-2024 LIBRARY; T=293.6K
Photon emission for (n,d)

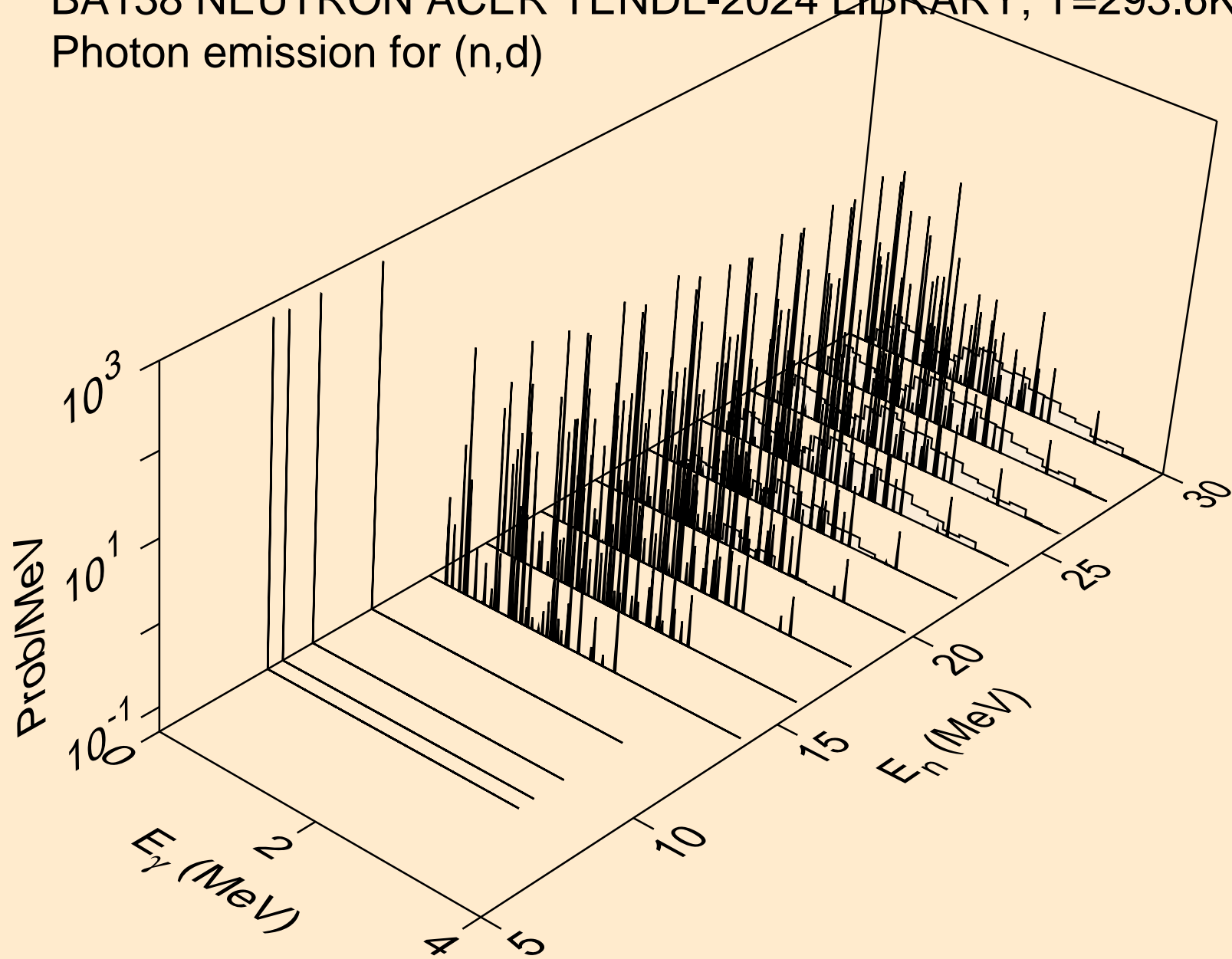

BA138 NEUTRON ACER TENDL-2024 LIBRARY; T=293.6K
Photon emission for (n,t)

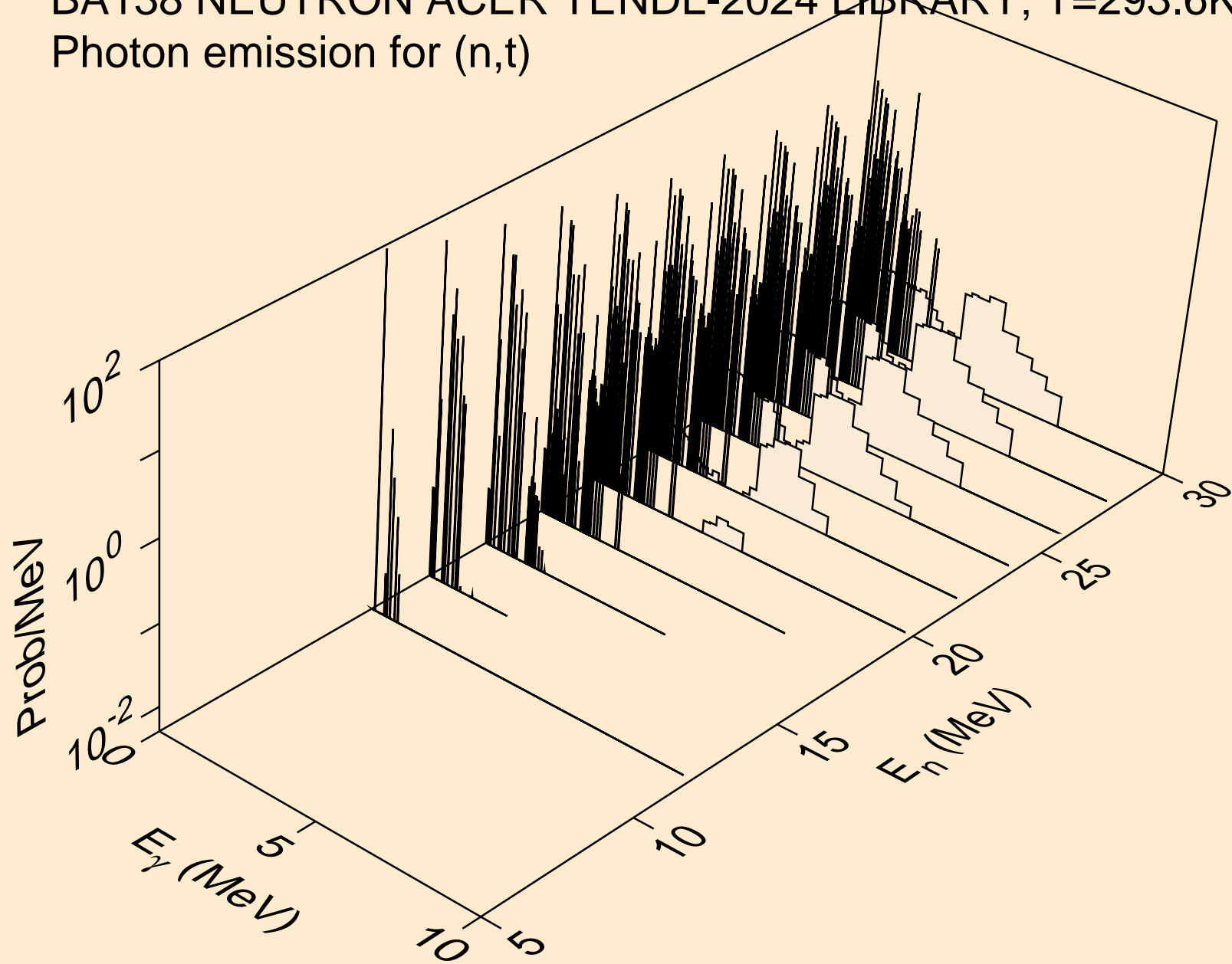

BA138 NEUTRON ACER TENDL-2024 LIBRARY; T=293.6K
Photon emission for (n,he3)

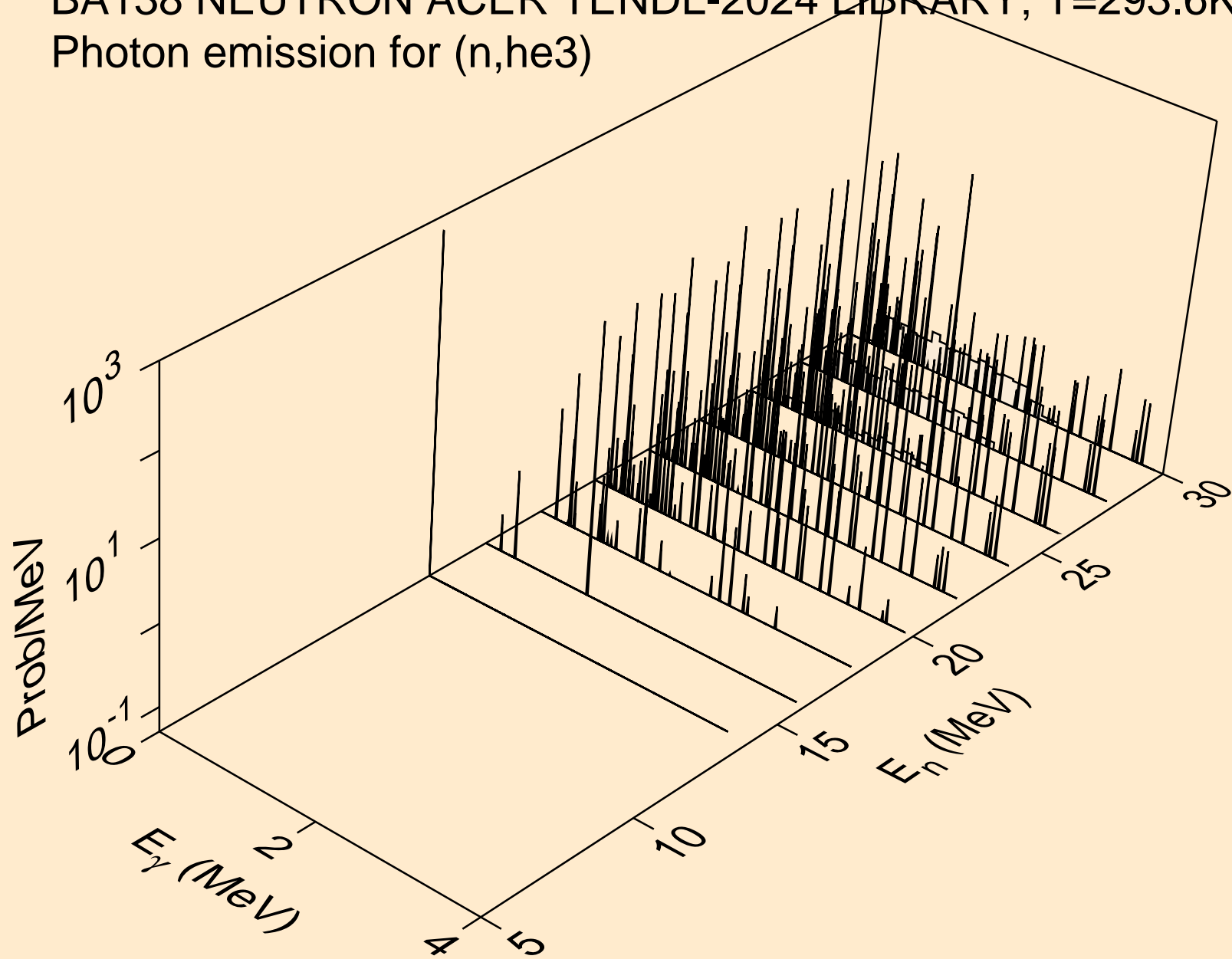

BA138 NEUTRON ACER TENDL-2024 LIBRARY; T=293.6K
Photon emission for (n,a)

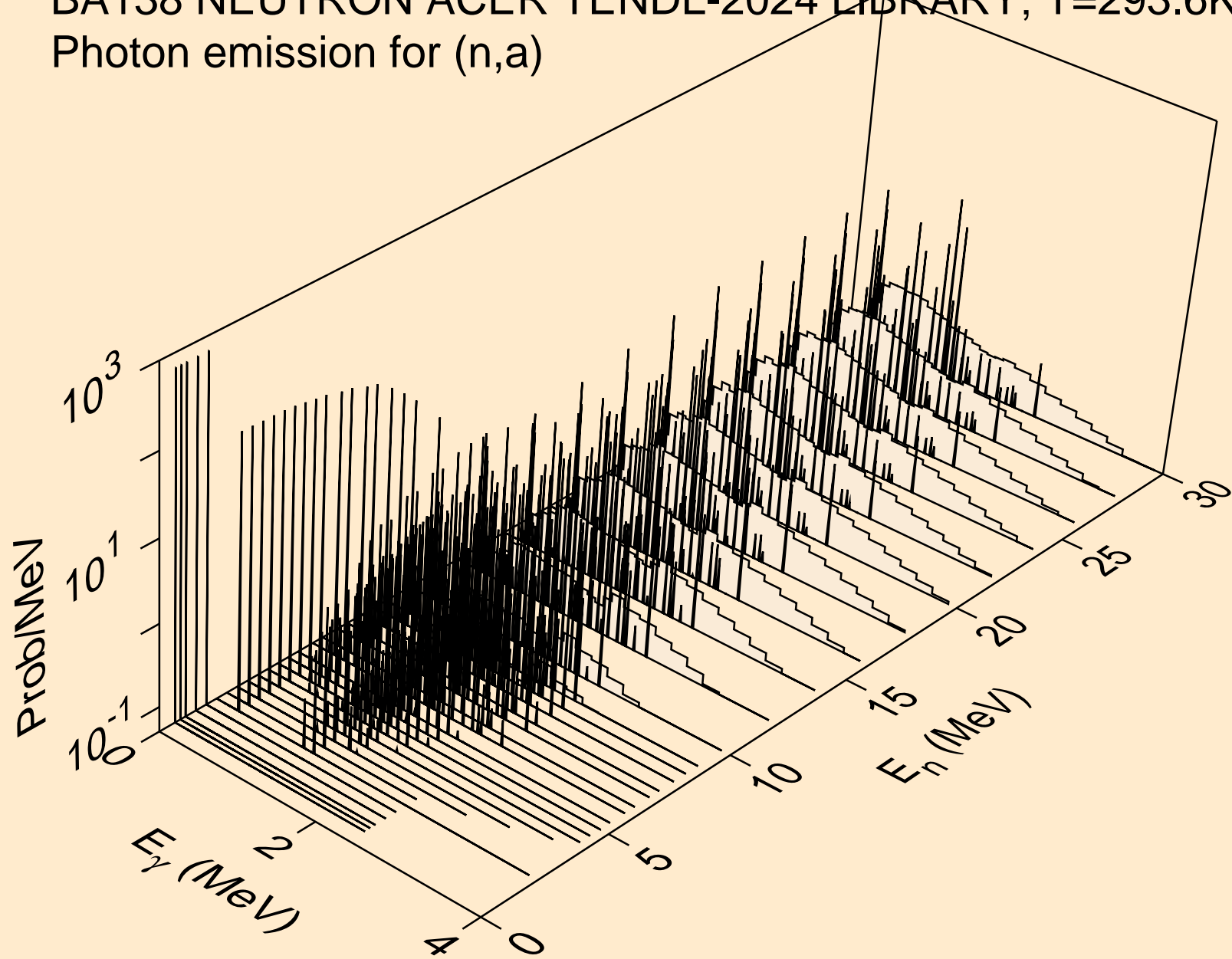

BA138 NEUTRON ACER TENDL-2024 LIBRARY; T=293.6K
Photon emission for (n,2a)

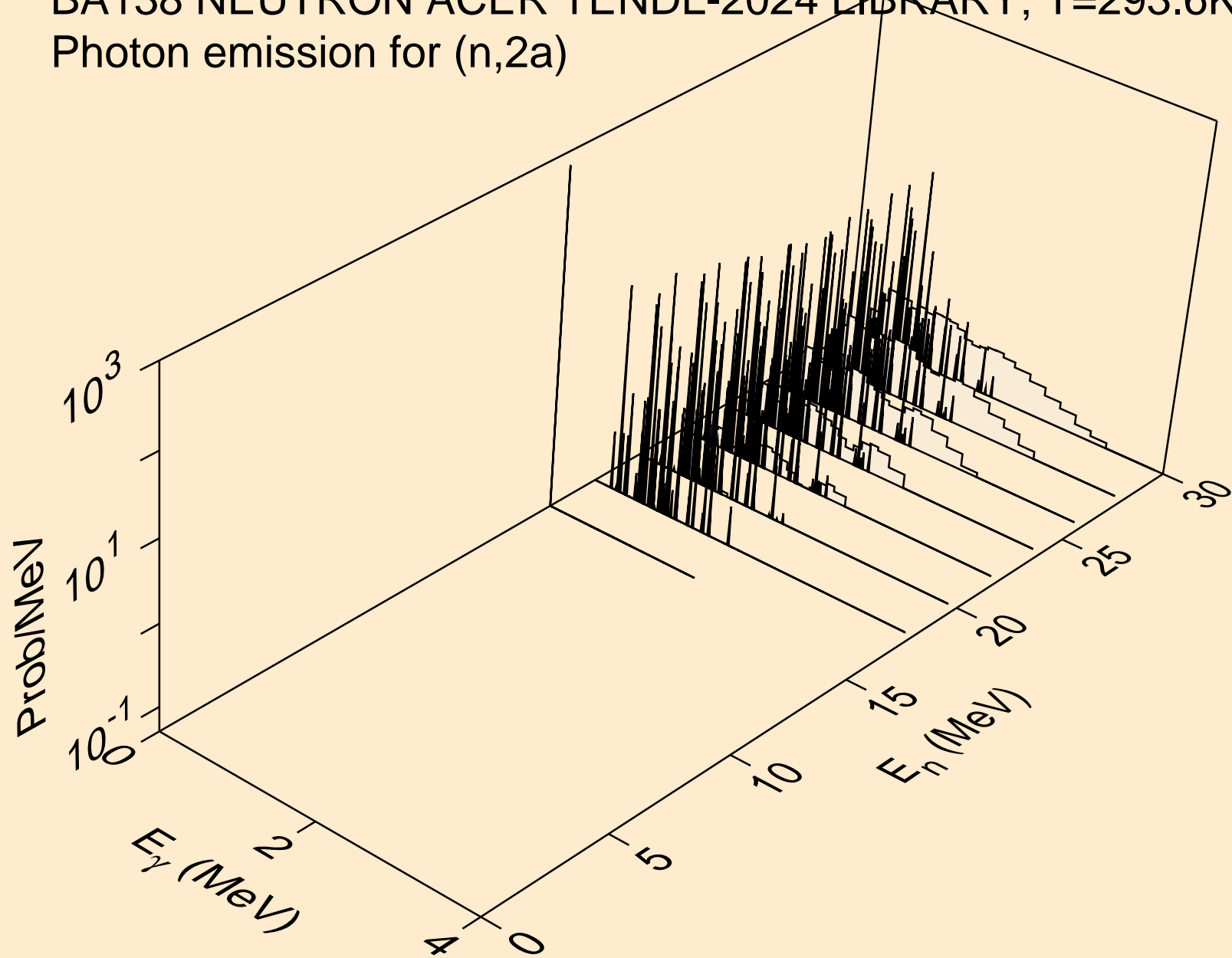

BA138 NEUTRON ACER TENDL-2024 LIBRARY; T=293.6K
Photon emission for (n,2p)

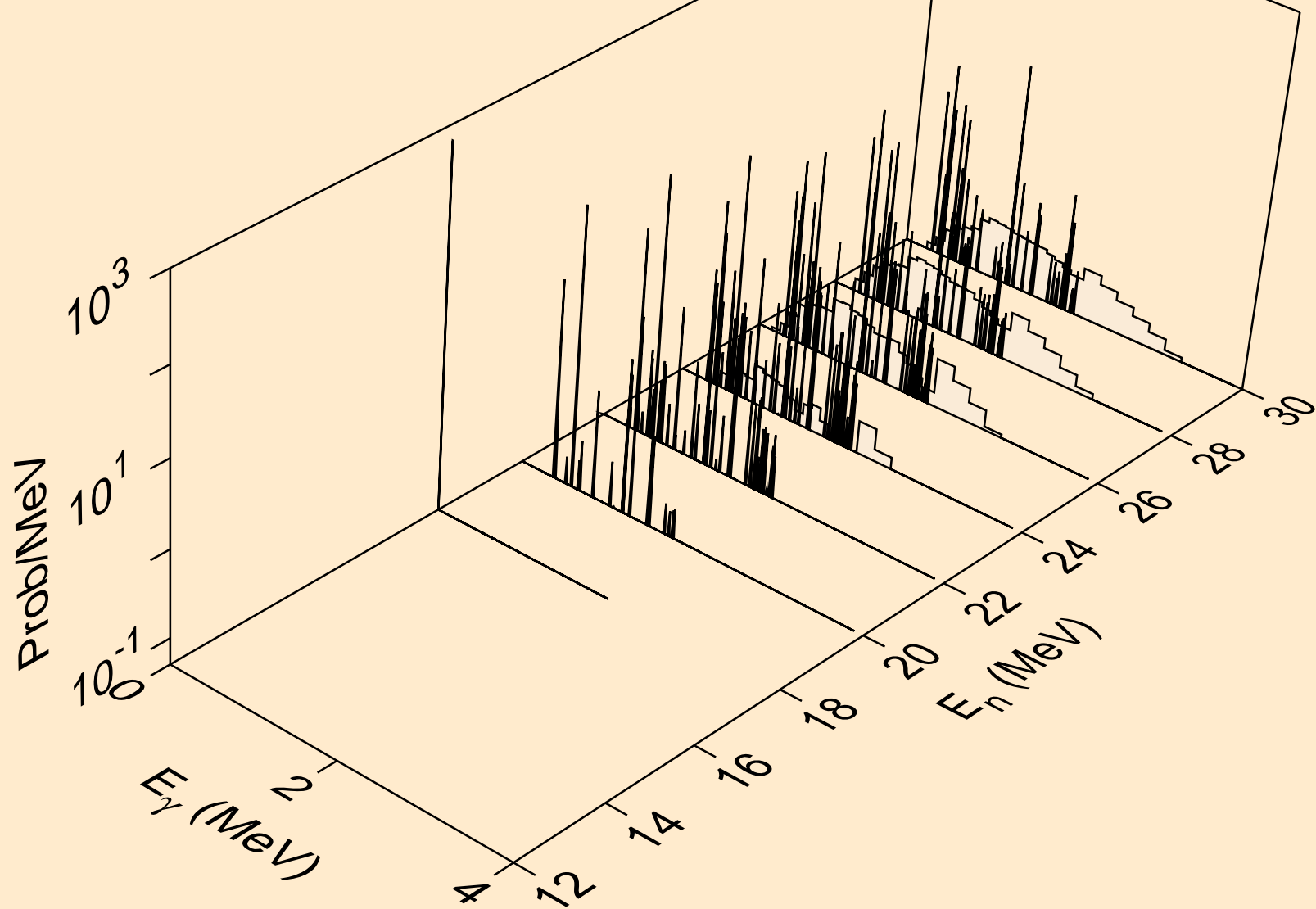

BA138 NEUTRON ACER TENDL-2024 LIBRARY; T=293.6K
Photon emission for (n,p)

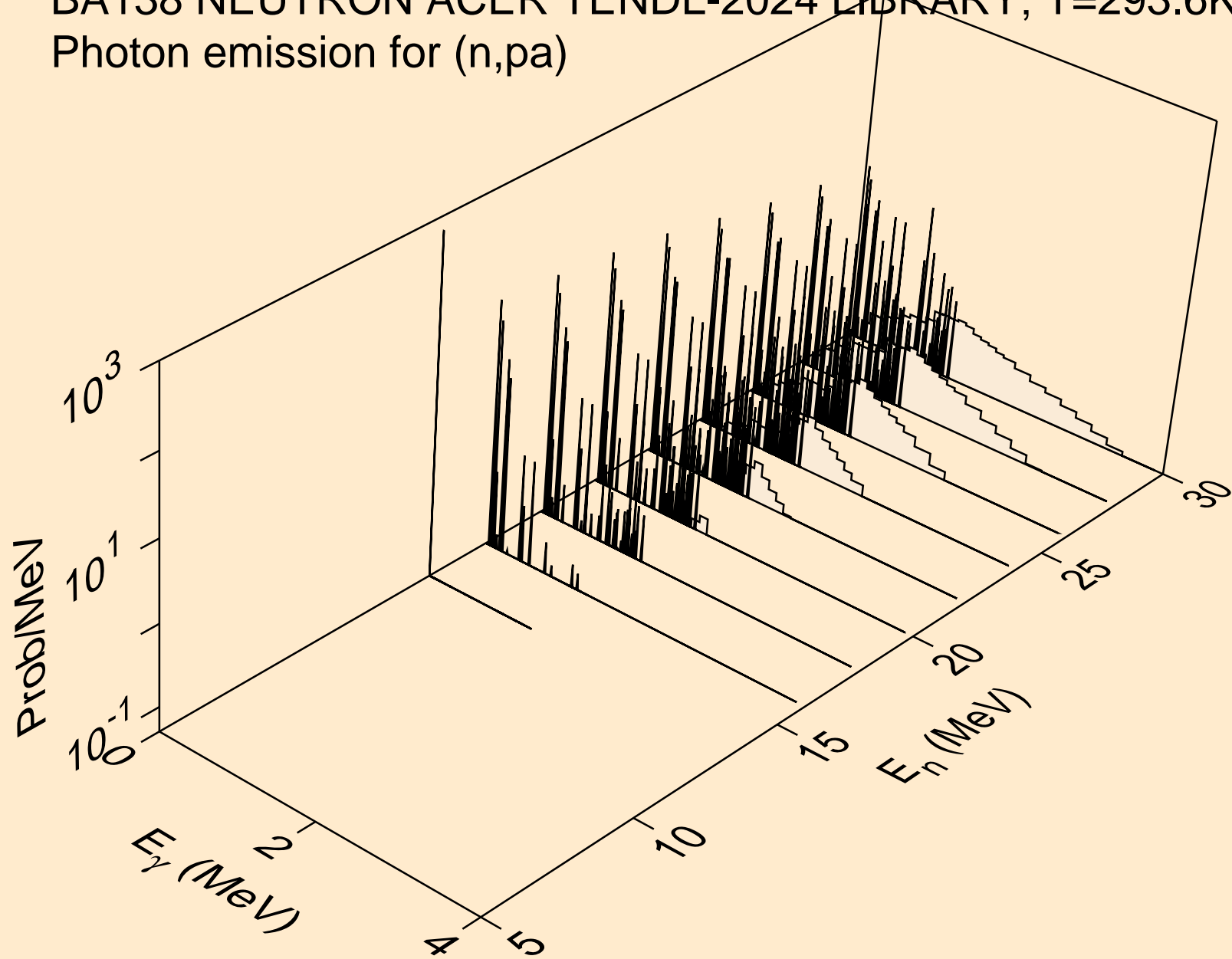

BA138 NEUTRON ACER TENDL-2024 LIBRARY; T=293.6K
Photon emission for (n,pd)

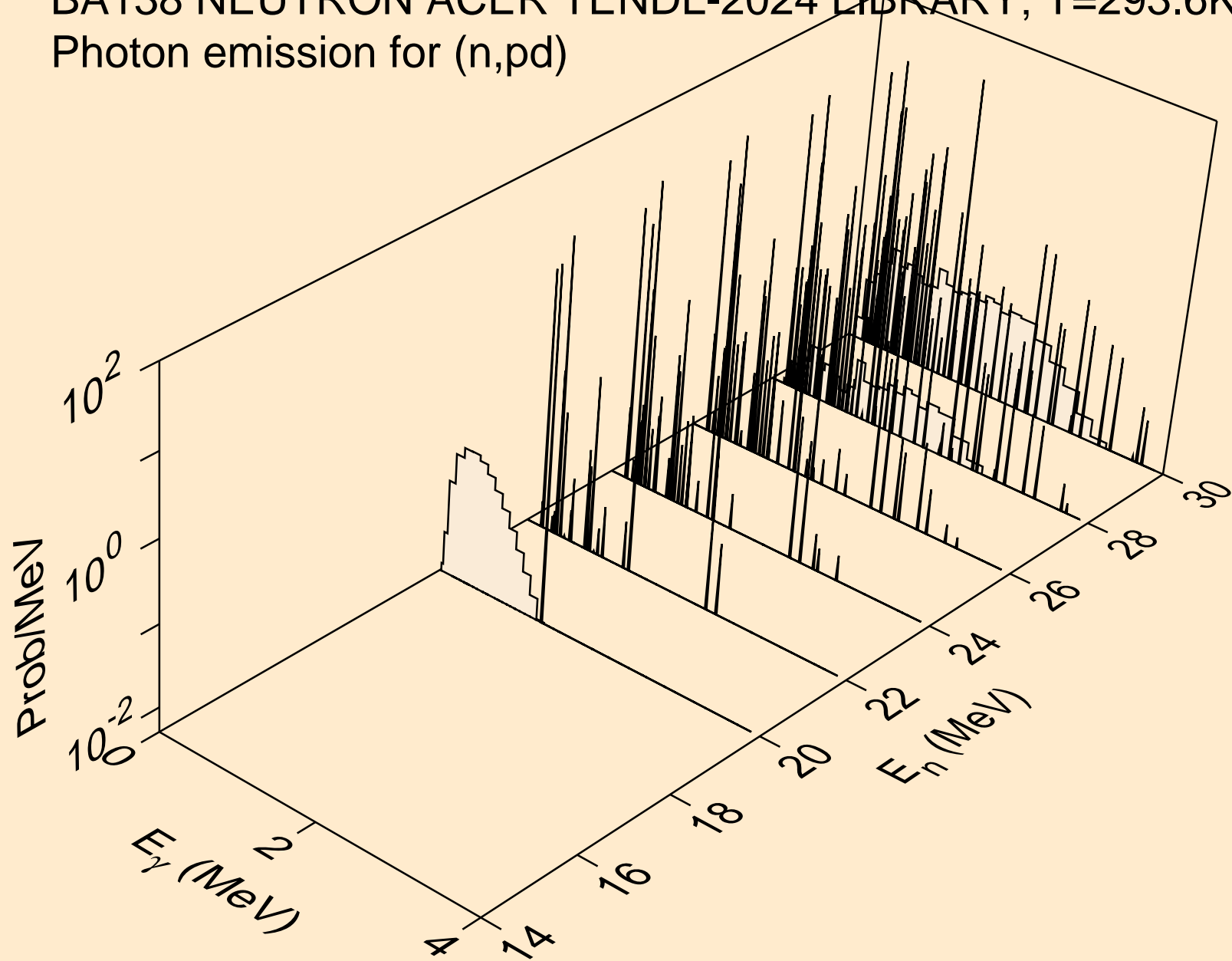

BA138 NEUTRON ACER TENDL-2024 LIBRARY; T=293.6K
Photon emission for (n,pt)

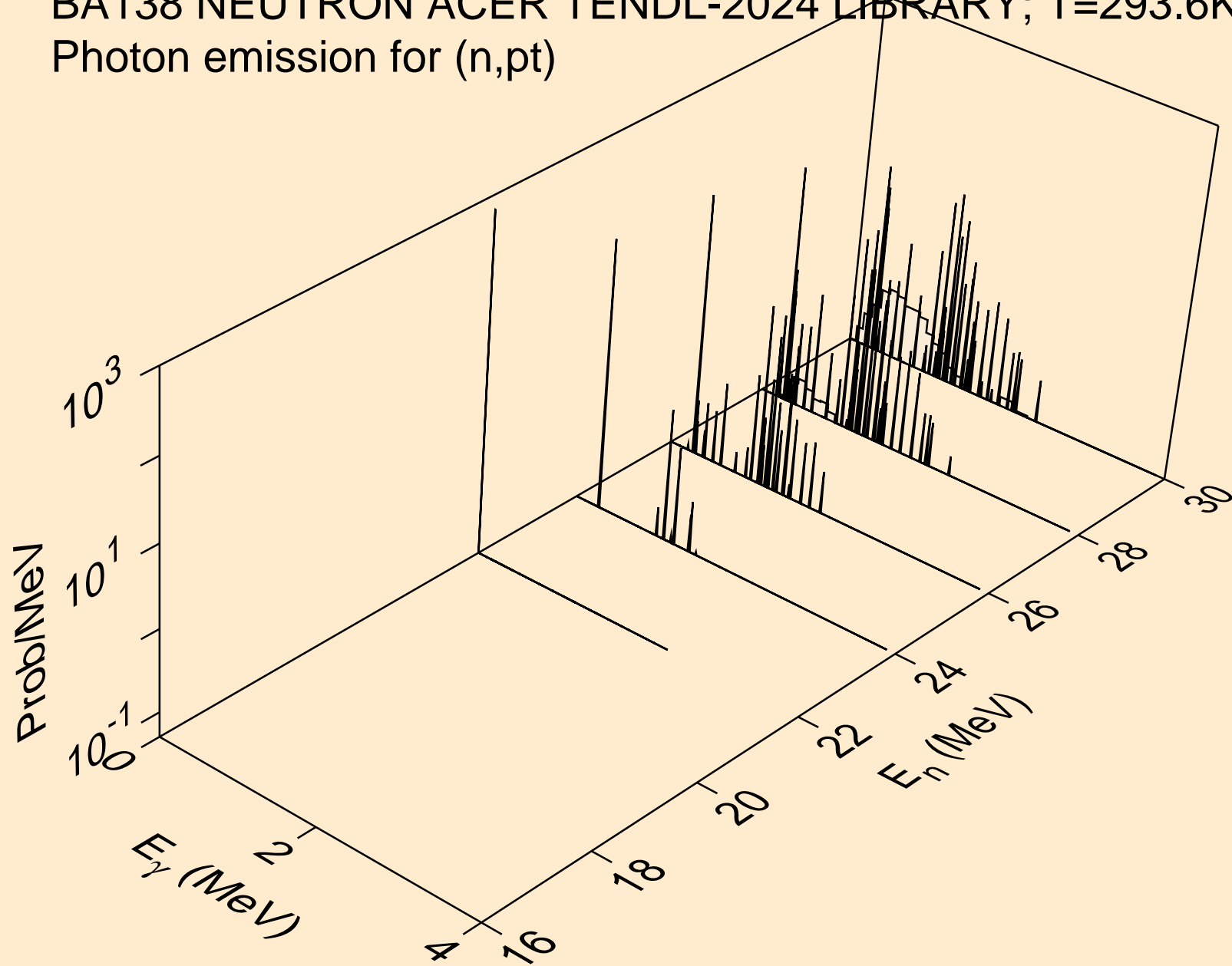

BA138 NEUTRON ACER TENDL-2024 LIBRARY; T=293.6K
Photon emission for (n,da)

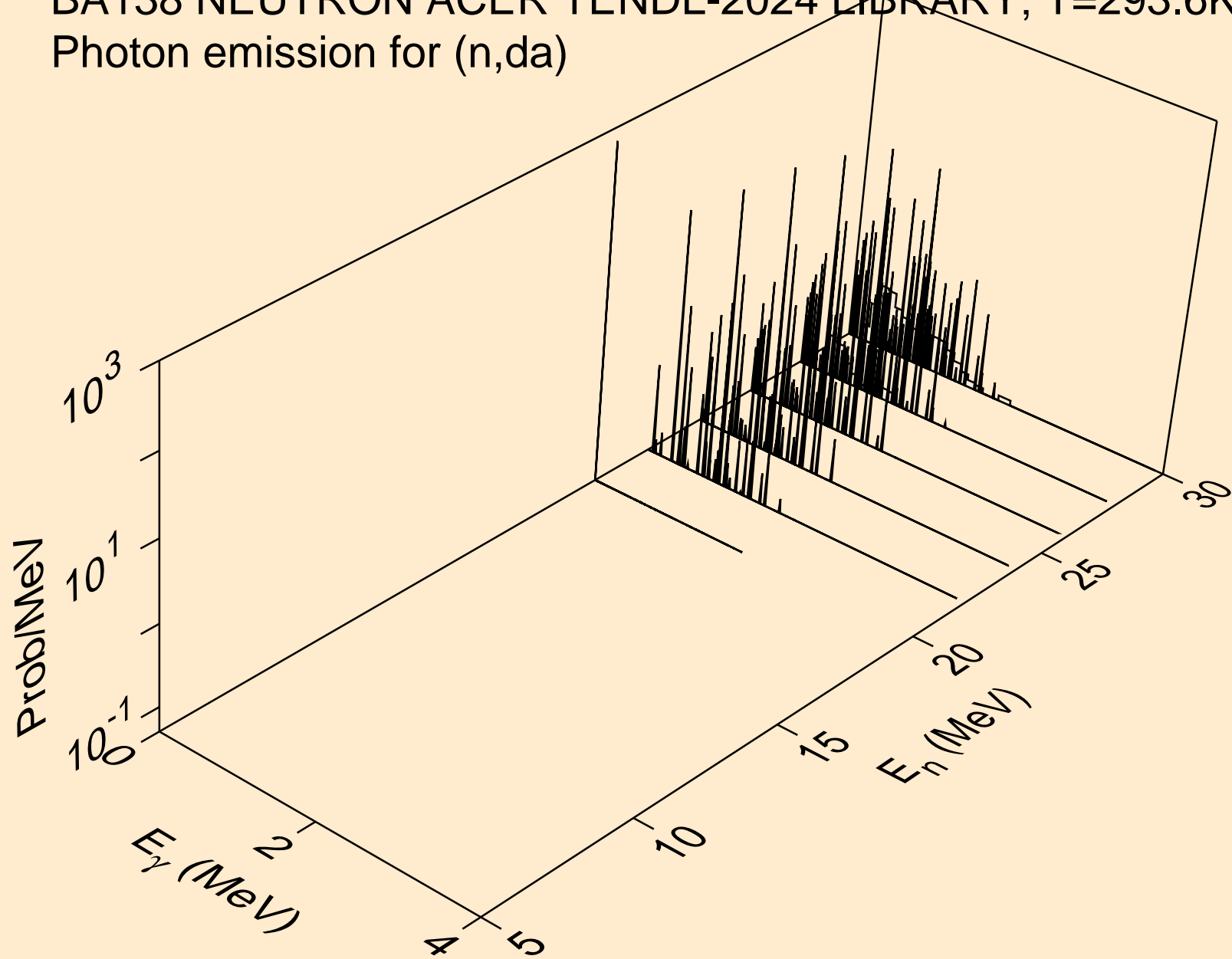

BA138 NEUTRON ACER TENDL-2024 LIBRARY; T=293.6K
thermal capture photon spectrum

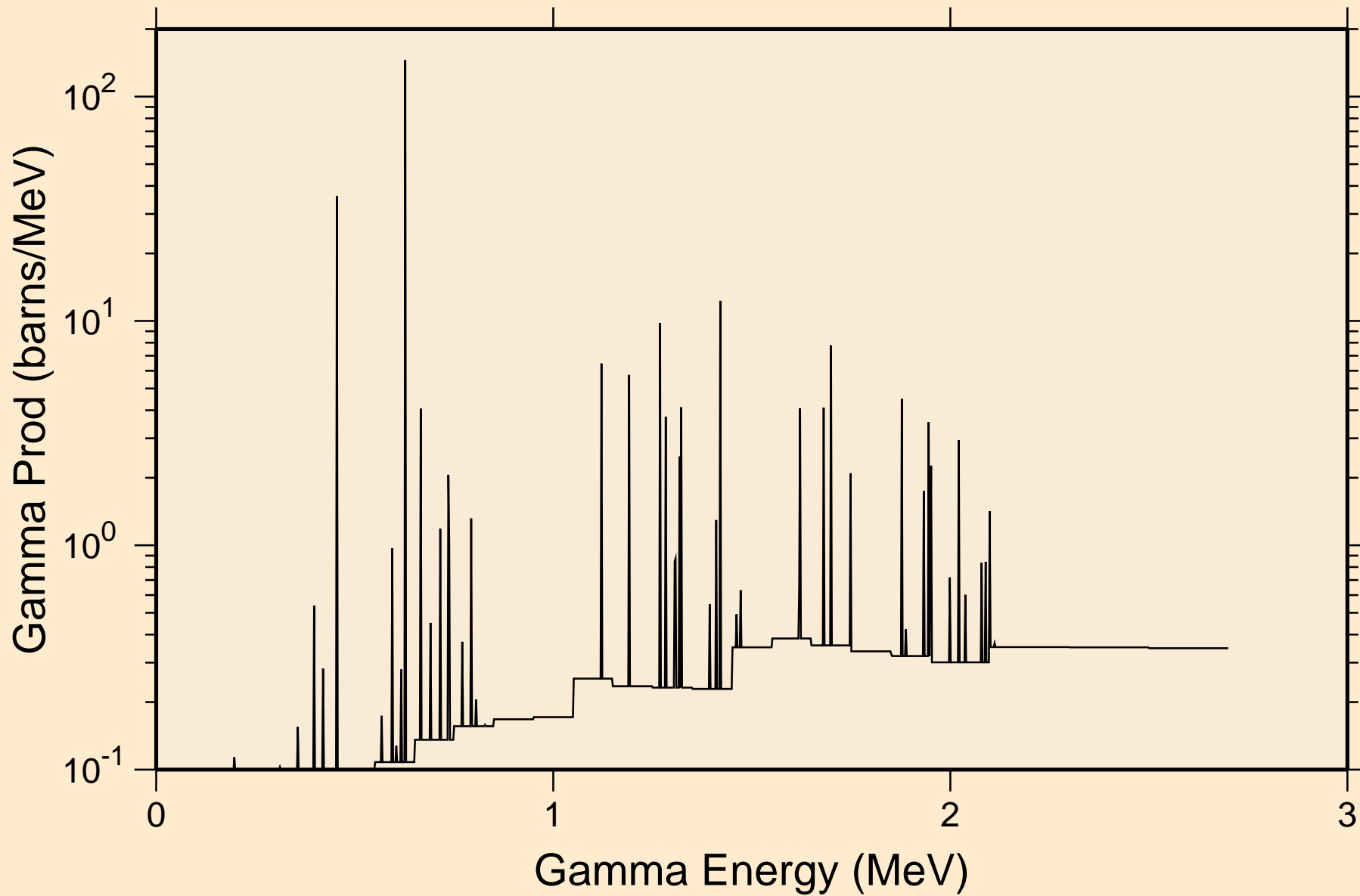

BA138 NEUTRON ACER TENDL-2024 LIBRARY; T=293.6K
14 MeV photon spectrum

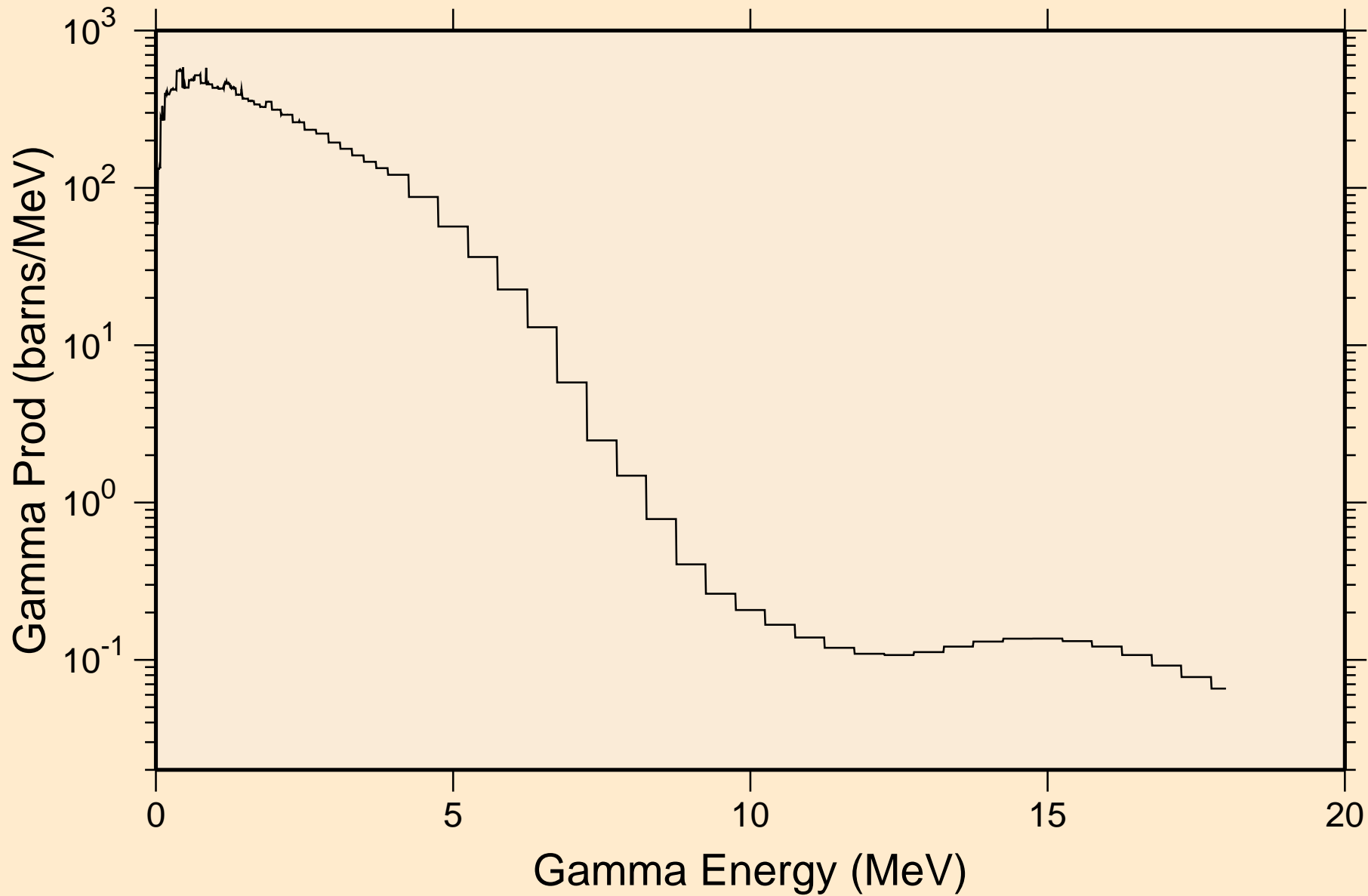

BA138 NEUTRON ACER TENDL-2024 LIBRARY; T=293.6K
Particle heating contributions

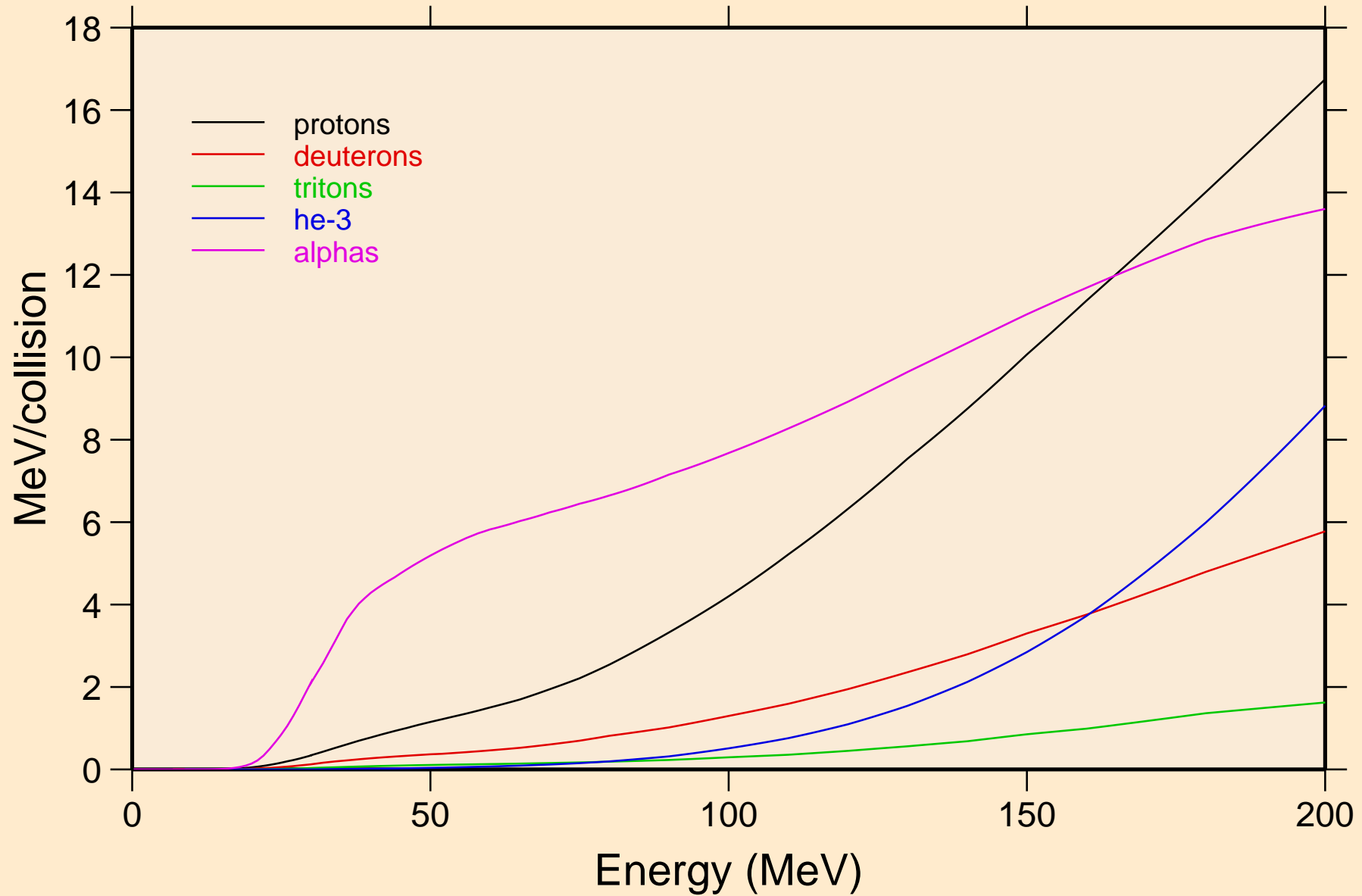

BA138 NEUTRON ACER TENDL-2024 LIBRARY; T=293.6K
Recoil Heating

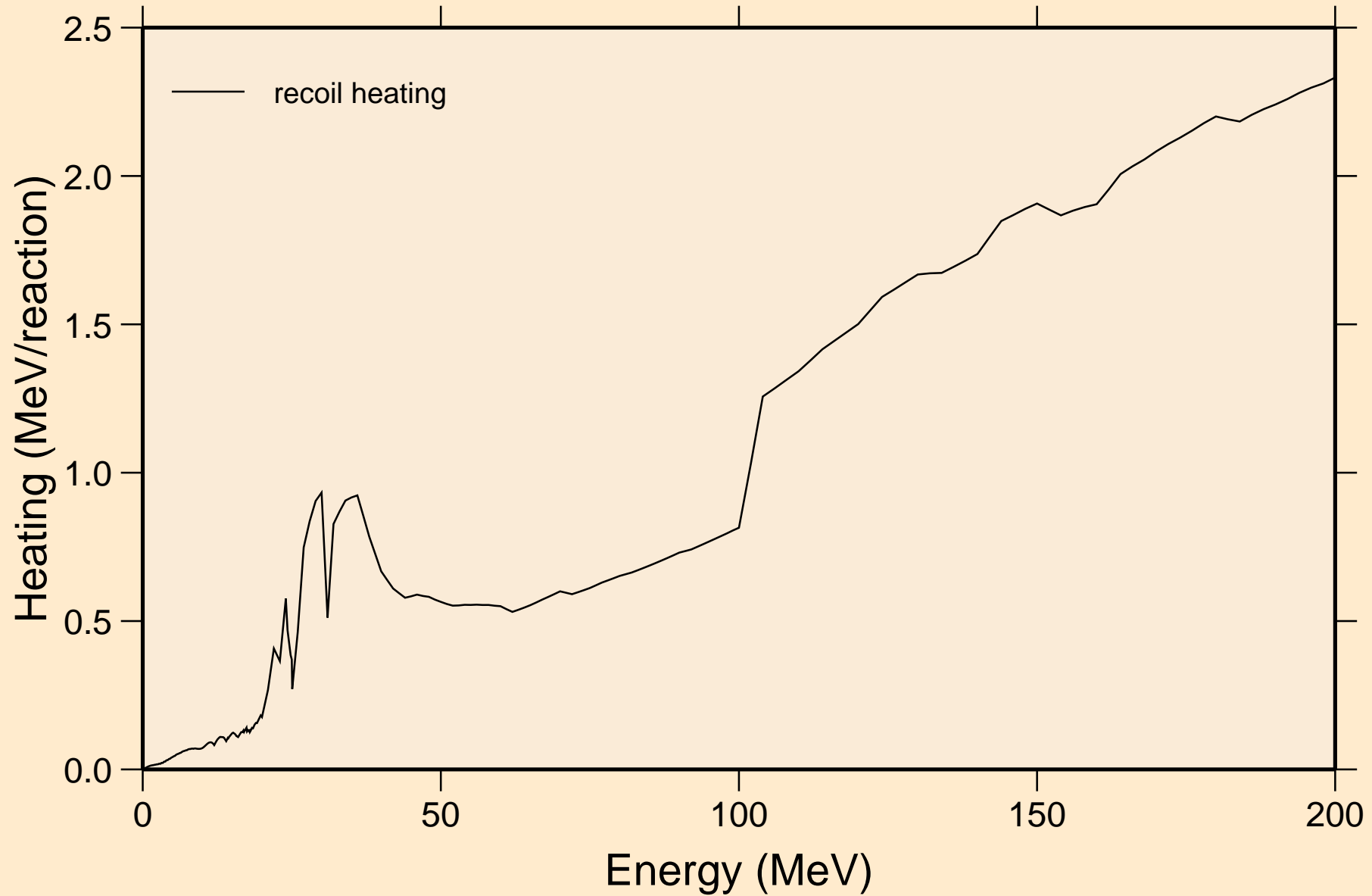

BA138 NEUTRON ACER TENDL-2024 LIBRARY; T=293.6K
Particle production cross sections

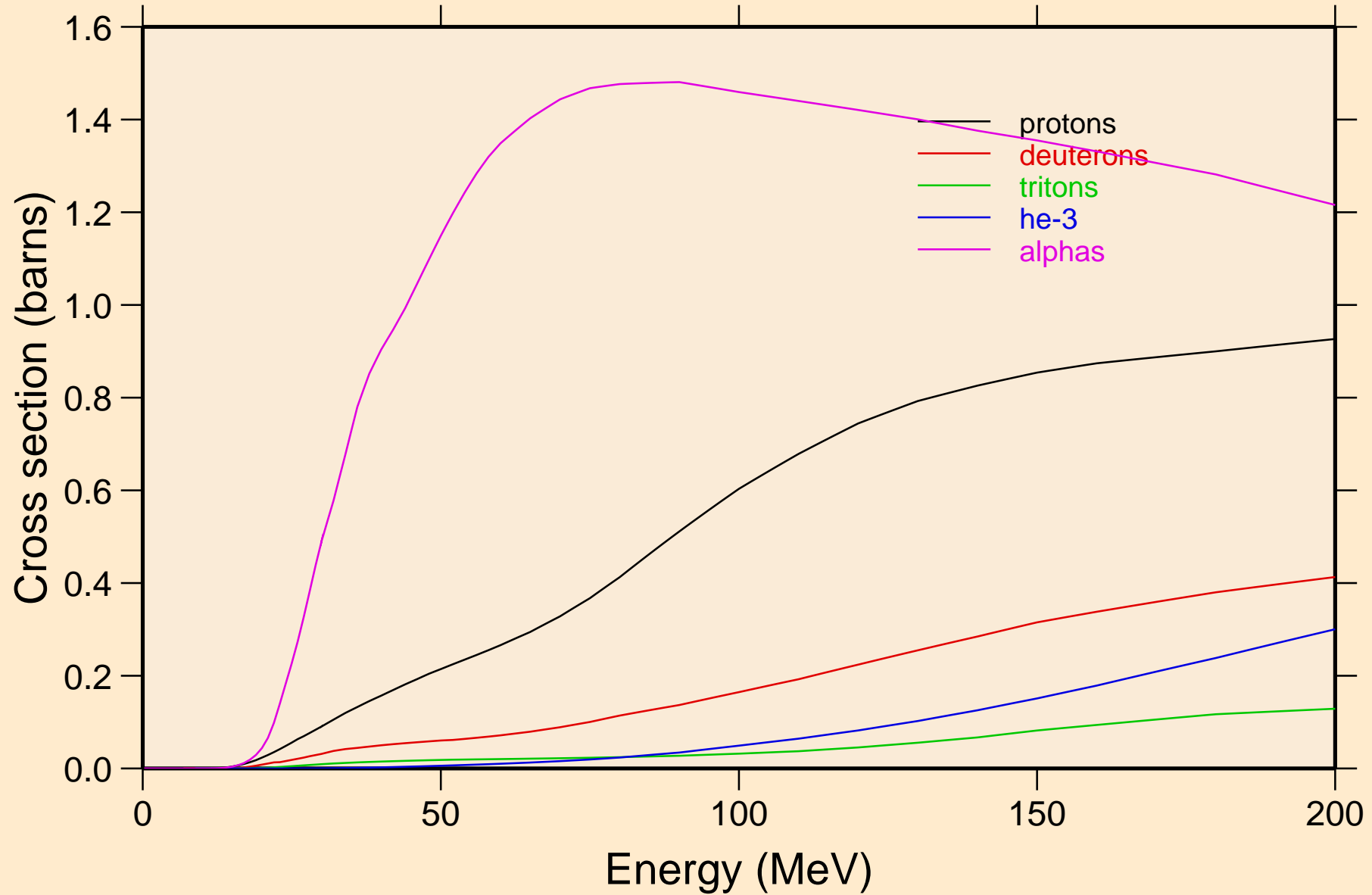

BA138 NEUTRON ACER TENDL-2024 LIBRARY; T=293.6K
protons from (n,x)

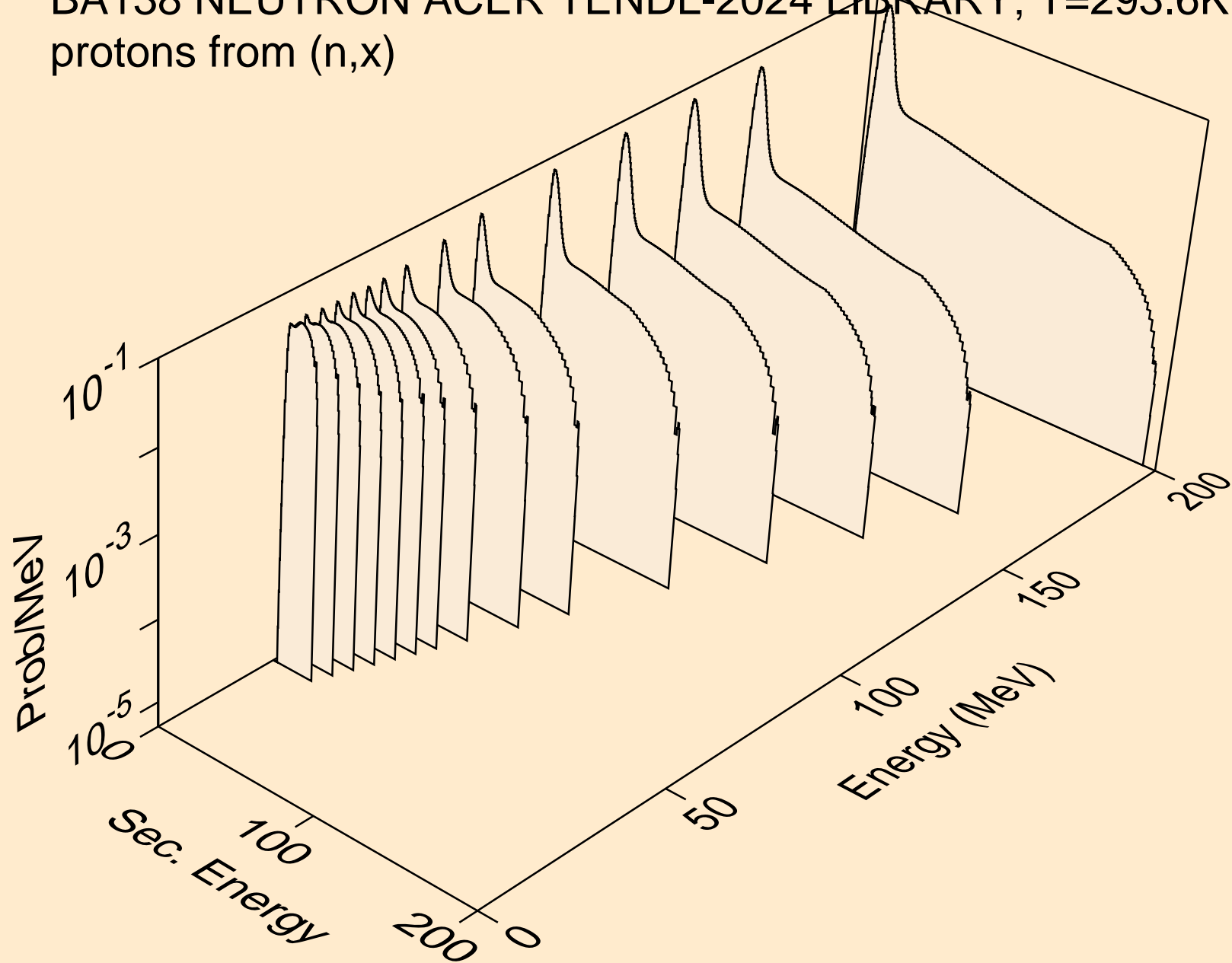

BA138 NEUTRON ACER TENDL-2024 LIBRARY; T=293.6K
protons from (n,n*)p

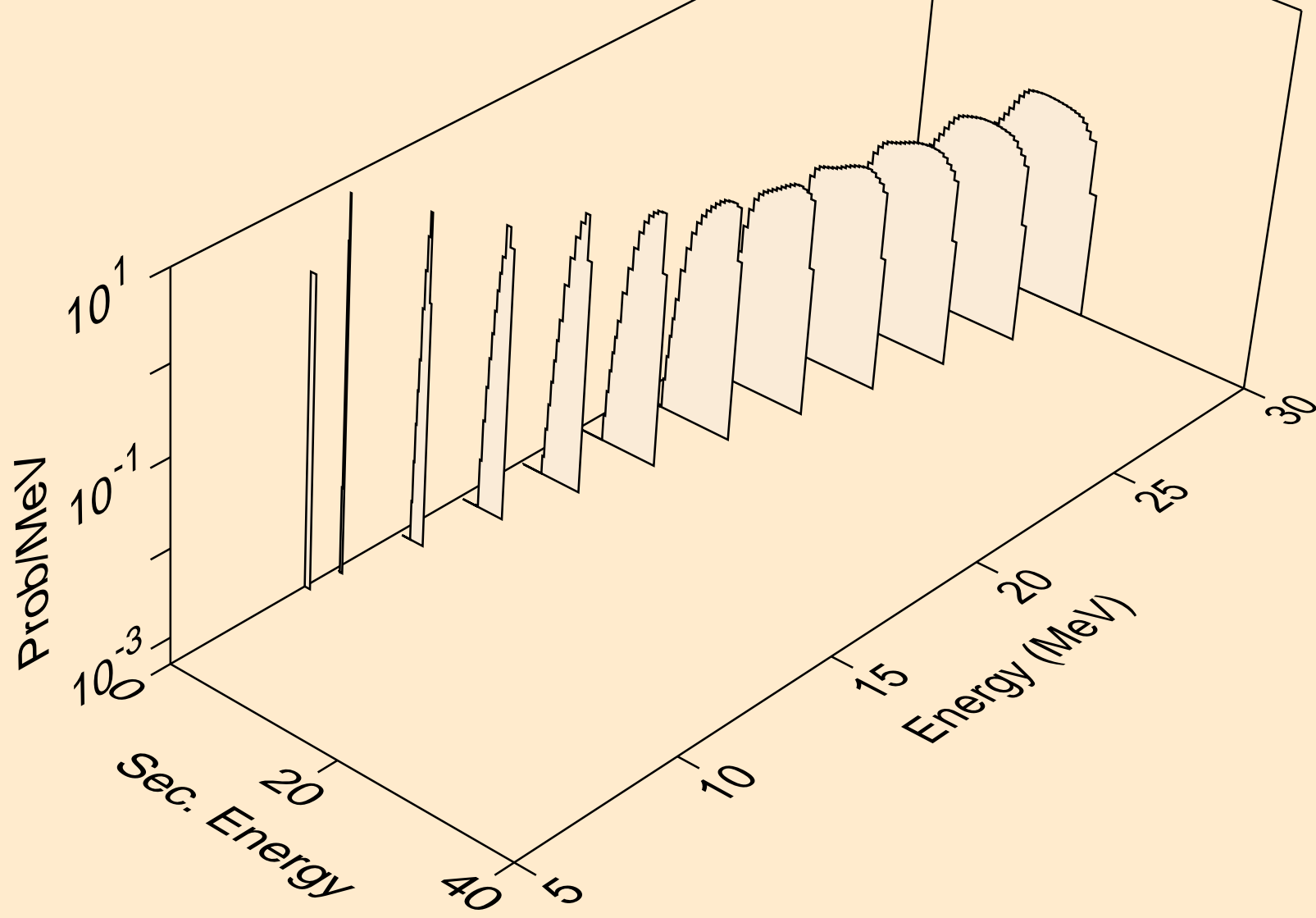

BA138 NEUTRON ACER TENDL-2024 LIBRARY; T=293.6K
protons from (n,2np)

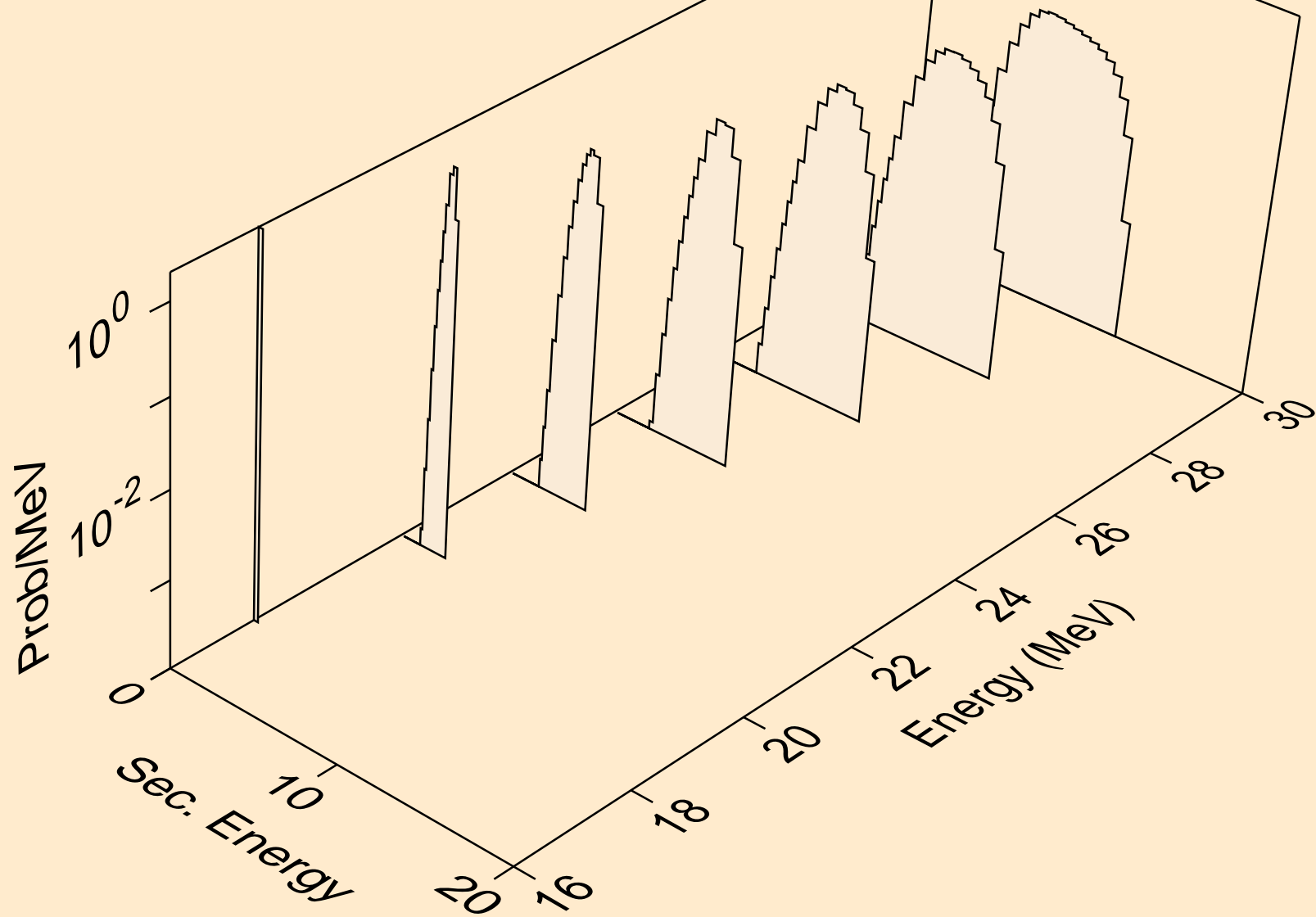

BA138 NEUTRON ACER TENDL-2024 LIBRARY; T=293.6K
protons from (n,3np)

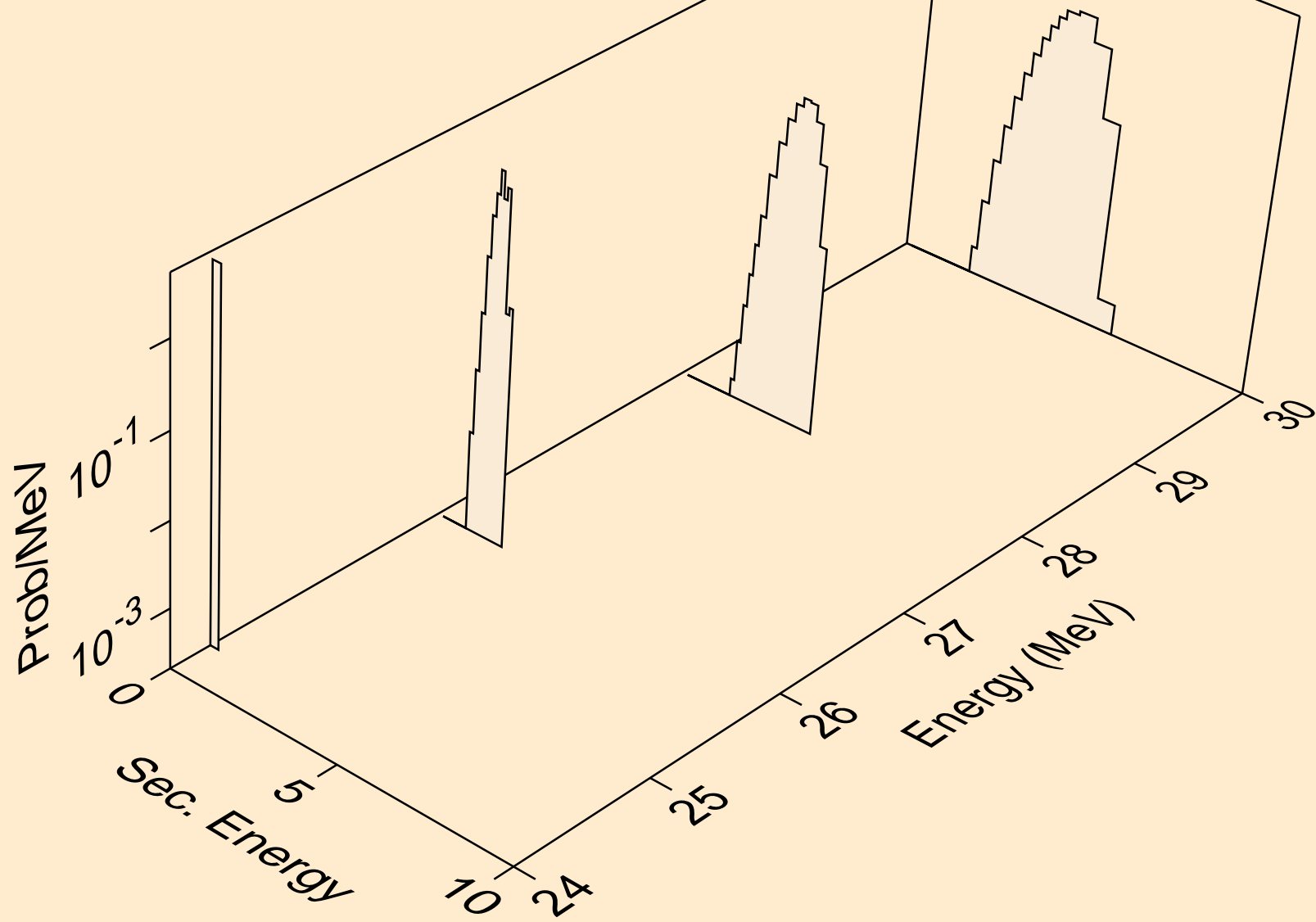

BA138 NEUTRON ACER TENDL-2024 LIBRARY; T=293.6K
protons from (n,n2p)

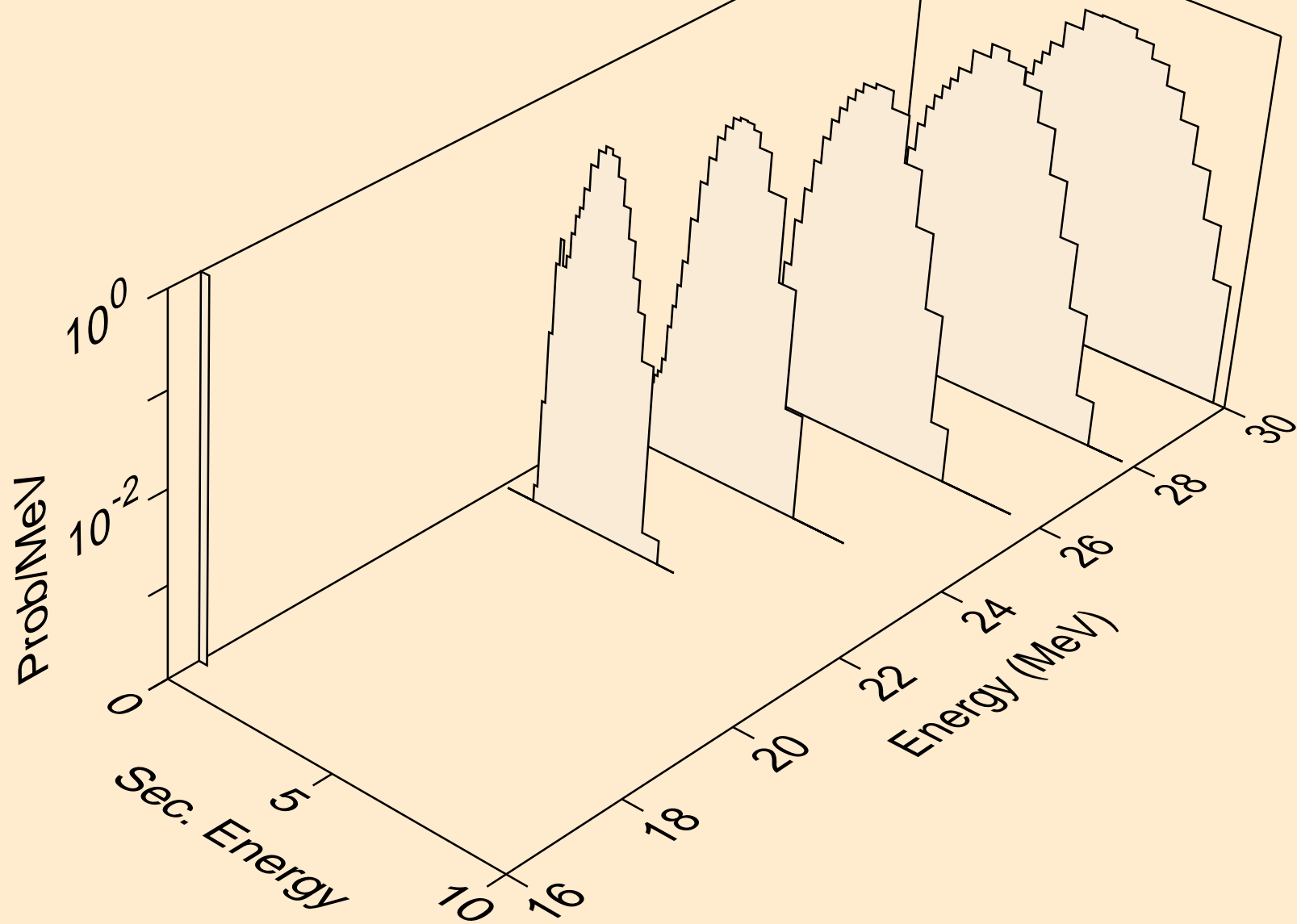

BA138 NEUTRON ACER TENDL-2024 LIBRARY; T=293.6K
protons from (n,npa)

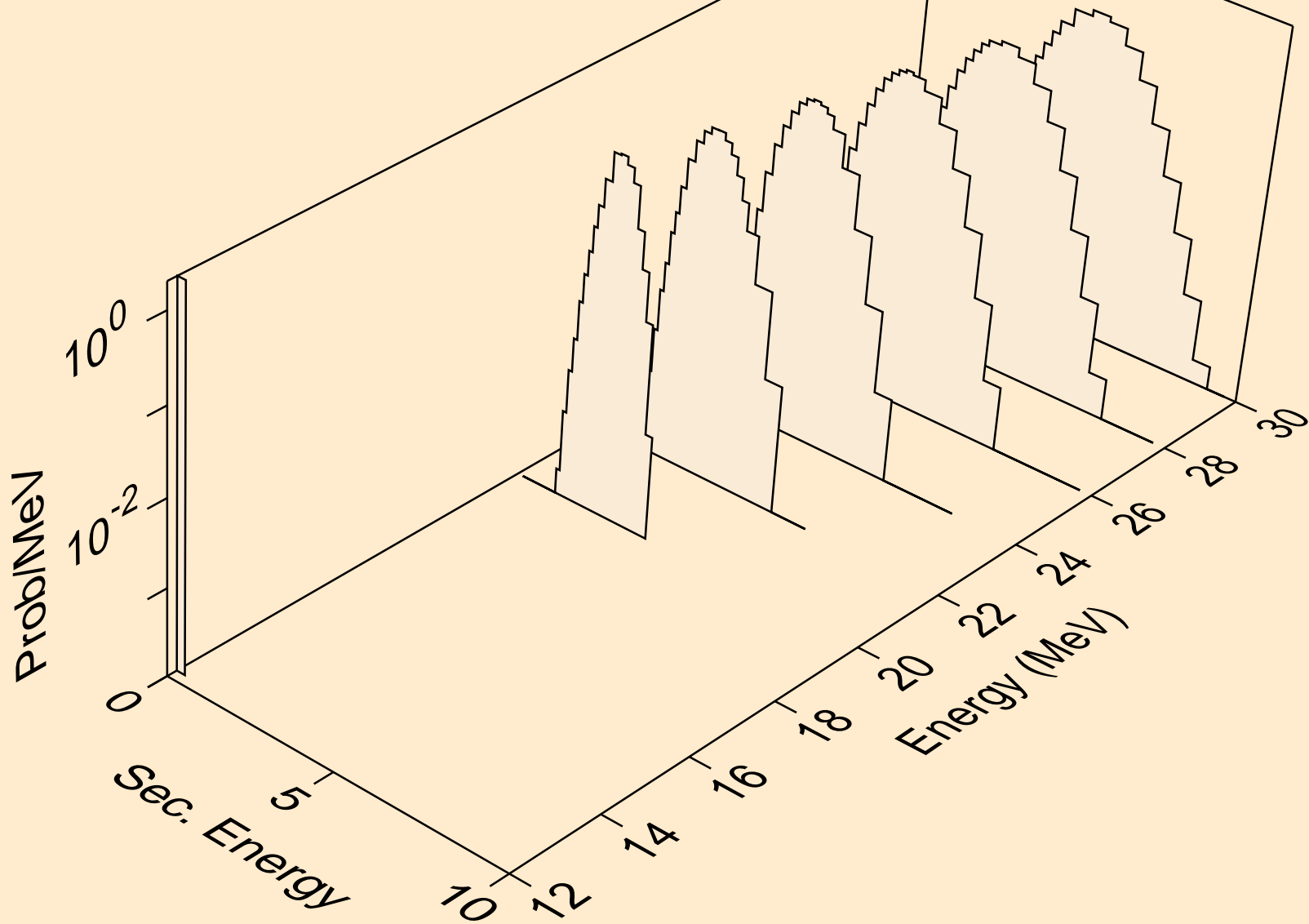

BA138 NEUTRON ACER TENDL-2024 LIBRARY; T=293.6K
protons from (n,p)

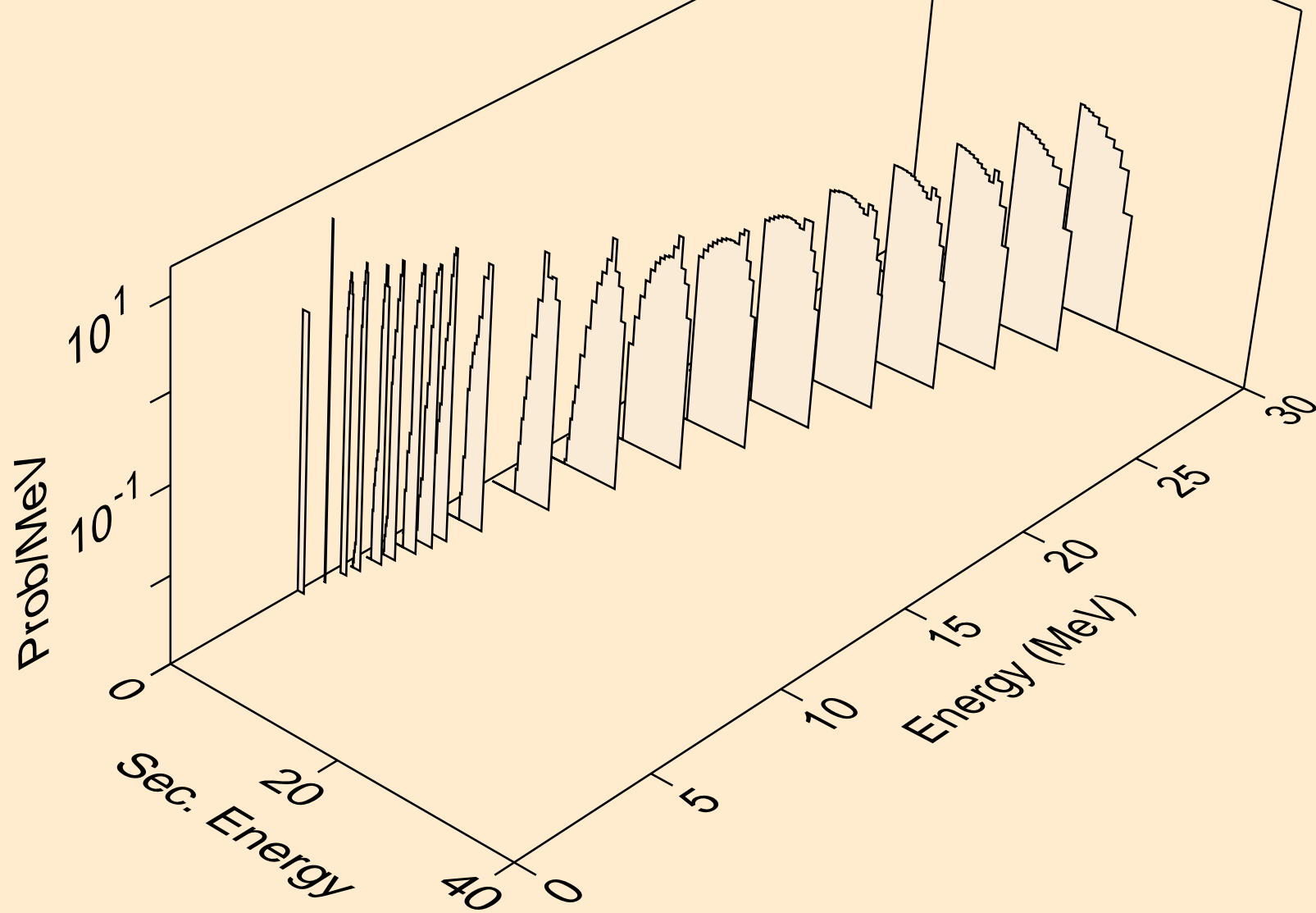

BA138 NEUTRON ACER TENDL-2024 LIBRARY; T=293.6K
protons from (n,2p)

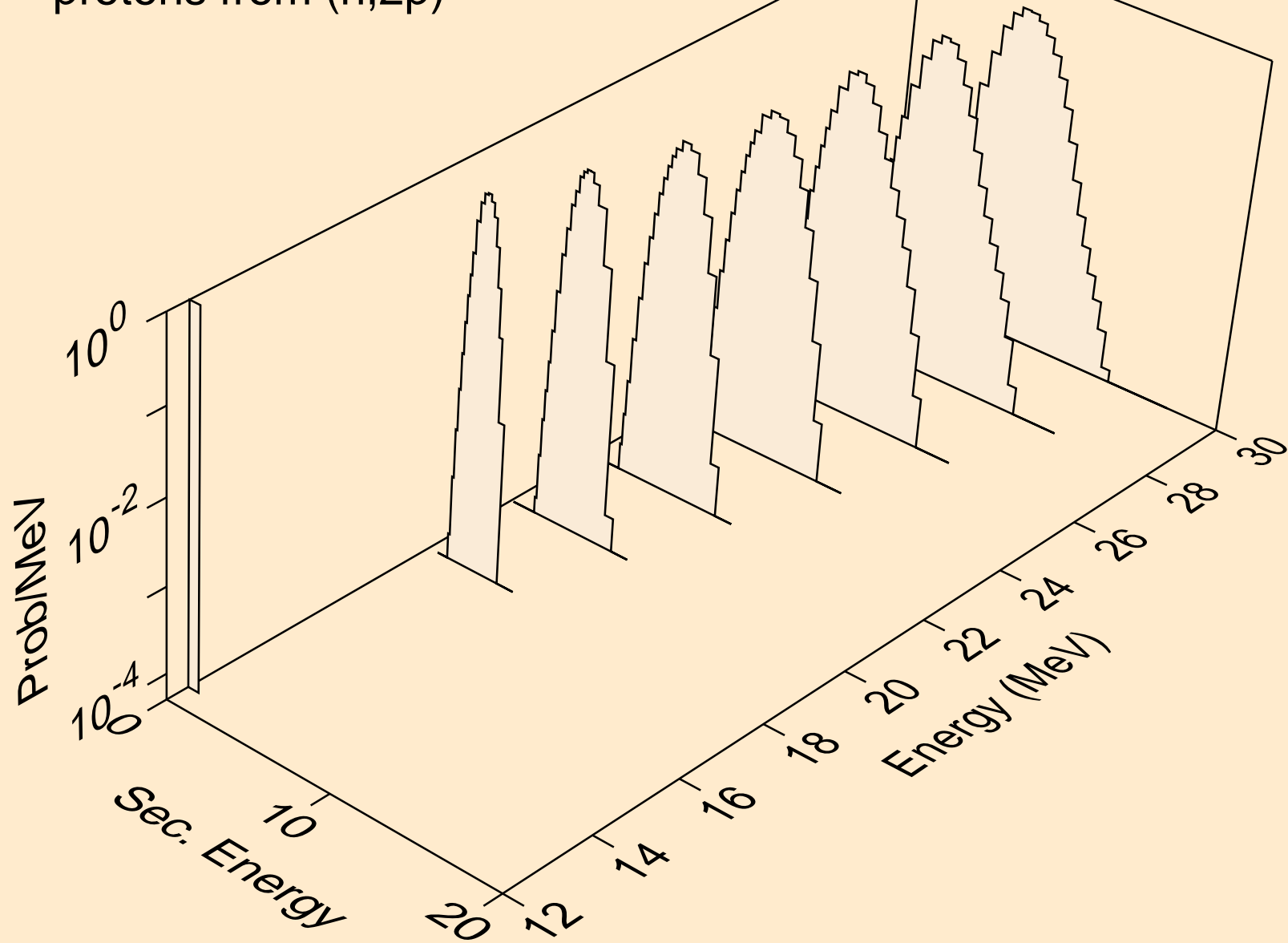

BA138 NEUTRON ACER TENDL-2024 LIBRARY; T=293.6K
protons from (n,p)

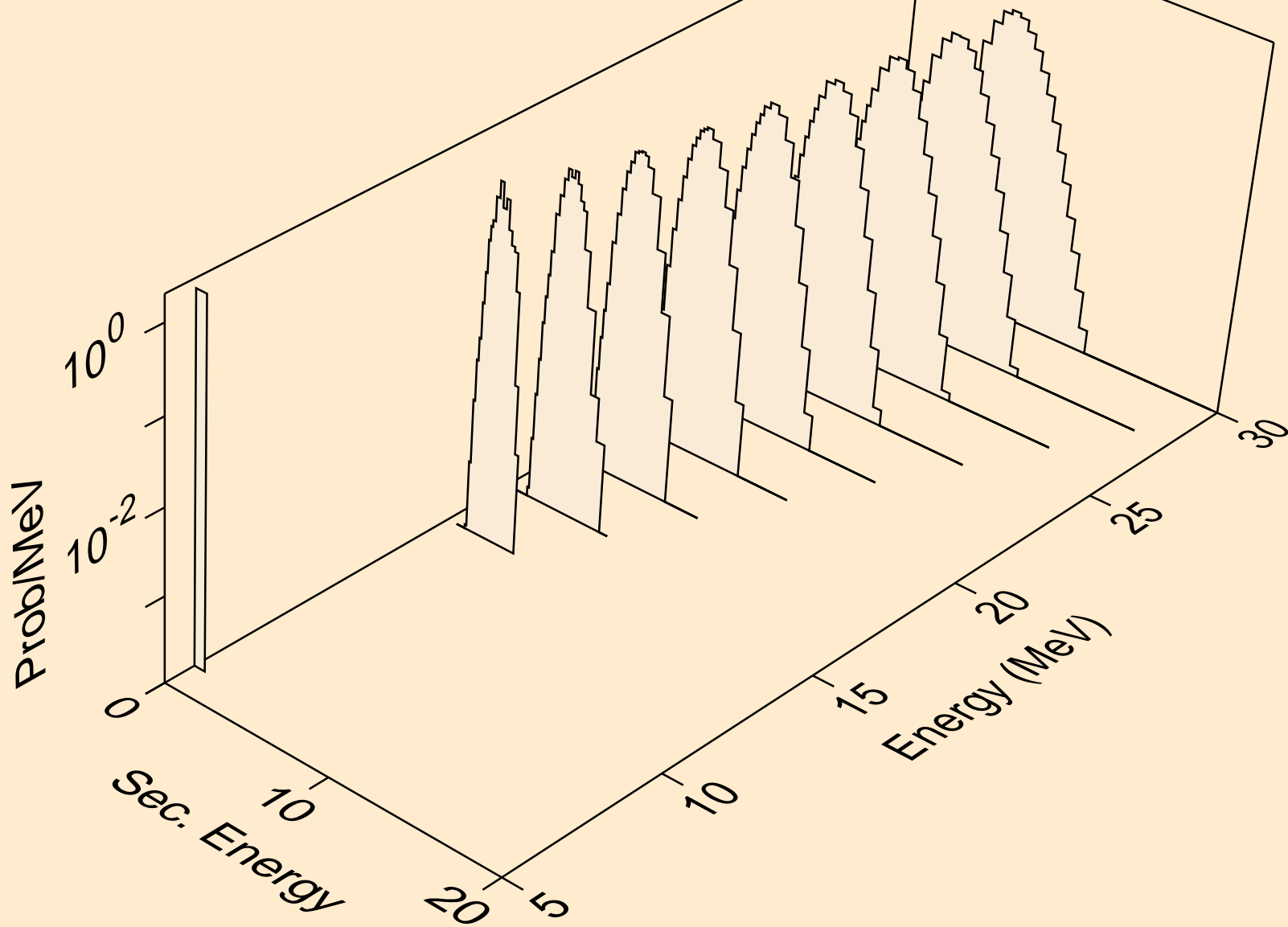

BA138 NEUTRON ACER TENDL-2024 LIBRARY; T=293.6K
protons from (n,pd)

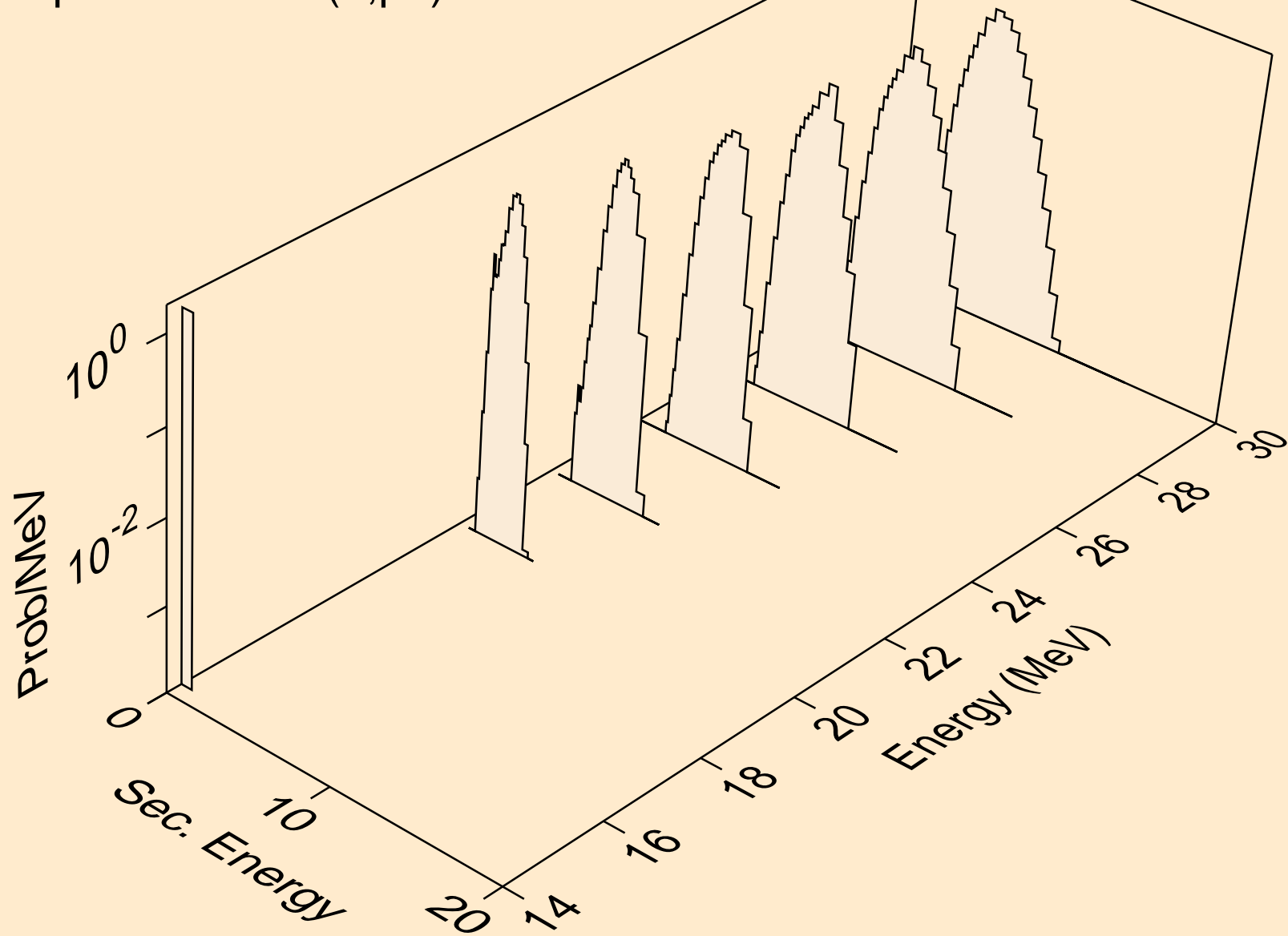

BA138 NEUTRON ACER TENDL-2024 LIBRARY; T=293.6K
protons from (n,pt)

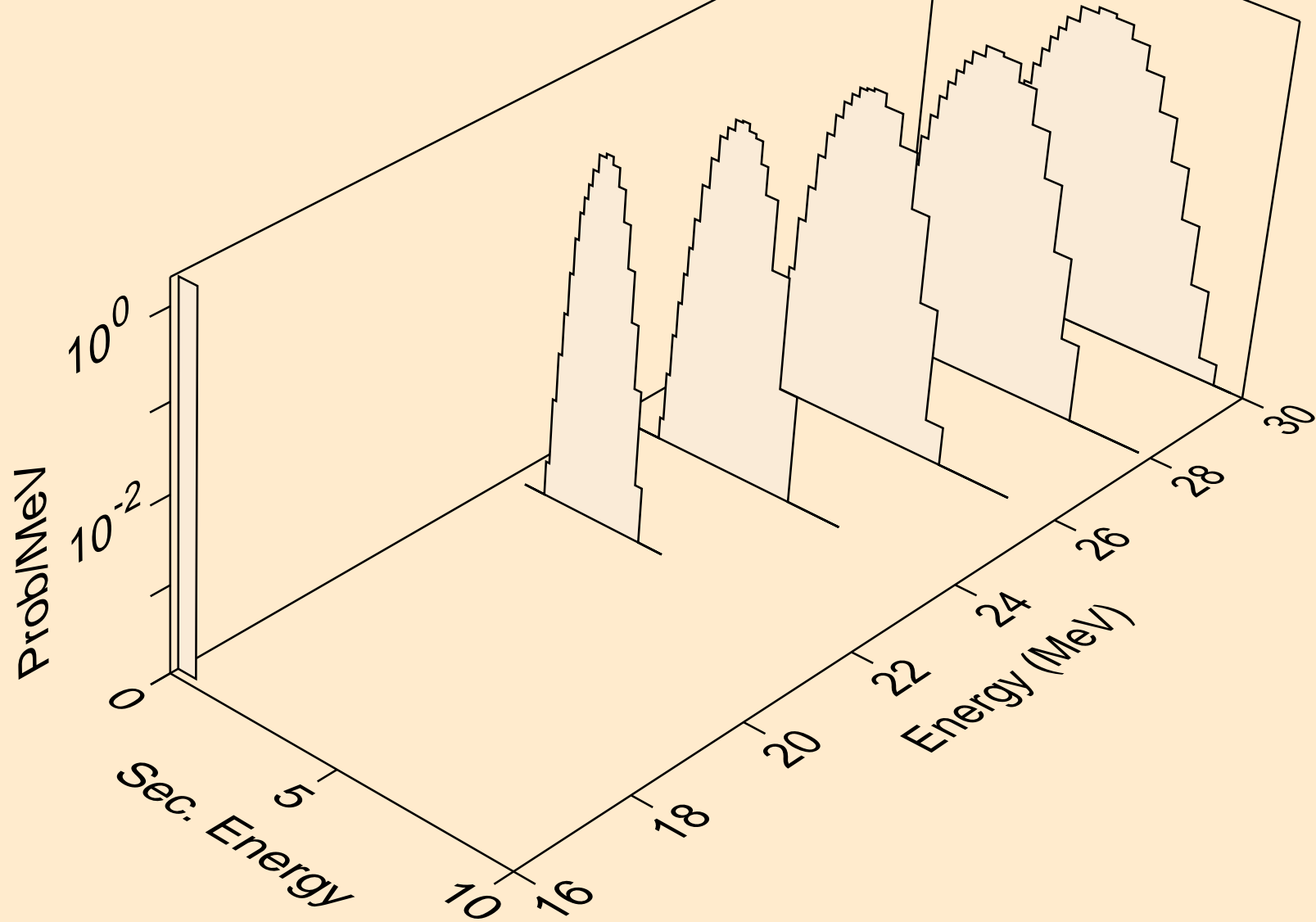

BA138 NEUTRON ACER TENDL-2024 LIBRARY; T=293.6K
deuterons from (n,x)

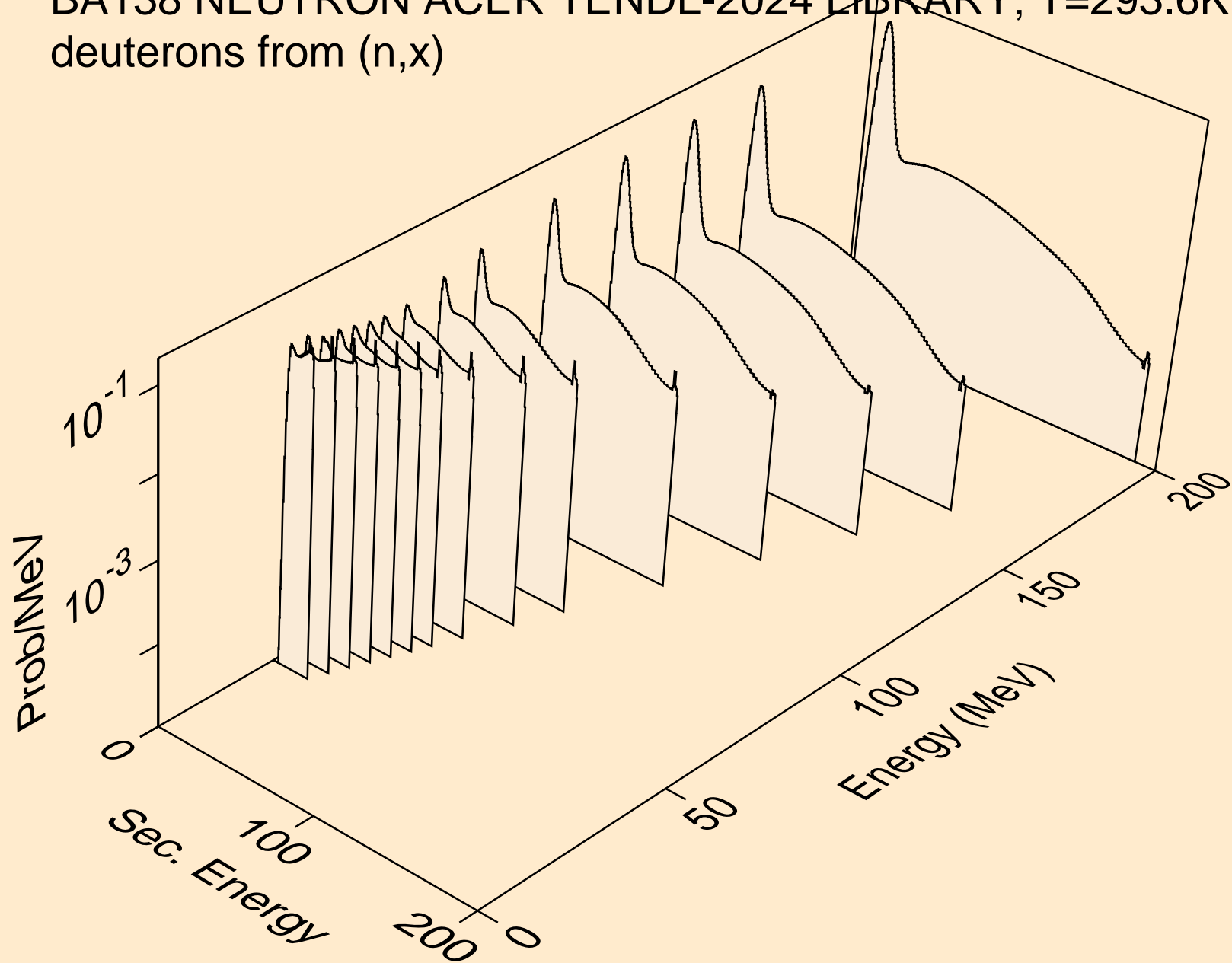

BA138 NEUTRON ACER TENDL-2024 LIBRARY; T=293.6K
deuterons from (n,2nd)

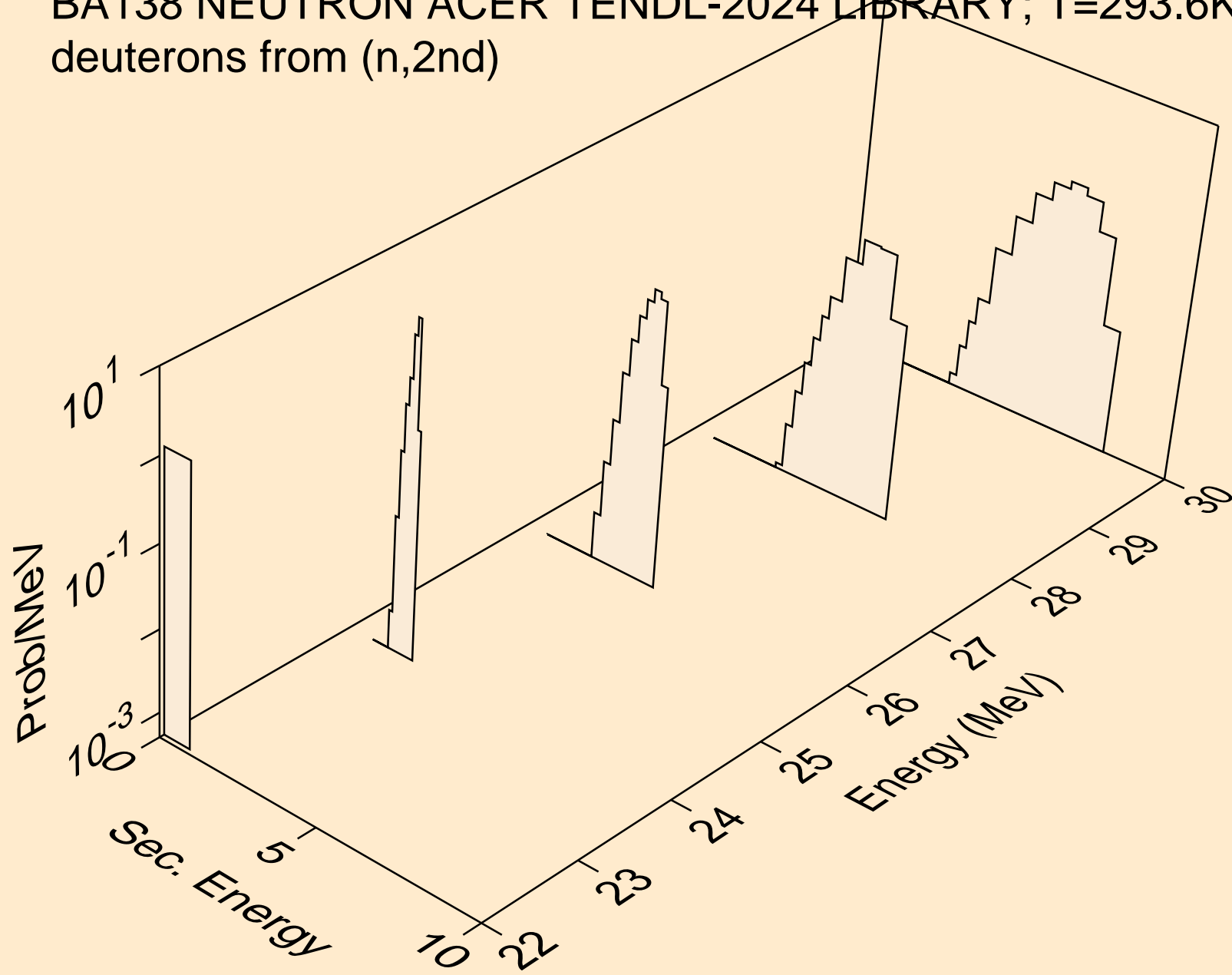

BA138 NEUTRON ACER TENDL-2024 LIBRARY; T=293.6K
deuterons from (n,n*)d

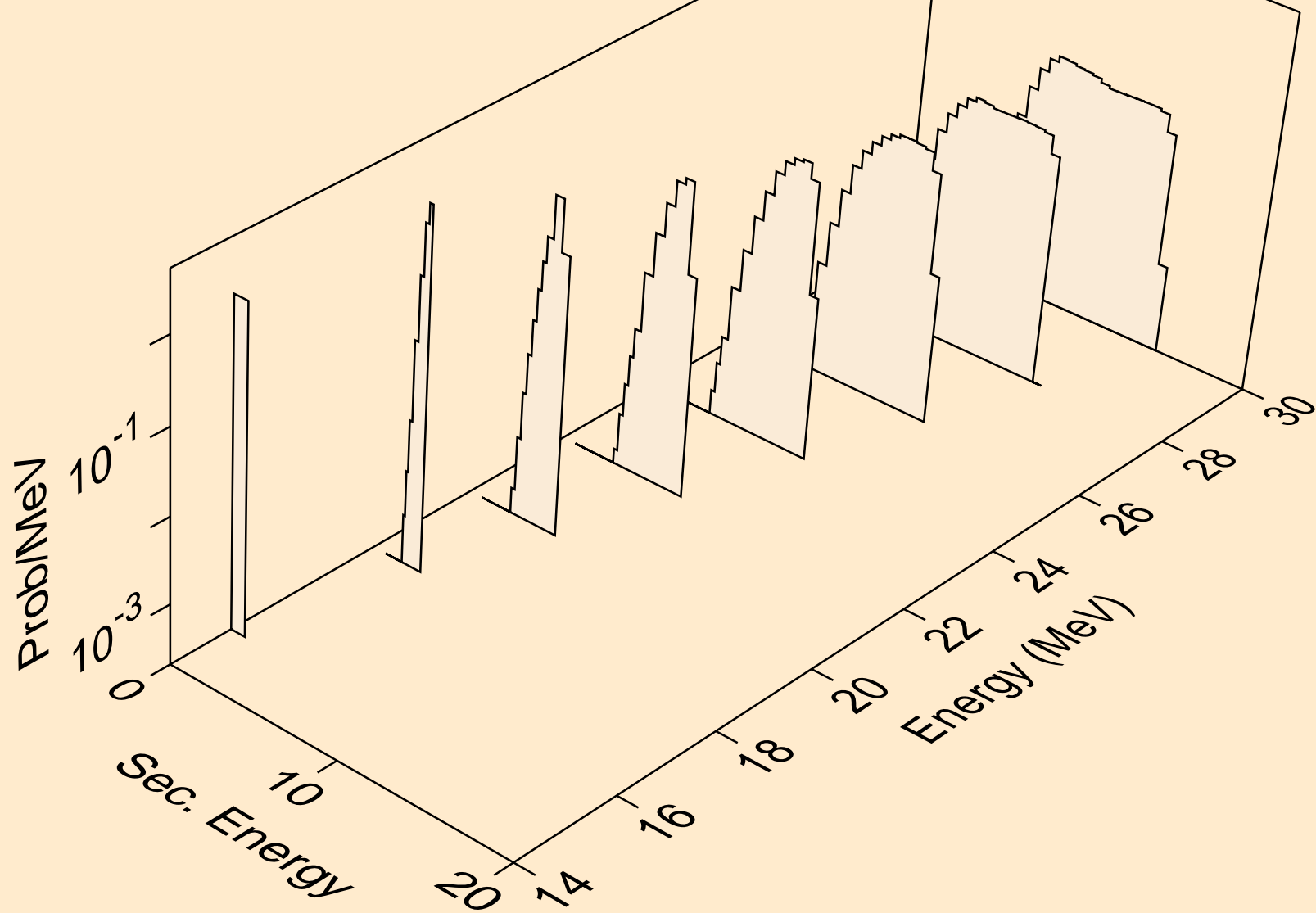

BA138 NEUTRON ACER TENDL-2024 LIBRARY; T=293.6K
deuterons from (n,d)

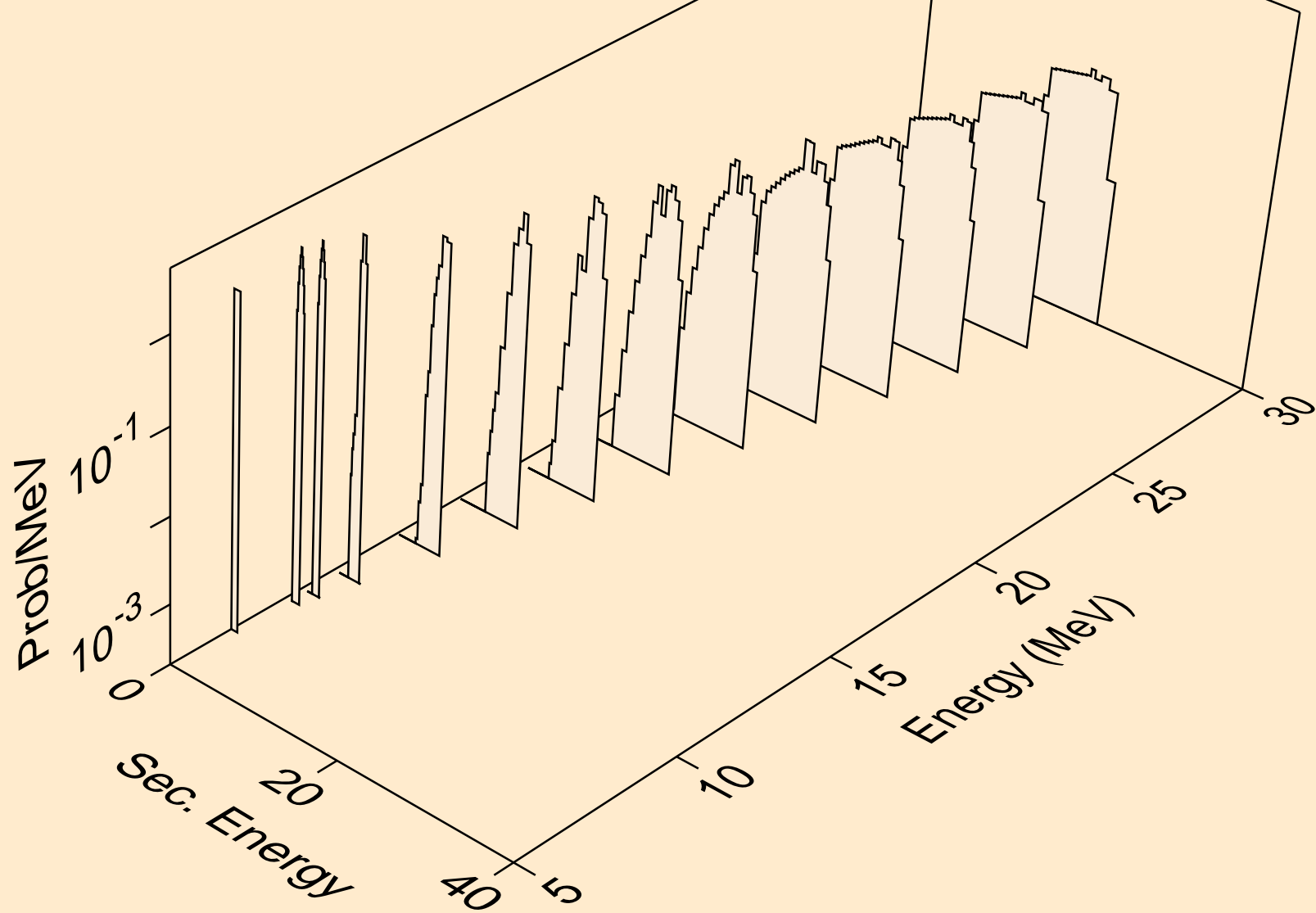

BA138 NEUTRON ACER TENDL-2024 LIBRARY; T=293.6K
deuterons from (n,pd)

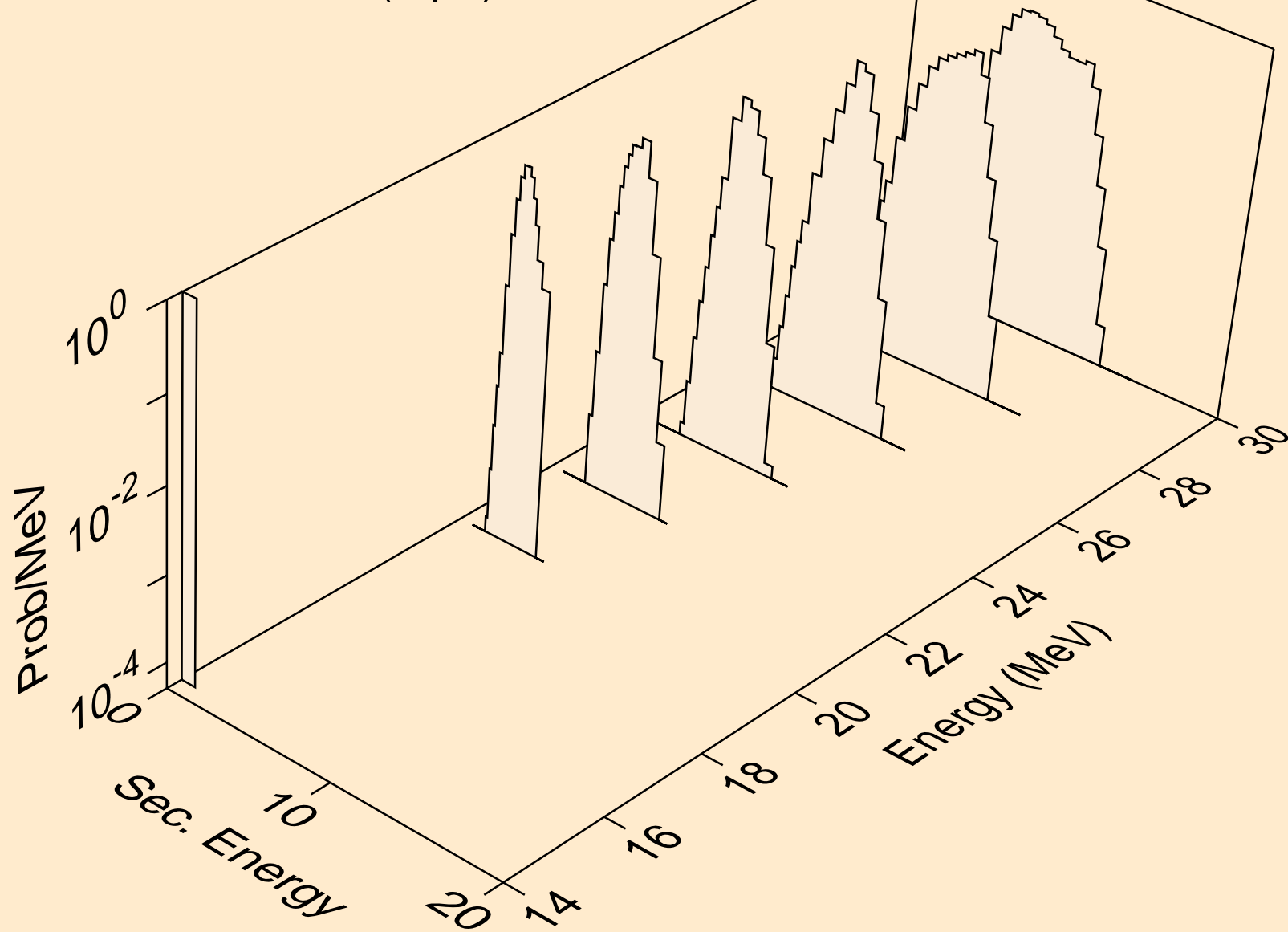

BA138 NEUTRON ACER TENDL-2024 LIBRARY; T=293.6K
deuterons from (n,da)

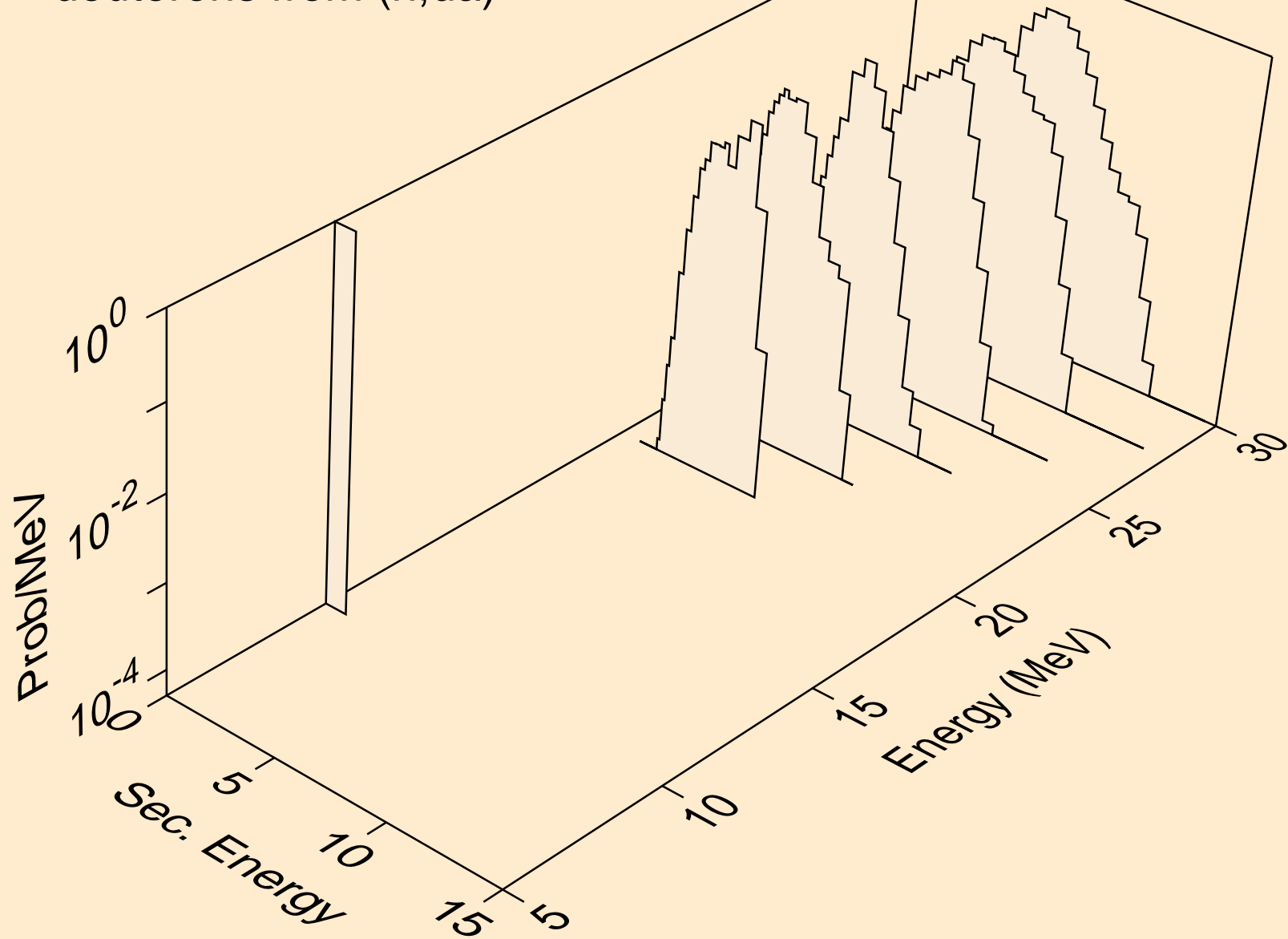

BA138 NEUTRON ACER TENDL-2024 LIBRARY; T=293.6K
tritons from (n,x)

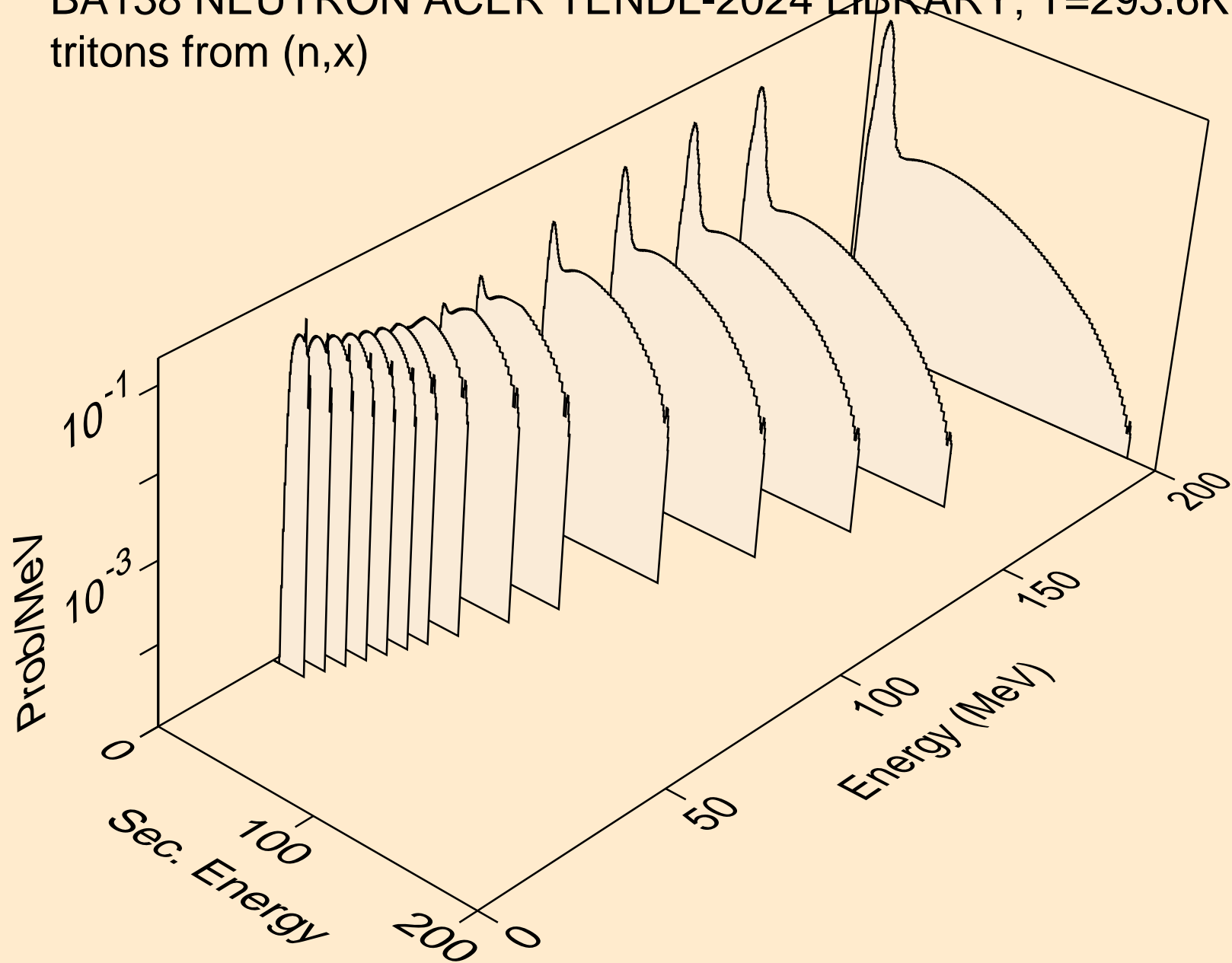

BA138 NEUTRON ACER TENDL-2024 LIBRARY; T=293.6K
tritons from (n,n*)t

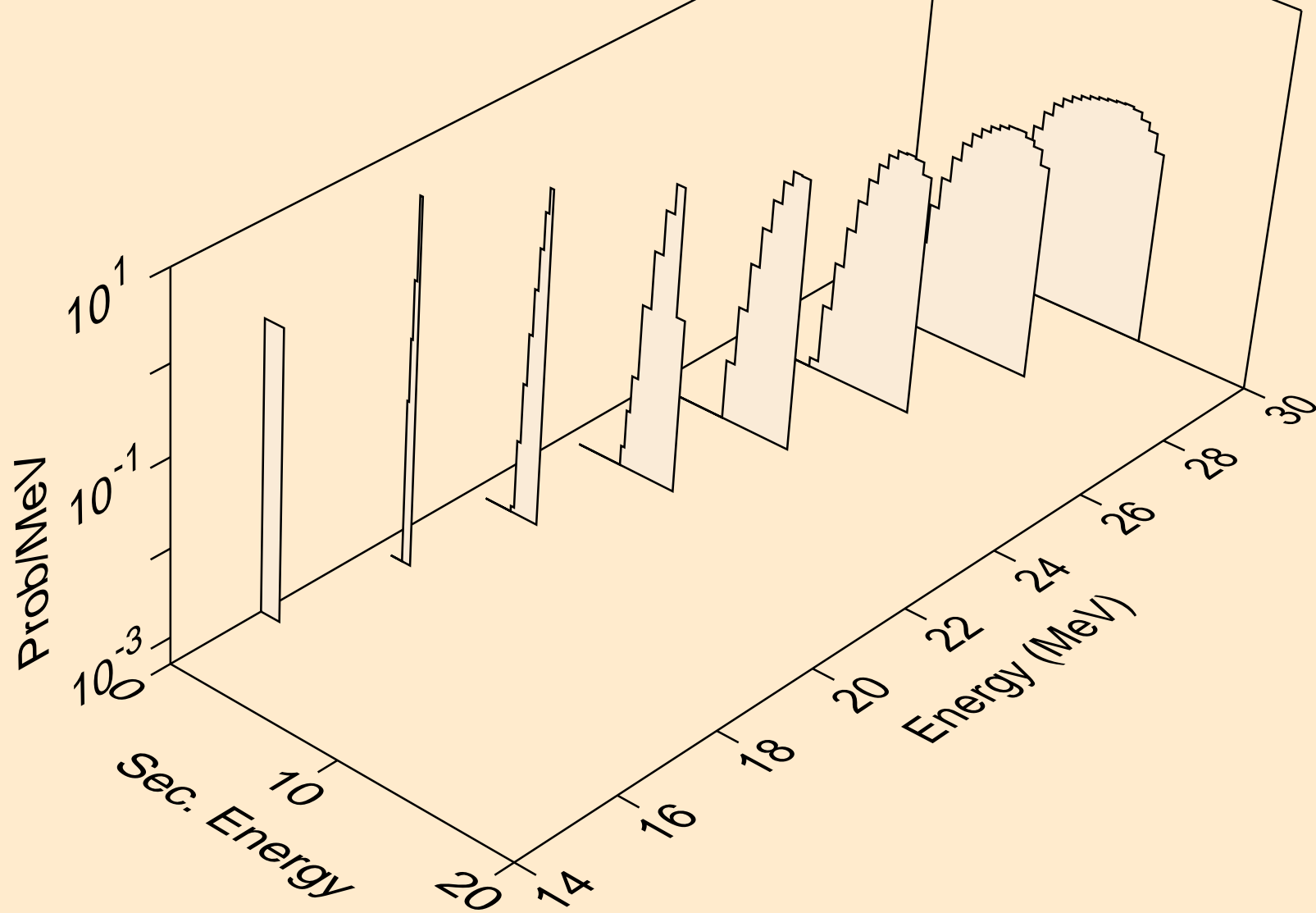

BA138 NEUTRON ACER TENDL-2024 LIBRARY; T=293.6K
tritons from (n,t)

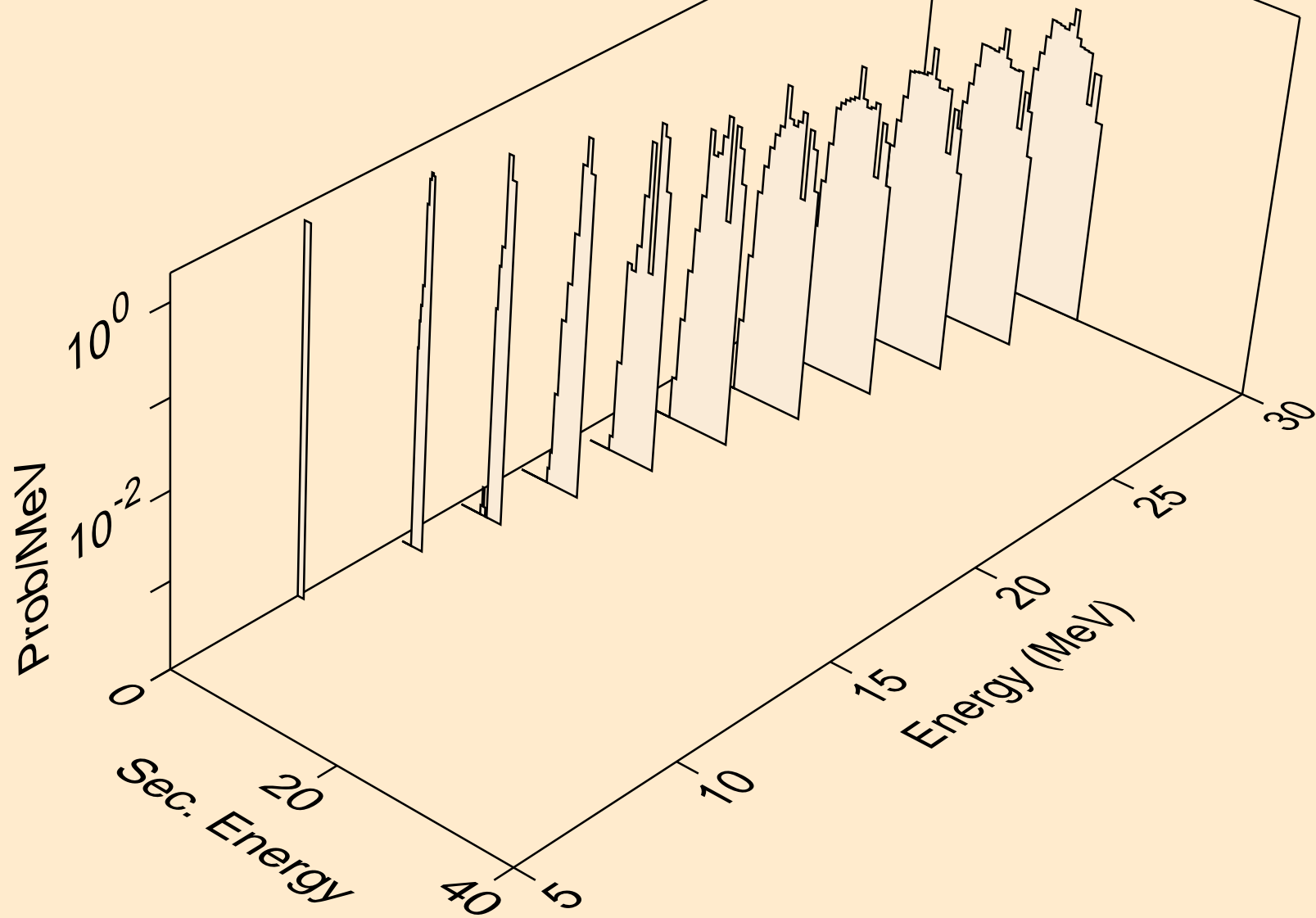

BA138 NEUTRON ACER TENDL-2024 LIBRARY; T=293.6K
tritons from (n,pt)

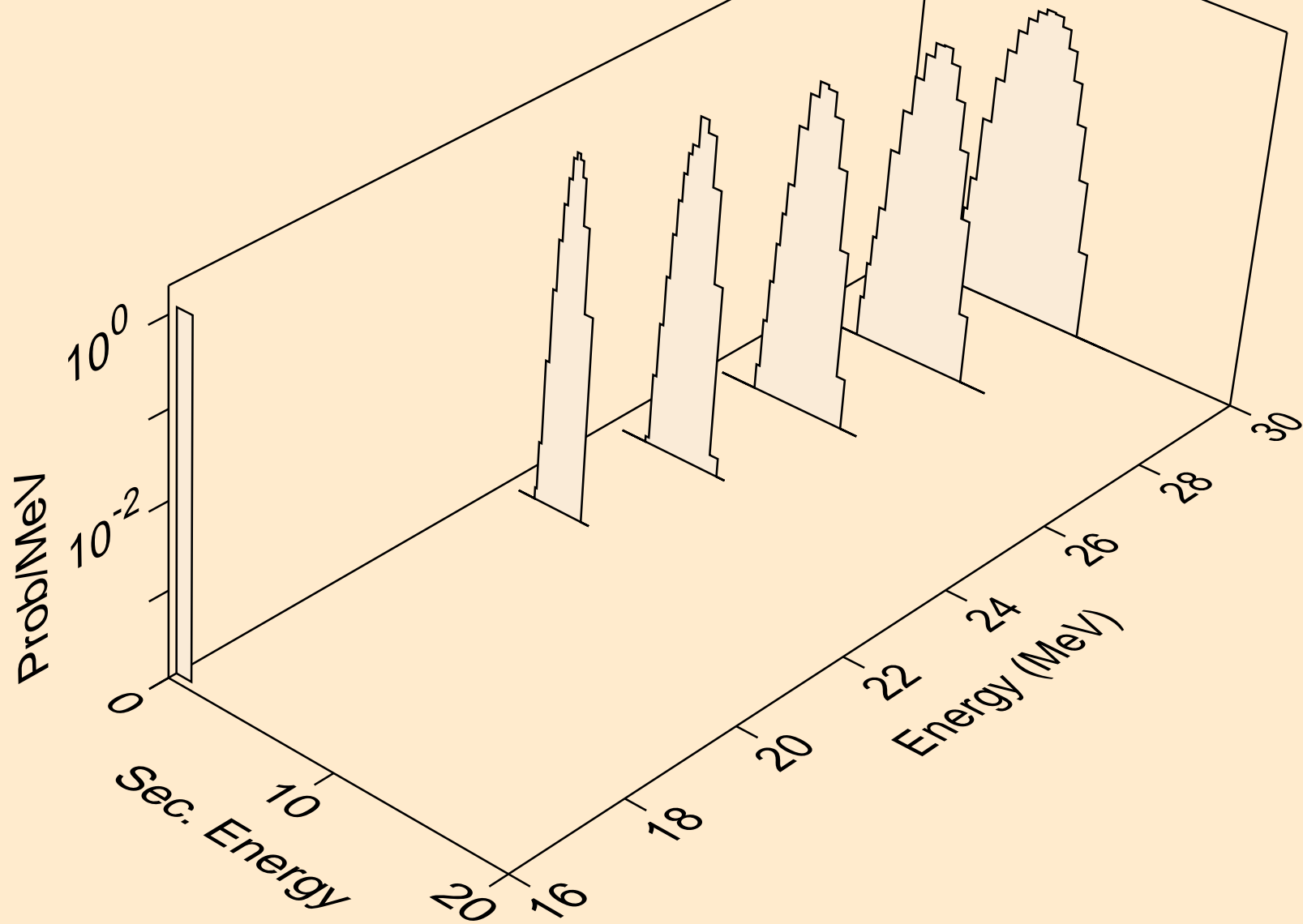

BA138 NEUTRON ACER TENDL-2024 LIBRARY; T=293.6K
he3s from (n,x)

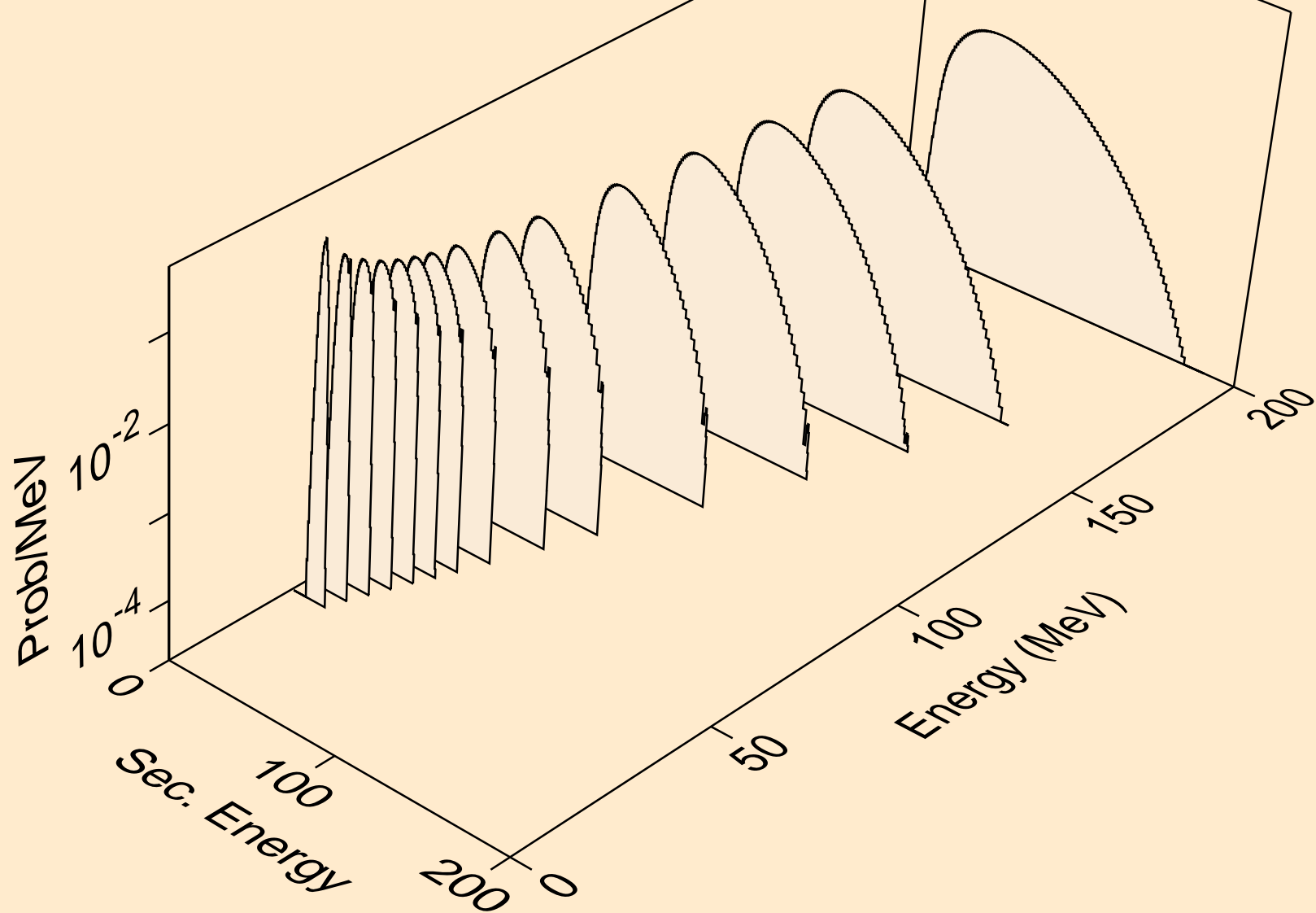

BA138 NEUTRON ACER TENDL-2024 LIBRARY; T=293.6K
he3s from (n,n*)he3

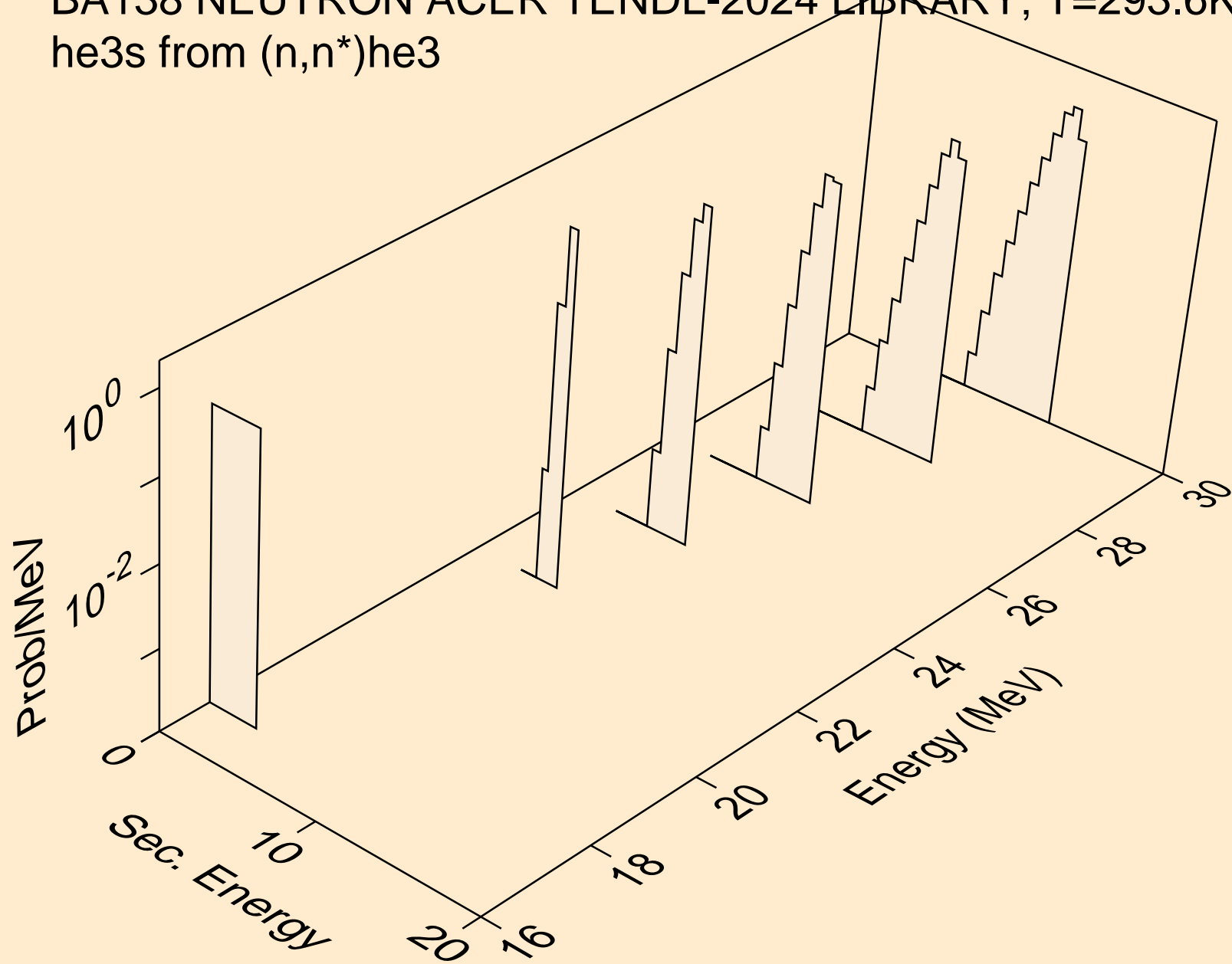

BA138 NEUTRON ACER TENDL-2024 LIBRARY; T=293.6K
he3s from (n,he3)

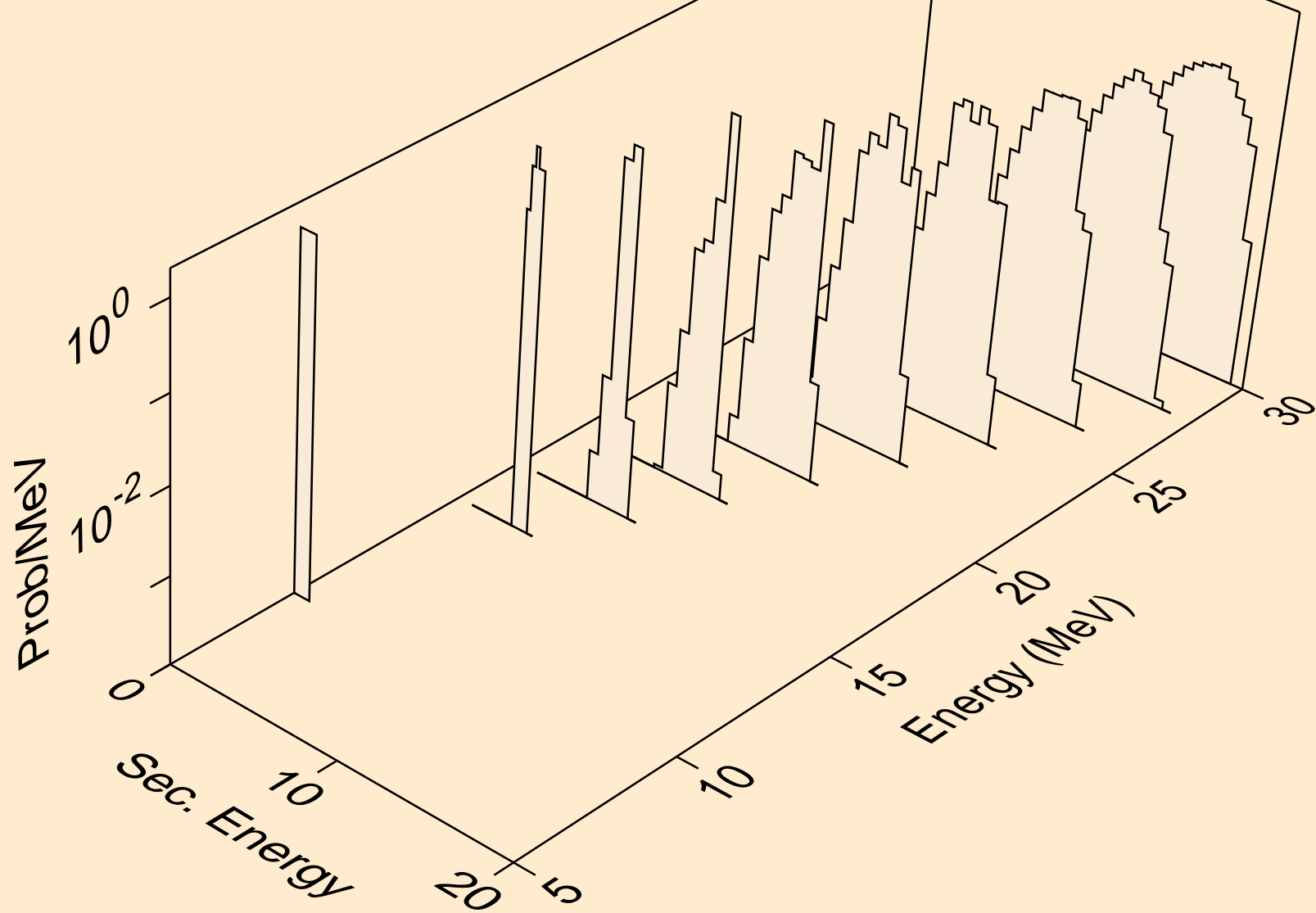

BA138 NEUTRON ACER TENDL-2024 LIBRARY; T=293.6K
alphas from (n,x)

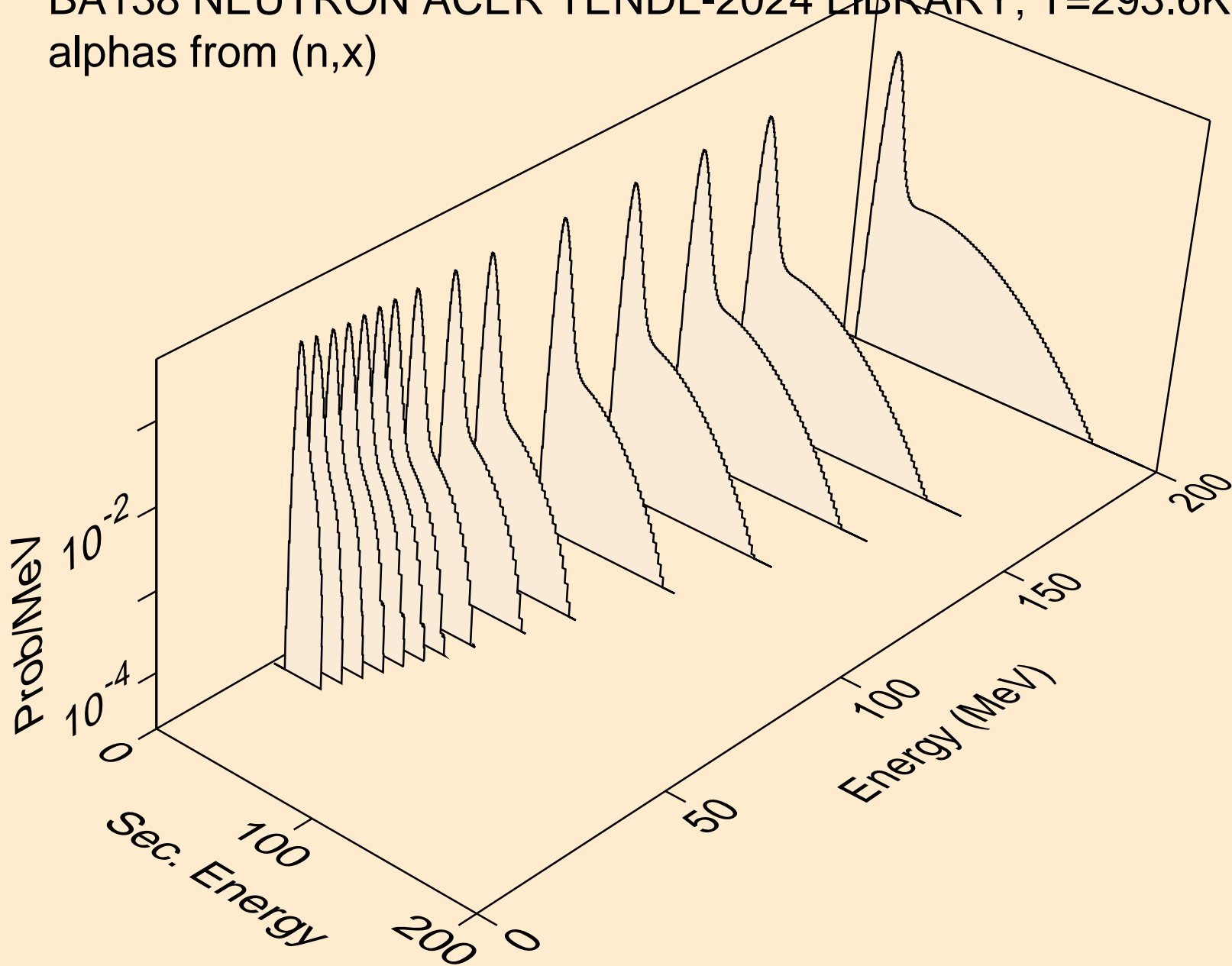

BA138 NEUTRON ACER TENDL-2024 LIBRARY; T=293.6K
alphas from (n,n*)a

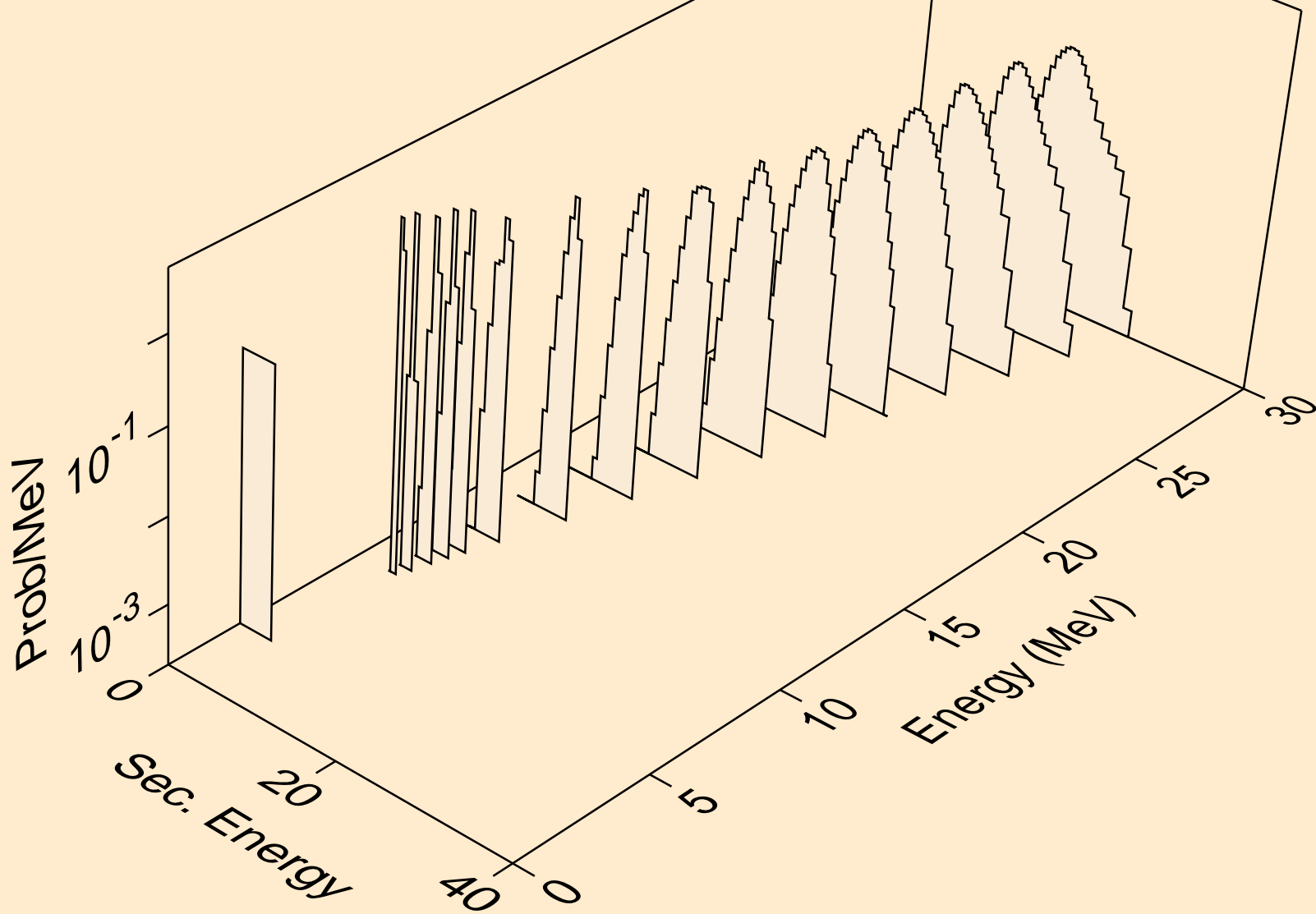

BA138 NEUTRON ACER TENDL-2024 LIBRARY; T=293.6K
alphas from (n,2n)a

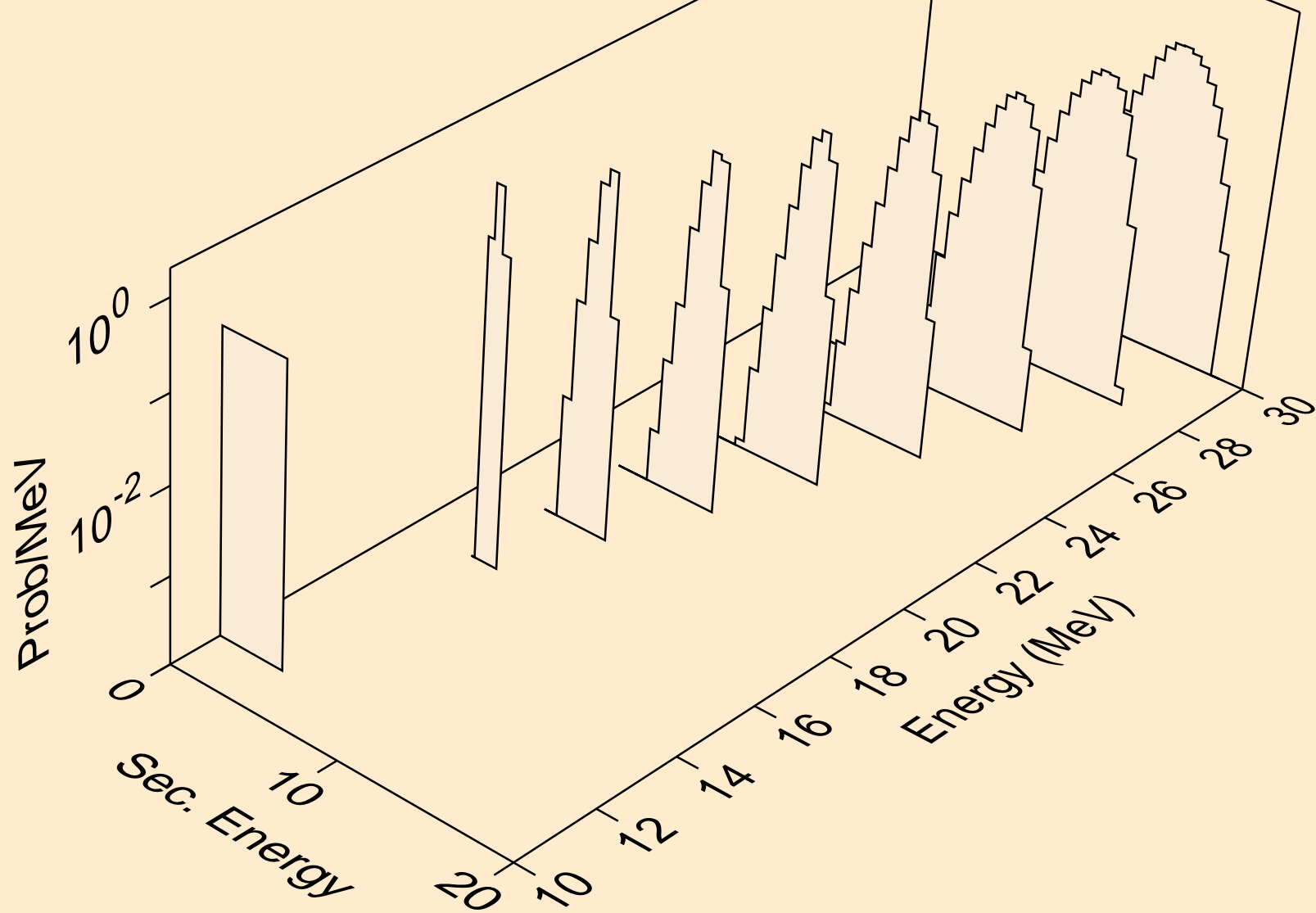

BA138 NEUTRON ACER TENDL-2024 LIBRARY; T=293.6K
alphas from (n,3n)a

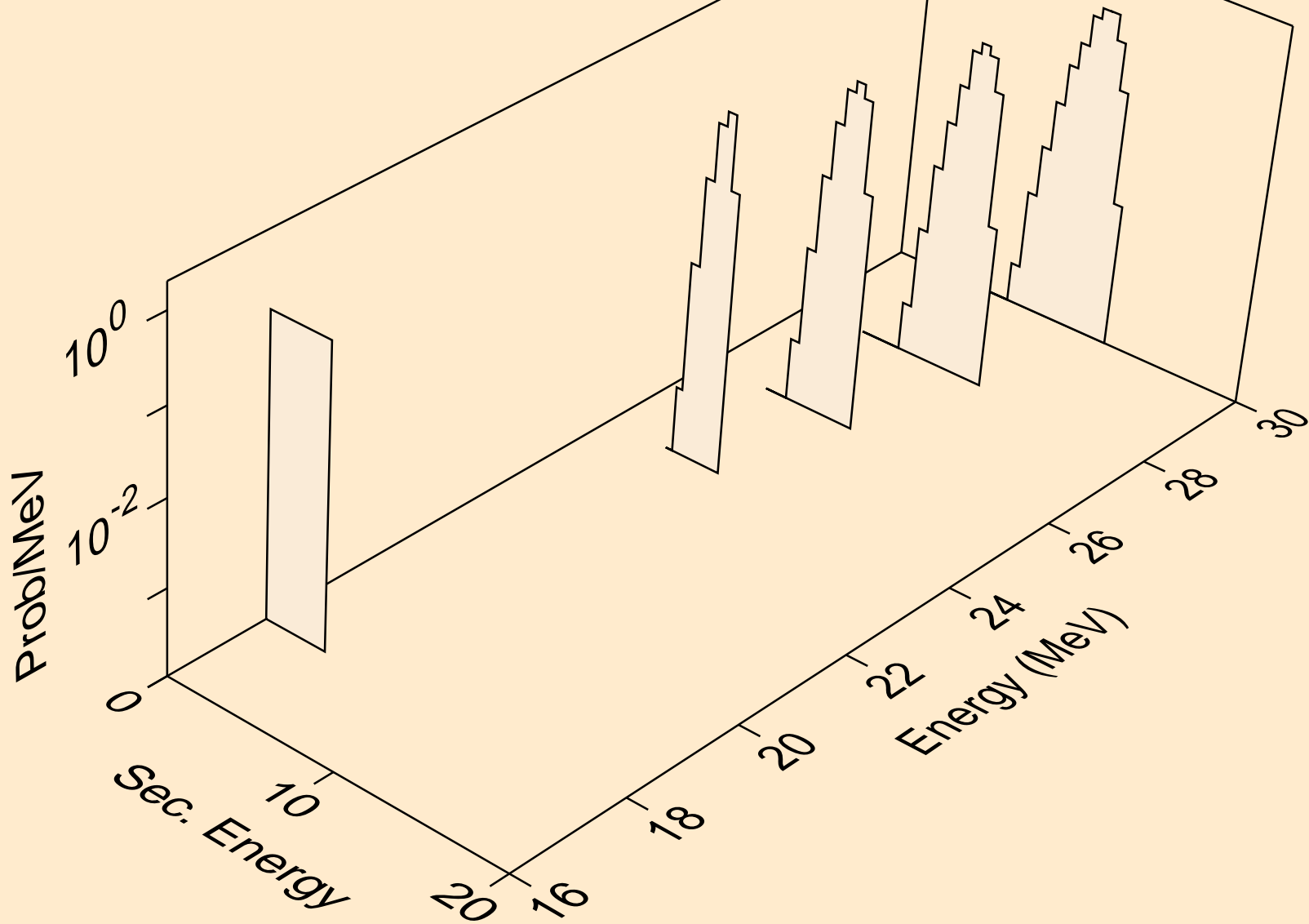

BA138 NEUTRON ACER TENDL-2024 LIBRARY; T=293.6K
alphas from (n,n*)2a

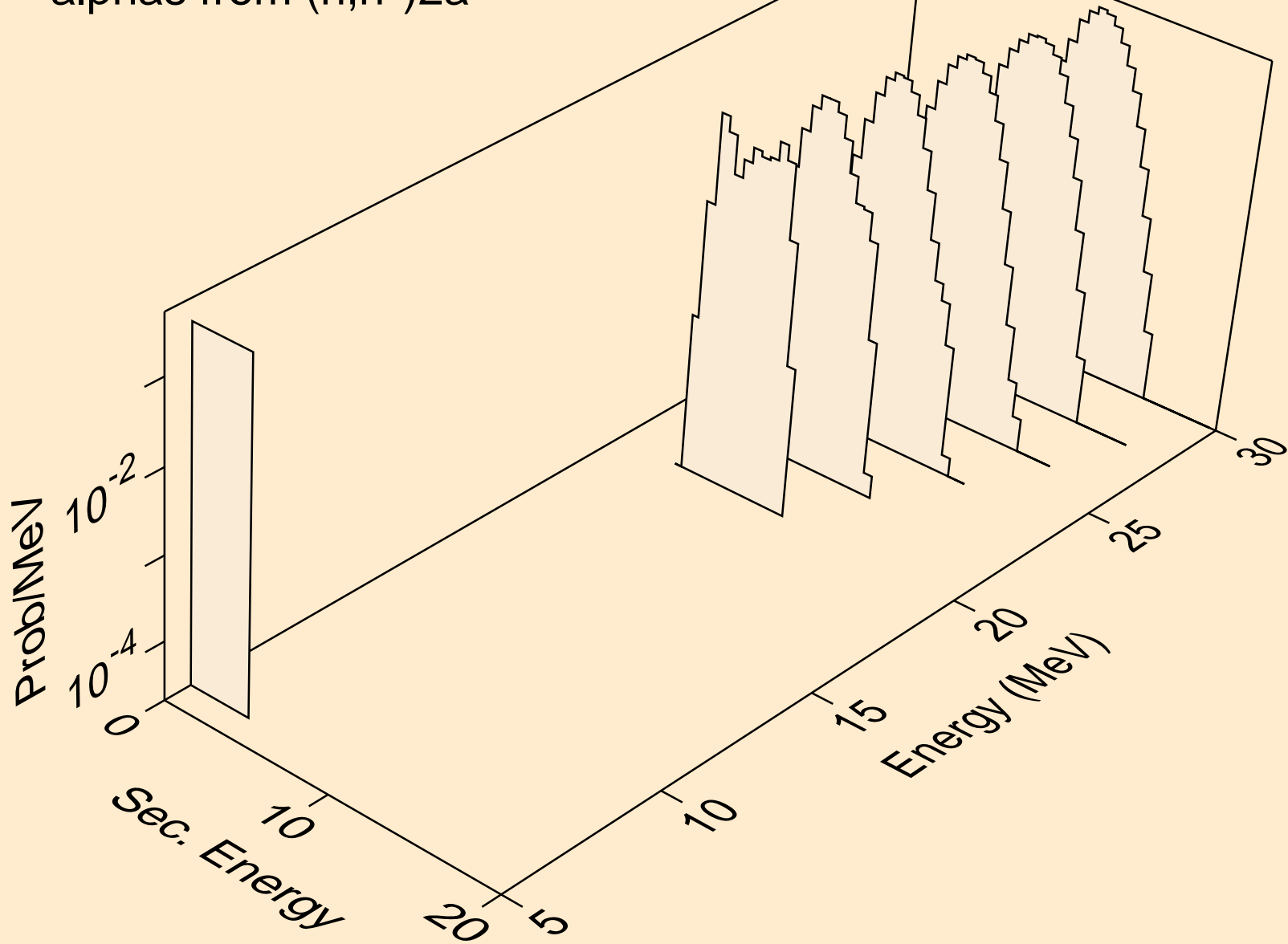

BA138 NEUTRON ACER TENDL-2024 LIBRARY; T=293.6K
alphas from (n,npa)

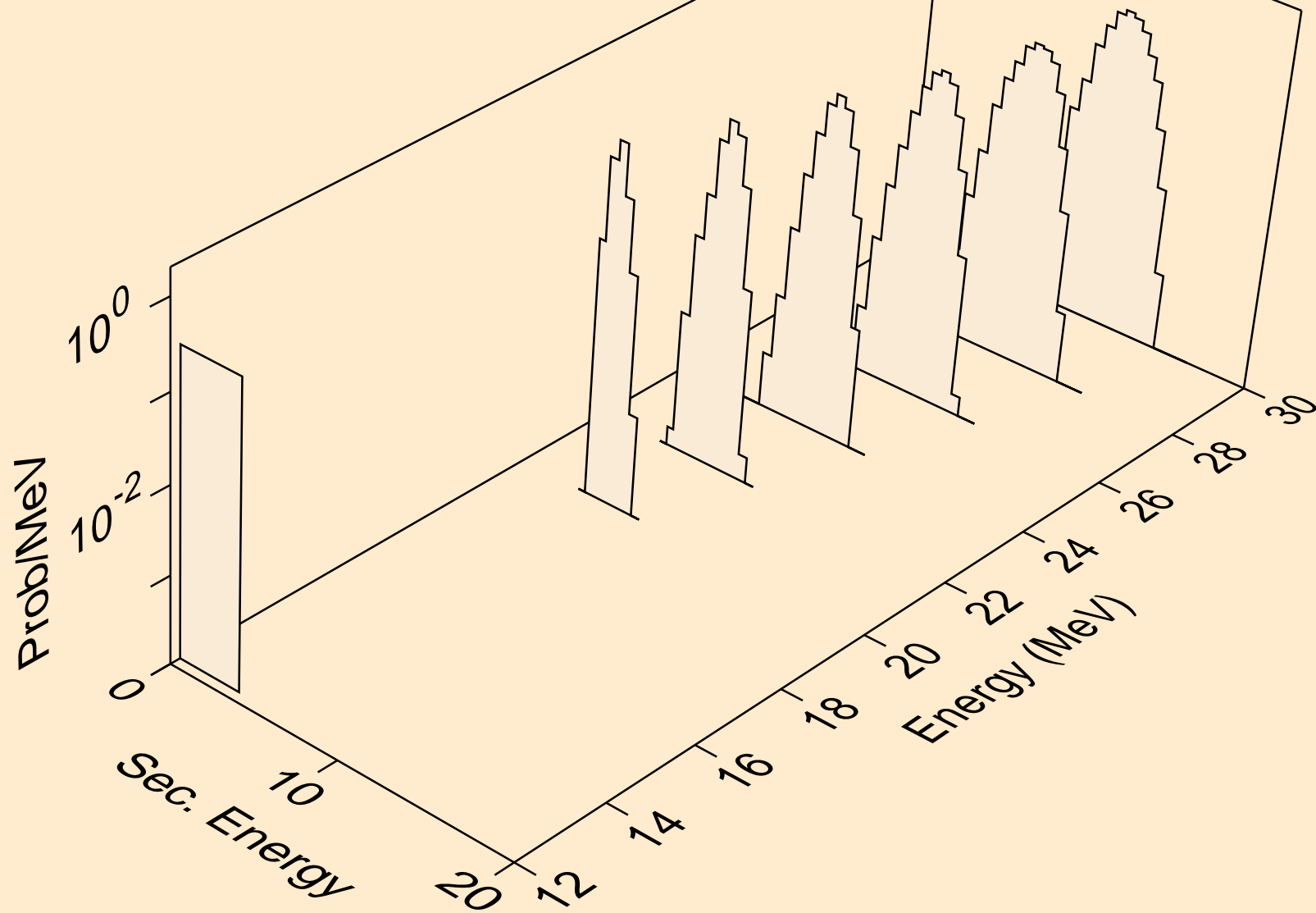

BA138 NEUTRON ACER TENDL-2024 LIBRARY; T=293.6K
alphas from (n,a)

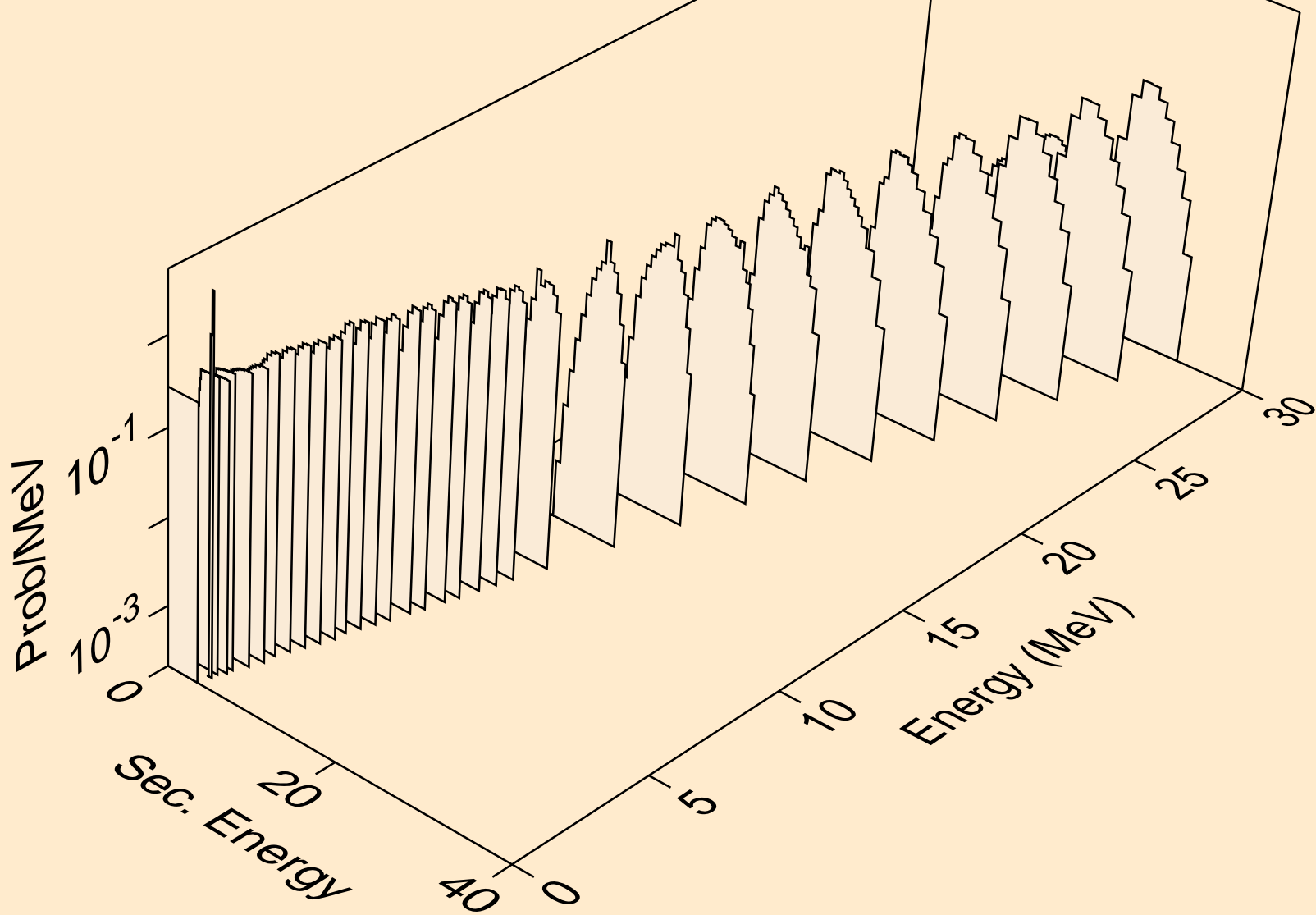

BA138 NEUTRON ACER TENDL-2024 LIBRARY; T=293.6K
alphas from (n,2a)

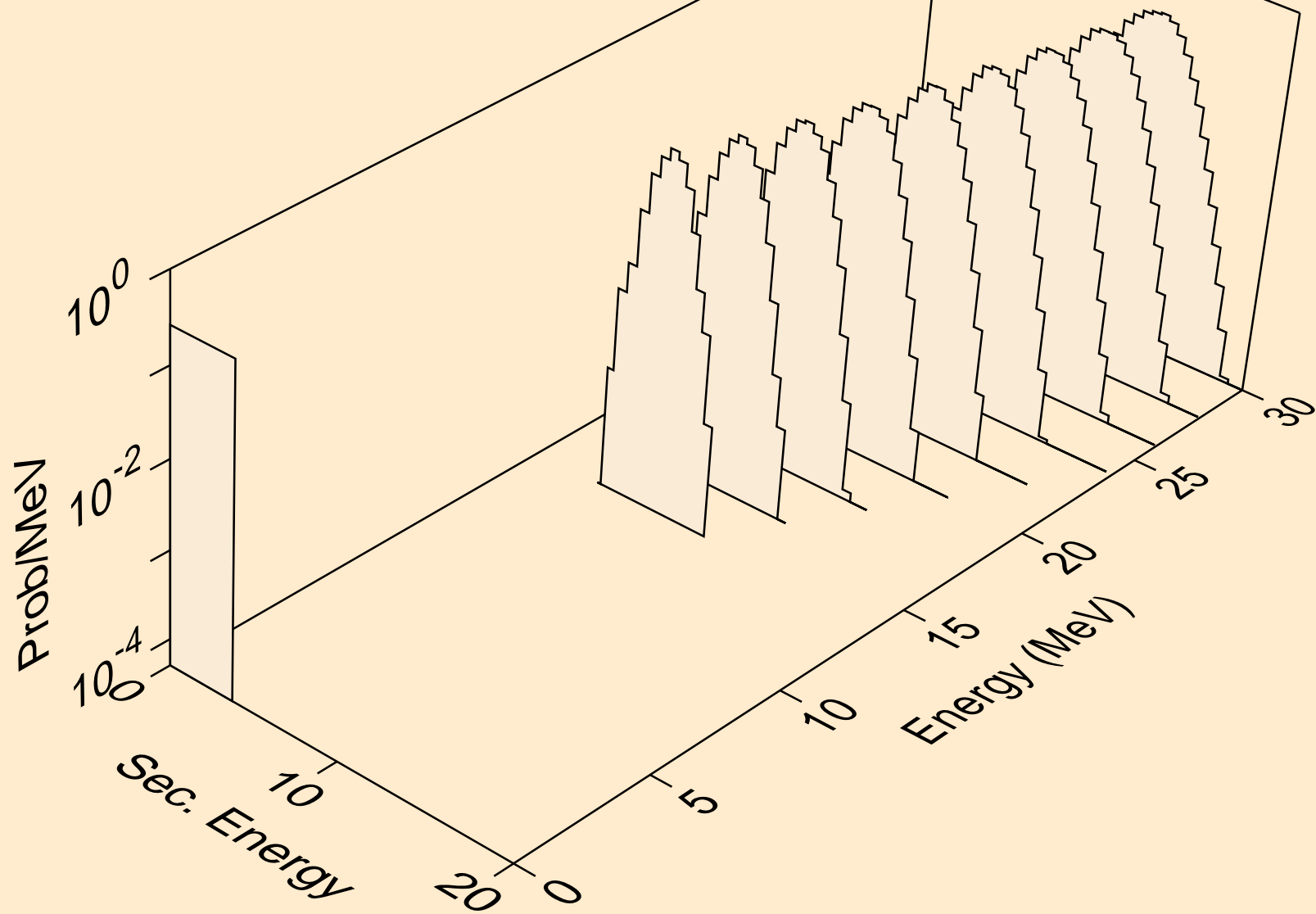

BA138 NEUTRON ACER TENDL-2024 LIBRARY; T=293.6K
alphas from (n,pa)

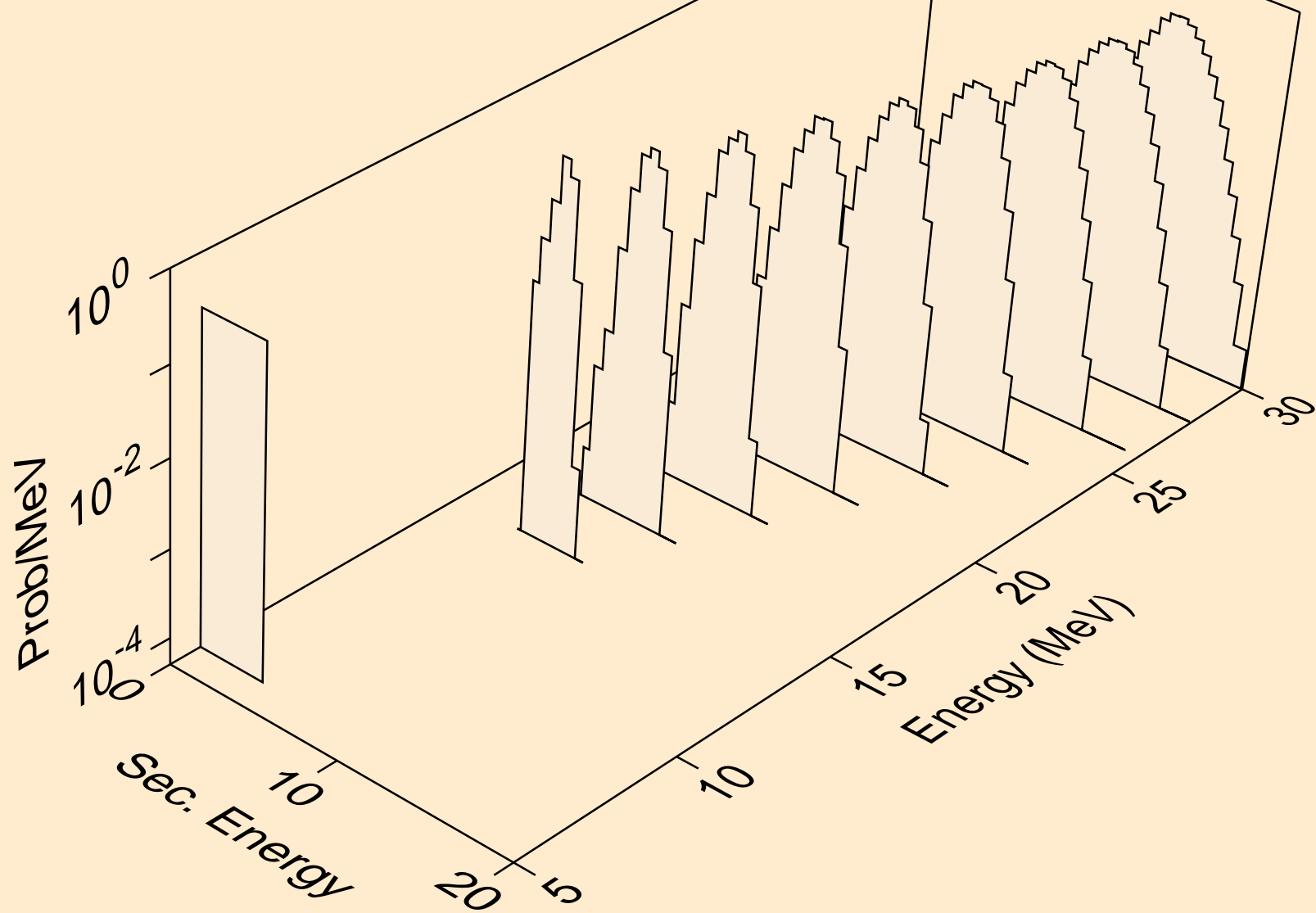

BA138 NEUTRON ACER TENDL-2024 LIBRARY; T=293.6K
alphas from (n,da)

