

BI190M NEUTRON ACER TENDL-2024 LIBRARY; T=293.6K  
Principal cross sections

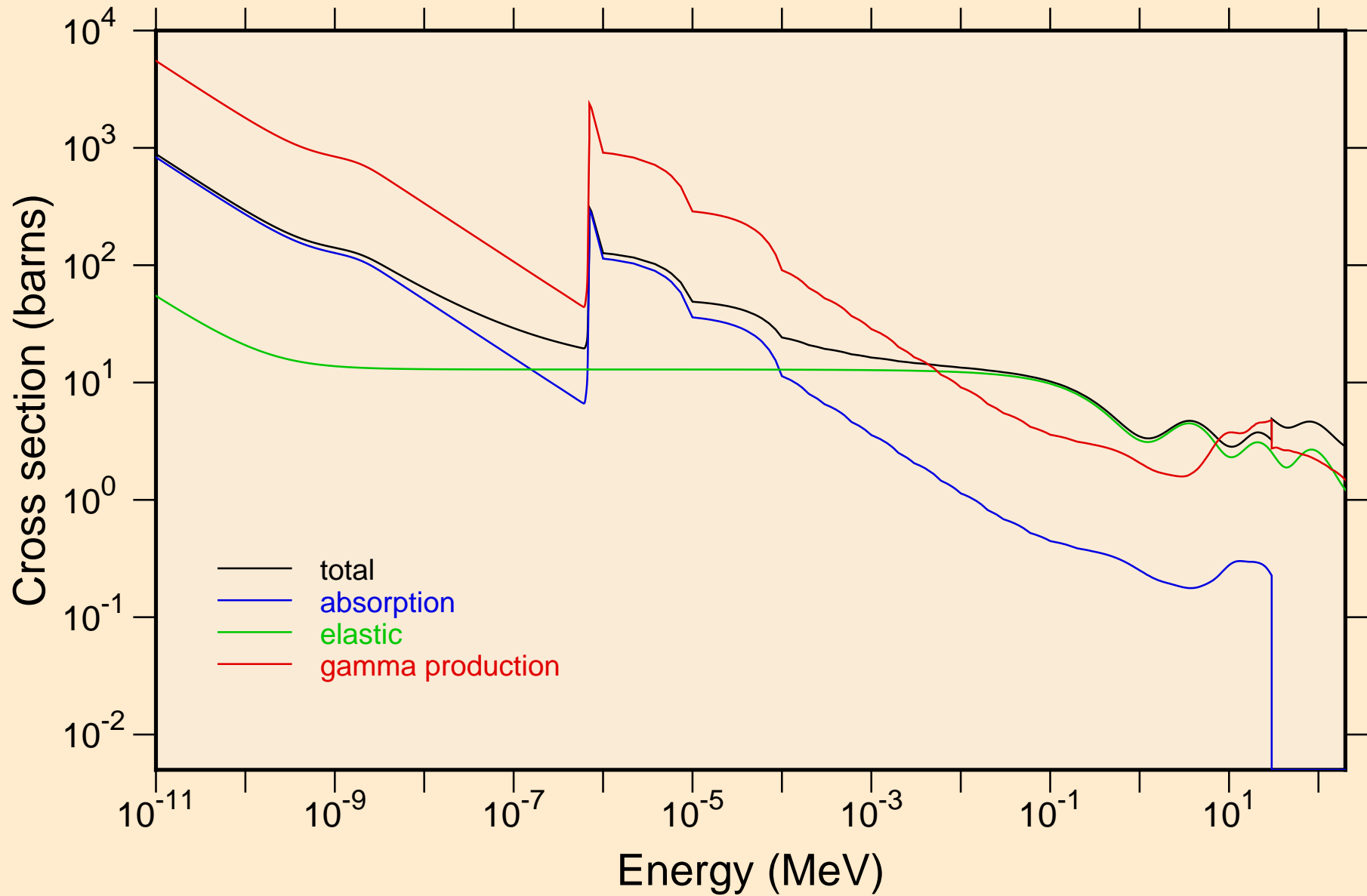

BI190M NEUTRON ACER TENDL-2024 LIBRARY; T=293.6K  
Heating

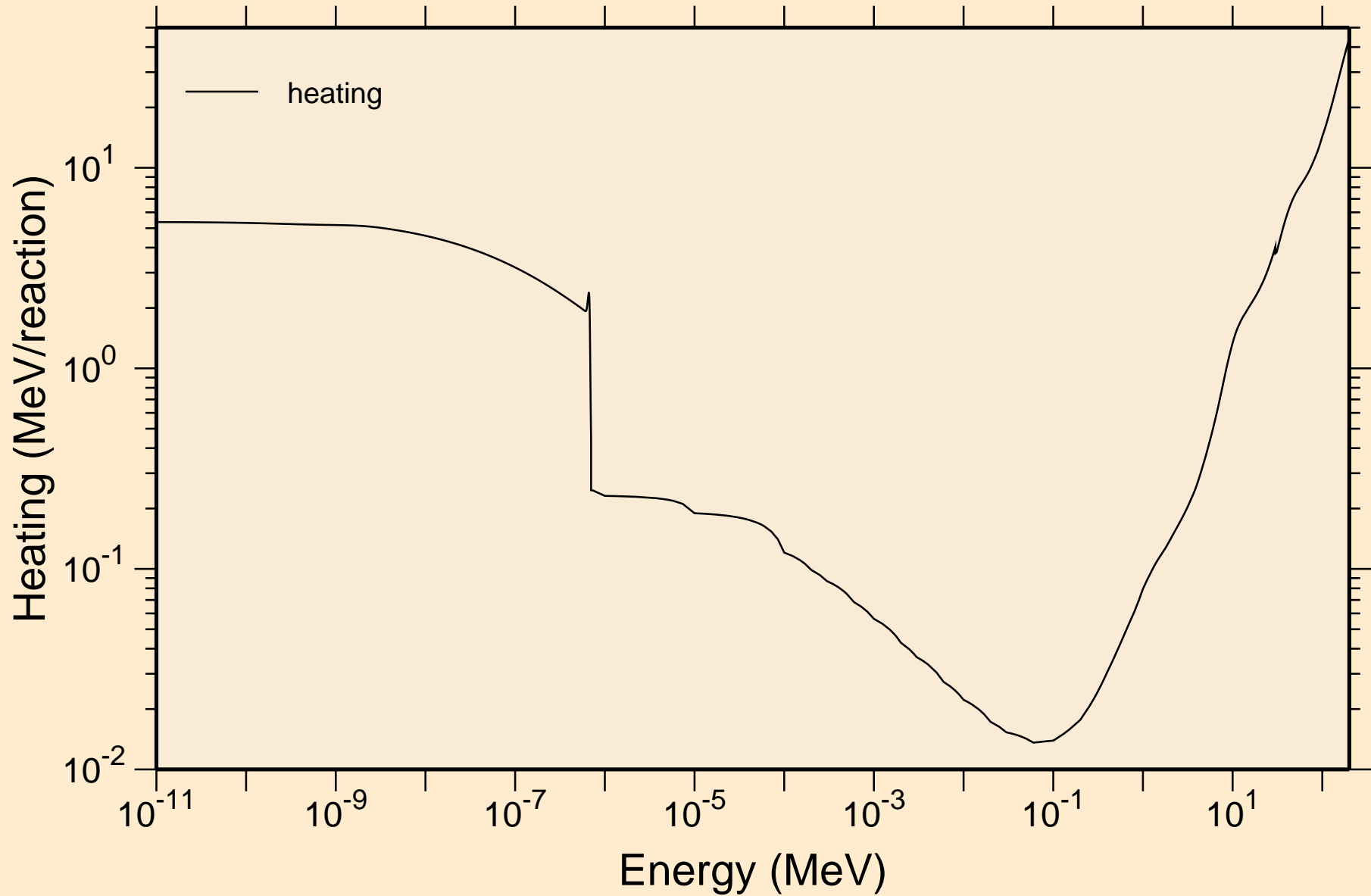

BI190M NEUTRON ACER TENDL-2024 LIBRARY; T=293.6K  
Damage

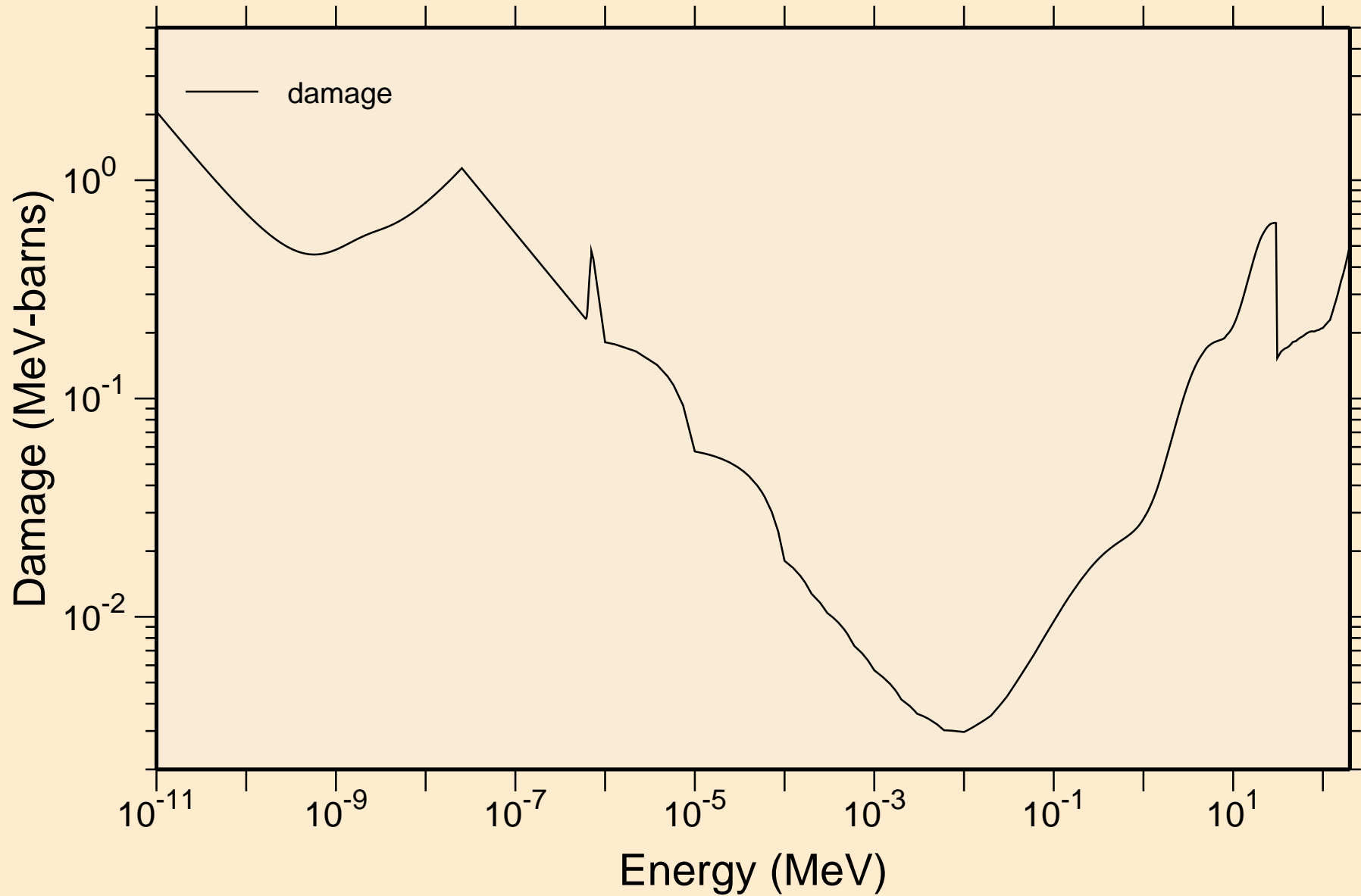

BI190M NEUTRON ACER TENDL-2024 LIBRARY; T=293.6K  
Non-threshold reactions

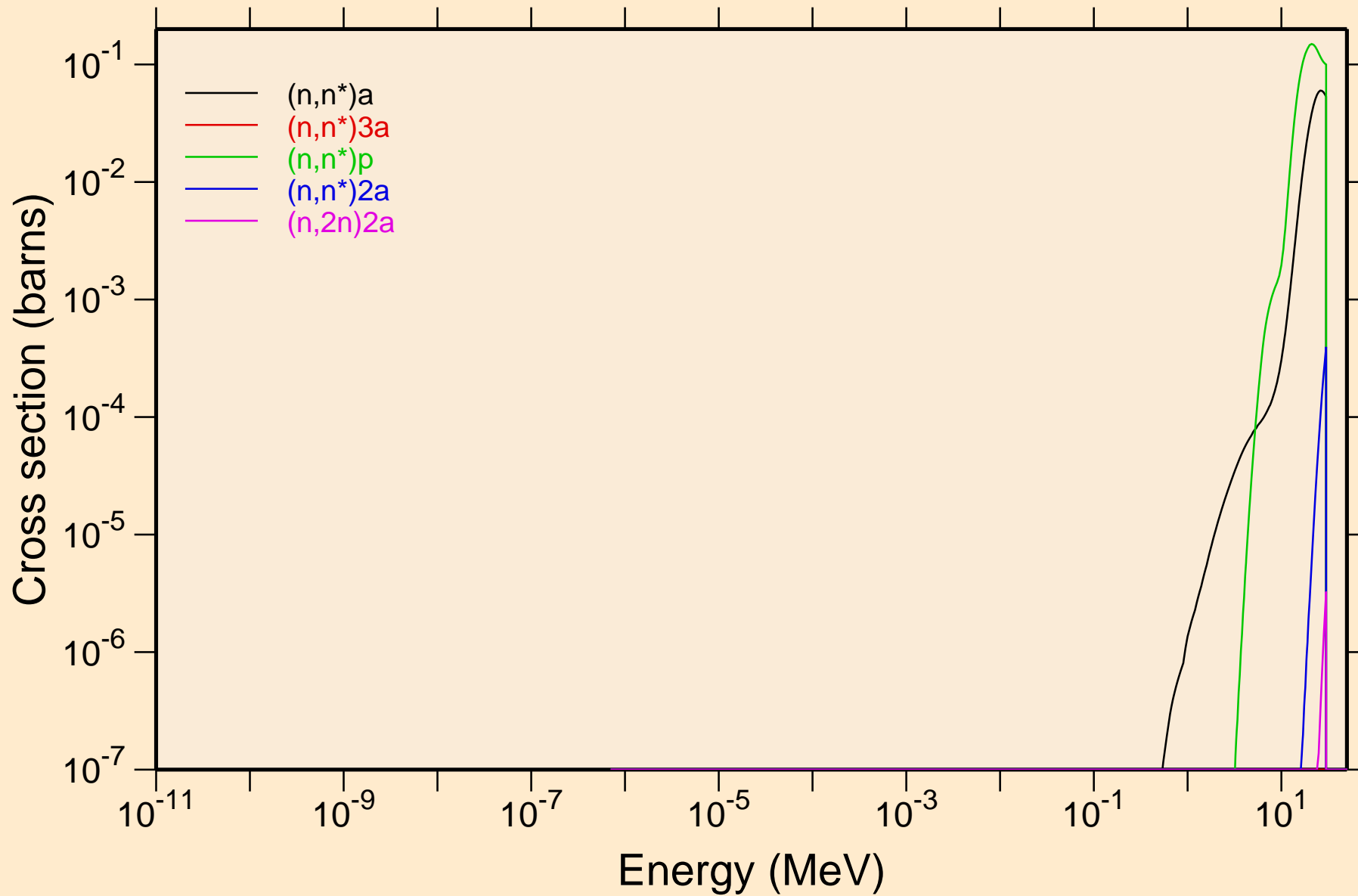

BI190M NEUTRON ACER TENDL-2024 LIBRARY; T=293.6K  
Non-threshold reactions

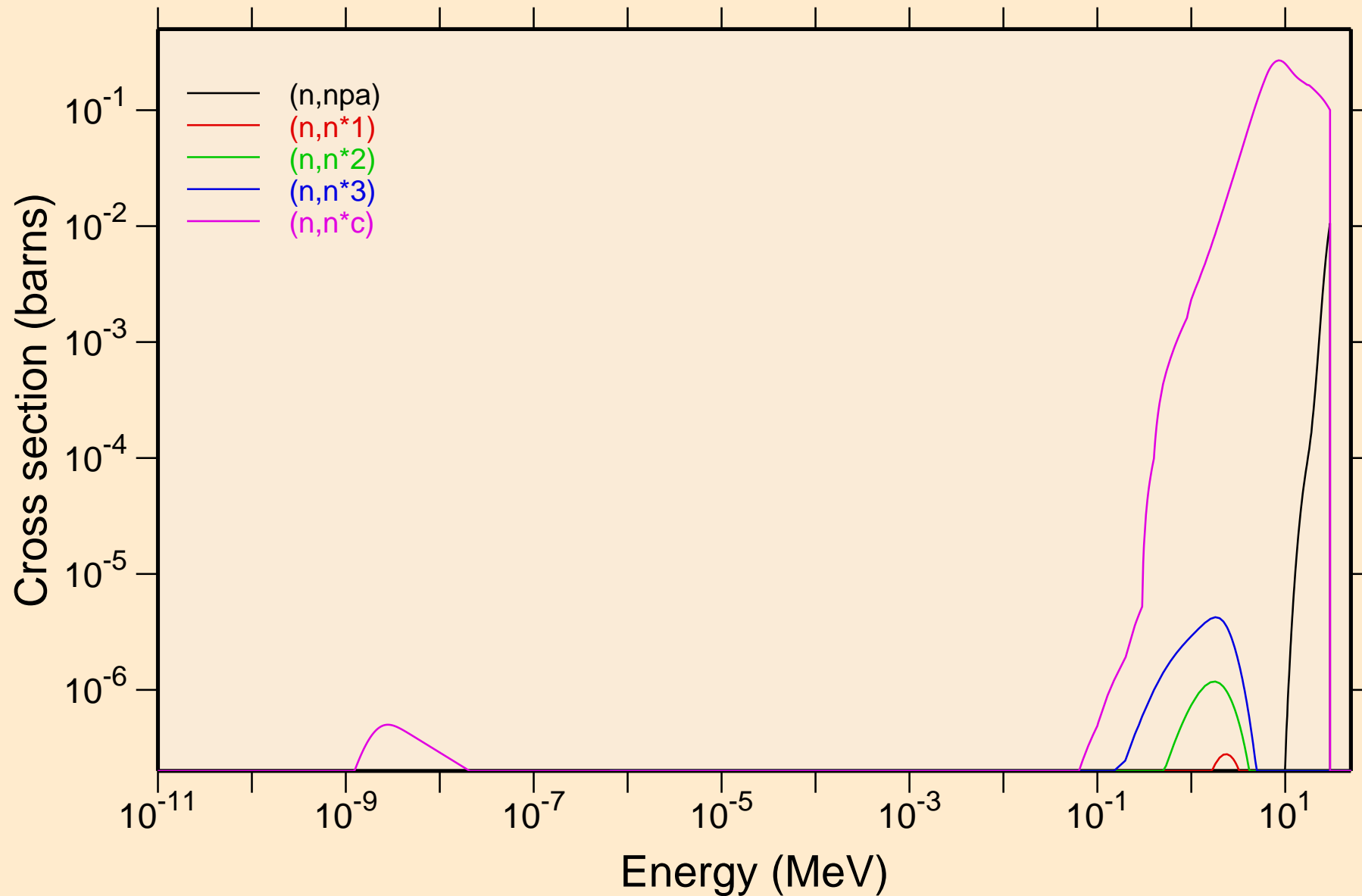

BI190M NEUTRON ACER TENDL-2024 LIBRARY; T=293.6K  
Non-threshold reactions

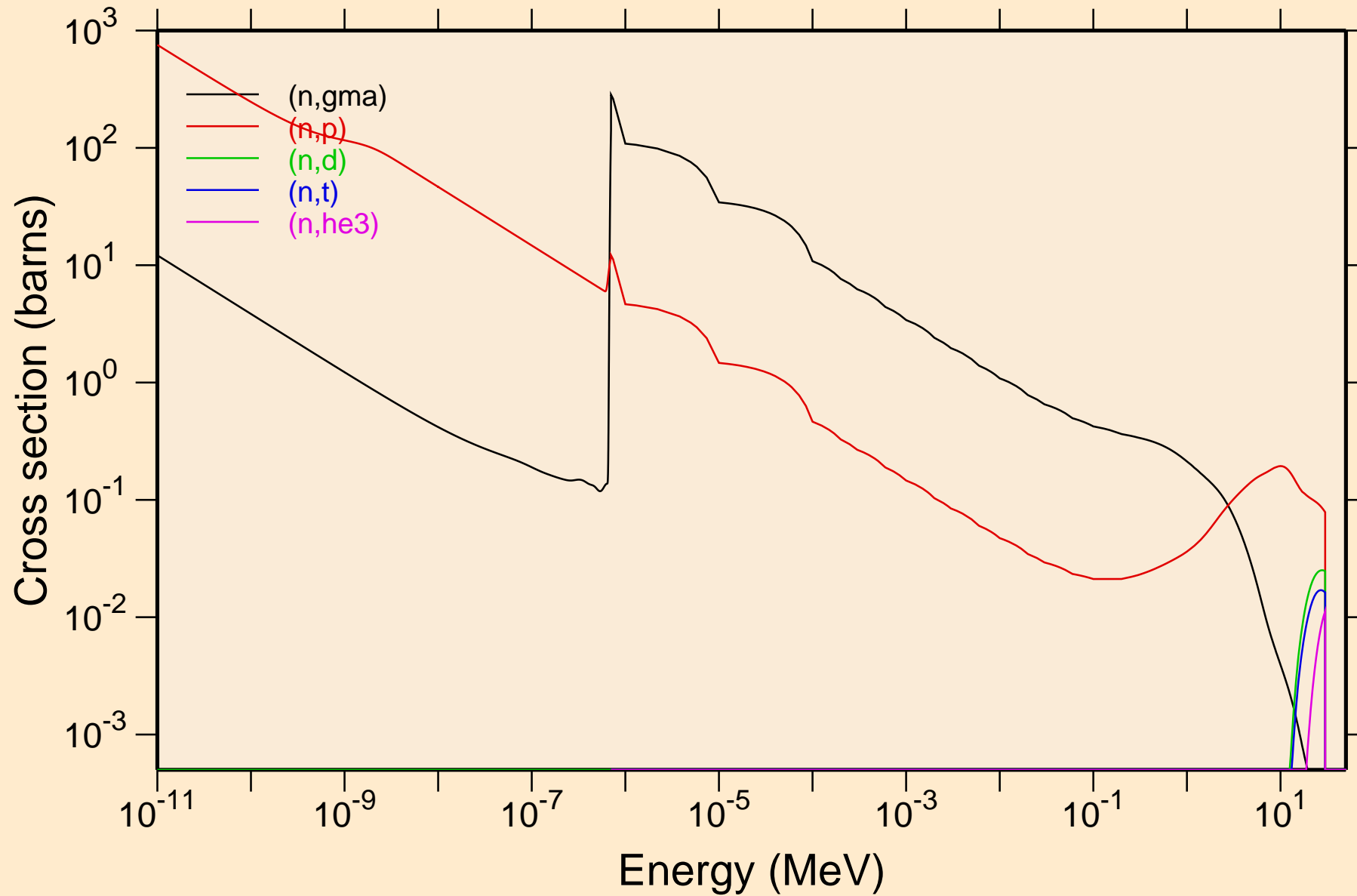

BI190M NEUTRON ACER TENDL-2024 LIBRARY; T=293.6K  
Non-threshold reactions

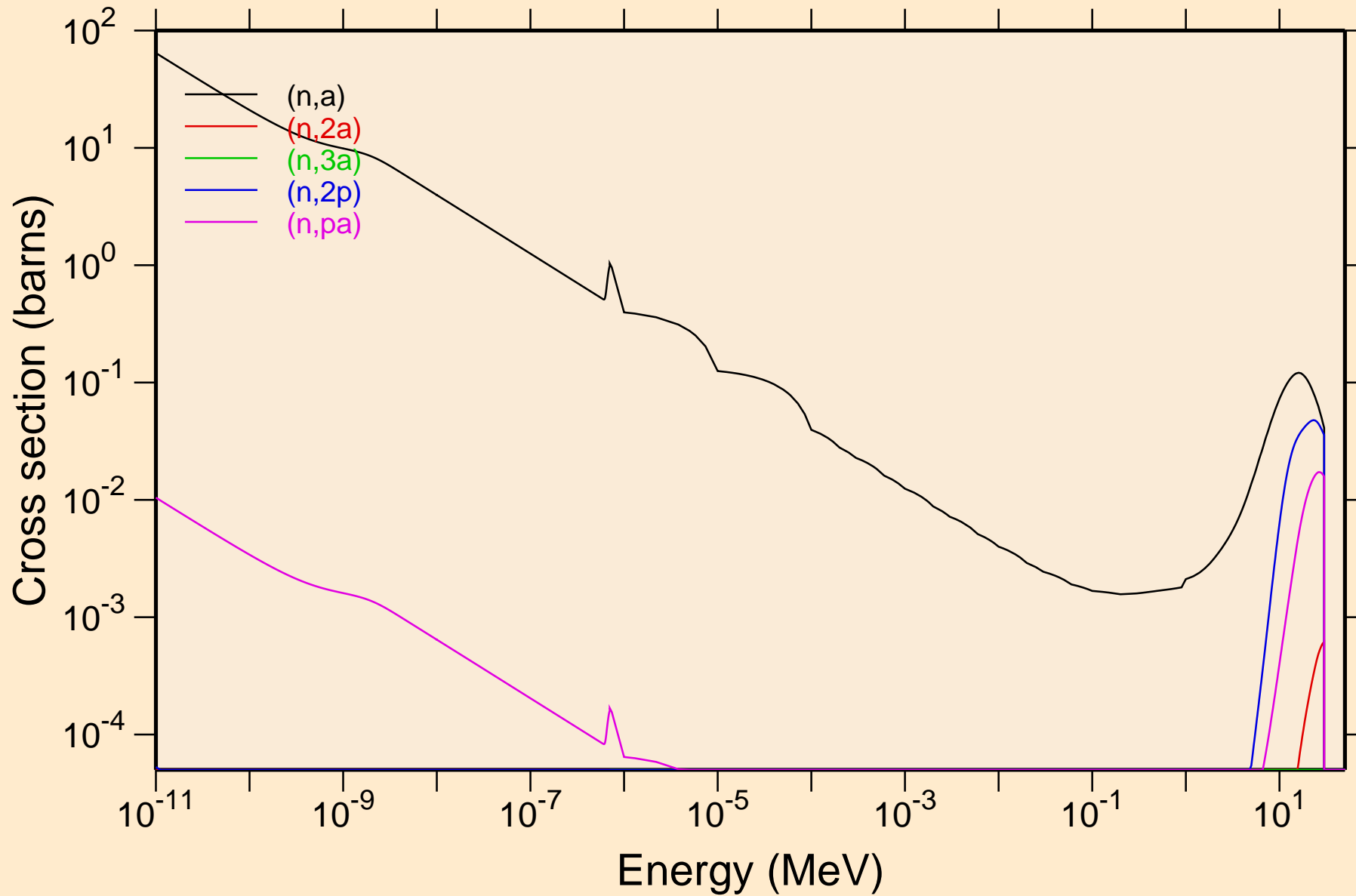

BI190M NEUTRON ACER TENDL-2024 LIBRARY; T=293.6K  
Non-threshold reactions

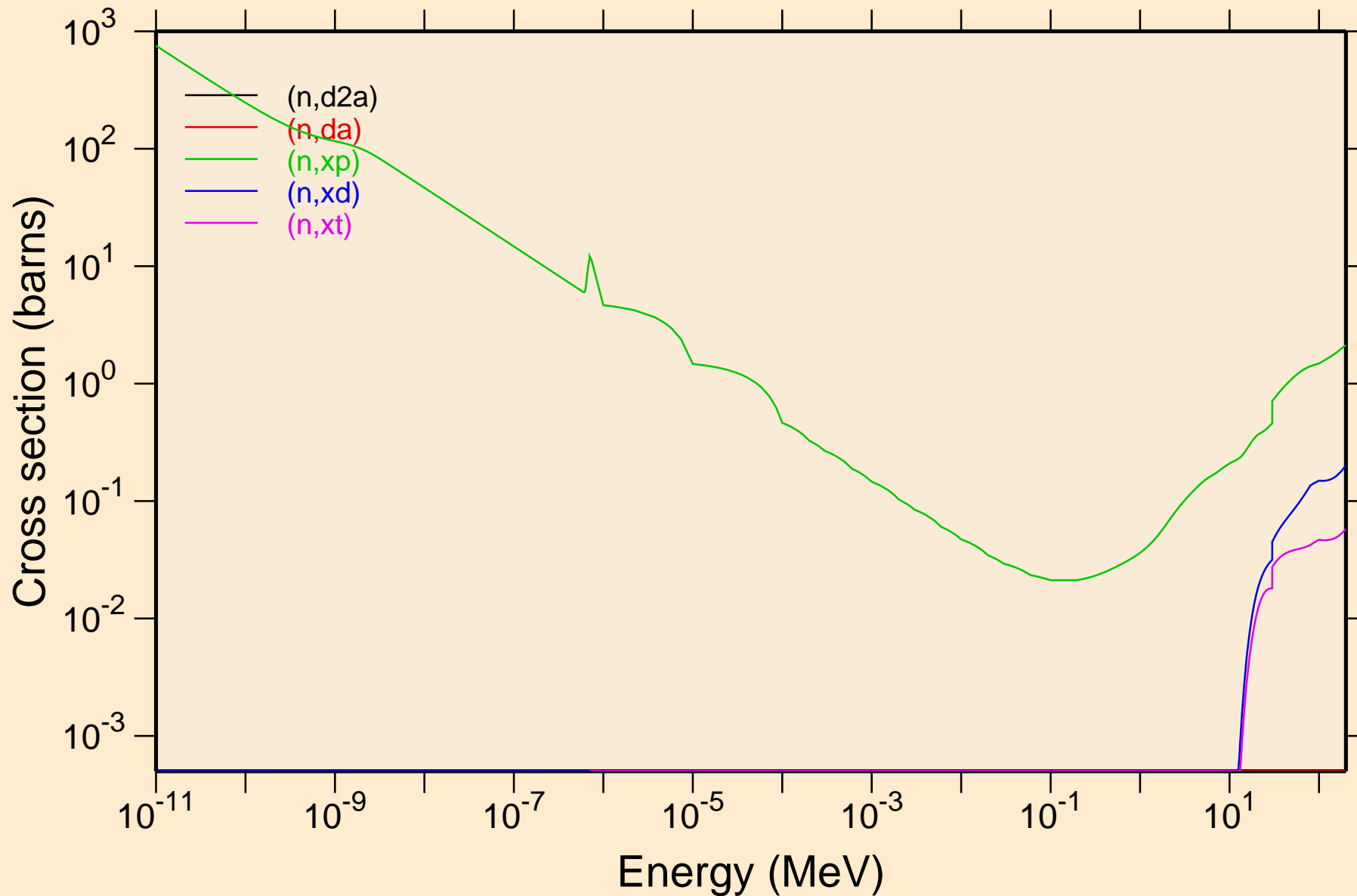

BI190M NEUTRON ACER TENDL-2024 LIBRARY; T=293.6K  
Non-threshold reactions

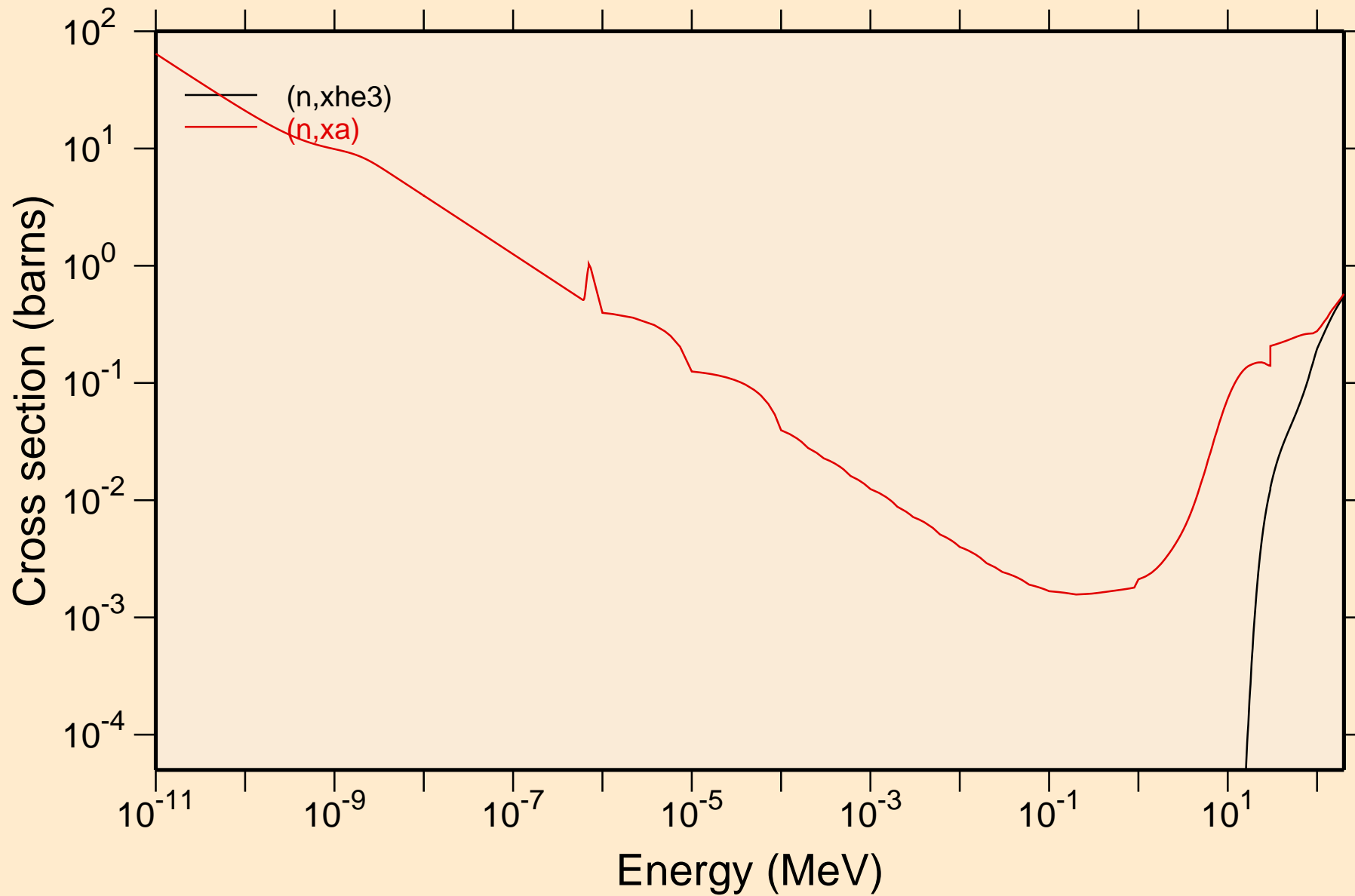

BI190M NEUTRON ACER TENDL-2024 LIBRARY; T=293.6K  
Principal cross sections

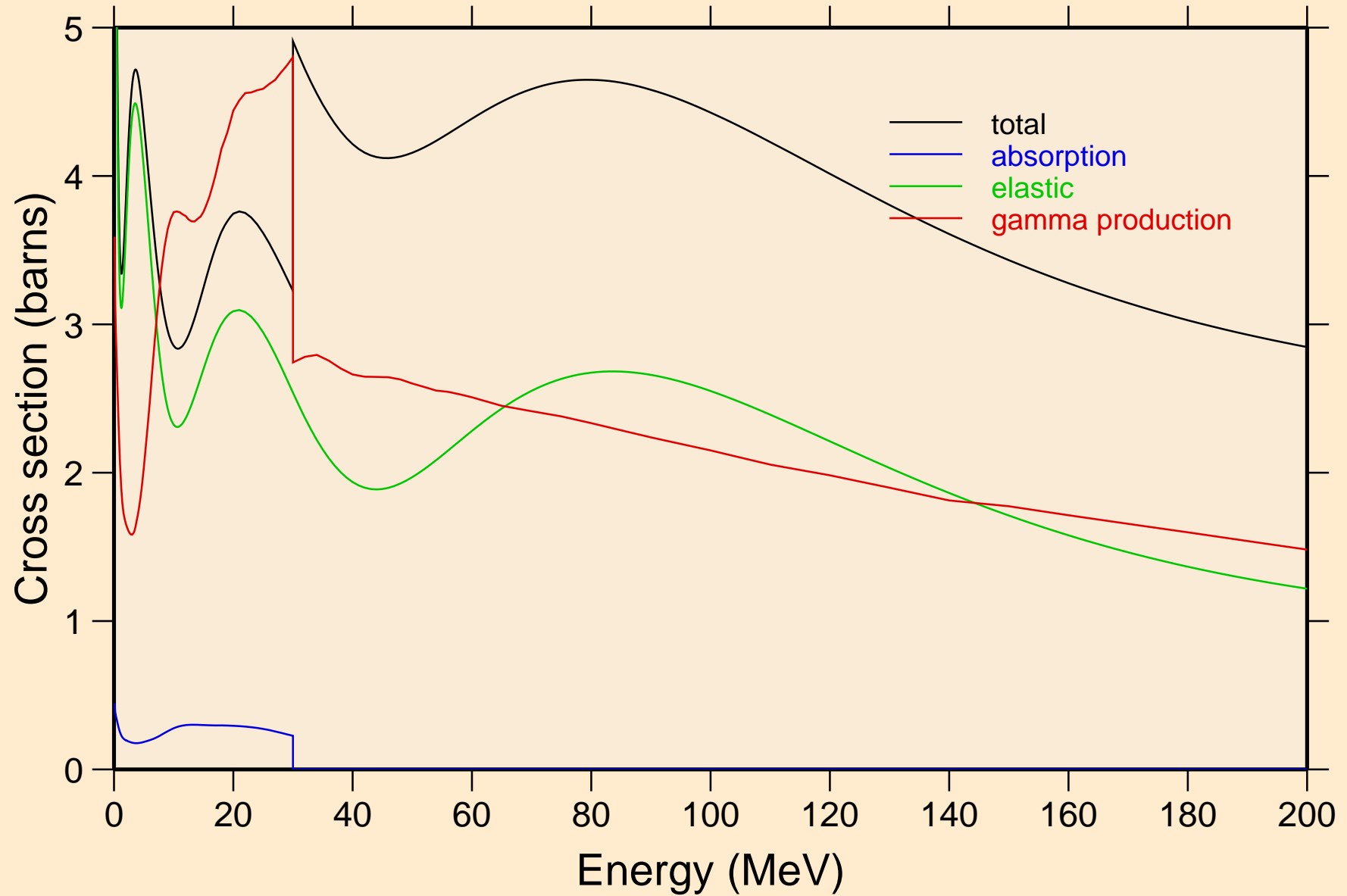

BI190M NEUTRON ACER TENDL-2024 LIBRARY; T=293.6K

Heating

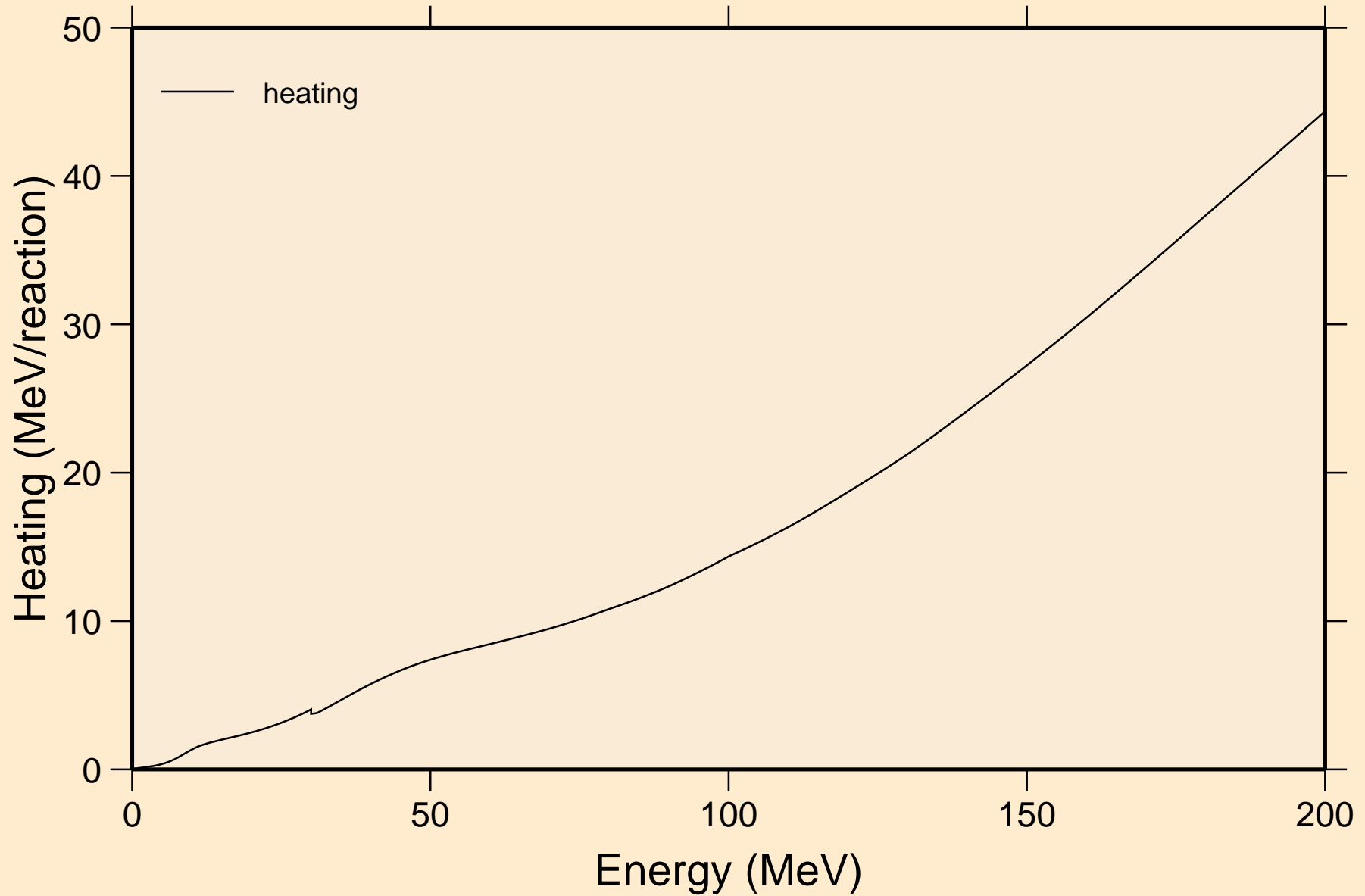

BI190M NEUTRON ACER TENDL-2024 LIBRARY; T=293.6K  
Damage

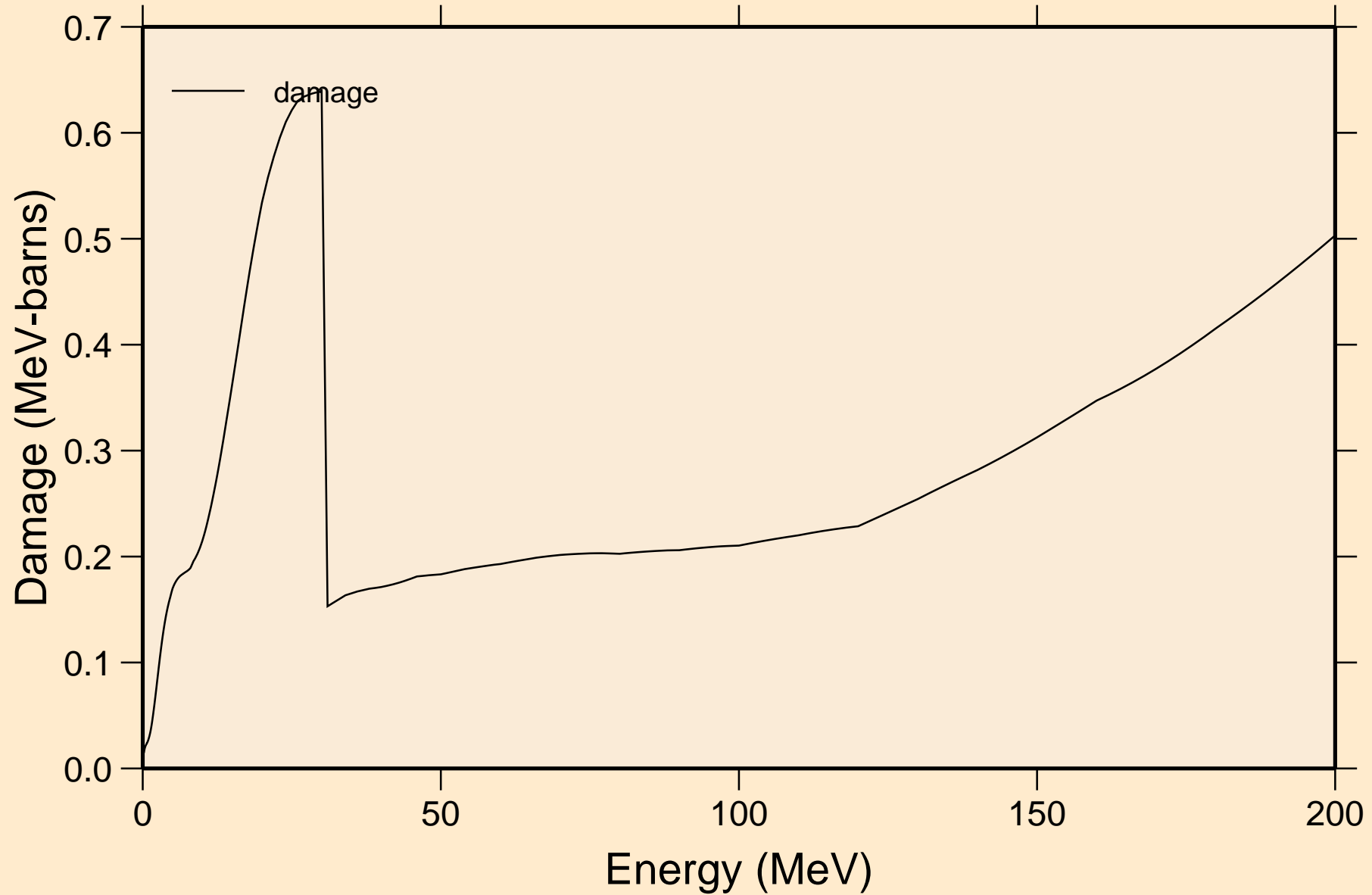

BI190M NEUTRON ACER TENDL-2024 LIBRARY; T=293.6K  
Non-threshold reactions

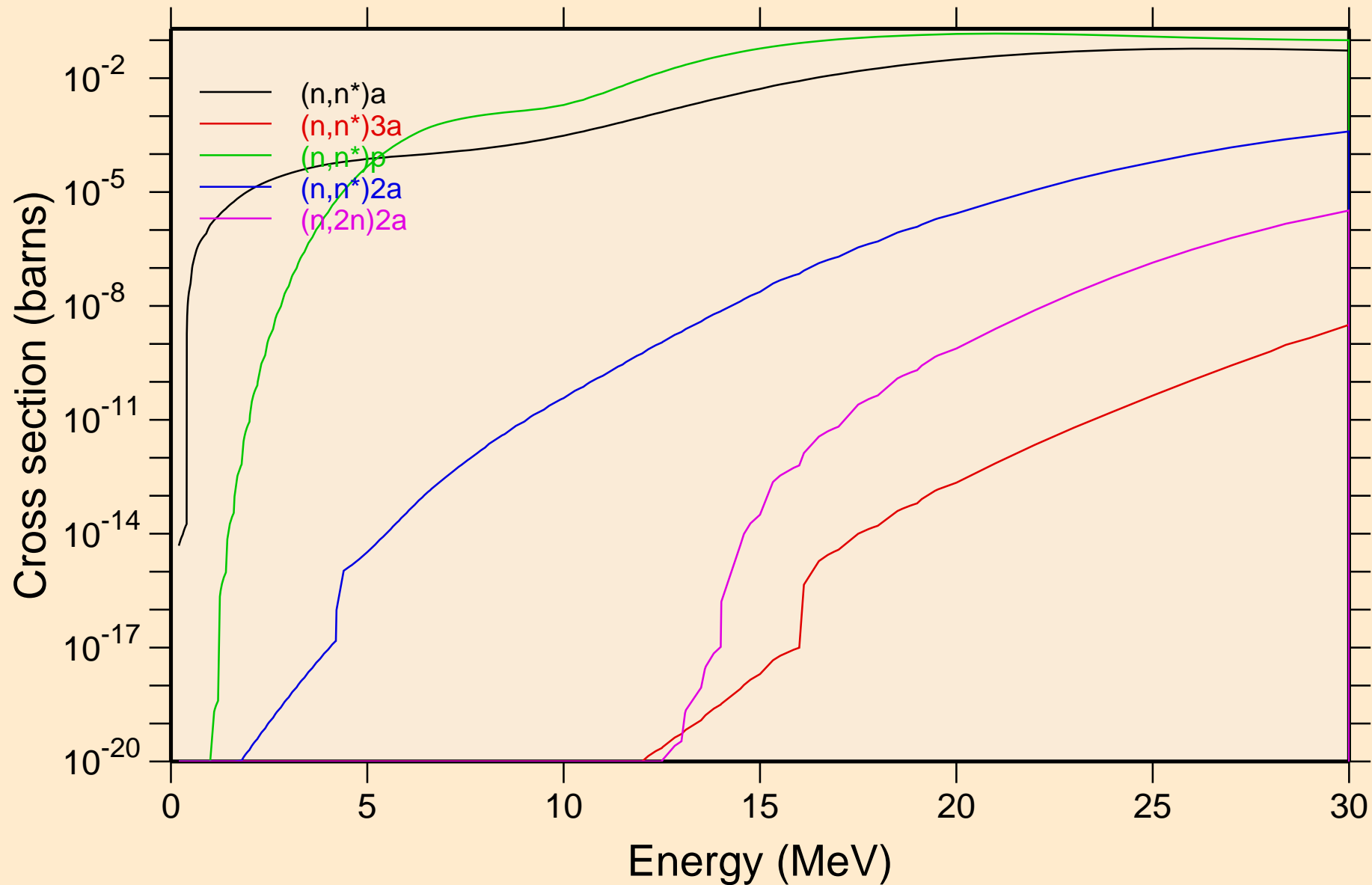

BI190M NEUTRON ACER TENDL-2024 LIBRARY; T=293.6K  
Non-threshold reactions

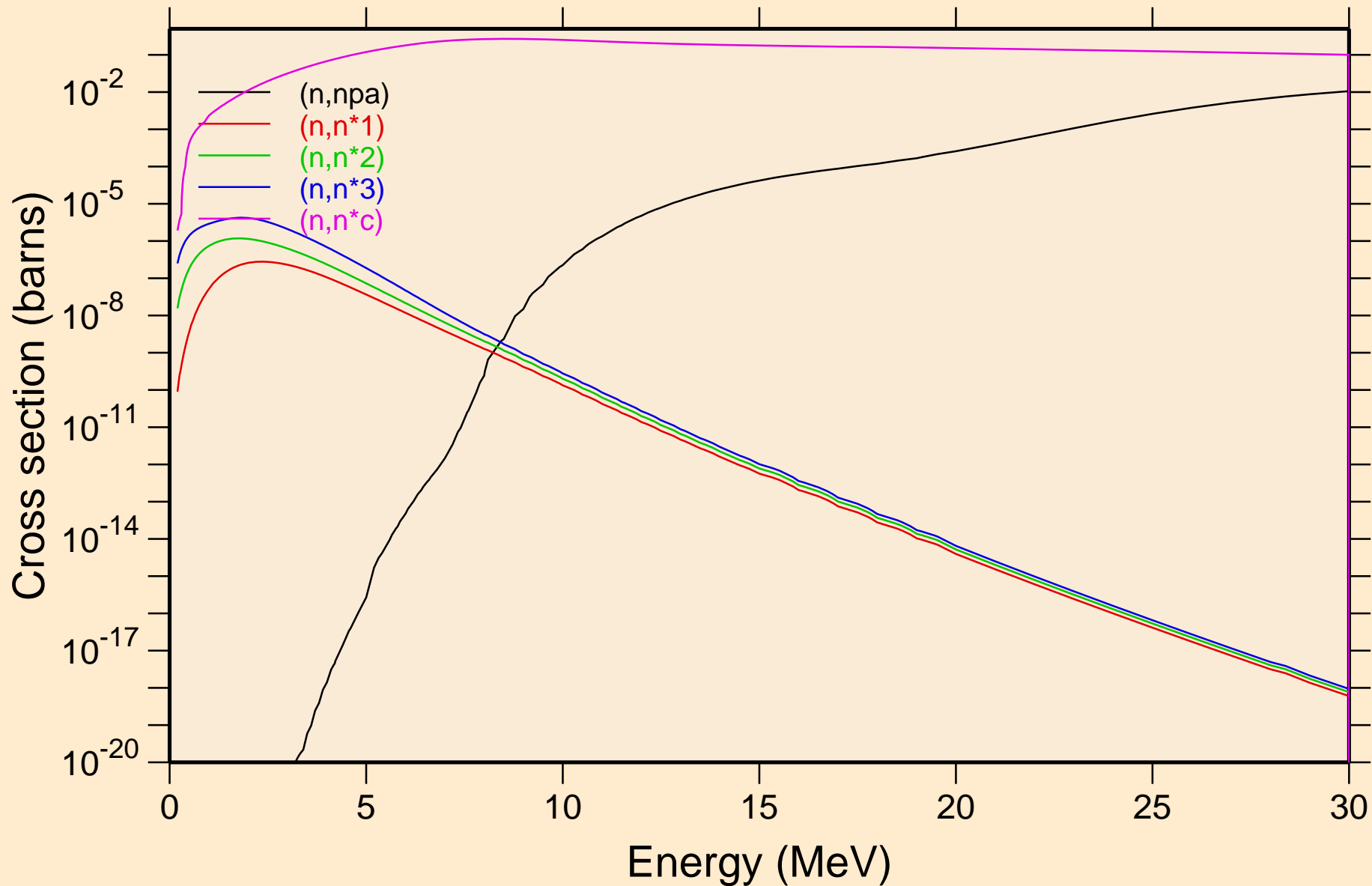

BI190M NEUTRON ACER TENDL-2024 LIBRARY; T=293.6K  
Non-threshold reactions

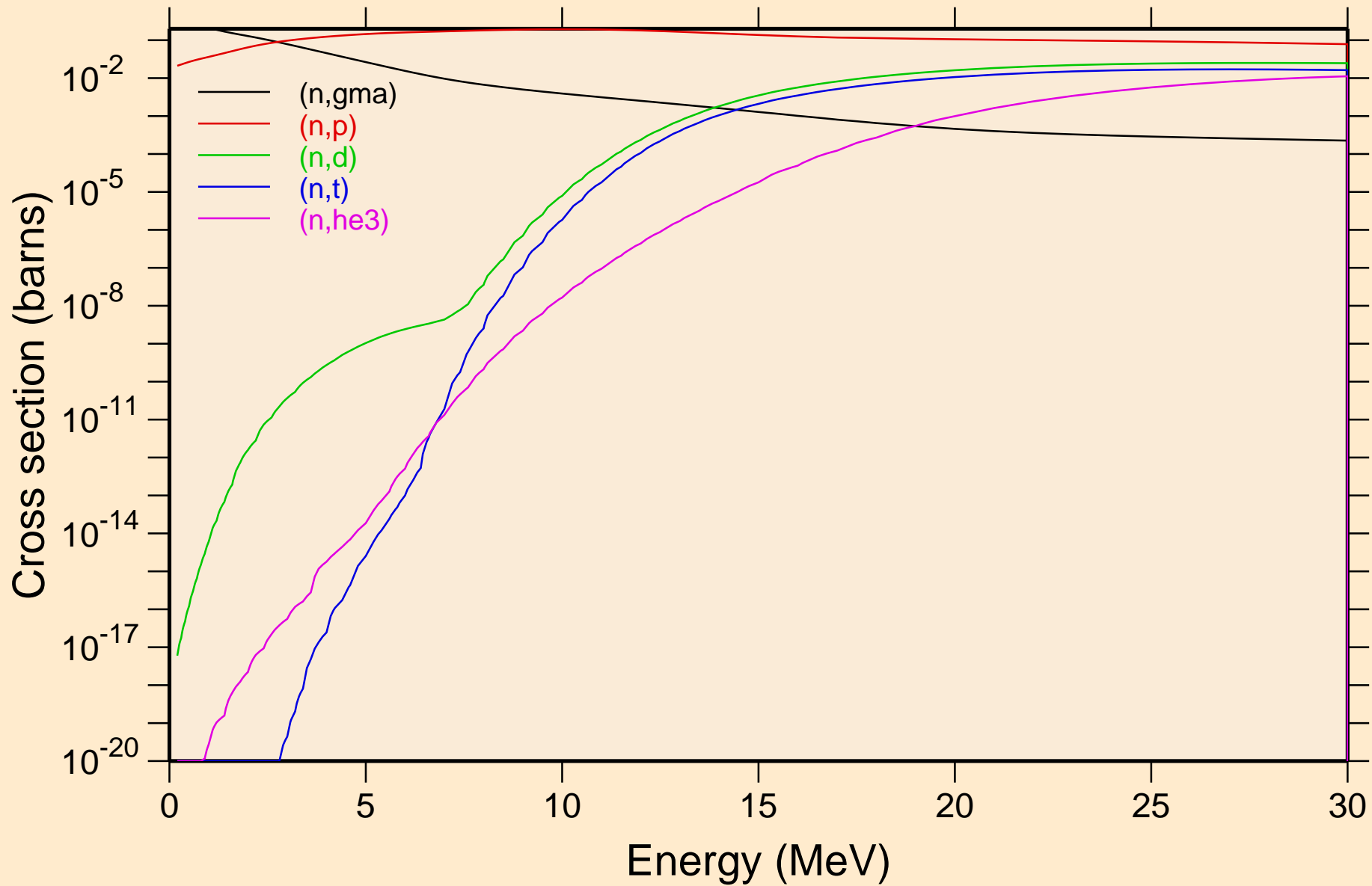

BI190M NEUTRON ACER TENDL-2024 LIBRARY; T=293.6K  
Non-threshold reactions

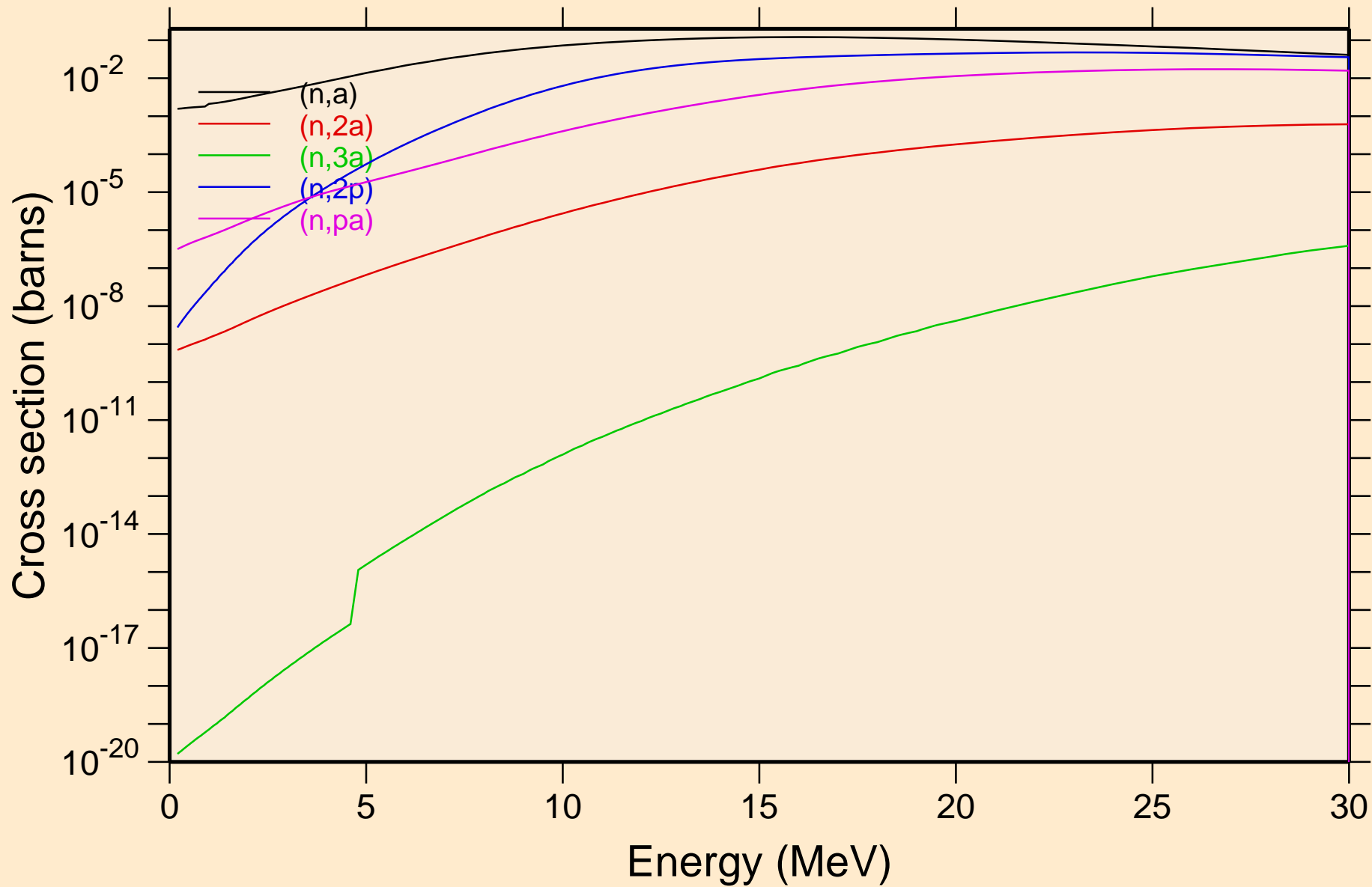

BI190M NEUTRON ACER TENDL-2024 LIBRARY; T=293.6K  
Non-threshold reactions

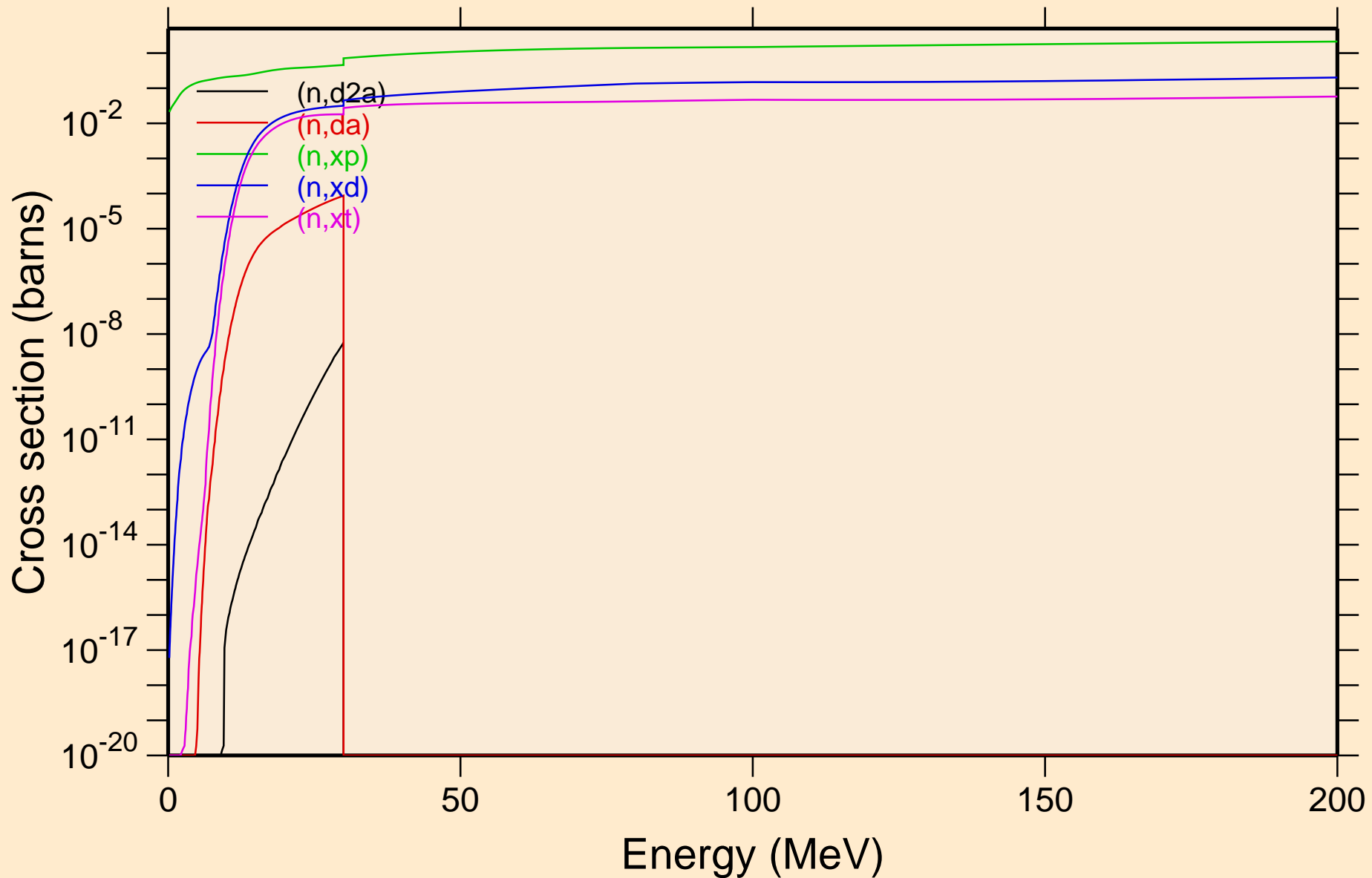

BI190M NEUTRON ACER TENDL-2024 LIBRARY; T=293.6K  
Non-threshold reactions

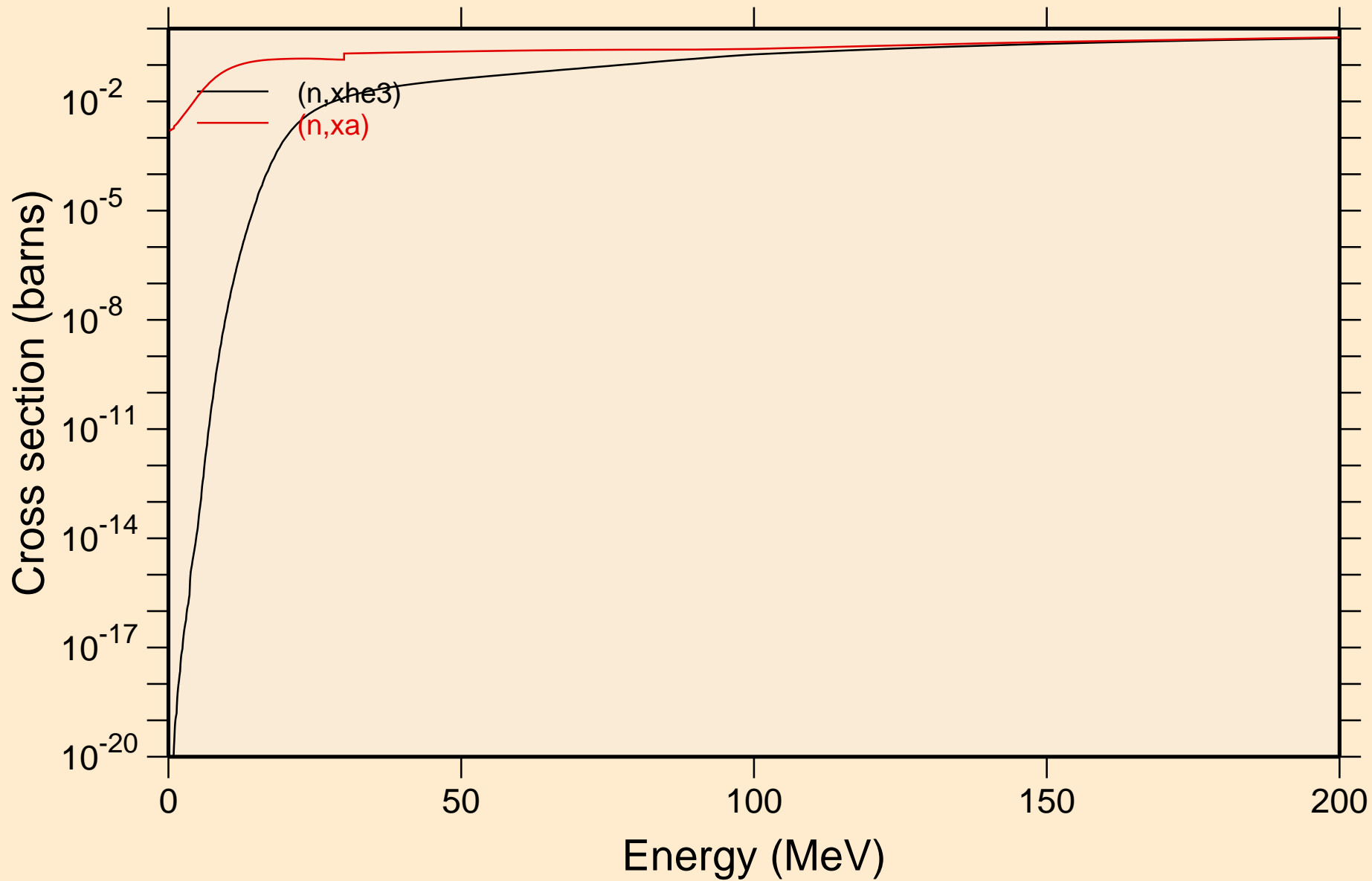

BI190M NEUTRON ACER TENDL-2024 LIBRARY; T=293.6K  
Inelastic levels

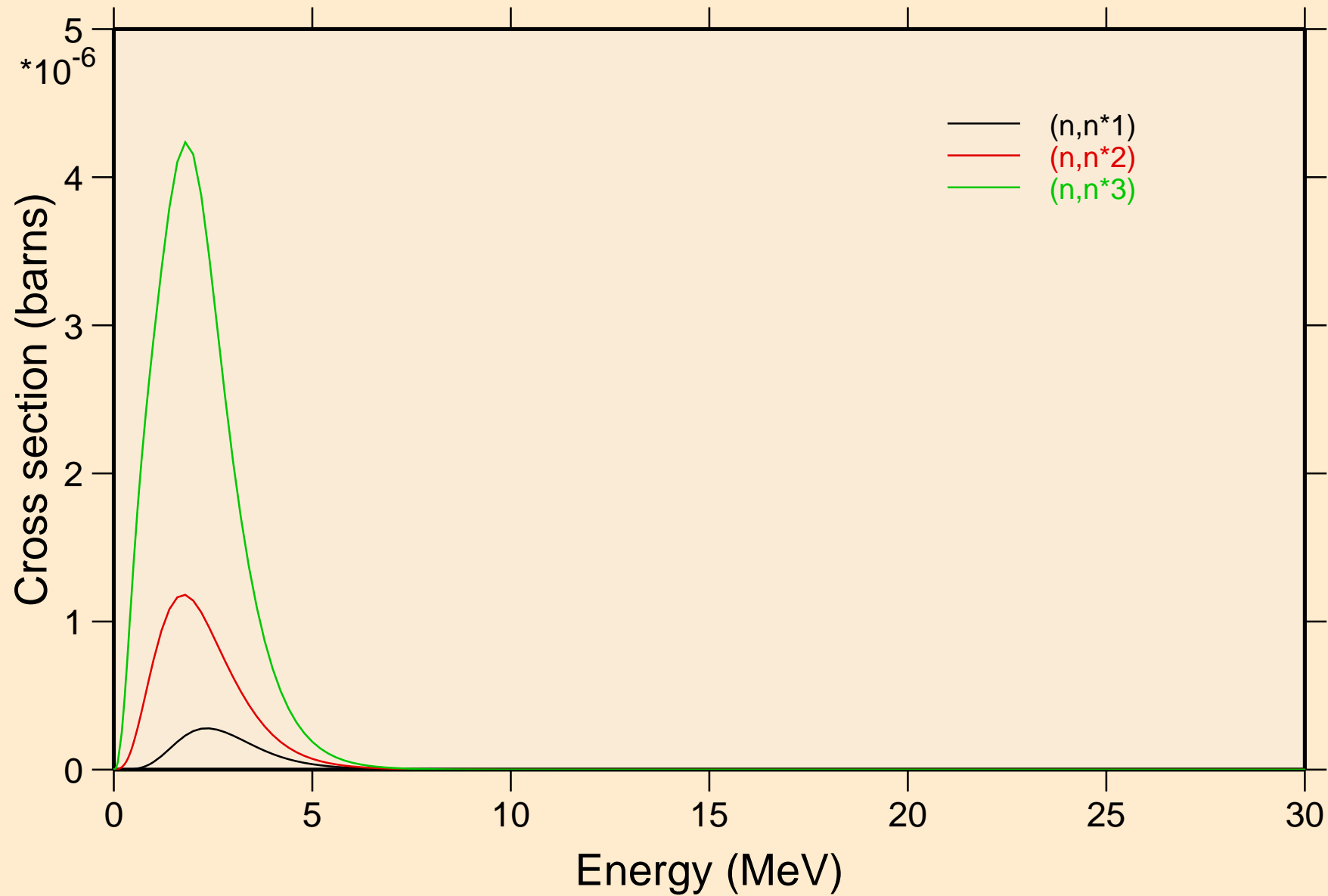

BI190M NEUTRON ACER TENDL-2024 LIBRARY; T=293.6K  
Threshold reactions

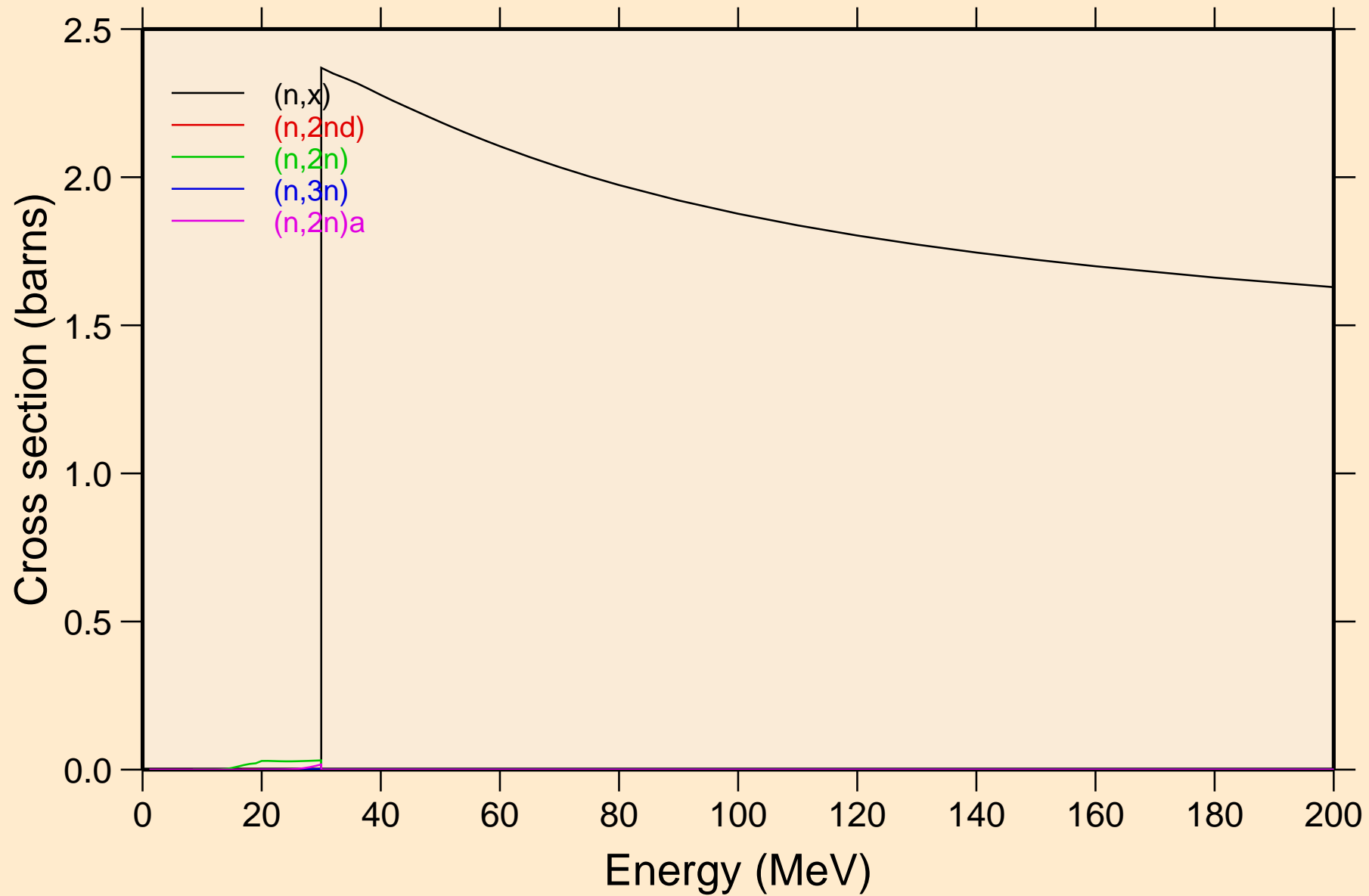

BI190M NEUTRON ACER TENDL-2024 LIBRARY; T=293.6K  
Threshold reactions

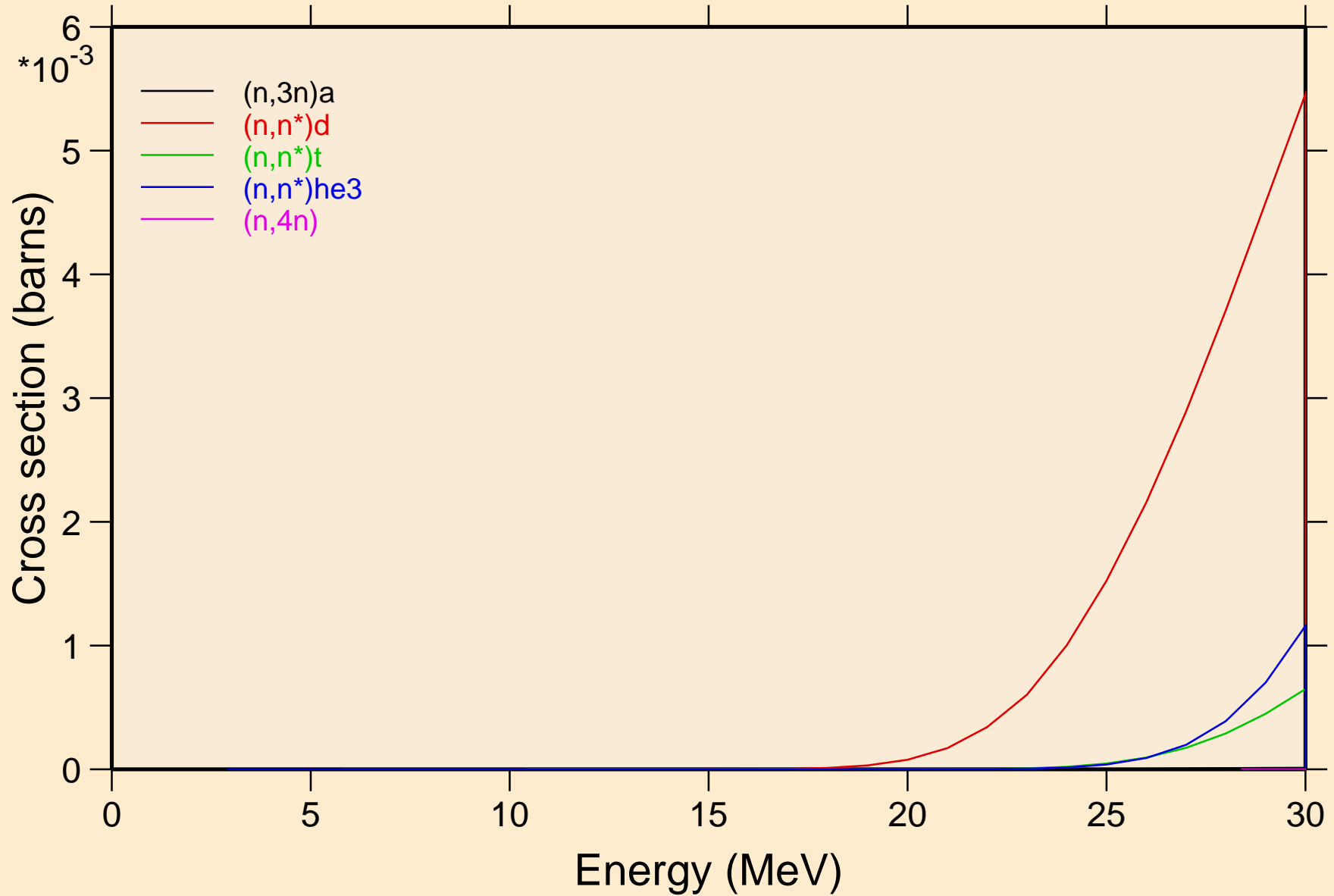

BI190M NEUTRON ACER TENDL-2024 LIBRARY; T=293.6K  
Threshold reactions

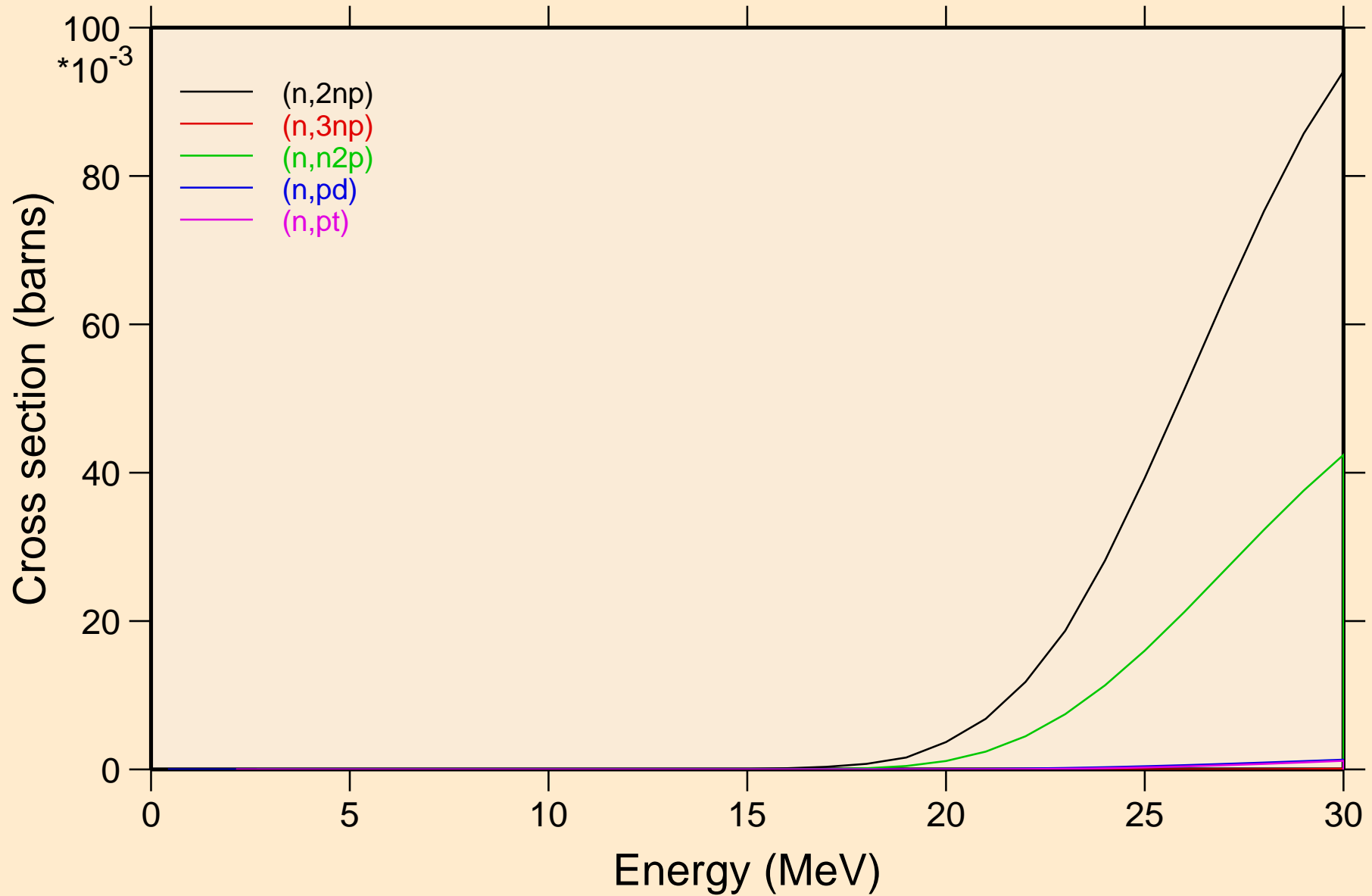

BI190M NEUTRON ACER TENDL-2024 LIBRARY; T=293.6K  
angular distribution for elastic

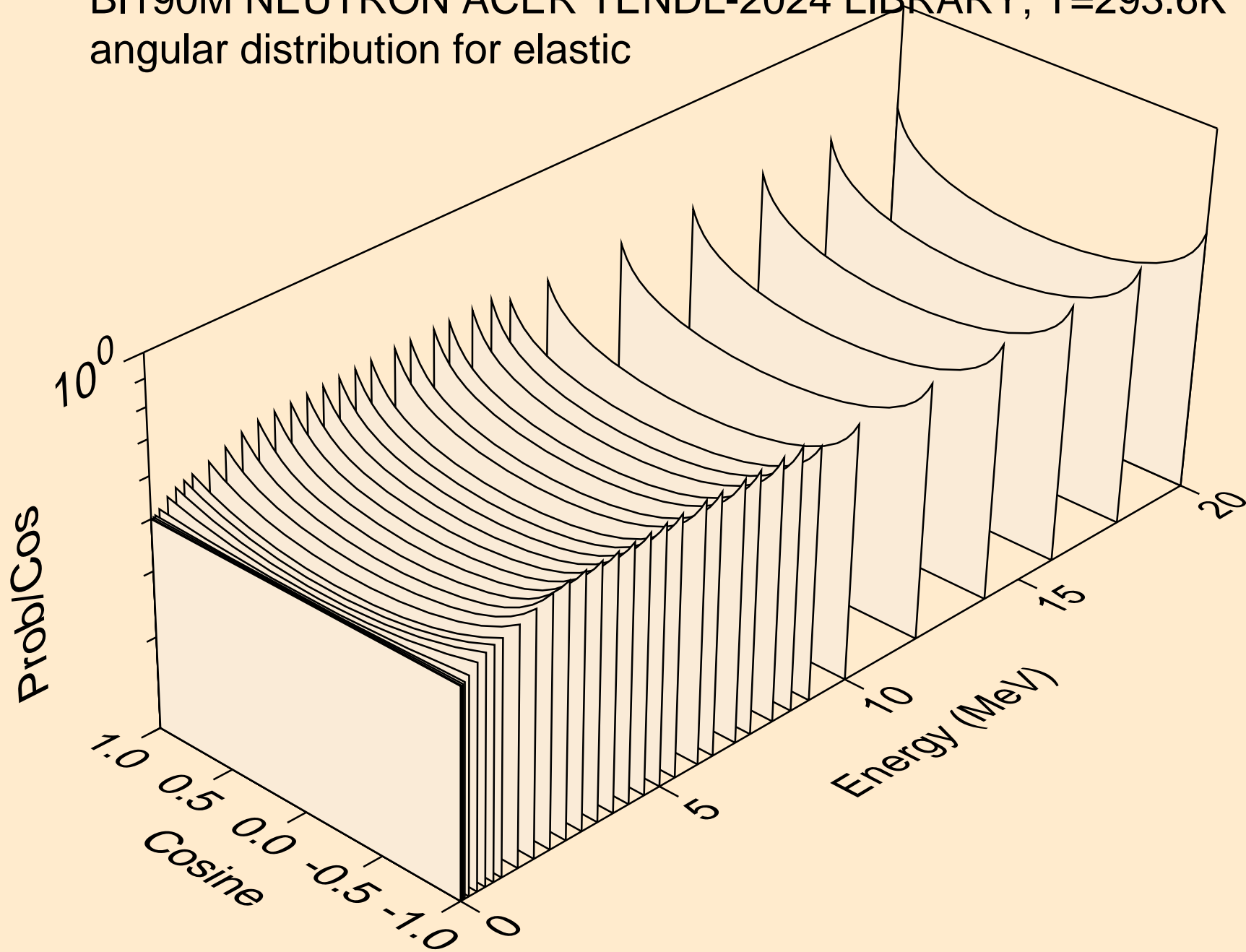

BI190M NEUTRON ACER TENDL-2024 LIBRARY; T=293.6K  
angular distribution for elastic

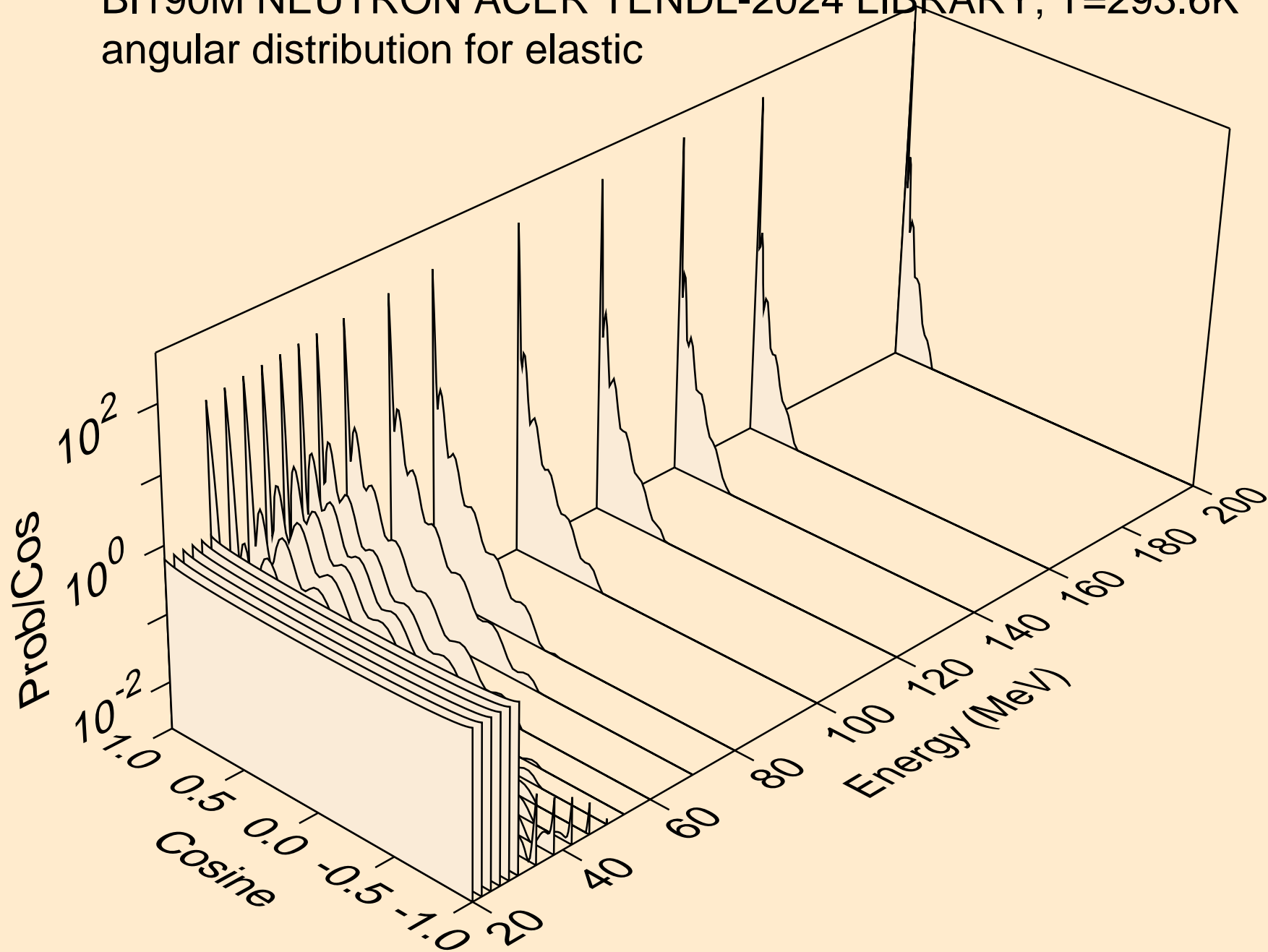

BI190M NEUTRON ACER TENDL-2024 LIBRARY; T=293.6K  
angular distribution for (n,n\*1)

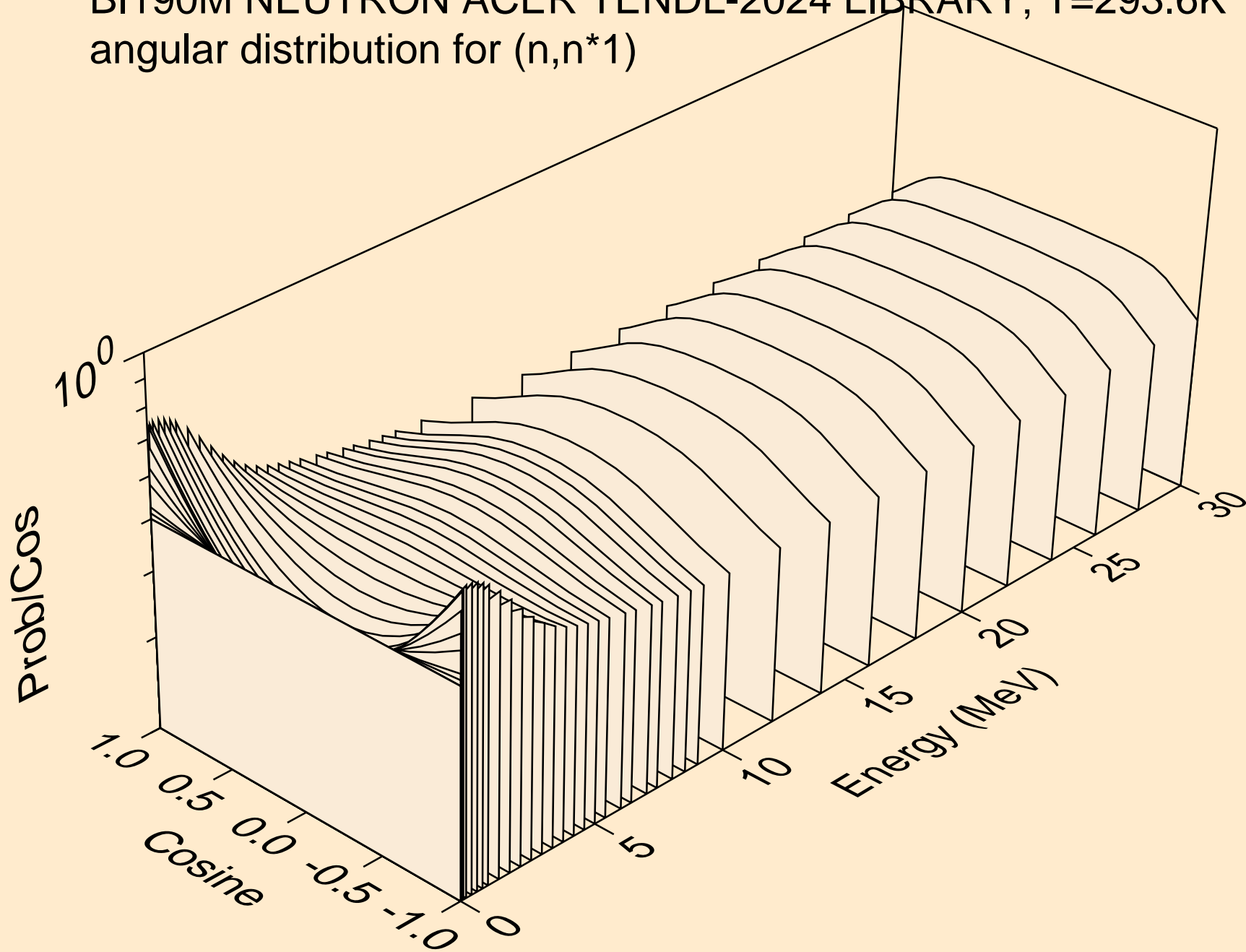

BI190M NEUTRON ACER TENDL-2024 LIBRARY; T=293.6K  
angular distribution for (n,n\*2)

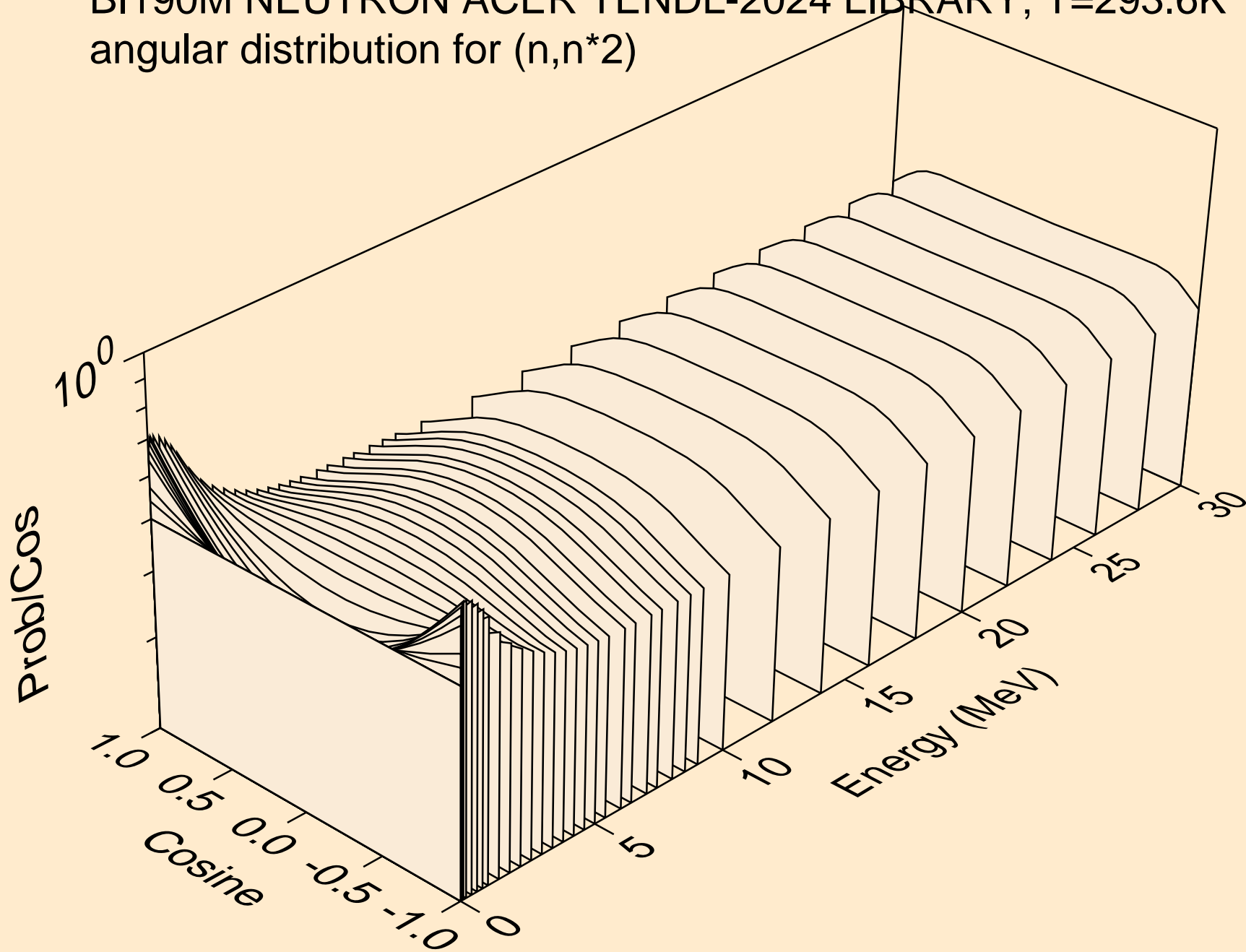

BI190M NEUTRON ACER TENDL-2024 LIBRARY; T=293.6K  
angular distribution for (n,n\*3)

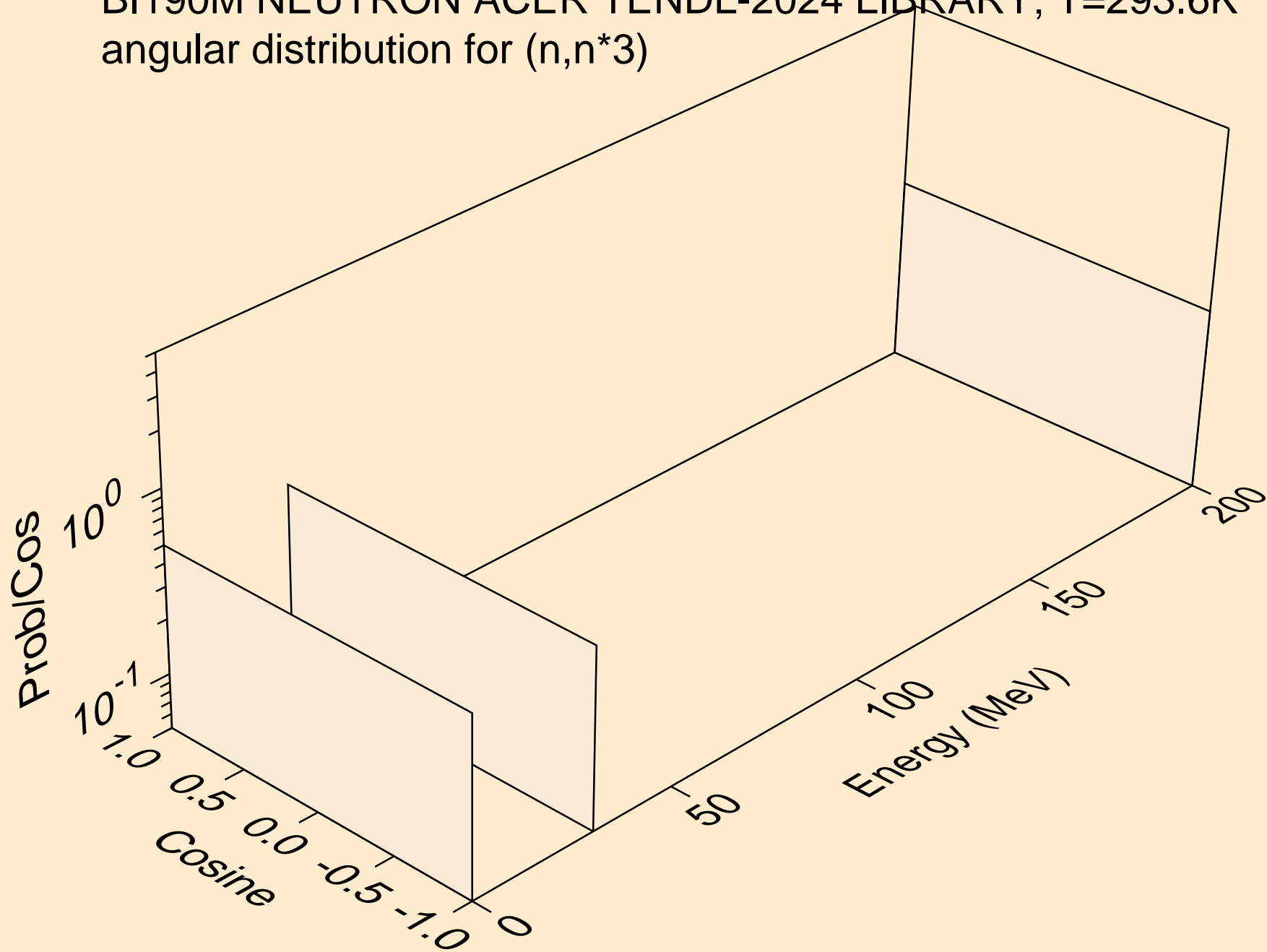

BI190M NEUTRON ACER TENDL-2024 LIBRARY; T=293.6K  
Neutron emission for (n,x)

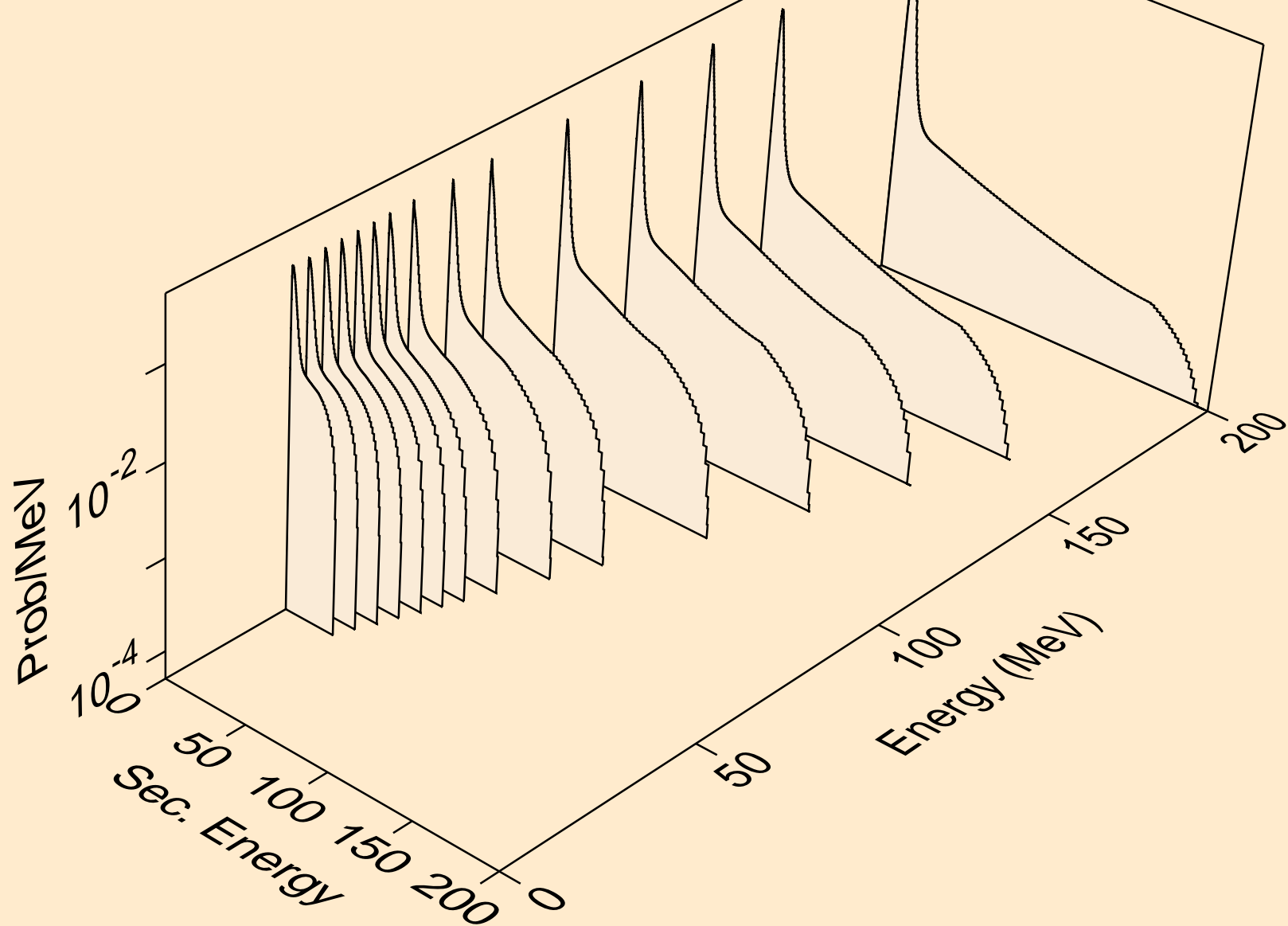

BI190M NEUTRON ACER TENDL-2024 LIBRARY; T=293.6K  
Neutron emission for (n,2nd)

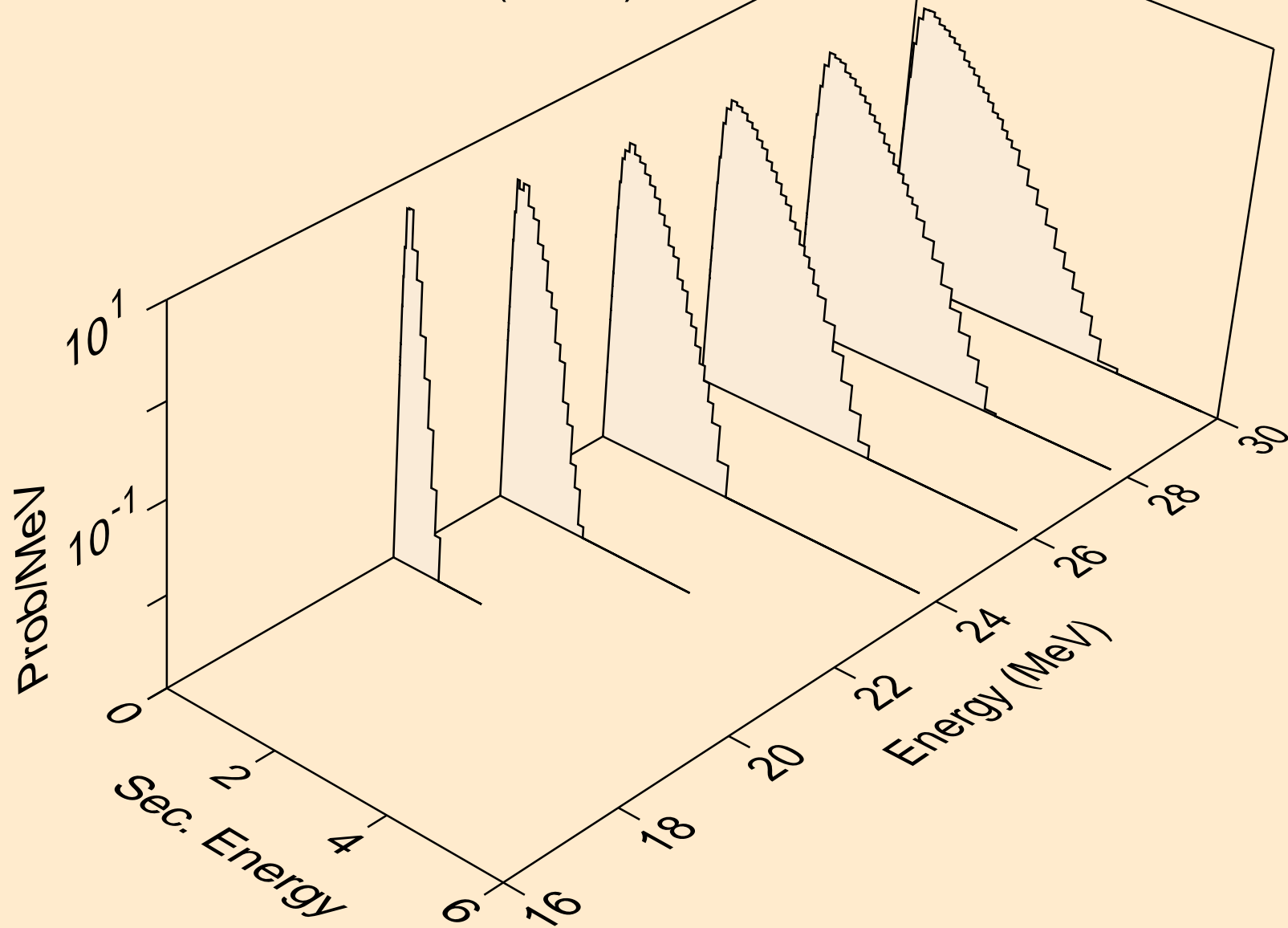

BI190M NEUTRON ACER TENDL-2024 LIBRARY; T=293.6K  
Neutron emission for (n,2n)

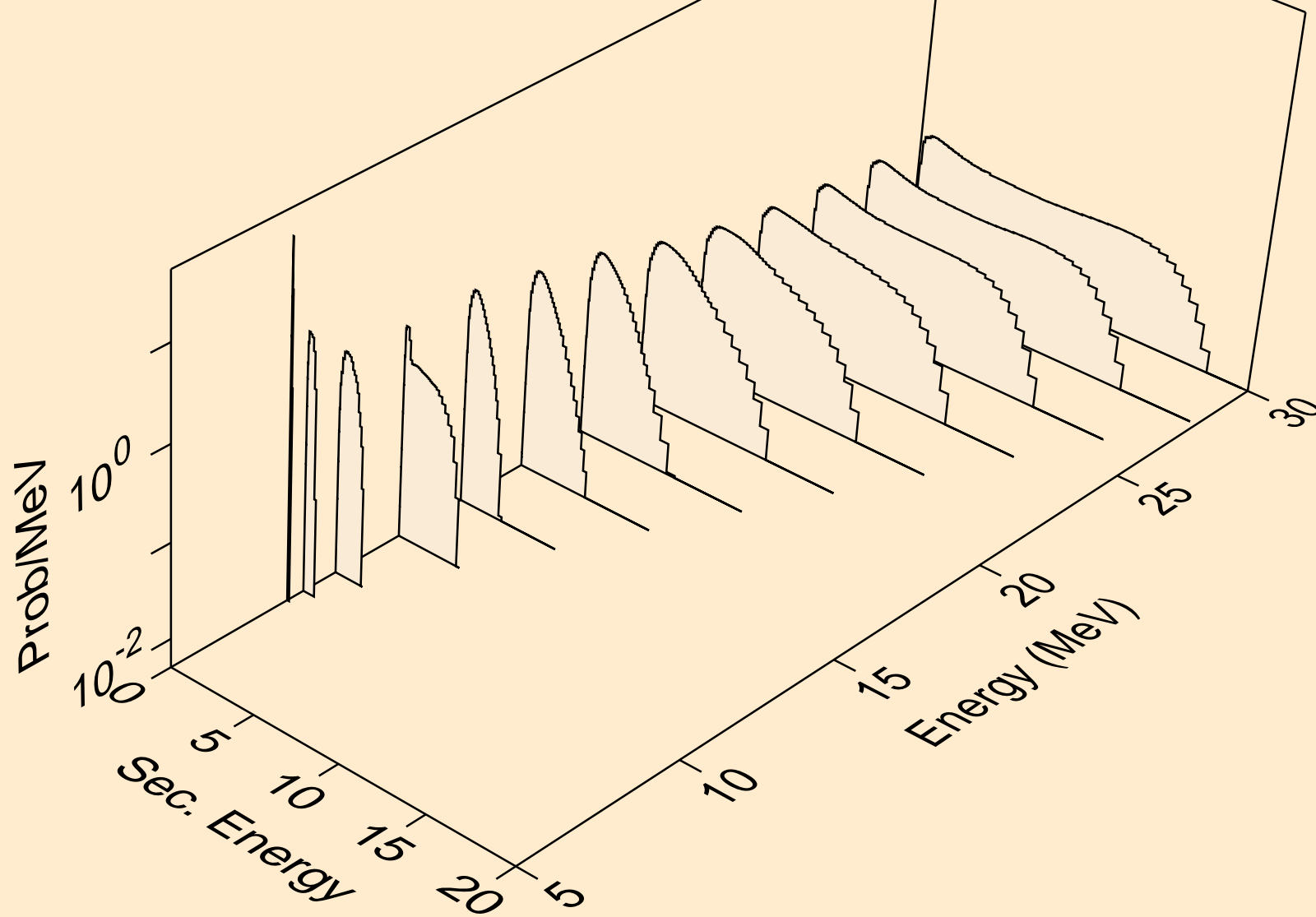

BI190M NEUTRON ACER TENDL-2024 LIBRARY; T=293.6K  
Neutron emission for (n,3n)

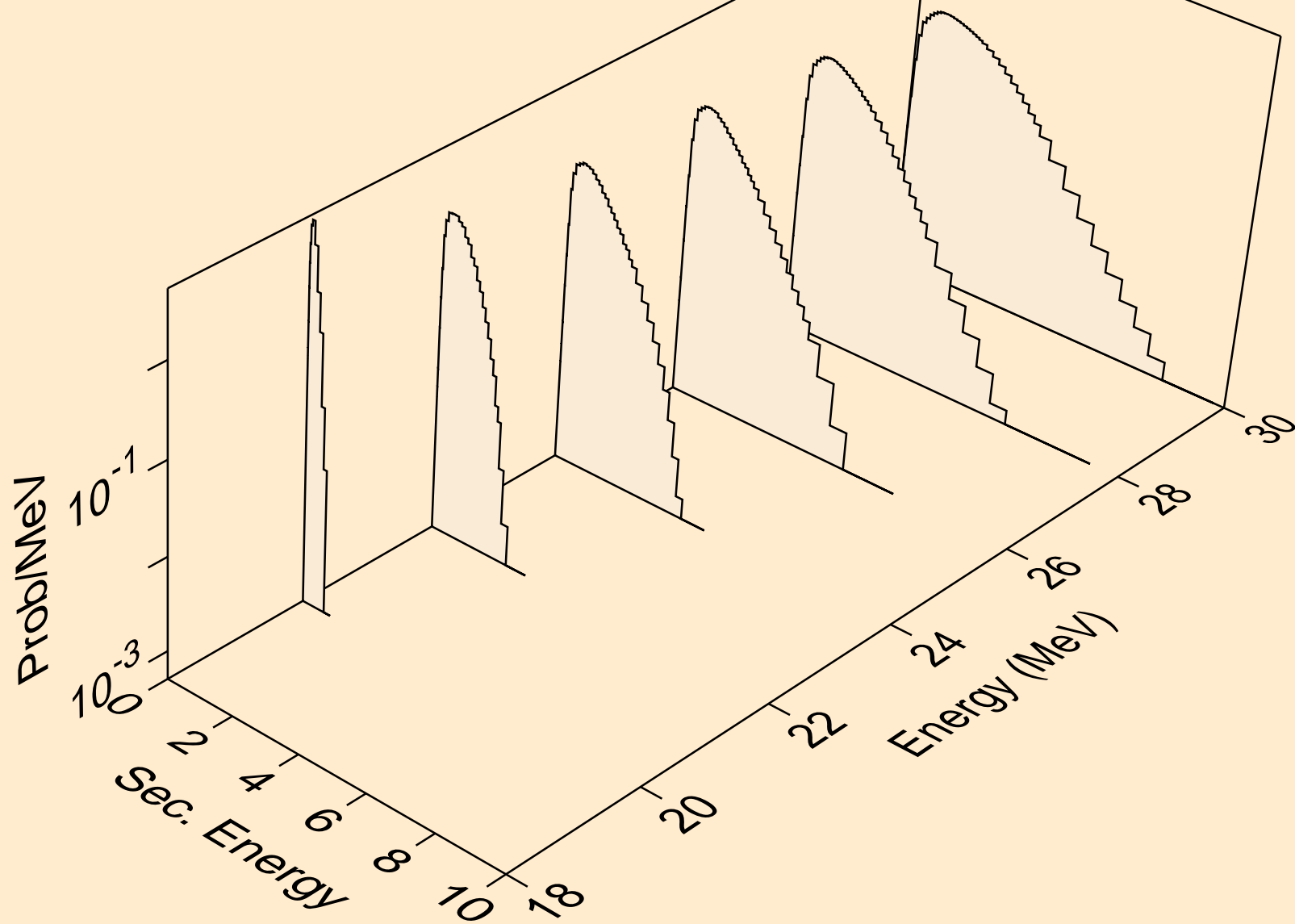

BI190M NEUTRON ACER TENDL-2024 LIBRARY; T=293.6K  
Neutron emission for (n,n\*)a

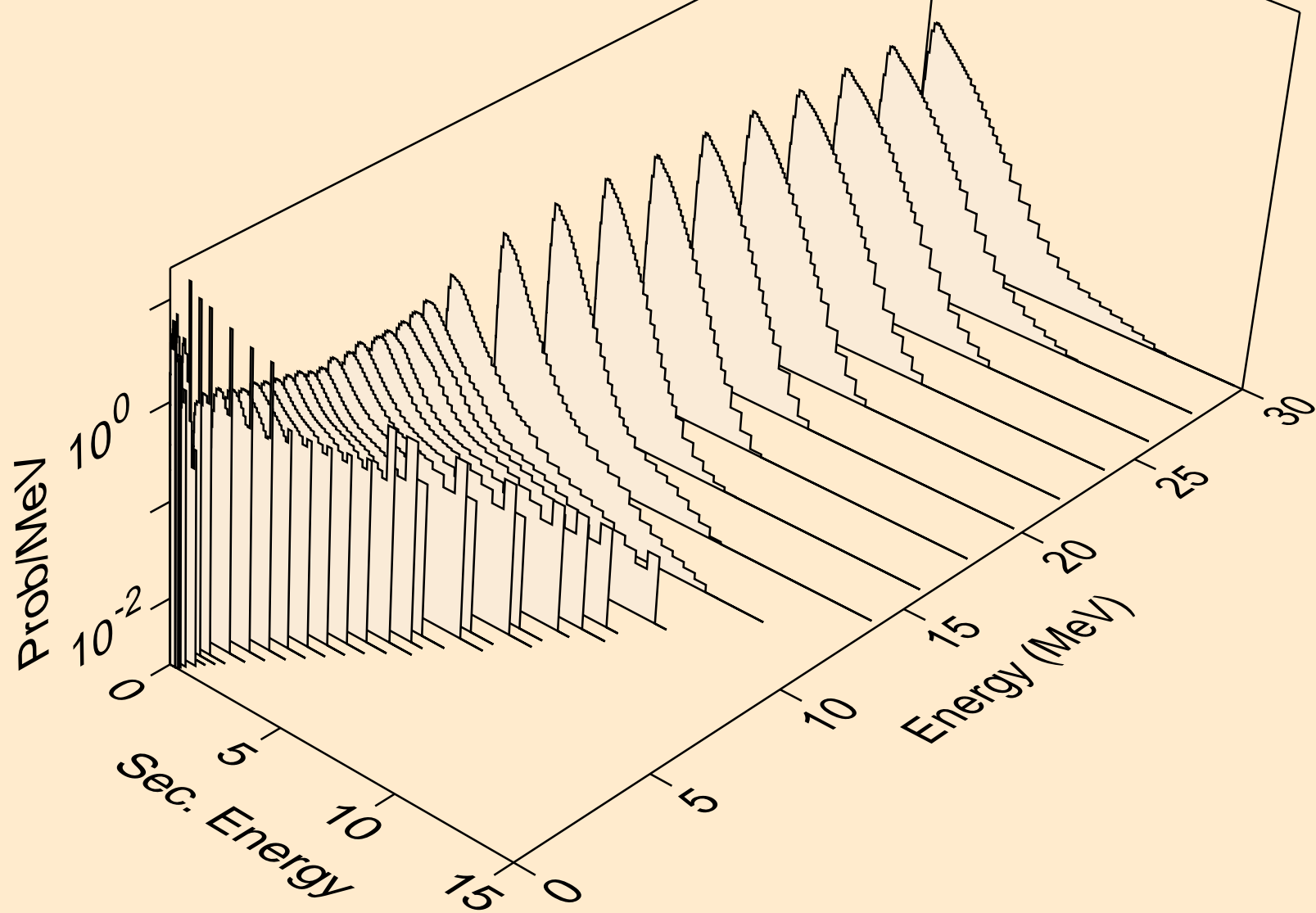

BI190M NEUTRON ACER TENDL-2024 LIBRARY; T=293.6K  
Neutron emission for (n,n\*)3a

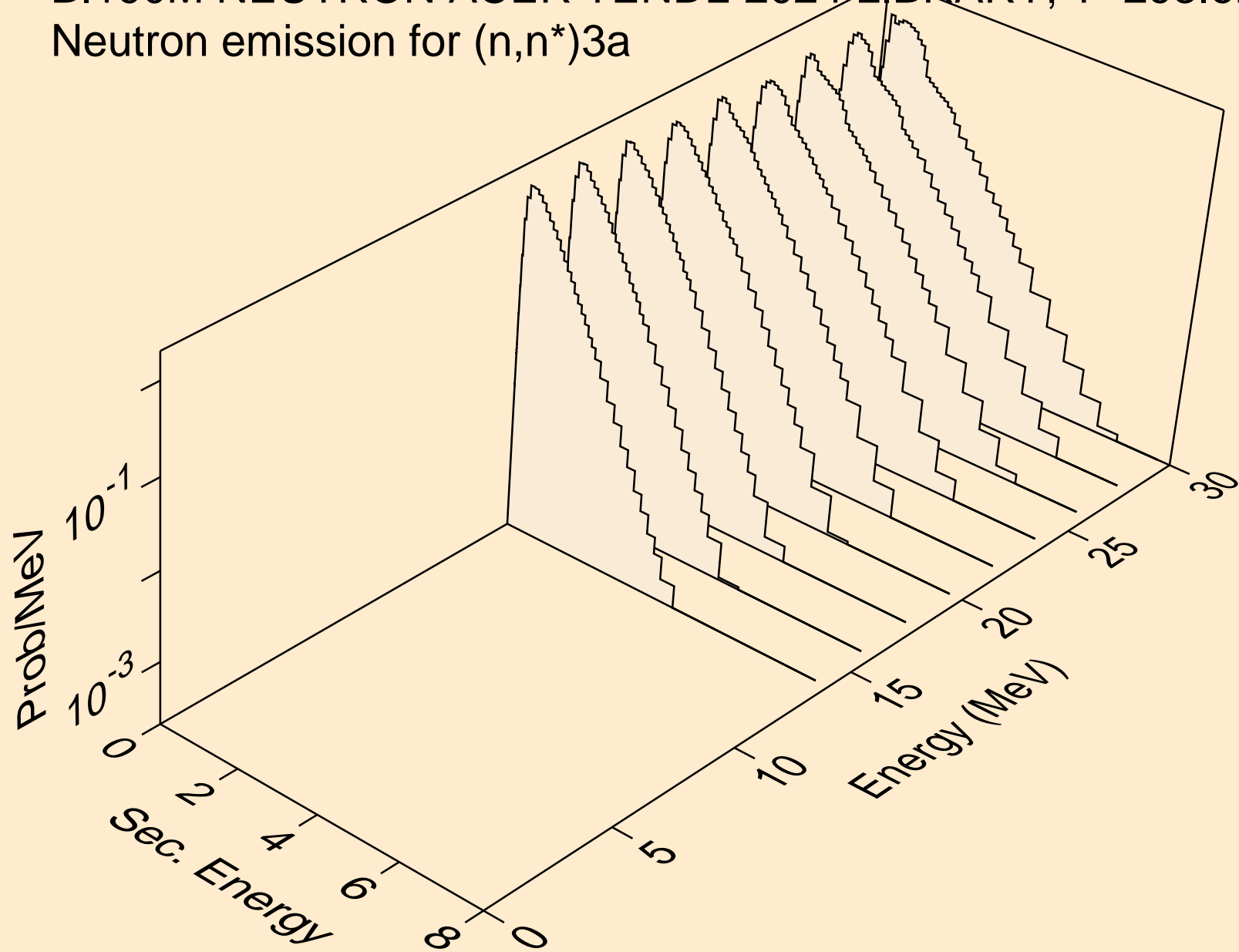

BI190M NEUTRON ACER TENDL-2024 LIBRARY; T=293.6K  
Neutron emission for (n,2n)a

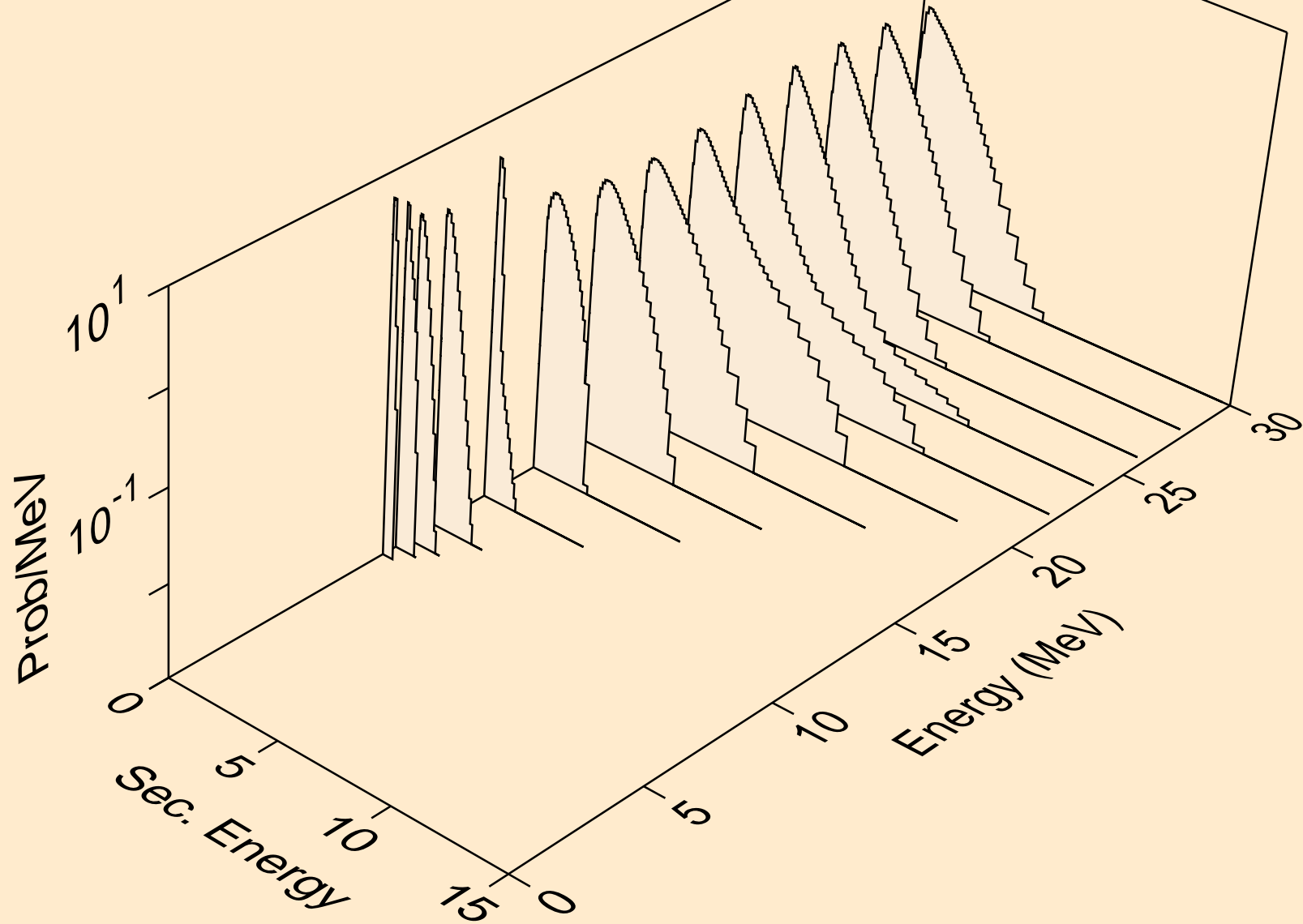

BI190M NEUTRON ACER TENDL-2024 LIBRARY; T=293.6K  
Neutron emission for (n,3n)a

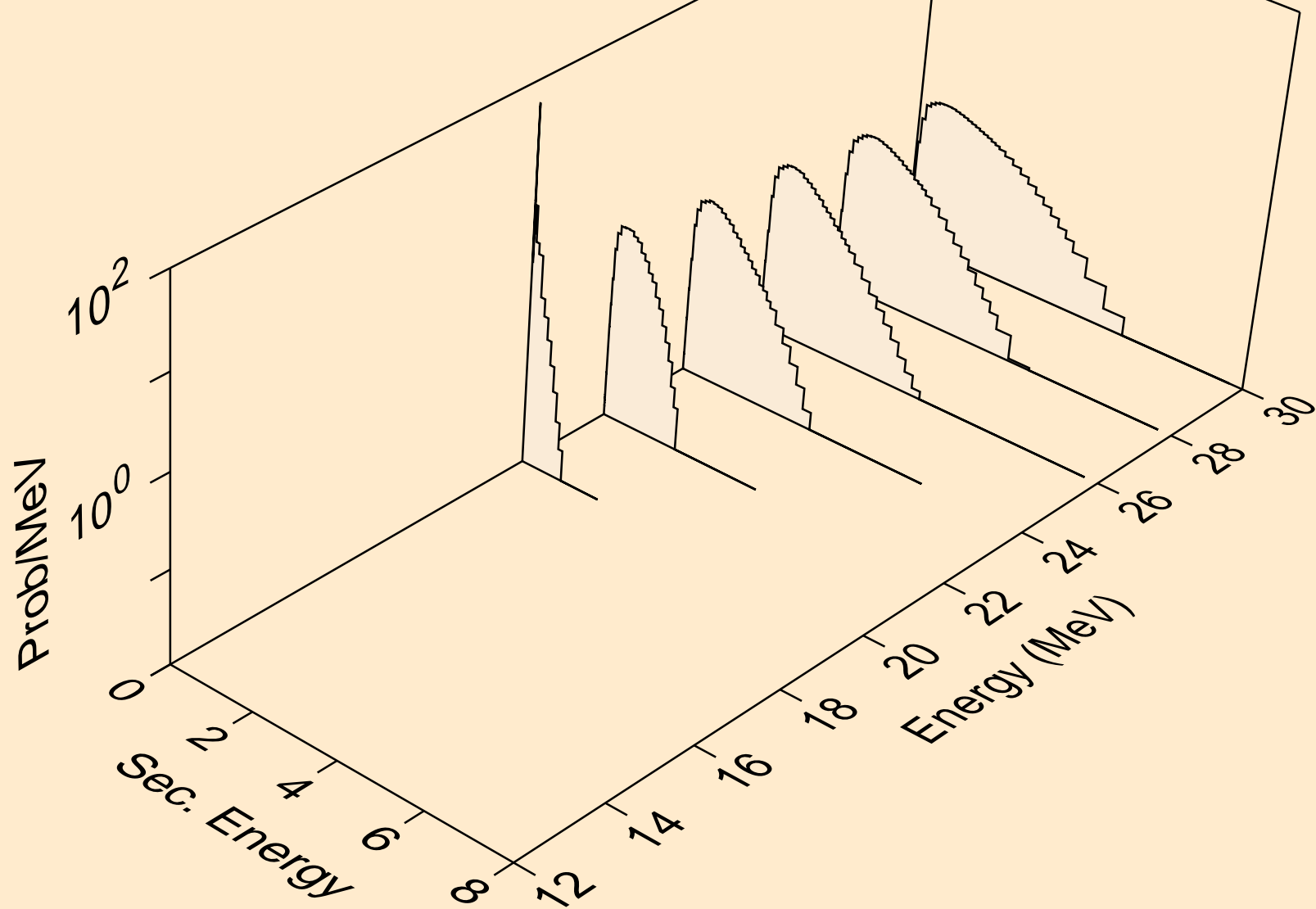

BI190M NEUTRON ACER TENDL-2024 LIBRARY; T=293.6K  
Neutron emission for (n,n\*)p

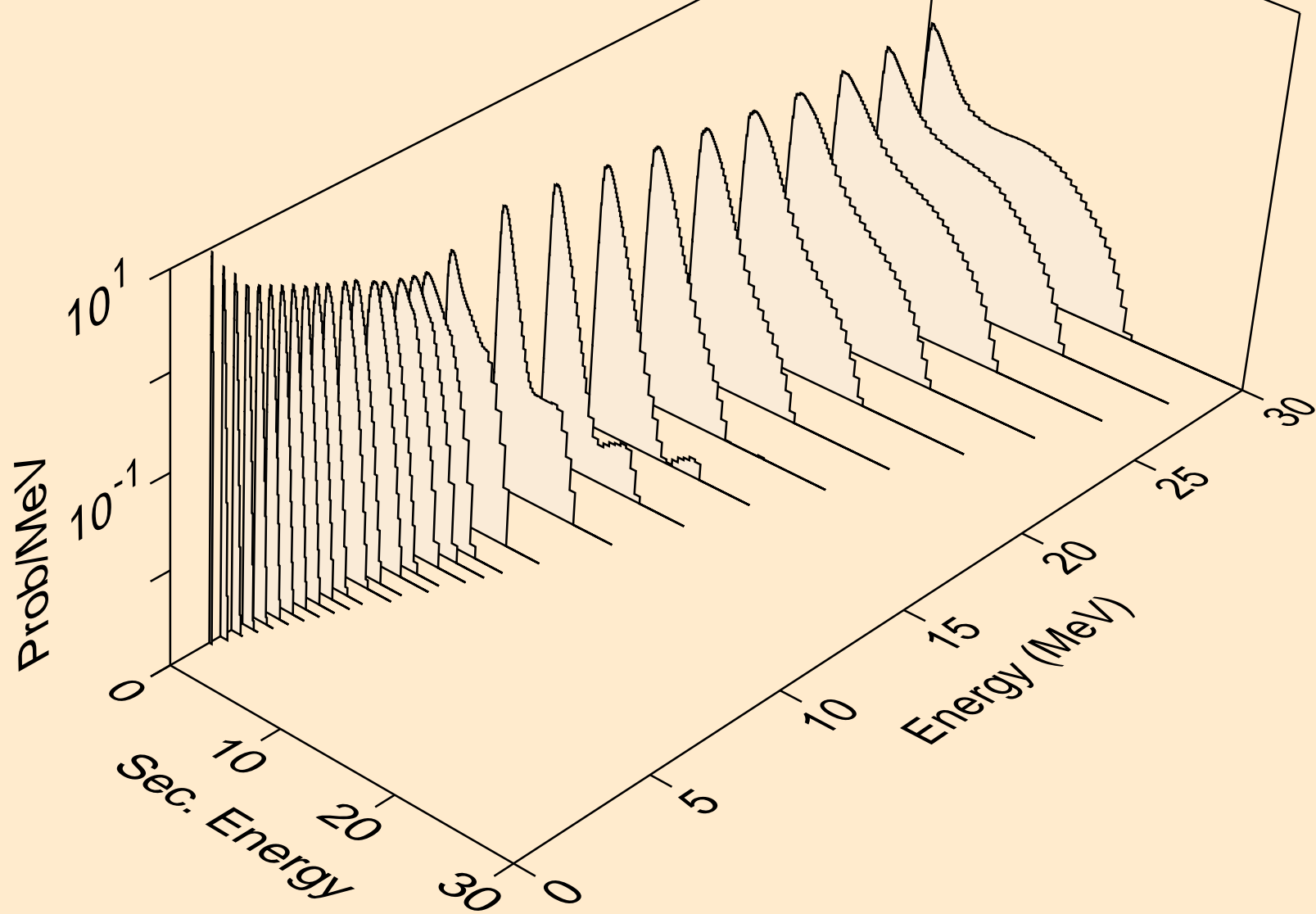

BI190M NEUTRON ACER TENDL-2024 LIBRARY; T=293.6K  
Neutron emission for (n,n\*)2a

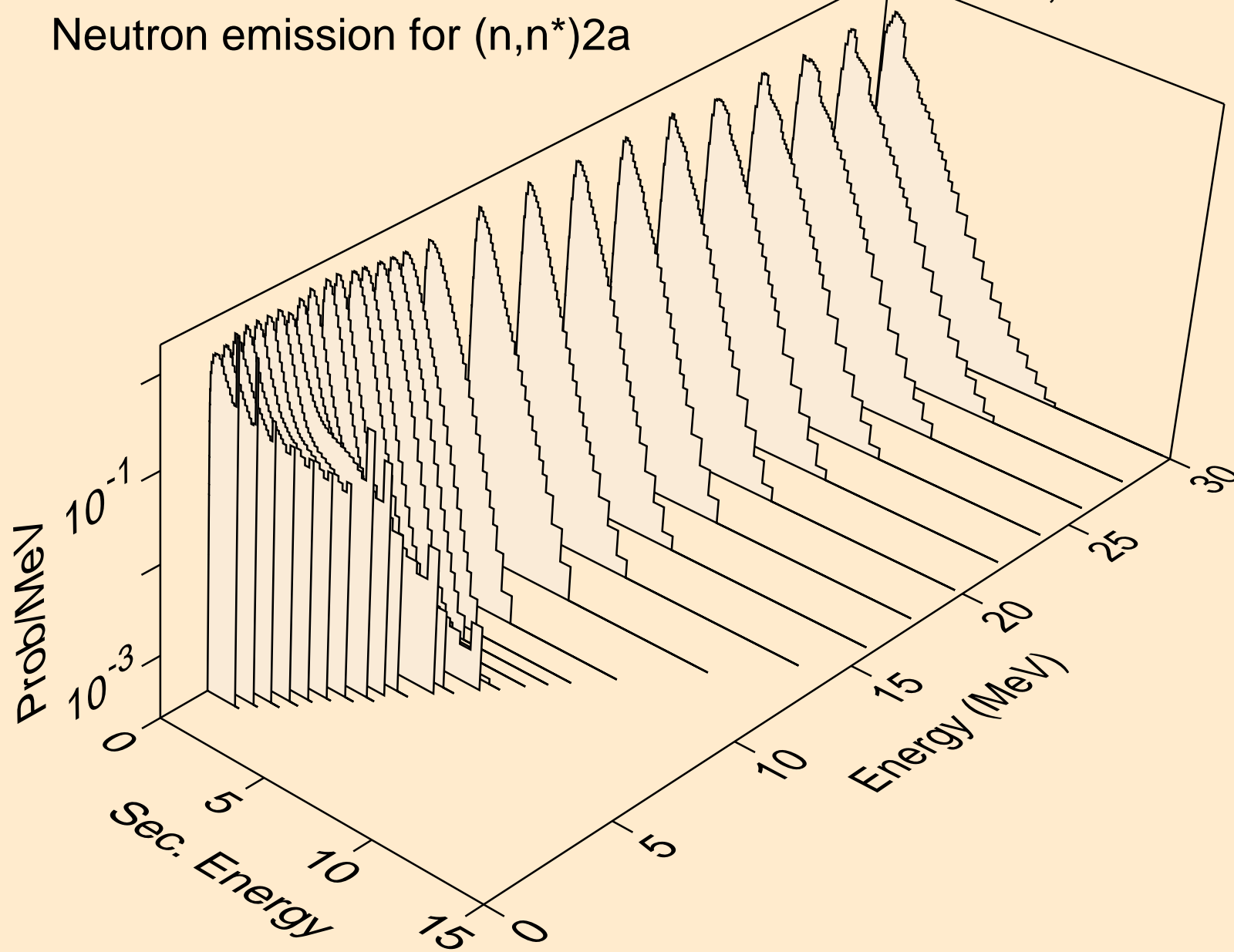

BI190M NEUTRON ACER TENDL-2024 LIBRARY; T=293.6K  
Neutron emission for (n,2n)2a

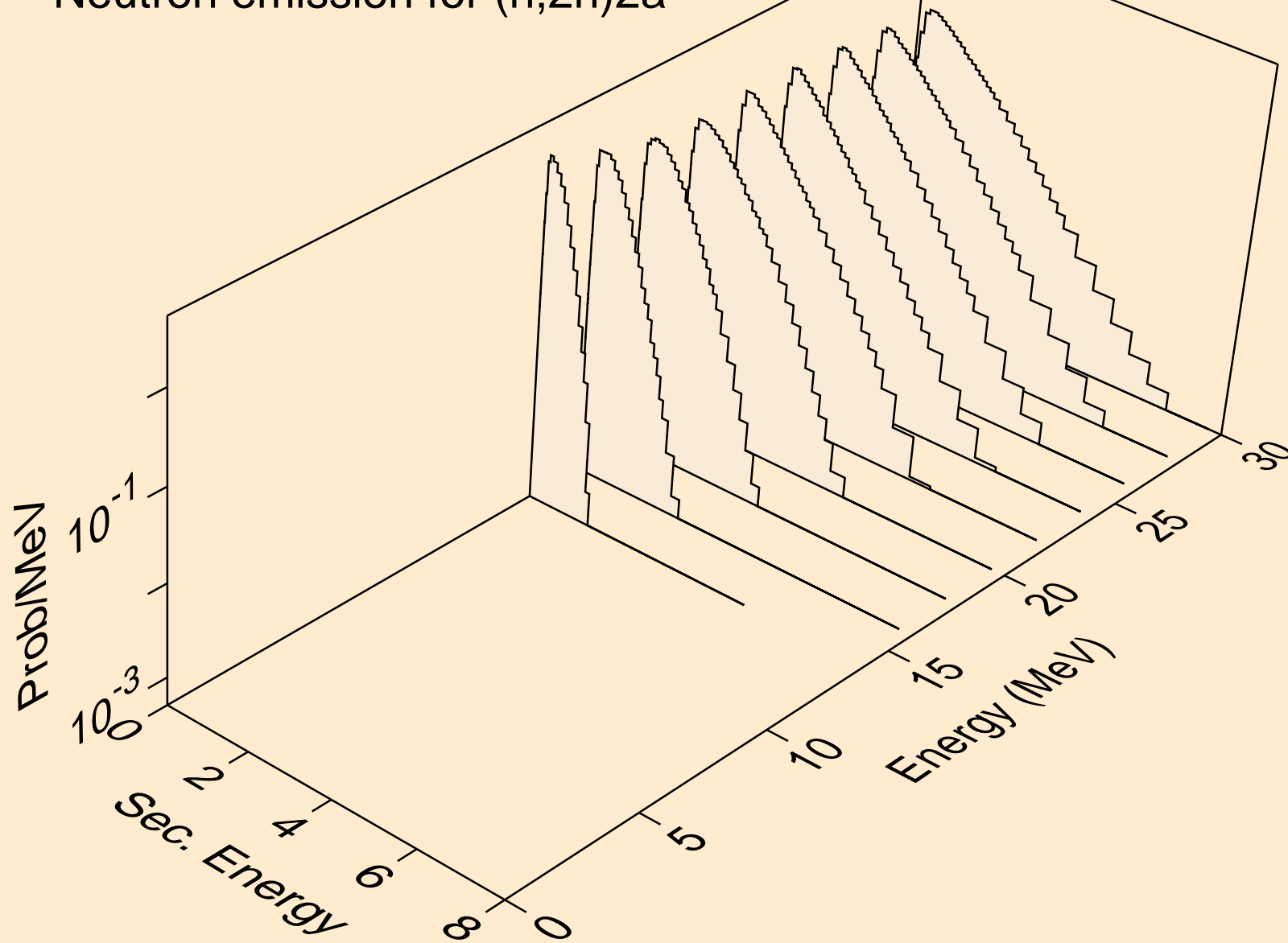

BI190M NEUTRON ACER TENDL-2024 LIBRARY; T=293.6K  
Neutron emission for (n,n\*)d

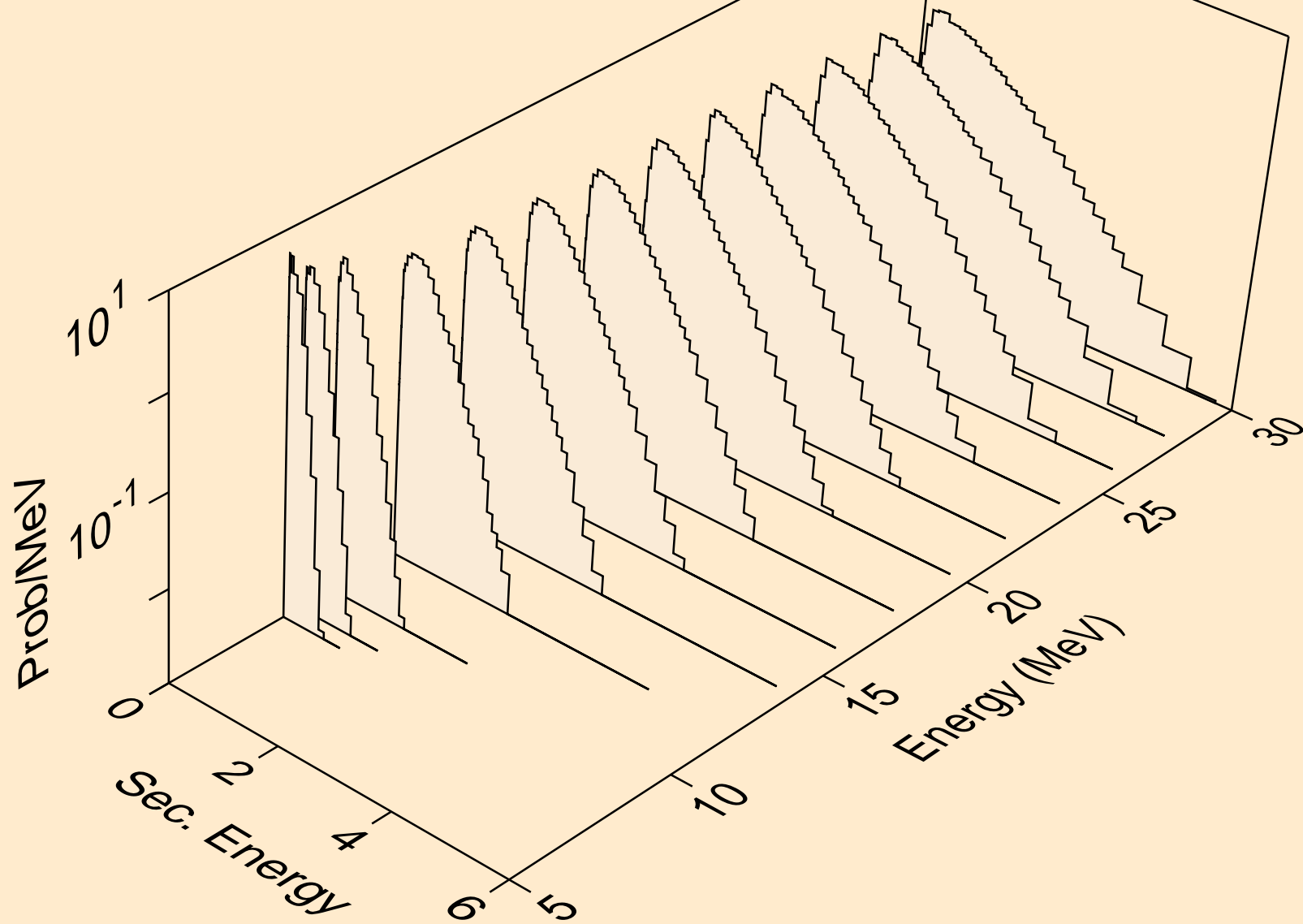

BI190M NEUTRON ACER TENDL-2024 LIBRARY; T=293.6K  
Neutron emission for (n,n\*)t

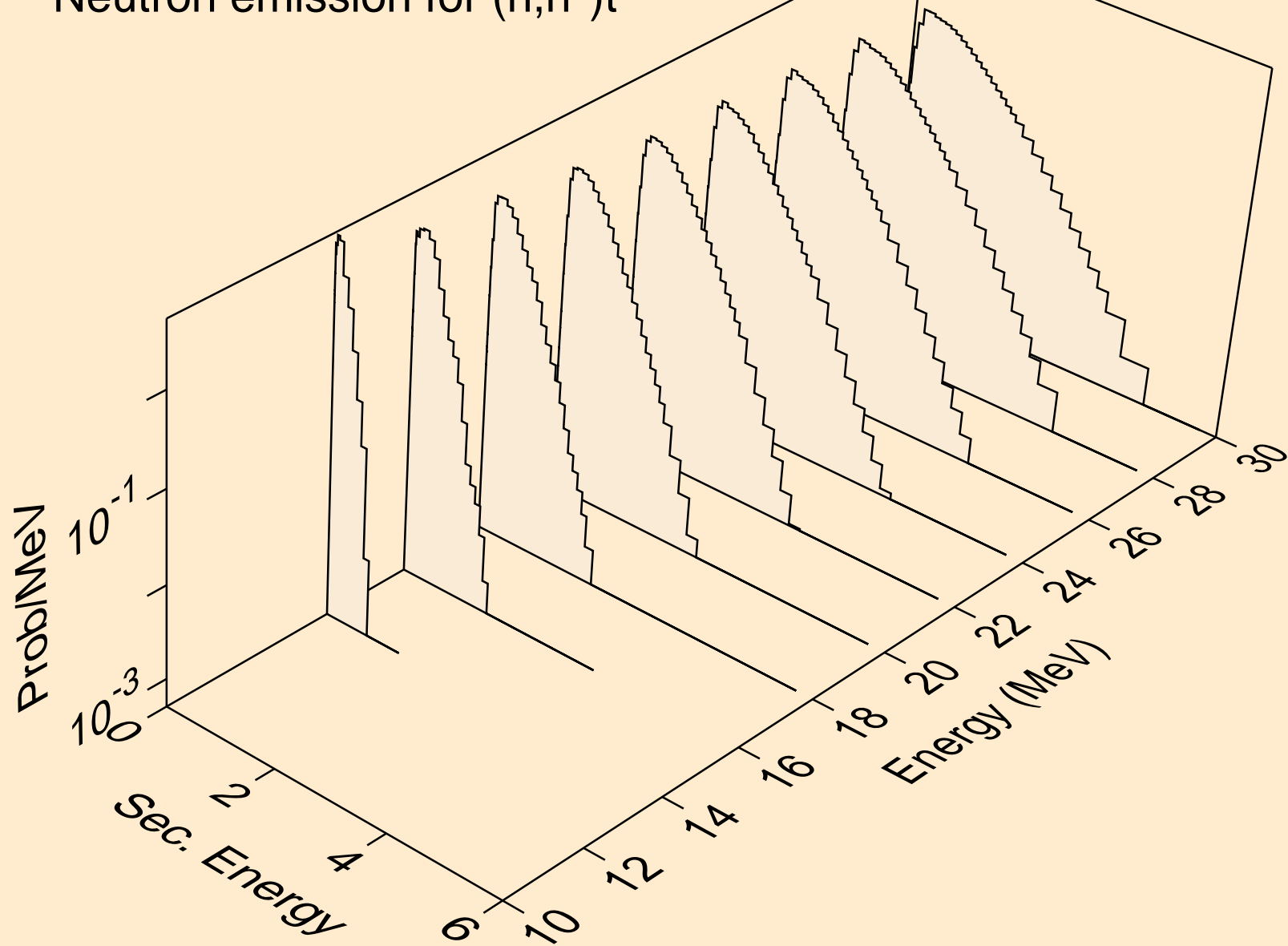

BI190M NEUTRON ACER TENDL-2024 LIBRARY; T=293.6K  
Neutron emission for (n,n\*)he3

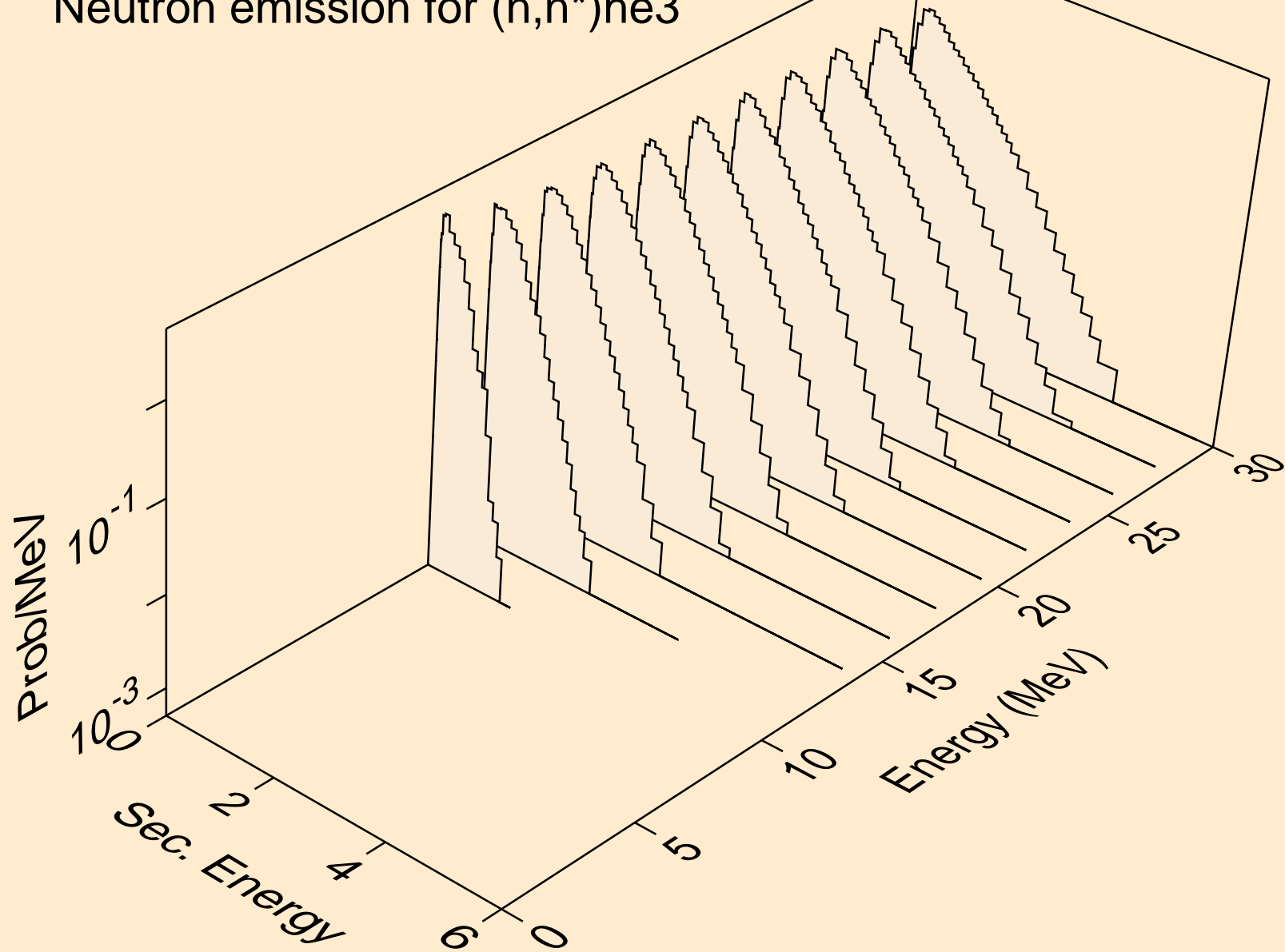

BI190M NEUTRON ACER TENDL-2024 LIBRARY; T=293.6K  
Neutron emission for (n,4n)

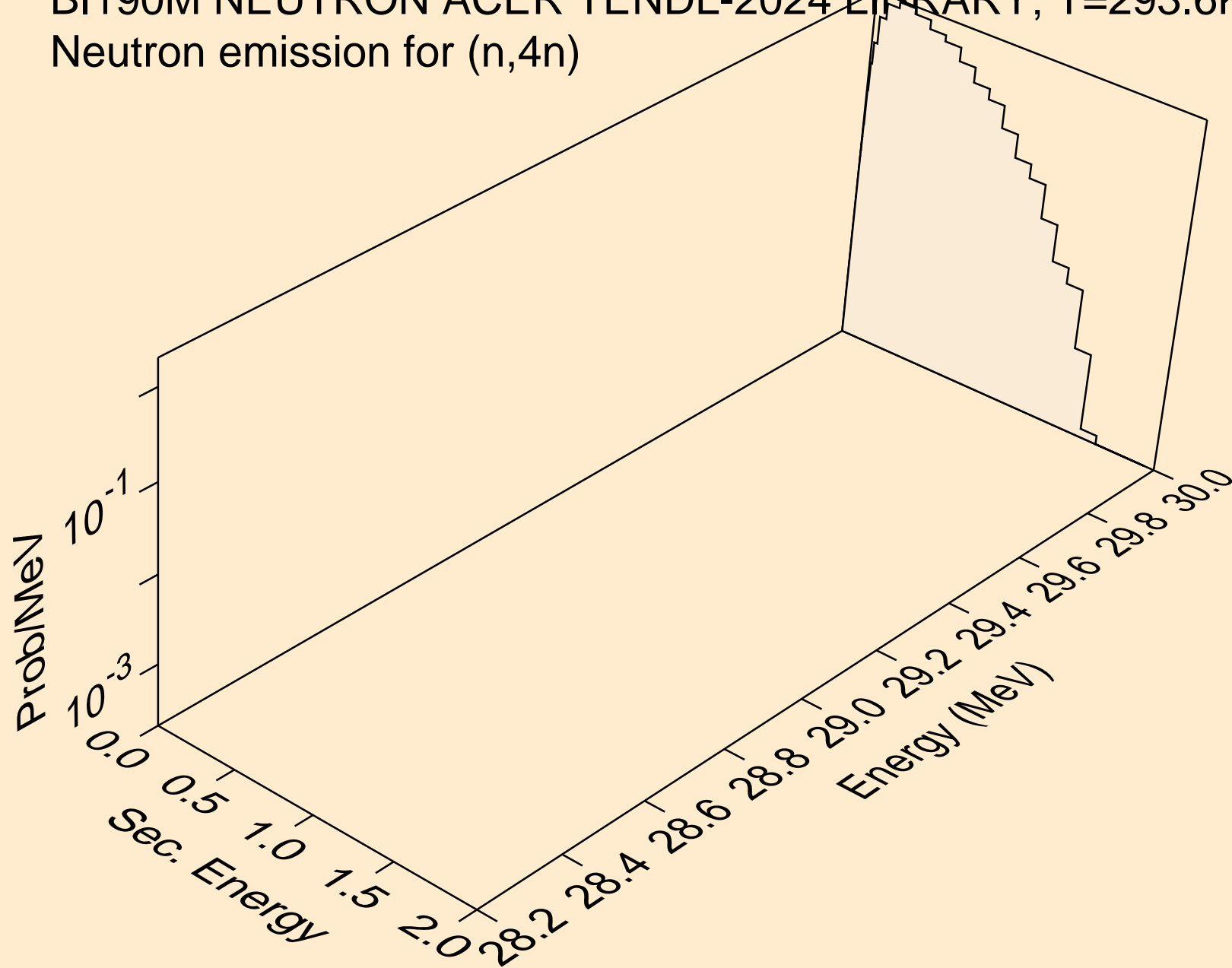

BI190M NEUTRON ACER TENDL-2024 LIBRARY; T=293.6K  
Neutron emission for (n,2np)

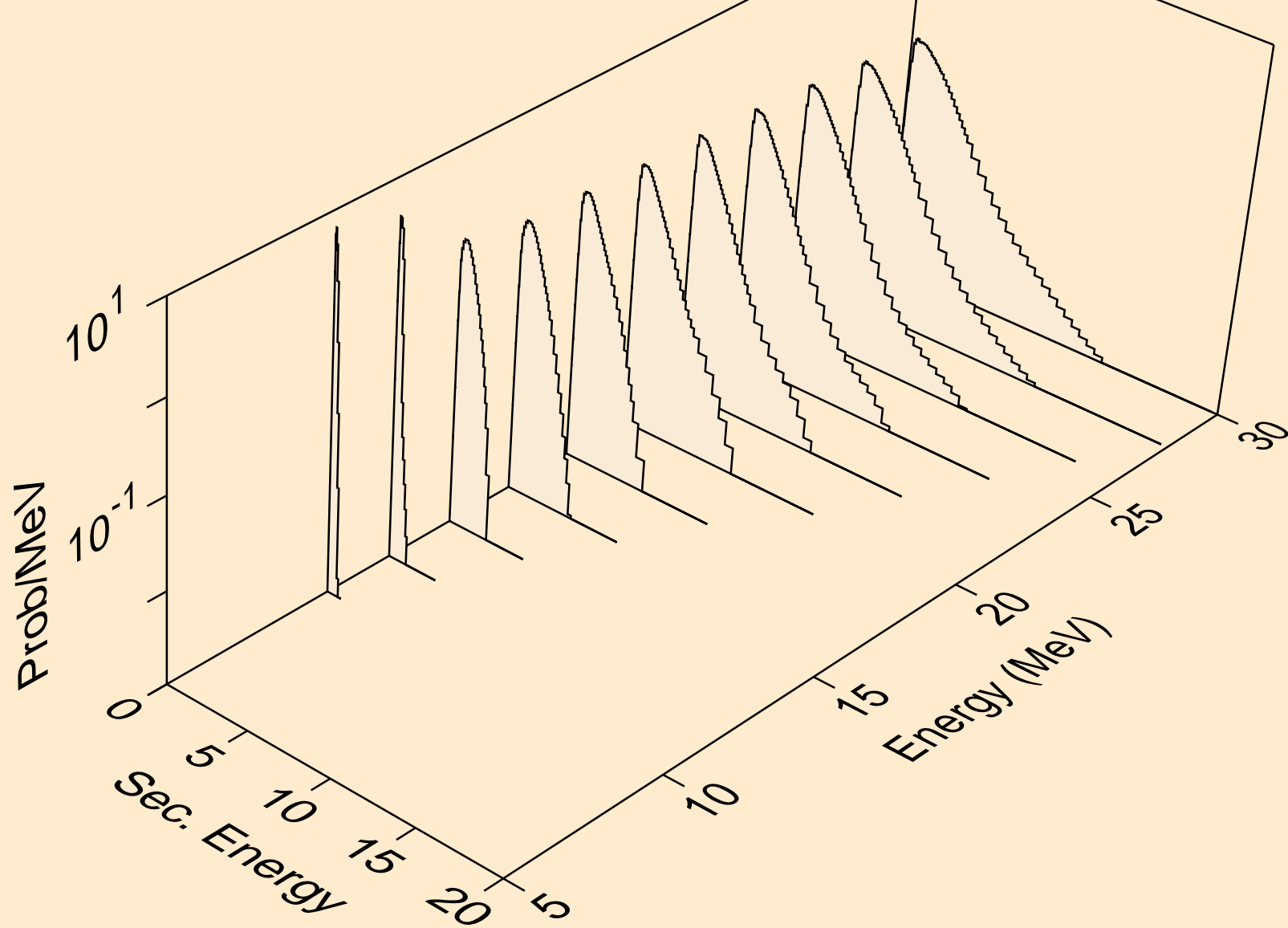

BI190M NEUTRON ACER TENDL-2024 LIBRARY; T=293.6K  
Neutron emission for (n,3np)

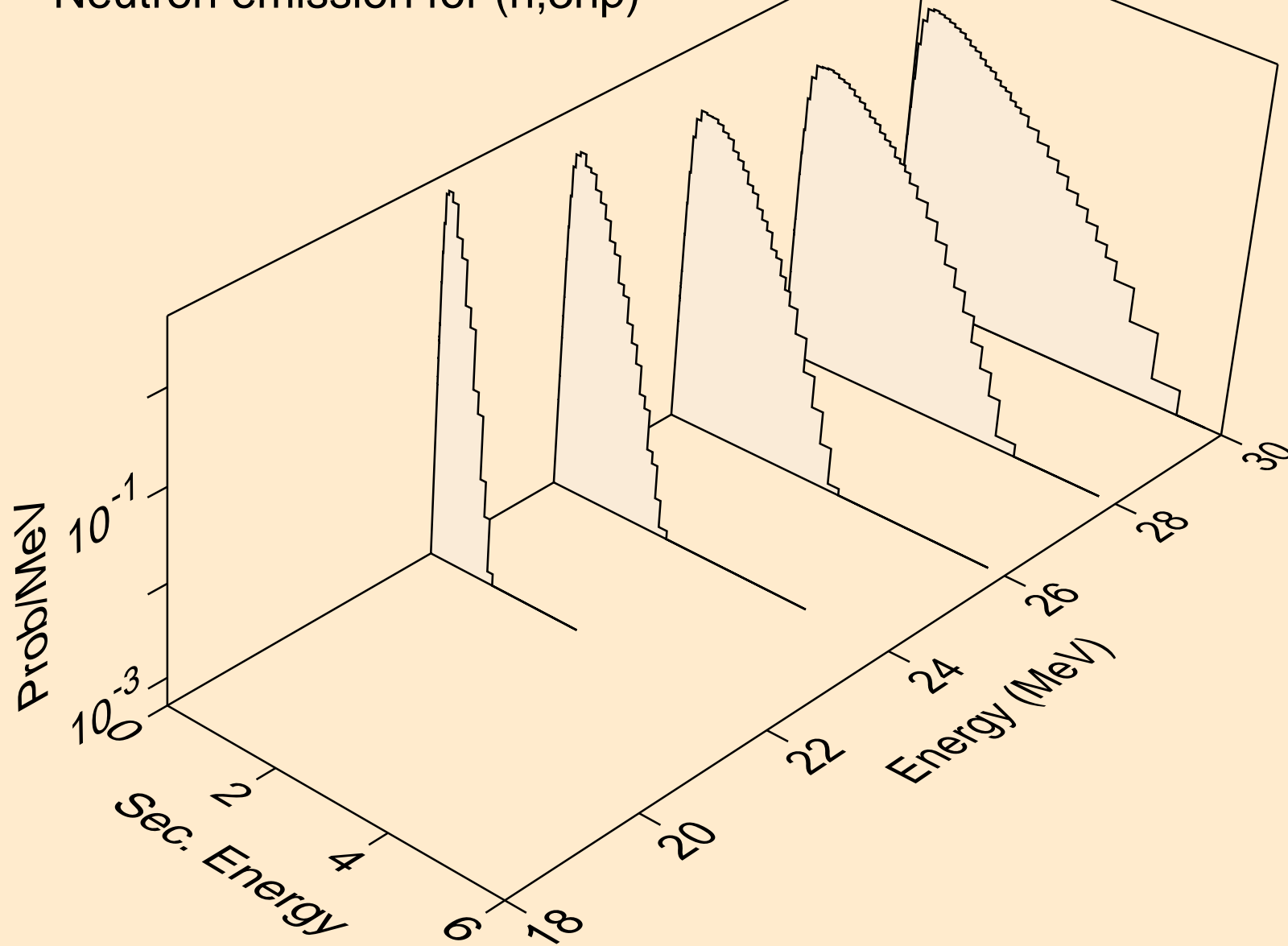

BI190M NEUTRON ACER TENDL-2024 LIBRARY; T=293.6K  
Neutron emission for (n,n2p)

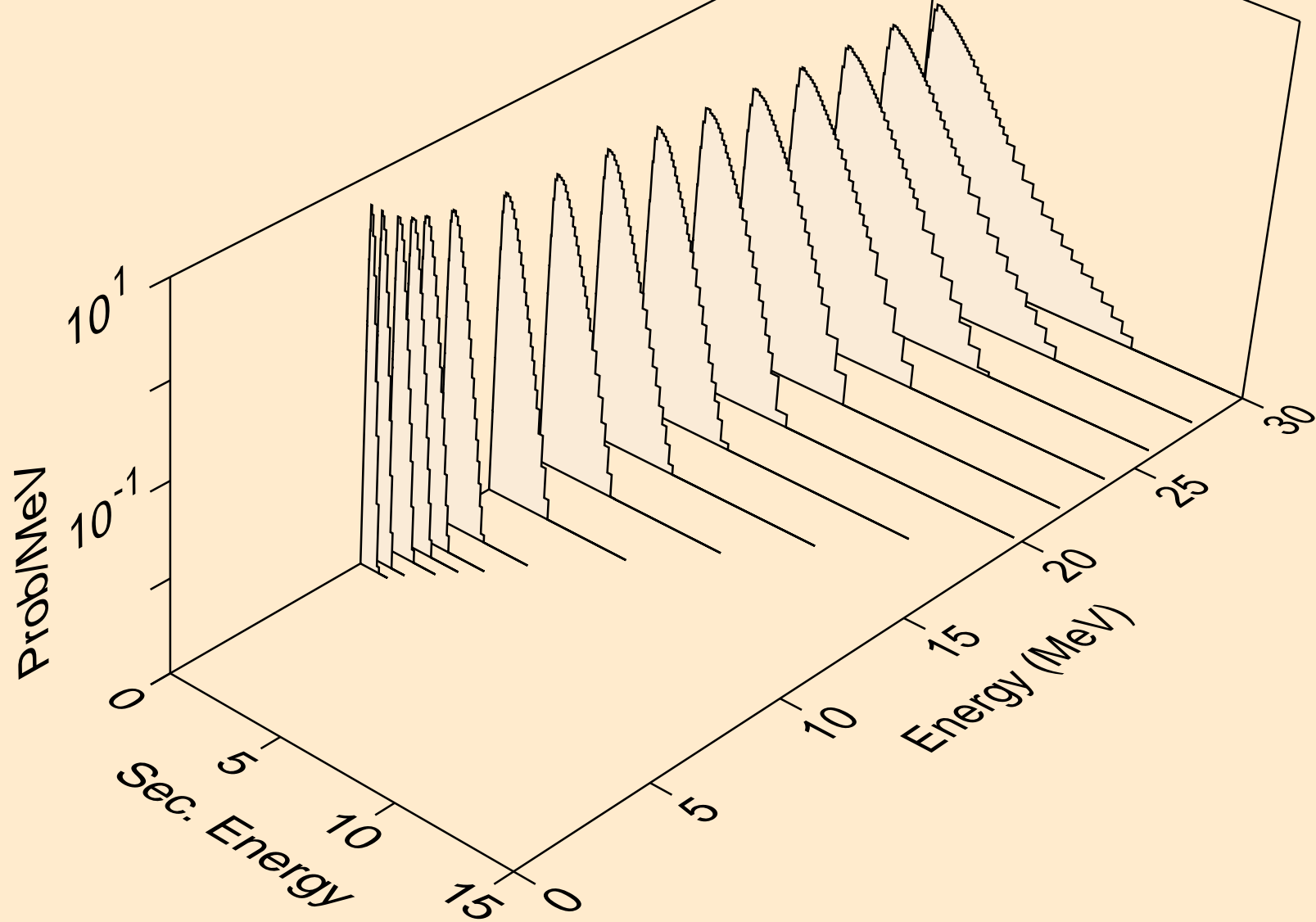

BI190M NEUTRON ACER TENDL-2024 LIBRARY; T=293.6K  
Neutron emission for (n,npa)

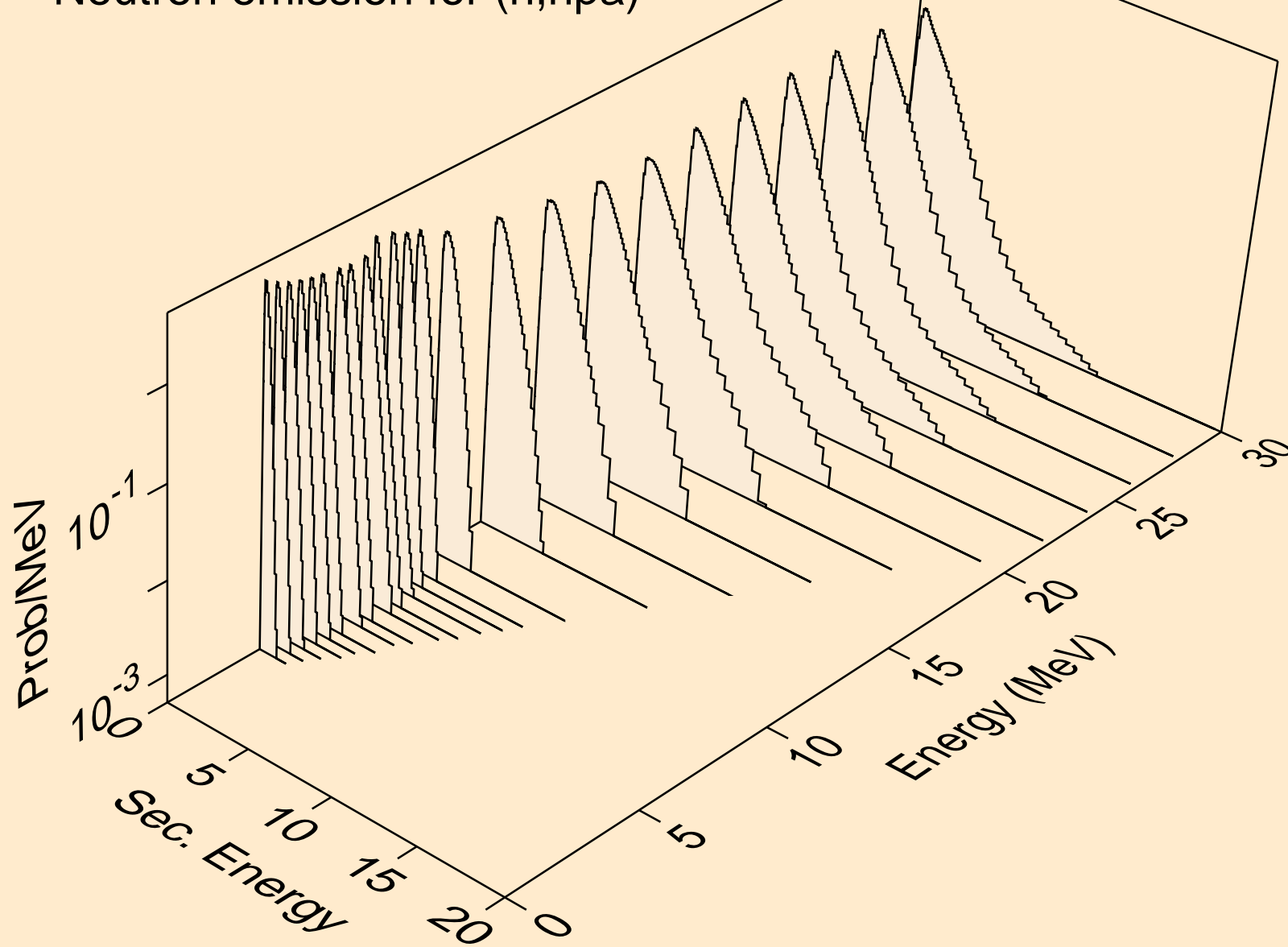

BI190M NEUTRON ACER TENDL-2024 LIBRARY; T=293.6K  
Neutron emission for (n,n\*c)

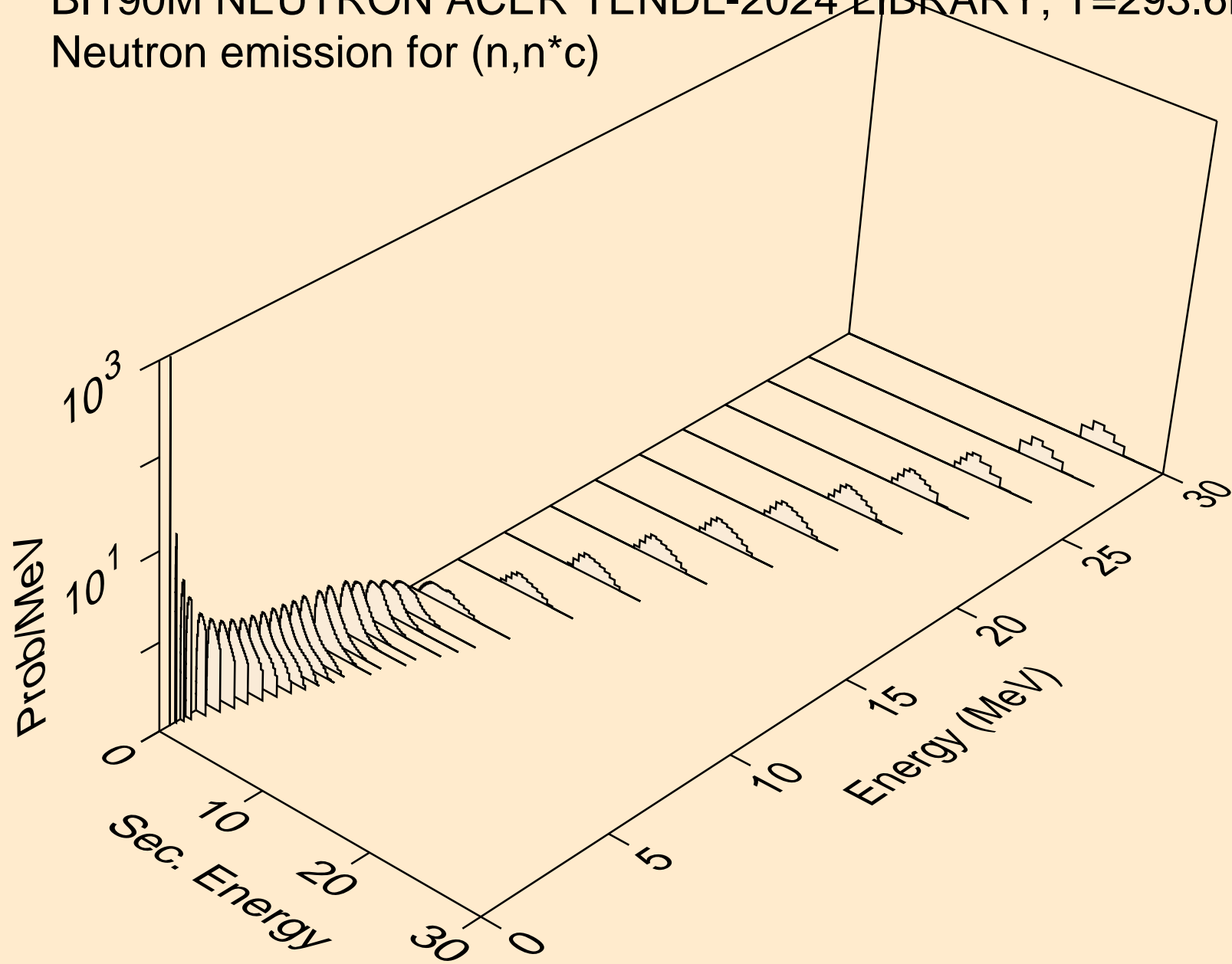

BI190M NEUTRON ACER TENDL-2024 LIBRARY; T=293.6K  
Photon emission for (n,x)

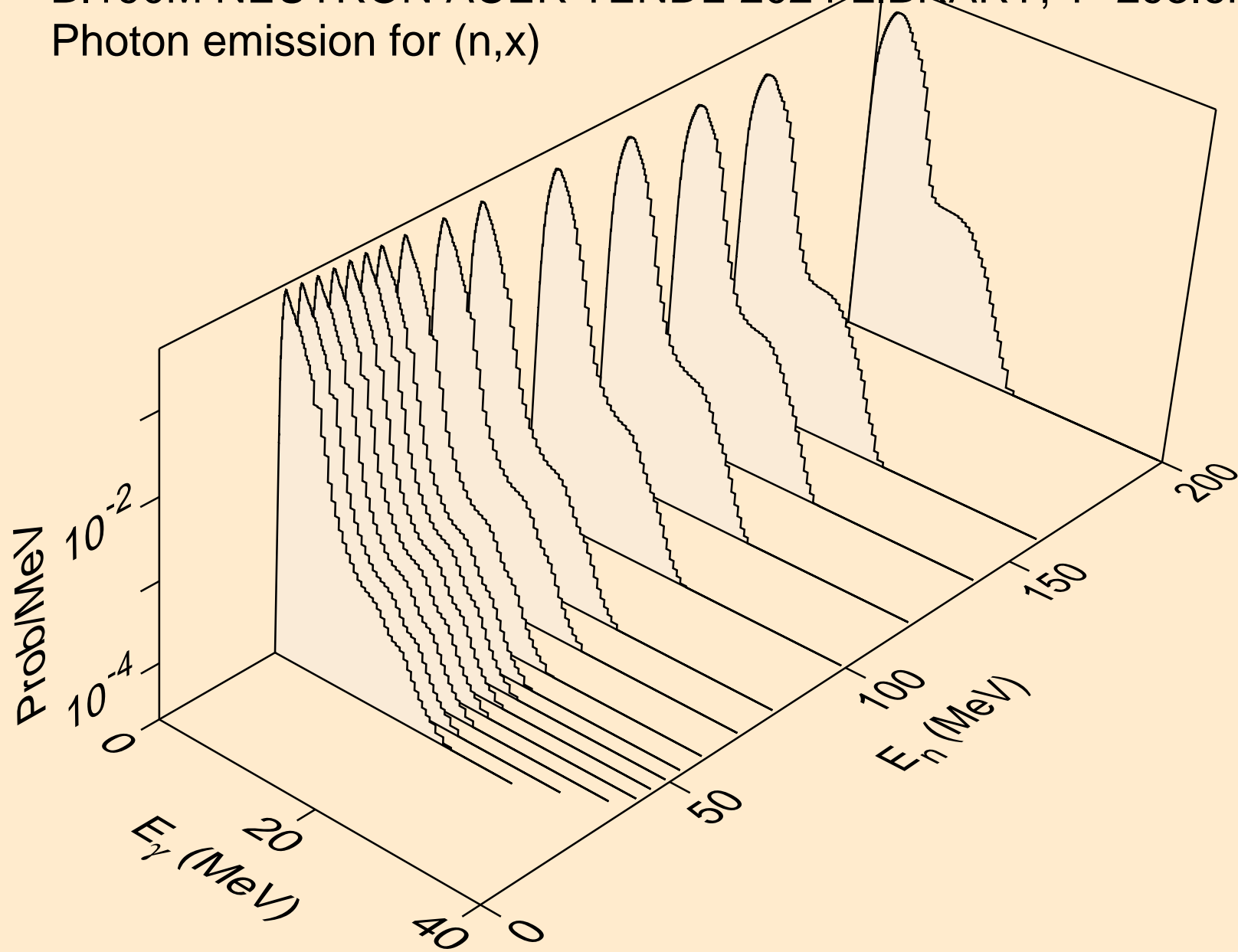

BI190M NEUTRON ACER TENDL-2024 LIBRARY; T=293.6K  
Photon emission for (n,2nd)

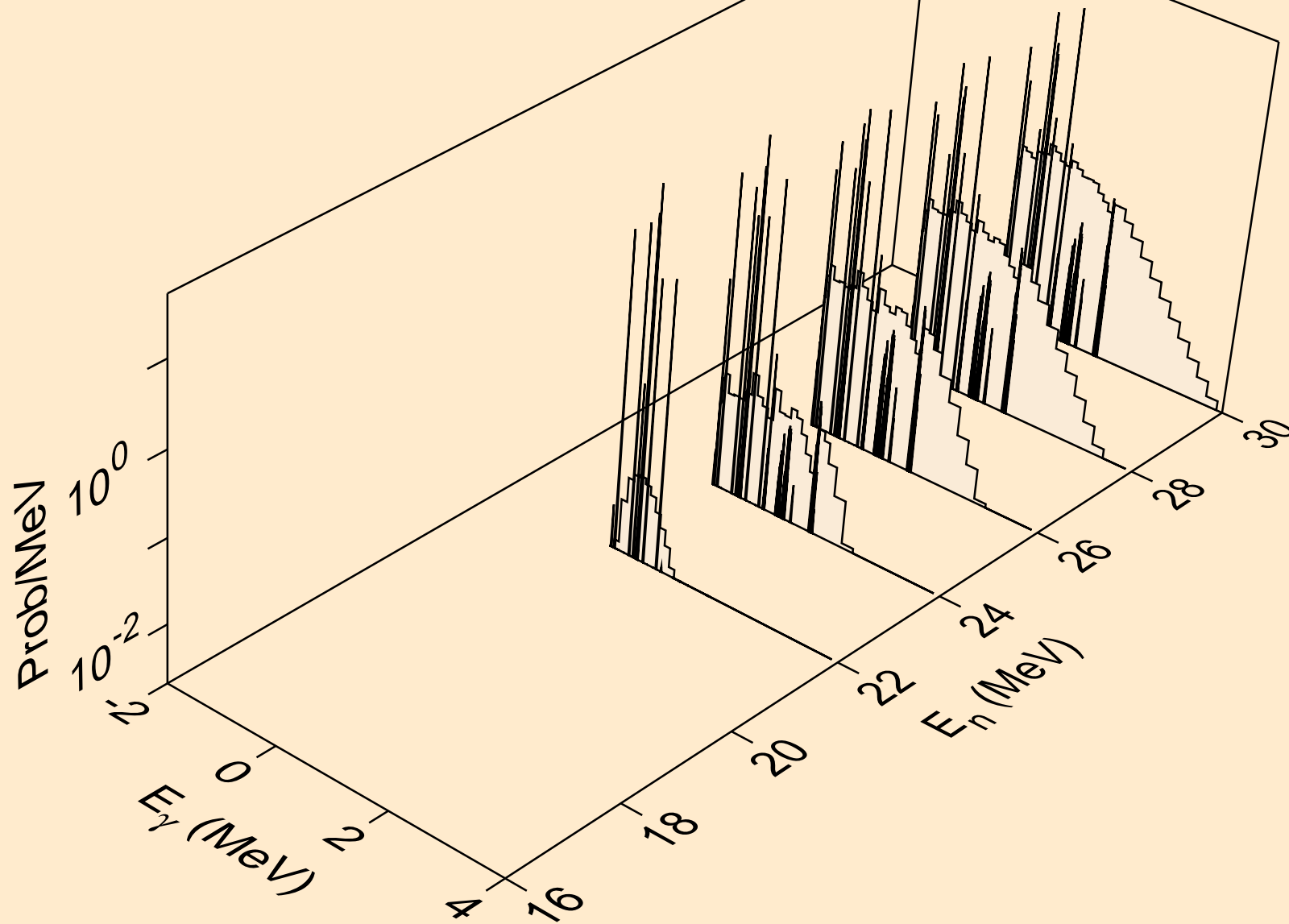

BI190M NEUTRON ACER TENDL-2024 LIBRARY; T=293.6K  
Photon emission for (n,2n)

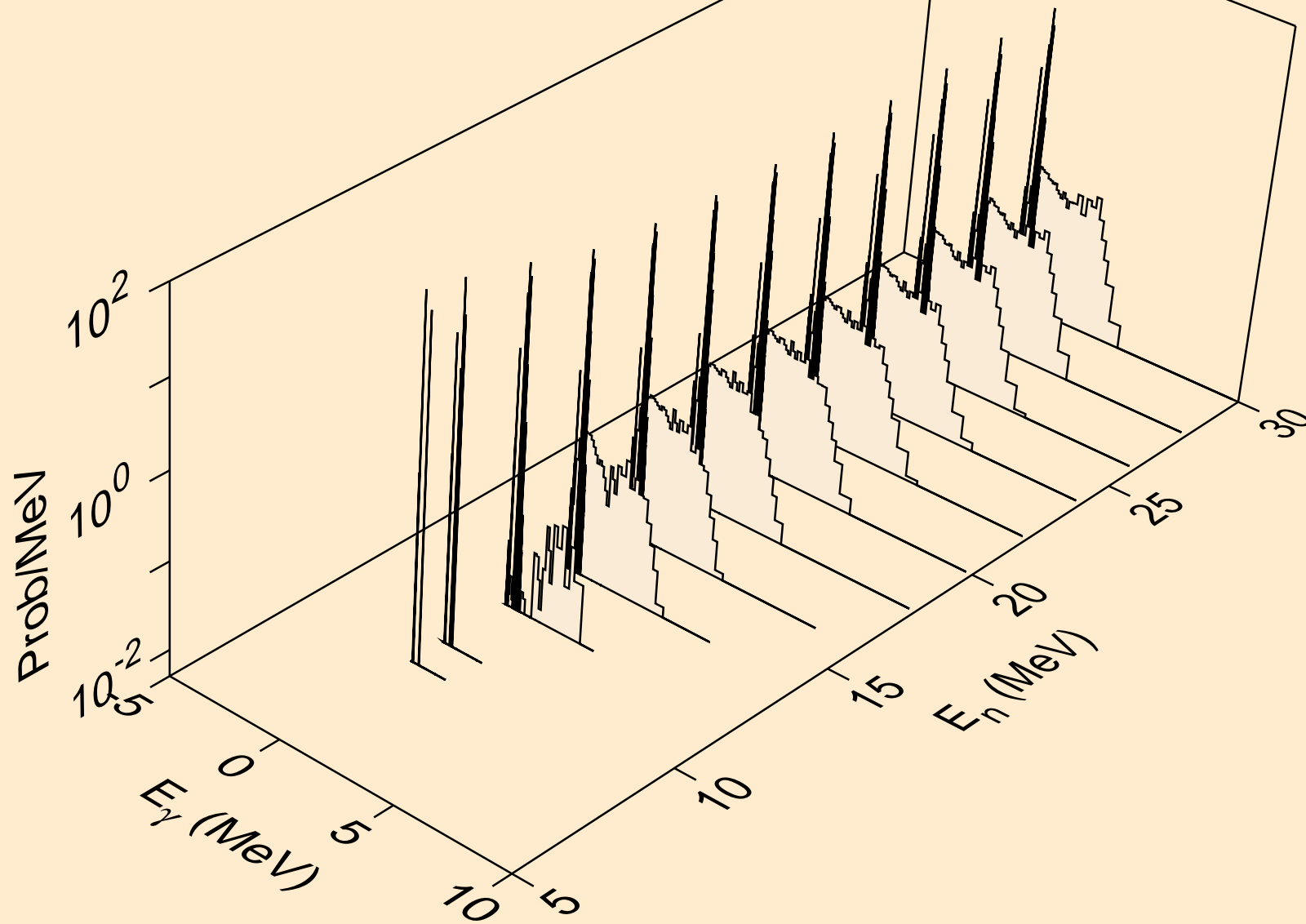

BI190M NEUTRON ACER TENDL-2024 LIBRARY; T=293.6K  
Photon emission for (n,3n)

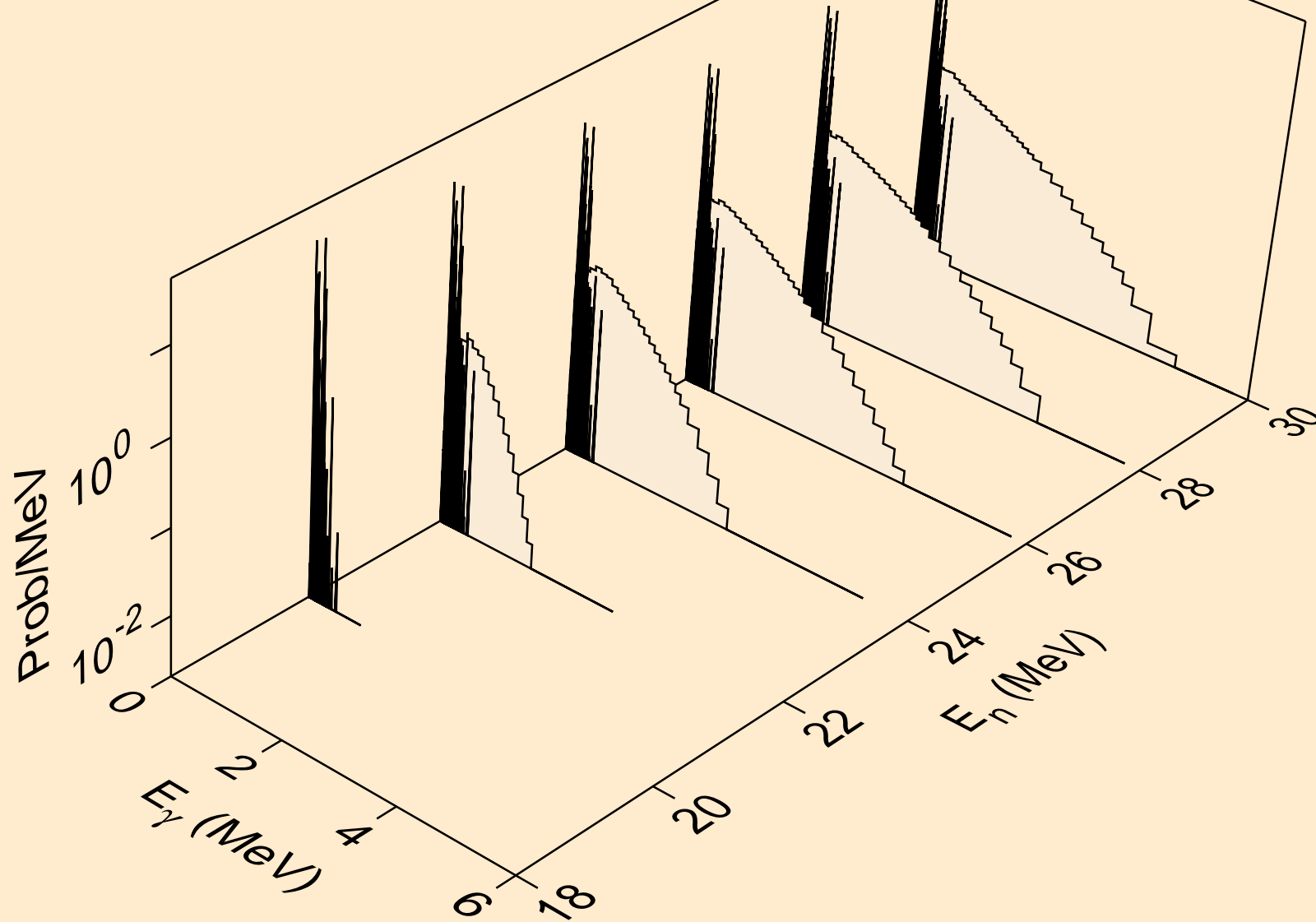

BI190M NEUTRON ACER TENDL-2024 LIBRARY; T=293.6K  
Photon emission for (n,n\*)a

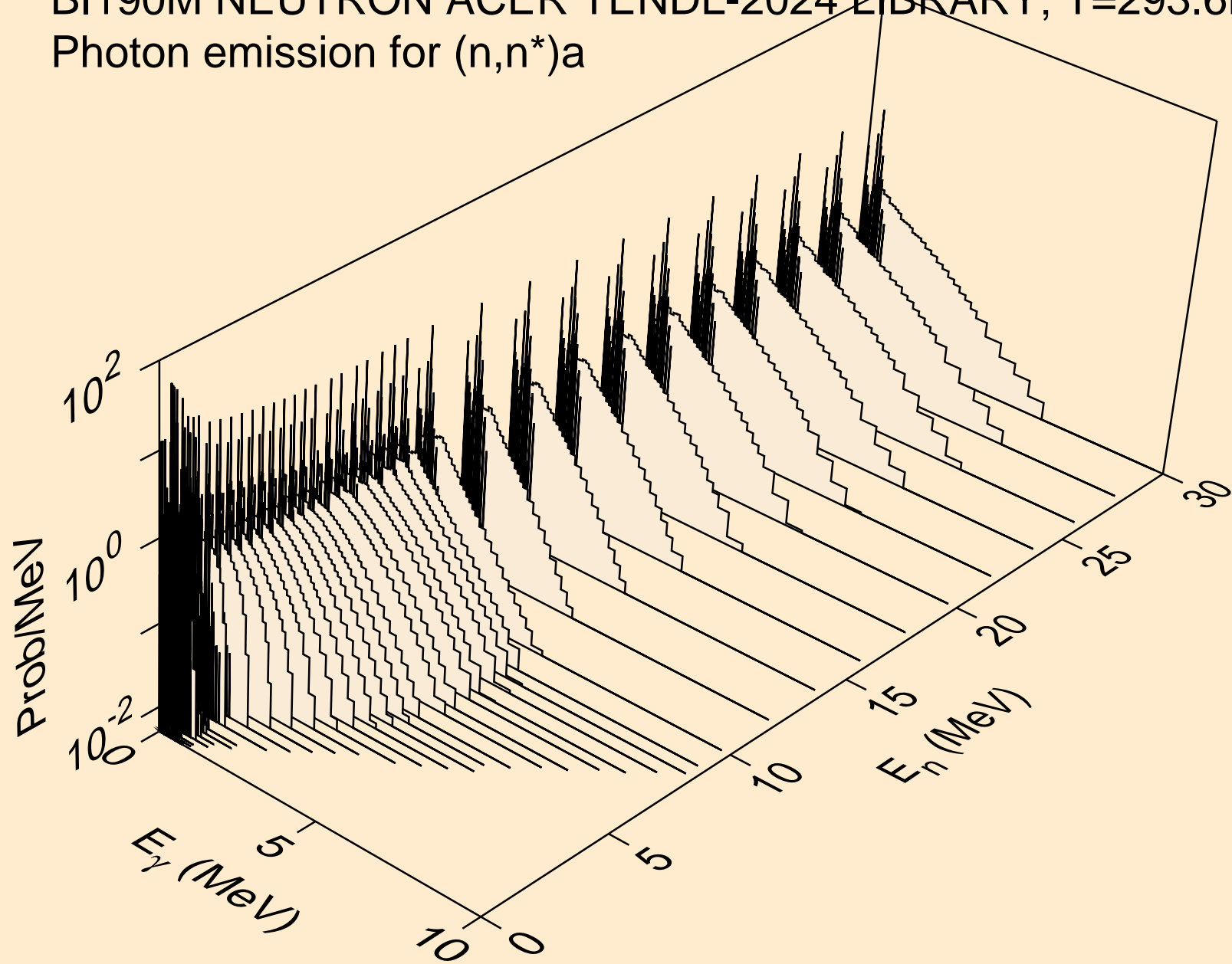

BI190M NEUTRON ACER TENDL-2024 LIBRARY; T=293.6K  
Photon emission for (n,n\*)3a

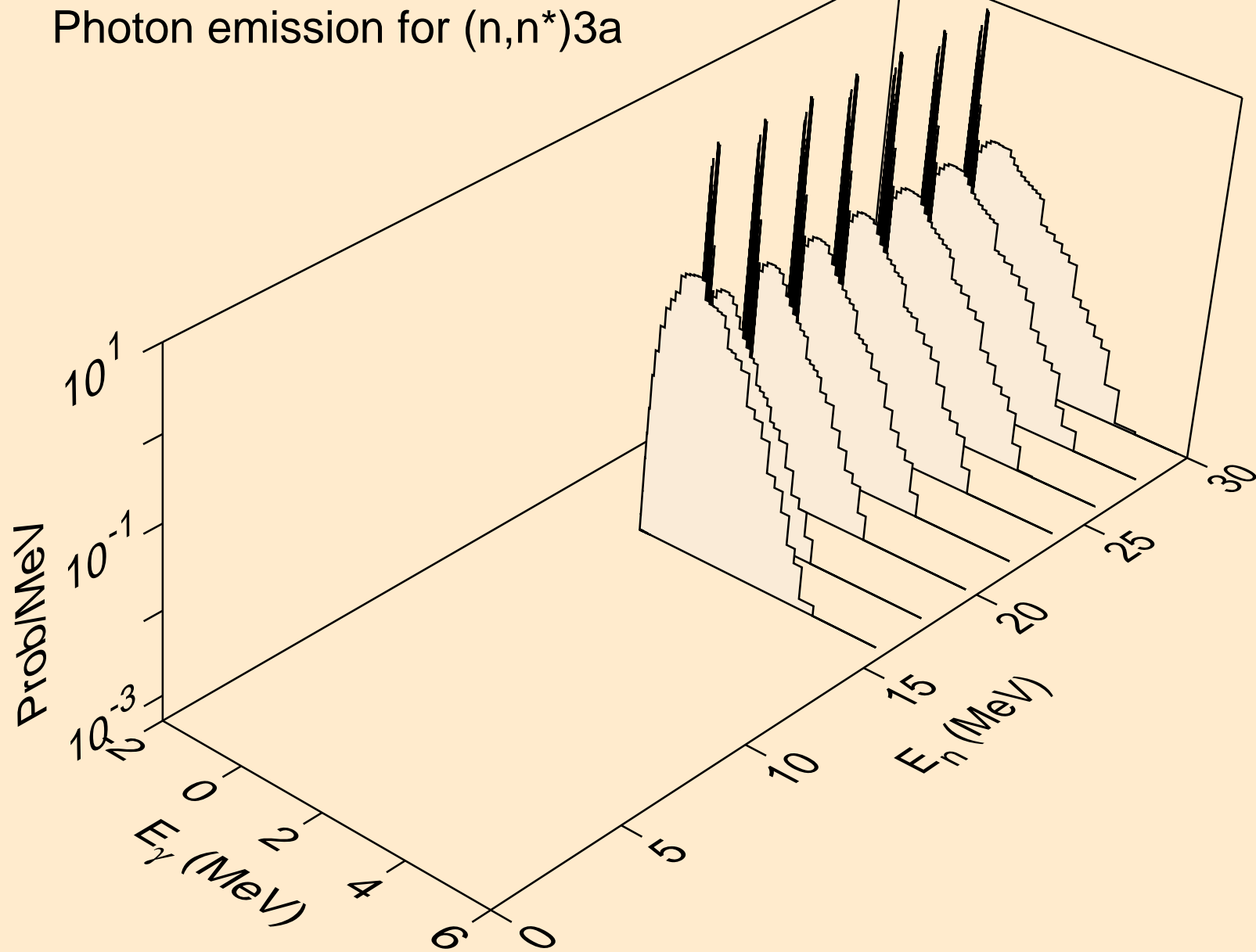

BI190M NEUTRON ACER TENDL-2024 LIBRARY; T=293.6K  
Photon emission for (n,2n)a

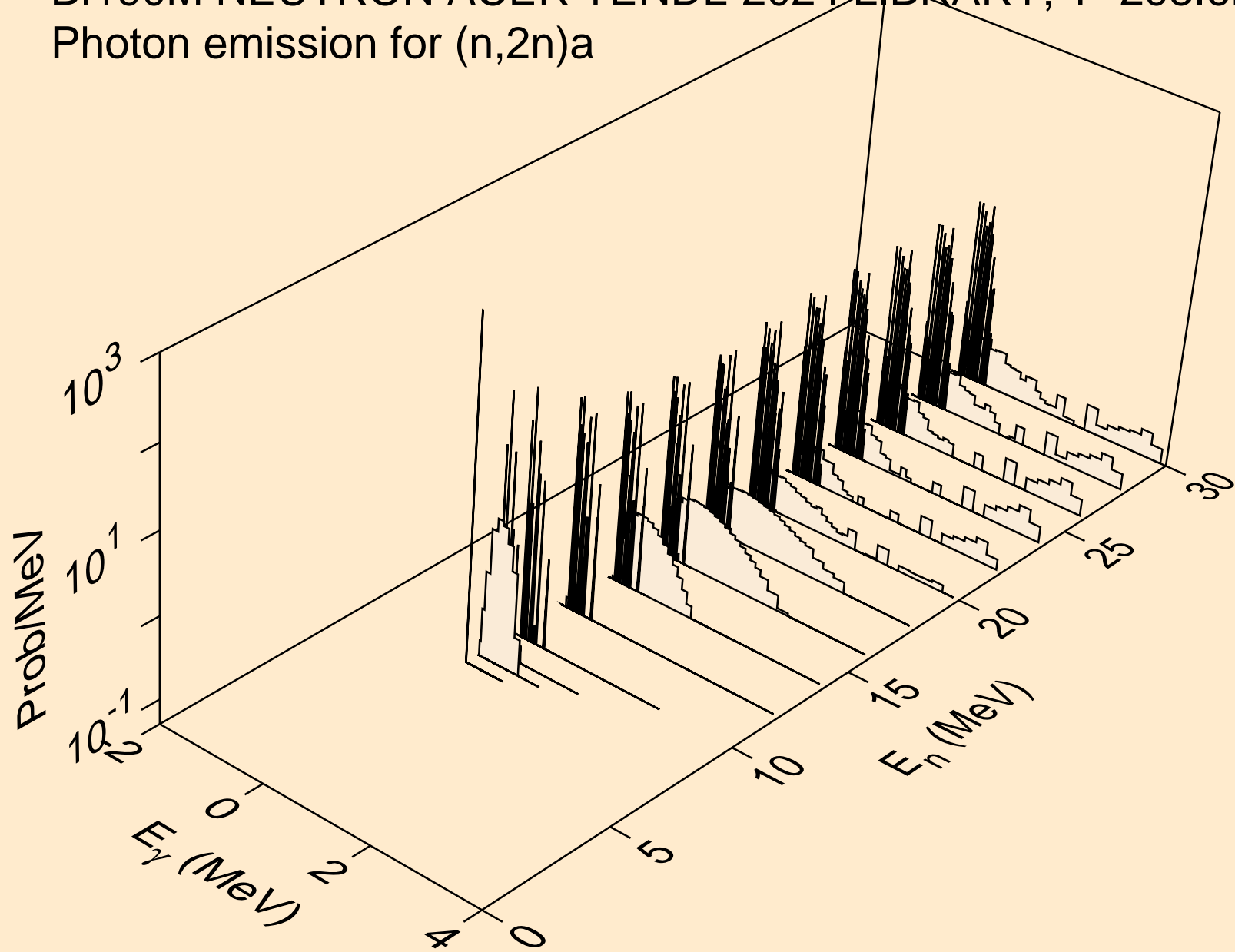

BI190M NEUTRON ACER TENDL-2024 LIBRARY; T=293.6K  
Photon emission for (n,3n)a

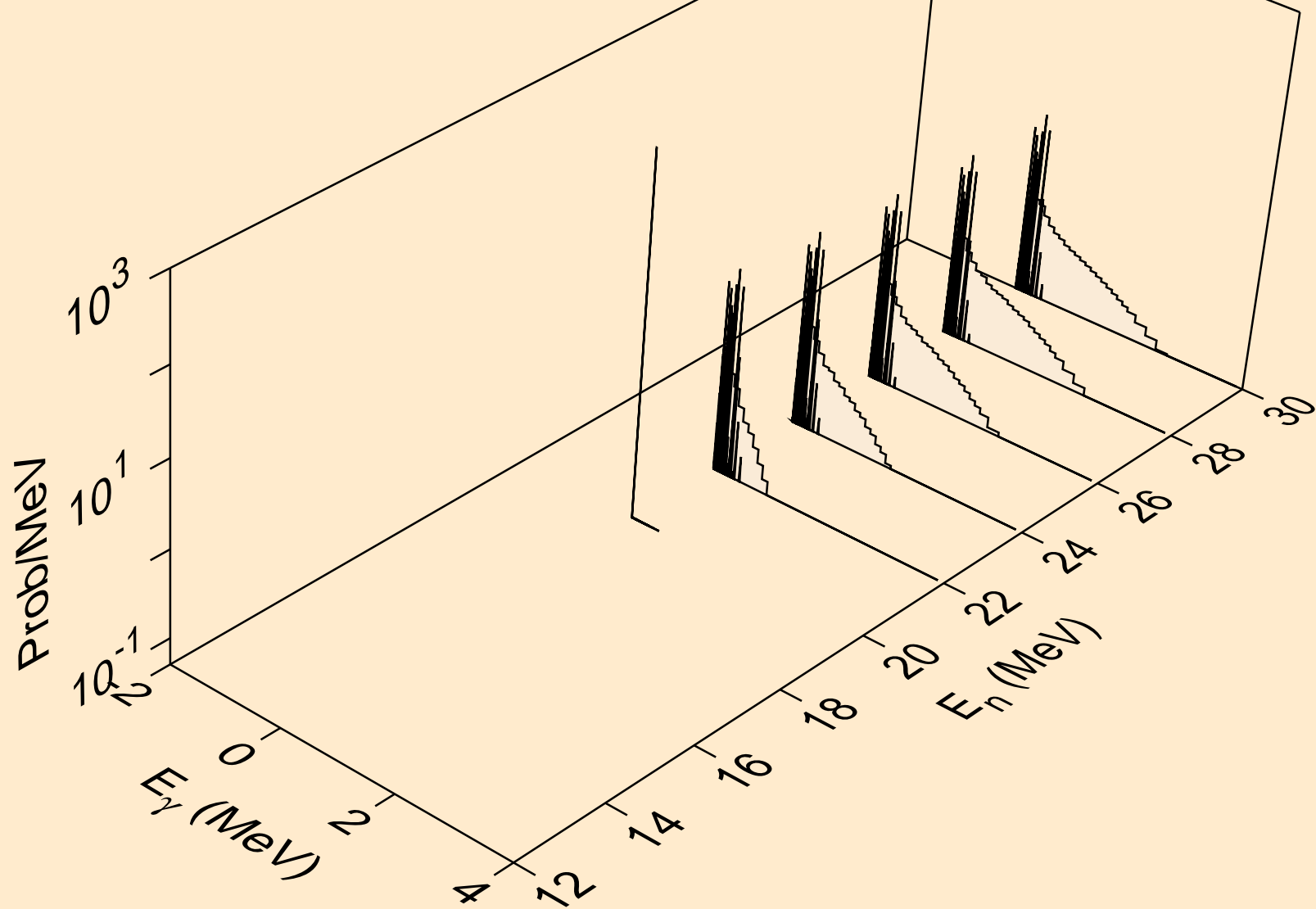

BI190M NEUTRON ACER TENDL-2024 LIBRARY; T=293.6K  
Photon emission for (n,n\*)p

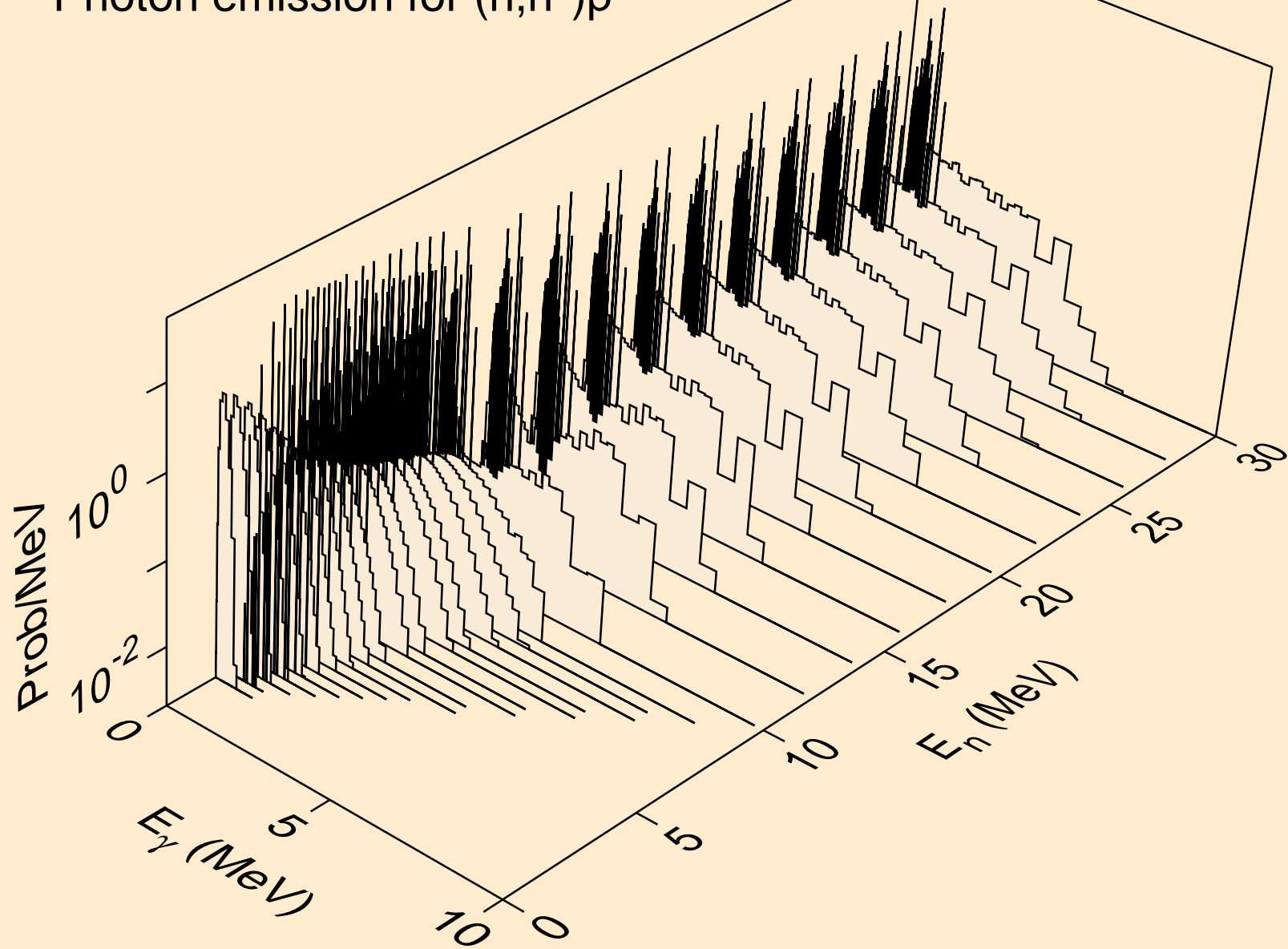

BI190M NEUTRON ACER TENDL-2024 LIBRARY; T=293.6K  
Photon emission for (n,n\*)2a

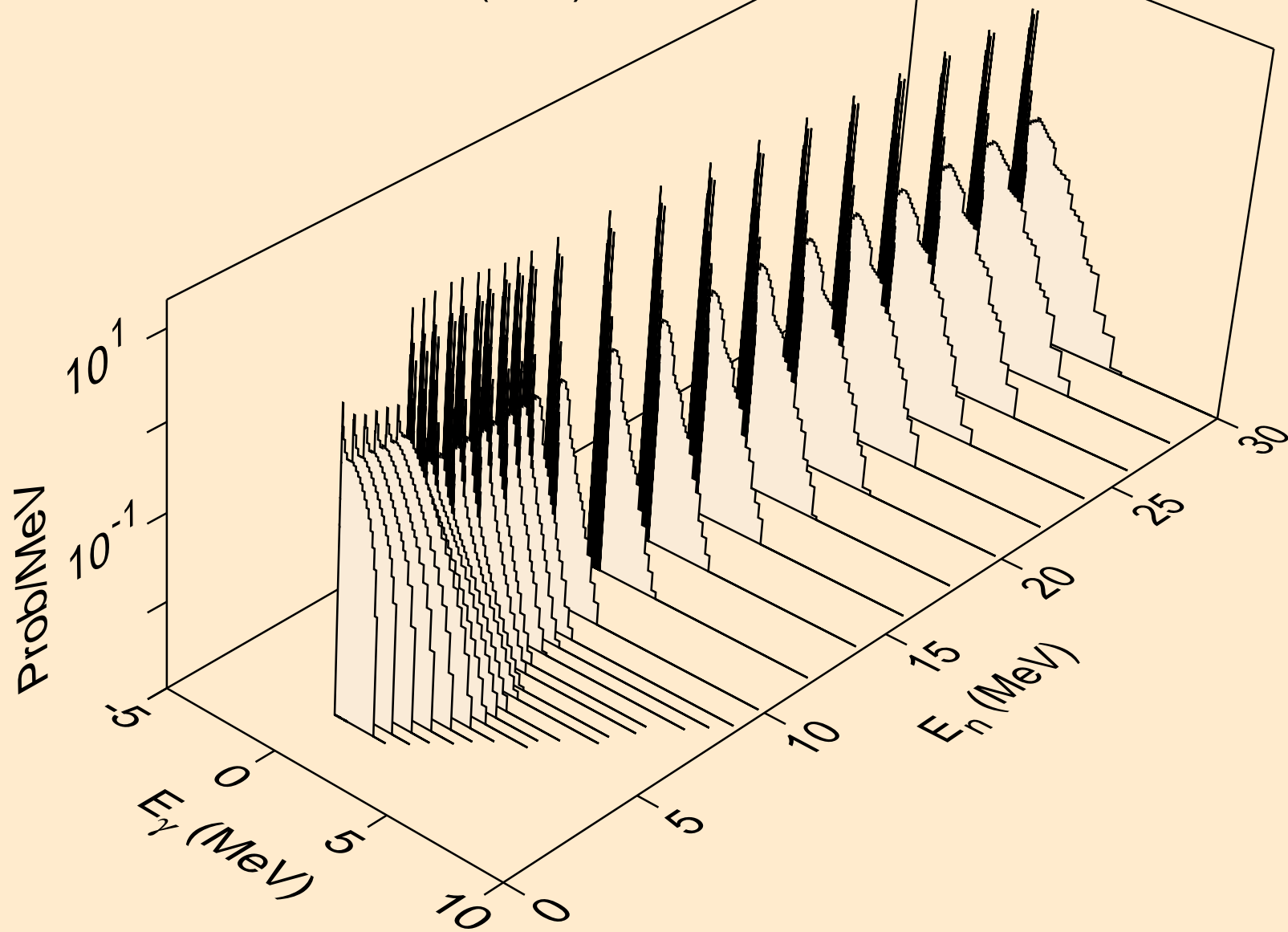

BI190M NEUTRON ACER TENDL-2024 LIBRARY; T=293.6K  
Photon emission for (n,2n)2a

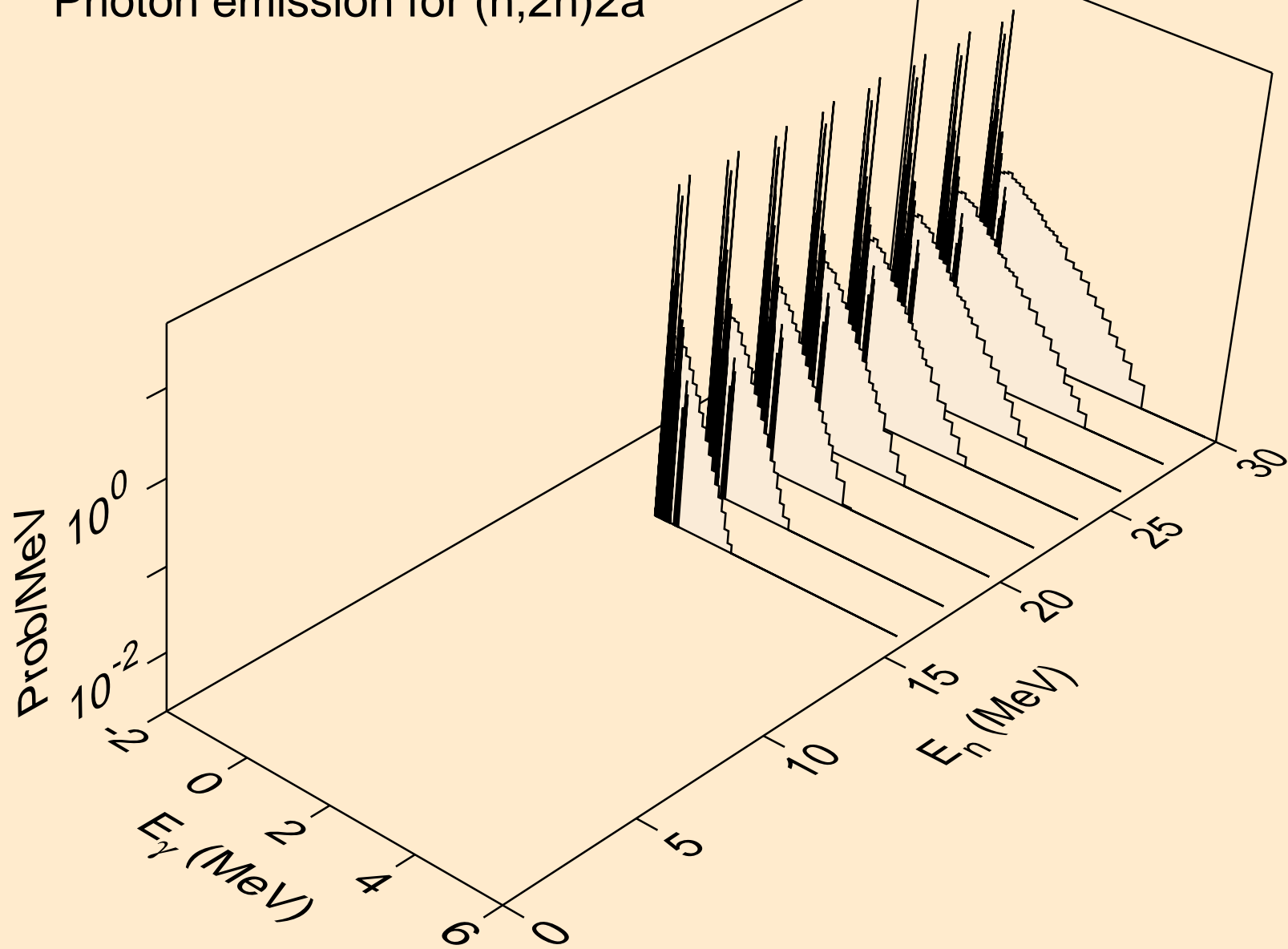

BI190M NEUTRON ACER TENDL-2024 LIBRARY; T=293.6K  
Photon emission for (n,n\*)d

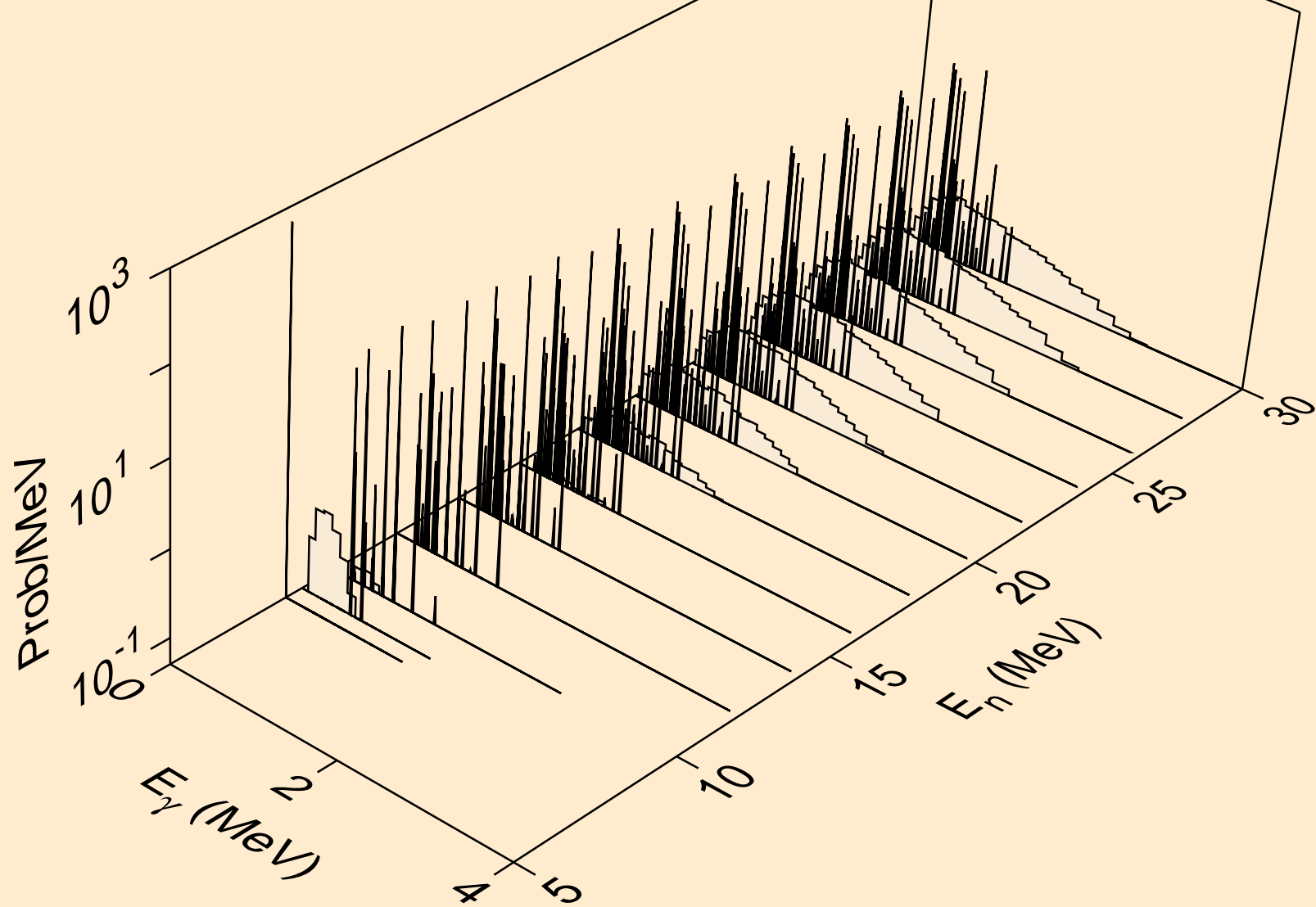

BI190M NEUTRON ACER TENDL-2024 LIBRARY; T=293.6K  
Photon emission for (n,n\*)t

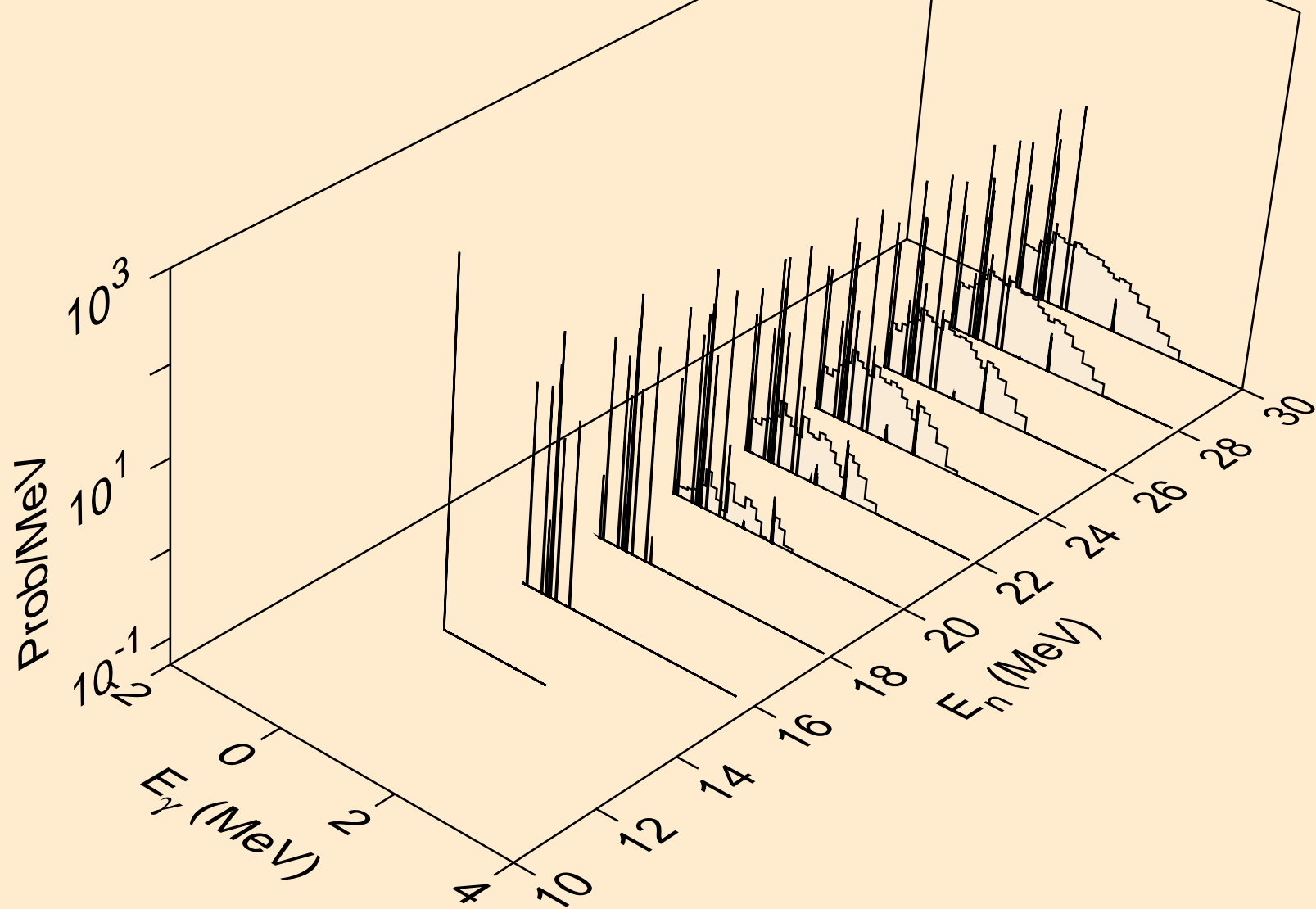

BI190M NEUTRON ACER TENDL-2024 LIBRARY; T=293.6K  
Photon emission for (n,n\*)he3

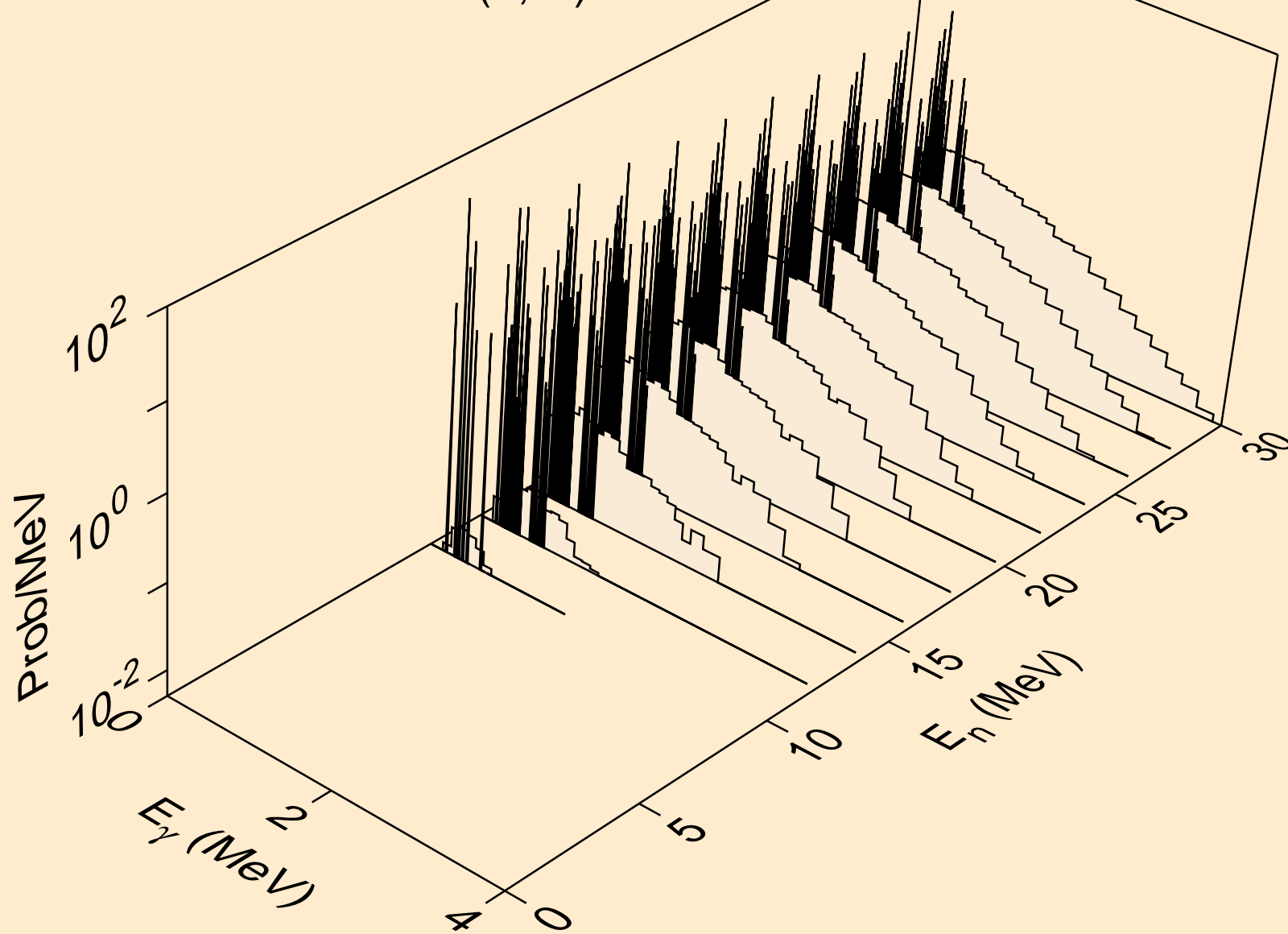

BI190M NEUTRON ACER TENDL-2024 LIBRARY; T=293.6K  
Photon emission for (n,4n)

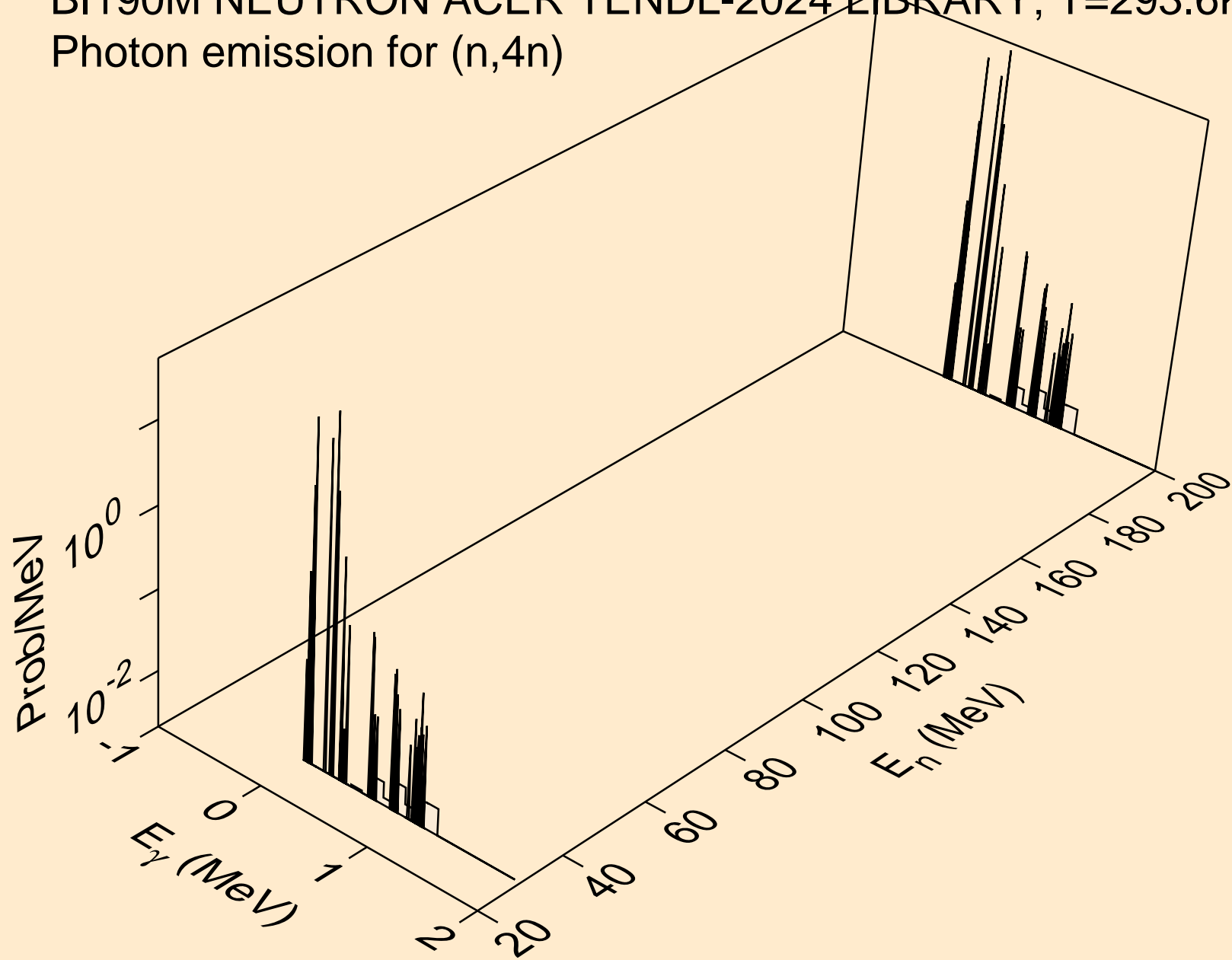

BI190M NEUTRON ACER TENDL-2024 LIBRARY; T=293.6K  
Photon emission for (n,2np)

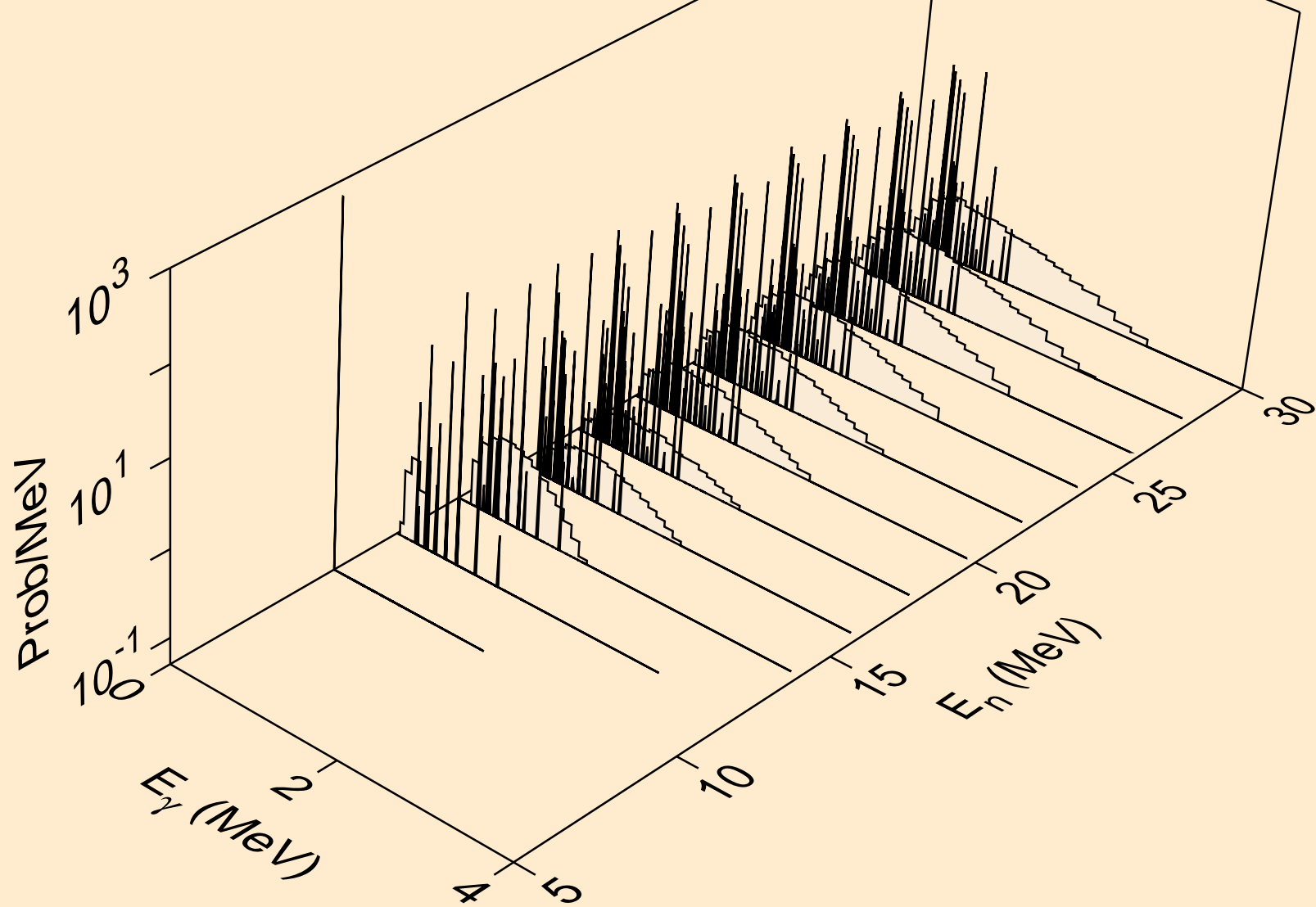

BI190M NEUTRON ACER TENDL-2024 LIBRARY; T=293.6K  
Photon emission for (n,3np)

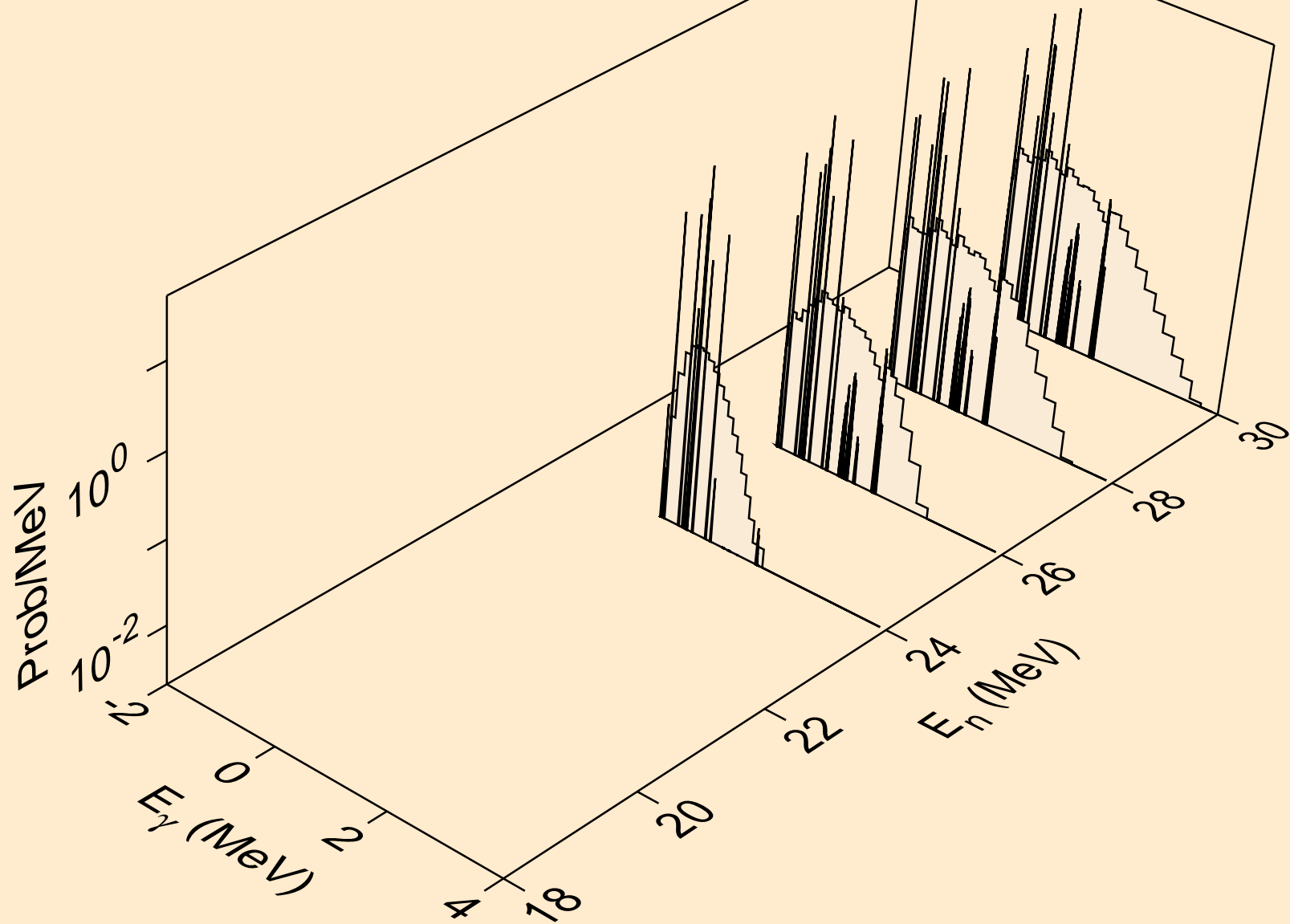

BI190M NEUTRON ACER TENDL-2024 LIBRARY; T=293.6K  
Photon emission for (n,n2p)

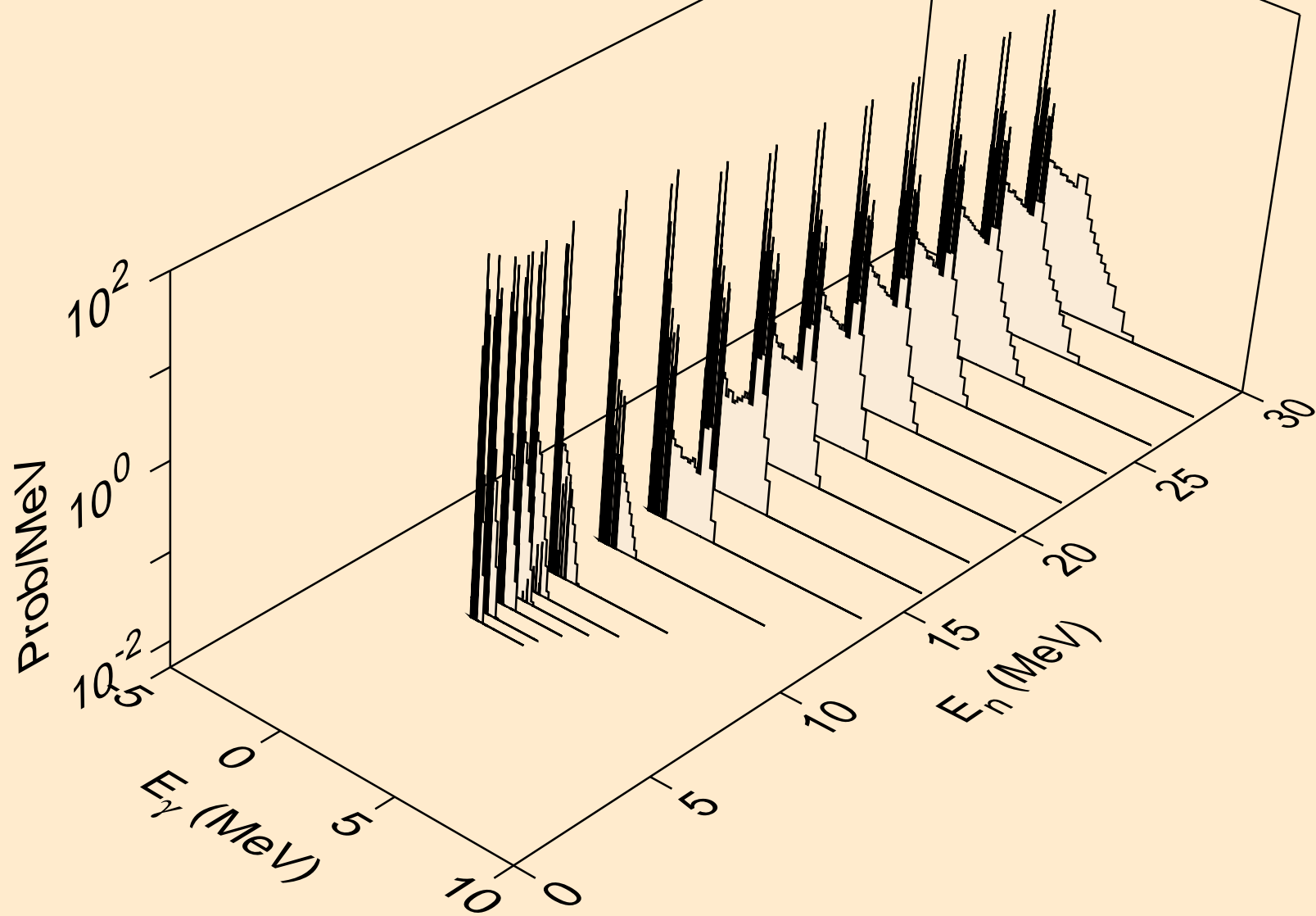

BI190M NEUTRON ACER TENDL-2024 LIBRARY; T=293.6K  
Photon emission for (n,npa)

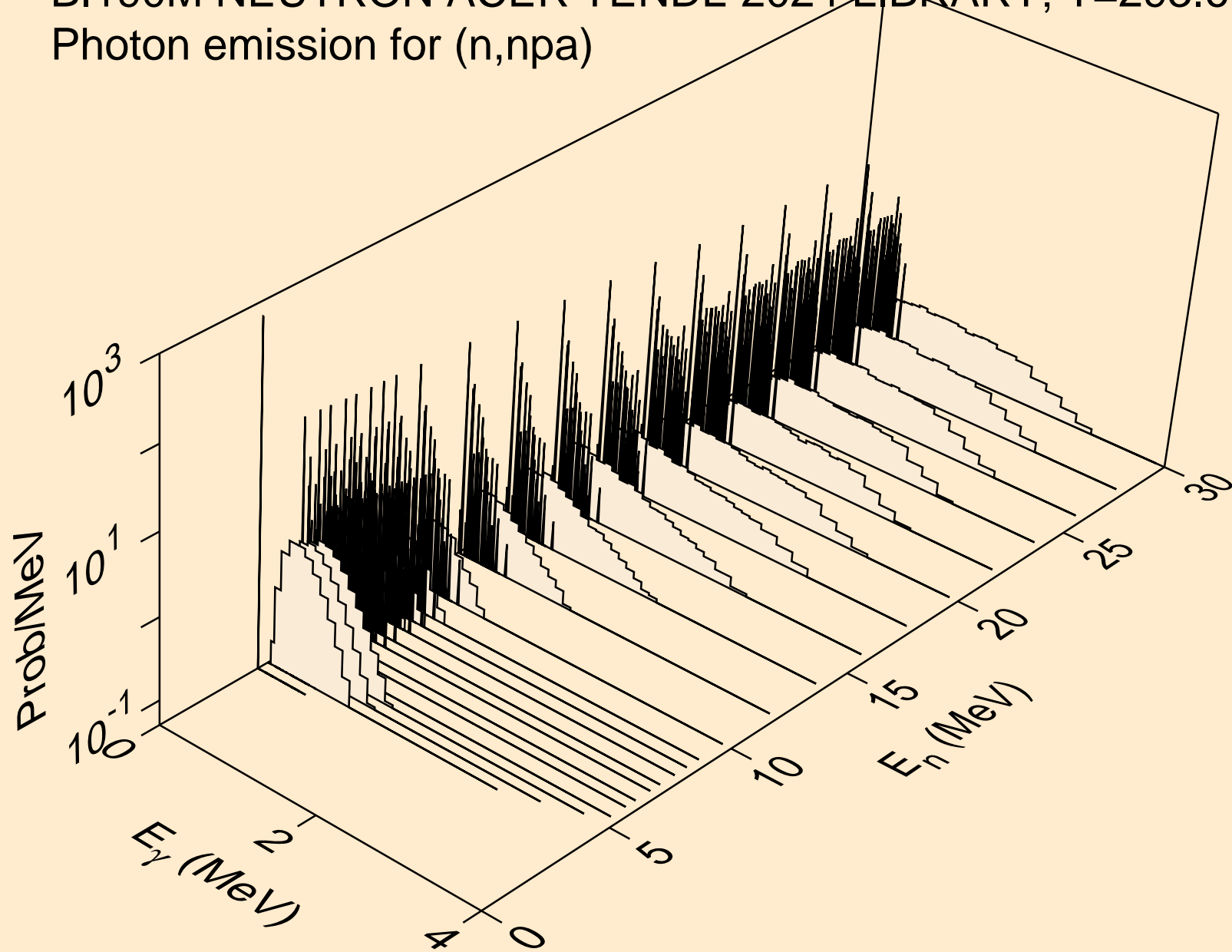

BI190M NEUTRON ACER TENDL-2024 LIBRARY; T=293.6K  
Photon emission for (n,n\*1)

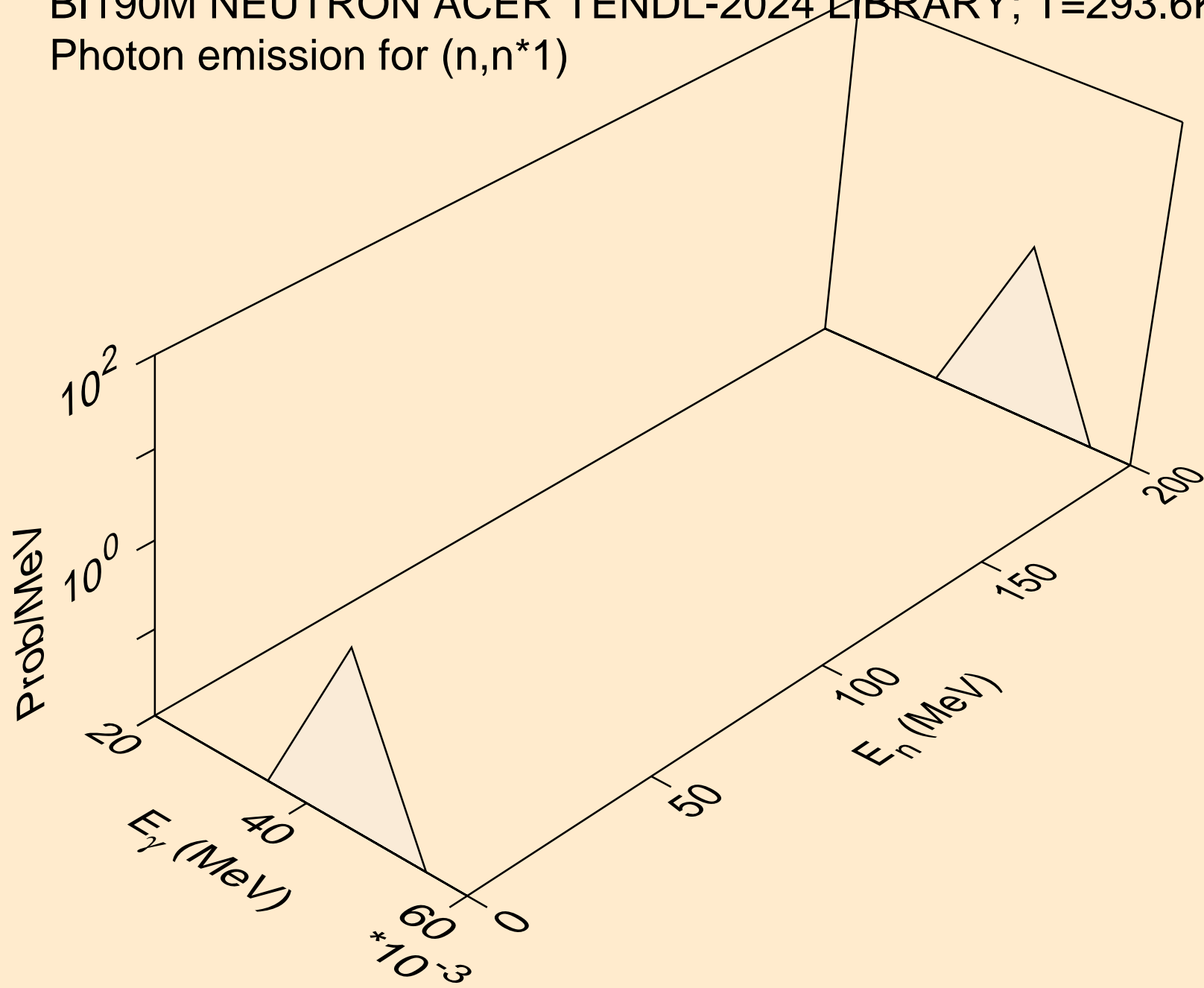

BI190M NEUTRON ACER TENDL-2024 LIBRARY; T=293.6K  
Photon emission for (n,n\*2)

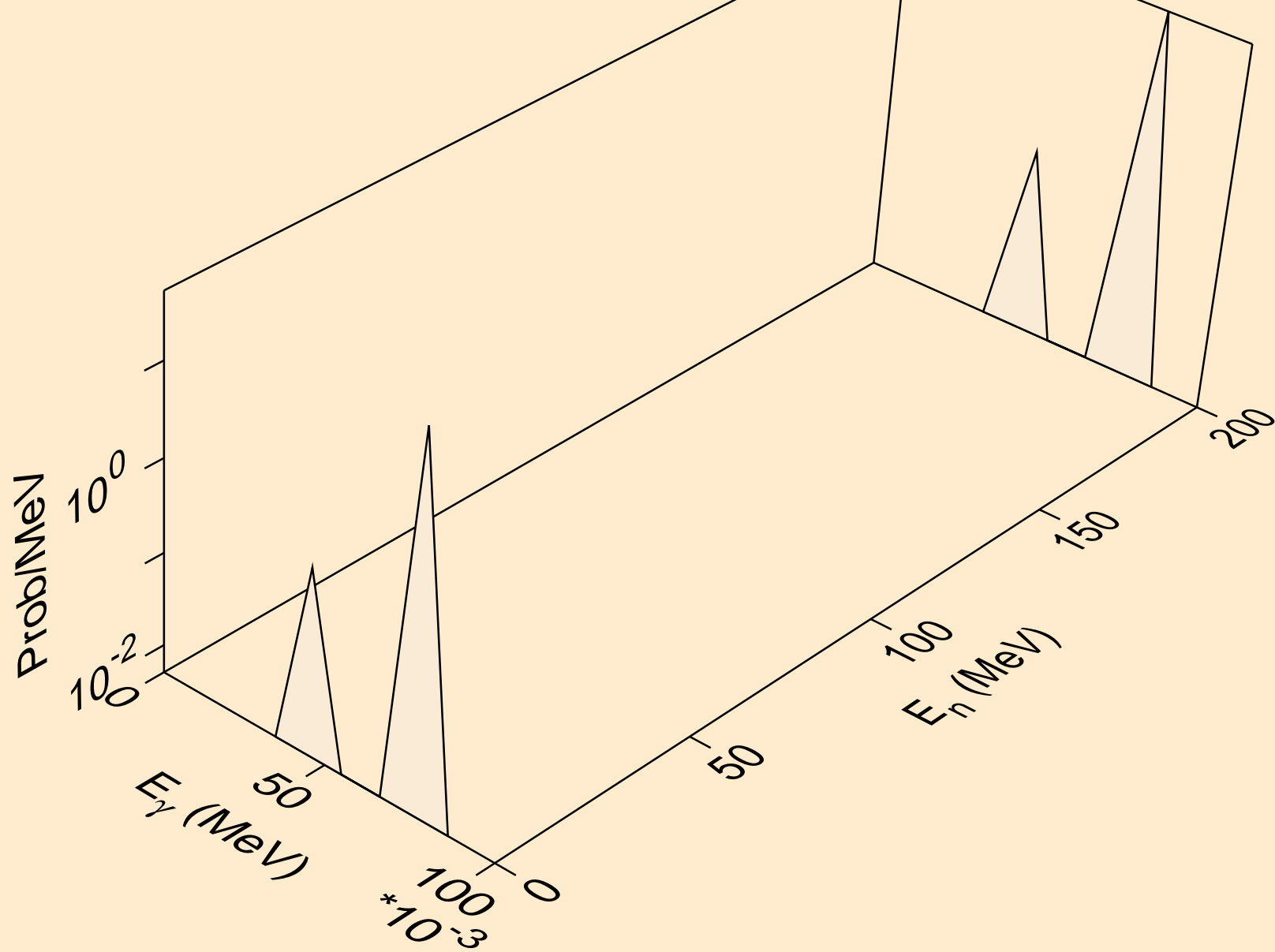

BI190M NEUTRON ACER TENDL-2024 LIBRARY; T=293.6K  
Photon emission for (n,n\*3)

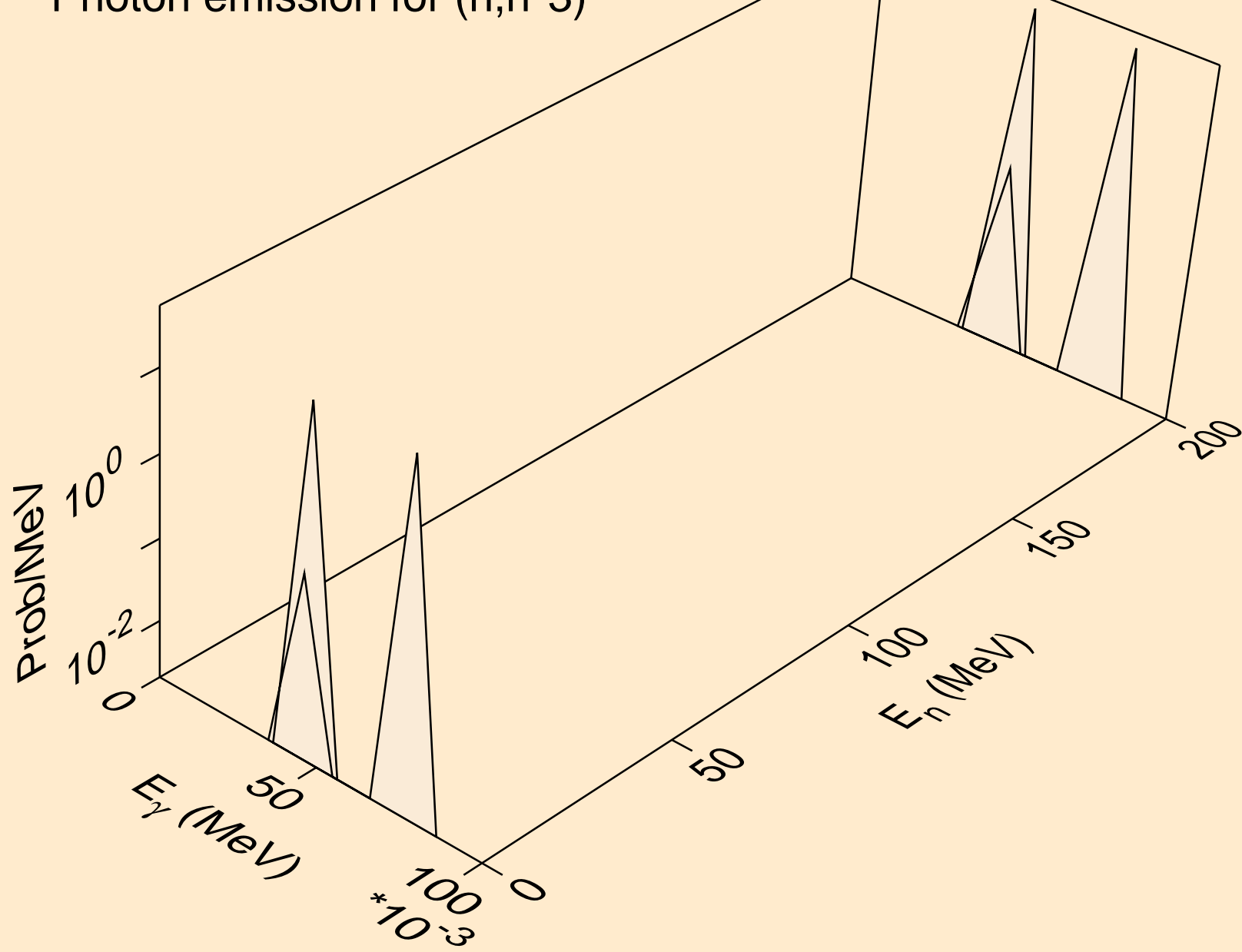

BI190M NEUTRON ACER TENDL-2024 LIBRARY; T=293.6K  
Photon emission for (n,n\*c)

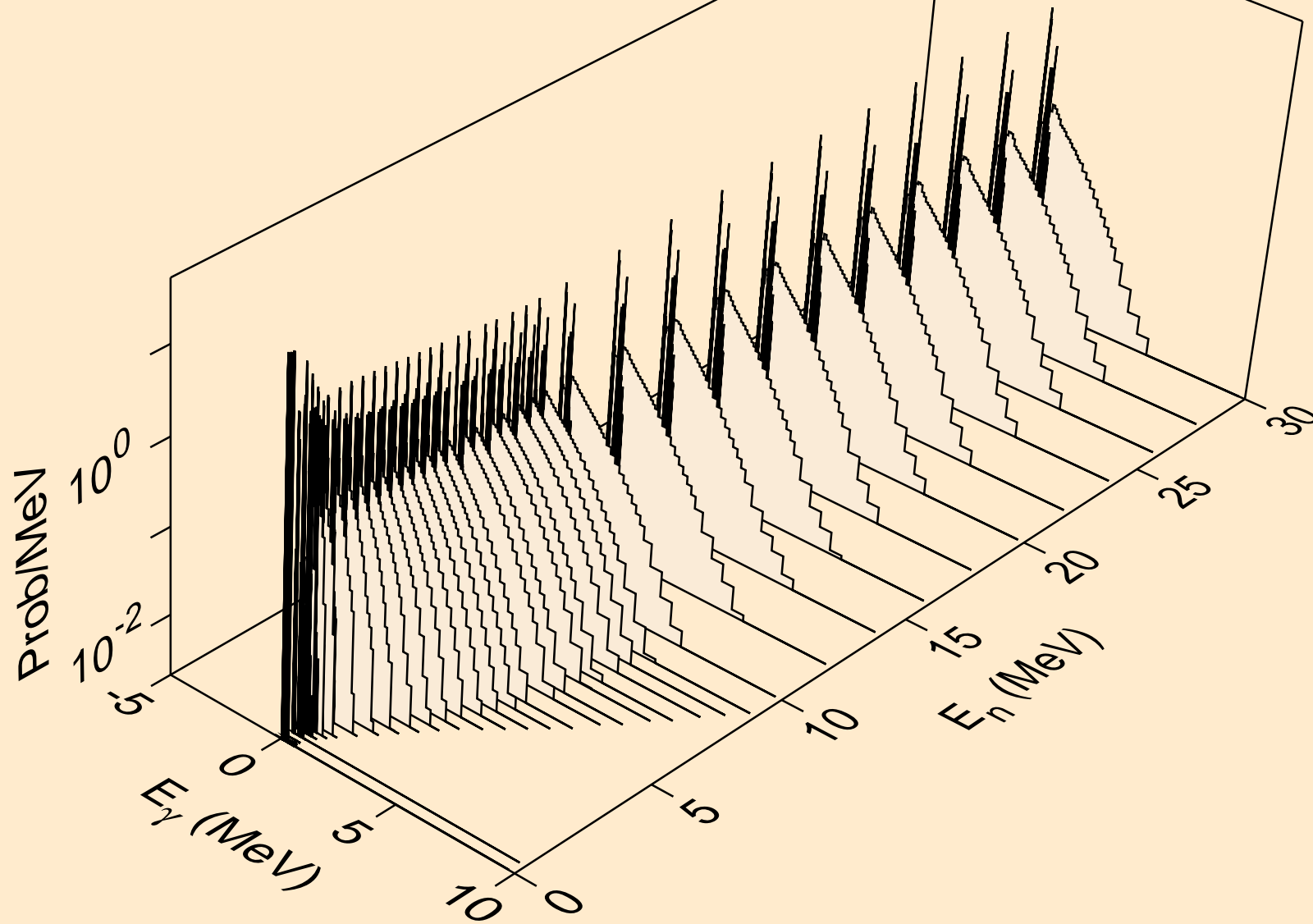

BI190M NEUTRON ACER TENDL-2024 LIBRARY; T=293.6K  
Photon emission for (n,gma)

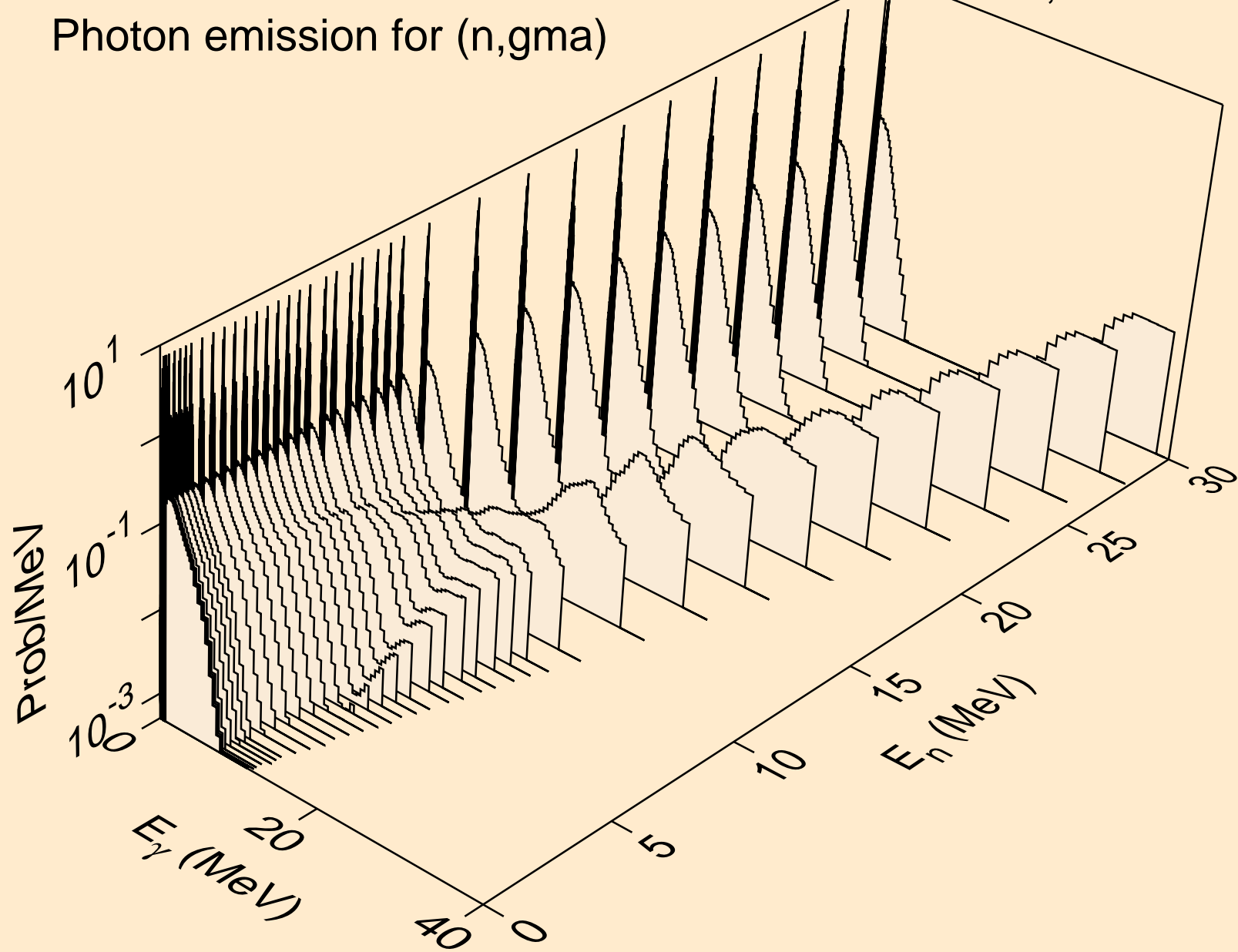

BI190M NEUTRON ACER TENDL-2024 LIBRARY; T=293.6K  
Photon emission for (n,p)

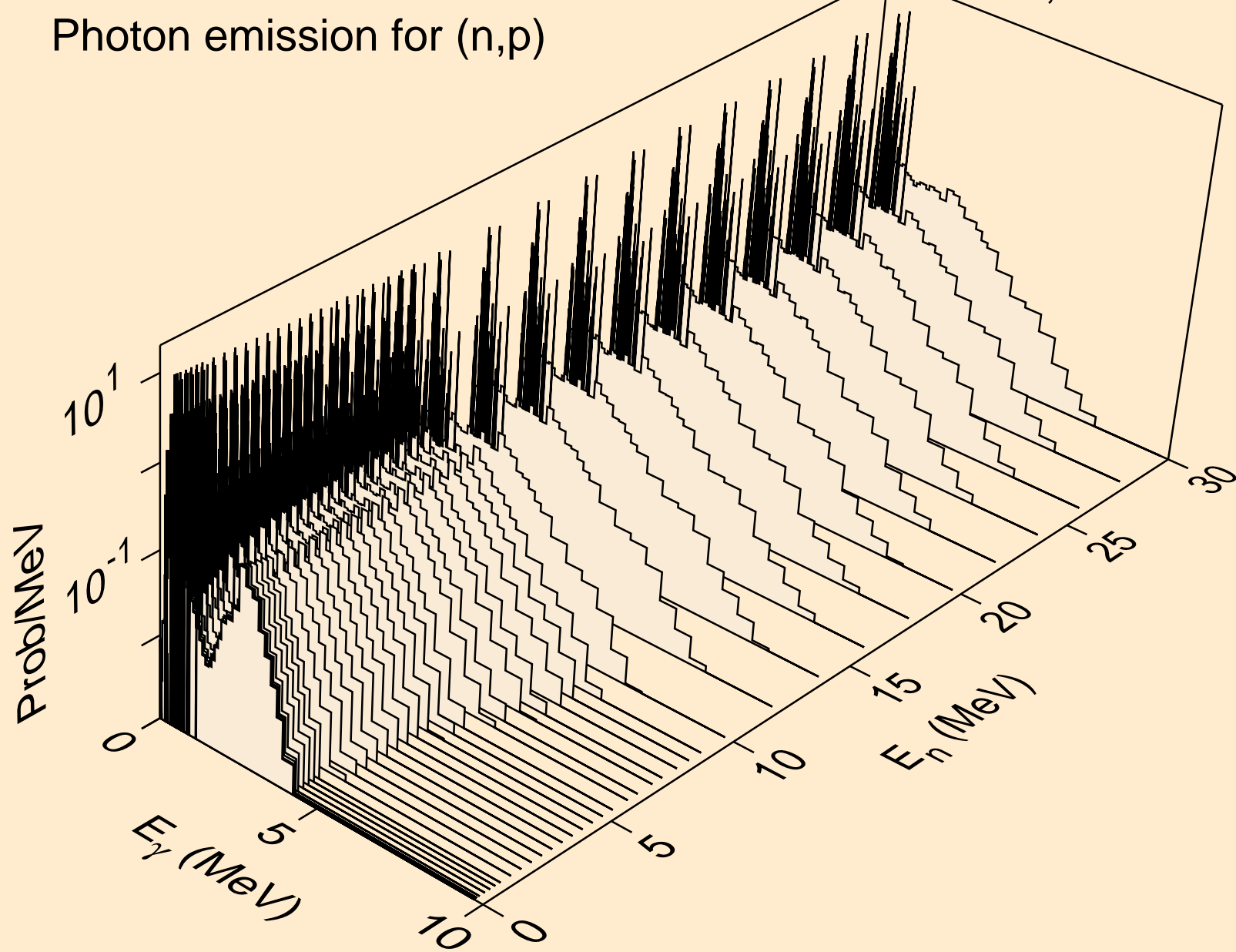

BI190M NEUTRON ACER TENDL-2024 LIBRARY; T=293.6K  
Photon emission for (n,d)

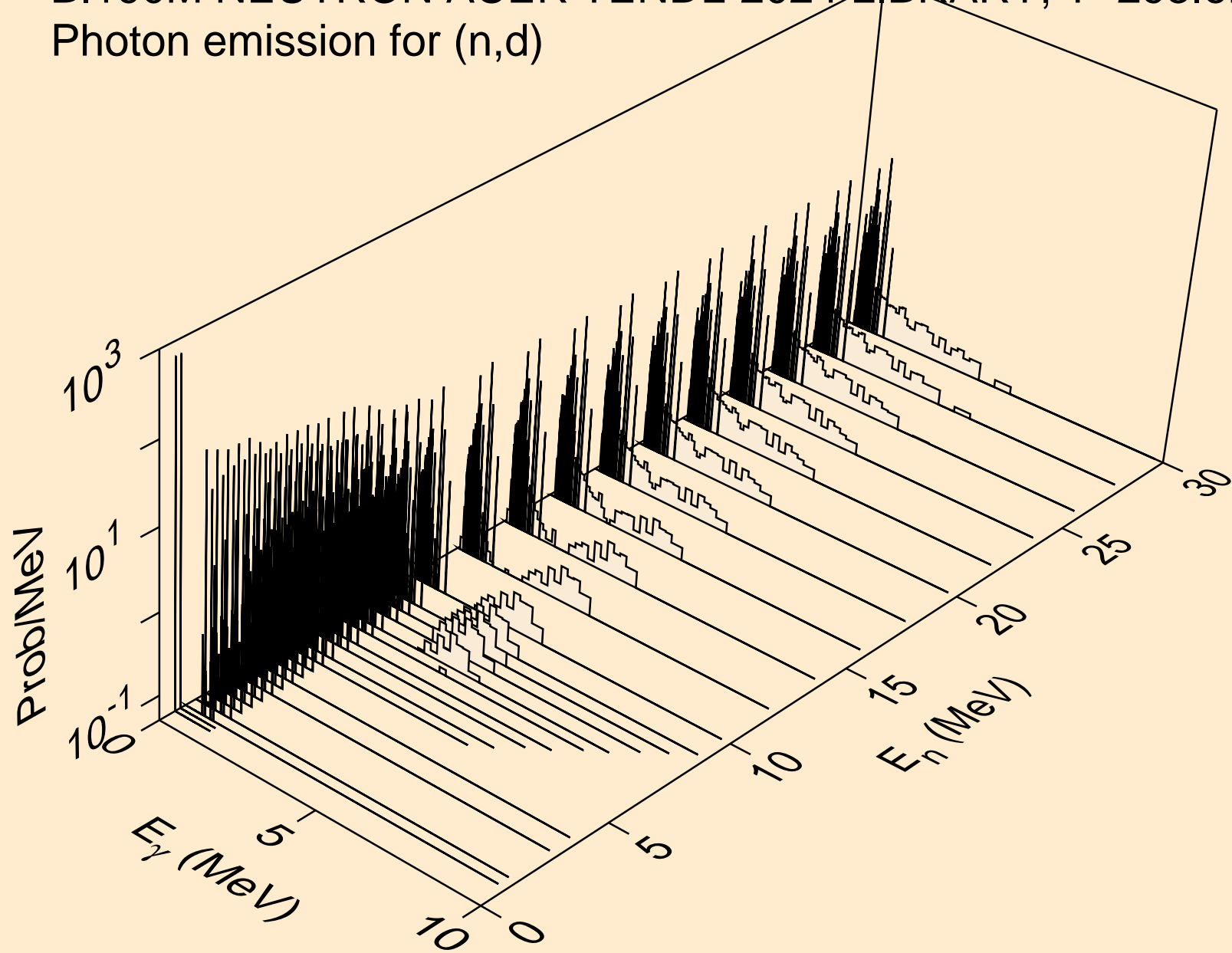

BI190M NEUTRON ACER TENDL-2024 LIBRARY; T=293.6K  
Photon emission for (n,t)

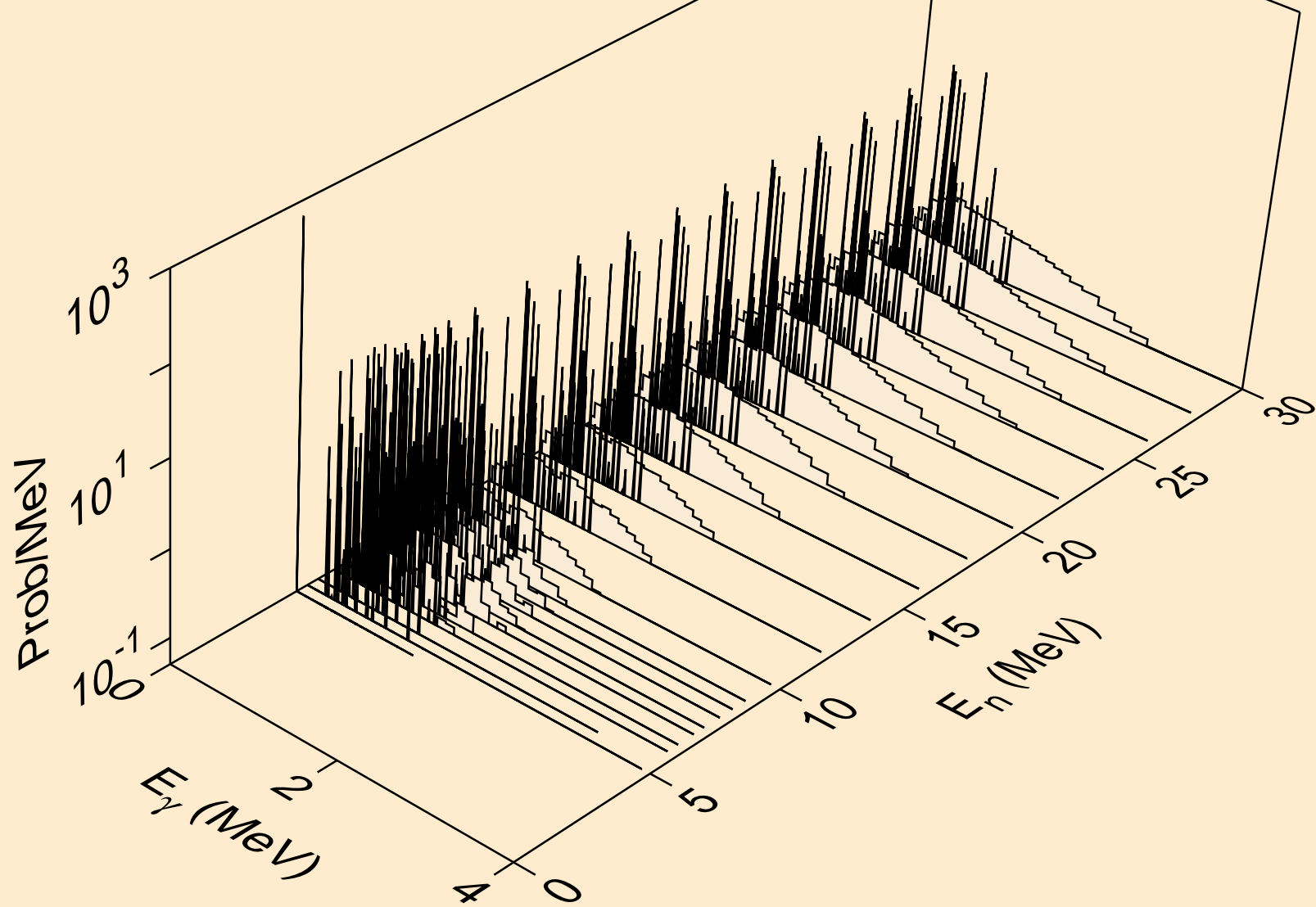

BI190M NEUTRON ACER TENDL-2024 LIBRARY; T=293.6K  
Photon emission for (n,he3)

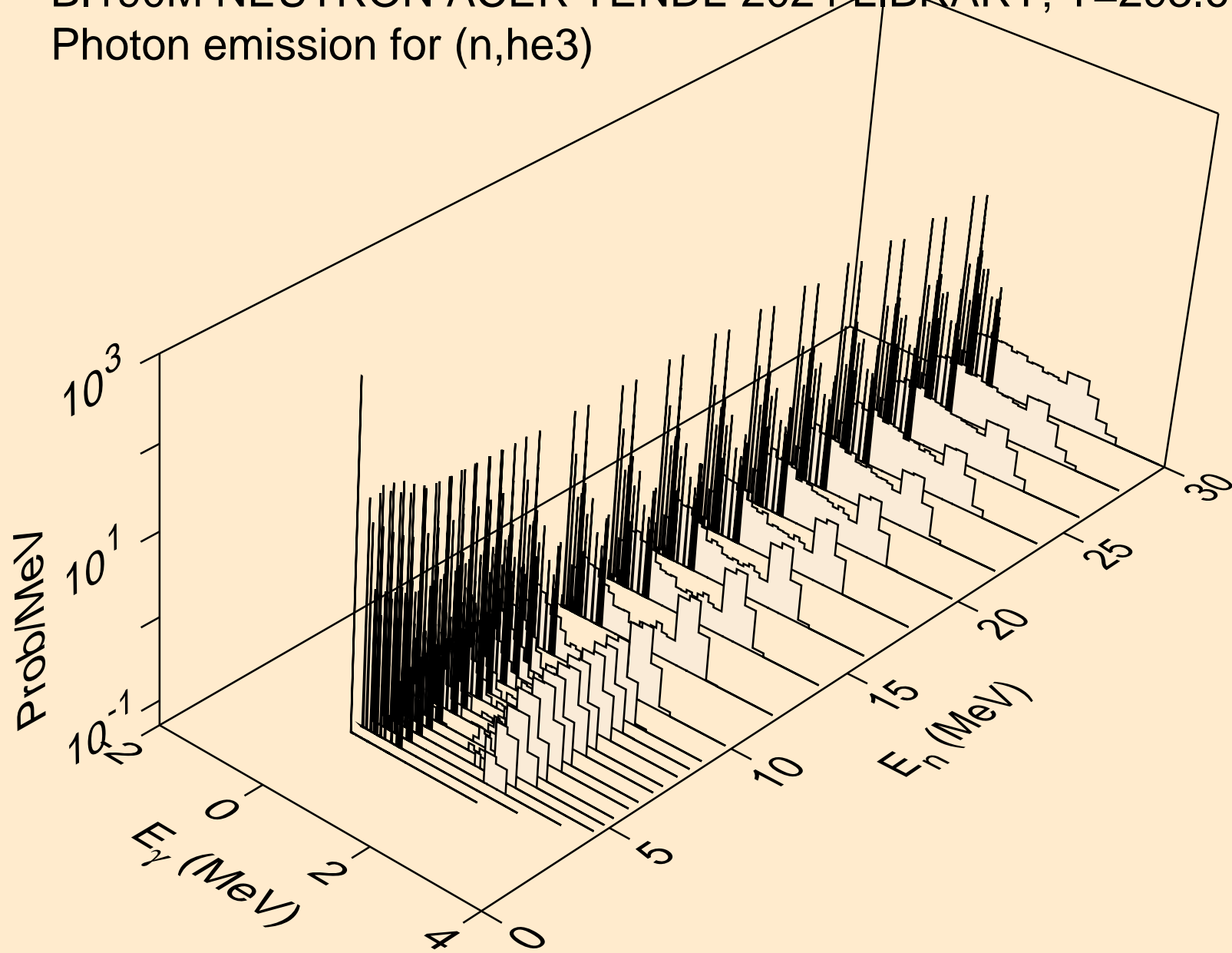

BI190M NEUTRON ACER TENDL-2024 LIBRARY; T=293.6K  
Photon emission for (n,a)

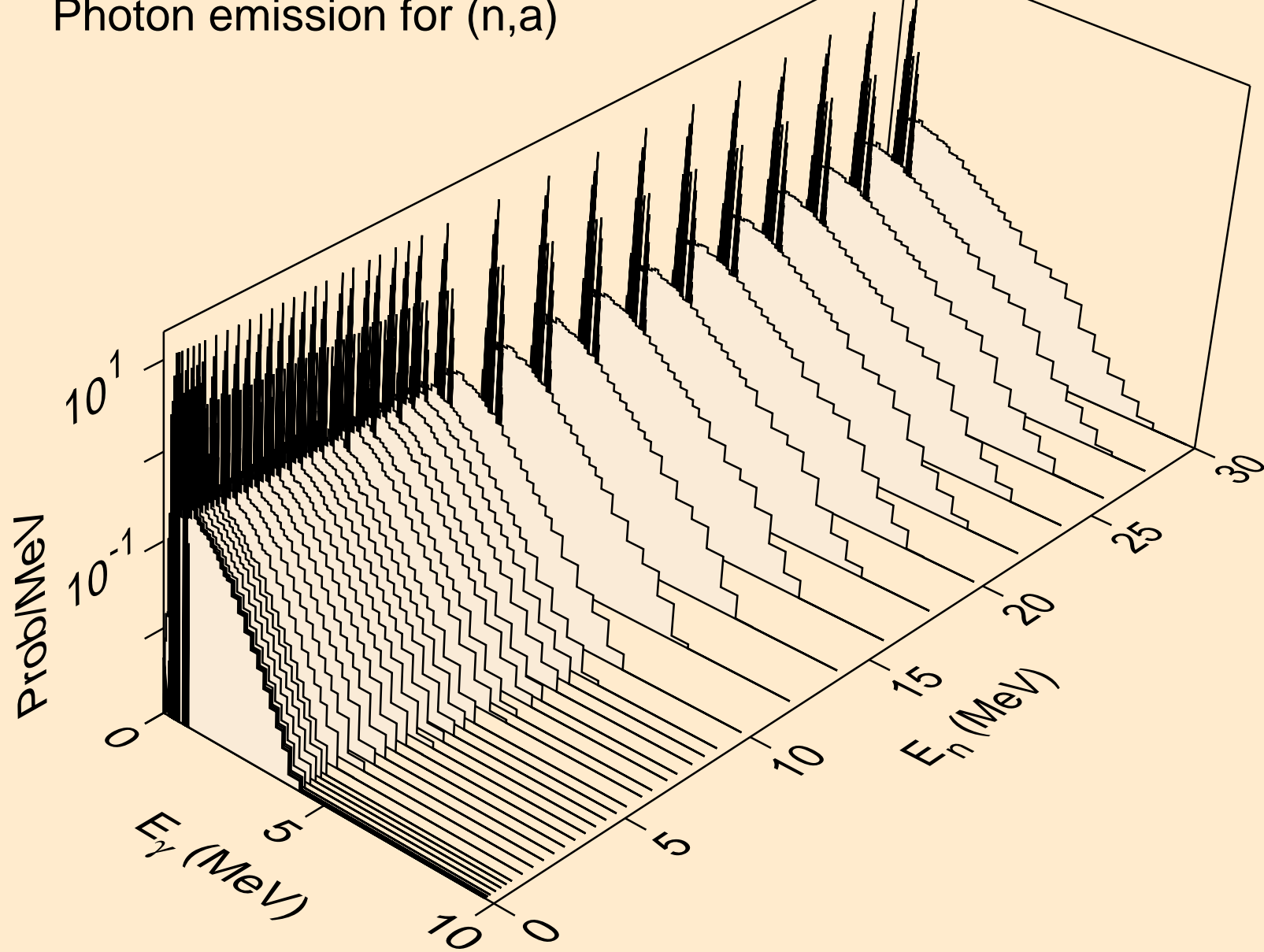

BI190M NEUTRON ACER TENDL-2024 LIBRARY; T=293.6K  
Photon emission for (n,2a)

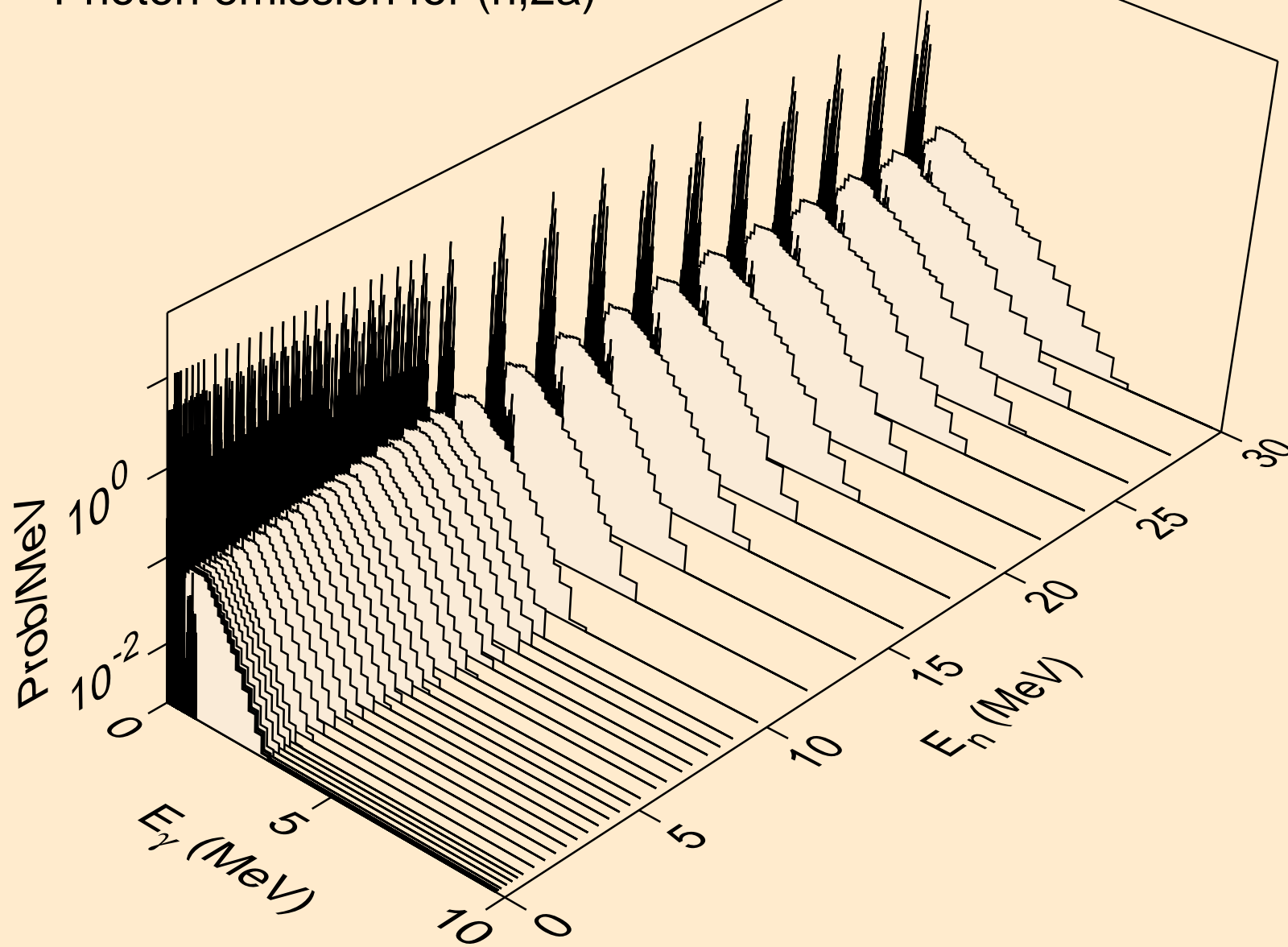

BI190M NEUTRON ACER TENDL-2024 LIBRARY; T=293.6K  
Photon emission for (n,3a)

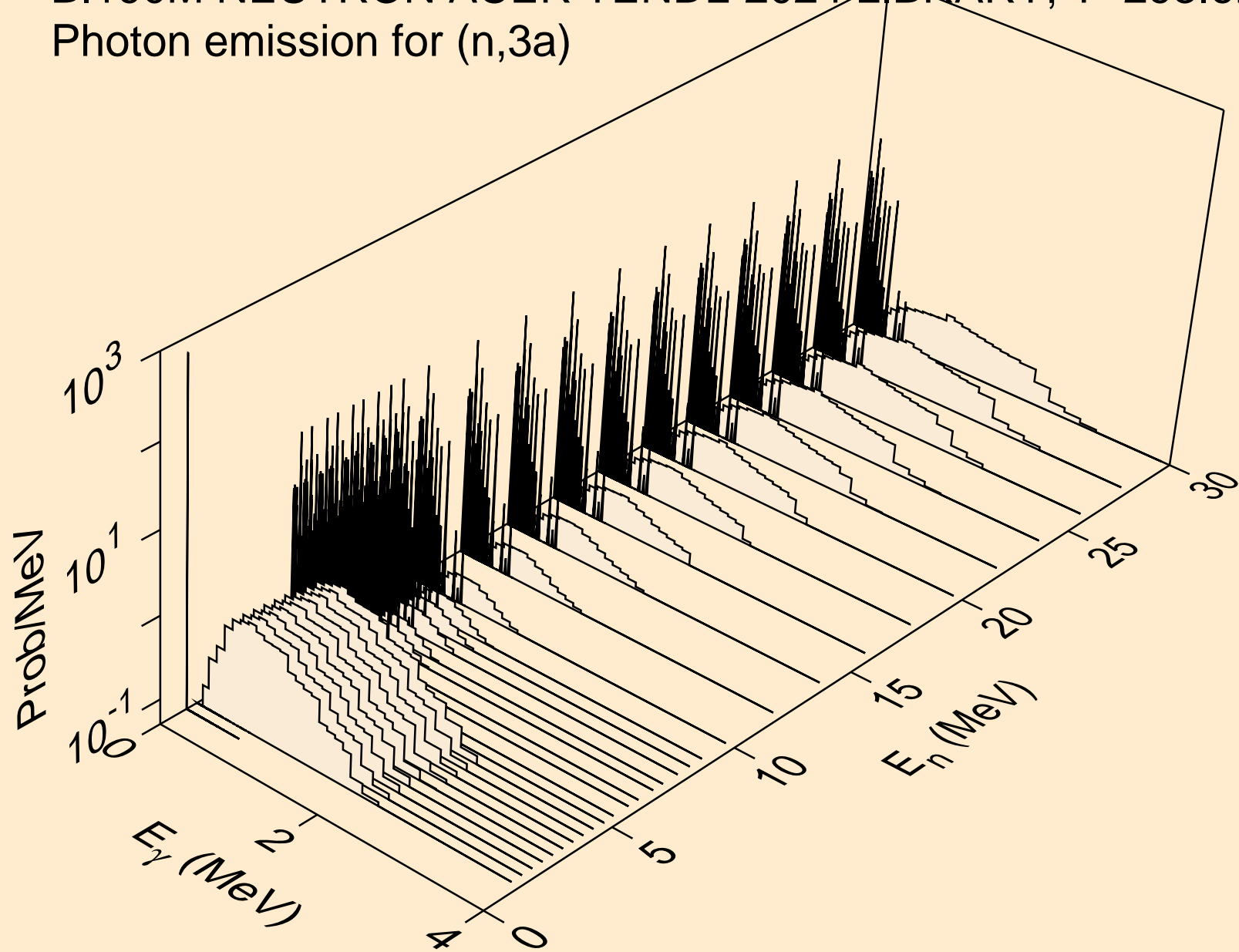

BI190M NEUTRON ACER TENDL-2024 LIBRARY; T=293.6K  
Photon emission for (n,2p)

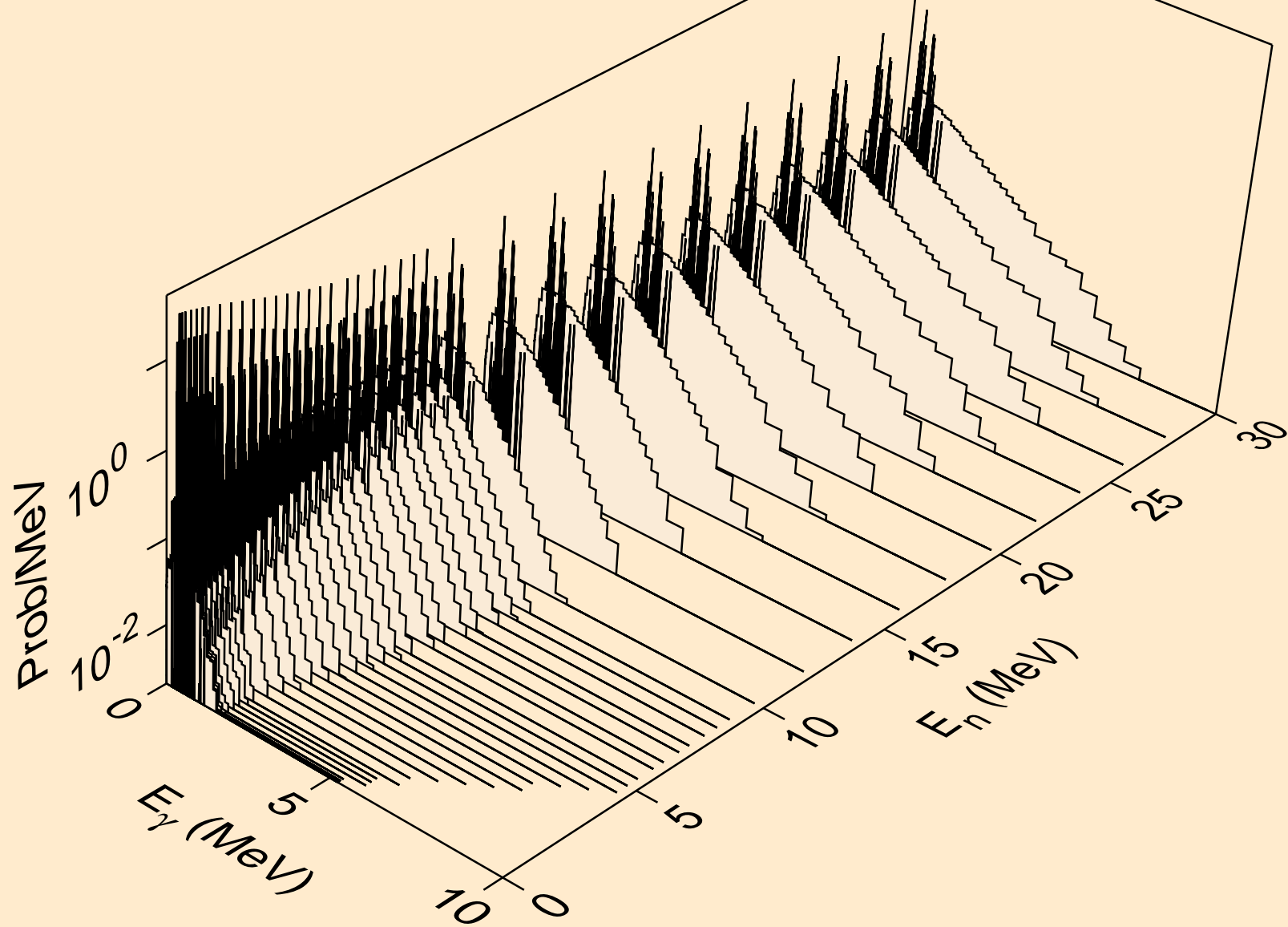

BI190M NEUTRON ACER TENDL-2024 LIBRARY; T=293.6K  
Photon emission for (n,p $\alpha$ )

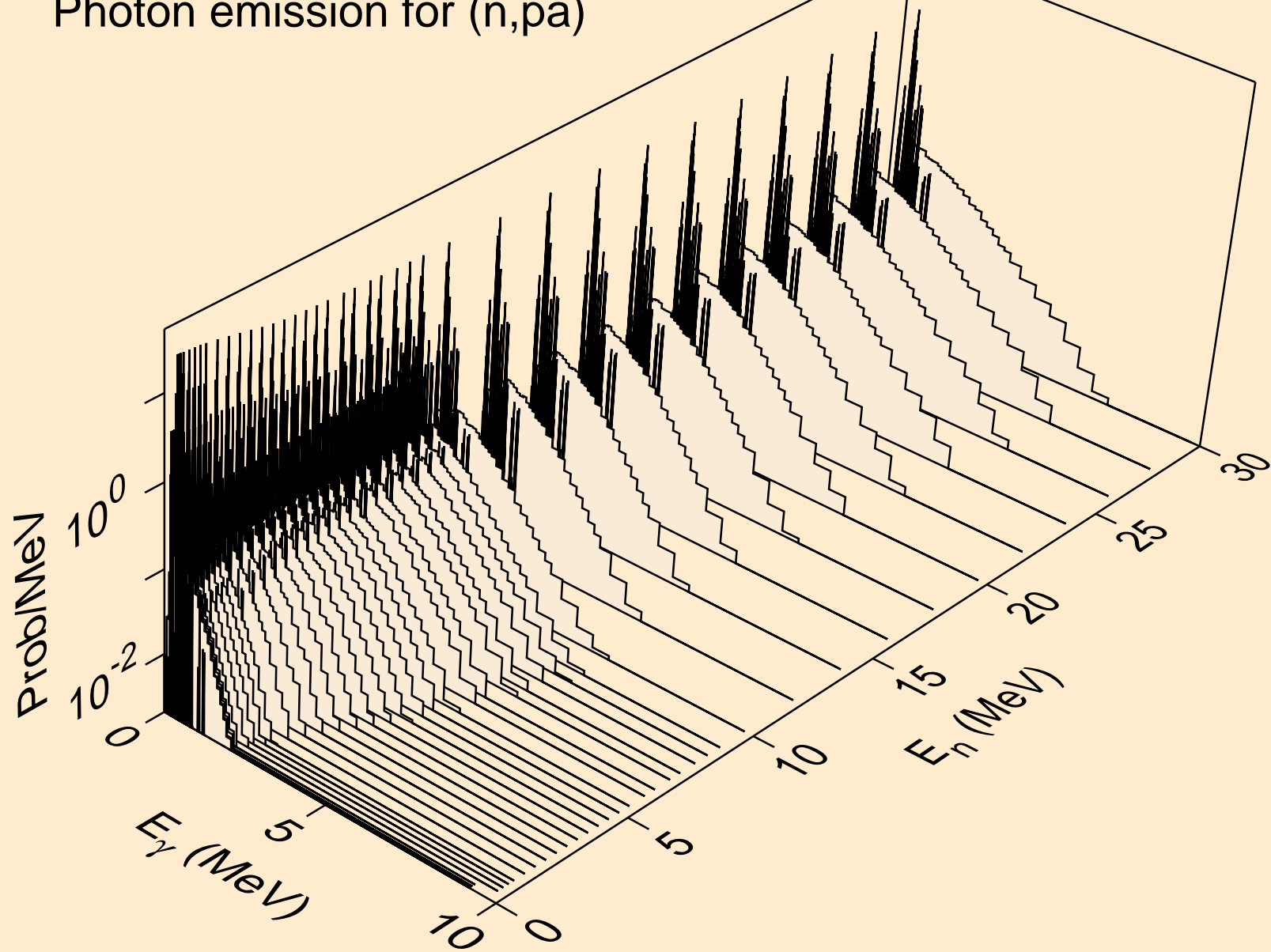

BI190M NEUTRON ACER TENDL-2024 LIBRARY; T=293.6K  
Photon emission for (n,d2a)

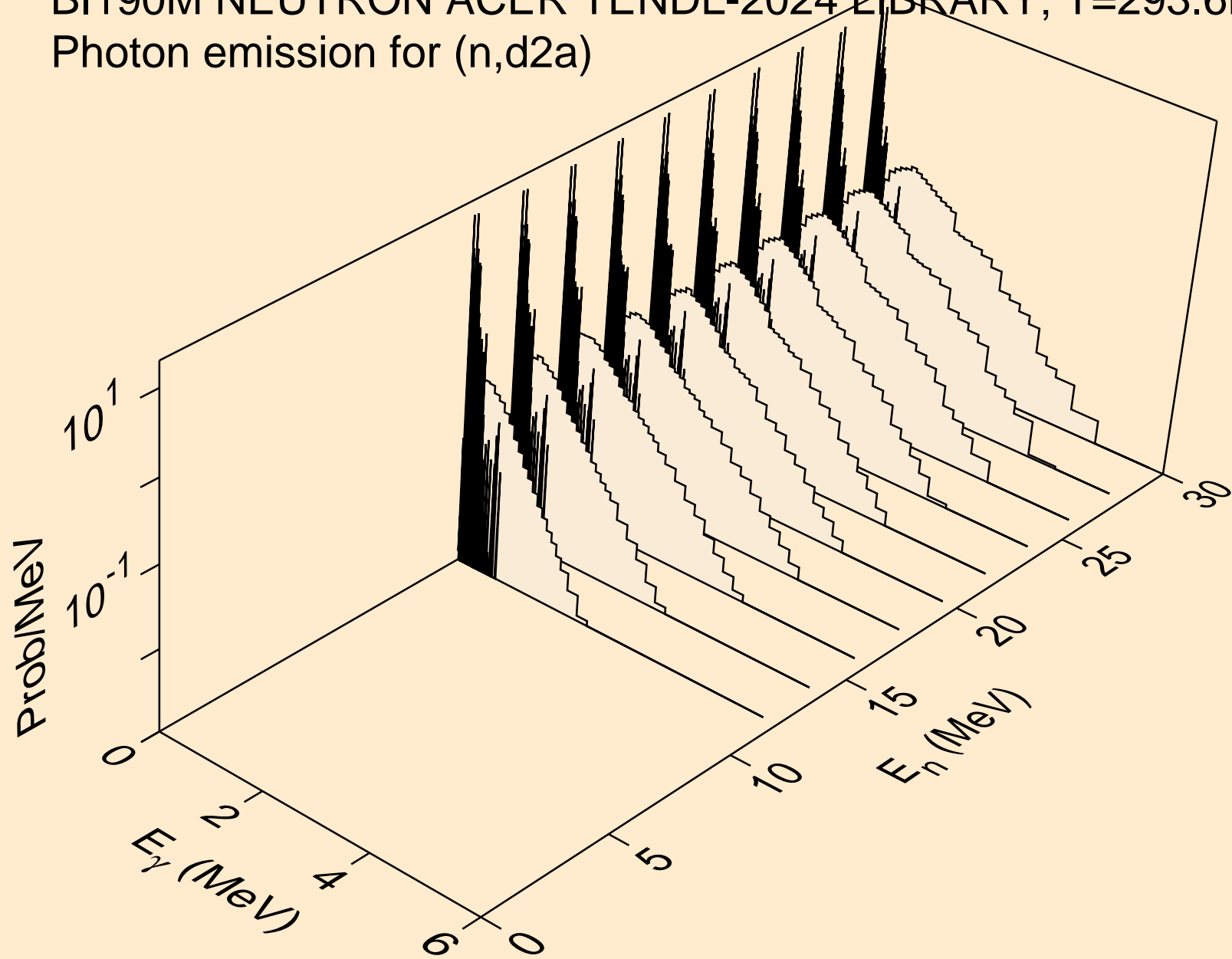

BI190M NEUTRON ACER TENDL-2024 LIBRARY; T=293.6K  
Photon emission for (n,pd)

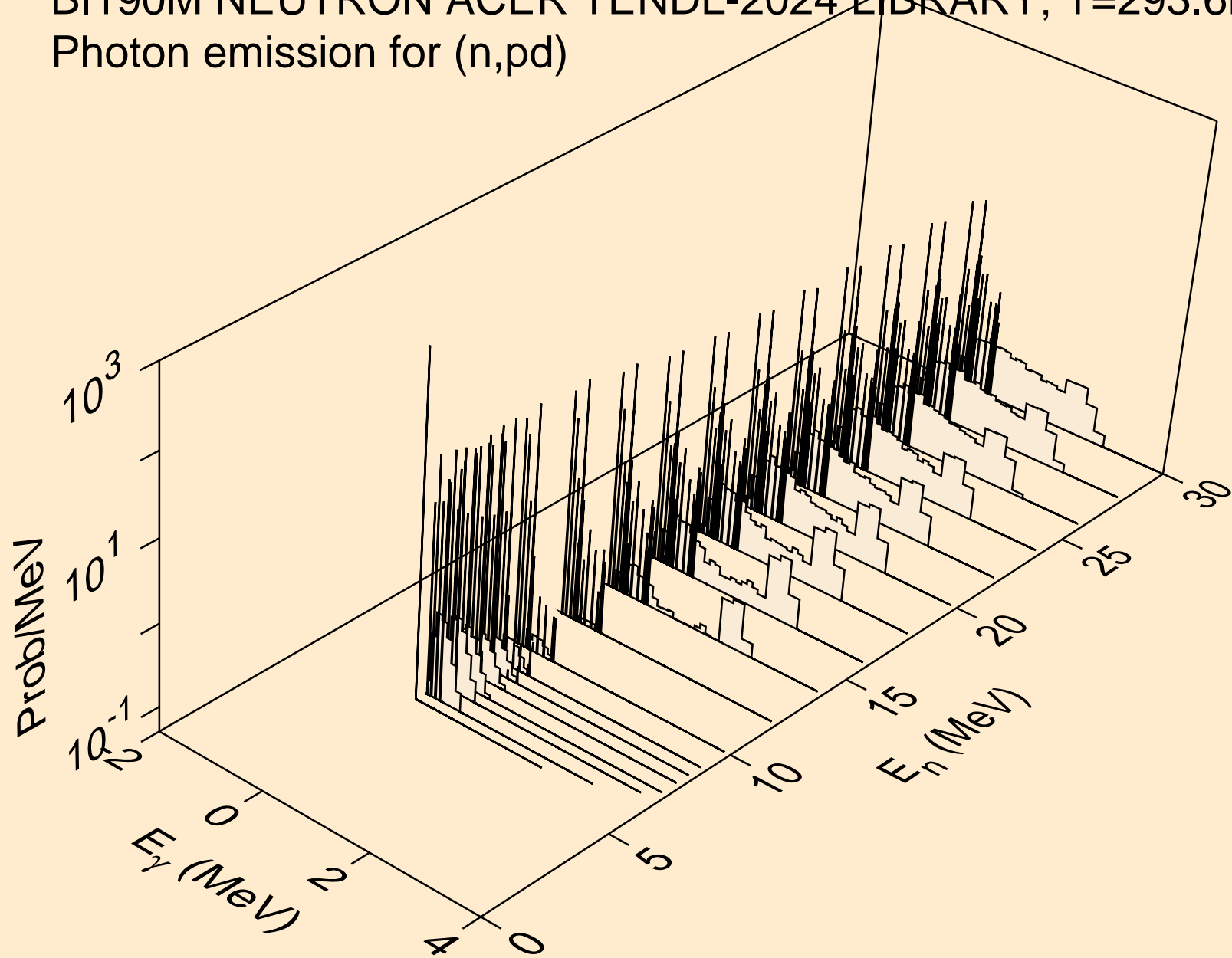

BI190M NEUTRON ACER TENDL-2024 LIBRARY; T=293.6K  
Photon emission for (n,pt)

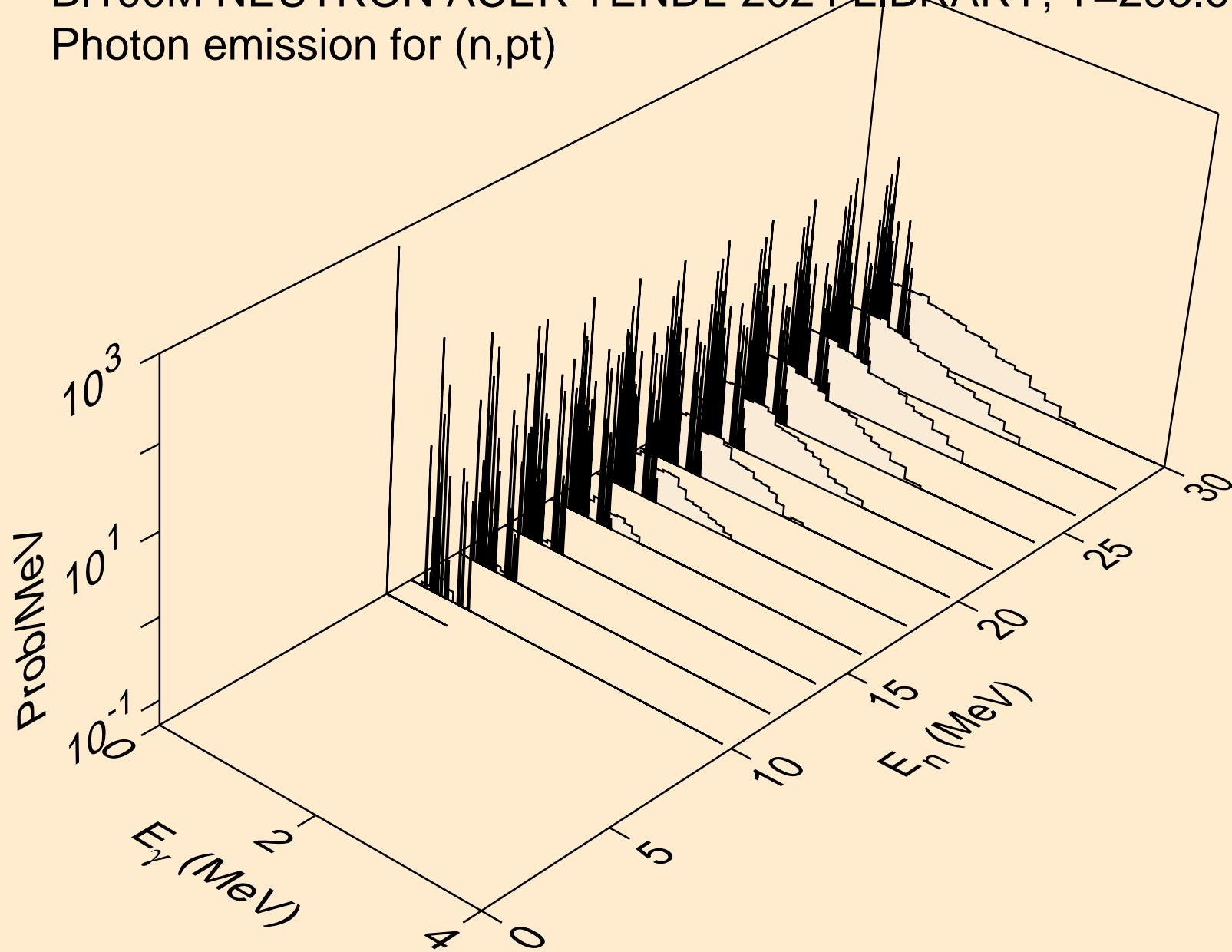

BI190M NEUTRON ACER TENDL-2024 LIBRARY; T=293.6K  
Photon emission for (n,da)

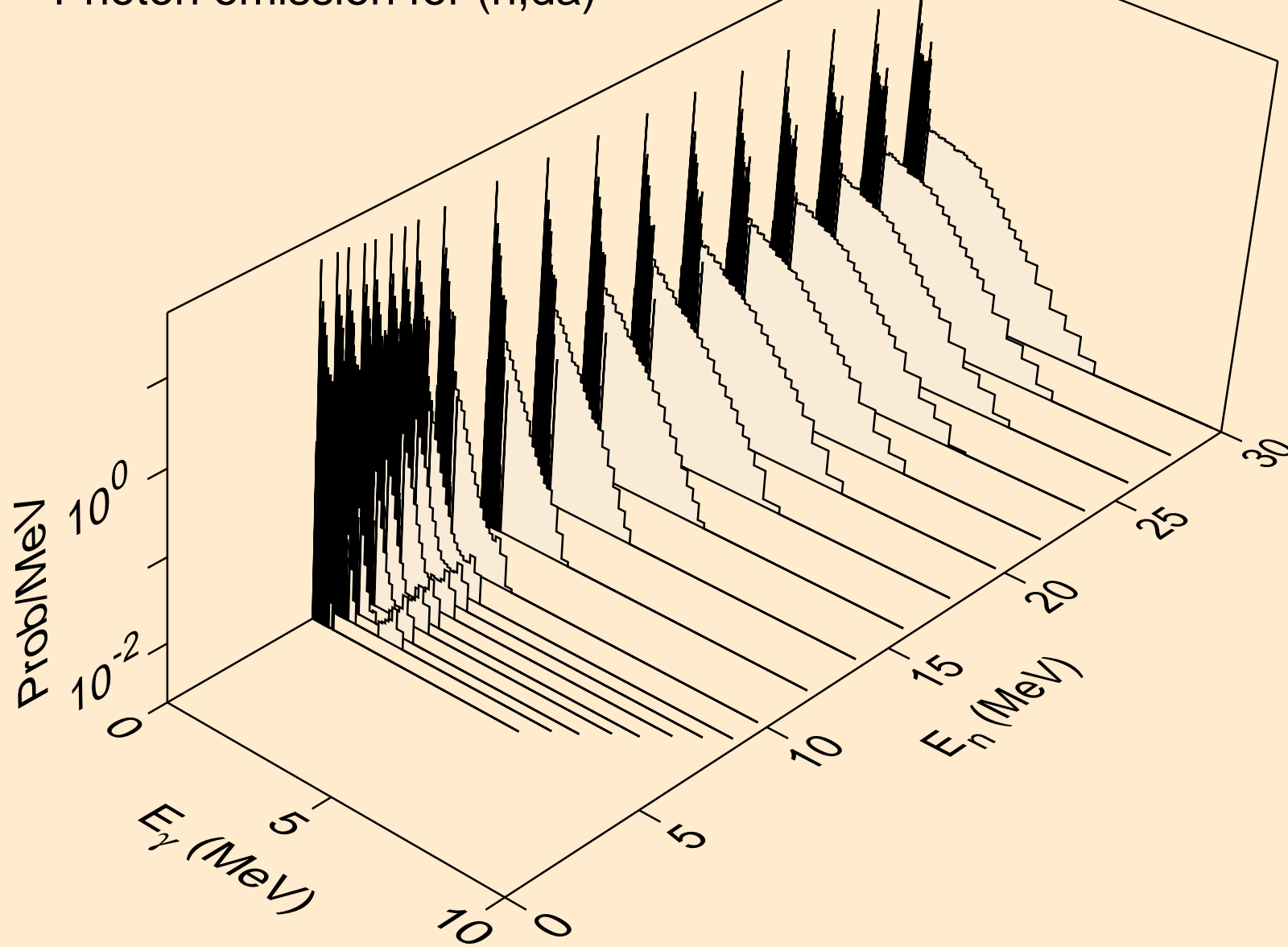

BI190M NEUTRON ACER TENDL-2024 LIBRARY; T=293.6K  
thermal capture photon spectrum

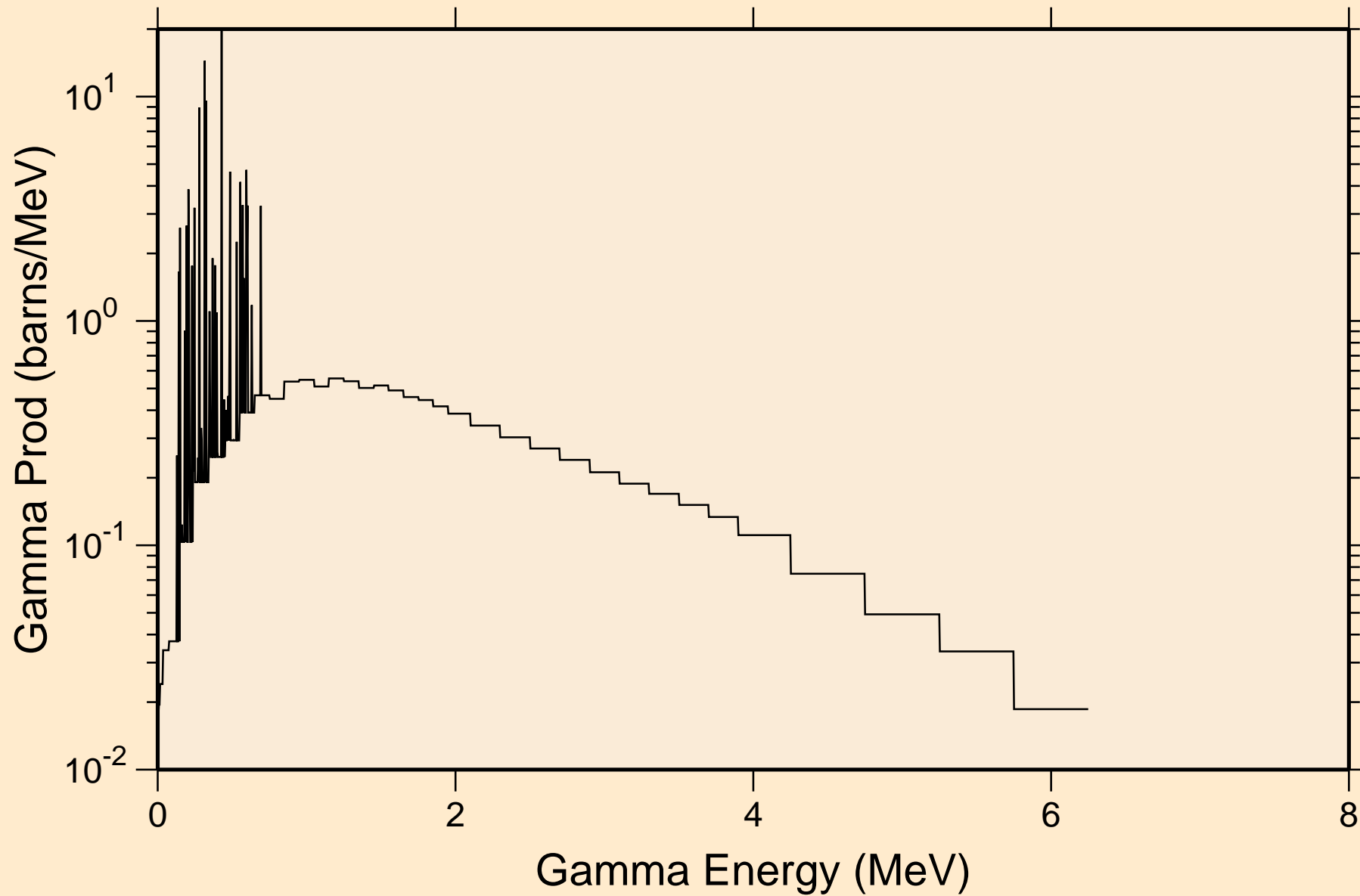

BI190M NEUTRON ACER TENDL-2024 LIBRARY; T=293.6K  
14 MeV photon spectrum

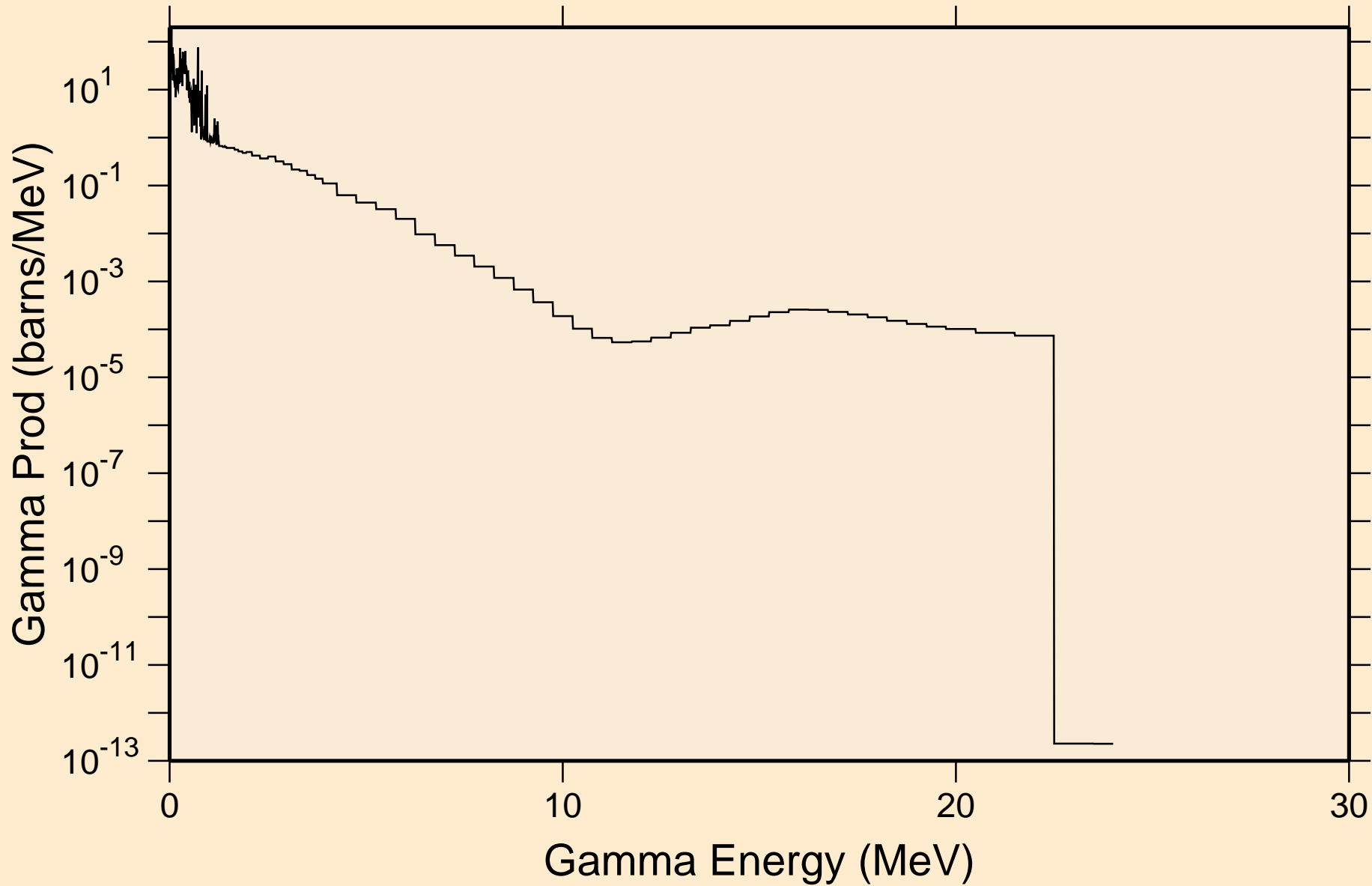

BI190M NEUTRON ACER TENDL-2024 LIBRARY; T=293.6K  
Particle heating contributions

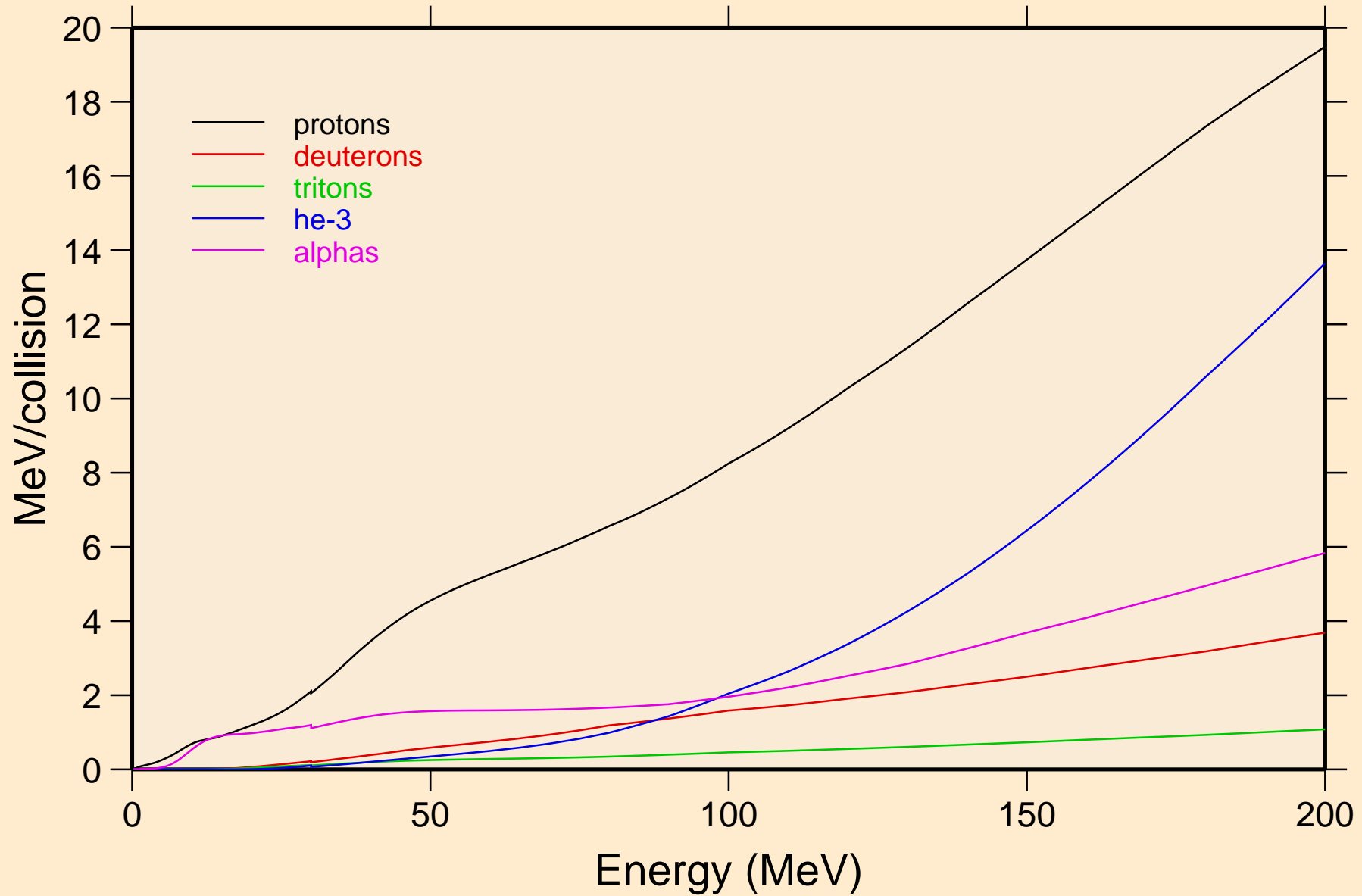

BI190M NEUTRON ACER TENDL-2024 LIBRARY; T=293.6K  
Recoil Heating

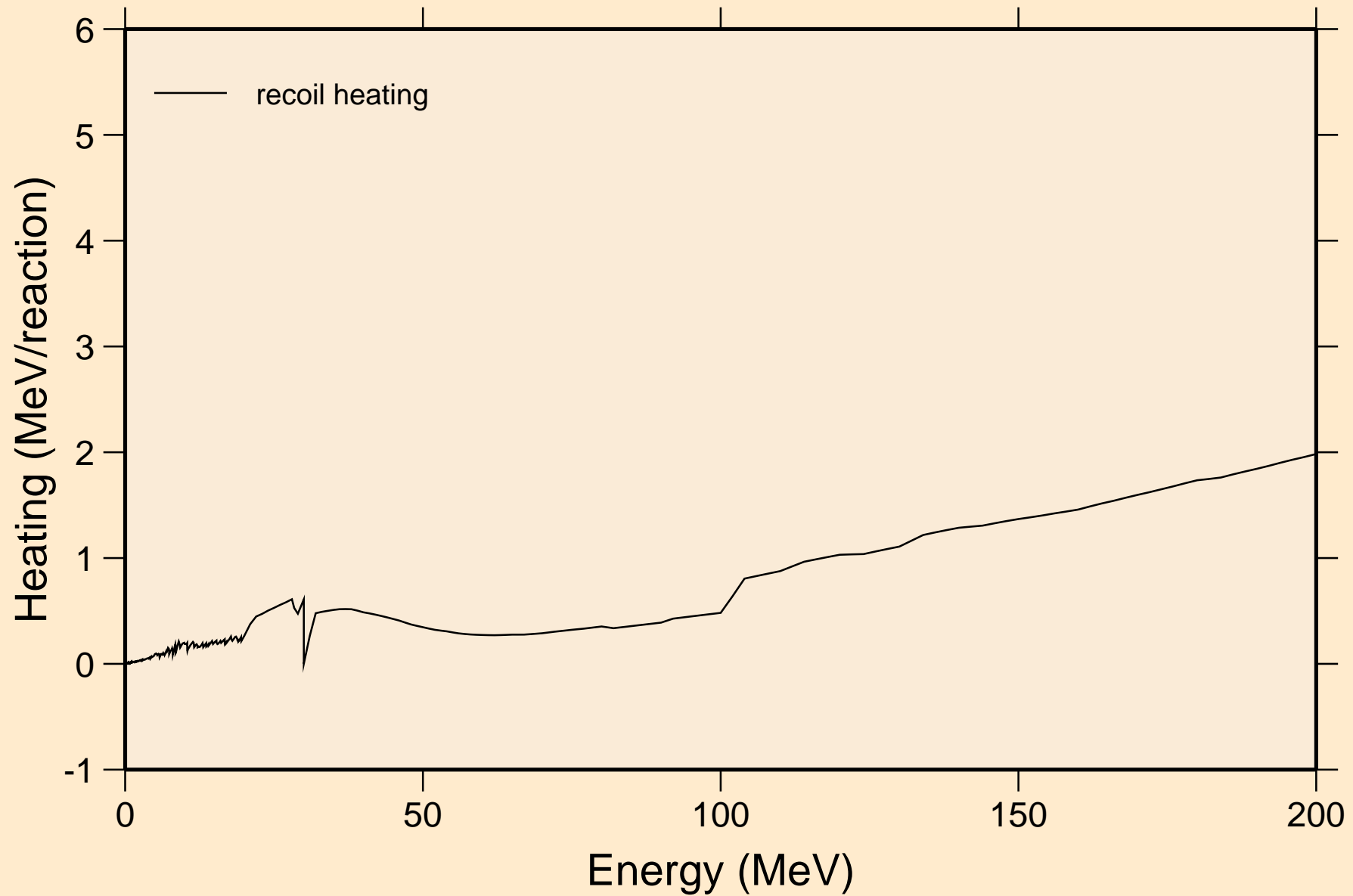

BI190M NEUTRON ACER TENDL-2024 LIBRARY; T=293.6K  
Particle production cross sections

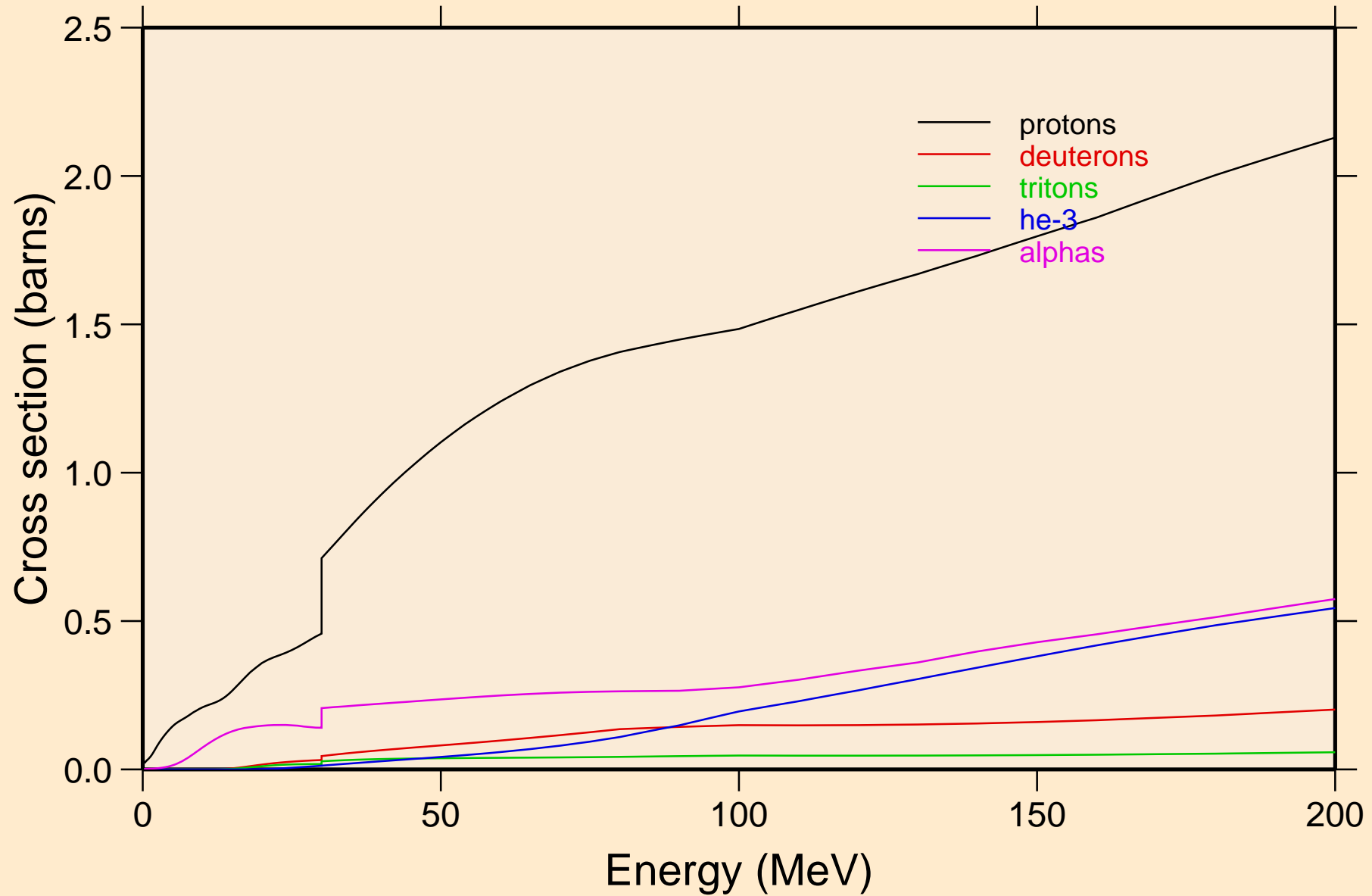

BI190M NEUTRON ACER TENDL-2024 LIBRARY; T=293.6K  
protons from (n,x)

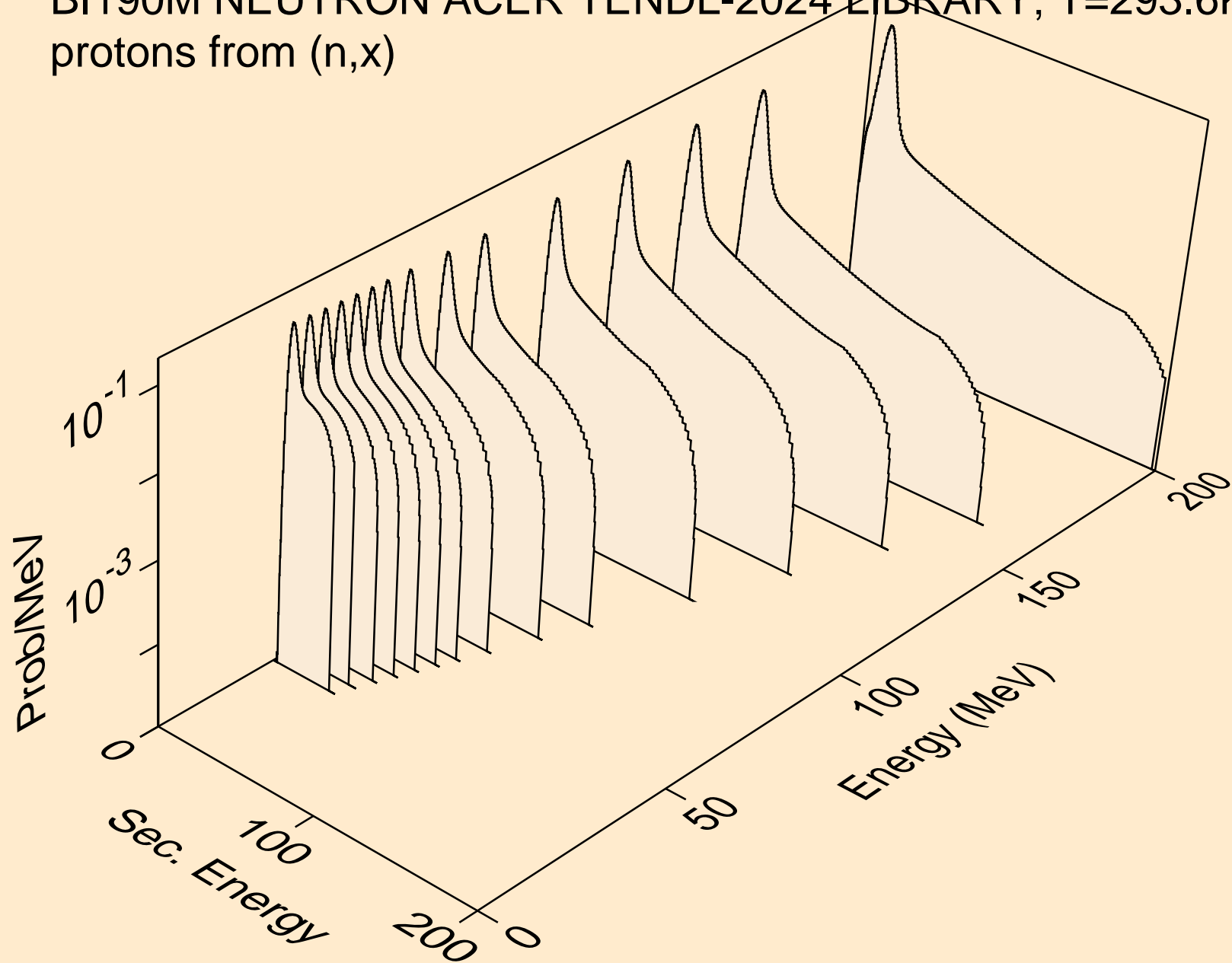

BI190M NEUTRON ACER TENDL-2024 LIBRARY; T=293.6K  
protons from (n,n\*)p

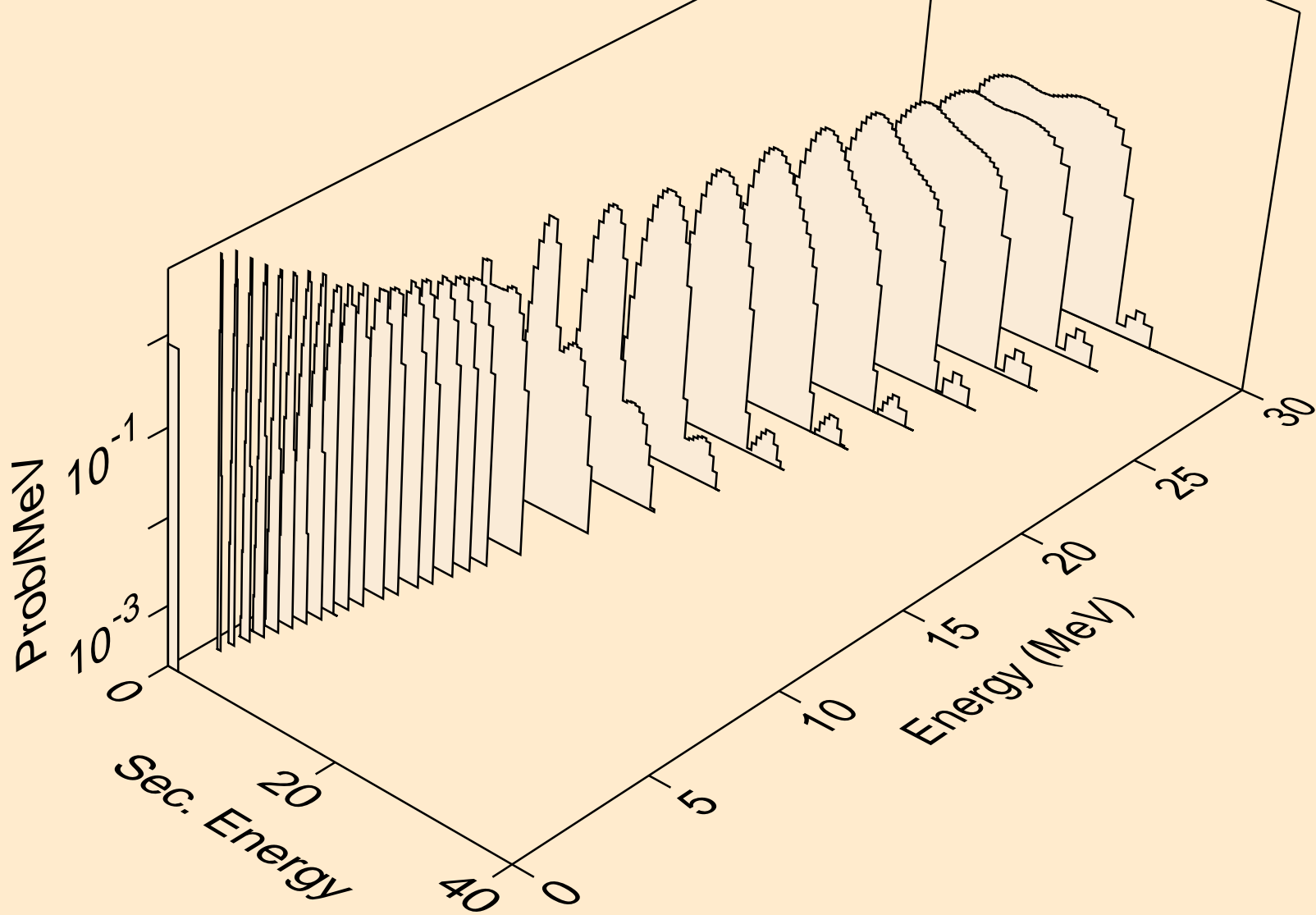

BI190M NEUTRON ACER TENDL-2024 LIBRARY; T=293.6K  
protons from (n,2np)

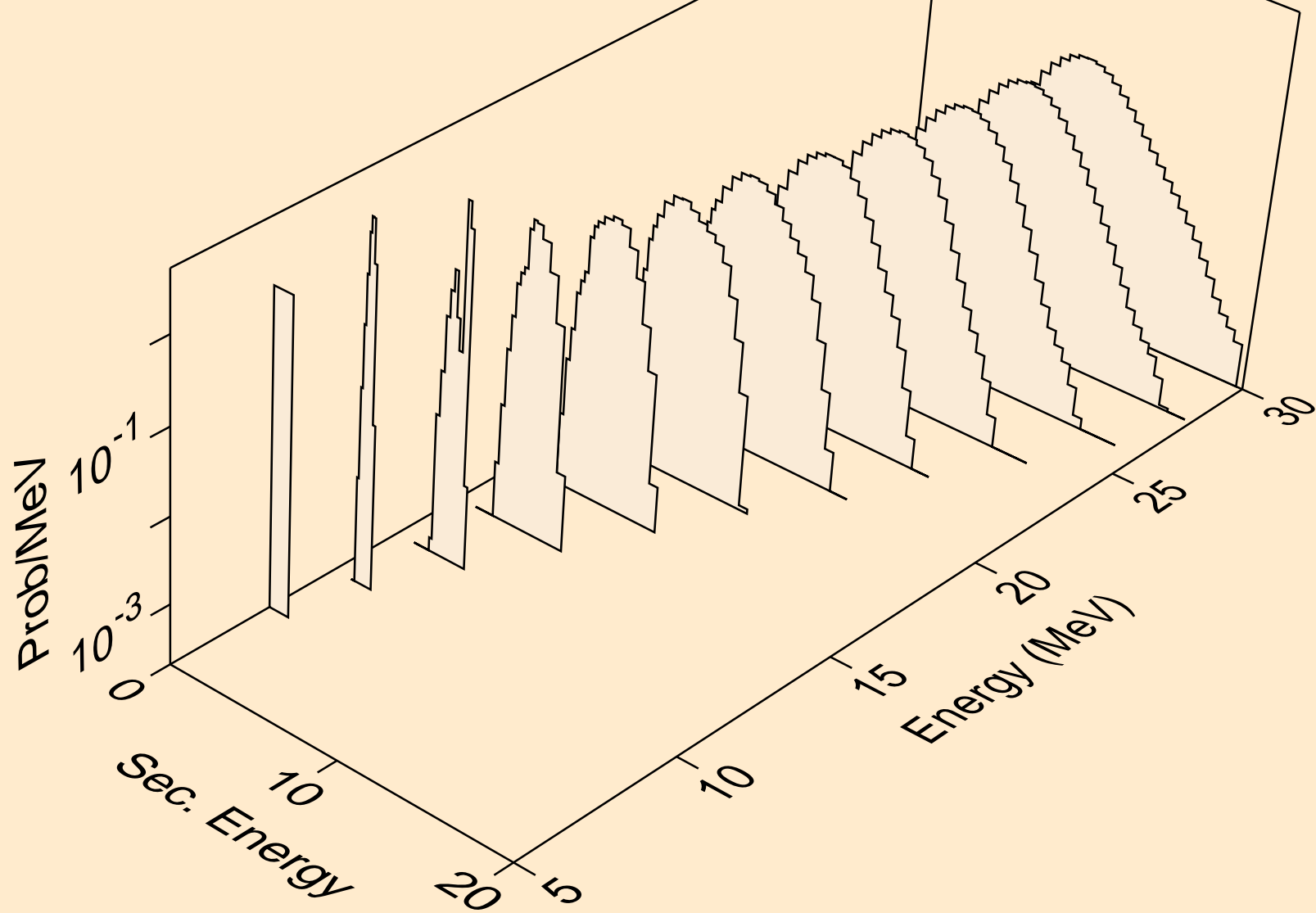

BI190M NEUTRON ACER TENDL-2024 LIBRARY; T=293.6K  
protons from (n,3np)

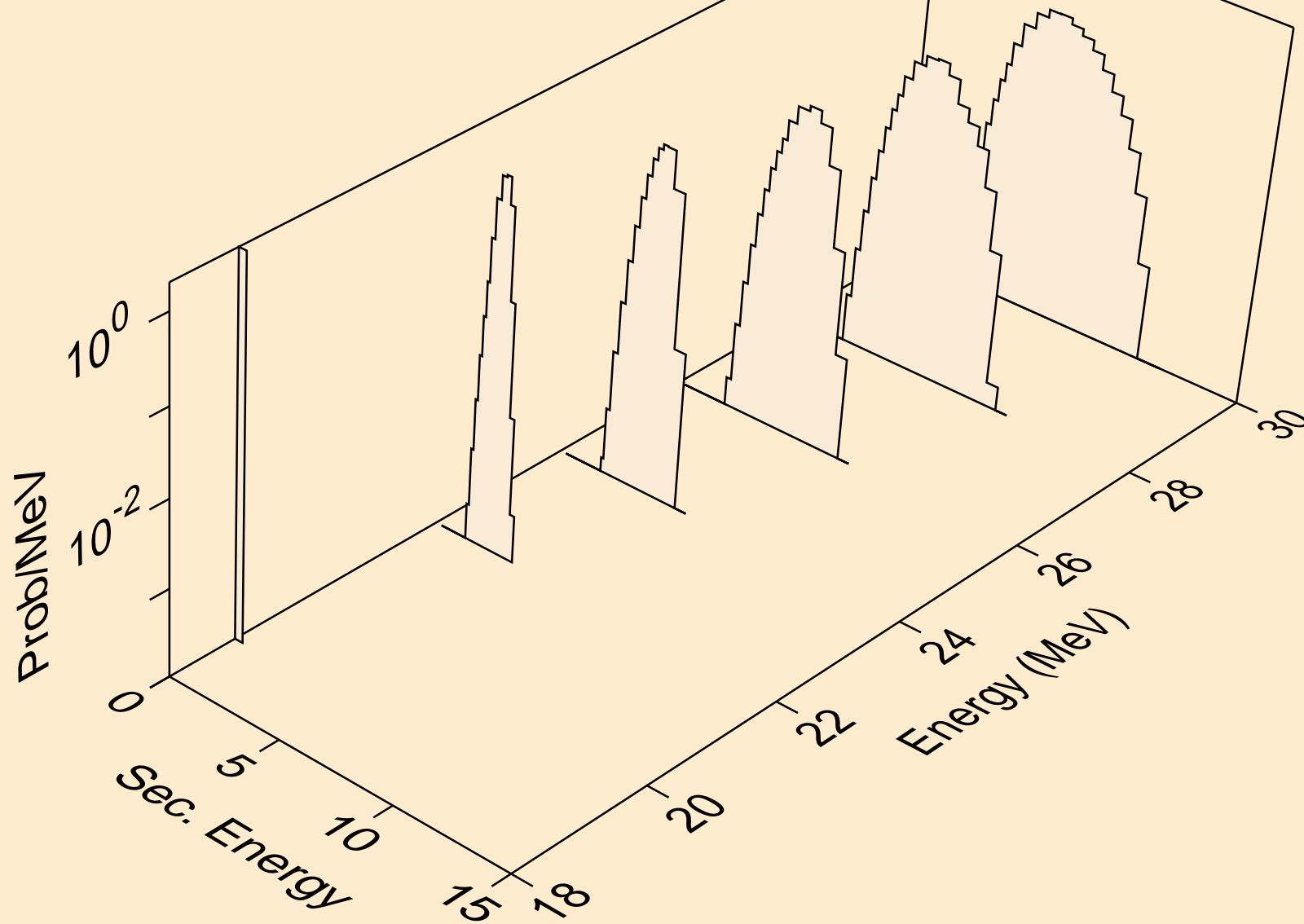

BI190M NEUTRON ACER TENDL-2024 LIBRARY; T=293.6K  
protons from (n,n2p)

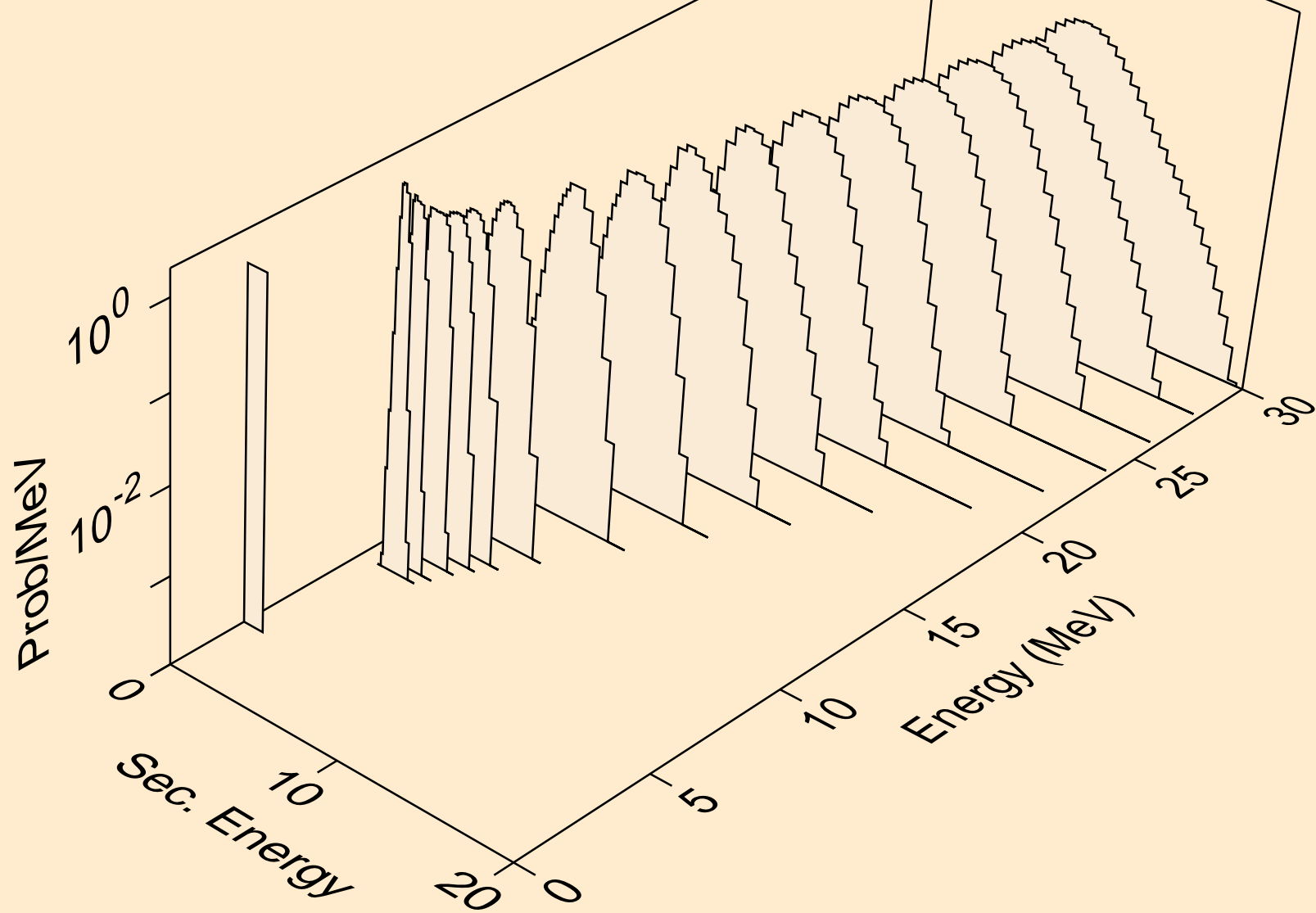

BI190M NEUTRON ACER TENDL-2024 LIBRARY; T=293.6K  
protons from (n,npa)

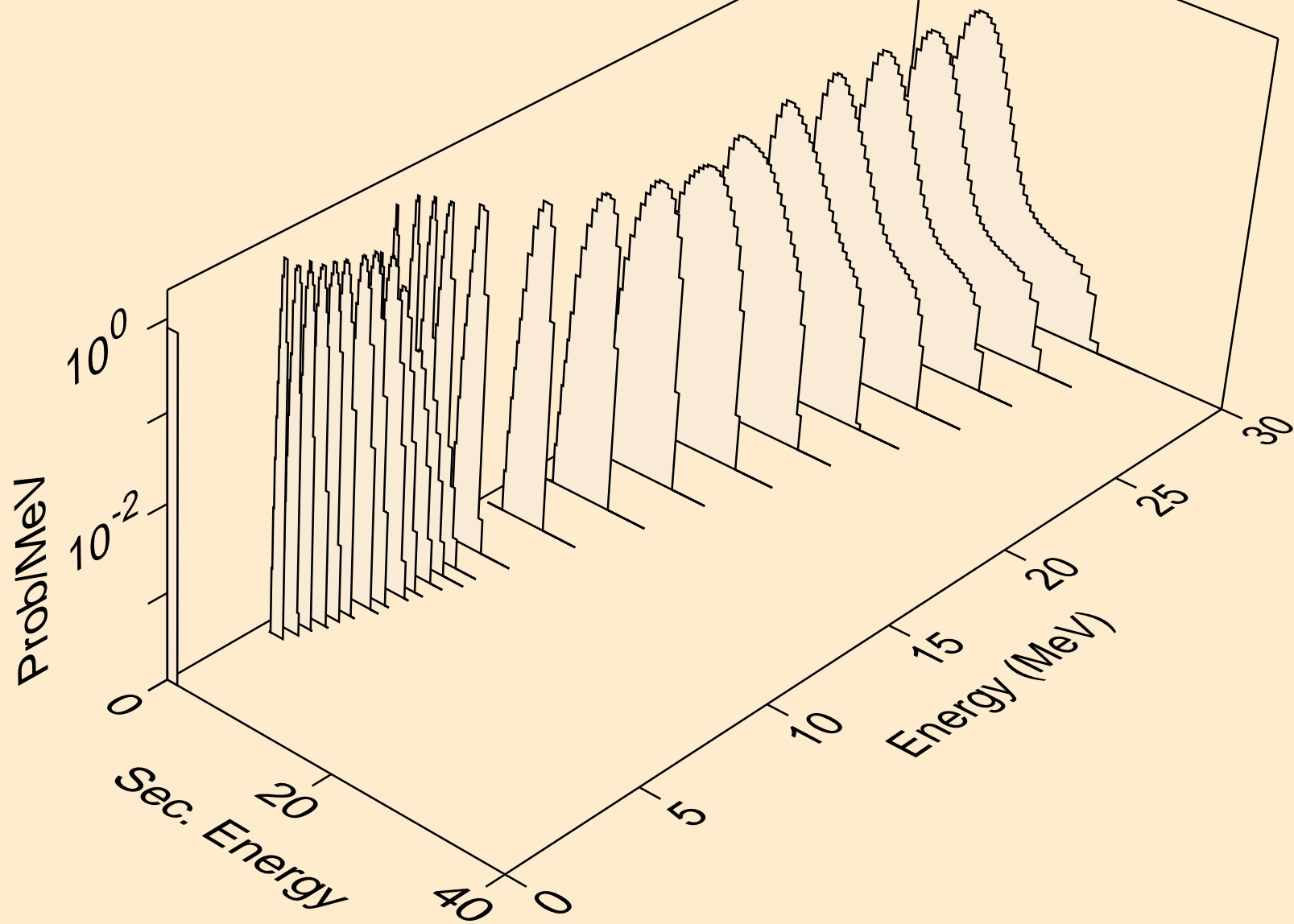

BI190M NEUTRON ACER TENDL-2024 LIBRARY; T=293.6K  
protons from (n,p)

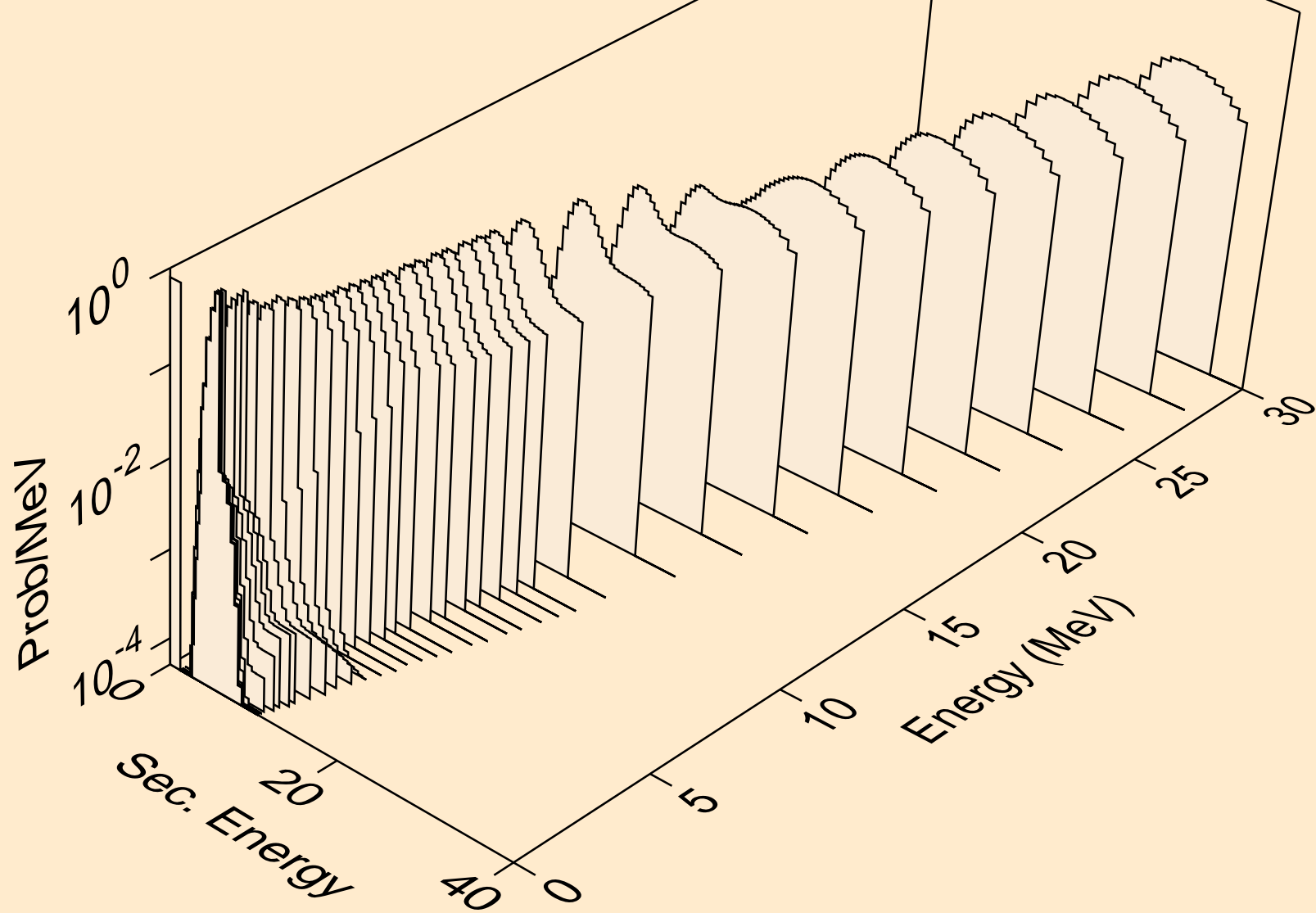

BI190M NEUTRON ACER TENDL-2024 LIBRARY; T=293.6K  
protons from (n,2p)

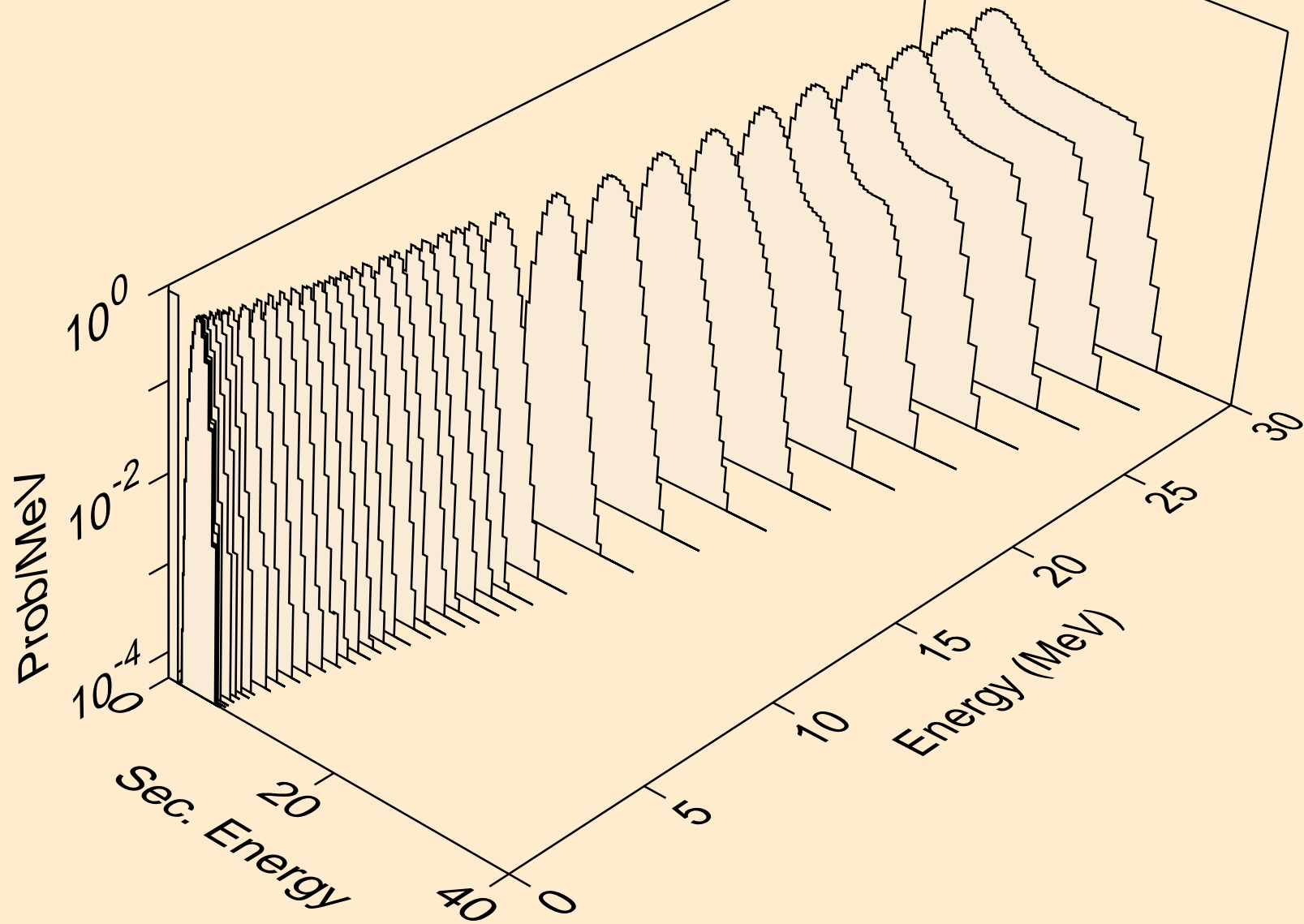

BI190M NEUTRON ACER TENDL-2024 LIBRARY; T=293.6K  
protons from (n,p)

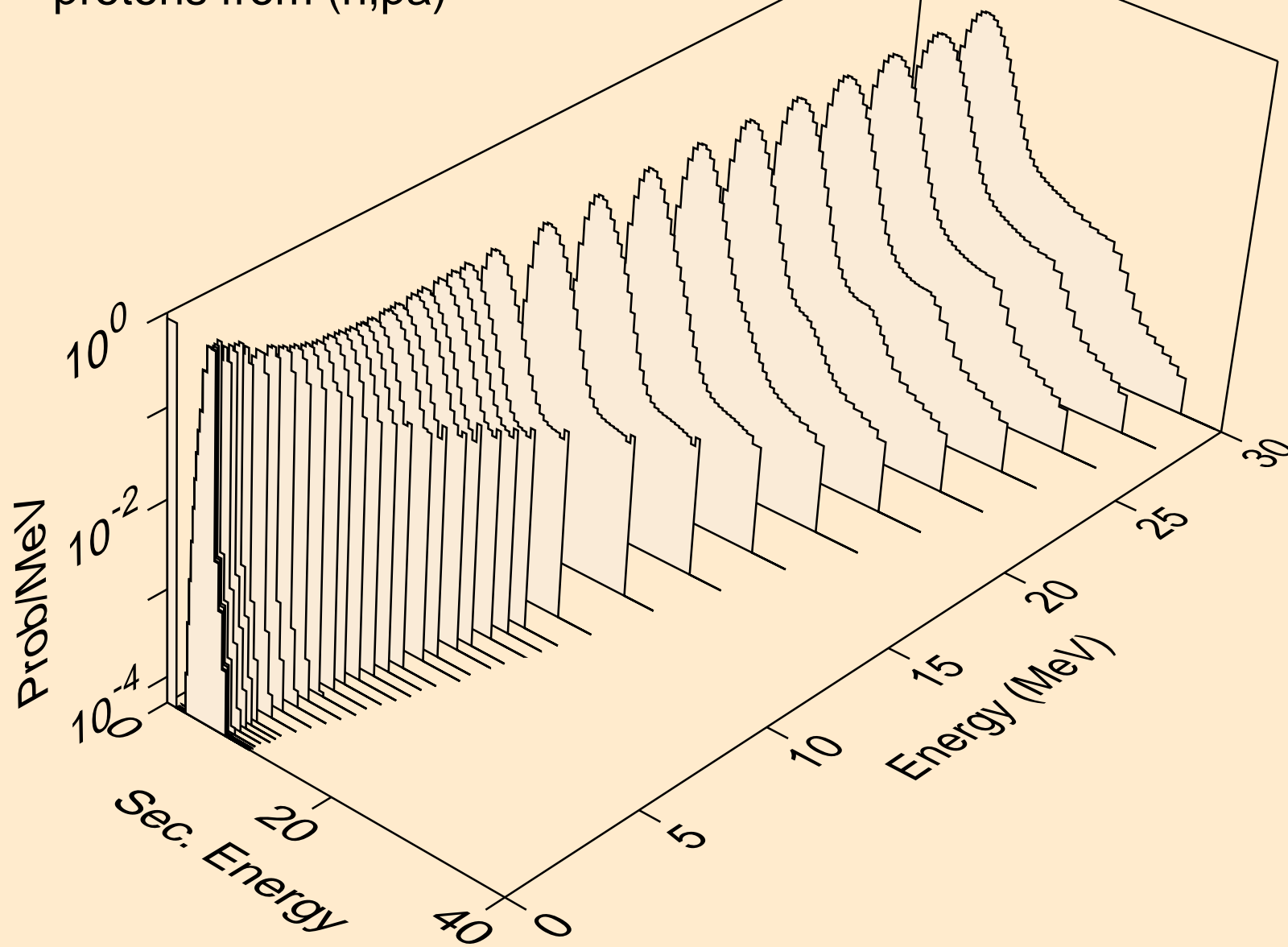

BI190M NEUTRON ACER TENDL-2024 LIBRARY; T=293.6K  
protons from (n,pd)

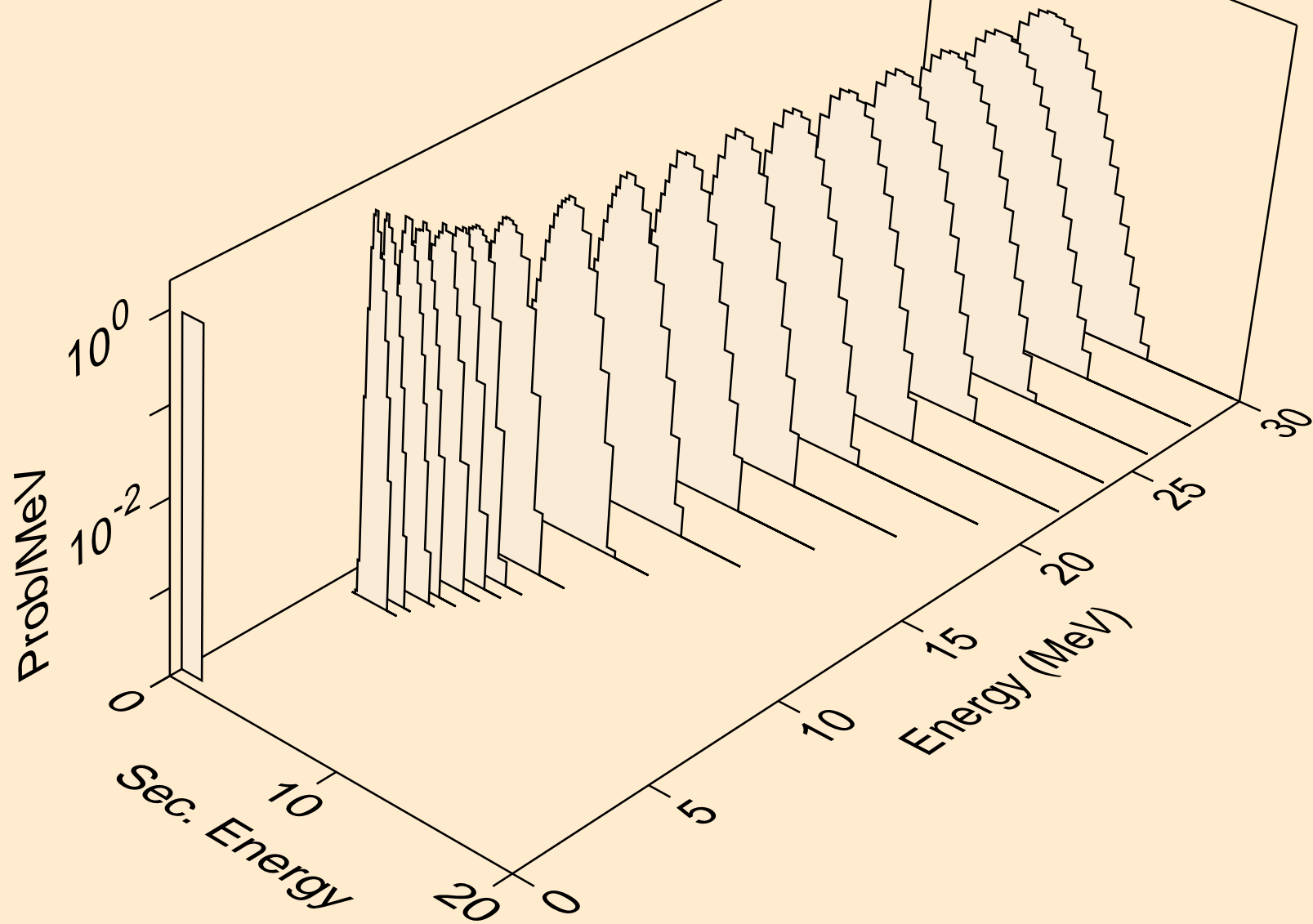

BI190M NEUTRON ACER TENDL-2024 LIBRARY; T=293.6K  
protons from (n,pt)

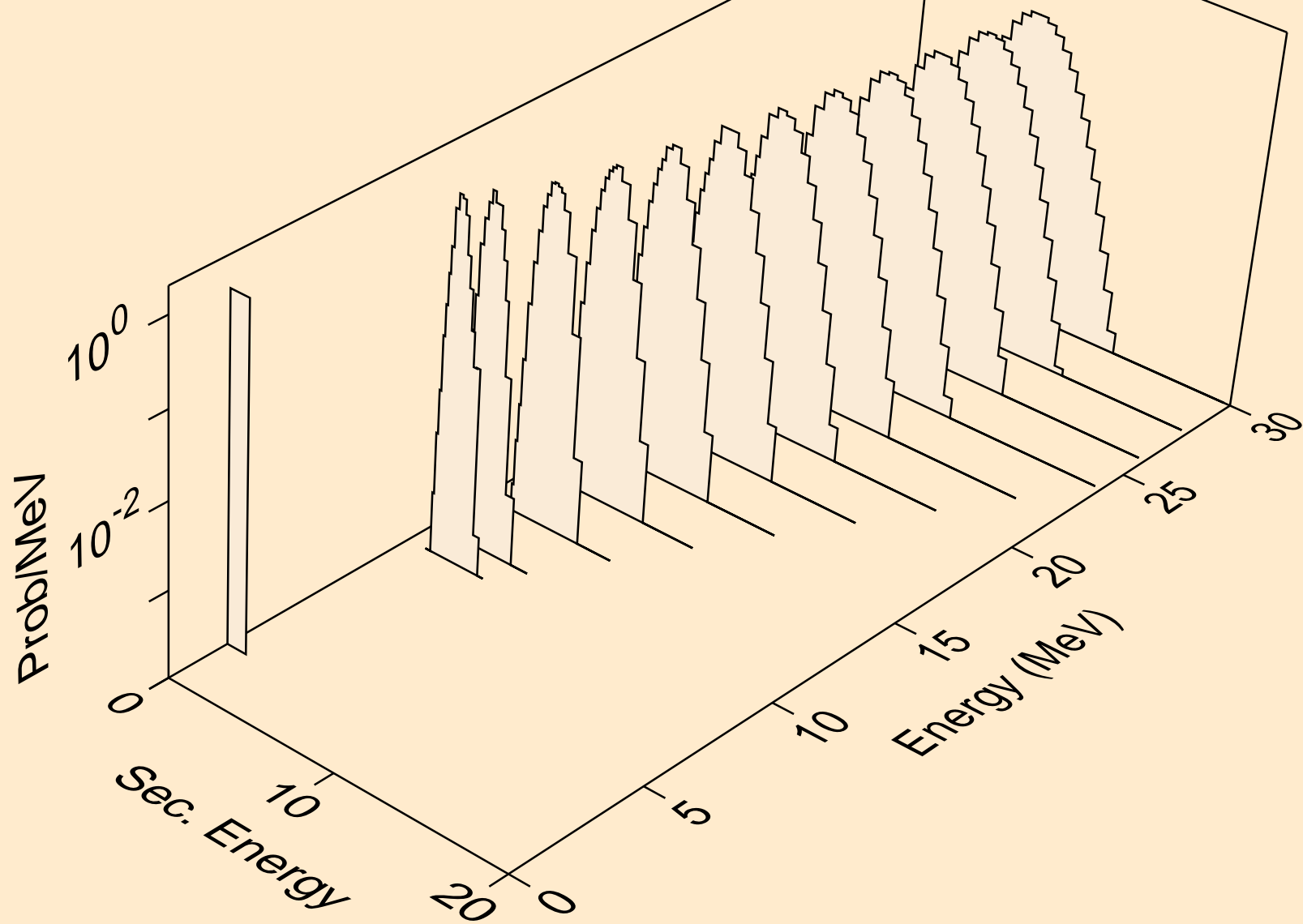

BI190M NEUTRON ACER TENDL-2024 LIBRARY; T=293.6K  
deuterons from (n,x)

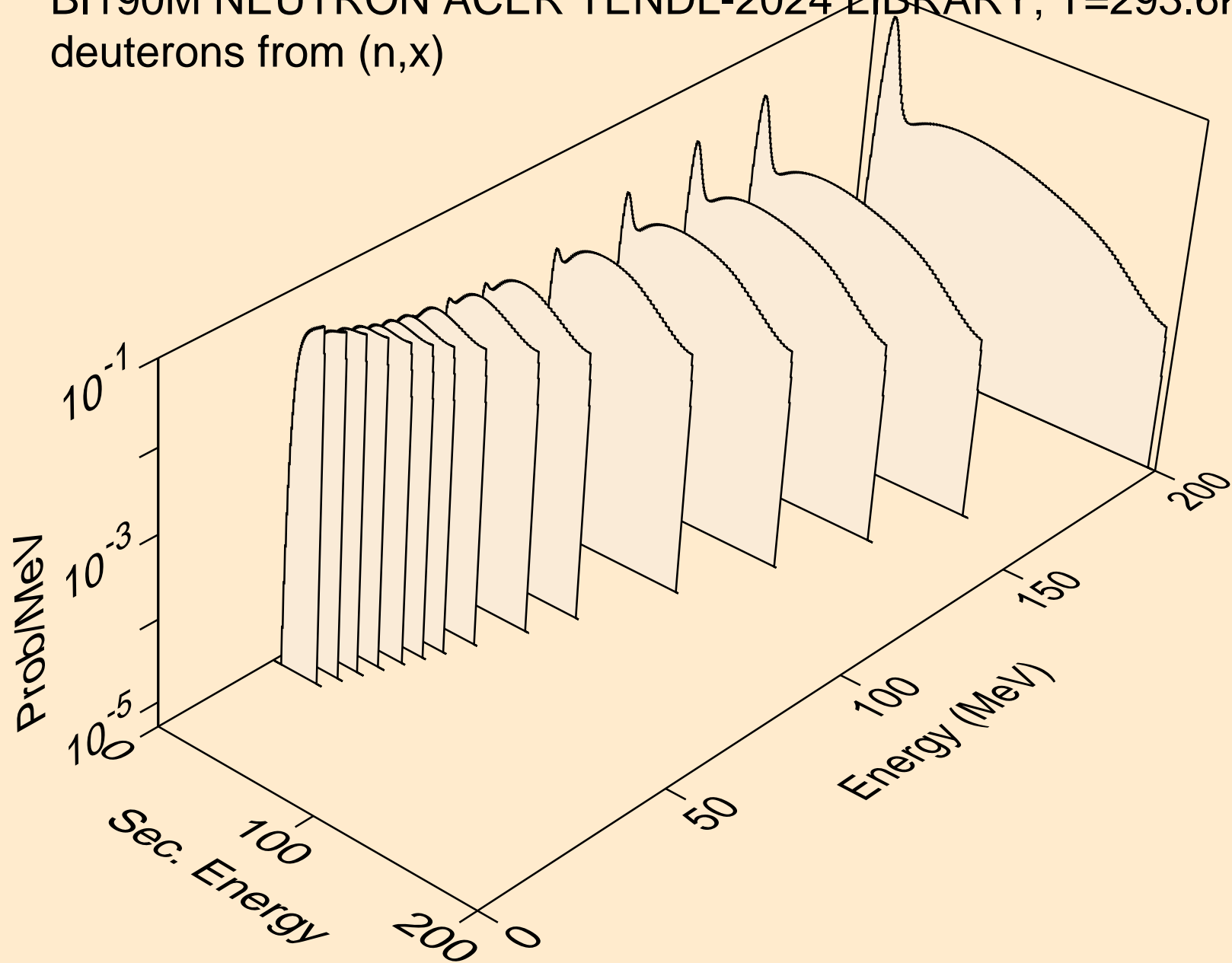

BI190M NEUTRON ACER TENDL-2024 LIBRARY; T=293.6K  
deuterons from (n,2nd)

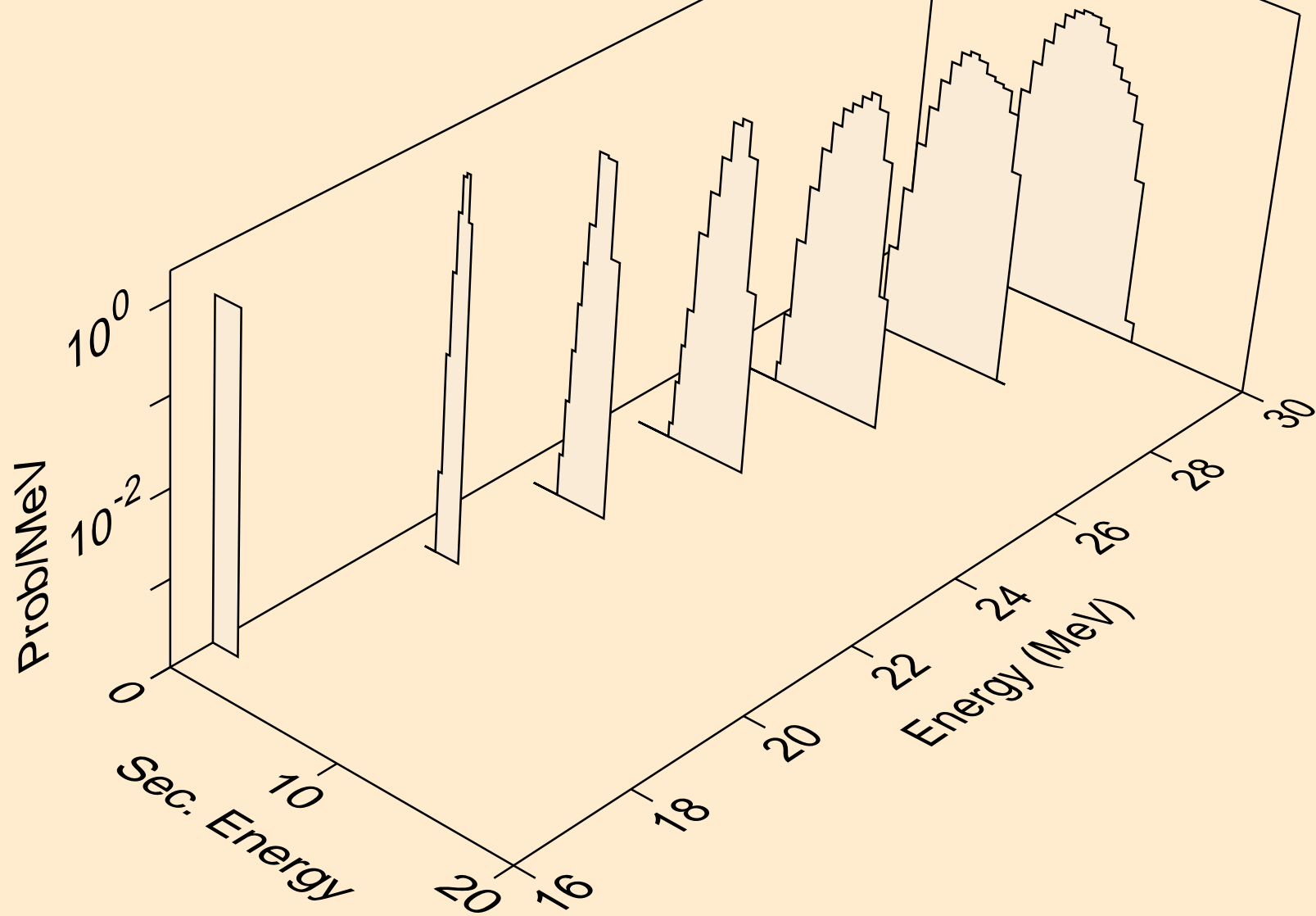

BI190M NEUTRON ACER TENDL-2024 LIBRARY; T=293.6K  
deuterons from (n,n\*)d

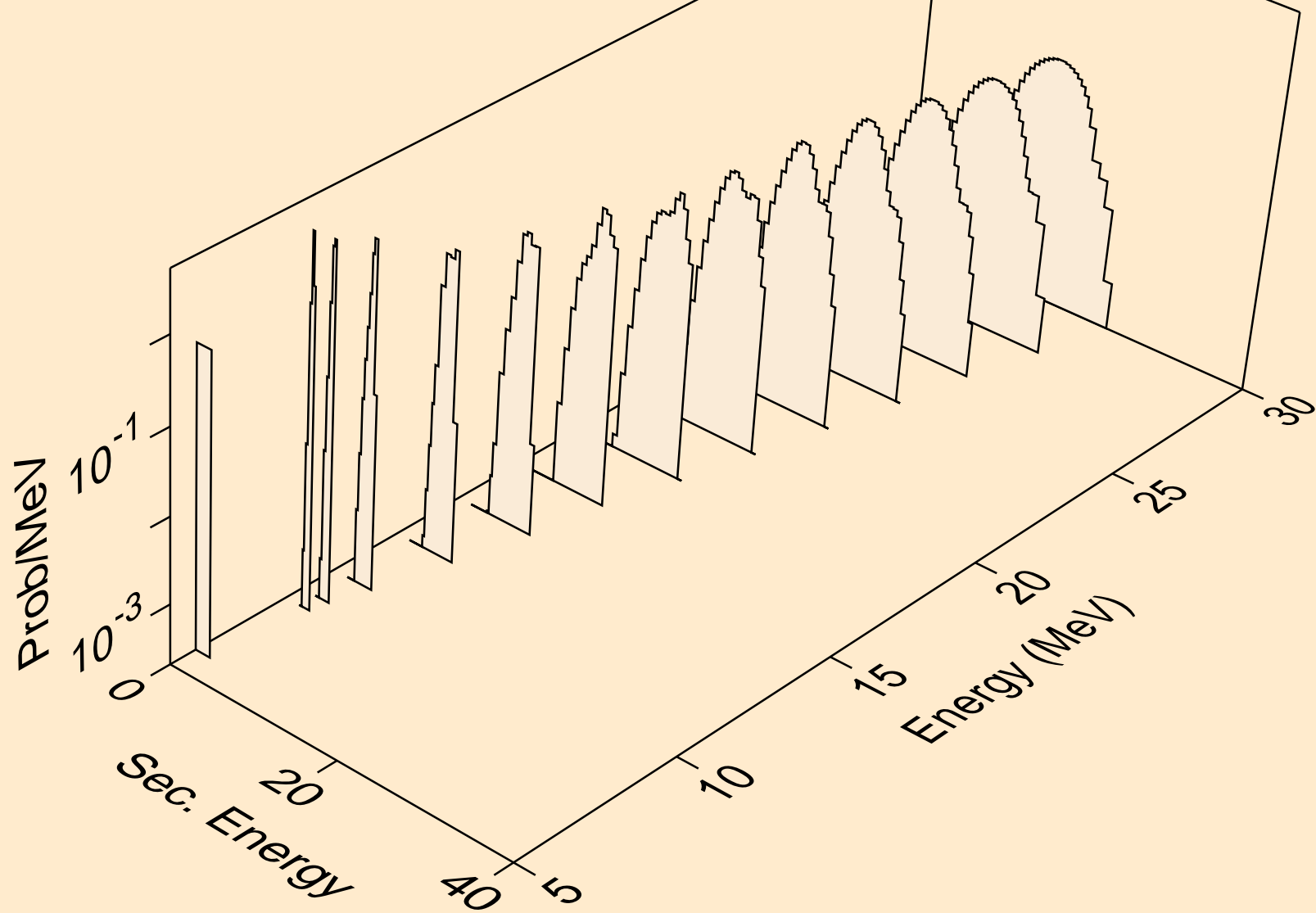

BI190M NEUTRON ACER TENDL-2024 LIBRARY; T=293.6K  
deuterons from (n,d)

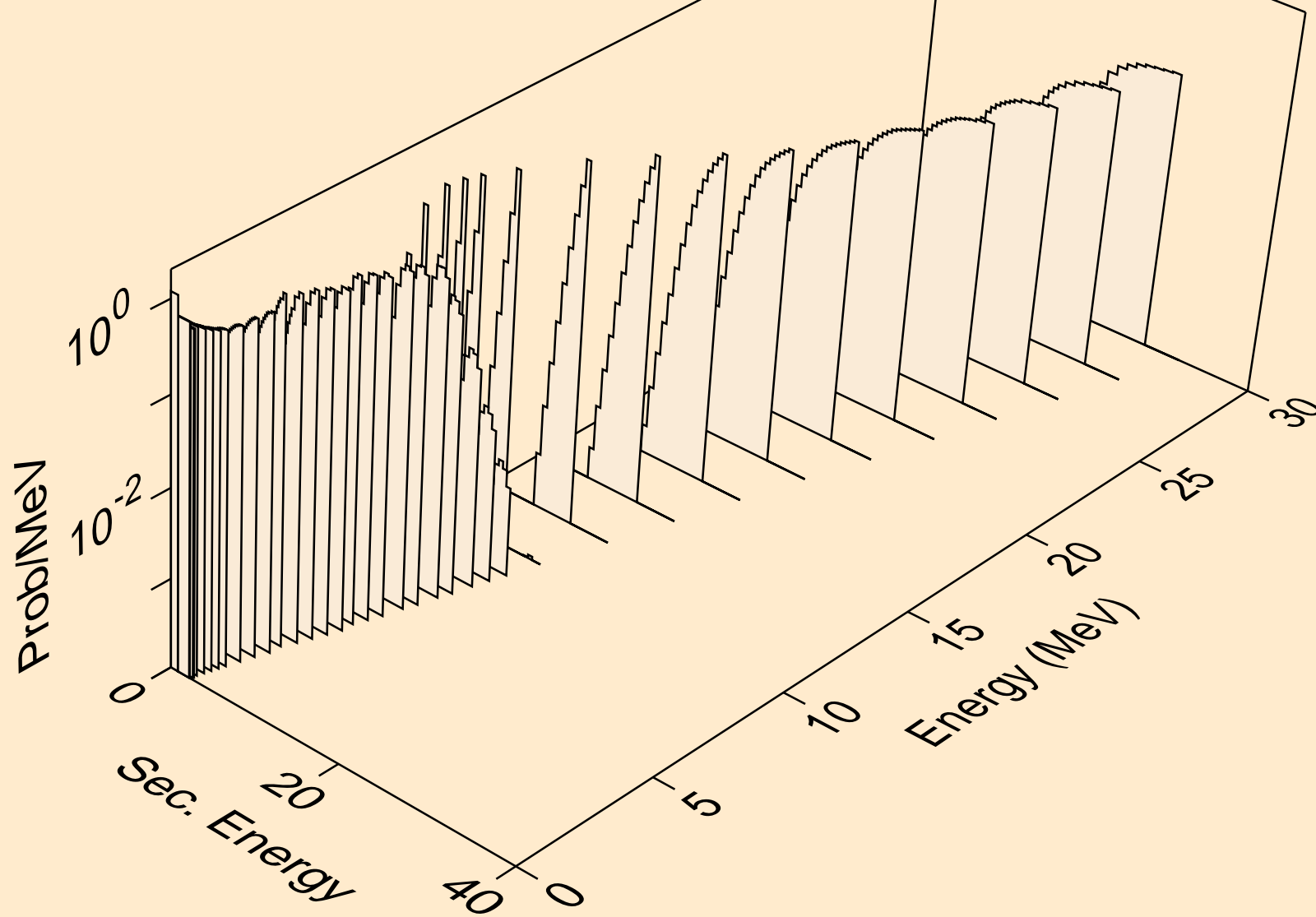

BI190M NEUTRON ACER TENDL-2024 LIBRARY; T=293.6K  
deuterons from (n,d2a)

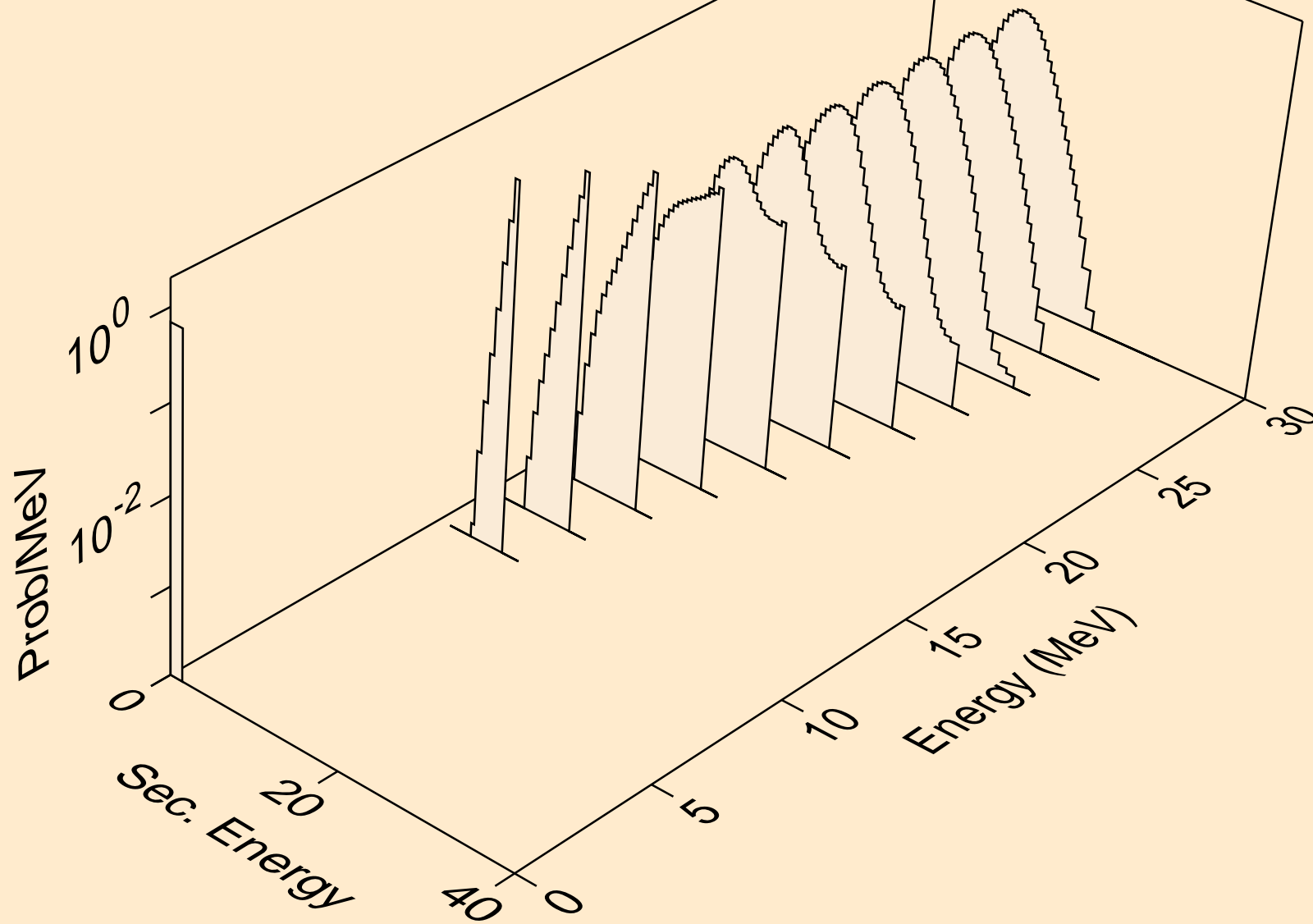

BI190M NEUTRON ACER TENDL-2024 LIBRARY; T=293.6K  
deuterons from (n,pd)

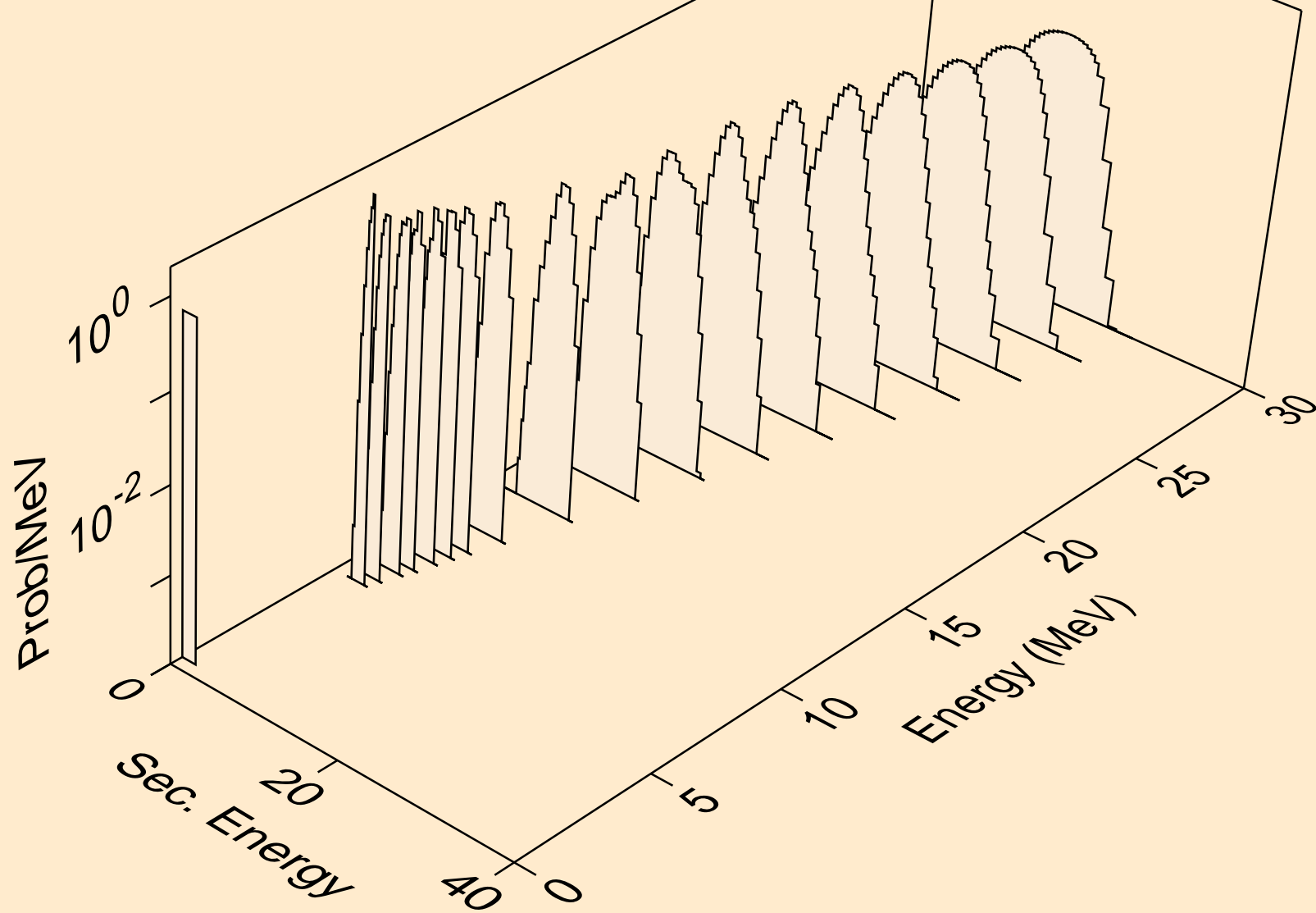

BI190M NEUTRON ACER TENDL-2024 LIBRARY; T=293.6K  
deuterons from (n,da)

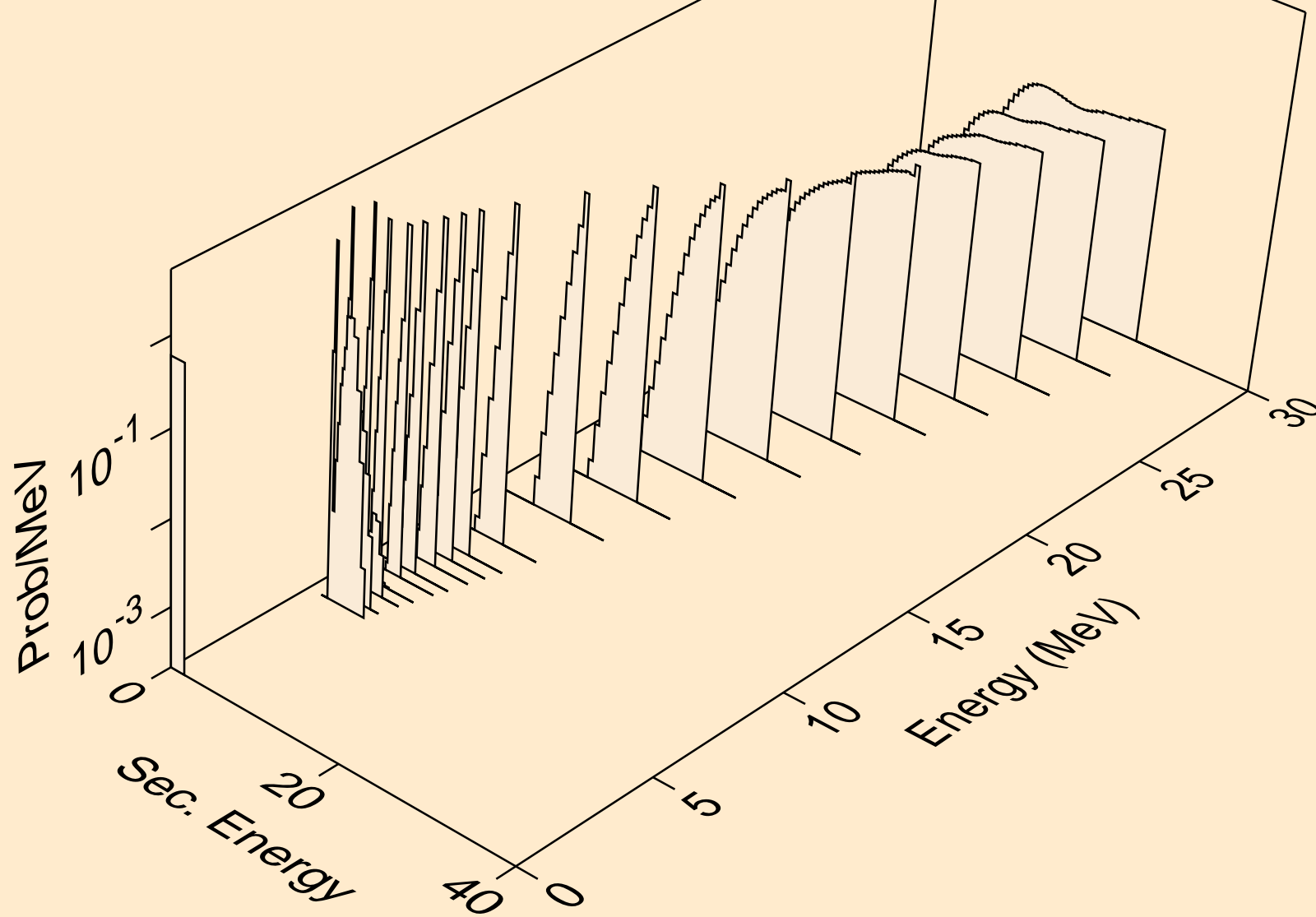

BI190M NEUTRON ACER TENDL-2024 LIBRARY; T=293.6K  
tritons from (n,x)

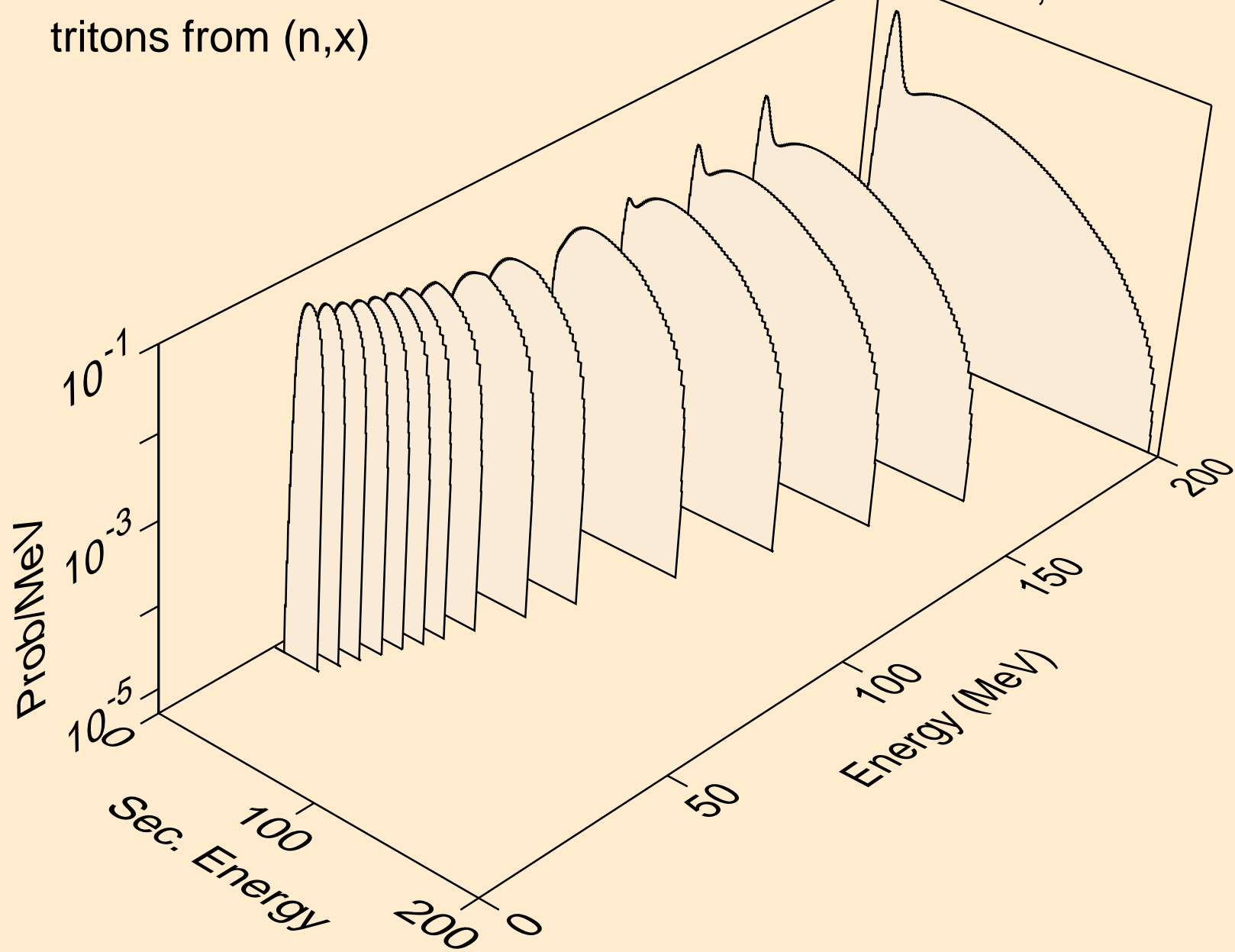

BI190M NEUTRON ACER TENDL-2024 LIBRARY; T=293.6K  
tritons from (n,n\*)t

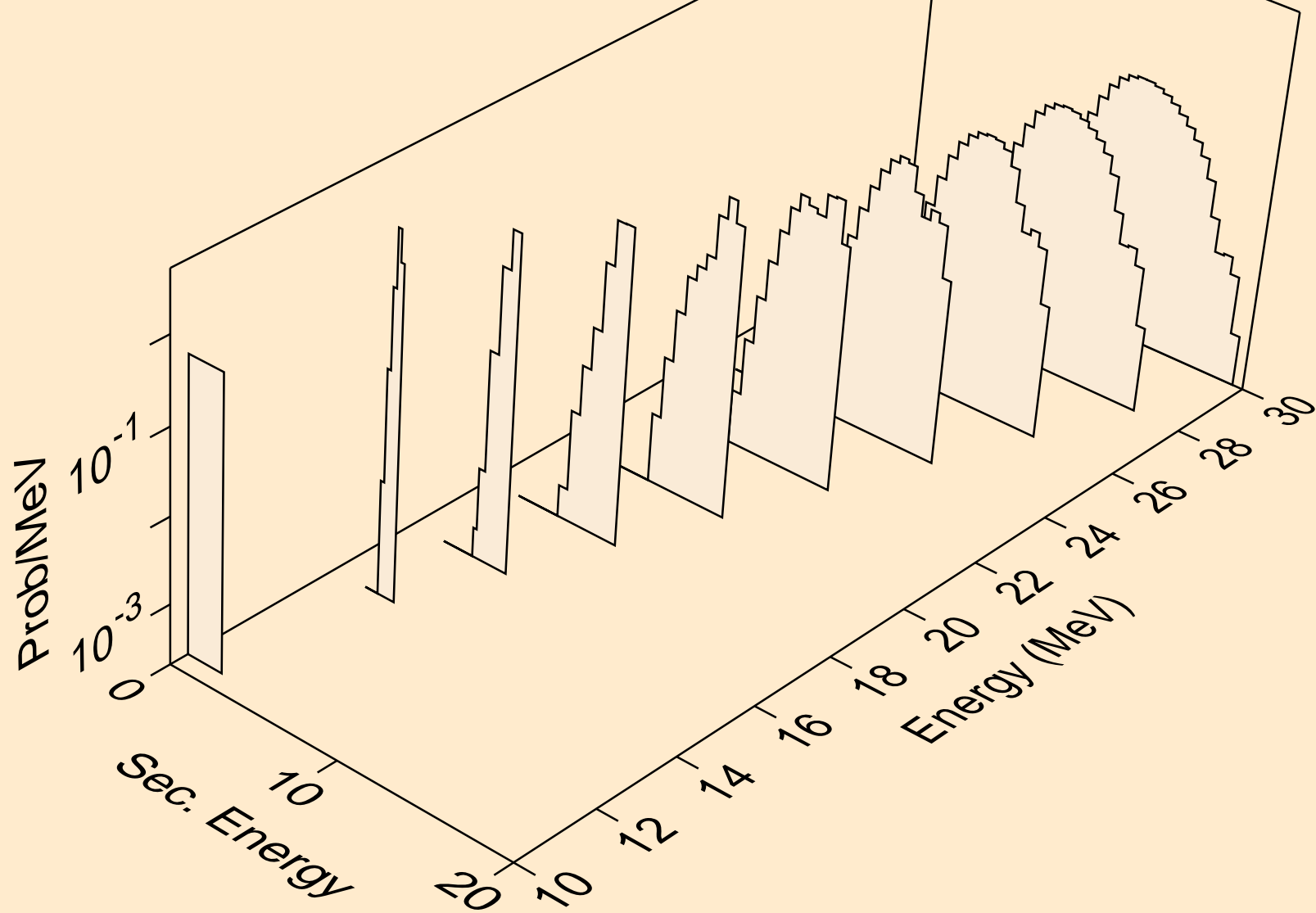

BI190M NEUTRON ACER TENDL-2024 LIBRARY; T=293.6K  
tritons from (n,t)

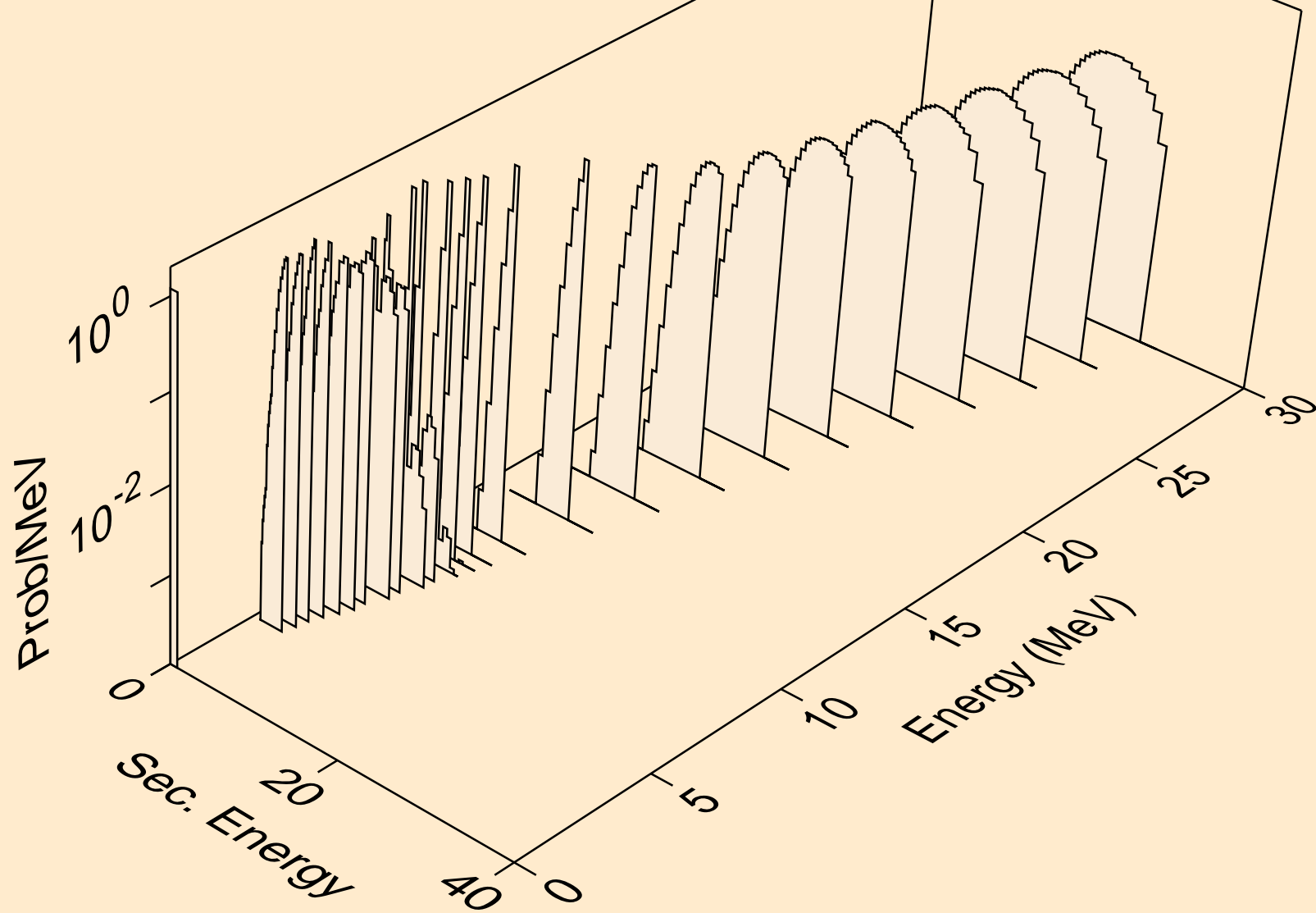

BI190M NEUTRON ACER TENDL-2024 LIBRARY; T=293.6K  
tritons from (n,pt)

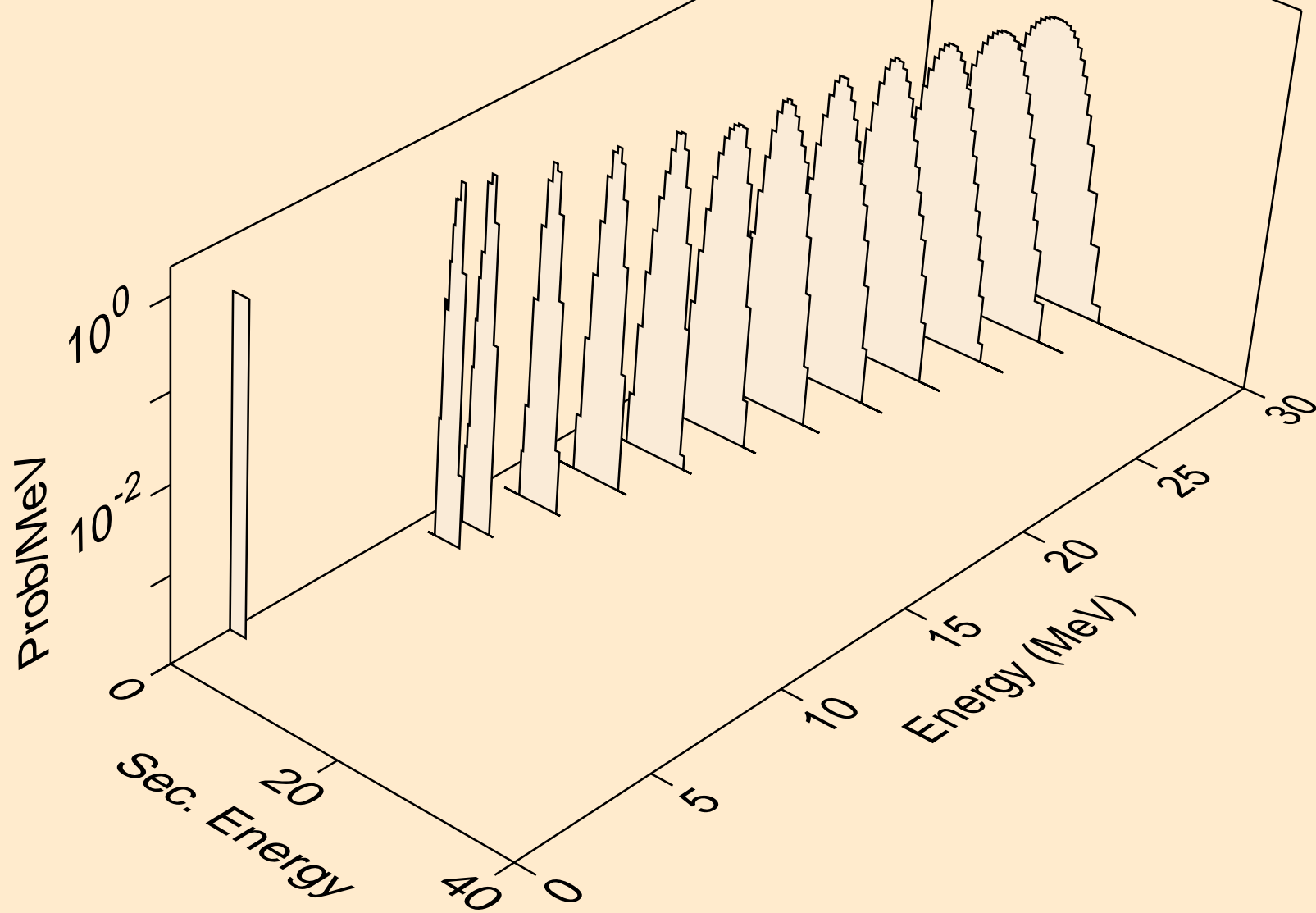

BI190M NEUTRON ACER TENDL-2024 LIBRARY; T=293.6K  
he3s from (n,x)

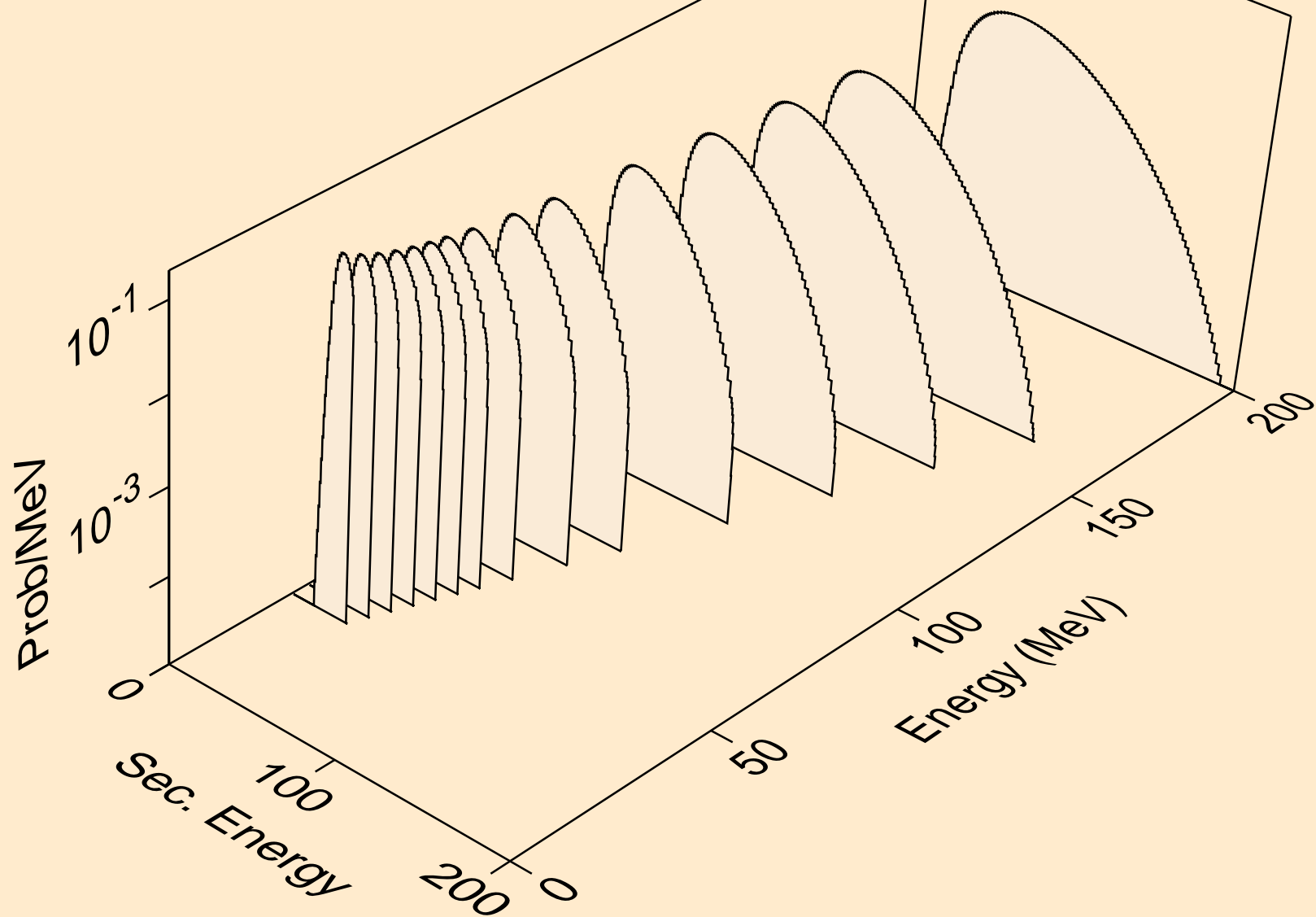

BI190M NEUTRON ACER TENDL-2024 LIBRARY; T=293.6K  
he3s from (n,n\*)he3

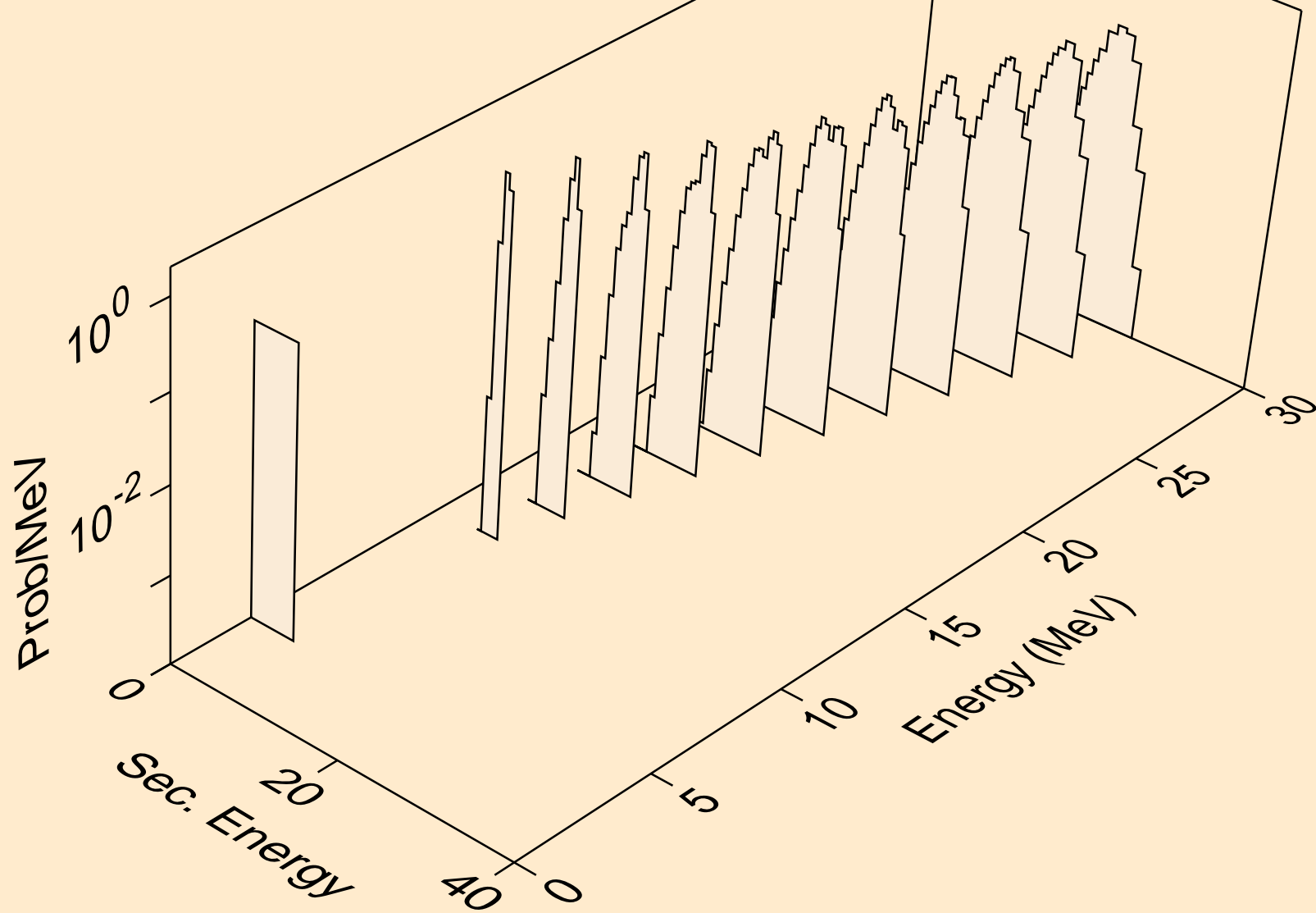

BI190M NEUTRON ACER TENDL-2024 LIBRARY; T=293.6K  
he3s from (n,he3)

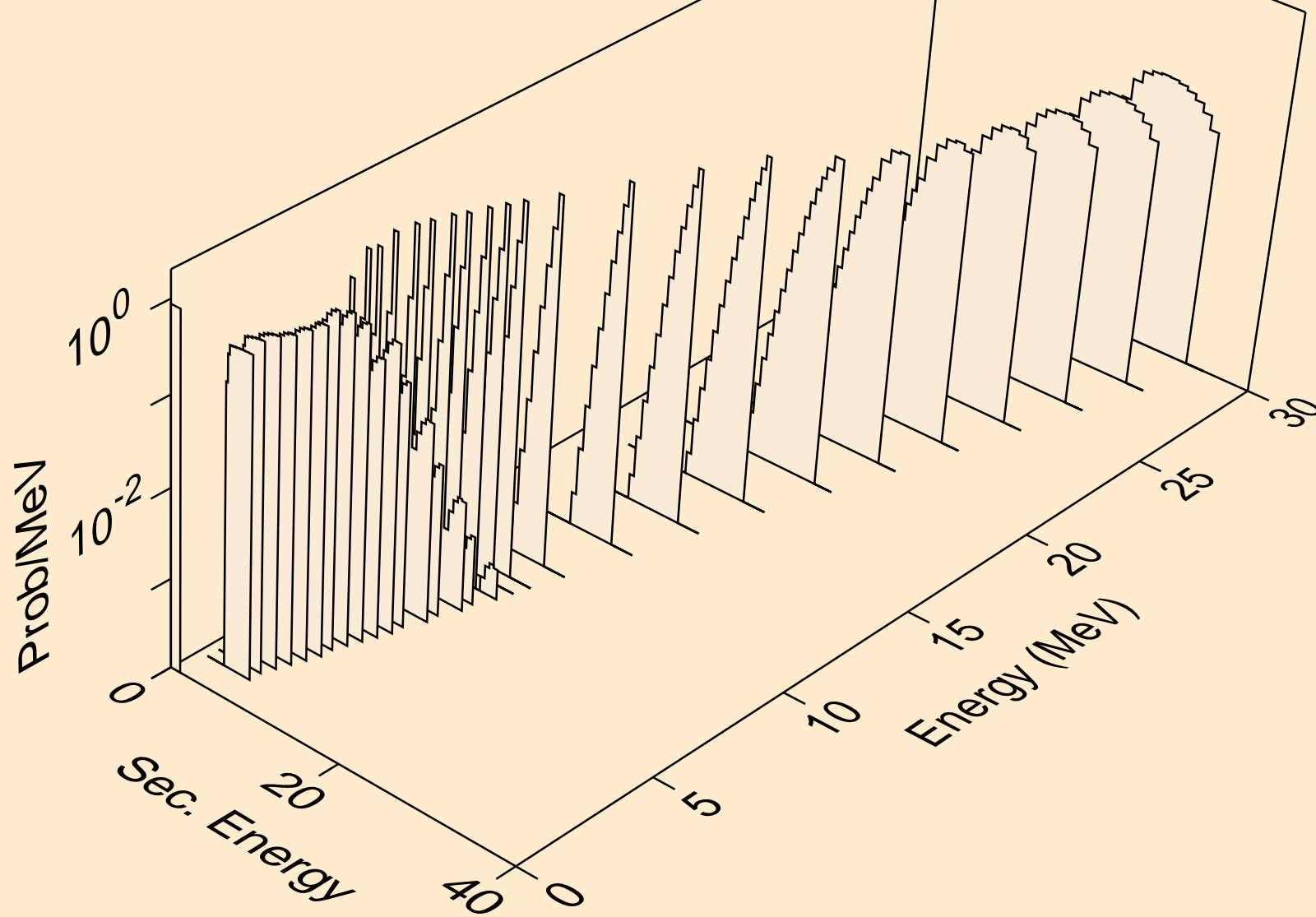

BI190M NEUTRON ACER TENDL-2024 LIBRARY; T=293.6K  
alphas from (n,x)

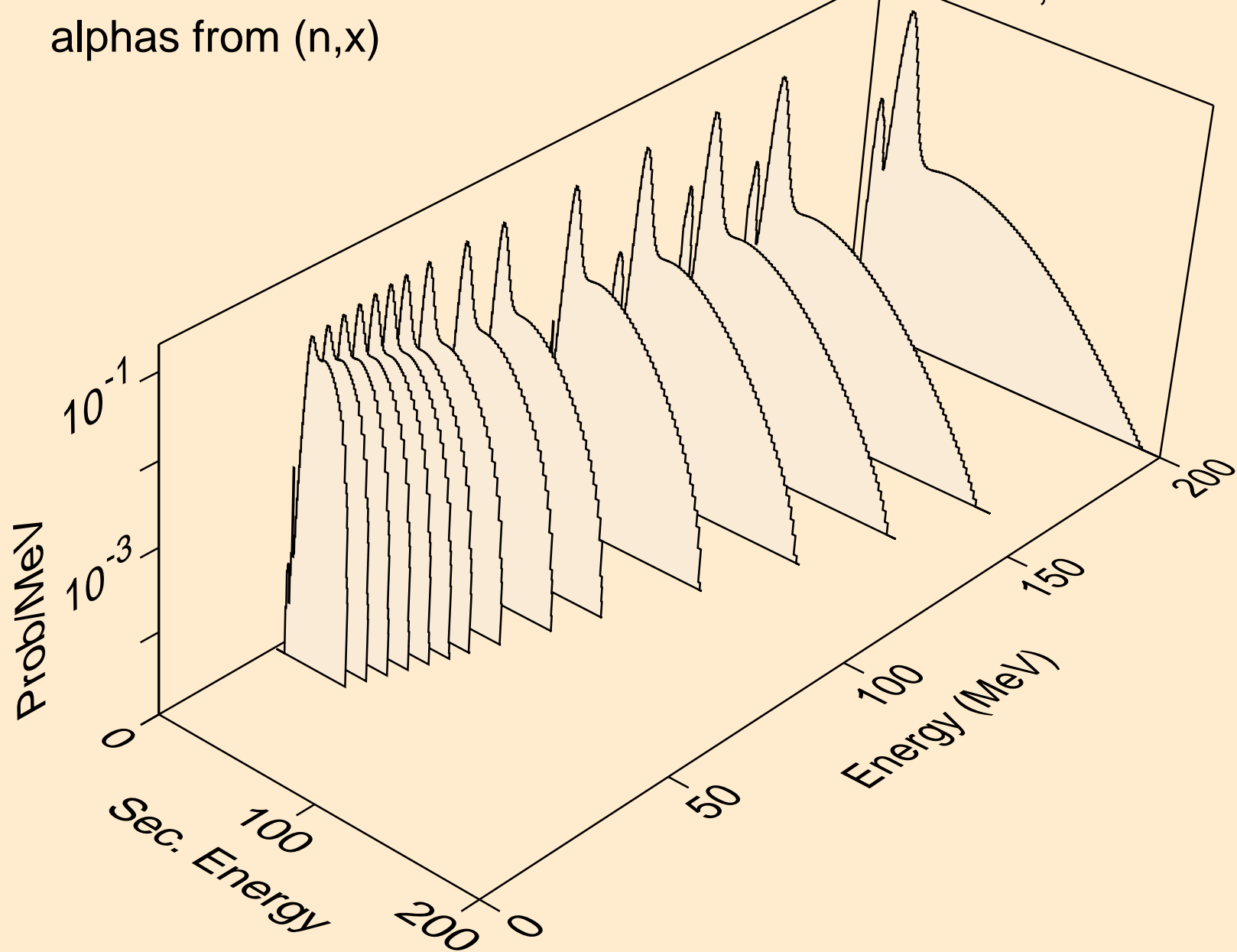

BI190M NEUTRON ACER TENDL-2024 LIBRARY; T=293.6K  
alphas from (n,n\*)a

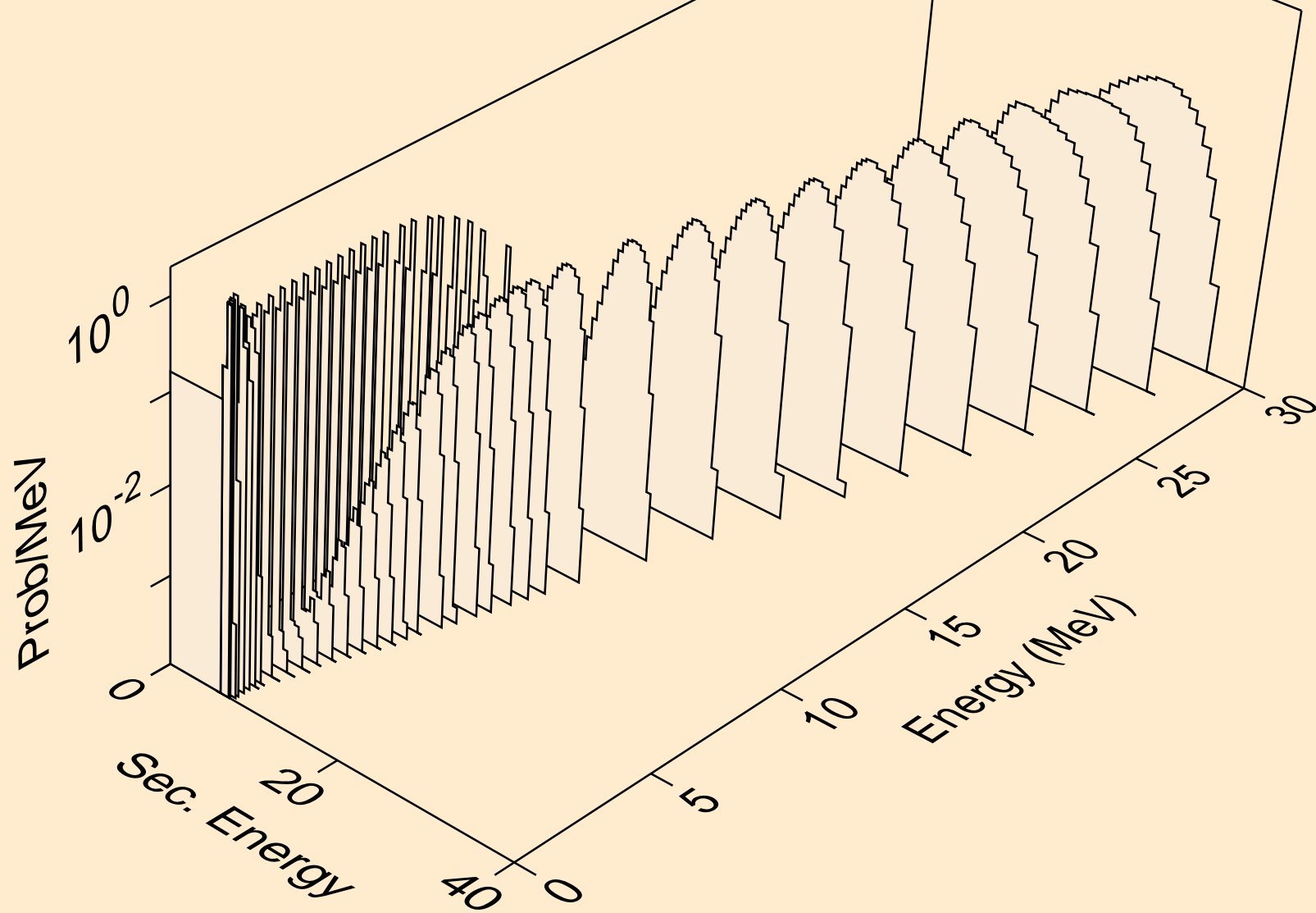

BI190M NEUTRON ACER TENDL-2024 LIBRARY; T=293.6K  
alphas from (n,n\*)3a

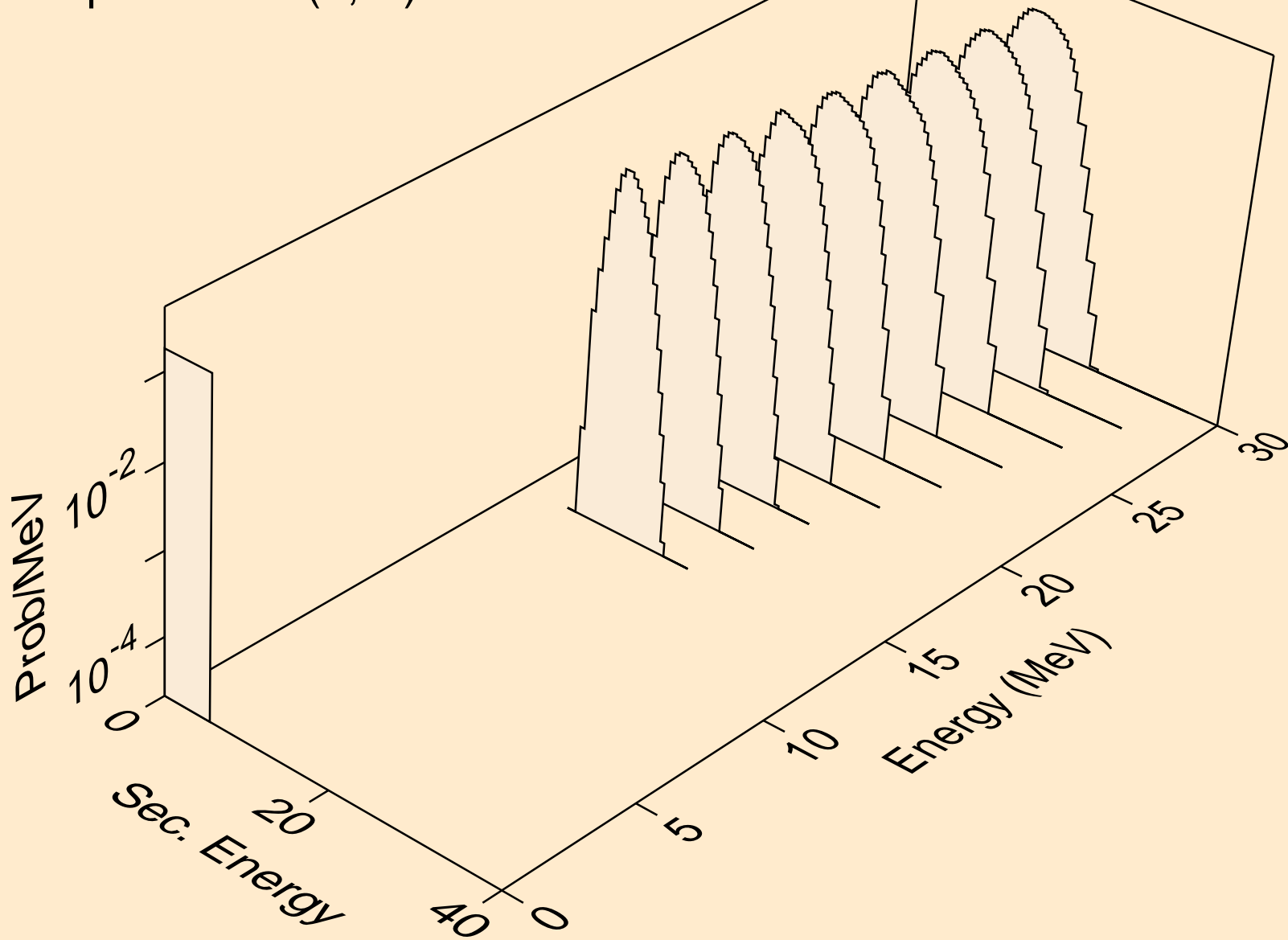

BI190M NEUTRON ACER TENDL-2024 LIBRARY; T=293.6K  
alphas from (n,2n)a

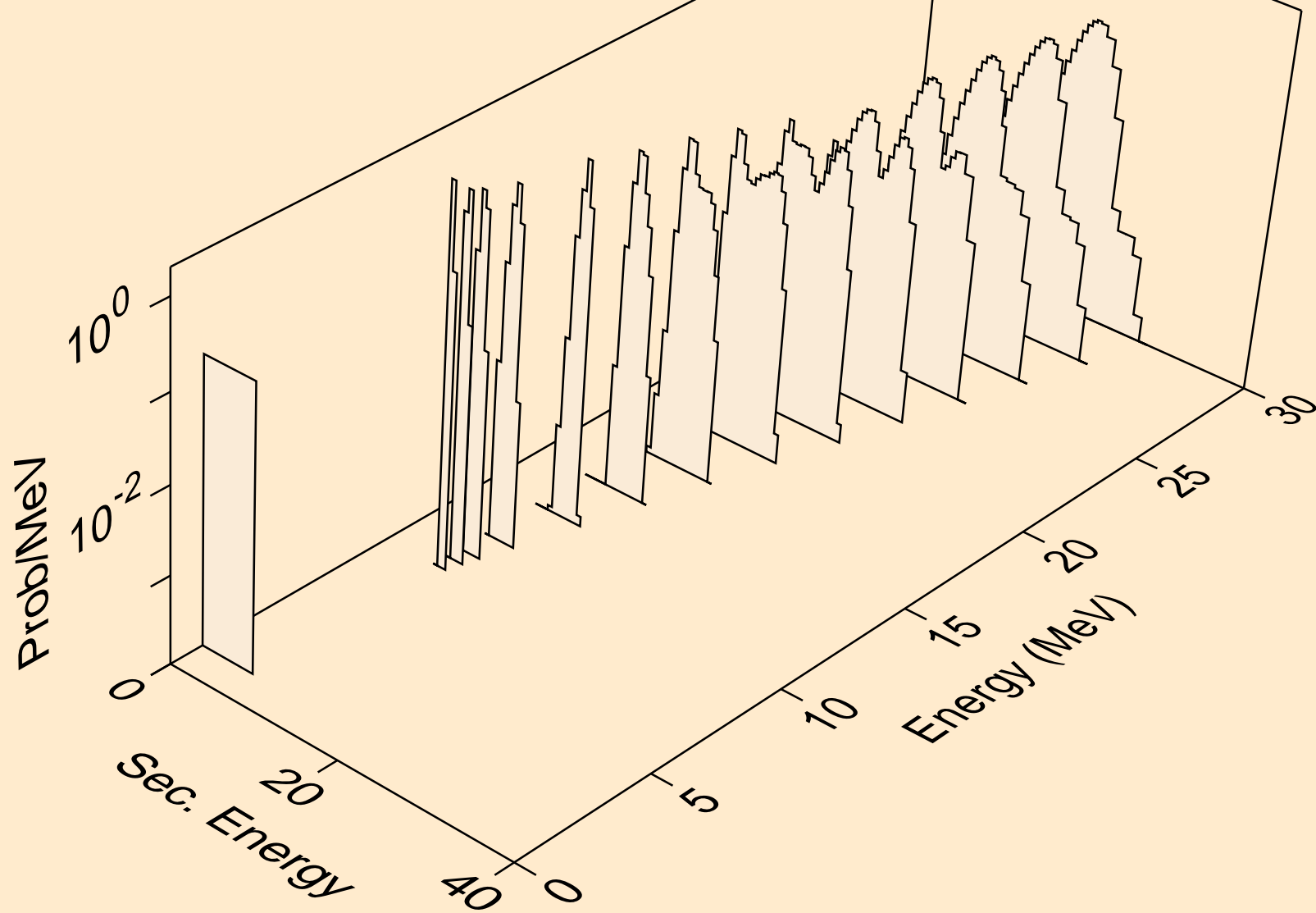

BI190M NEUTRON ACER TENDL-2024 LIBRARY; T=293.6K  
alphas from (n,3n)a

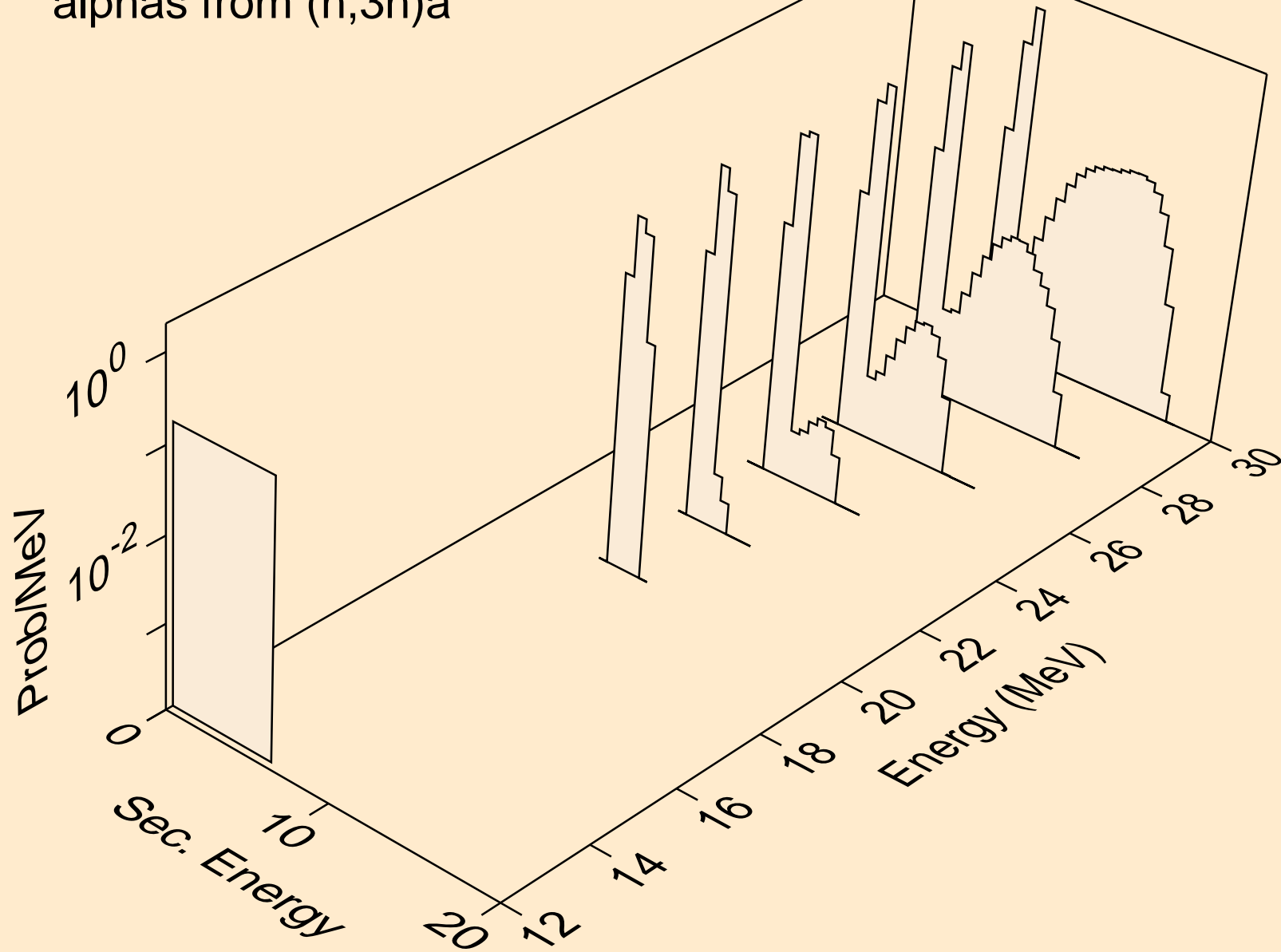

BI190M NEUTRON ACER TENDL-2024 LIBRARY; T=293.6K  
alphas from (n,n\*)2a

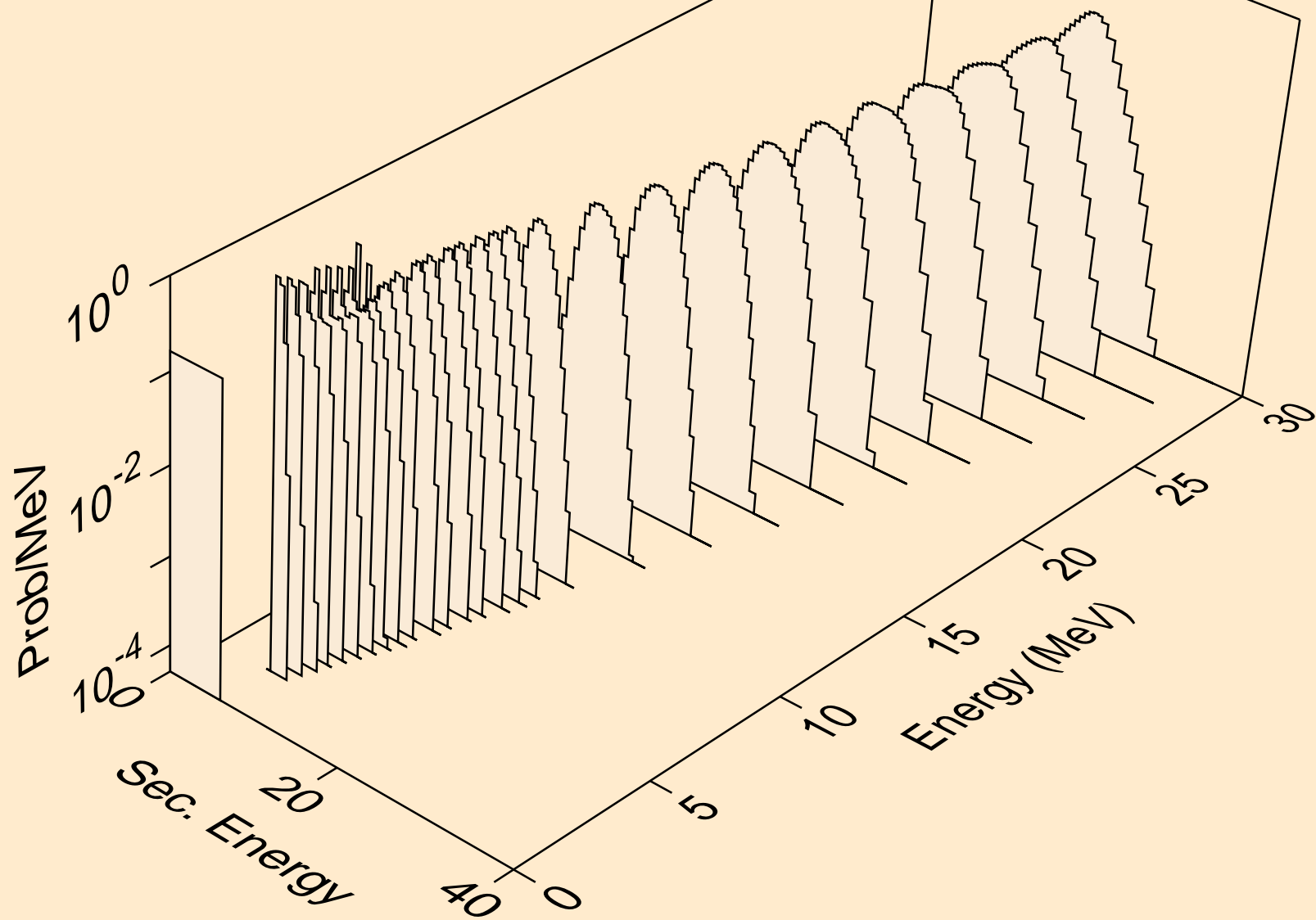

BI190M NEUTRON ACER TENDL-2024 LIBRARY; T=293.6K  
alphas from (n,2n)2a

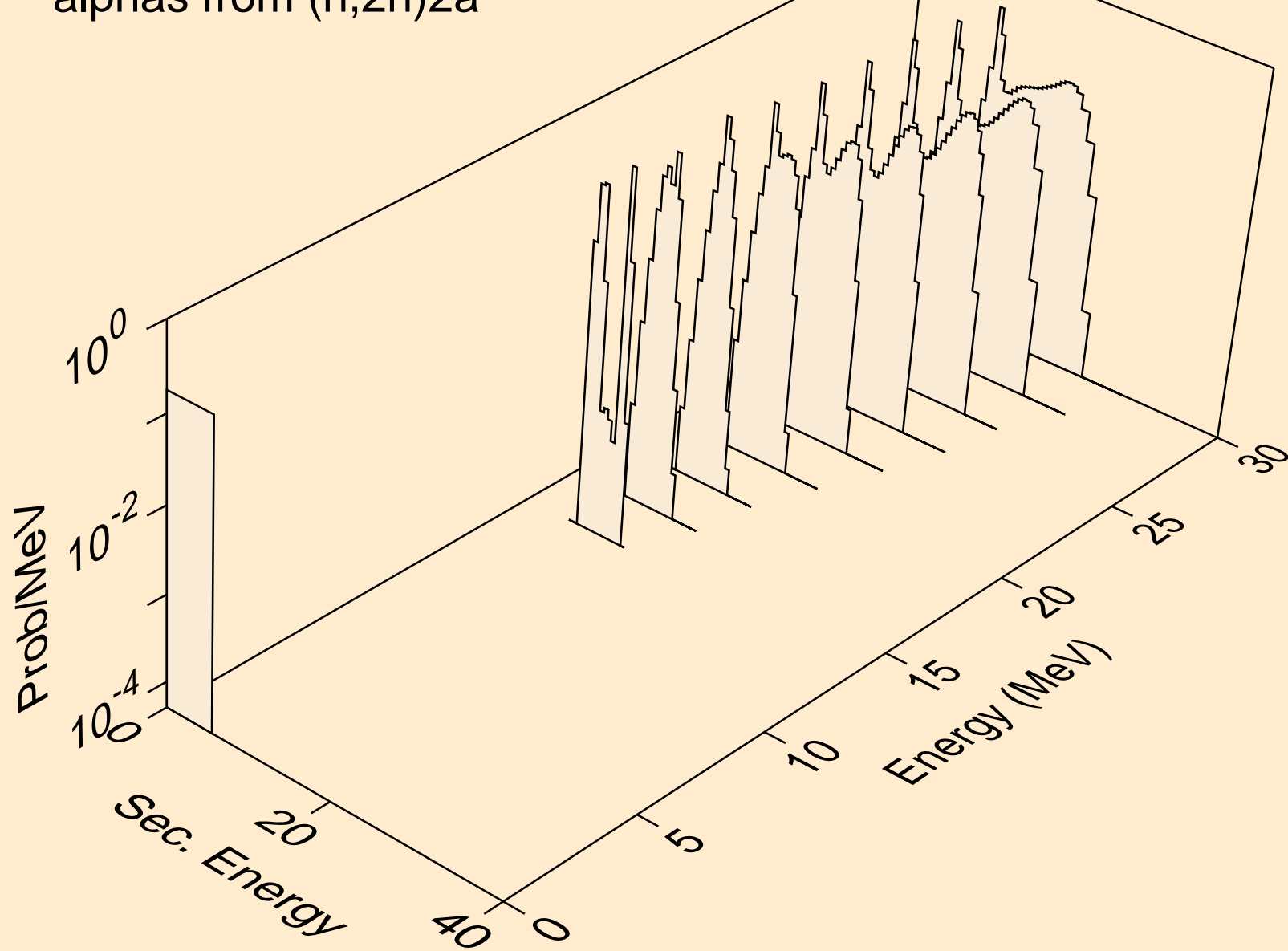

BI190M NEUTRON ACER TENDL-2024 LIBRARY; T=293.6K  
alphas from (n,npa)

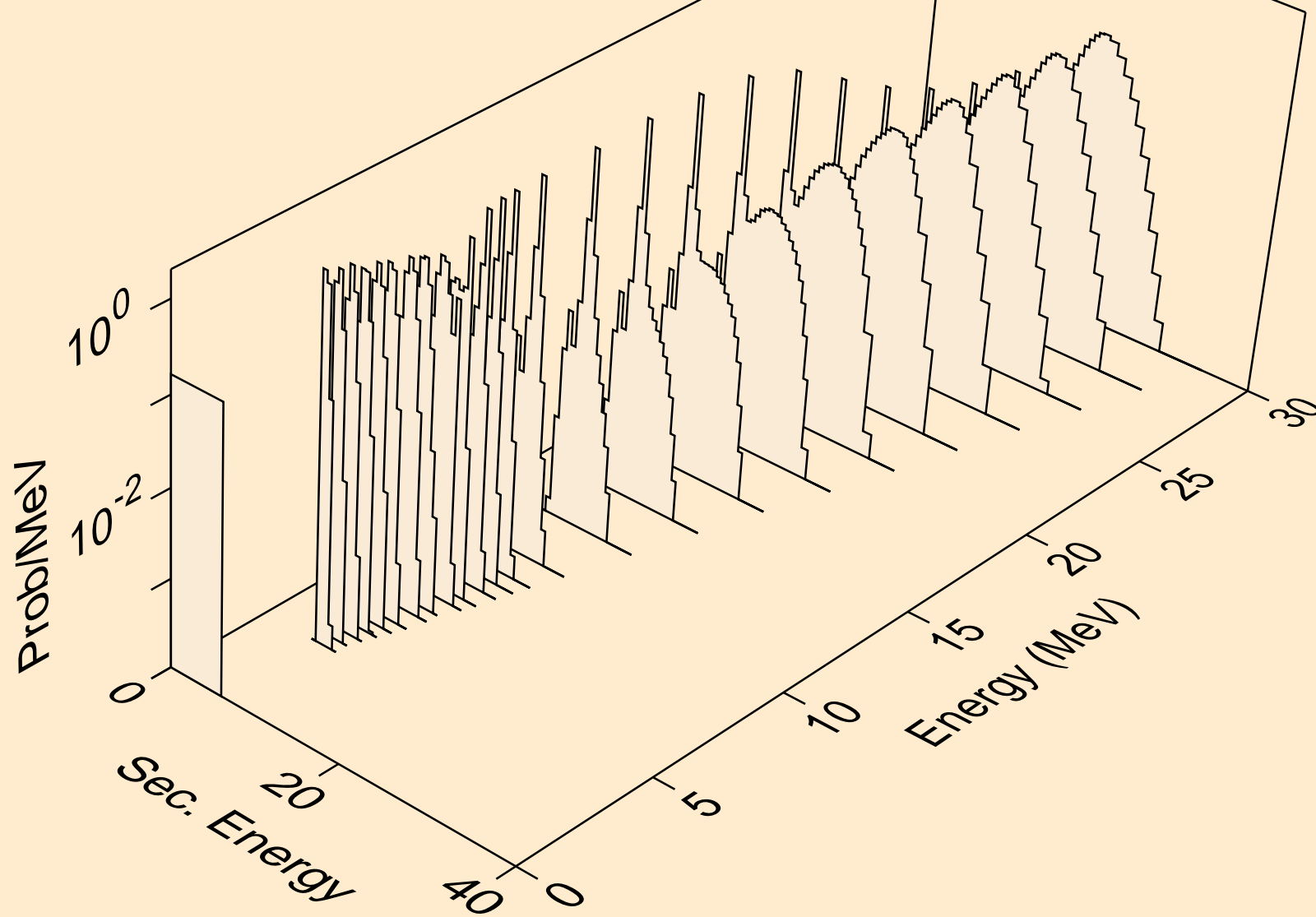

BI190M NEUTRON ACER TENDL-2024 LIBRARY; T=293.6K  
alphas from (n,a)

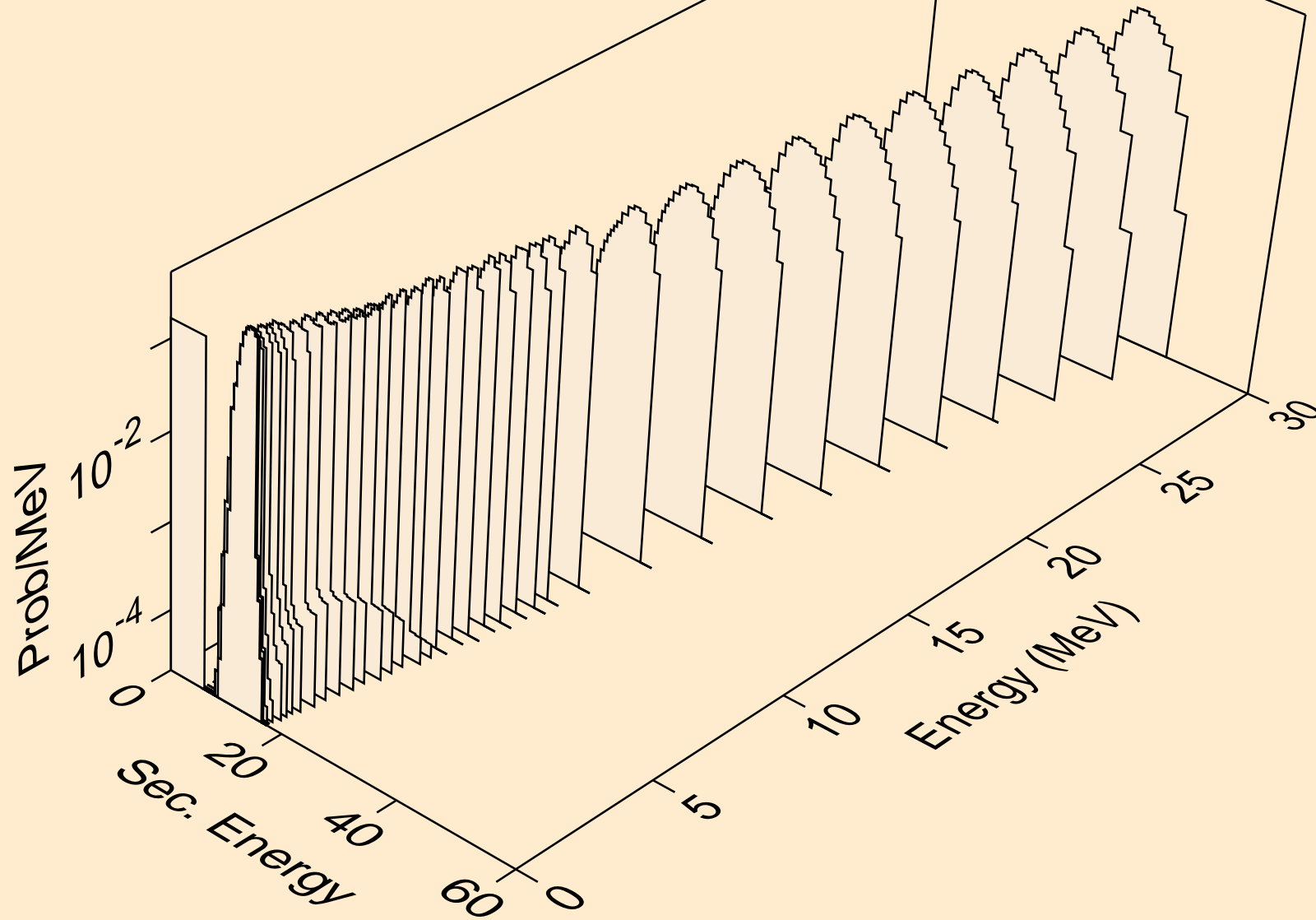

BI190M NEUTRON ACER TENDL-2024 LIBRARY; T=293.6K  
alphas from (n,2a)

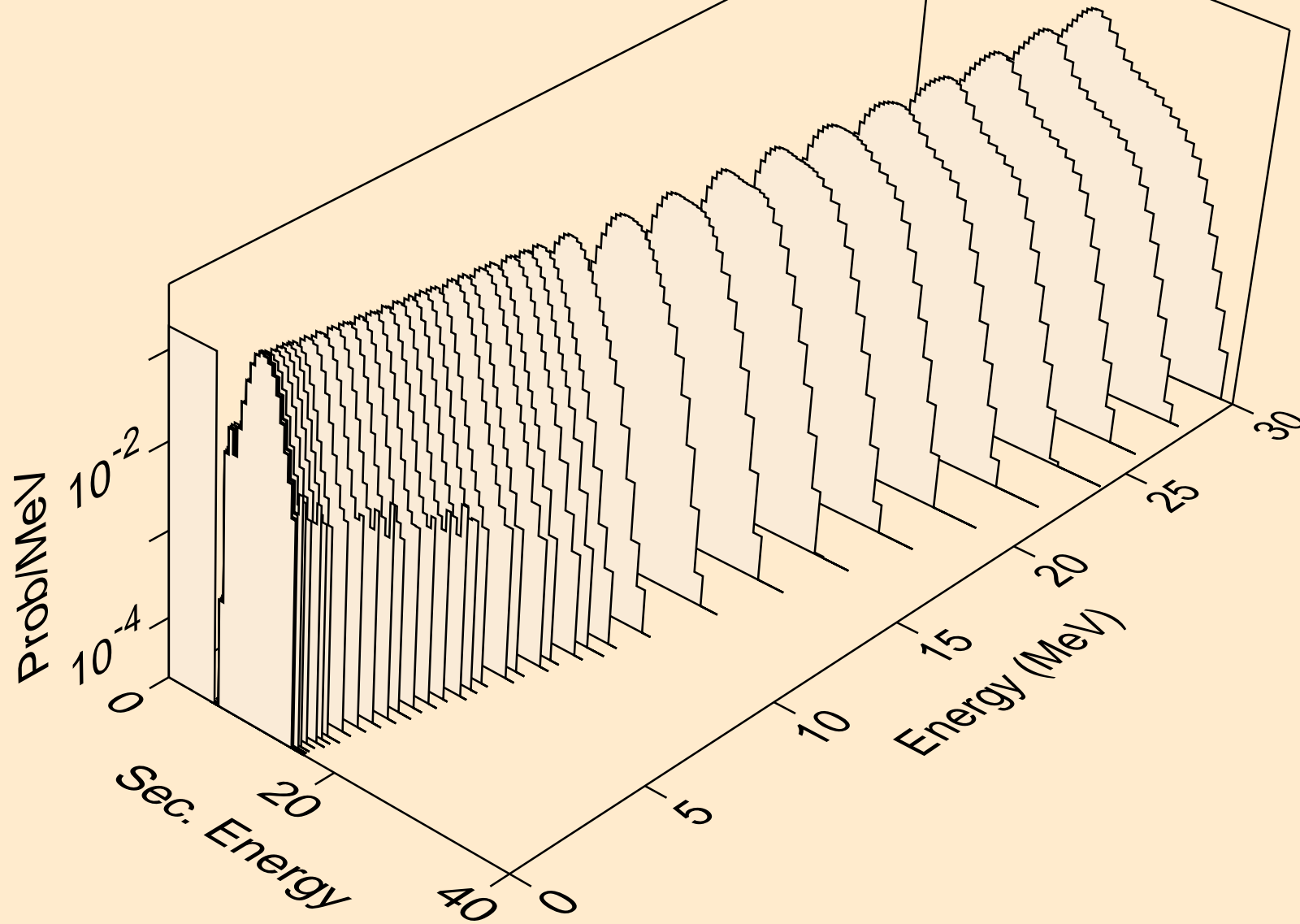

BI190M NEUTRON ACER TENDL-2024 LIBRARY; T=293.6K  
alphas from (n,3a)

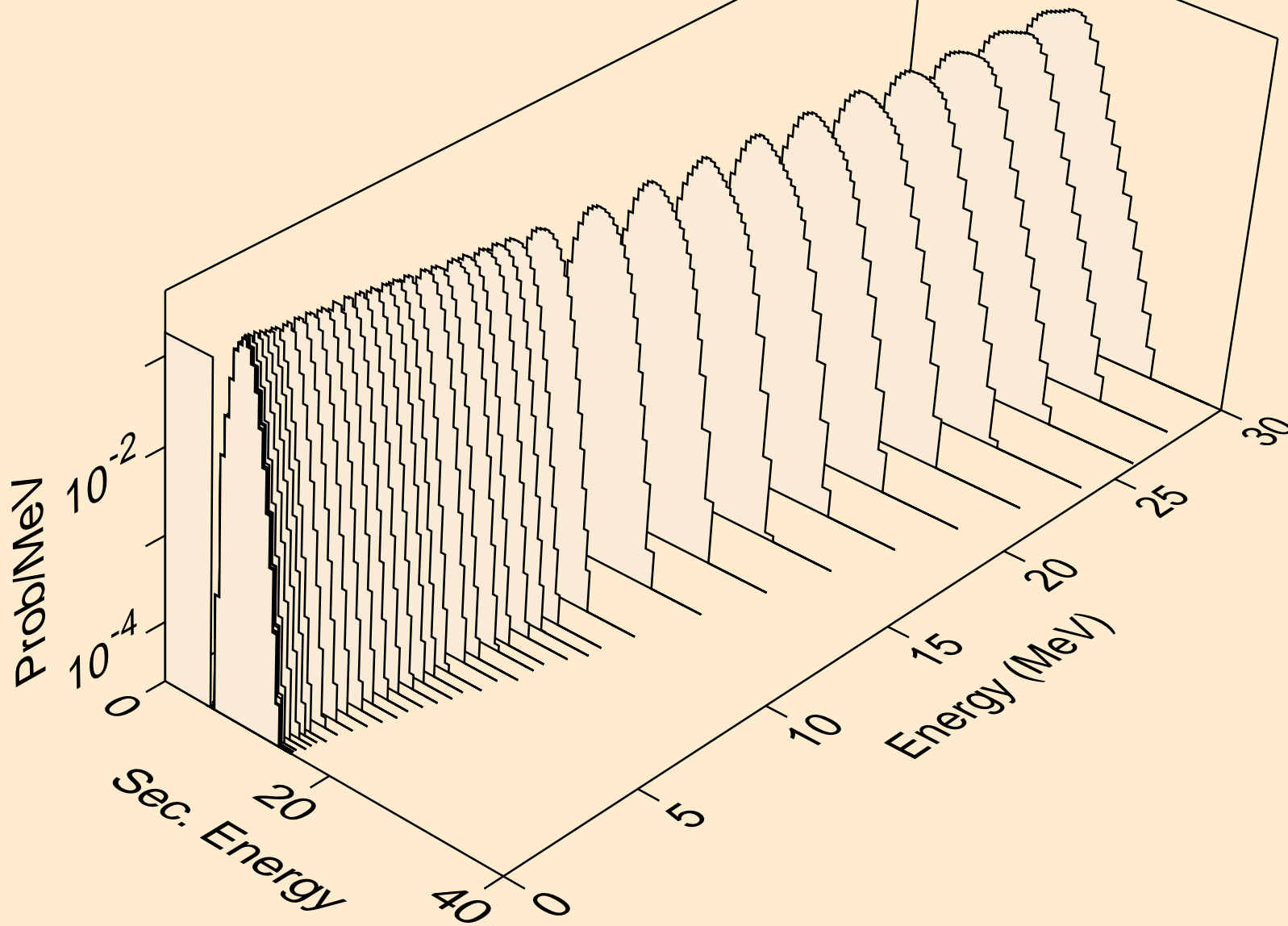

BI190M NEUTRON ACER TENDL-2024 LIBRARY; T=293.6K  
alphas from (n,pa)

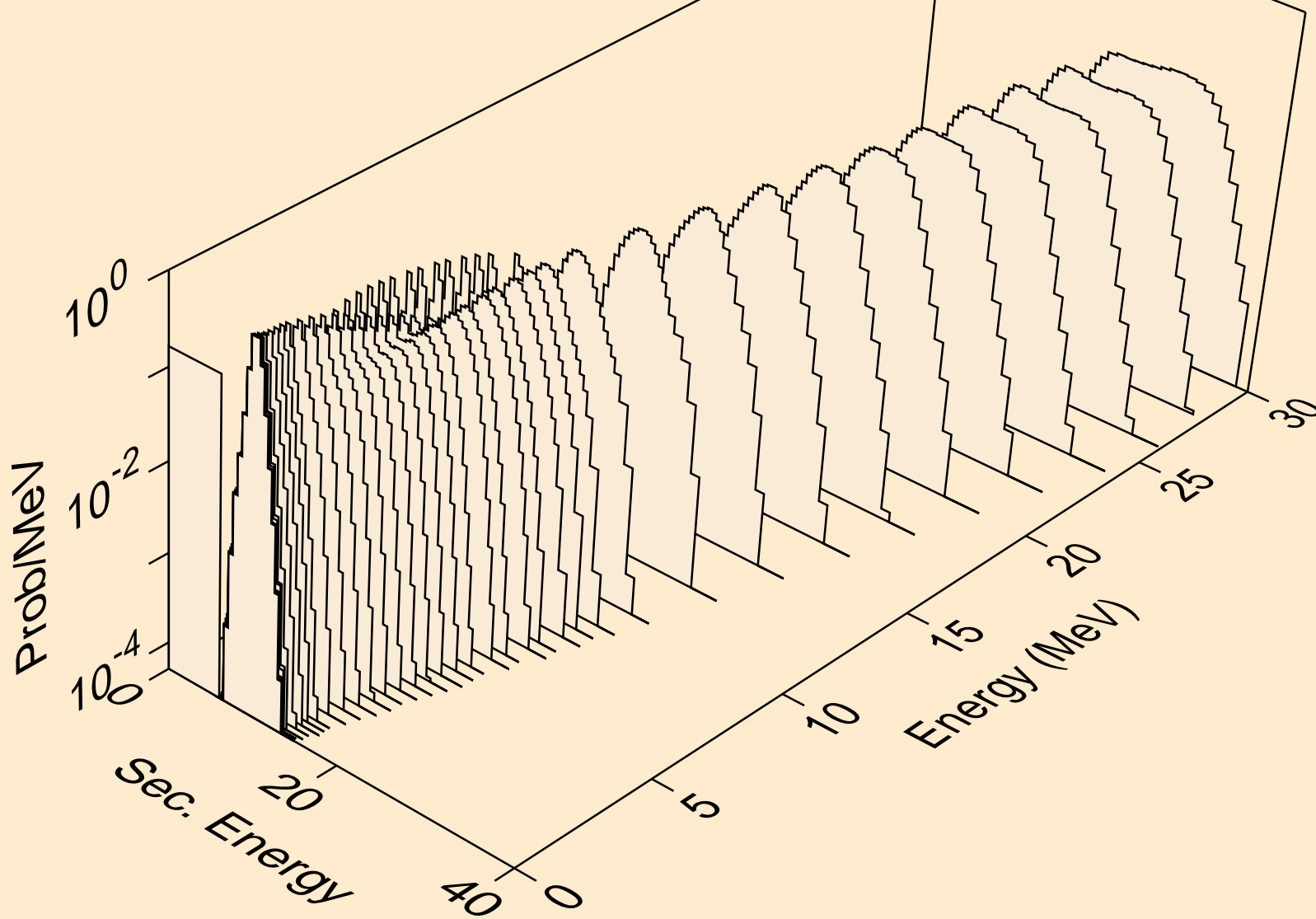

BI190M NEUTRON ACER TENDL-2024 LIBRARY; T=293.6K  
alphas from (n,d2a)

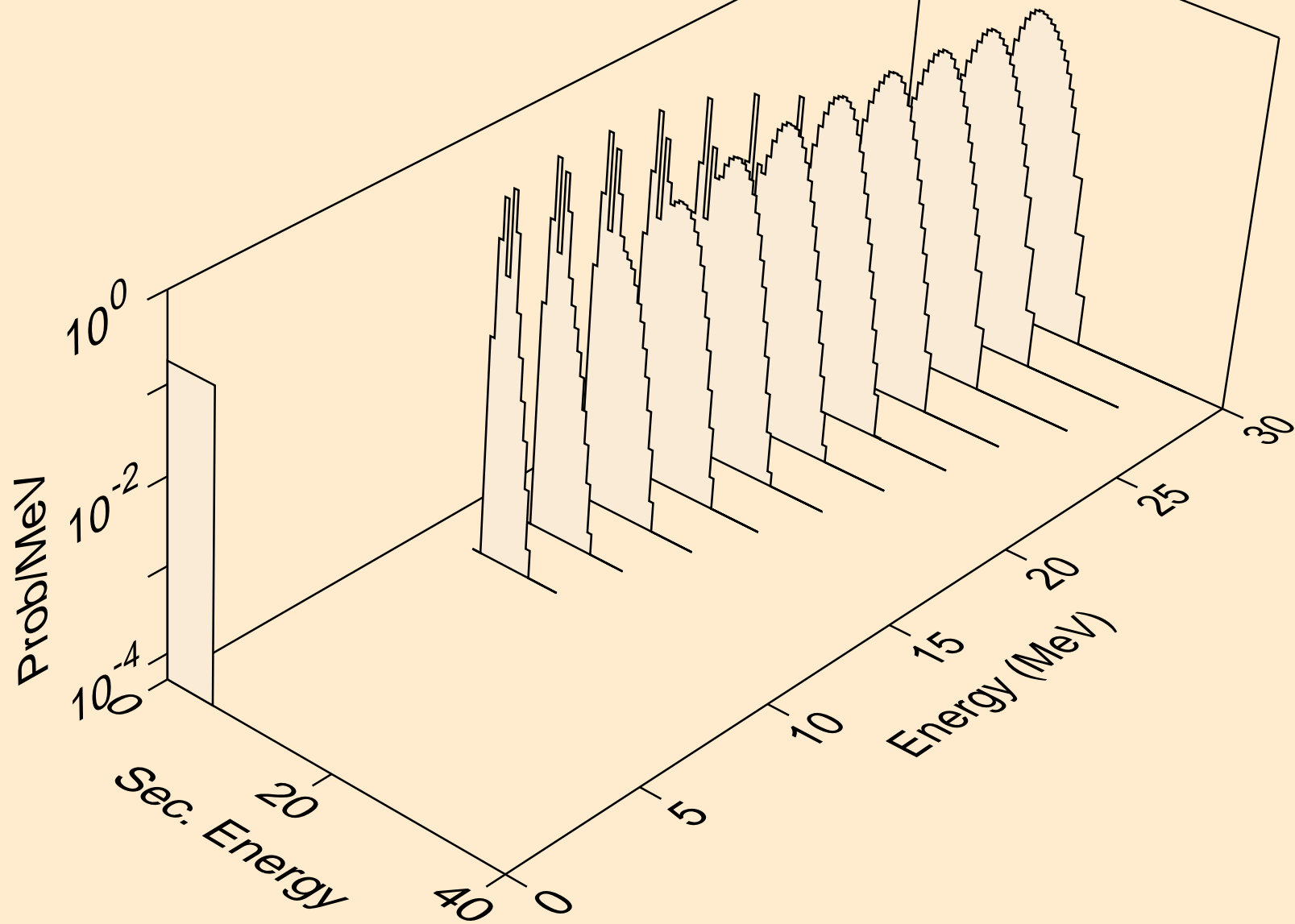

BI190M NEUTRON ACER TENDL-2024 LIBRARY; T=293.6K  
alphas from (n,da)

