

BI223 NEUTRON ACER TENDL-2024 LIBRARY; T=293.6K  
Principal cross sections

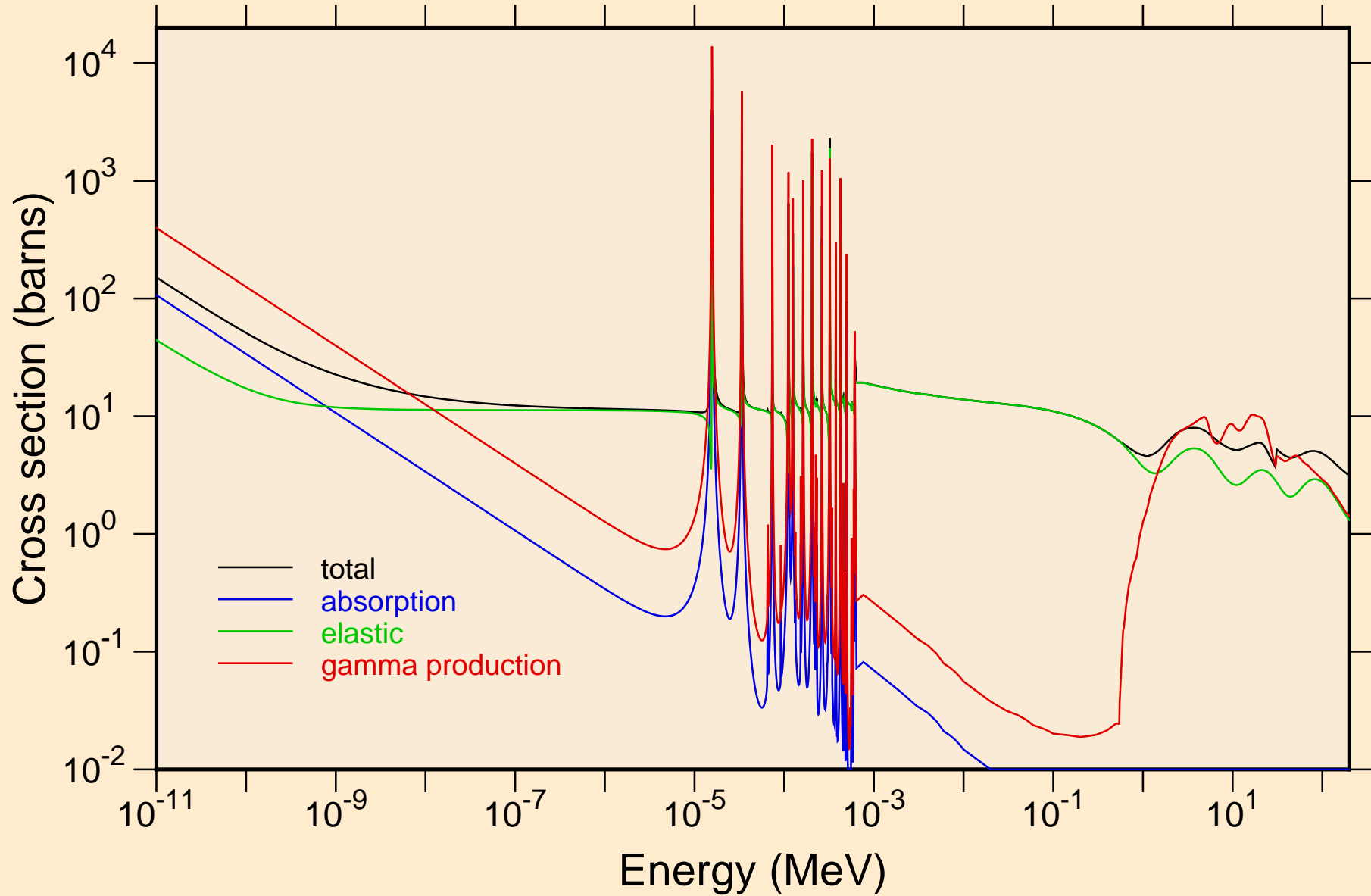

BI223 NEUTRON ACER TENDL-2024 LIBRARY; T=293.6K  
resonance total cross section

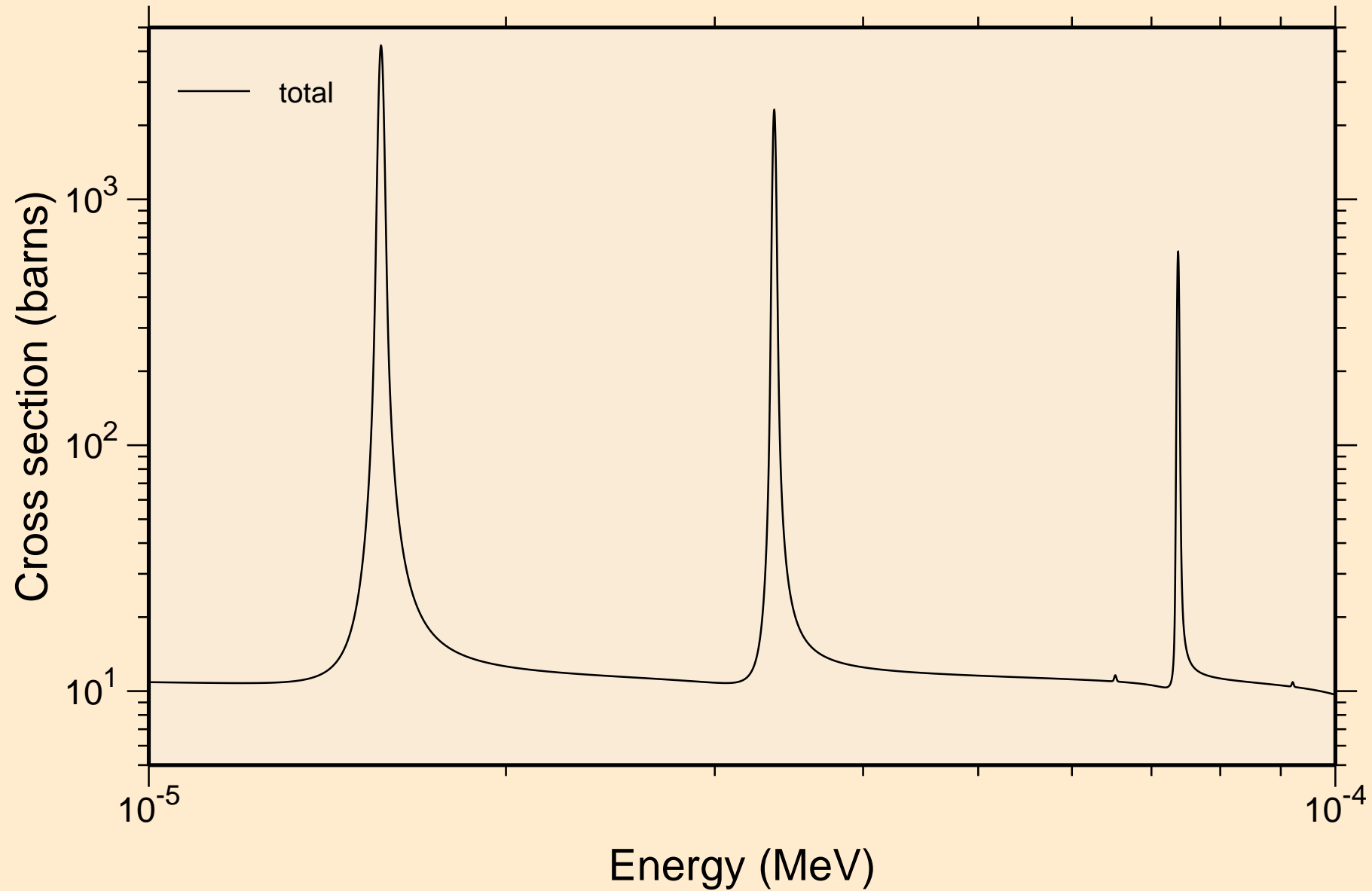

BI223 NEUTRON ACER TENDL-2024 LIBRARY; T=293.6K  
resonance total cross section

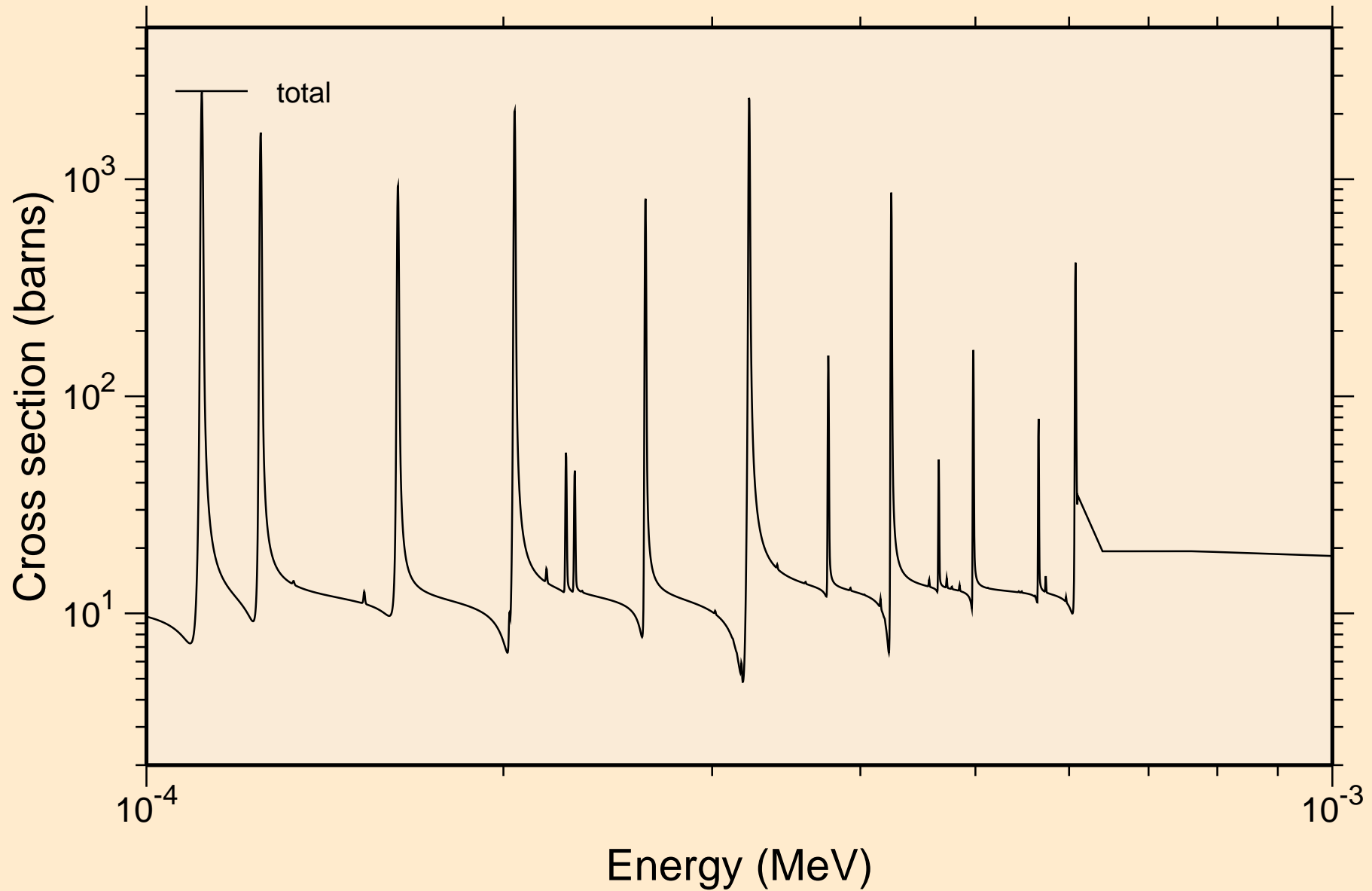

BI223 NEUTRON ACER TENDL-2024 LIBRARY; T=293.6K  
resonance total cross section

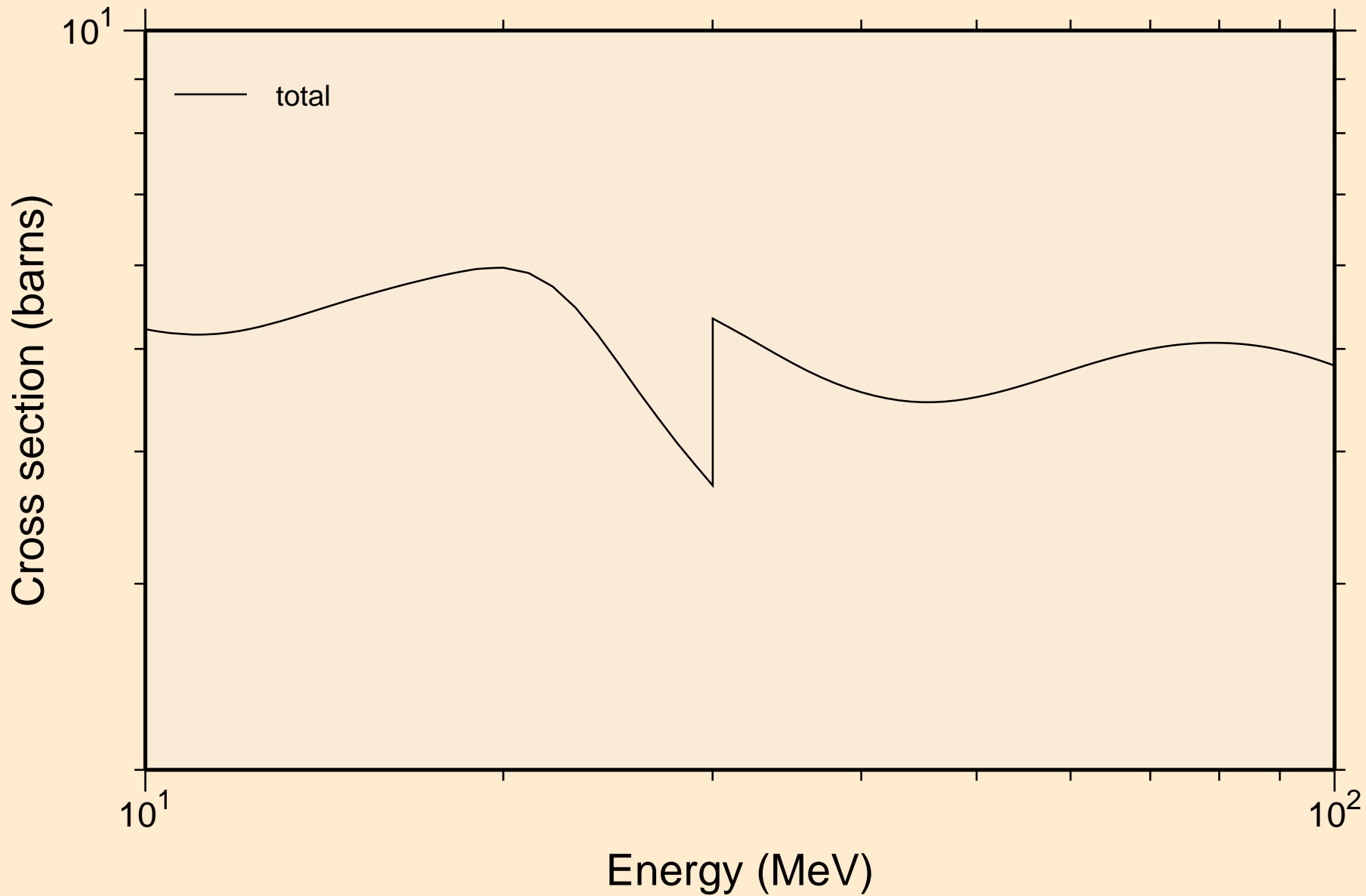

BI223 NEUTRON ACER TENDL-2024 LIBRARY; T=293.6K  
resonance absorption cross sections

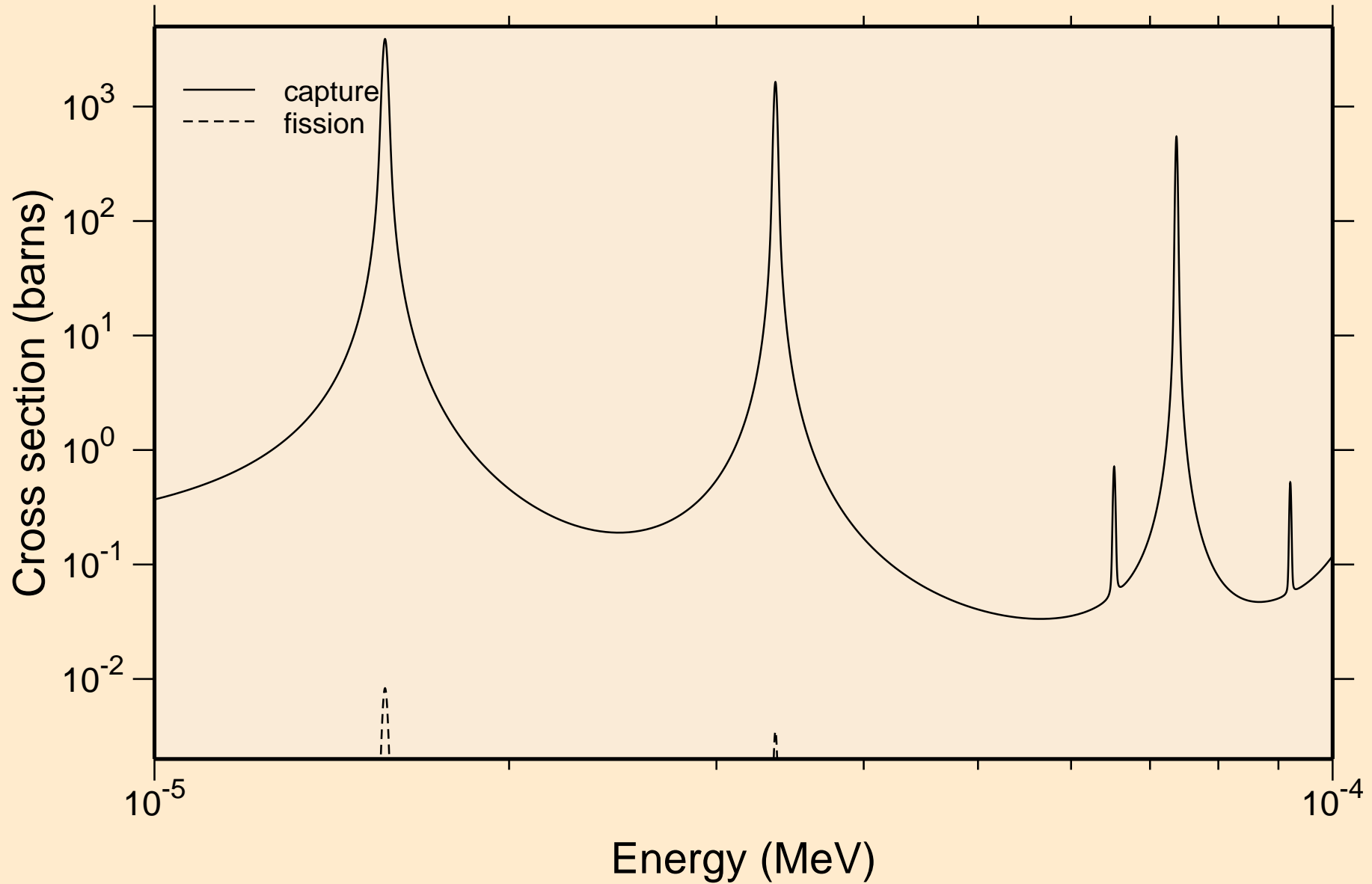

BI223 NEUTRON ACER TENDL-2024 LIBRARY; T=293.6K  
resonance absorption cross sections

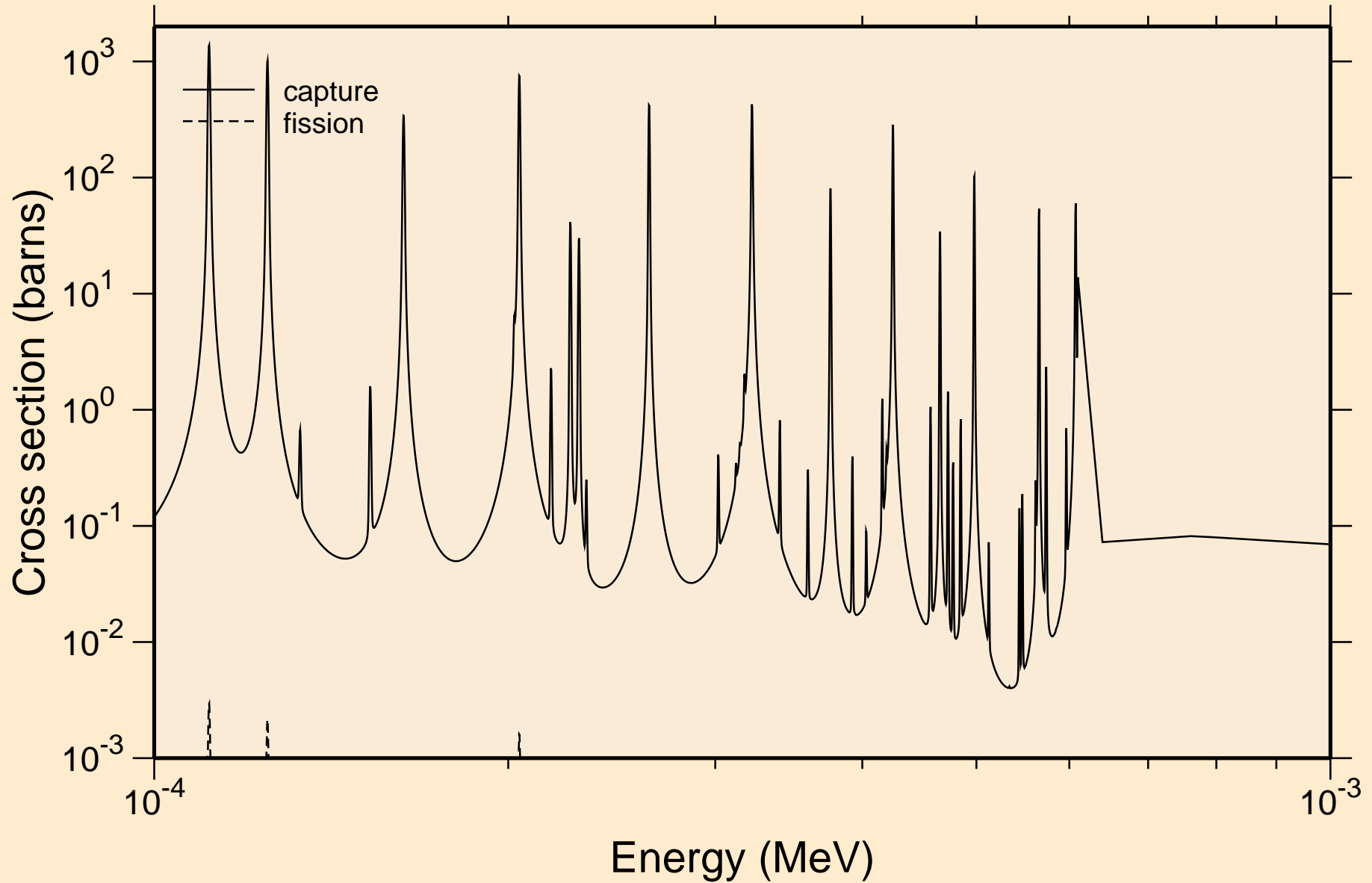

BI223 NEUTRON ACER TENDL-2024 LIBRARY; T=293.6K  
resonance absorption cross sections

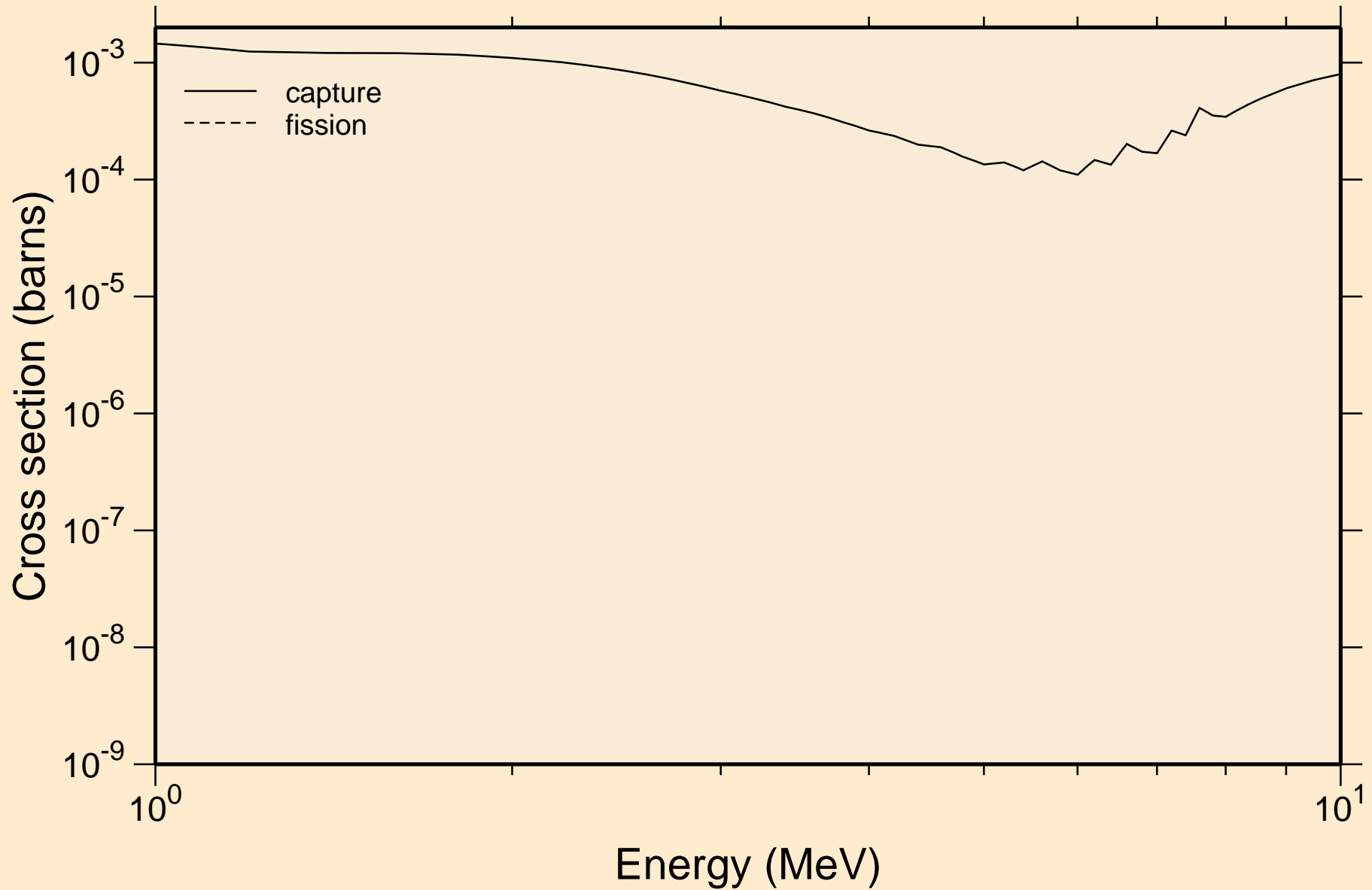

BI223 NEUTRON ACER TENDL-2024 LIBRARY; T=293.6K  
Heating

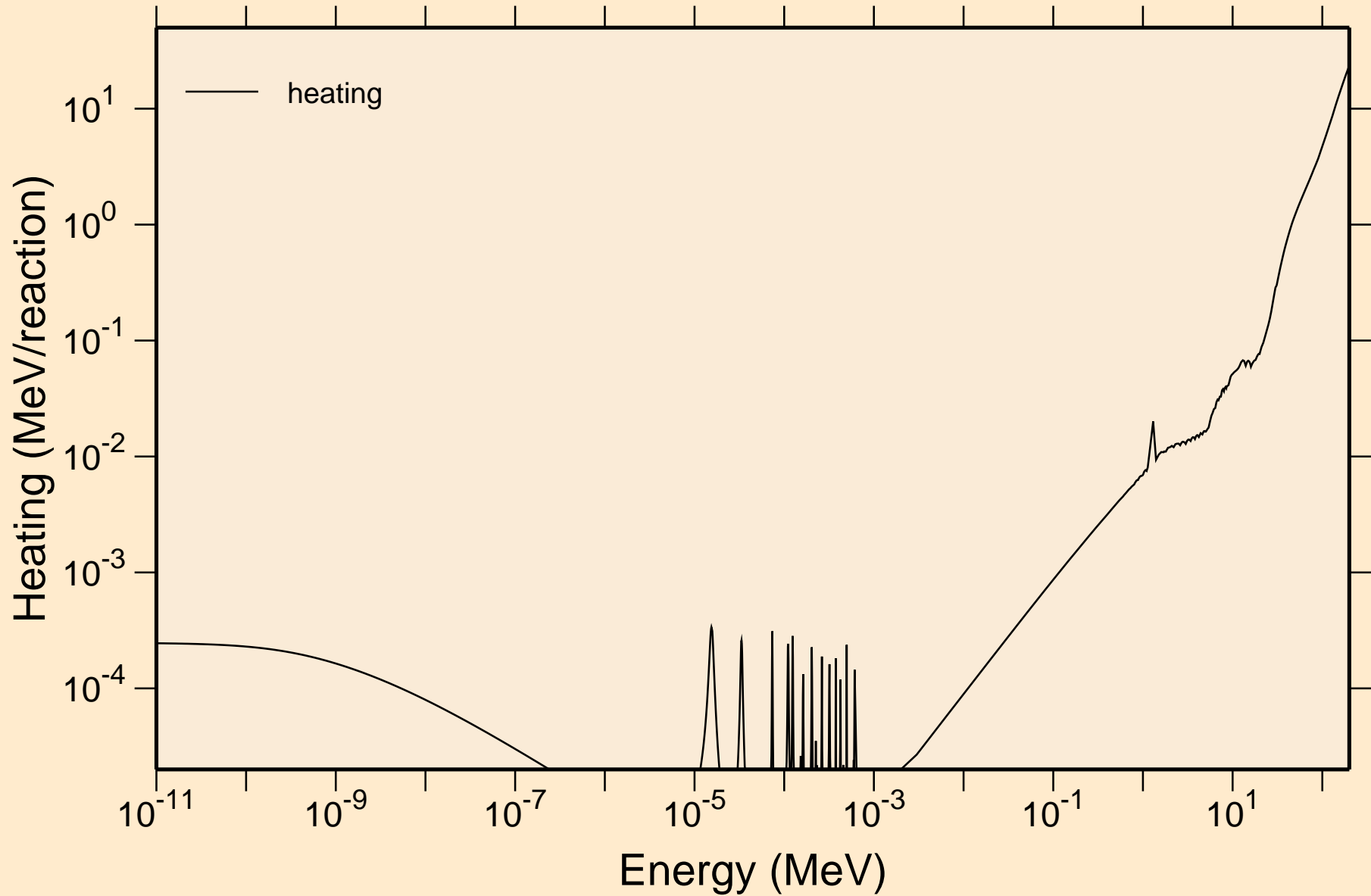

BI223 NEUTRON ACER TENDL-2024 LIBRARY; T=293.6K  
Damage

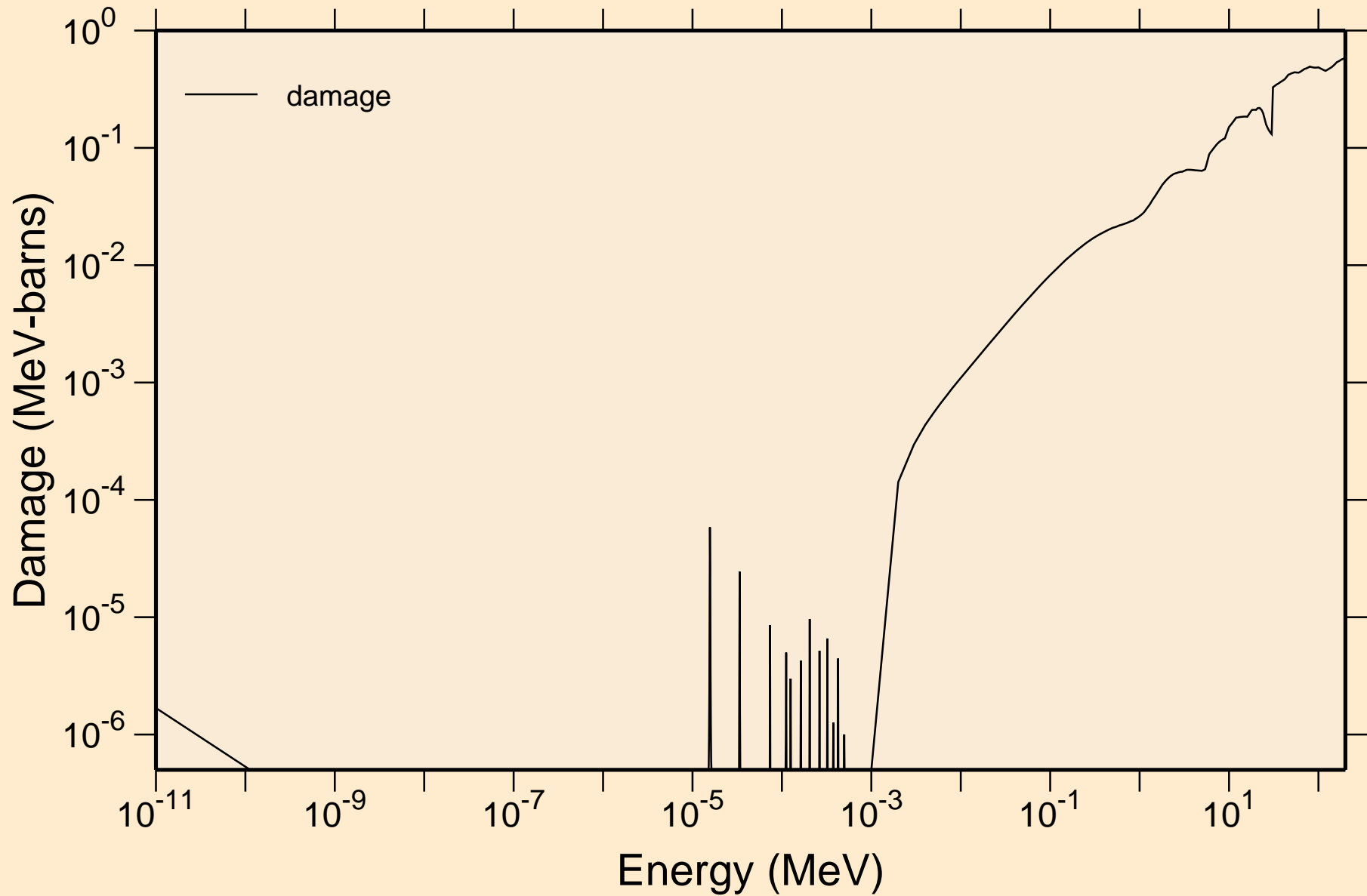

BI223 NEUTRON ACER TENDL-2024 LIBRARY; T=293.6K  
Non-threshold reactions

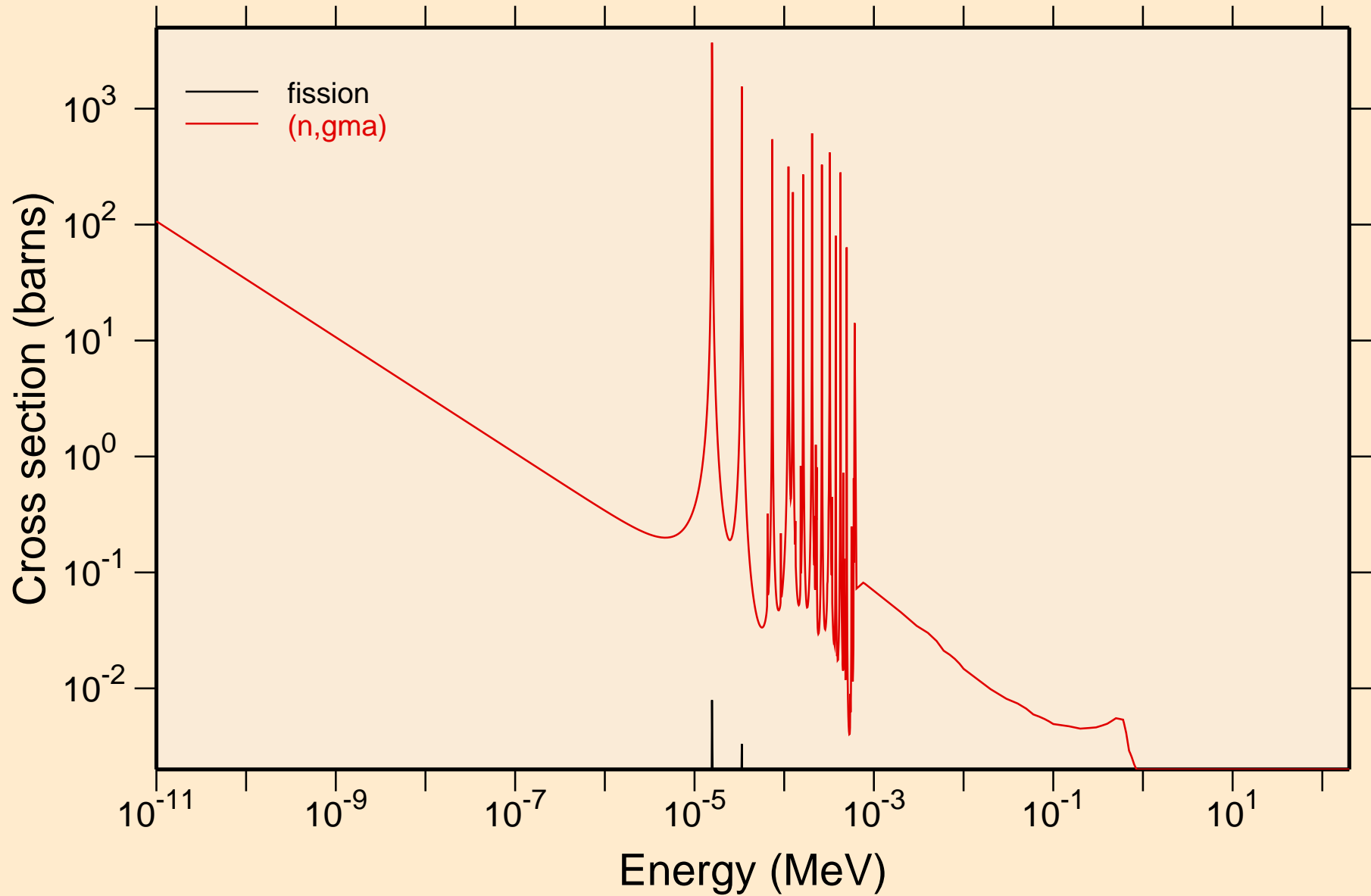

BI223 NEUTRON ACER TENDL-2024 LIBRARY; T=293.6K  
Principal cross sections

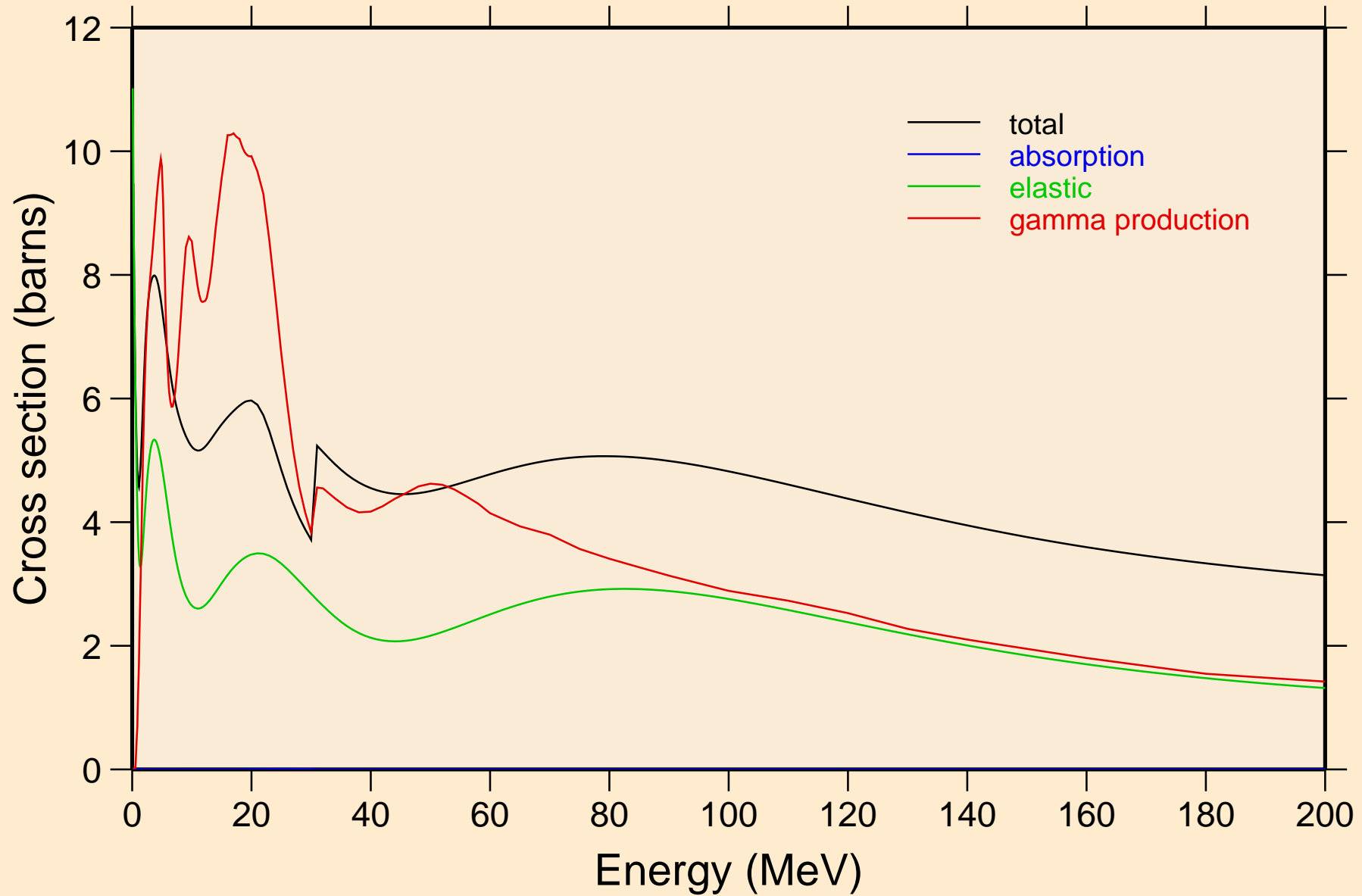

BI223 NEUTRON ACER TENDL-2024 LIBRARY; T=293.6K  
Heating

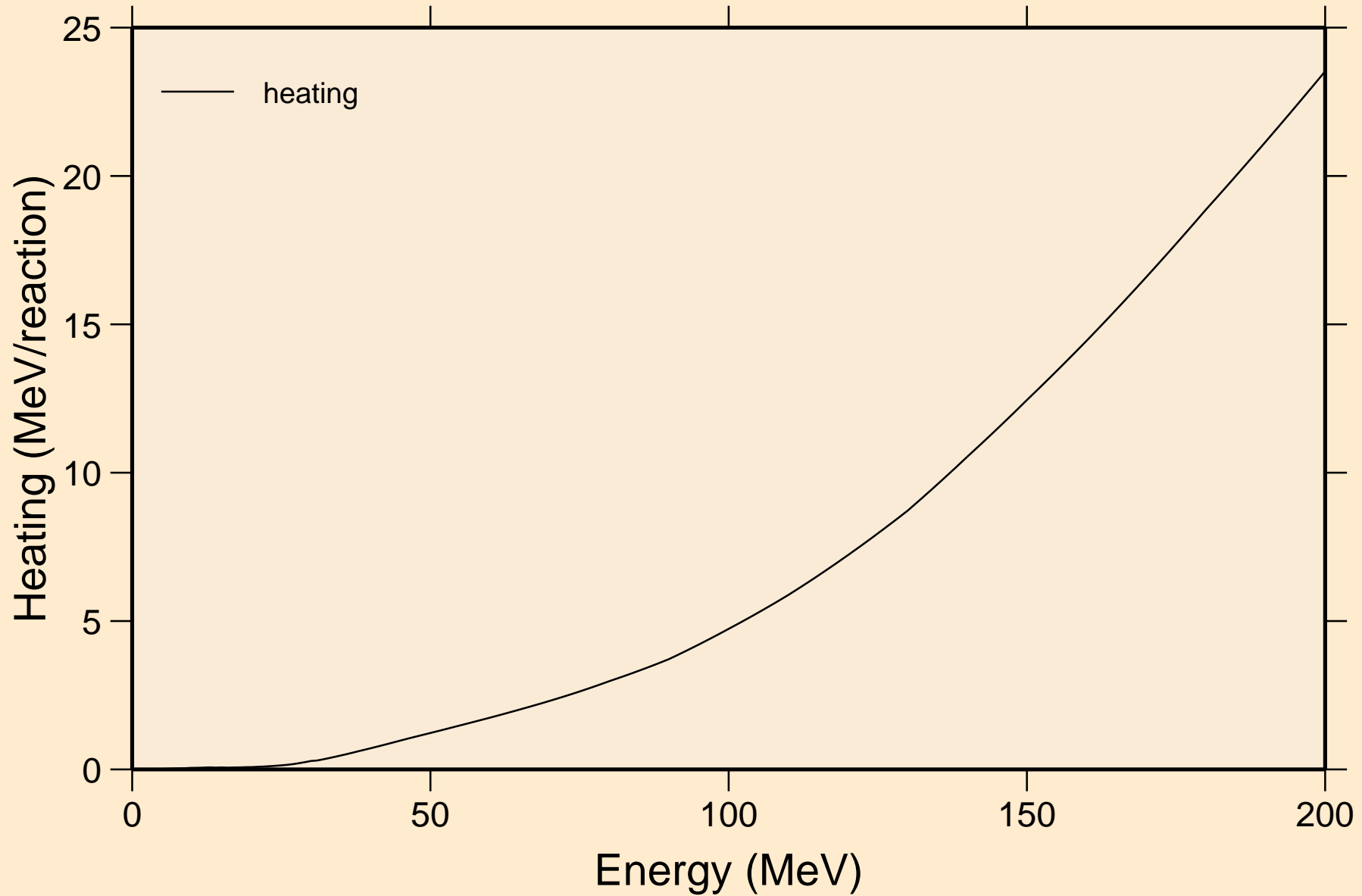

BI223 NEUTRON ACER TENDL-2024 LIBRARY; T=293.6K  
Damage

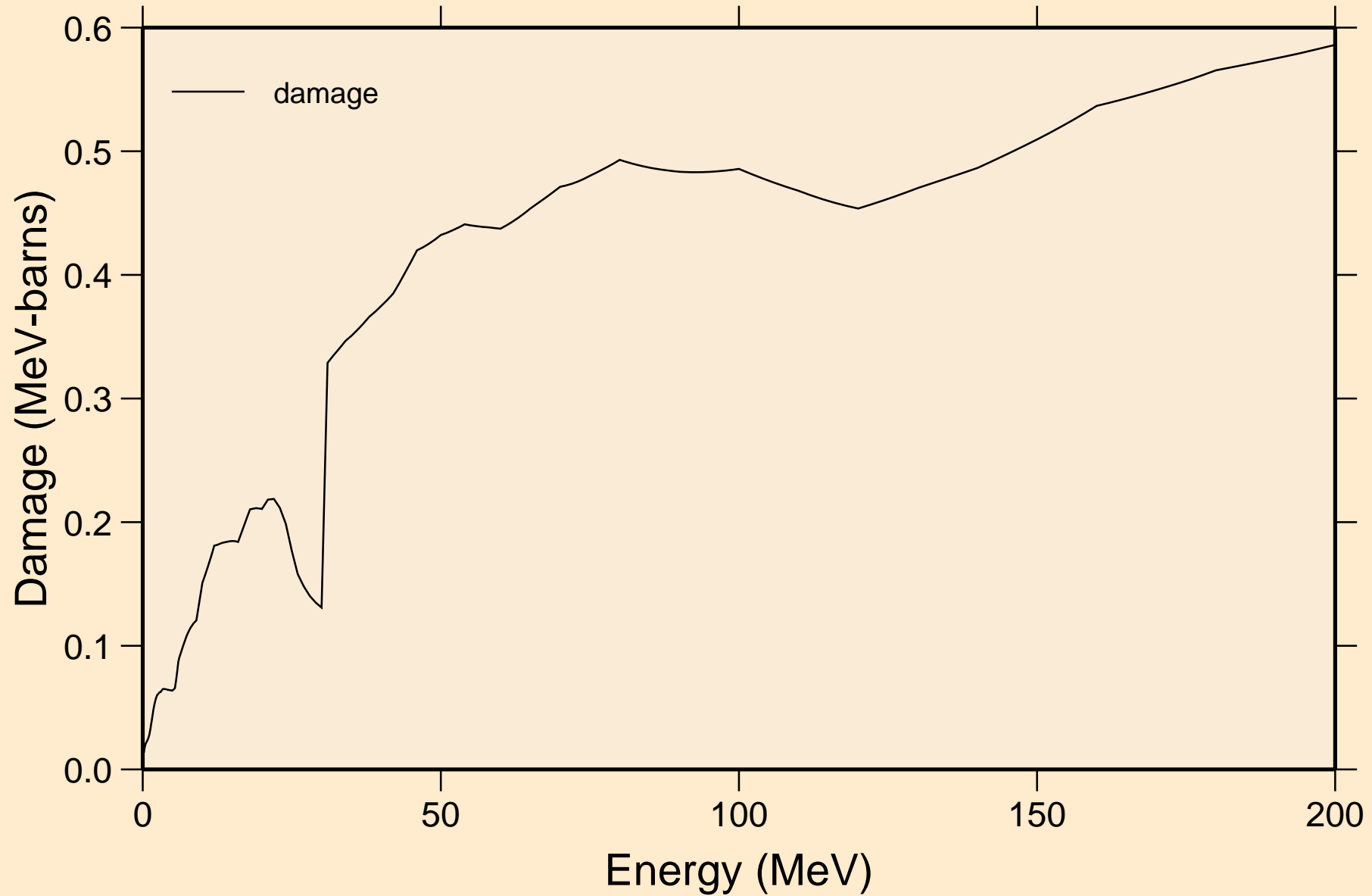

BI223 NEUTRON ACER TENDL-2024 LIBRARY; T=293.6K  
Non-threshold reactions

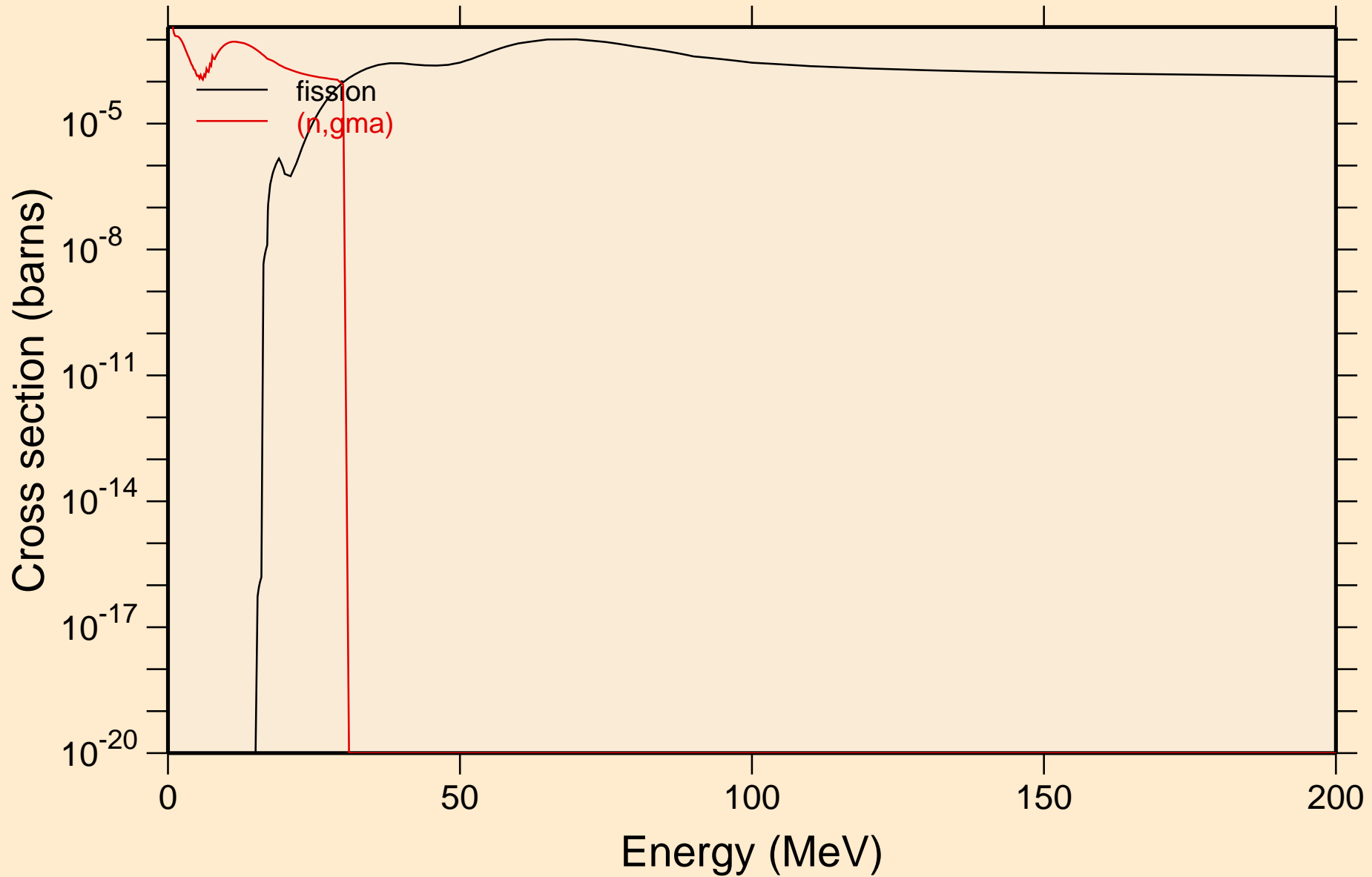

BI223 NEUTRON ACER TENDL-2024 LIBRARY; T=293.6K  
Inelastic levels

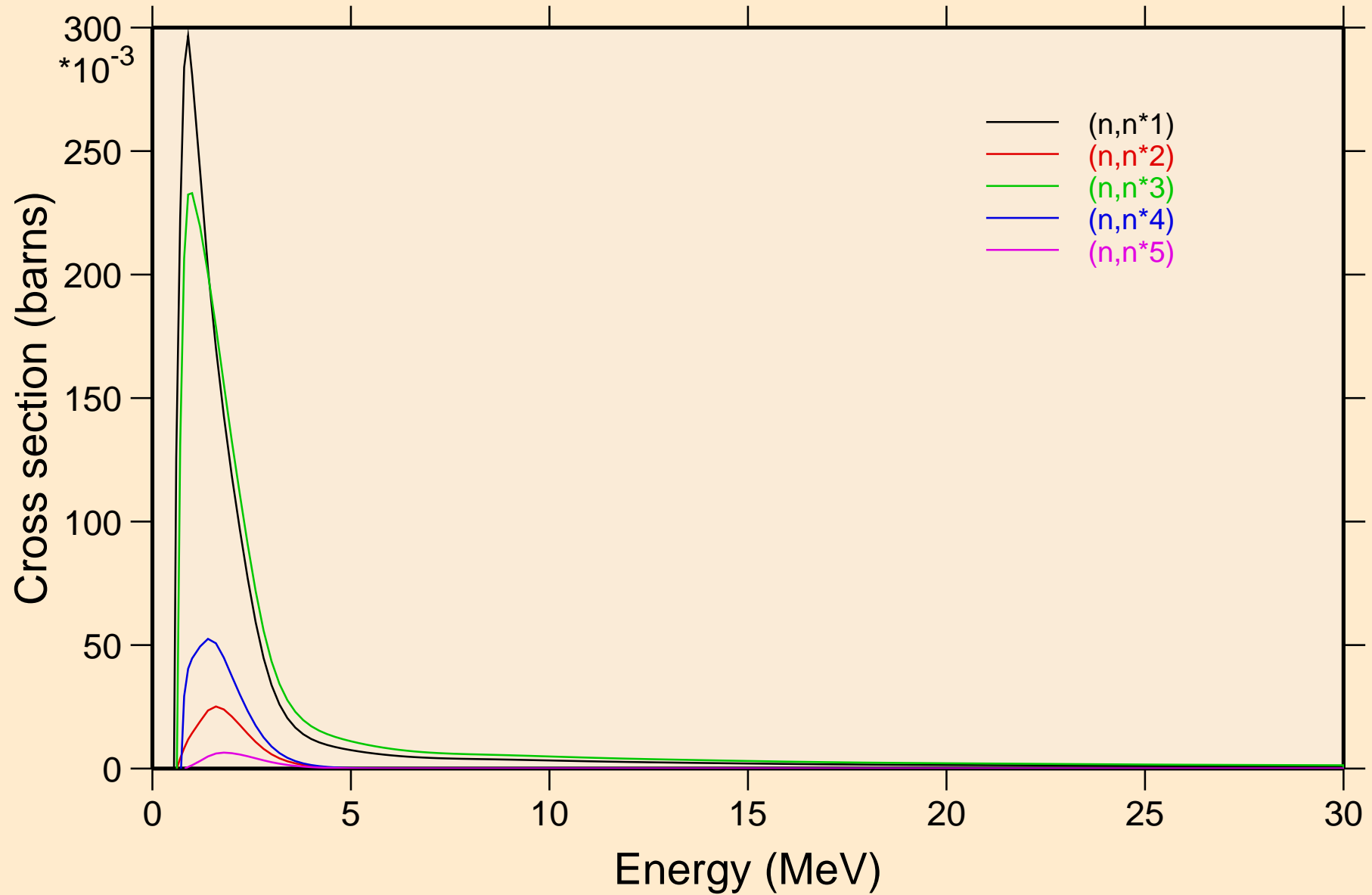

BI223 NEUTRON ACER TENDL-2024 LIBRARY; T=293.6K  
Inelastic levels

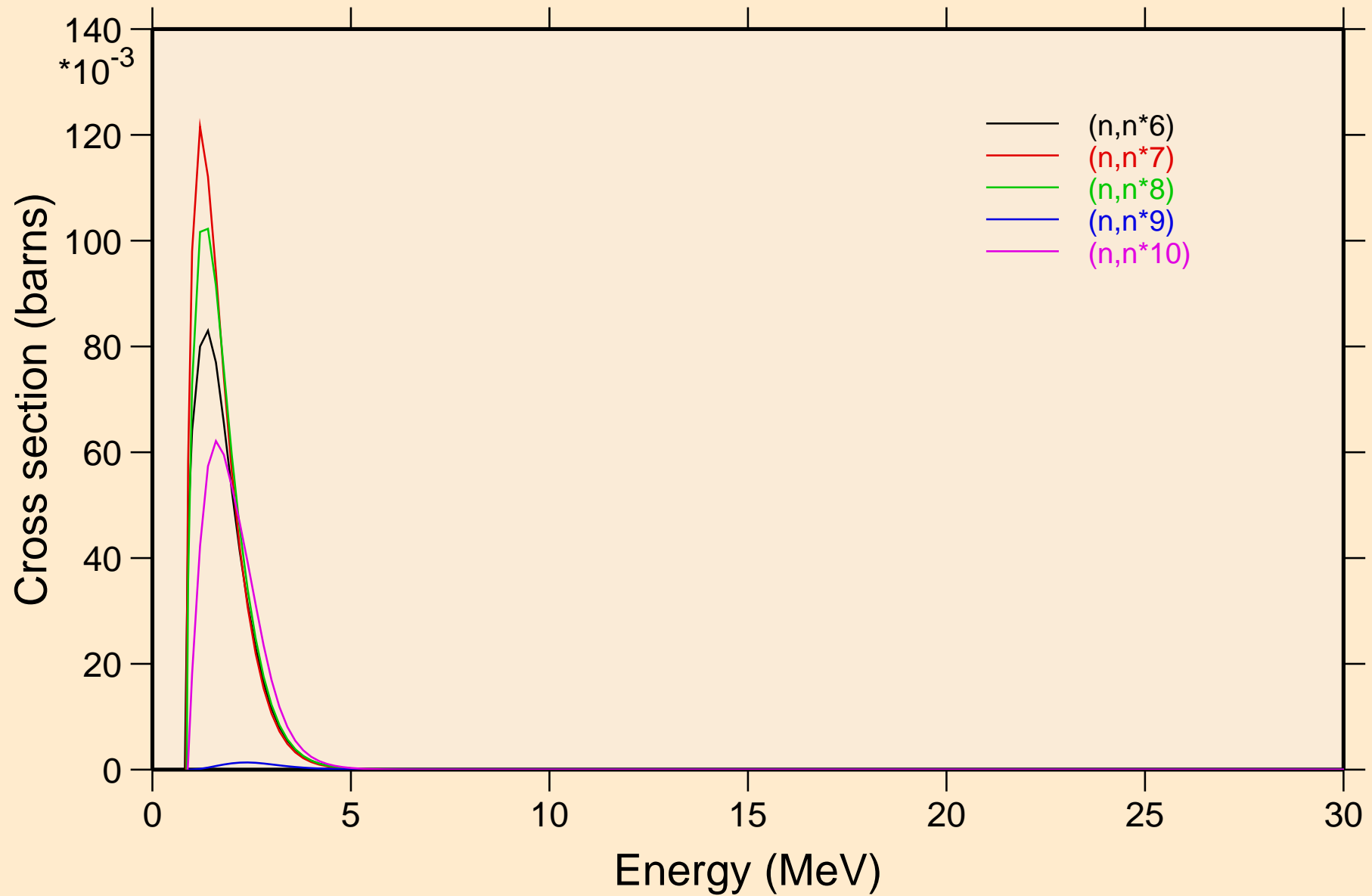

BI223 NEUTRON ACER TENDL-2024 LIBRARY; T=293.6K  
Inelastic levels

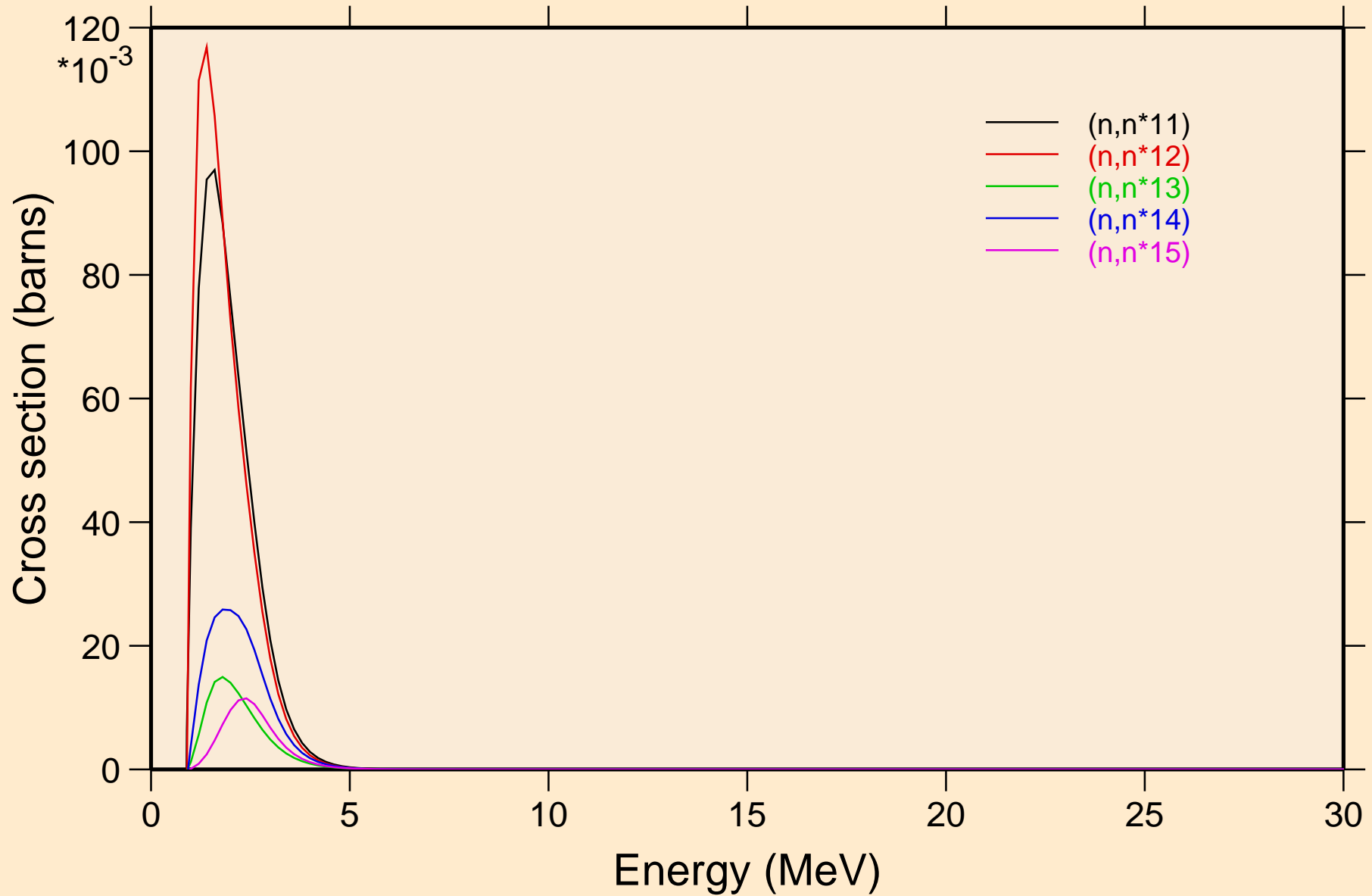

BI223 NEUTRON ACER TENDL-2024 LIBRARY; T=293.6K  
Inelastic levels

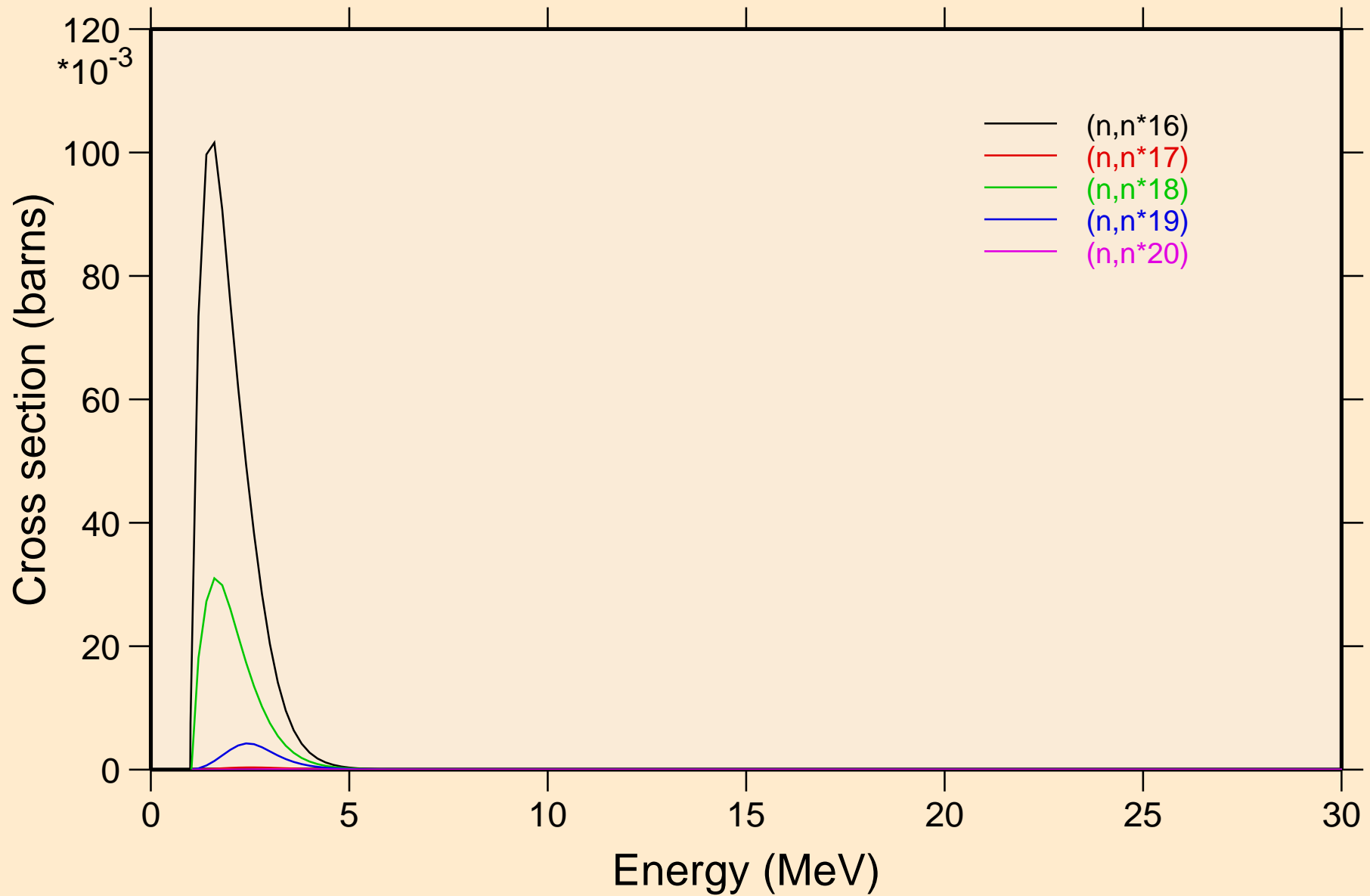

BI223 NEUTRON ACER TENDL-2024 LIBRARY; T=293.6K  
Inelastic levels

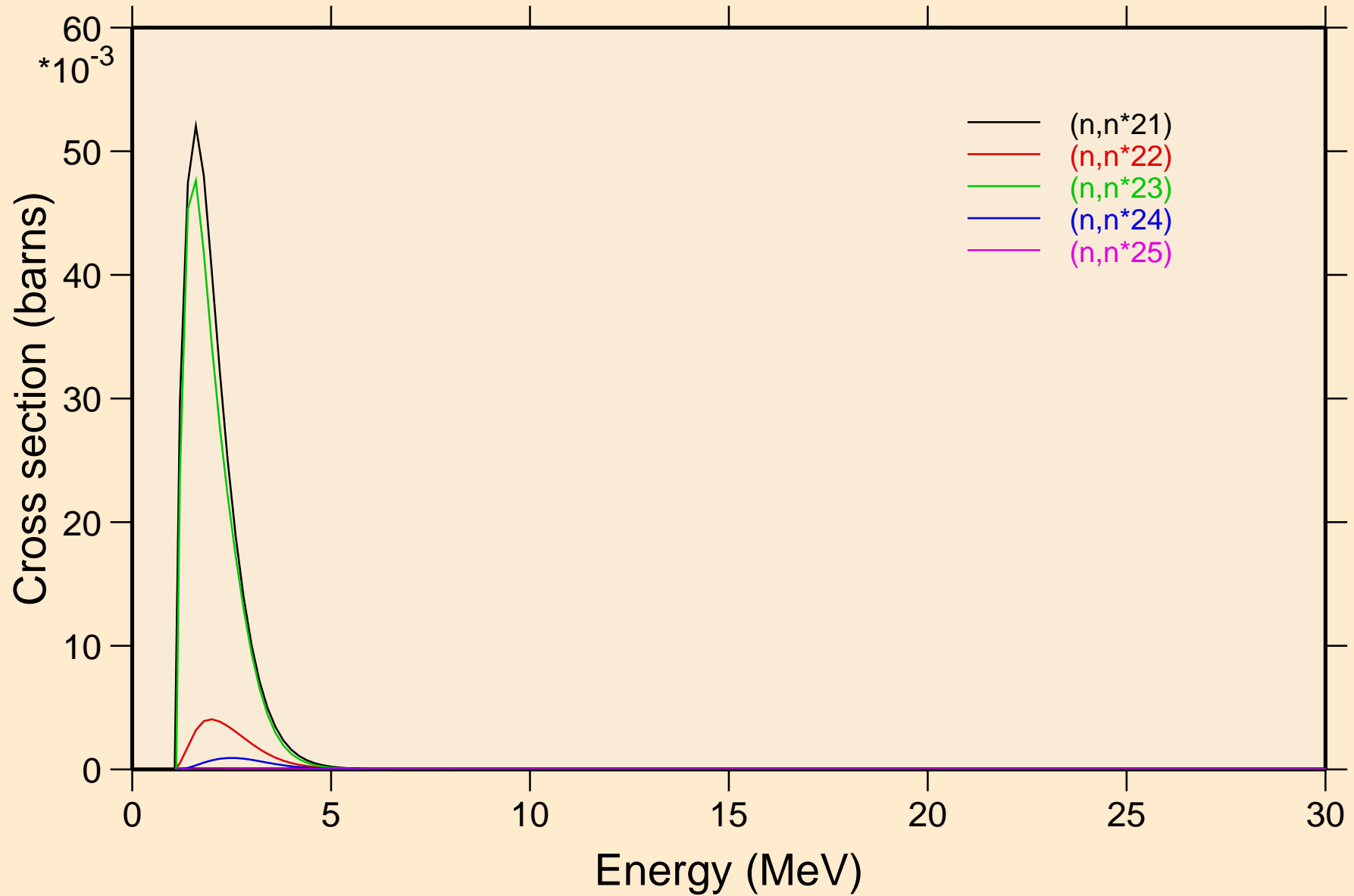

BI223 NEUTRON ACER TENDL-2024 LIBRARY; T=293.6K  
Inelastic levels

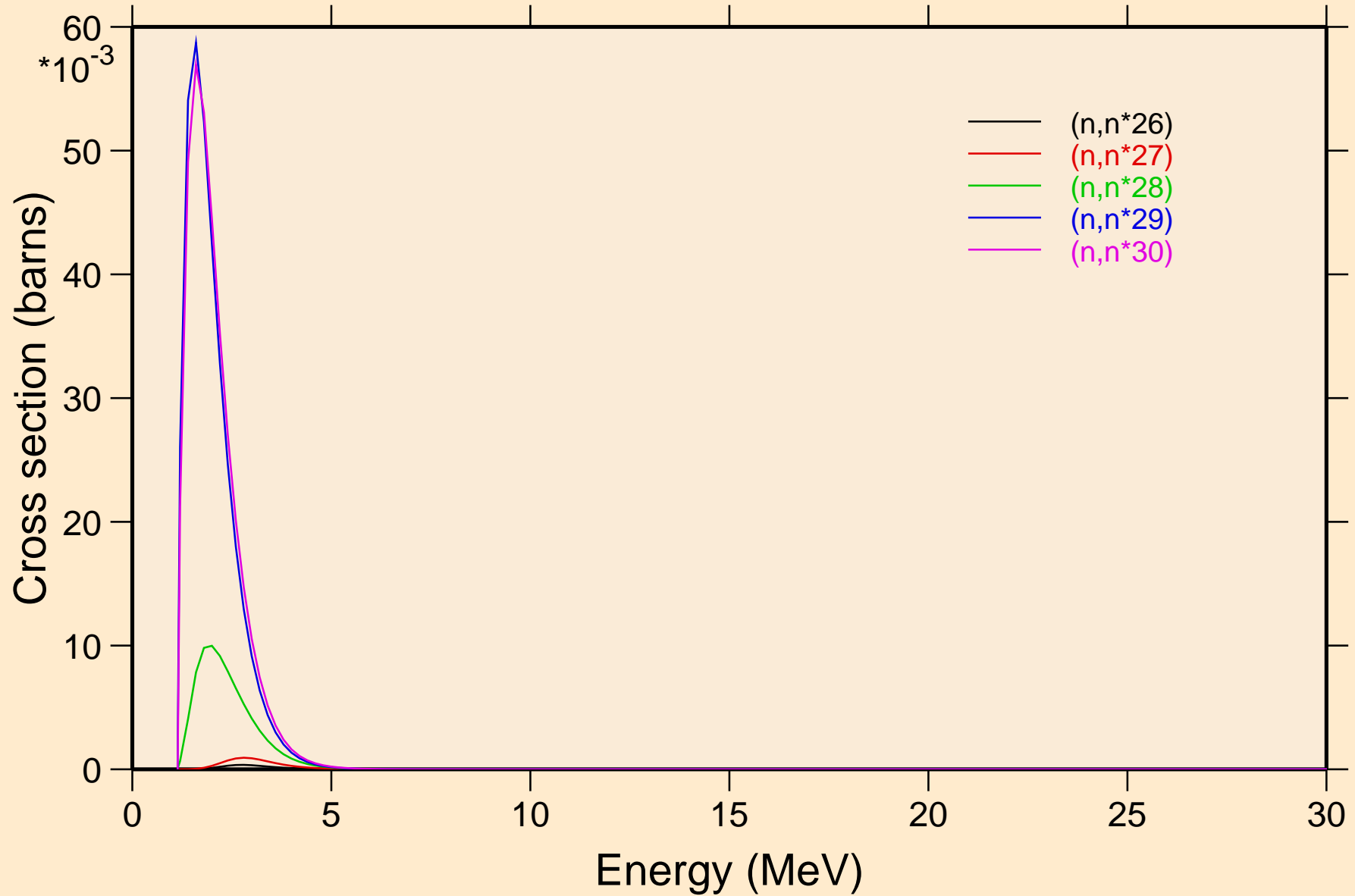

BI223 NEUTRON ACER TENDL-2024 LIBRARY; T=293.6K  
Threshold reactions

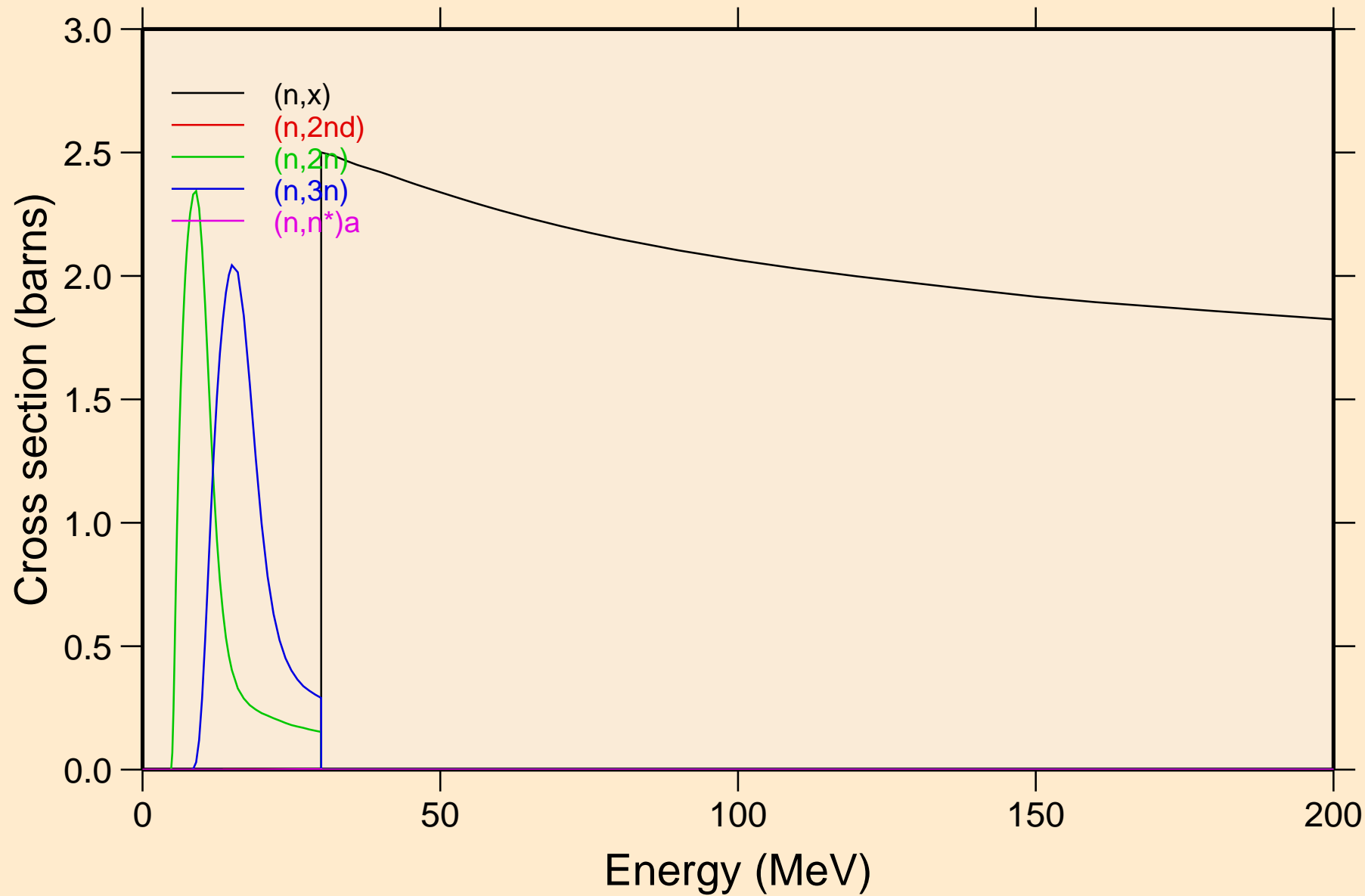

BI223 NEUTRON ACER TENDL-2024 LIBRARY; T=293.6K  
Threshold reactions

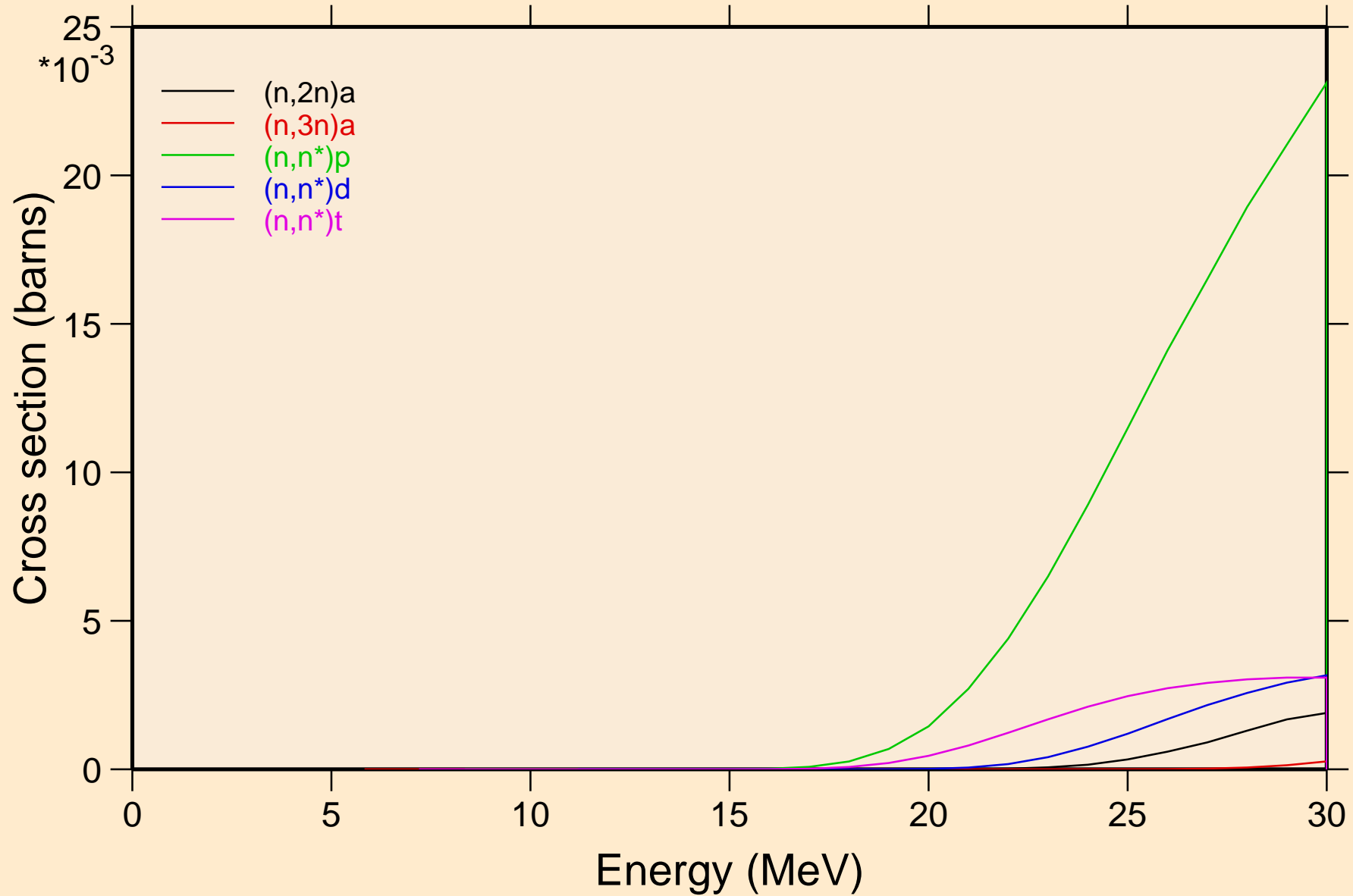

BI223 NEUTRON ACER TENDL-2024 LIBRARY; T=293.6K  
Threshold reactions

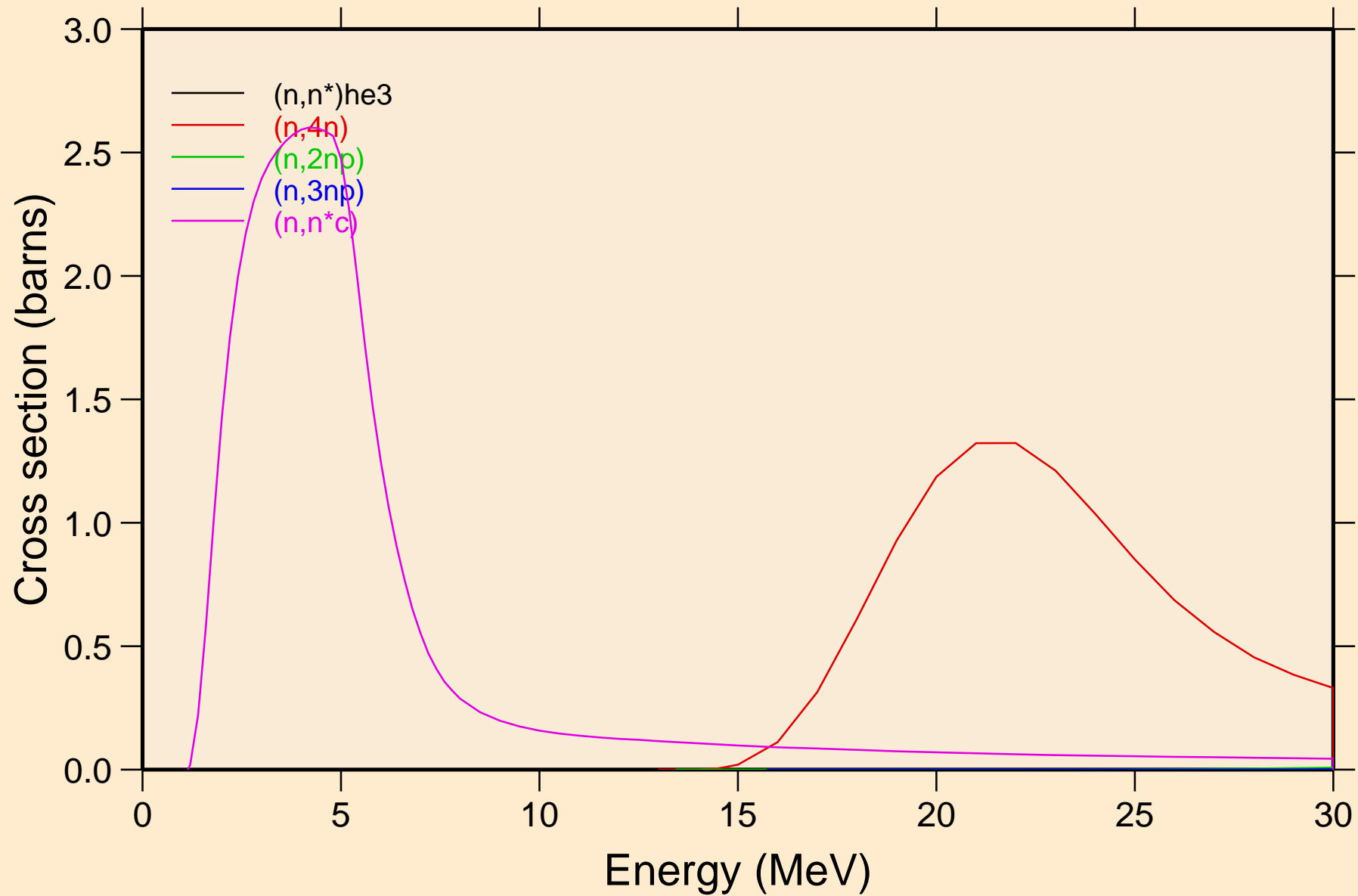

BI223 NEUTRON ACER TENDL-2024 LIBRARY; T=293.6K  
Threshold reactions

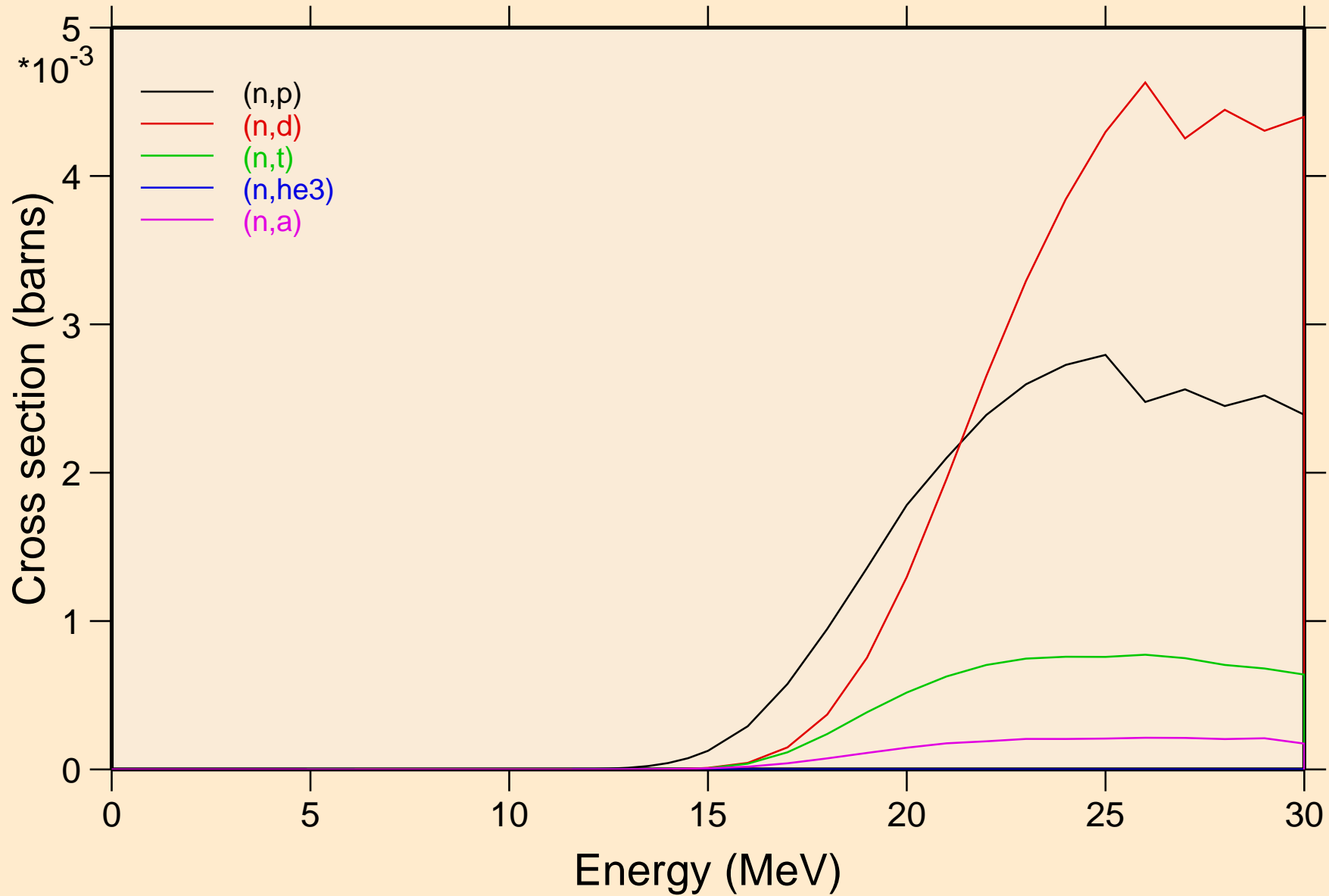

BI223 NEUTRON ACER TENDL-2024 LIBRARY; T=293.6K  
Threshold reactions

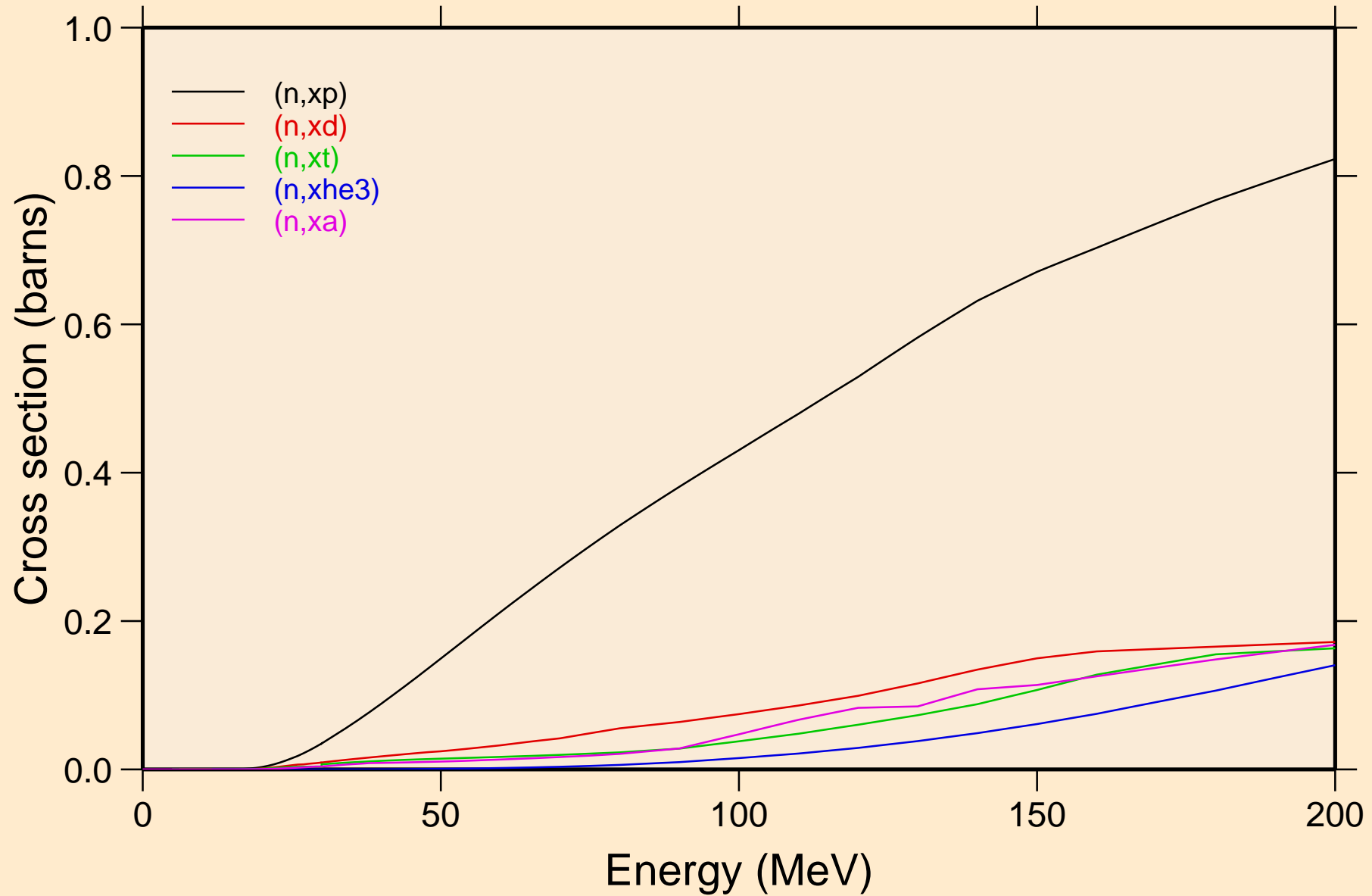

BI223 NEUTRON ACER TENDL-2024 LIBRARY; T=293.6K  
angular distribution for elastic

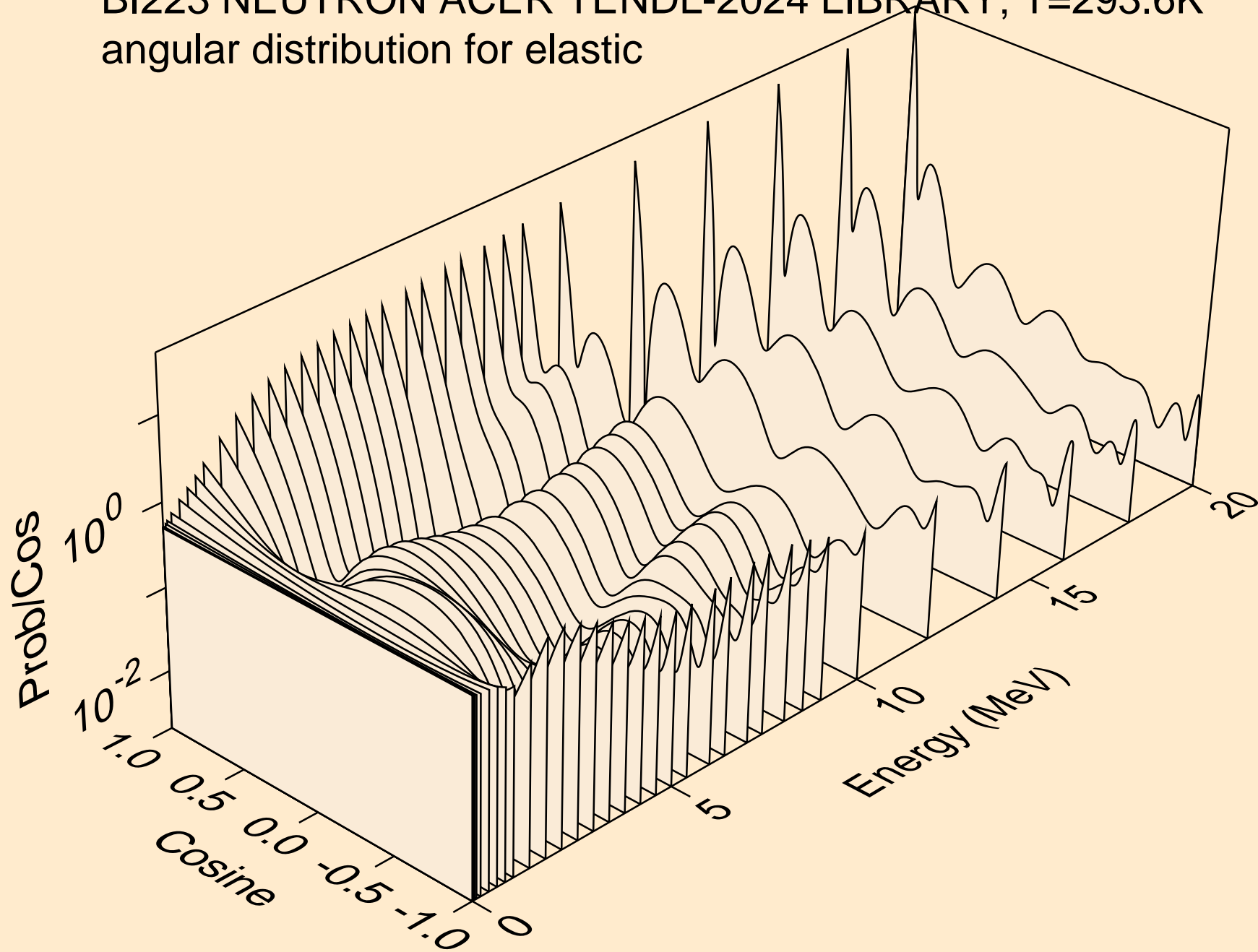

BI223 NEUTRON ACER TENDL-2024 LIBRARY; T=293.6K  
angular distribution for elastic

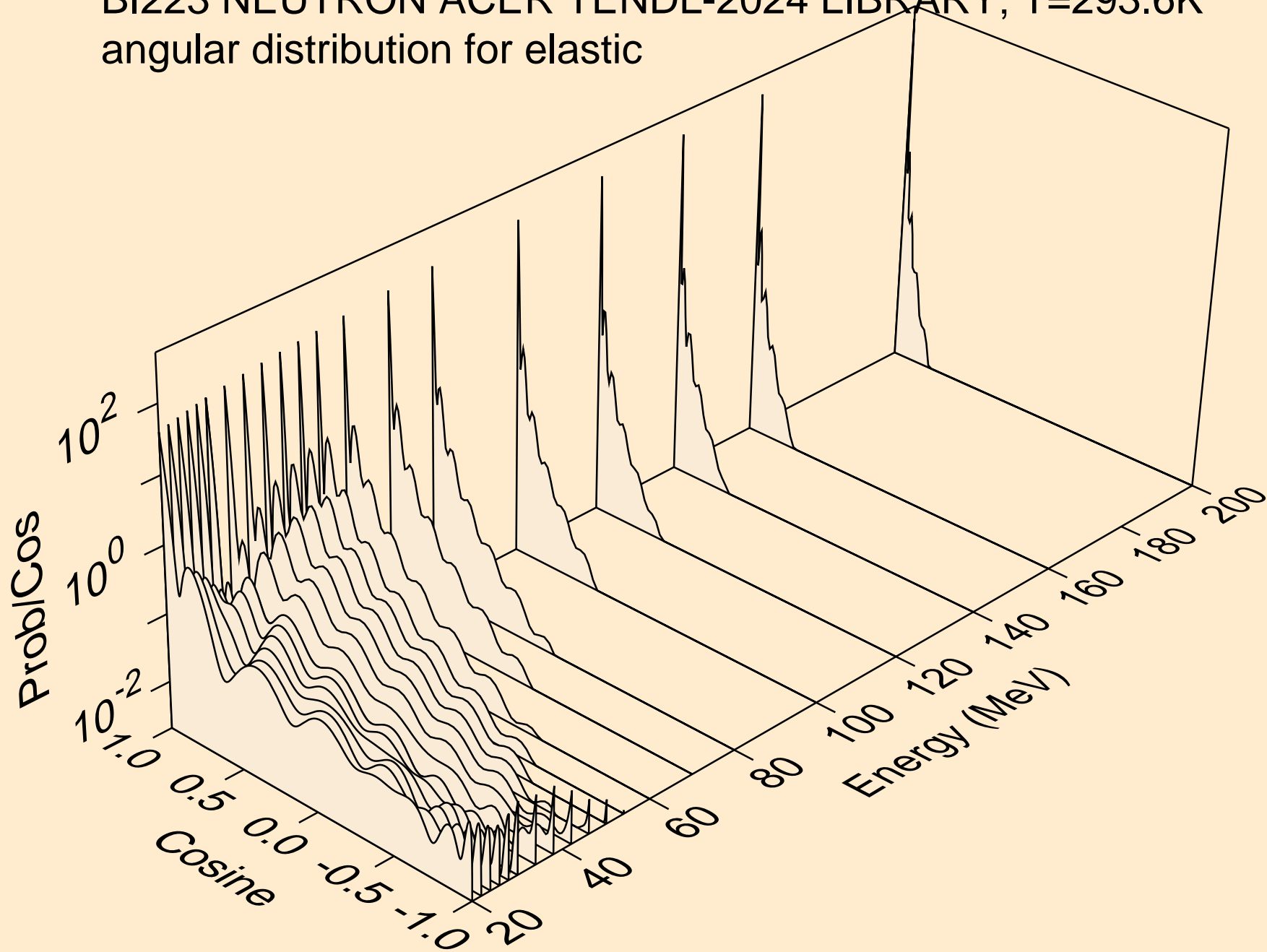

BI223 NEUTRON ACER TENDL-2024 LIBRARY; T=293.6K  
angular distribution for (n,n\*1)

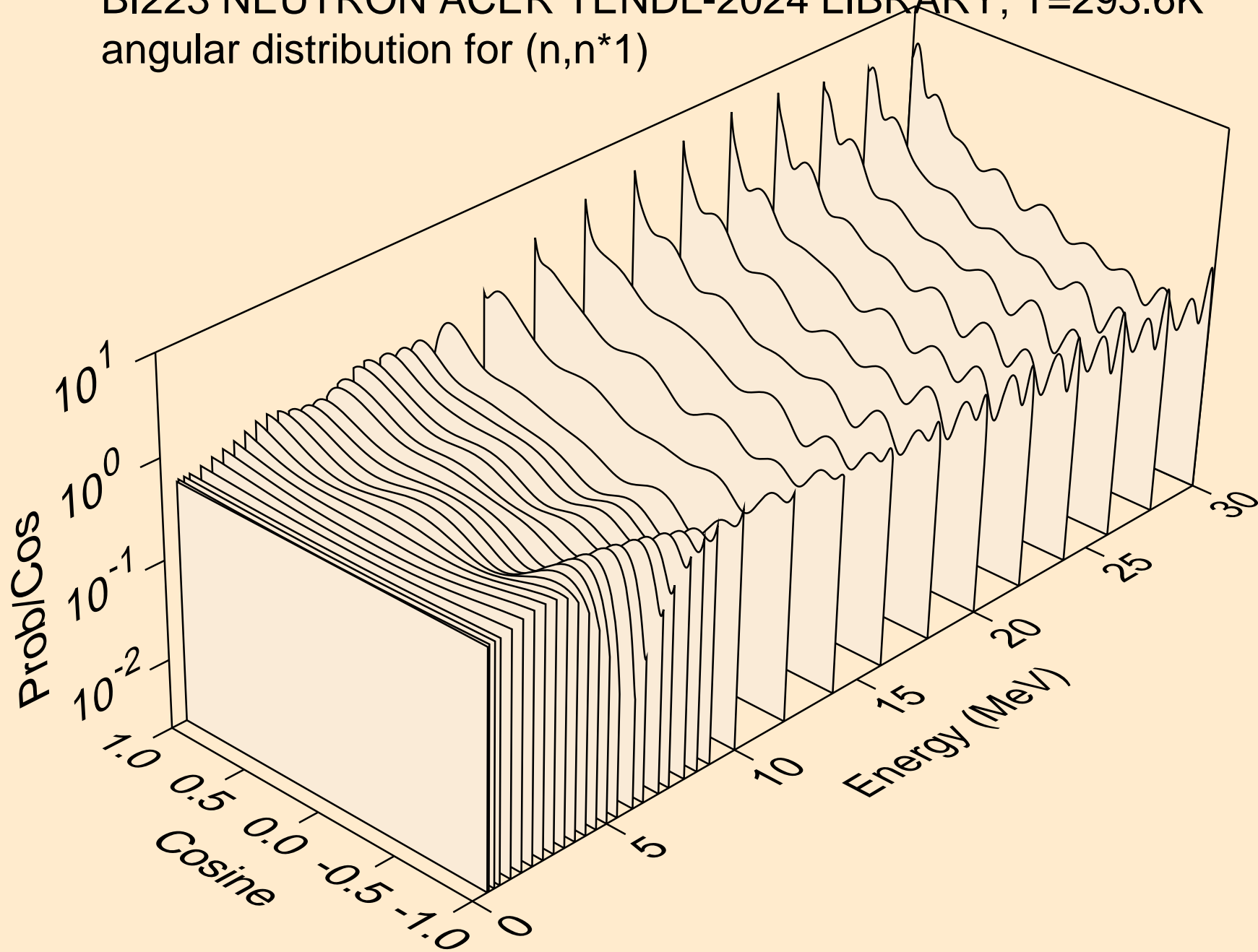

BI223 NEUTRON ACER TENDL-2024 LIBRARY; T=293.6K  
angular distribution for (n,n\*2)

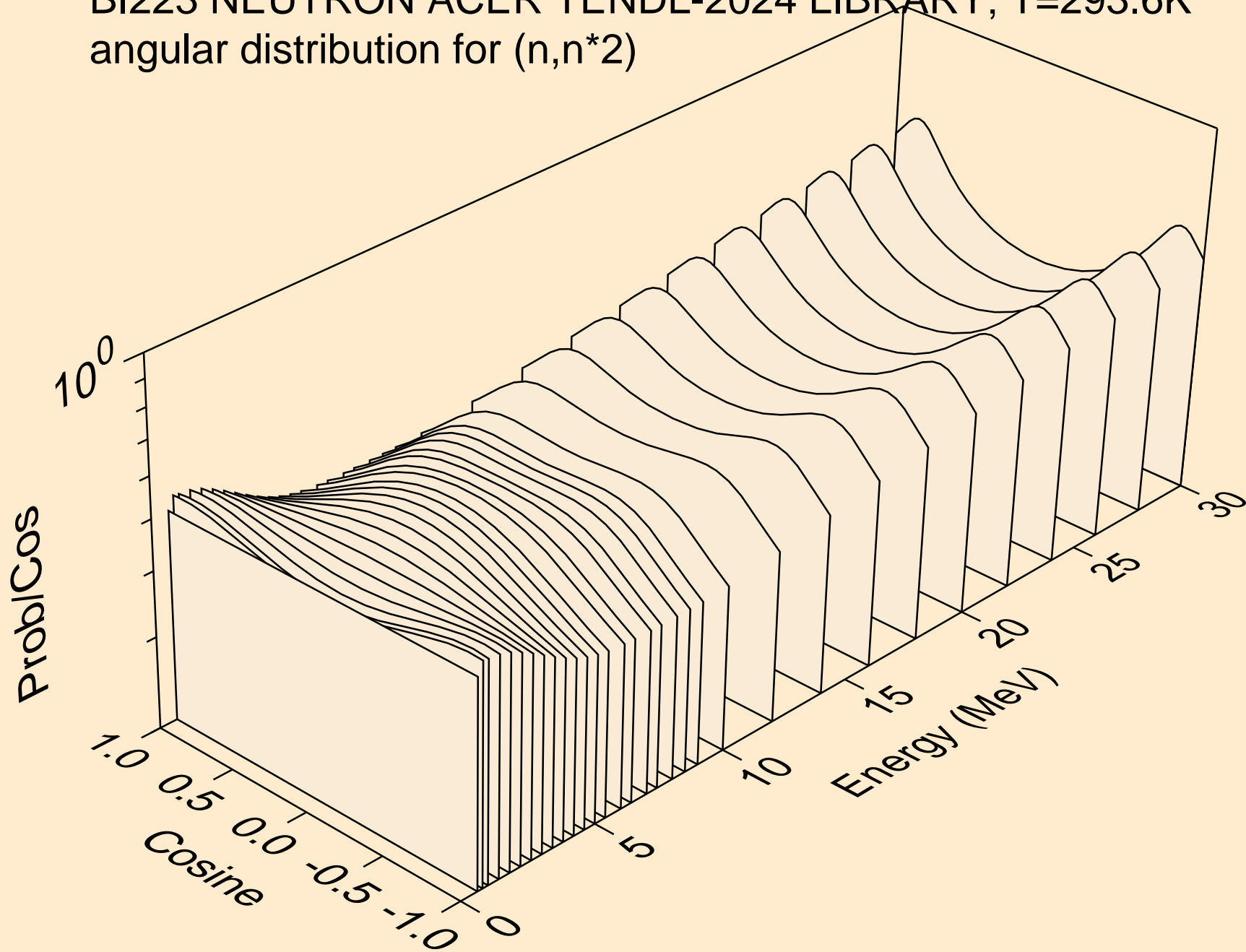

BI223 NEUTRON ACER TENDL-2024 LIBRARY; T=293.6K  
angular distribution for (n,n\*3)

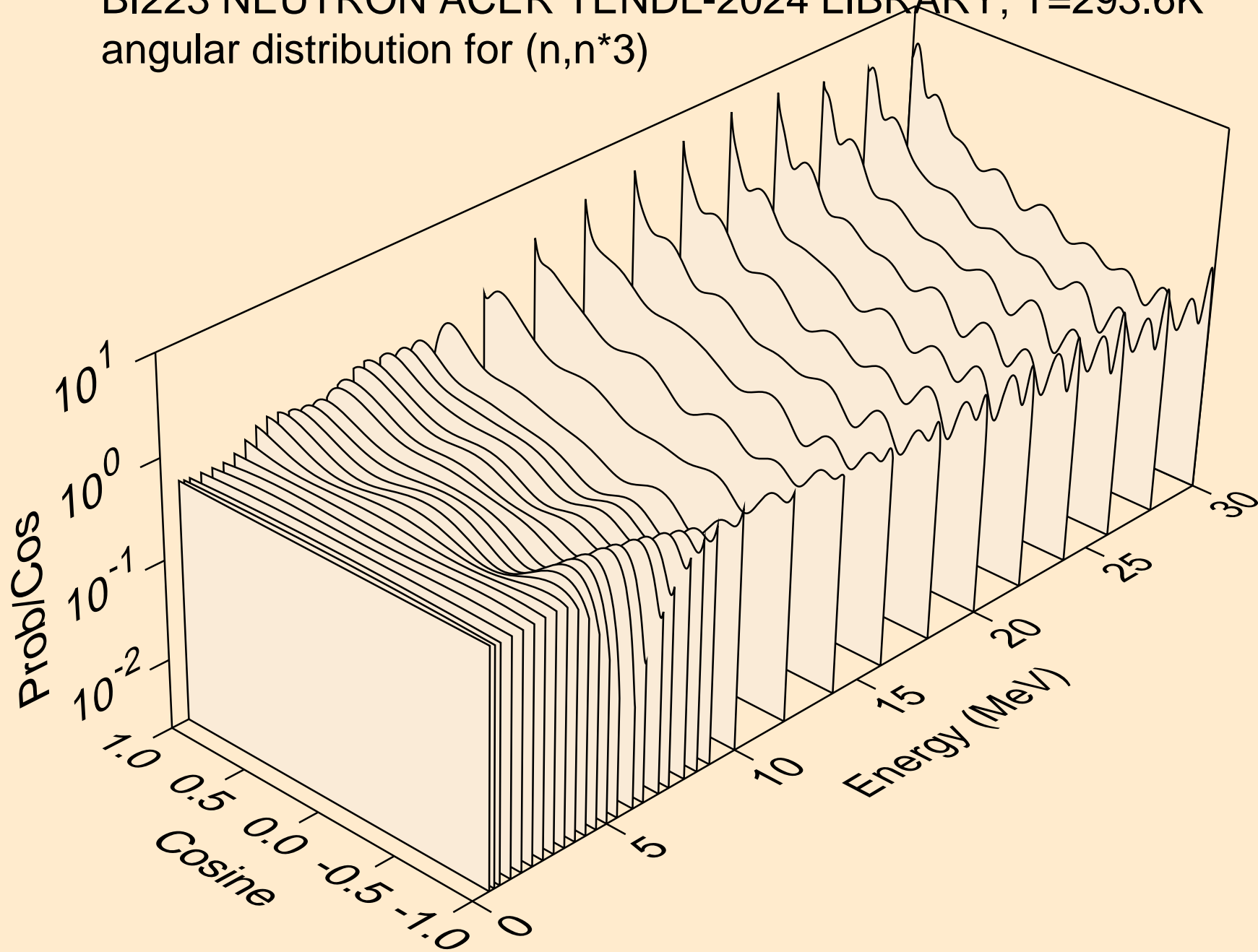

BI223 NEUTRON ACER TENDL-2024 LIBRARY; T=293.6K  
angular distribution for (n,n\*4)

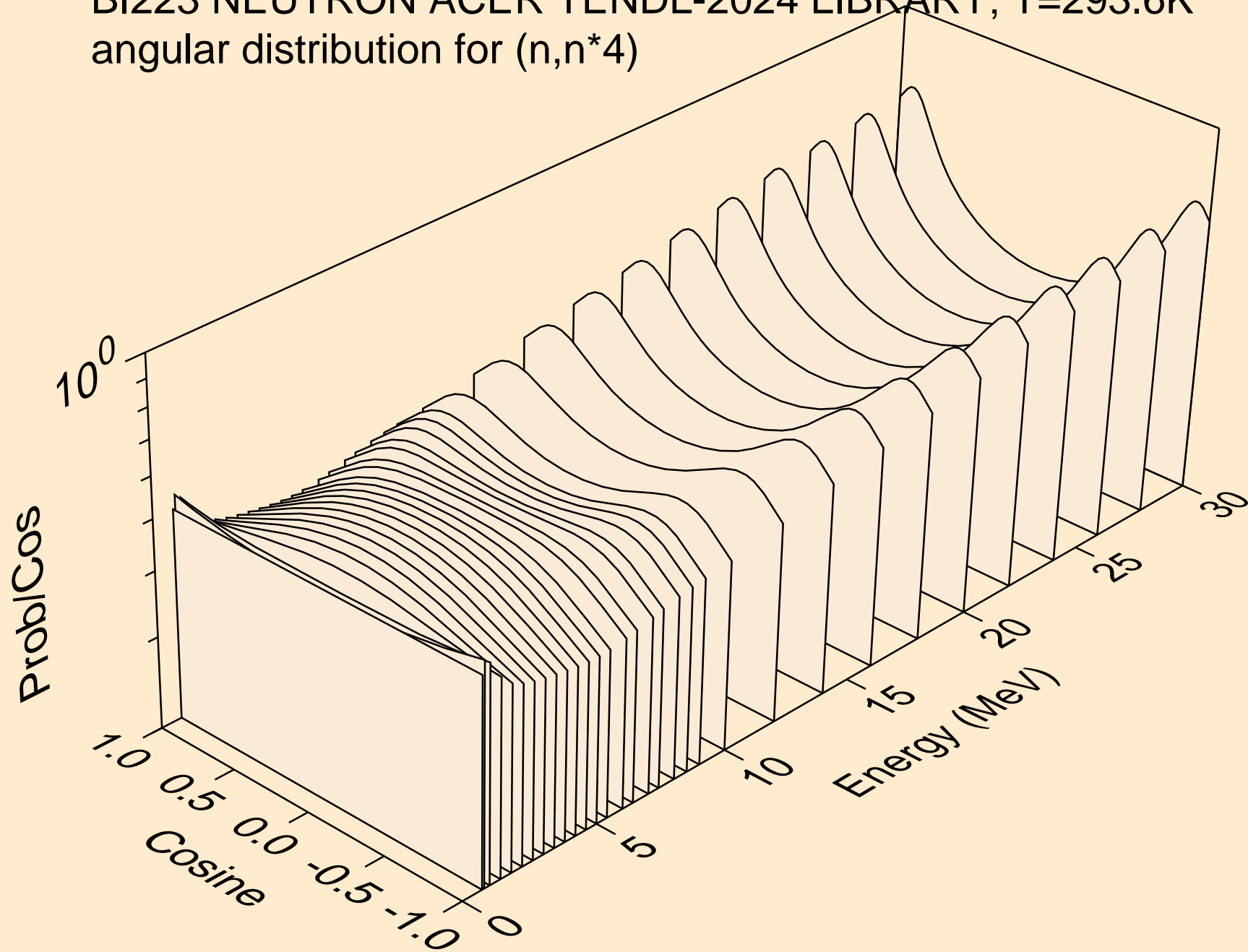

BI223 NEUTRON ACER TENDL-2024 LIBRARY; T=293.6K  
angular distribution for (n,n\*5)

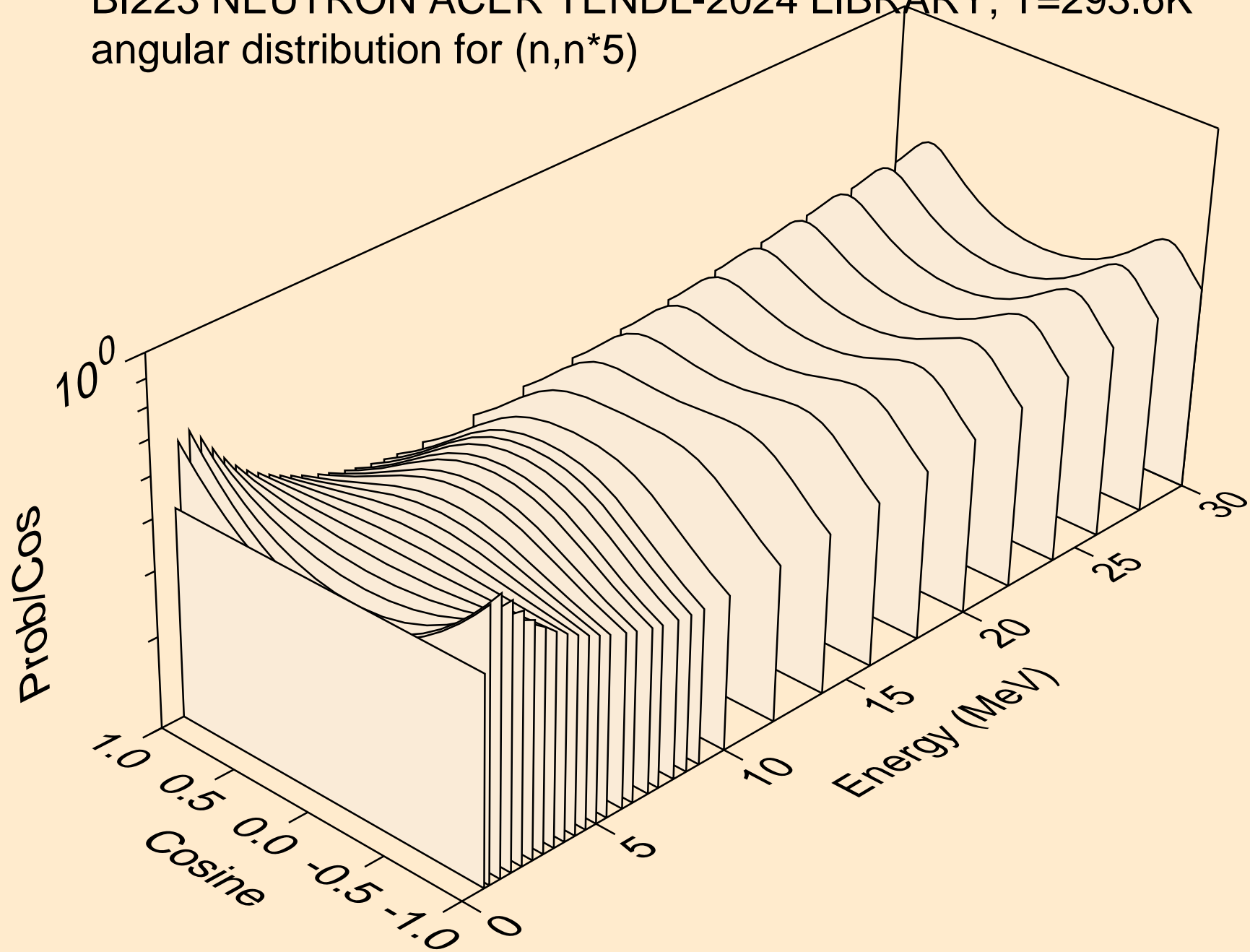

BI223 NEUTRON ACER TENDL-2024 LIBRARY; T=293.6K  
angular distribution for (n,n\*6)

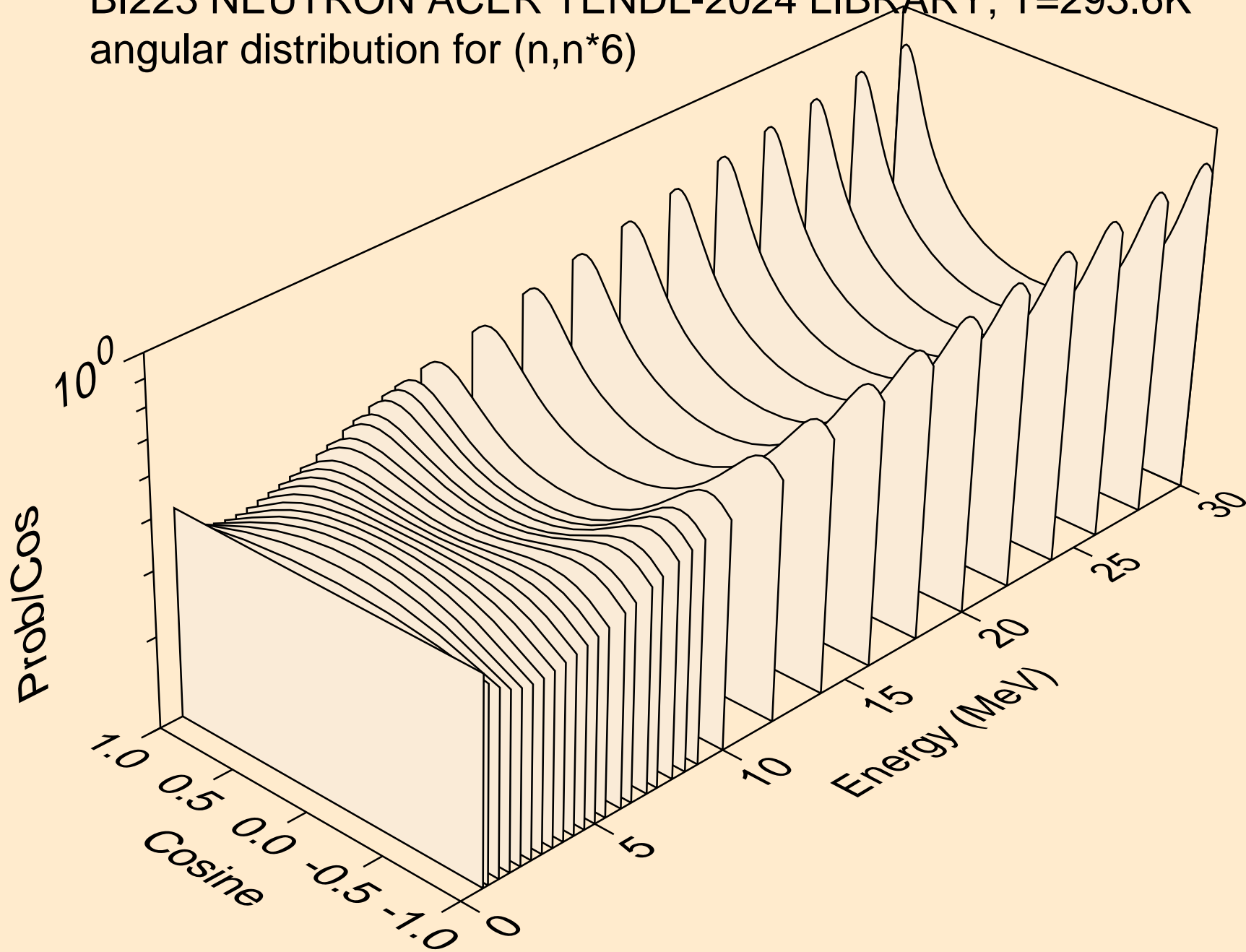

BI223 NEUTRON ACER TENDL-2024 LIBRARY; T=293.6K  
angular distribution for (n,n\*7)

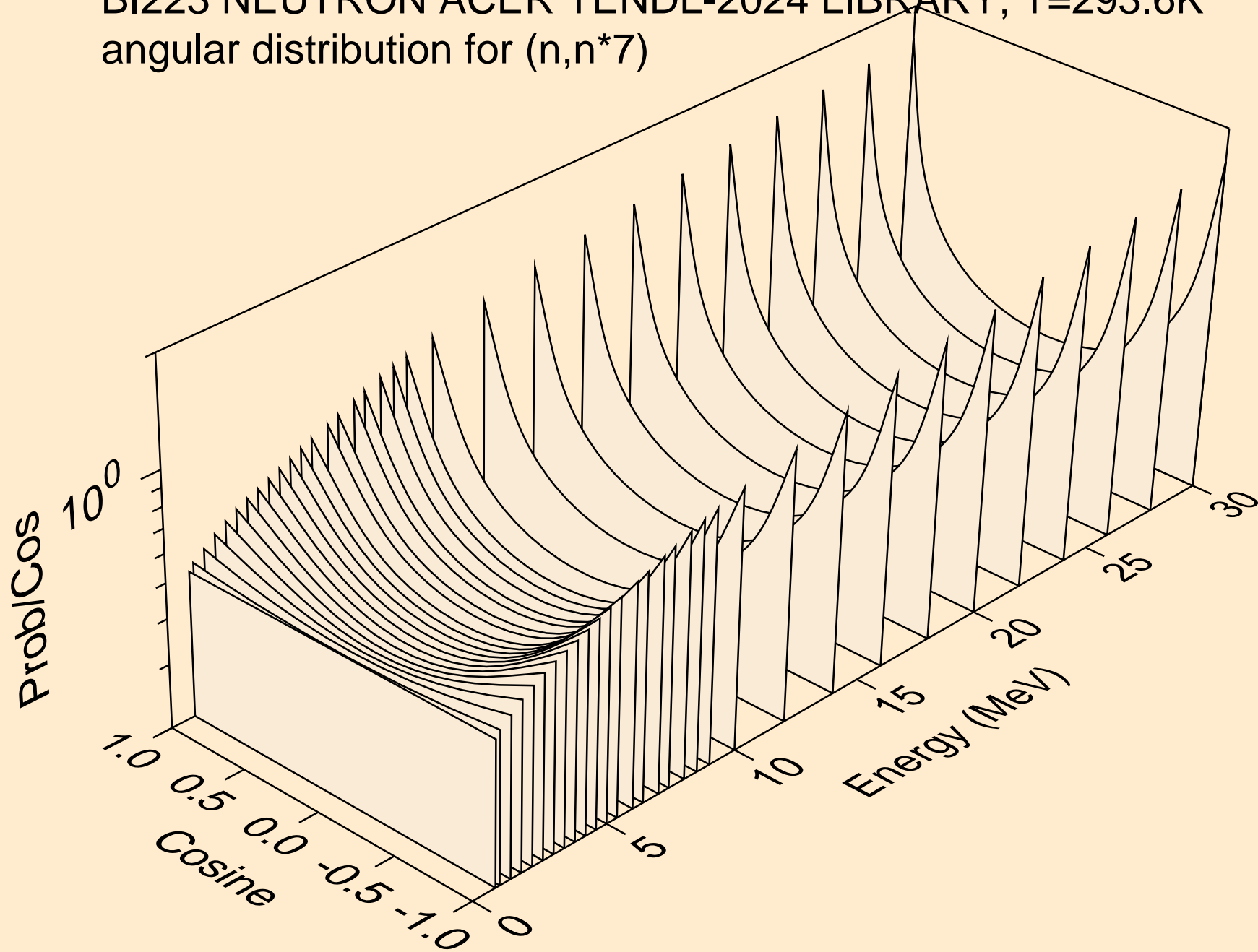

BI223 NEUTRON ACER TENDL-2024 LIBRARY; T=293.6K  
angular distribution for (n,n\*8)

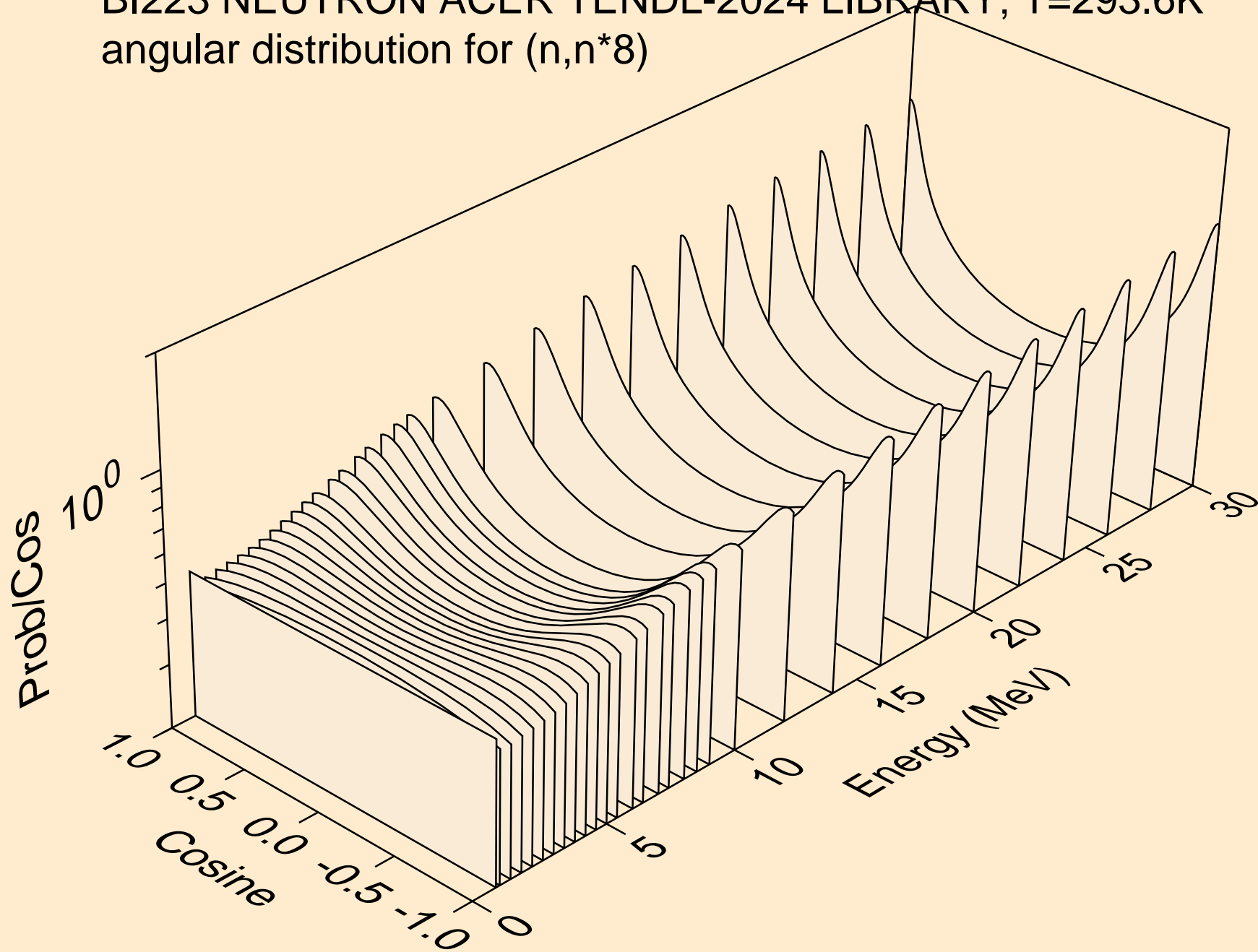

BI223 NEUTRON ACER TENDL-2024 LIBRARY; T=293.6K  
angular distribution for (n,n\*9)

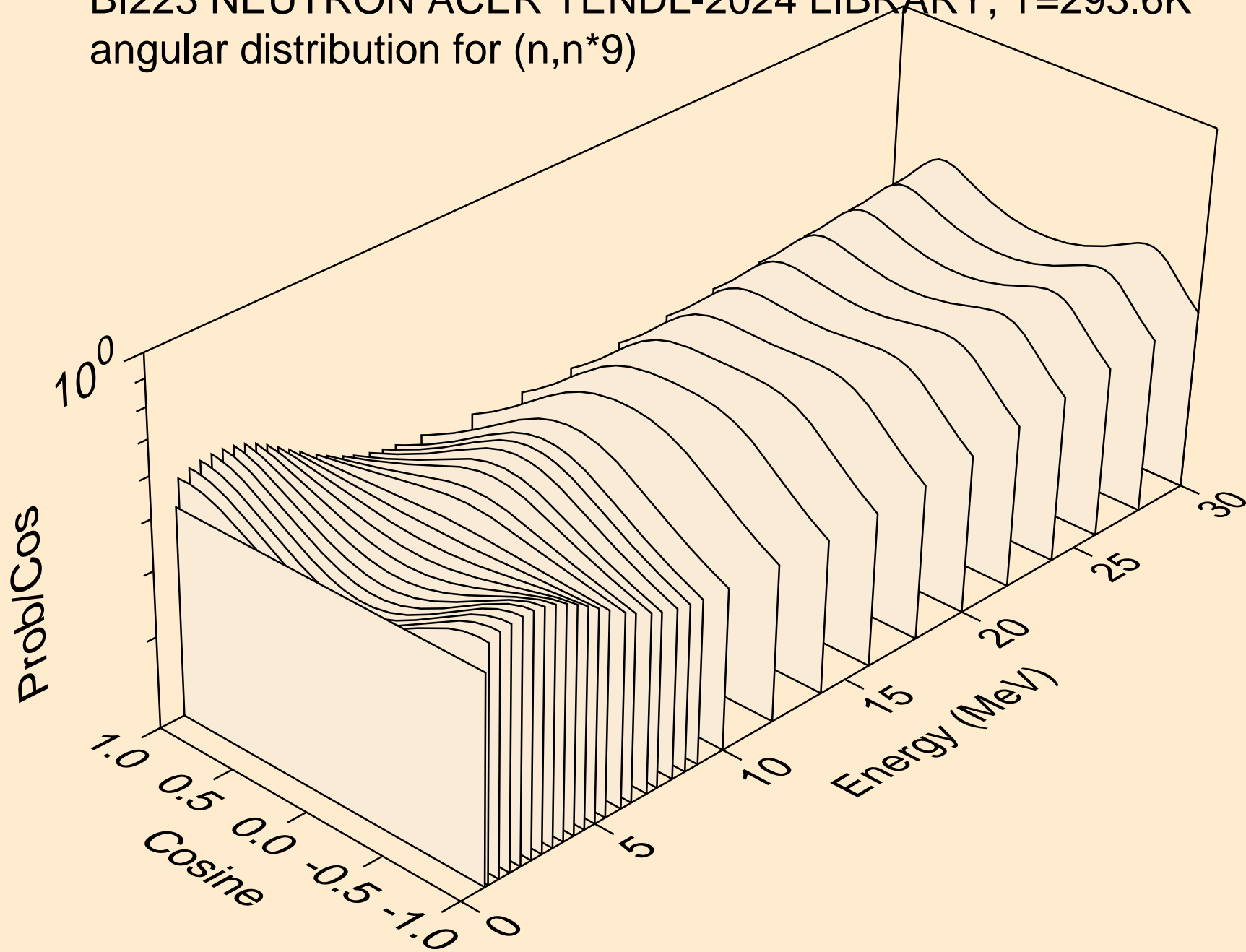

BI223 NEUTRON ACER TENDL-2024 LIBRARY; T=293.6K  
angular distribution for (n,n\*10)

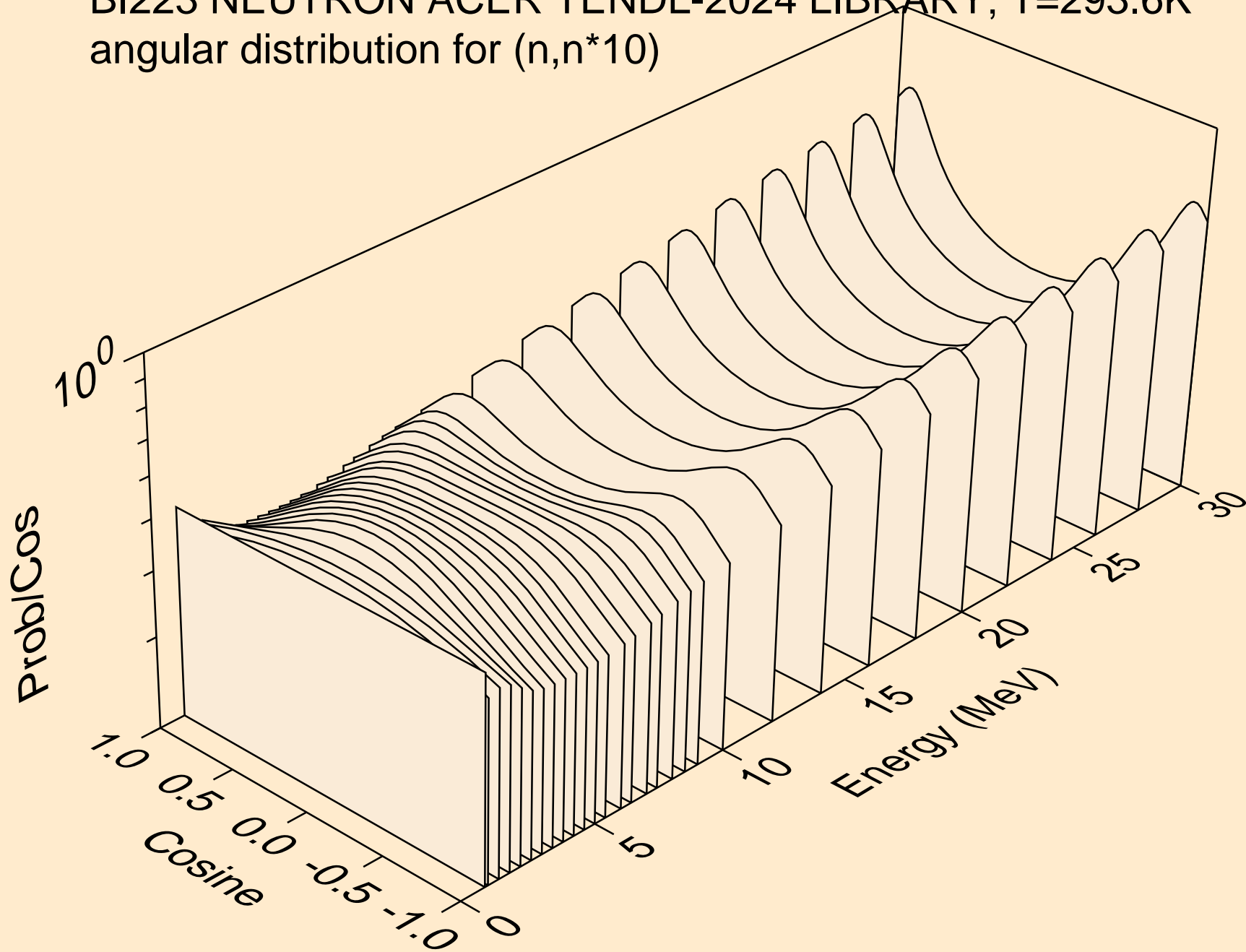

BI223 NEUTRON ACER TENDL-2024 LIBRARY; T=293.6K  
angular distribution for (n,n\*11)

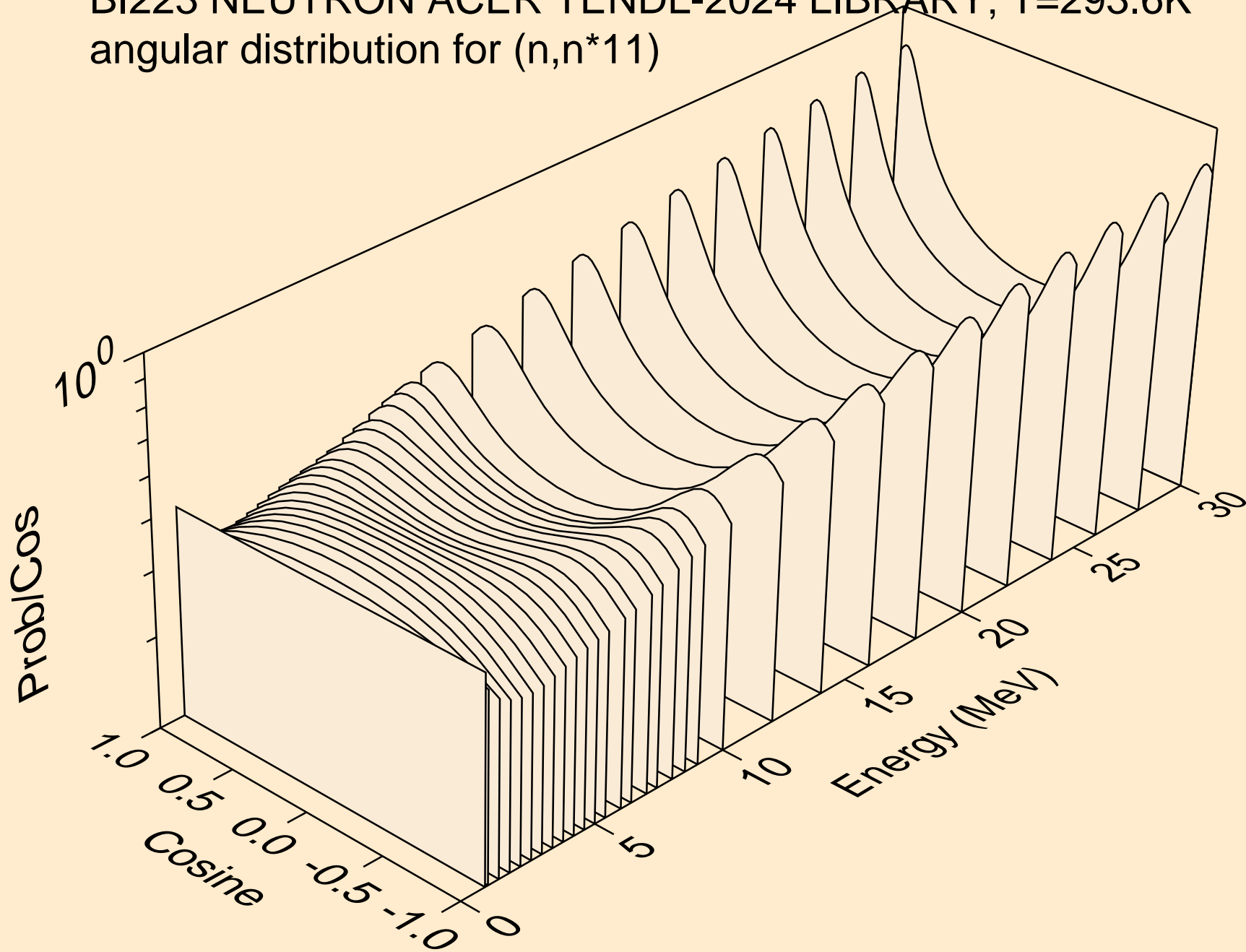

BI223 NEUTRON ACER TENDL-2024 LIBRARY; T=293.6K  
angular distribution for (n,n\*12)

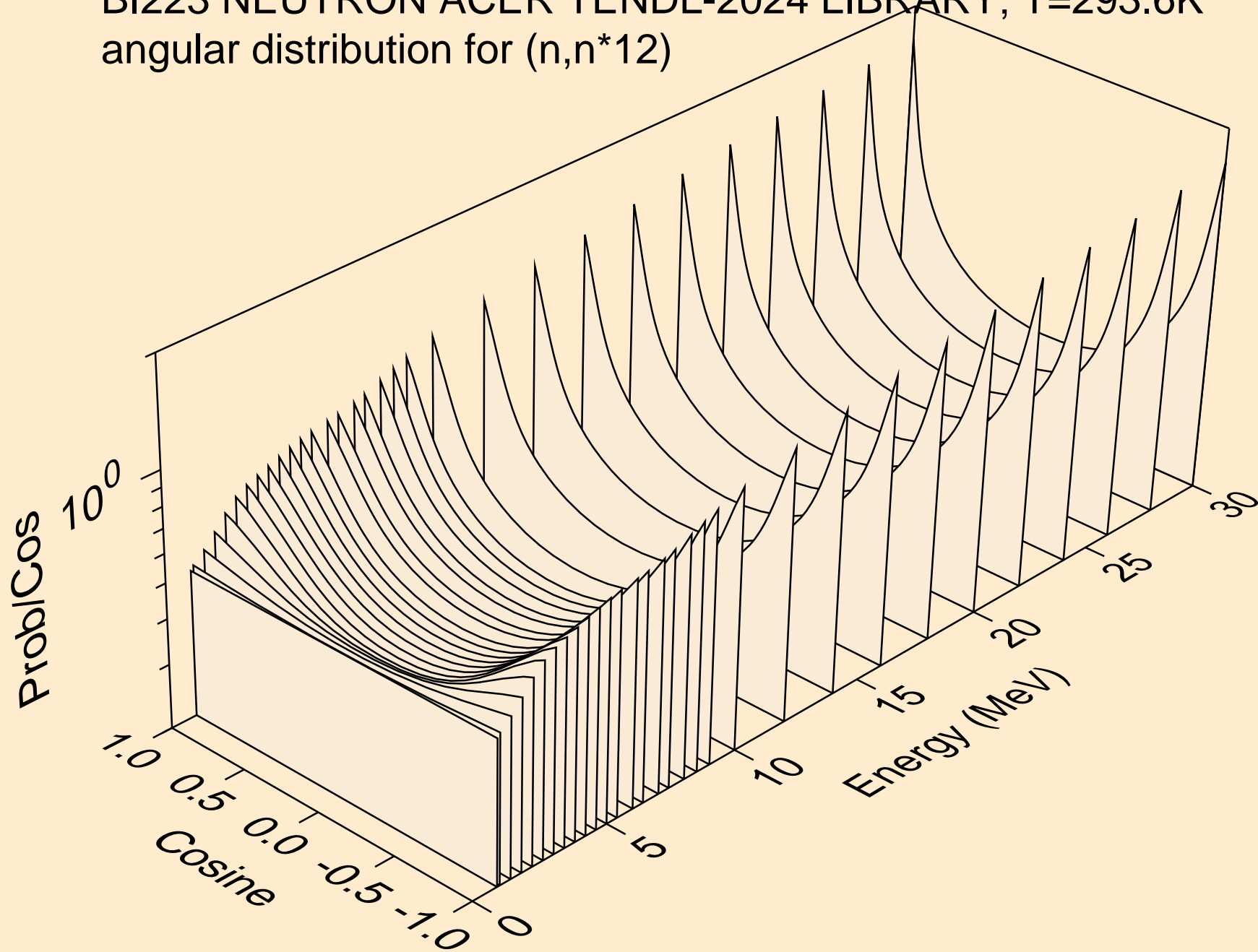

BI223 NEUTRON ACER TENDL-2024 LIBRARY; T=293.6K  
angular distribution for (n,n\*13)

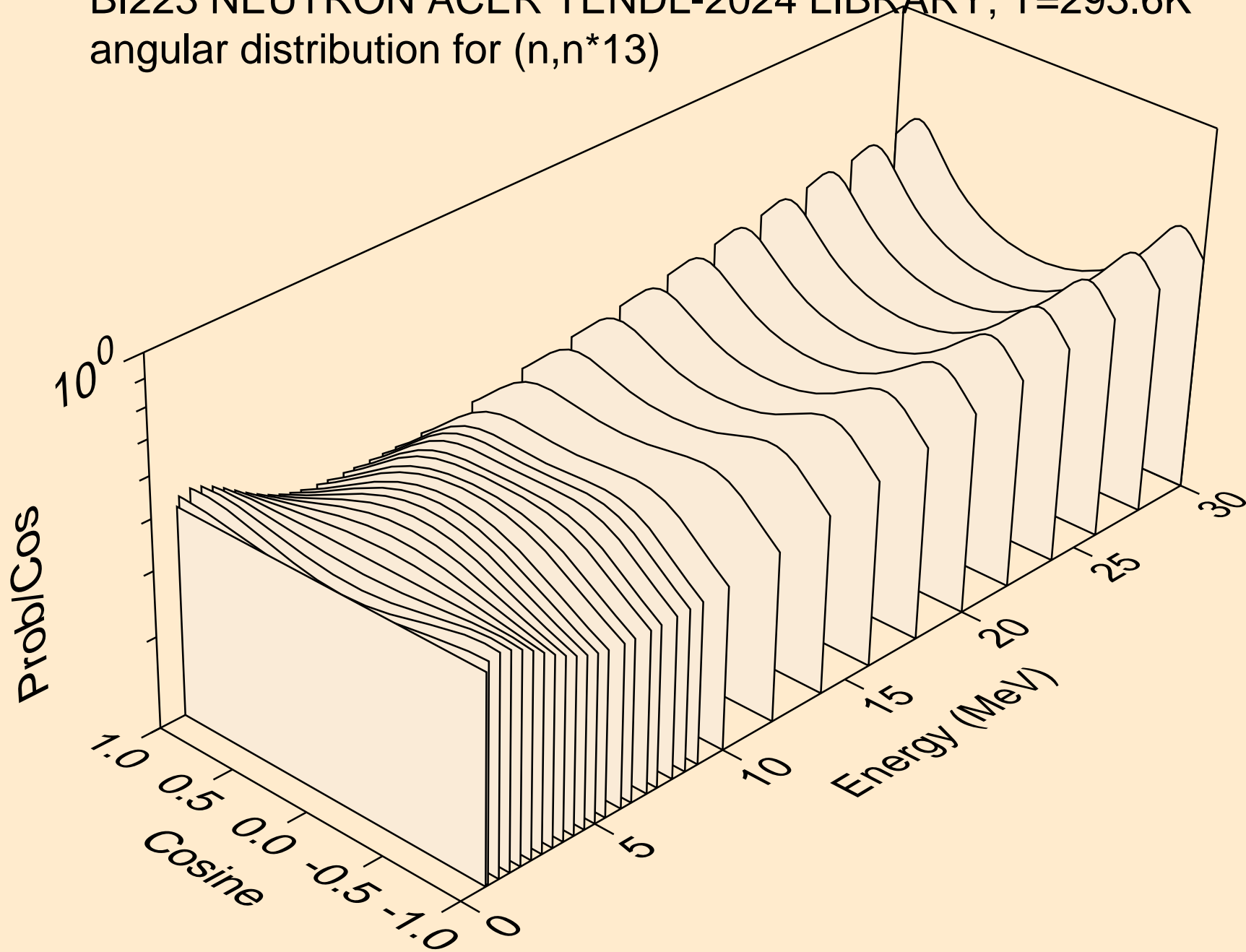

BI223 NEUTRON ACER TENDL-2024 LIBRARY; T=293.6K  
angular distribution for (n,n\*14)

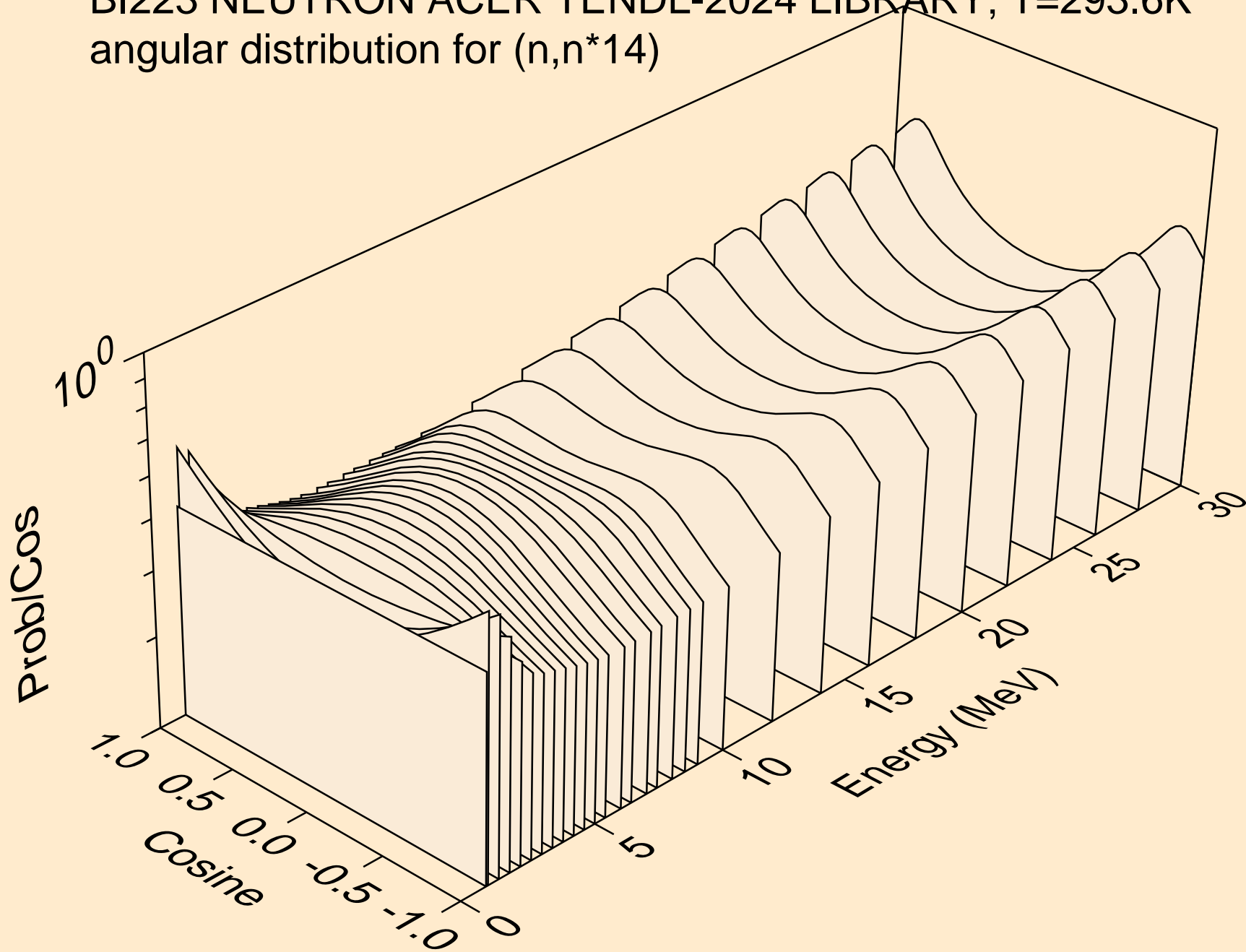

BI223 NEUTRON ACER TENDL-2024 LIBRARY; T=293.6K  
angular distribution for (n,n\*15)

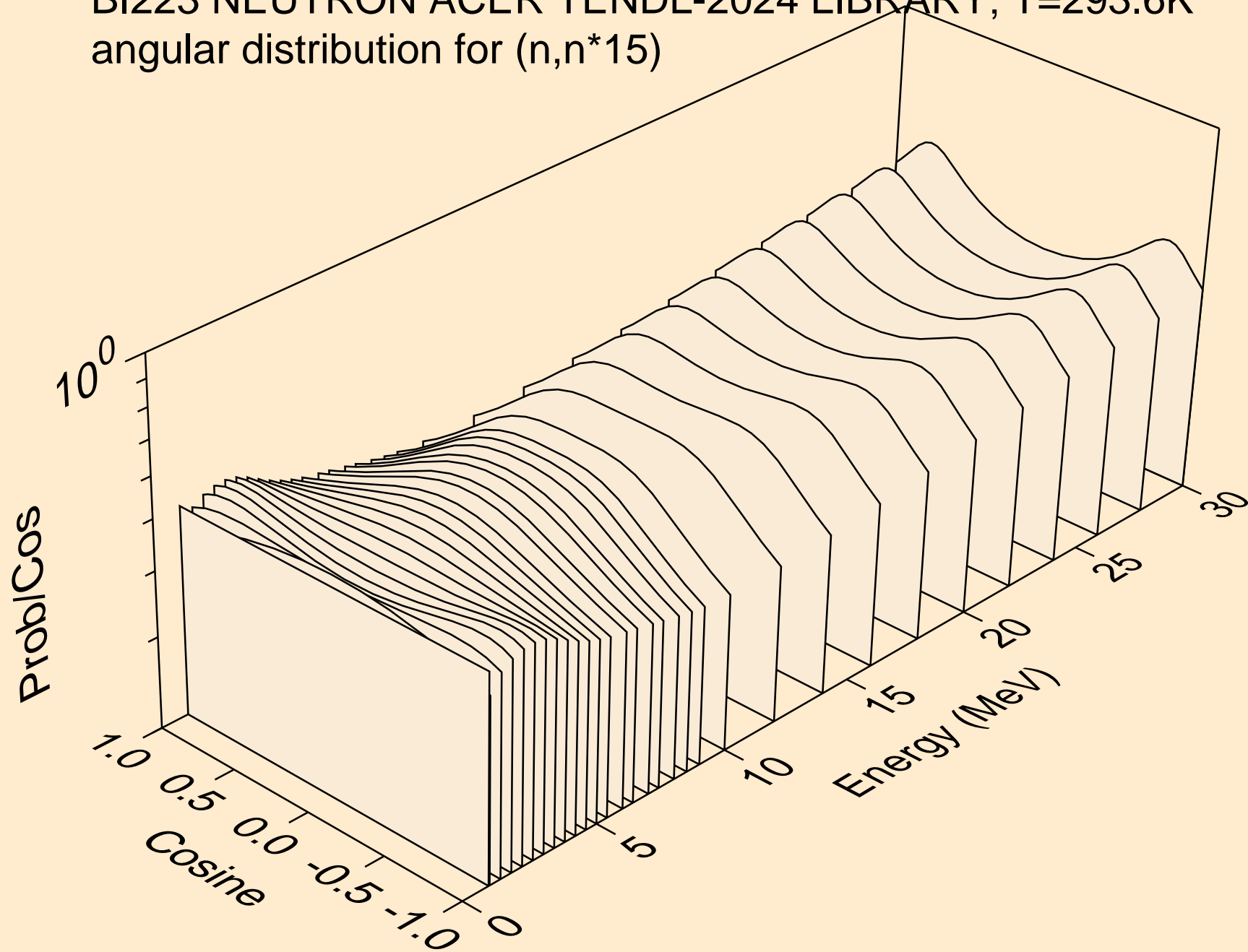

BI223 NEUTRON ACER TENDL-2024 LIBRARY; T=293.6K  
angular distribution for (n,n\*16)

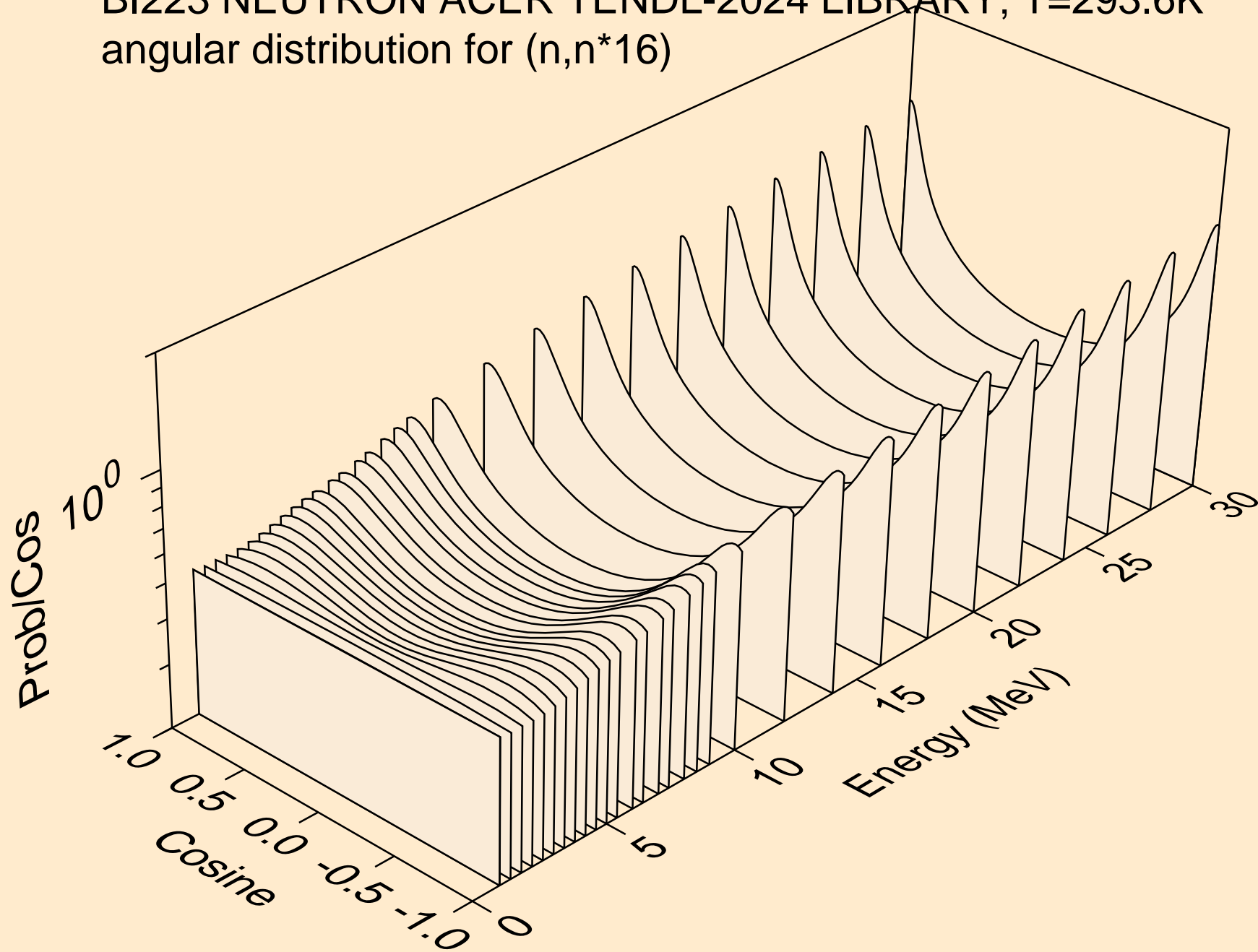

BI223 NEUTRON ACER TENDL-2024 LIBRARY; T=293.6K  
angular distribution for (n,n\*17)

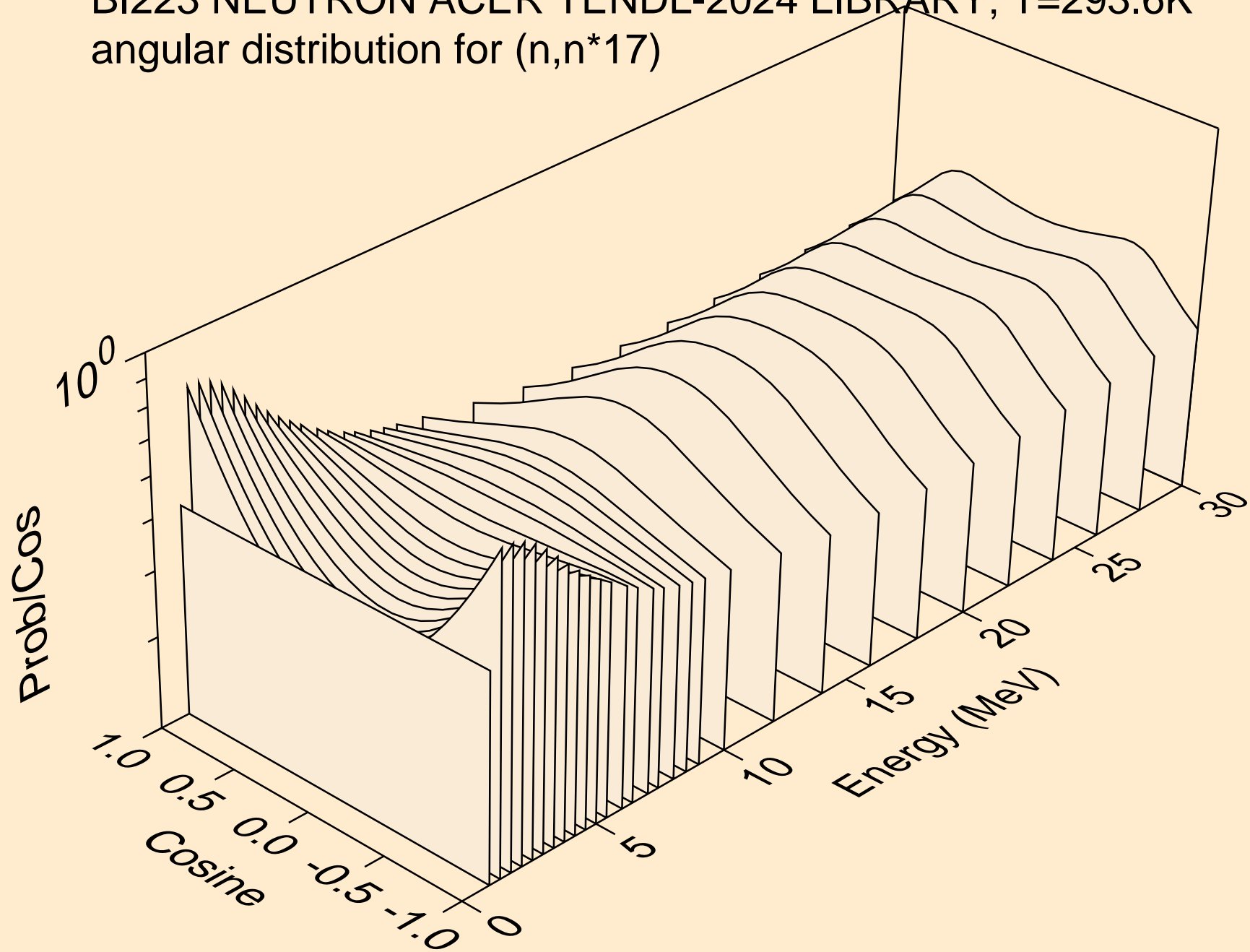

BI223 NEUTRON ACER TENDL-2024 LIBRARY; T=293.6K  
angular distribution for (n,n\*18)

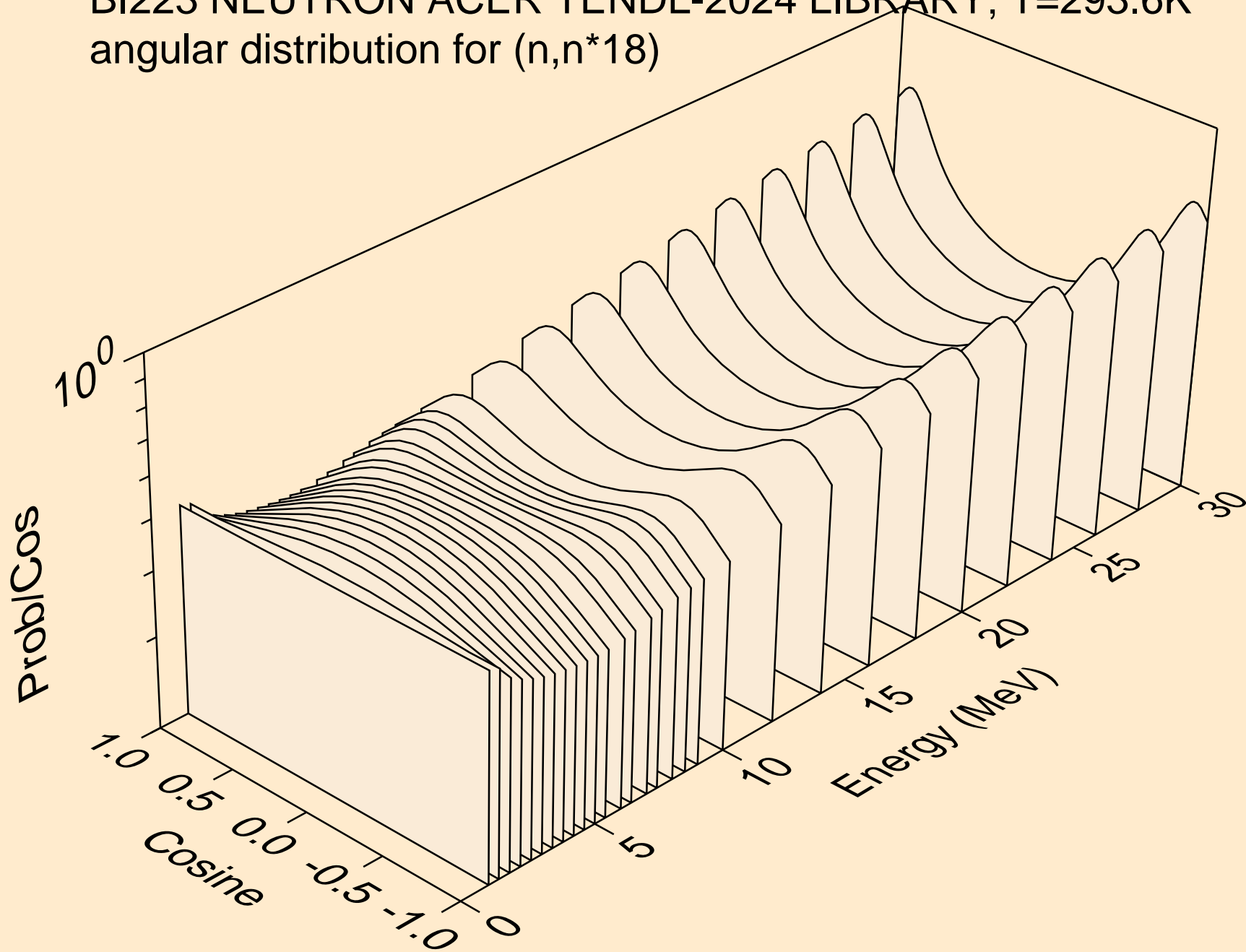

BI223 NEUTRON ACER TENDL-2024 LIBRARY; T=293.6K  
angular distribution for (n,n\*19)

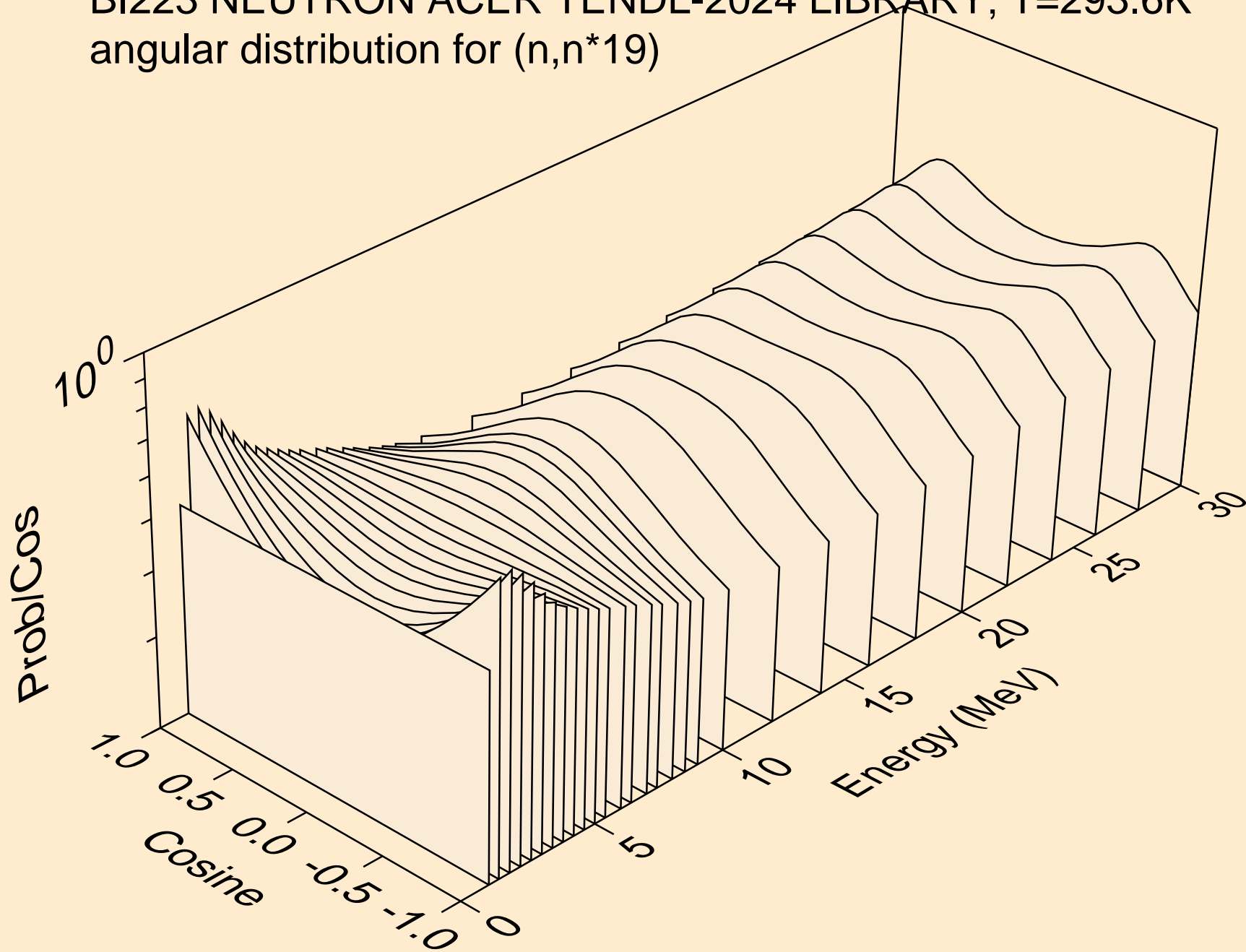

BI223 NEUTRON ACER TENDL-2024 LIBRARY; T=293.6K  
angular distribution for (n,n\*20)

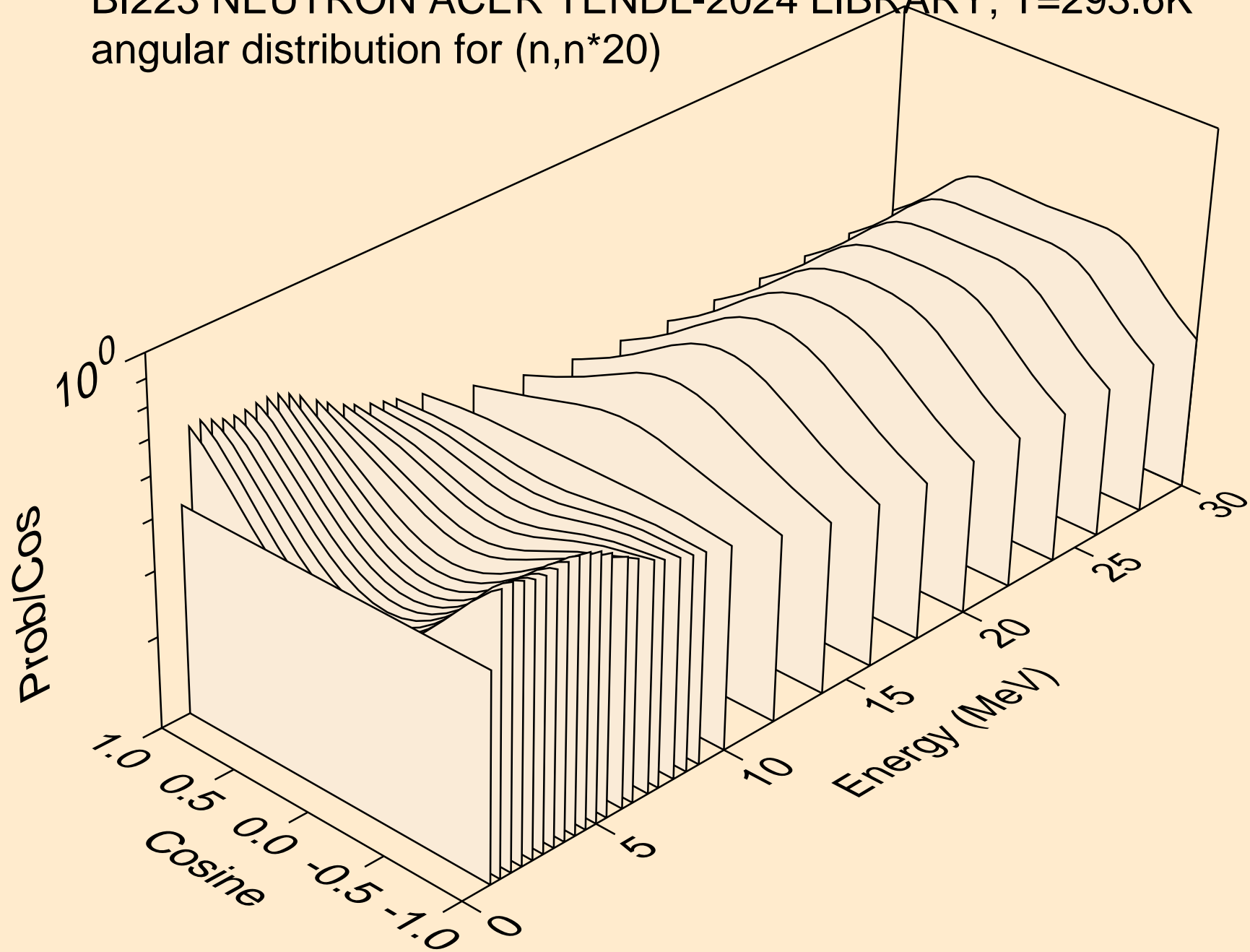

BI223 NEUTRON ACER TENDL-2024 LIBRARY; T=293.6K  
angular distribution for (n,n\*21)

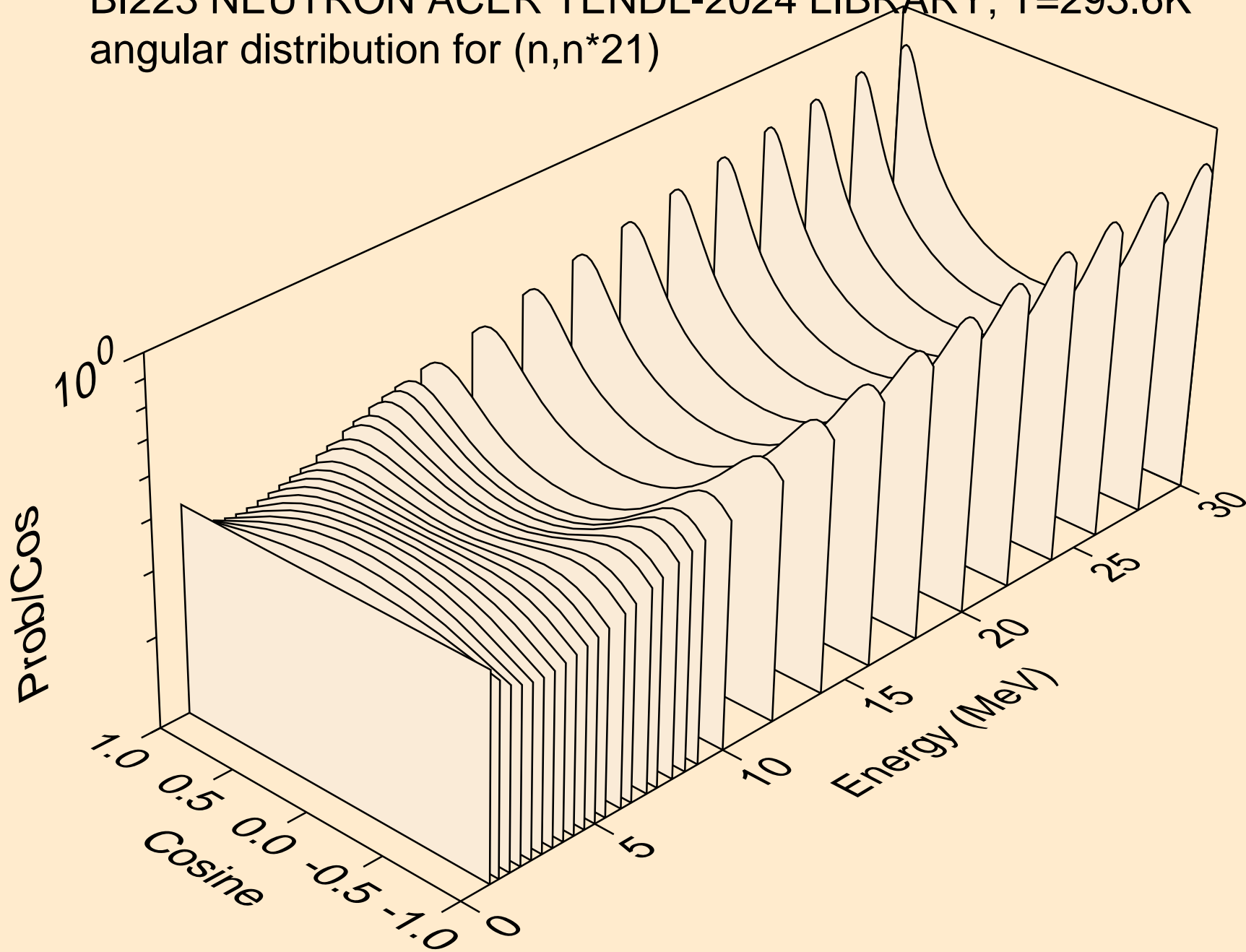

BI223 NEUTRON ACER TENDL-2024 LIBRARY; T=293.6K  
angular distribution for (n,n\*22)

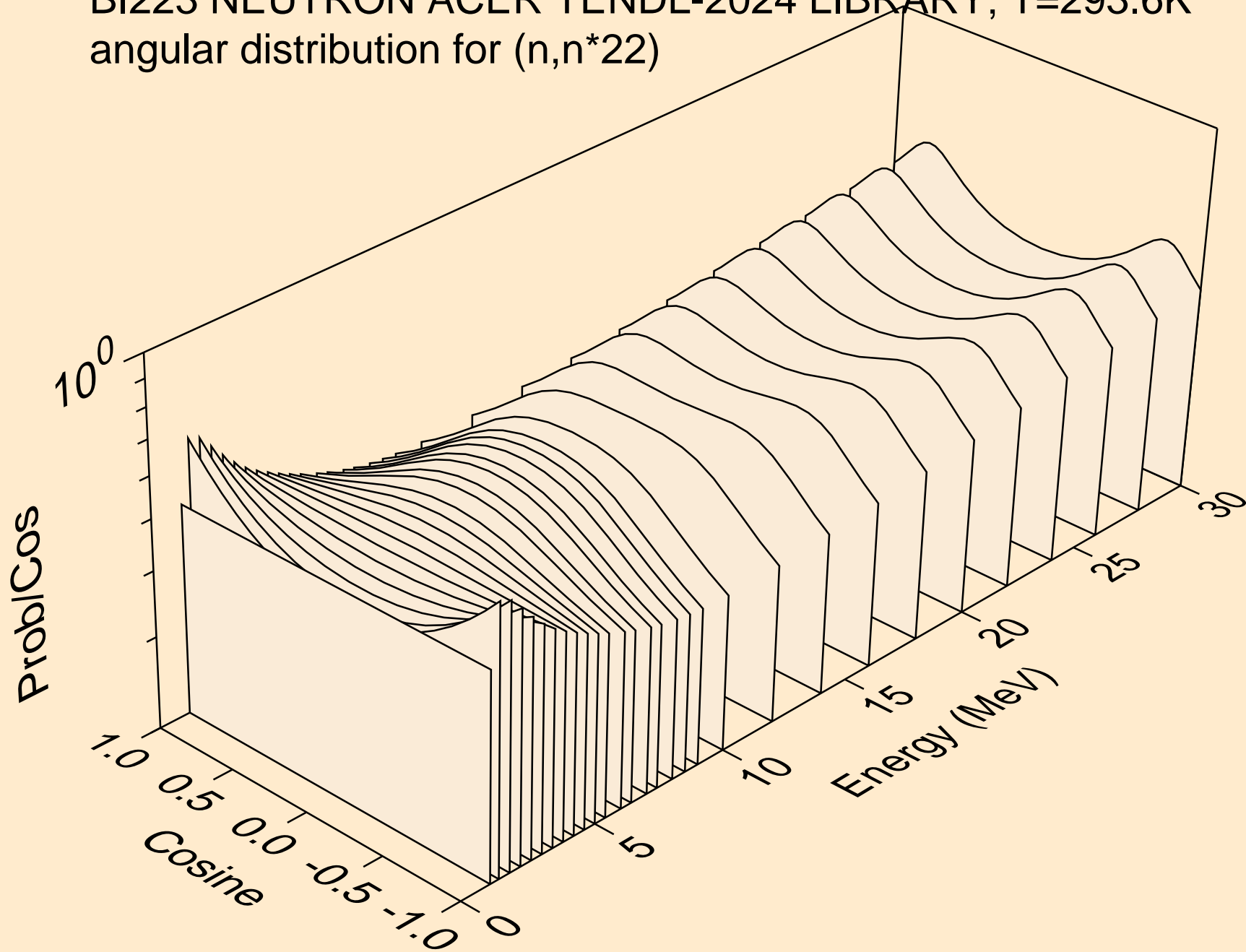

BI223 NEUTRON ACER TENDL-2024 LIBRARY; T=293.6K  
angular distribution for (n,n\*23)

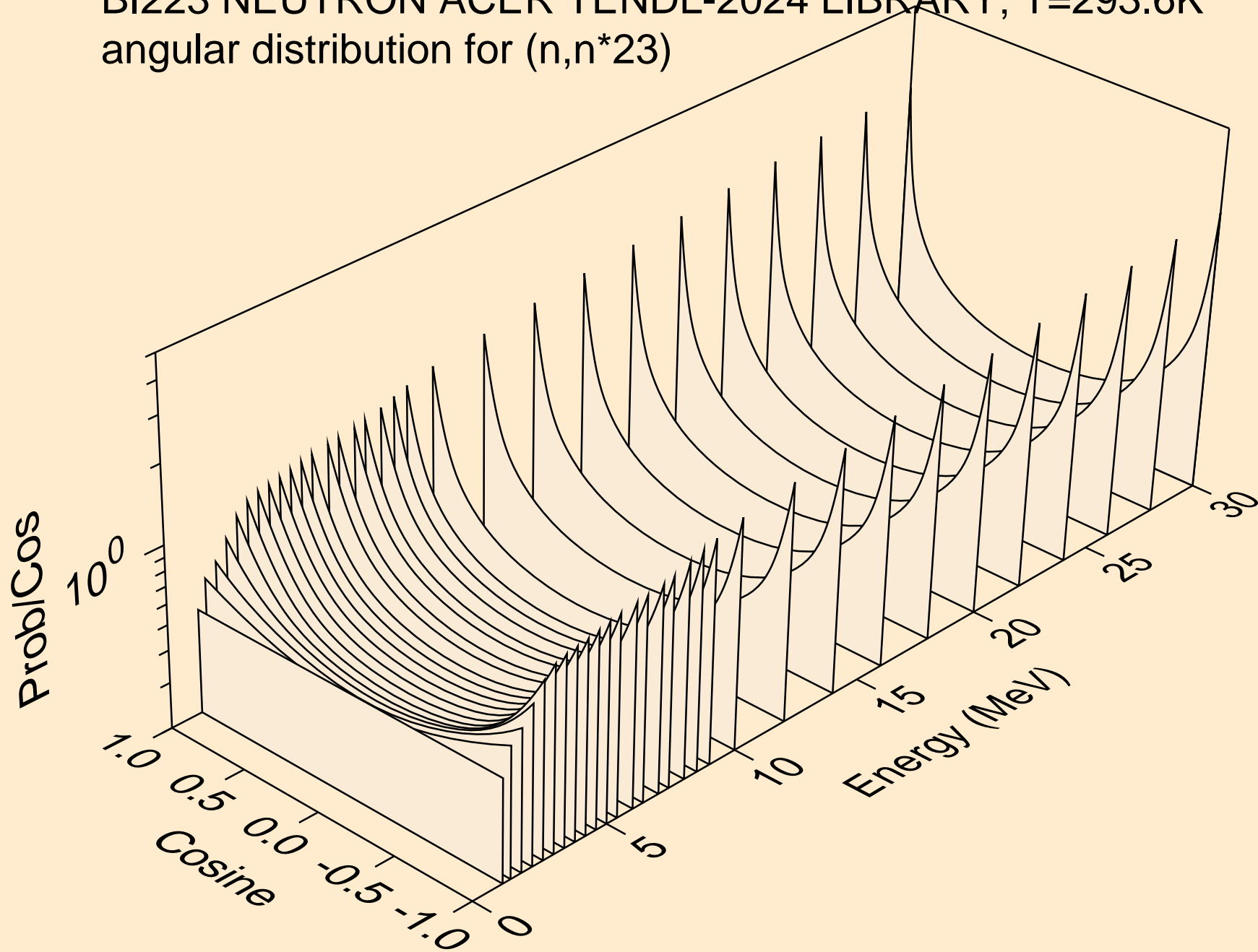

BI223 NEUTRON ACER TENDL-2024 LIBRARY; T=293.6K  
angular distribution for (n,n\*24)

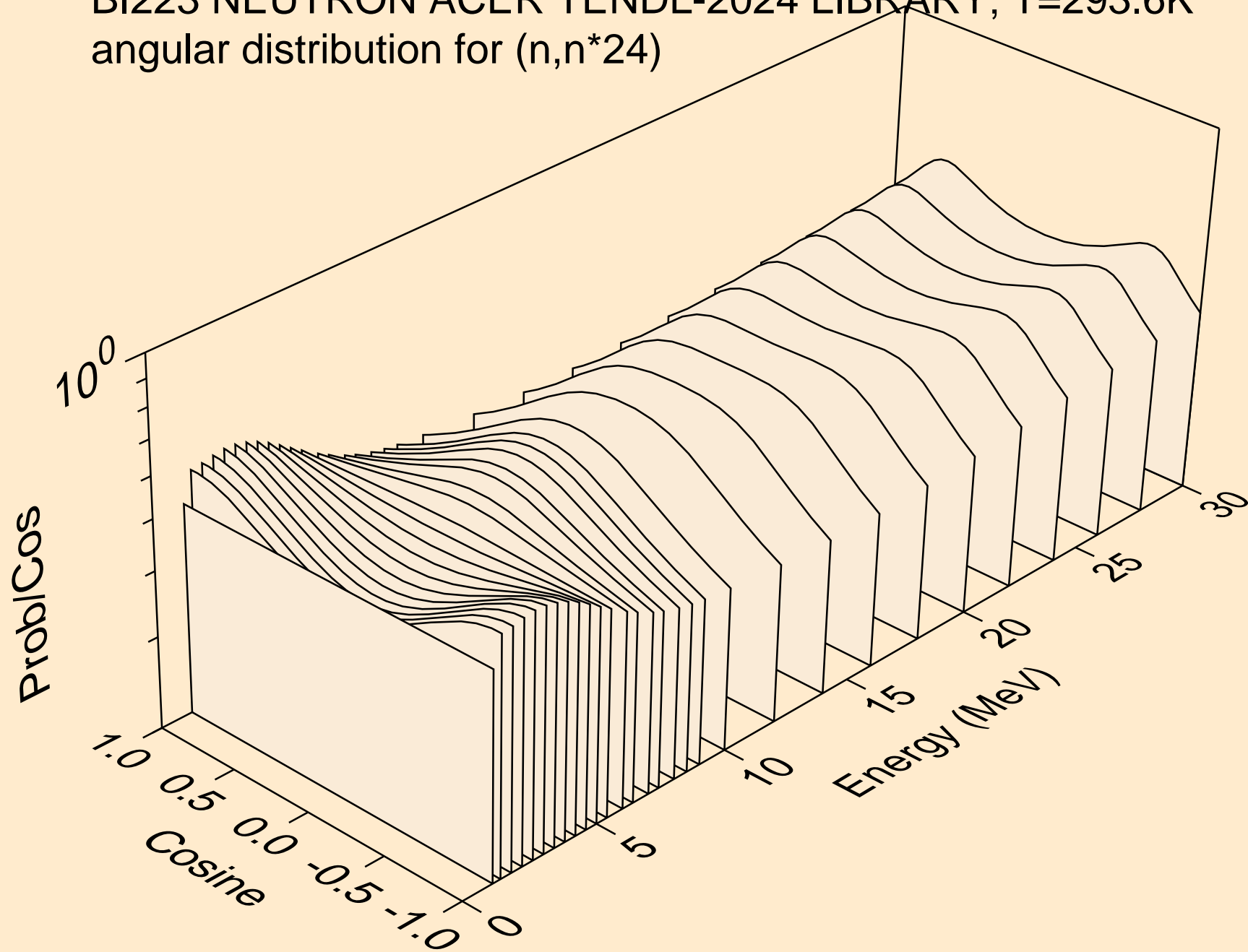

BI223 NEUTRON ACER TENDL-2024 LIBRARY; T=293.6K  
angular distribution for (n,n\*25)

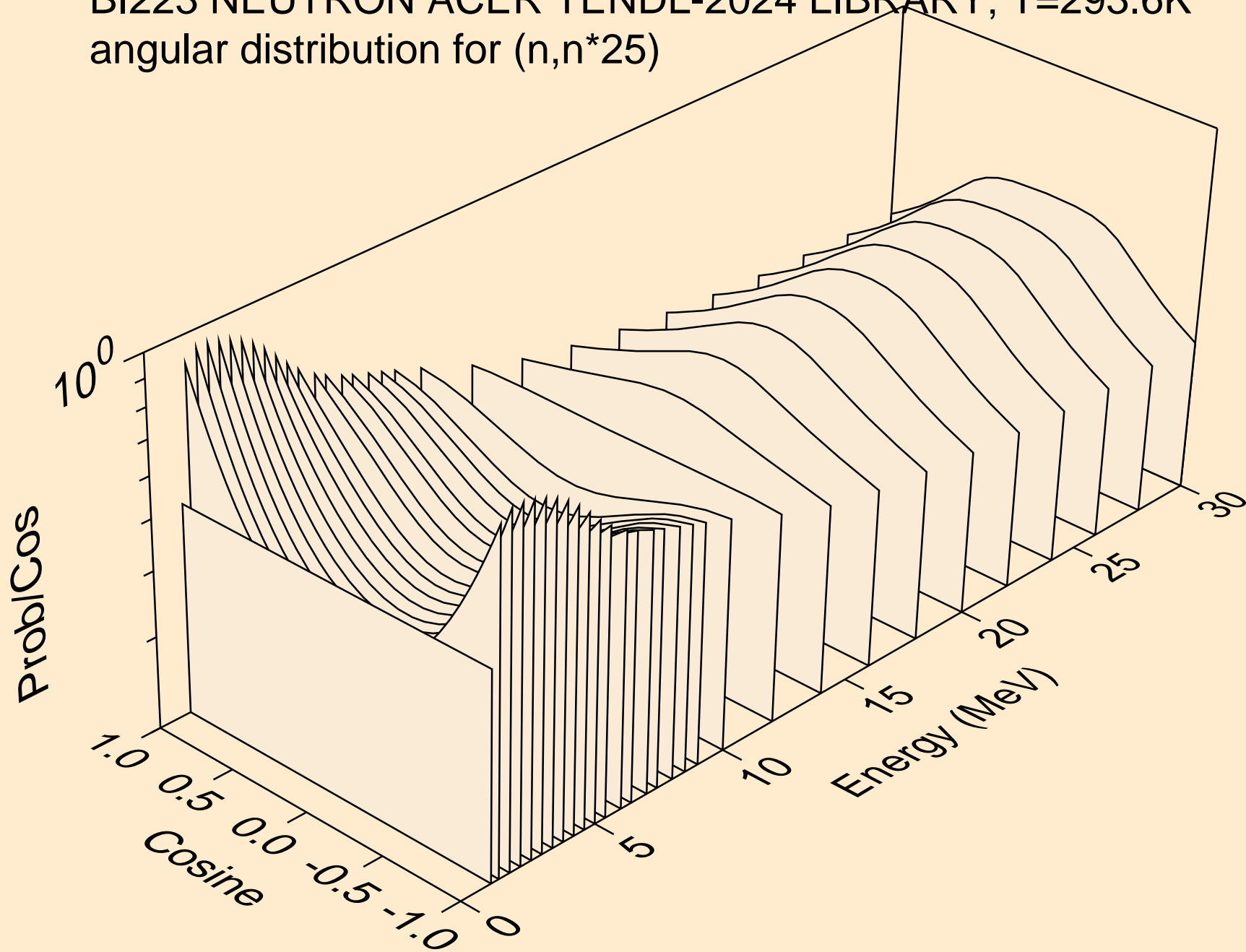

BI223 NEUTRON ACER TENDL-2024 LIBRARY; T=293.6K  
angular distribution for (n,n\*26)

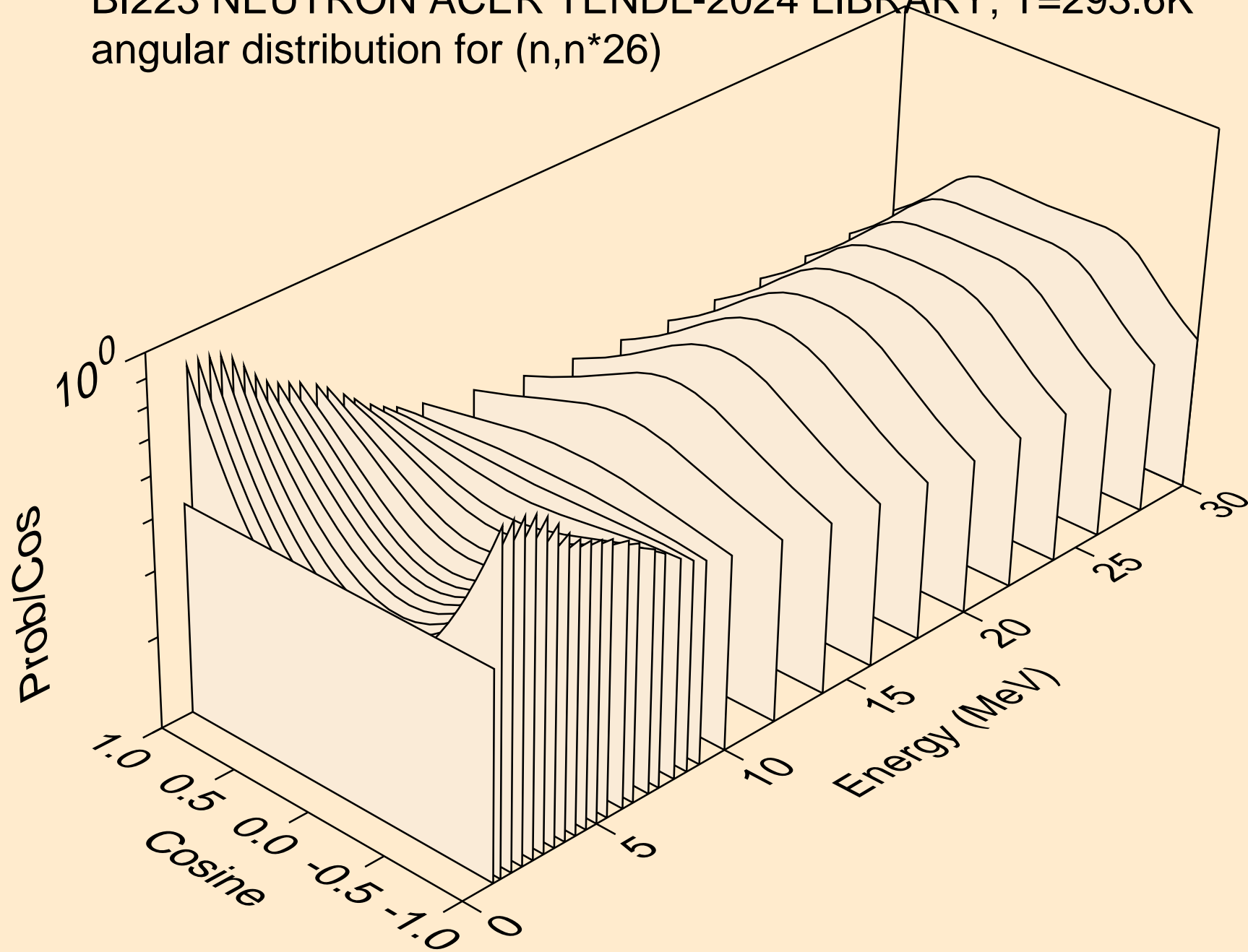

BI223 NEUTRON ACER TENDL-2024 LIBRARY; T=293.6K  
angular distribution for (n,n\*27)

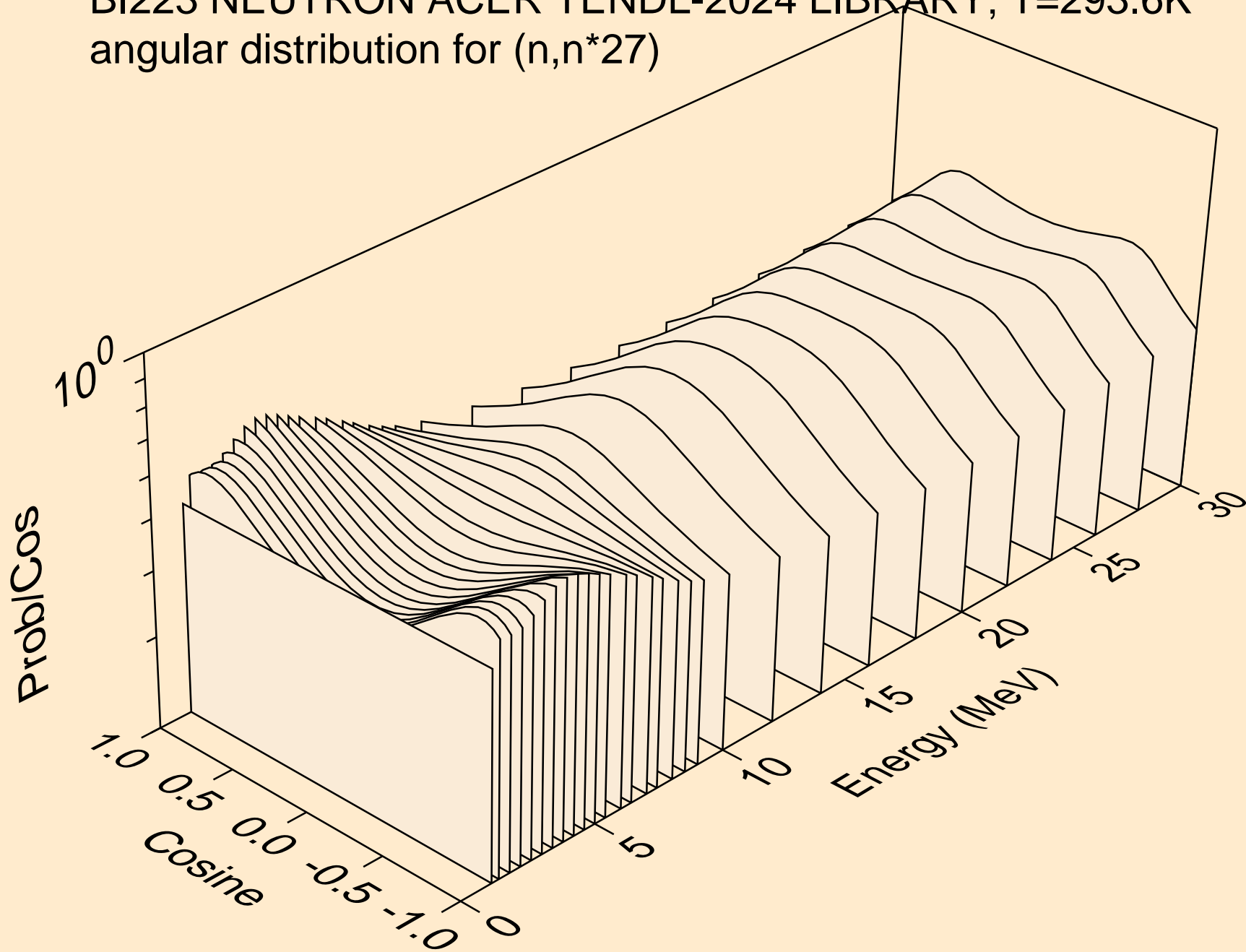

BI223 NEUTRON ACER TENDL-2024 LIBRARY; T=293.6K  
angular distribution for (n,n\*28)

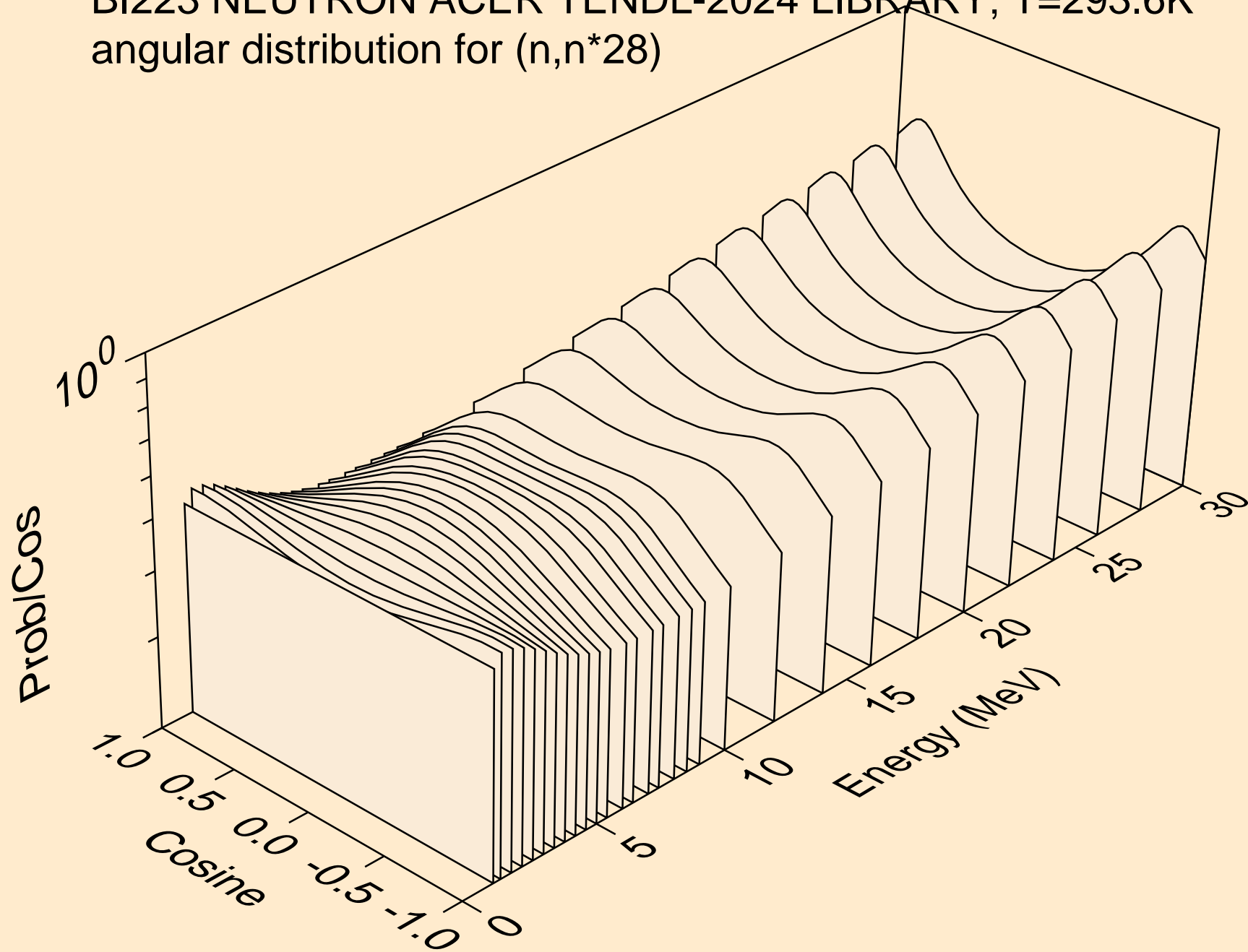

BI223 NEUTRON ACER TENDL-2024 LIBRARY; T=293.6K  
angular distribution for (n,n\*29)

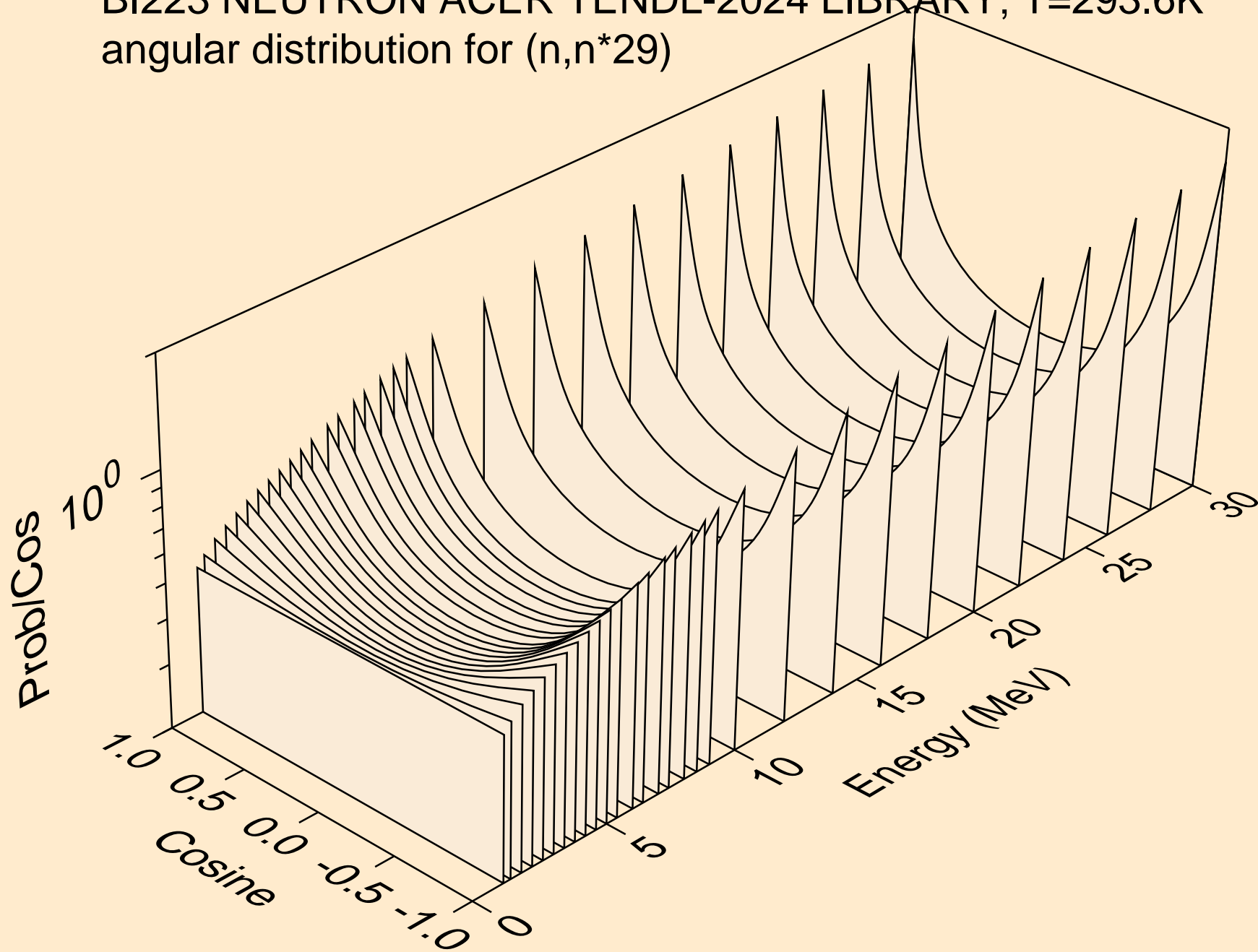

BI223 NEUTRON ACER TENDL-2024 LIBRARY; T=293.6K  
angular distribution for (n,n\*30)

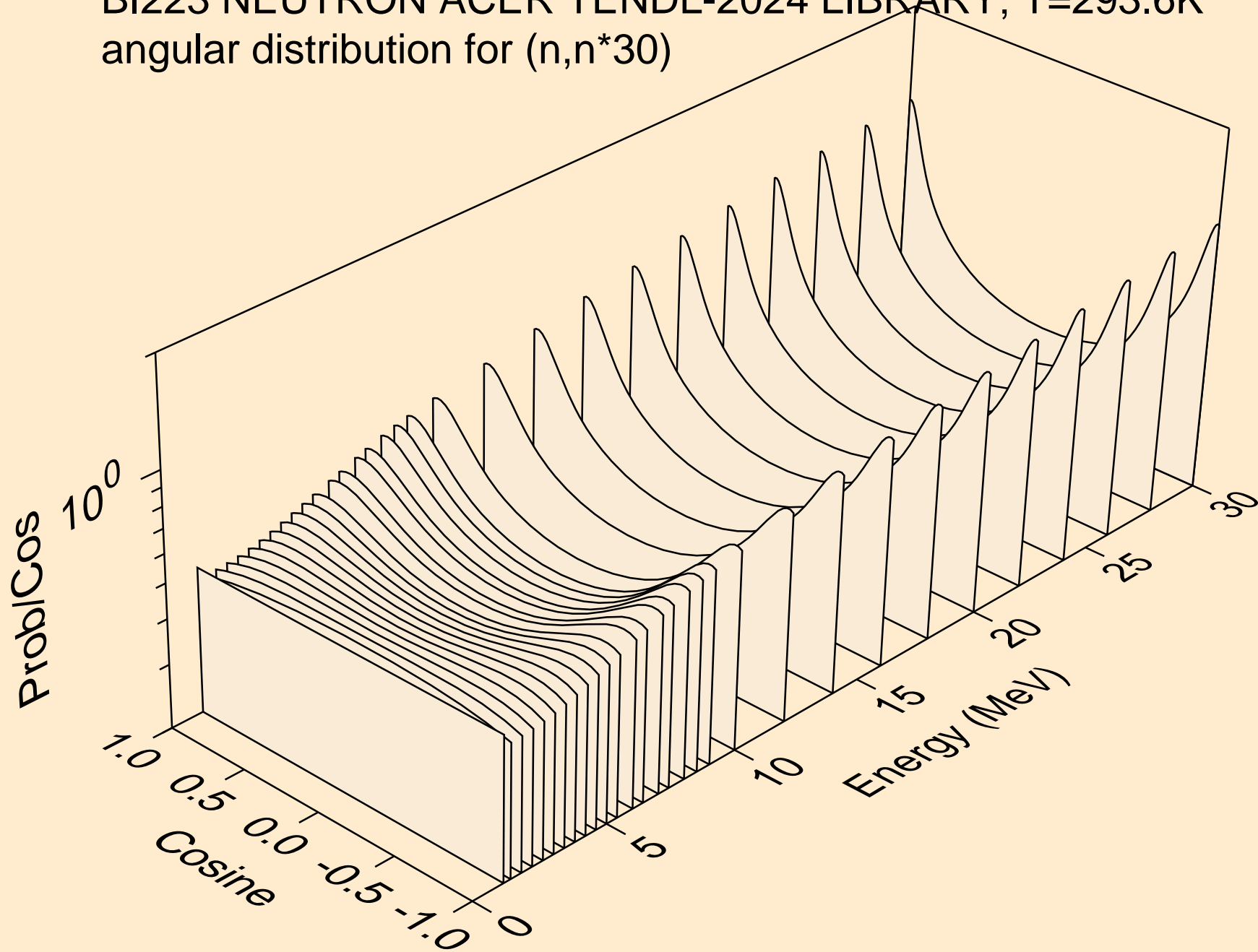

BI223 NEUTRON ACER TENDL-2024 LIBRARY; T=293.6K  
Total fission nubar

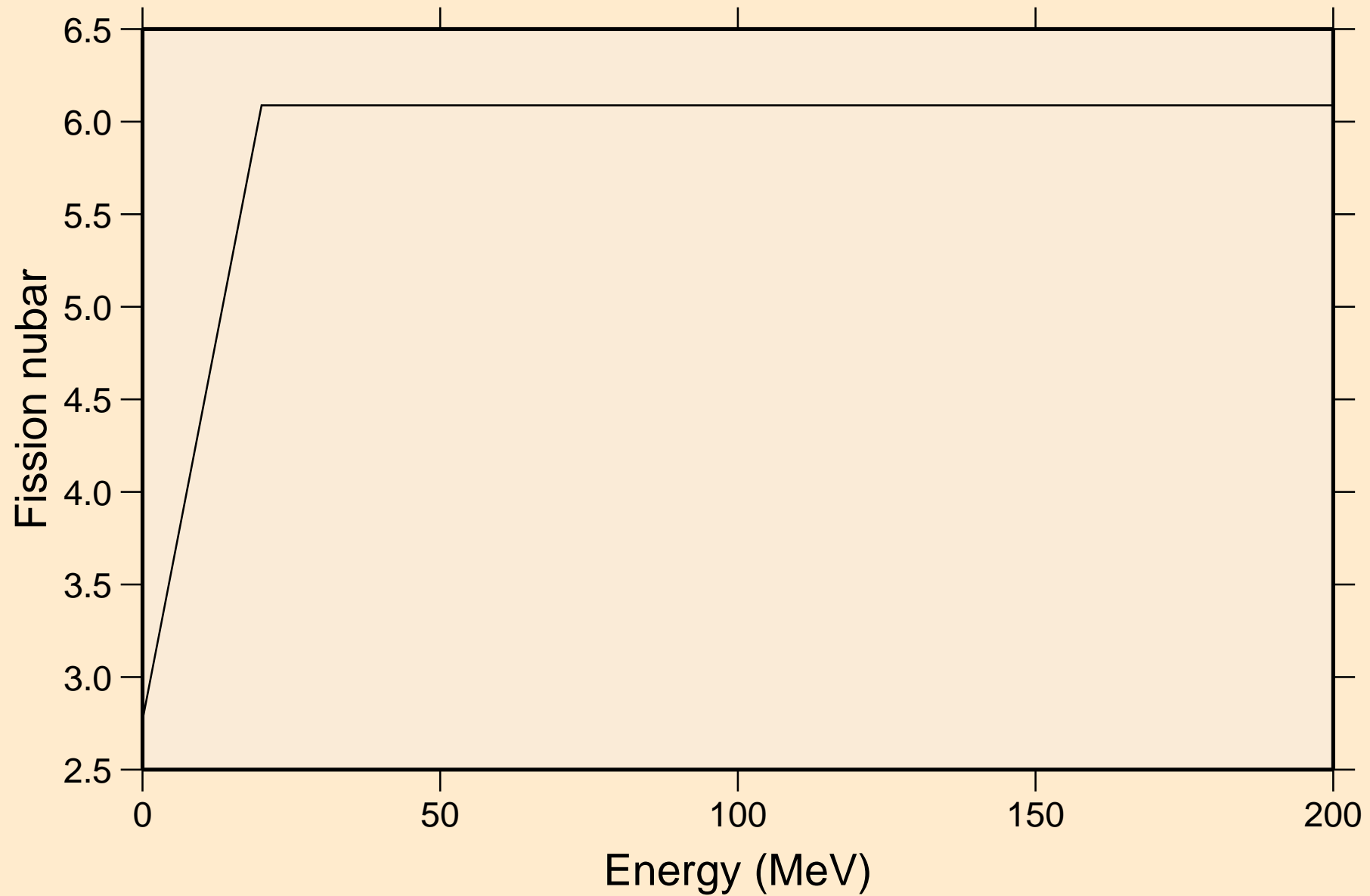

BI223 NEUTRON ACER TENDL-2024 LIBRARY; T=293.6K  
Neutron emission for (n,x)

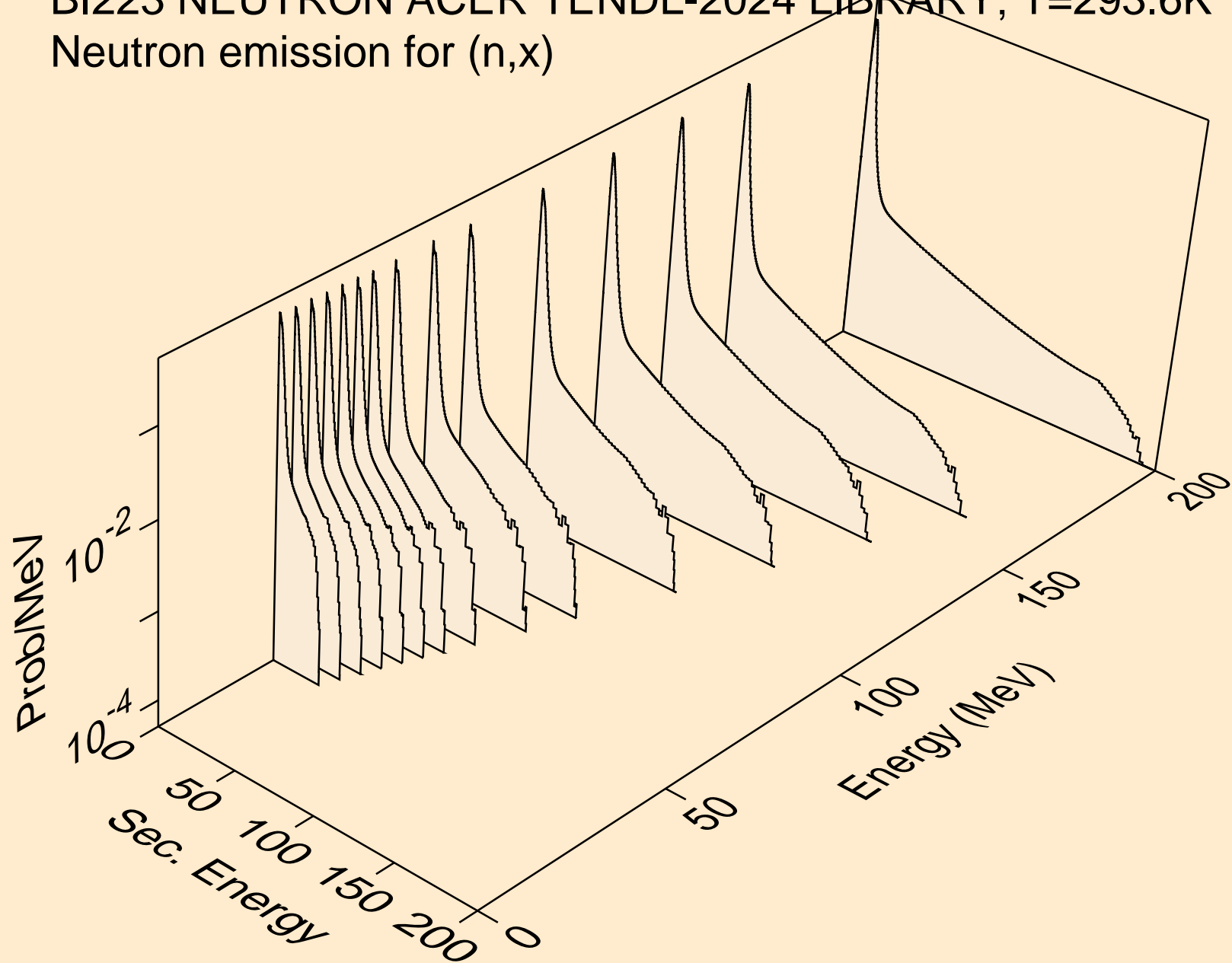

BI223 NEUTRON ACER TENDL-2024 LIBRARY; T=293.6K  
Neutron emission for (n,2nd)

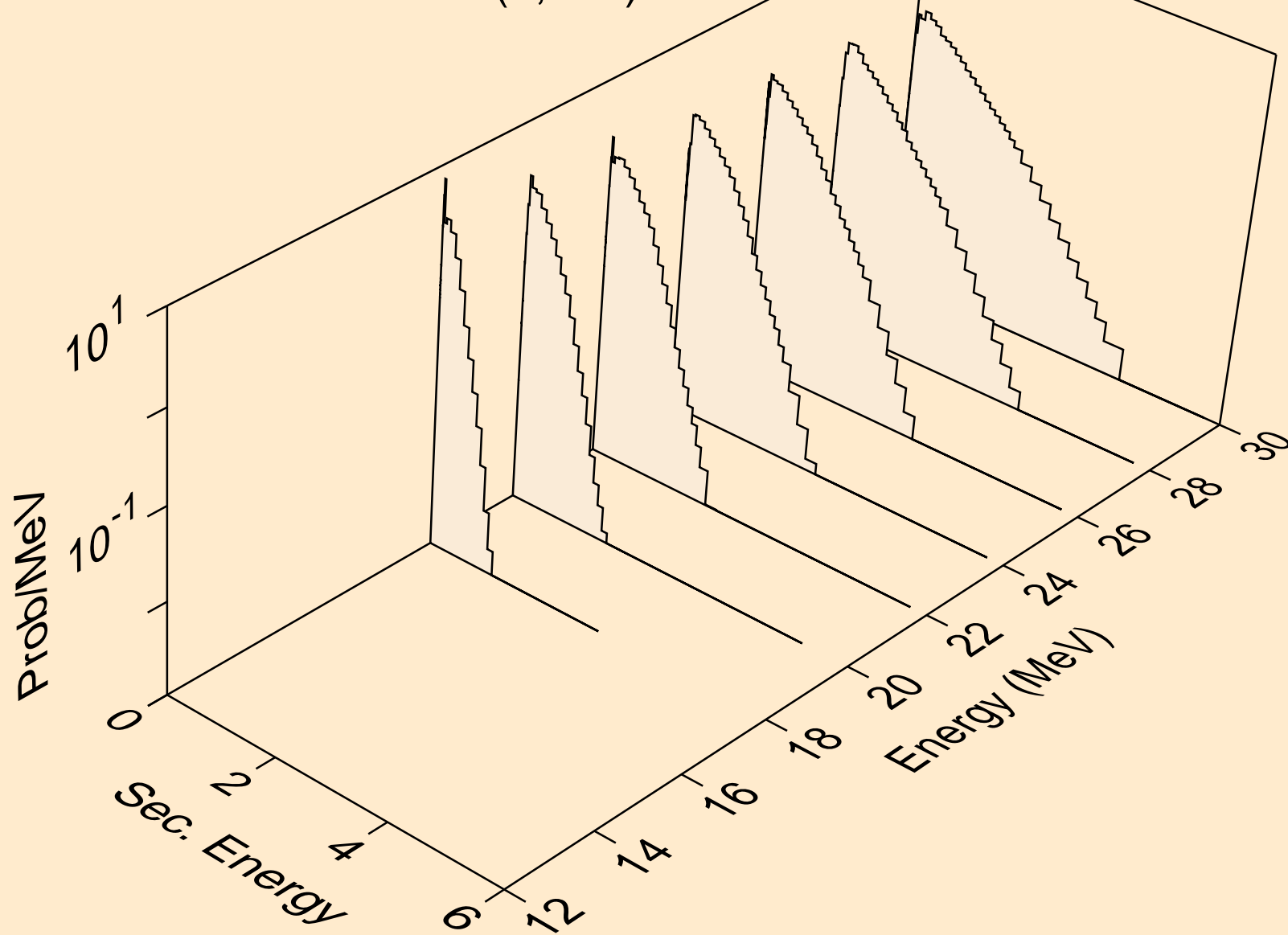

BI223 NEUTRON ACER TENDL-2024 LIBRARY; T=293.6K  
Neutron emission for (n,2n)

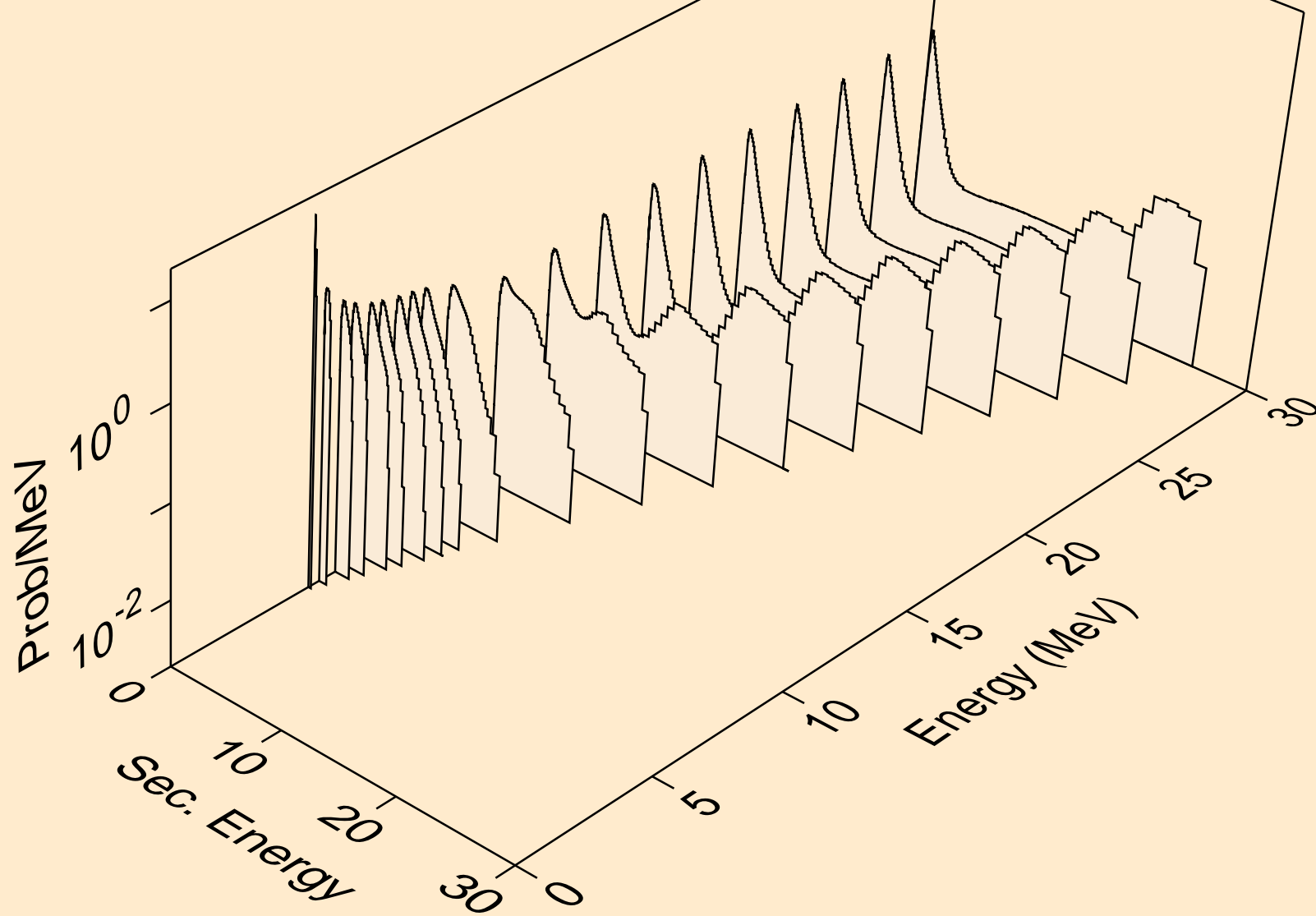

BI223 NEUTRON ACER TENDL-2024 LIBRARY; T=293.6K  
Neutron emission for (n,3n)

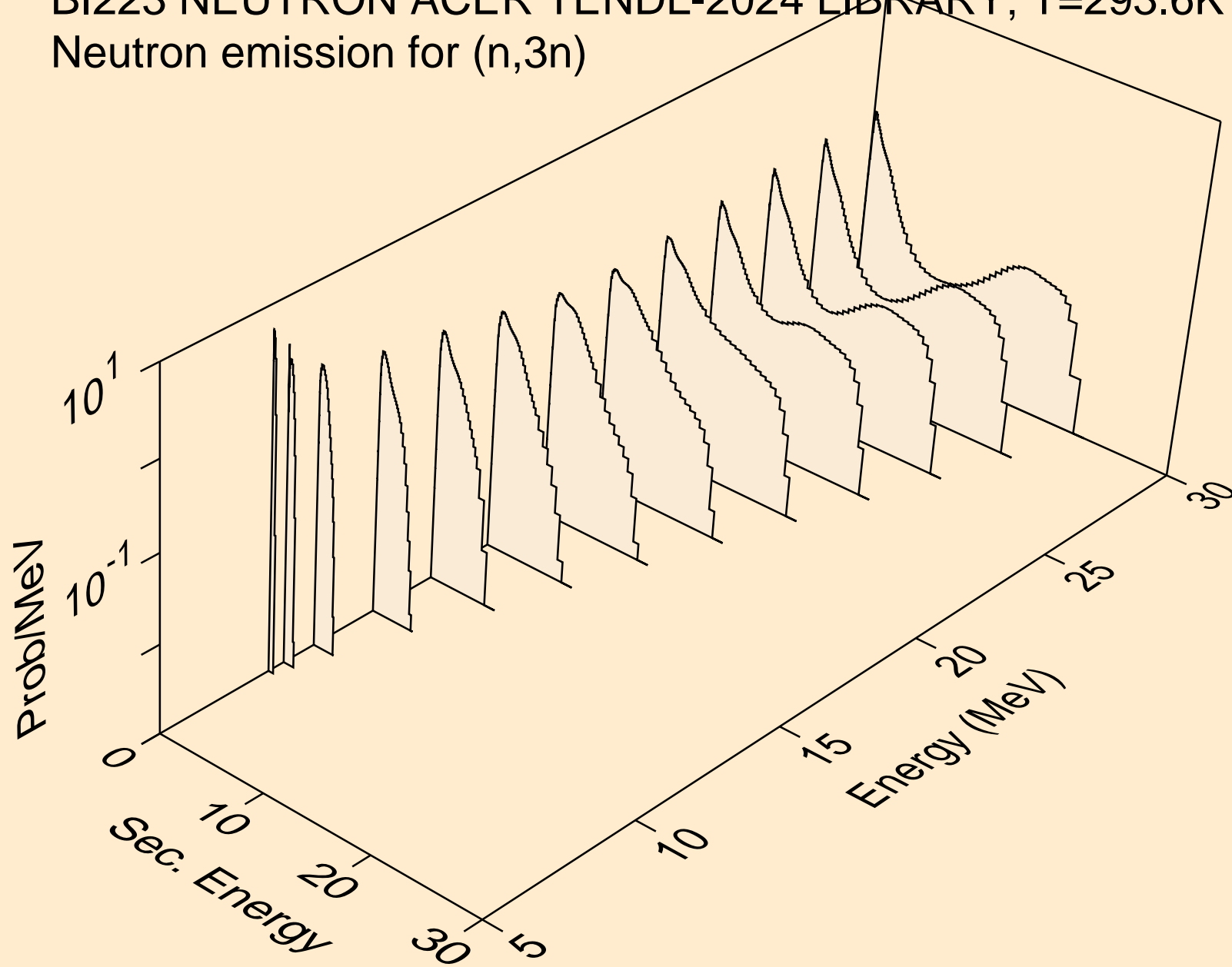

BI223 NEUTRON ACER TENDL-2024 LIBRARY; T=293.6K  
Neutron emission for fission

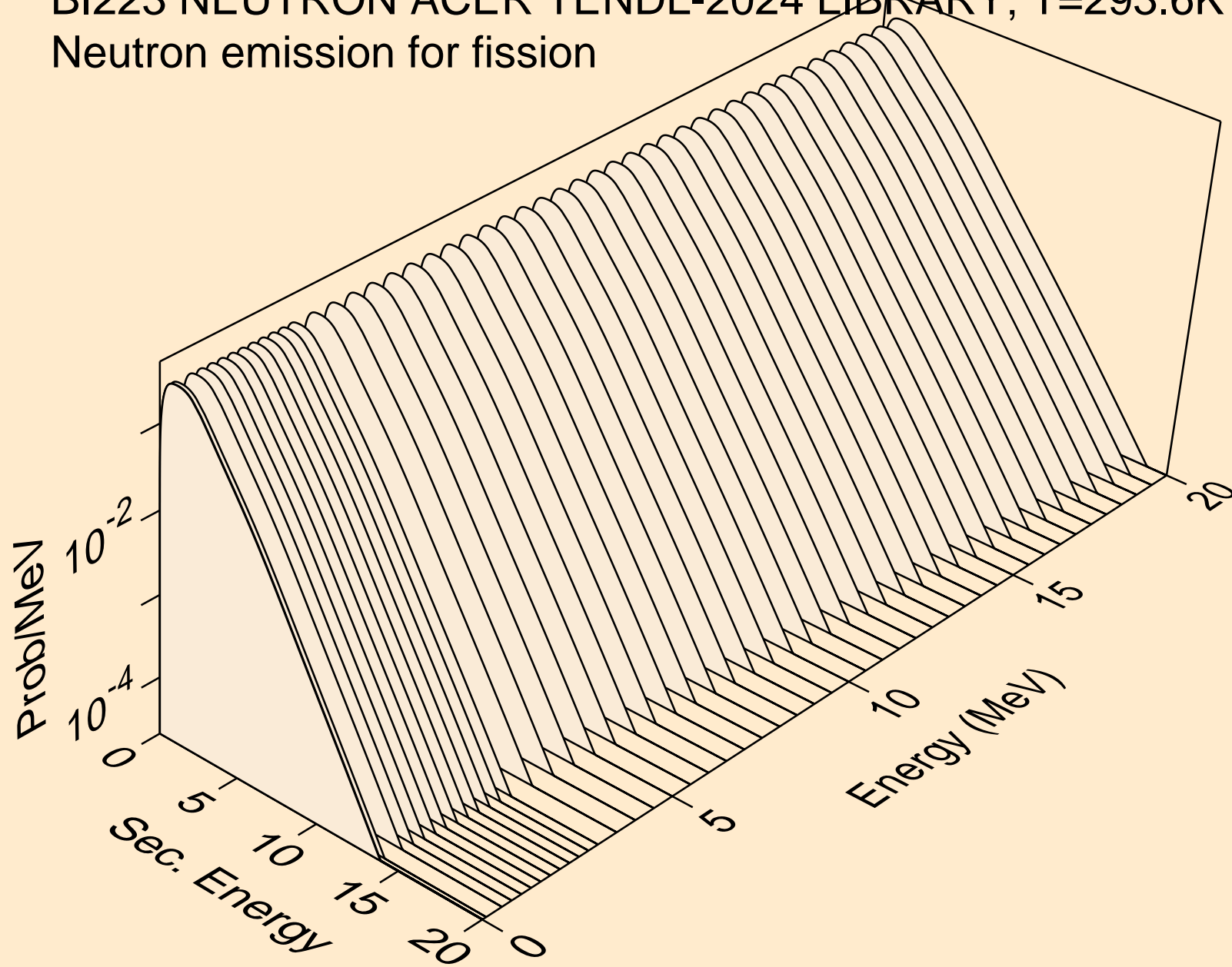

BI223 NEUTRON ACER TENDL-2024 LIBRARY; T=293.6K  
Neutron emission for (n,n\*)a

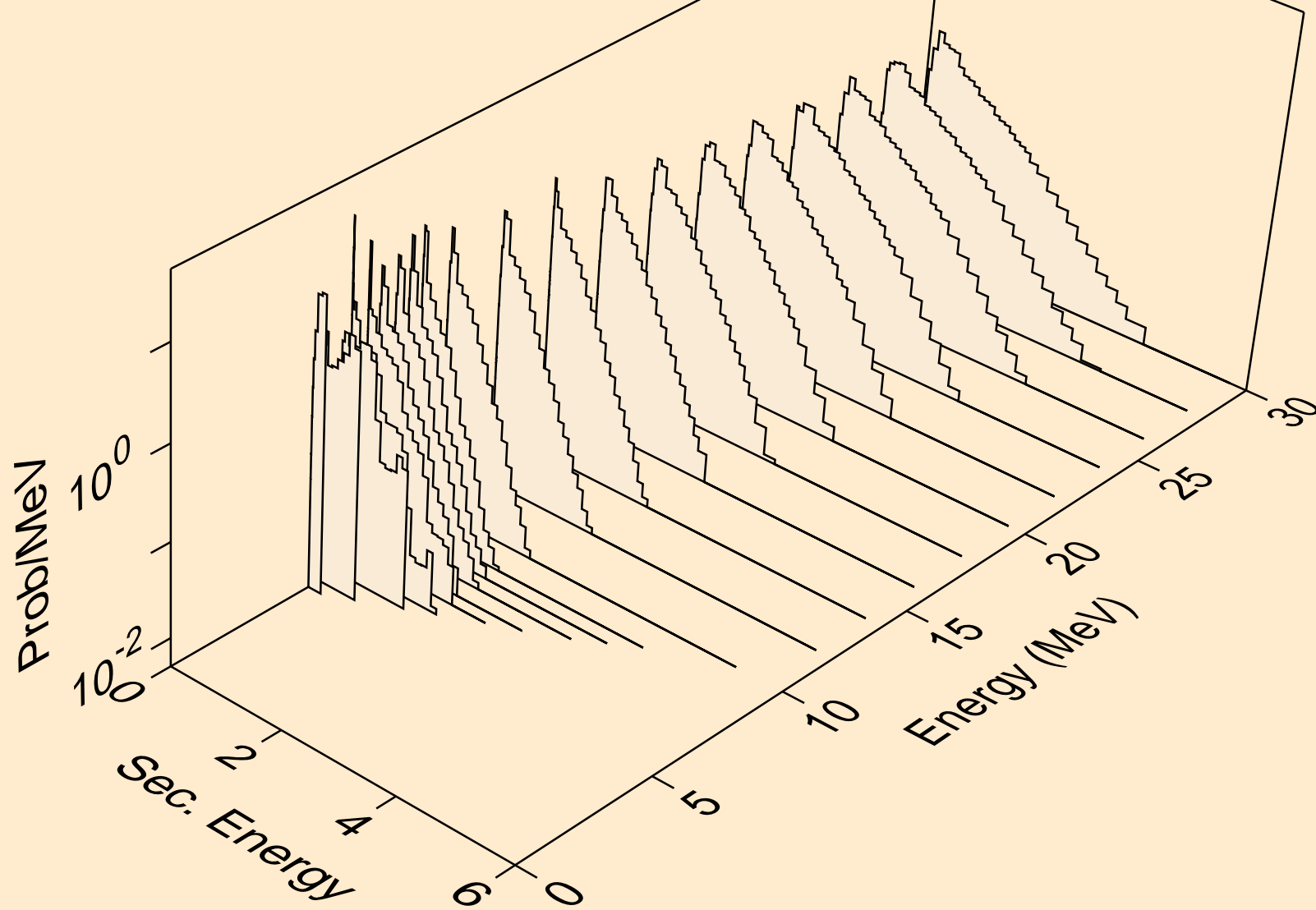

BI223 NEUTRON ACER TENDL-2024 LIBRARY; T=293.6K  
Neutron emission for (n,2n)a

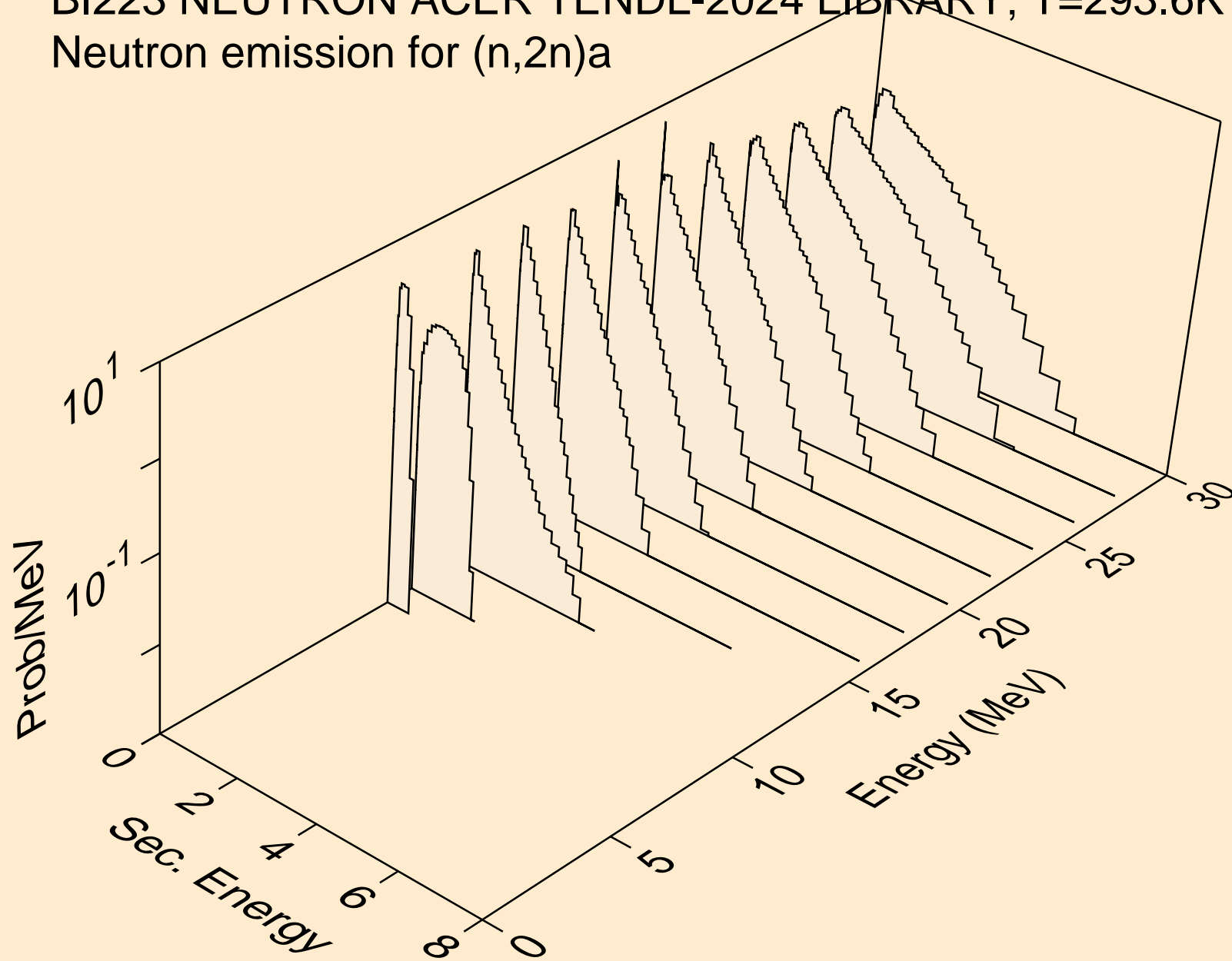

BI223 NEUTRON ACER TENDL-2024 LIBRARY; T=293.6K  
Neutron emission for (n,3n)a

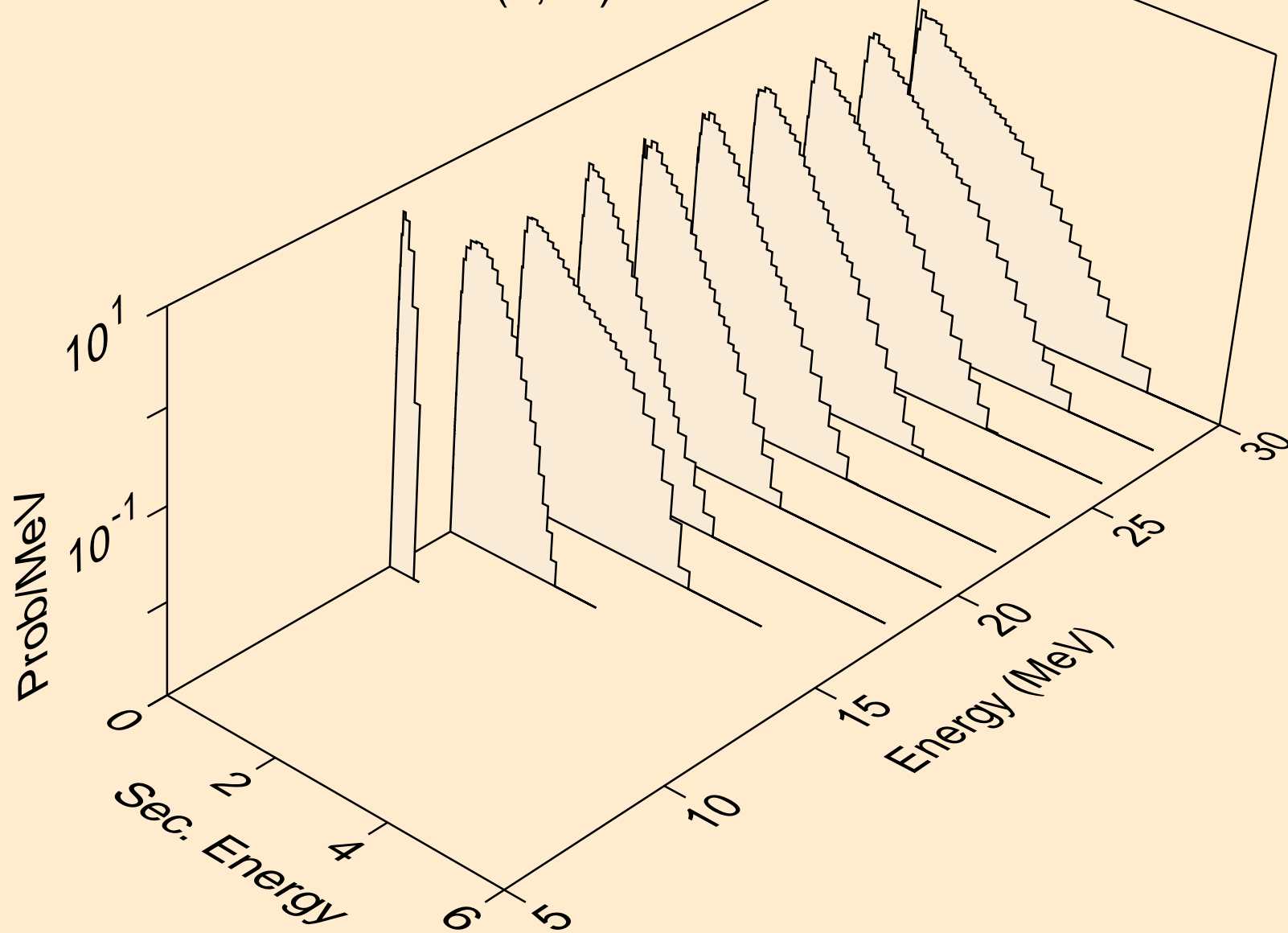

BI223 NEUTRON ACER TENDL-2024 LIBRARY; T=293.6K  
Neutron emission for (n,n\*)p

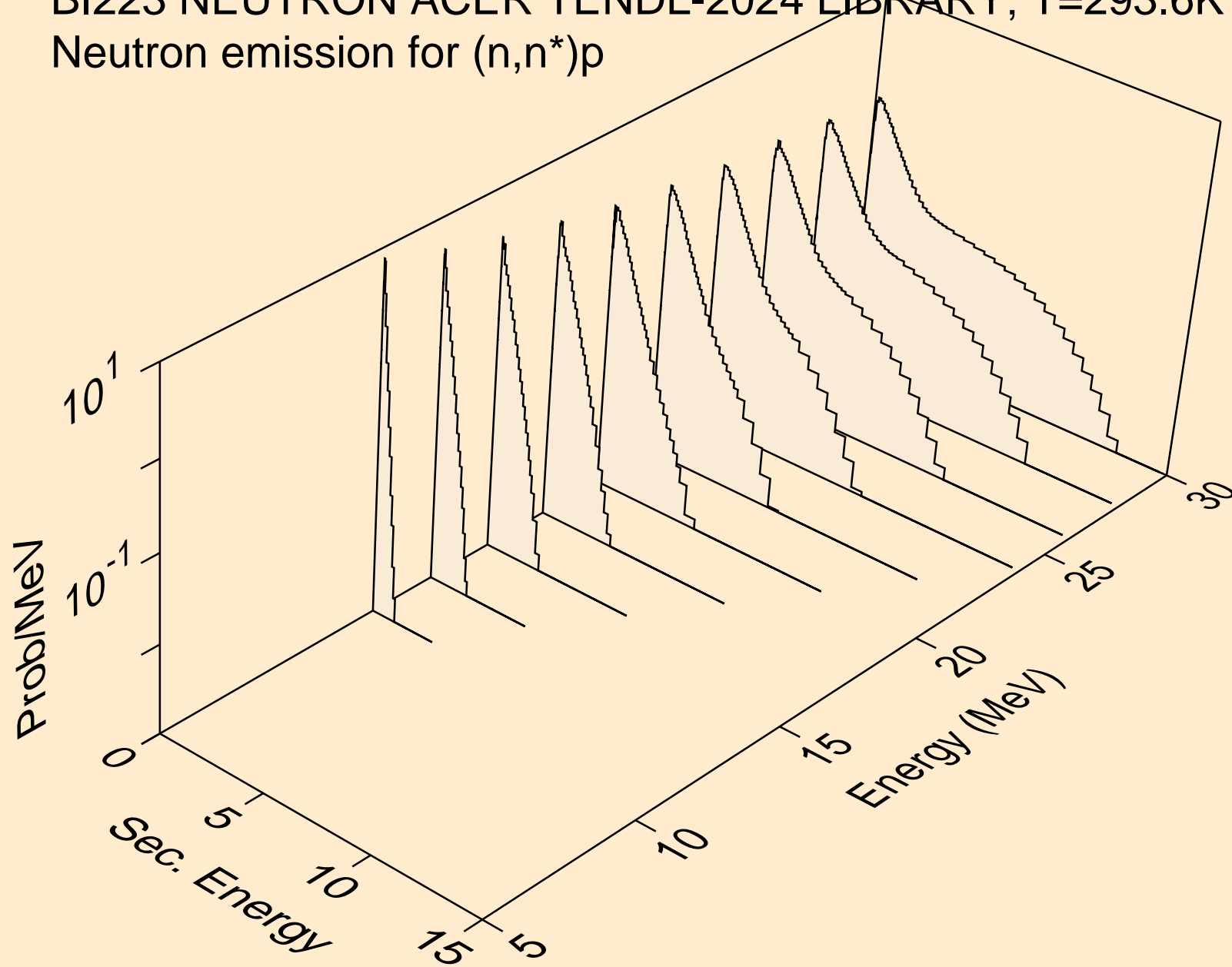

BI223 NEUTRON ACER TENDL-2024 LIBRARY; T=293.6K  
Neutron emission for (n,n\*)d

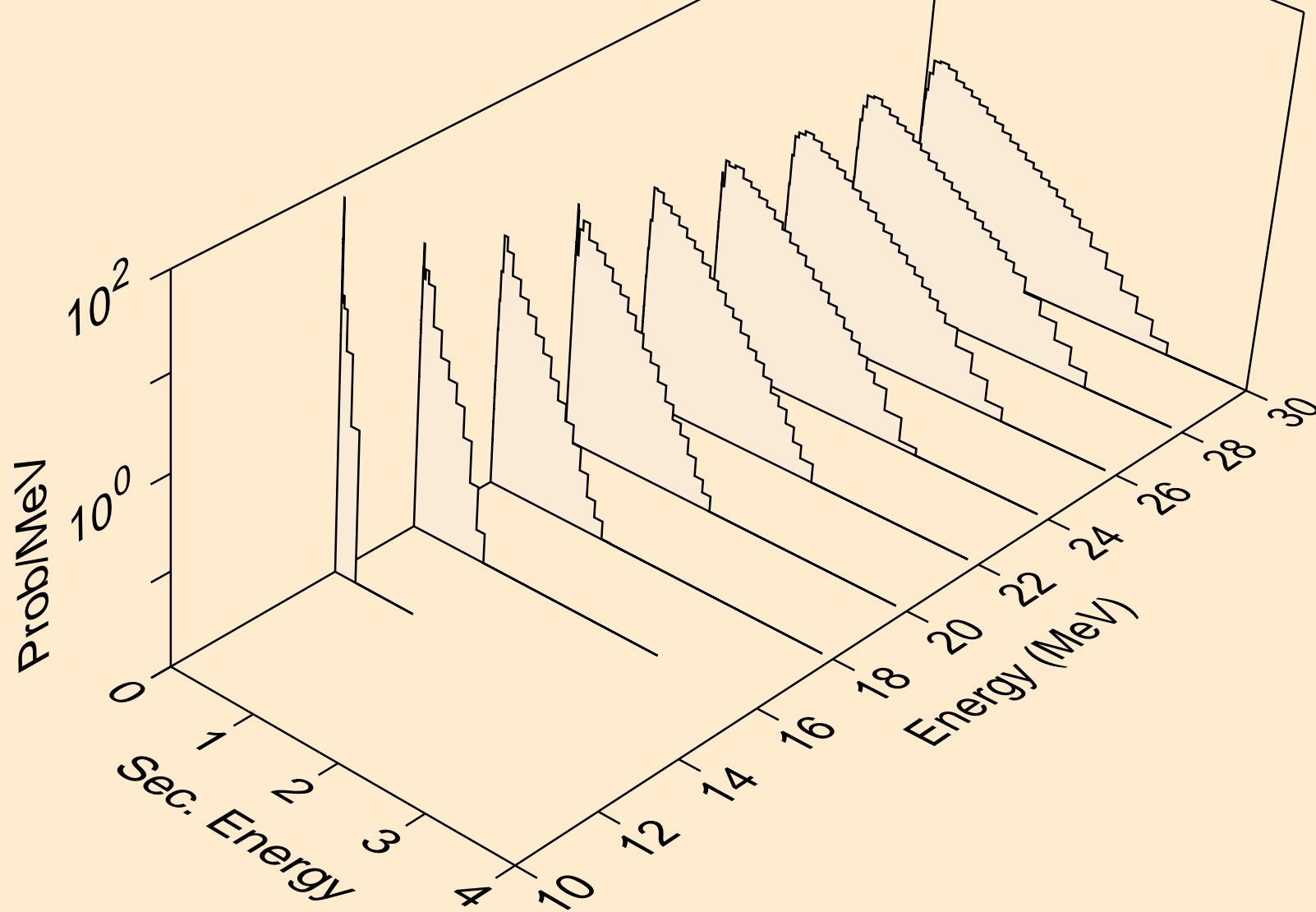

BI223 NEUTRON ACER TENDL-2024 LIBRARY; T=293.6K  
Neutron emission for (n,n\*)t

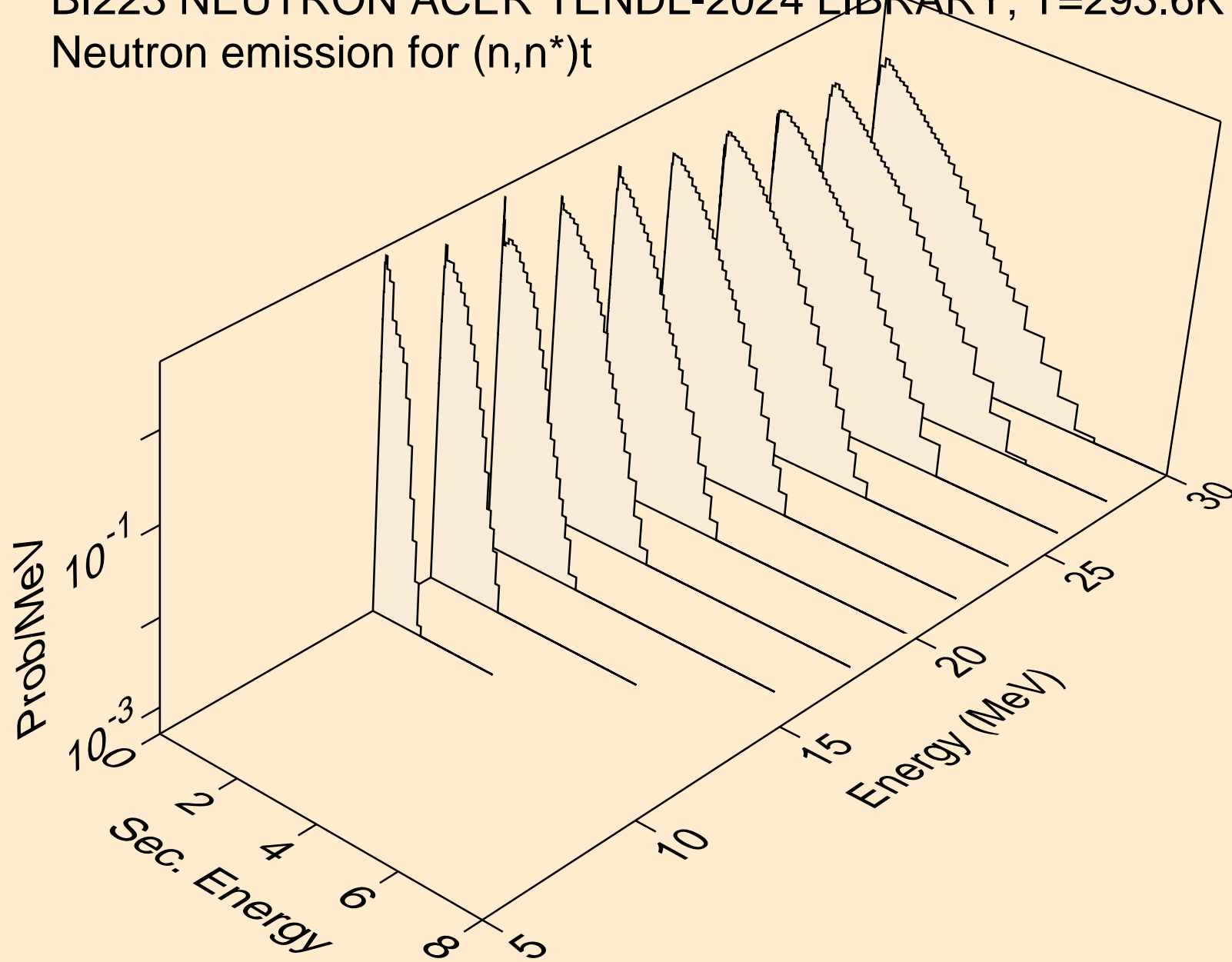

BI223 NEUTRON ACER TENDL-2024 LIBRARY; T=293.6K  
Neutron emission for (n,n\*)he3

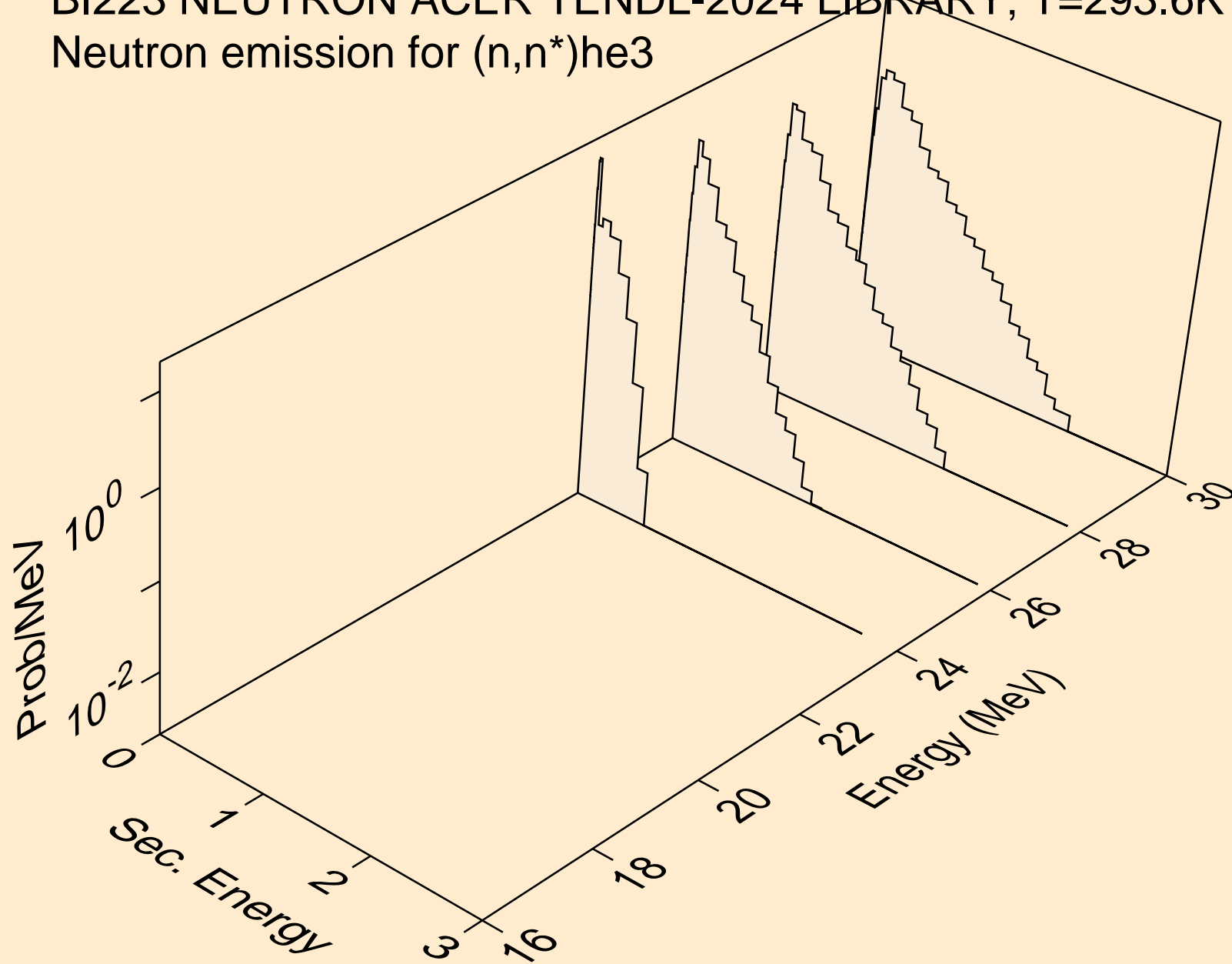

BI223 NEUTRON ACER TENDL-2024 LIBRARY; T=293.6K  
Neutron emission for (n,4n)

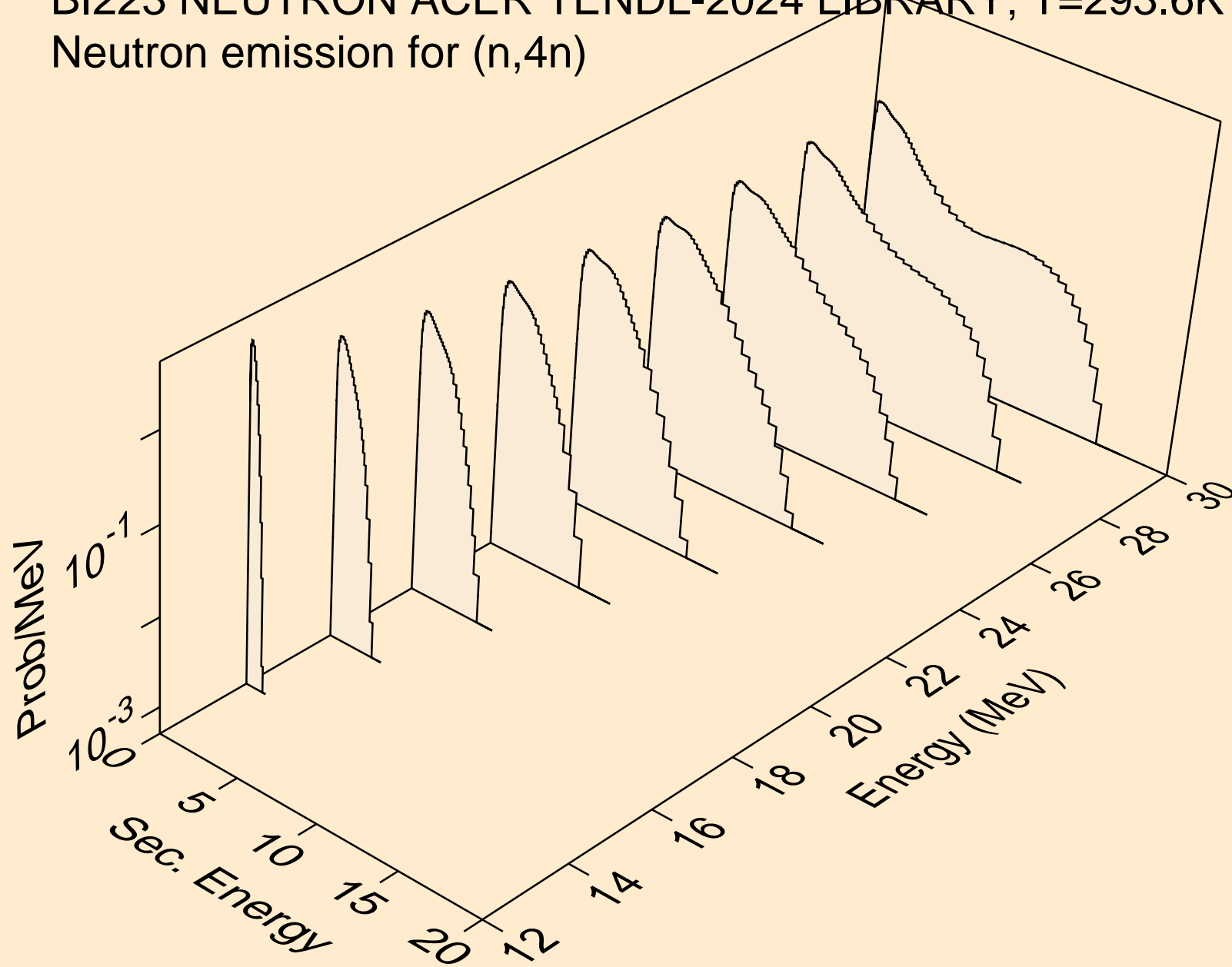

BI223 NEUTRON ACER TENDL-2024 LIBRARY; T=293.6K  
Neutron emission for (n,2np)

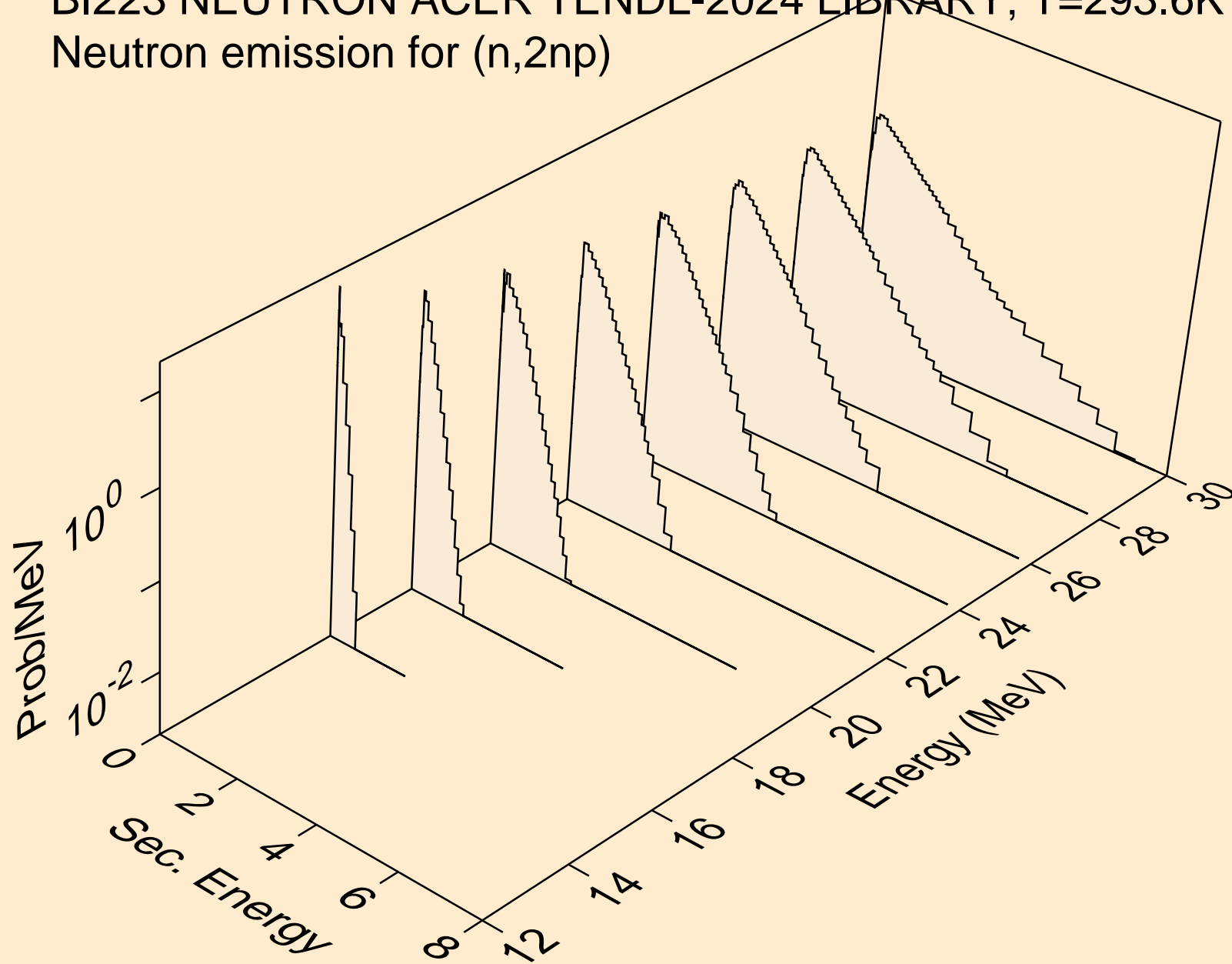

BI223 NEUTRON ACER TENDL-2024 LIBRARY; T=293.6K  
Neutron emission for (n,3np)

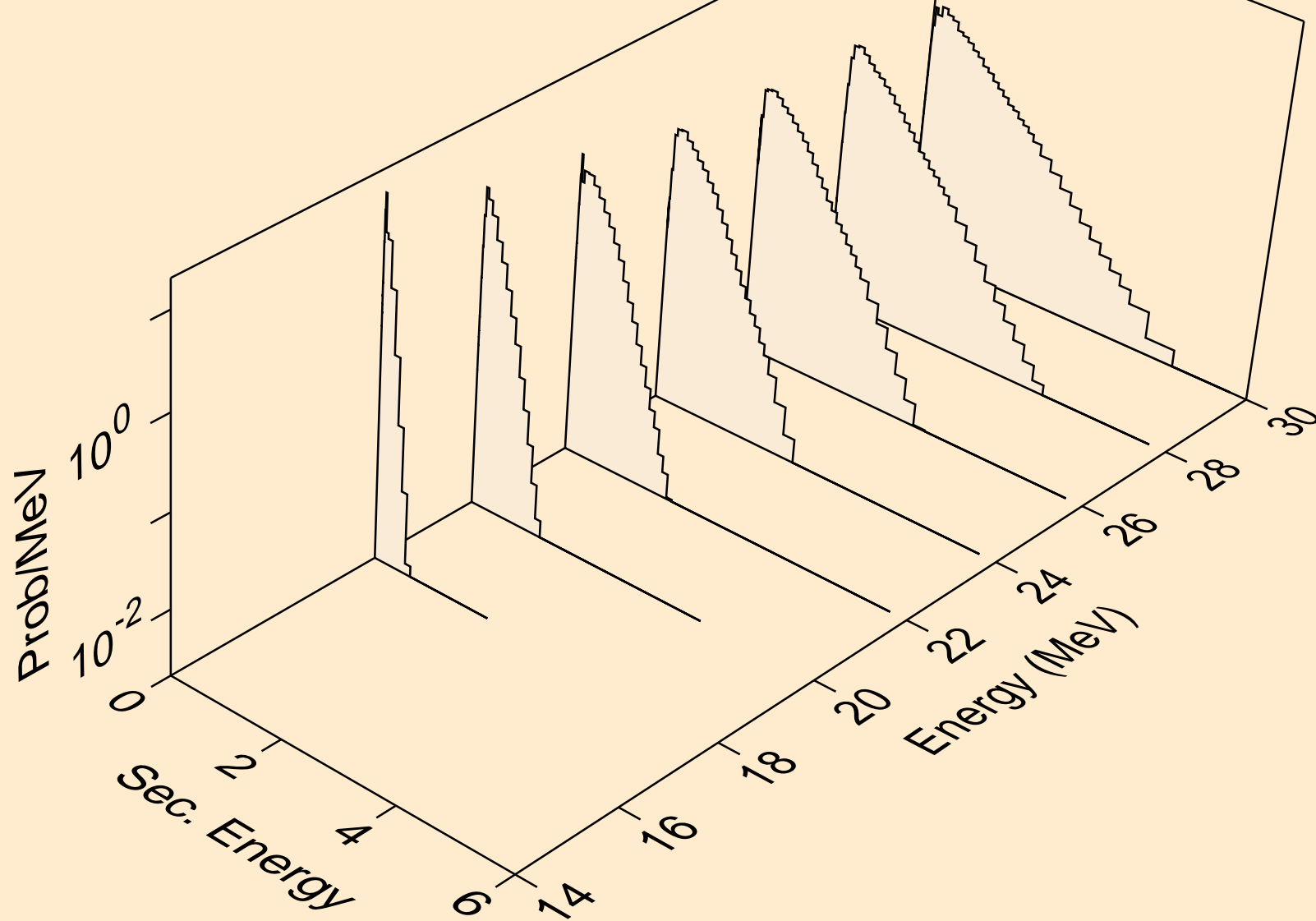

BI223 NEUTRON ACER TENDL-2024 LIBRARY; T=293.6K  
Neutron emission for (n,n\*c)

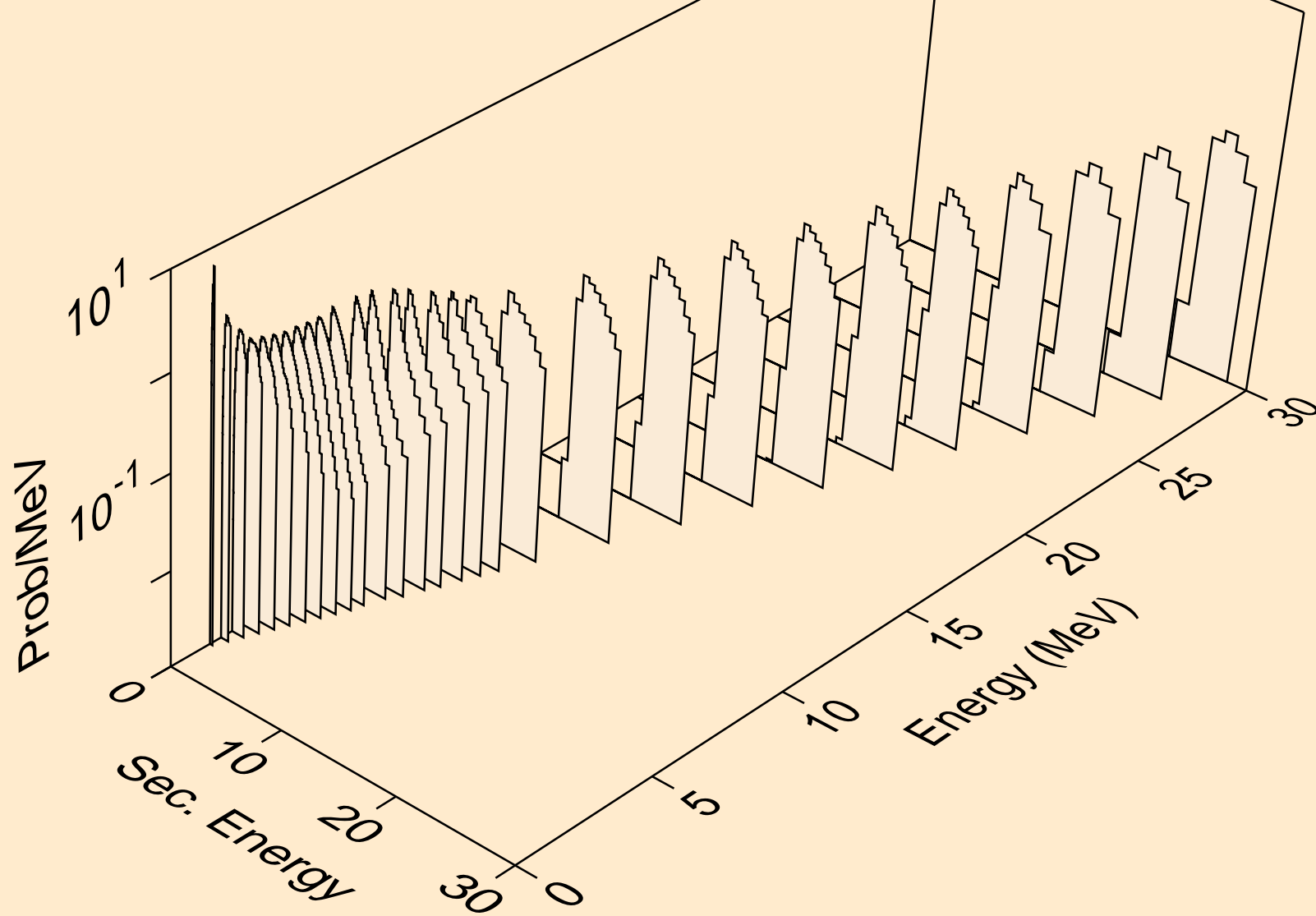

# BI223 NEUTRON ACER TENDL-2024 LIBRARY; T=293.6K

## Delayed nubar

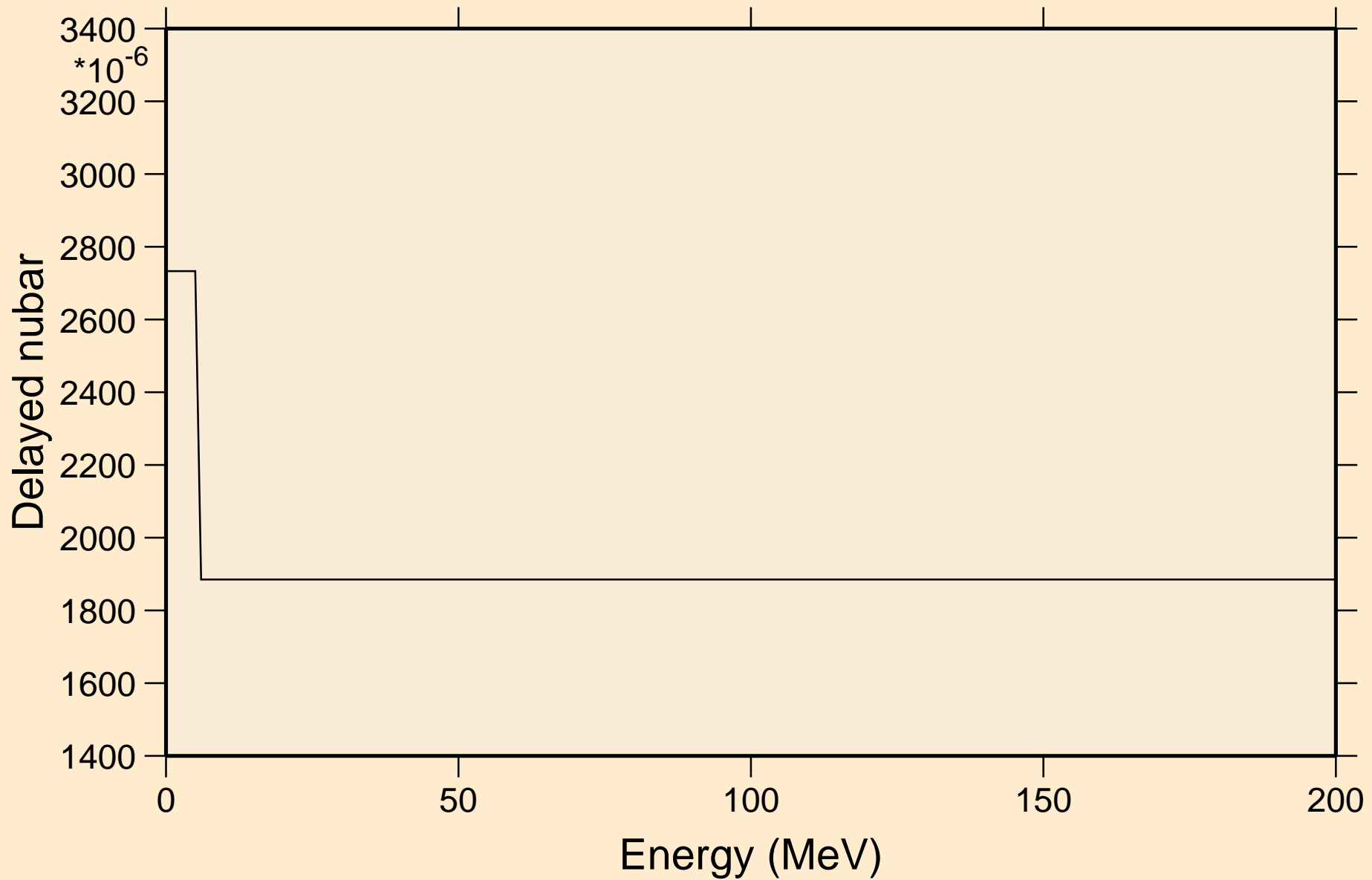

# BI223 NEUTRON ACER TENDL-2024 LIBRARY; T=293.6K

## Delayed neutron spectra

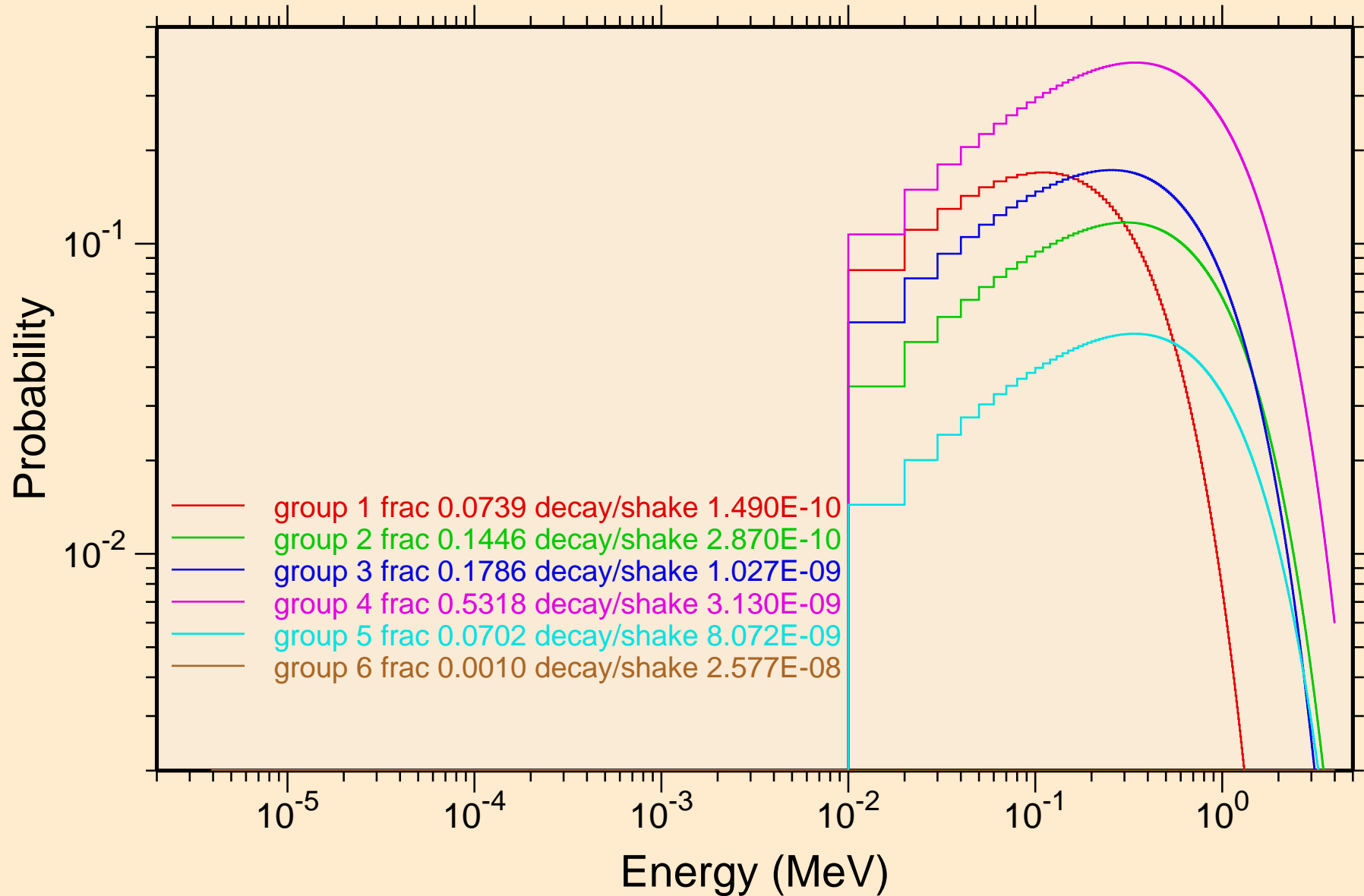

BI223 NEUTRON ACER TENDL-2024 LIBRARY; T=293.6K  
Photon emission for (n,x)

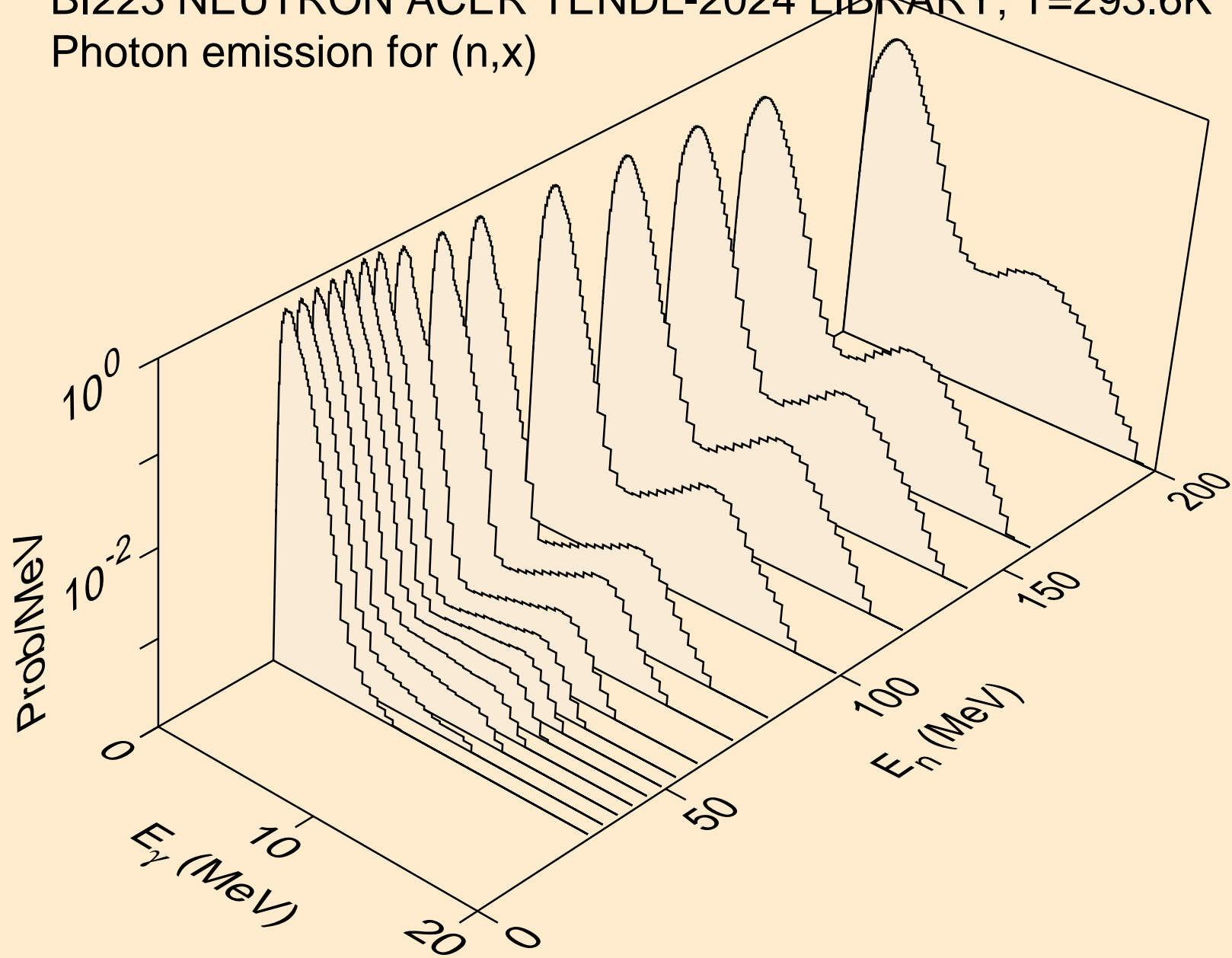

BI223 NEUTRON ACER TENDL-2024 LIBRARY; T=293.6K  
Photon emission for (n,2nd)

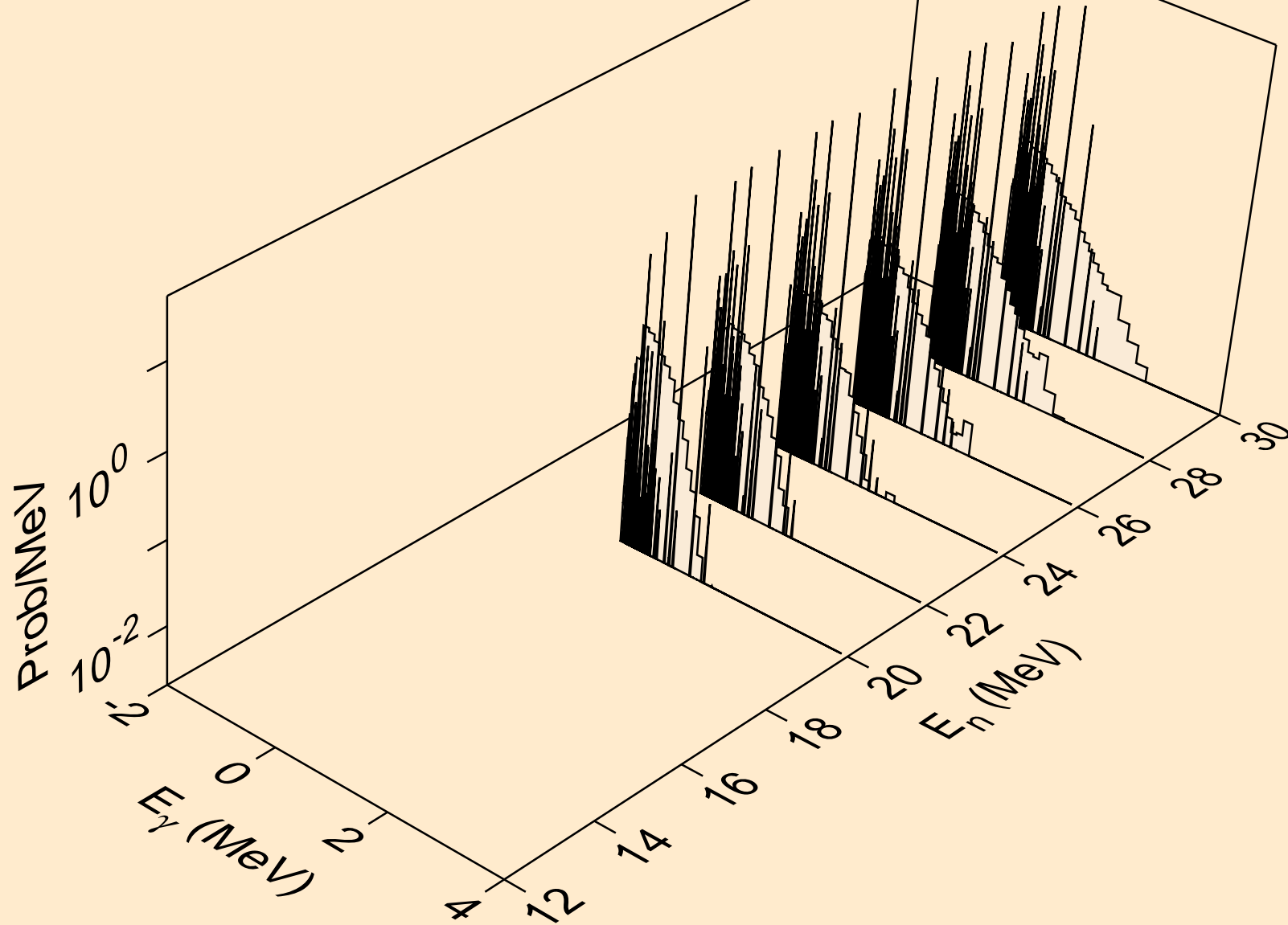

BI223 NEUTRON ACER TENDL-2024 LIBRARY; T=293.6K  
Photon emission for (n,2n)

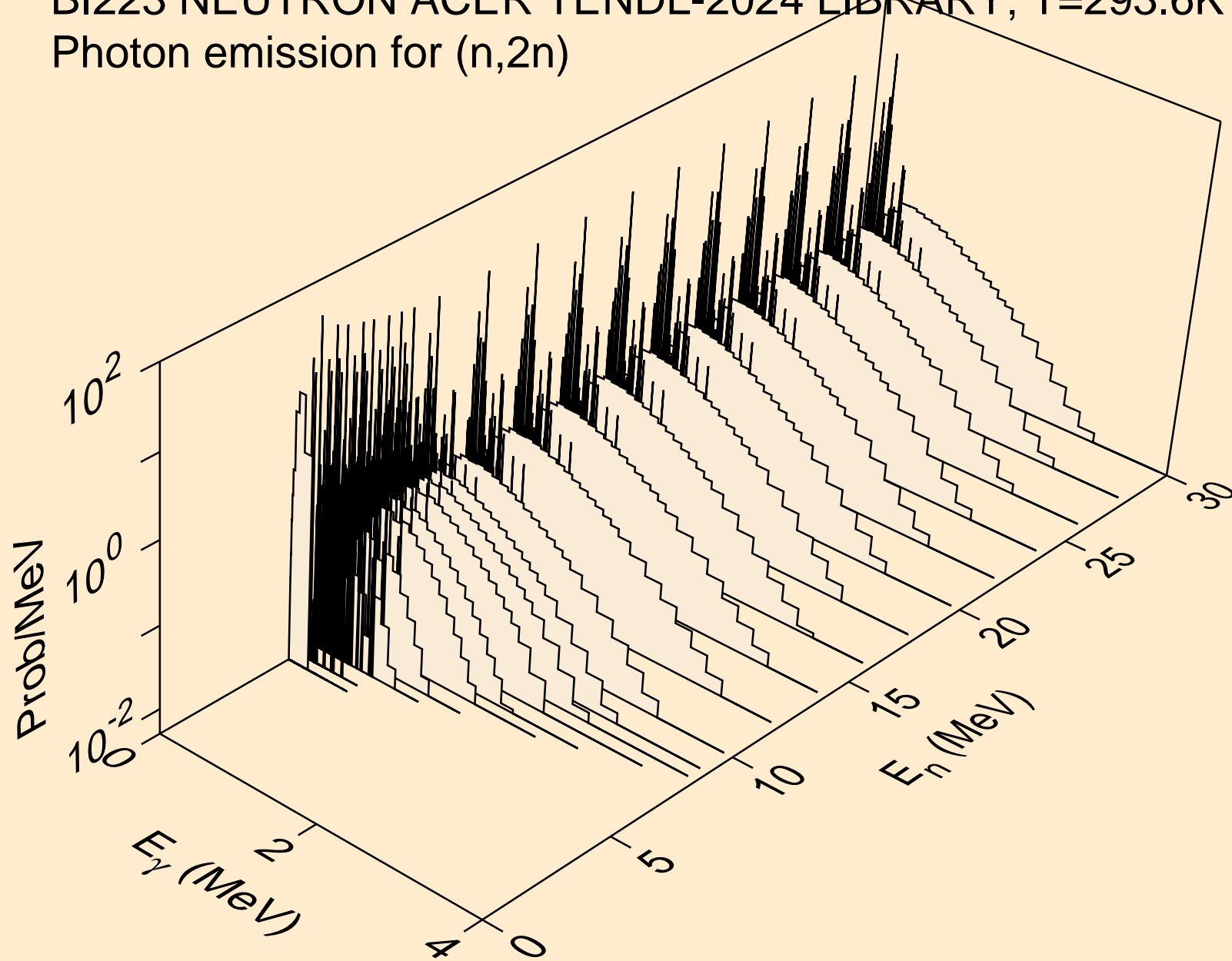

BI223 NEUTRON ACER TENDL-2024 LIBRARY; T=293.6K  
Photon emission for (n,3n)

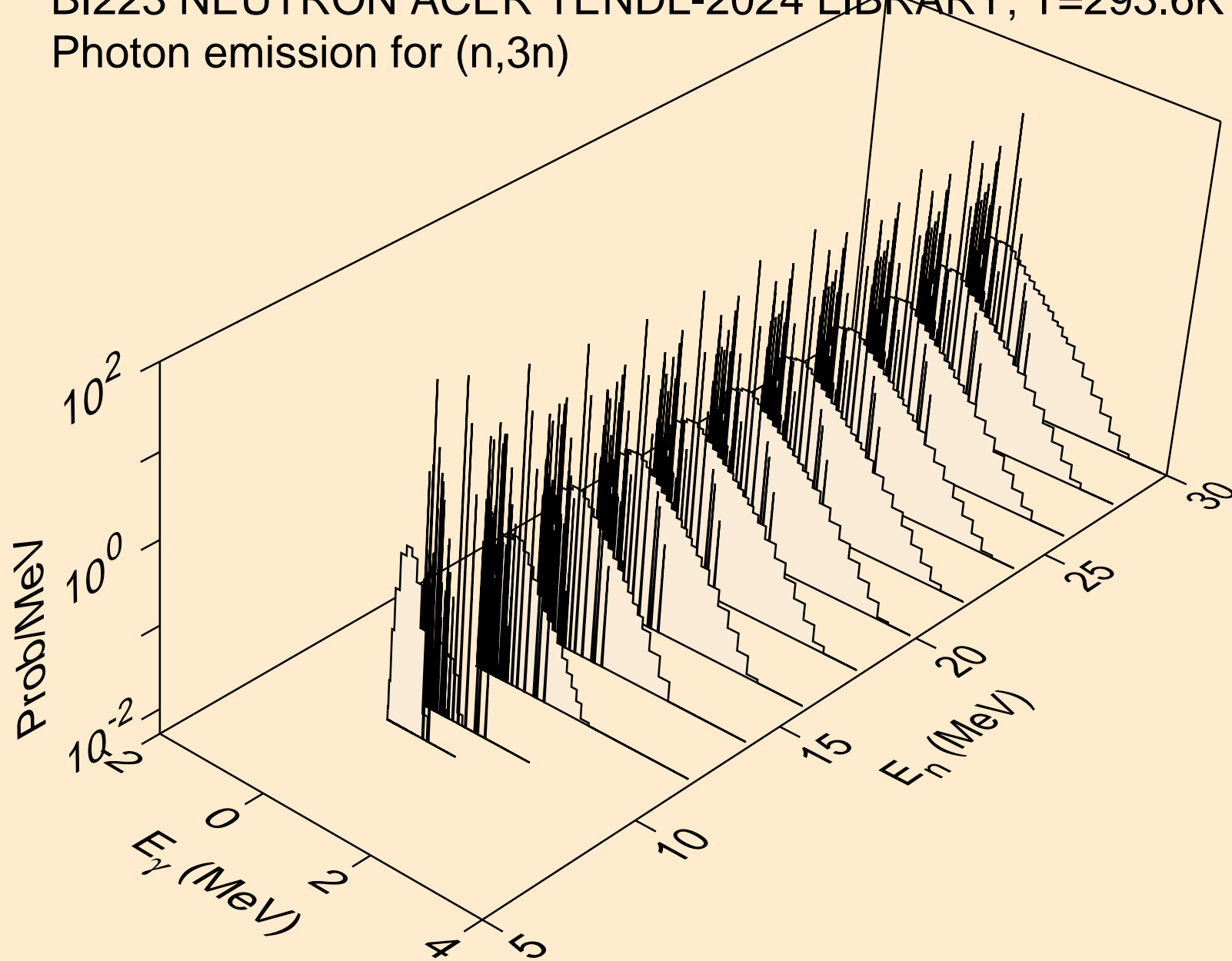

BI223 NEUTRON ACER TENDL-2024 LIBRARY; T=293.6K  
Photon emission for (n,n\*)a

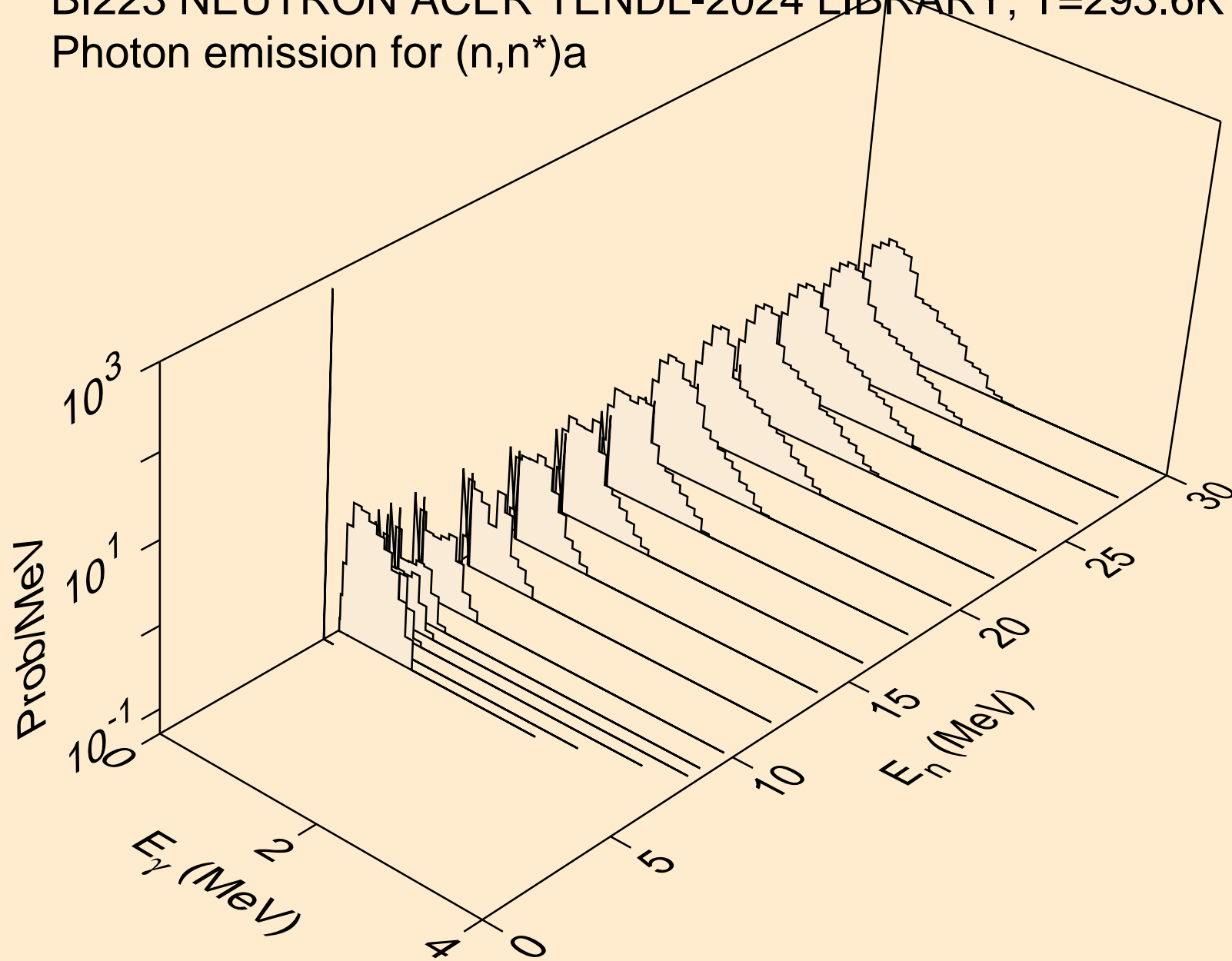

BI223 NEUTRON ACER TENDL-2024 LIBRARY; T=293.6K  
Photon emission for (n,2n)a

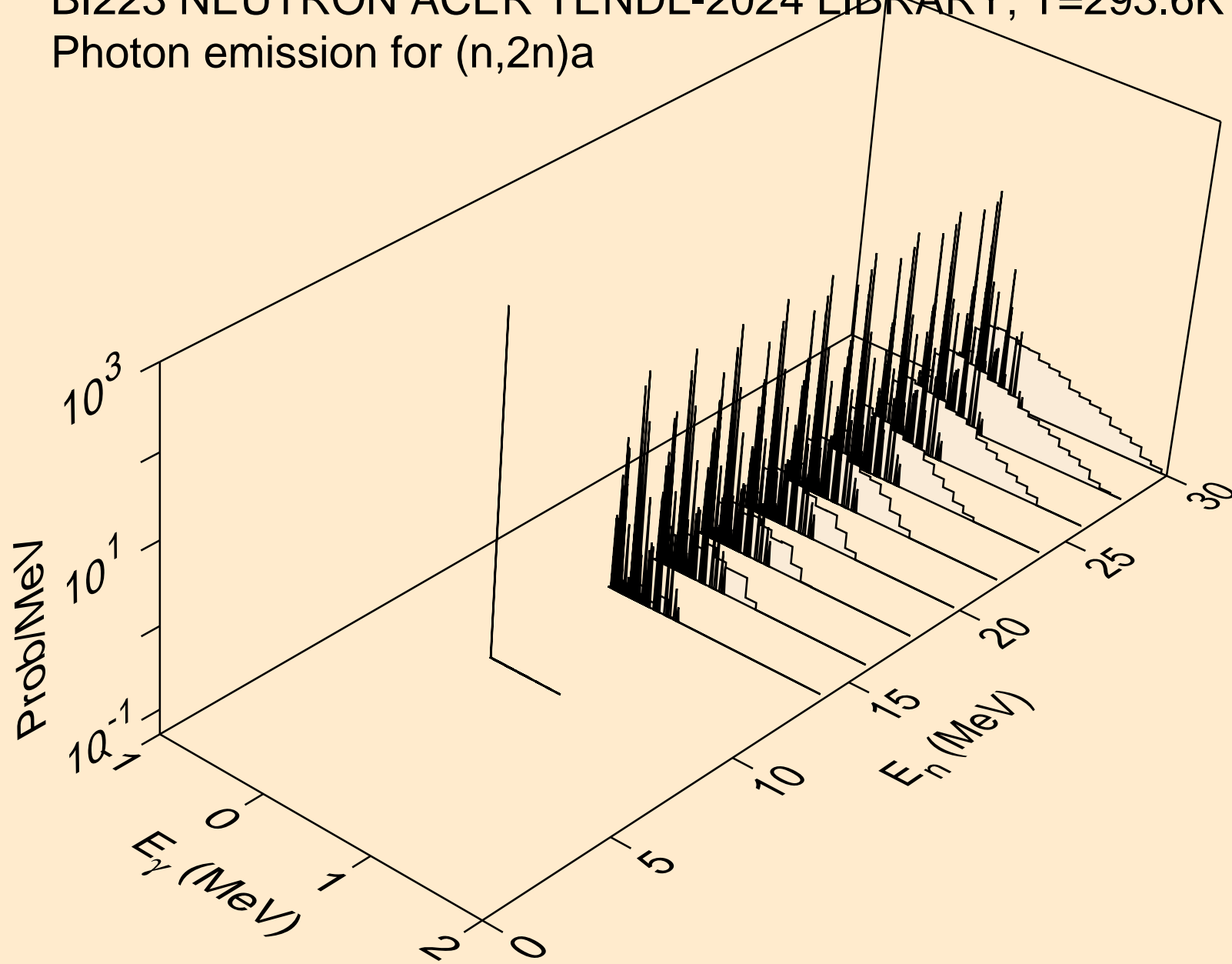

BI223 NEUTRON ACER TENDL-2024 LIBRARY; T=293.6K  
Photon emission for (n,3n)a

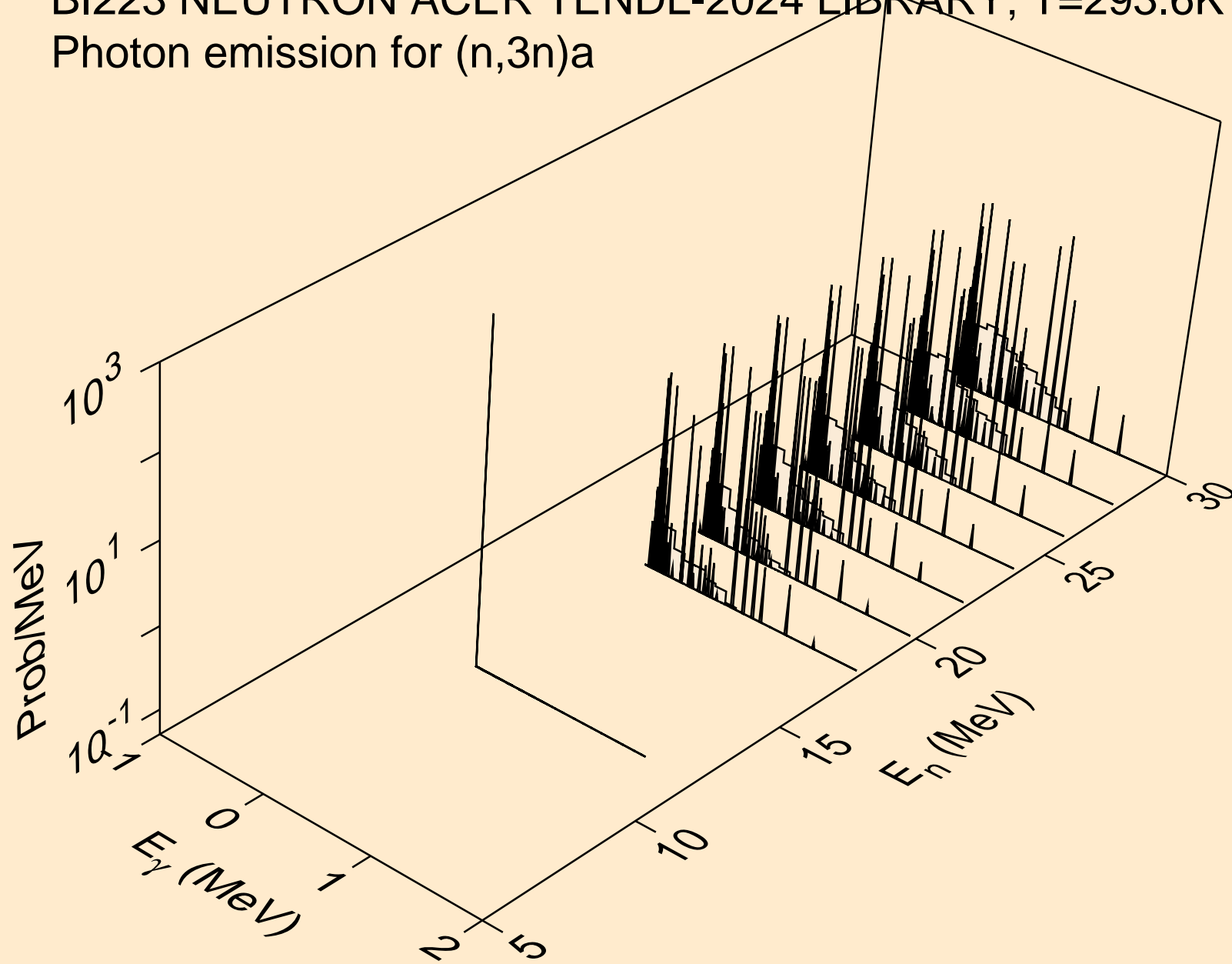

BI223 NEUTRON ACER TENDL-2024 LIBRARY; T=293.6K  
Photon emission for (n,n\*)p

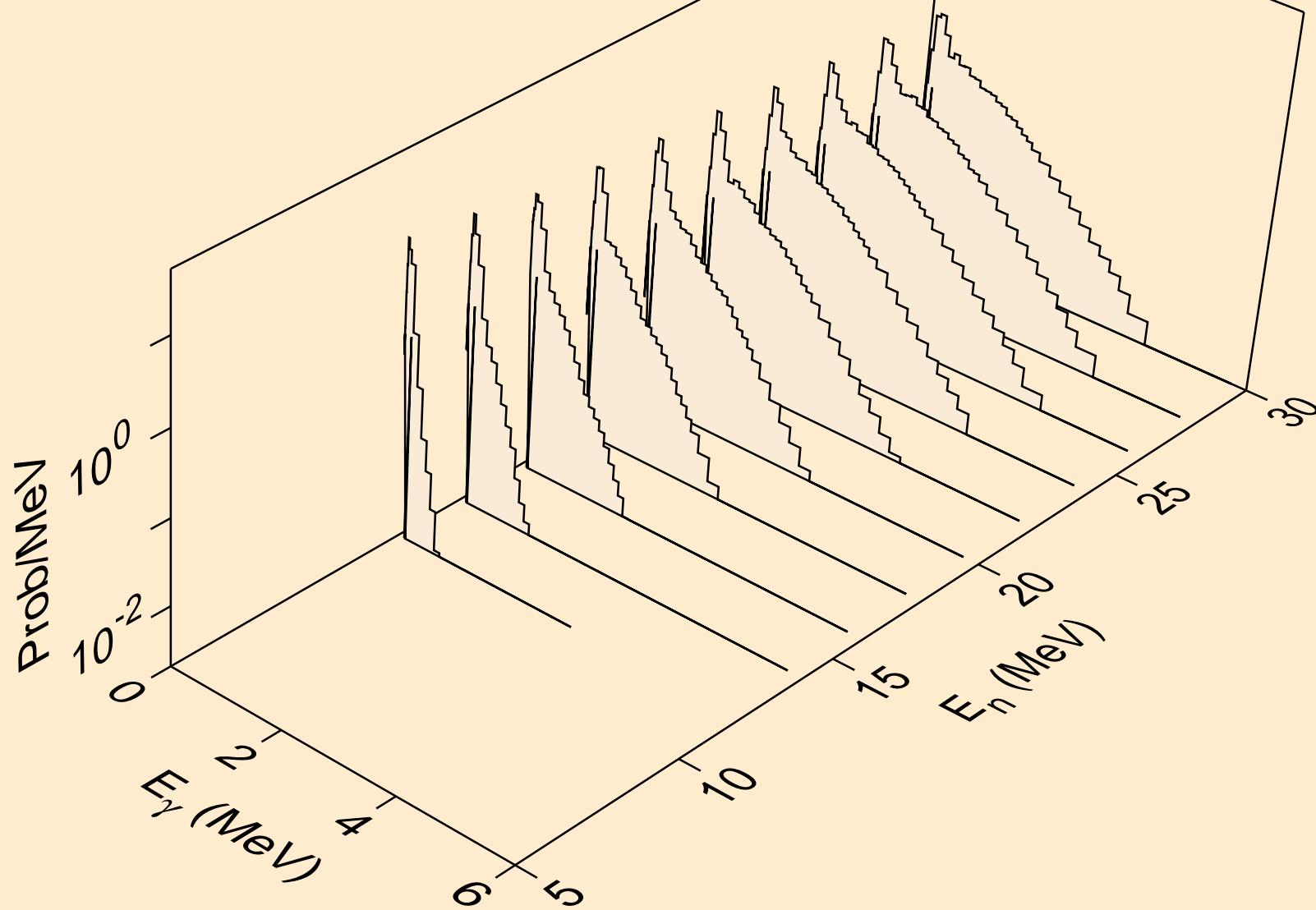

BI223 NEUTRON ACER TENDL-2024 LIBRARY; T=293.6K  
Photon emission for (n,n\*)d

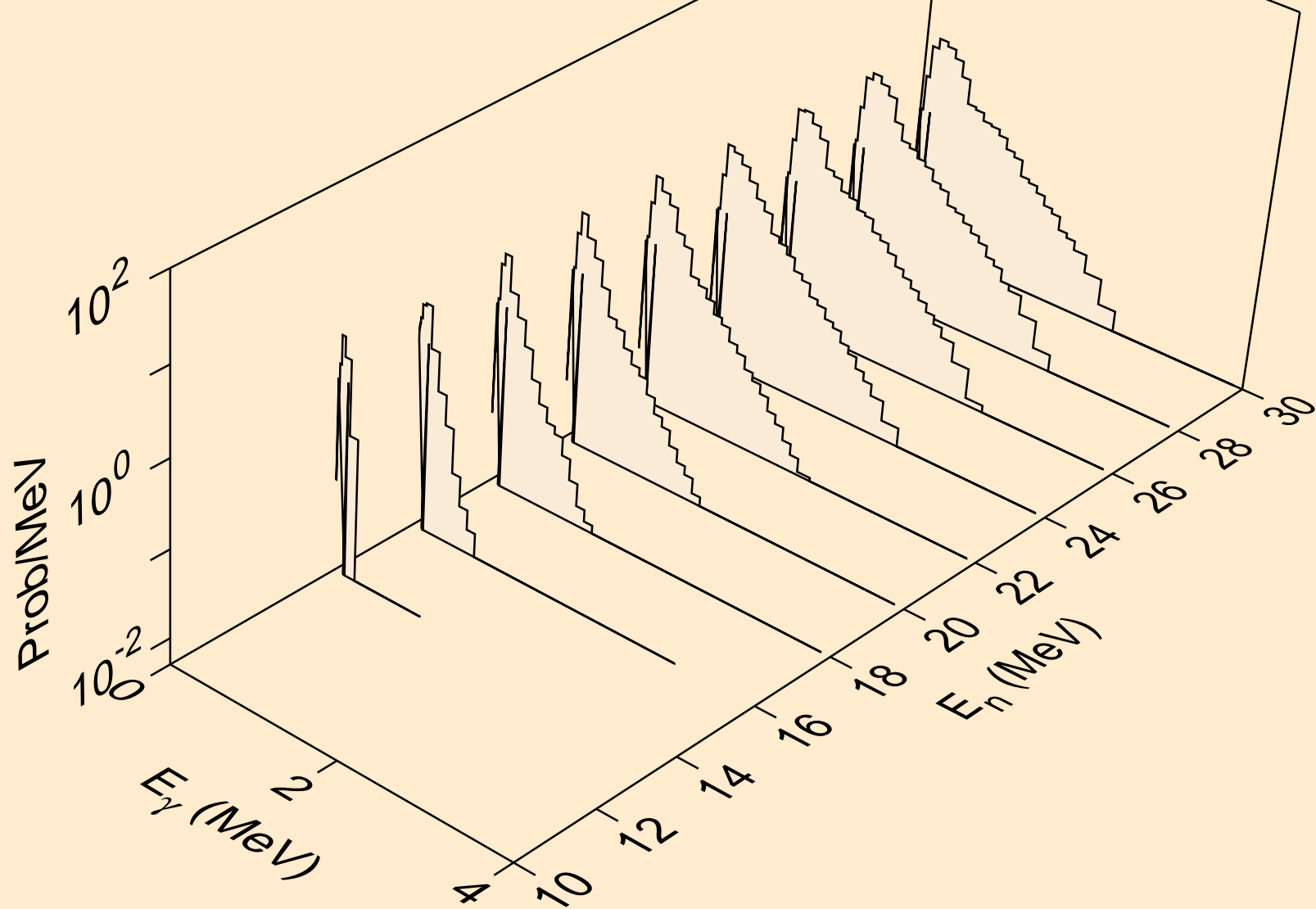

BI223 NEUTRON ACER TENDL-2024 LIBRARY; T=293.6K  
Photon emission for (n,n\*)t

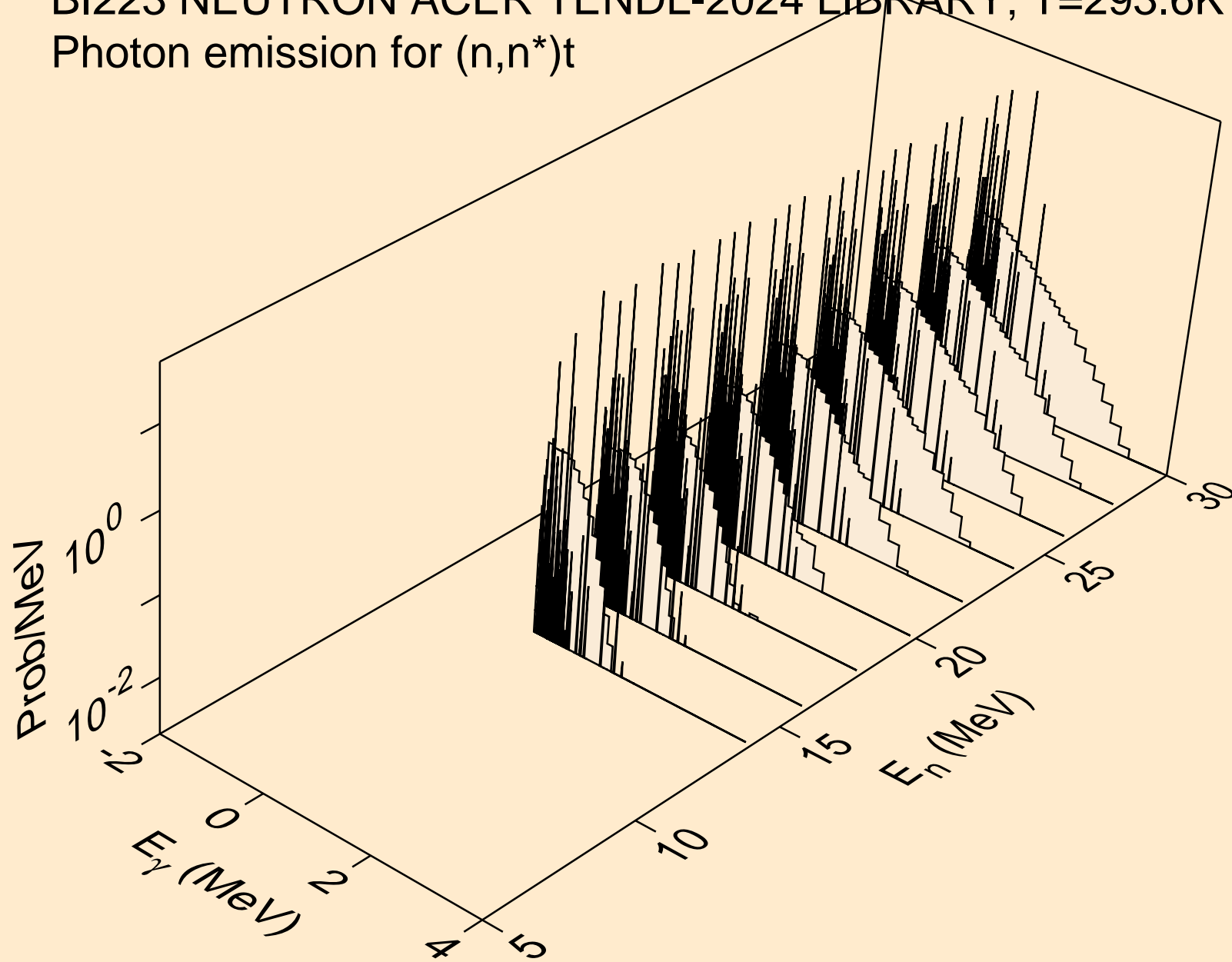

BI223 NEUTRON ACER TENDL-2024 LIBRARY; T=293.6K  
Photon emission for (n,n\*)he3

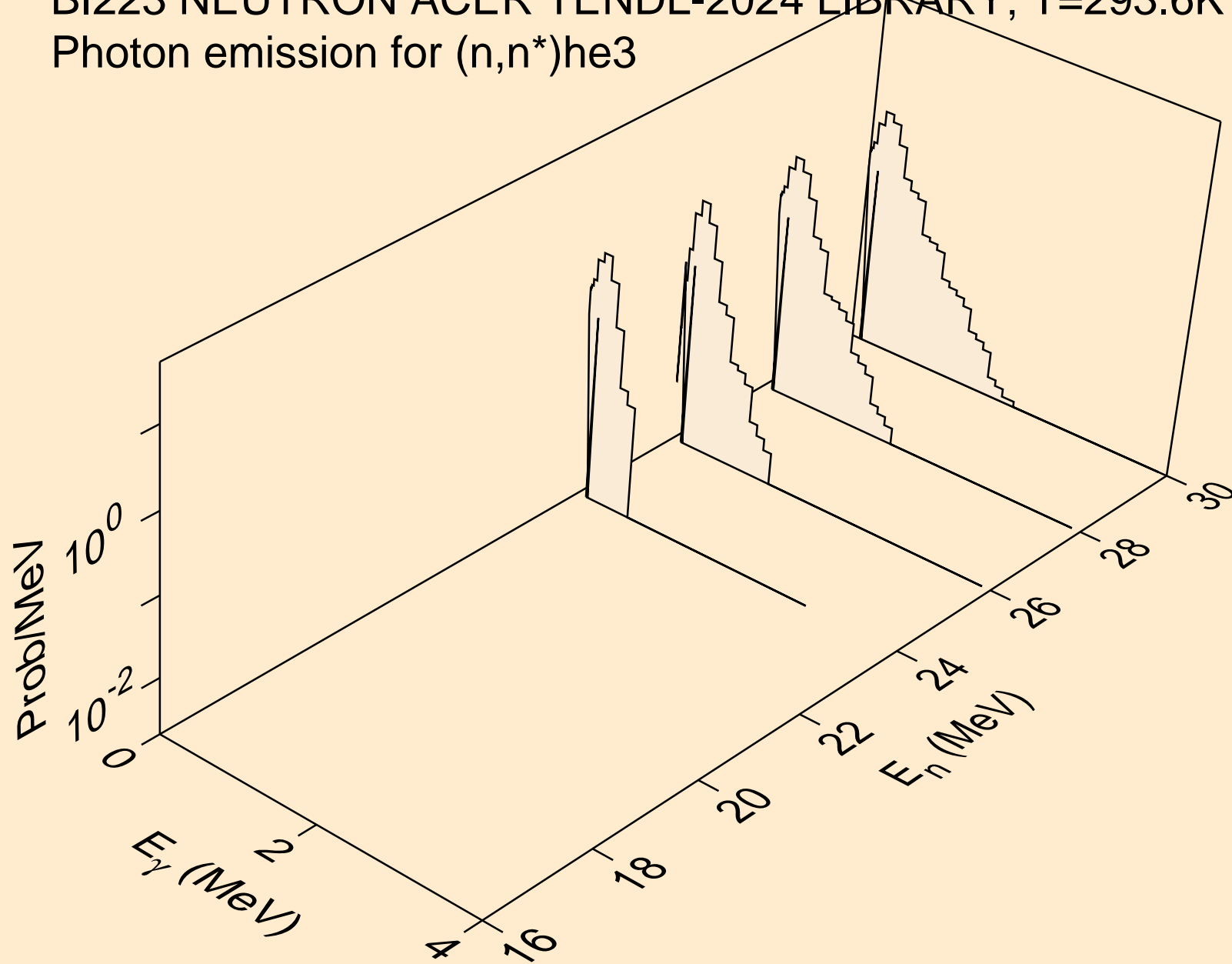

BI223 NEUTRON ACER TENDL-2024 LIBRARY; T=293.6K  
Photon emission for (n,4n)

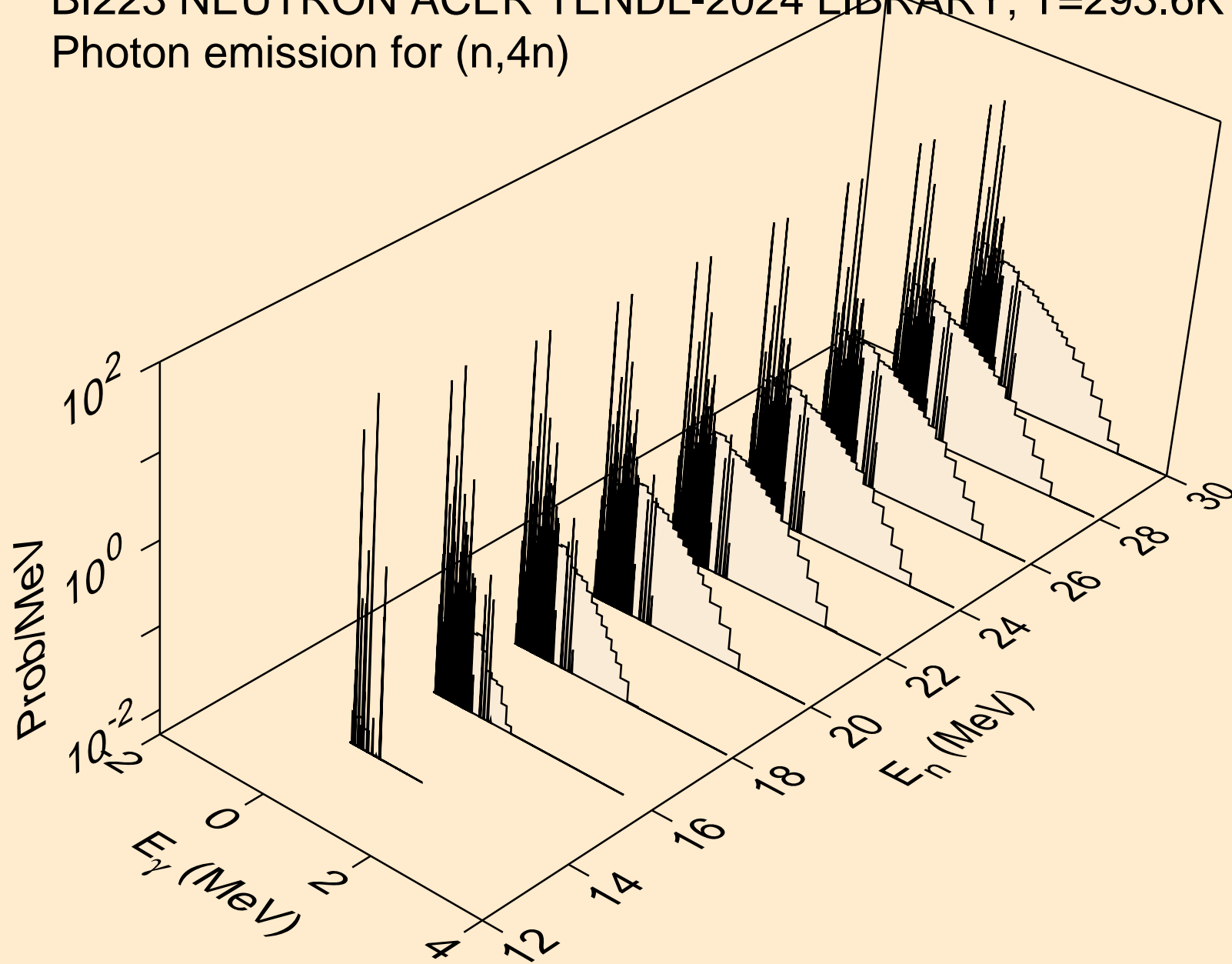

BI223 NEUTRON ACER TENDL-2024 LIBRARY; T=293.6K  
Photon emission for (n,2np)

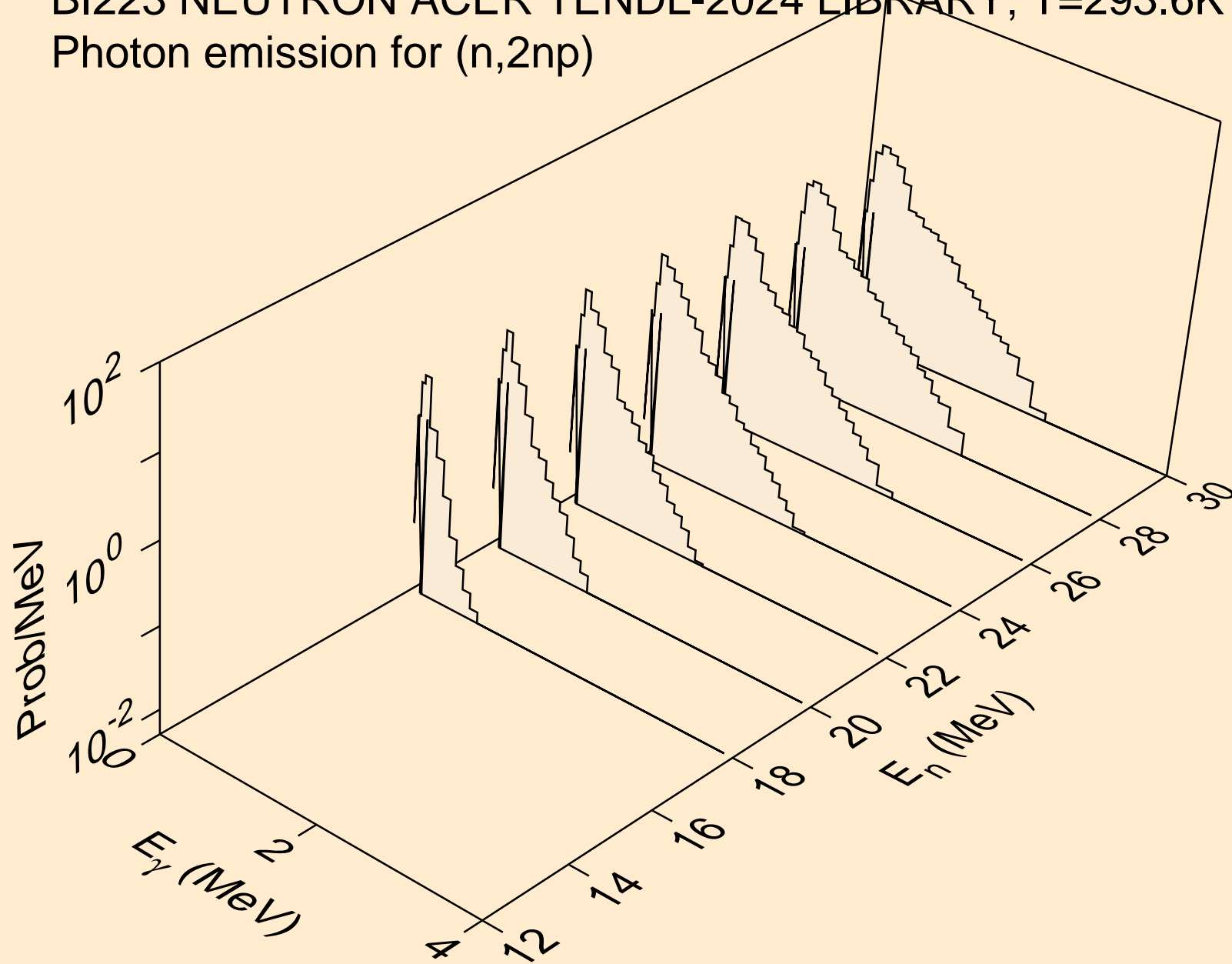

BI223 NEUTRON ACER TENDL-2024 LIBRARY; T=293.6K  
Photon emission for (n,3np)

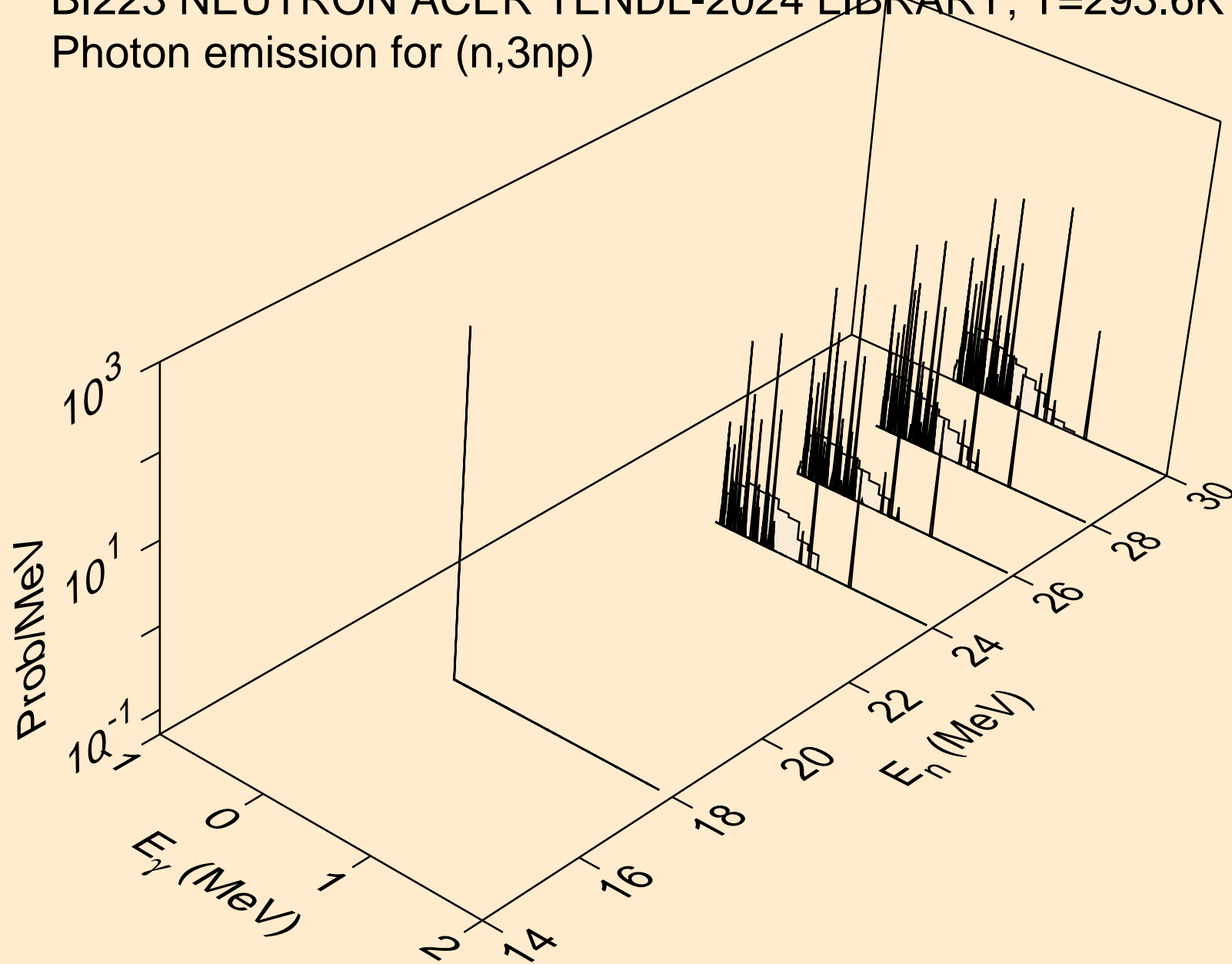

BI223 NEUTRON ACER TENDL-2024 LIBRARY; T=293.6K  
Photon emission for (n,n\*c)

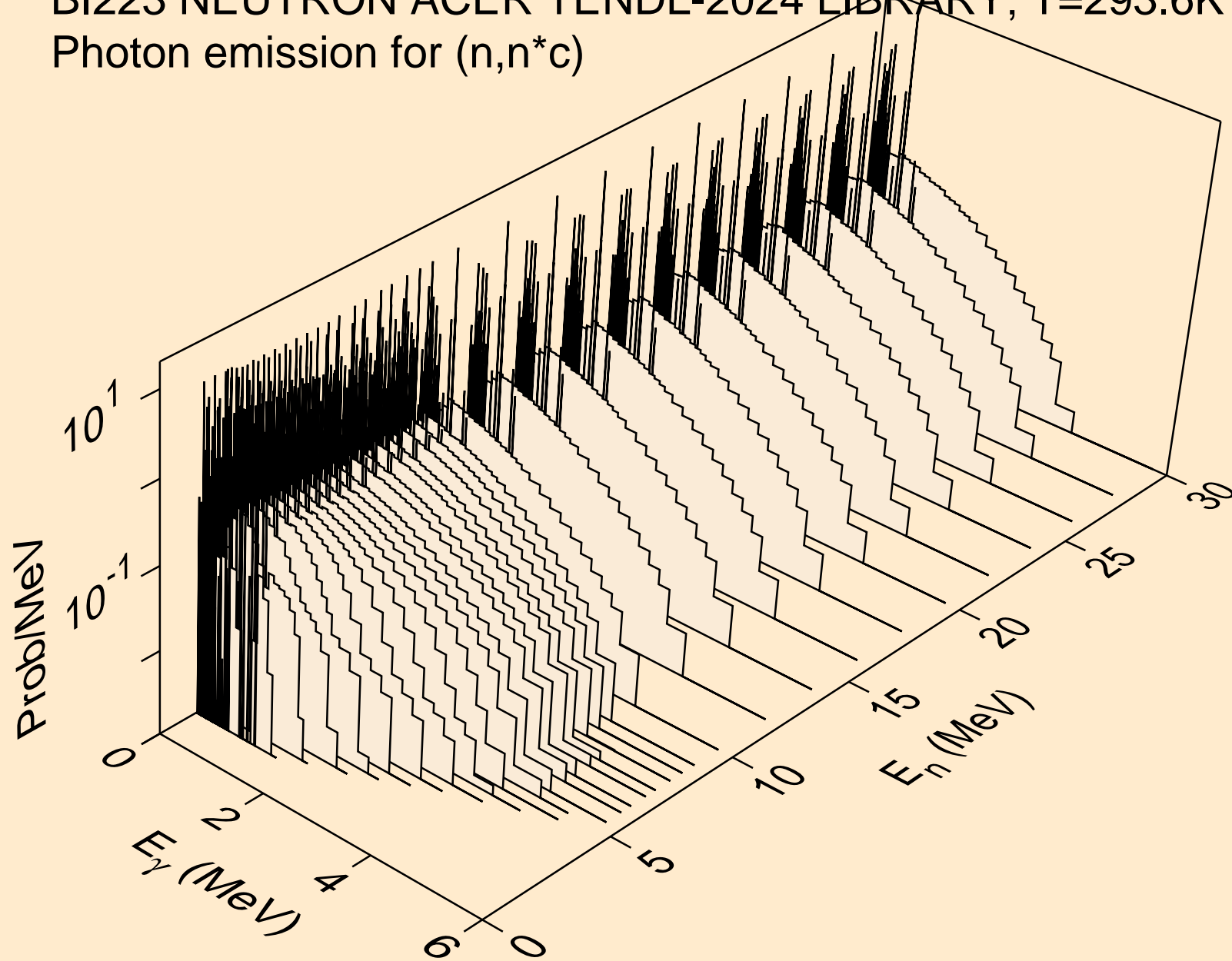

BI223 NEUTRON ACER TENDL-2024 LIBRARY; T=293.6K  
Photon emission for (n,gma)

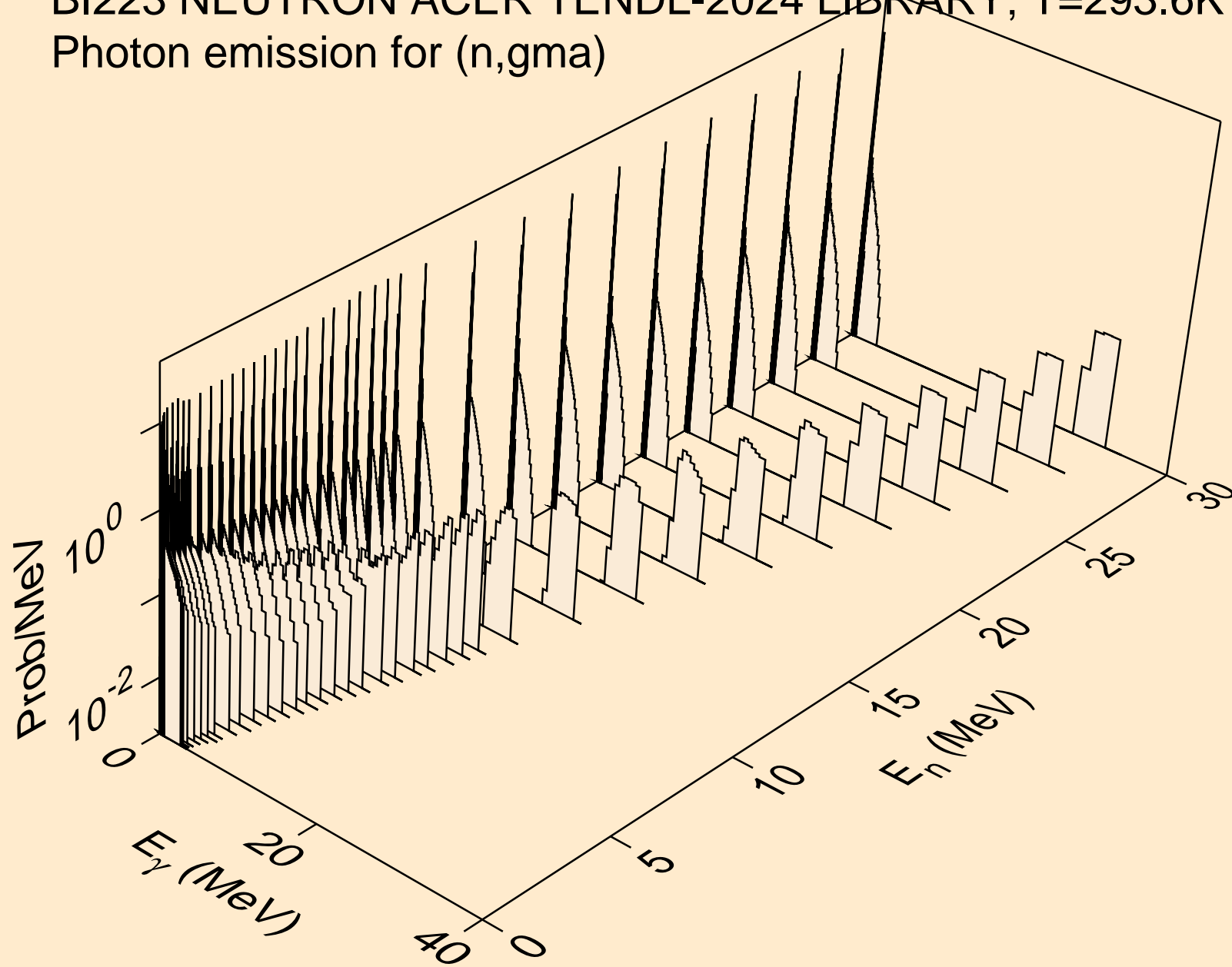

BI223 NEUTRON ACER TENDL-2024 LIBRARY; T=293.6K  
Photon emission for (n,p)

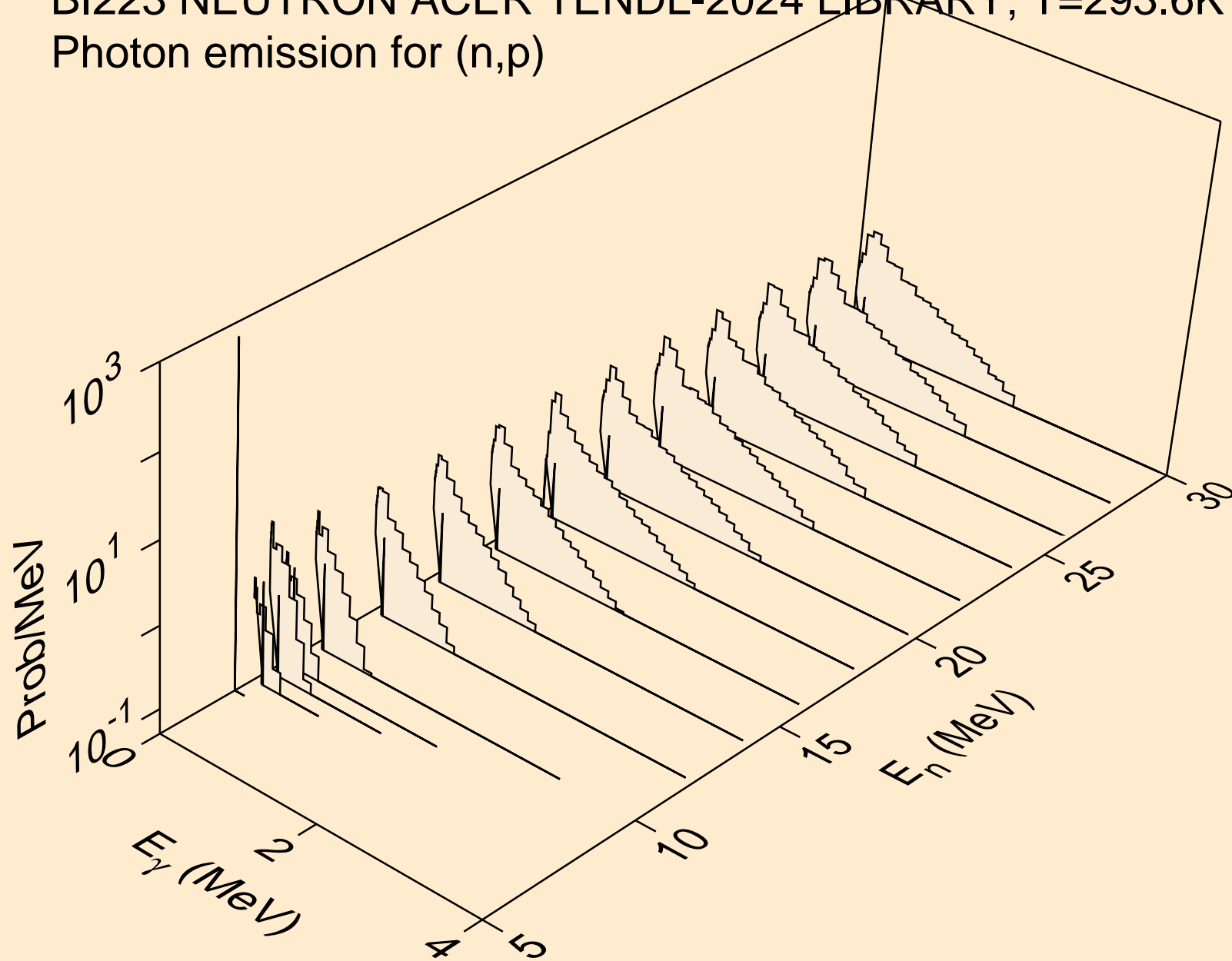

BI223 NEUTRON ACER TENDL-2024 LIBRARY; T=293.6K  
Photon emission for (n,d)

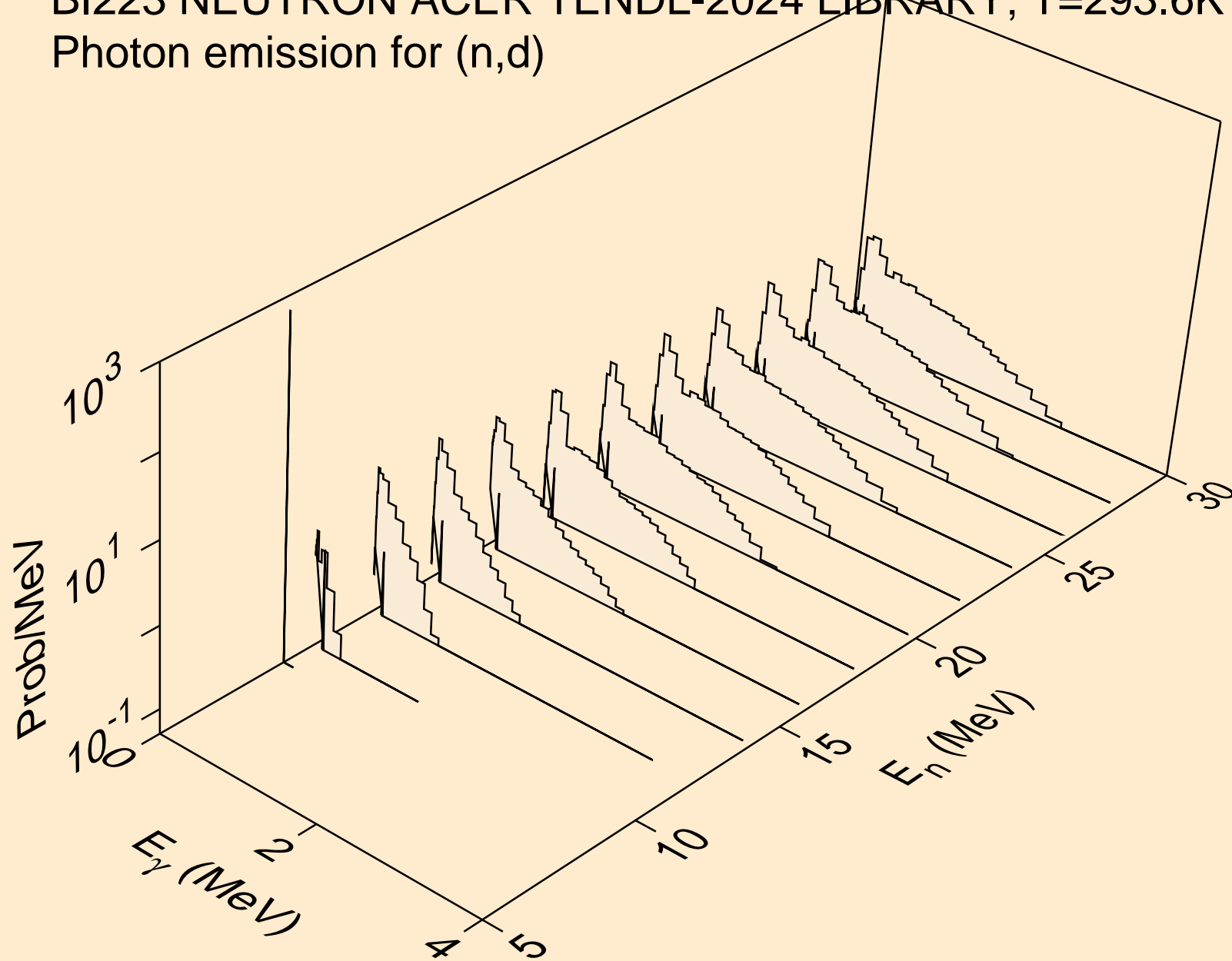

BI223 NEUTRON ACER TENDL-2024 LIBRARY; T=293.6K  
Photon emission for (n,t)

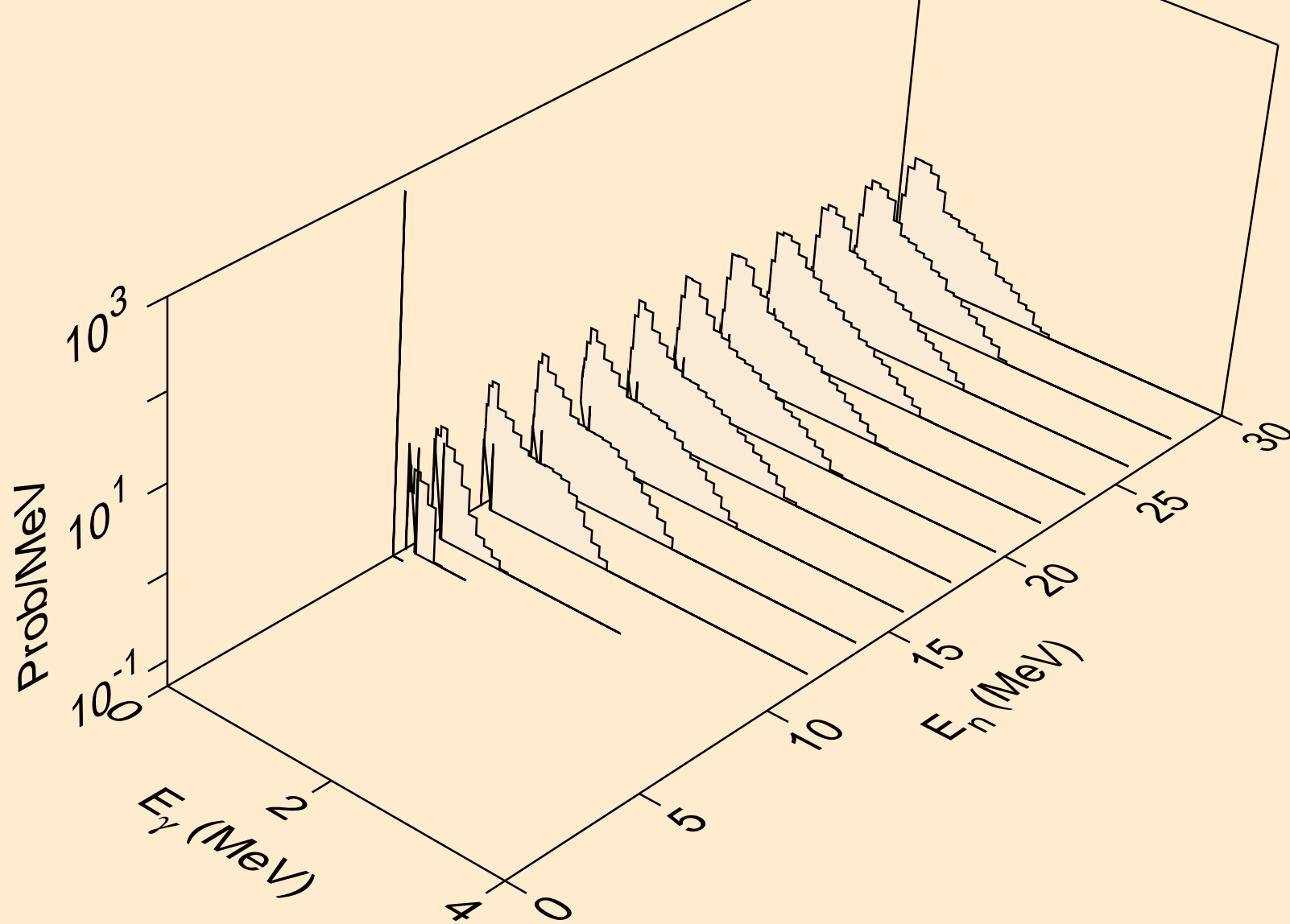

BI223 NEUTRON ACER TENDL-2024 LIBRARY; T=293.6K  
Photon emission for (n,he3)

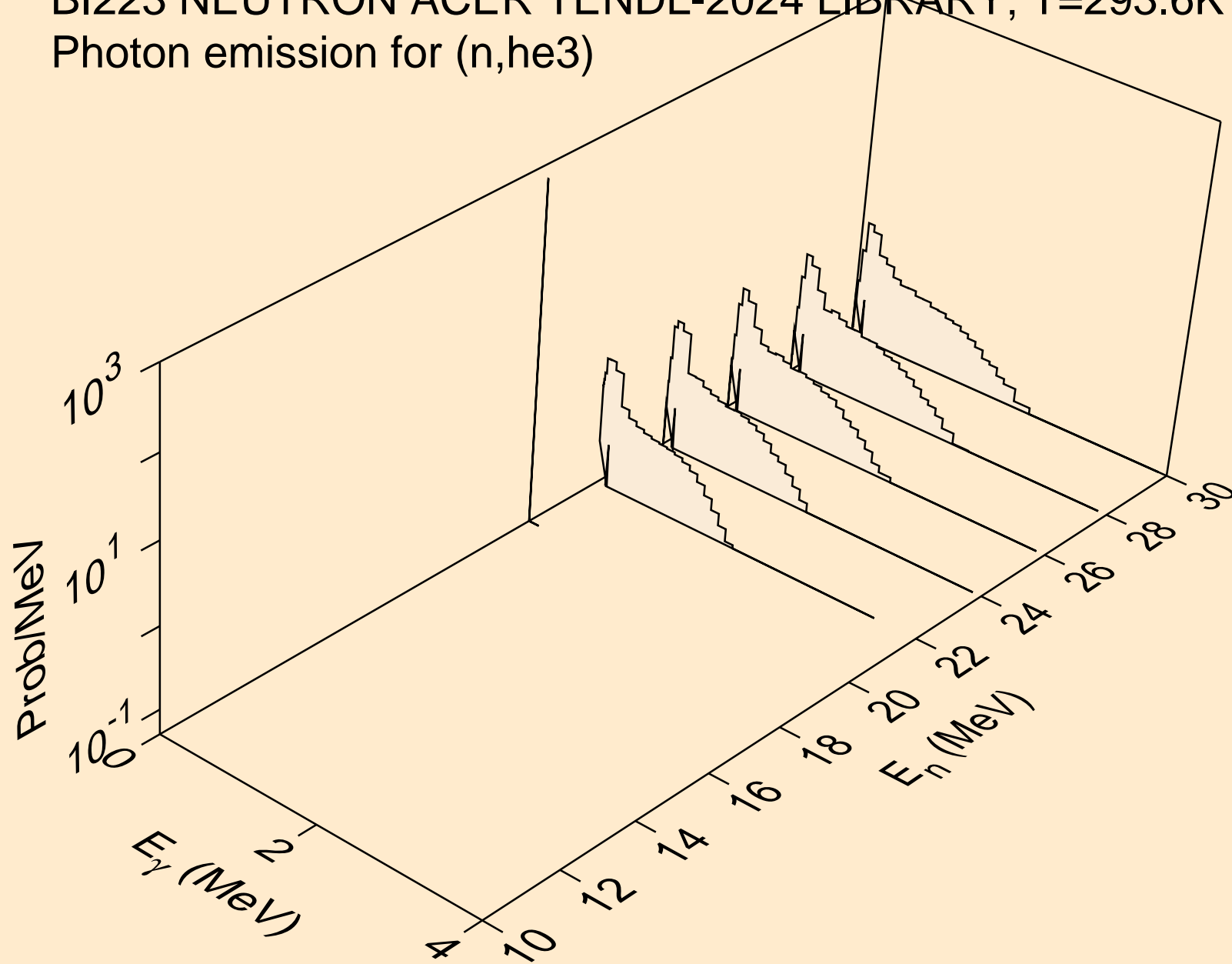

BI223 NEUTRON ACER TENDL-2024 LIBRARY; T=293.6K  
Photon emission for (n,a)

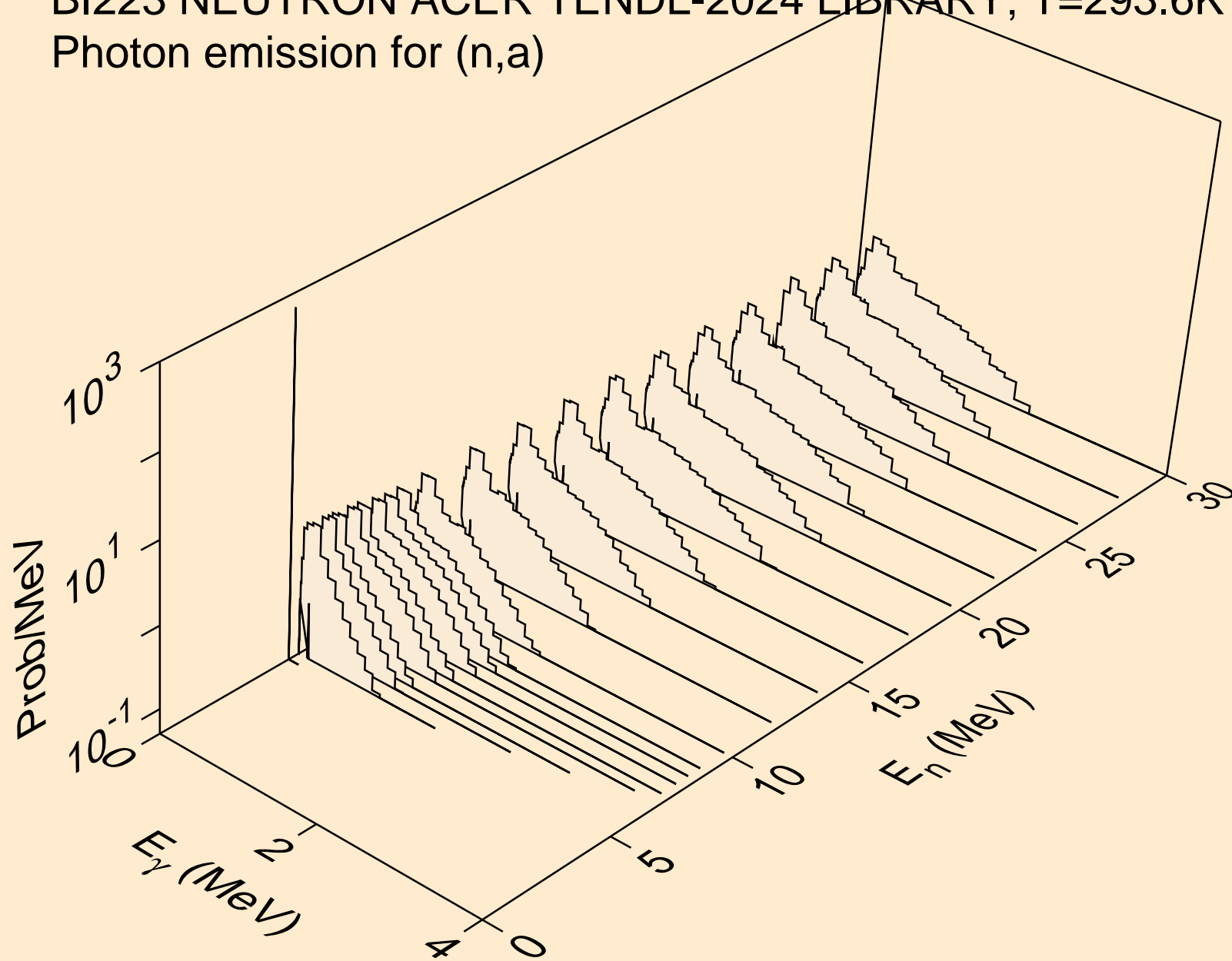



BI223 NEUTRON ACER TENDL-2024 LIBRARY; T=293.6K  
14 MeV photon spectrum

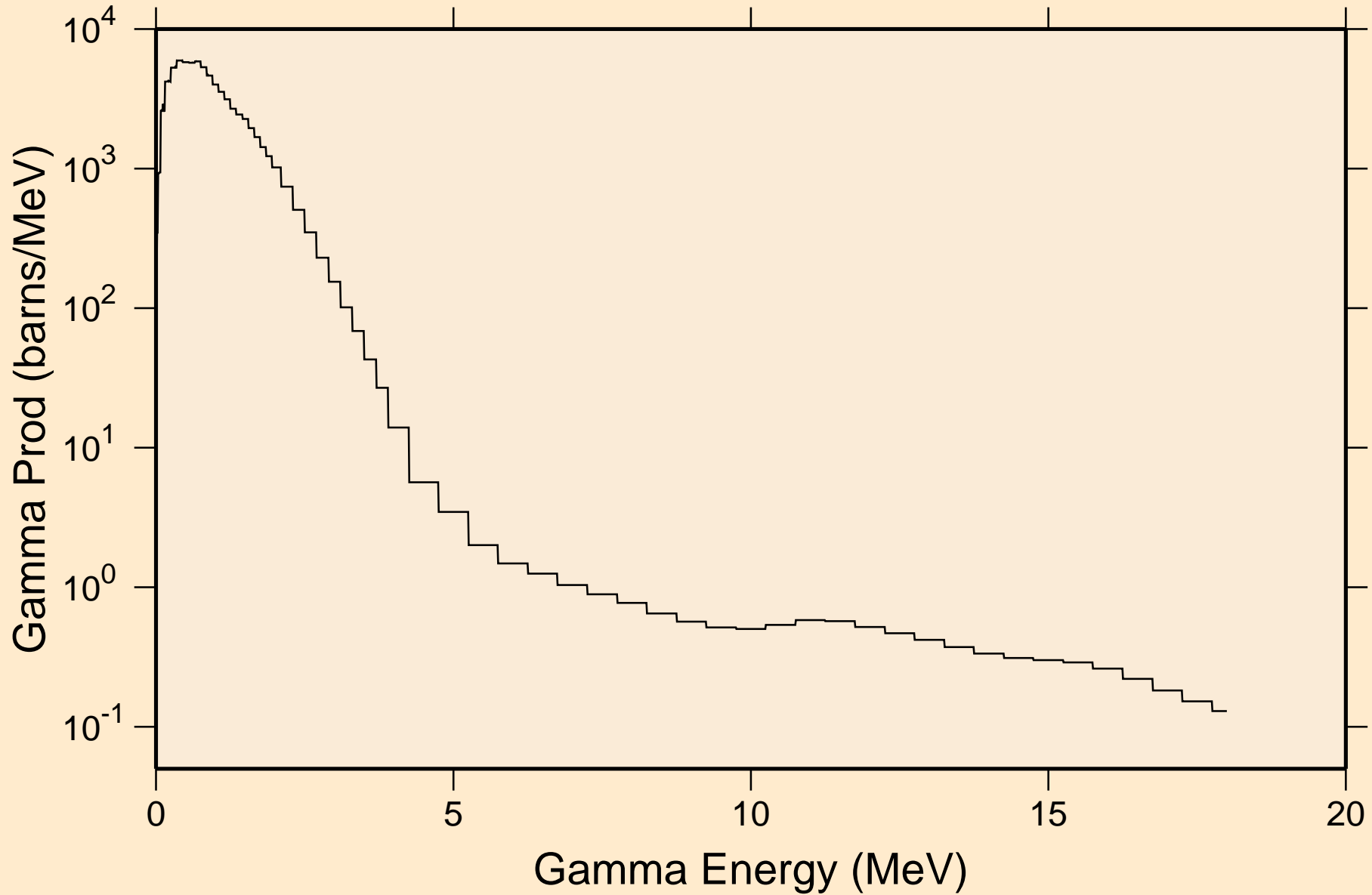

# BI223 NEUTRON ACER TENDL-2024 LIBRARY; T=293.6K

## Particle heating contributions

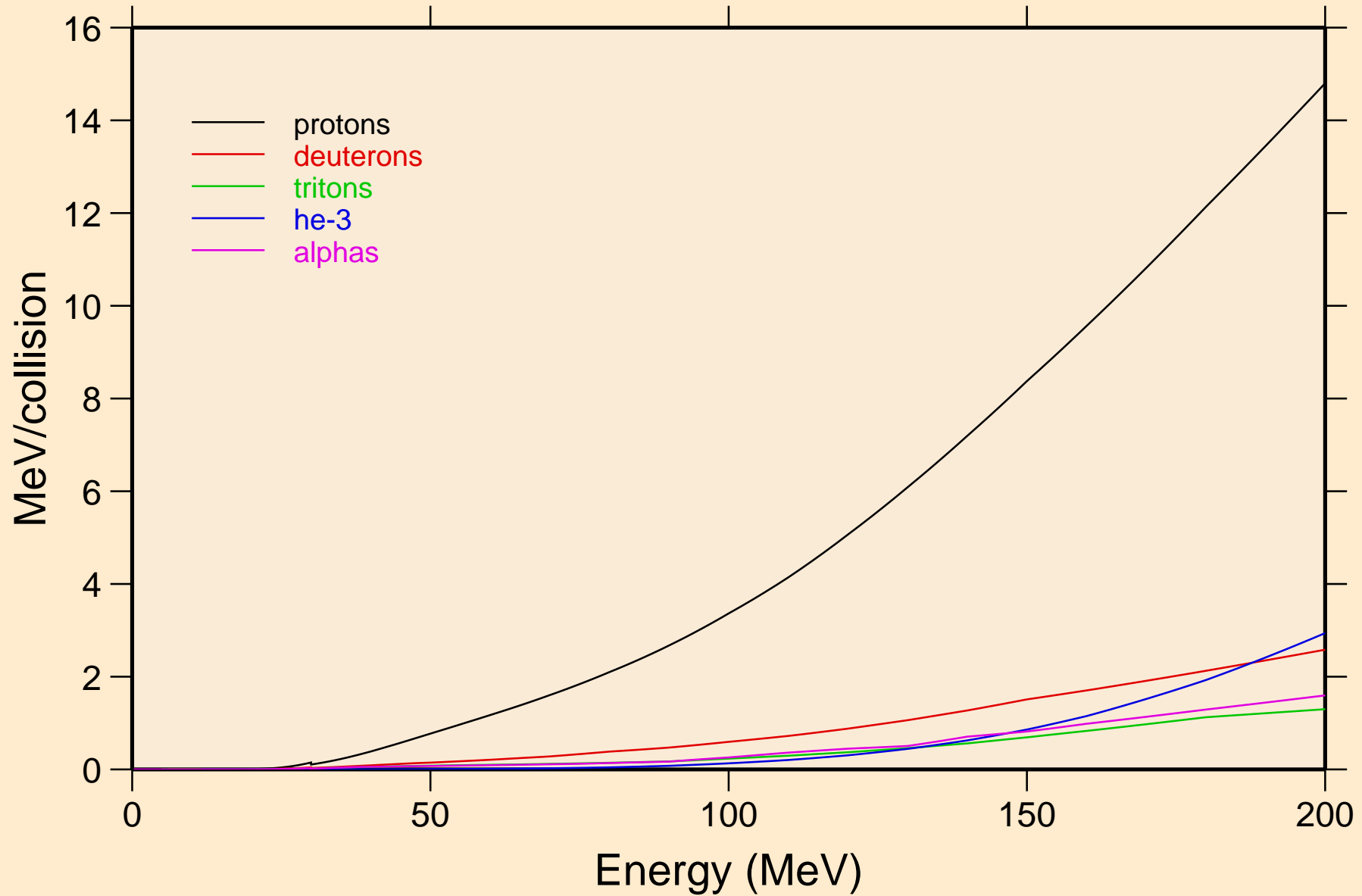

BI223 NEUTRON ACER TENDL-2024 LIBRARY; T=293.6K  
Recoil Heating

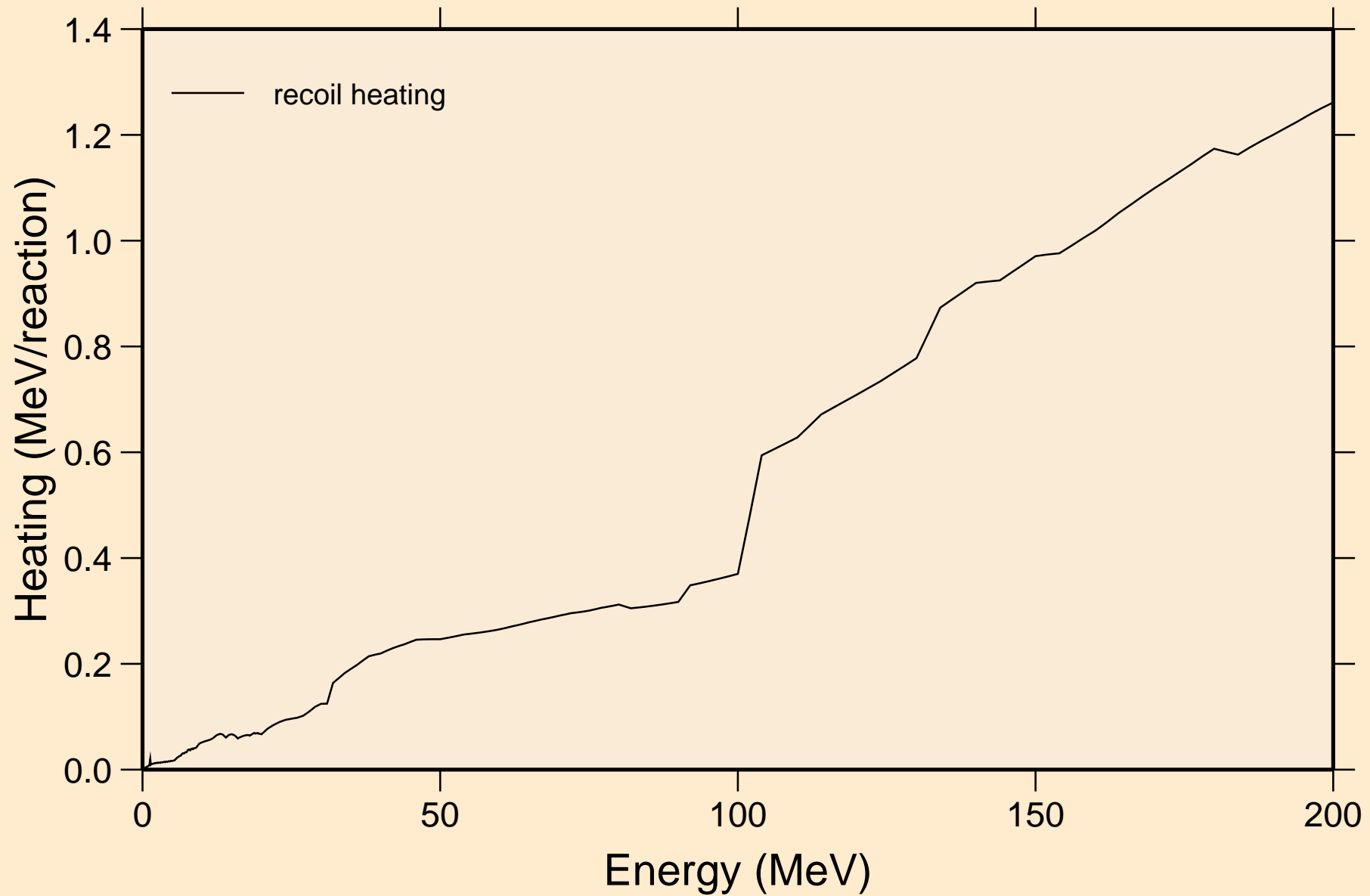

BI223 NEUTRON ACER TENDL-2024 LIBRARY; T=293.6K  
Particle production cross sections

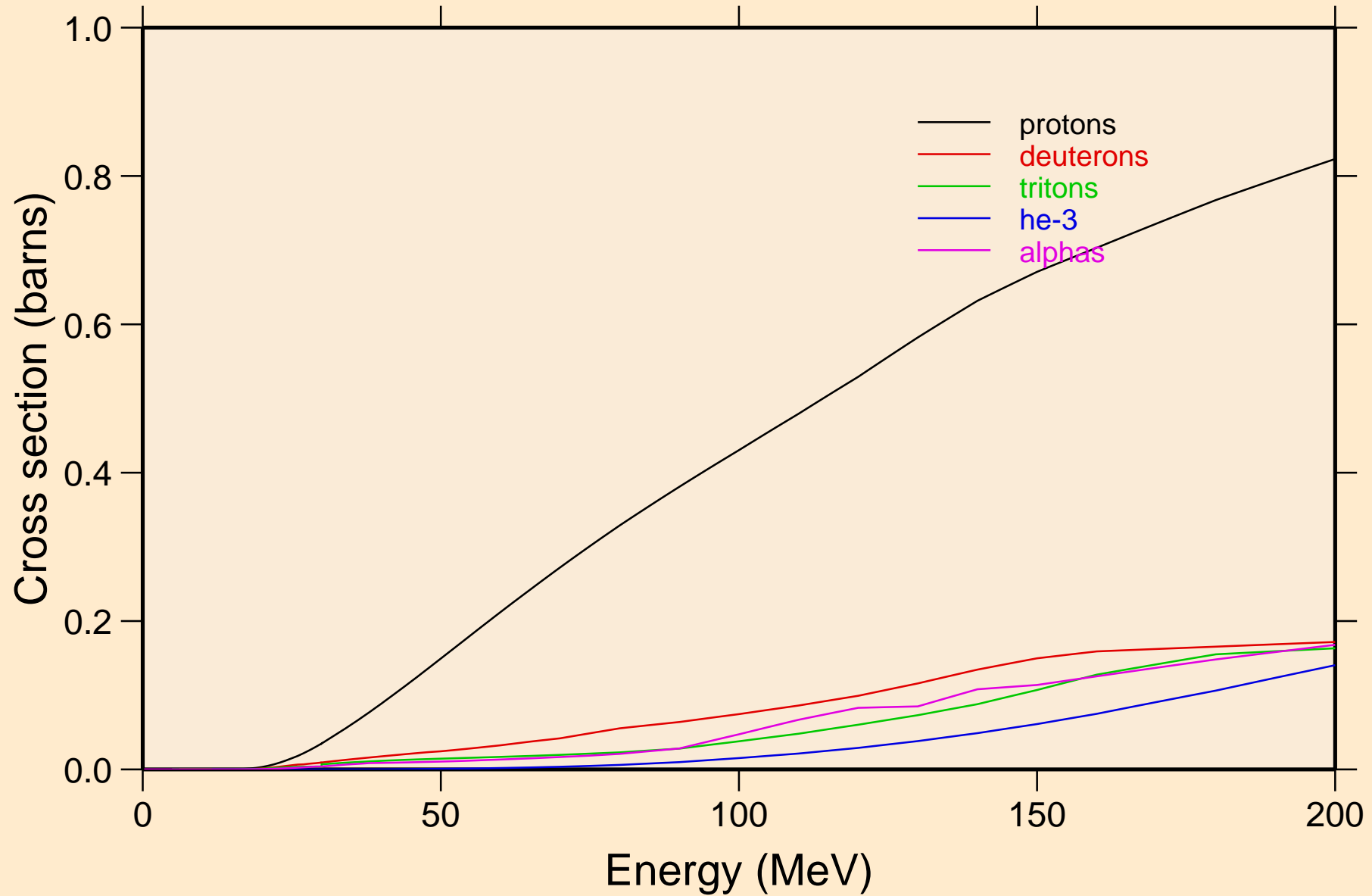

BI223 NEUTRON ACER TENDL-2024 LIBRARY; T=293.6K  
protons from (n,x)

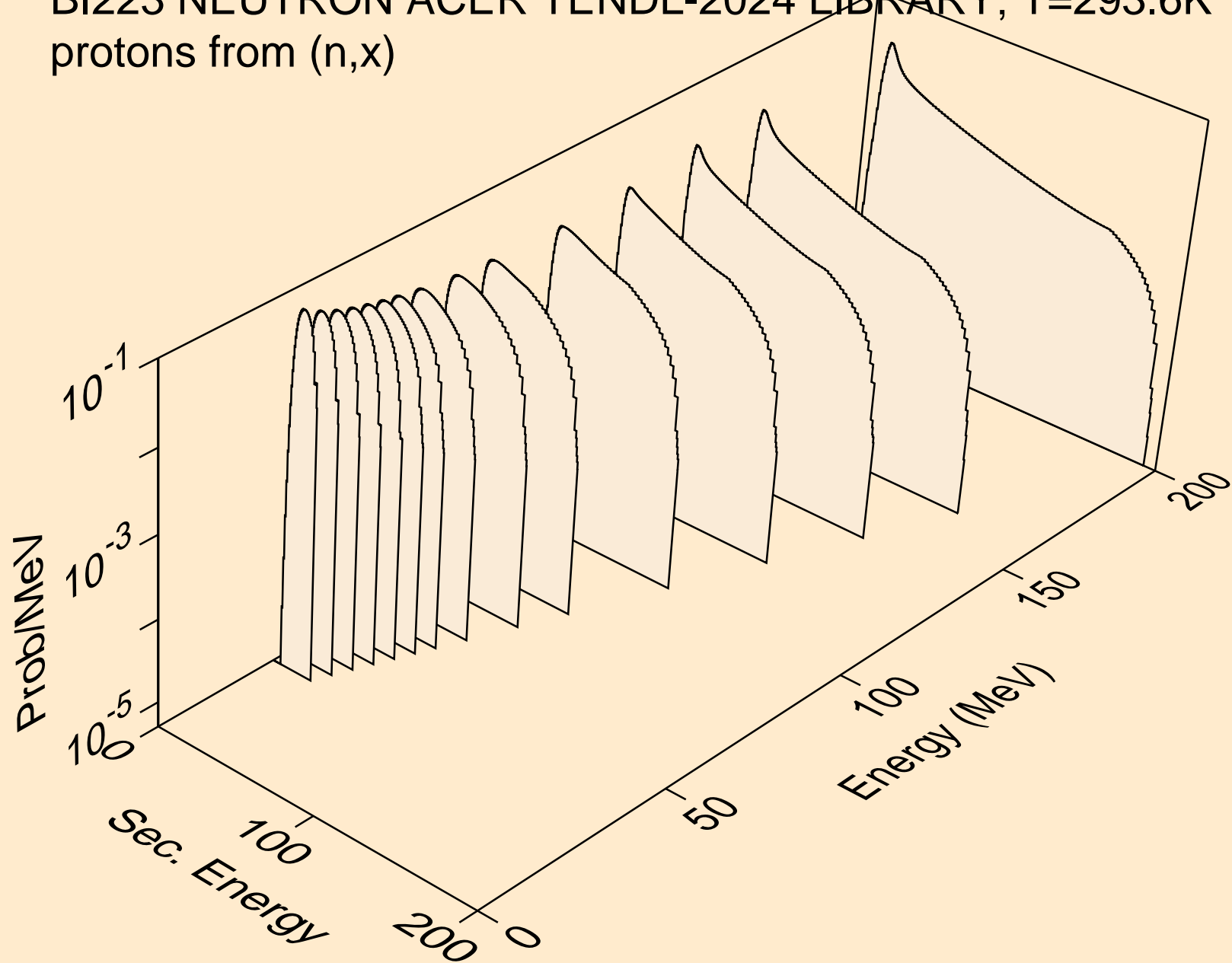

BI223 NEUTRON ACER TENDL-2024 LIBRARY; T=293.6K  
protons from (n,n\*)p

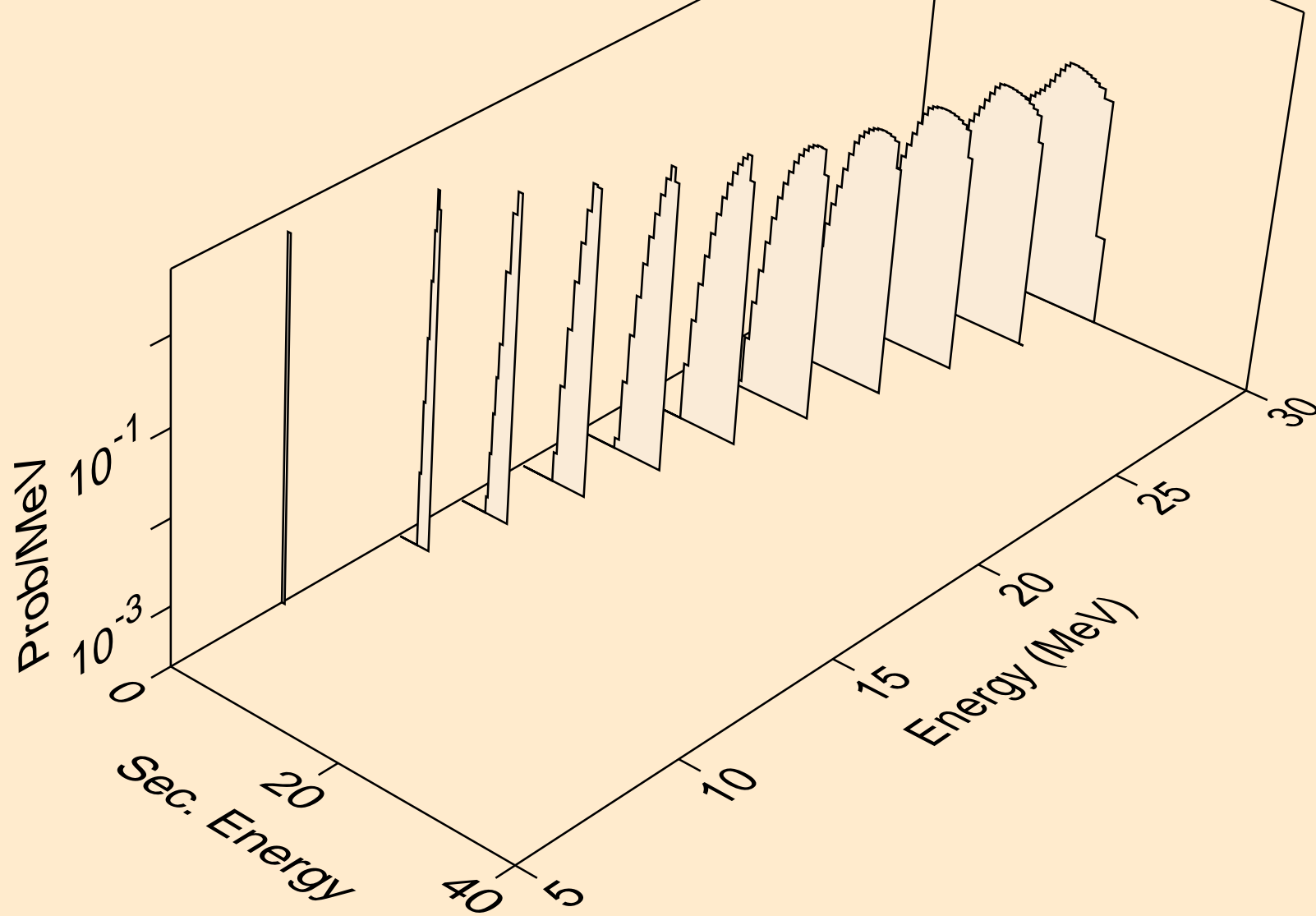

BI223 NEUTRON ACER TENDL-2024 LIBRARY; T=293.6K  
protons from (n,2np)

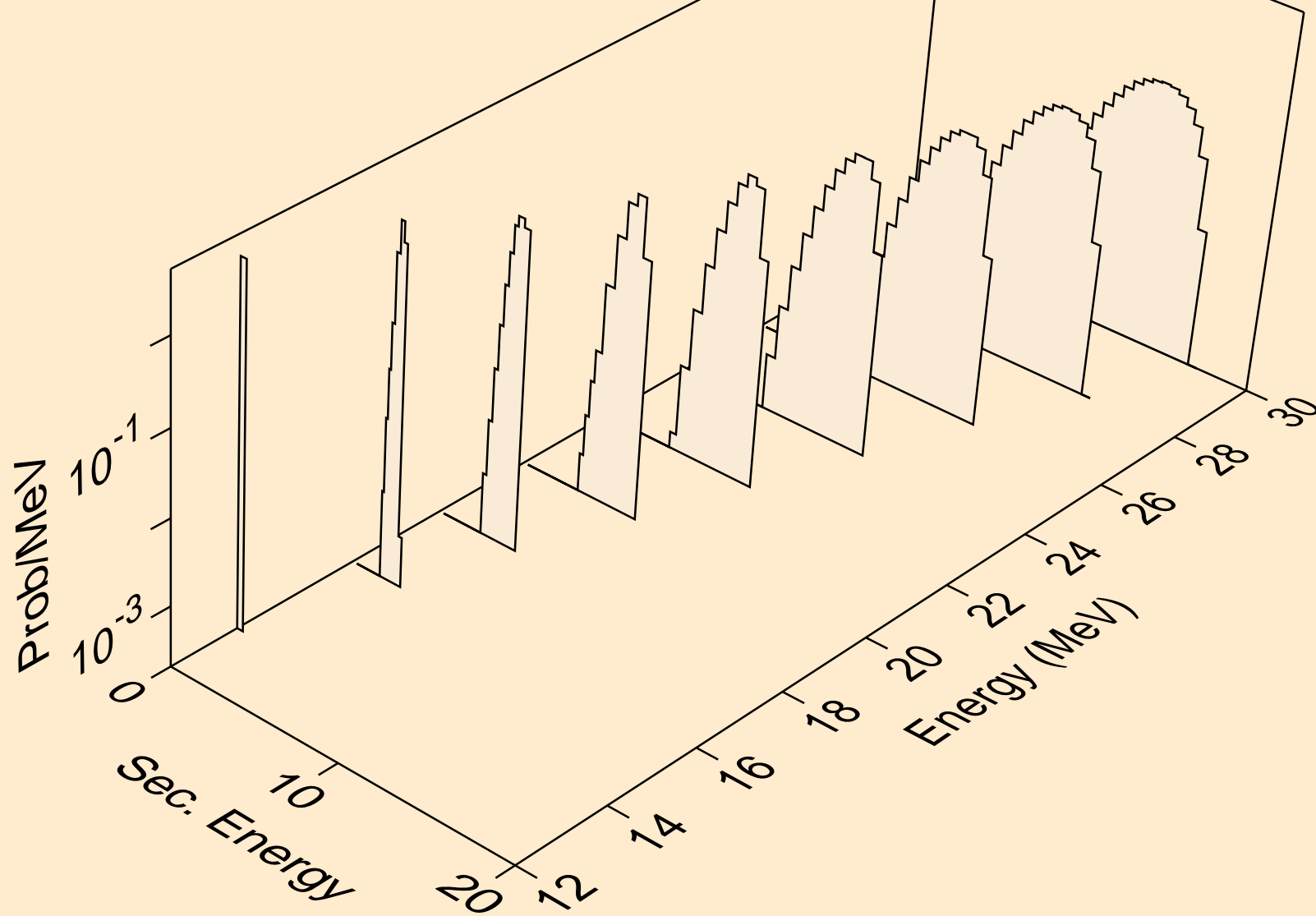

BI223 NEUTRON ACER TENDL-2024 LIBRARY; T=293.6K  
protons from (n,3np)

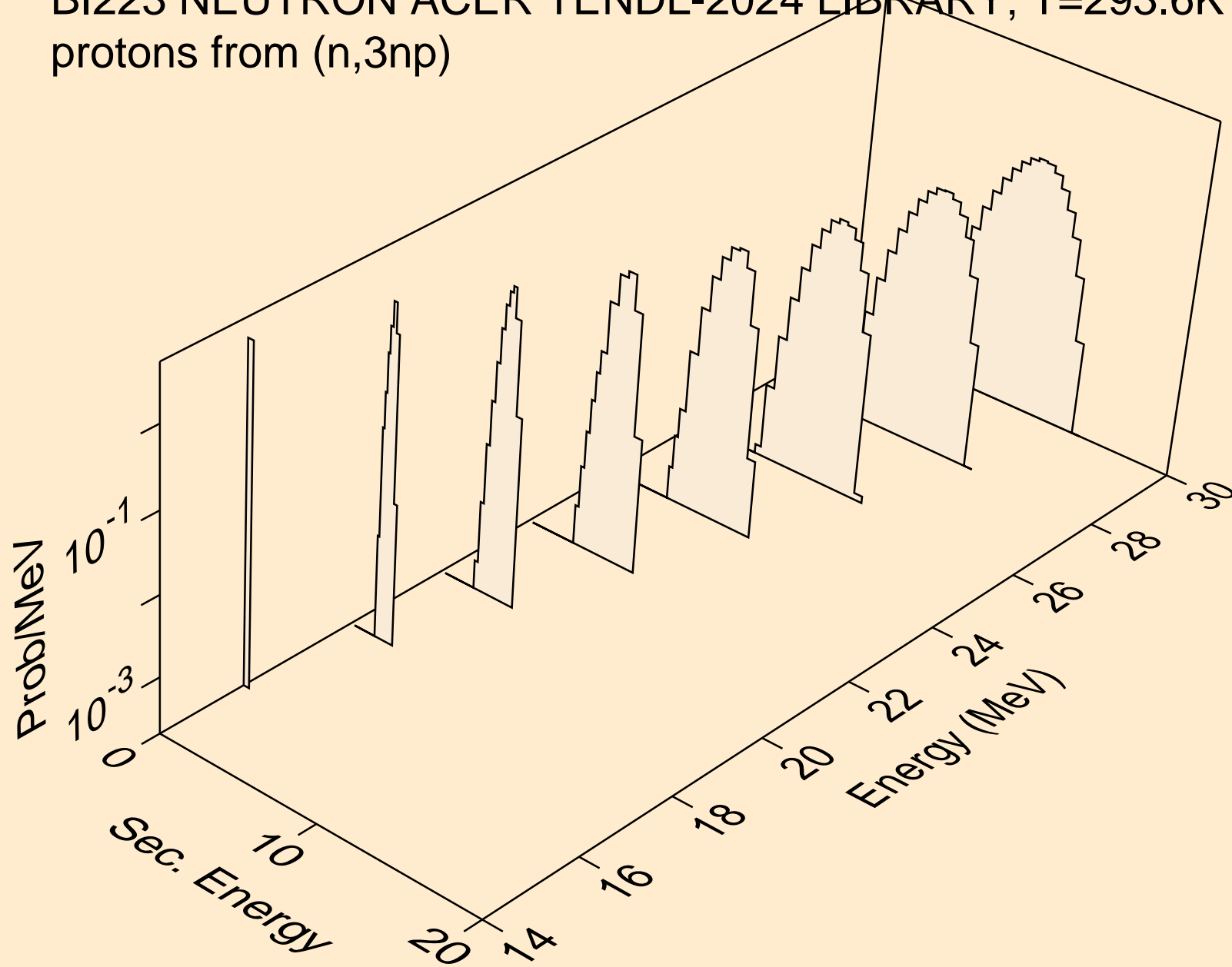

BI223 NEUTRON ACER TENDL-2024 LIBRARY; T=293.6K  
protons from (n,p)

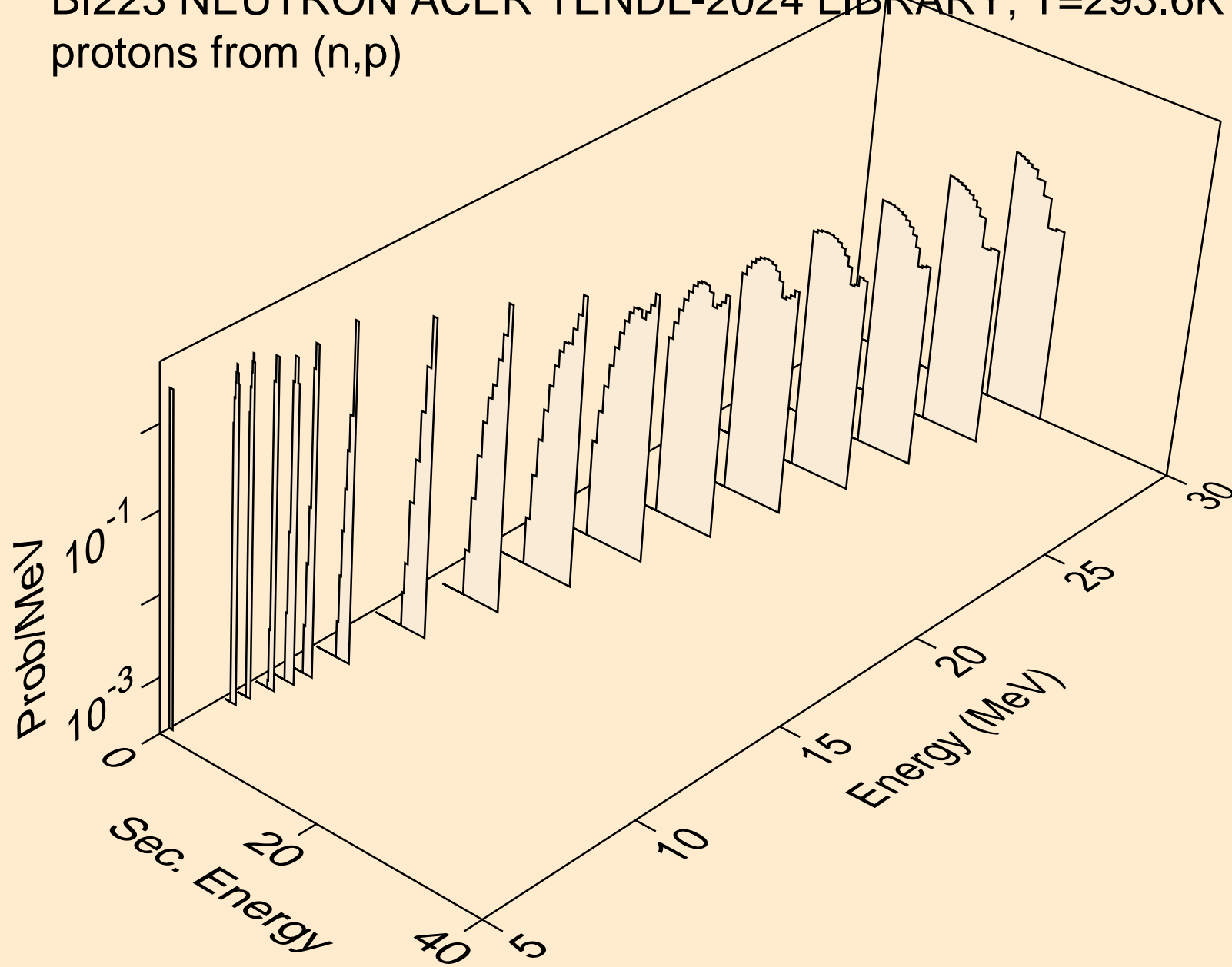

BI223 NEUTRON ACER TENDL-2024 LIBRARY; T=293.6K  
deuterons from (n,x)

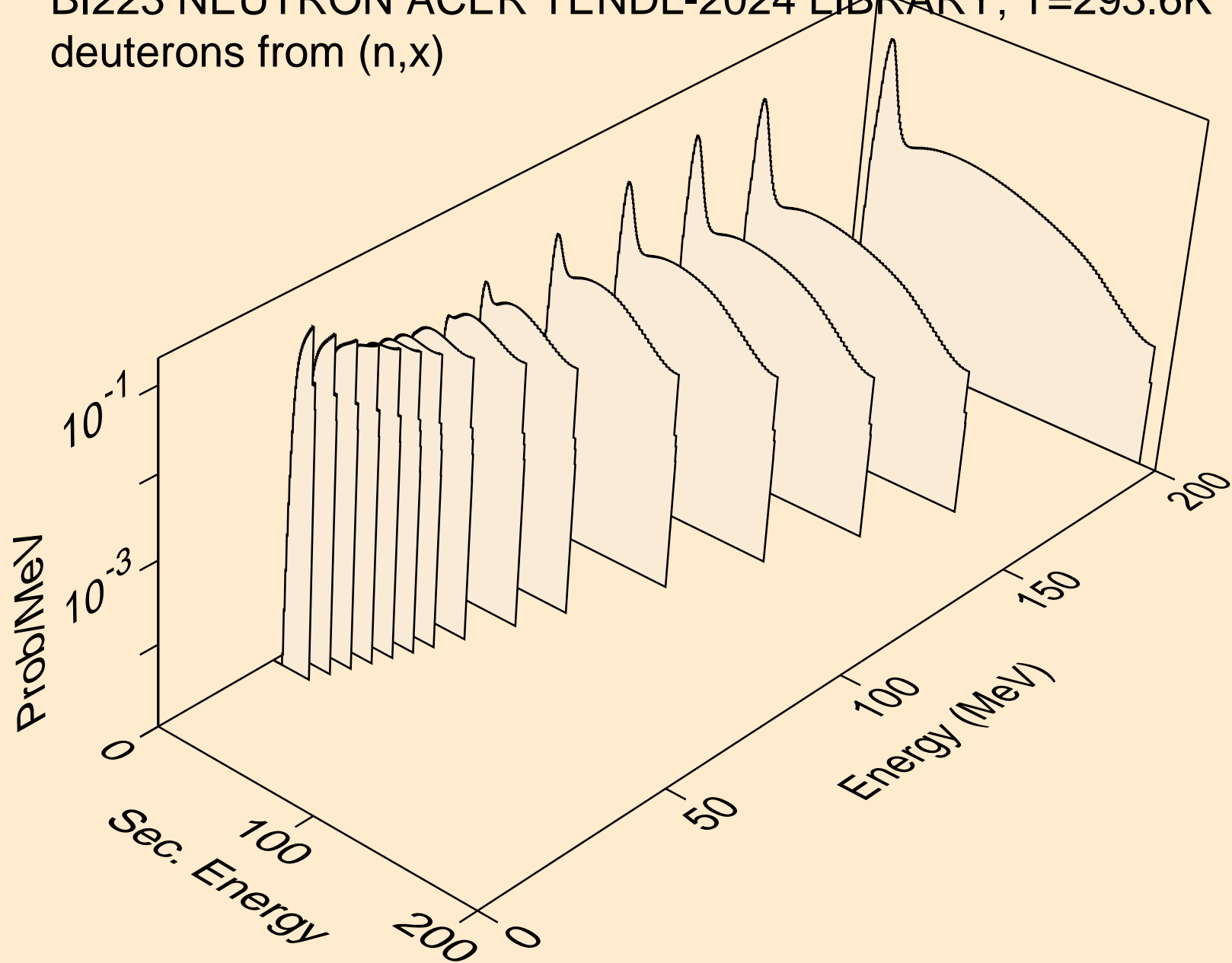

BI223 NEUTRON ACER TENDL-2024 LIBRARY; T=293.6K  
deuterons from (n,2nd)

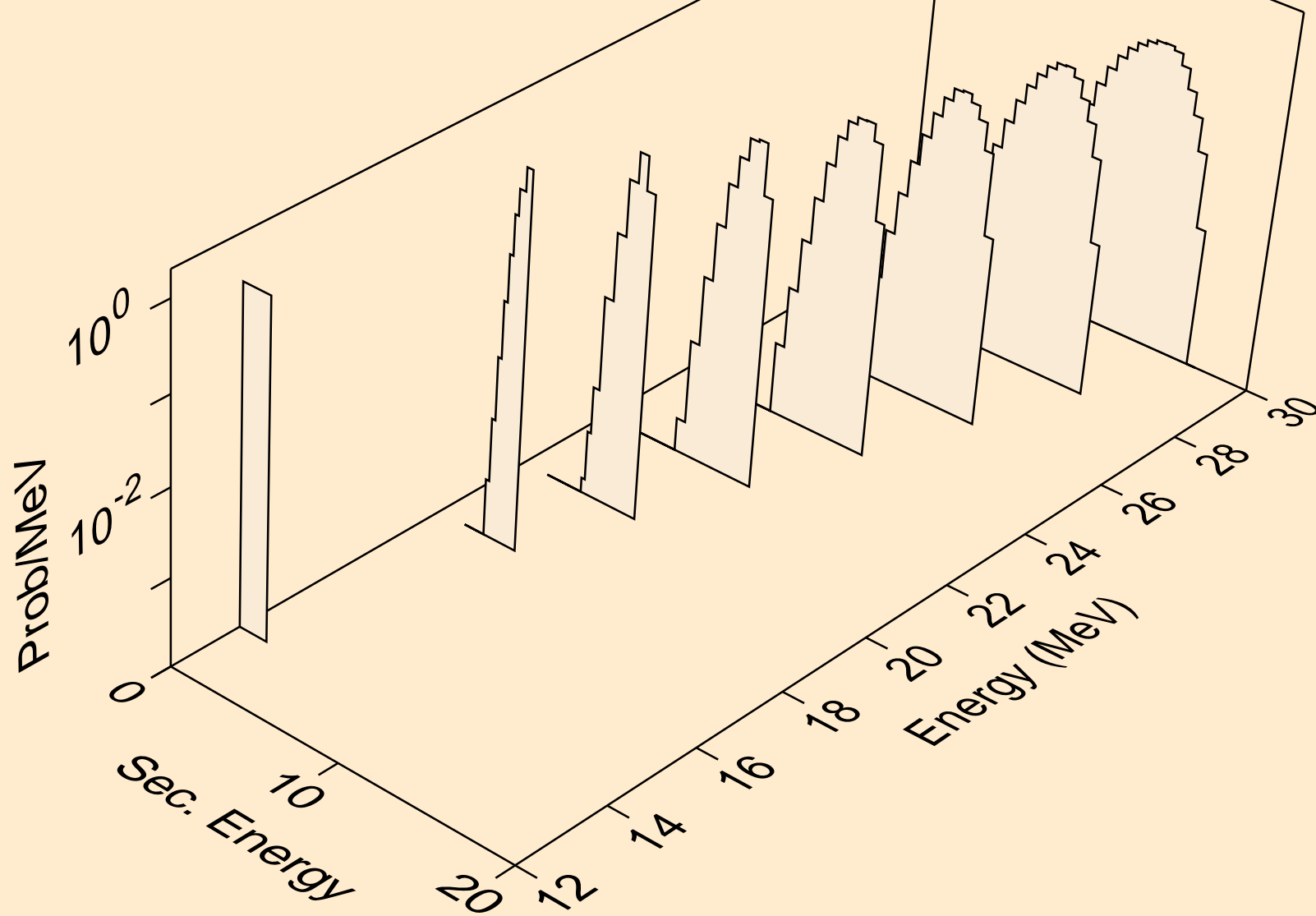

BI223 NEUTRON ACER TENDL-2024 LIBRARY; T=293.6K  
deuterons from (n,n\*)d

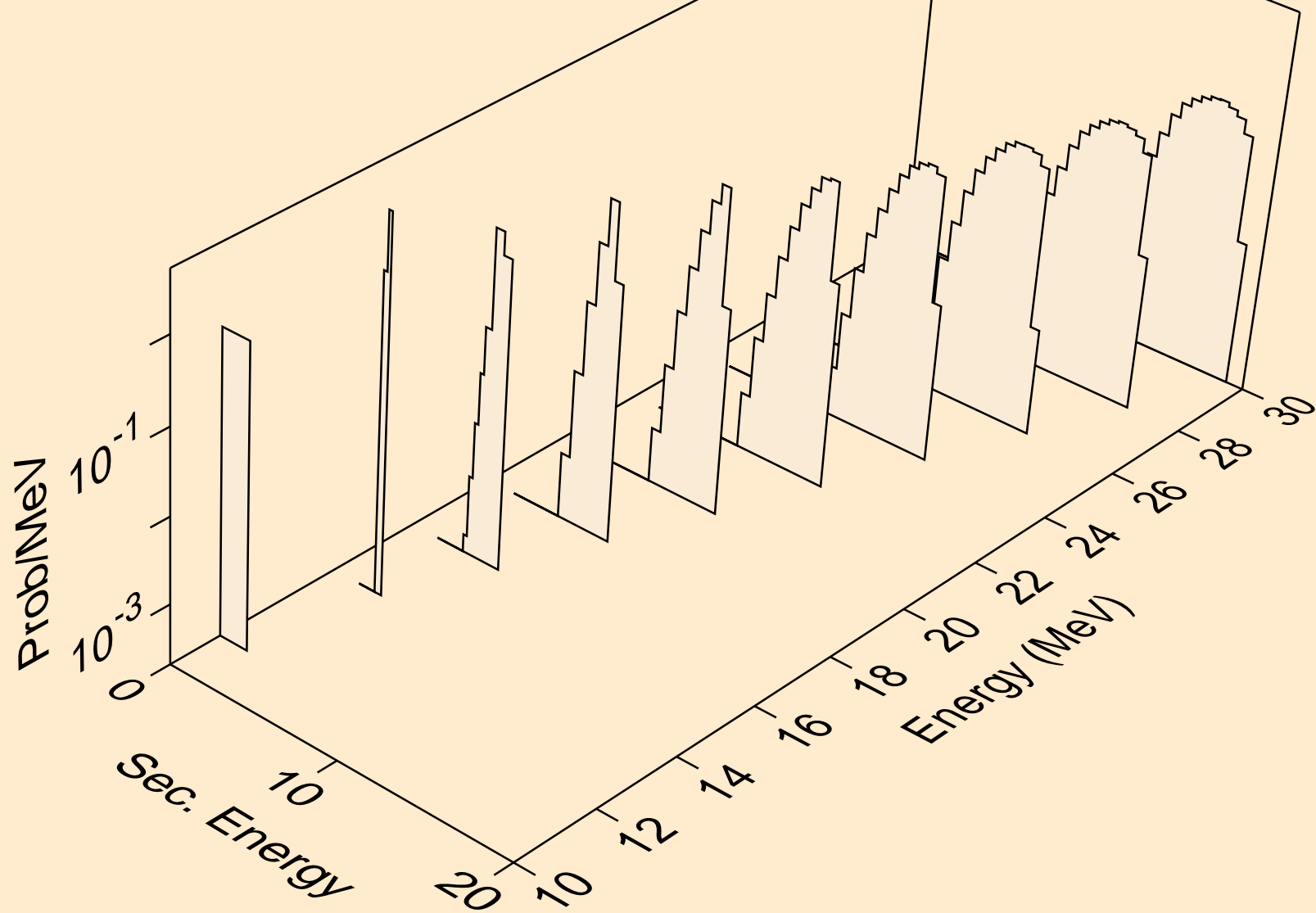

BI223 NEUTRON ACER TENDL-2024 LIBRARY; T=293.6K  
deuterons from (n,d)

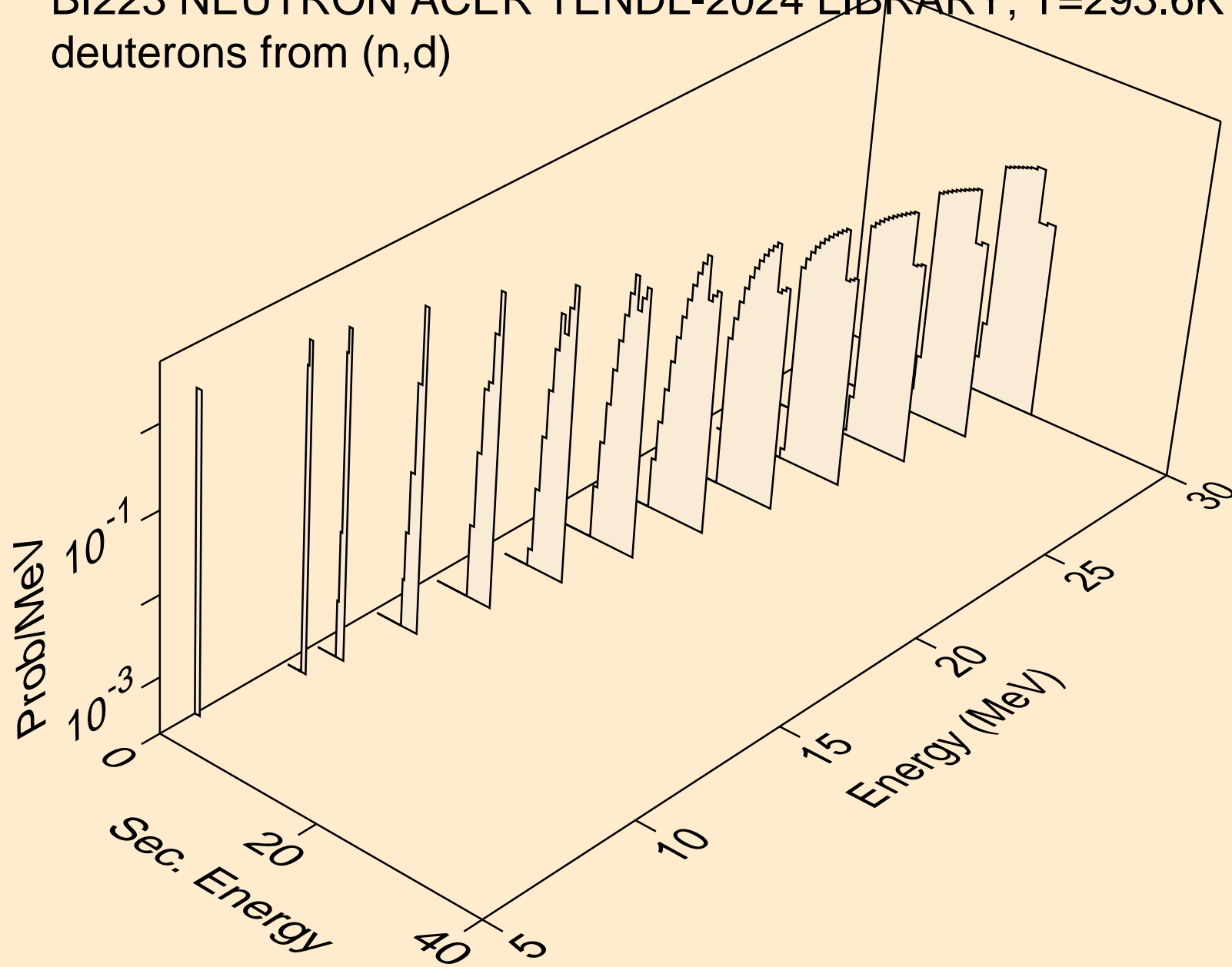

BI223 NEUTRON ACER TENDL-2024 LIBRARY; T=293.6K  
tritons from (n,x)

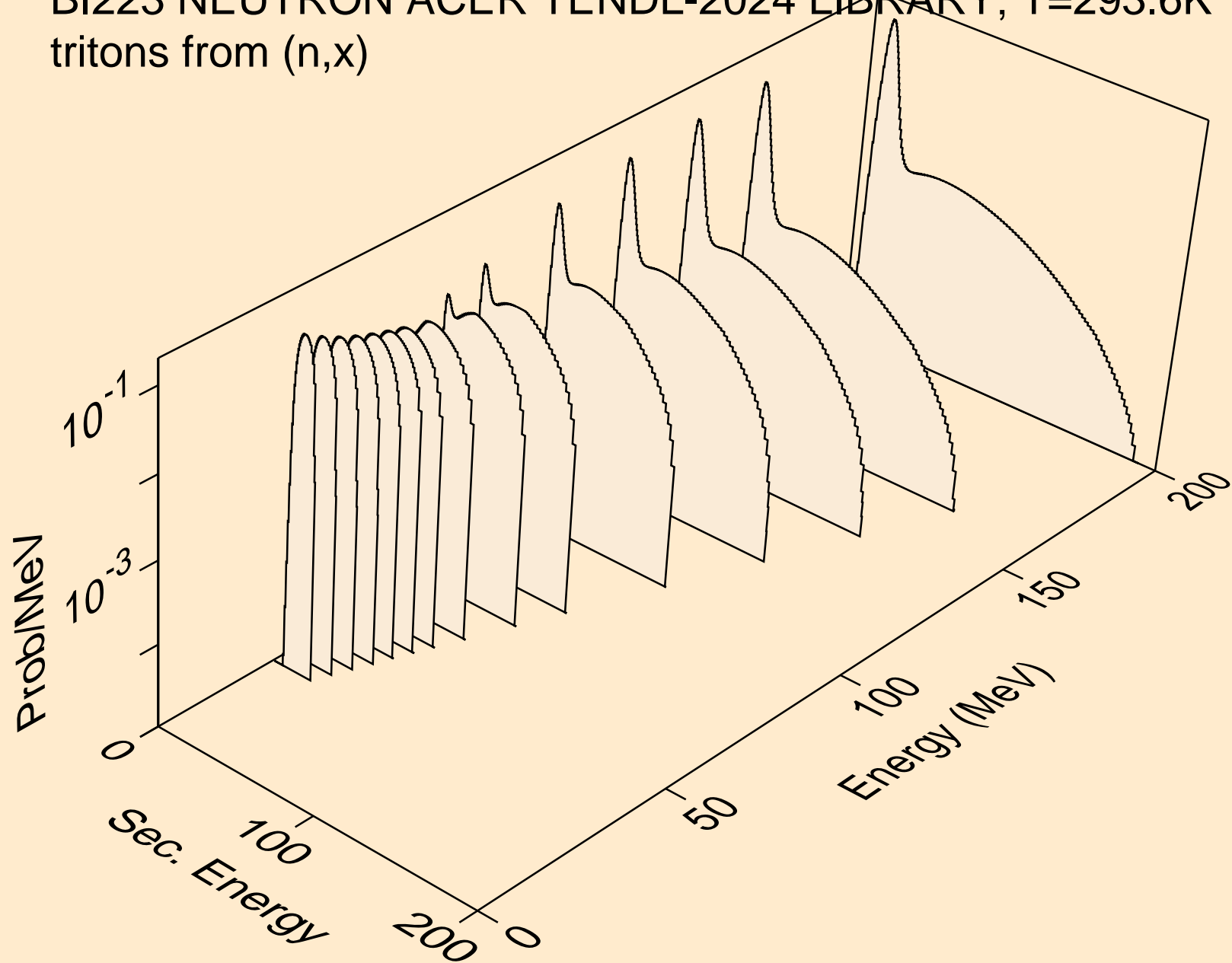

BI223 NEUTRON ACER TENDL-2024 LIBRARY; T=293.6K  
tritons from (n,n\*)t

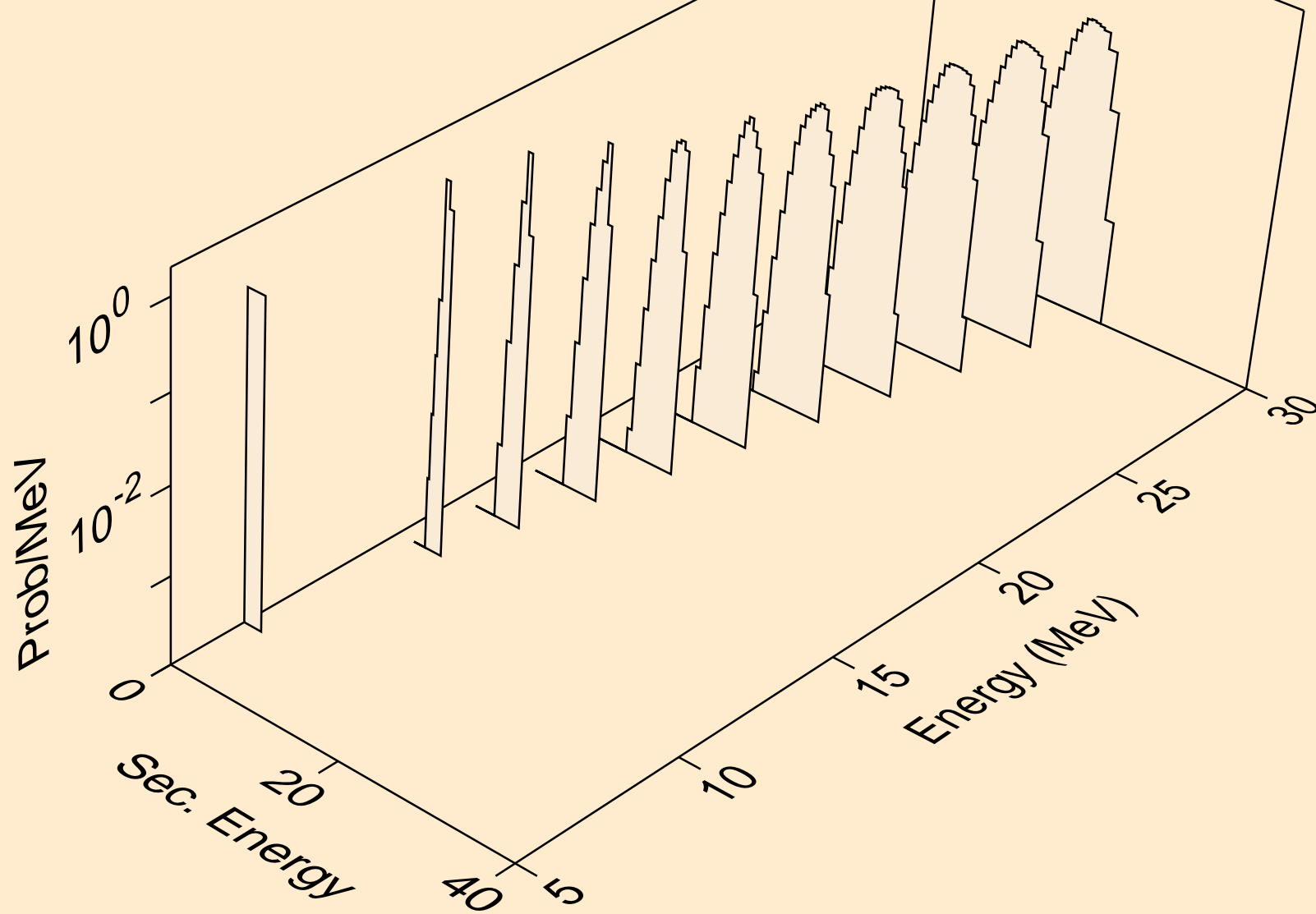

BI223 NEUTRON ACER TENDL-2024 LIBRARY; T=293.6K  
tritons from (n,t)

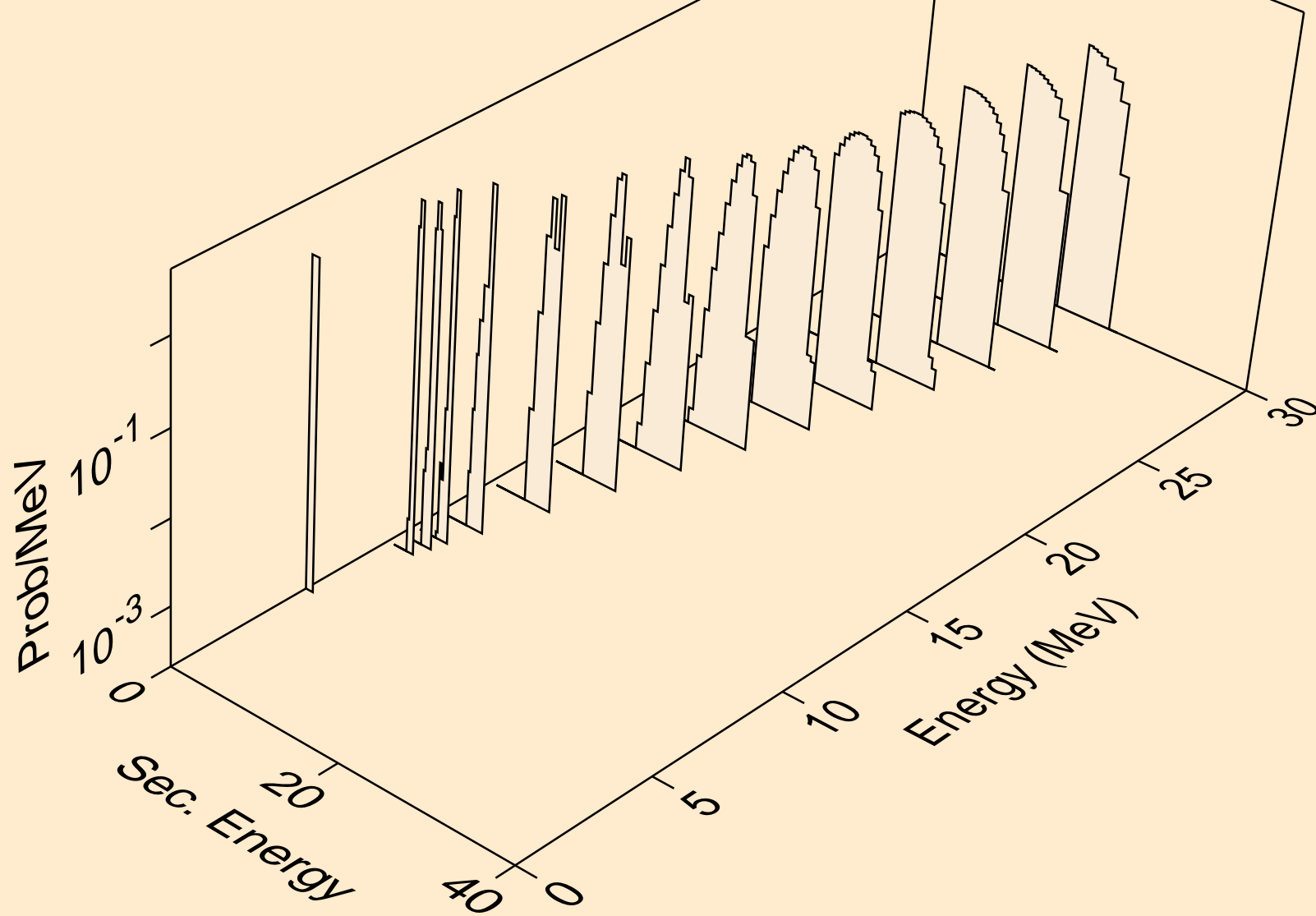

BI223 NEUTRON ACER TENDL-2024 LIBRARY; T=293.6K  
he3s from (n,x)

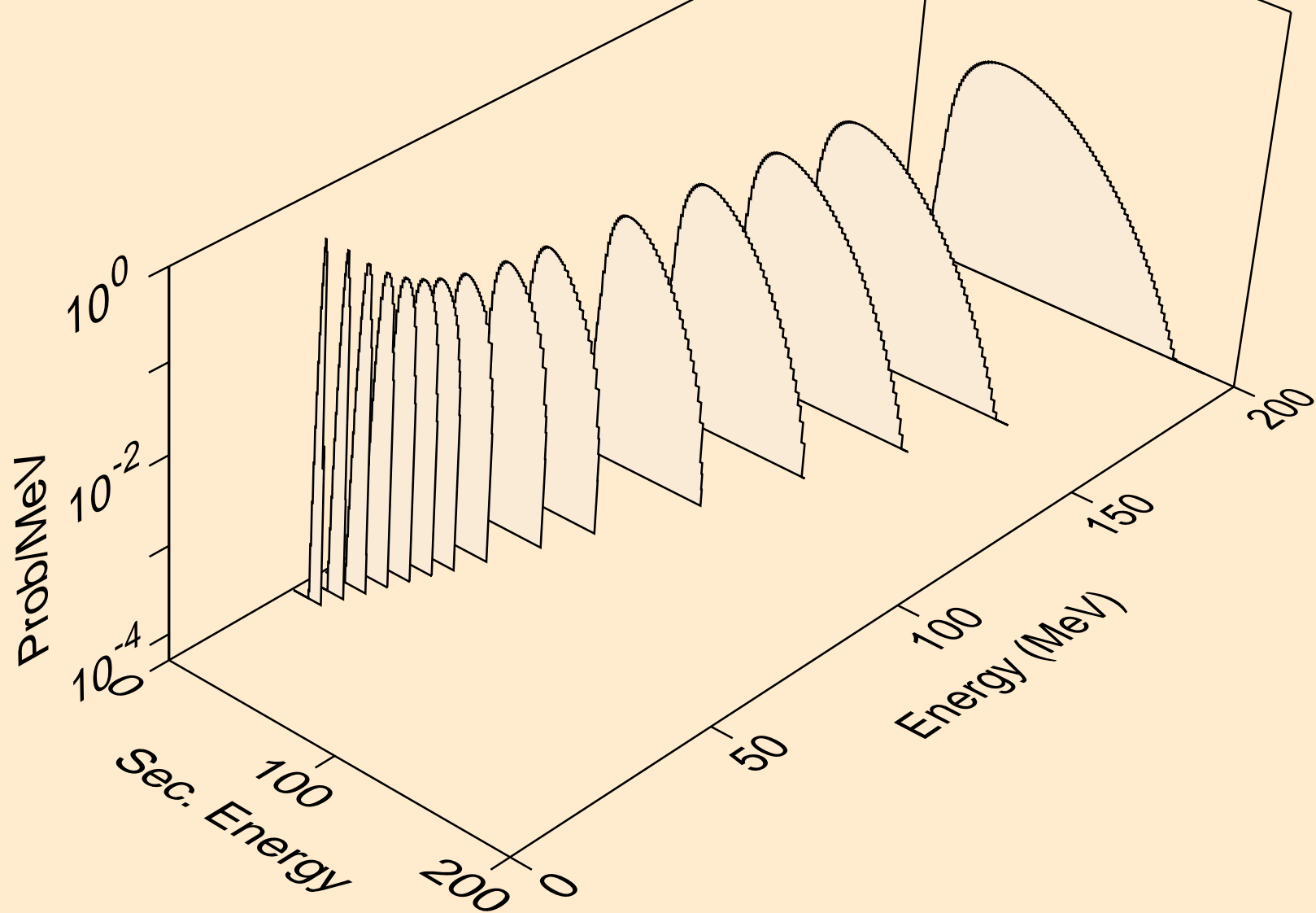

BI223 NEUTRON ACER TENDL-2024 LIBRARY; T=293.6K  
he3s from (n,n\*)he3

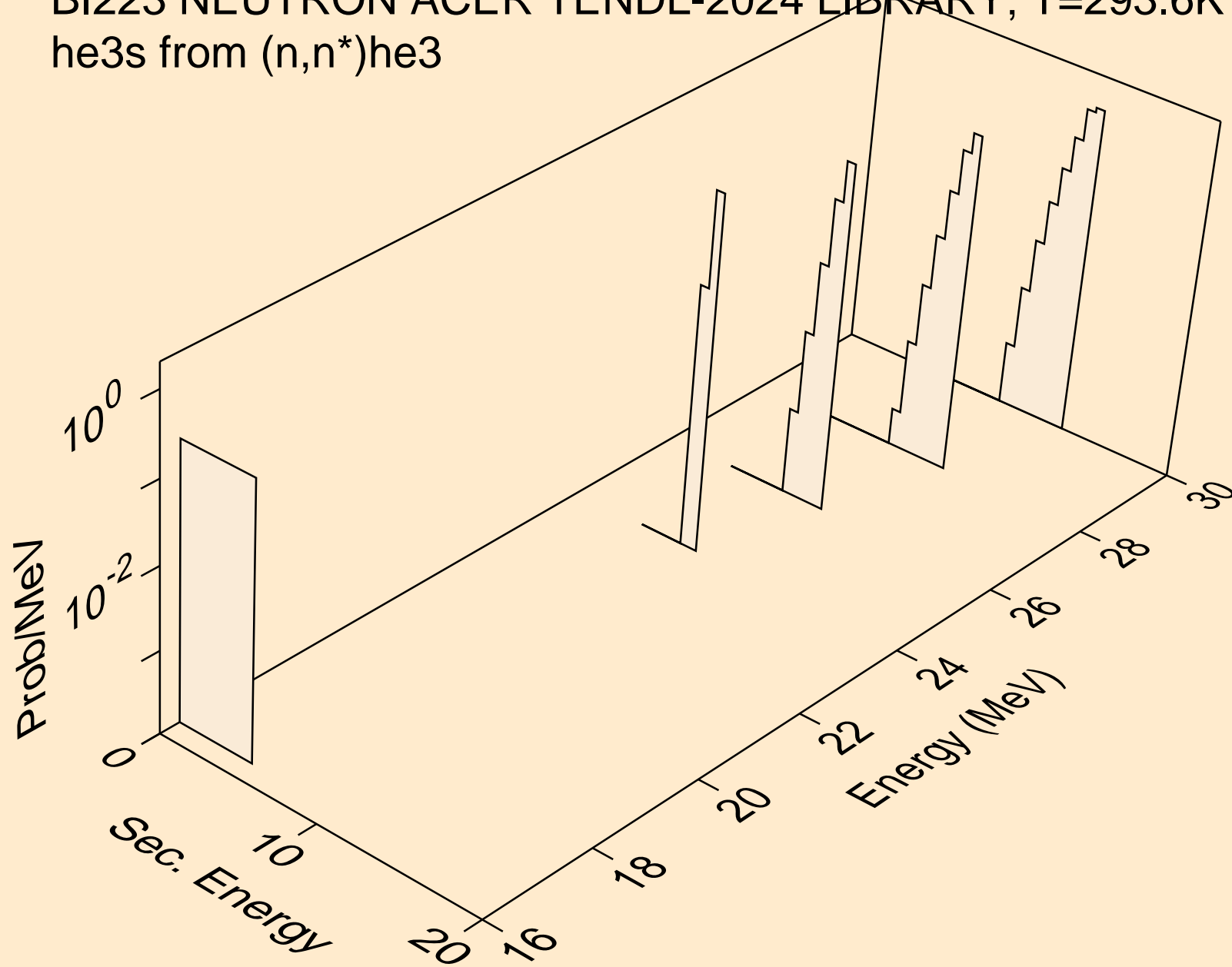

BI223 NEUTRON ACER TENDL-2024 LIBRARY; T=293.6K  
he3s from (n,he3)

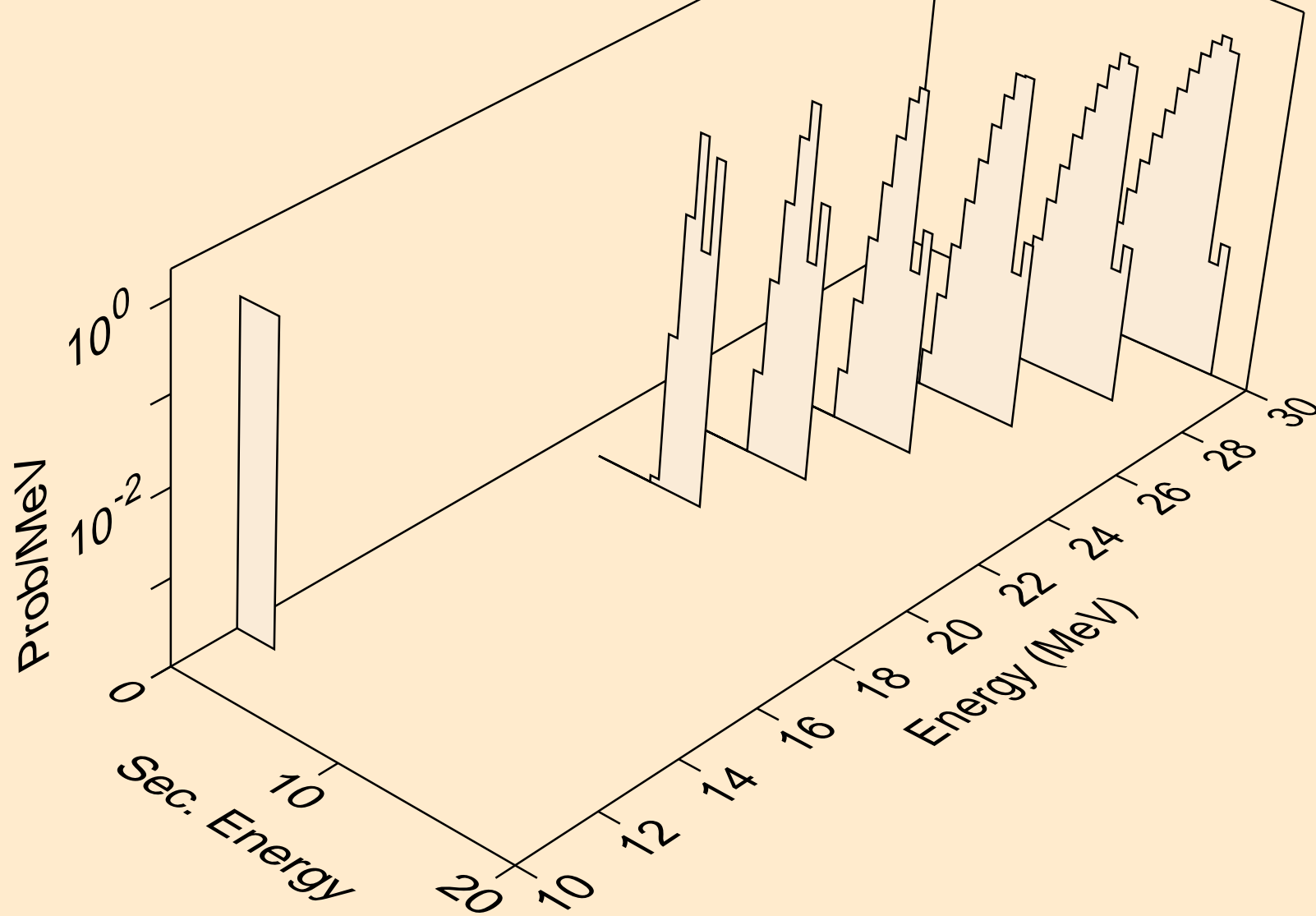

BI223 NEUTRON ACER TENDL-2024 LIBRARY; T=293.6K  
alphas from (n,x)

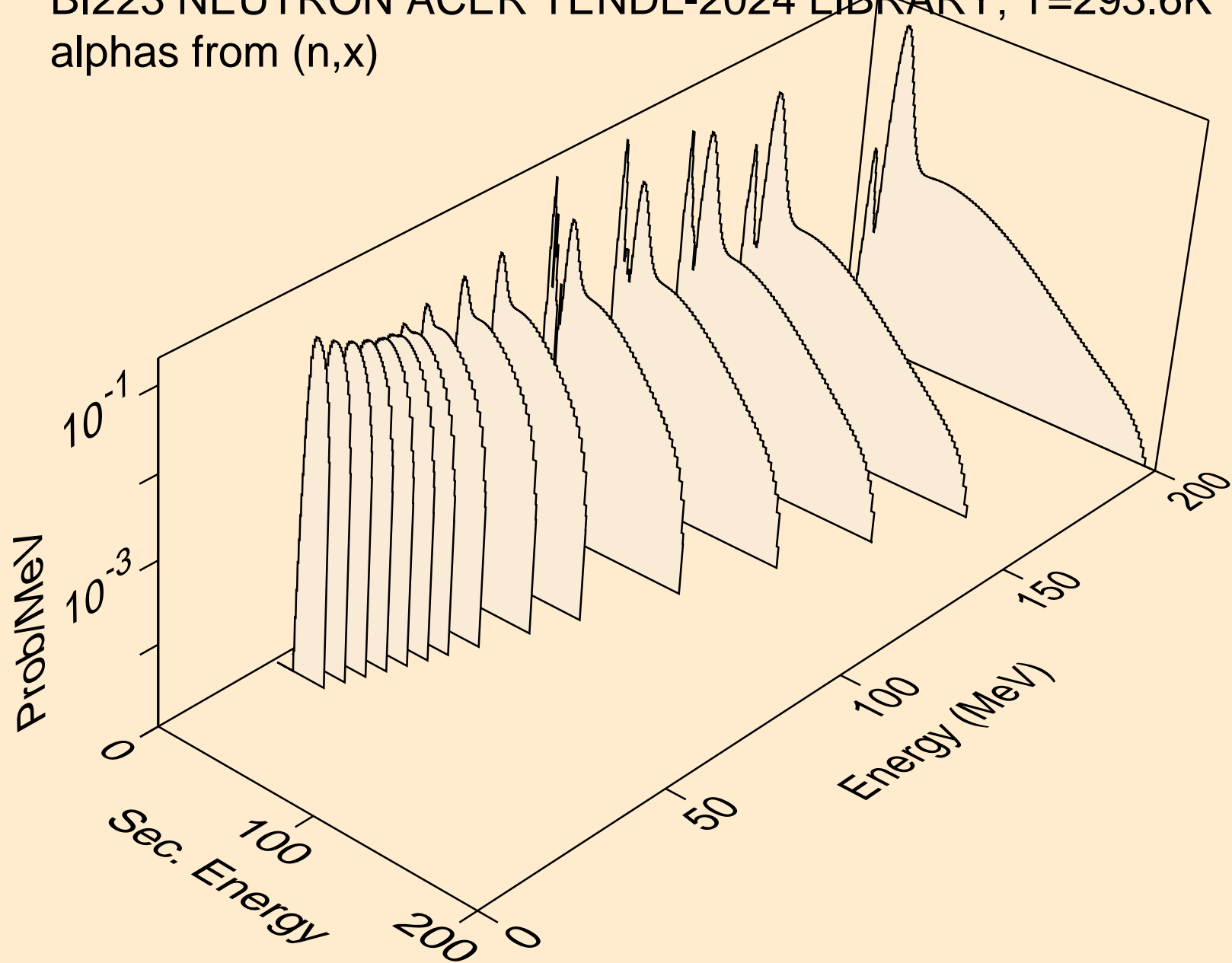

BI223 NEUTRON ACER TENDL-2024 LIBRARY; T=293.6K  
alphas from (n,n\*)a

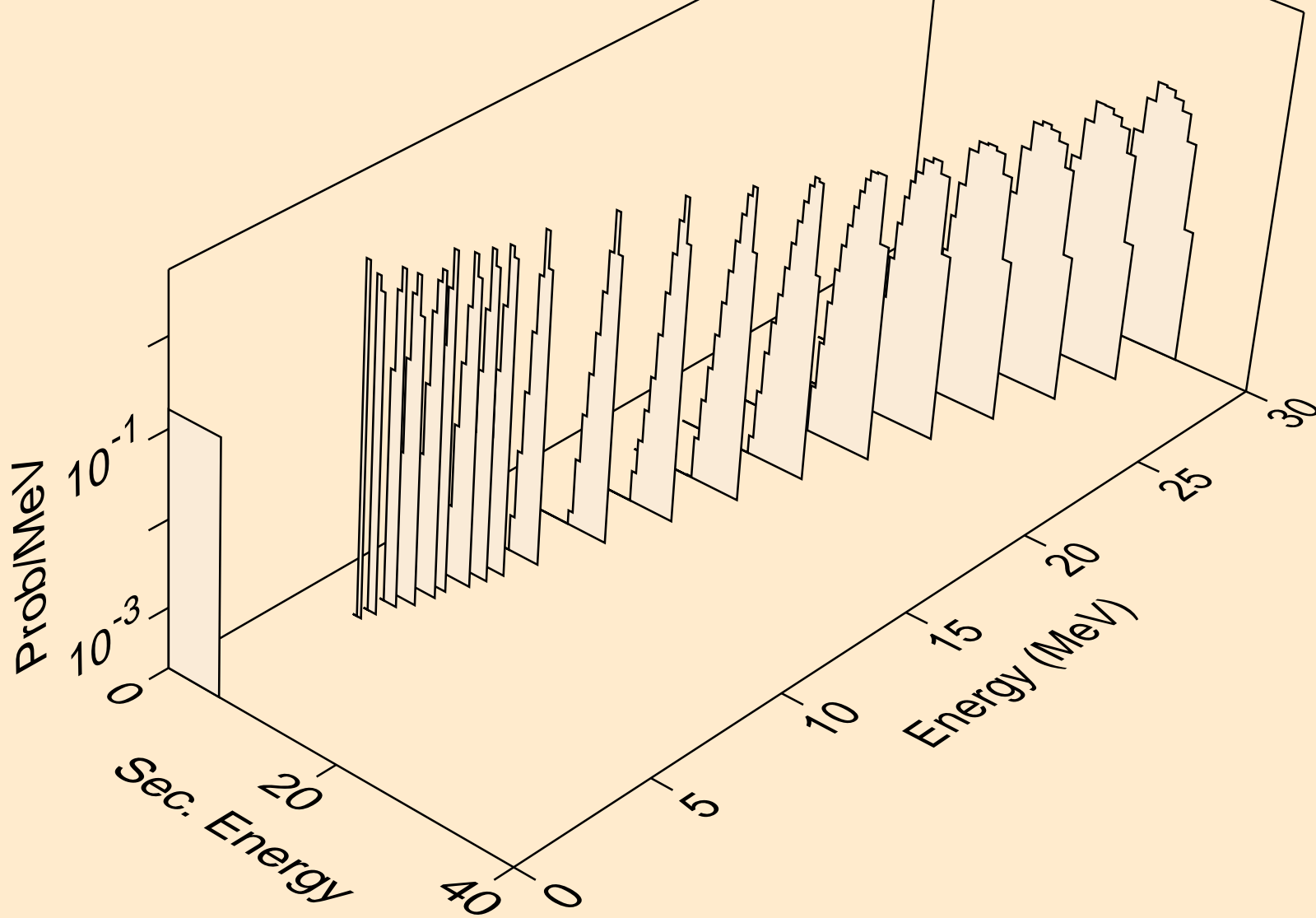

BI223 NEUTRON ACER TENDL-2024 LIBRARY; T=293.6K  
alphas from (n,2n)a

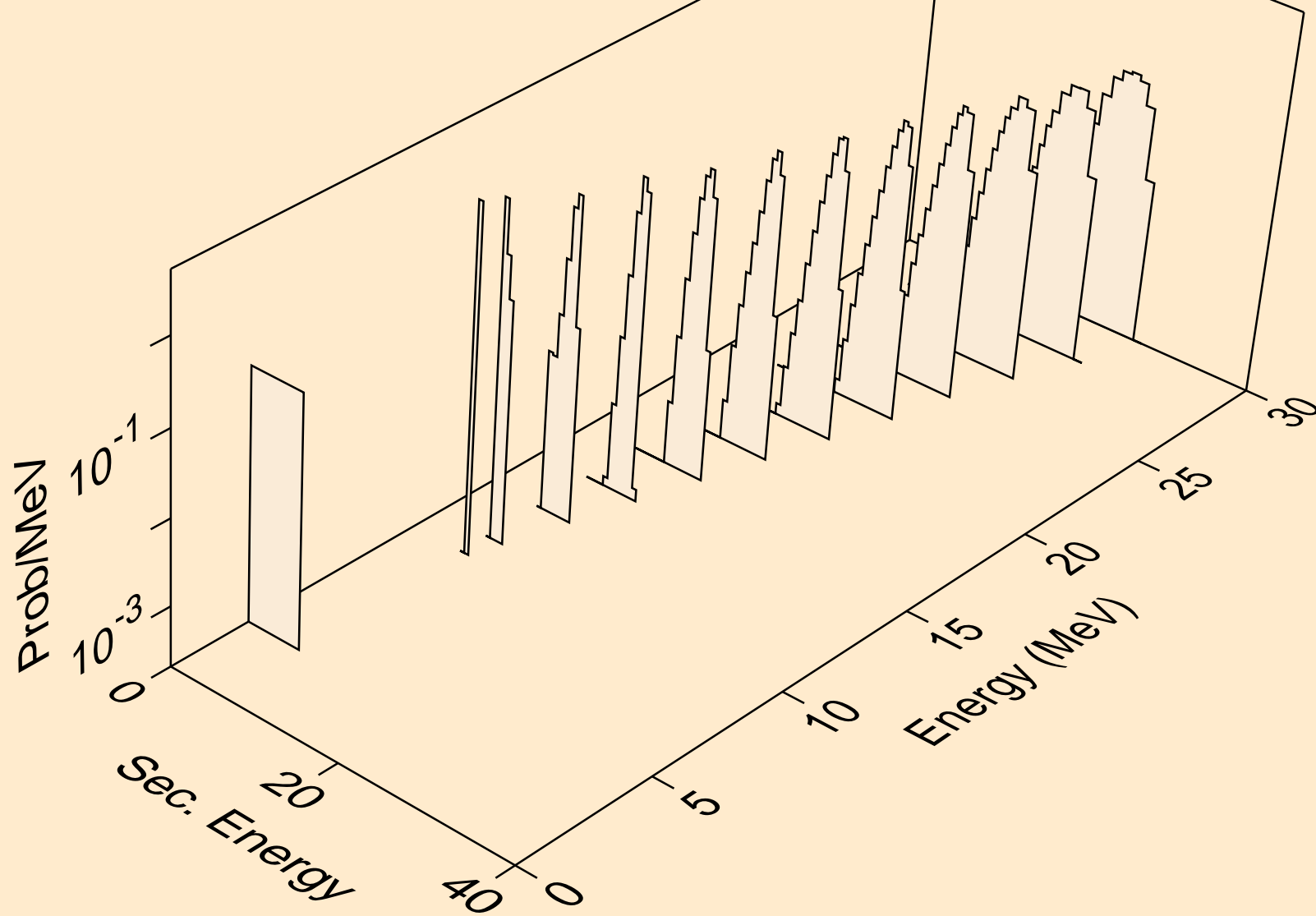

BI223 NEUTRON ACER TENDL-2024 LIBRARY; T=293.6K  
alphas from (n,3n)a

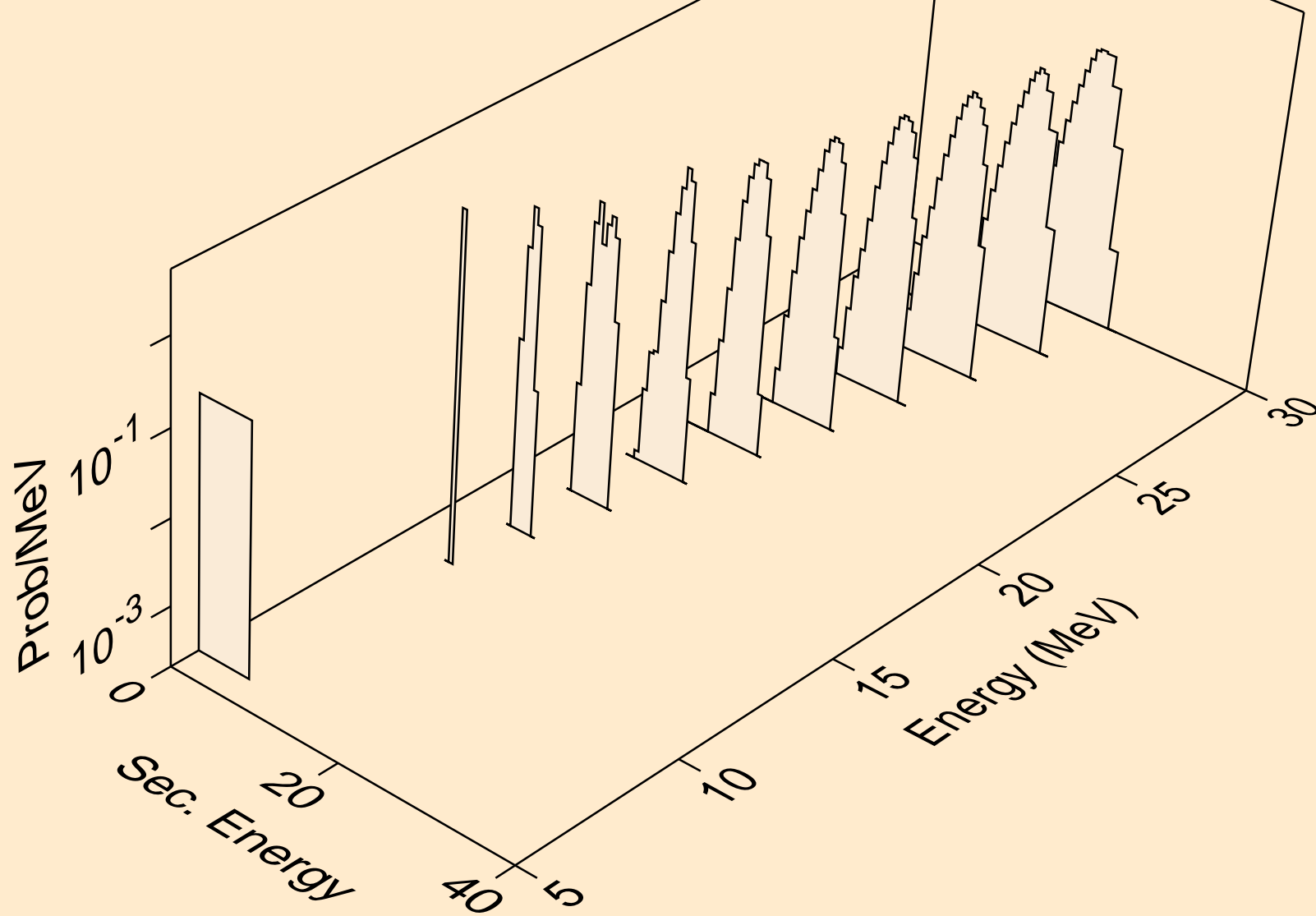

BI223 NEUTRON ACER TENDL-2024 LIBRARY; T=293.6K  
alphas from (n,a)

