

BK236 NEUTRON ACER TENDL-2024 LIBRARY; T=293.6K

Principal cross sections

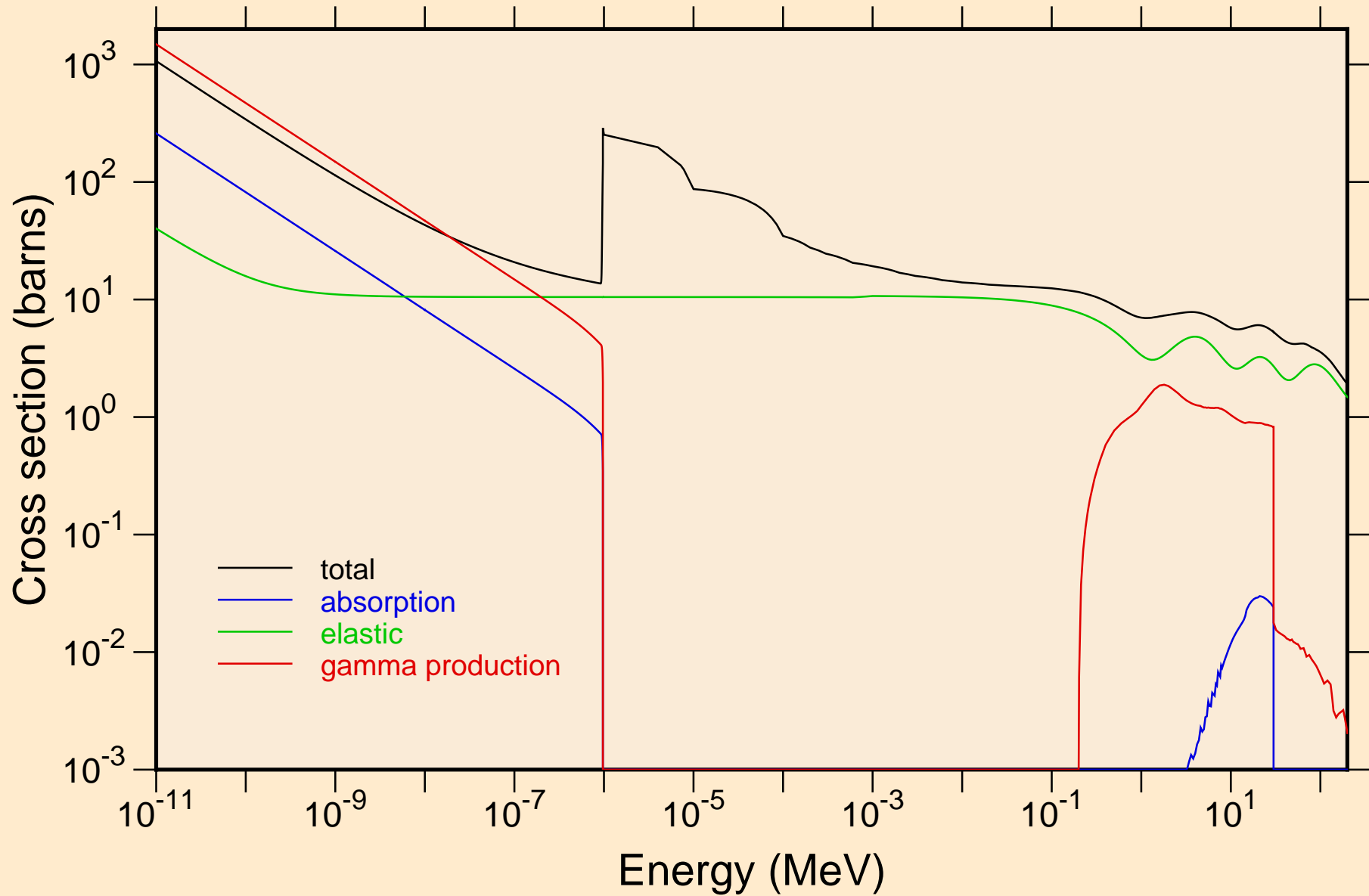

BK236 NEUTRON ACER TENDL-2024 LIBRARY; T=293.6K
Heating

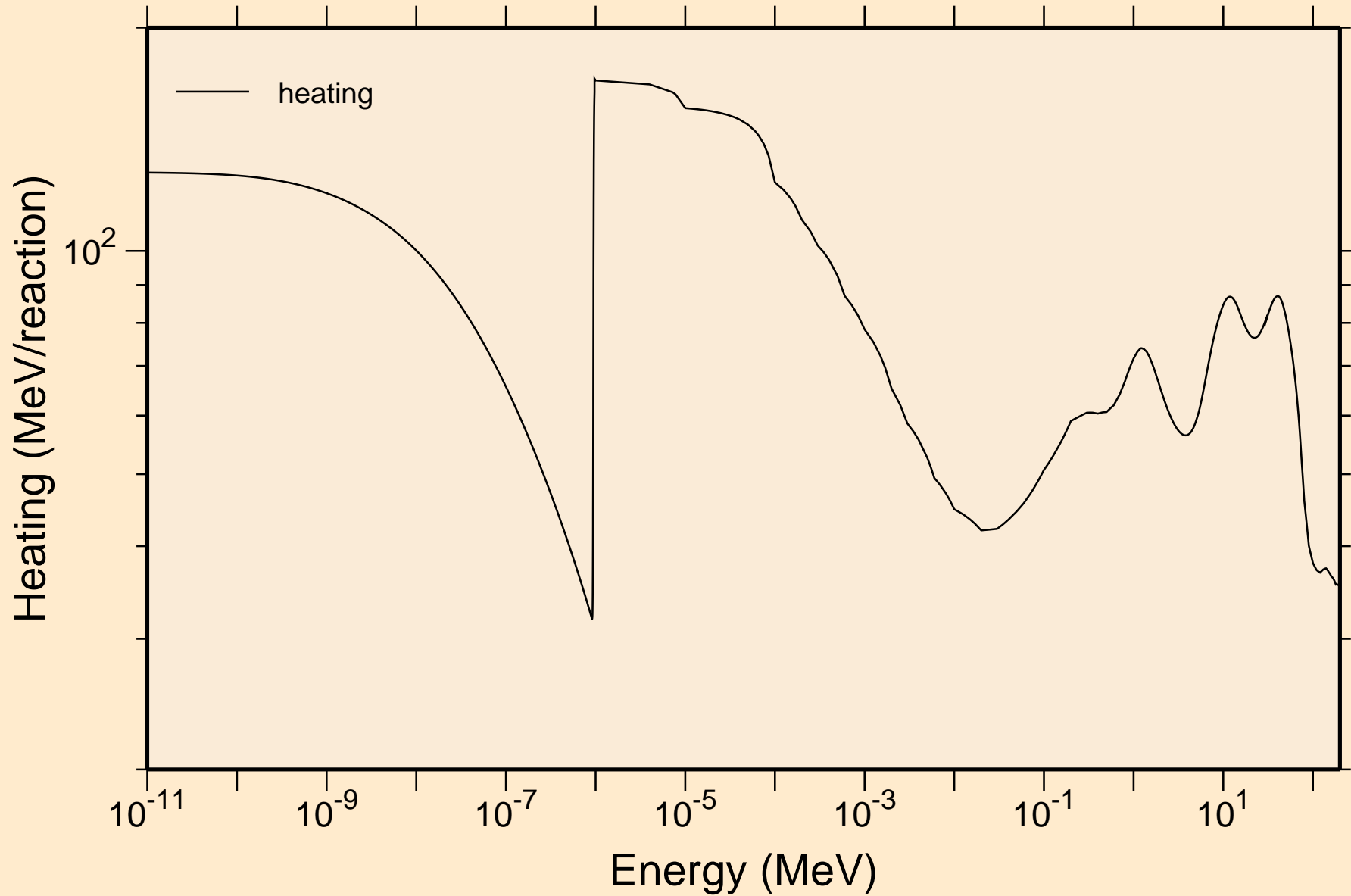

BK236 NEUTRON ACER TENDL-2024 LIBRARY; T=293.6K
Damage

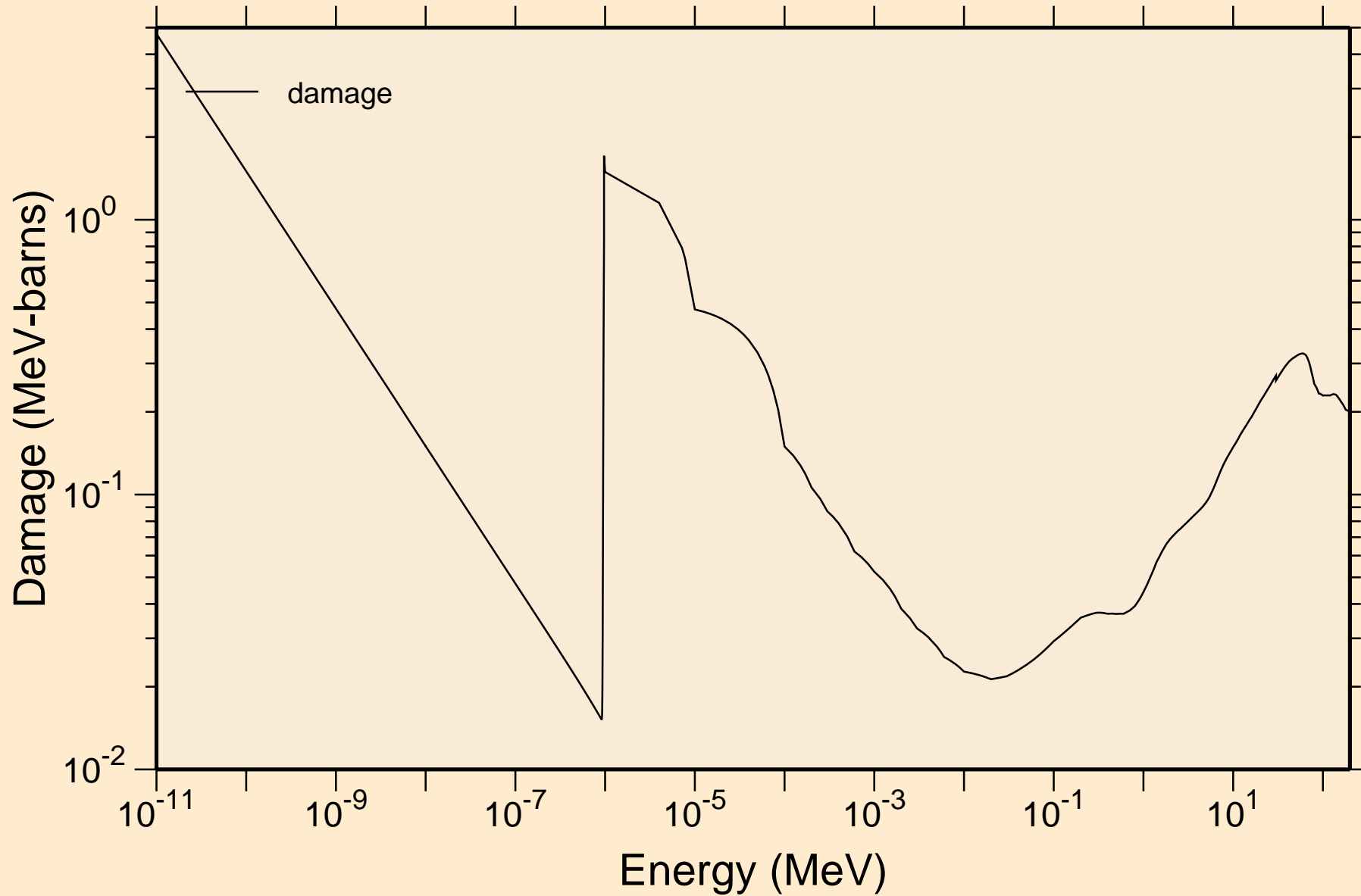

BK236 NEUTRON ACER TENDL-2024 LIBRARY; T=293.6K
Non-threshold reactions

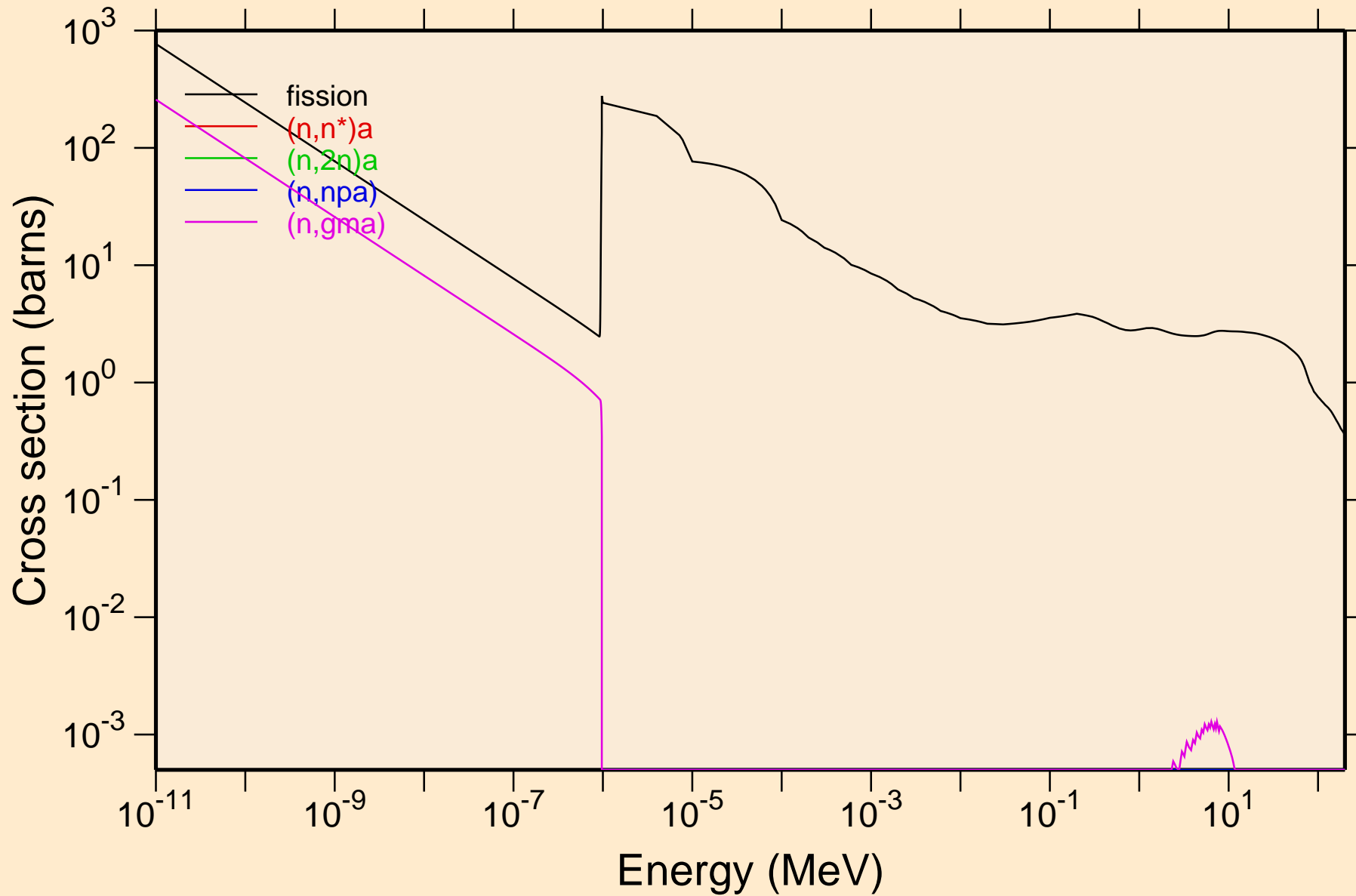

BK236 NEUTRON ACER TENDL-2024 LIBRARY; T=293.6K
Non-threshold reactions

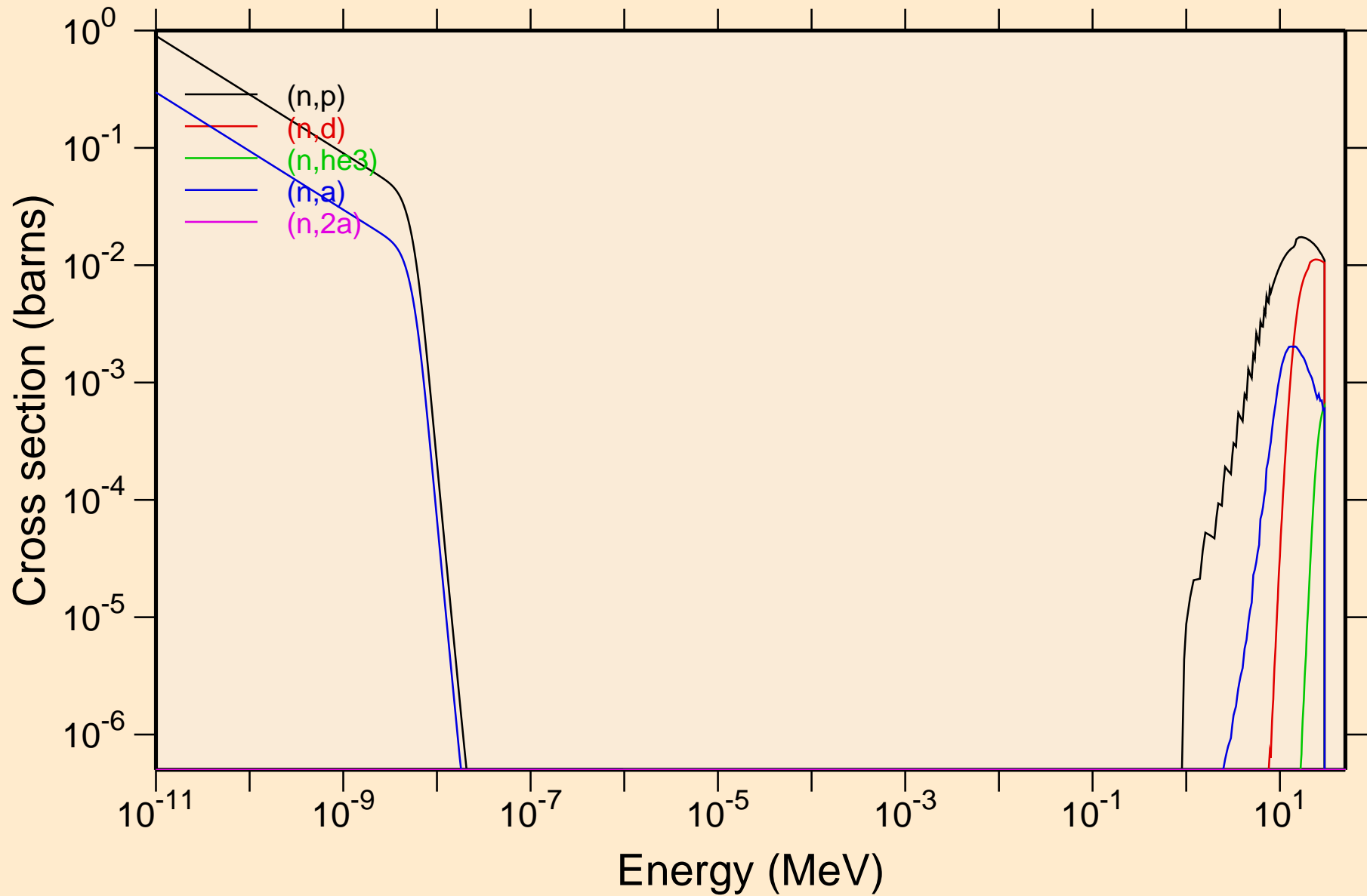

BK236 NEUTRON ACER TENDL-2024 LIBRARY; T=293.6K
Non-threshold reactions

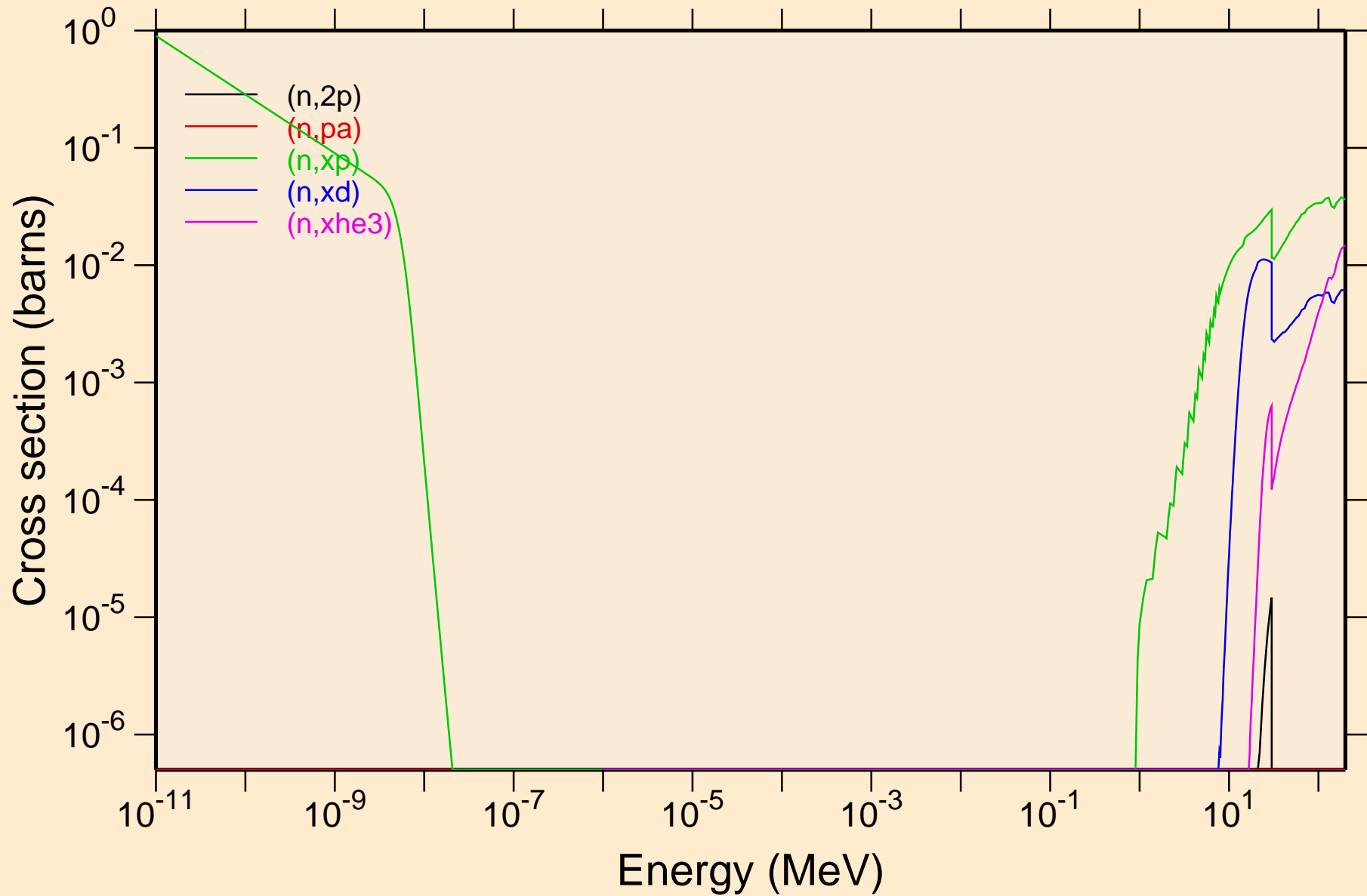

BK236 NEUTRON ACER TENDL-2024 LIBRARY; T=293.6K
Non-threshold reactions

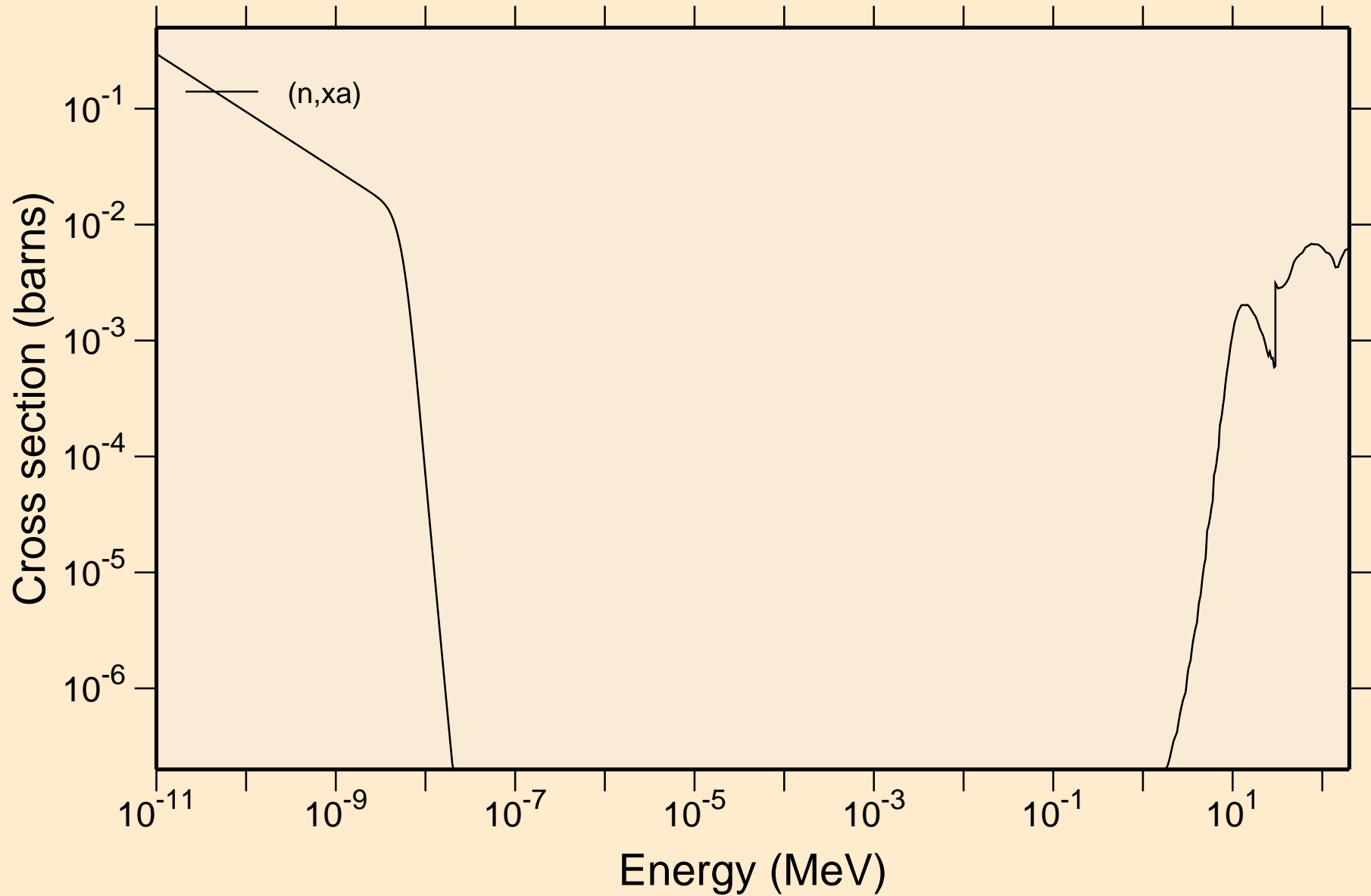

BK236 NEUTRON ACER TENDL-2024 LIBRARY; T=293.6K
Principal cross sections

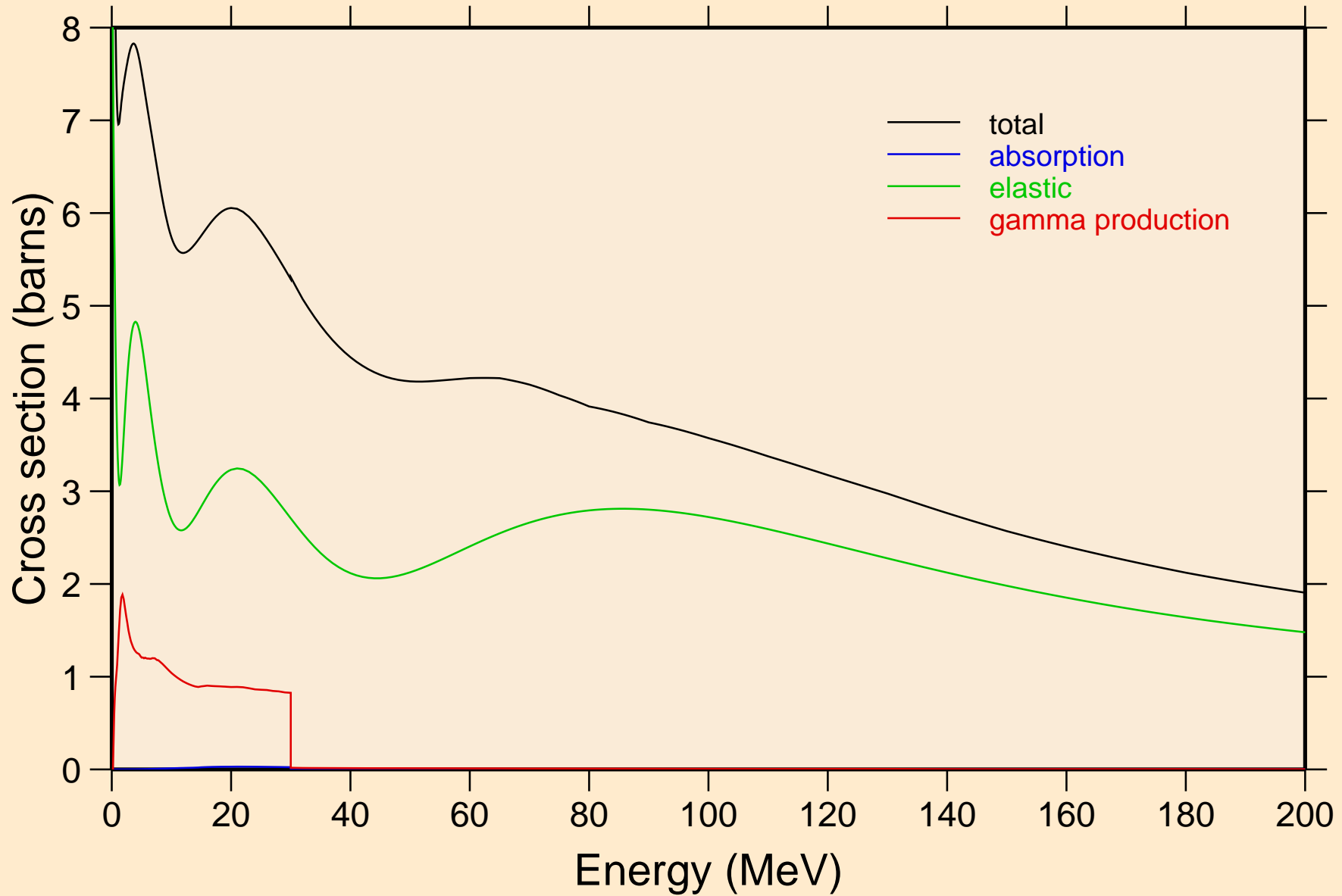

BK236 NEUTRON ACER TENDL-2024 LIBRARY; T=293.6K
Heating

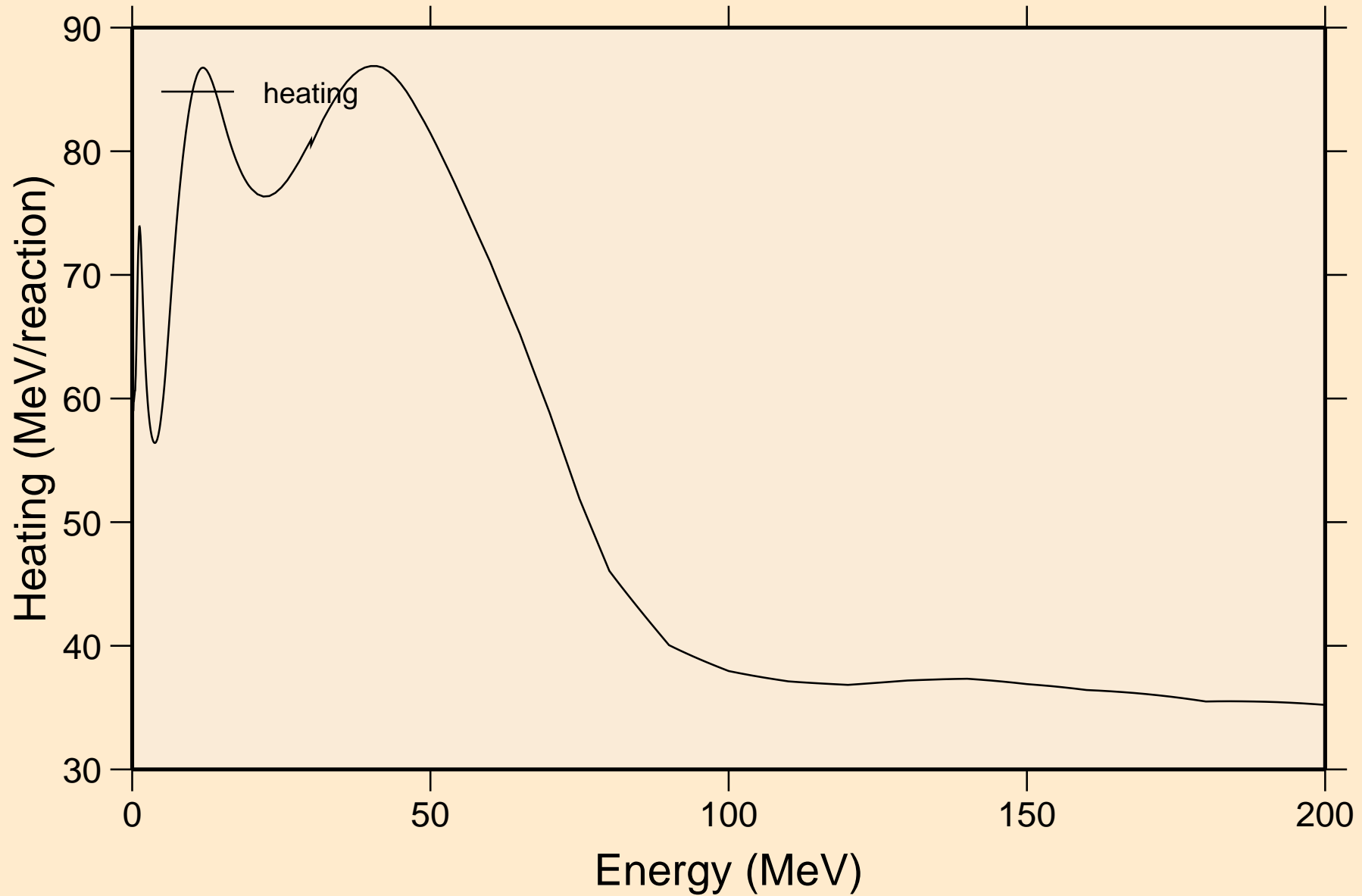

BK236 NEUTRON ACER TENDL-2024 LIBRARY; T=293.6K
Damage

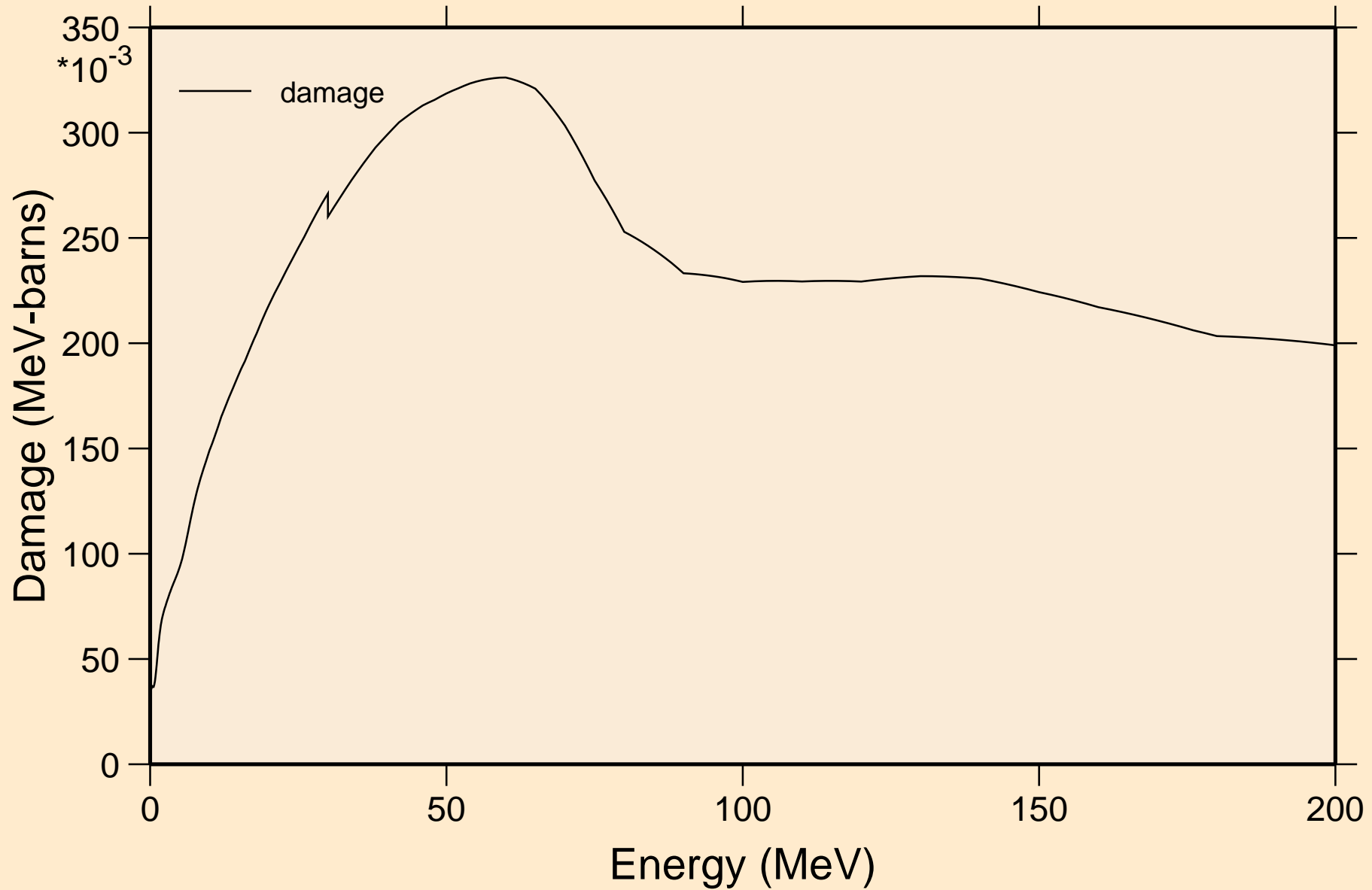

BK236 NEUTRON ACER TENDL-2024 LIBRARY; T=293.6K
Non-threshold reactions

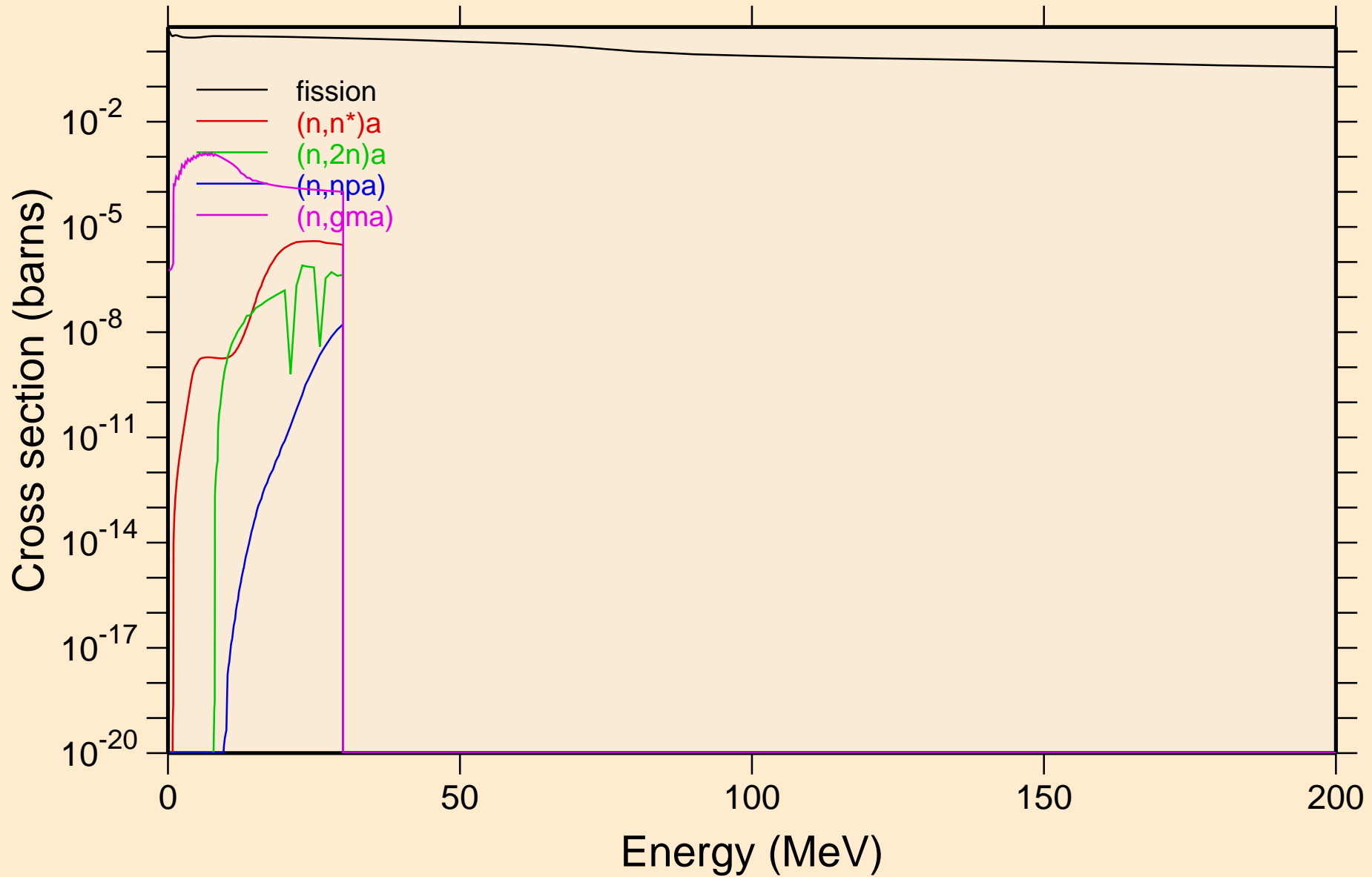

BK236 NEUTRON ACER TENDL-2024 LIBRARY; T=293.6K
Non-threshold reactions

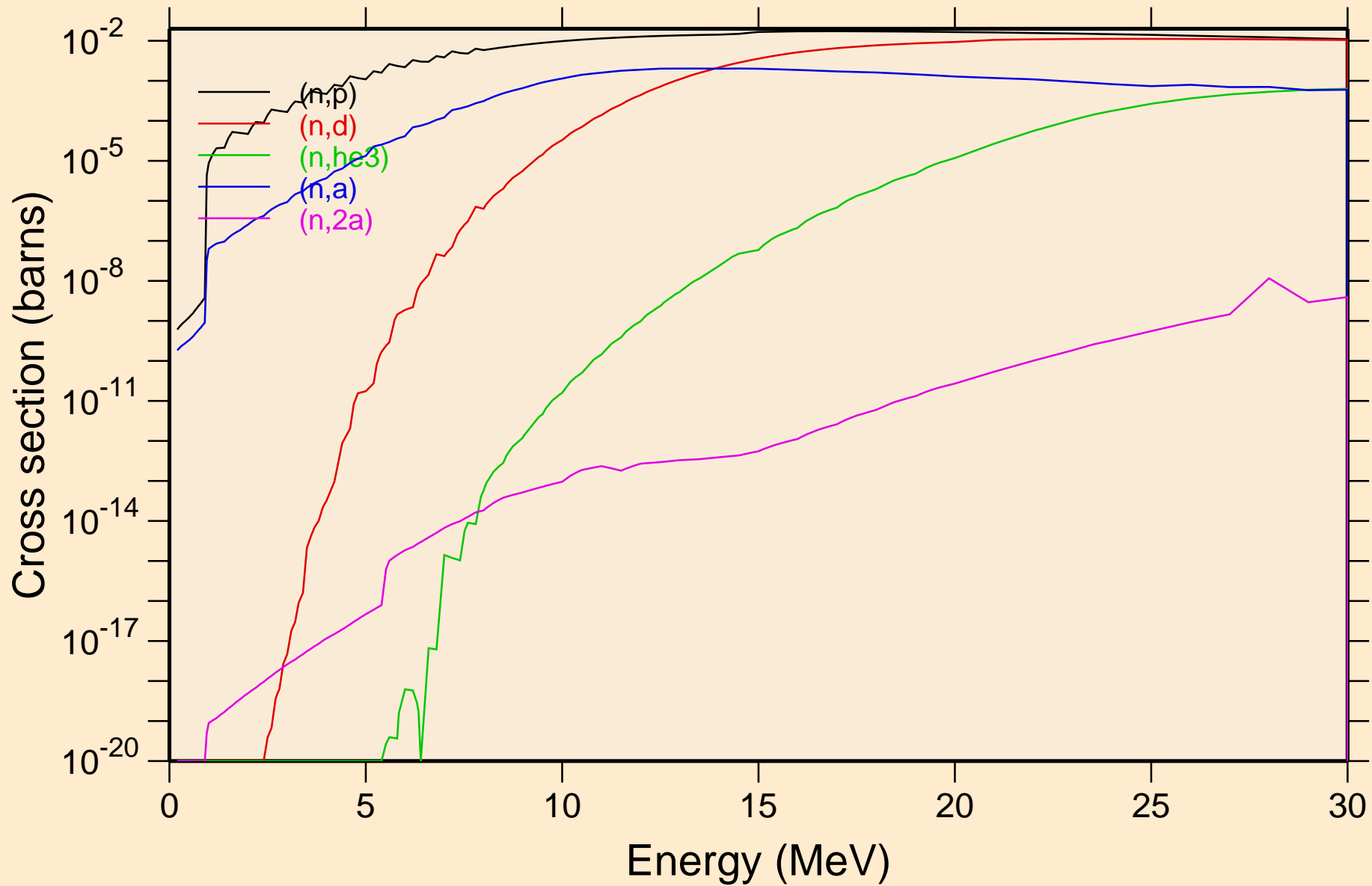

BK236 NEUTRON ACER TENDL-2024 LIBRARY; T=293.6K

Non-threshold reactions

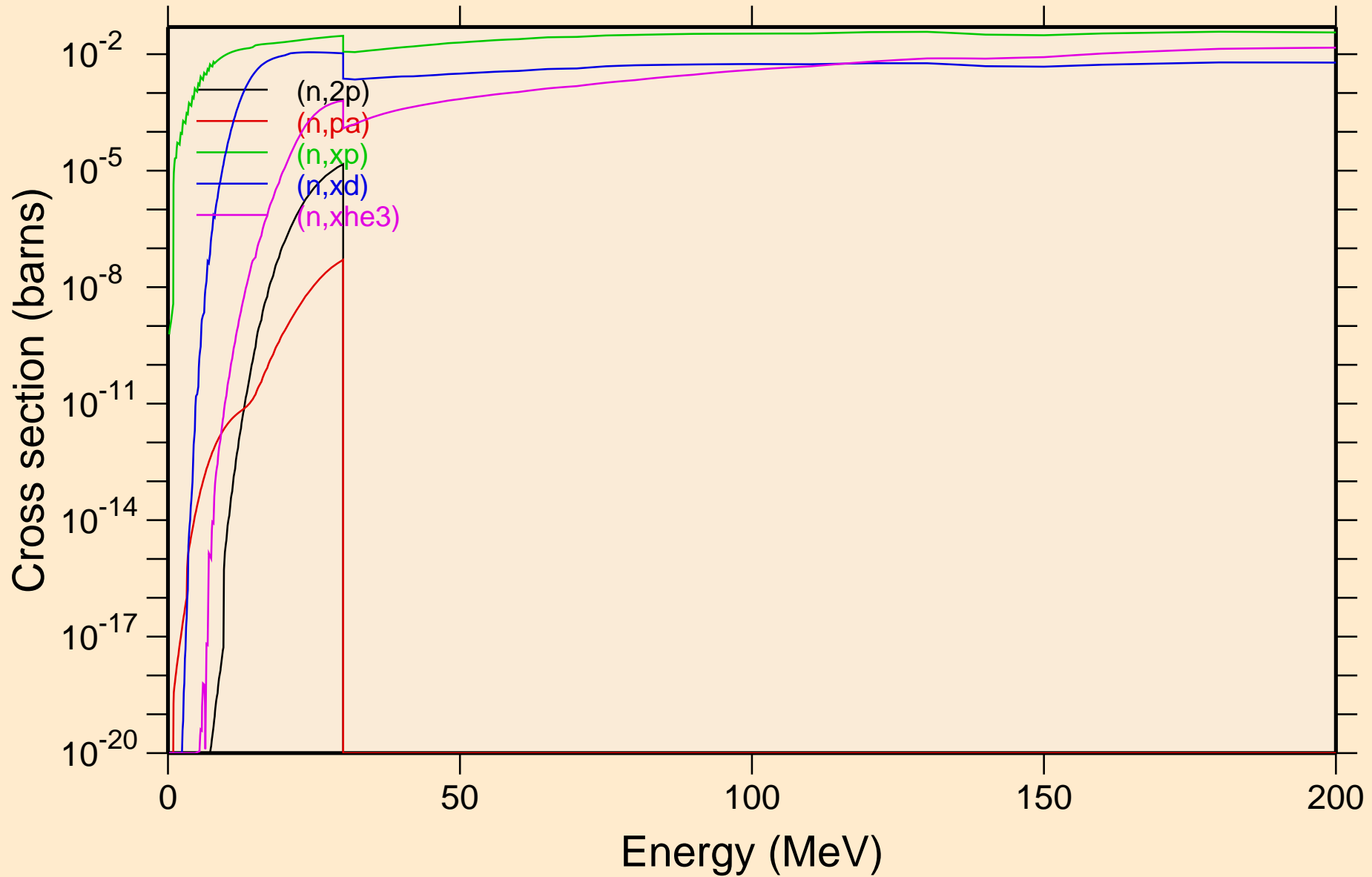

BK236 NEUTRON ACER TENDL-2024 LIBRARY; T=293.6K
Non-threshold reactions

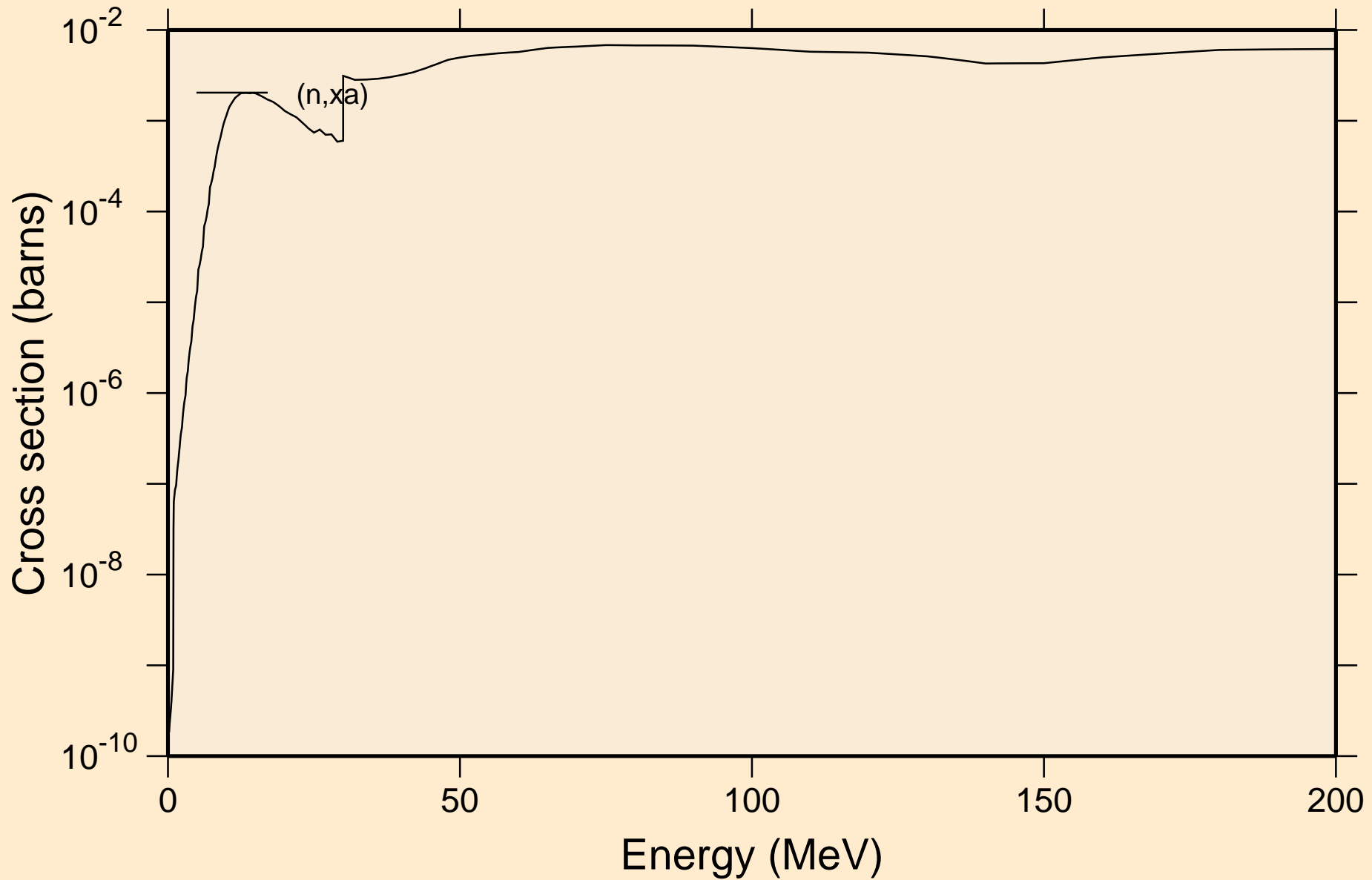

BK236 NEUTRON ACER TENDL-2024 LIBRARY; T=293.6K
Inelastic levels

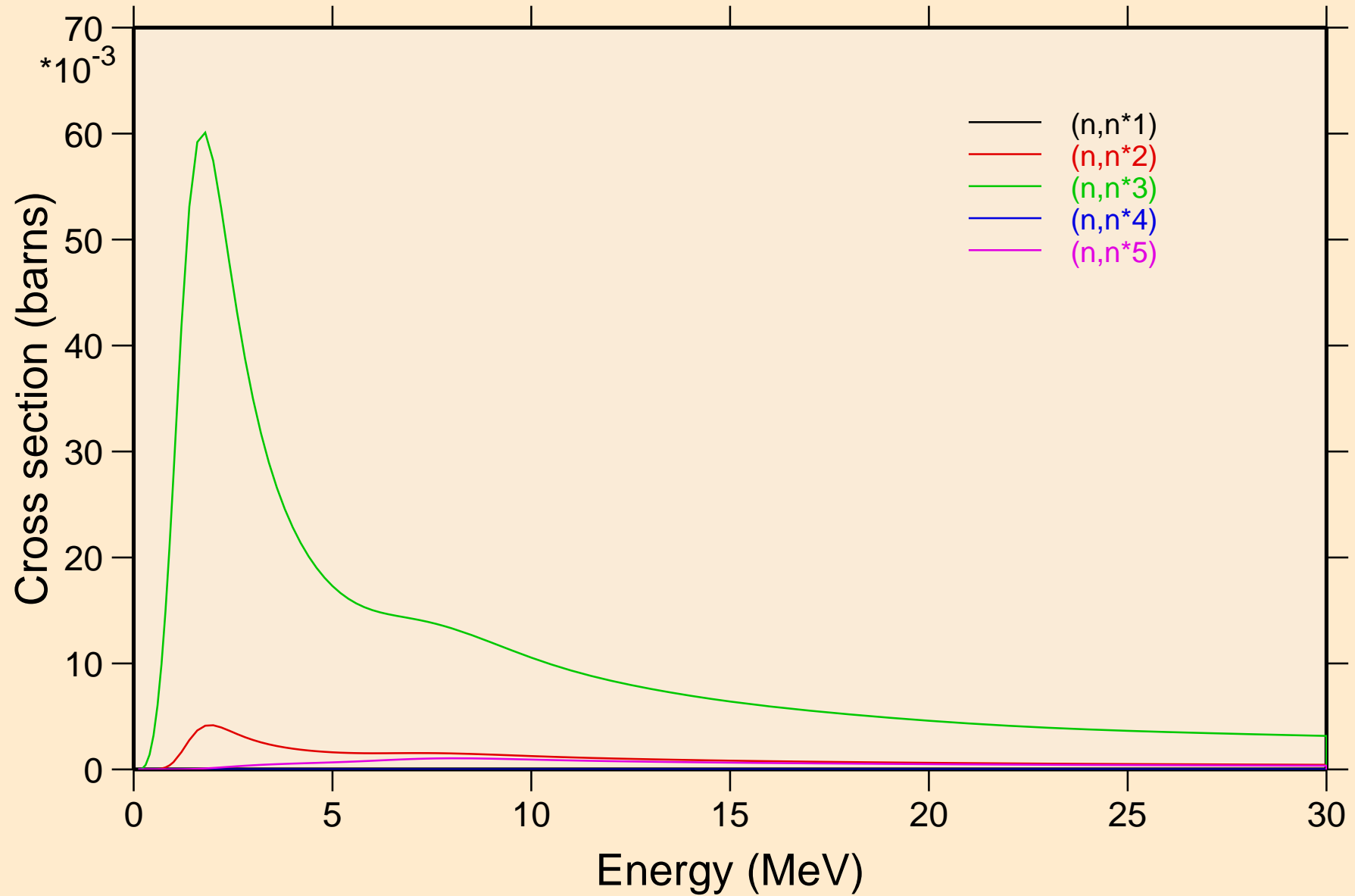

BK236 NEUTRON ACER TENDL-2024 LIBRARY; T=293.6K
Inelastic levels

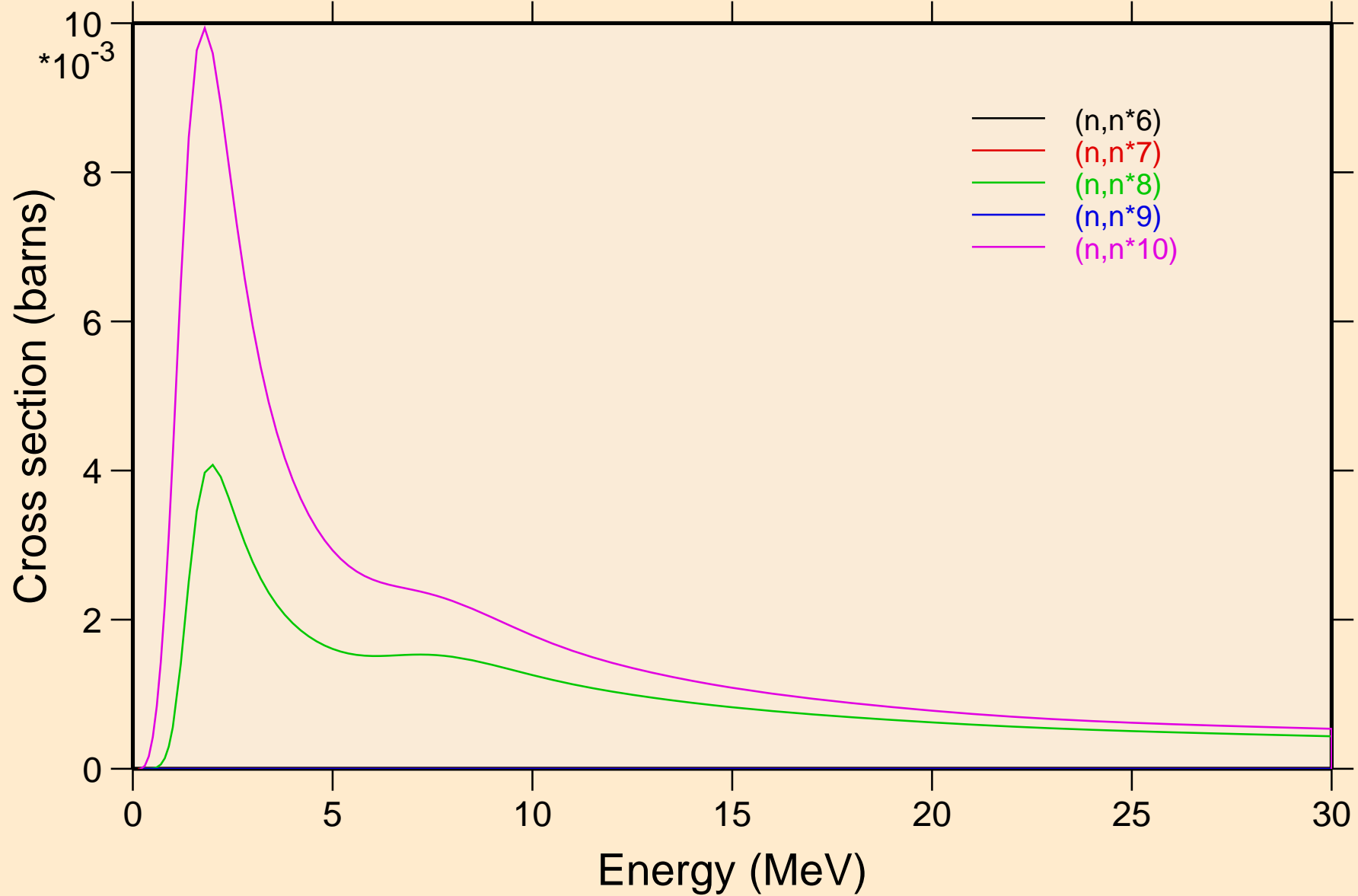

BK236 NEUTRON ACER TENDL-2024 LIBRARY; T=293.6K
Inelastic levels

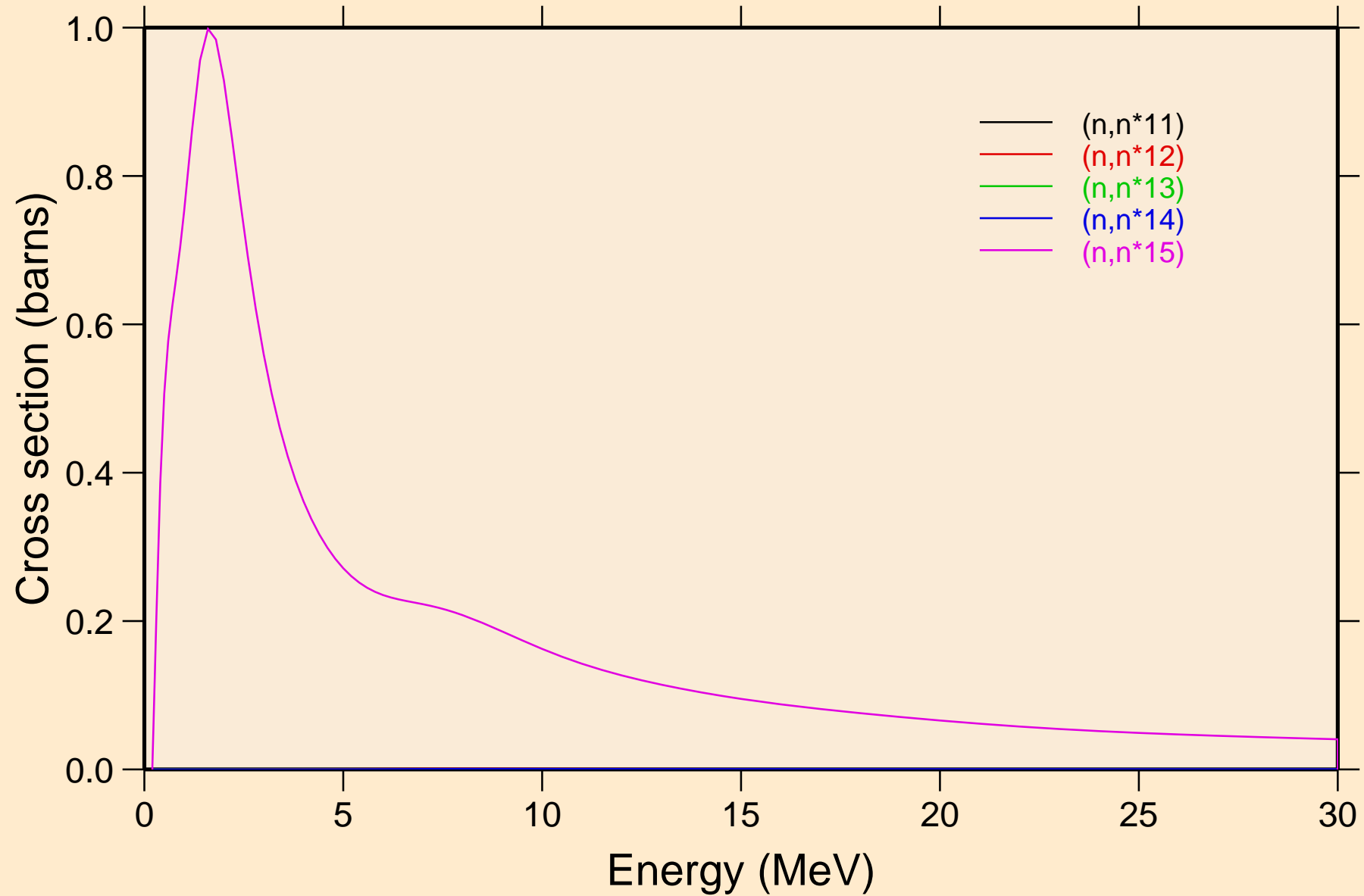

BK236 NEUTRON ACER TENDL-2024 LIBRARY; T=293.6K
Inelastic levels

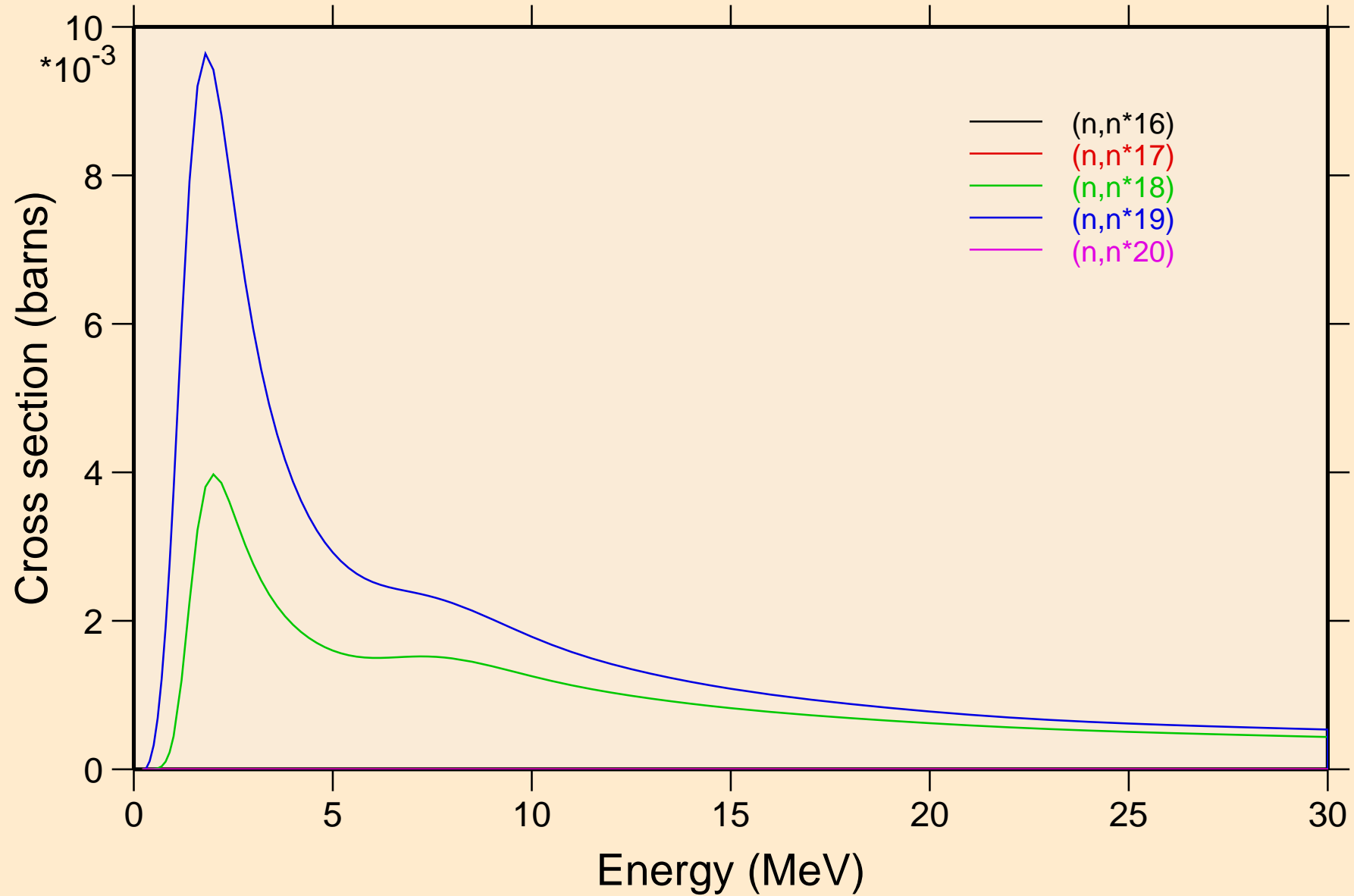

BK236 NEUTRON ACER TENDL-2024 LIBRARY; T=293.6K
Inelastic levels

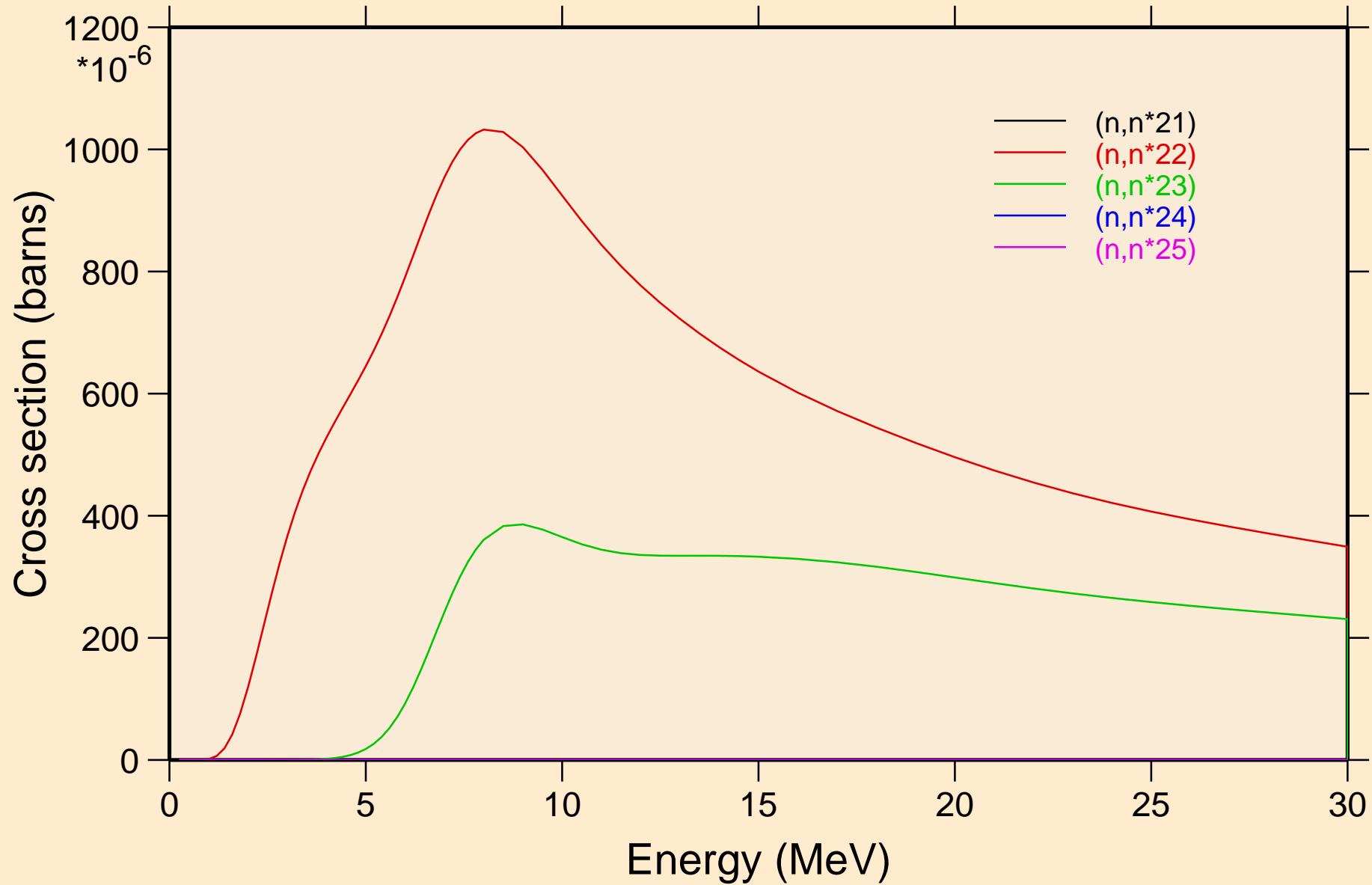

BK236 NEUTRON ACER TENDL-2024 LIBRARY; T=293.6K
Inelastic levels

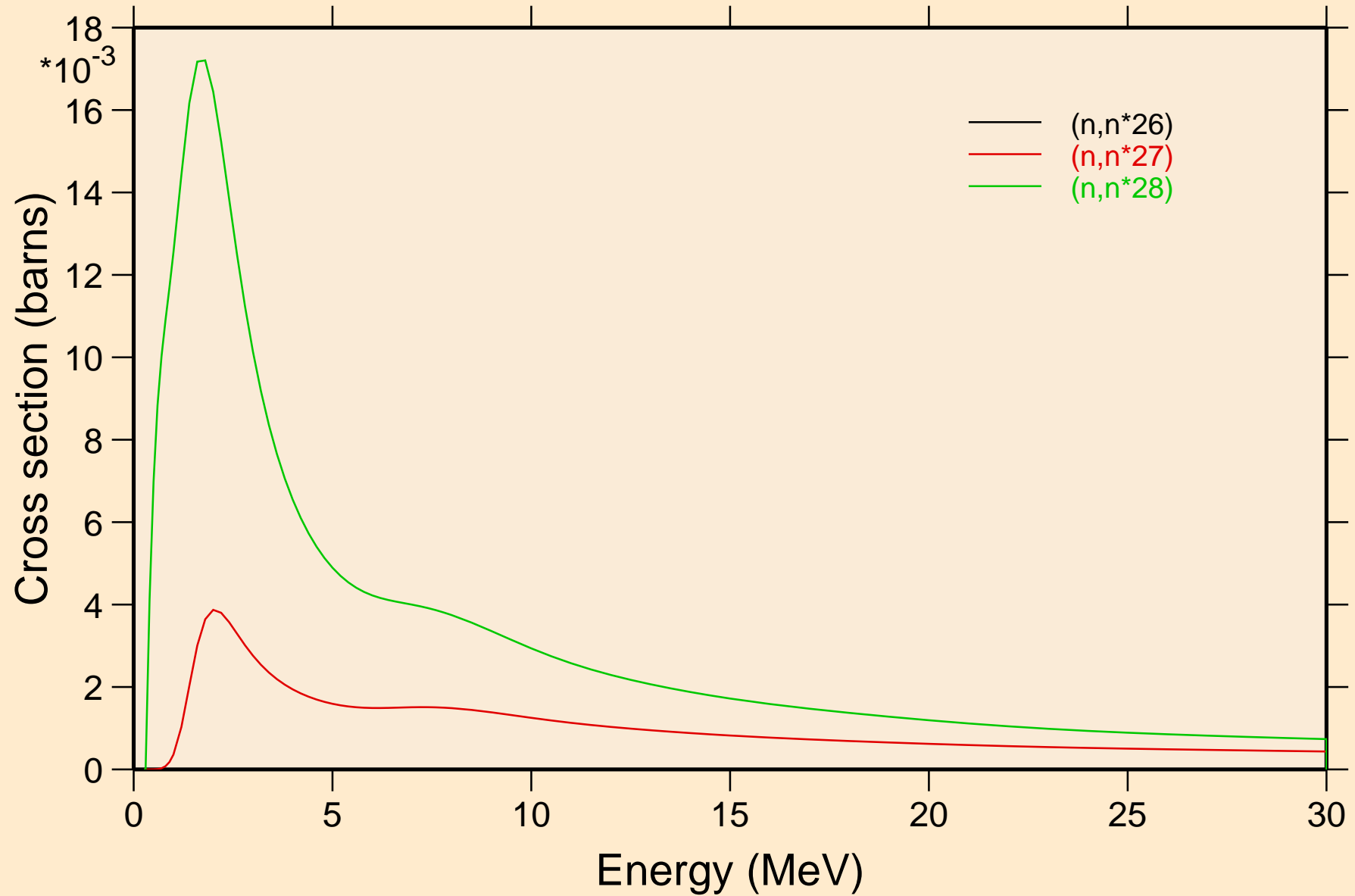

BK236 NEUTRON ACER TENDL-2024 LIBRARY; T=293.6K

Threshold reactions

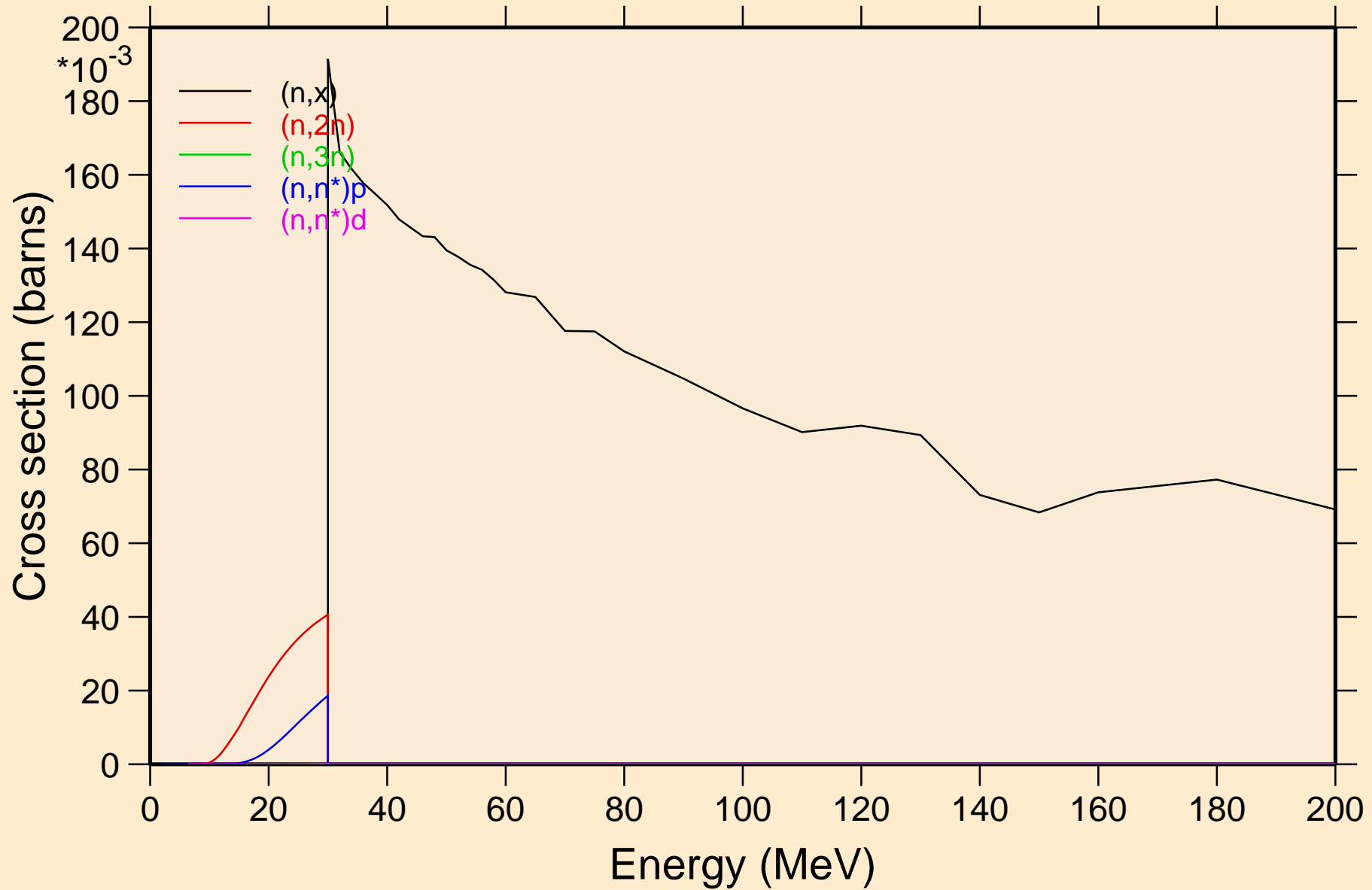

BK236 NEUTRON ACER TENDL-2024 LIBRARY; T=293.6K
Threshold reactions

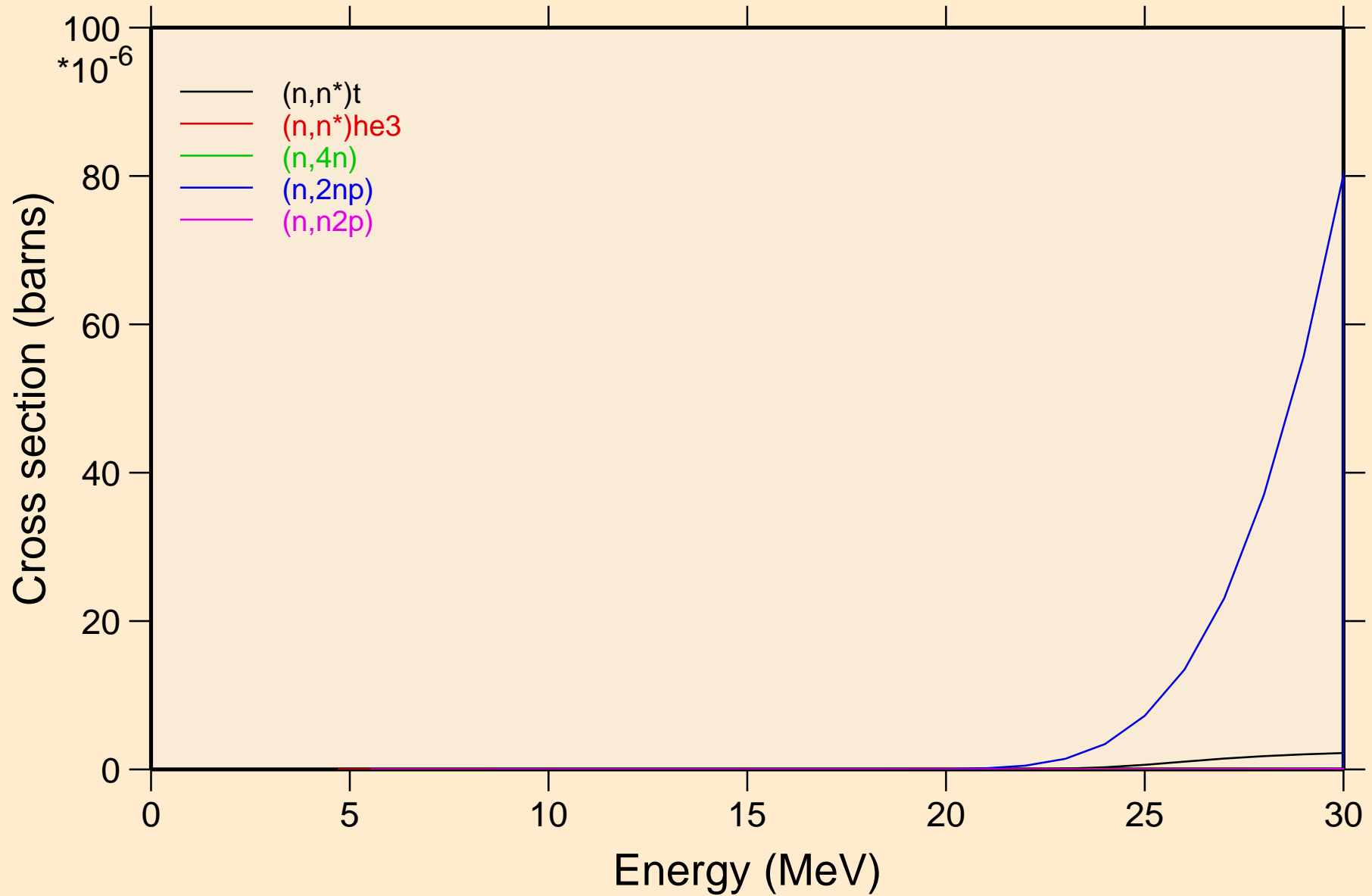

BK236 NEUTRON ACER TENDL-2024 LIBRARY; T=293.6K
Threshold reactions

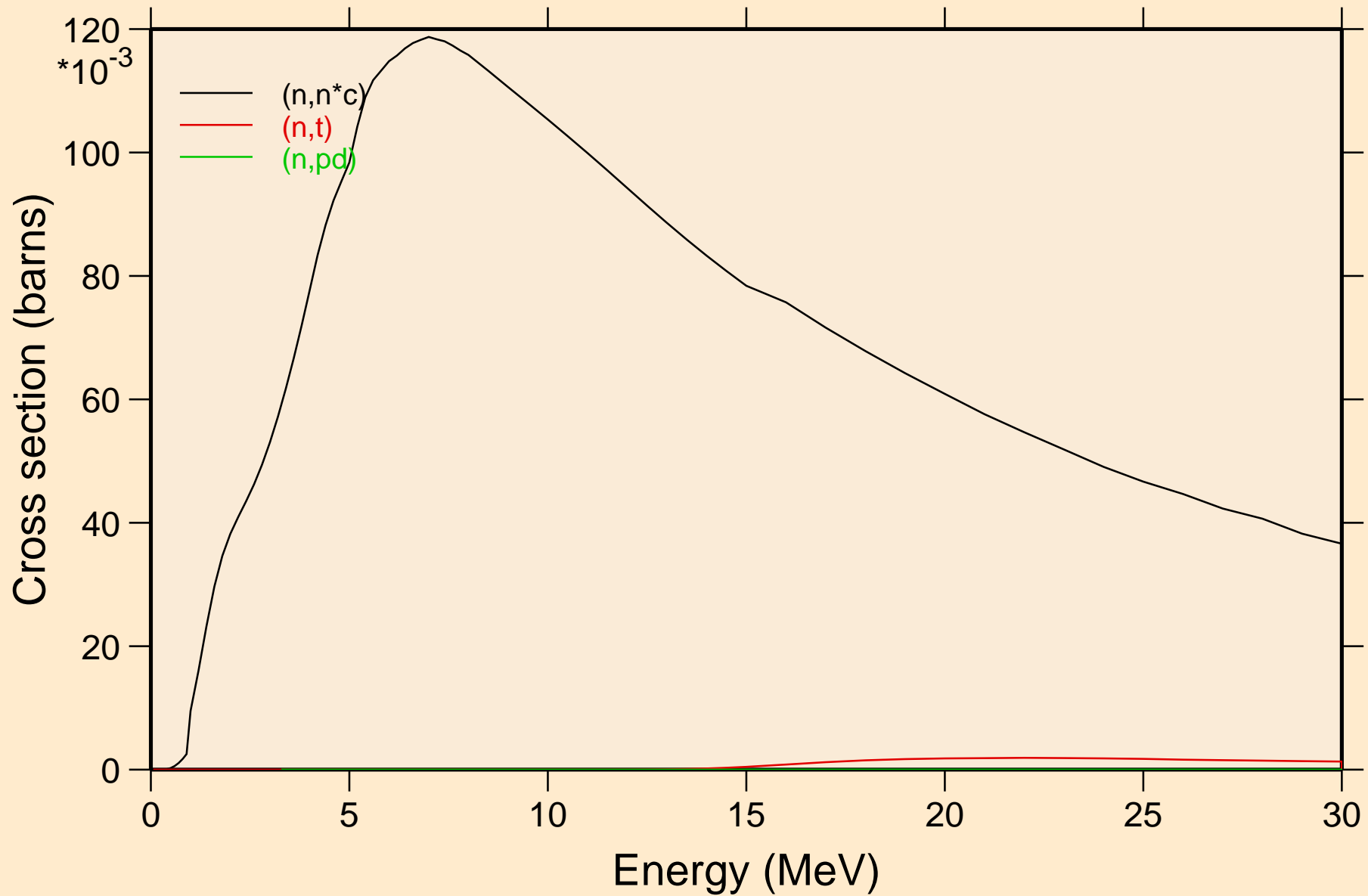

BK236 NEUTRON ACER TENDL-2024 LIBRARY; T=293.6K
Threshold reactions

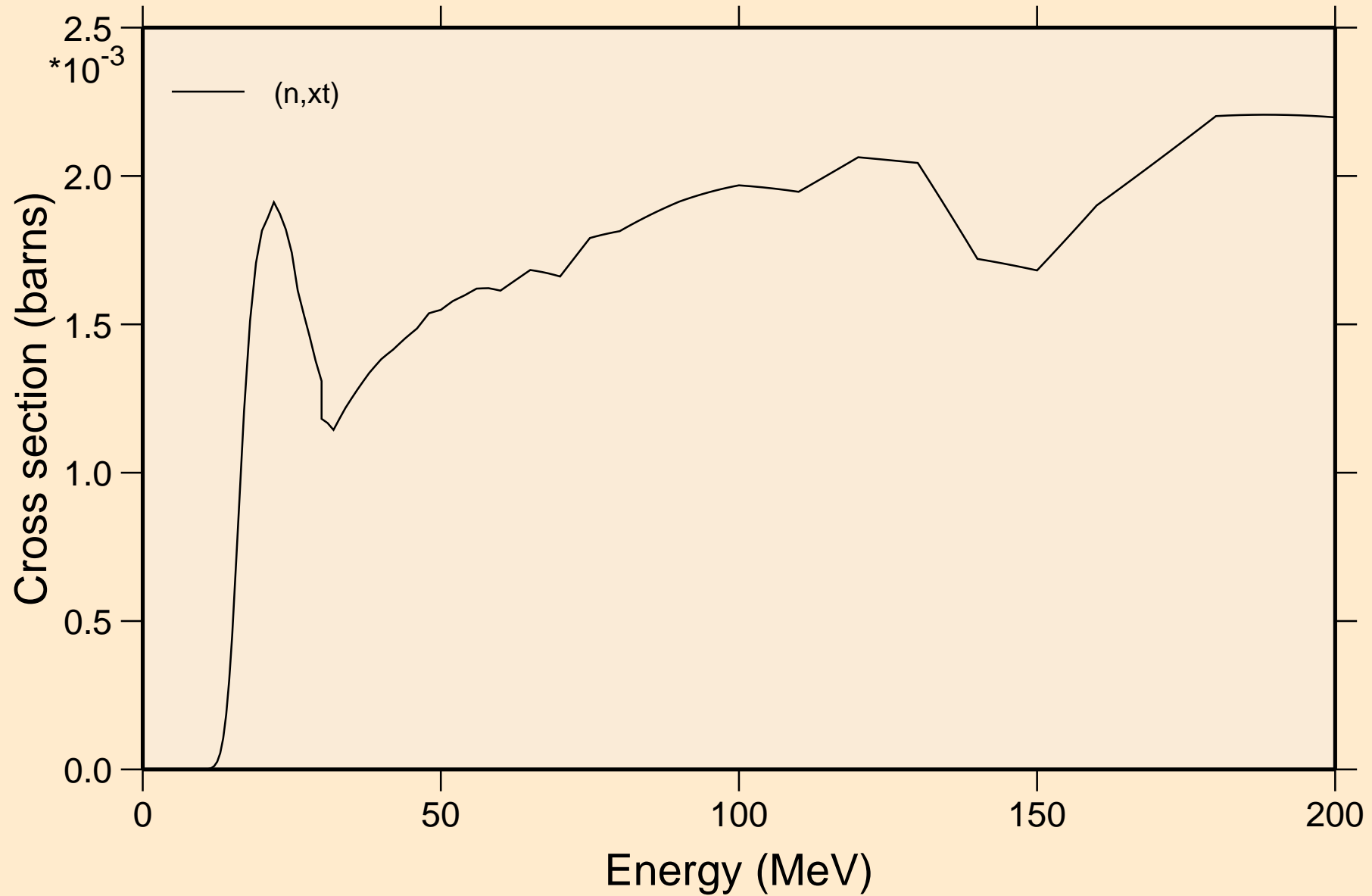

BK236 NEUTRON ACER TENDL-2024 LIBRARY; T=293.6K
angular distribution for elastic

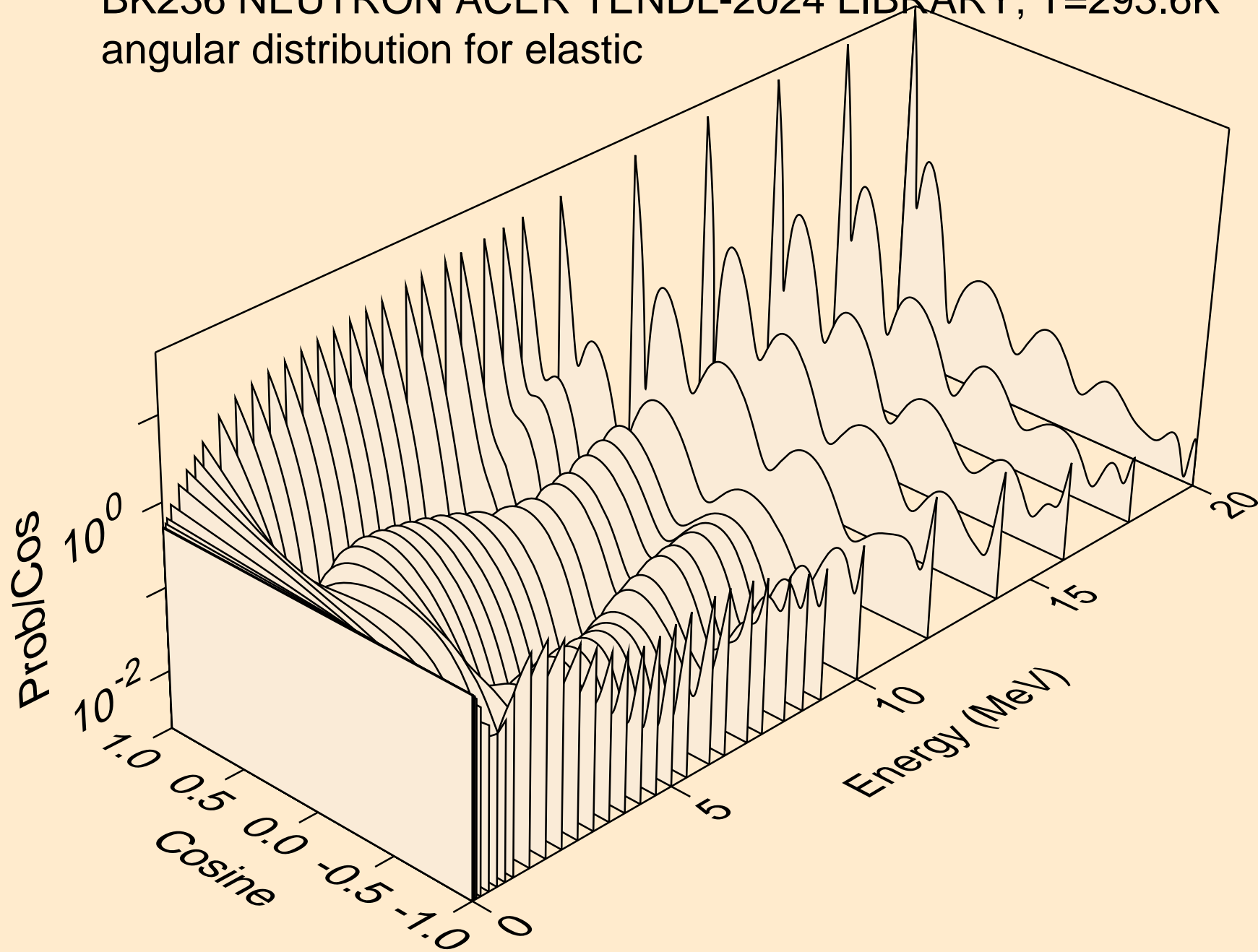

BK236 NEUTRON ACER TENDL-2024 LIBRARY; T=293.6K
angular distribution for elastic

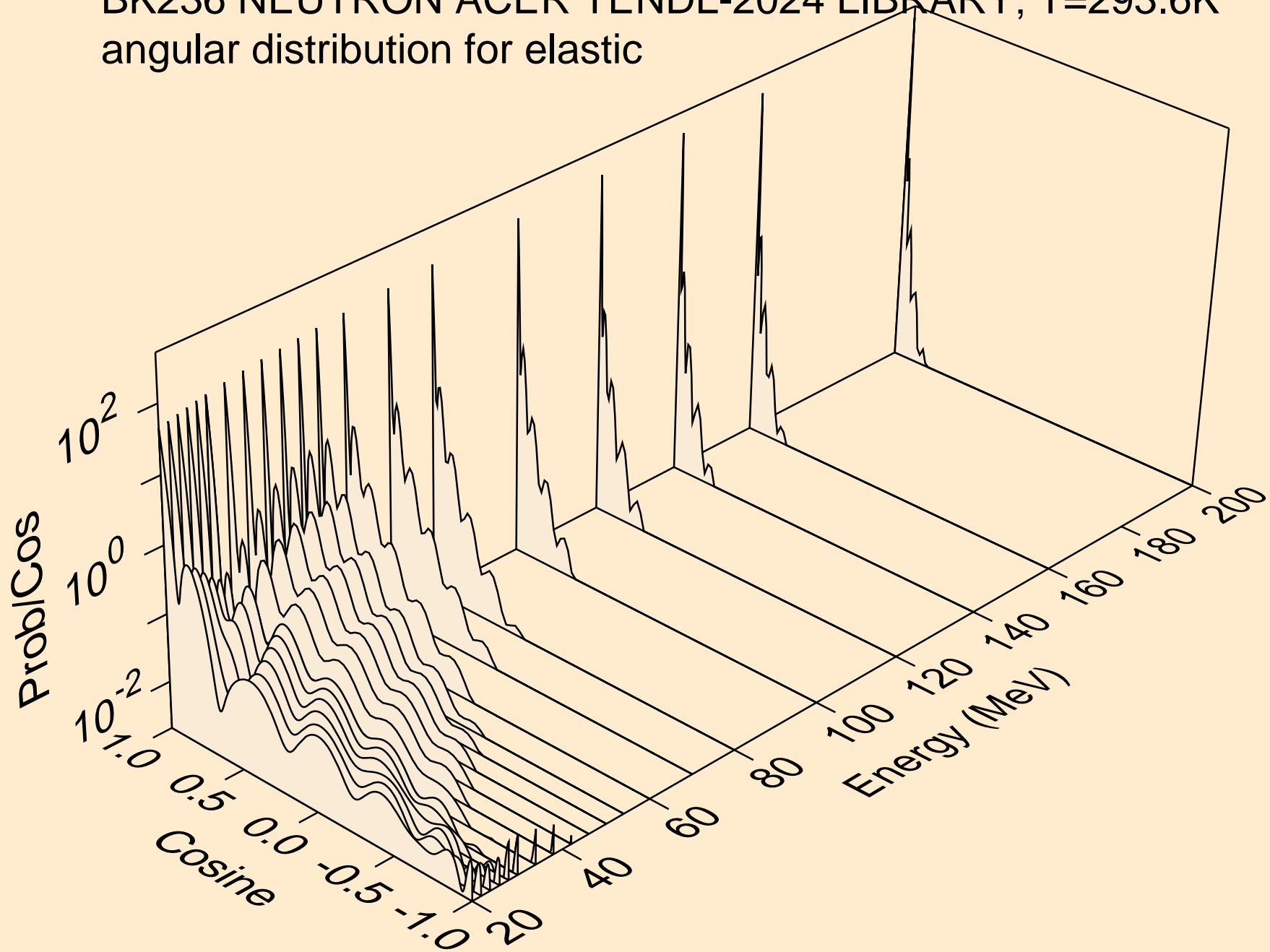

BK236 NEUTRON ACER TENDL-2024 LIBRARY; T=293.6K
angular distribution for (n,n*1)

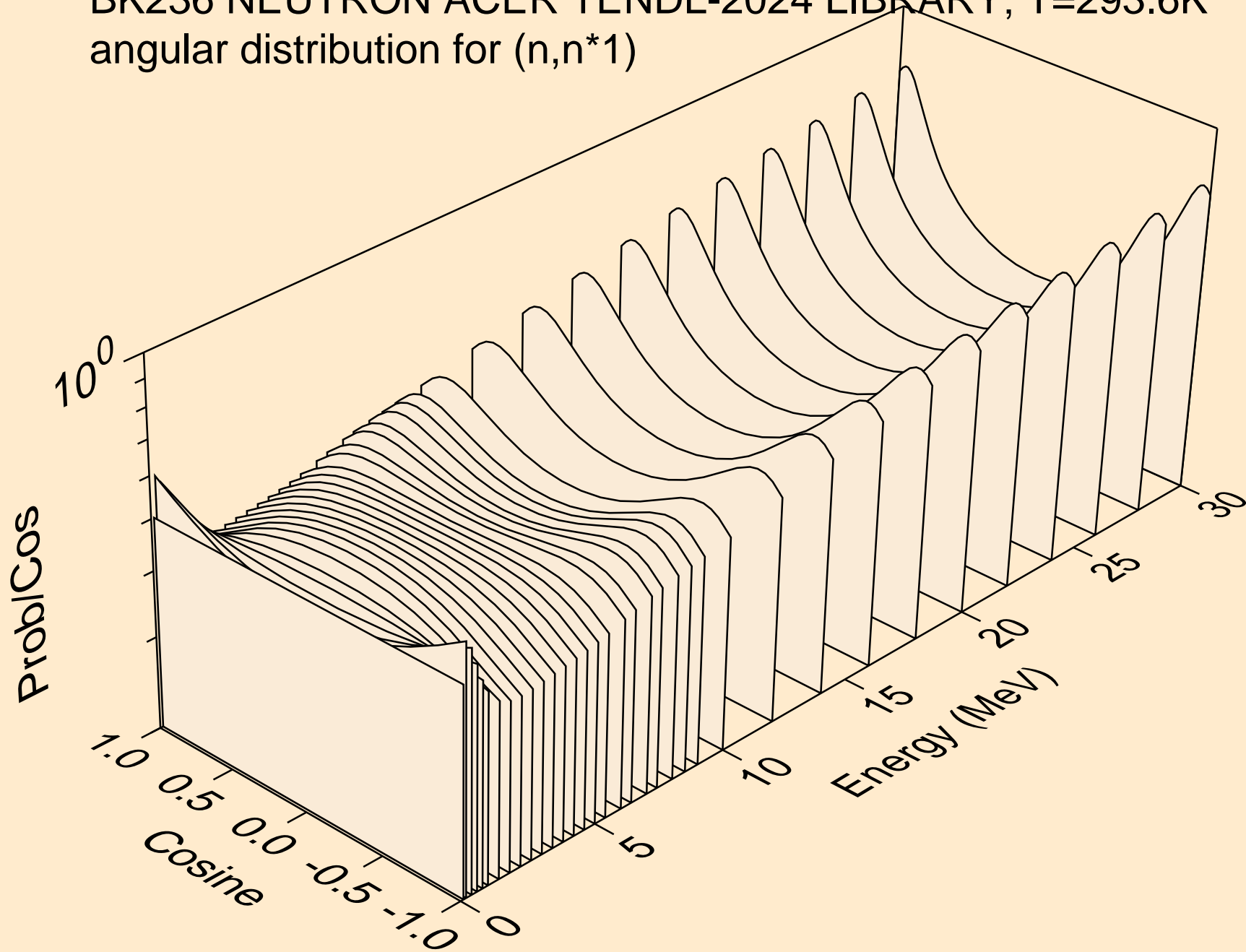

BK236 NEUTRON ACER TENDL-2024 LIBRARY; T=293.6K
angular distribution for (n,n*2)

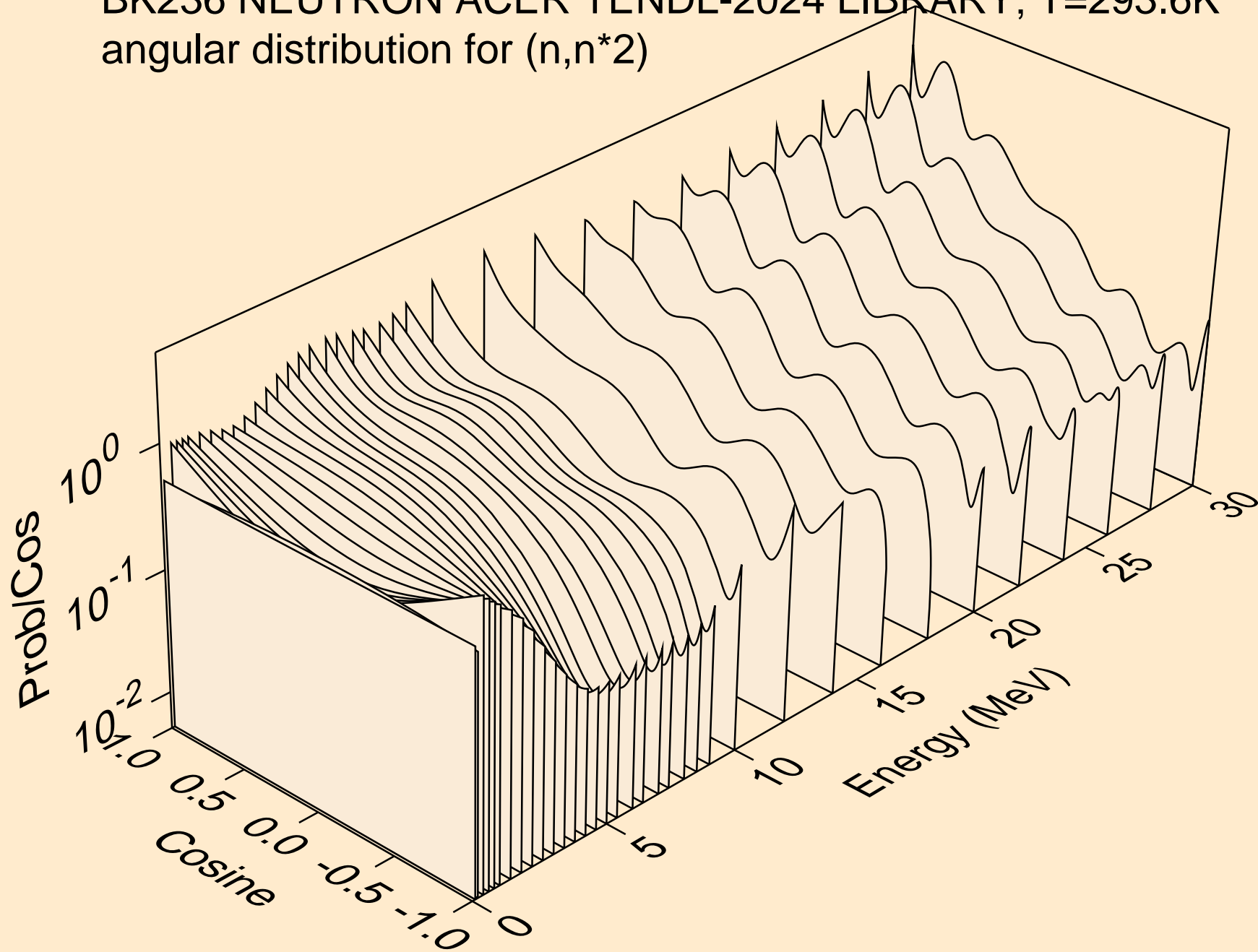

BK236 NEUTRON ACER TENDL-2024 LIBRARY; T=293.6K
angular distribution for (n,n*3)

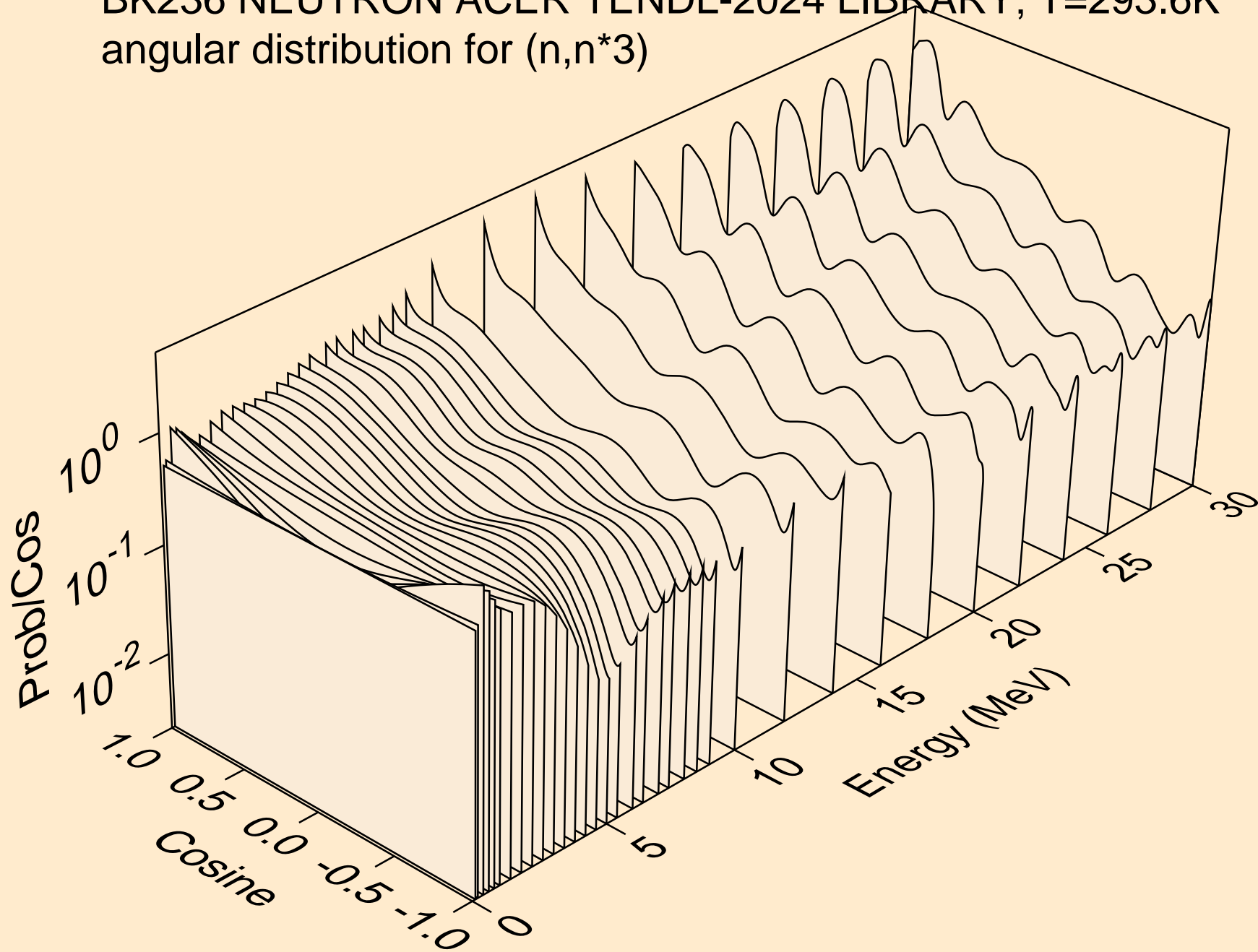

BK236 NEUTRON ACER TENDL-2024 LIBRARY; T=293.6K
angular distribution for (n,n*4)

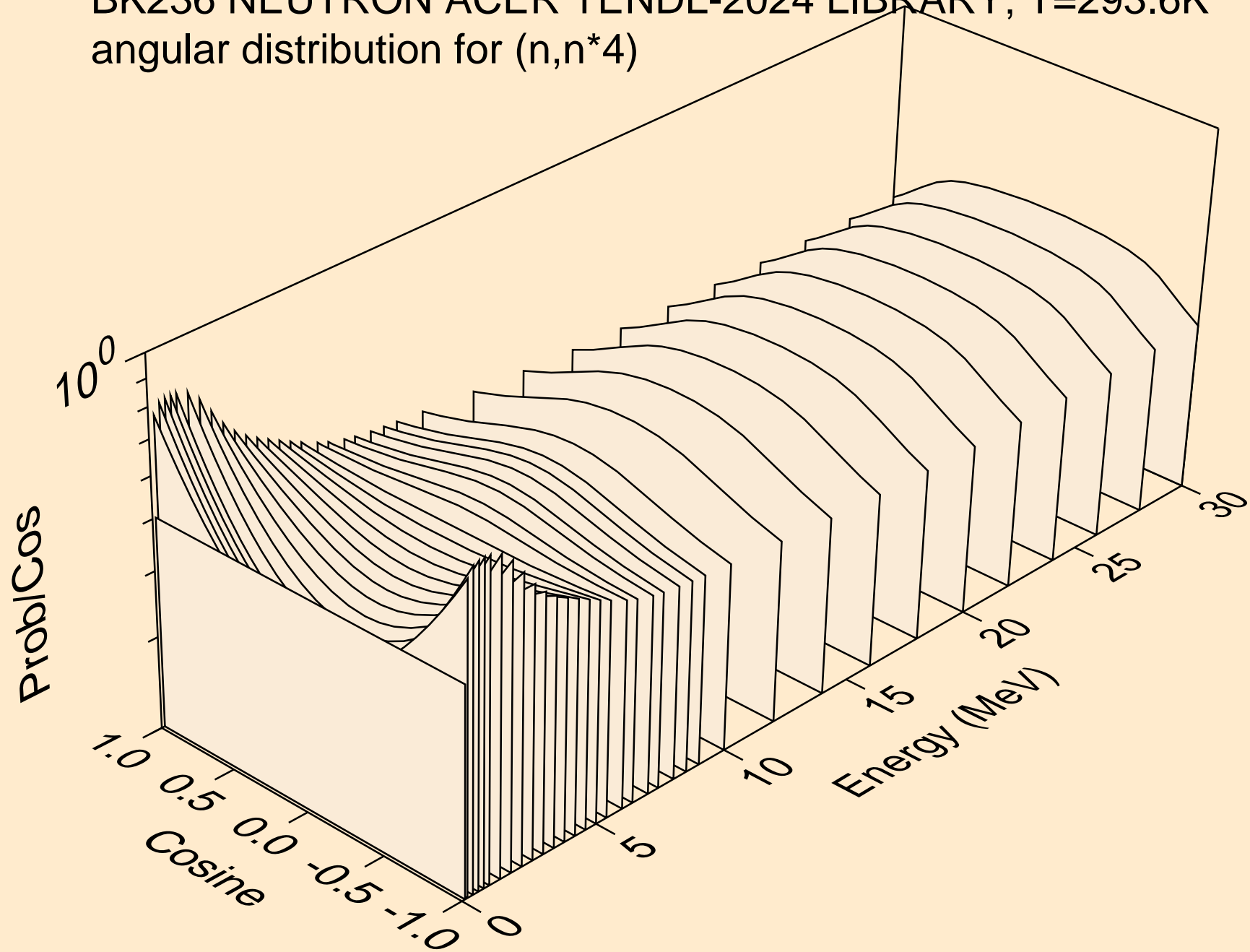

BK236 NEUTRON ACER TENDL-2024 LIBRARY; T=293.6K
angular distribution for (n,n*5)

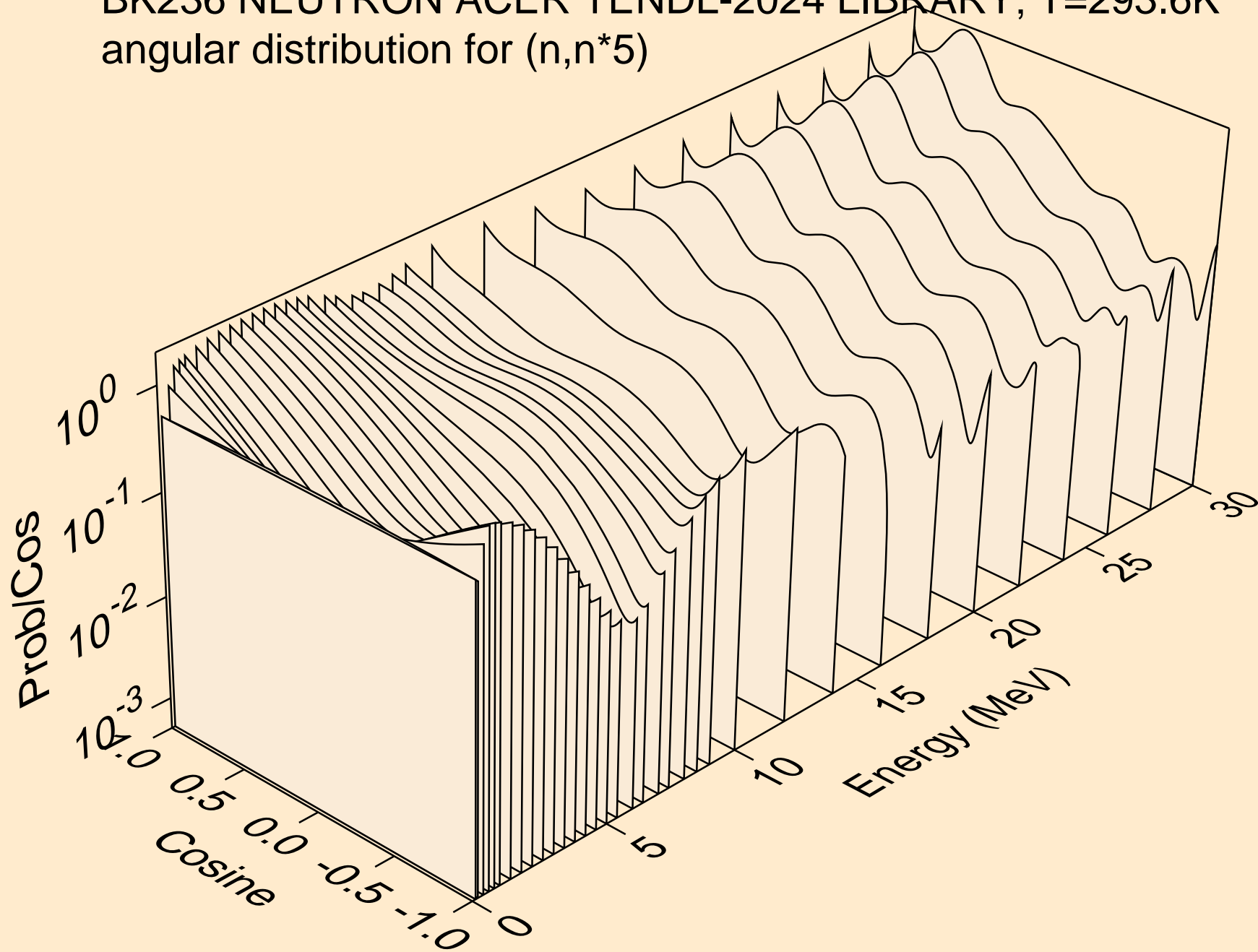

BK236 NEUTRON ACER TENDL-2024 LIBRARY; T=293.6K
angular distribution for (n,n*6)

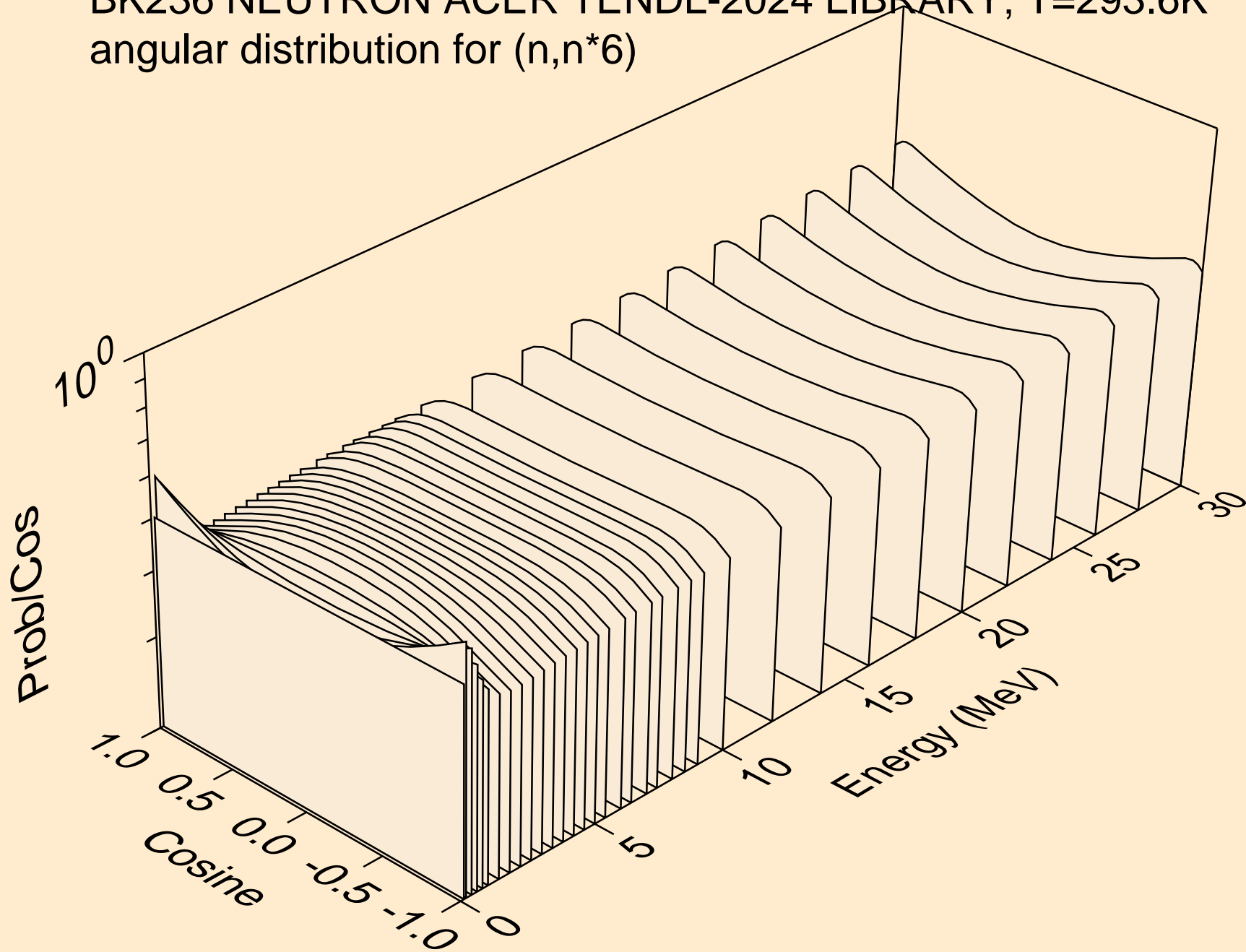

BK236 NEUTRON ACER TENDL-2024 LIBRARY; T=293.6K
angular distribution for (n,n*7)

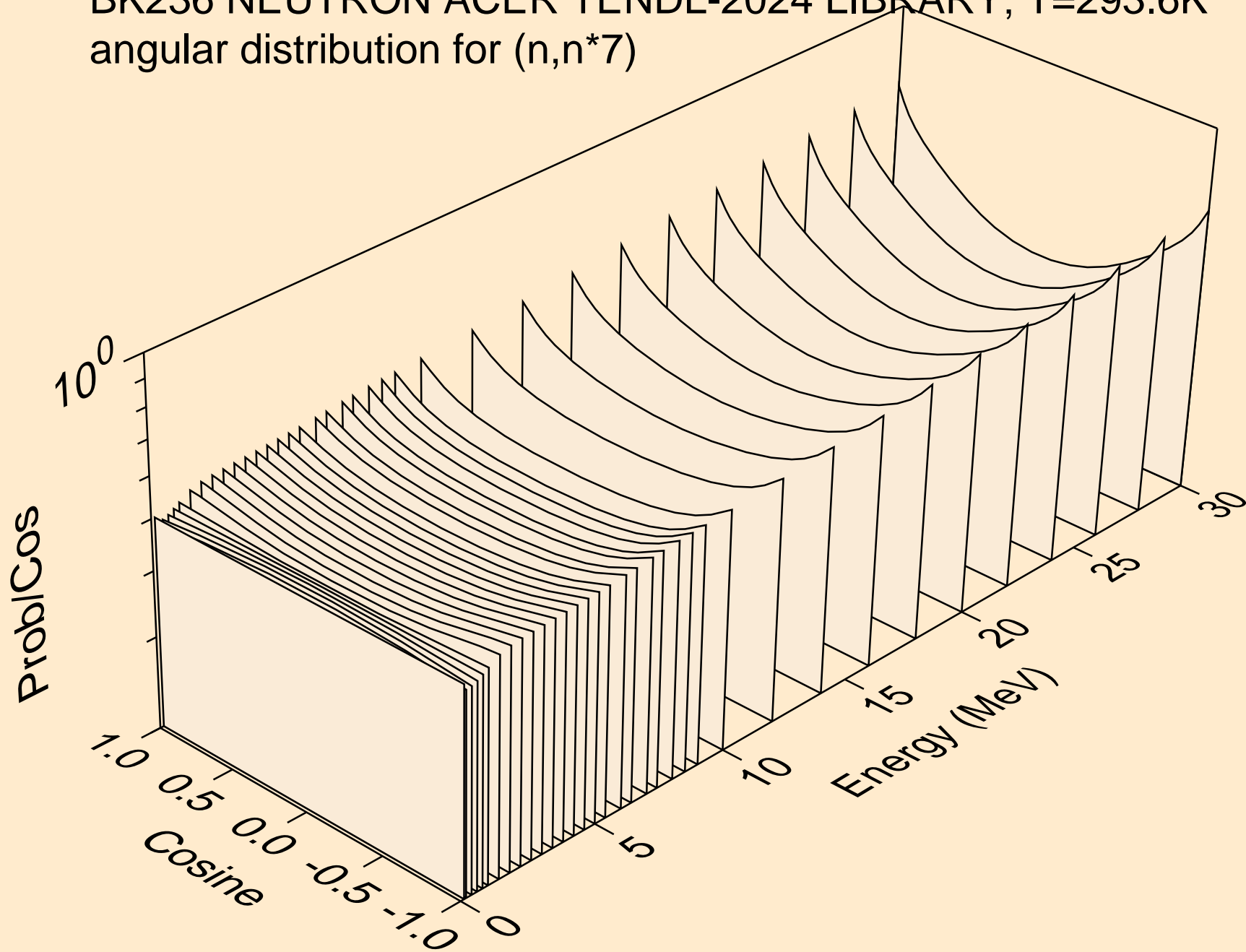

BK236 NEUTRON ACER TENDL-2024 LIBRARY; T=293.6K
angular distribution for (n,n*8)

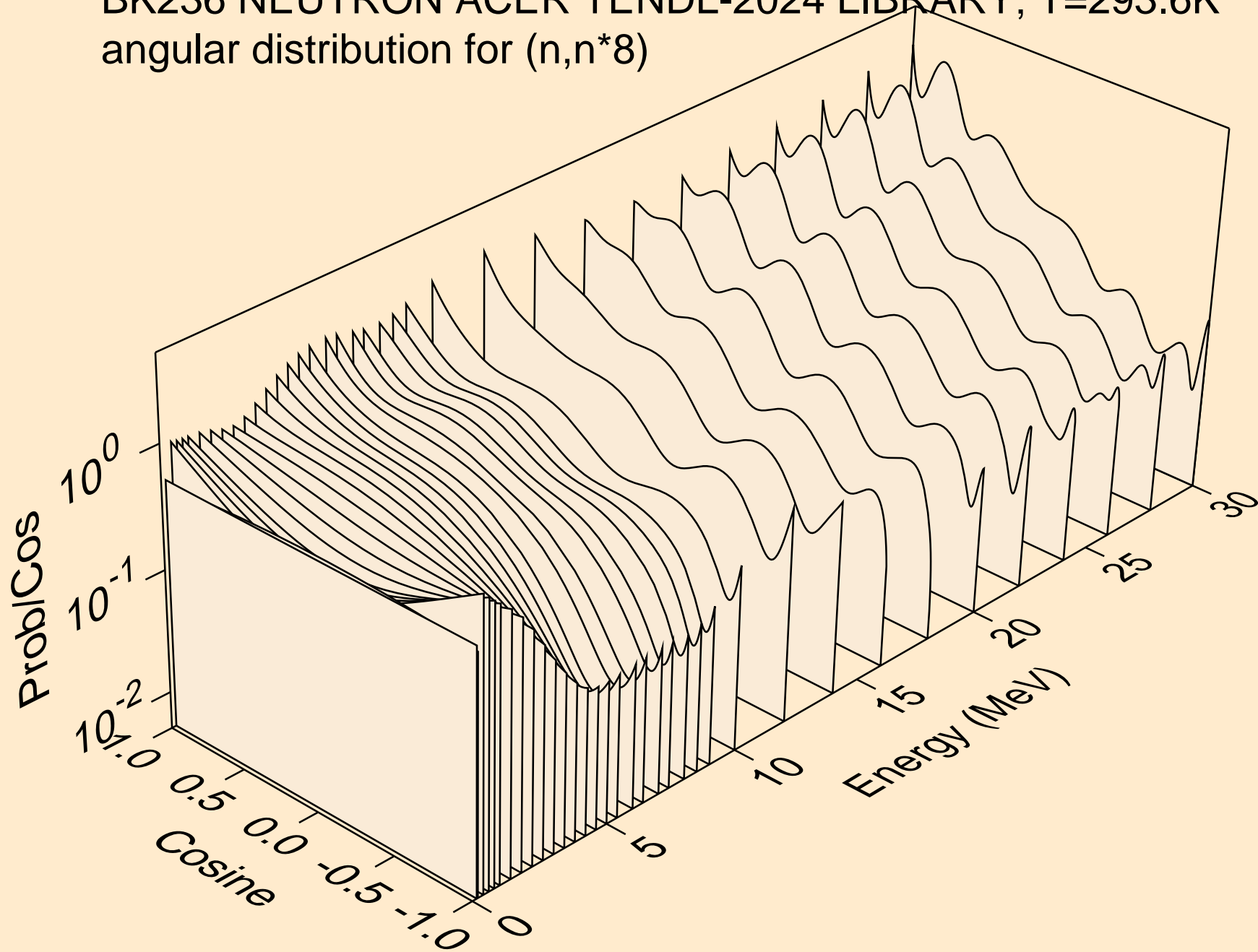

BK236 NEUTRON ACER TENDL-2024 LIBRARY; T=293.6K
angular distribution for (n,n*9)

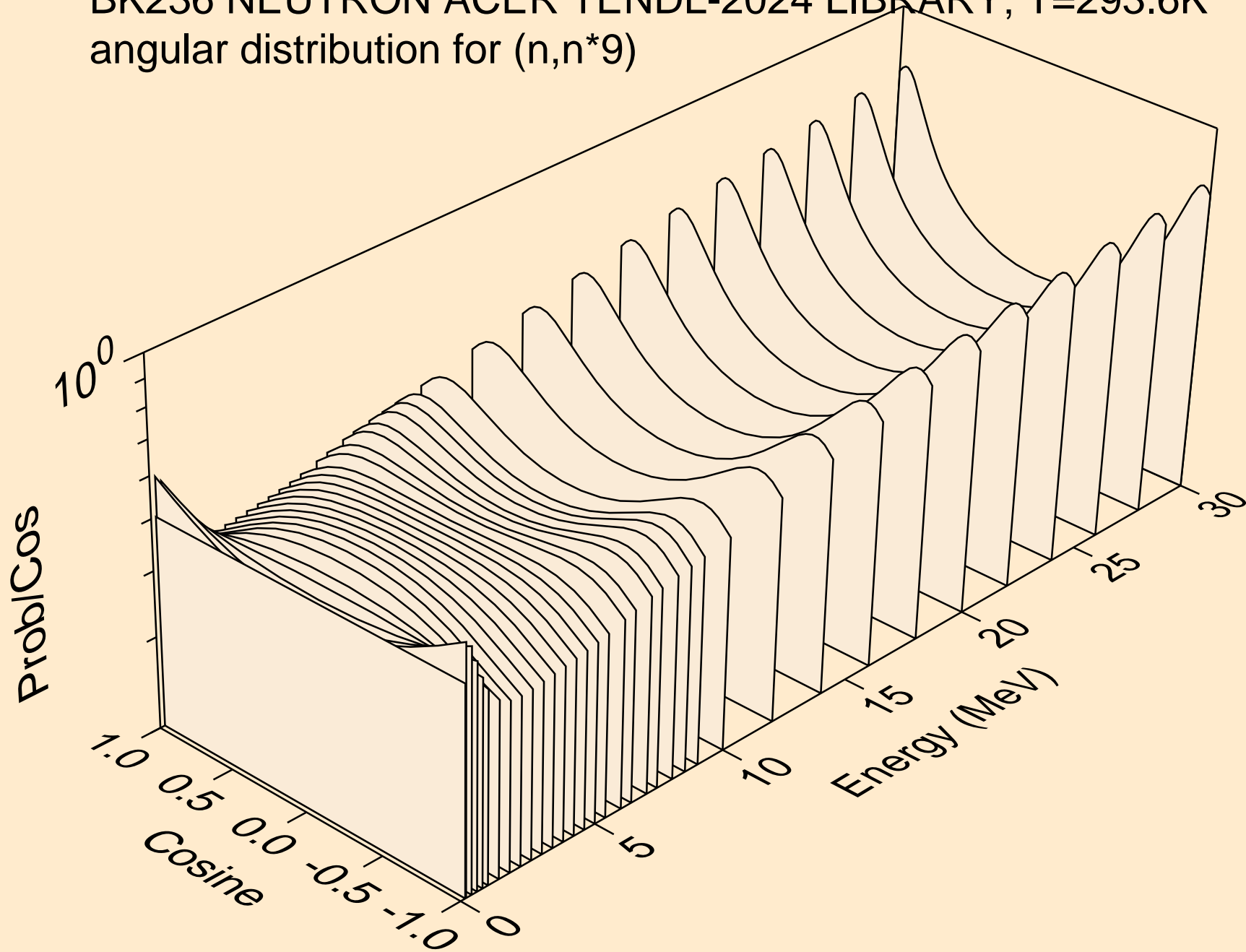

BK236 NEUTRON ACER TENDL-2024 LIBRARY; T=293.6K
angular distribution for (n,n*10)

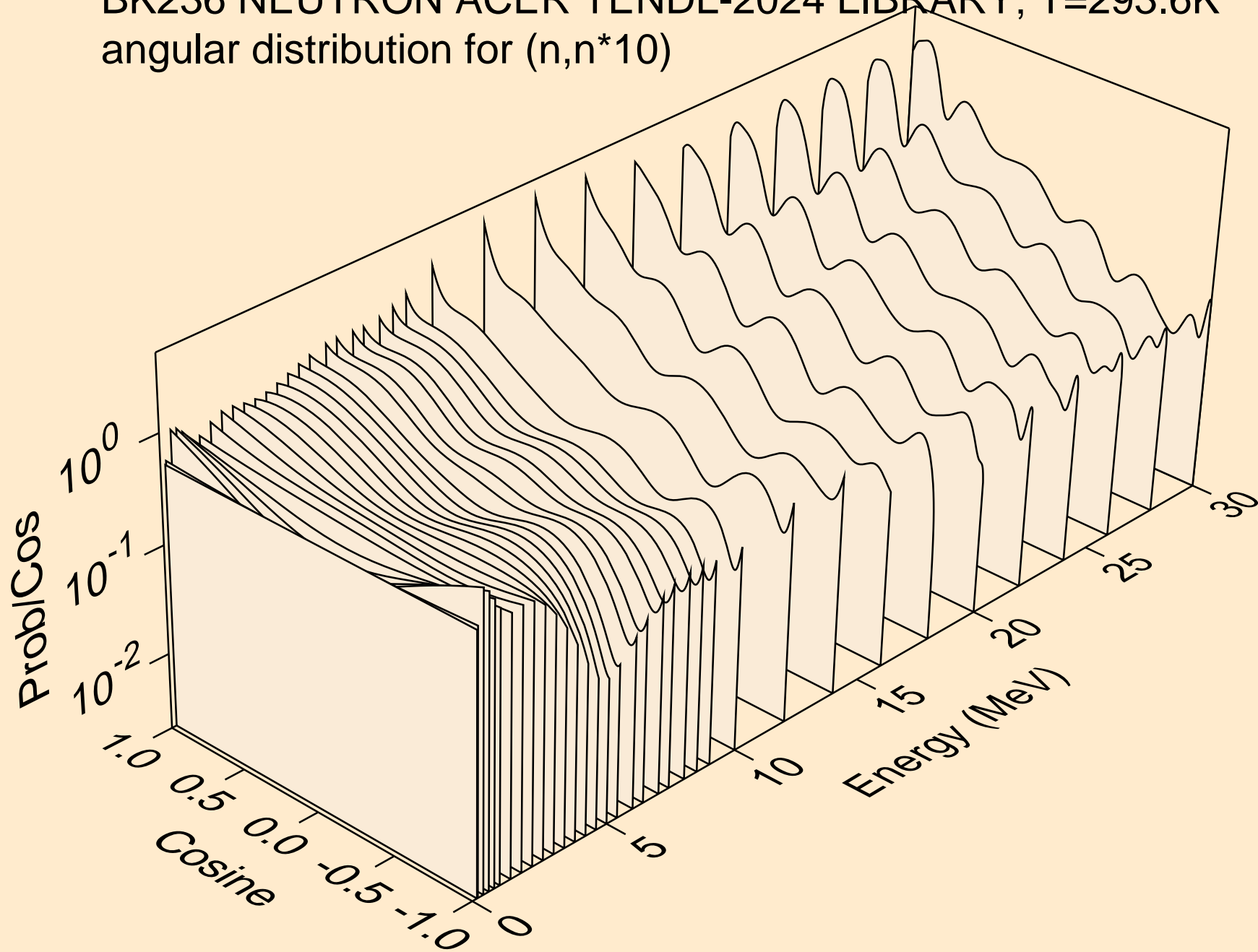

BK236 NEUTRON ACER TENDL-2024 LIBRARY; T=293.6K
angular distribution for (n,n*11)

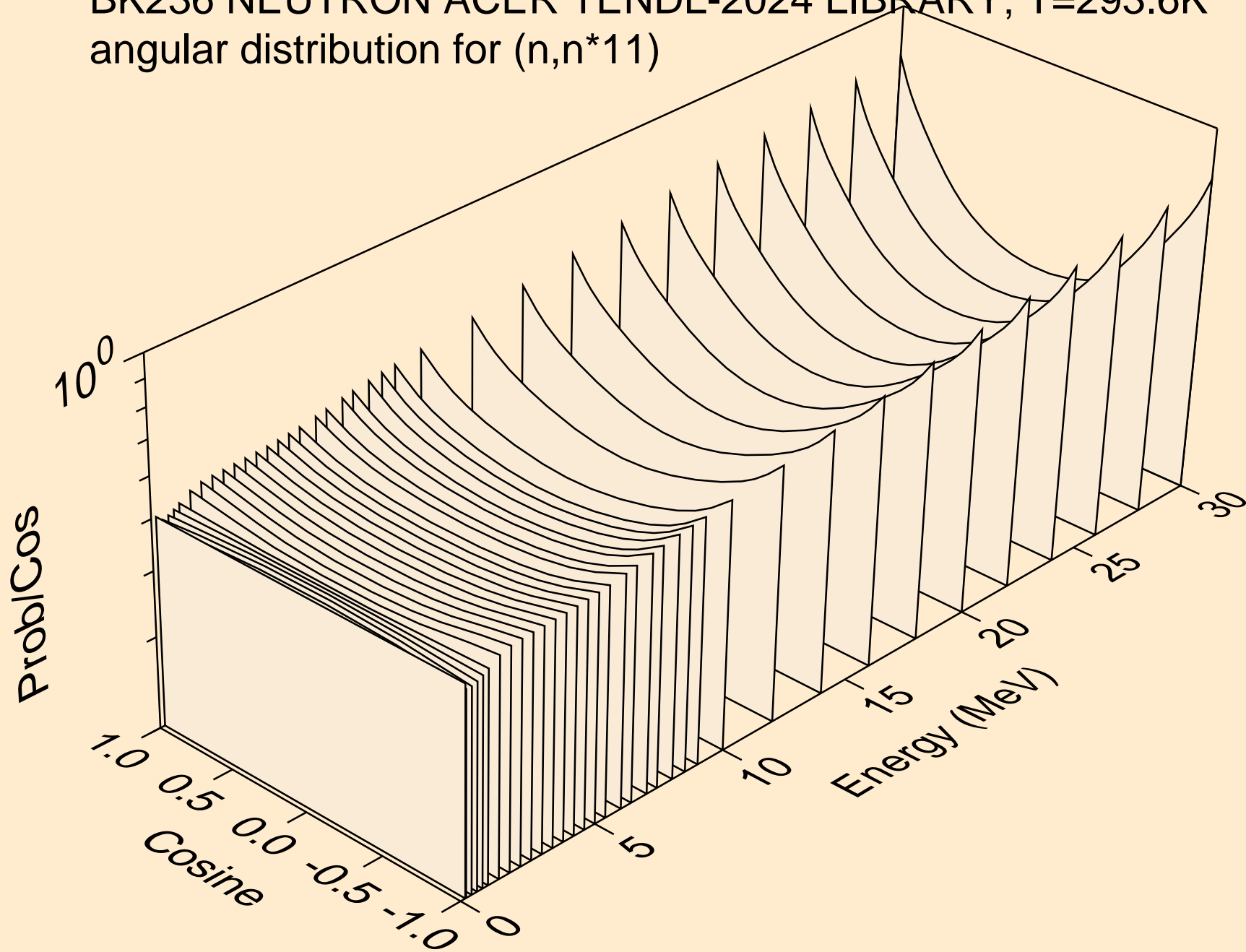

BK236 NEUTRON ACER TENDL-2024 LIBRARY; T=293.6K
angular distribution for (n,n*12)

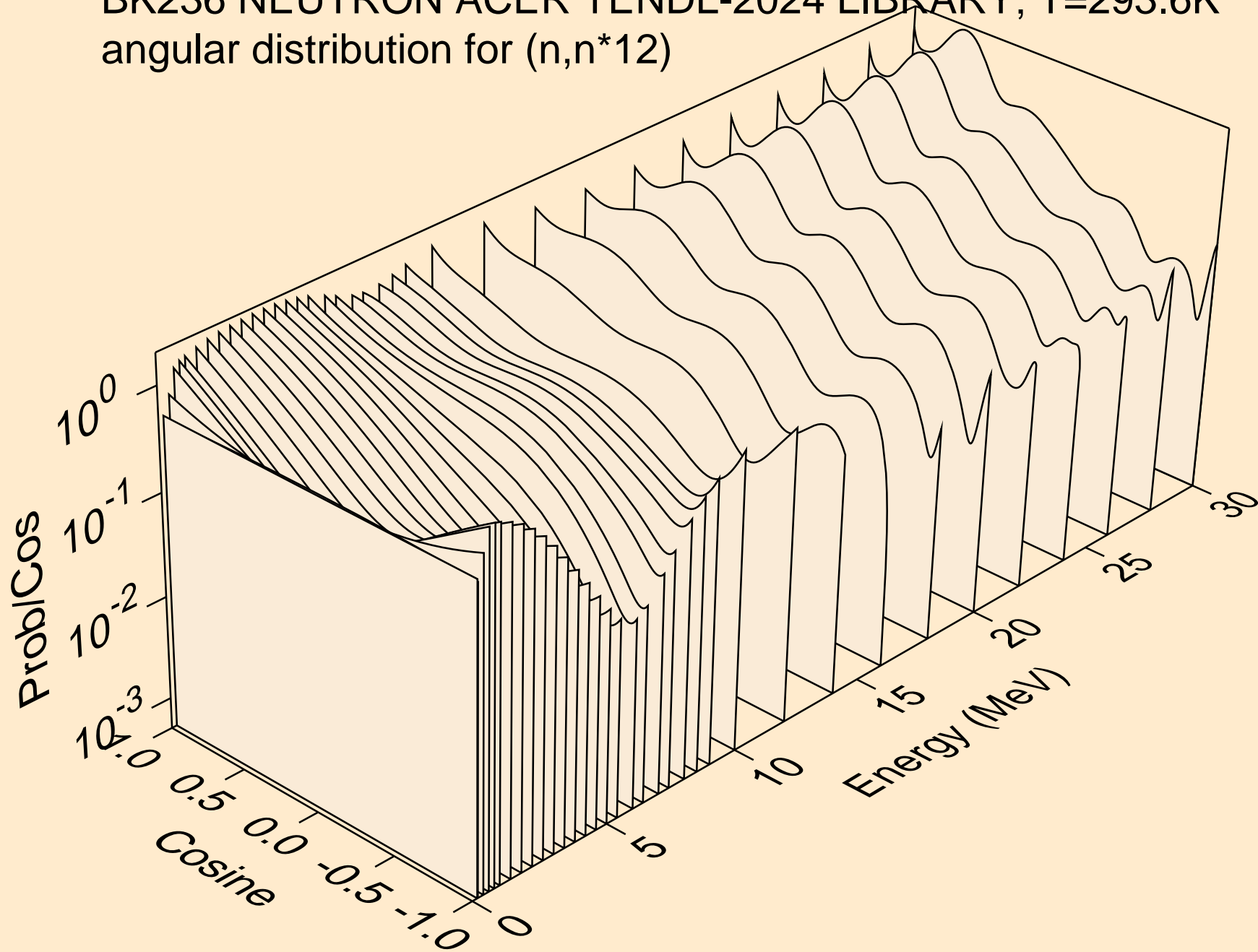

BK236 NEUTRON ACER TENDL-2024 LIBRARY; T=293.6K
angular distribution for (n,n*13)

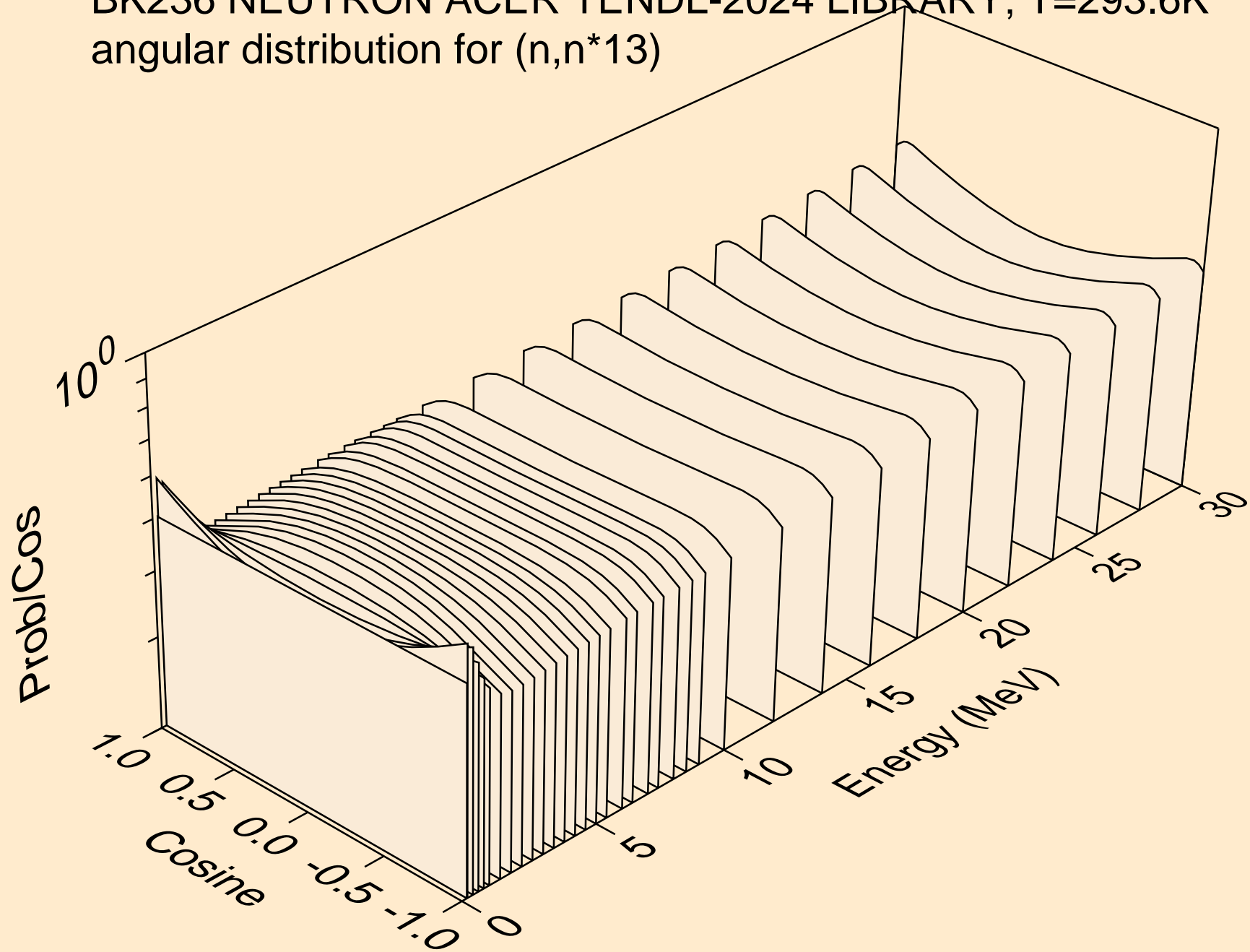

BK236 NEUTRON ACER TENDL-2024 LIBRARY; T=293.6K
angular distribution for (n,n*14)

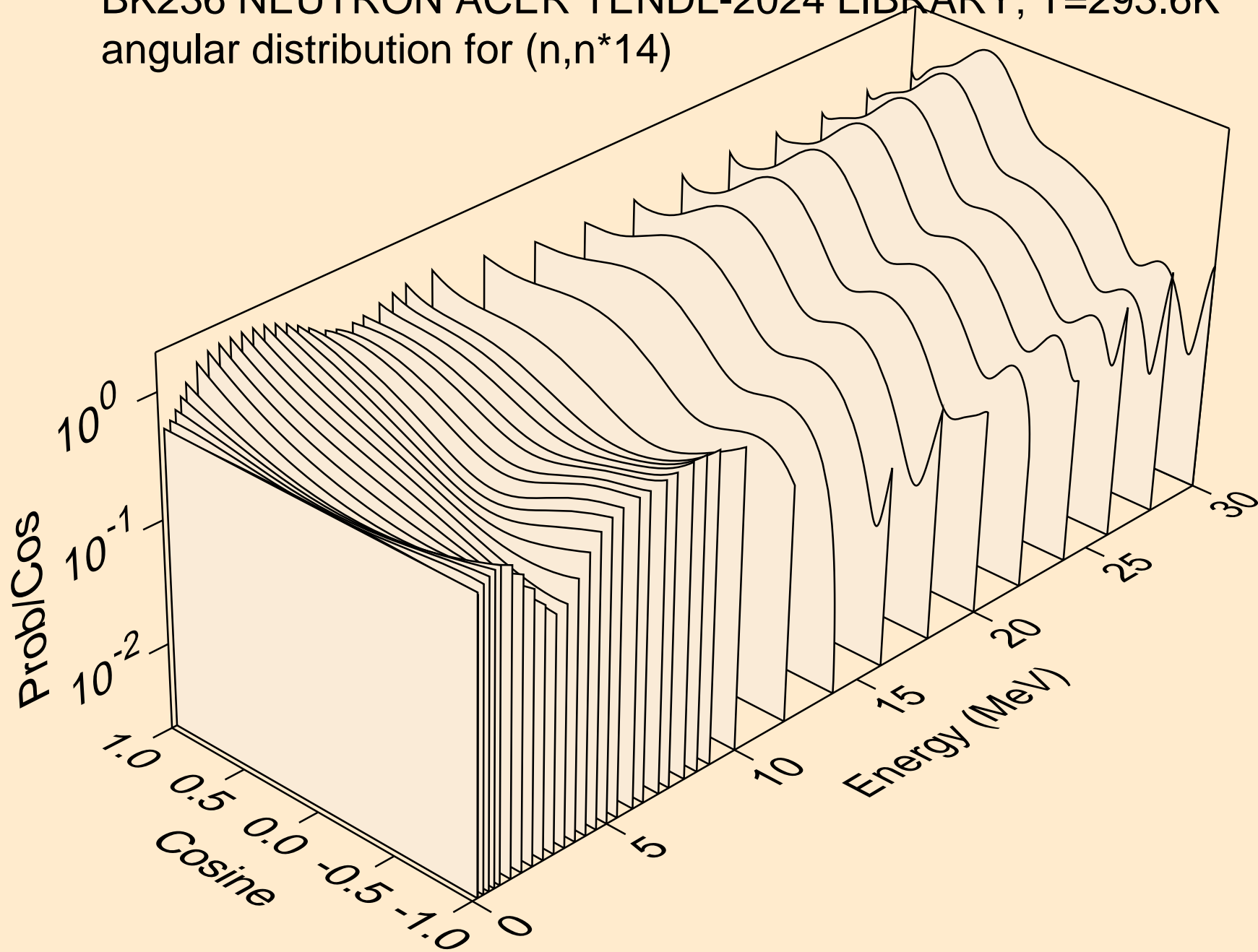

BK236 NEUTRON ACER TENDL-2024 LIBRARY; T=293.6K
angular distribution for (n,n*15)

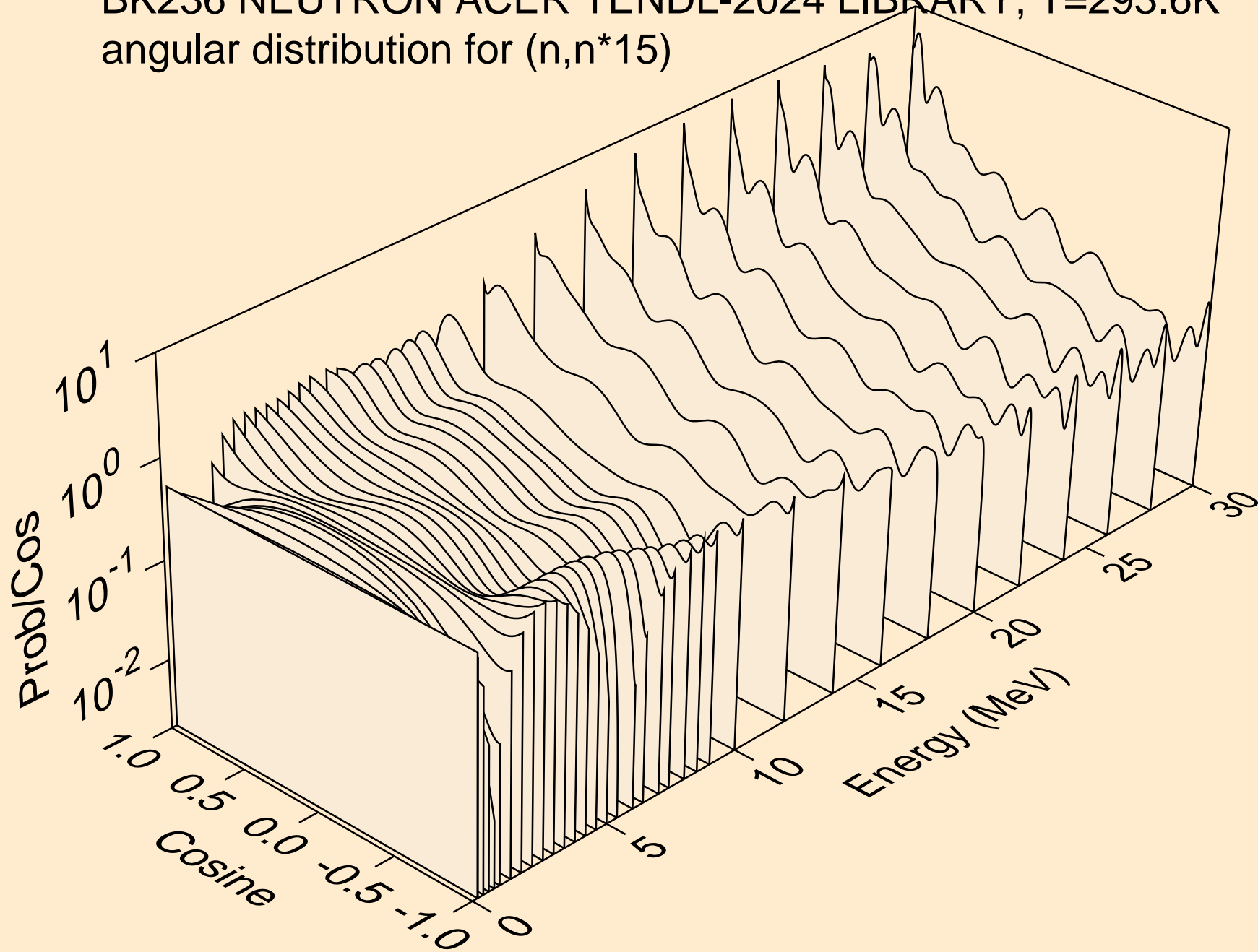

BK236 NEUTRON ACER TENDL-2024 LIBRARY; T=293.6K
angular distribution for (n,n*16)

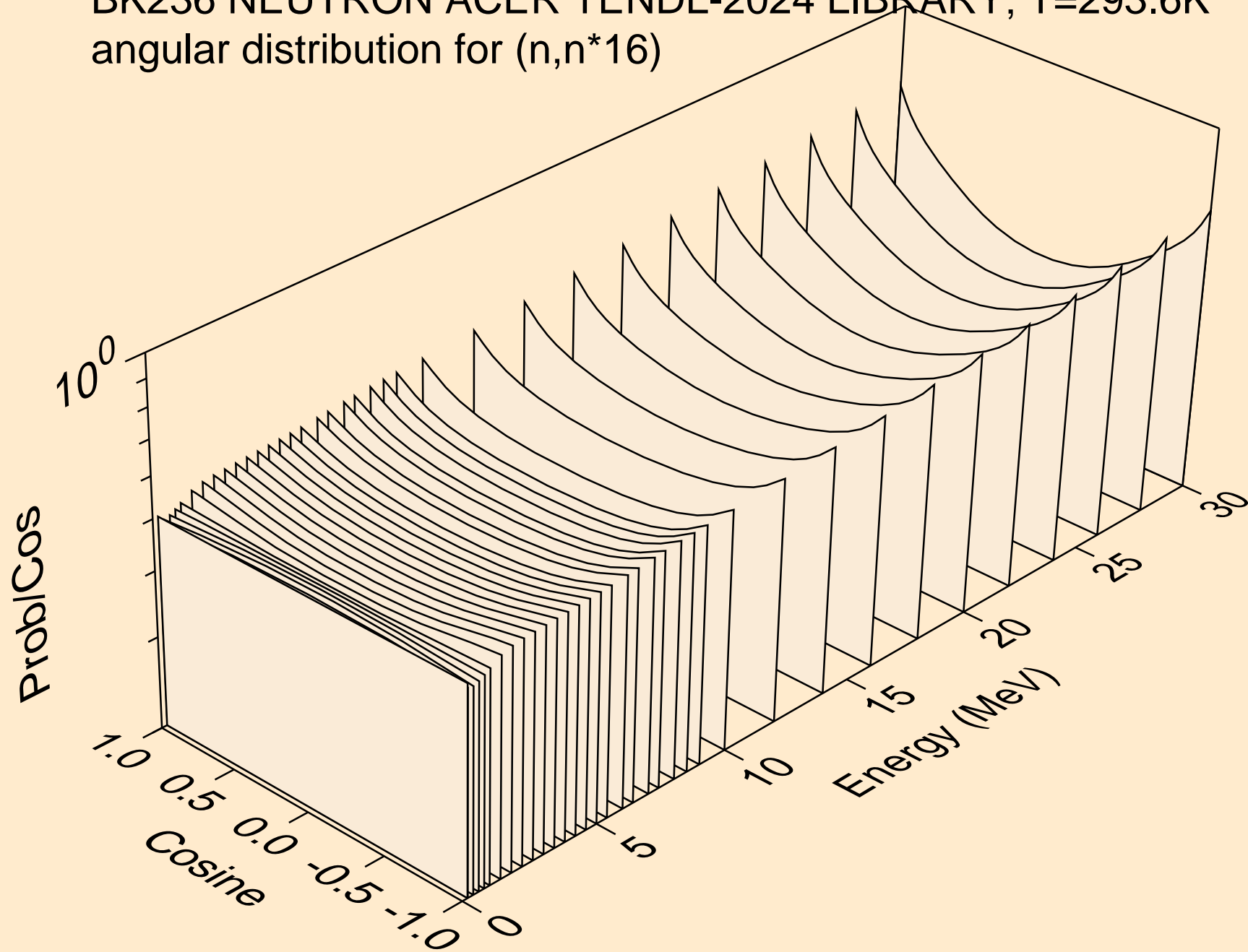

BK236 NEUTRON ACER TENDL-2024 LIBRARY; T=293.6K
angular distribution for (n,n*17)

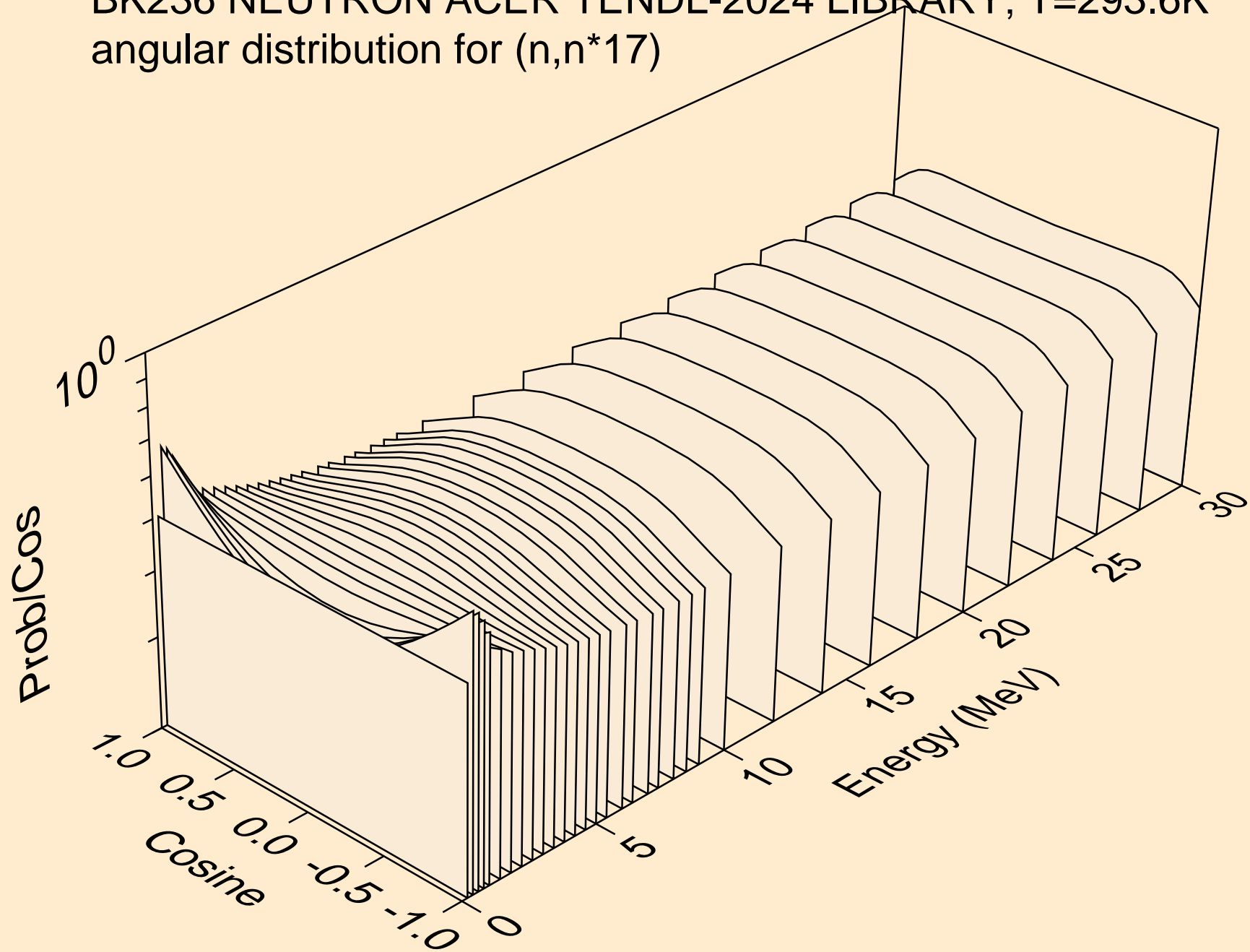

BK236 NEUTRON ACER TENDL-2024 LIBRARY; T=293.6K
angular distribution for (n,n*18)

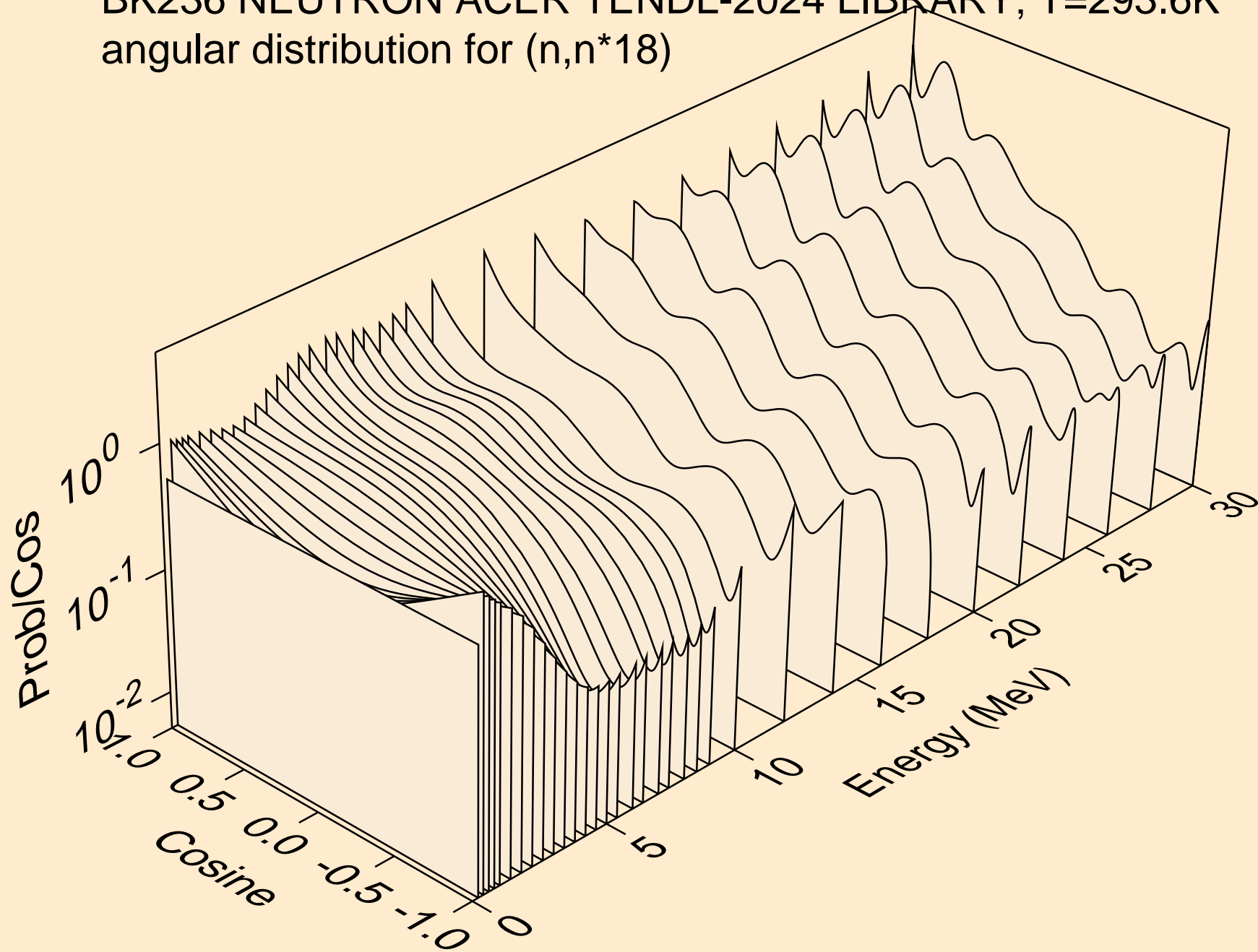

BK236 NEUTRON ACER TENDL-2024 LIBRARY; T=293.6K
angular distribution for (n,n*19)

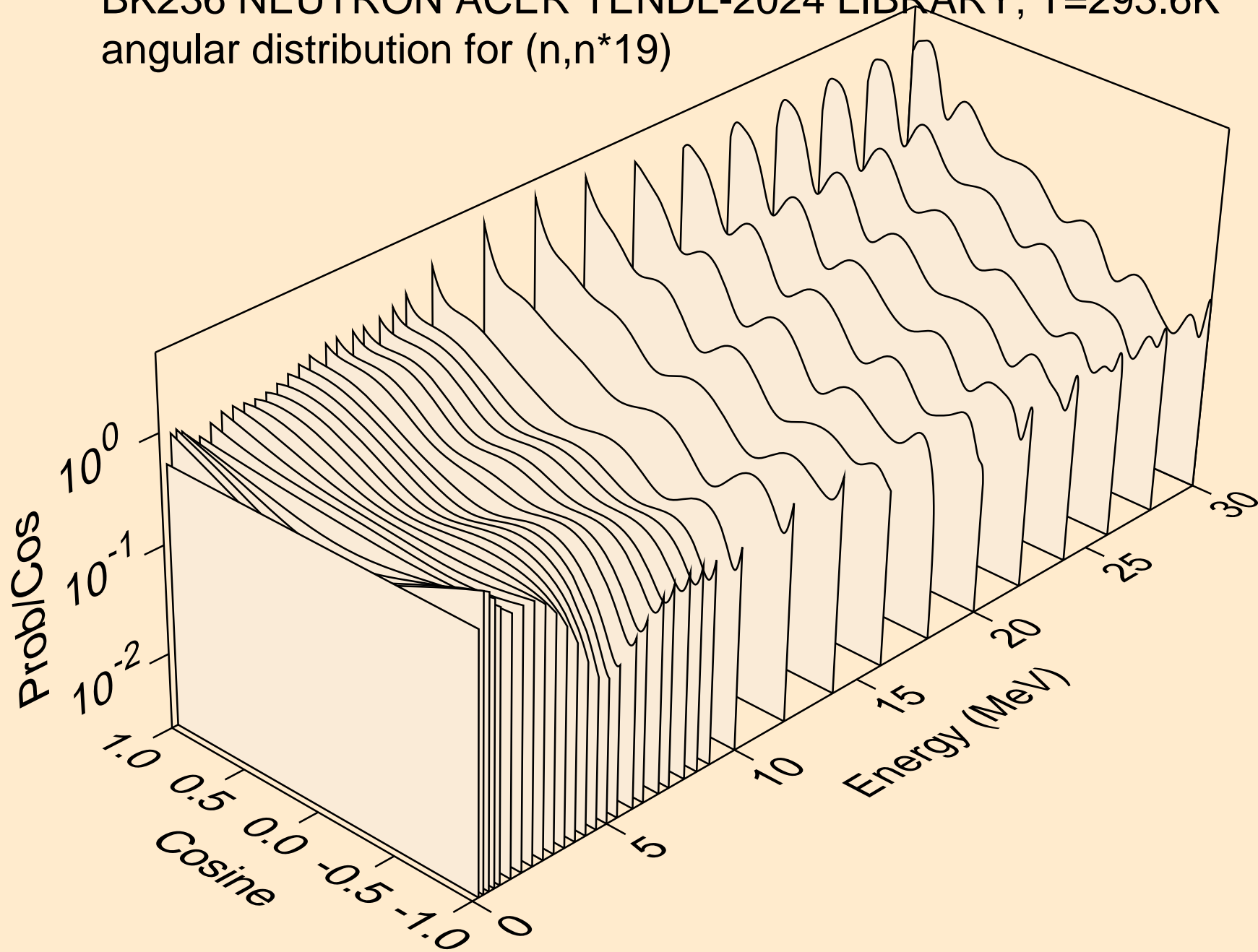

BK236 NEUTRON ACER TENDL-2024 LIBRARY; T=293.6K
angular distribution for (n,n*20)

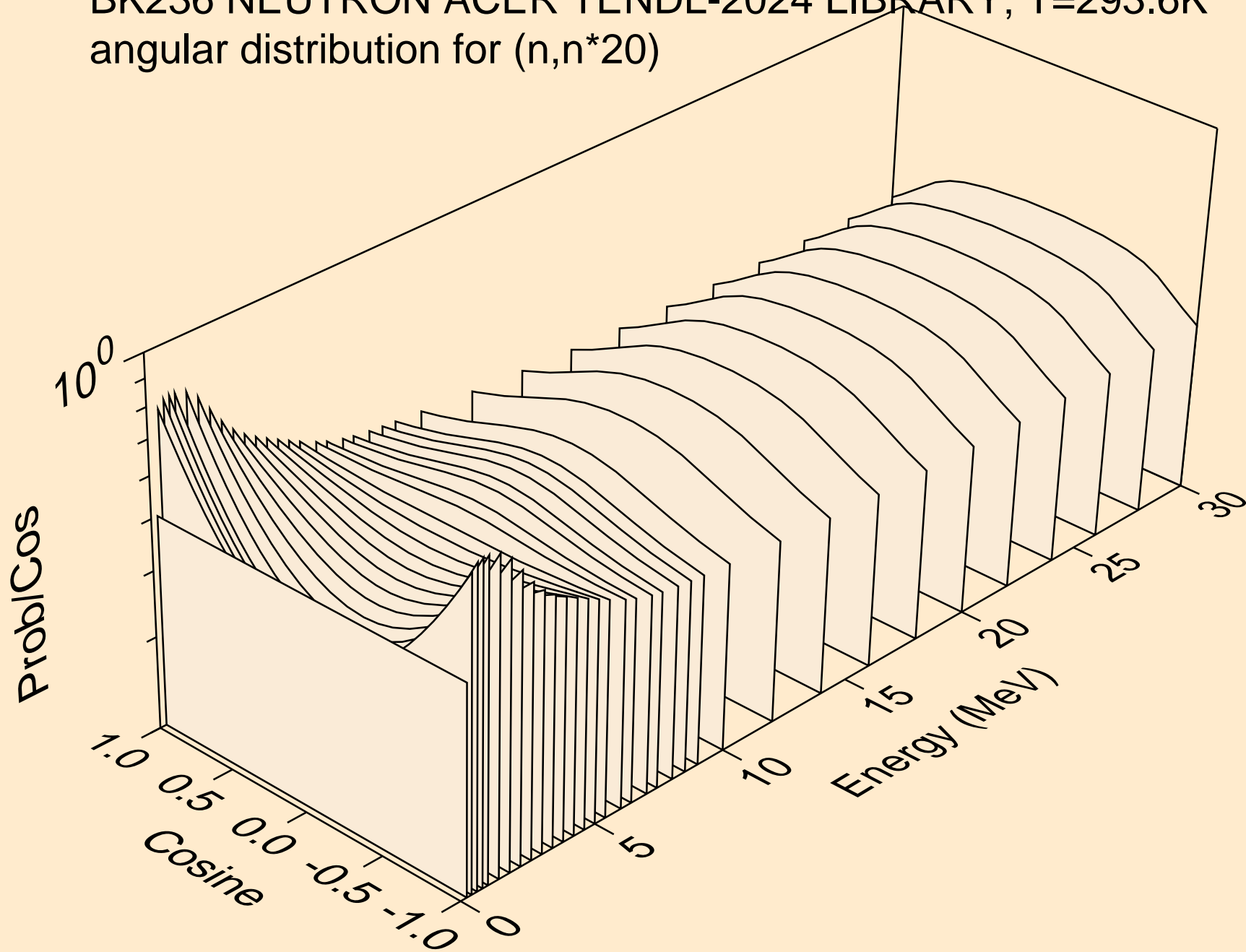

BK236 NEUTRON ACER TENDL-2024 LIBRARY; T=293.6K
angular distribution for (n,n*21)

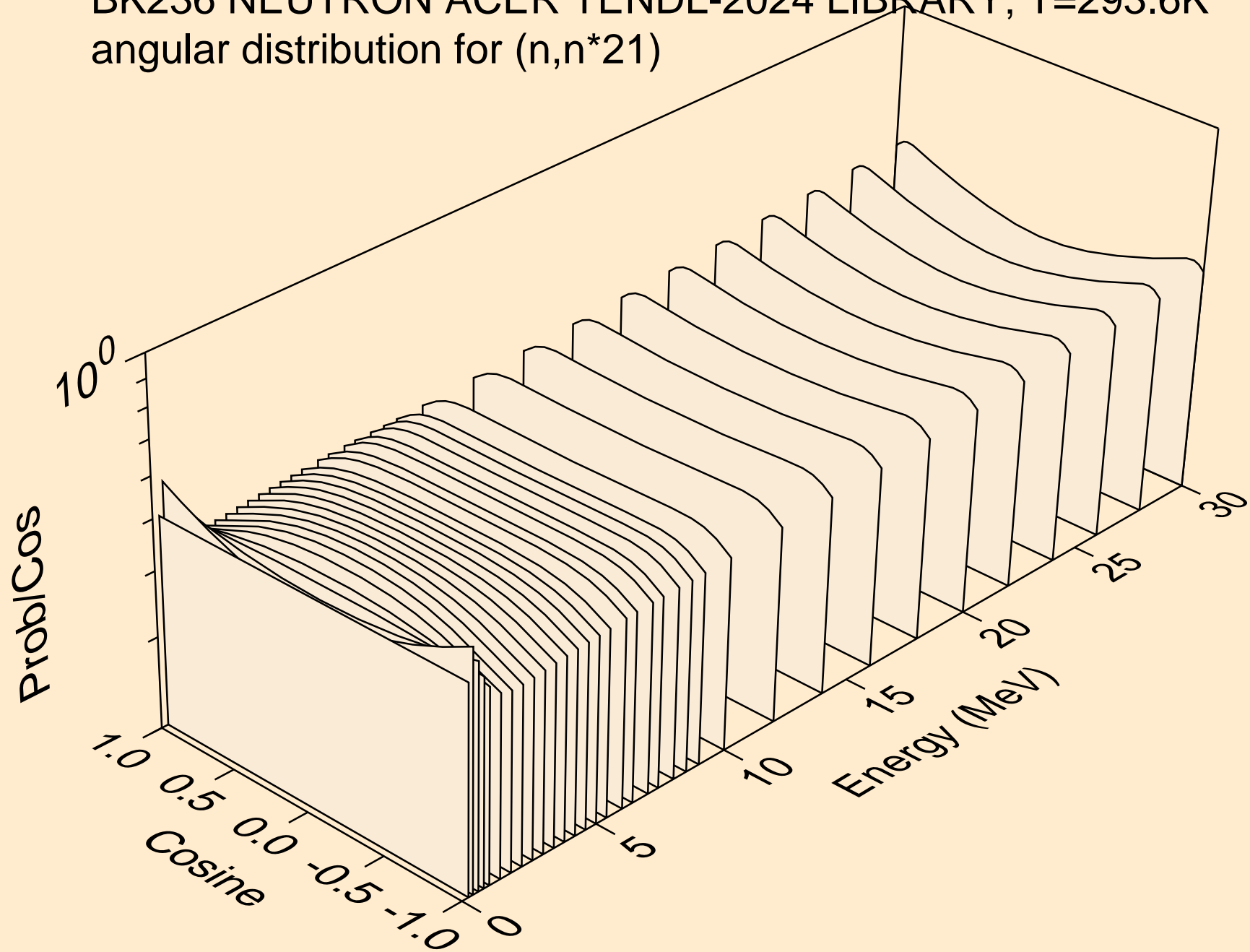

BK236 NEUTRON ACER TENDL-2024 LIBRARY; T=293.6K
angular distribution for (n,n*22)

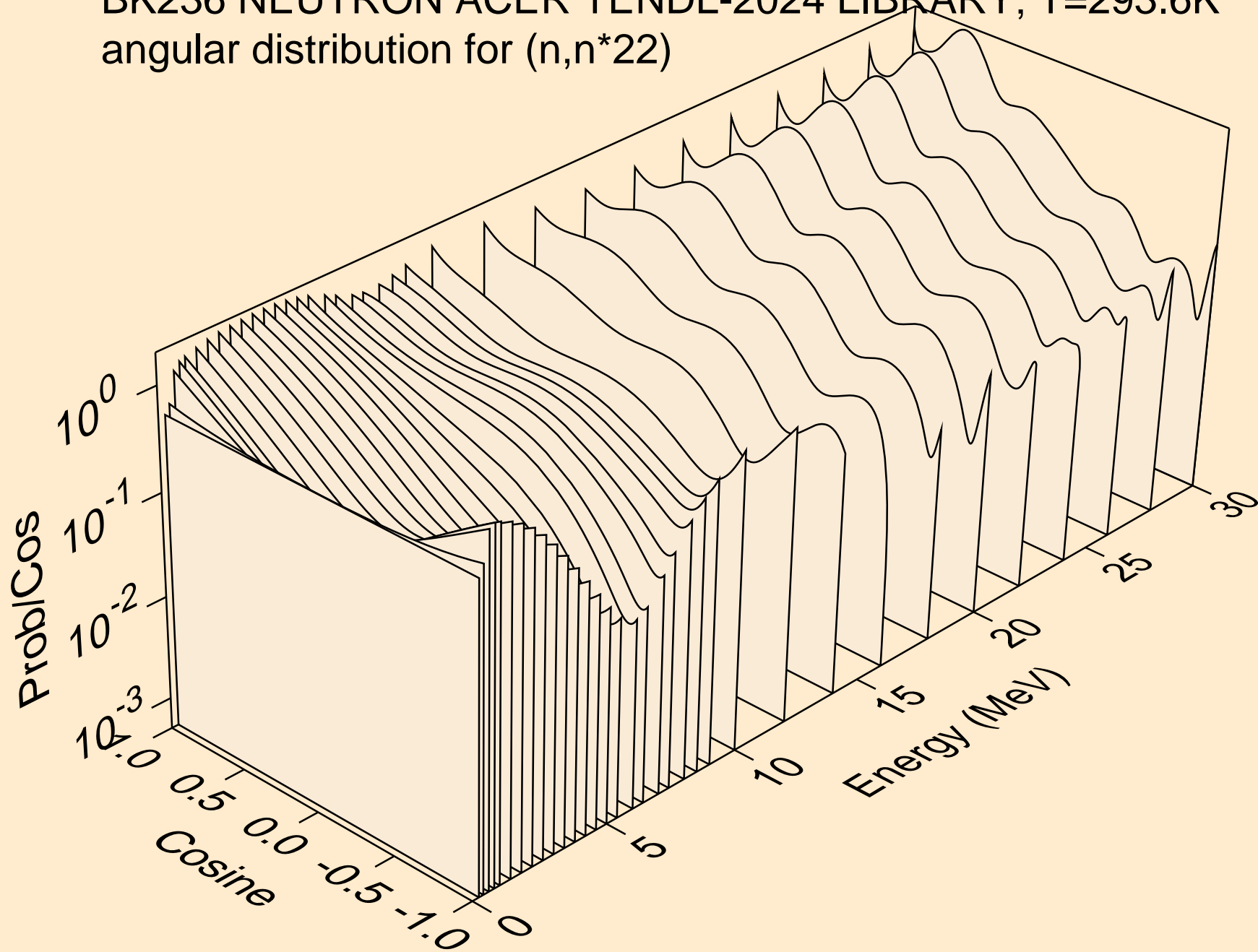

BK236 NEUTRON ACER TENDL-2024 LIBRARY; T=293.6K
angular distribution for (n,n*23)

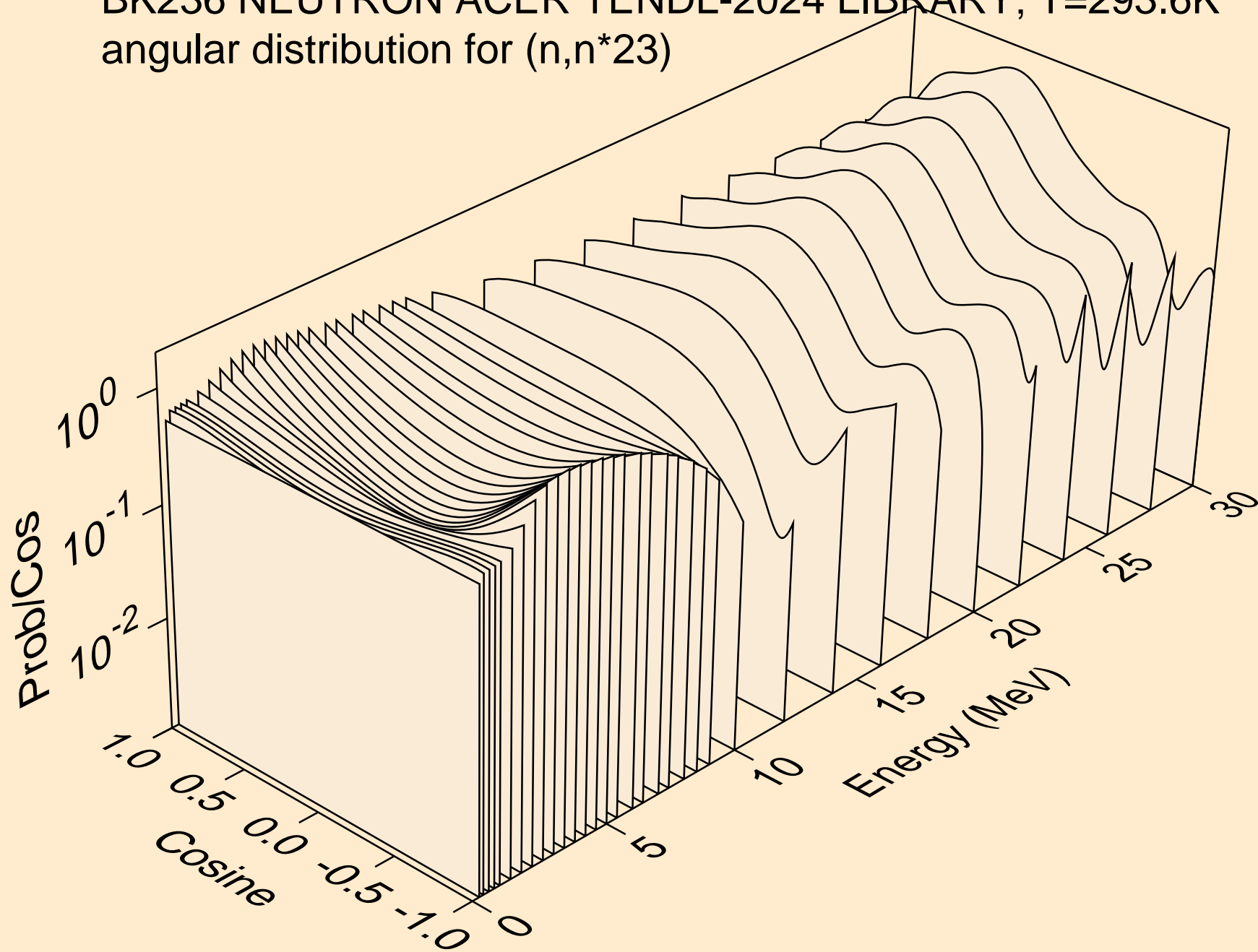

BK236 NEUTRON ACER TENDL-2024 LIBRARY; T=293.6K
angular distribution for (n,n*24)

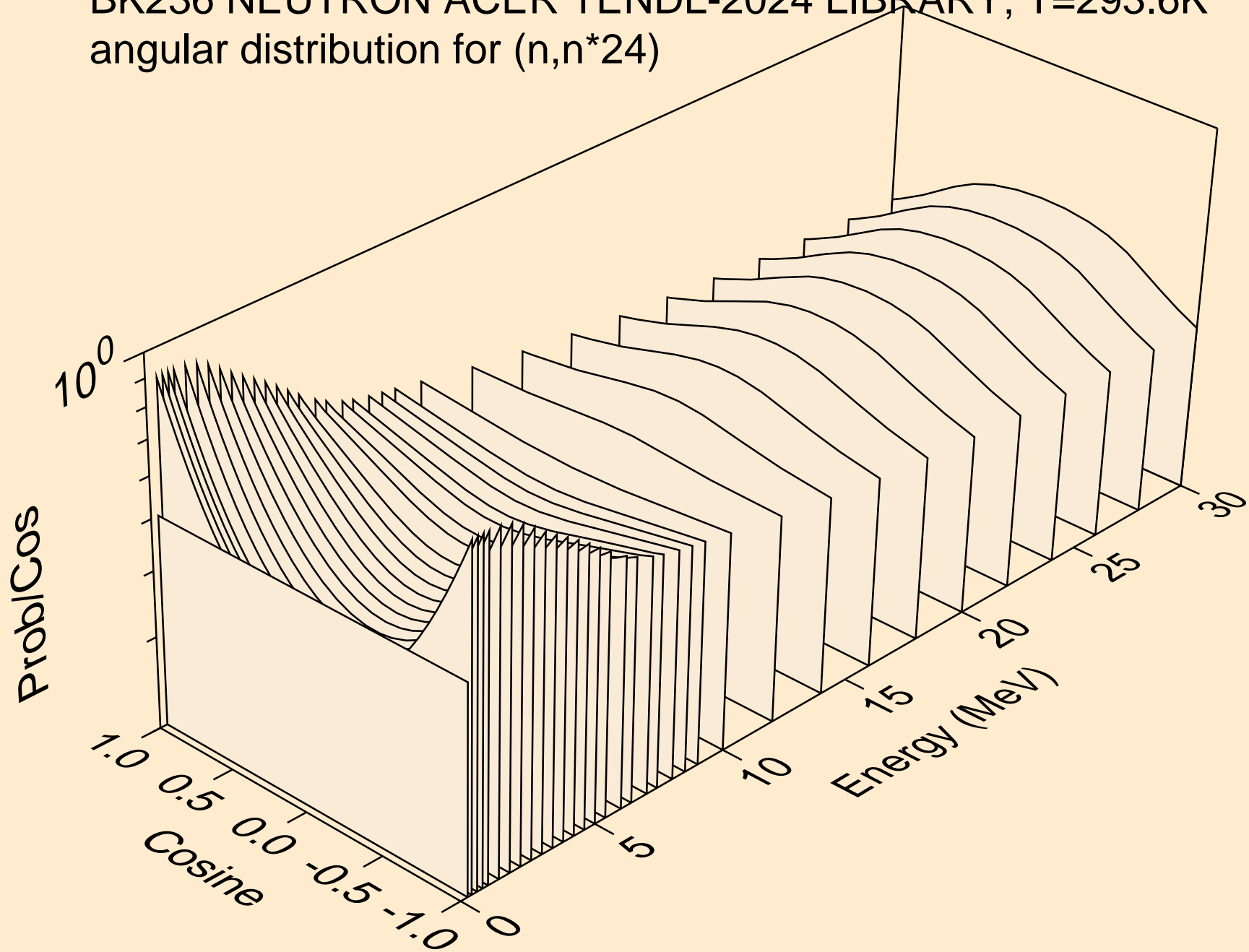

BK236 NEUTRON ACER TENDL-2024 LIBRARY; T=293.6K
angular distribution for (n,n*25)

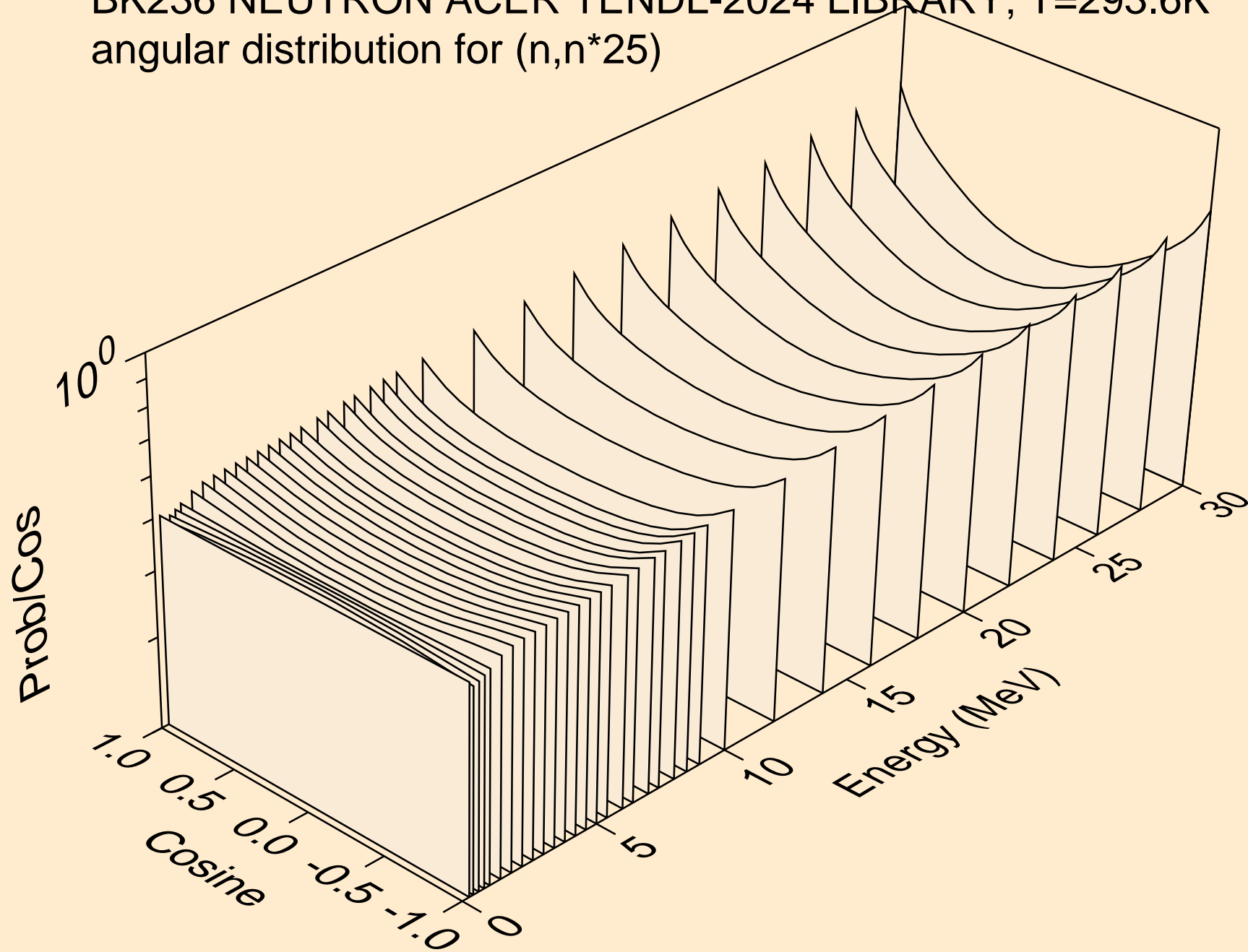

BK236 NEUTRON ACER TENDL-2024 LIBRARY; T=293.6K
angular distribution for (n,n*26)

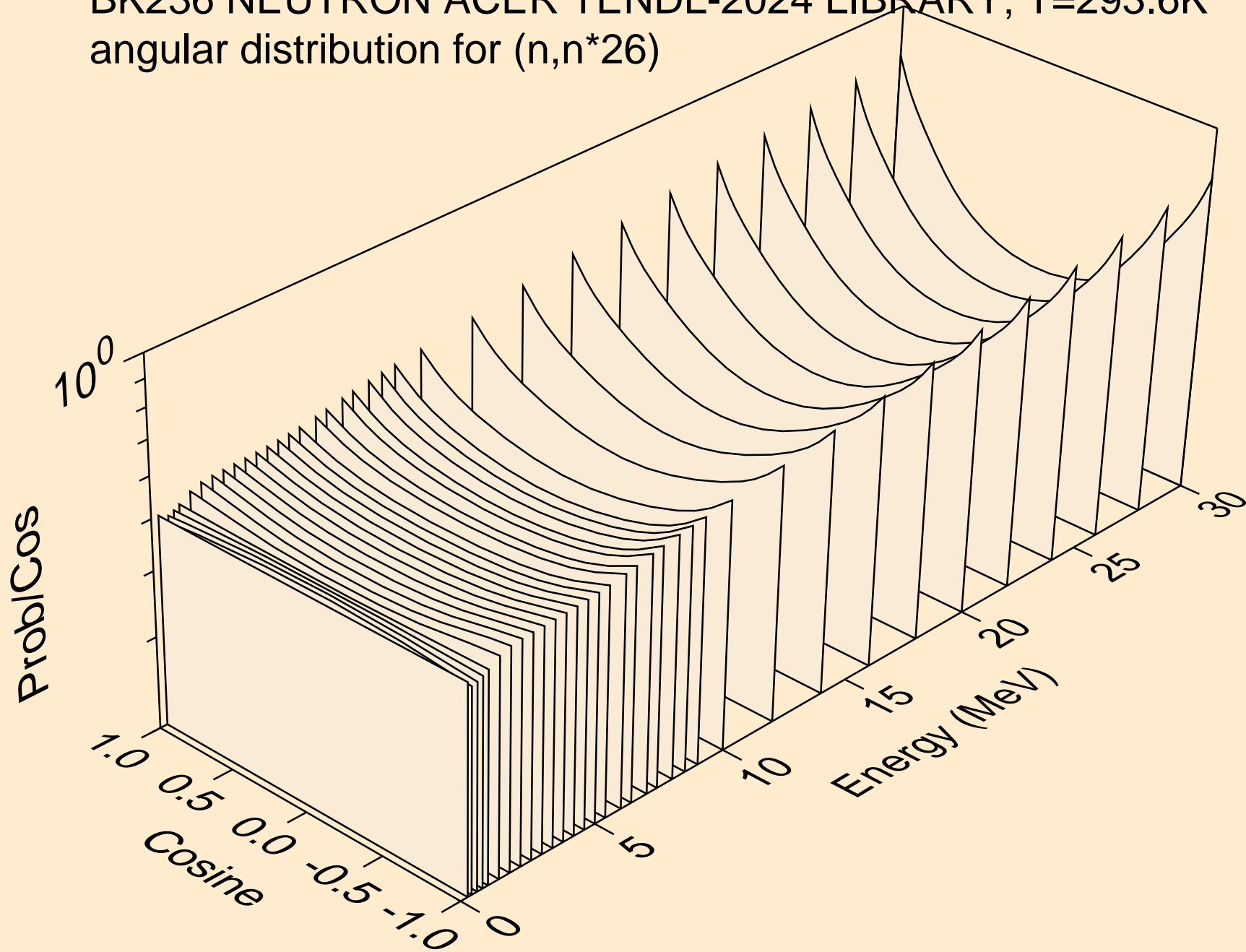

BK236 NEUTRON ACER TENDL-2024 LIBRARY; T=293.6K
angular distribution for (n,n*27)

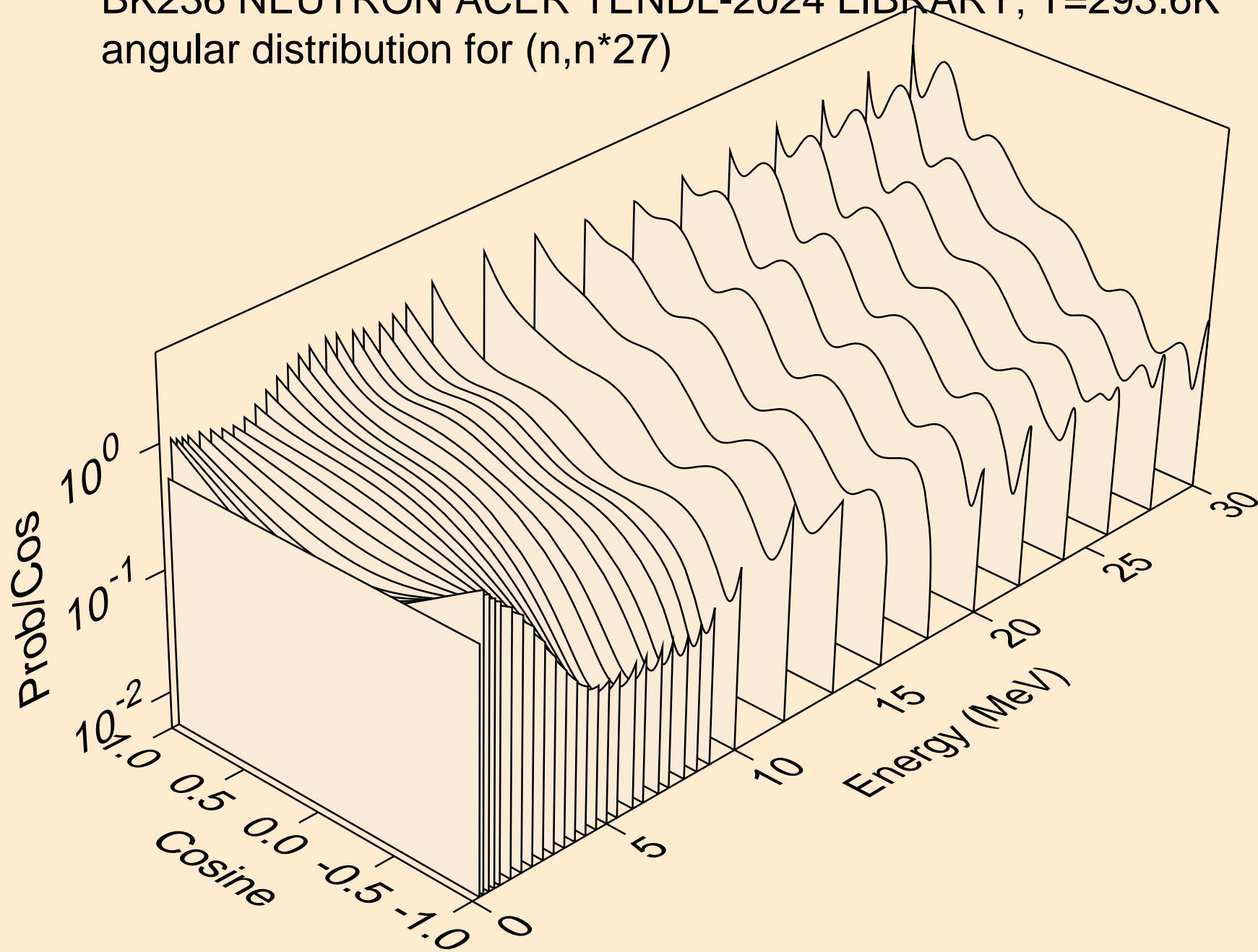

BK236 NEUTRON ACER TENDL-2024 LIBRARY; T=293.6K
angular distribution for (n,n*28)

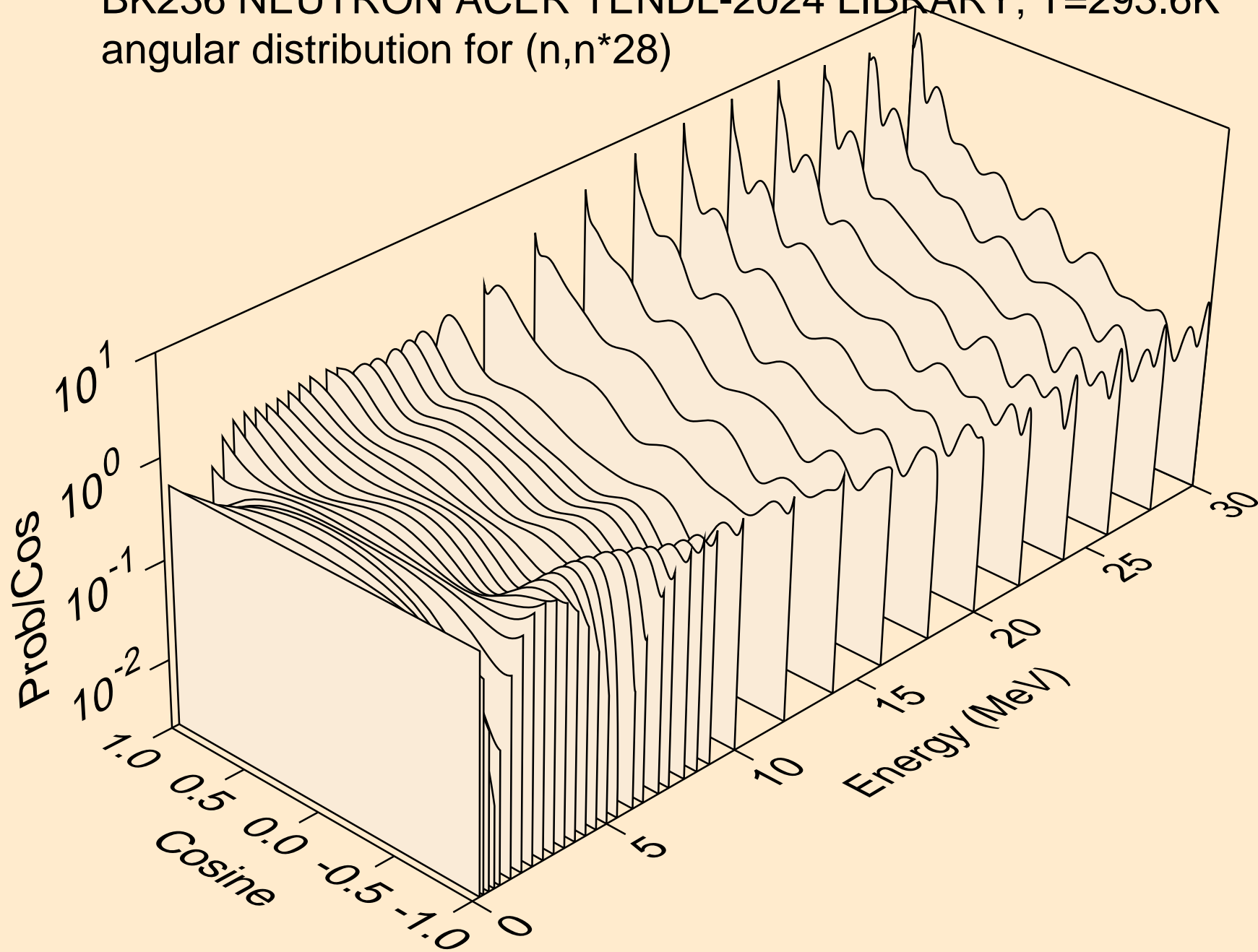

BK236 NEUTRON ACER TENDL-2024 LIBRARY; T=293.6K
Total fission nubar

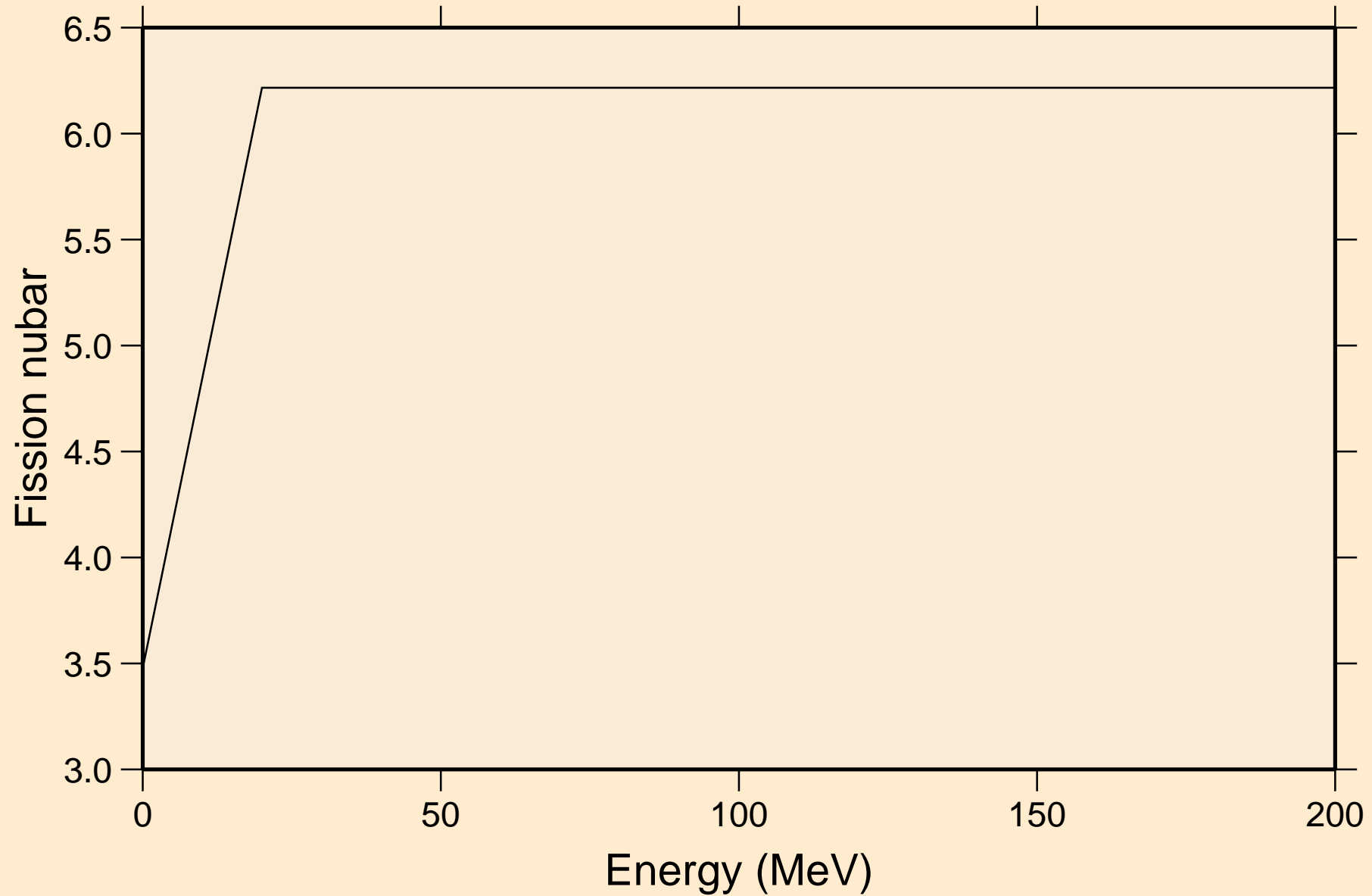

BK236 NEUTRON ACER TENDL-2024 LIBRARY; T=293.6K
Neutron emission for (n,x)

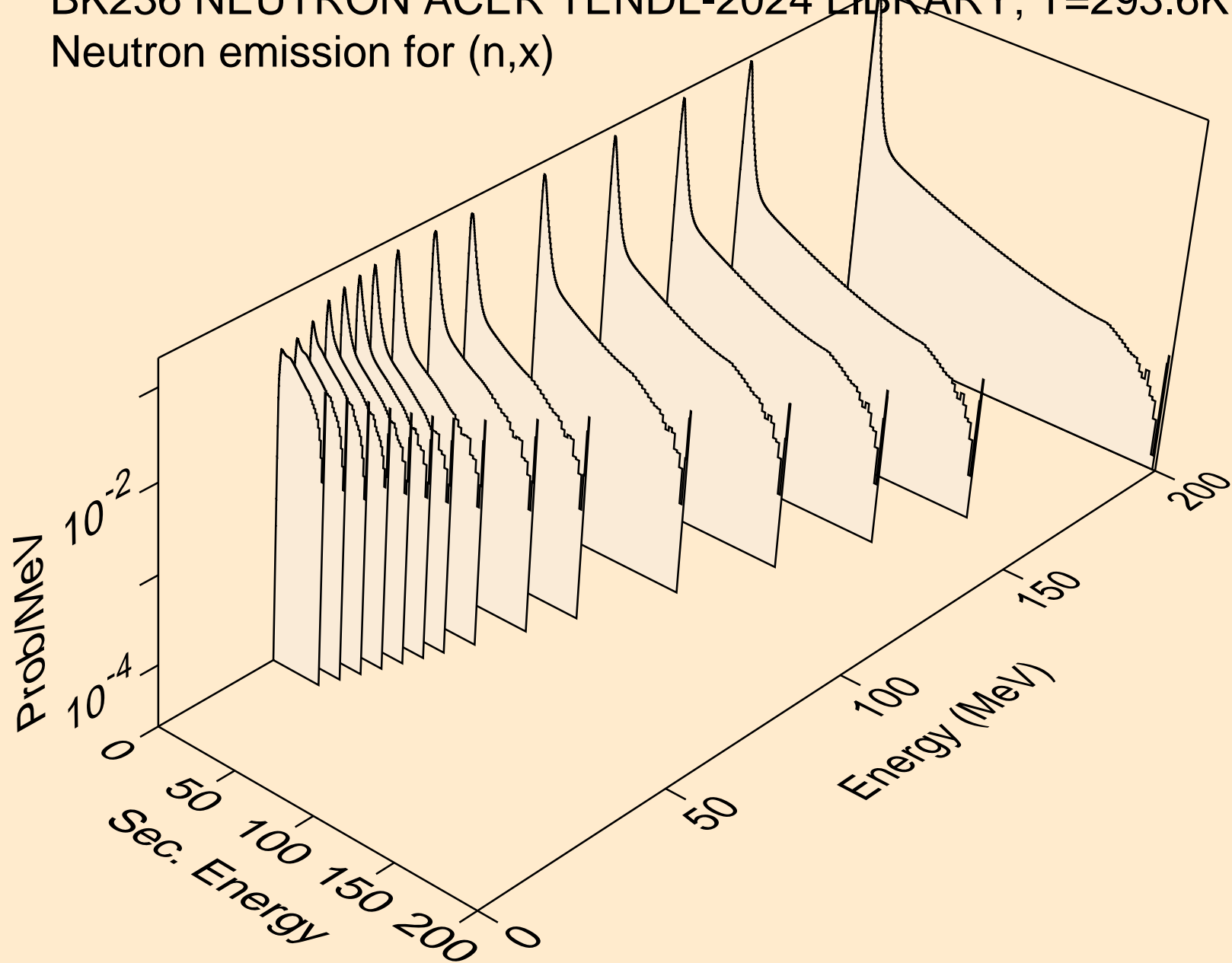

BK236 NEUTRON ACER TENDL-2024 LIBRARY; T=293.6K
Neutron emission for (n,2n)

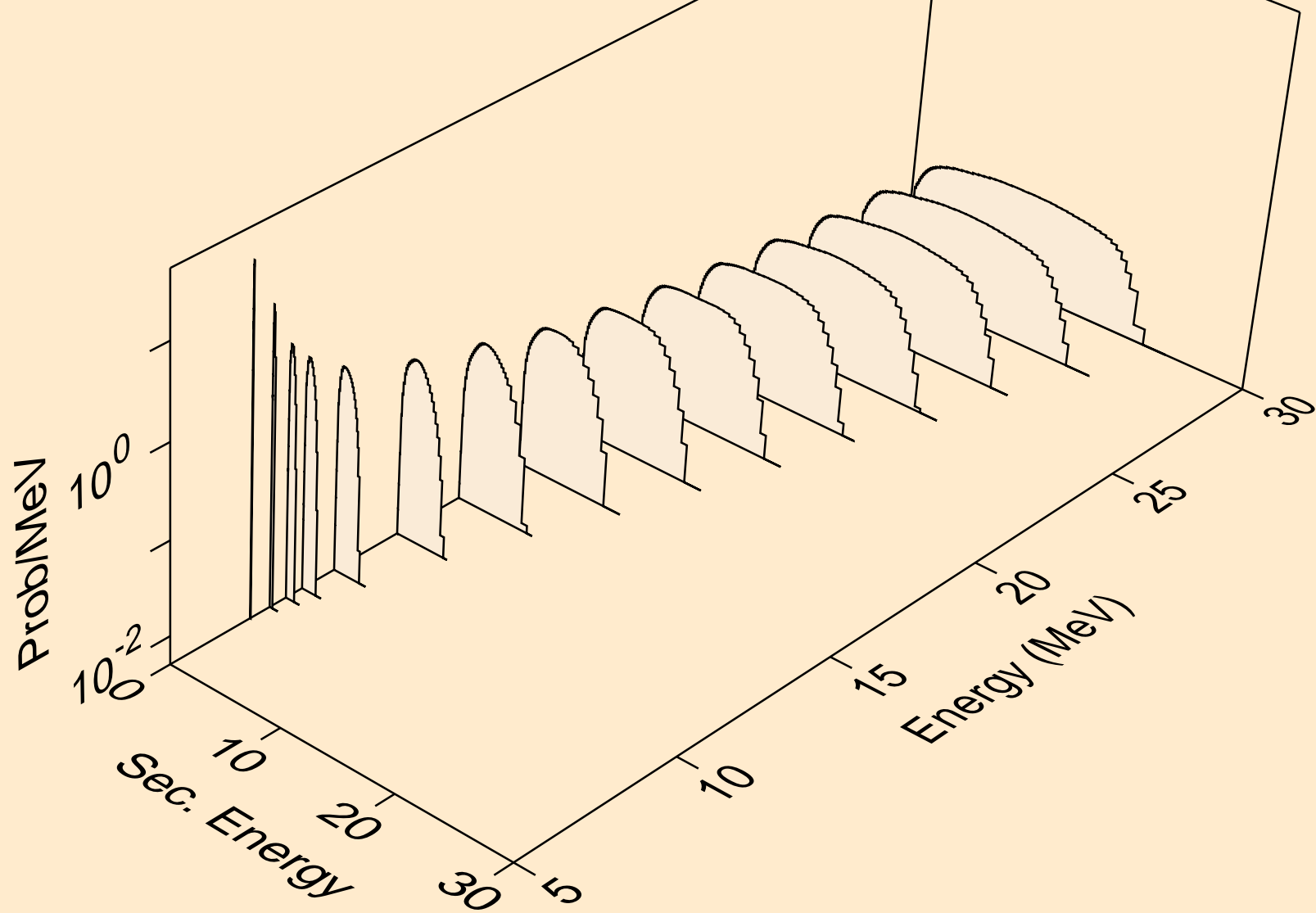

BK236 NEUTRON ACER TENDL-2024 LIBRARY; T=293.6K
Neutron emission for (n,3n)

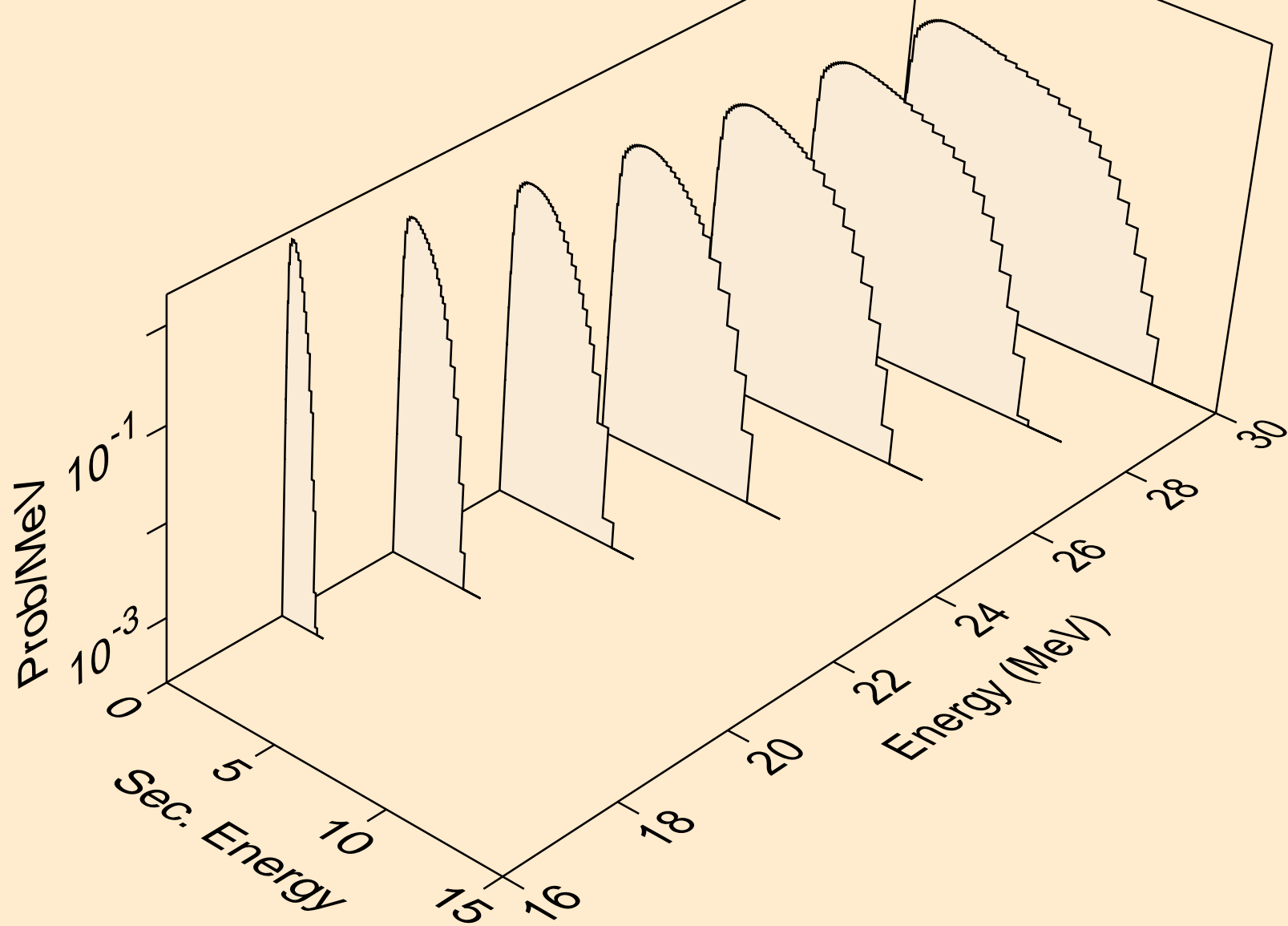

BK236 NEUTRON ACER TENDL-2024 LIBRARY; T=293.6K
Neutron emission for fission

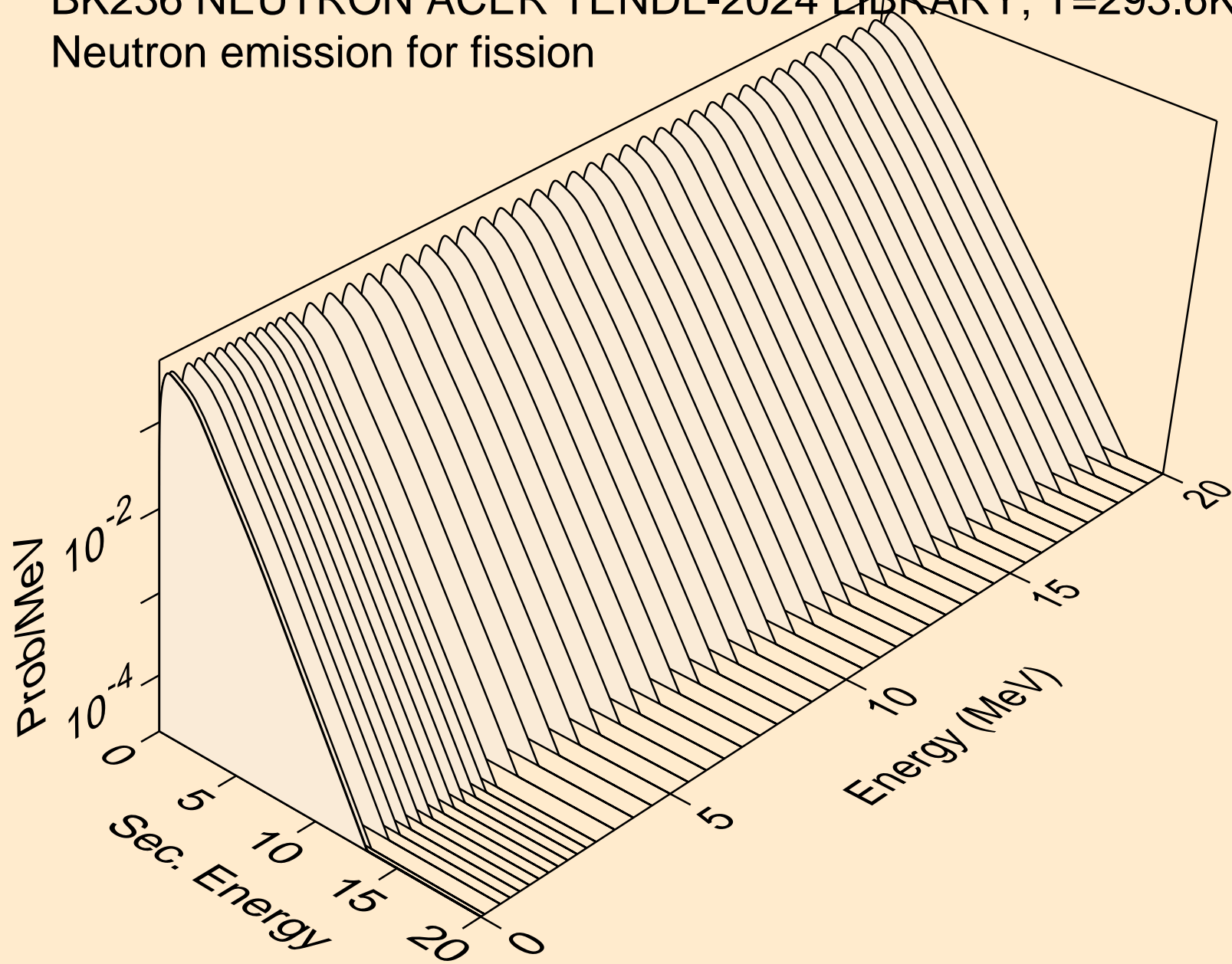

BK236 NEUTRON ACER TENDL-2024 LIBRARY; T=293.6K
Neutron emission for (n,n*)a

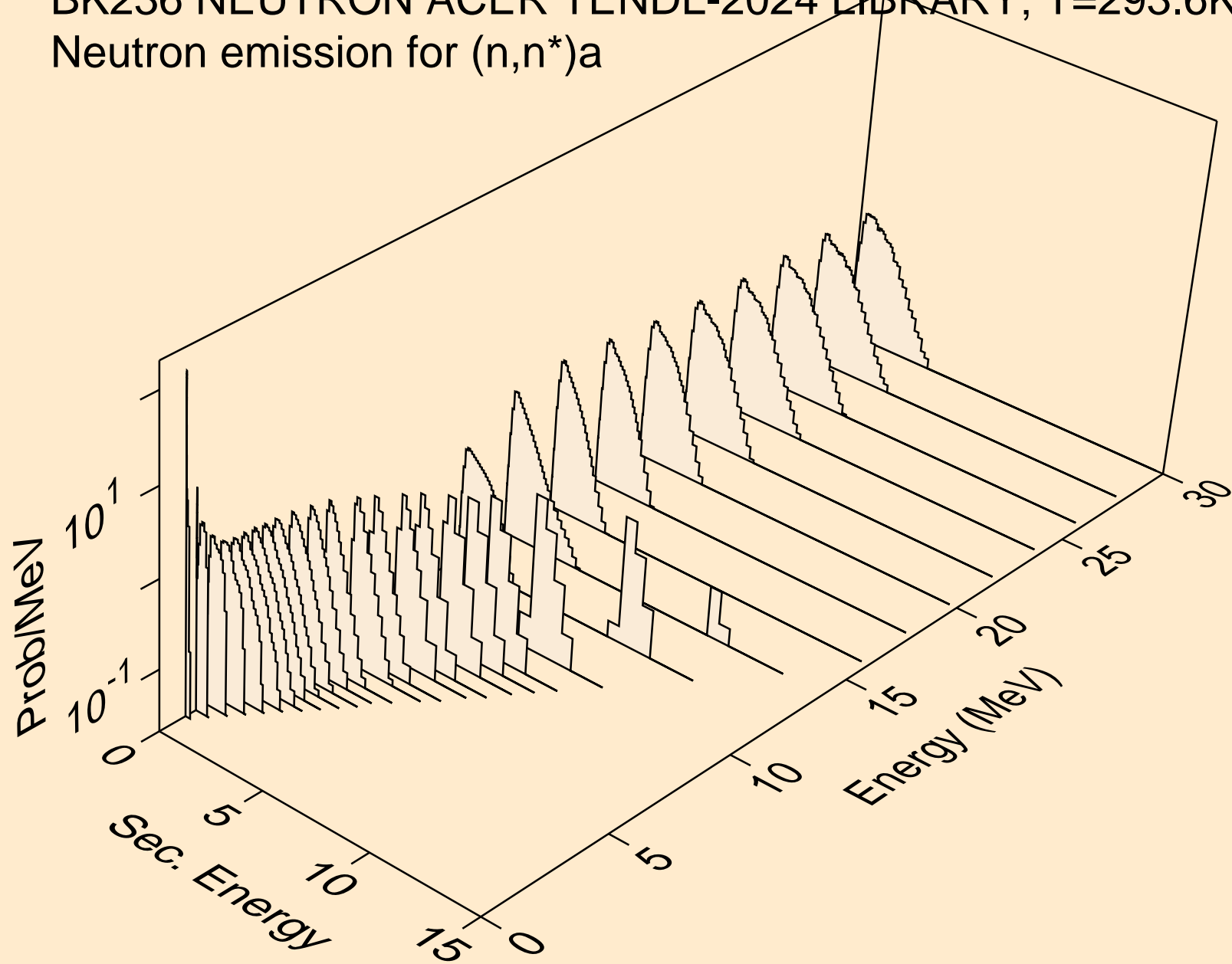

BK236 NEUTRON ACER TENDL-2024 LIBRARY; T=293.6K
Neutron emission for (n,2n)a

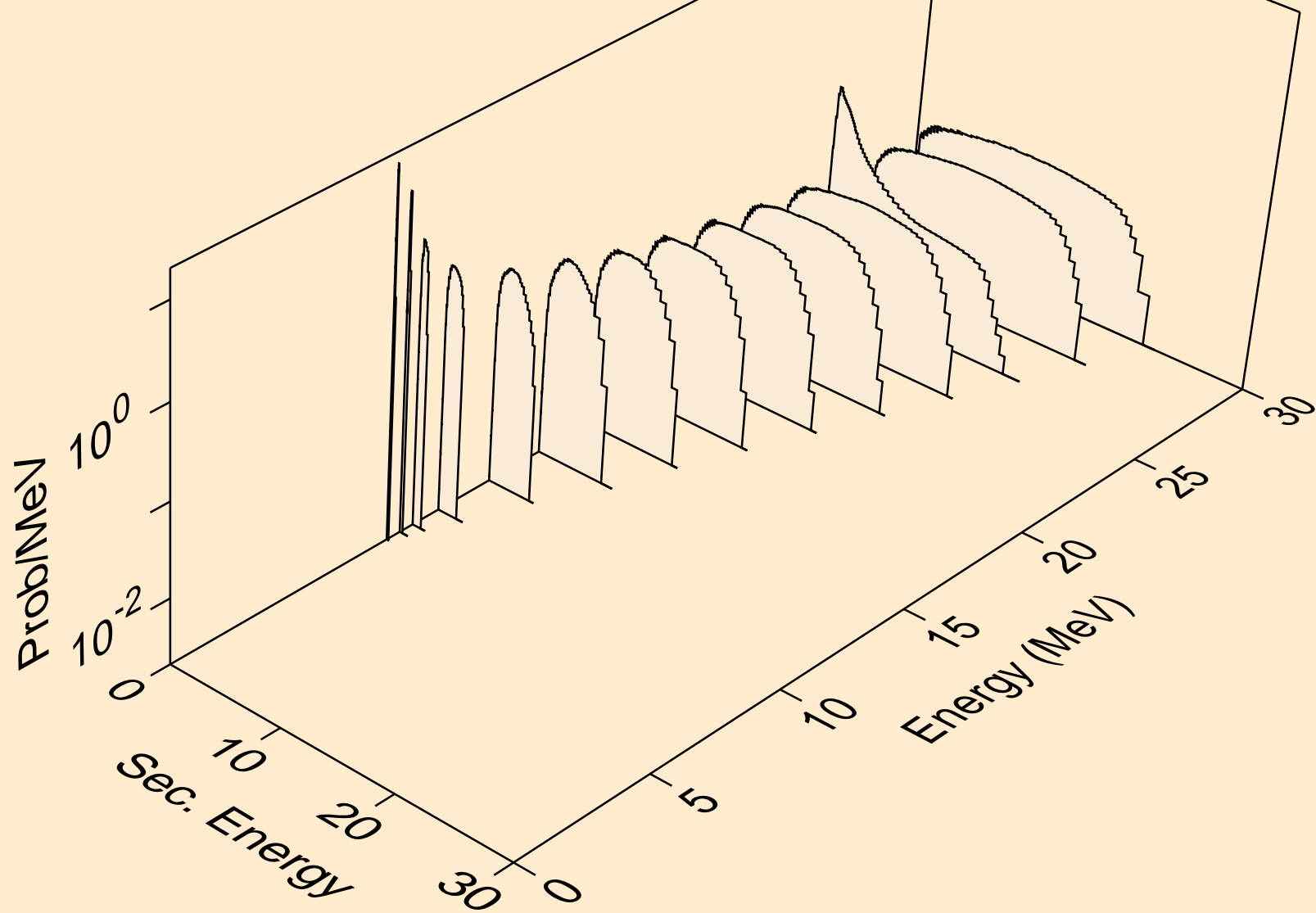

BK236 NEUTRON ACER TENDL-2024 LIBRARY; T=293.6K
Neutron emission for (n,n*)p

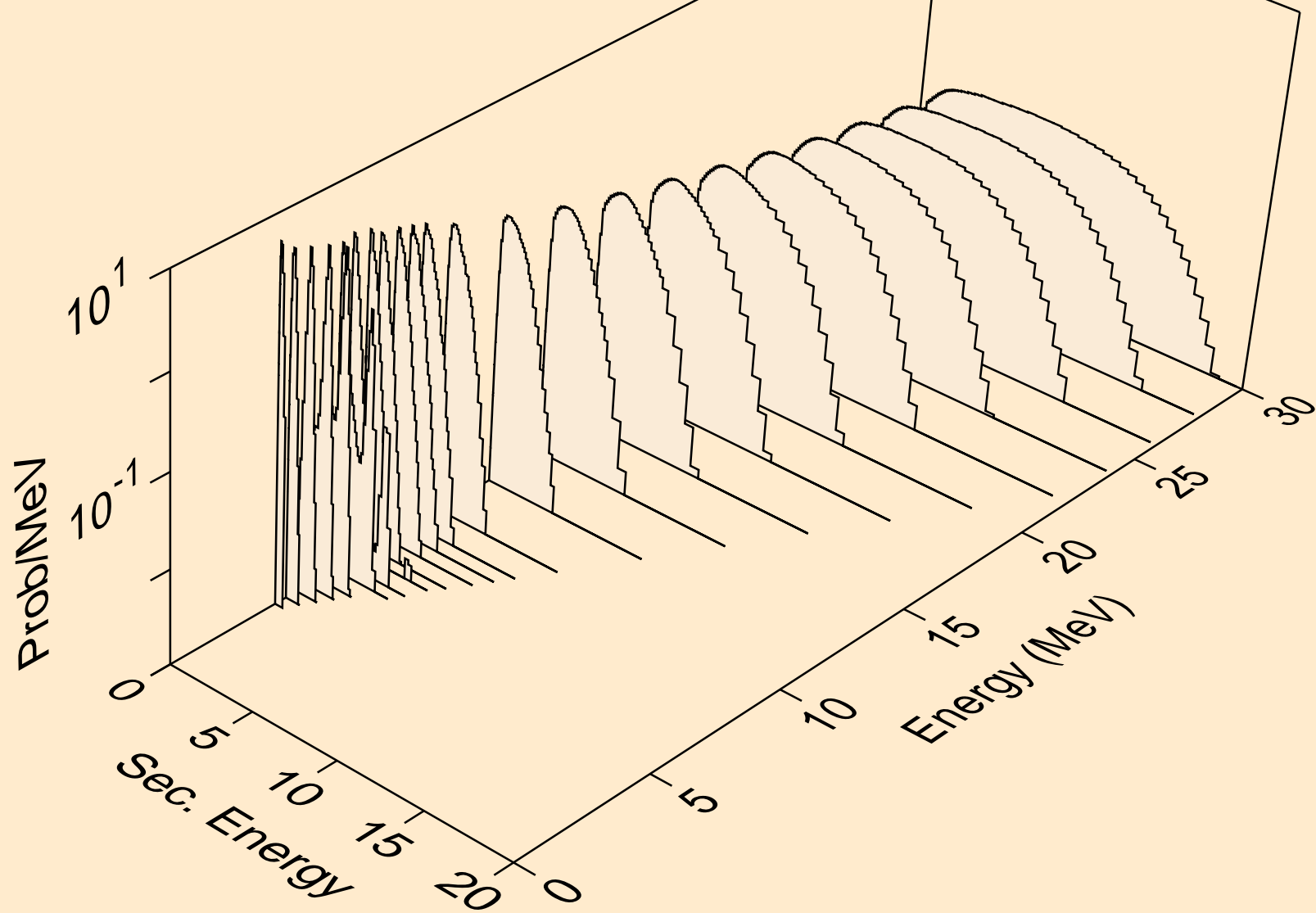

BK236 NEUTRON ACER TENDL-2024 LIBRARY; T=293.6K
Neutron emission for (n,n*)d

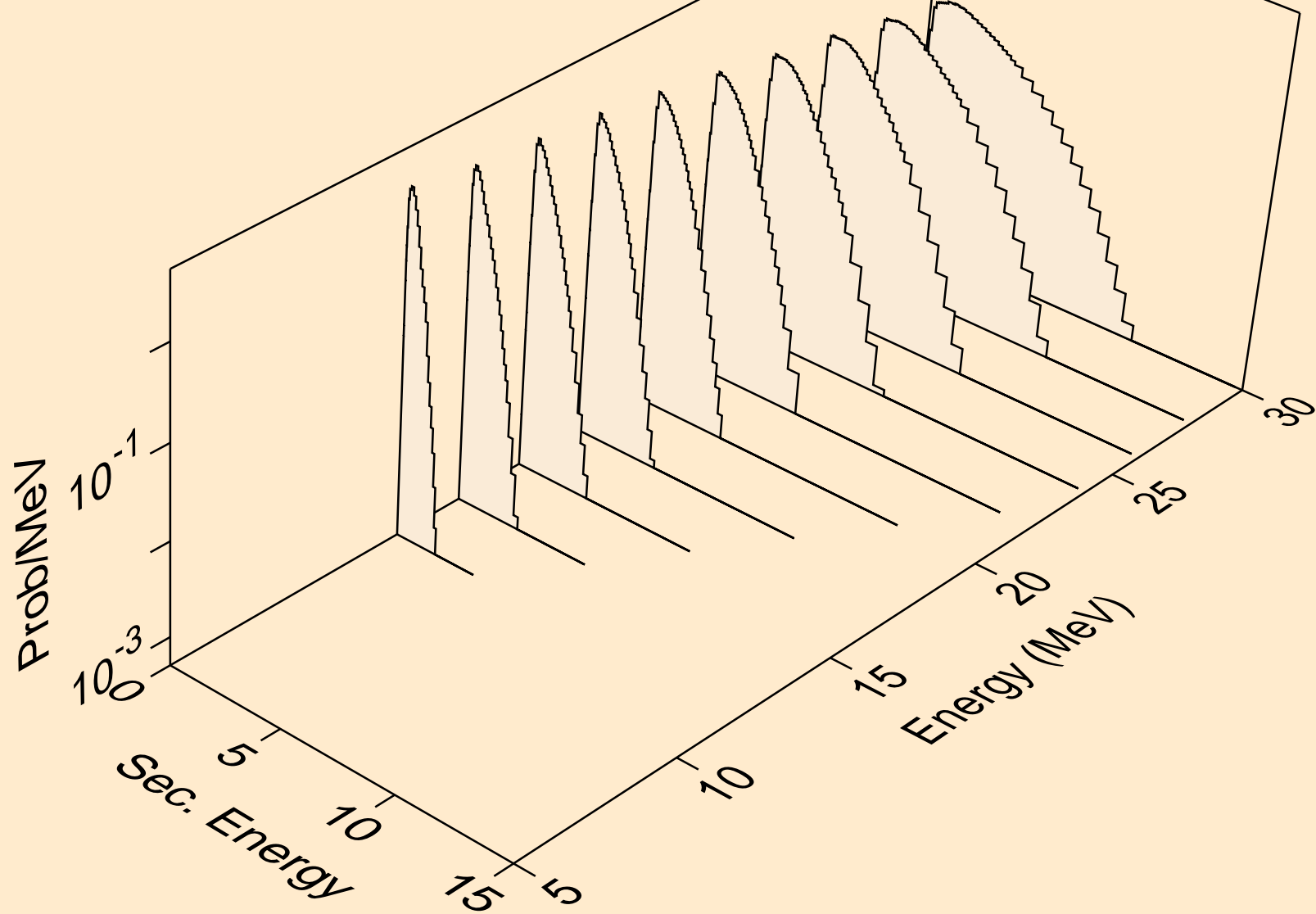

BK236 NEUTRON ACER TENDL-2024 LIBRARY; T=293.6K
Neutron emission for (n,n*)t

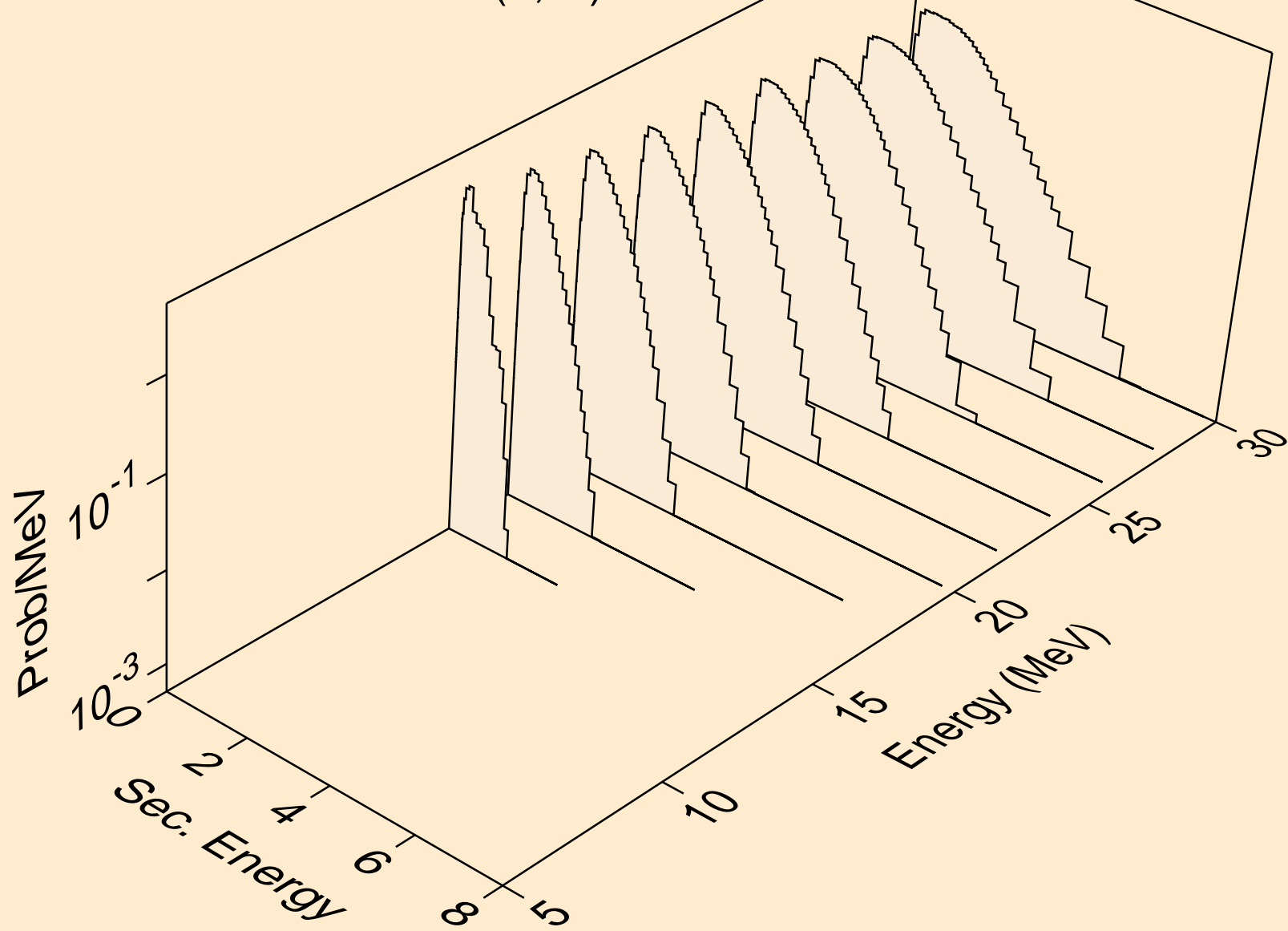

BK236 NEUTRON ACER TENDL-2024 LIBRARY; T=293.6K
Neutron emission for (n,n*)he3

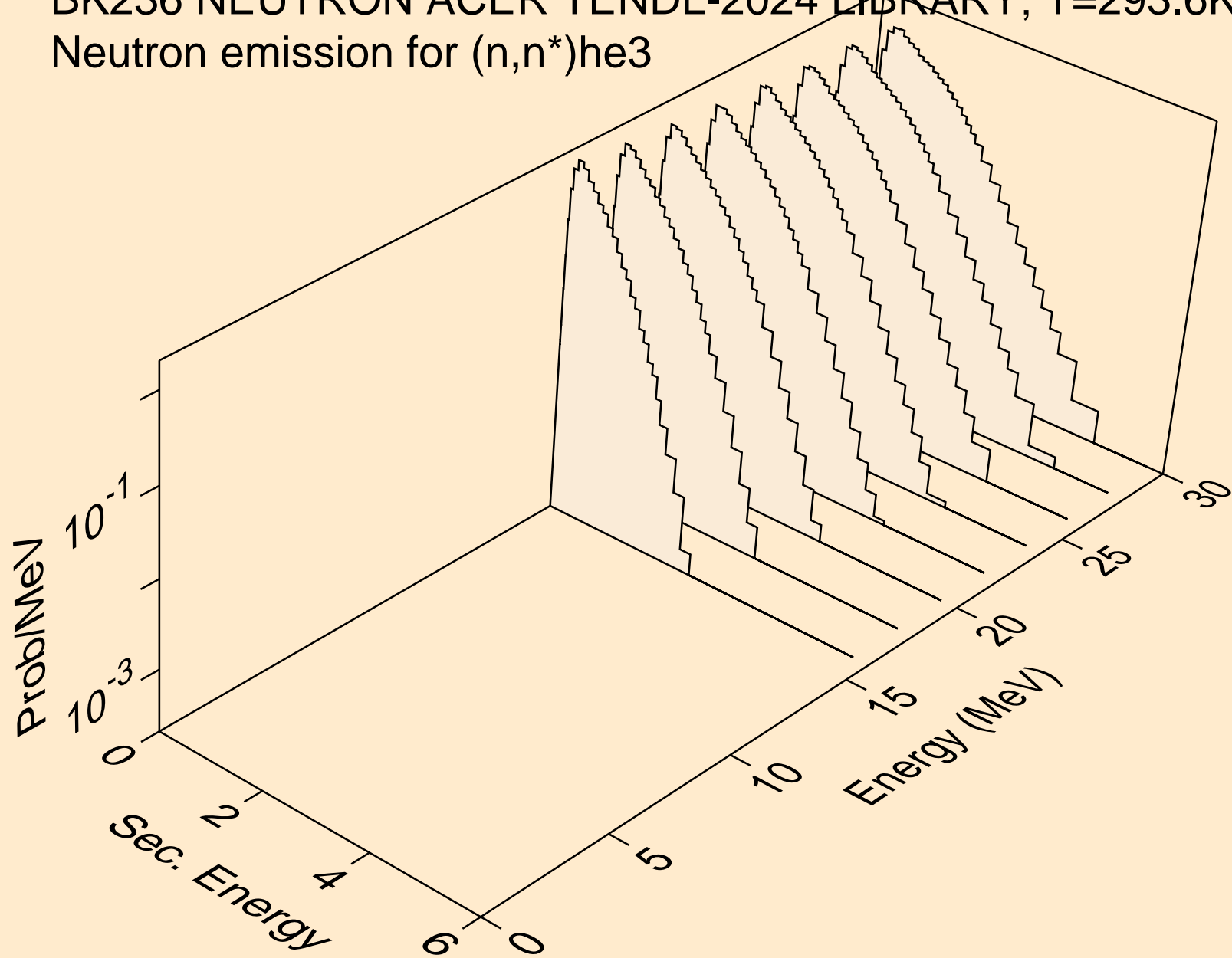

BK236 NEUTRON ACER TENDL-2024 LIBRARY; T=293.6K
Neutron emission for (n,4n)

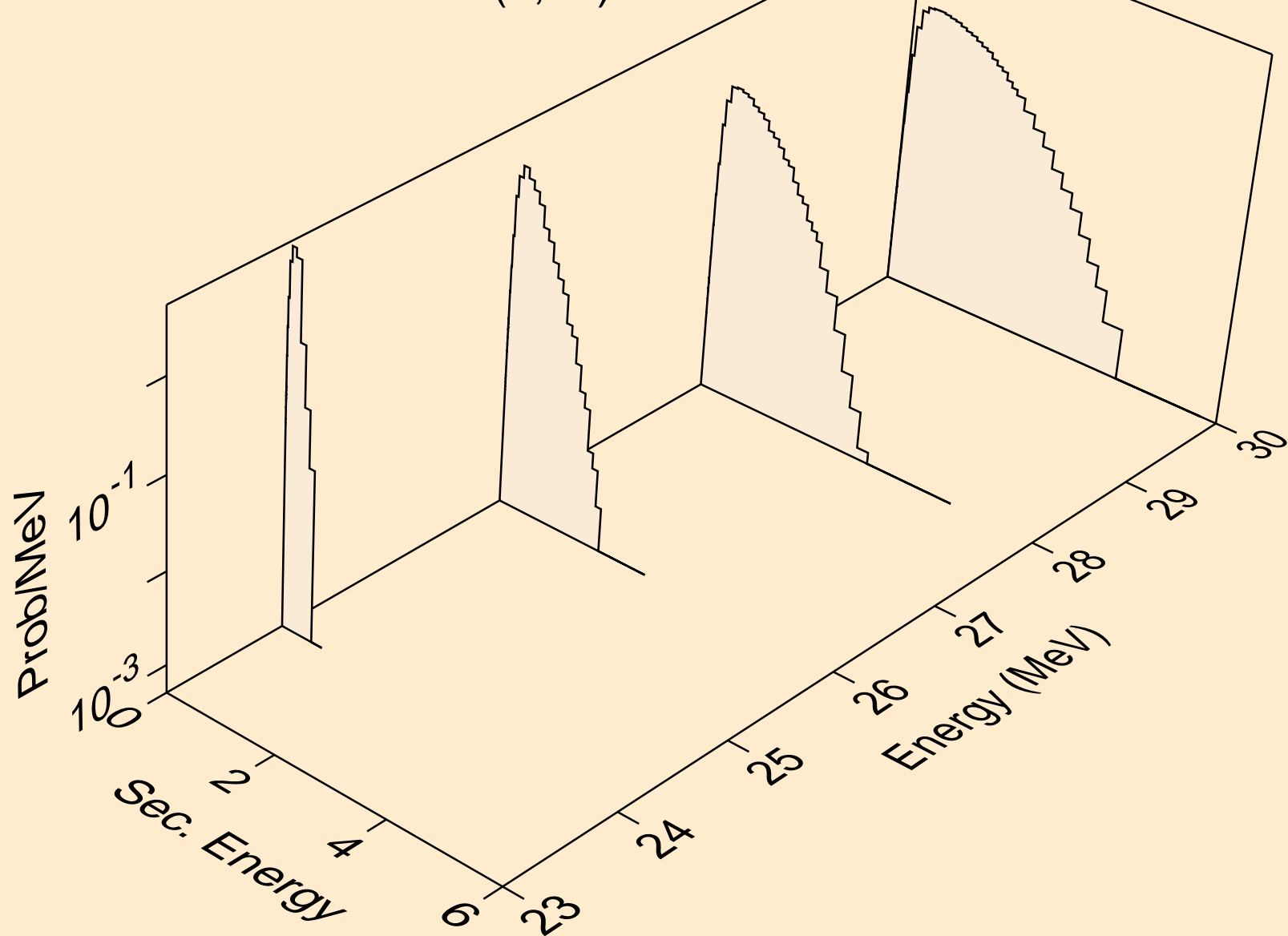

BK236 NEUTRON ACER TENDL-2024 LIBRARY; T=293.6K
Neutron emission for (n,2np)

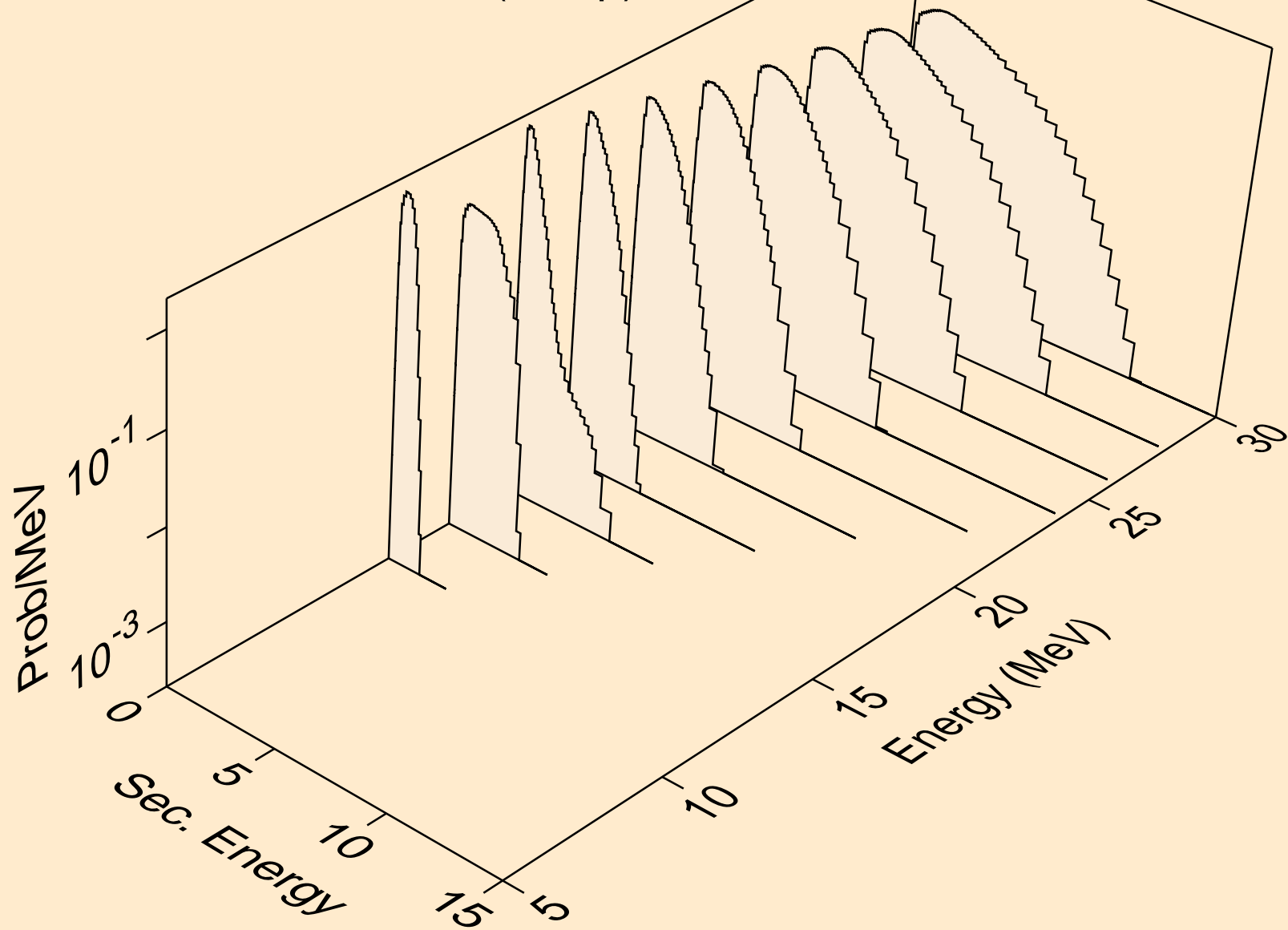

BK236 NEUTRON ACER TENDL-2024 LIBRARY; T=293.6K
Neutron emission for (n,n2p)

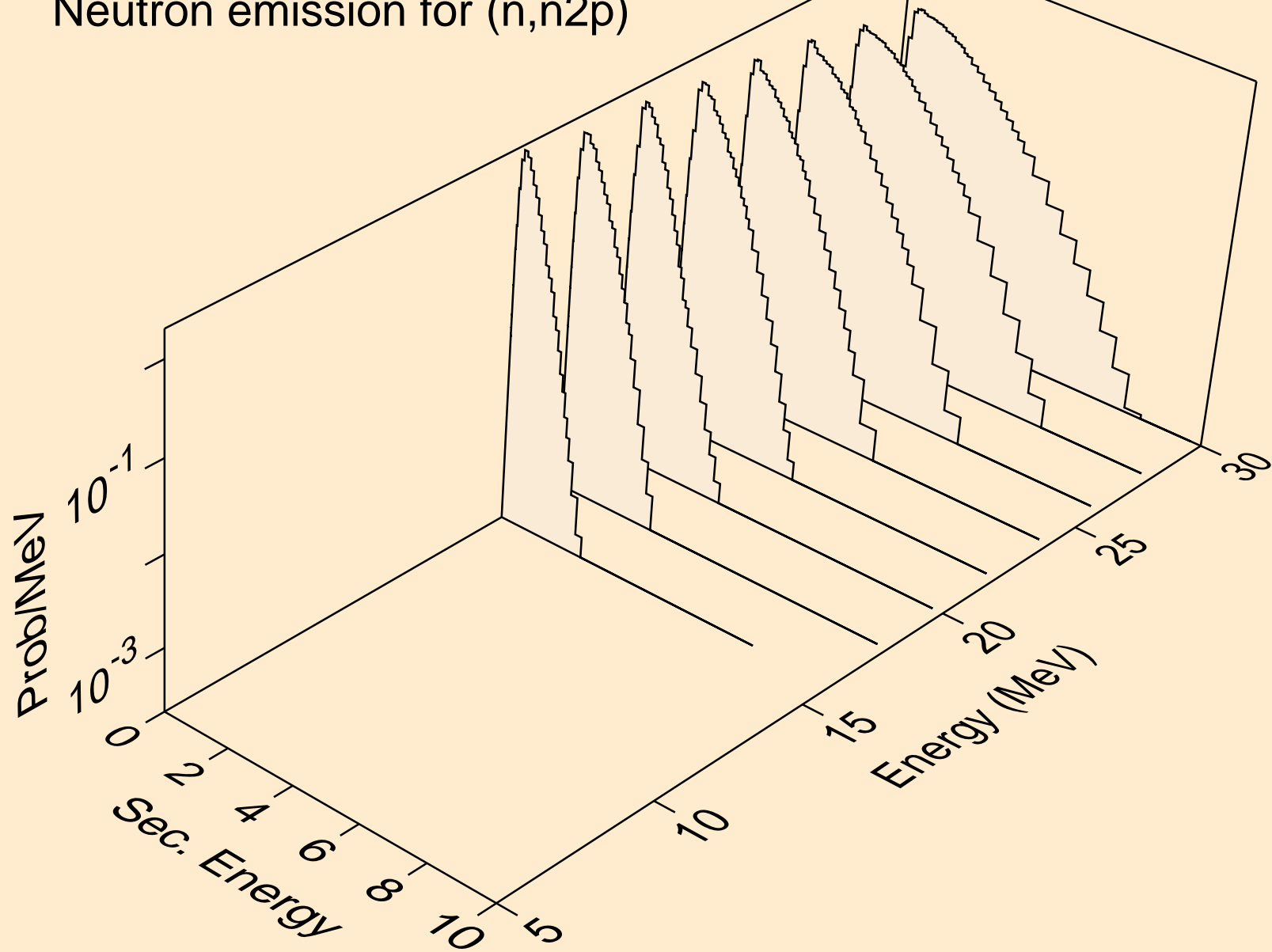

BK236 NEUTRON ACER TENDL-2024 LIBRARY; T=293.6K
Neutron emission for (n,npa)

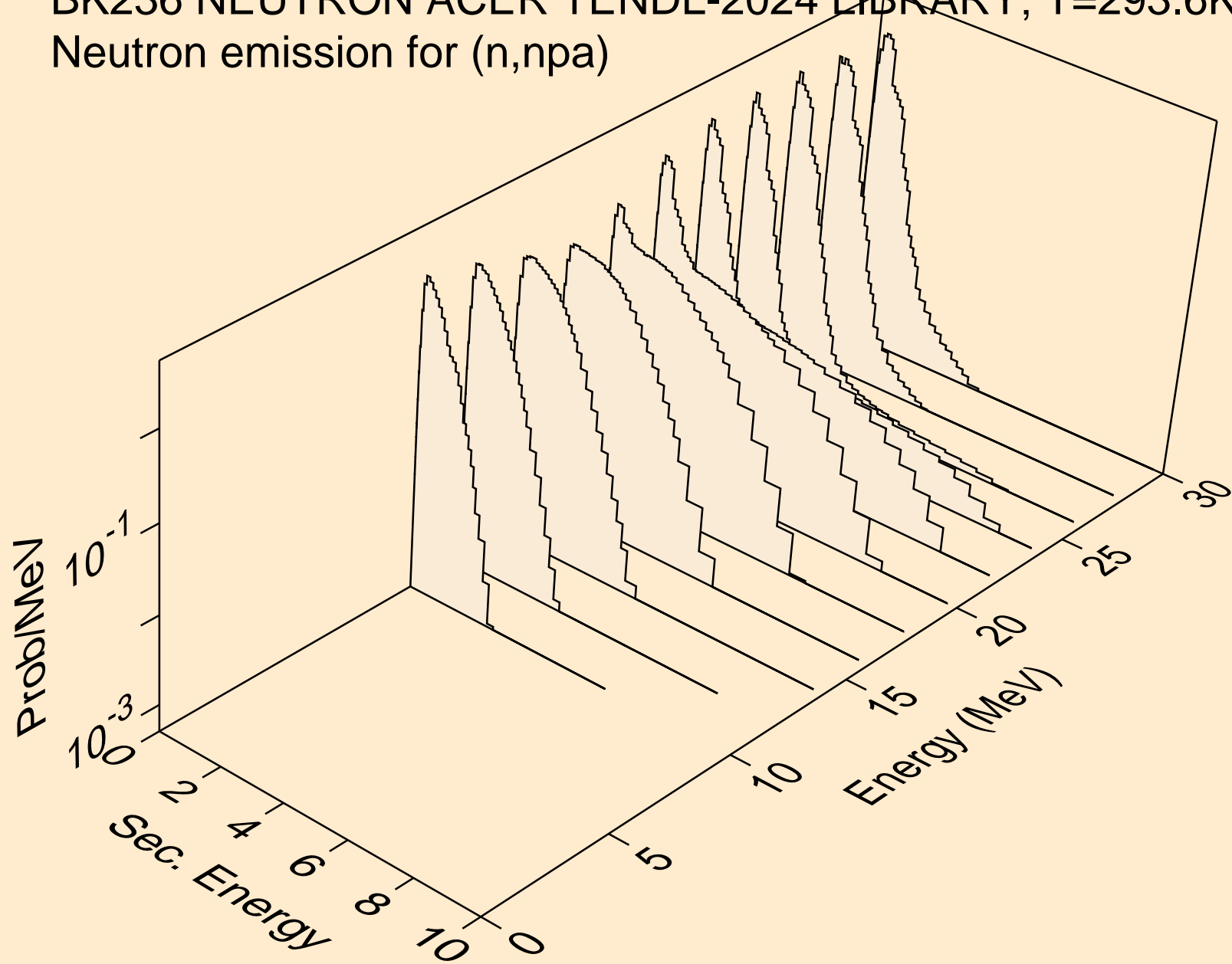

BK236 NEUTRON ACER TENDL-2024 LIBRARY; T=293.6K
Neutron emission for (n,n*c)

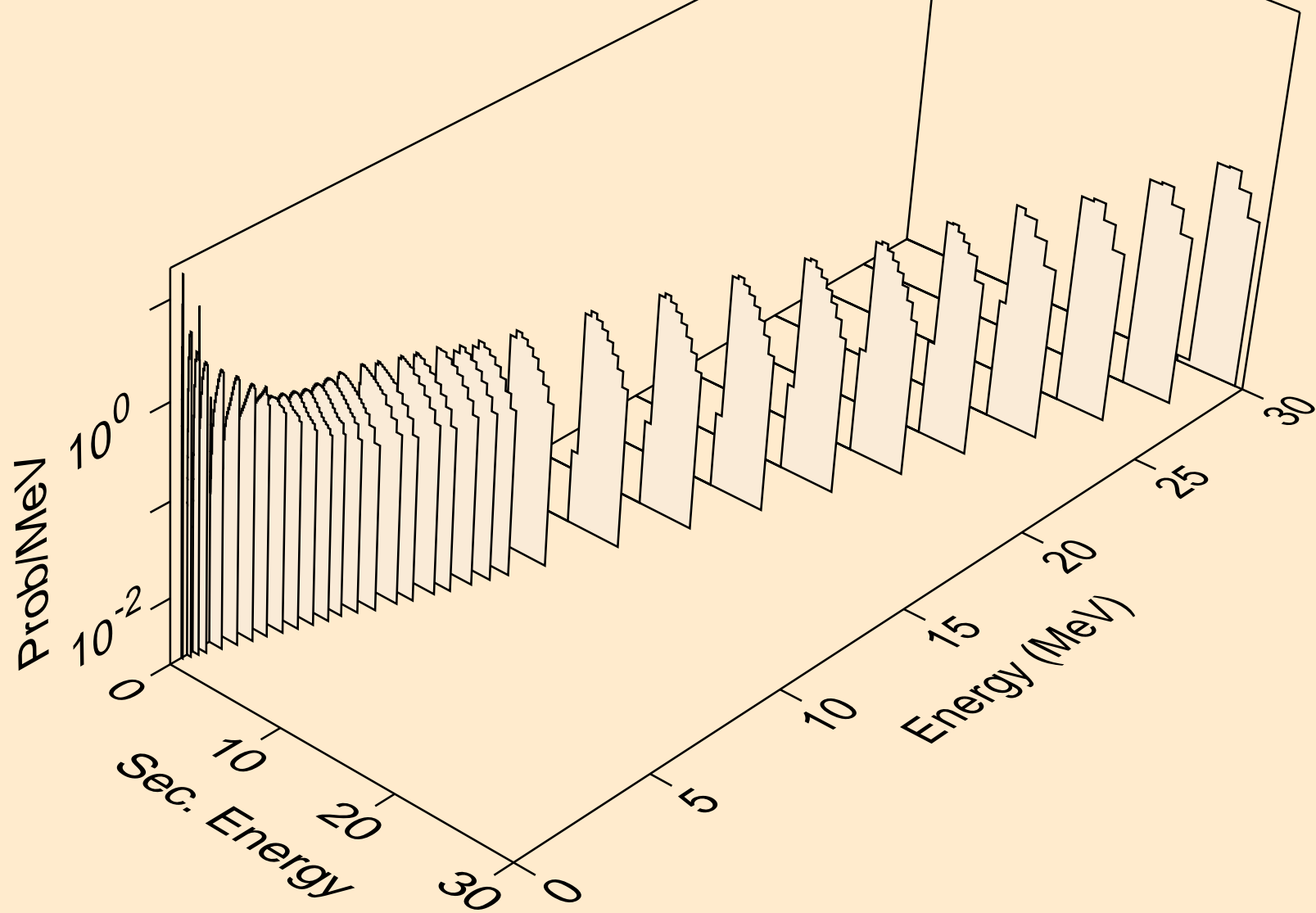

BK236 NEUTRON ACER TENDL-2024 LIBRARY; T=293.6K
Delayed nubar

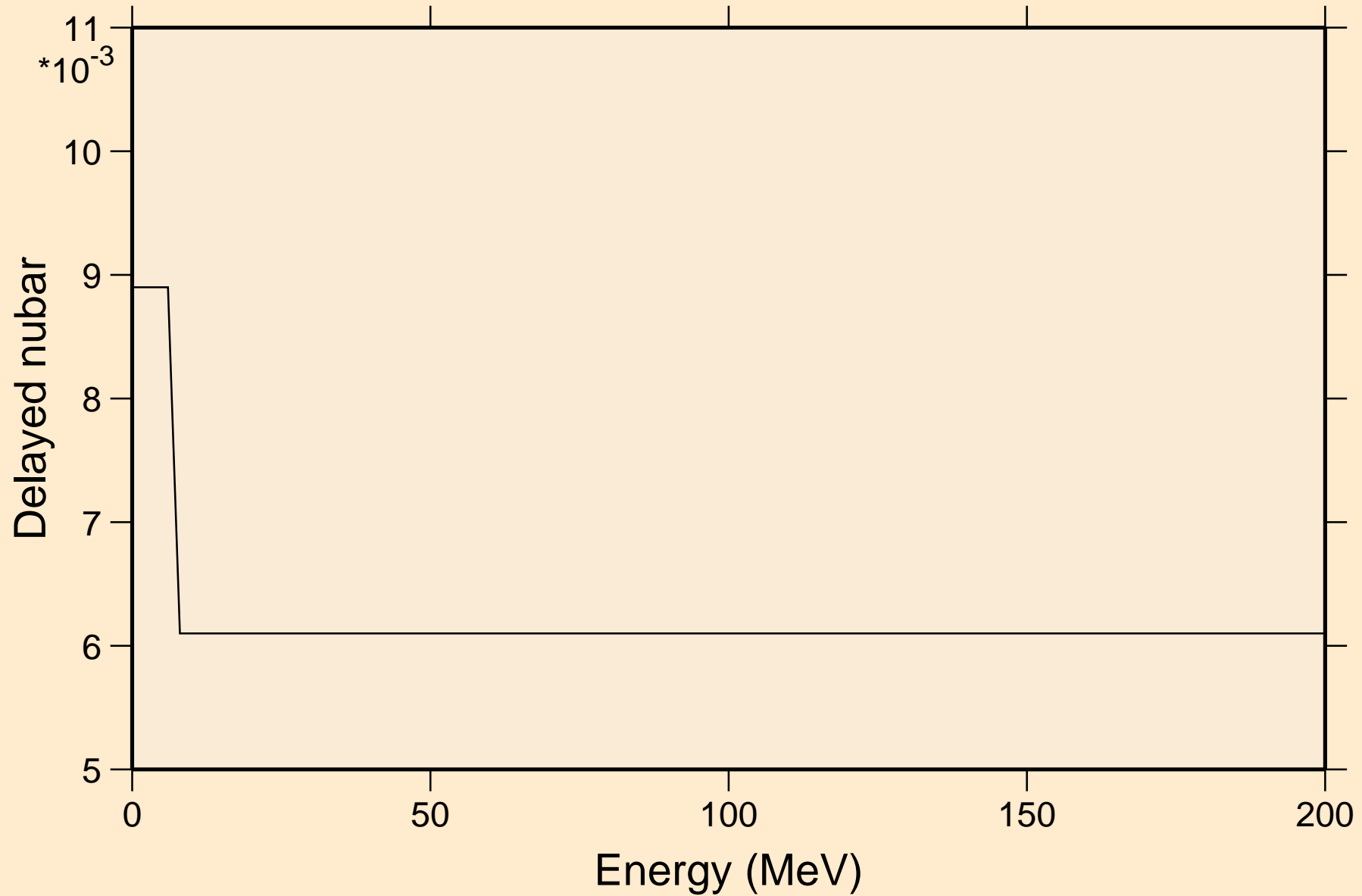

BK236 NEUTRON ACER TENDL-2024 LIBRARY; T=293.6K
Delayed neutron spectra

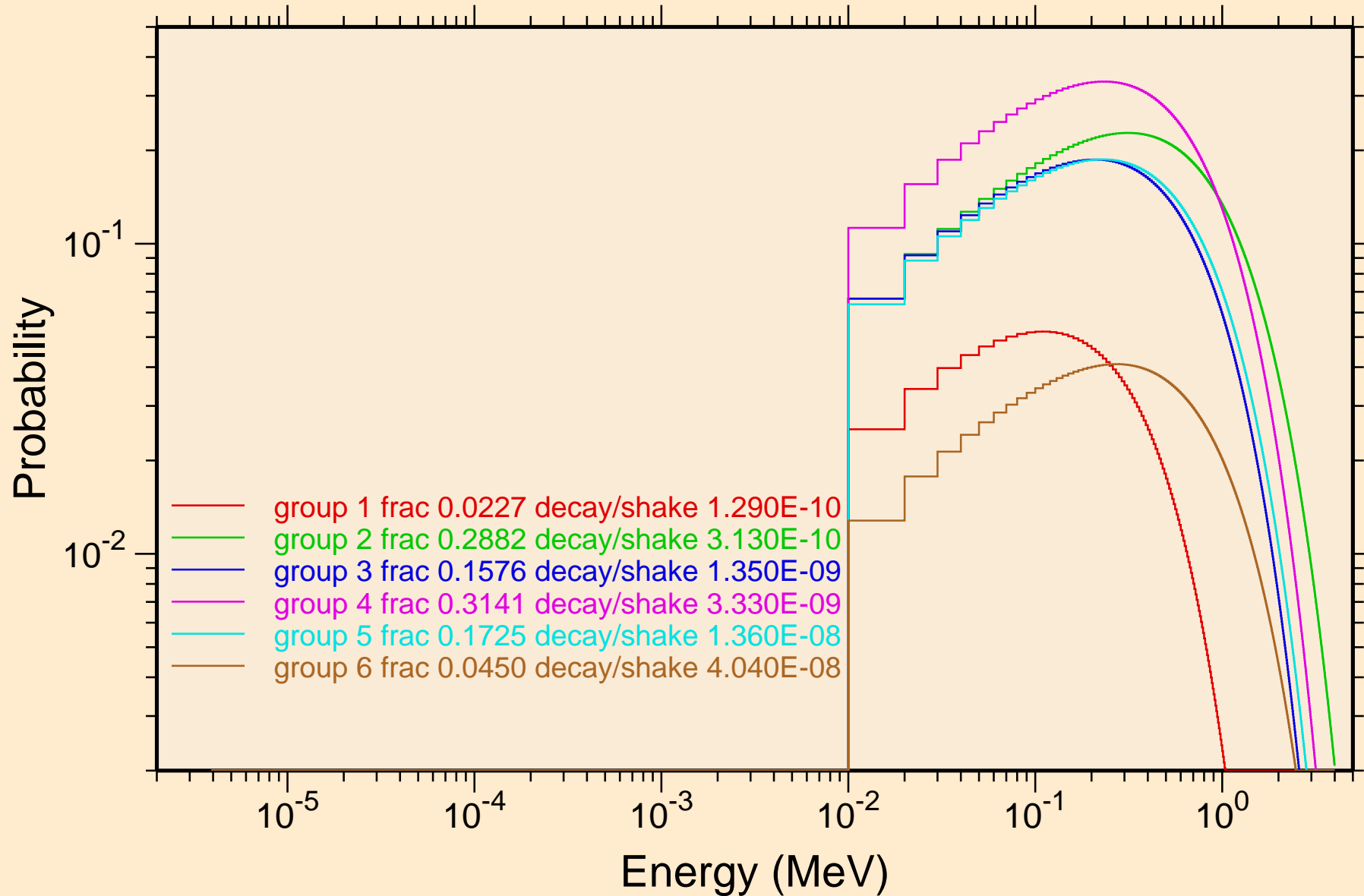

BK236 NEUTRON ACER TENDL-2024 LIBRARY; T=293.6K
Photon emission for (n,x)

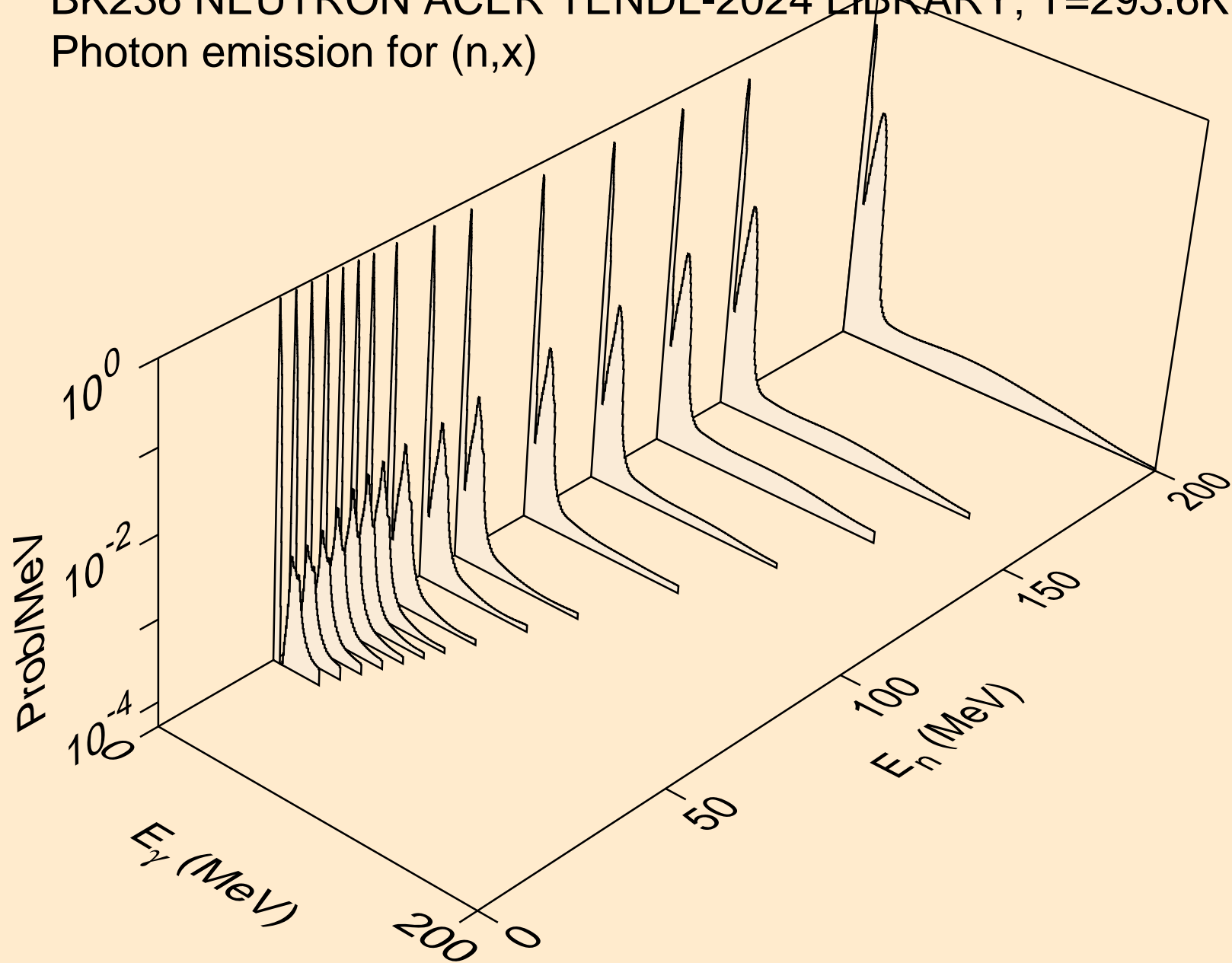

BK236 NEUTRON ACER TENDL-2024 LIBRARY; T=293.6K
Photon emission for (n,2n)

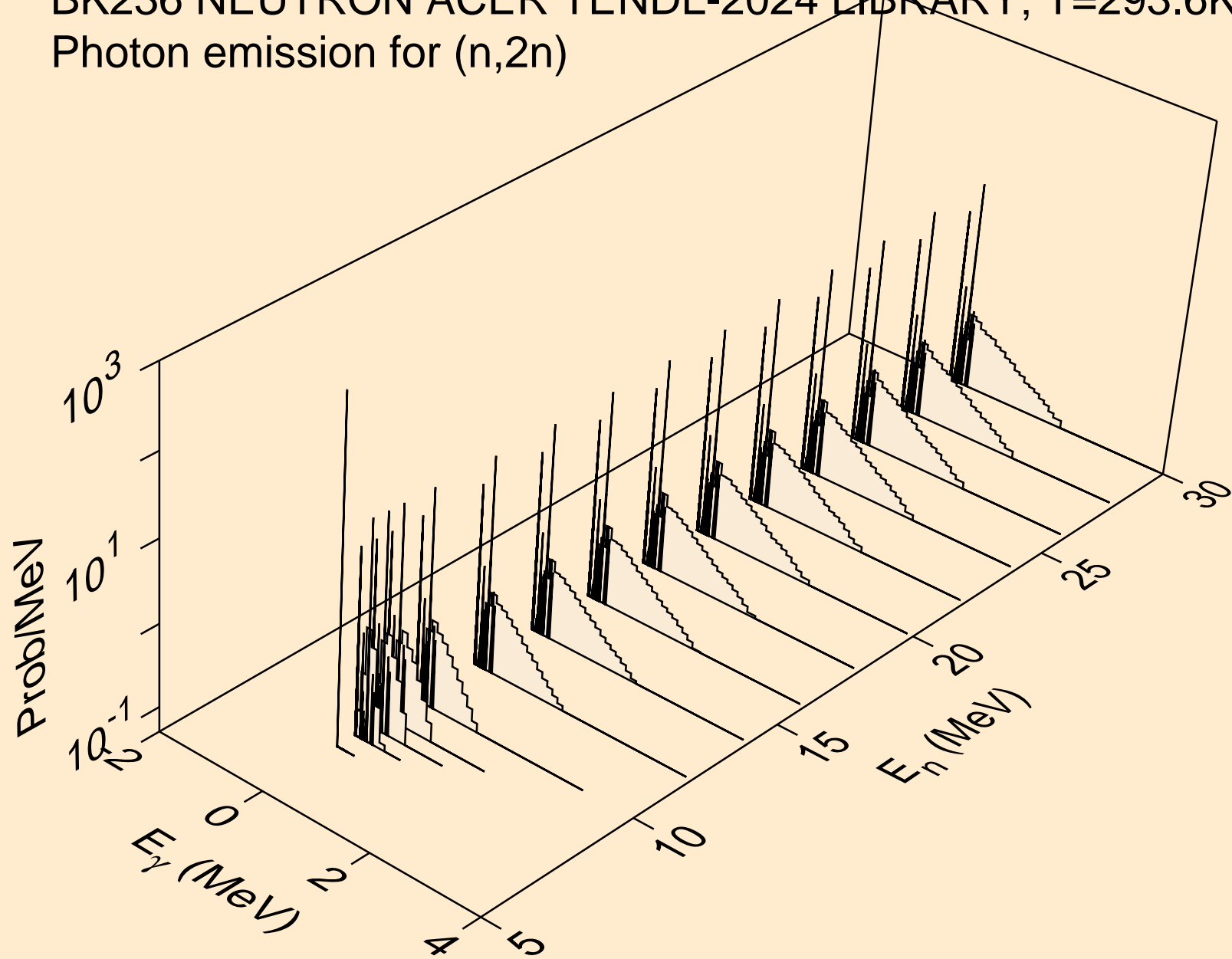

BK236 NEUTRON ACER TENDL-2024 LIBRARY; T=293.6K
Photon emission for (n,3n)

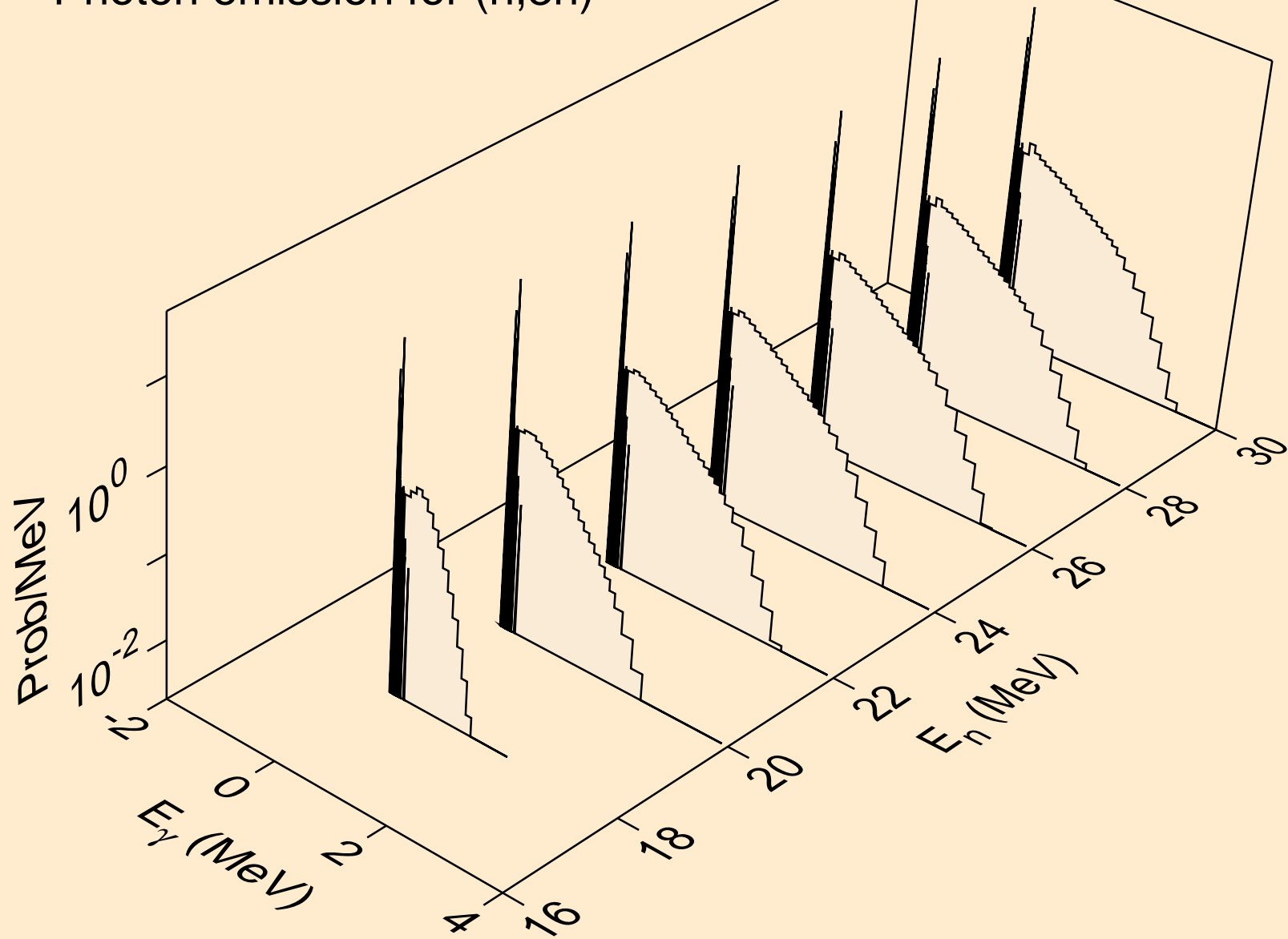

BK236 NEUTRON ACER TENDL-2024 LIBRARY; T=293.6K
Photon emission for (n,n*)a

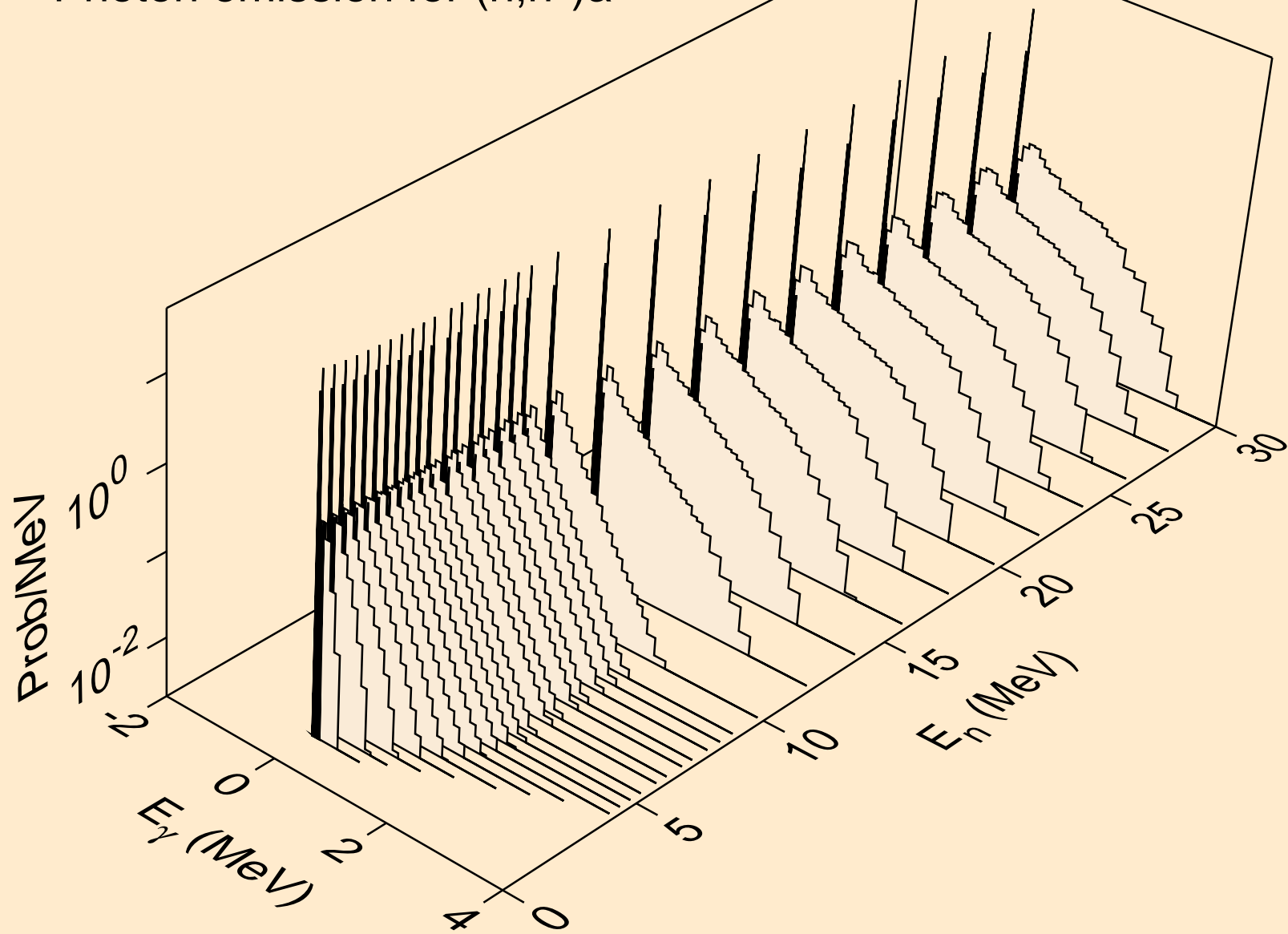

BK236 NEUTRON ACER TENDL-2024 LIBRARY; T=293.6K
Photon emission for (n,2n) α

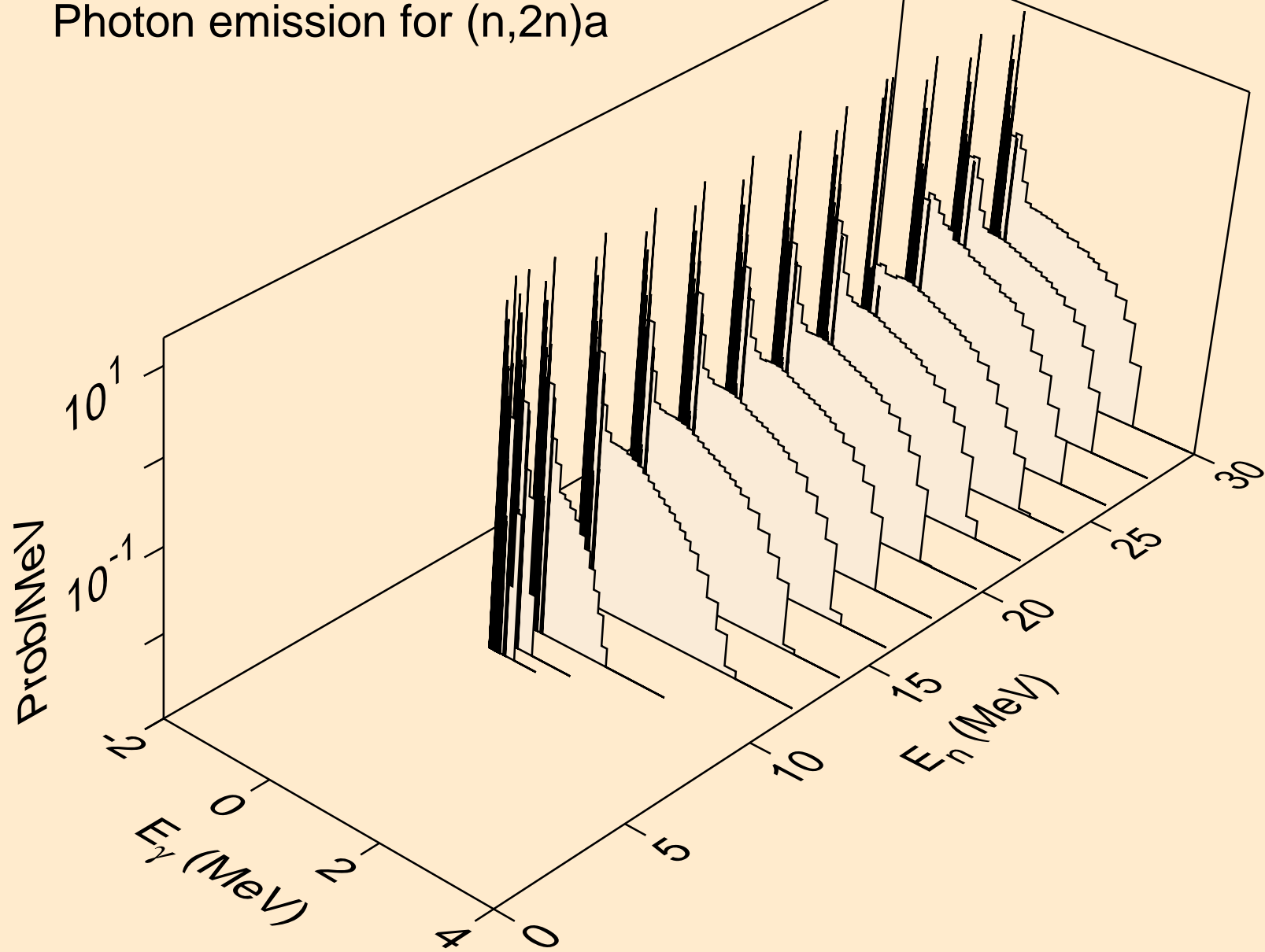

BK236 NEUTRON ACER TENDL-2024 LIBRARY; T=293.6K
Photon emission for (n,n*)p

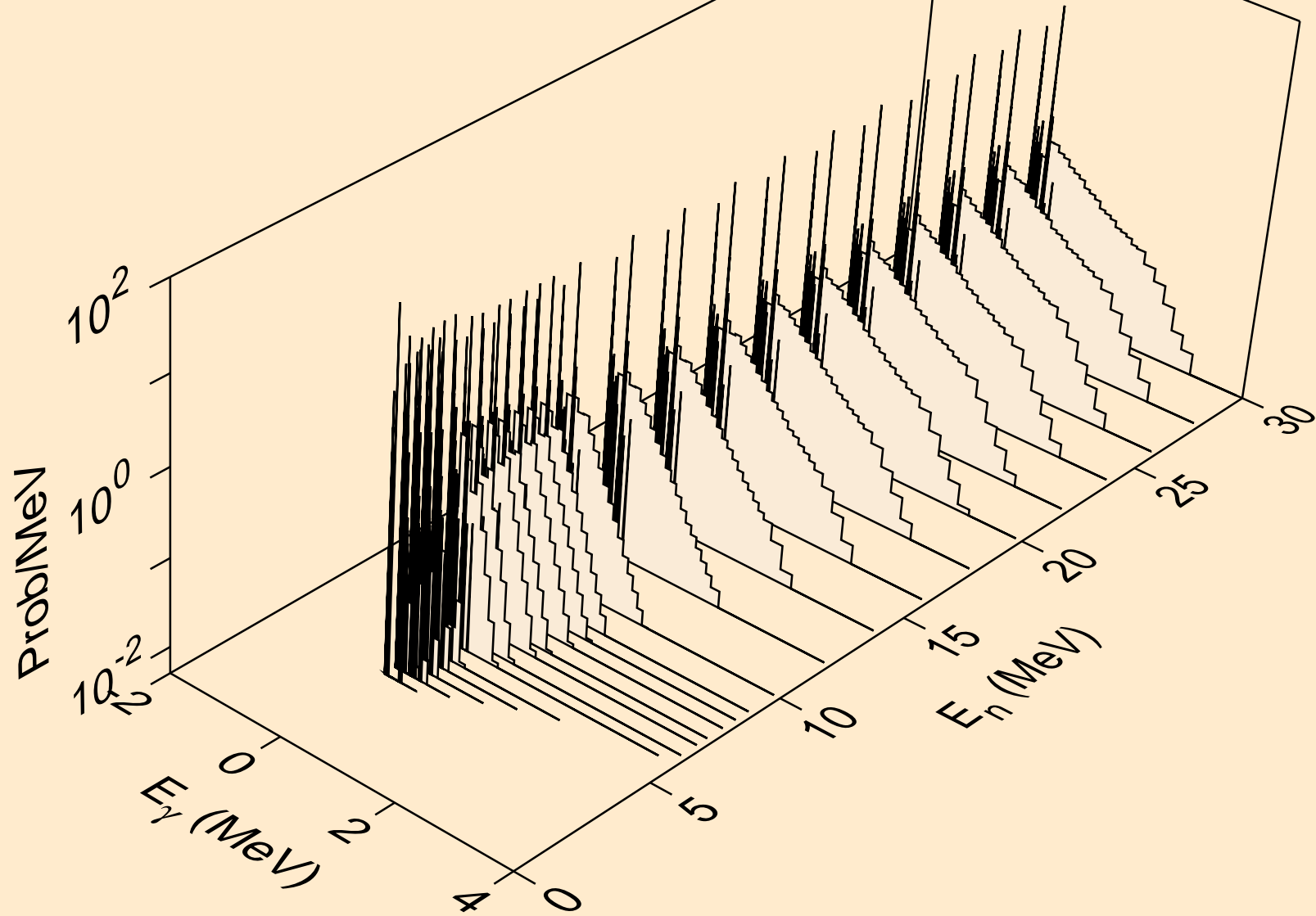

BK236 NEUTRON ACER TENDL-2024 LIBRARY; T=293.6K
Photon emission for (n,n*)d

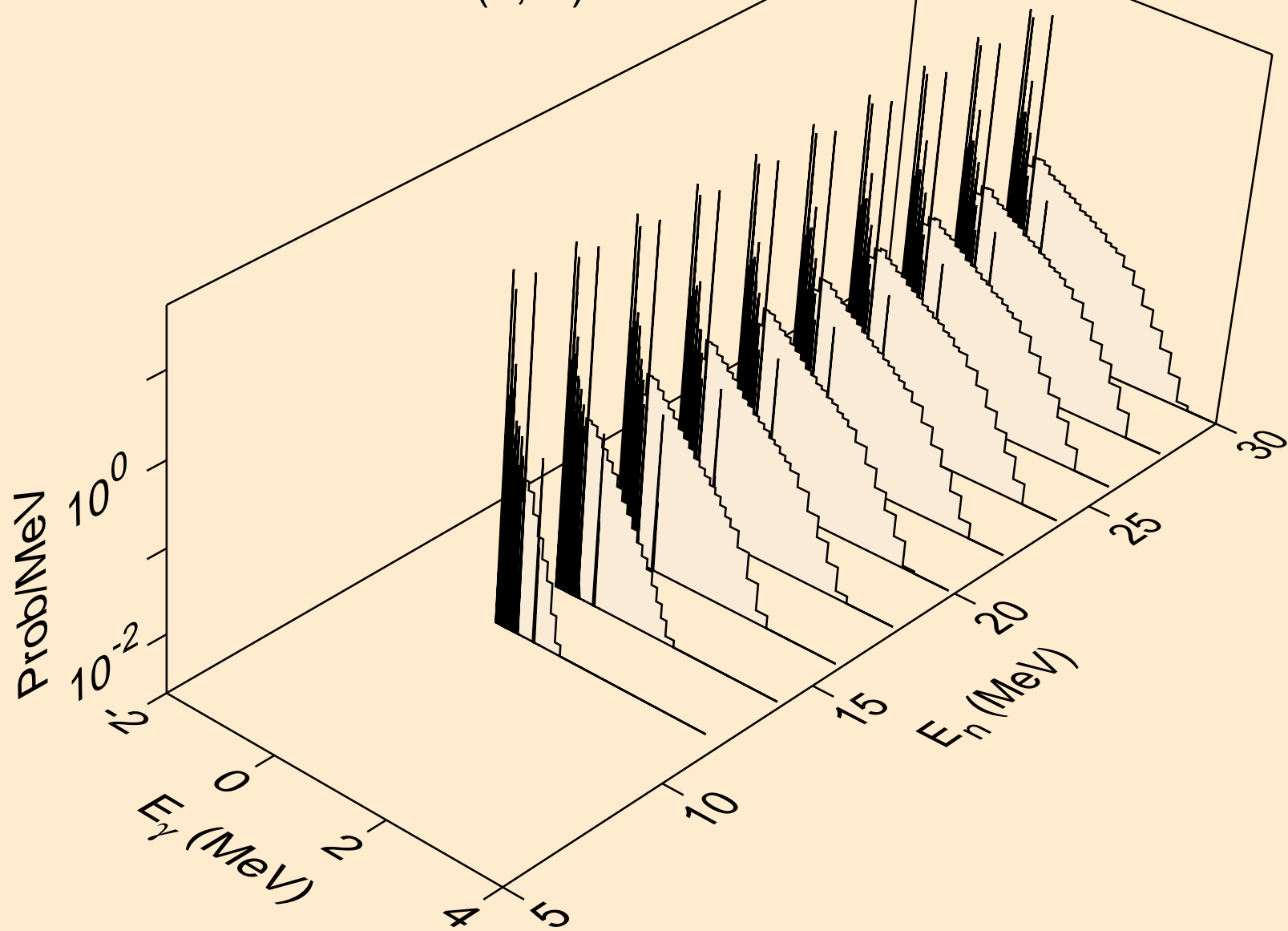

BK236 NEUTRON ACER TENDL-2024 LIBRARY; T=293.6K
Photon emission for (n,n*)t

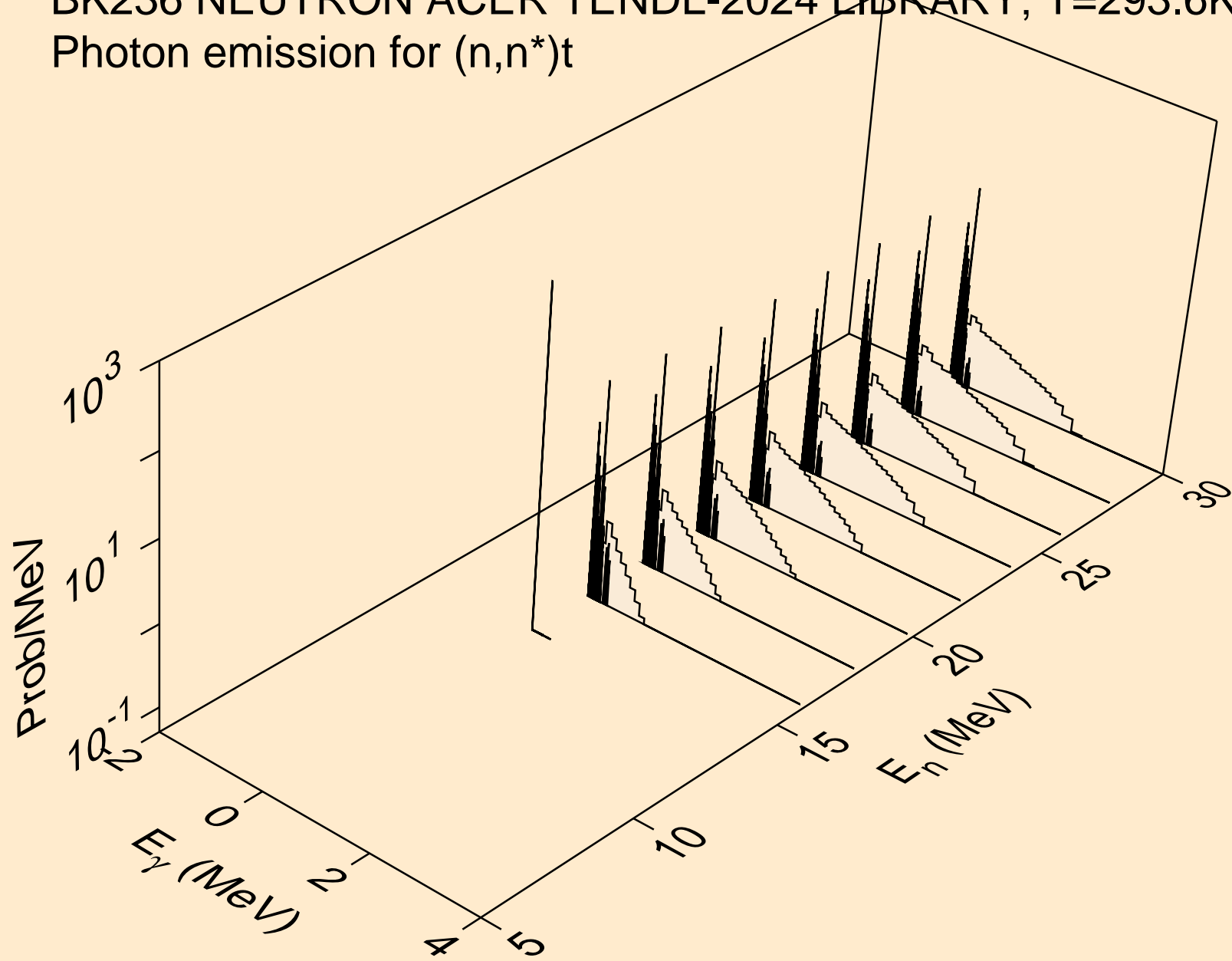

BK236 NEUTRON ACER TENDL-2024 LIBRARY; T=293.6K
Photon emission for (n,n*)he3

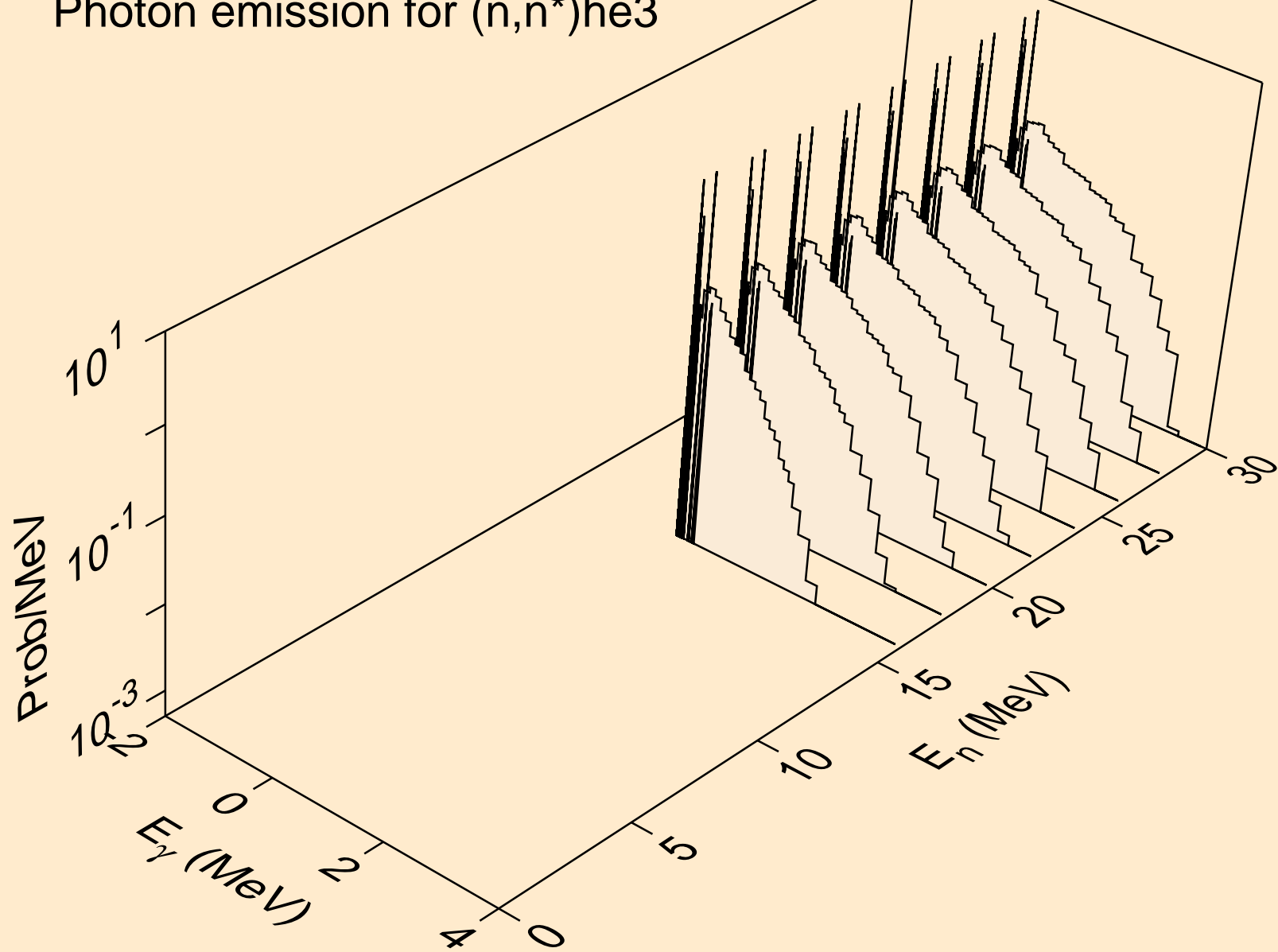

BK236 NEUTRON ACER TENDL-2024 LIBRARY; T=293.6K
Photon emission for (n,4n)

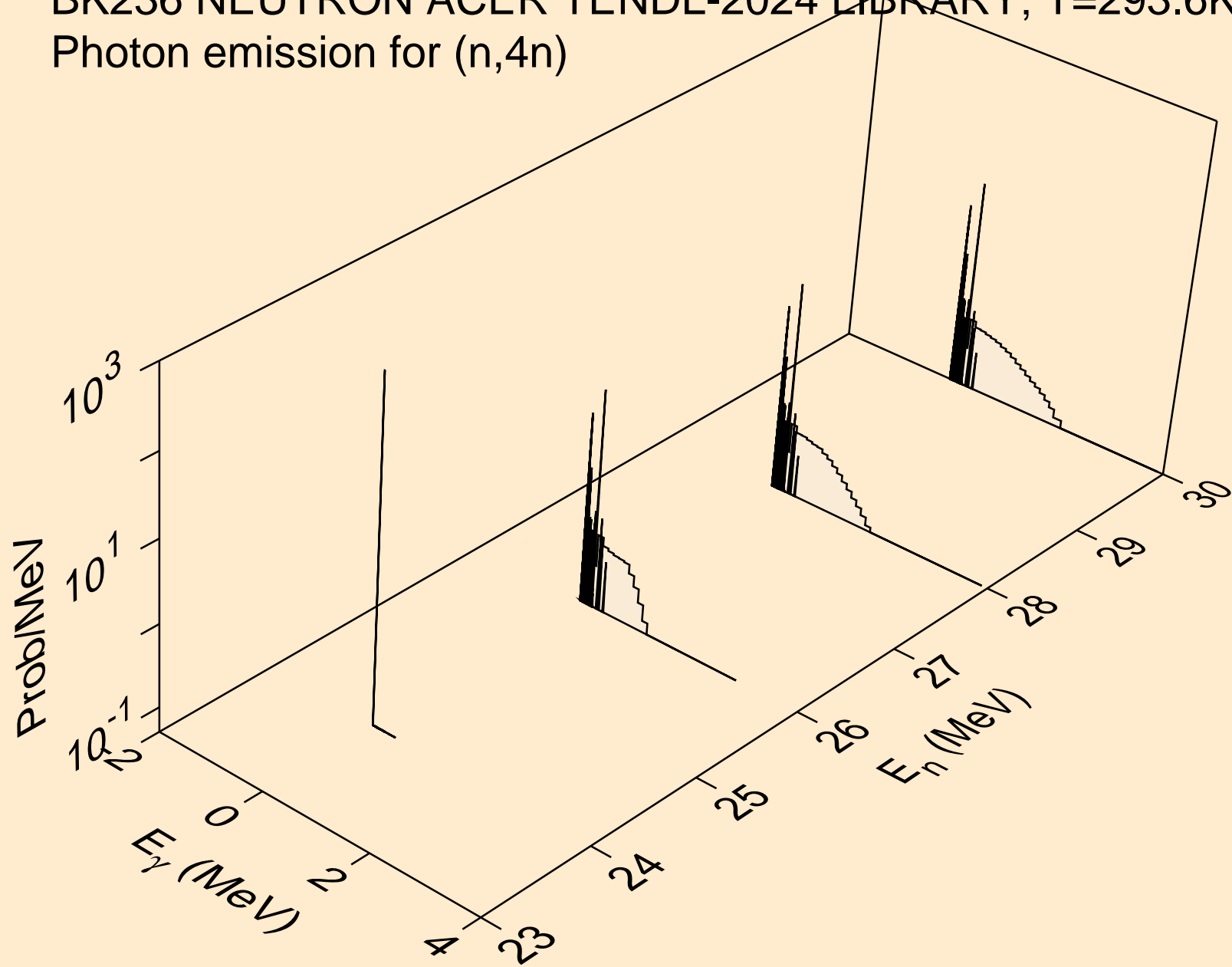

BK236 NEUTRON ACER TENDL-2024 LIBRARY; T=293.6K
Photon emission for (n,2np)

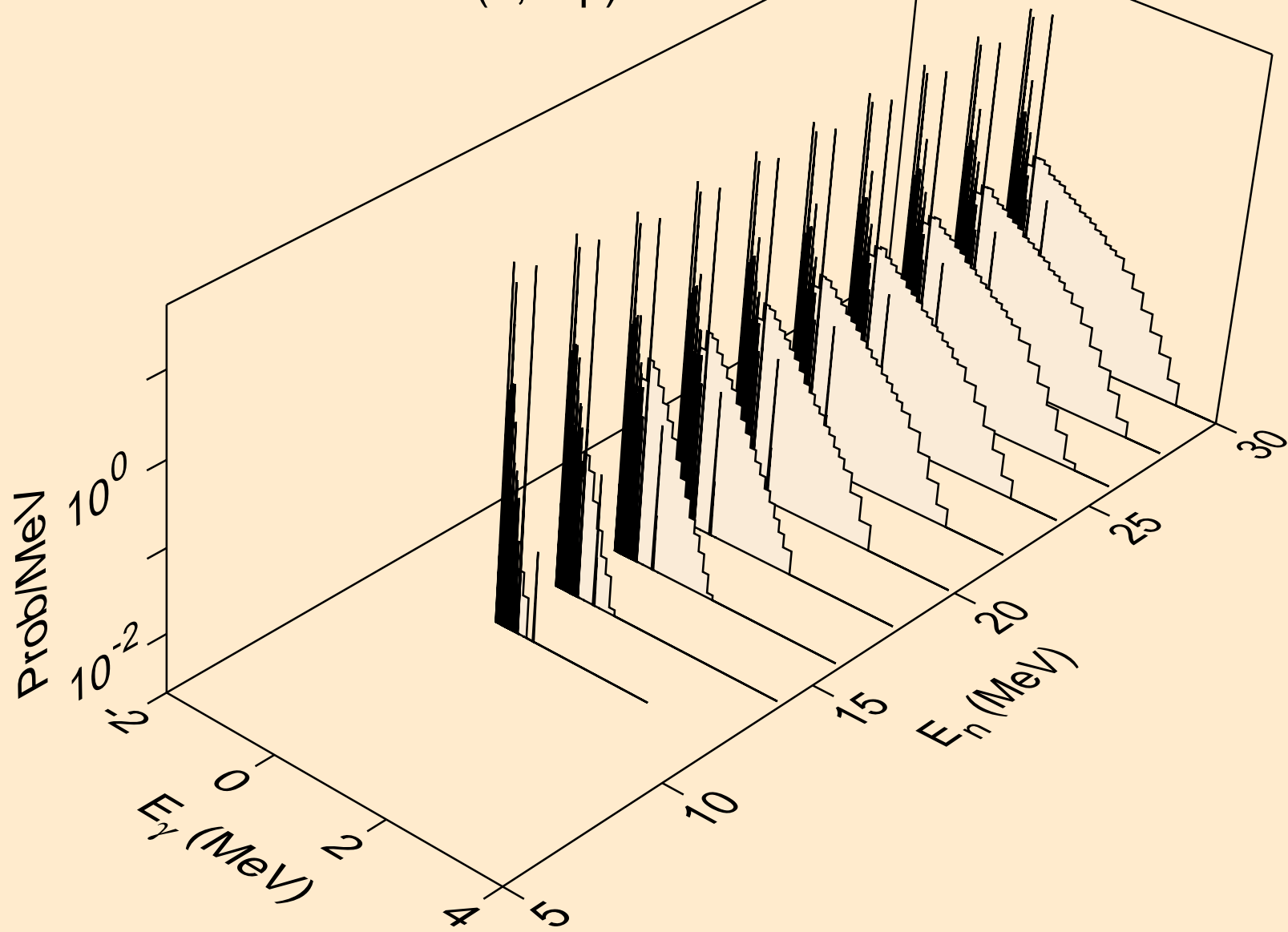

BK236 NEUTRON ACER TENDL-2024 LIBRARY; T=293.6K
Photon emission for (n,n2p)

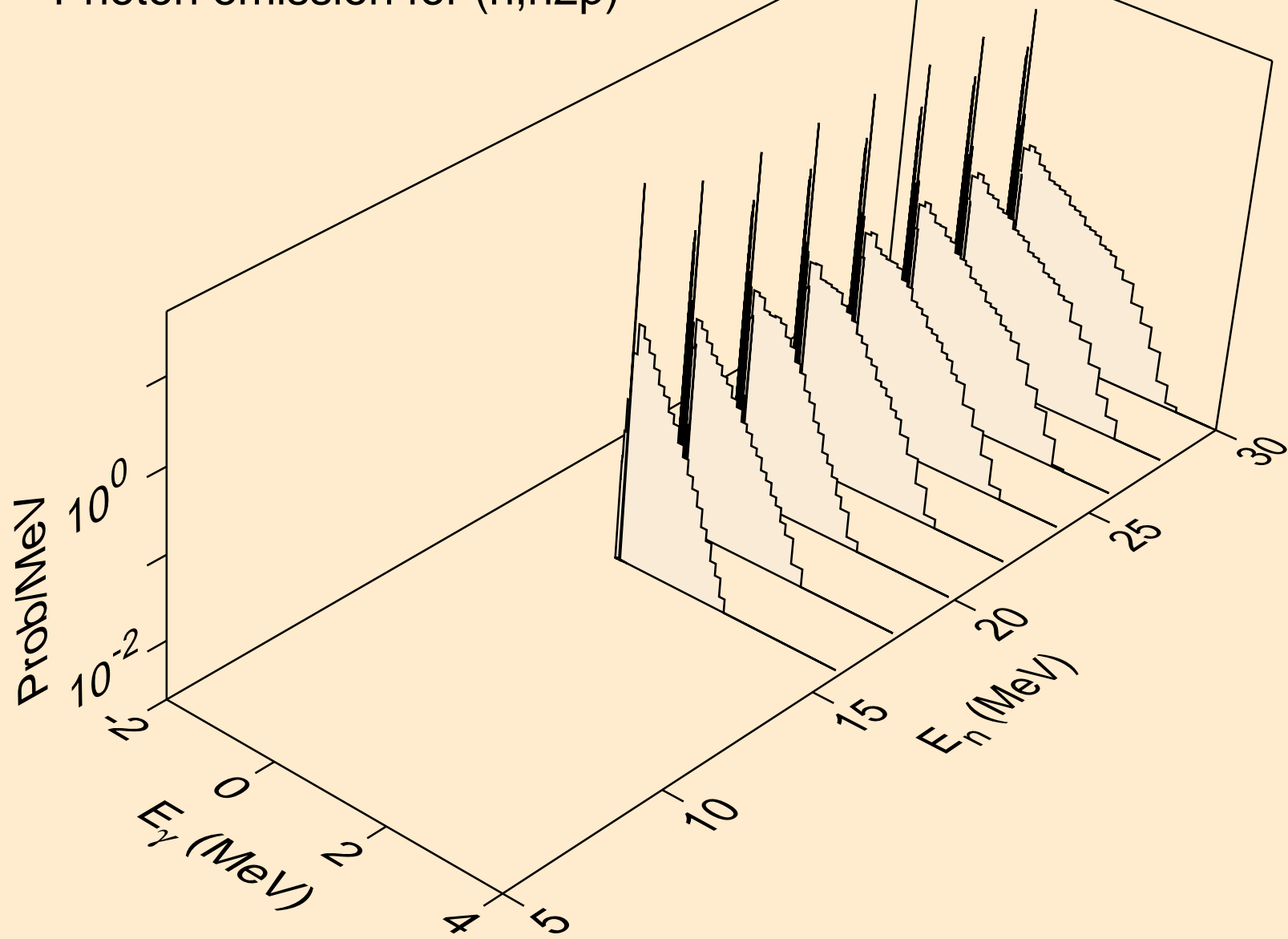

BK236 NEUTRON ACER TENDL-2024 LIBRARY; T=293.6K
Photon emission for (n,npa)

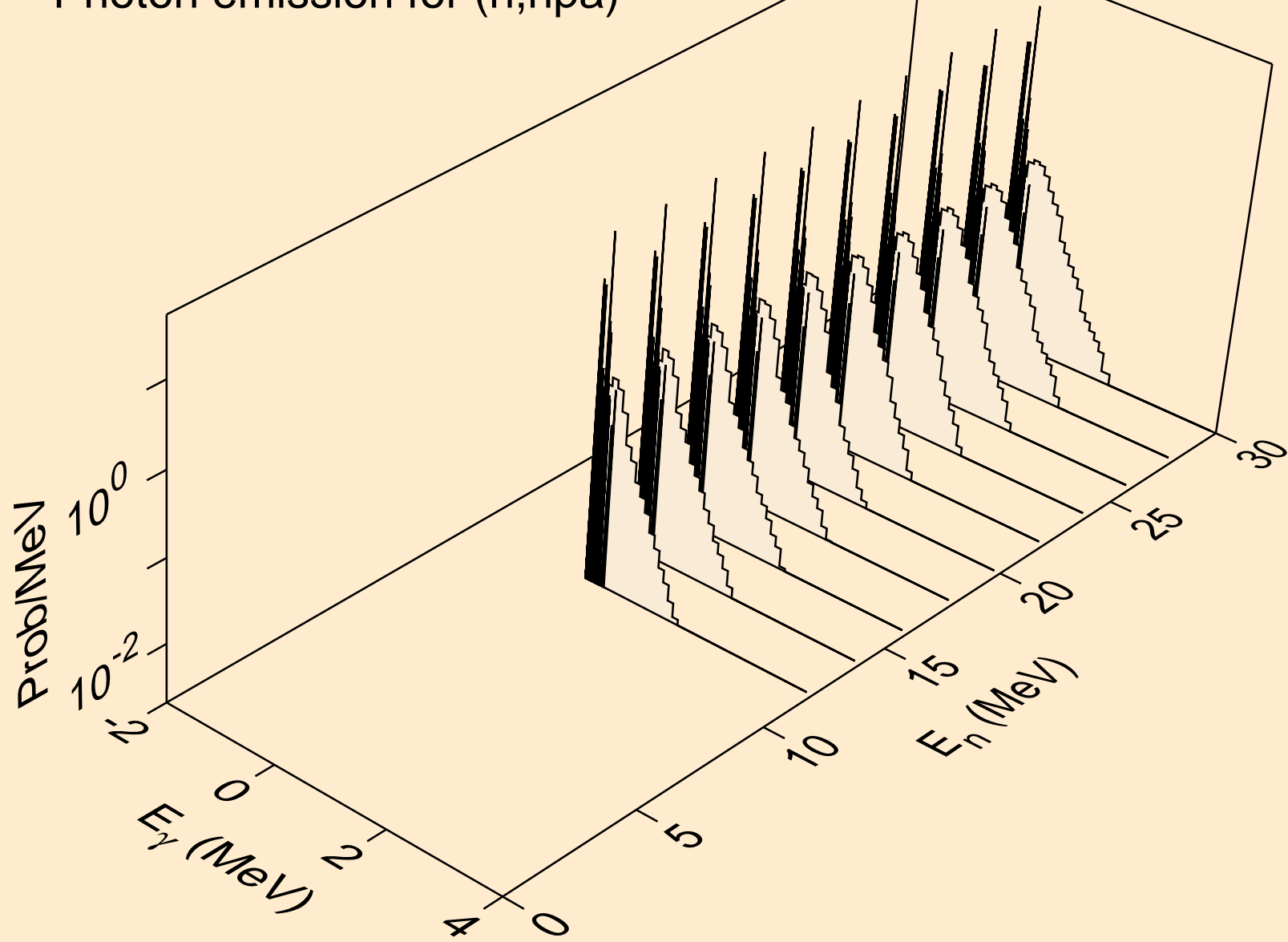

BK236 NEUTRON ACER TENDL-2024 LIBRARY; T=293.6K
Photon emission for (n,n*c)

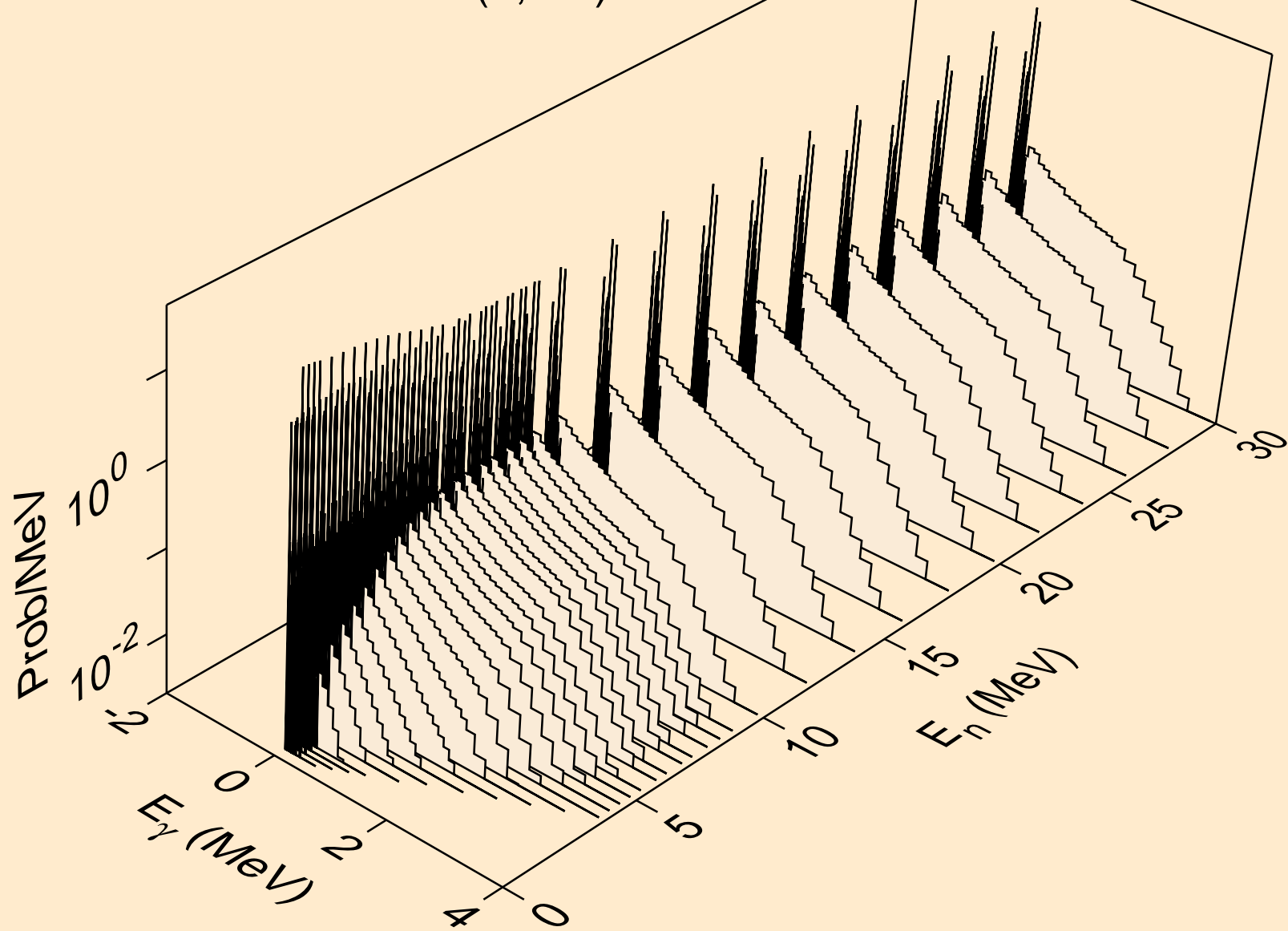

BK236 NEUTRON ACER TENDL-2024 LIBRARY; T=293.6K
Photon emission for (n,gma)

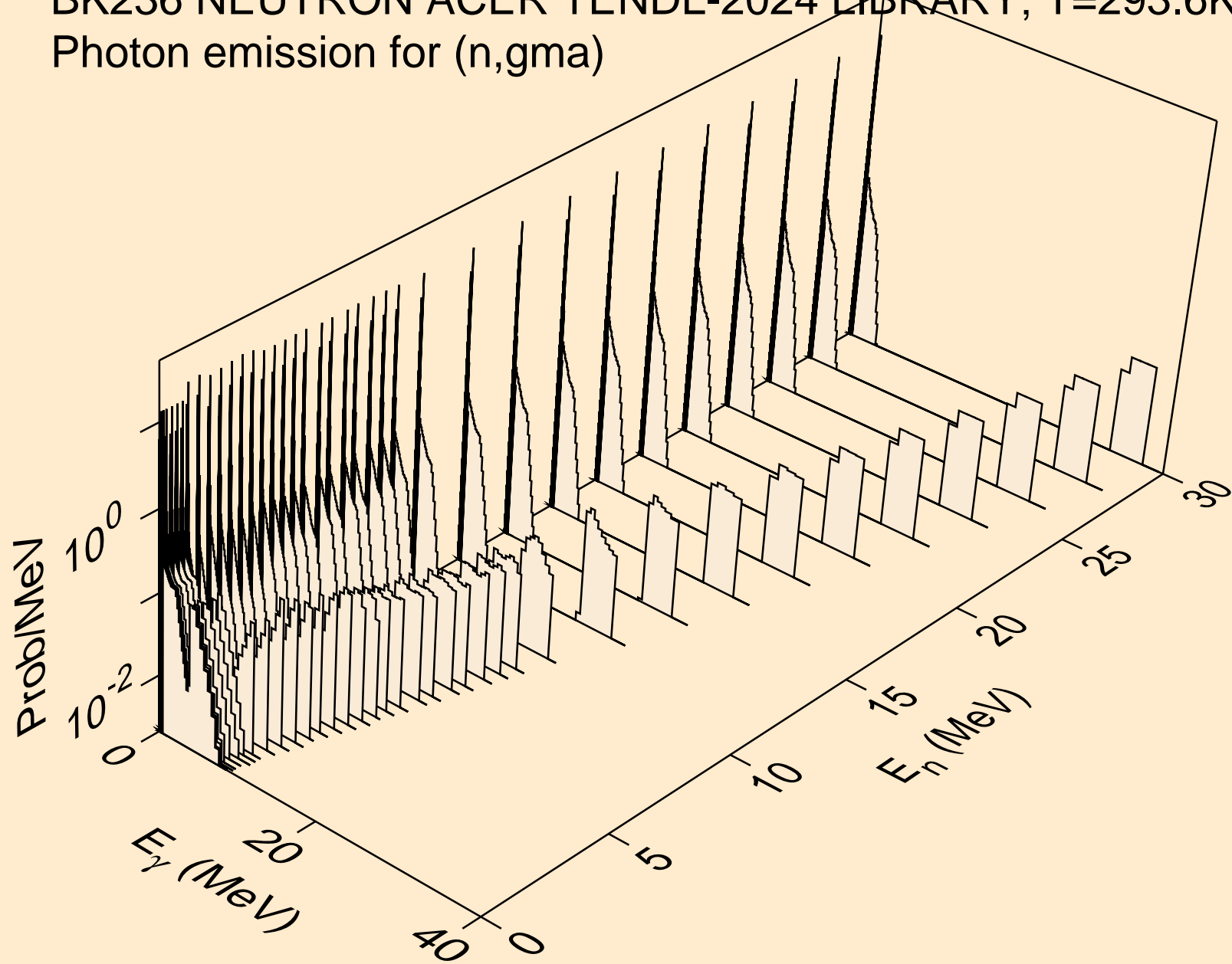

BK236 NEUTRON ACER TENDL-2024 LIBRARY; T=293.6K
Photon emission for (n,p)

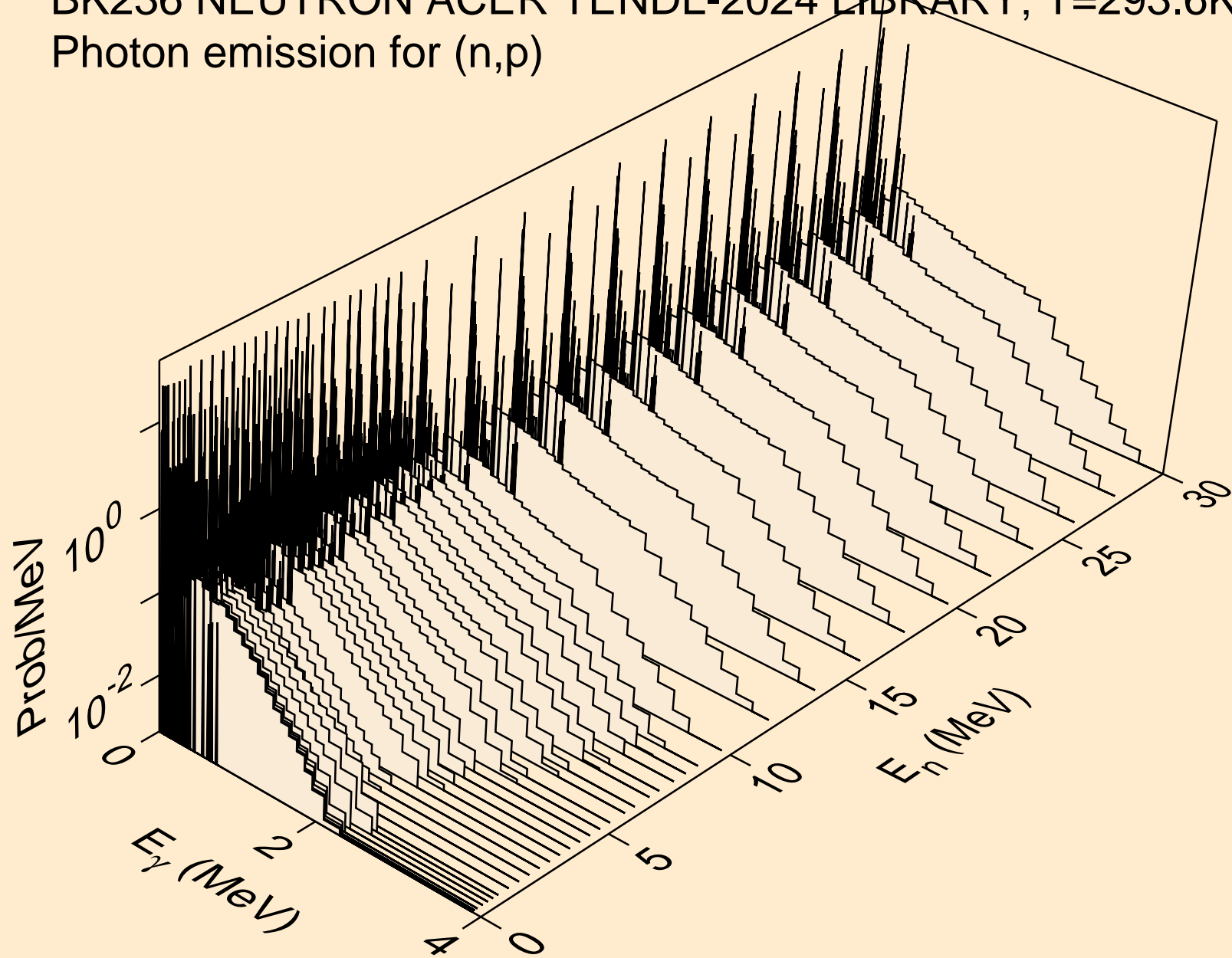

BK236 NEUTRON ACER TENDL-2024 LIBRARY; T=293.6K
Photon emission for (n,d)

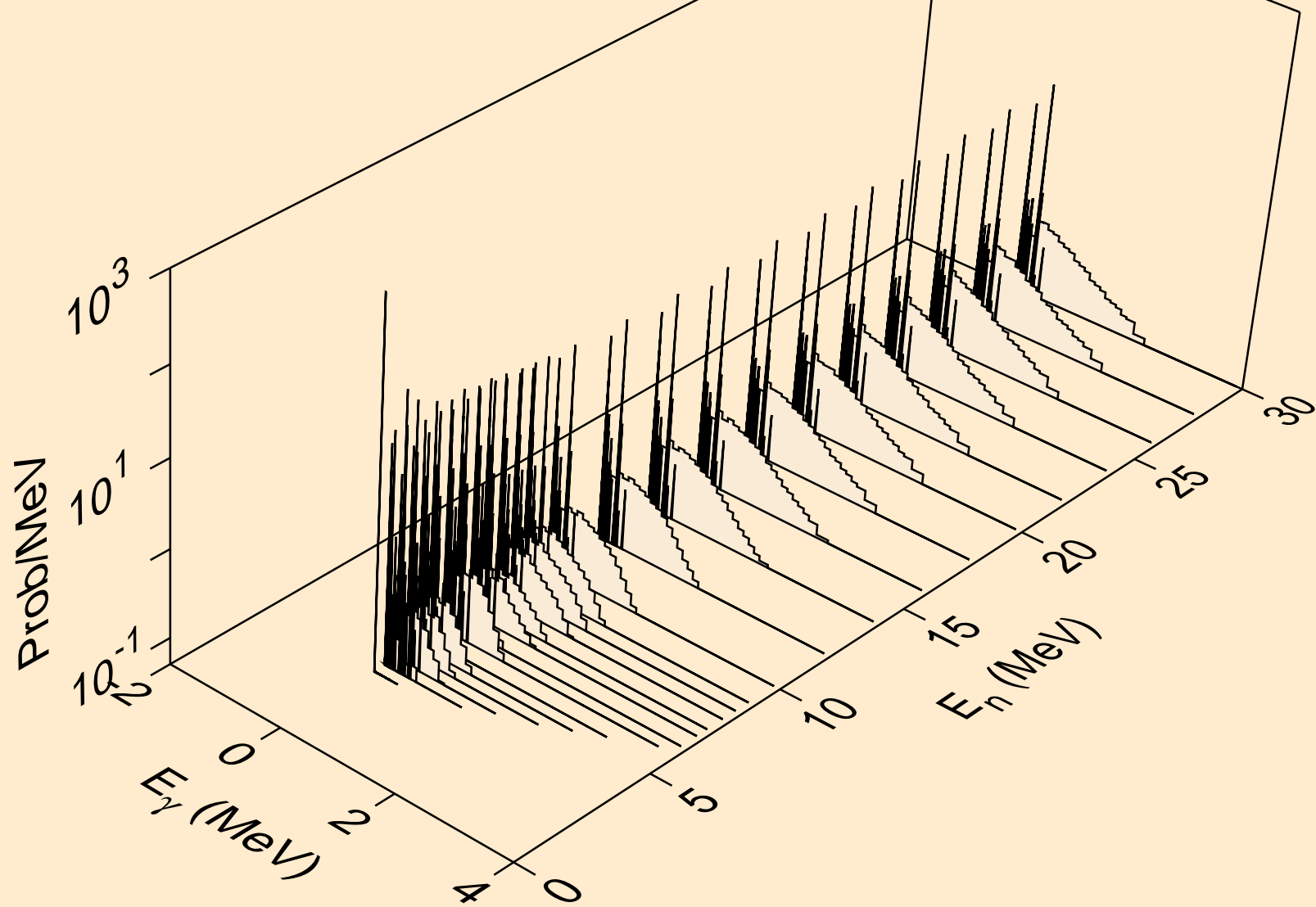

BK236 NEUTRON ACER TENDL-2024 LIBRARY; T=293.6K
Photon emission for (n,t)

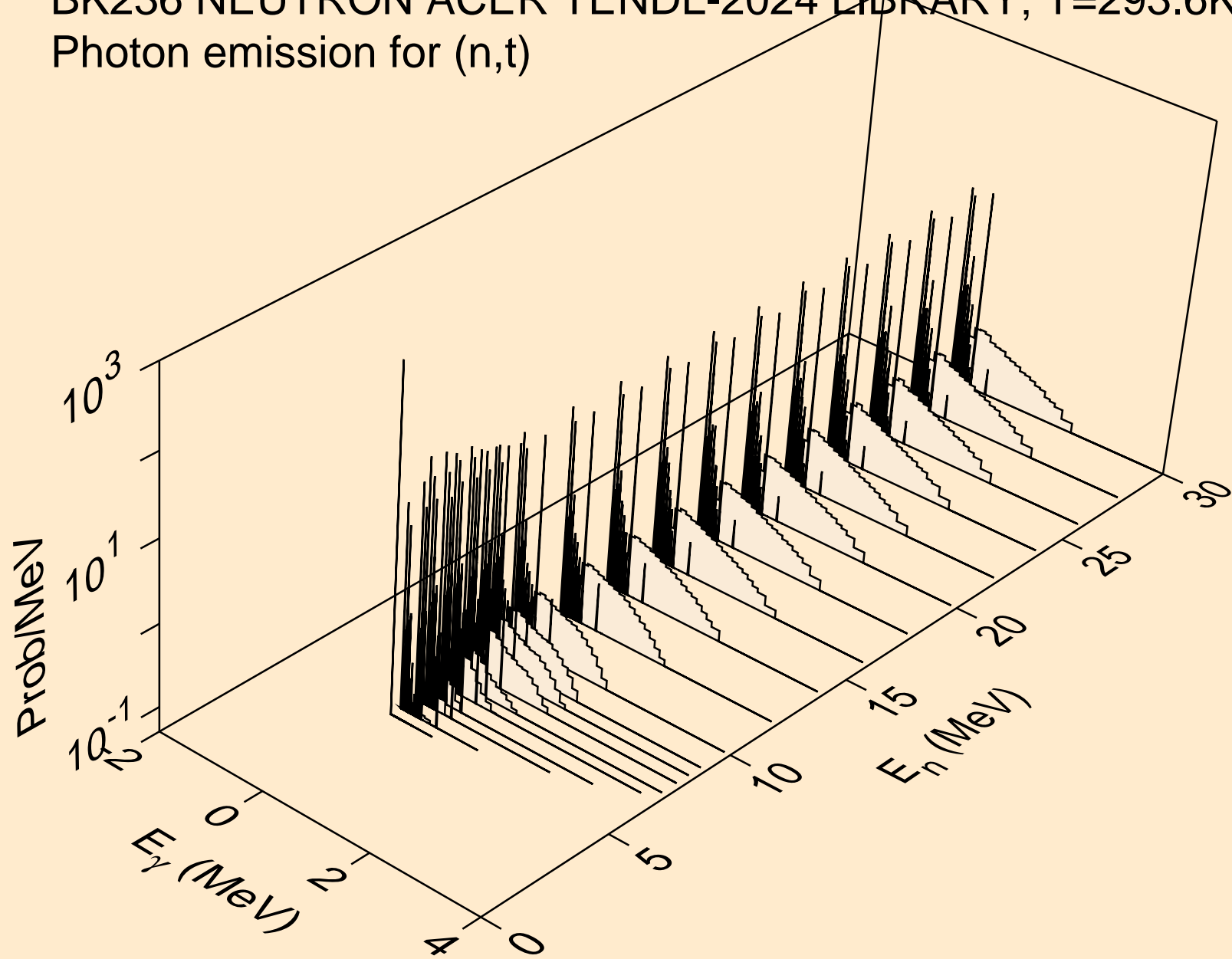

BK236 NEUTRON ACER TENDL-2024 LIBRARY; T=293.6K
Photon emission for (n,he3)

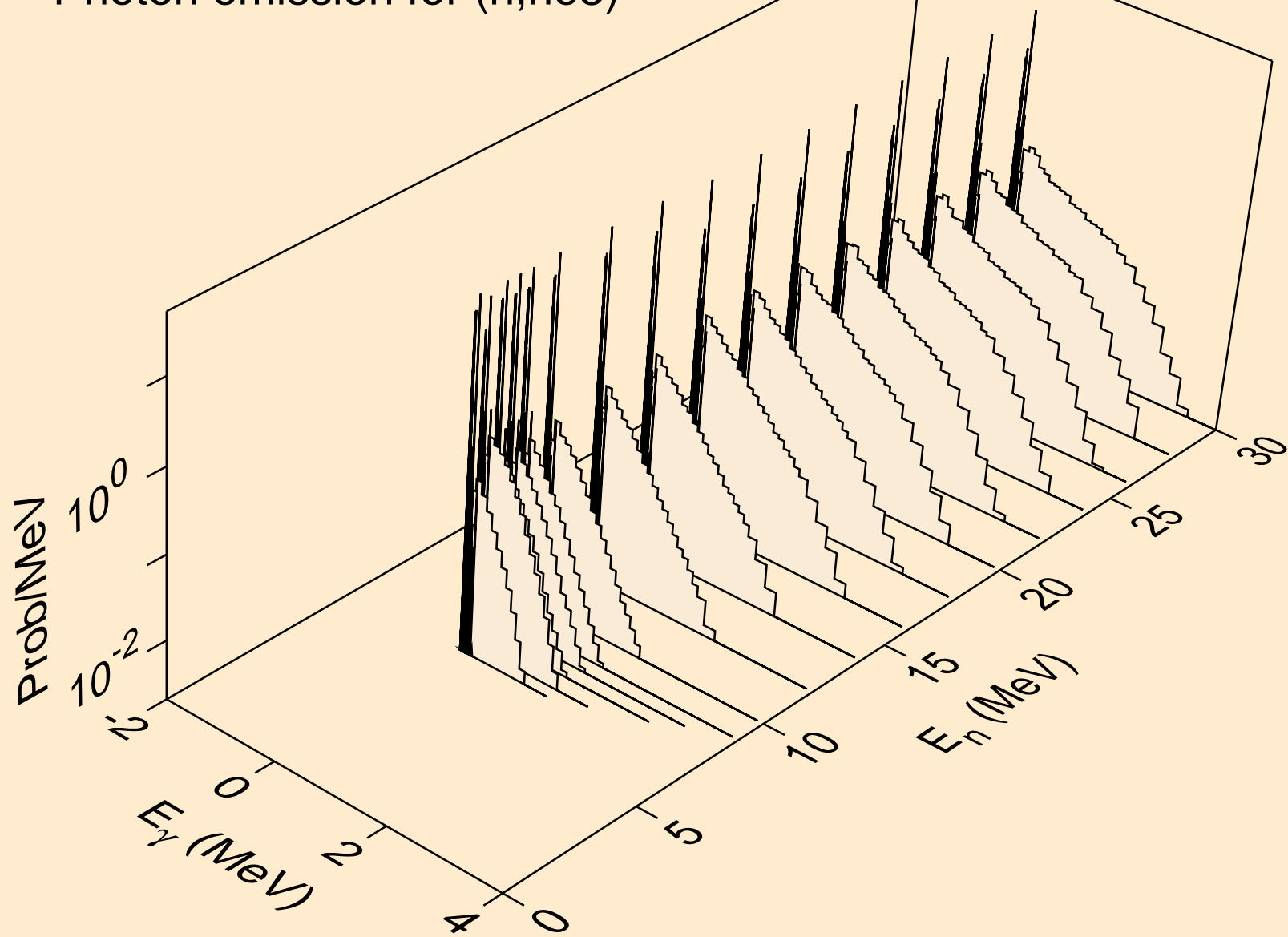

BK236 NEUTRON ACER TENDL-2024 LIBRARY; T=293.6K
Photon emission for (n,a)

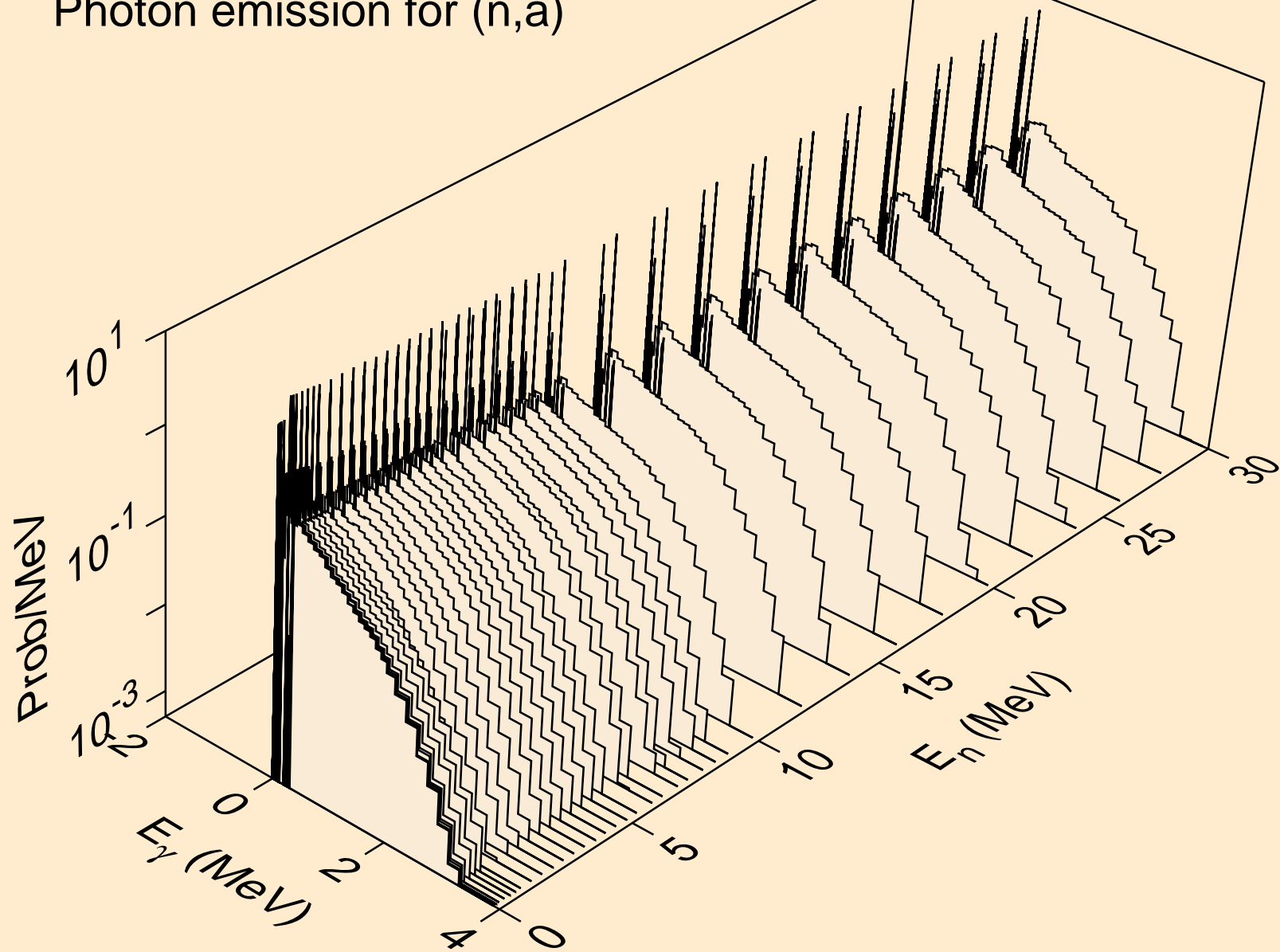

BK236 NEUTRON ACER TENDL-2024 LIBRARY; T=293.6K
Photon emission for (n,2a)

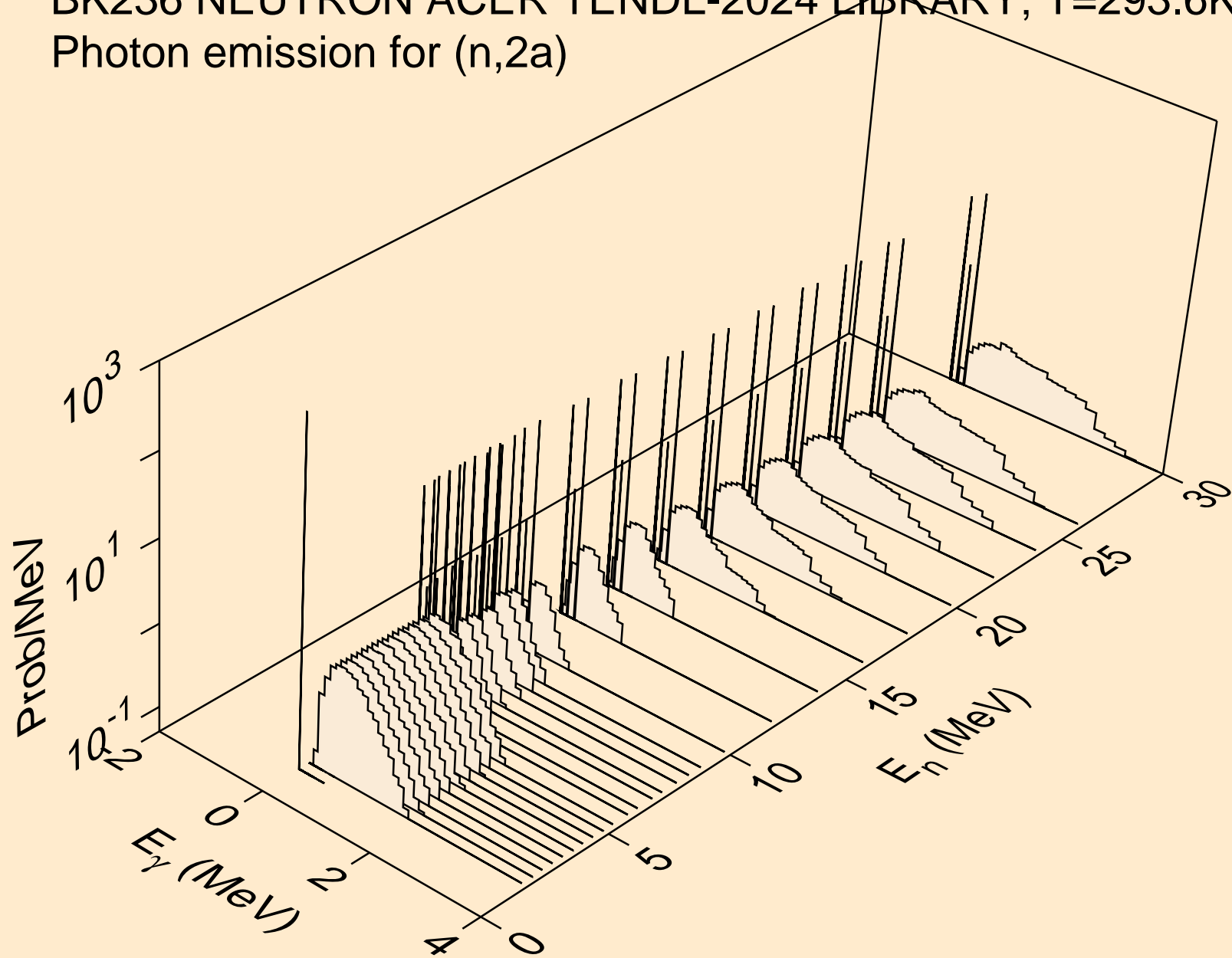

BK236 NEUTRON ACER TENDL-2024 LIBRARY; T=293.6K
Photon emission for (n,2p)

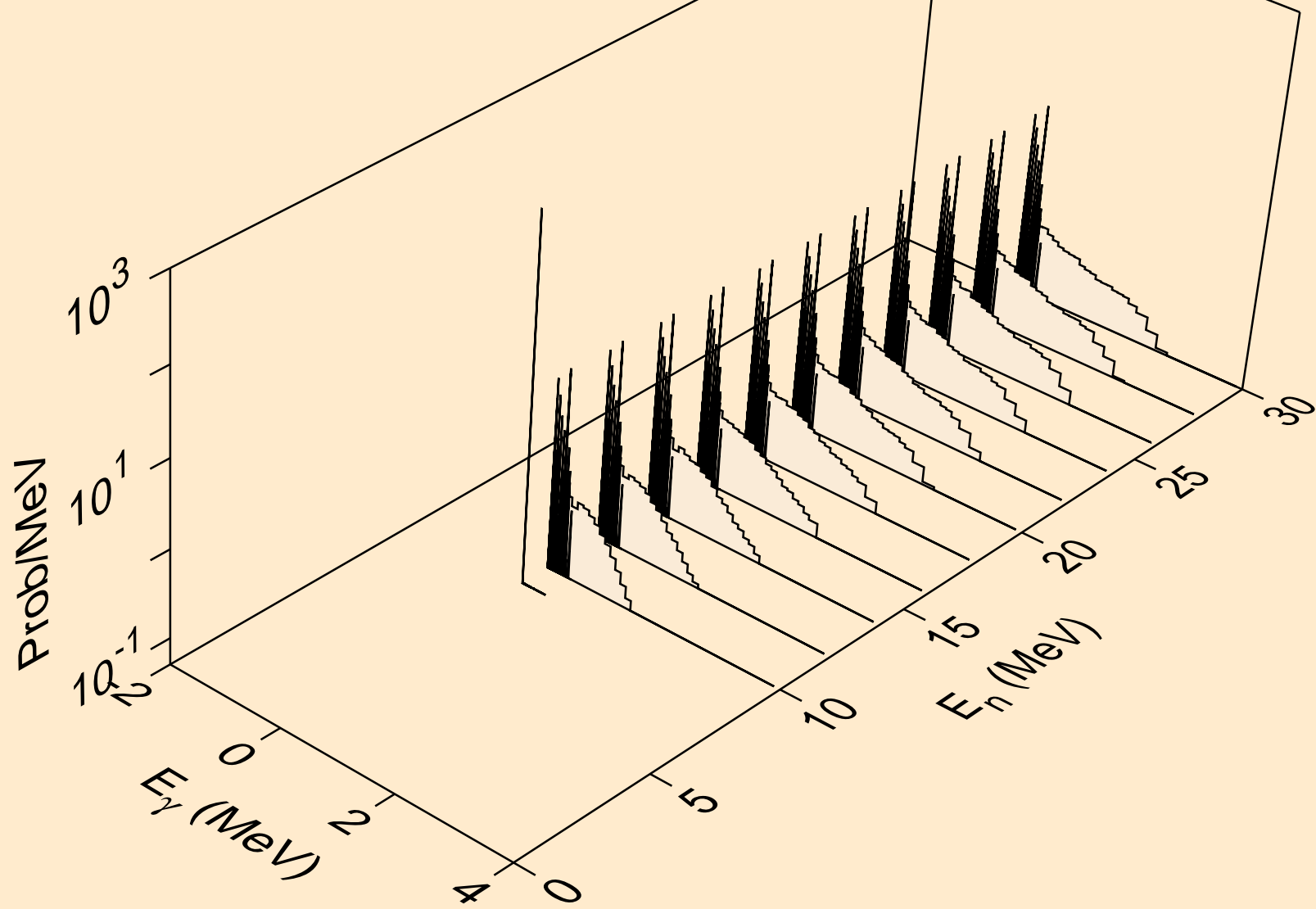

BK236 NEUTRON ACER TENDL-2024 LIBRARY; T=293.6K
Photon emission for (n,p α)

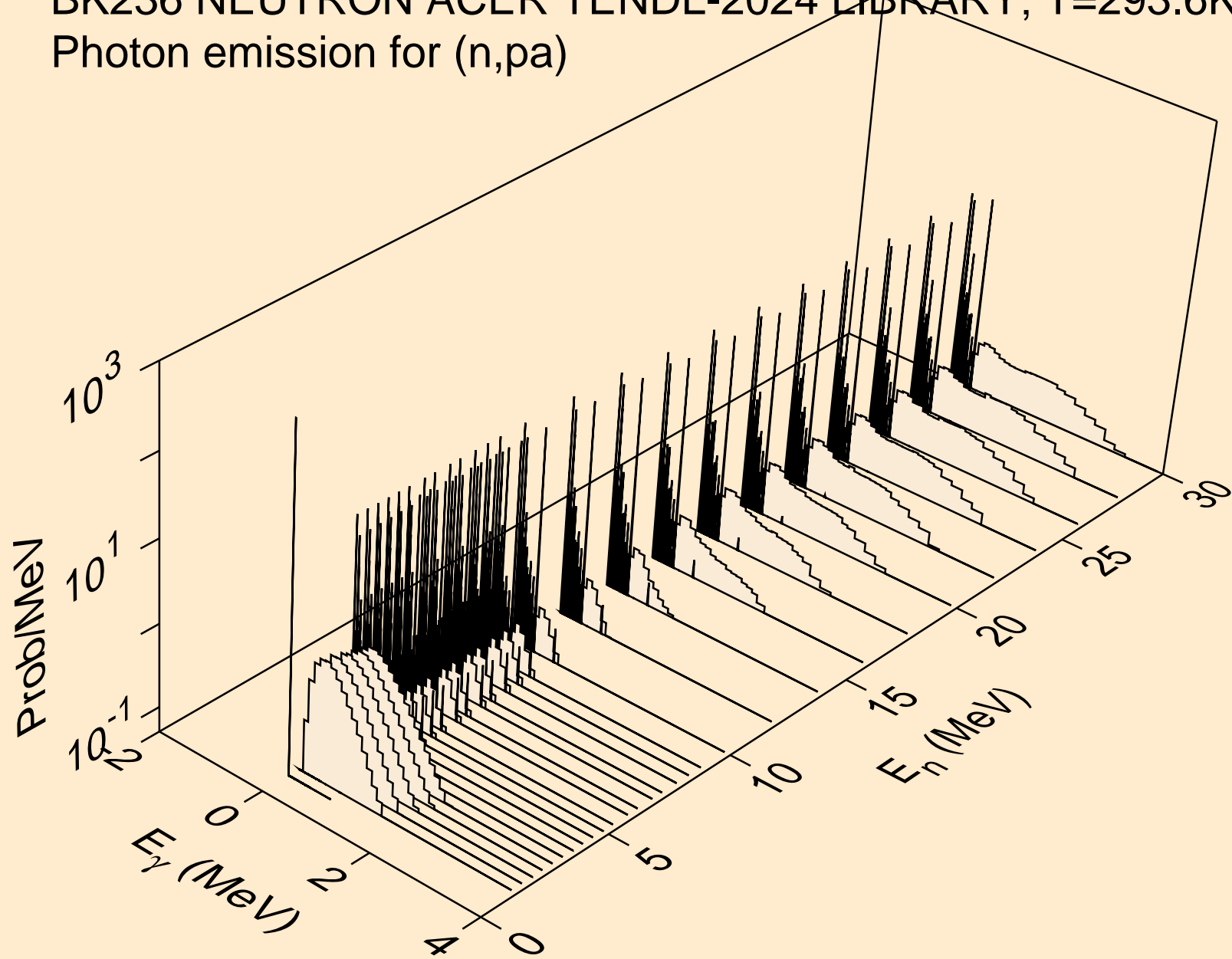

BK236 NEUTRON ACER TENDL-2024 LIBRARY; T=293.6K
Photon emission for (n,pd)

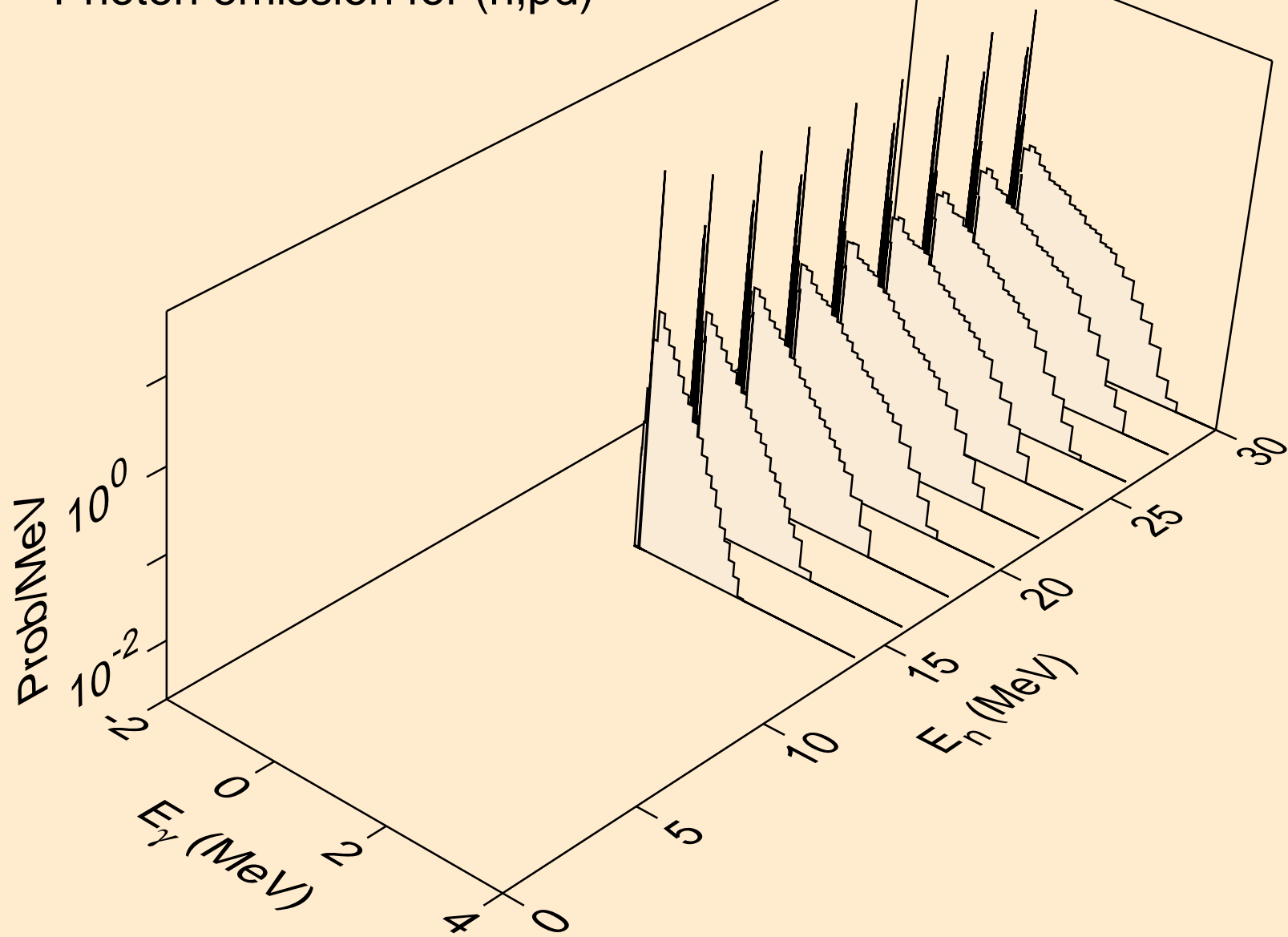

BK236 NEUTRON ACER TENDL-2024 LIBRARY; T=293.6K
thermal capture photon spectrum

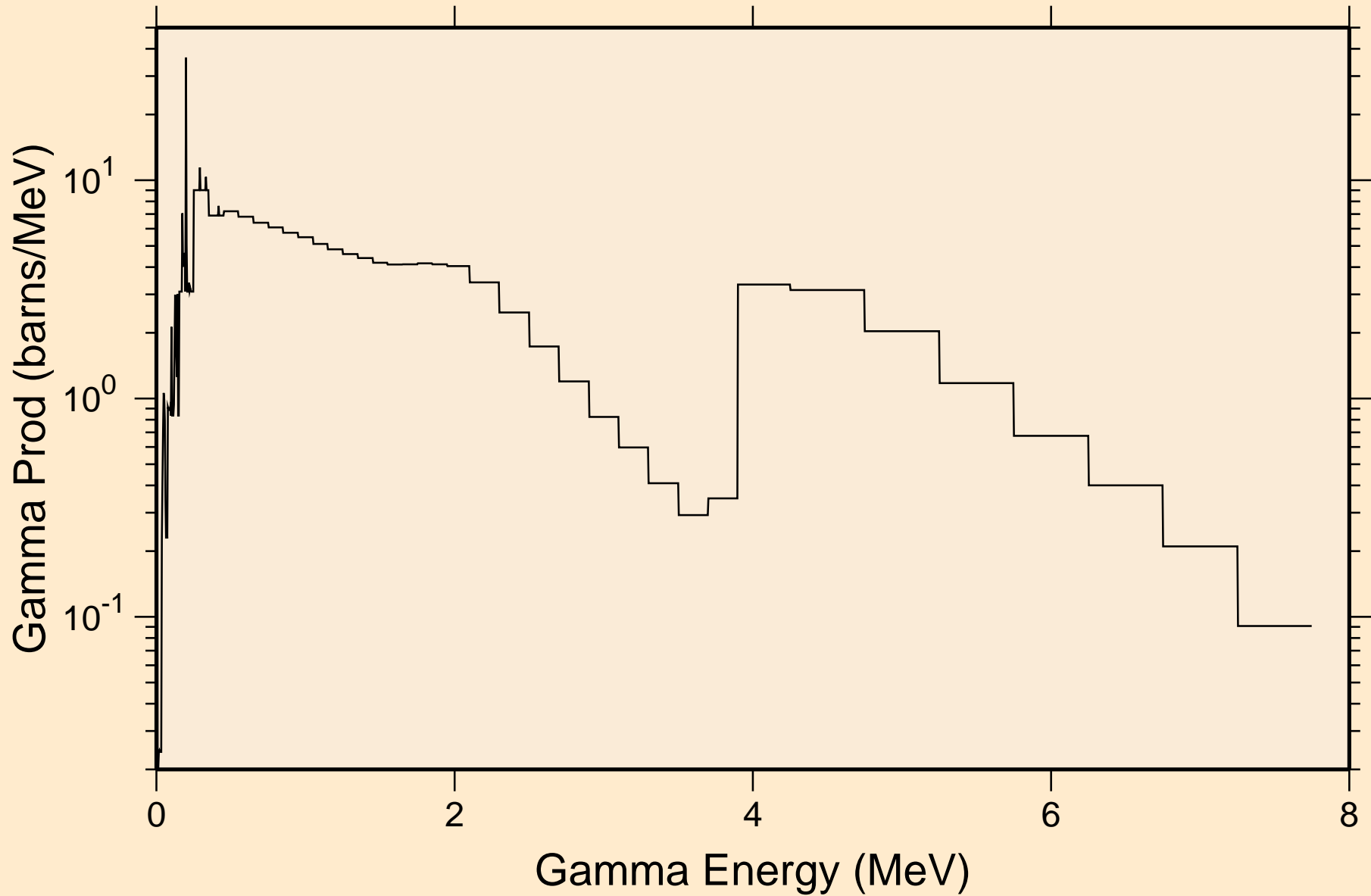

BK236 NEUTRON ACER TENDL-2024 LIBRARY; T=293.6K
14 MeV photon spectrum

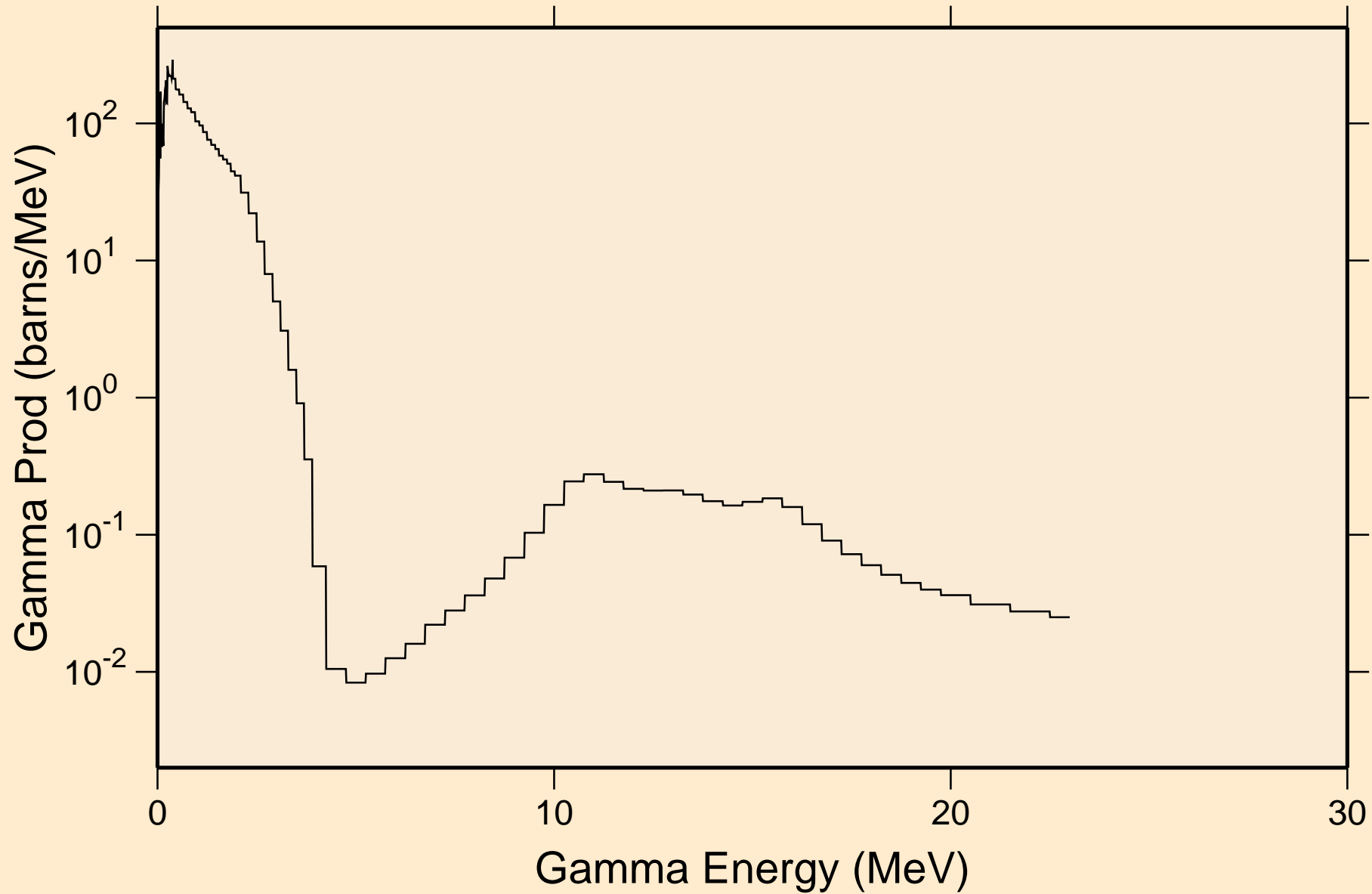

BK236 NEUTRON ACER TENDL-2024 LIBRARY; T=293.6K

Particle heating contributions

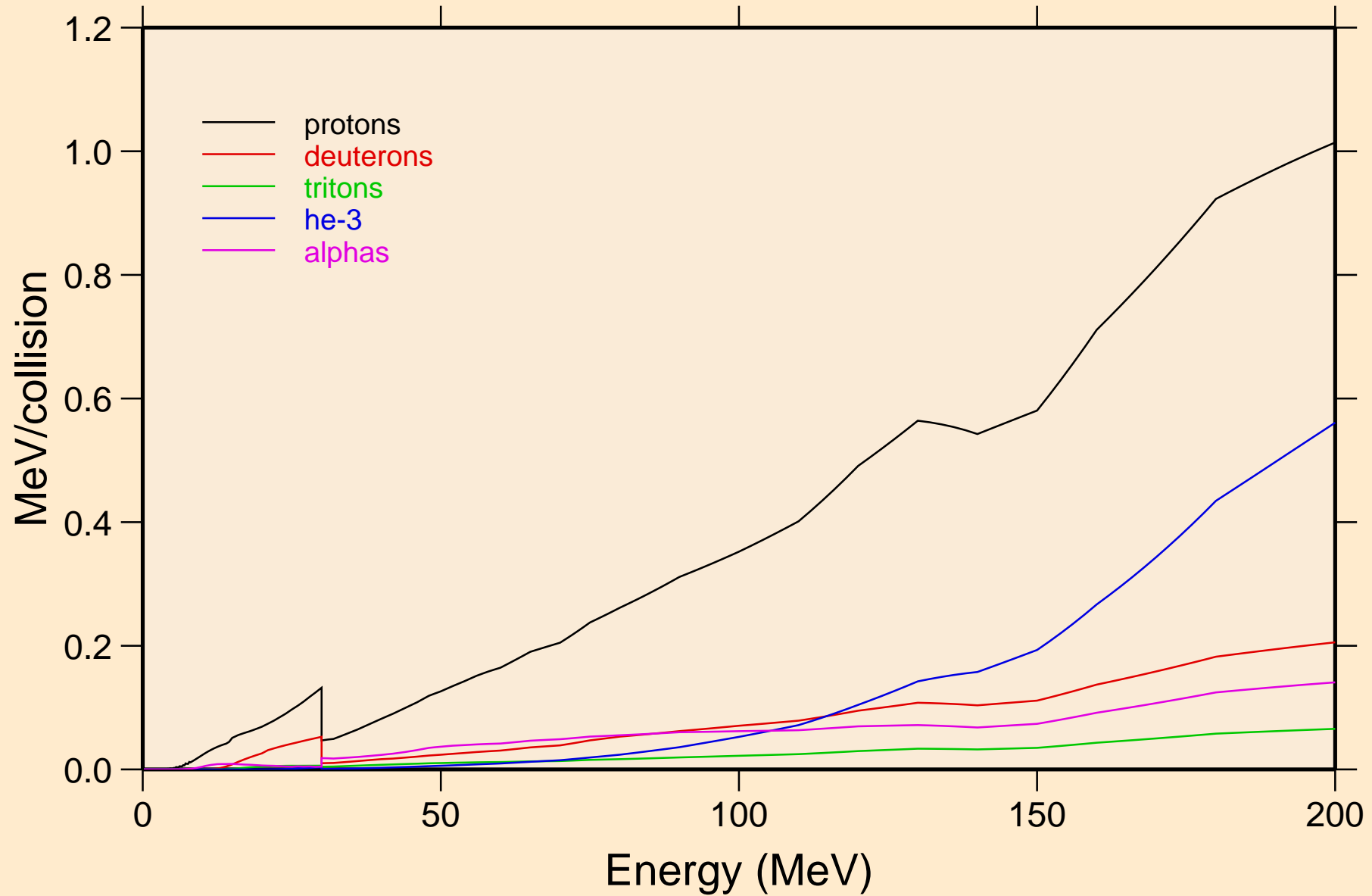

BK236 NEUTRON ACER TENDL-2024 LIBRARY; T=293.6K
Recoil Heating

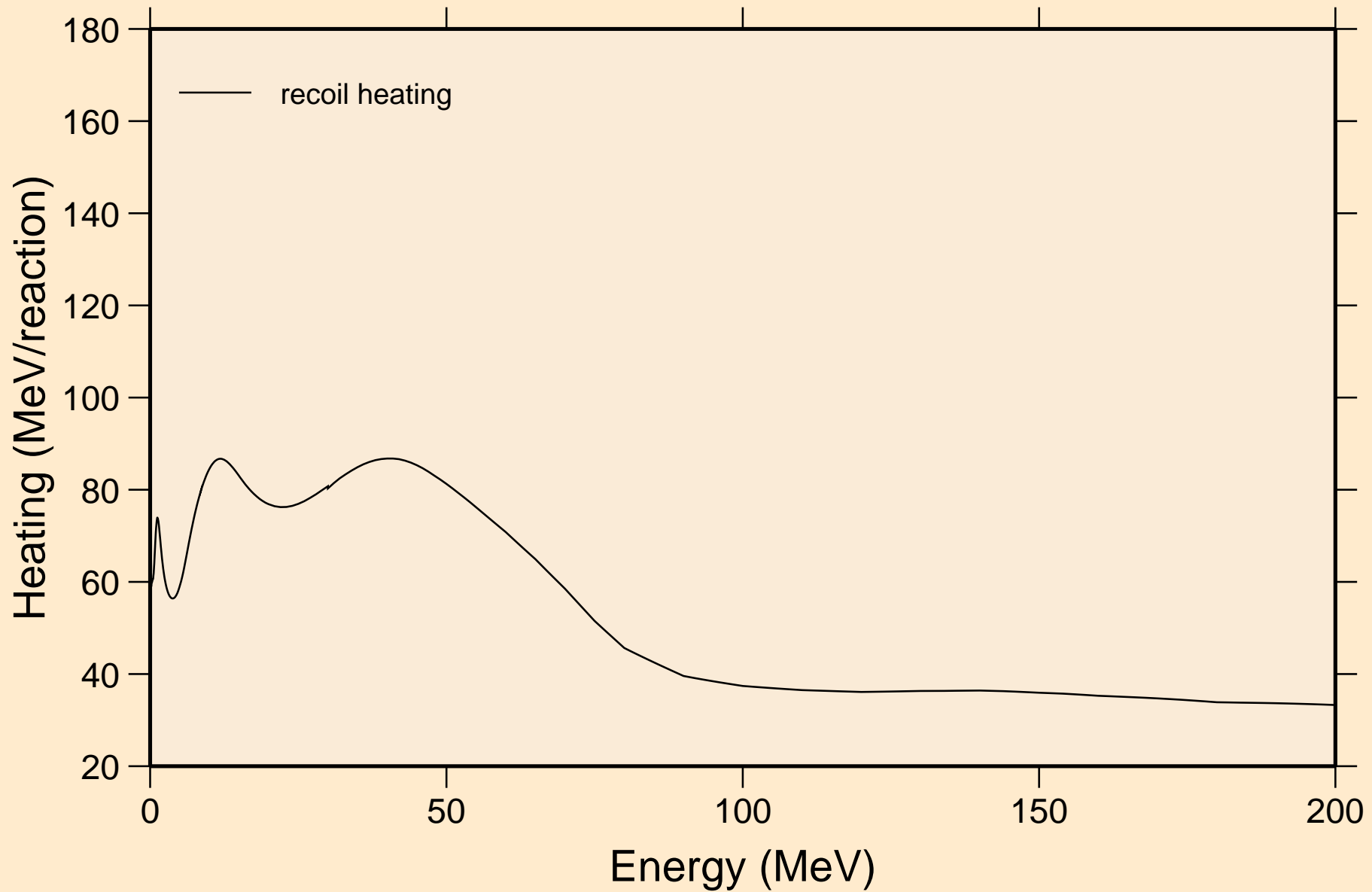

BK236 NEUTRON ACER TENDL-2024 LIBRARY; T=293.6K
Particle production cross sections

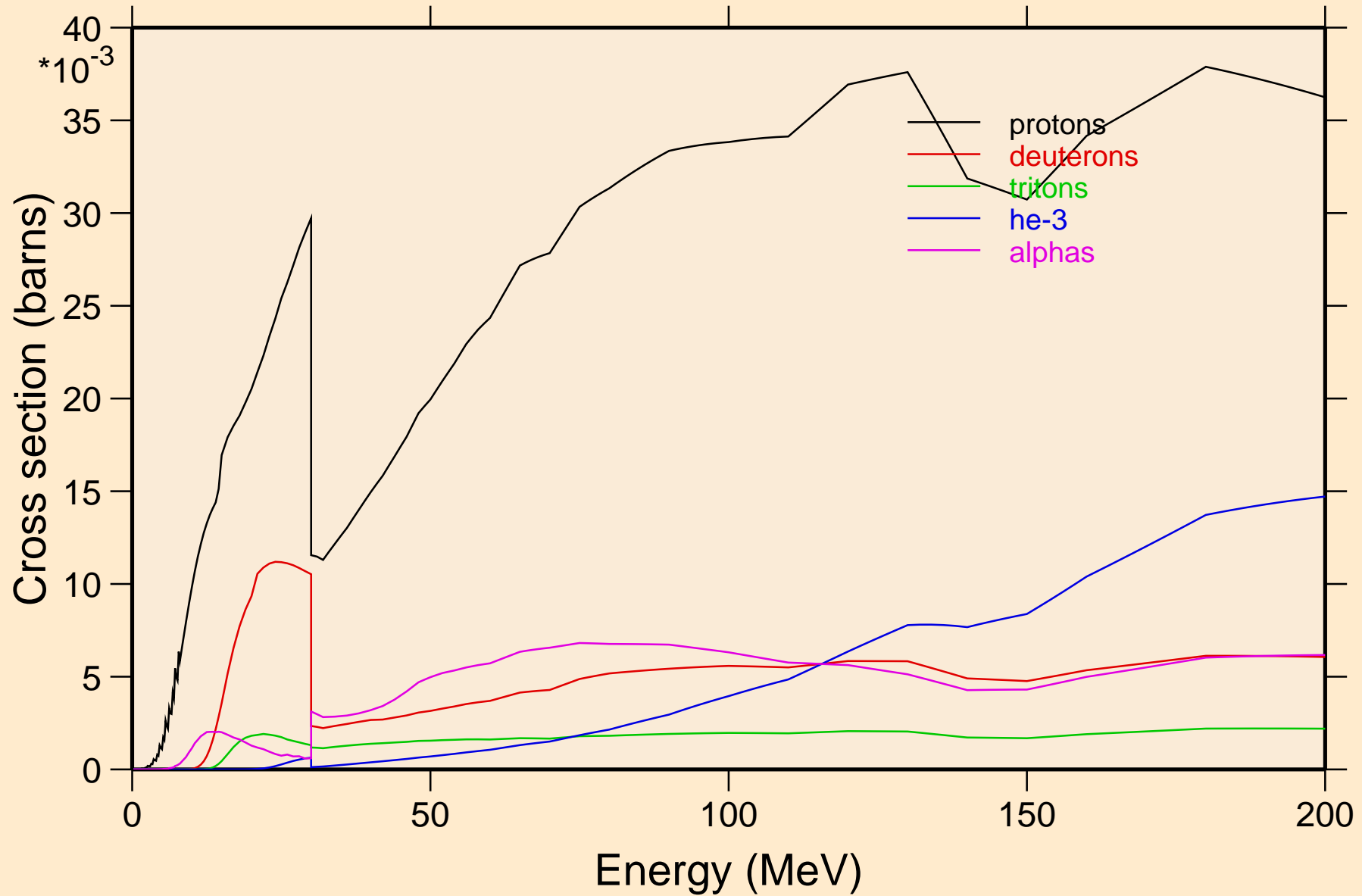

BK236 NEUTRON ACER TENDL-2024 LIBRARY; T=293.6K
protons from (n,x)

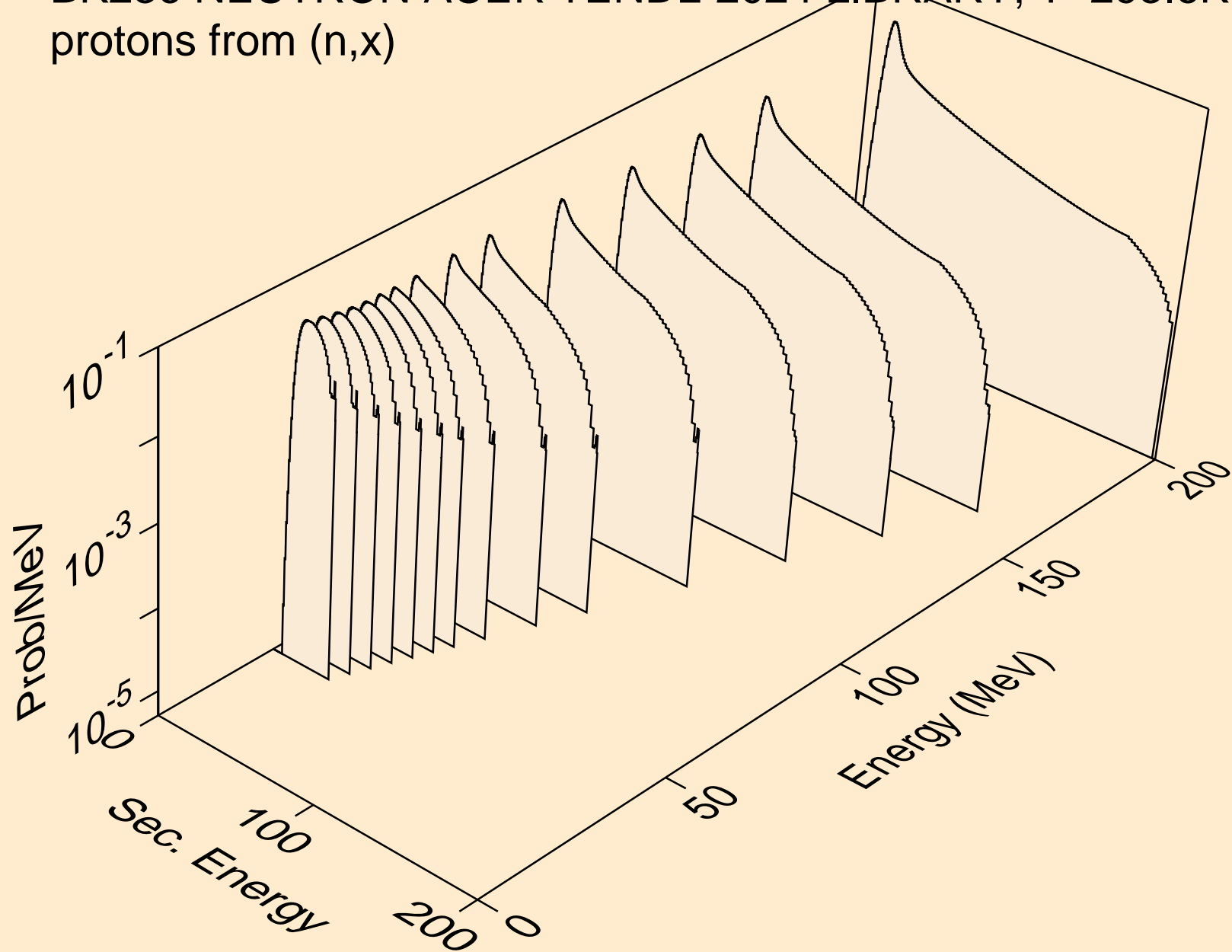

BK236 NEUTRON ACER TENDL-2024 LIBRARY; T=293.6K
protons from (n,n*)p

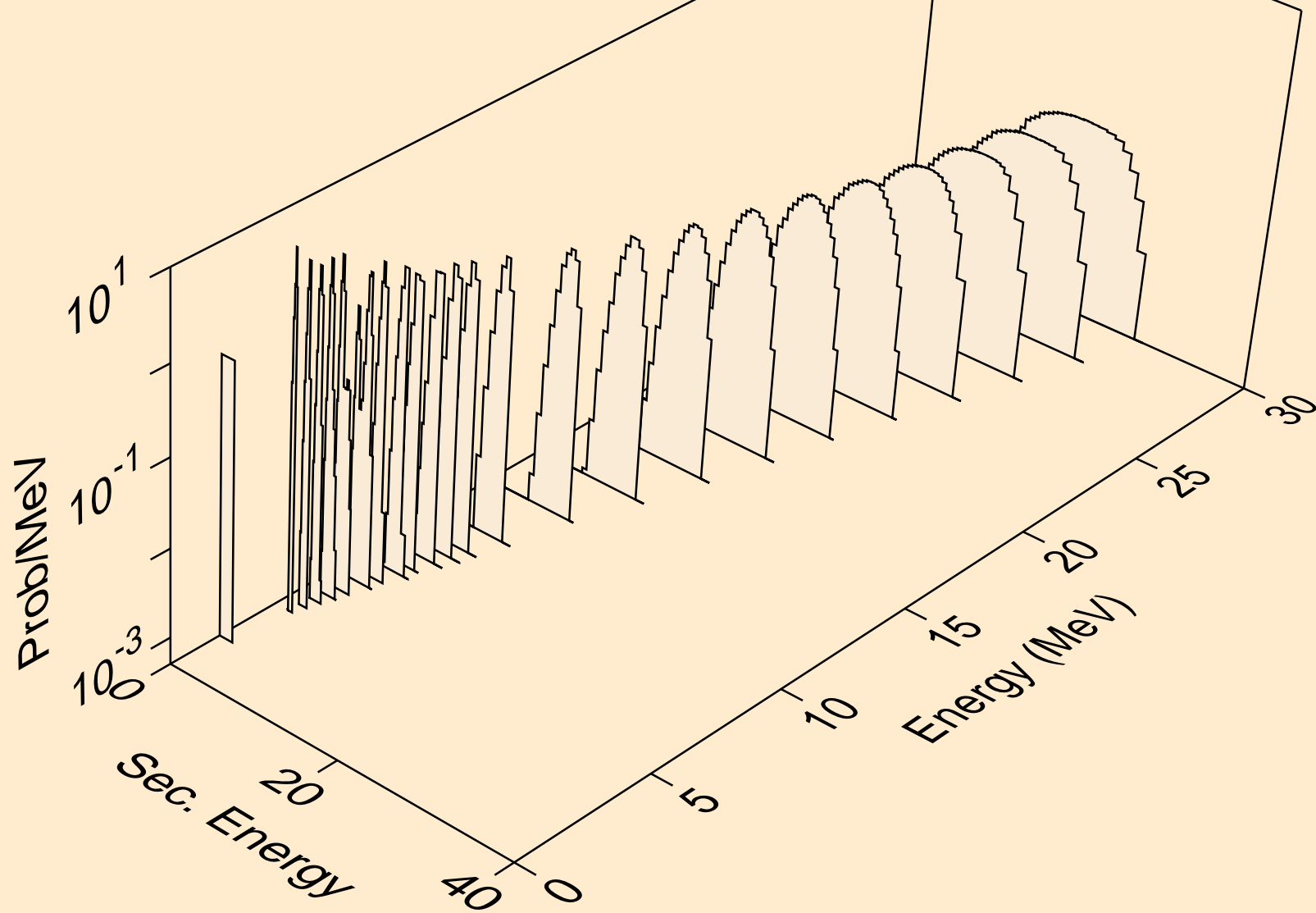

BK236 NEUTRON ACER TENDL-2024 LIBRARY; T=293.6K
protons from (n,2np)

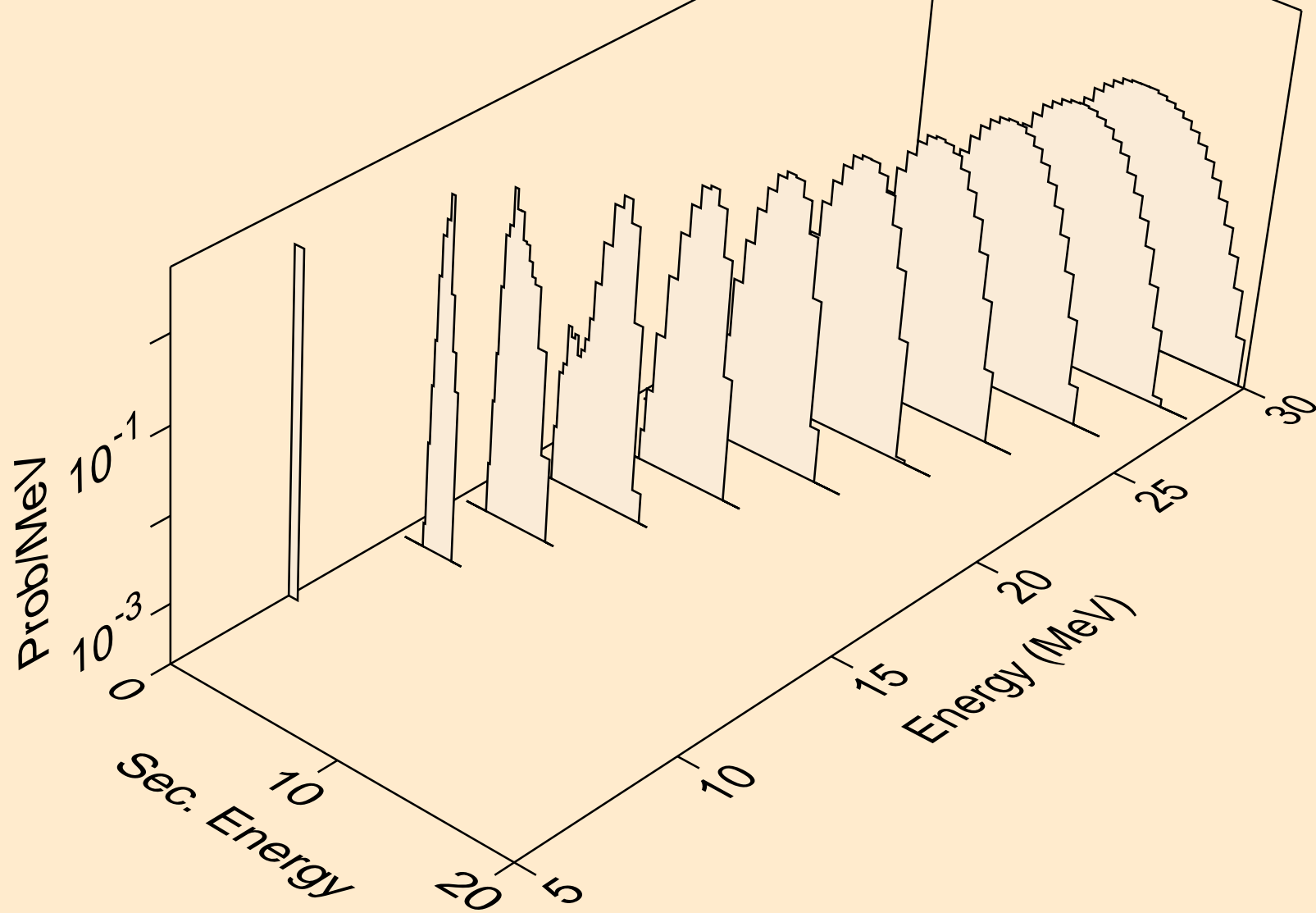

BK236 NEUTRON ACER TENDL-2024 LIBRARY; T=293.6K
protons from (n,n2p)

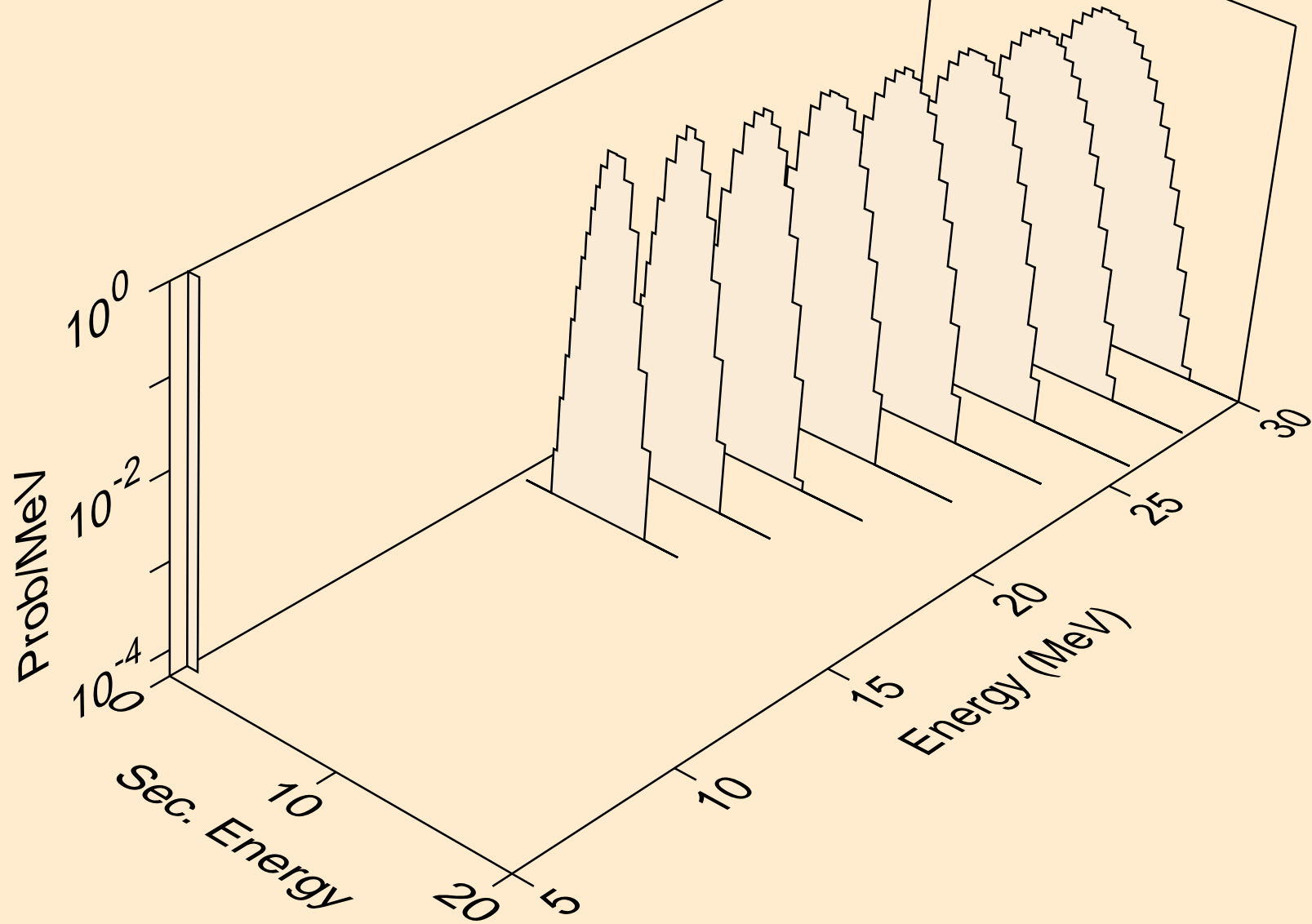

BK236 NEUTRON ACER TENDL-2024 LIBRARY; T=293.6K
protons from (n,npa)

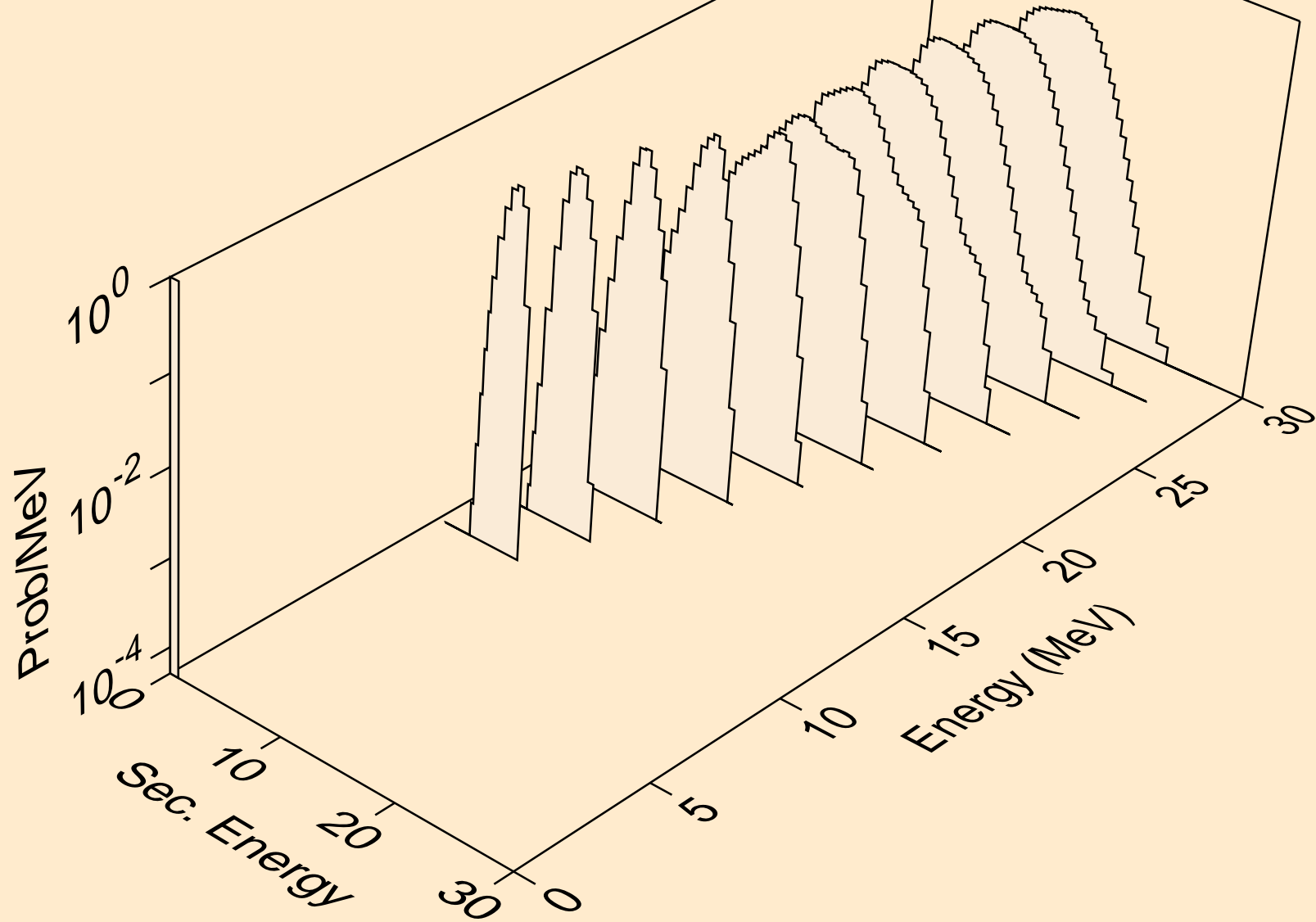

BK236 NEUTRON ACER TENDL-2024 LIBRARY; T=293.6K
protons from (n,p)

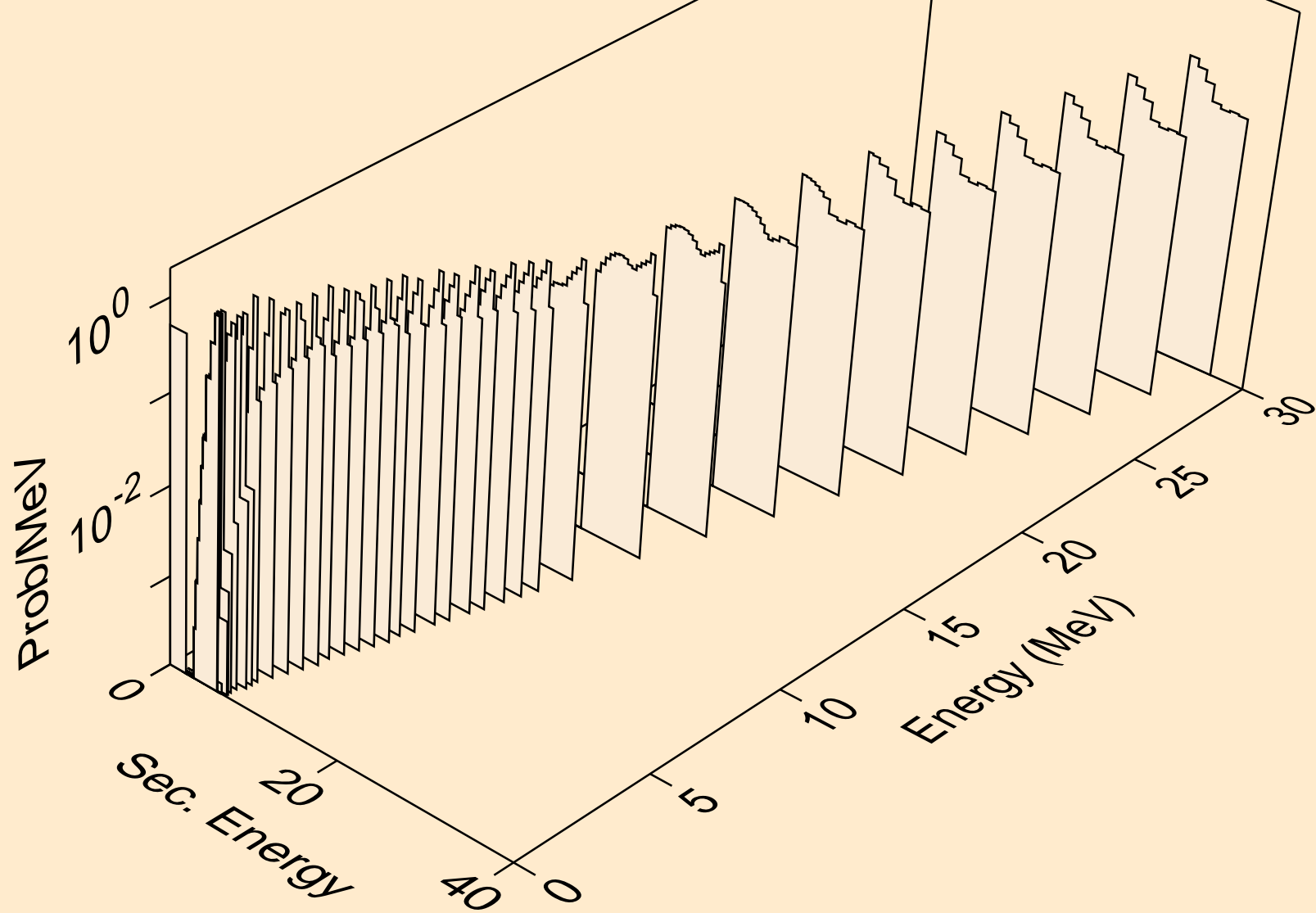

BK236 NEUTRON ACER TENDL-2024 LIBRARY; T=293.6K
protons from (n,2p)

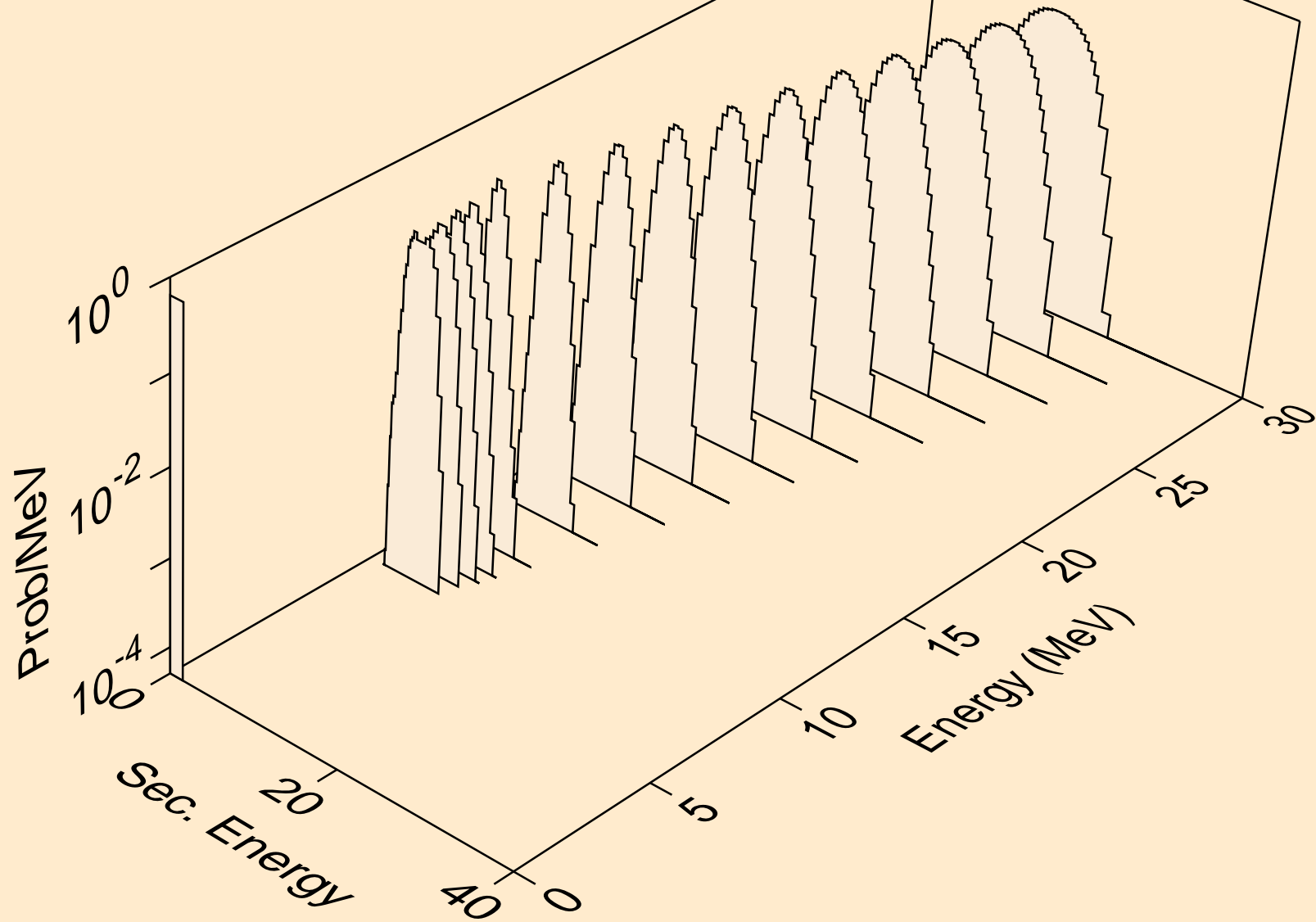

BK236 NEUTRON ACER TENDL-2024 LIBRARY; T=293.6K
protons from (n,p)

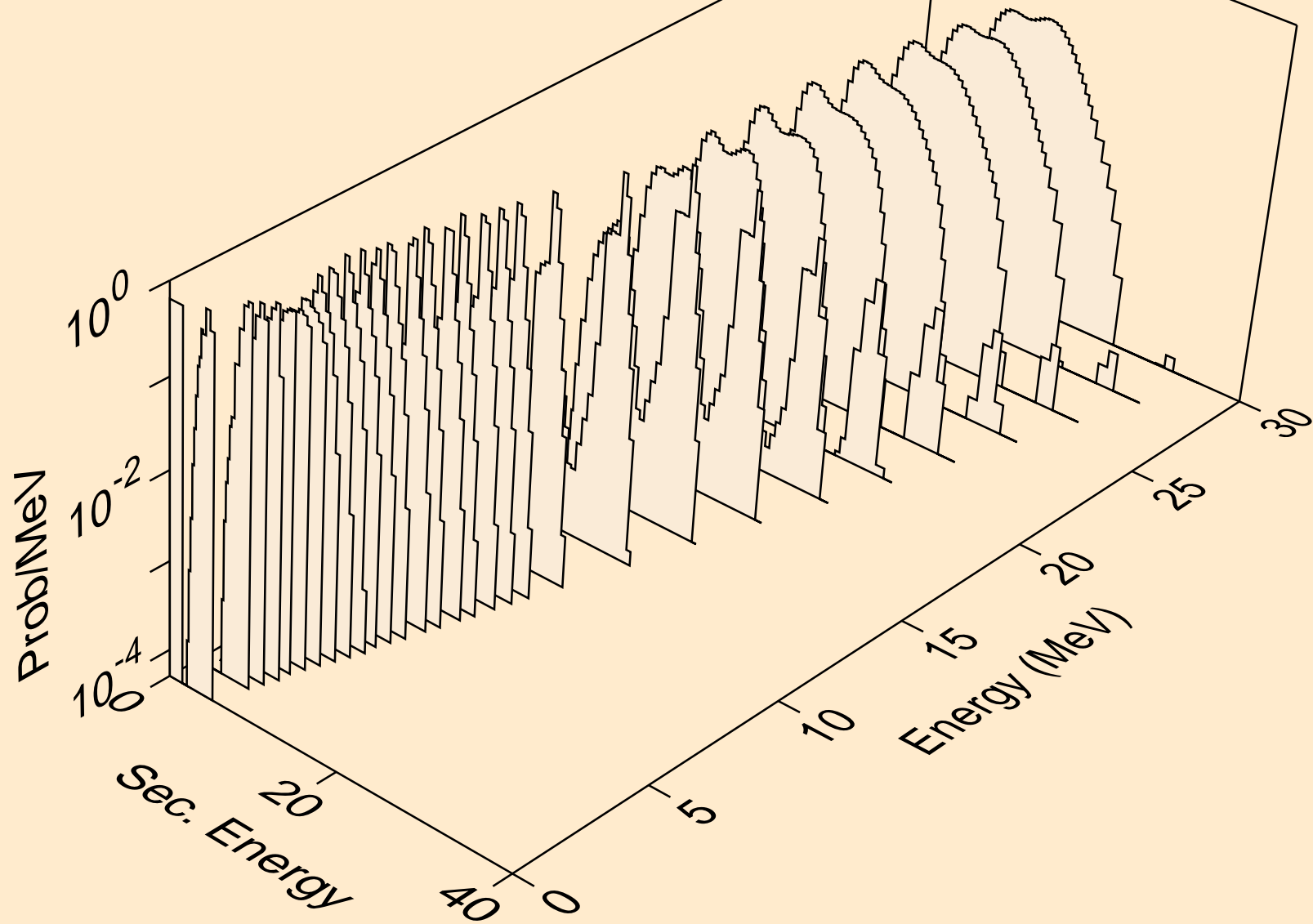

BK236 NEUTRON ACER TENDL-2024 LIBRARY; T=293.6K
protons from (n,pd)

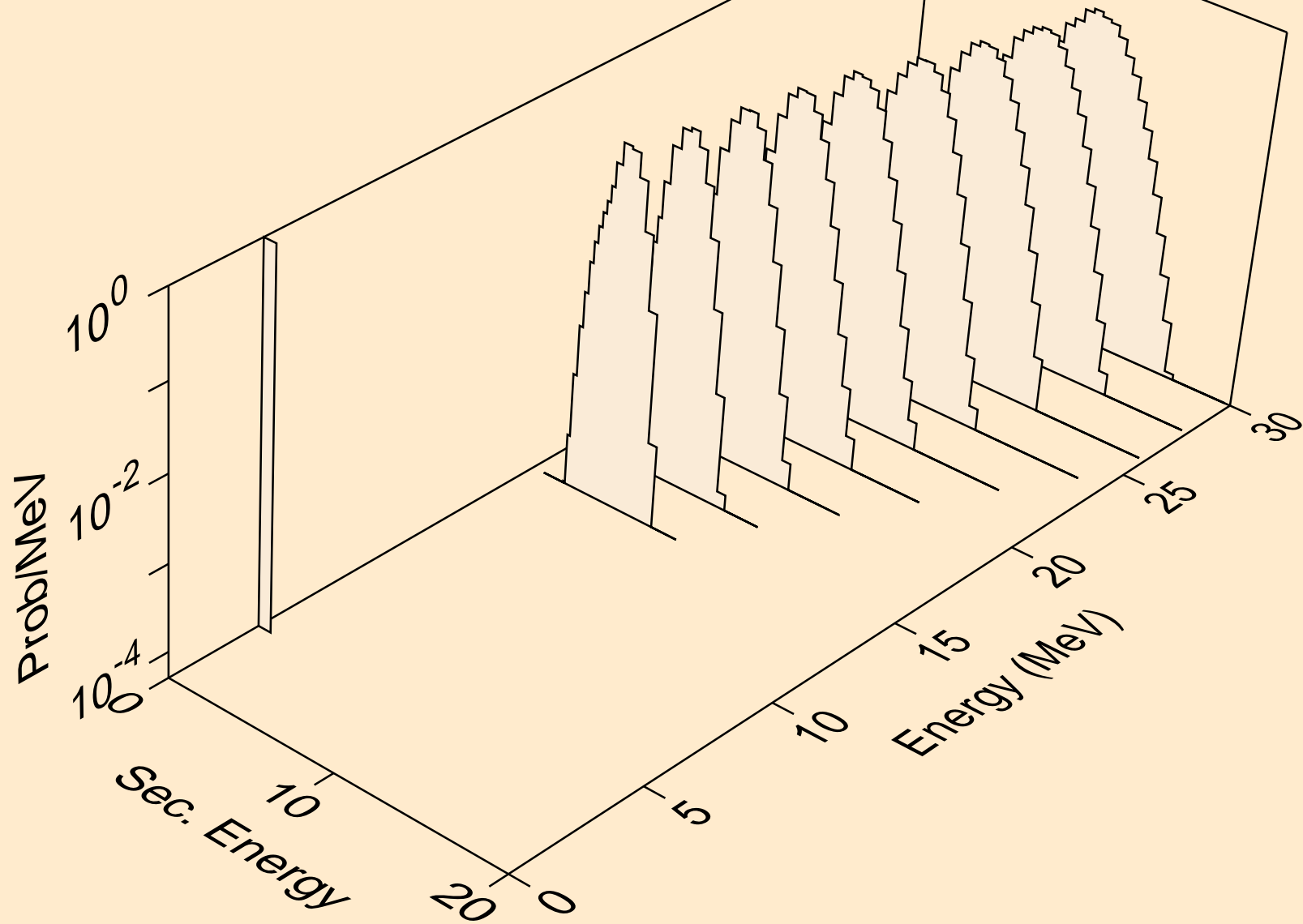

BK236 NEUTRON ACER TENDL-2024 LIBRARY; T=293.6K
deuterons from (n,x)

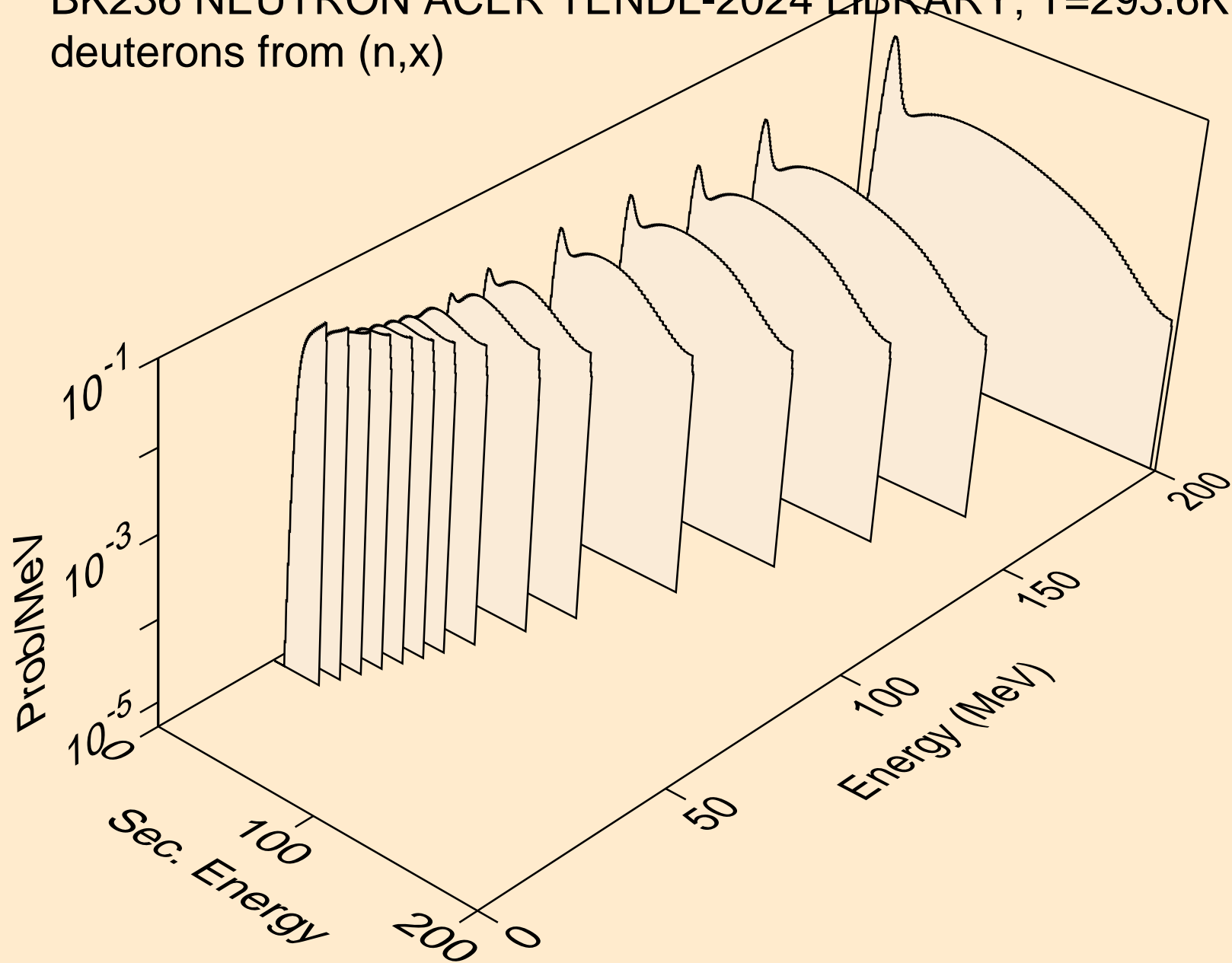

BK236 NEUTRON ACER TENDL-2024 LIBRARY; T=293.6K
deuterons from (n,n*)d

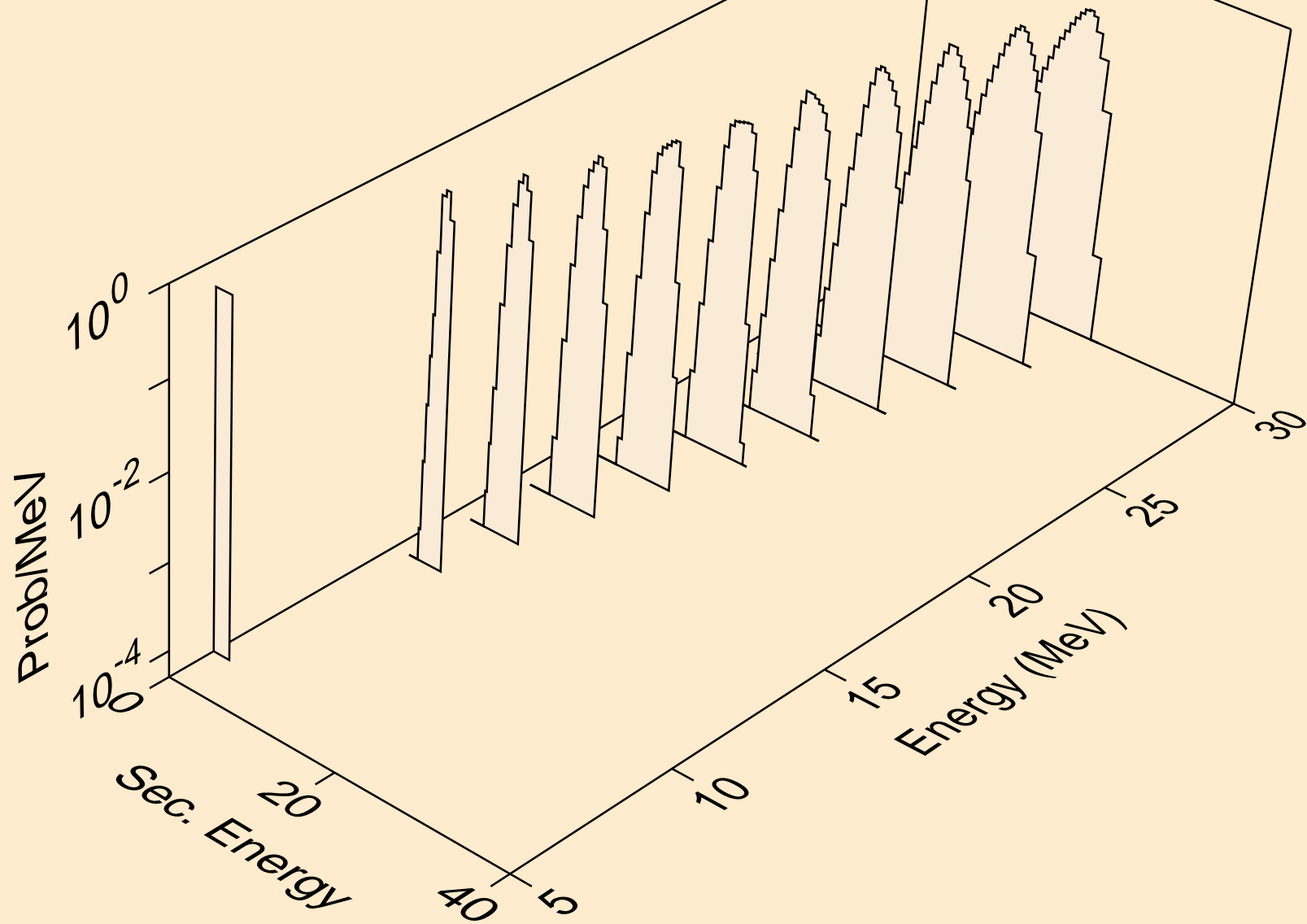

BK236 NEUTRON ACER TENDL-2024 LIBRARY; T=293.6K
deuterons from (n,d)

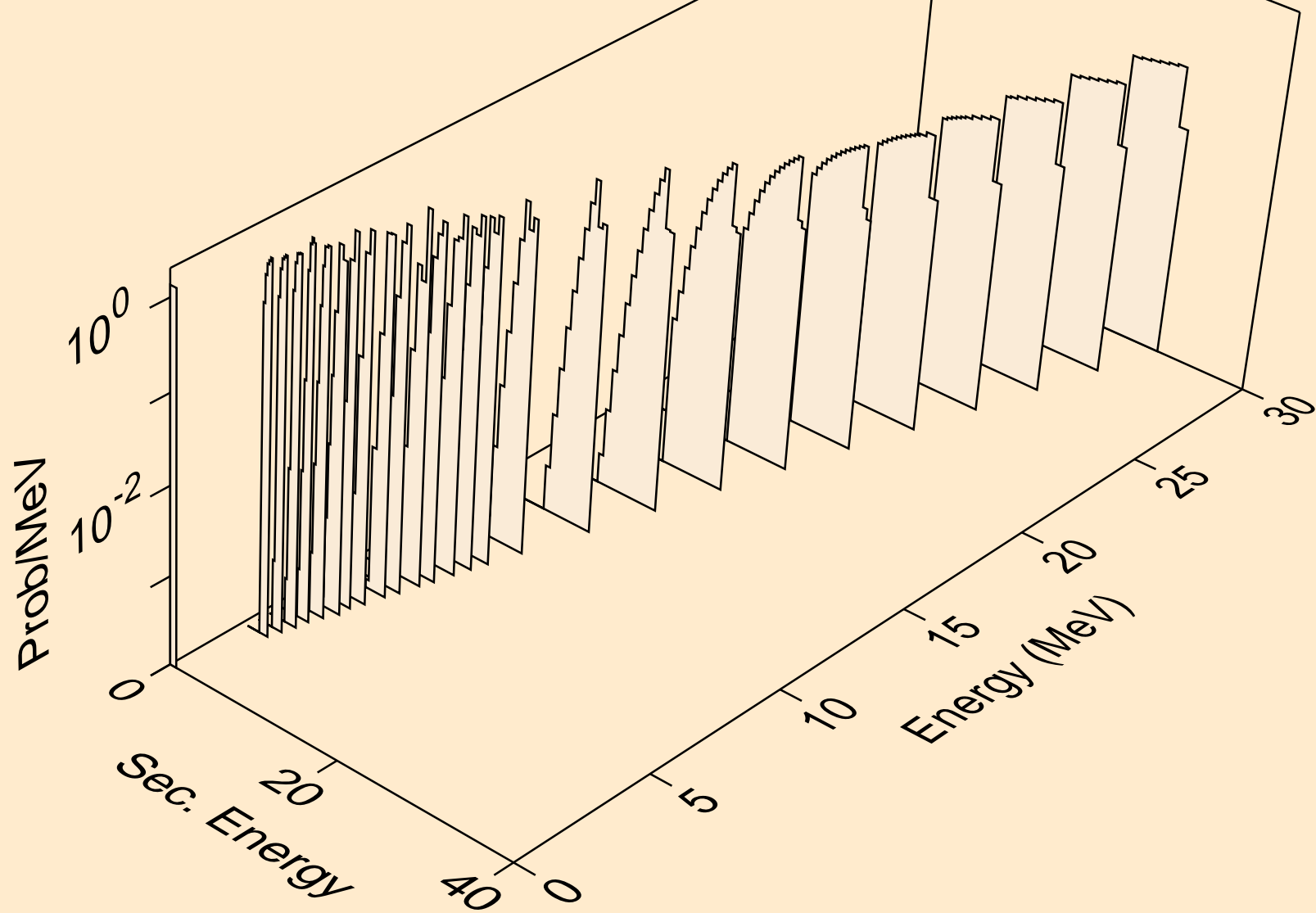

BK236 NEUTRON ACER TENDL-2024 LIBRARY; T=293.6K
deuterons from (n,pd)

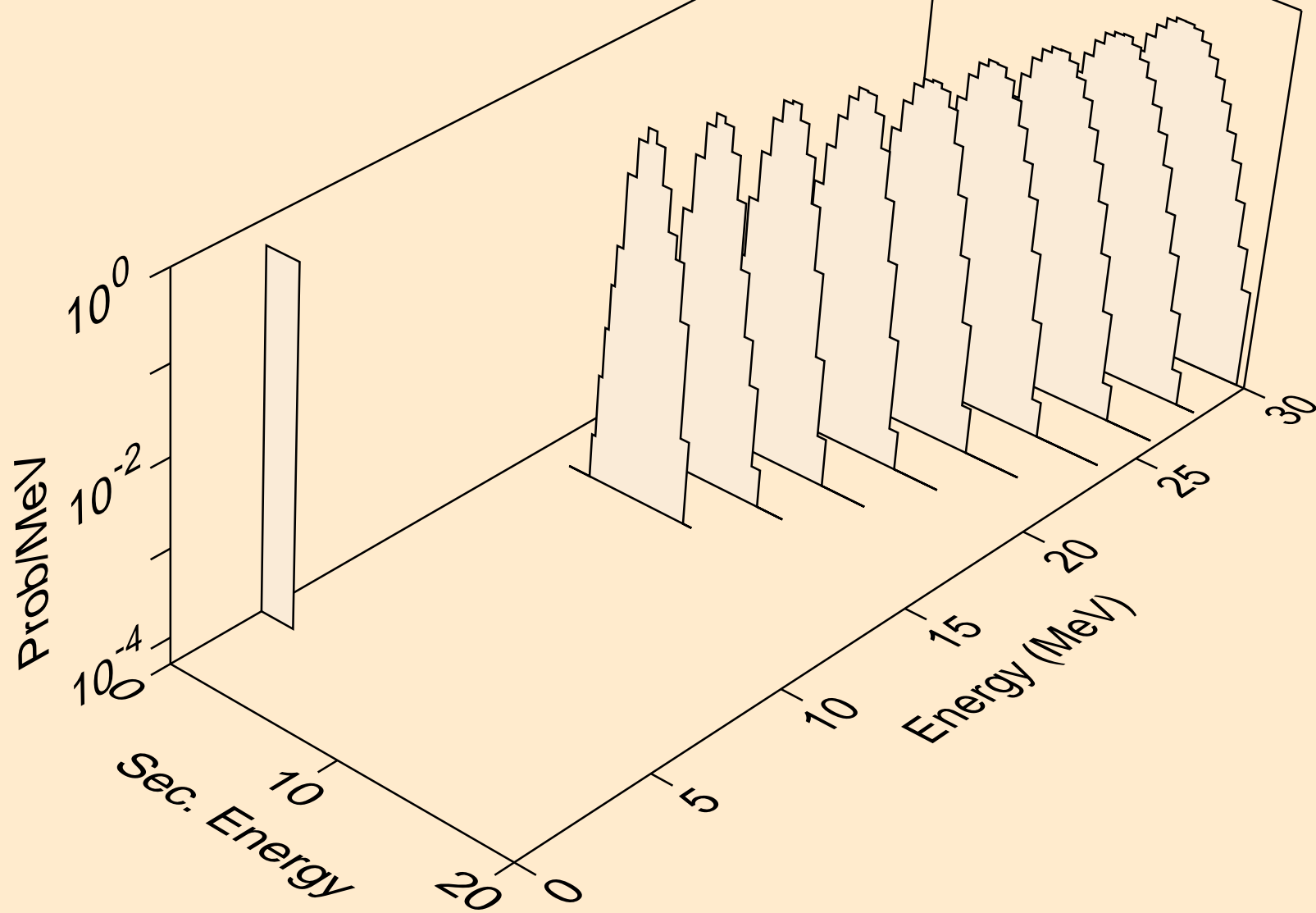

BK236 NEUTRON ACER TENDL-2024 LIBRARY; T=293.6K
tritons from (n,x)

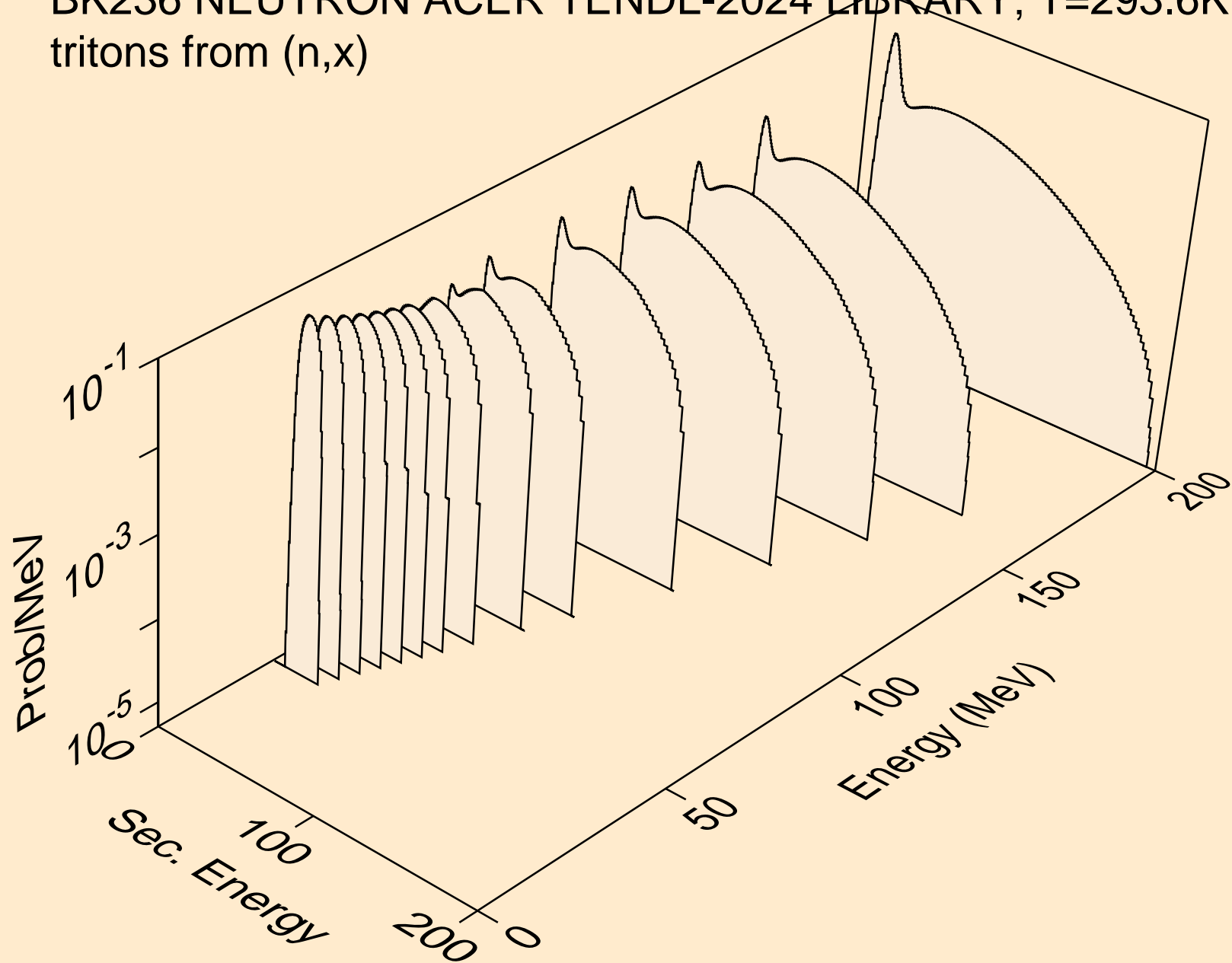

BK236 NEUTRON ACER TENDL-2024 LIBRARY; T=293.6K
tritons from (n,n*)t

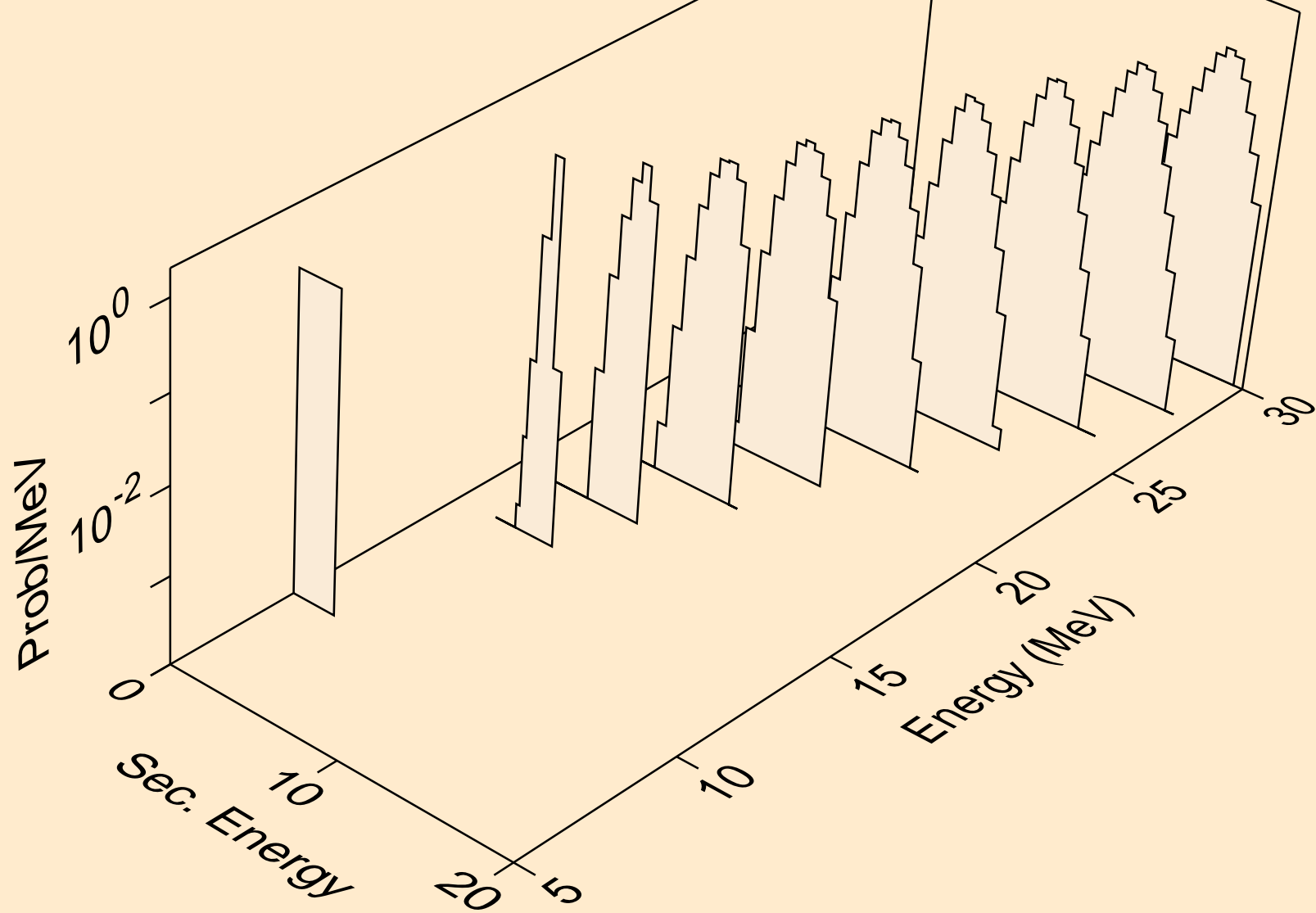

BK236 NEUTRON ACER TENDL-2024 LIBRARY; T=293.6K
tritons from (n,t)

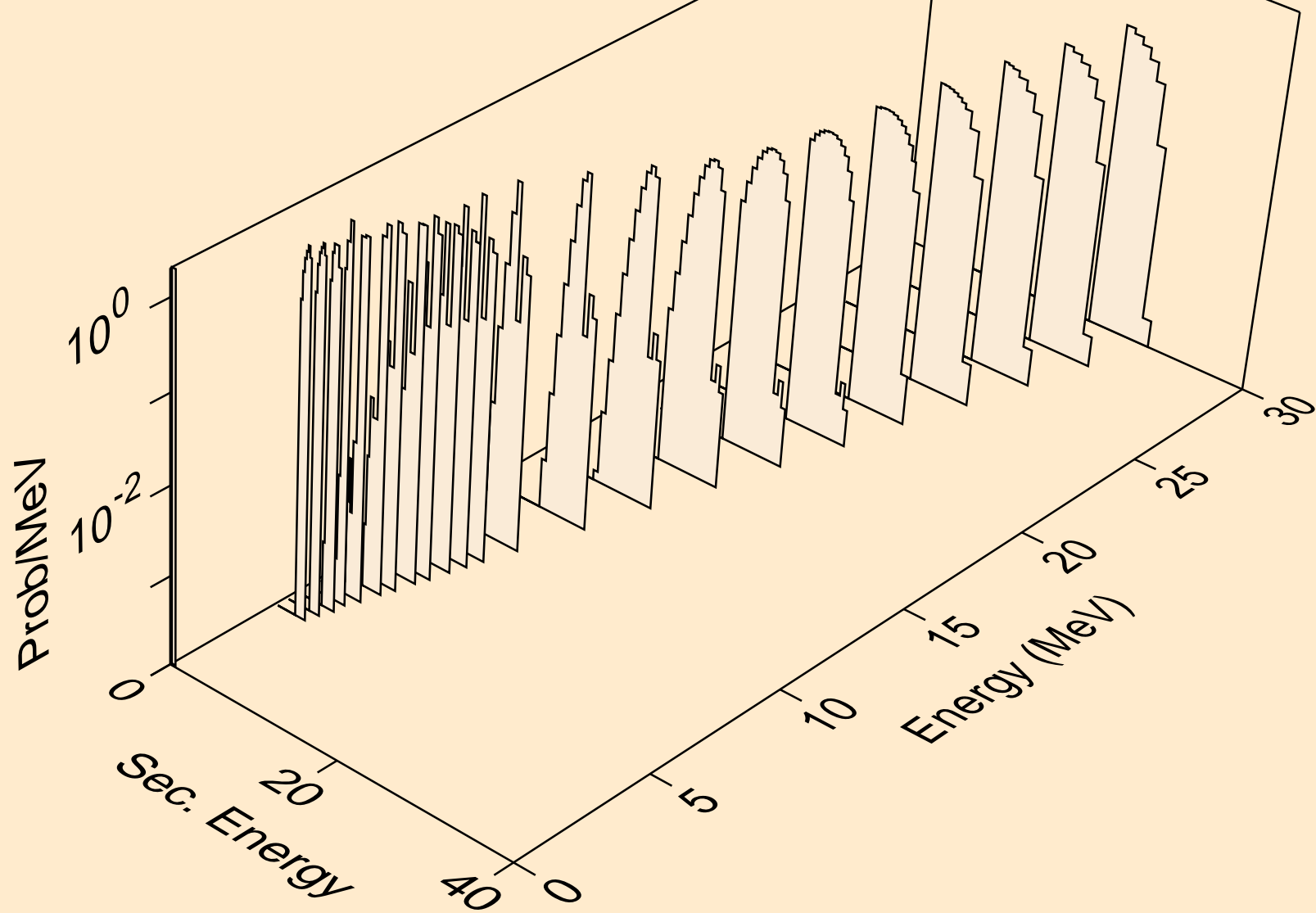

BK236 NEUTRON ACER TENDL-2024 LIBRARY; T=293.6K
he3s from (n,x)

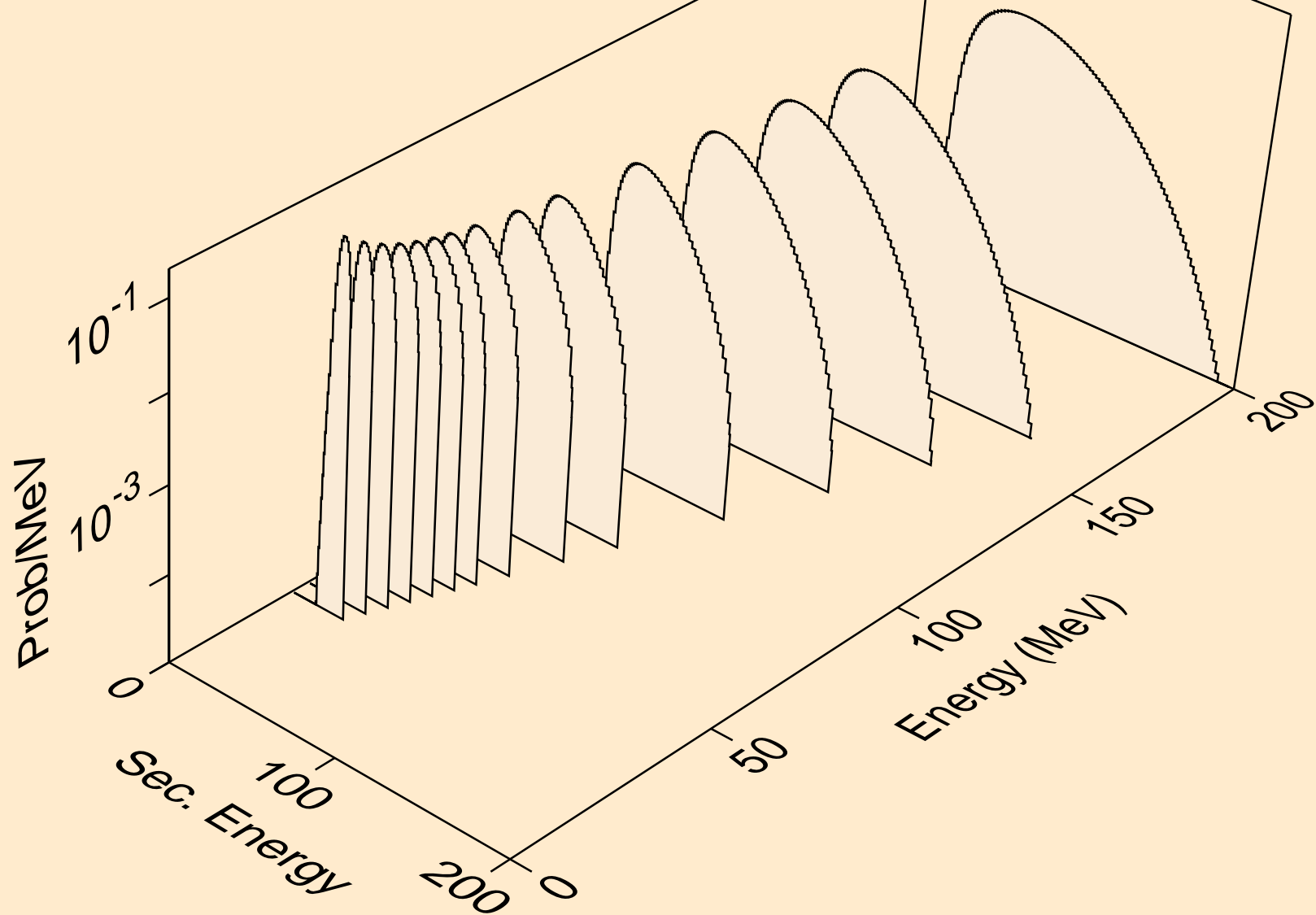

BK236 NEUTRON ACER TENDL-2024 LIBRARY; T=293.6K
he3s from (n,n*)he3

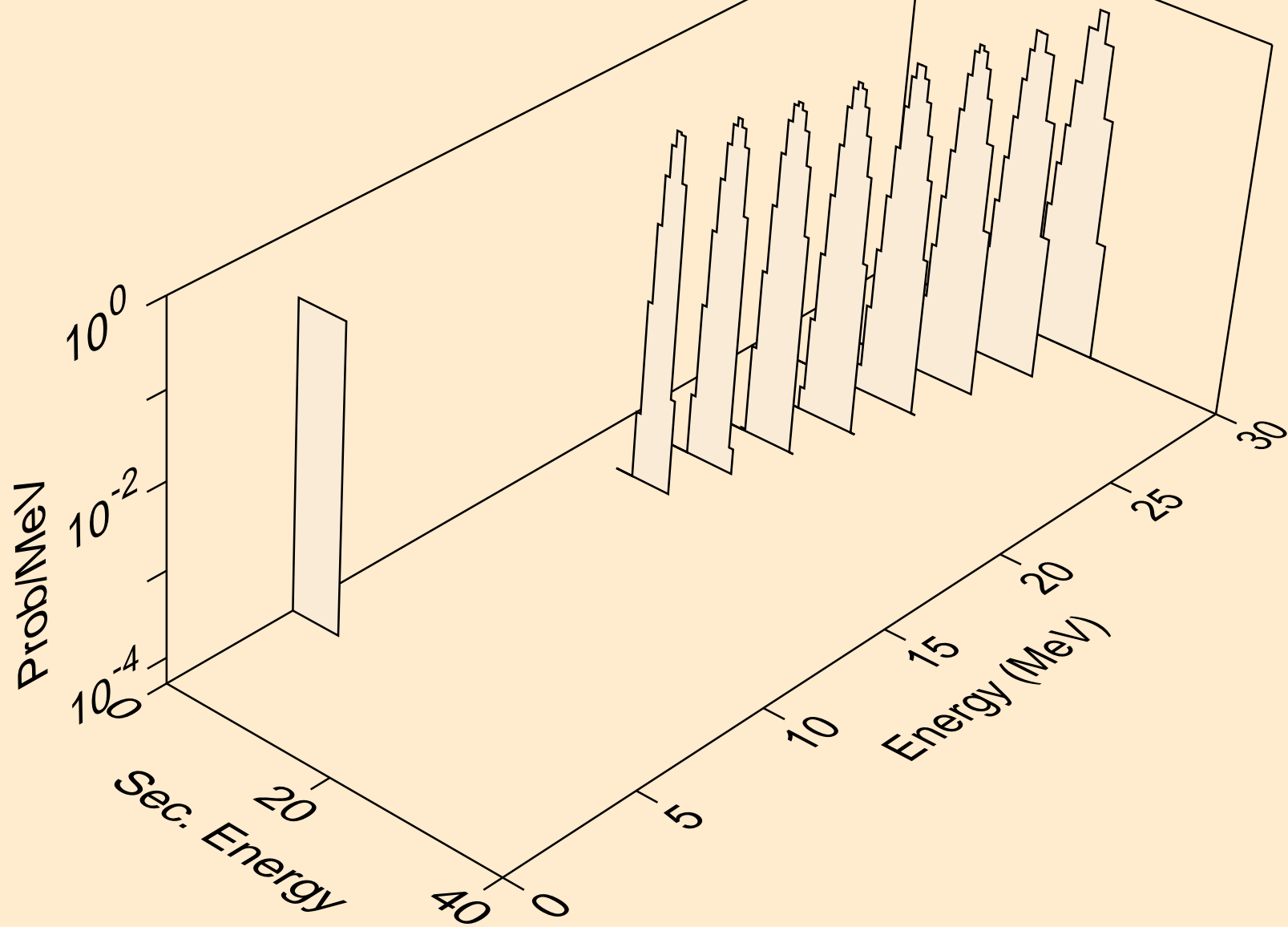

BK236 NEUTRON ACER TENDL-2024 LIBRARY; T=293.6K
he3s from (n,he3)

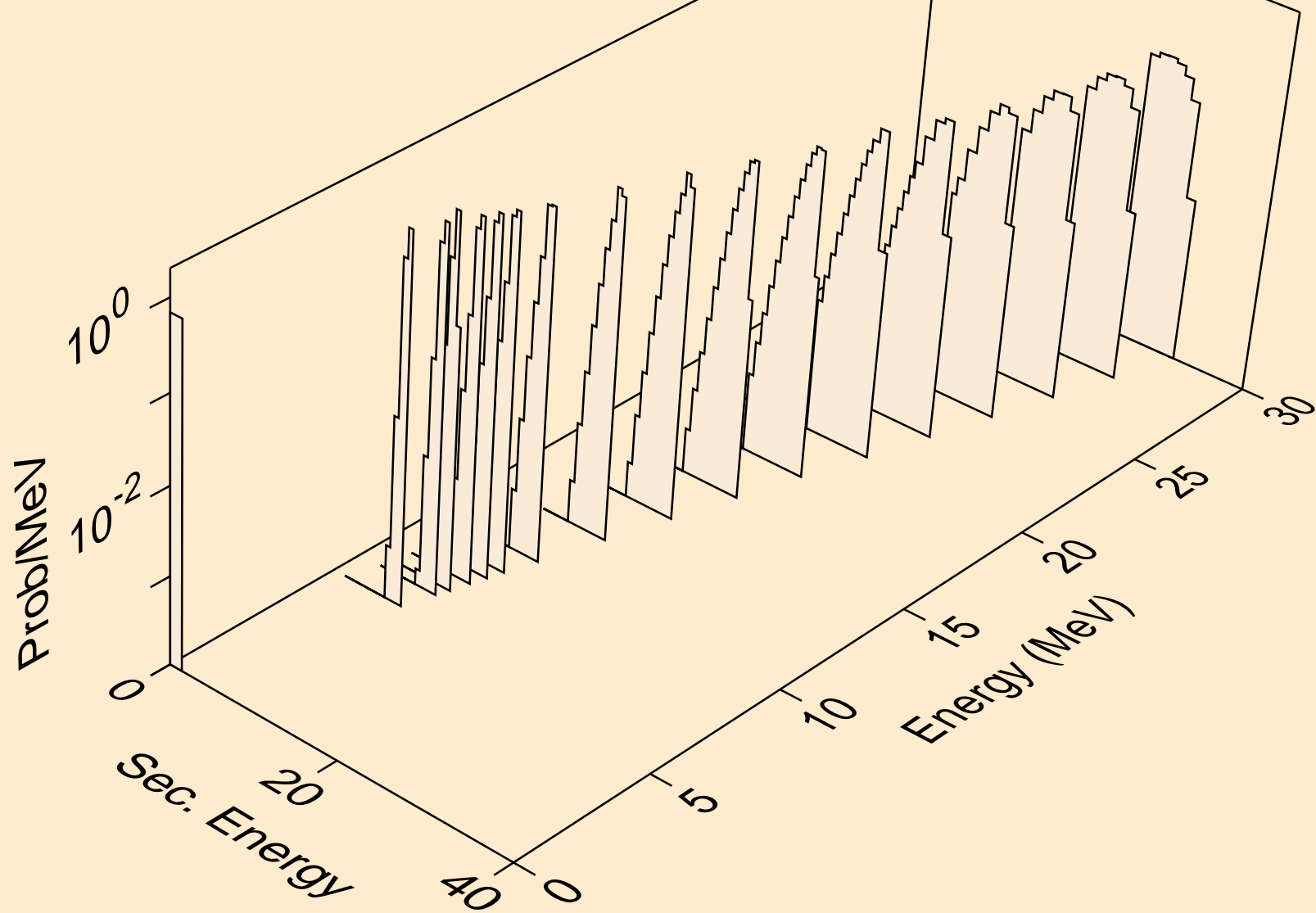

BK236 NEUTRON ACER TENDL-2024 LIBRARY; T=293.6K
alphas from (n,x)

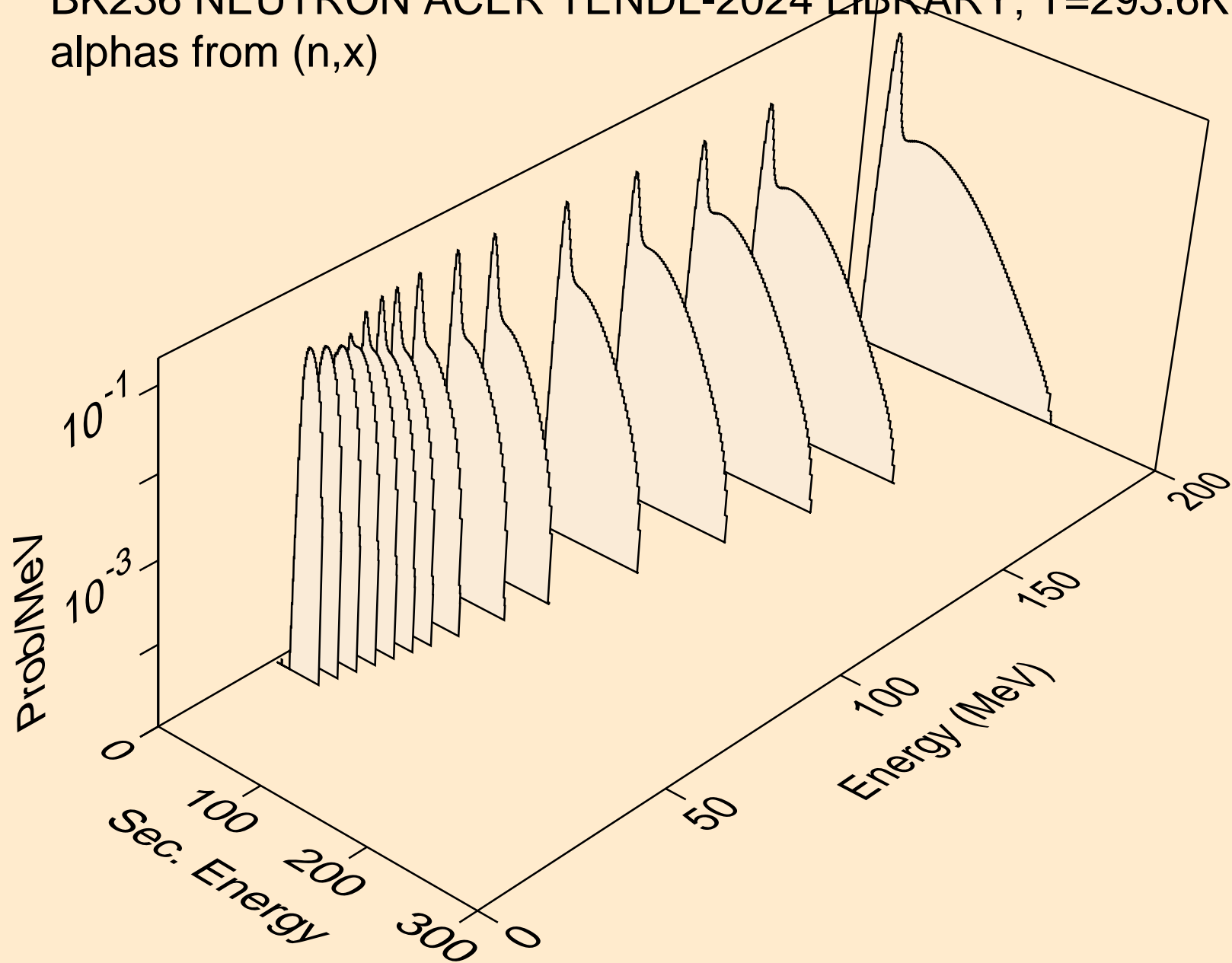

BK236 NEUTRON ACER TENDL-2024 LIBRARY; T=293.6K
alphas from (n,n*)a

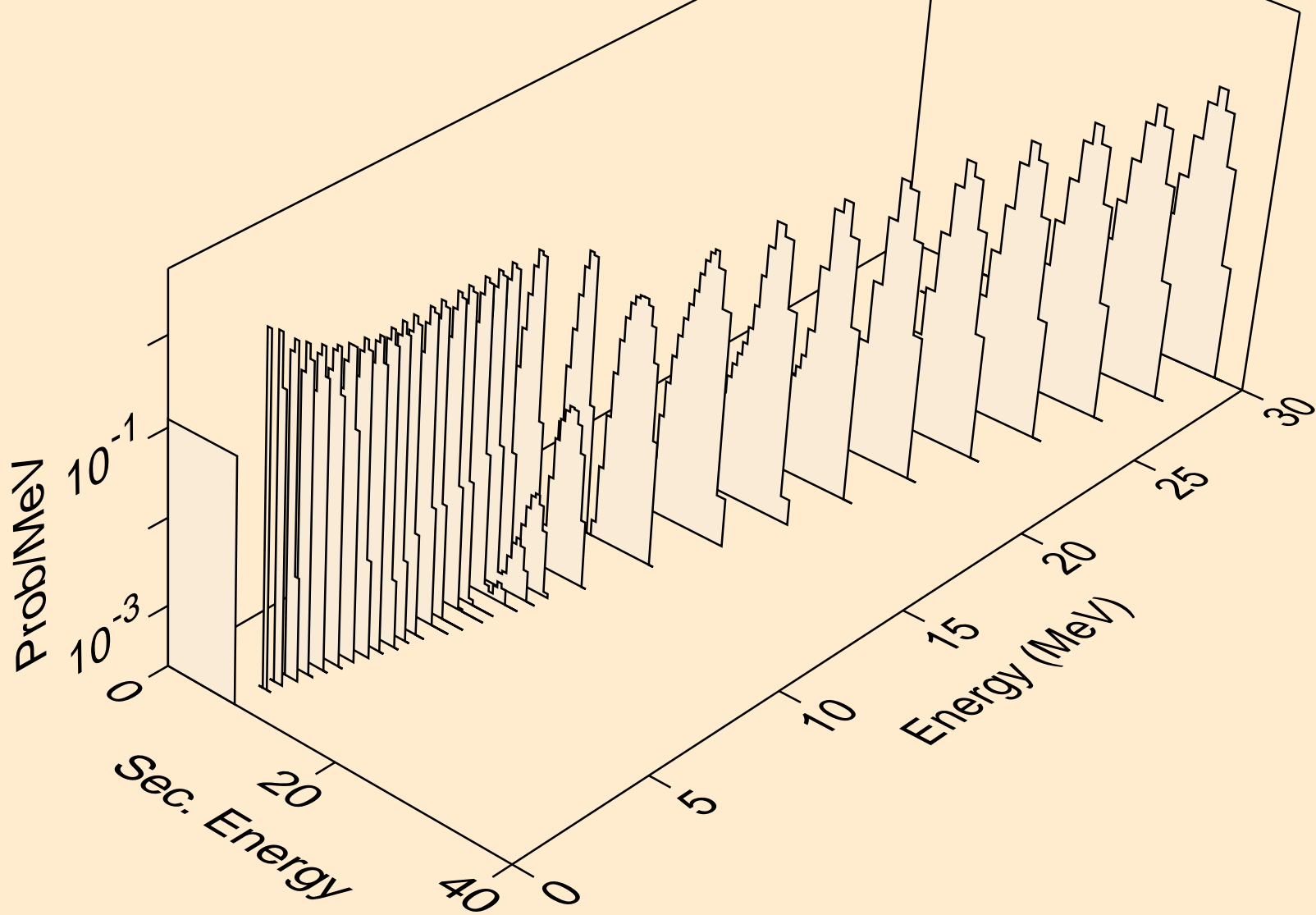

BK236 NEUTRON ACER TENDL-2024 LIBRARY; T=293.6K
alphas from (n,2n)a

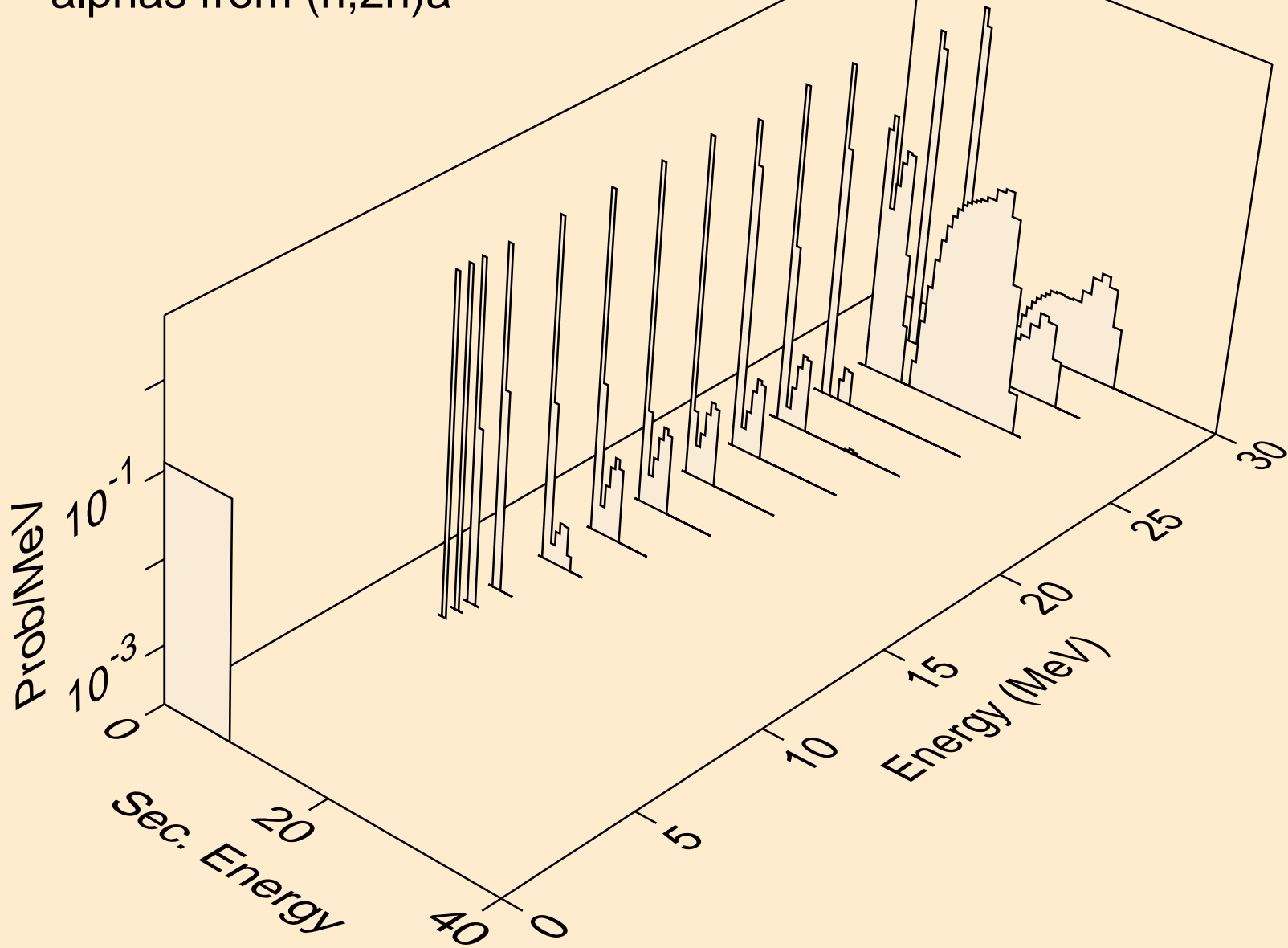

BK236 NEUTRON ACER TENDL-2024 LIBRARY; T=293.6K
alphas from (n,npa)

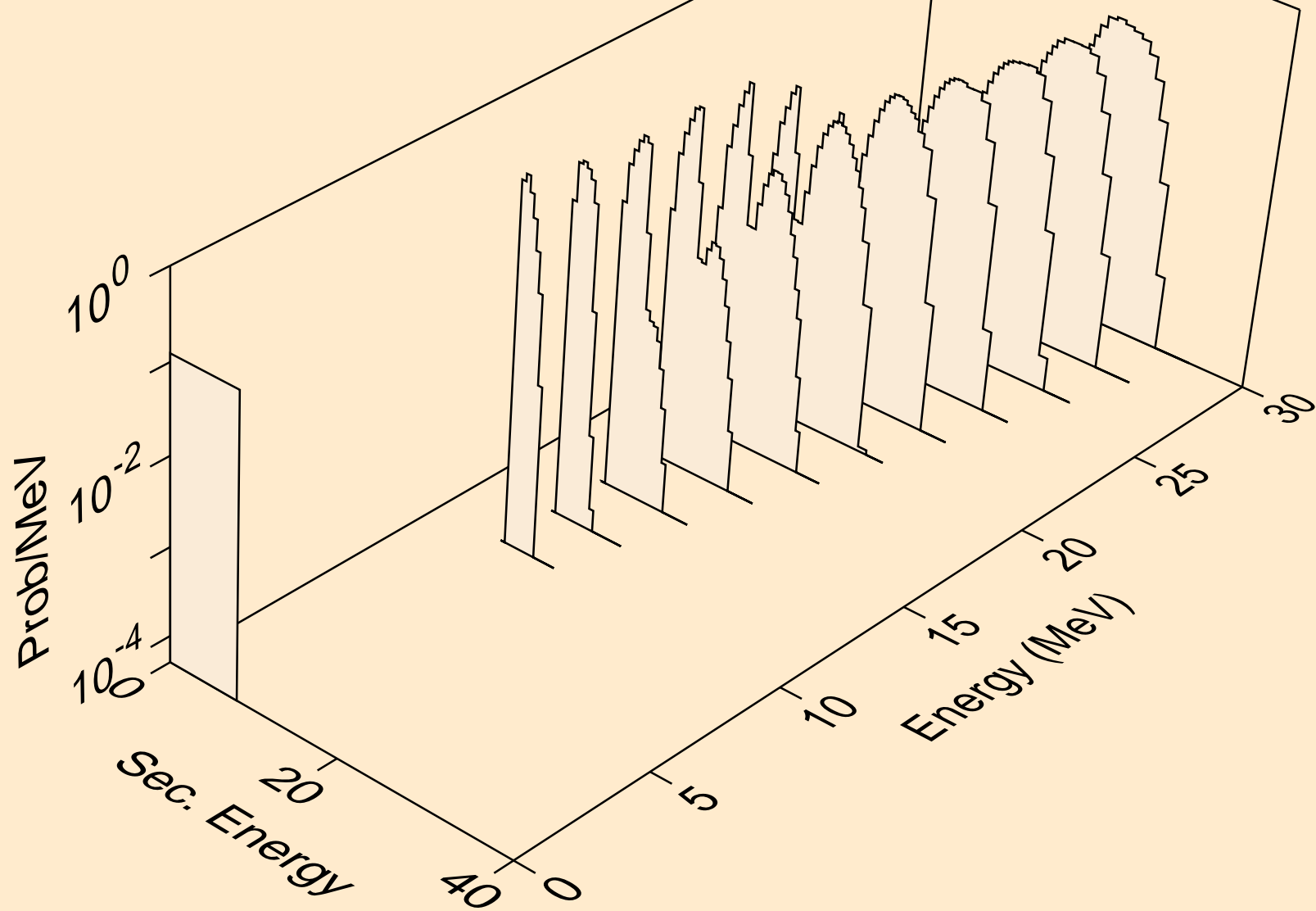

BK236 NEUTRON ACER TENDL-2024 LIBRARY; T=293.6K
alphas from (n,a)

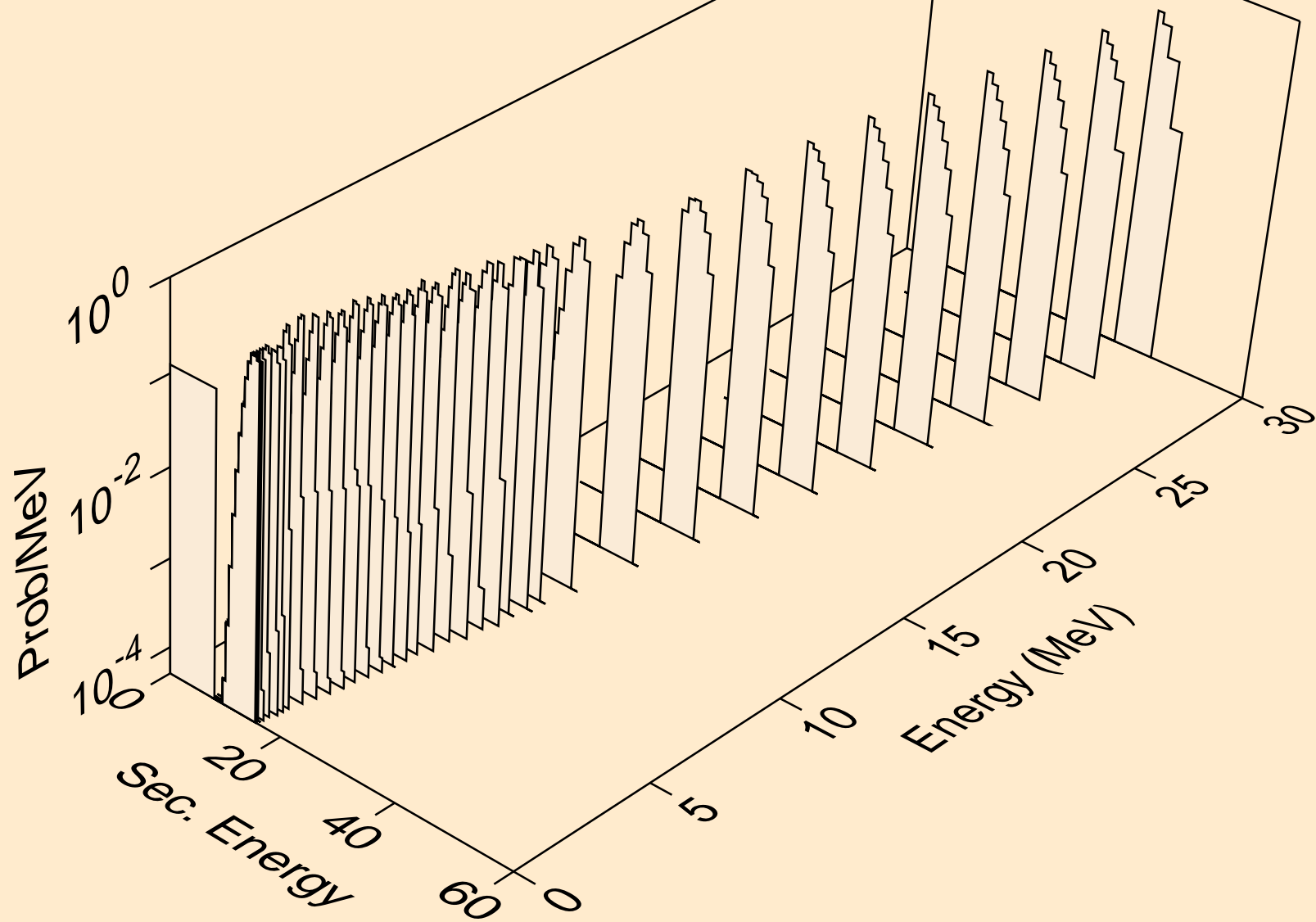

BK236 NEUTRON ACER TENDL-2024 LIBRARY; T=293.6K
alphas from (n,2a)

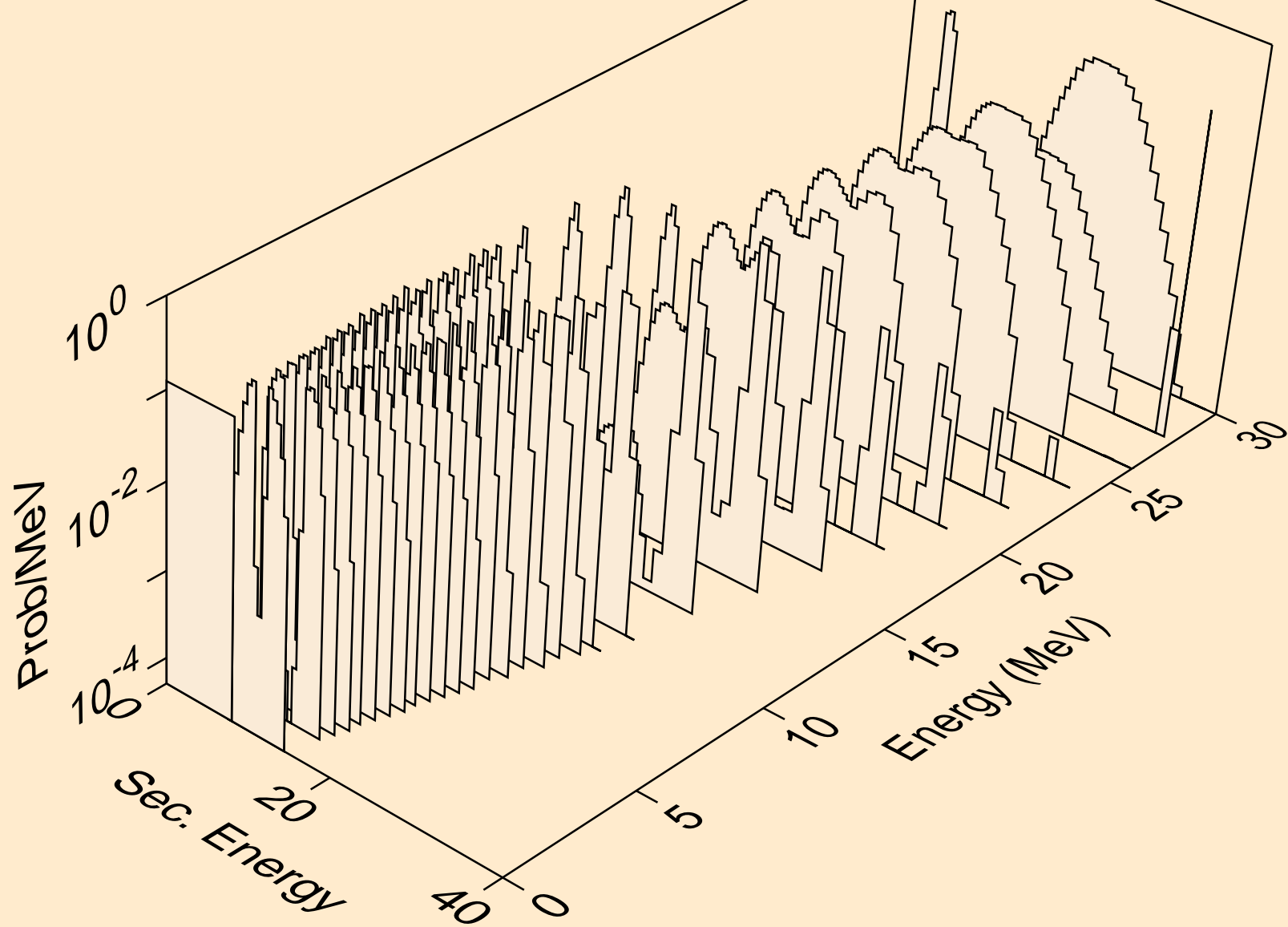

BK236 NEUTRON ACER TENDL-2024 LIBRARY; T=293.6K
alphas from (n,pa)

