

CD096 NEUTRON ACER TENDL-2024 LIBRARY; T=293.6K

Principal cross sections

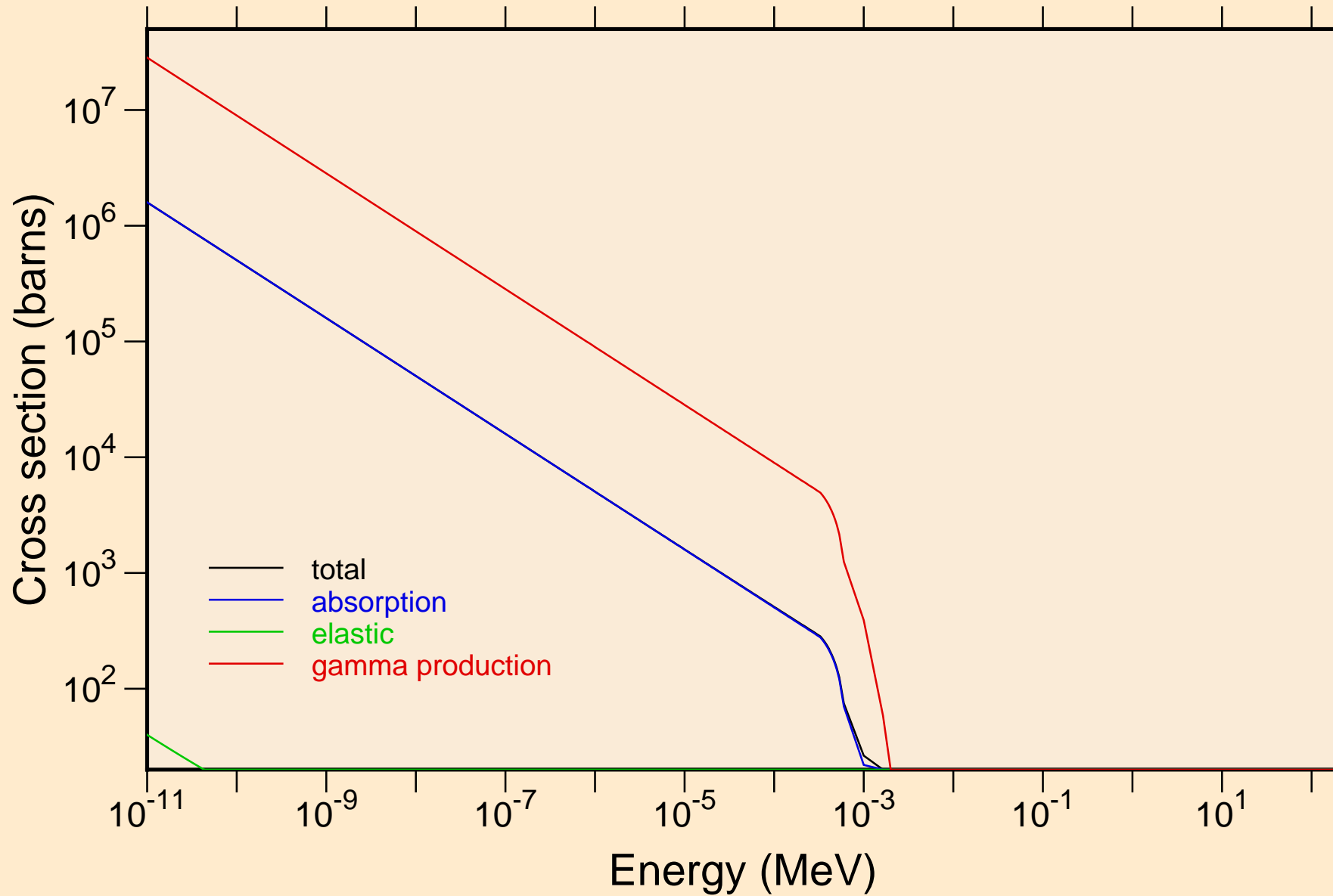

CD096 NEUTRON ACER TENDL-2024 LIBRARY; T=293.6K
Heating

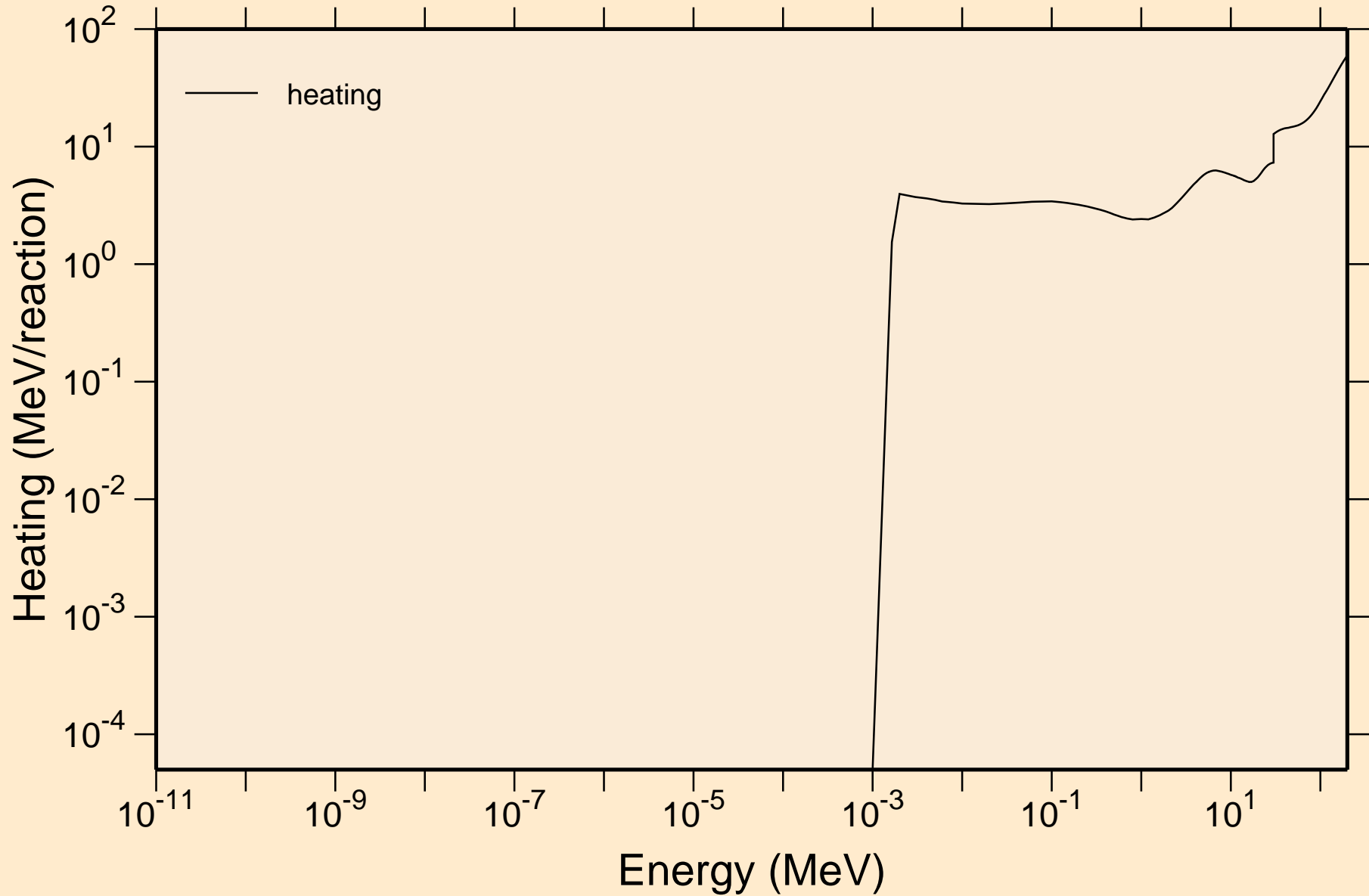

CD096 NEUTRON ACER TENDL-2024 LIBRARY; T=293.6K

Damage

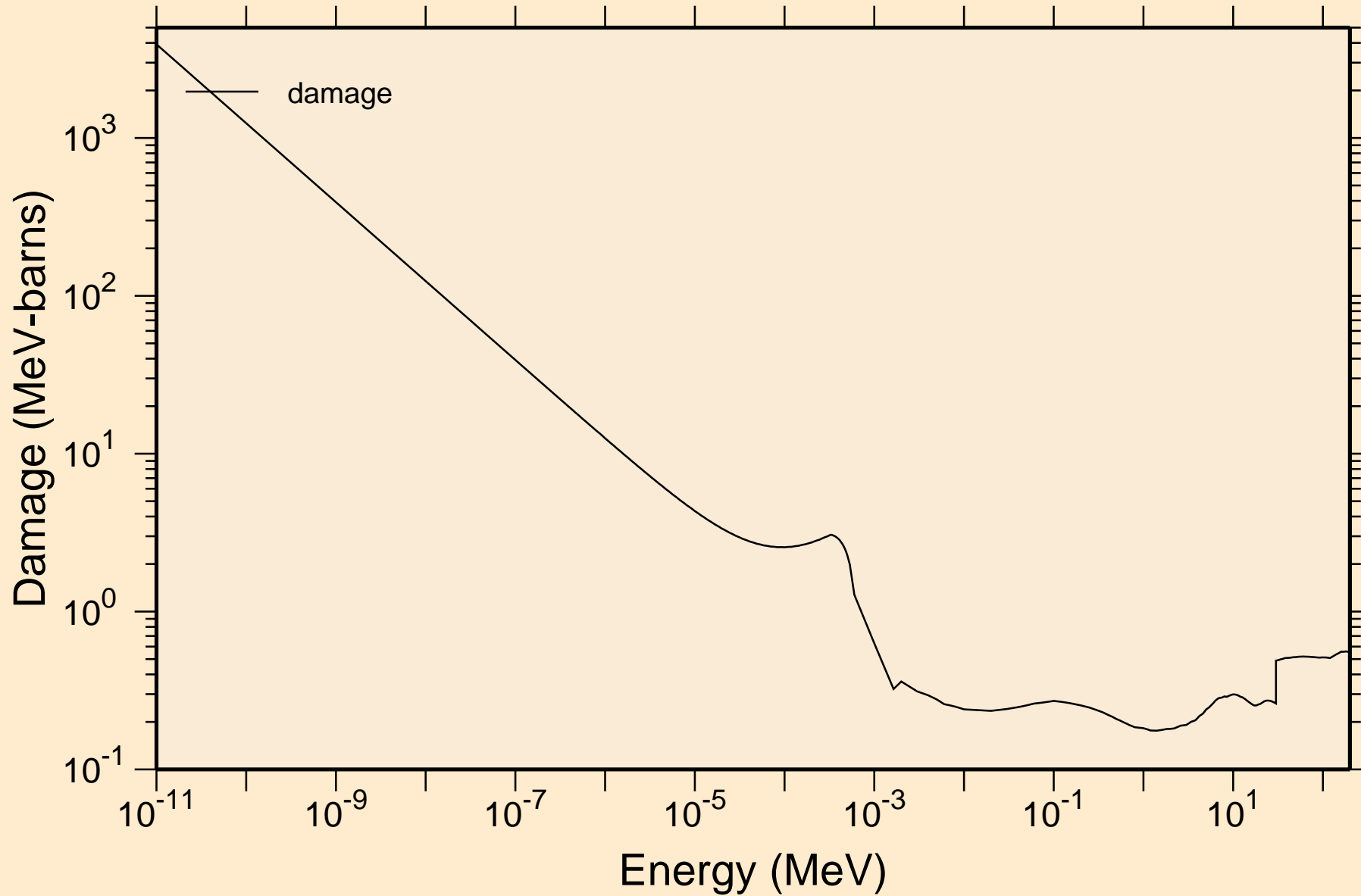

CD096 NEUTRON ACER TENDL-2024 LIBRARY; T=293.6K

Non-threshold reactions

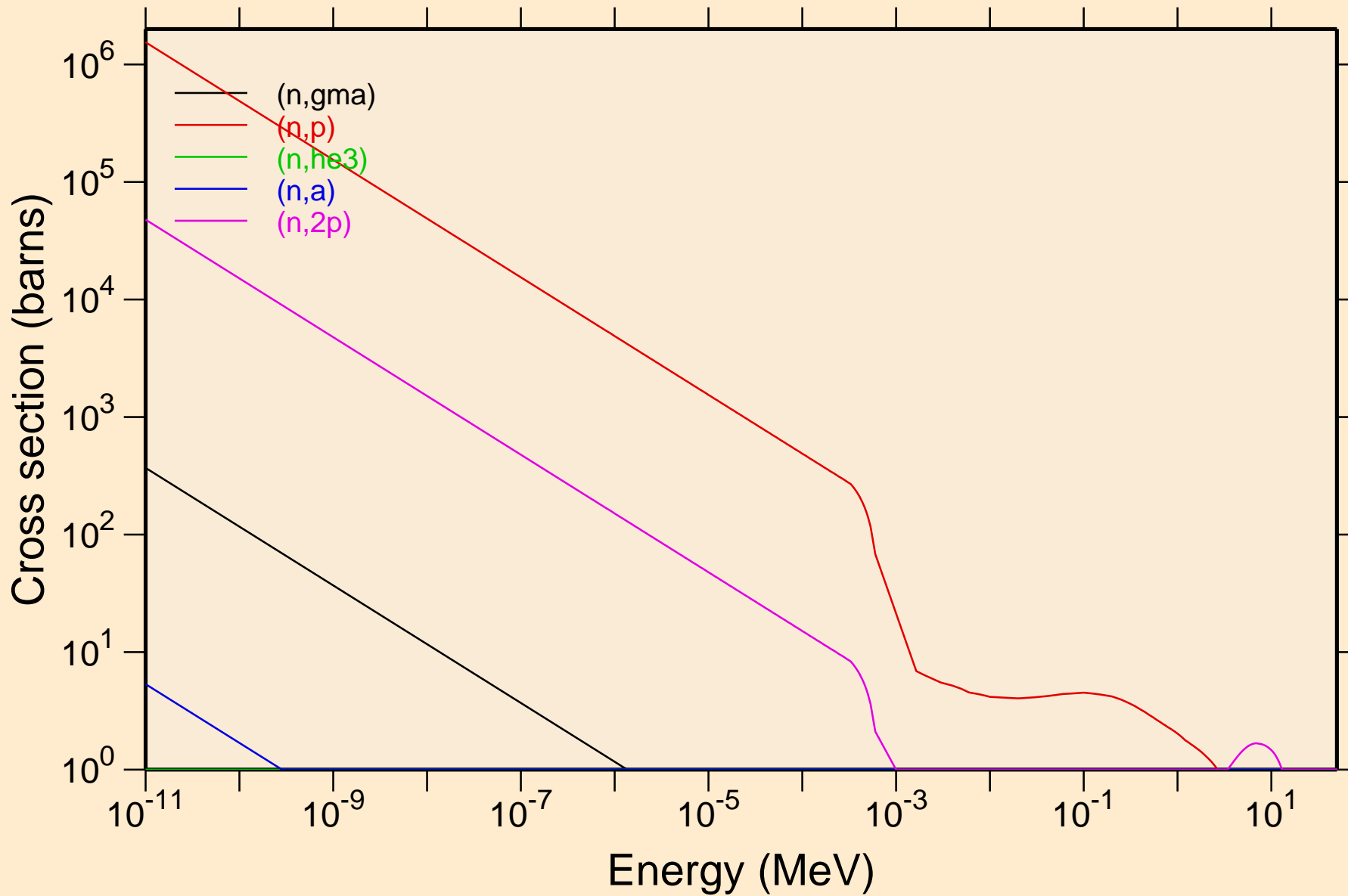

CD096 NEUTRON ACER TENDL-2024 LIBRARY; T=293.6K

Non-threshold reactions

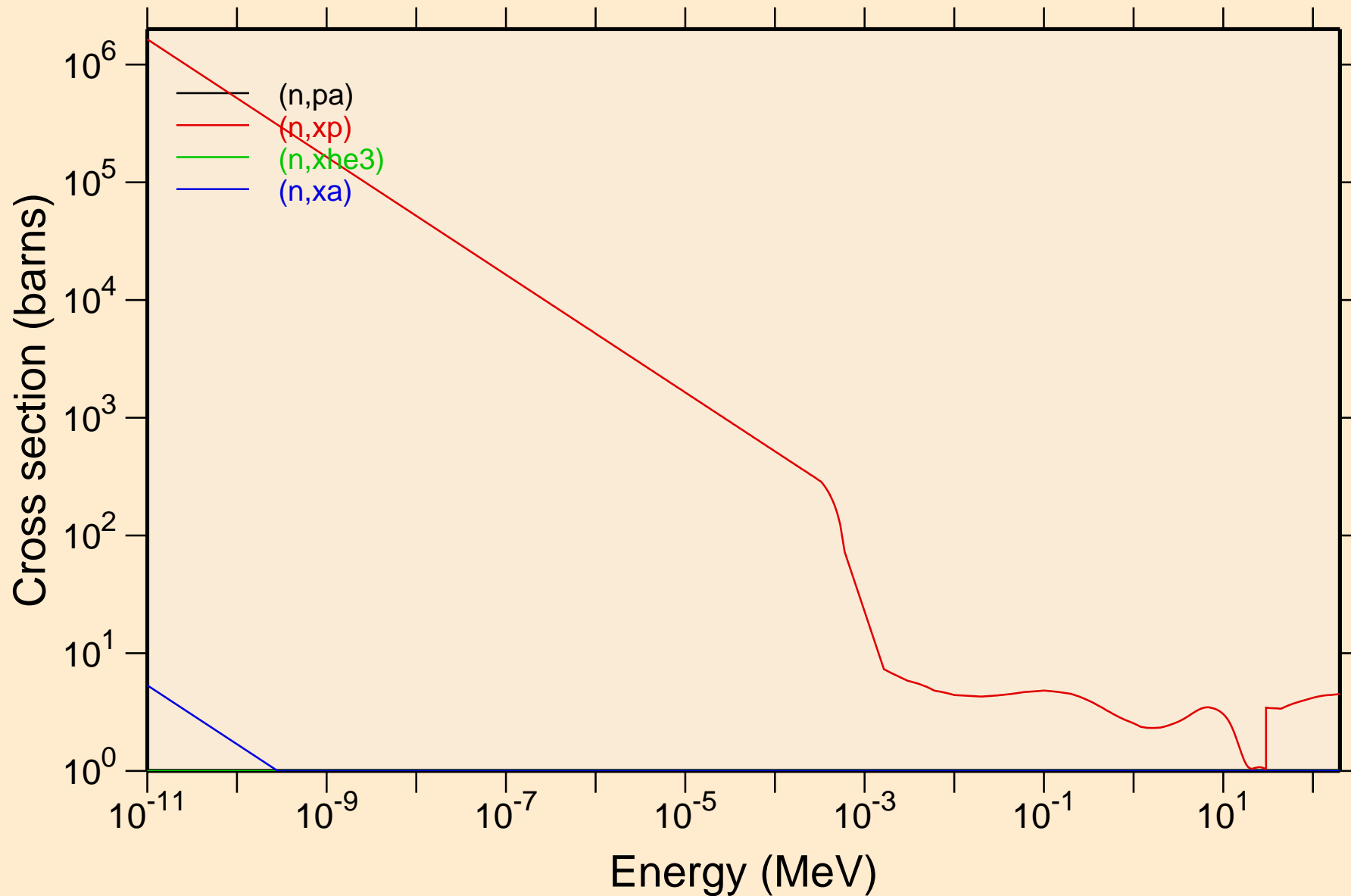

CD096 NEUTRON ACER TENDL-2024 LIBRARY; T=293.6K

Principal cross sections

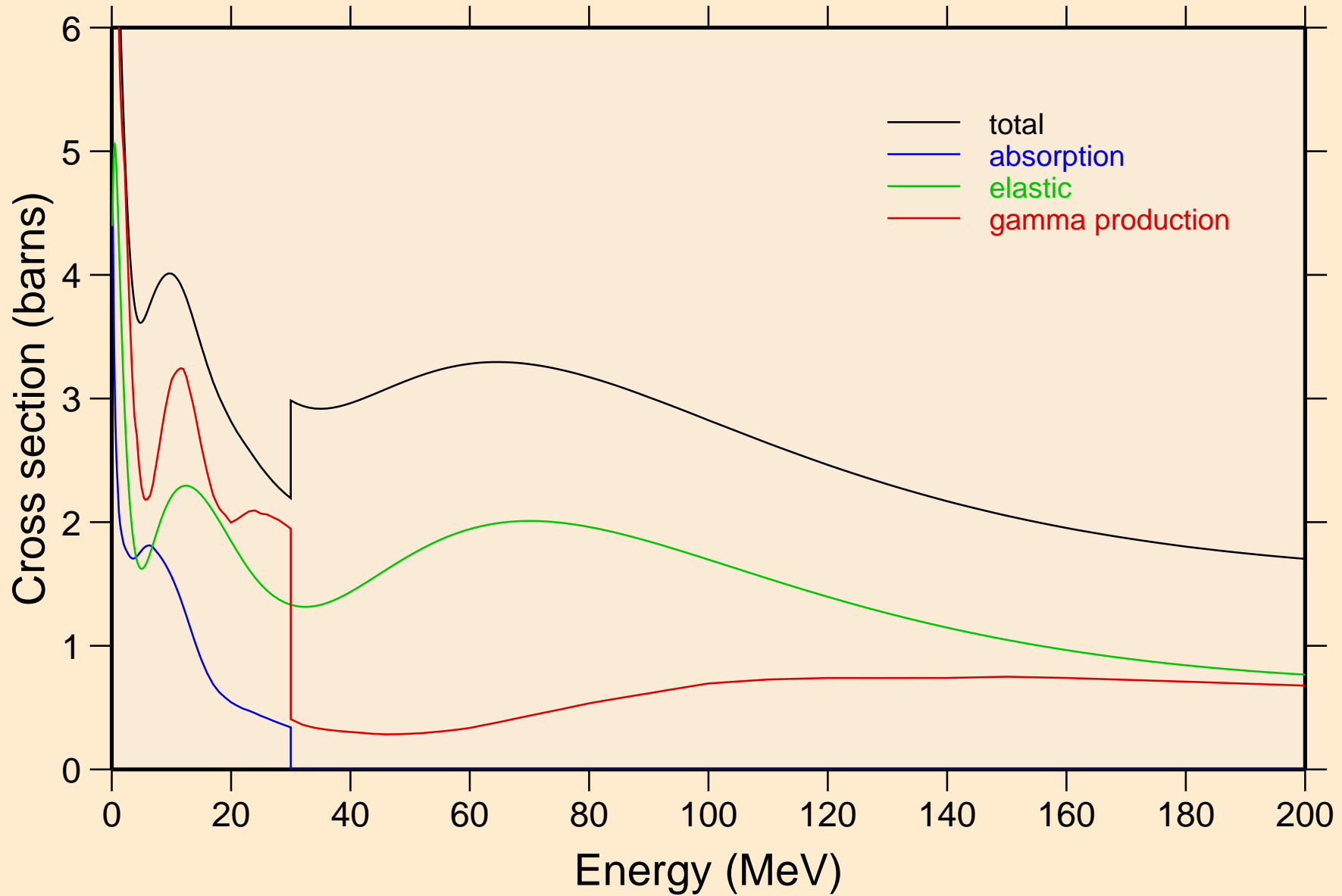

CD096 NEUTRON ACER TENDL-2024 LIBRARY; T=293.6K
Heating

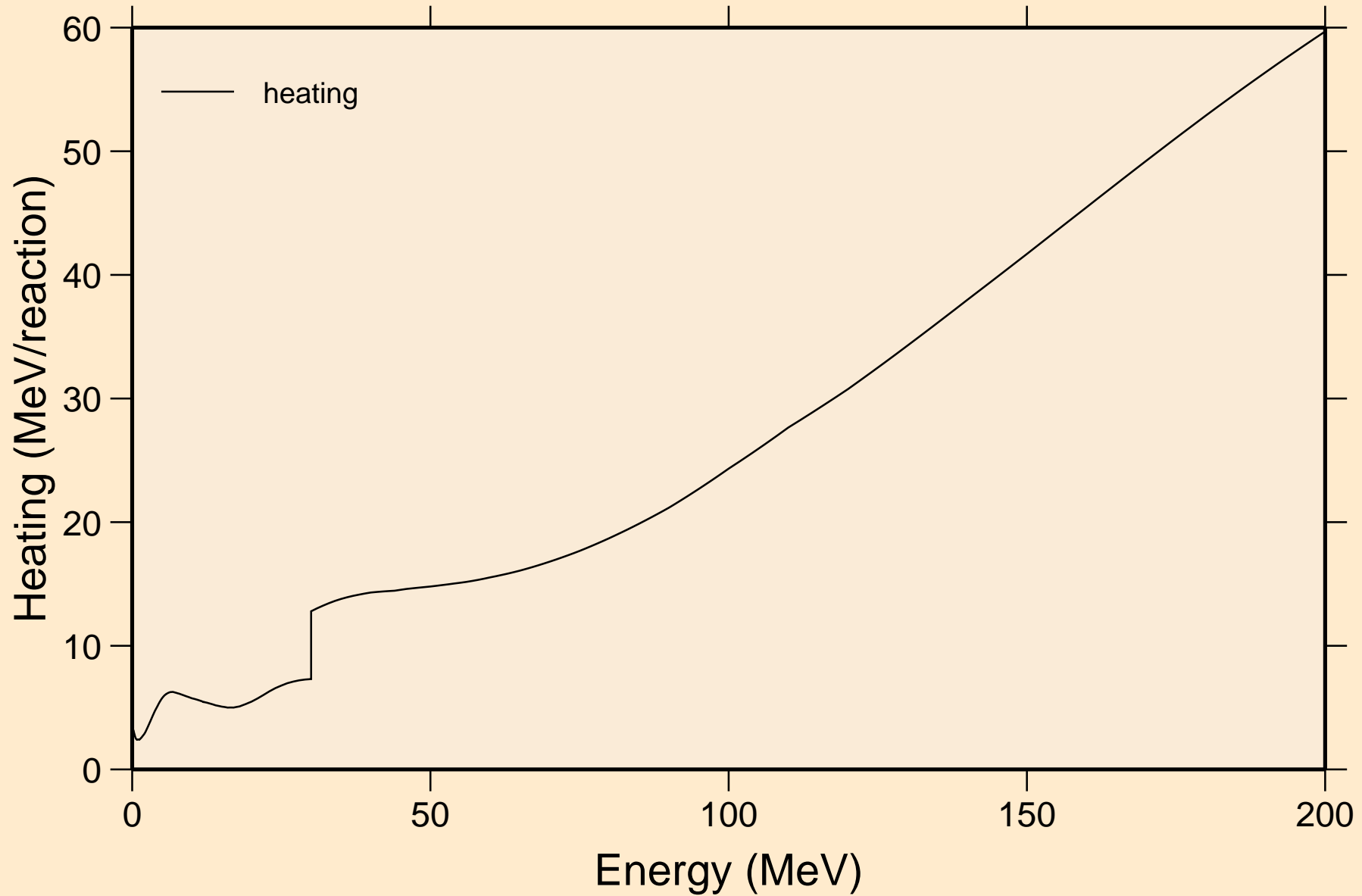

CD096 NEUTRON ACER TENDL-2024 LIBRARY; T=293.6K

Damage

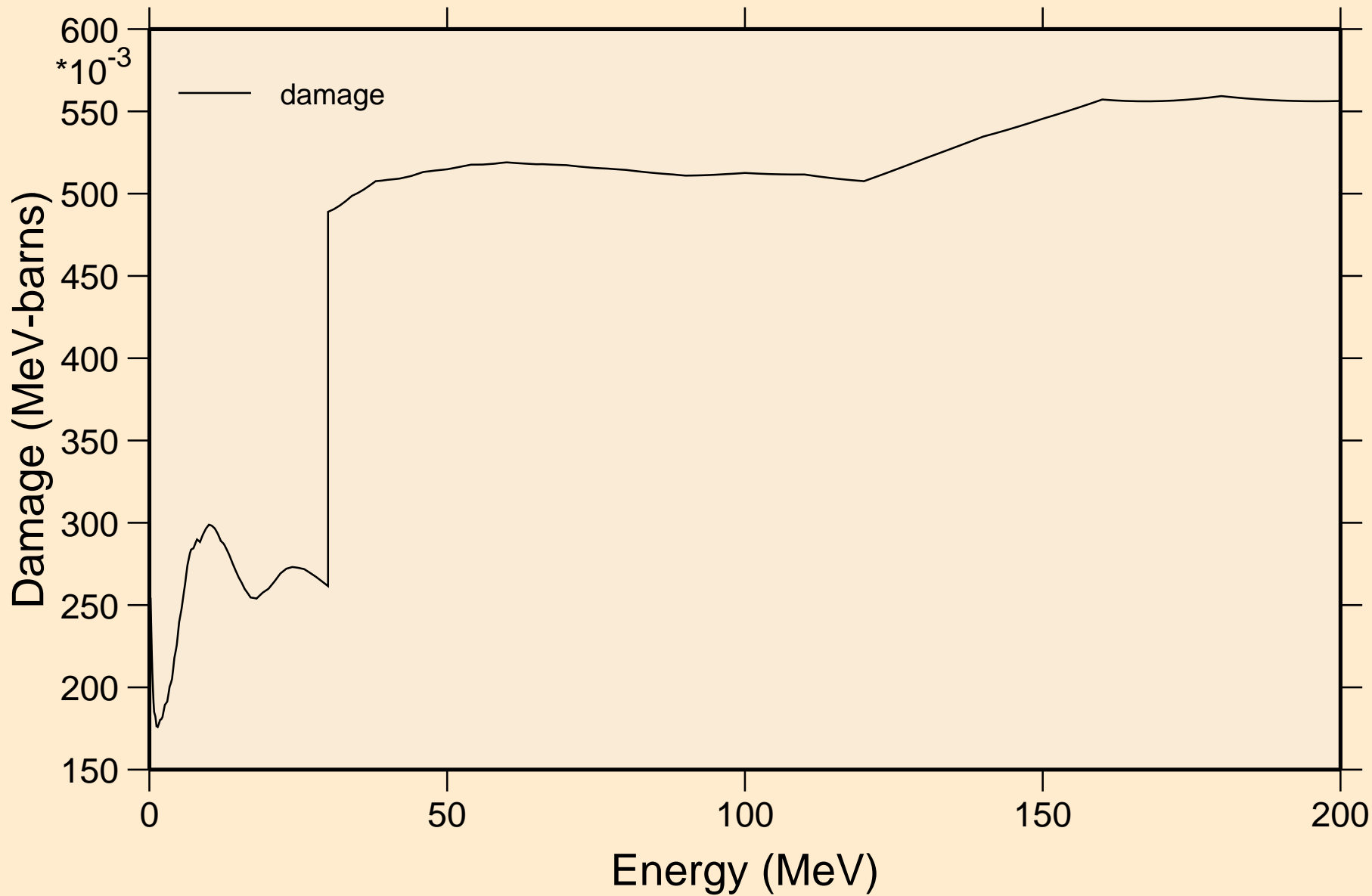

CD096 NEUTRON ACER TENDL-2024 LIBRARY; T=293.6K
Non-threshold reactions

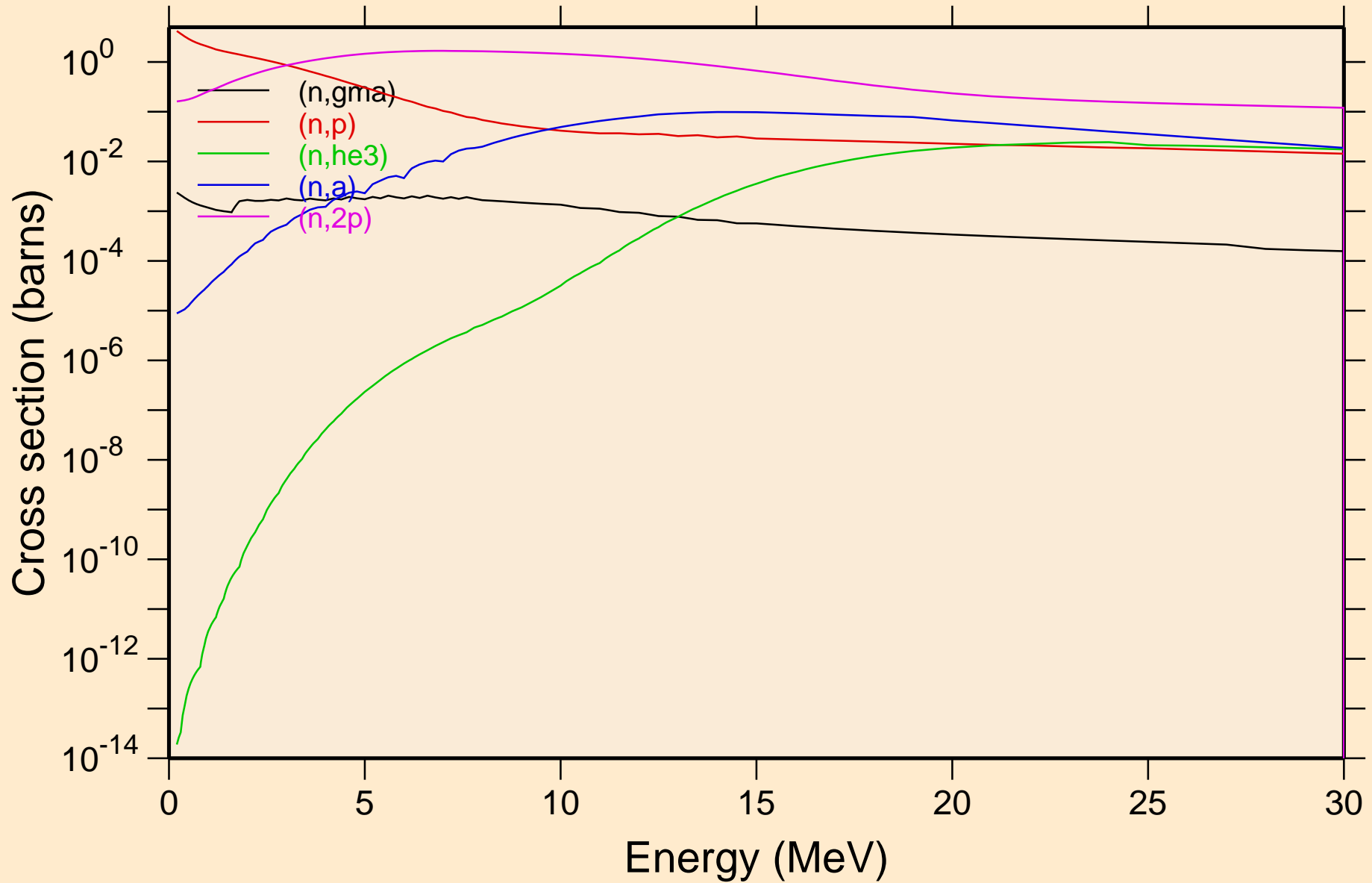

CD096 NEUTRON ACER TENDL-2024 LIBRARY; T=293.6K
Non-threshold reactions

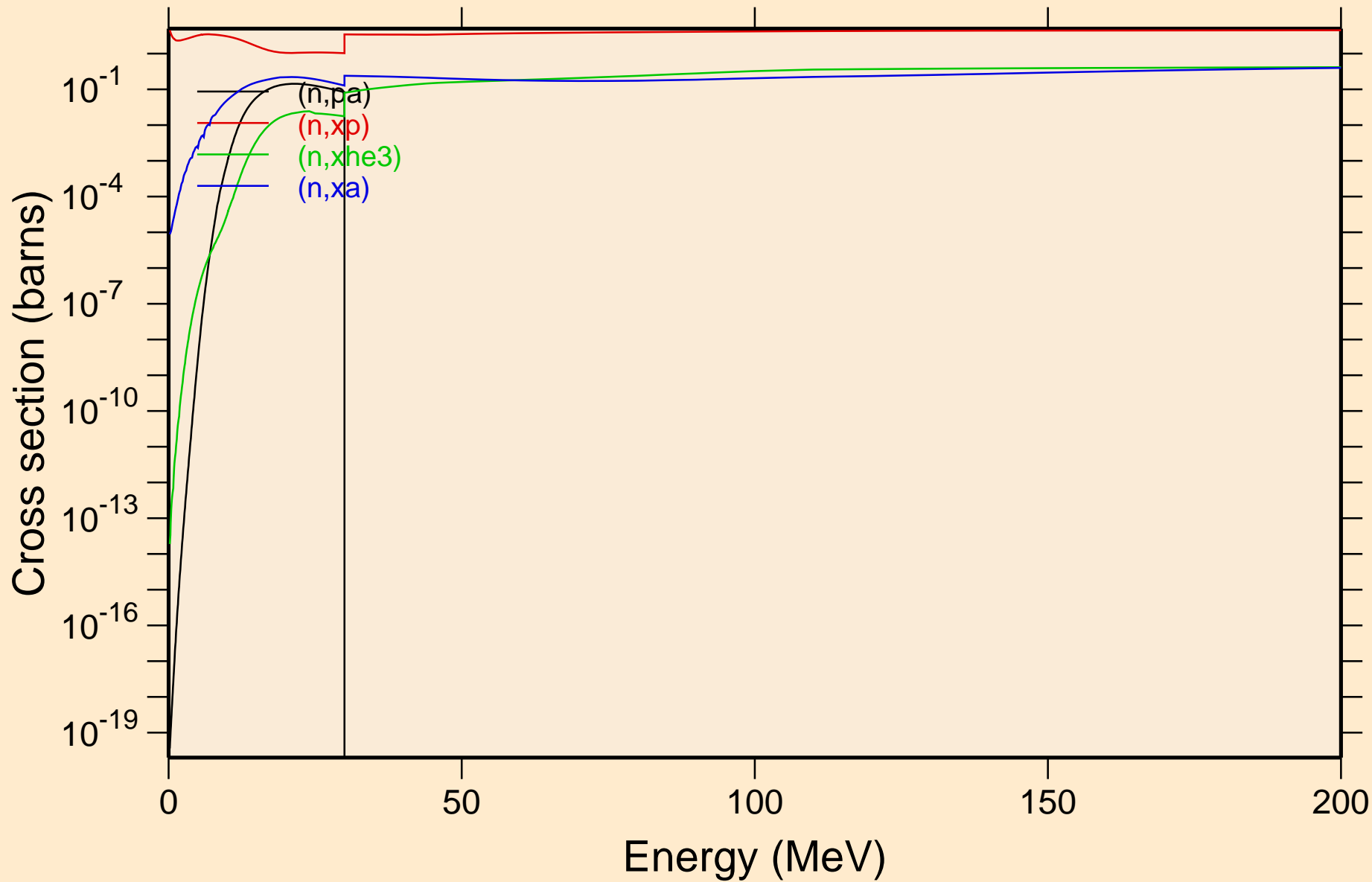

CD096 NEUTRON ACER TENDL-2024 LIBRARY; T=293.6K
Inelastic levels

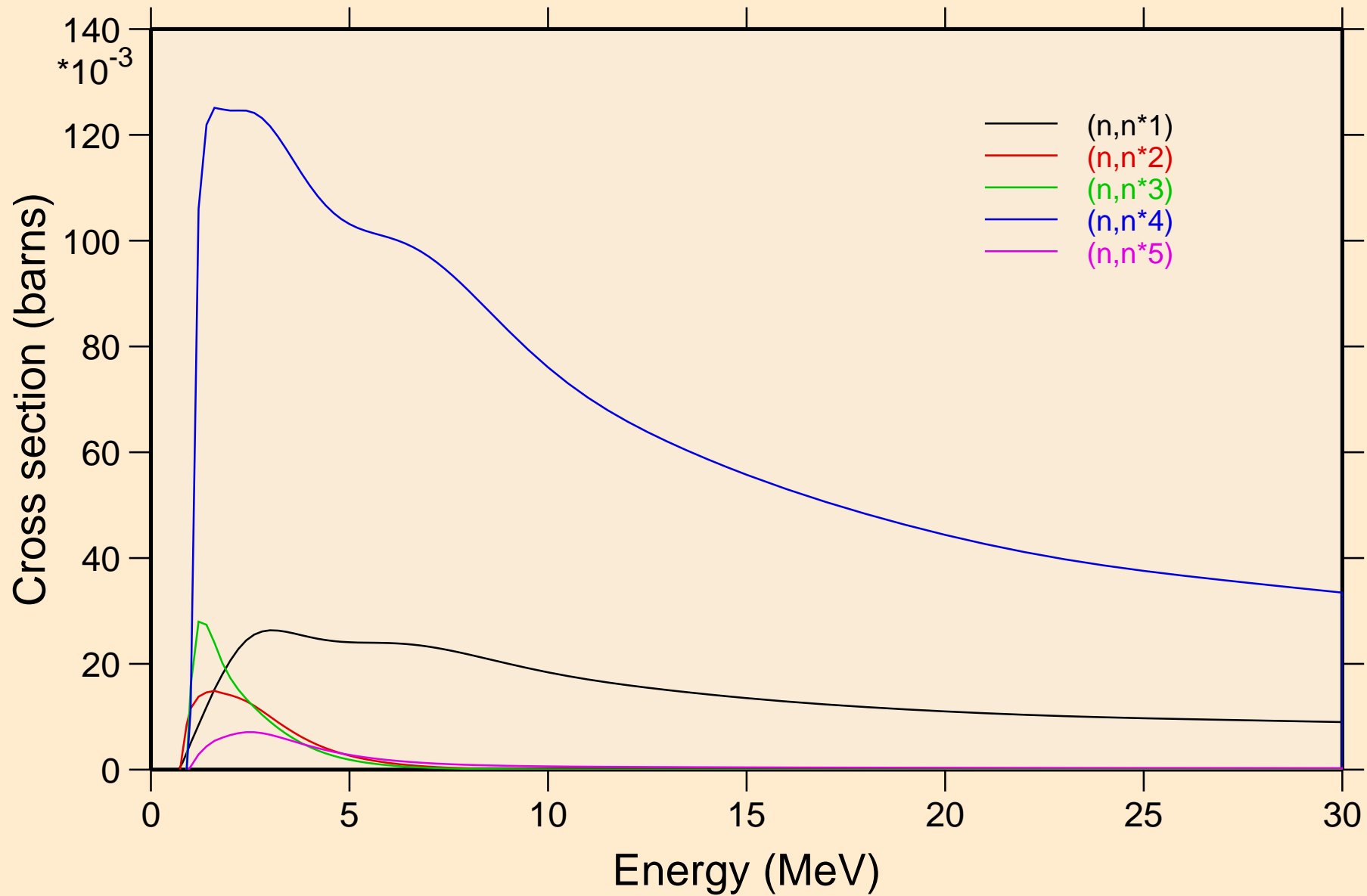

CD096 NEUTRON ACER TENDL-2024 LIBRARY; T=293.6K
Inelastic levels

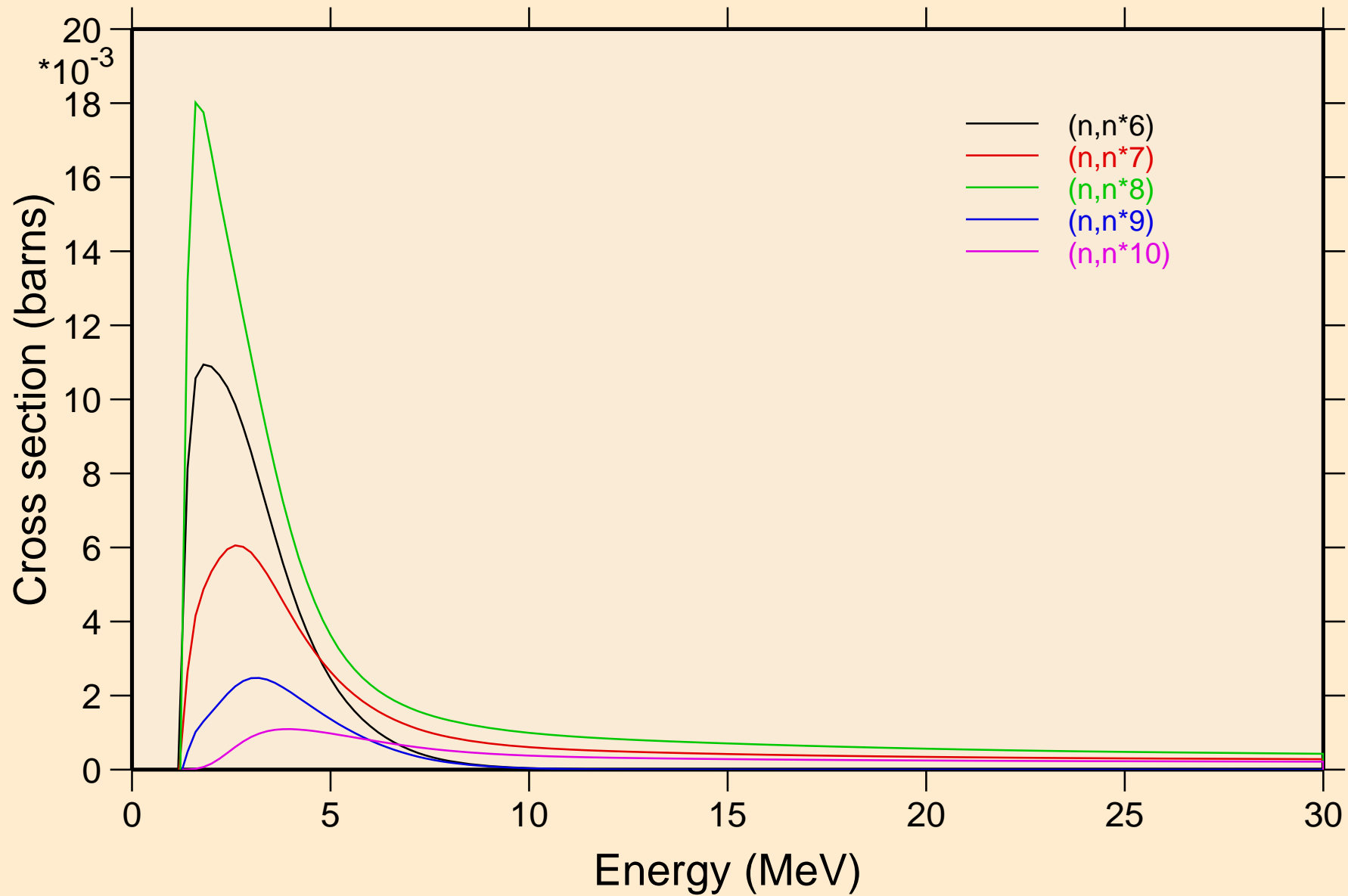

CD096 NEUTRON ACER TENDL-2024 LIBRARY; T=293.6K
Inelastic levels

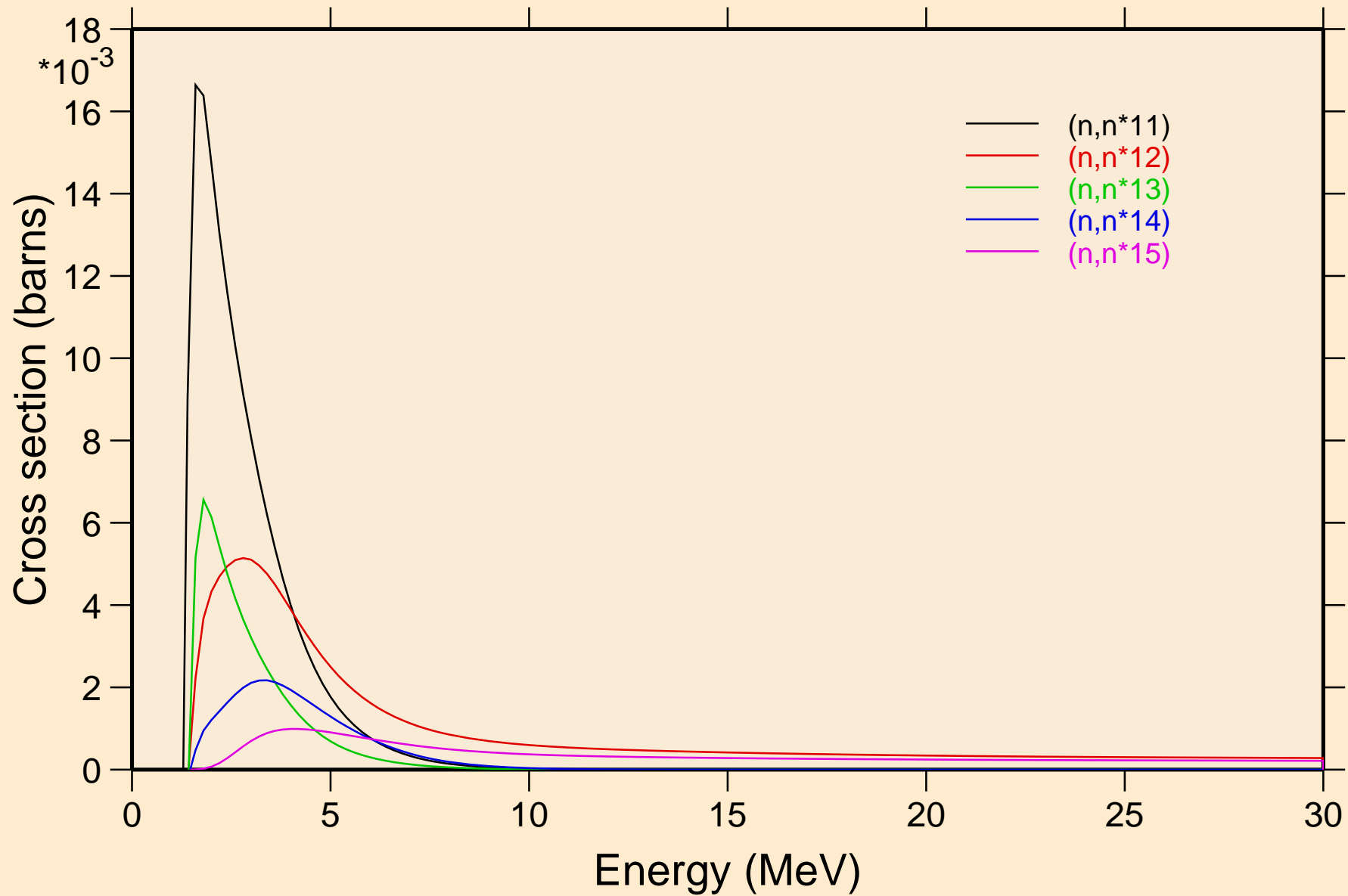

CD096 NEUTRON ACER TENDL-2024 LIBRARY; T=293.6K
Inelastic levels

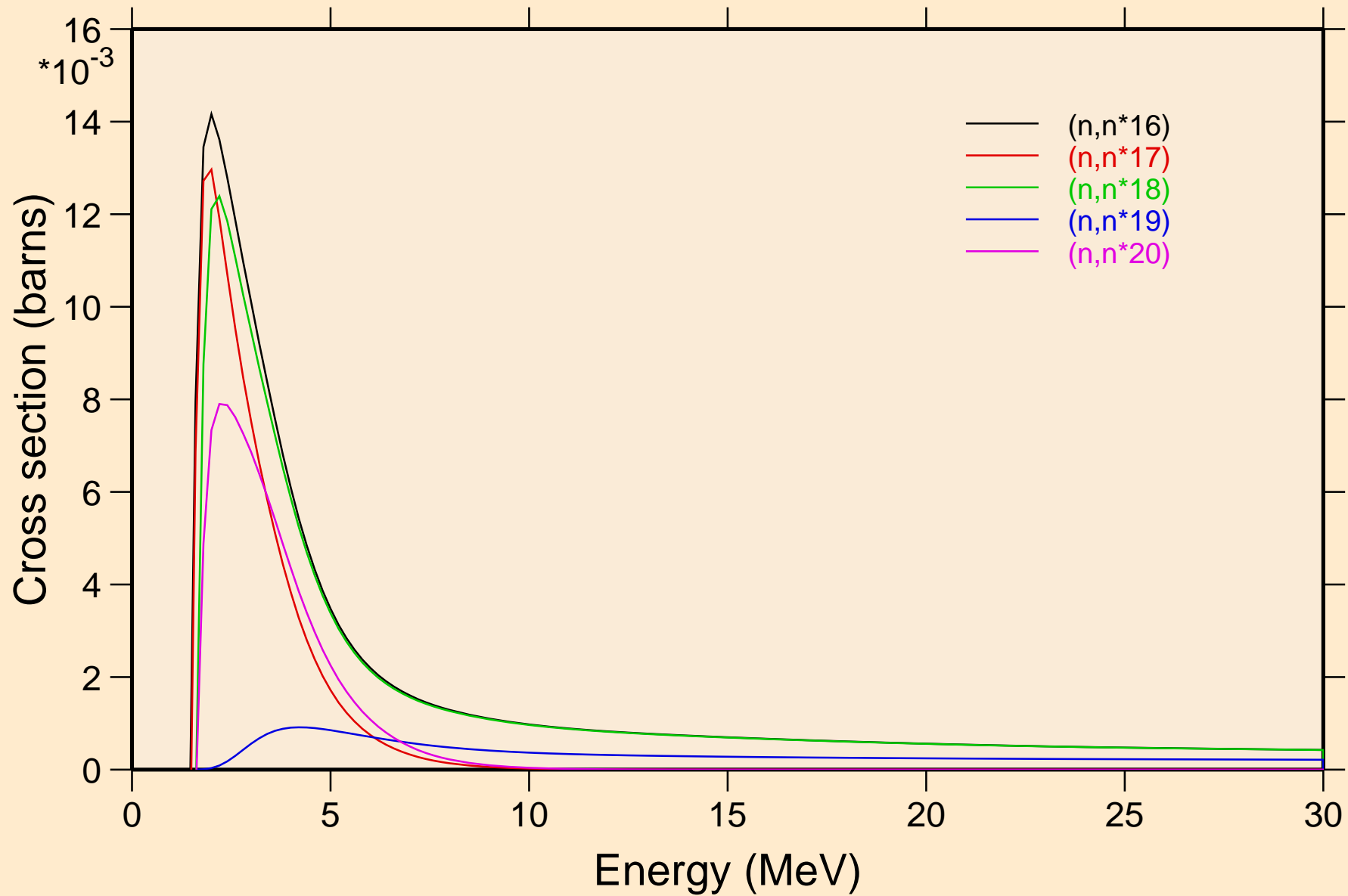

CD096 NEUTRON ACER TENDL-2024 LIBRARY; T=293.6K
Inelastic levels

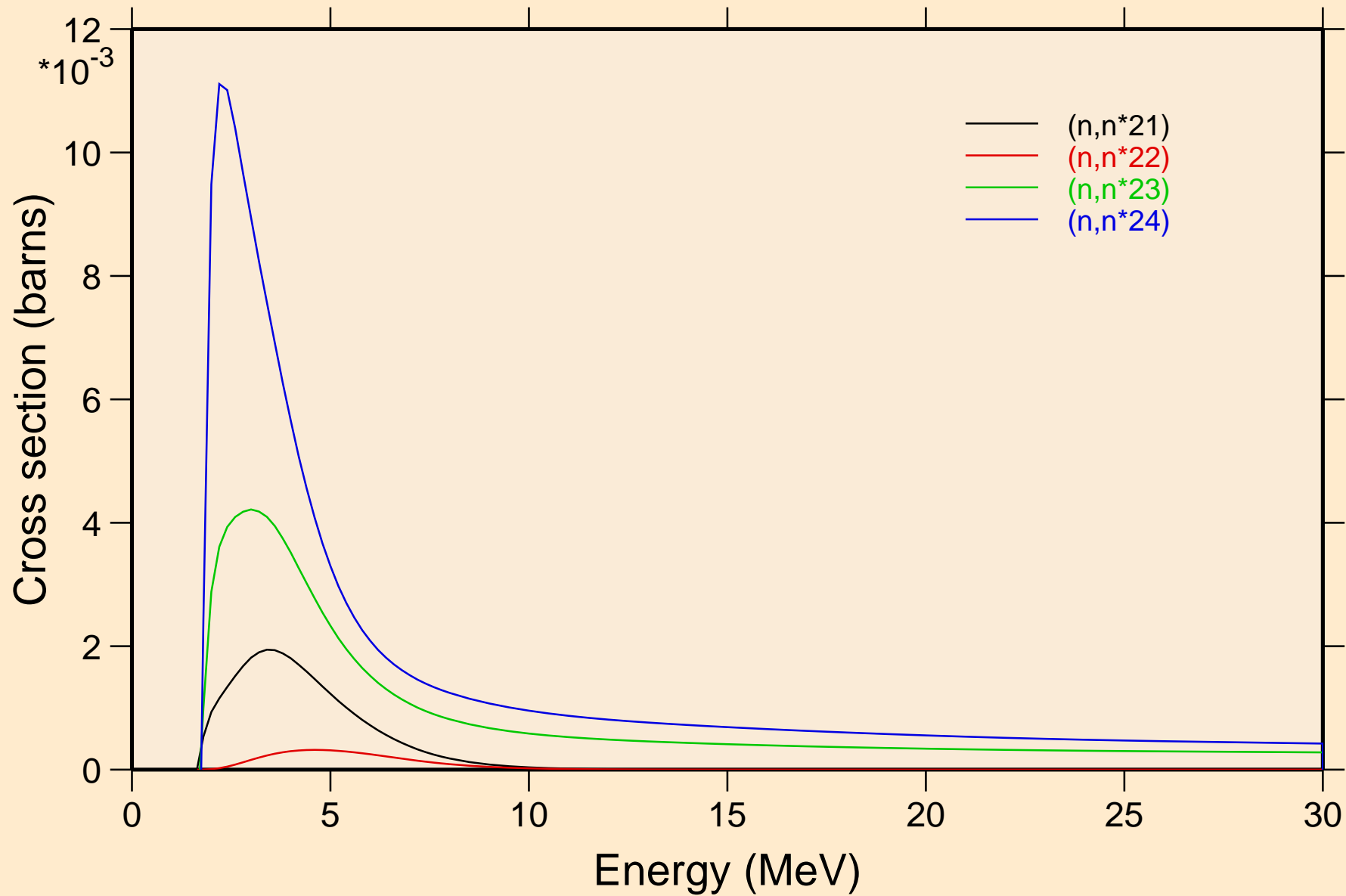

CD096 NEUTRON ACER TENDL-2024 LIBRARY; T=293.6K

Threshold reactions

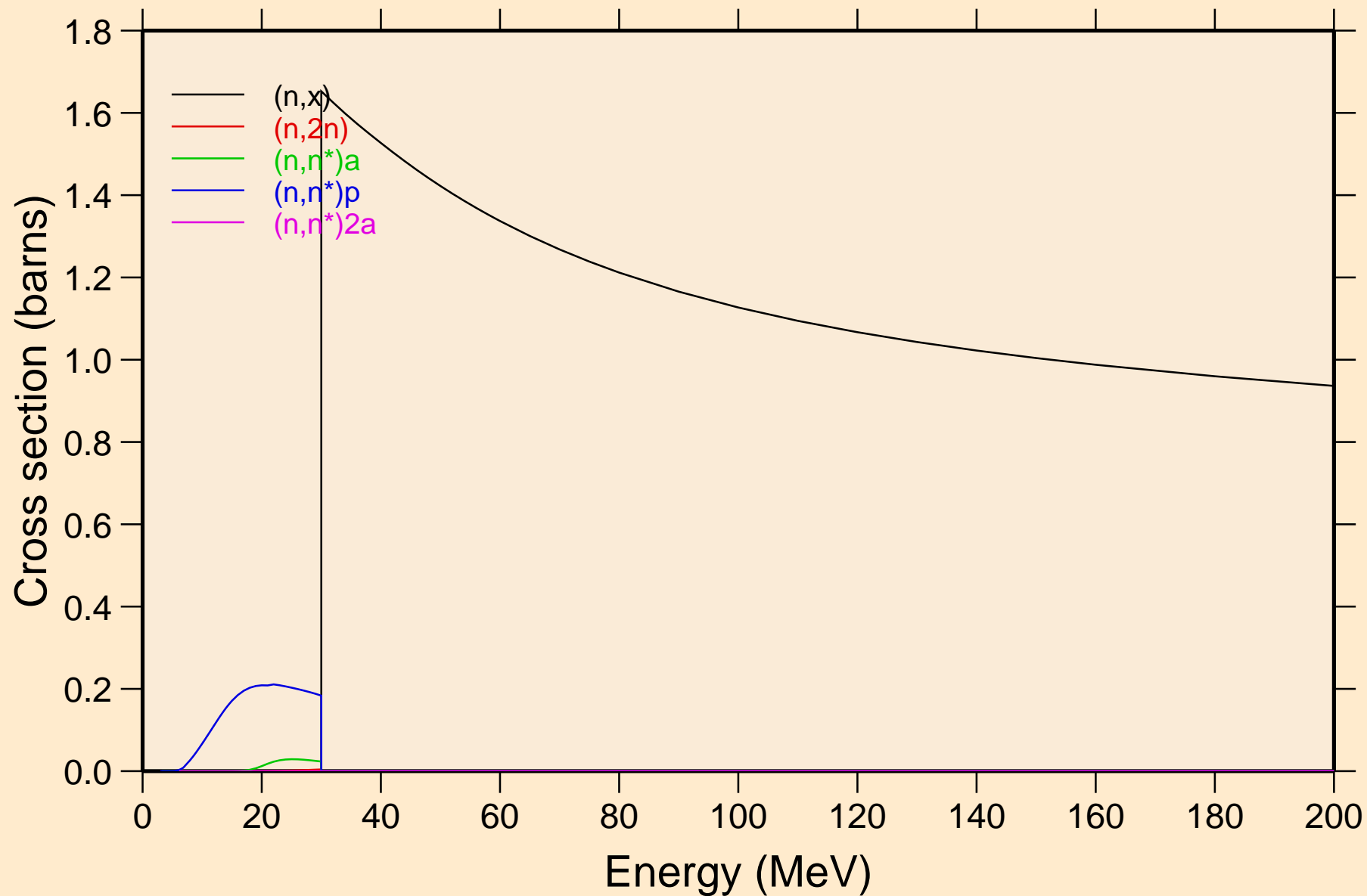

CD096 NEUTRON ACER TENDL-2024 LIBRARY; T=293.6K
Threshold reactions

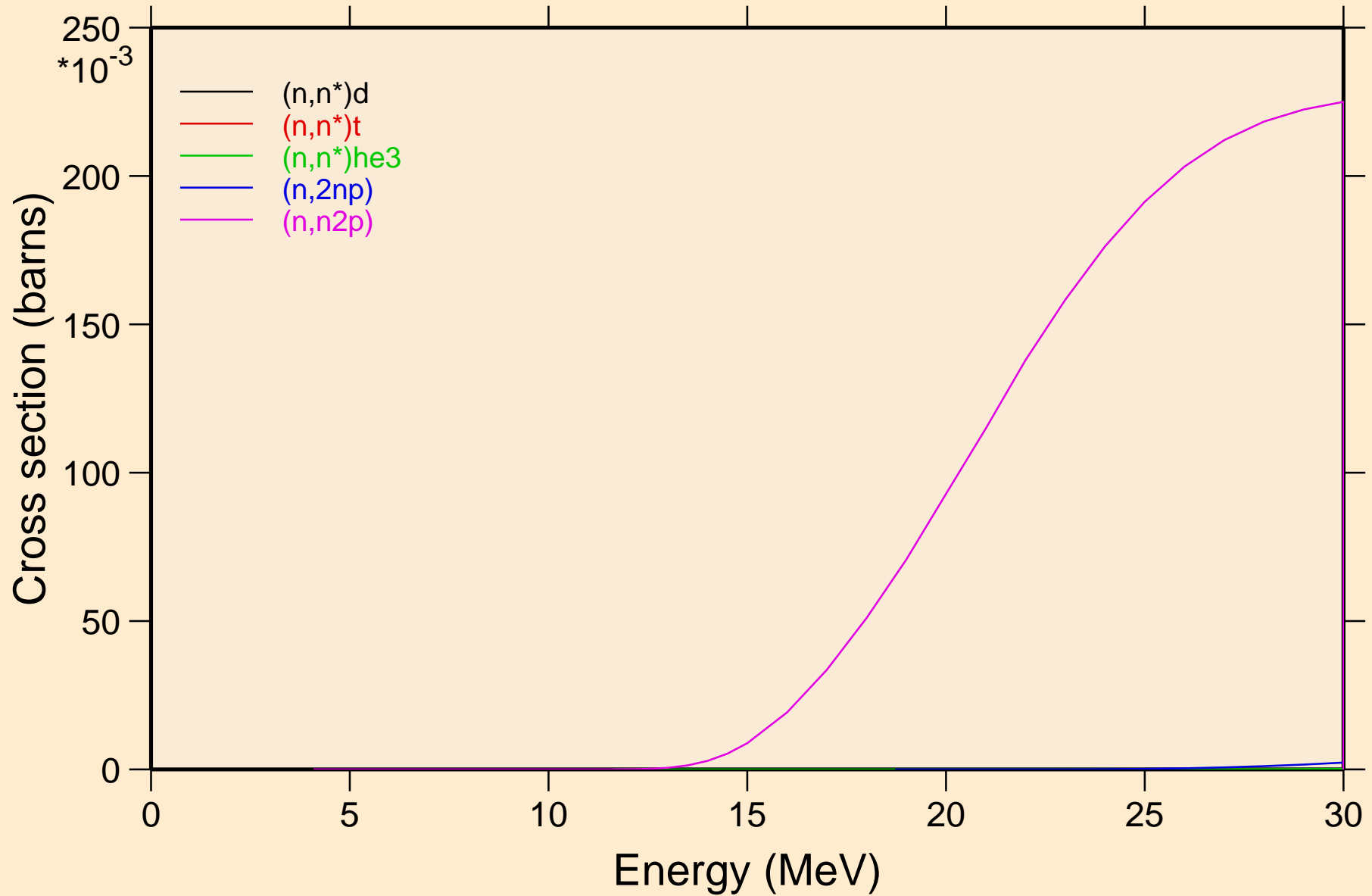

CD096 NEUTRON ACER TENDL-2024 LIBRARY; T=293.6K

Threshold reactions

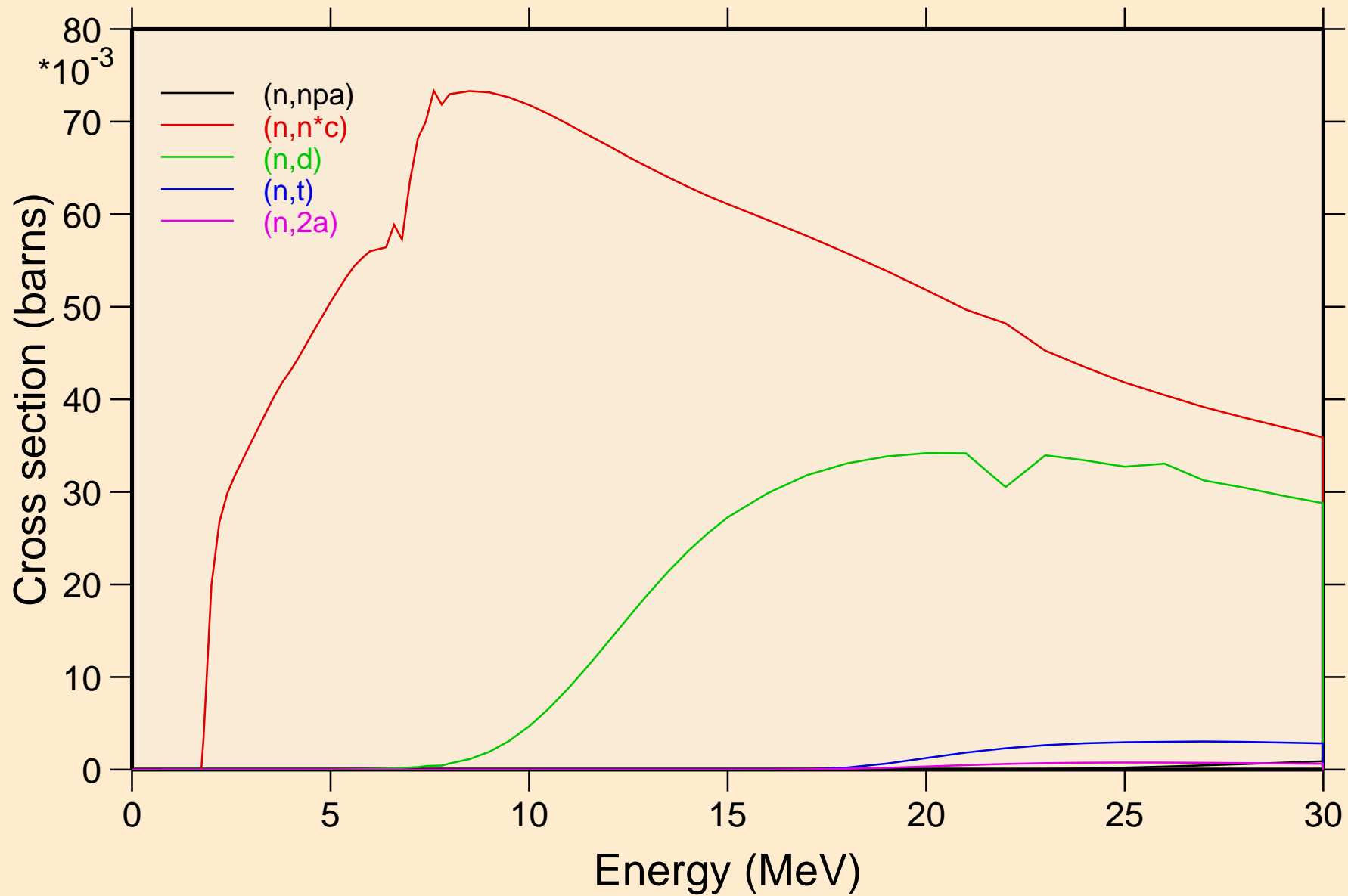

CD096 NEUTRON ACER TENDL-2024 LIBRARY; T=293.6K
Threshold reactions

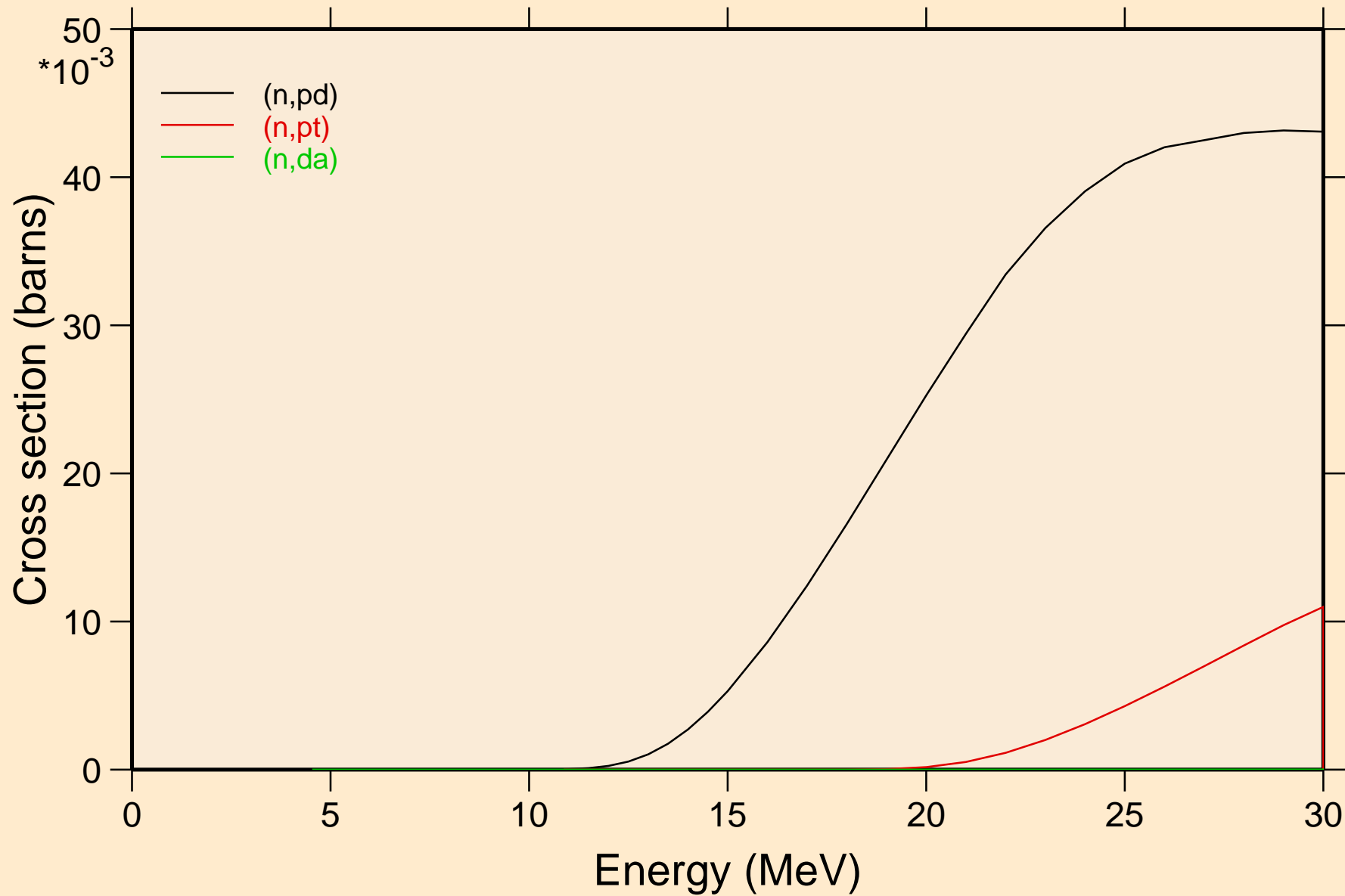

CD096 NEUTRON ACER TENDL-2024 LIBRARY; T=293.6K

Threshold reactions

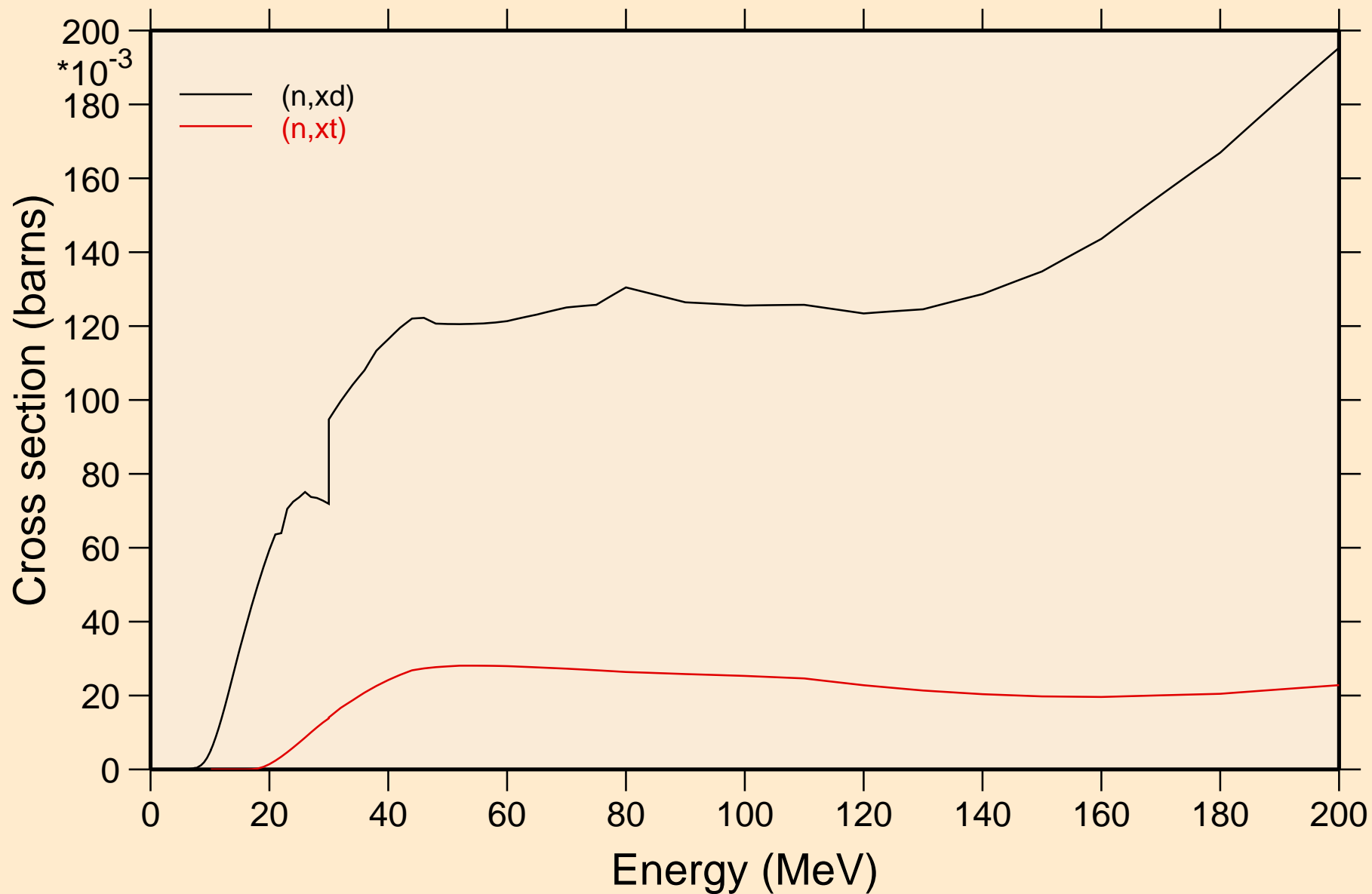

CD096 NEUTRON ACER TENDL-2024 LIBRARY; T=293.6K
angular distribution for elastic

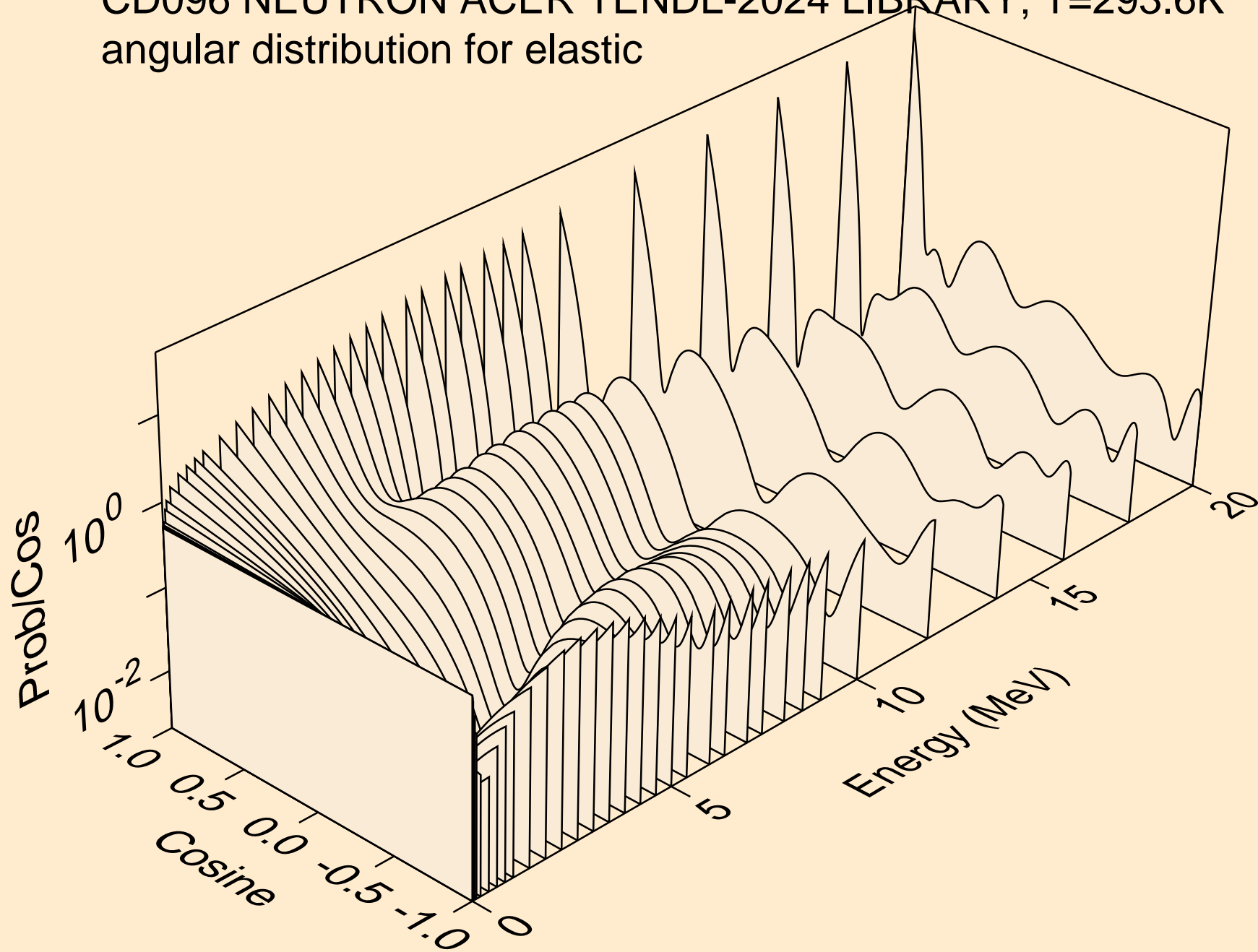

CD096 NEUTRON ACER TENDL-2024 LIBRARY; T=293.6K
angular distribution for elastic

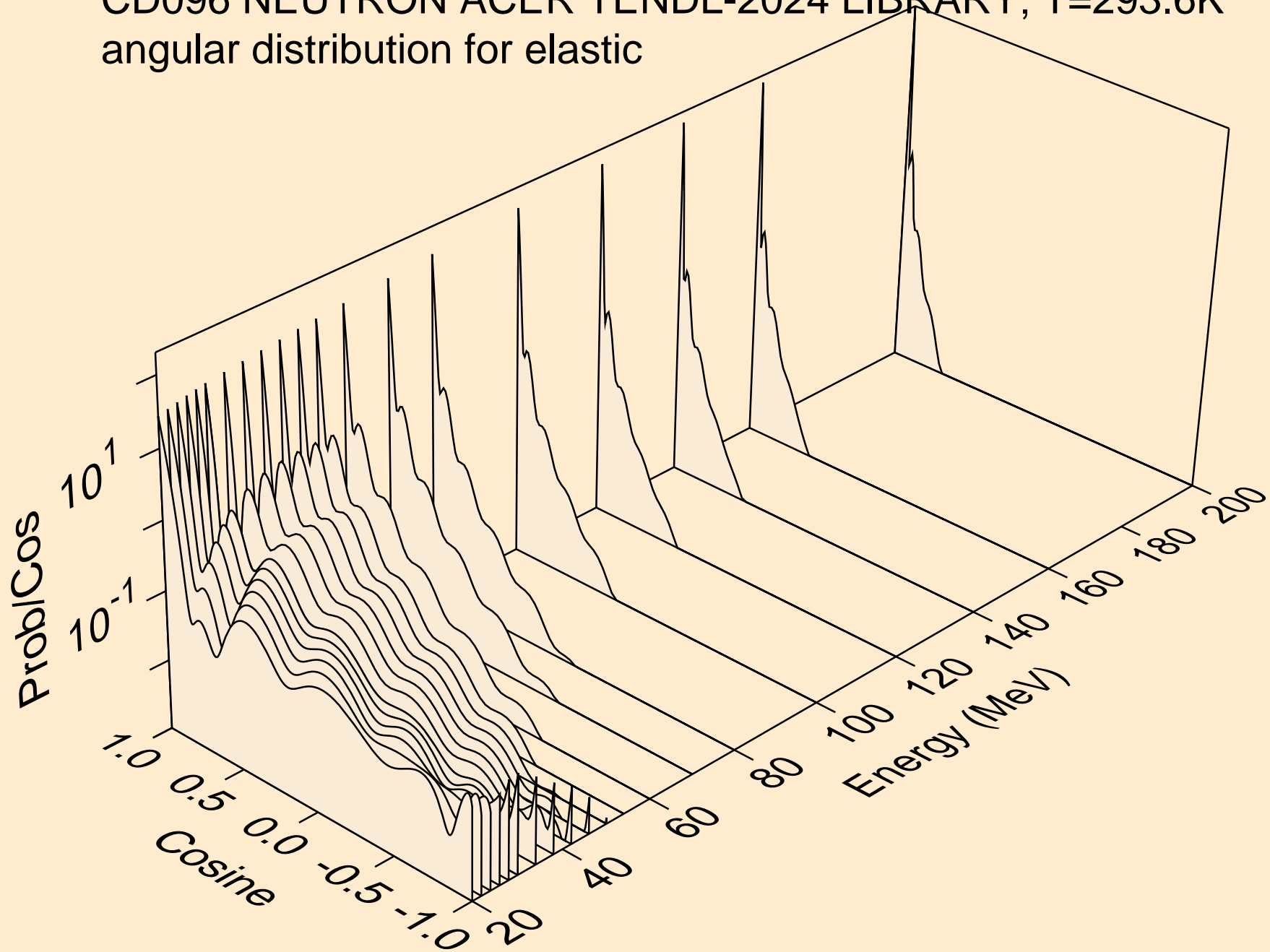

CD096 NEUTRON ACER TENDL-2024 LIBRARY; T=293.6K
angular distribution for (n,n*1)

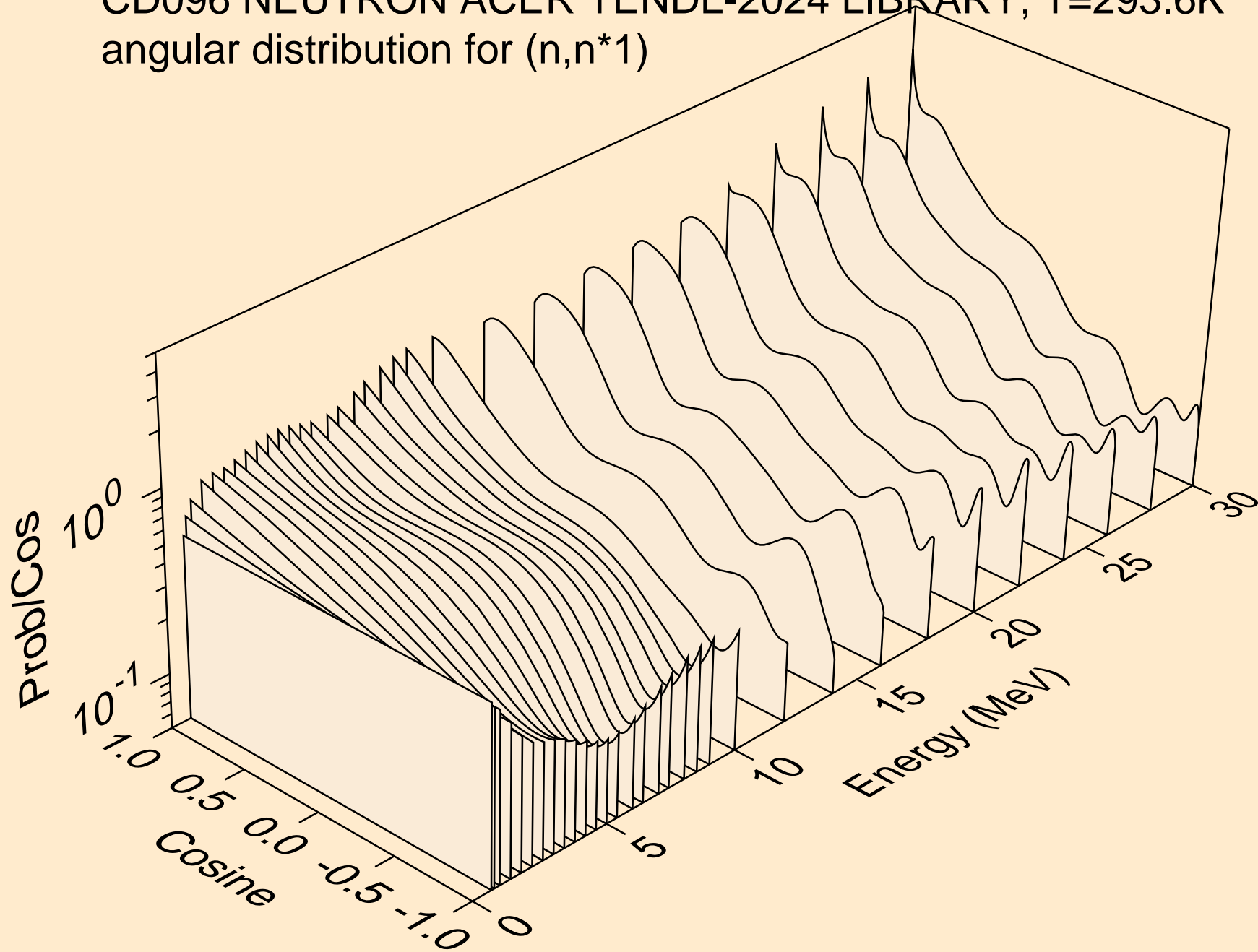

CD096 NEUTRON ACER TENDL-2024 LIBRARY; T=293.6K
angular distribution for (n,n*2)

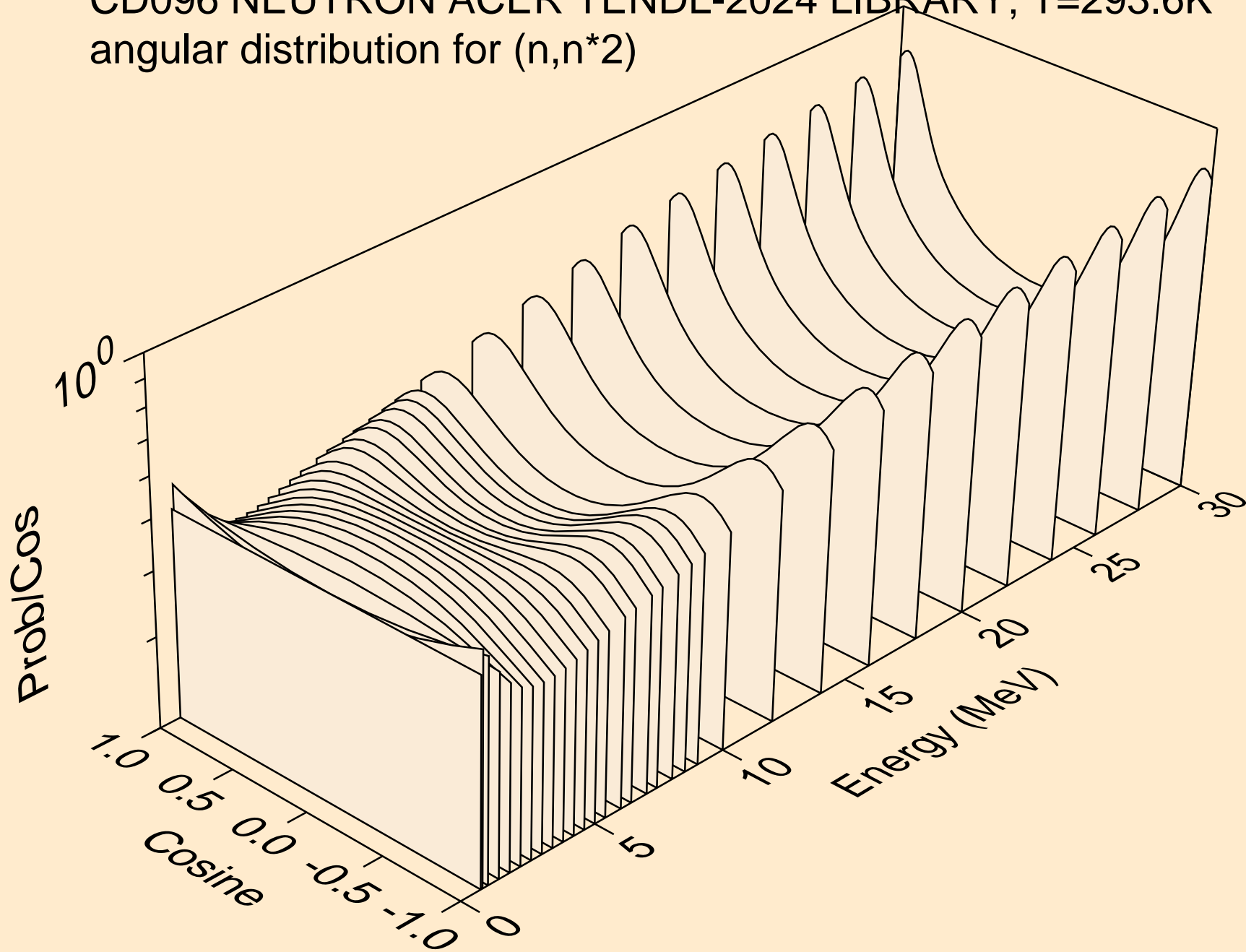

CD096 NEUTRON ACER TENDL-2024 LIBRARY; T=293.6K
angular distribution for (n,n*3)

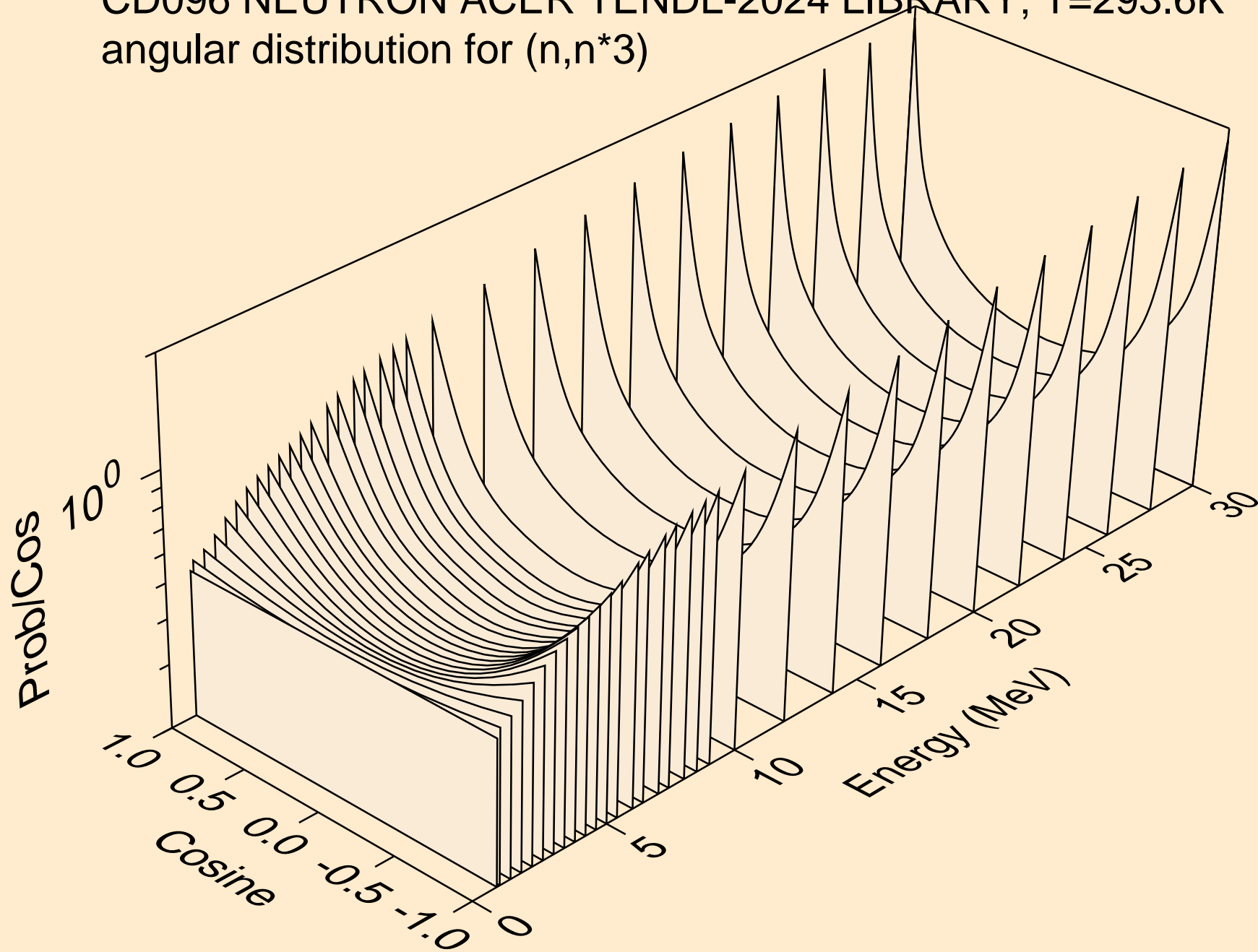

CD096 NEUTRON ACER TENDL-2024 LIBRARY; T=293.6K
angular distribution for (n,n*4)

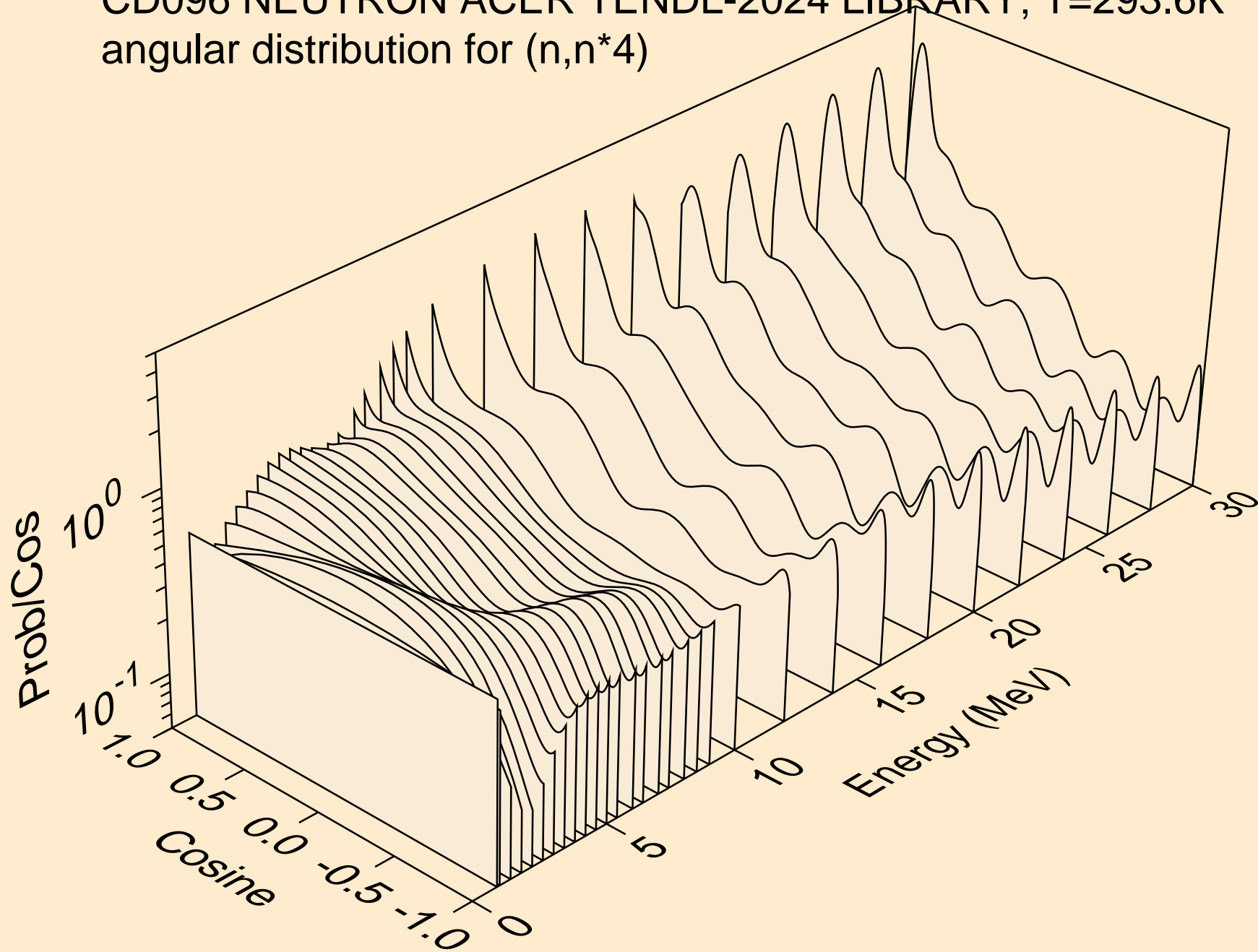

CD096 NEUTRON ACER TENDL-2024 LIBRARY; T=293.6K
angular distribution for (n,n*5)

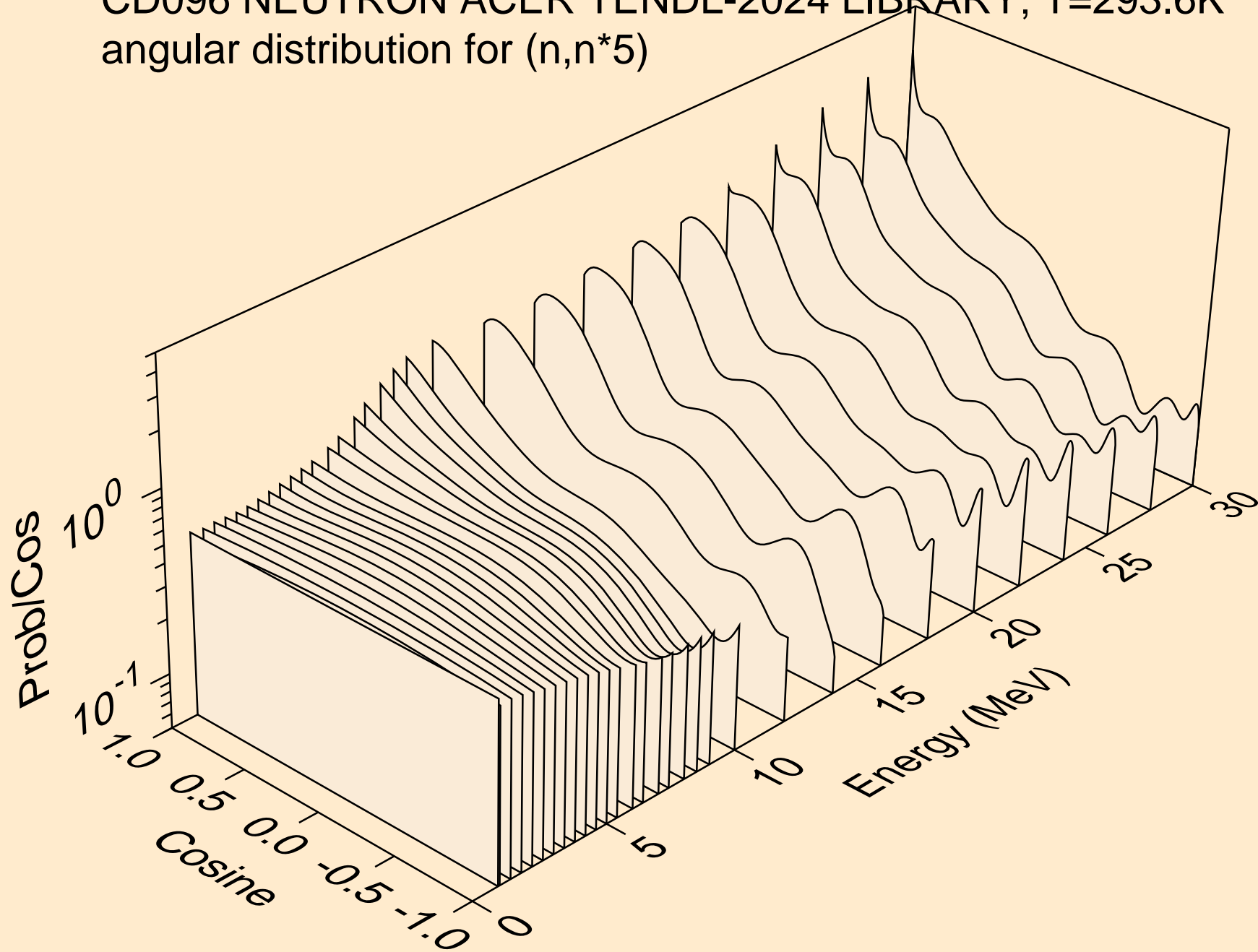

CD096 NEUTRON ACER TENDL-2024 LIBRARY; T=293.6K
angular distribution for (n,n*6)

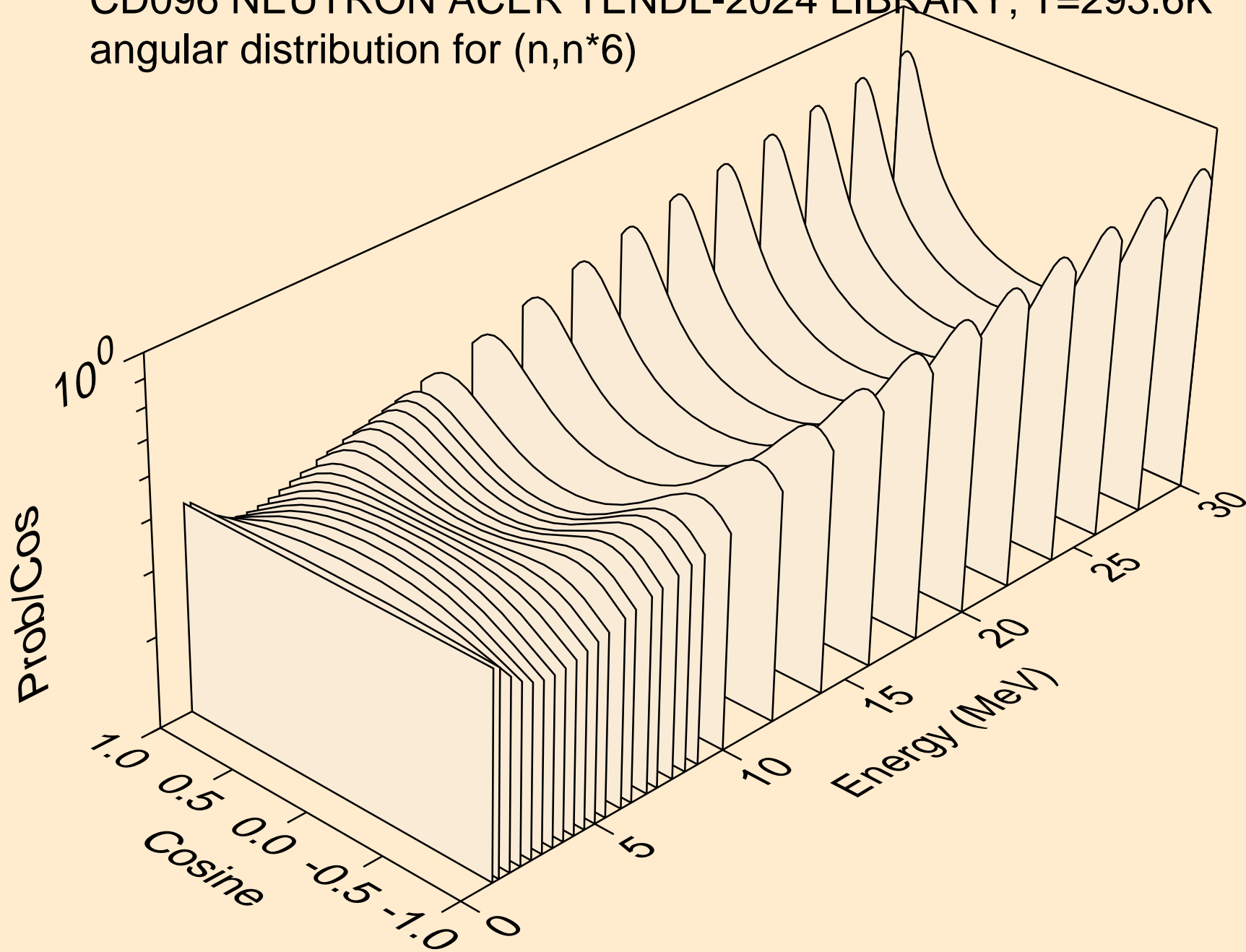

CD096 NEUTRON ACER TENDL-2024 LIBRARY; T=293.6K
angular distribution for (n,n*7)

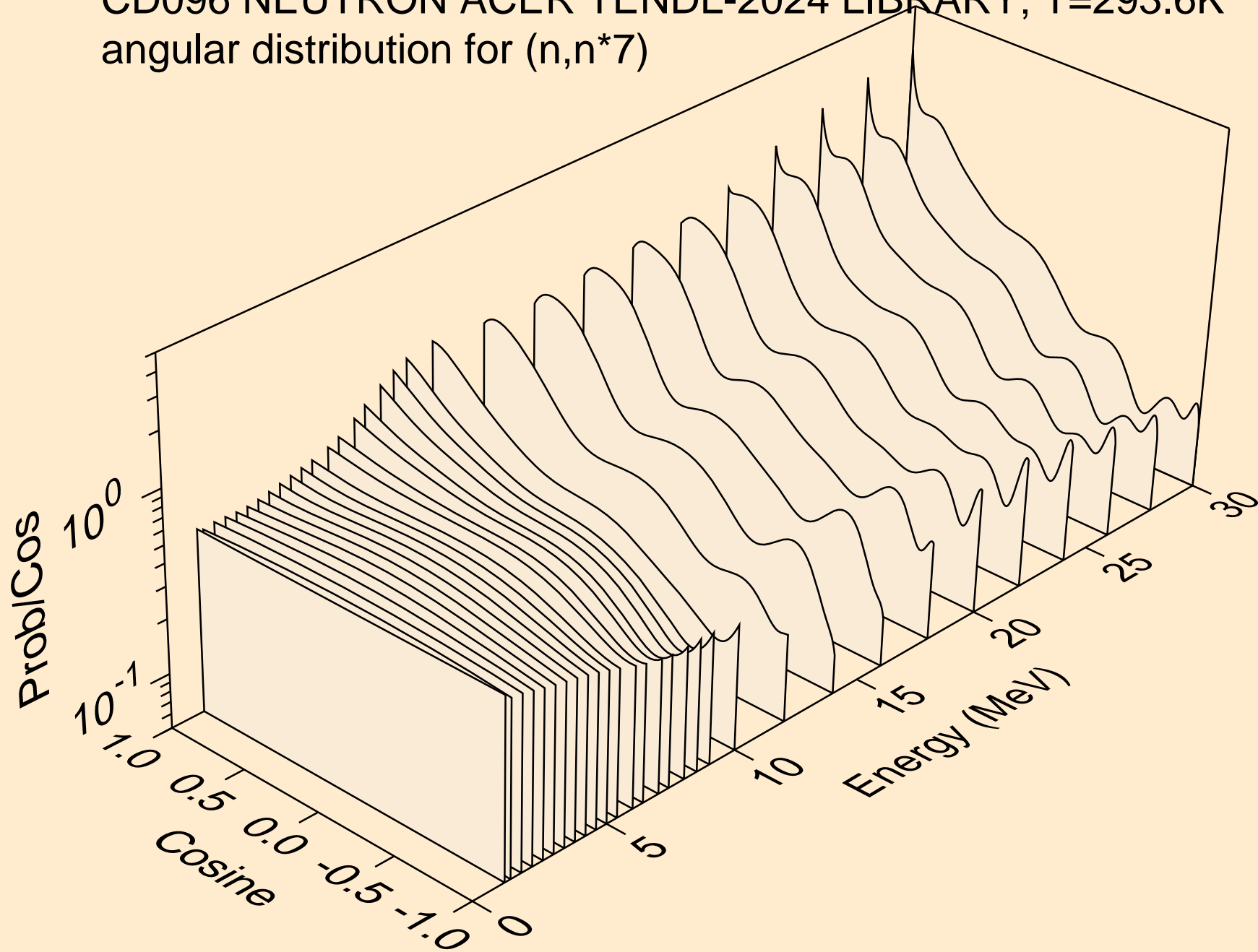

CD096 NEUTRON ACER TENDL-2024 LIBRARY; T=293.6K
angular distribution for (n,n*8)

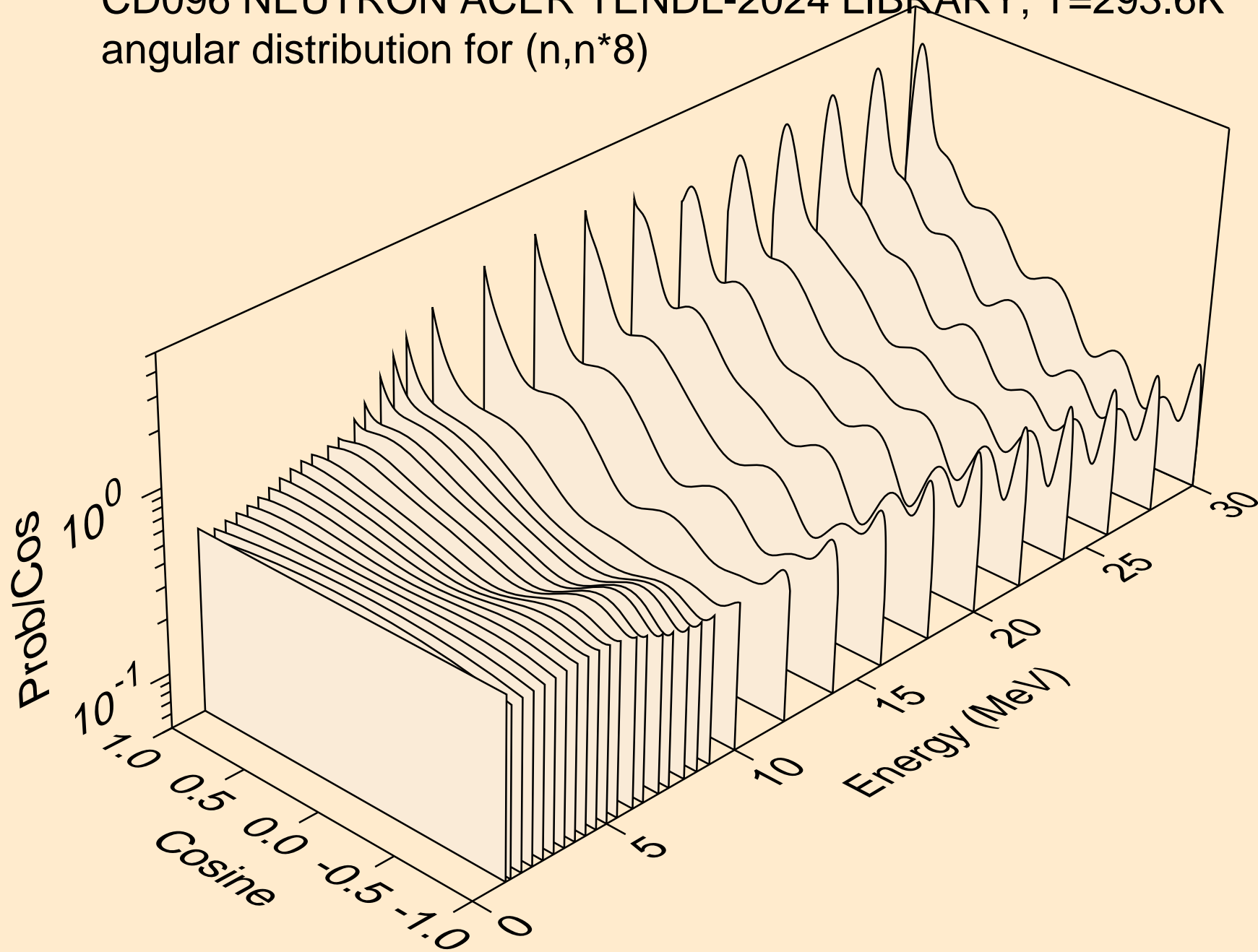

CD096 NEUTRON ACER TENDL-2024 LIBRARY; T=293.6K
angular distribution for (n,n*9)

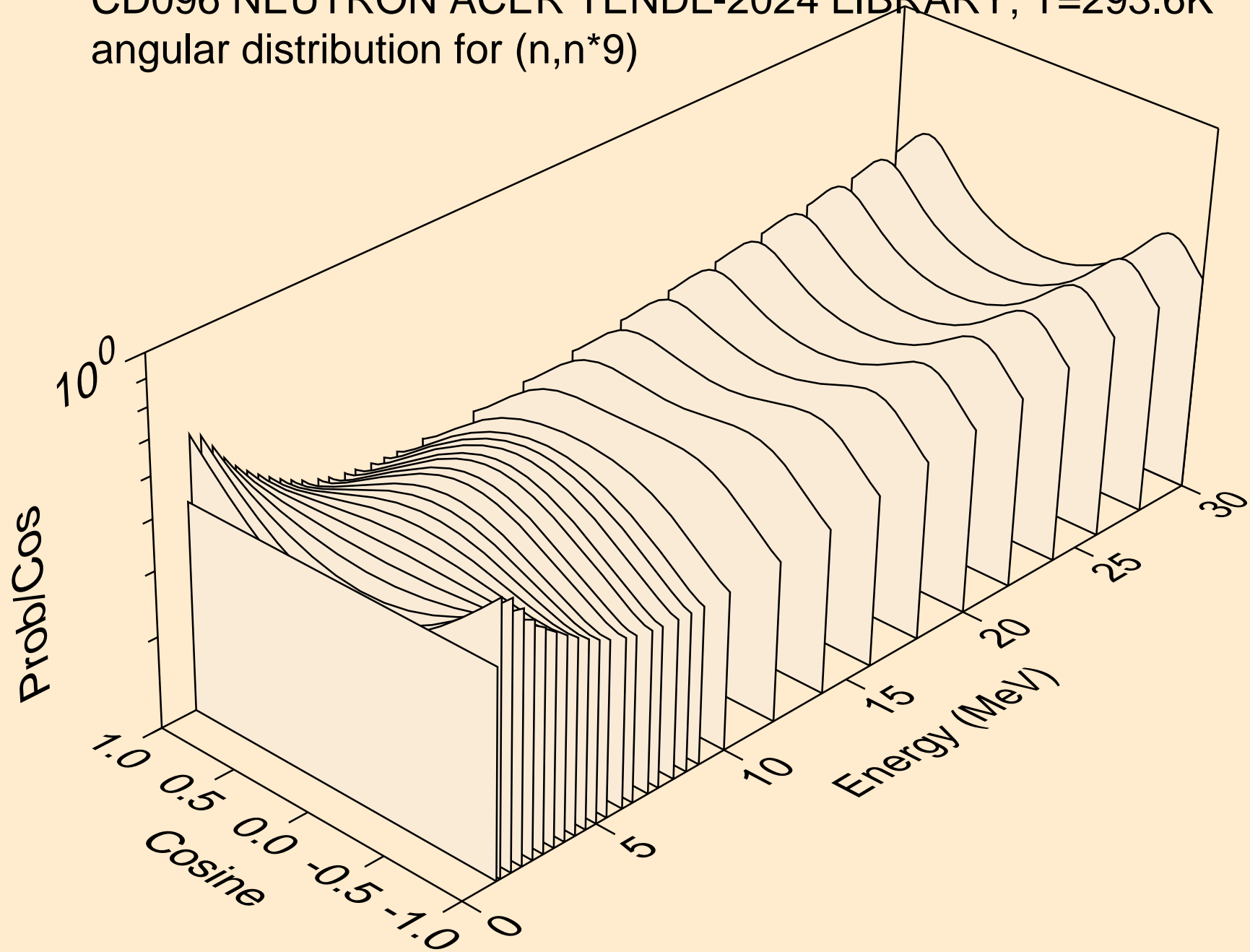

CD096 NEUTRON ACER TENDL-2024 LIBRARY; T=293.6K
angular distribution for (n,n*10)

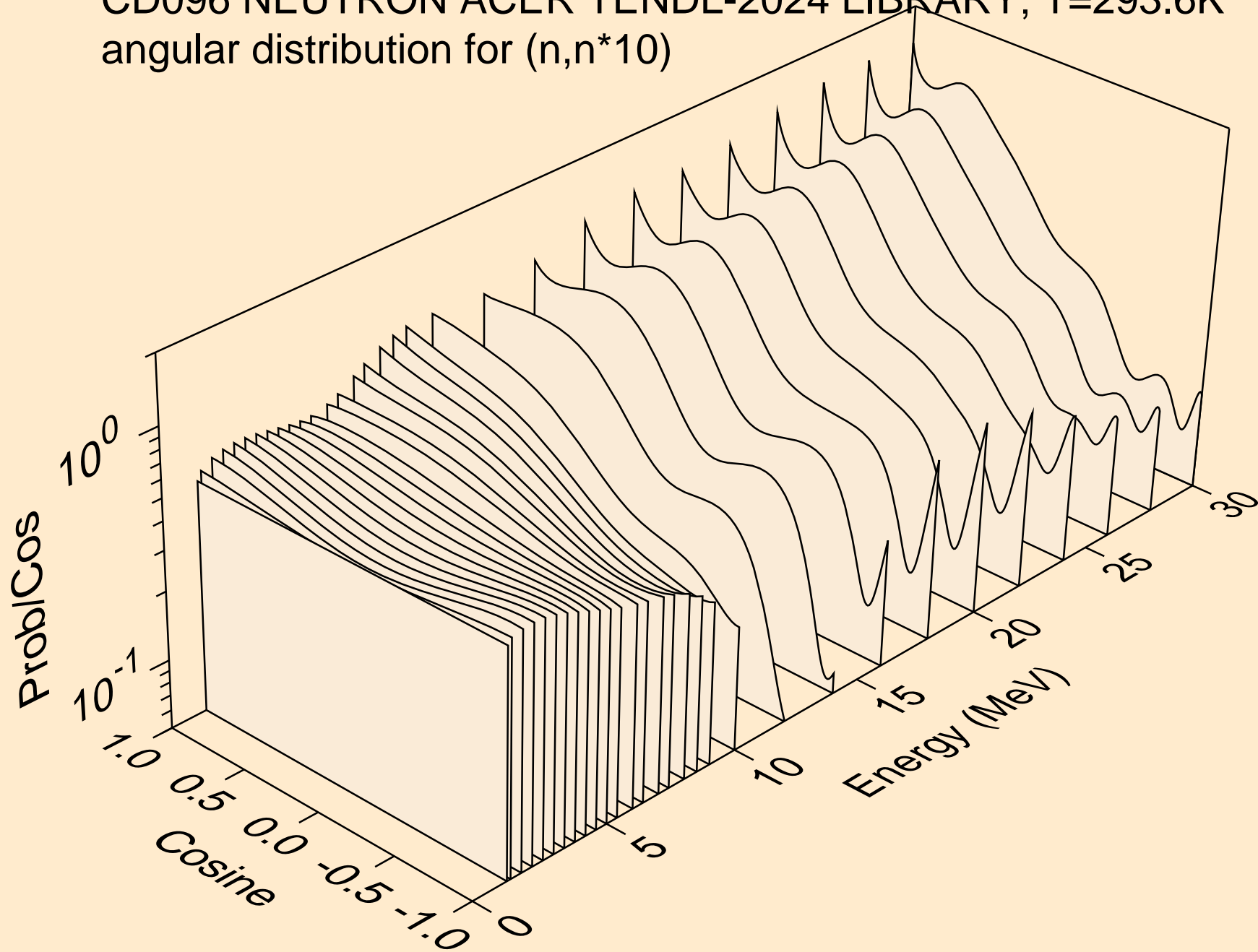

CD096 NEUTRON ACER TENDL-2024 LIBRARY; T=293.6K
angular distribution for (n,n*11)

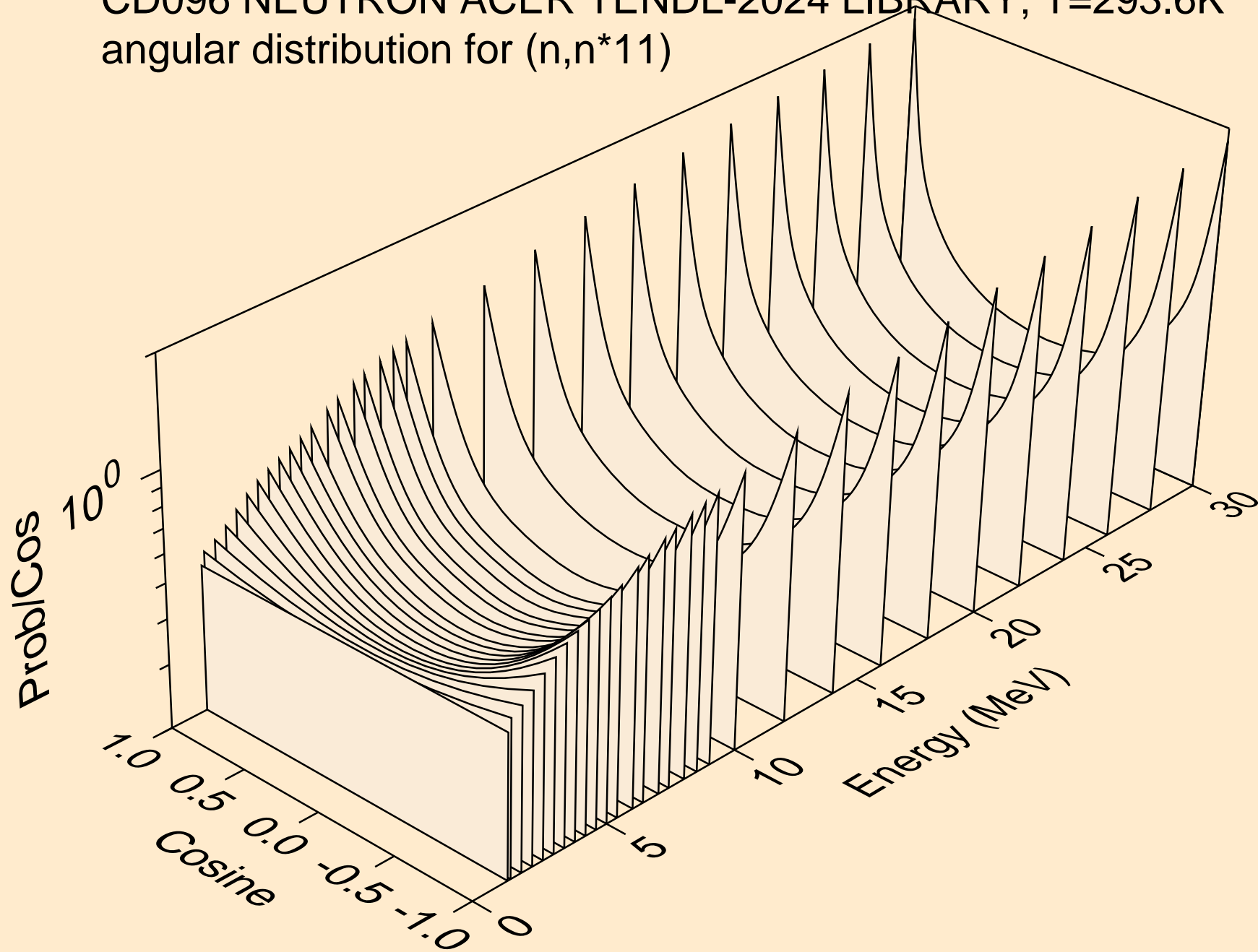

CD096 NEUTRON ACER TENDL-2024 LIBRARY; T=293.6K
angular distribution for (n,n*12)

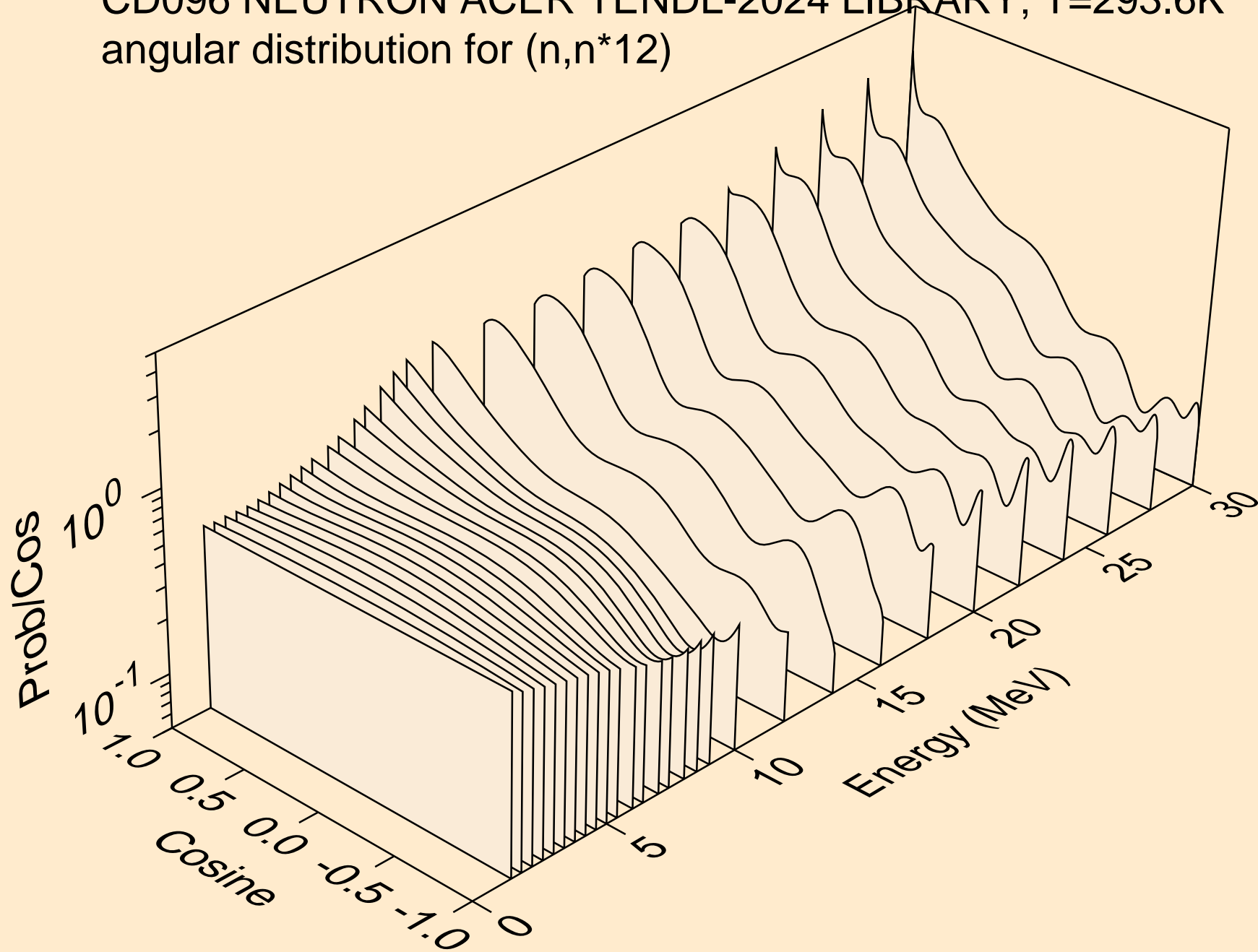

CD096 NEUTRON ACER TENDL-2024 LIBRARY; T=293.6K
angular distribution for (n,n*13)

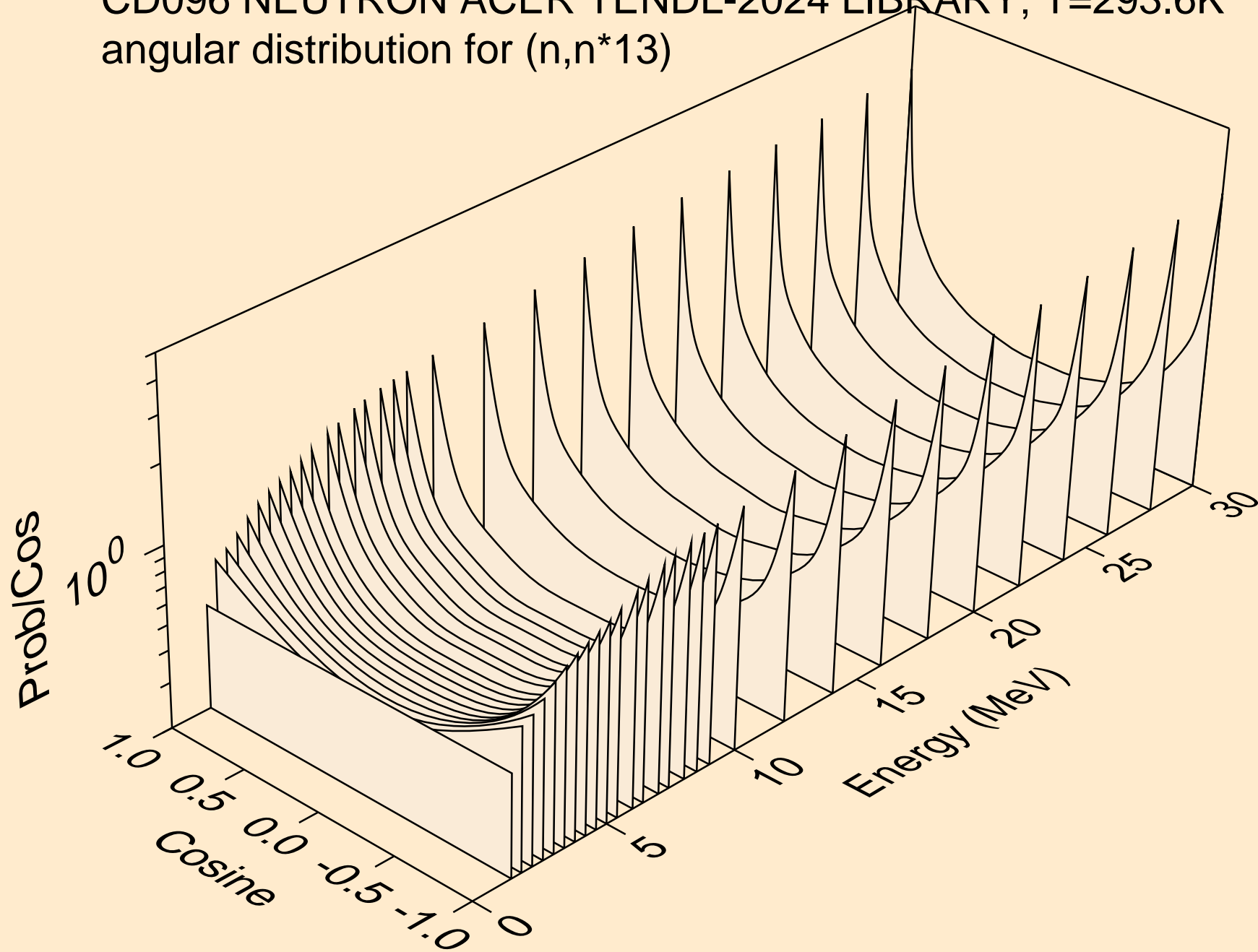

CD096 NEUTRON ACER TENDL-2024 LIBRARY; T=293.6K
angular distribution for (n,n*14)

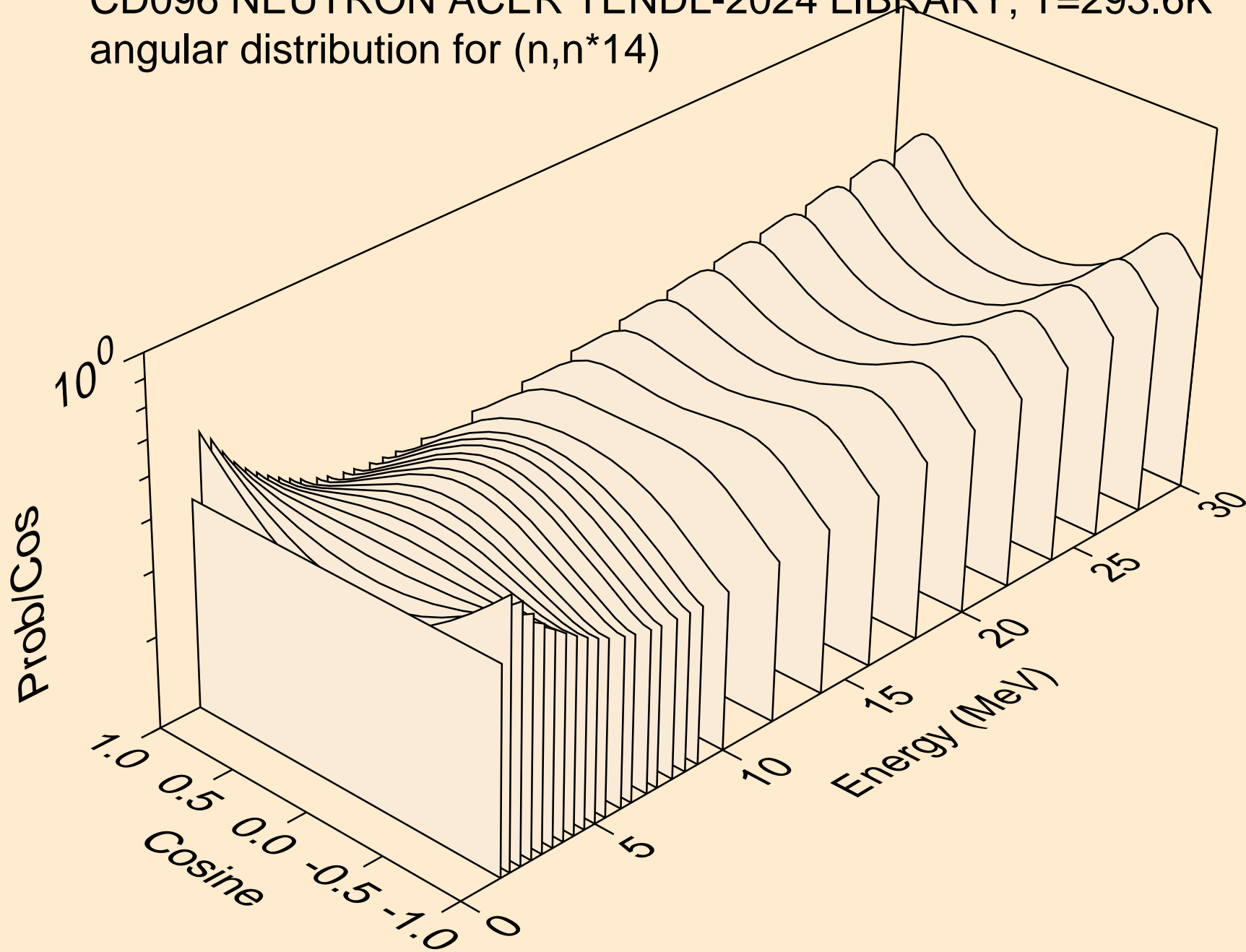

CD096 NEUTRON ACER TENDL-2024 LIBRARY; T=293.6K
angular distribution for (n,n*15)

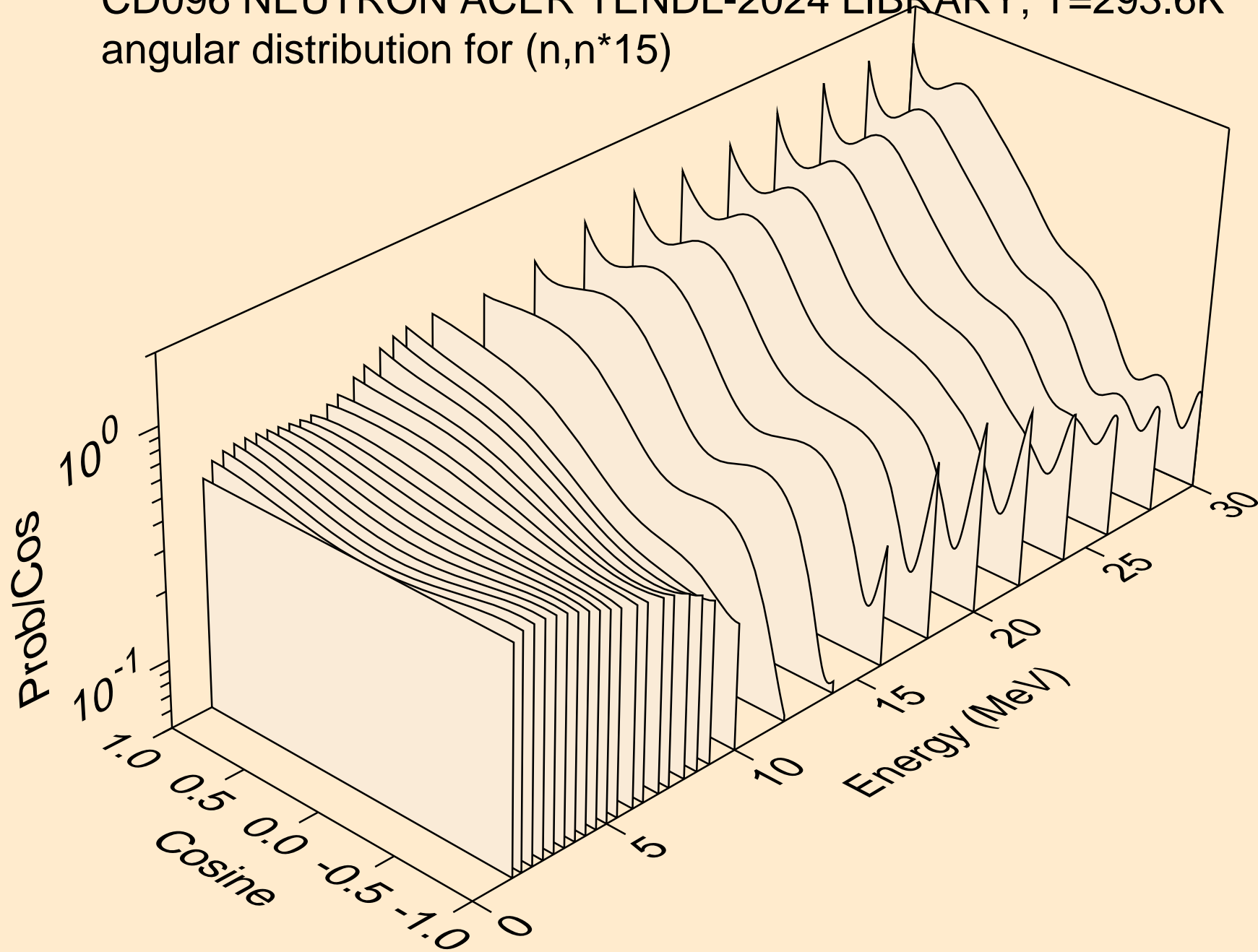

CD096 NEUTRON ACER TENDL-2024 LIBRARY; T=293.6K
angular distribution for (n,n*16)

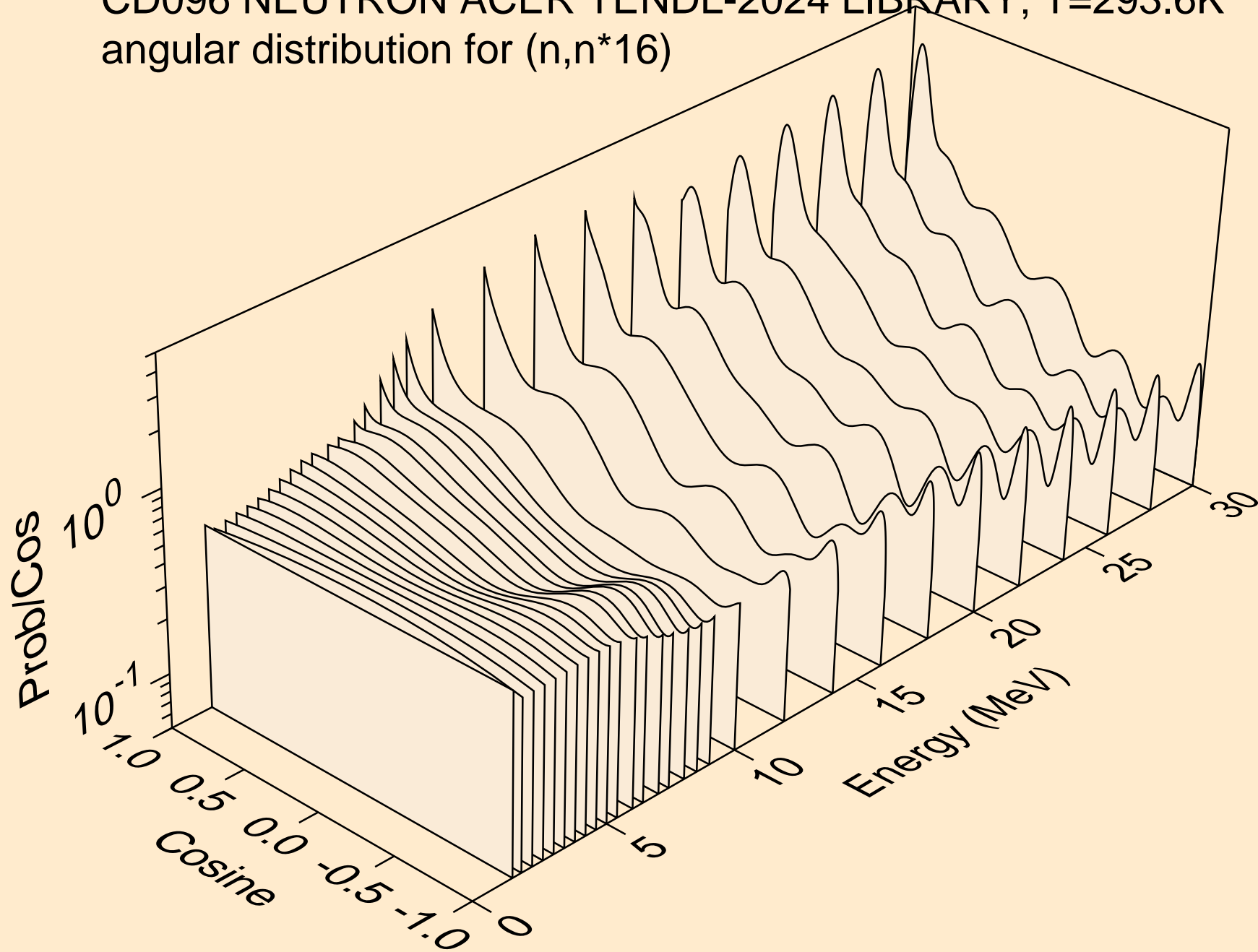

CD096 NEUTRON ACER TENDL-2024 LIBRARY; T=293.6K
angular distribution for (n,n*17)

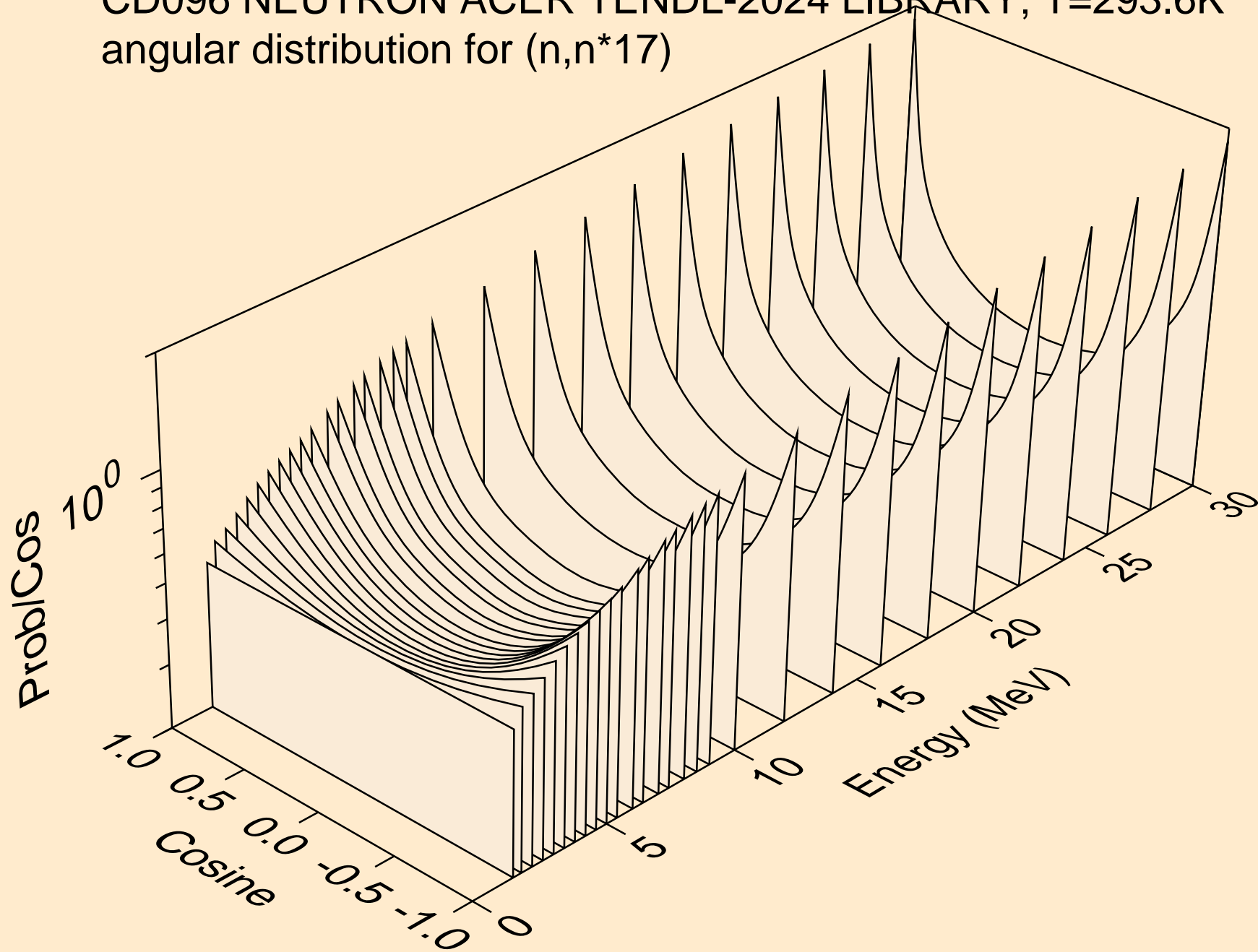

CD096 NEUTRON ACER TENDL-2024 LIBRARY; T=293.6K
angular distribution for (n,n*18)

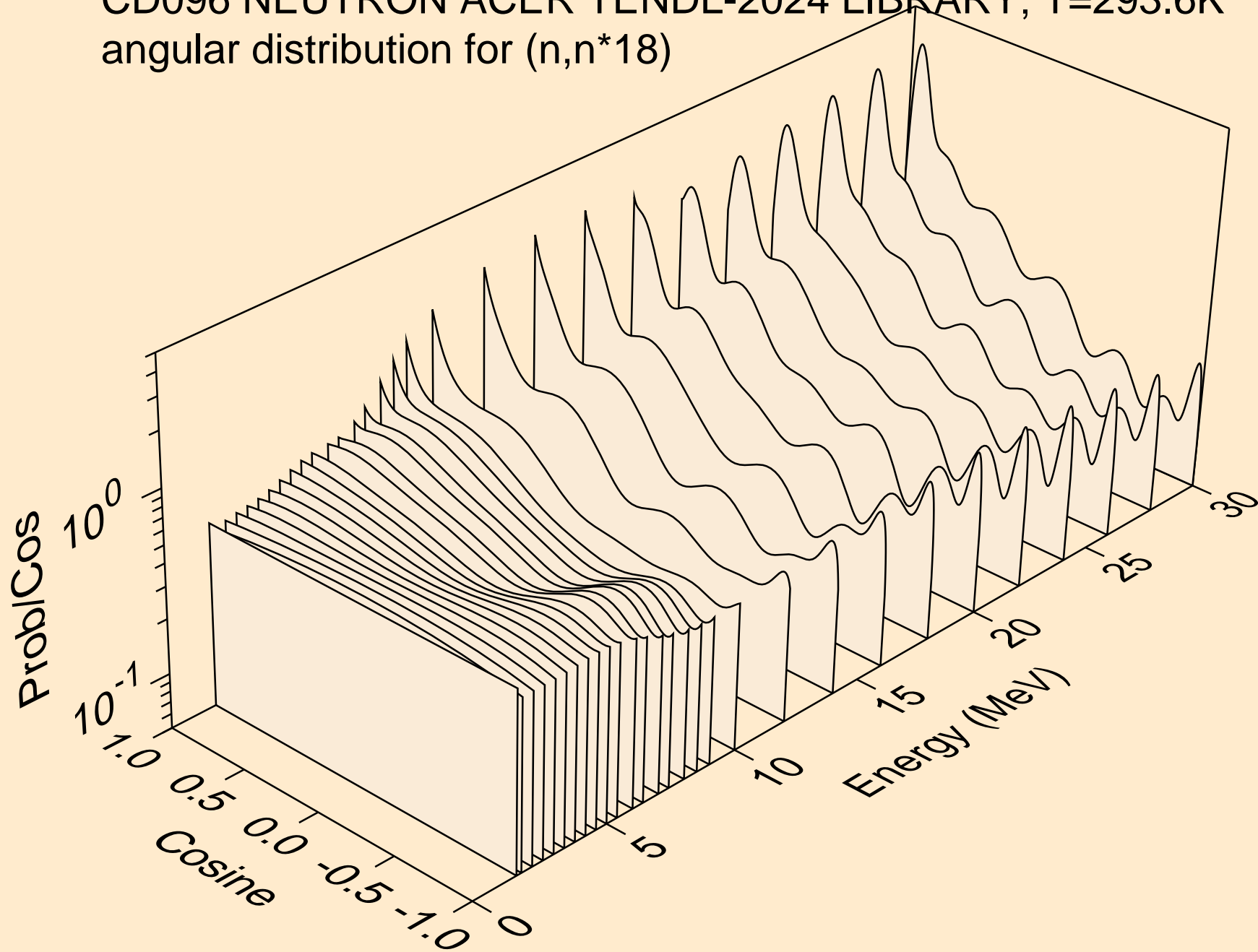

CD096 NEUTRON ACER TENDL-2024 LIBRARY; T=293.6K
angular distribution for (n,n*19)

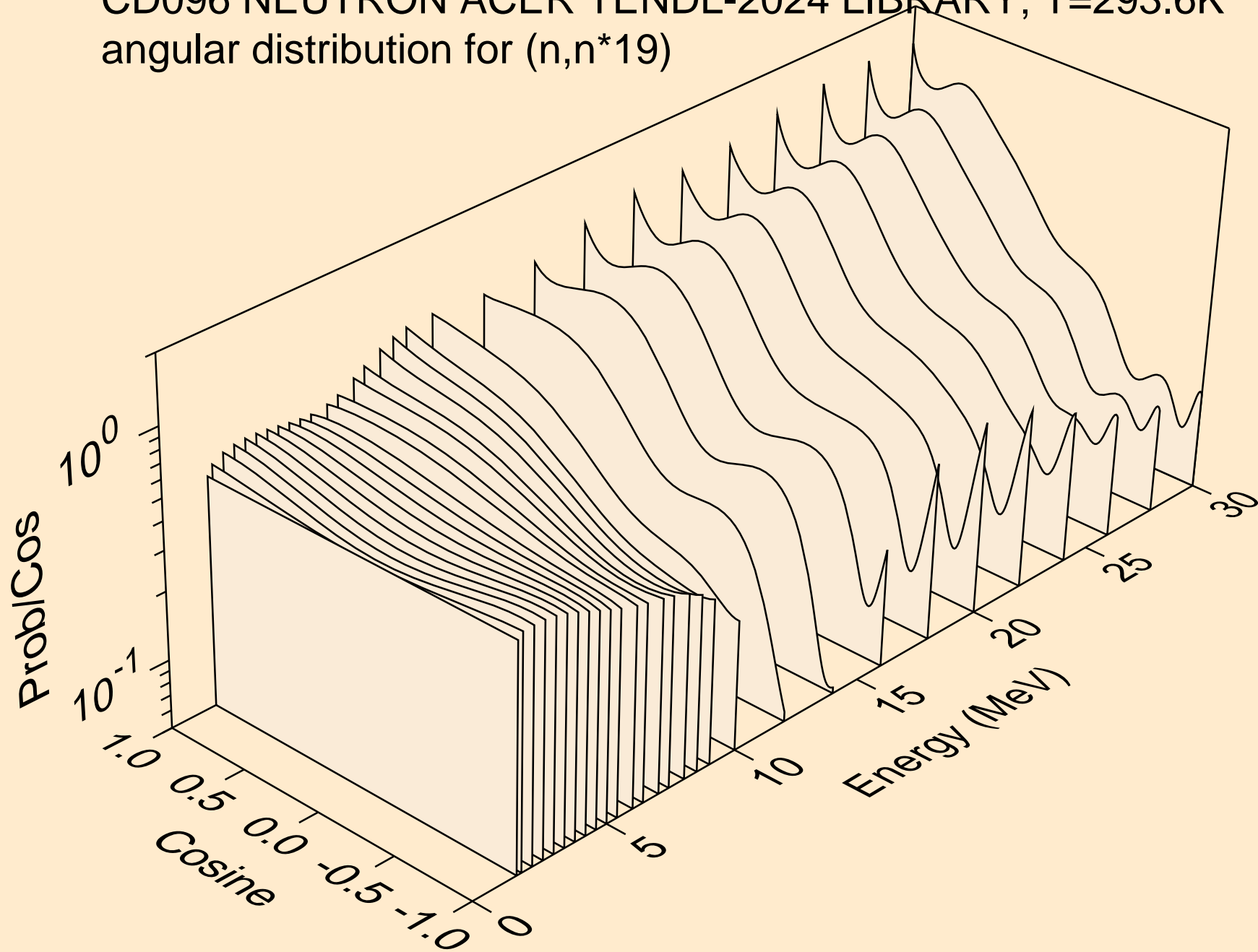

CD096 NEUTRON ACER TENDL-2024 LIBRARY; T=293.6K
angular distribution for (n,n*20)

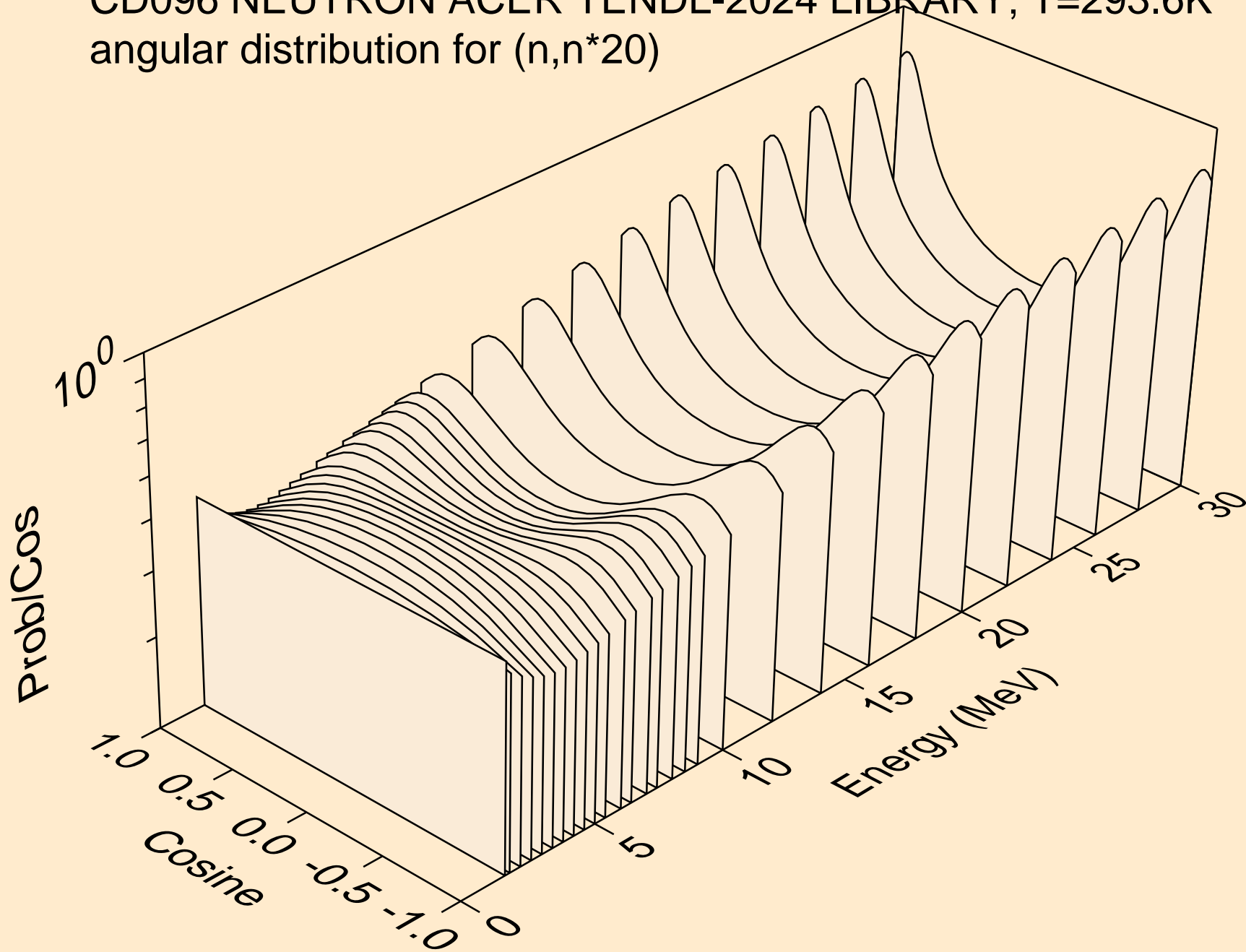

CD096 NEUTRON ACER TENDL-2024 LIBRARY; T=293.6K
angular distribution for (n,n*21)

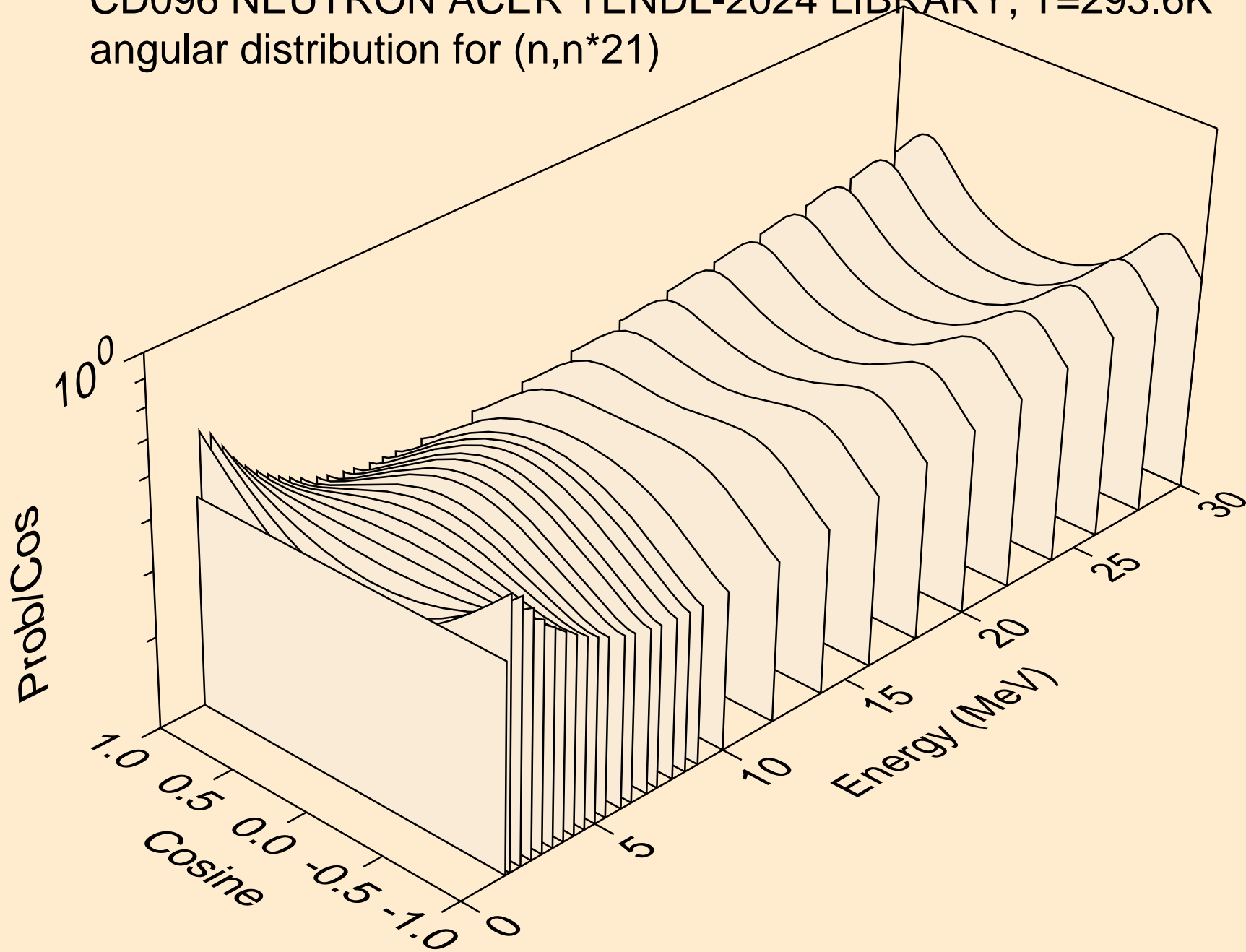

CD096 NEUTRON ACER TENDL-2024 LIBRARY; T=293.6K
angular distribution for (n,n*22)

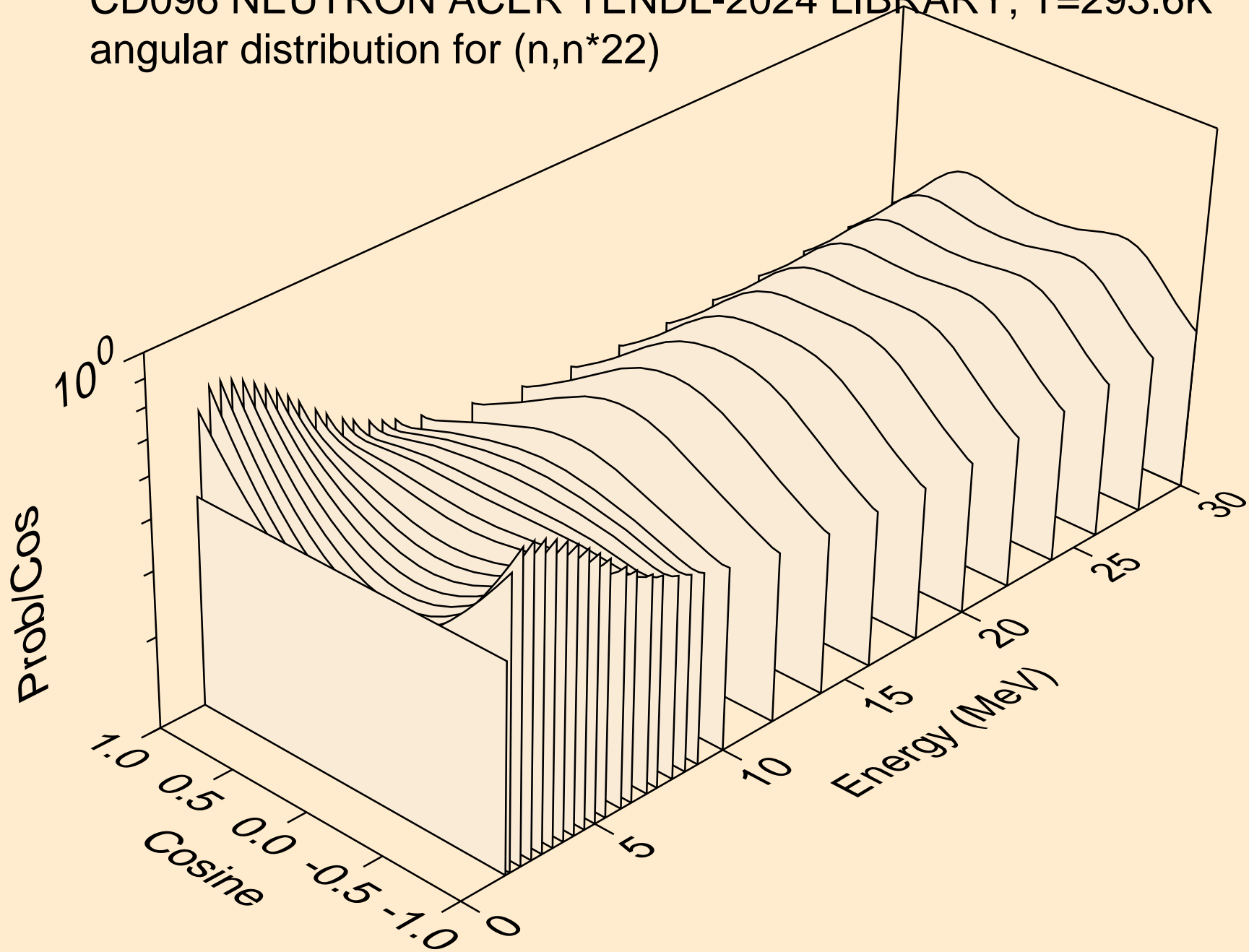

CD096 NEUTRON ACER TENDL-2024 LIBRARY; T=293.6K
angular distribution for (n,n*23)

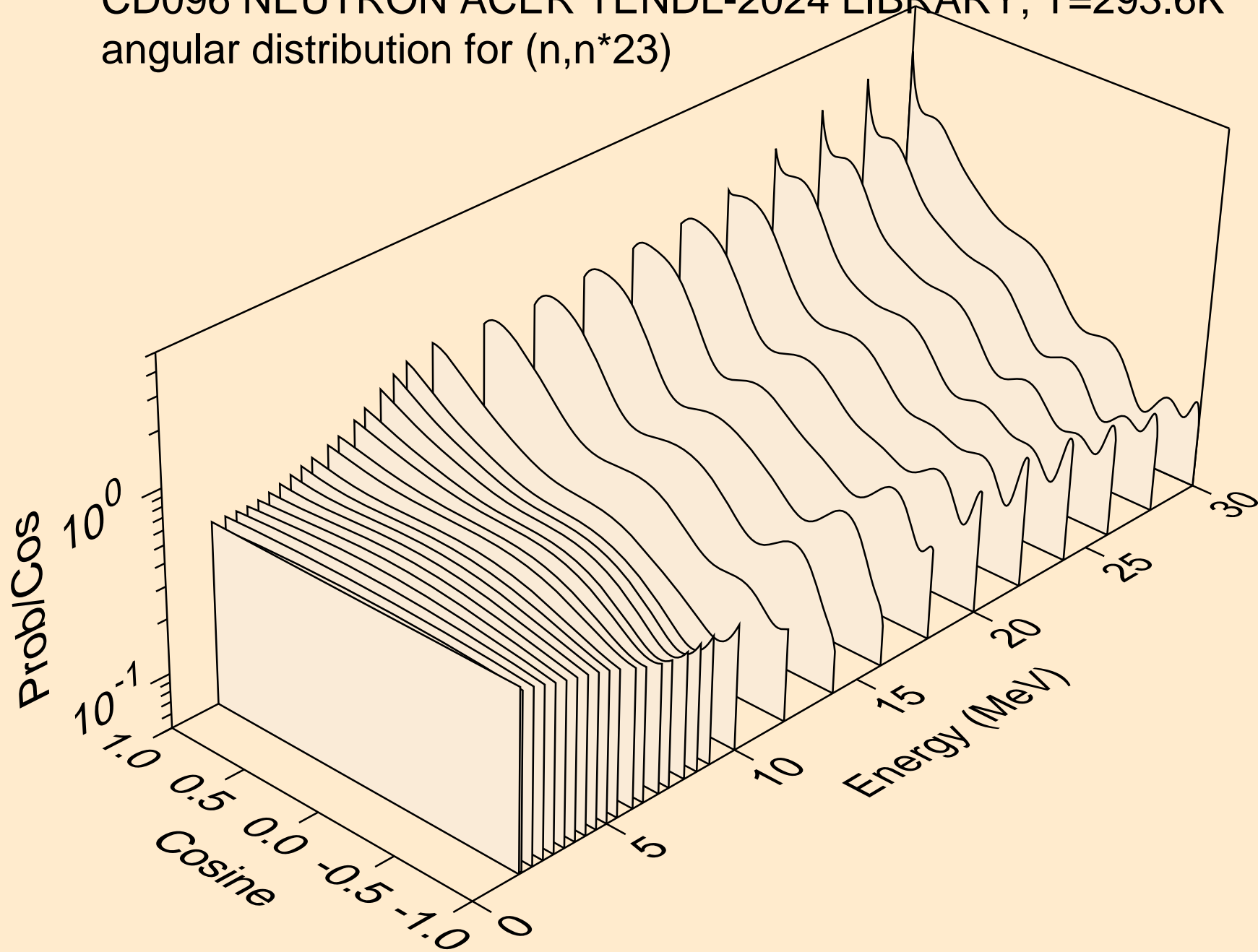

CD096 NEUTRON ACER TENDL-2024 LIBRARY; T=293.6K
angular distribution for (n,n*24)

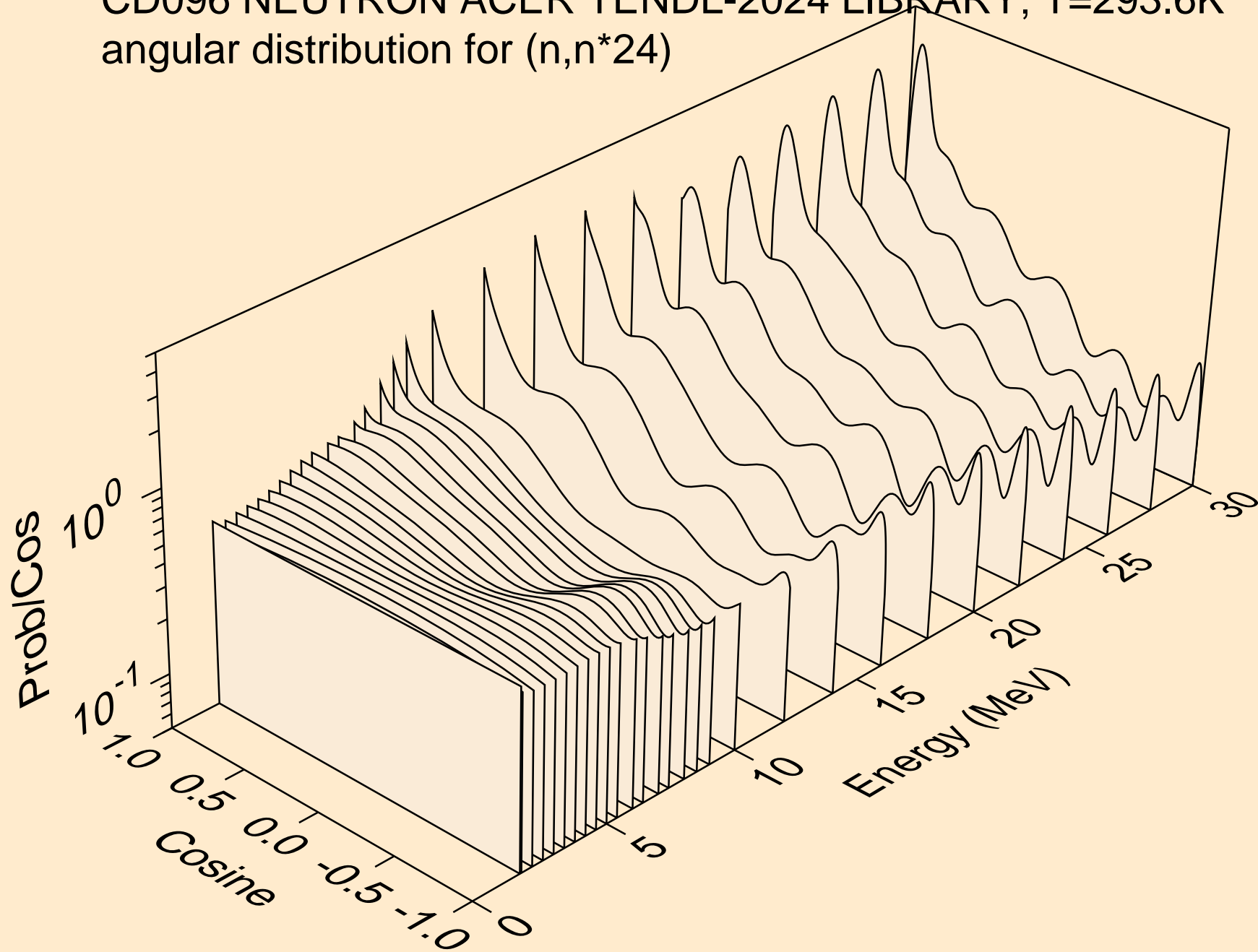

CD096 NEUTRON ACER TENDL-2024 LIBRARY; T=293.6K
Neutron emission for (n,x)

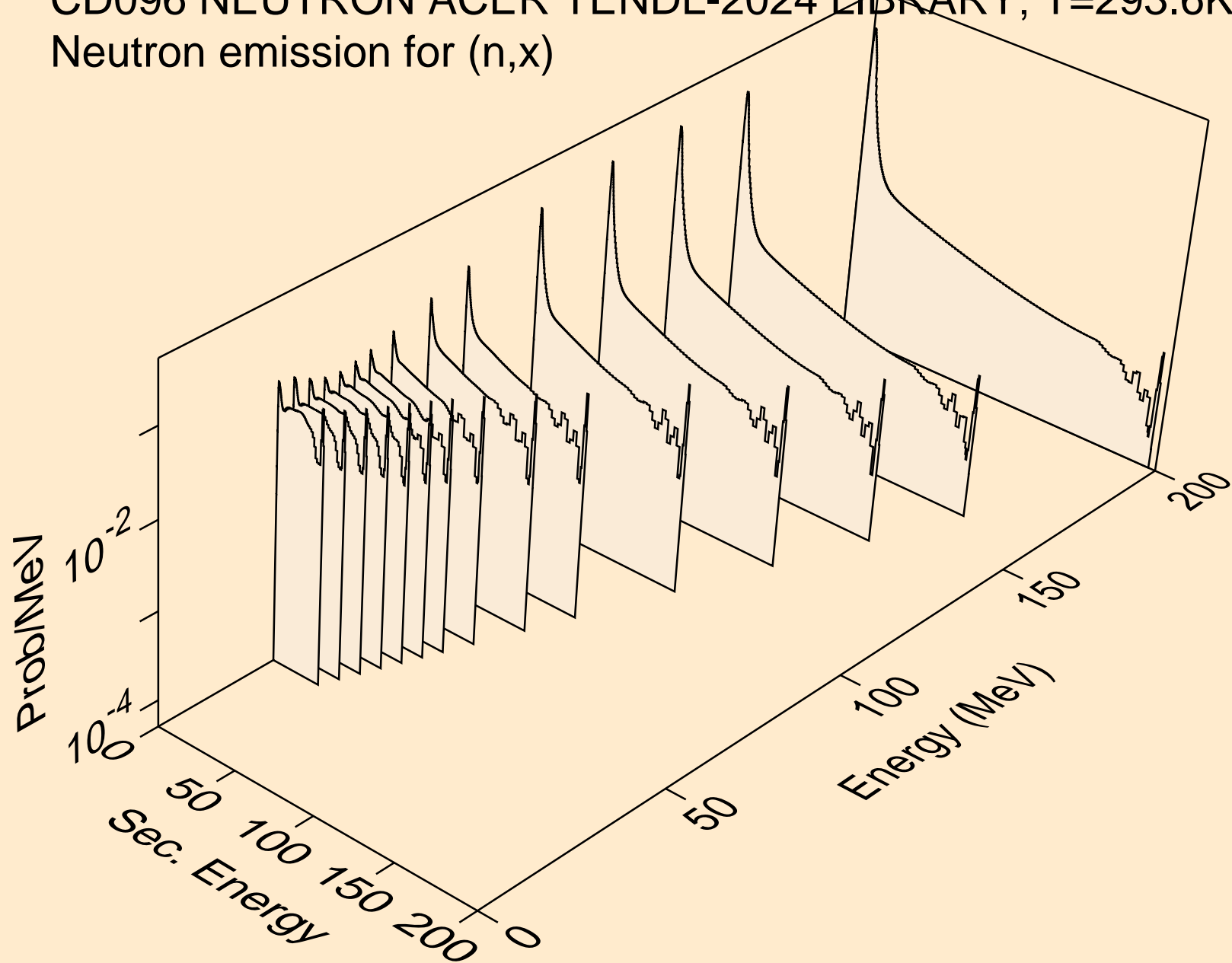

CD096 NEUTRON ACER TENDL-2024 LIBRARY; T=293.6K
Neutron emission for (n,2n)

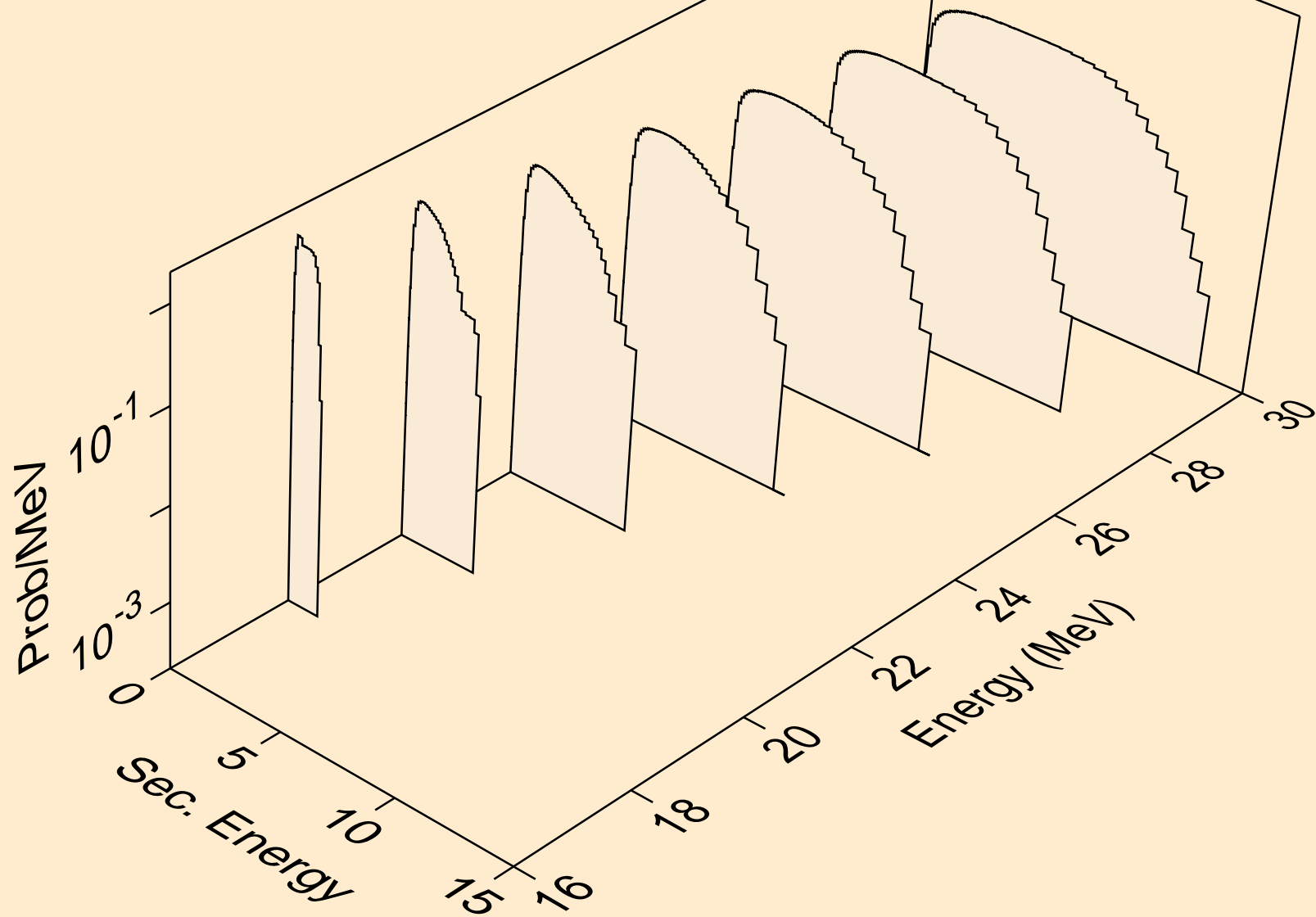

CD096 NEUTRON ACER TENDL-2024 LIBRARY; T=293.6K
Neutron emission for (n,n*)a

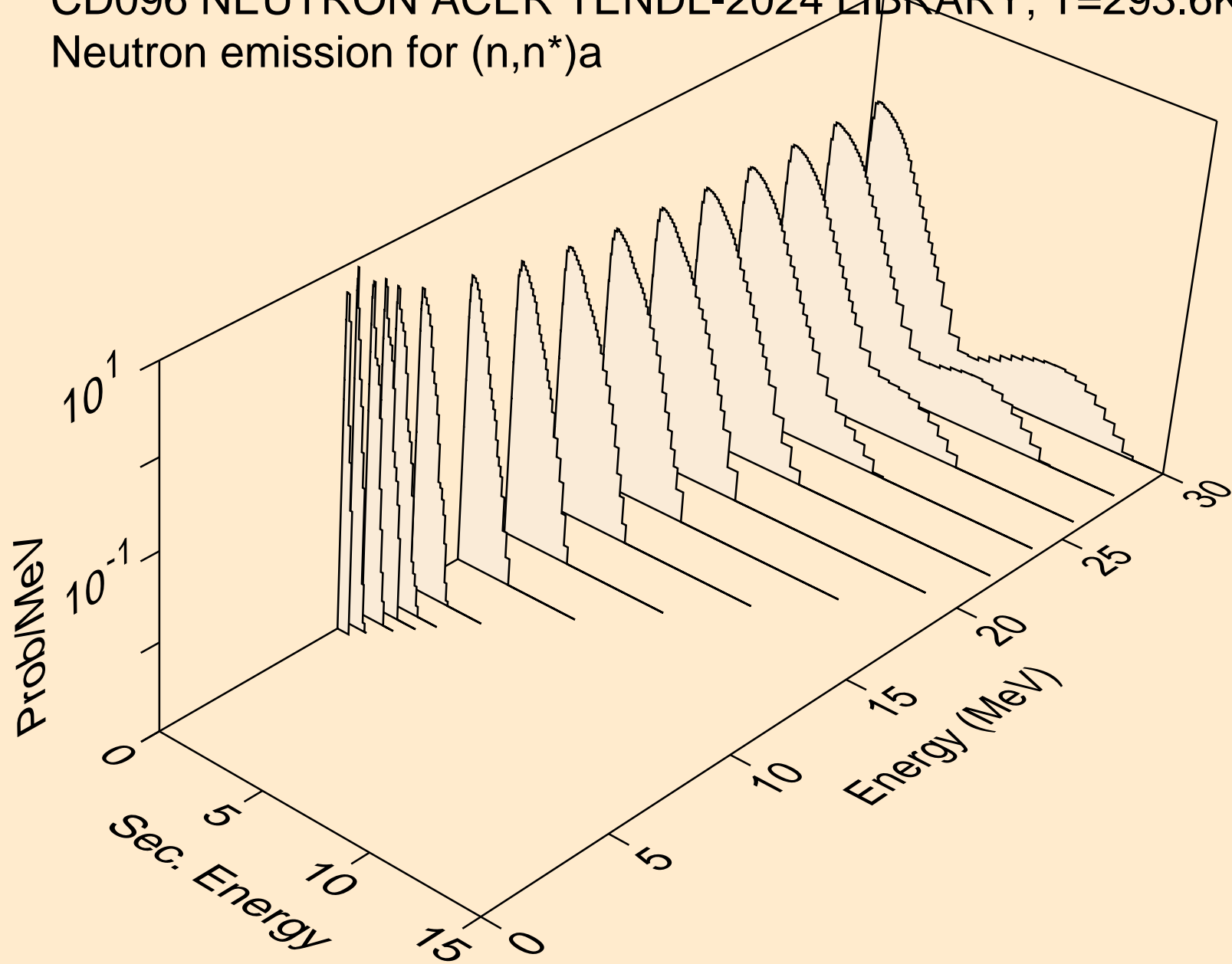

CD096 NEUTRON ACER TENDL-2024 LIBRARY; T=293.6K
Neutron emission for (n,n*)p

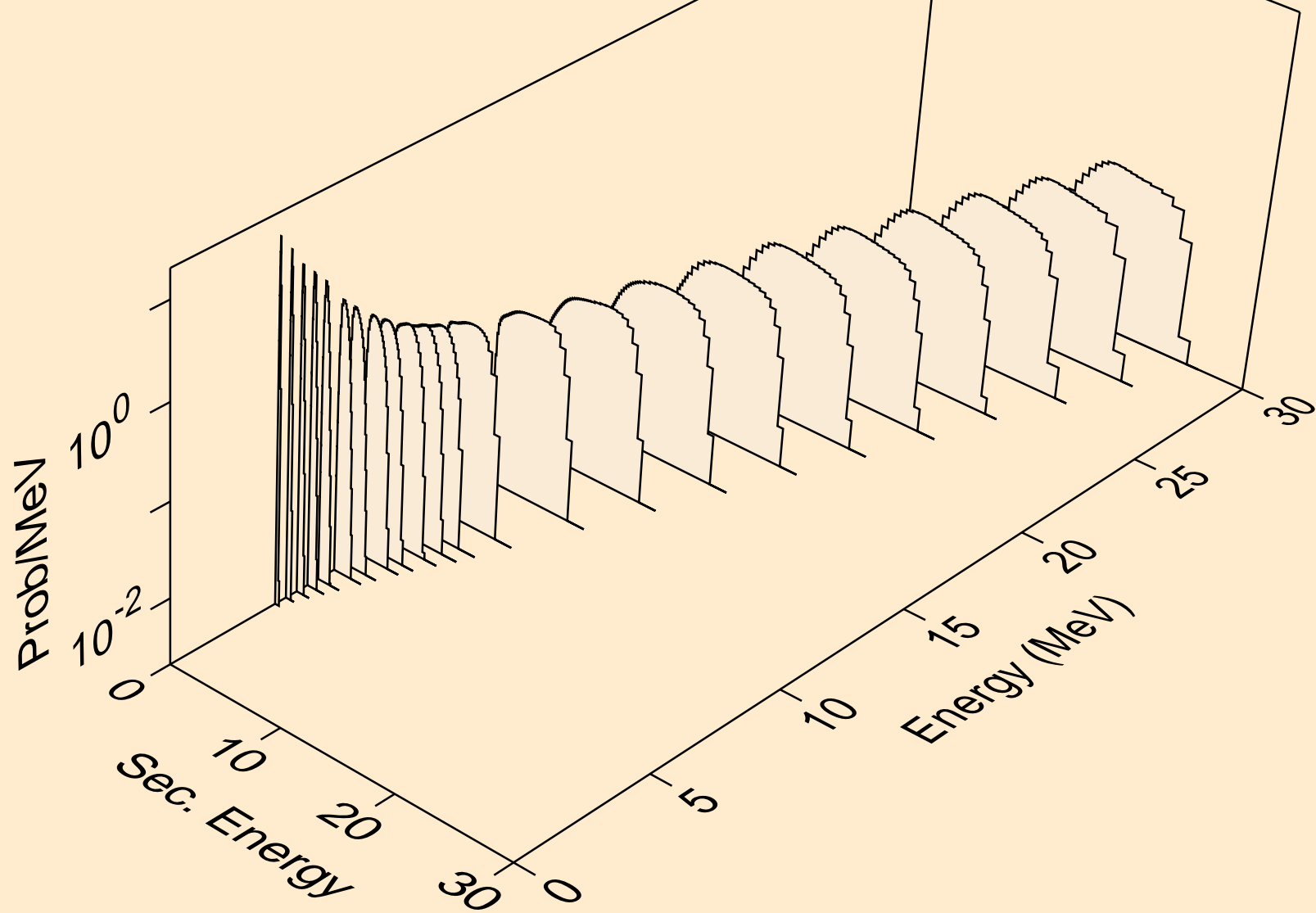

CD096 NEUTRON ACER TENDL-2024 LIBRARY; T=293.6K
Neutron emission for (n,n*)2a

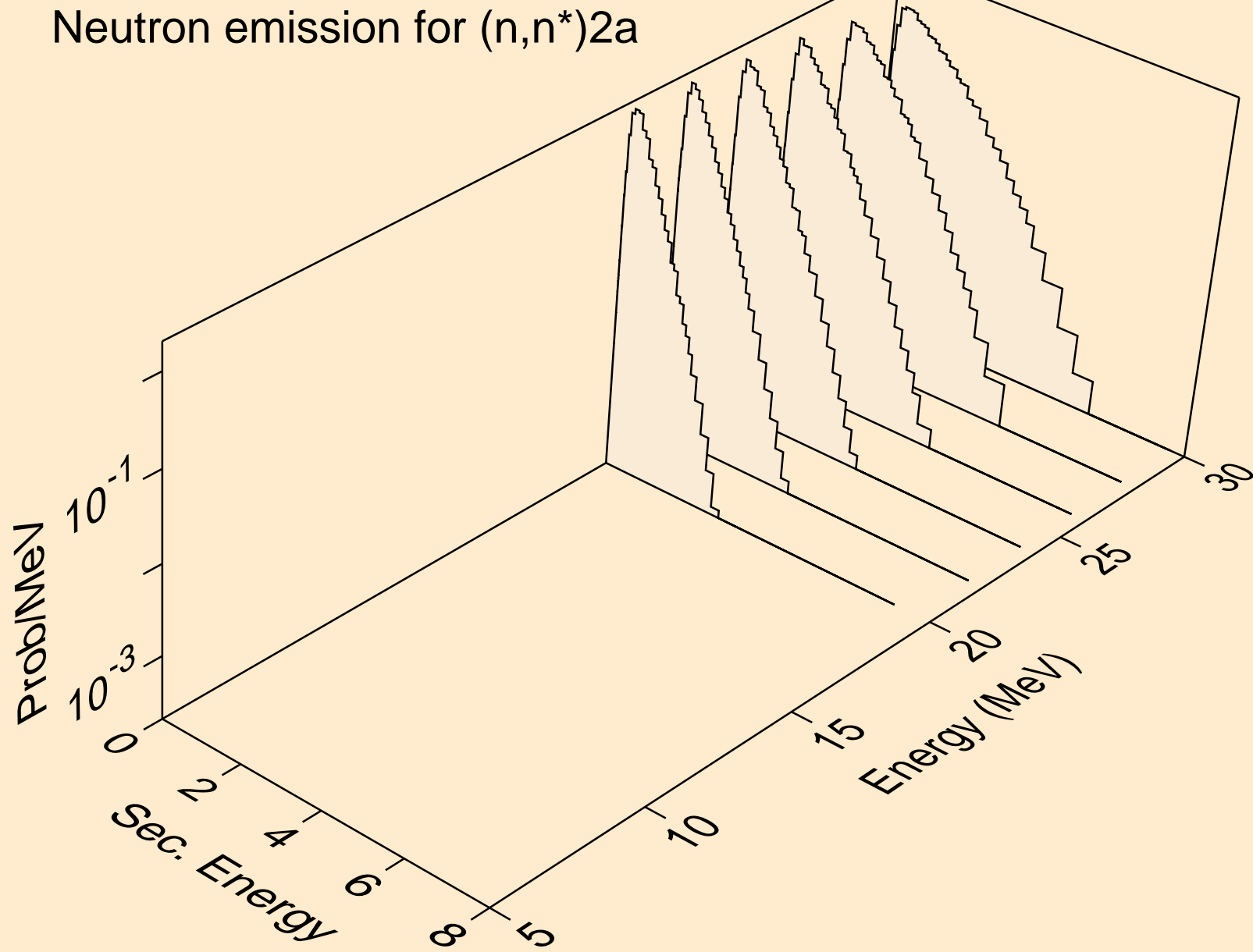

CD096 NEUTRON ACER TENDL-2024 LIBRARY; T=293.6K
Neutron emission for (n,n*)d

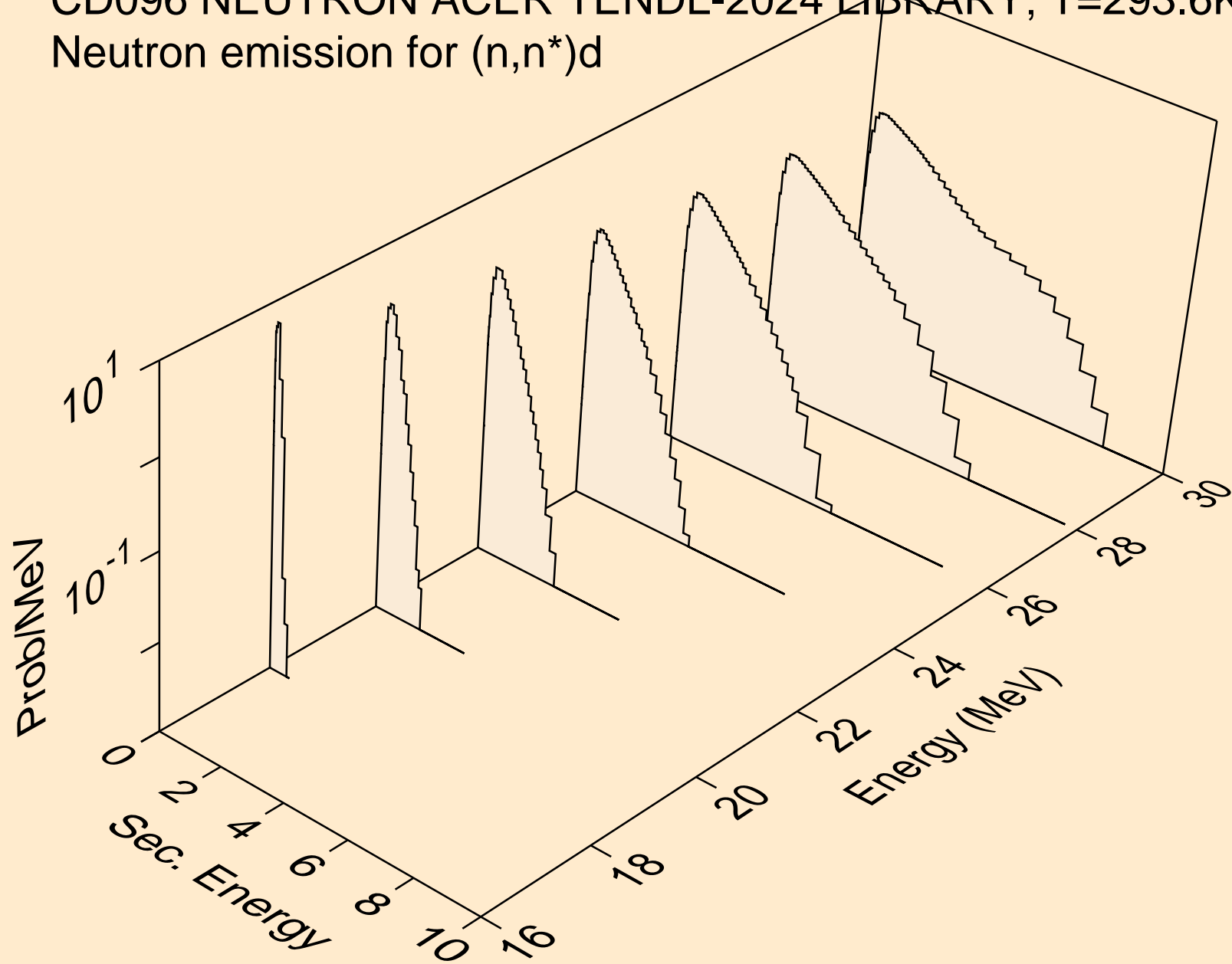

CD096 NEUTRON ACER TENDL-2024 LIBRARY; T=293.6K
Neutron emission for (n,n*)t

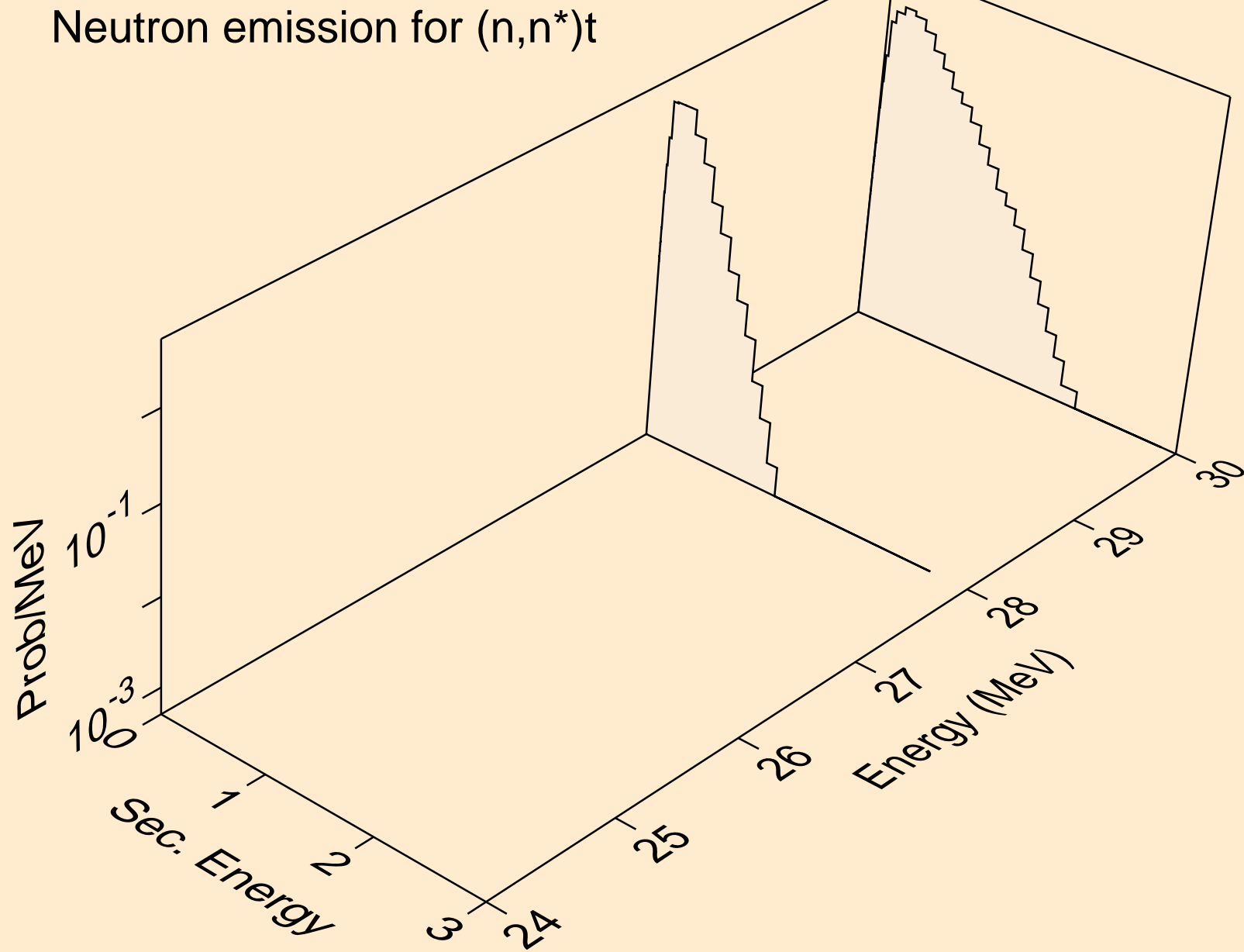

CD096 NEUTRON ACER TENDL-2024 LIBRARY; T=293.6K
Neutron emission for (n,n*)he3

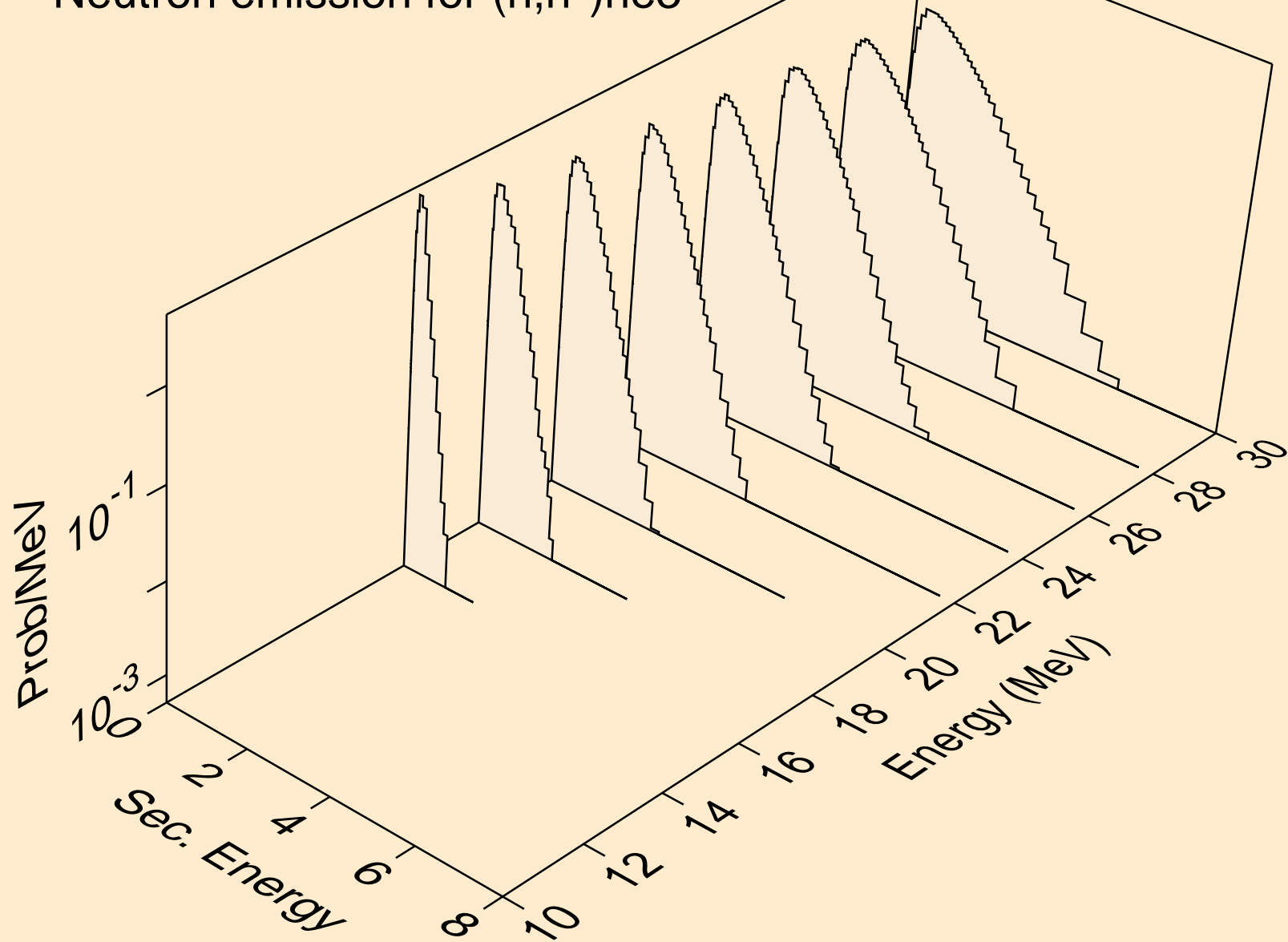

CD096 NEUTRON ACER TENDL-2024 LIBRARY; T=293.6K
Neutron emission for (n,2np)

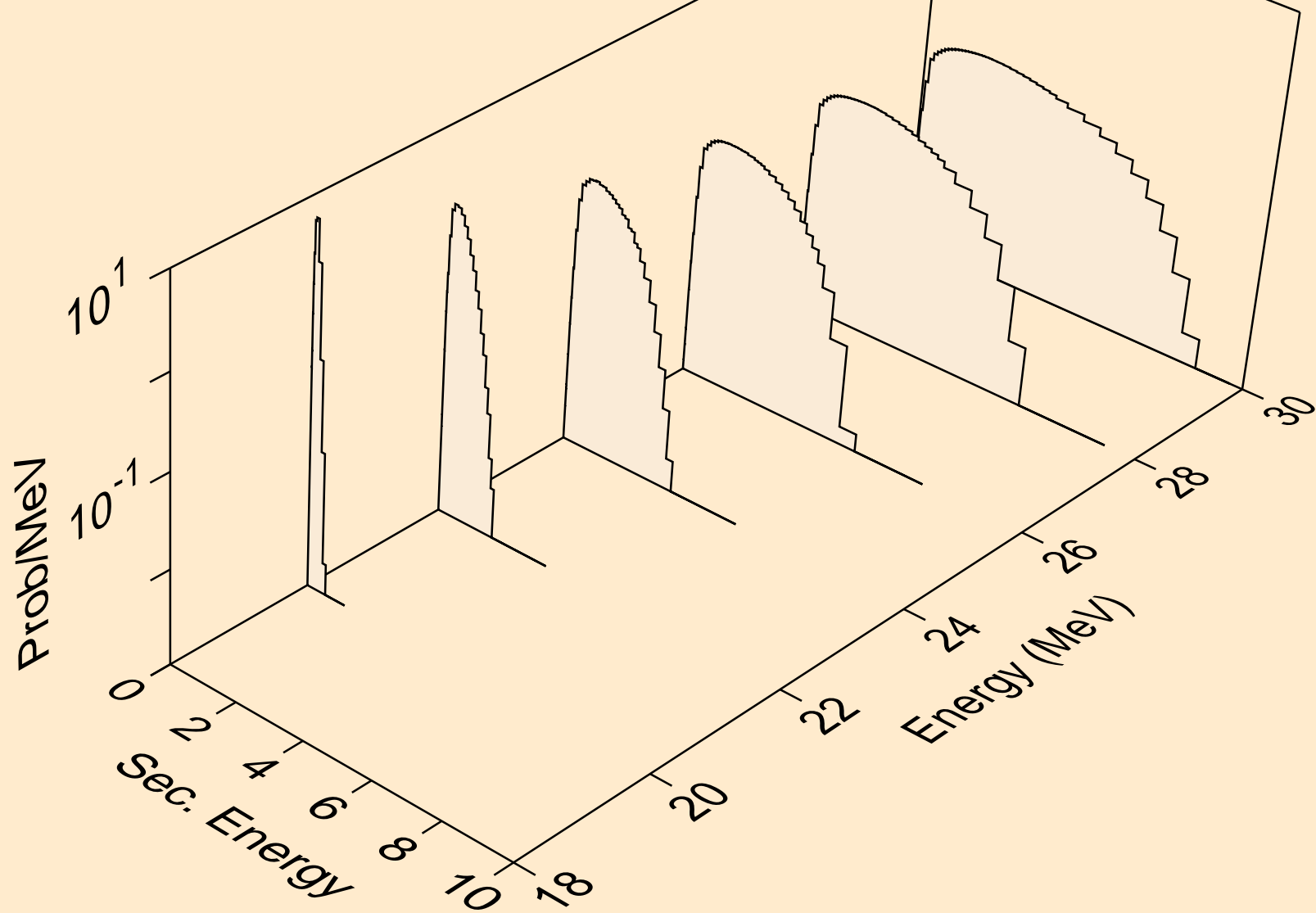

CD096 NEUTRON ACER TENDL-2024 LIBRARY; T=293.6K
Neutron emission for (n,n2p)

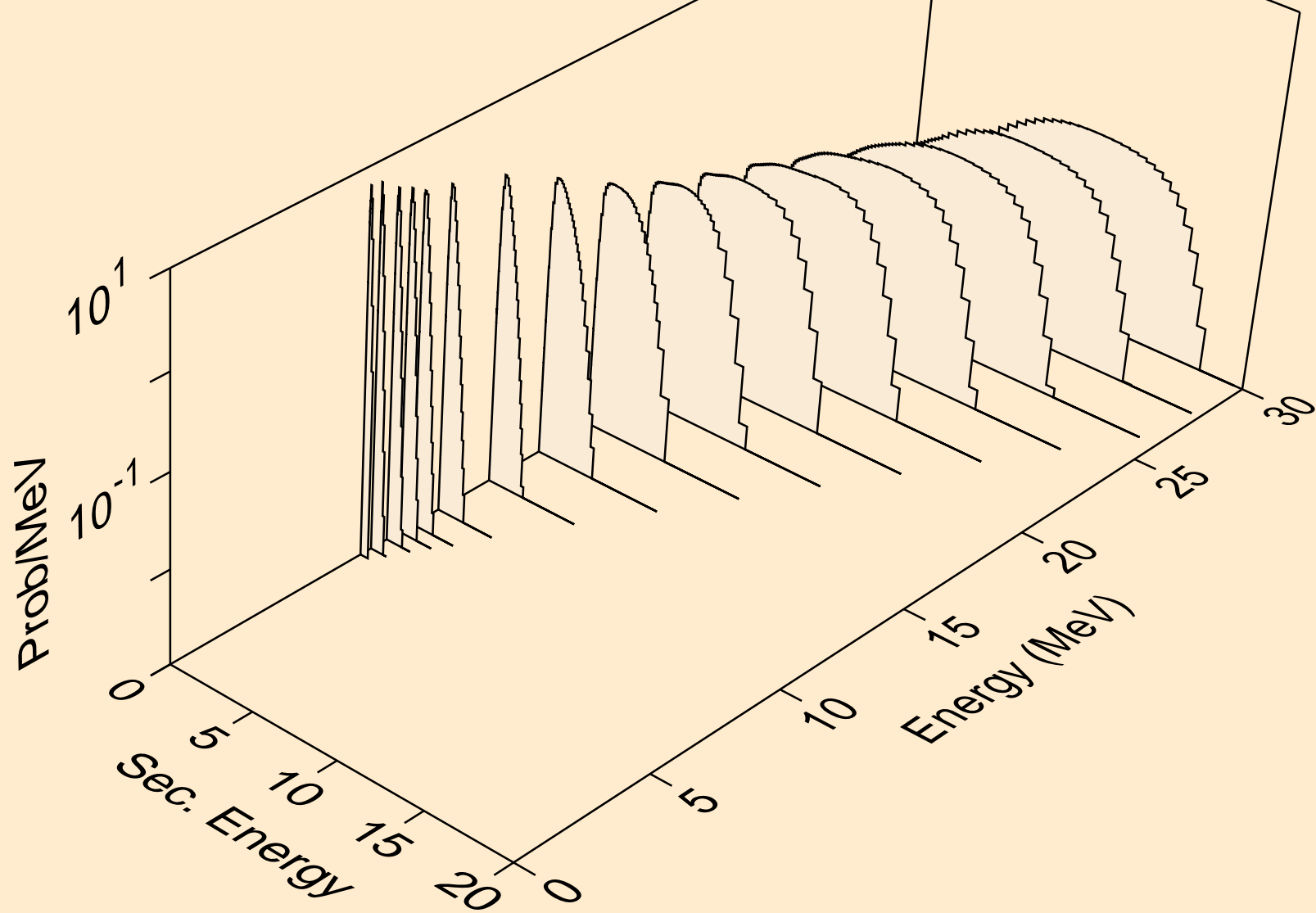

CD096 NEUTRON ACER TENDL-2024 LIBRARY; T=293.6K
Neutron emission for (n,npa)

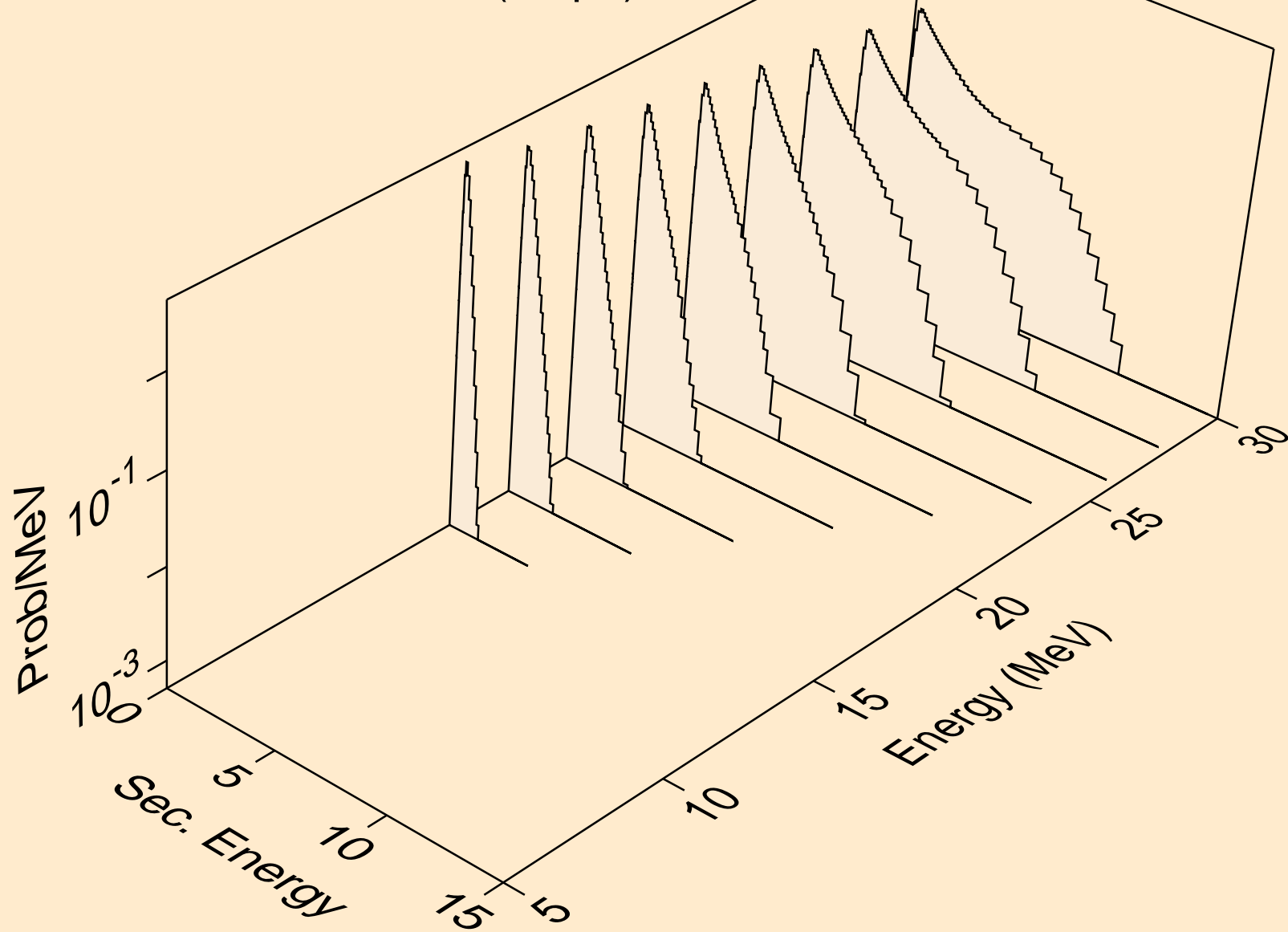

CD096 NEUTRON ACER TENDL-2024 LIBRARY; T=293.6K
Neutron emission for (n,n*c)

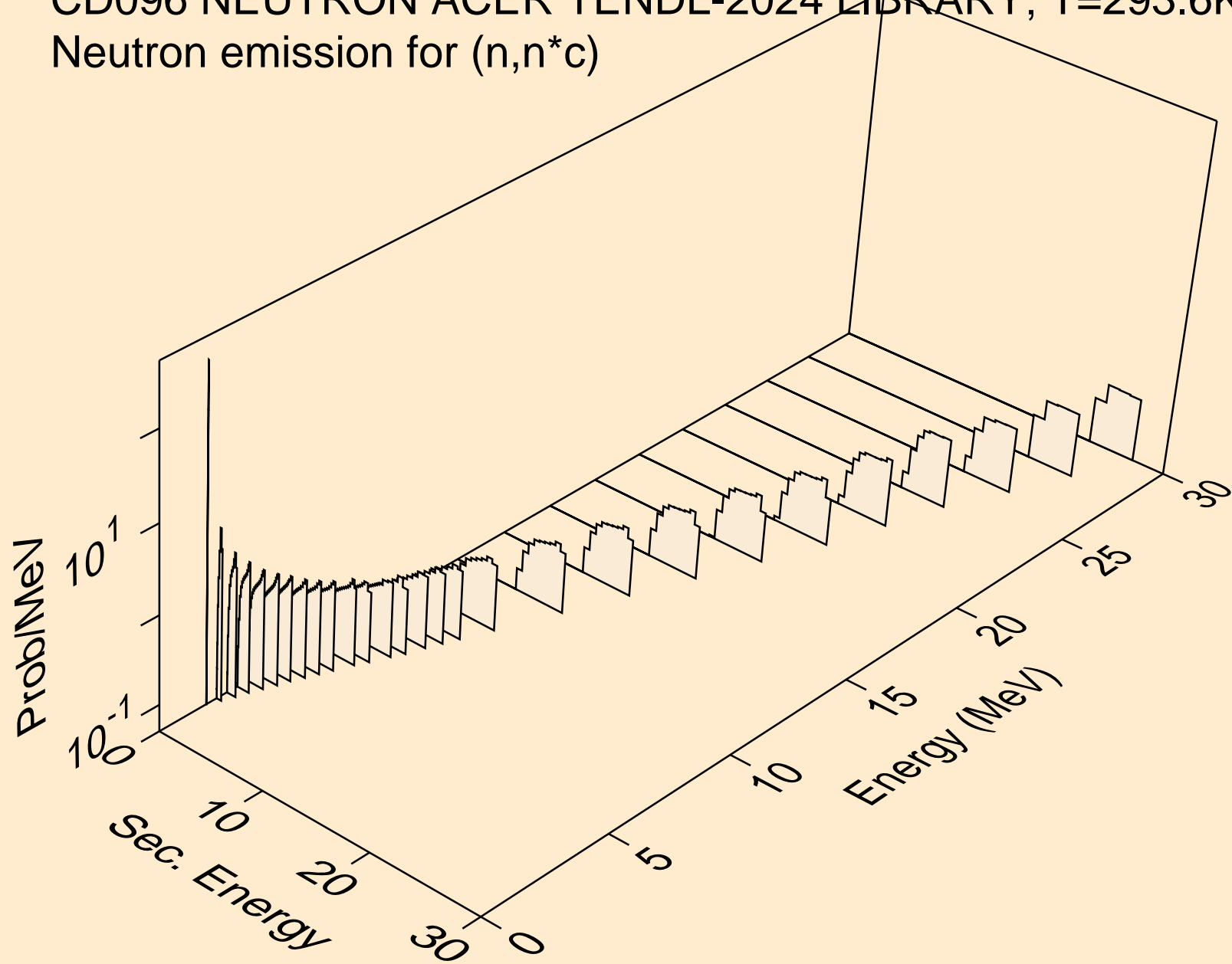

CD096 NEUTRON ACER TENDL-2024 LIBRARY; T=293.6K
Photon emission for (n,x)

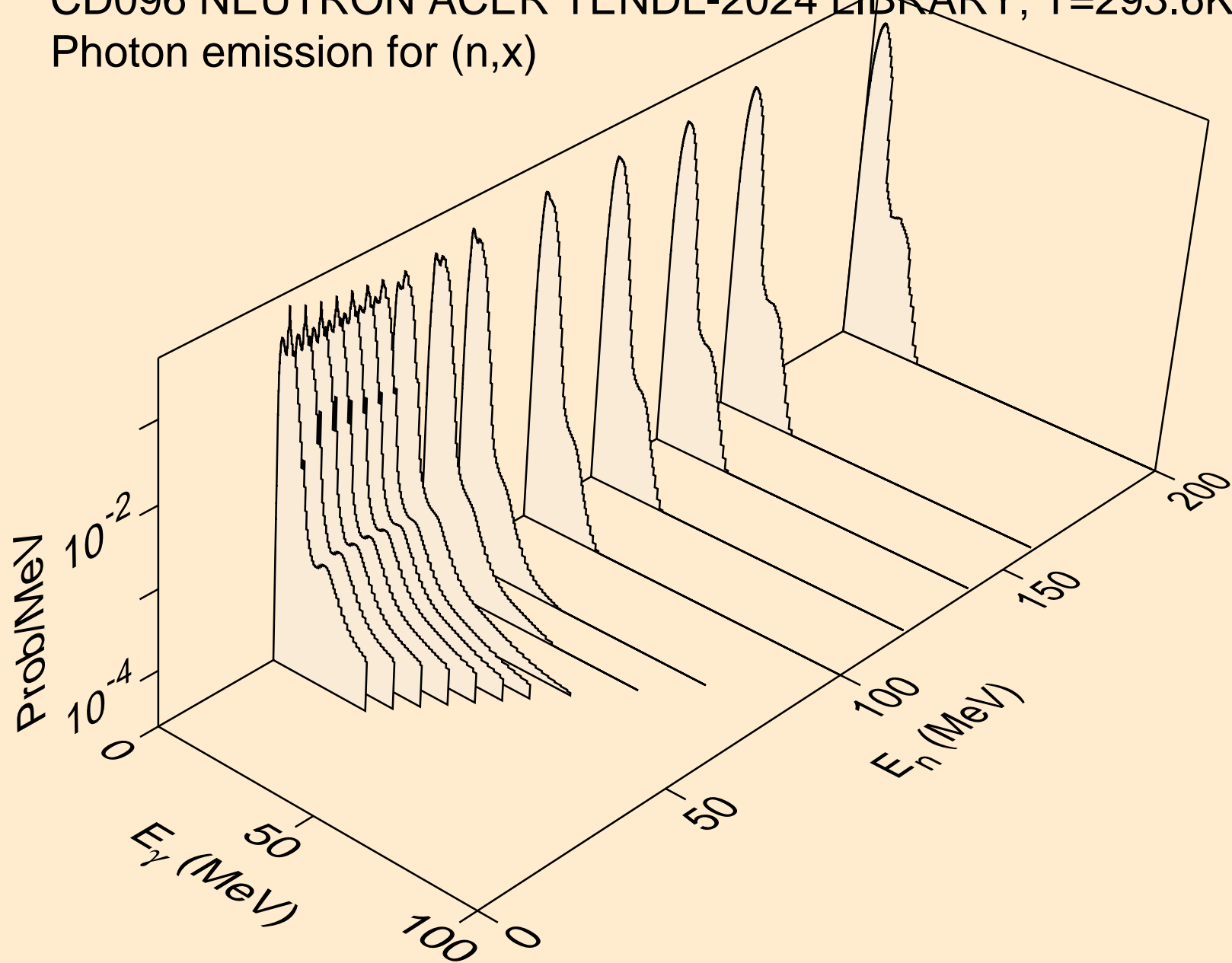

CD096 NEUTRON ACER TENDL-2024 LIBRARY; T=293.6K
Photon emission for (n,2n)

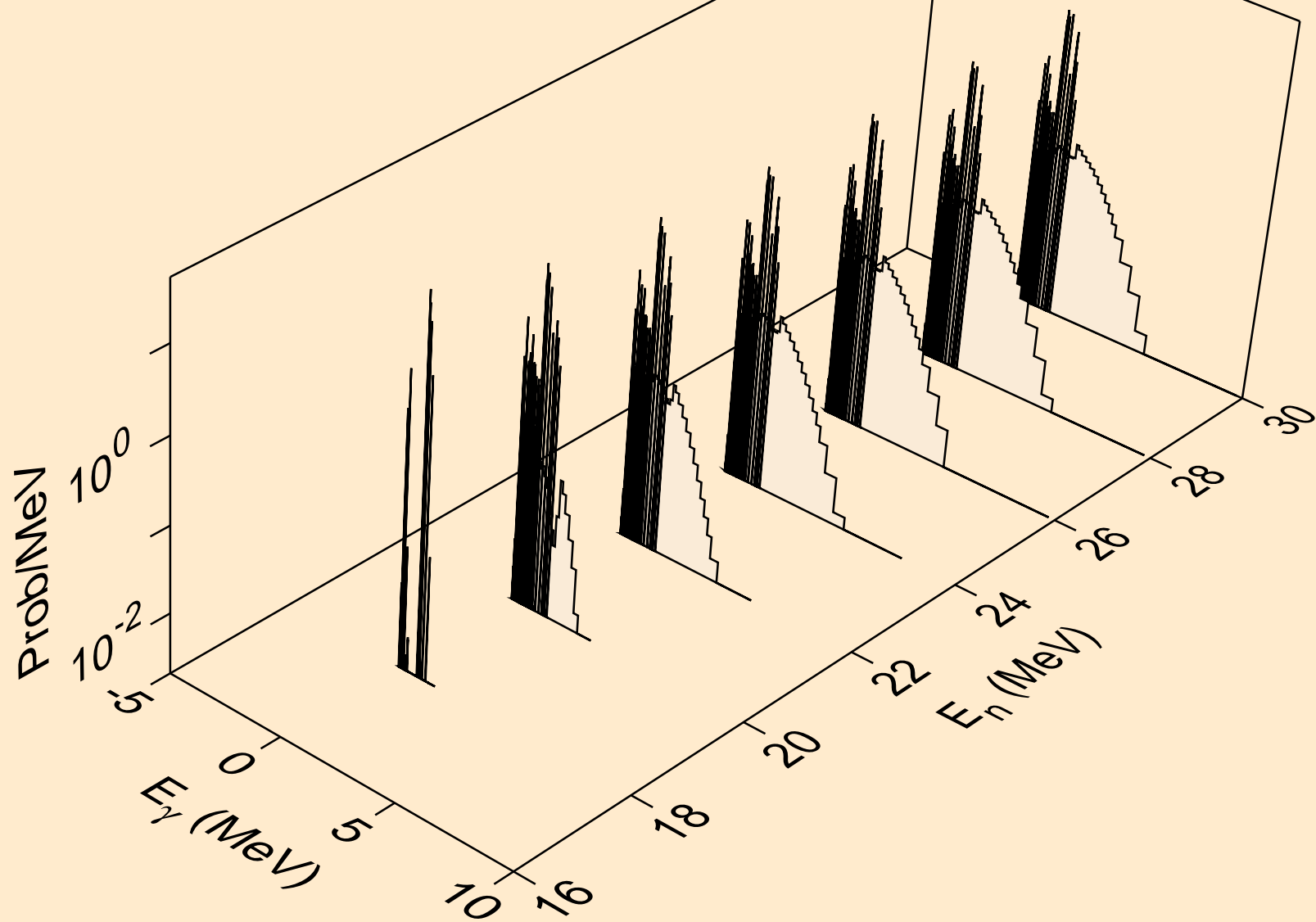

CD096 NEUTRON ACER TENDL-2024 LIBRARY; T=293.6K
Photon emission for (n,n*)a

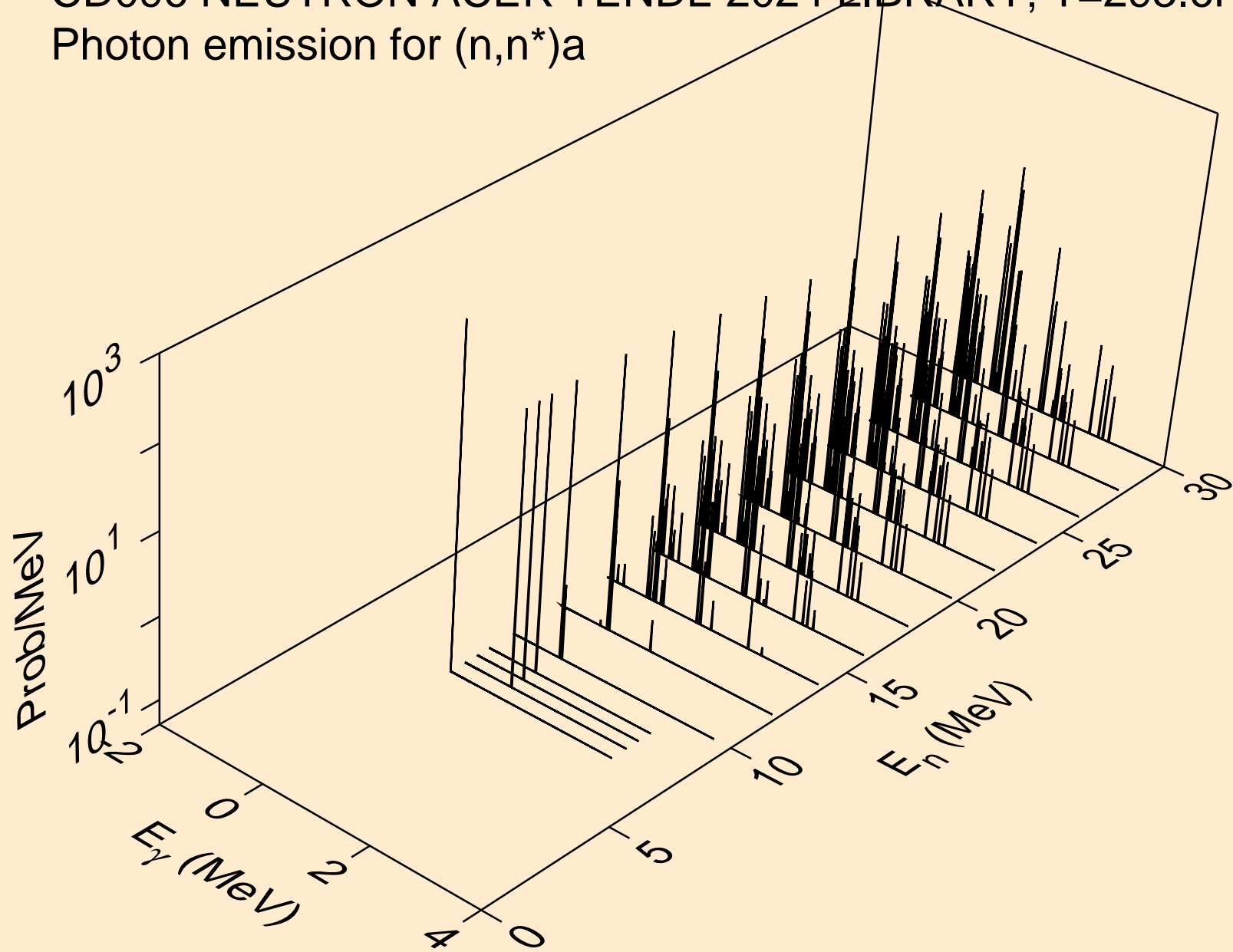

CD096 NEUTRON ACER TENDL-2024 LIBRARY; T=293.6K
Photon emission for (n,n*)p

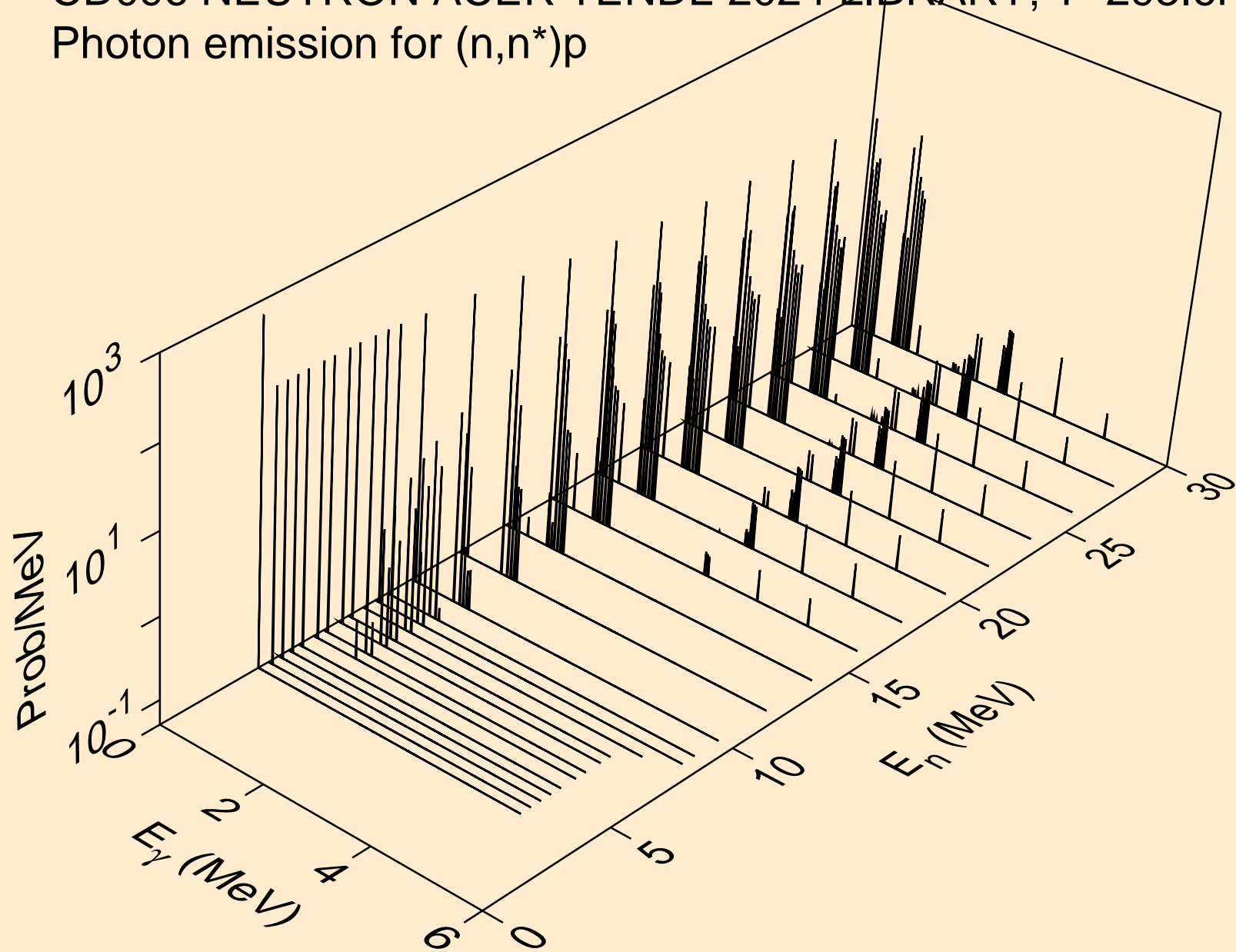

CD096 NEUTRON ACER TENDL-2024 LIBRARY; T=293.6K
Photon emission for (n,n*)2a

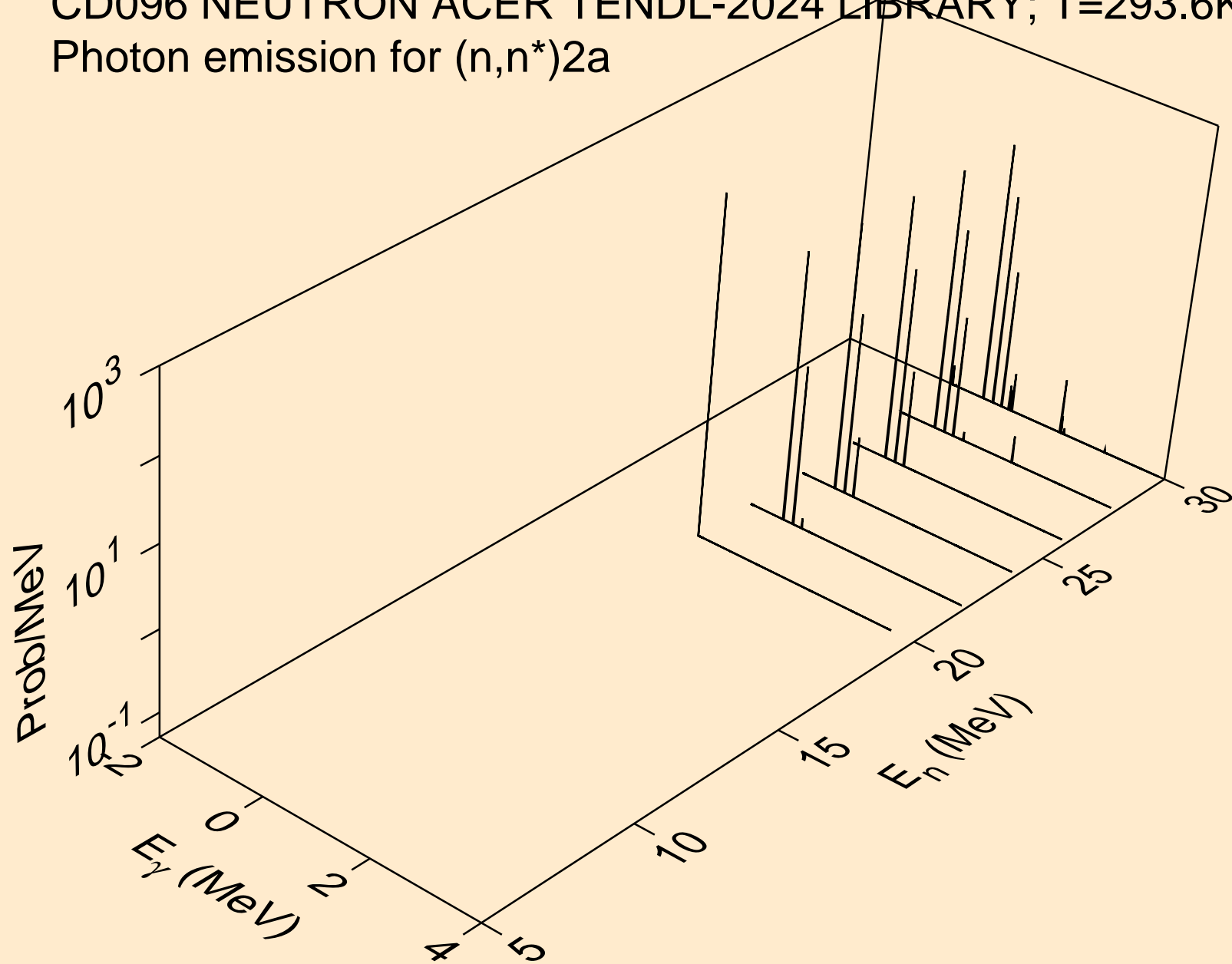

CD096 NEUTRON ACER TENDL-2024 LIBRARY; T=293.6K
Photon emission for (n,n*)d

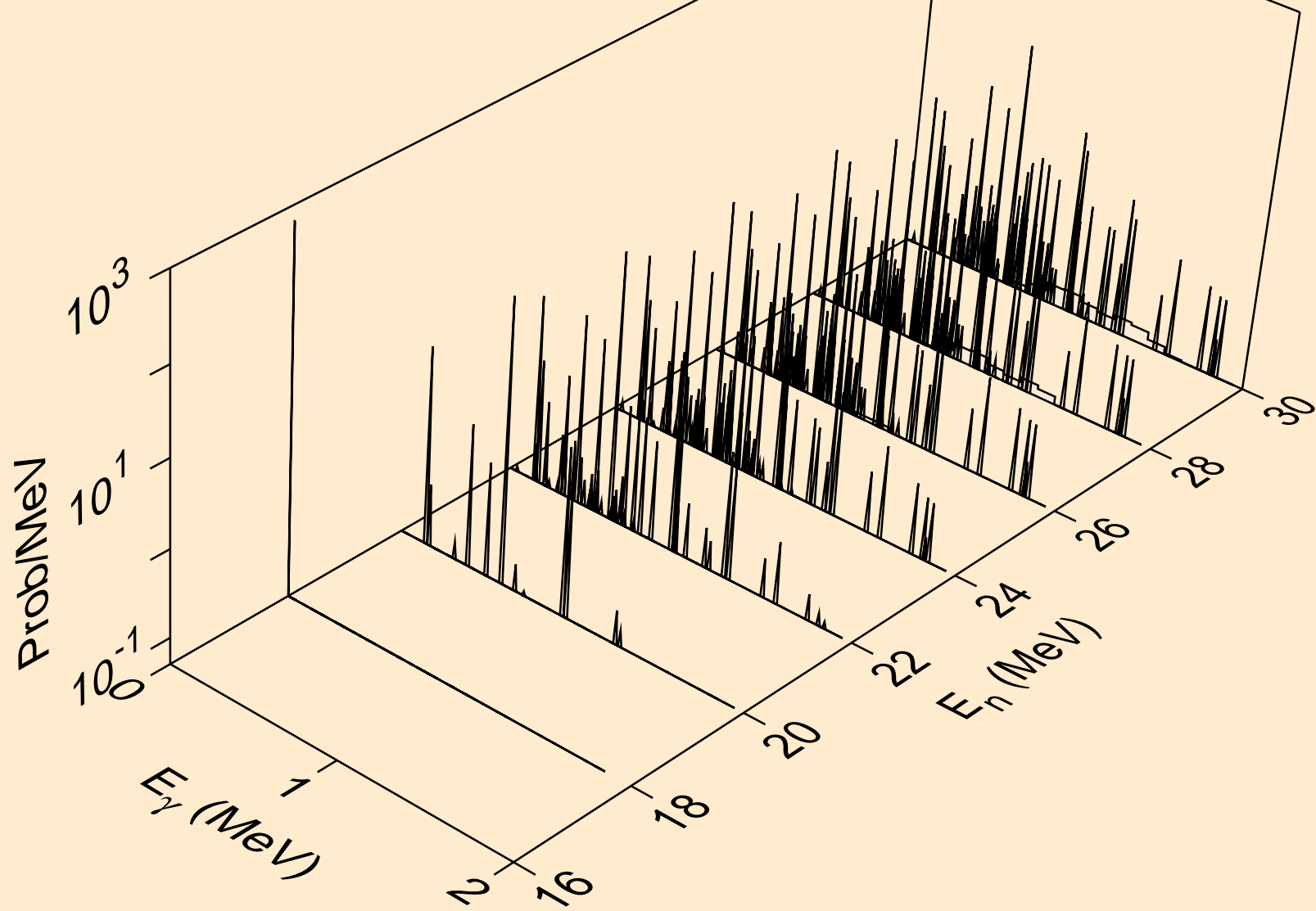

CD096 NEUTRON ACER TENDL-2024 LIBRARY; T=293.6K
Photon emission for (n,n*)t

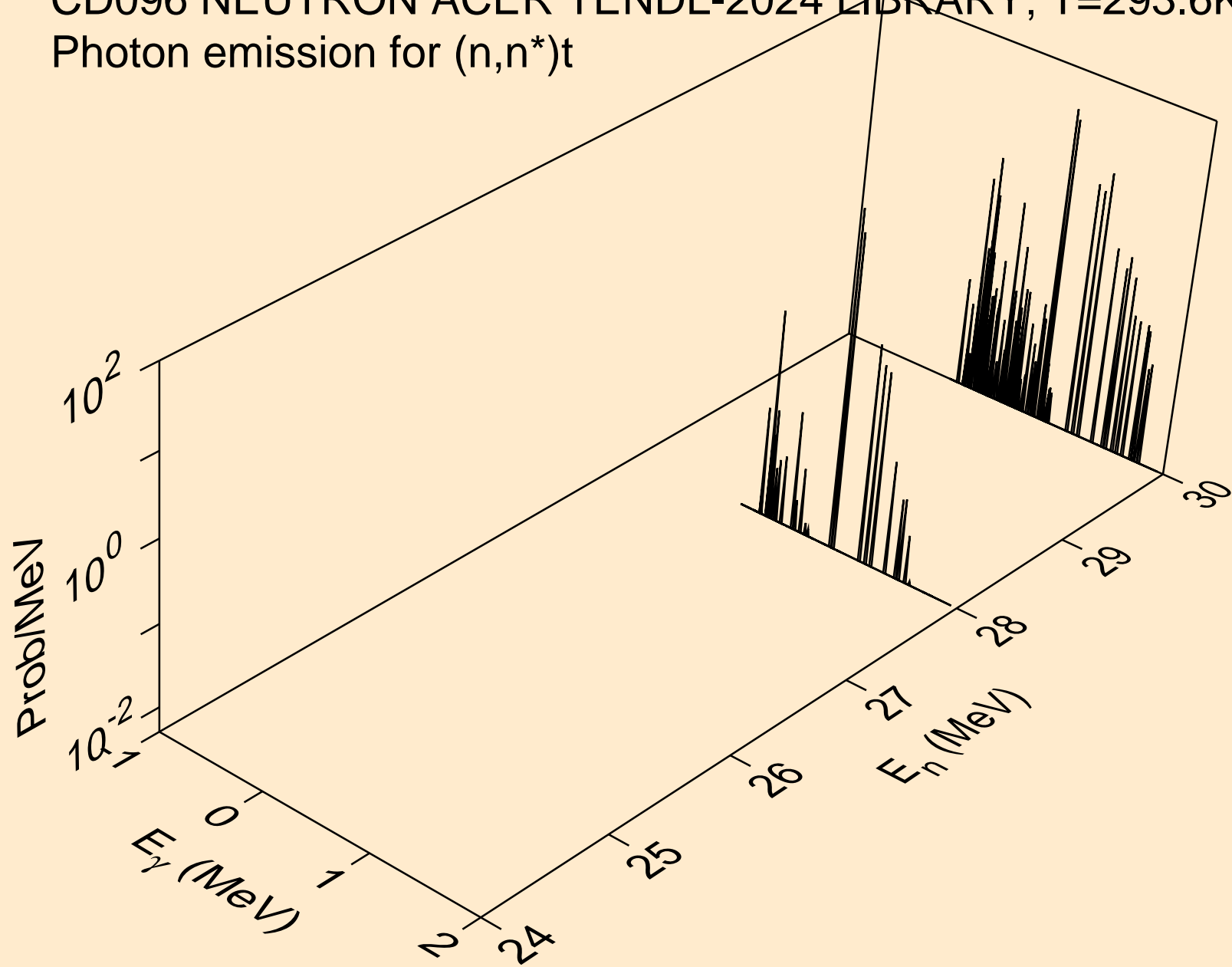

CD096 NEUTRON ACER TENDL-2024 LIBRARY; T=293.6K
Photon emission for (n,n*)he3

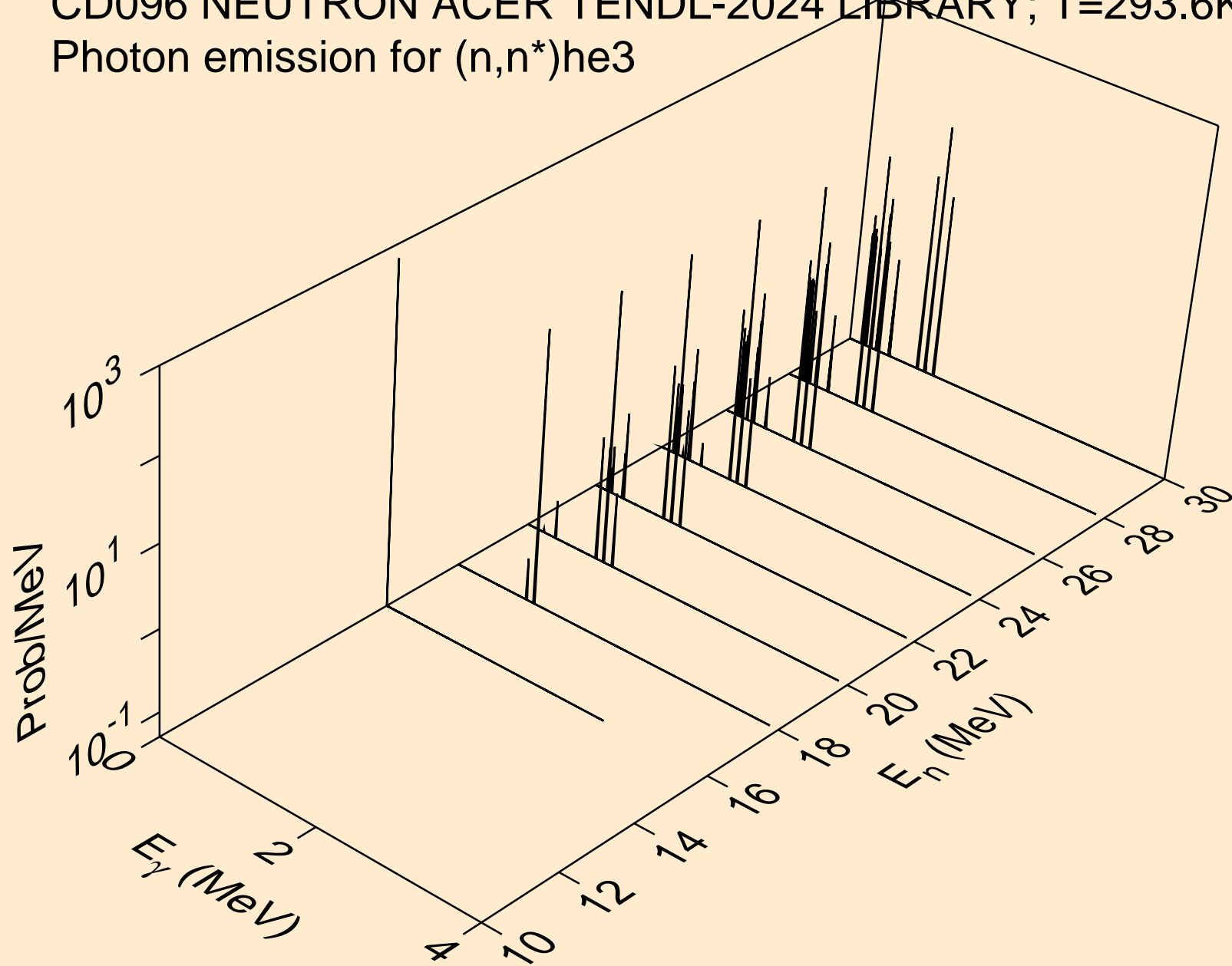

CD096 NEUTRON ACER TENDL-2024 LIBRARY; T=293.6K
Photon emission for (n,2np)

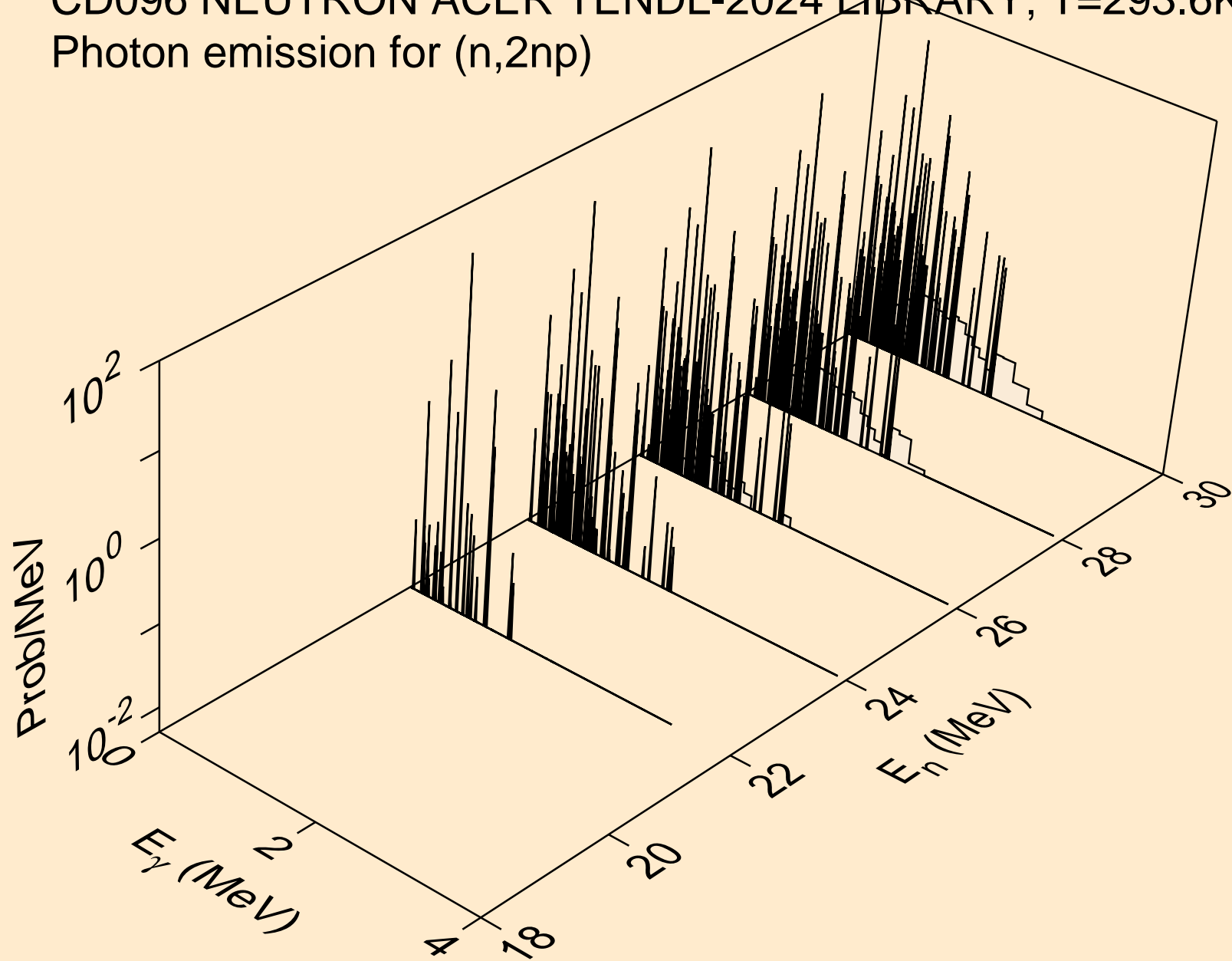

CD096 NEUTRON ACER TENDL-2024 LIBRARY; T=293.6K
Photon emission for (n,n2p)

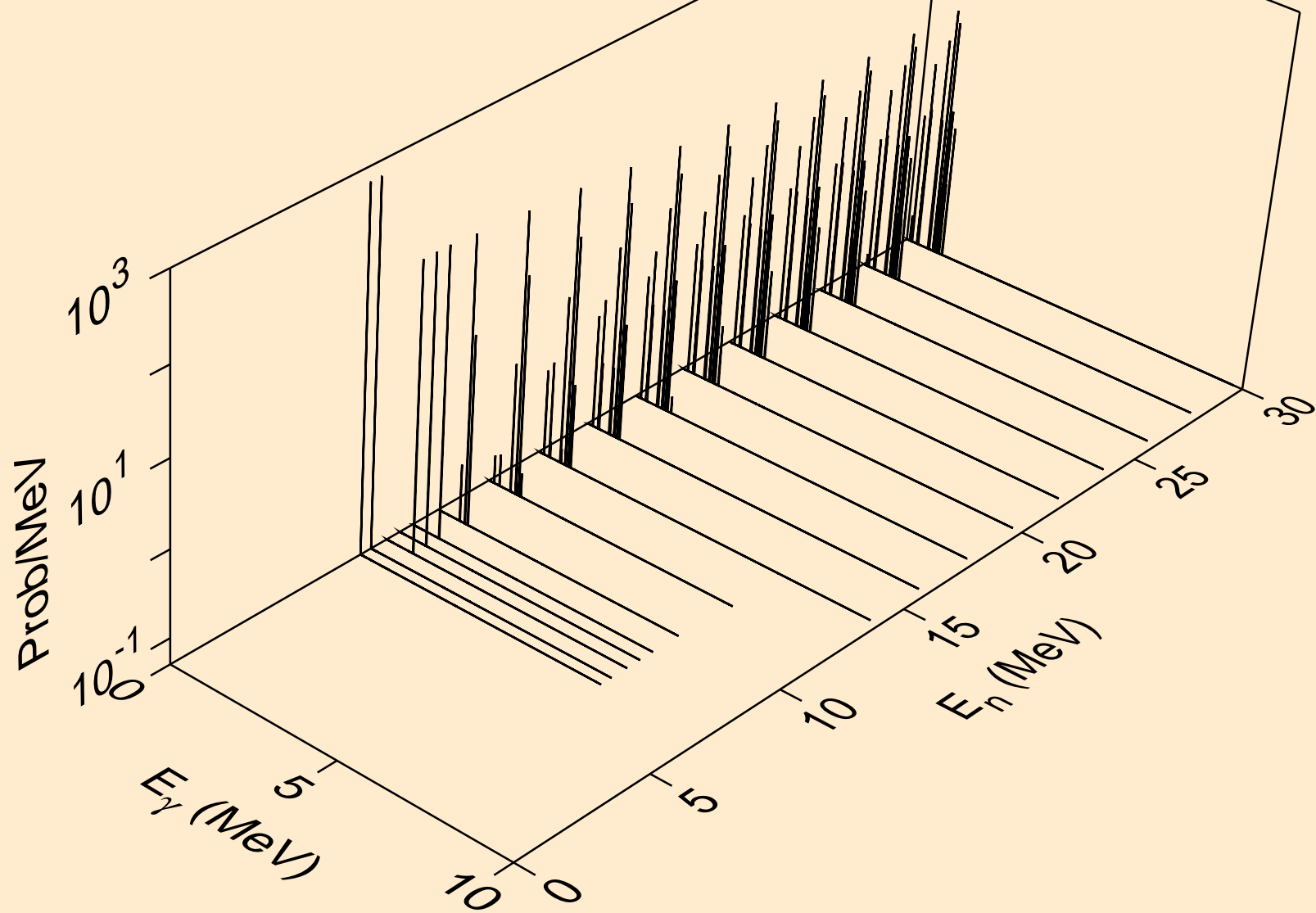

CD096 NEUTRON ACER TENDL-2024 LIBRARY; T=293.6K
Photon emission for (n,npa)

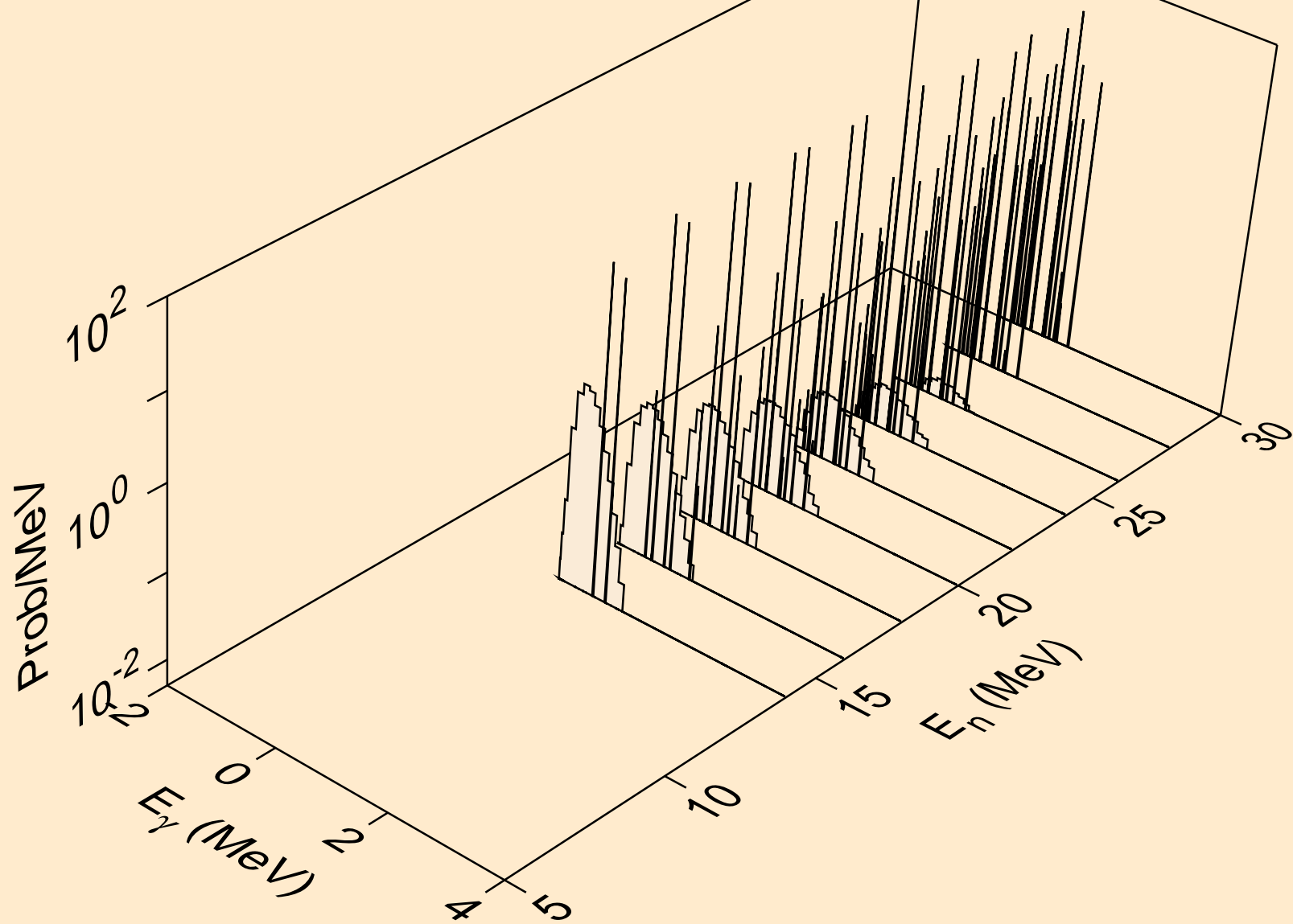

CD096 NEUTRON ACER TENDL-2024 LIBRARY; T=293.6K
Photon emission for (n,n*c)

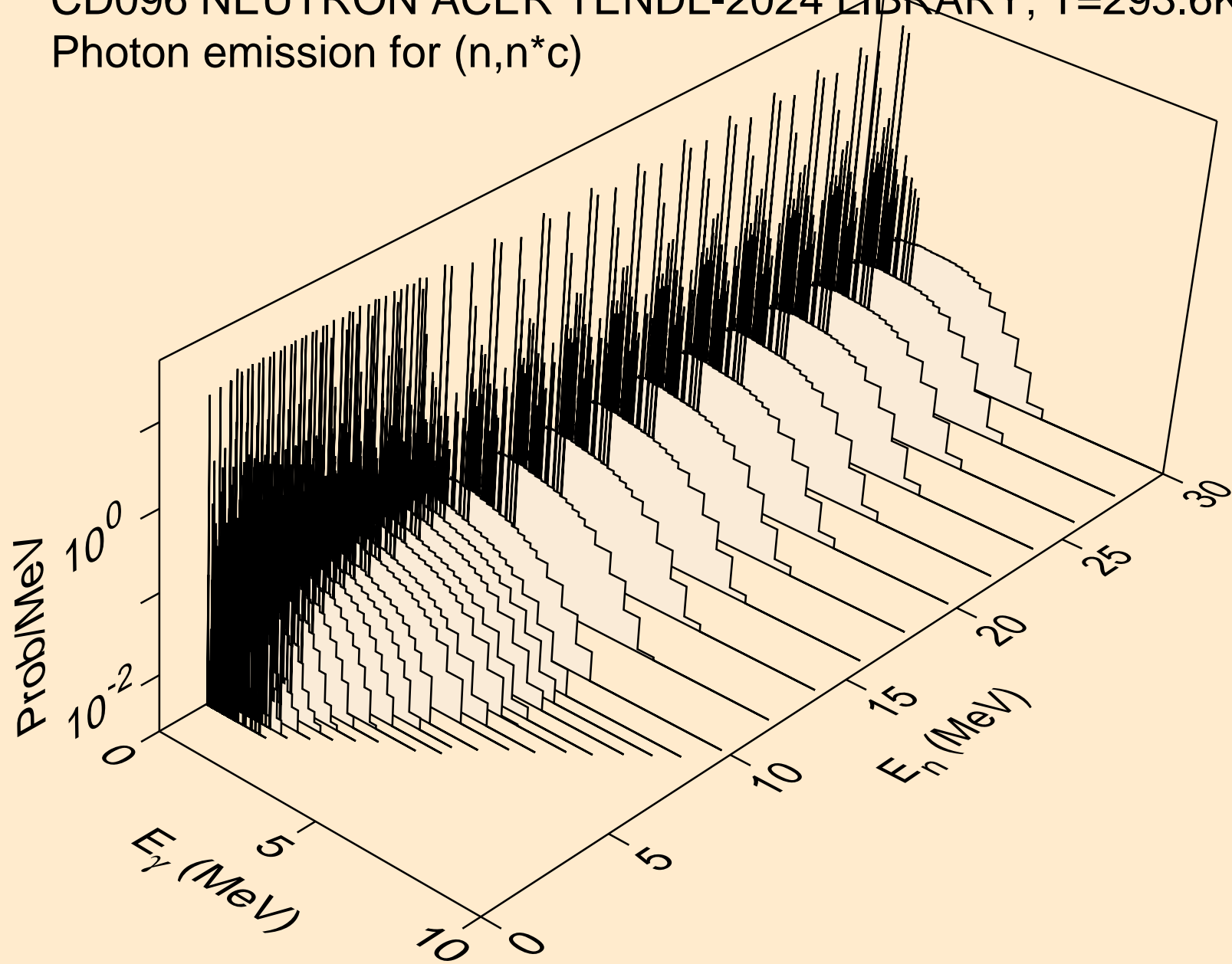

CD096 NEUTRON ACER TENDL-2024 LIBRARY; T=293.6K
Photon emission for (n,gma)

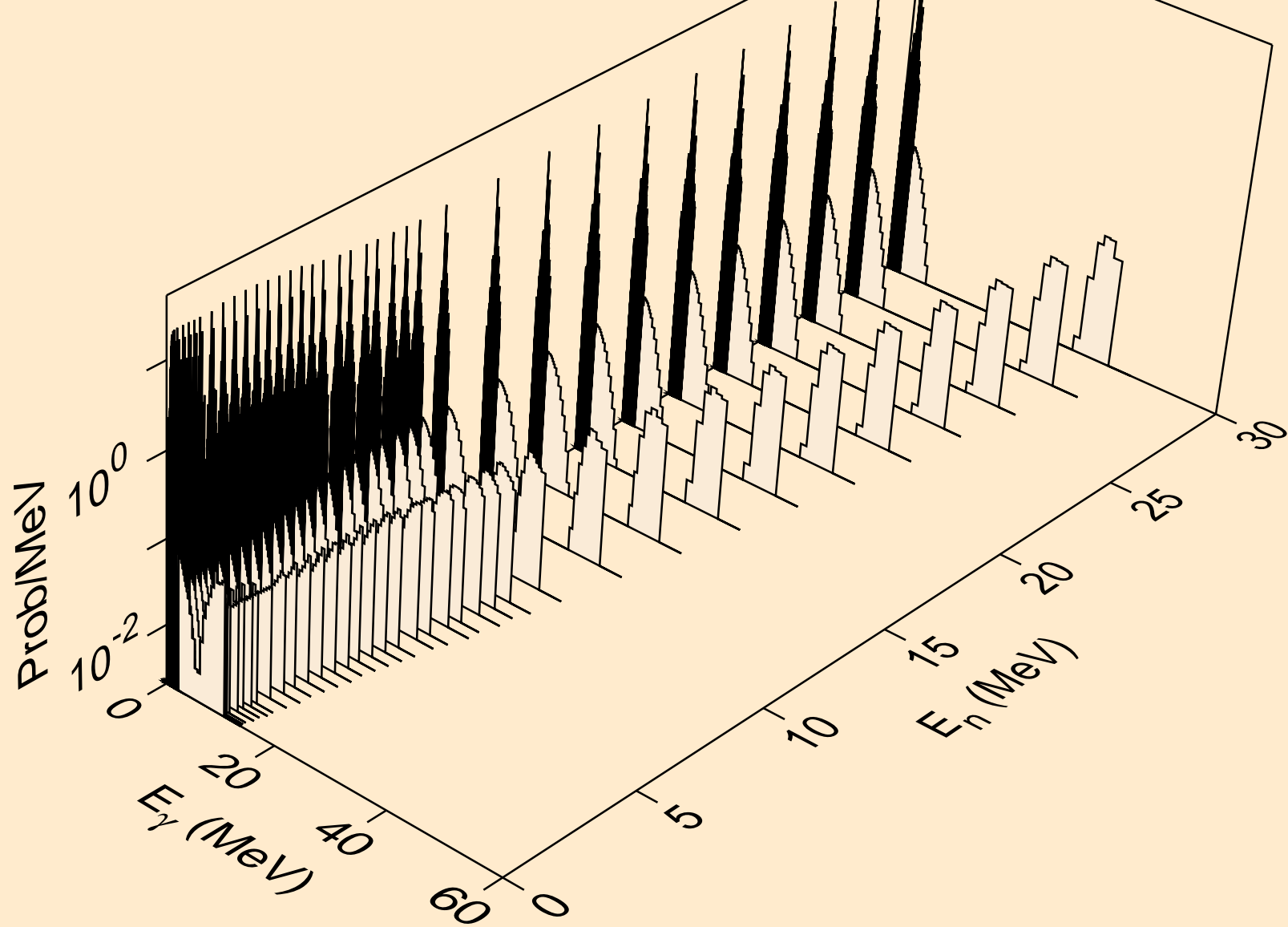

CD096 NEUTRON ACER TENDL-2024 LIBRARY; T=293.6K
Photon emission for (n,p)

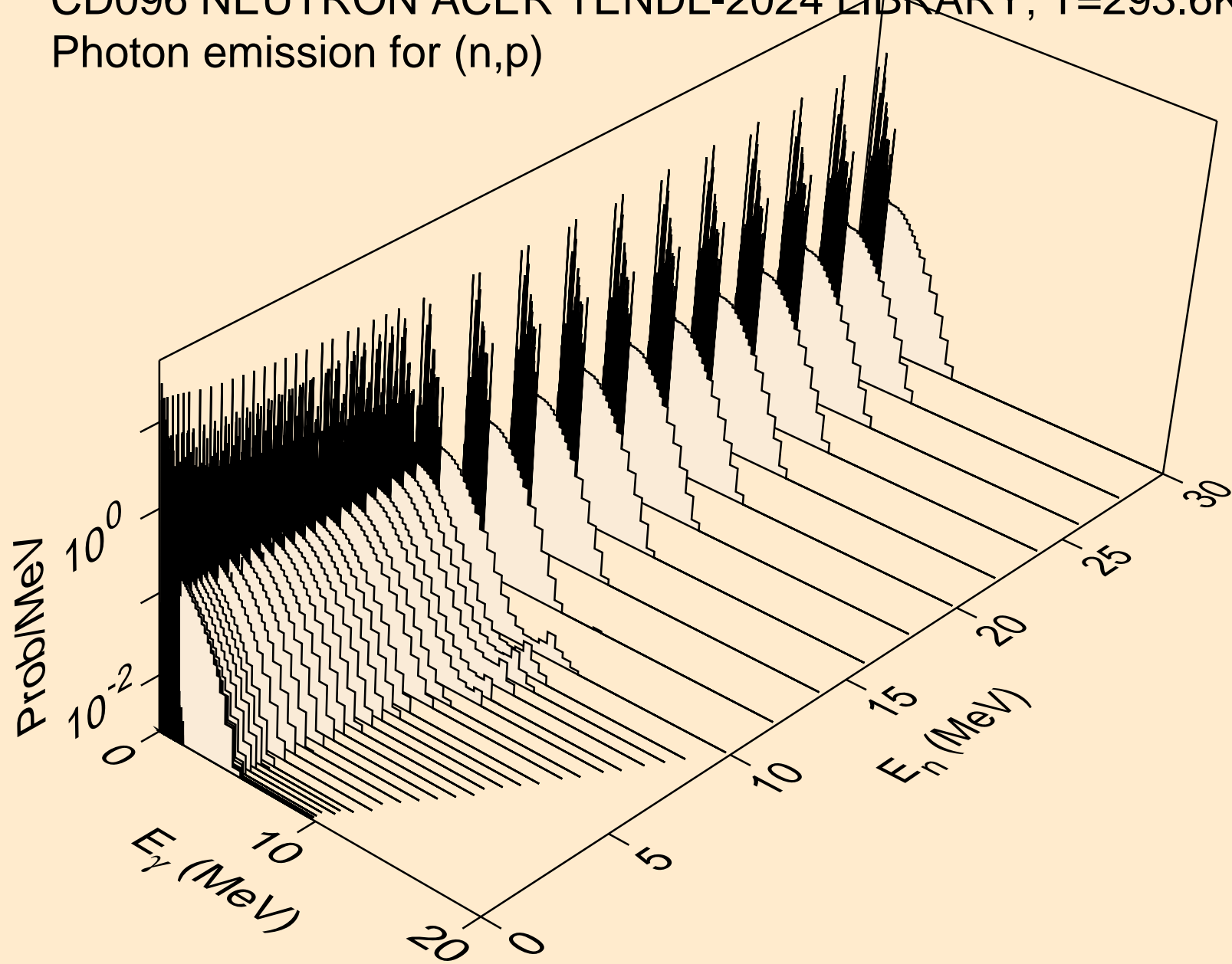

CD096 NEUTRON ACER TENDL-2024 LIBRARY; T=293.6K
Photon emission for (n,d)

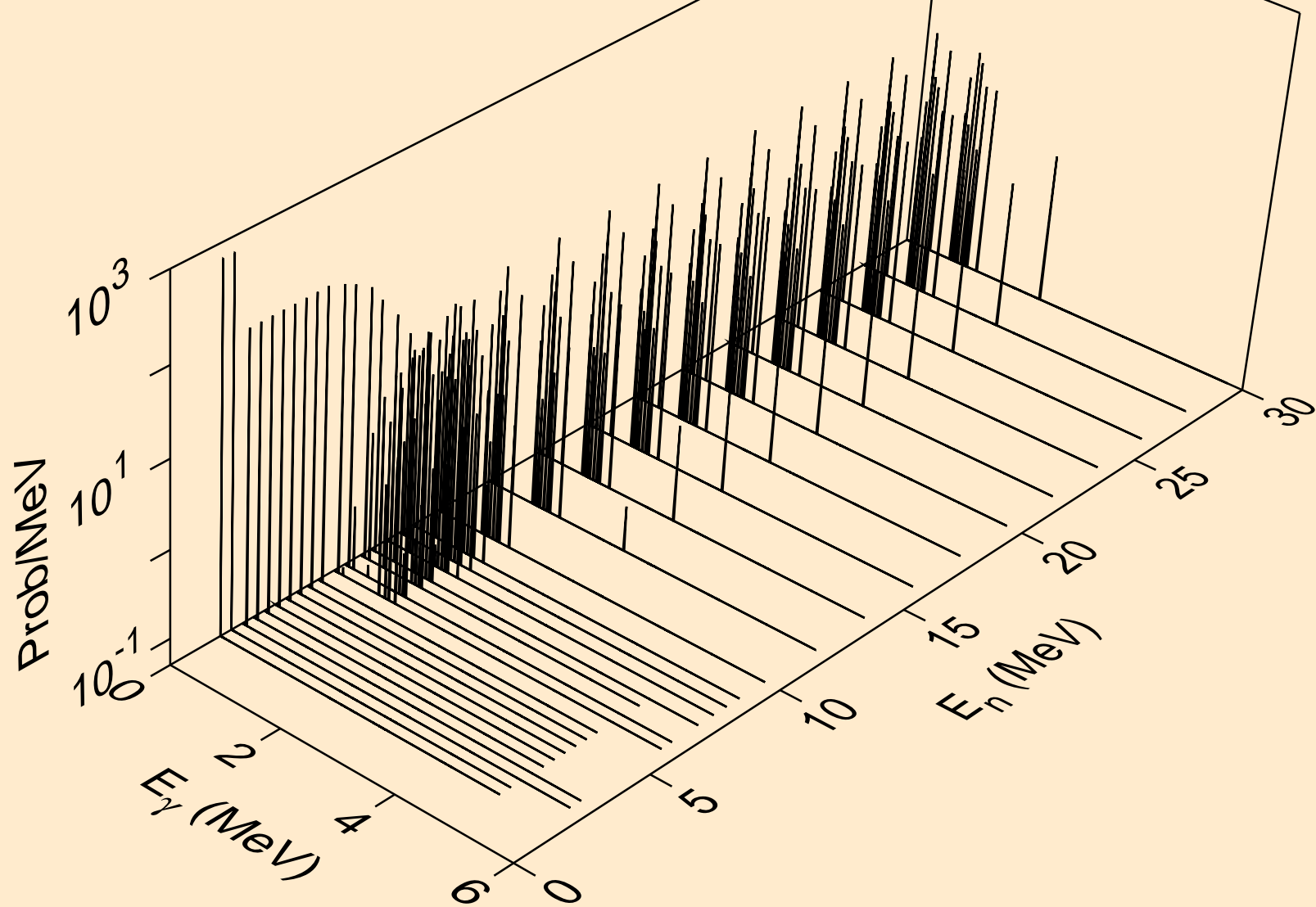

CD096 NEUTRON ACER TENDL-2024 LIBRARY; T=293.6K
Photon emission for (n,t)

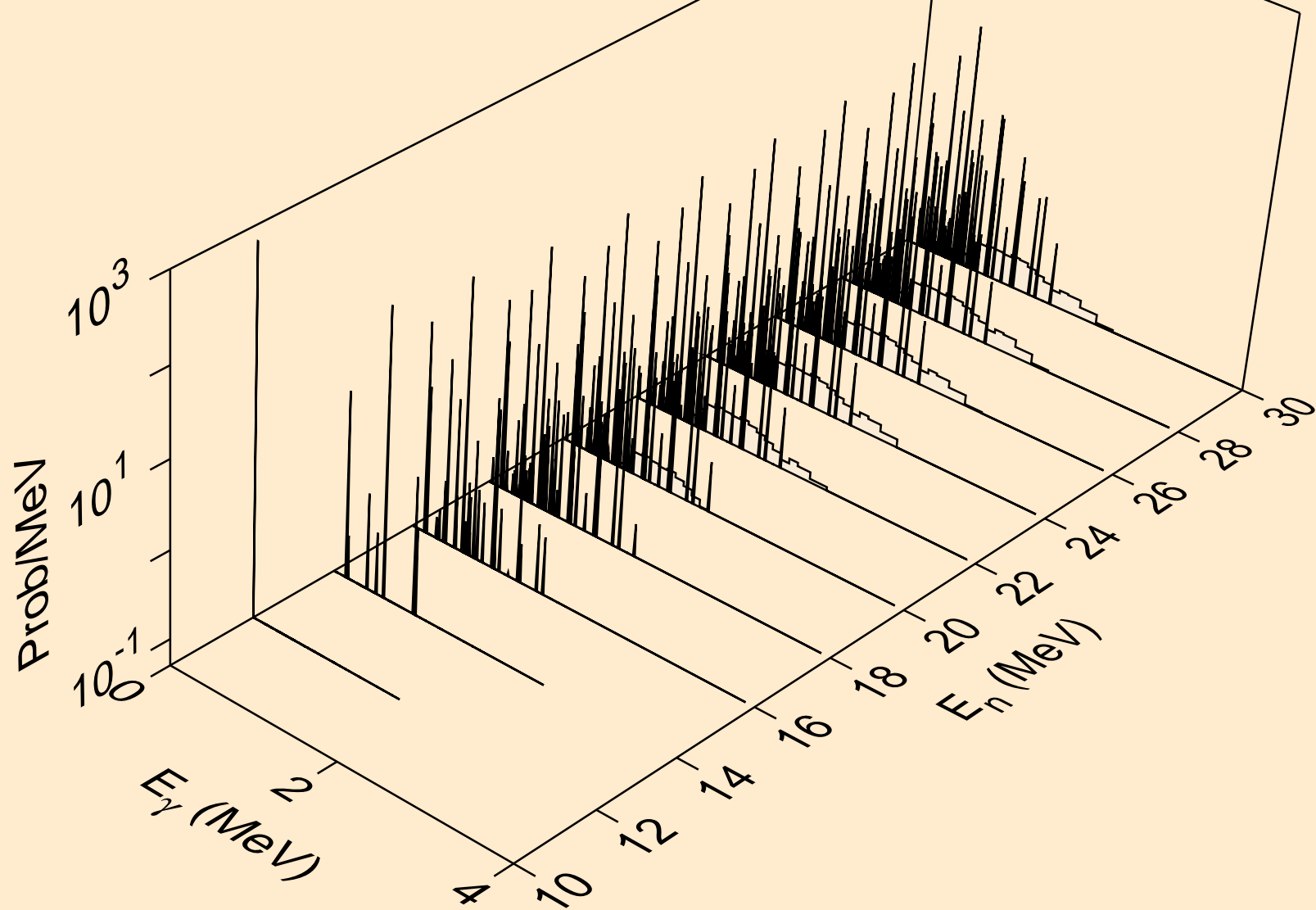

CD096 NEUTRON ACER TENDL-2024 LIBRARY; T=293.6K
Photon emission for (n,he3)

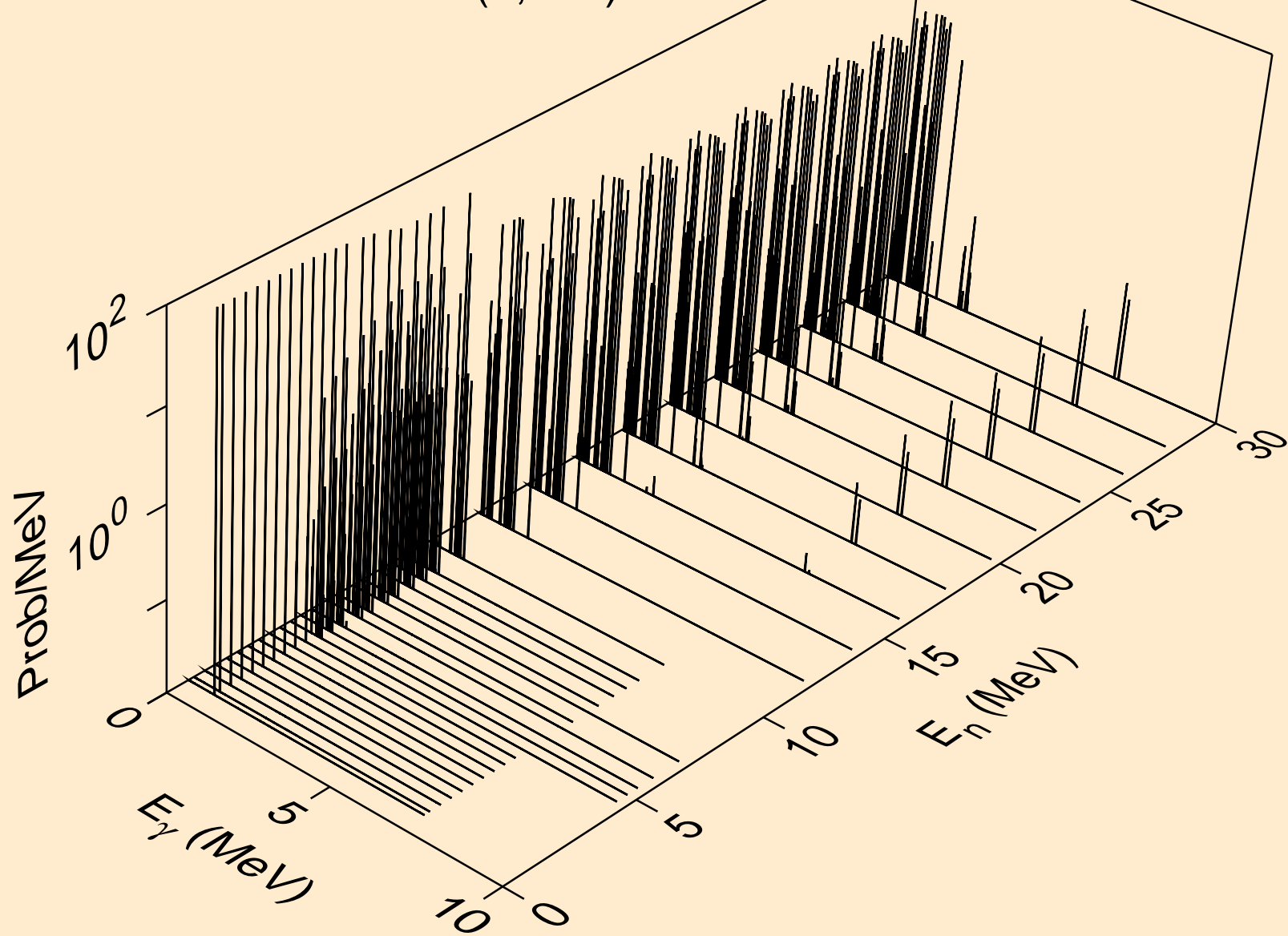

CD096 NEUTRON ACER TENDL-2024 LIBRARY; T=293.6K
Photon emission for (n,a)

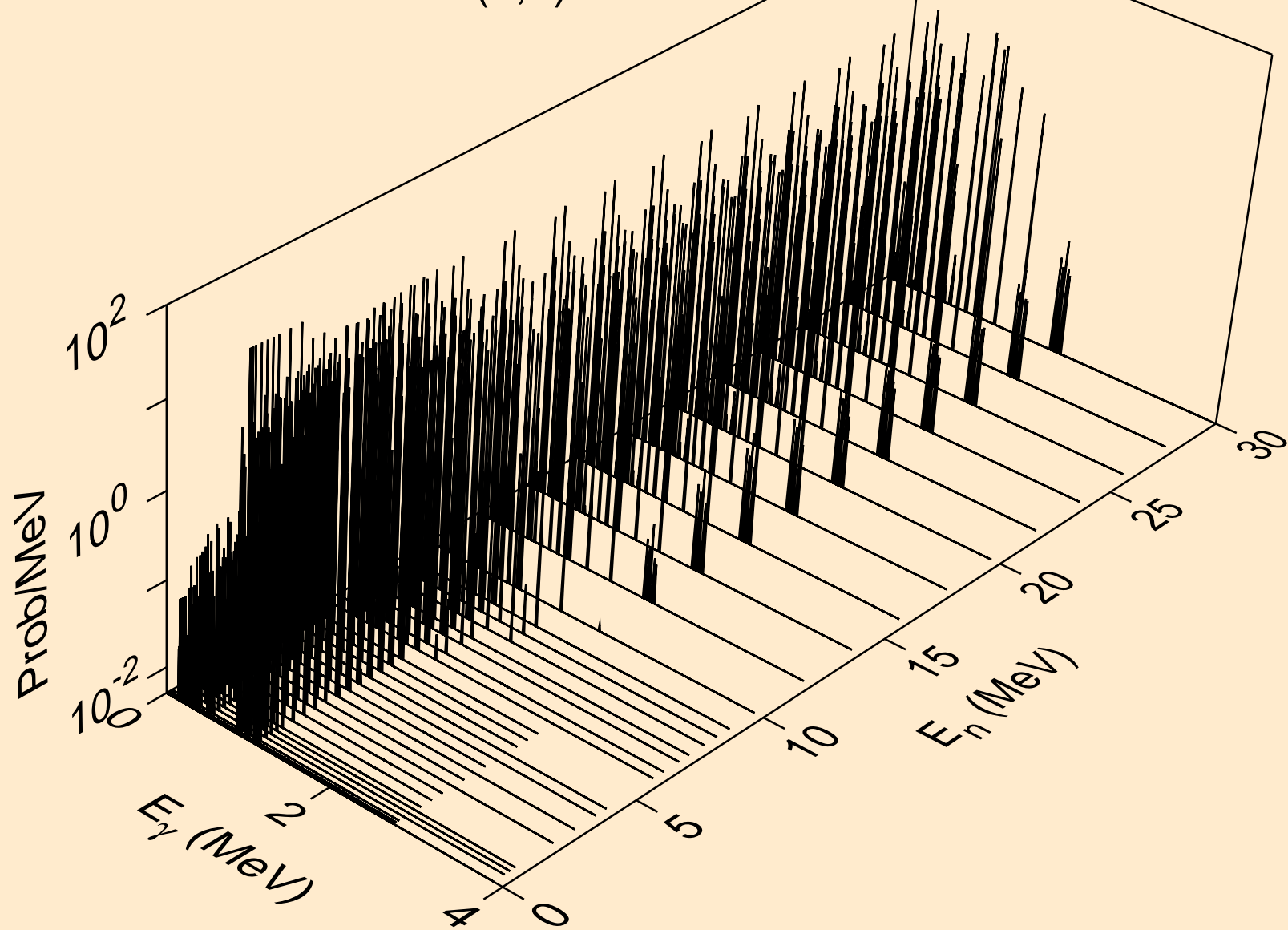

CD096 NEUTRON ACER TENDL-2024 LIBRARY; T=293.6K
Photon emission for (n,2a)

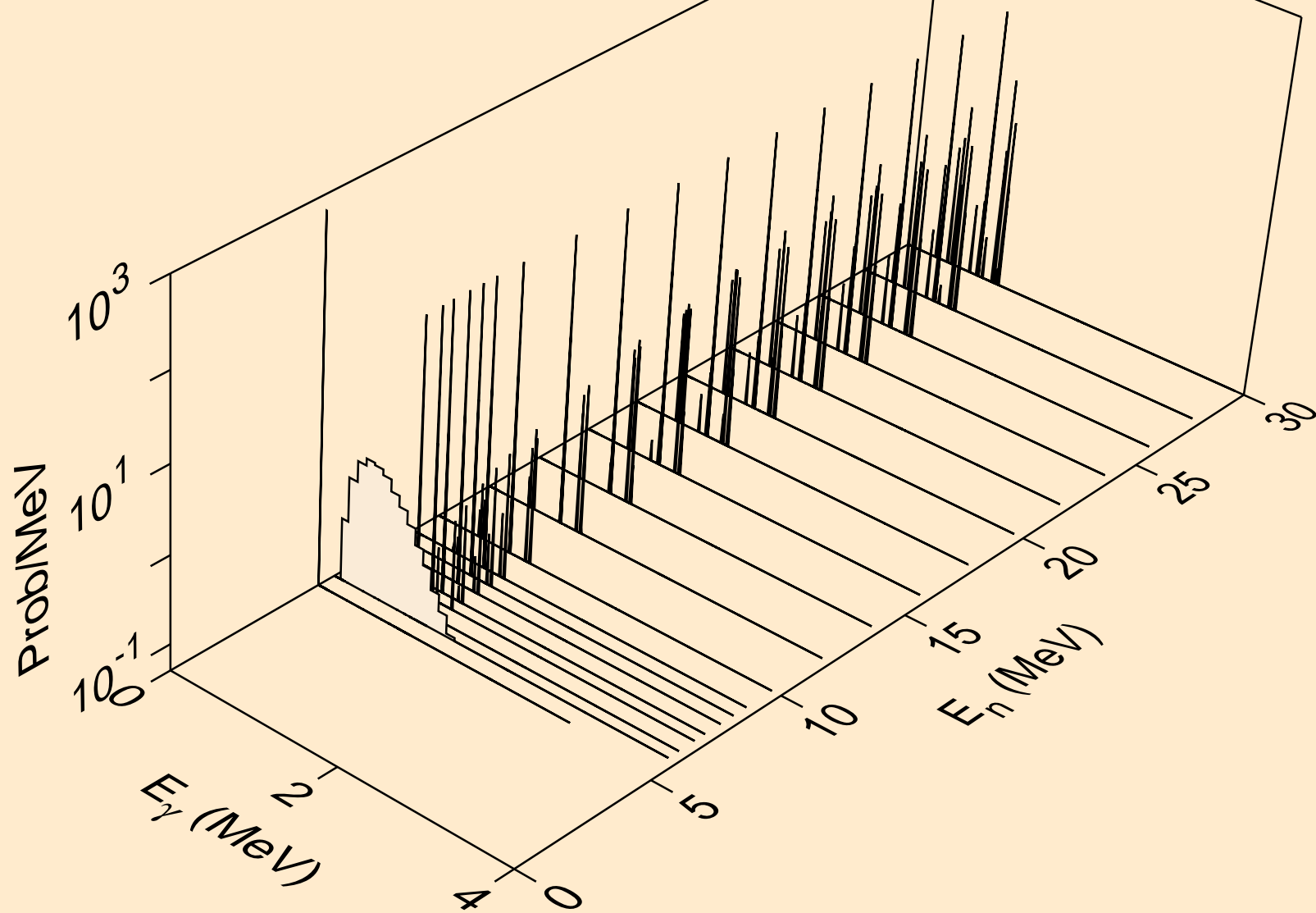

CD096 NEUTRON ACER TENDL-2024 LIBRARY; T=293.6K
Photon emission for (n,2p)

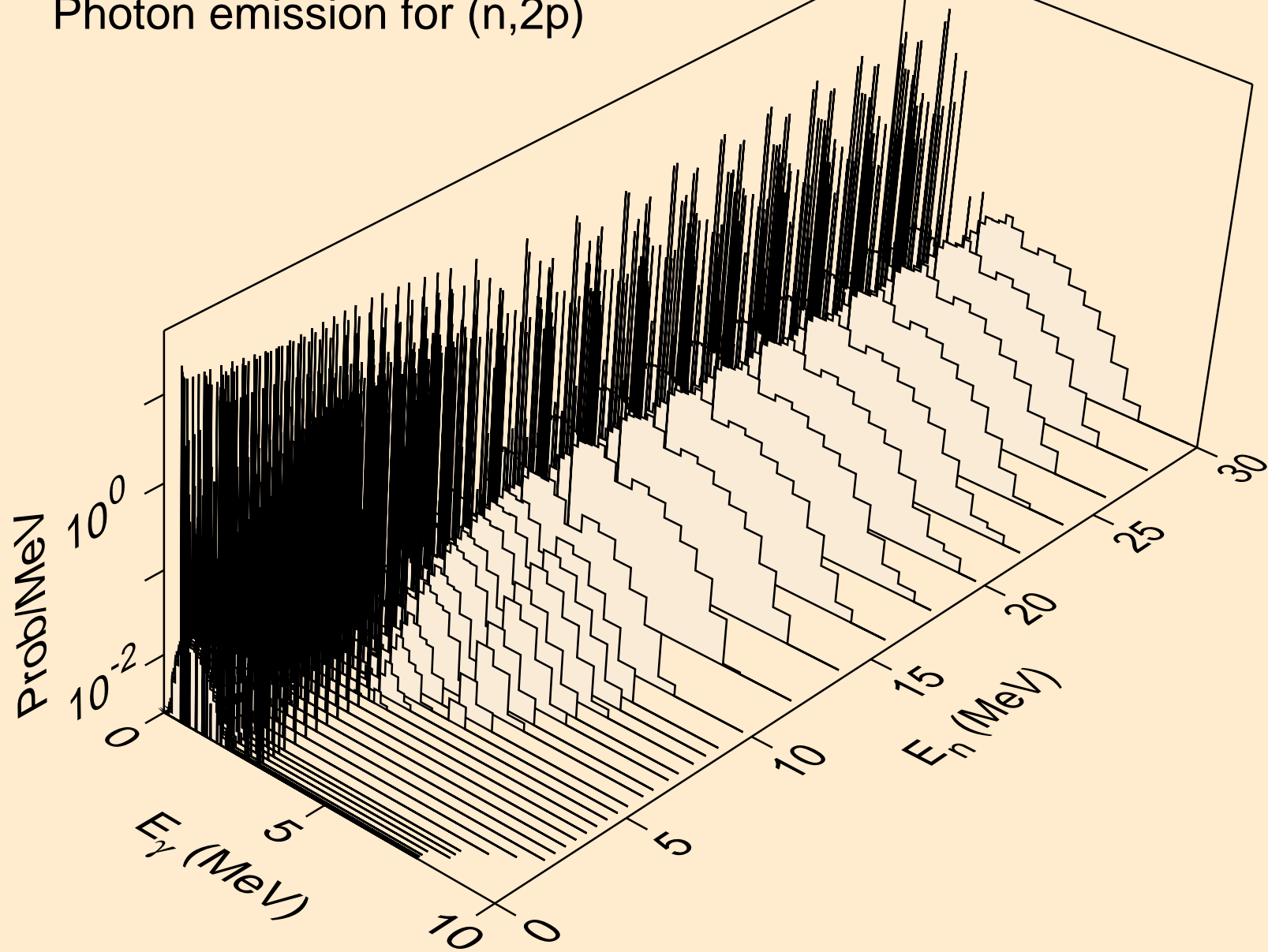

CD096 NEUTRON ACER TENDL-2024 LIBRARY; T=293.6K
Photon emission for (n,p α)

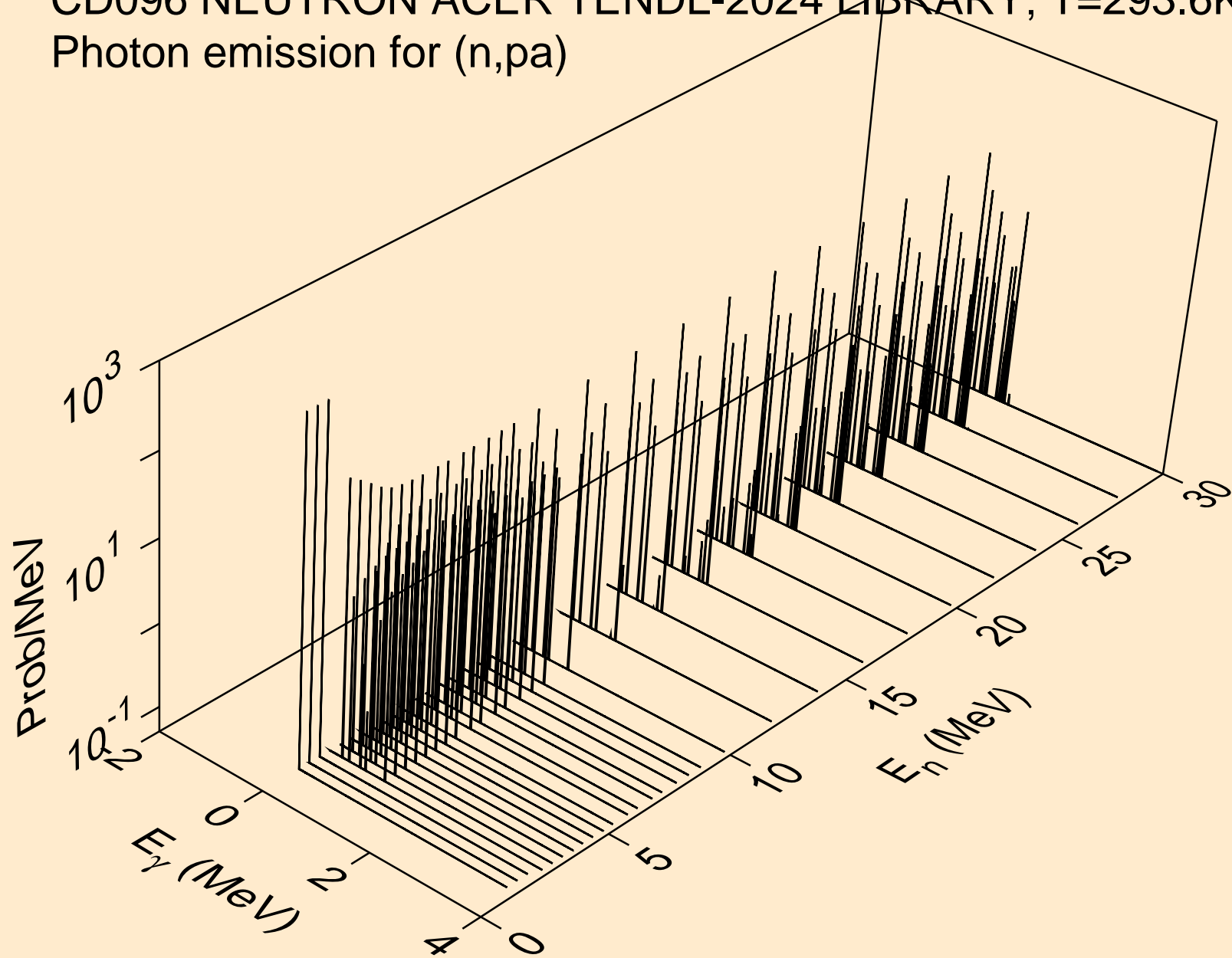

CD096 NEUTRON ACER TENDL-2024 LIBRARY; T=293.6K
Photon emission for (n,pd)

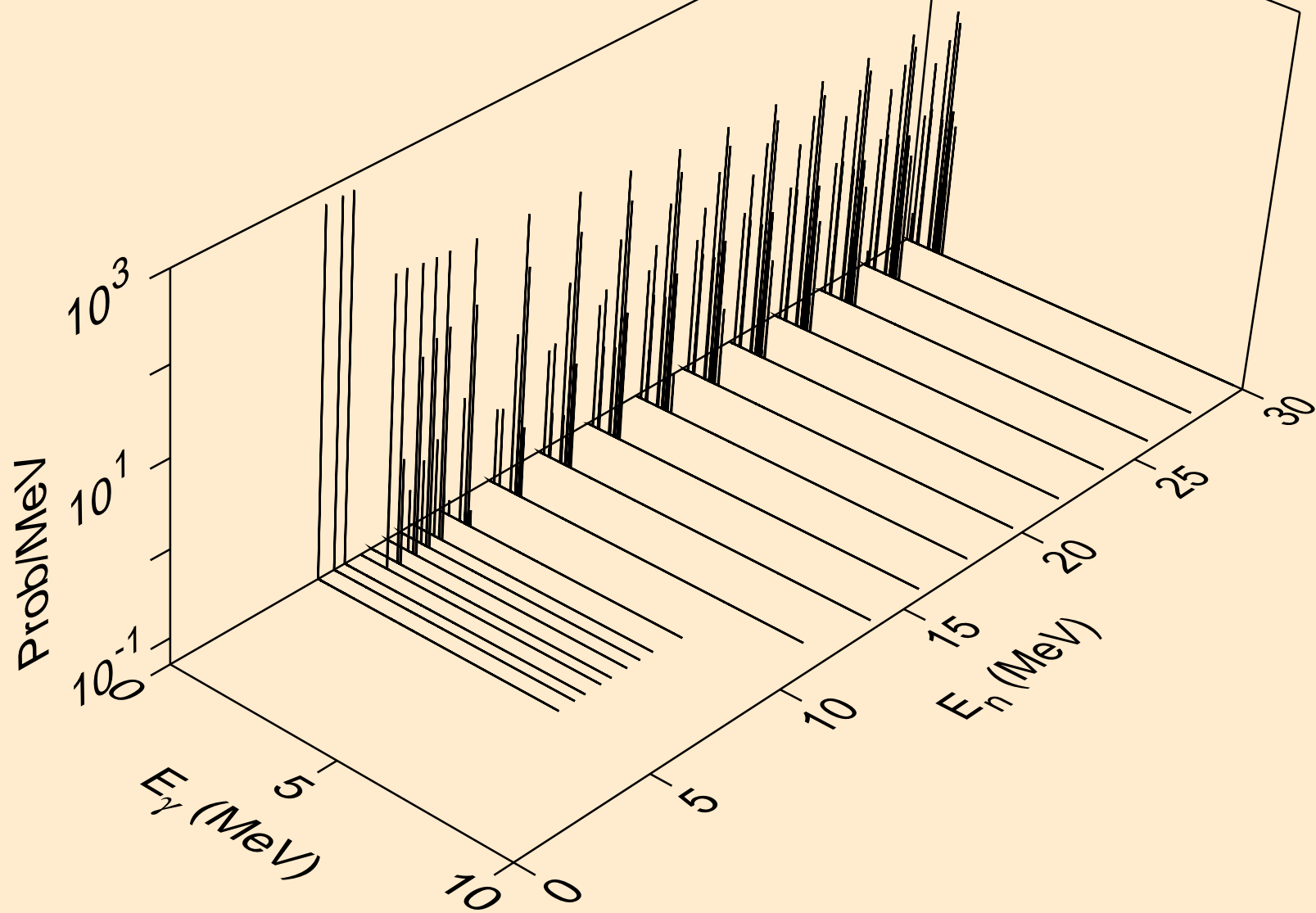

CD096 NEUTRON ACER TENDL-2024 LIBRARY; T=293.6K
Photon emission for (n,pt)

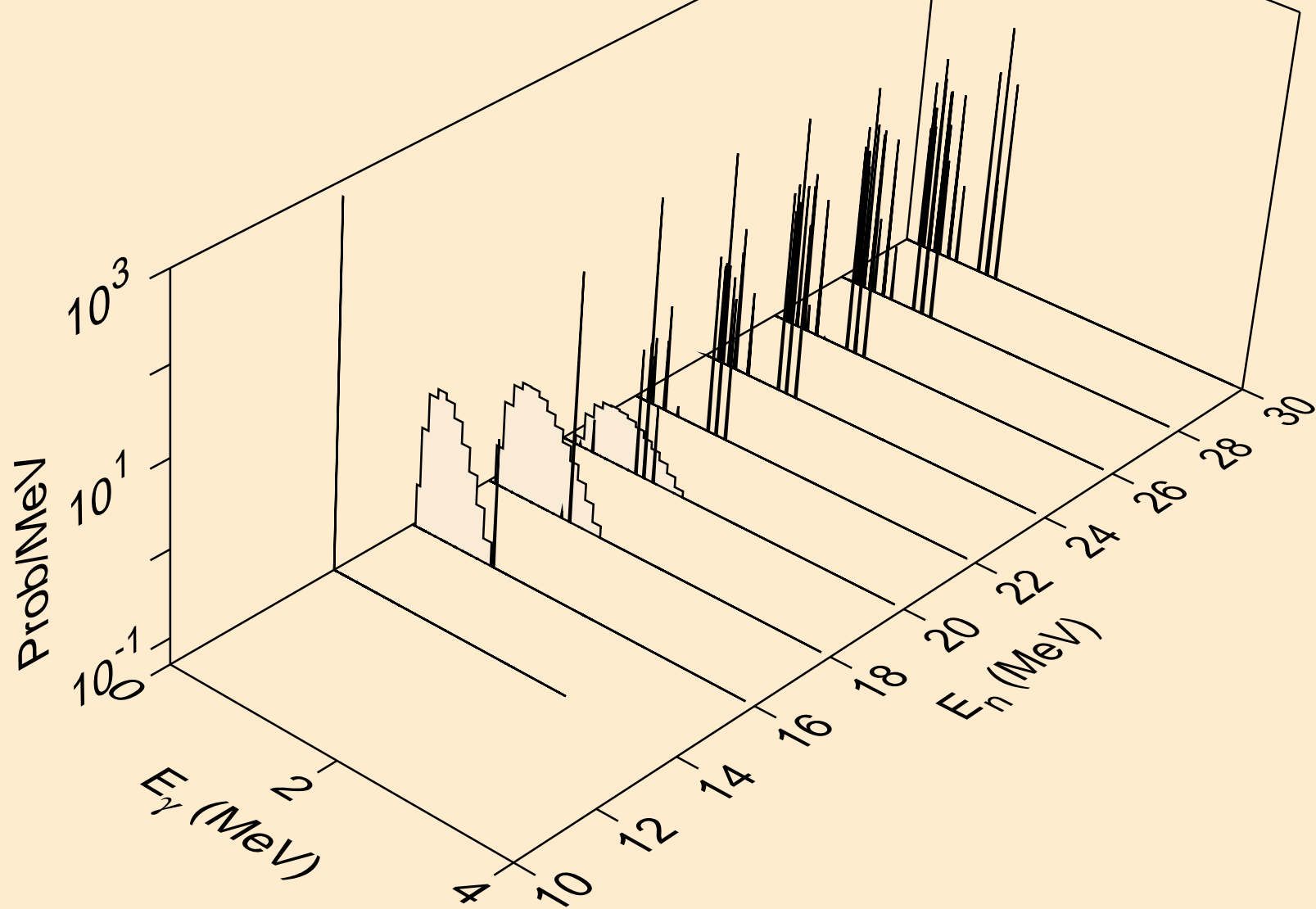

CD096 NEUTRON ACER TENDL-2024 LIBRARY; T=293.6K
Photon emission for (n,da)

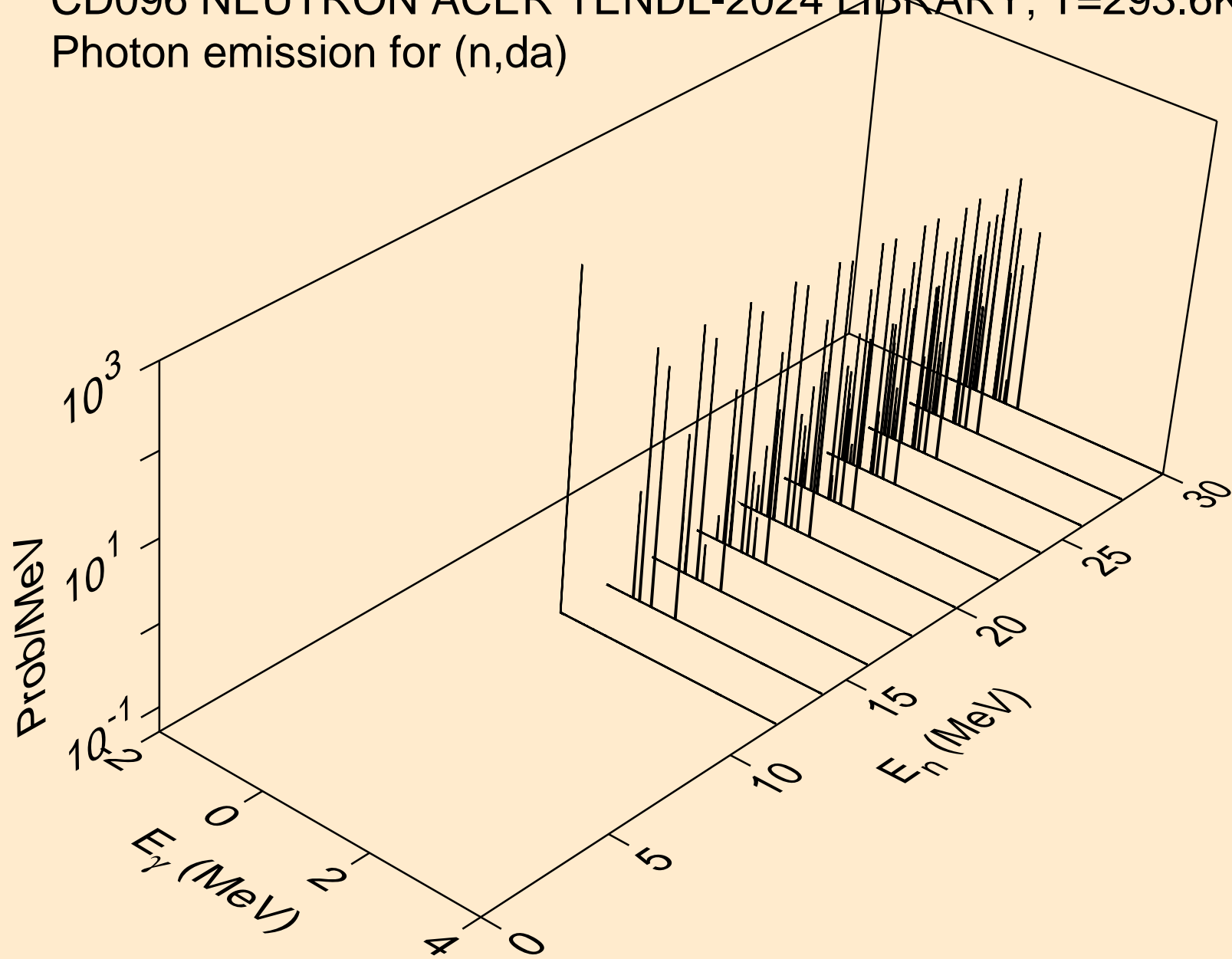

CD096 NEUTRON ACER TENDL-2024 LIBRARY; T=293.6K
thermal capture photon spectrum

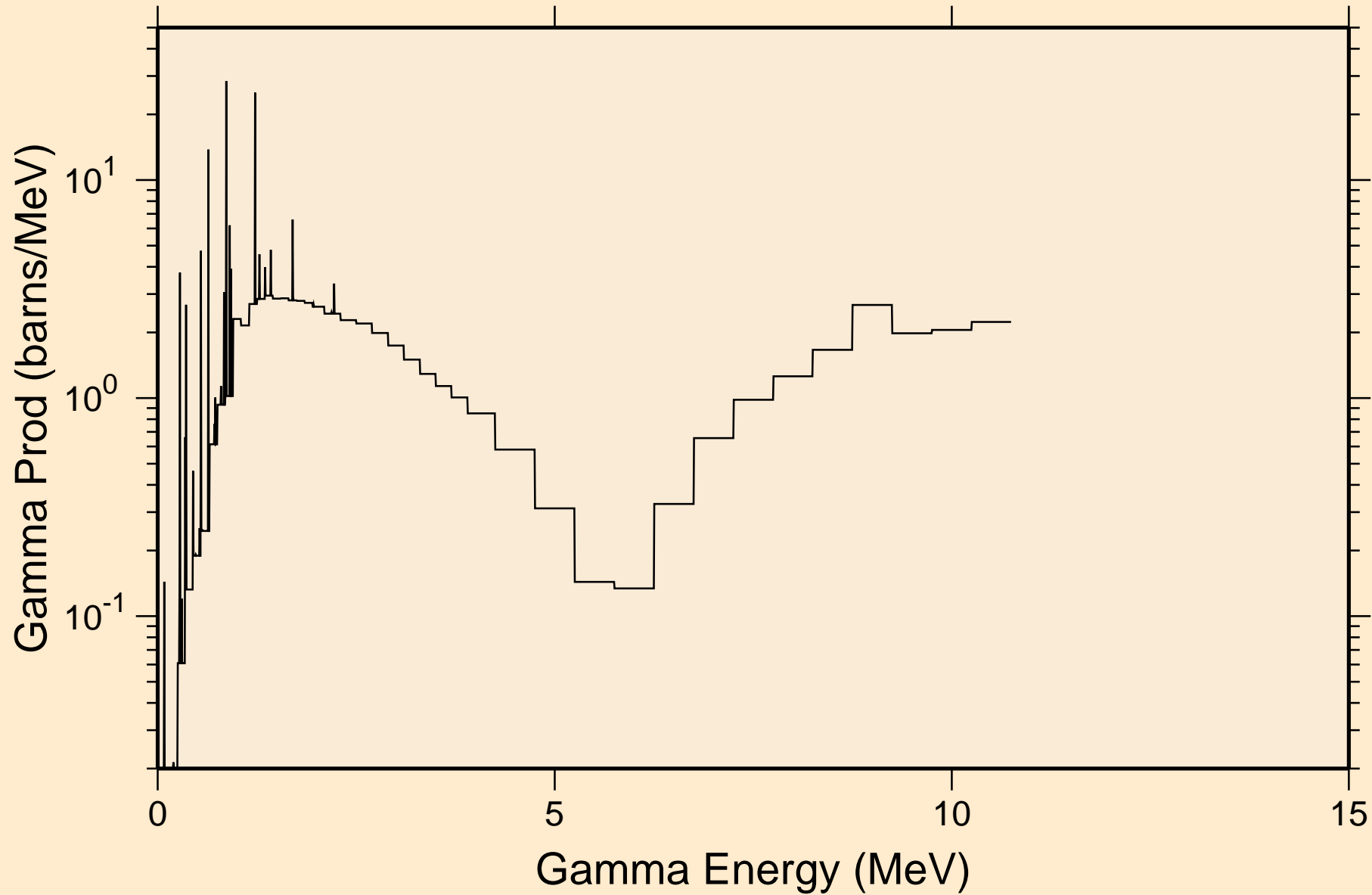

CD096 NEUTRON ACER TENDL-2024 LIBRARY; T=293.6K
14 MeV photon spectrum

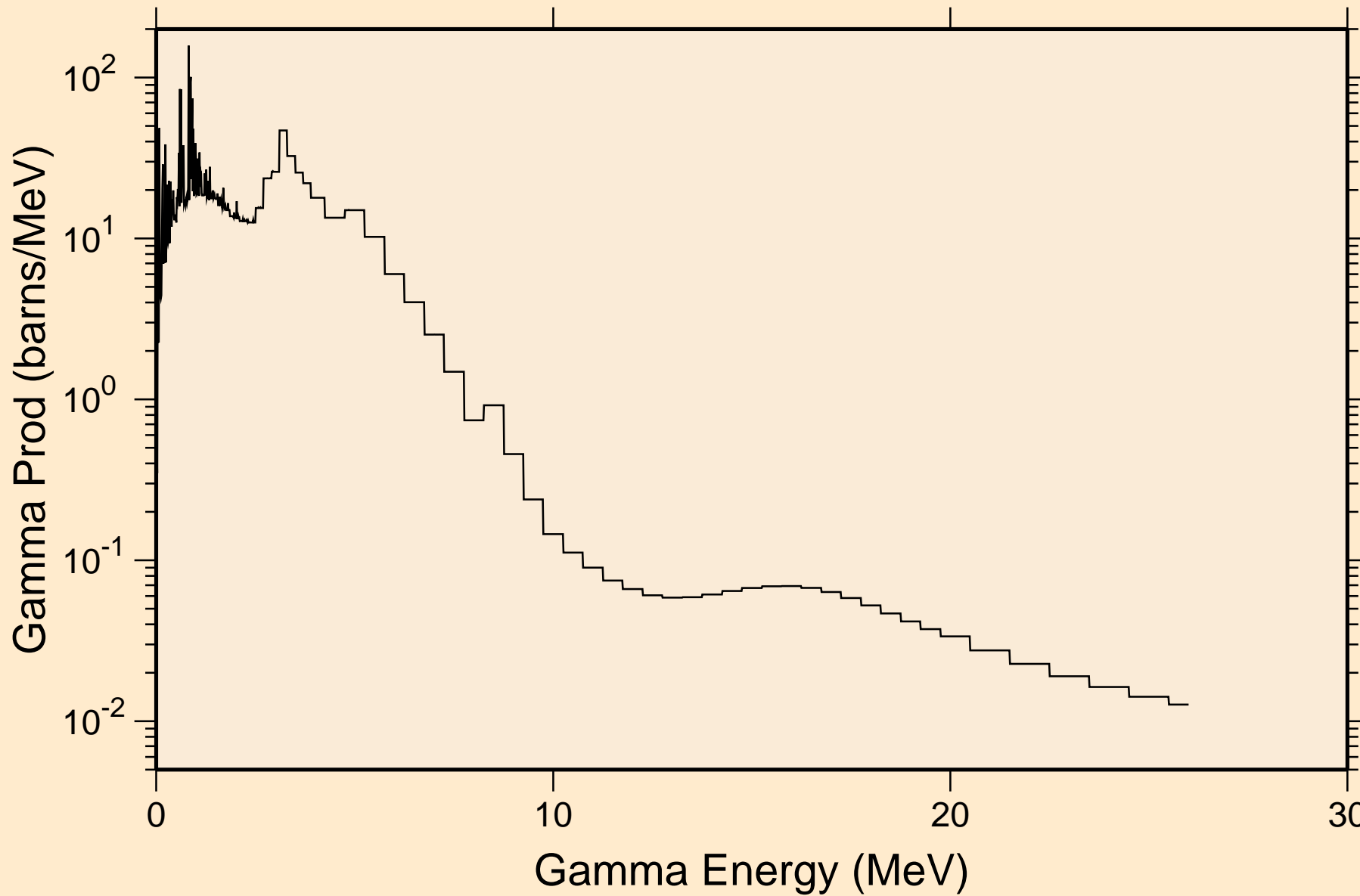

CD096 NEUTRON ACER TENDL-2024 LIBRARY; T=293.6K

Particle heating contributions

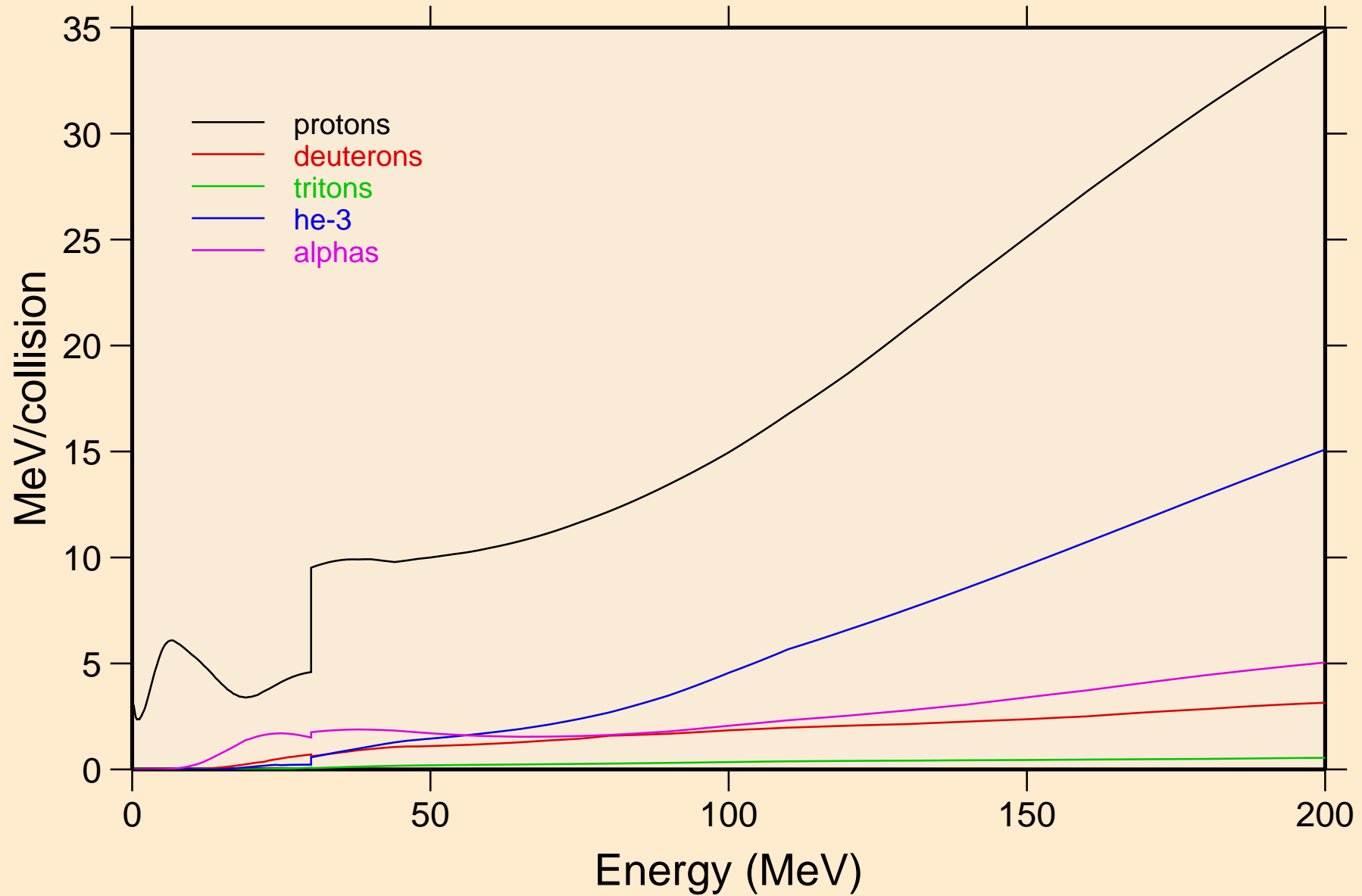

CD096 NEUTRON ACER TENDL-2024 LIBRARY; T=293.6K
Recoil Heating

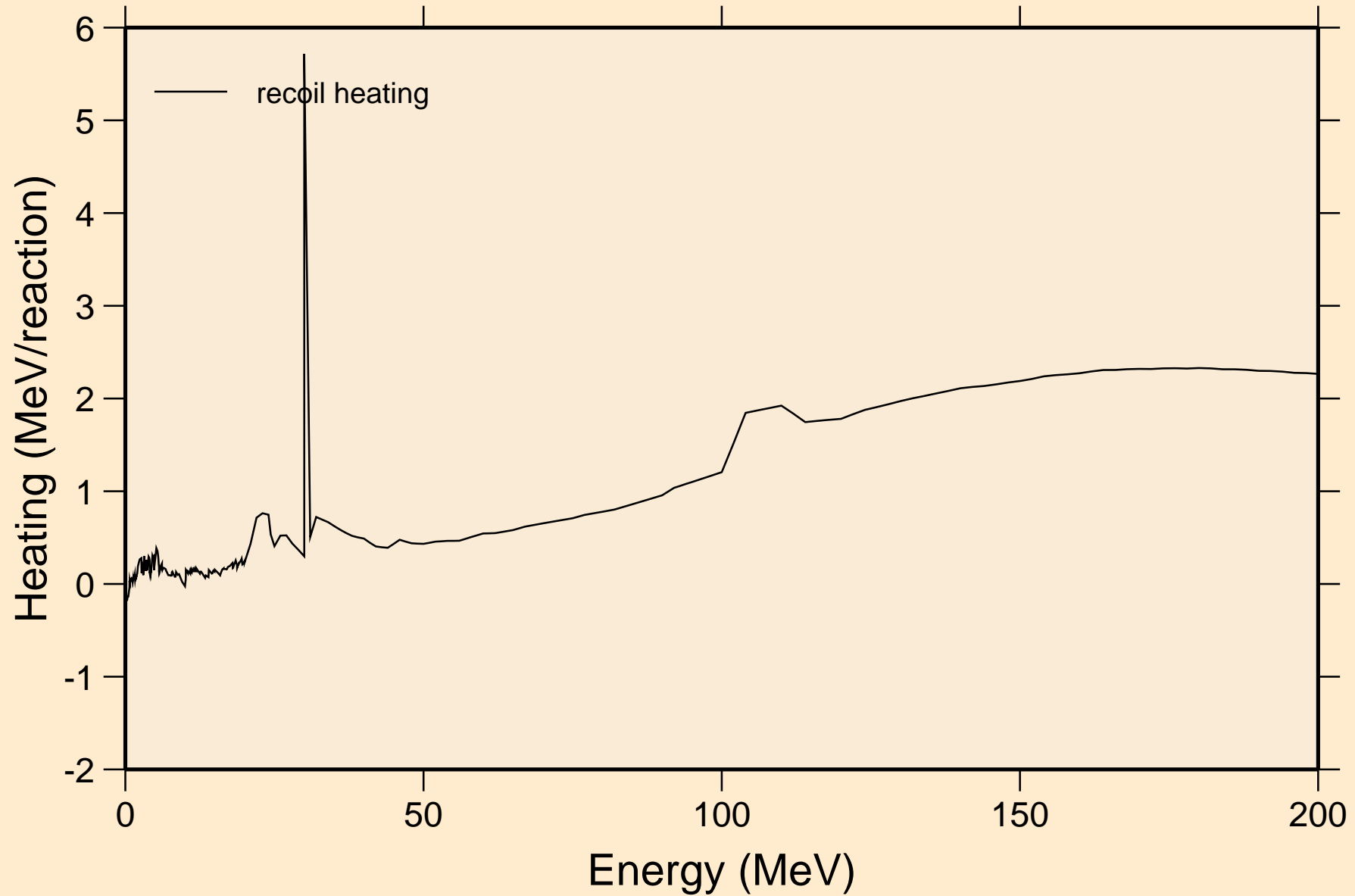

CD096 NEUTRON ACER TENDL-2024 LIBRARY; T=293.6K

Particle production cross sections

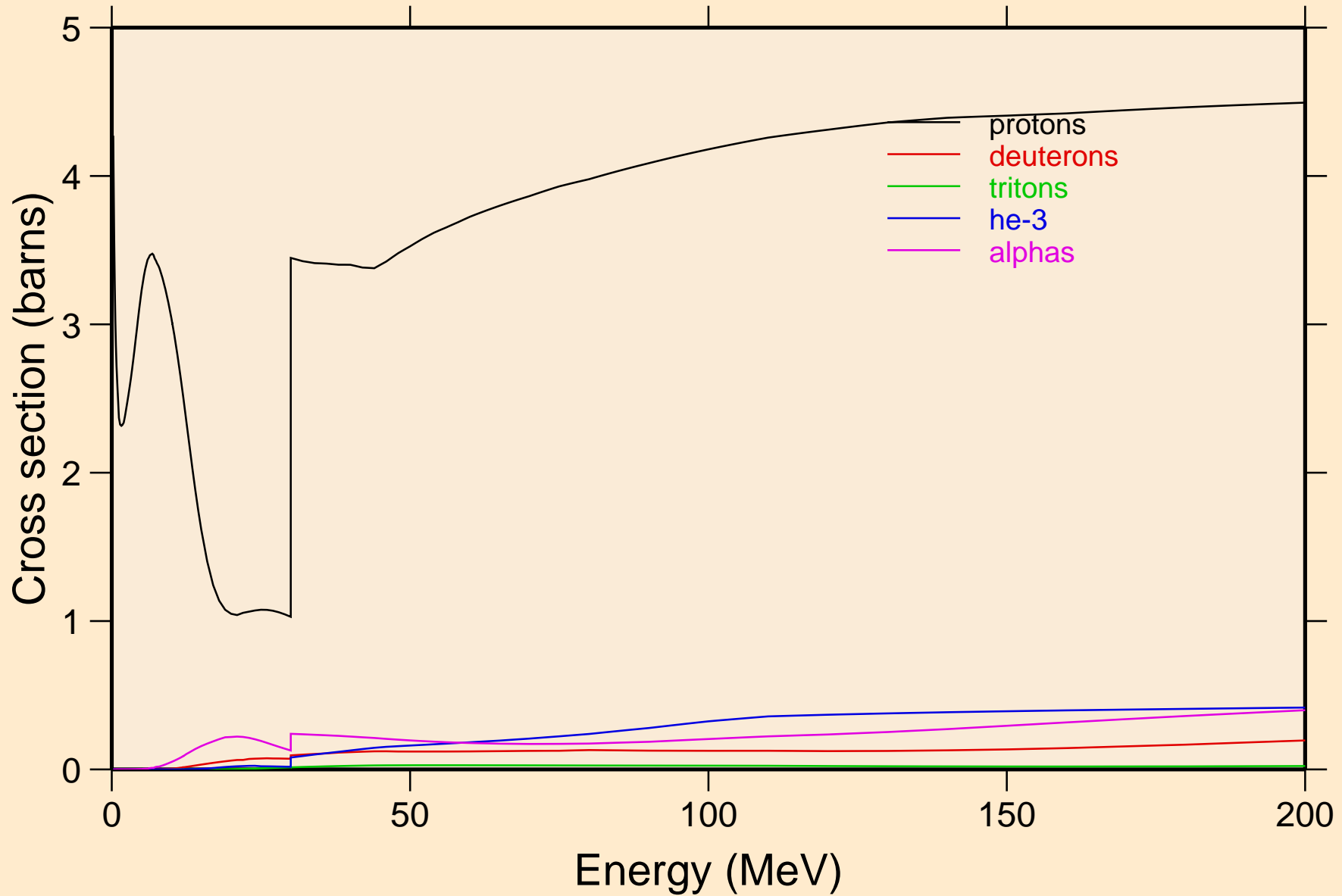

CD096 NEUTRON ACER TENDL-2024 LIBRARY; T=293.6K
protons from (n,x)

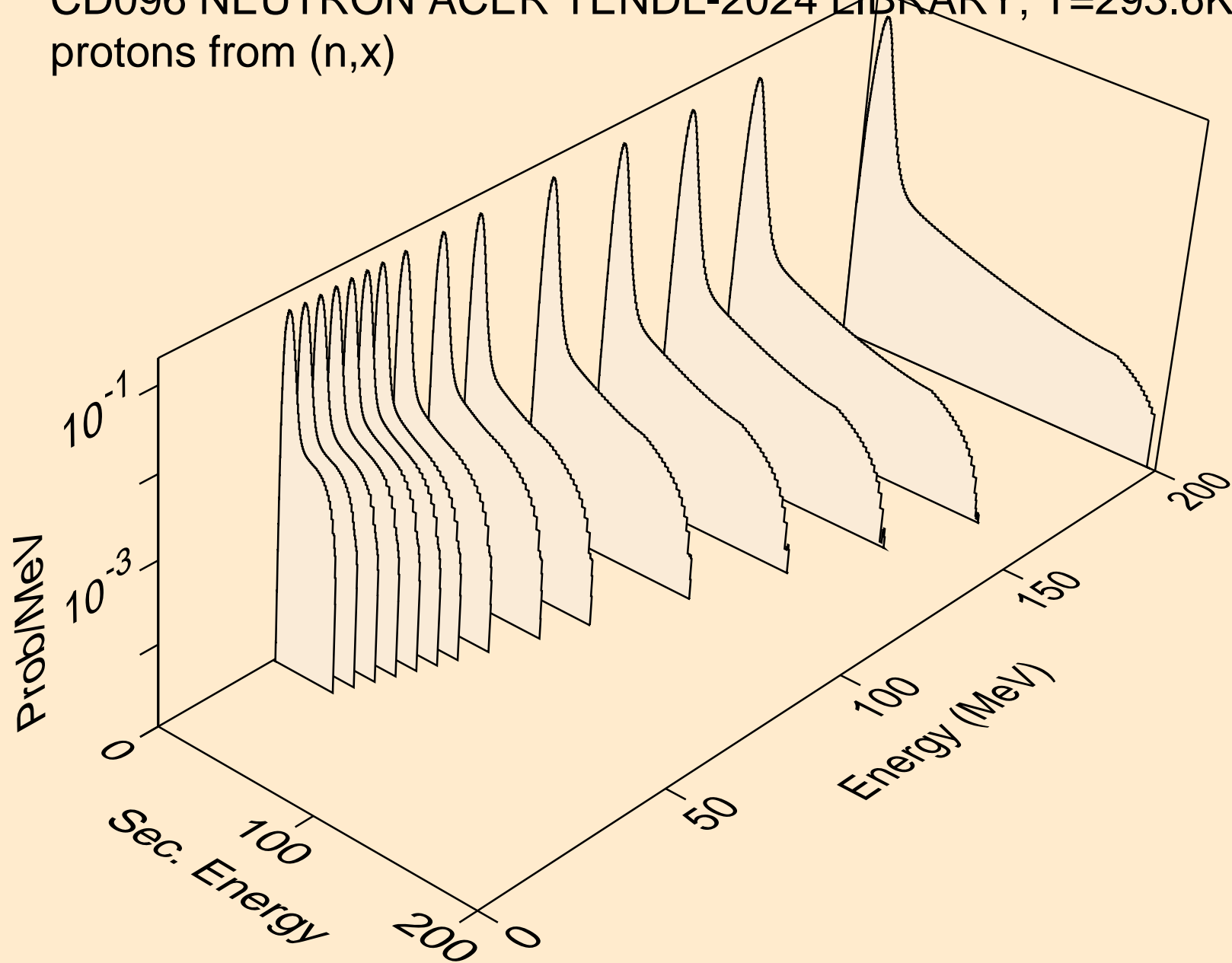

CD096 NEUTRON ACER TENDL-2024 LIBRARY; T=293.6K
protons from (n,n*)p

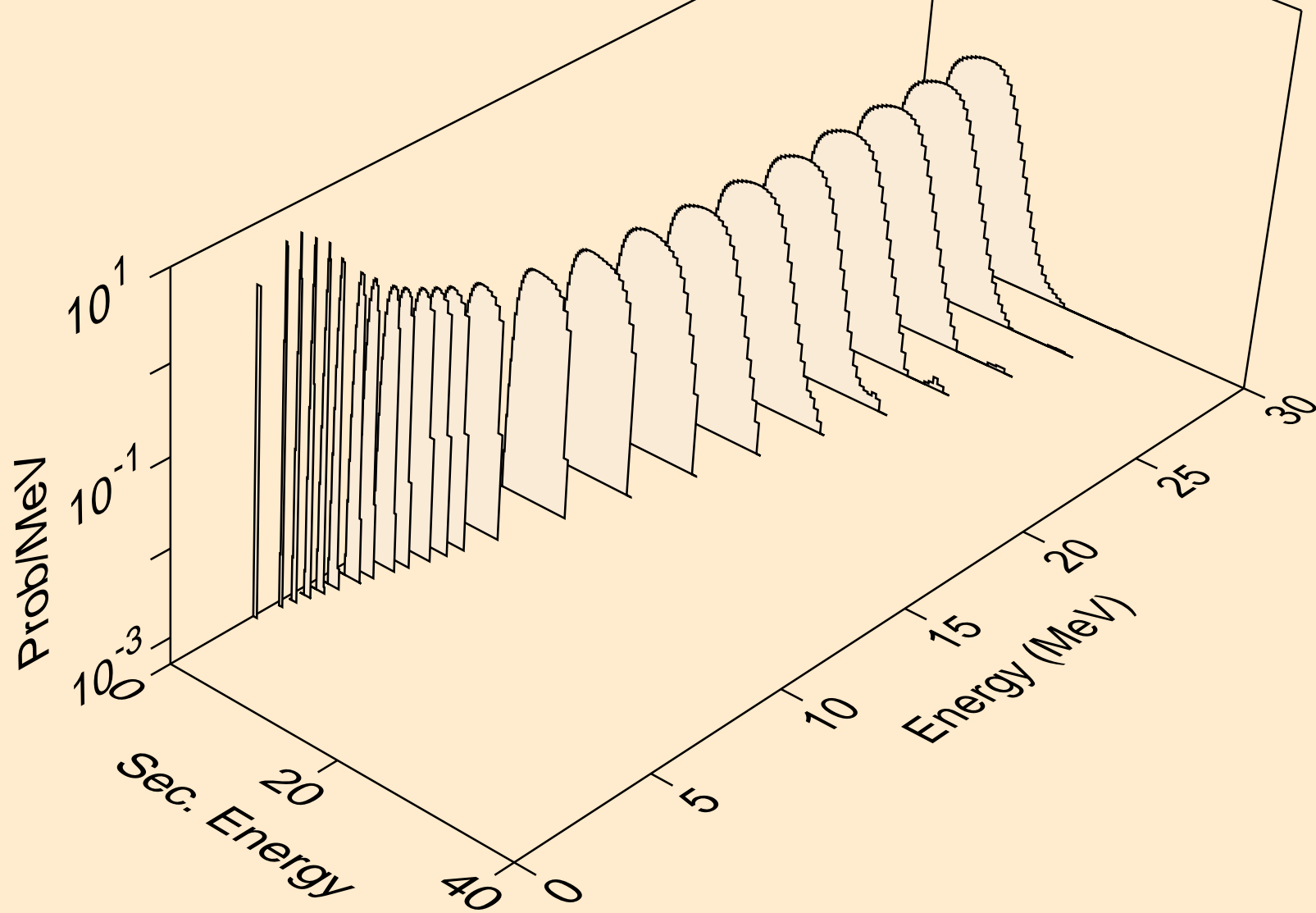

CD096 NEUTRON ACER TENDL-2024 LIBRARY; T=293.6K
protons from (n,2np)

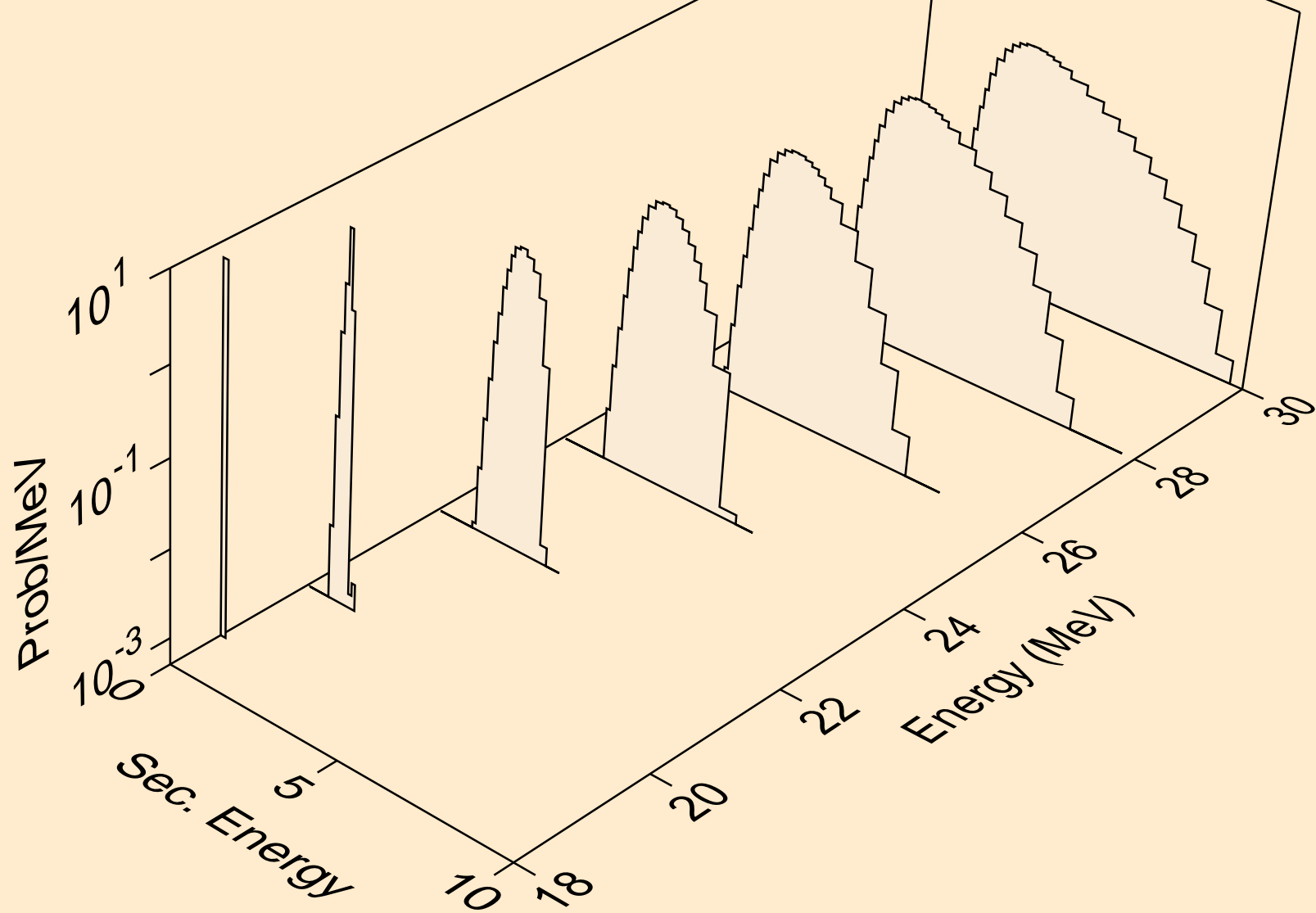

CD096 NEUTRON ACER TENDL-2024 LIBRARY; T=293.6K
protons from (n,n2p)

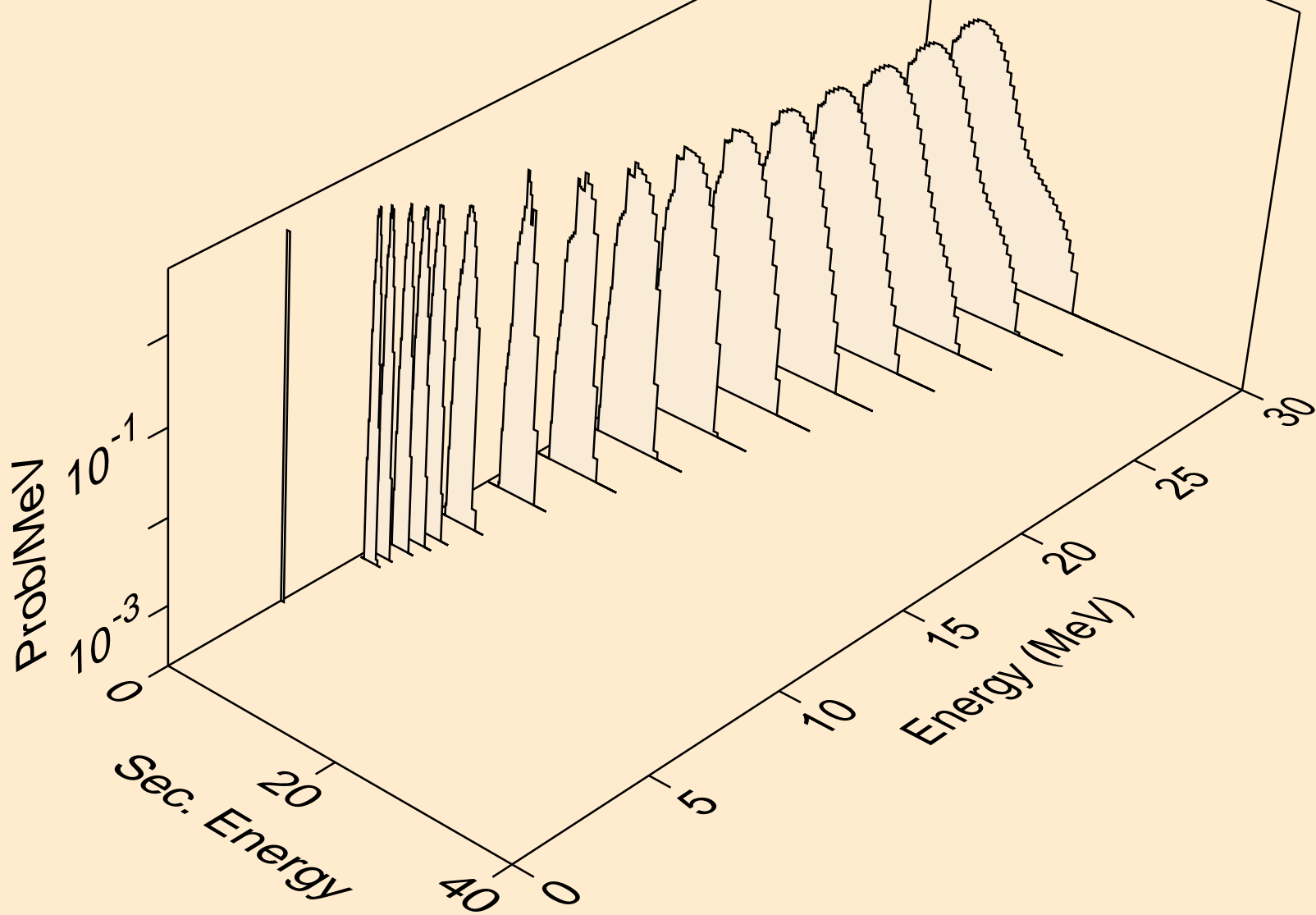

CD096 NEUTRON ACER TENDL-2024 LIBRARY; T=293.6K
protons from (n,npa)

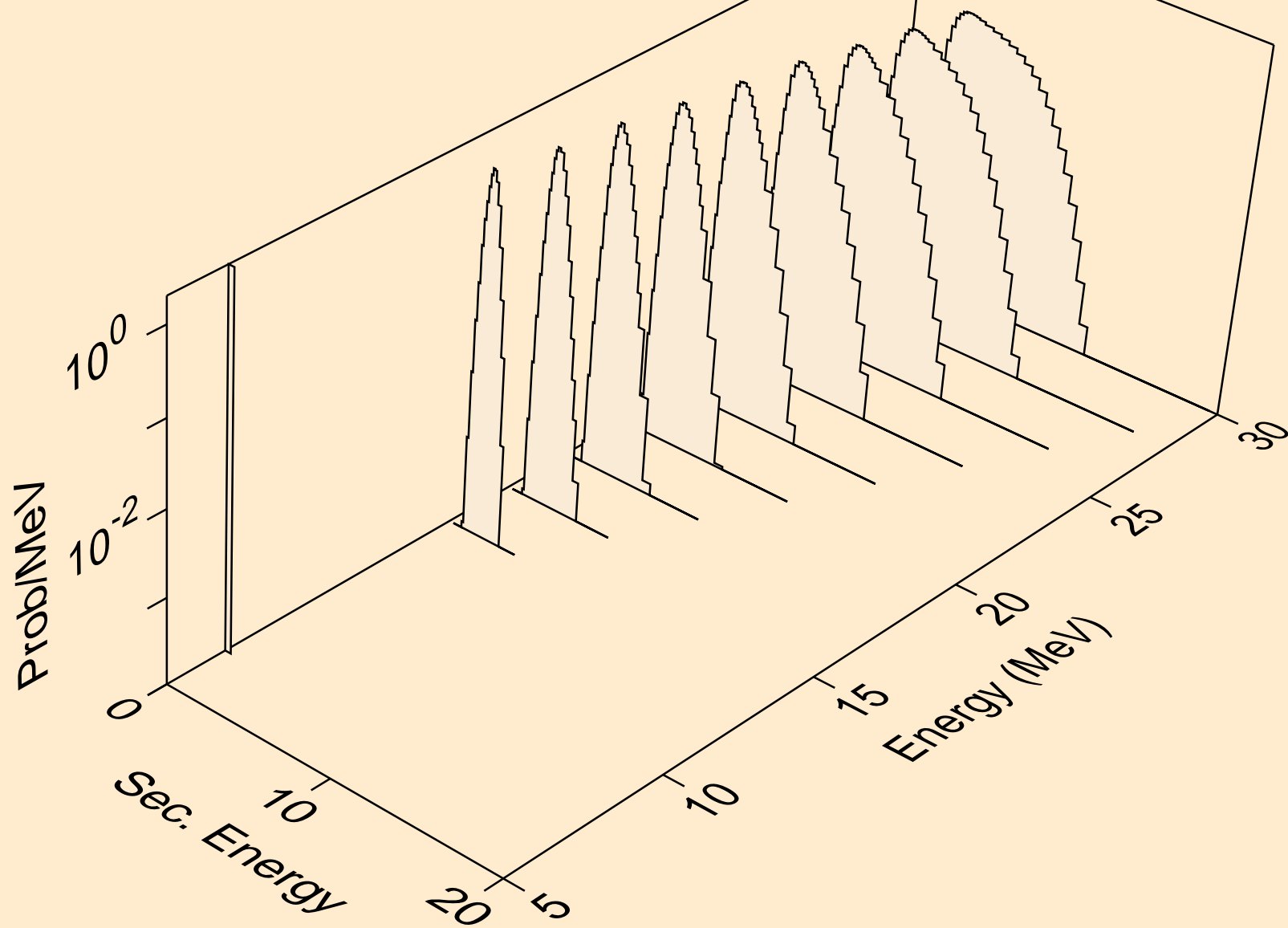

CD096 NEUTRON ACER TENDL-2024 LIBRARY; T=293.6K
protons from (n,p)

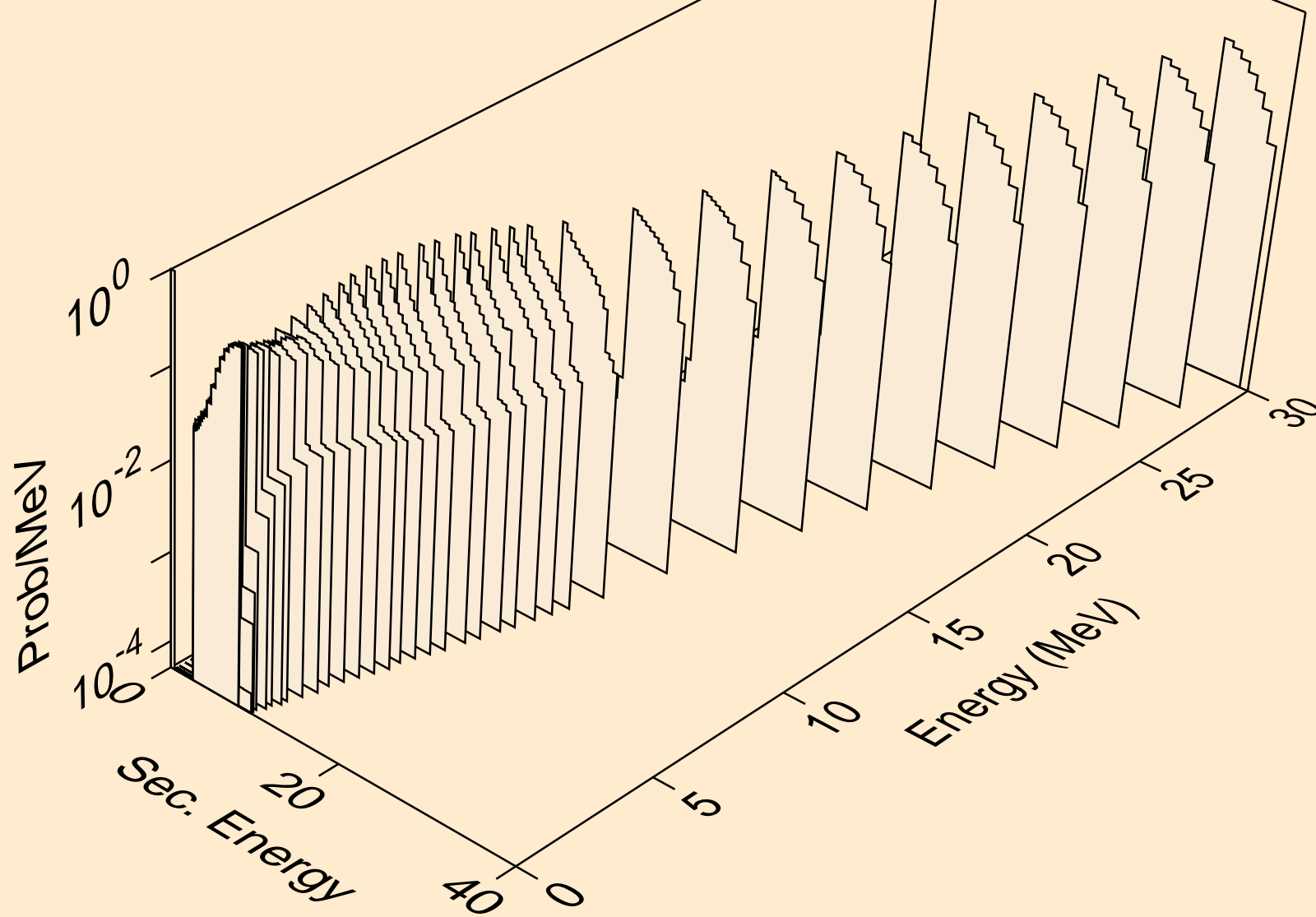

CD096 NEUTRON ACER TENDL-2024 LIBRARY; T=293.6K
protons from (n,2p)

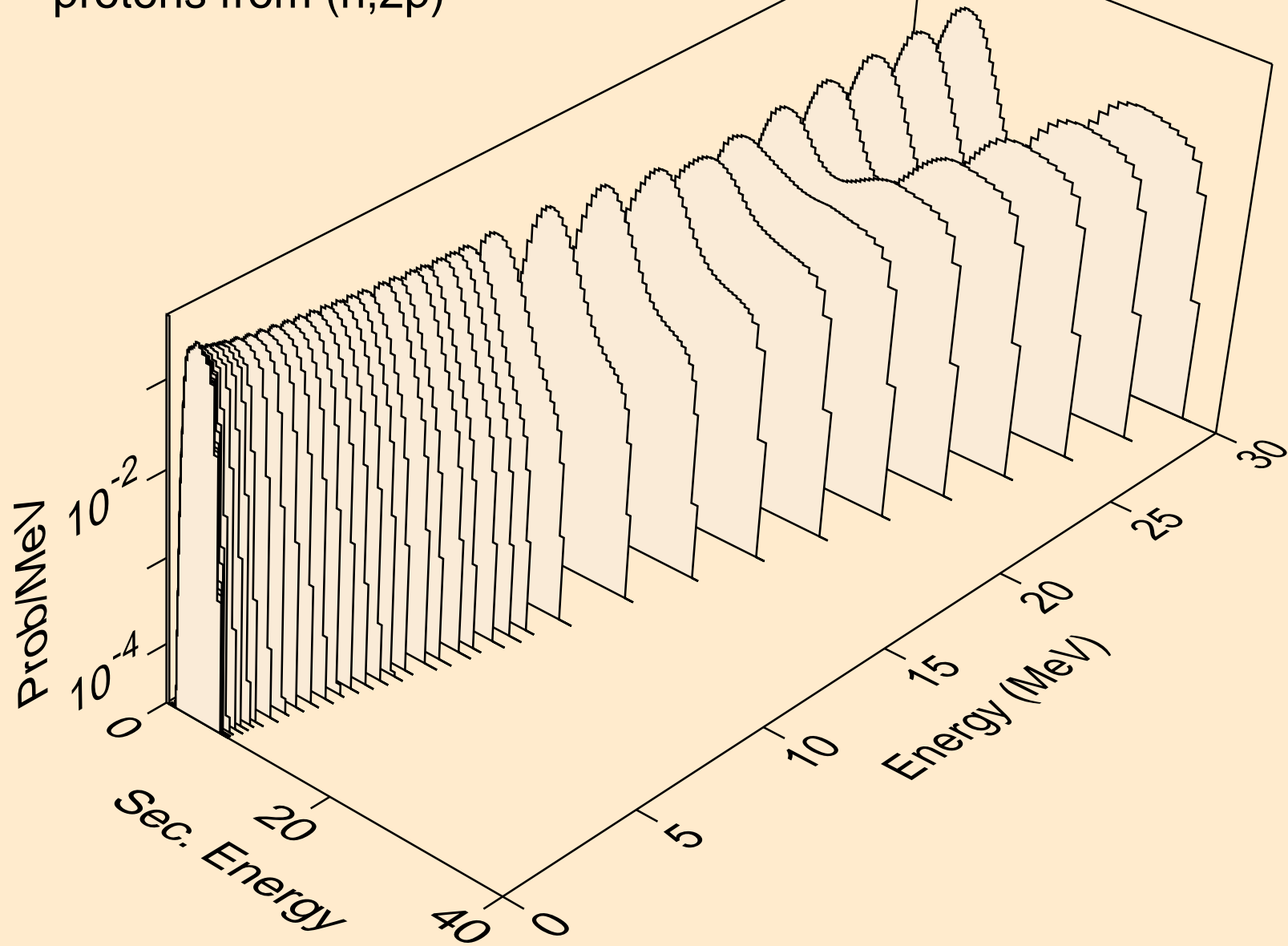

CD096 NEUTRON ACER TENDL-2024 LIBRARY; T=293.6K
protons from (n,p)

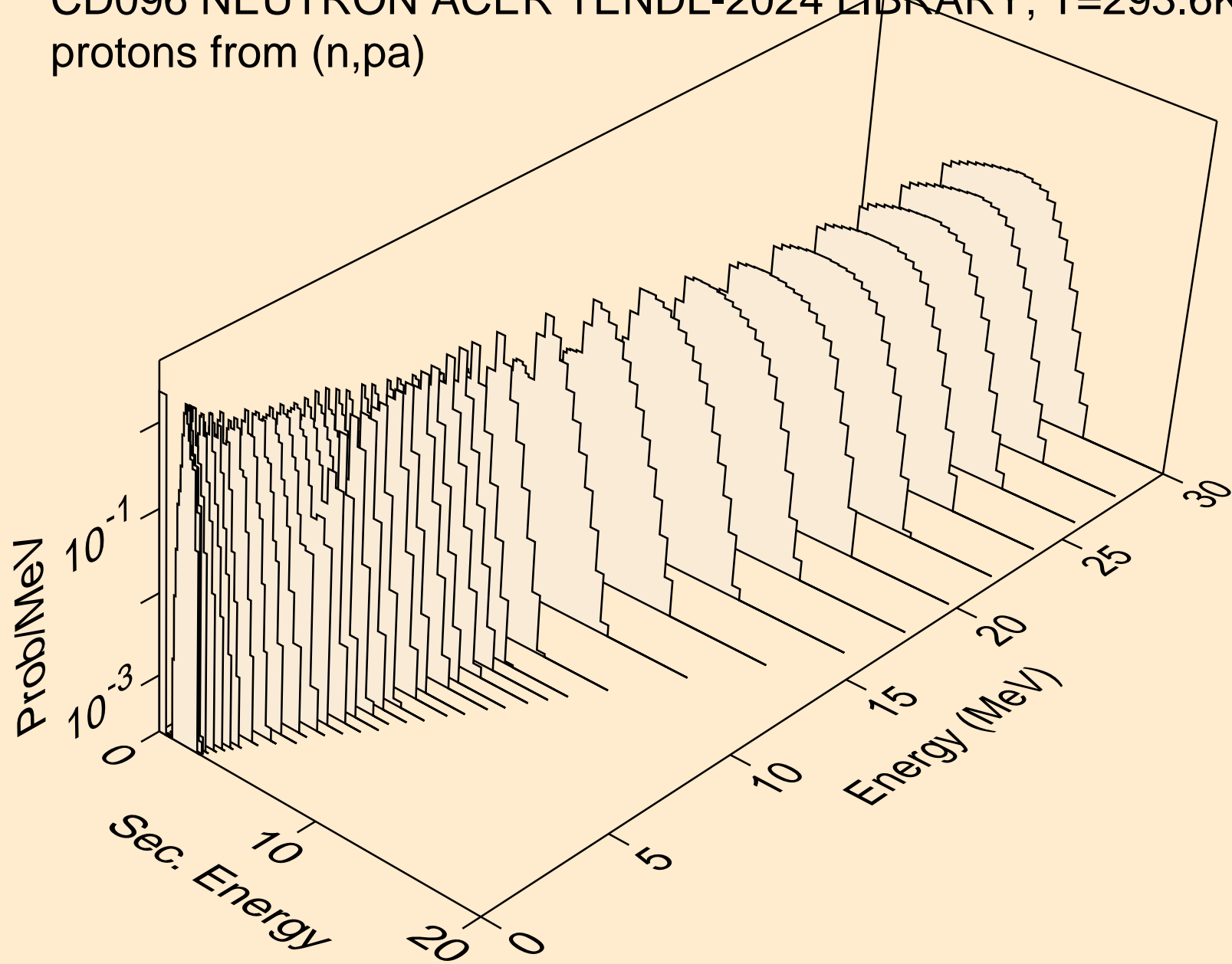

CD096 NEUTRON ACER TENDL-2024 LIBRARY; T=293.6K
protons from (n,pd)

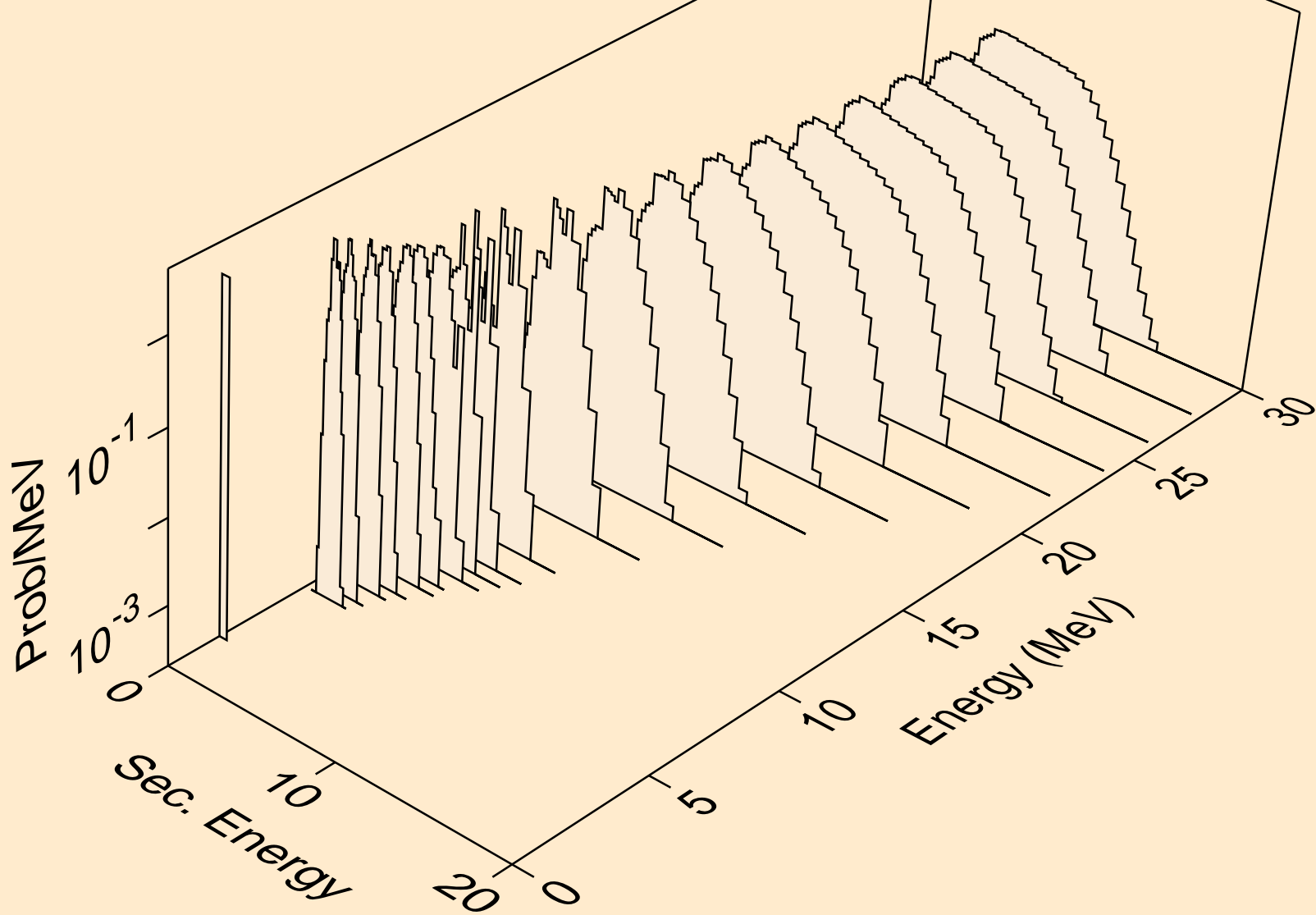

CD096 NEUTRON ACER TENDL-2024 LIBRARY; T=293.6K
protons from (n,pt)

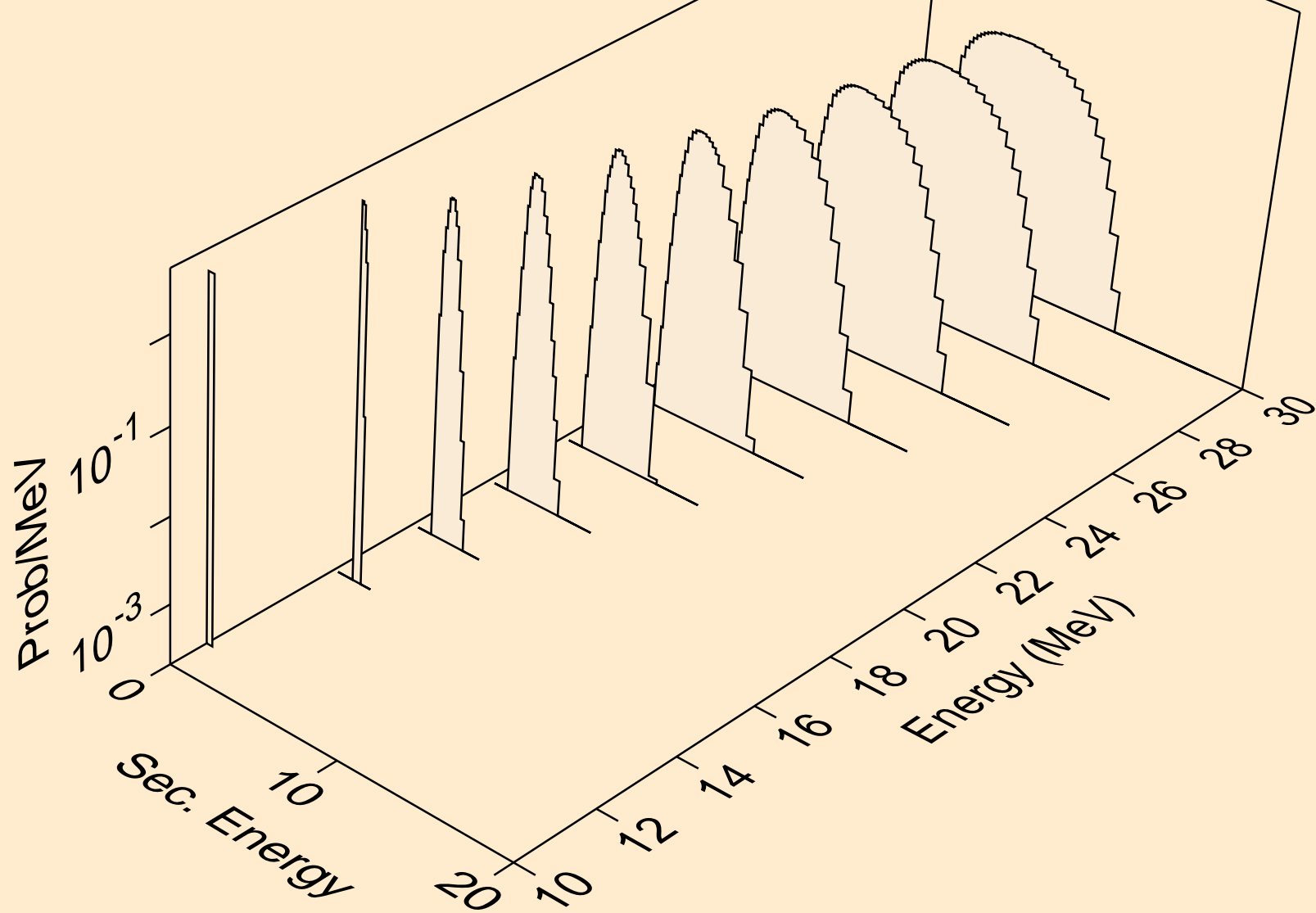

CD096 NEUTRON ACER TENDL-2024 LIBRARY; T=293.6K
deuterons from (n,x)

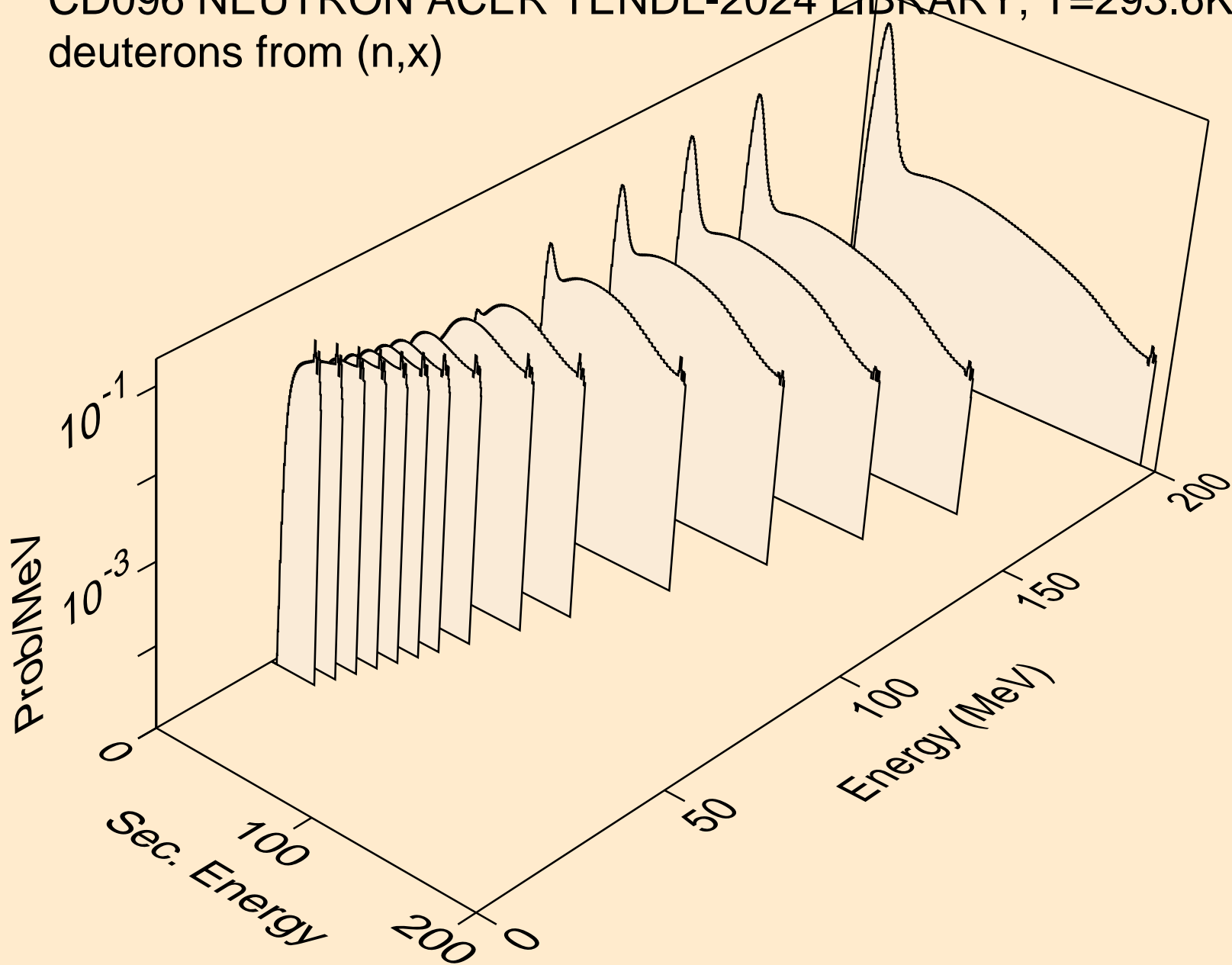

CD096 NEUTRON ACER TENDL-2024 LIBRARY; T=293.6K
deuterons from (n,n*)d

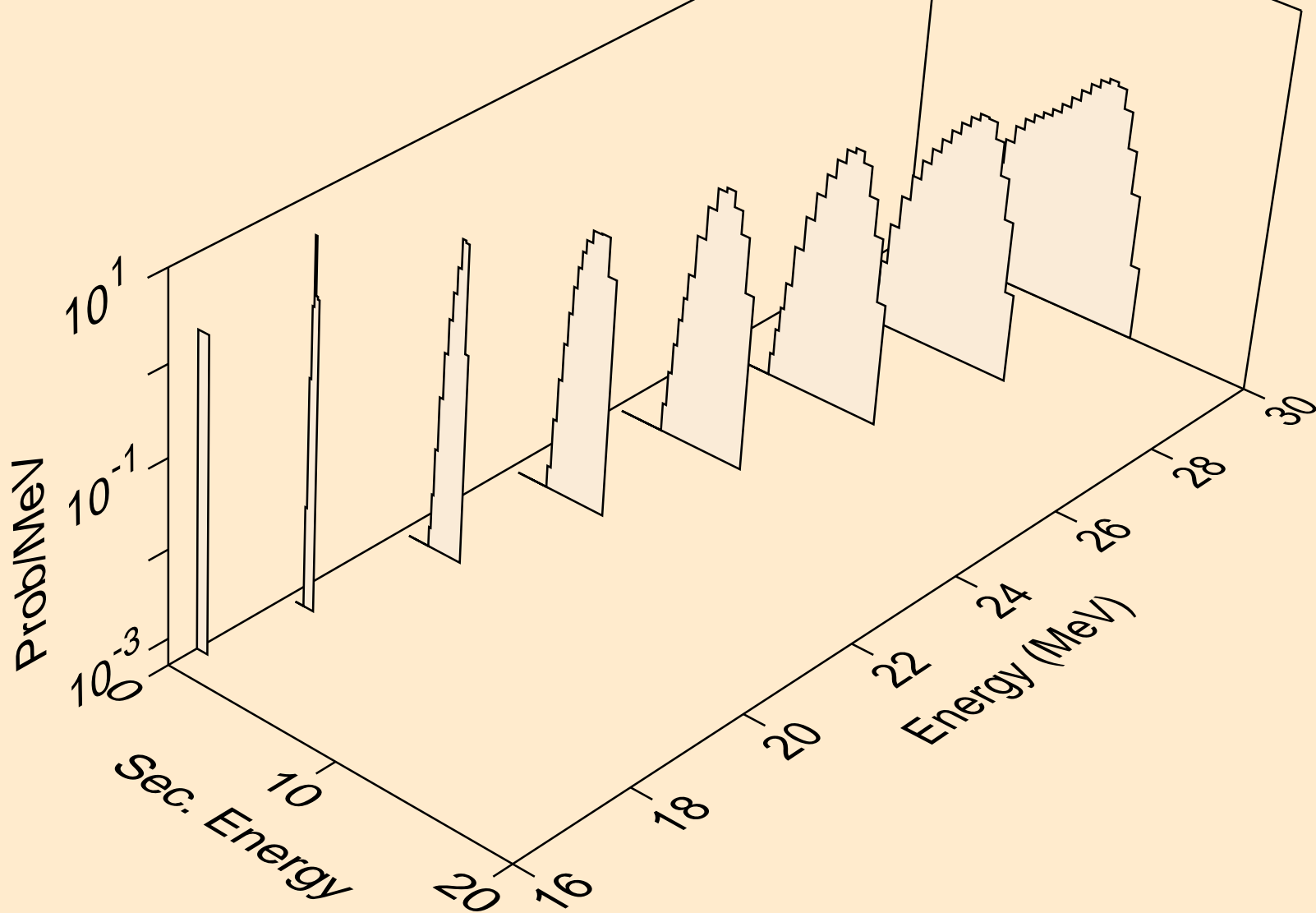

CD096 NEUTRON ACER TENDL-2024 LIBRARY; T=293.6K
deuterons from (n,d)

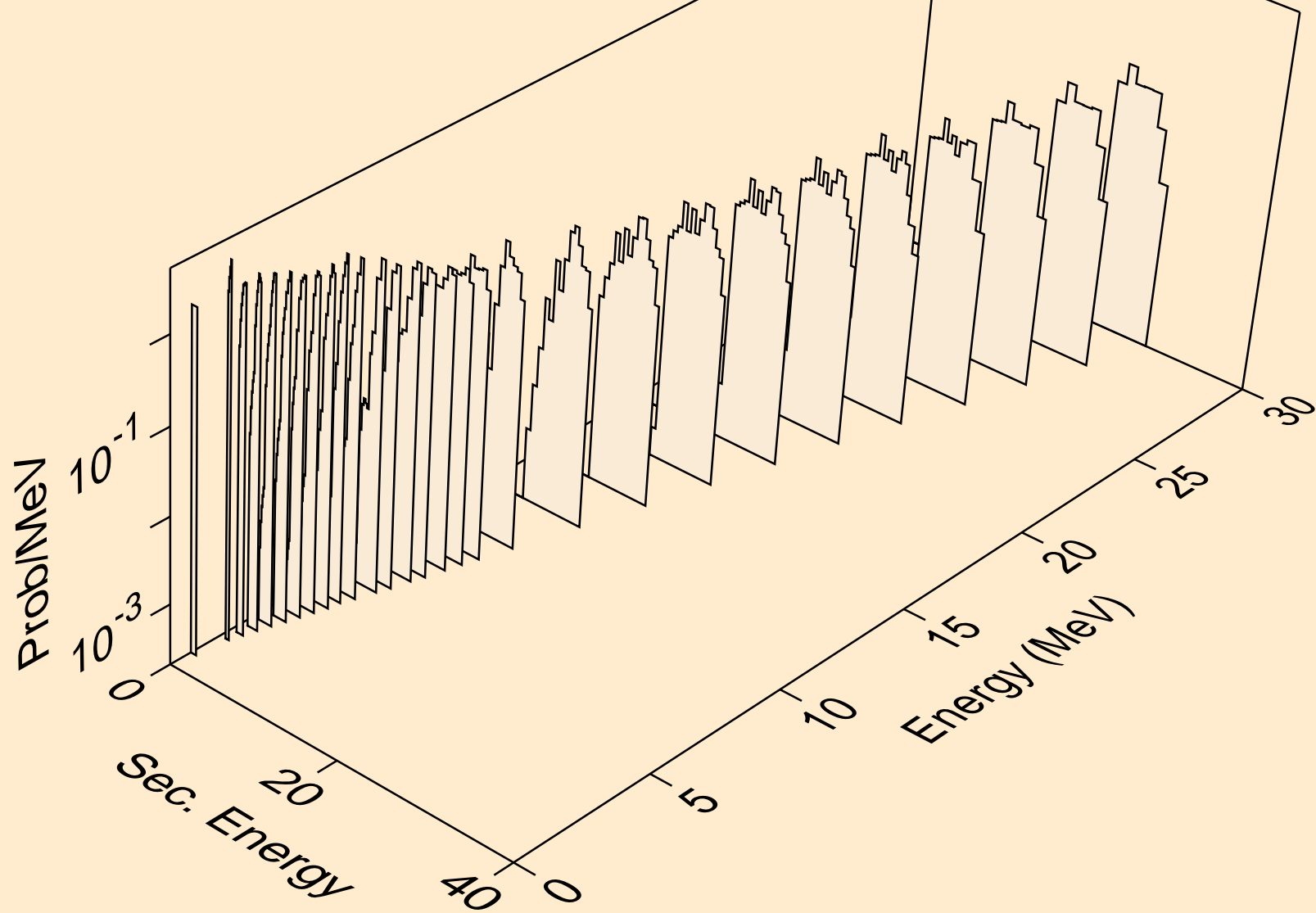

CD096 NEUTRON ACER TENDL-2024 LIBRARY; T=293.6K
deuterons from (n,pd)

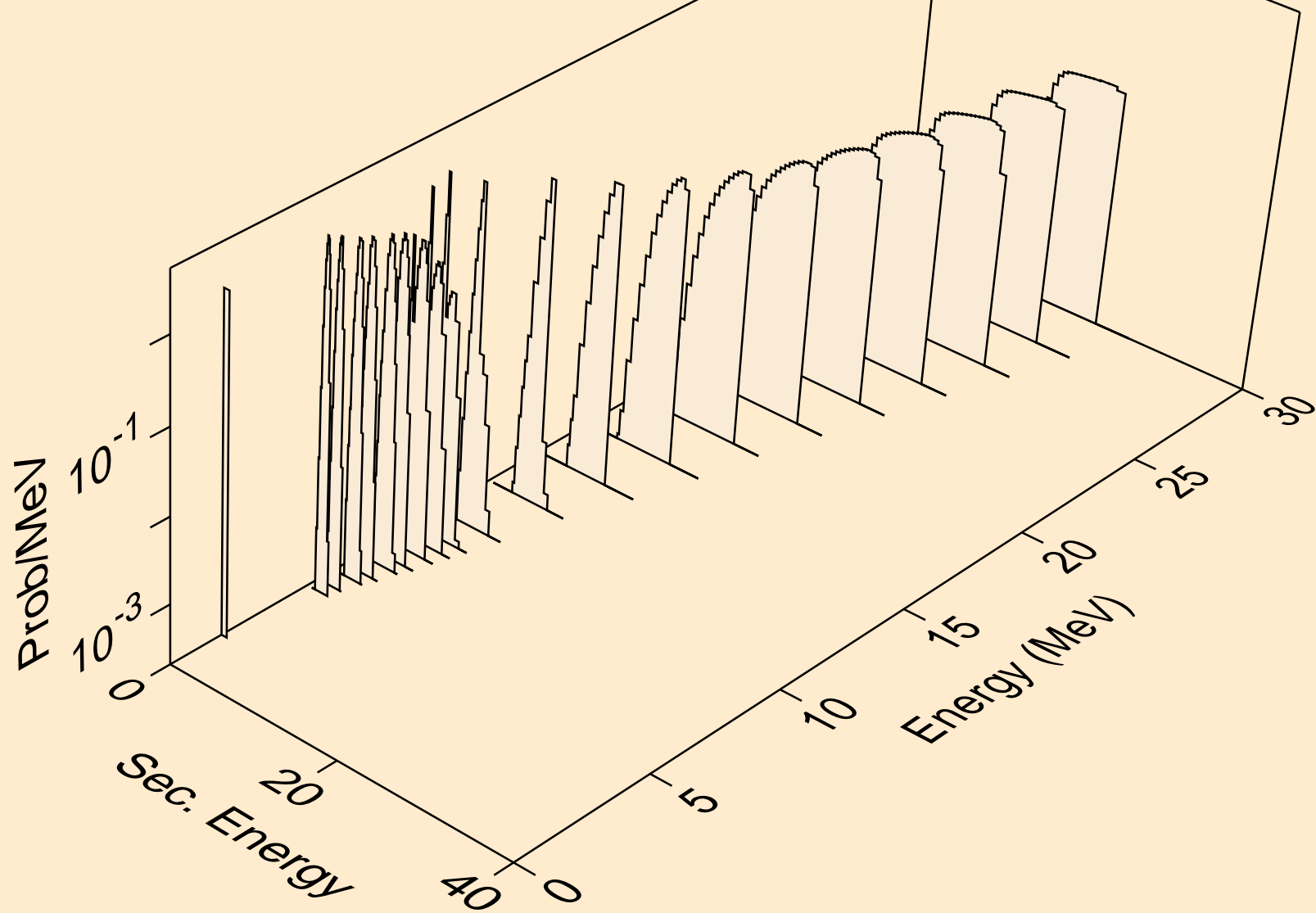

CD096 NEUTRON ACER TENDL-2024 LIBRARY; T=293.6K
deuterons from (n,da)

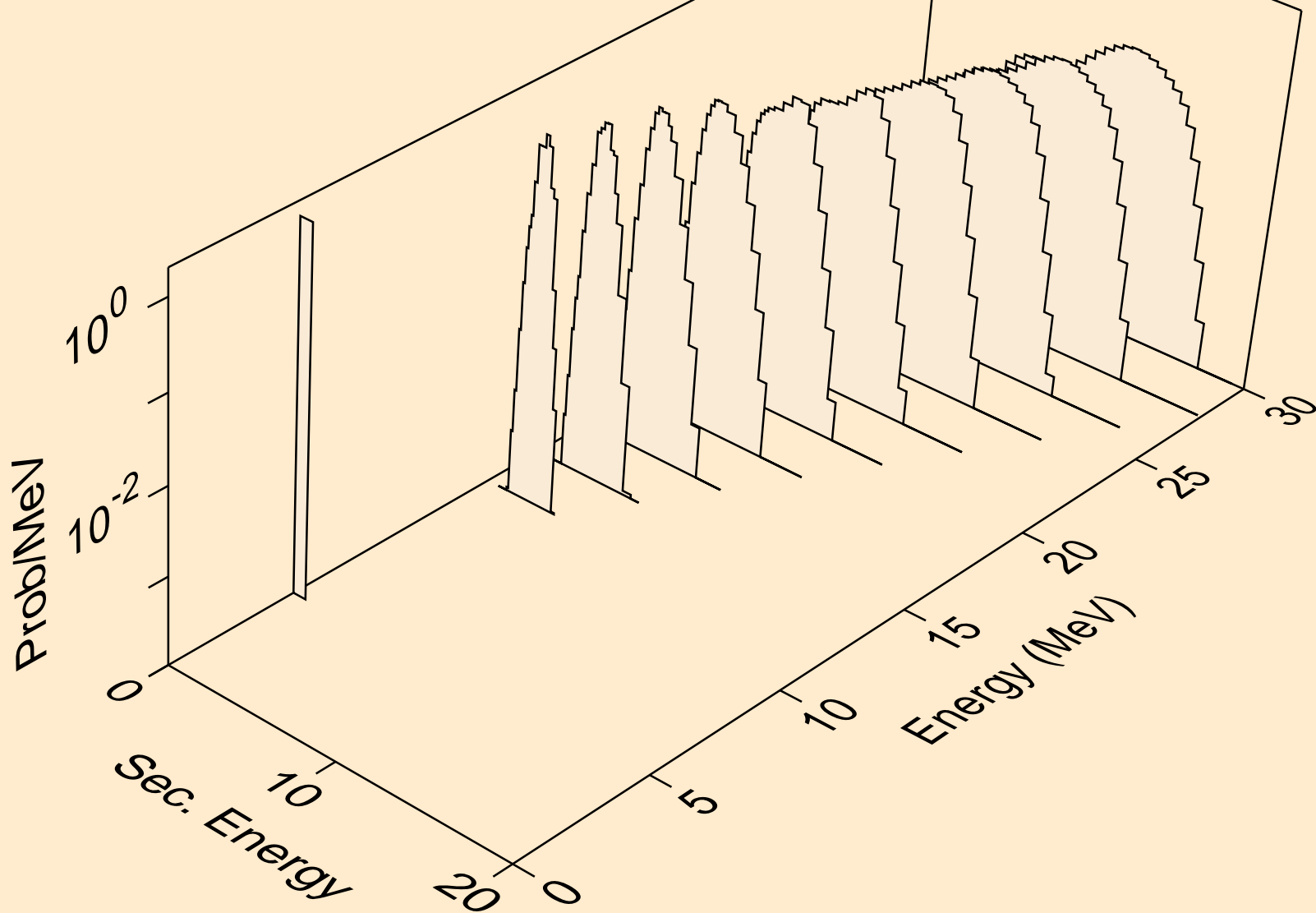

CD096 NEUTRON ACER TENDL-2024 LIBRARY; T=293.6K
tritons from (n,x)

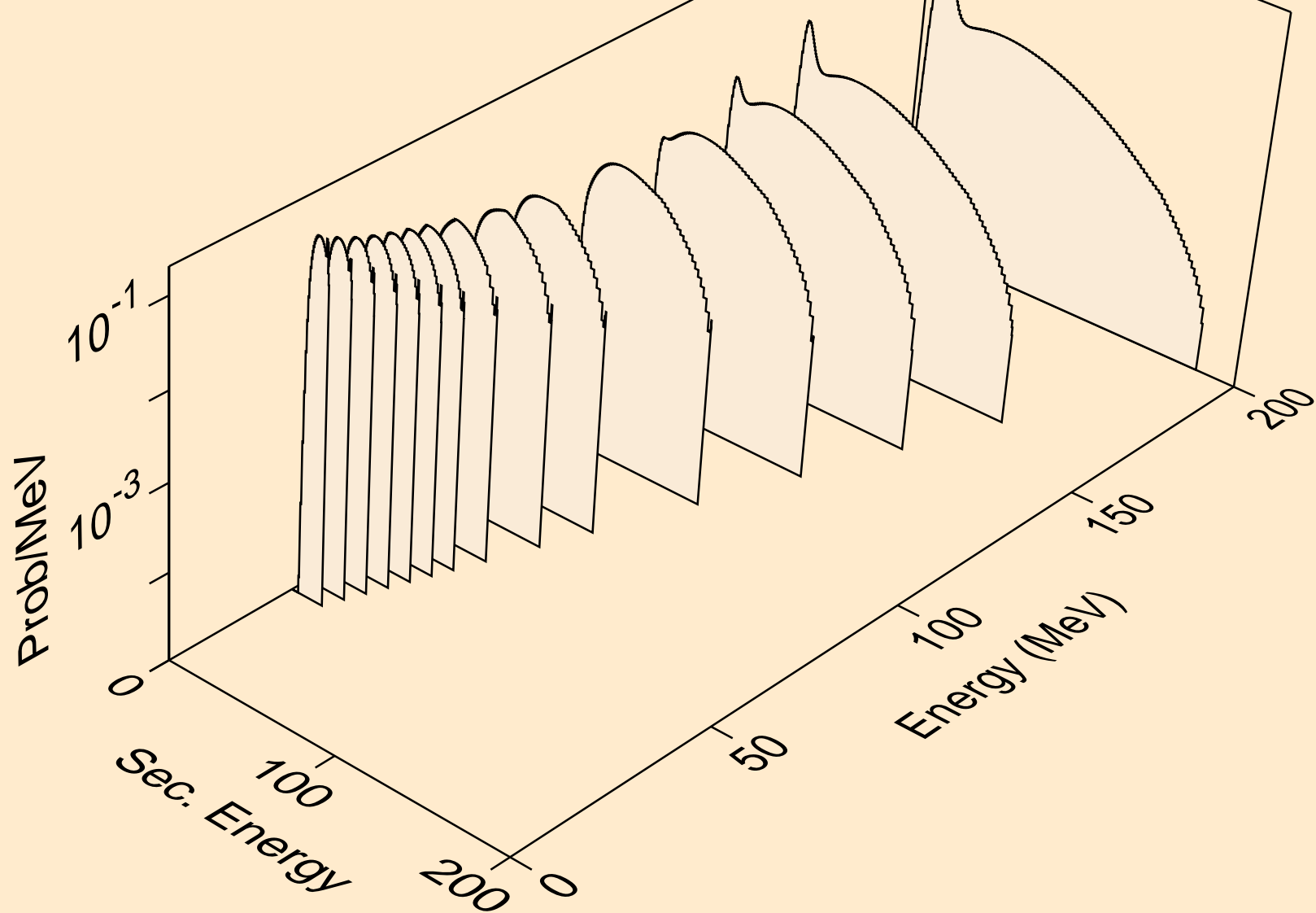

CD096 NEUTRON ACER TENDL-2024 LIBRARY; T=293.6K
tritons from (n,n*)t

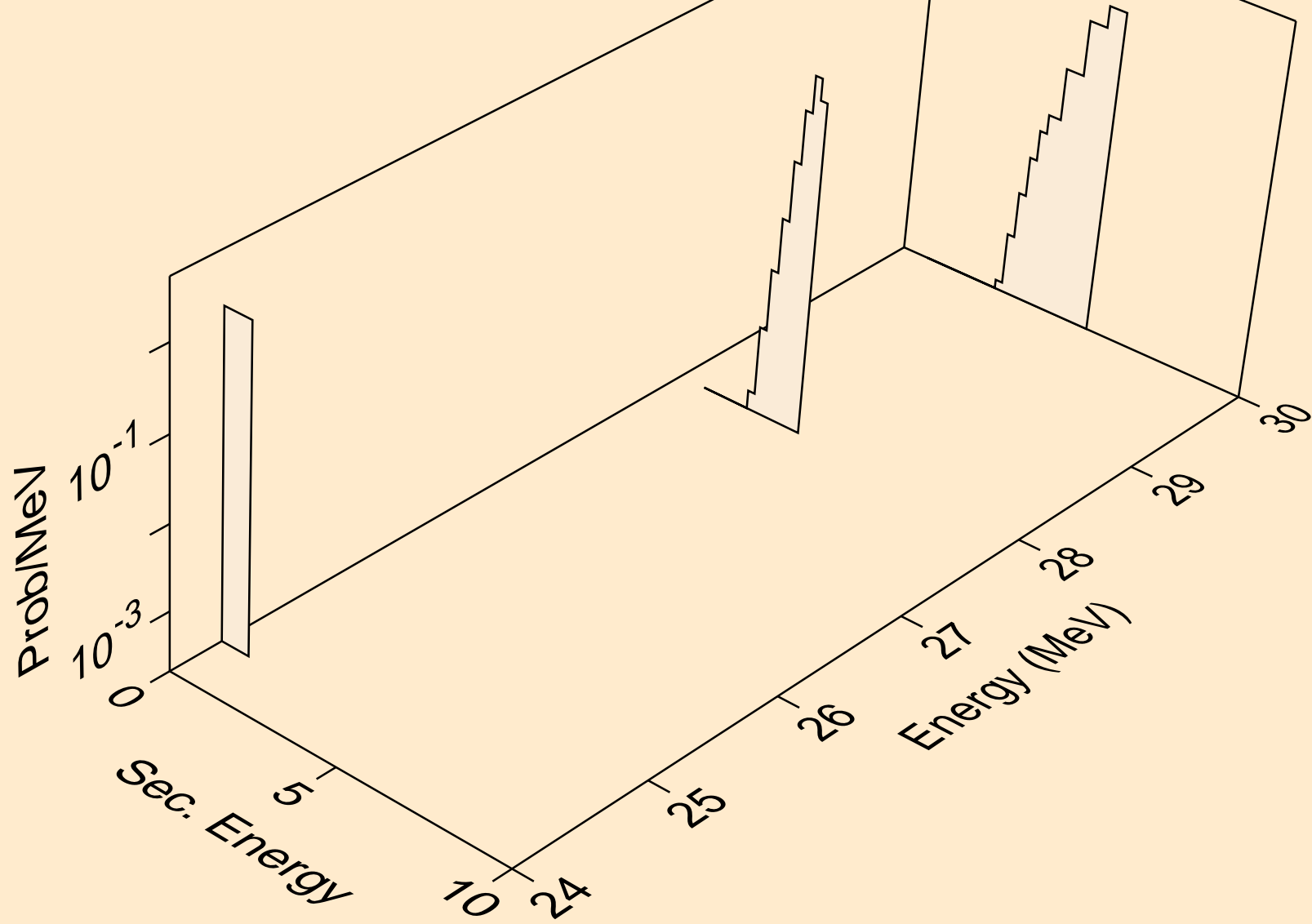

CD096 NEUTRON ACER TENDL-2024 LIBRARY; T=293.6K
tritons from (n,t)

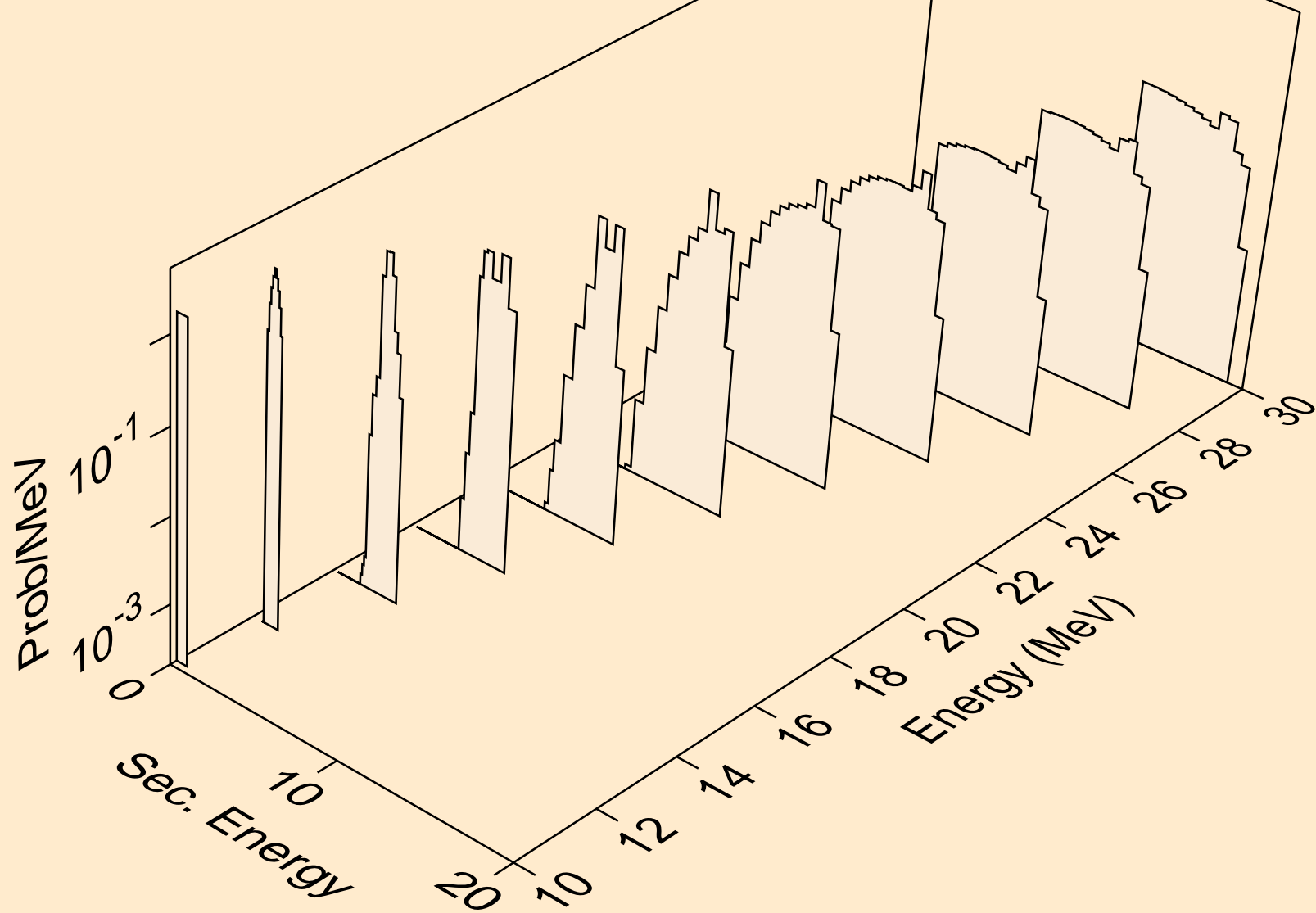

CD096 NEUTRON ACER TENDL-2024 LIBRARY; T=293.6K
tritons from (n,pt)

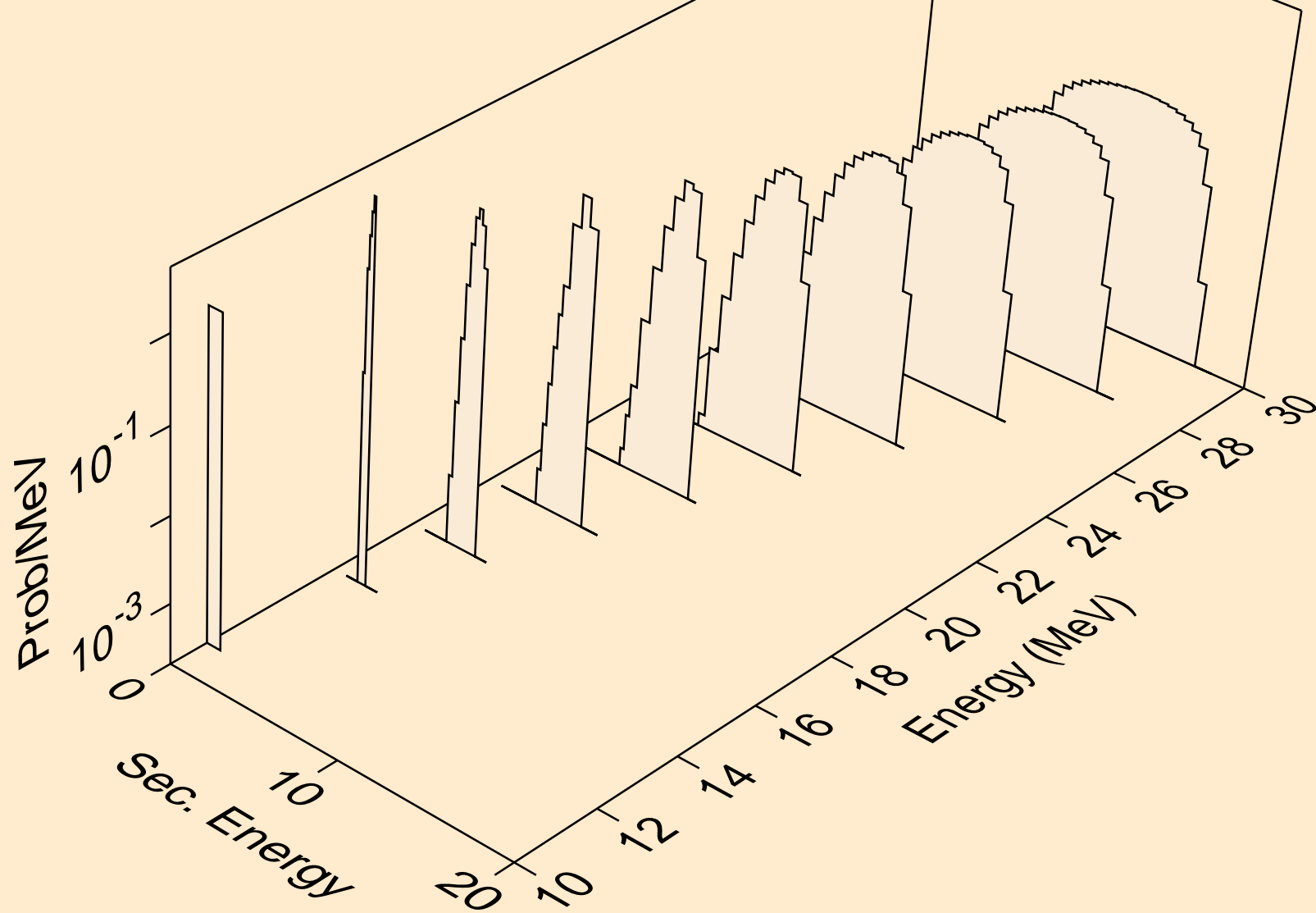

CD096 NEUTRON ACER TENDL-2024 LIBRARY; T=293.6K
he3s from (n,x)

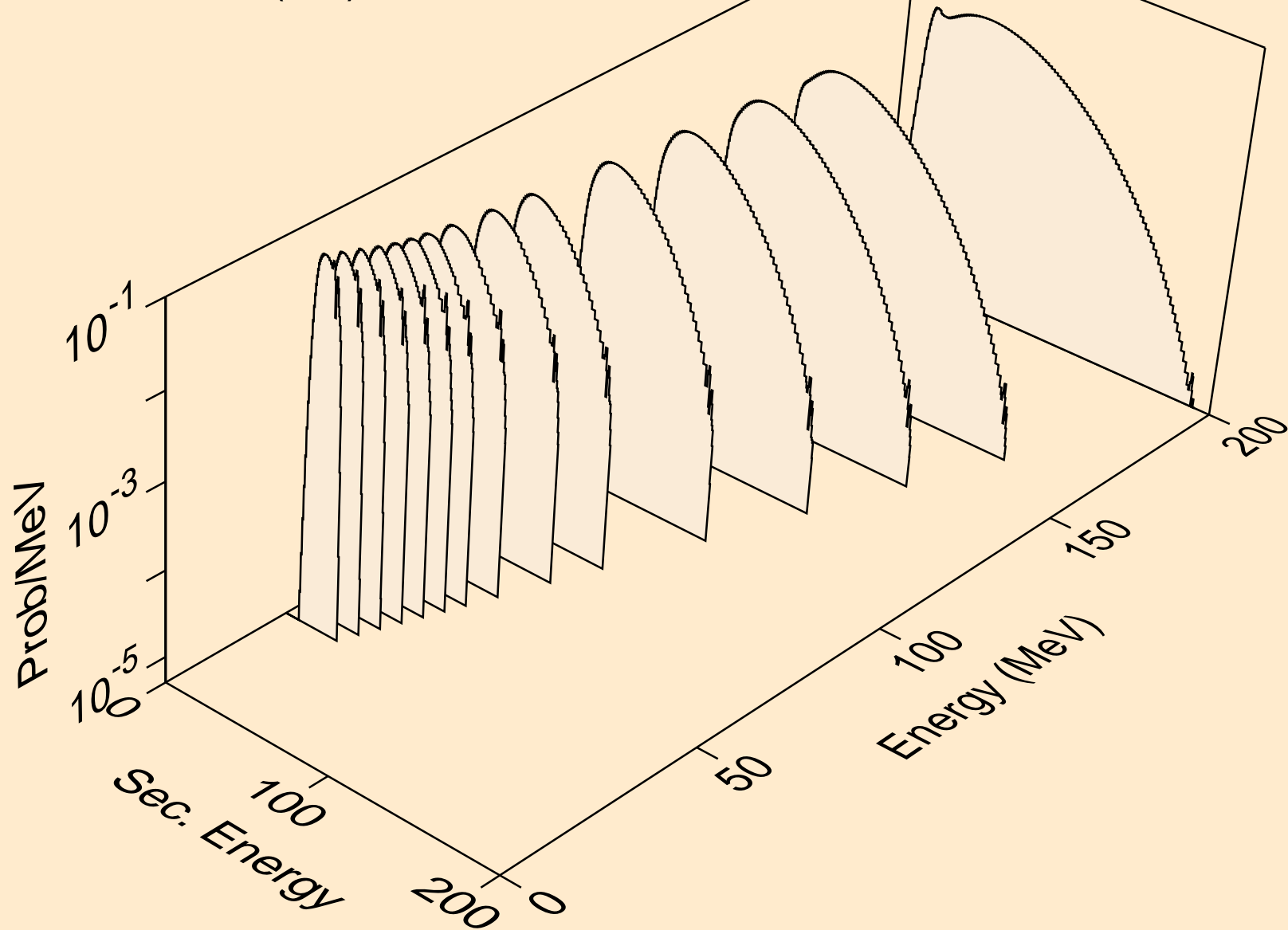

CD096 NEUTRON ACER TENDL-2024 LIBRARY; T=293.6K
he3s from (n,n*)he3

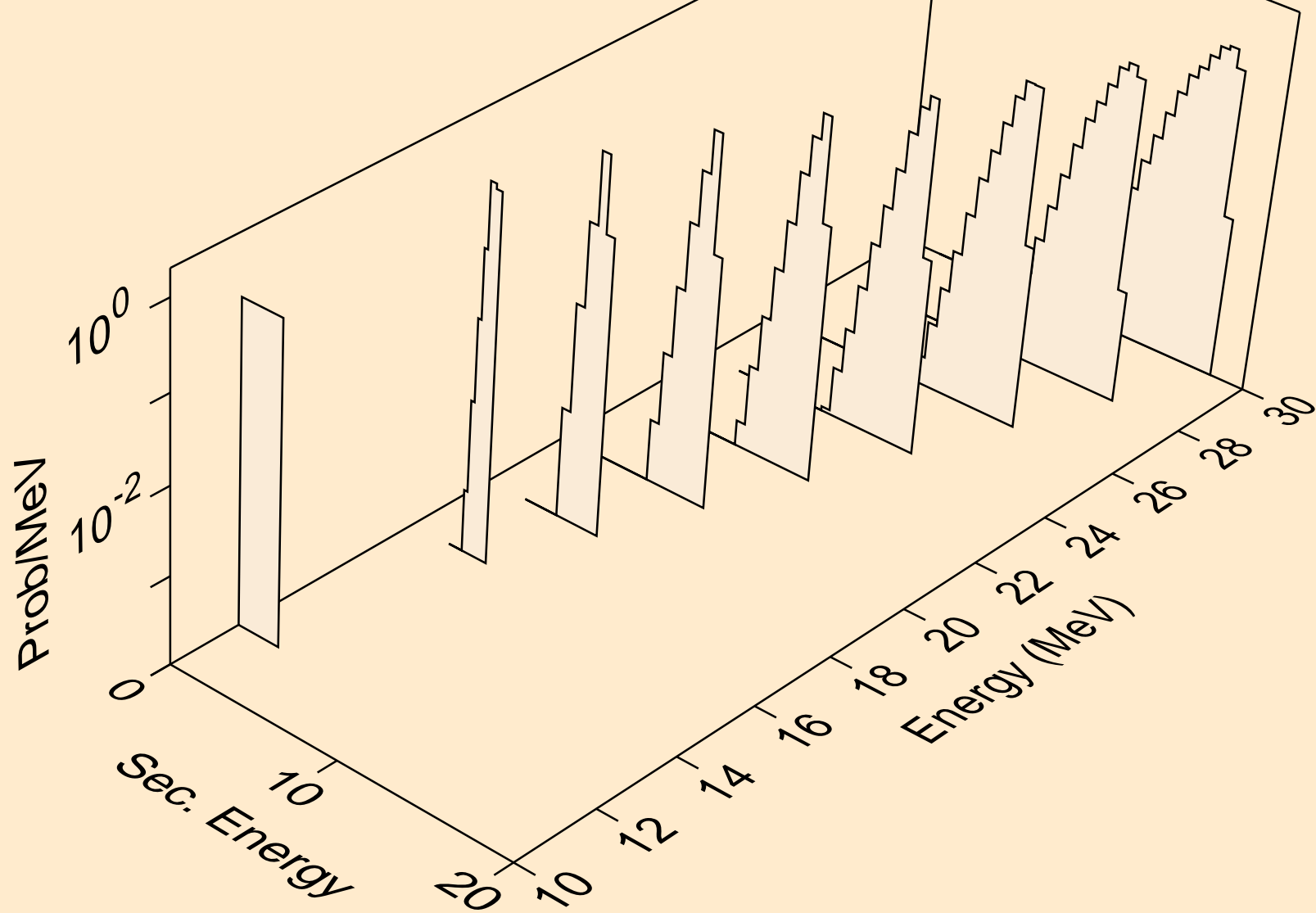

CD096 NEUTRON ACER TENDL-2024 LIBRARY; T=293.6K
he3s from (n,he3)

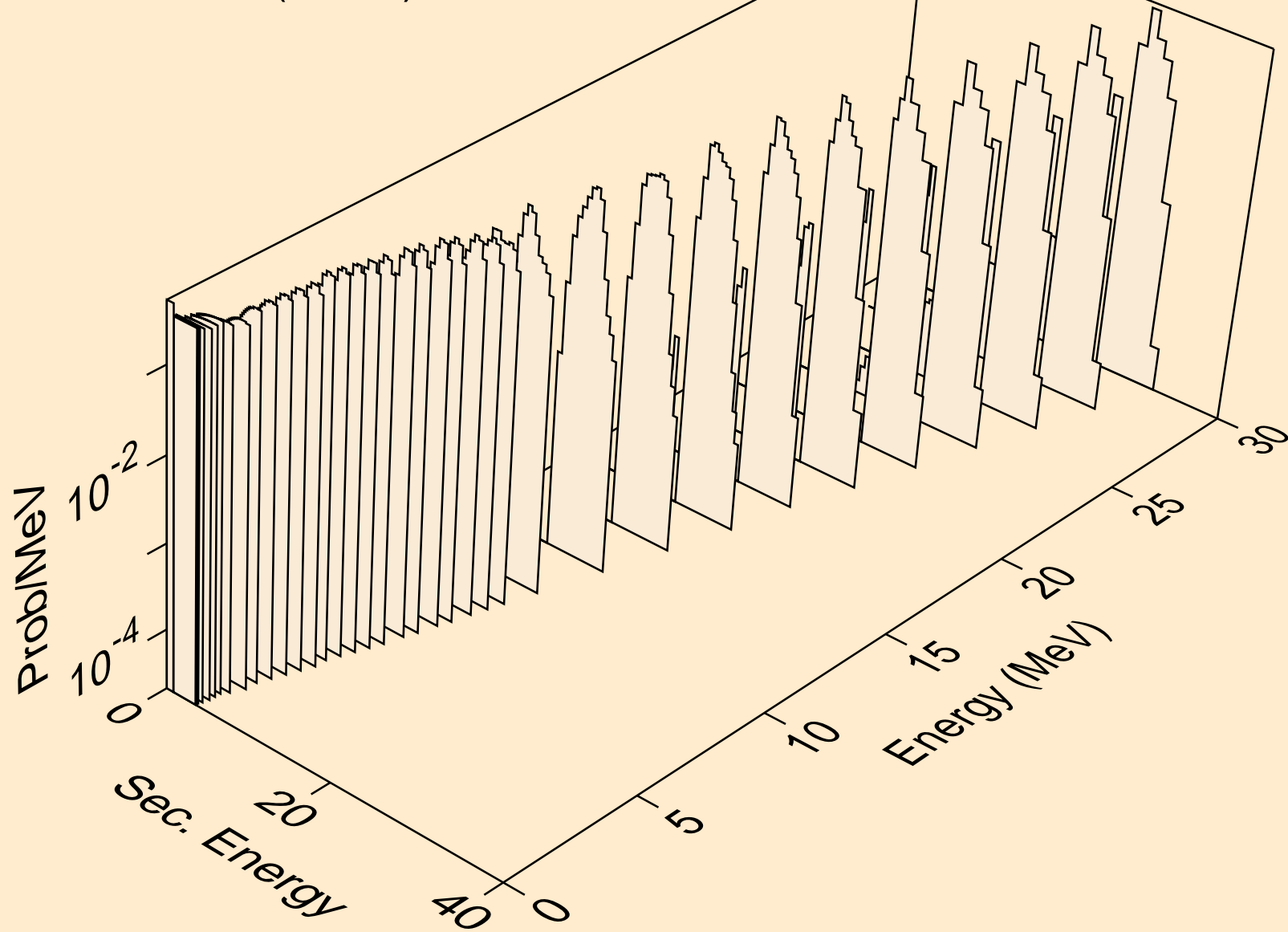

CD096 NEUTRON ACER TENDL-2024 LIBRARY; T=293.6K
alphas from (n,x)

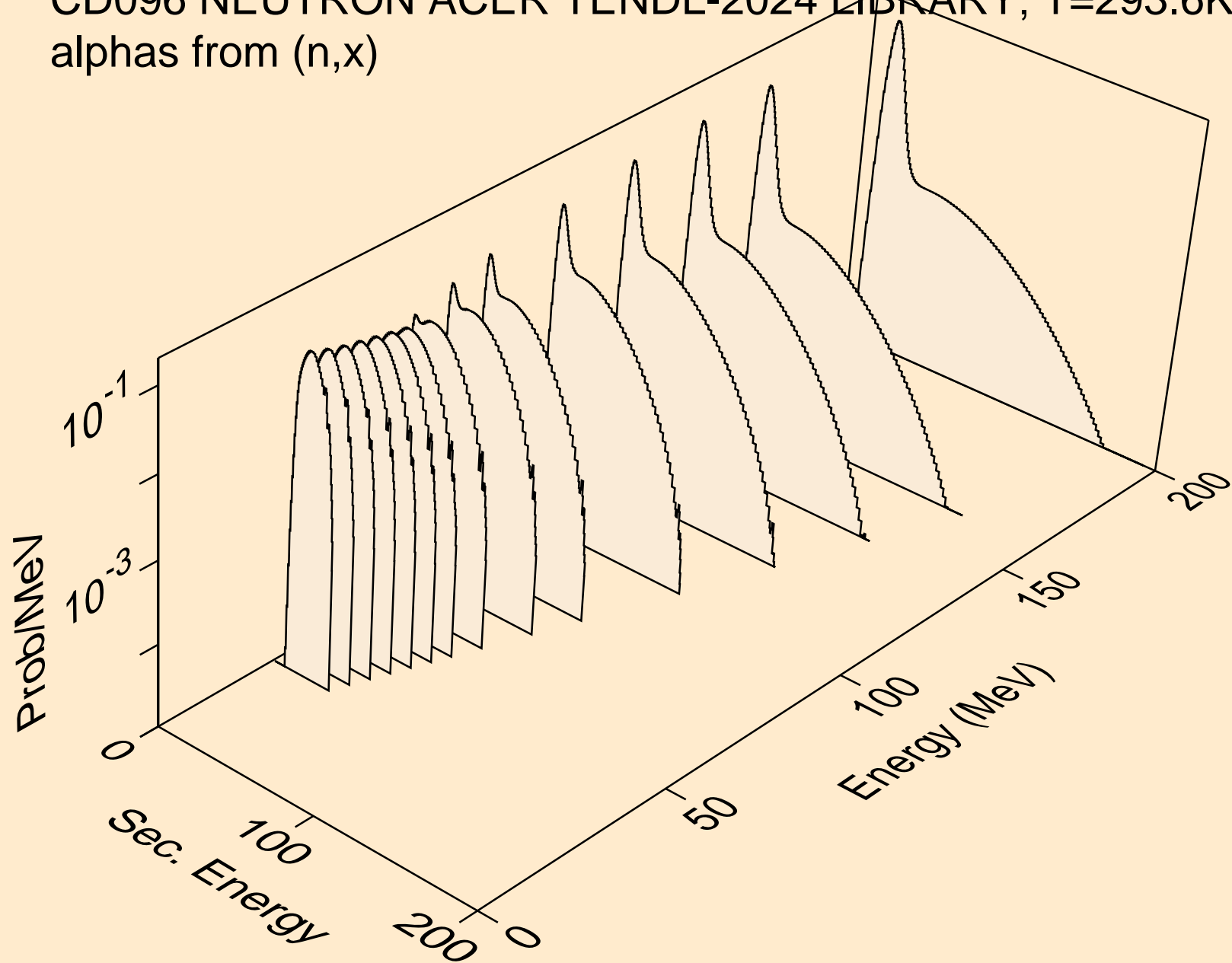

CD096 NEUTRON ACER TENDL-2024 LIBRARY; T=293.6K
alphas from (n,n*)a

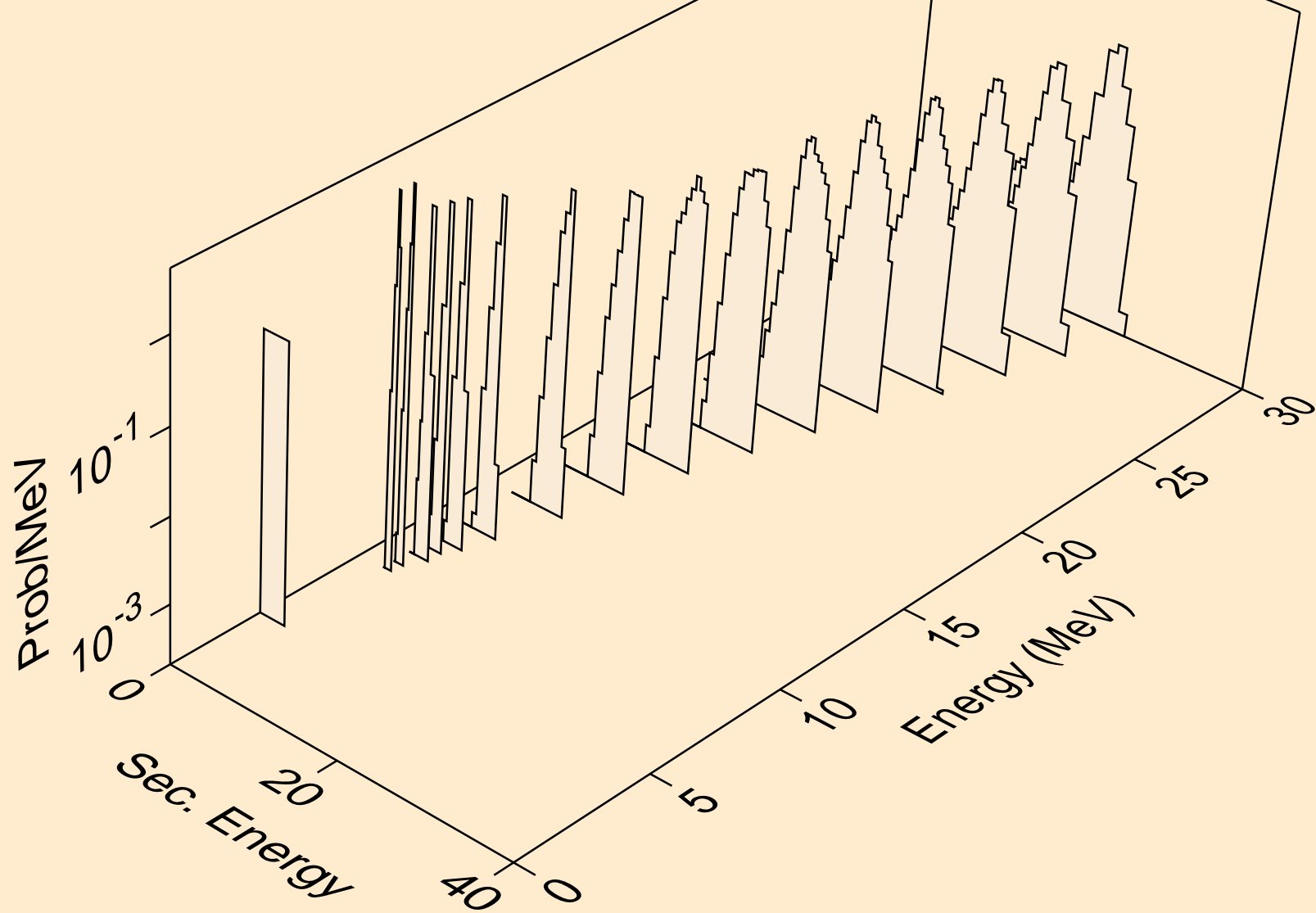

CD096 NEUTRON ACER TENDL-2024 LIBRARY; T=293.6K
alphas from (n,n*)2a

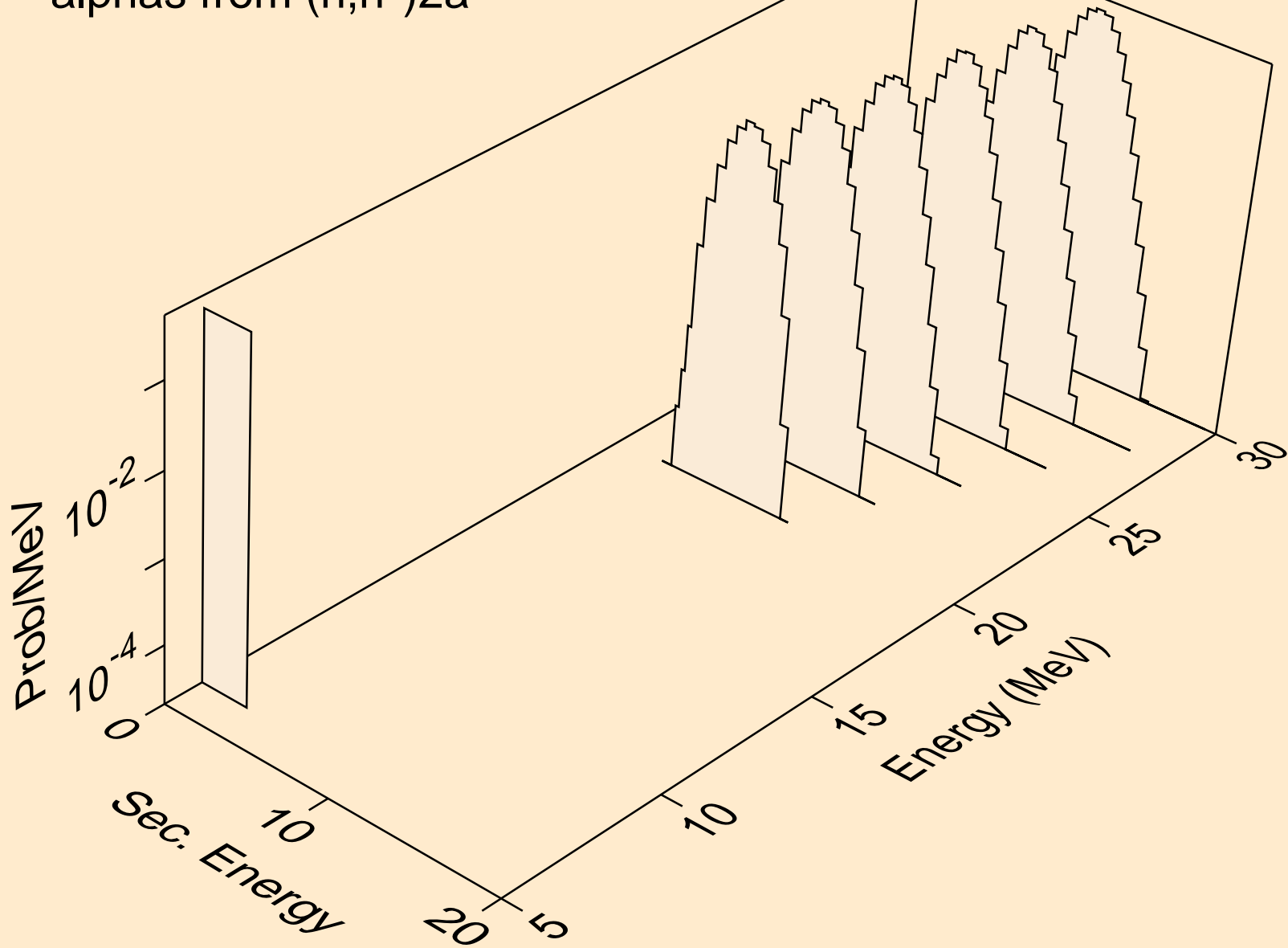

CD096 NEUTRON ACER TENDL-2024 LIBRARY; T=293.6K
alphas from (n,npa)

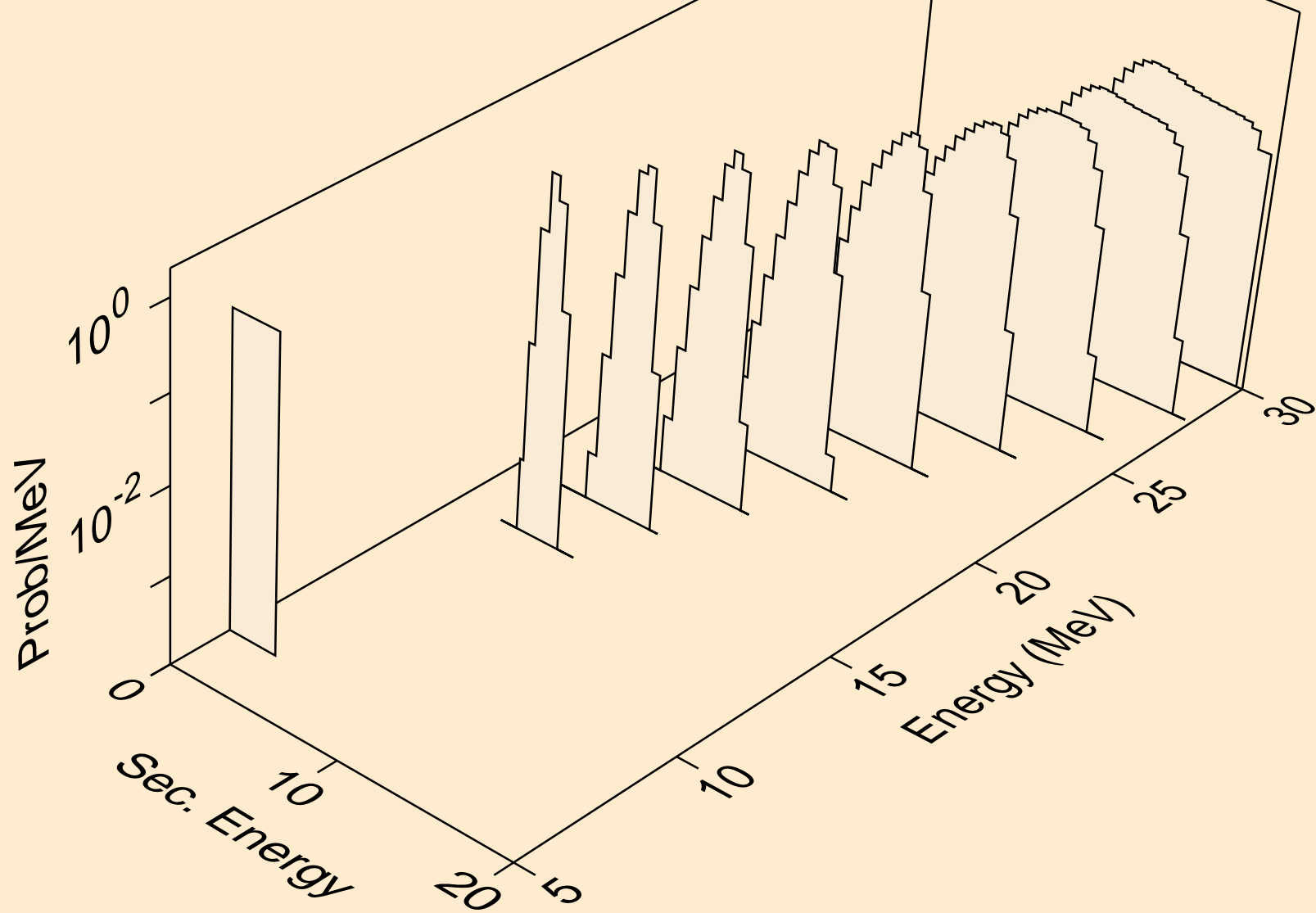

CD096 NEUTRON ACER TENDL-2024 LIBRARY; T=293.6K
alphas from (n,a)

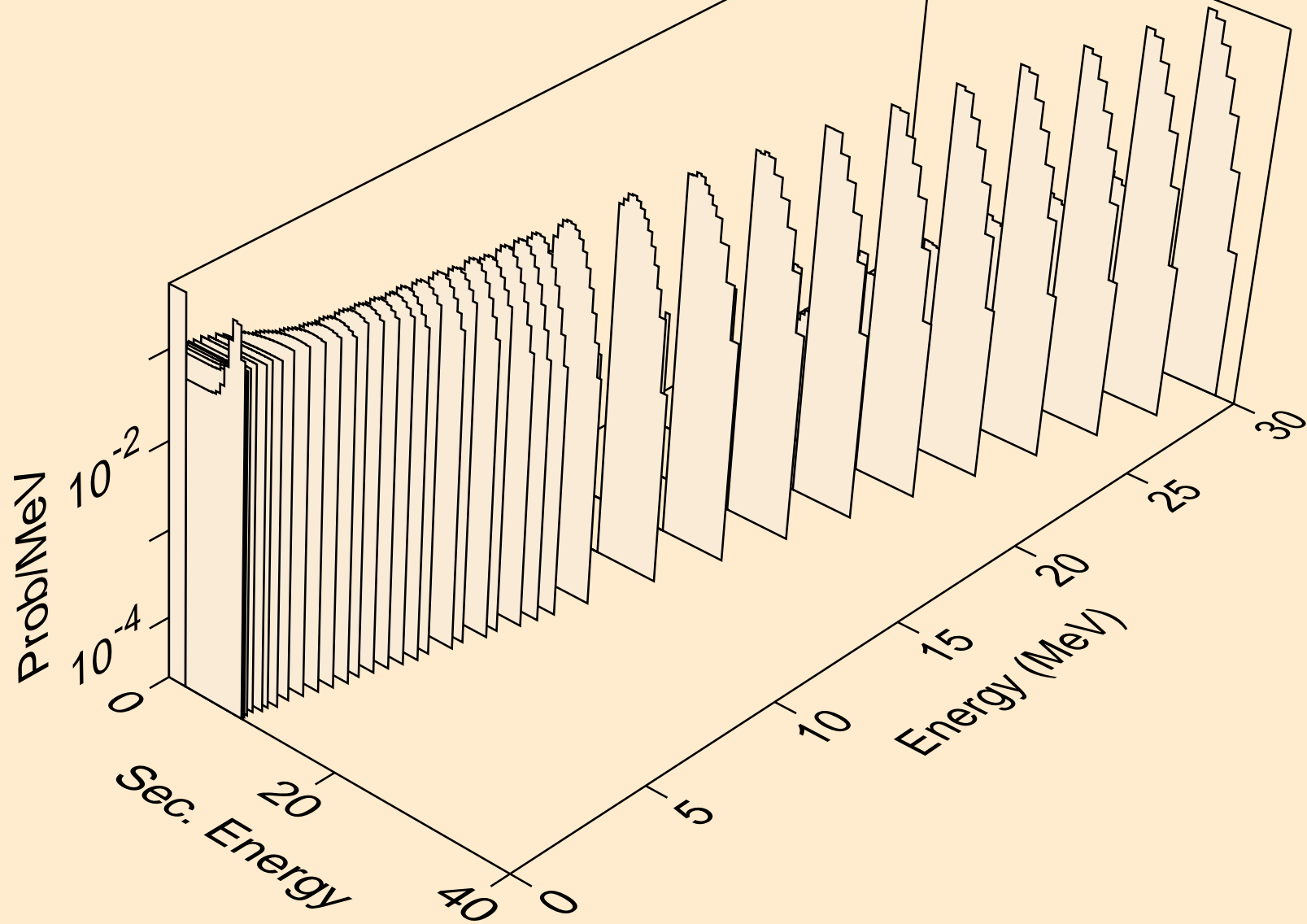

CD096 NEUTRON ACER TENDL-2024 LIBRARY; T=293.6K
alphas from (n,2a)

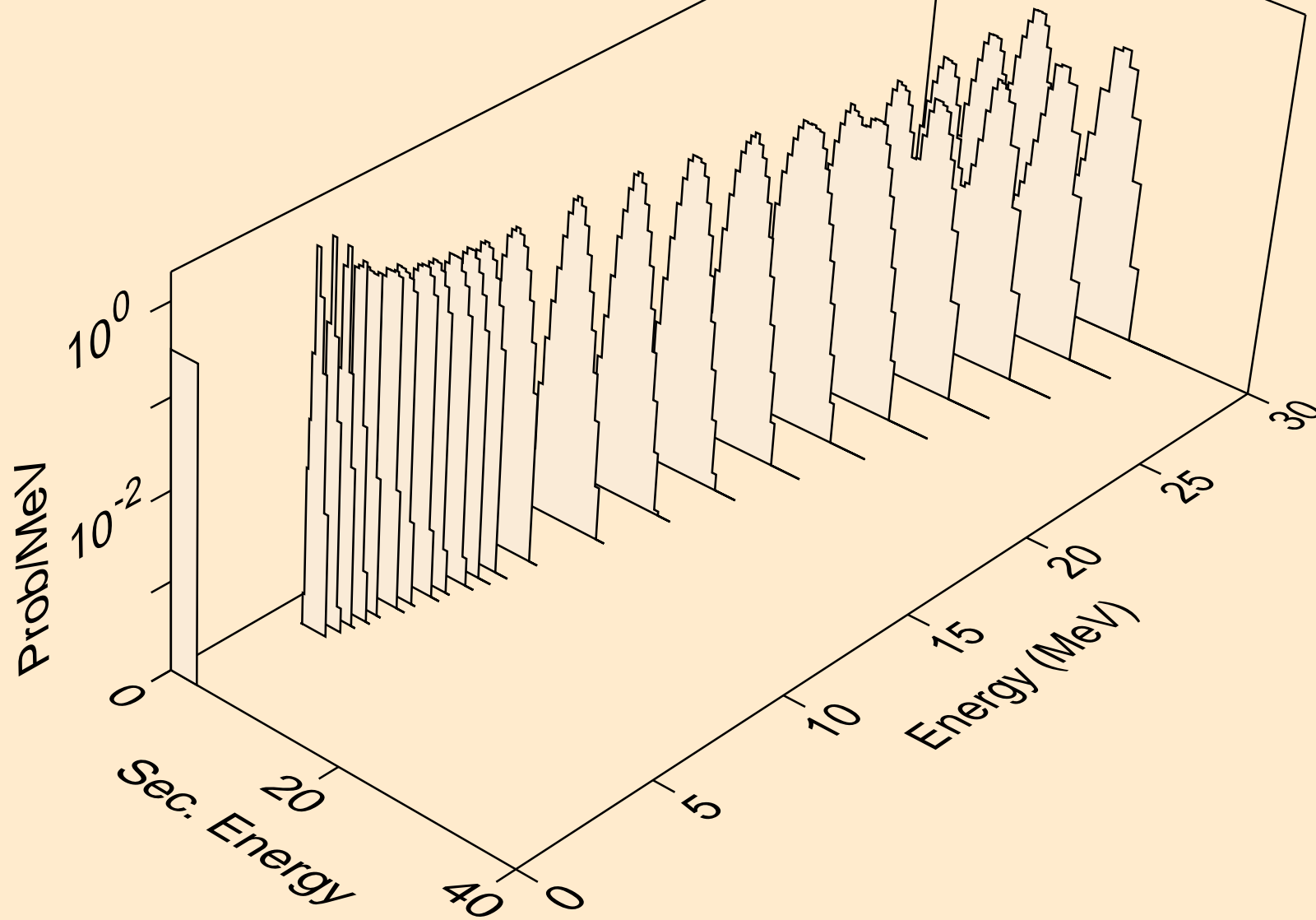

CD096 NEUTRON ACER TENDL-2024 LIBRARY; T=293.6K
alphas from (n,pa)

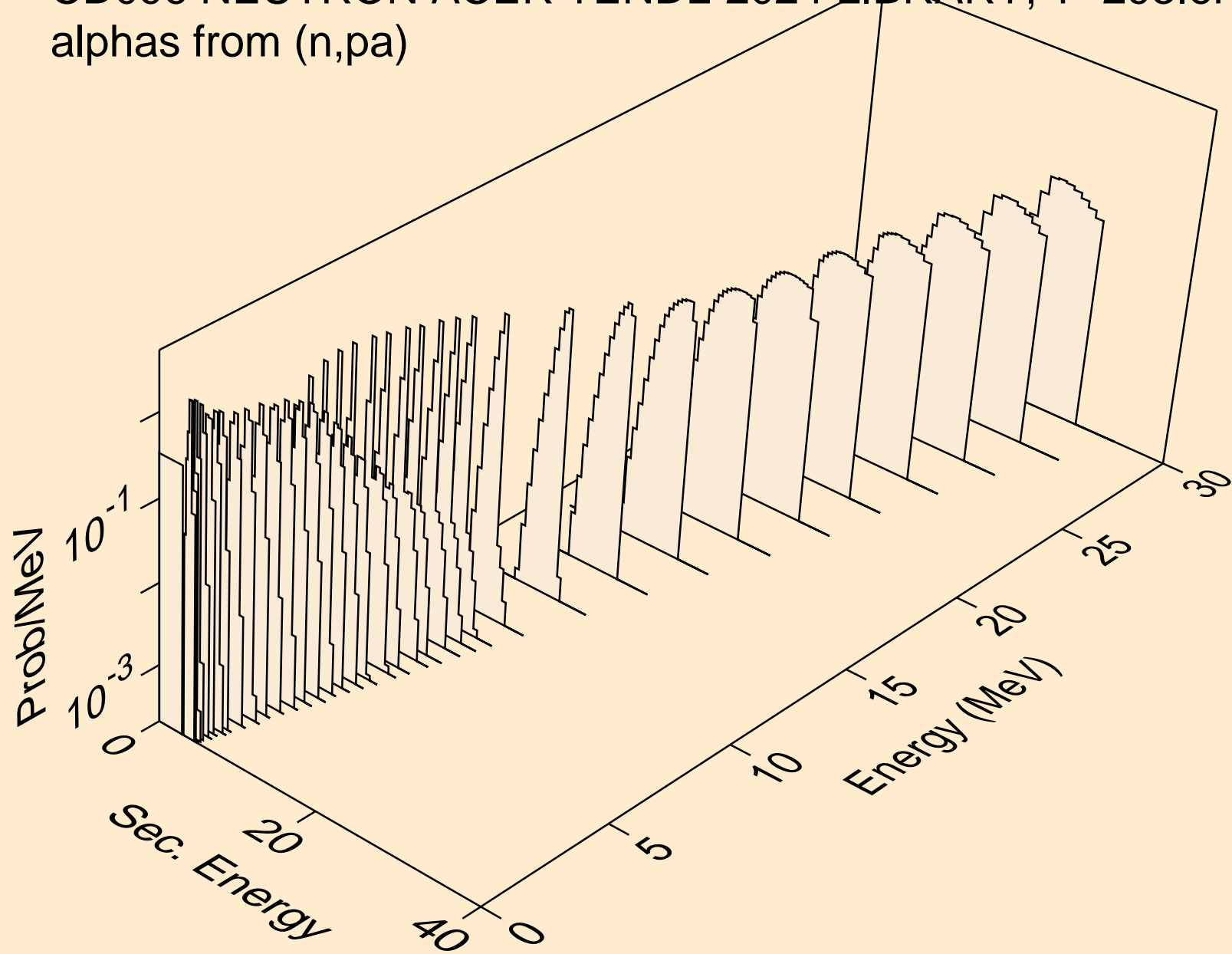

CD096 NEUTRON ACER TENDL-2024 LIBRARY; T=293.6K
alphas from (n,da)

