

# CD101 NEUTRON ACER TENDL-2024 LIBRARY; T=293.6K

## Principal cross sections

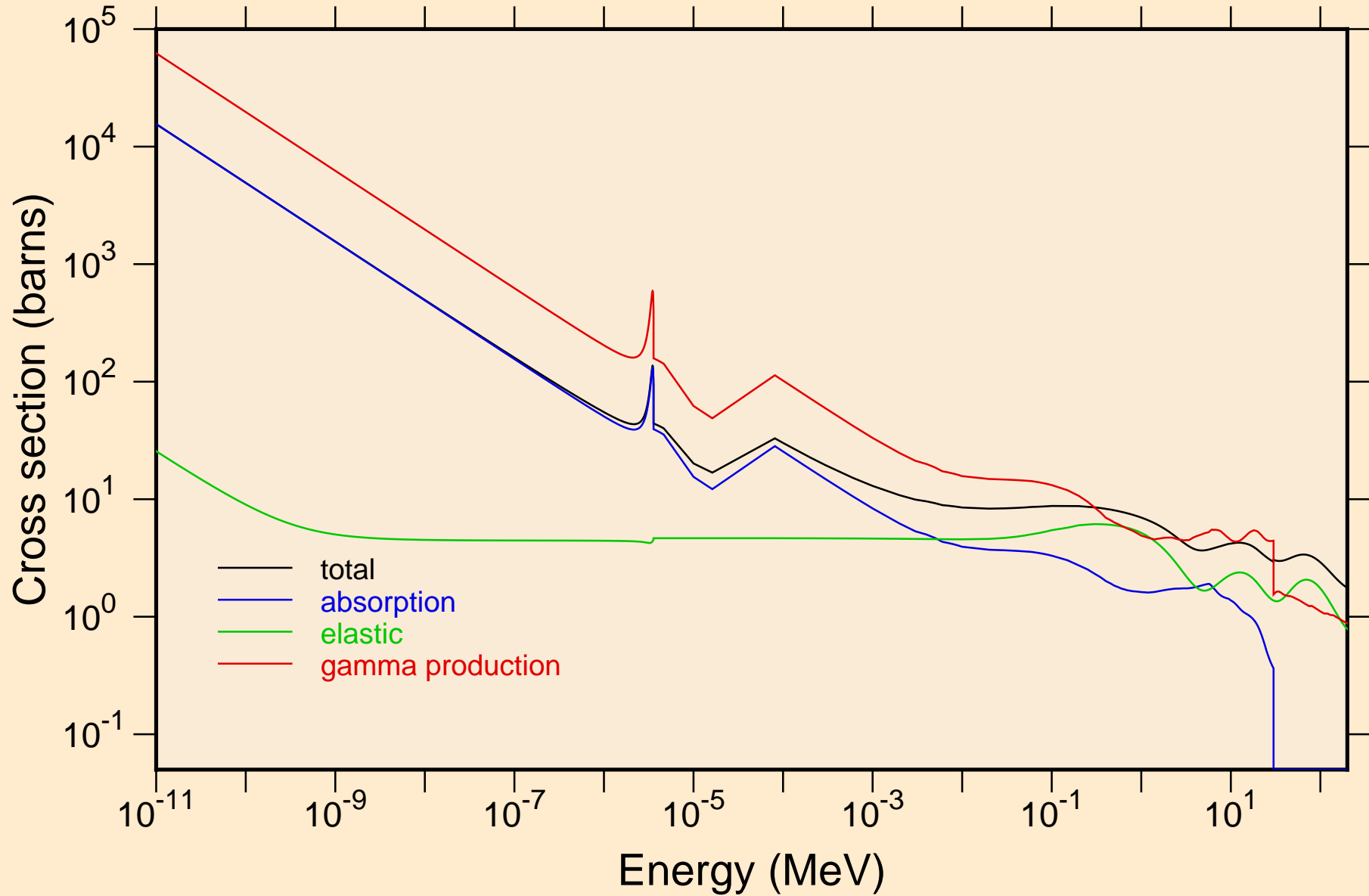

CD101 NEUTRON ACER TENDL-2024 LIBRARY; T=293.6K  
Heating

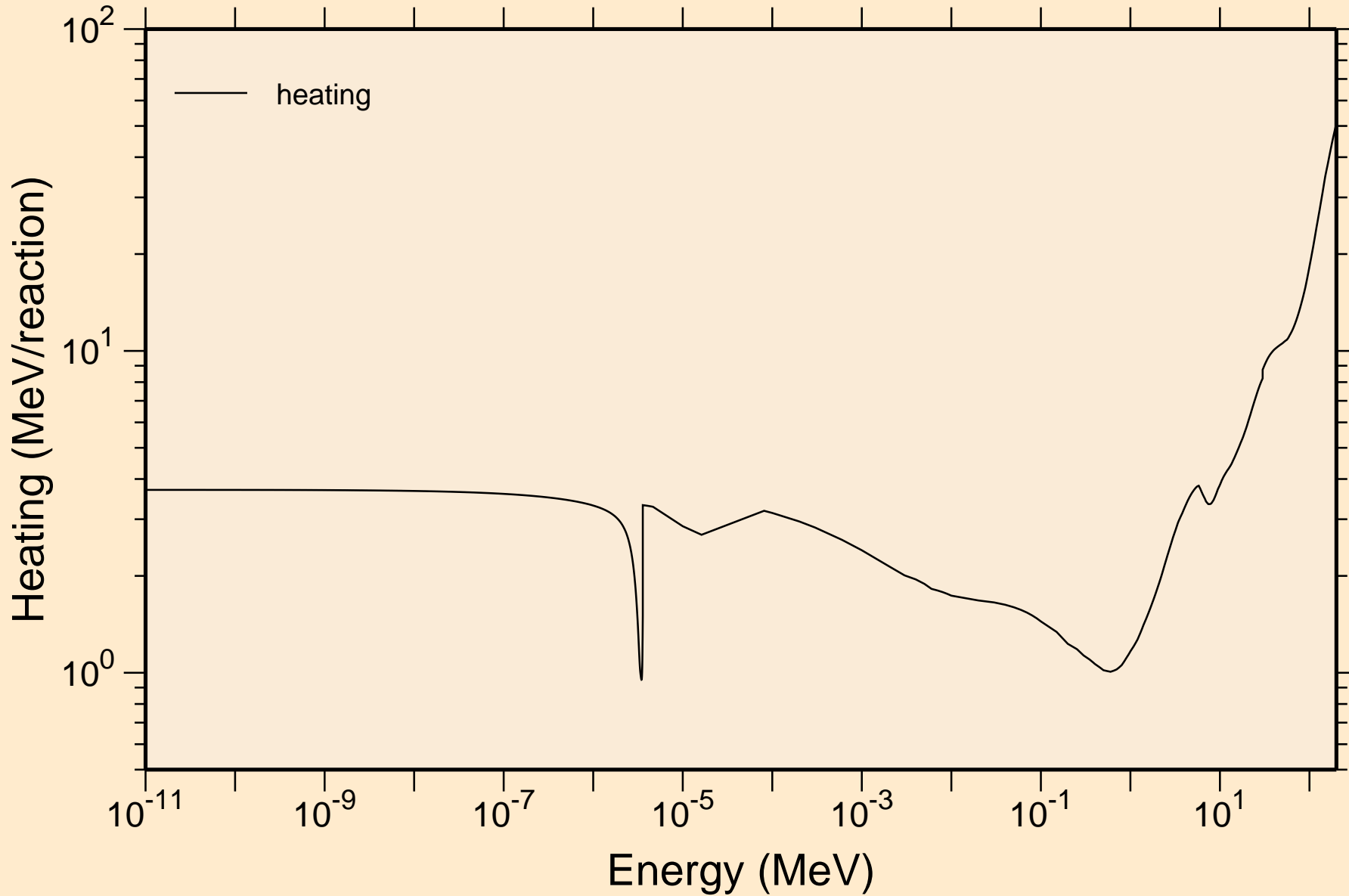

CD101 NEUTRON ACER TENDL-2024 LIBRARY; T=293.6K  
Damage

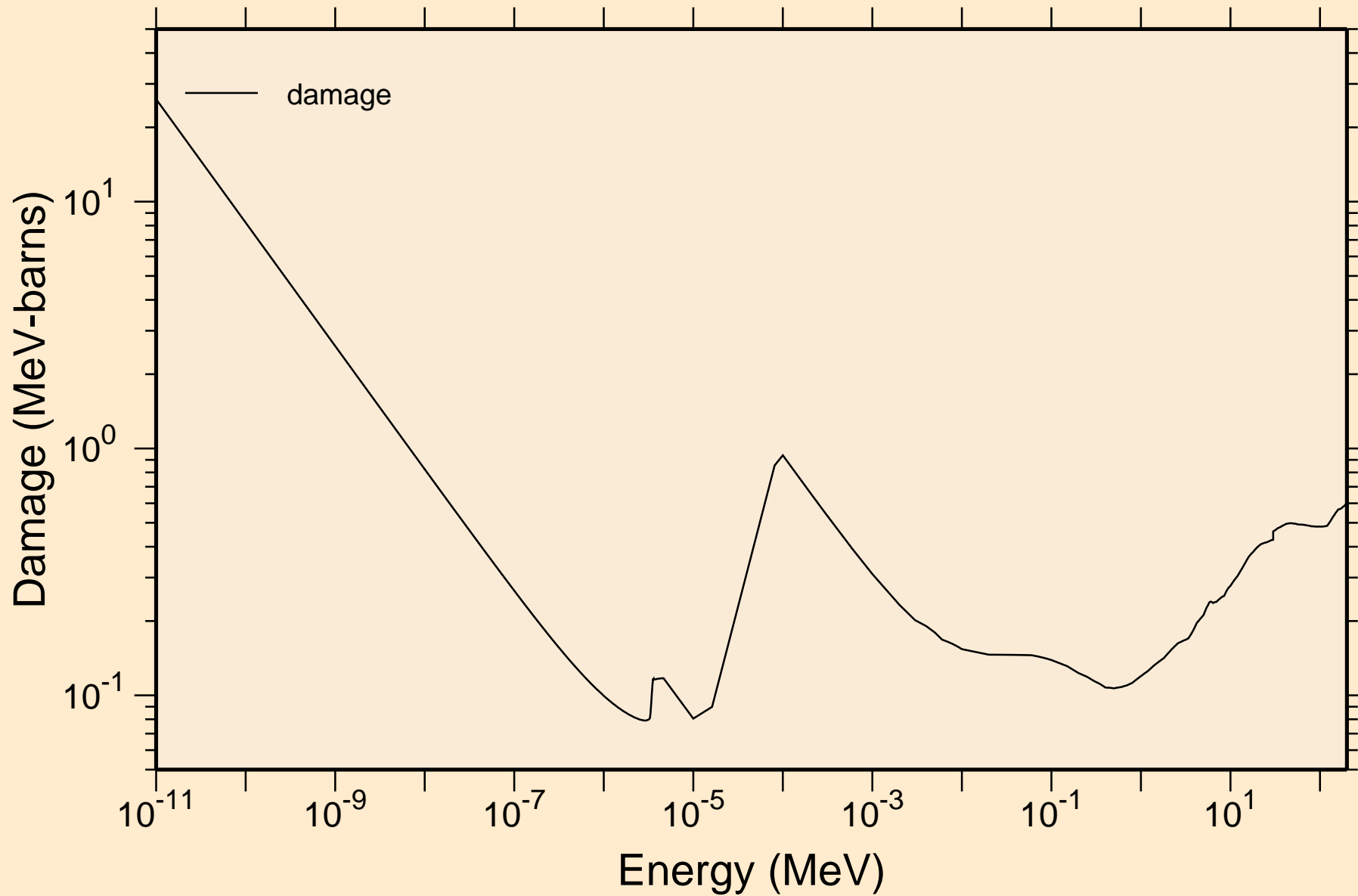

# CD101 NEUTRON ACER TENDL-2024 LIBRARY; T=293.6K

## Non-threshold reactions

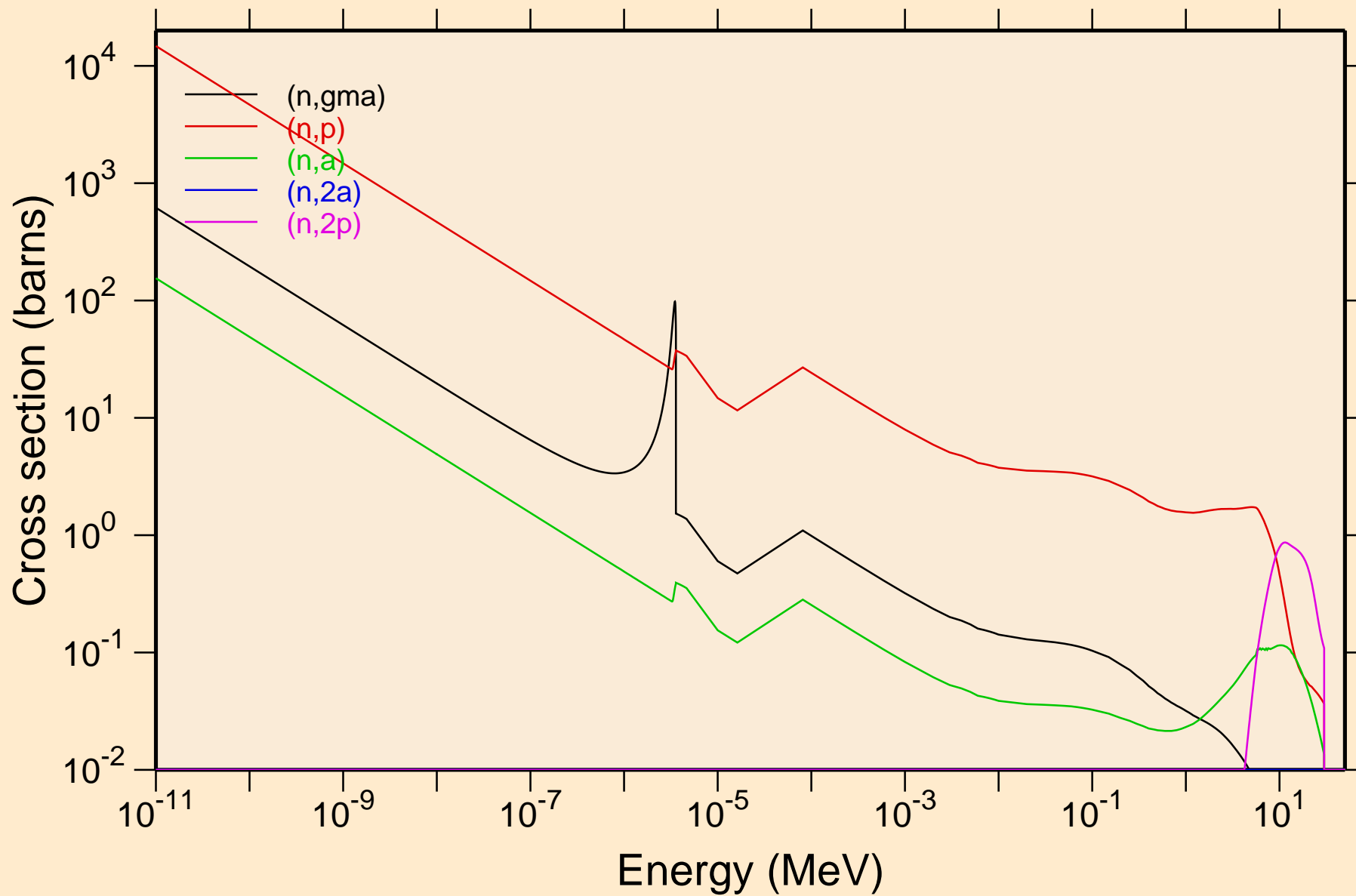

# CD101 NEUTRON ACER TENDL-2024 LIBRARY; T=293.6K

## Non-threshold reactions

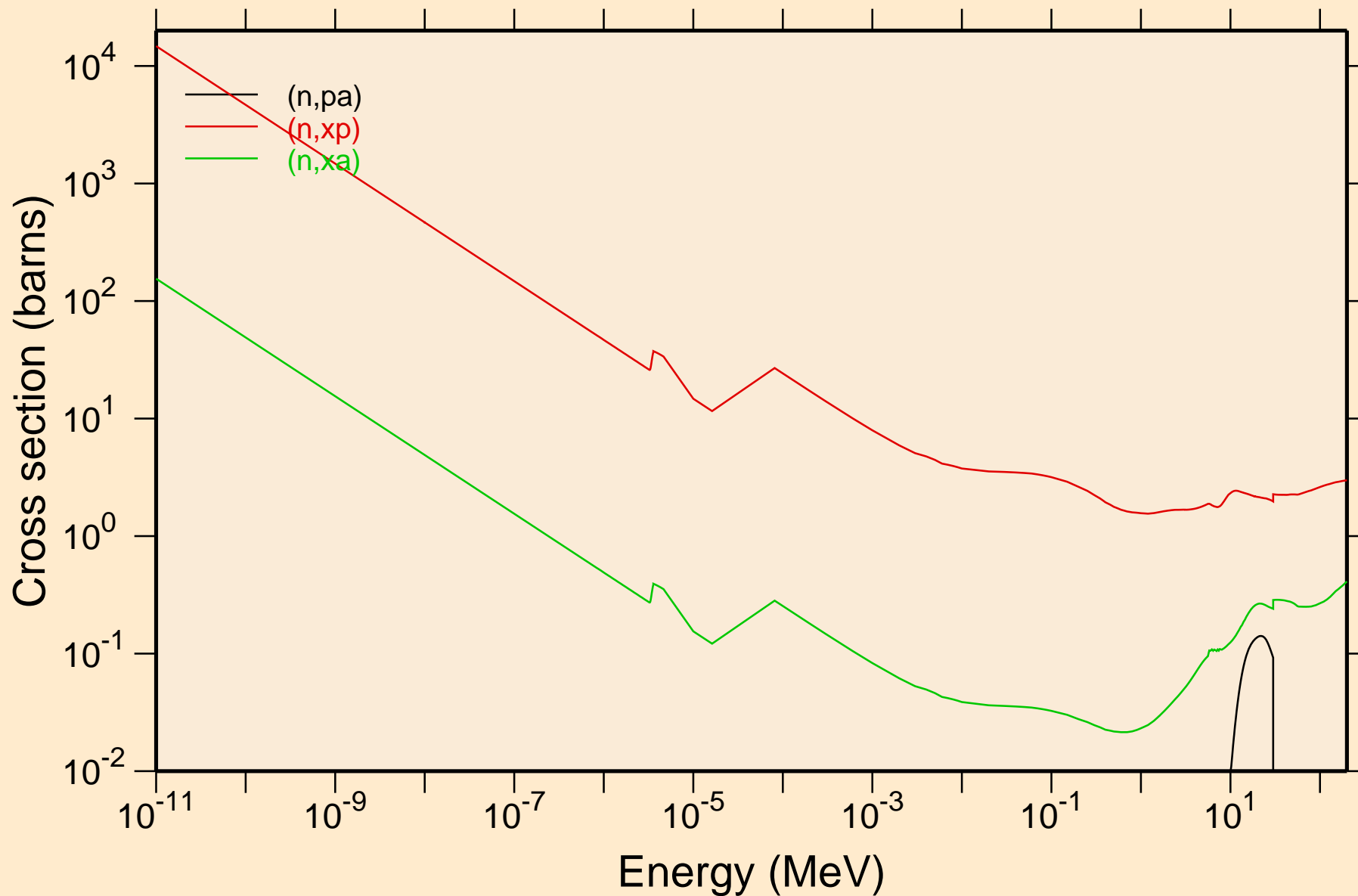

# CD101 NEUTRON ACER TENDL-2024 LIBRARY; T=293.6K

## Principal cross sections

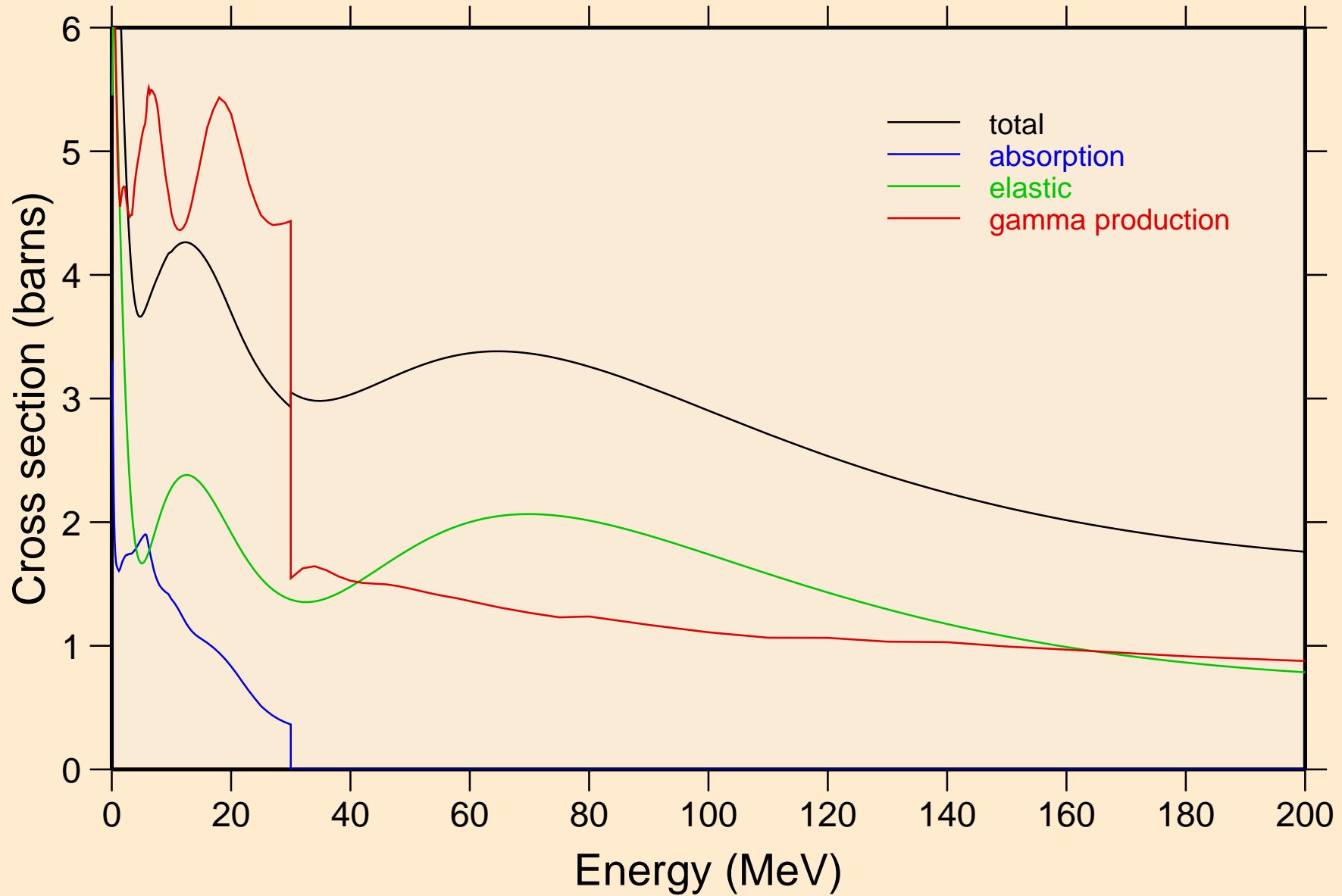

CD101 NEUTRON ACER TENDL-2024 LIBRARY; T=293.6K  
Heating

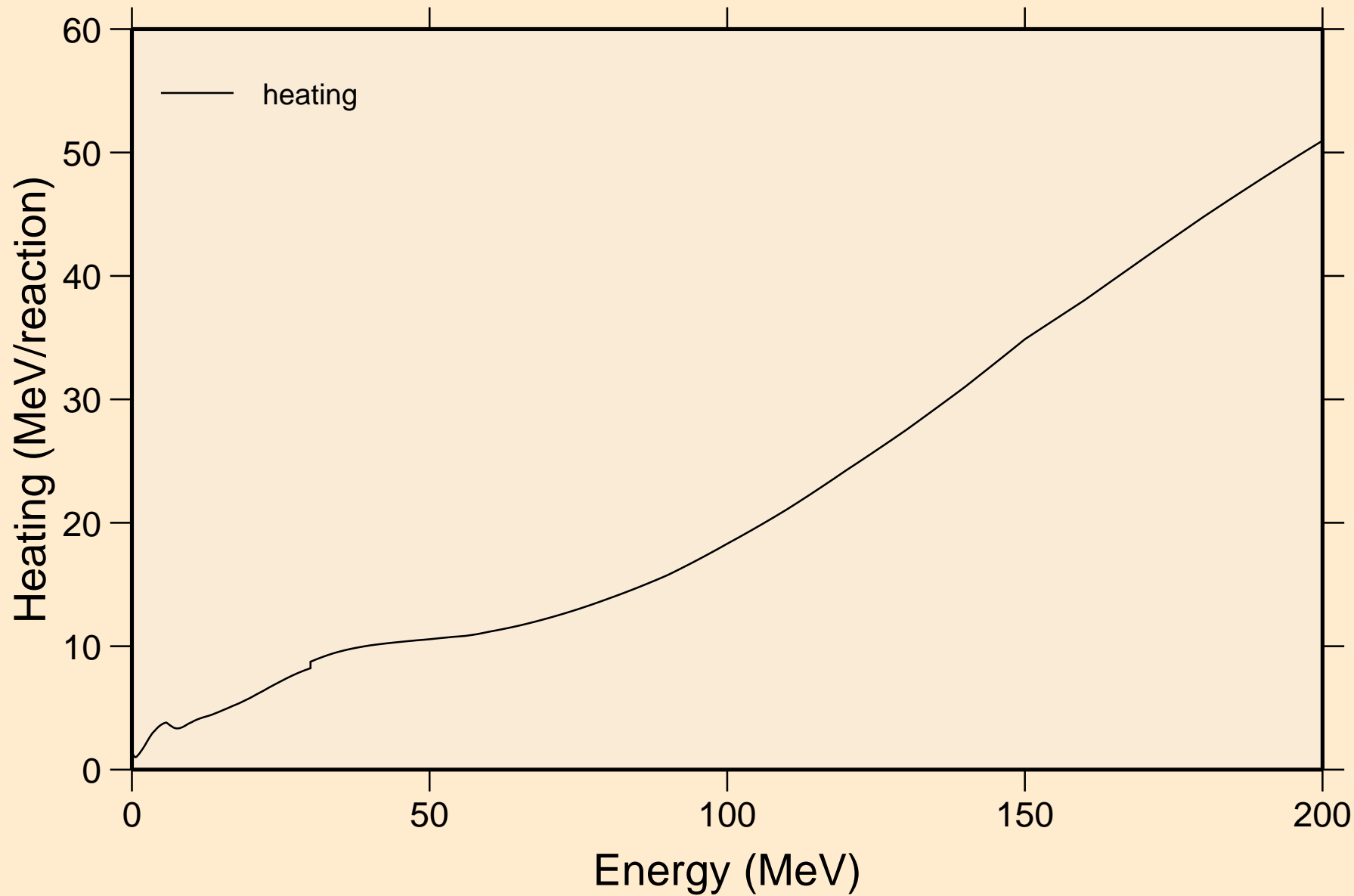

# CD101 NEUTRON ACER TENDL-2024 LIBRARY; T=293.6K

## Damage

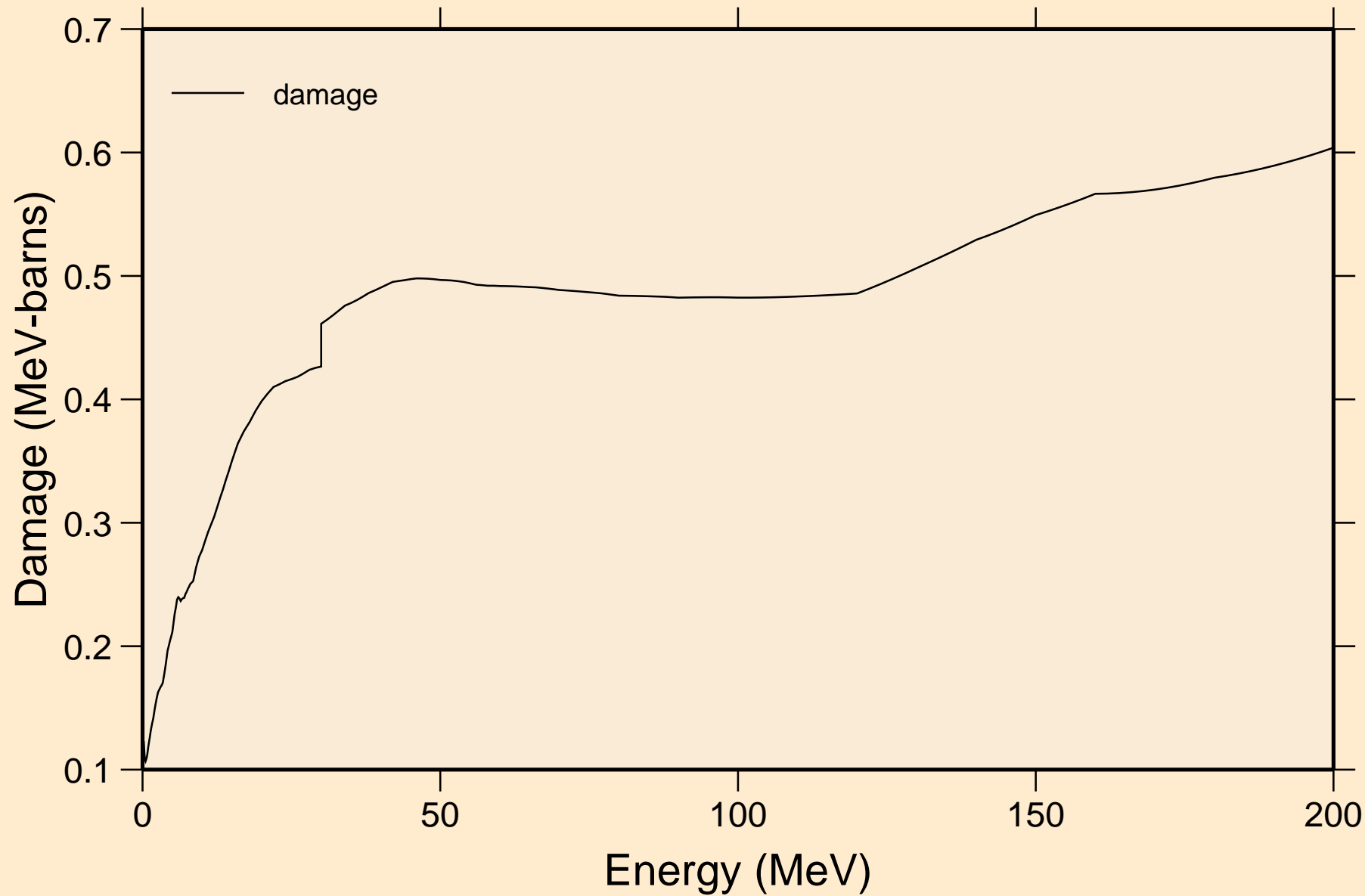

# CD101 NEUTRON ACER TENDL-2024 LIBRARY; T=293.6K

## Non-threshold reactions

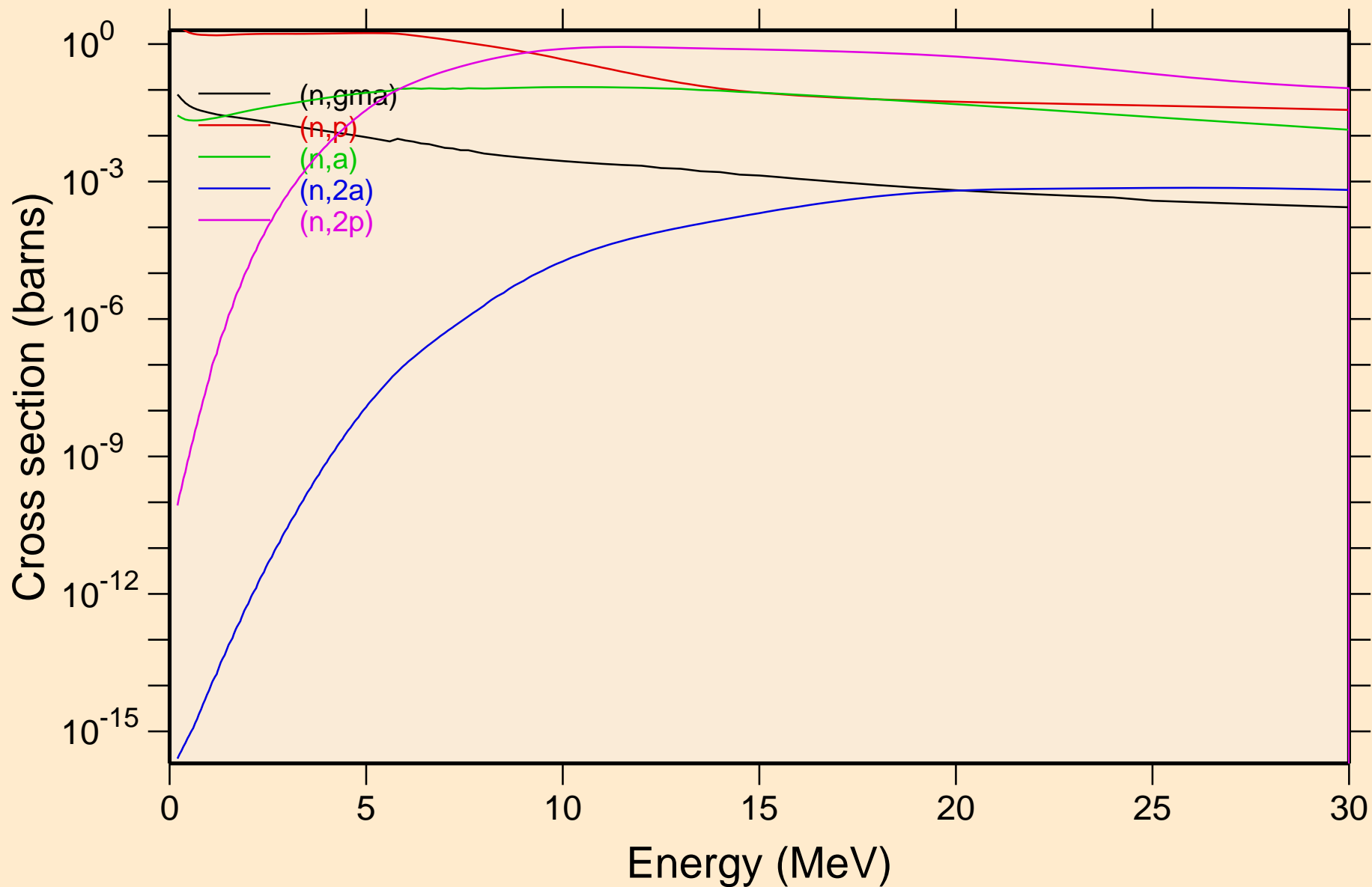

CD101 NEUTRON ACER TENDL-2024 LIBRARY; T=293.6K  
Non-threshold reactions

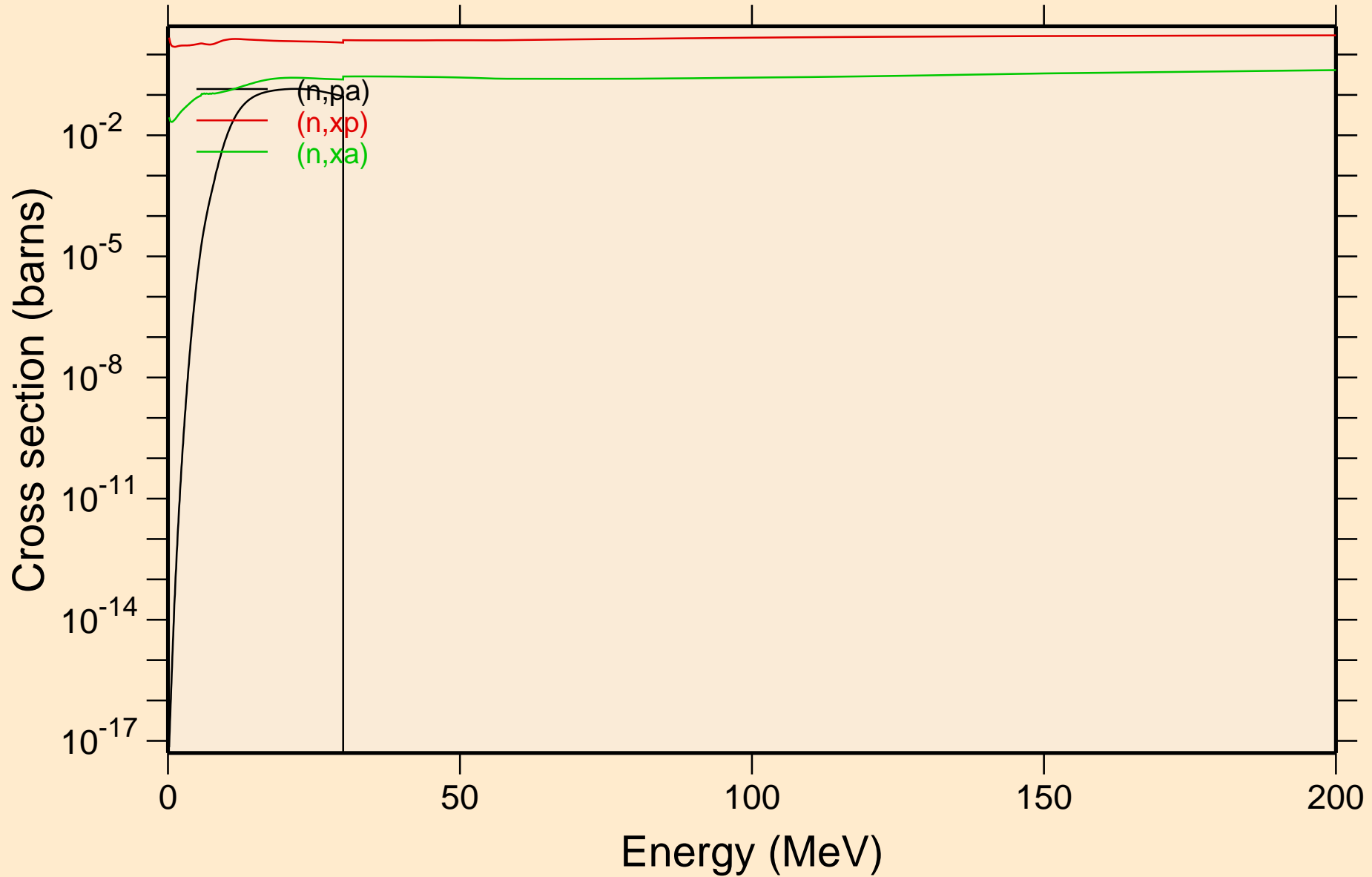

# CD101 NEUTRON ACER TENDL-2024 LIBRARY; T=293.6K

## Inelastic levels

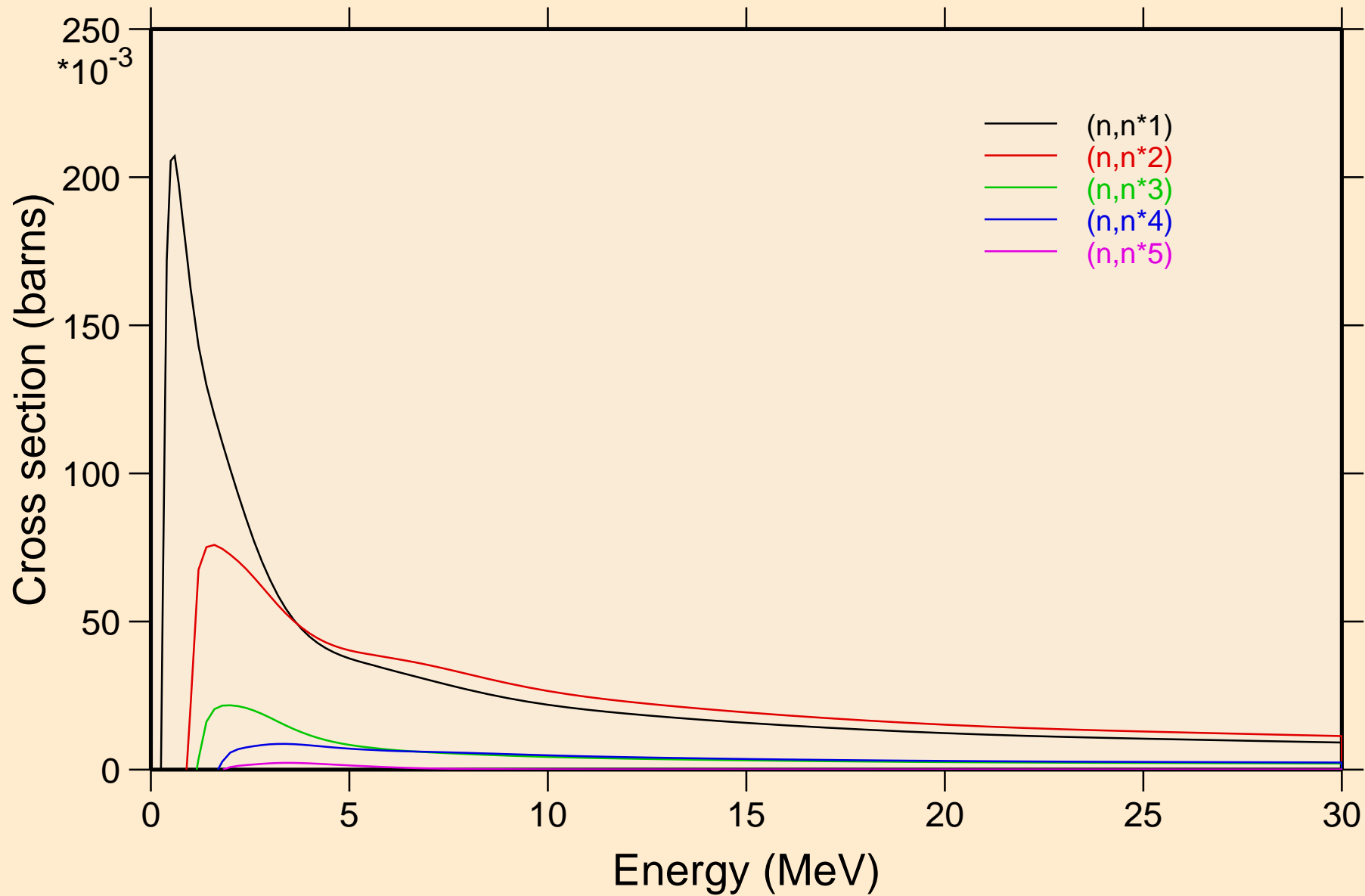

CD101 NEUTRON ACER TENDL-2024 LIBRARY; T=293.6K  
Inelastic levels

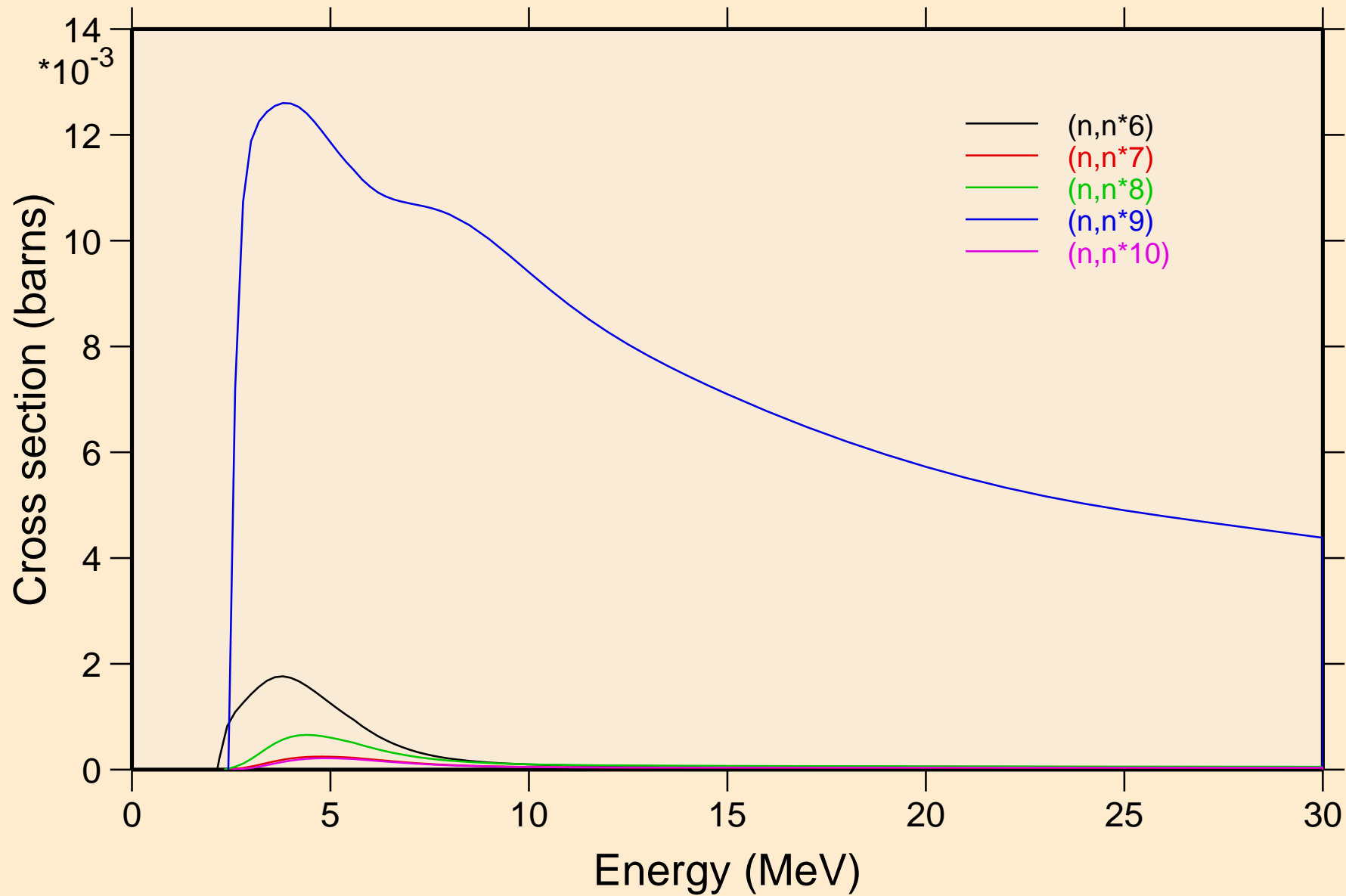

CD101 NEUTRON ACER TENDL-2024 LIBRARY; T=293.6K  
Inelastic levels

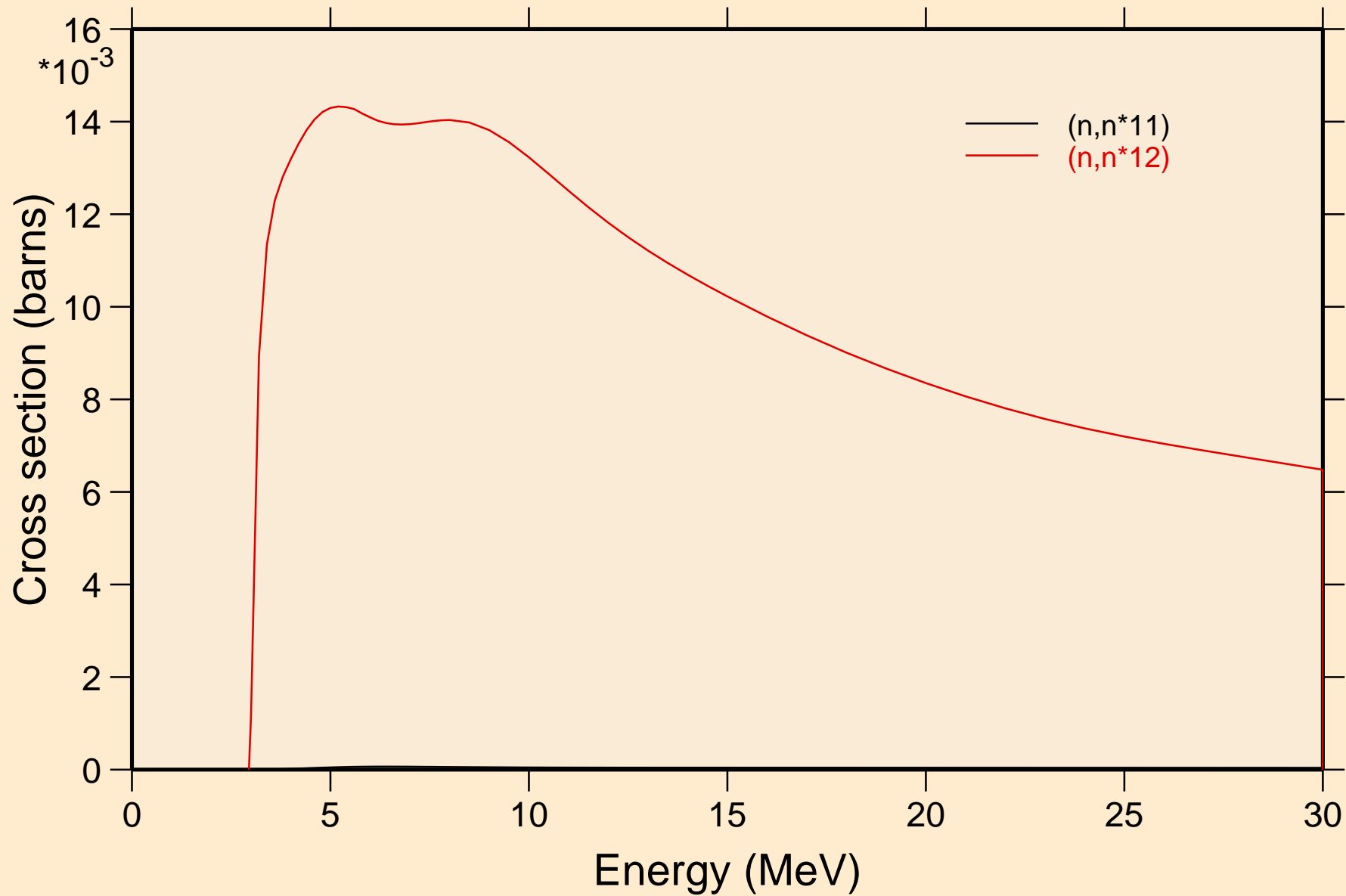

CD101 NEUTRON ACER TENDL-2024 LIBRARY; T=293.6K  
Threshold reactions

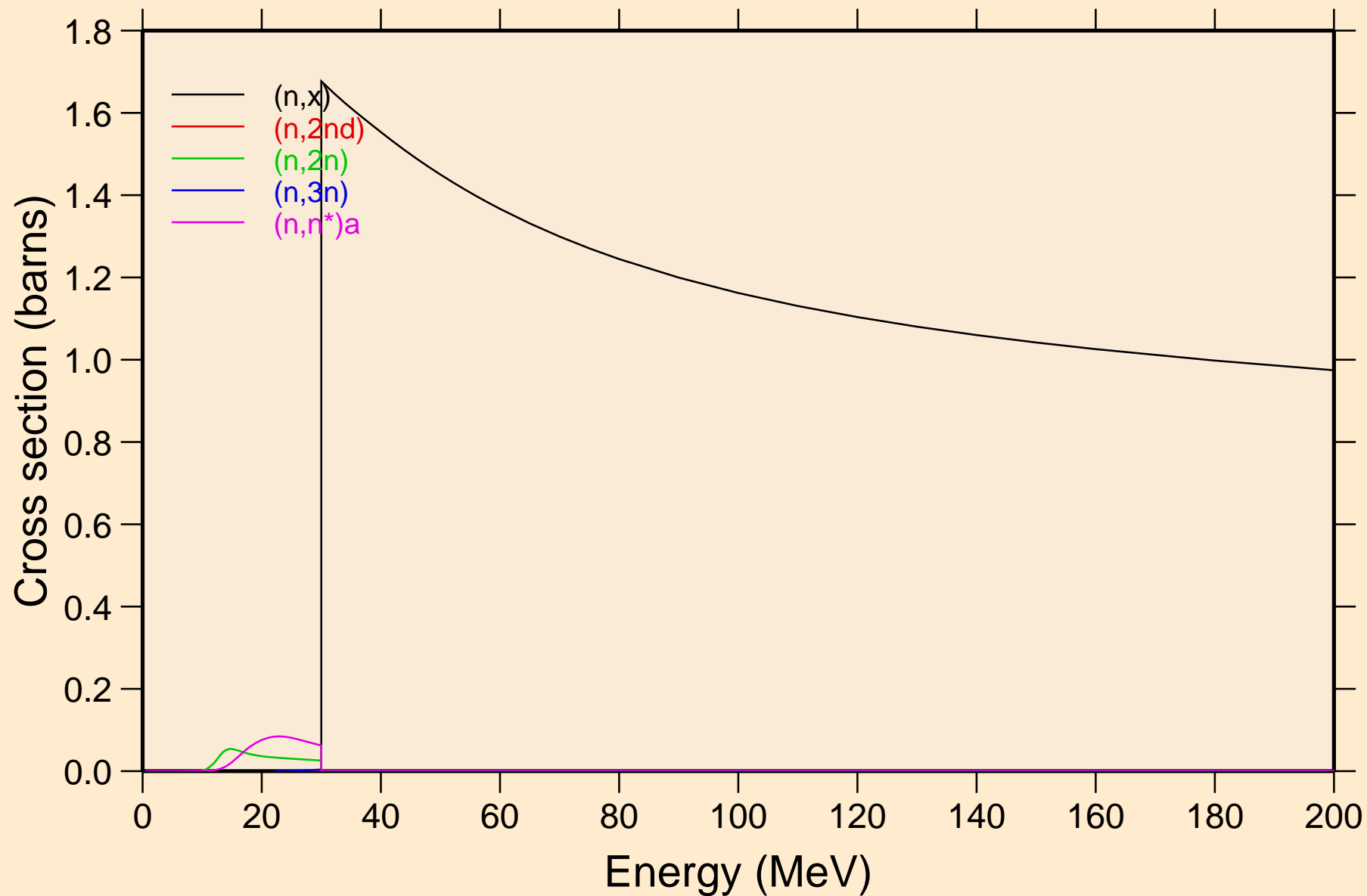

# CD101 NEUTRON ACER TENDL-2024 LIBRARY; T=293.6K

## Threshold reactions

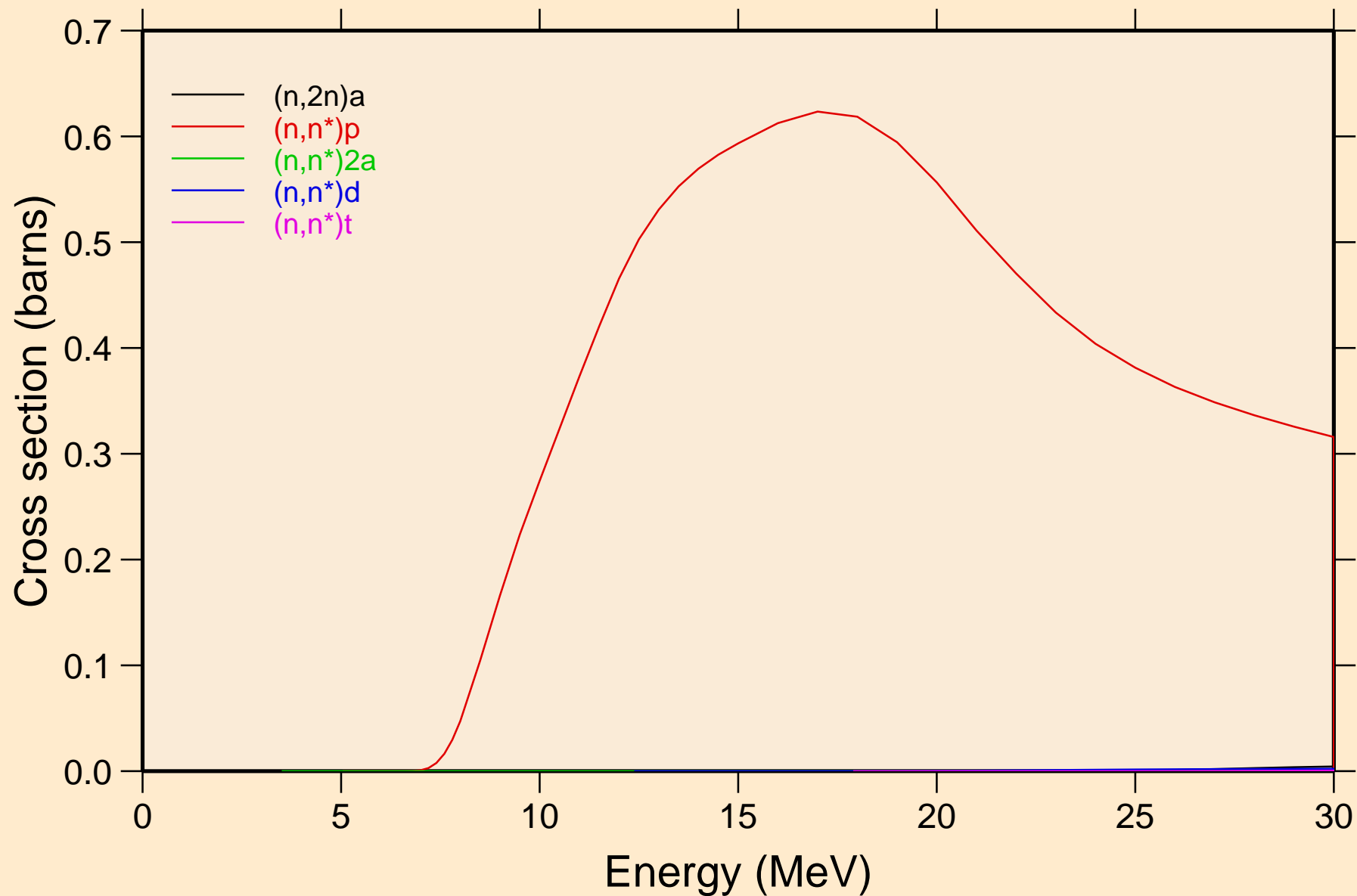

# CD101 NEUTRON ACER TENDL-2024 LIBRARY; T=293.6K

## Threshold reactions

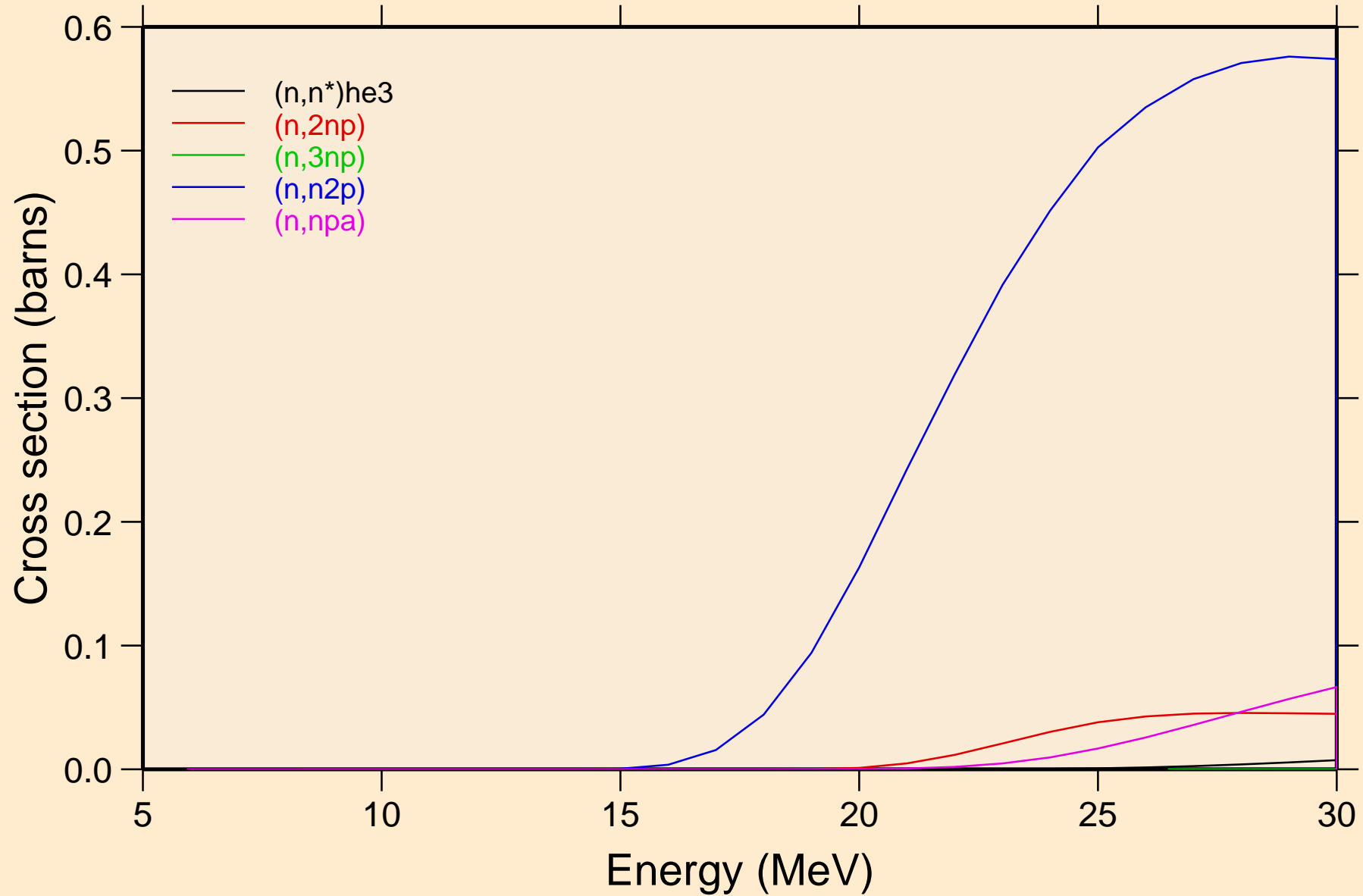

# CD101 NEUTRON ACER TENDL-2024 LIBRARY; T=293.6K

## Threshold reactions

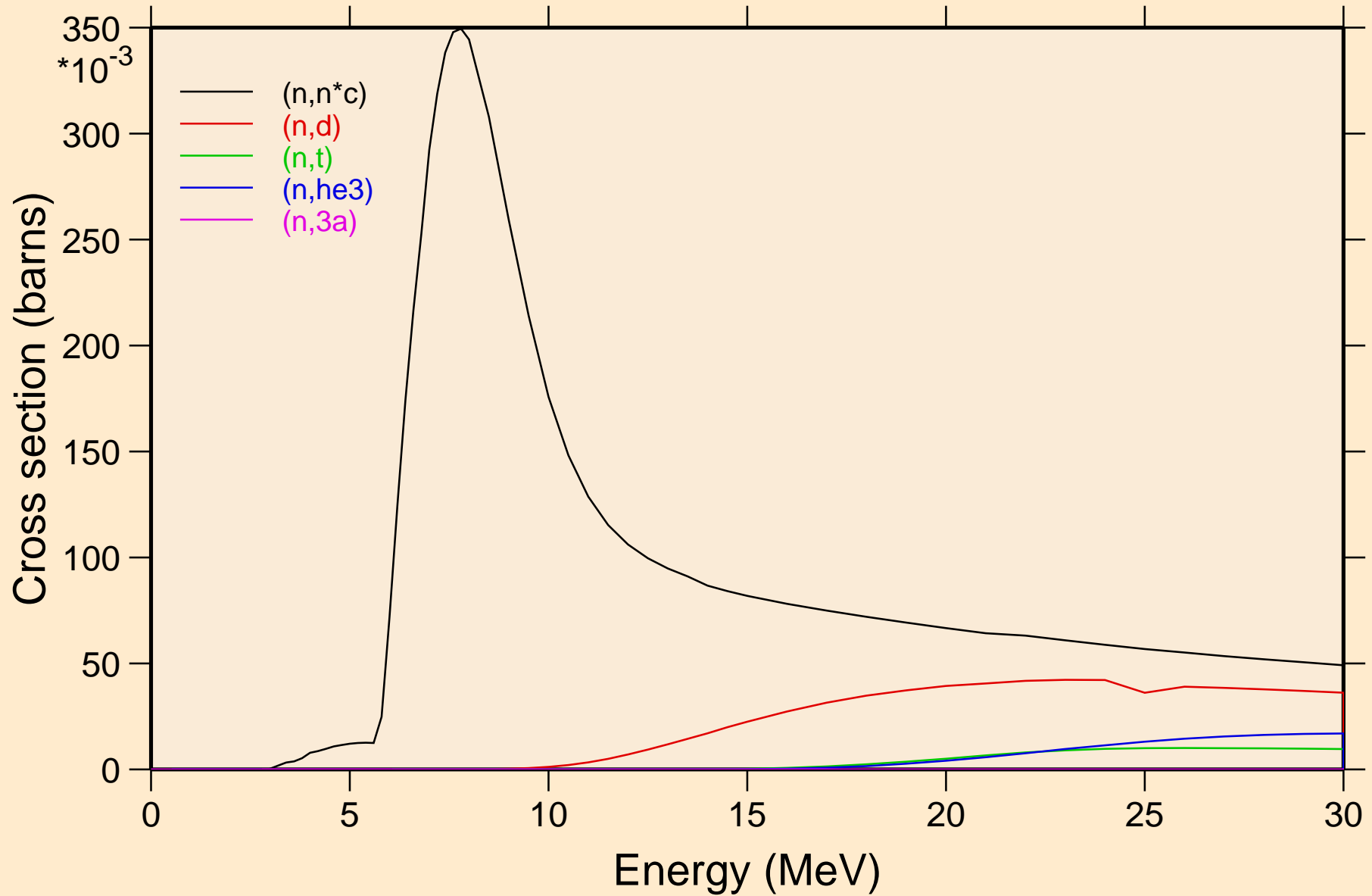

# CD101 NEUTRON ACER TENDL-2024 LIBRARY; T=293.6K

## Threshold reactions

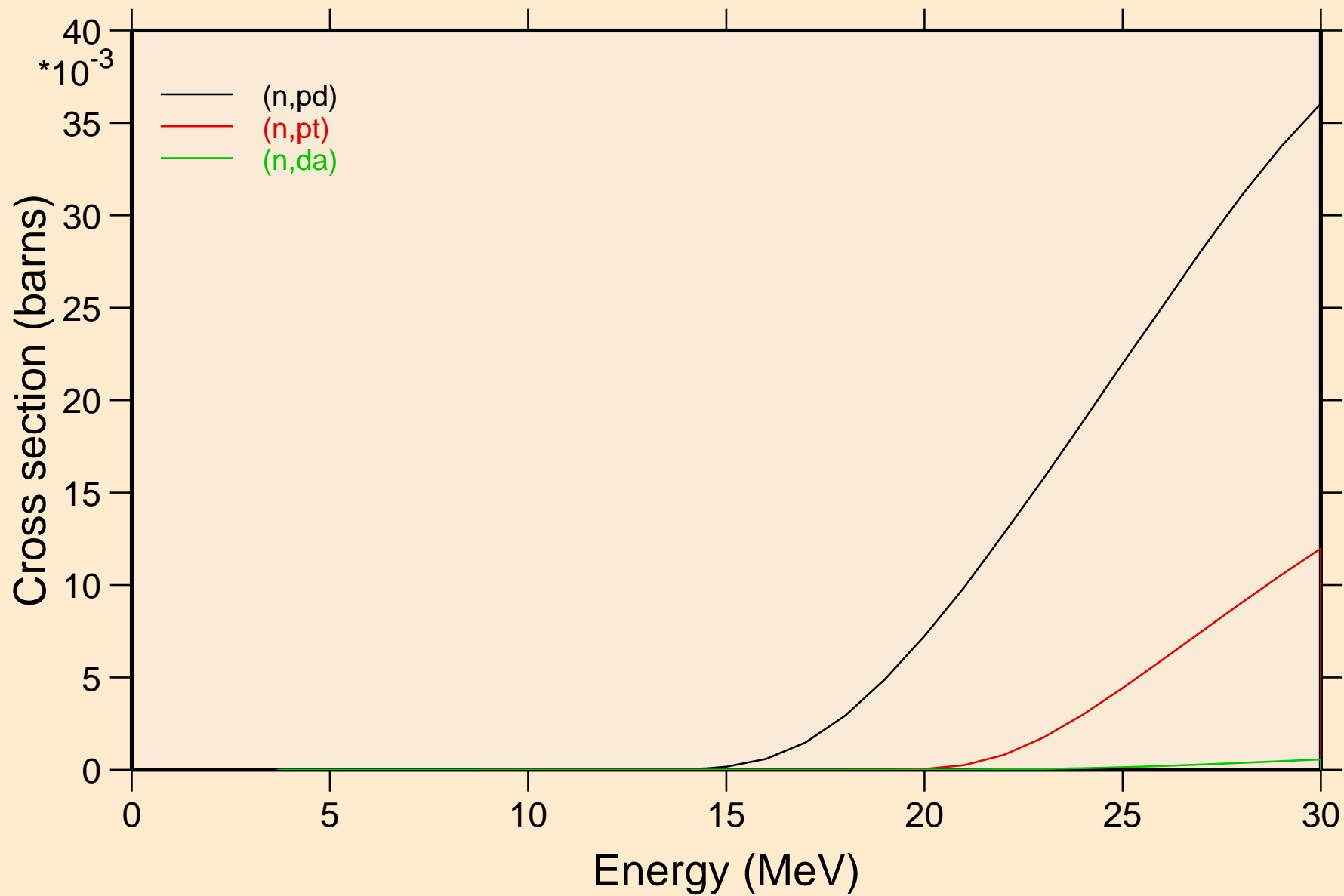

# CD101 NEUTRON ACER TENDL-2024 LIBRARY; T=293.6K

## Threshold reactions

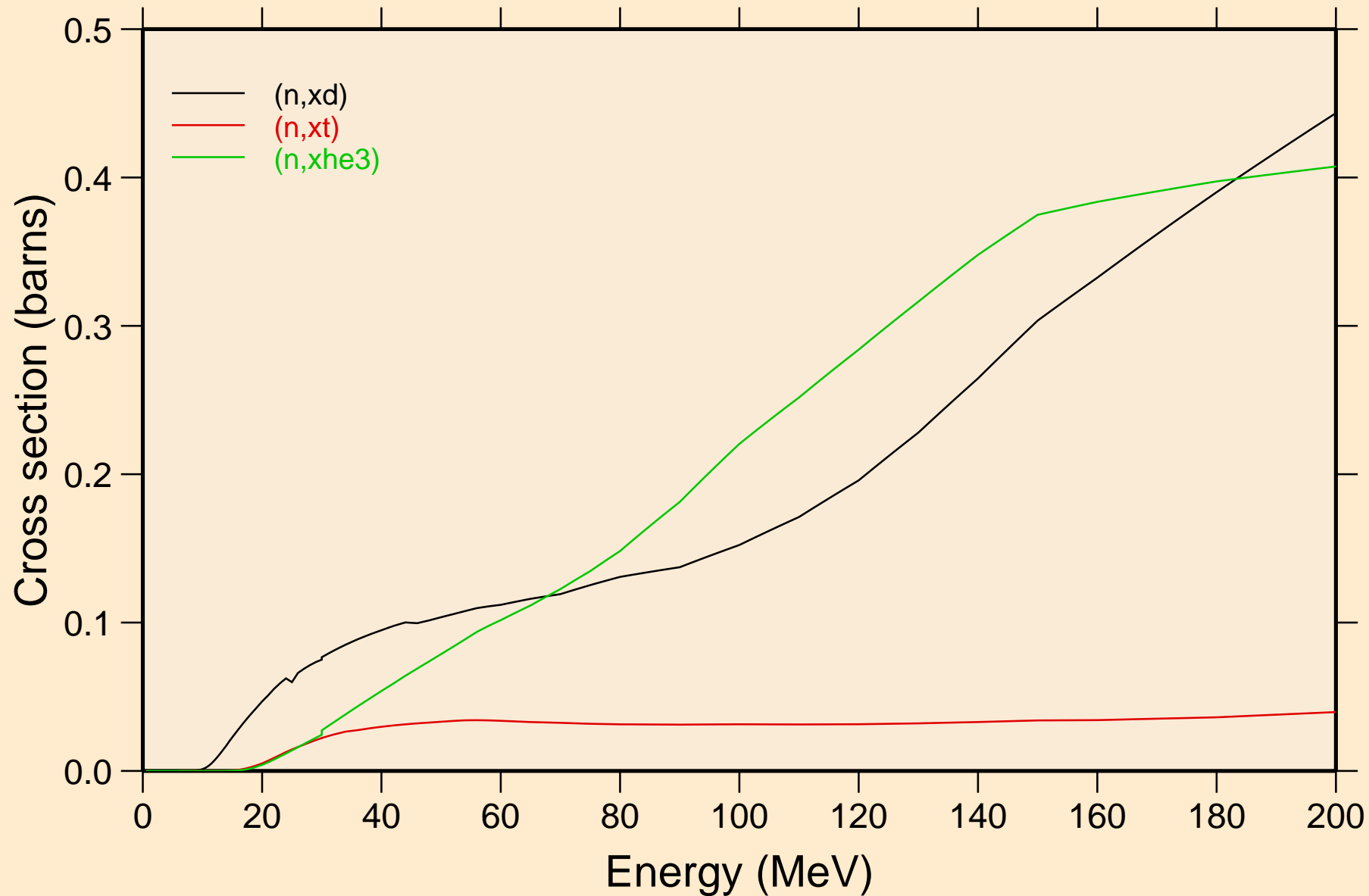

CD101 NEUTRON ACER TENDL-2024 LIBRARY; T=293.6K  
angular distribution for elastic

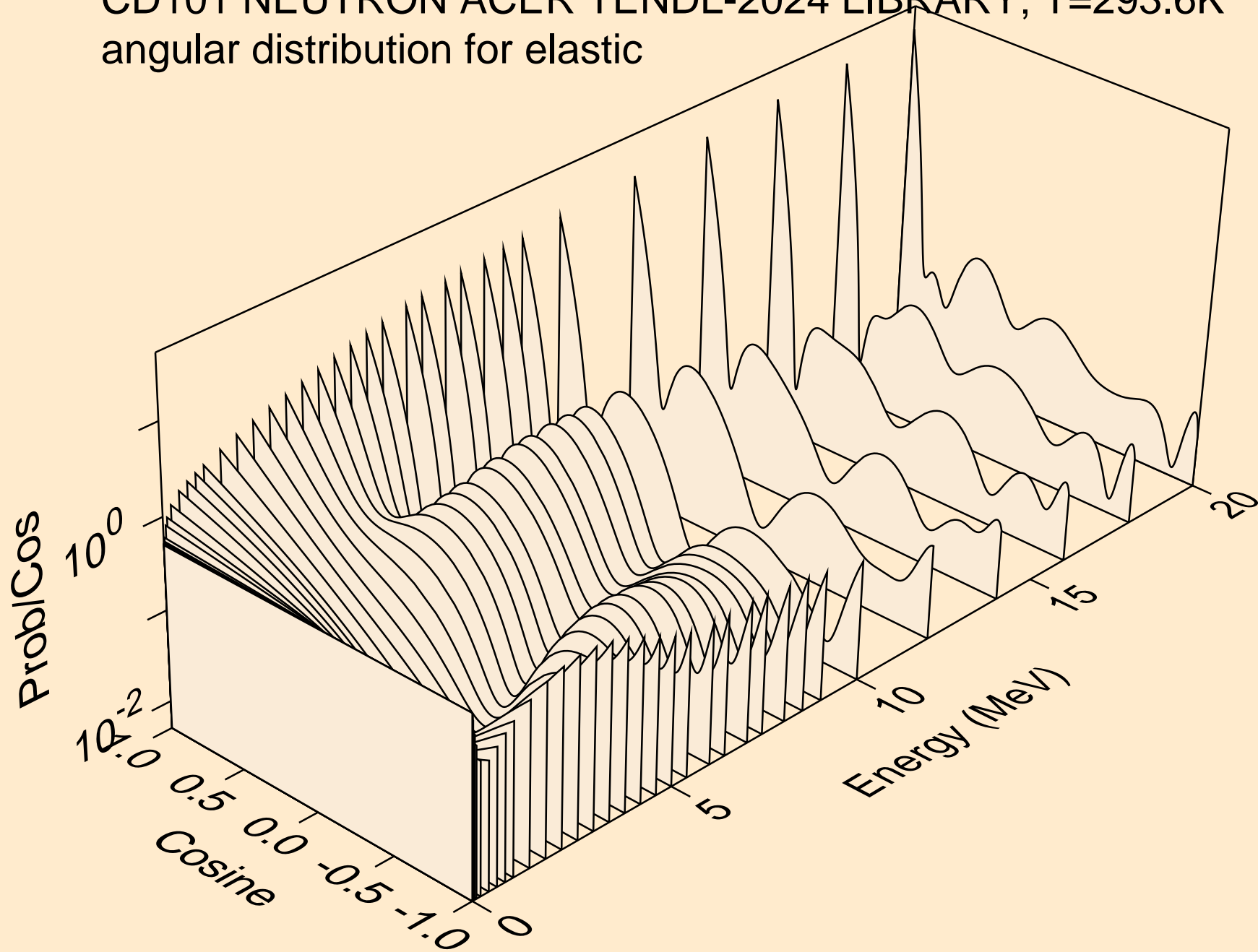

CD101 NEUTRON ACER TENDL-2024 LIBRARY; T=293.6K  
angular distribution for elastic

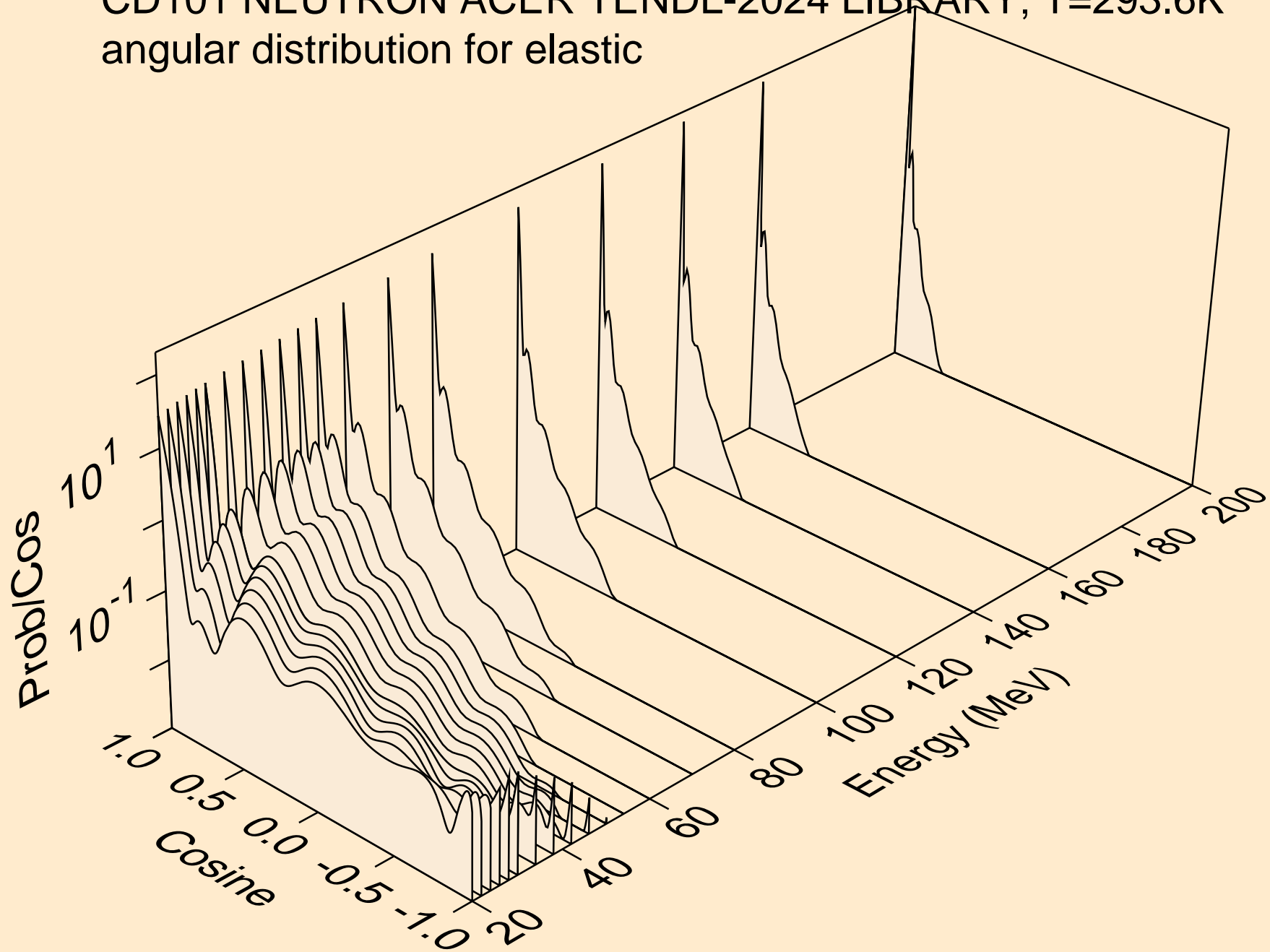

CD101 NEUTRON ACER TENDL-2024 LIBRARY; T=293.6K  
angular distribution for (n,n\*1)

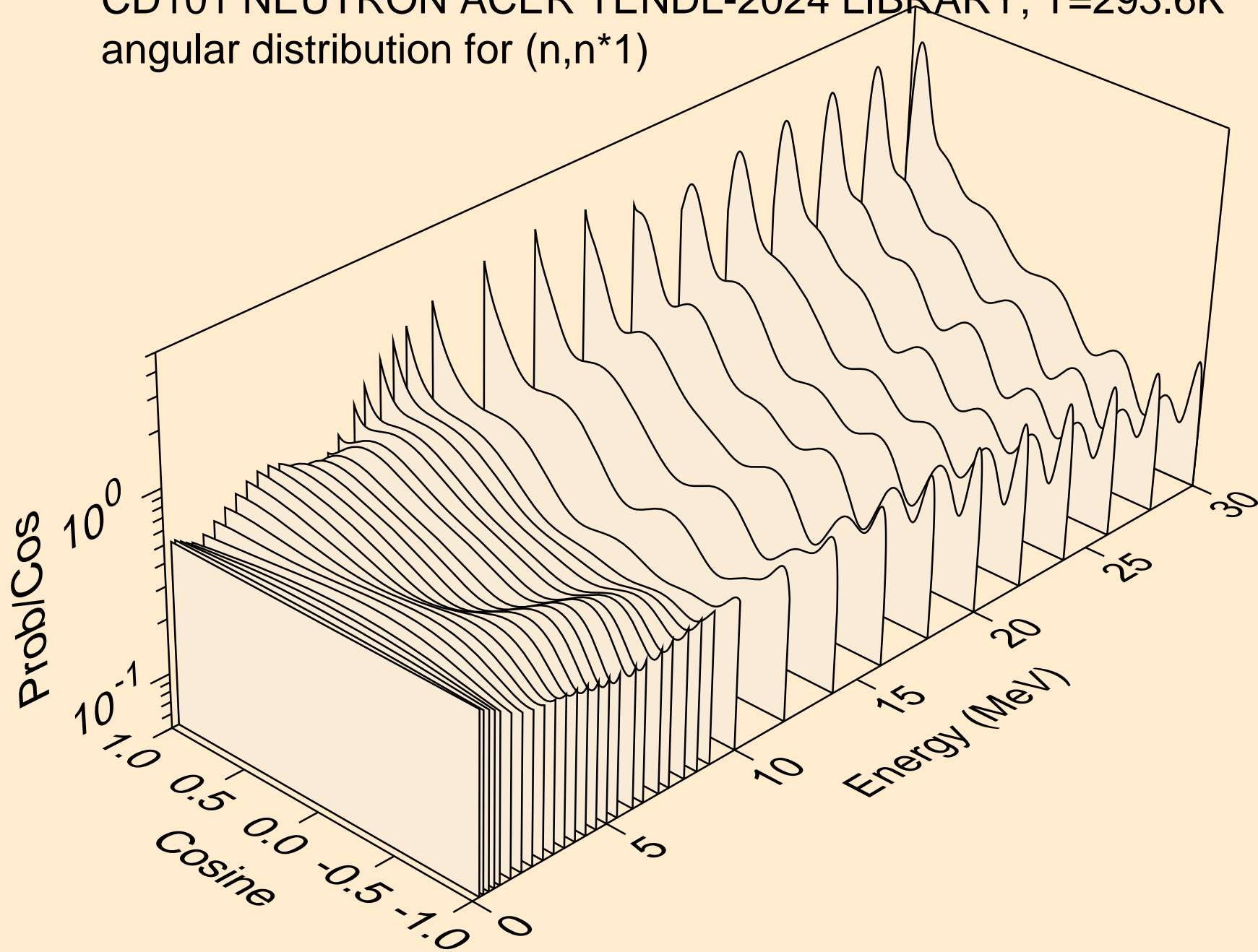

CD101 NEUTRON ACER TENDL-2024 LIBRARY; T=293.6K  
angular distribution for (n,n\*2)

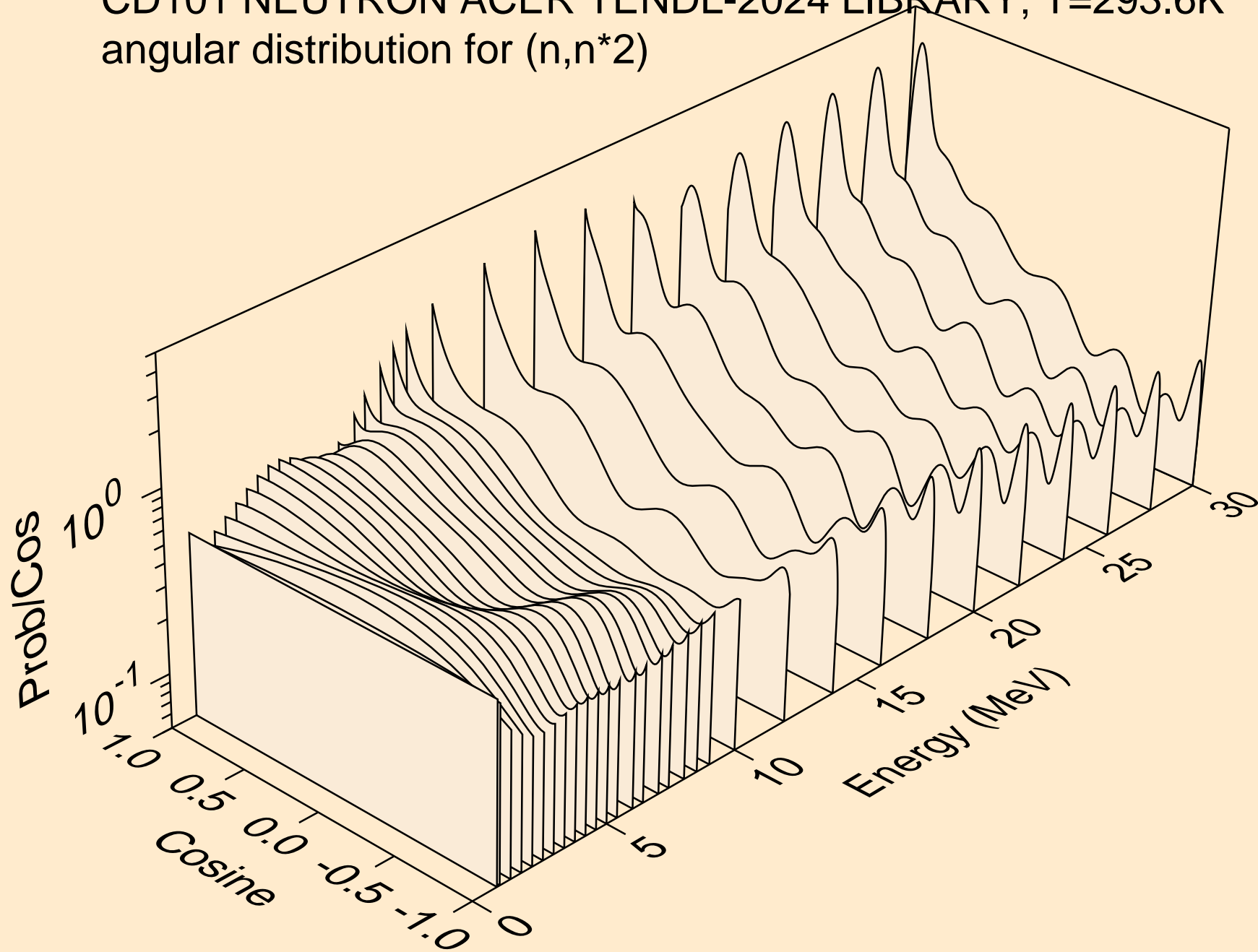

CD101 NEUTRON ACER TENDL-2024 LIBRARY; T=293.6K  
angular distribution for (n,n\*3)

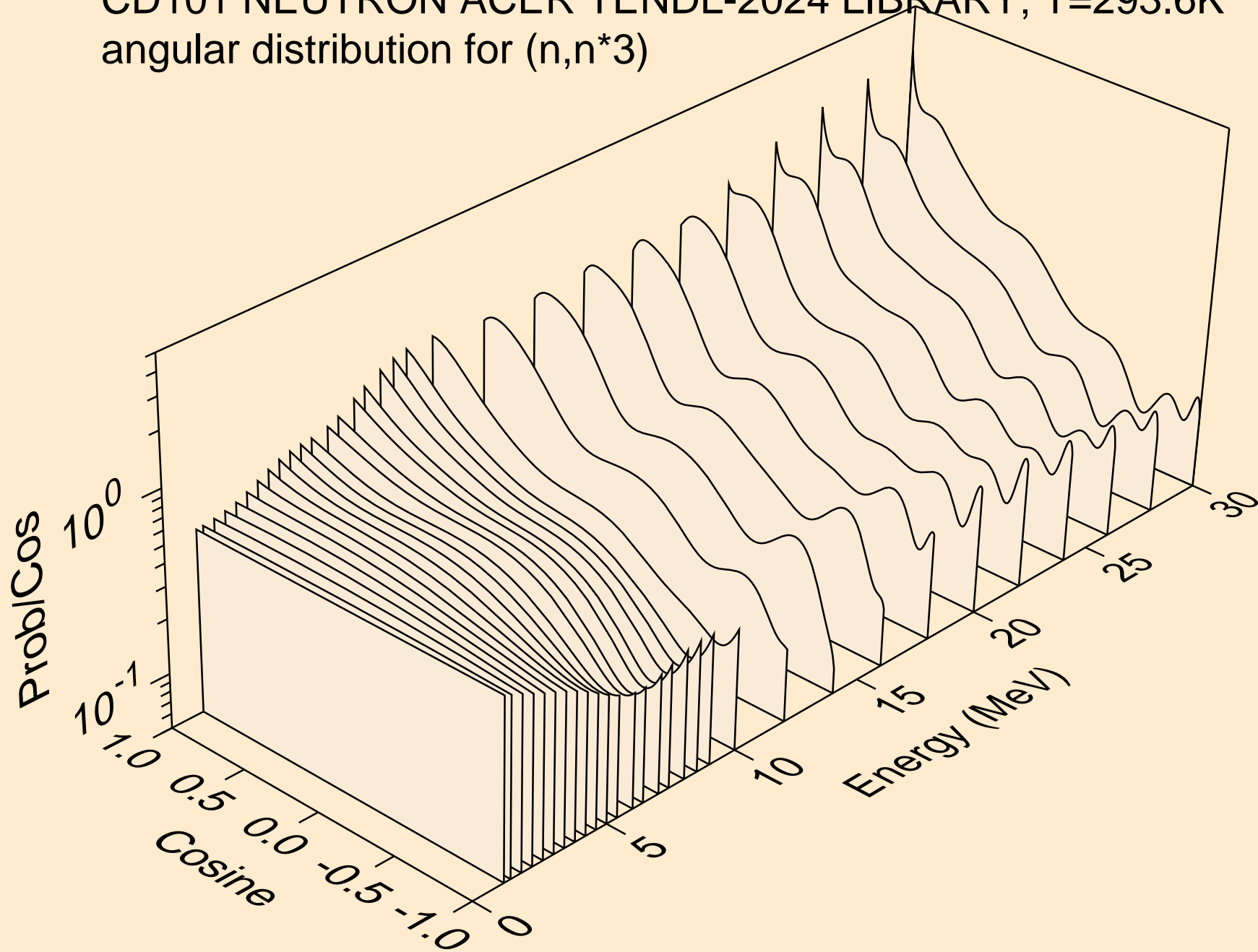

CD101 NEUTRON ACER TENDL-2024 LIBRARY; T=293.6K  
angular distribution for (n,n\*4)

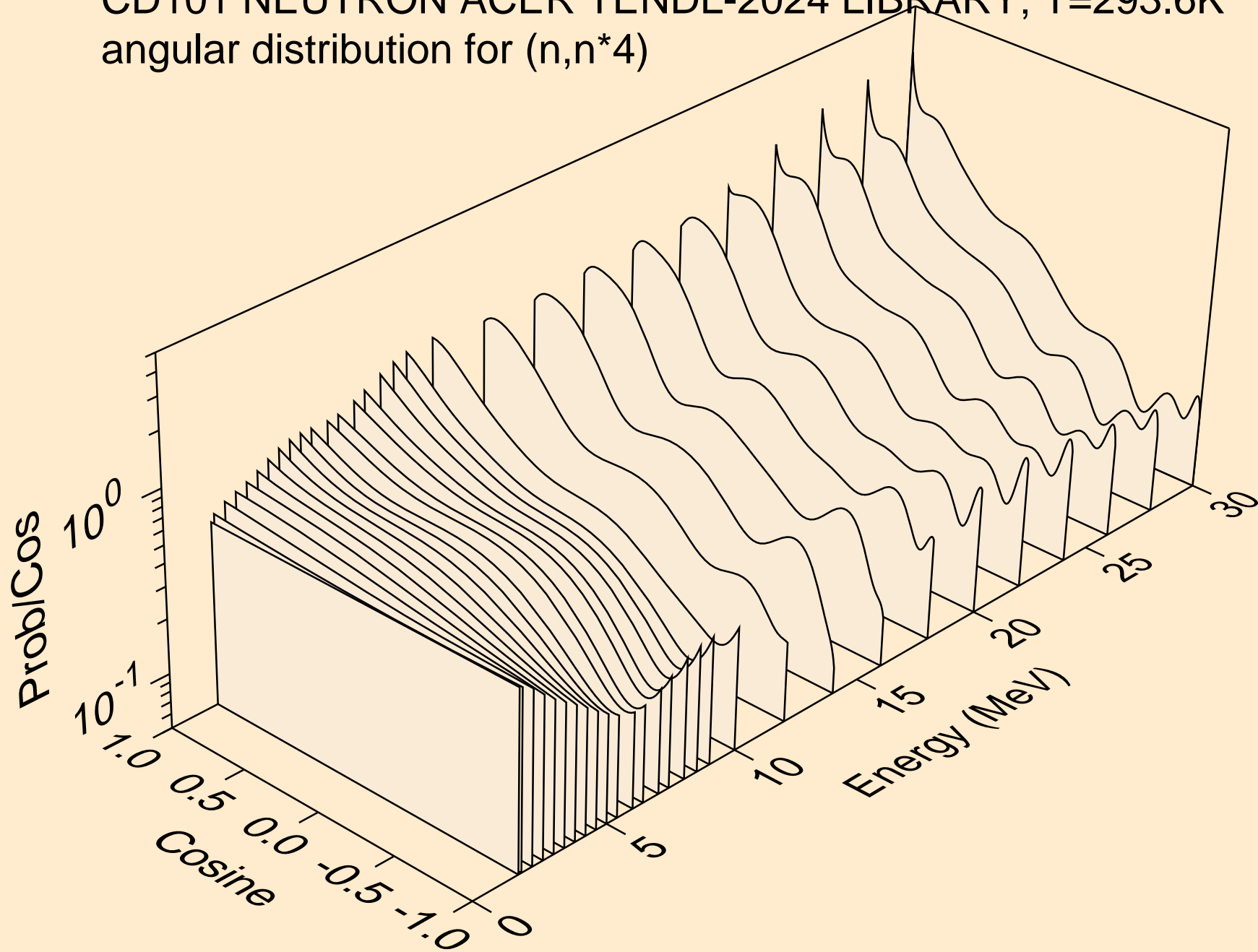

CD101 NEUTRON ACER TENDL-2024 LIBRARY; T=293.6K  
angular distribution for (n,n\*5)

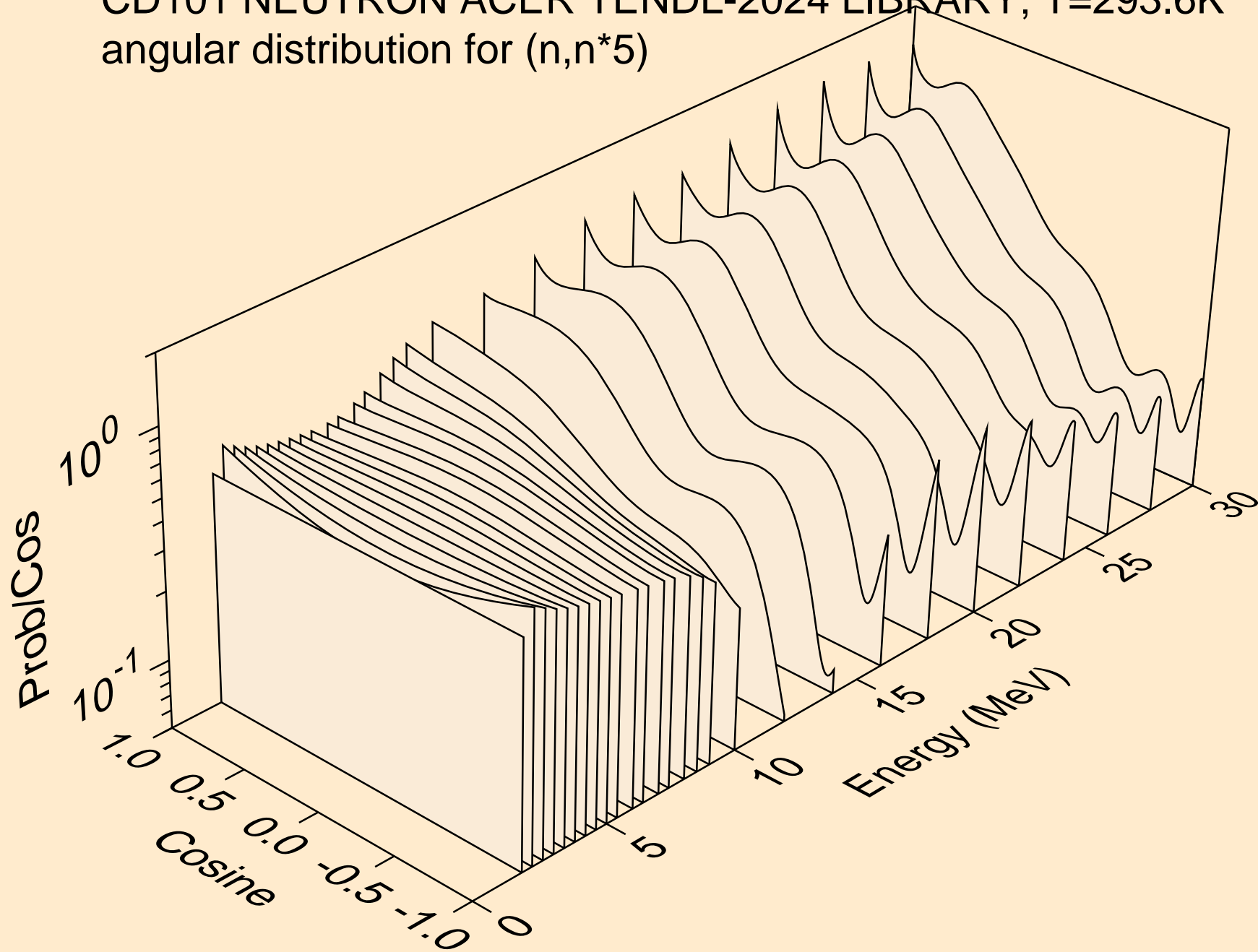

CD101 NEUTRON ACER TENDL-2024 LIBRARY; T=293.6K  
angular distribution for (n,n\*6)

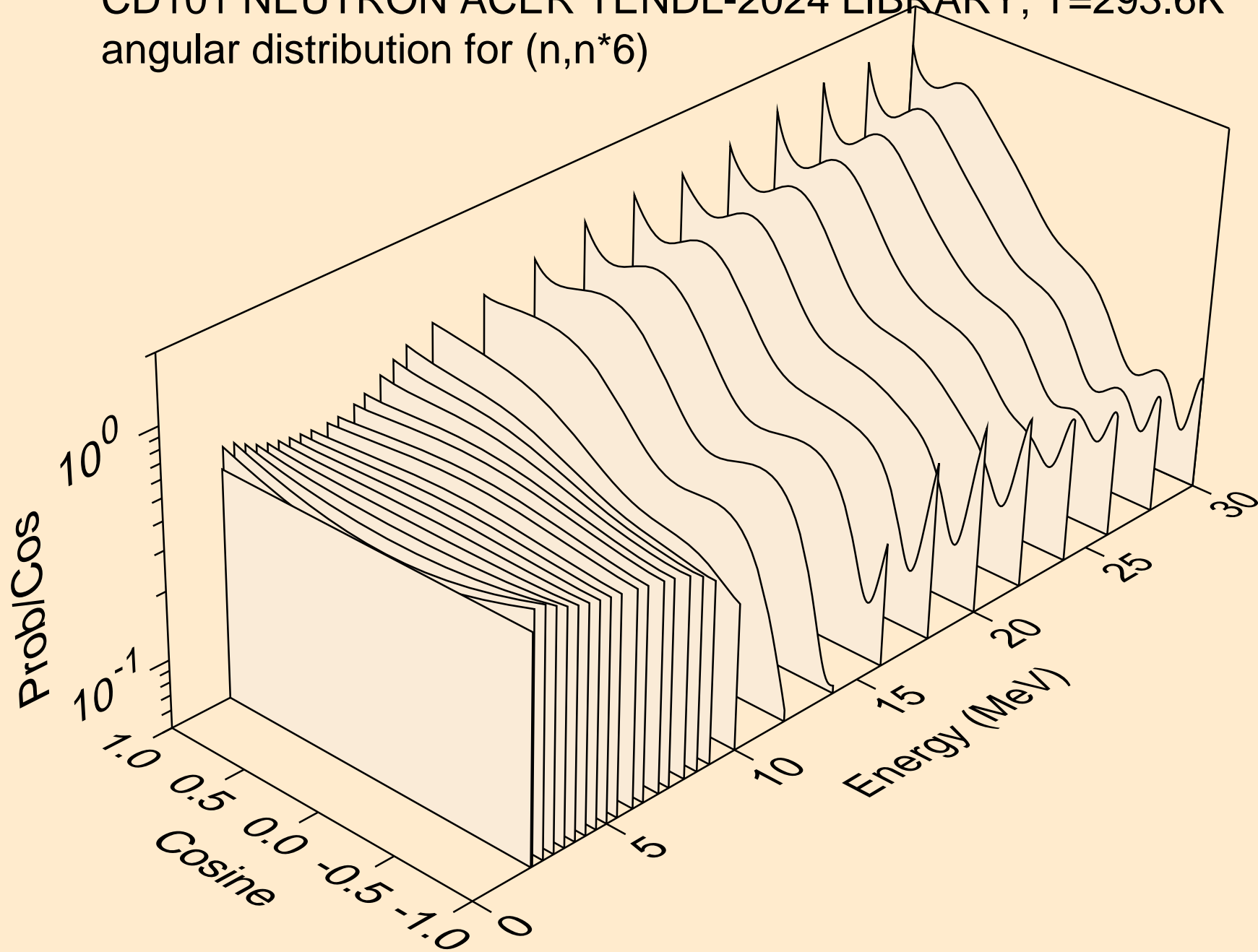

CD101 NEUTRON ACER TENDL-2024 LIBRARY; T=293.6K  
angular distribution for (n,n\*7)

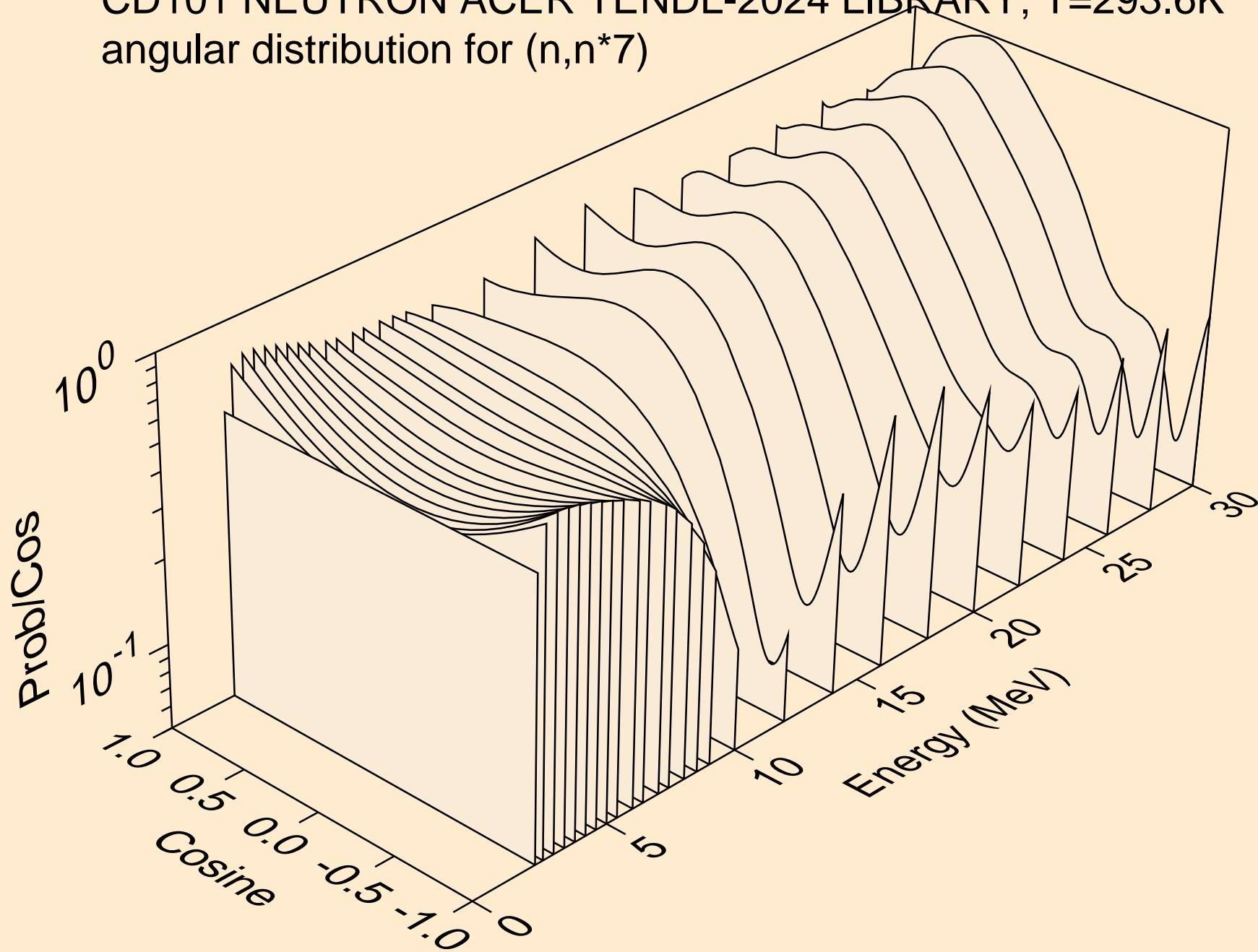

CD101 NEUTRON ACER TENDL-2024 LIBRARY; T=293.6K  
angular distribution for (n,n\*8)

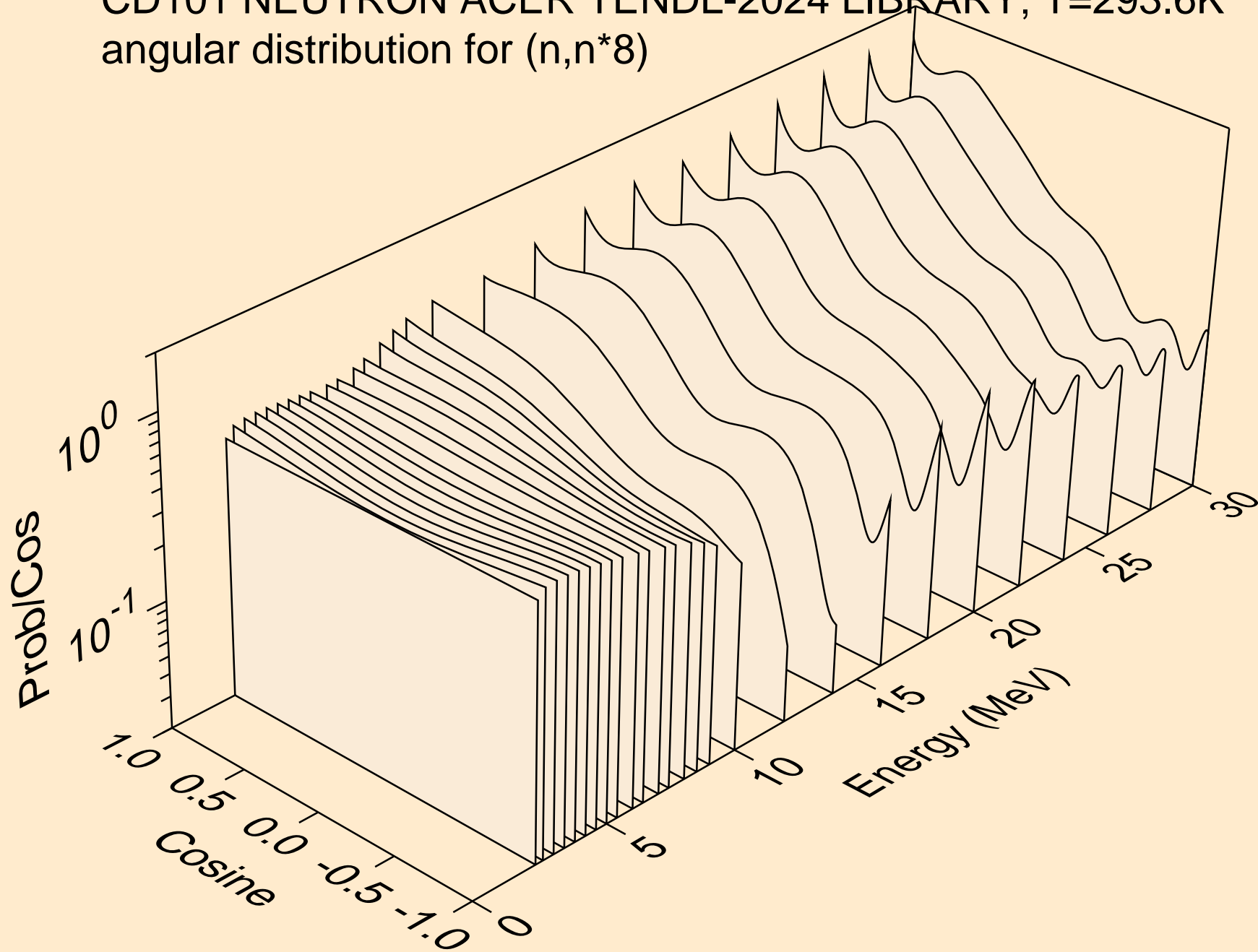

CD101 NEUTRON ACER TENDL-2024 LIBRARY; T=293.6K  
angular distribution for (n,n\*9)

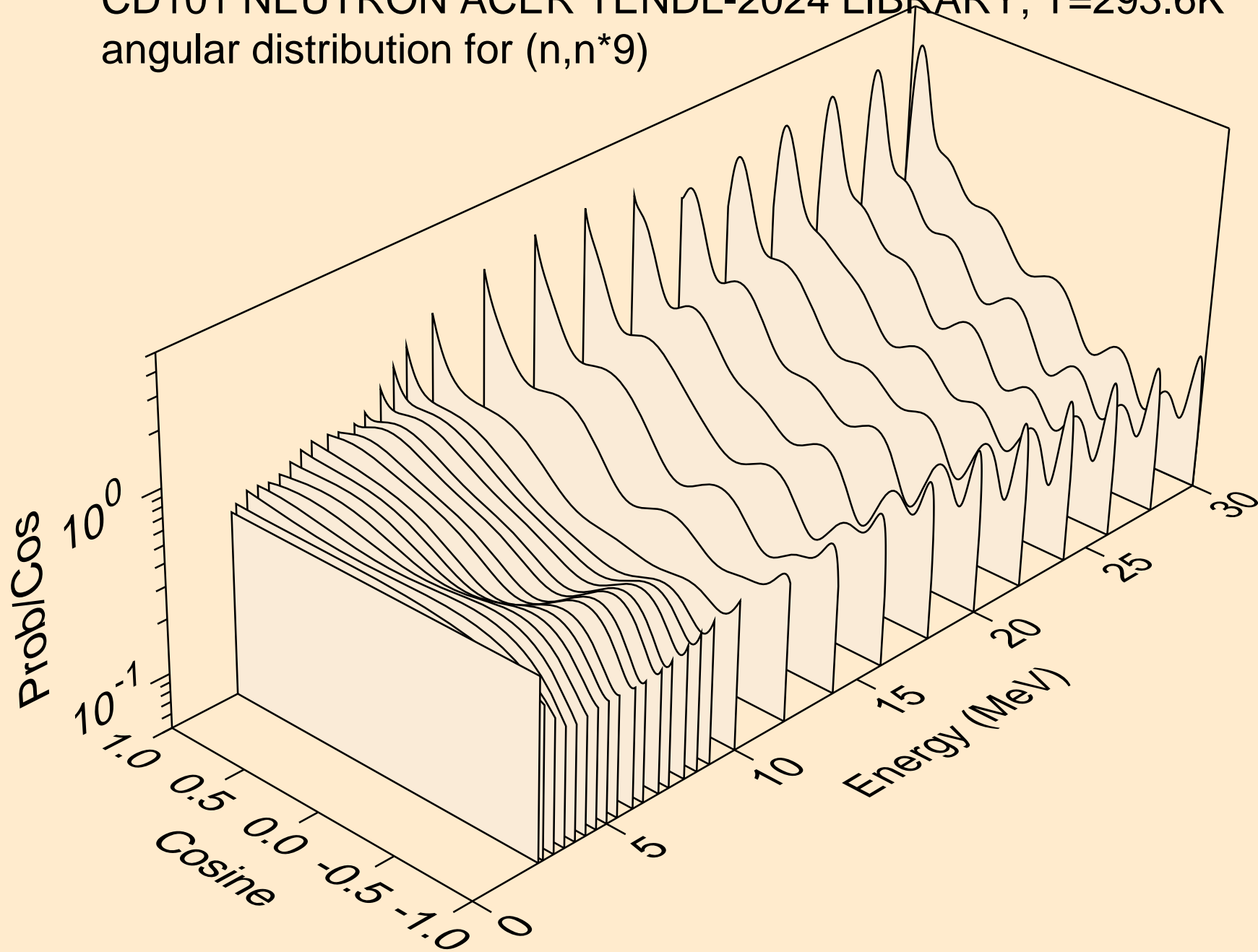

CD101 NEUTRON ACER TENDL-2024 LIBRARY; T=293.6K  
angular distribution for (n,n\*10)

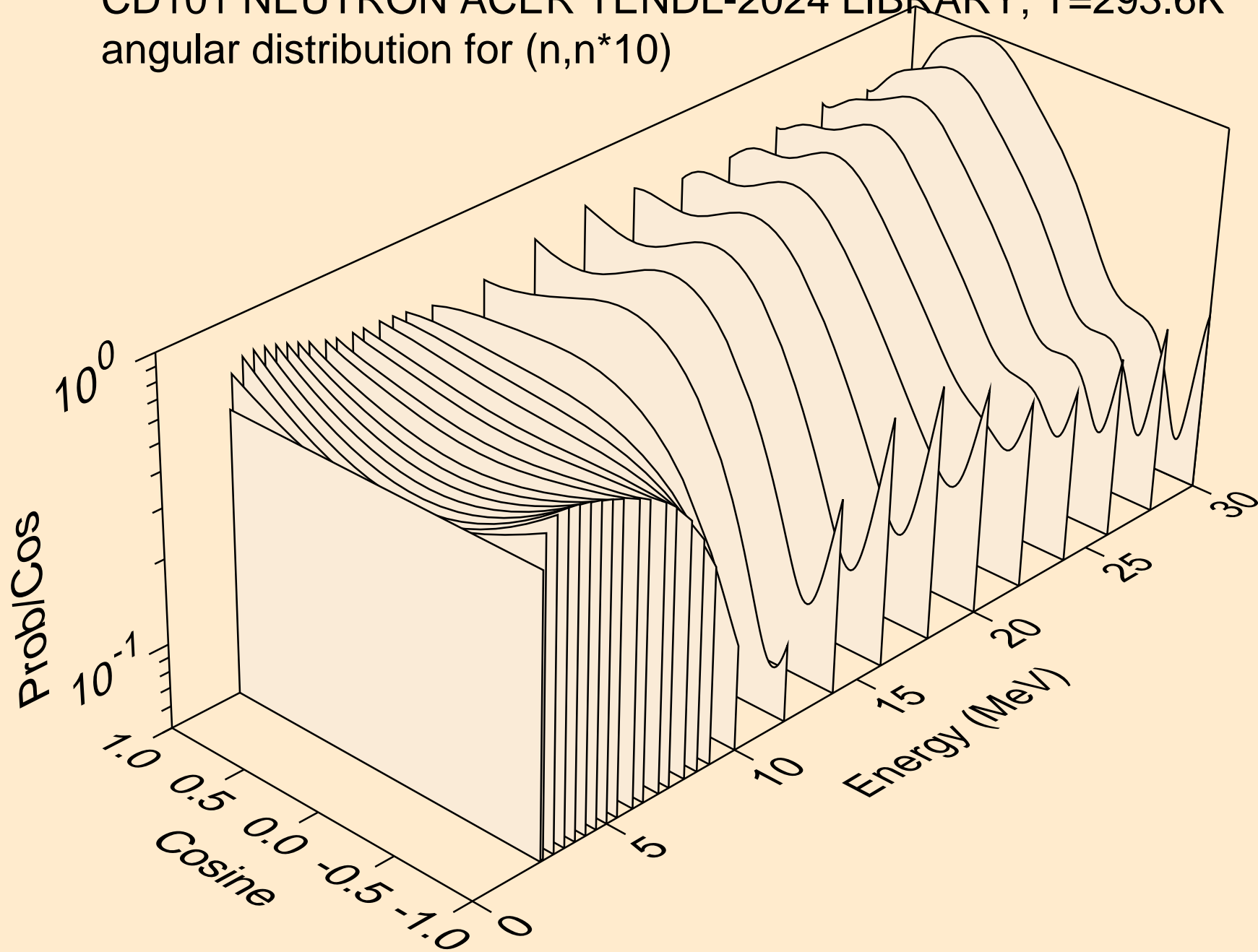

CD101 NEUTRON ACER TENDL-2024 LIBRARY; T=293.6K  
angular distribution for (n,n\*11)

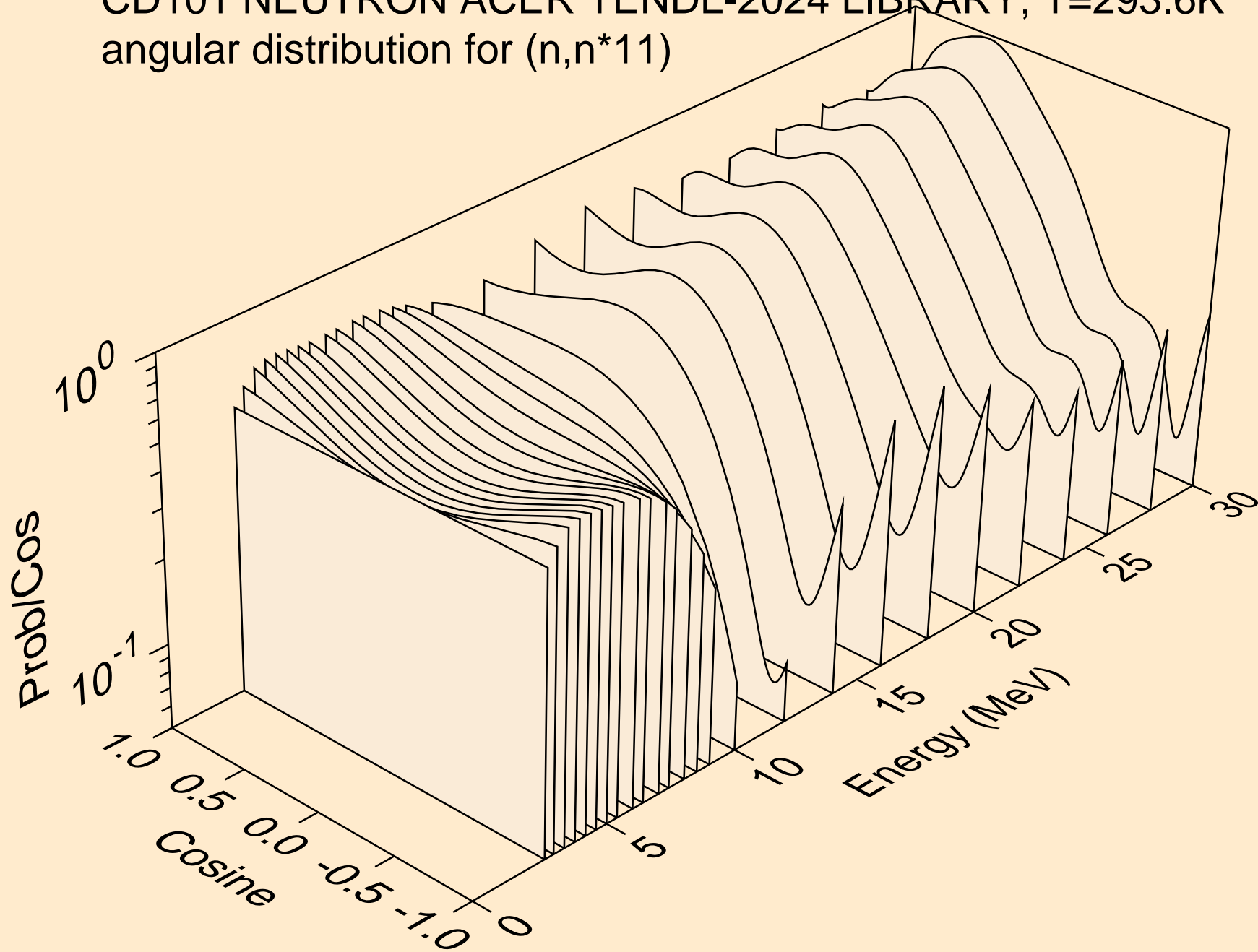

CD101 NEUTRON ACER TENDL-2024 LIBRARY; T=293.6K  
angular distribution for (n,n\*12)

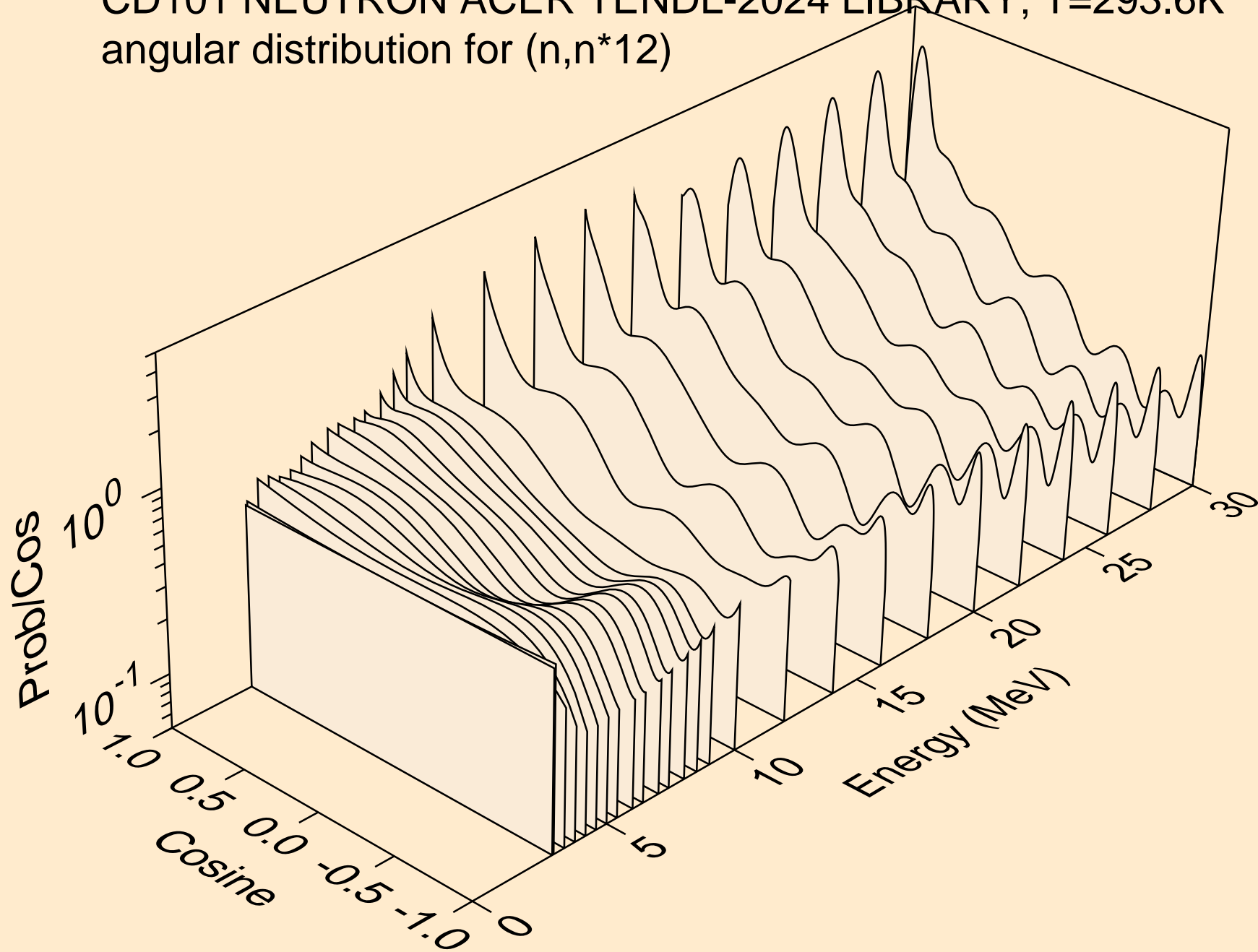

CD101 NEUTRON ACER TENDL-2024 LIBRARY; T=293.6K  
Neutron emission for (n,x)

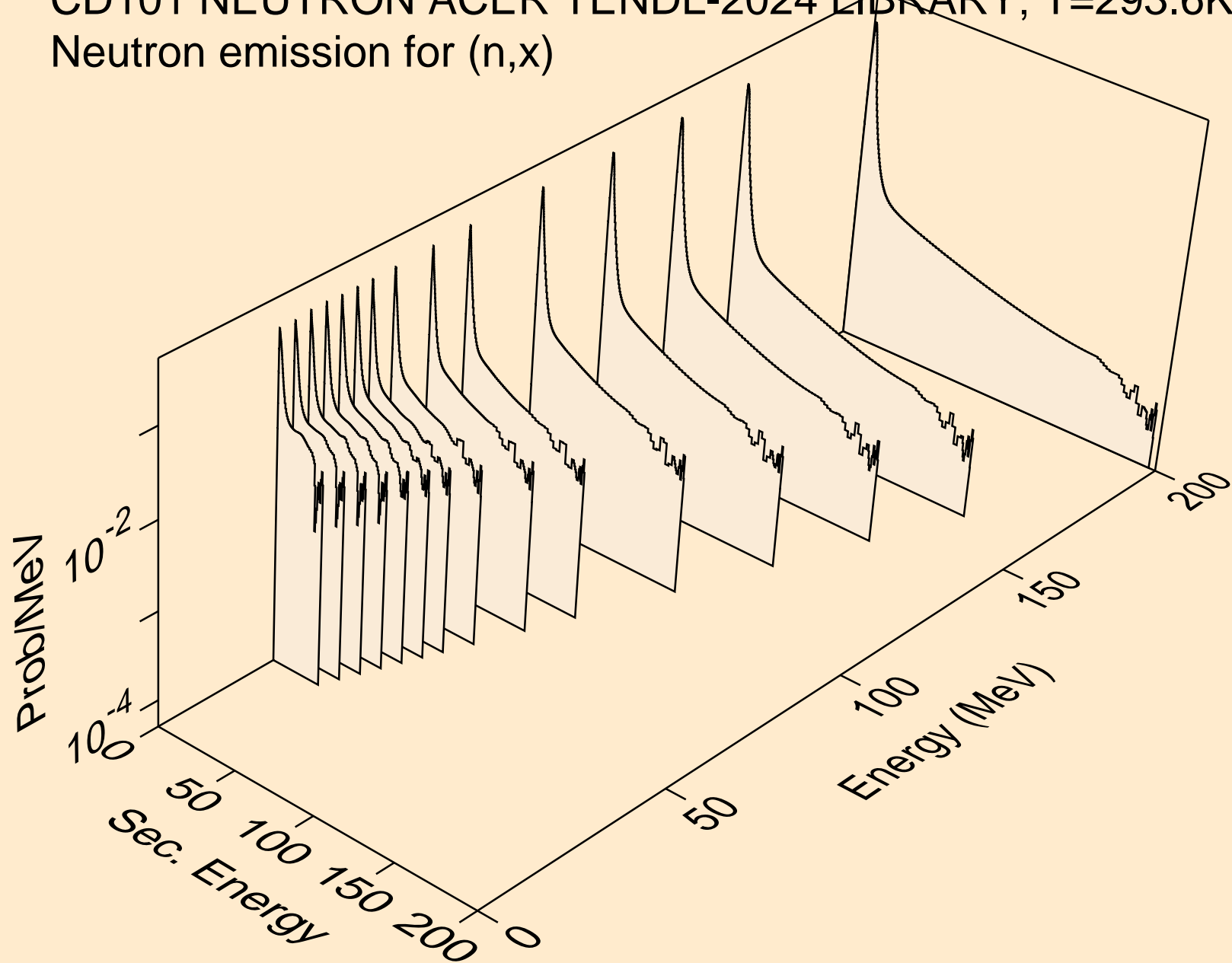

CD101 NEUTRON ACER TENDL-2024 LIBRARY; T=293.6K  
Neutron emission for (n,2nd)

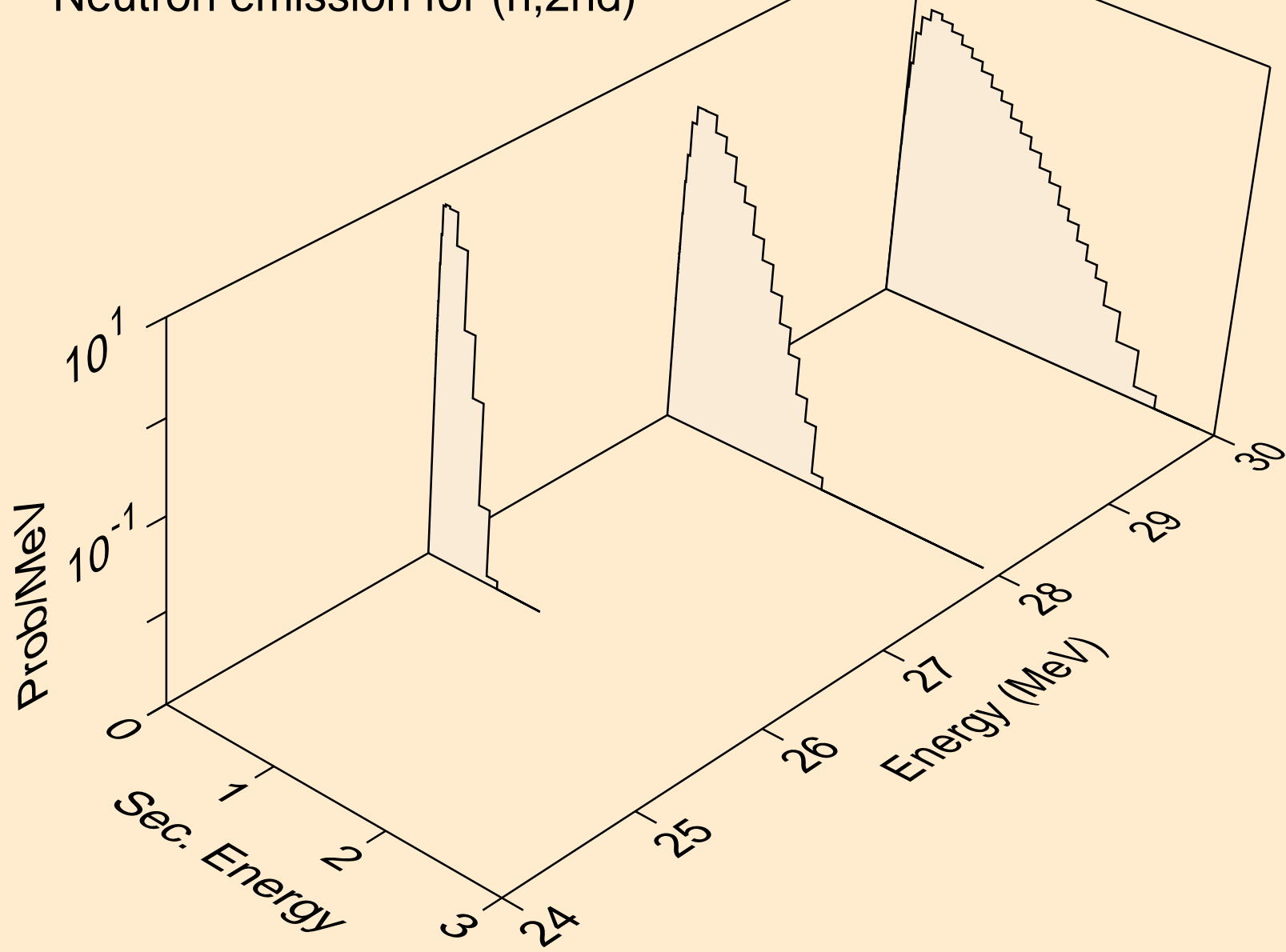

CD101 NEUTRON ACER TENDL-2024 LIBRARY; T=293.6K  
Neutron emission for (n,2n)

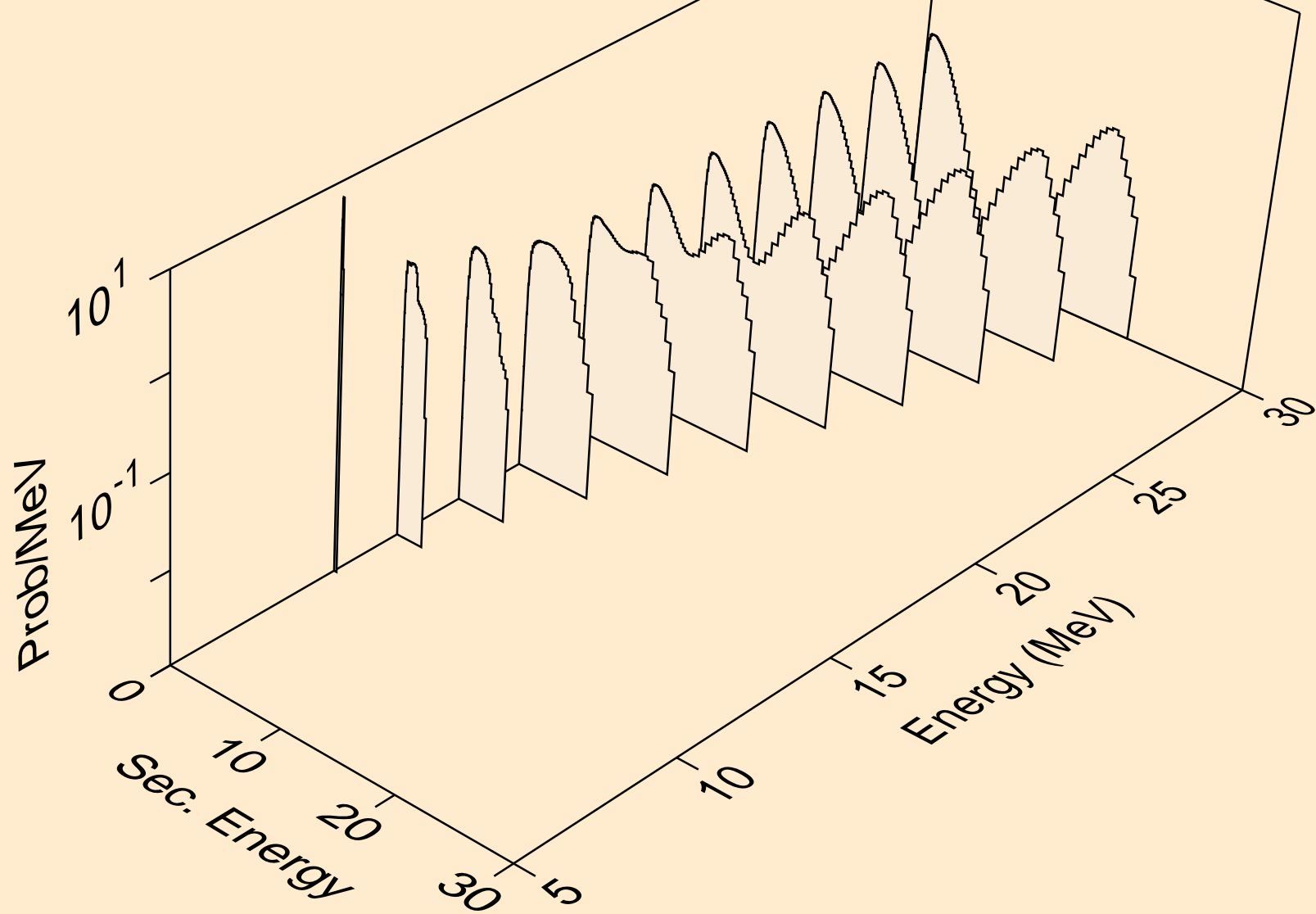

CD101 NEUTRON ACER TENDL-2024 LIBRARY; T=293.6K  
Neutron emission for (n,3n)

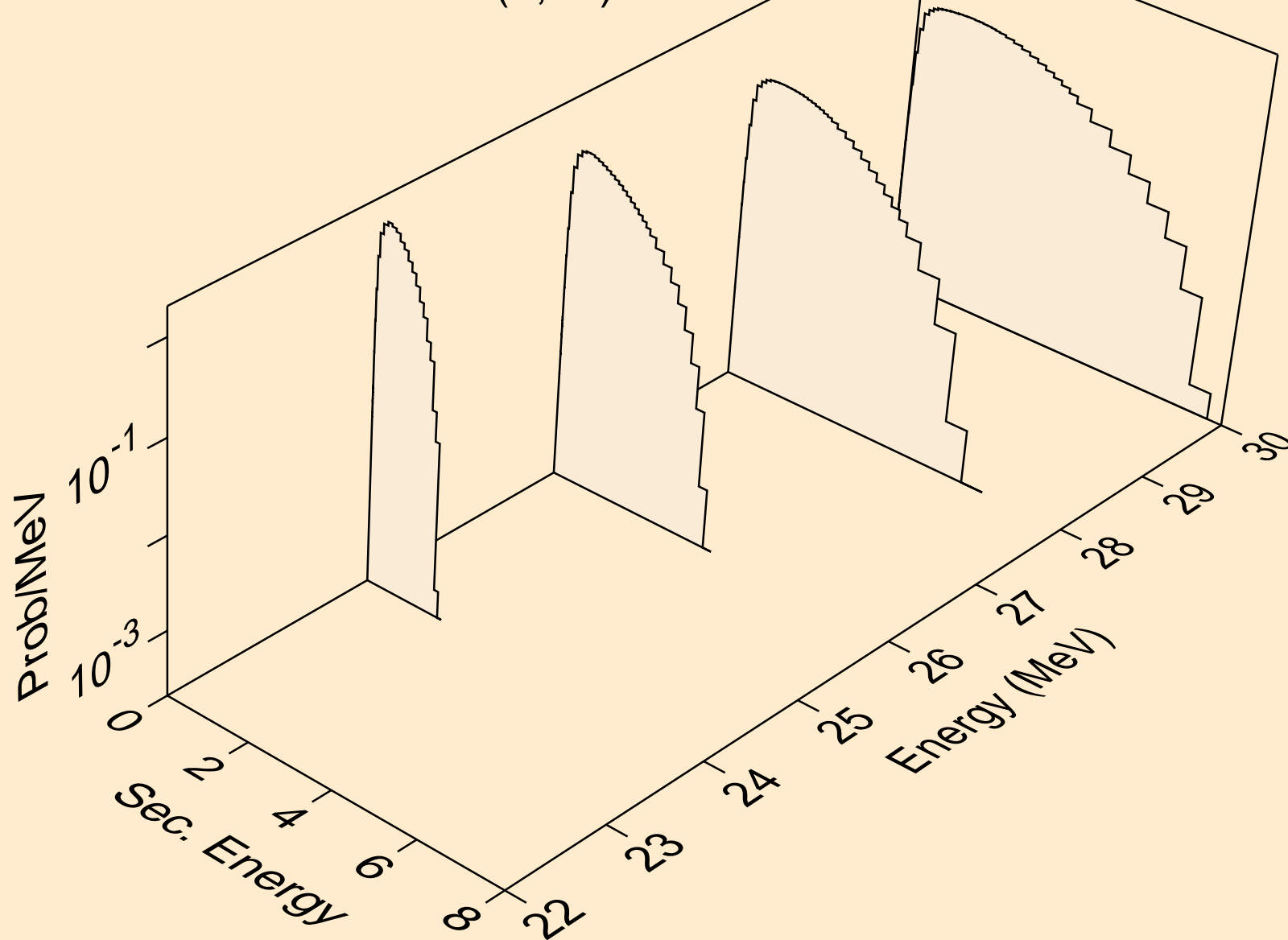

CD101 NEUTRON ACER TENDL-2024 LIBRARY; T=293.6K  
Neutron emission for (n,n\*)a

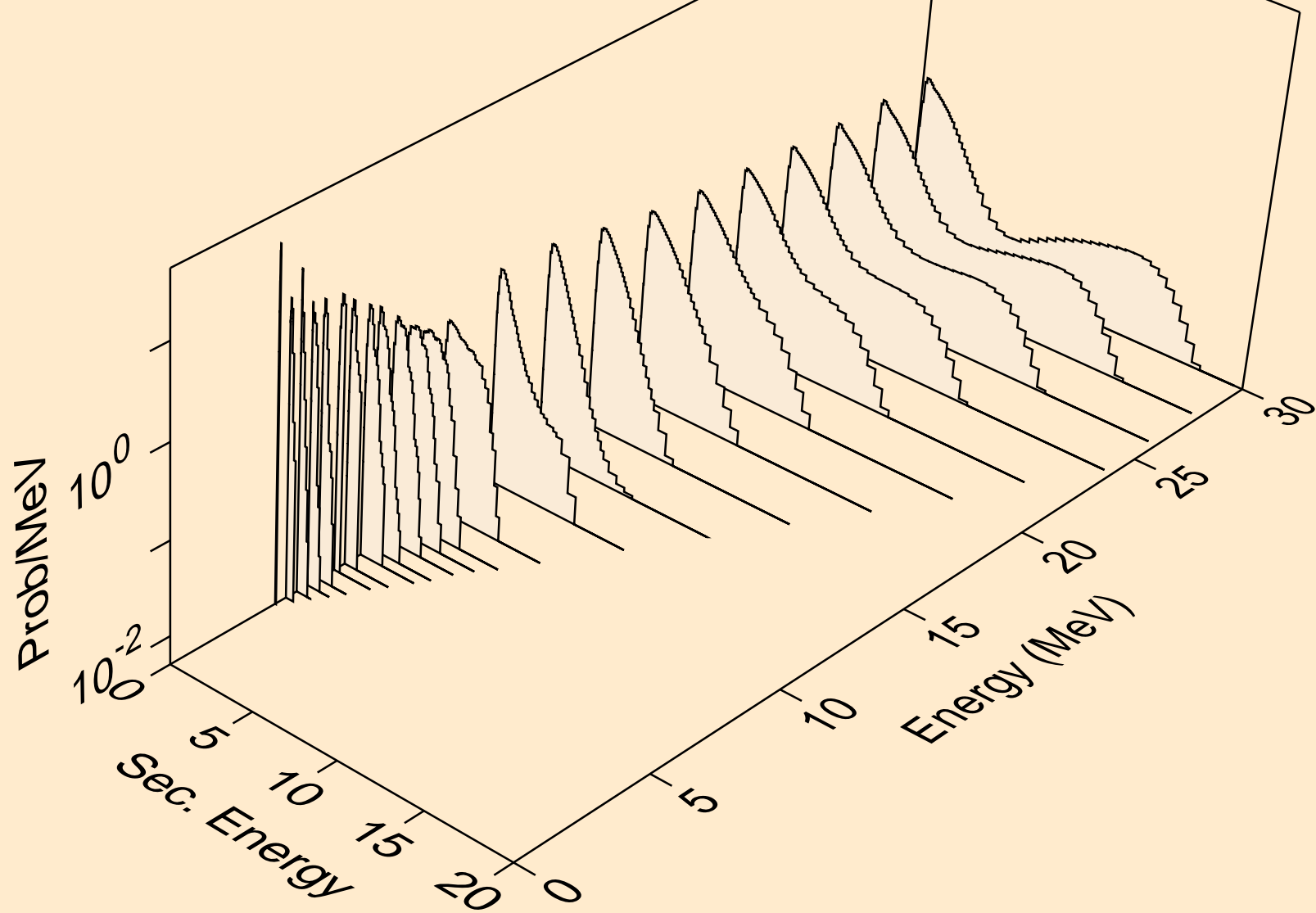

CD101 NEUTRON ACER TENDL-2024 LIBRARY; T=293.6K  
Neutron emission for (n,2n)<sub>a</sub>

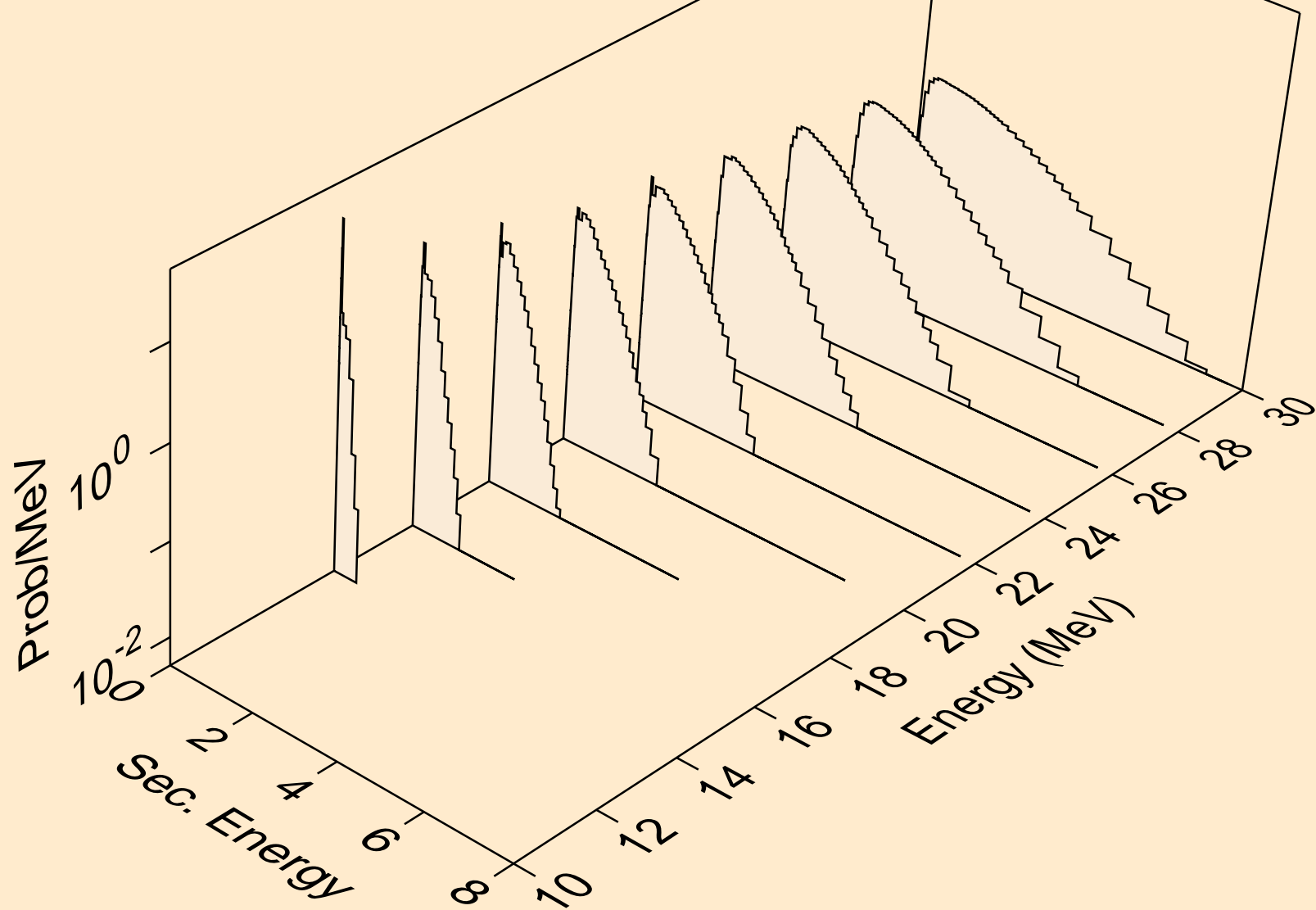

CD101 NEUTRON ACER TENDL-2024 LIBRARY; T=293.6K  
Neutron emission for (n,n\*)p

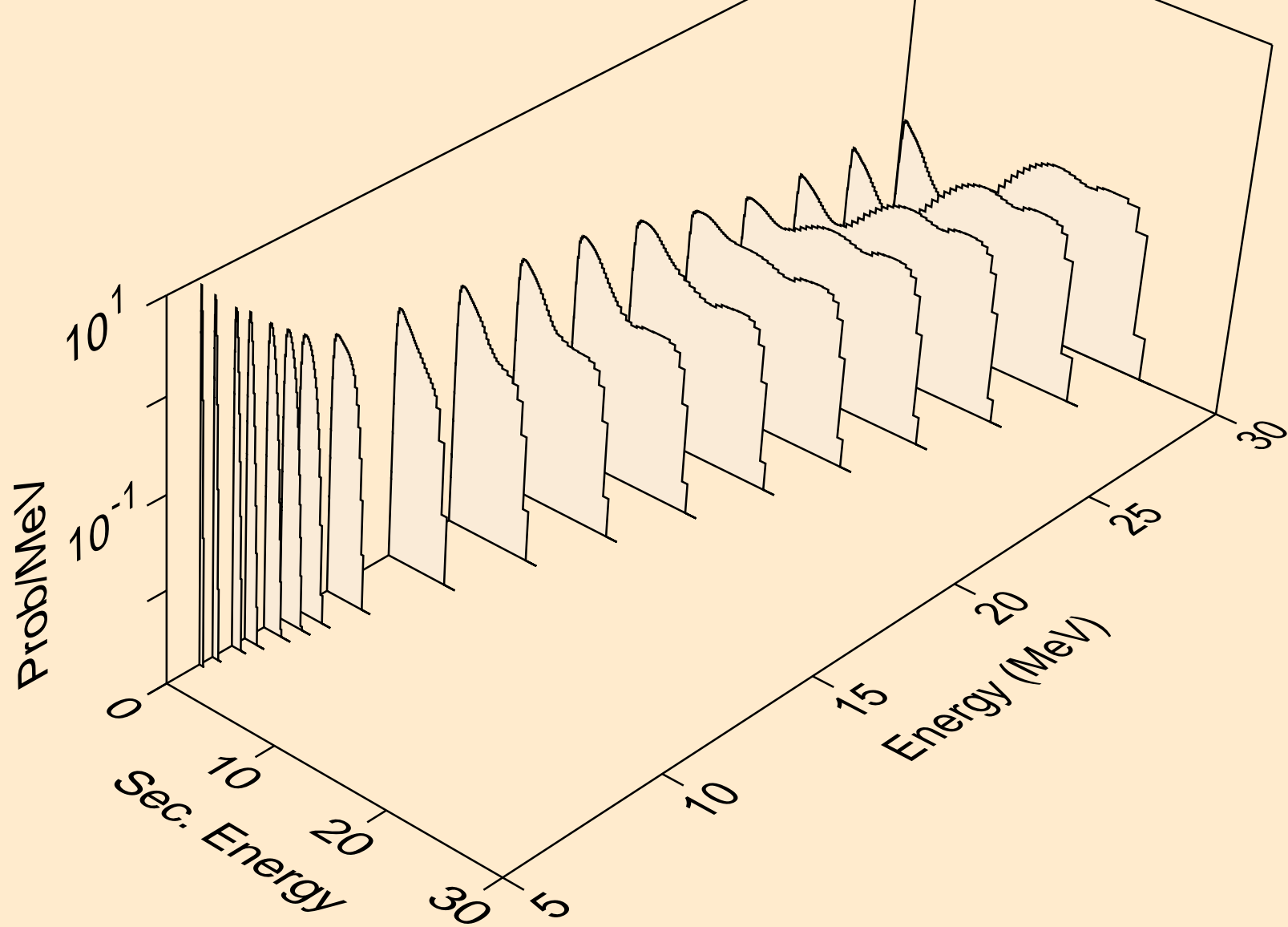

CD101 NEUTRON ACER TENDL-2024 LIBRARY; T=293.6K  
Neutron emission for (n,n\*)2a

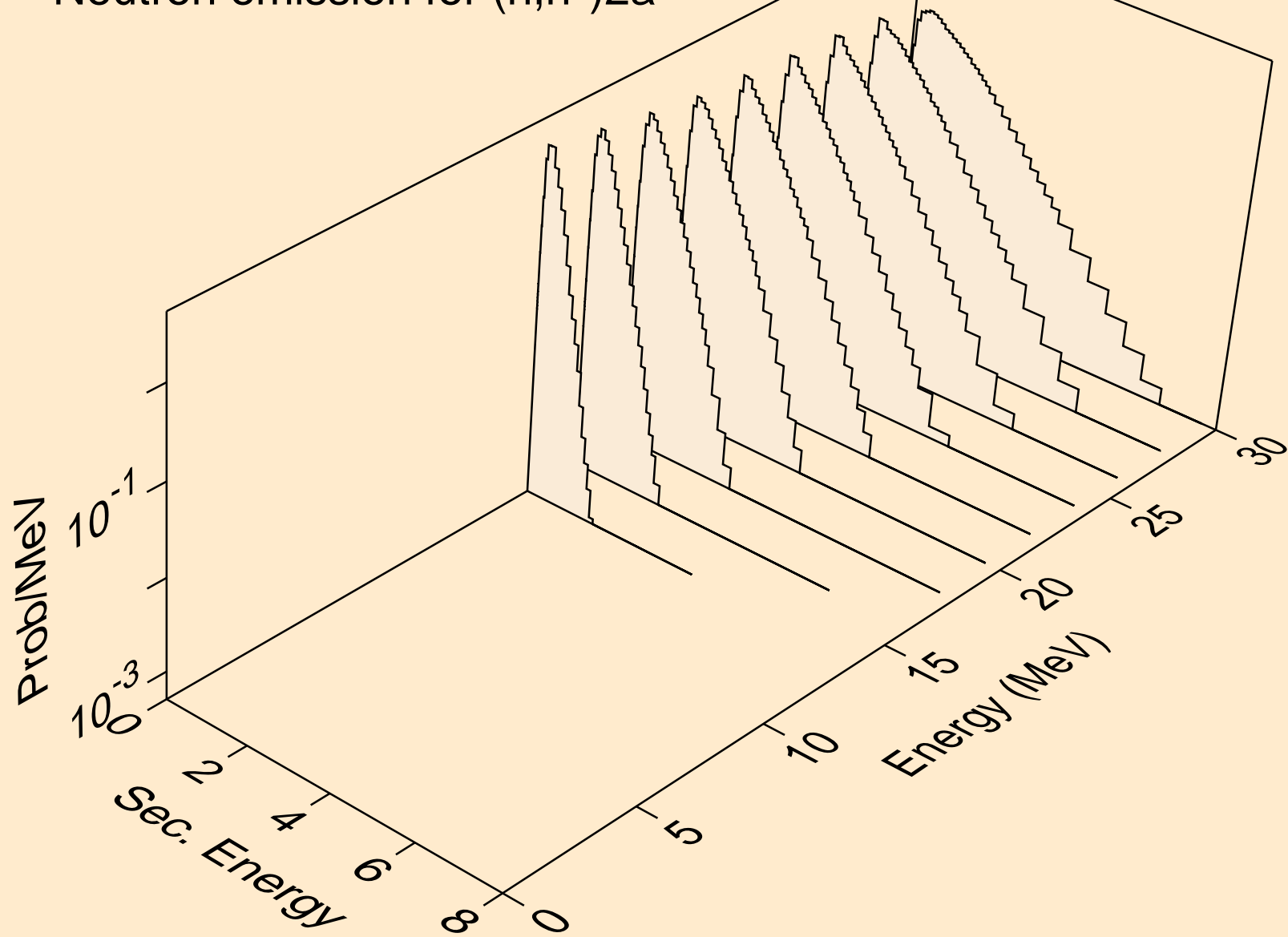

CD101 NEUTRON ACER TENDL-2024 LIBRARY; T=293.6K  
Neutron emission for (n,n\*)d

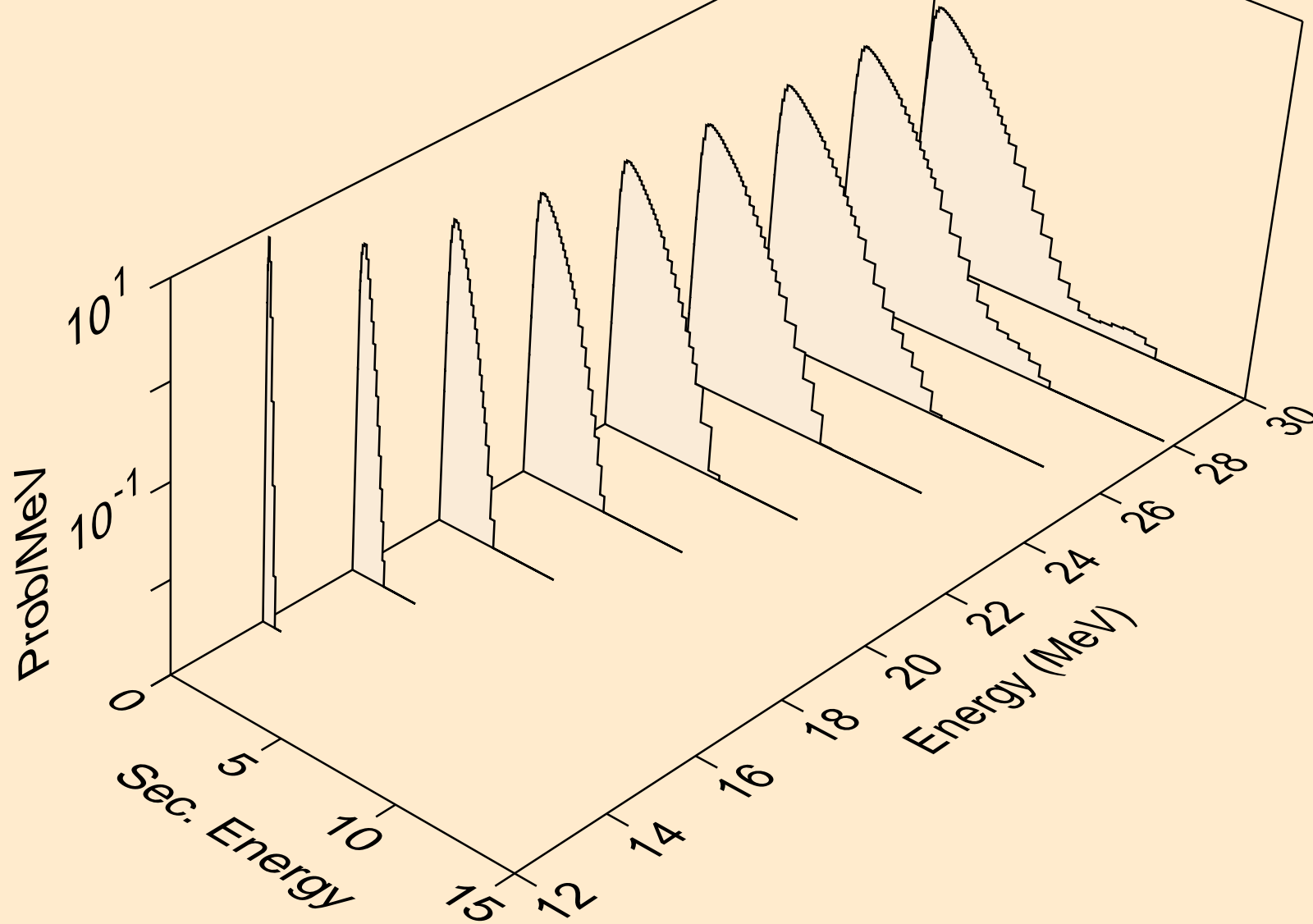

CD101 NEUTRON ACER TENDL-2024 LIBRARY; T=293.6K  
Neutron emission for (n,n\*)t

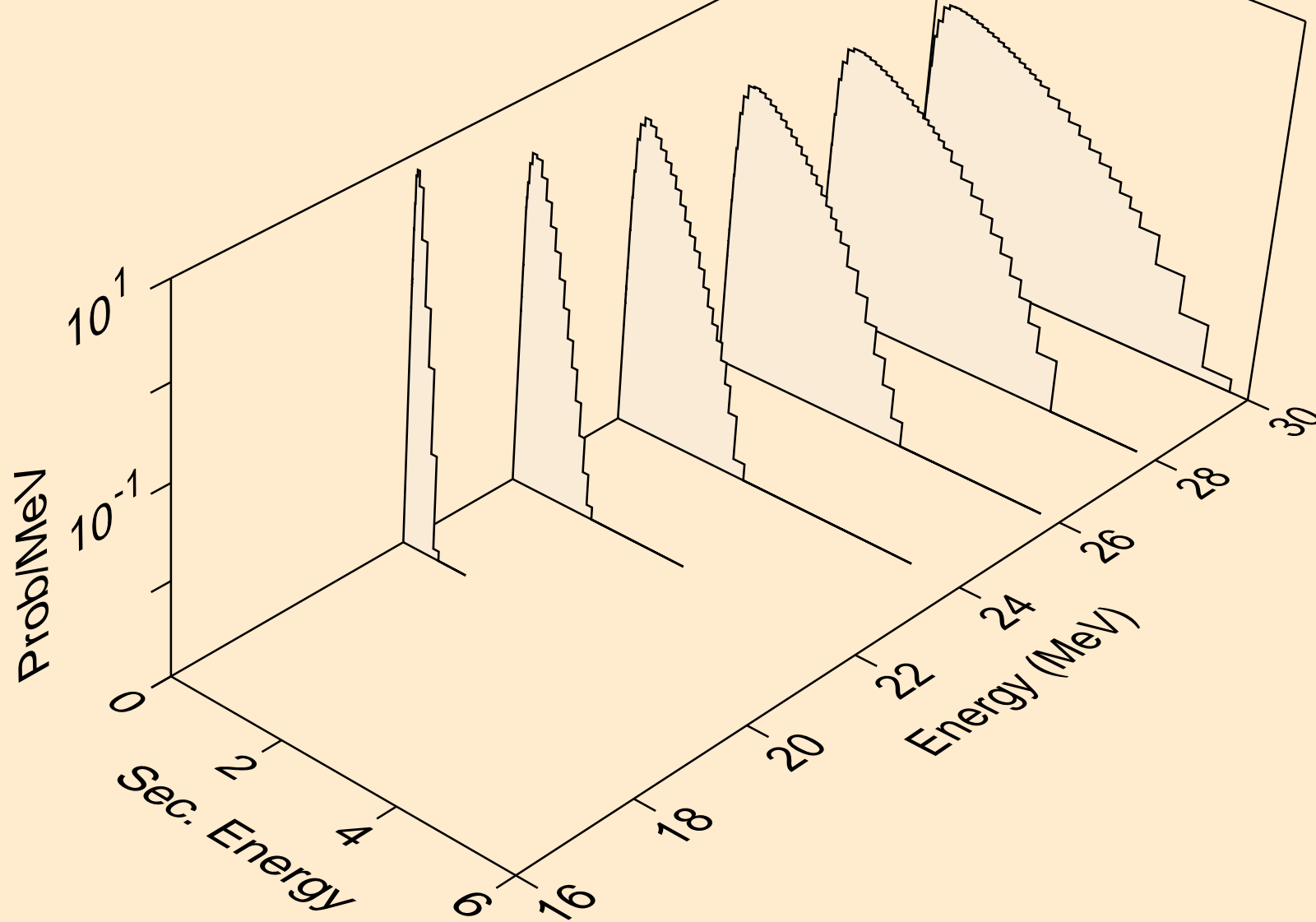

CD101 NEUTRON ACER TENDL-2024 LIBRARY; T=293.6K  
Neutron emission for (n,n\*)he3

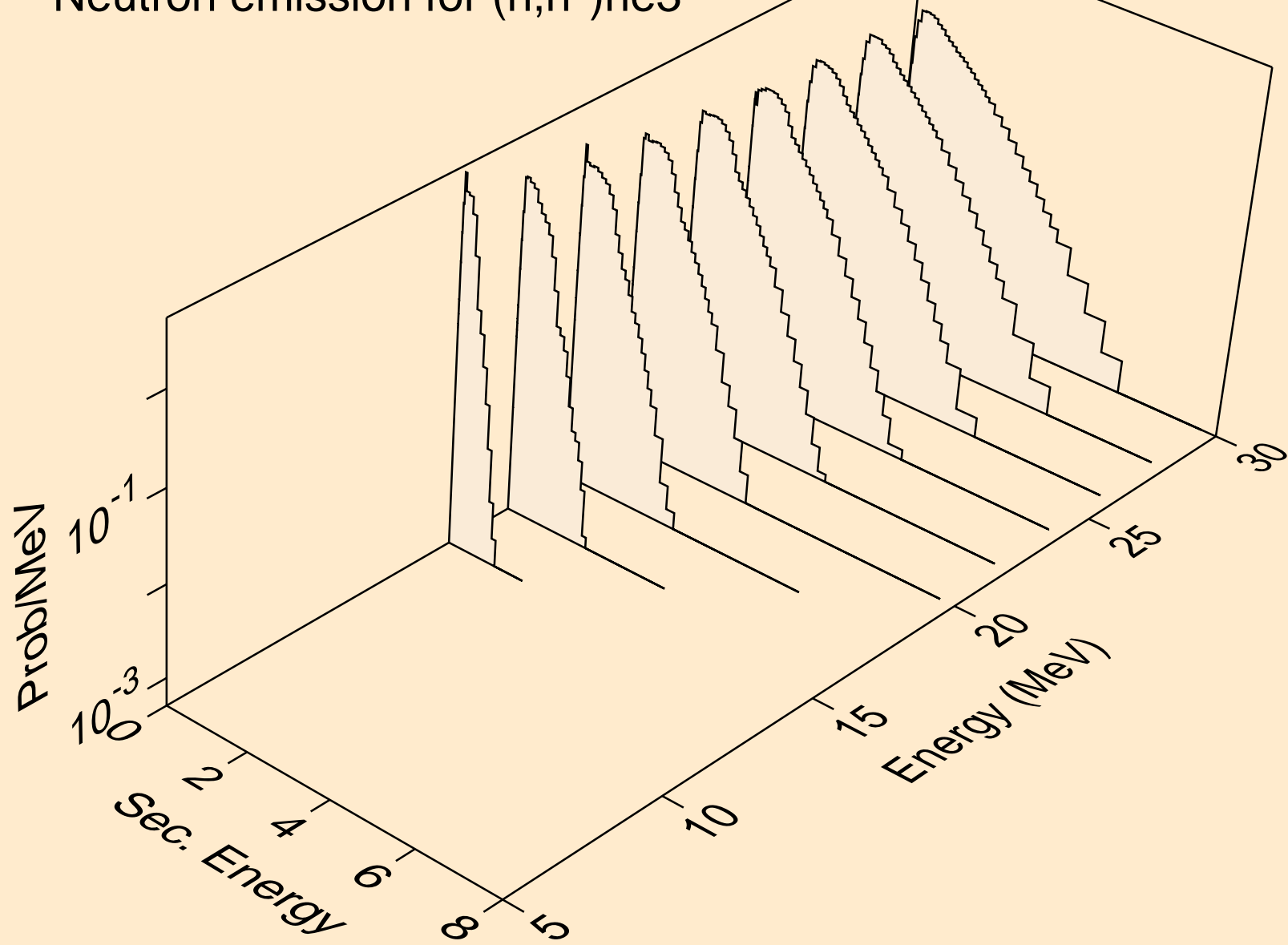

CD101 NEUTRON ACER TENDL-2024 LIBRARY; T=293.6K  
Neutron emission for (n,2np)

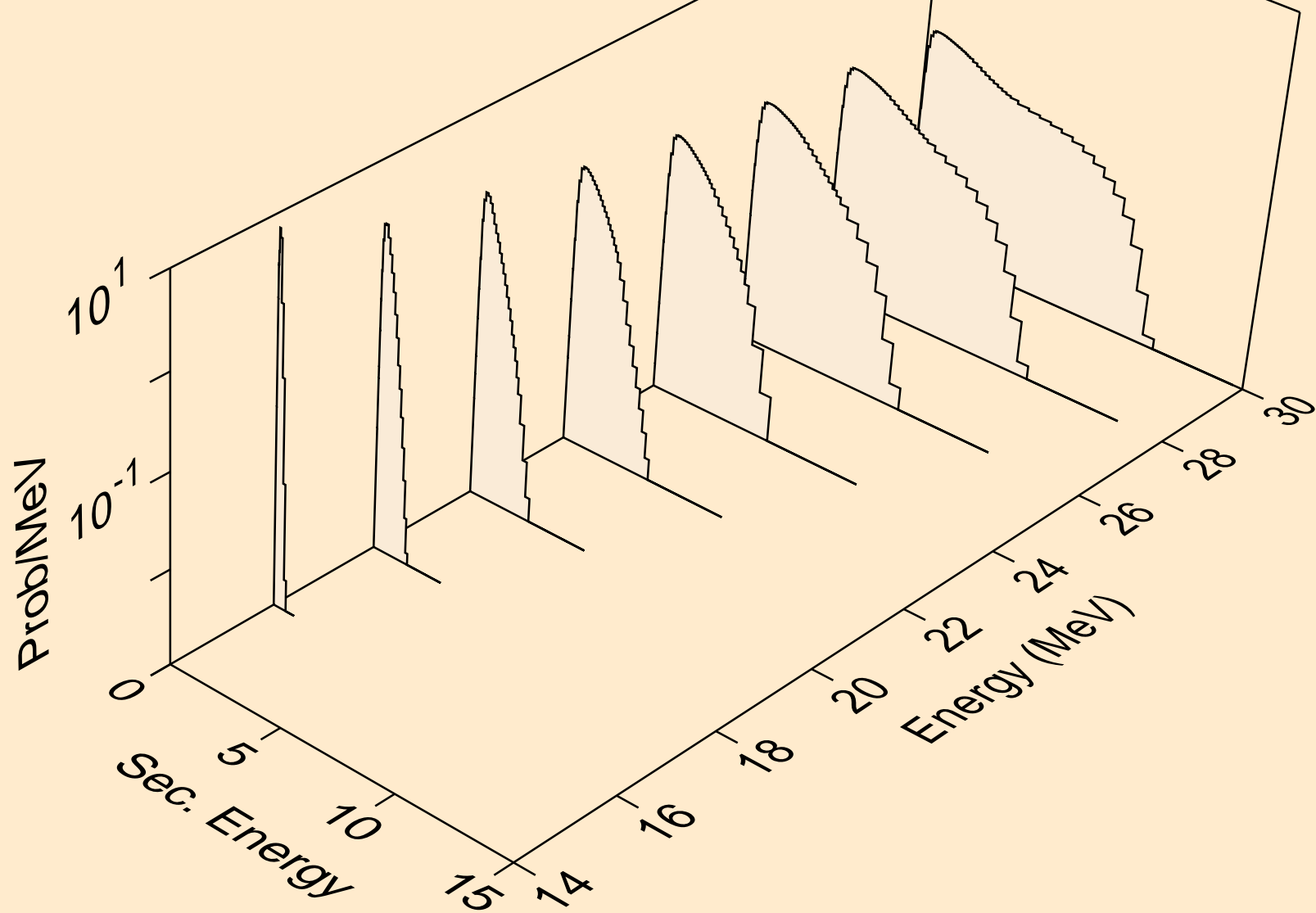

CD101 NEUTRON ACER TENDL-2024 LIBRARY; T=293.6K  
Neutron emission for (n,3np)

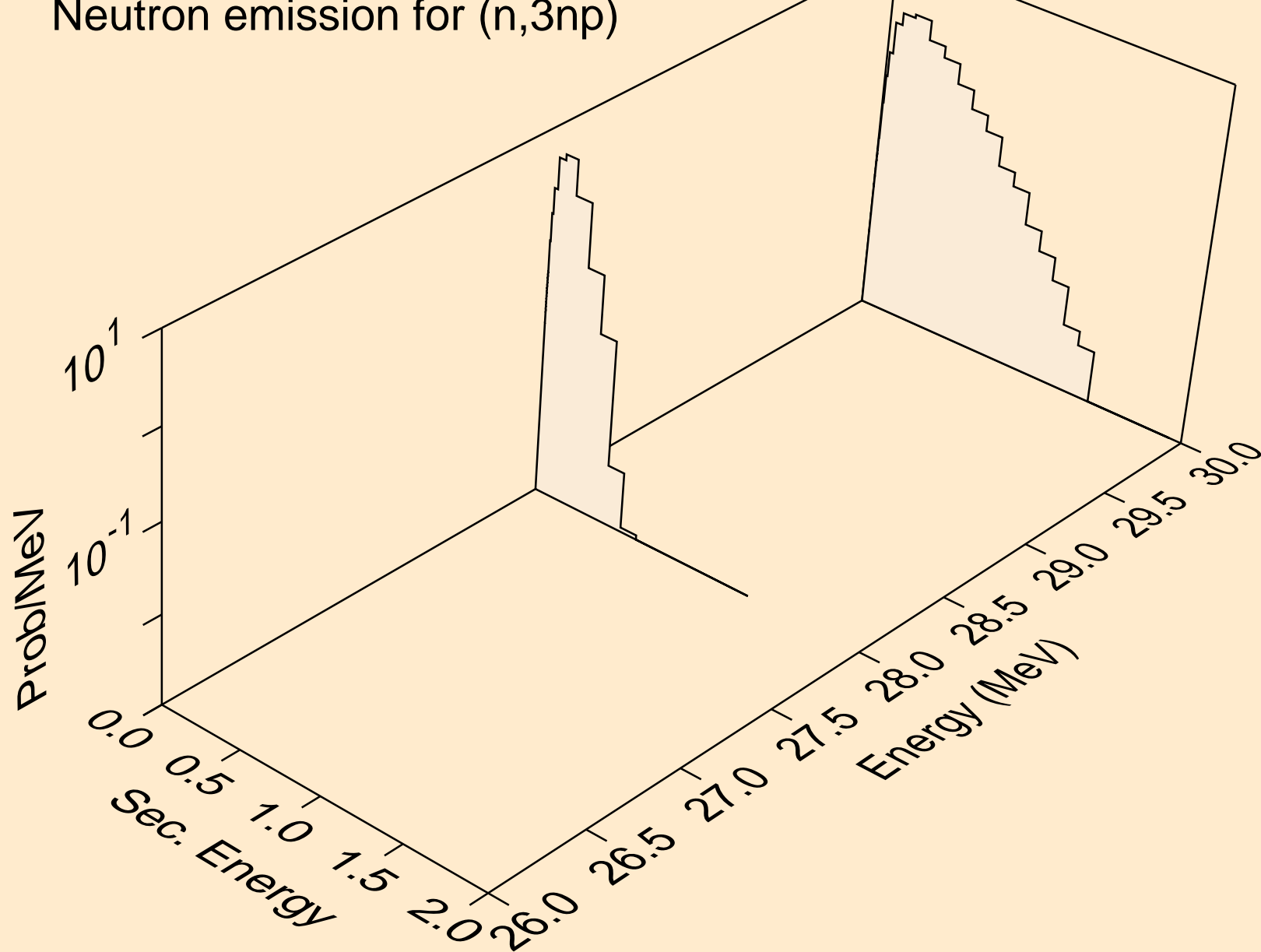

CD101 NEUTRON ACER TENDL-2024 LIBRARY; T=293.6K  
Neutron emission for (n,n2p)

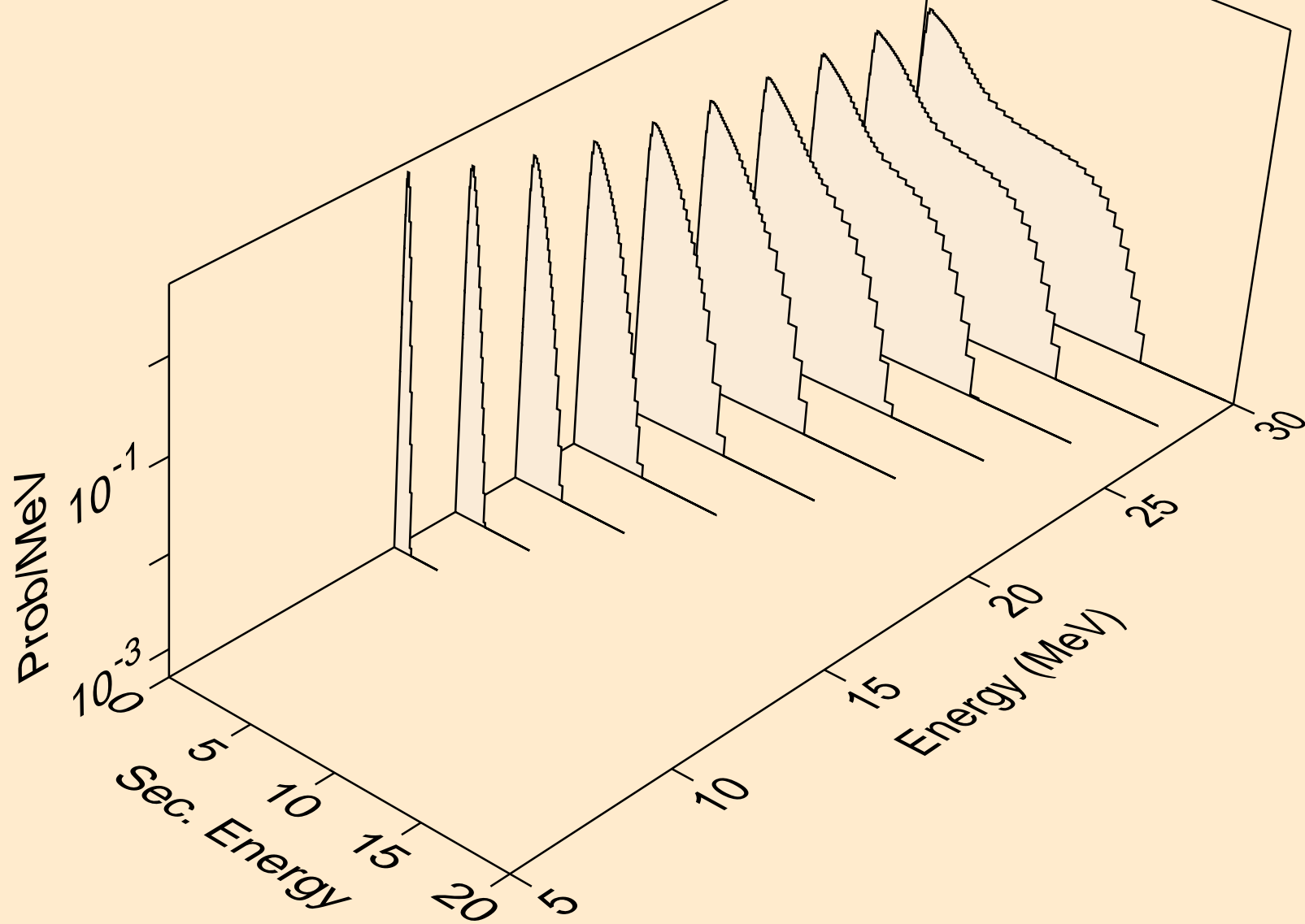

CD101 NEUTRON ACER TENDL-2024 LIBRARY; T=293.6K  
Neutron emission for (n,npa)

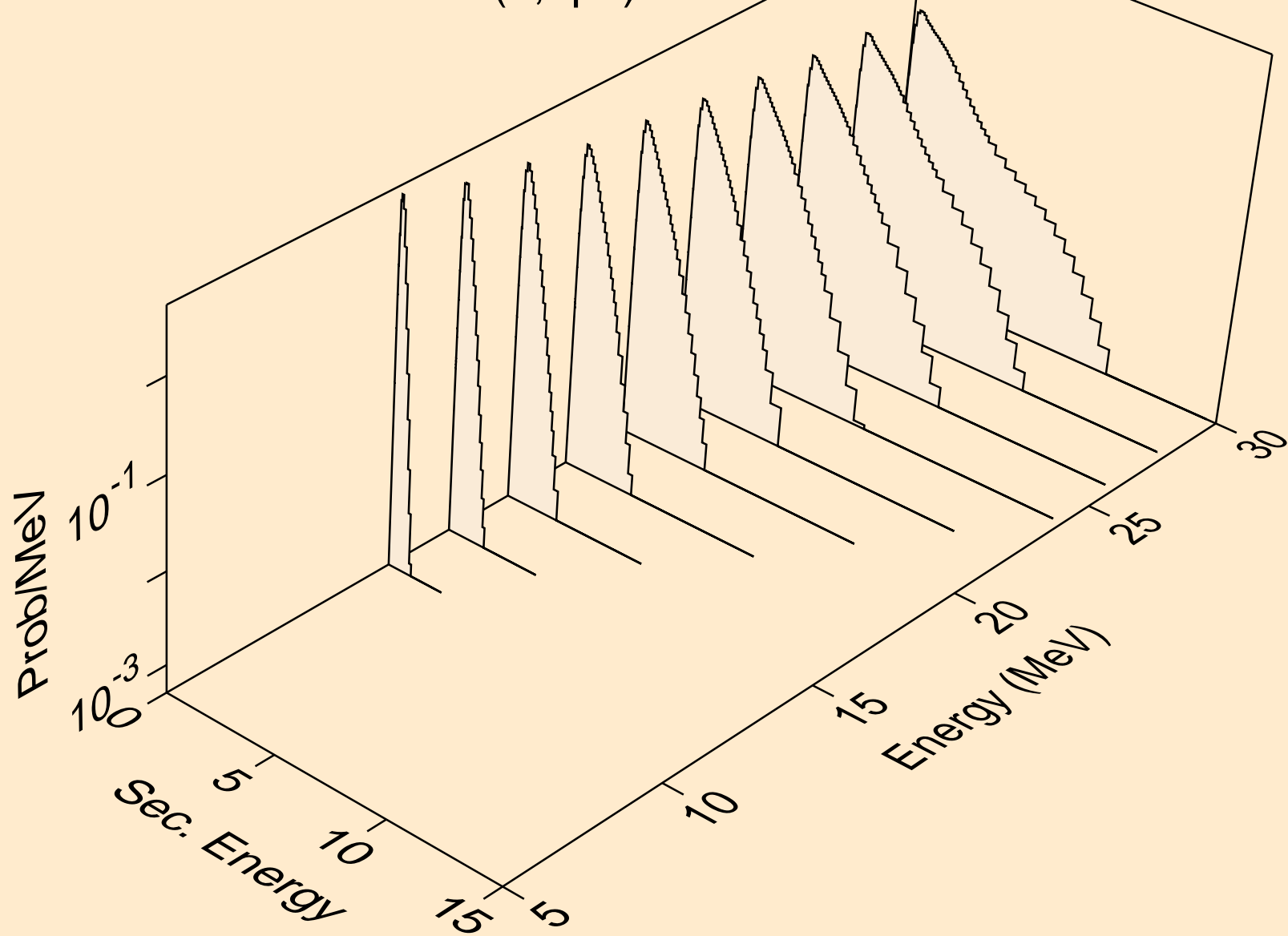

CD101 NEUTRON ACER TENDL-2024 LIBRARY; T=293.6K  
Neutron emission for (n,n\*c)

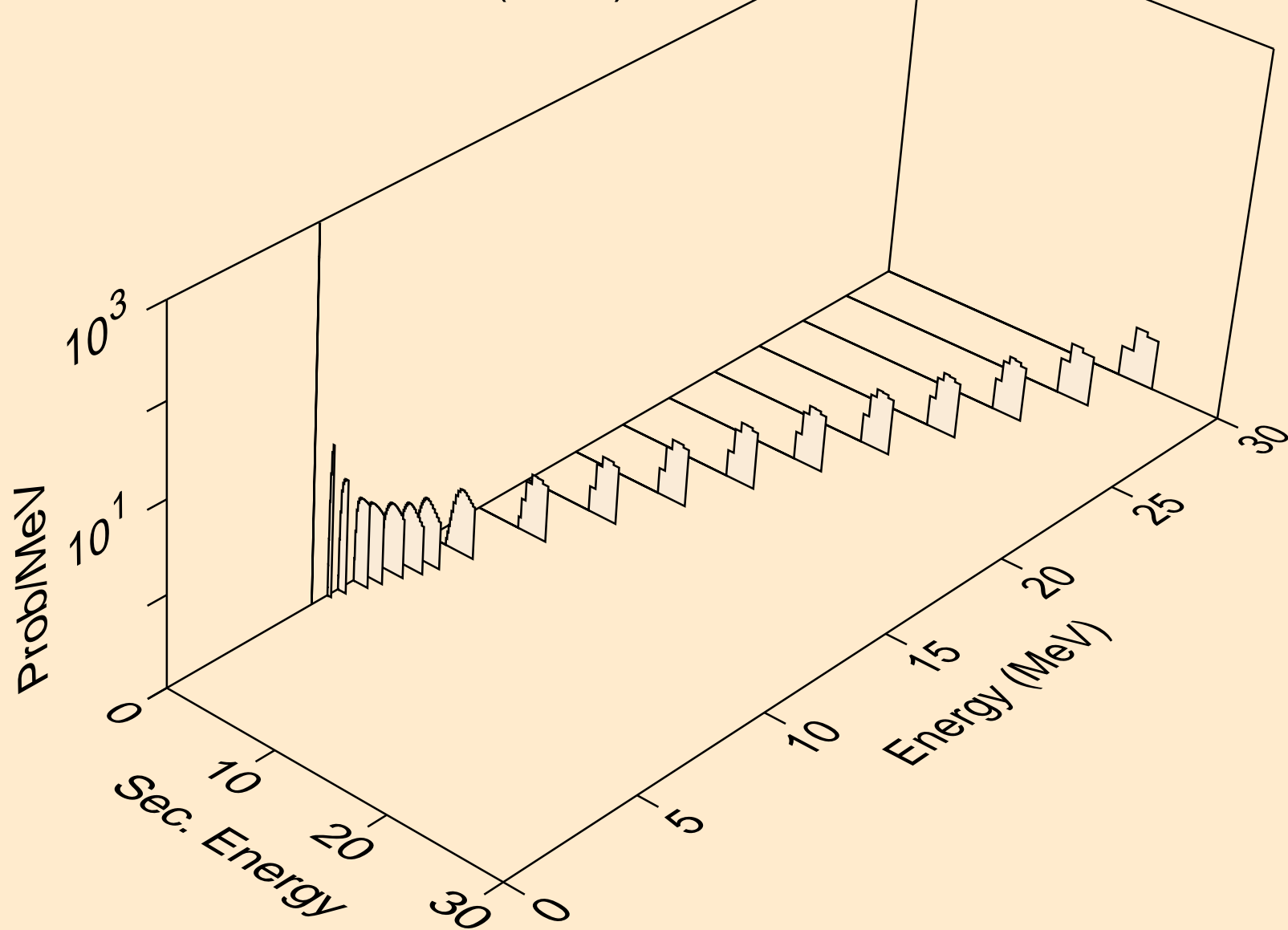

CD101 NEUTRON ACER TENDL-2024 LIBRARY; T=293.6K  
Photon emission for (n,x)

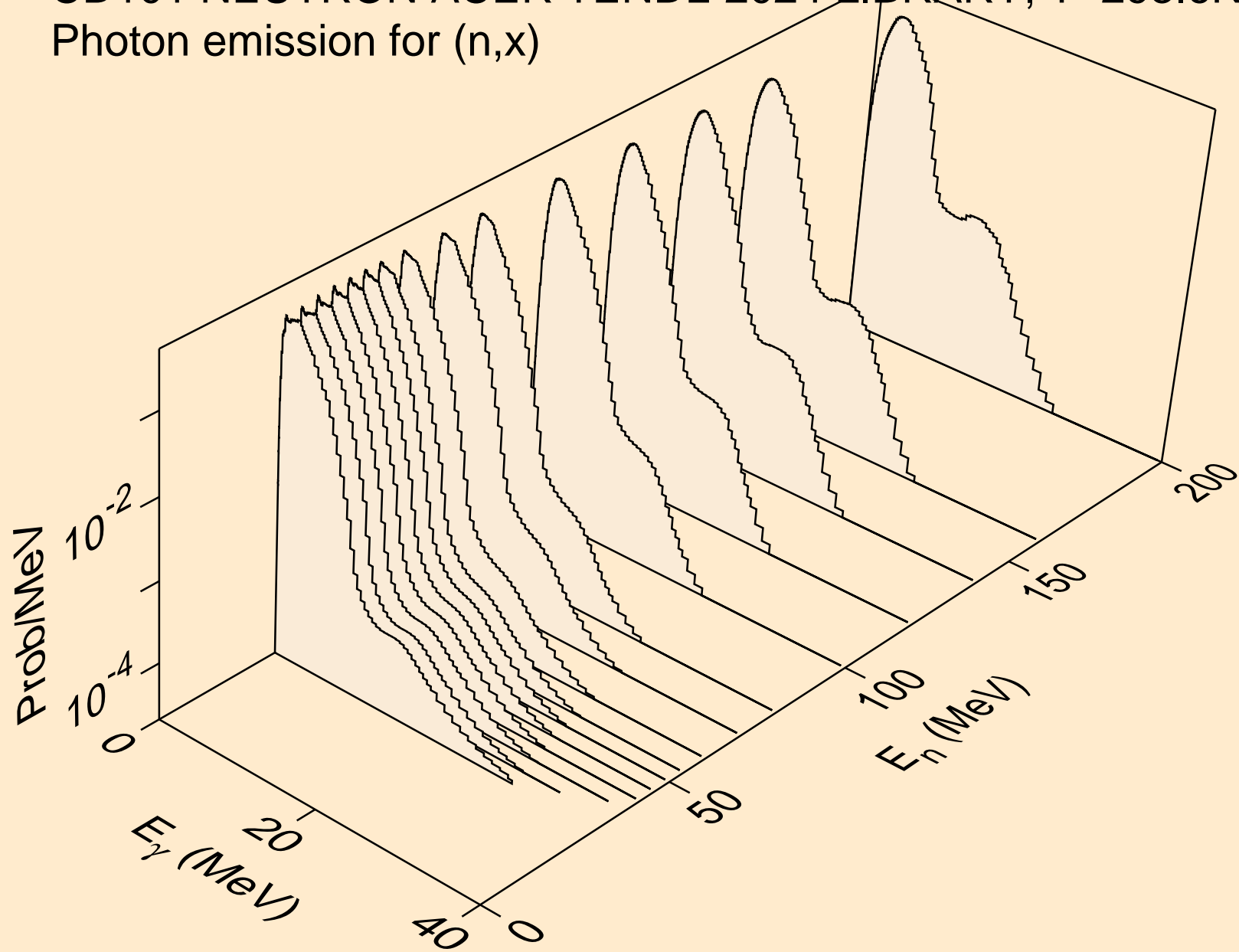

CD101 NEUTRON ACER TENDL-2024 LIBRARY; T=293.6K  
Photon emission for (n,2nd)

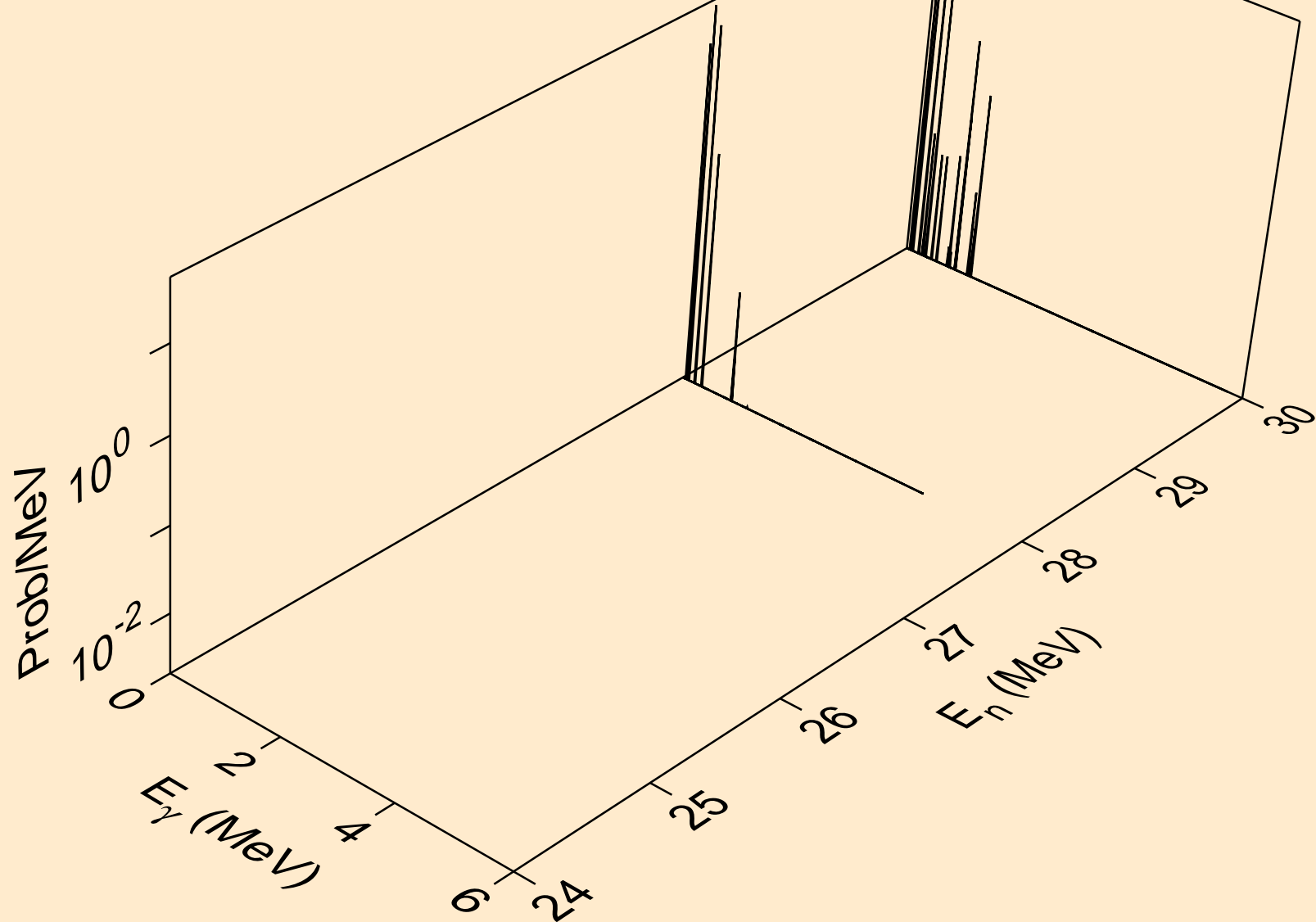

CD101 NEUTRON ACER TENDL-2024 LIBRARY; T=293.6K  
Photon emission for (n,2n)

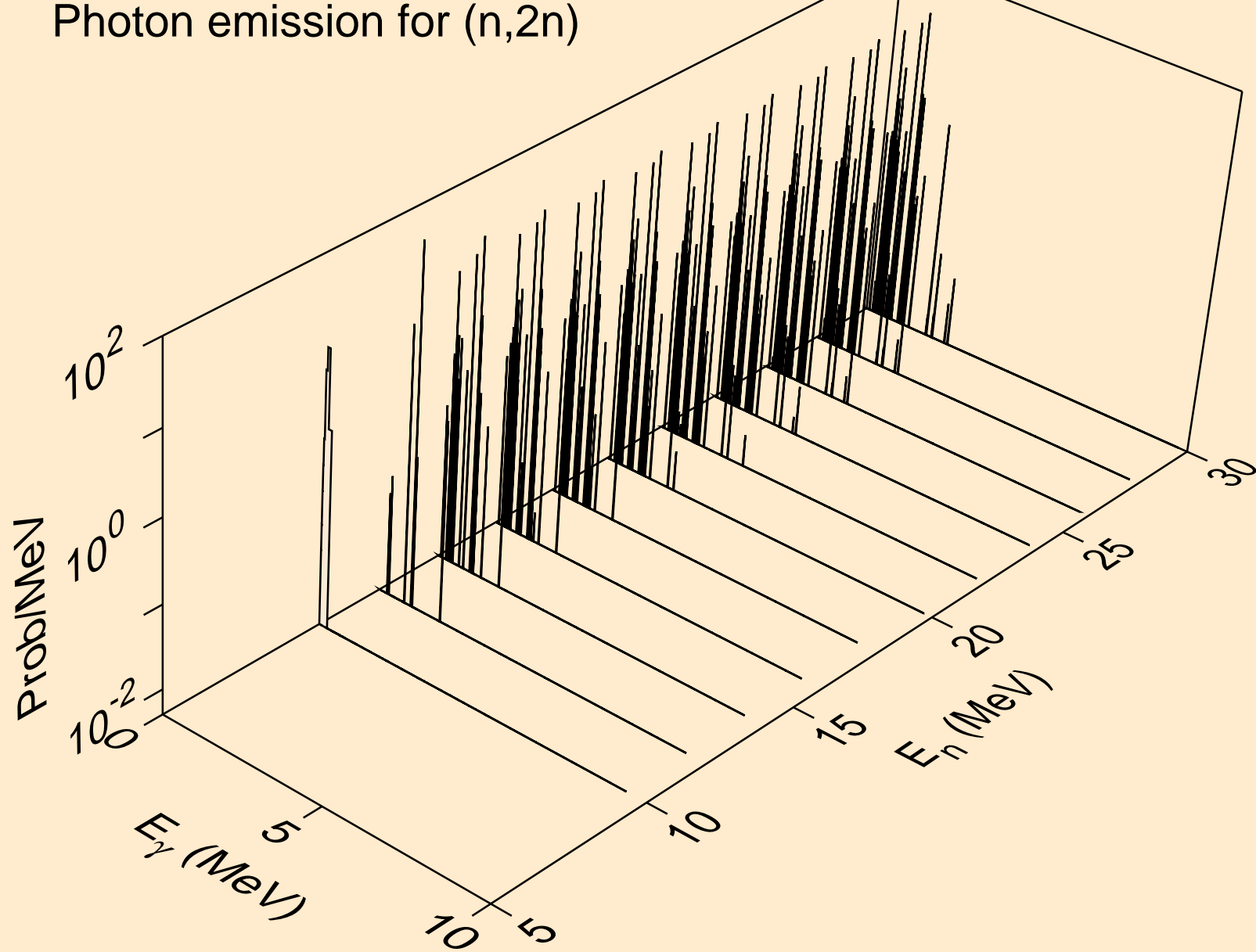

CD101 NEUTRON ACER TENDL-2024 LIBRARY; T=293.6K  
Photon emission for (n,3n)

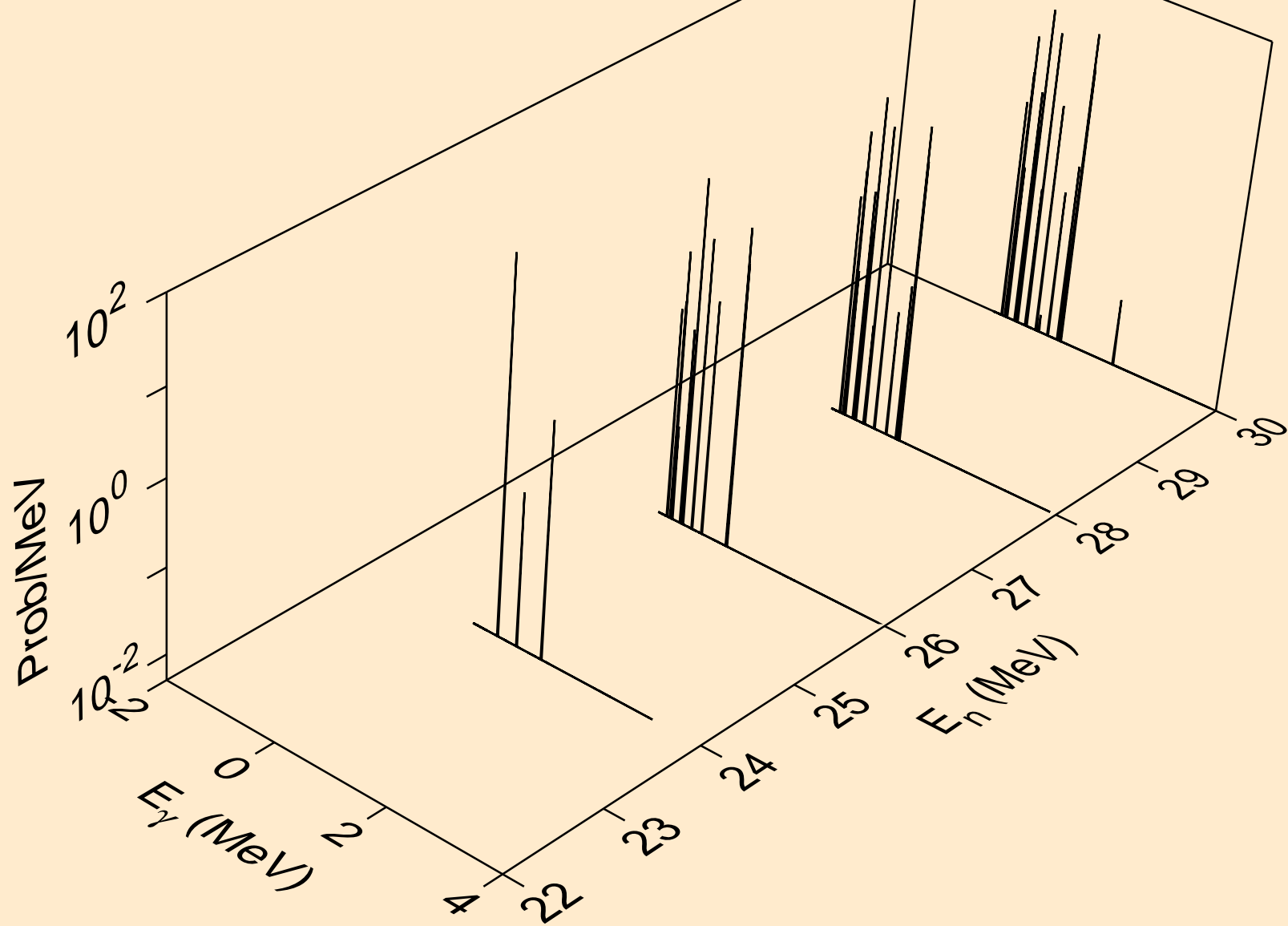

CD101 NEUTRON ACER TENDL-2024 LIBRARY; T=293.6K  
Photon emission for (n,n\*)a

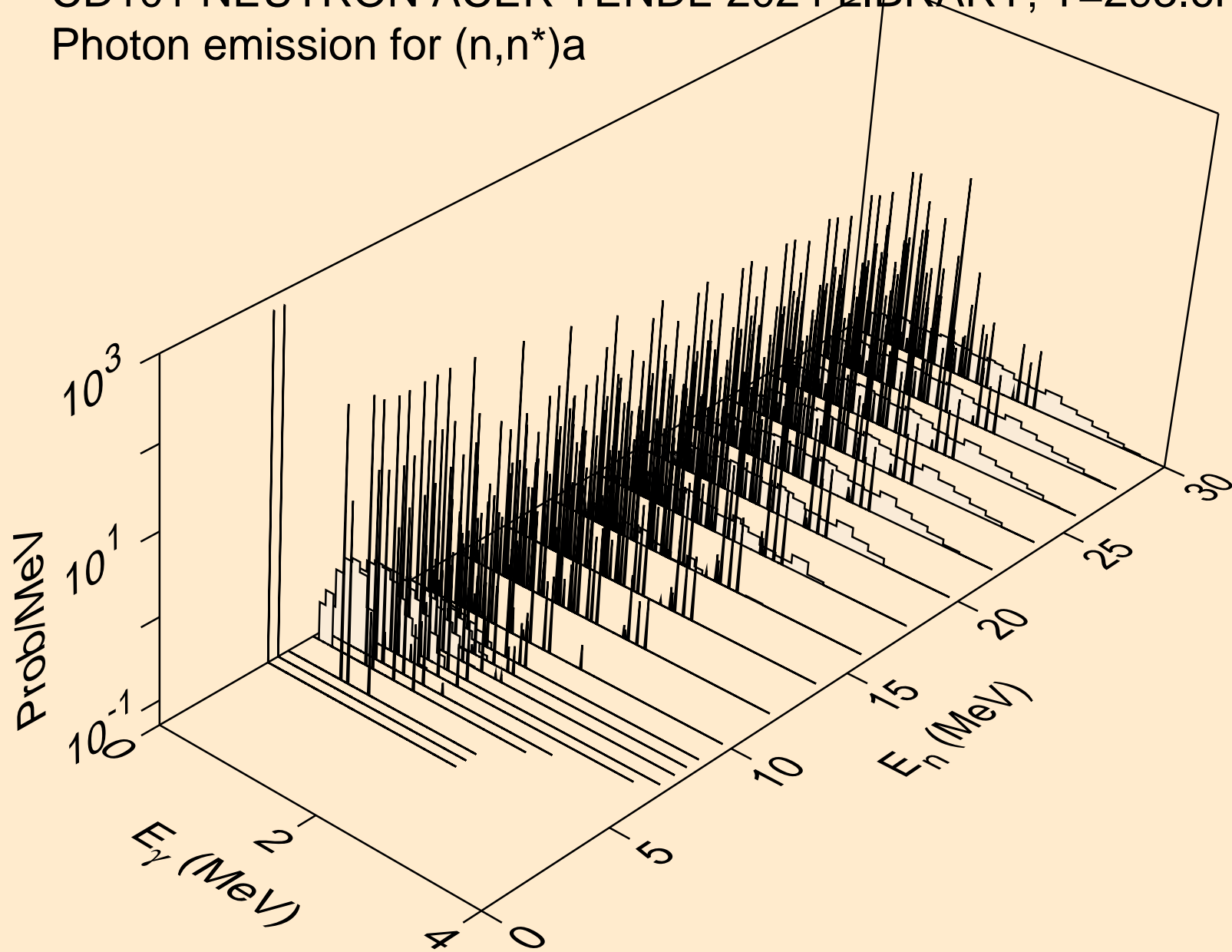

CD101 NEUTRON ACER TENDL-2024 LIBRARY; T=293.6K  
Photon emission for (n,2n)a

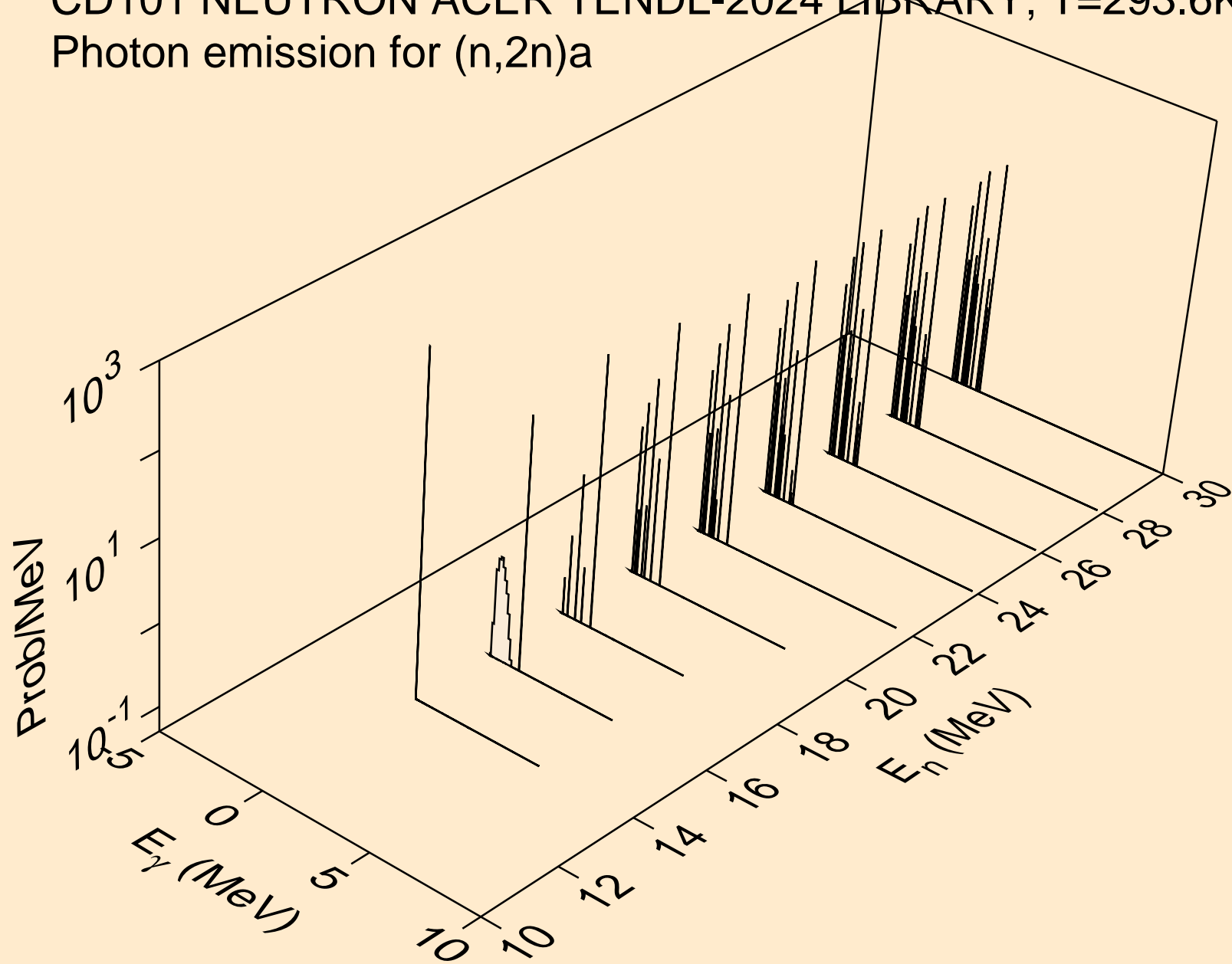

CD101 NEUTRON ACER TENDL-2024 LIBRARY; T=293.6K  
Photon emission for (n,n\*)p

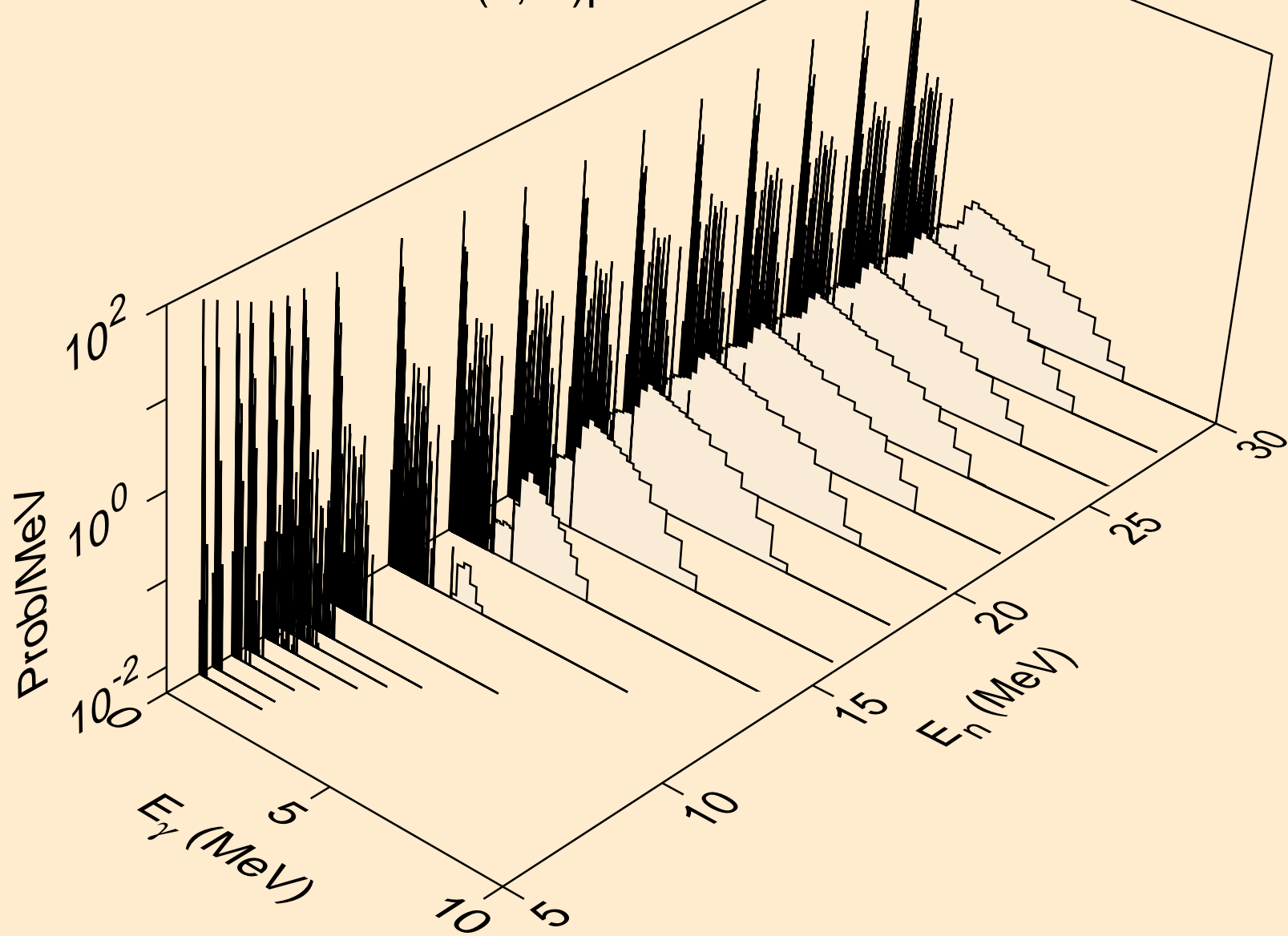

CD101 NEUTRON ACER TENDL-2024 LIBRARY; T=293.6K  
Photon emission for (n,n\*)2a

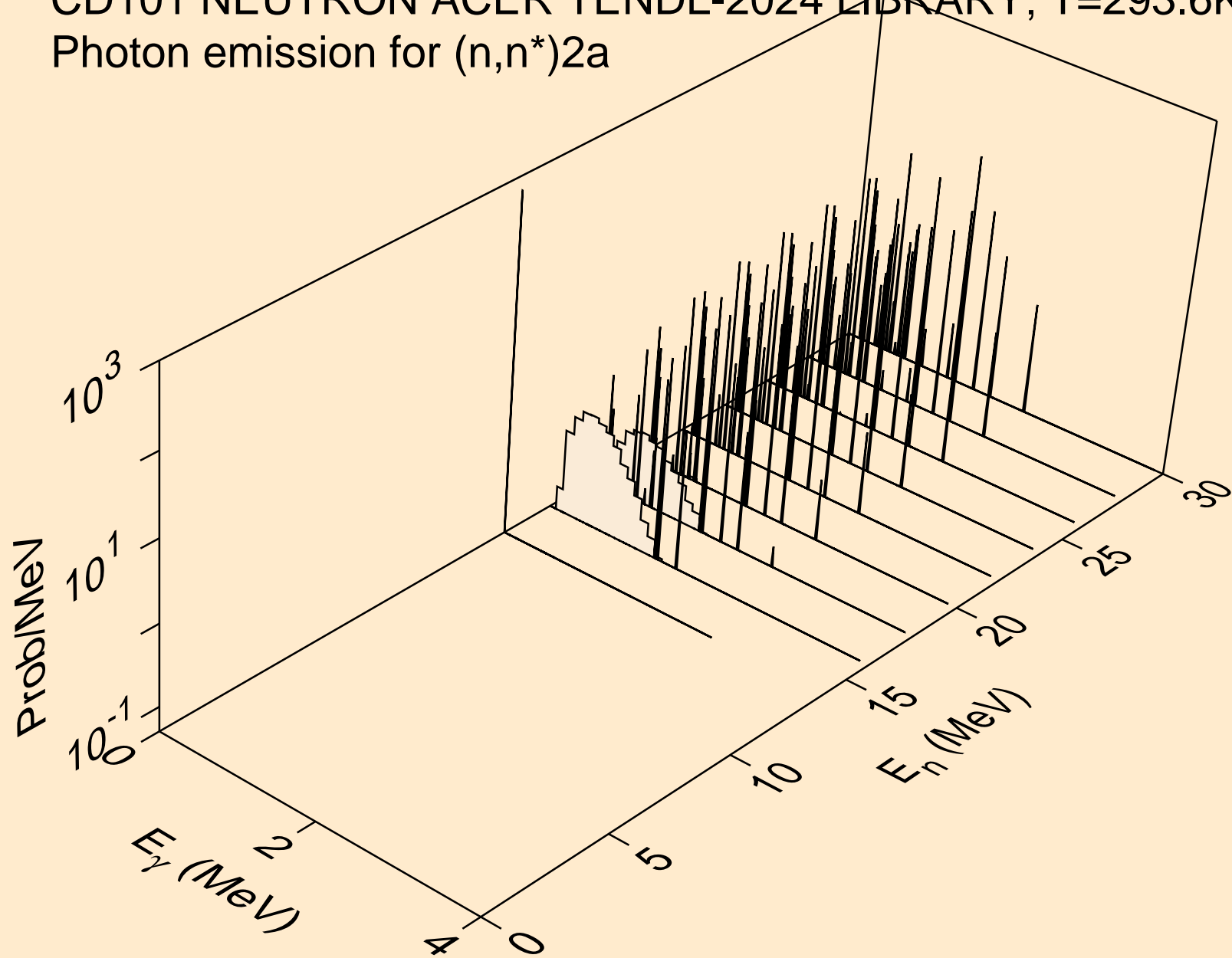

CD101 NEUTRON ACER TENDL-2024 LIBRARY; T=293.6K  
Photon emission for (n,n\*)d

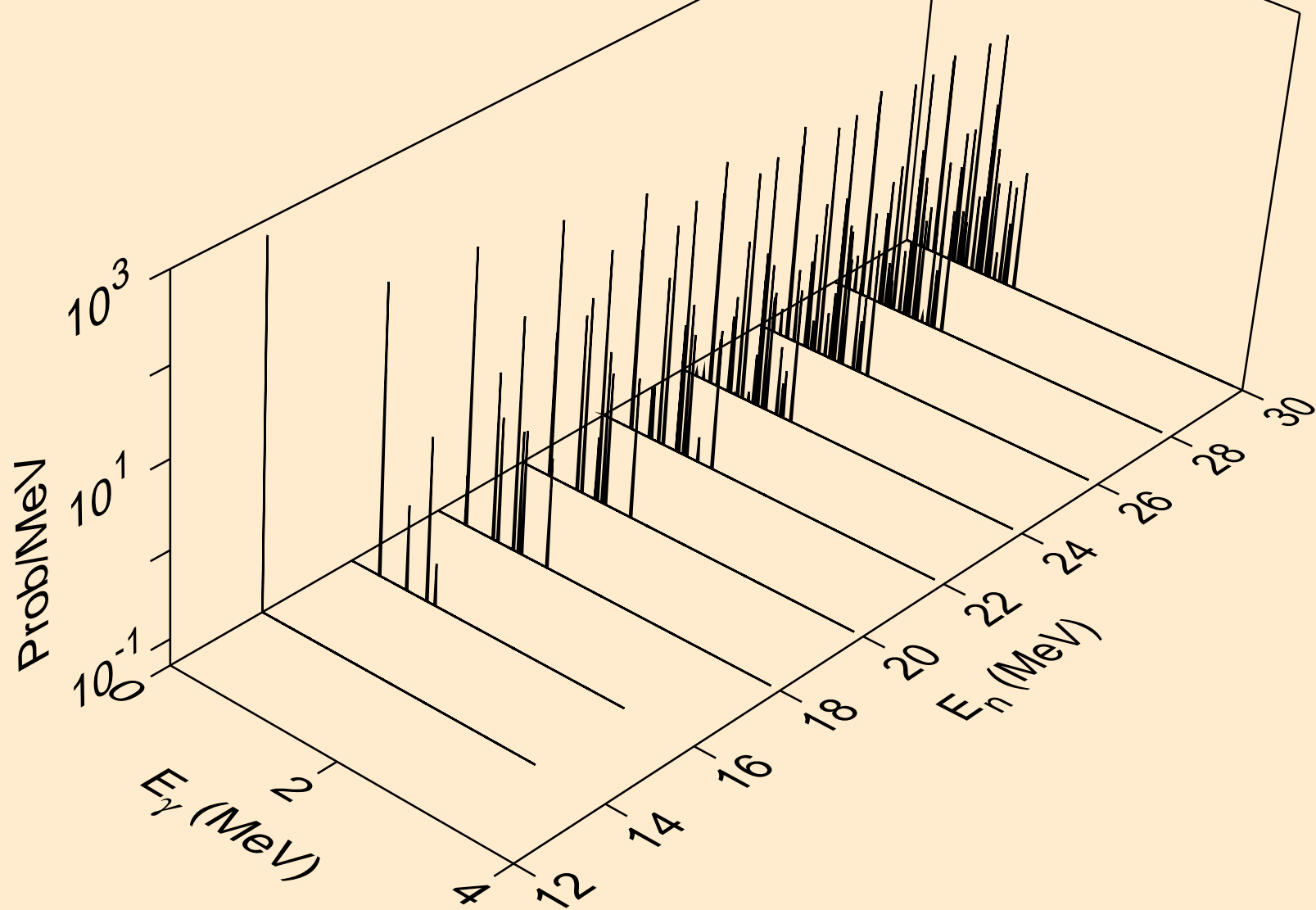

CD101 NEUTRON ACER TENDL-2024 LIBRARY; T=293.6K  
Photon emission for (n,n\*)t

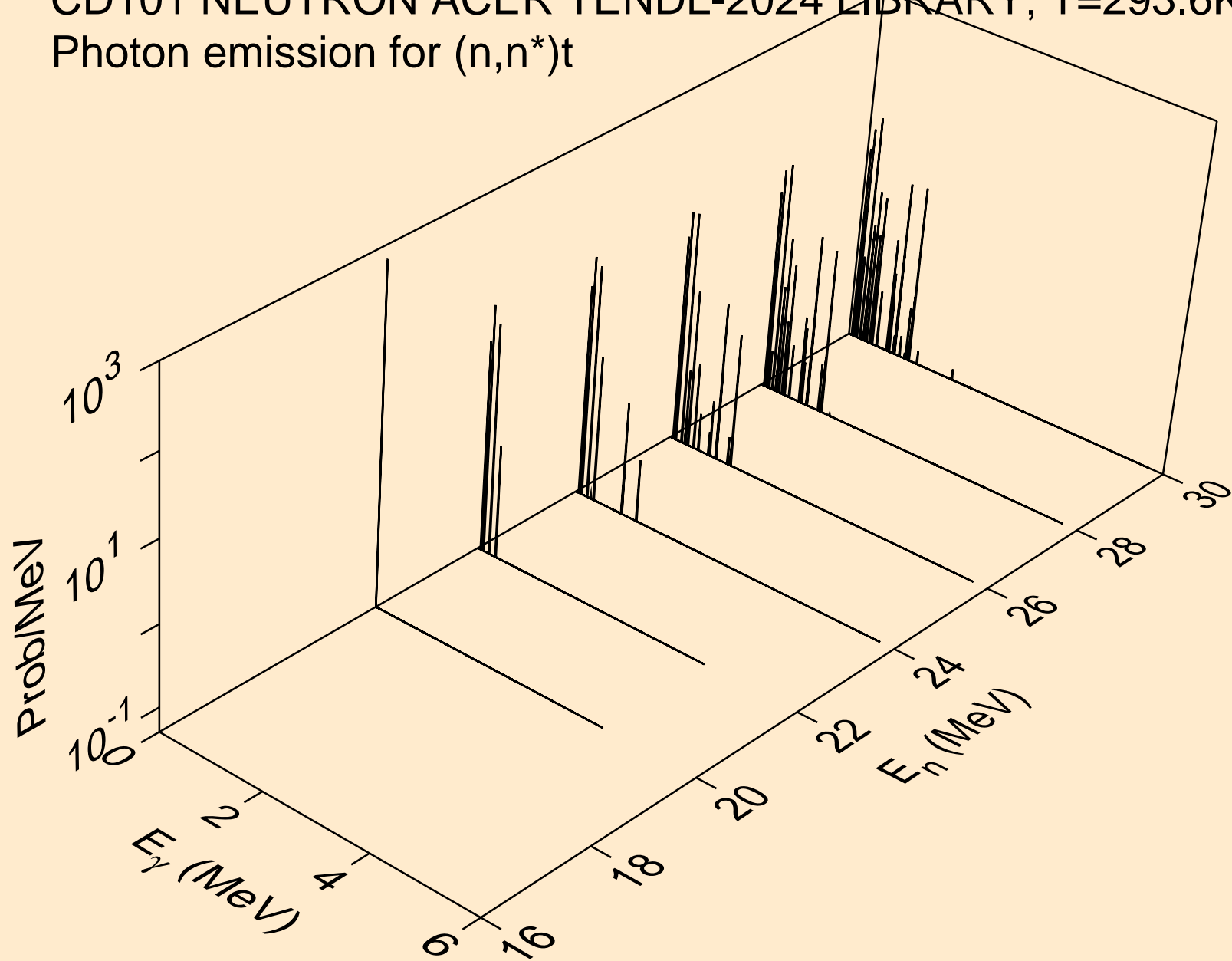

CD101 NEUTRON ACER TENDL-2024 LIBRARY; T=293.6K  
Photon emission for (n,n\*)he3

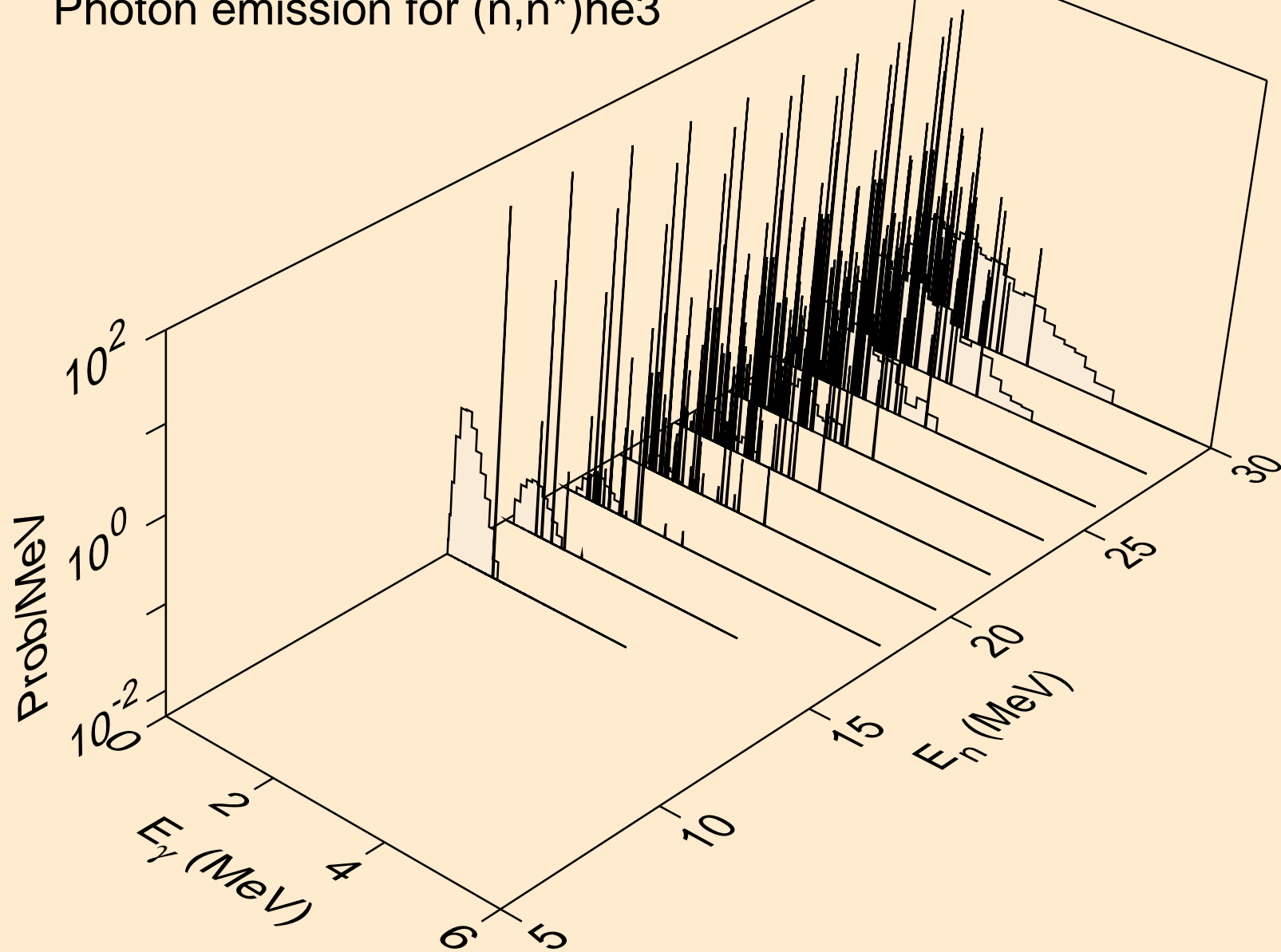

CD101 NEUTRON ACER TENDL-2024 LIBRARY; T=293.6K  
Photon emission for (n,2np)

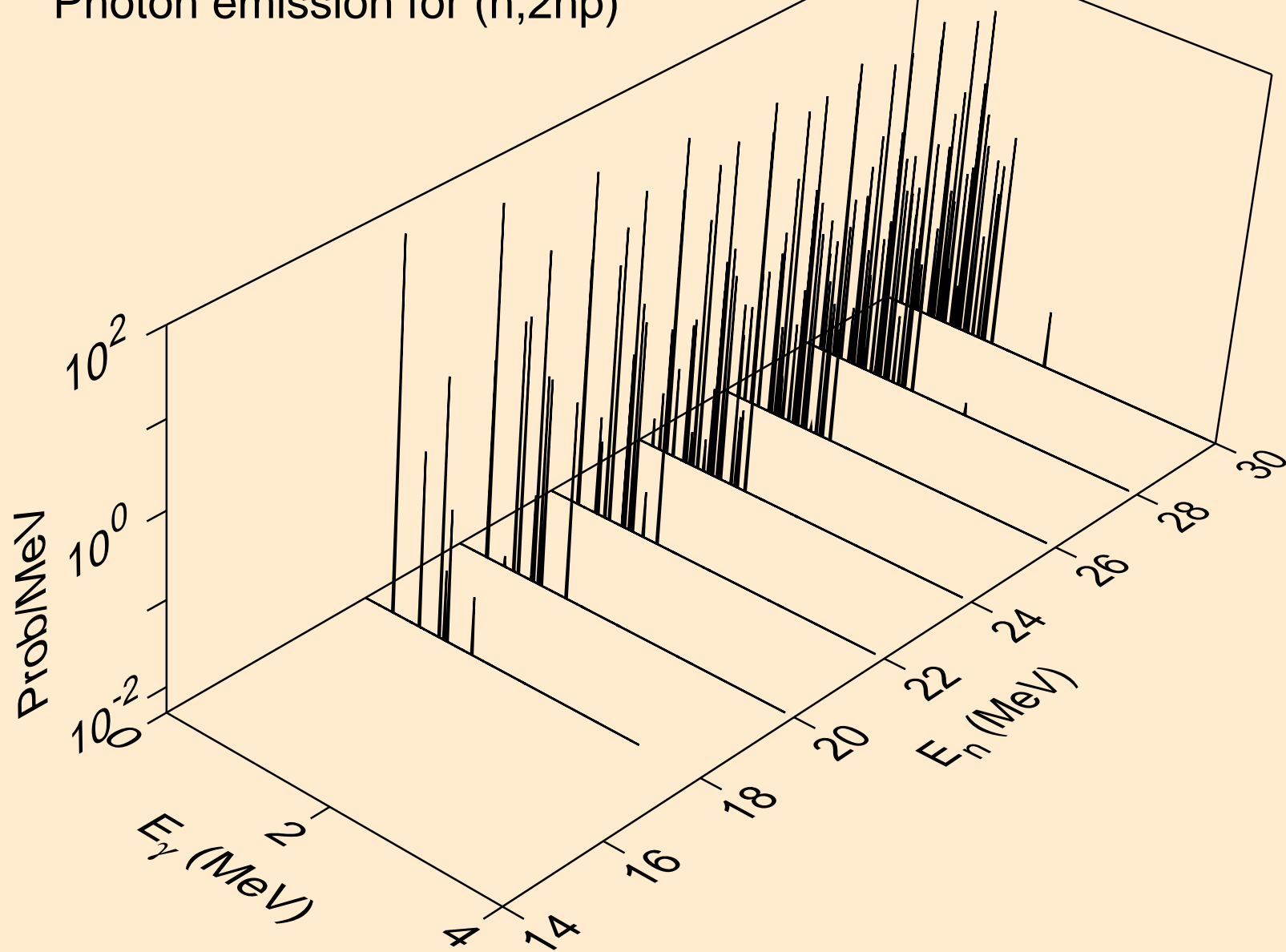

CD101 NEUTRON ACER TENDL-2024 LIBRARY; T=293.6K  
Photon emission for (n,3np)

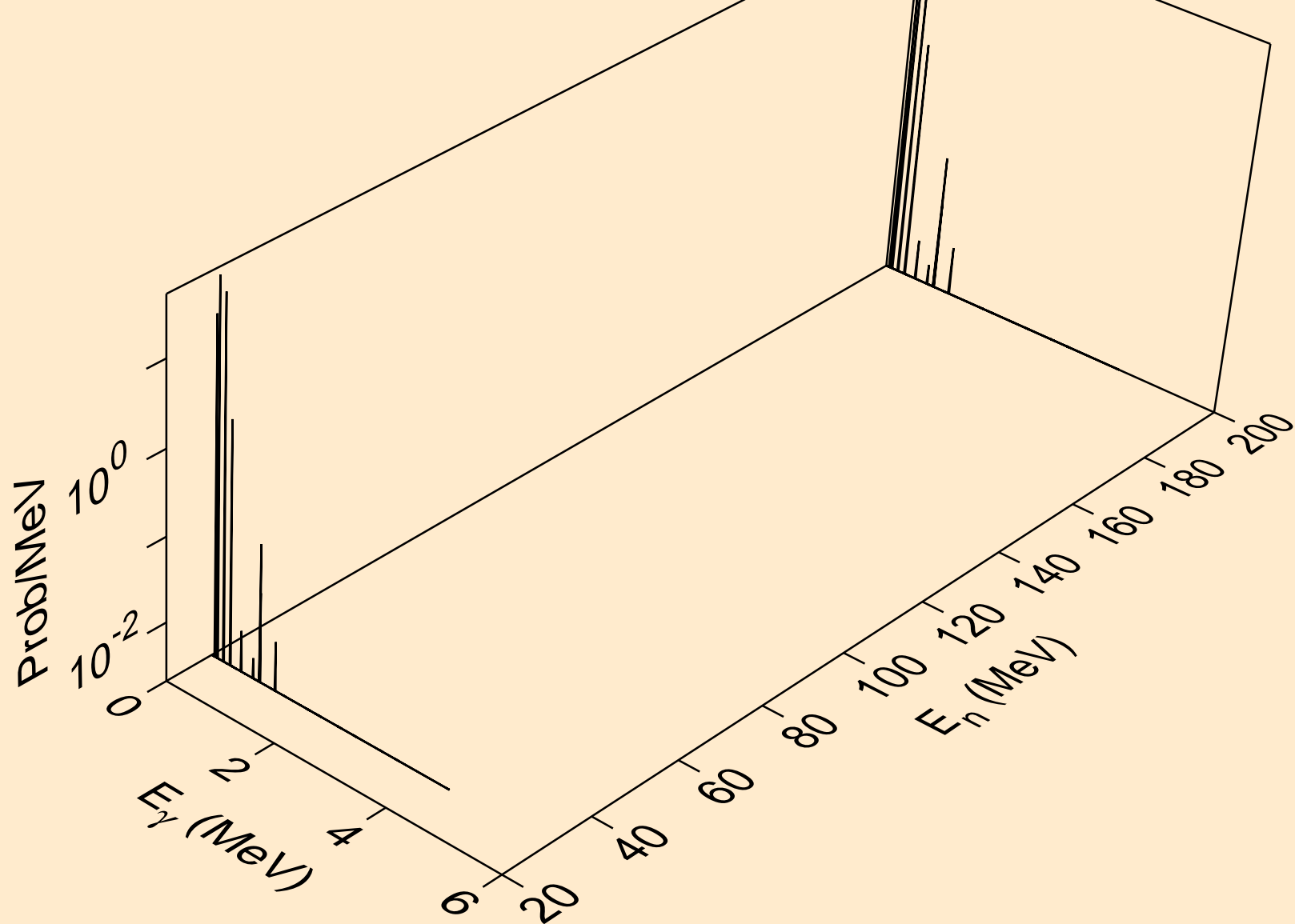

CD101 NEUTRON ACER TENDL-2024 LIBRARY; T=293.6K  
Photon emission for (n,n2p)

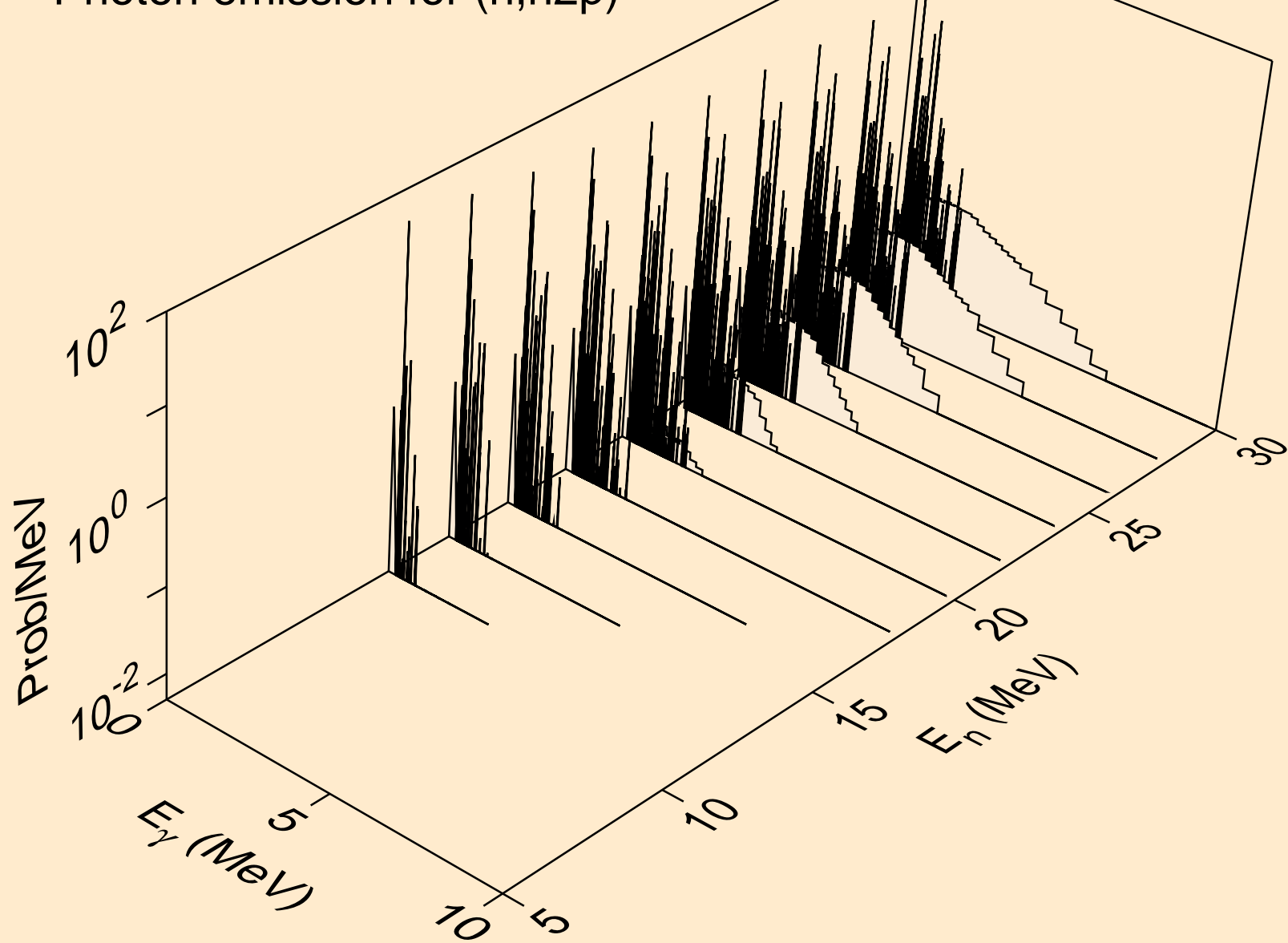

CD101 NEUTRON ACER TENDL-2024 LIBRARY; T=293.6K  
Photon emission for (n,npa)

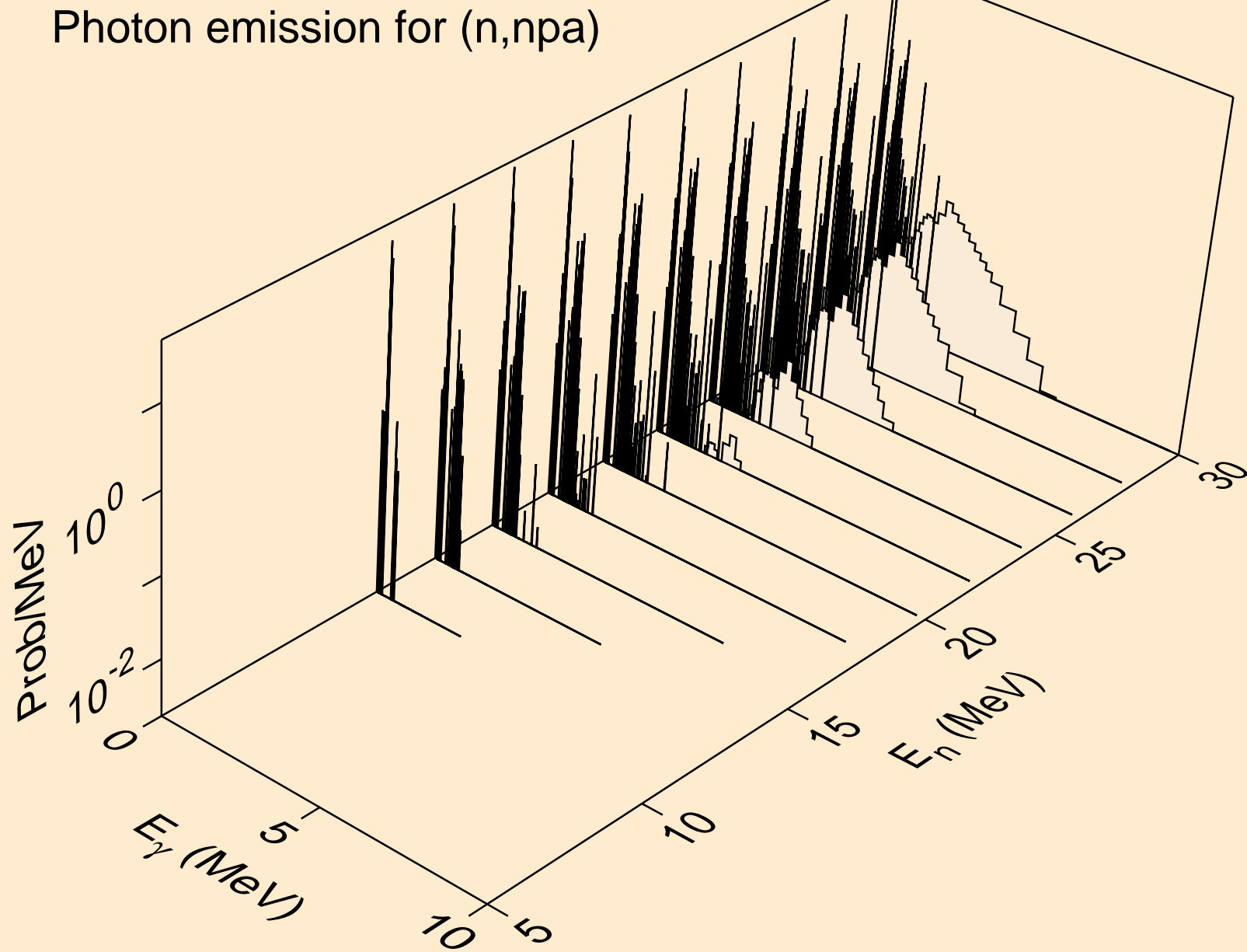

CD101 NEUTRON ACER TENDL-2024 LIBRARY; T=293.6K  
Photon emission for (n,n\*c)

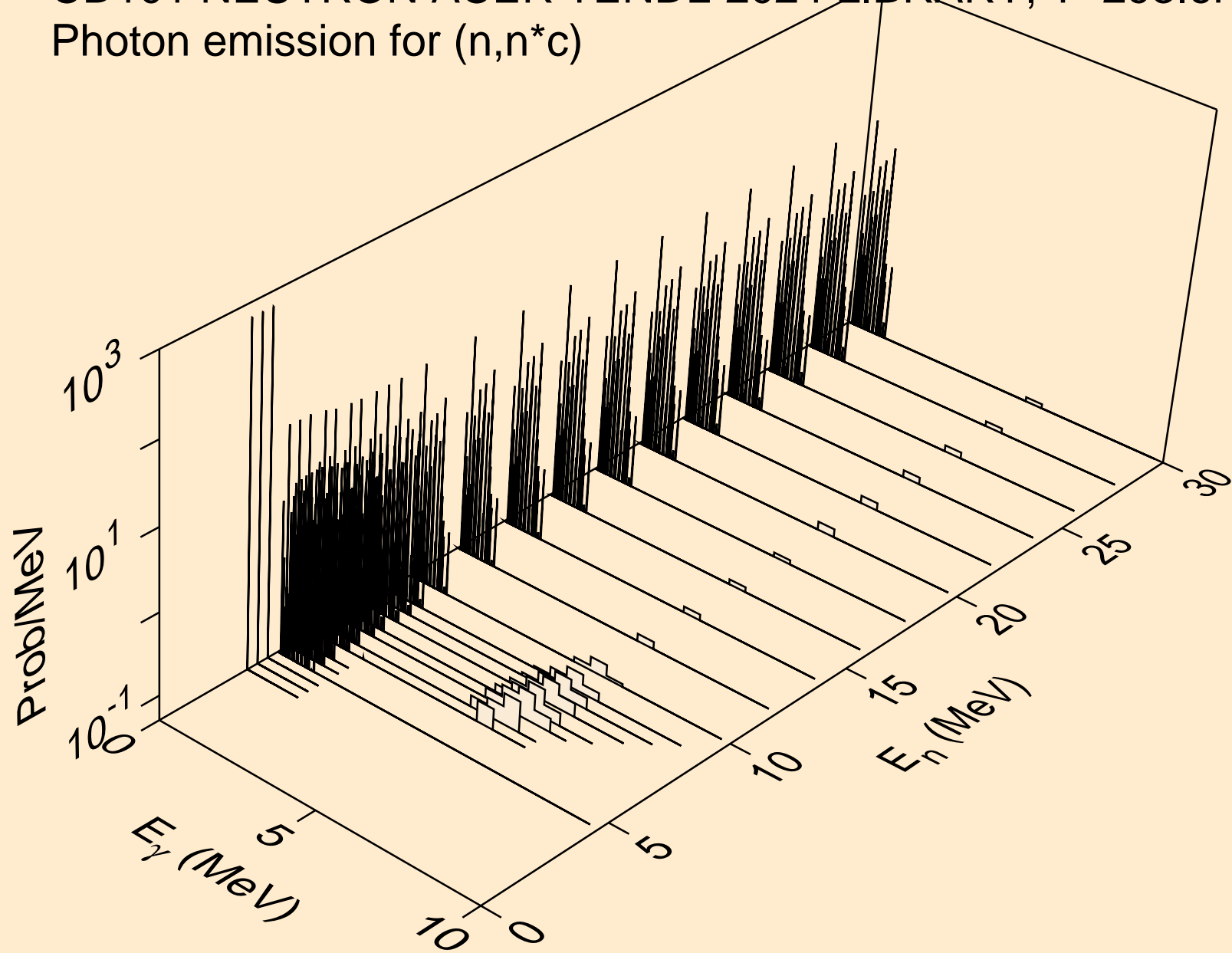

CD101 NEUTRON ACER TENDL-2024 LIBRARY; T=293.6K  
Photon emission for (n,gma)

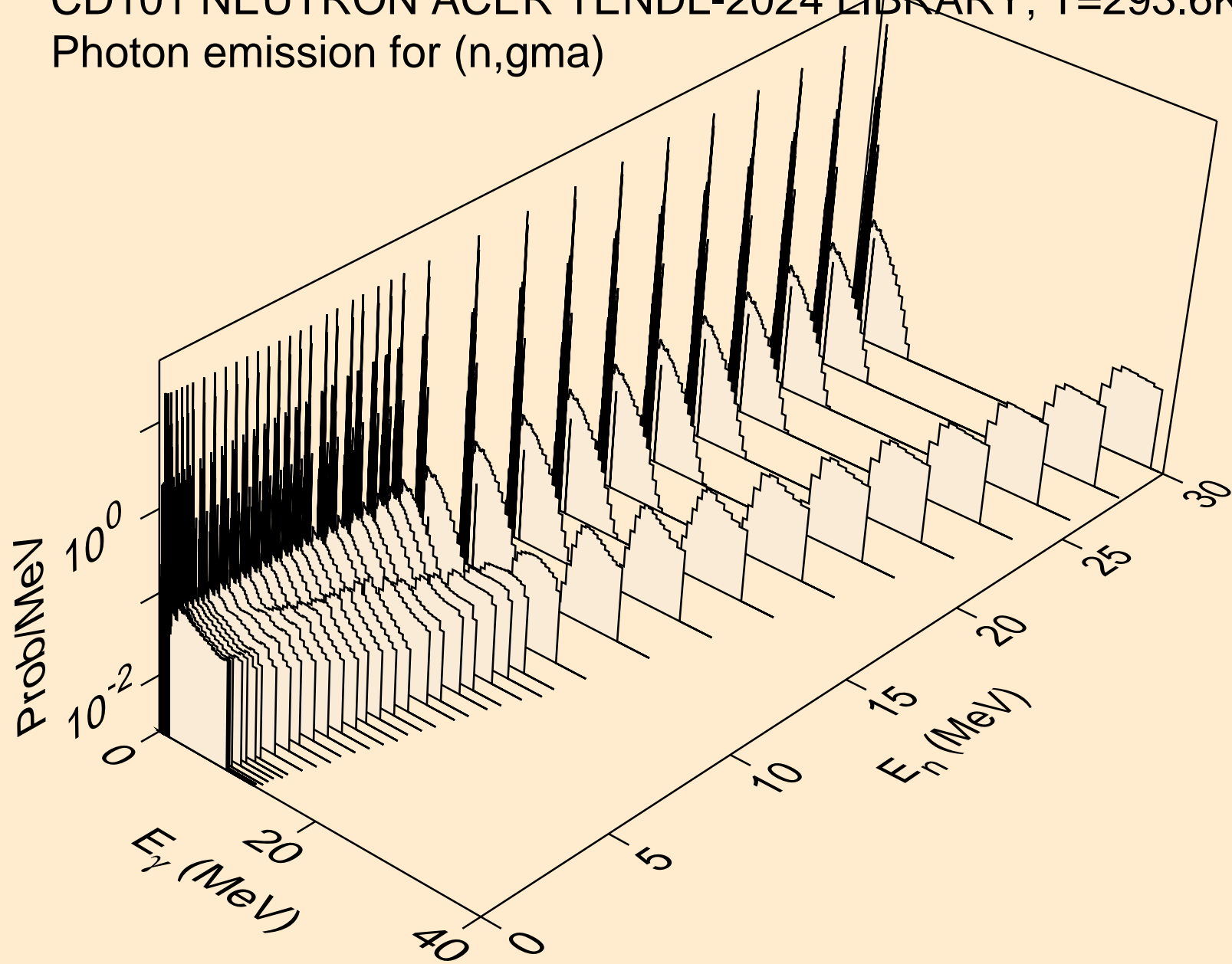

CD101 NEUTRON ACER TENDL-2024 LIBRARY; T=293.6K  
Photon emission for (n,p)

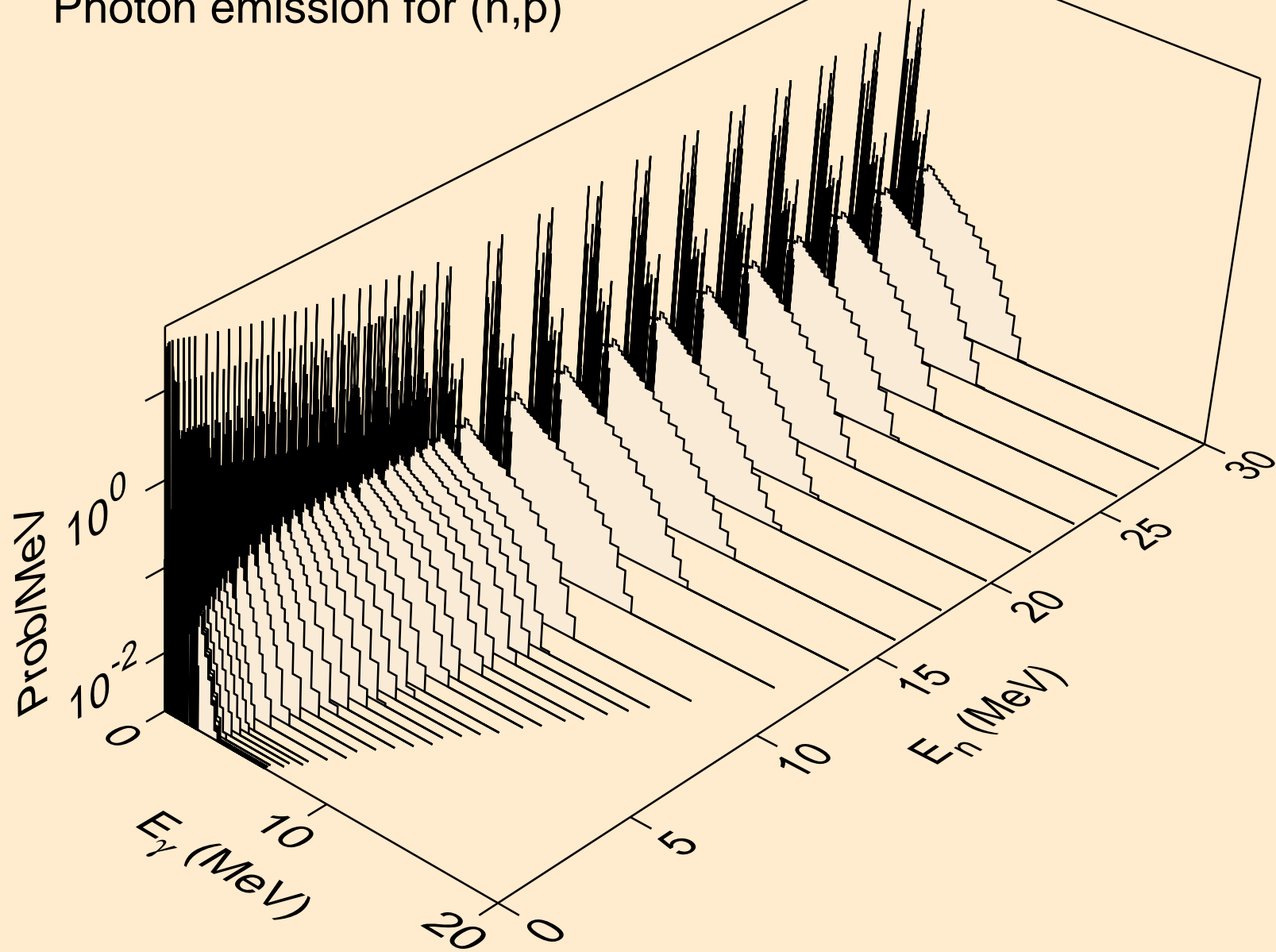

CD101 NEUTRON ACER TENDL-2024 LIBRARY; T=293.6K  
Photon emission for (n,d)

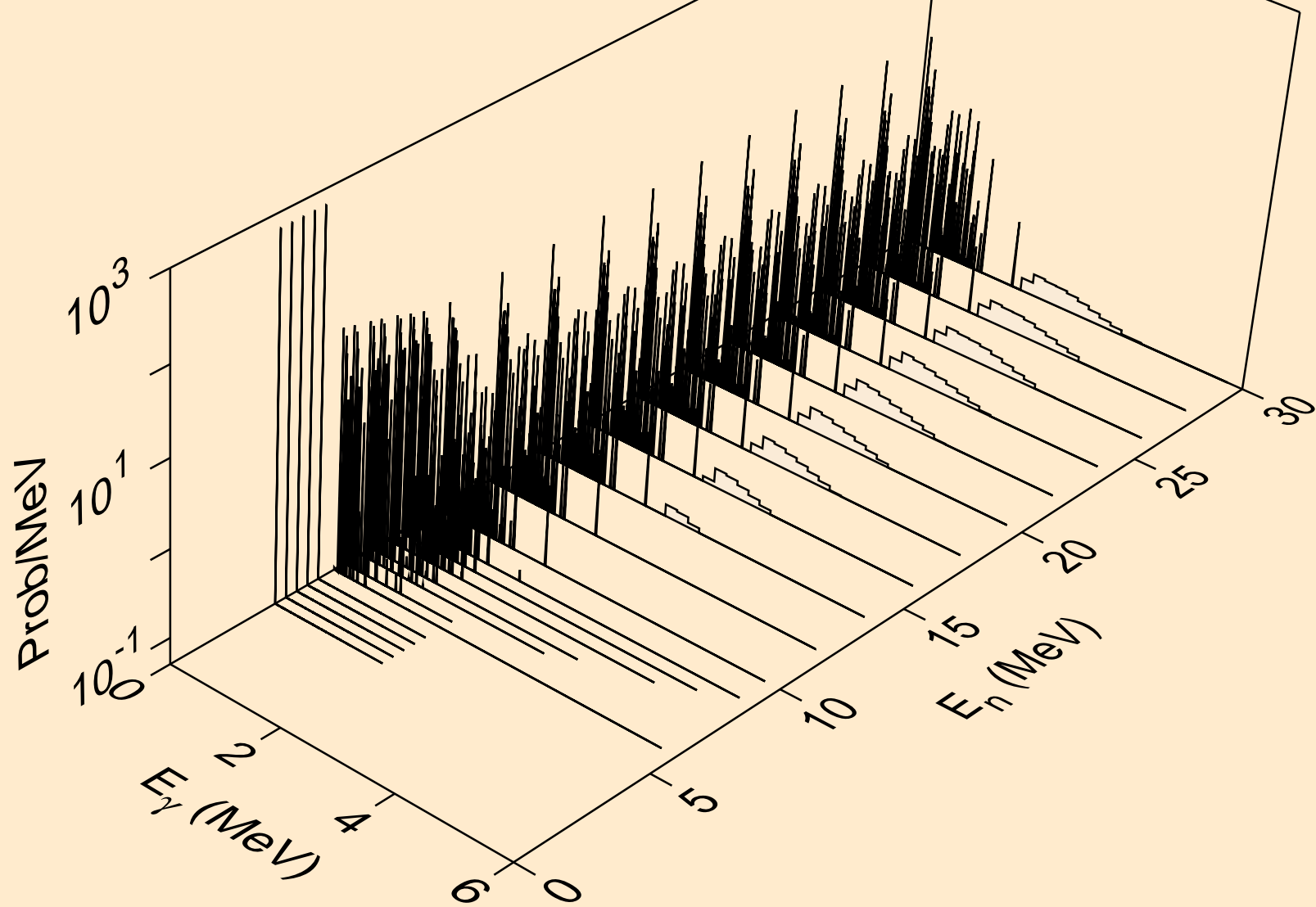

CD101 NEUTRON ACER TENDL-2024 LIBRARY; T=293.6K  
Photon emission for (n,t)

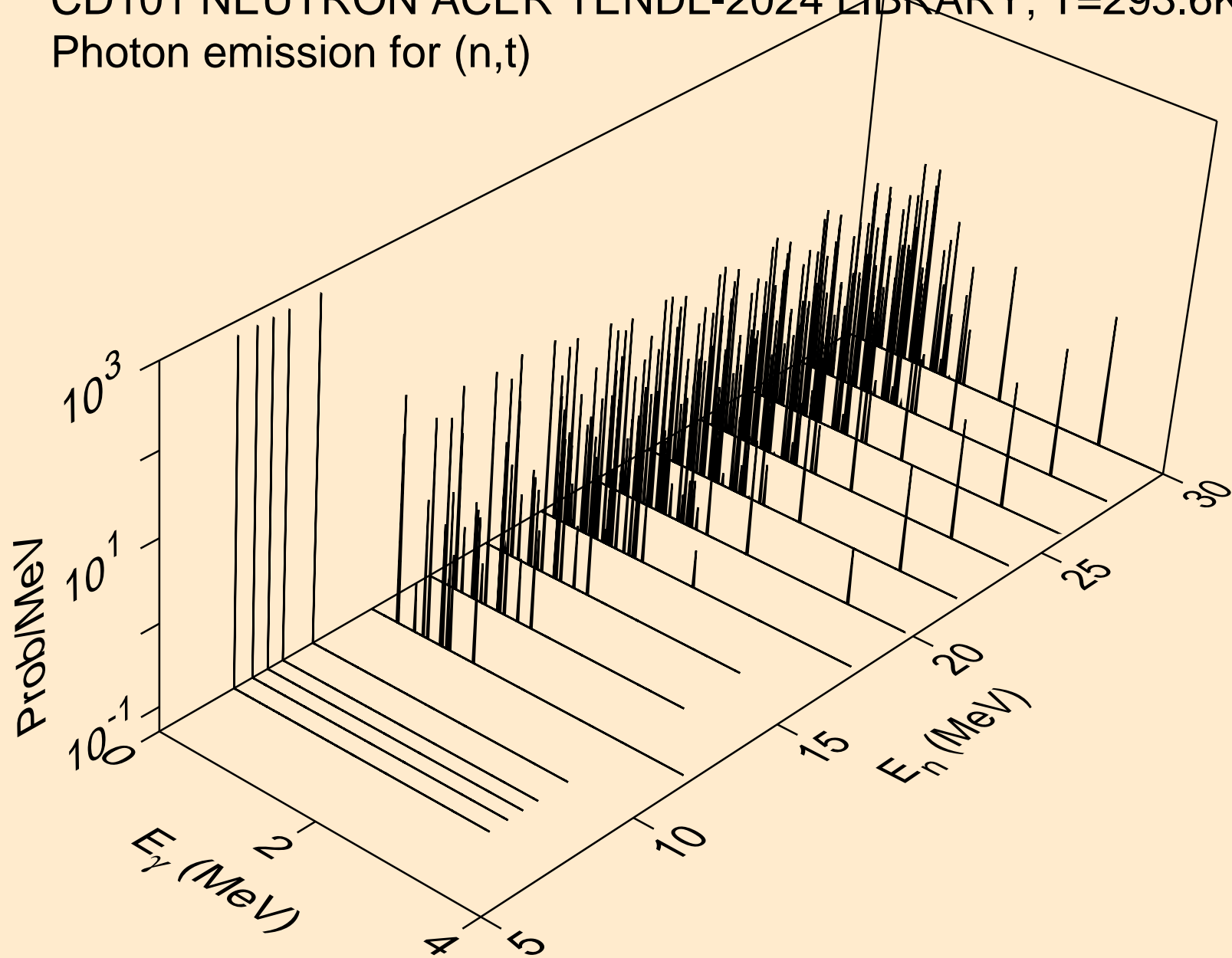

CD101 NEUTRON ACER TENDL-2024 LIBRARY; T=293.6K  
Photon emission for (n,he3)

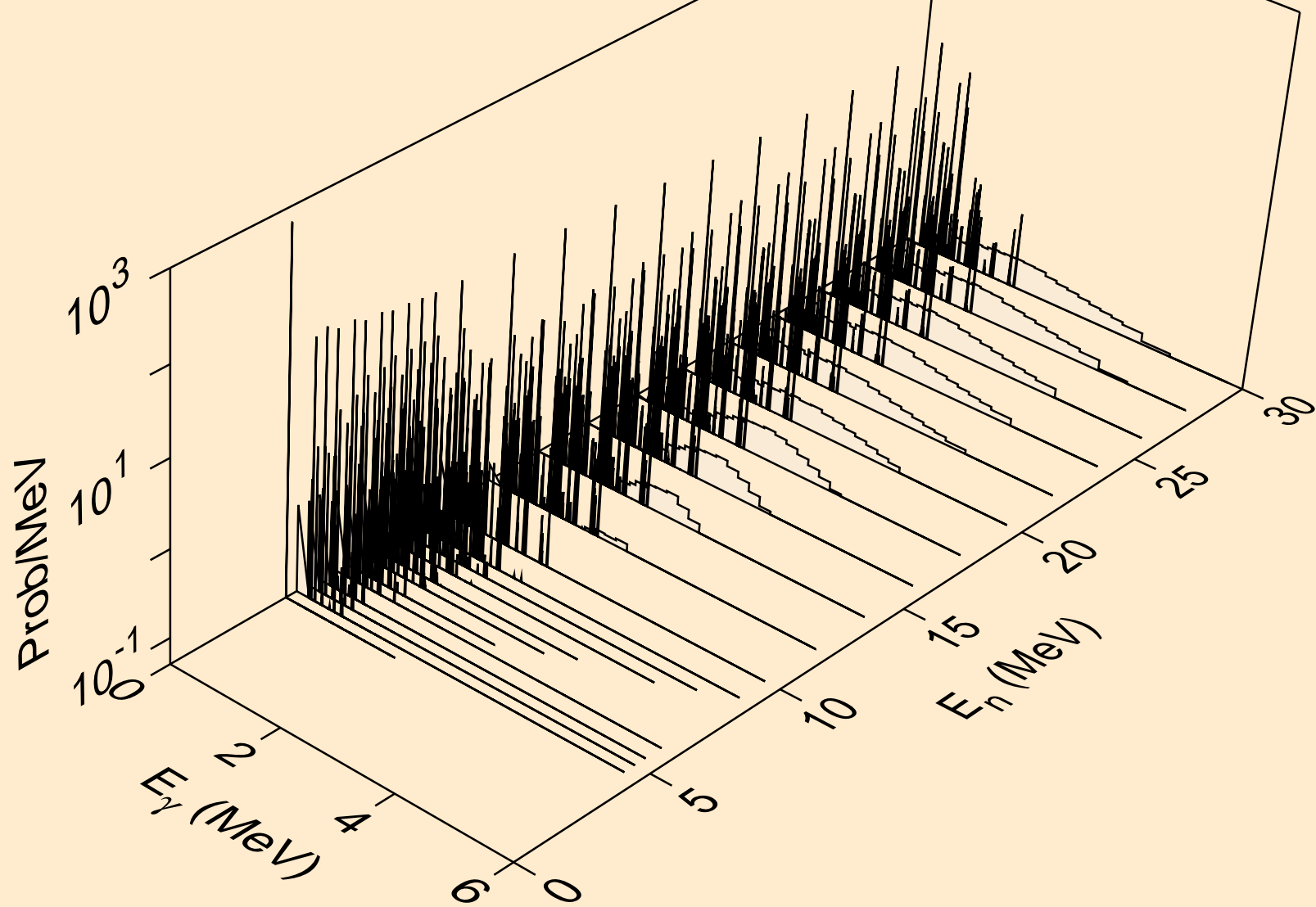

CD101 NEUTRON ACER TENDL-2024 LIBRARY; T=293.6K  
Photon emission for (n,a)

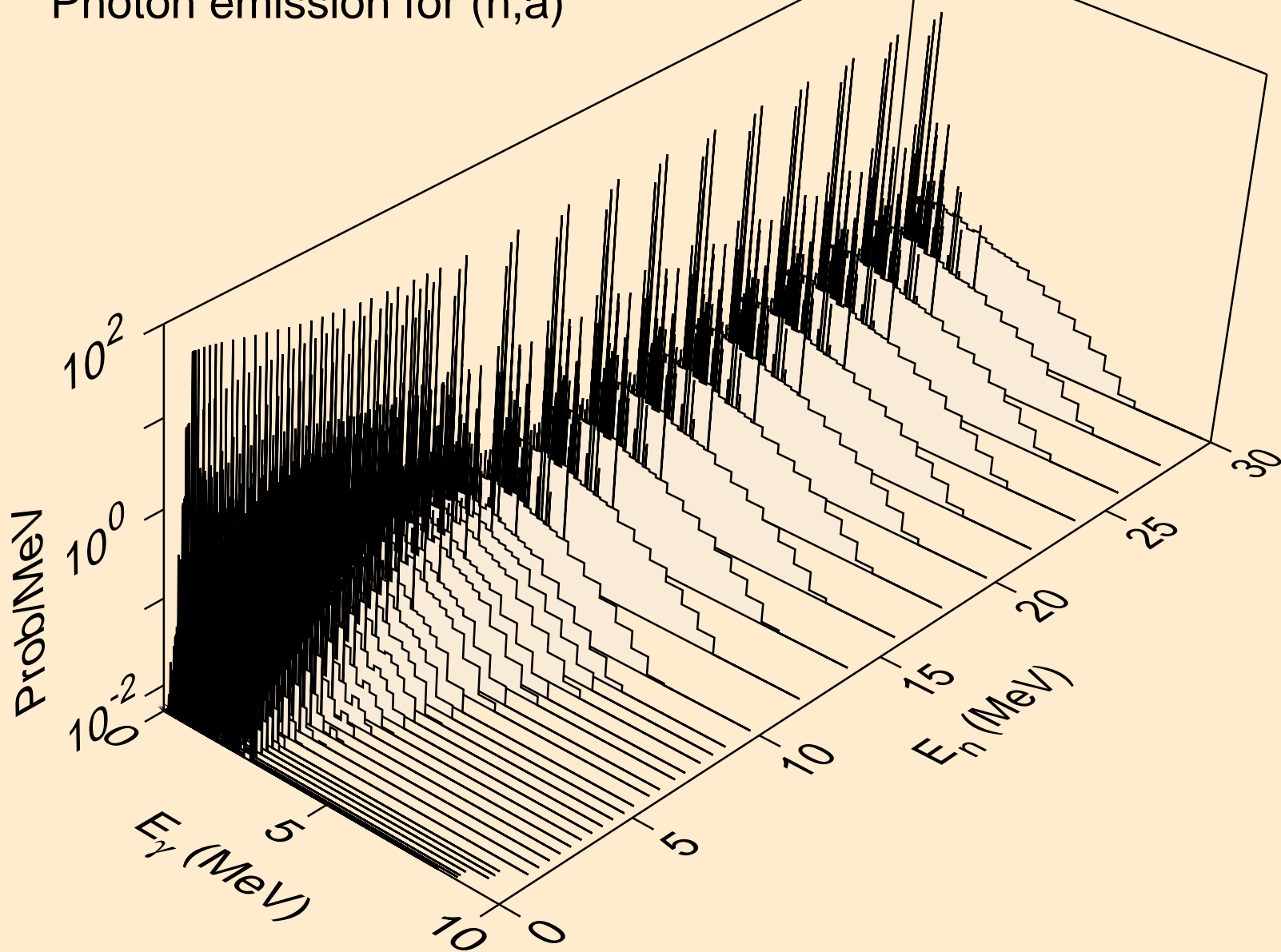

CD101 NEUTRON ACER TENDL-2024 LIBRARY; T=293.6K  
Photon emission for (n,2a)

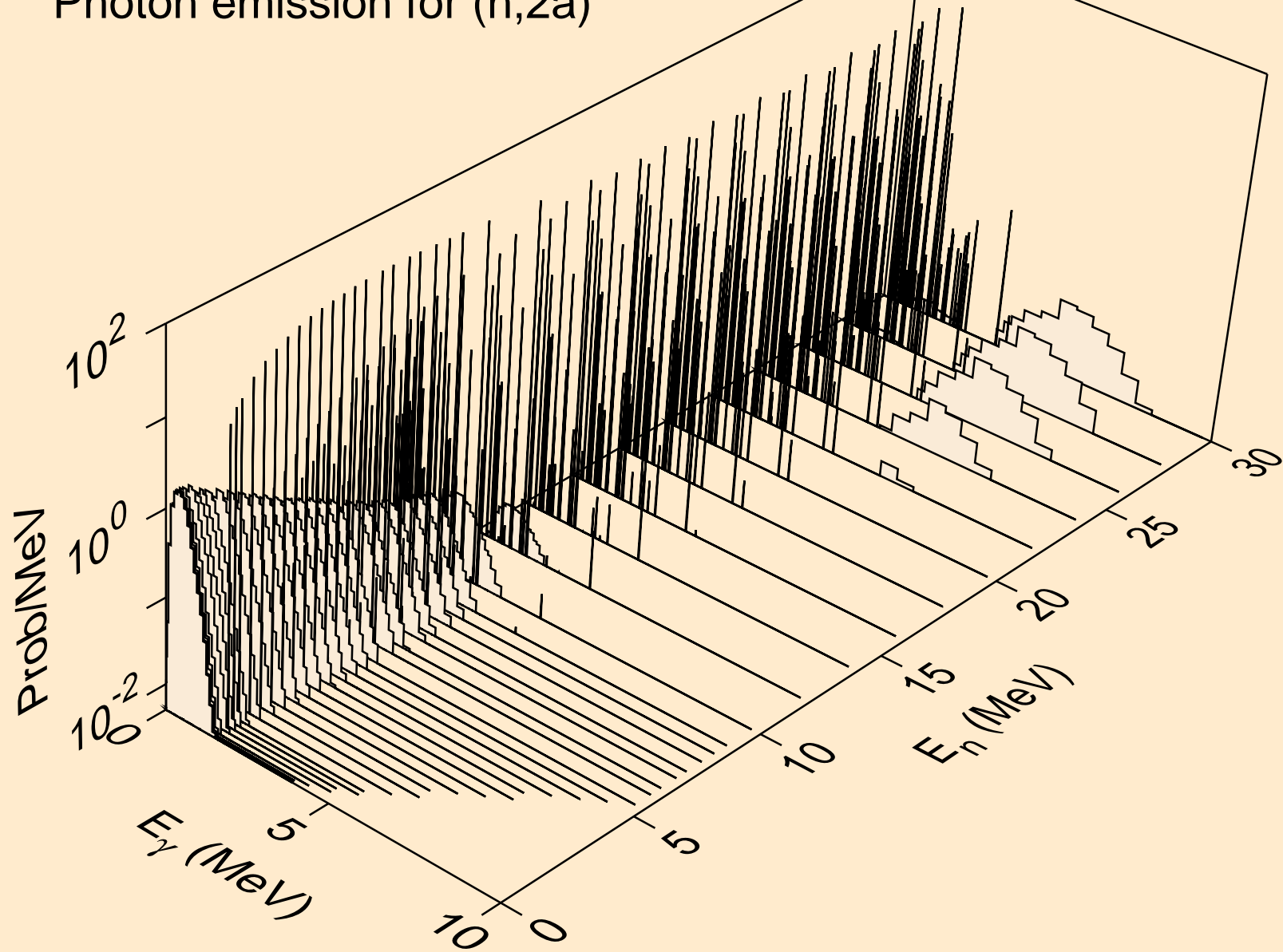

CD101 NEUTRON ACER TENDL-2024 LIBRARY; T=293.6K  
Photon emission for (n,3a)

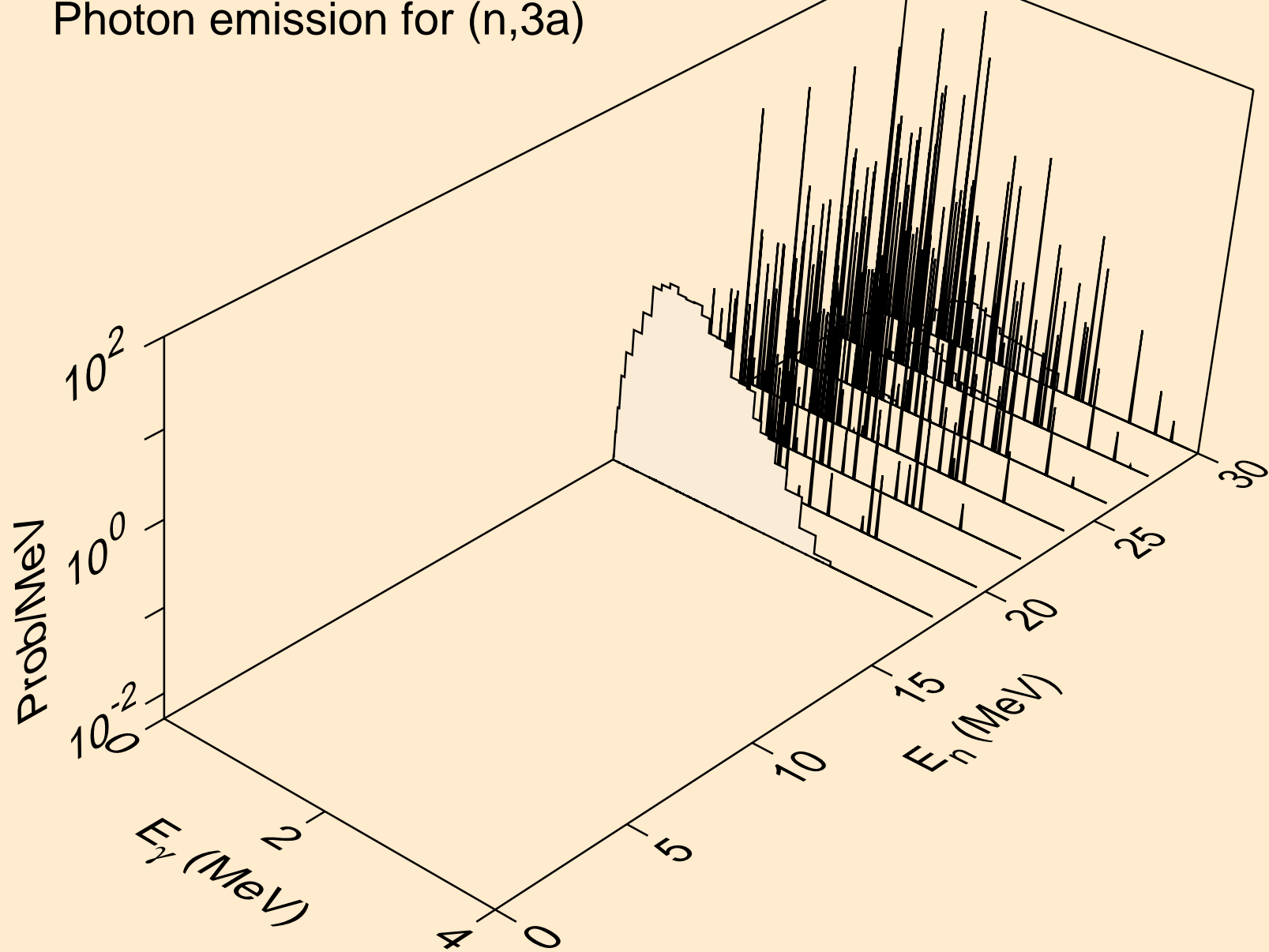

CD101 NEUTRON ACER TENDL-2024 LIBRARY; T=293.6K  
Photon emission for (n,2p)

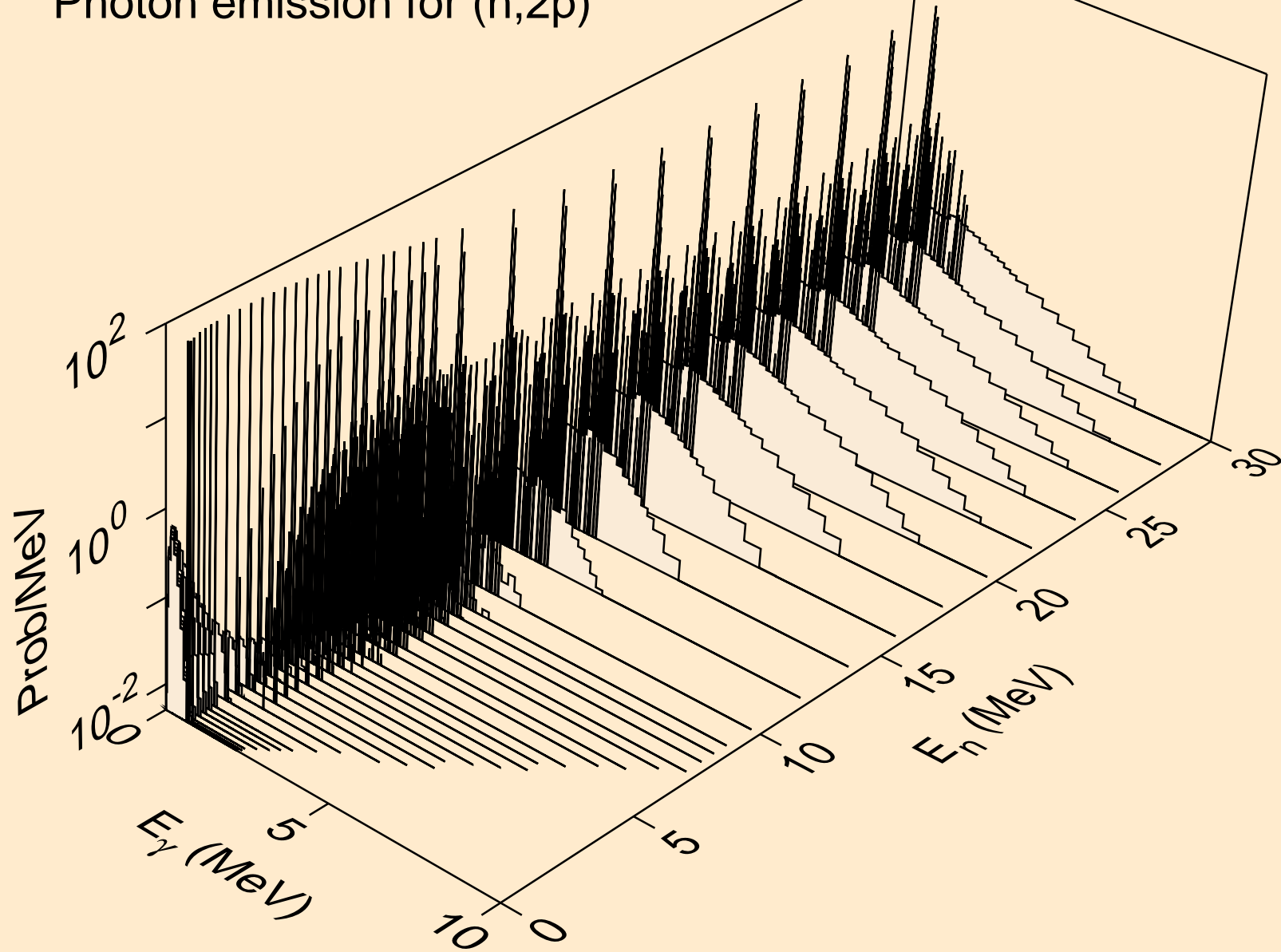

CD101 NEUTRON ACER TENDL-2024 LIBRARY; T=293.6K  
Photon emission for (n,p)

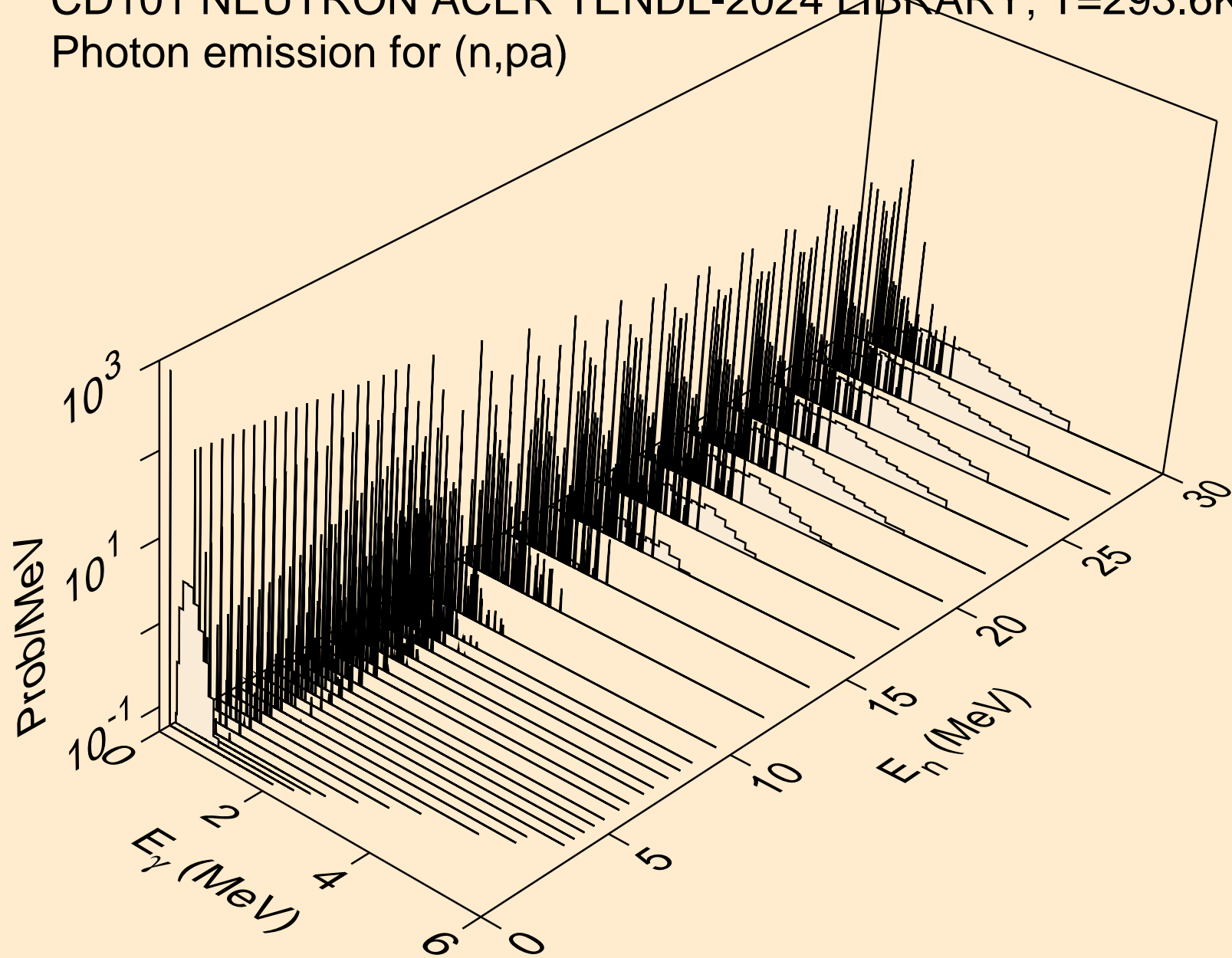

CD101 NEUTRON ACER TENDL-2024 LIBRARY; T=293.6K  
Photon emission for (n,pd)

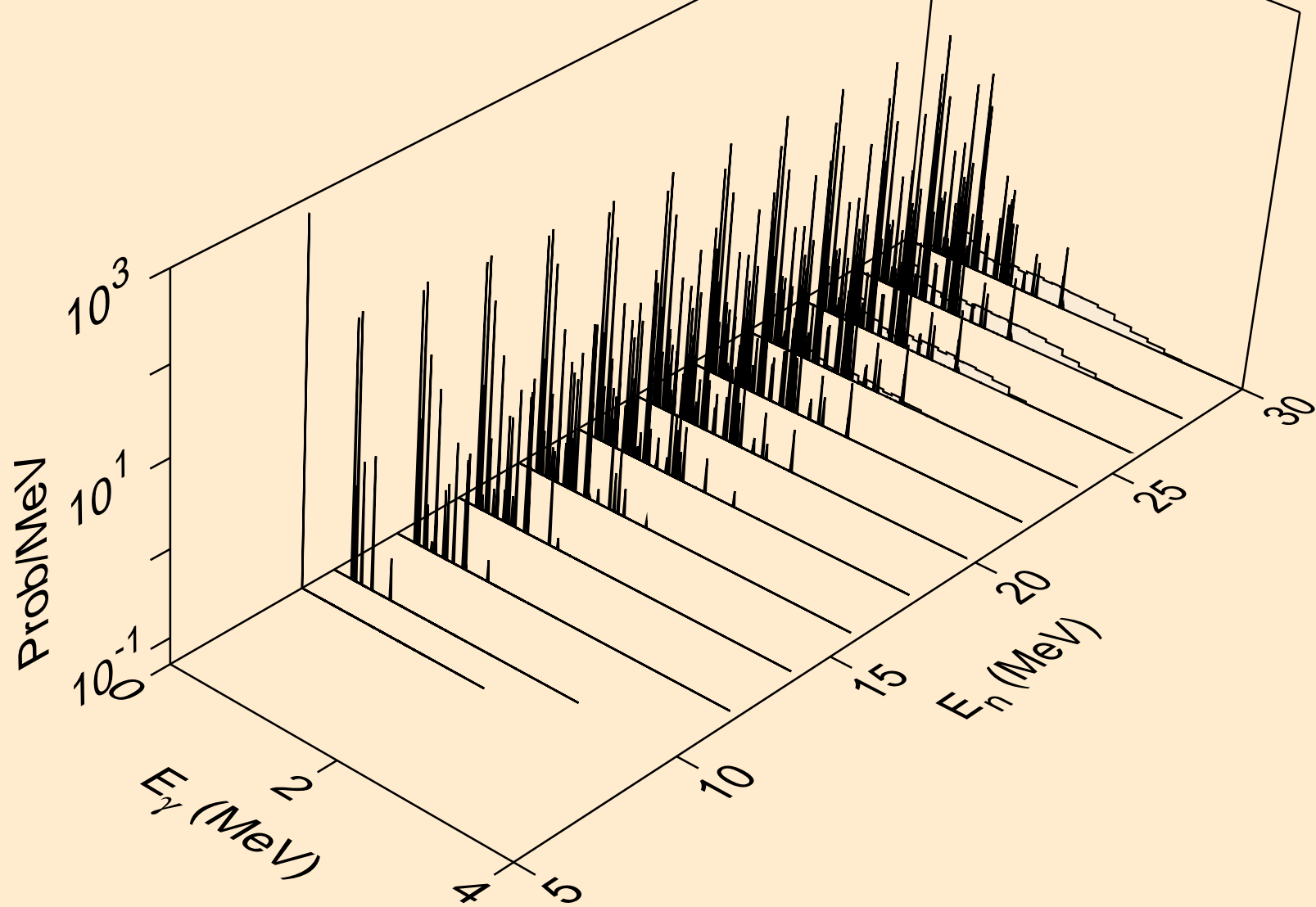

CD101 NEUTRON ACER TENDL-2024 LIBRARY; T=293.6K  
Photon emission for (n,pt)

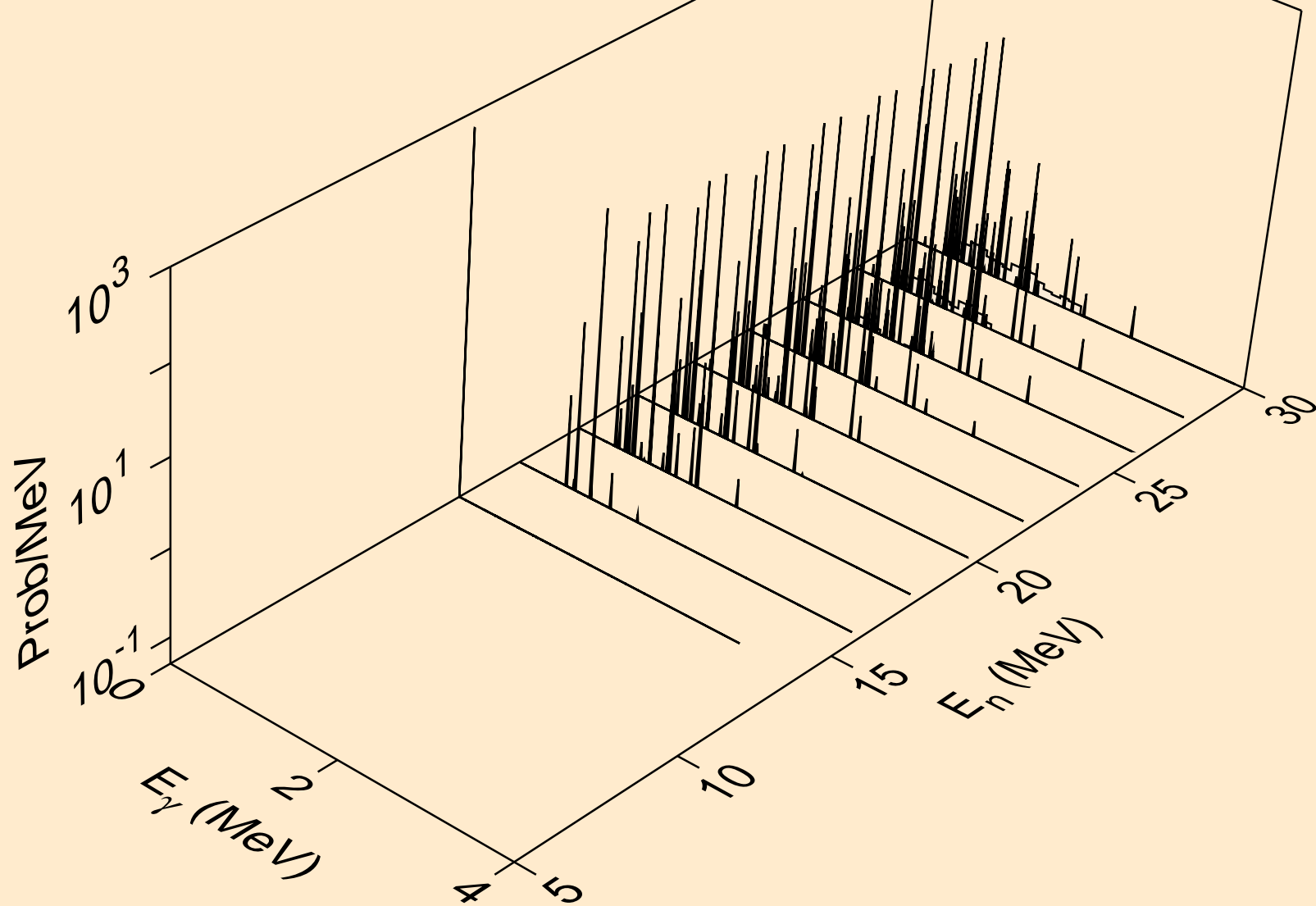

CD101 NEUTRON ACER TENDL-2024 LIBRARY; T=293.6K  
Photon emission for (n,da)

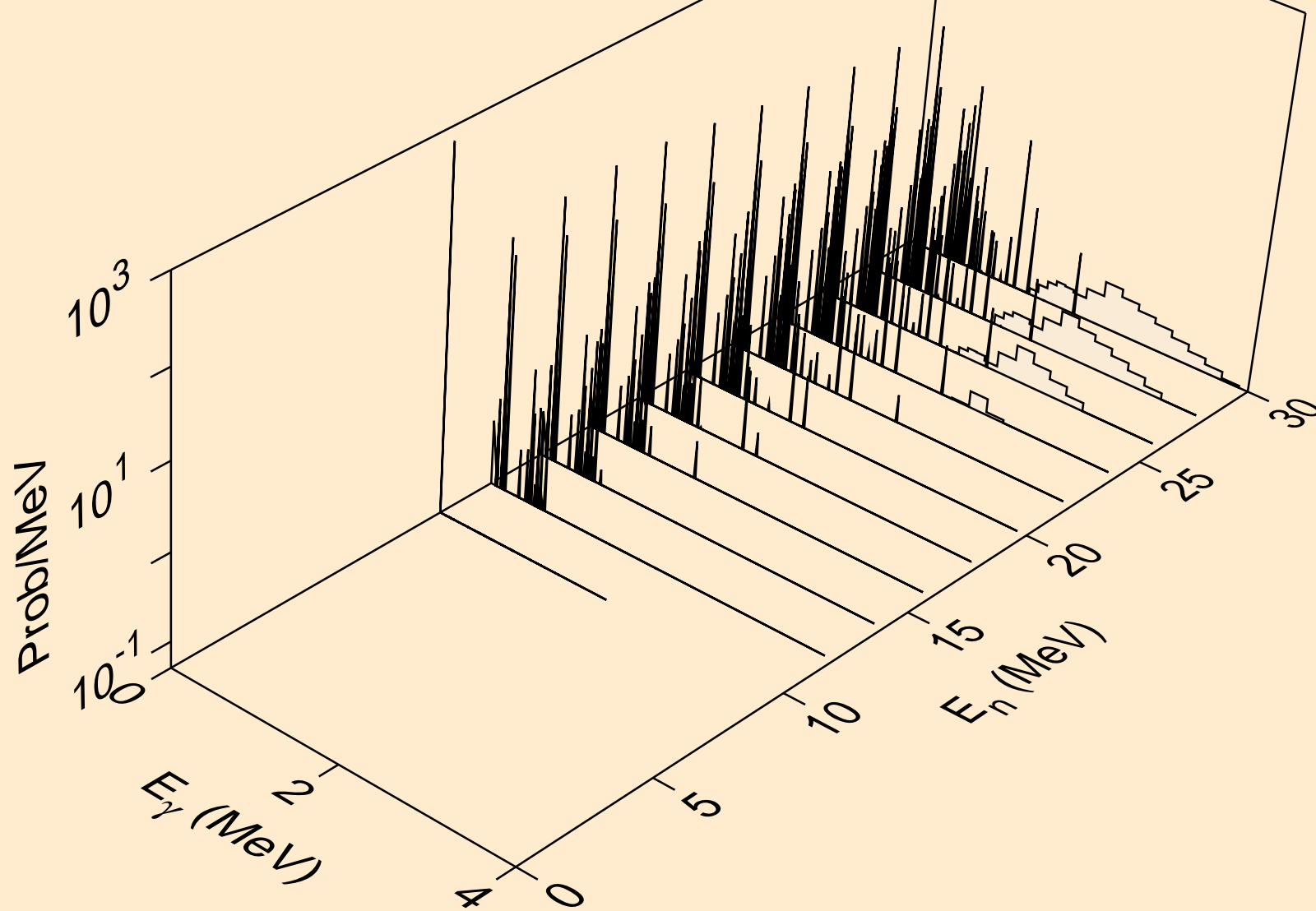

CD101 NEUTRON ACER TENDL-2024 LIBRARY; T=293.6K  
thermal capture photon spectrum

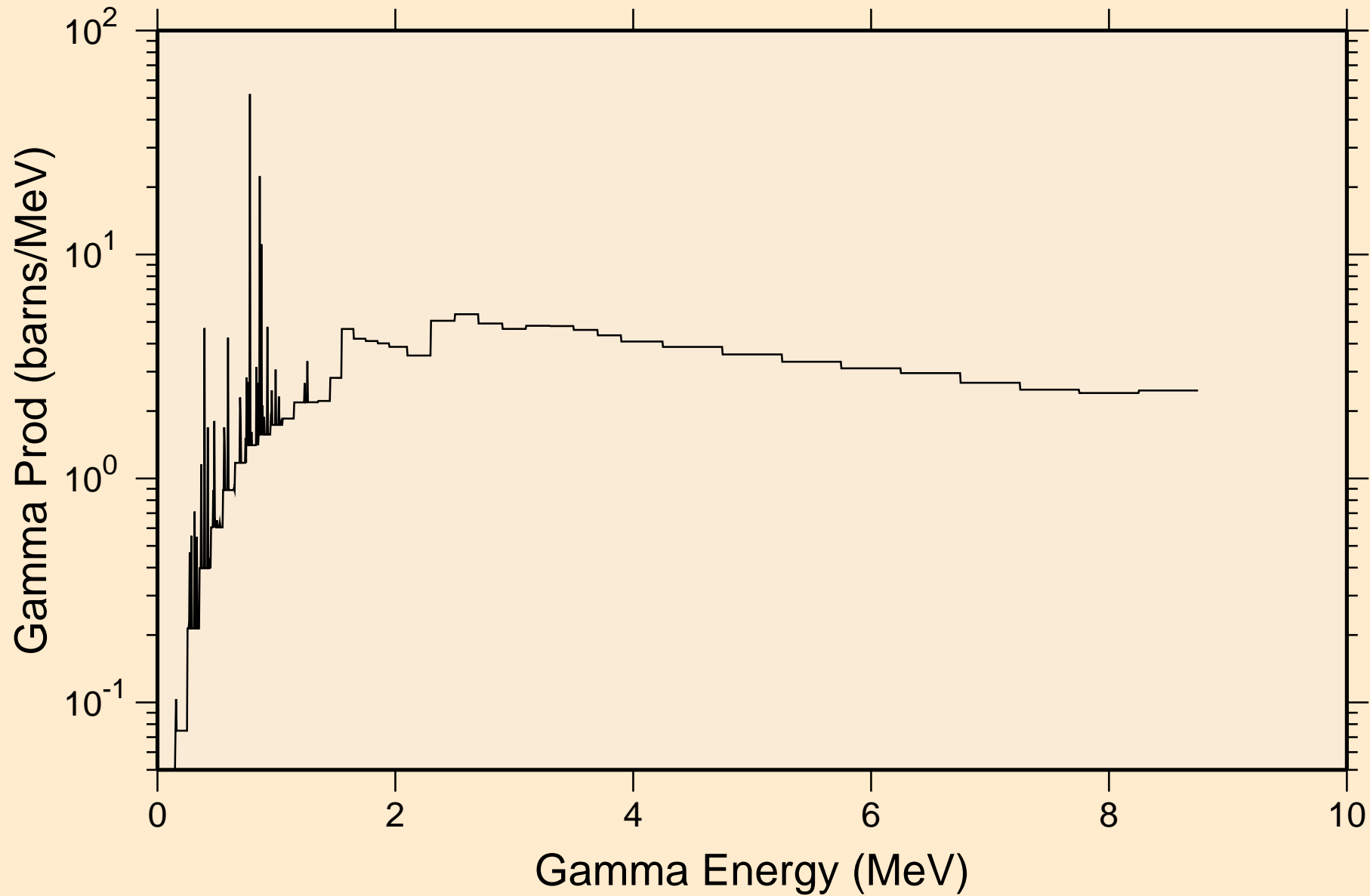

CD101 NEUTRON ACER TENDL-2024 LIBRARY; T=293.6K  
14 MeV photon spectrum

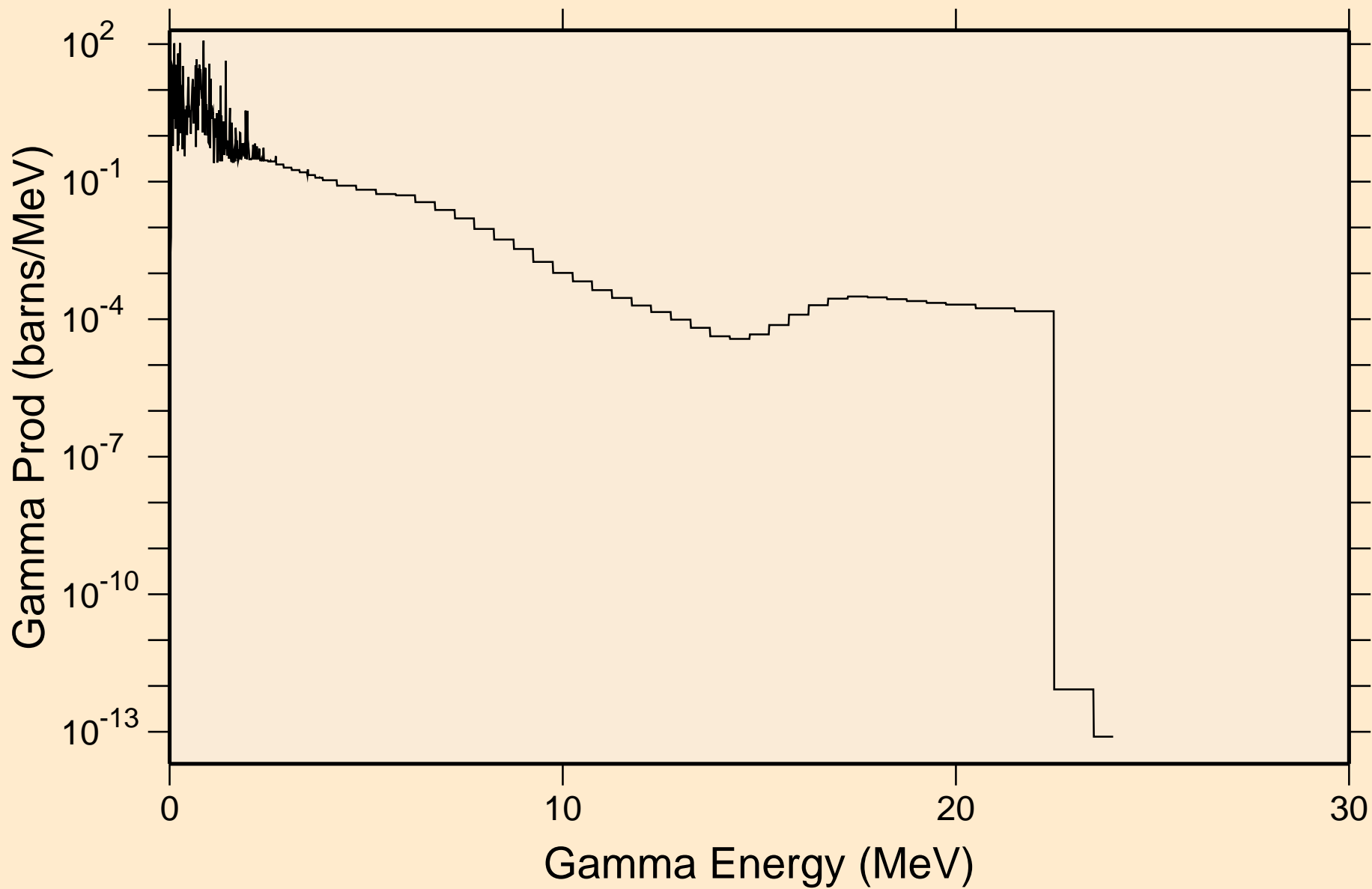

# CD101 NEUTRON ACER TENDL-2024 LIBRARY; T=293.6K

## Particle heating contributions

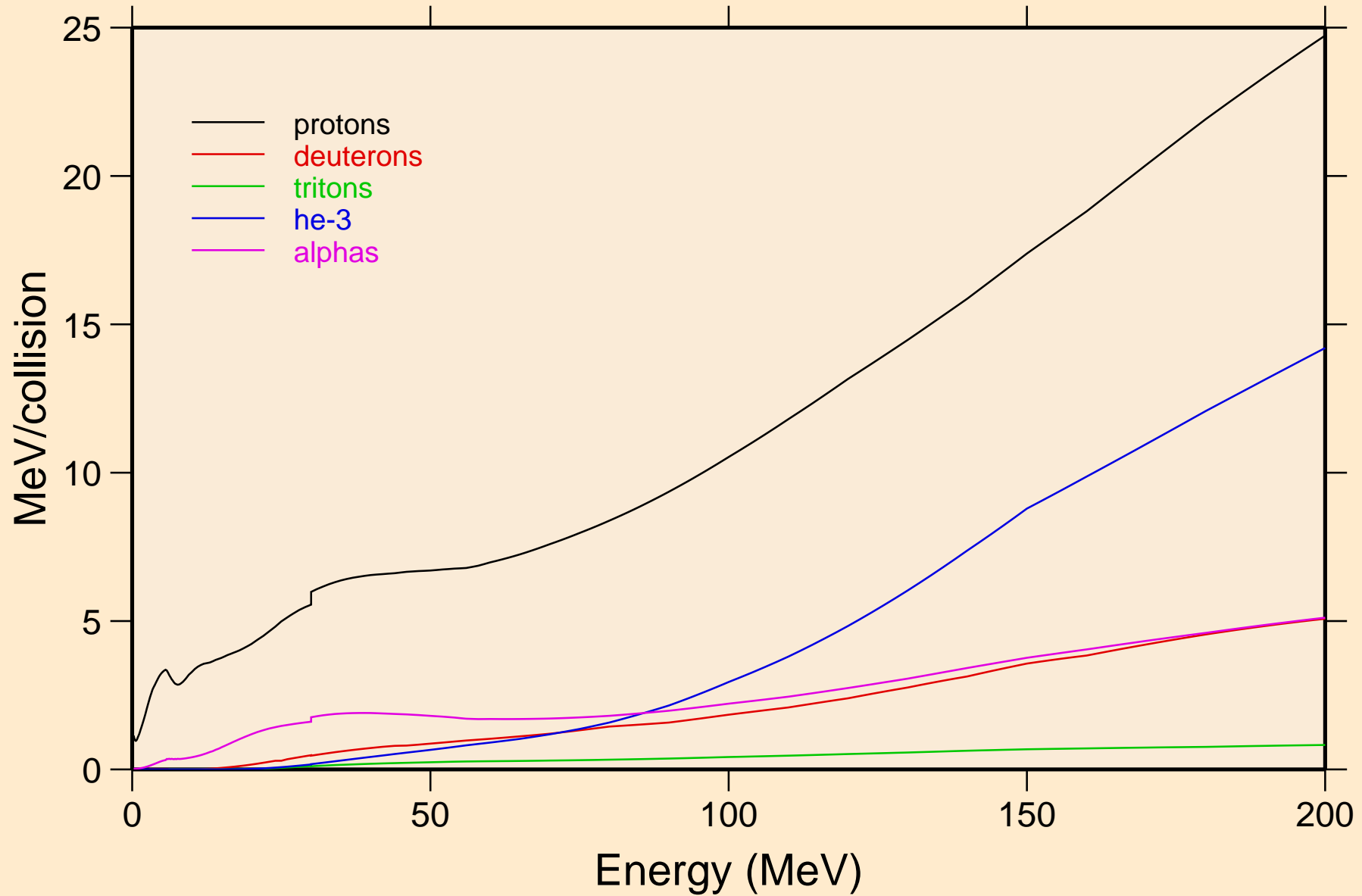

CD101 NEUTRON ACER TENDL-2024 LIBRARY; T=293.6K  
Recoil Heating

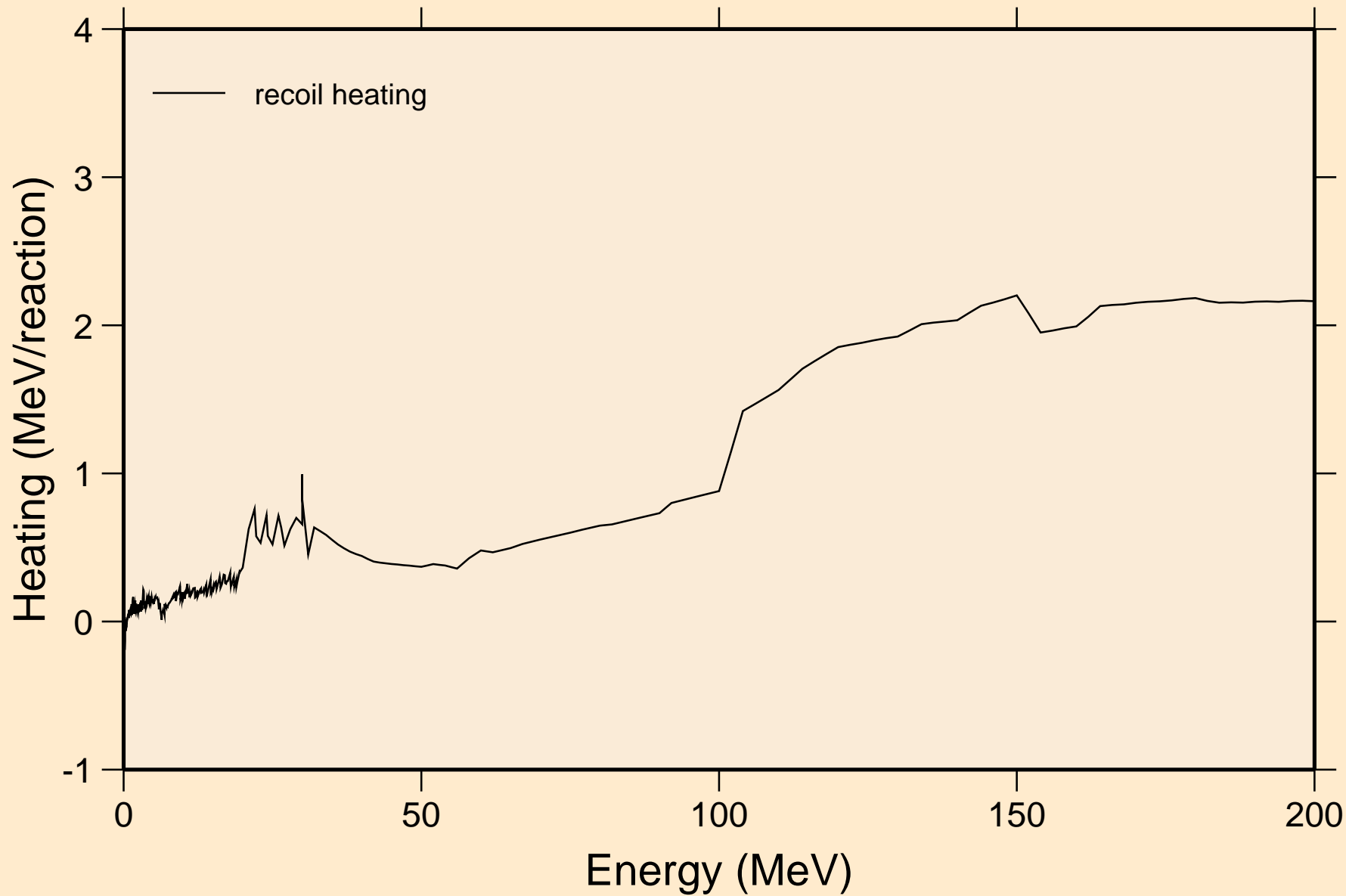

# CD101 NEUTRON ACER TENDL-2024 LIBRARY; T=293.6K

## Particle production cross sections

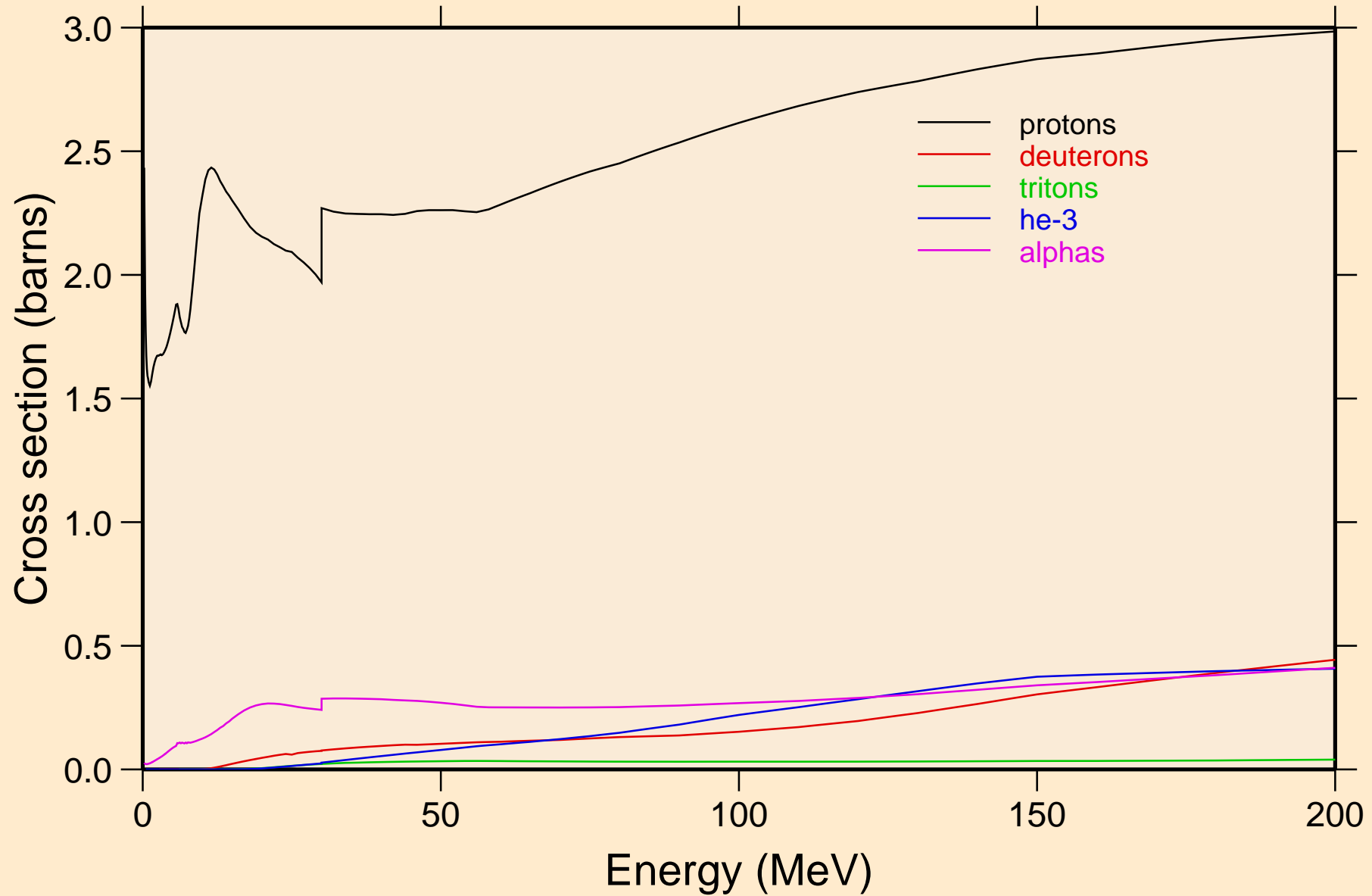

CD101 NEUTRON ACER TENDL-2024 LIBRARY; T=293.6K  
protons from (n,x)

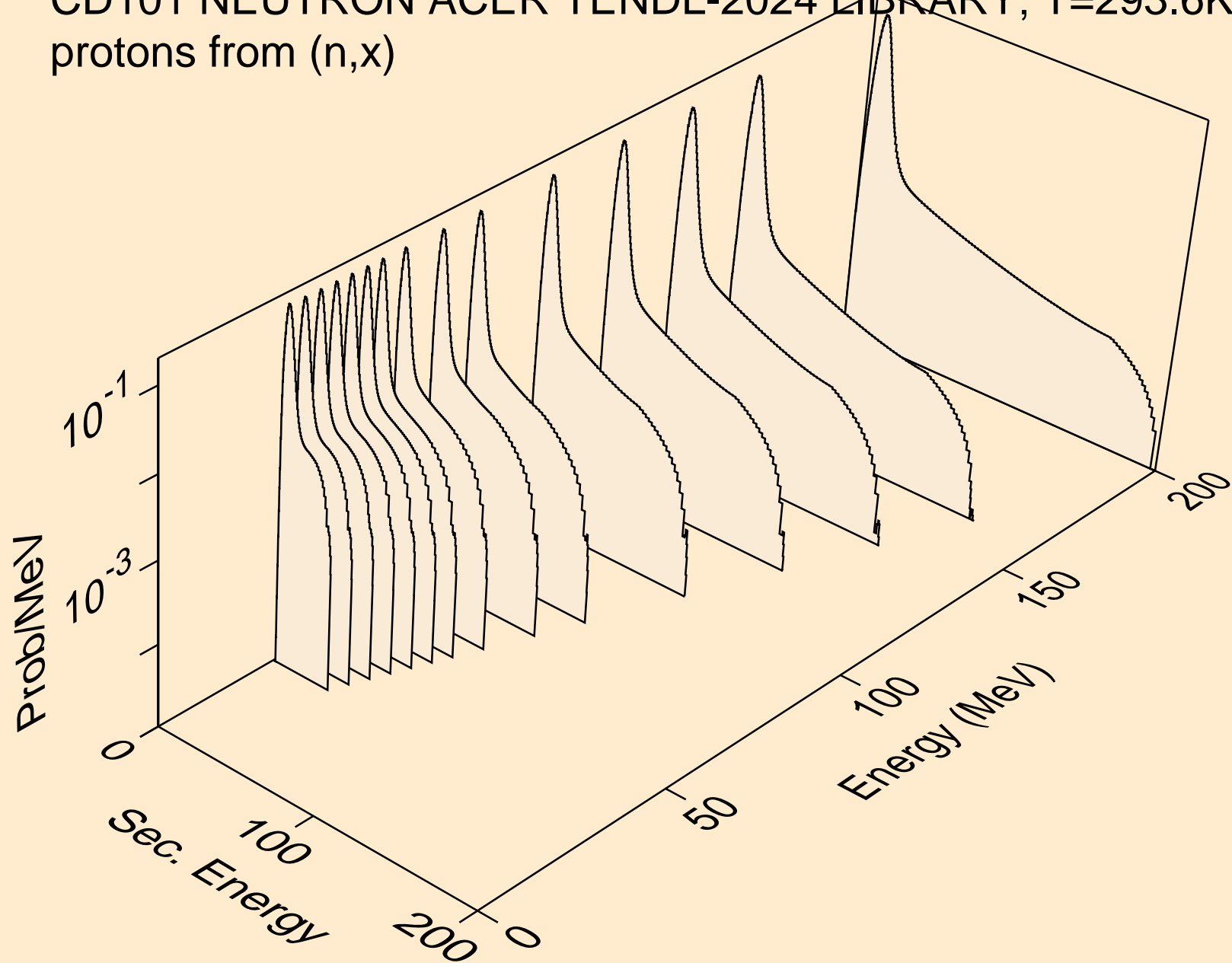

CD101 NEUTRON ACER TENDL-2024 LIBRARY; T=293.6K  
protons from (n,n\*)p

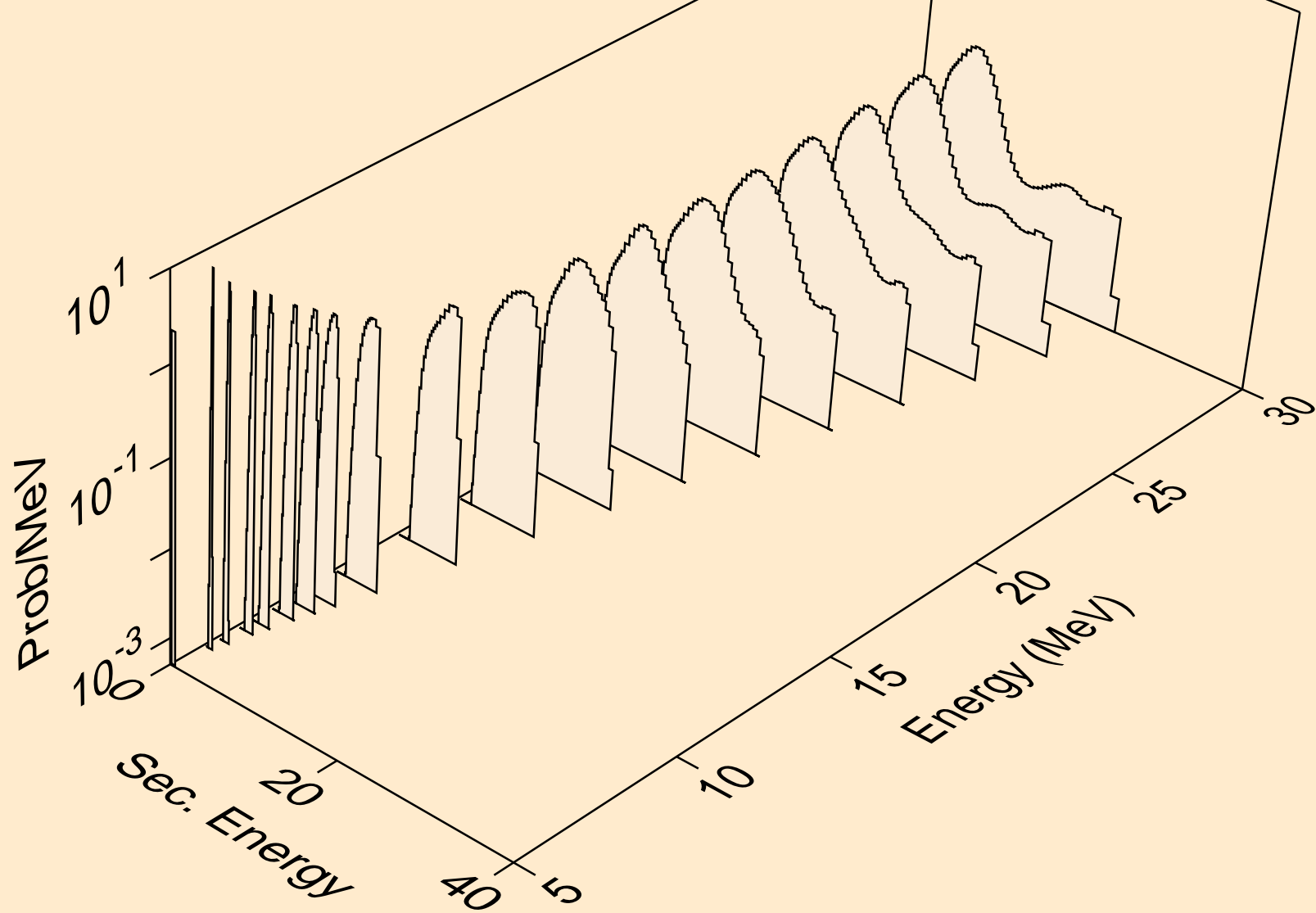

CD101 NEUTRON ACER TENDL-2024 LIBRARY; T=293.6K  
protons from (n,2np)

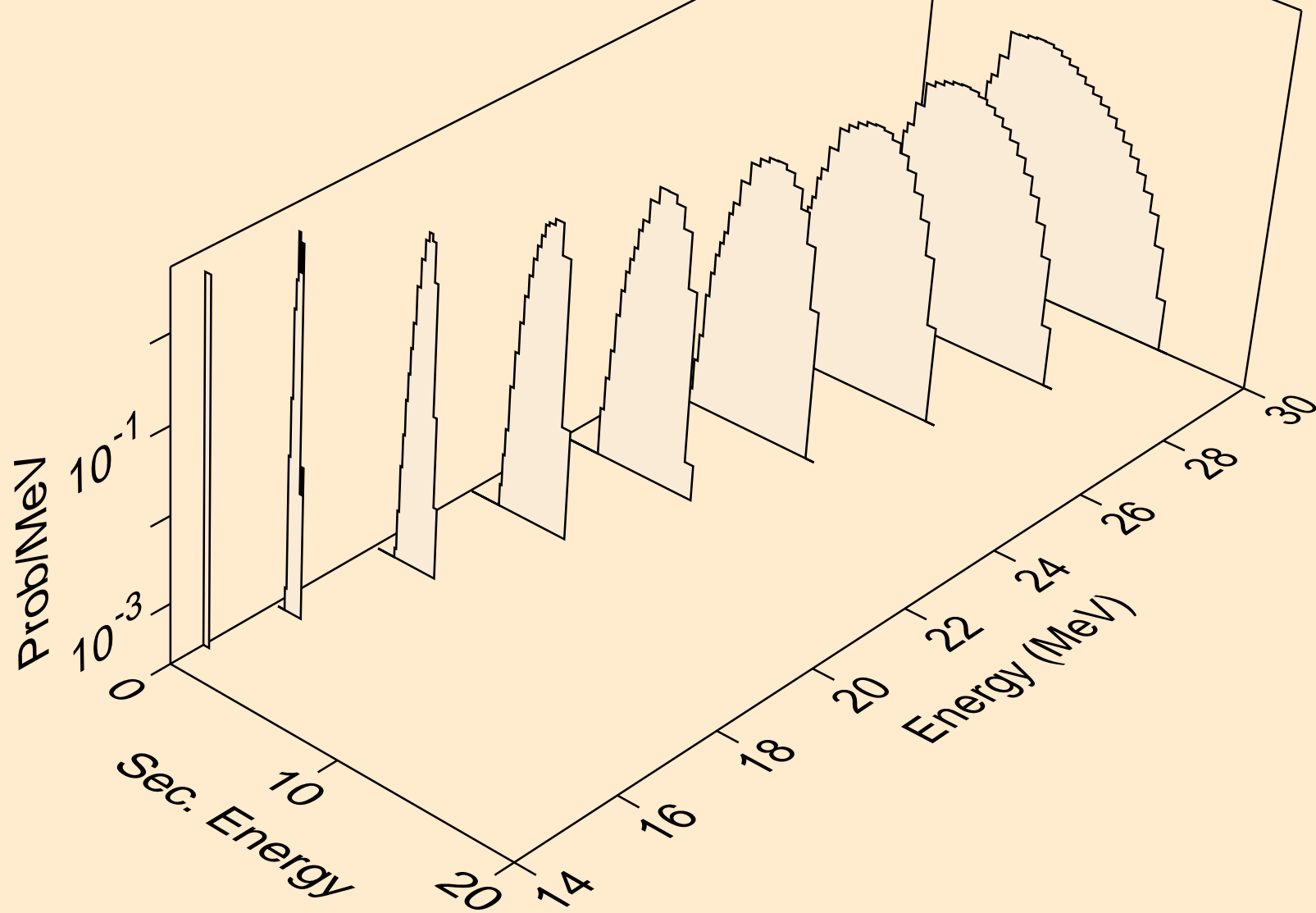

CD101 NEUTRON ACER TENDL-2024 LIBRARY; T=293.6K  
protons from (n,3np)

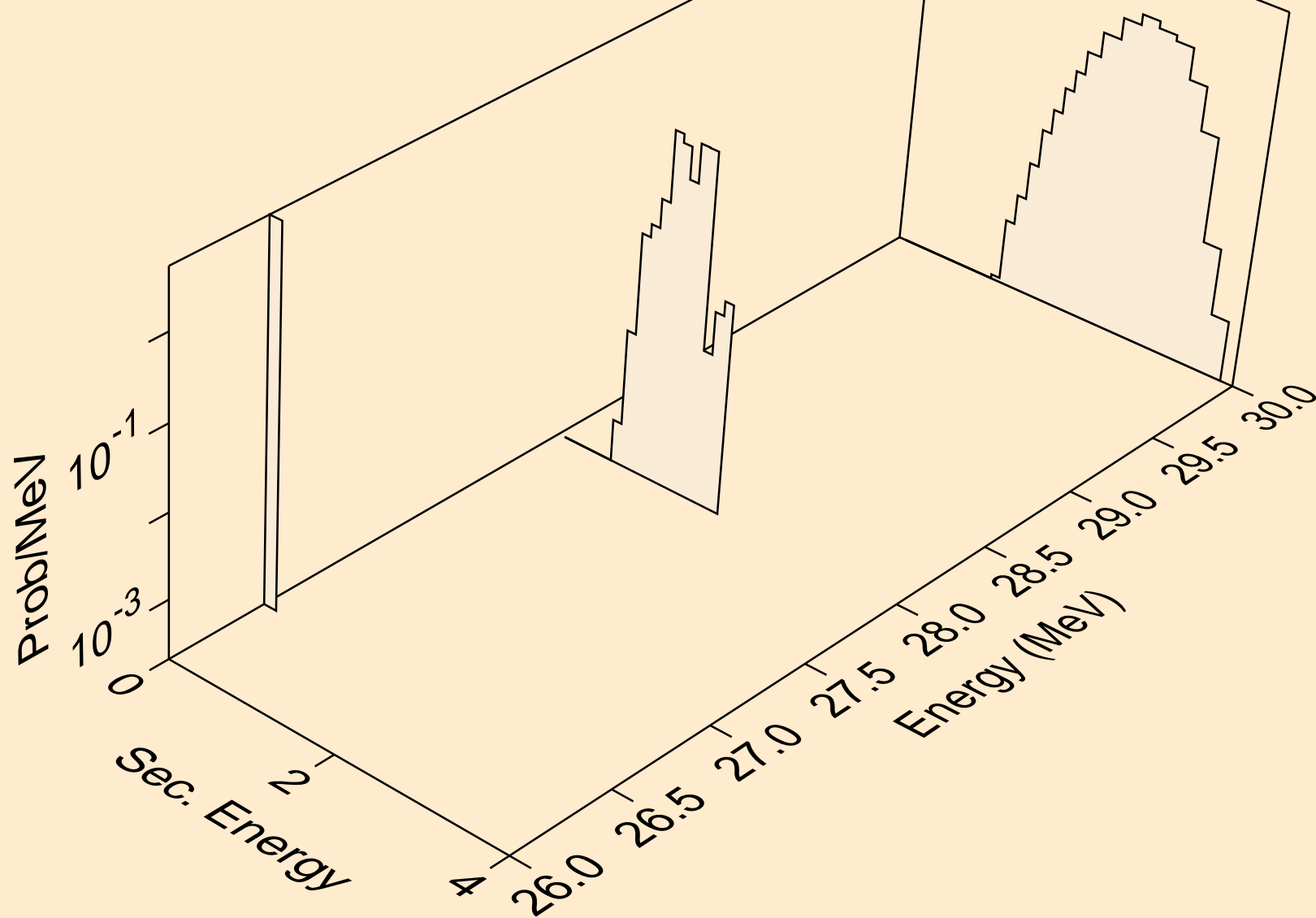

CD101 NEUTRON ACER TENDL-2024 LIBRARY; T=293.6K  
protons from (n,n2p)

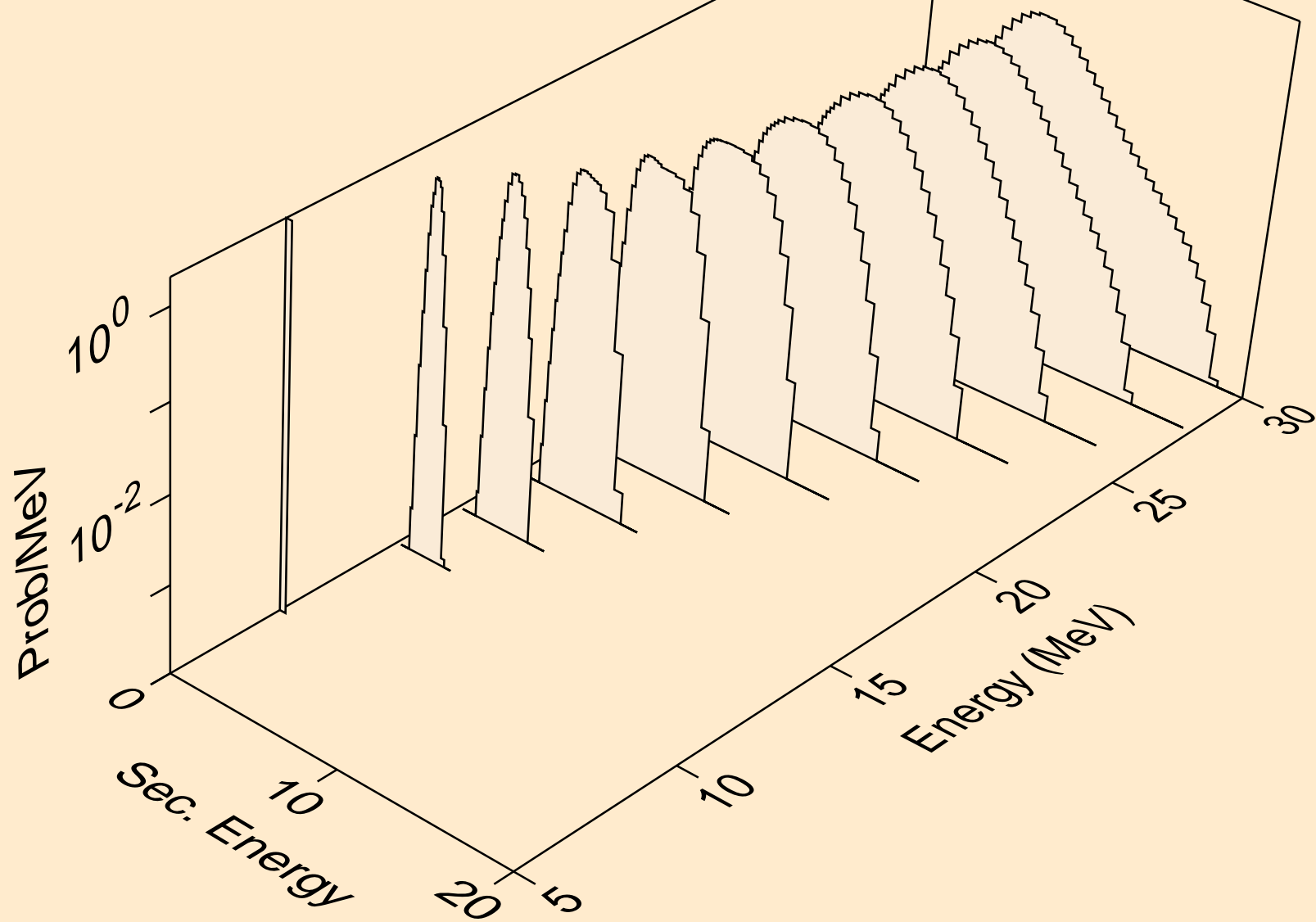

CD101 NEUTRON ACER TENDL-2024 LIBRARY; T=293.6K  
protons from (n,npa)

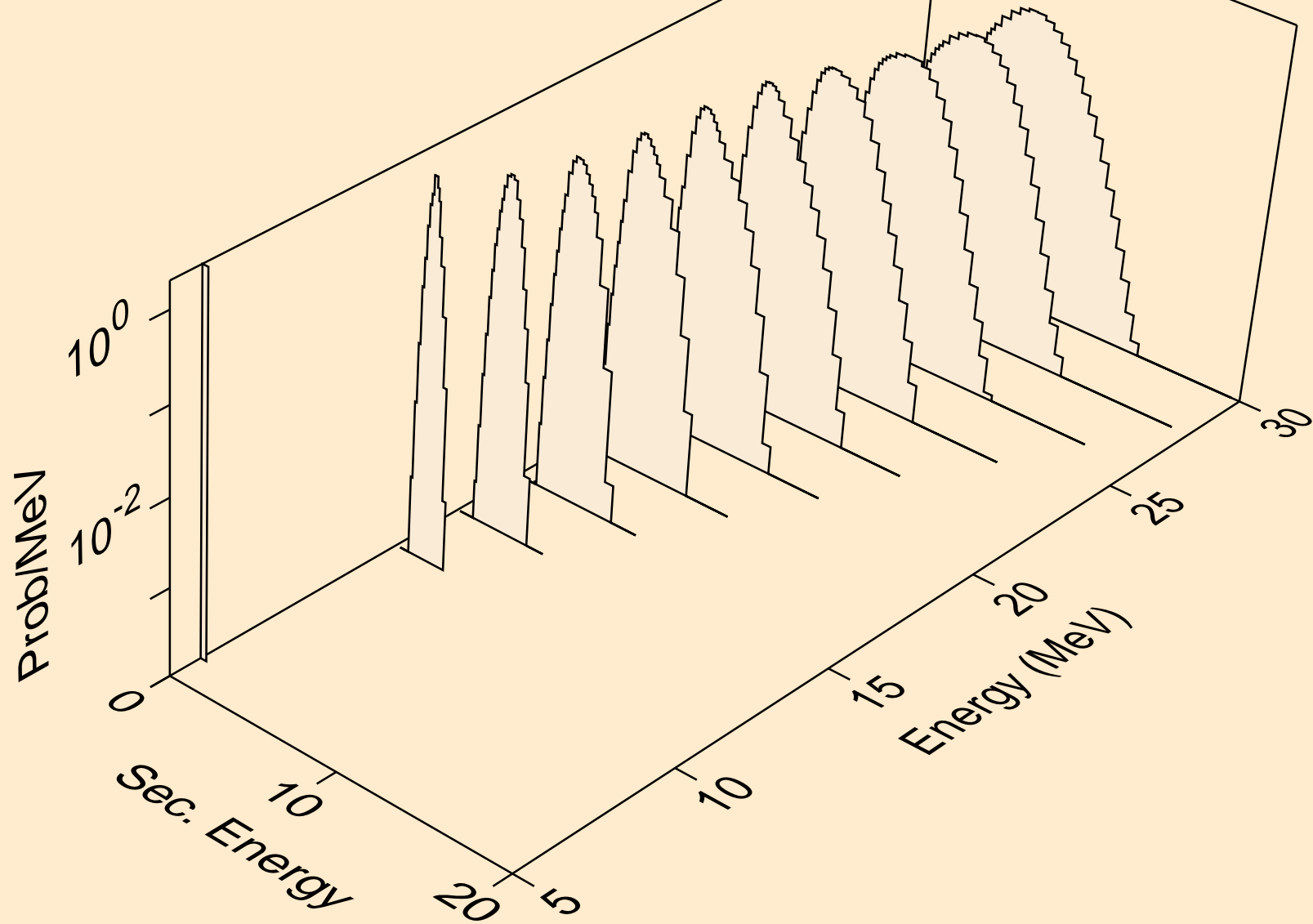

CD101 NEUTRON ACER TENDL-2024 LIBRARY; T=293.6K  
protons from (n,p)

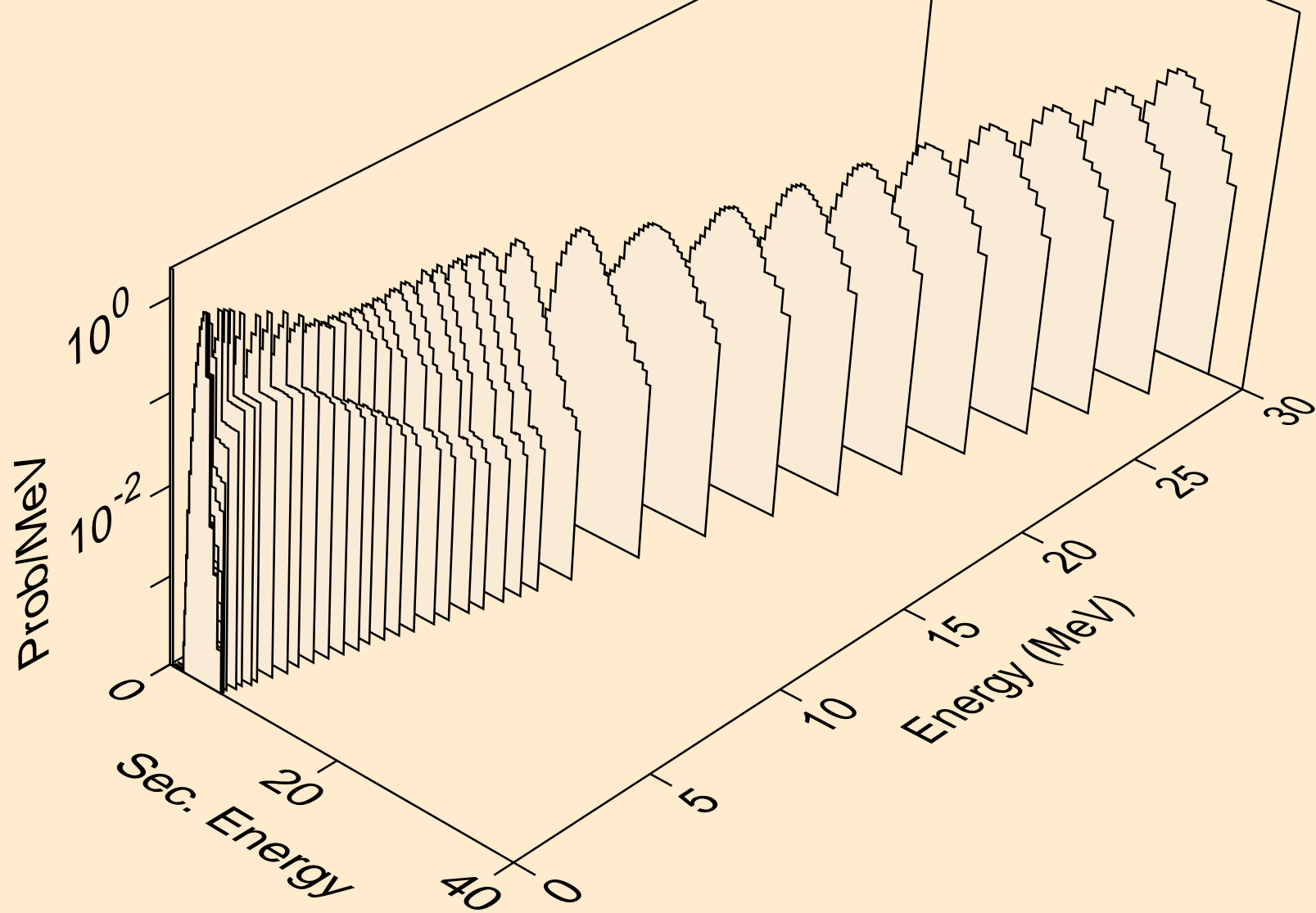

CD101 NEUTRON ACER TENDL-2024 LIBRARY; T=293.6K  
protons from (n,2p)

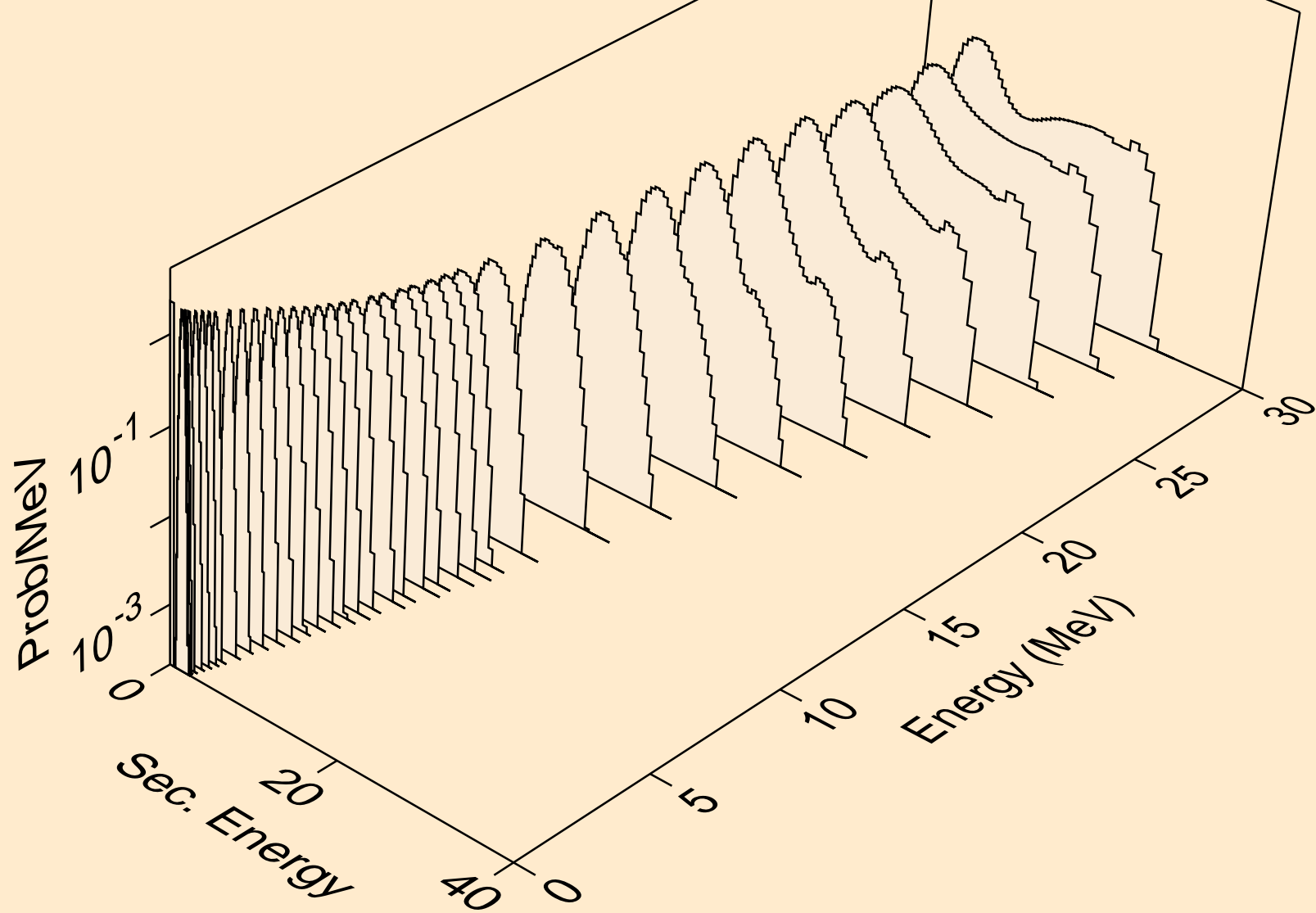

CD101 NEUTRON ACER TENDL-2024 LIBRARY; T=293.6K  
protons from (n,p)

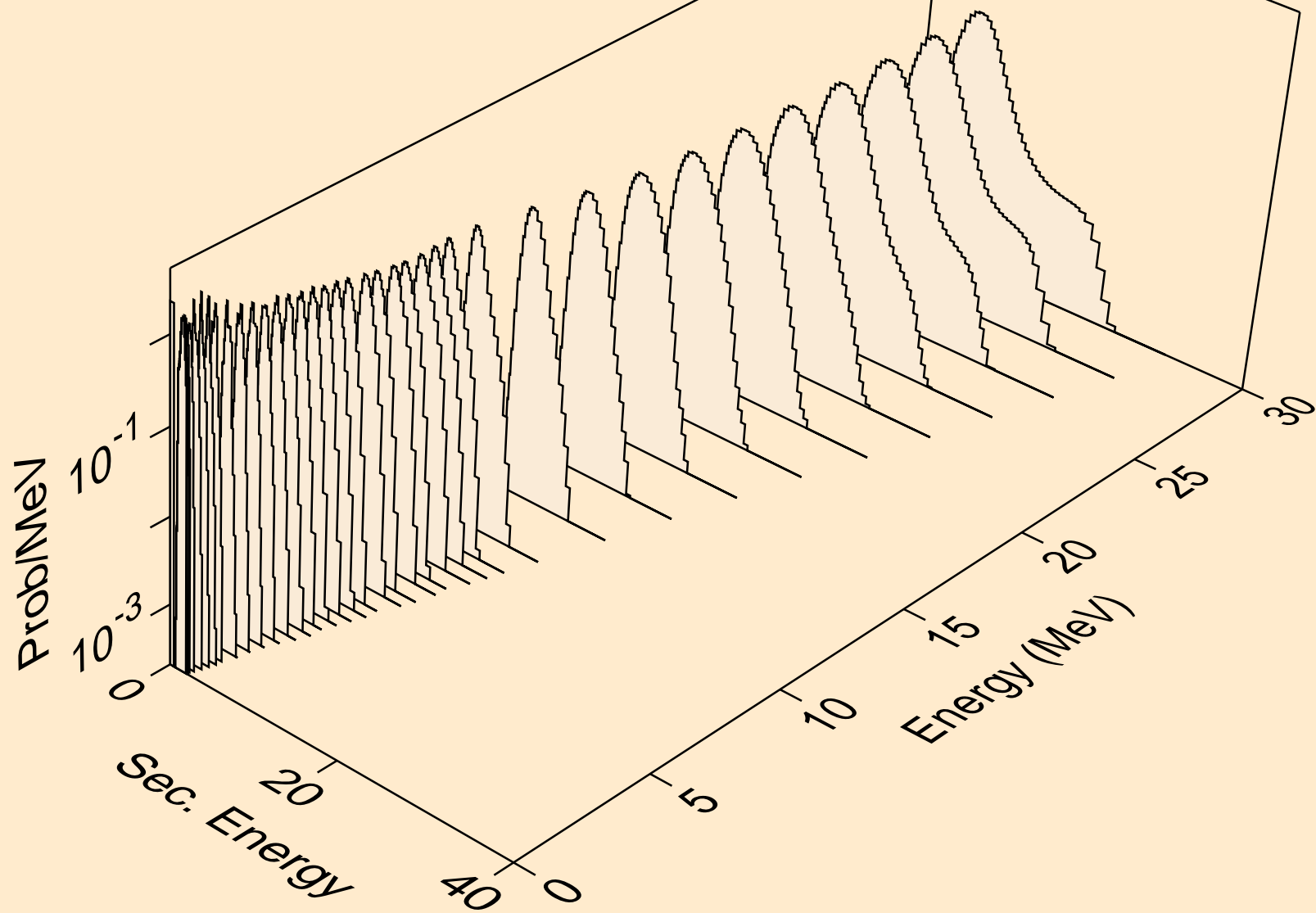

CD101 NEUTRON ACER TENDL-2024 LIBRARY; T=293.6K  
protons from (n,pd)

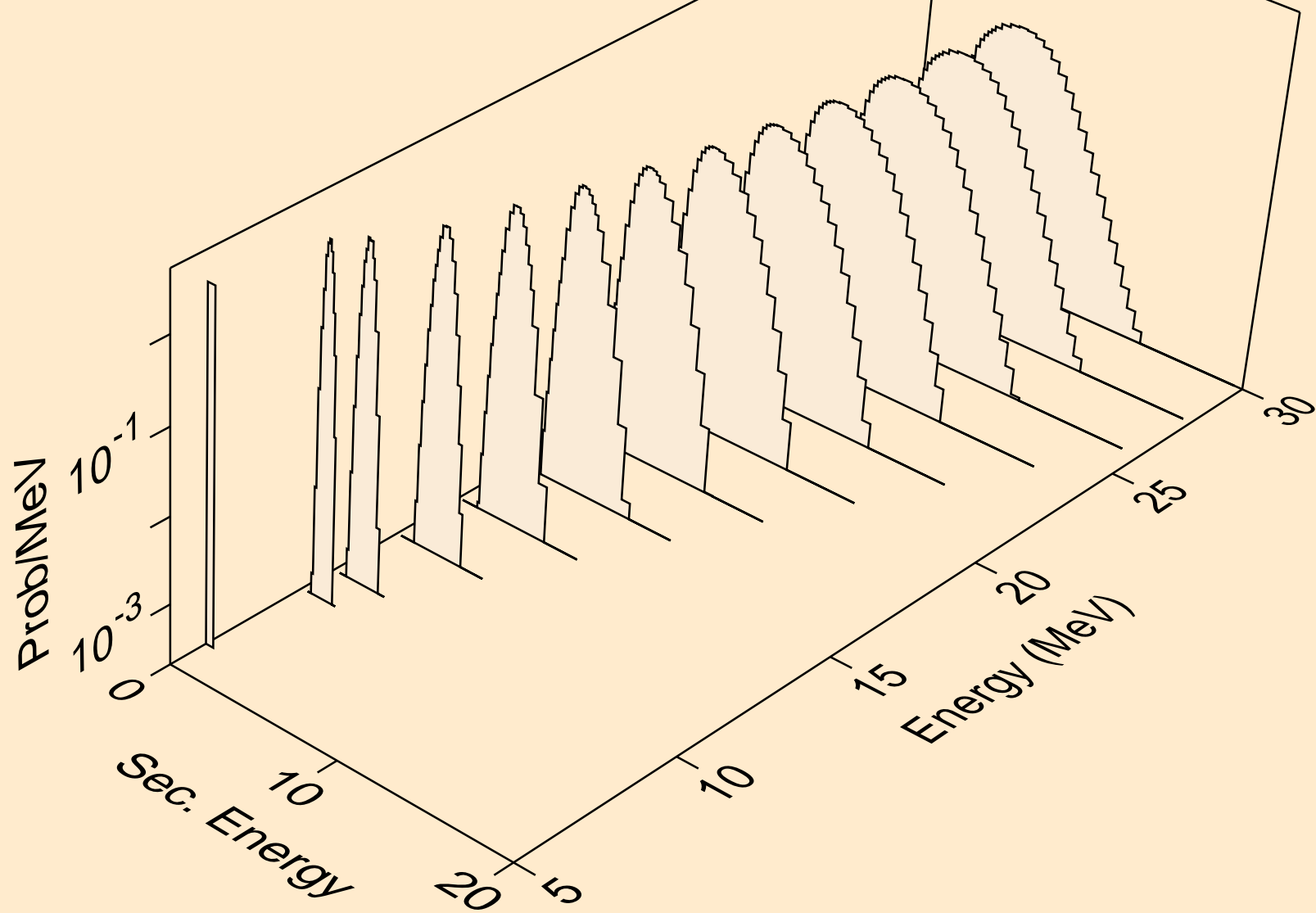

CD101 NEUTRON ACER TENDL-2024 LIBRARY; T=293.6K  
protons from (n,pt)

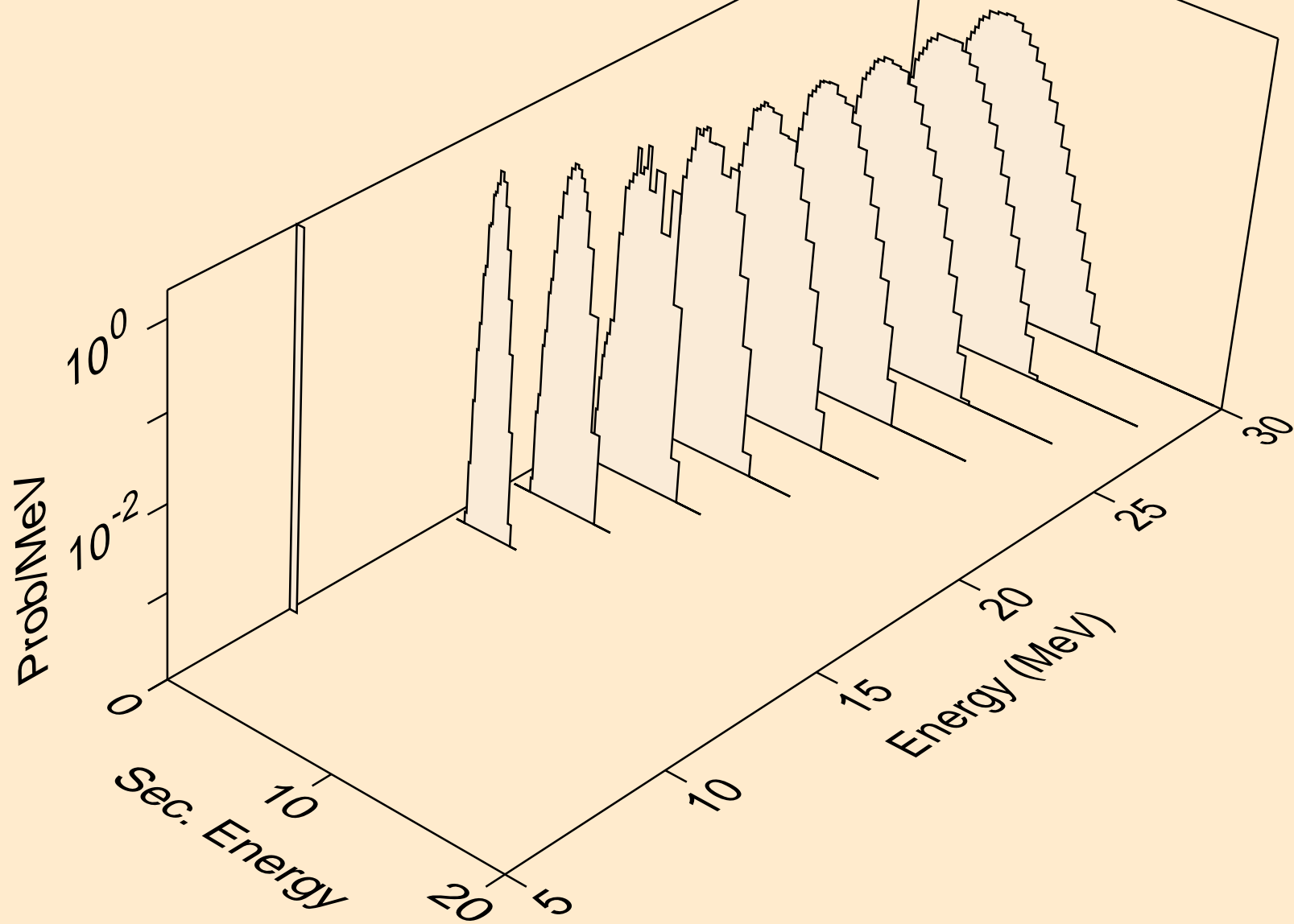

CD101 NEUTRON ACER TENDL-2024 LIBRARY; T=293.6K  
deuterons from (n,x)

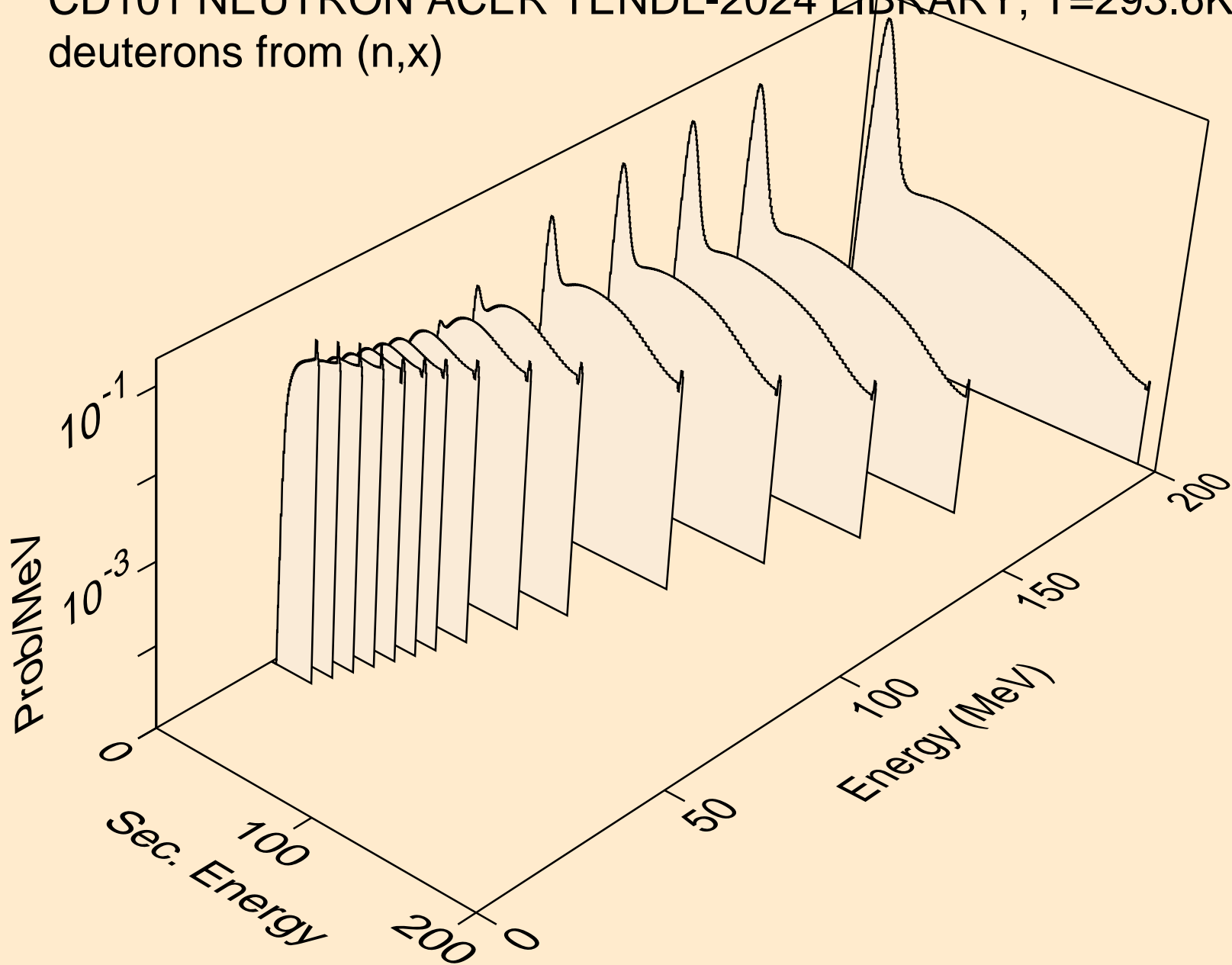

CD101 NEUTRON ACER TENDL-2024 LIBRARY; T=293.6K  
deuterons from (n,2nd)

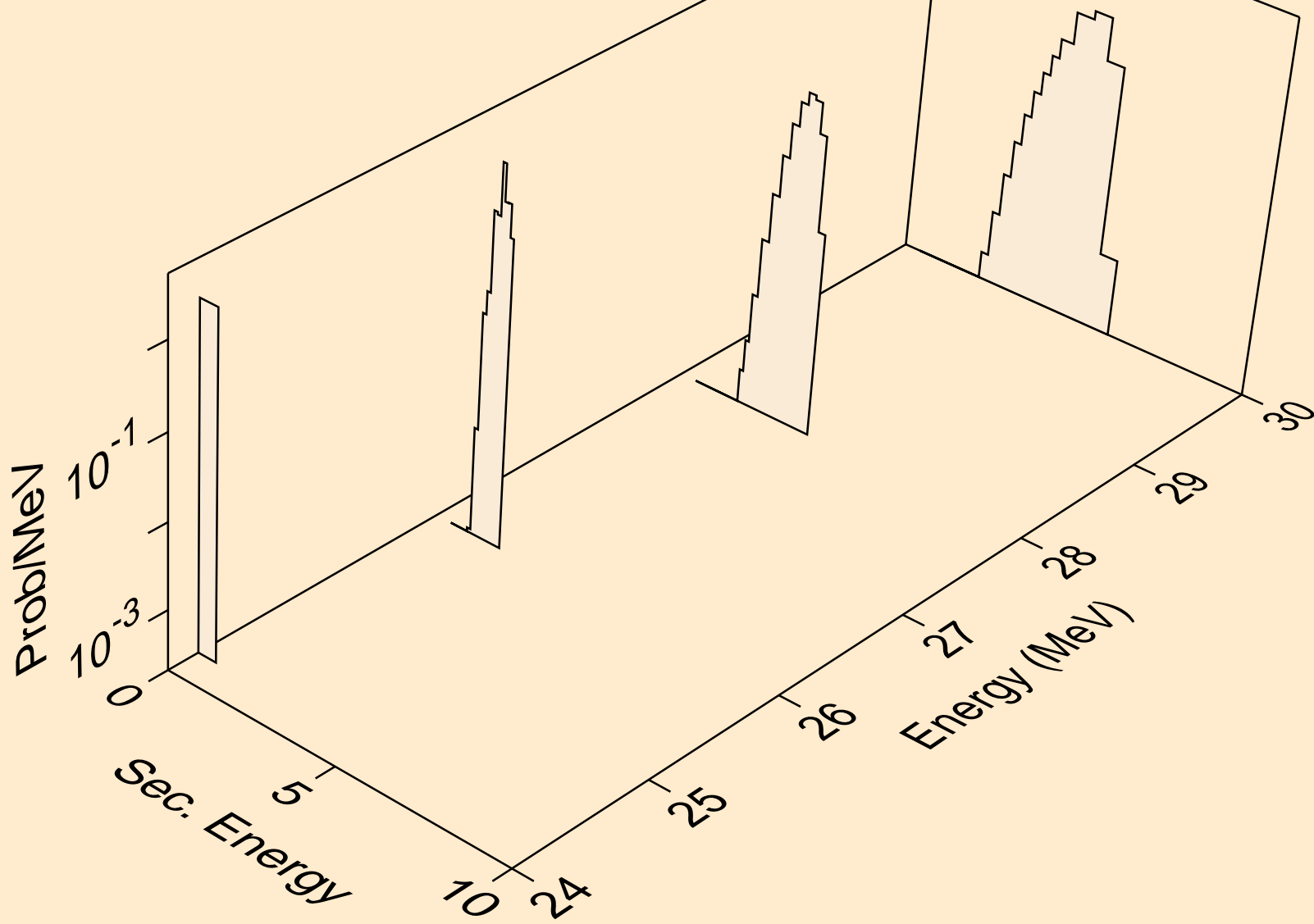

CD101 NEUTRON ACER TENDL-2024 LIBRARY; T=293.6K  
deuterons from (n,n\*)d

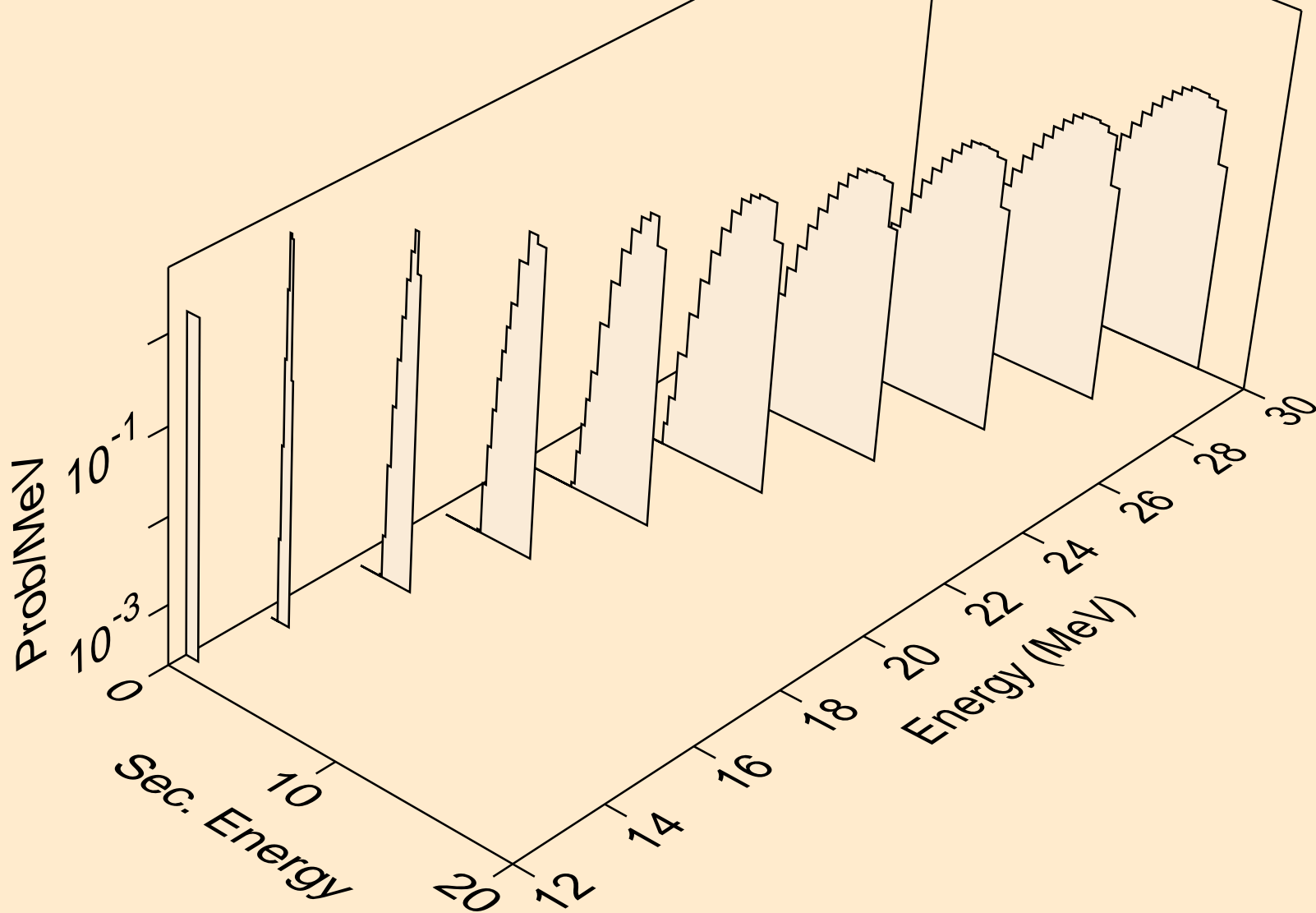

CD101 NEUTRON ACER TENDL-2024 LIBRARY; T=293.6K  
deuterons from (n,d)

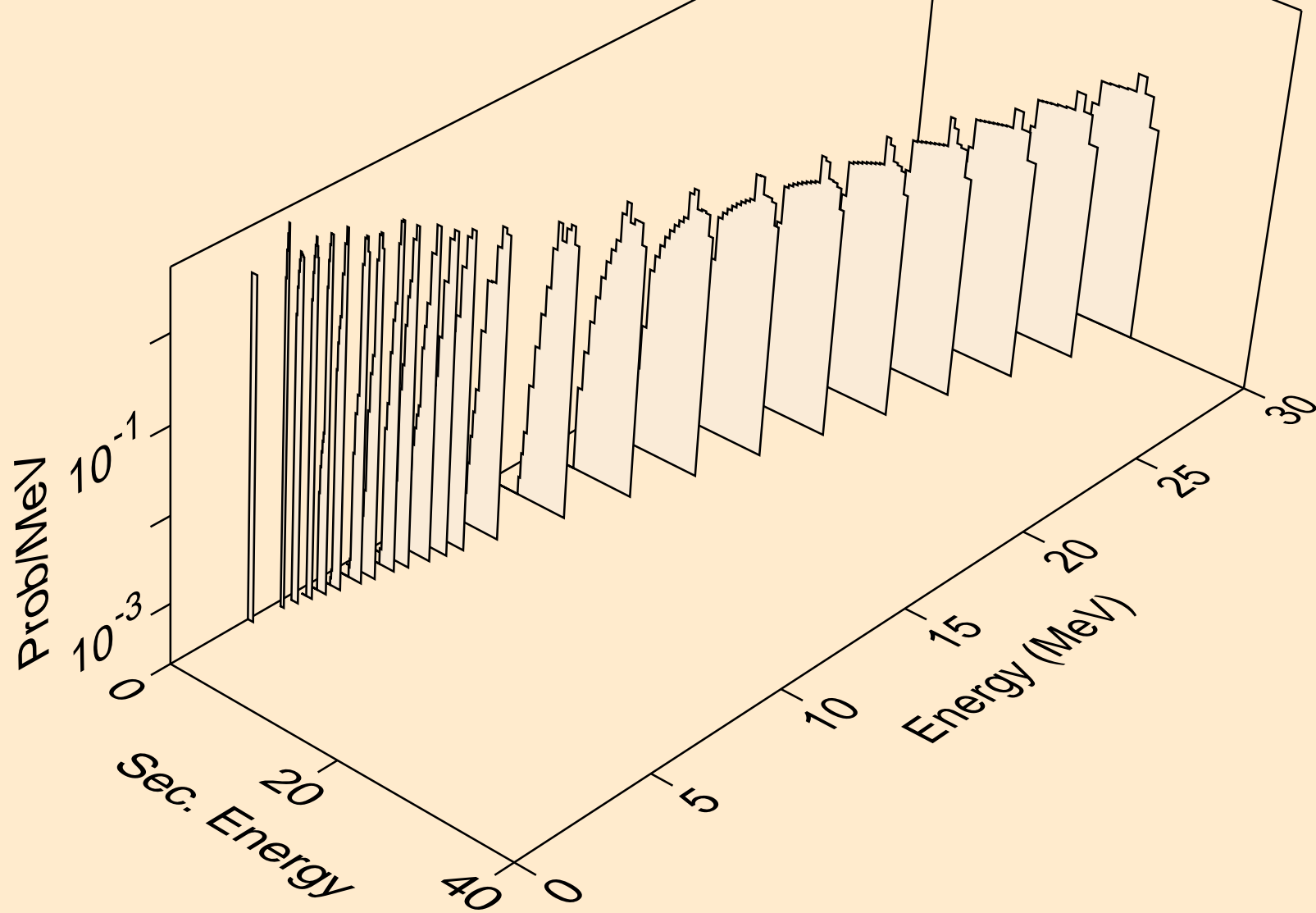

CD101 NEUTRON ACER TENDL-2024 LIBRARY; T=293.6K  
deuterons from (n,pd)

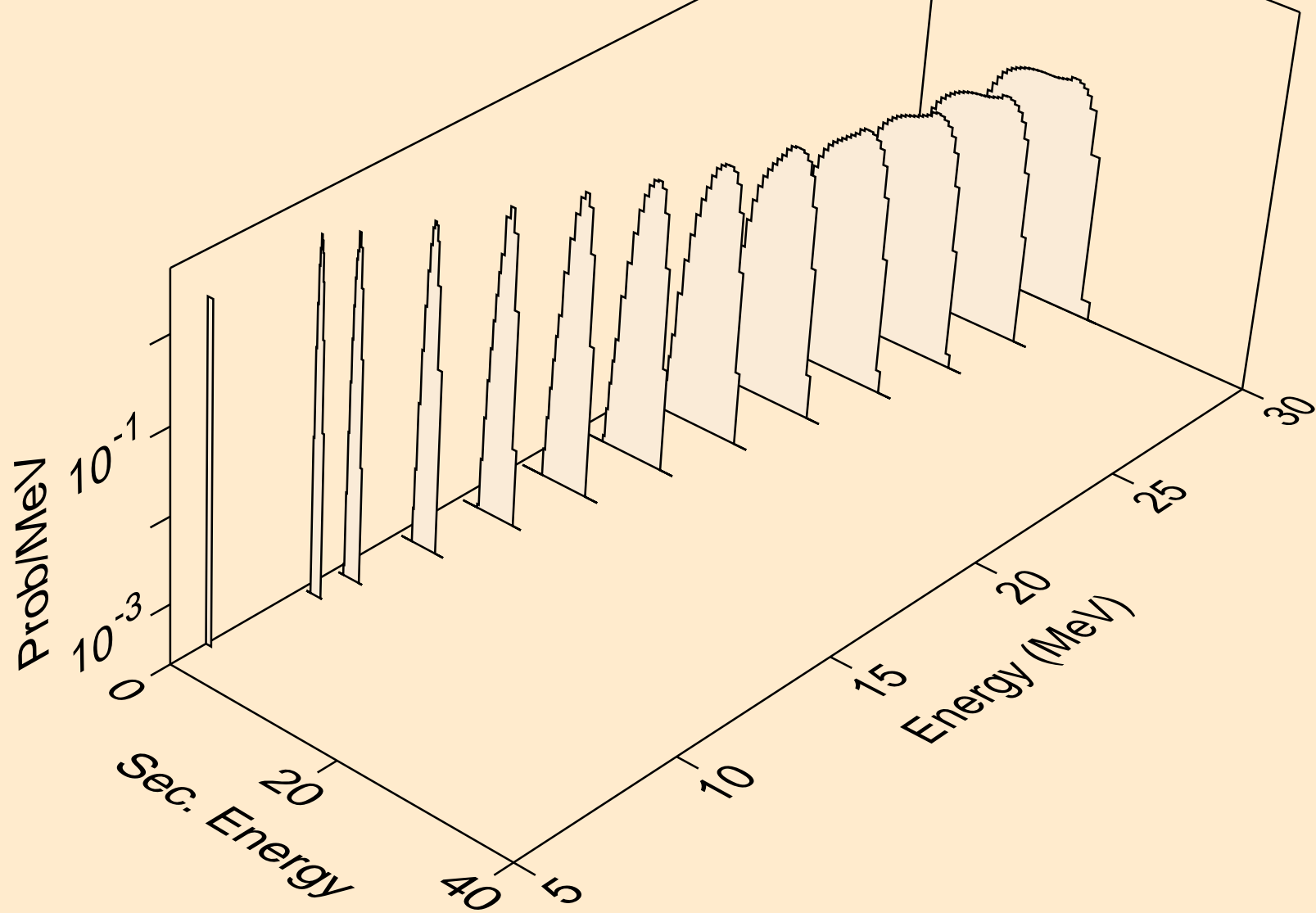

CD101 NEUTRON ACER TENDL-2024 LIBRARY; T=293.6K  
deuterons from (n,da)

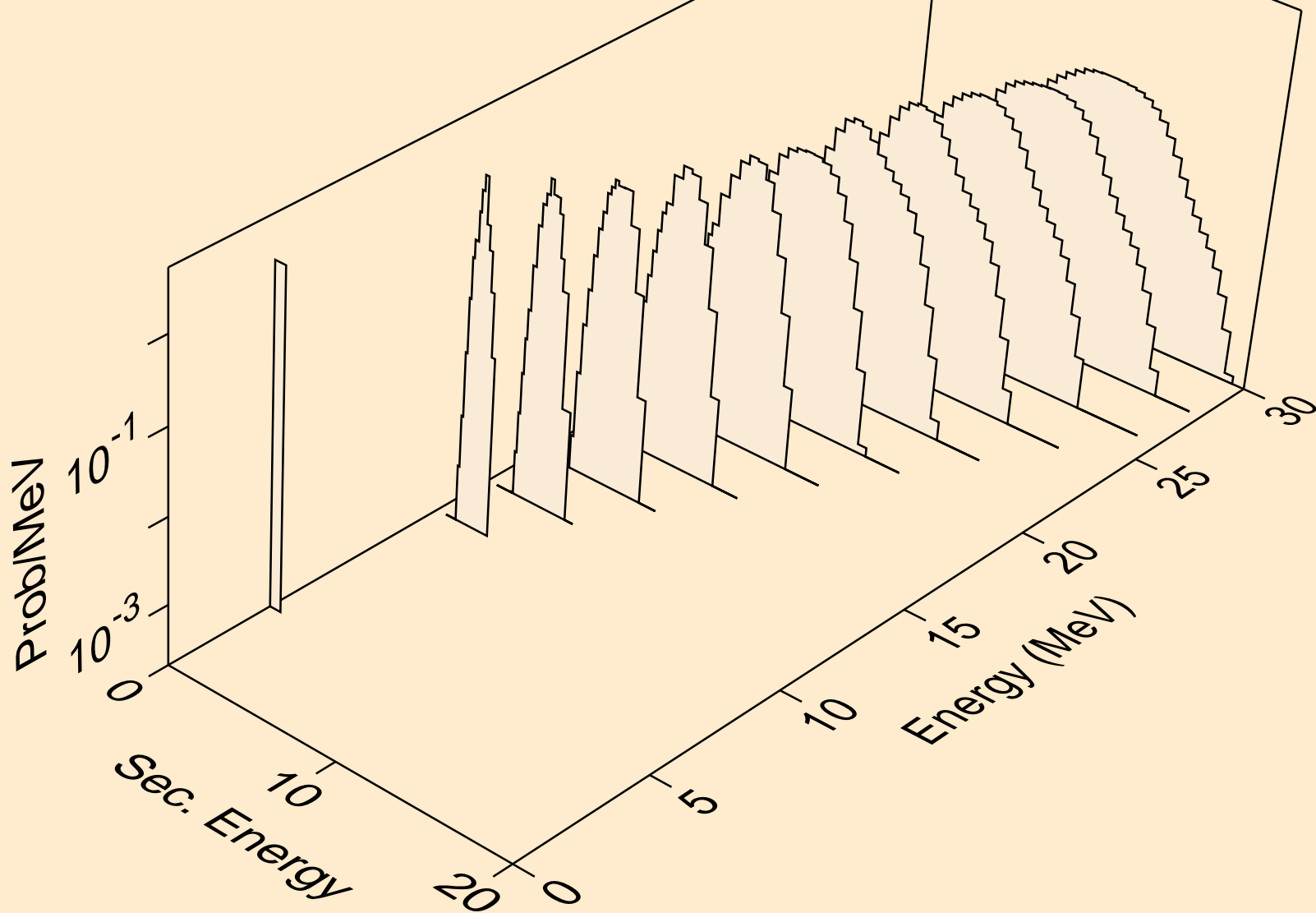

CD101 NEUTRON ACER TENDL-2024 LIBRARY; T=293.6K  
tritons from (n,x)

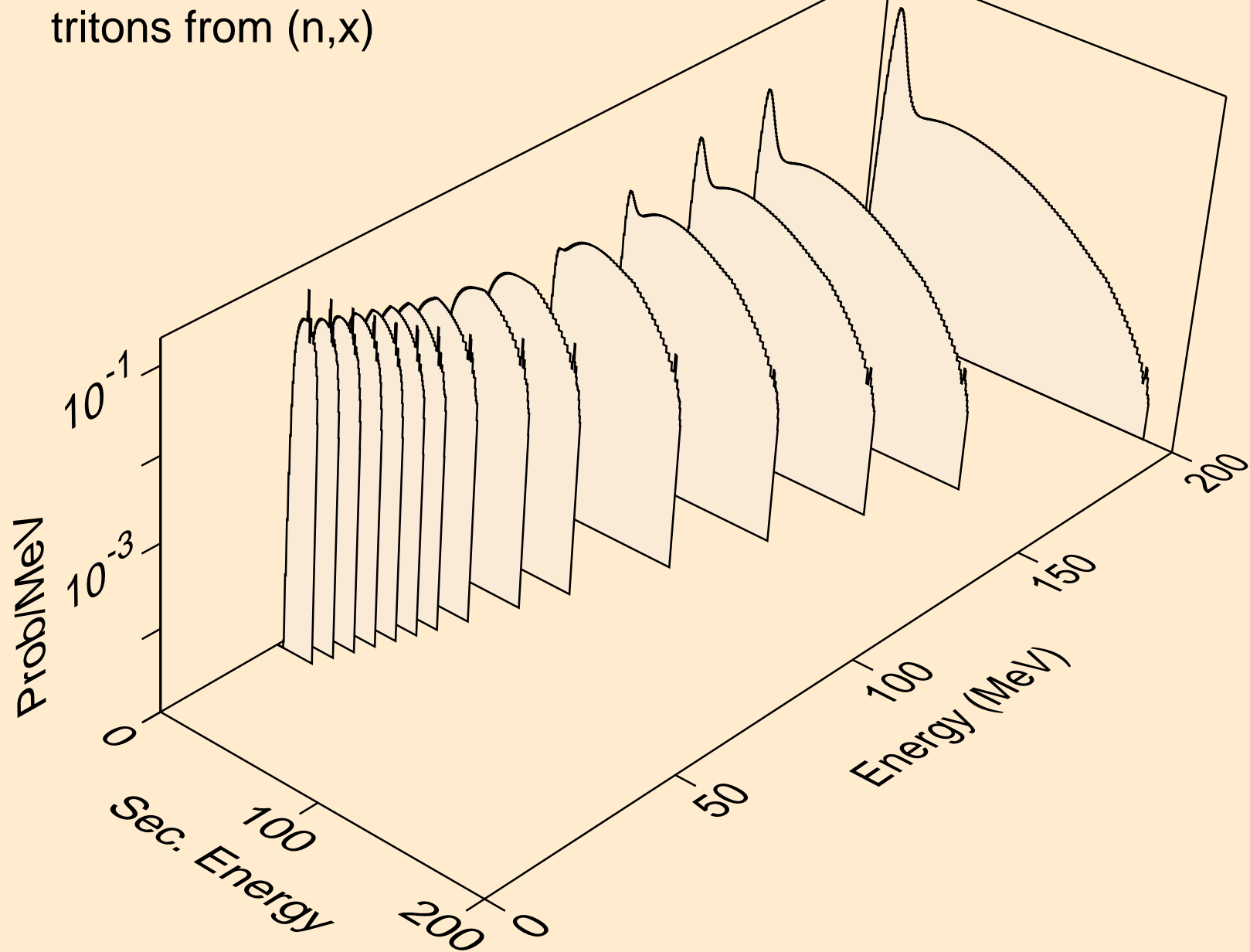

CD101 NEUTRON ACER TENDL-2024 LIBRARY; T=293.6K  
tritons from (n,n\*)t

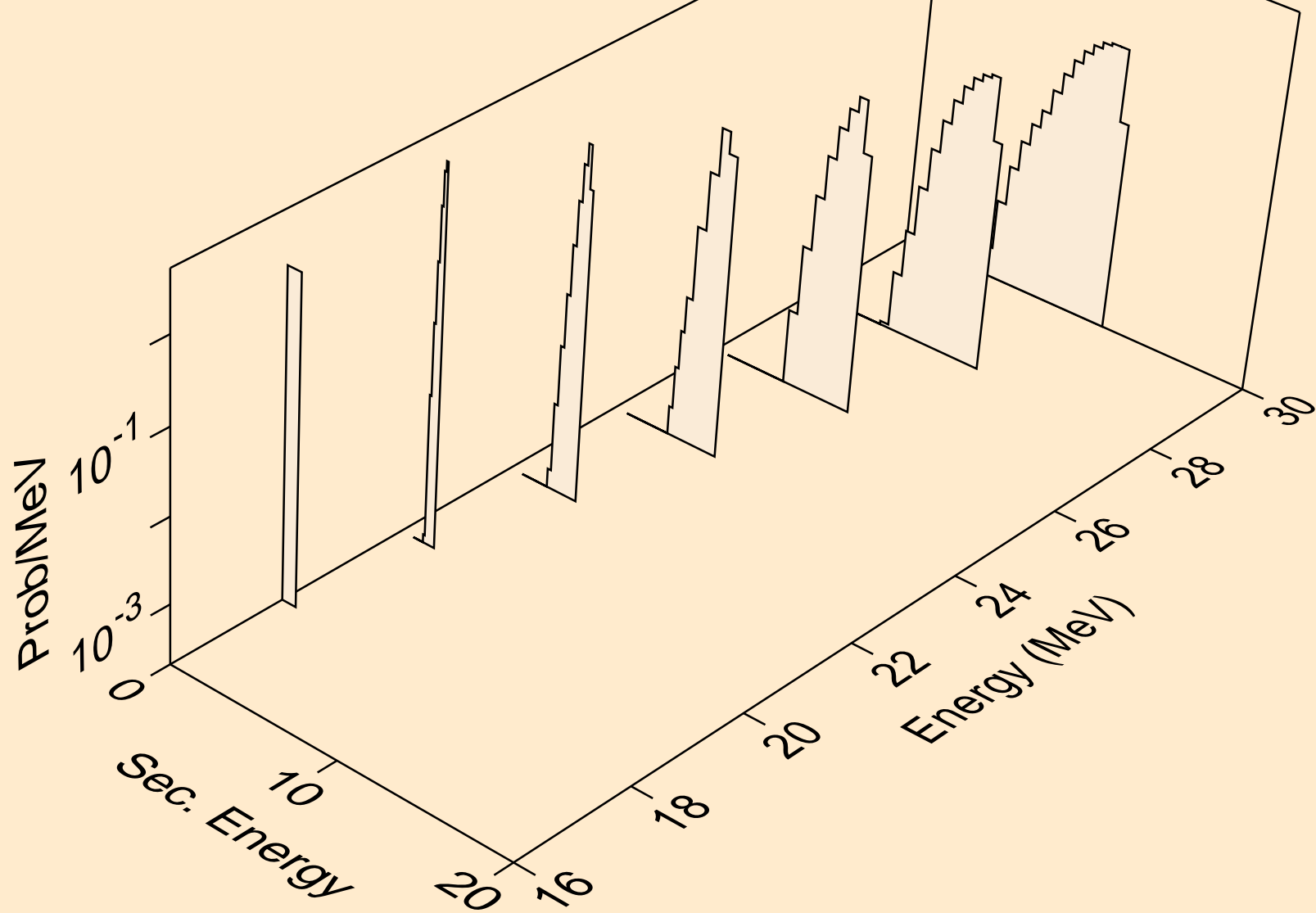

CD101 NEUTRON ACER TENDL-2024 LIBRARY; T=293.6K  
tritons from (n,t)

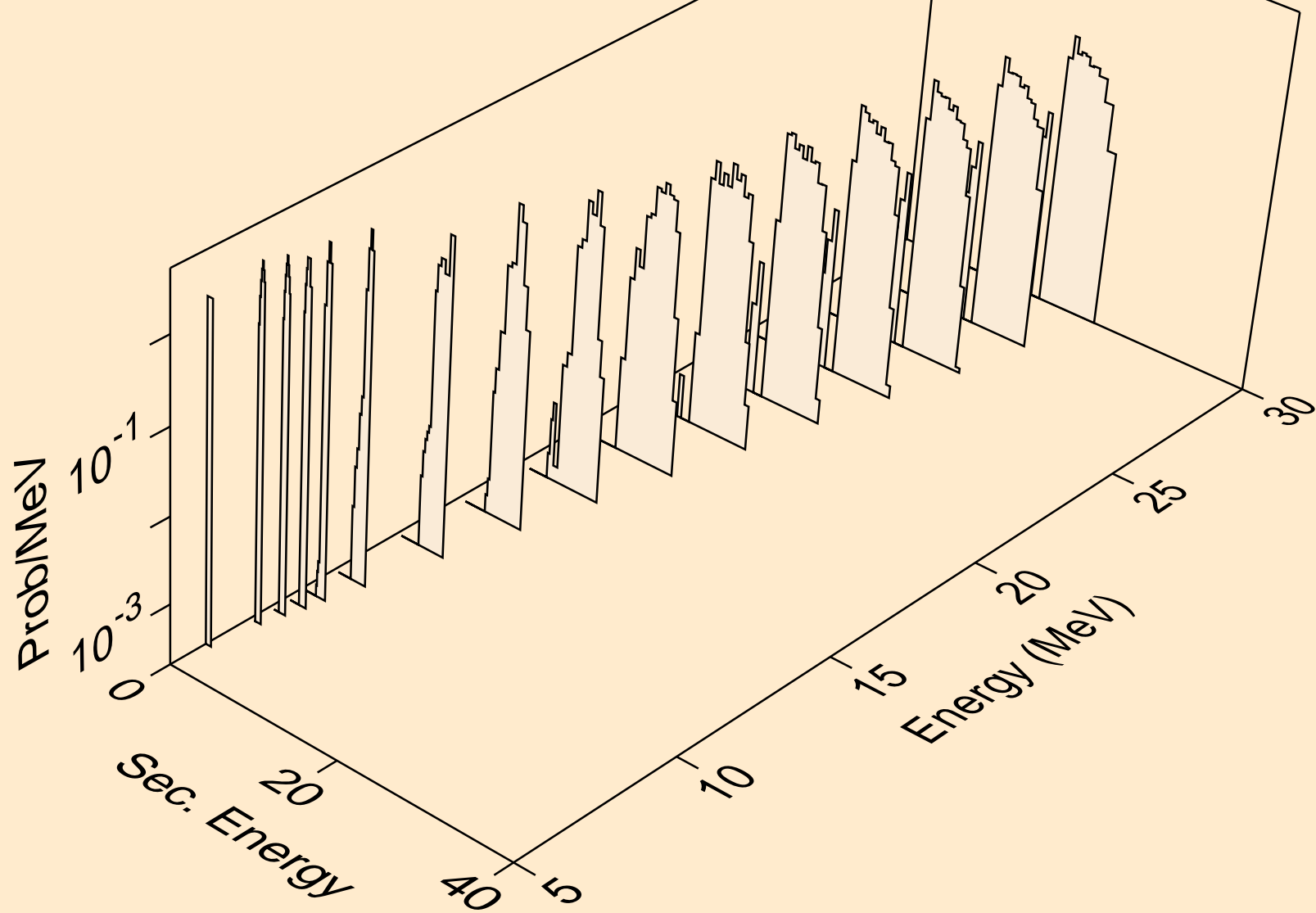

CD101 NEUTRON ACER TENDL-2024 LIBRARY; T=293.6K  
tritons from (n,pt)

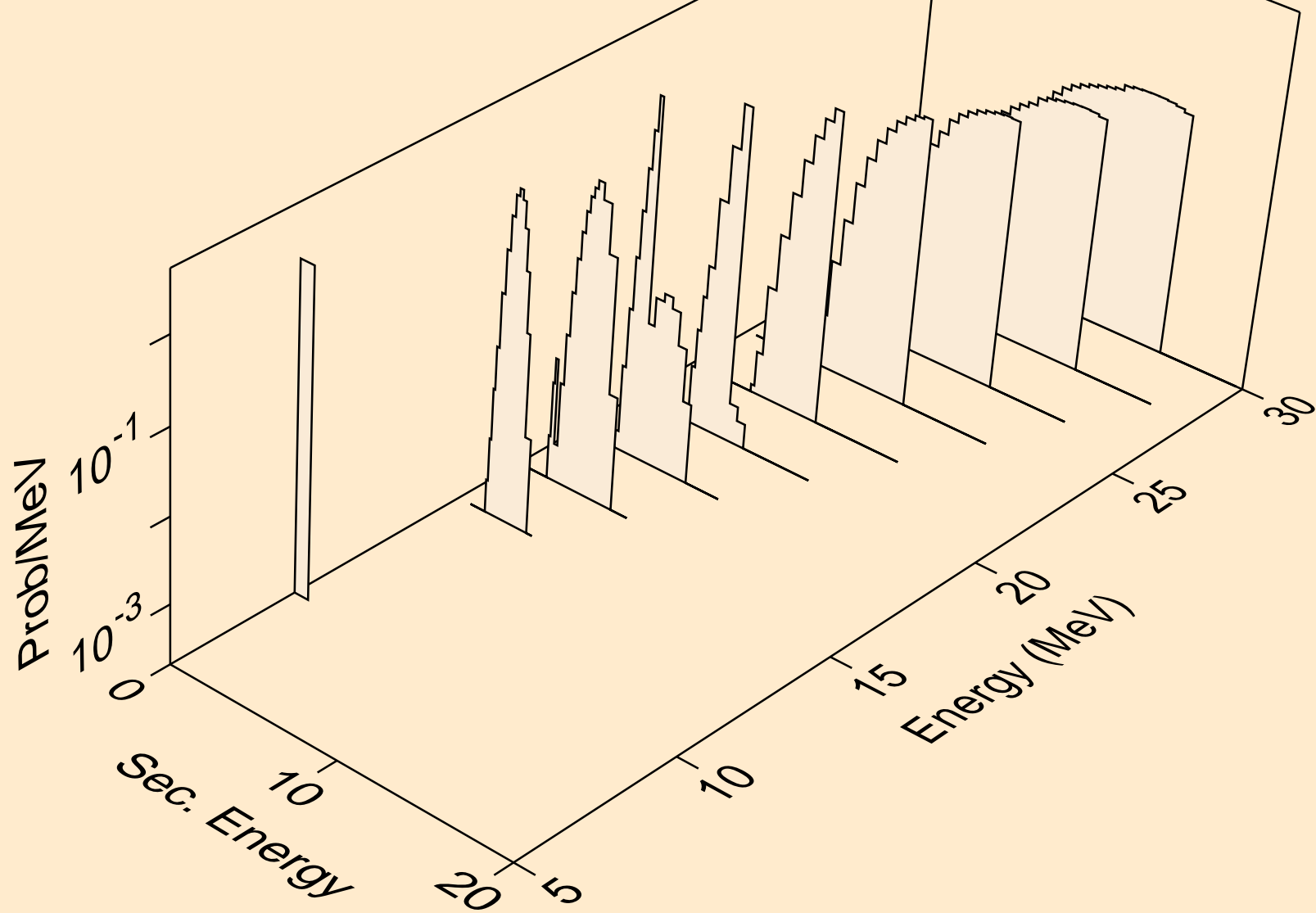

CD101 NEUTRON ACER TENDL-2024 LIBRARY; T=293.6K  
he3s from (n,x)

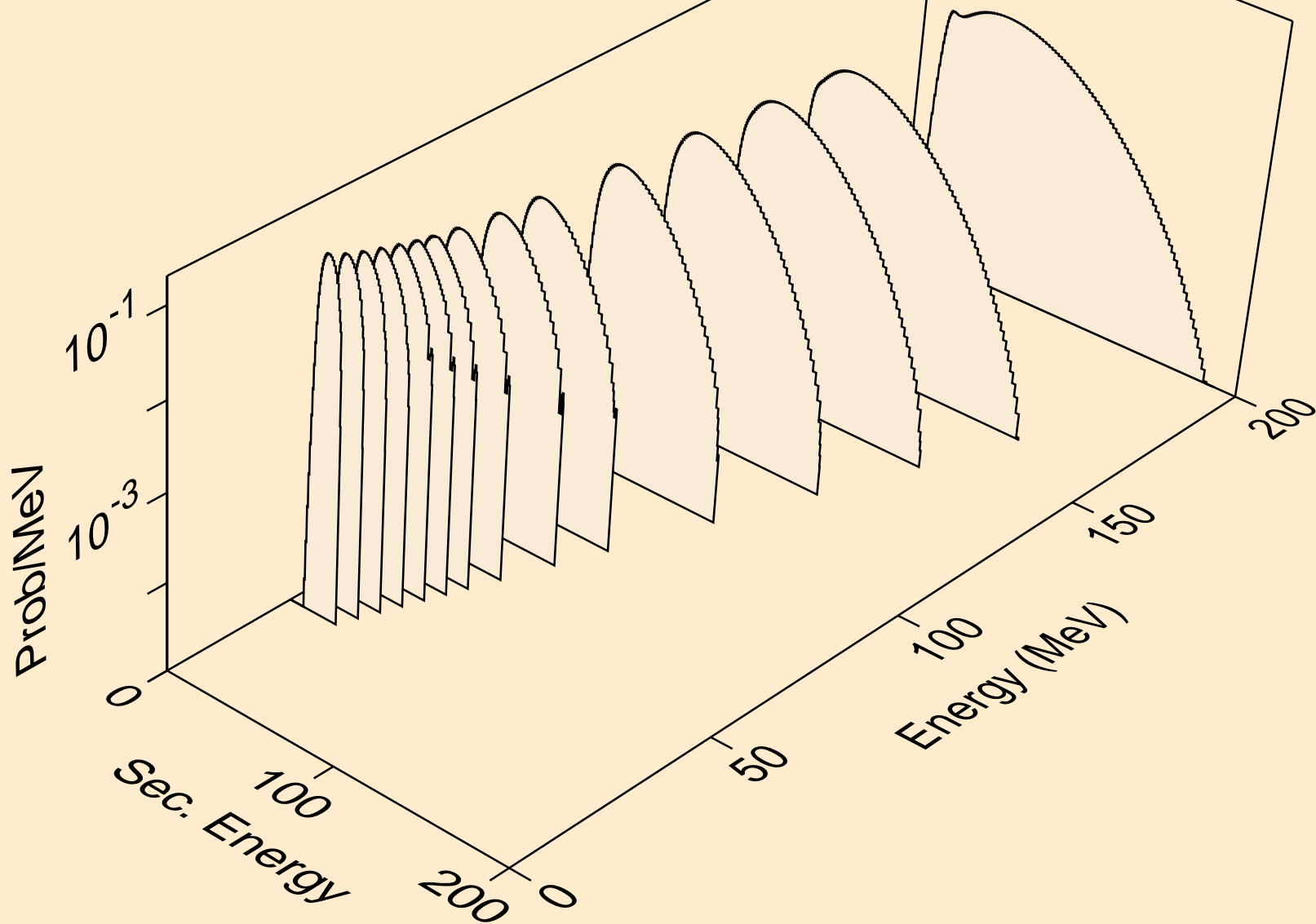

CD101 NEUTRON ACER TENDL-2024 LIBRARY; T=293.6K  
he3s from (n,n\*)he3

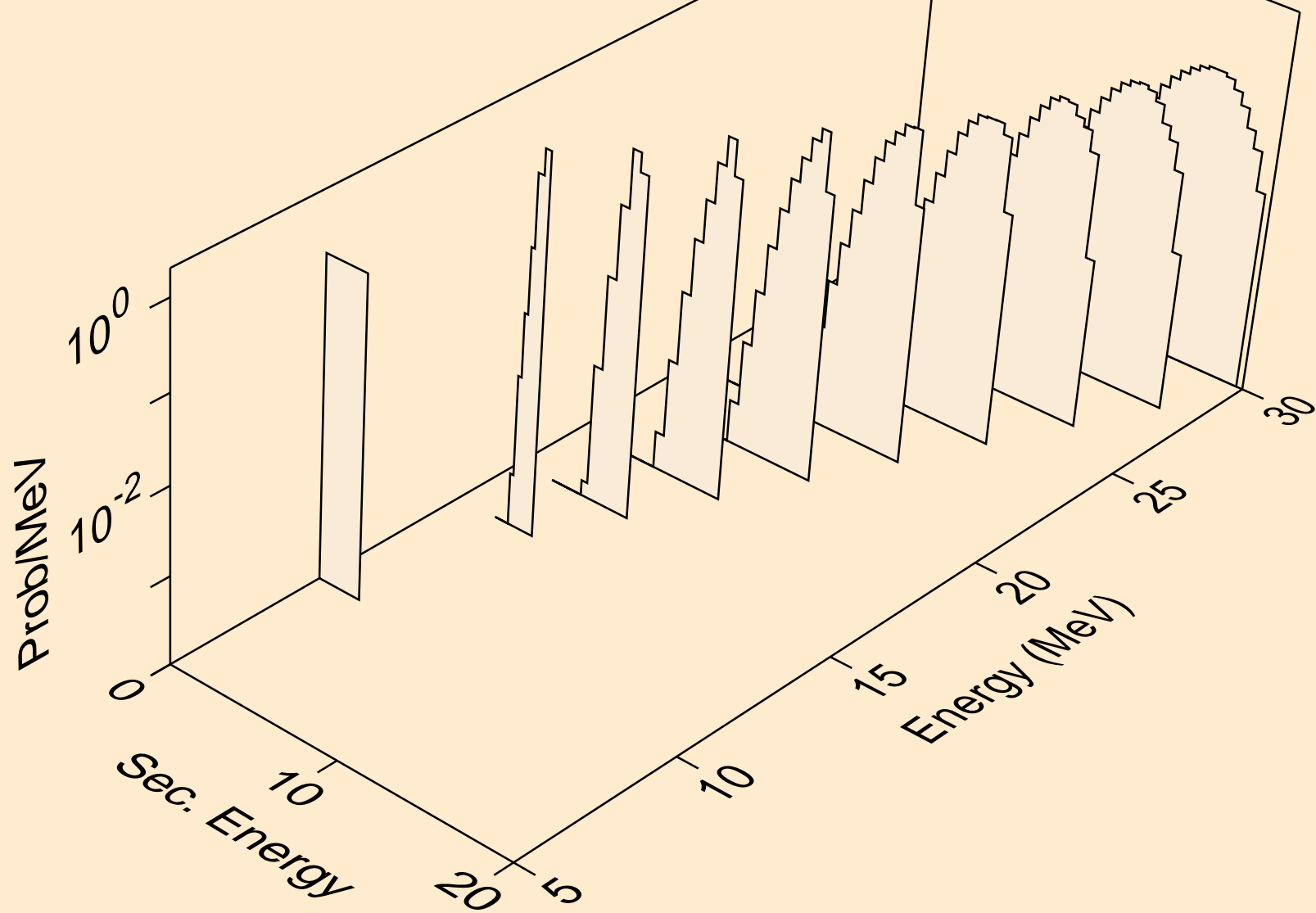

CD101 NEUTRON ACER TENDL-2024 LIBRARY; T=293.6K  
he3s from (n,he3)

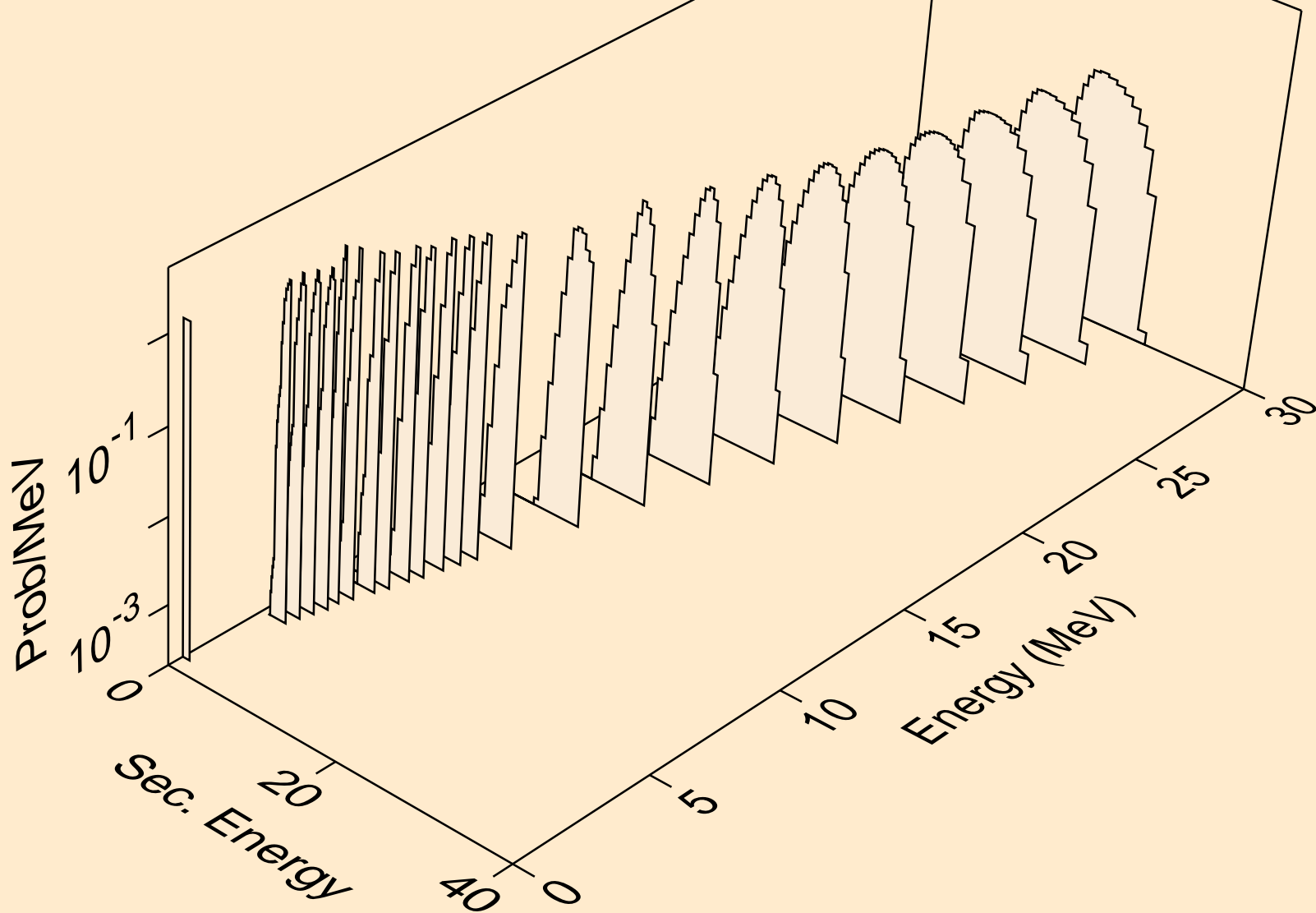

CD101 NEUTRON ACER TENDL-2024 LIBRARY; T=293.6K  
alphas from (n,x)

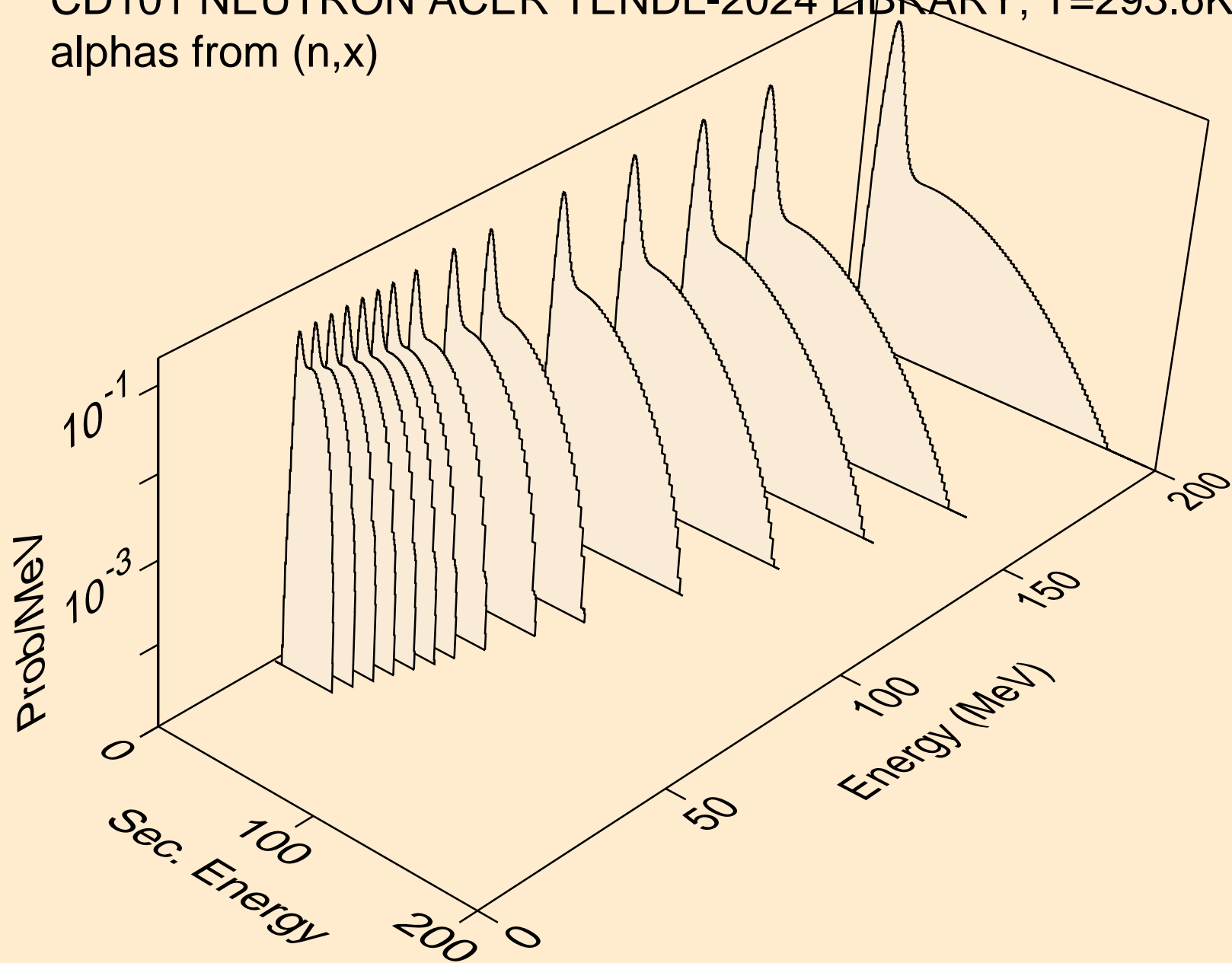

CD101 NEUTRON ACER TENDL-2024 LIBRARY; T=293.6K  
alphas from (n,n\*)a

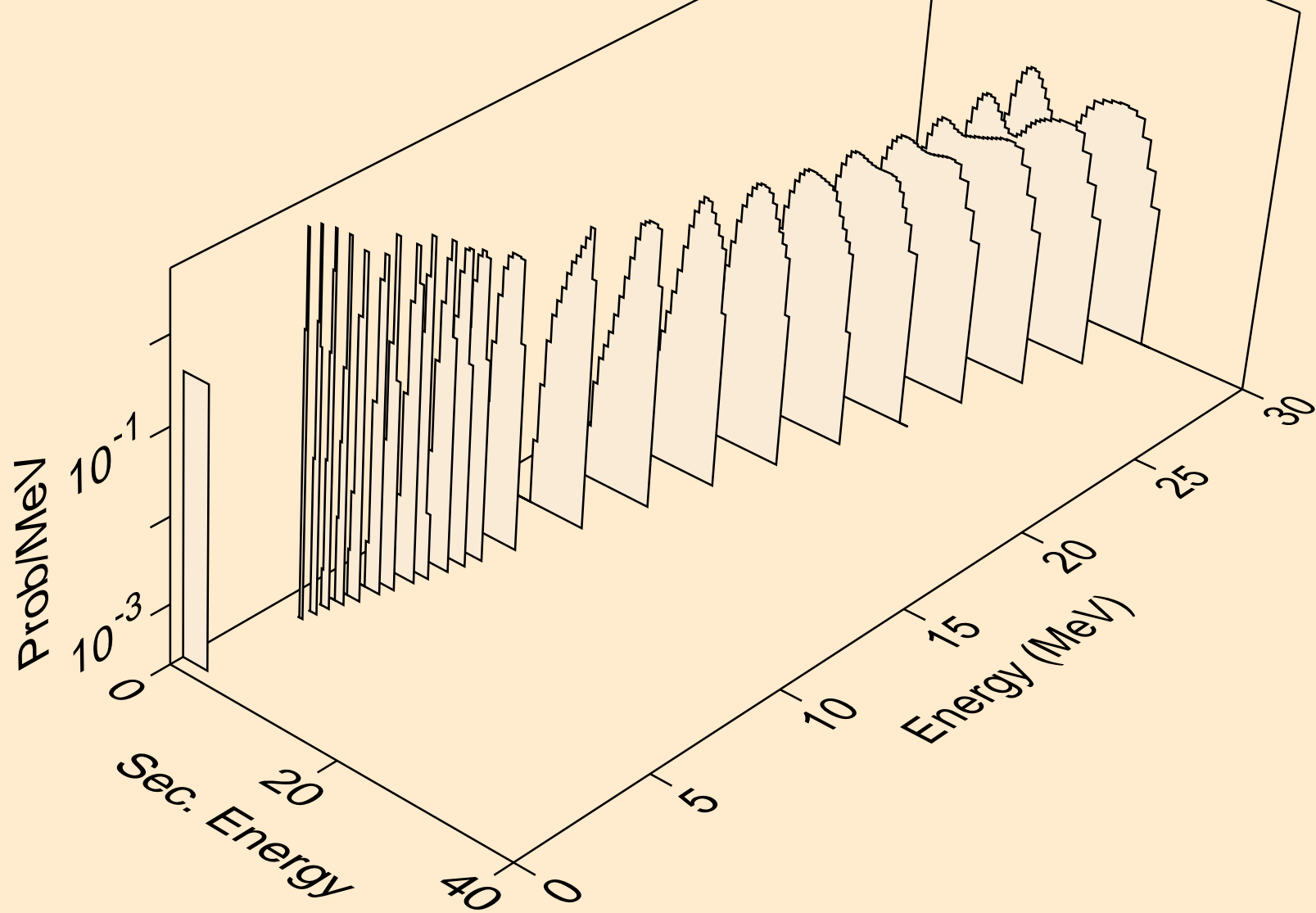

CD101 NEUTRON ACER TENDL-2024 LIBRARY; T=293.6K  
alphas from (n,2n)a

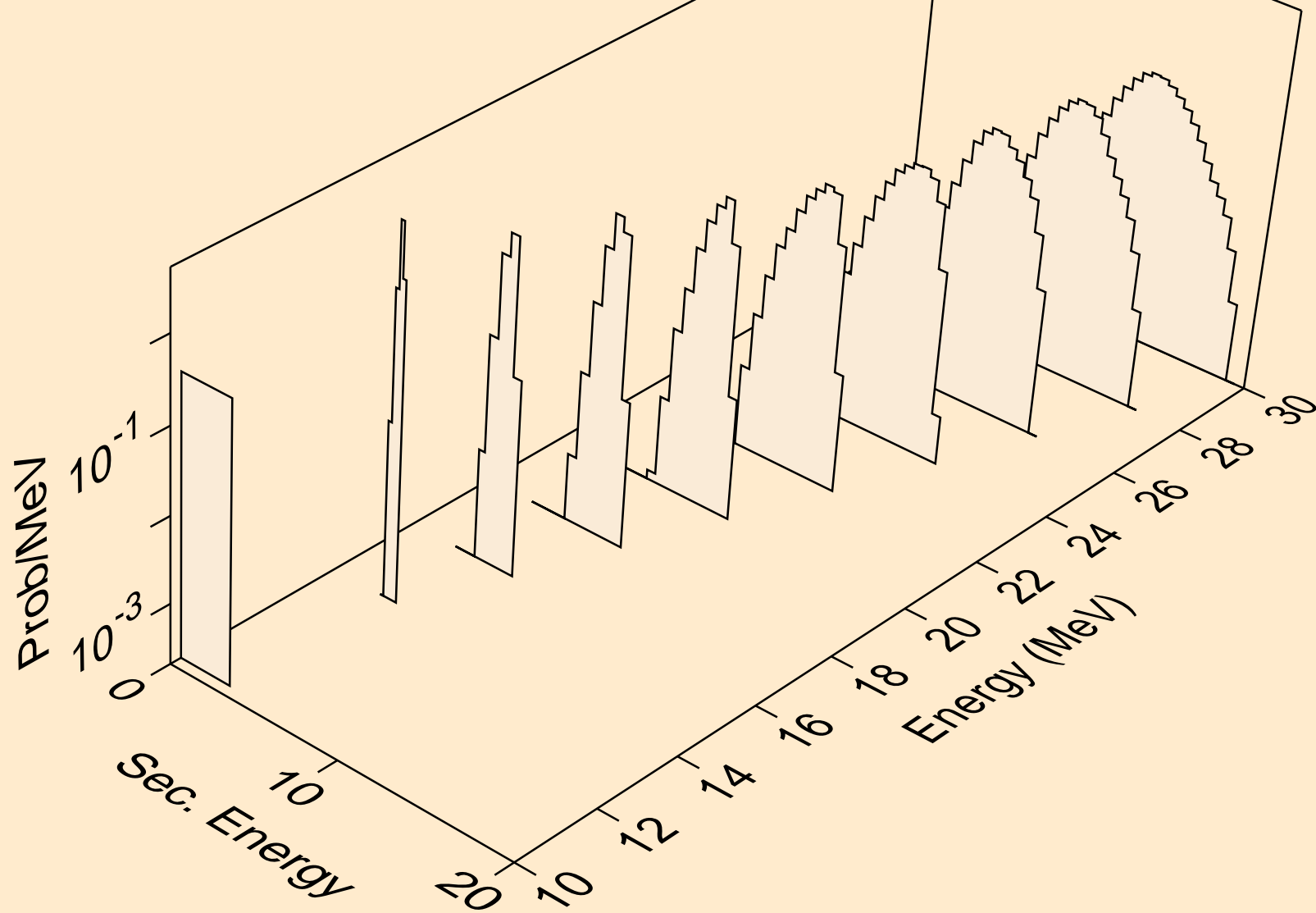

CD101 NEUTRON ACER TENDL-2024 LIBRARY; T=293.6K  
alphas from (n,n\*)2a

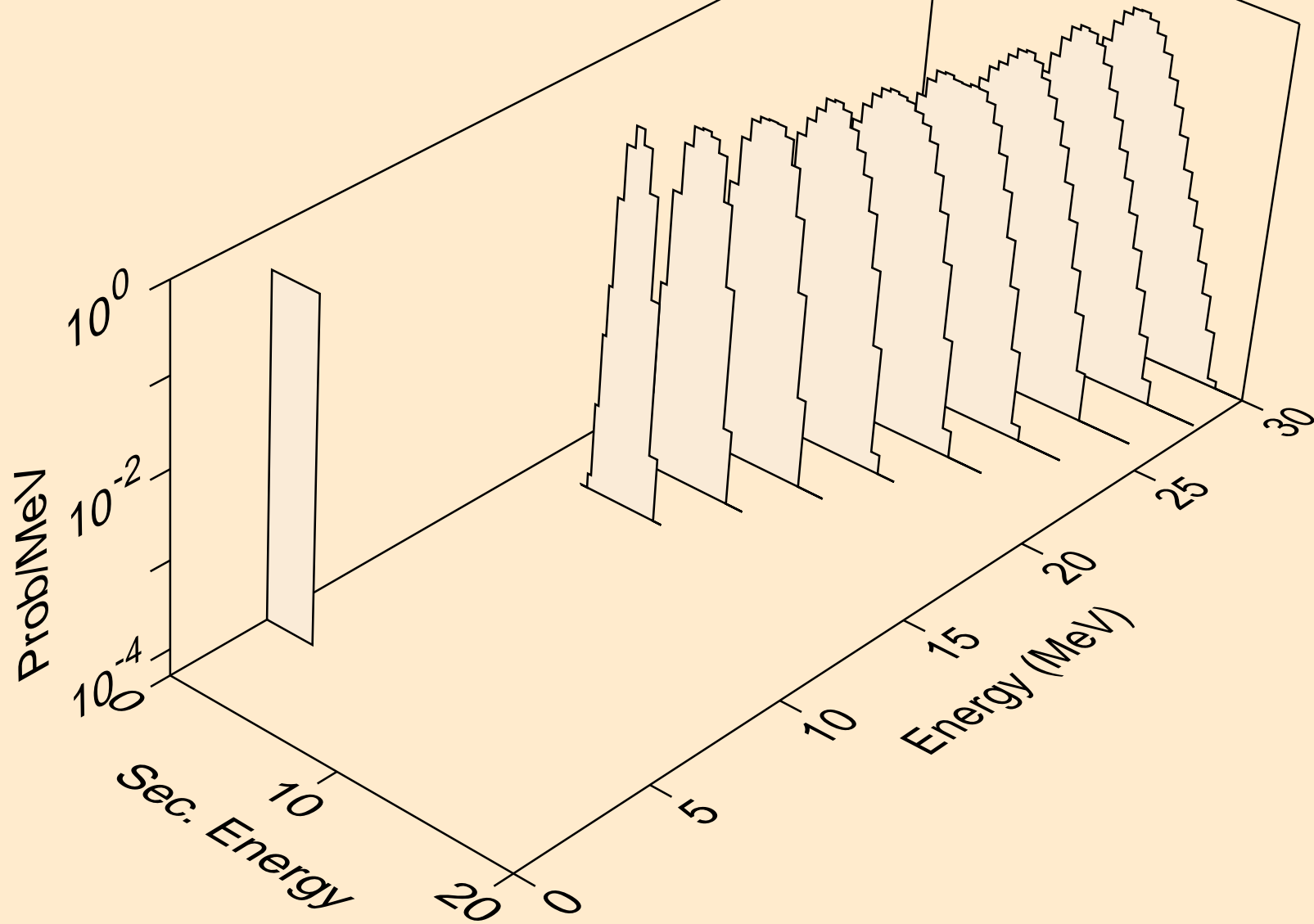

CD101 NEUTRON ACER TENDL-2024 LIBRARY; T=293.6K  
alphas from (n,npa)

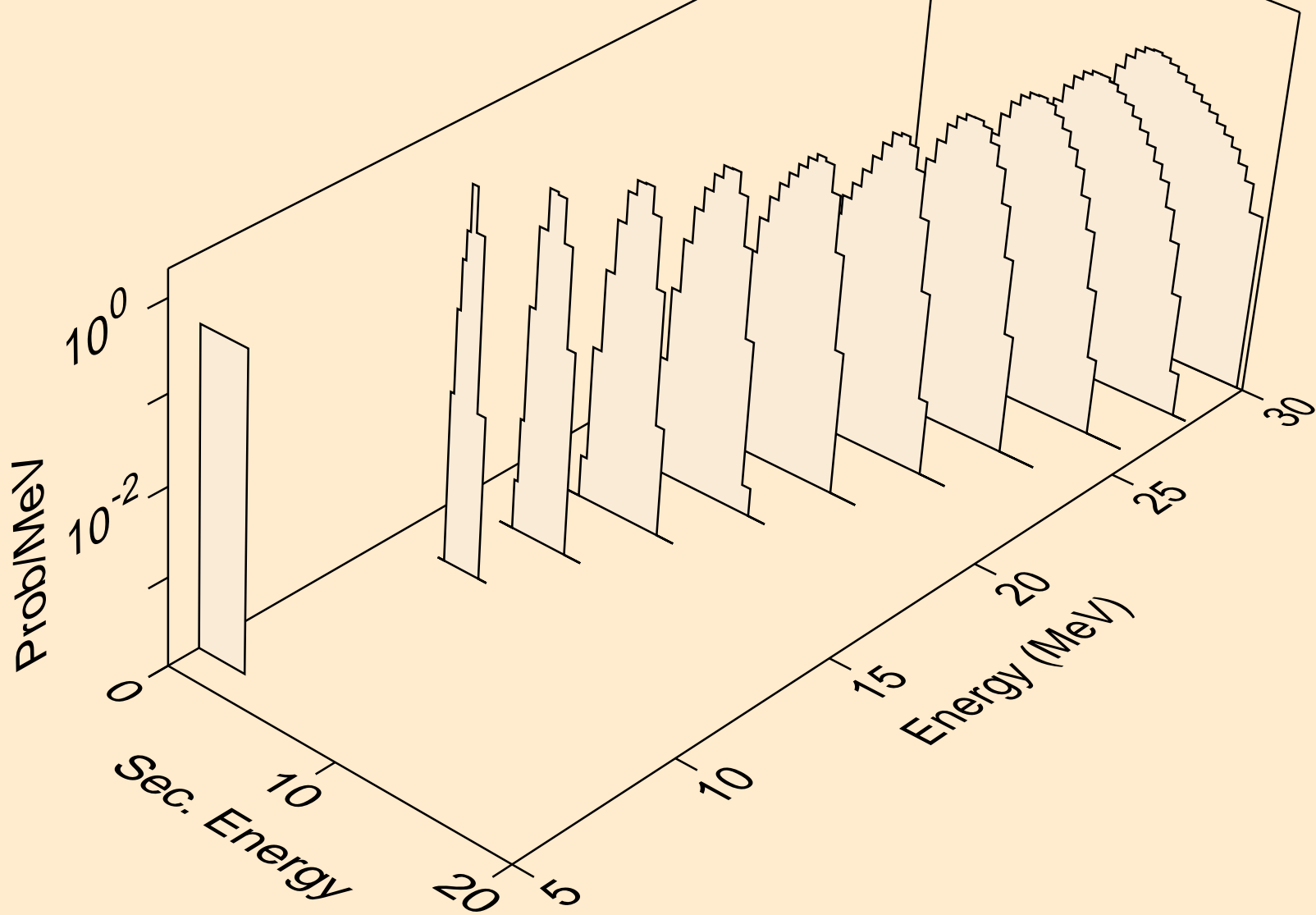

CD101 NEUTRON ACER TENDL-2024 LIBRARY; T=293.6K  
alphas from (n,a)

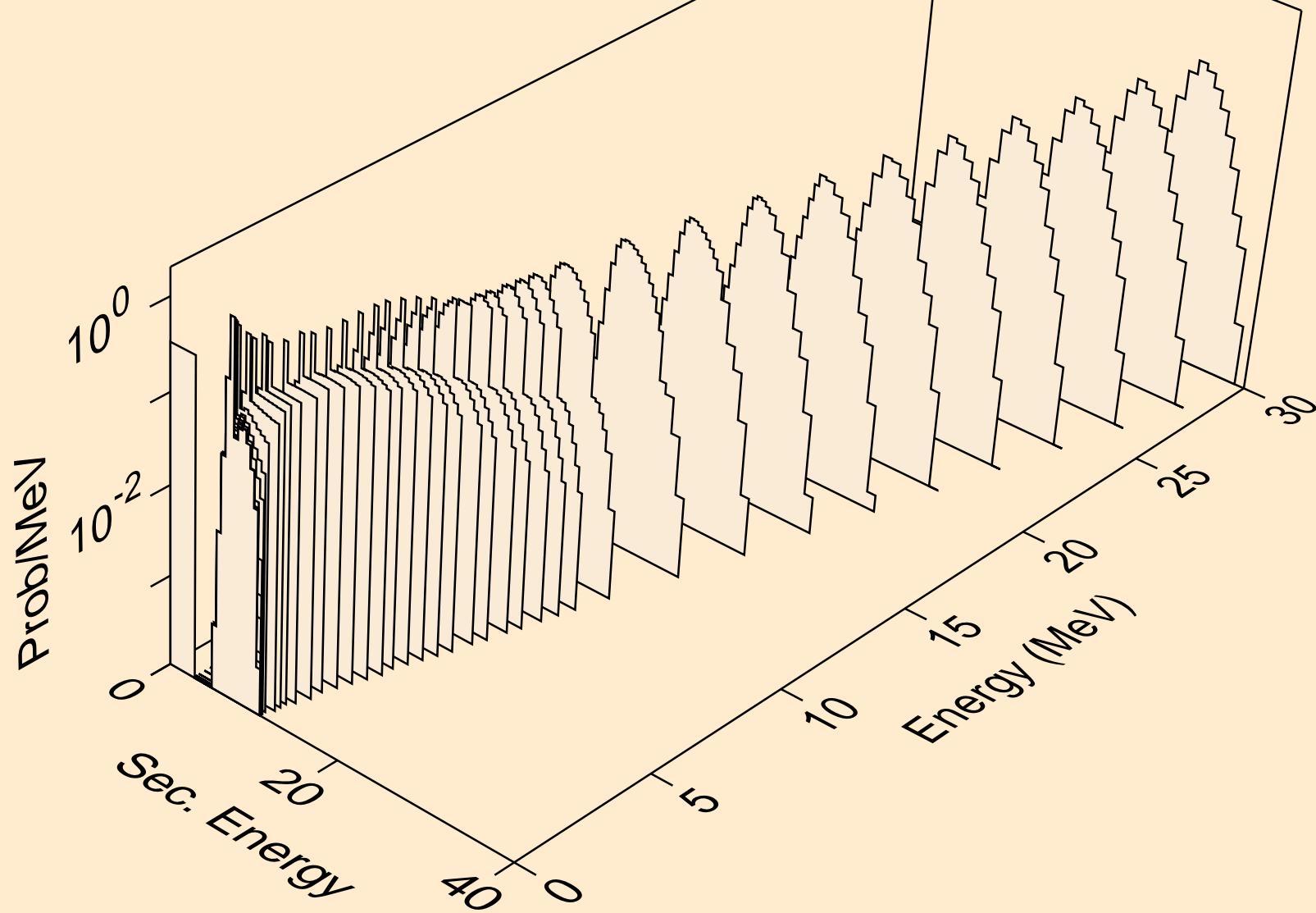

CD101 NEUTRON ACER TENDL-2024 LIBRARY; T=293.6K  
alphas from (n,2a)

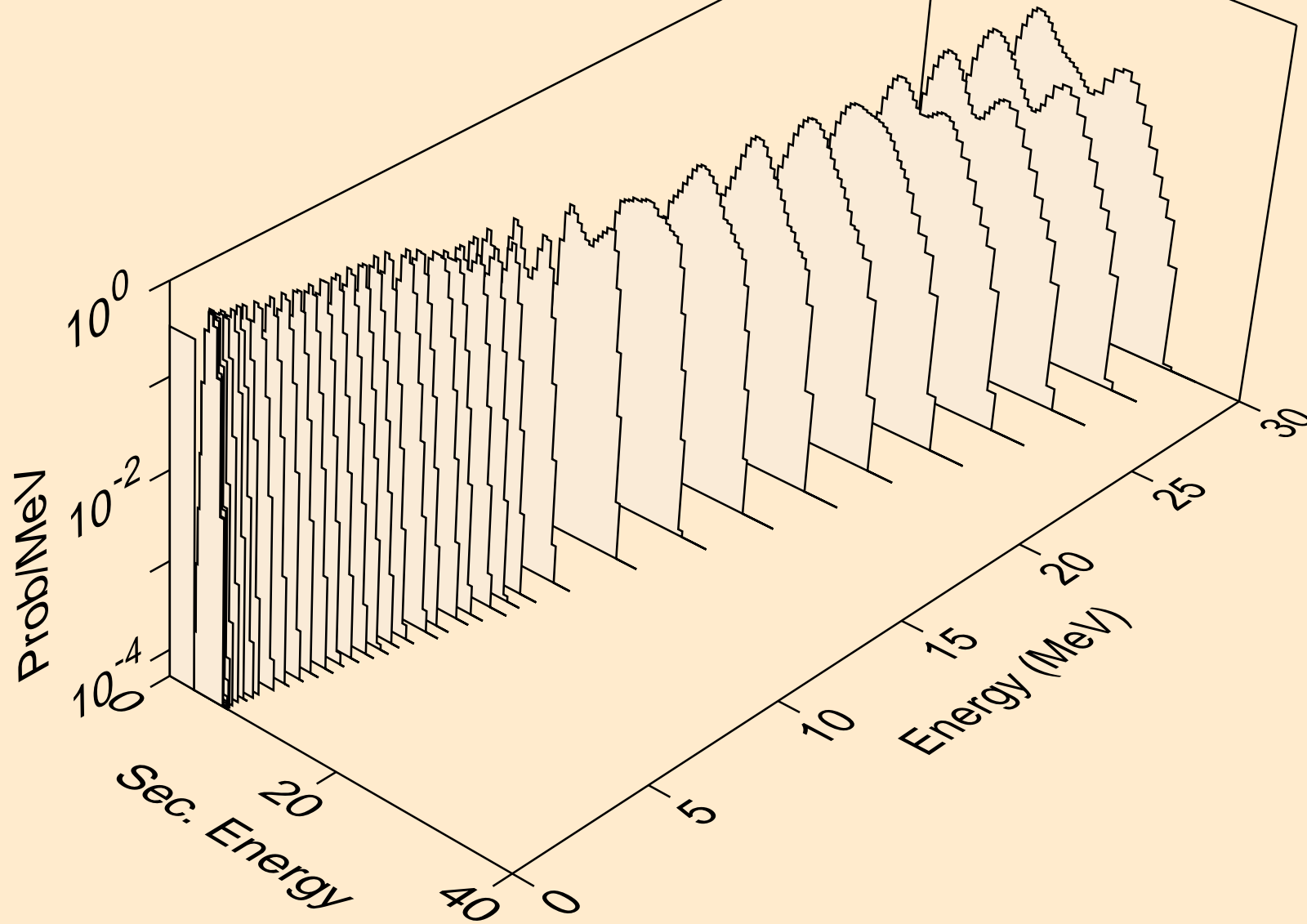

CD101 NEUTRON ACER TENDL-2024 LIBRARY; T=293.6K  
alphas from (n,3a)

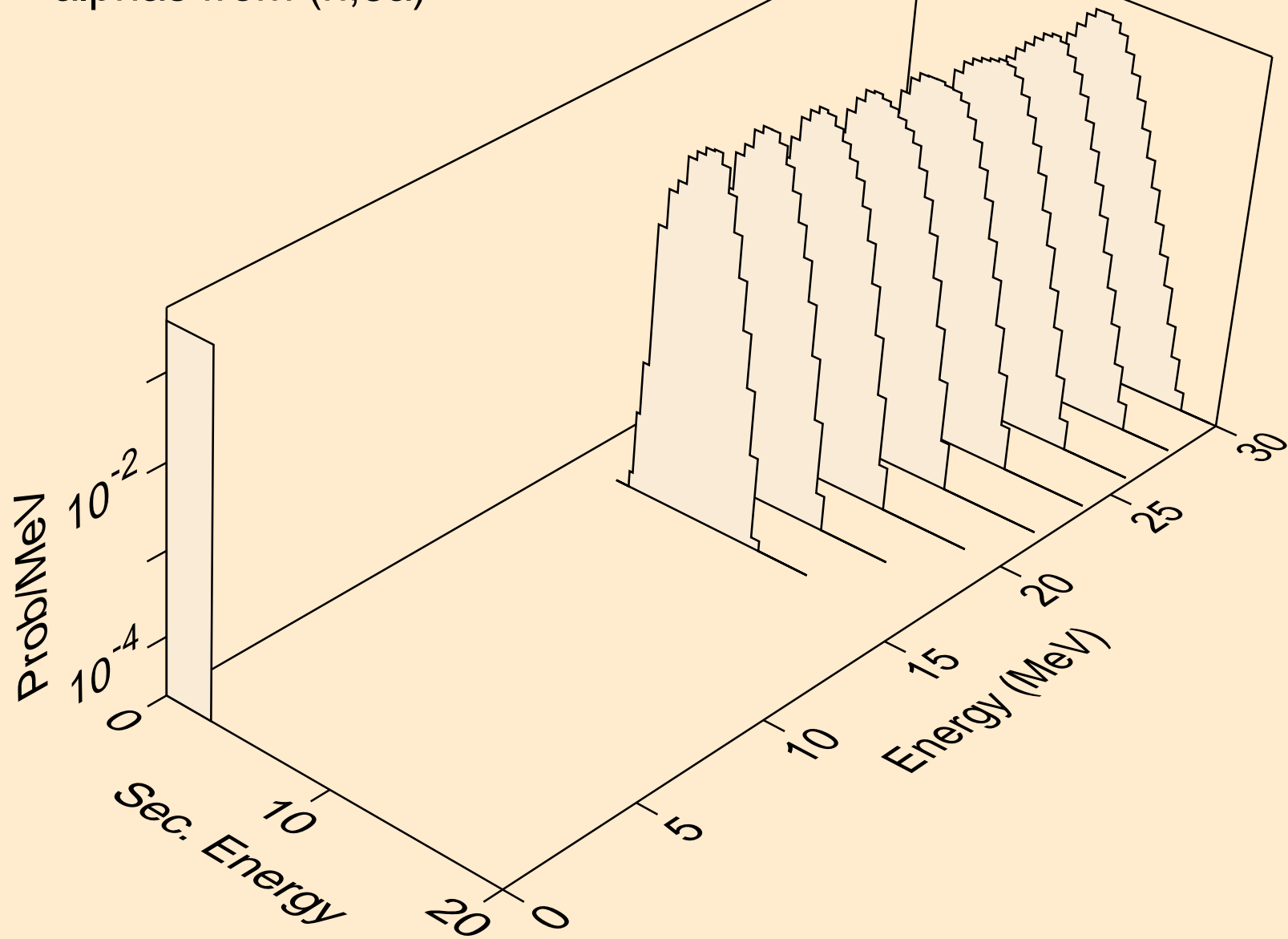

CD101 NEUTRON ACER TENDL-2024 LIBRARY; T=293.6K  
alphas from (n,pa)

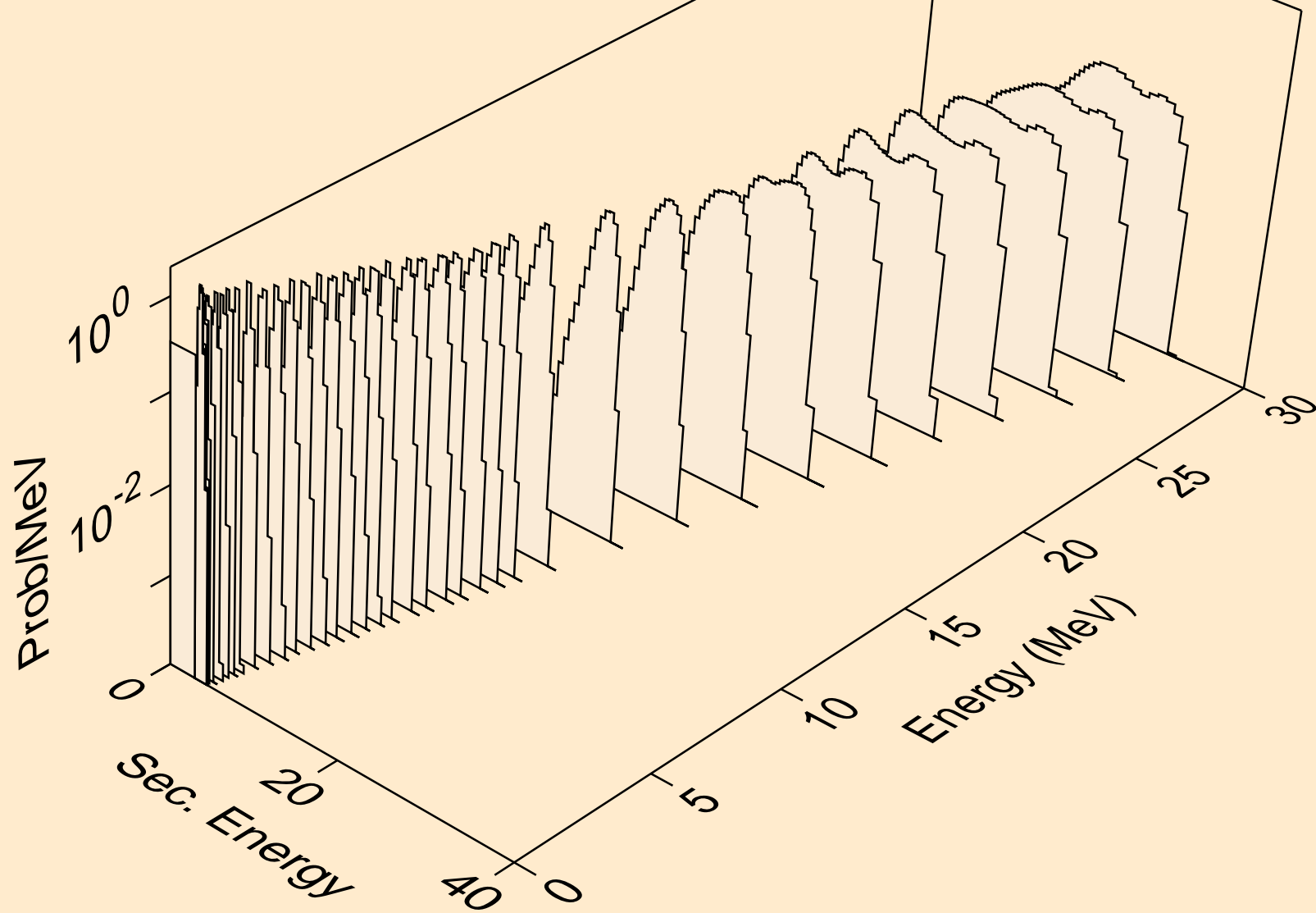

CD101 NEUTRON ACER TENDL-2024 LIBRARY; T=293.6K  
alphas from (n,da)

