

CS117 NEUTRON ACER TENDL-2024 LIBRARY; T=293.6K

Principal cross sections

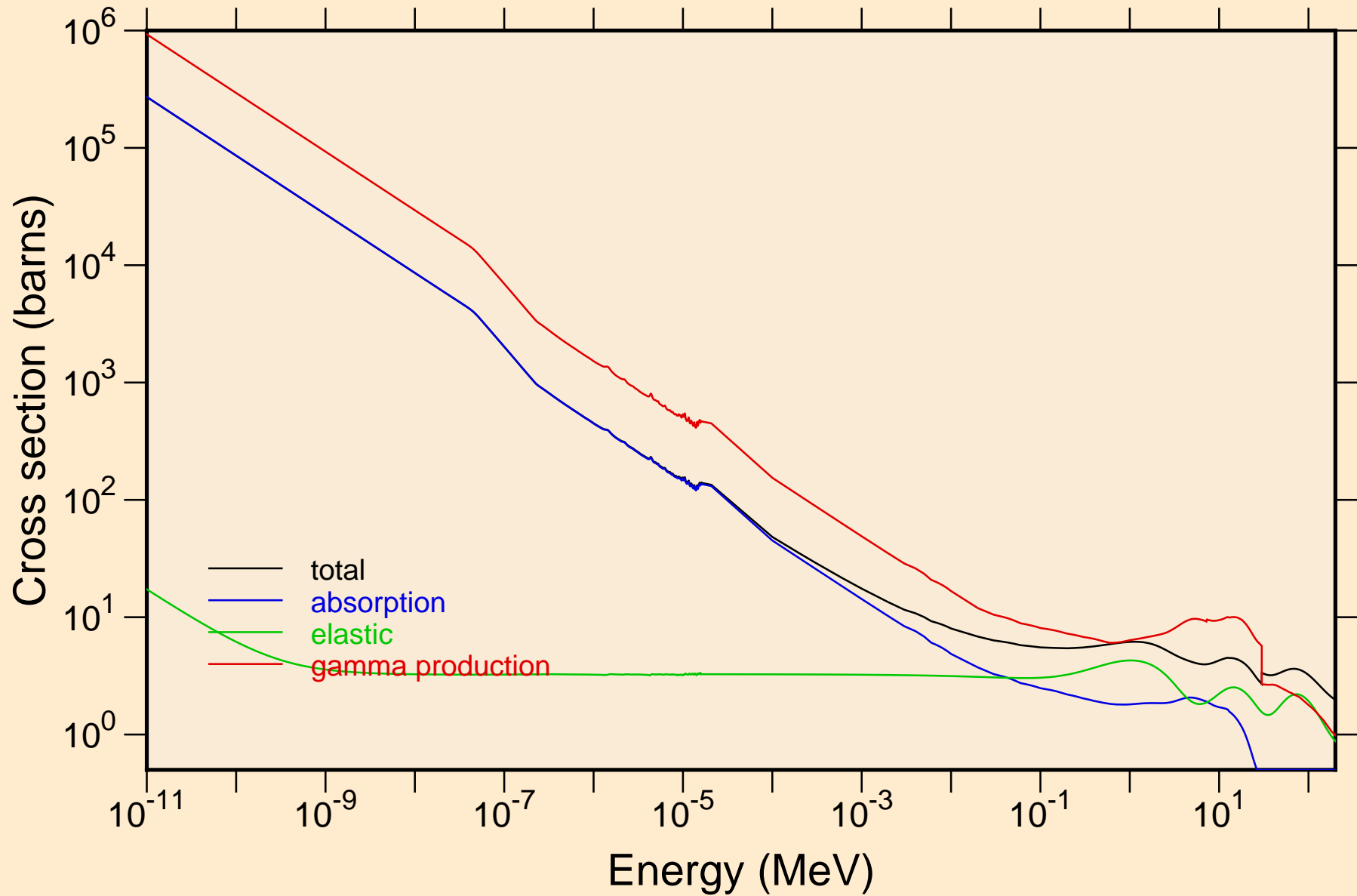

CS117 NEUTRON ACER TENDL-2024 LIBRARY; T=293.6K
resonance total cross section

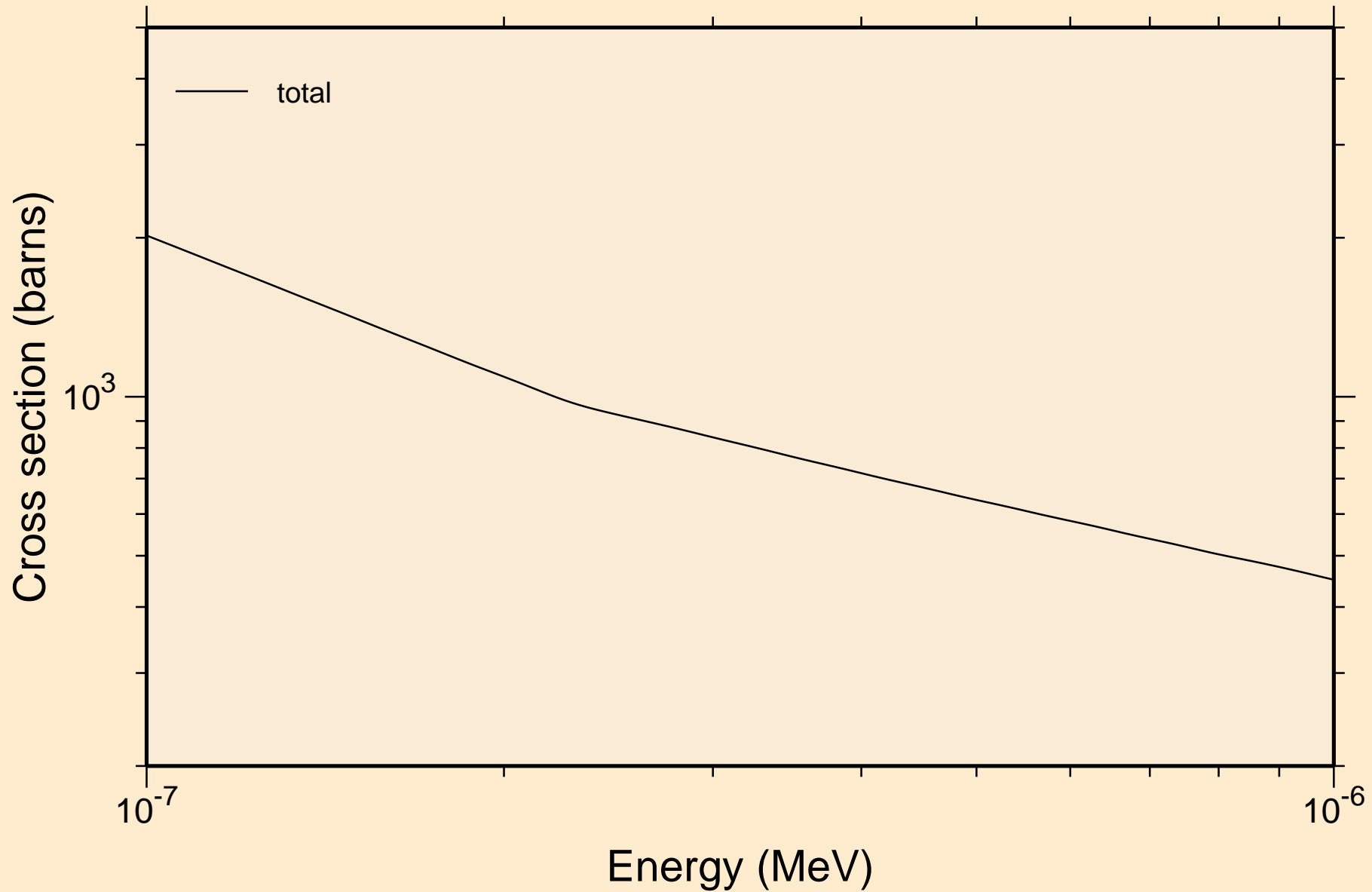

CS117 NEUTRON ACER TENDL-2024 LIBRARY; T=293.6K
resonance total cross section

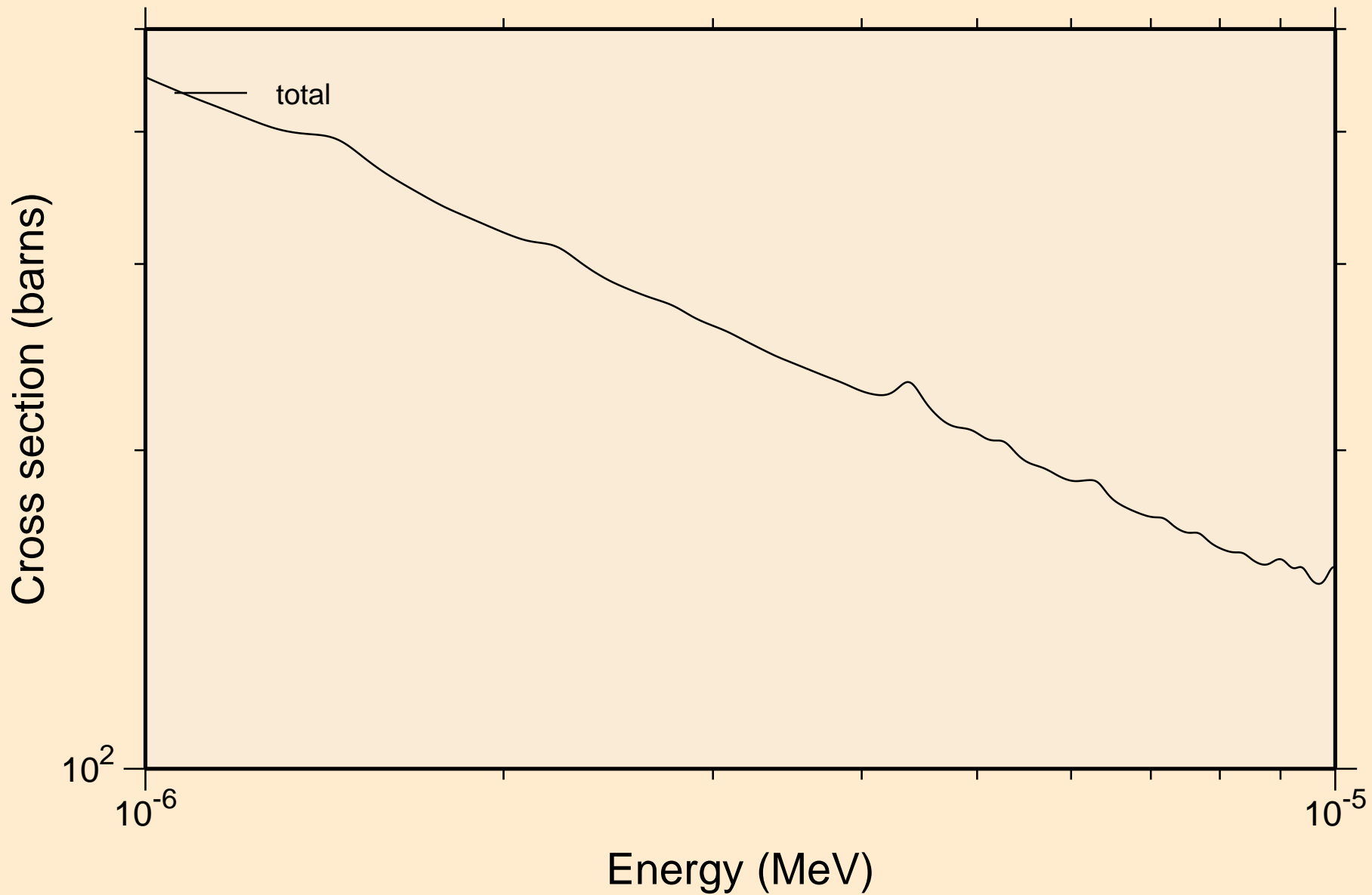

CS117 NEUTRON ACER TENDL-2024 LIBRARY; T=293.6K
resonance total cross section

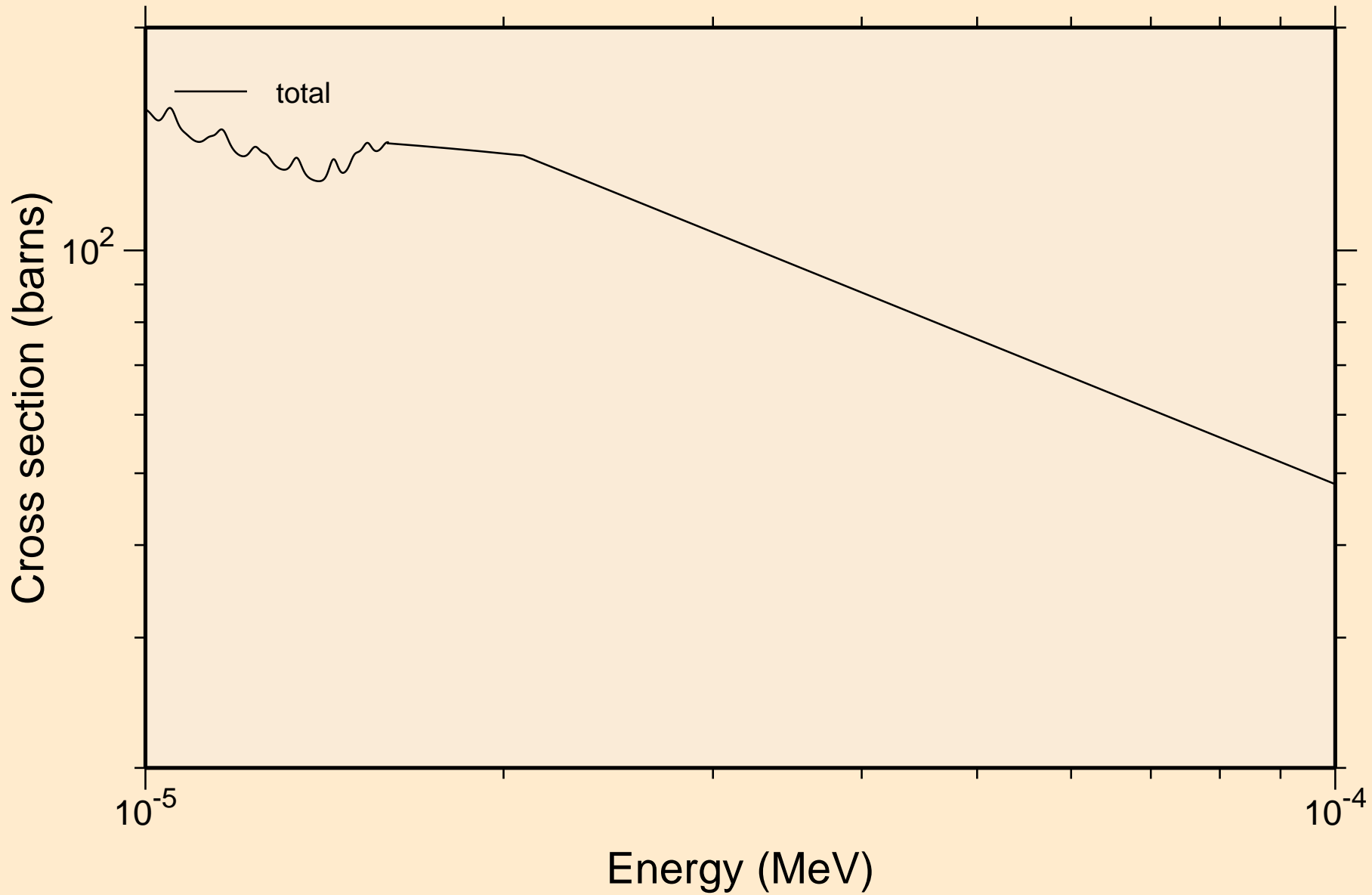

CS117 NEUTRON ACER TENDL-2024 LIBRARY; T=293.6K
resonance total cross section

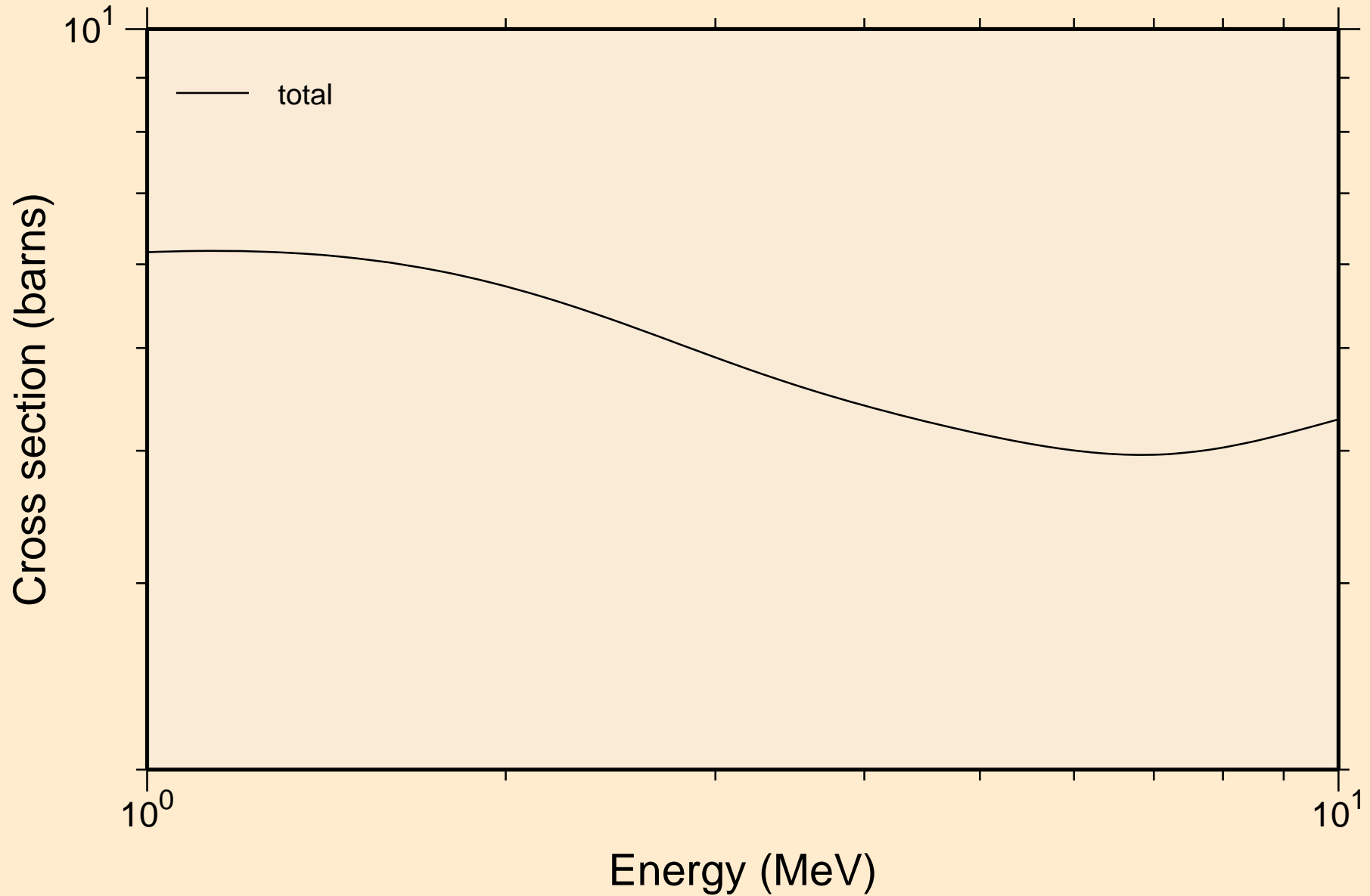

CS117 NEUTRON ACER TENDL-2024 LIBRARY; T=293.6K
resonance absorption cross sections

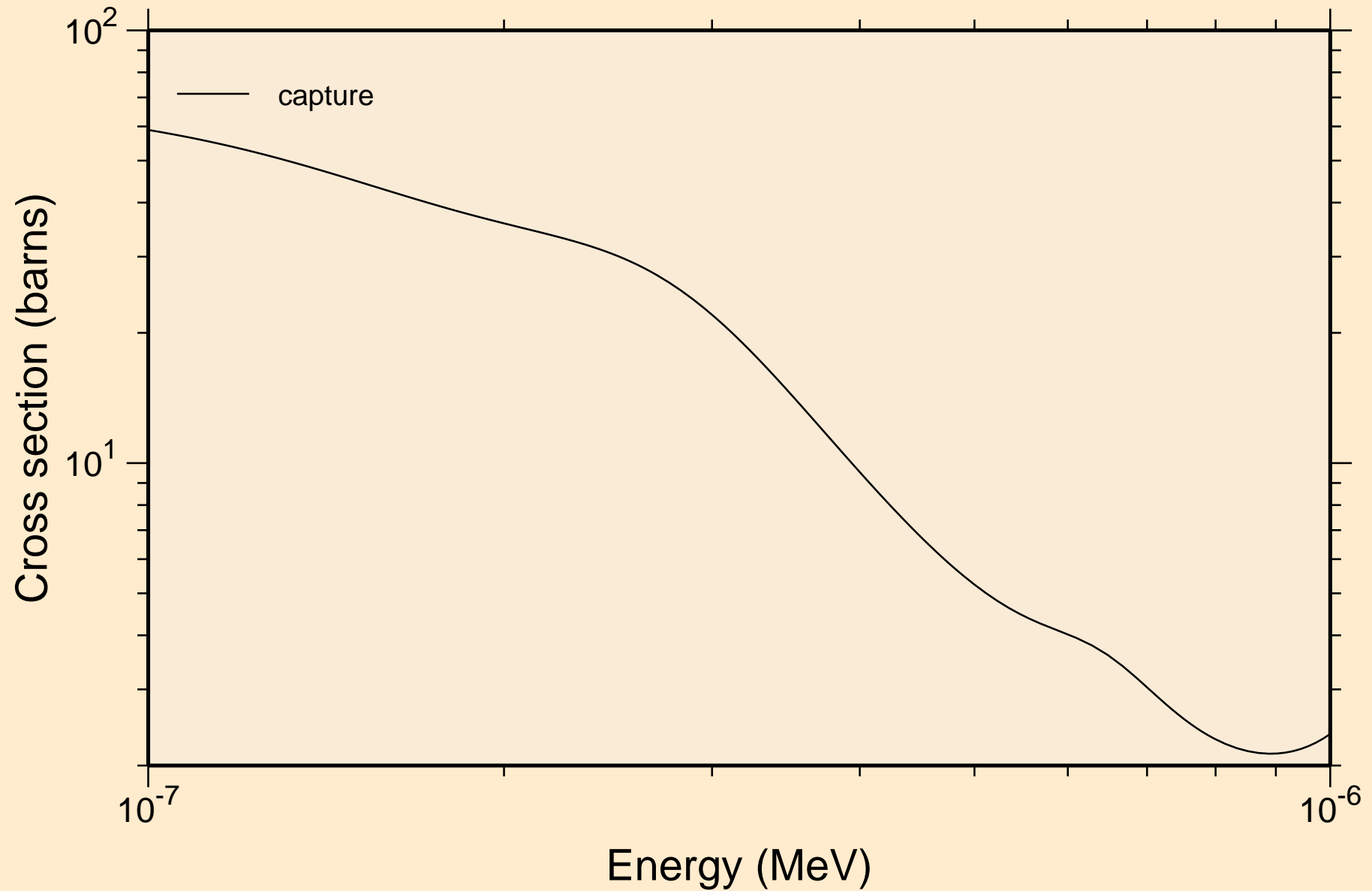

CS117 NEUTRON ACER TENDL-2024 LIBRARY; T=293.6K
resonance absorption cross sections

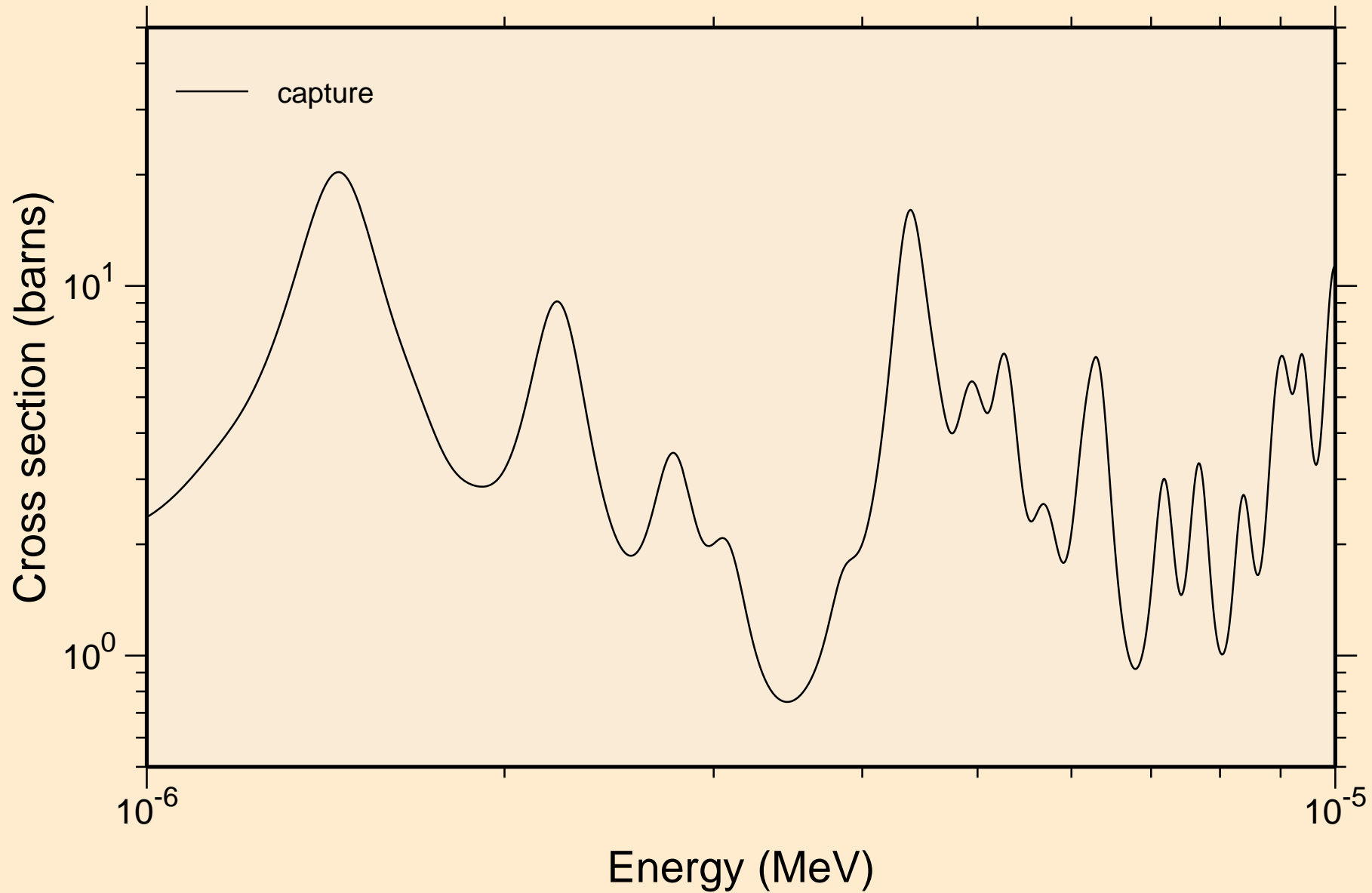

CS117 NEUTRON ACER TENDL-2024 LIBRARY; T=293.6K
resonance absorption cross sections

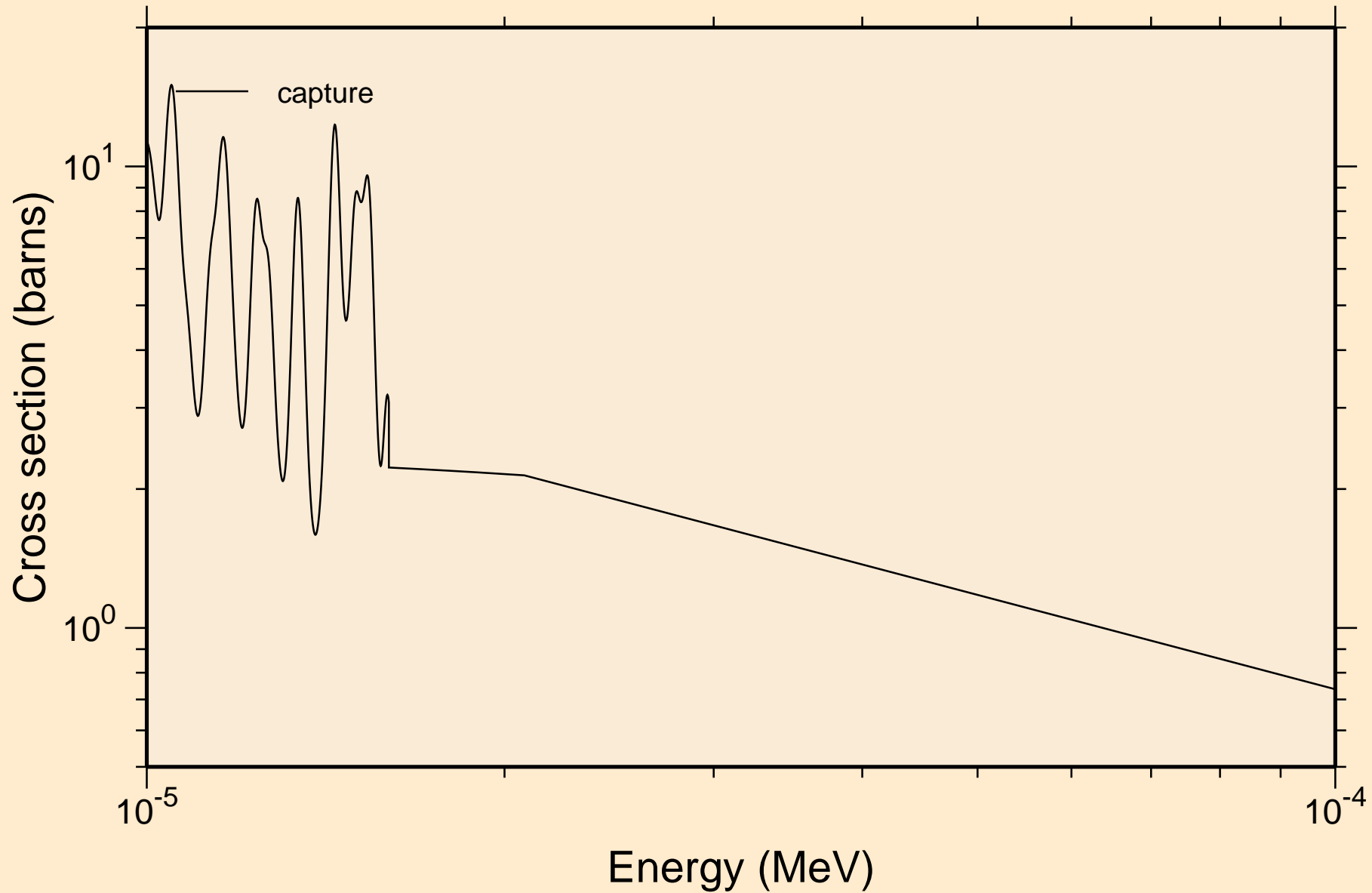

CS117 NEUTRON ACER TENDL-2024 LIBRARY; T=293.6K
resonance absorption cross sections

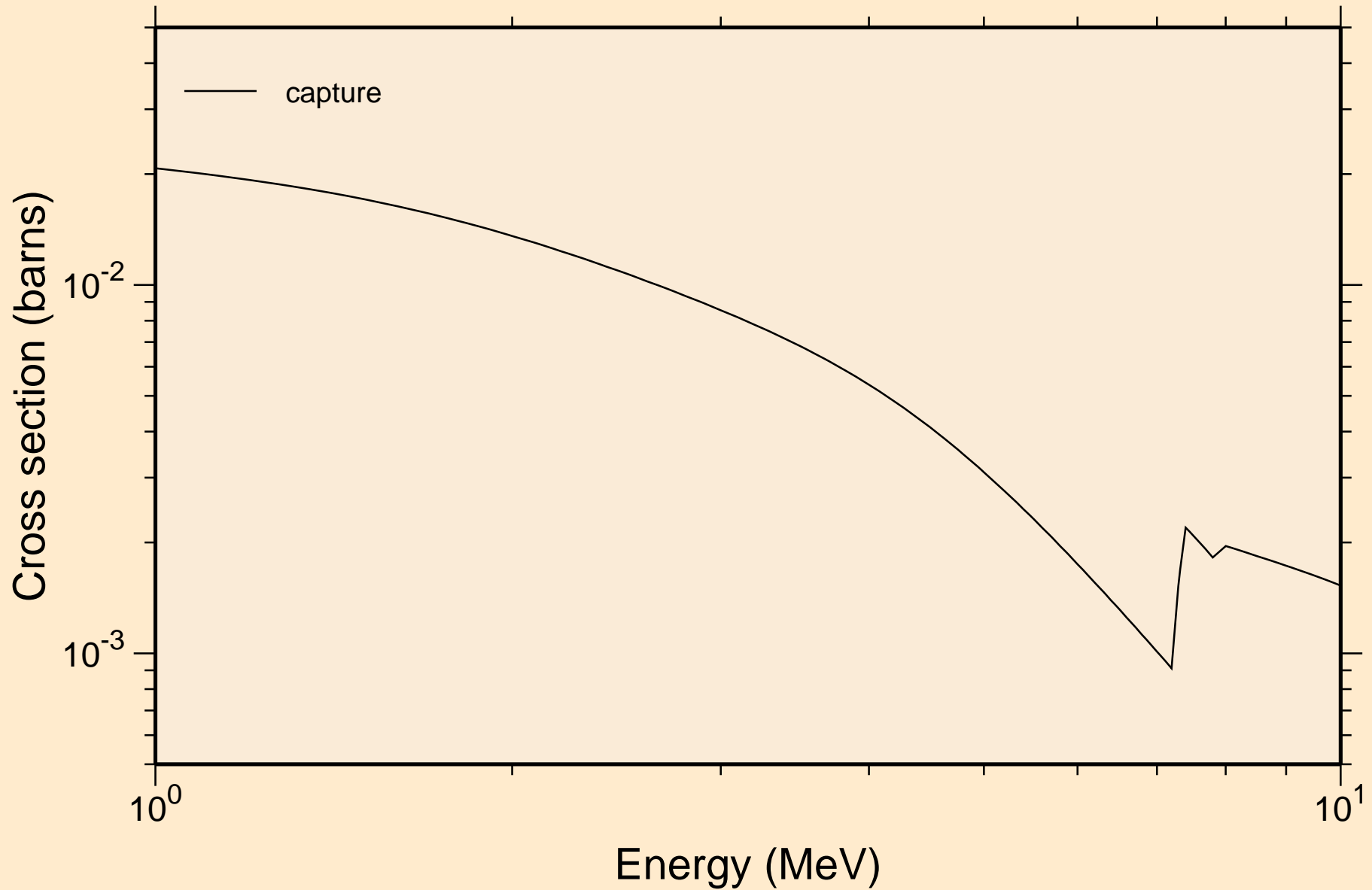

CS117 NEUTRON ACER TENDL-2024 LIBRARY; T=293.6K
Heating

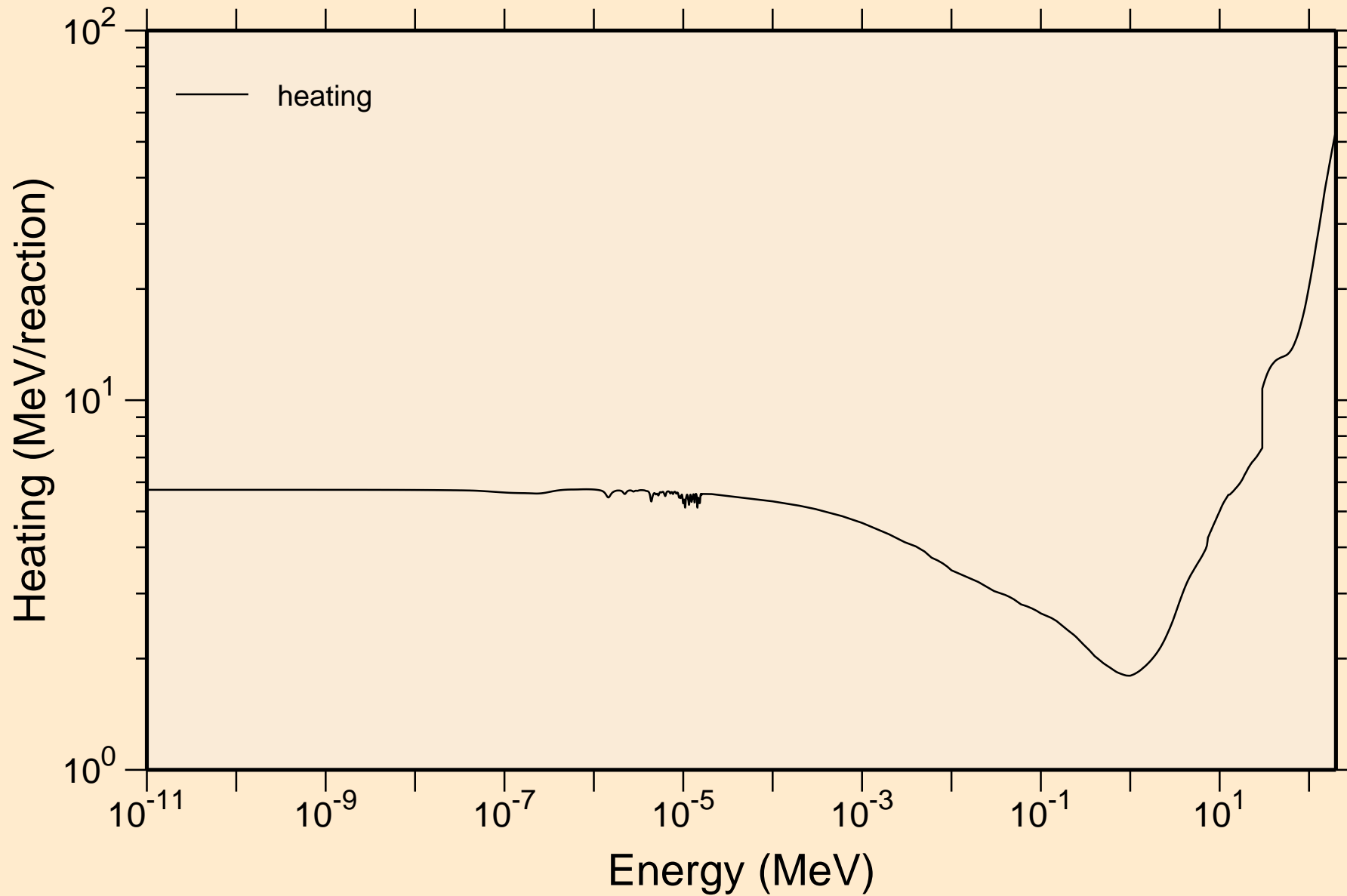

CS117 NEUTRON ACER TENDL-2024 LIBRARY; T=293.6K
Damage

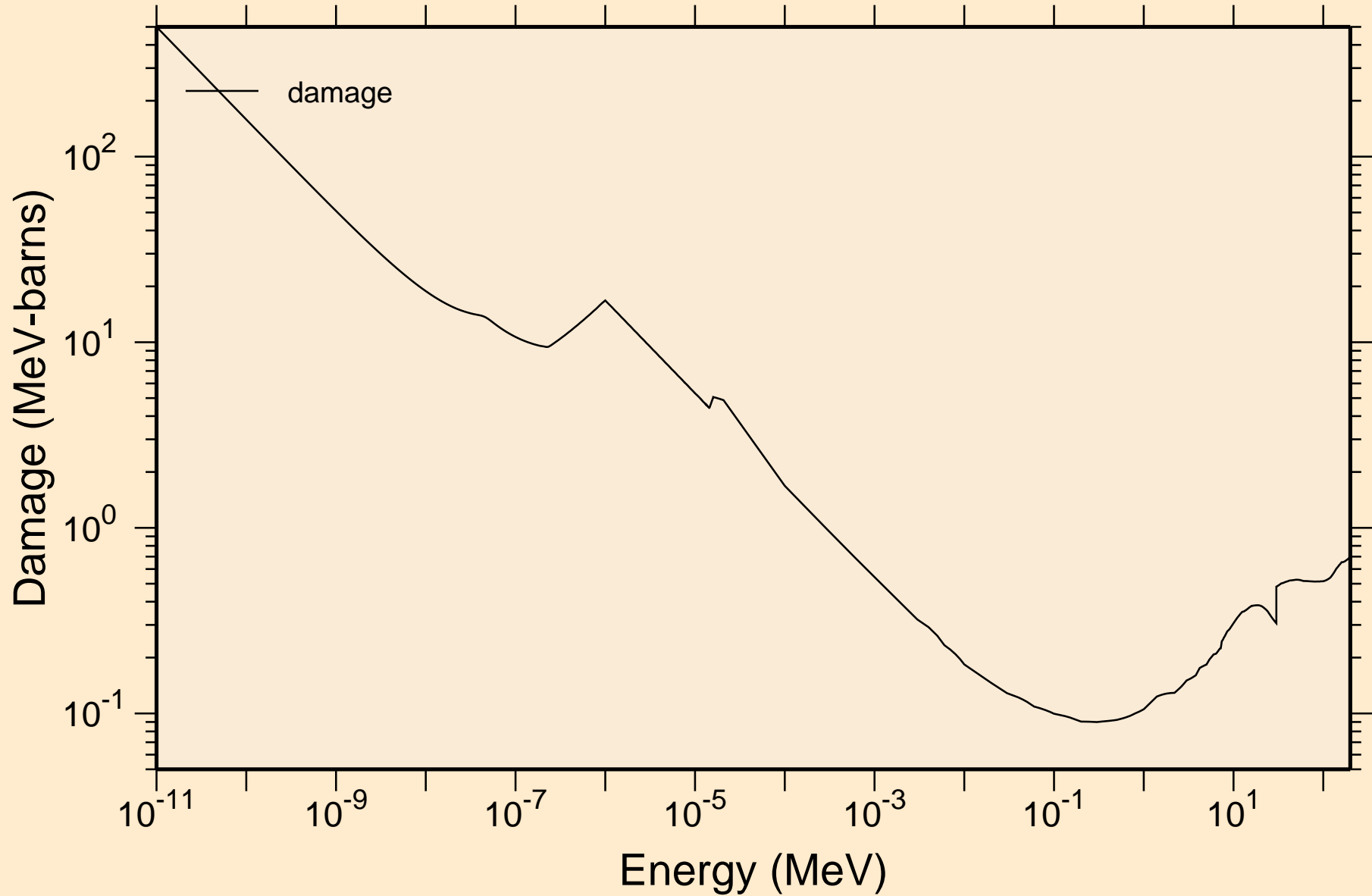

CS117 NEUTRON ACER TENDL-2024 LIBRARY; T=293.6K

Non-threshold reactions

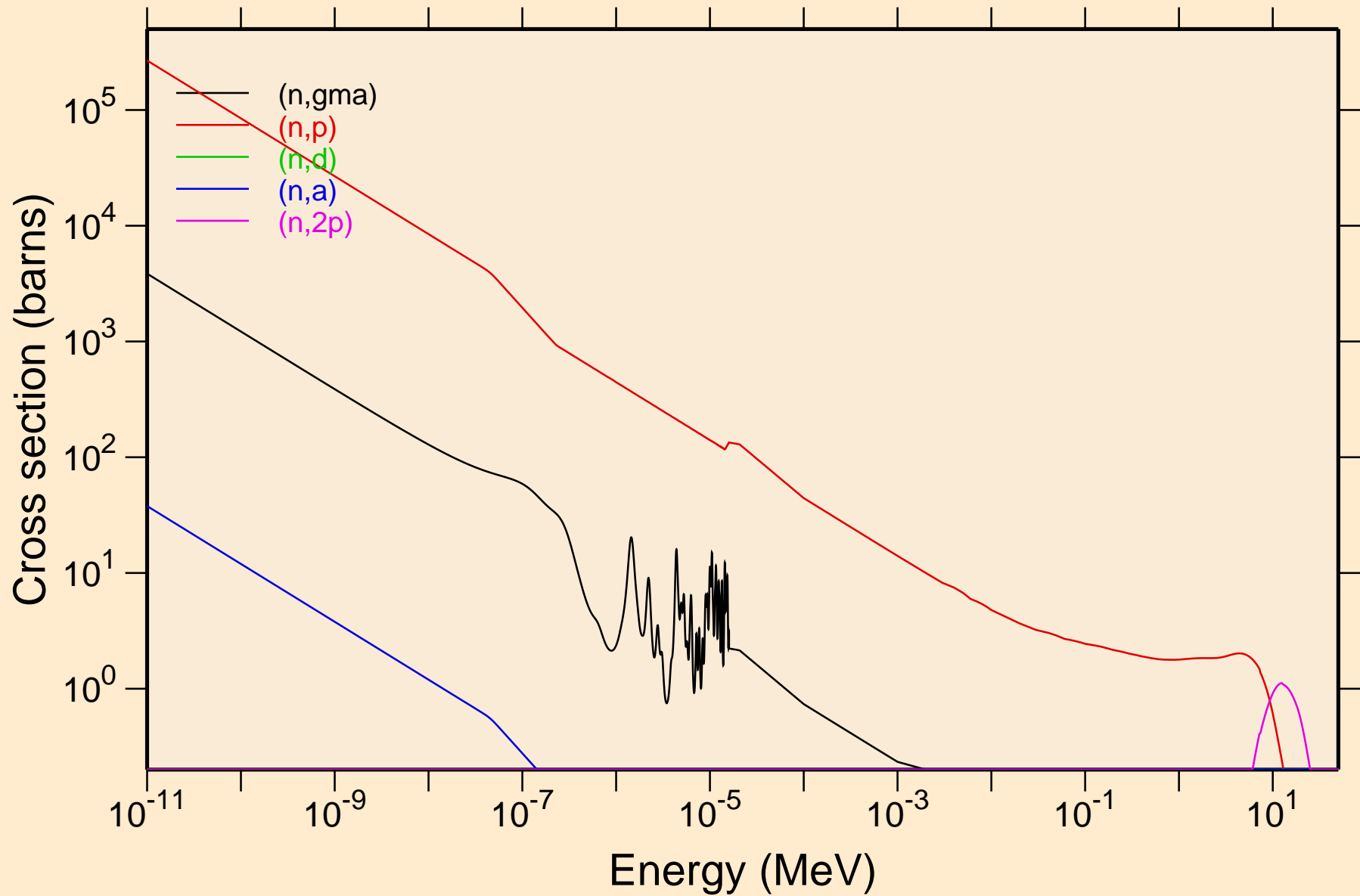

CS117 NEUTRON ACER TENDL-2024 LIBRARY; T=293.6K

Non-threshold reactions

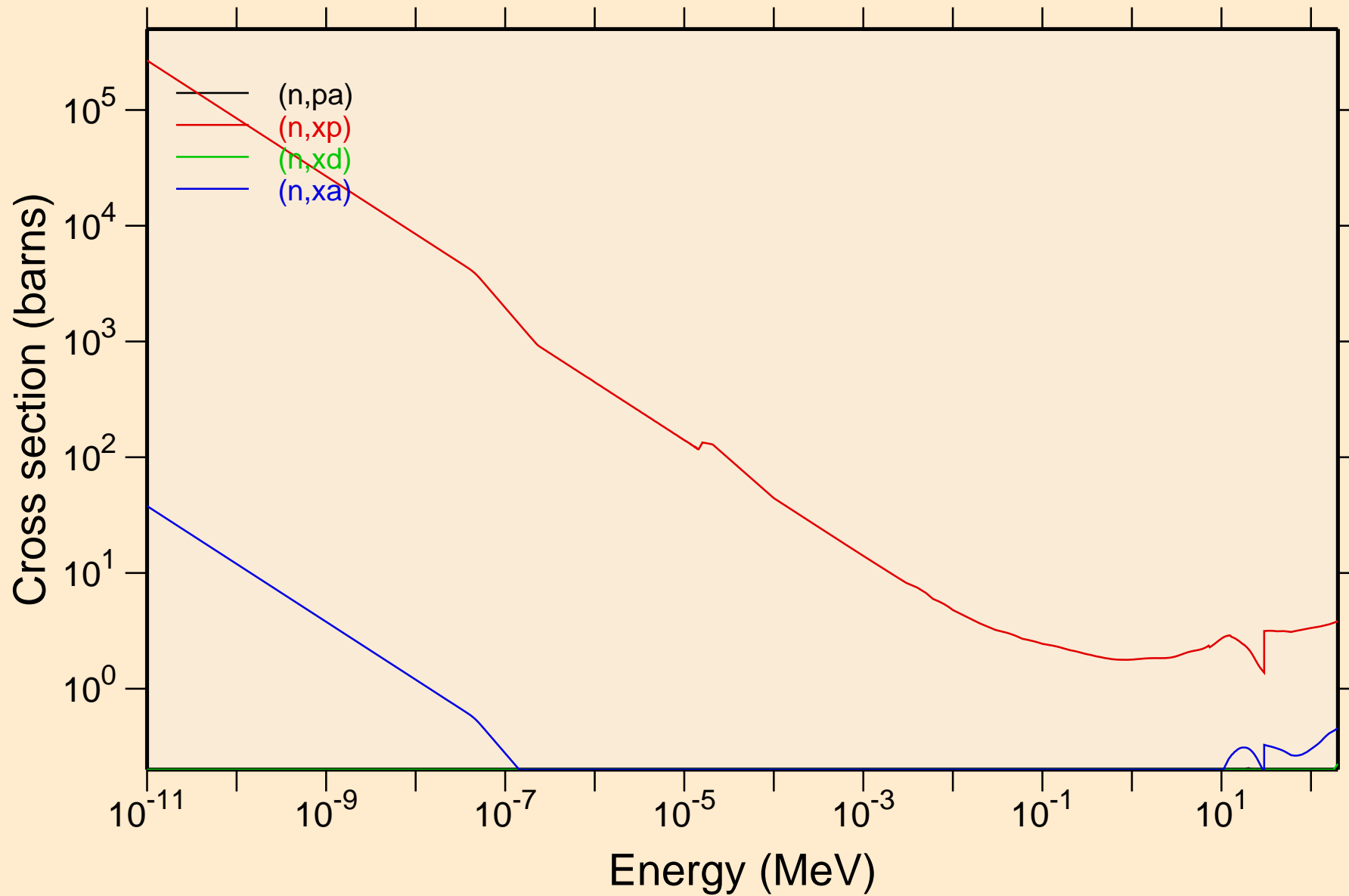

CS117 NEUTRON ACER TENDL-2024 LIBRARY; T=293.6K

Principal cross sections

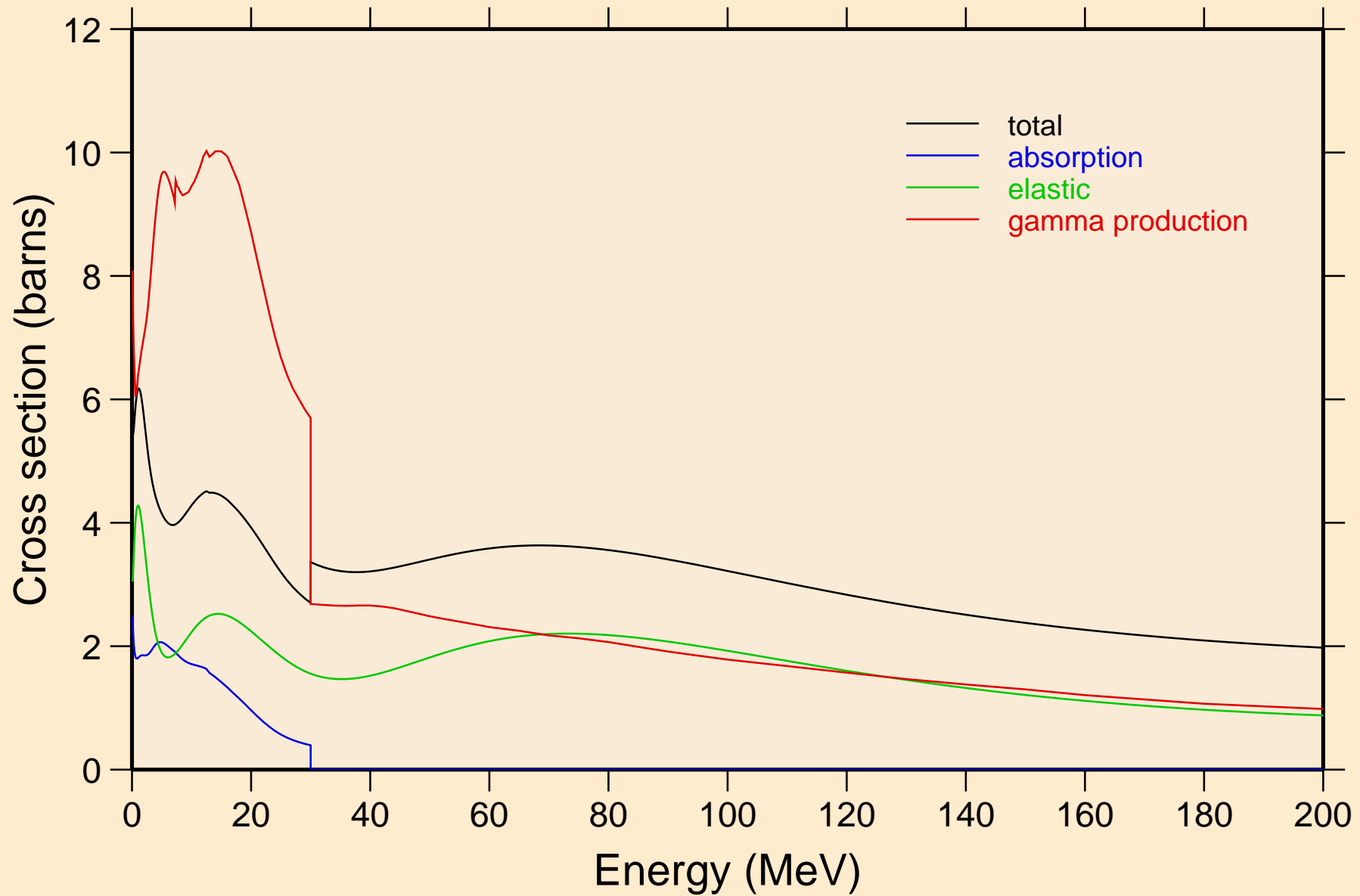

CS117 NEUTRON ACER TENDL-2024 LIBRARY; T=293.6K

Heating

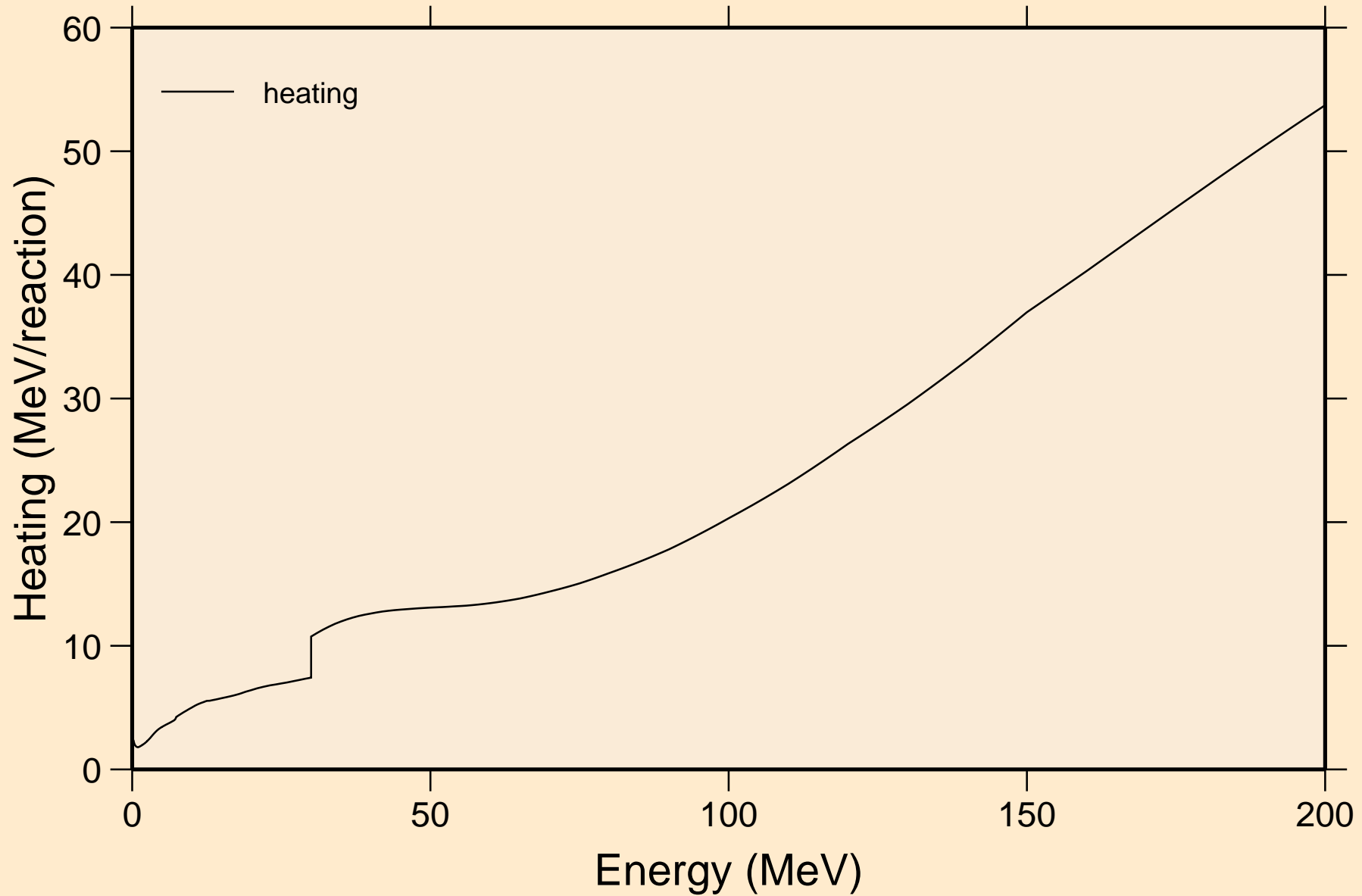

CS117 NEUTRON ACER TENDL-2024 LIBRARY; T=293.6K
Damage

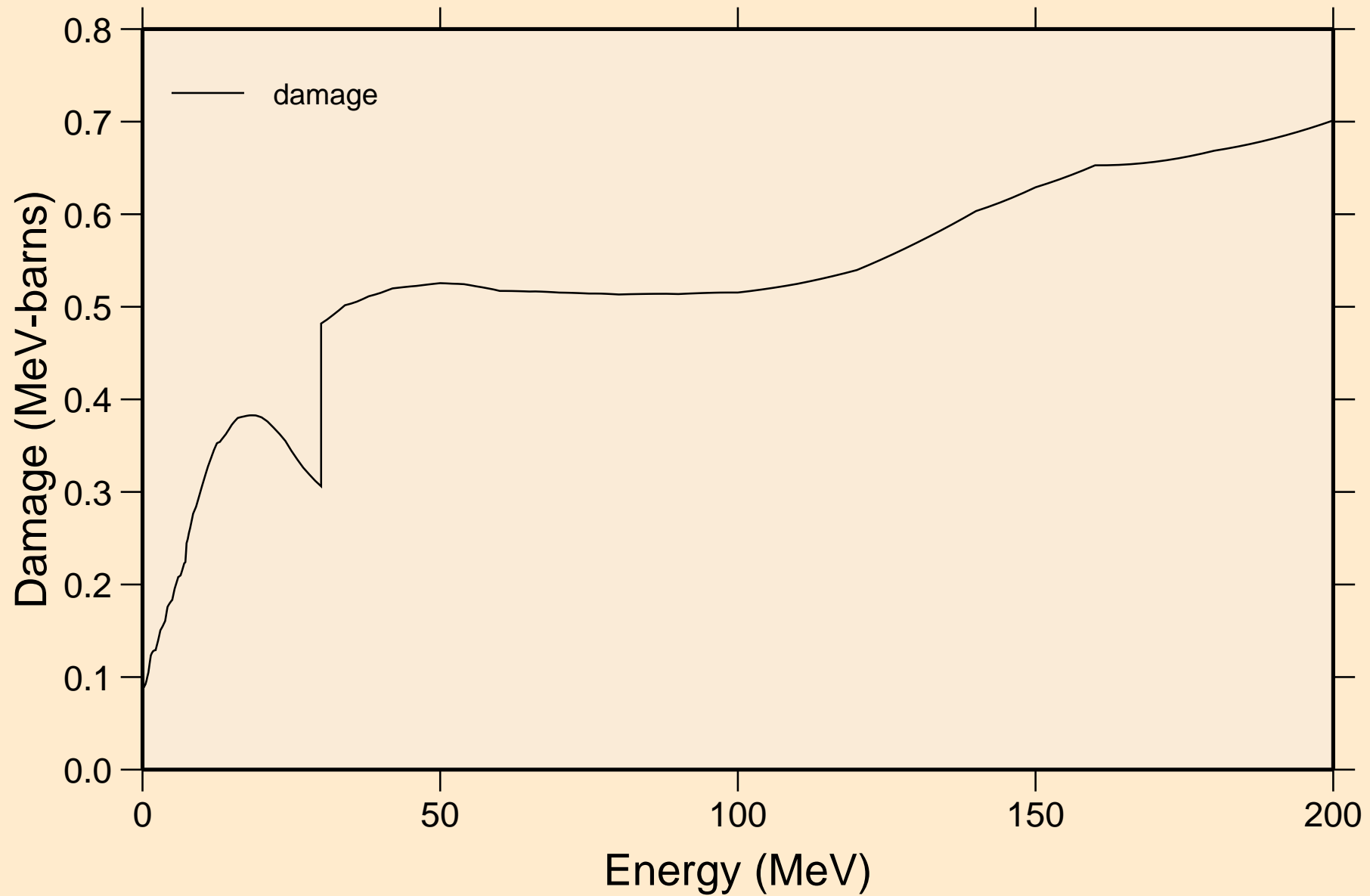

CS117 NEUTRON ACER TENDL-2024 LIBRARY; T=293.6K
Non-threshold reactions

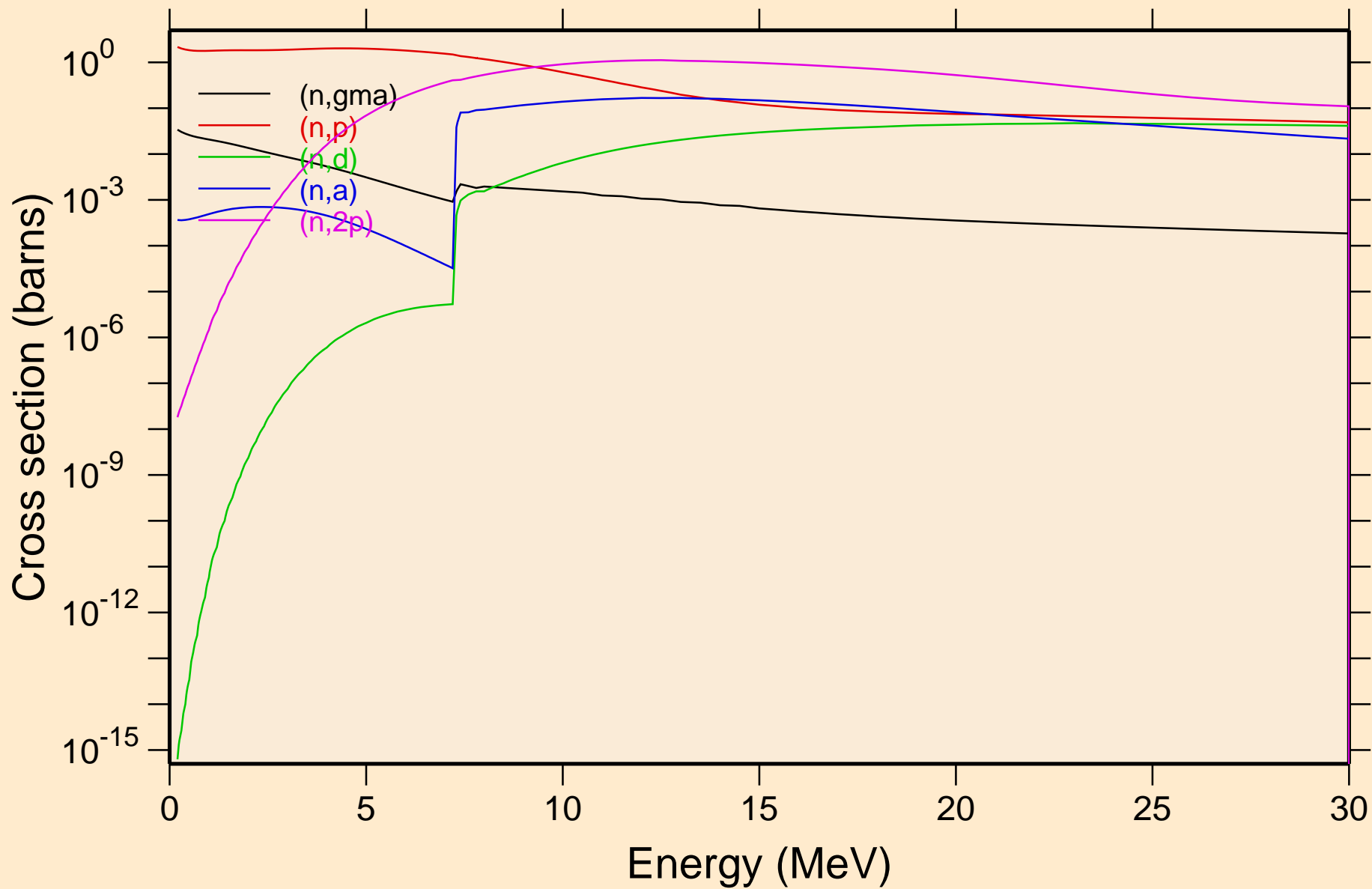

CS117 NEUTRON ACER TENDL-2024 LIBRARY; T=293.6K
Non-threshold reactions

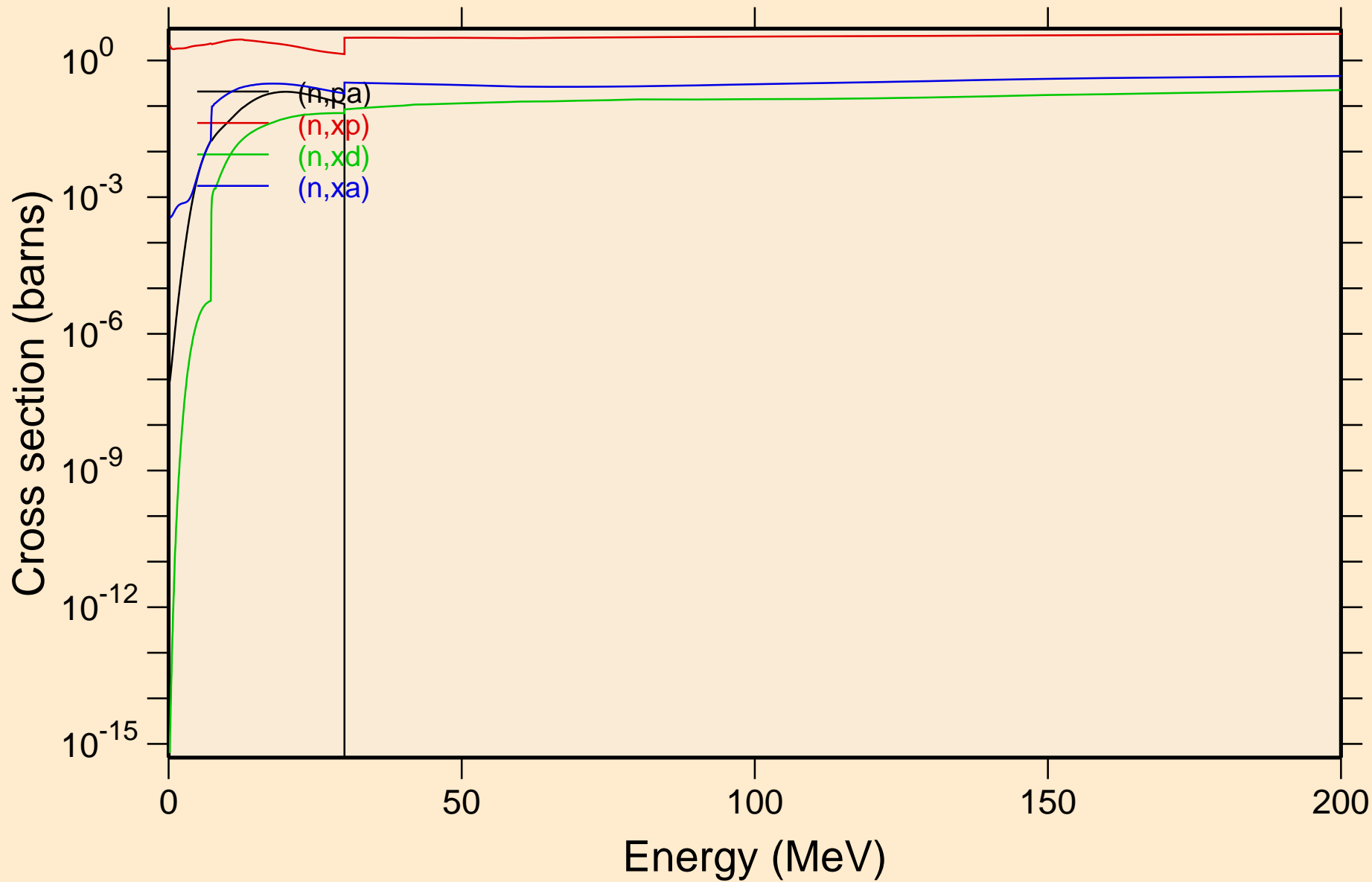

CS117 NEUTRON ACER TENDL-2024 LIBRARY; T=293.6K
Inelastic levels

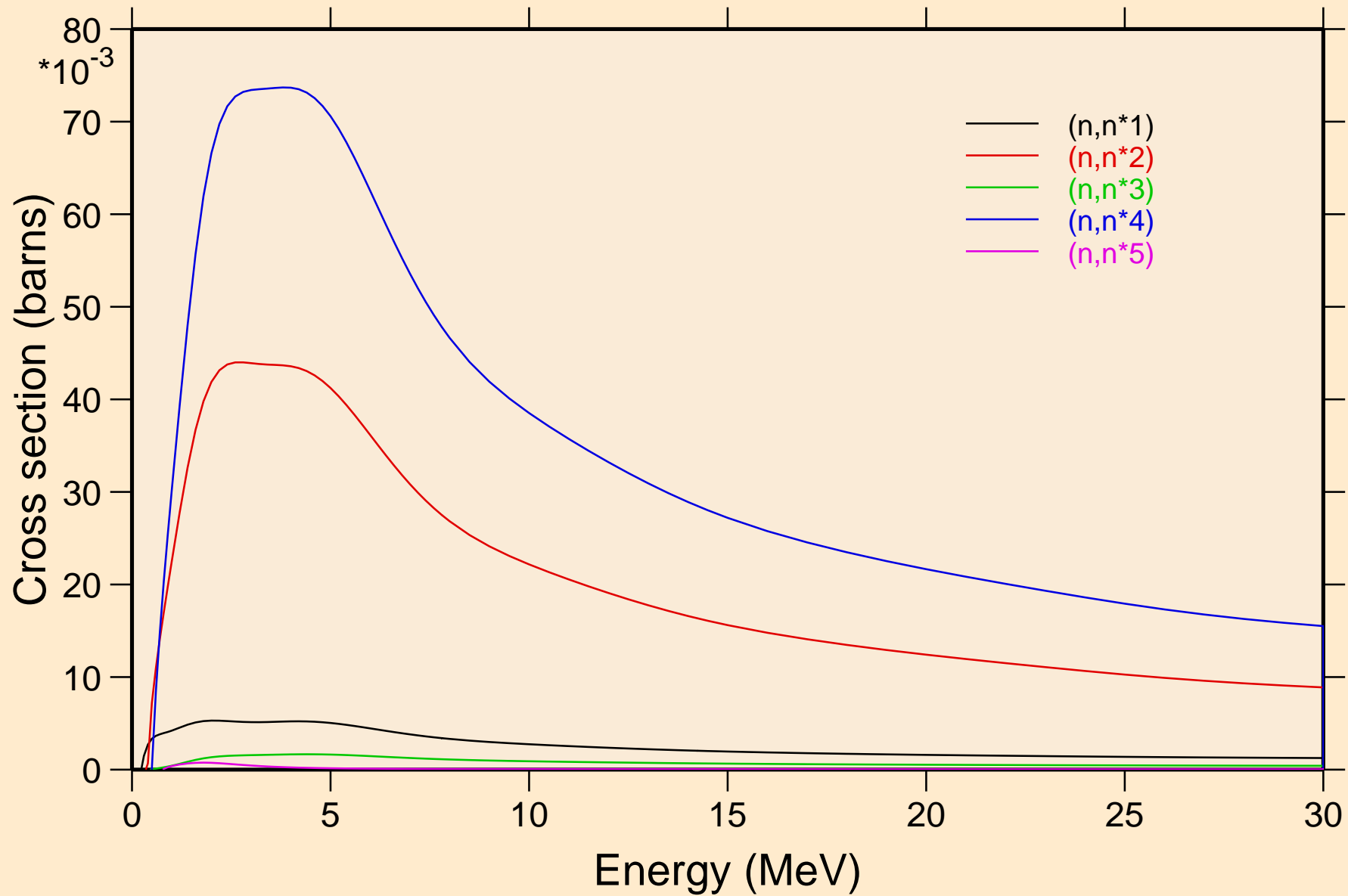

CS117 NEUTRON ACER TENDL-2024 LIBRARY; T=293.6K
Inelastic levels

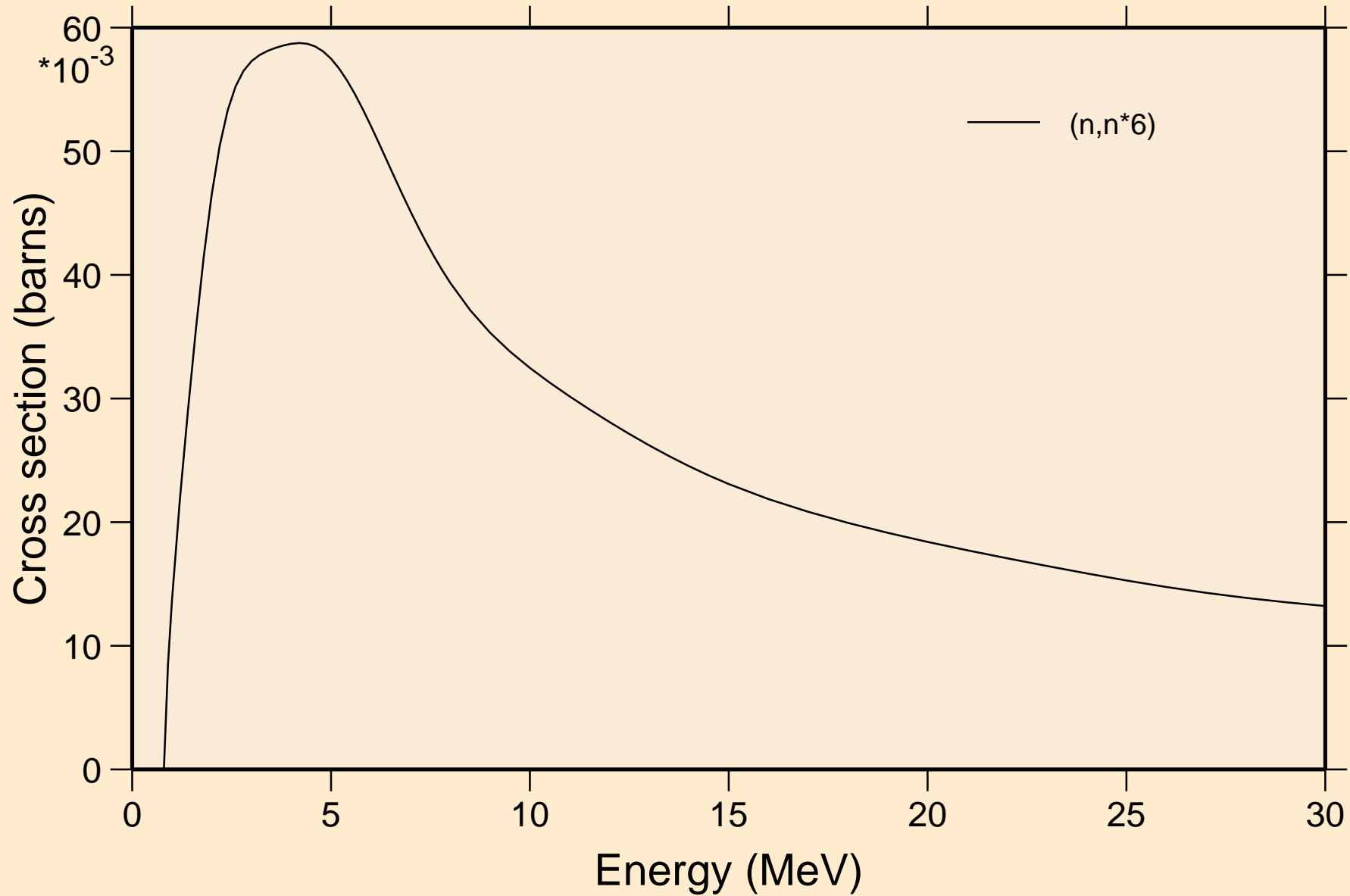

CS117 NEUTRON ACER TENDL-2024 LIBRARY; T=293.6K

Threshold reactions

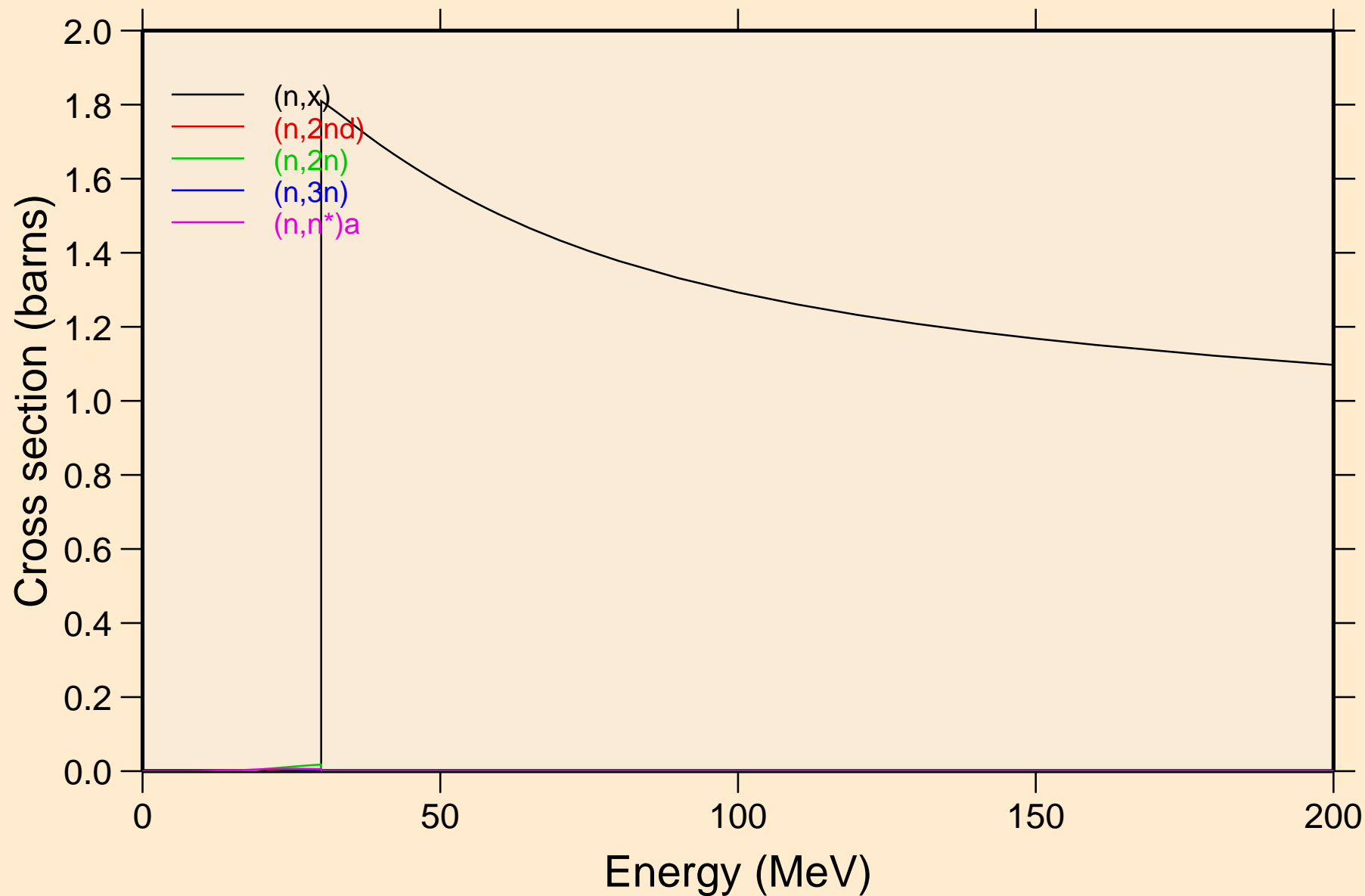

CS117 NEUTRON ACER TENDL-2024 LIBRARY; T=293.6K
Threshold reactions

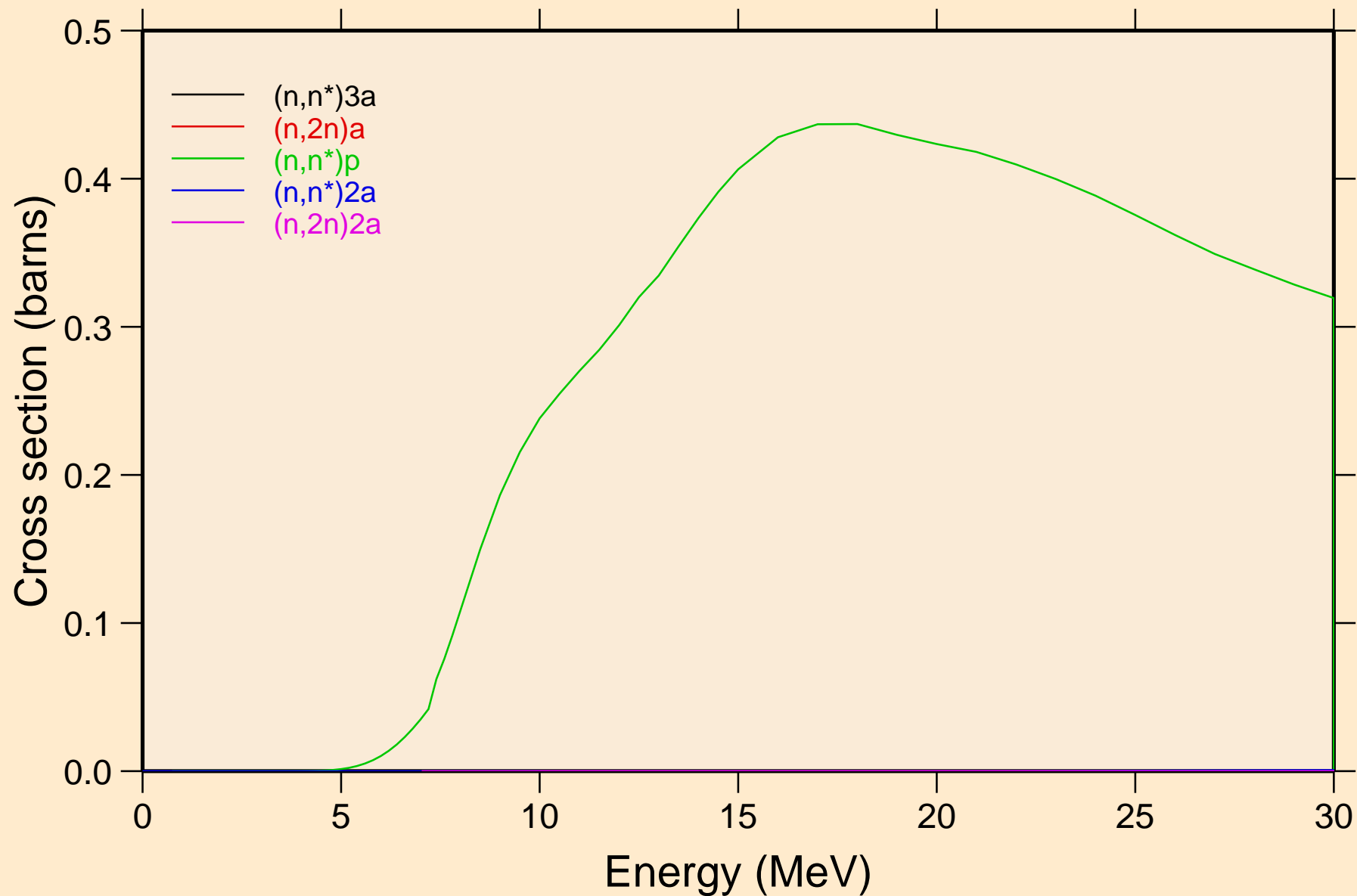

CS117 NEUTRON ACER TENDL-2024 LIBRARY; T=293.6K

Threshold reactions

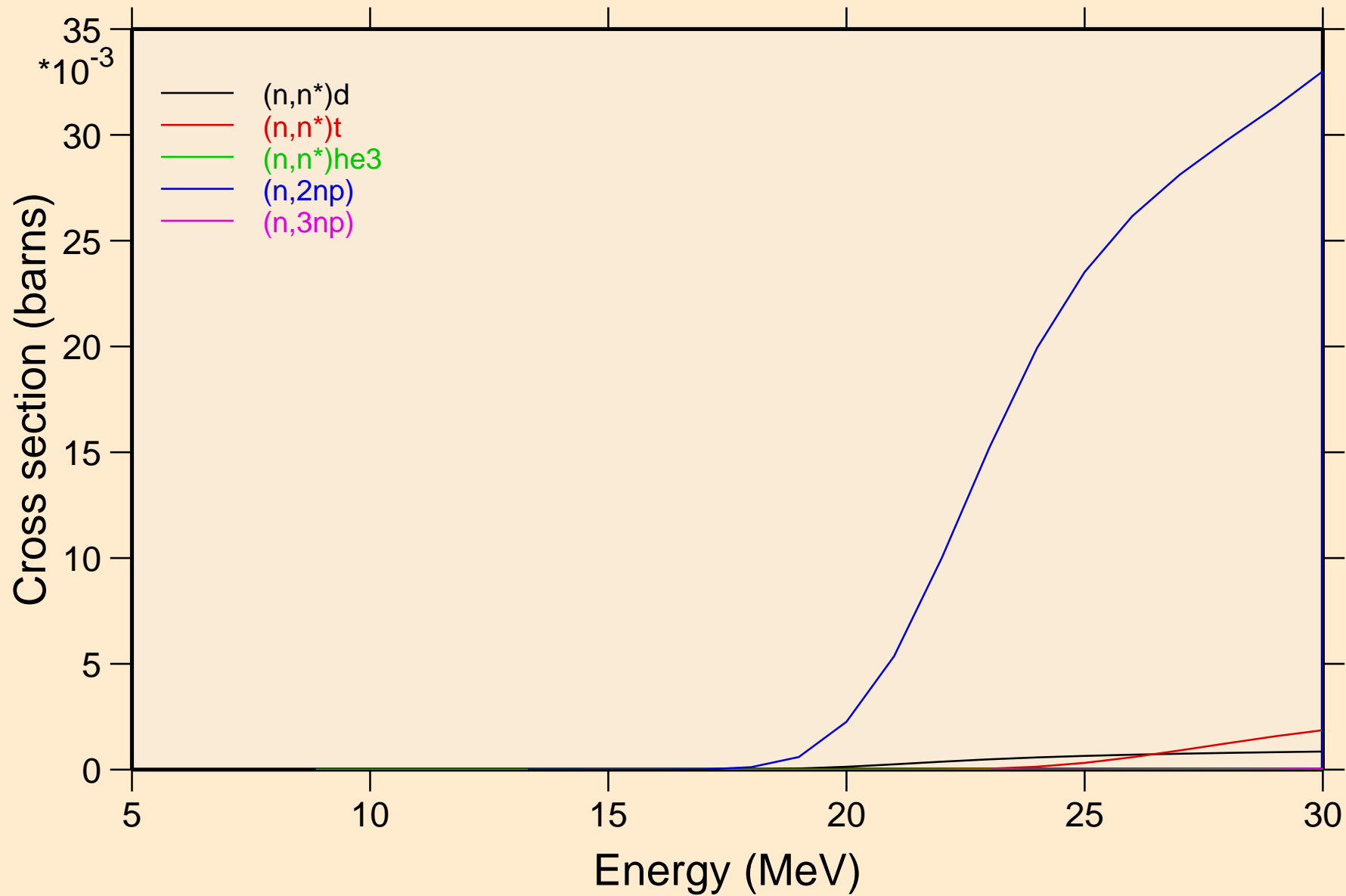

CS117 NEUTRON ACER TENDL-2024 LIBRARY; T=293.6K
Threshold reactions

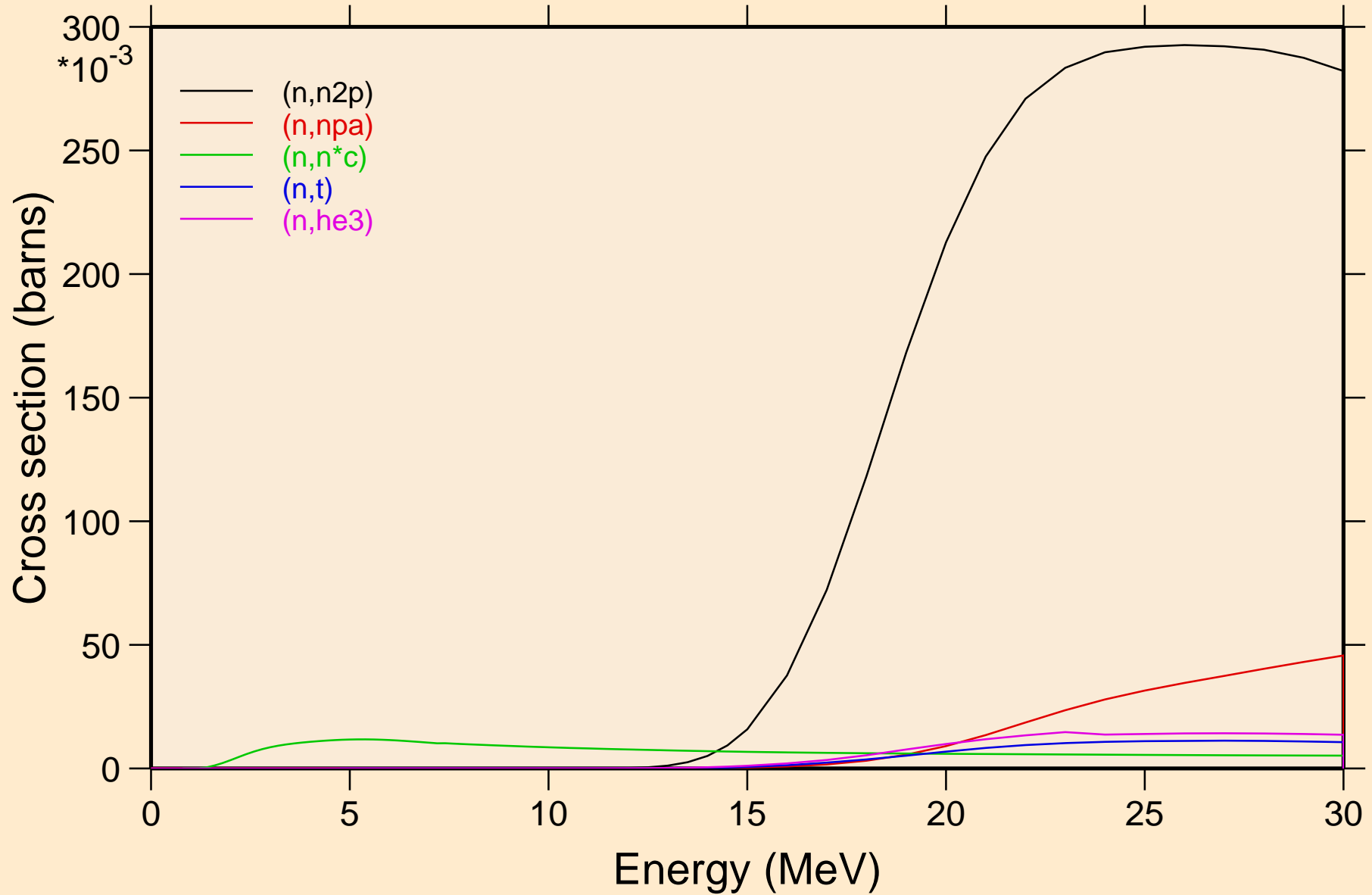

CS117 NEUTRON ACER TENDL-2024 LIBRARY; T=293.6K
Threshold reactions

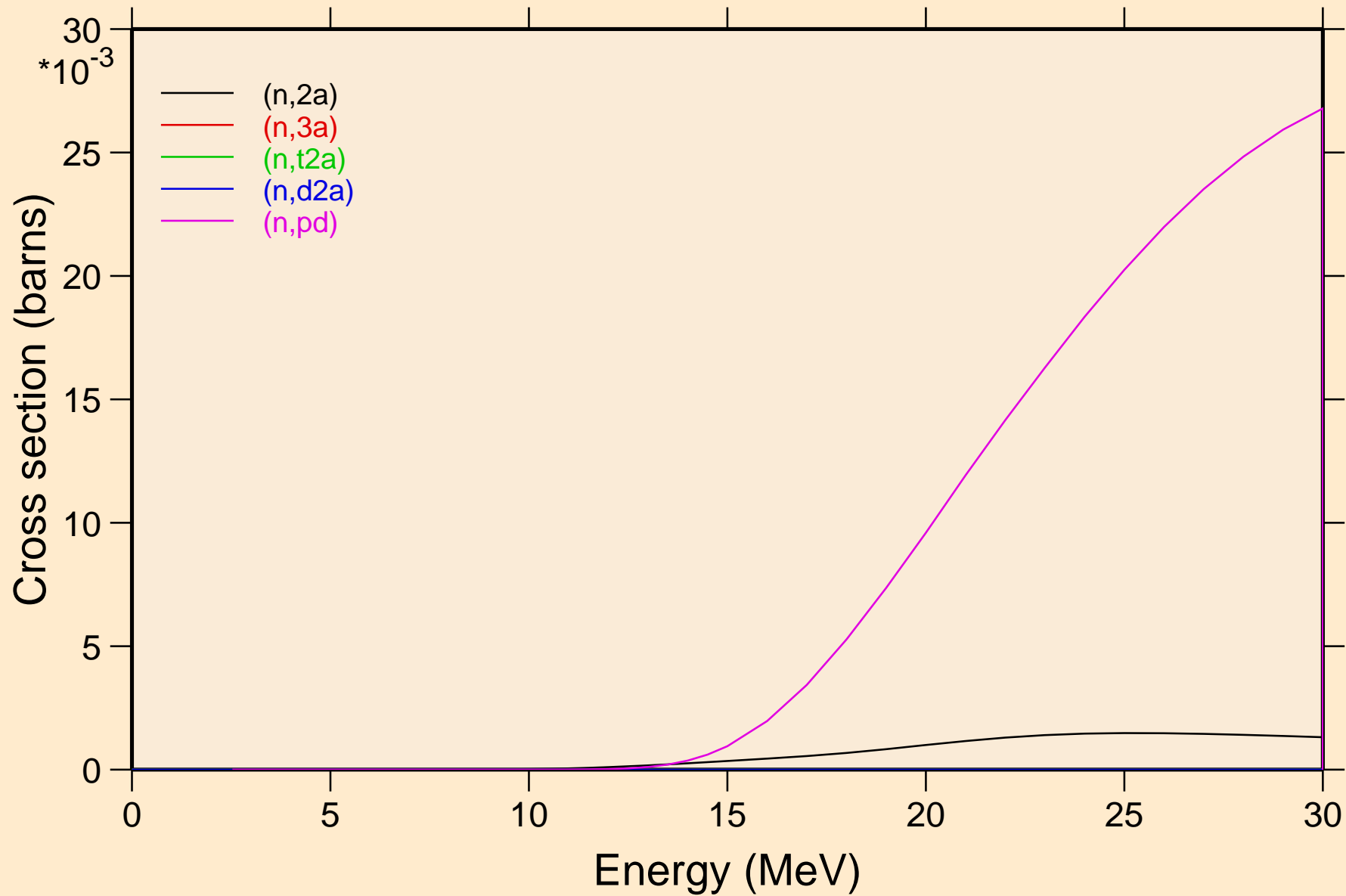

CS117 NEUTRON ACER TENDL-2024 LIBRARY; T=293.6K
Threshold reactions

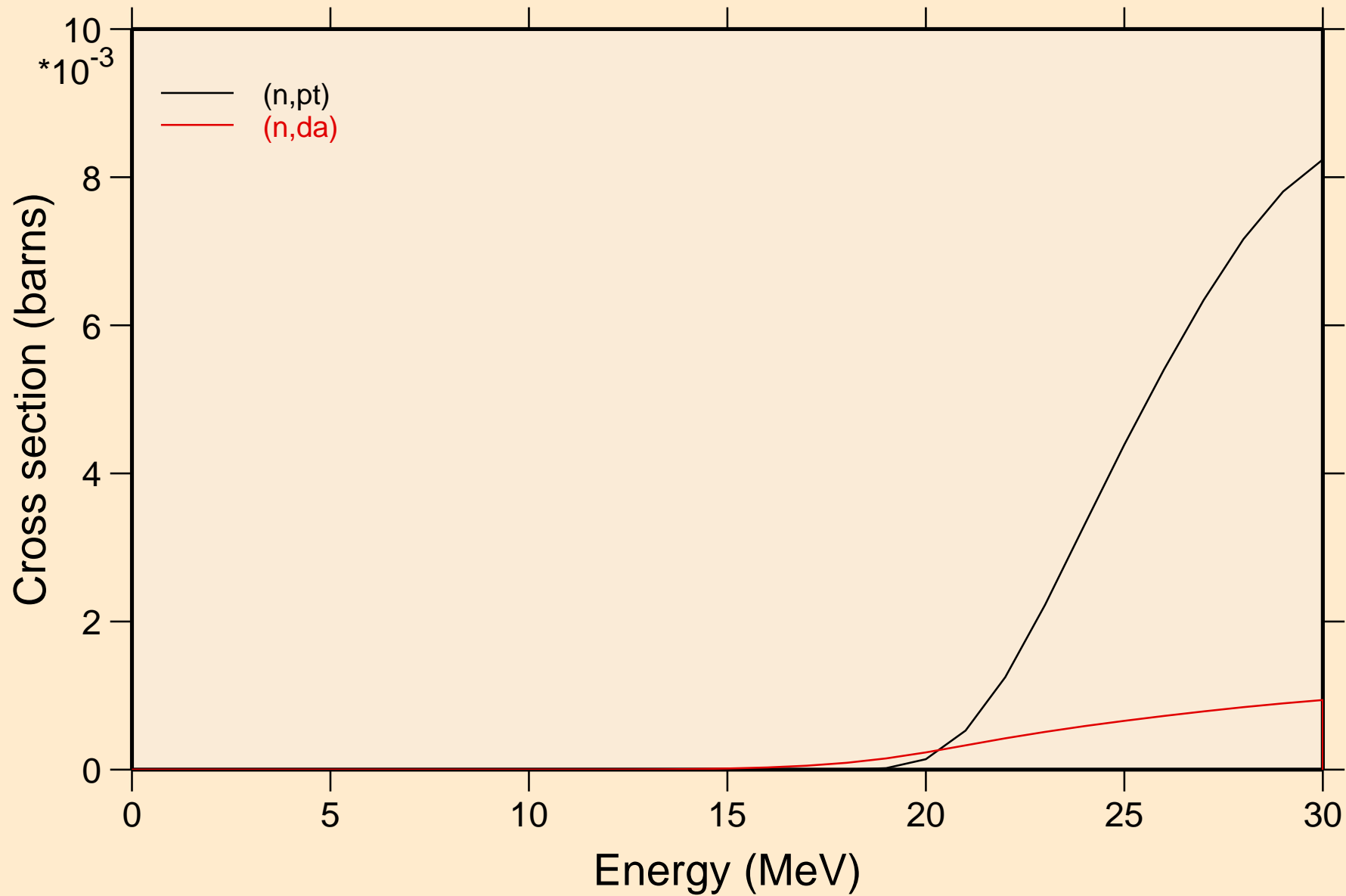

CS117 NEUTRON ACER TENDL-2024 LIBRARY; T=293.6K
Threshold reactions

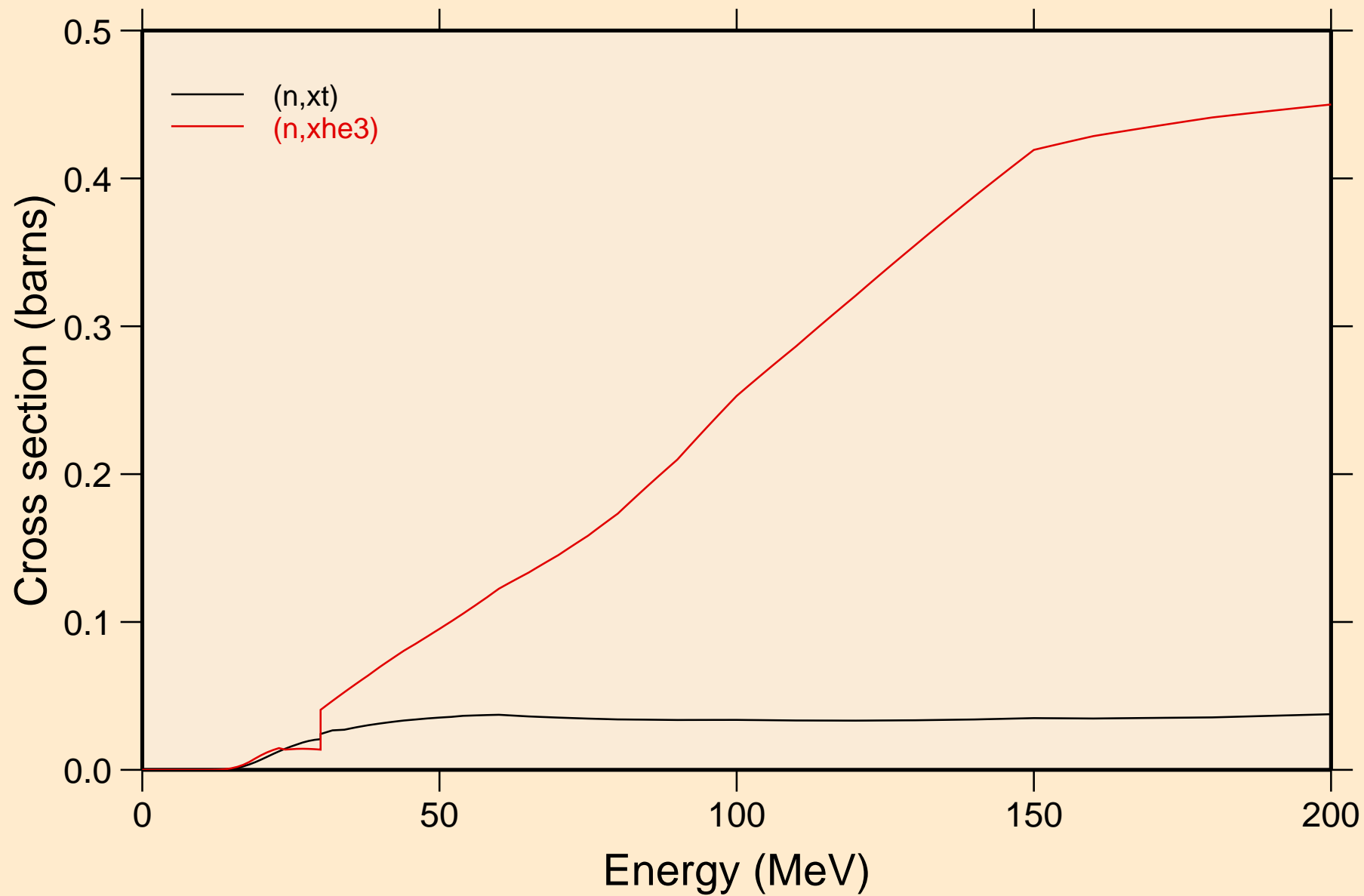

CS117 NEUTRON ACER TENDL-2024 LIBRARY; T=293.6K
angular distribution for elastic

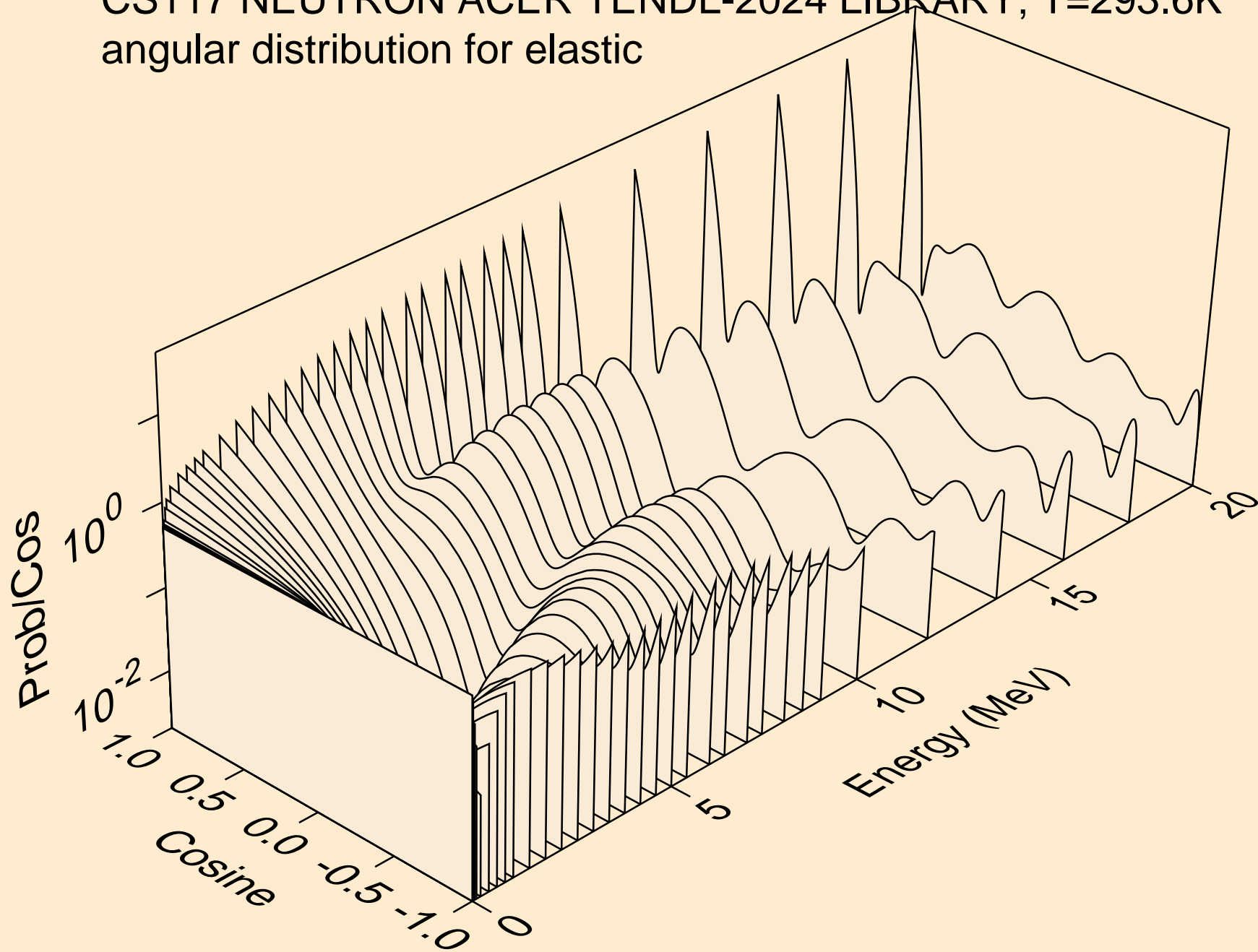

CS117 NEUTRON ACER TENDL-2024 LIBRARY; T=293.6K
angular distribution for elastic

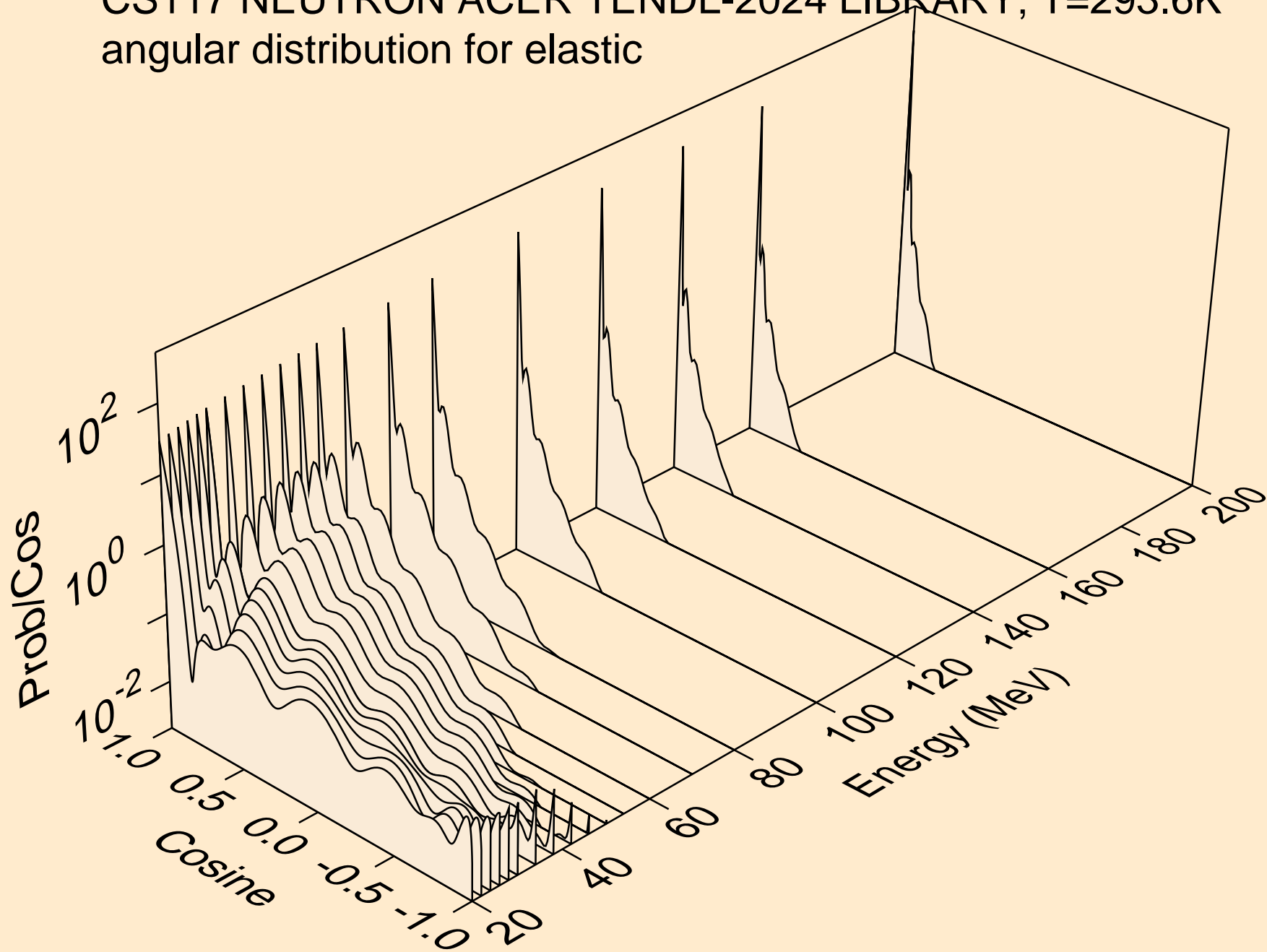

CS117 NEUTRON ACER TENDL-2024 LIBRARY; T=293.6K
angular distribution for (n,n*1)

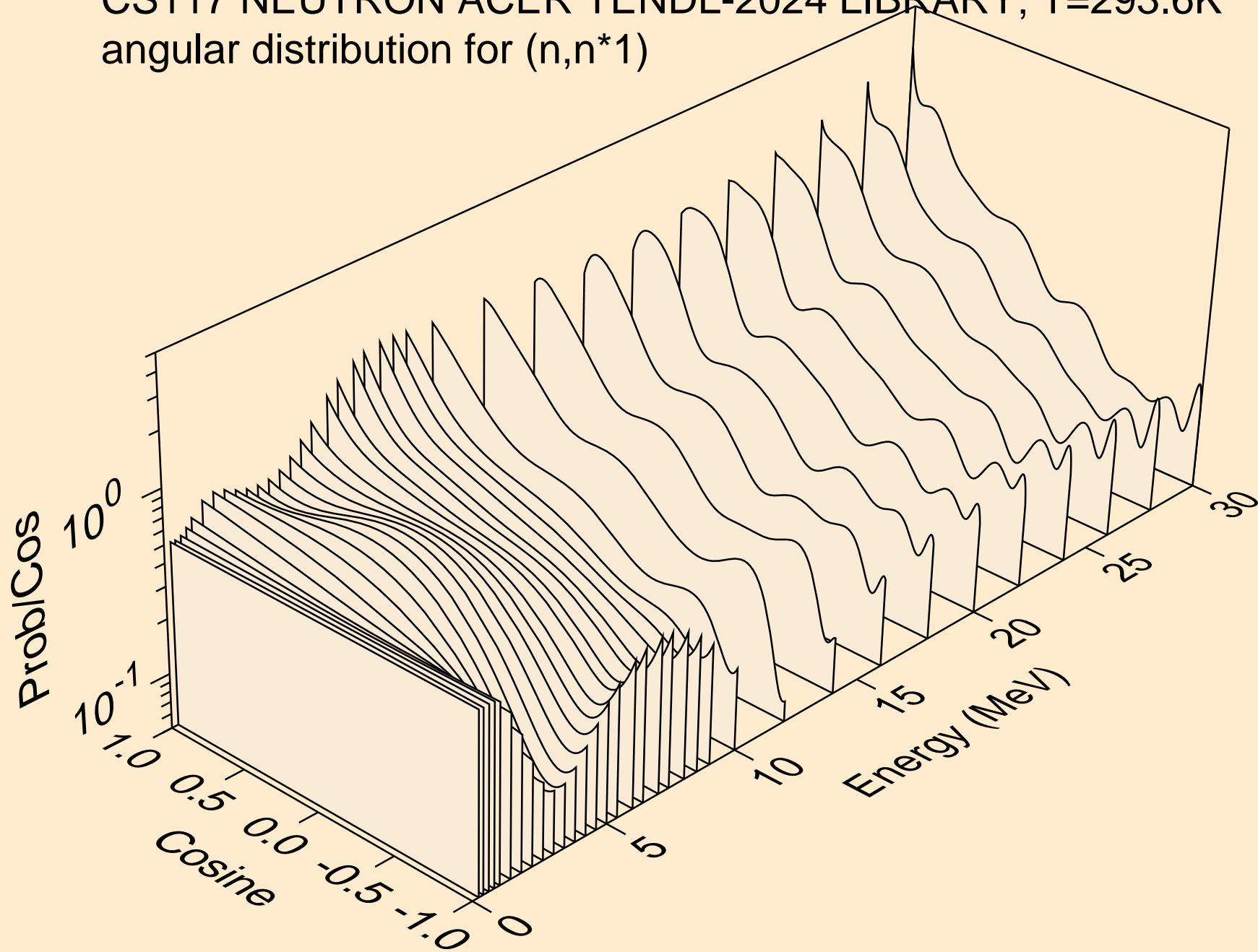

CS117 NEUTRON ACER TENDL-2024 LIBRARY; T=293.6K
angular distribution for (n,n*2)

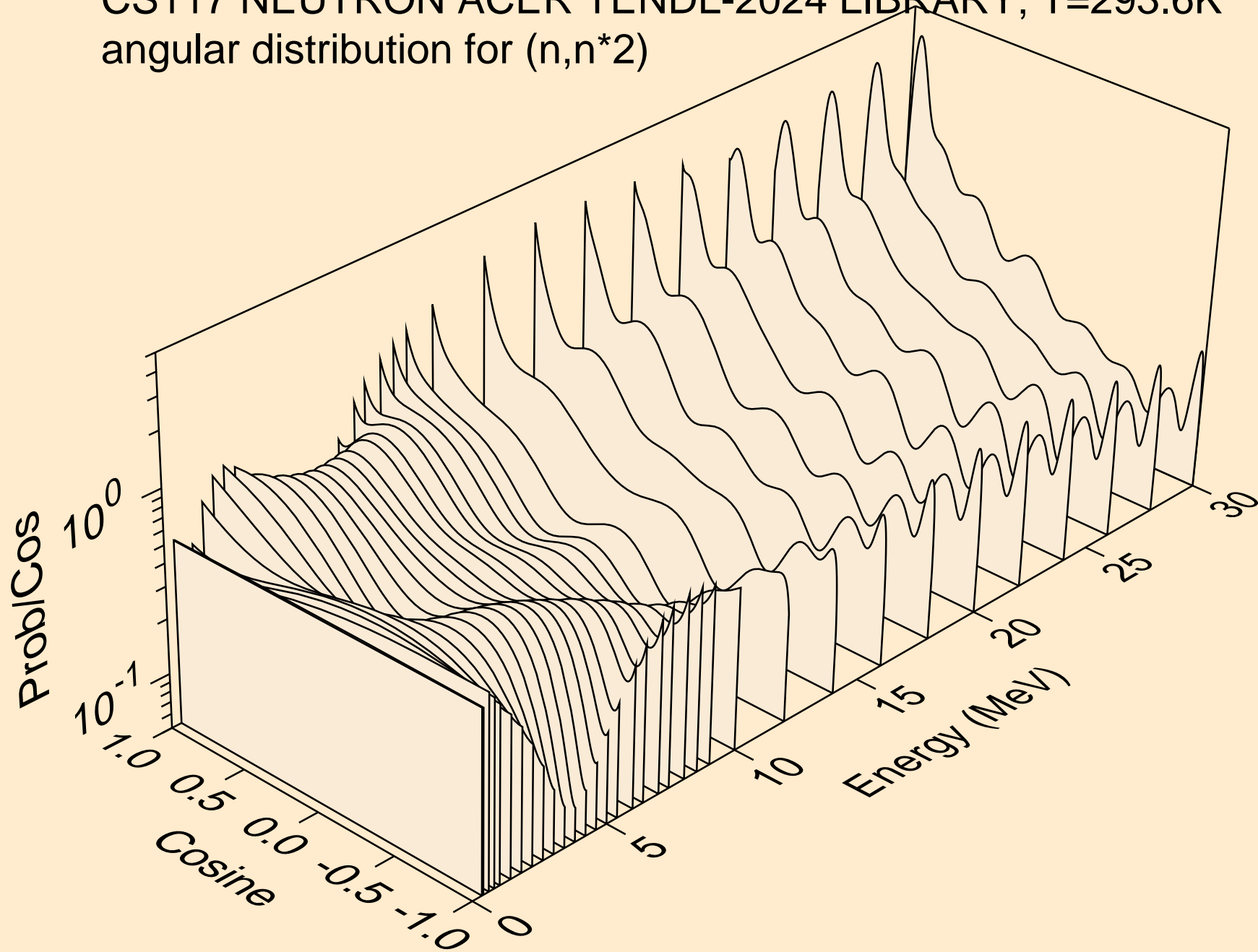

CS117 NEUTRON ACER TENDL-2024 LIBRARY; T=293.6K
angular distribution for (n,n*3)

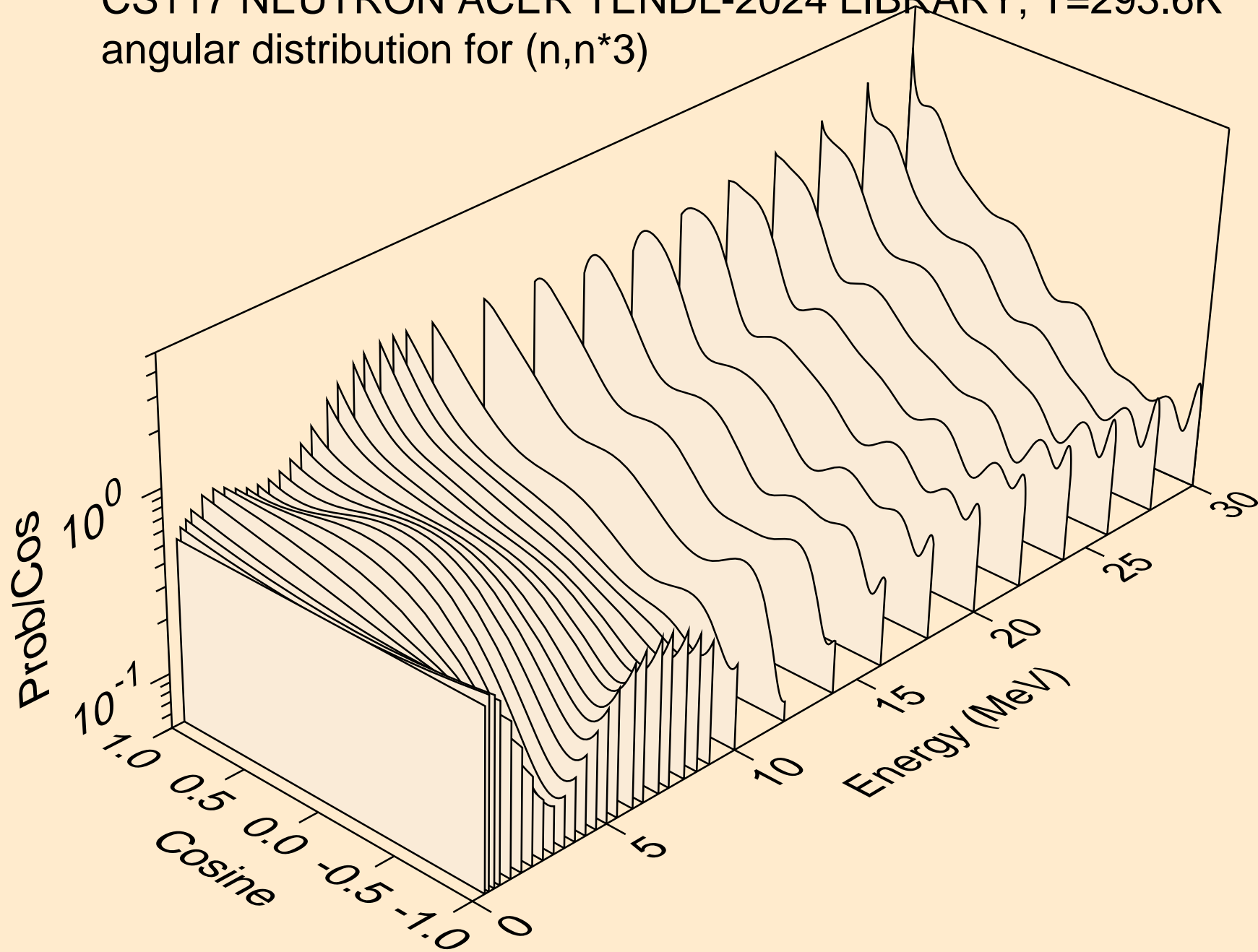

CS117 NEUTRON ACER TENDL-2024 LIBRARY; T=293.6K
angular distribution for (n,n*4)

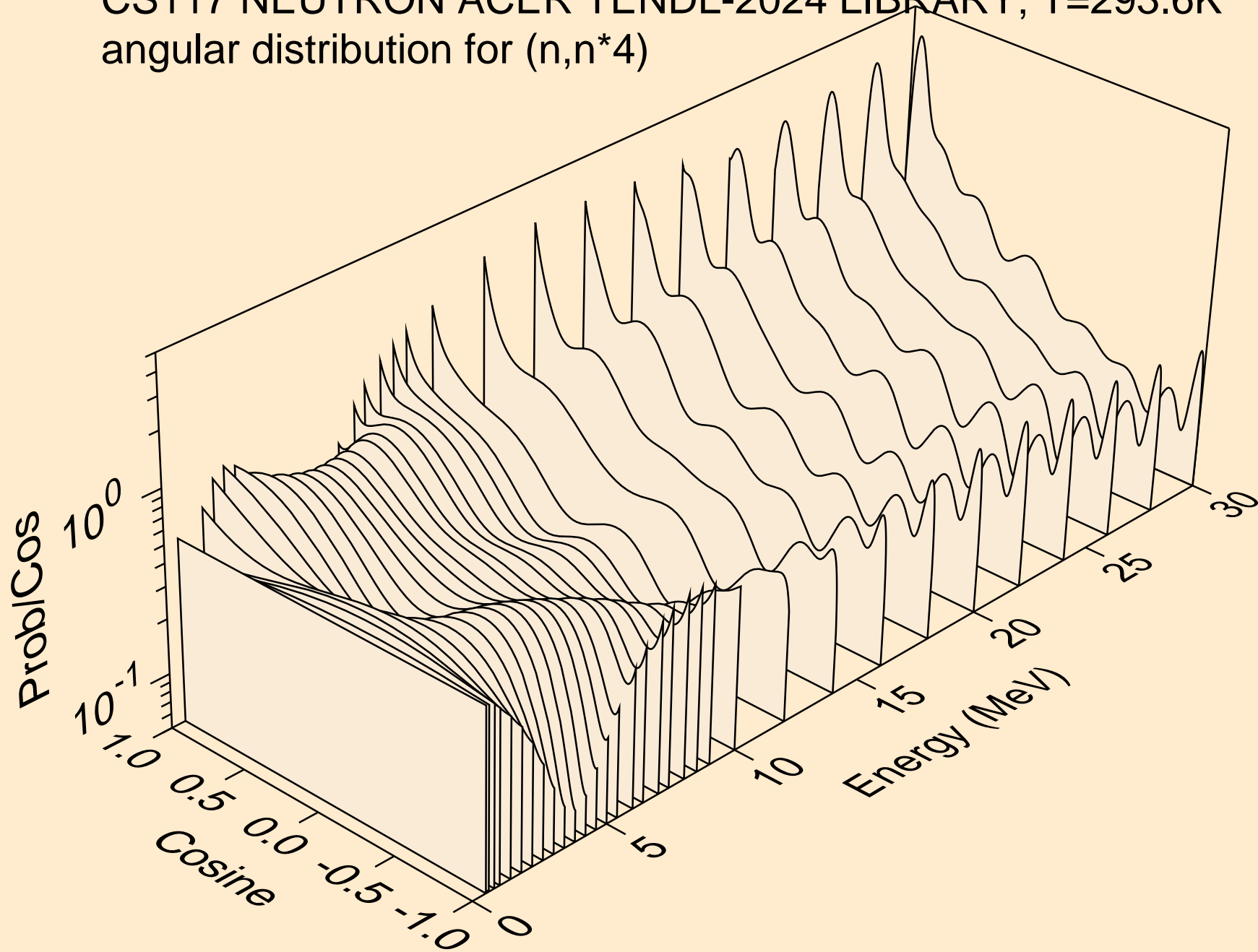

CS117 NEUTRON ACER TENDL-2024 LIBRARY; T=293.6K
angular distribution for (n,n*5)

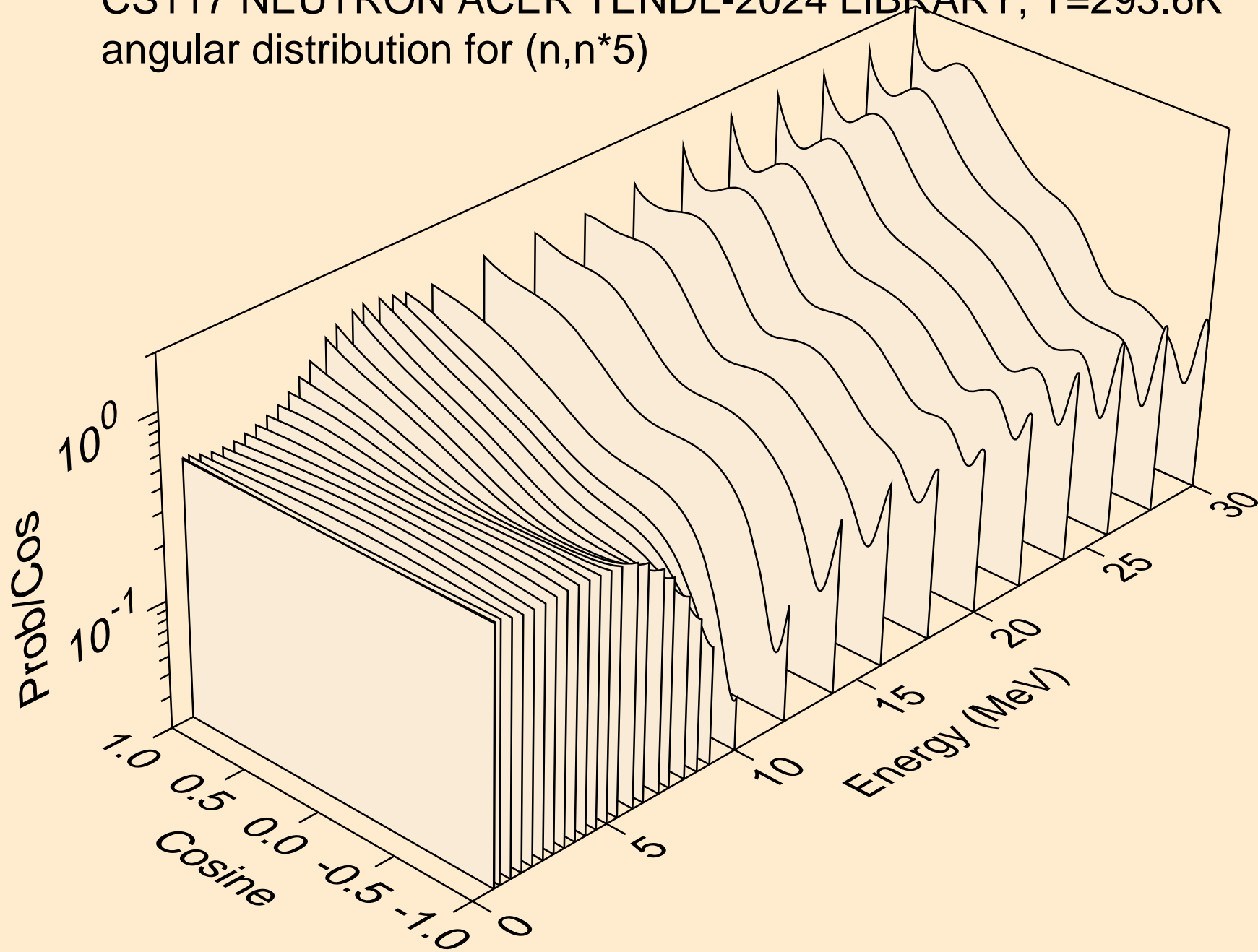

CS117 NEUTRON ACER TENDL-2024 LIBRARY; T=293.6K
angular distribution for (n,n*6)

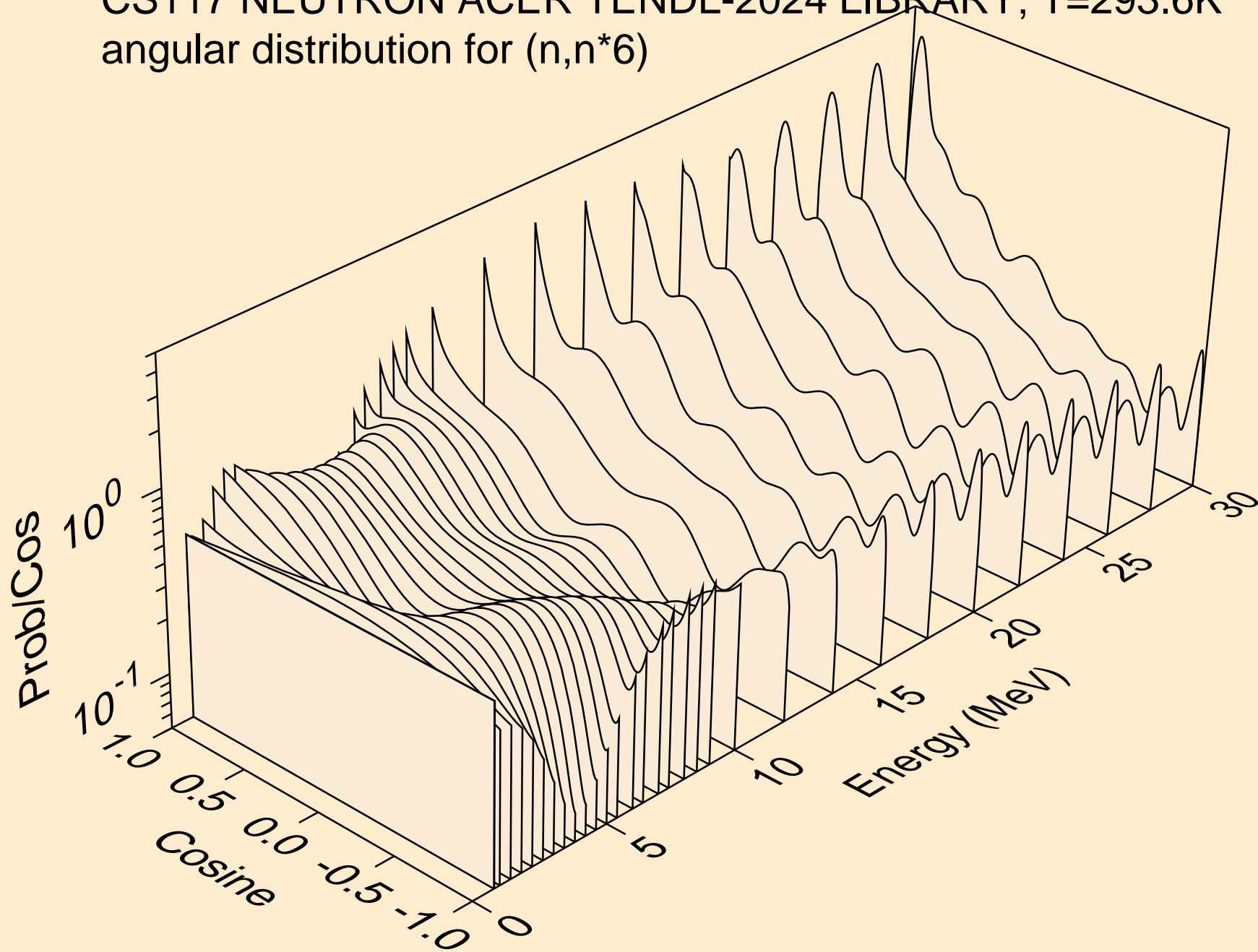

CS117 NEUTRON ACER TENDL-2024 LIBRARY; T=293.6K
Neutron emission for (n,x)

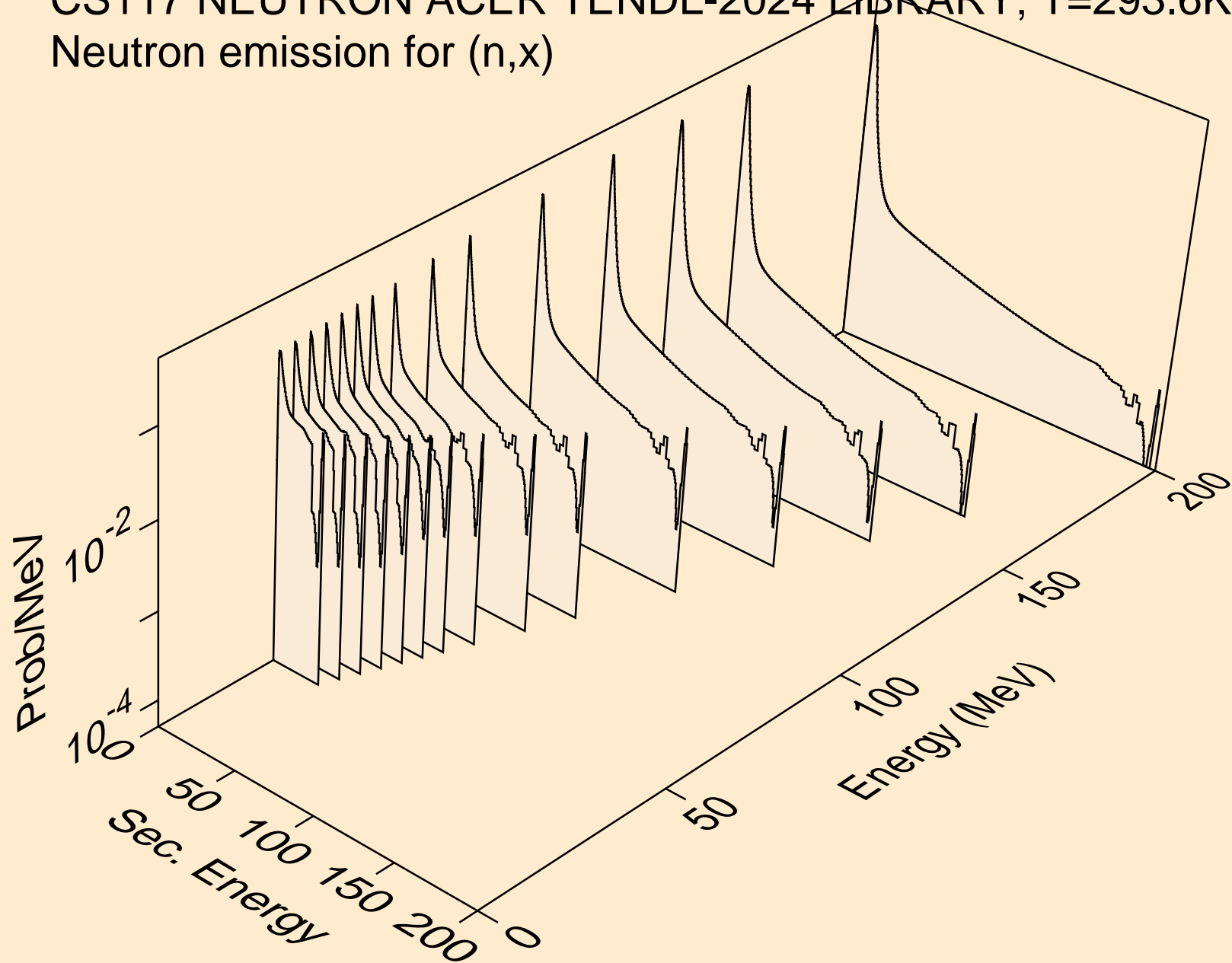

CS117 NEUTRON ACER TENDL-2024 LIBRARY; T=293.6K
Neutron emission for (n,2nd)

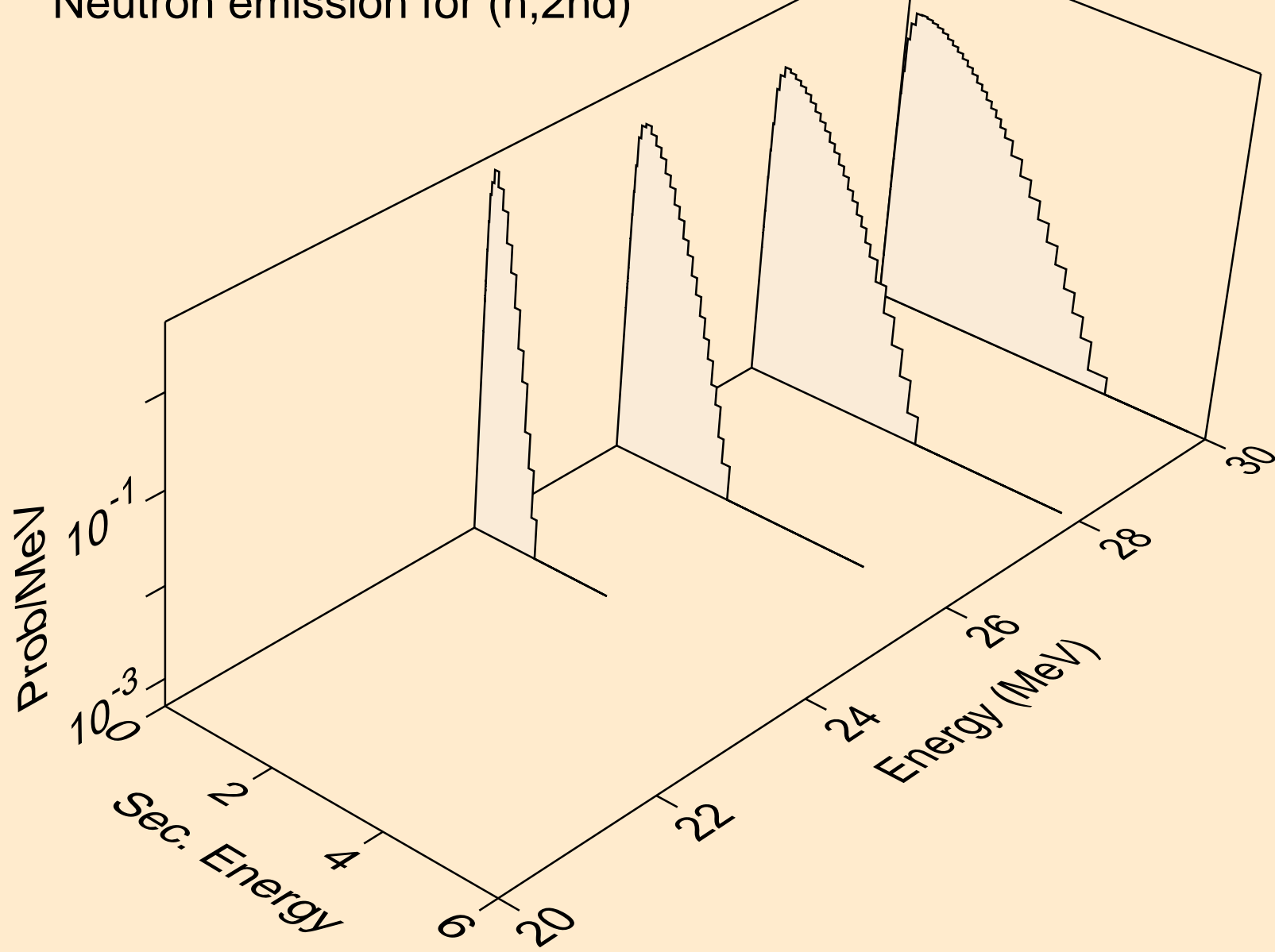

CS117 NEUTRON ACER TENDL-2024 LIBRARY; T=293.6K
Neutron emission for (n,2n)

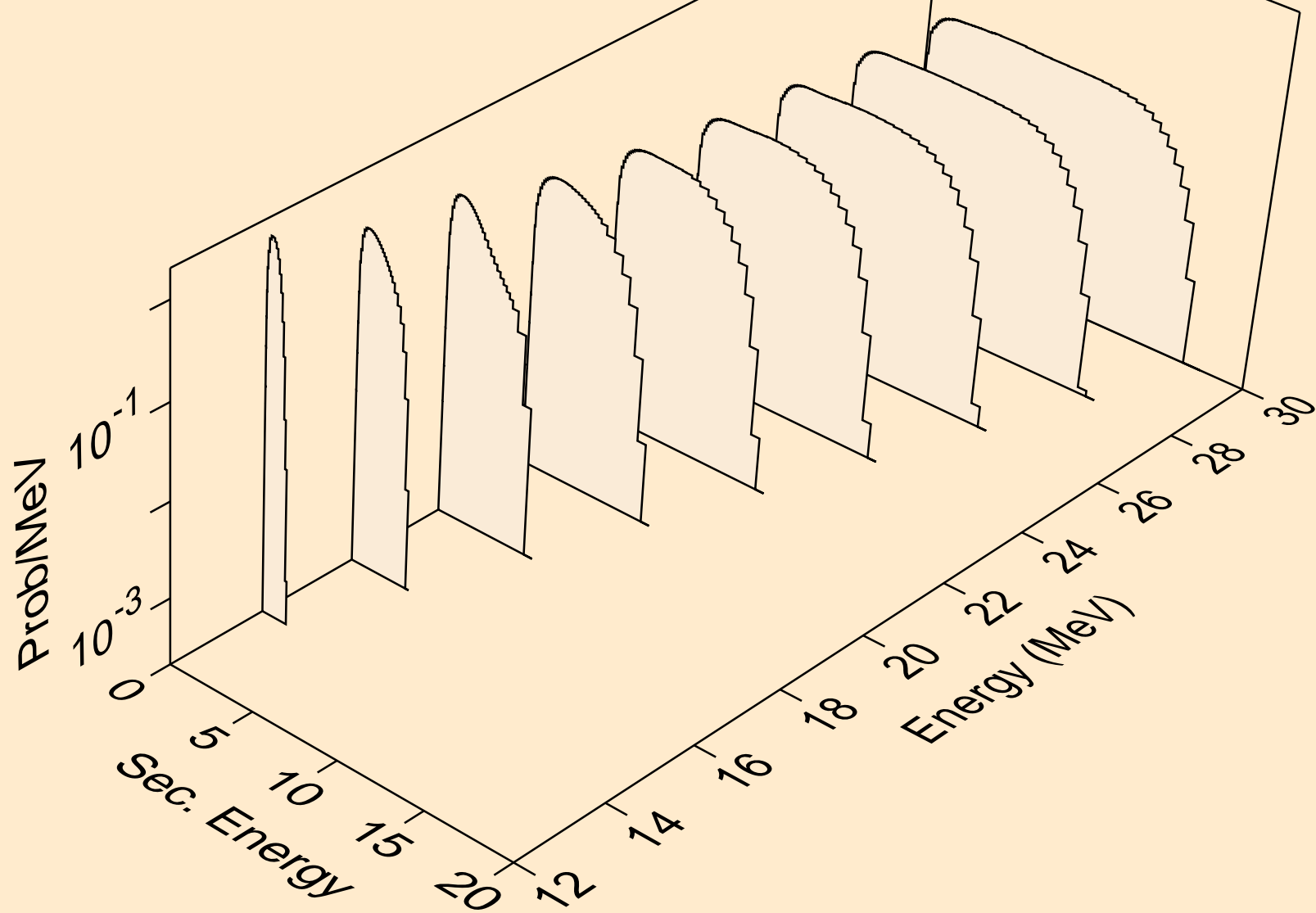

CS117 NEUTRON ACER TENDL-2024 LIBRARY; T=293.6K
Neutron emission for (n,3n)

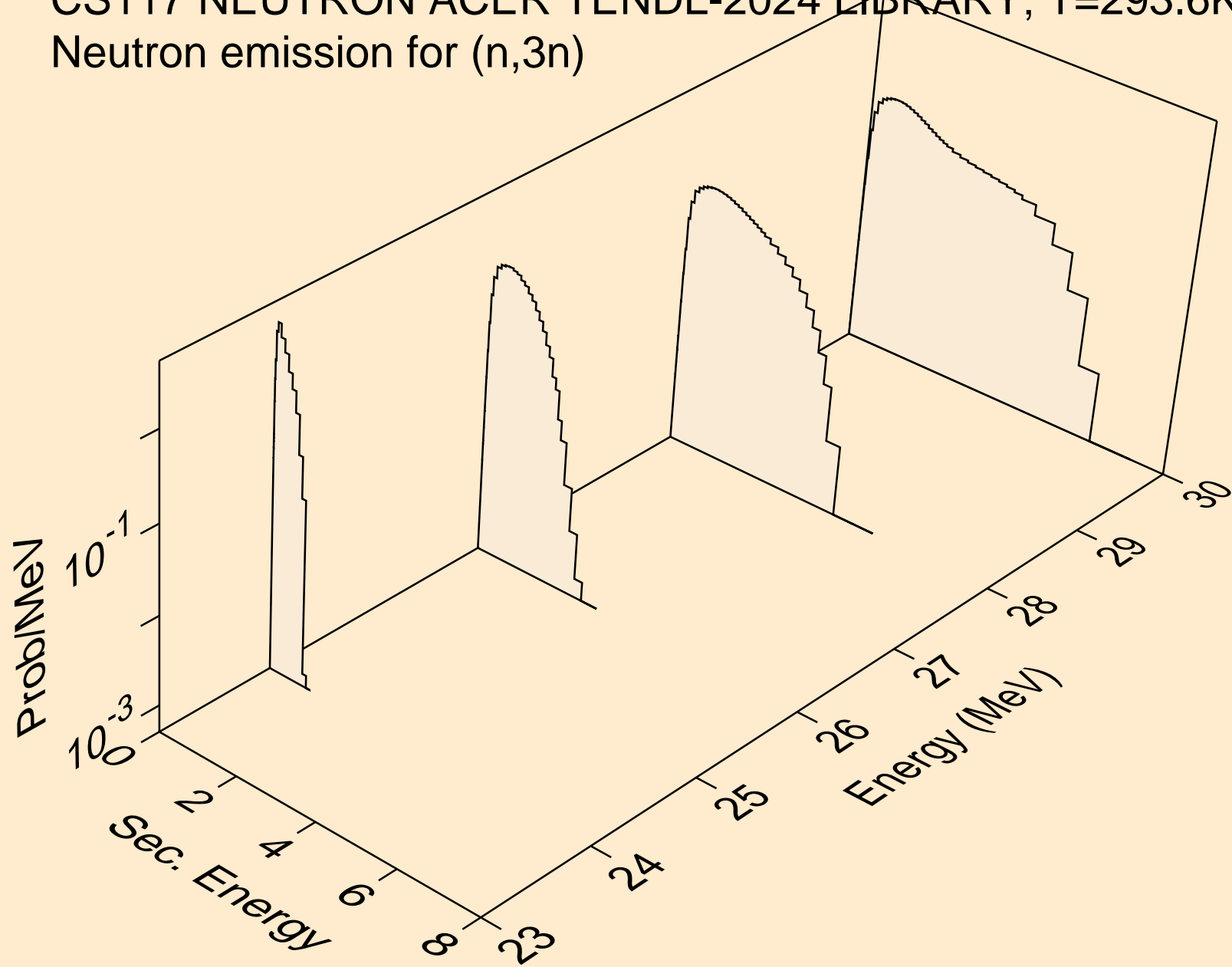

CS117 NEUTRON ACER TENDL-2024 LIBRARY; T=293.6K
Neutron emission for (n,n*)a

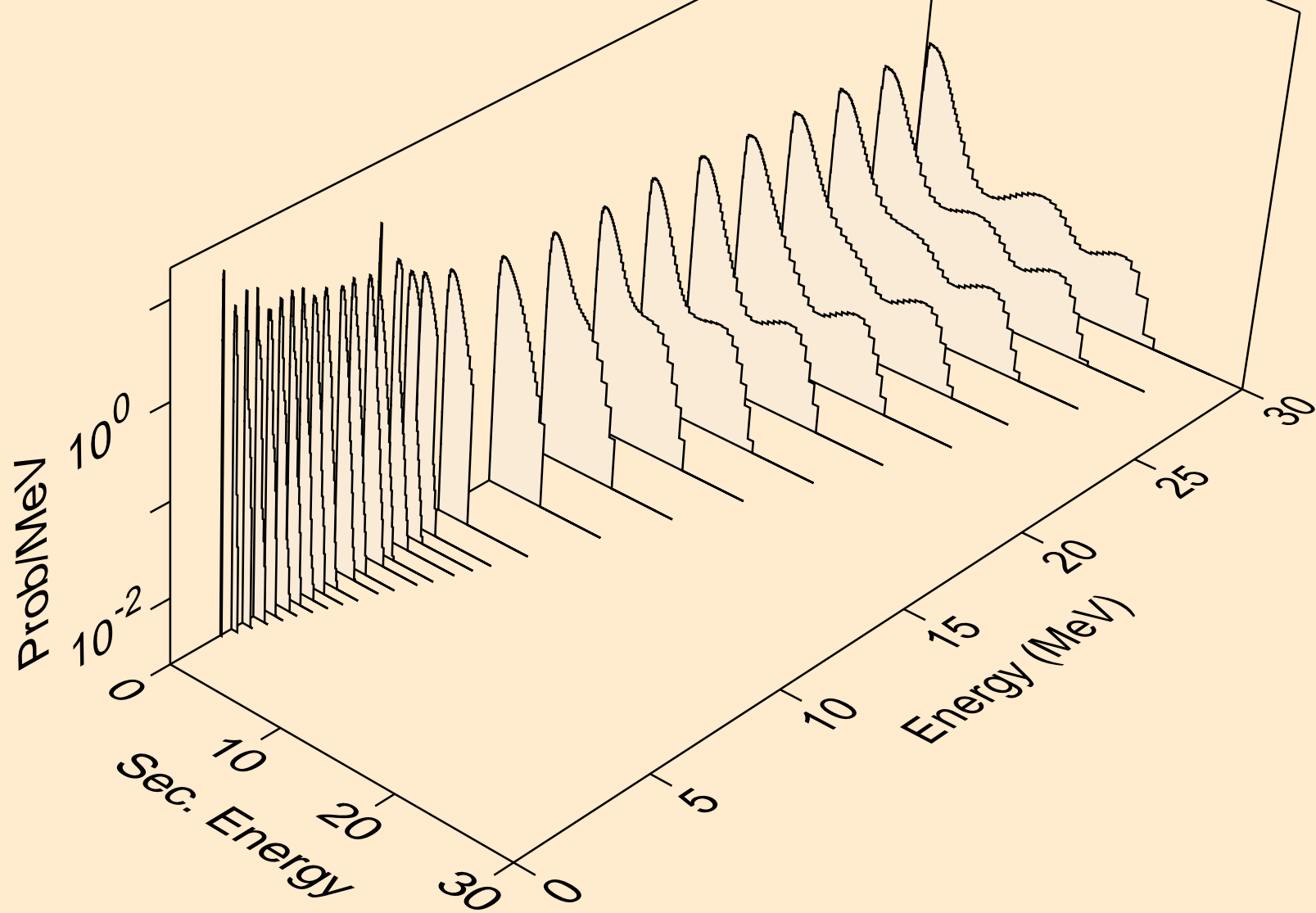

CS117 NEUTRON ACER TENDL-2024 LIBRARY; T=293.6K
Neutron emission for (n,n*)3a

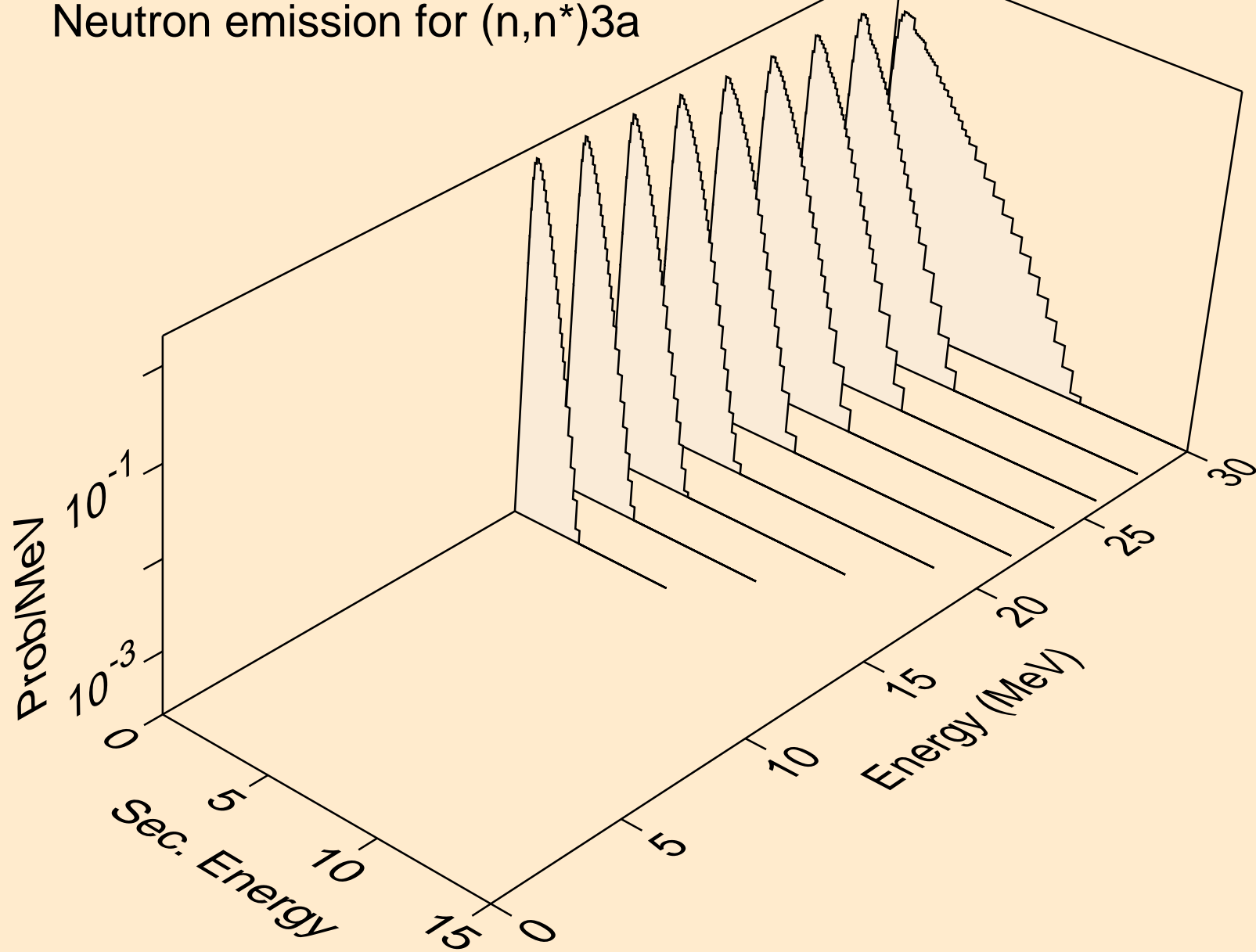

CS117 NEUTRON ACER TENDL-2024 LIBRARY; T=293.6K
Neutron emission for (n,2n)a

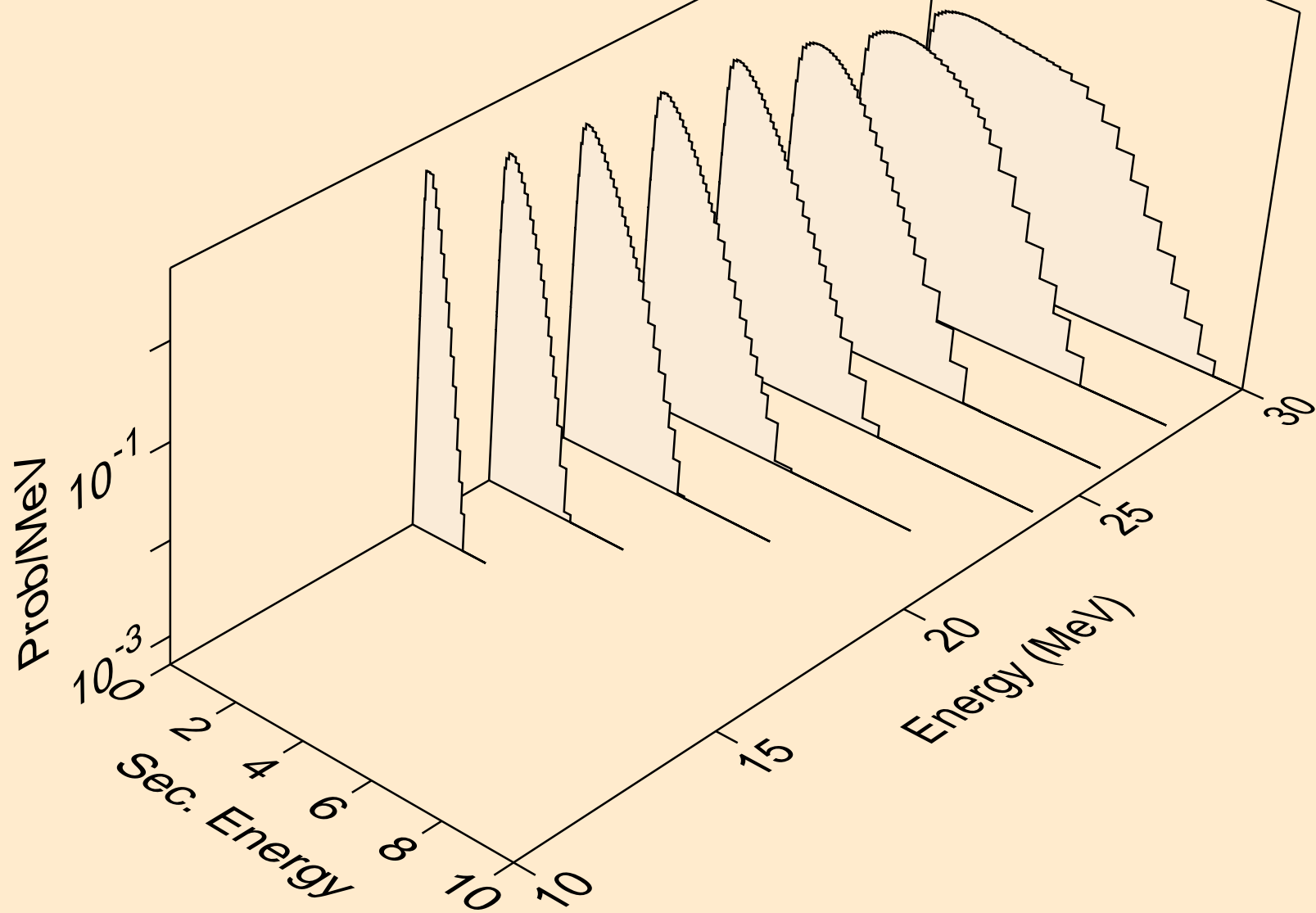

CS117 NEUTRON ACER TENDL-2024 LIBRARY; T=293.6K
Neutron emission for (n,n*)p

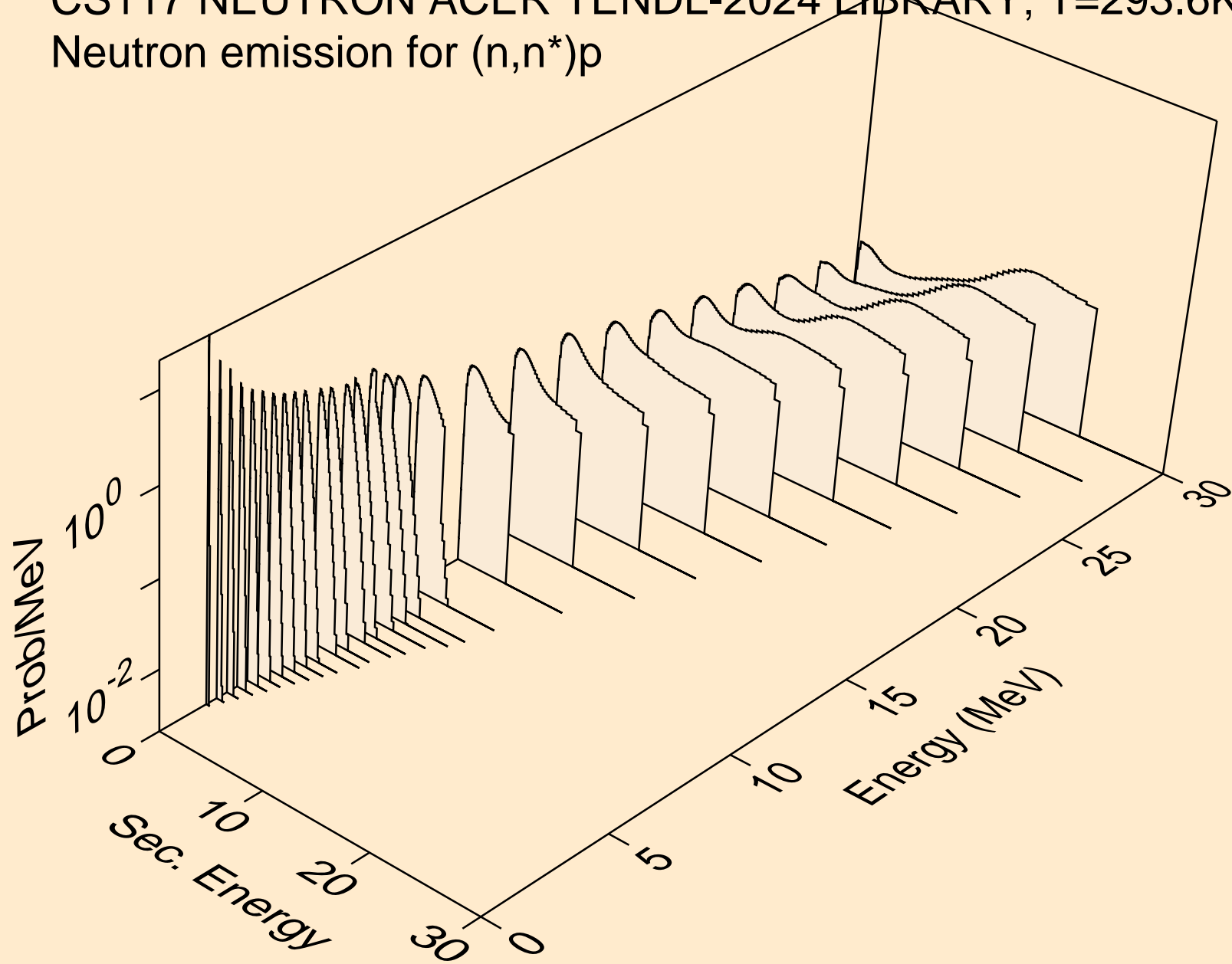

CS117 NEUTRON ACER TENDL-2024 LIBRARY; T=293.6K
Neutron emission for (n,n*)2a

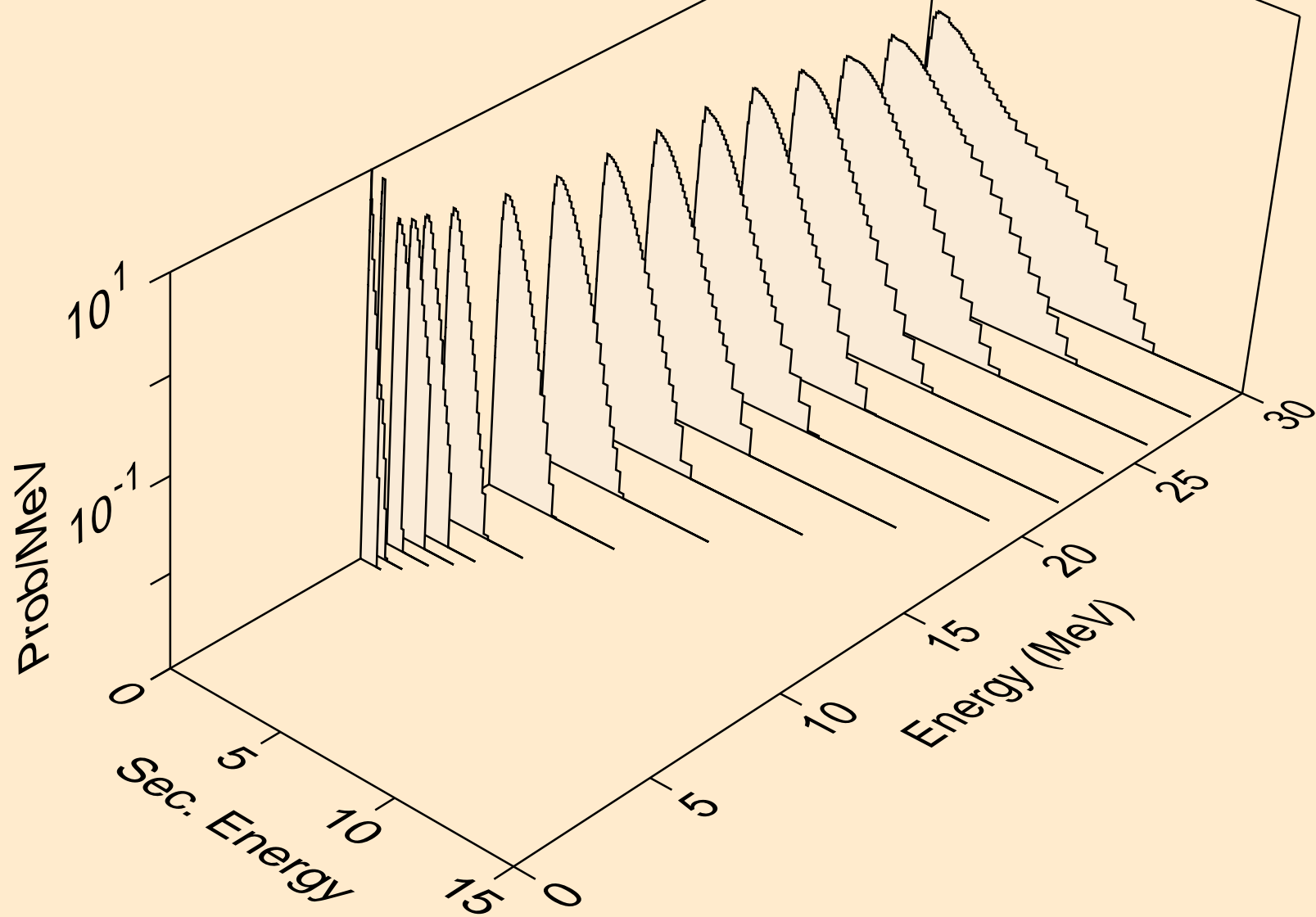

CS117 NEUTRON ACER TENDL-2024 LIBRARY; T=293.6K
Neutron emission for (n,2n)2a

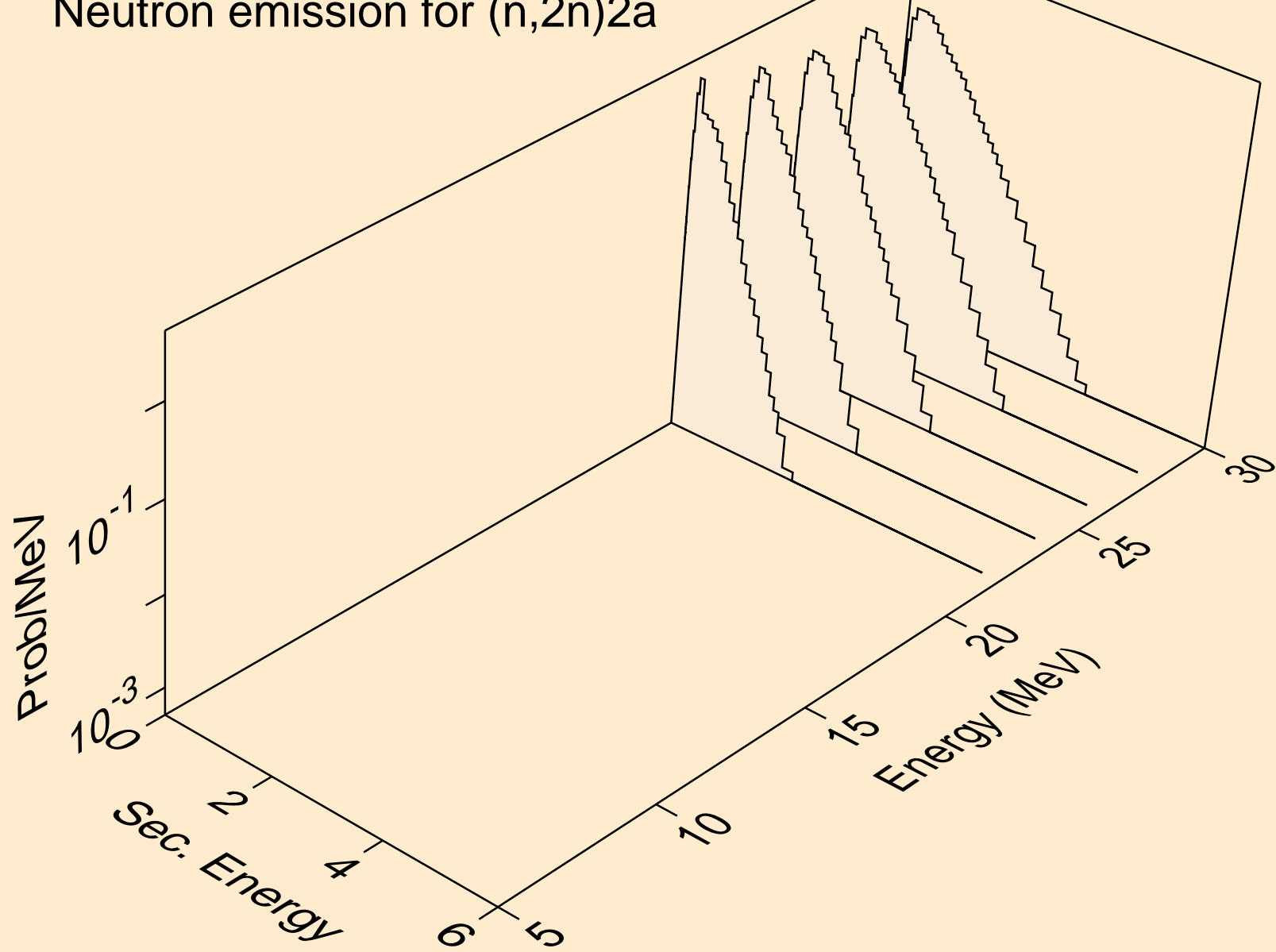

CS117 NEUTRON ACER TENDL-2024 LIBRARY; T=293.6K
Neutron emission for (n,n*)d

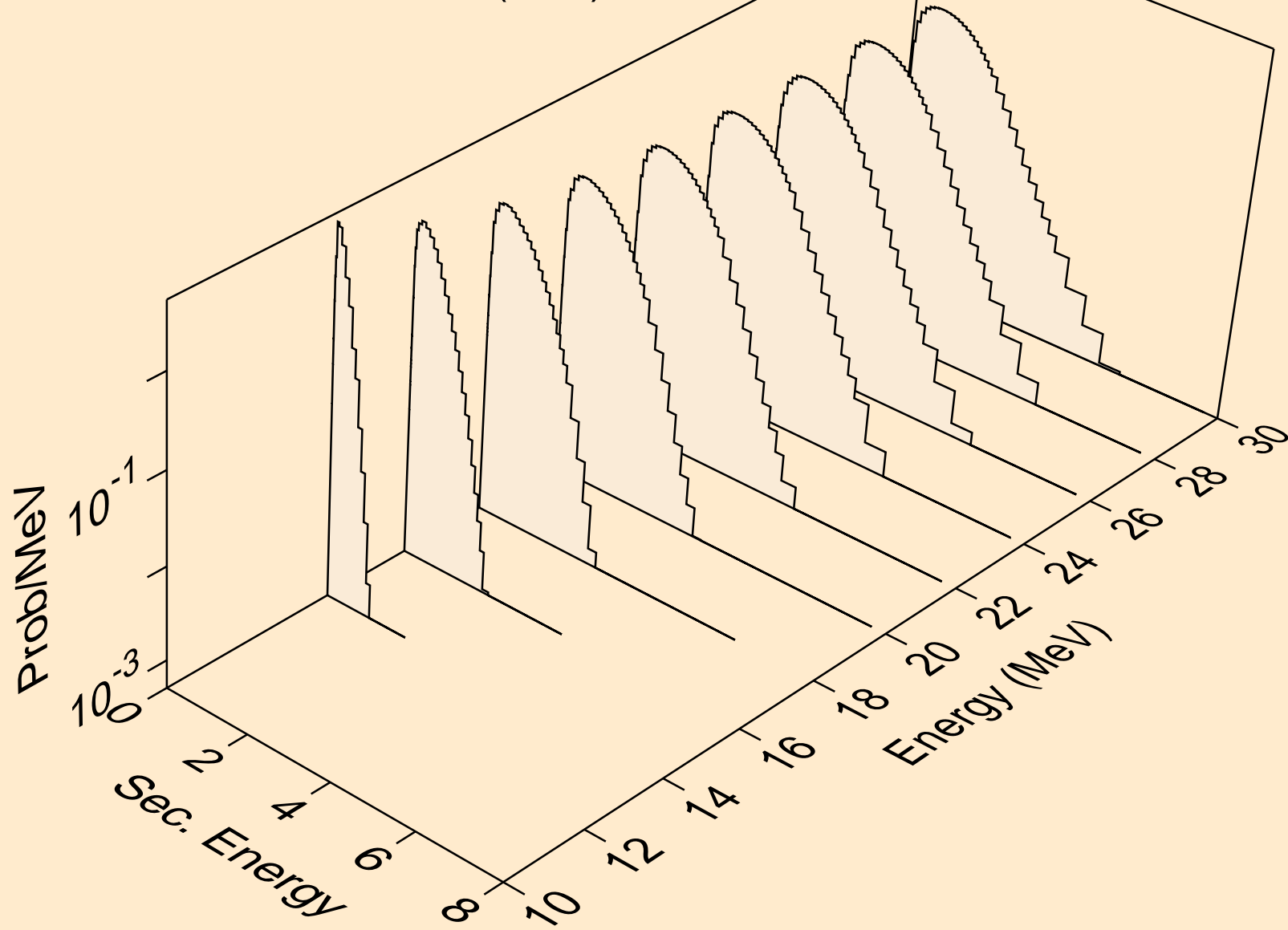

CS117 NEUTRON ACER TENDL-2024 LIBRARY; T=293.6K
Neutron emission for (n,n*)t

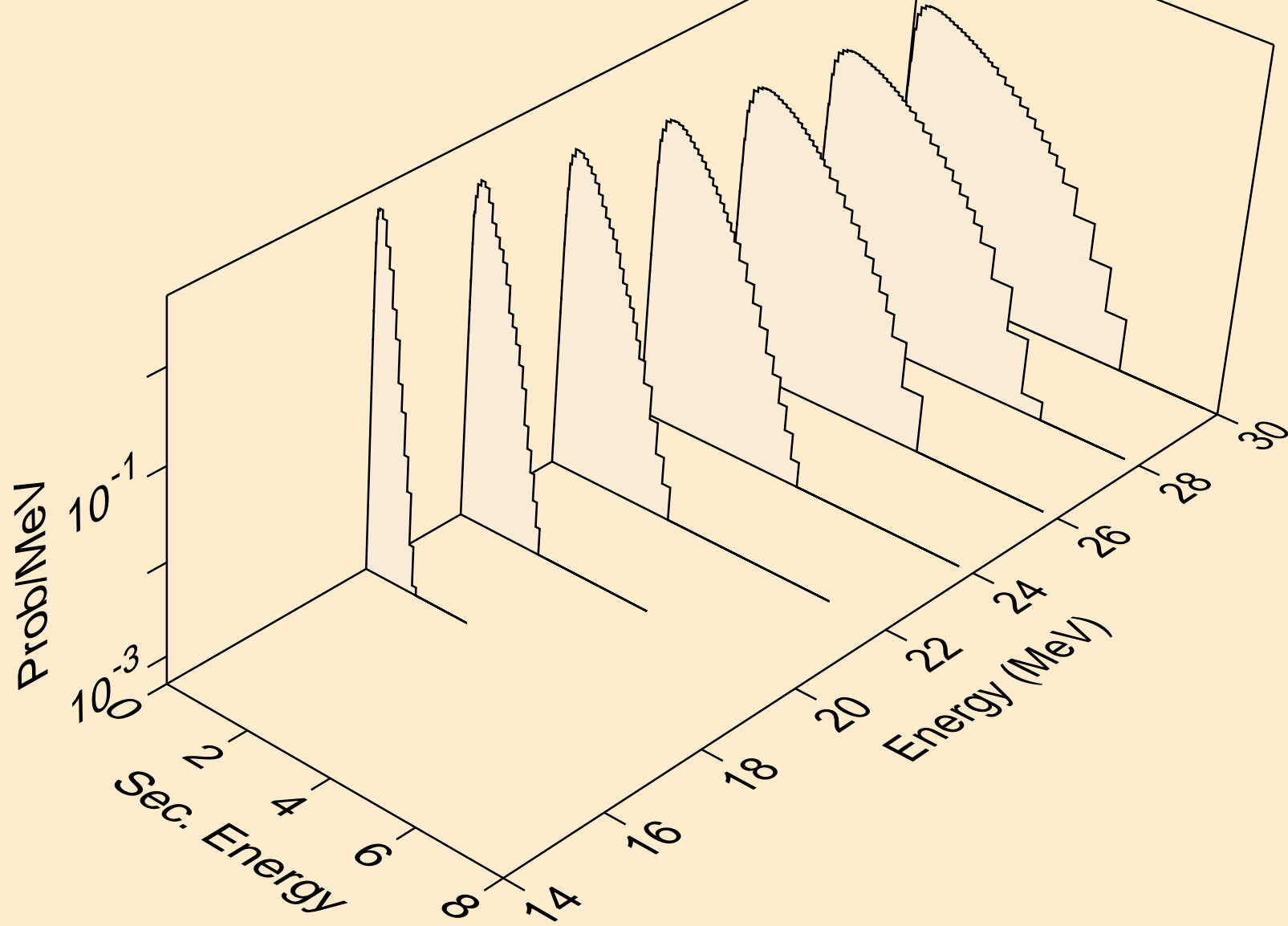

CS117 NEUTRON ACER TENDL-2024 LIBRARY; T=293.6K
Neutron emission for (n,n*)he3

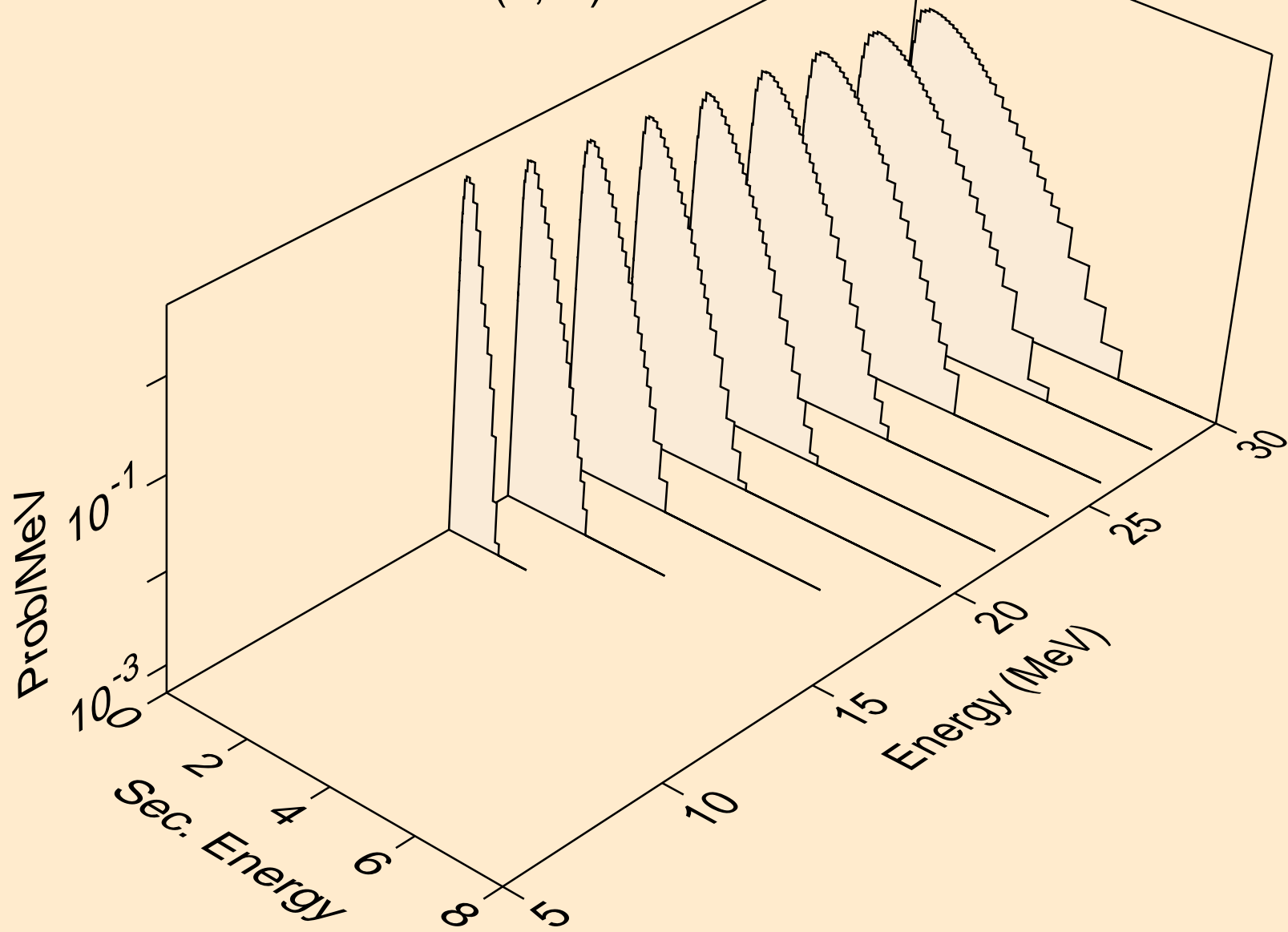

CS117 NEUTRON ACER TENDL-2024 LIBRARY; T=293.6K
Neutron emission for (n,2np)

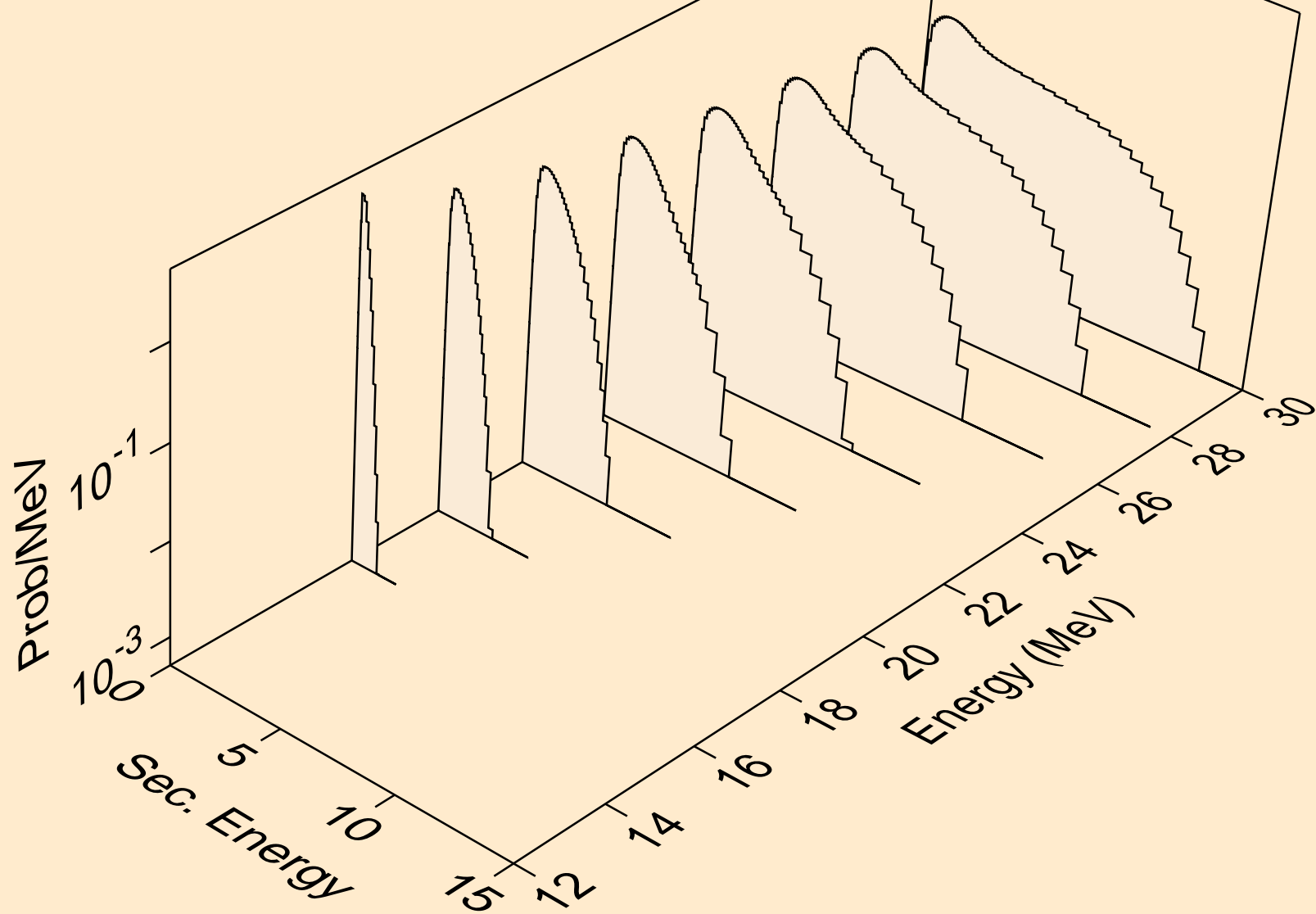

CS117 NEUTRON ACER TENDL-2024 LIBRARY; T=293.6K
Neutron emission for (n,3np)

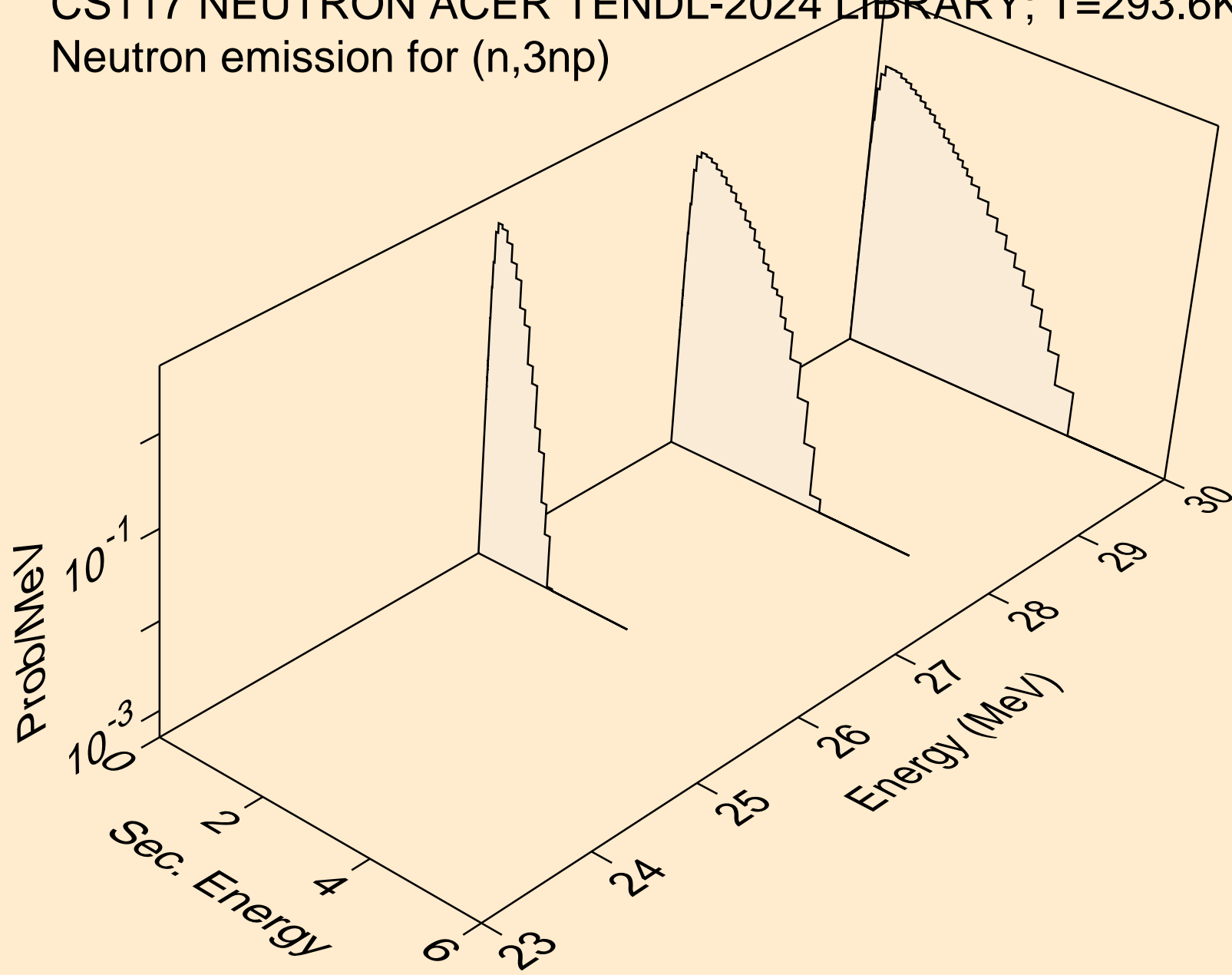

CS117 NEUTRON ACER TENDL-2024 LIBRARY; T=293.6K
Neutron emission for (n,n2p)

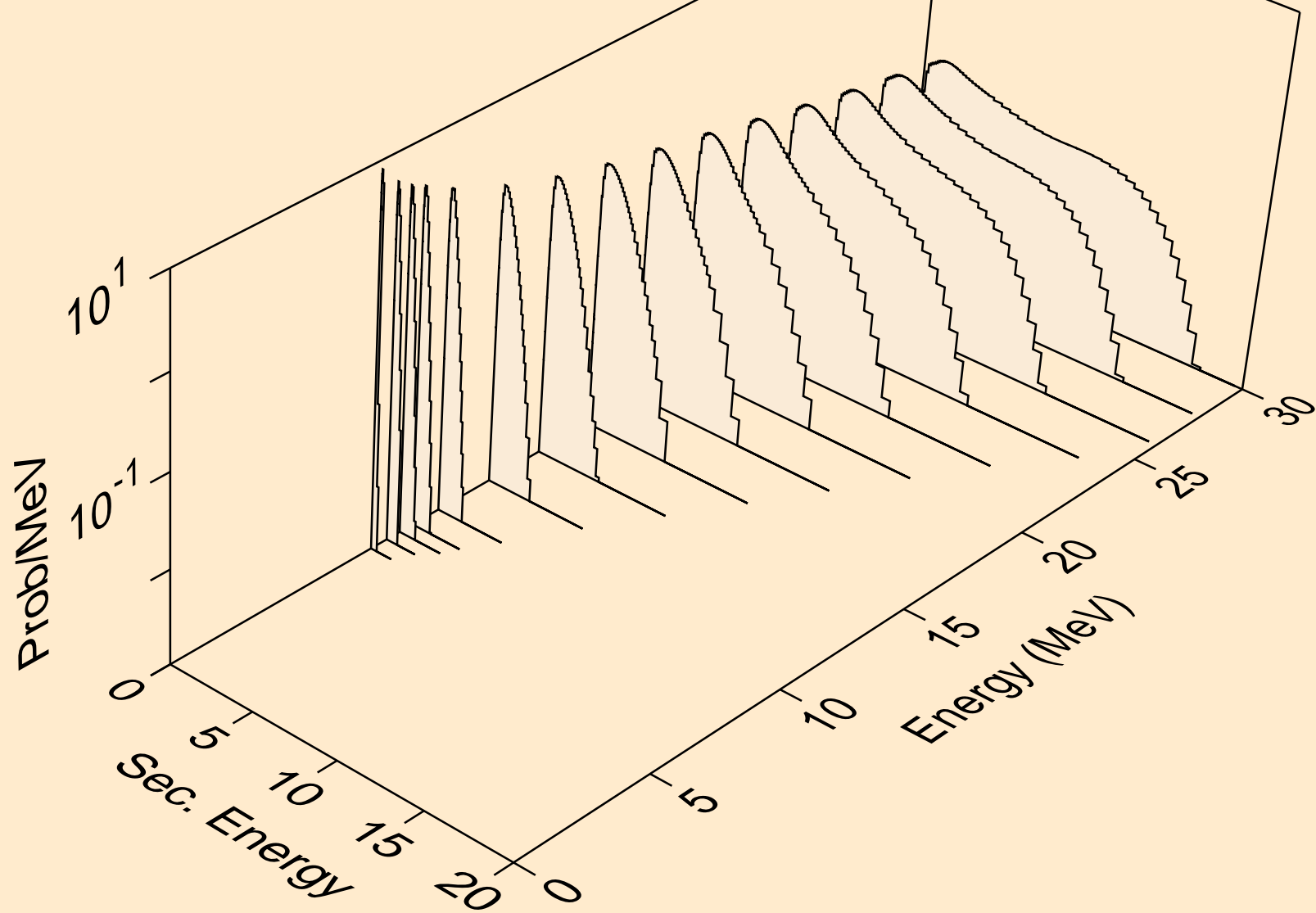

CS117 NEUTRON ACER TENDL-2024 LIBRARY; T=293.6K
Neutron emission for (n,npa)

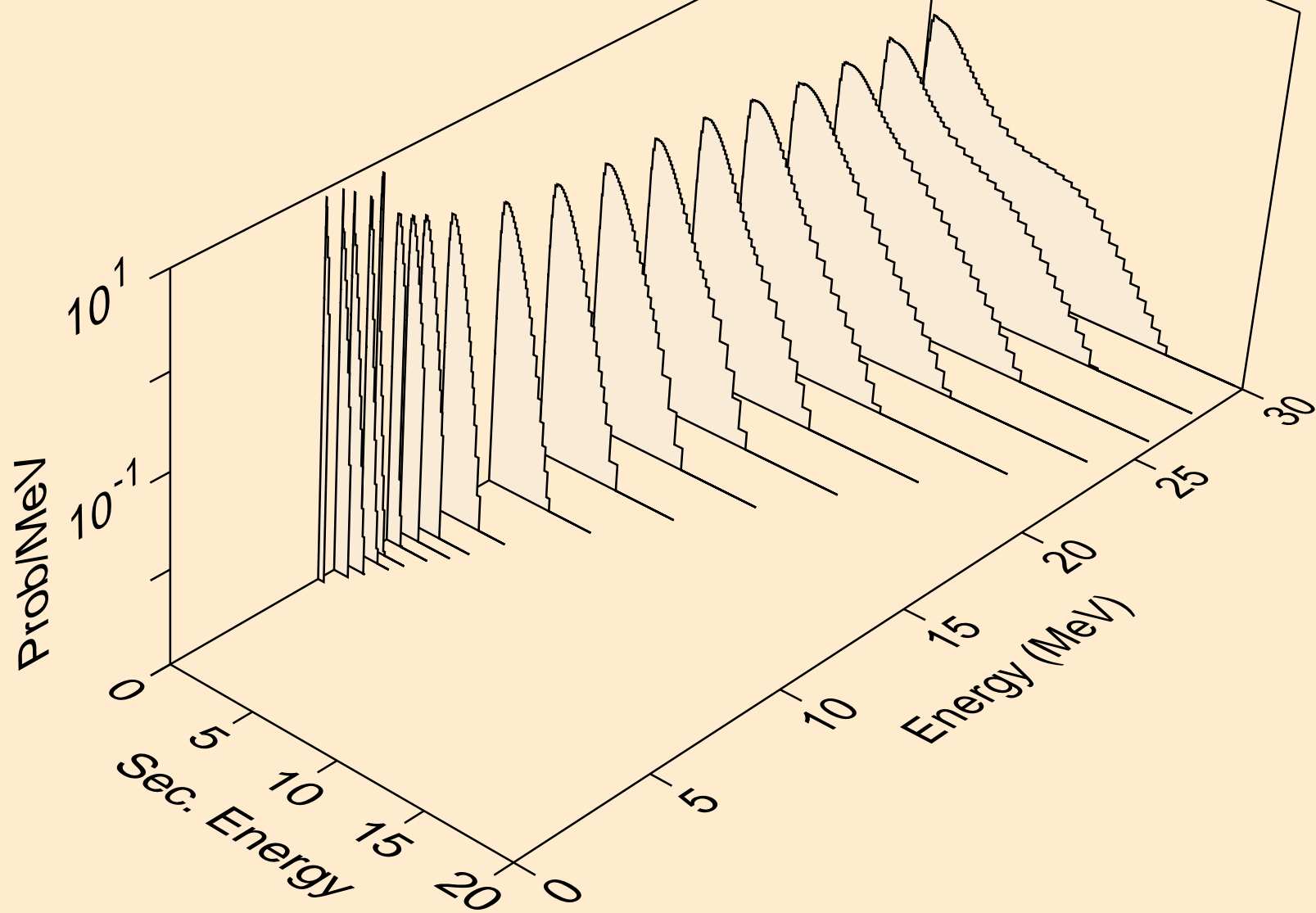

CS117 NEUTRON ACER TENDL-2024 LIBRARY; T=293.6K
Neutron emission for (n,n*c)

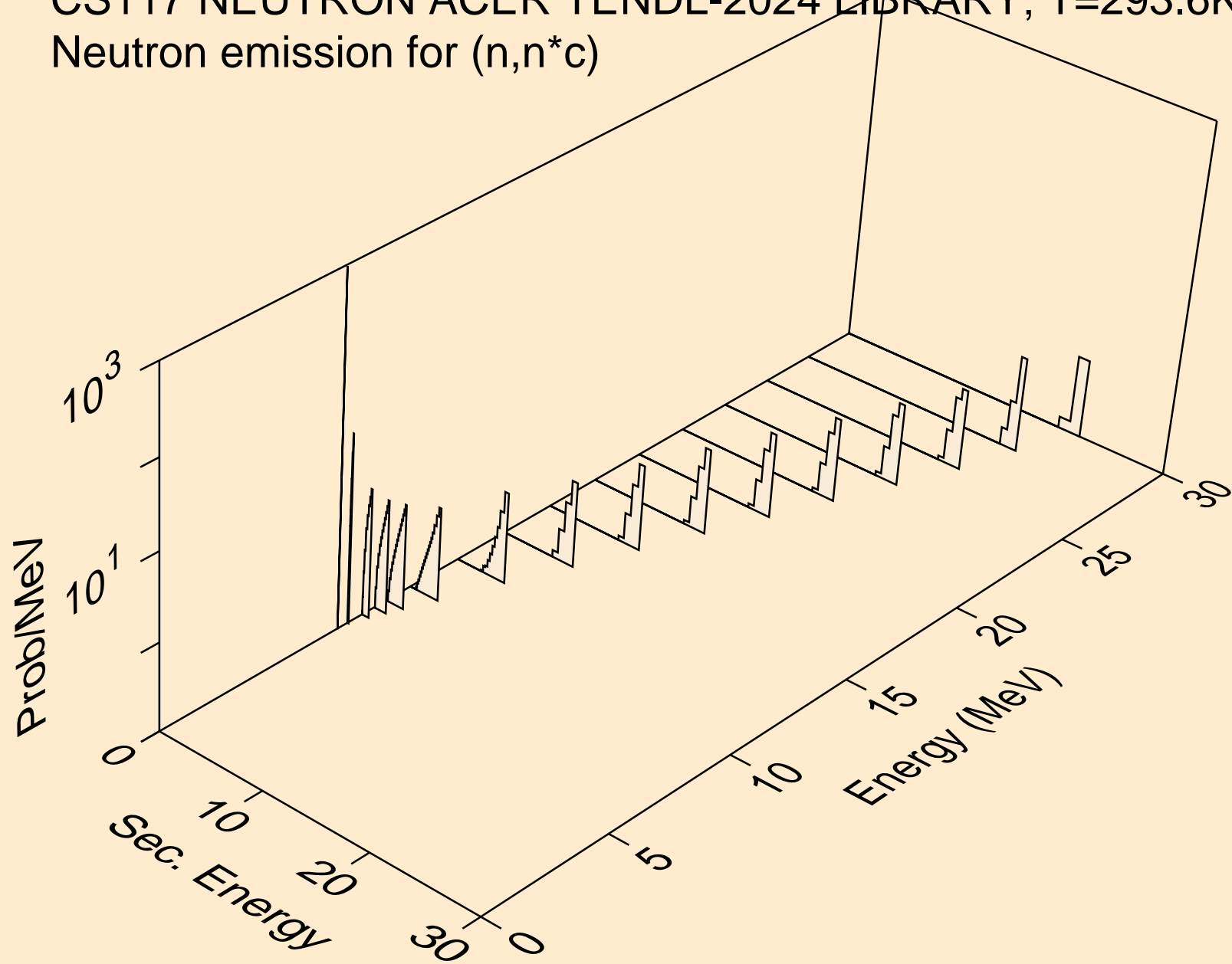

CS117 NEUTRON ACER TENDL-2024 LIBRARY; T=293.6K
Photon emission for (n,x)

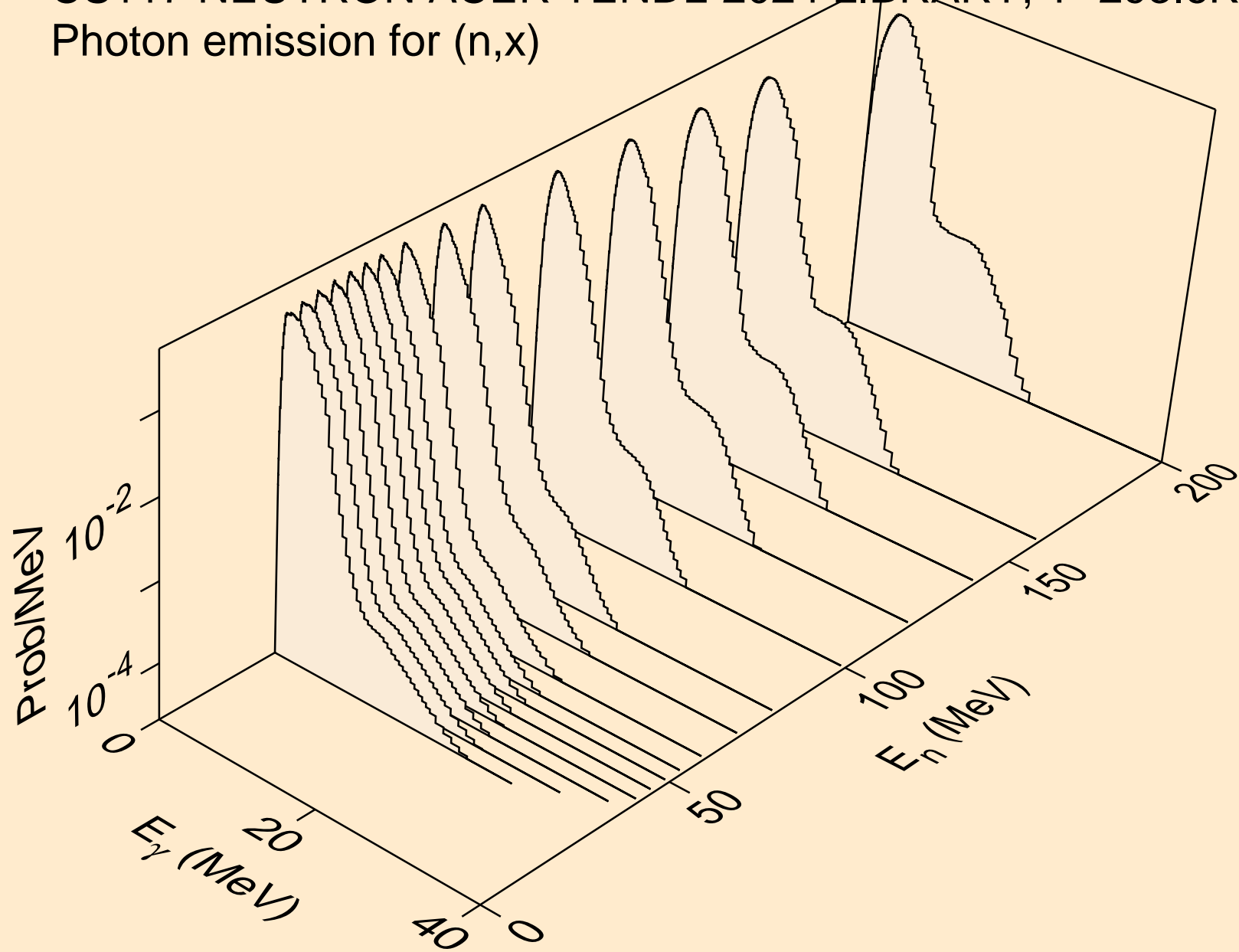

CS117 NEUTRON ACER TENDL-2024 LIBRARY; T=293.6K
Photon emission for (n,2nd)

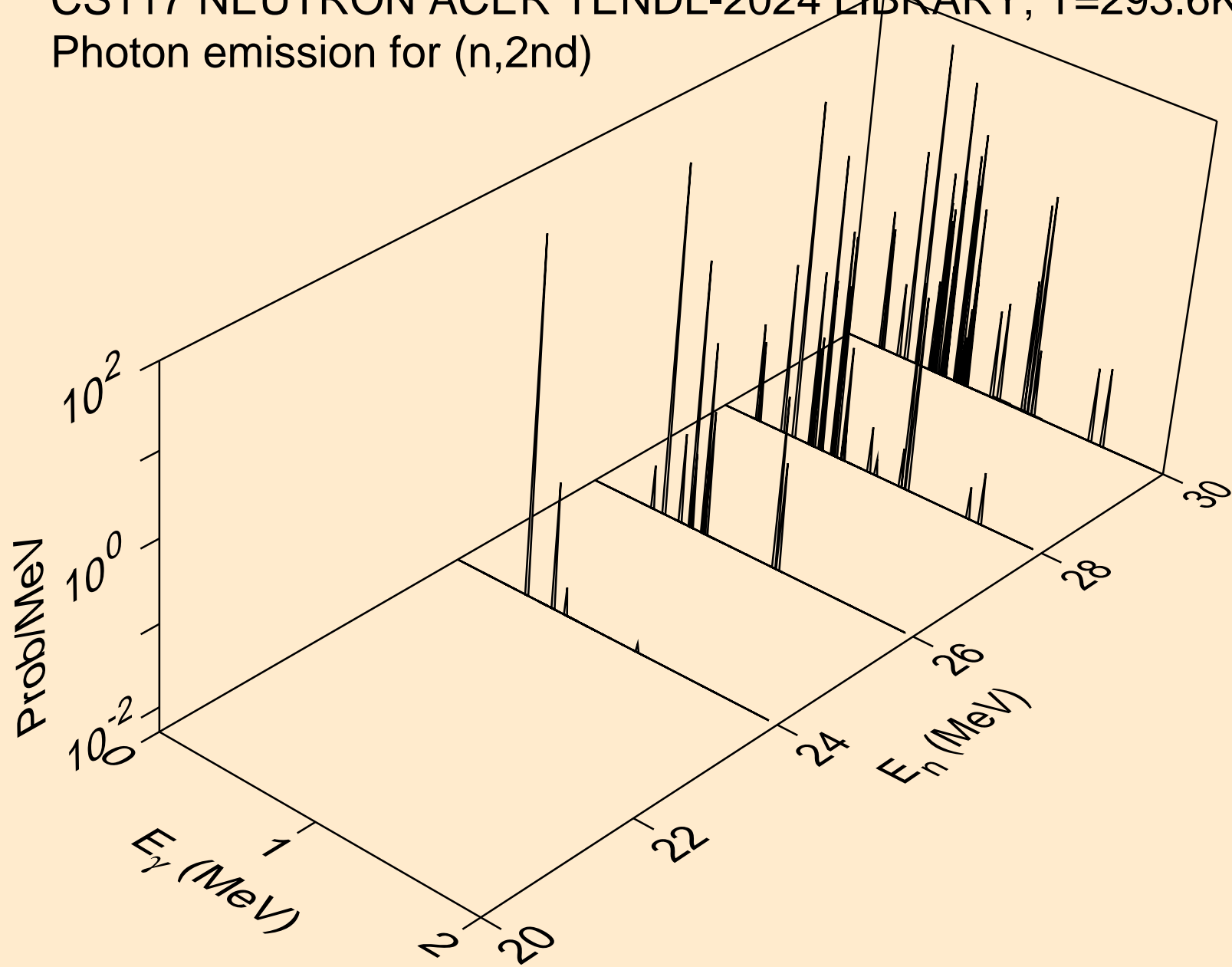

CS117 NEUTRON ACER TENDL-2024 LIBRARY; T=293.6K
Photon emission for (n,2n)

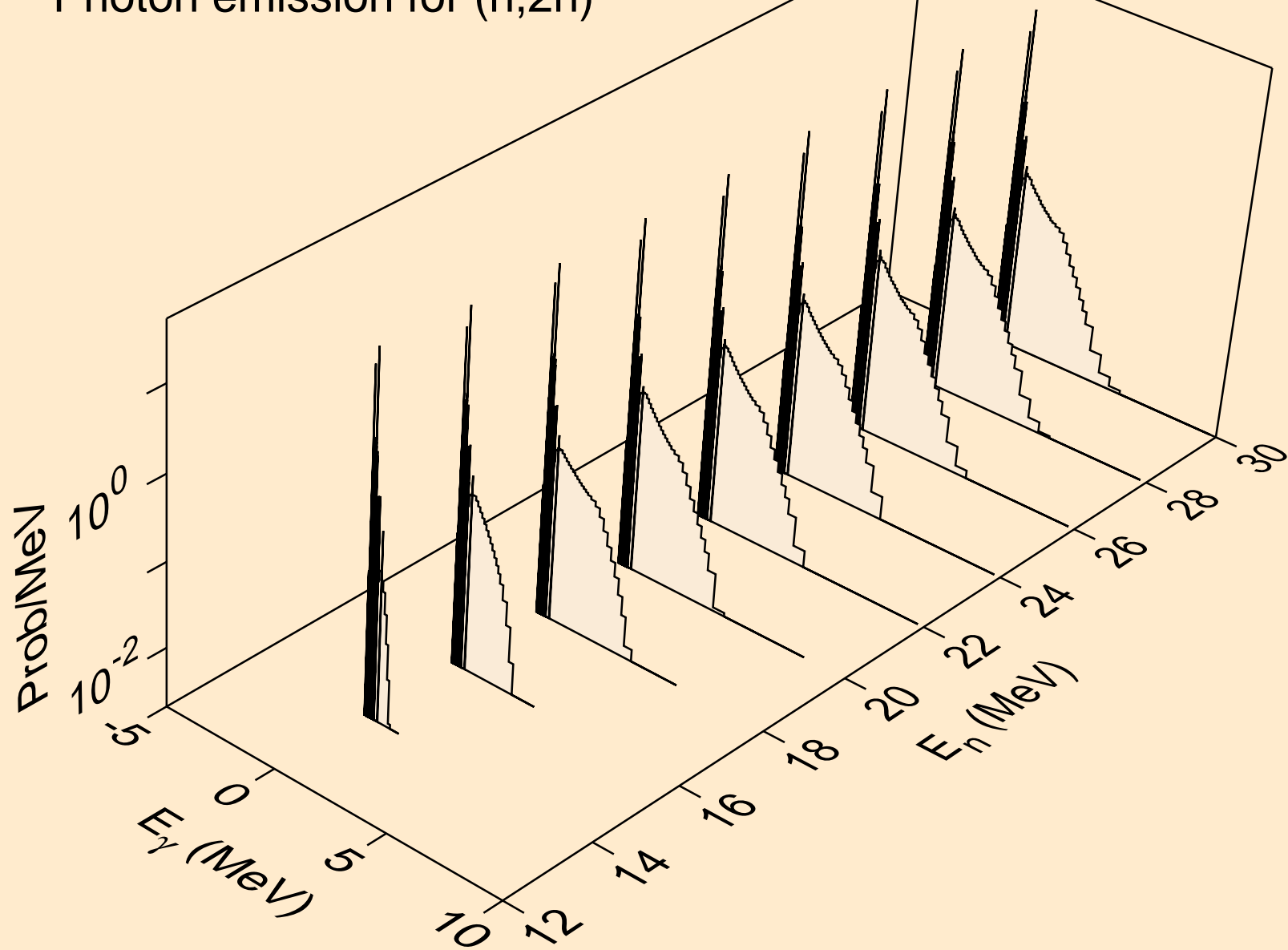

CS117 NEUTRON ACER TENDL-2024 LIBRARY; T=293.6K
Photon emission for (n,3n)

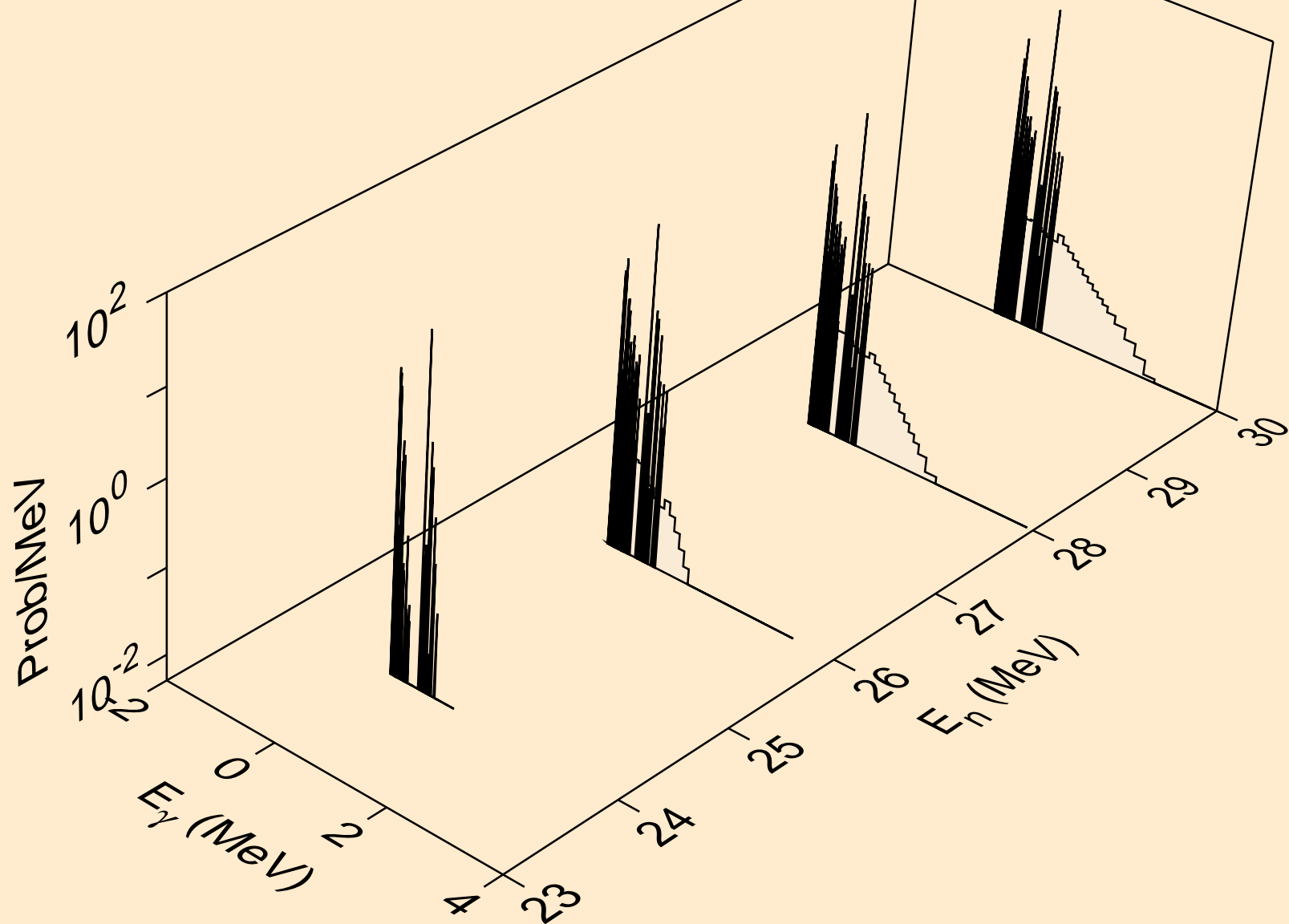

CS117 NEUTRON ACER TENDL-2024 LIBRARY; T=293.6K
Photon emission for (n,n*)a

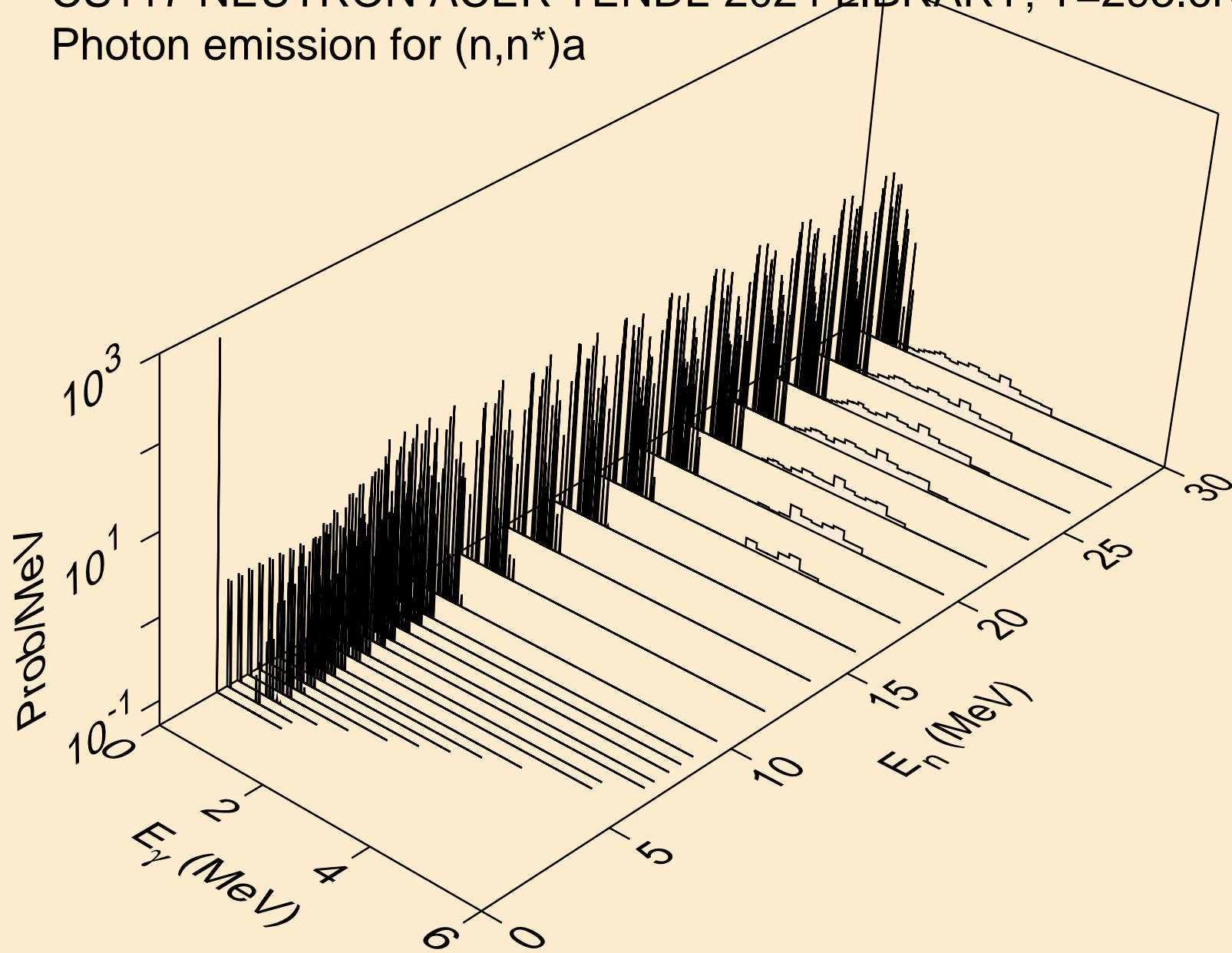

CS117 NEUTRON ACER TENDL-2024 LIBRARY; T=293.6K
Photon emission for (n,n*)3a

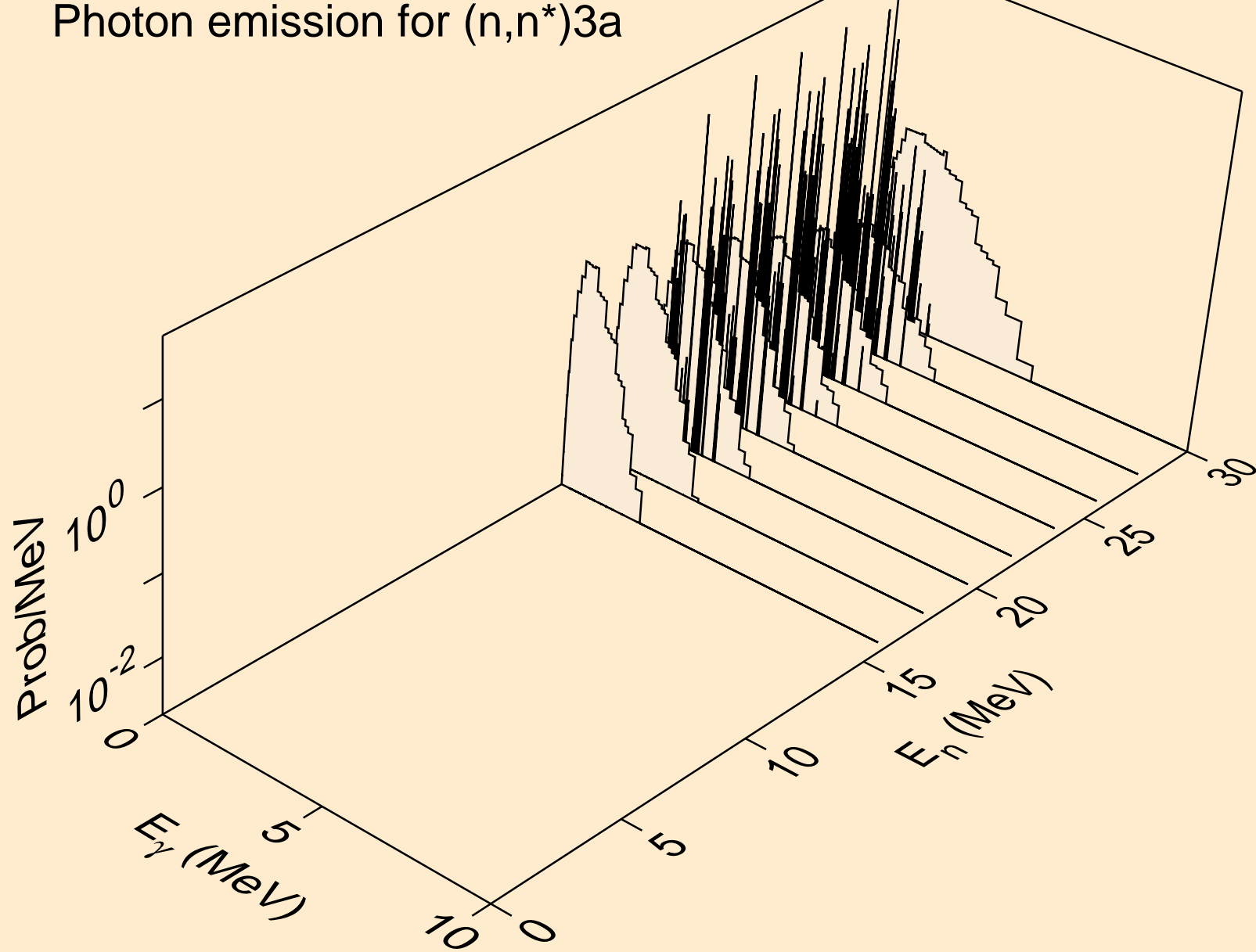

CS117 NEUTRON ACER TENDL-2024 LIBRARY; T=293.6K
Photon emission for (n,2n)a

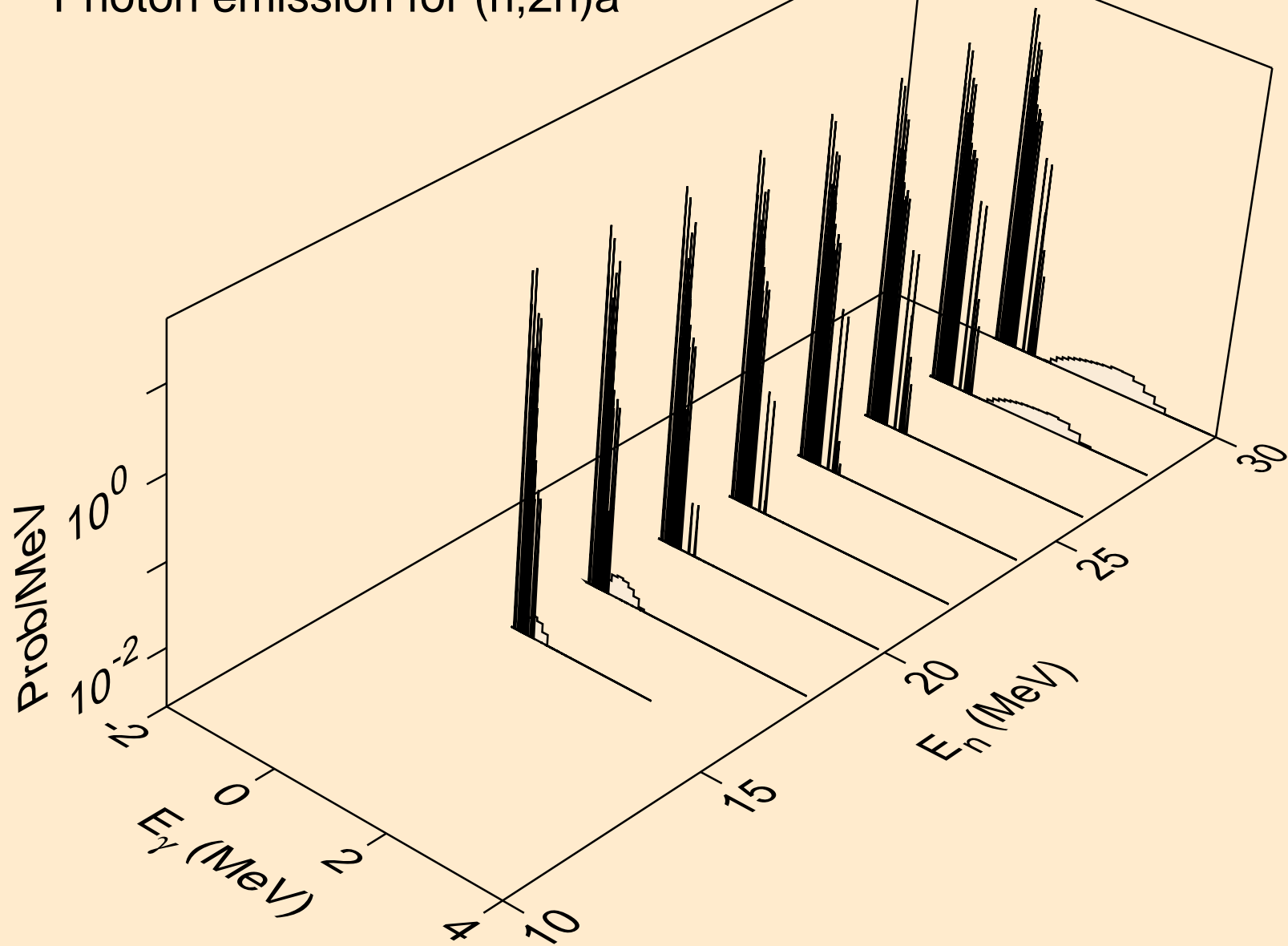

CS117 NEUTRON ACER TENDL-2024 LIBRARY; T=293.6K
Photon emission for (n,n*)p

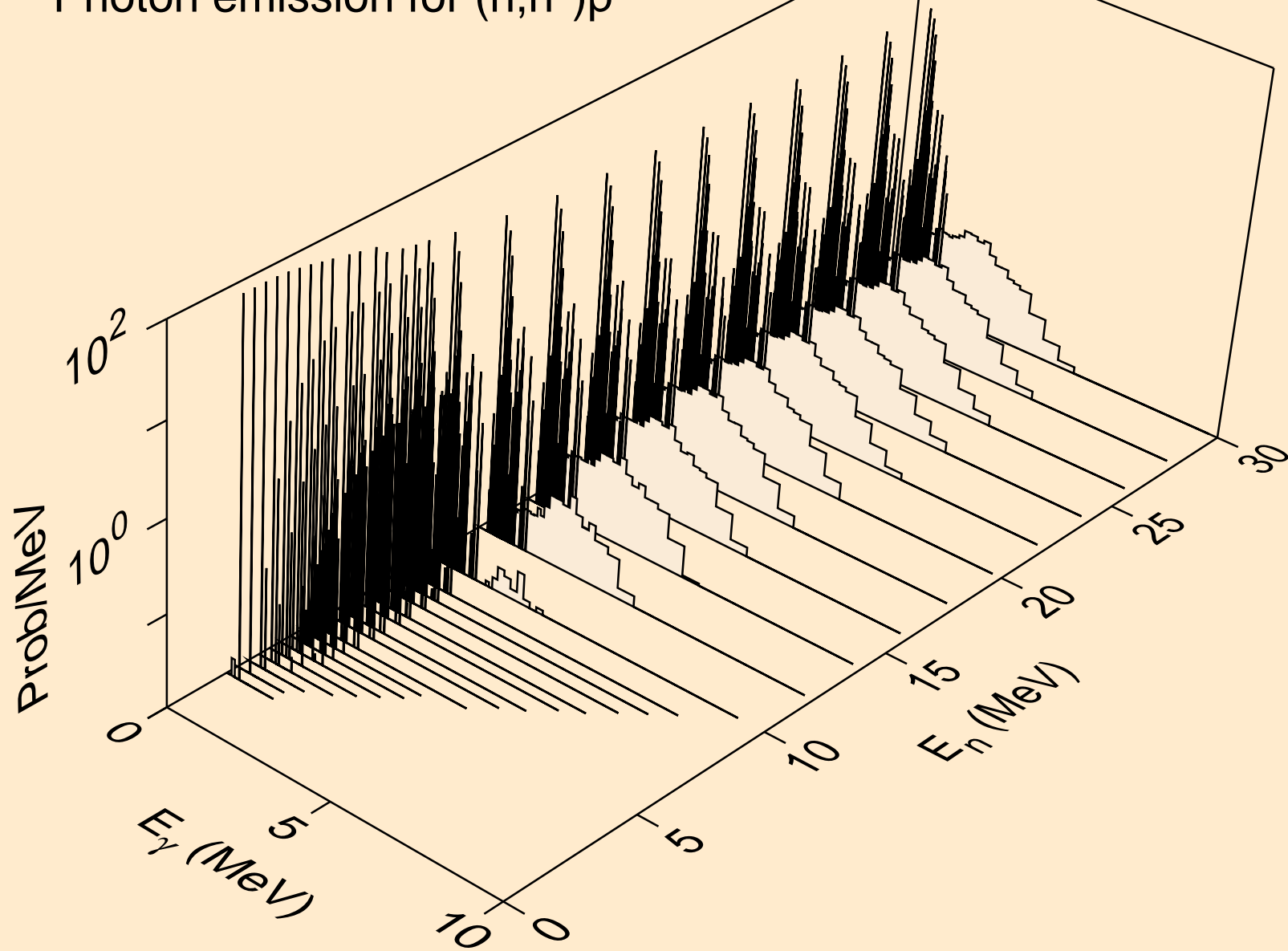

CS117 NEUTRON ACER TENDL-2024 LIBRARY; T=293.6K
Photon emission for (n,n*)2a

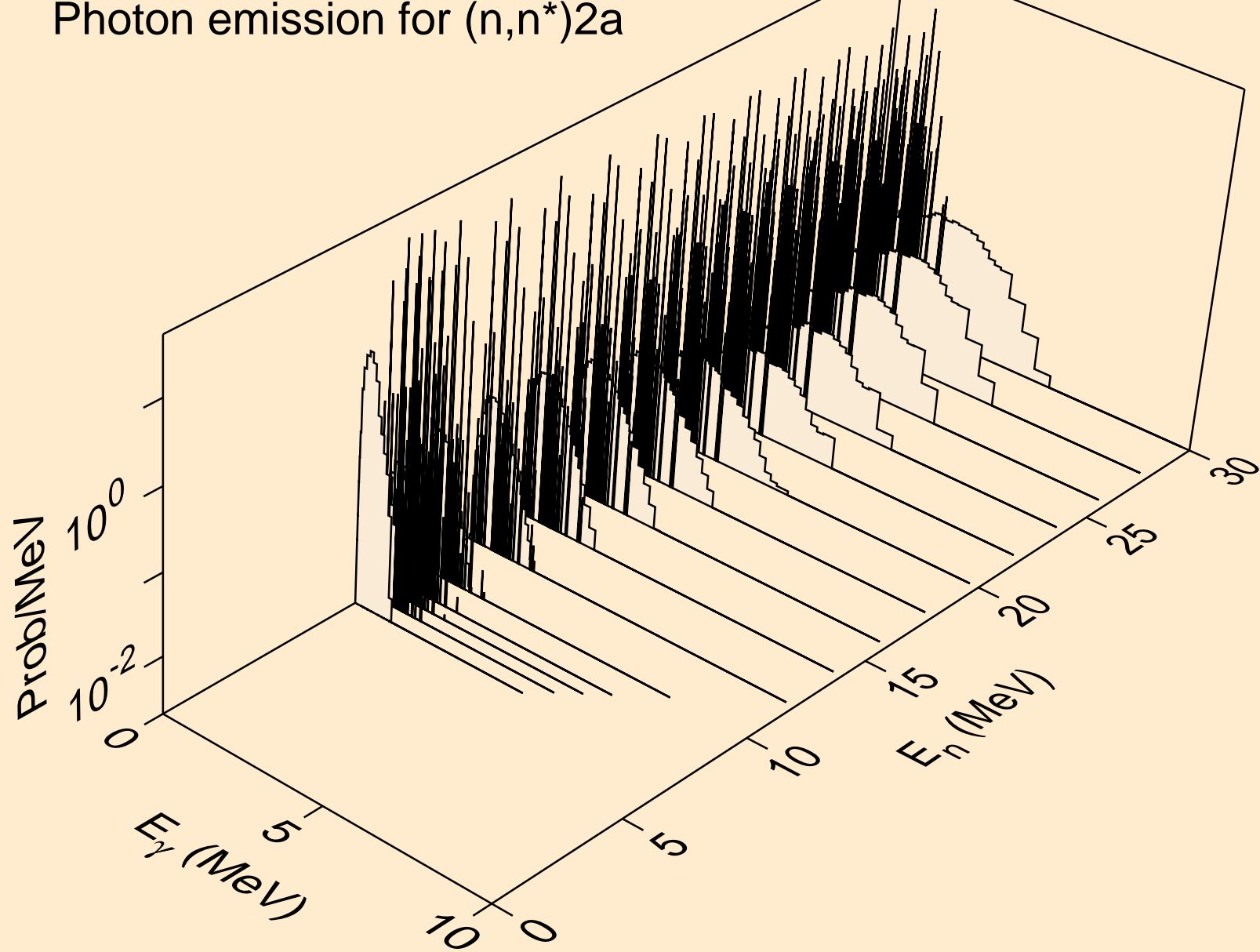

CS117 NEUTRON ACER TENDL-2024 LIBRARY; T=293.6K
Photon emission for (n,2n)2a

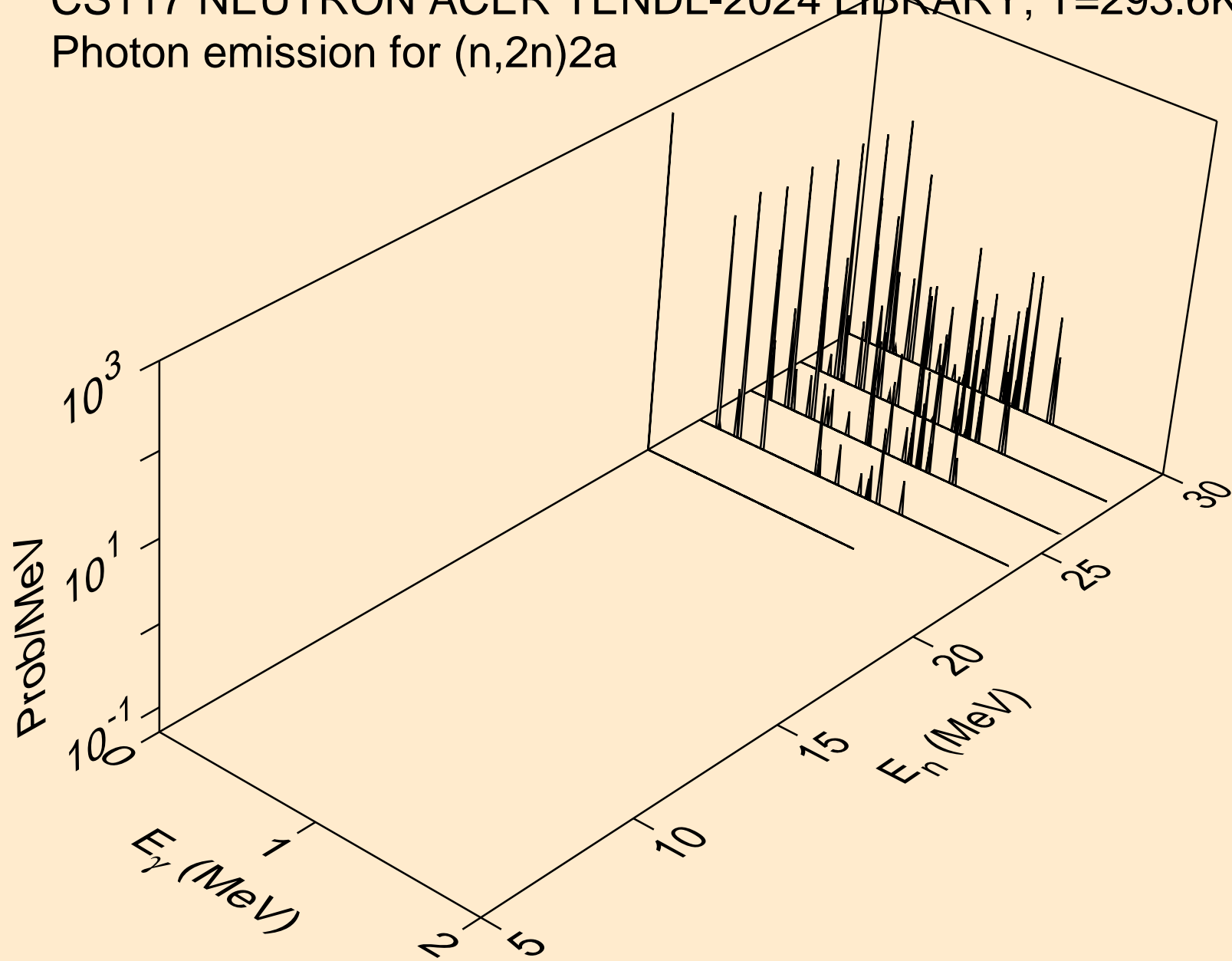

CS117 NEUTRON ACER TENDL-2024 LIBRARY; T=293.6K
Photon emission for (n,n*)d

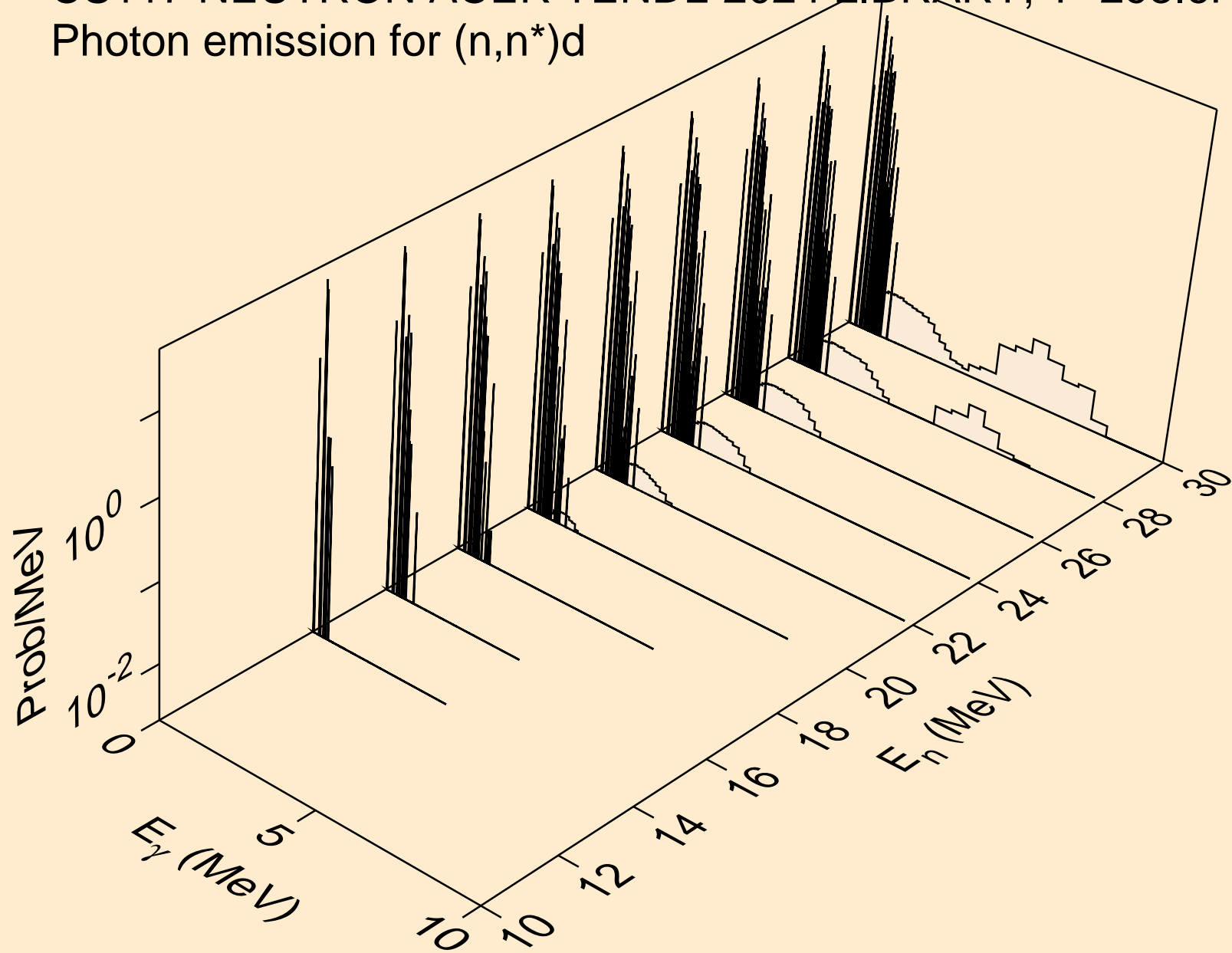

CS117 NEUTRON ACER TENDL-2024 LIBRARY; T=293.6K
Photon emission for (n,n*)t

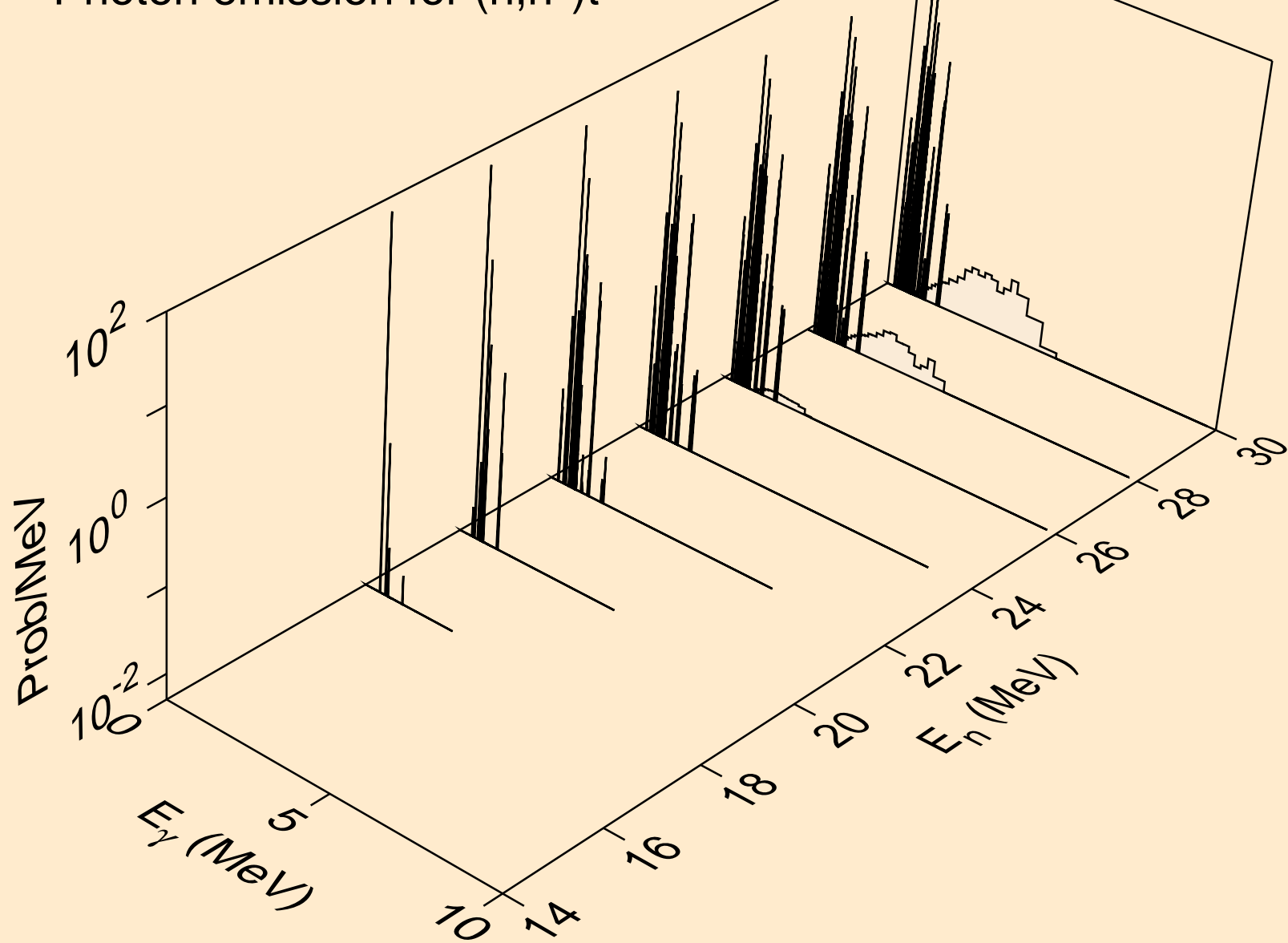

CS117 NEUTRON ACER TENDL-2024 LIBRARY; T=293.6K
Photon emission for (n,n*)he3

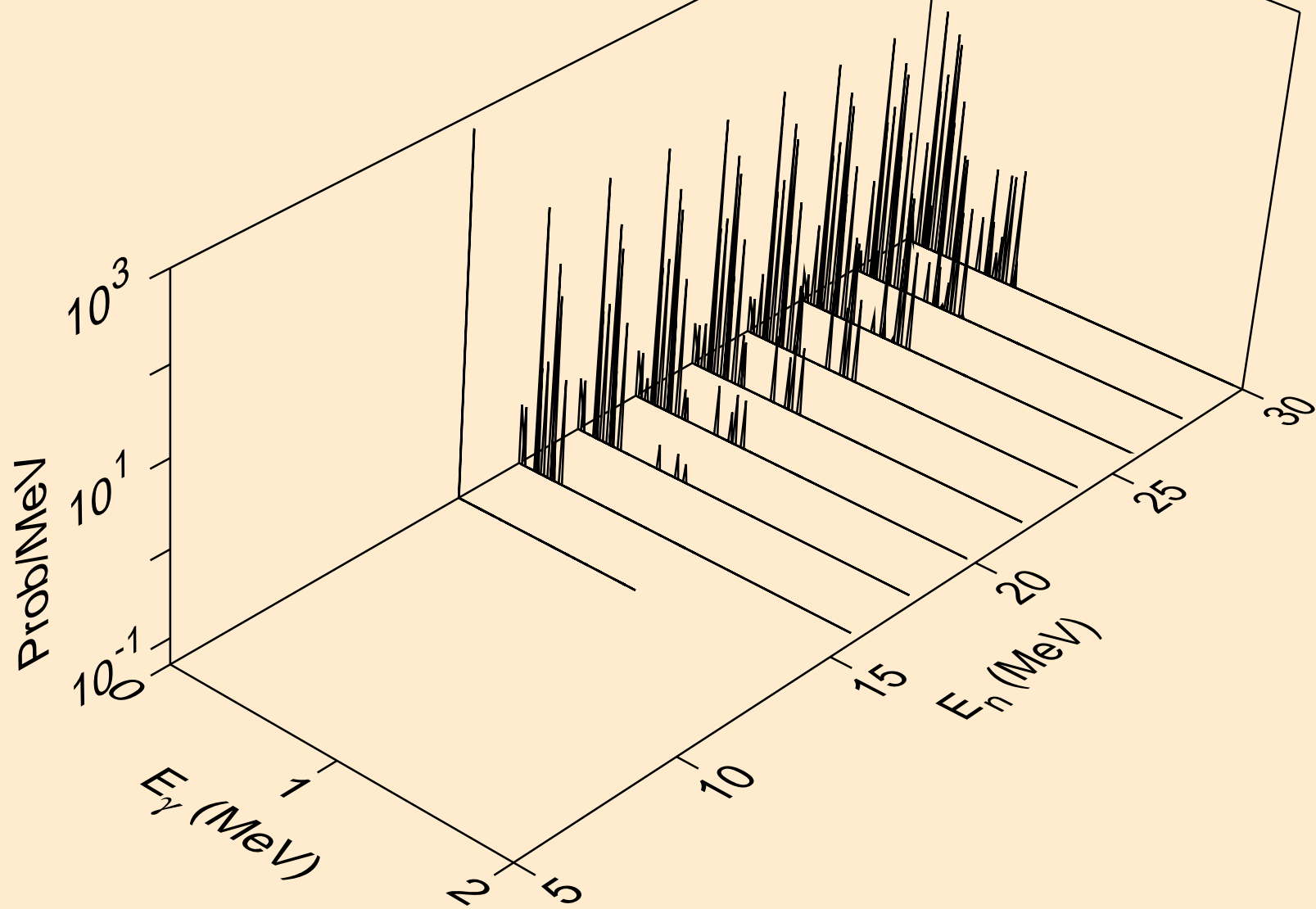

CS117 NEUTRON ACER TENDL-2024 LIBRARY; T=293.6K
Photon emission for (n,2np)

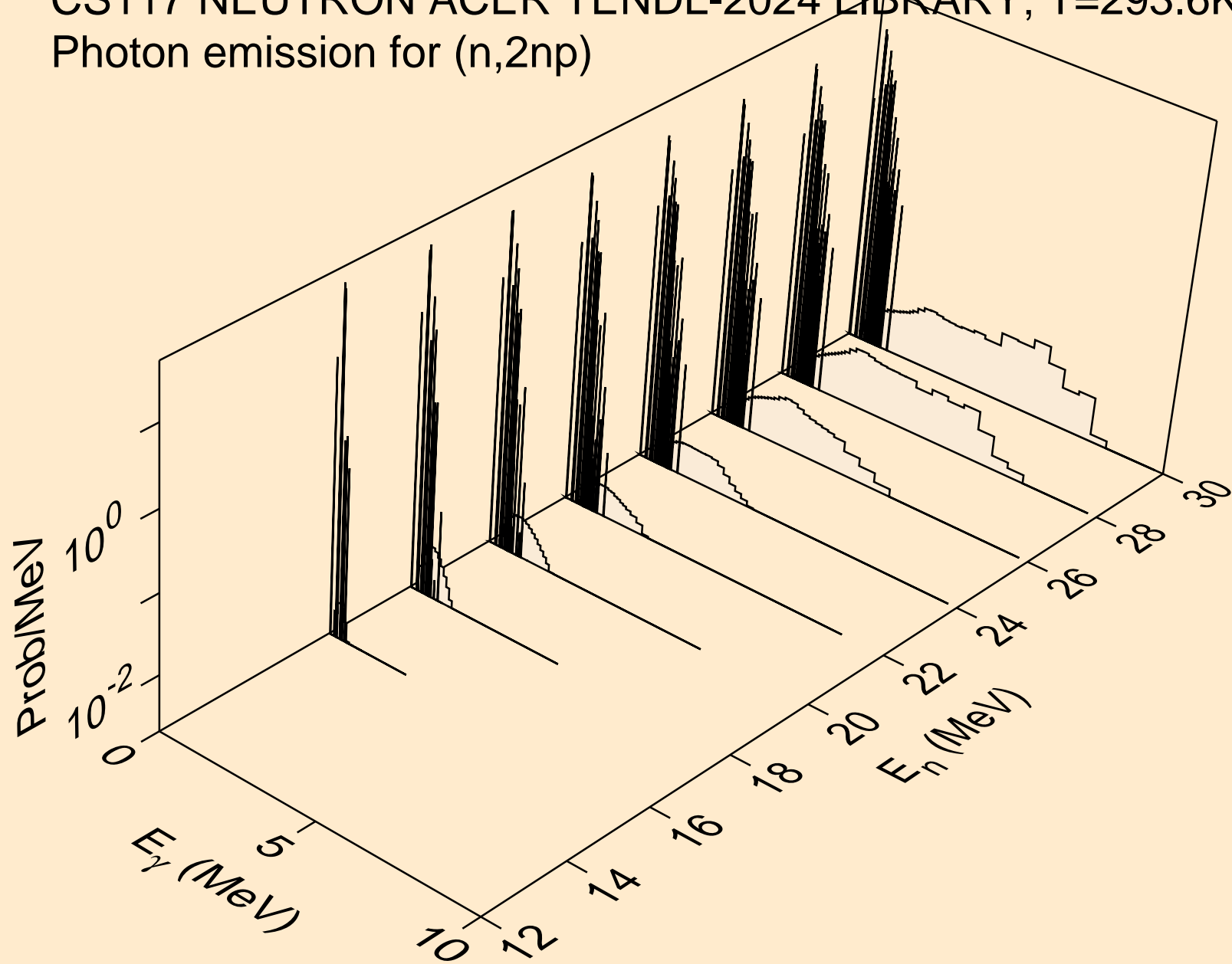

CS117 NEUTRON ACER TENDL-2024 LIBRARY; T=293.6K
Photon emission for (n,3np)

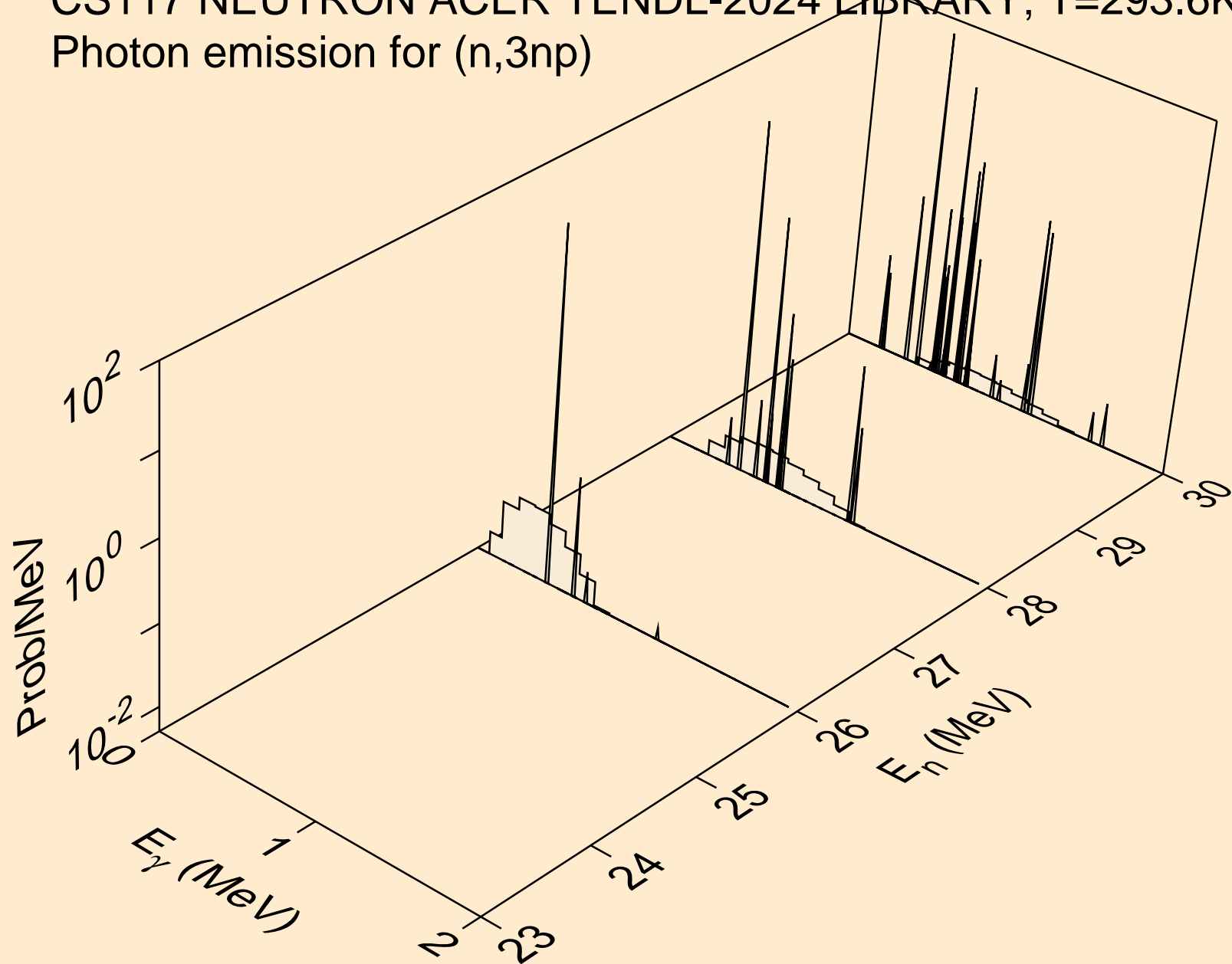

CS117 NEUTRON ACER TENDL-2024 LIBRARY; T=293.6K
Photon emission for (n,n2p)

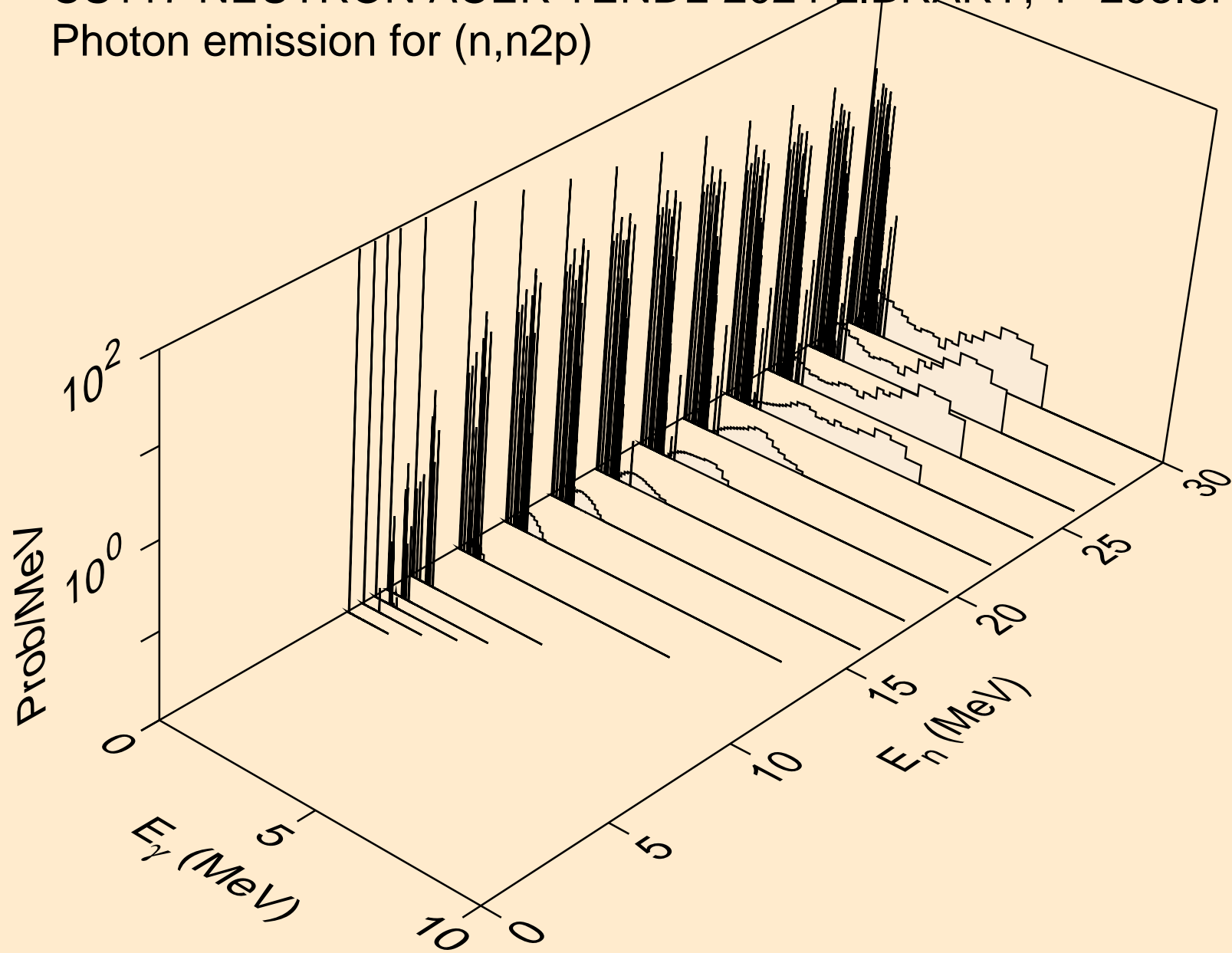

CS117 NEUTRON ACER TENDL-2024 LIBRARY; T=293.6K
Photon emission for (n,npa)

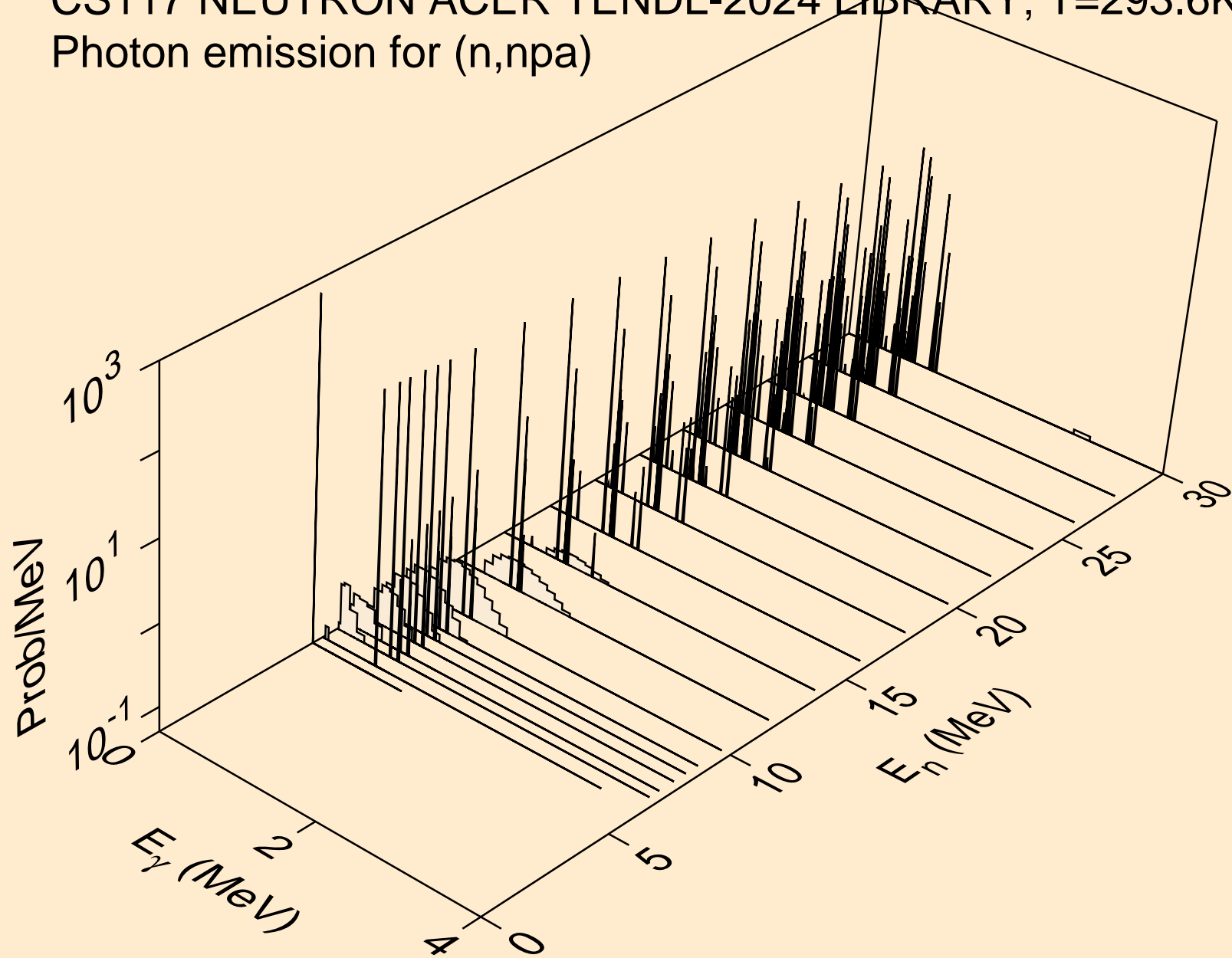

CS117 NEUTRON ACER TENDL-2024 LIBRARY; T=293.6K
Photon emission for (n,n*c)

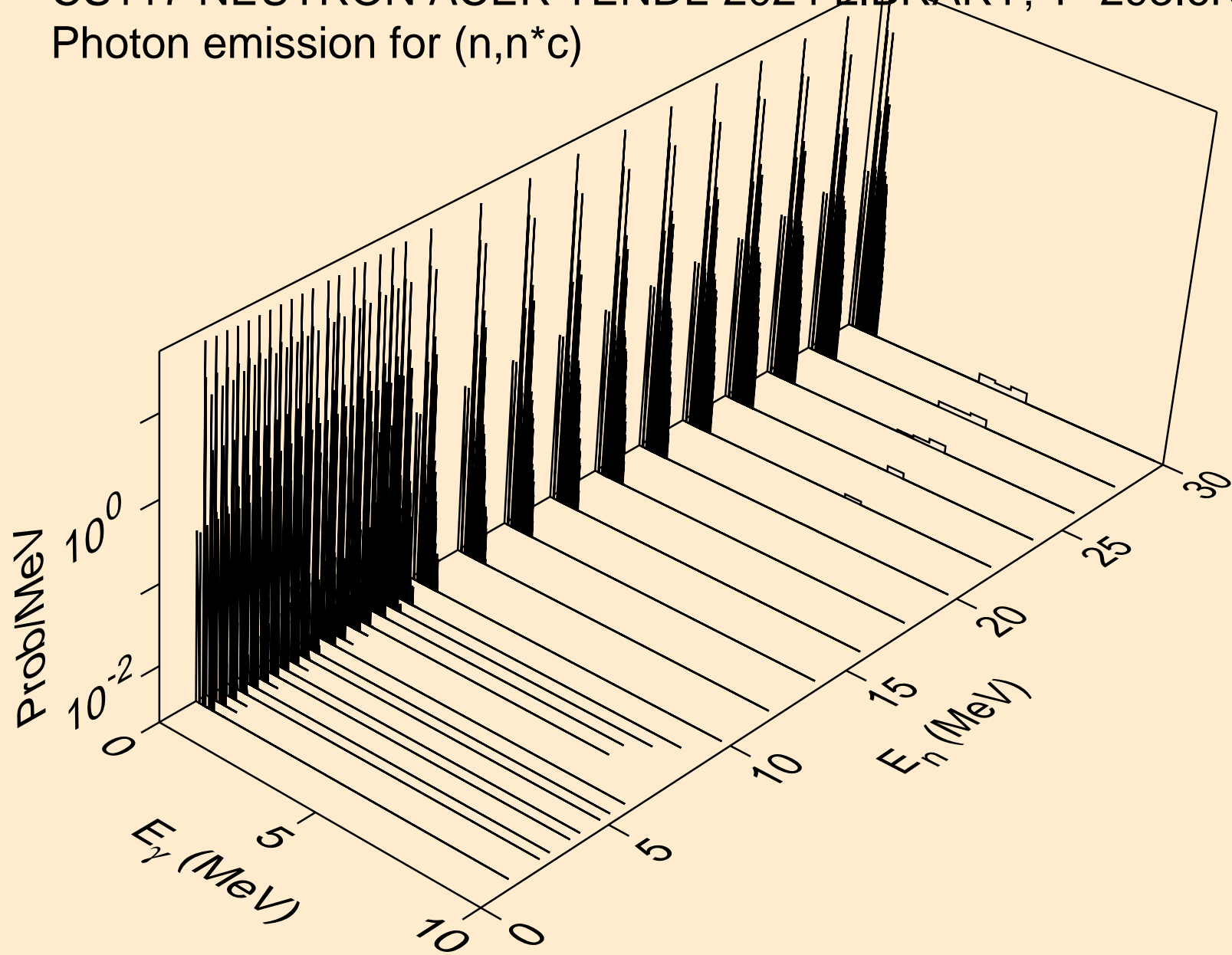

CS117 NEUTRON ACER TENDL-2024 LIBRARY; T=293.6K
Photon emission for (n,gma)

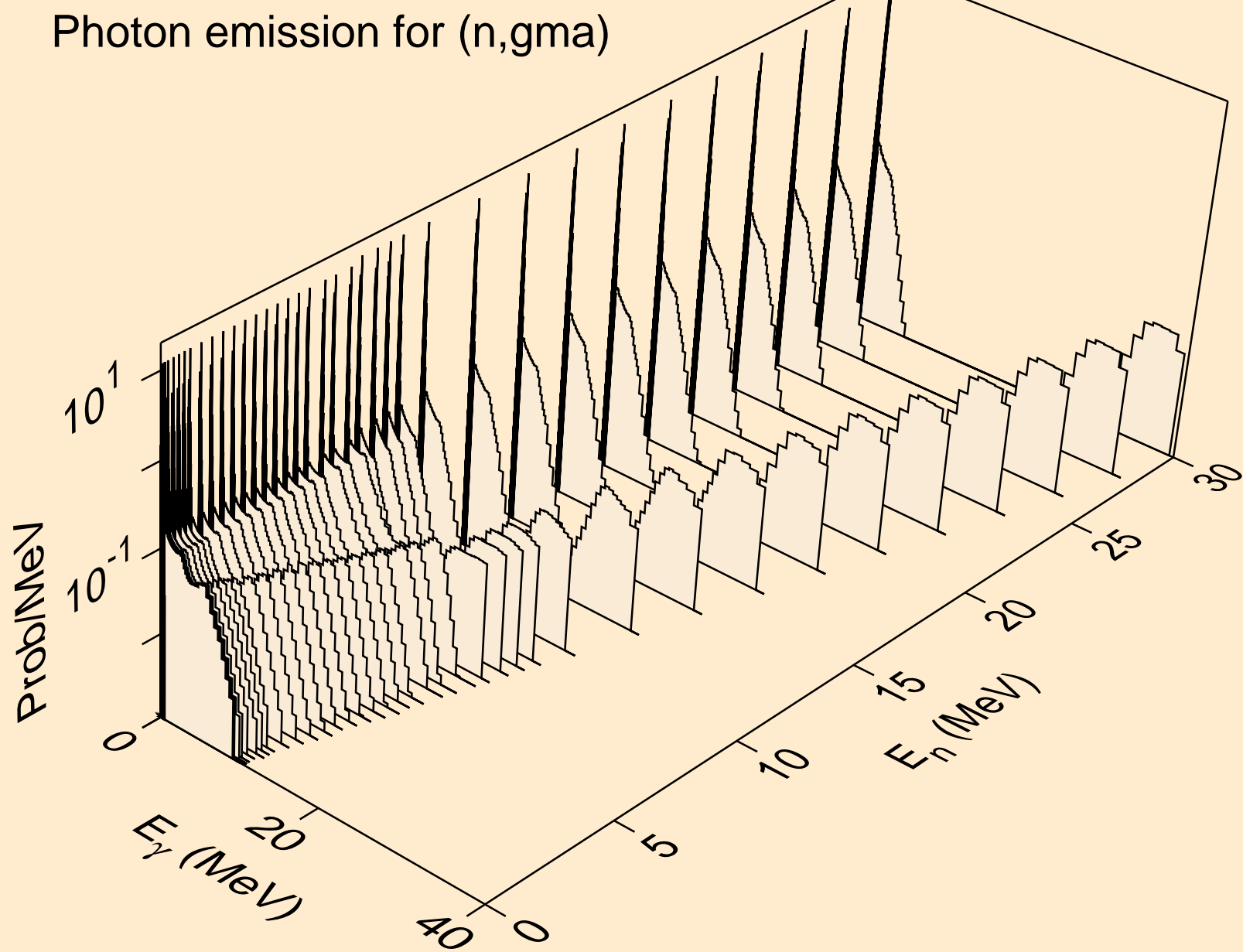

CS117 NEUTRON ACER TENDL-2024 LIBRARY; T=293.6K
Photon emission for (n,p)

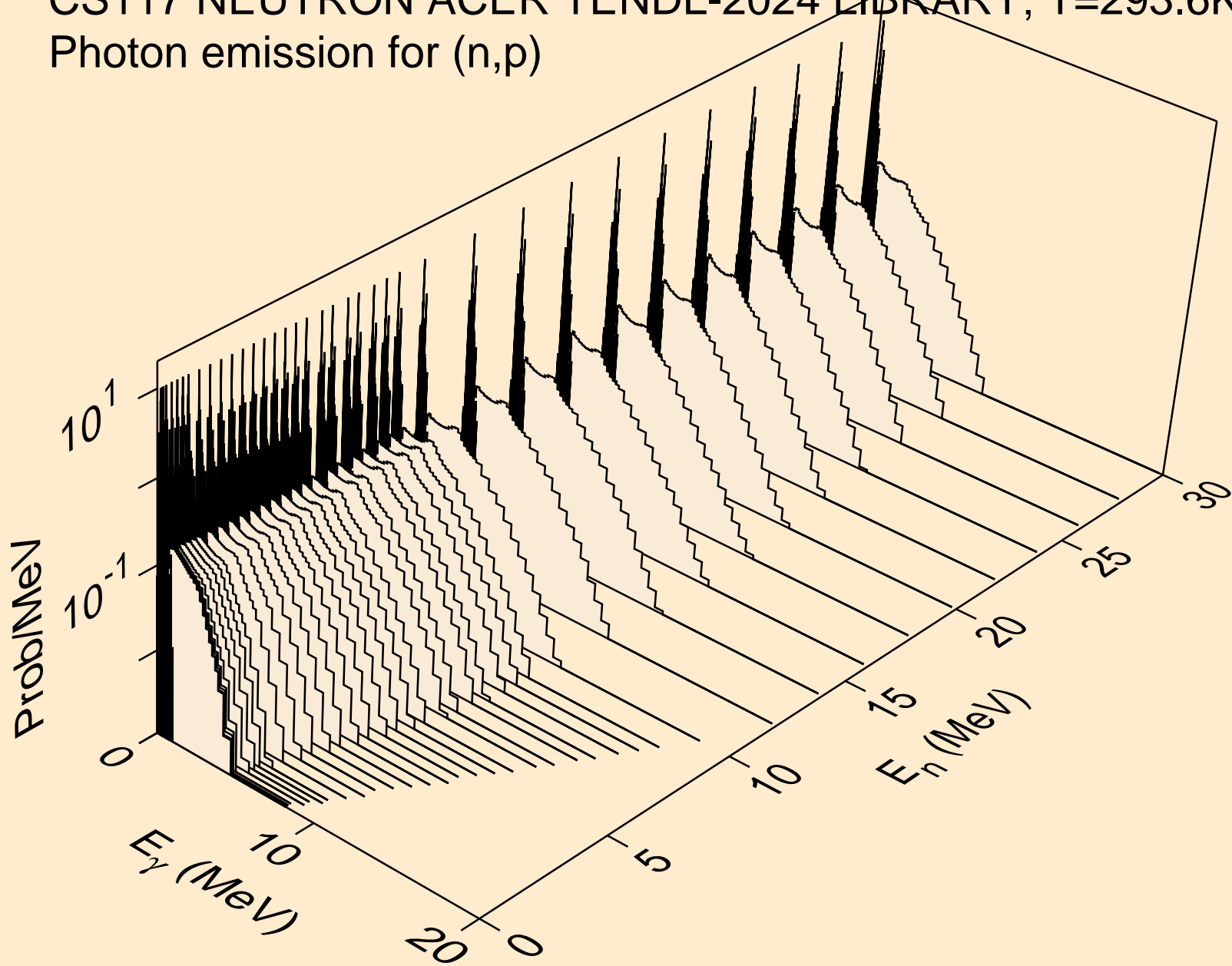

CS117 NEUTRON ACER TENDL-2024 LIBRARY; T=293.6K
Photon emission for (n,d)

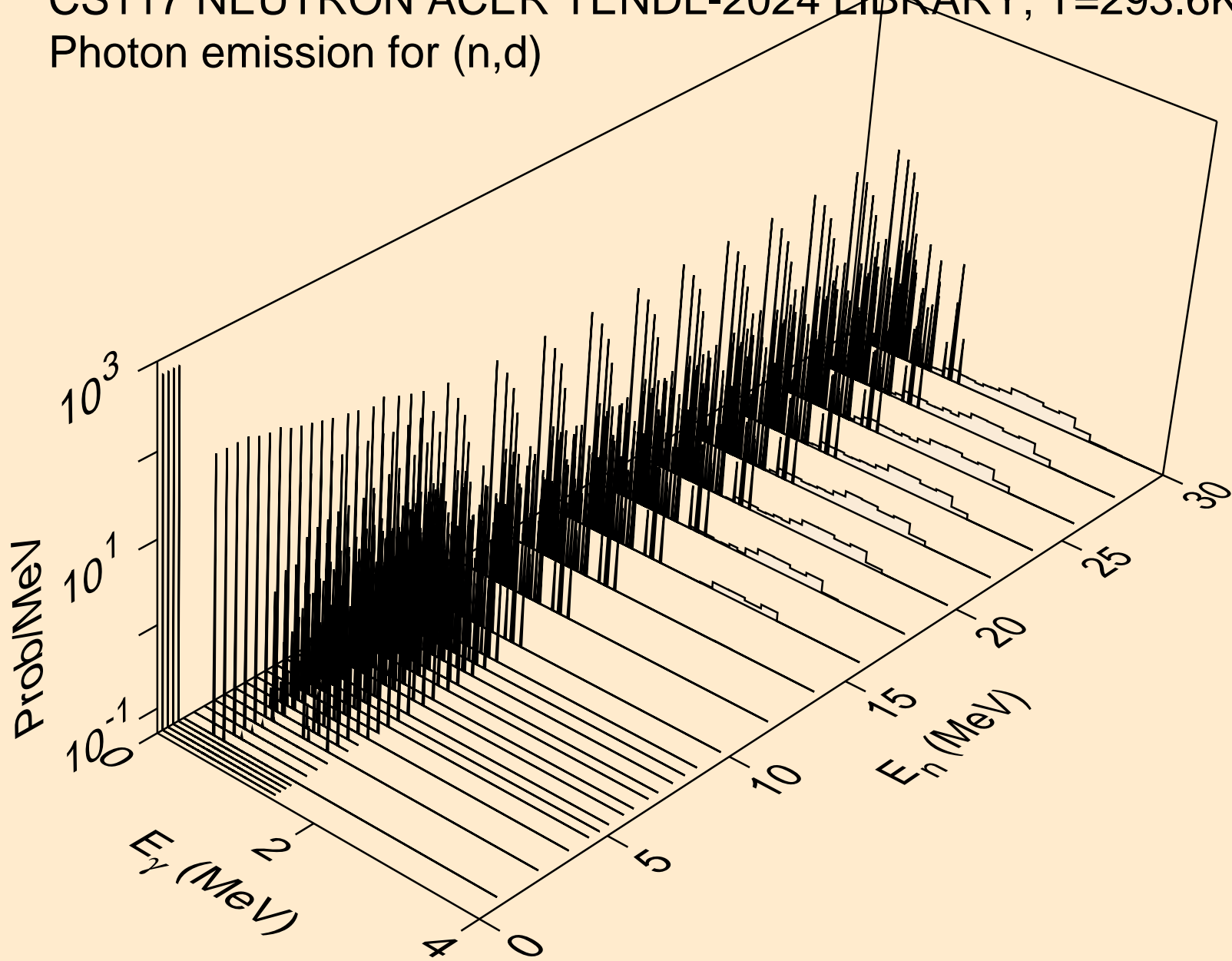

CS117 NEUTRON ACER TENDL-2024 LIBRARY; T=293.6K
Photon emission for (n,t)

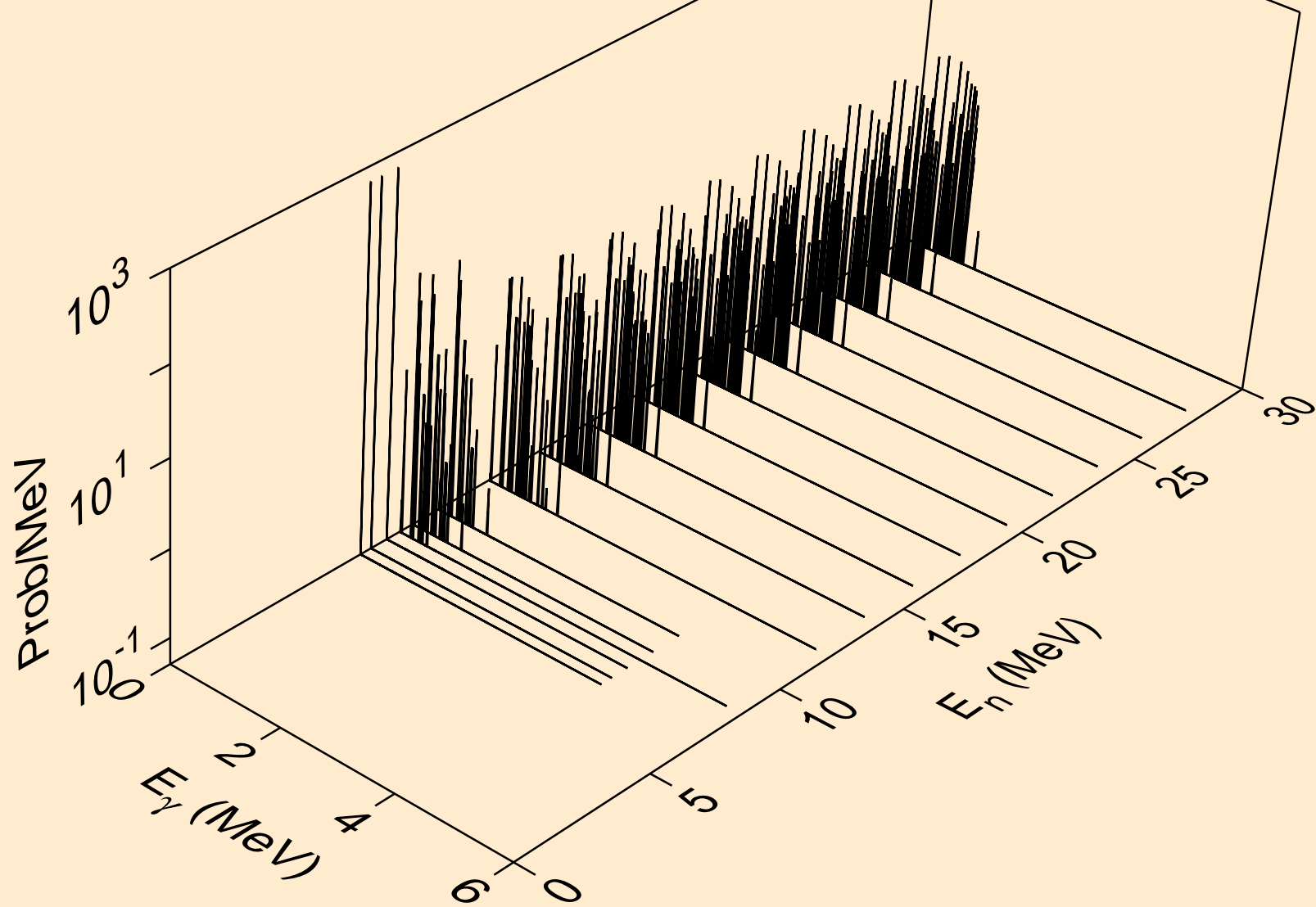

CS117 NEUTRON ACER TENDL-2024 LIBRARY; T=293.6K
Photon emission for (n,he3)

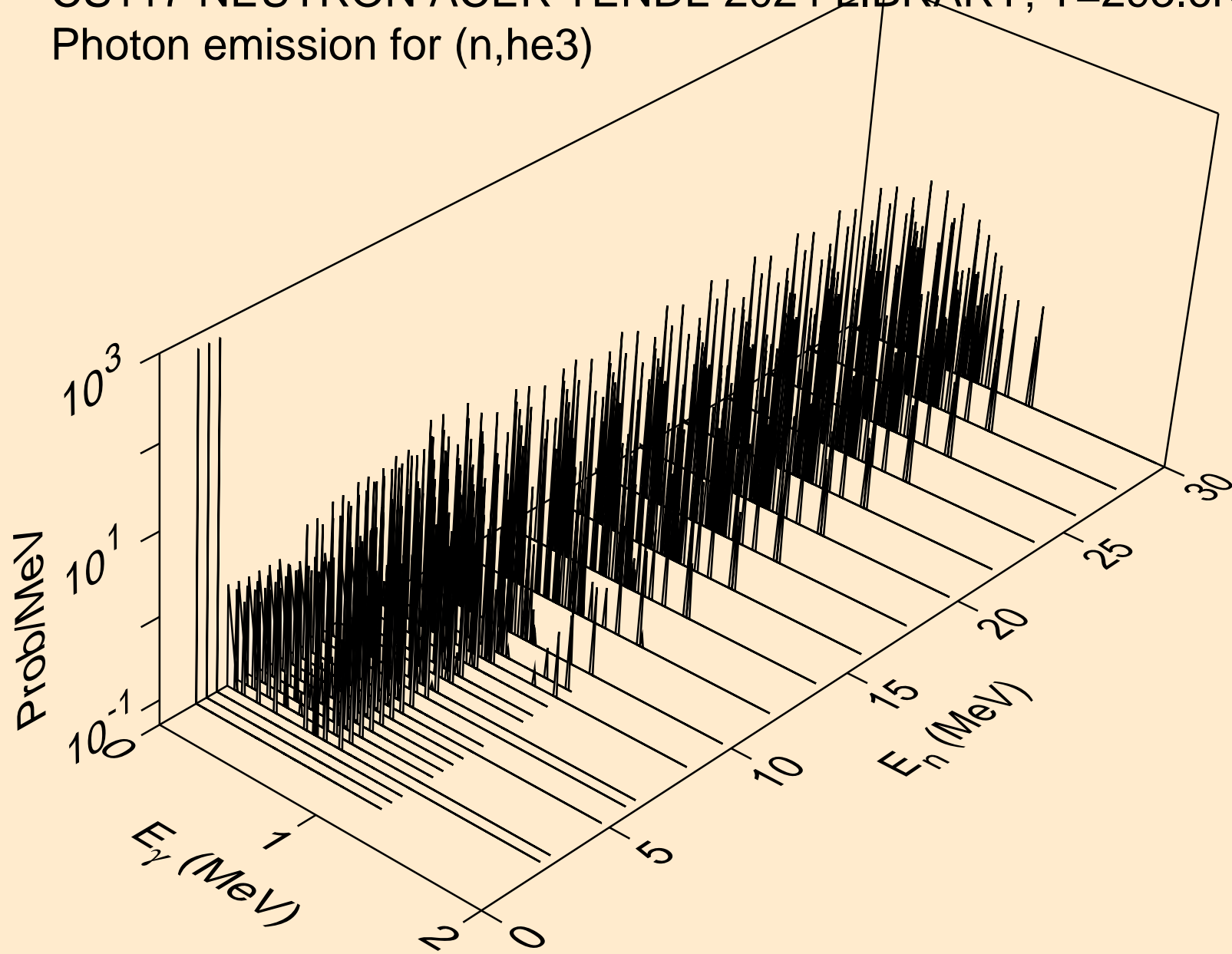

CS117 NEUTRON ACER TENDL-2024 LIBRARY; T=293.6K
Photon emission for (n,a)

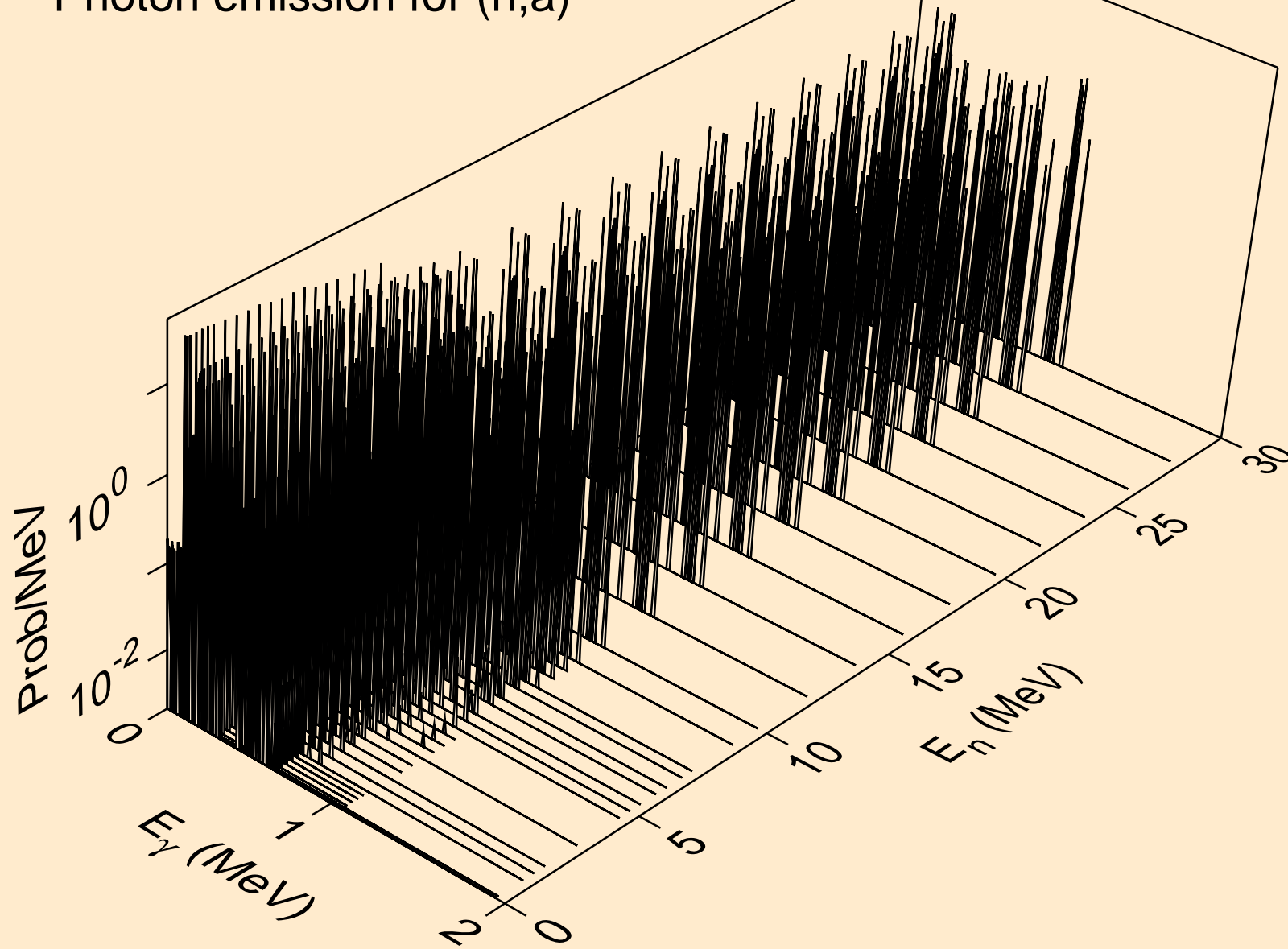

CS117 NEUTRON ACER TENDL-2024 LIBRARY; T=293.6K
Photon emission for (n,2a)

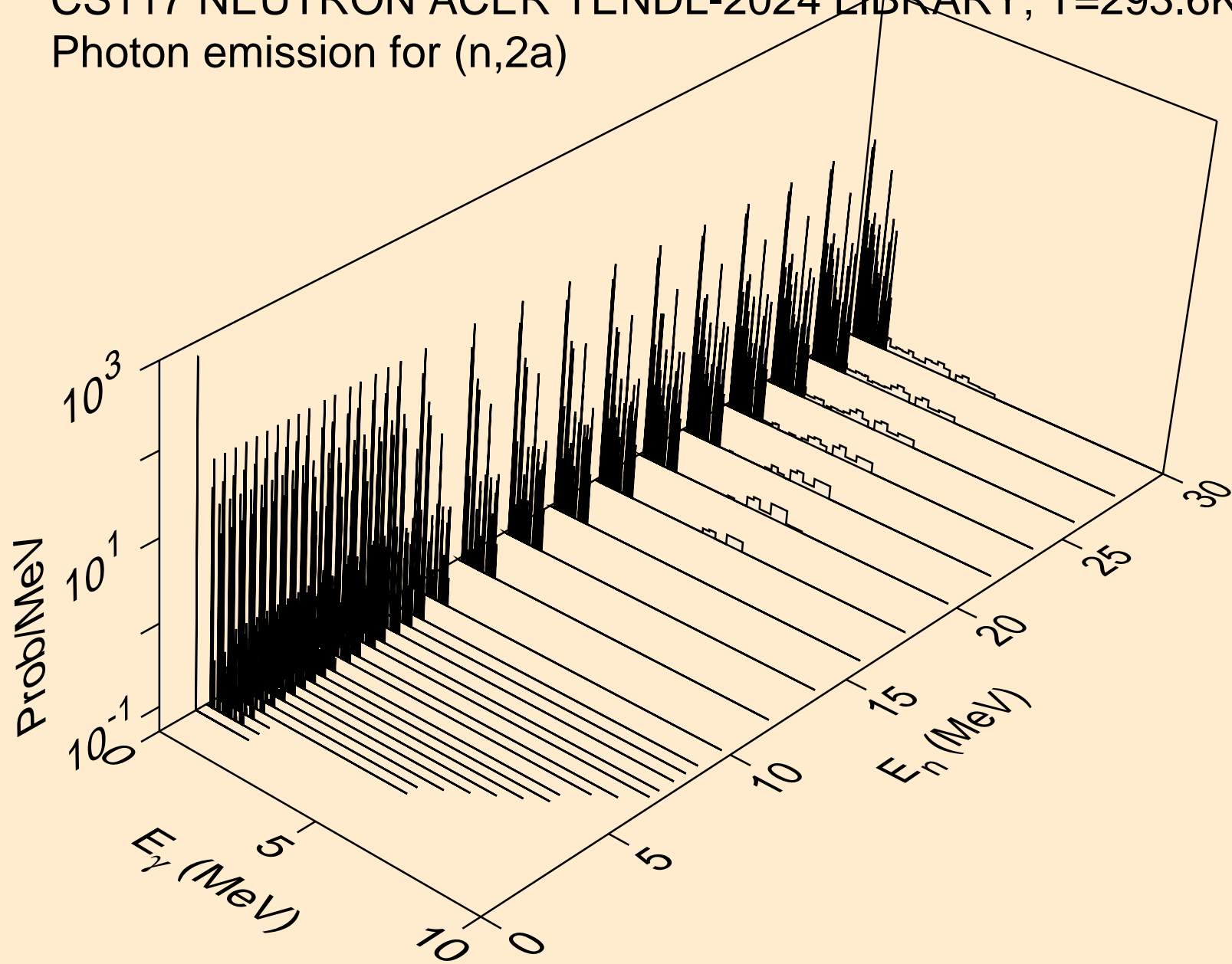

CS117 NEUTRON ACER TENDL-2024 LIBRARY; T=293.6K
Photon emission for (n,3a)

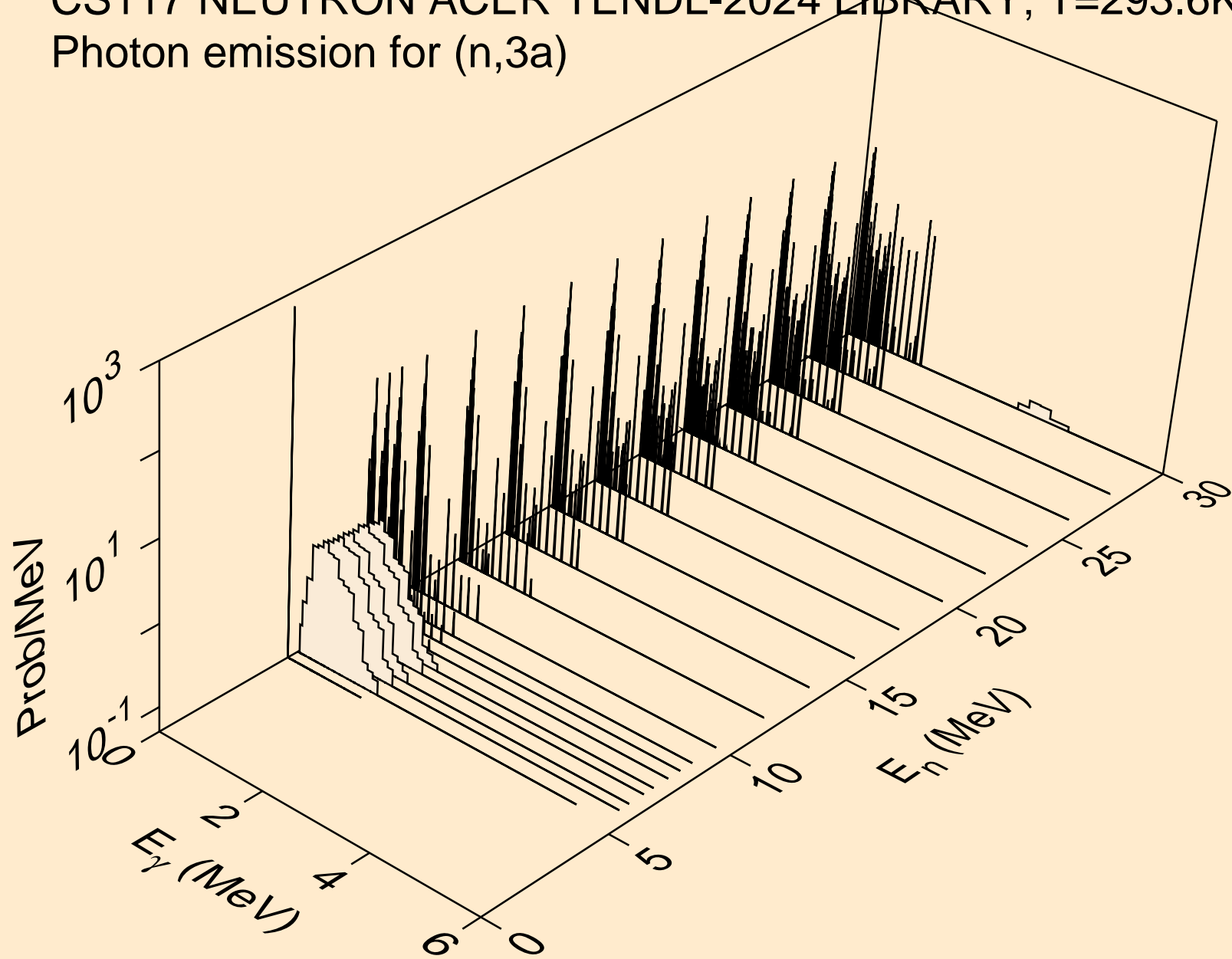

CS117 NEUTRON ACER TENDL-2024 LIBRARY; T=293.6K
Photon emission for (n,2p)

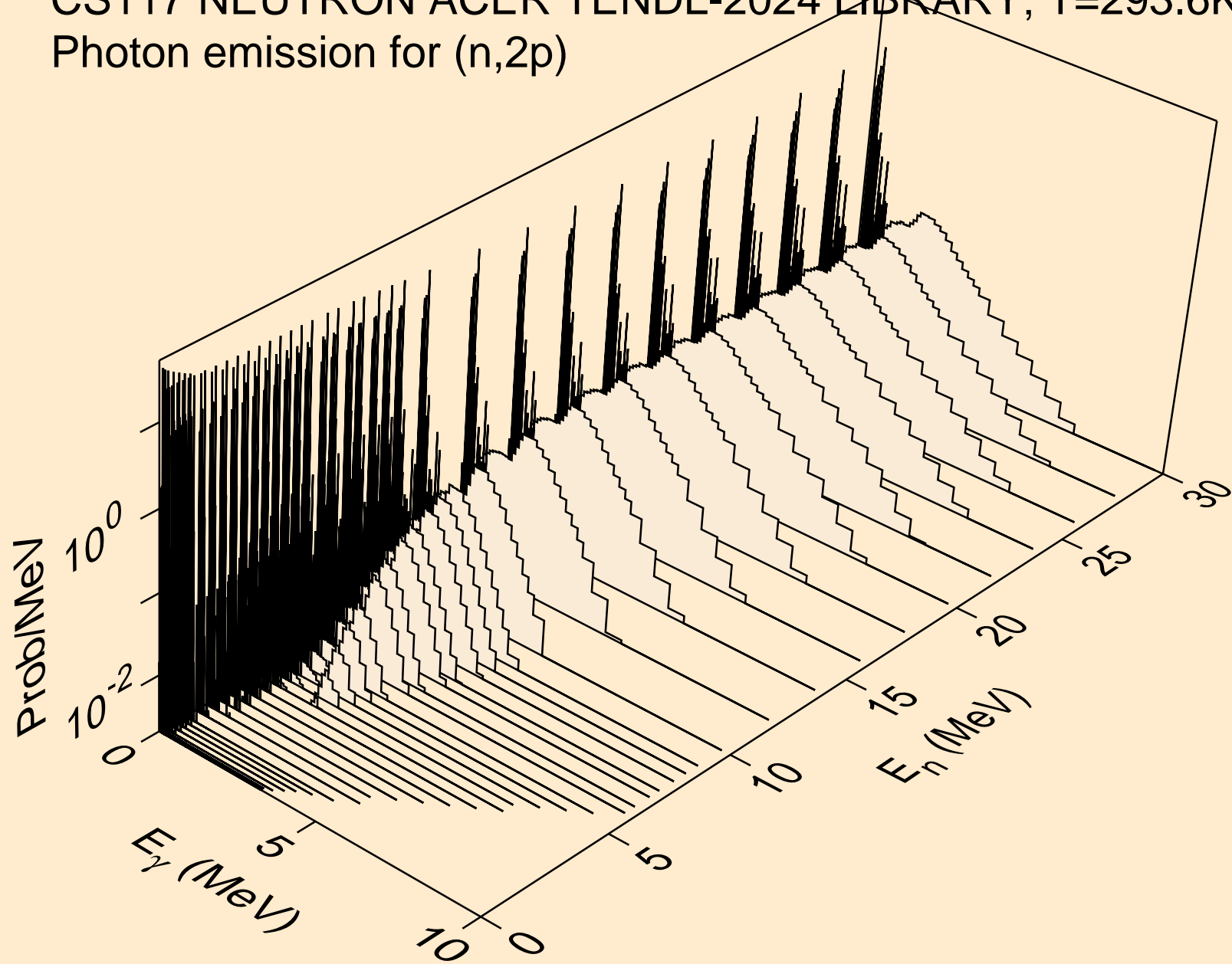

CS117 NEUTRON ACER TENDL-2024 LIBRARY; T=293.6K
Photon emission for (n,p α)

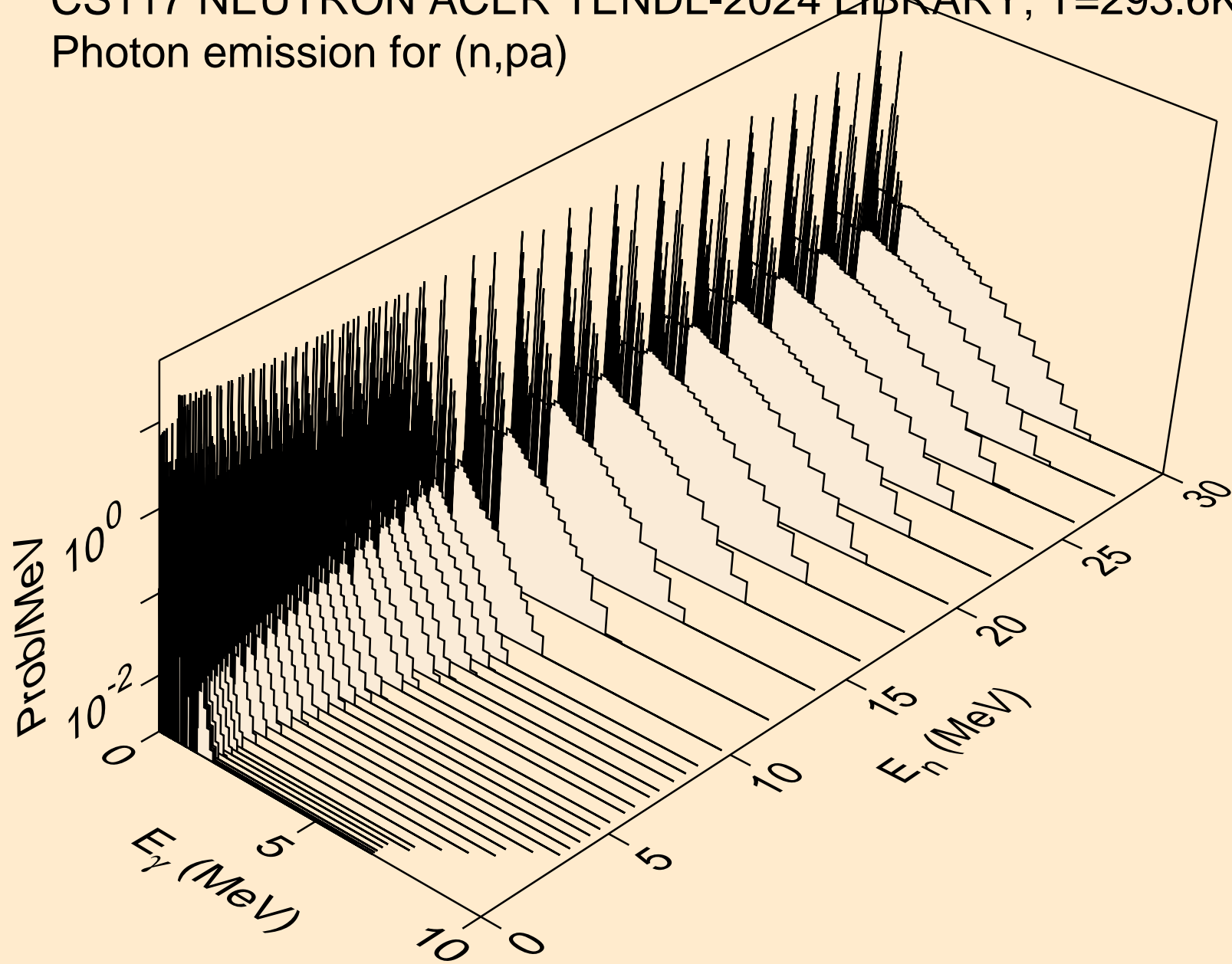

CS117 NEUTRON ACER TENDL-2024 LIBRARY; T=293.6K
Photon emission for (n,t2a)

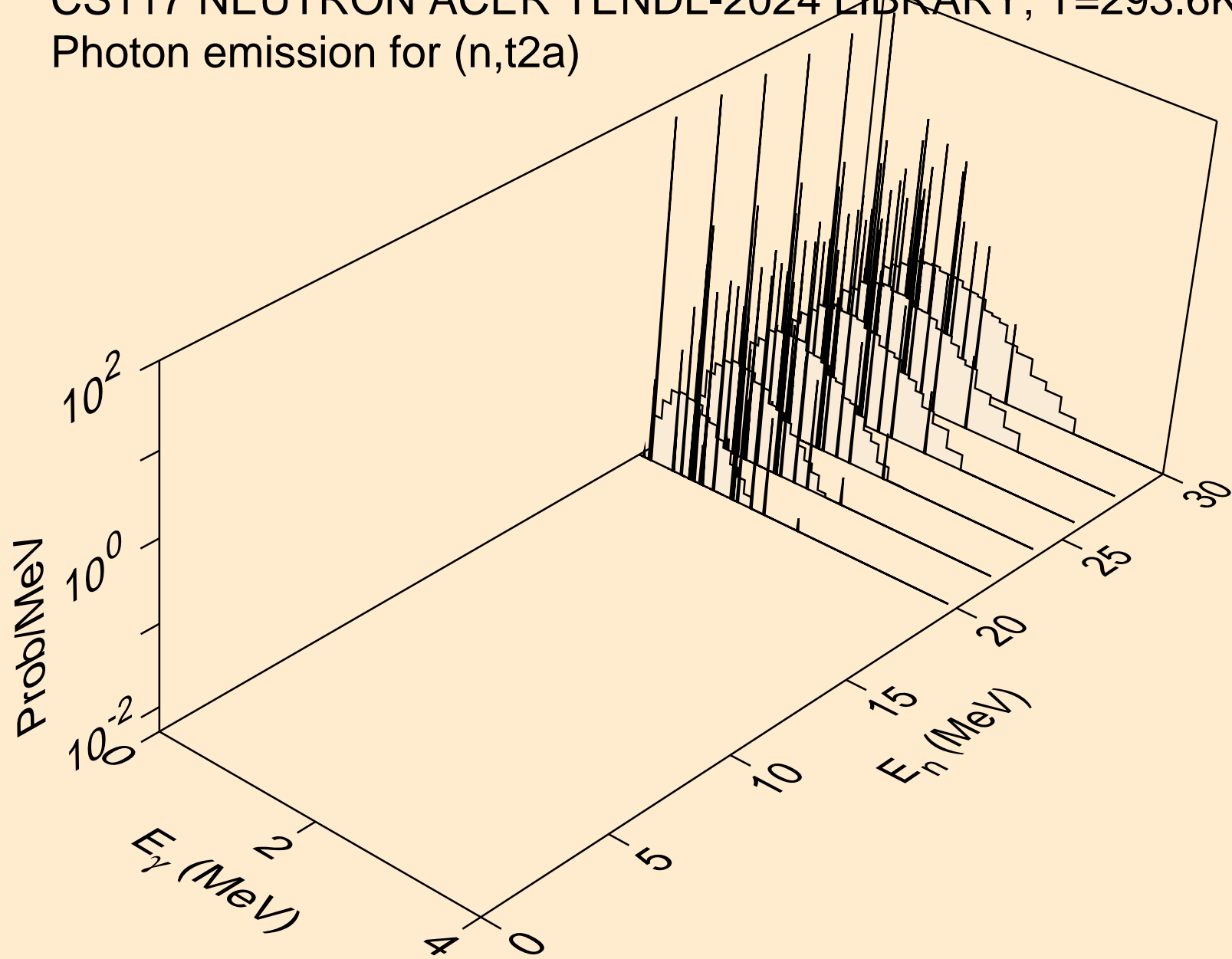

CS117 NEUTRON ACER TENDL-2024 LIBRARY; T=293.6K
Photon emission for (n,d2a)

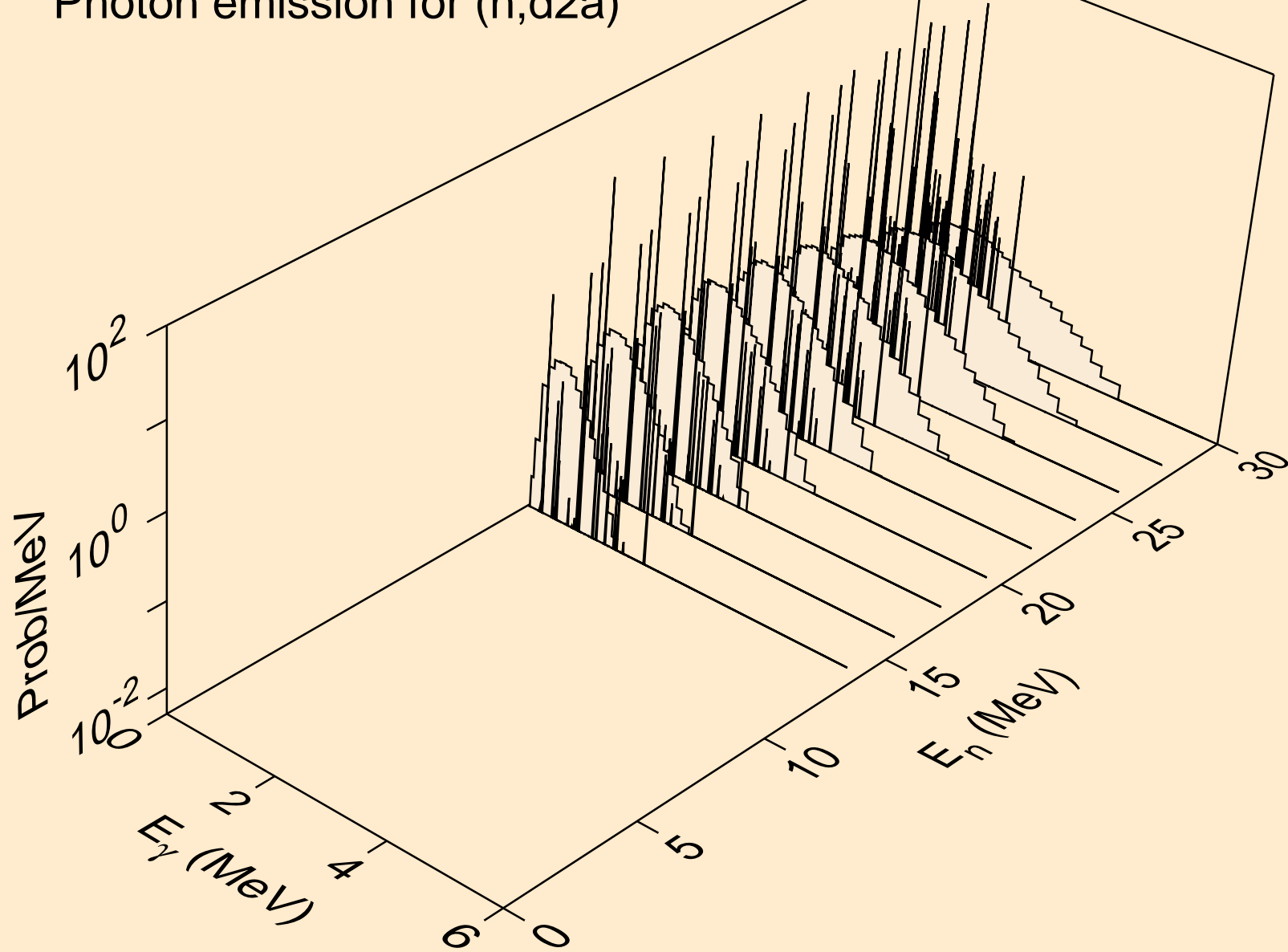

CS117 NEUTRON ACER TENDL-2024 LIBRARY; T=293.6K
Photon emission for (n,pd)

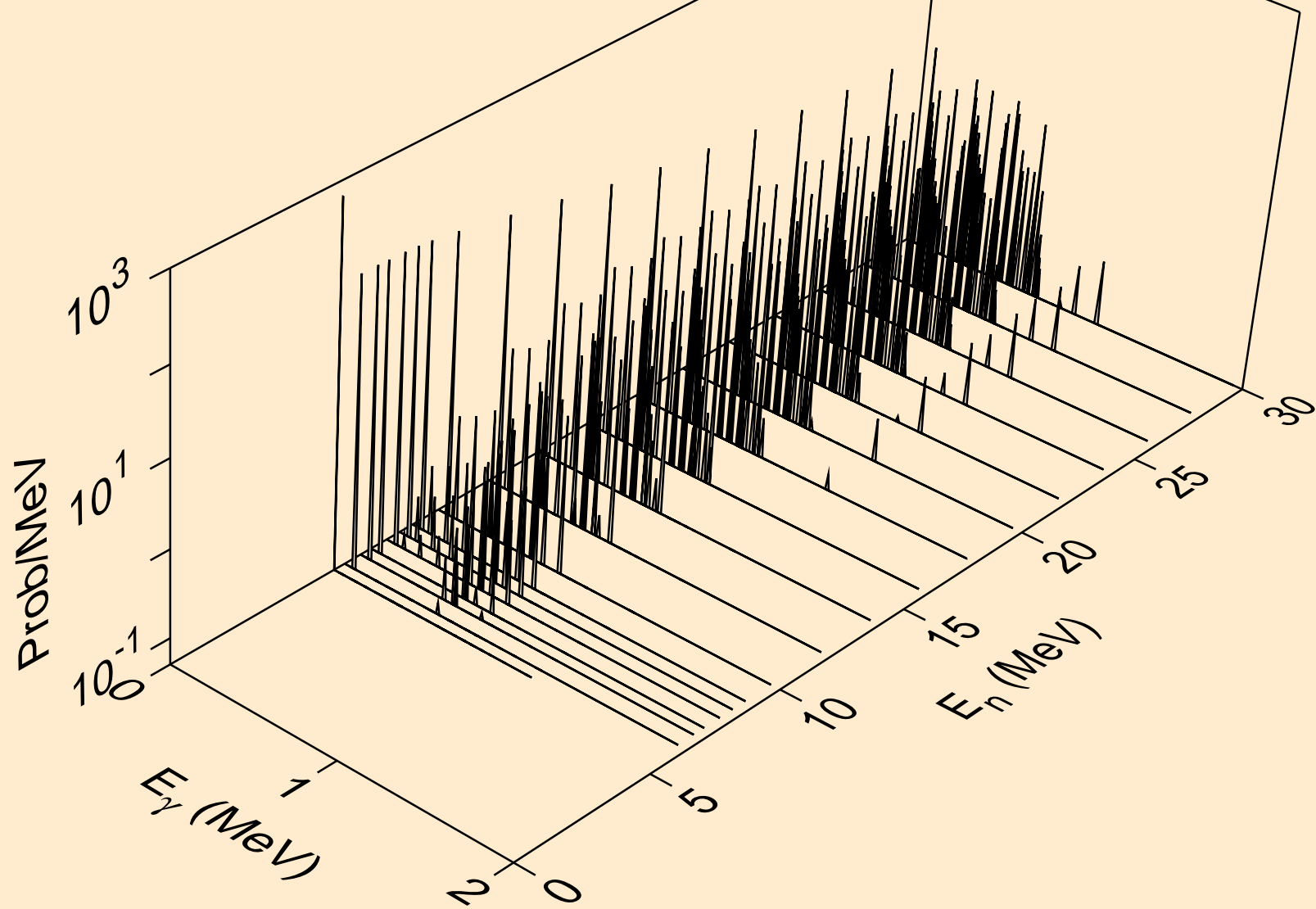

CS117 NEUTRON ACER TENDL-2024 LIBRARY; T=293.6K
Photon emission for (n,pt)

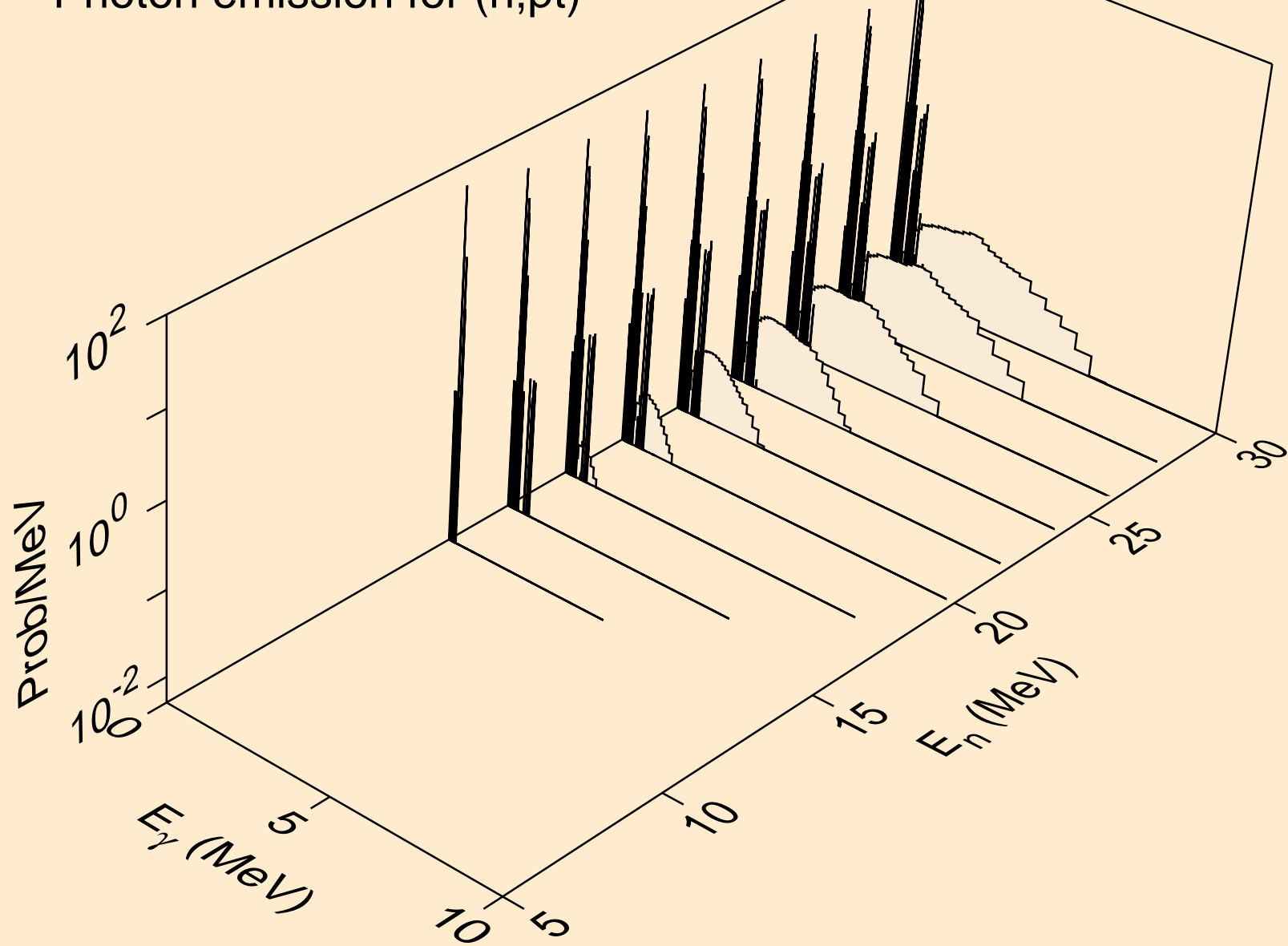

CS117 NEUTRON ACER TENDL-2024 LIBRARY; T=293.6K
Photon emission for (n,da)

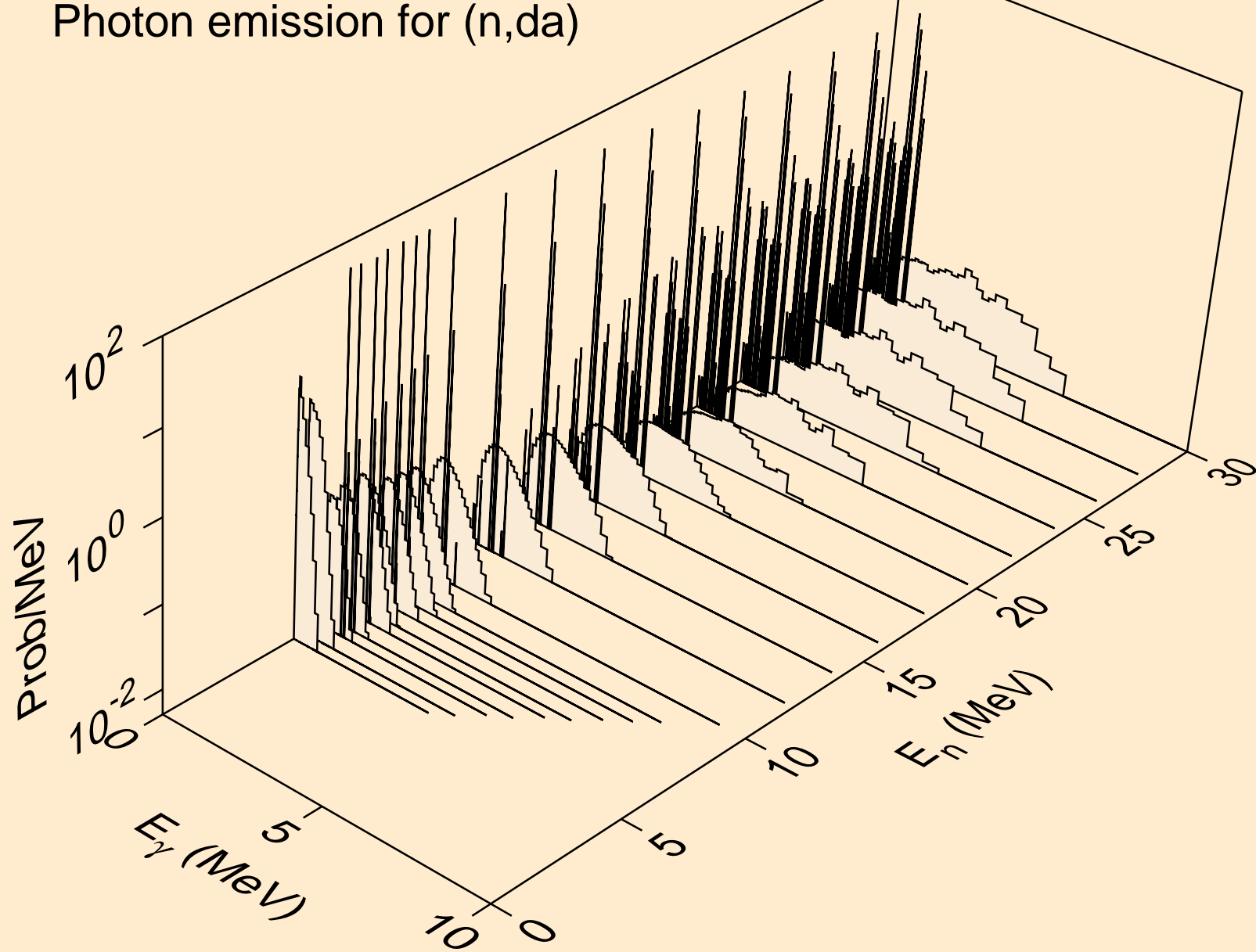

CS117 NEUTRON ACER TENDL-2024 LIBRARY; T=293.6K
thermal capture photon spectrum

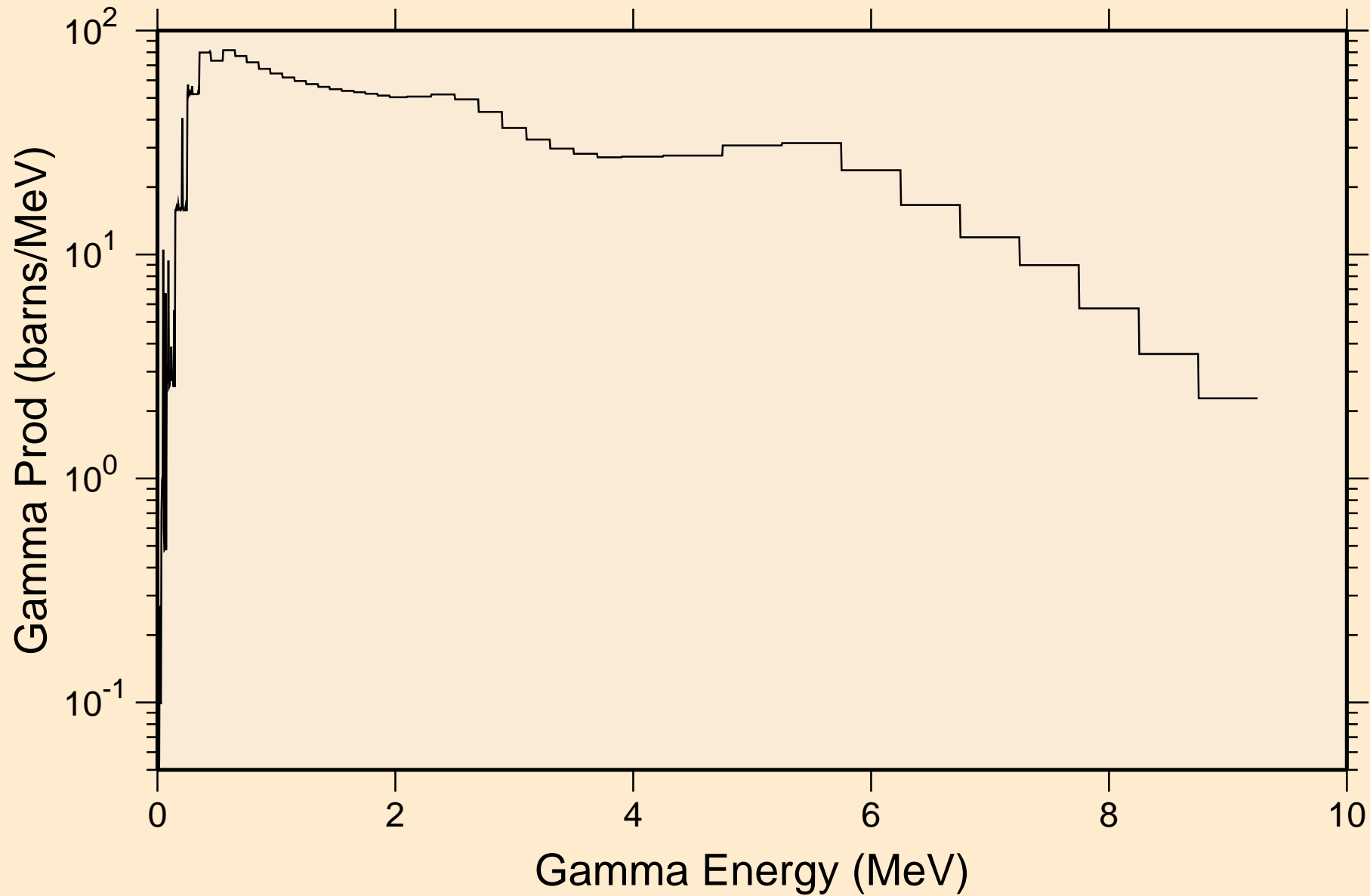

CS117 NEUTRON ACER TENDL-2024 LIBRARY; T=293.6K
14 MeV photon spectrum

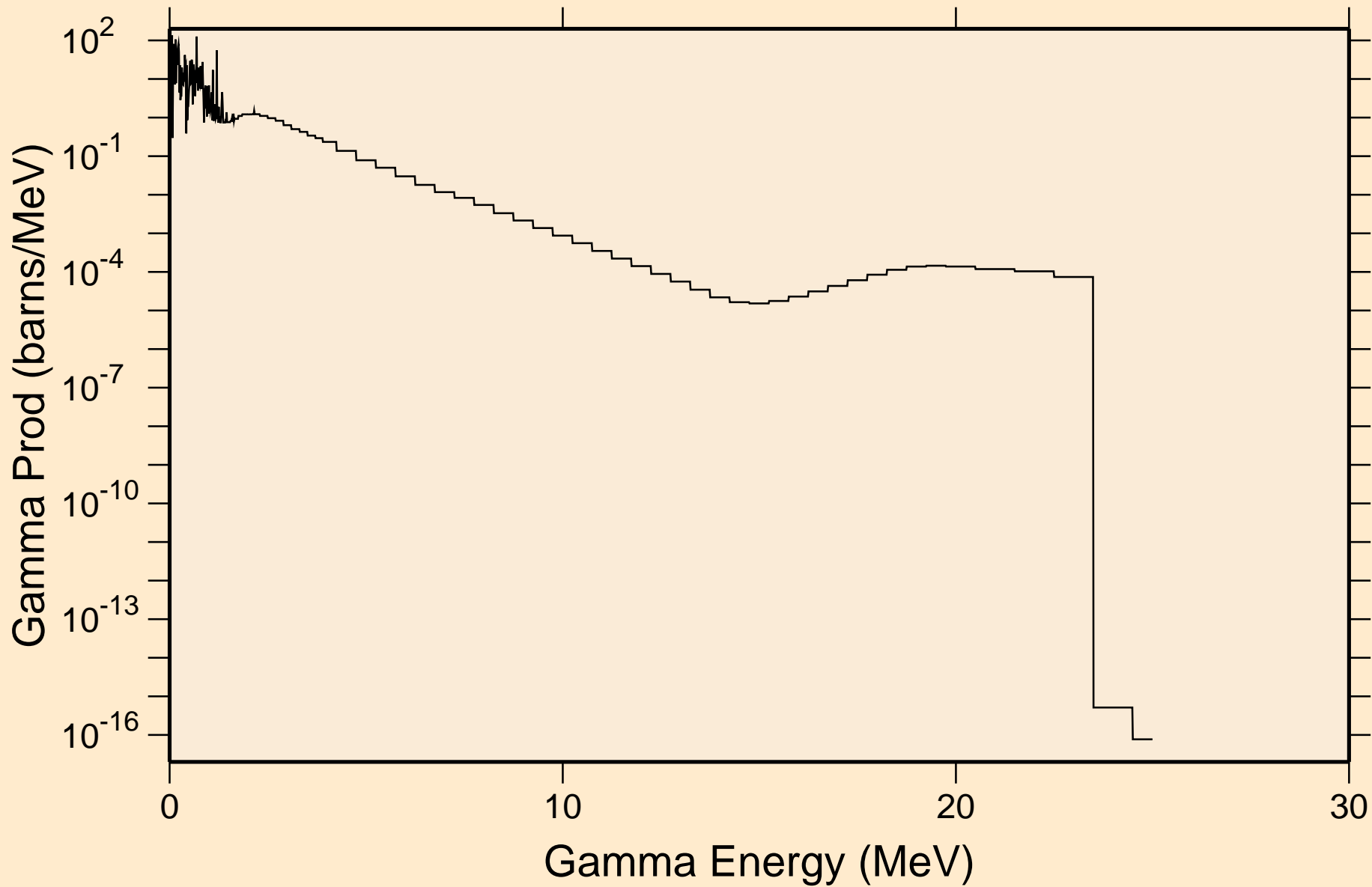

CS117 NEUTRON ACER TENDL-2024 LIBRARY; T=293.6K

Particle heating contributions

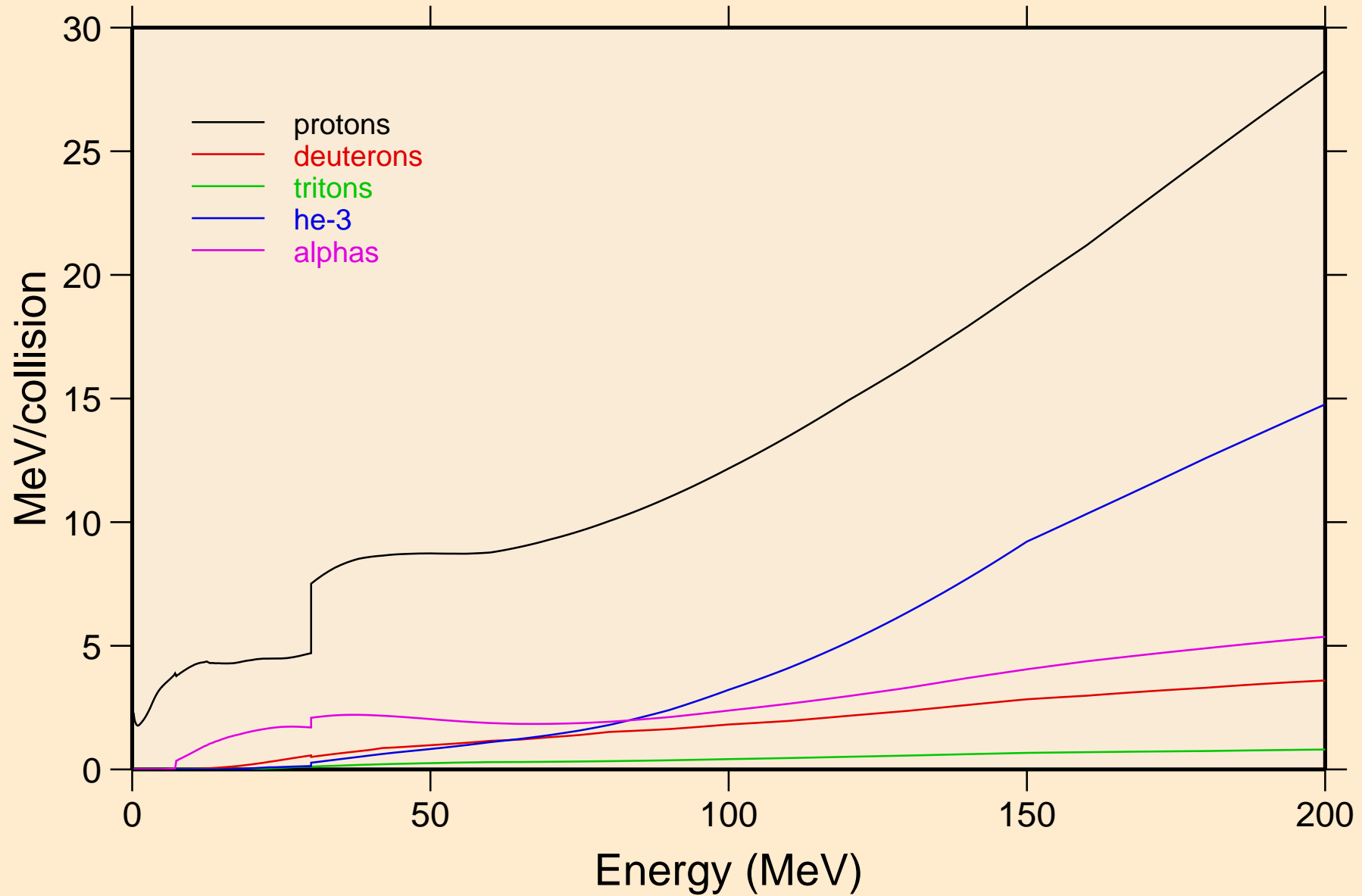

CS117 NEUTRON ACER TENDL-2024 LIBRARY; T=293.6K
Recoil Heating

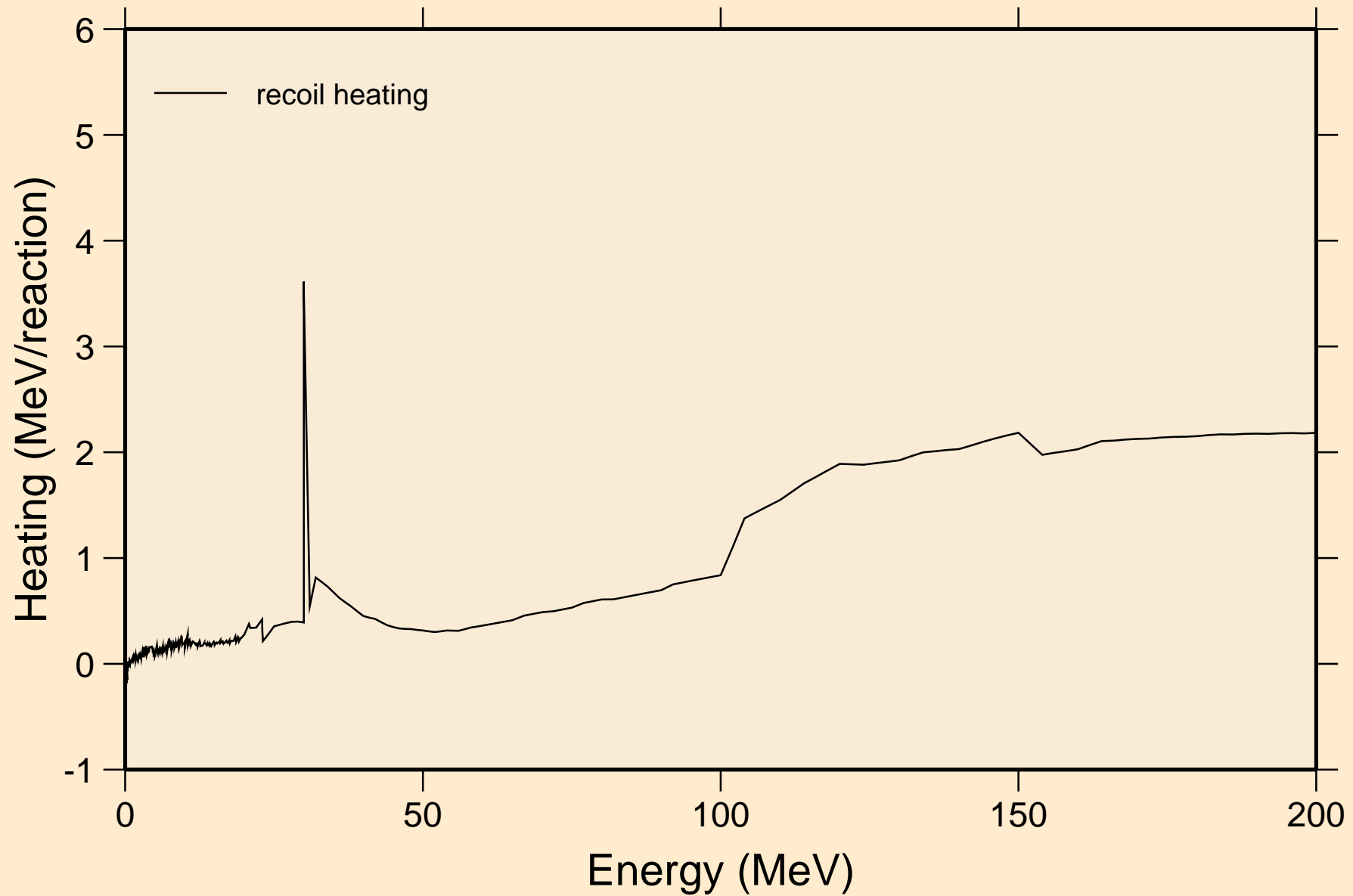

CS117 NEUTRON ACER TENDL-2024 LIBRARY; T=293.6K

Particle production cross sections

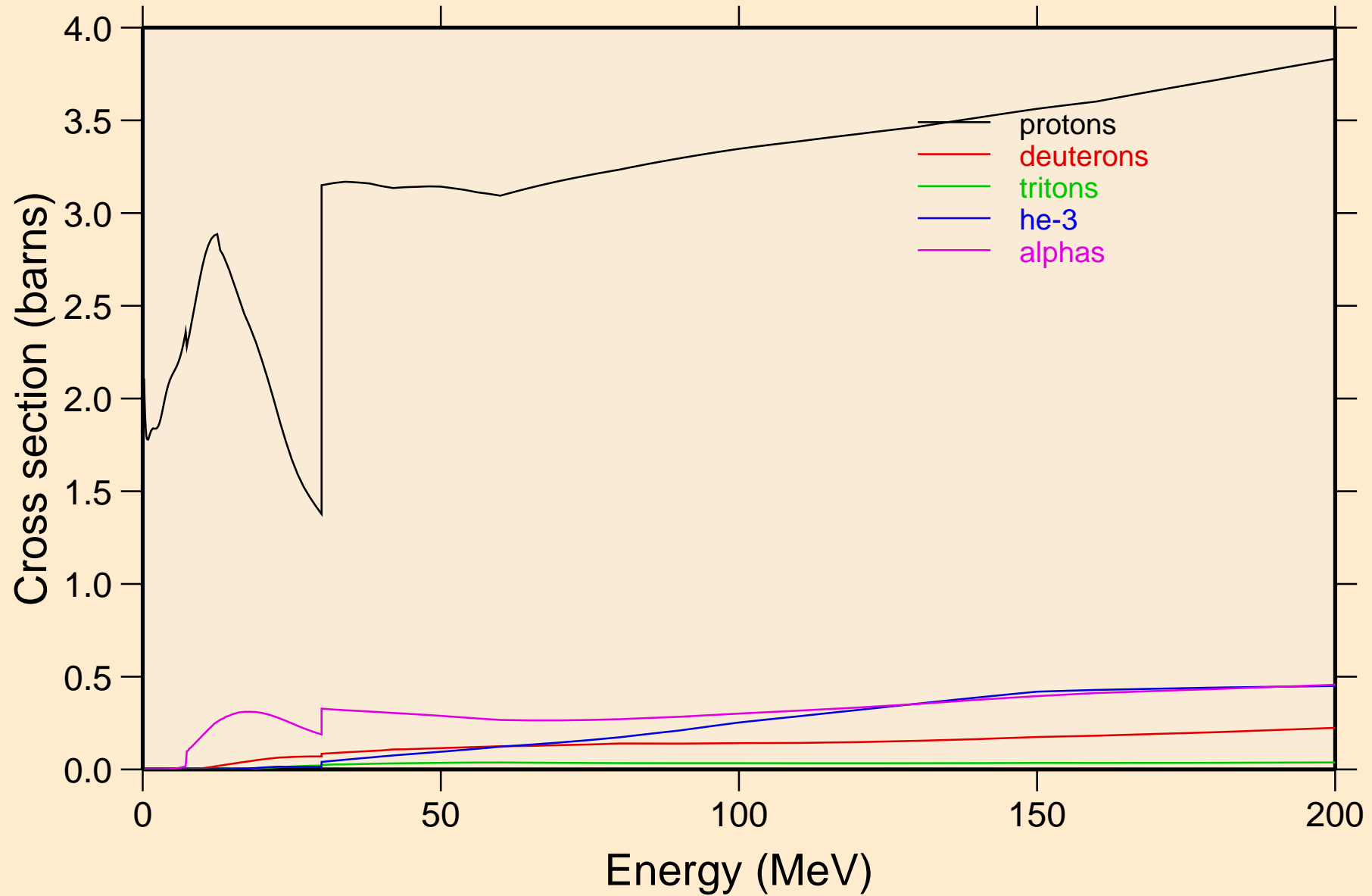

CS117 NEUTRON ACER TENDL-2024 LIBRARY; T=293.6K
protons from (n,x)

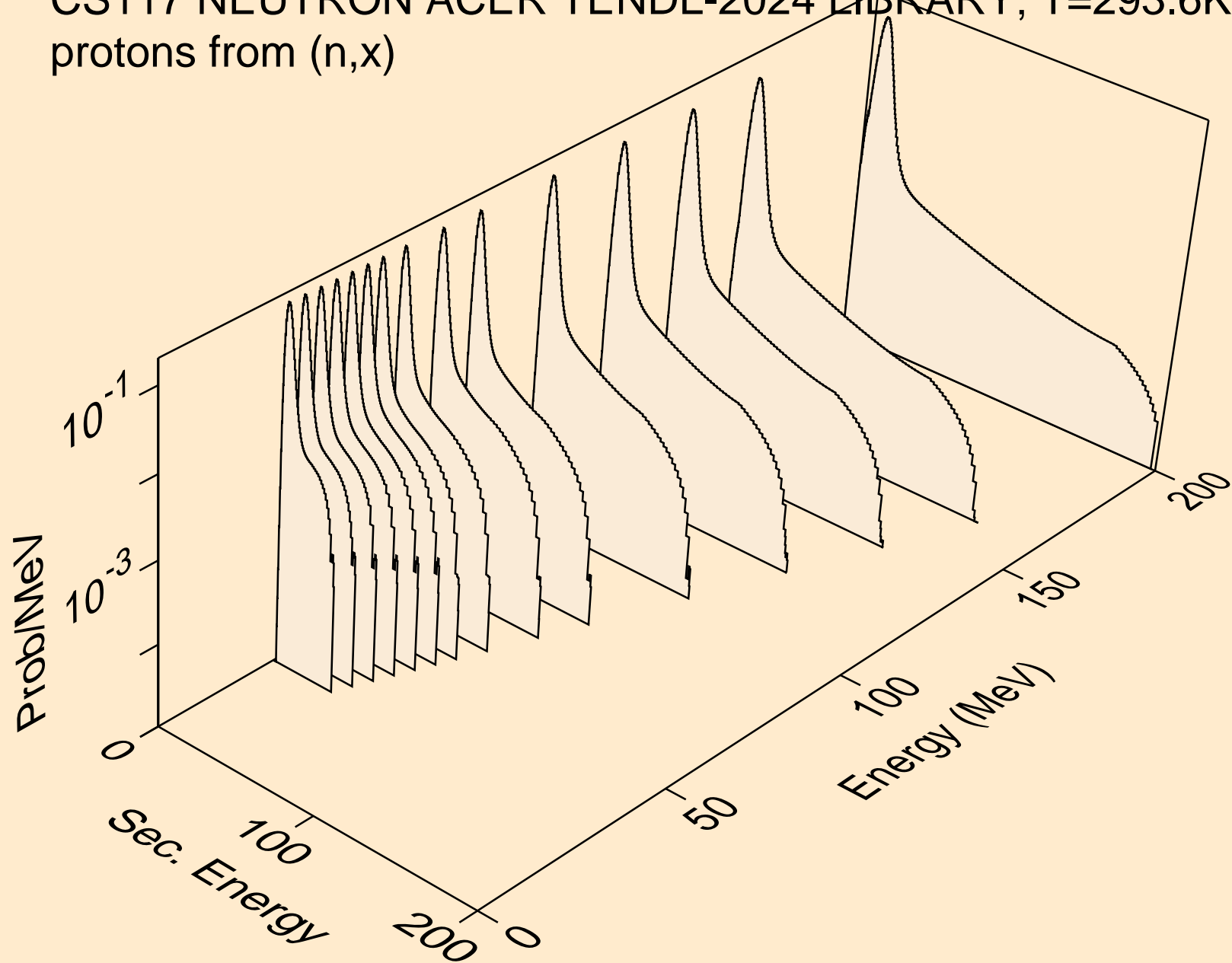

CS117 NEUTRON ACER TENDL-2024 LIBRARY; T=293.6K
protons from (n,n*)p

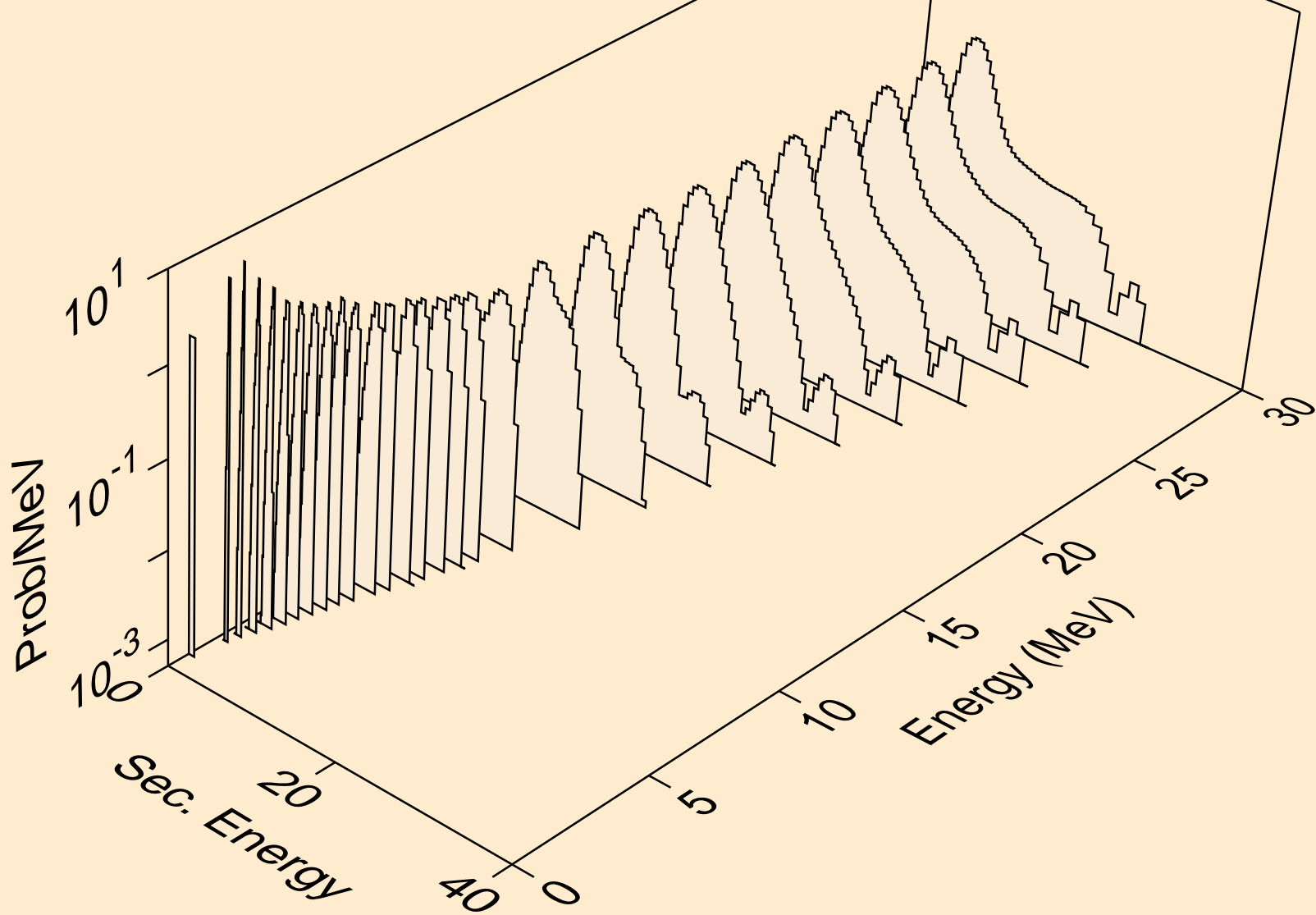

CS117 NEUTRON ACER TENDL-2024 LIBRARY; T=293.6K
protons from (n,2np)

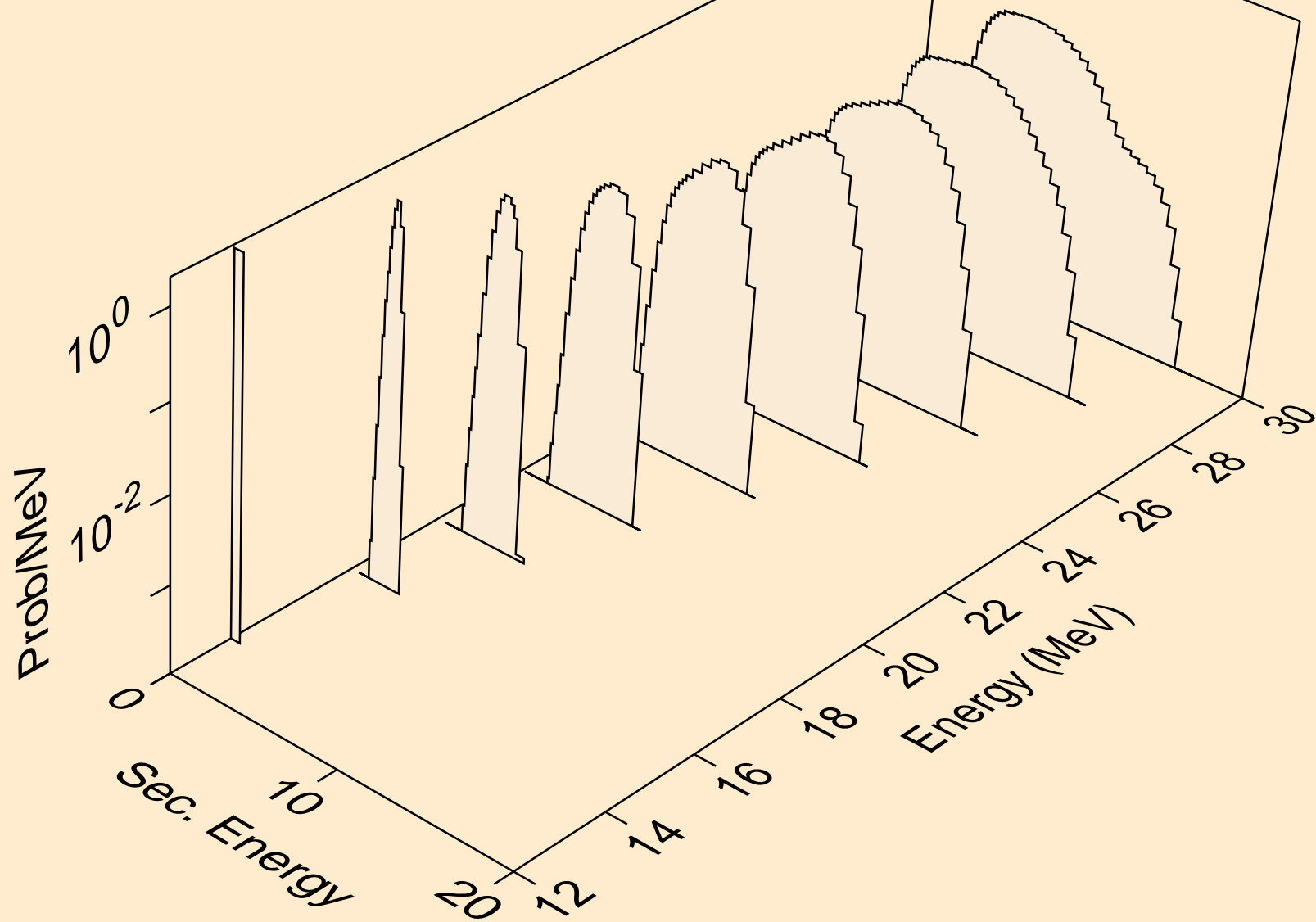

CS117 NEUTRON ACER TENDL-2024 LIBRARY; T=293.6K
protons from (n,3np)

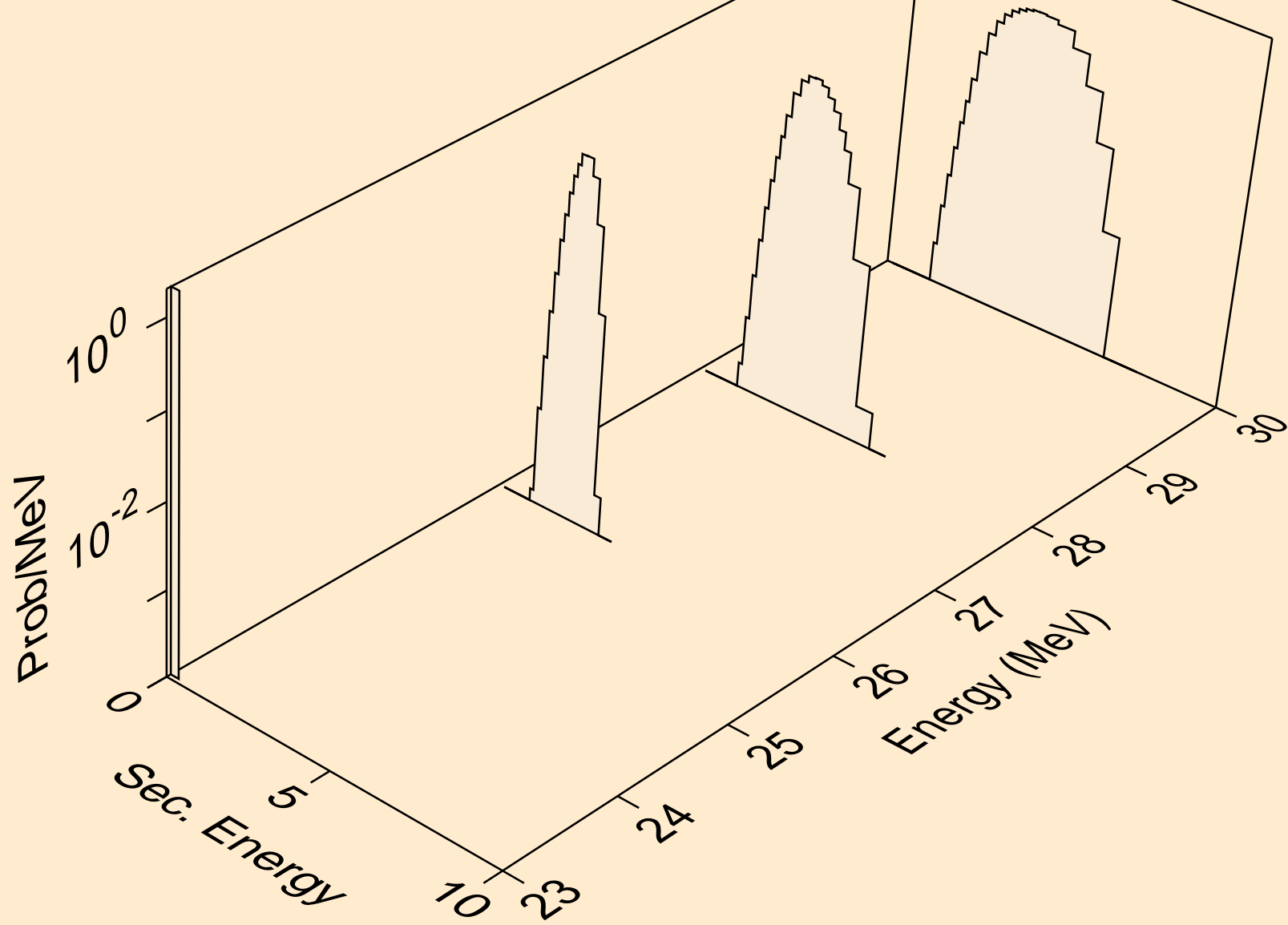

CS117 NEUTRON ACER TENDL-2024 LIBRARY; T=293.6K
protons from (n,n2p)

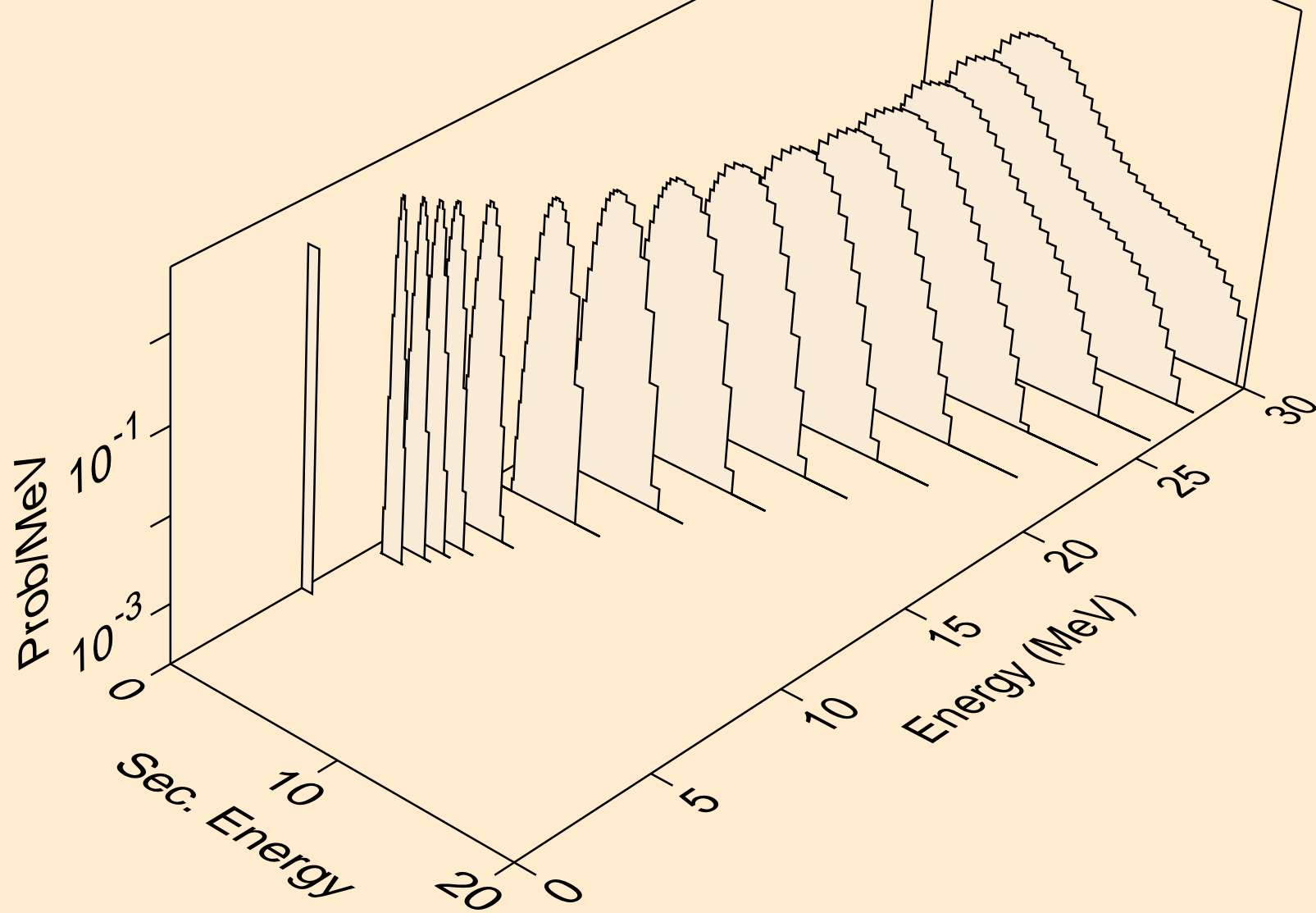

CS117 NEUTRON ACER TENDL-2024 LIBRARY; T=293.6K
protons from (n,npa)

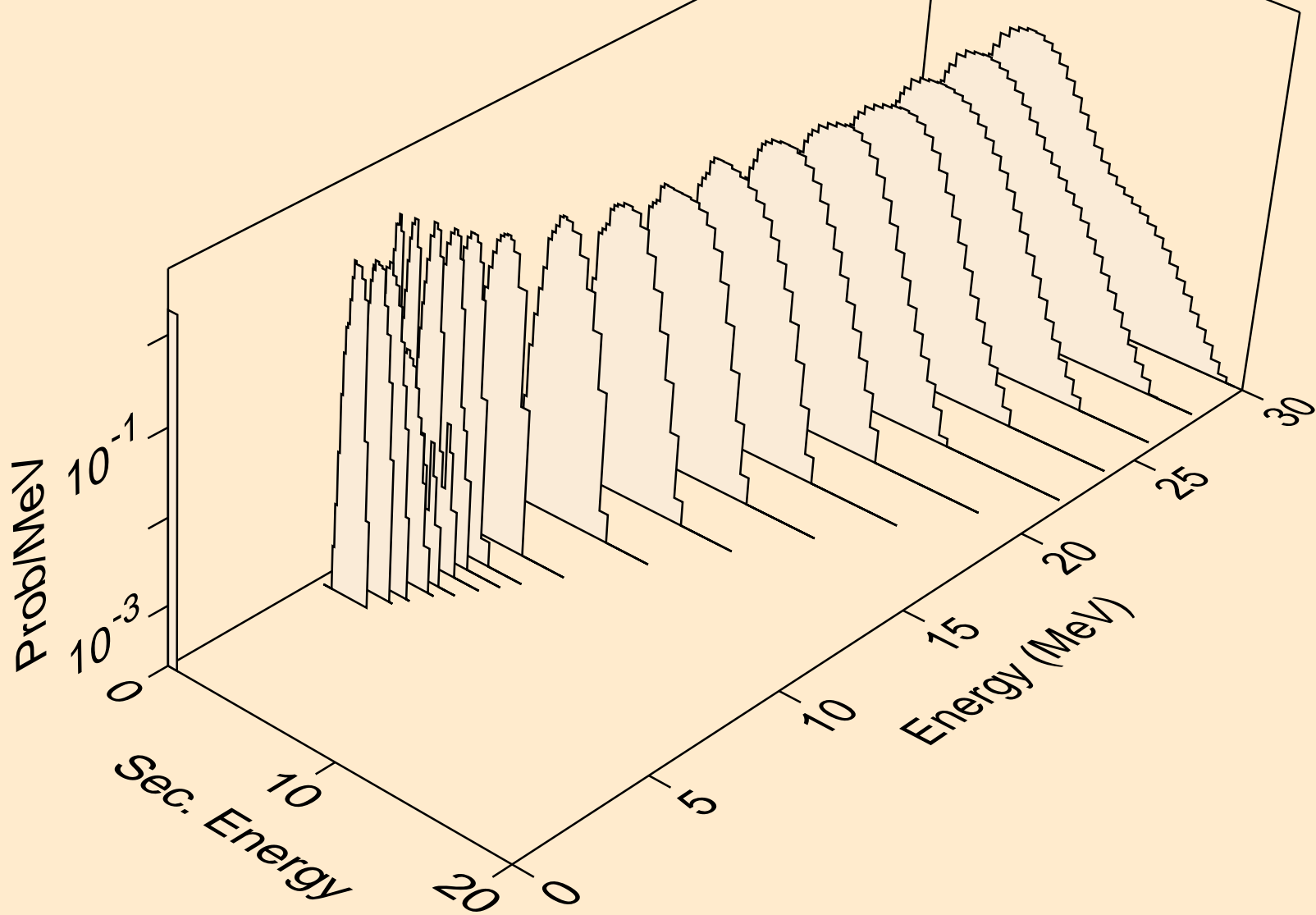

CS117 NEUTRON ACER TENDL-2024 LIBRARY; T=293.6K
protons from (n,p)

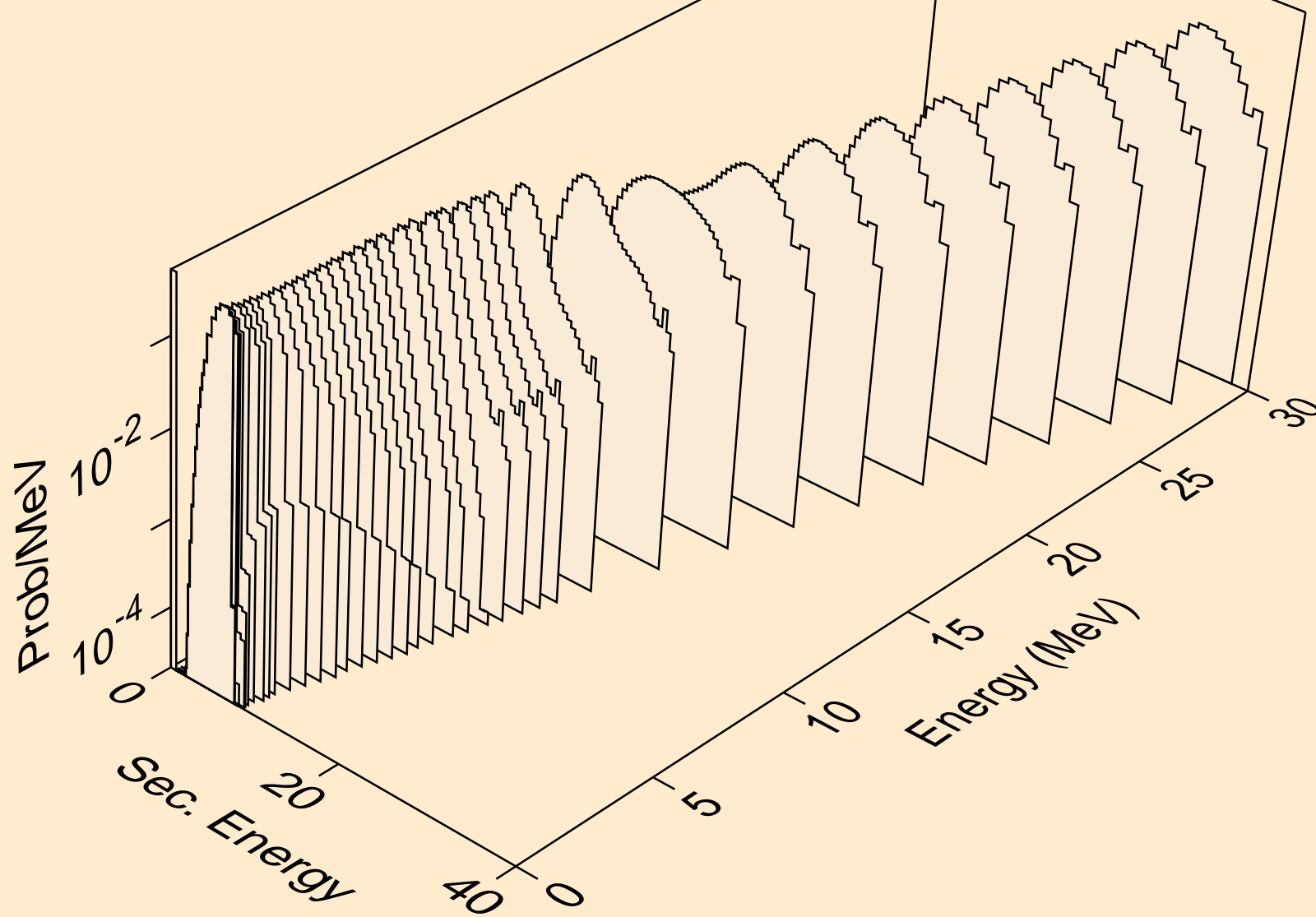

CS117 NEUTRON ACER TENDL-2024 LIBRARY; T=293.6K
protons from (n,2p)

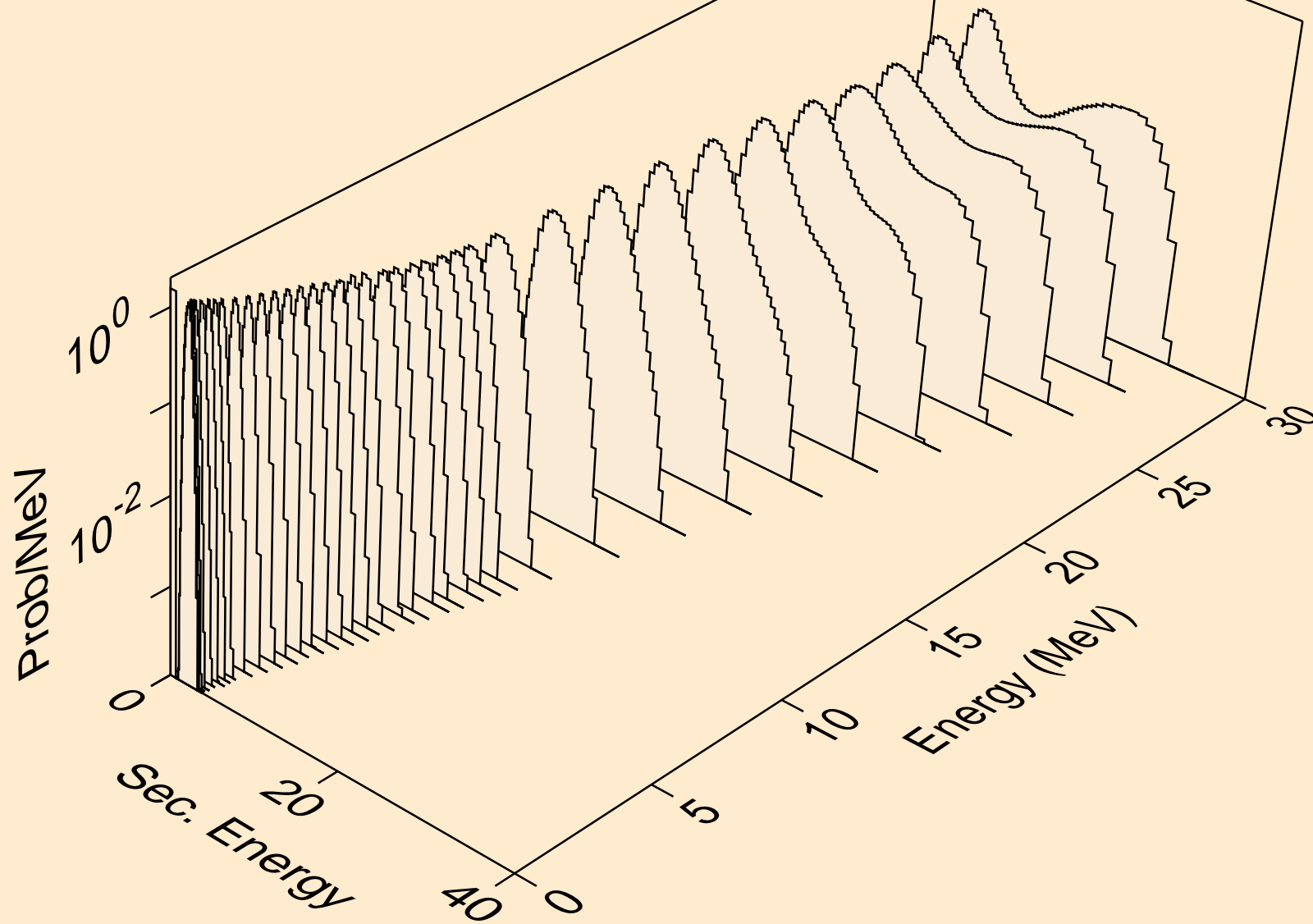

CS117 NEUTRON ACER TENDL-2024 LIBRARY; T=293.6K
protons from (n,p)

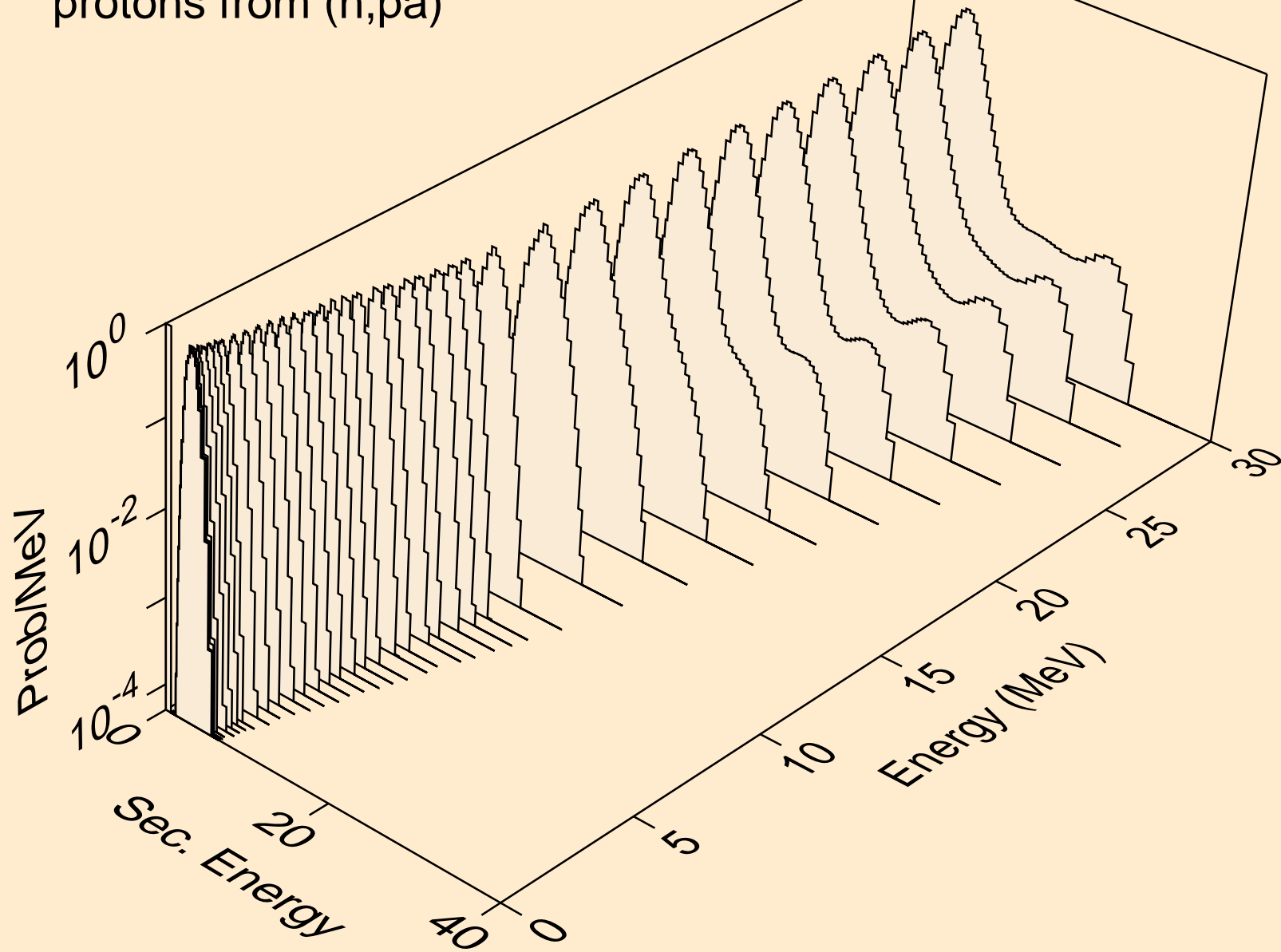

CS117 NEUTRON ACER TENDL-2024 LIBRARY; T=293.6K
protons from (n,pd)

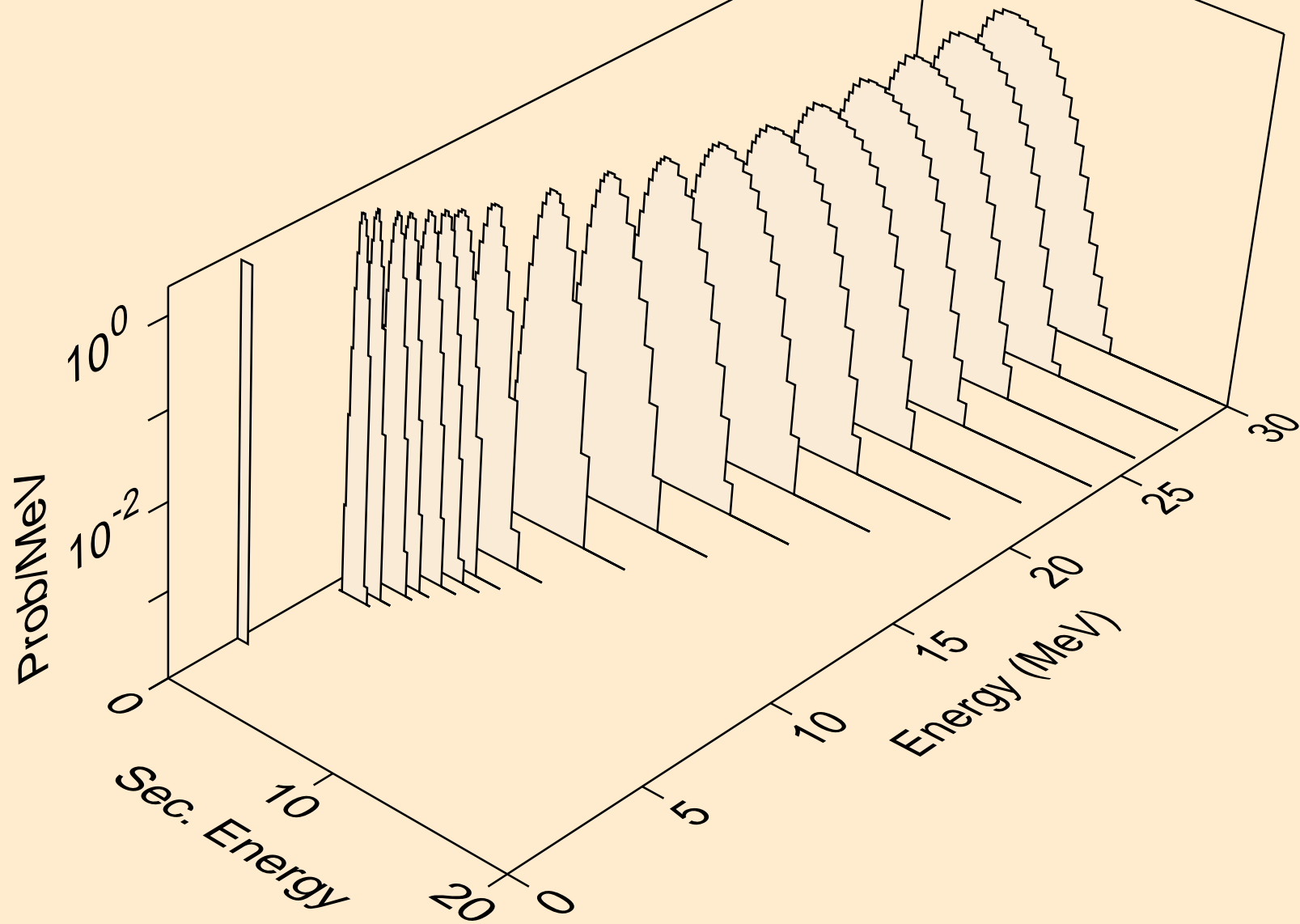

CS117 NEUTRON ACER TENDL-2024 LIBRARY; T=293.6K
protons from (n,pt)

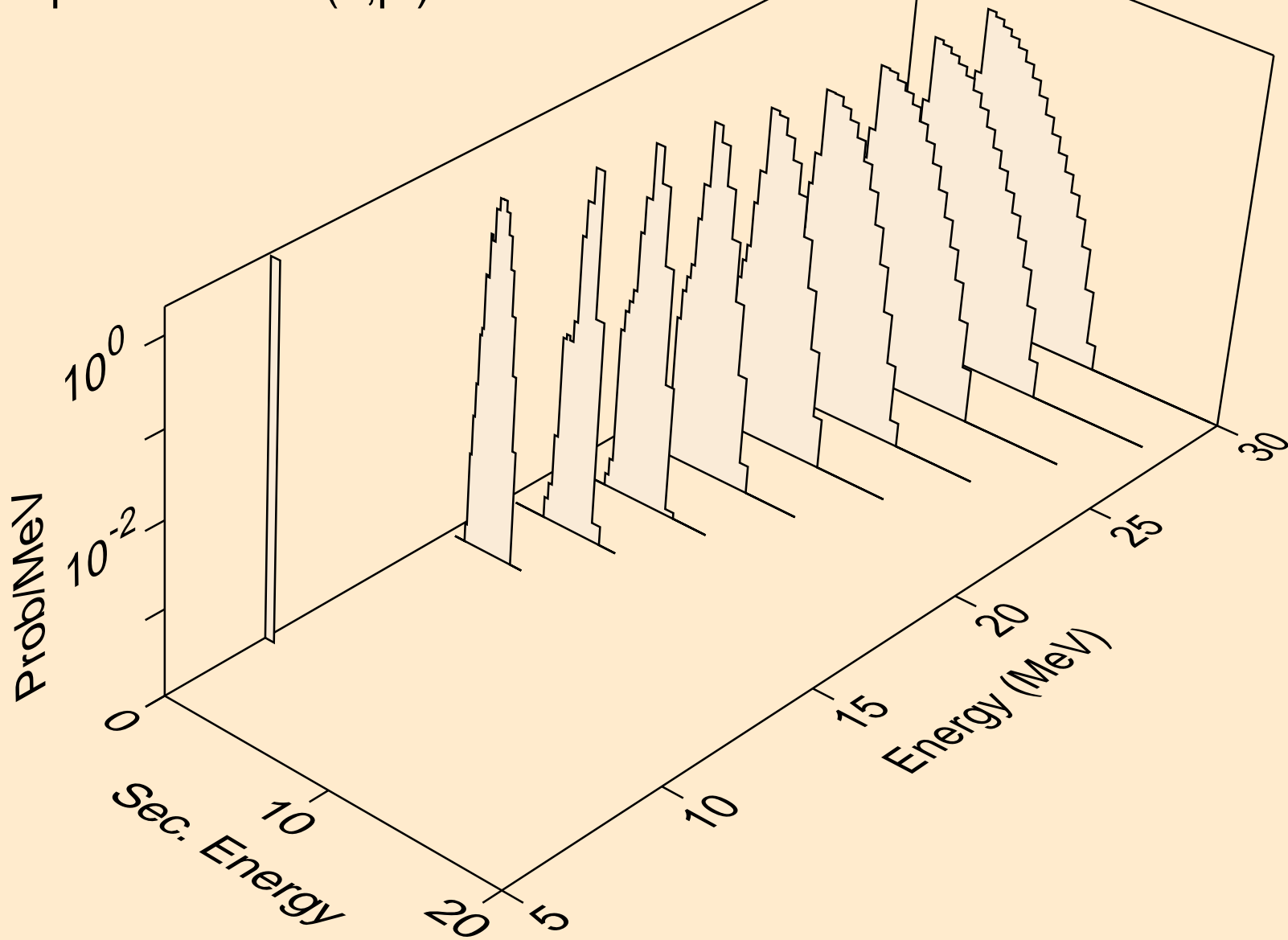

CS117 NEUTRON ACER TENDL-2024 LIBRARY; T=293.6K
deuterons from (n,x)

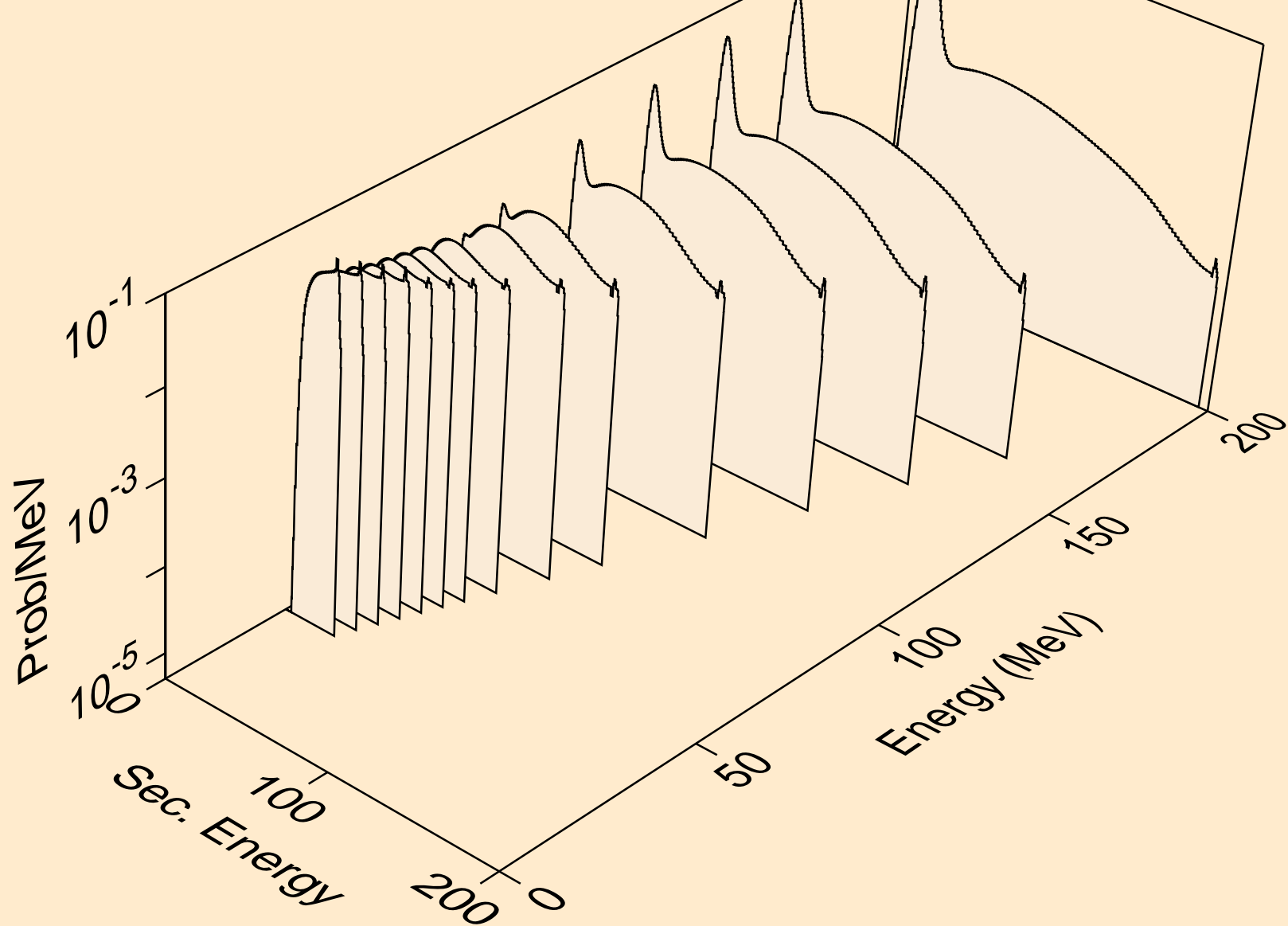

CS117 NEUTRON ACER TENDL-2024 LIBRARY; T=293.6K
deuterons from (n,2nd)

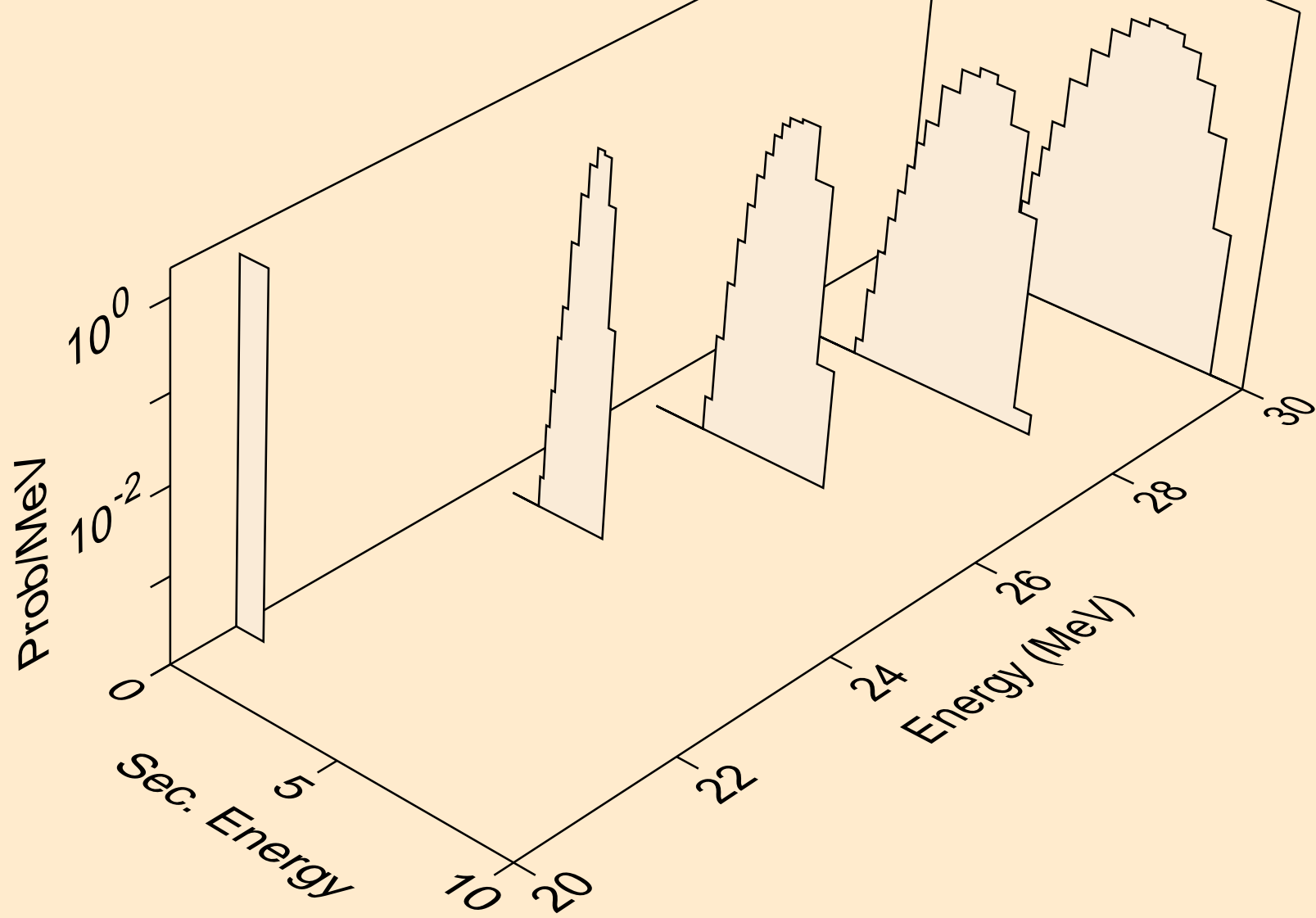

CS117 NEUTRON ACER TENDL-2024 LIBRARY; T=293.6K
deuterons from (n,n*)d

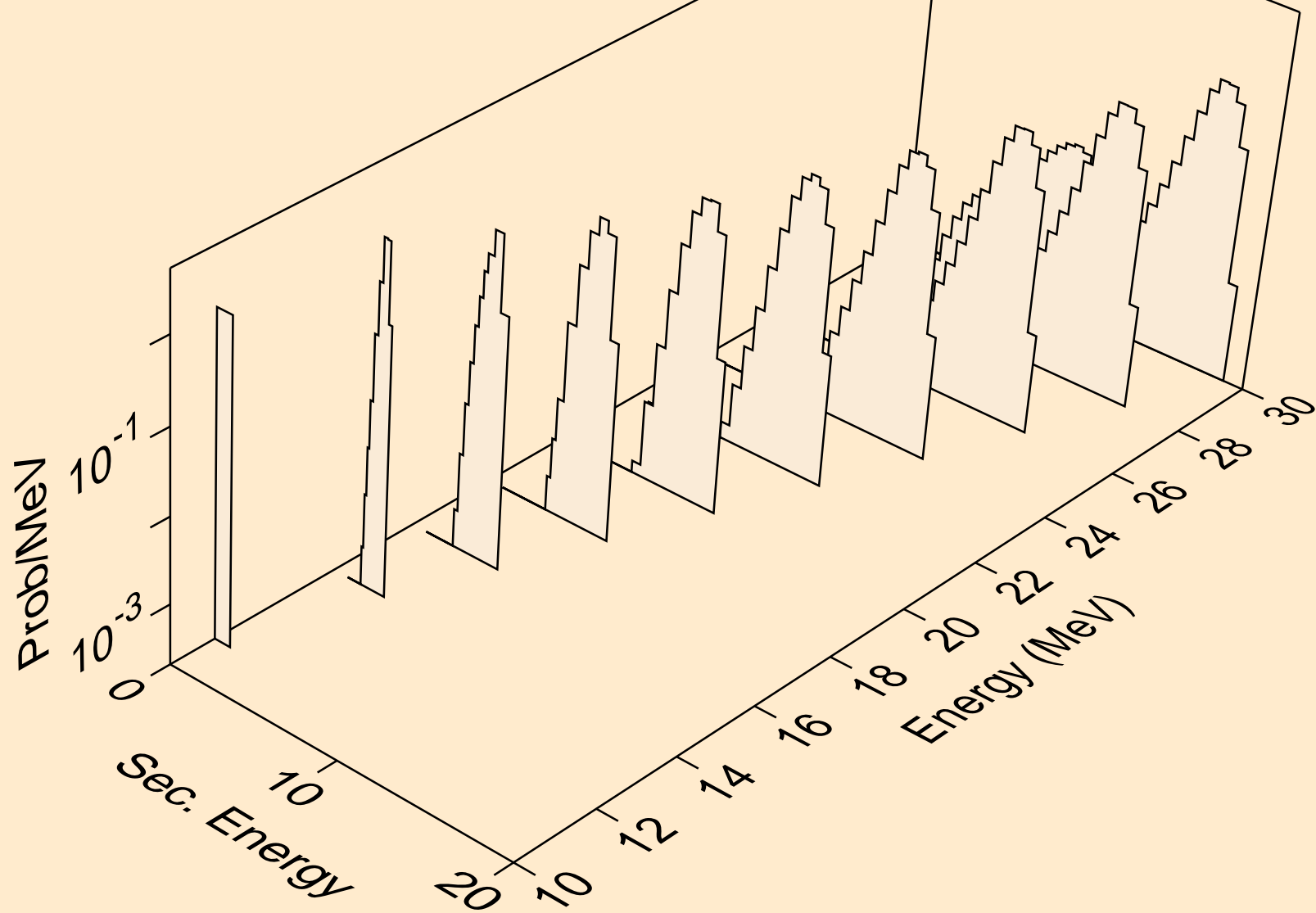

CS117 NEUTRON ACER TENDL-2024 LIBRARY; T=293.6K
deuterons from (n,d)

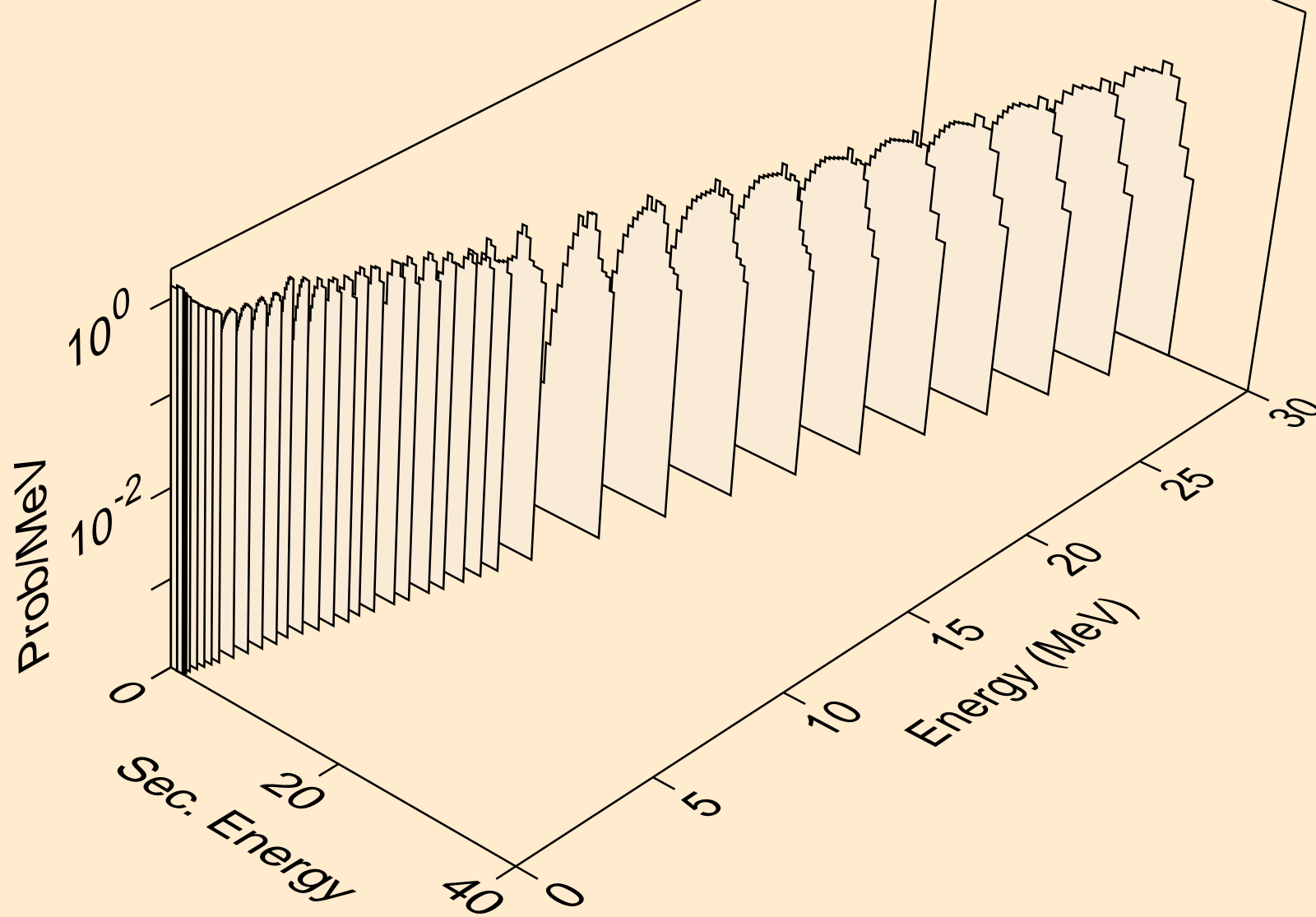

CS117 NEUTRON ACER TENDL-2024 LIBRARY; T=293.6K
deuterons from (n,d2a)

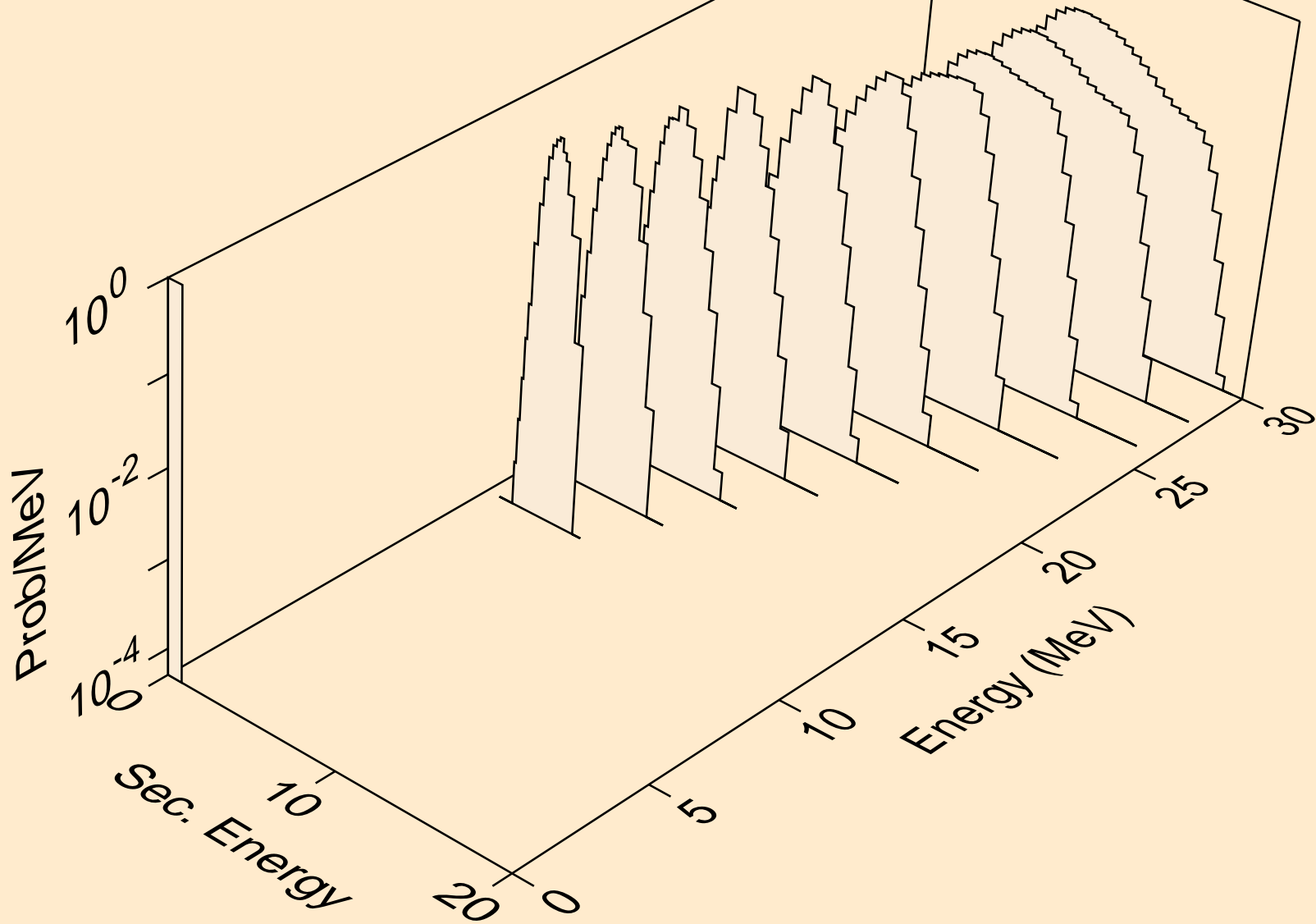

CS117 NEUTRON ACER TENDL-2024 LIBRARY; T=293.6K
deuterons from (n,pd)

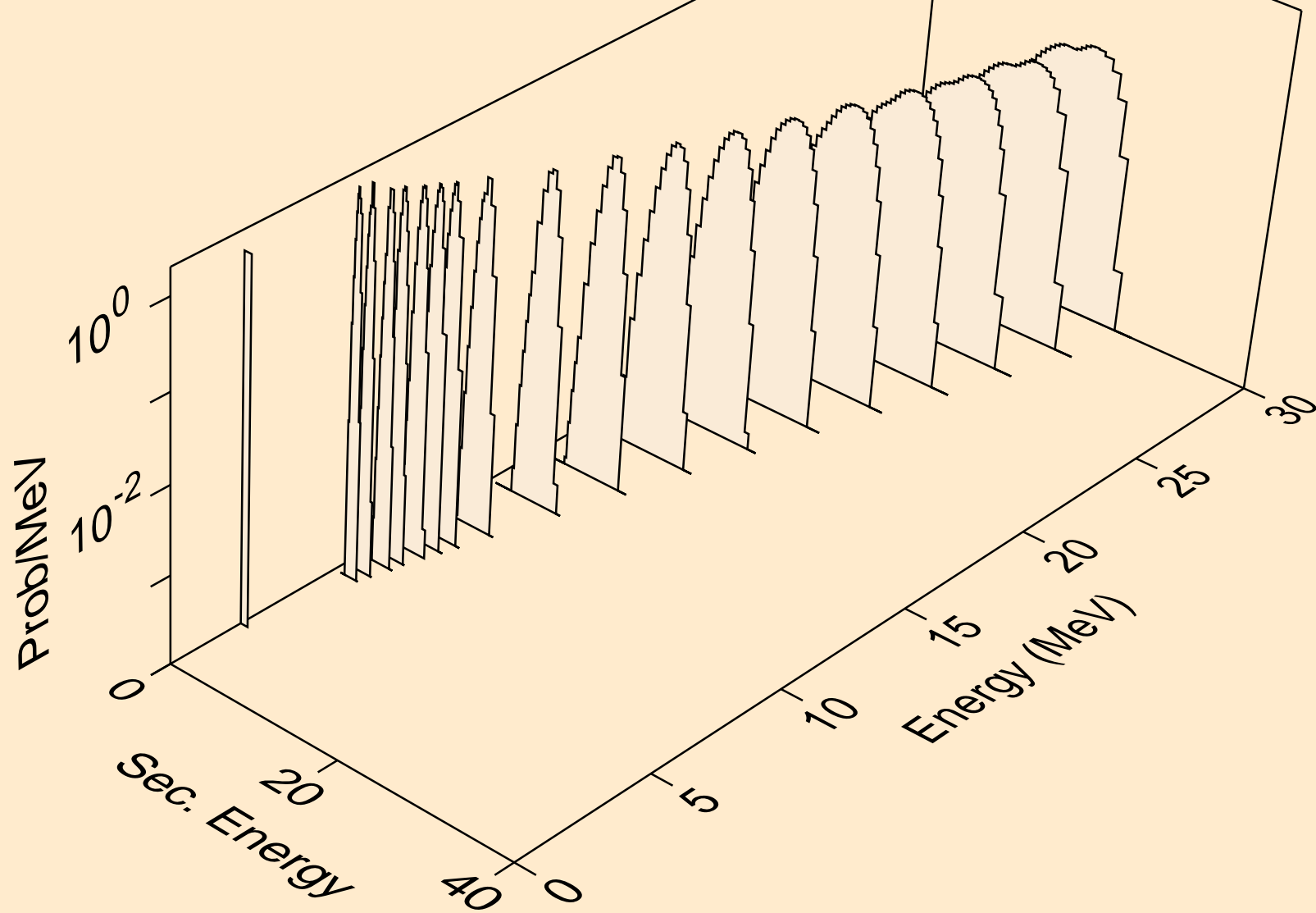

CS117 NEUTRON ACER TENDL-2024 LIBRARY; T=293.6K
deuterons from (n,da)

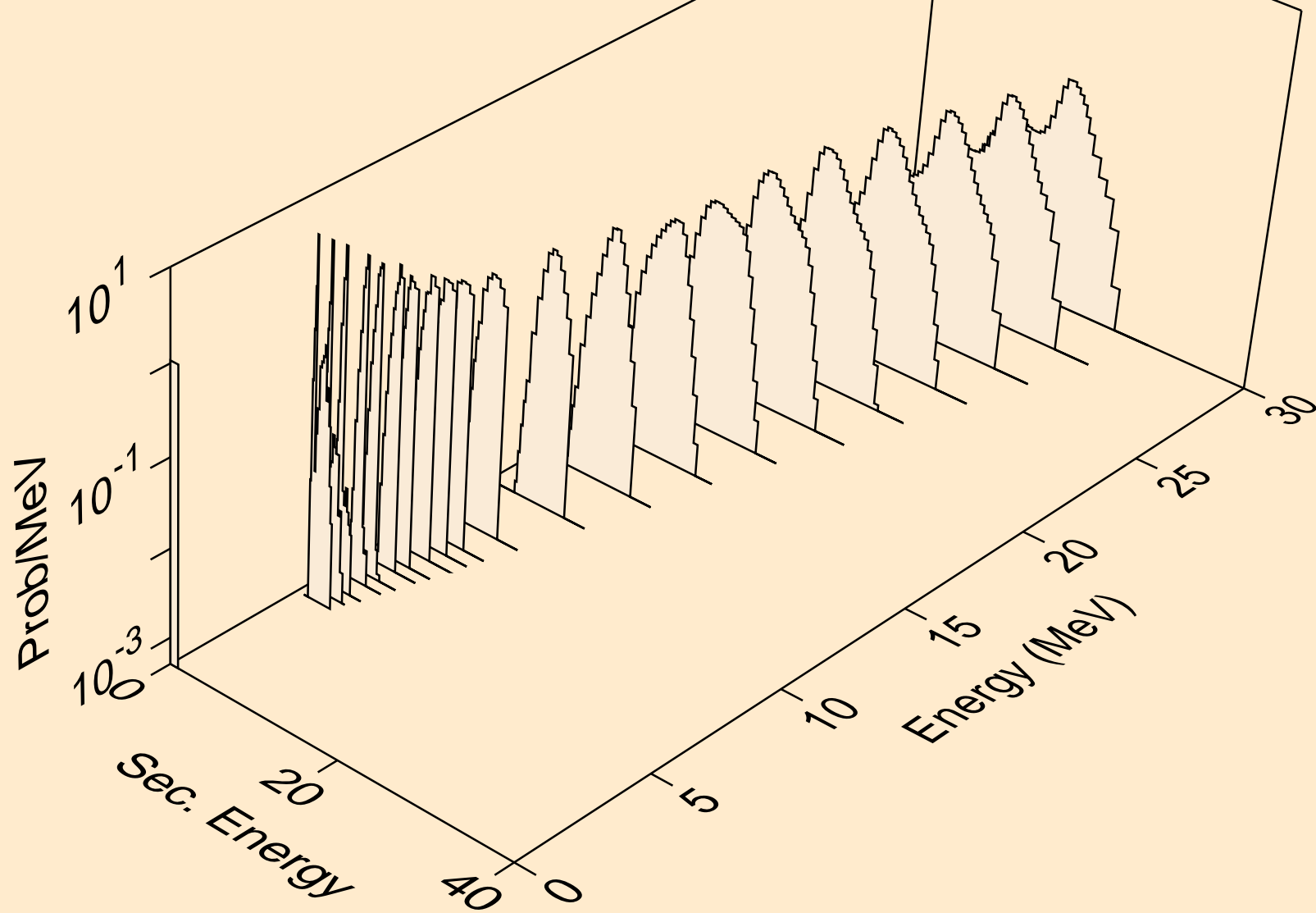

CS117 NEUTRON ACER TENDL-2024 LIBRARY; T=293.6K
tritons from (n,x)

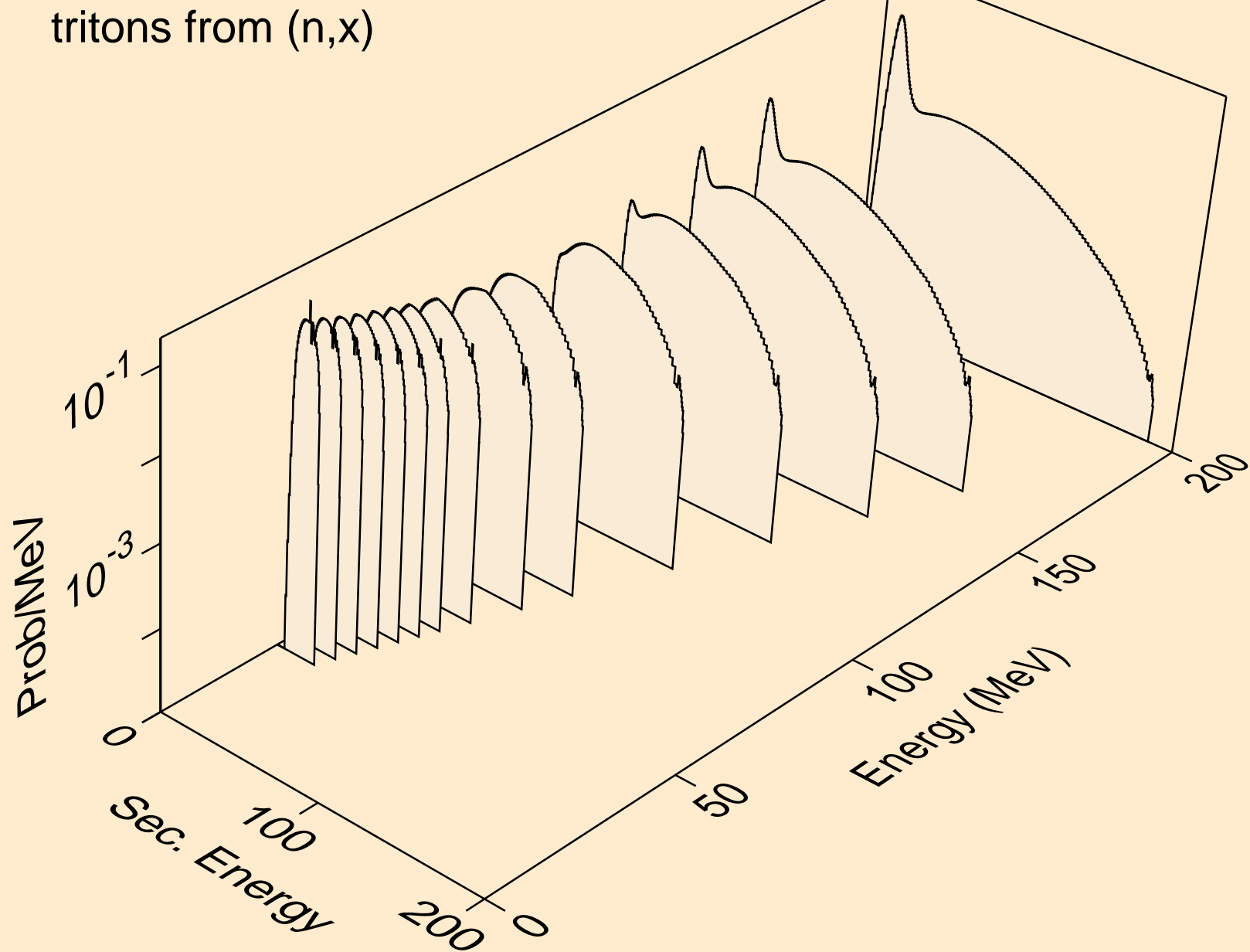

CS117 NEUTRON ACER TENDL-2024 LIBRARY; T=293.6K
tritons from (n,n*)t

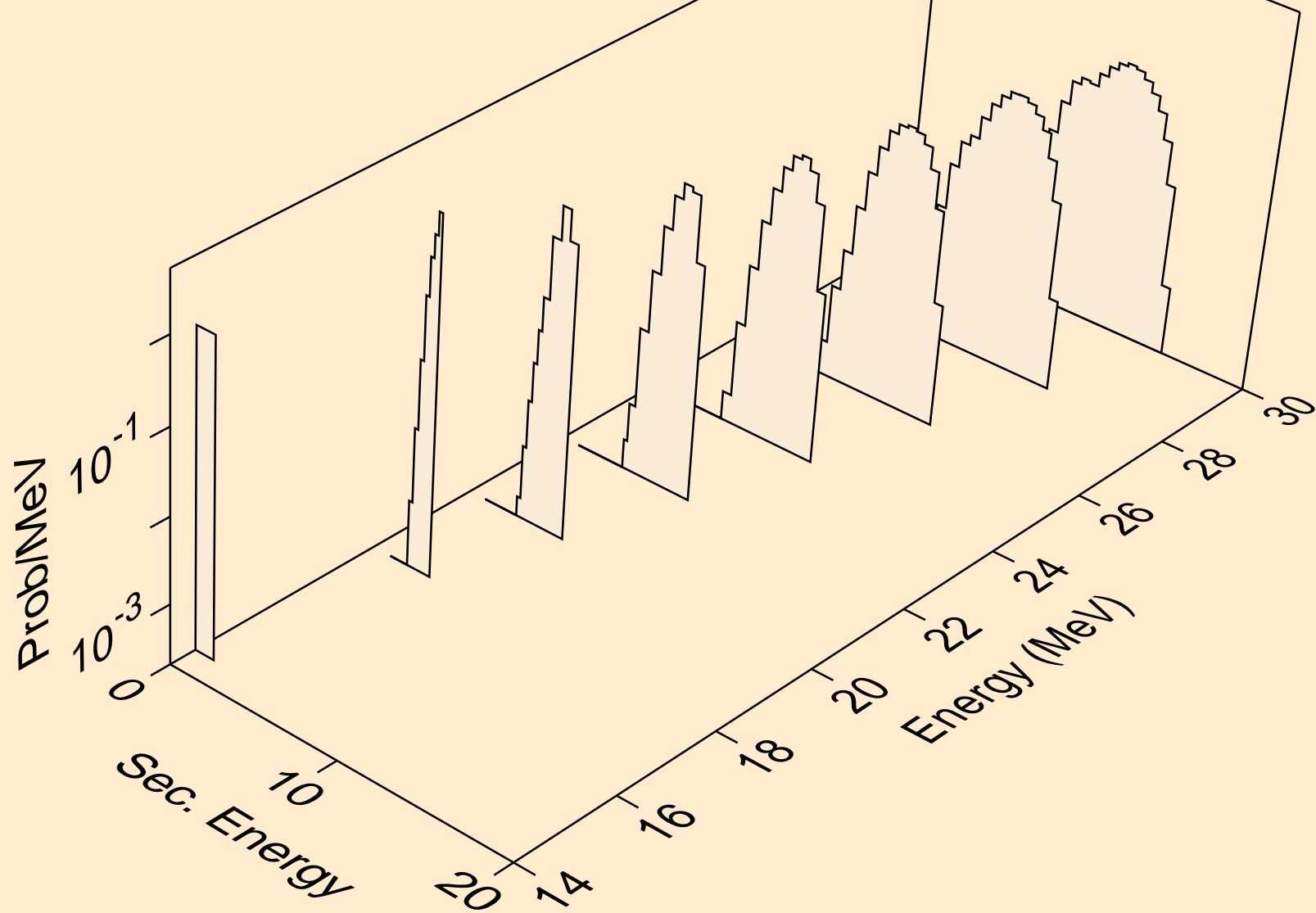

CS117 NEUTRON ACER TENDL-2024 LIBRARY; T=293.6K
tritons from (n,t)

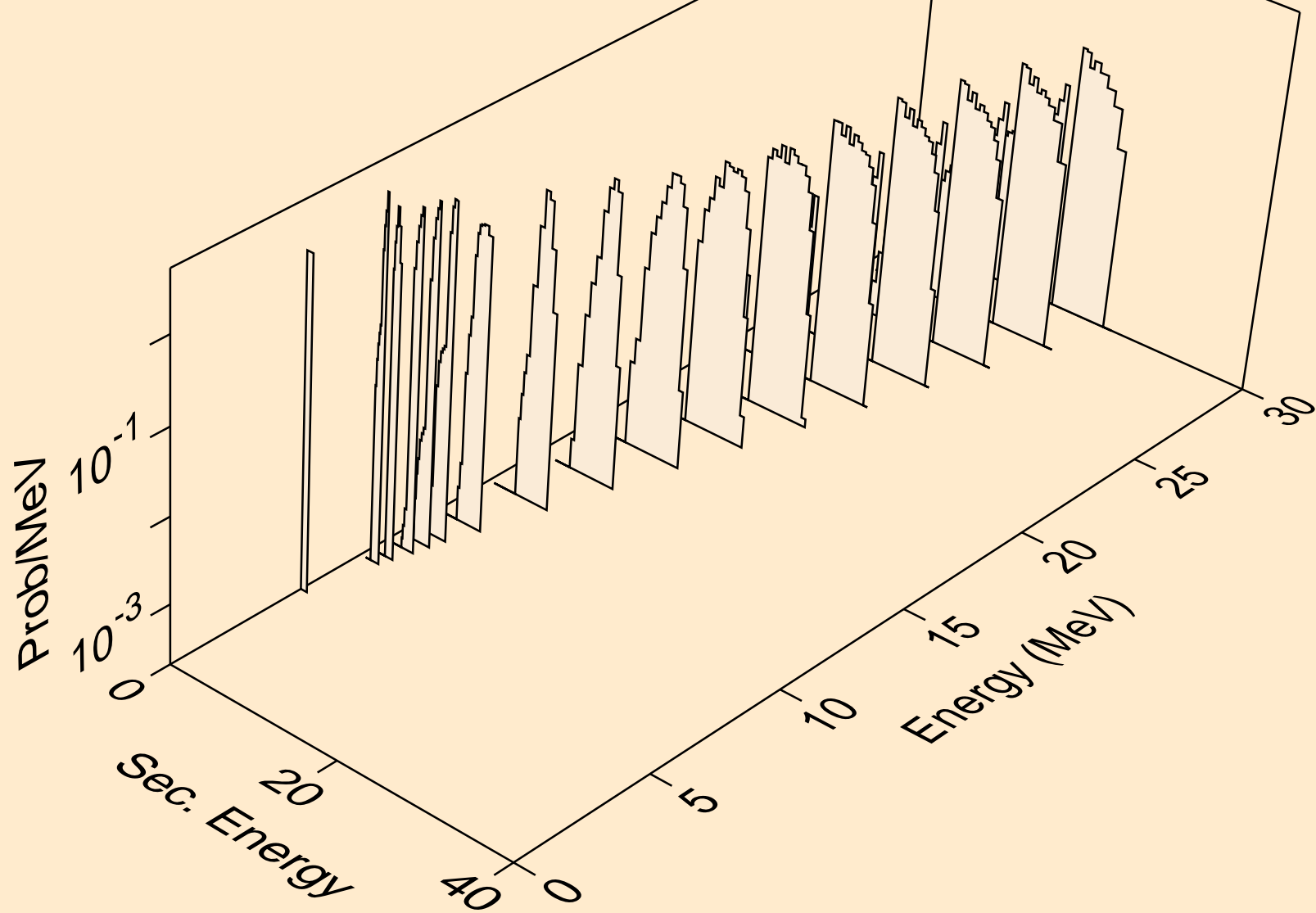

CS117 NEUTRON ACER TENDL-2024 LIBRARY; T=293.6K
tritons from (n,t2a)

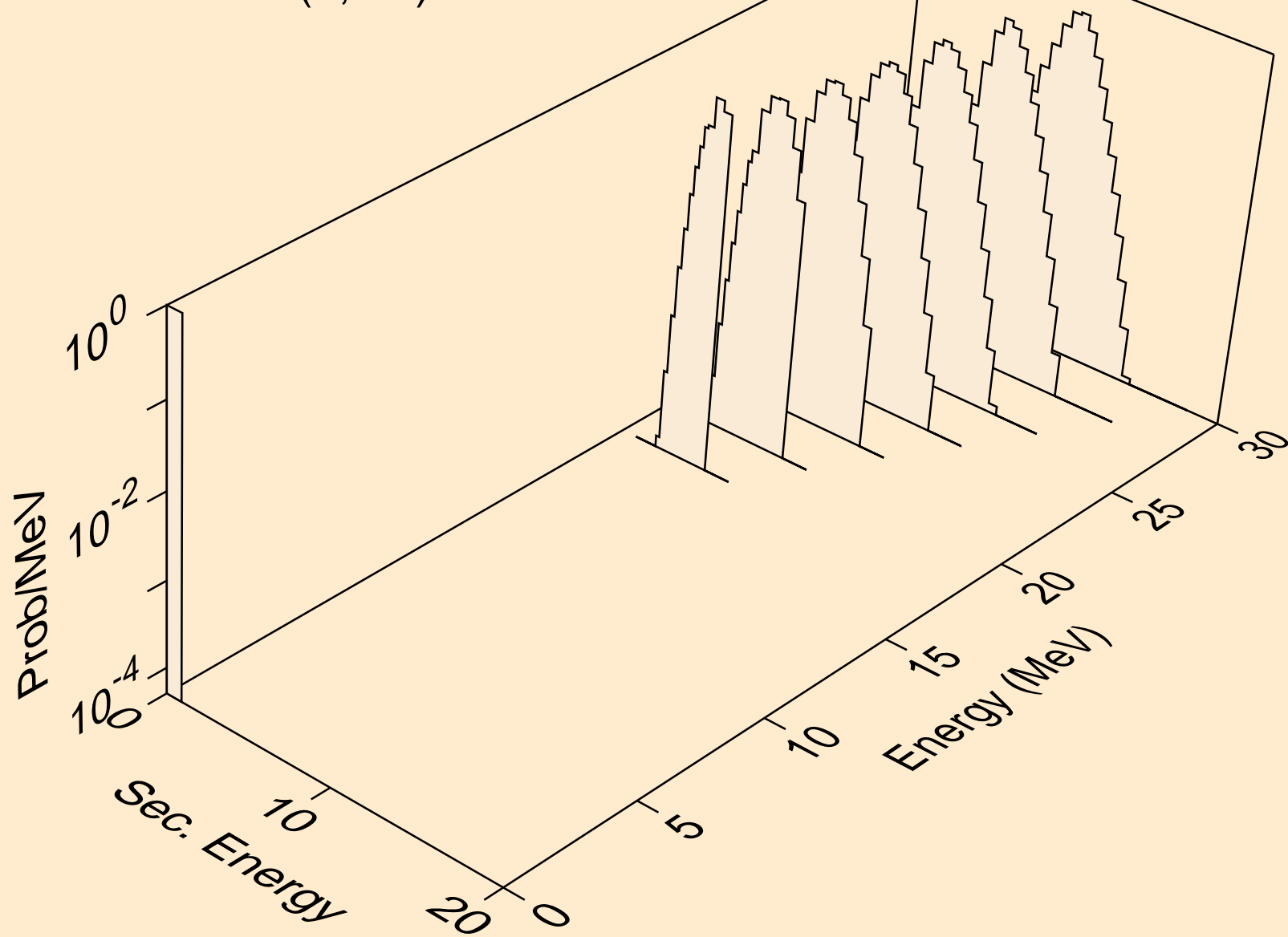

CS117 NEUTRON ACER TENDL-2024 LIBRARY; T=293.6K
tritons from (n,pt)

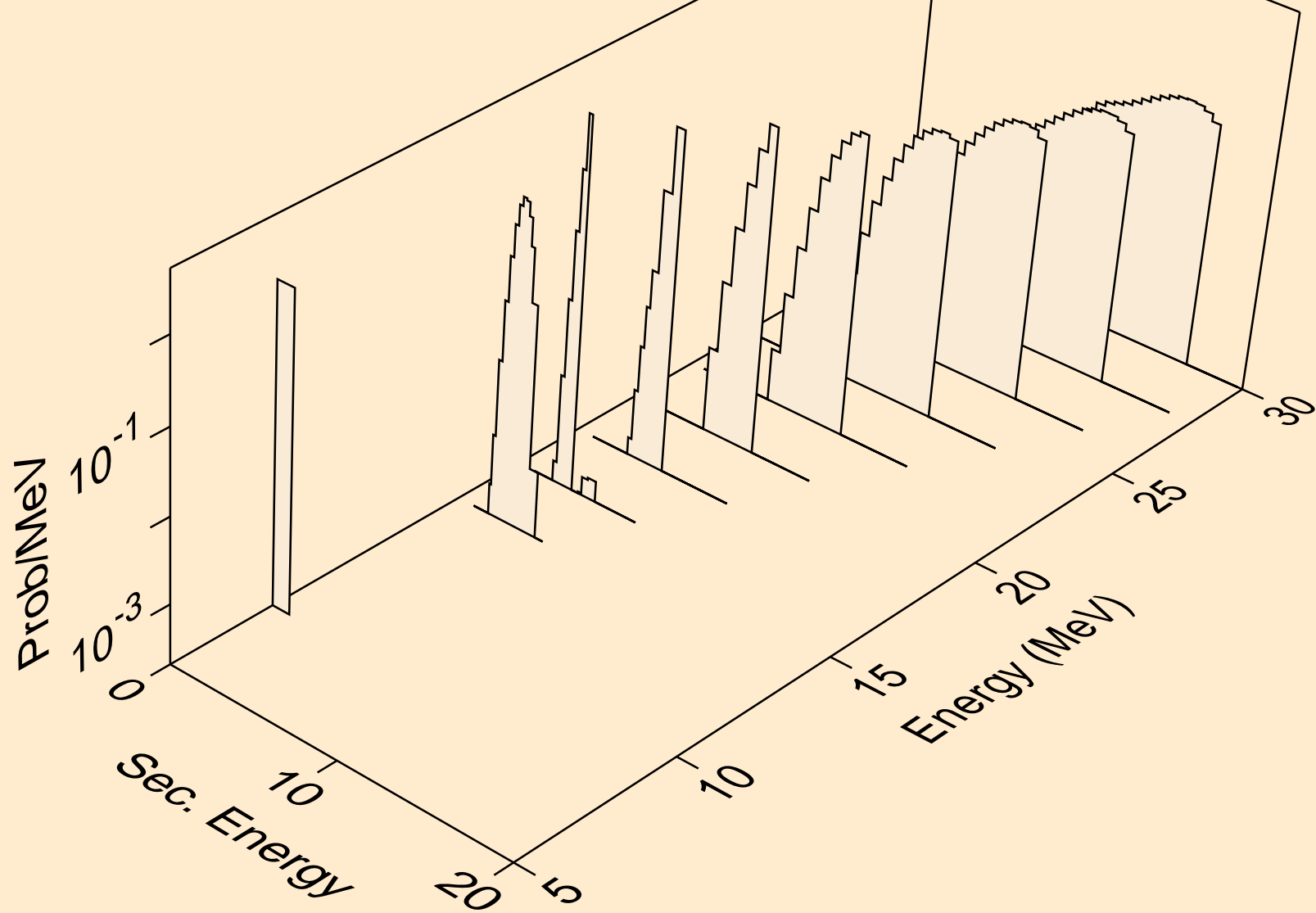

CS117 NEUTRON ACER TENDL-2024 LIBRARY; T=293.6K
he3s from (n,x)

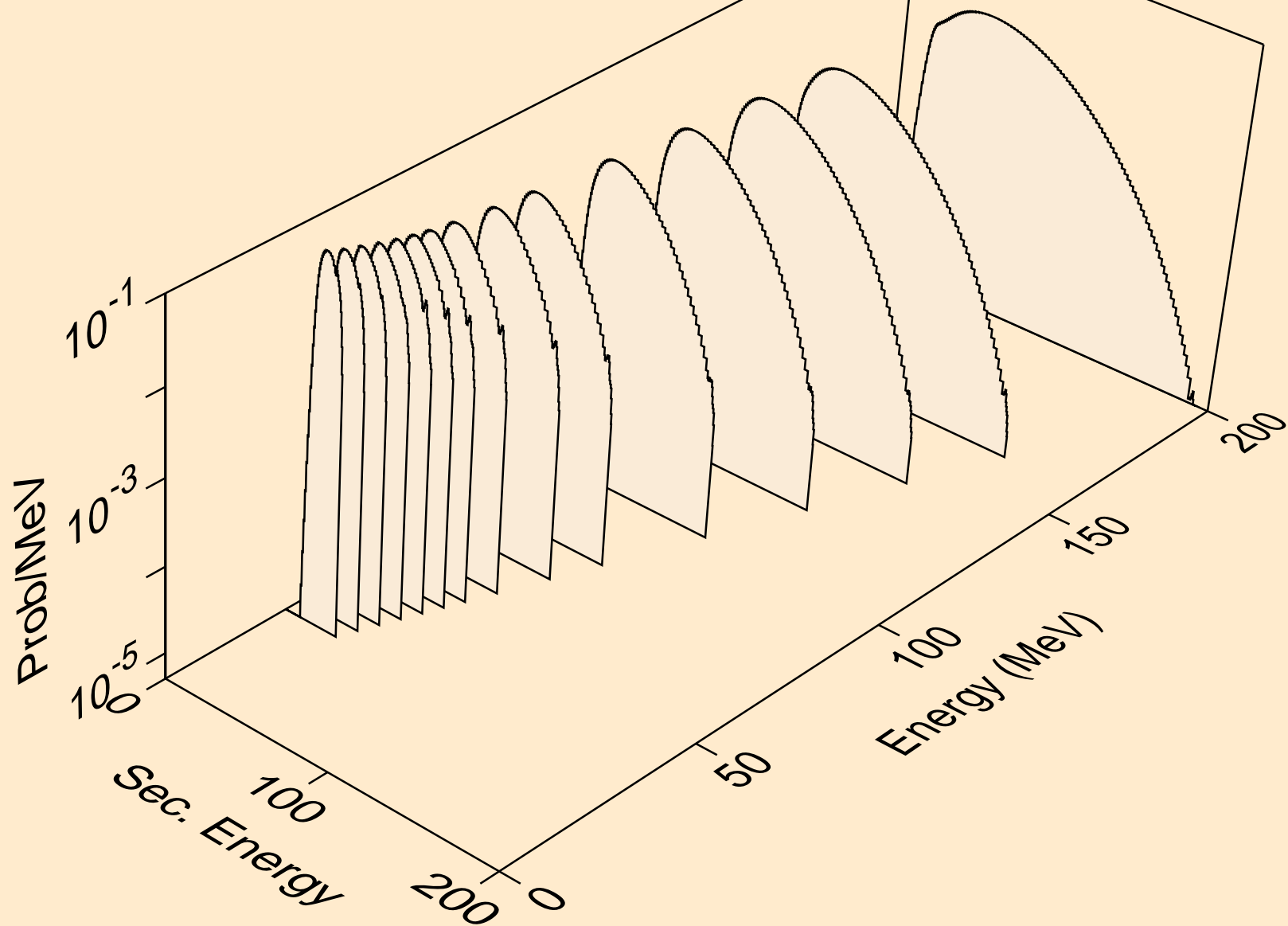

CS117 NEUTRON ACER TENDL-2024 LIBRARY; T=293.6K
he3s from (n,n*)he3

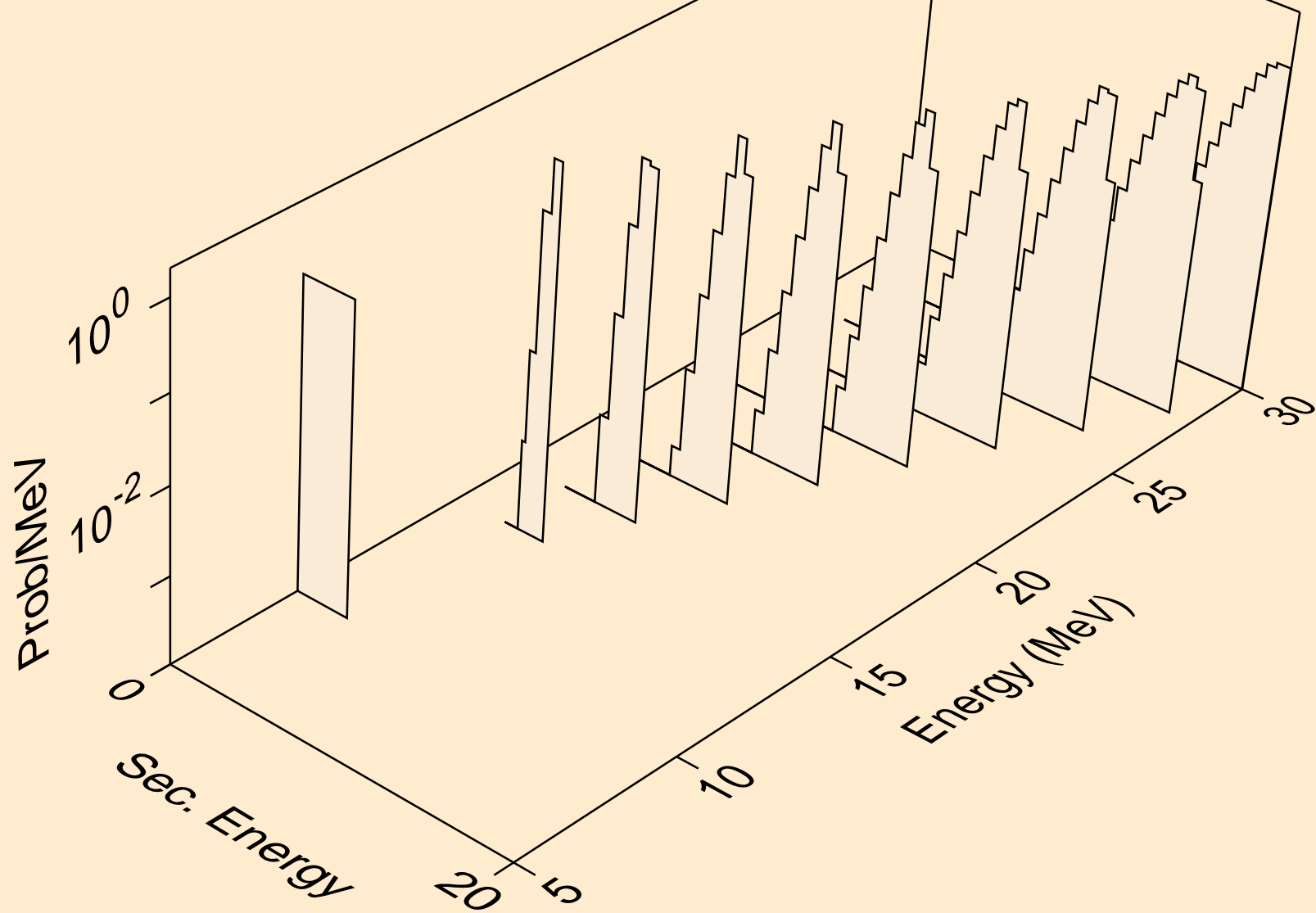

CS117 NEUTRON ACER TENDL-2024 LIBRARY; T=293.6K
he3s from (n,he3)

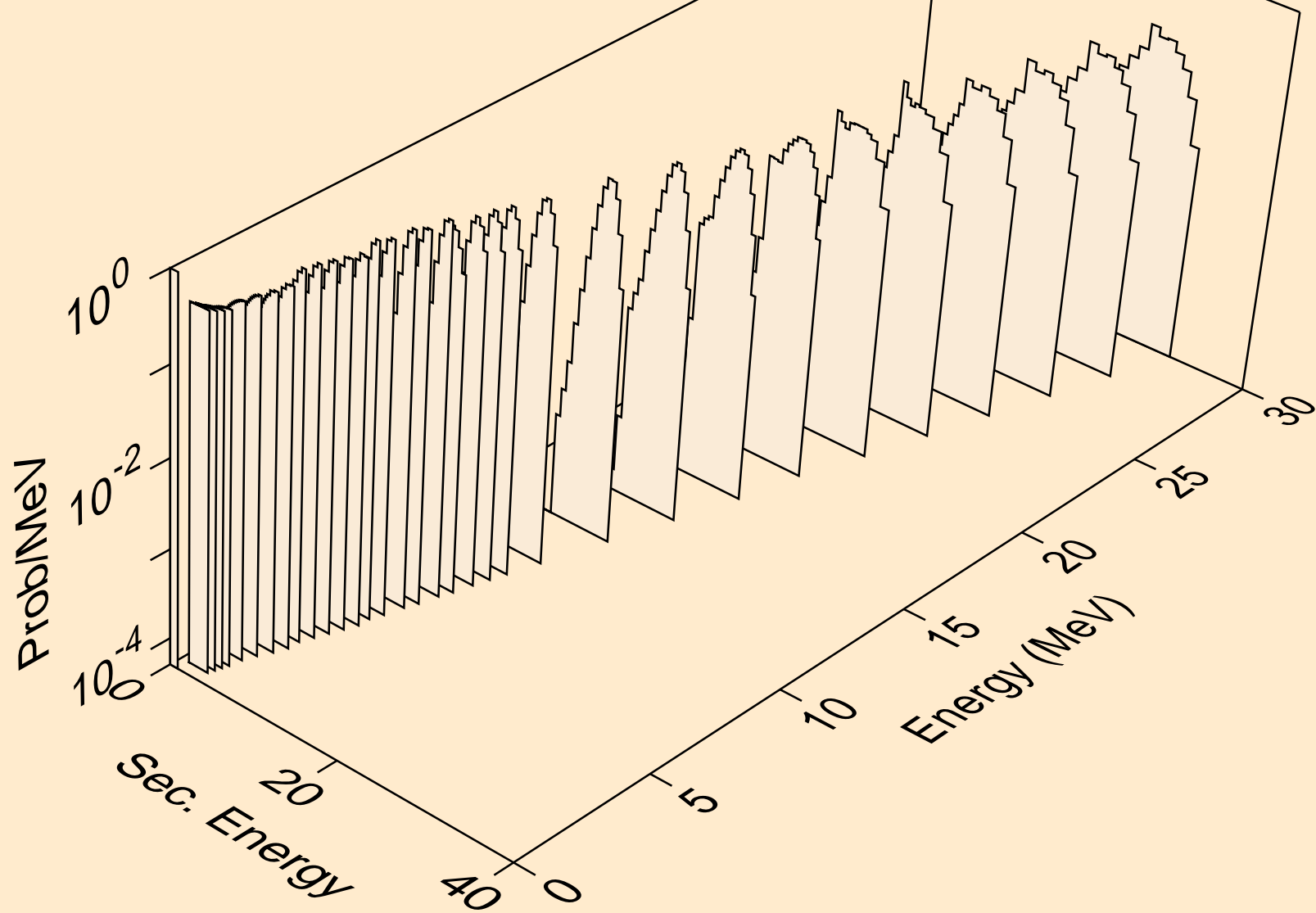

CS117 NEUTRON ACER TENDL-2024 LIBRARY; T=293.6K
alphas from (n,x)

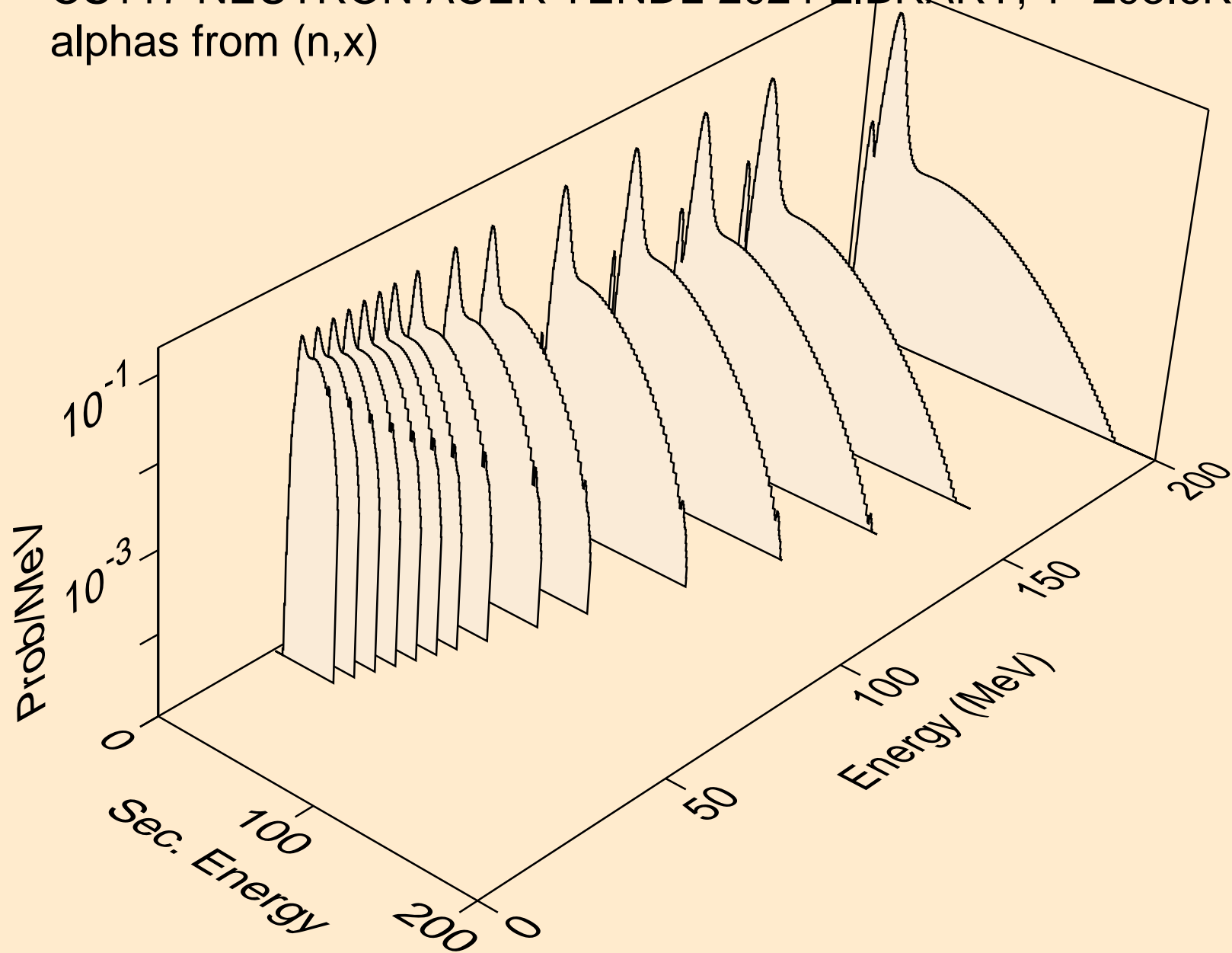

CS117 NEUTRON ACER TENDL-2024 LIBRARY; T=293.6K
alphas from (n,n*)a

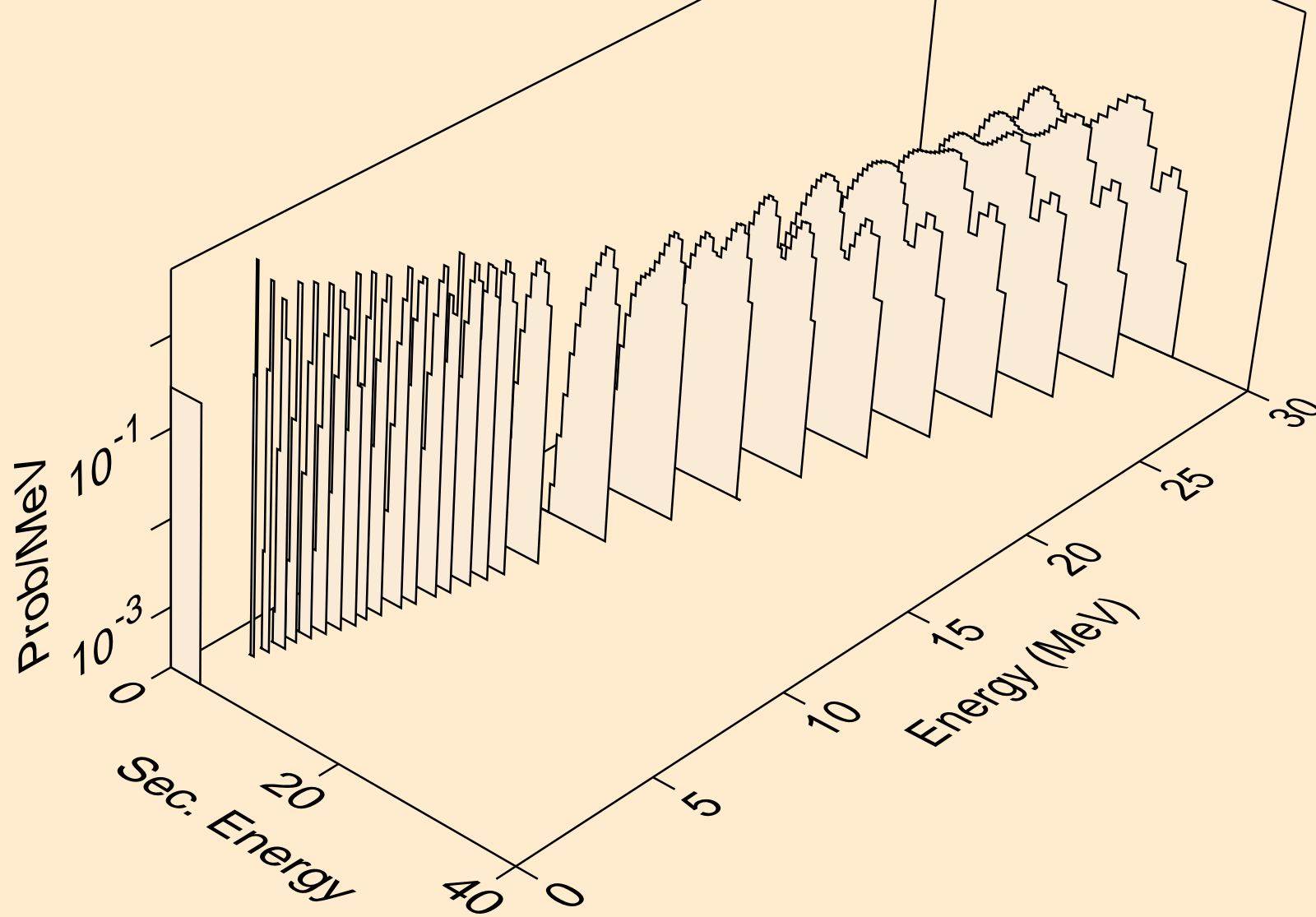

CS117 NEUTRON ACER TENDL-2024 LIBRARY; T=293.6K
alphas from (n,n*)3a

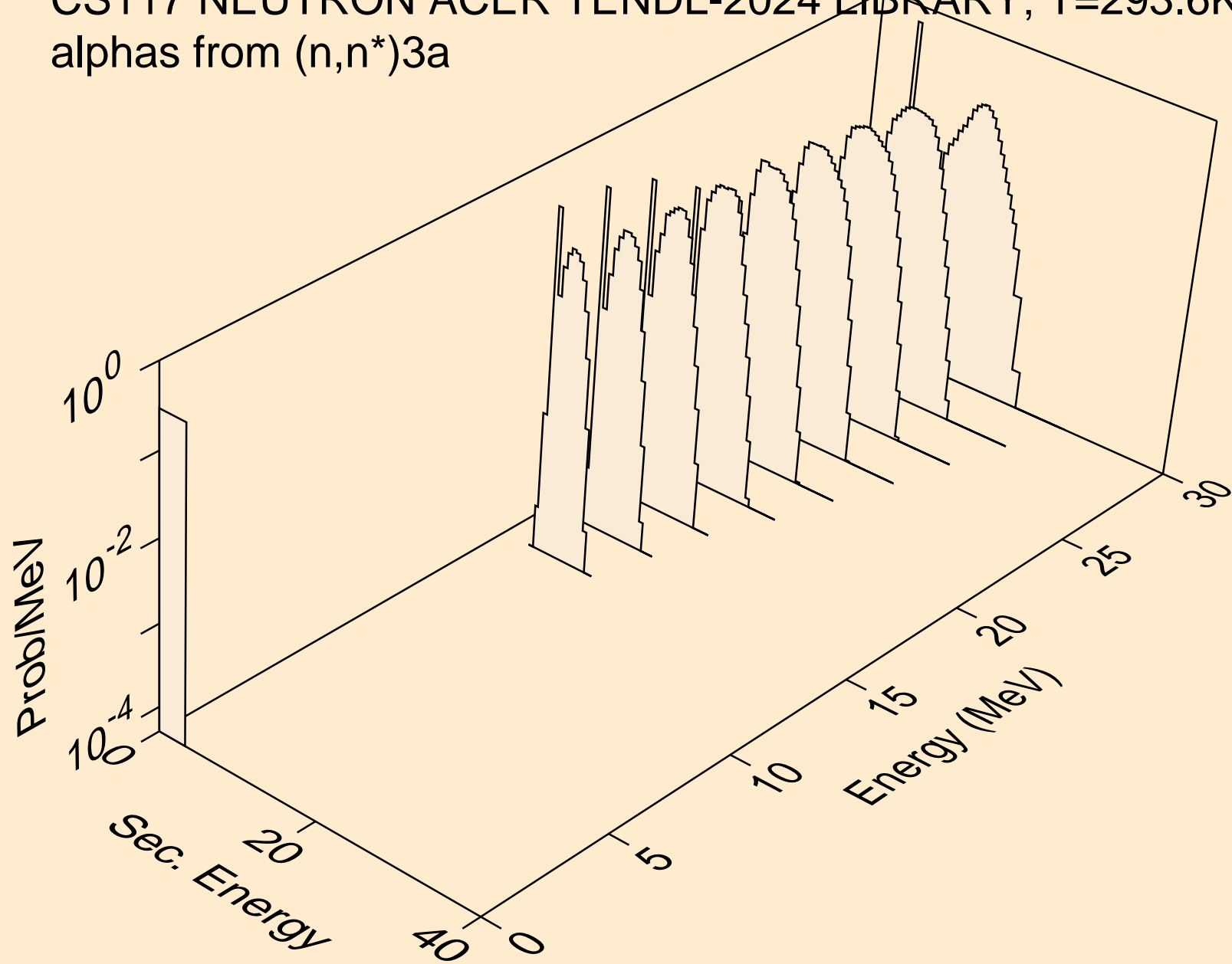

CS117 NEUTRON ACER TENDL-2024 LIBRARY; T=293.6K
alphas from (n,2n)a

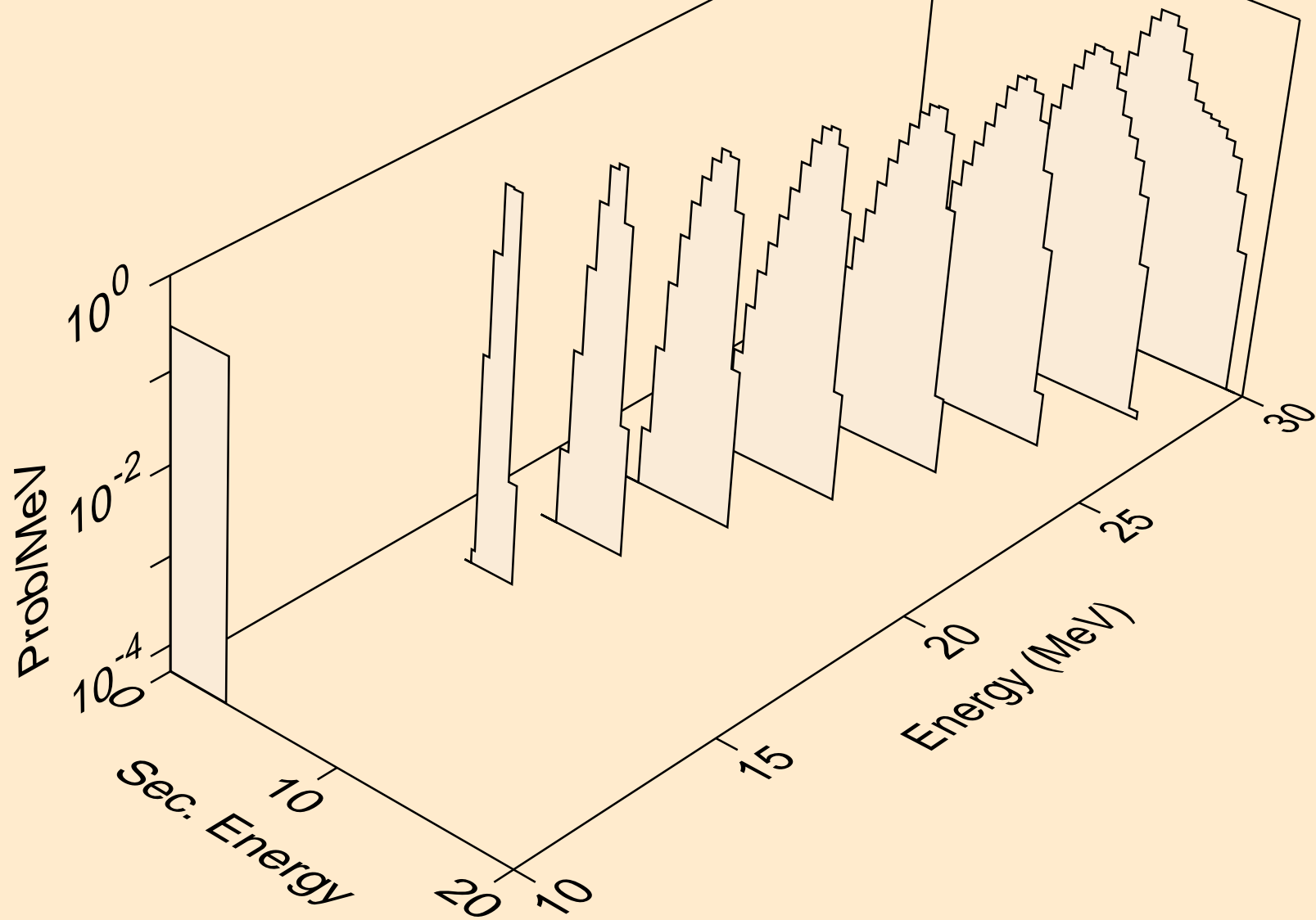

CS117 NEUTRON ACER TENDL-2024 LIBRARY; T=293.6K
alphas from (n,n*)2a

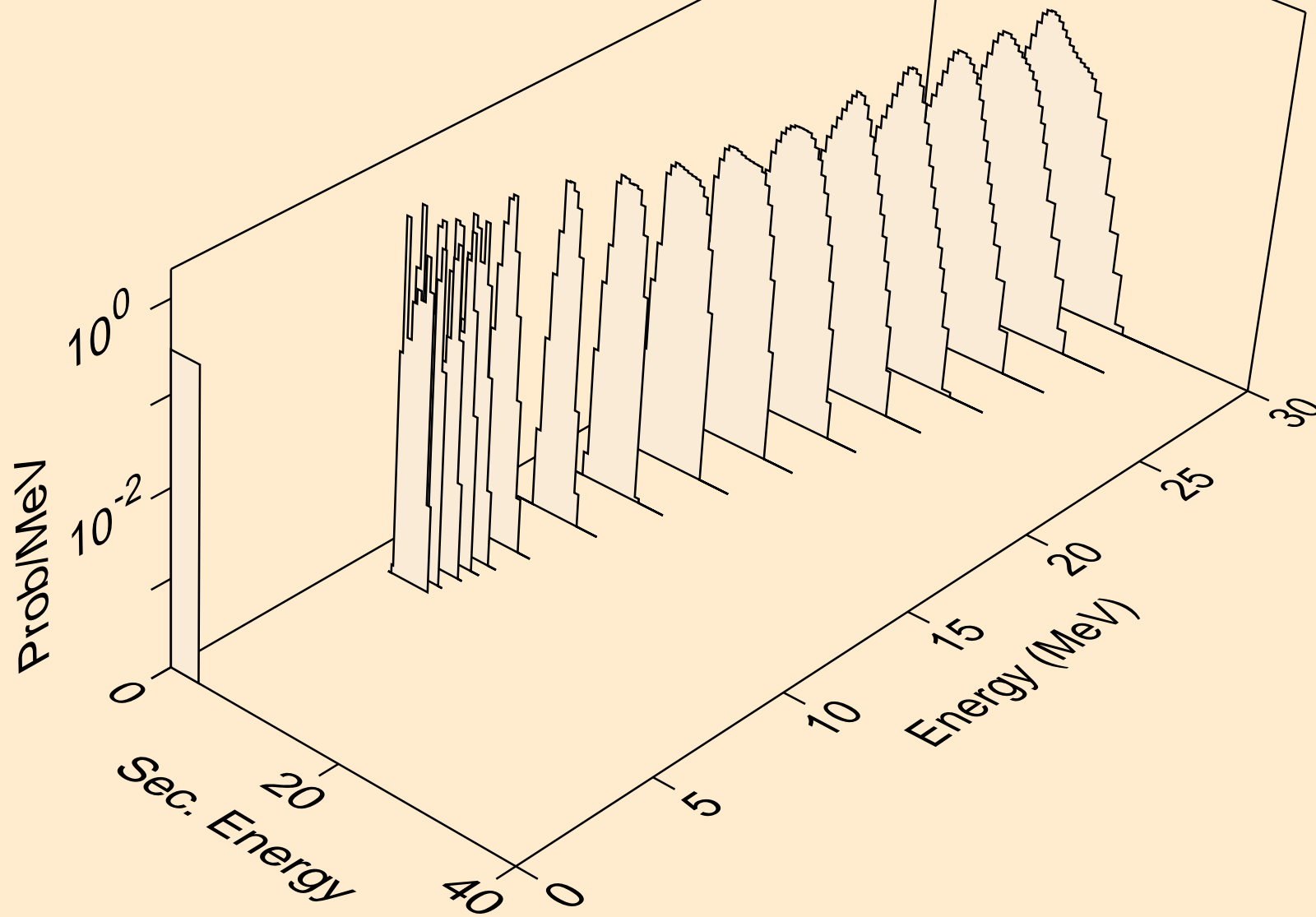

CS117 NEUTRON ACER TENDL-2024 LIBRARY; T=293.6K
alphas from (n,2n)2a

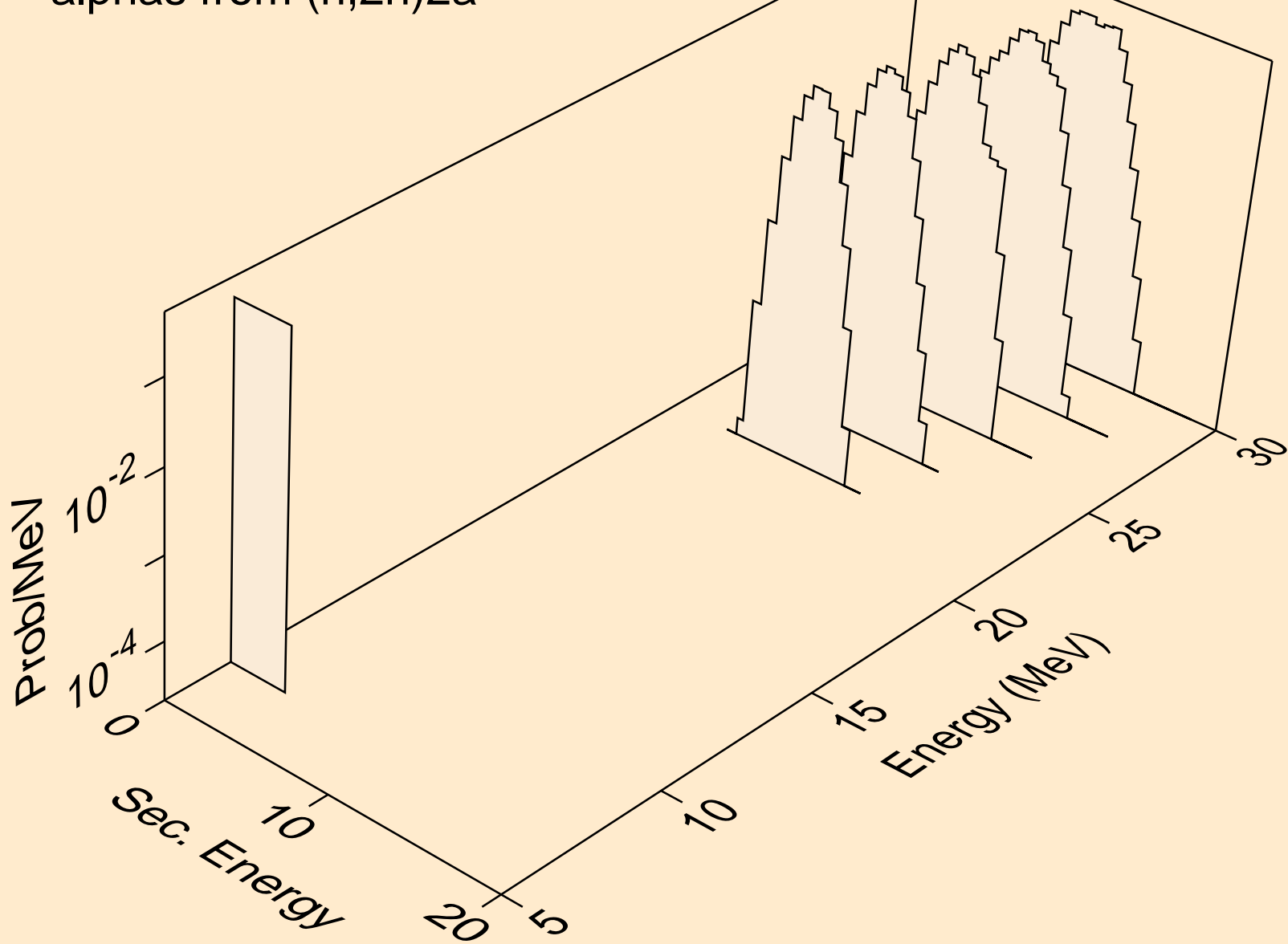

CS117 NEUTRON ACER TENDL-2024 LIBRARY; T=293.6K
alphas from (n,npa)

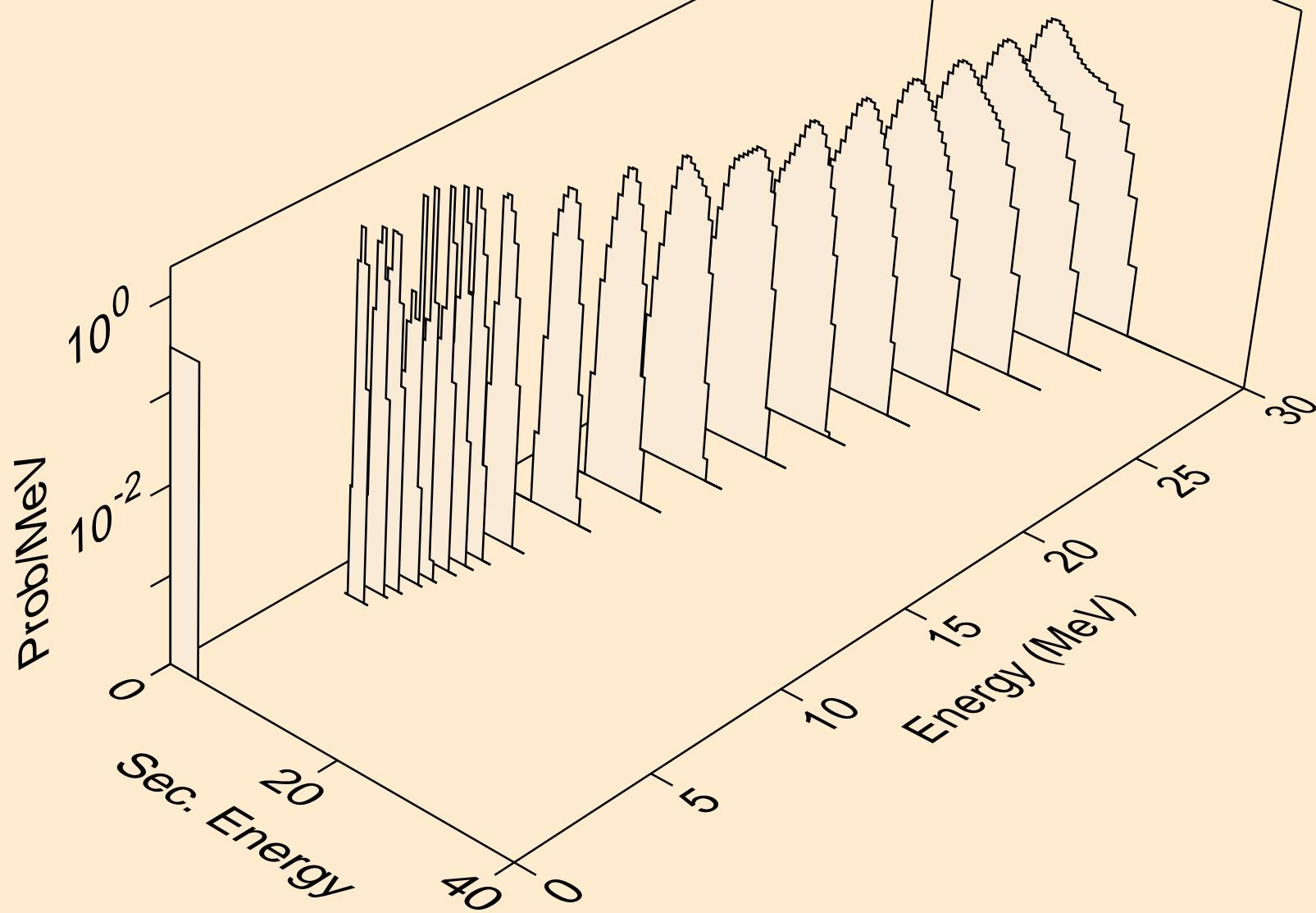

CS117 NEUTRON ACER TENDL-2024 LIBRARY; T=293.6K
alphas from (n,a)

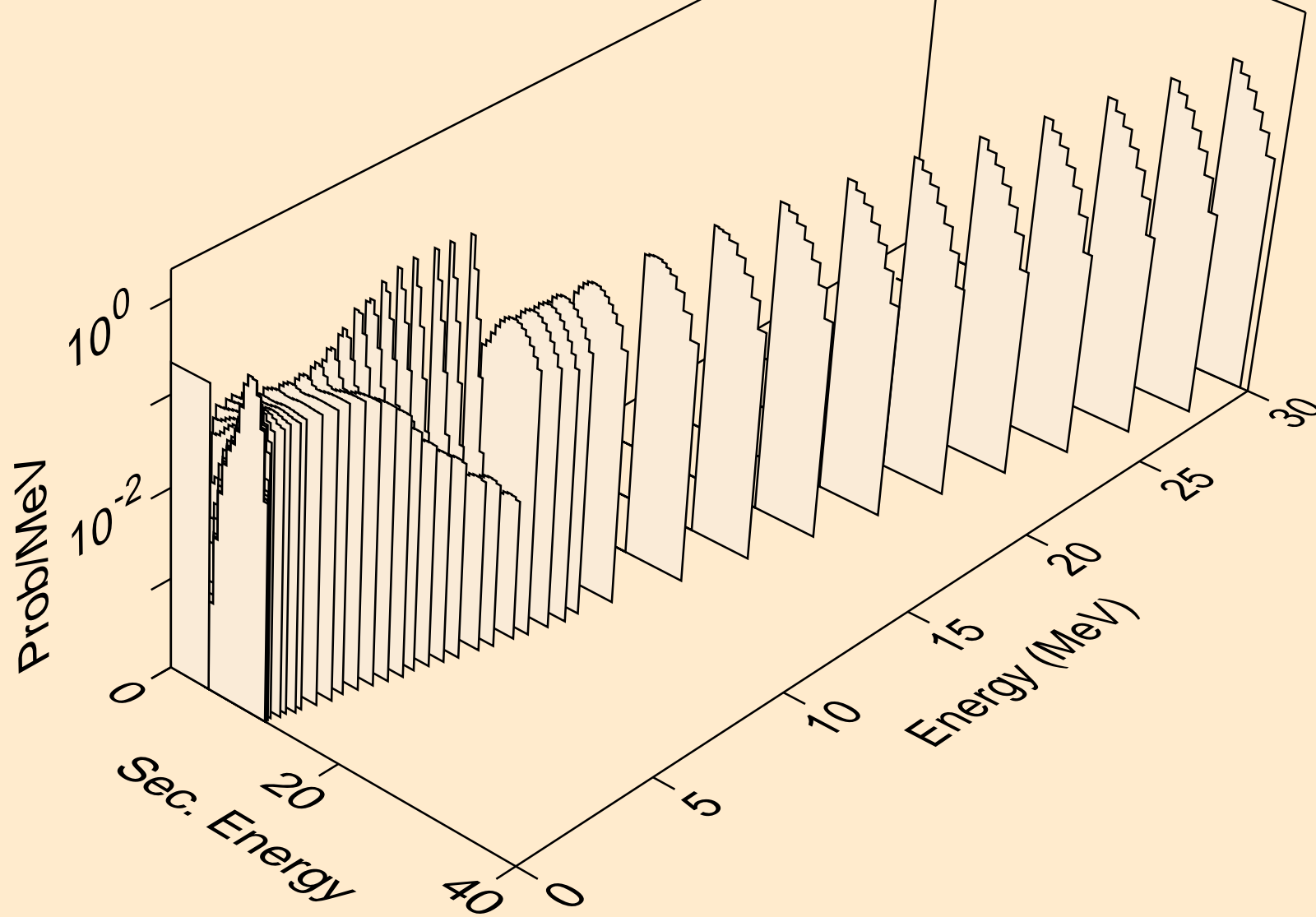

CS117 NEUTRON ACER TENDL-2024 LIBRARY; T=293.6K
alphas from (n,2a)

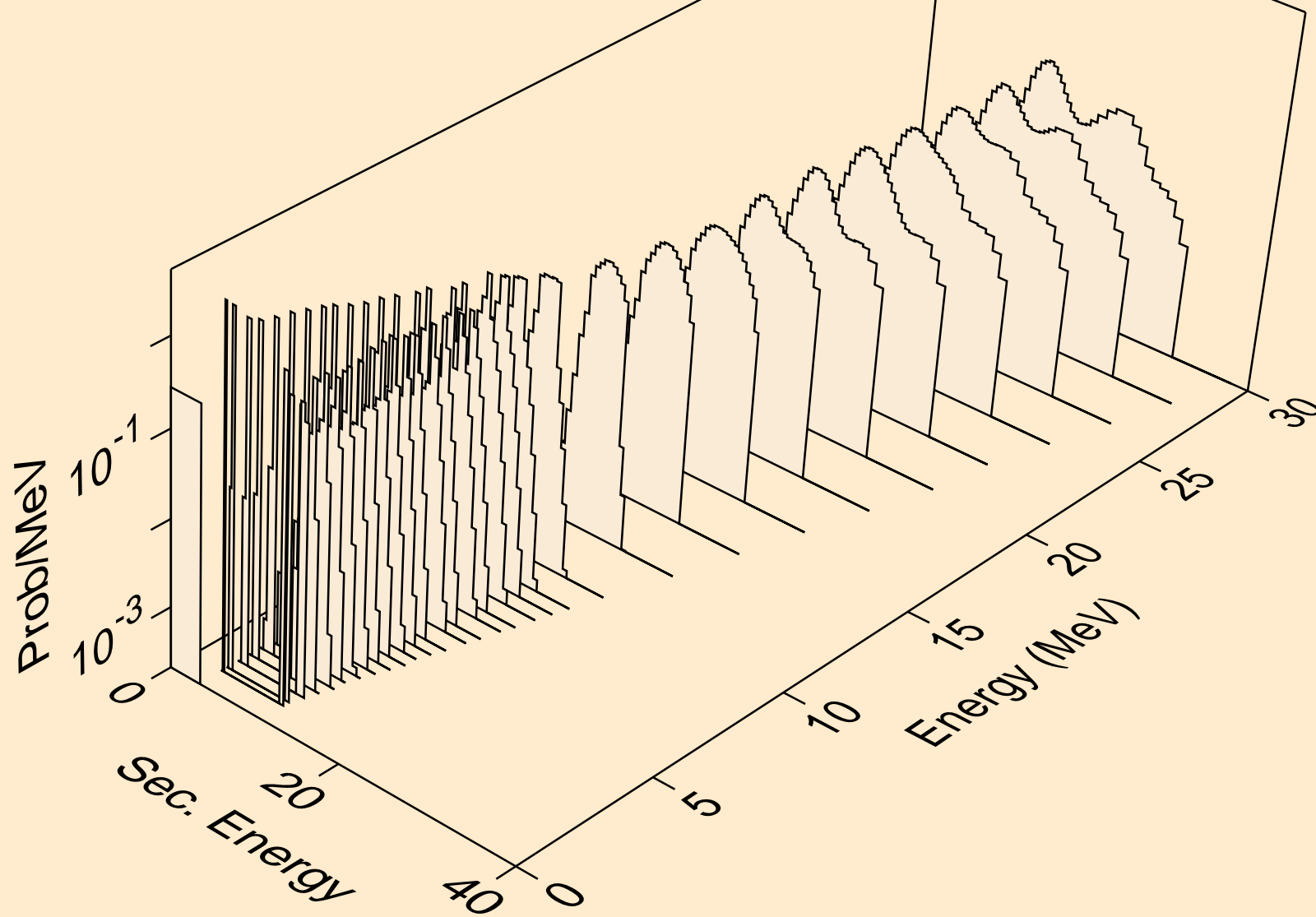

CS117 NEUTRON ACER TENDL-2024 LIBRARY; T=293.6K
alphas from (n,3a)

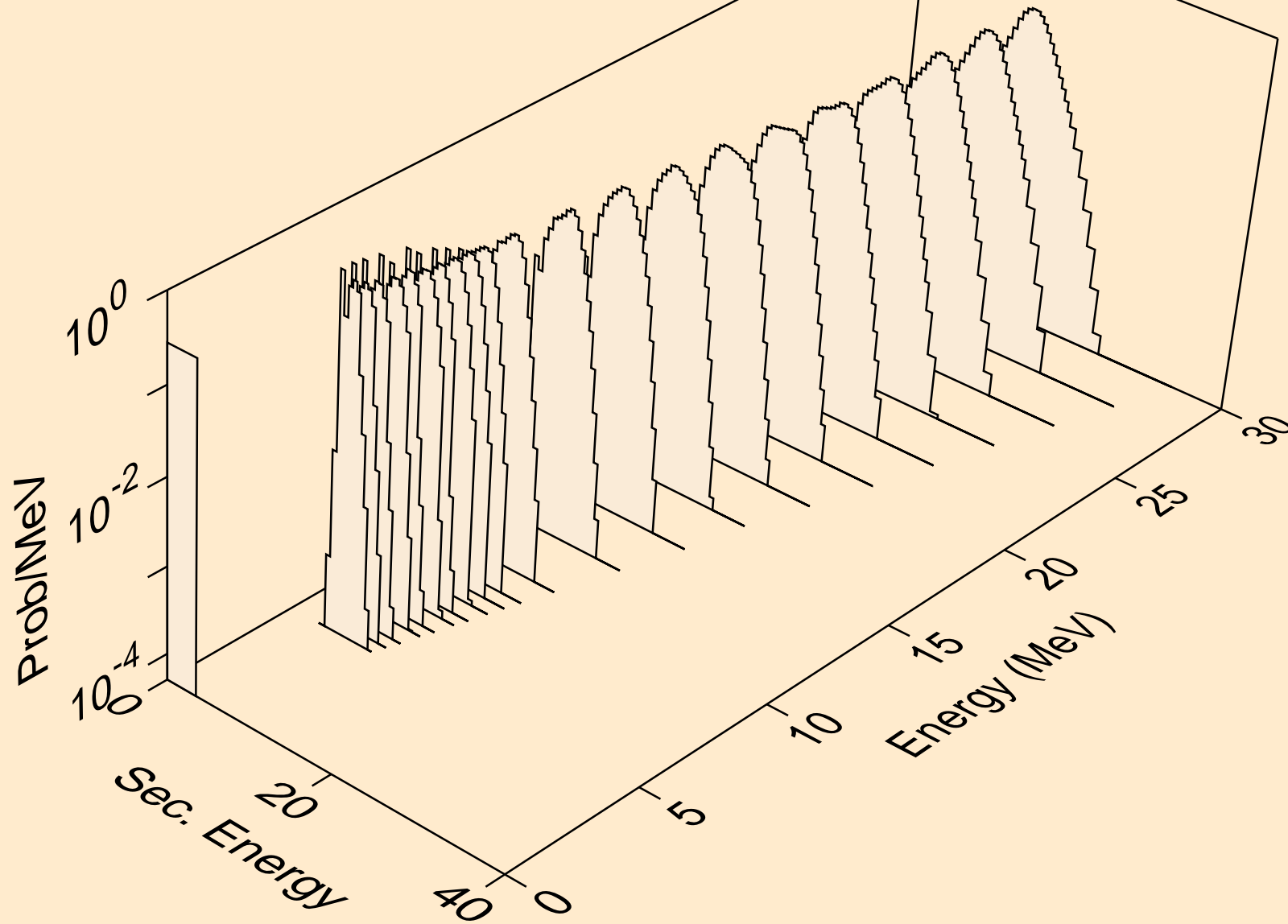

CS117 NEUTRON ACER TENDL-2024 LIBRARY; T=293.6K
alphas from (n,pa)

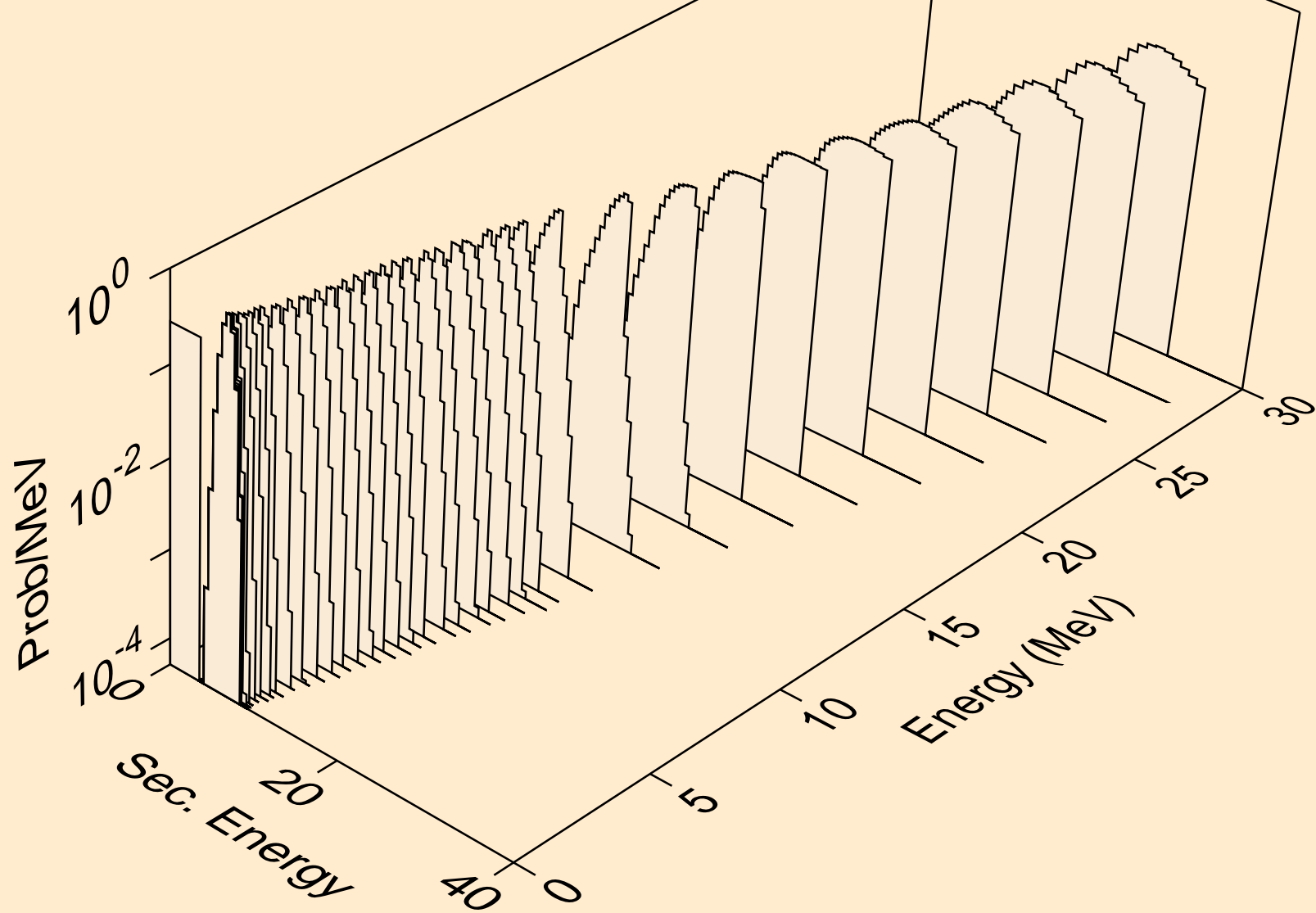

CS117 NEUTRON ACER TENDL-2024 LIBRARY; T=293.6K
alphas from (n,t2a)

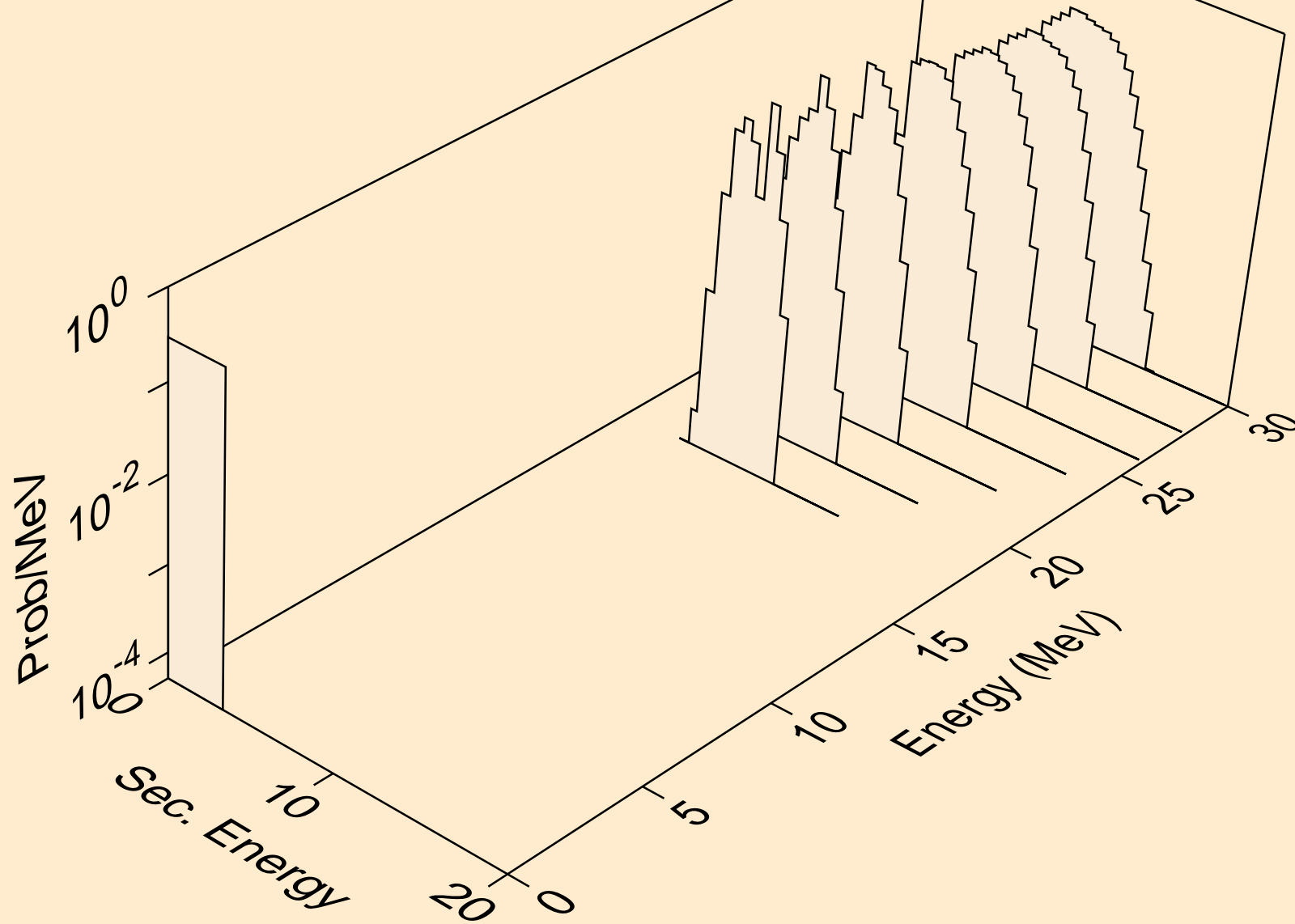

CS117 NEUTRON ACER TENDL-2024 LIBRARY; T=293.6K
alphas from (n,d2a)

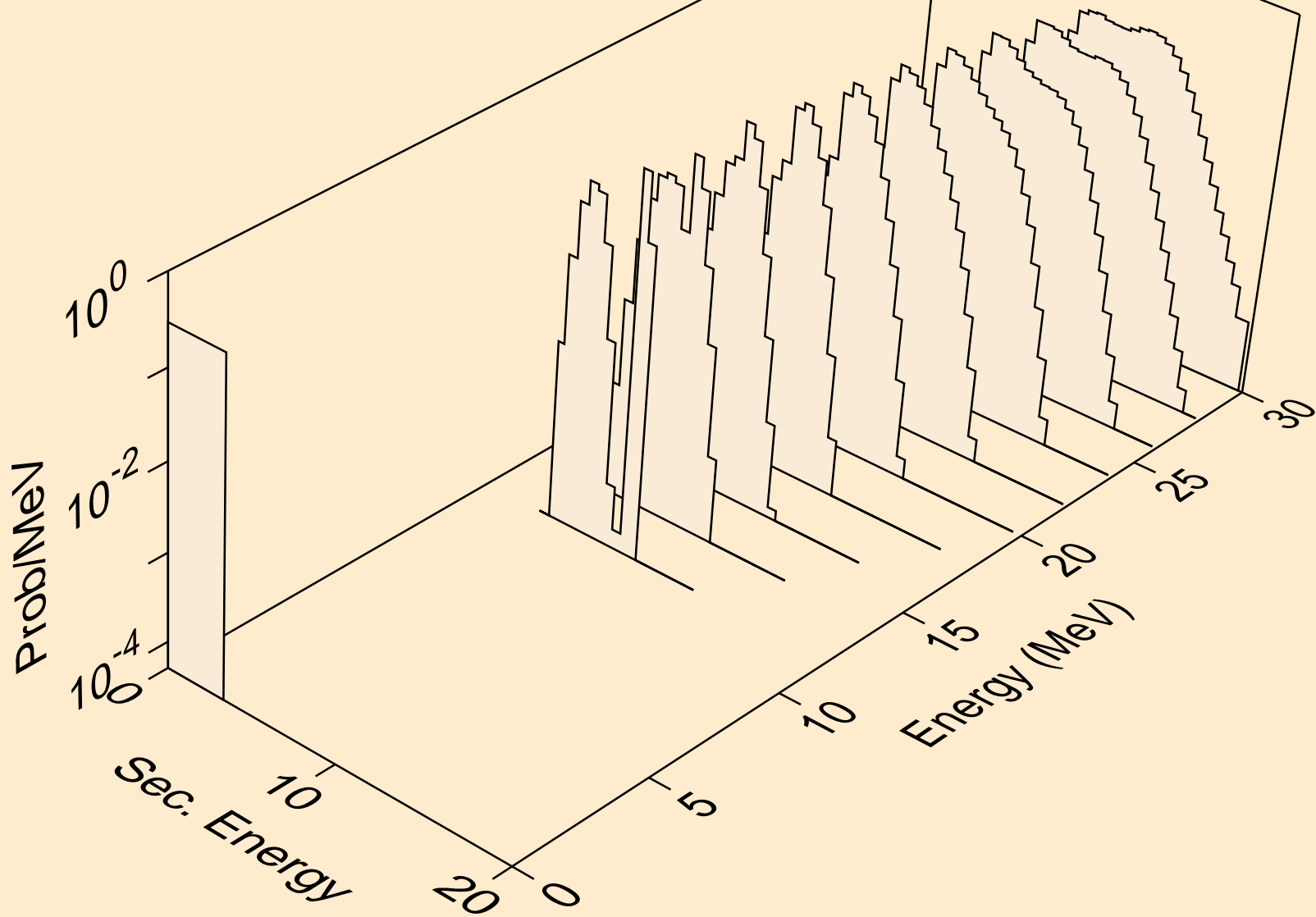

CS117 NEUTRON ACER TENDL-2024 LIBRARY; T=293.6K
alphas from (n,da)

