

DB266 NEUTRON ACER TENDL-2024 LIBRARY; T=293.6K

Principal cross sections

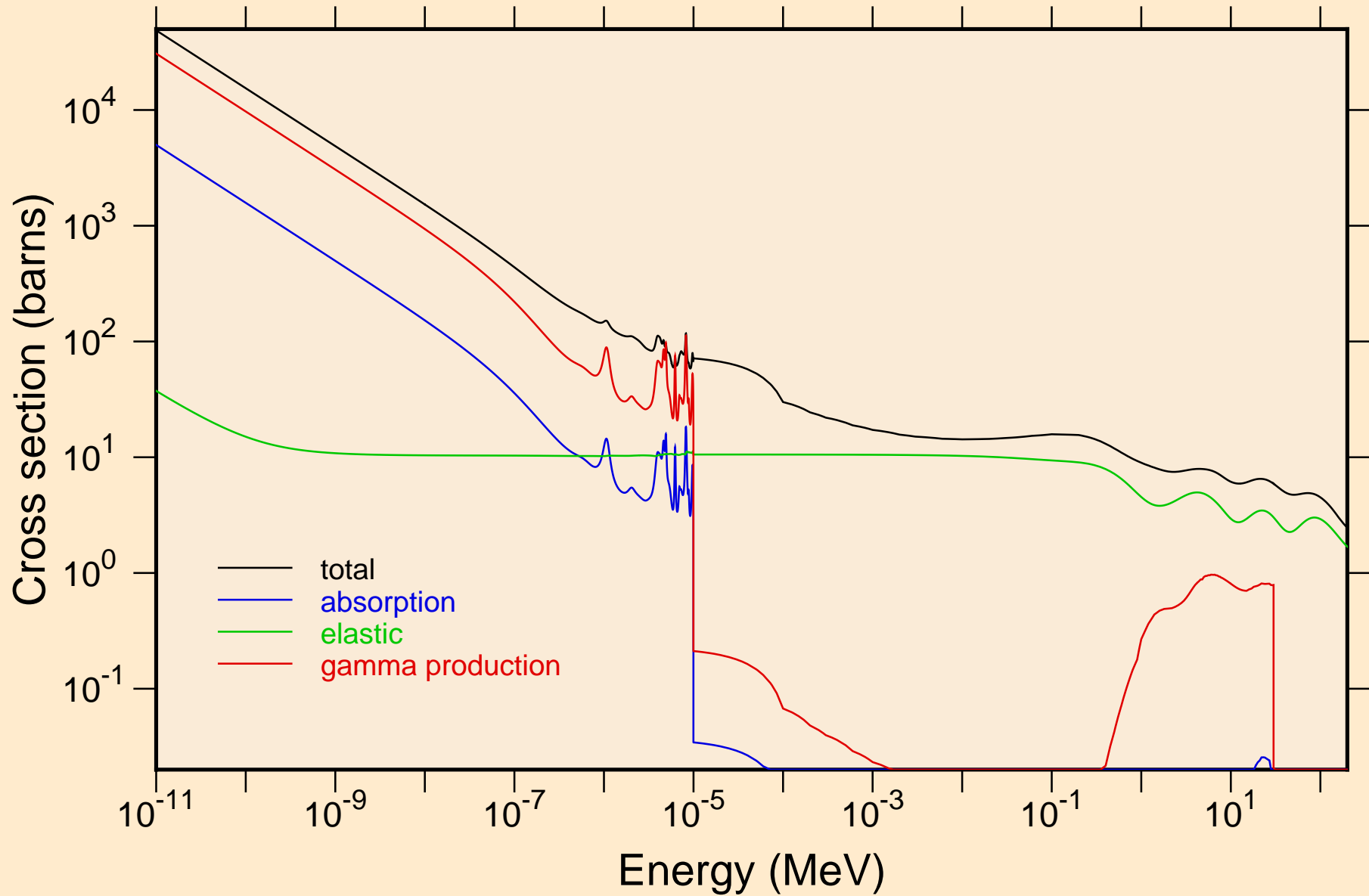

DB266 NEUTRON ACER TENDL-2024 LIBRARY; T=293.6K
resonance total cross section

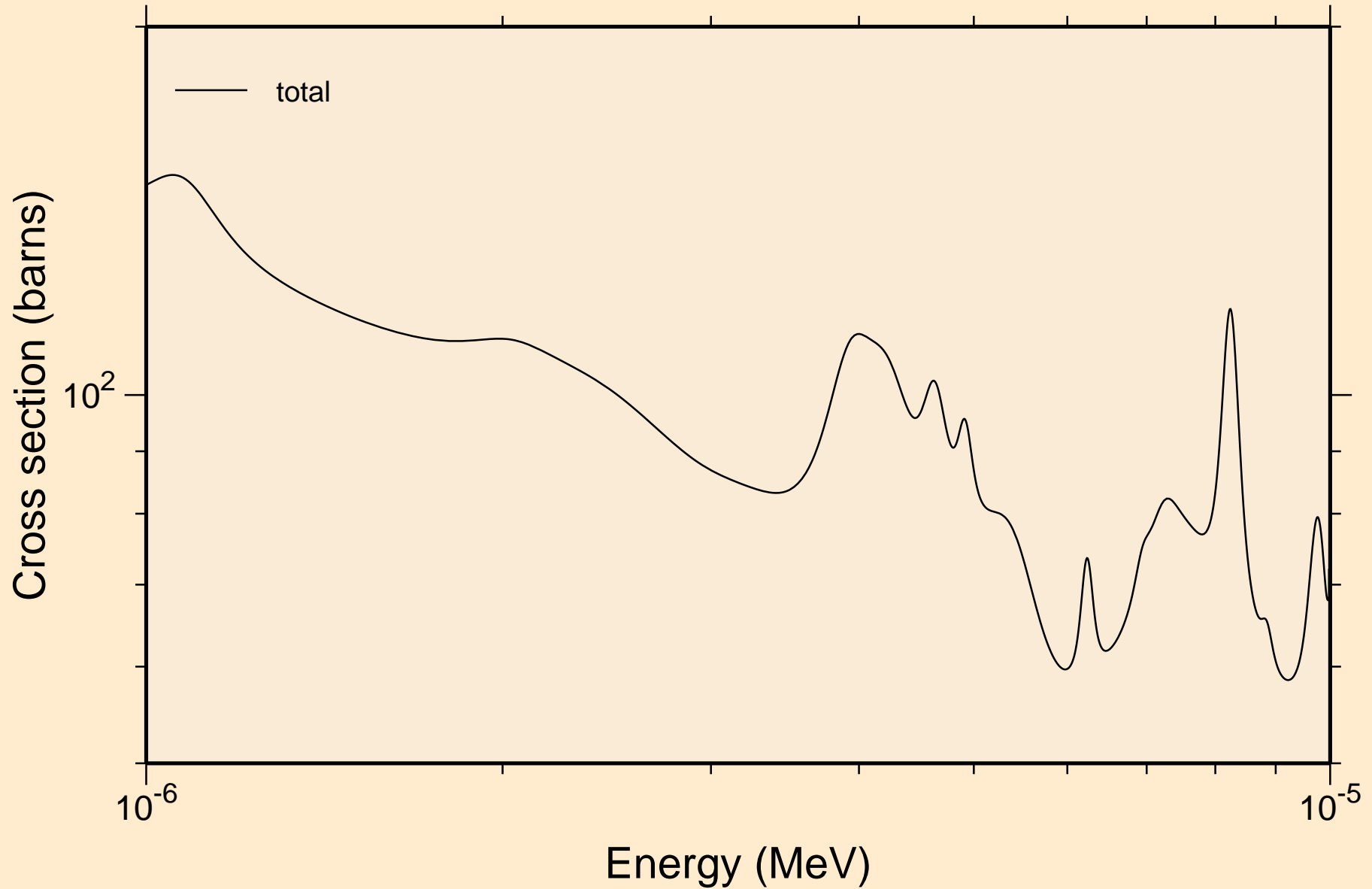

DB266 NEUTRON ACER TENDL-2024 LIBRARY; T=293.6K
resonance total cross section

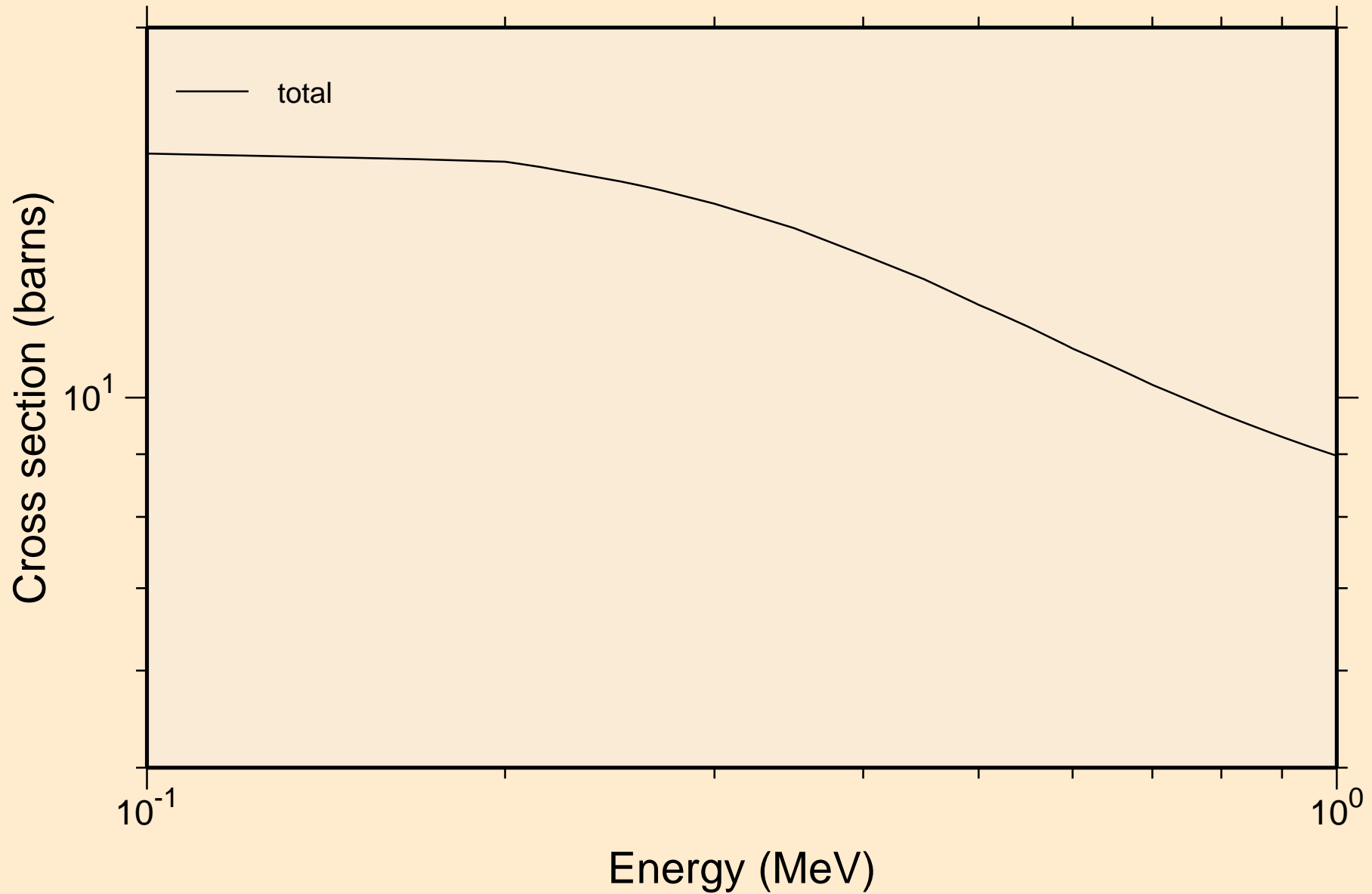

DB266 NEUTRON ACER TENDL-2024 LIBRARY; T=293.6K
resonance total cross section

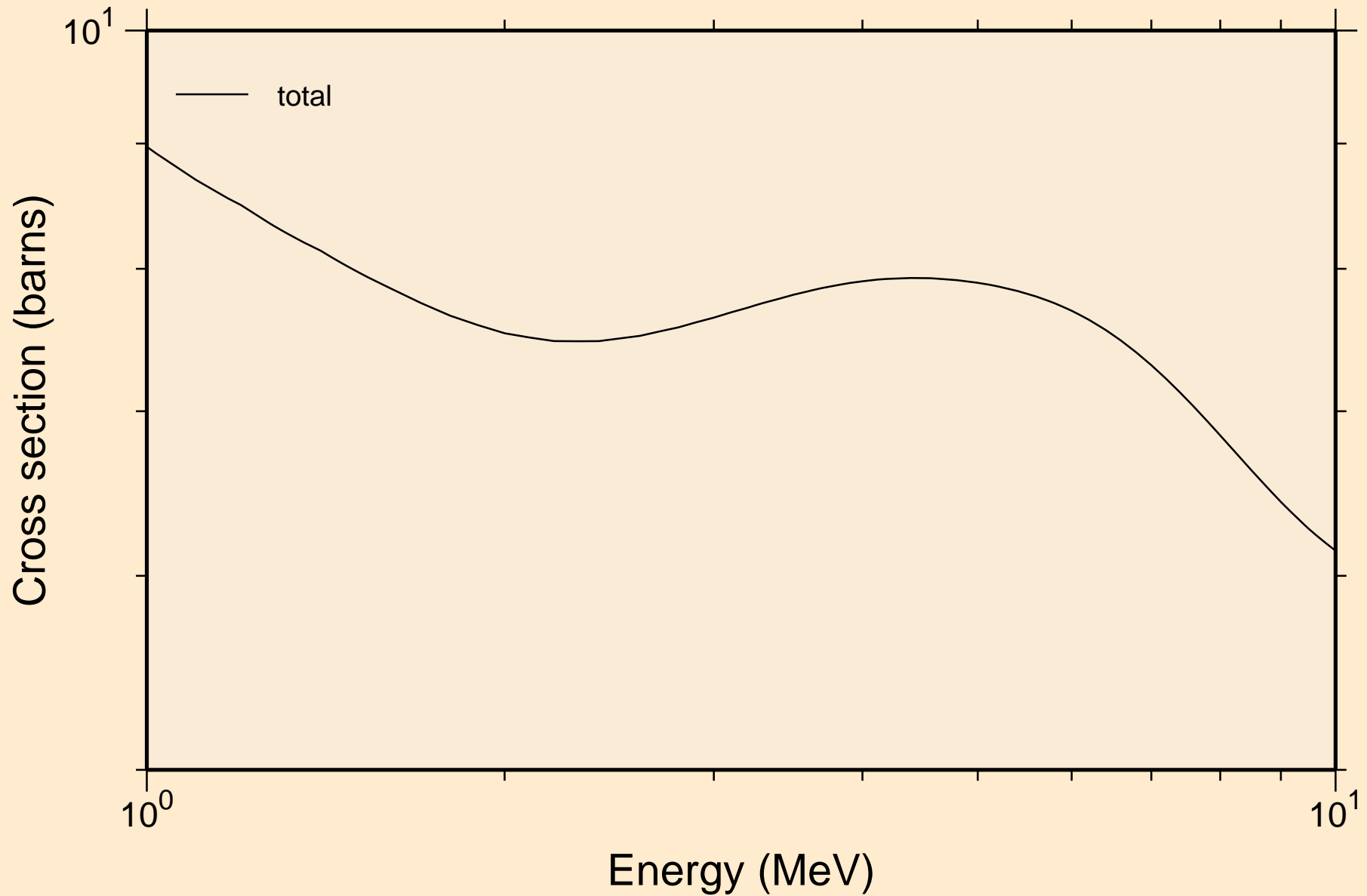

DB266 NEUTRON ACER TENDL-2024 LIBRARY; T=293.6K
resonance absorption cross sections

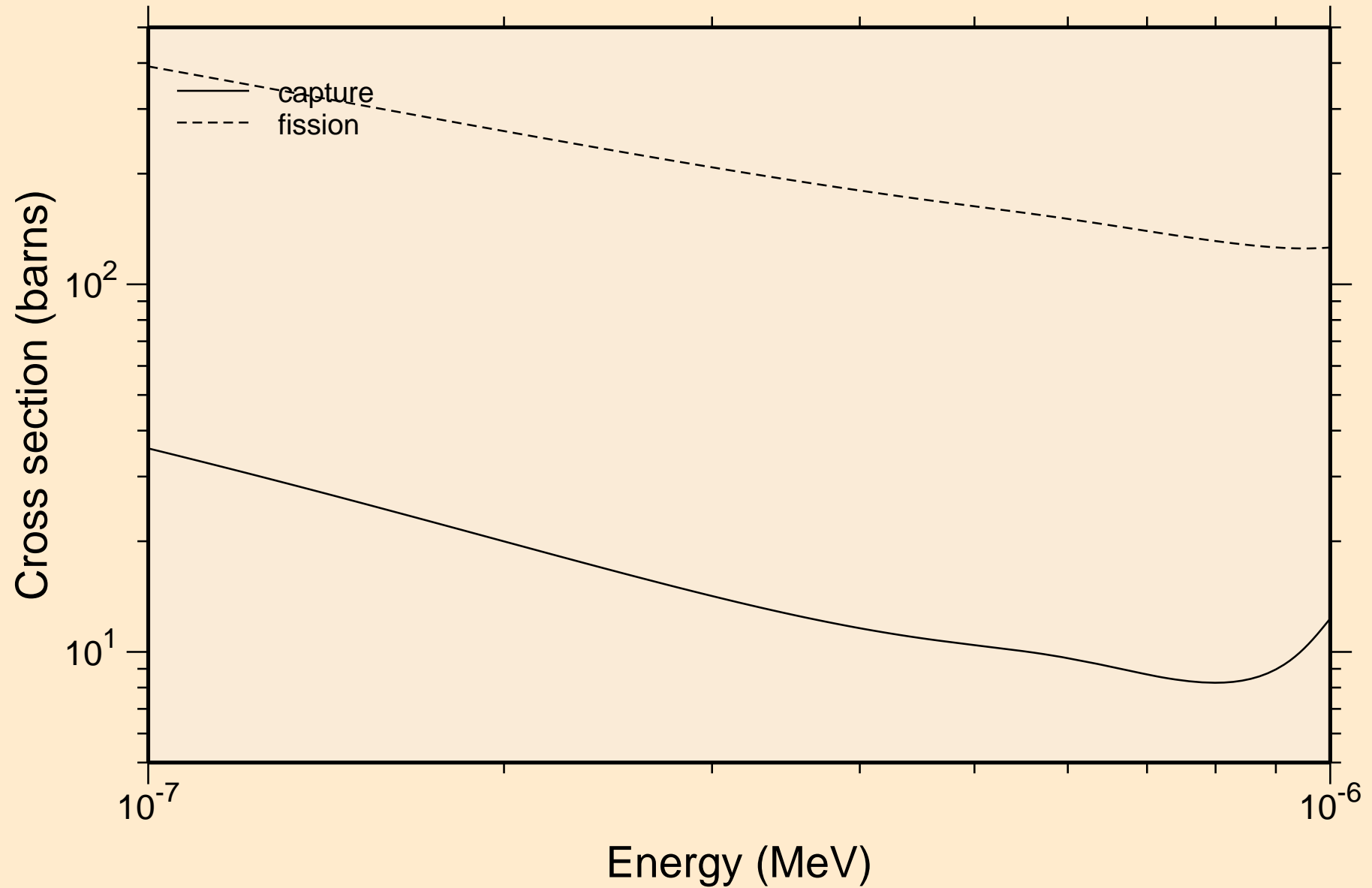

DB266 NEUTRON ACER TENDL-2024 LIBRARY; T=293.6K
resonance absorption cross sections

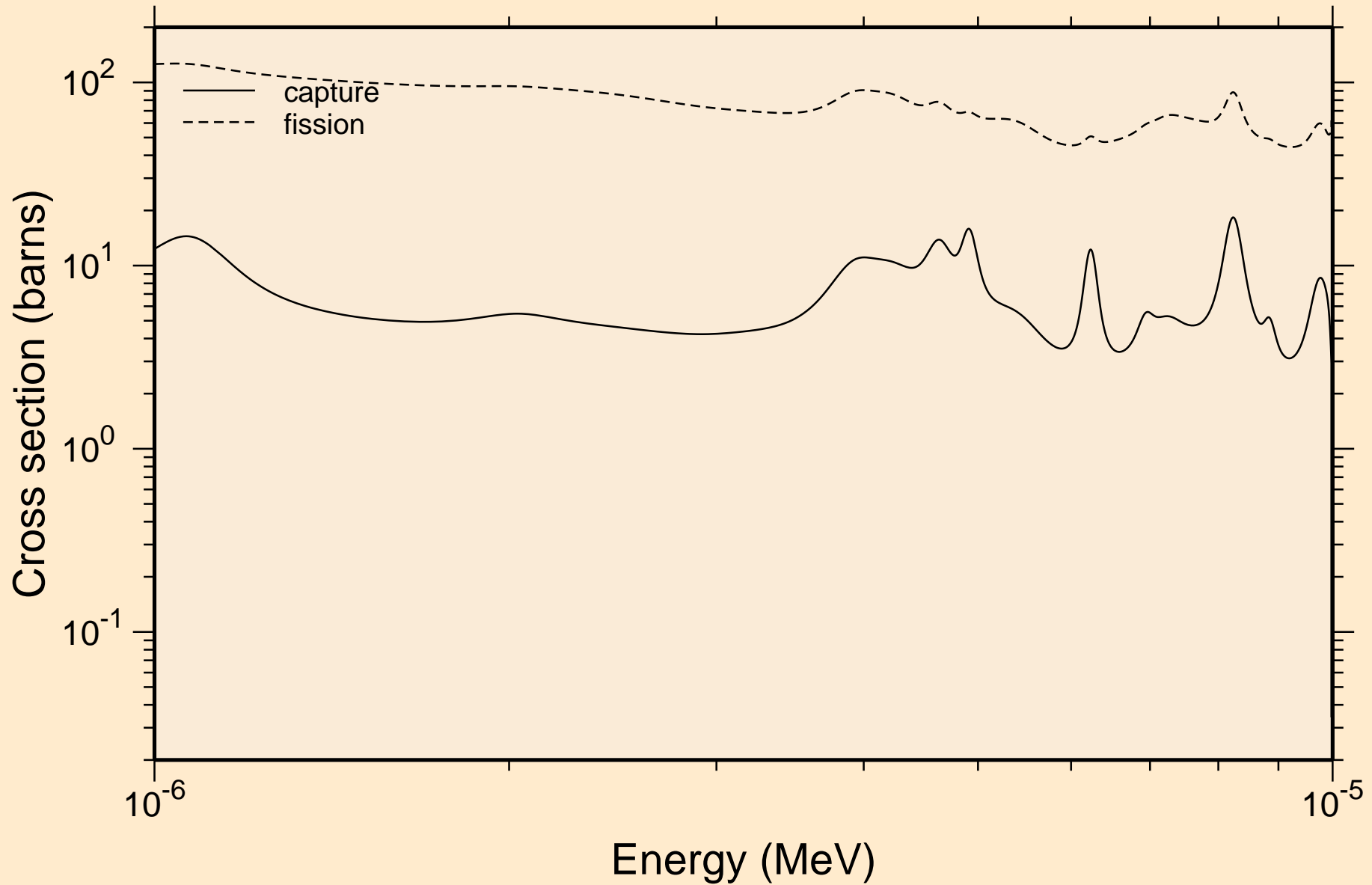

DB266 NEUTRON ACER TENDL-2024 LIBRARY; T=293.6K
resonance absorption cross sections

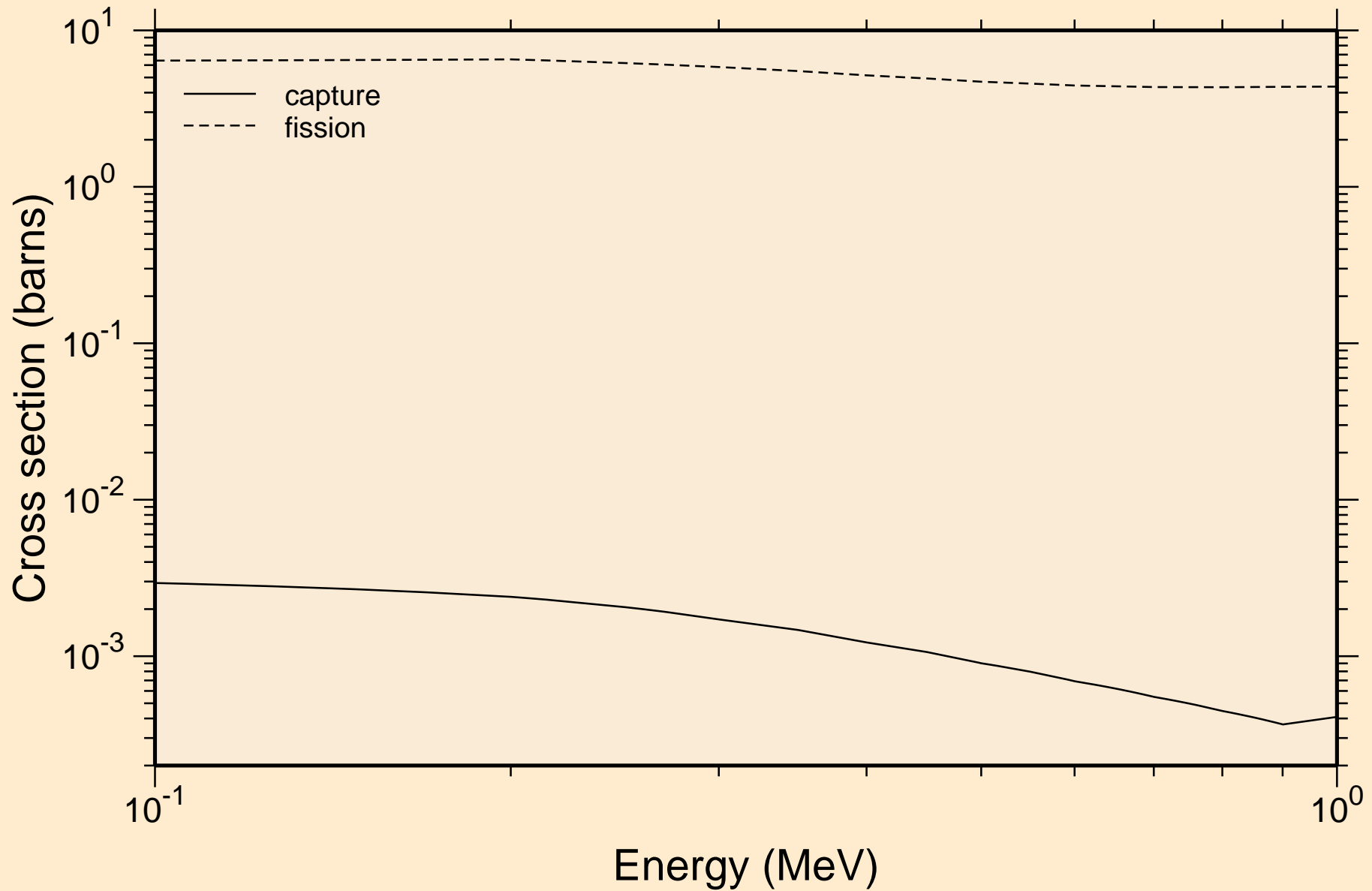

DB266 NEUTRON ACER TENDL-2024 LIBRARY; T=293.6K
resonance absorption cross sections

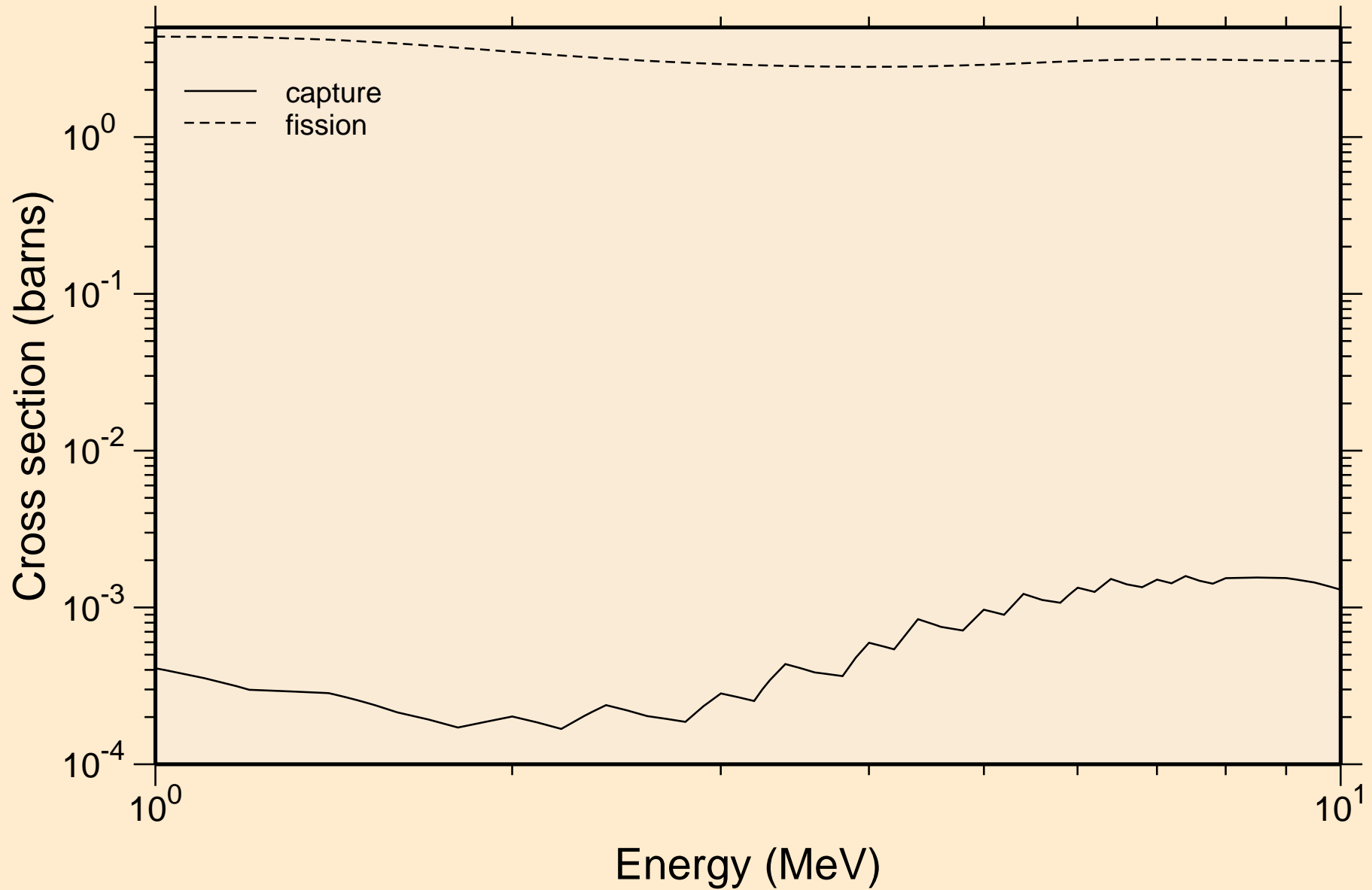

DB266 NEUTRON ACER TENDL-2024 LIBRARY; T=293.6K
Heating

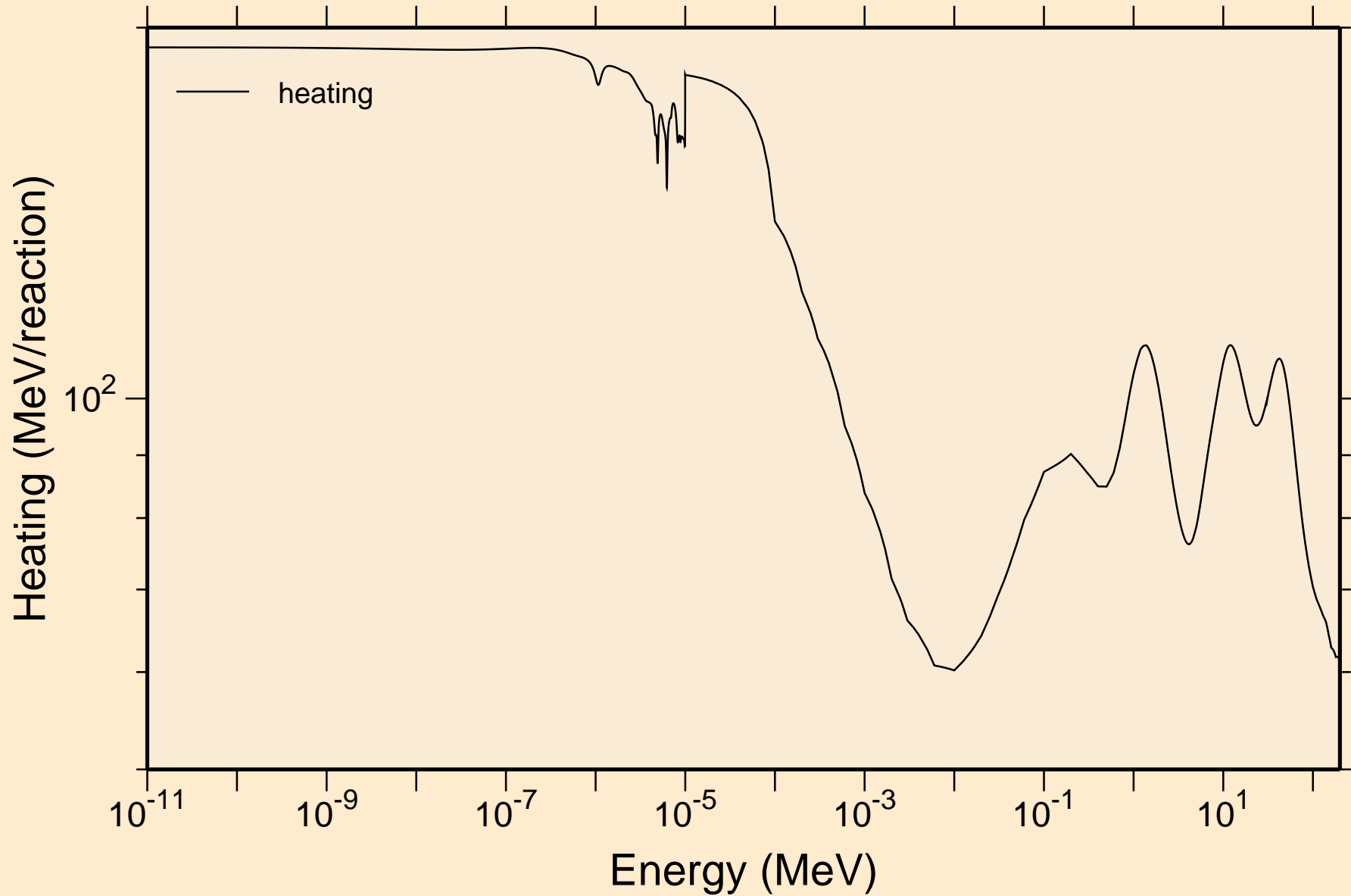

DB266 NEUTRON ACER TENDL-2024 LIBRARY; T=293.6K
Damage

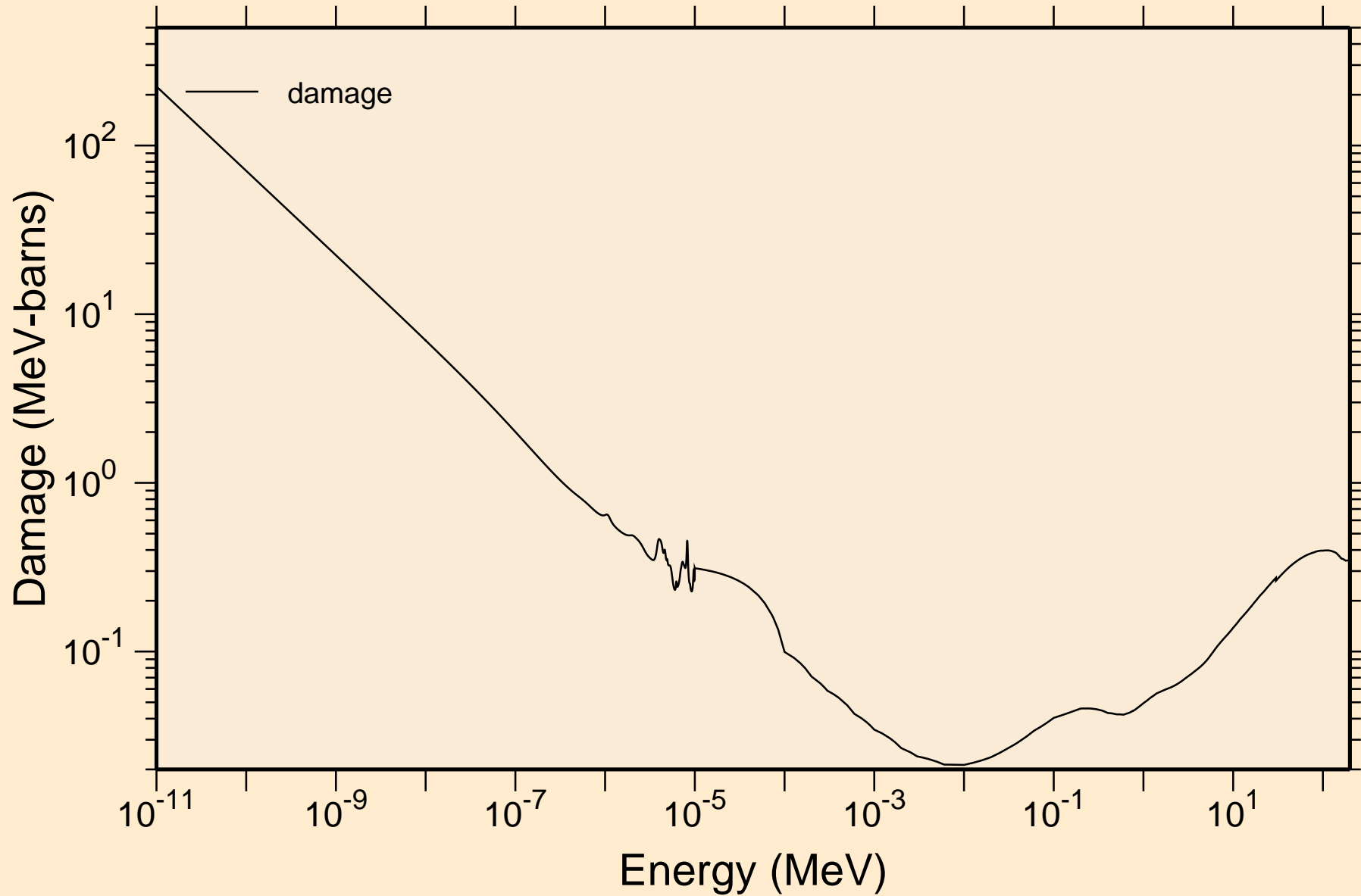

DB266 NEUTRON ACER TENDL-2024 LIBRARY; T=293.6K
Non-threshold reactions

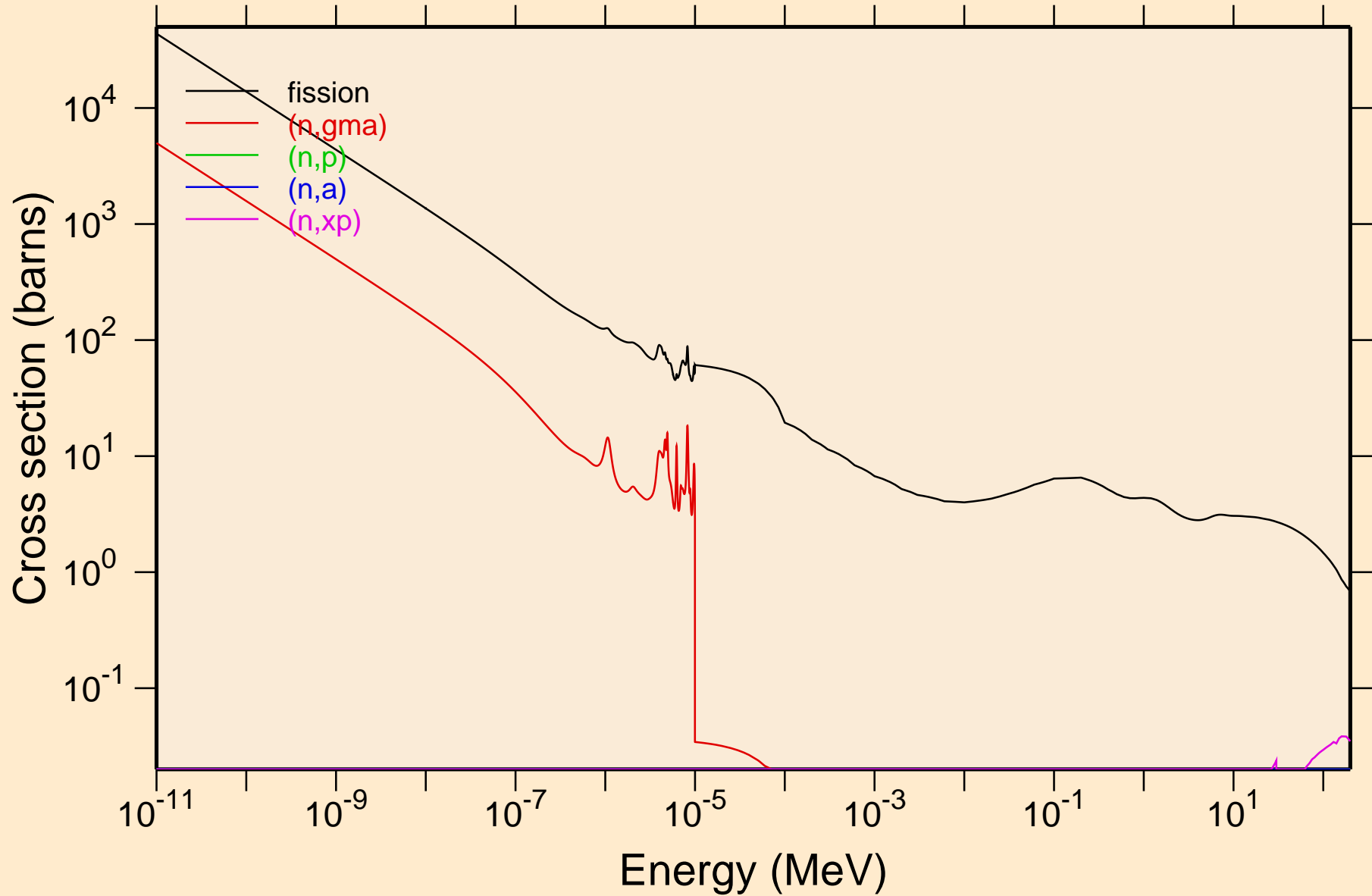

DB266 NEUTRON ACER TENDL-2024 LIBRARY; T=293.6K
Non-threshold reactions

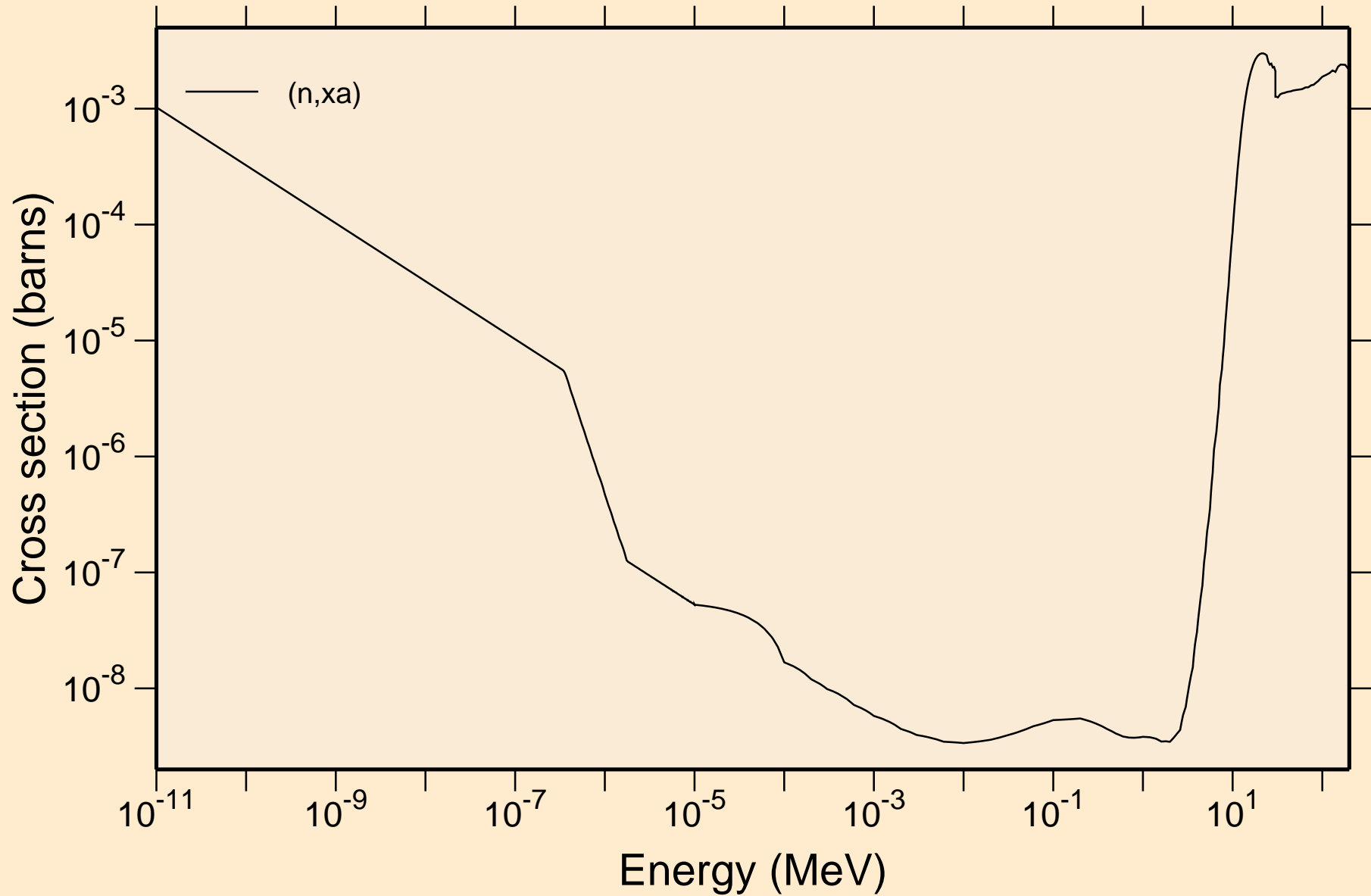

DB266 NEUTRON ACER TENDL-2024 LIBRARY; T=293.6K

Principal cross sections

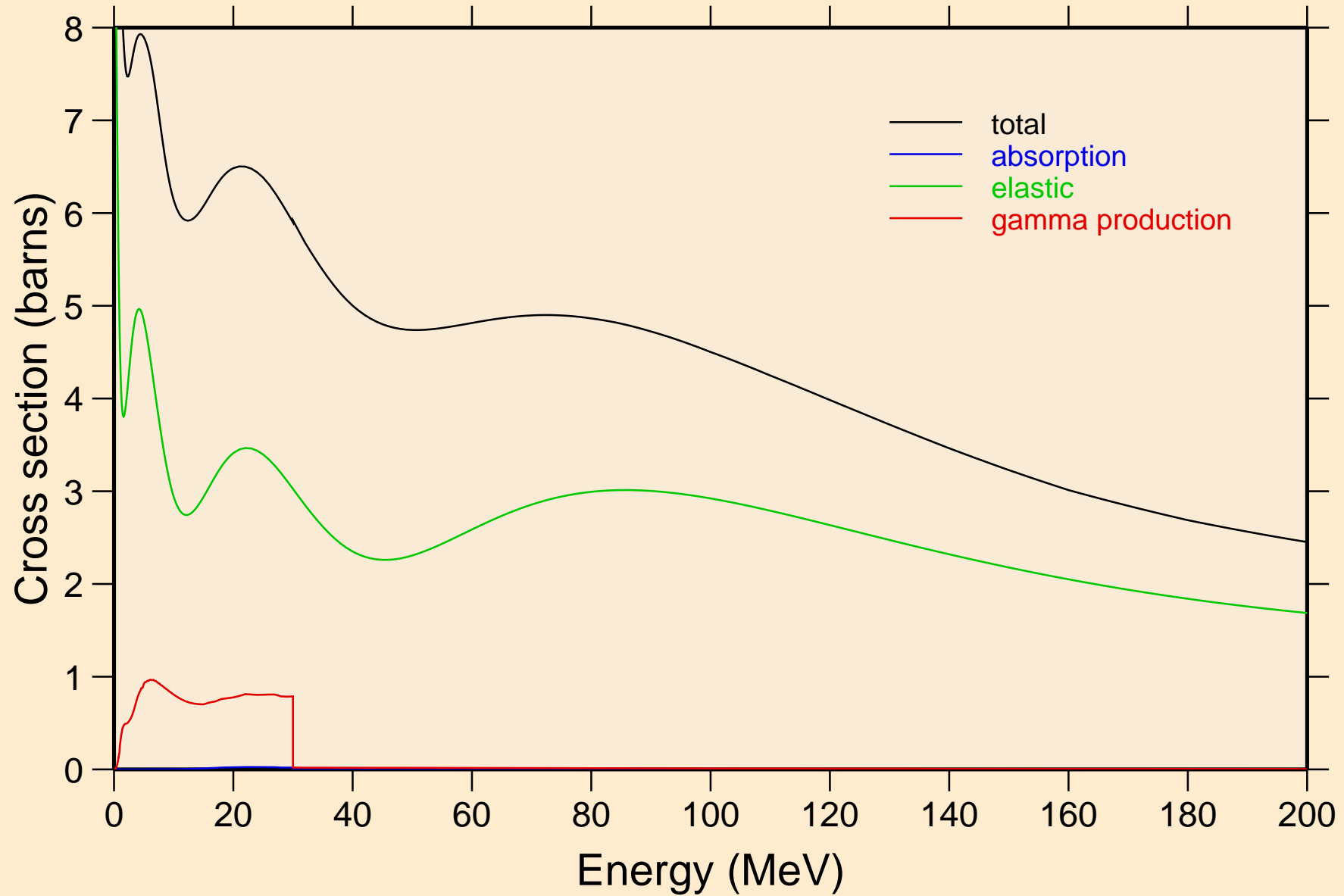

DB266 NEUTRON ACER TENDL-2024 LIBRARY; T=293.6K
Heating

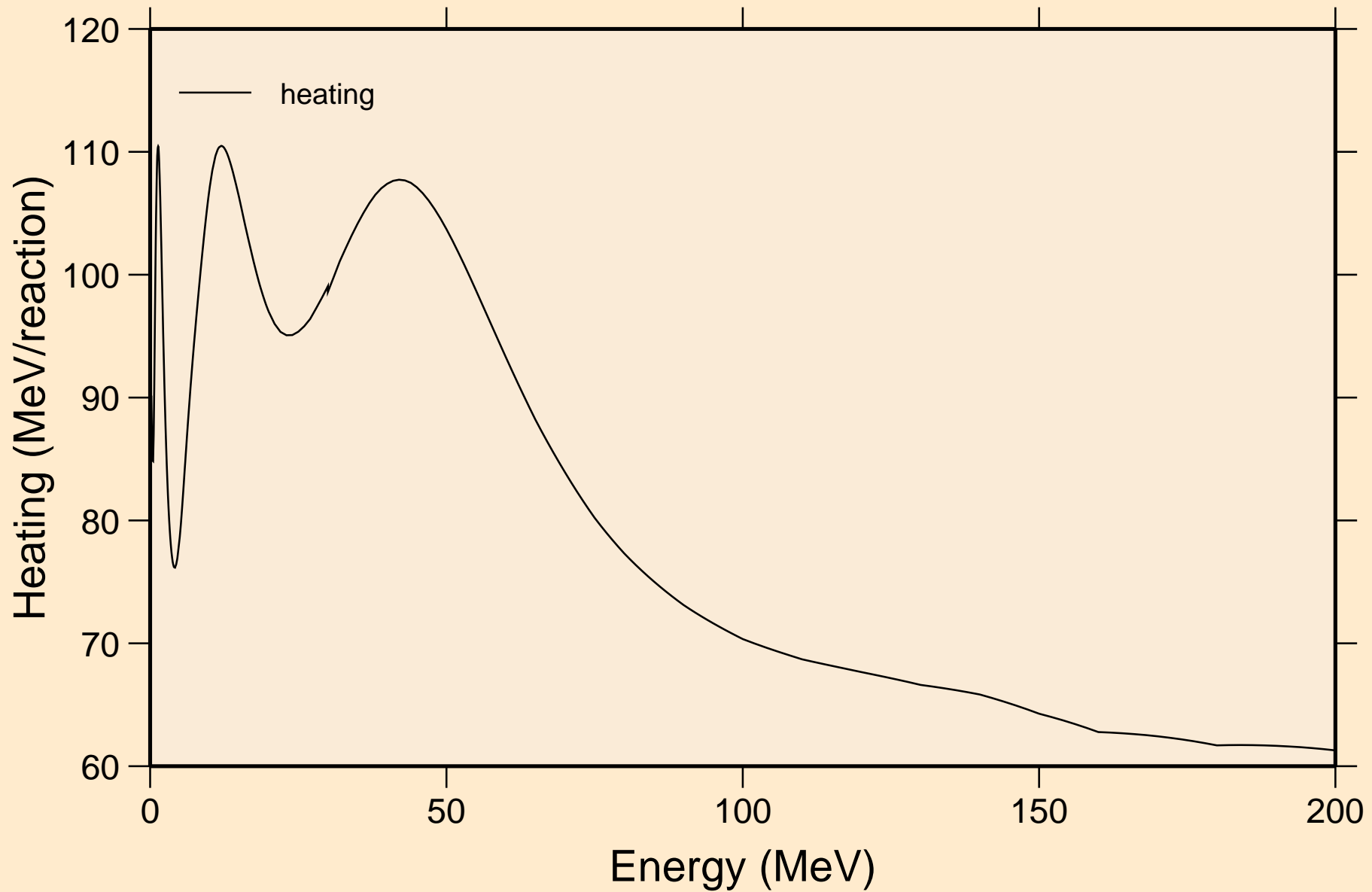

DB266 NEUTRON ACER TENDL-2024 LIBRARY; T=293.6K
Damage

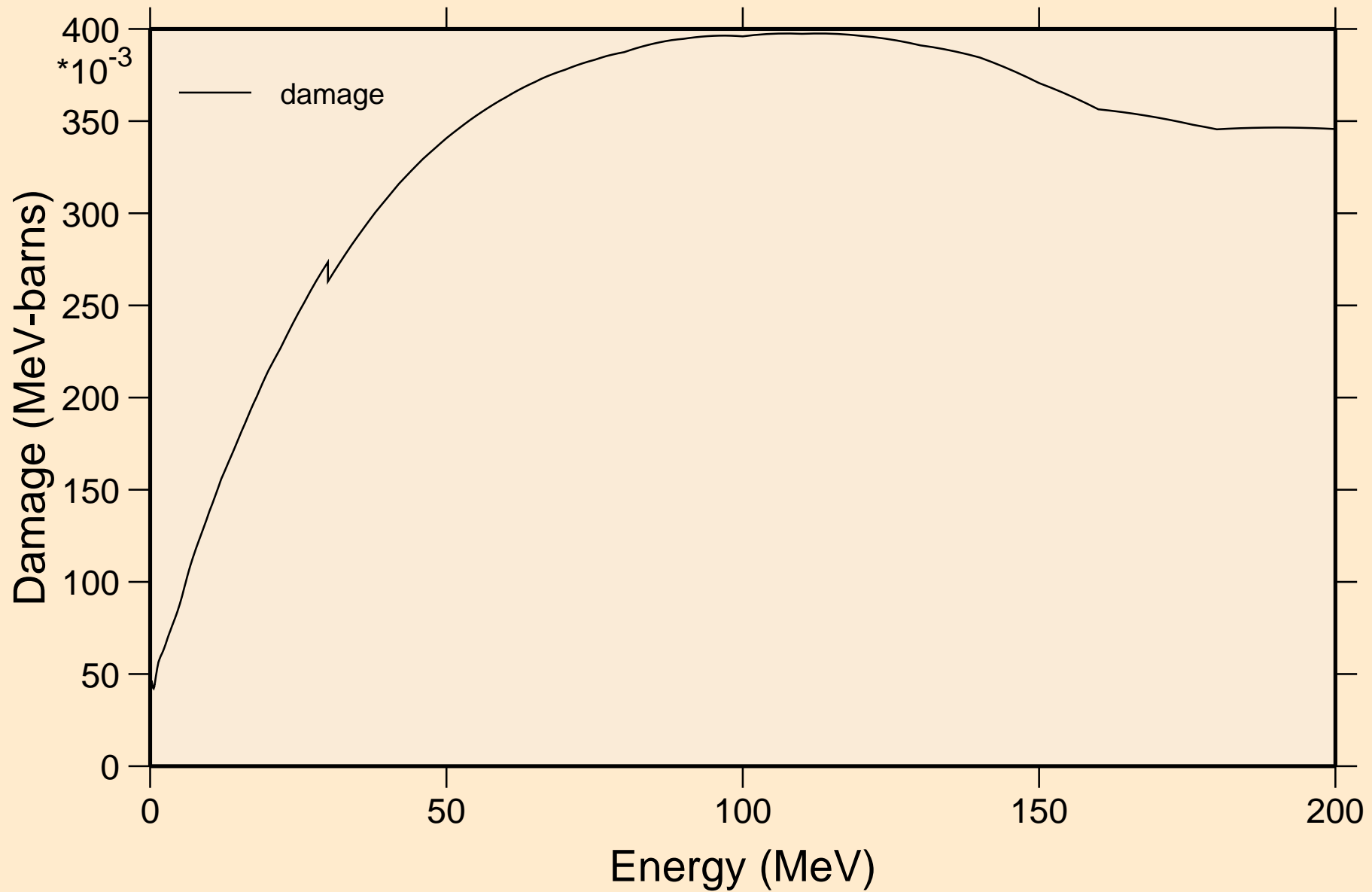

DB266 NEUTRON ACER TENDL-2024 LIBRARY; T=293.6K
Non-threshold reactions

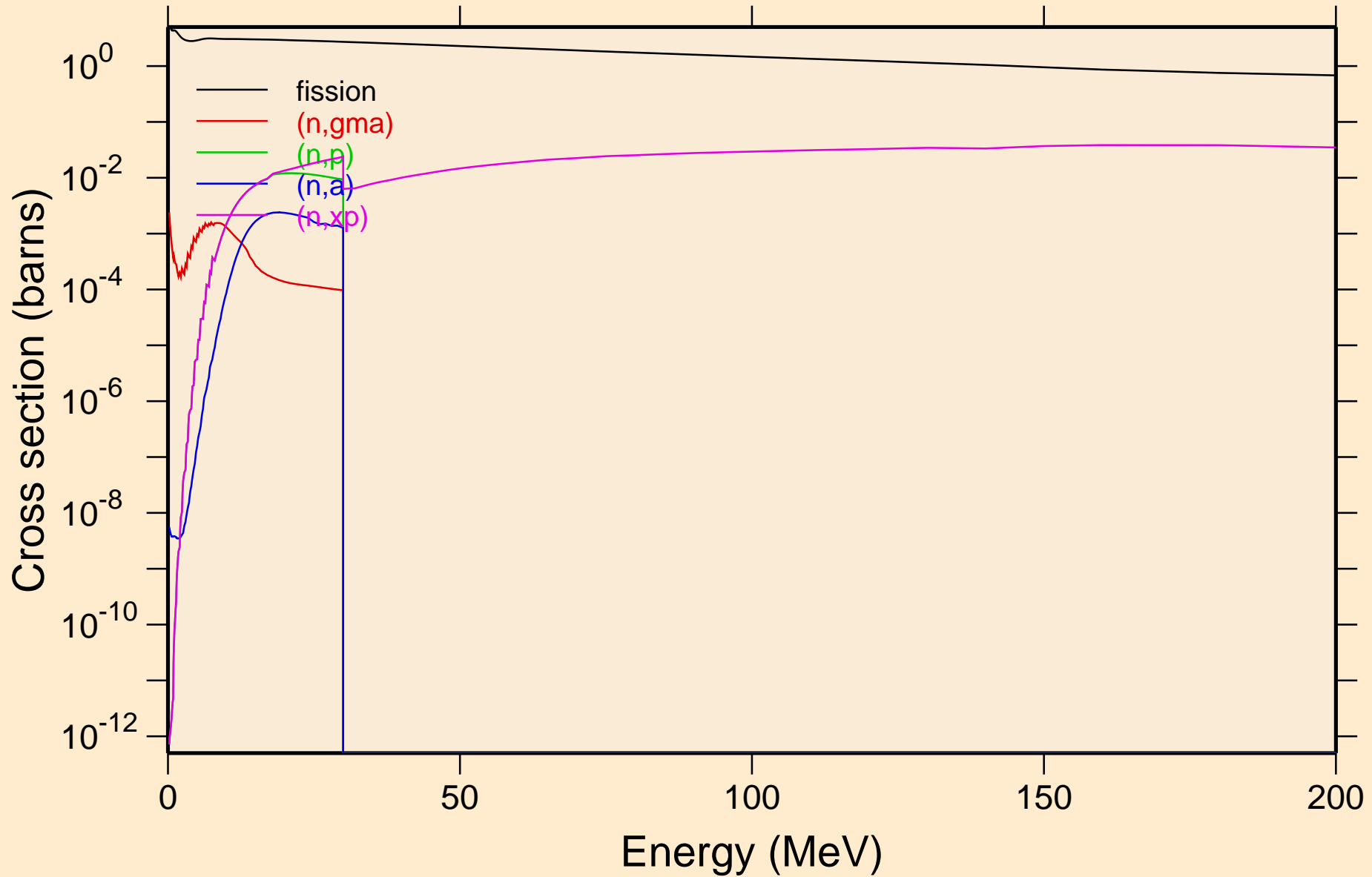

DB266 NEUTRON ACER TENDL-2024 LIBRARY; T=293.6K
Non-threshold reactions

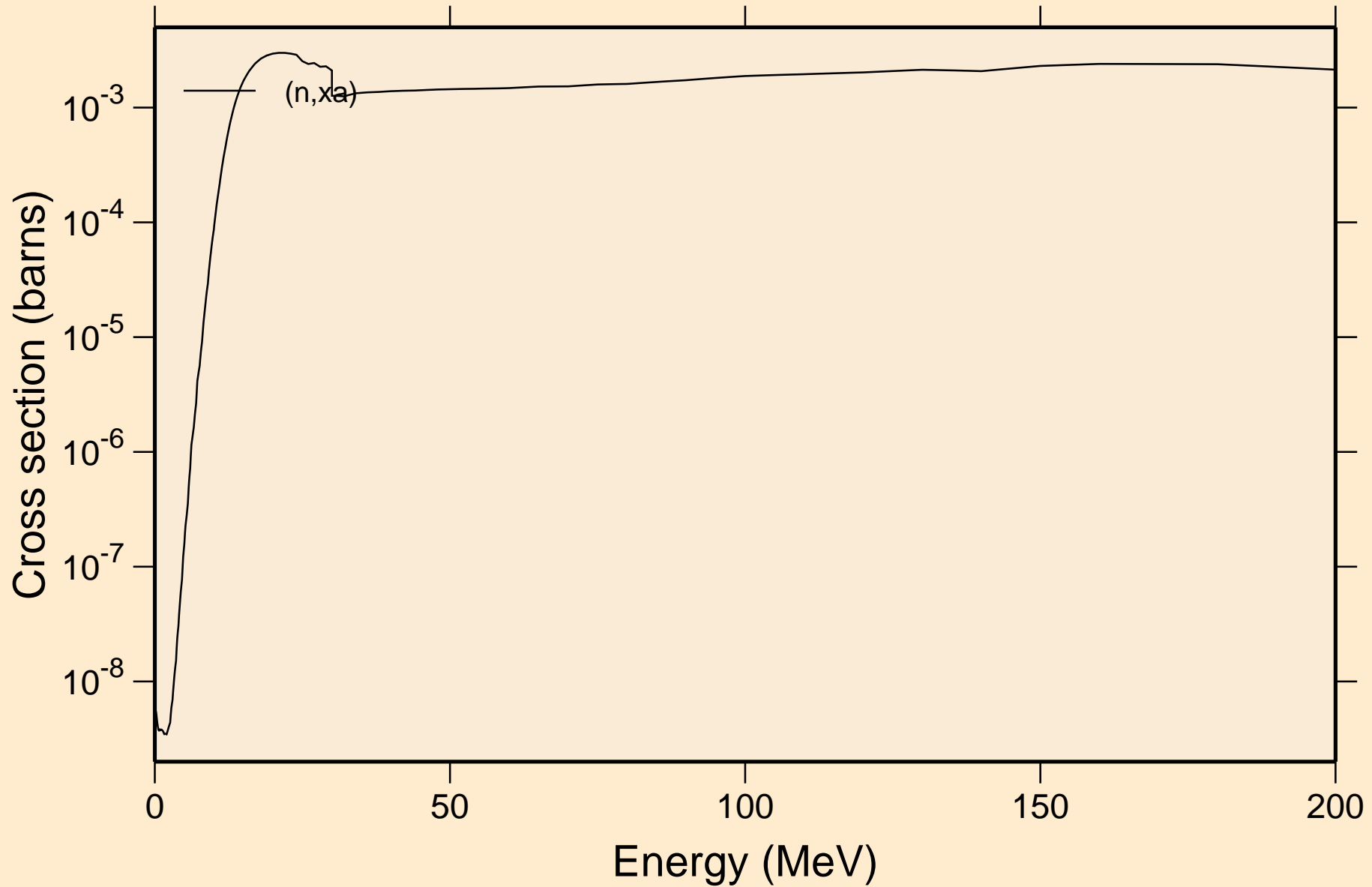

DB266 NEUTRON ACER TENDL-2024 LIBRARY; T=293.6K
Inelastic levels

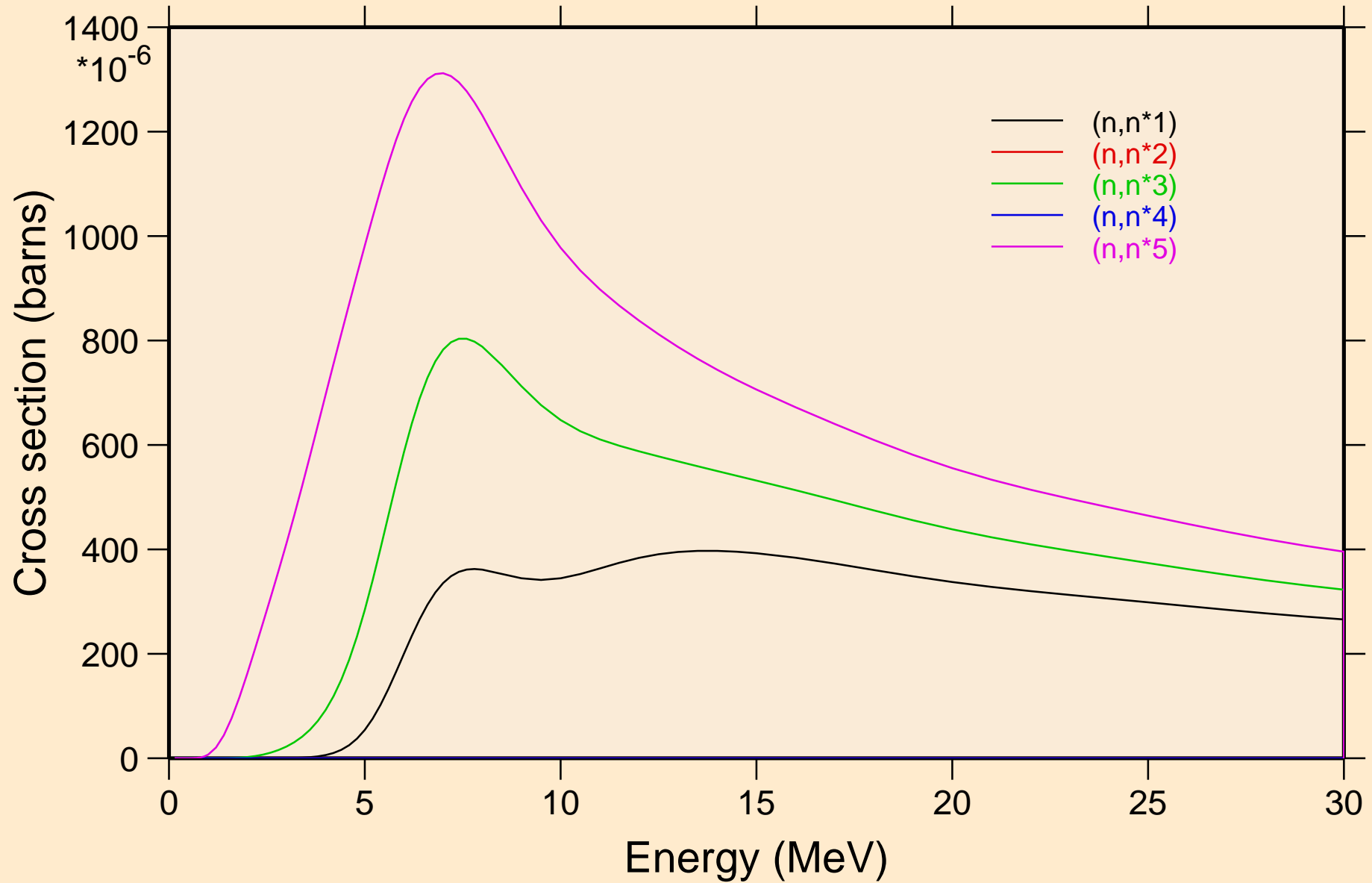

DB266 NEUTRON ACER TENDL-2024 LIBRARY; T=293.6K
Inelastic levels

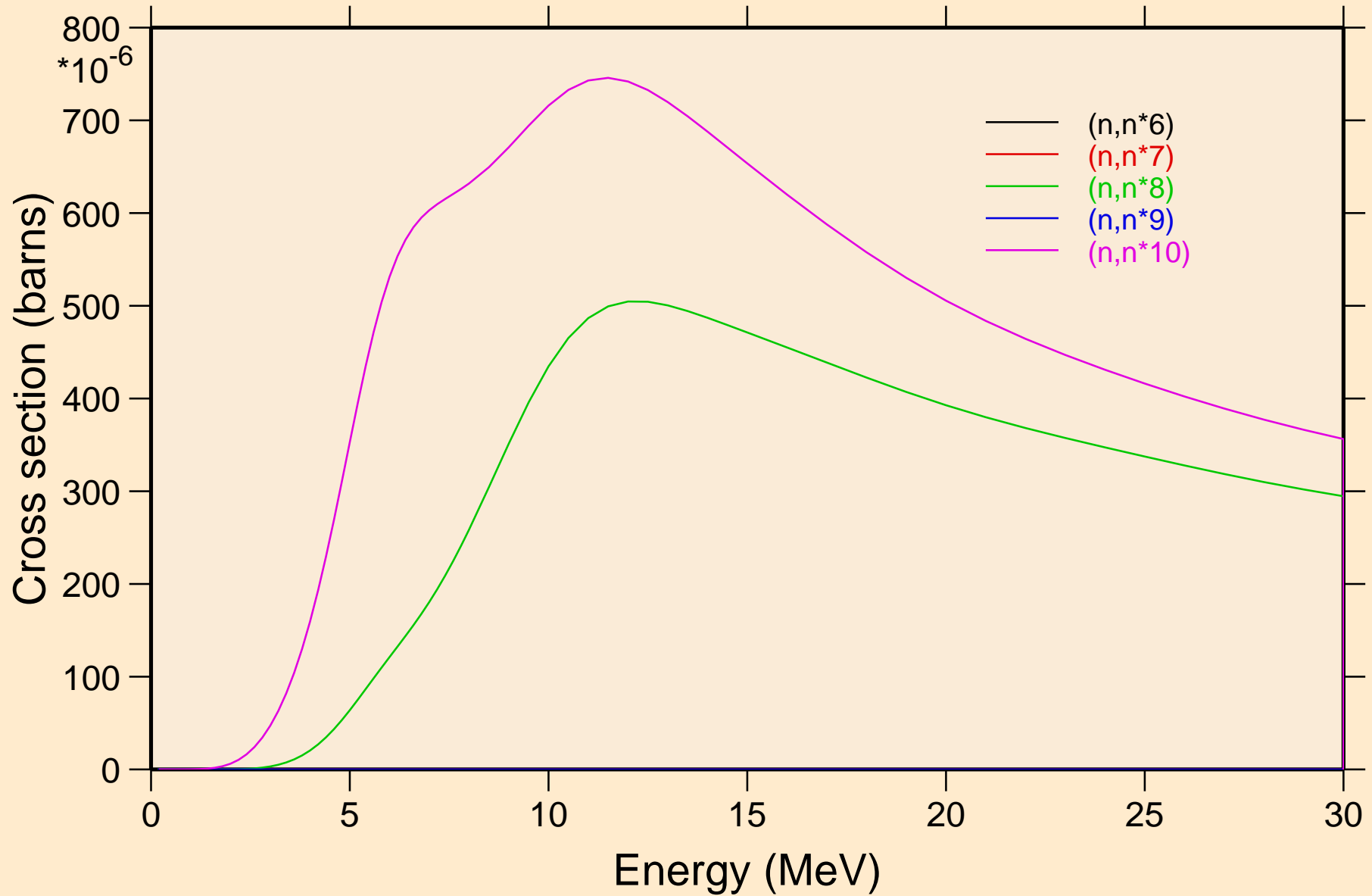

DB266 NEUTRON ACER TENDL-2024 LIBRARY; T=293.6K
Inelastic levels

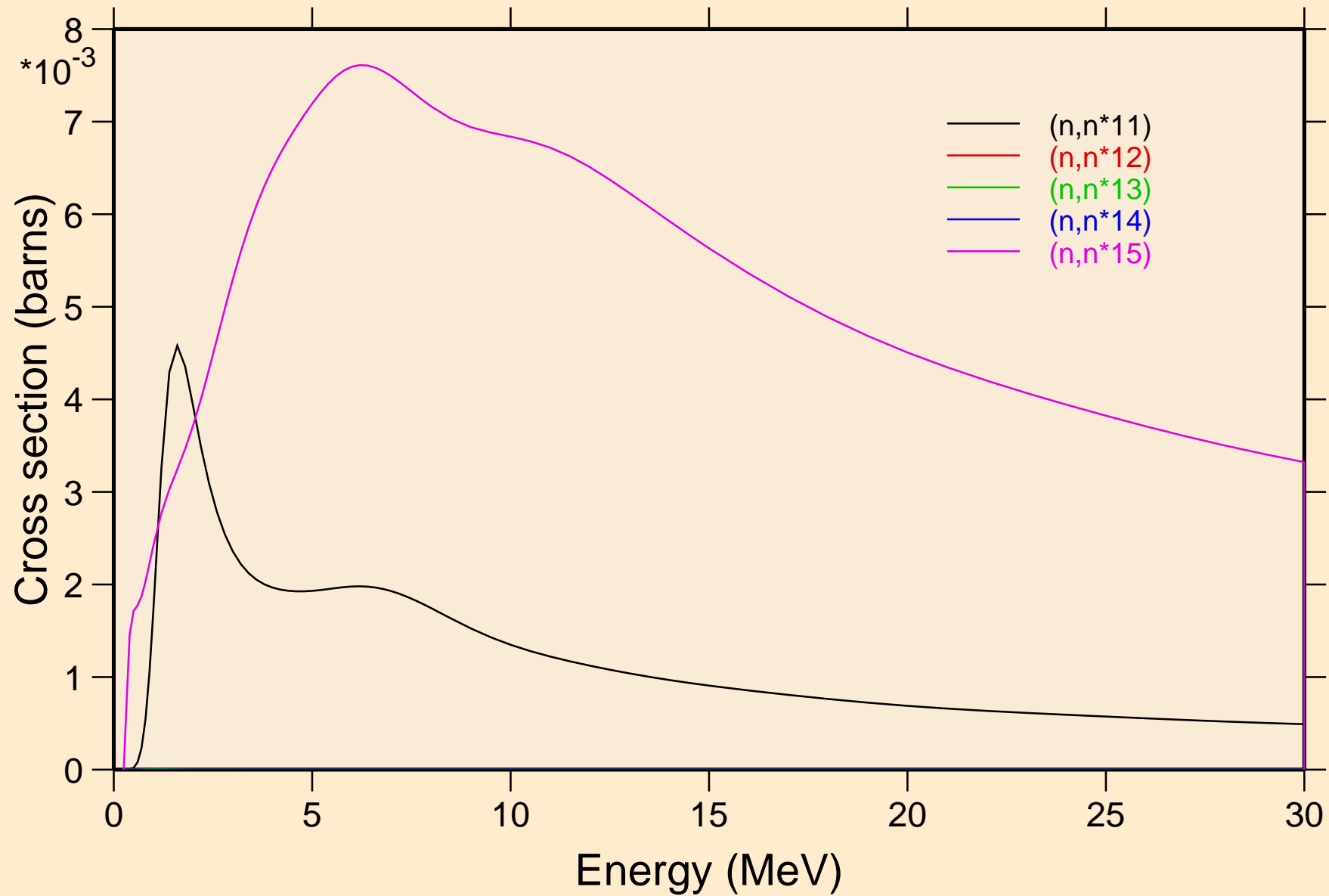

DB266 NEUTRON ACER TENDL-2024 LIBRARY; T=293.6K
Inelastic levels

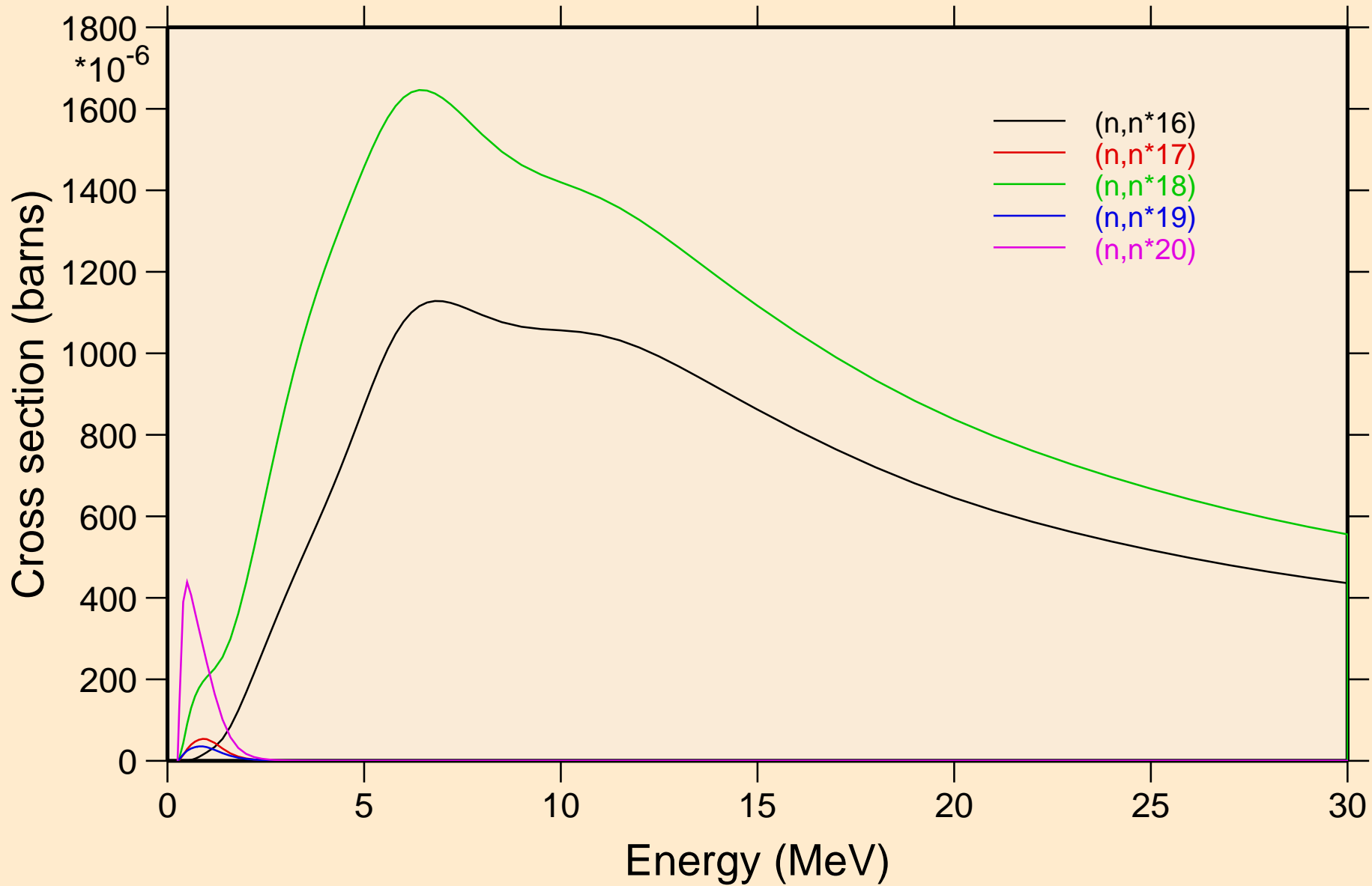

DB266 NEUTRON ACER TENDL-2024 LIBRARY; T=293.6K
Inelastic levels

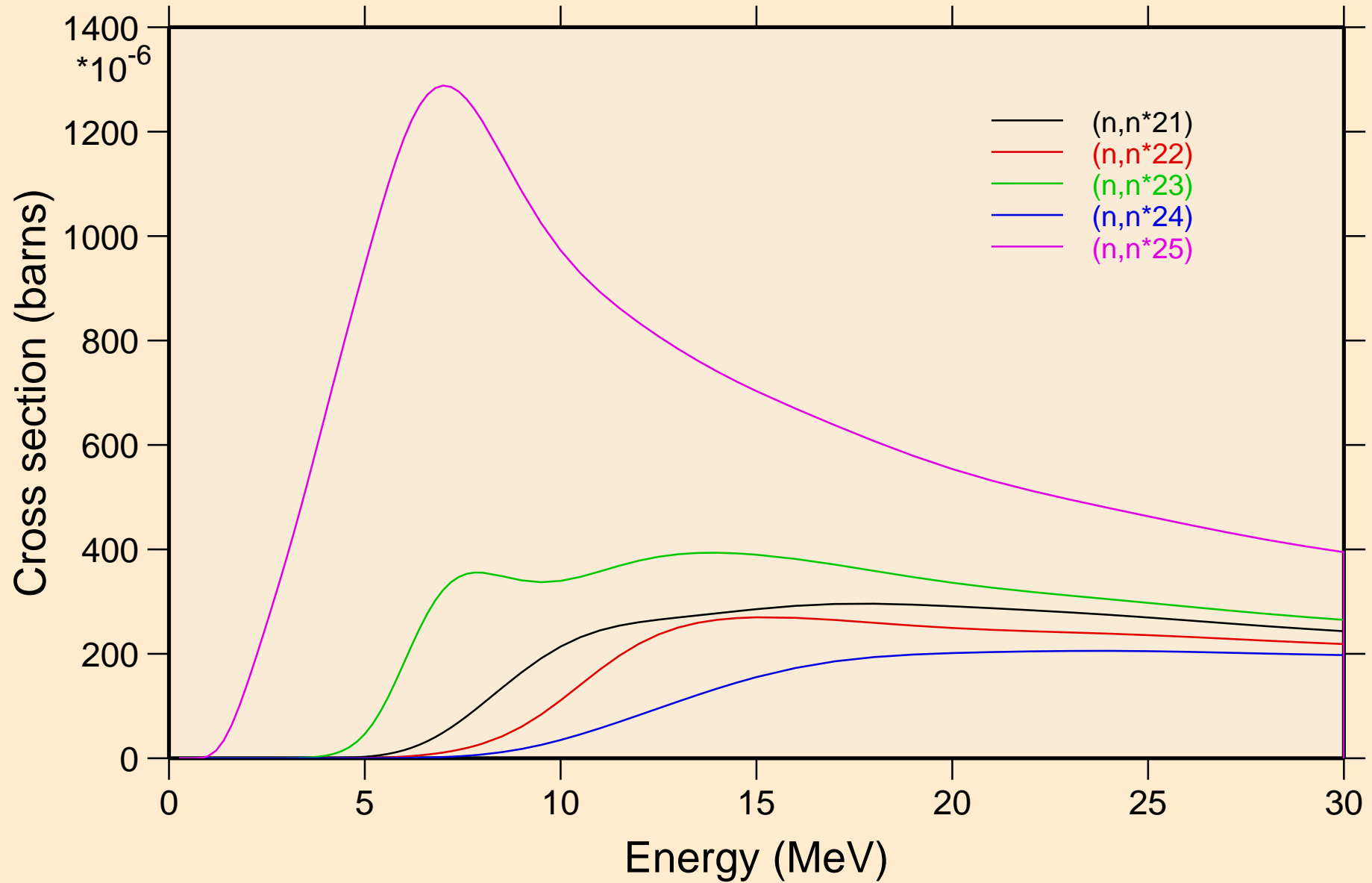

DB266 NEUTRON ACER TENDL-2024 LIBRARY; T=293.6K
Inelastic levels

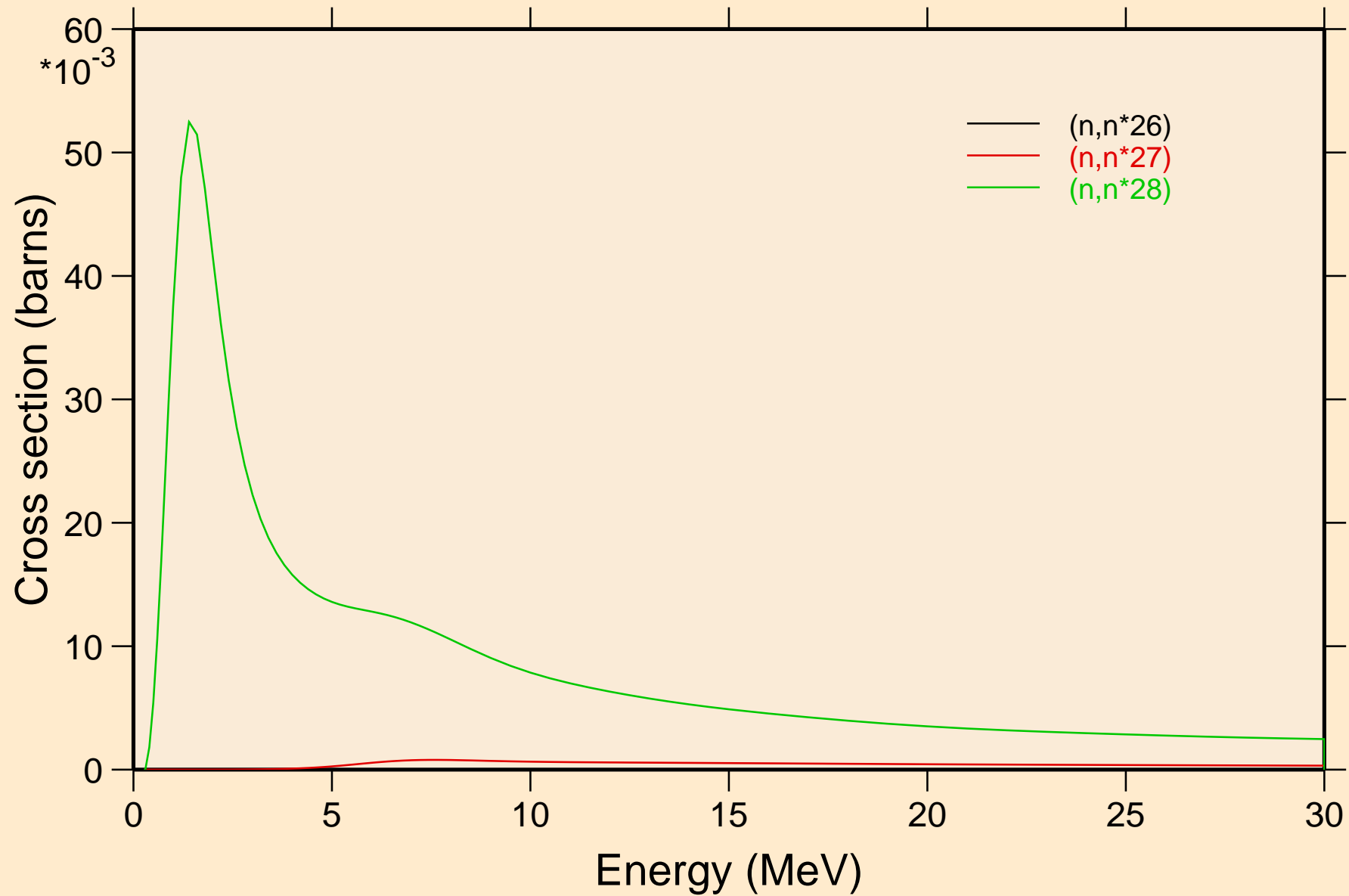

DB266 NEUTRON ACER TENDL-2024 LIBRARY; T=293.6K

Threshold reactions

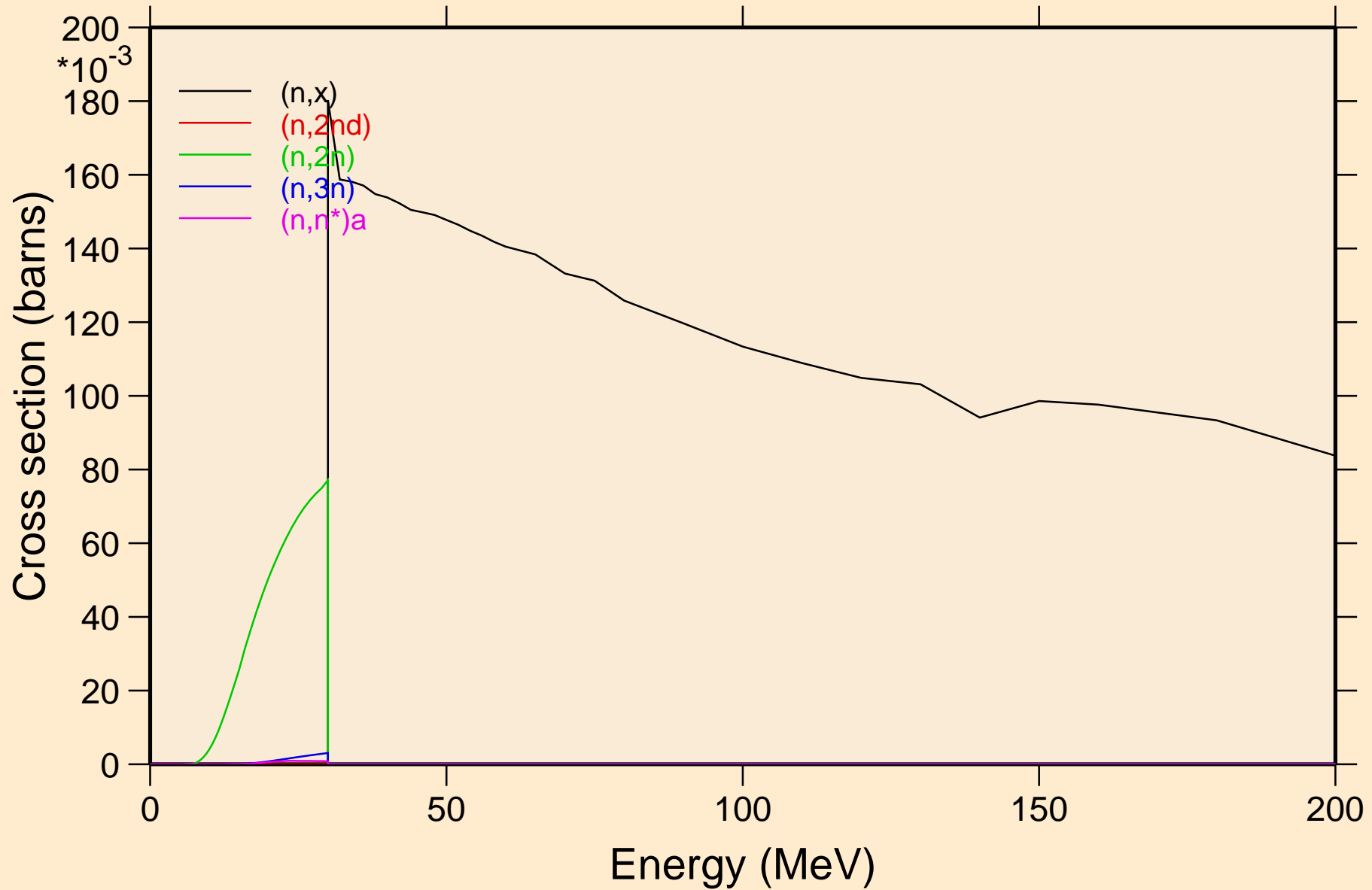

DB266 NEUTRON ACER TENDL-2024 LIBRARY; T=293.6K
Threshold reactions

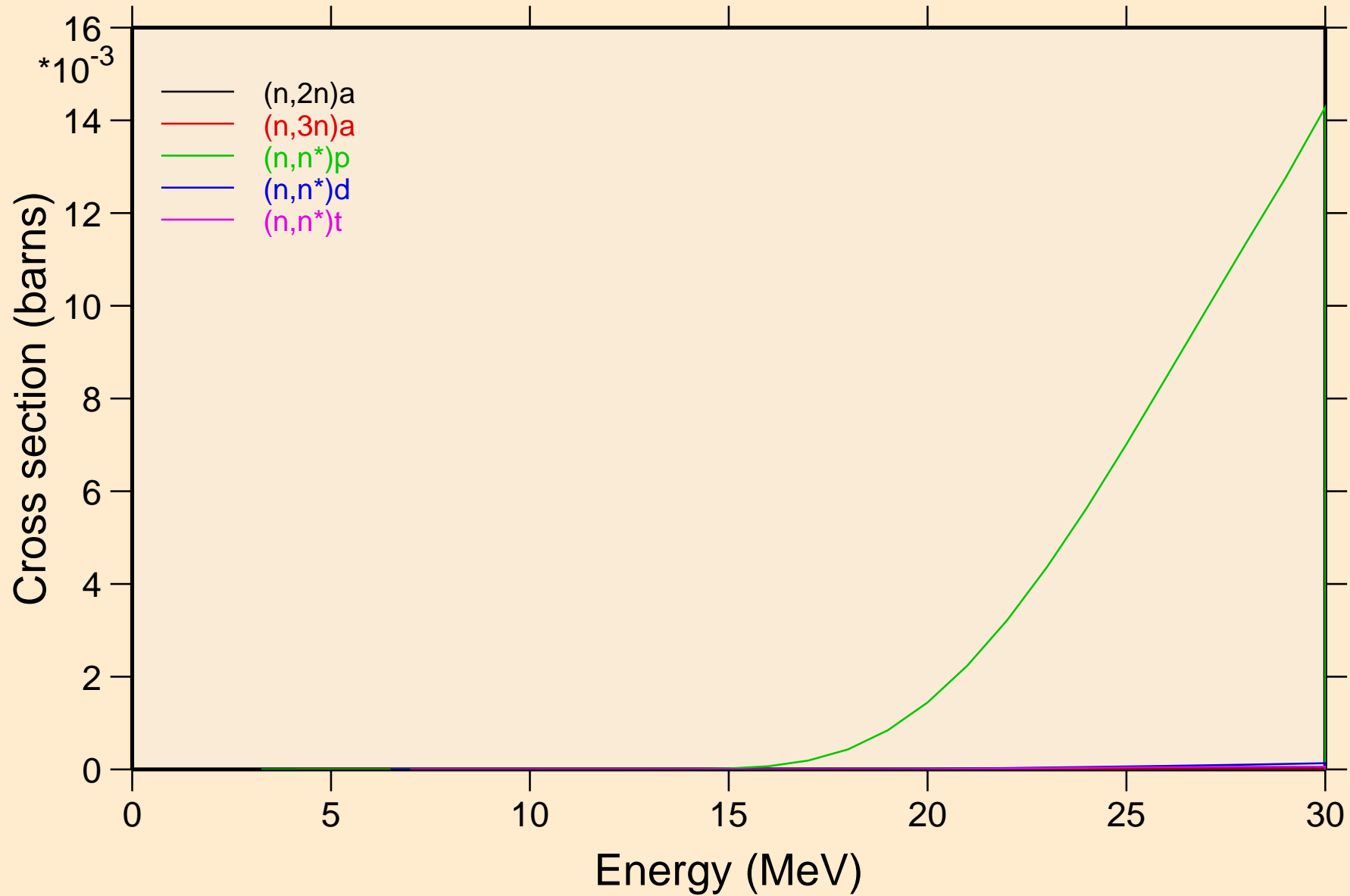

DB266 NEUTRON ACER TENDL-2024 LIBRARY; T=293.6K
Threshold reactions

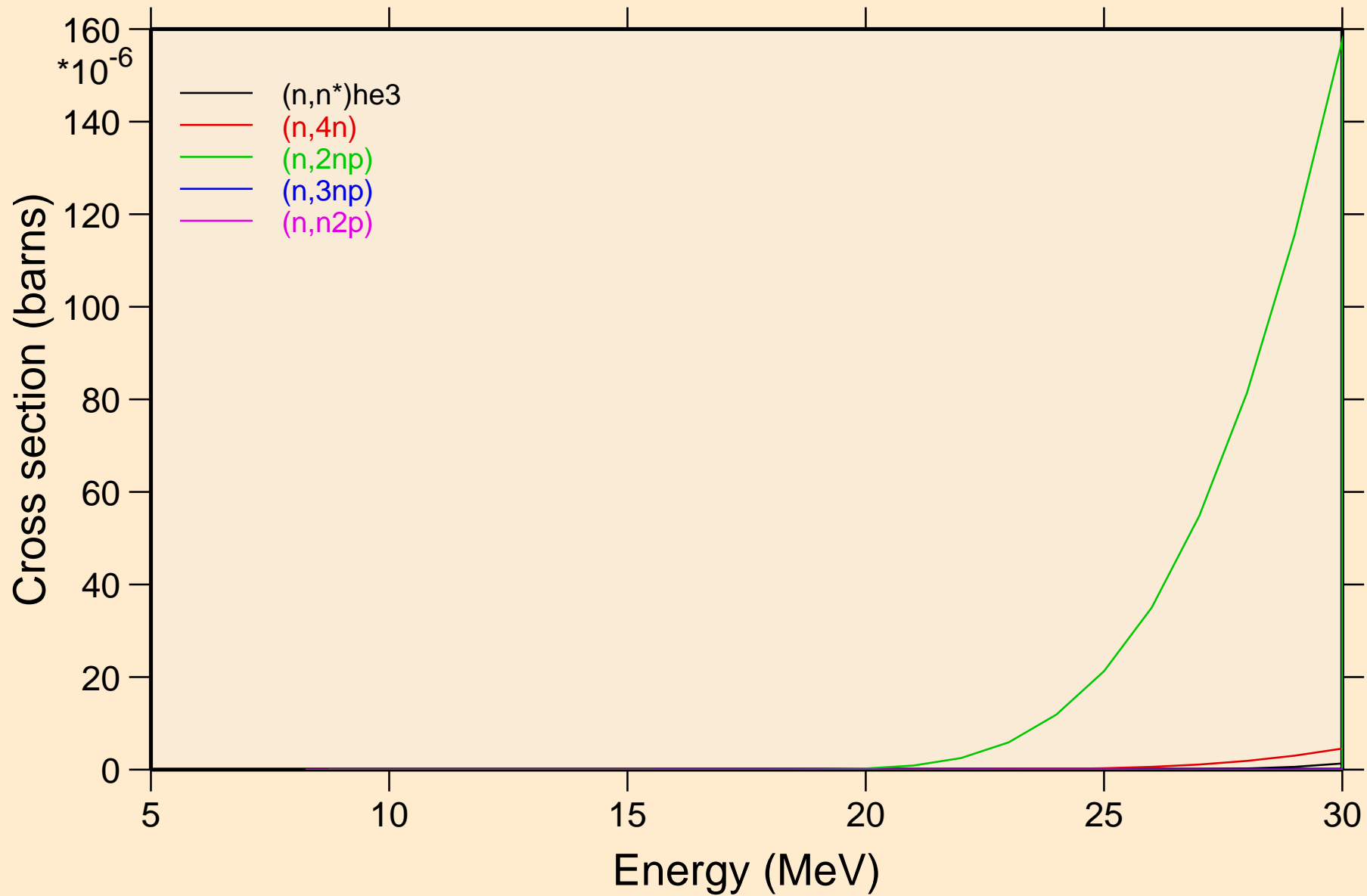

DB266 NEUTRON ACER TENDL-2024 LIBRARY; T=293.6K
Threshold reactions

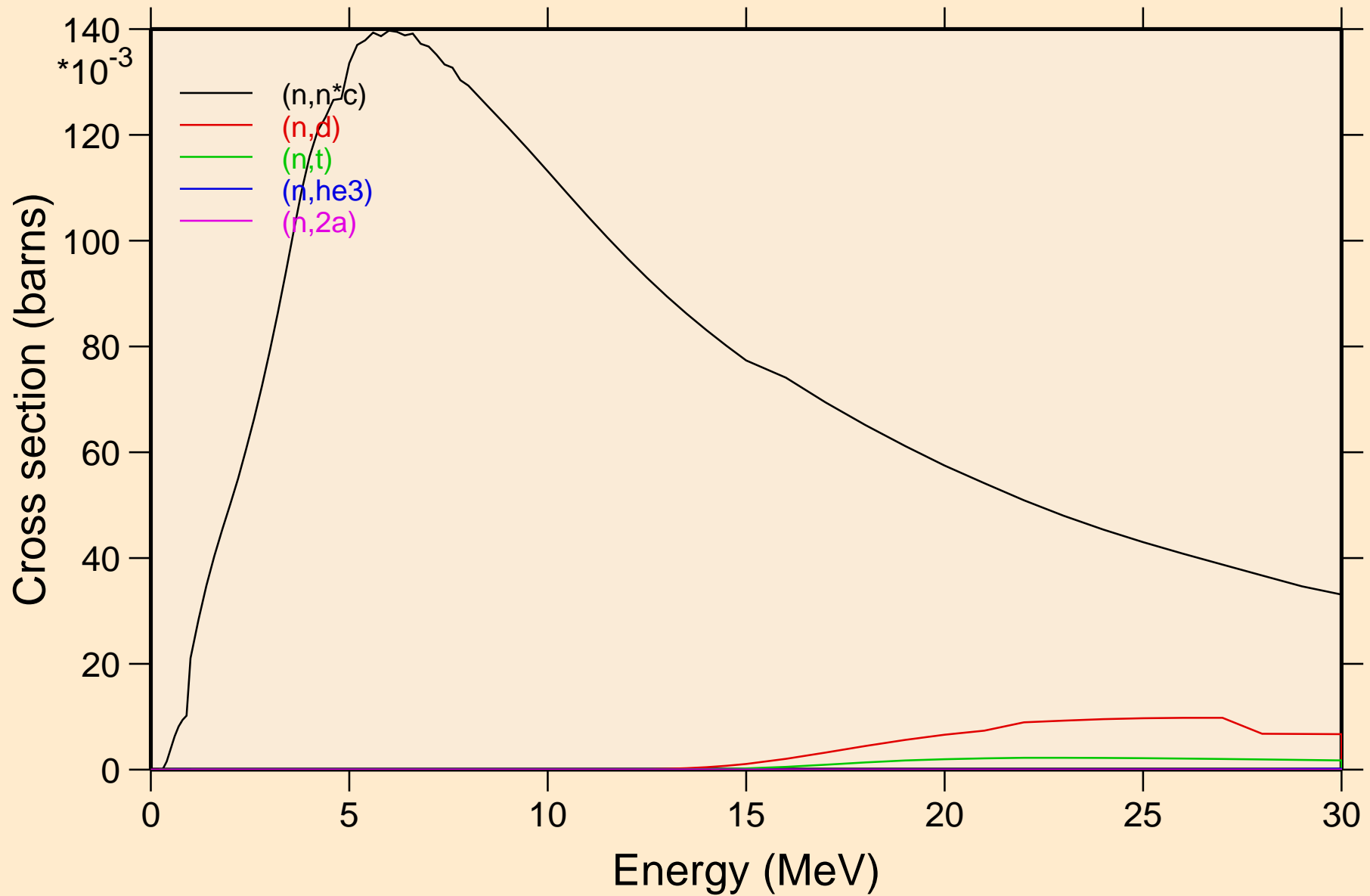

DB266 NEUTRON ACER TENDL-2024 LIBRARY; T=293.6K
Threshold reactions

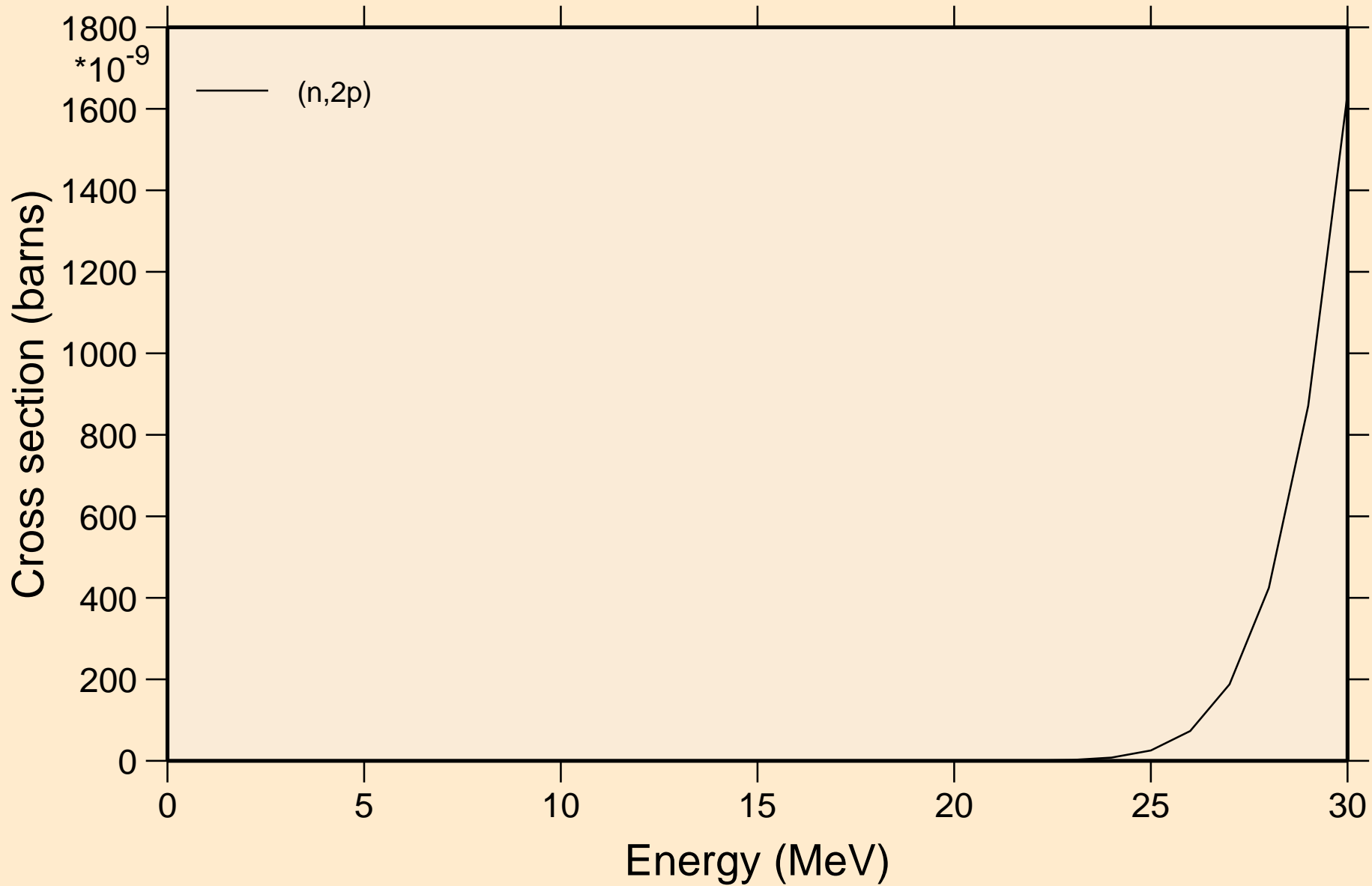

DB266 NEUTRON ACER TENDL-2024 LIBRARY; T=293.6K
Threshold reactions

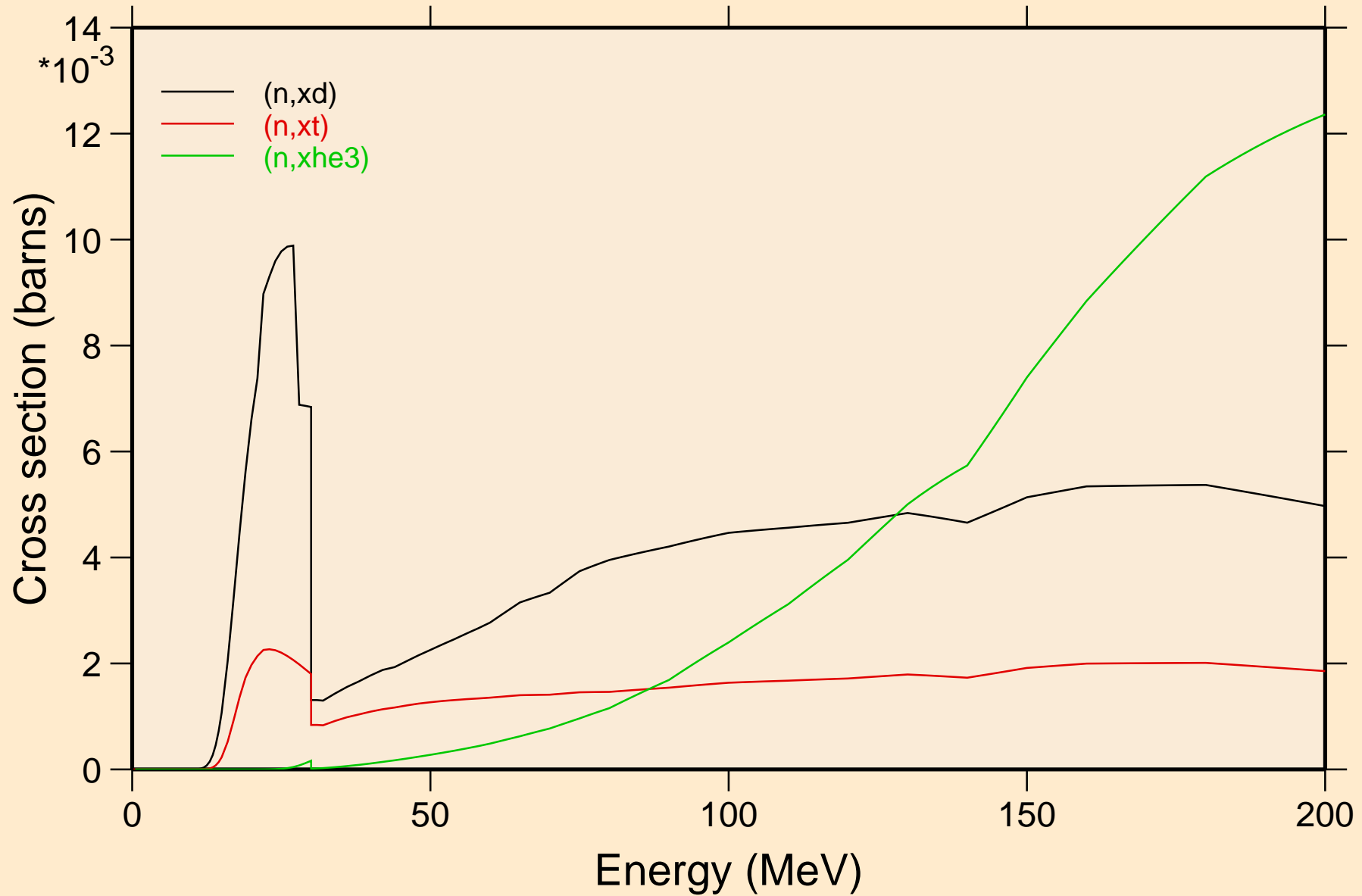

DB266 NEUTRON ACER TENDL-2024 LIBRARY; T=293.6K
angular distribution for elastic

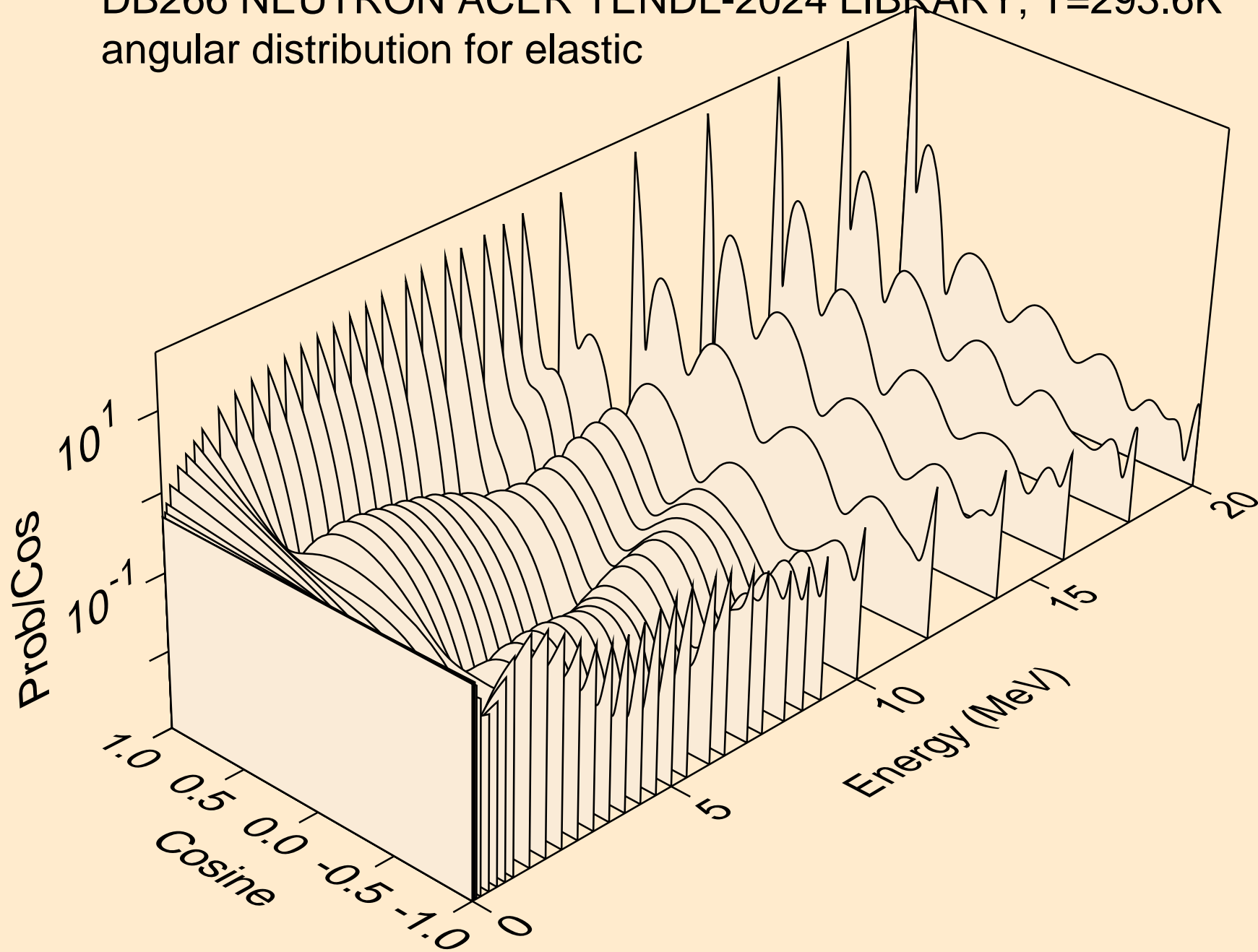

DB266 NEUTRON ACER TENDL-2024 LIBRARY; T=293.6K
angular distribution for elastic

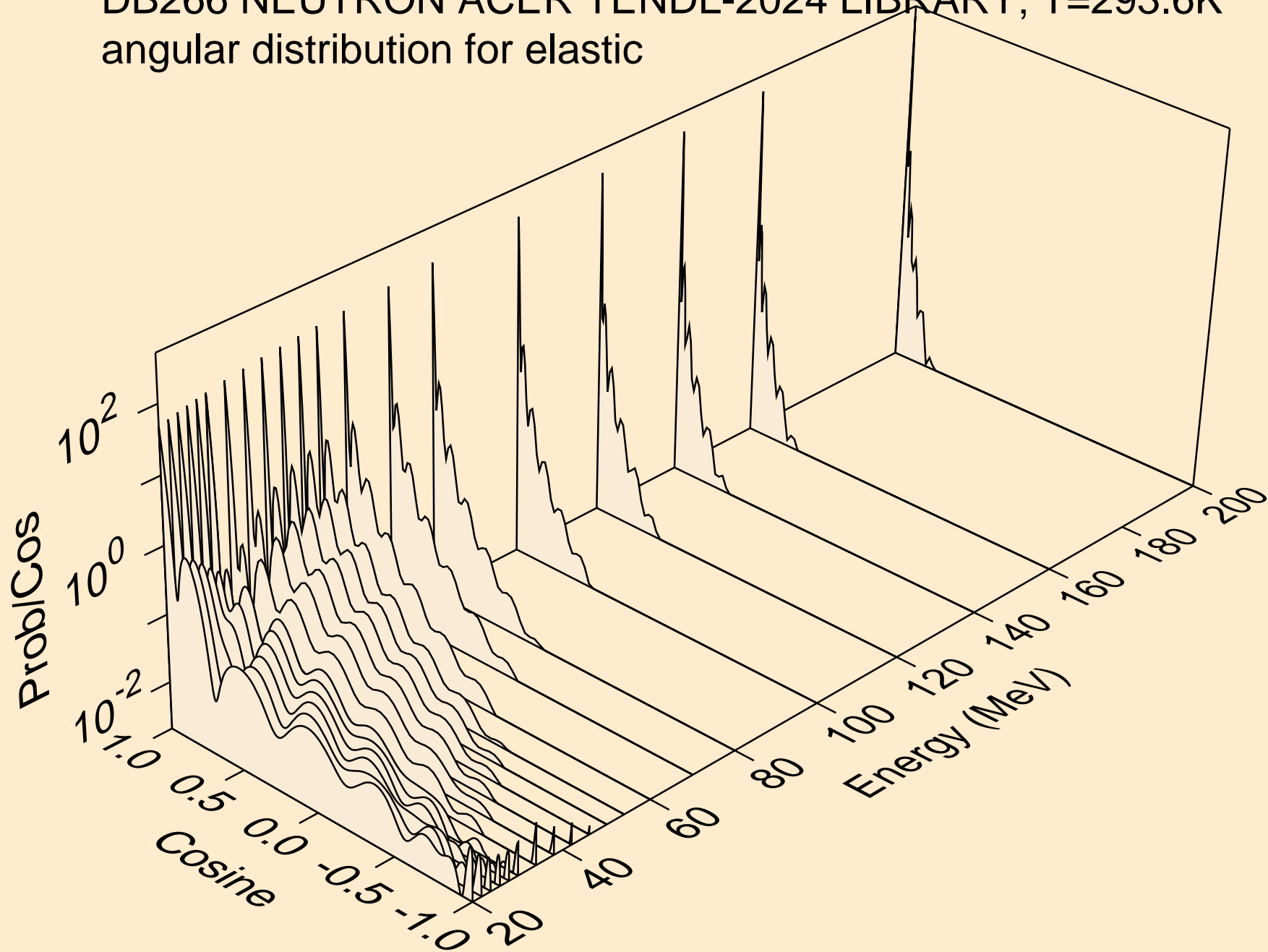

DB266 NEUTRON ACER TENDL-2024 LIBRARY; T=293.6K
angular distribution for (n,n*1)

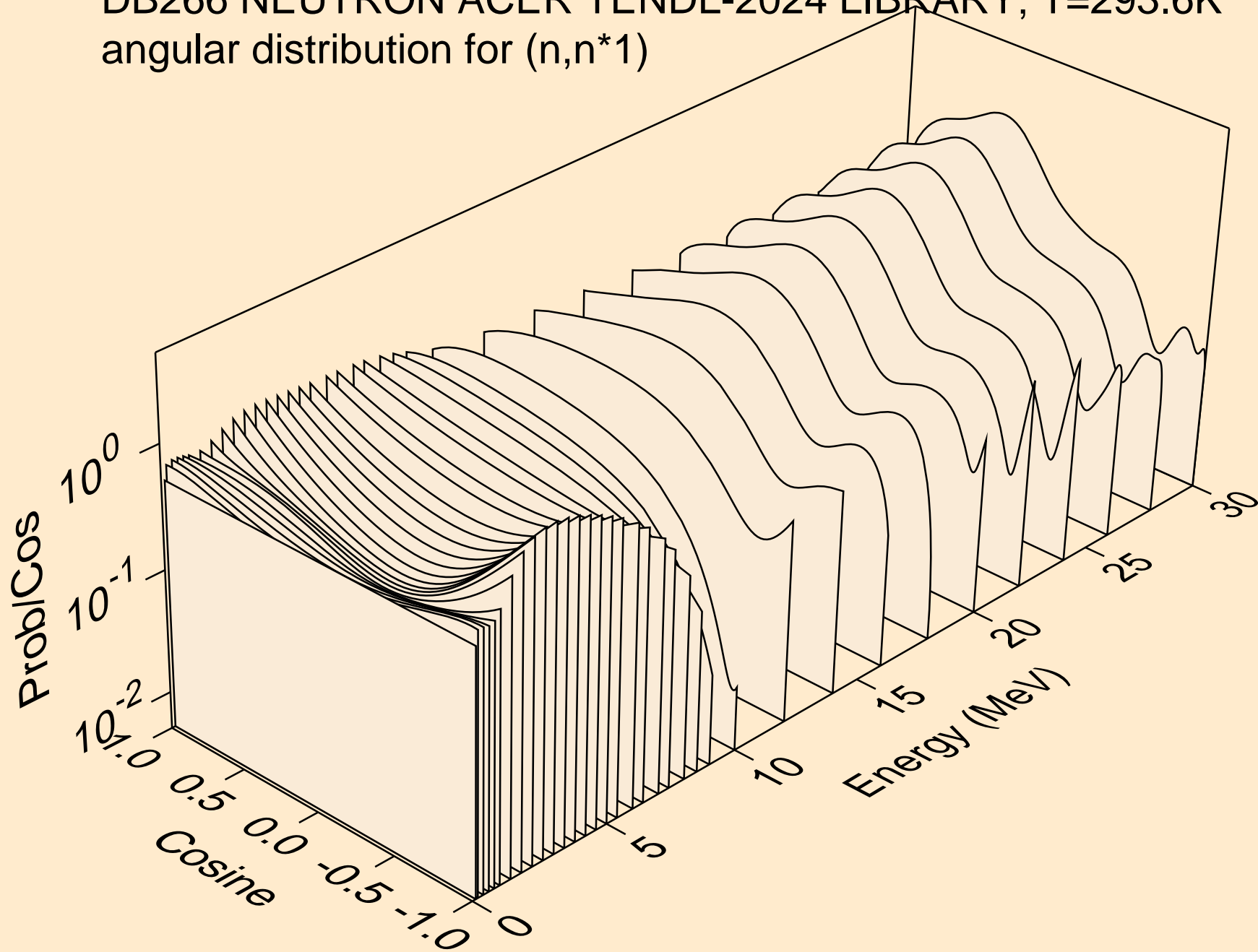

DB266 NEUTRON ACER TENDL-2024 LIBRARY; T=293.6K
angular distribution for (n,n*2)

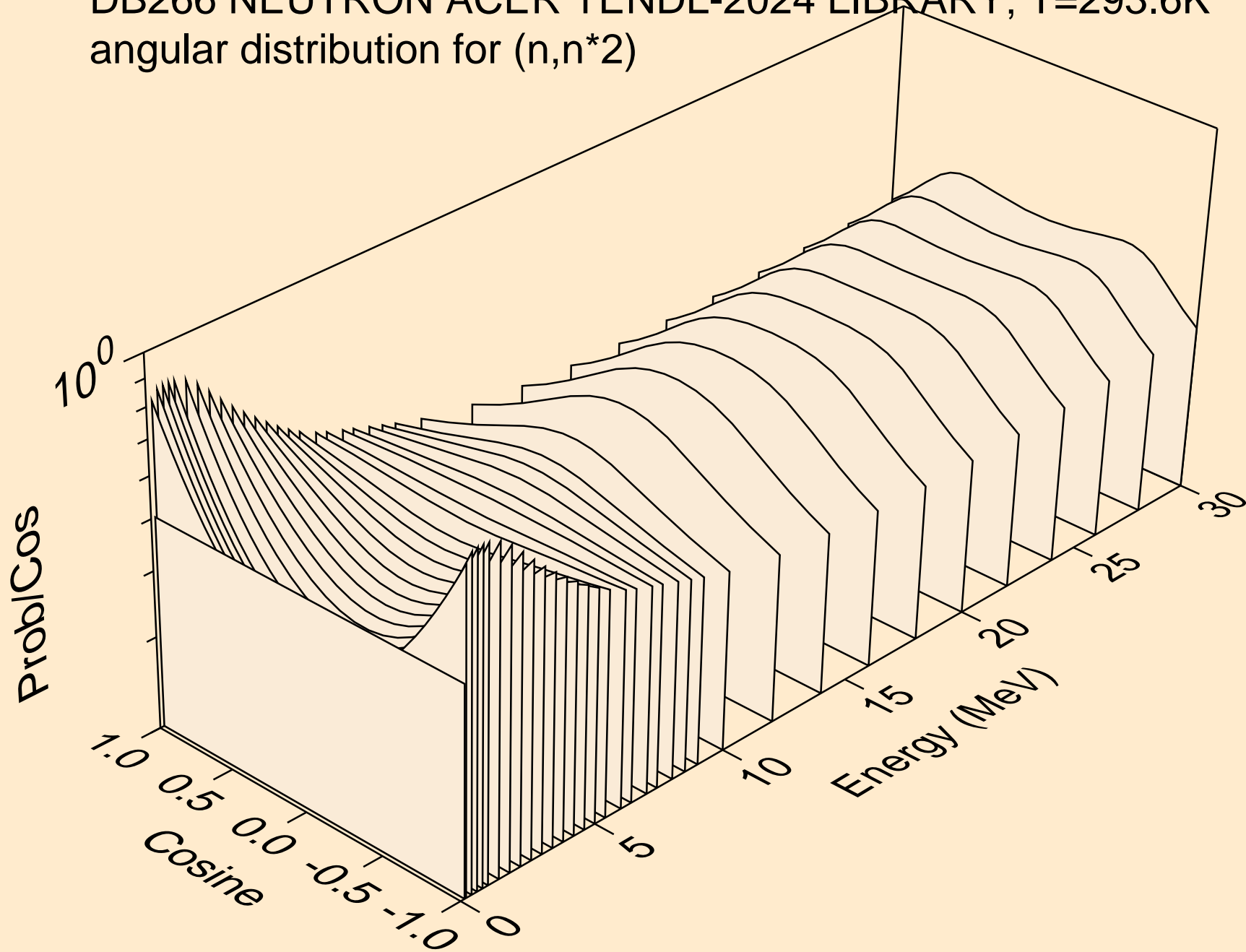

DB266 NEUTRON ACER TENDL-2024 LIBRARY; T=293.6K
angular distribution for (n,n*3)

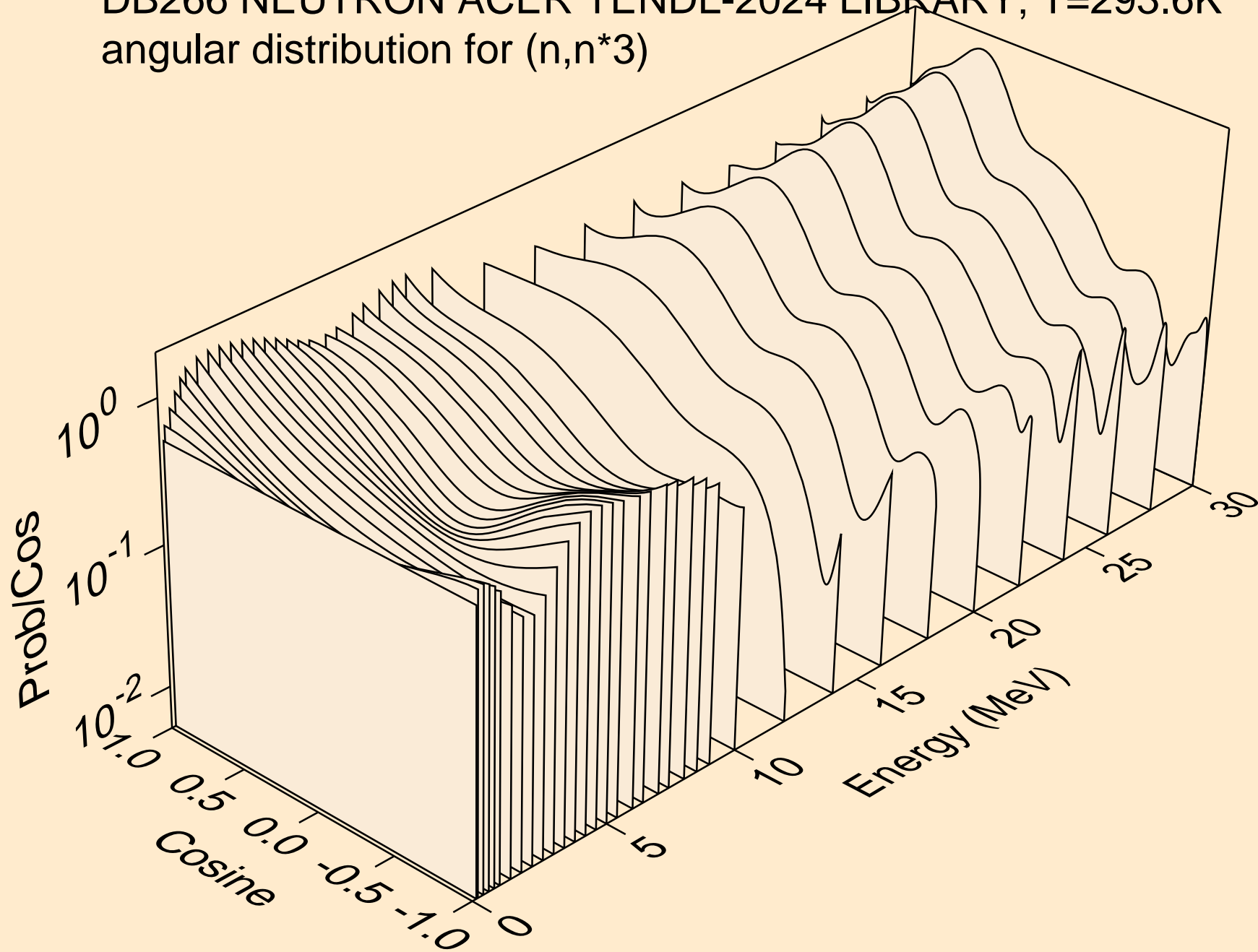

DB266 NEUTRON ACER TENDL-2024 LIBRARY; T=293.6K
angular distribution for (n,n*4)

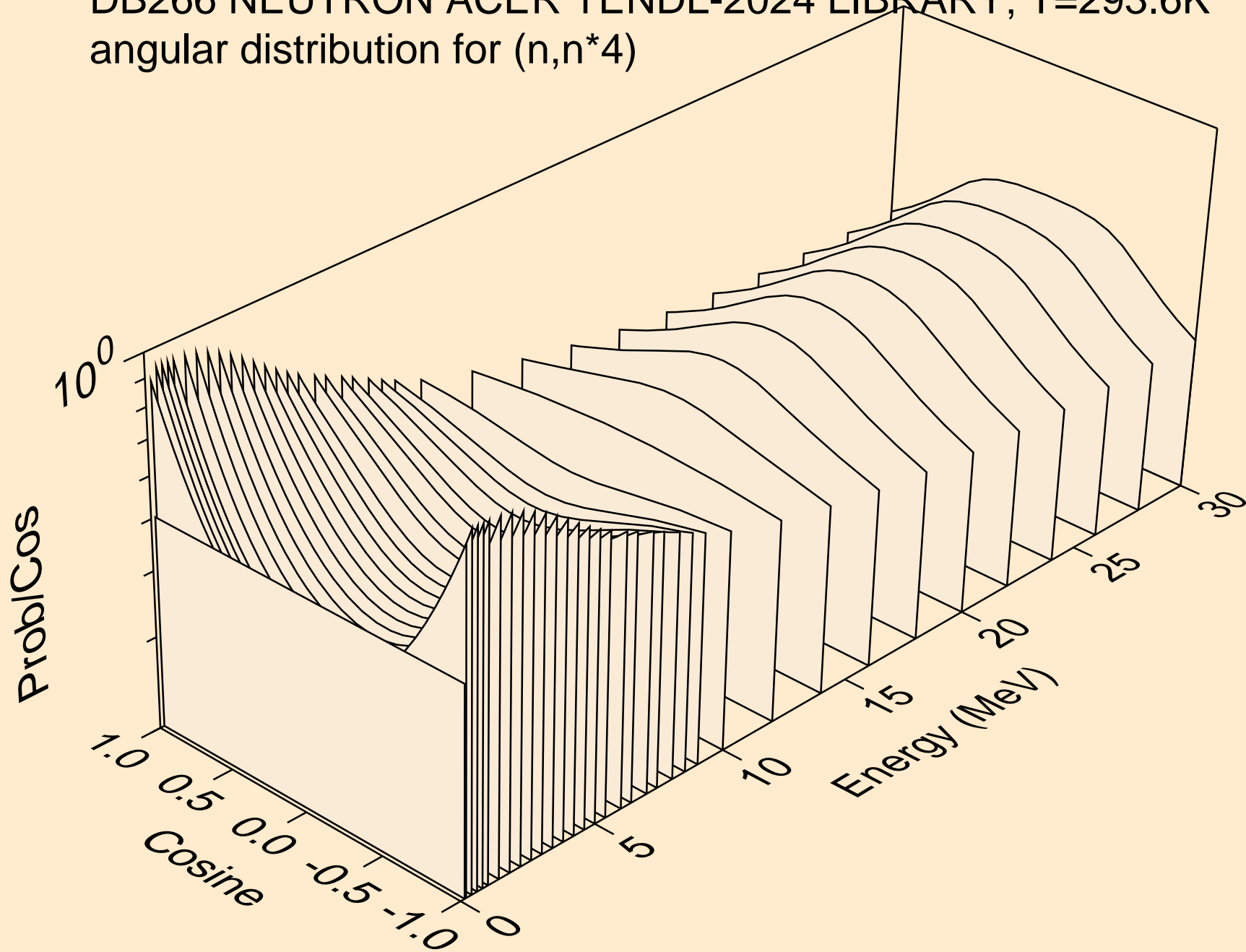

DB266 NEUTRON ACER TENDL-2024 LIBRARY; T=293.6K
angular distribution for (n,n*5)

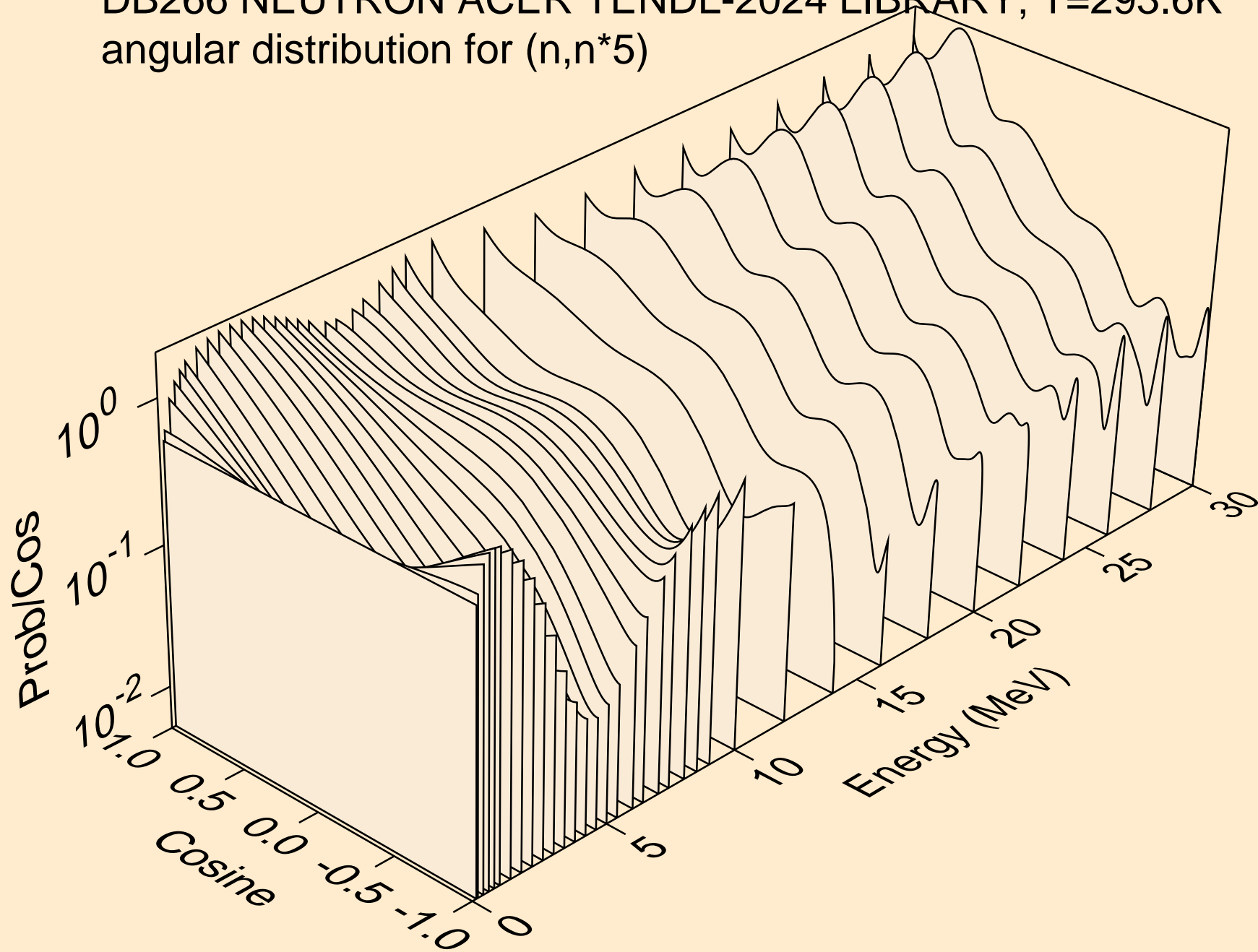

DB266 NEUTRON ACER TENDL-2024 LIBRARY; T=293.6K
angular distribution for (n,n*6)

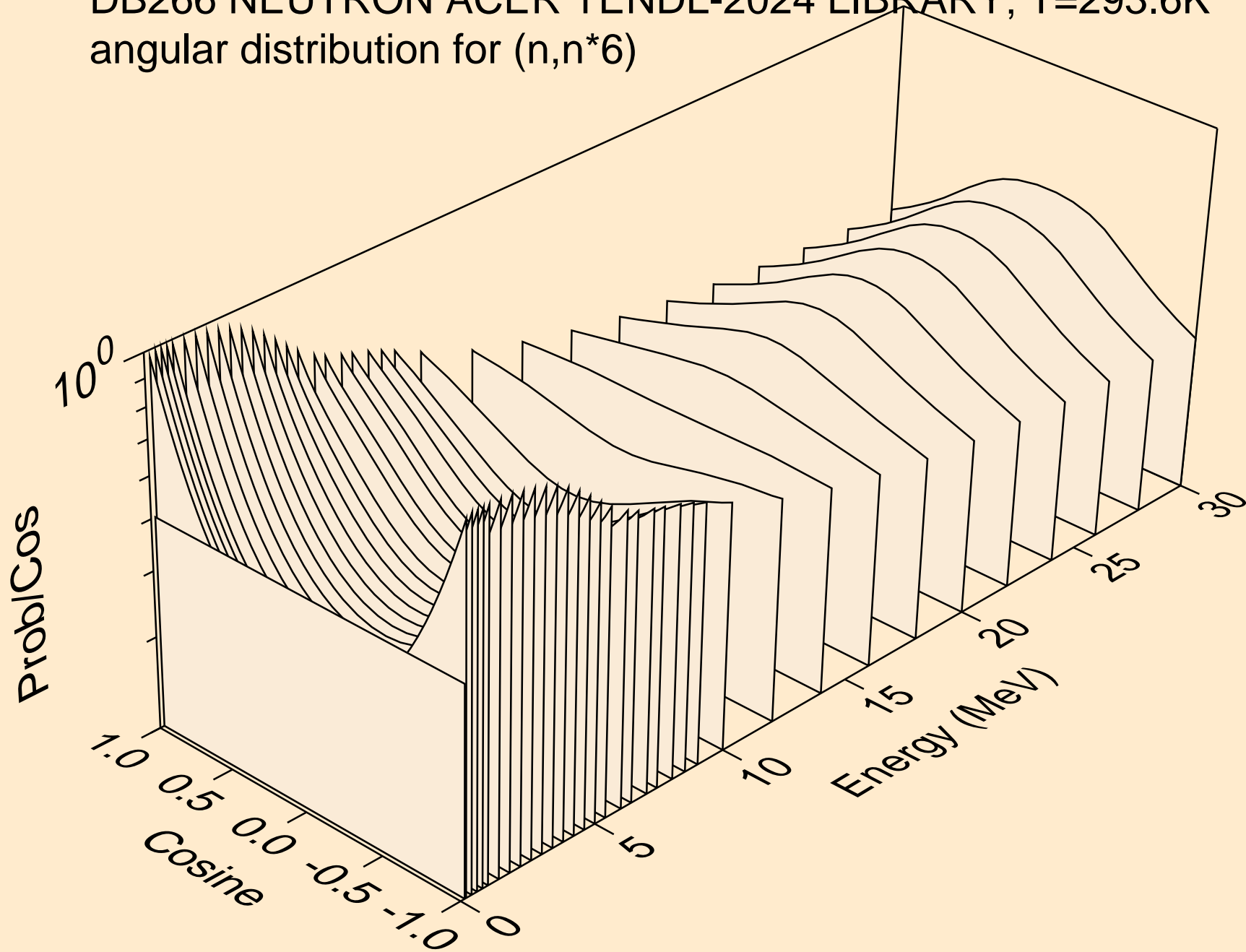

DB266 NEUTRON ACER TENDL-2024 LIBRARY; T=293.6K
angular distribution for (n,n*7)

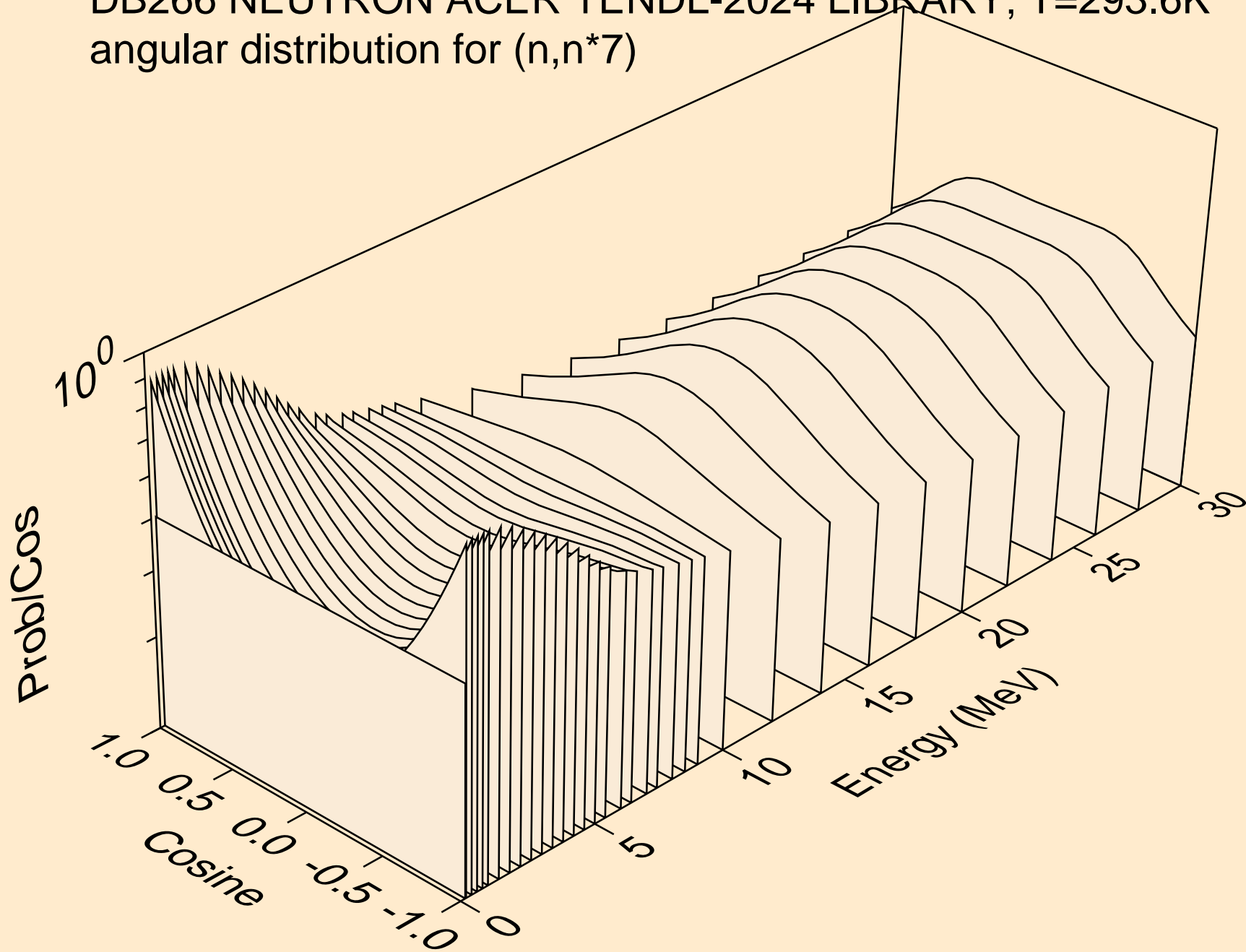

DB266 NEUTRON ACER TENDL-2024 LIBRARY; T=293.6K
angular distribution for (n,n*8)

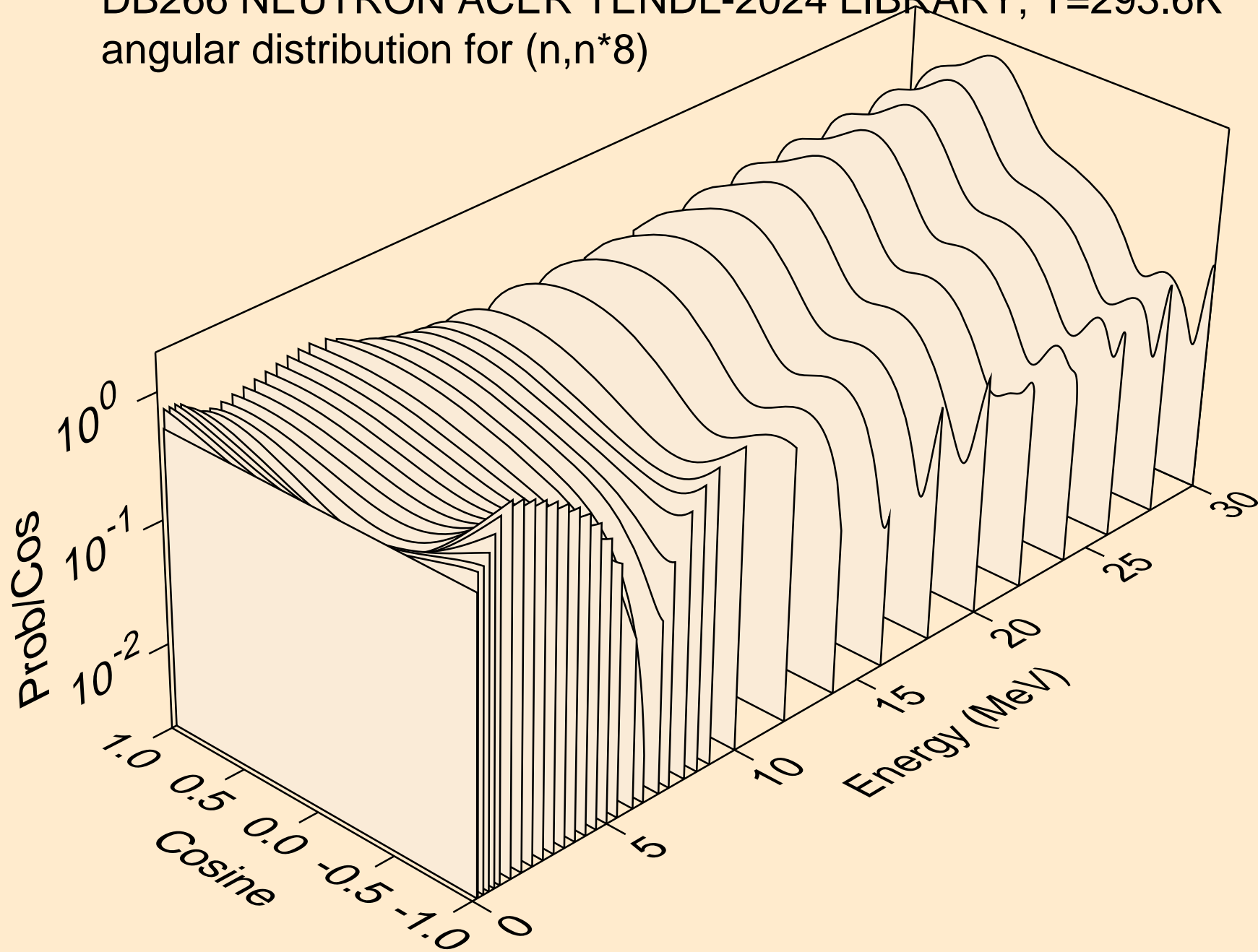

DB266 NEUTRON ACER TENDL-2024 LIBRARY; T=293.6K
angular distribution for (n,n*9)

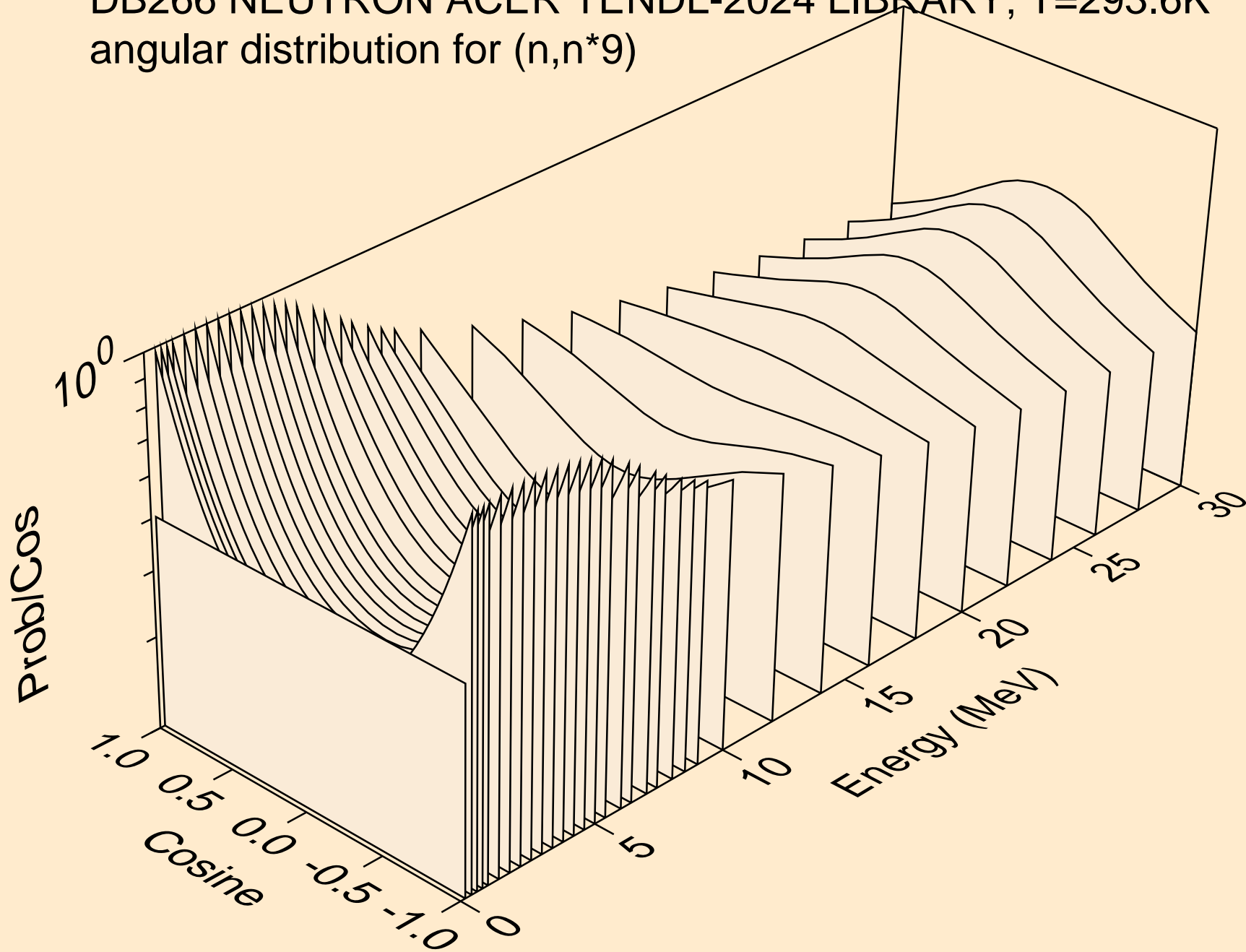

DB266 NEUTRON ACER TENDL-2024 LIBRARY; T=293.6K
angular distribution for (n,n*10)

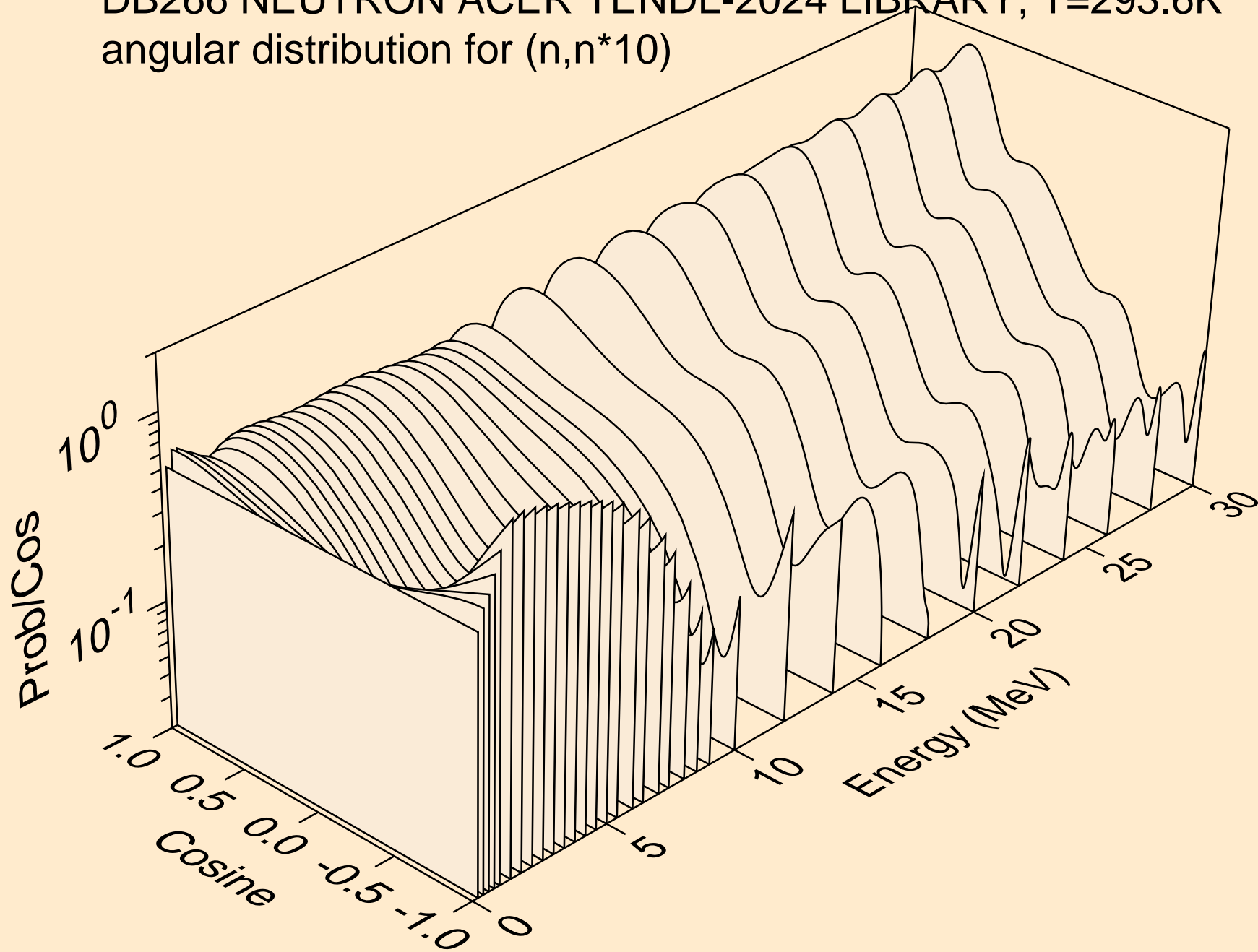

DB266 NEUTRON ACER TENDL-2024 LIBRARY; T=293.6K
angular distribution for (n,n*11)

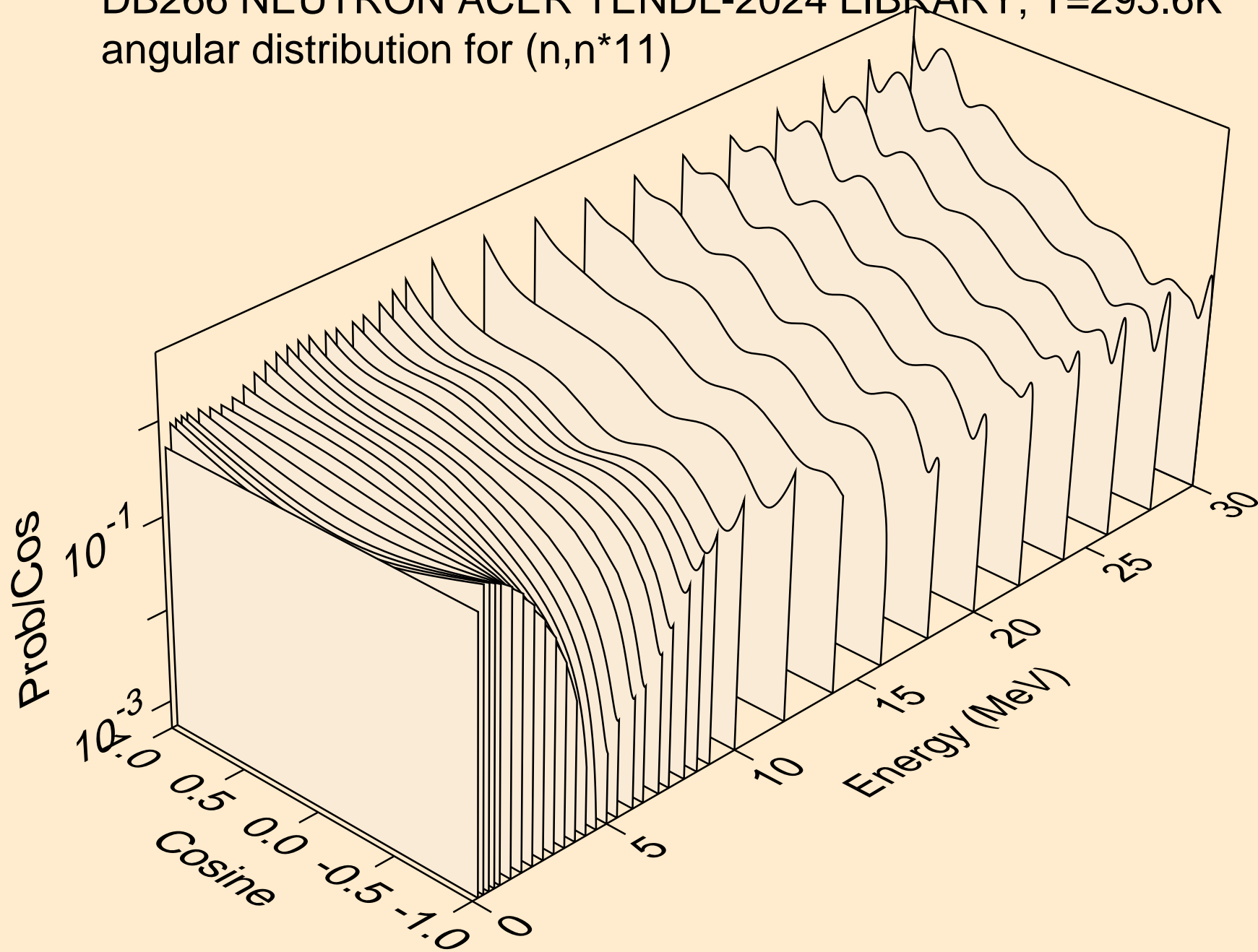

DB266 NEUTRON ACER TENDL-2024 LIBRARY; T=293.6K
angular distribution for (n,n*12)

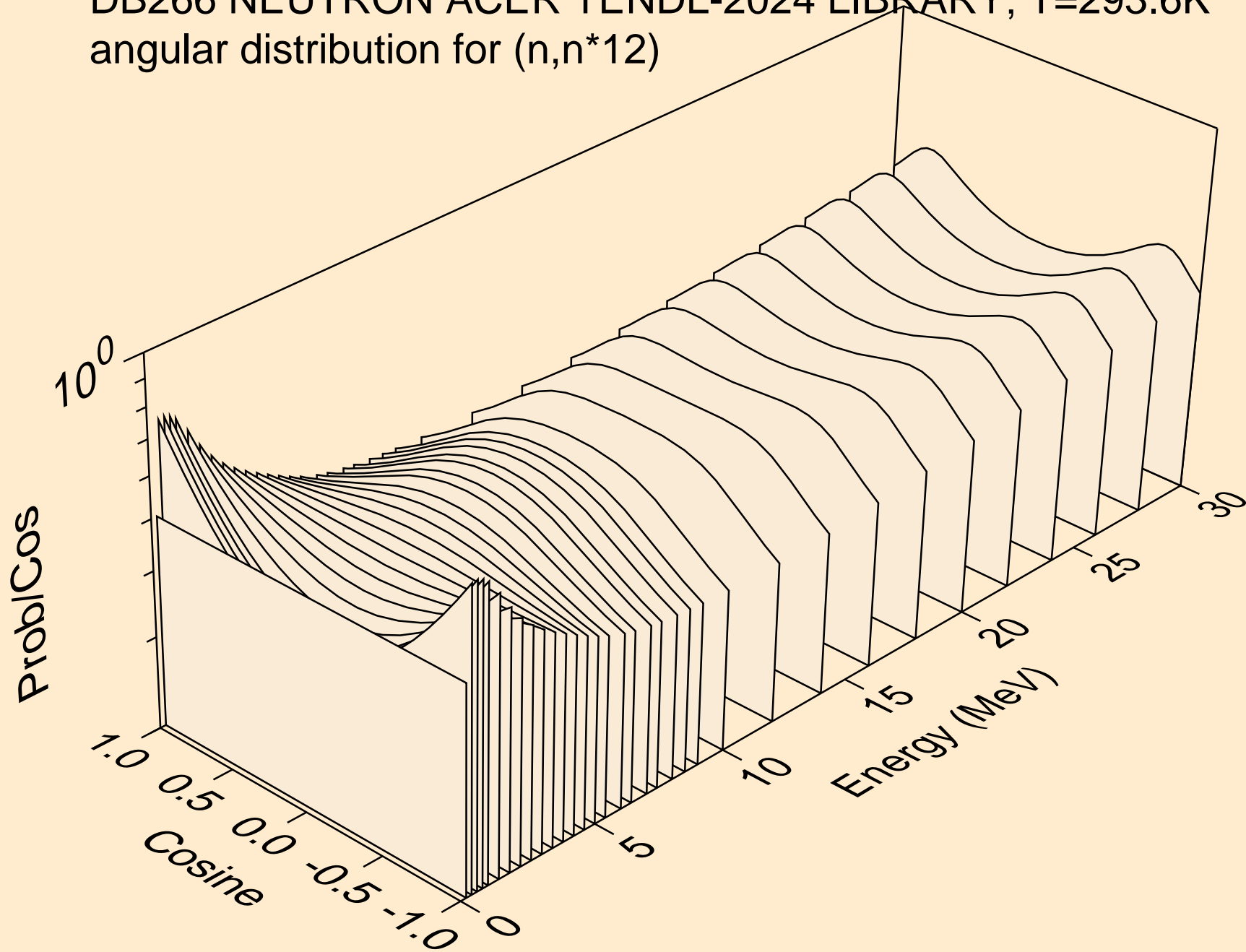

DB266 NEUTRON ACER TENDL-2024 LIBRARY; T=293.6K
angular distribution for (n,n*13)

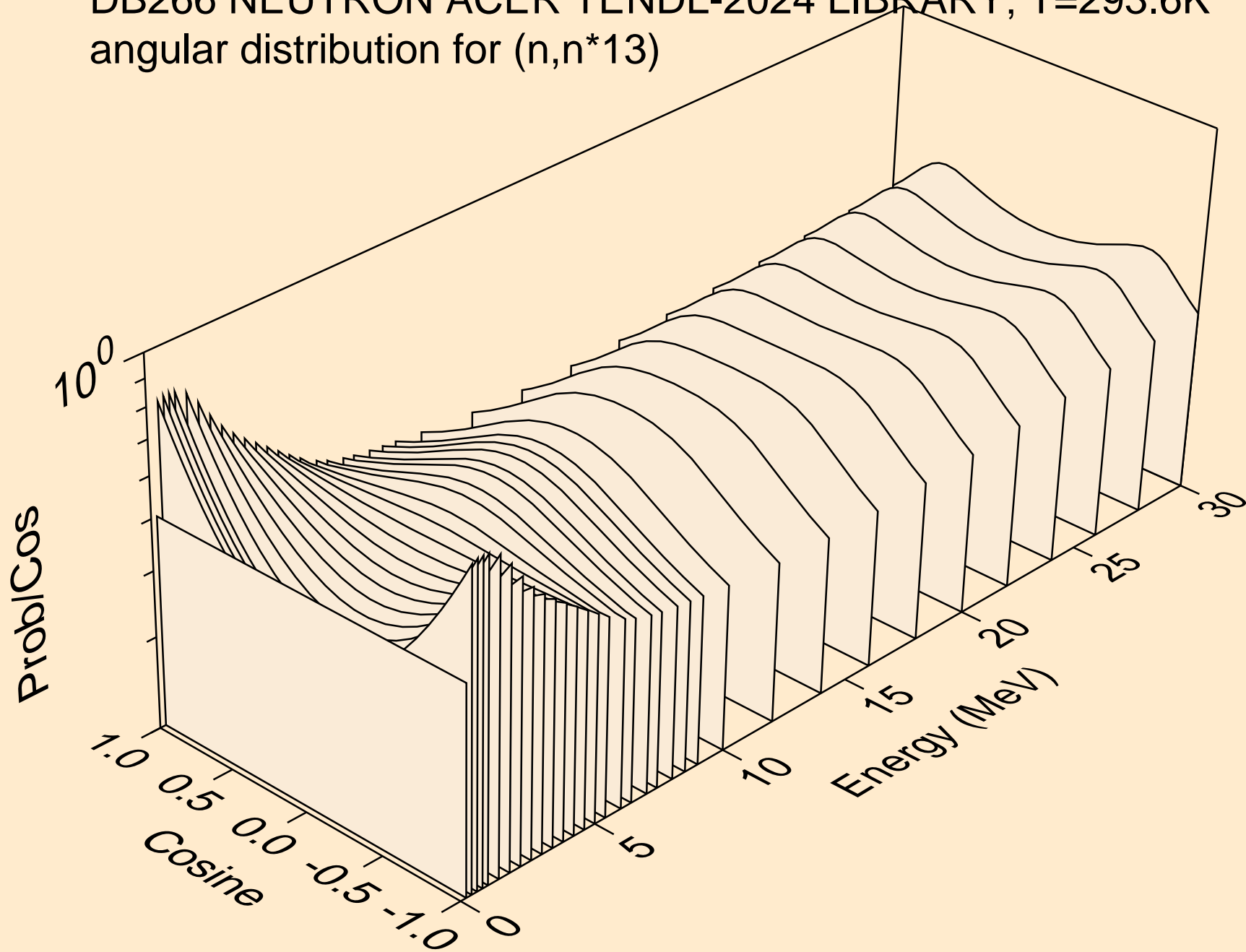

DB266 NEUTRON ACER TENDL-2024 LIBRARY; T=293.6K
angular distribution for (n,n*14)

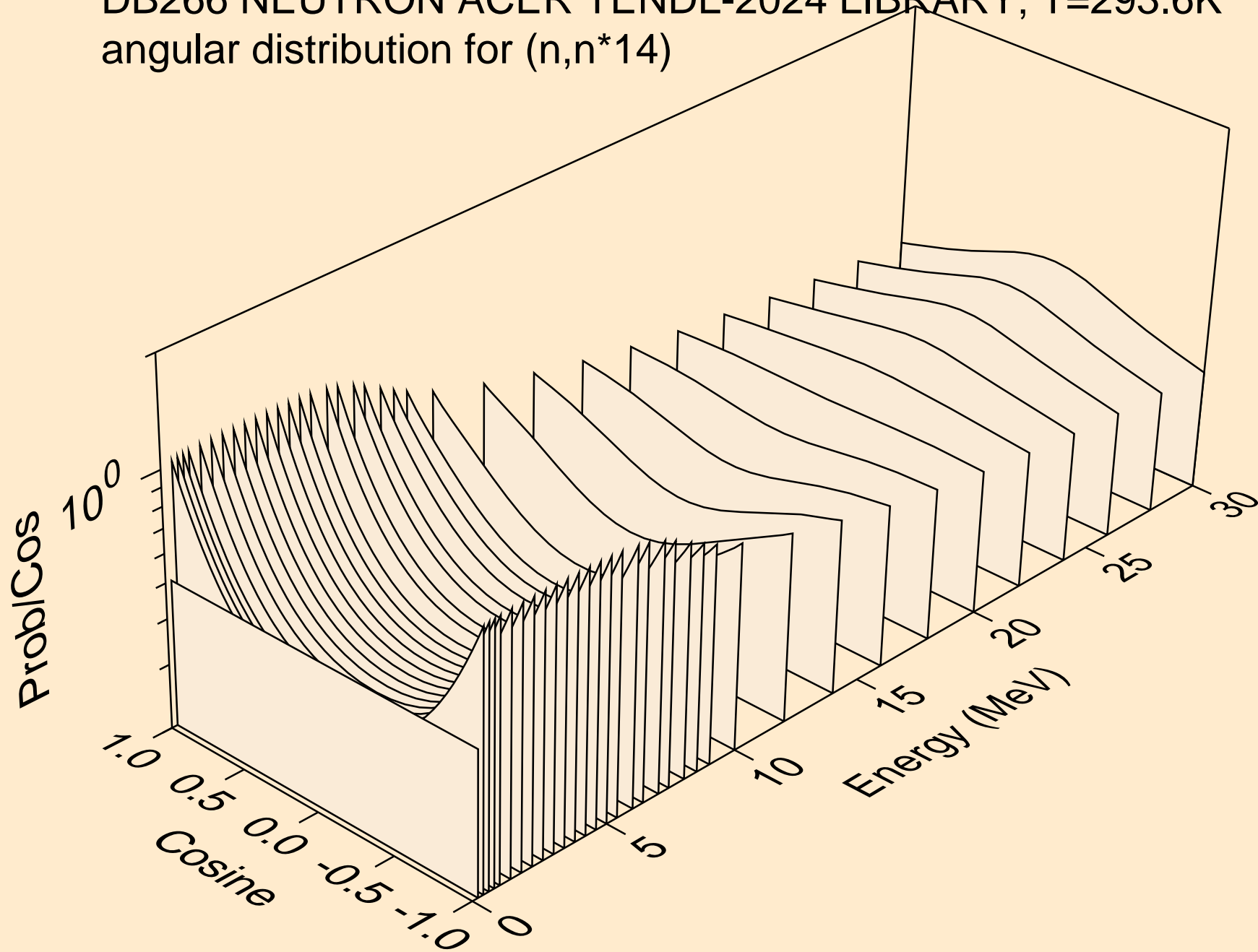

DB266 NEUTRON ACER TENDL-2024 LIBRARY; T=293.6K
angular distribution for (n,n*15)

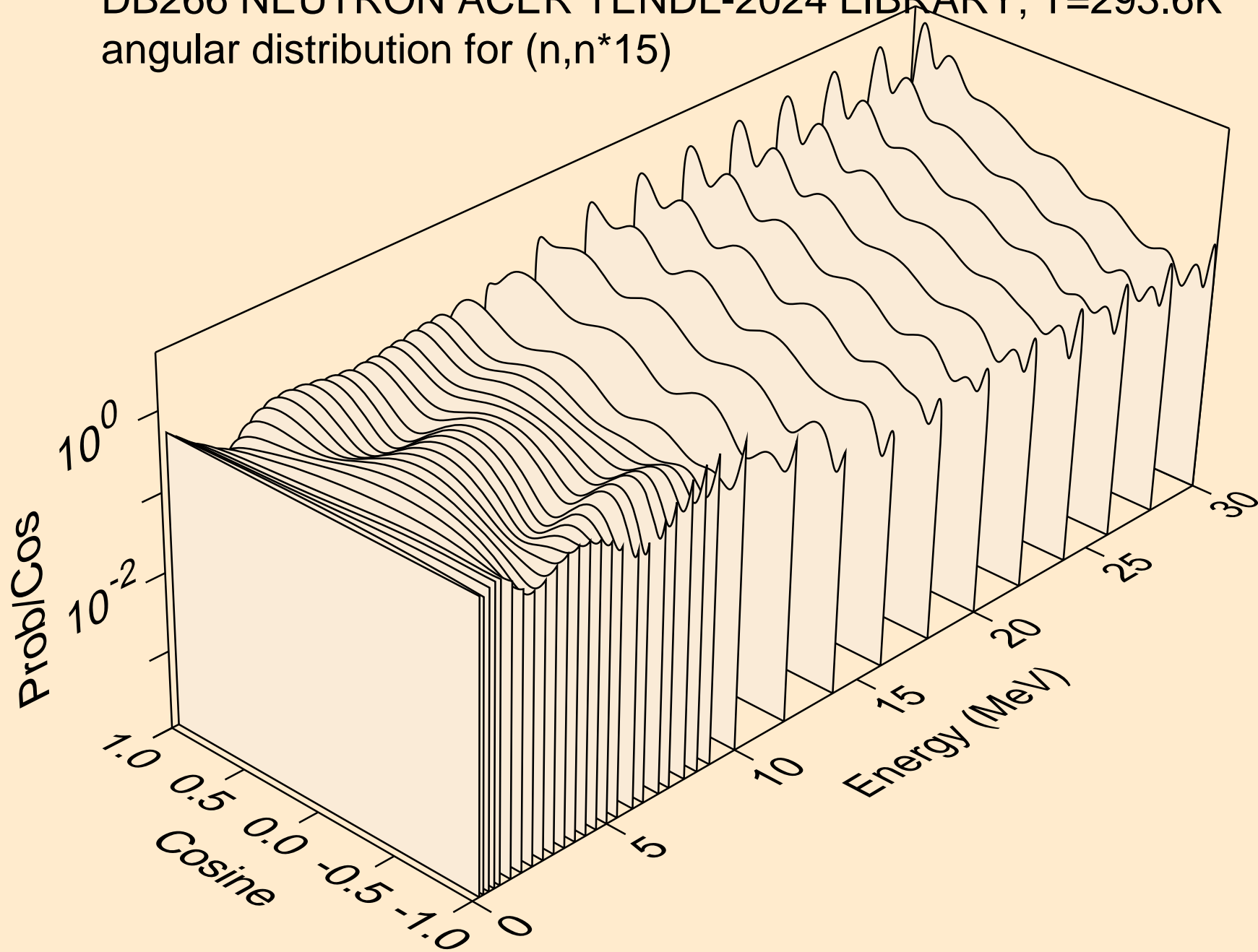

DB266 NEUTRON ACER TENDL-2024 LIBRARY; T=293.6K
angular distribution for (n,n*16)

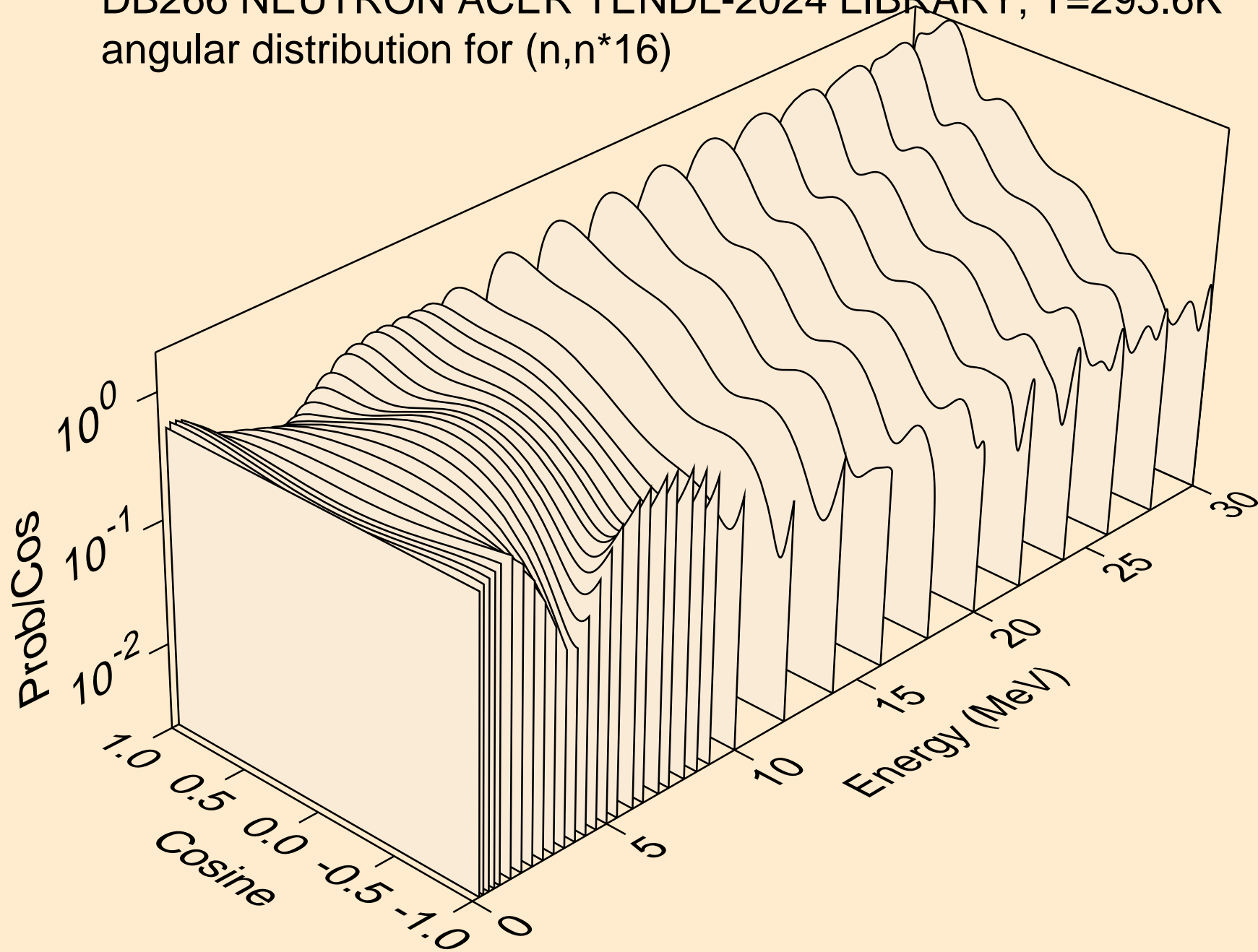

DB266 NEUTRON ACER TENDL-2024 LIBRARY; T=293.6K
angular distribution for (n,n*17)

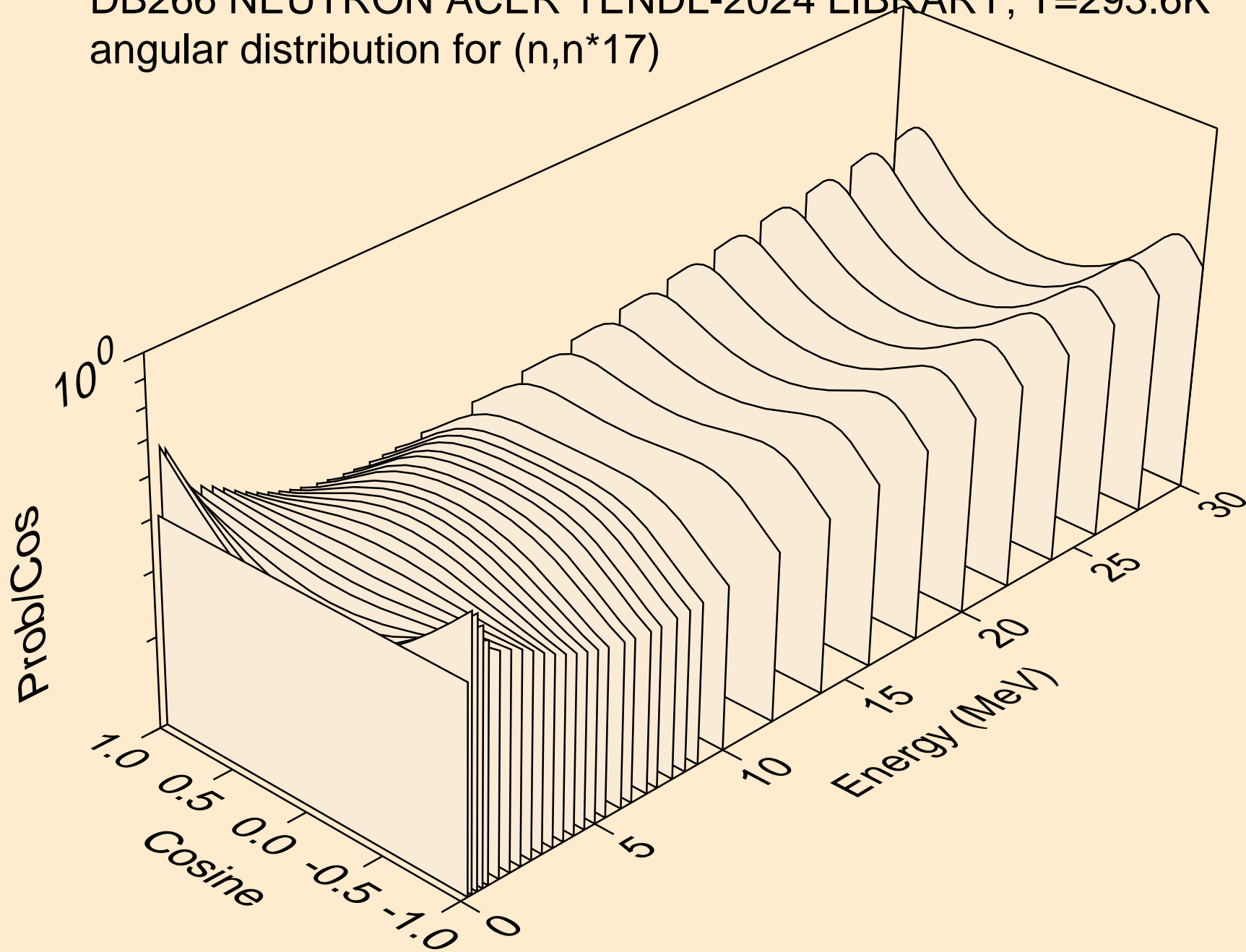

DB266 NEUTRON ACER TENDL-2024 LIBRARY; T=293.6K
angular distribution for (n,n*18)

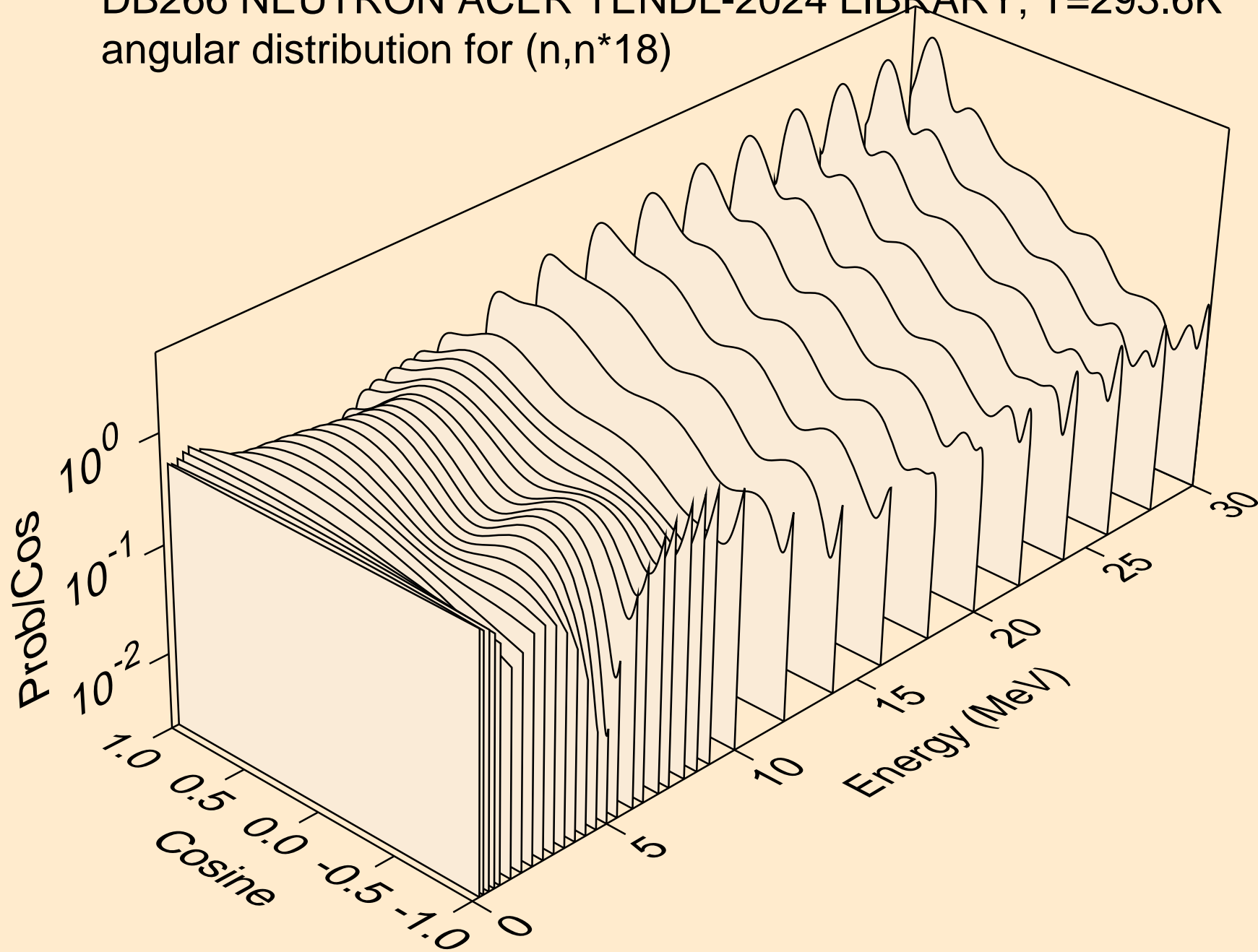

DB266 NEUTRON ACER TENDL-2024 LIBRARY; T=293.6K
angular distribution for (n,n*19)

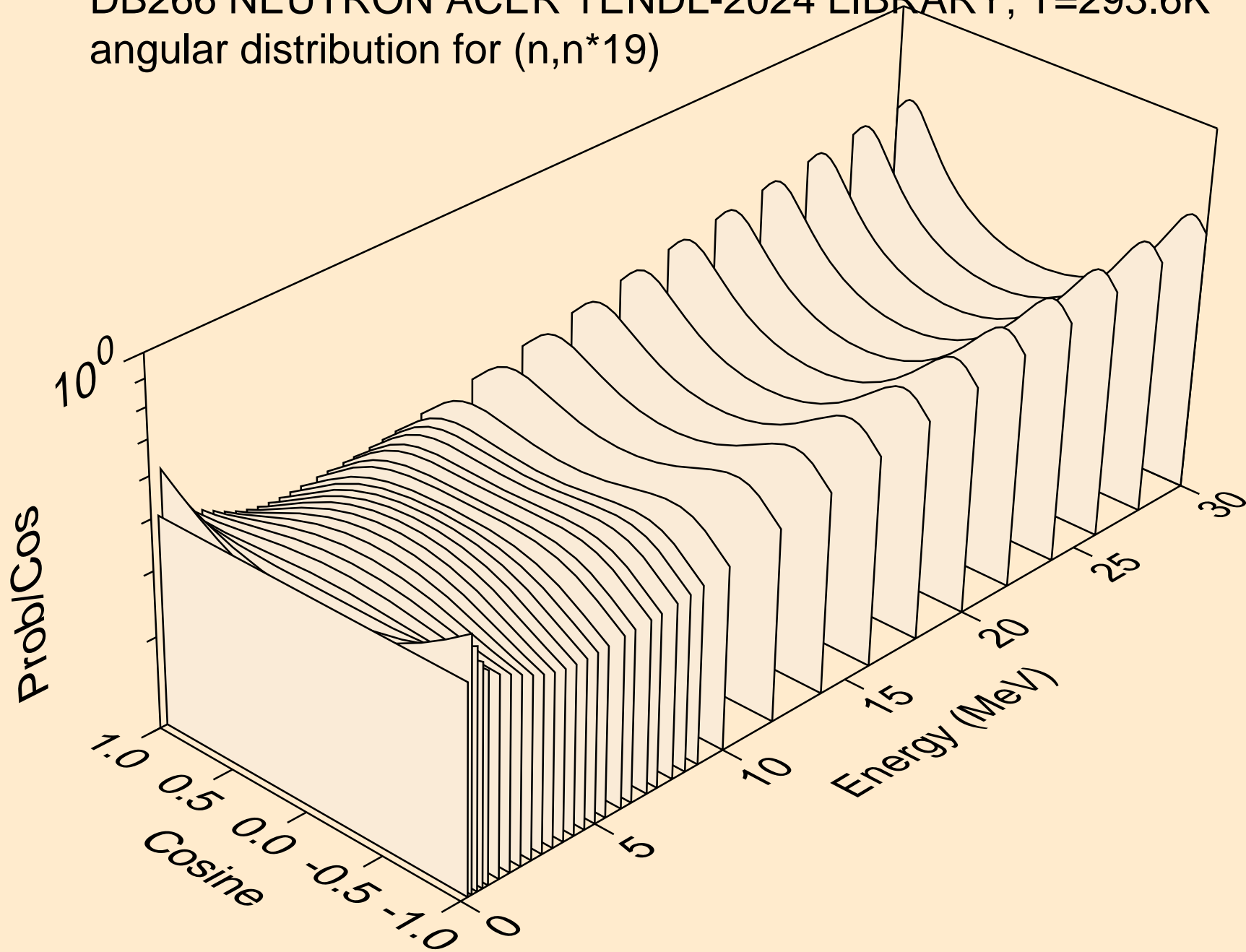

DB266 NEUTRON ACER TENDL-2024 LIBRARY; T=293.6K
angular distribution for (n,n*20)

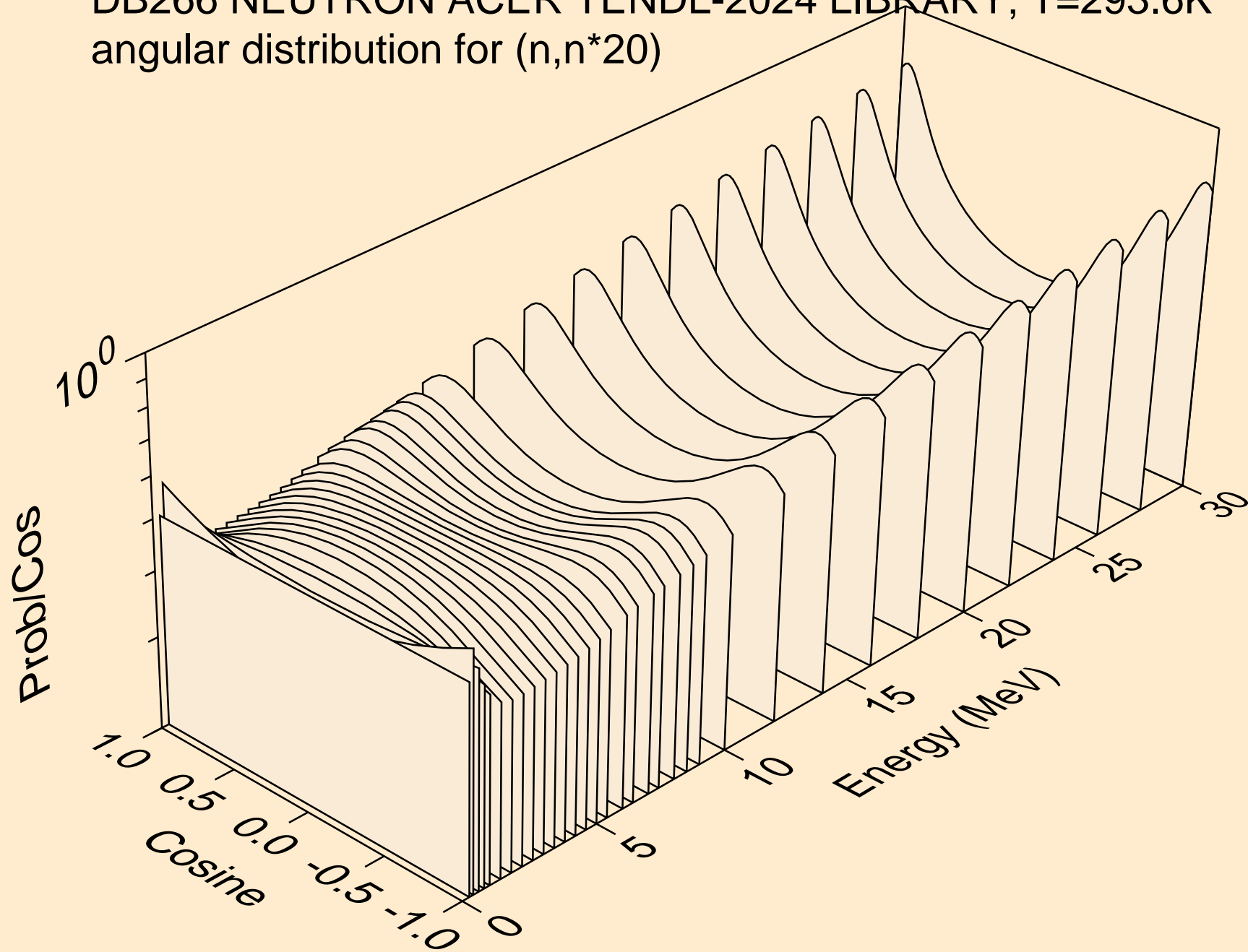

DB266 NEUTRON ACER TENDL-2024 LIBRARY; T=293.6K
angular distribution for (n,n*21)

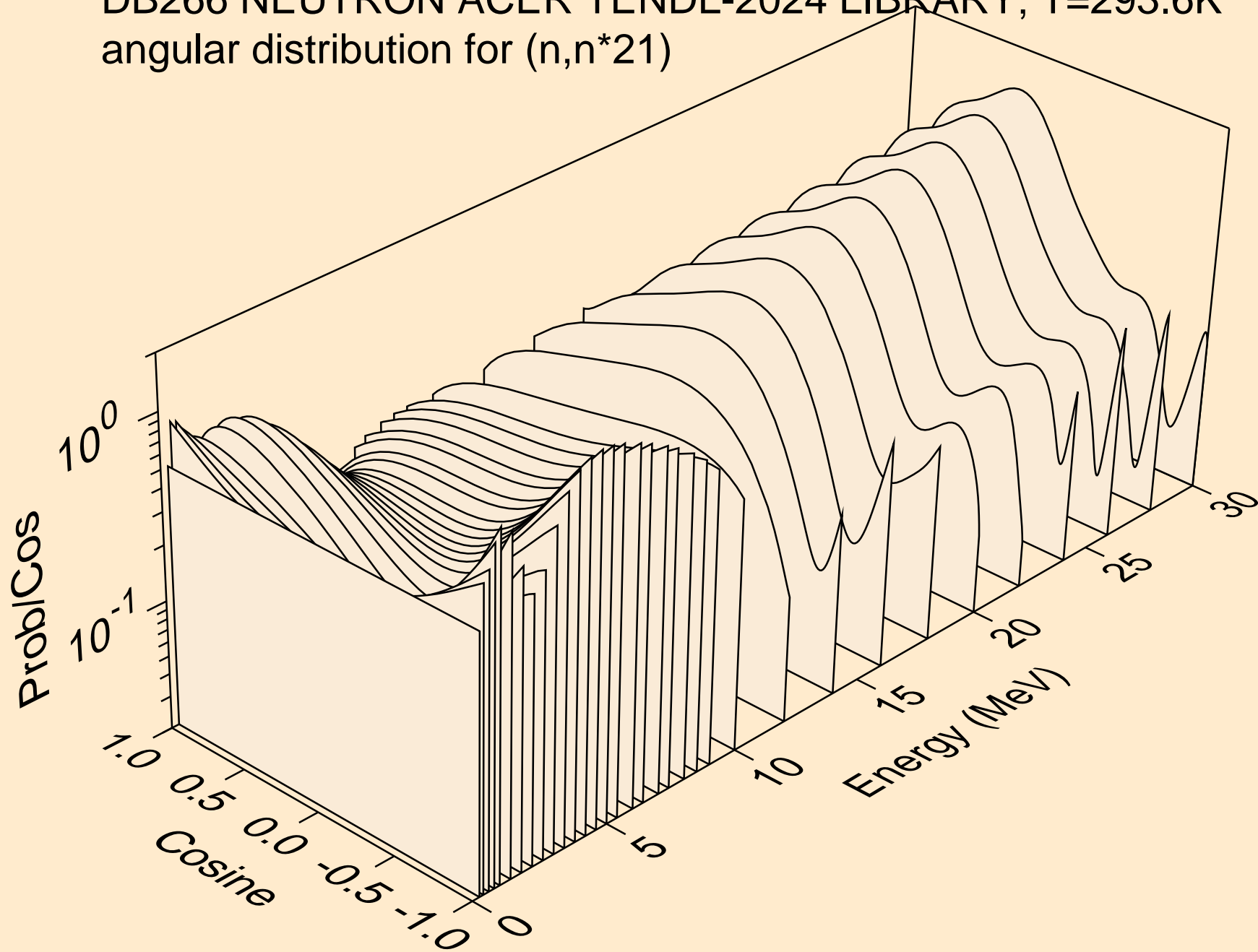

DB266 NEUTRON ACER TENDL-2024 LIBRARY; T=293.6K
angular distribution for (n,n*22)

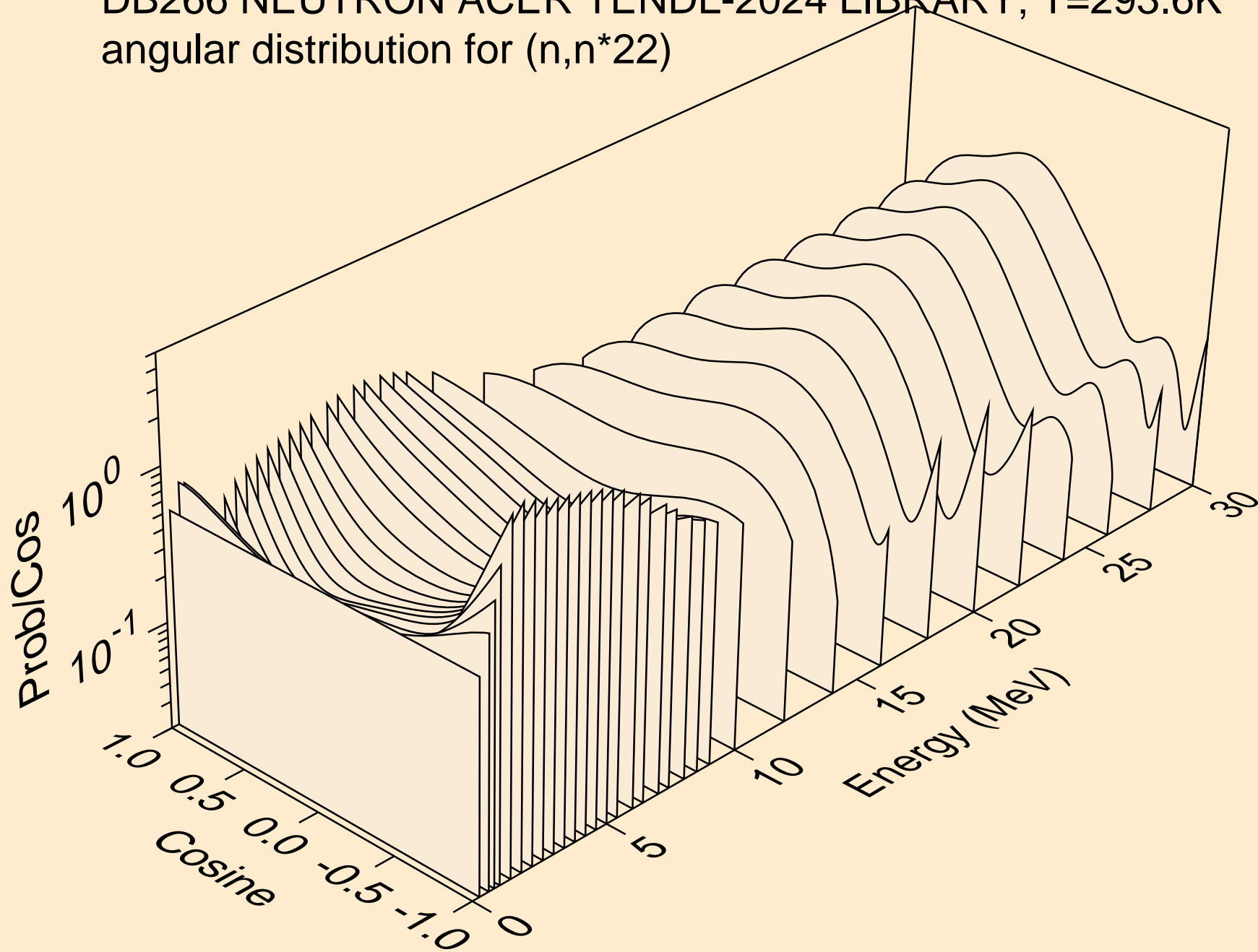

DB266 NEUTRON ACER TENDL-2024 LIBRARY; T=293.6K
angular distribution for (n,n*23)

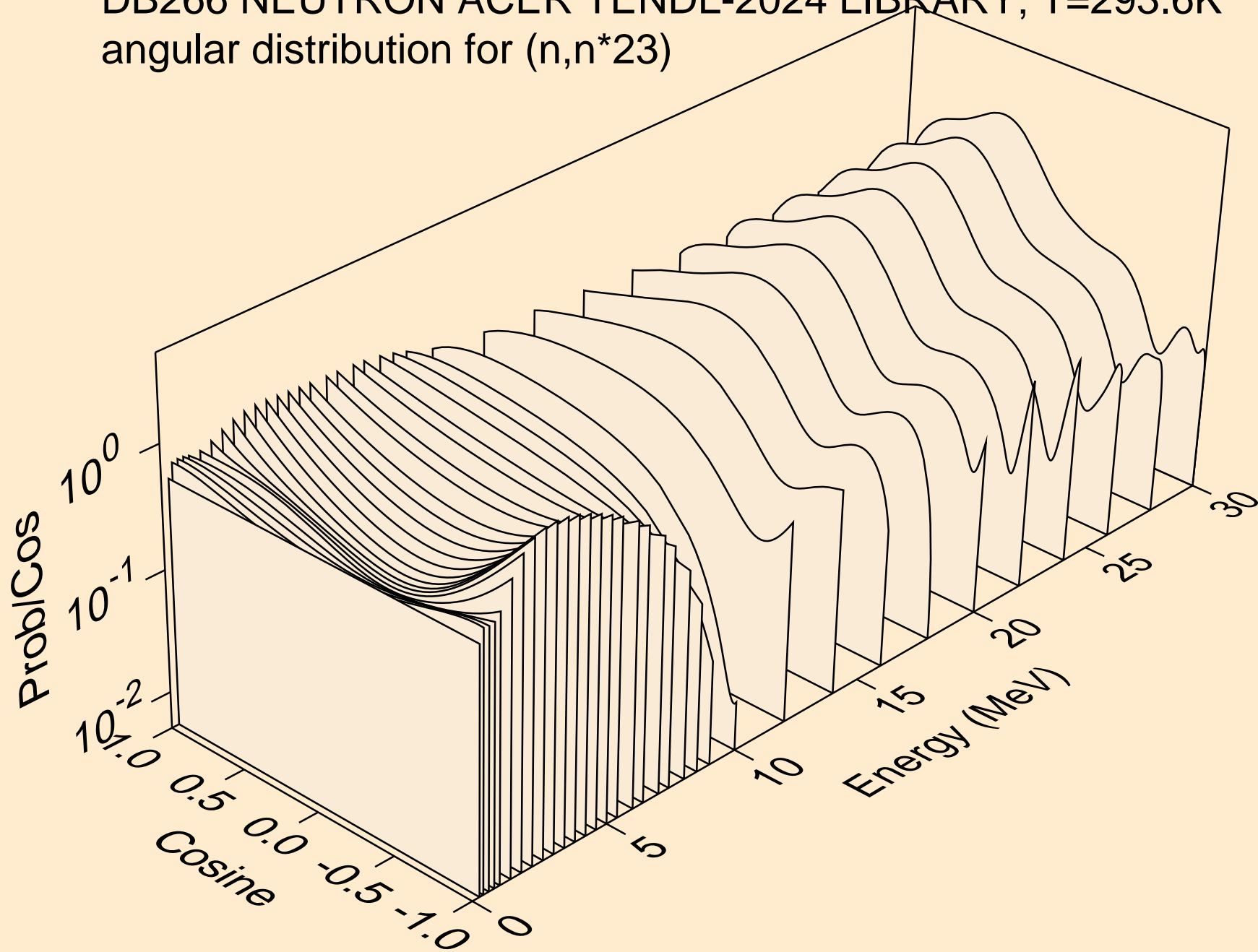

DB266 NEUTRON ACER TENDL-2024 LIBRARY; T=293.6K
angular distribution for (n,n*24)

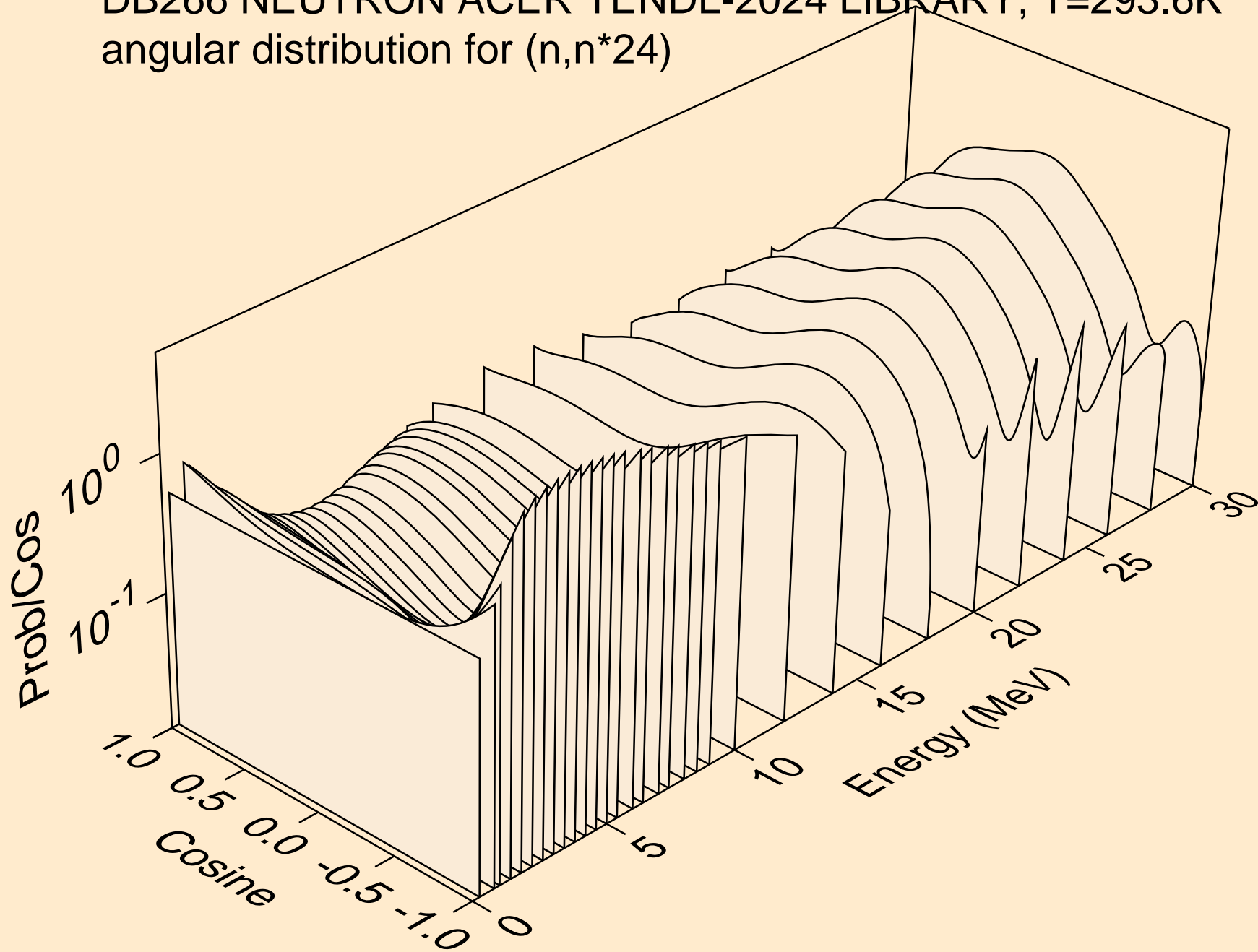

DB266 NEUTRON ACER TENDL-2024 LIBRARY; T=293.6K
angular distribution for (n,n*25)

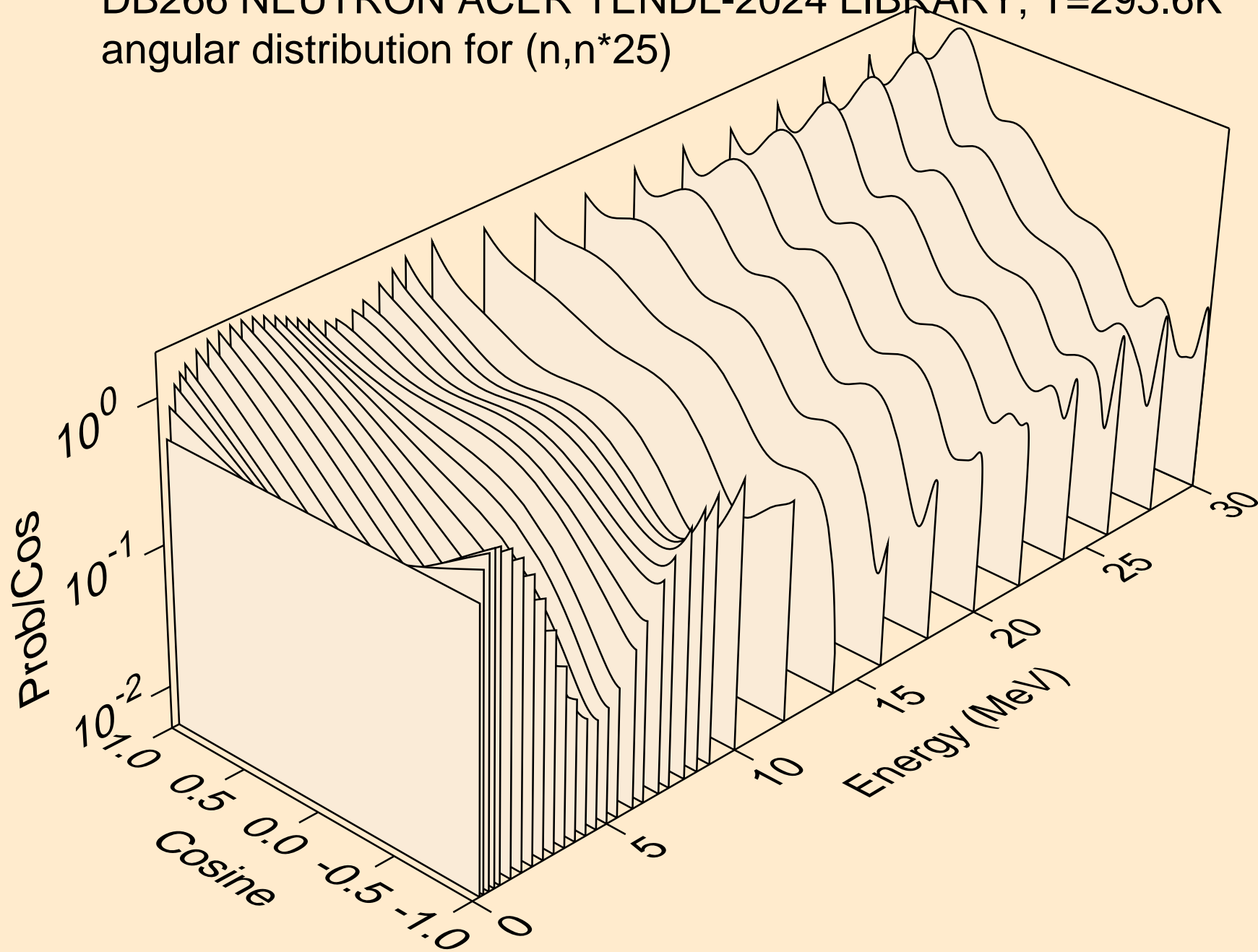

DB266 NEUTRON ACER TENDL-2024 LIBRARY; T=293.6K
angular distribution for (n,n*26)

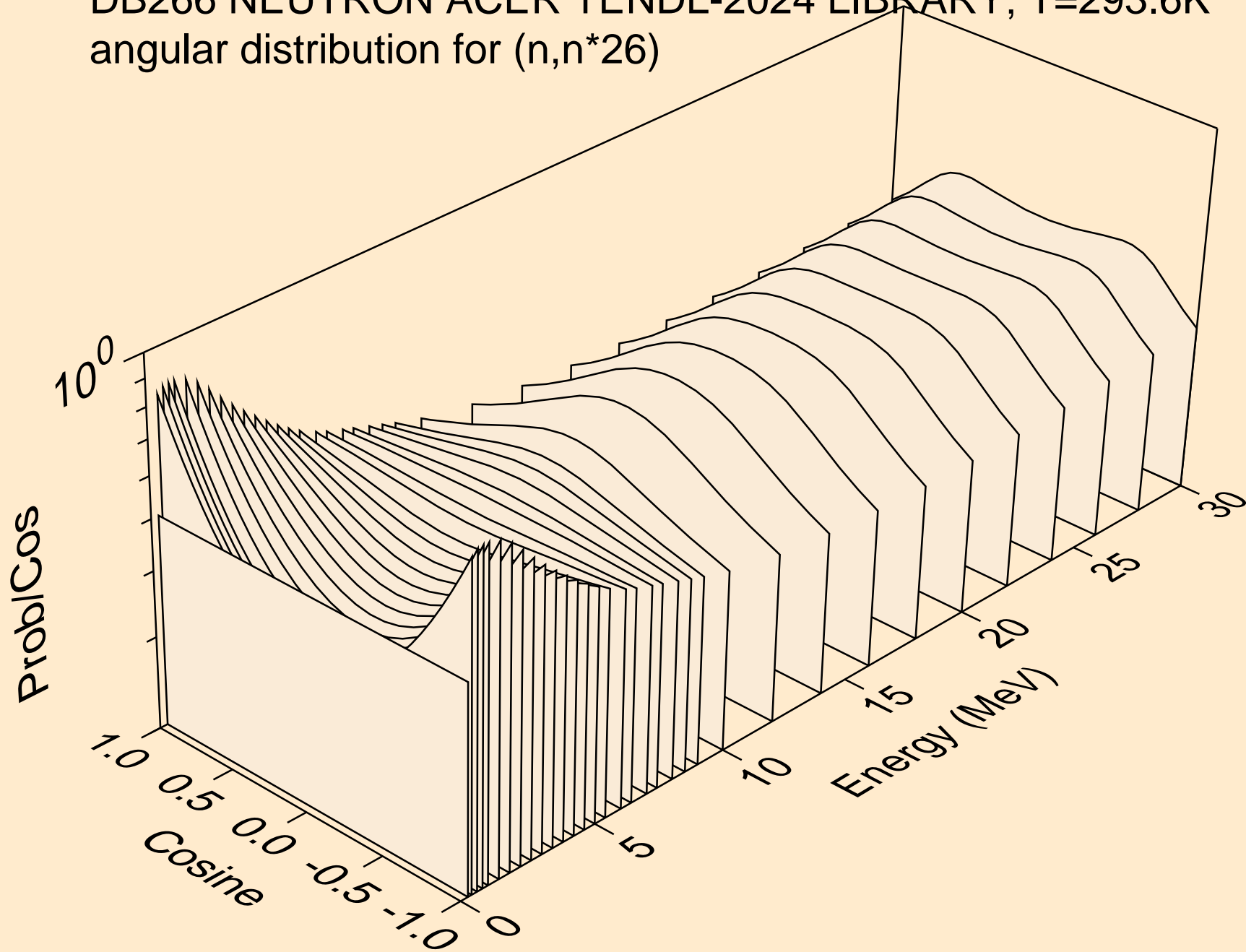

DB266 NEUTRON ACER TENDL-2024 LIBRARY; T=293.6K
angular distribution for (n,n*27)

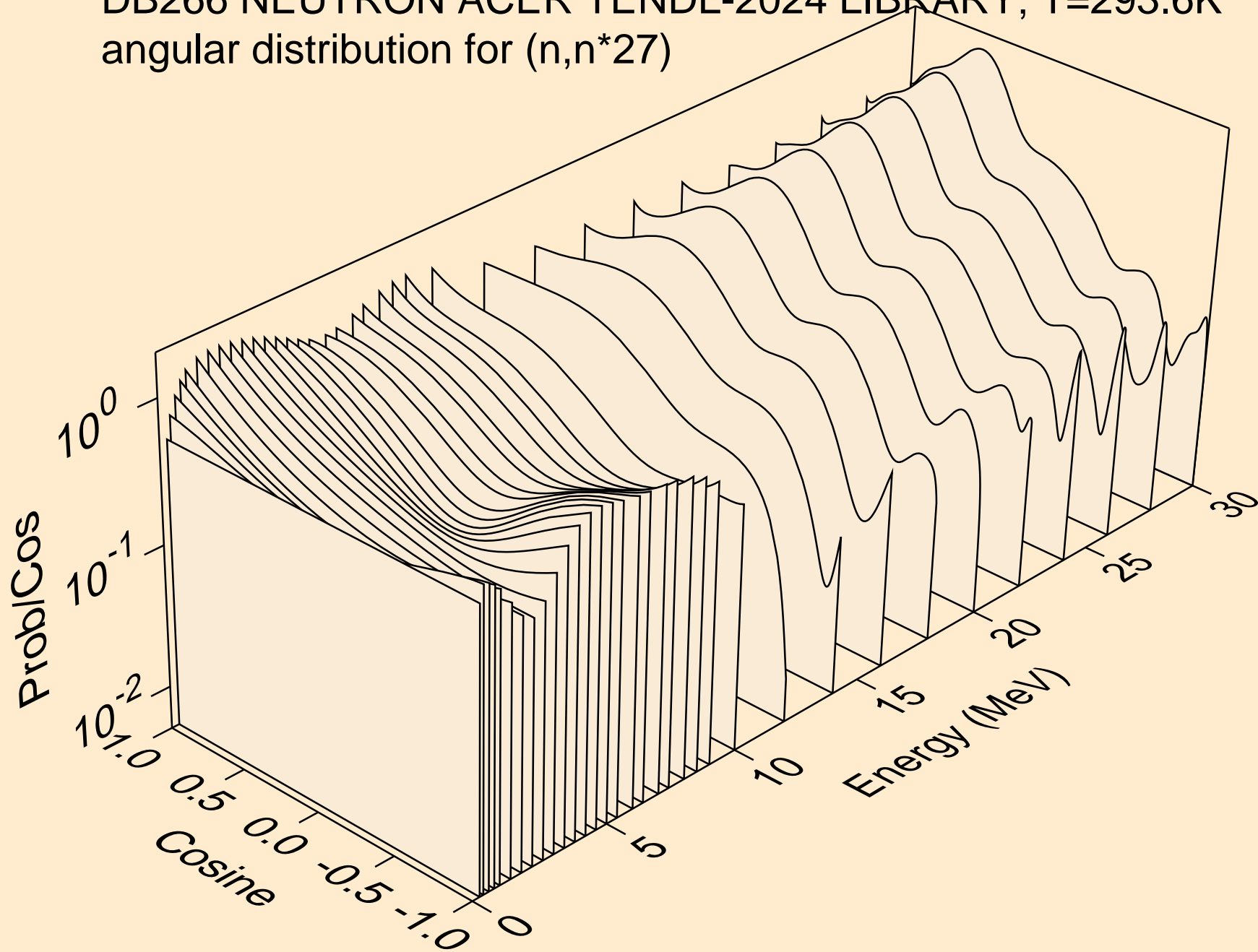

DB266 NEUTRON ACER TENDL-2024 LIBRARY; T=293.6K
angular distribution for (n,n*28)

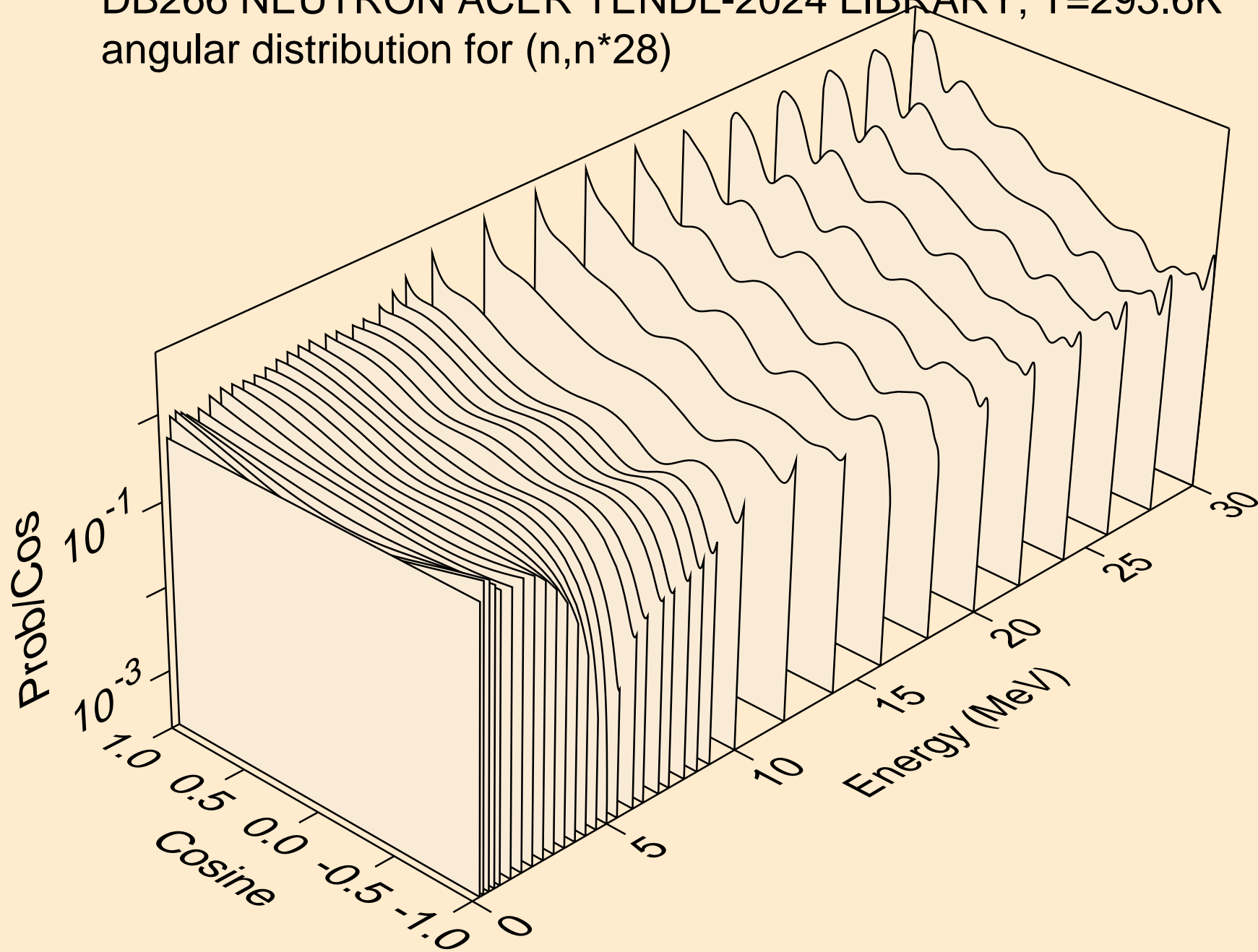

DB266 NEUTRON ACER TENDL-2024 LIBRARY; T=293.6K
Total fission nubar

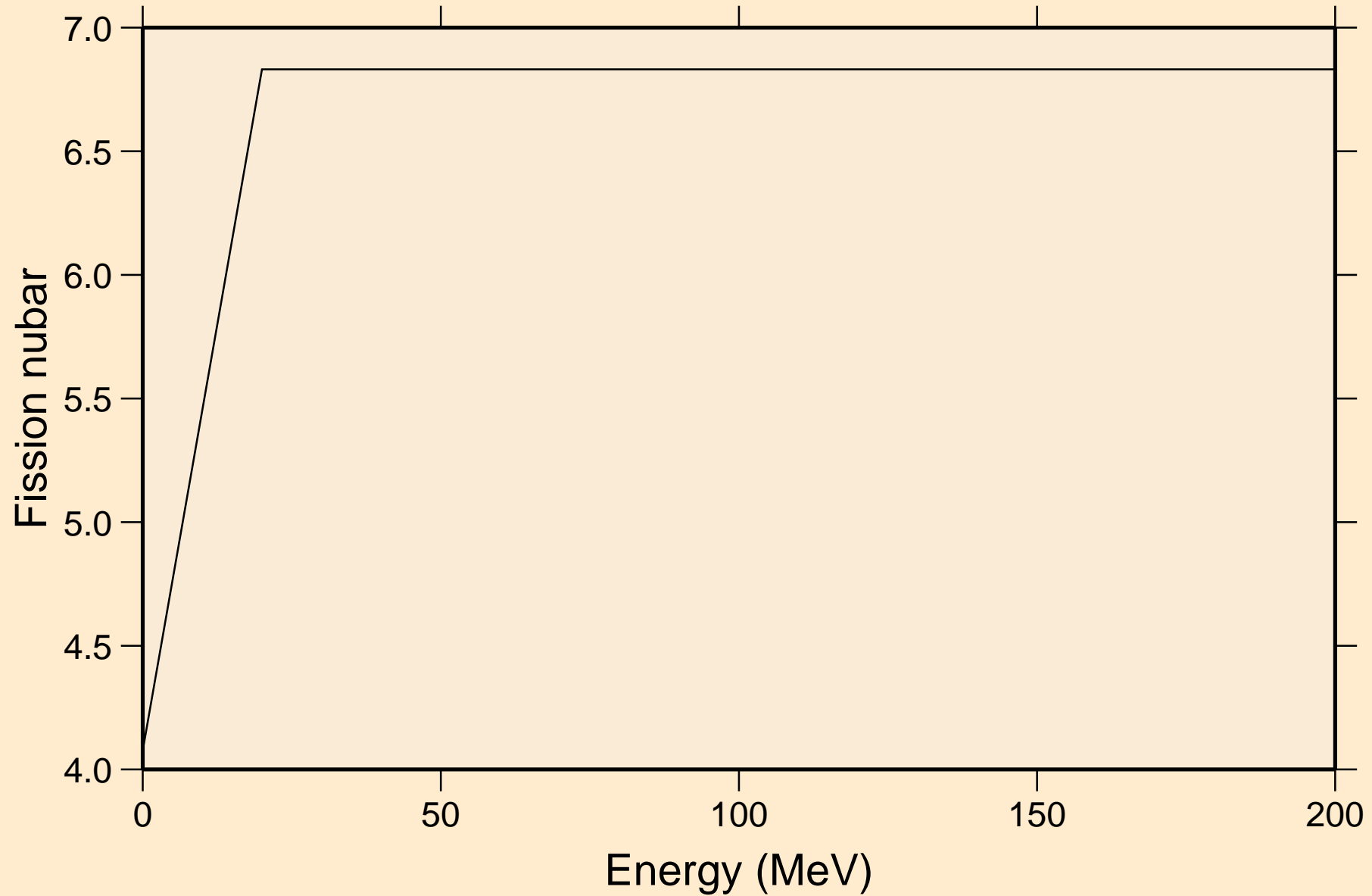

DB266 NEUTRON ACER TENDL-2024 LIBRARY; T=293.6K
Neutron emission for (n,x)

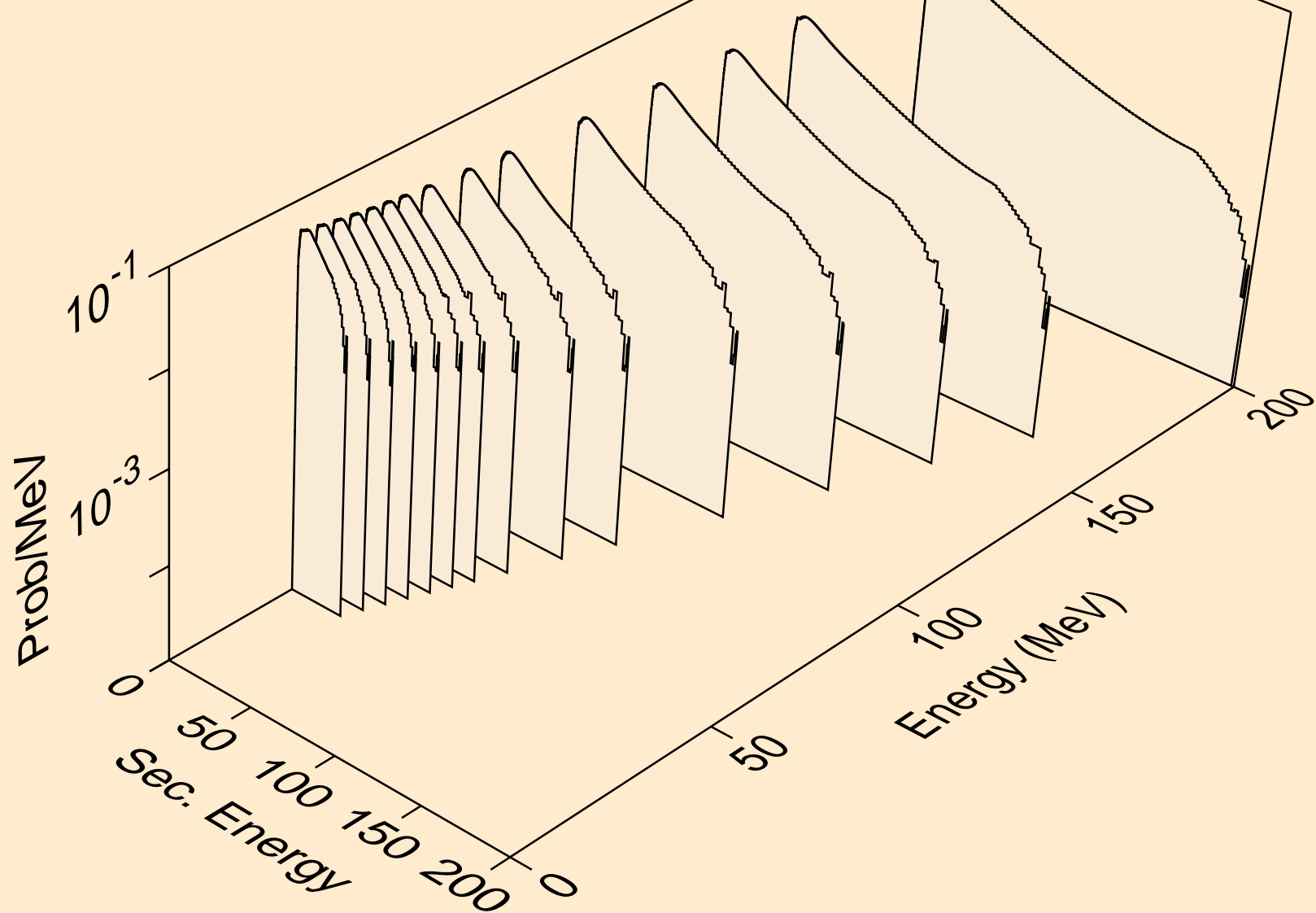

DB266 NEUTRON ACER TENDL-2024 LIBRARY; T=293.6K
Neutron emission for (n,2nd)

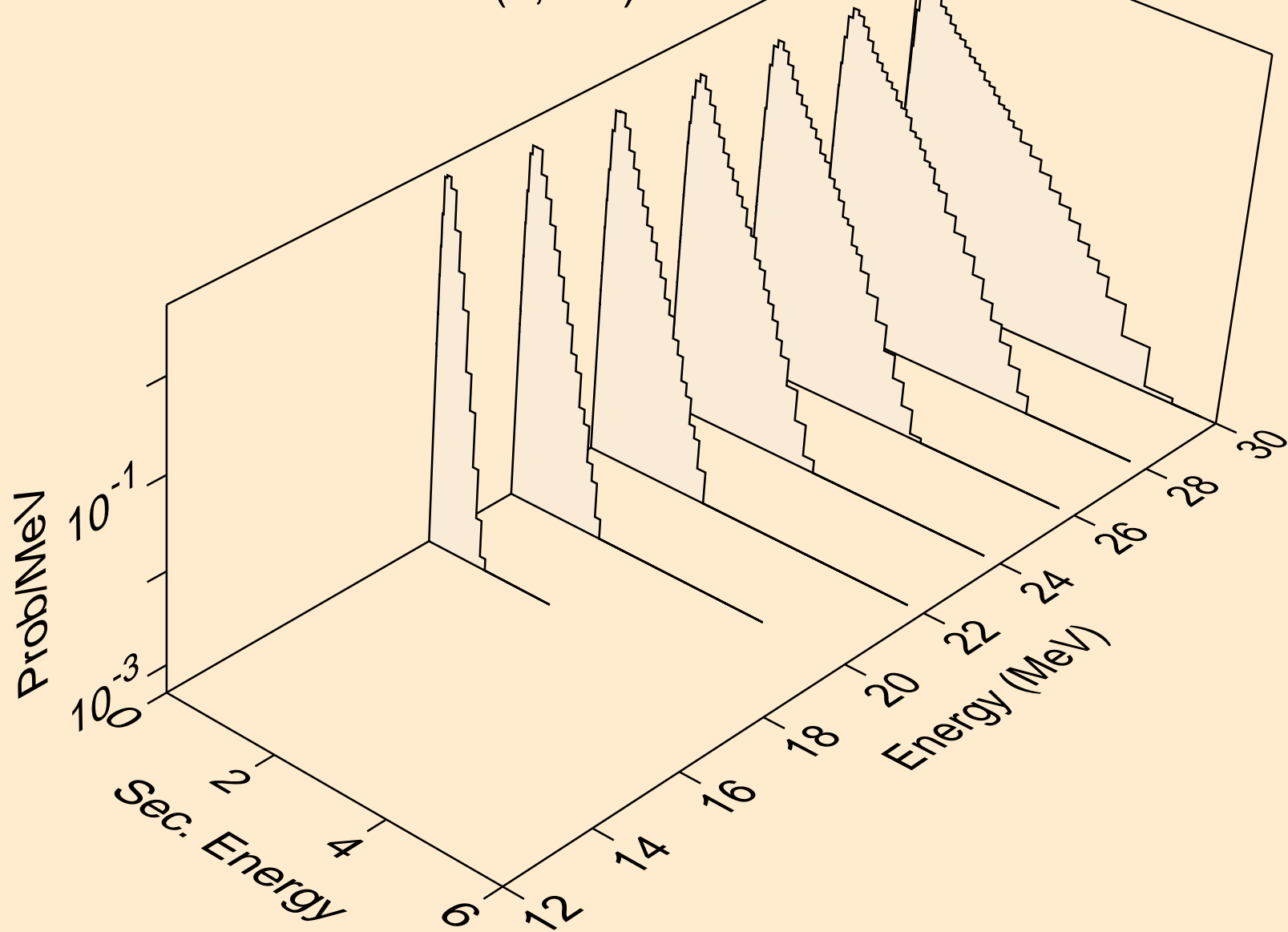

DB266 NEUTRON ACER TENDL-2024 LIBRARY; T=293.6K
Neutron emission for (n,2n)

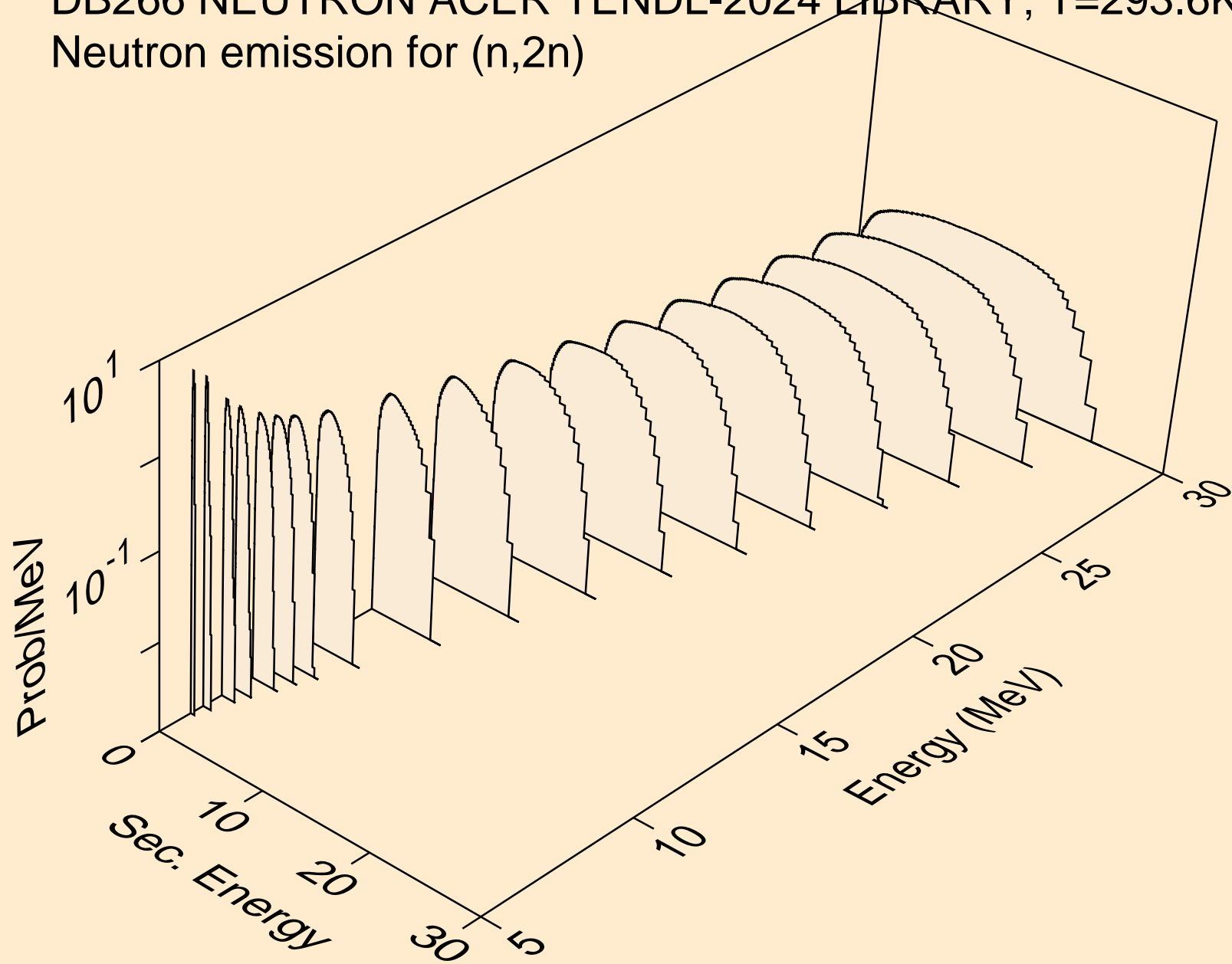

DB266 NEUTRON ACER TENDL-2024 LIBRARY; T=293.6K
Neutron emission for (n,3n)

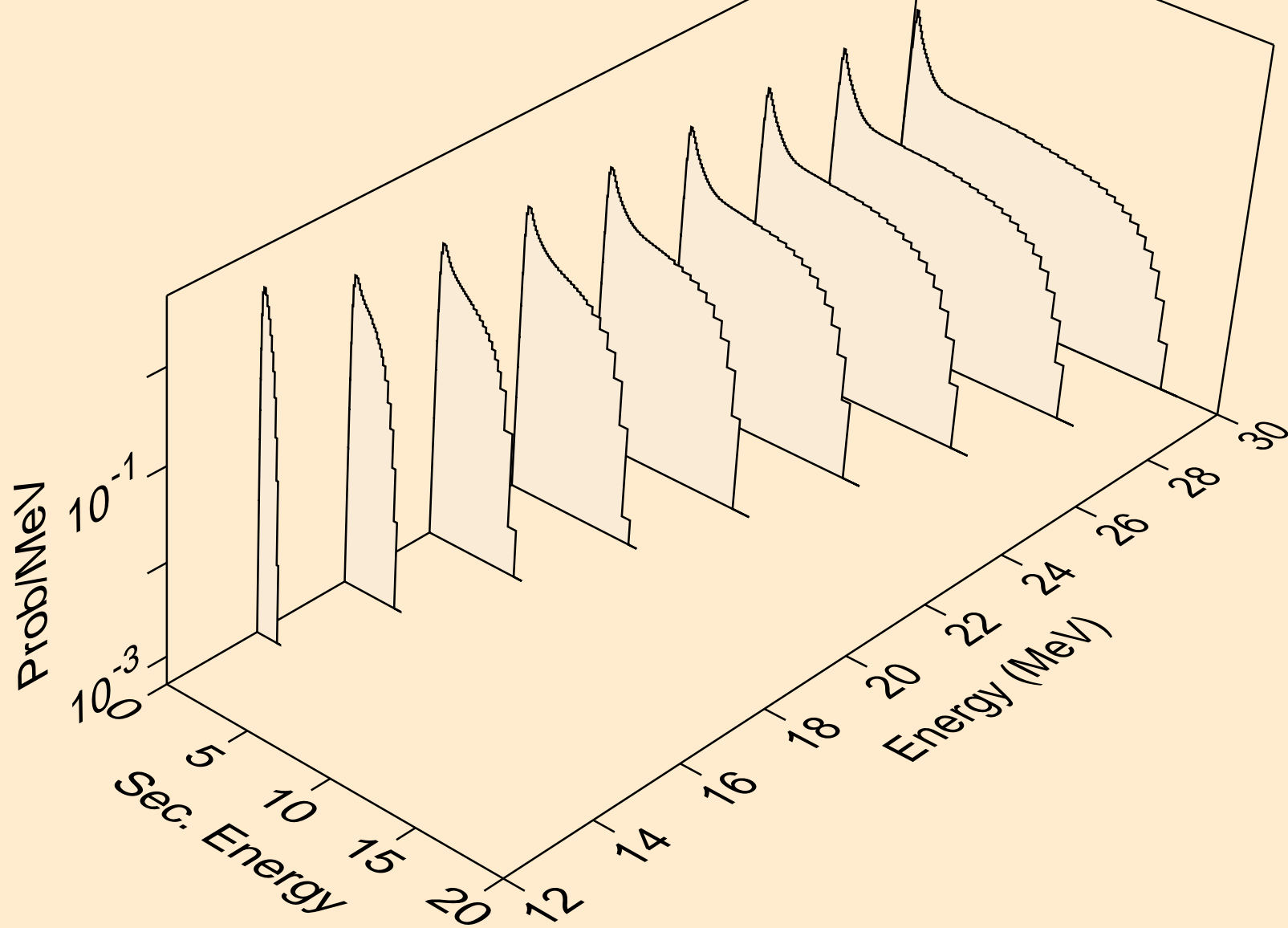

DB266 NEUTRON ACER TENDL-2024 LIBRARY; T=293.6K
Neutron emission for fission

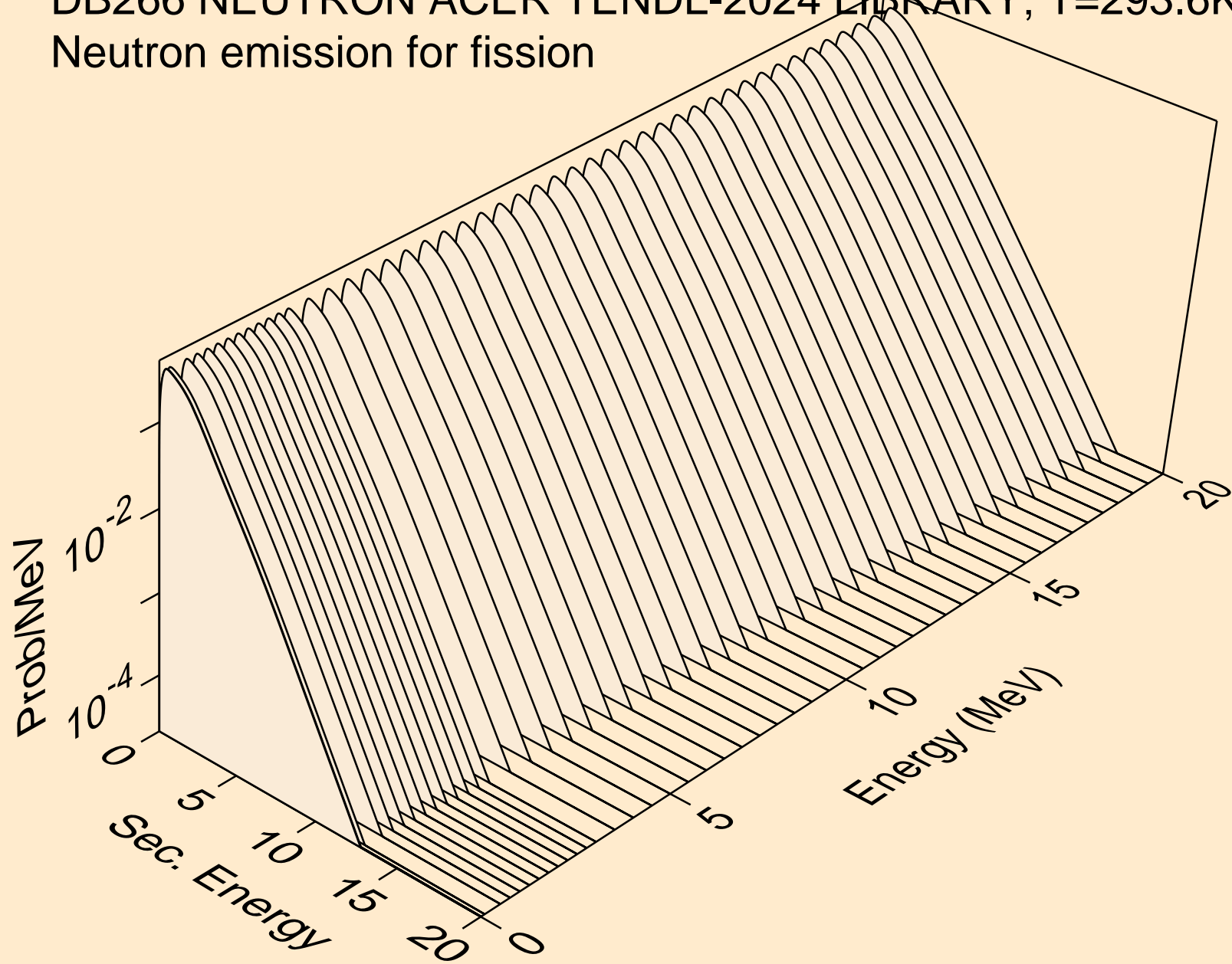

DB266 NEUTRON ACER TENDL-2024 LIBRARY; T=293.6K
Neutron emission for (n,n*)a

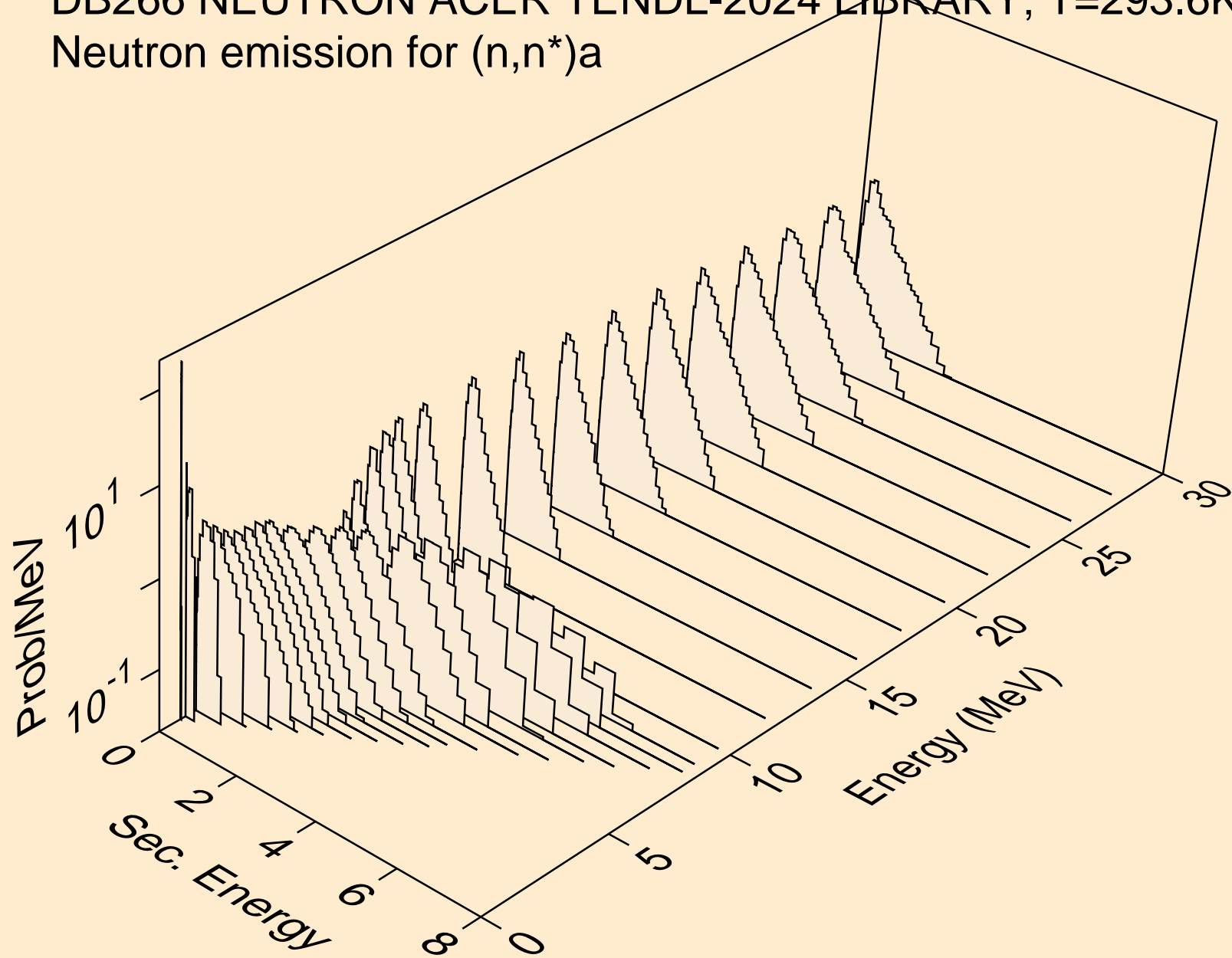

DB266 NEUTRON ACER TENDL-2024 LIBRARY; T=293.6K
Neutron emission for (n,2n)a

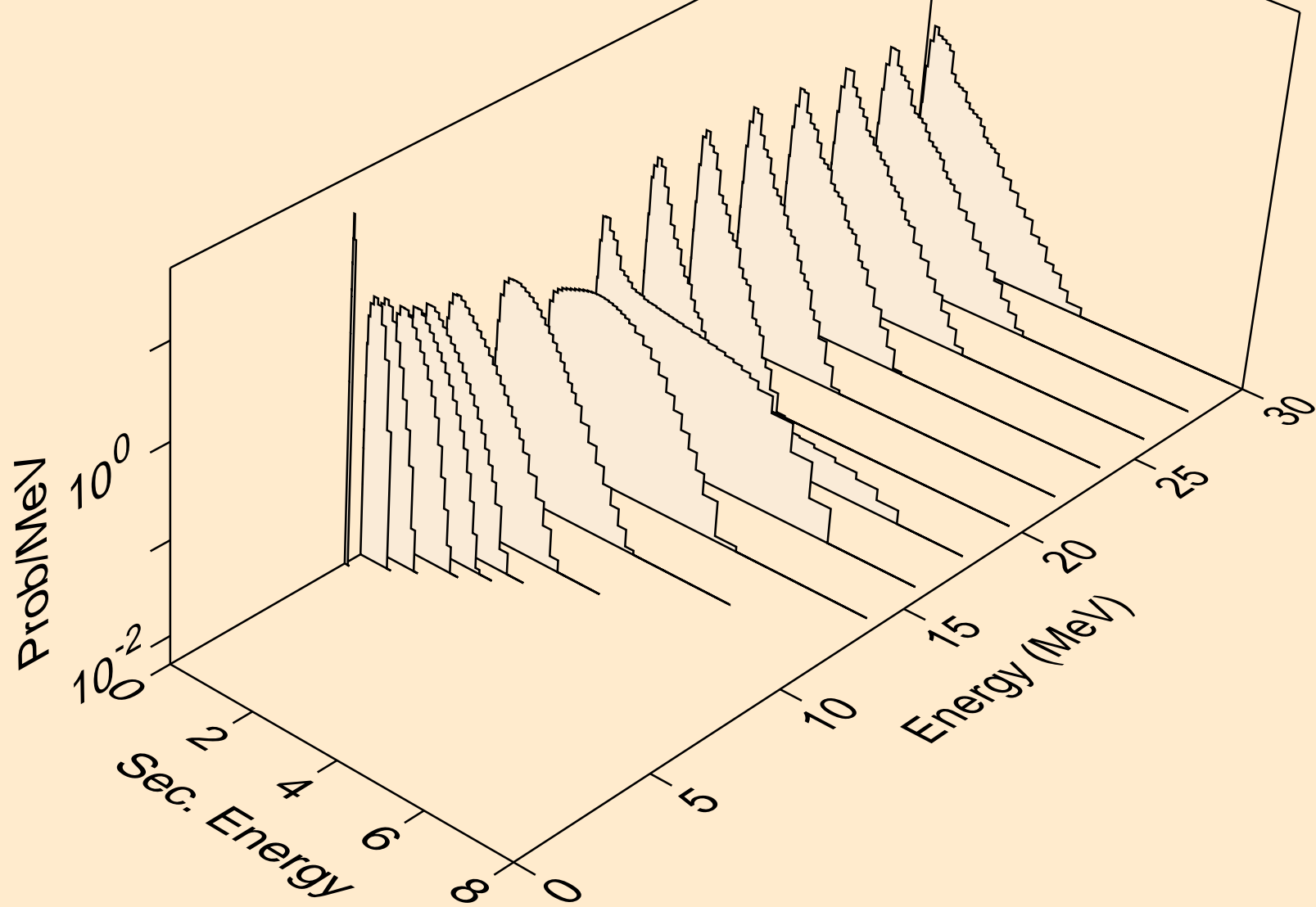

DB266 NEUTRON ACER TENDL-2024 LIBRARY; T=293.6K
Neutron emission for (n,3n)a

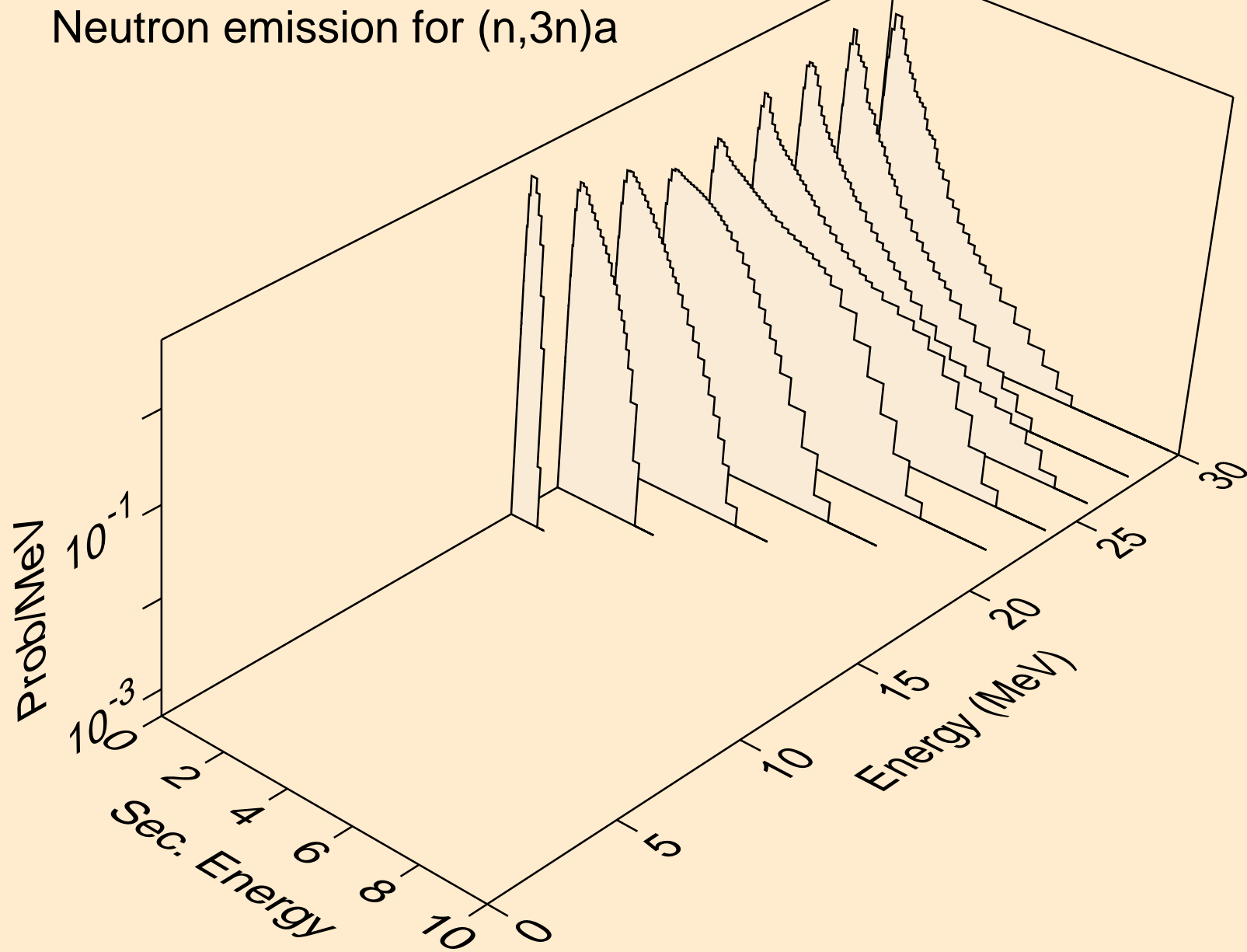

DB266 NEUTRON ACER TENDL-2024 LIBRARY; T=293.6K
Neutron emission for (n,n*)p

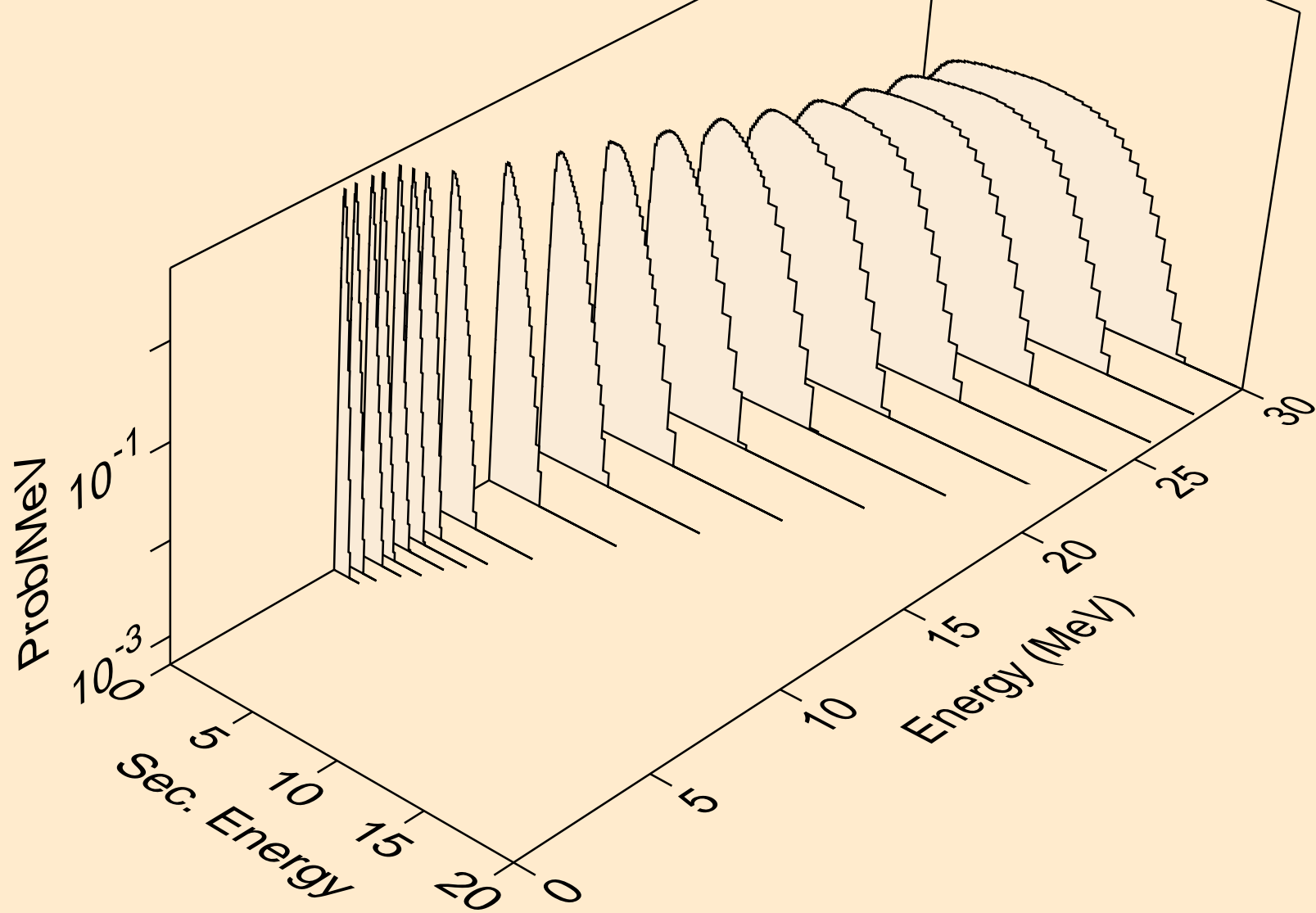

DB266 NEUTRON ACER TENDL-2024 LIBRARY; T=293.6K
Neutron emission for (n,n*)d

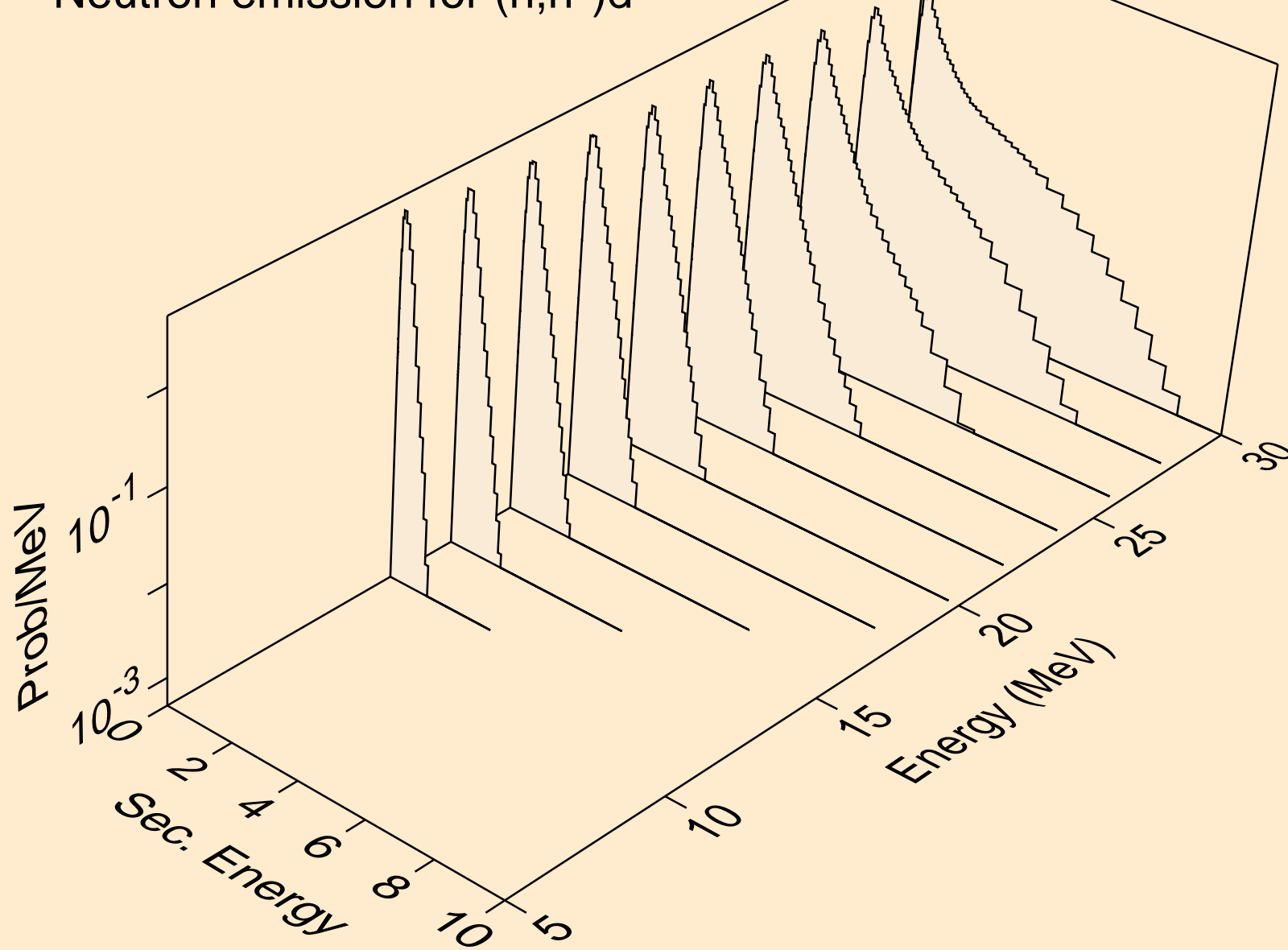

DB266 NEUTRON ACER TENDL-2024 LIBRARY; T=293.6K
Neutron emission for (n,n*)t

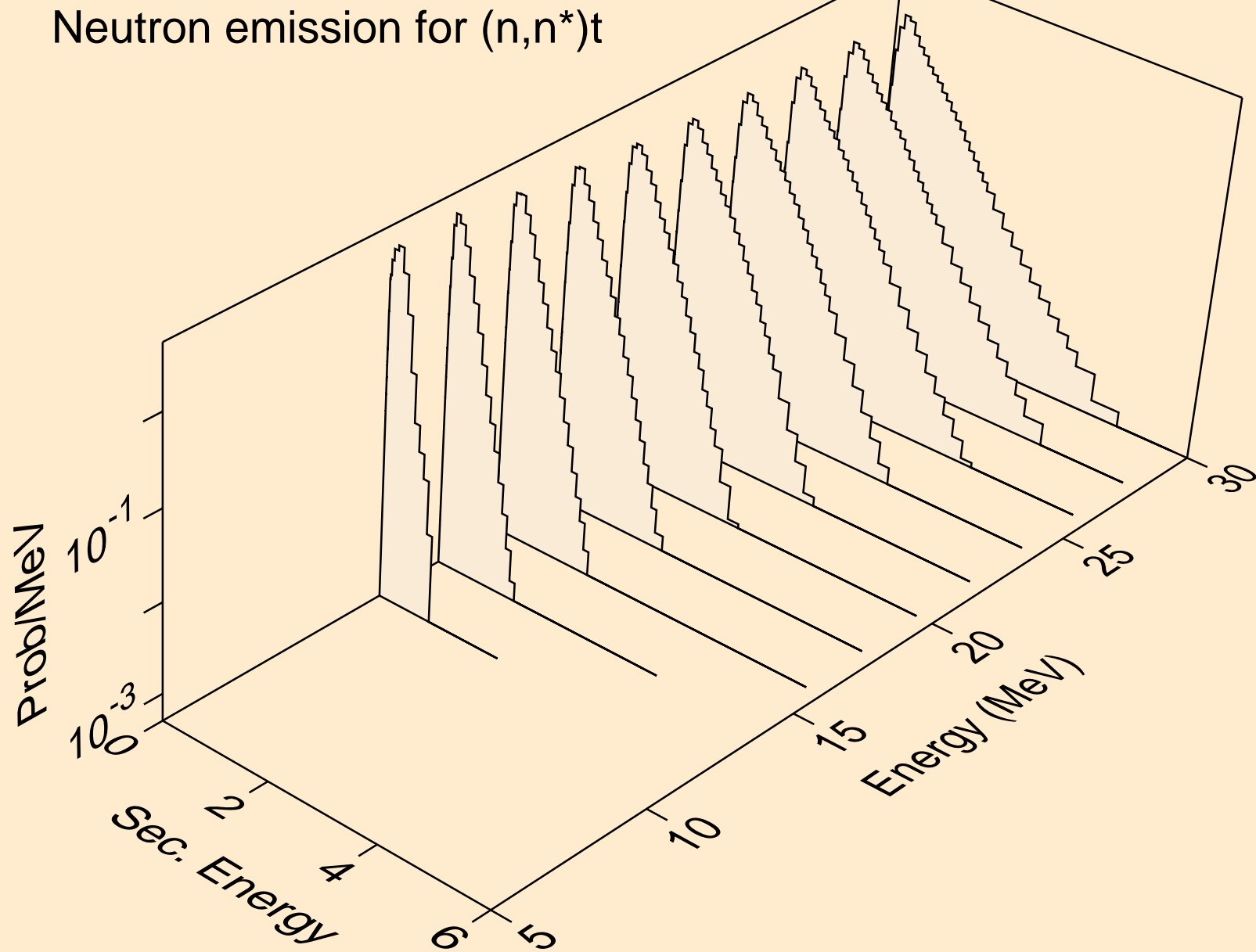

DB266 NEUTRON ACER TENDL-2024 LIBRARY; T=293.6K
Neutron emission for (n,n*)he3

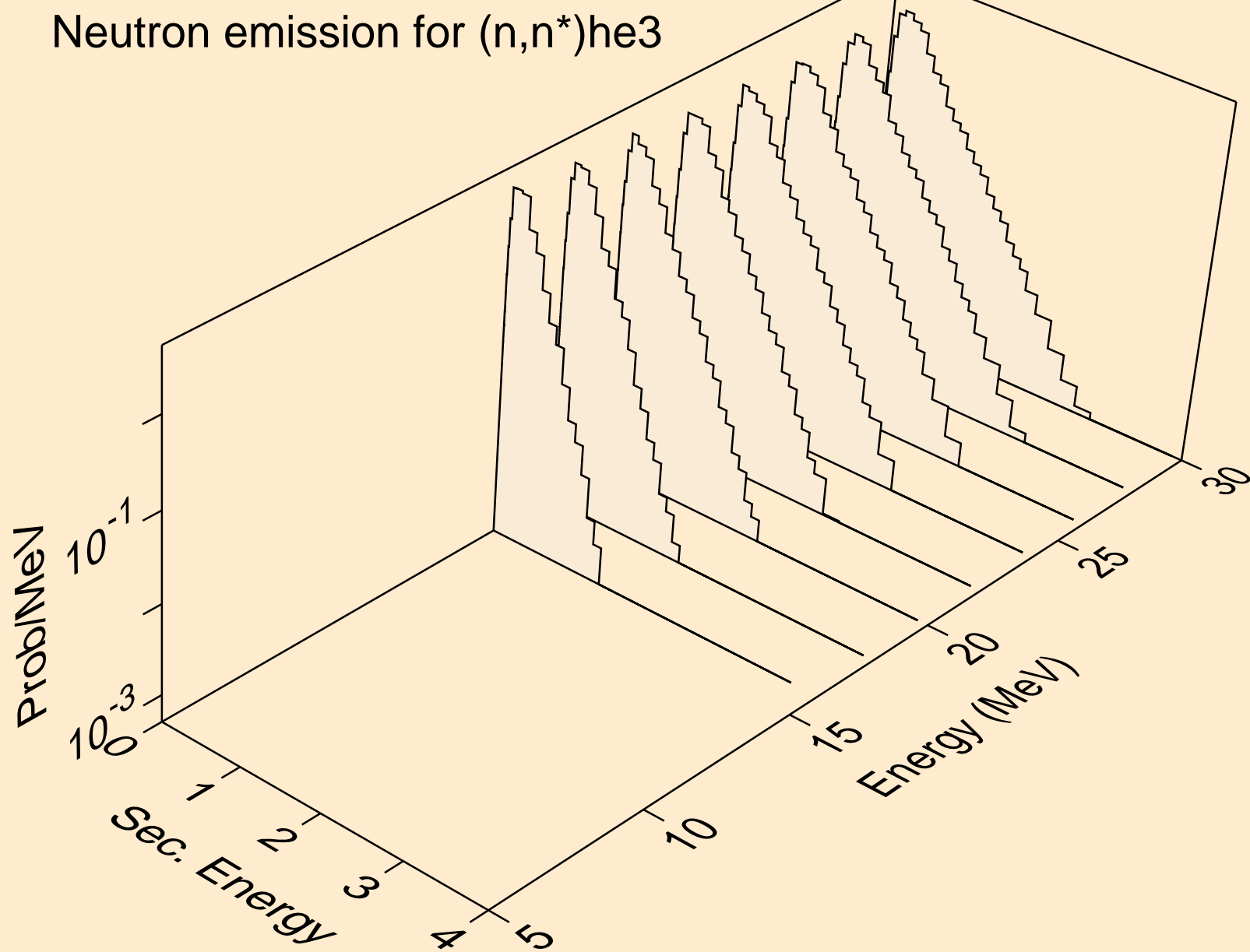

DB266 NEUTRON ACER TENDL-2024 LIBRARY; T=293.6K
Neutron emission for (n,4n)

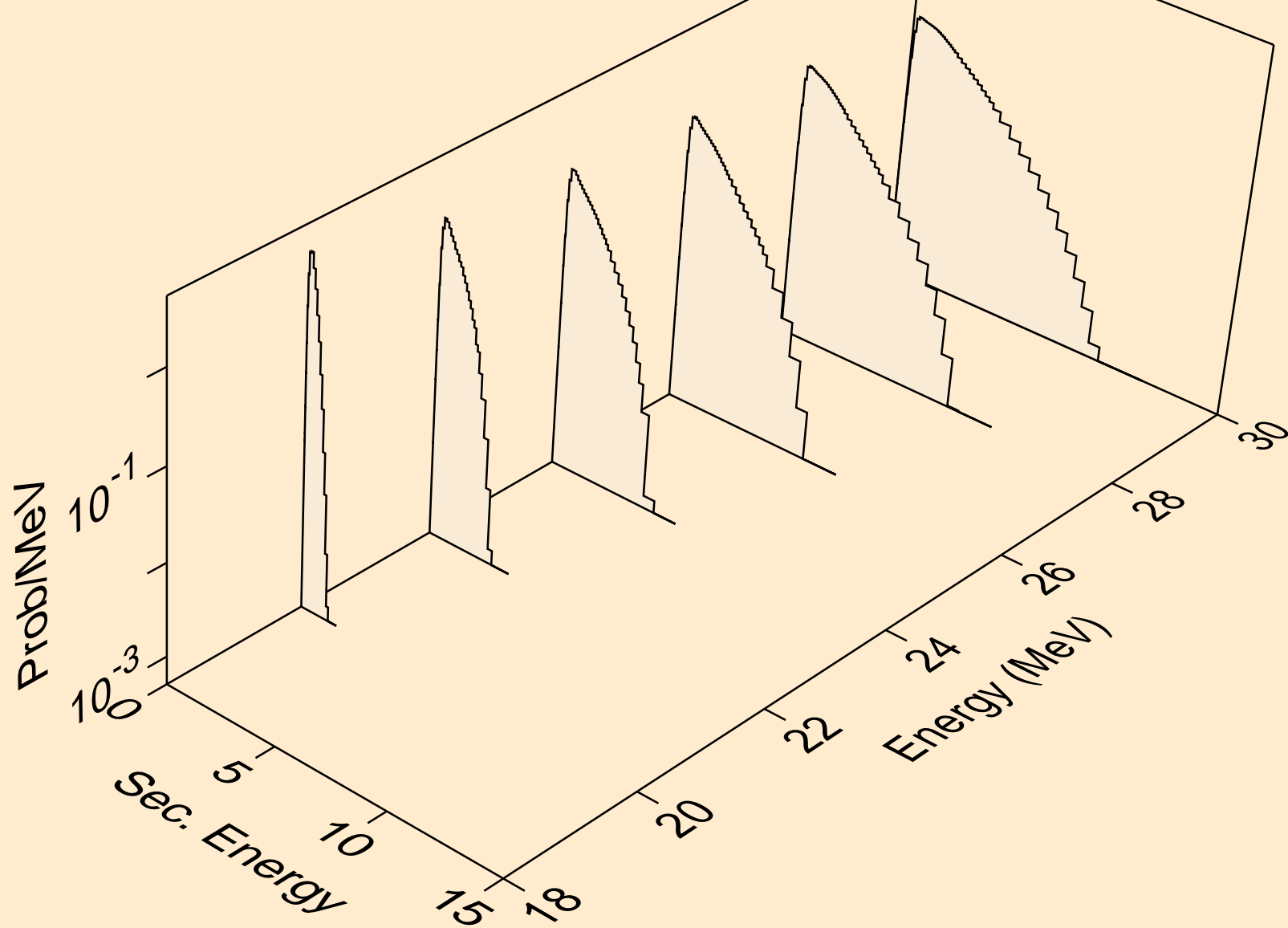

DB266 NEUTRON ACER TENDL-2024 LIBRARY; T=293.6K
Neutron emission for (n,2np)

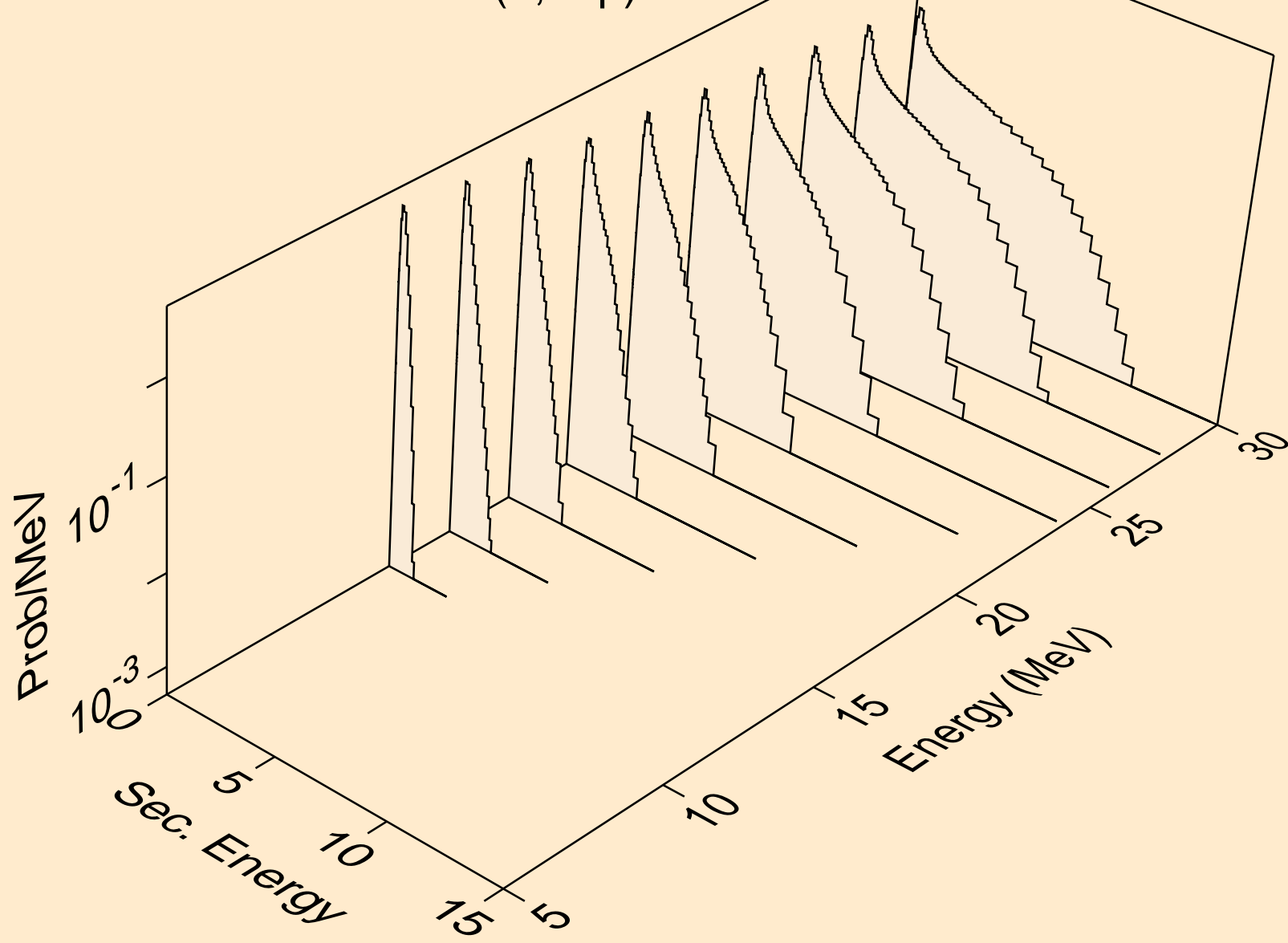

DB266 NEUTRON ACER TENDL-2024 LIBRARY; T=293.6K
Neutron emission for (n,3np)

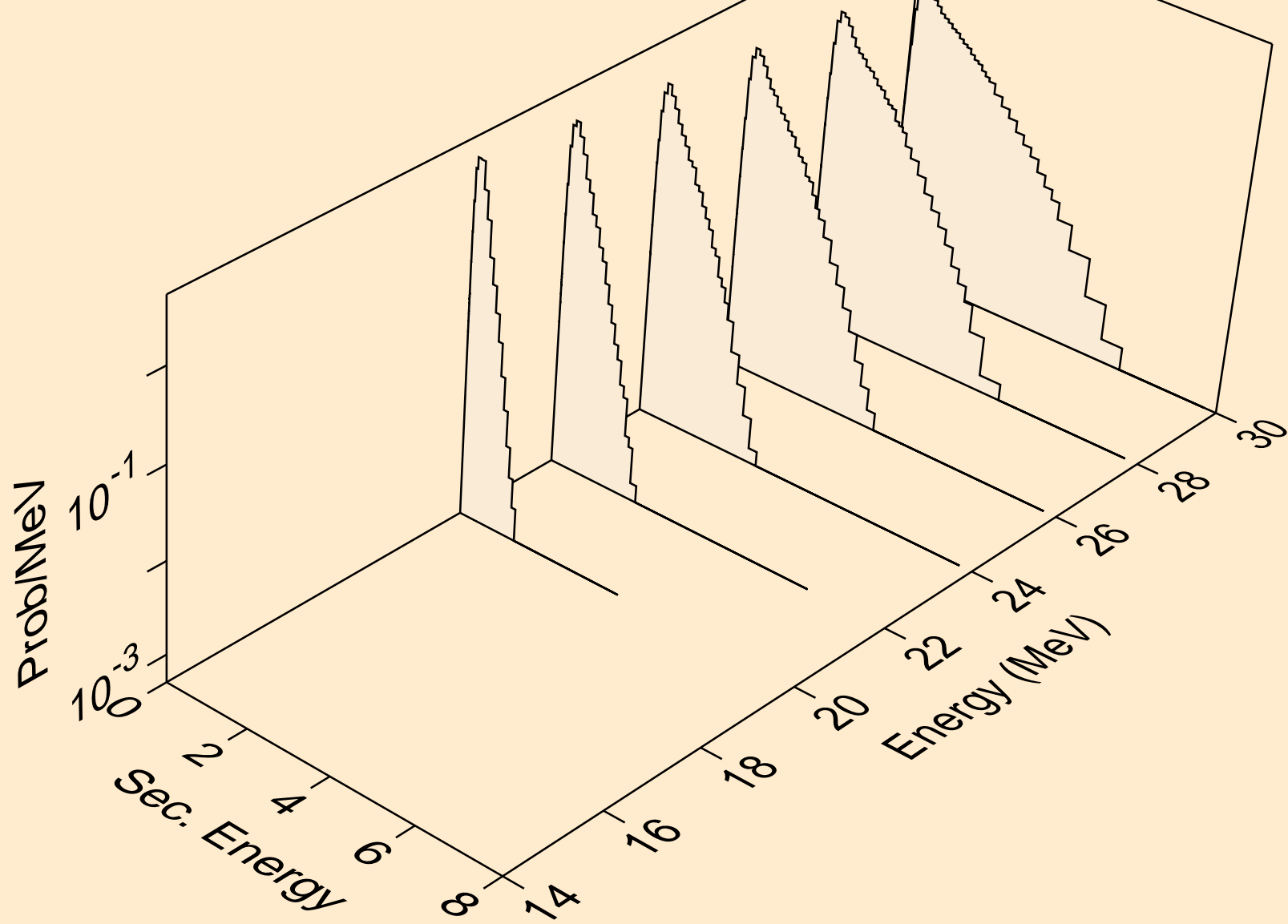

DB266 NEUTRON ACER TENDL-2024 LIBRARY; T=293.6K
Neutron emission for (n,n2p)

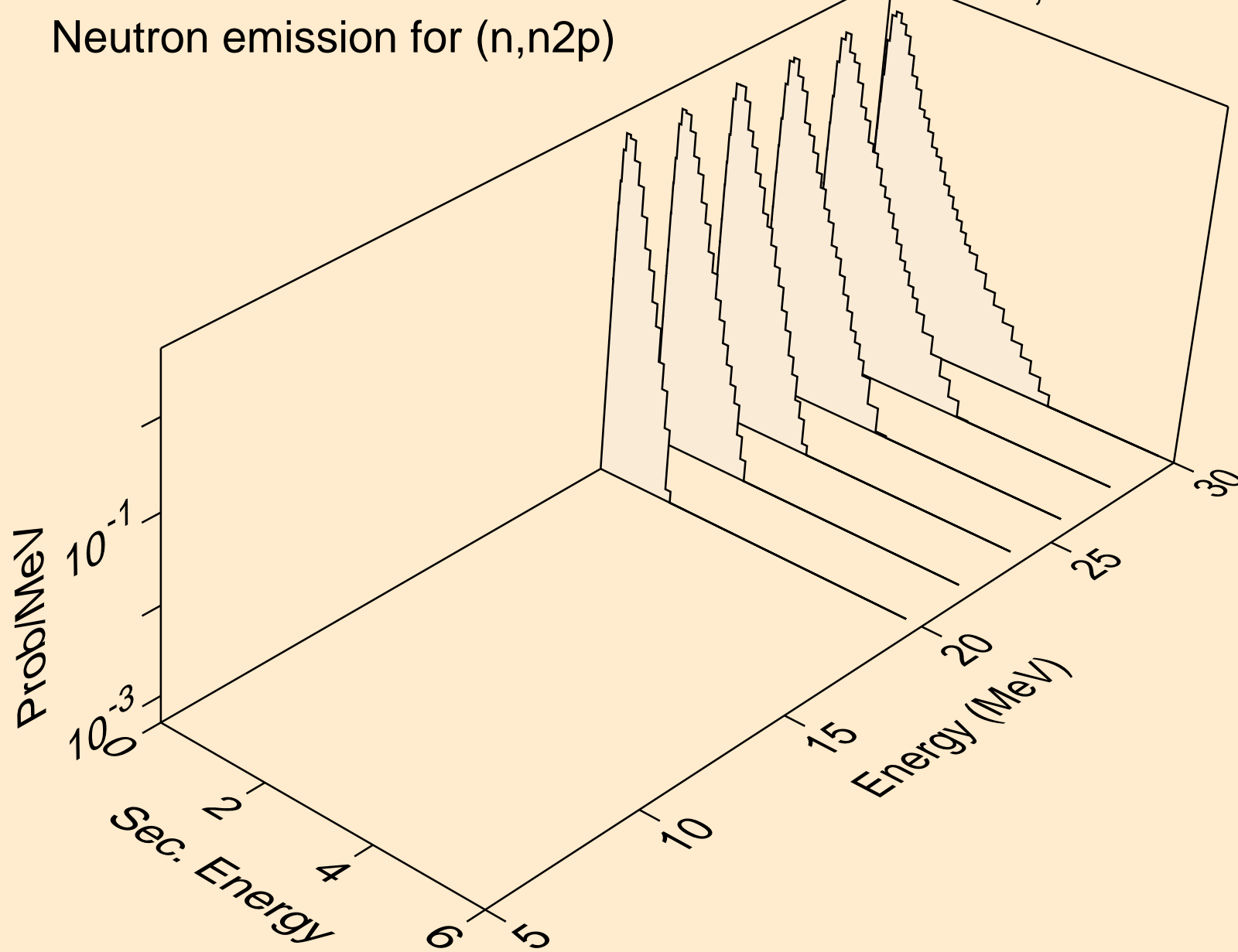

DB266 NEUTRON ACER TENDL-2024 LIBRARY; T=293.6K
Neutron emission for (n,n*c)

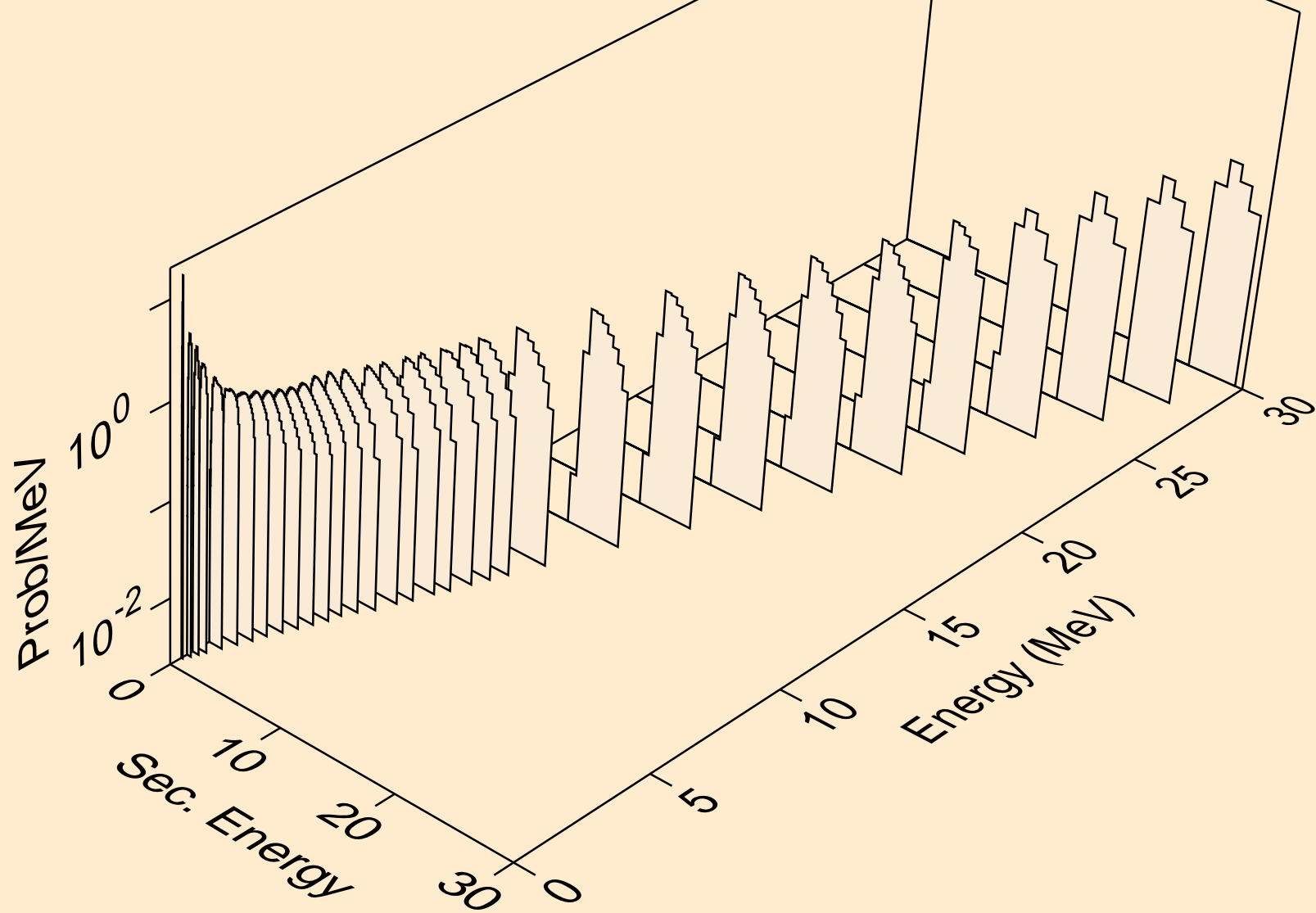

DB266 NEUTRON ACER TENDL-2024 LIBRARY; T=293.6K

Delayed nubar

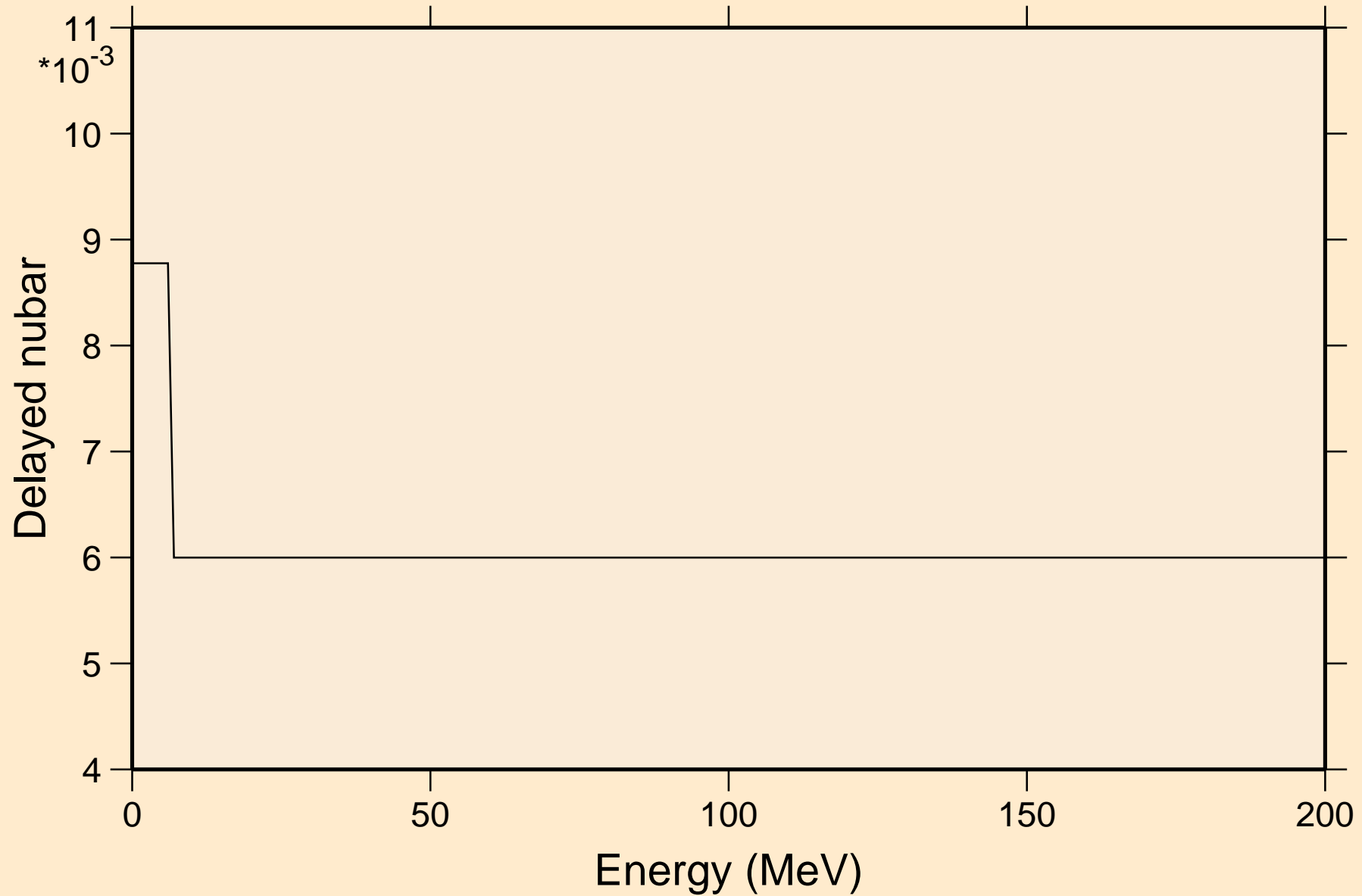

DB266 NEUTRON ACER TENDL-2024 LIBRARY; T=293.6K

Delayed neutron spectra

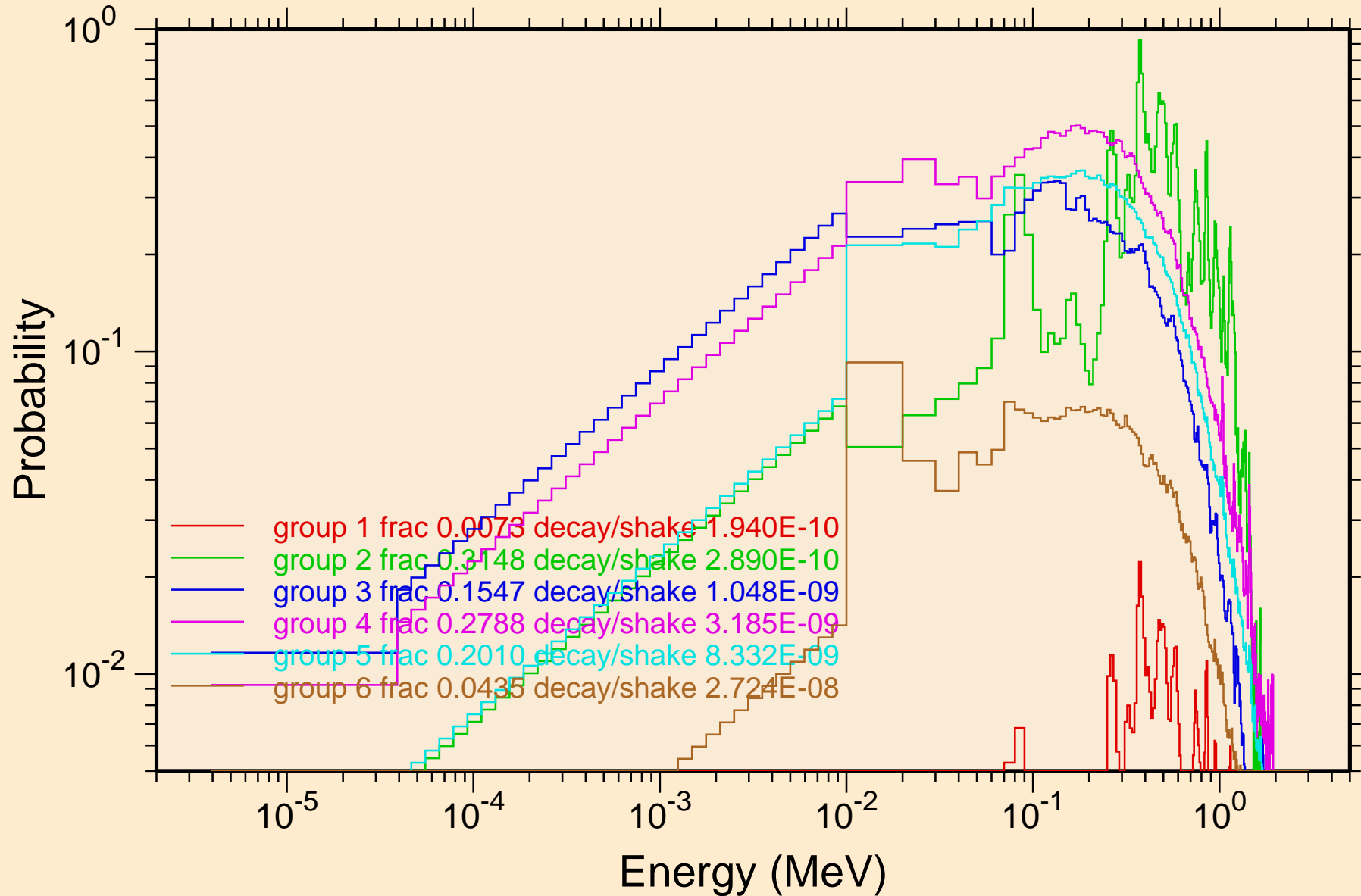

DB266 NEUTRON ACER TENDL-2024 LIBRARY; T=293.6K
Photon emission for (n,x)

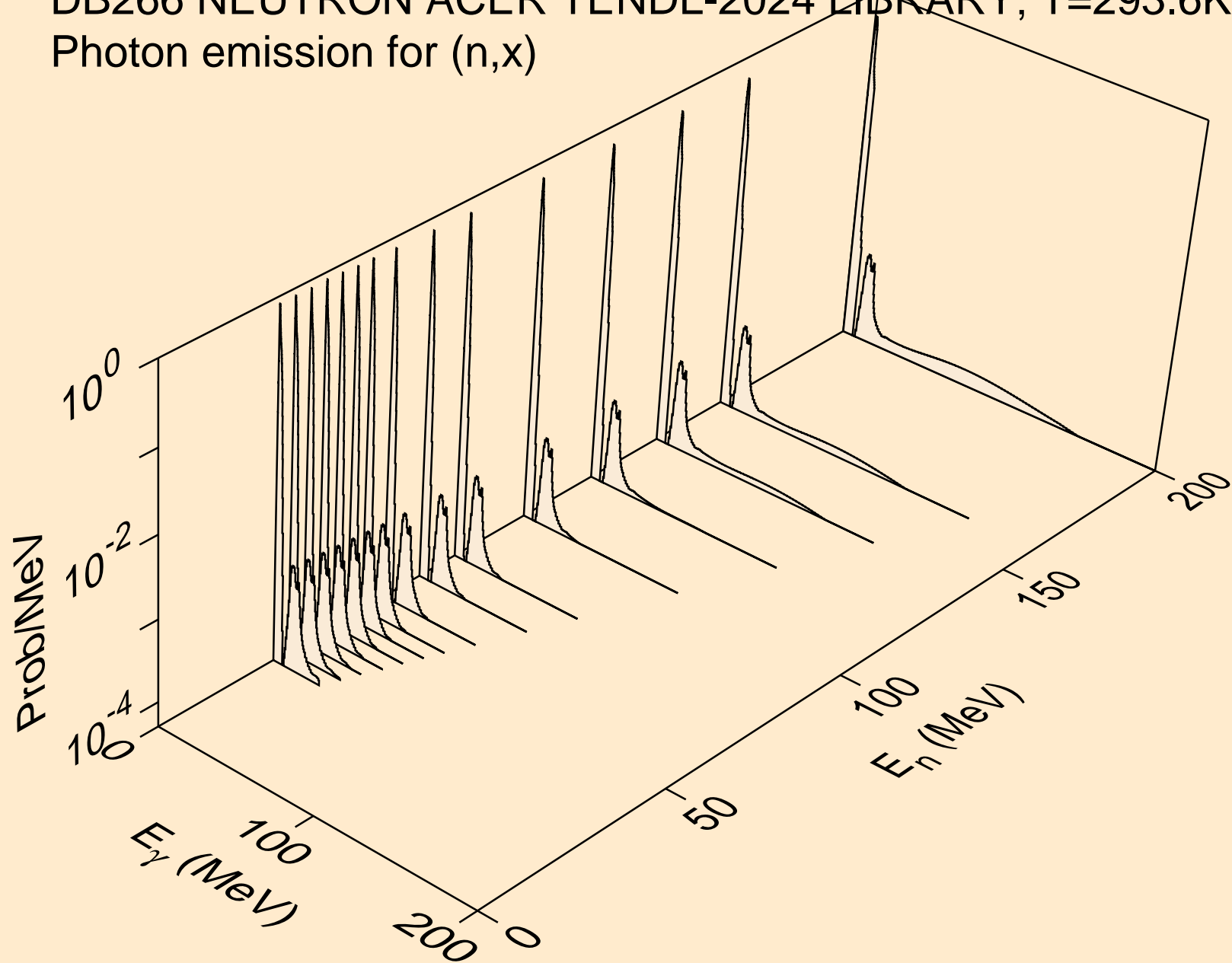

DB266 NEUTRON ACER TENDL-2024 LIBRARY; T=293.6K
Photon emission for (n,2nd)

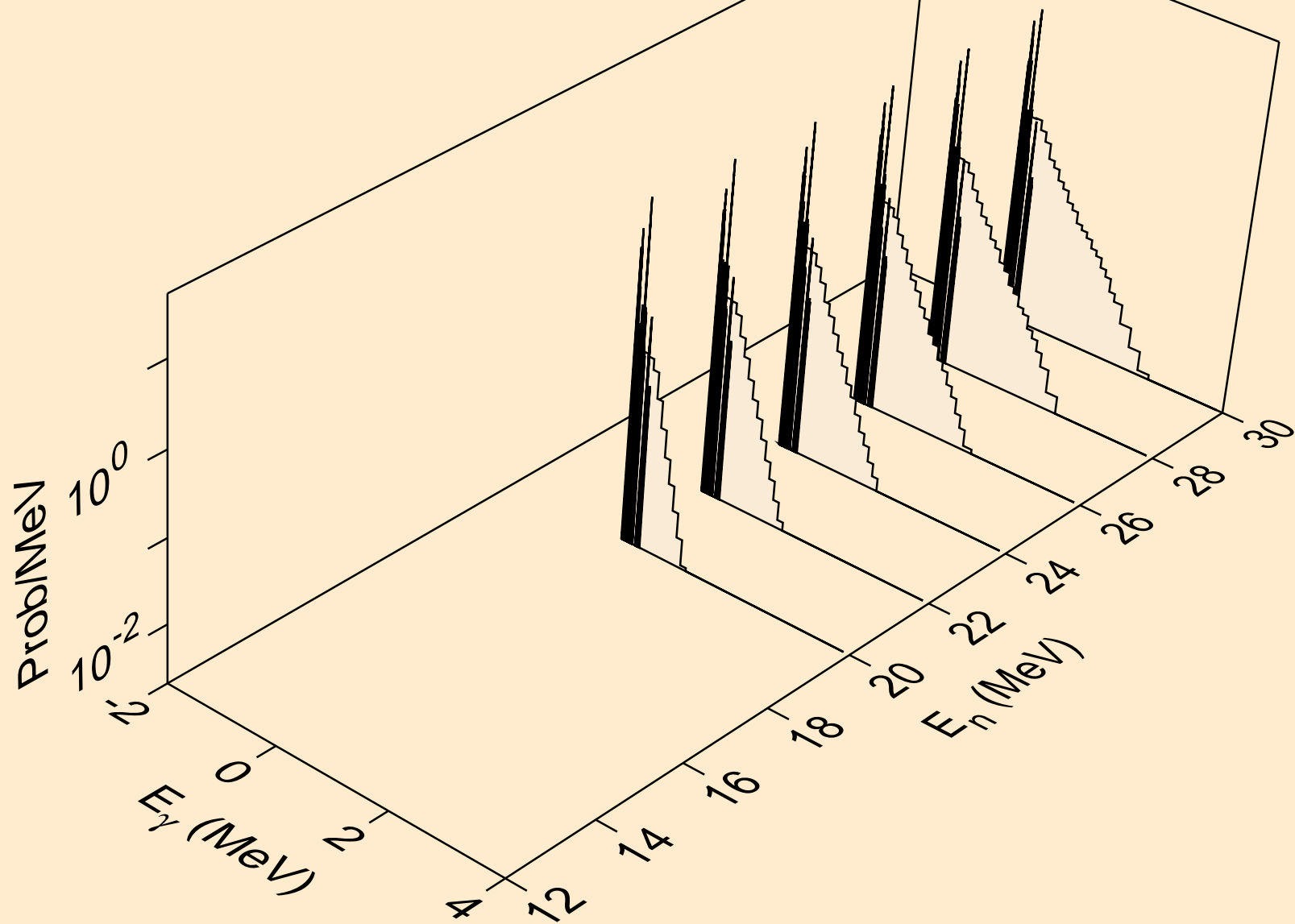

DB266 NEUTRON ACER TENDL-2024 LIBRARY; T=293.6K
Photon emission for (n,2n)

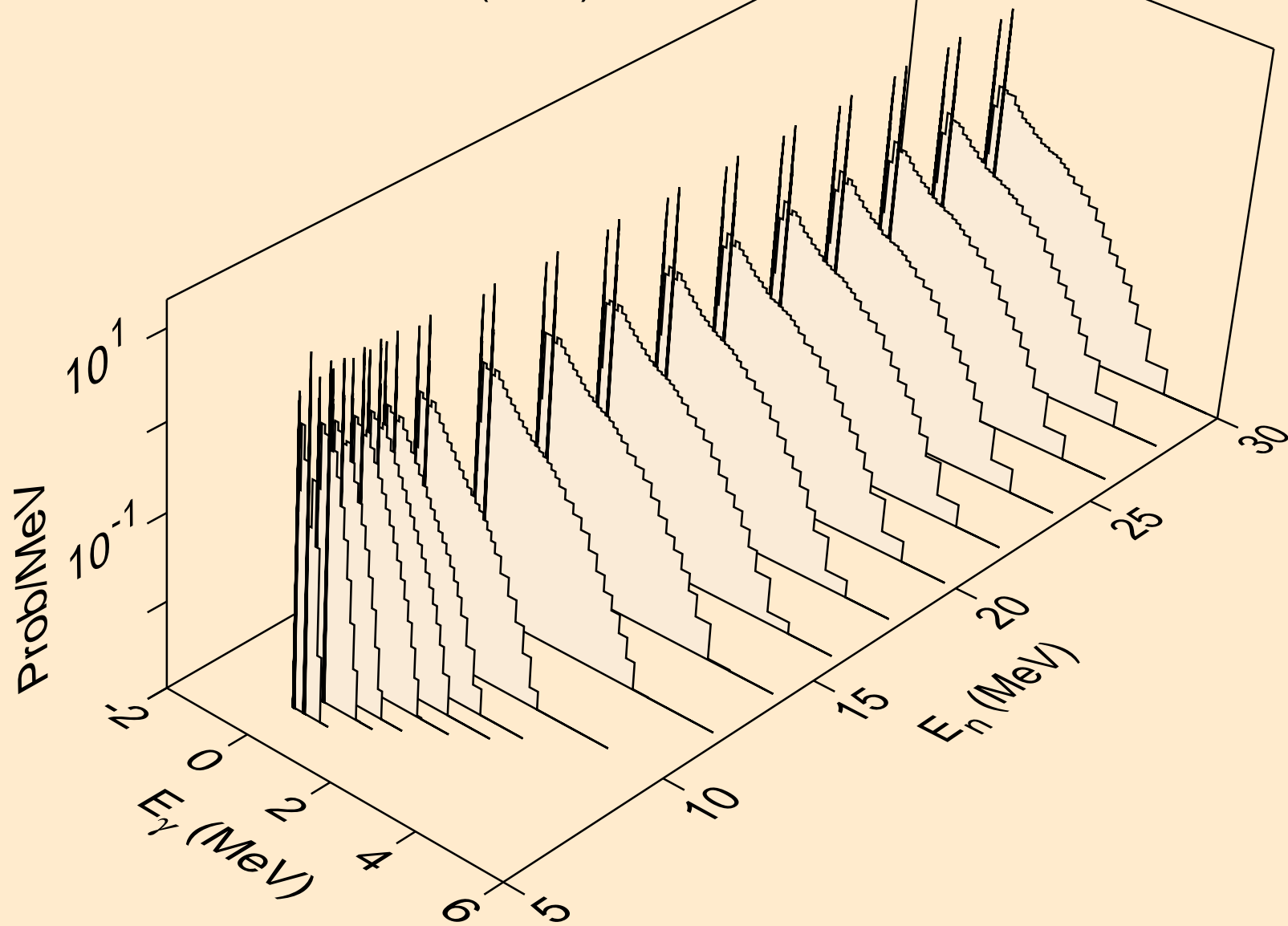

DB266 NEUTRON ACER TENDL-2024 LIBRARY; T=293.6K
Photon emission for (n,3n)

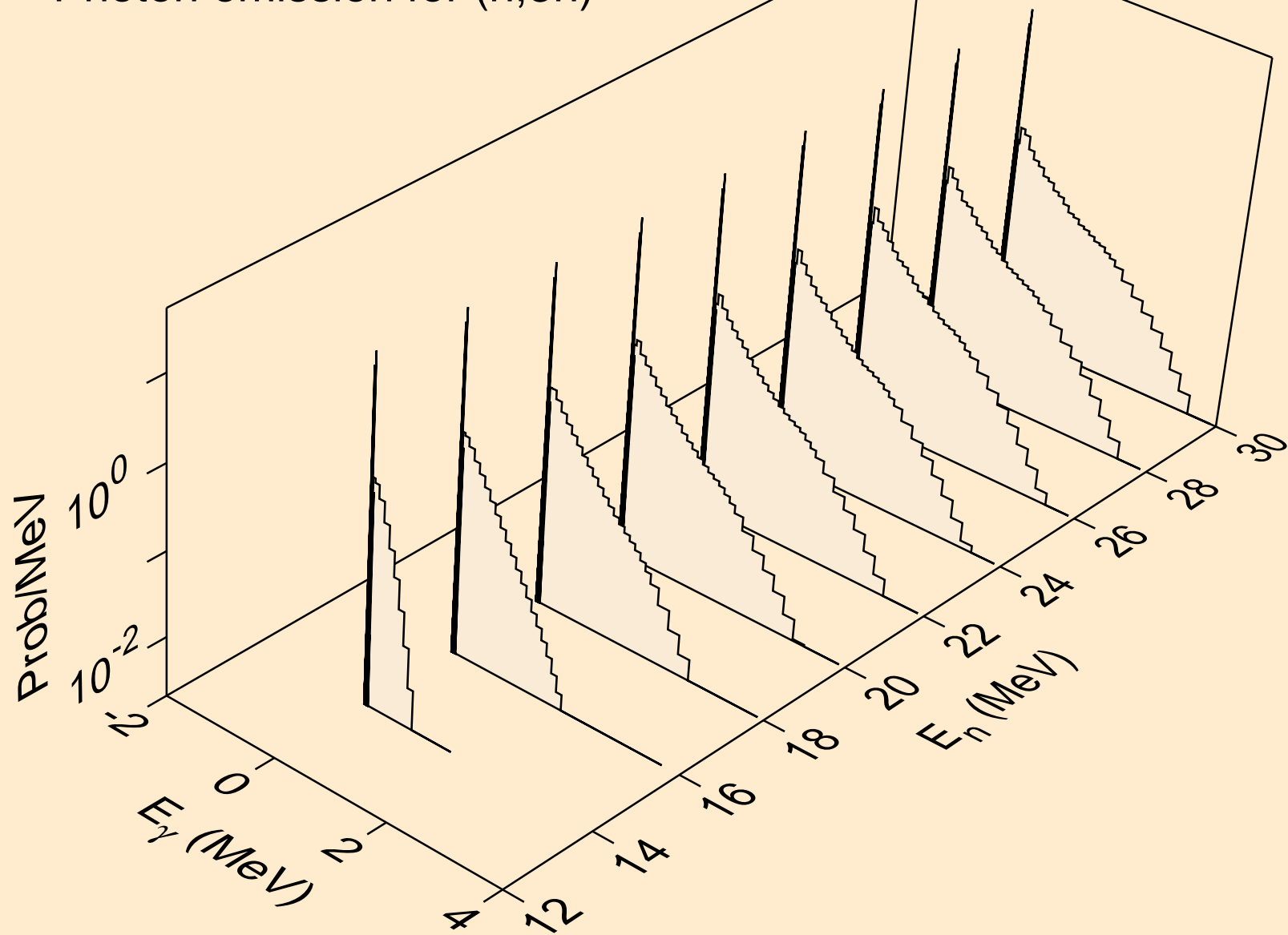

DB266 NEUTRON ACER TENDL-2024 LIBRARY; T=293.6K
Photon emission for (n,n*)a

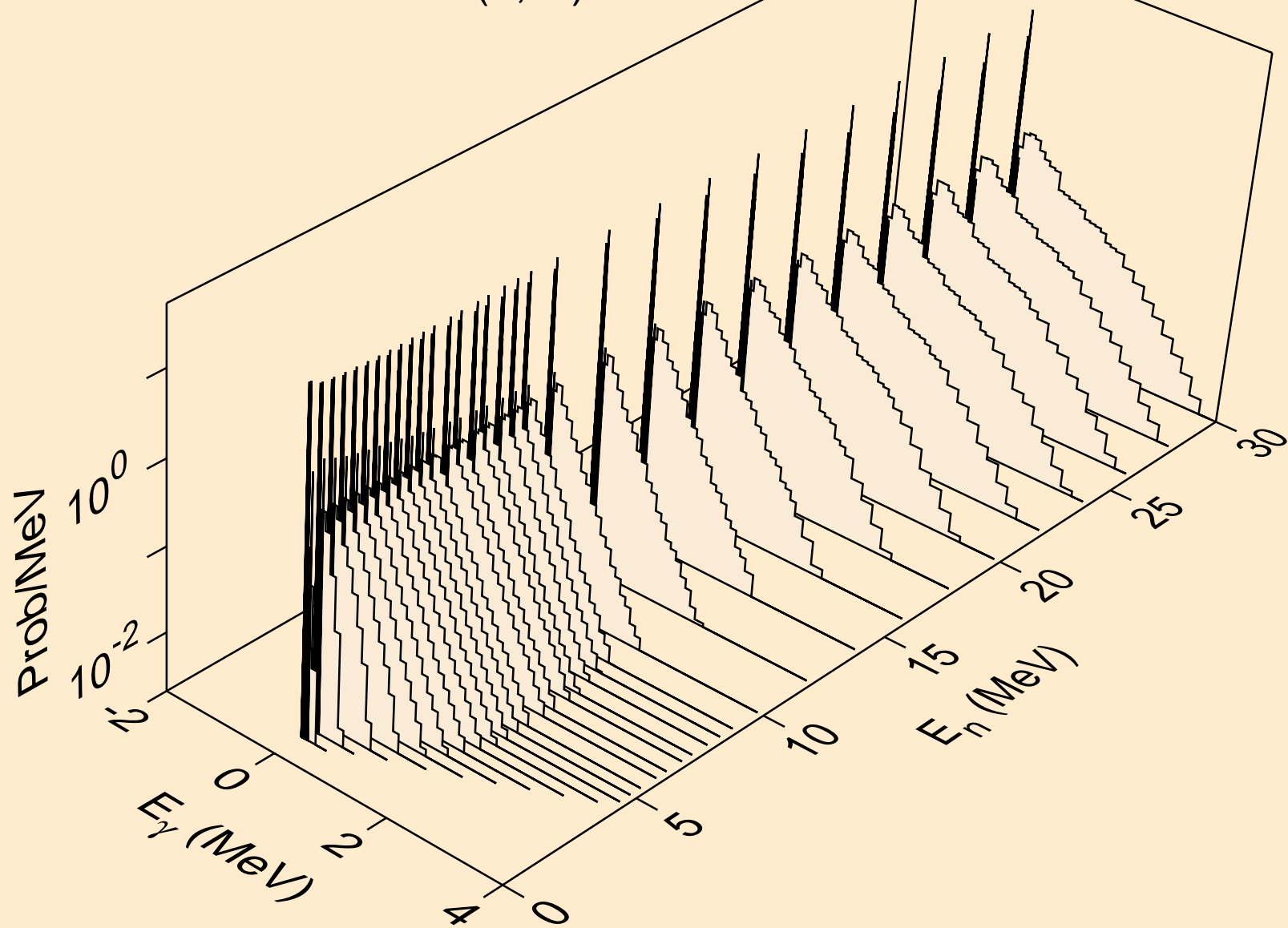

DB266 NEUTRON ACER TENDL-2024 LIBRARY; T=293.6K
Photon emission for (n,2n)a

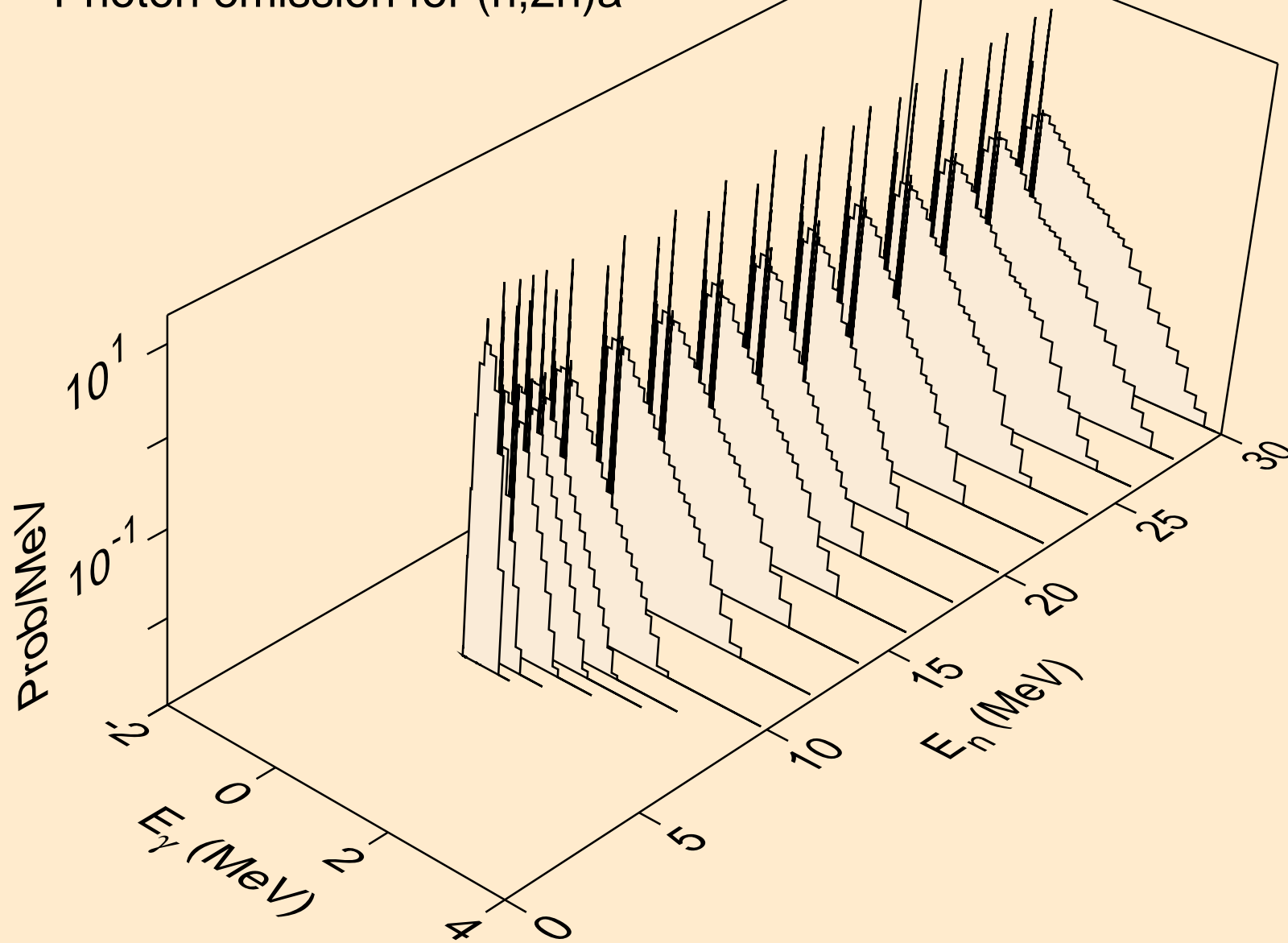

DB266 NEUTRON ACER TENDL-2024 LIBRARY; T=293.6K
Photon emission for (n,3n)a

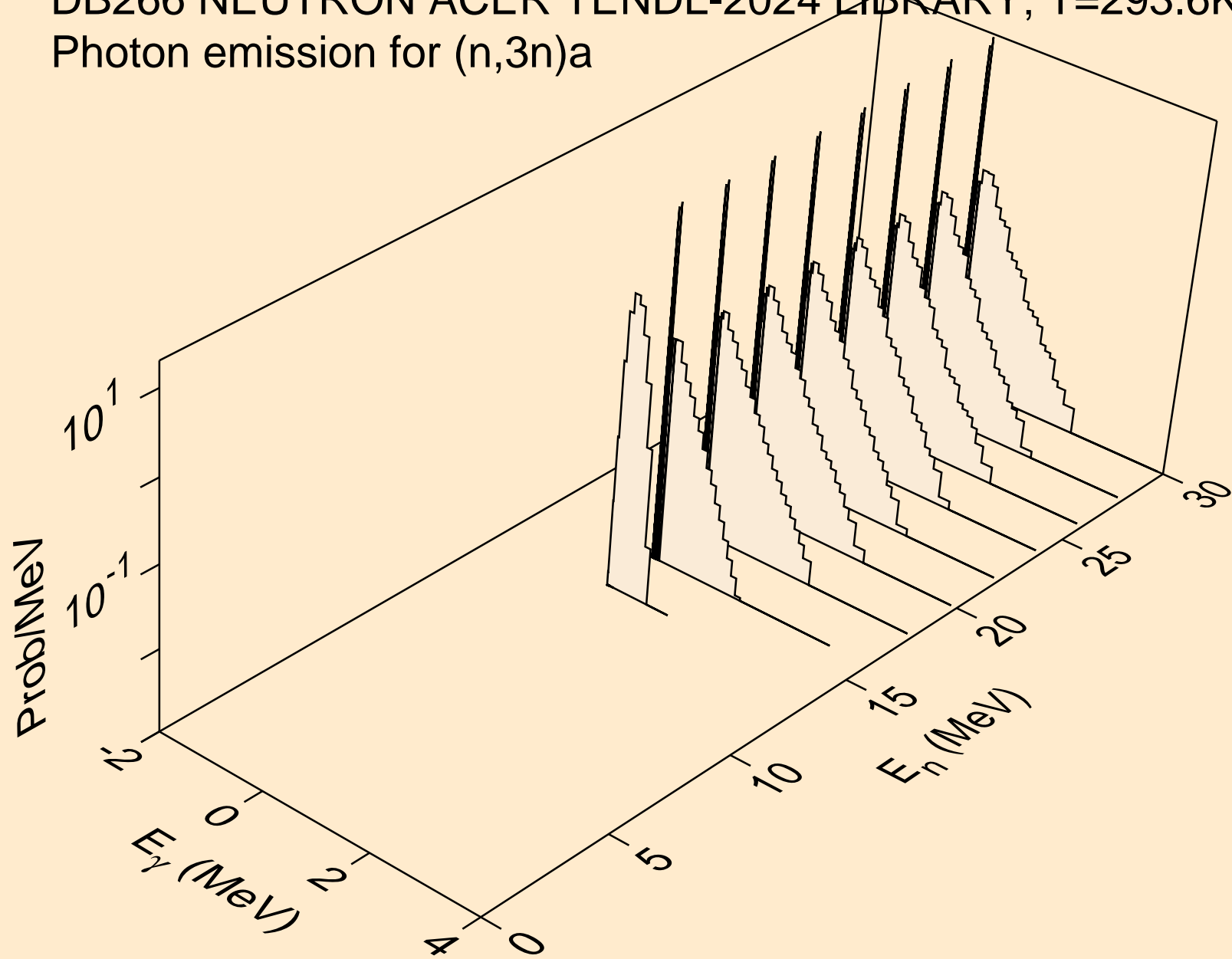

DB266 NEUTRON ACER TENDL-2024 LIBRARY; T=293.6K
Photon emission for (n,n*)p

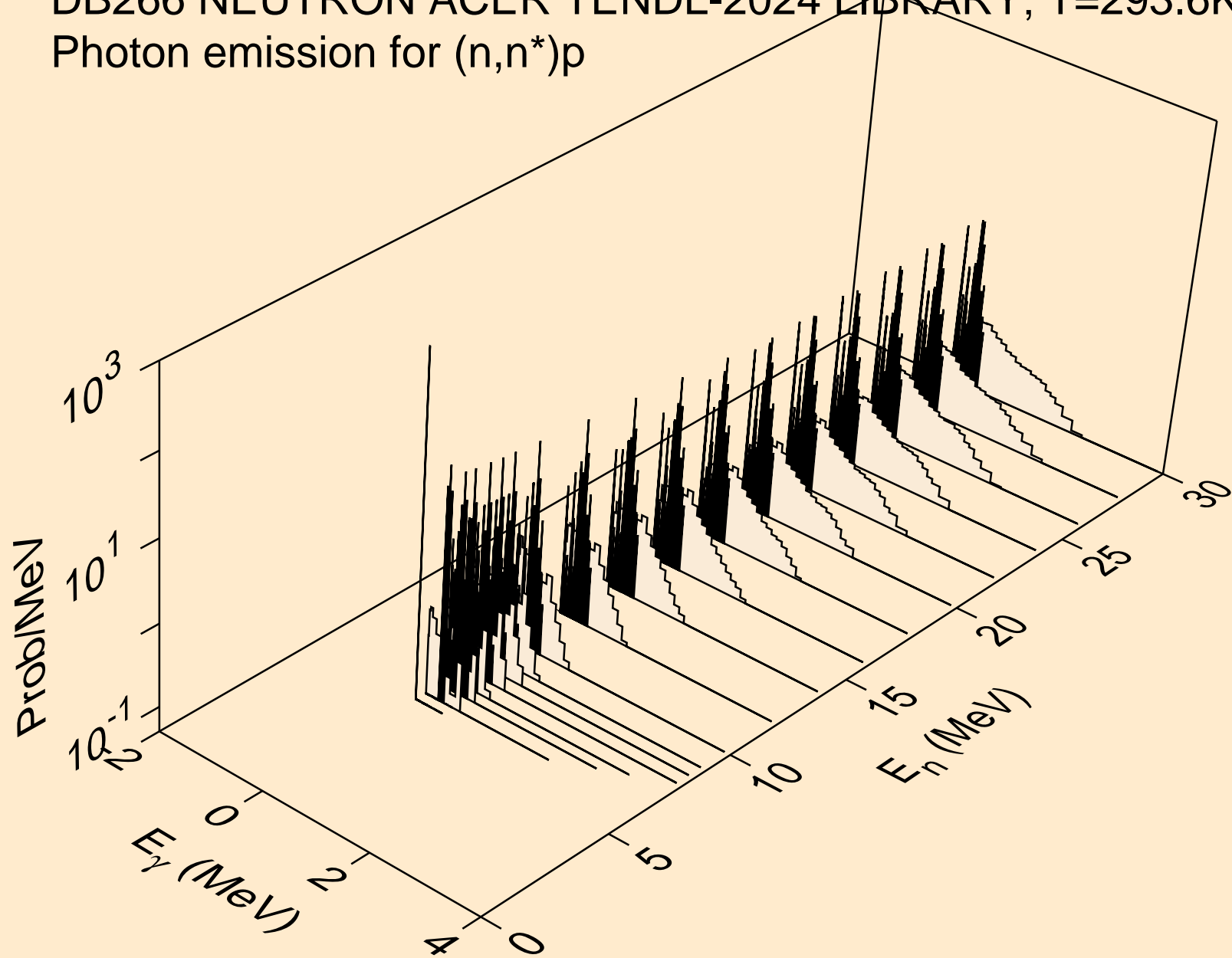

DB266 NEUTRON ACER TENDL-2024 LIBRARY; T=293.6K
Photon emission for (n,n*)d

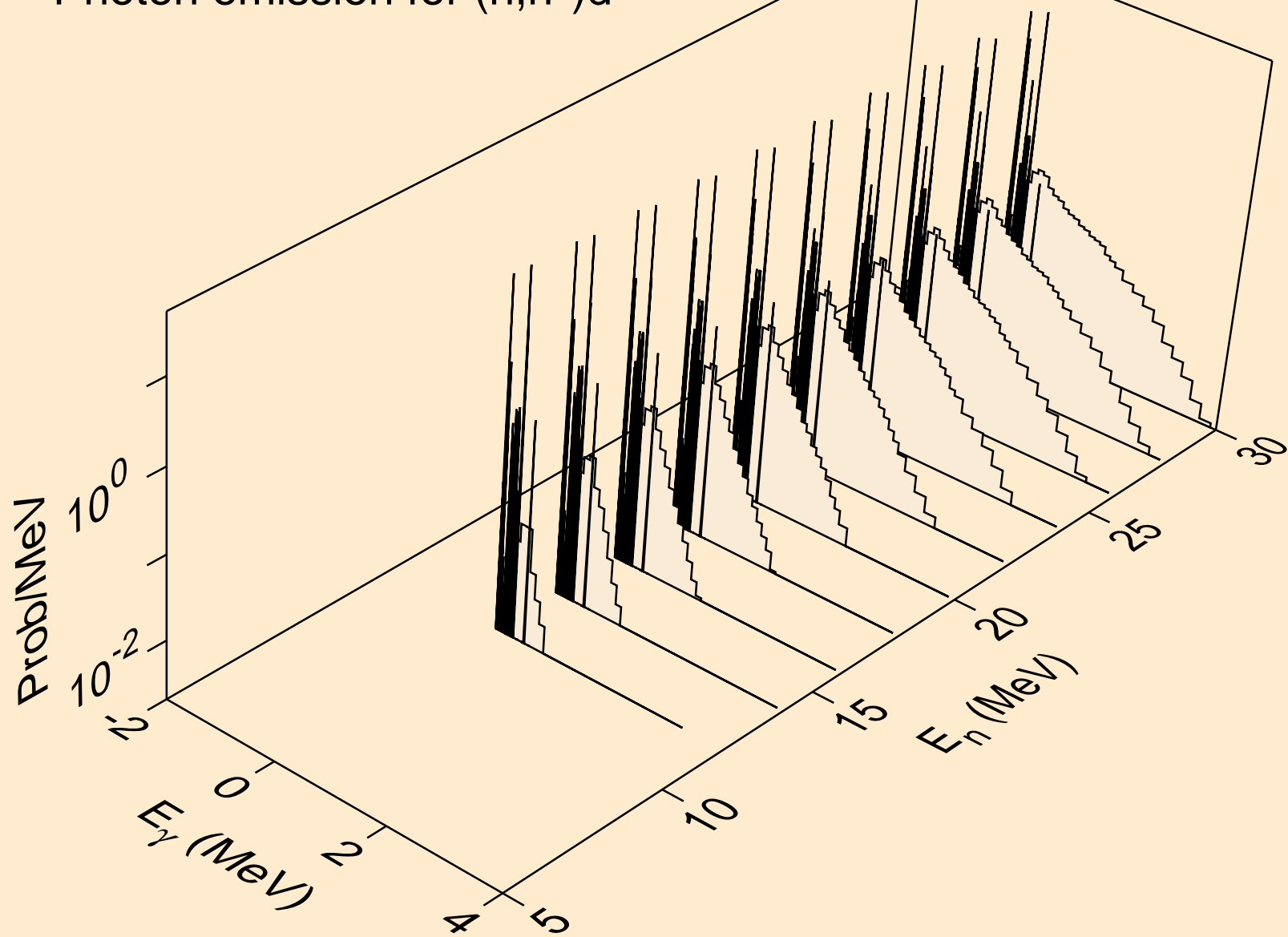

DB266 NEUTRON ACER TENDL-2024 LIBRARY; T=293.6K
Photon emission for (n,n*)t

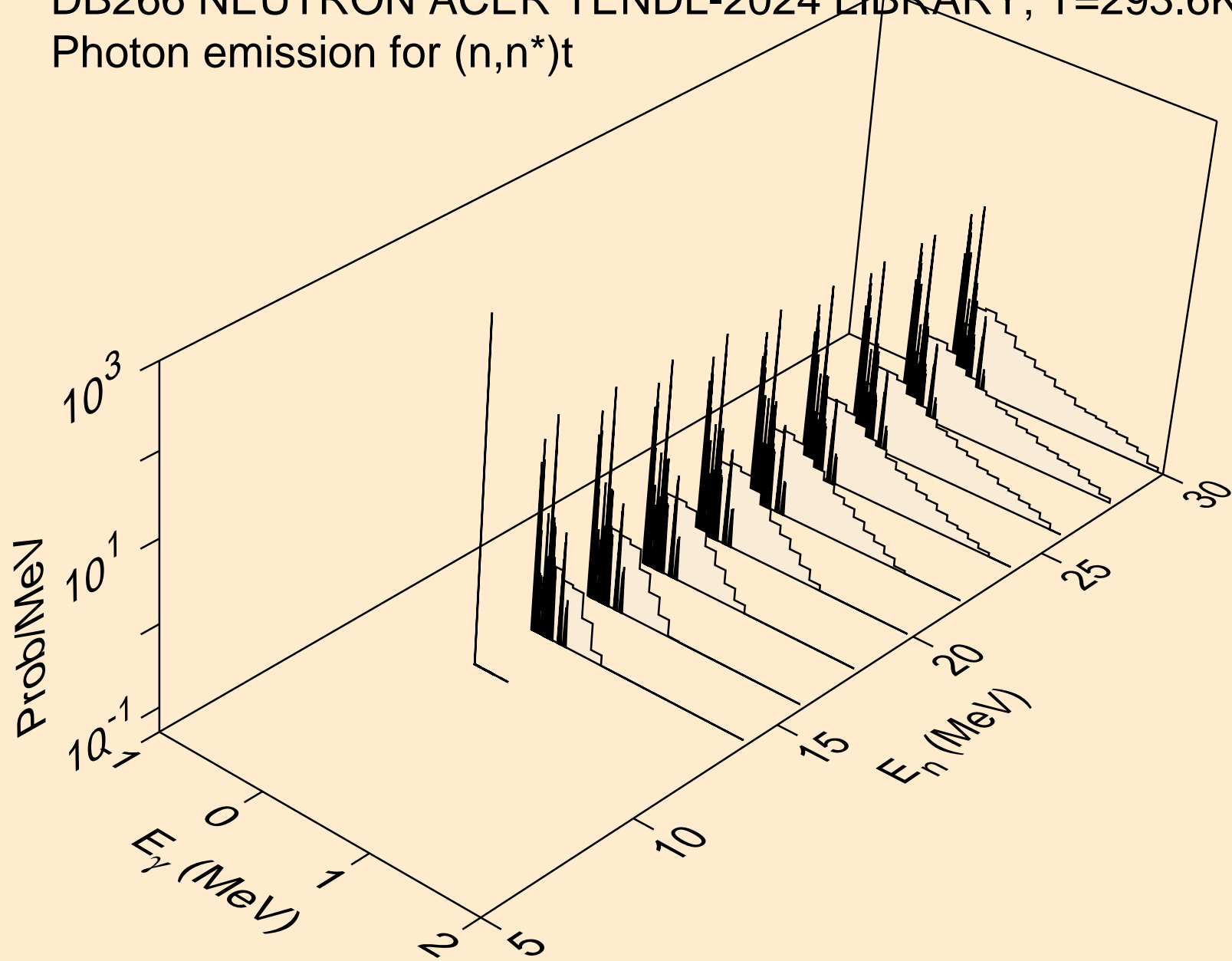

DB266 NEUTRON ACER TENDL-2024 LIBRARY; T=293.6K
Photon emission for (n,n*)he3

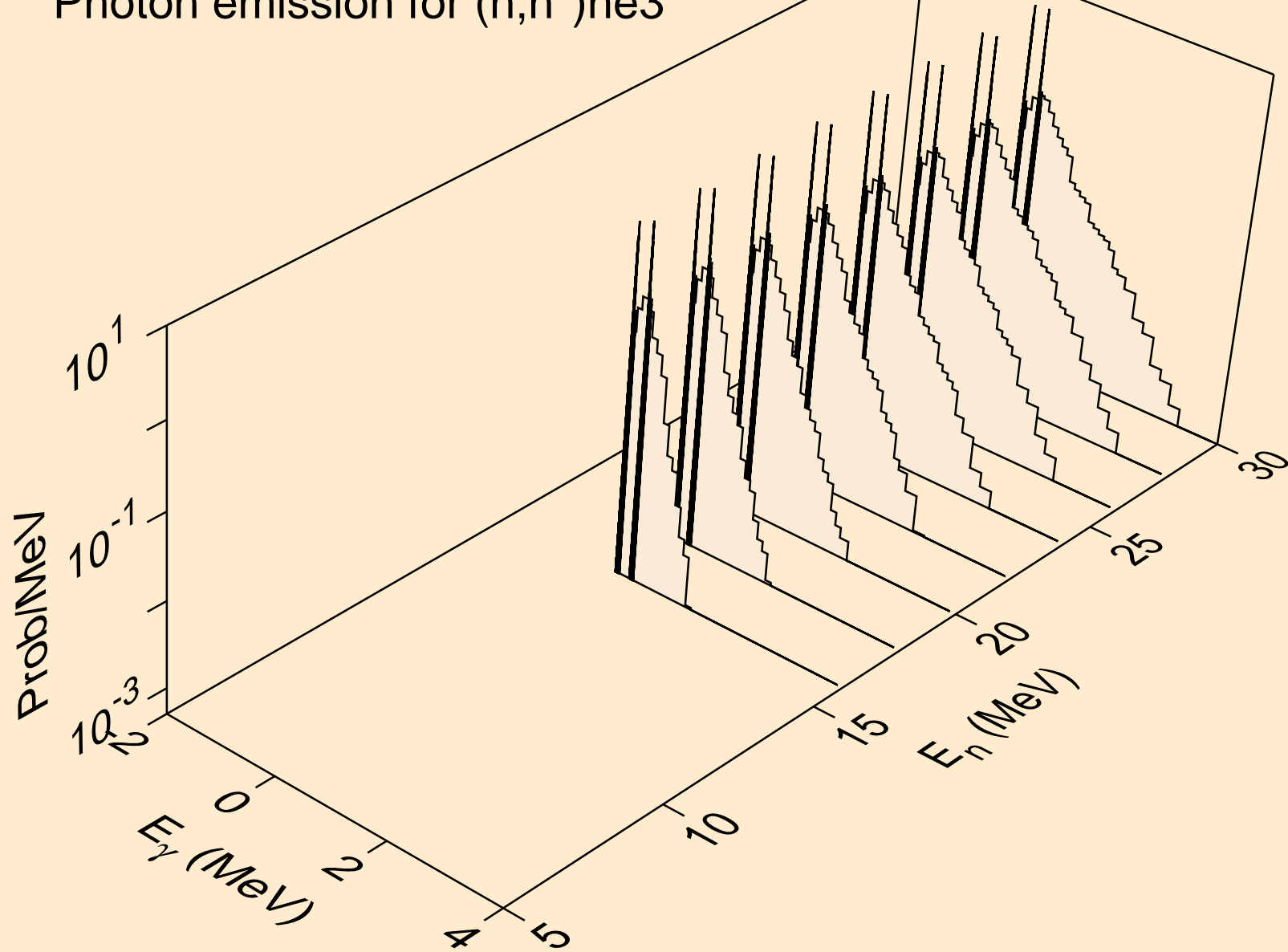

DB266 NEUTRON ACER TENDL-2024 LIBRARY; T=293.6K
Photon emission for (n,4n)

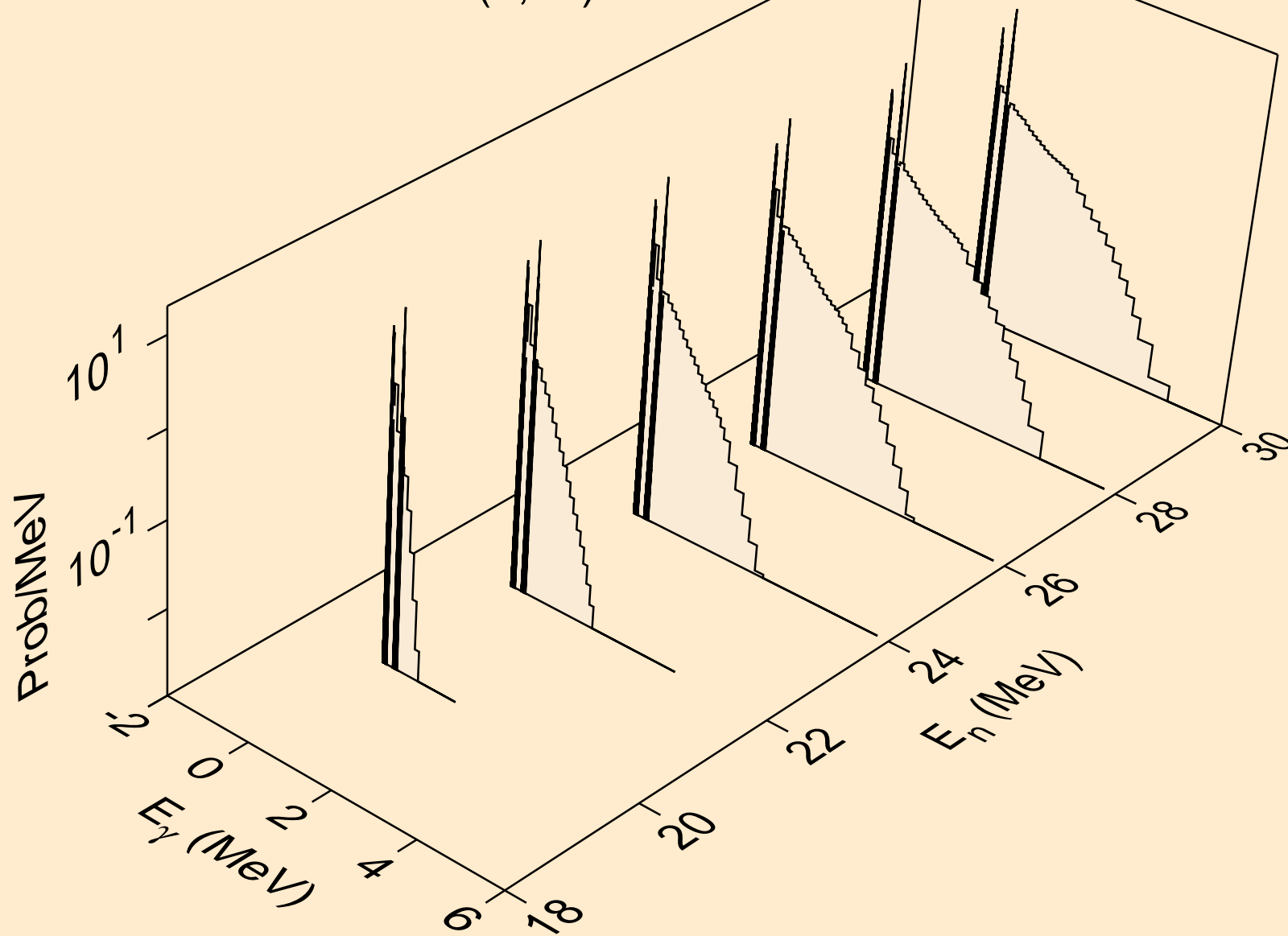

DB266 NEUTRON ACER TENDL-2024 LIBRARY; T=293.6K
Photon emission for (n,2np)

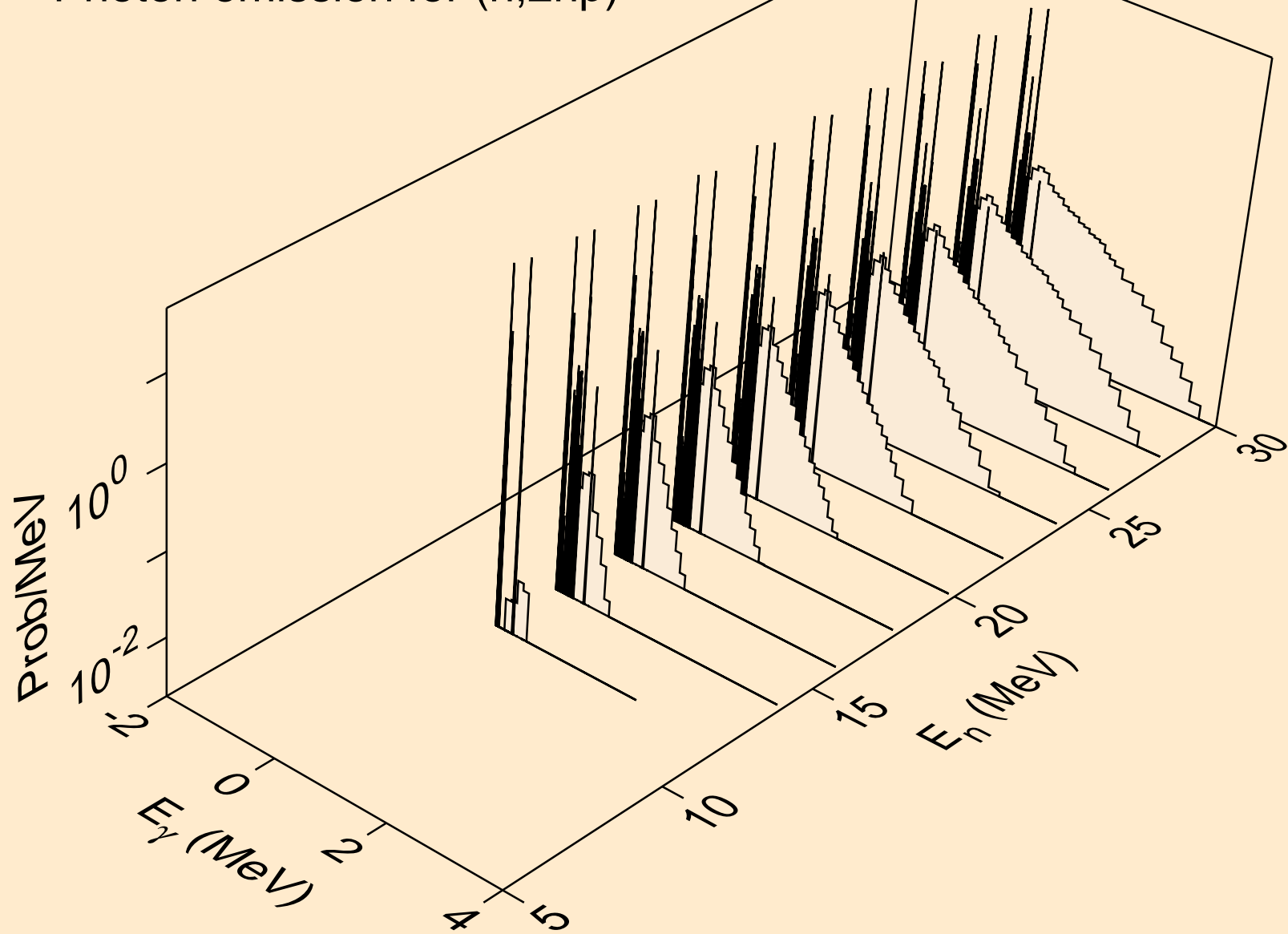

DB266 NEUTRON ACER TENDL-2024 LIBRARY; T=293.6K
Photon emission for (n,3np)

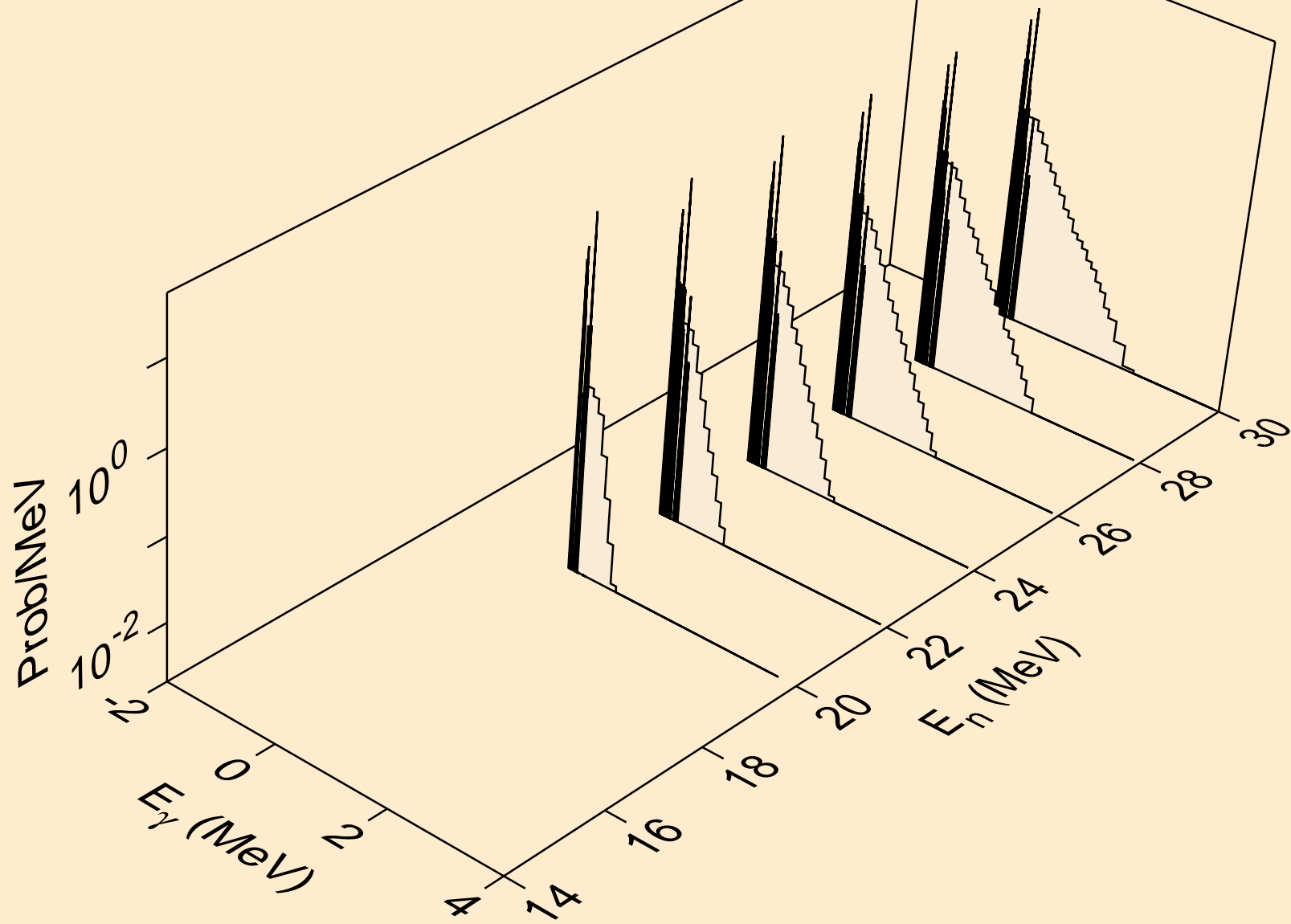

DB266 NEUTRON ACER TENDL-2024 LIBRARY; T=293.6K
Photon emission for (n,n2p)

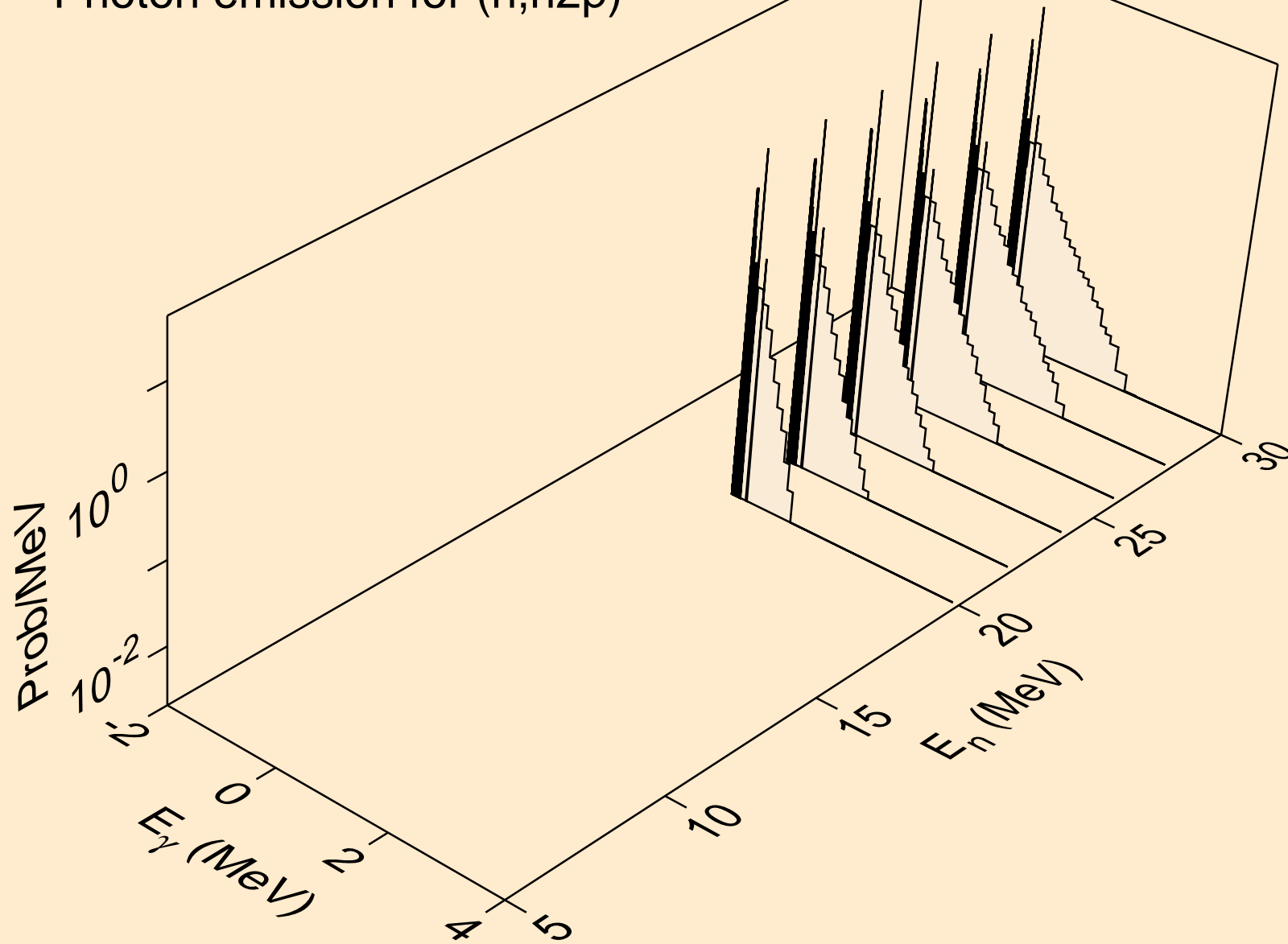

DB266 NEUTRON ACER TENDL-2024 LIBRARY; T=293.6K
Photon emission for (n,n*c)

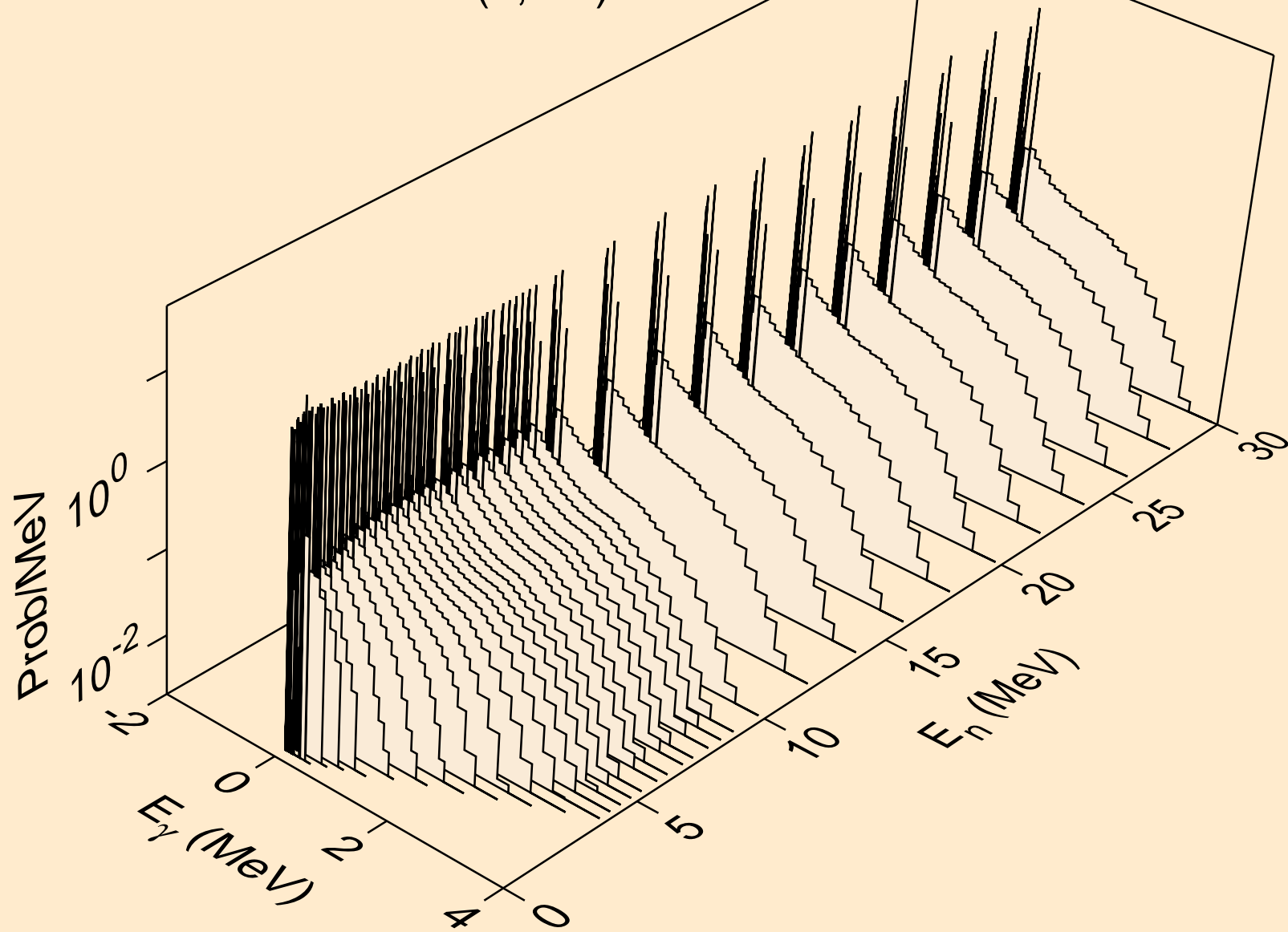

DB266 NEUTRON ACER TENDL-2024 LIBRARY; T=293.6K
Photon emission for (n,gma)

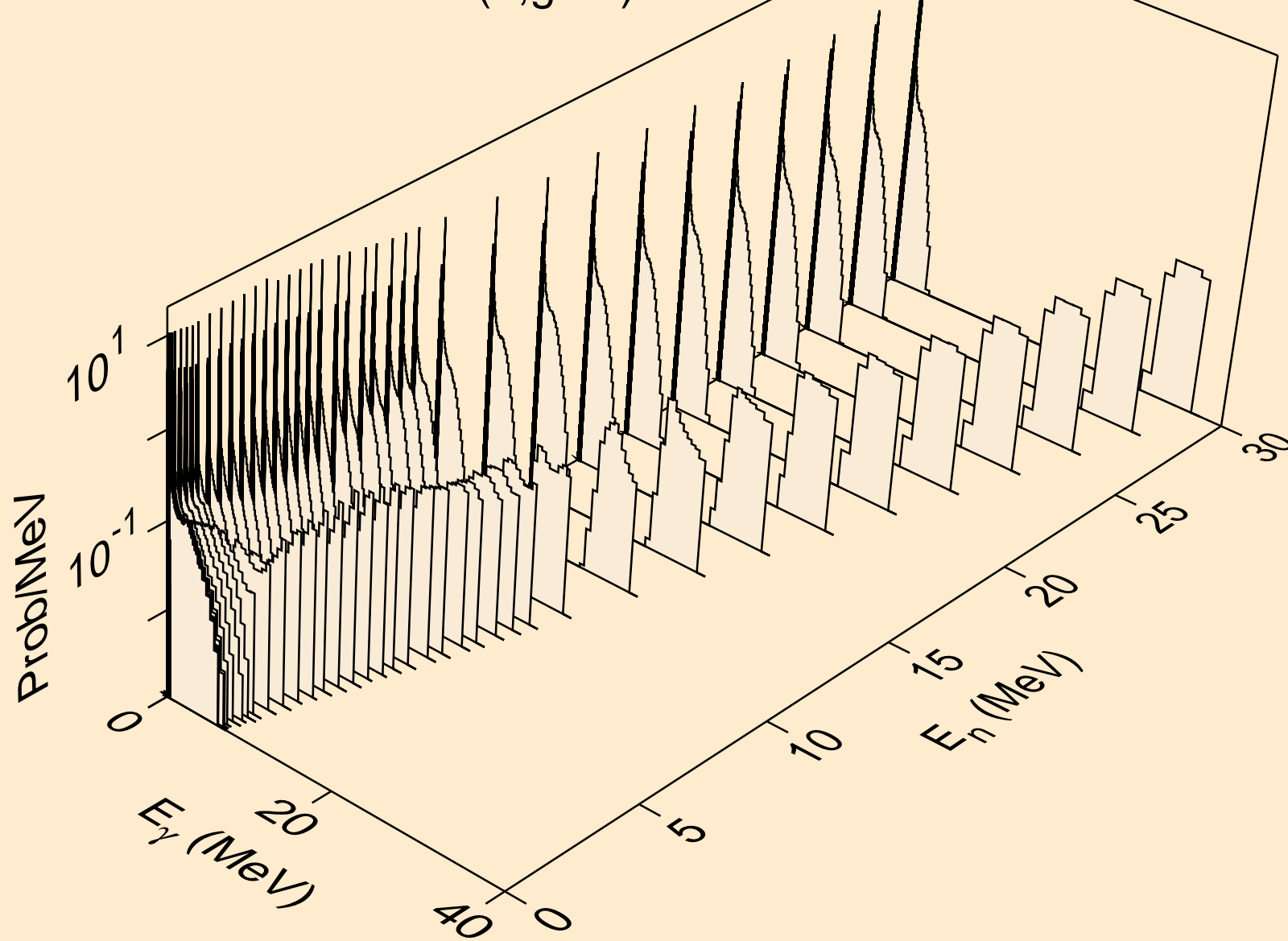

DB266 NEUTRON ACER TENDL-2024 LIBRARY; T=293.6K
Photon emission for (n,p)

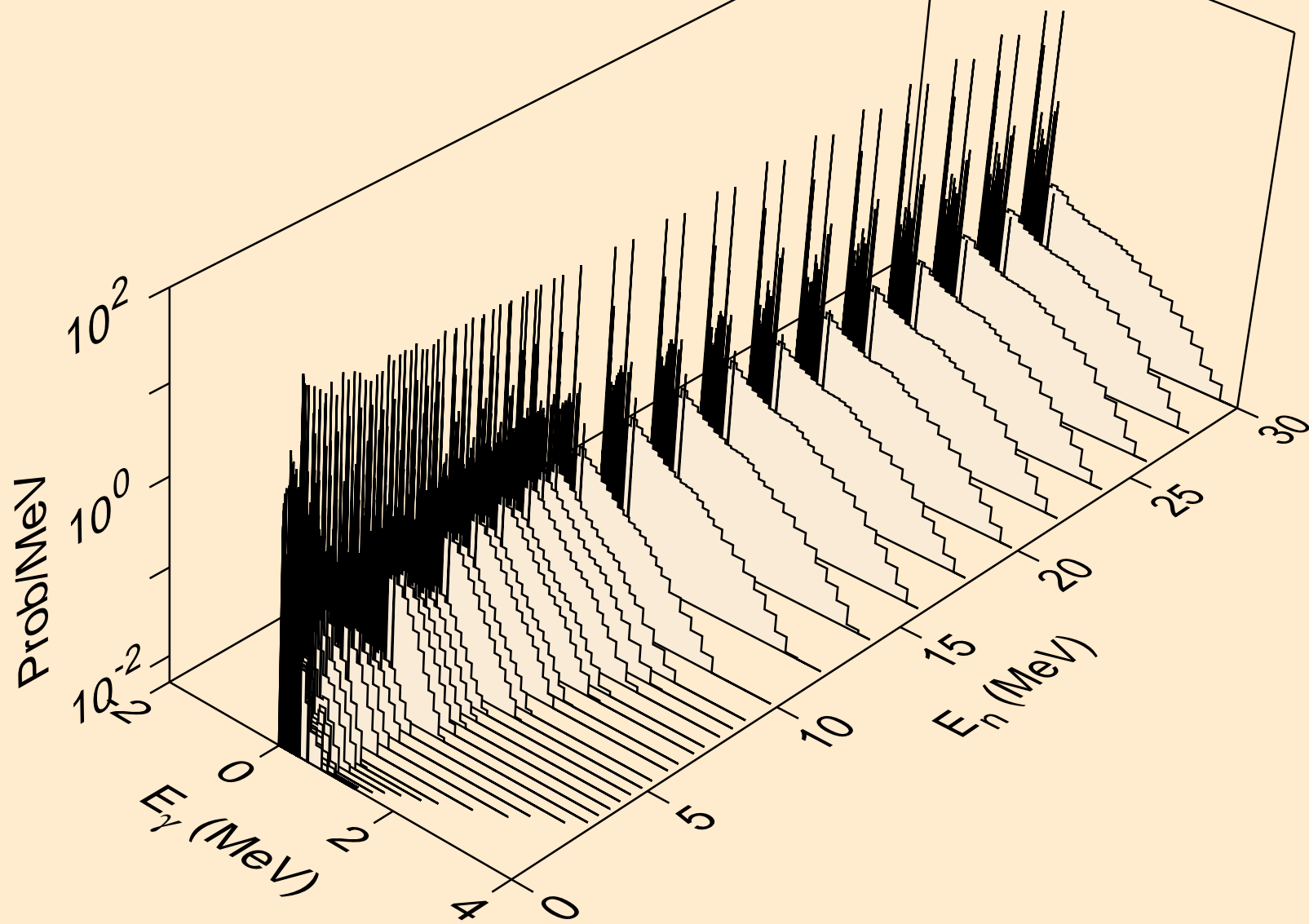

DB266 NEUTRON ACER TENDL-2024 LIBRARY; T=293.6K
Photon emission for (n,d)

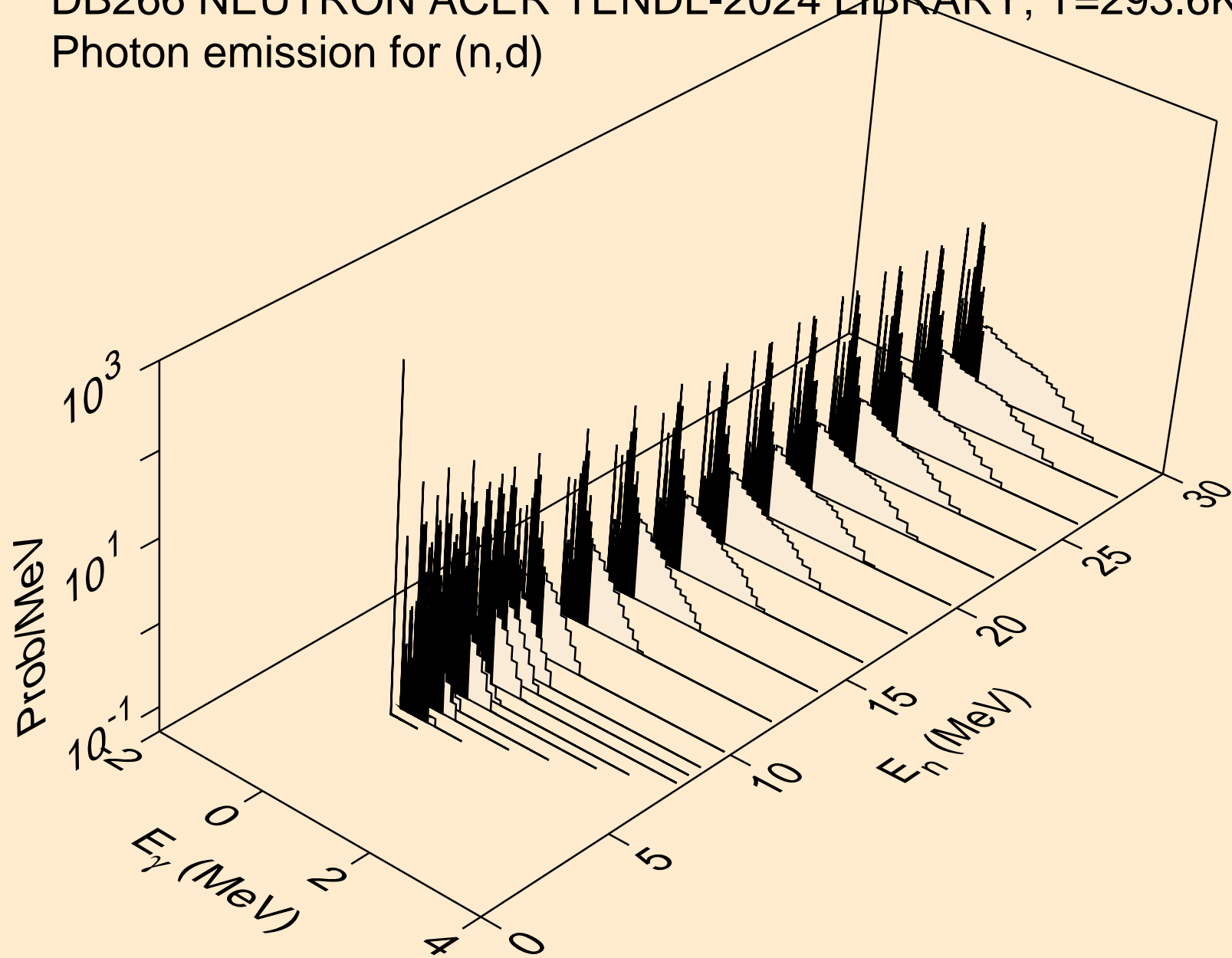

DB266 NEUTRON ACER TENDL-2024 LIBRARY; T=293.6K
Photon emission for (n,t)

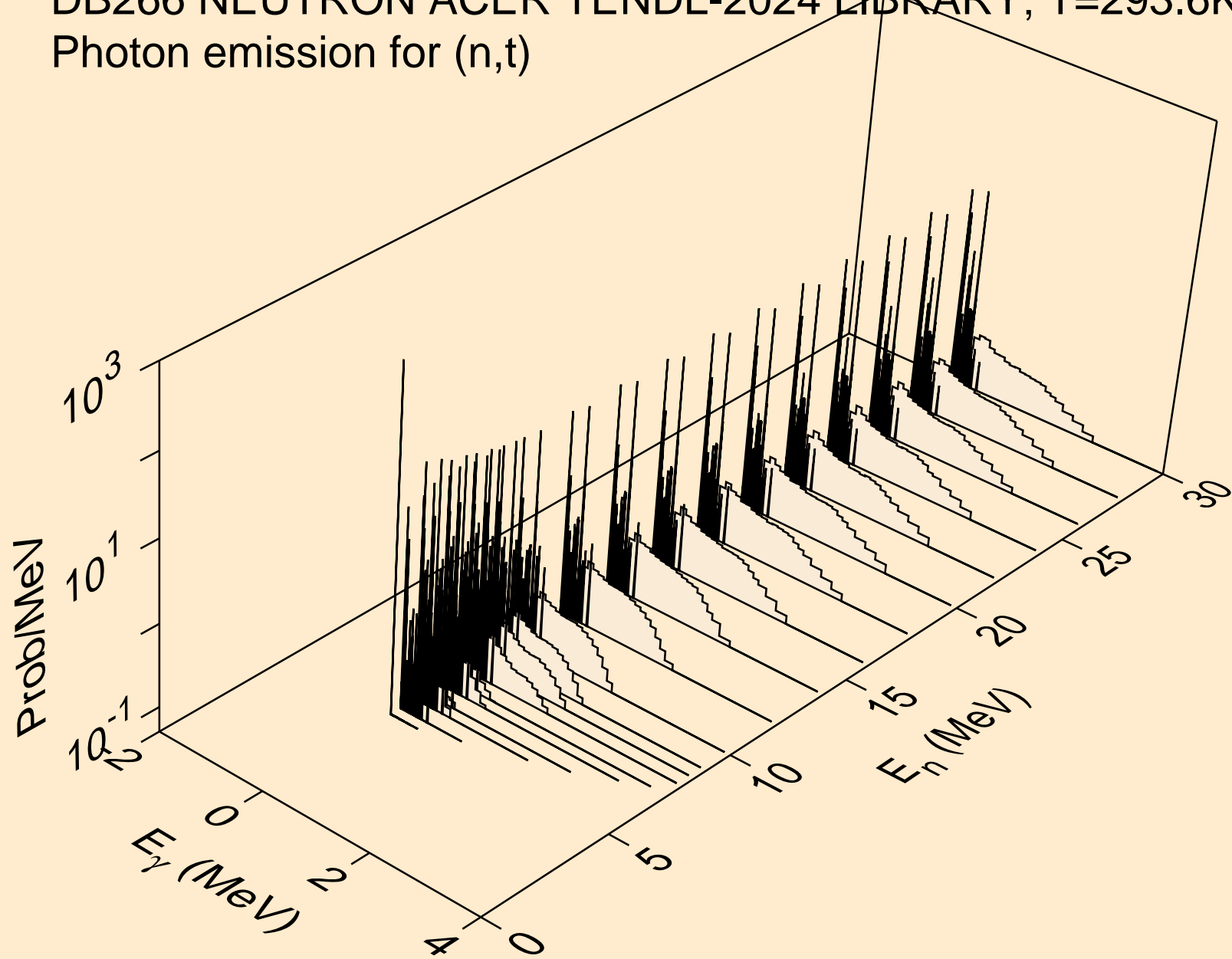

DB266 NEUTRON ACER TENDL-2024 LIBRARY; T=293.6K
Photon emission for (n,he3)

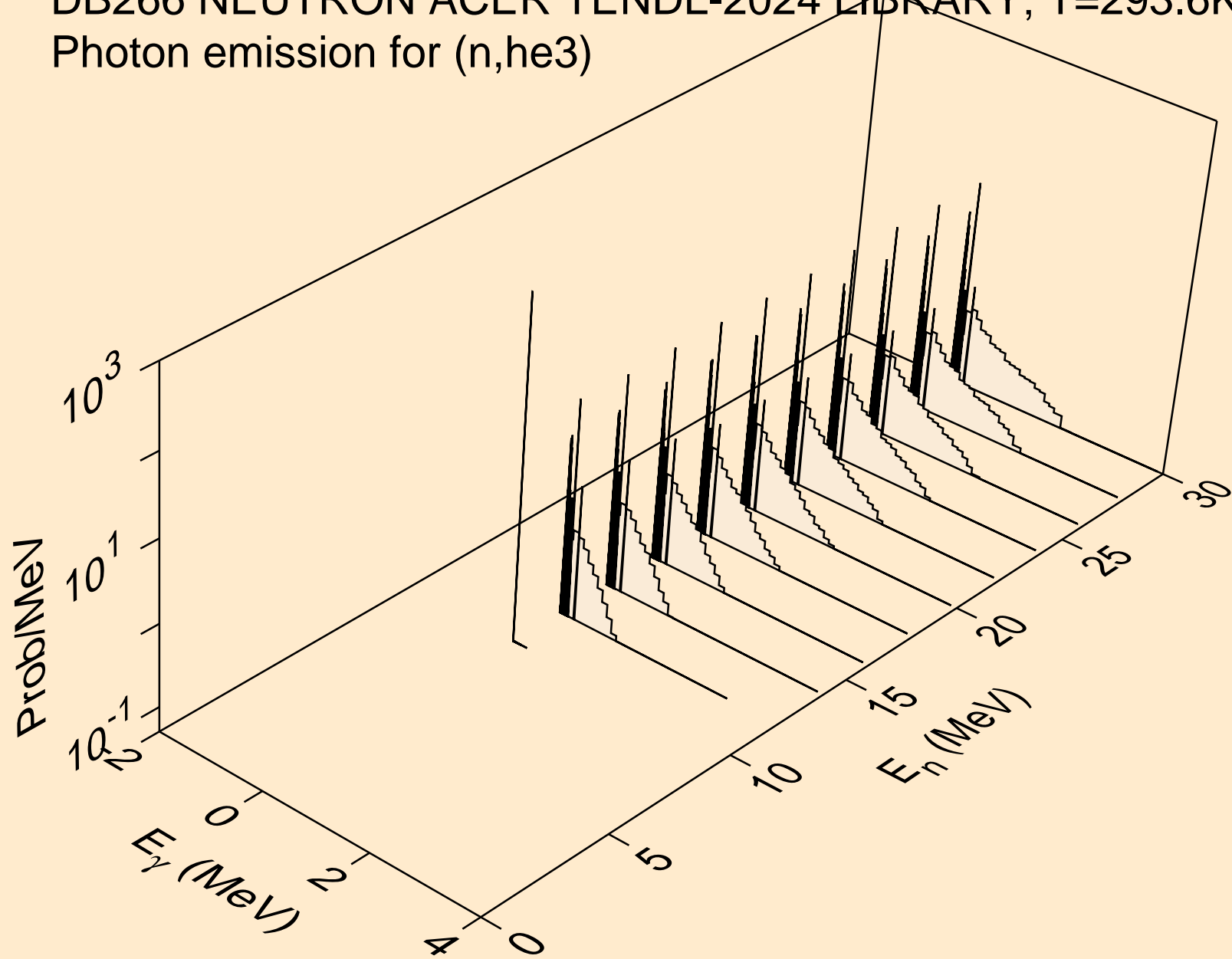

DB266 NEUTRON ACER TENDL-2024 LIBRARY; T=293.6K
Photon emission for (n,a)

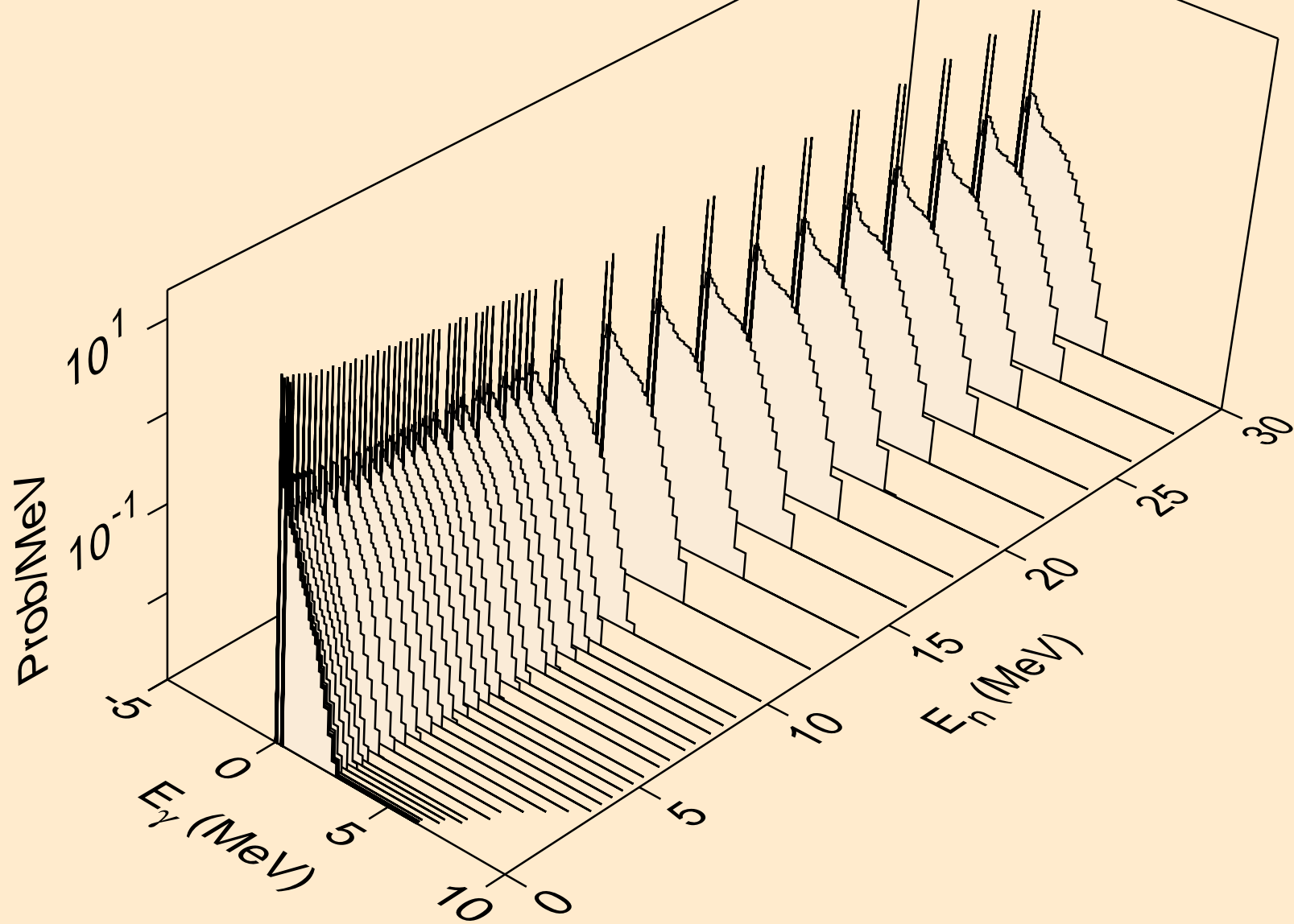

DB266 NEUTRON ACER TENDL-2024 LIBRARY; T=293.6K
Photon emission for (n,2a)

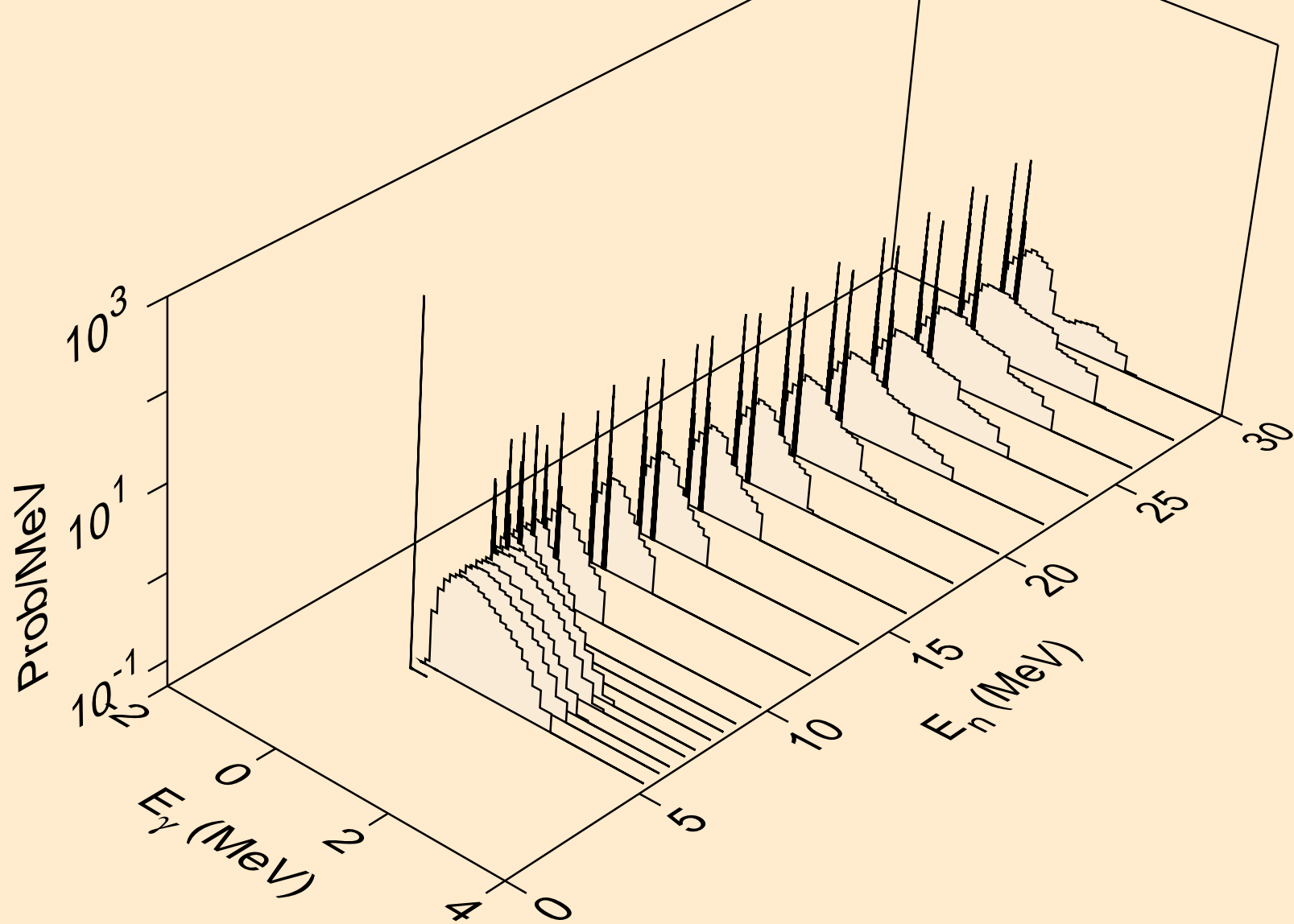

DB266 NEUTRON ACER TENDL-2024 LIBRARY; T=293.6K
Photon emission for (n,2p)

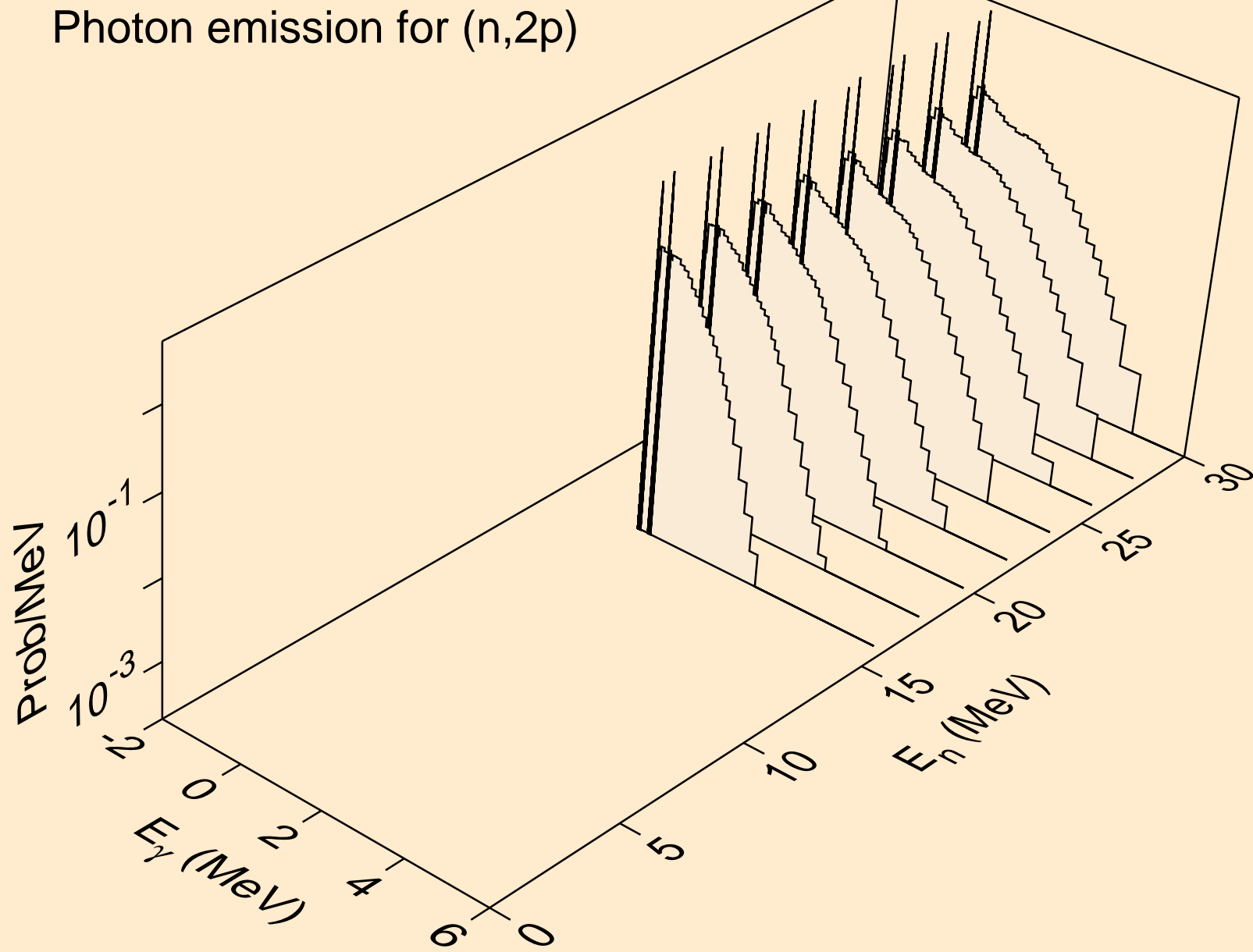

DB266 NEUTRON ACER TENDL-2024 LIBRARY; T=293.6K
thermal capture photon spectrum

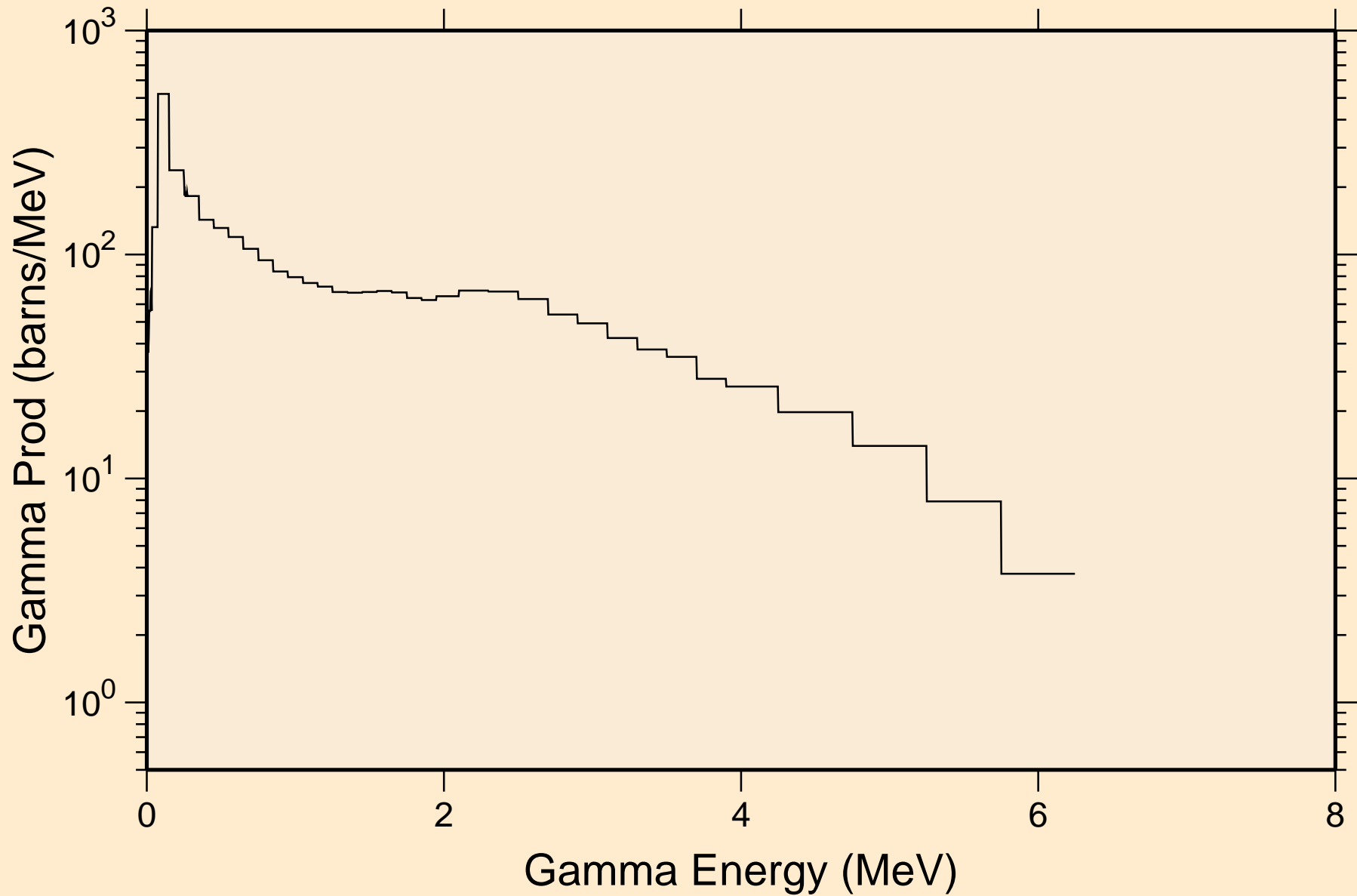

DB266 NEUTRON ACER TENDL-2024 LIBRARY; T=293.6K
14 MeV photon spectrum

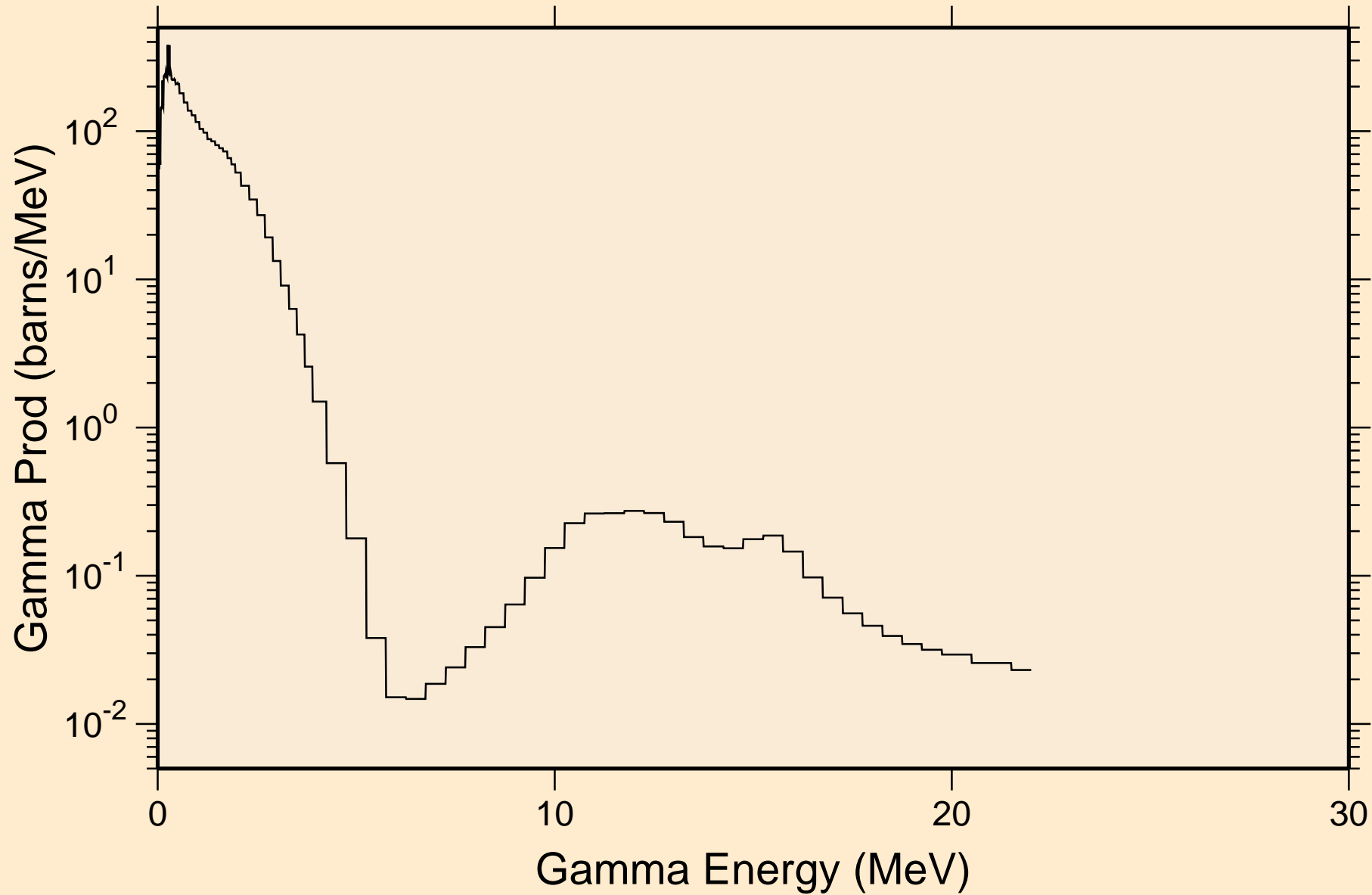

DB266 NEUTRON ACER TENDL-2024 LIBRARY; T=293.6K

Particle heating contributions

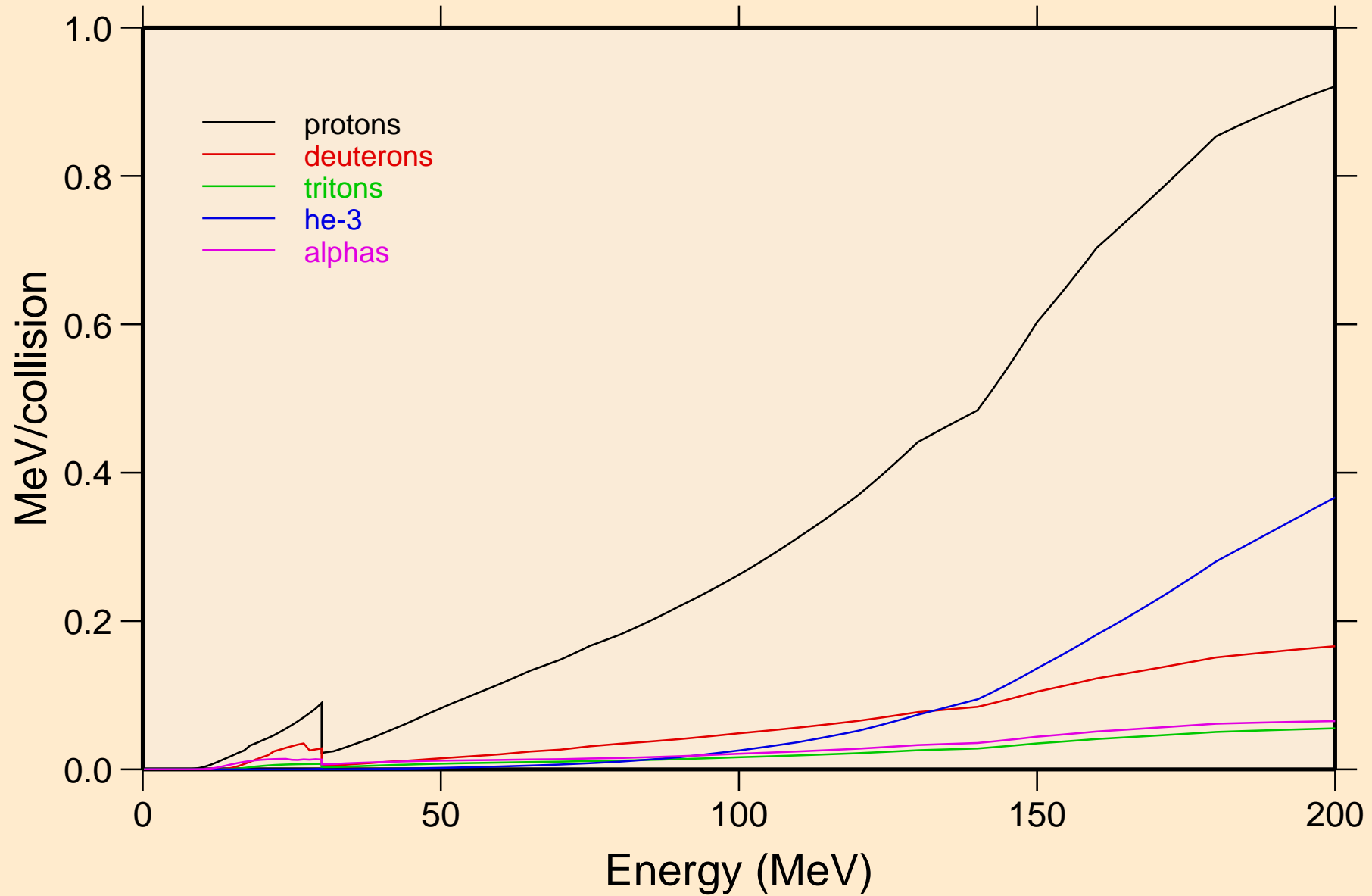

DB266 NEUTRON ACER TENDL-2024 LIBRARY; T=293.6K
Recoil Heating

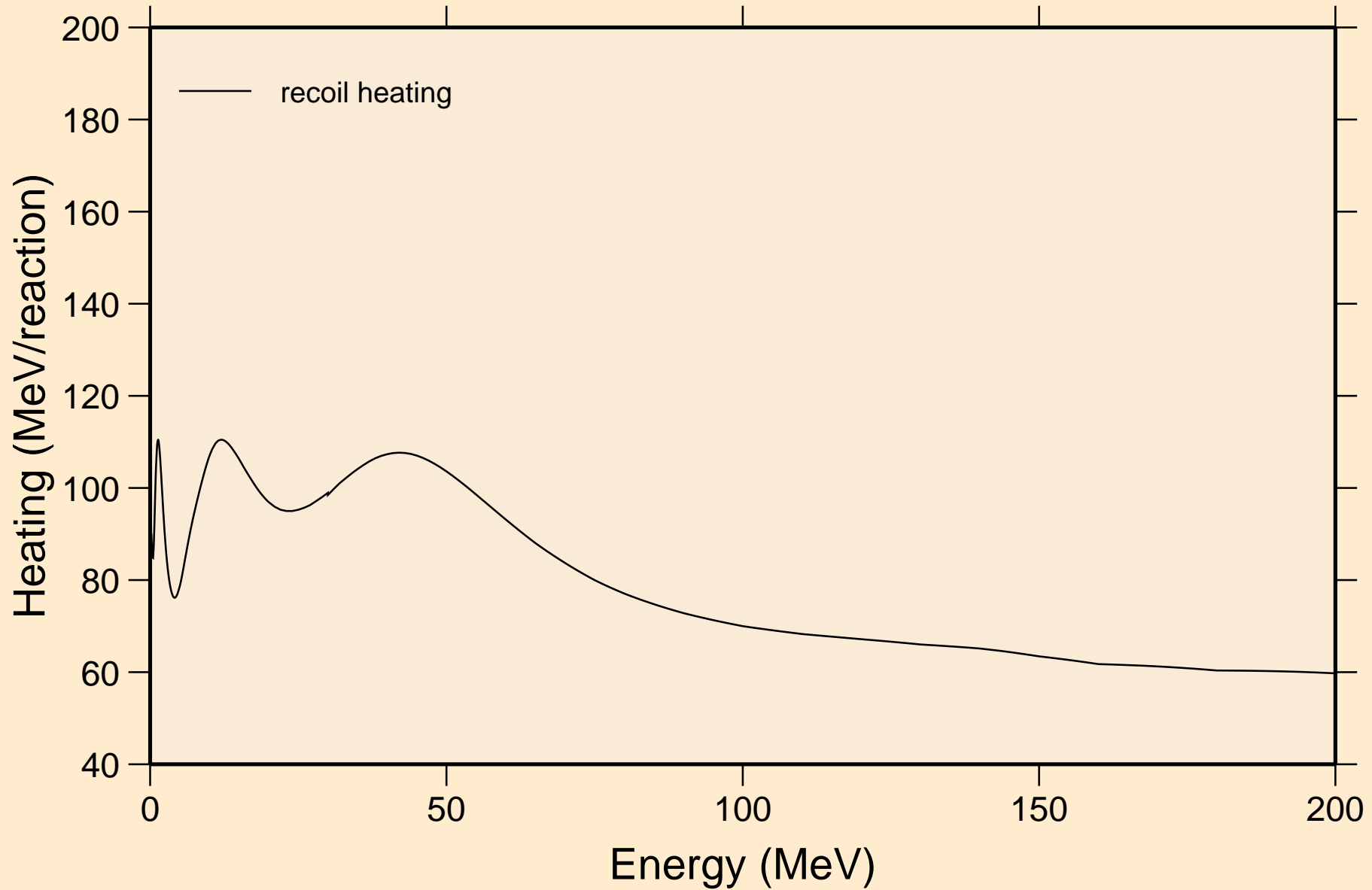

DB266 NEUTRON ACER TENDL-2024 LIBRARY; T=293.6K
Particle production cross sections

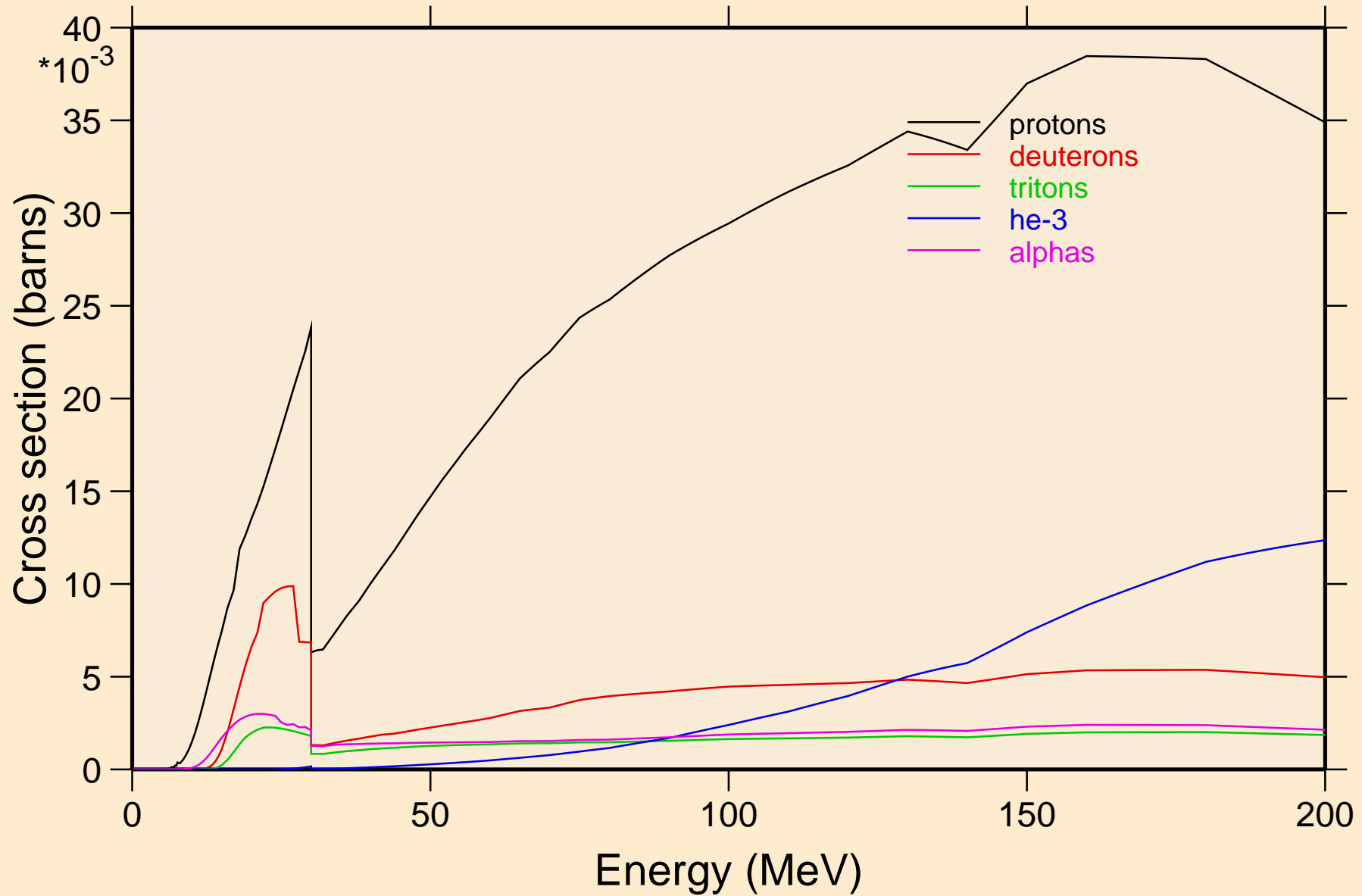

DB266 NEUTRON ACER TENDL-2024 LIBRARY; T=293.6K
protons from (n,x)

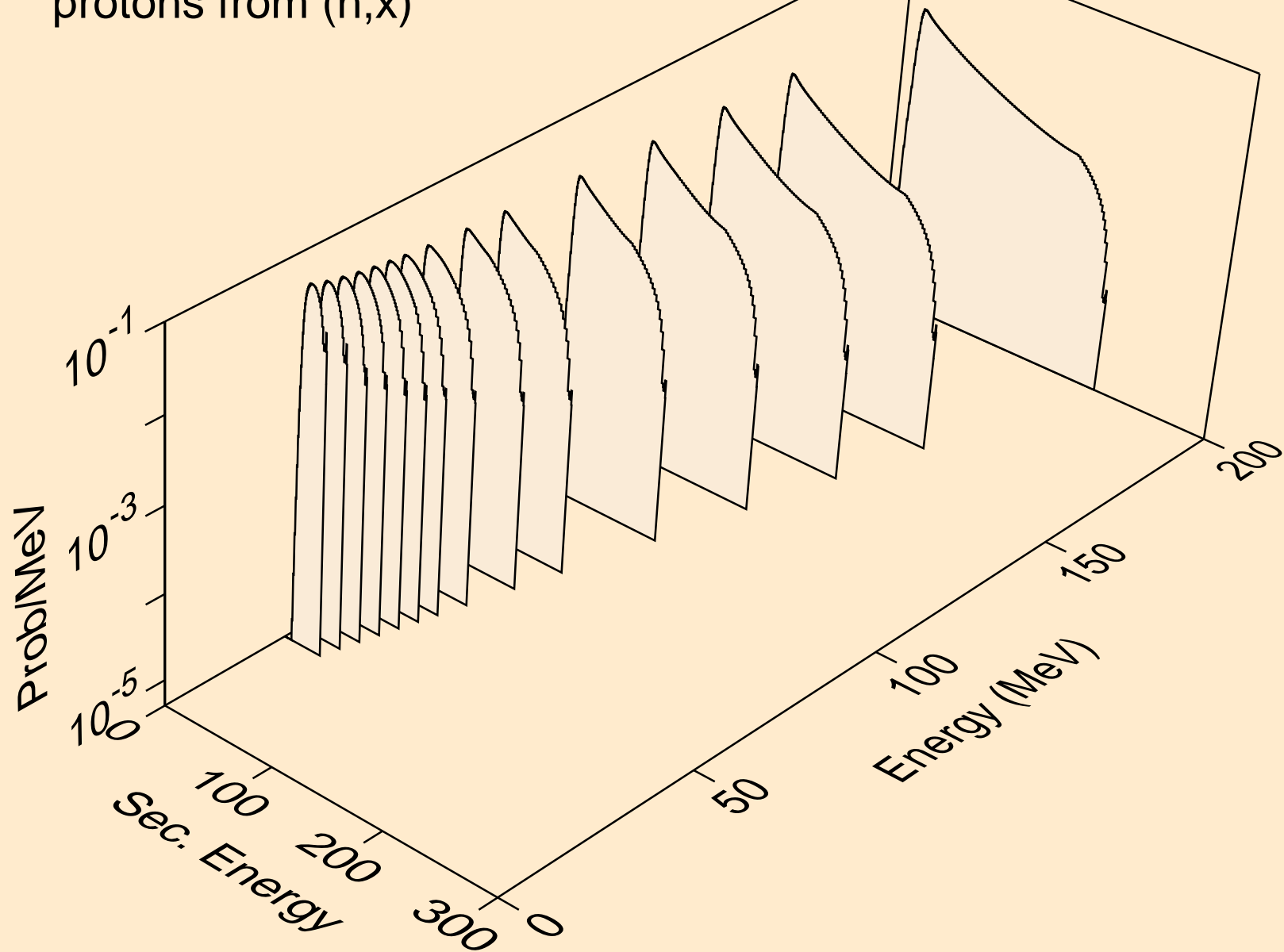

DB266 NEUTRON ACER TENDL-2024 LIBRARY; T=293.6K
protons from (n,n*)p

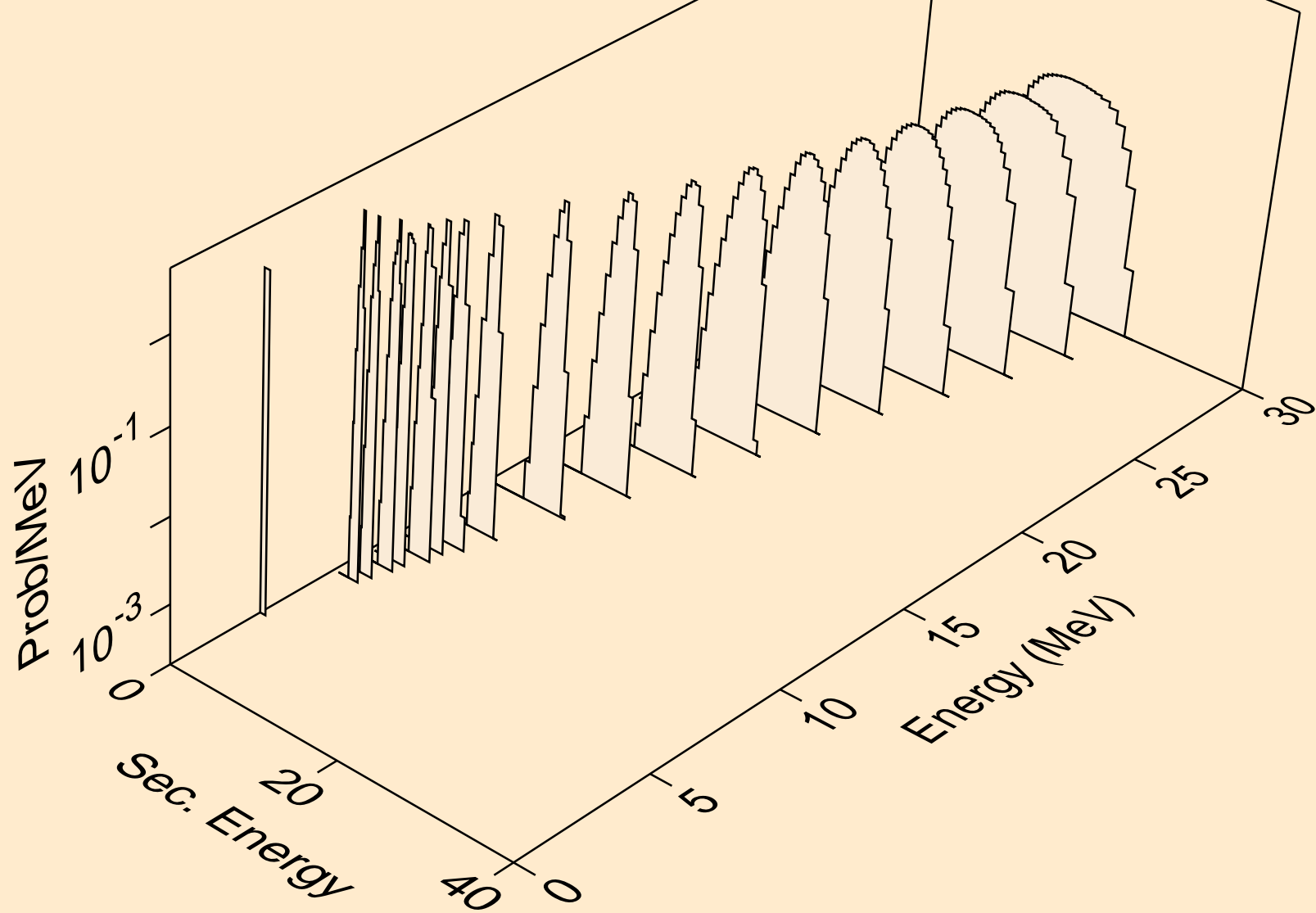

DB266 NEUTRON ACER TENDL-2024 LIBRARY; T=293.6K
protons from (n,2np)

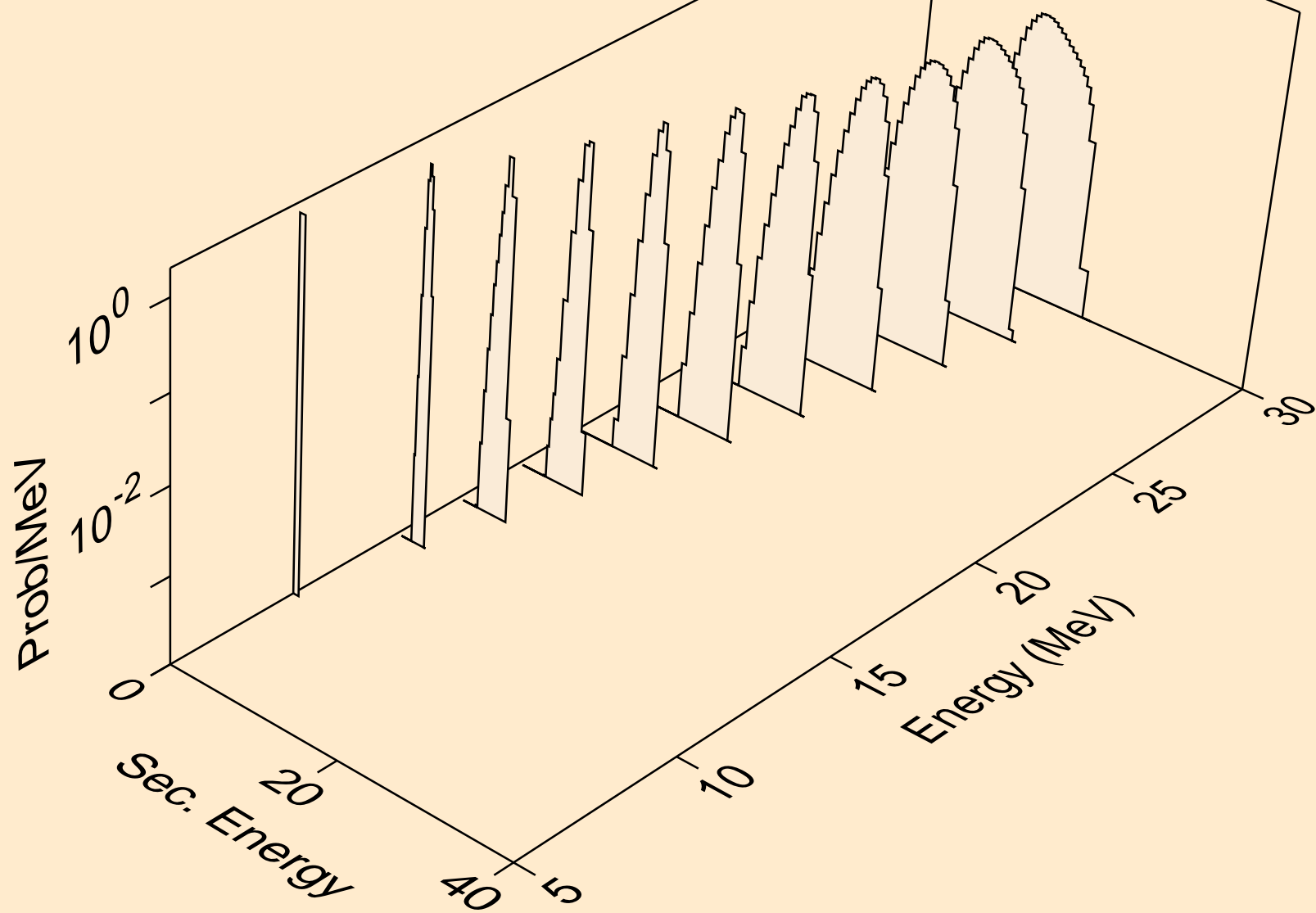

DB266 NEUTRON ACER TENDL-2024 LIBRARY; T=293.6K
protons from (n,3np)

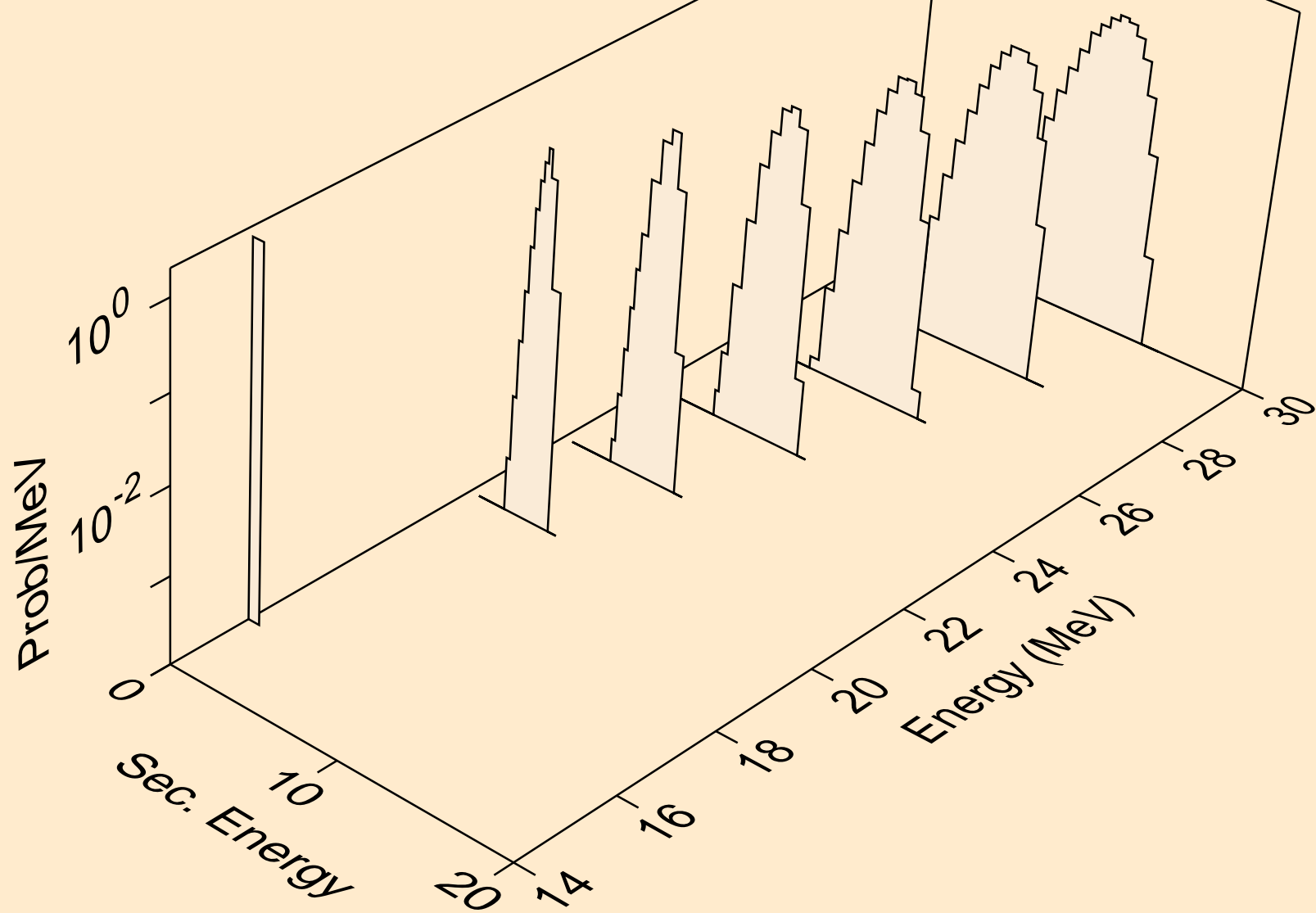

DB266 NEUTRON ACER TENDL-2024 LIBRARY; T=293.6K
protons from (n,n2p)

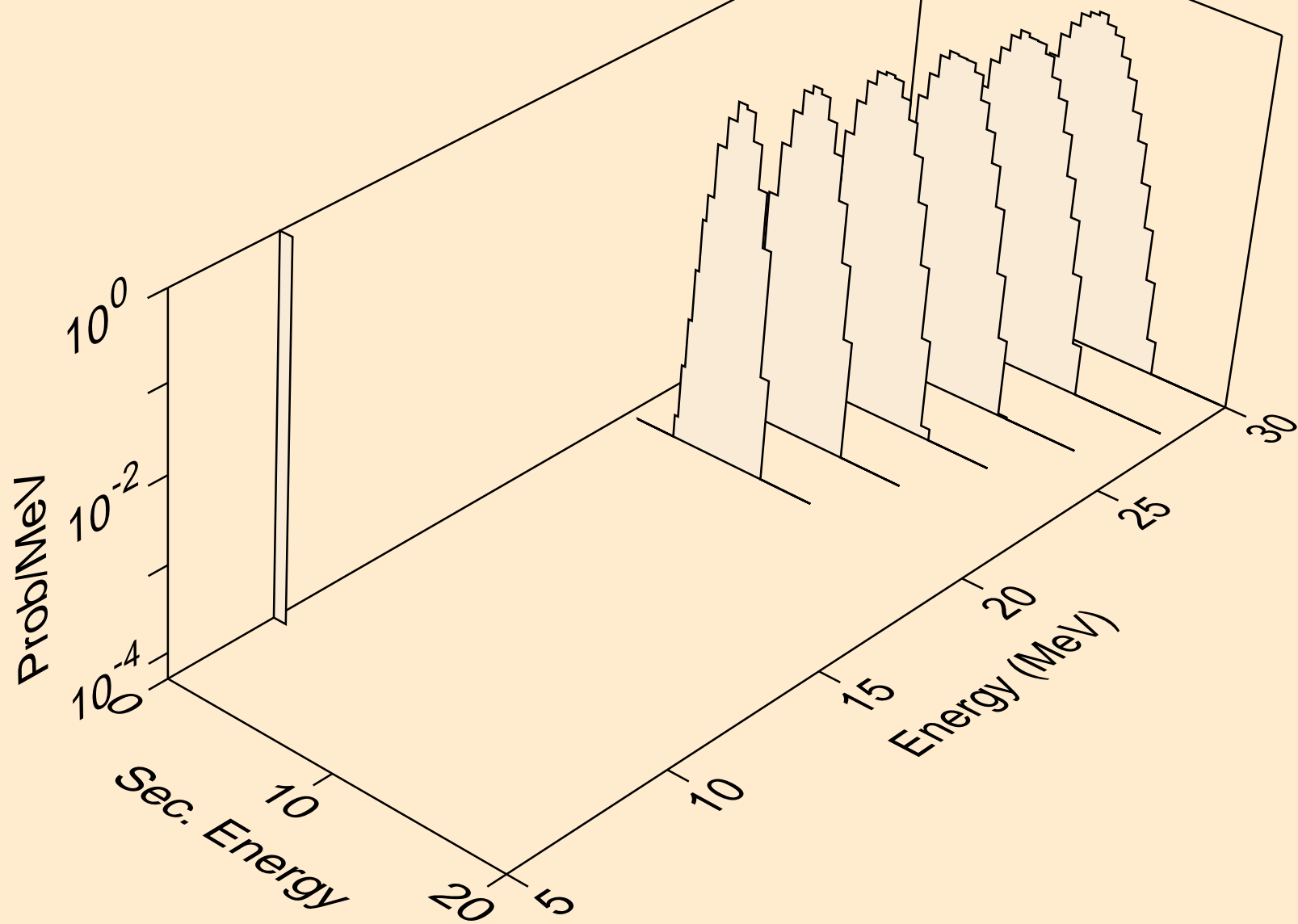

DB266 NEUTRON ACER TENDL-2024 LIBRARY; T=293.6K
protons from (n,p)

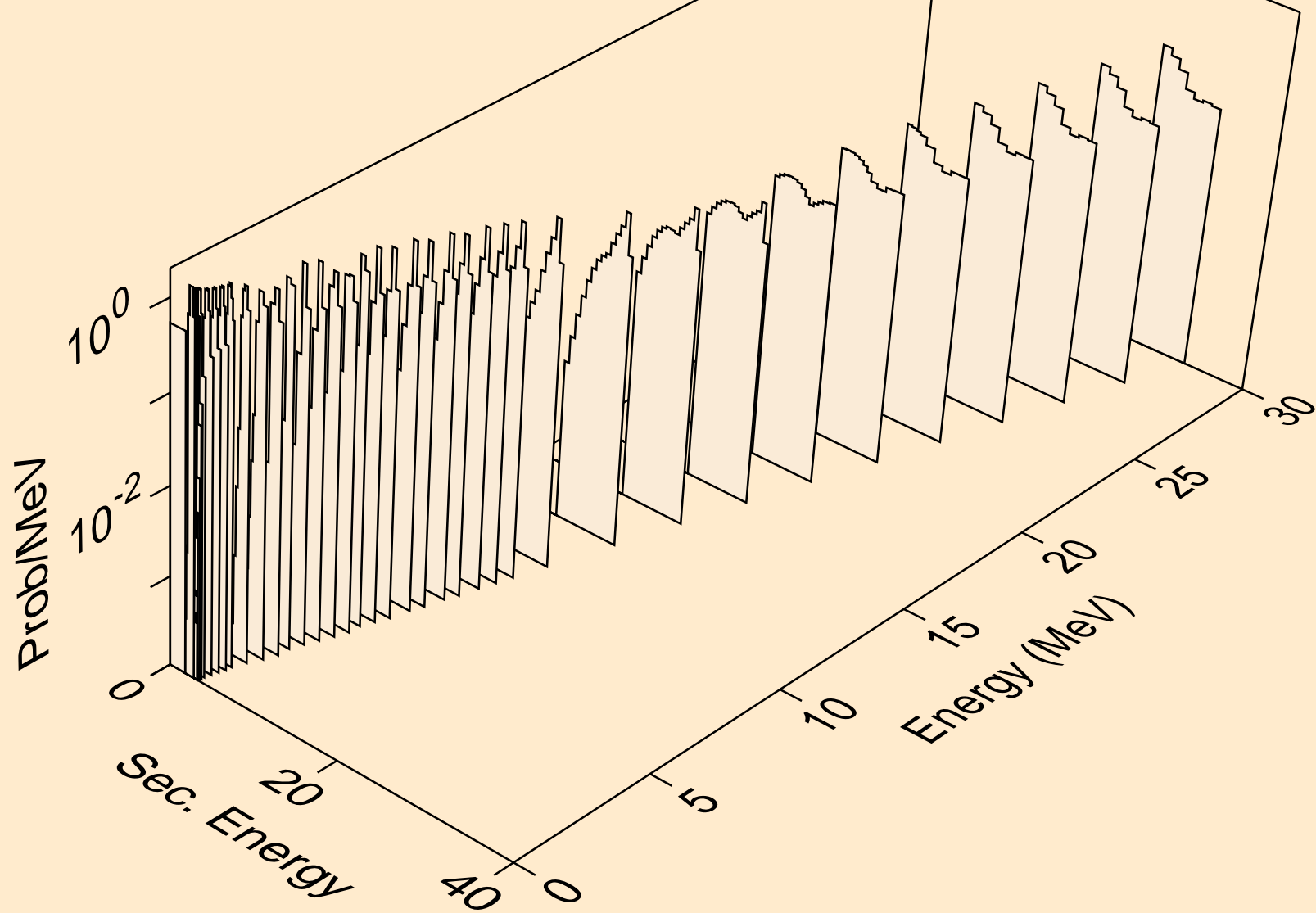

DB266 NEUTRON ACER TENDL-2024 LIBRARY; T=293.6K
protons from (n,2p)

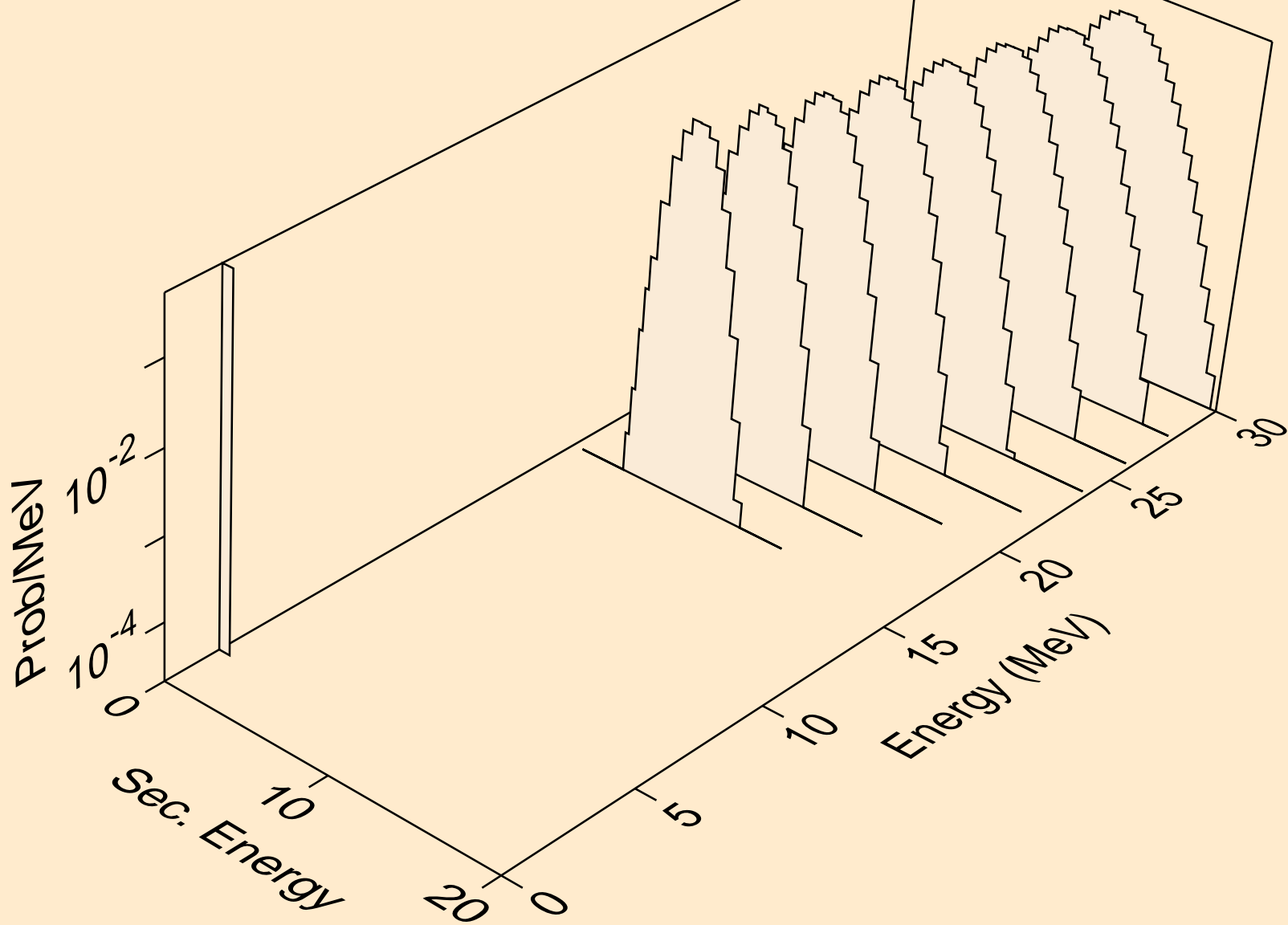

DB266 NEUTRON ACER TENDL-2024 LIBRARY; T=293.6K
deuterons from (n,x)

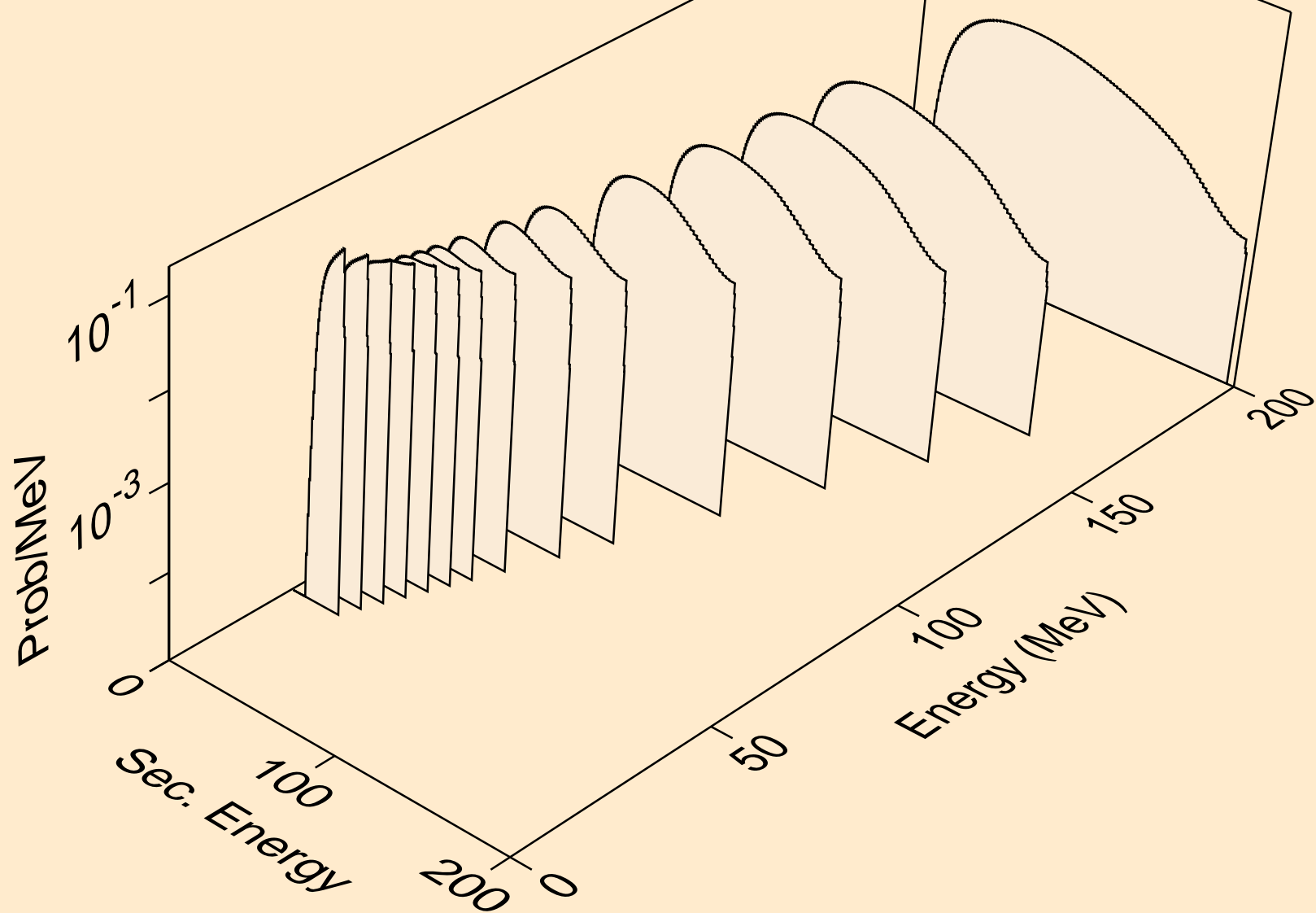

DB266 NEUTRON ACER TENDL-2024 LIBRARY; T=293.6K
deuterons from (n,2nd)

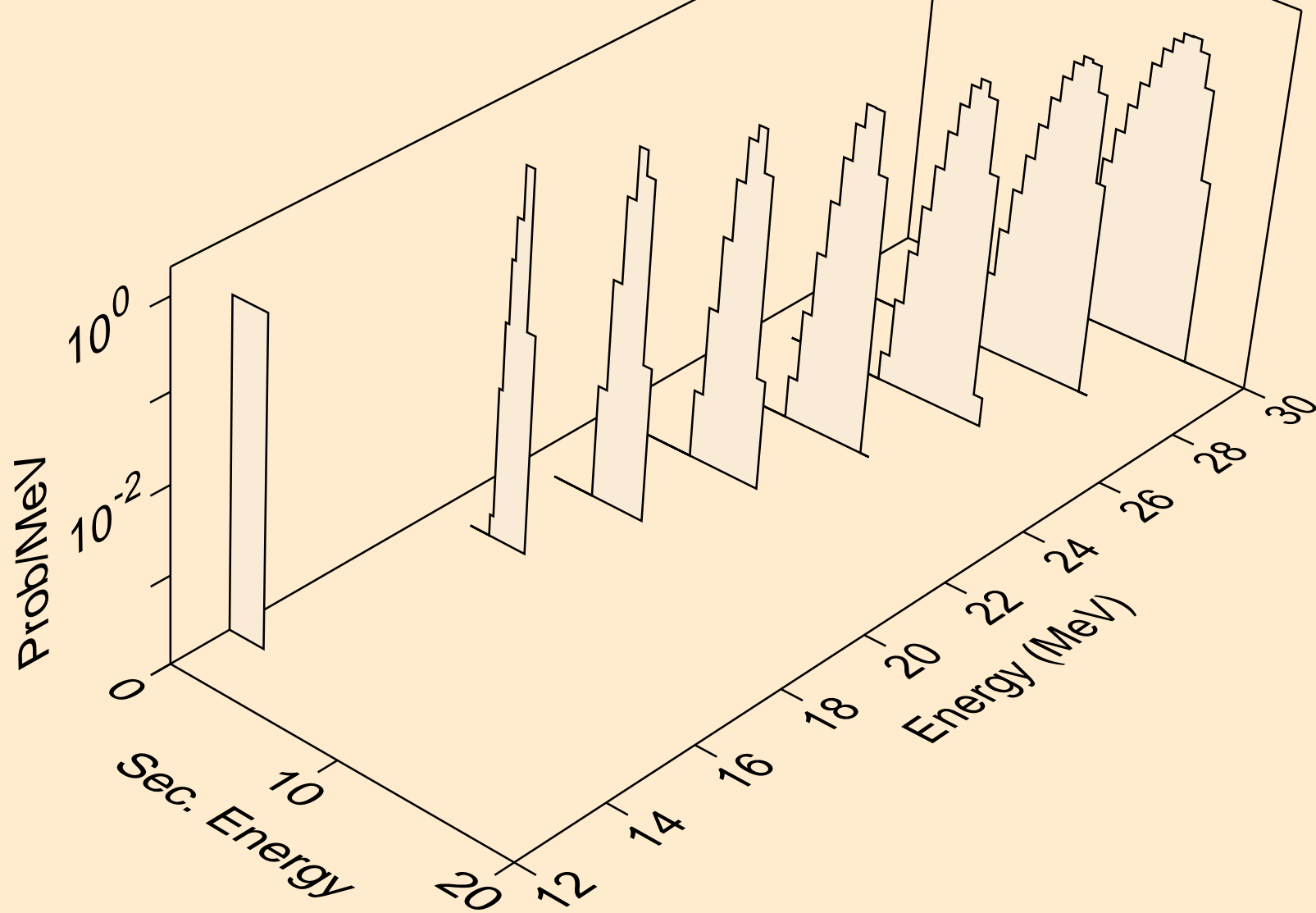

DB266 NEUTRON ACER TENDL-2024 LIBRARY; T=293.6K
deuterons from (n,n*)d

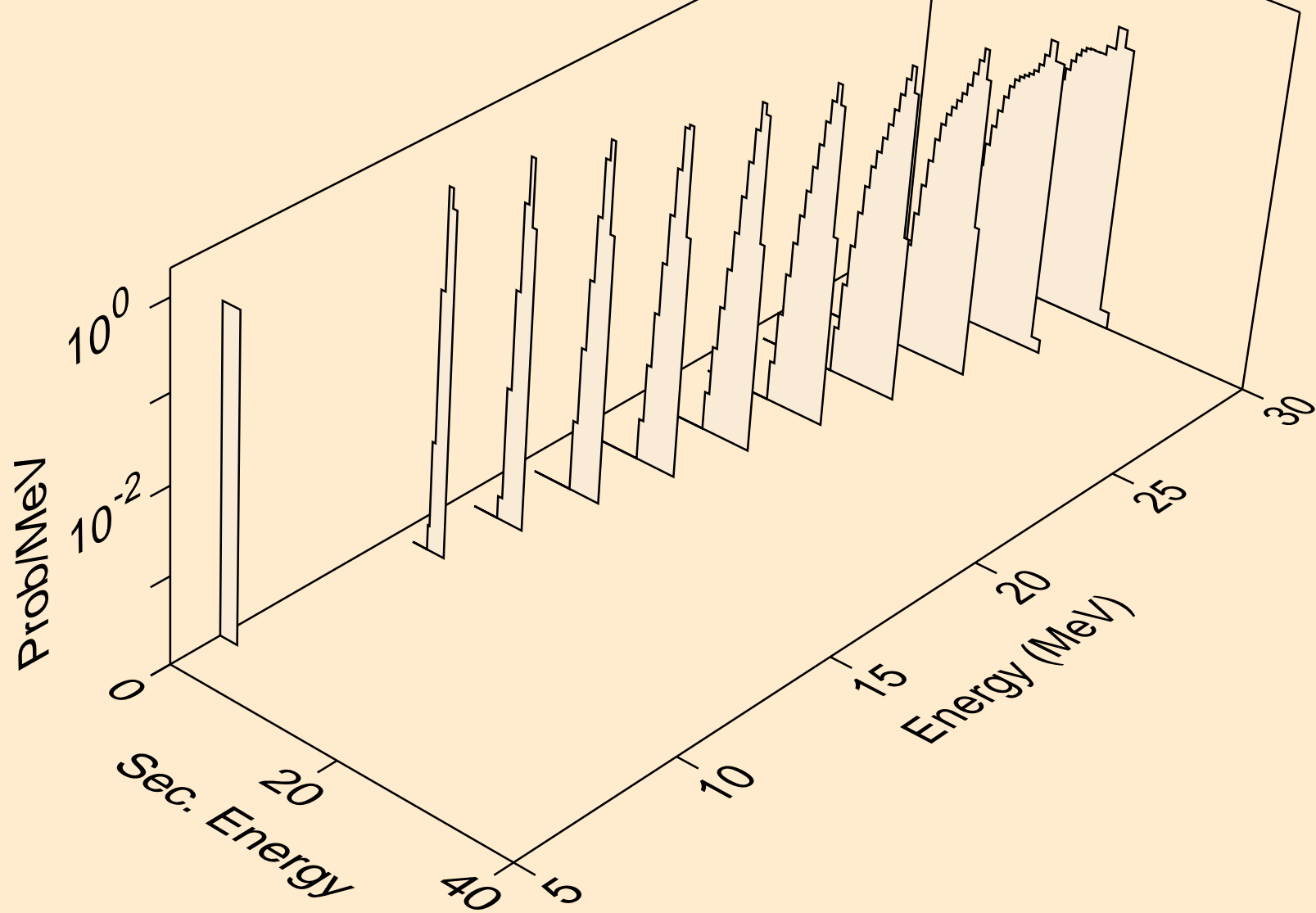

DB266 NEUTRON ACER TENDL-2024 LIBRARY; T=293.6K
deuterons from (n,d)

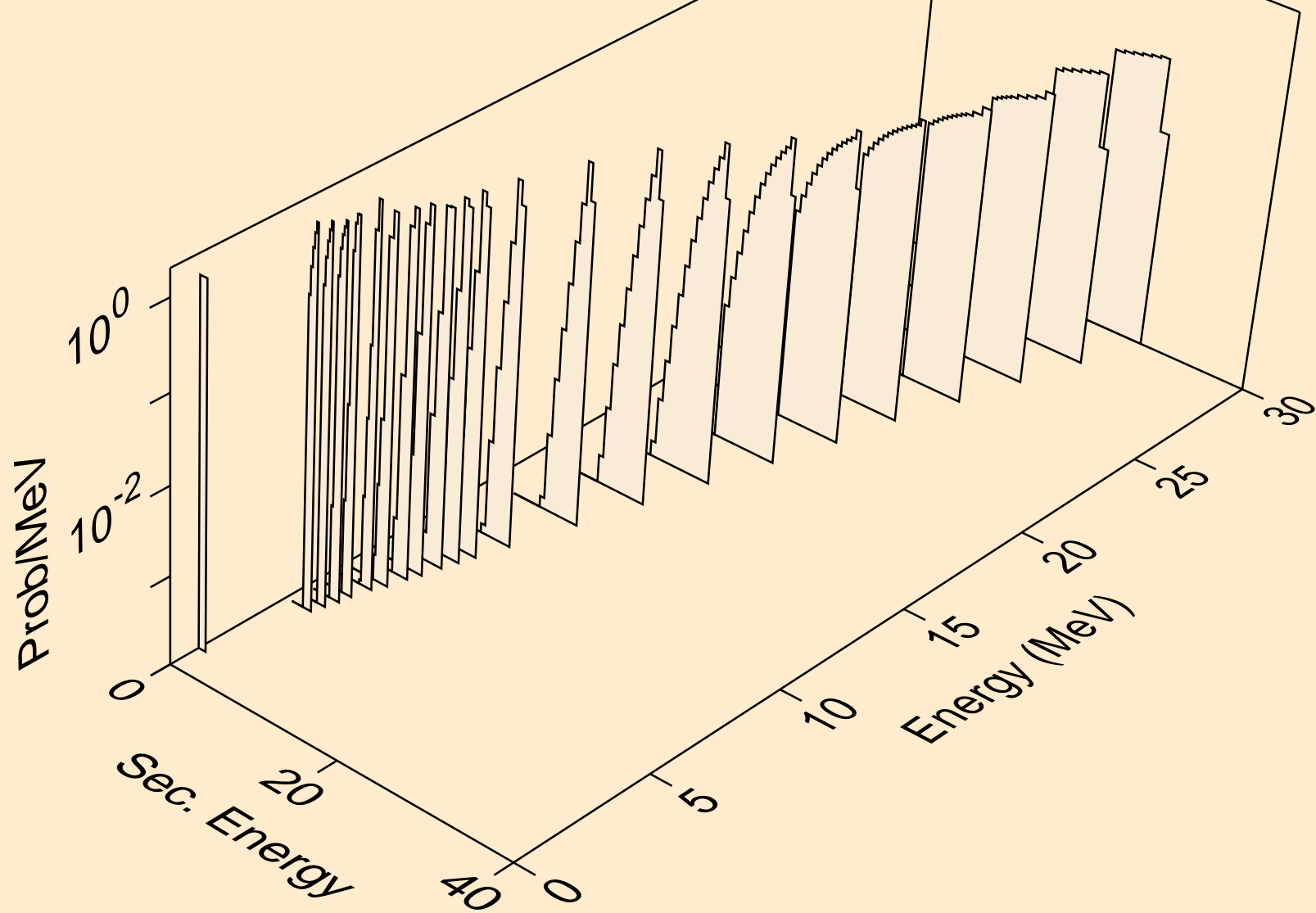

DB266 NEUTRON ACER TENDL-2024 LIBRARY; T=293.6K
tritons from (n,x)

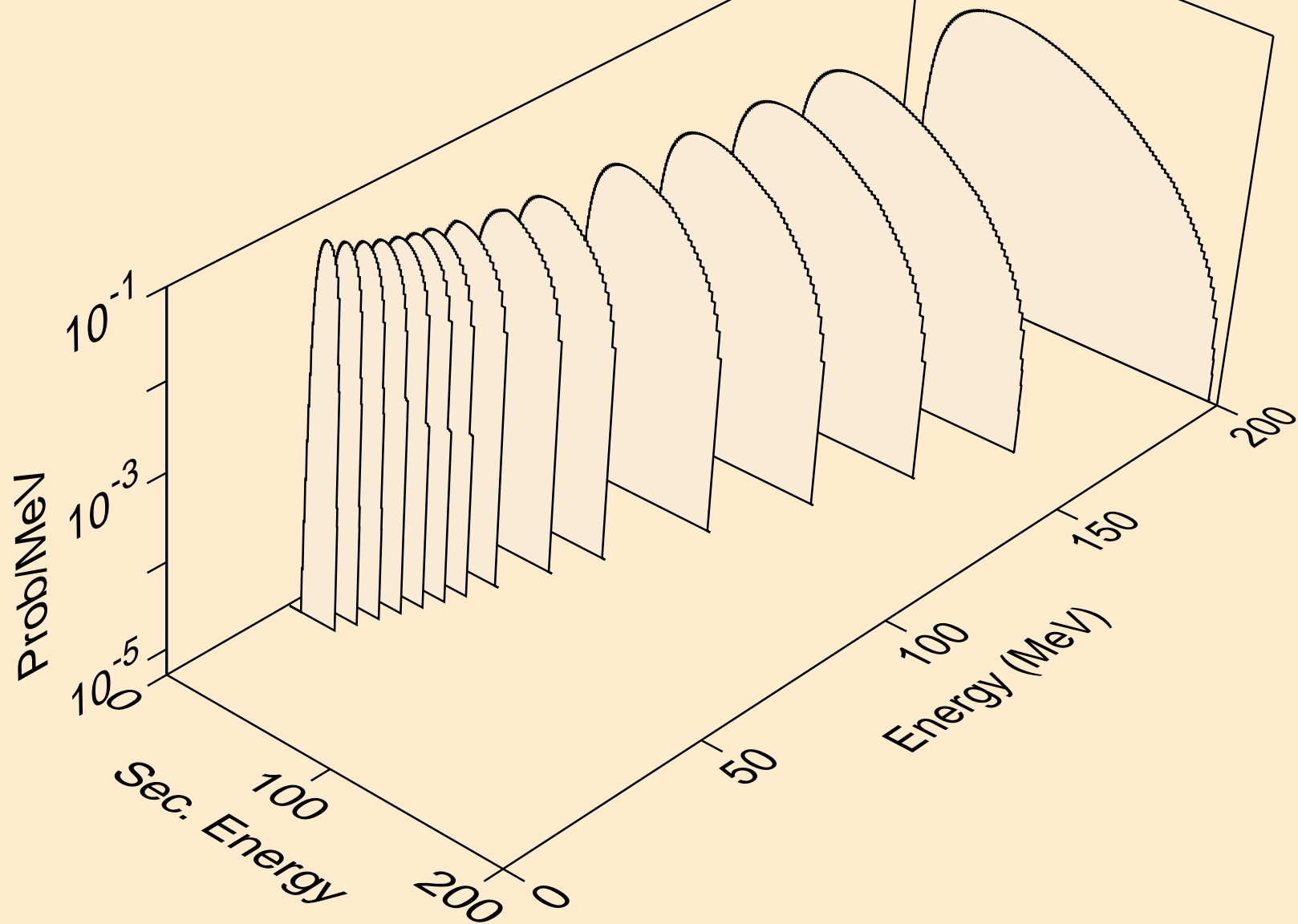

DB266 NEUTRON ACER TENDL-2024 LIBRARY; T=293.6K
tritons from (n,n*)t

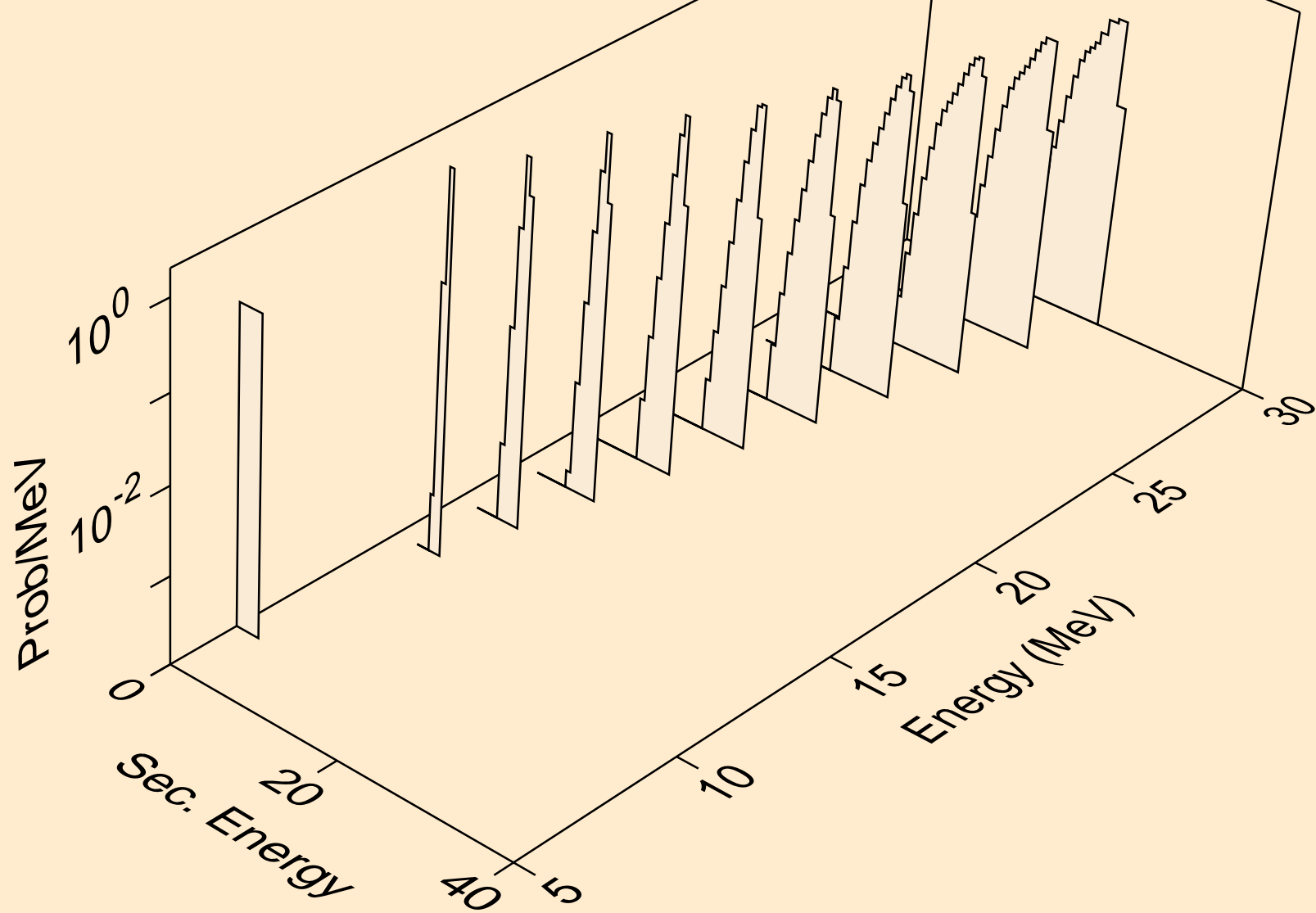

DB266 NEUTRON ACER TENDL-2024 LIBRARY; T=293.6K
tritons from (n,t)

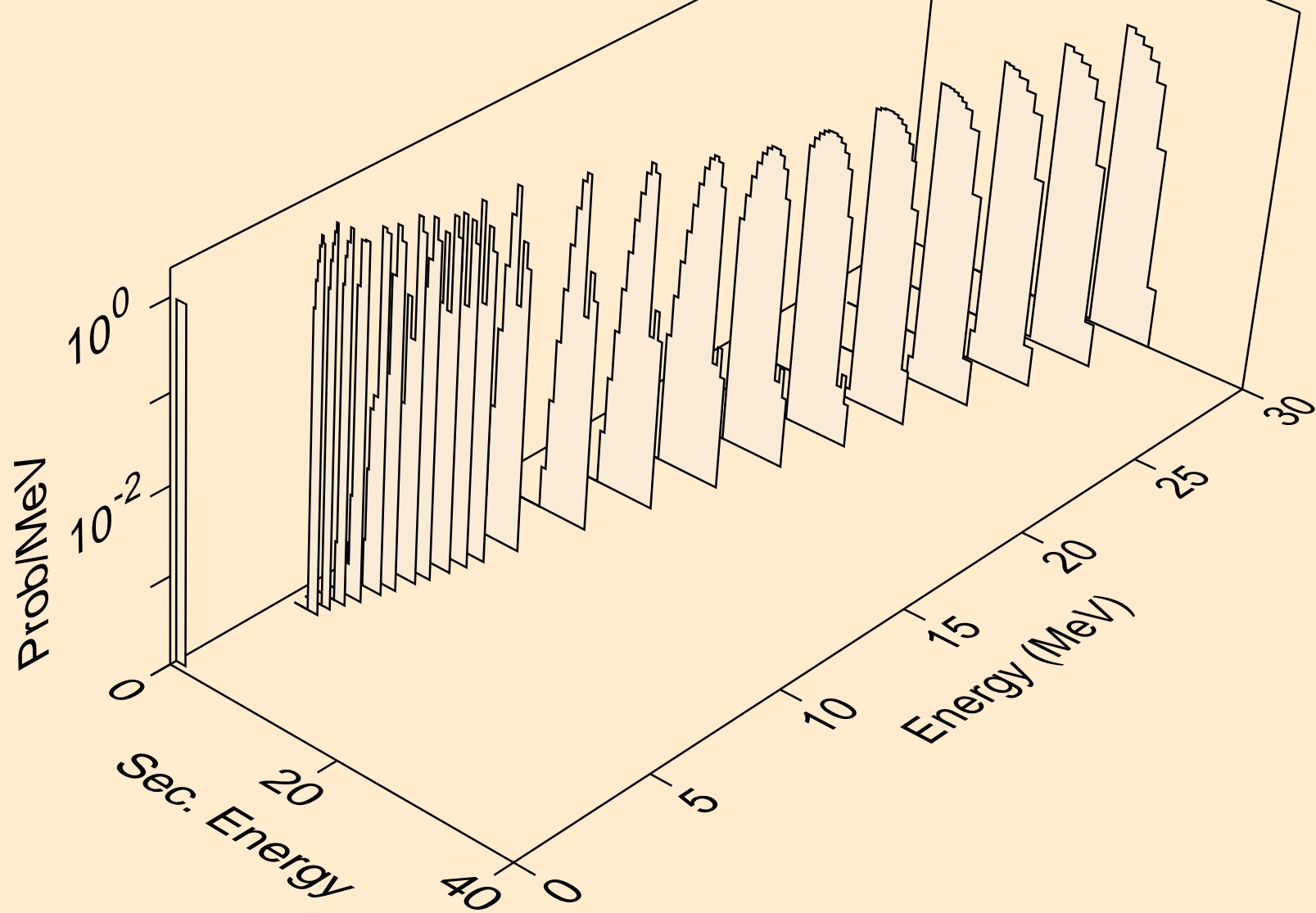

DB266 NEUTRON ACER TENDL-2024 LIBRARY; T=293.6K
he3s from (n,x)

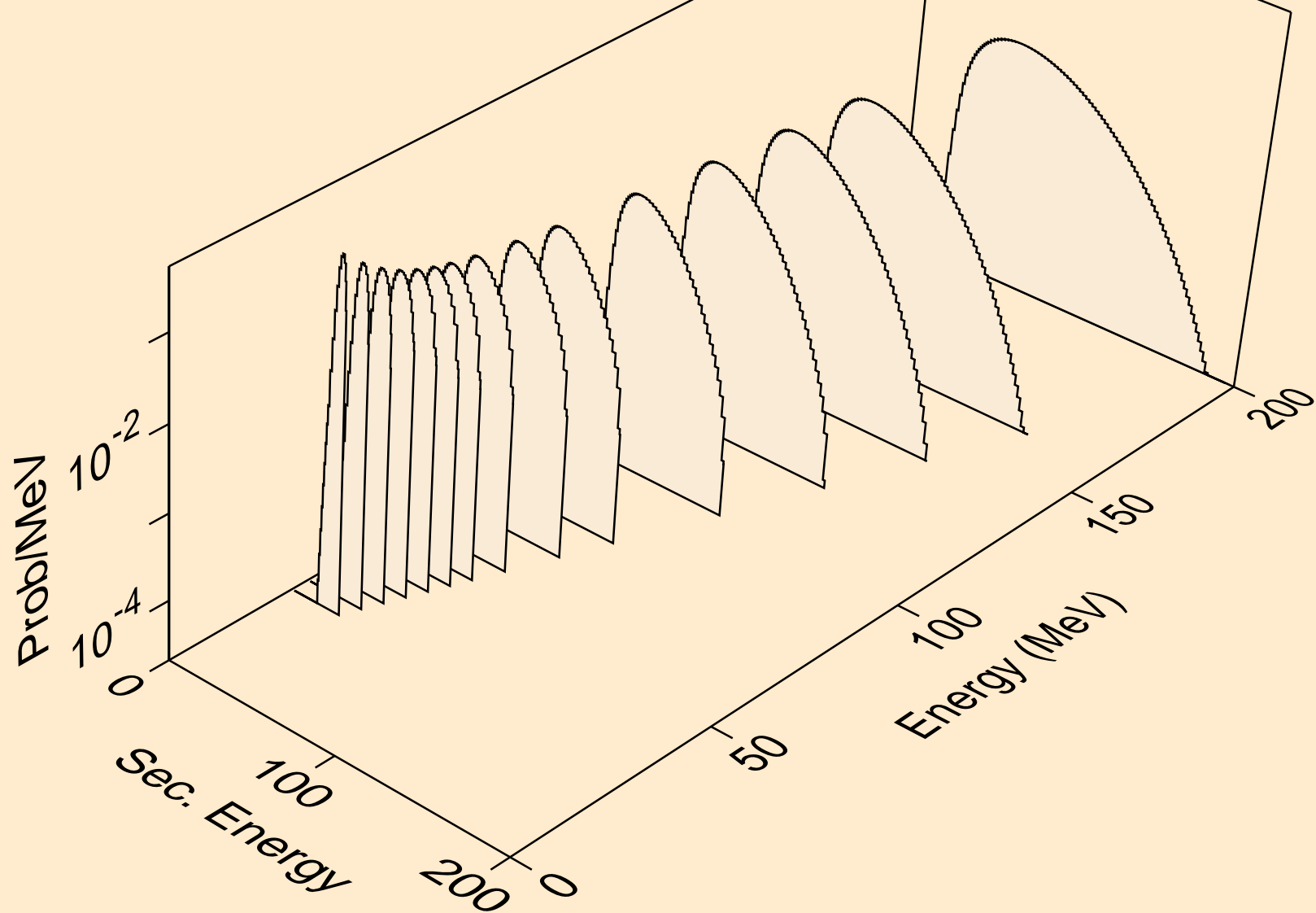

DB266 NEUTRON ACER TENDL-2024 LIBRARY; T=293.6K
he3s from (n,n*)he3

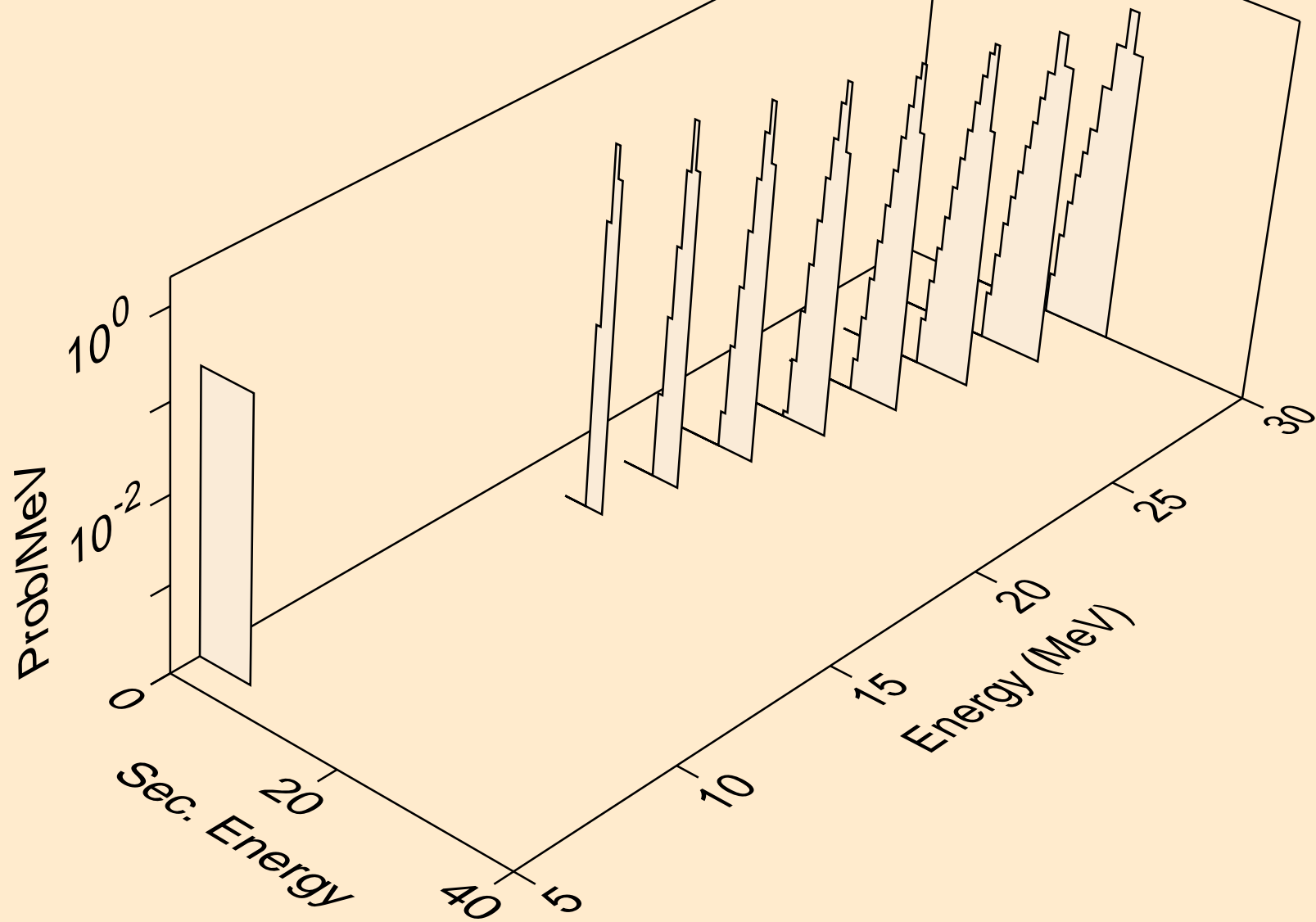

DB266 NEUTRON ACER TENDL-2024 LIBRARY; T=293.6K
he3s from (n,he3)

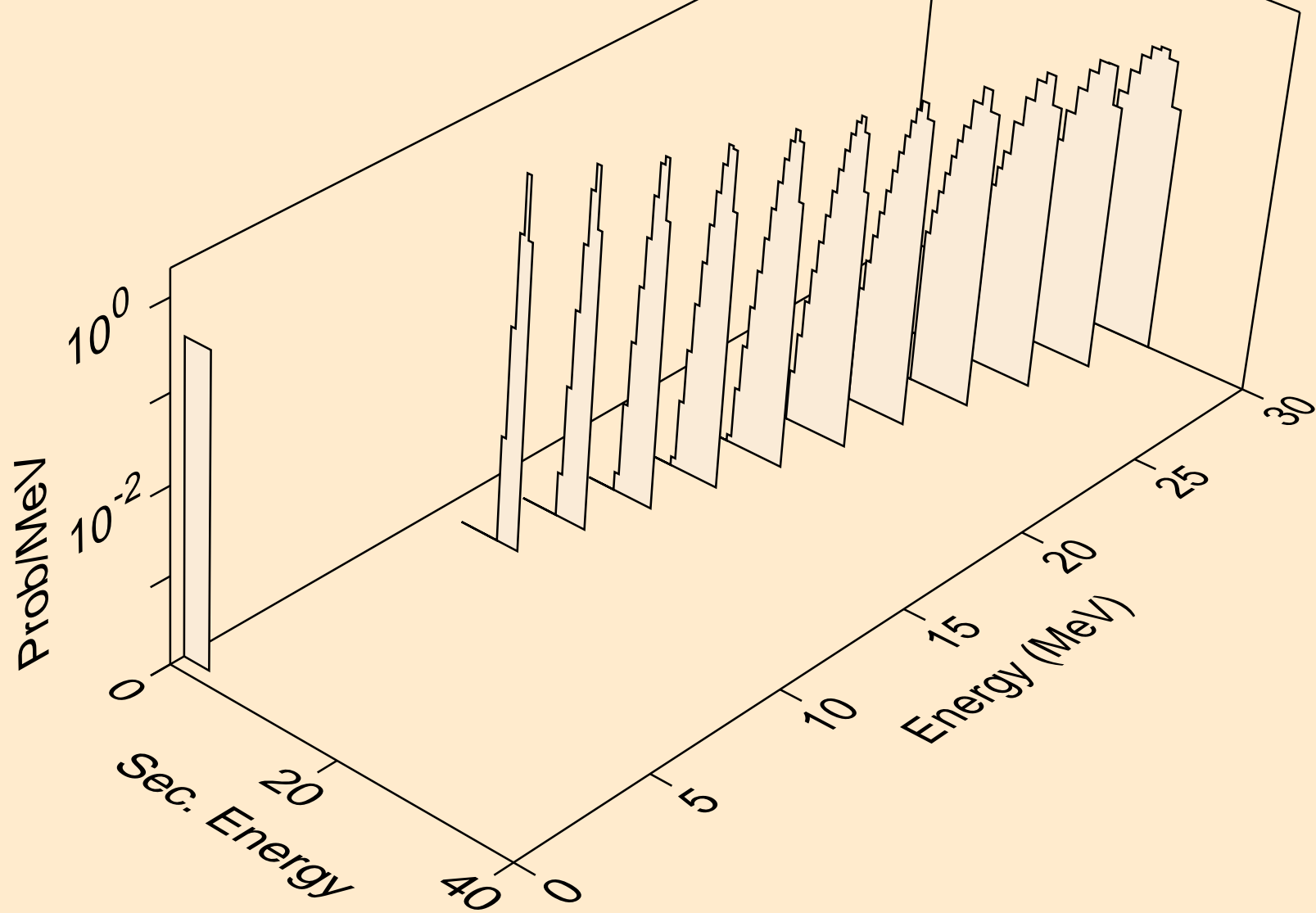

DB266 NEUTRON ACER TENDL-2024 LIBRARY; T=293.6K
alphas from (n,x)

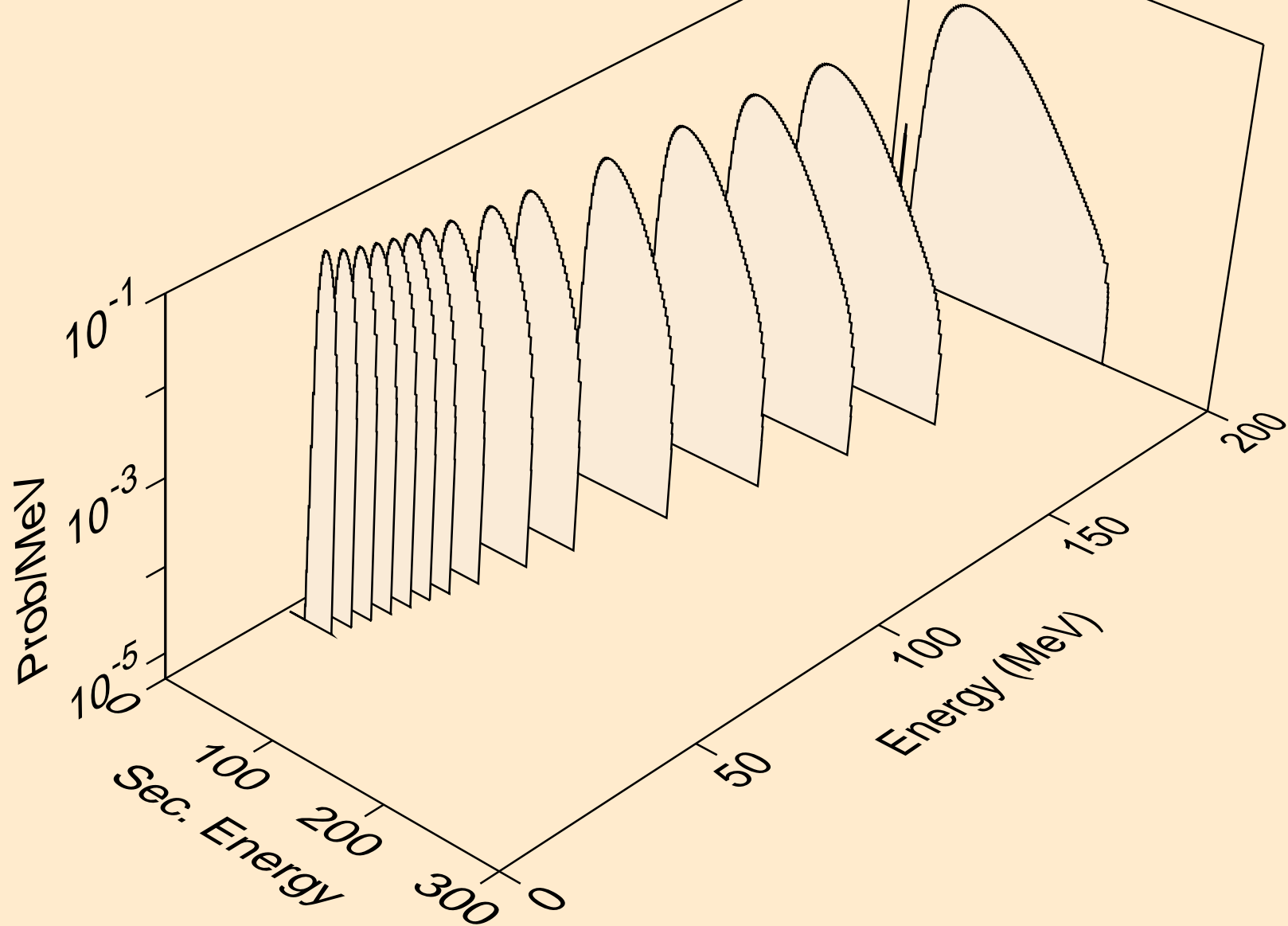

DB266 NEUTRON ACER TENDL-2024 LIBRARY; T=293.6K
alphas from (n,n*)a

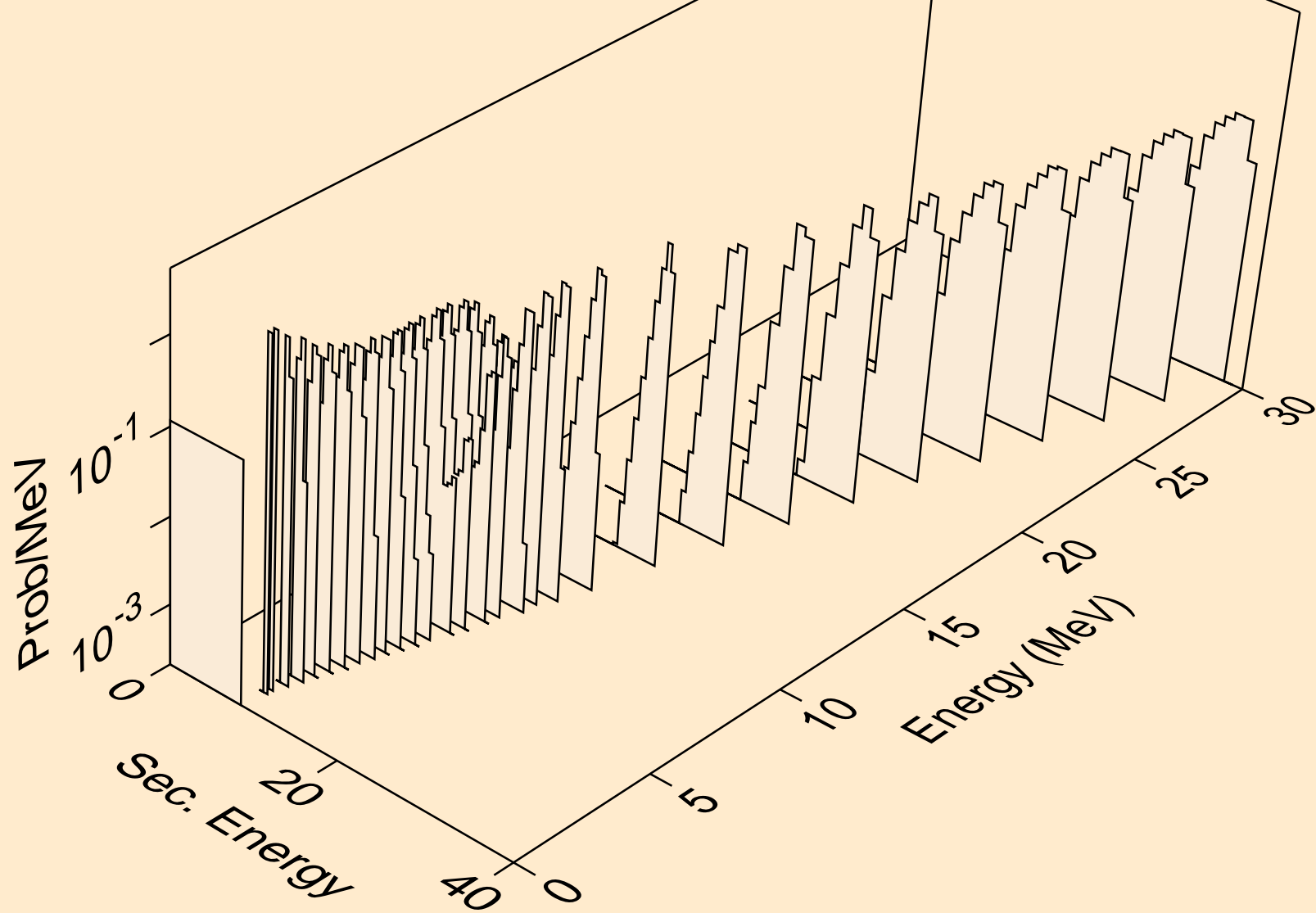

DB266 NEUTRON ACER TENDL-2024 LIBRARY; T=293.6K
alphas from (n,2n)a

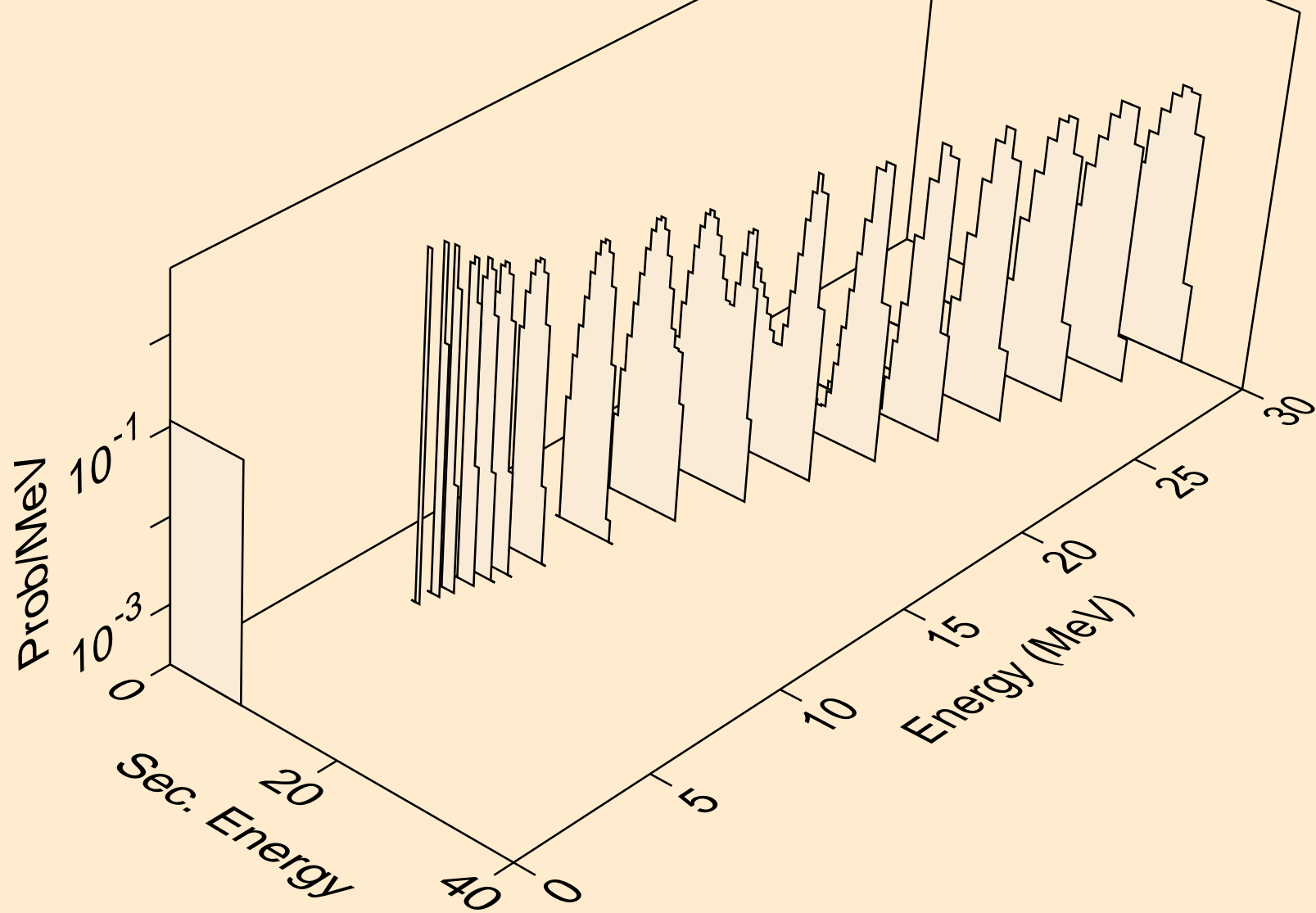

DB266 NEUTRON ACER TENDL-2024 LIBRARY; T=293.6K
alphas from (n,3n)a

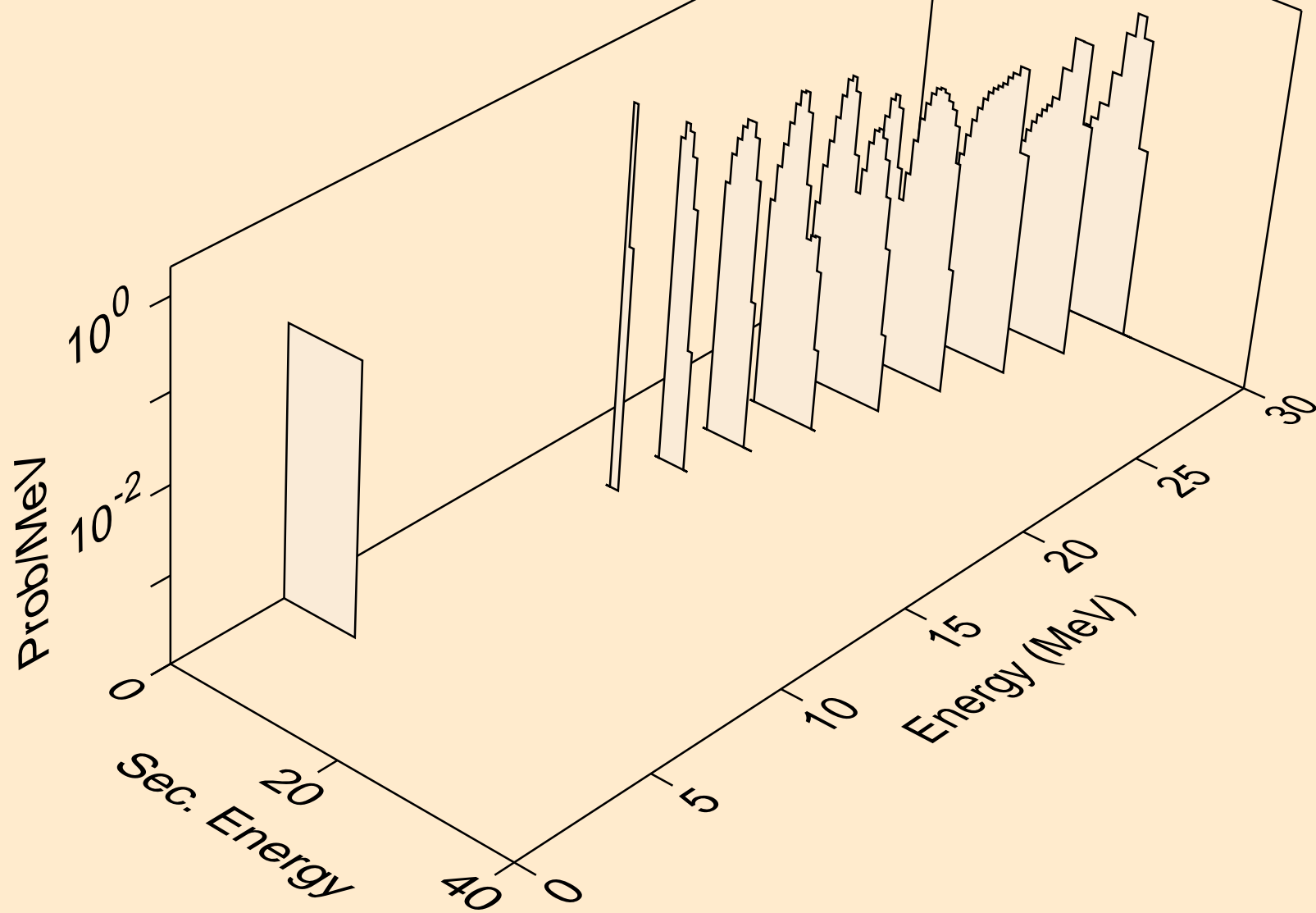

DB266 NEUTRON ACER TENDL-2024 LIBRARY; T=293.6K
alphas from (n,a)

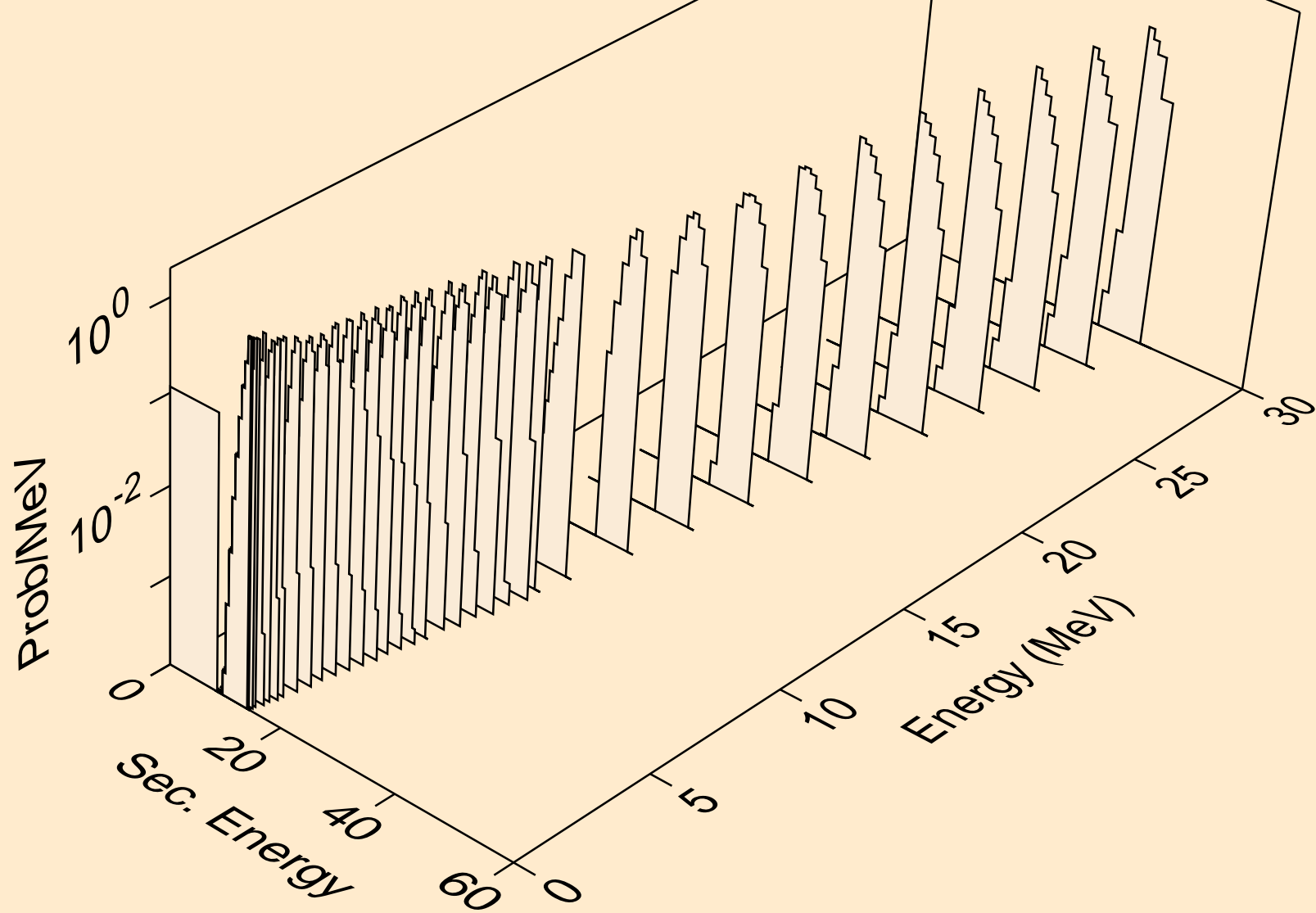

DB266 NEUTRON ACER TENDL-2024 LIBRARY; T=293.6K
alphas from (n,2a)

