

DY149 NEUTRON ACER TENDL-2024 LIBRARY; T=293.6K  
Principal cross sections

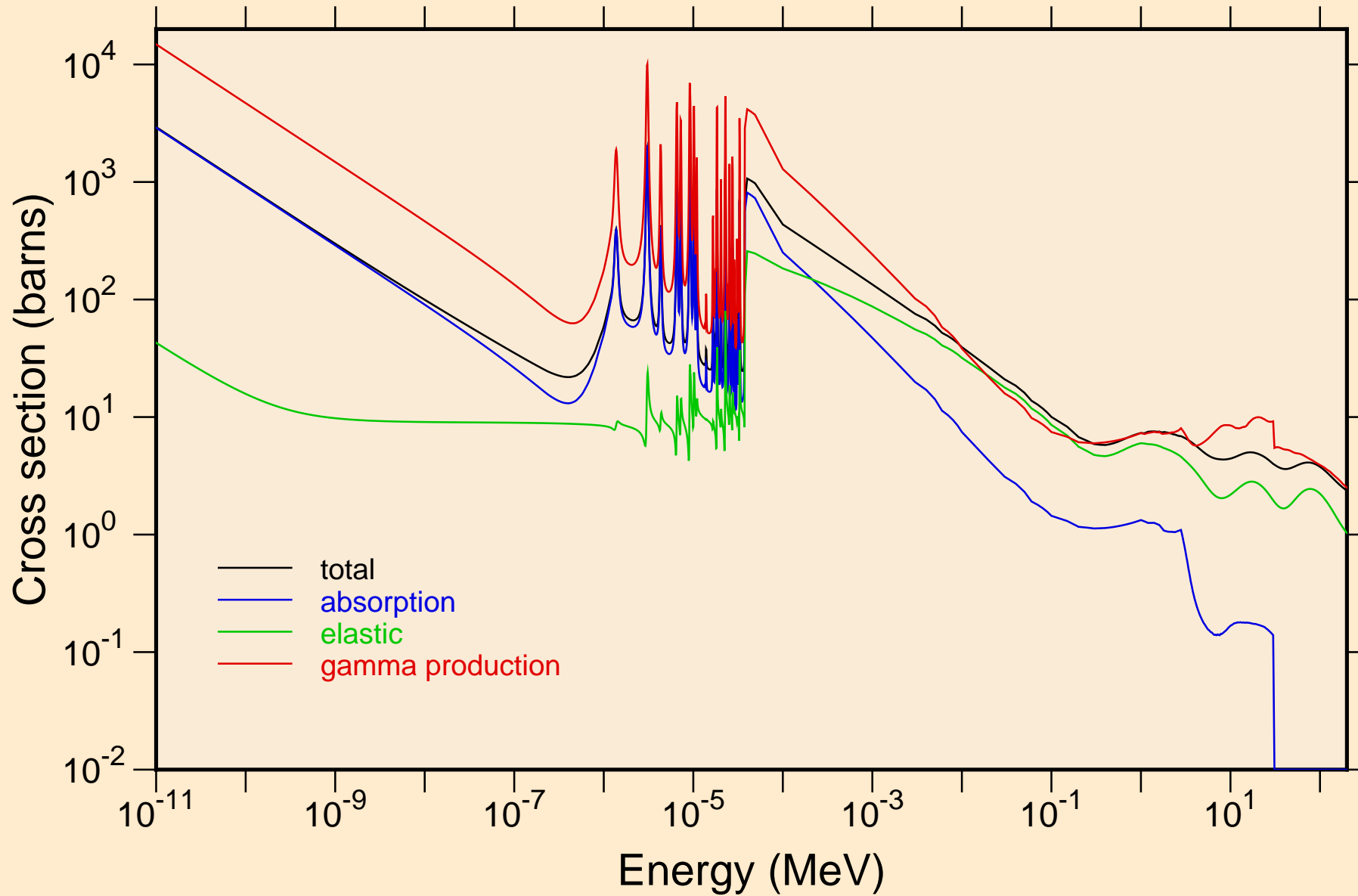

DY149 NEUTRON ACER TENDL-2024 LIBRARY; T=293.6K  
resonance total cross section

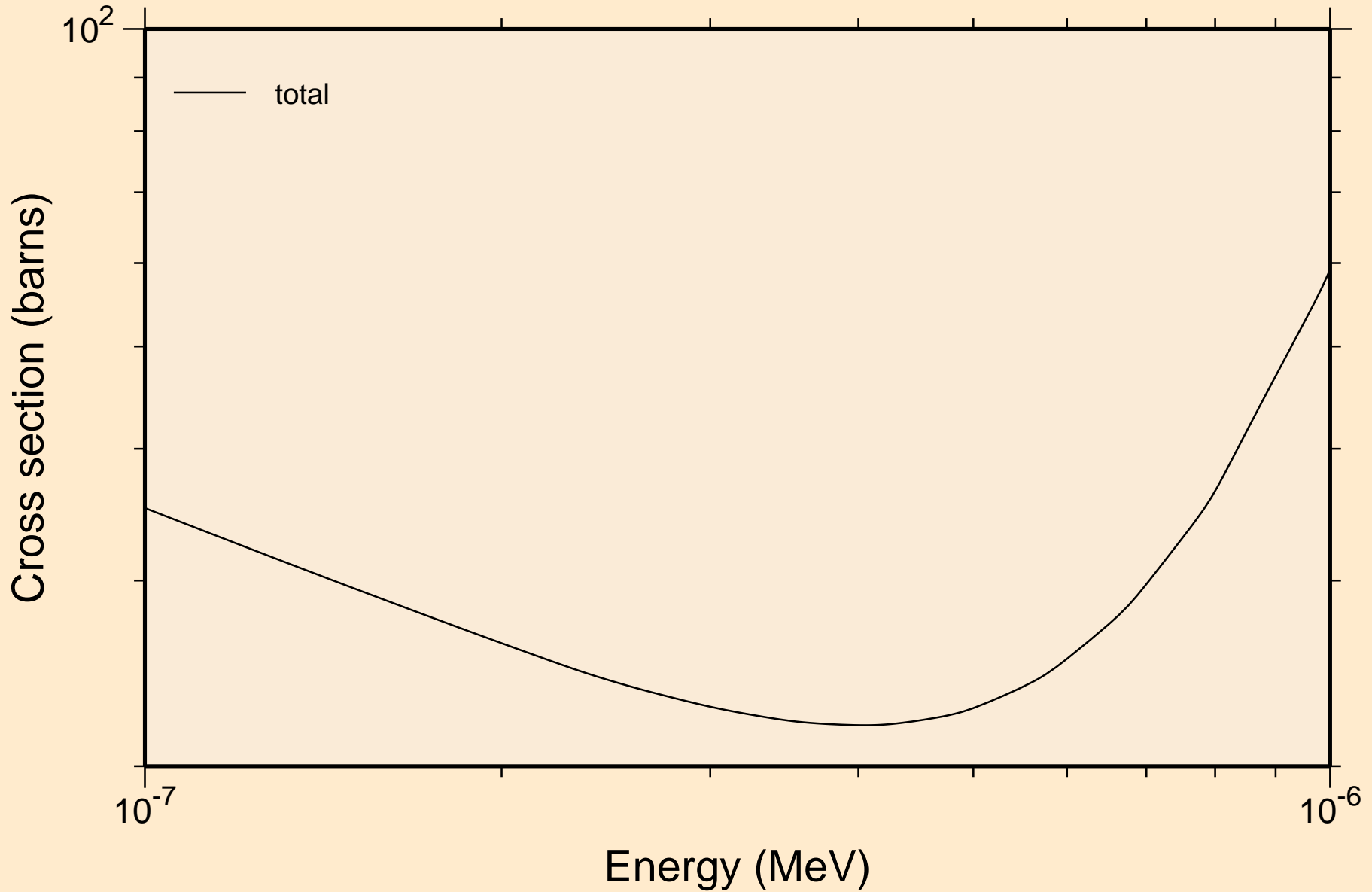

DY149 NEUTRON ACER TENDL-2024 LIBRARY; T=293.6K  
resonance total cross section

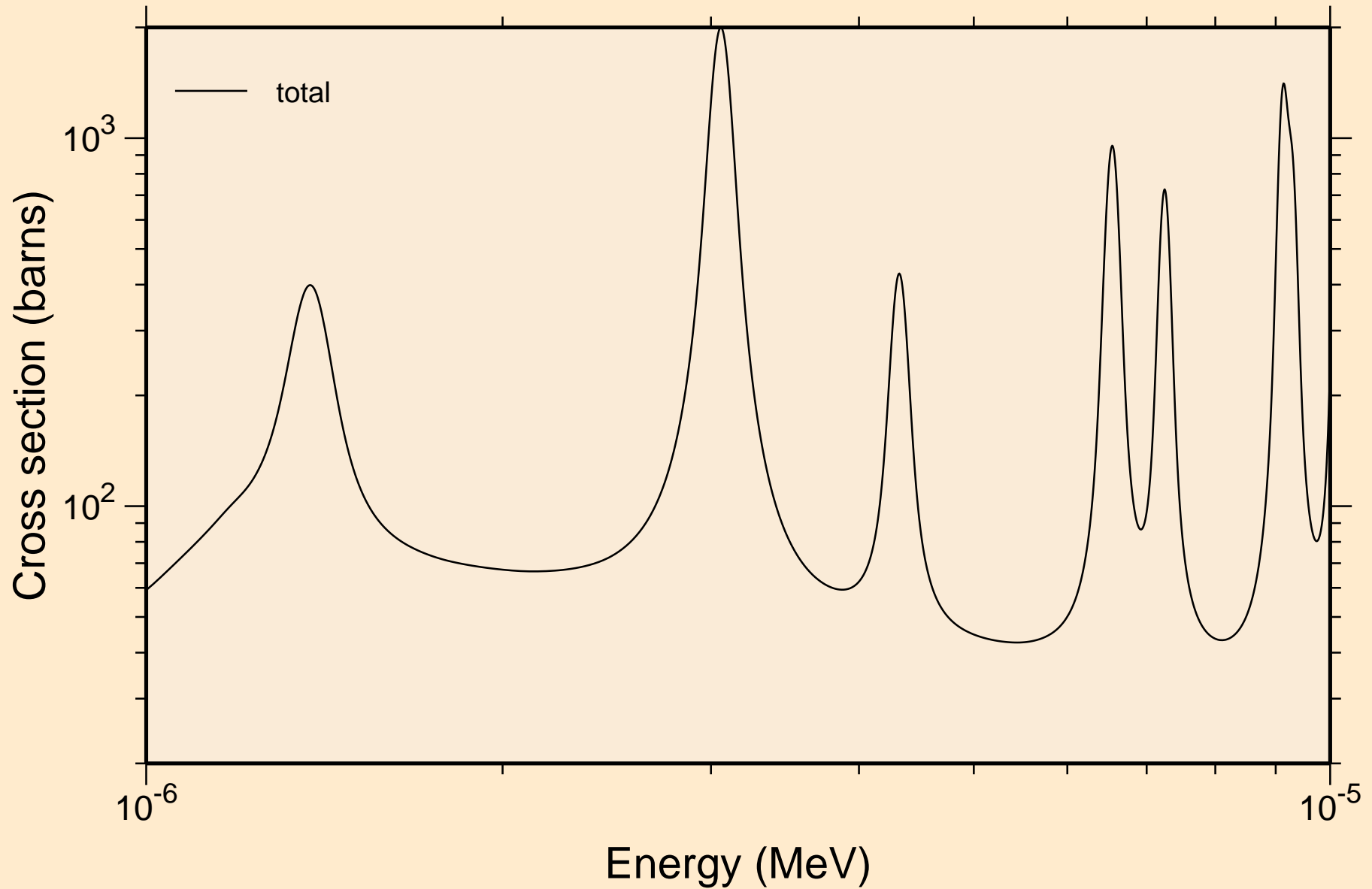

DY149 NEUTRON ACER TENDL-2024 LIBRARY; T=293.6K  
resonance total cross section

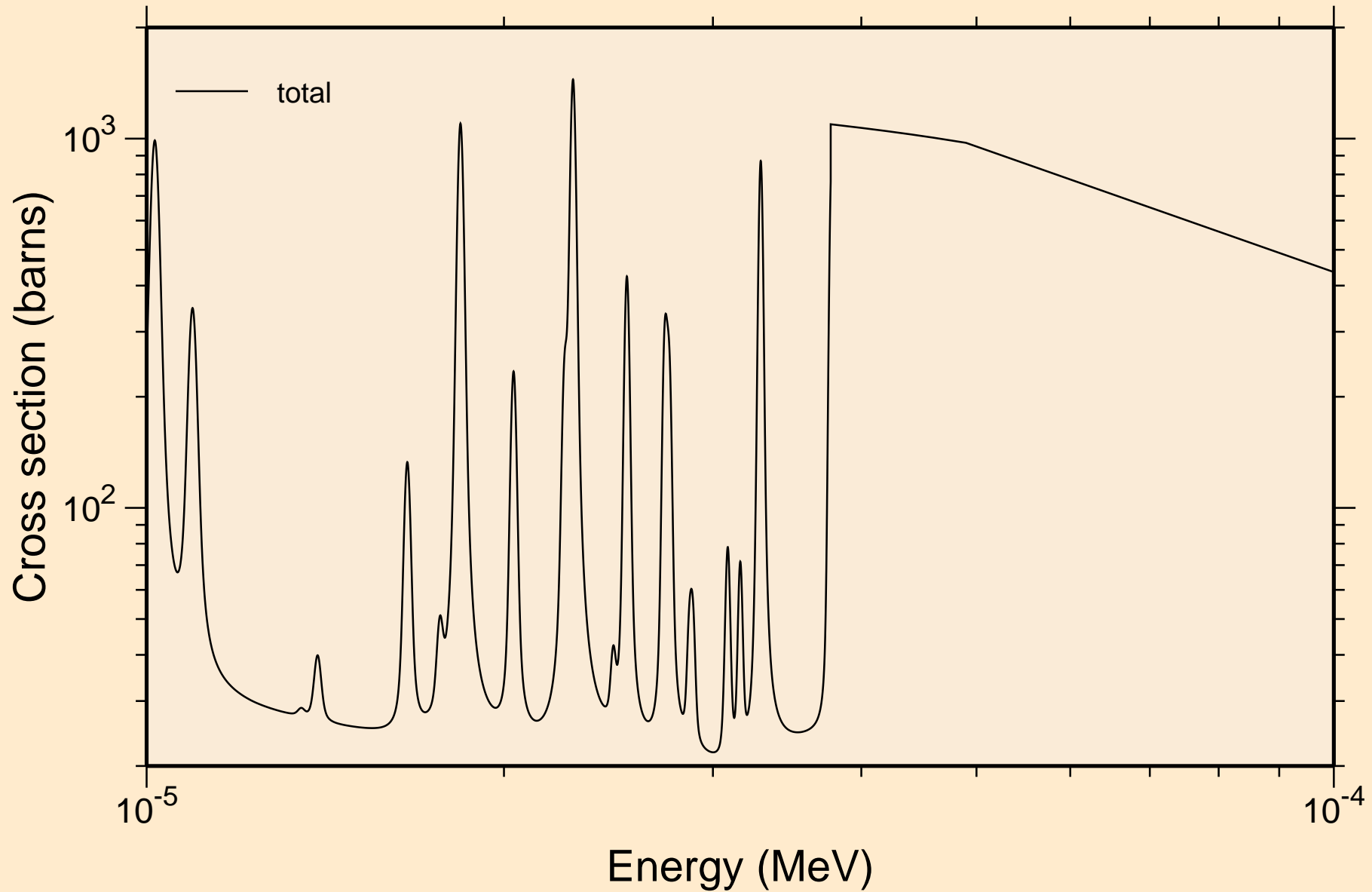

DY149 NEUTRON ACER TENDL-2024 LIBRARY; T=293.6K  
resonance total cross section

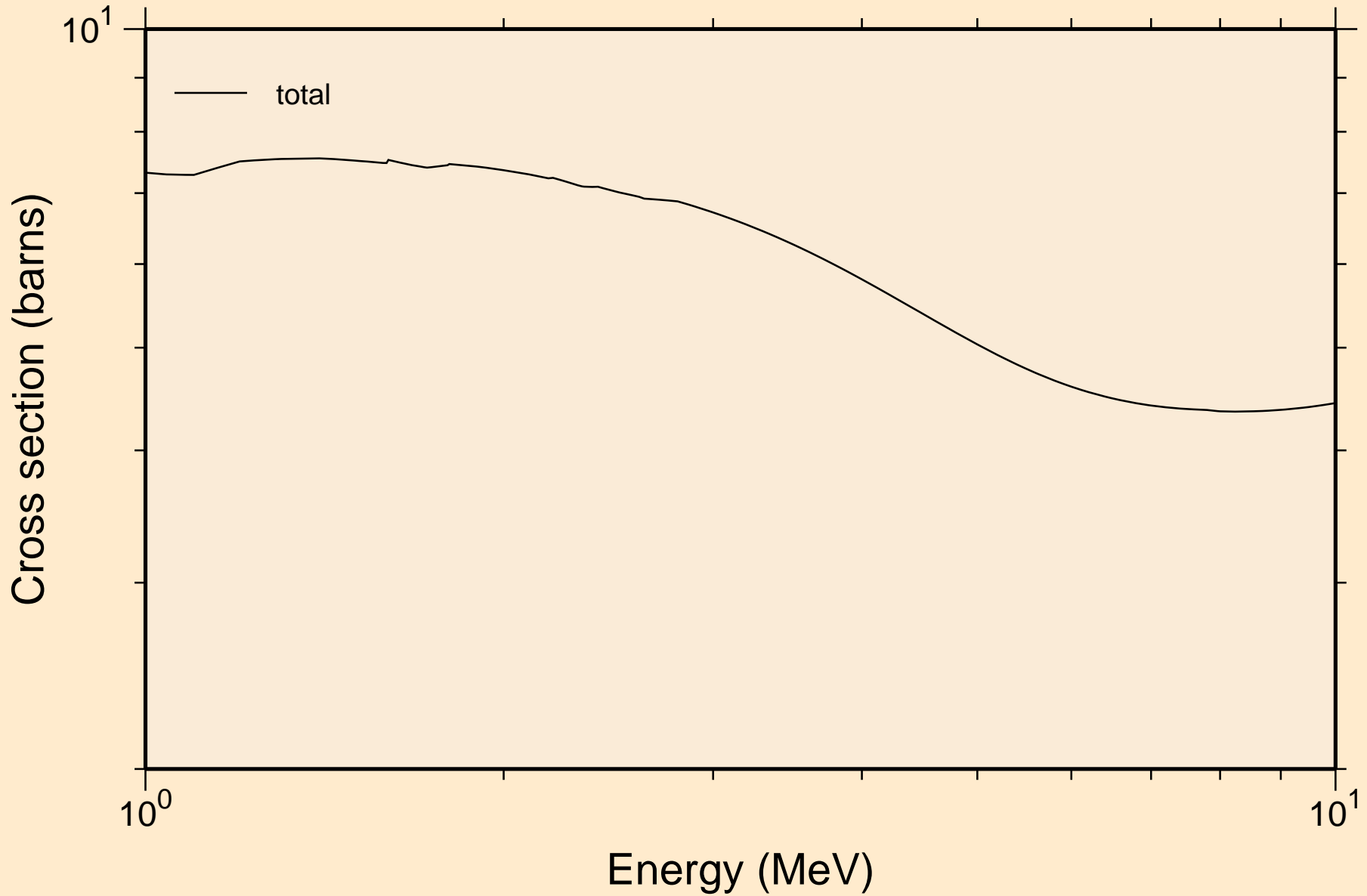

DY149 NEUTRON ACER TENDL-2024 LIBRARY; T=293.6K  
resonance absorption cross sections

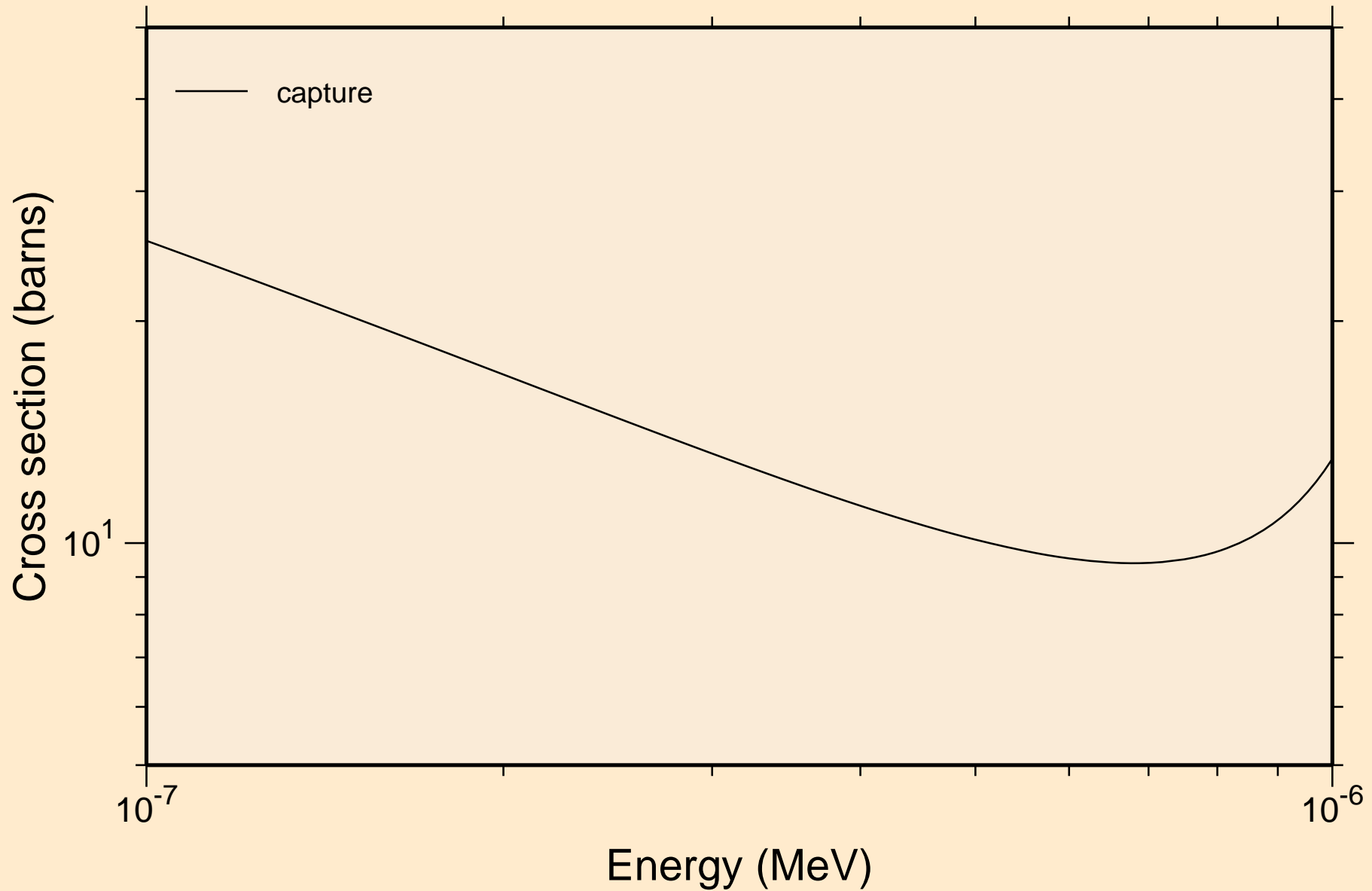

DY149 NEUTRON ACER TENDL-2024 LIBRARY; T=293.6K  
resonance absorption cross sections

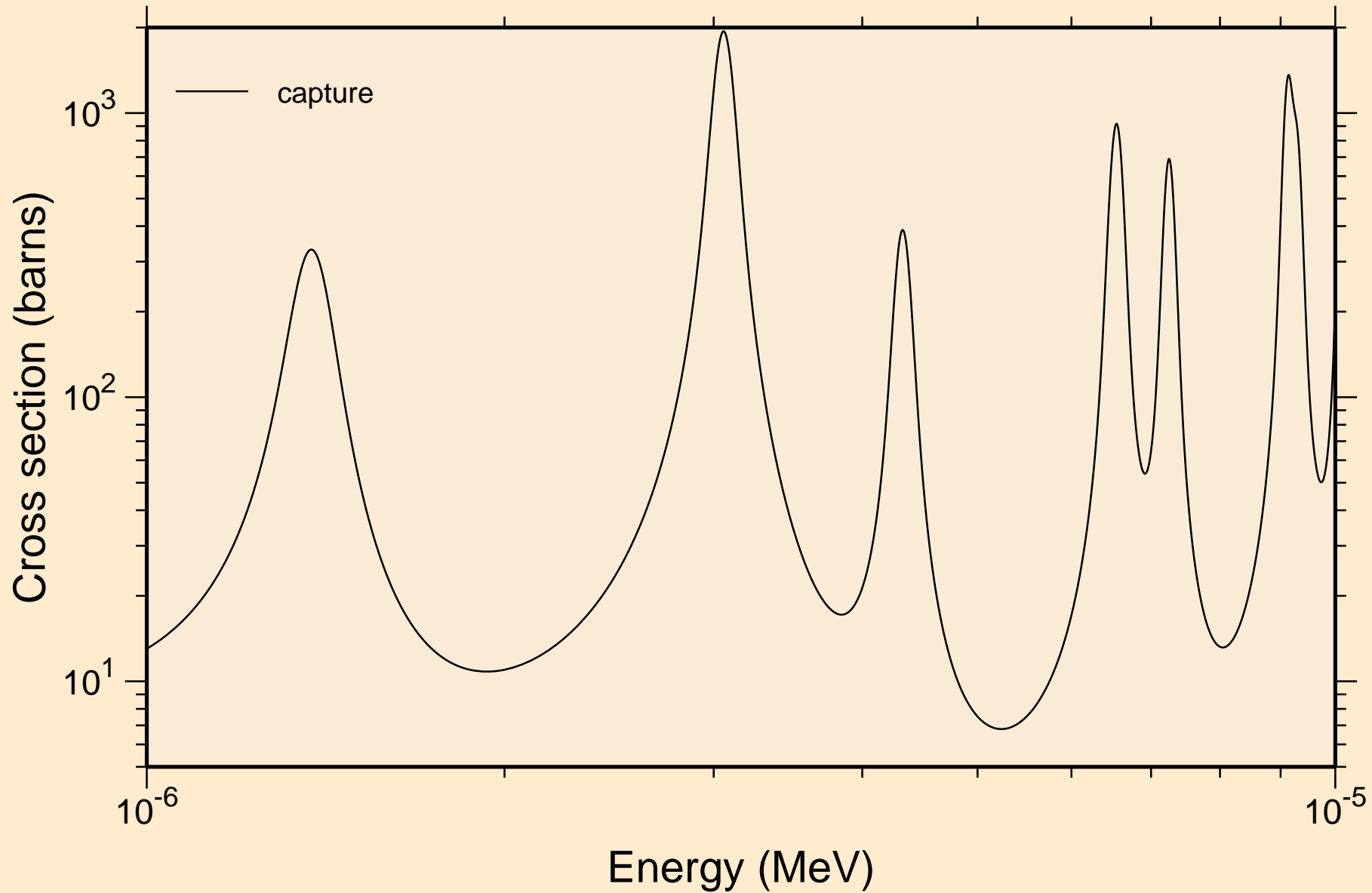

DY149 NEUTRON ACER TENDL-2024 LIBRARY; T=293.6K  
resonance absorption cross sections

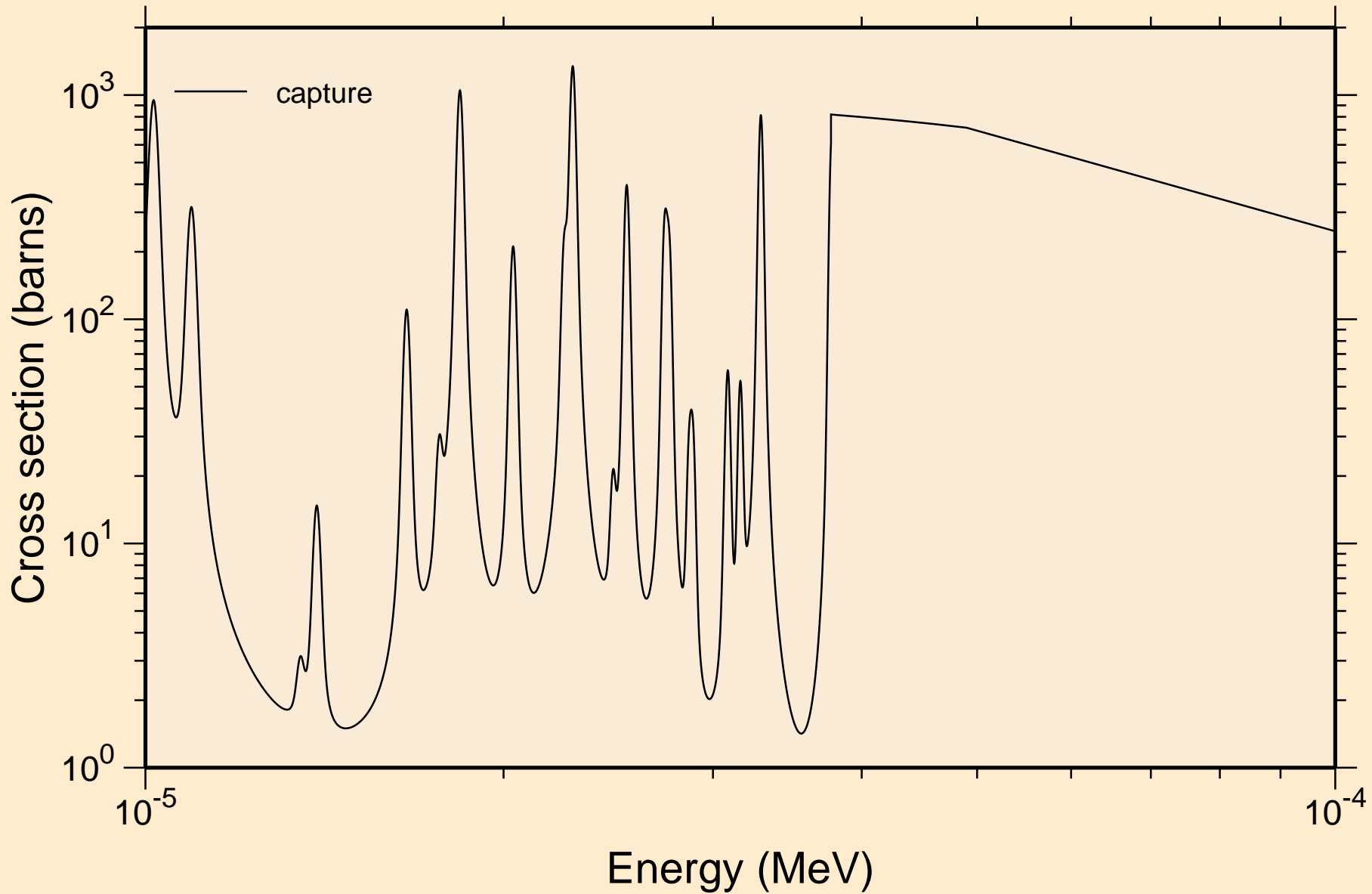

DY149 NEUTRON ACER TENDL-2024 LIBRARY; T=293.6K  
resonance absorption cross sections

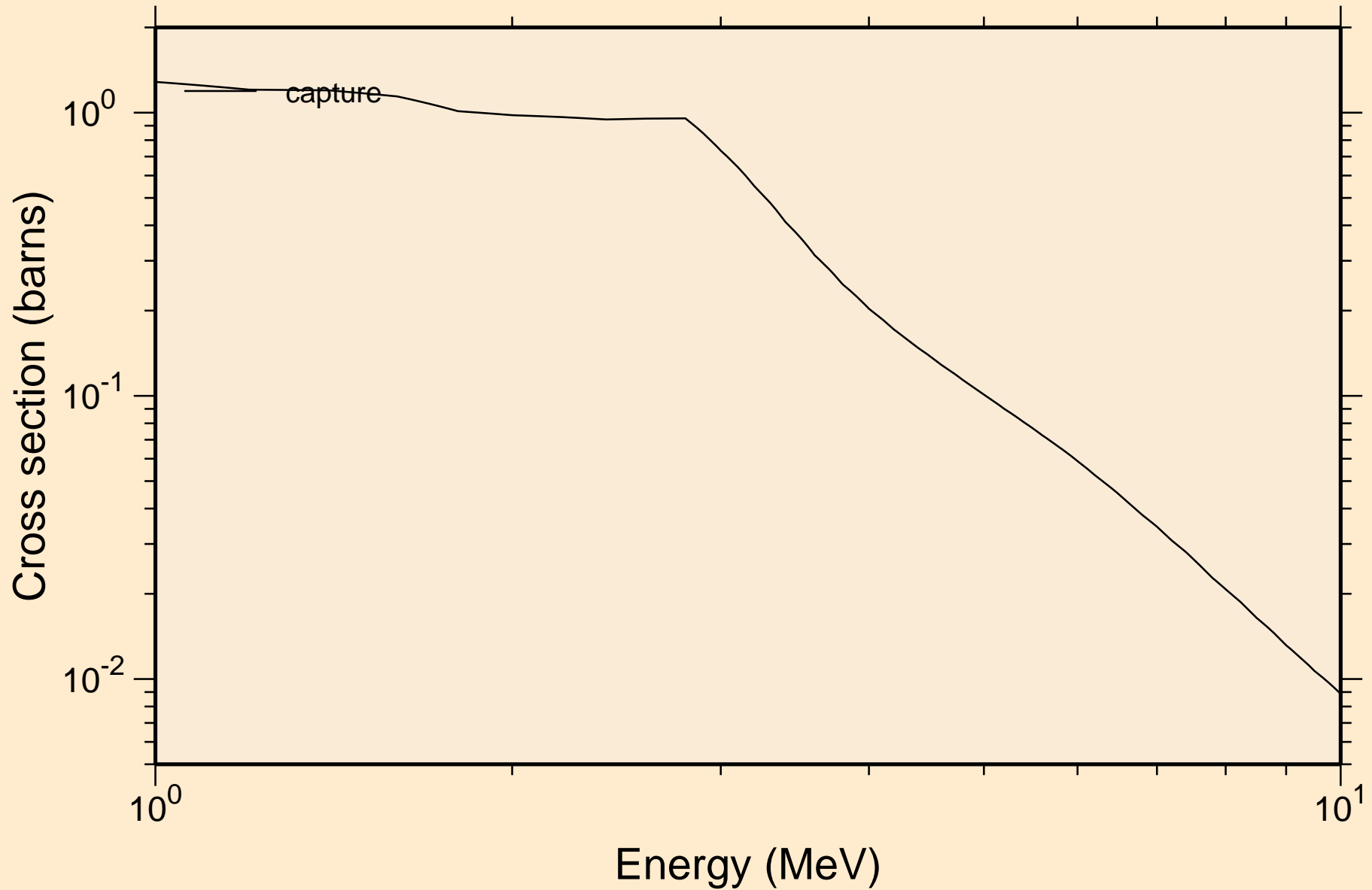

DY149 NEUTRON ACER TENDL-2024 LIBRARY; T=293.6K  
Heating

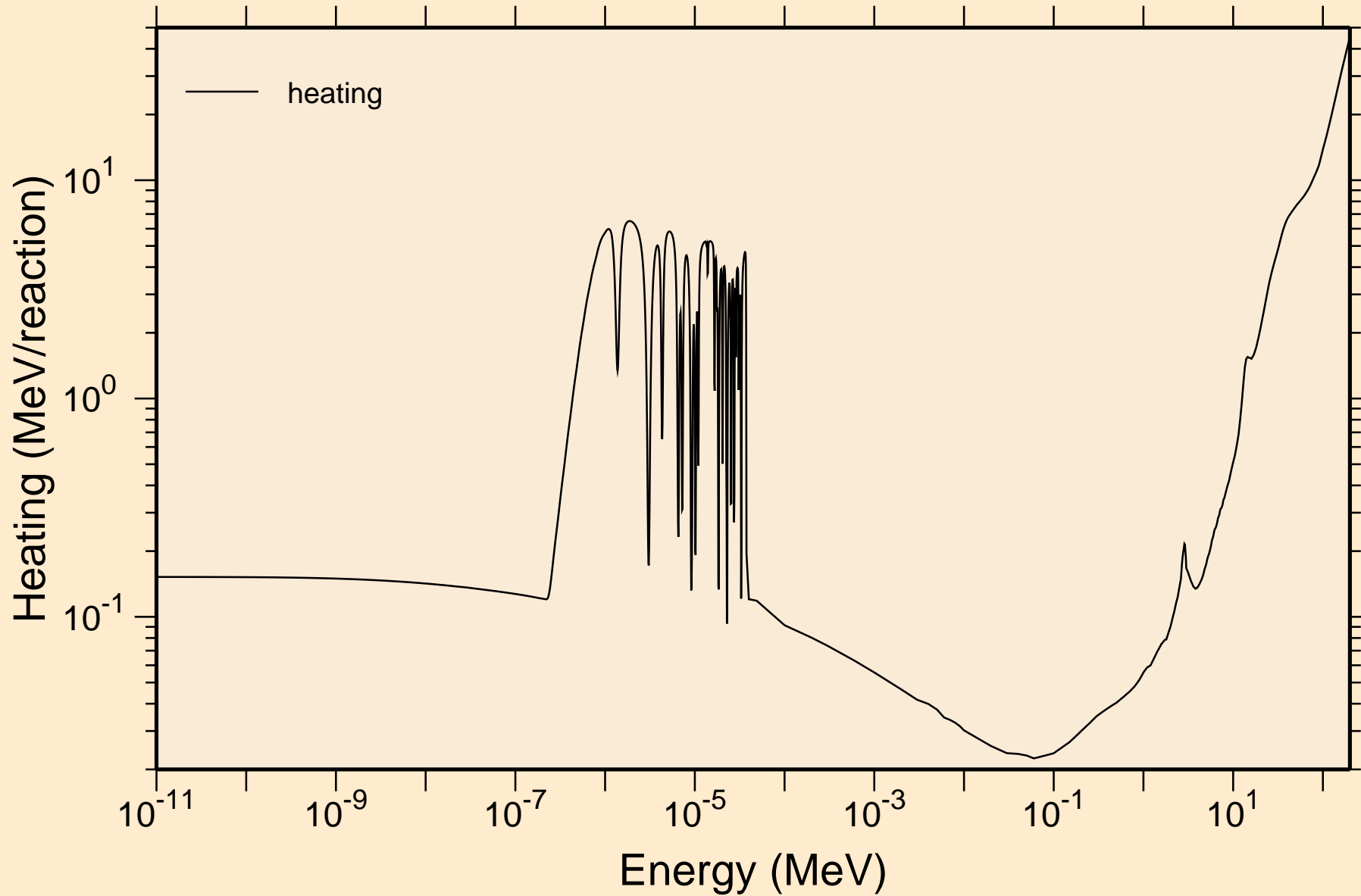

DY149 NEUTRON ACER TENDL-2024 LIBRARY; T=293.6K  
Damage

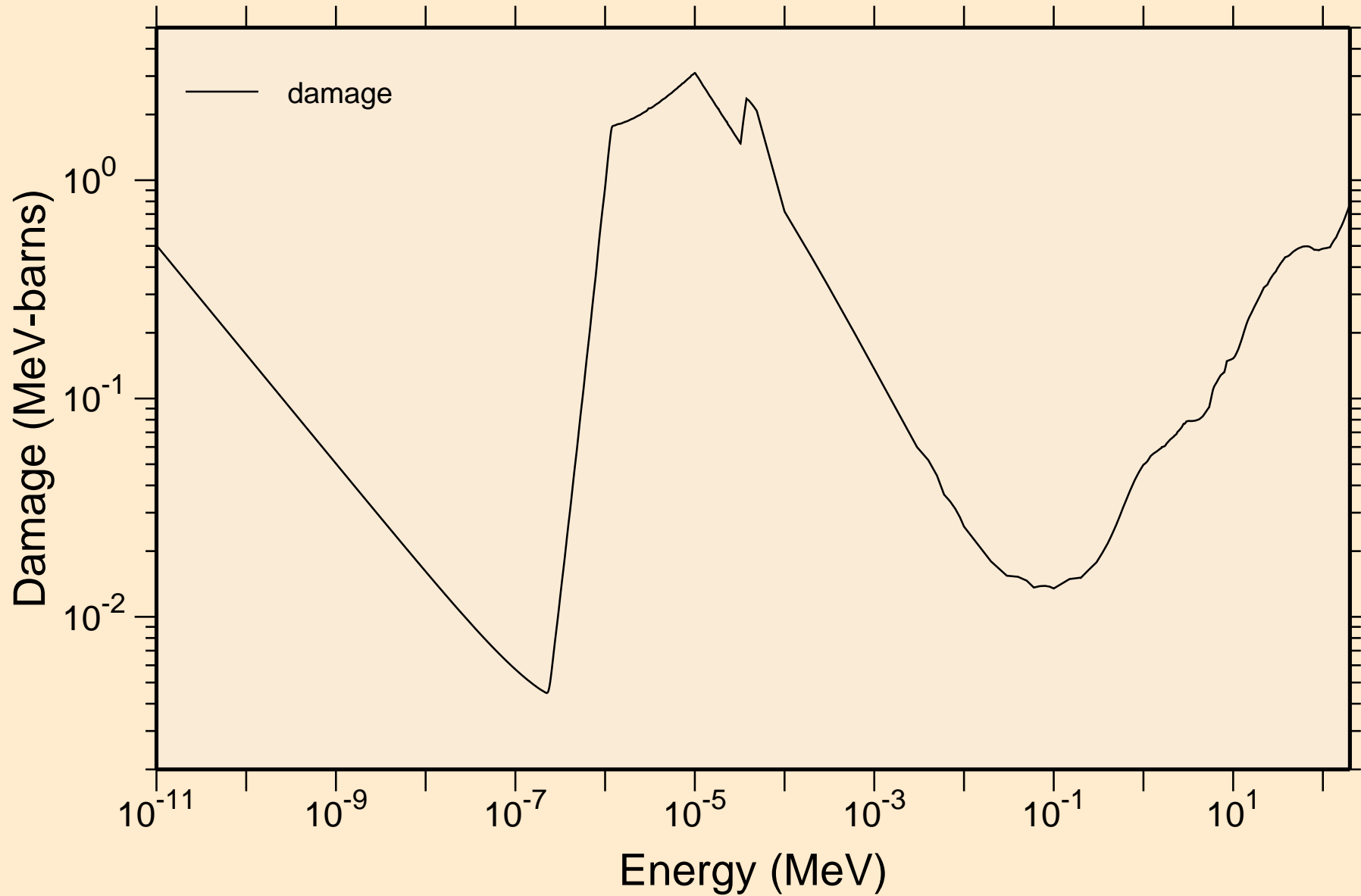

DY149 NEUTRON ACER TENDL-2024 LIBRARY; T=293.6K  
Non-threshold reactions

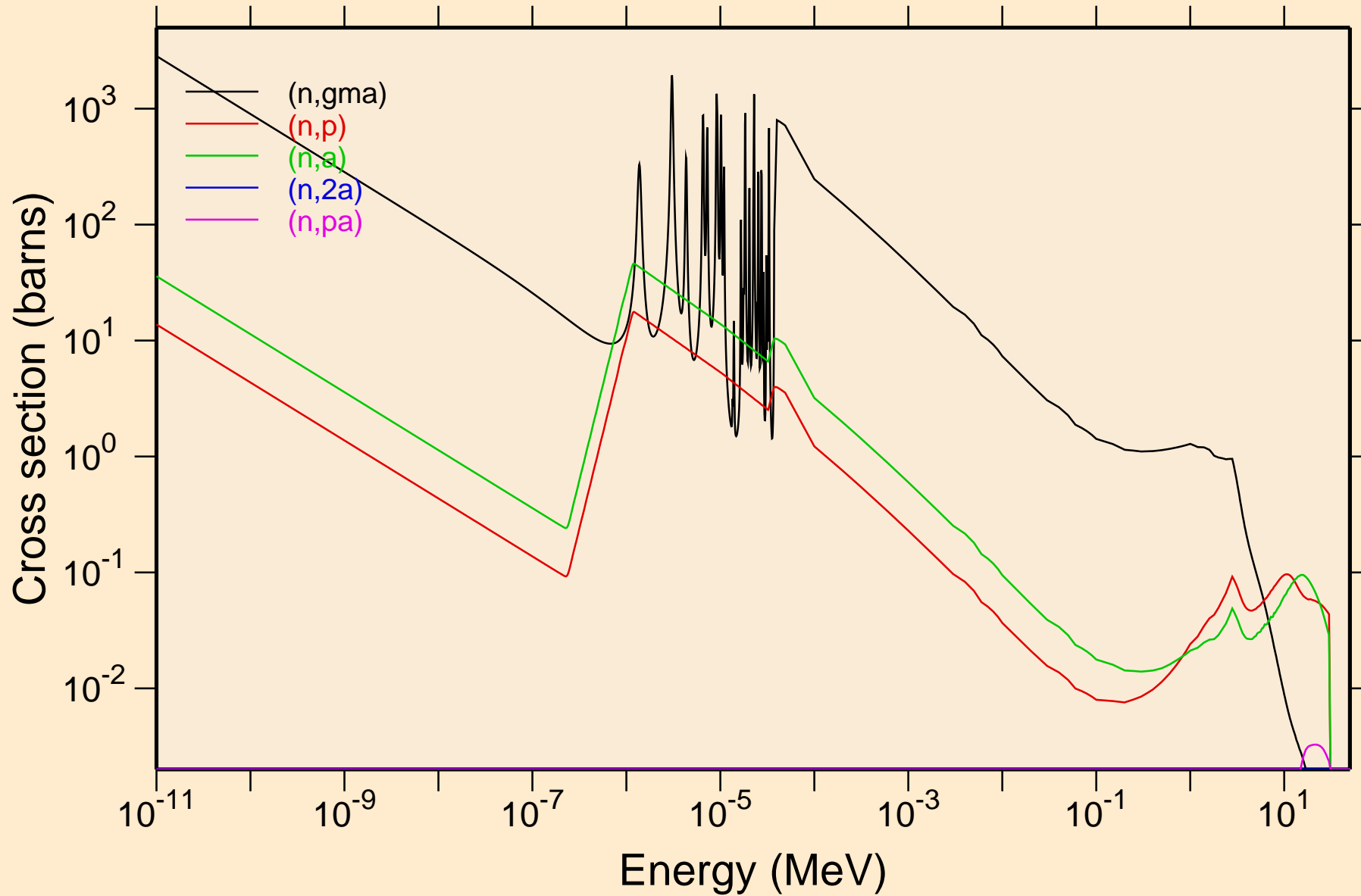

DY149 NEUTRON ACER TENDL-2024 LIBRARY; T=293.6K  
Non-threshold reactions

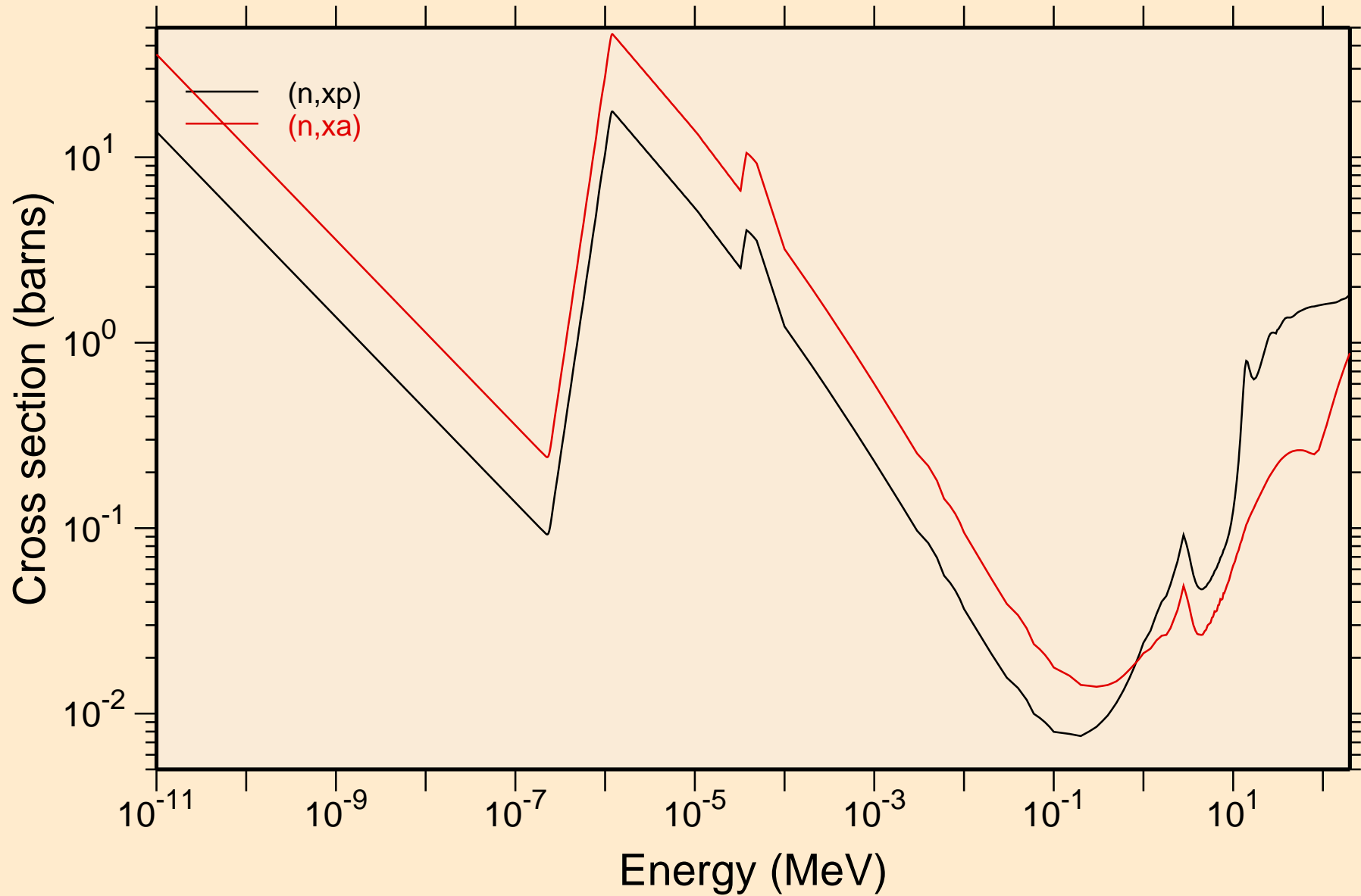

DY149 NEUTRON ACER TENDL-2024 LIBRARY; T=293.6K  
Principal cross sections

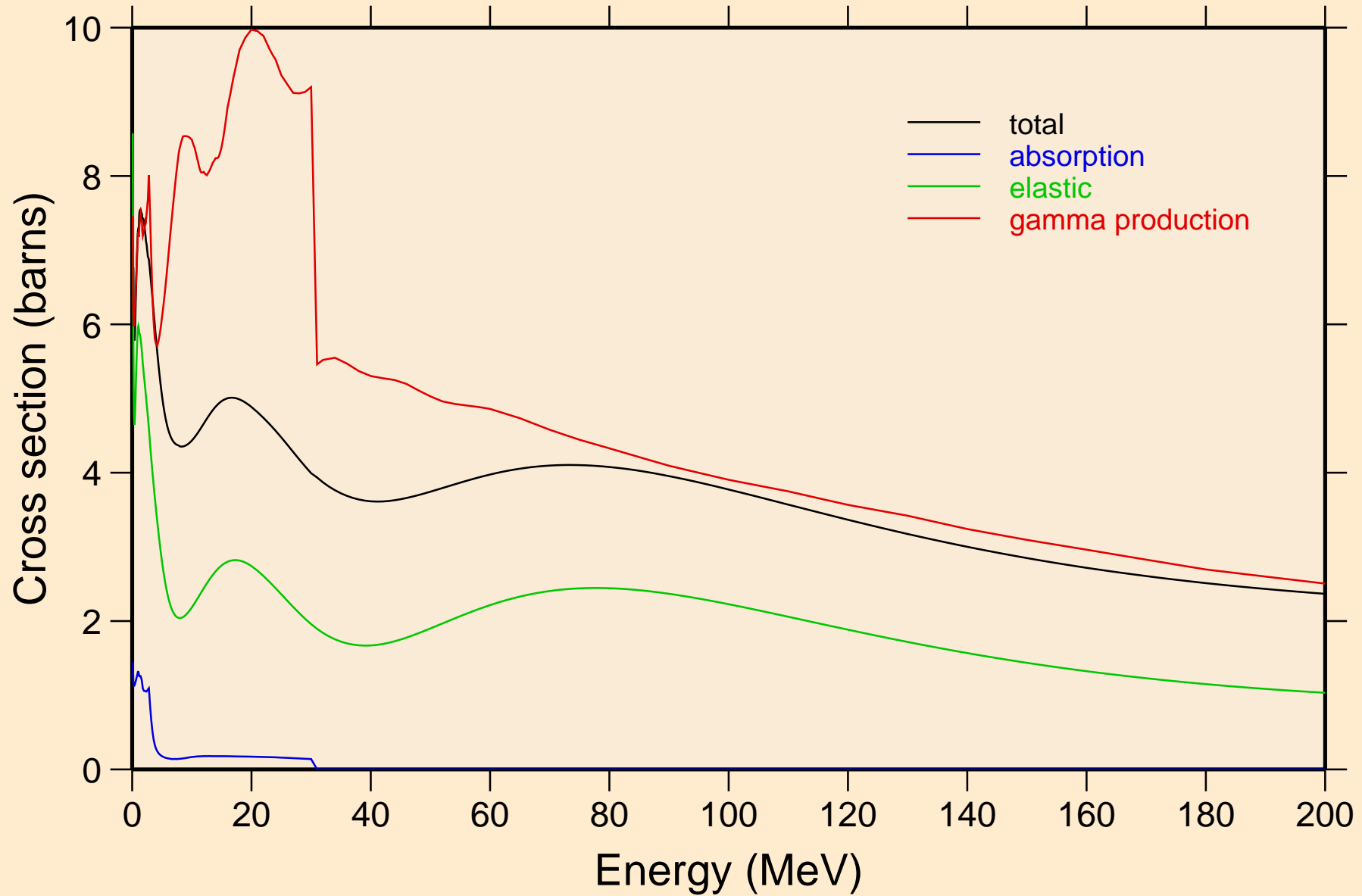

DY149 NEUTRON ACER TENDL-2024 LIBRARY; T=293.6K  
Heating

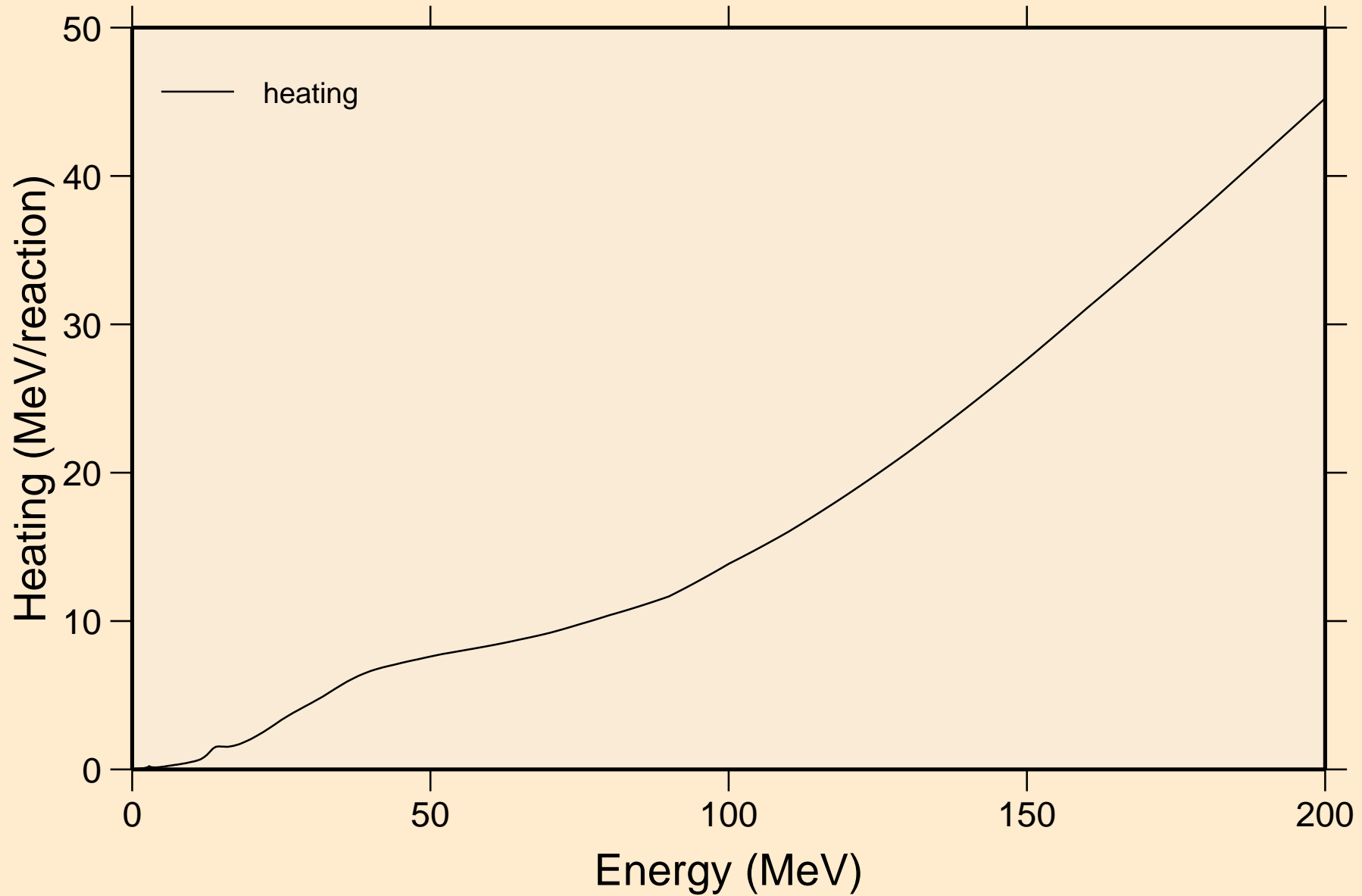

DY149 NEUTRON ACER TENDL-2024 LIBRARY; T=293.6K  
Damage

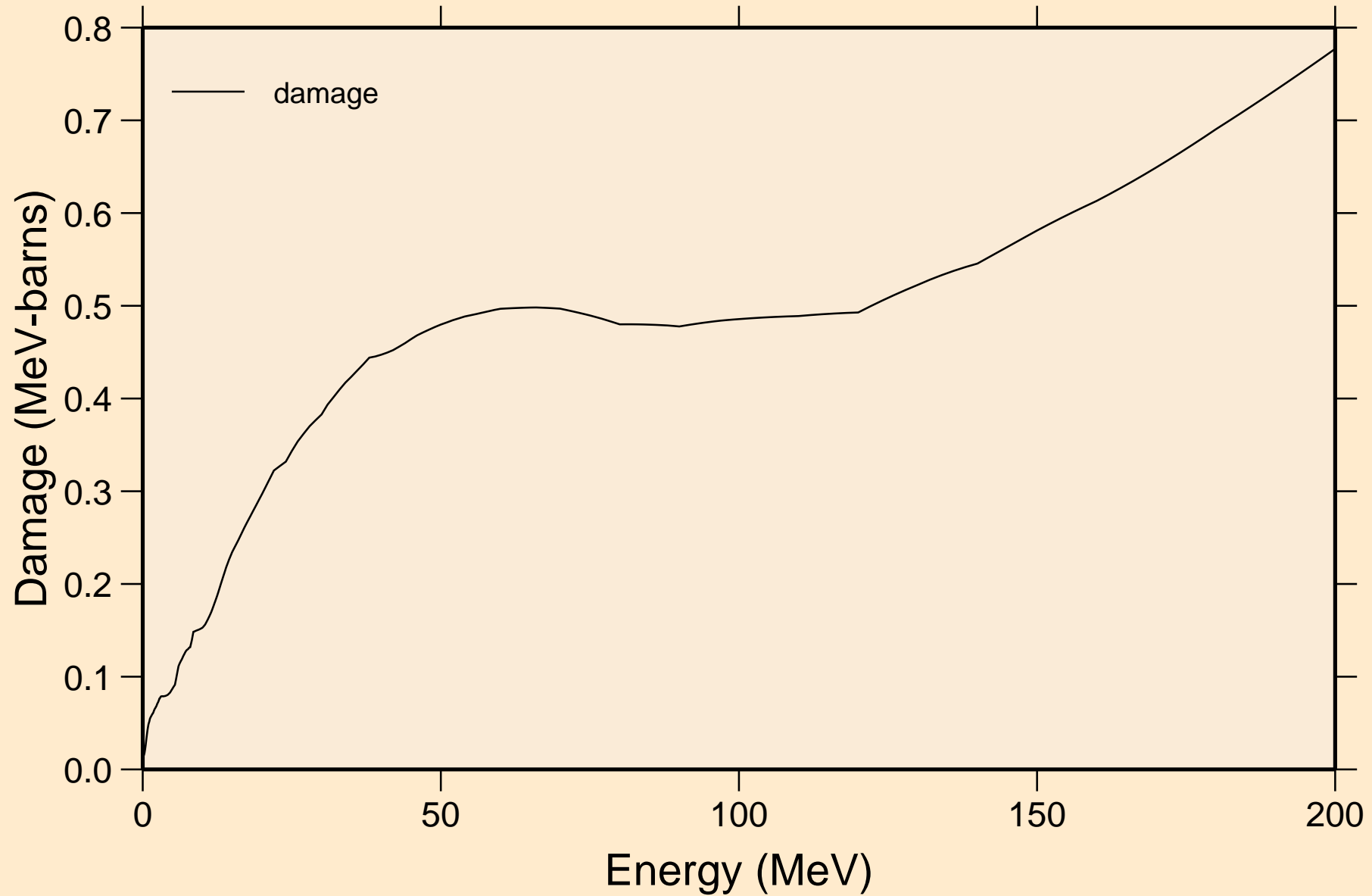

DY149 NEUTRON ACER TENDL-2024 LIBRARY; T=293.6K  
Non-threshold reactions

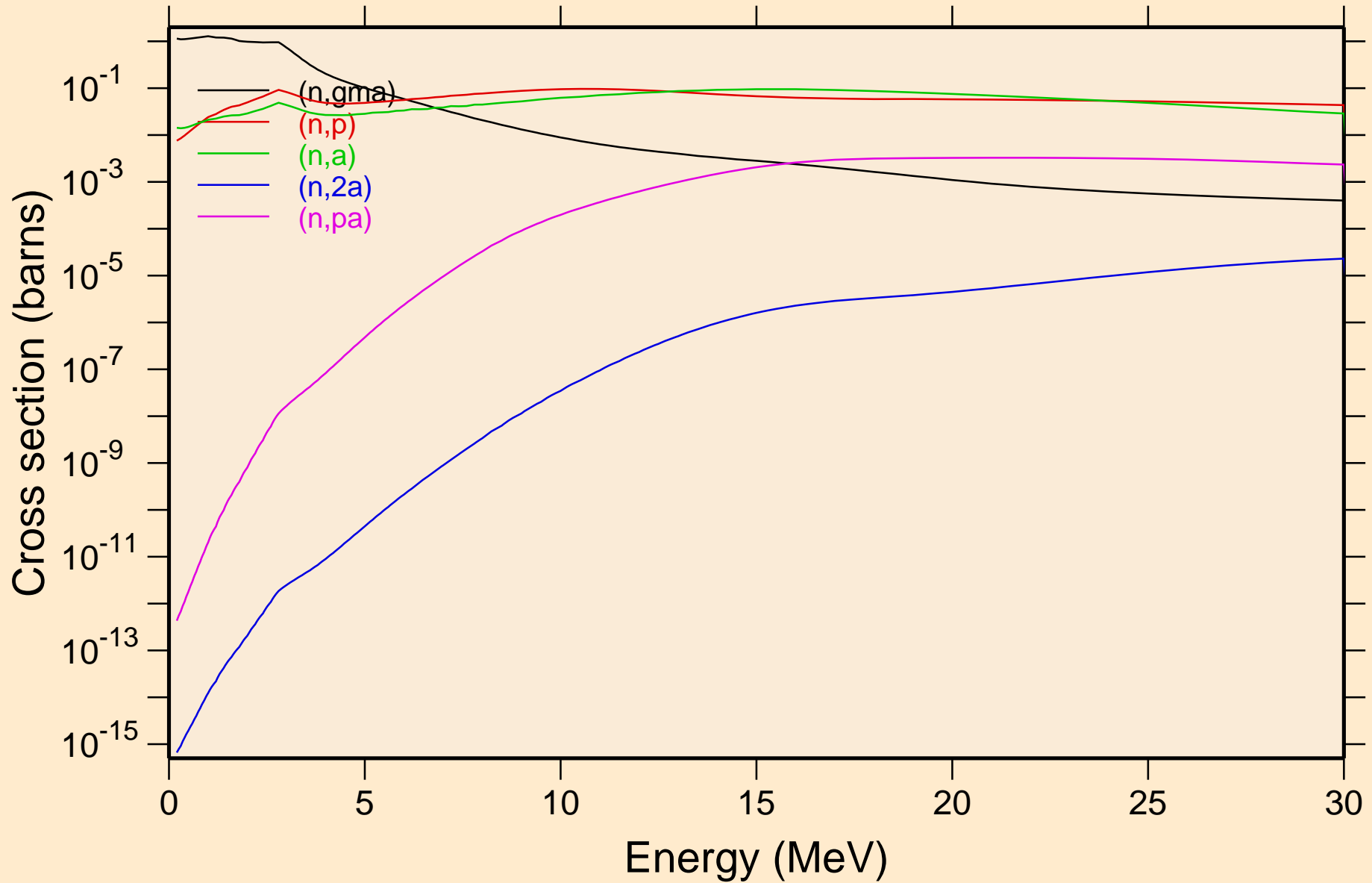

DY149 NEUTRON ACER TENDL-2024 LIBRARY; T=293.6K  
Non-threshold reactions

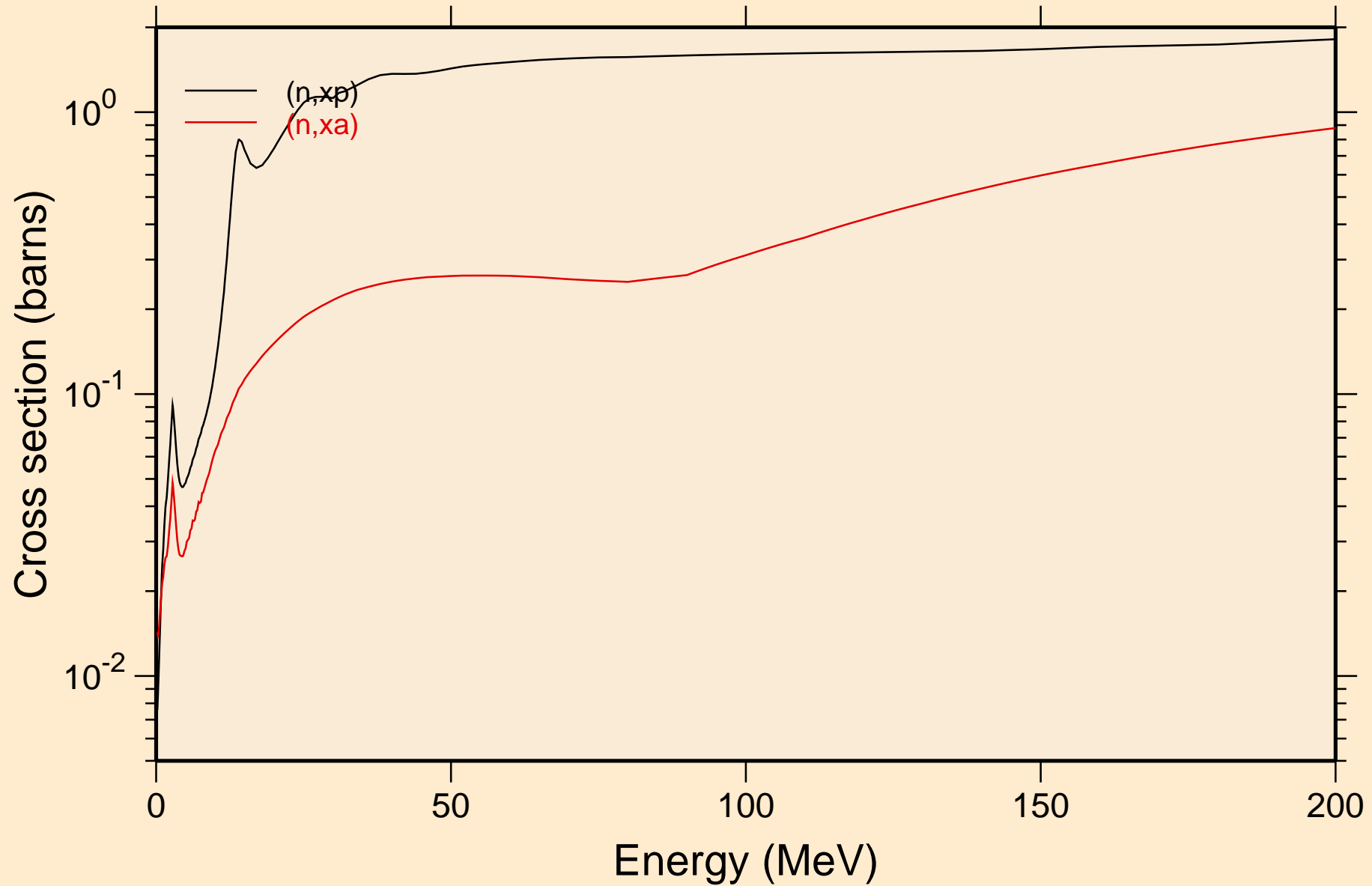

DY149 NEUTRON ACER TENDL-2024 LIBRARY; T=293.6K  
Inelastic levels

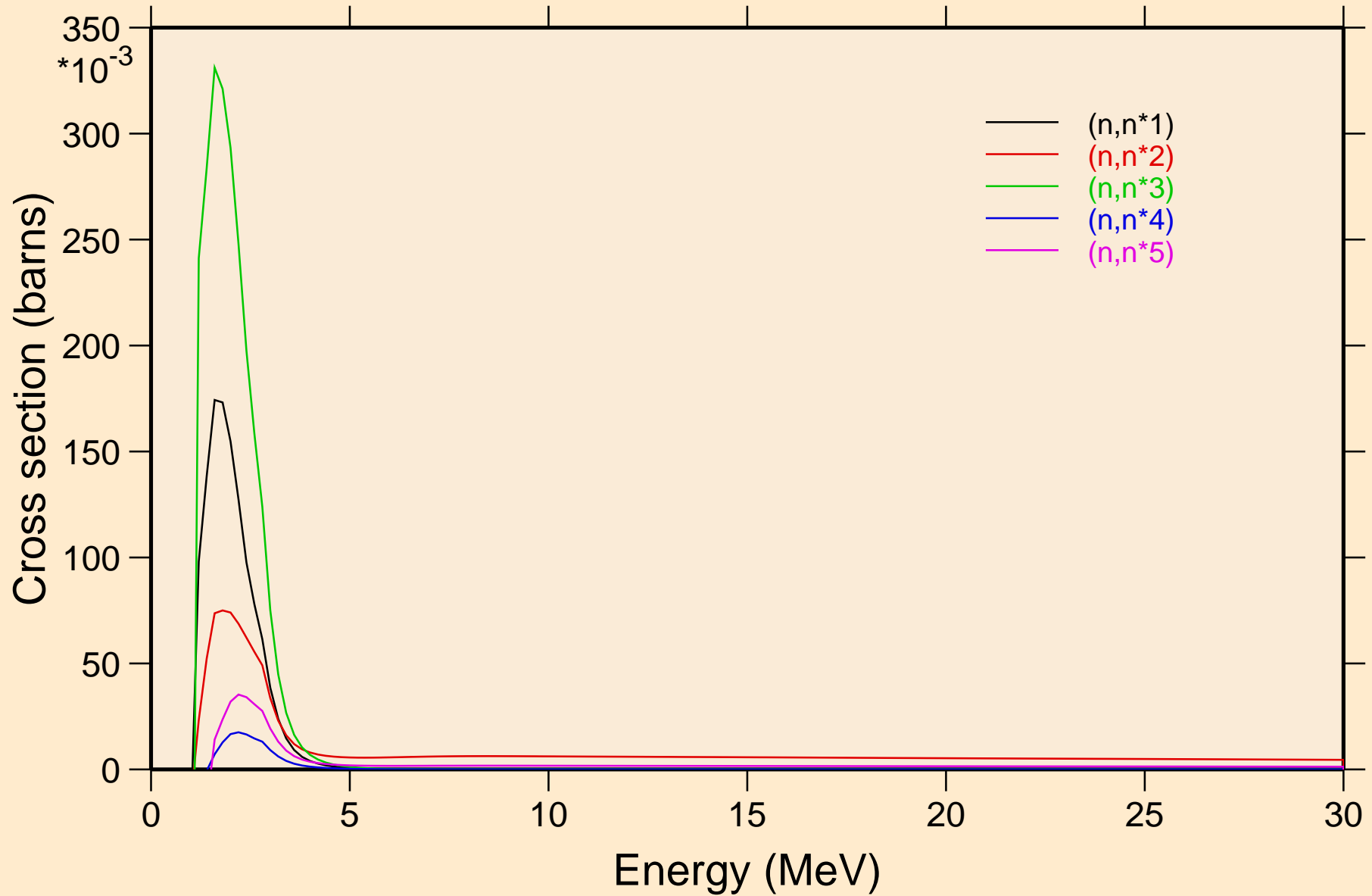

DY149 NEUTRON ACER TENDL-2024 LIBRARY; T=293.6K  
Inelastic levels

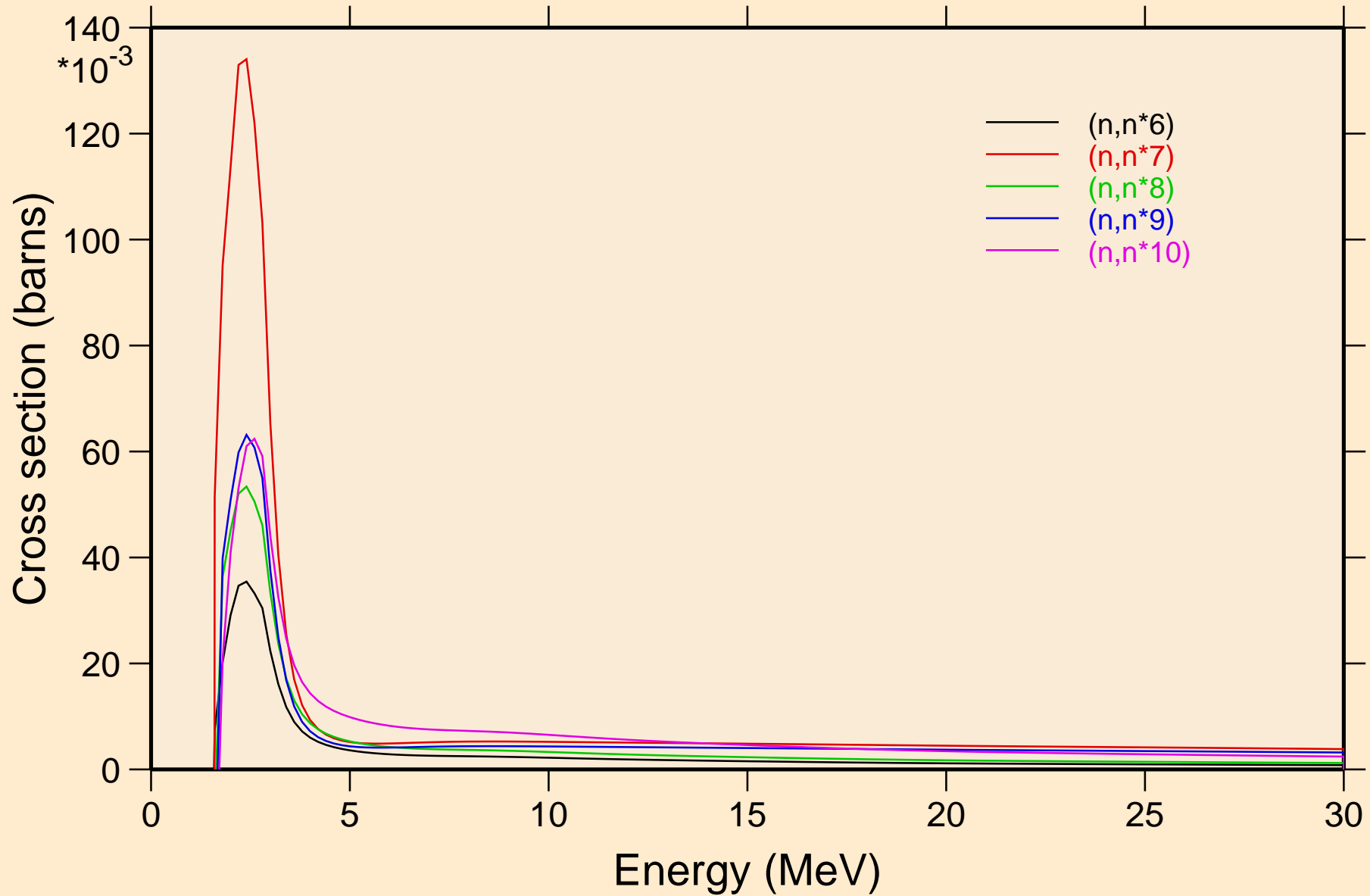

DY149 NEUTRON ACER TENDL-2024 LIBRARY; T=293.6K  
Inelastic levels

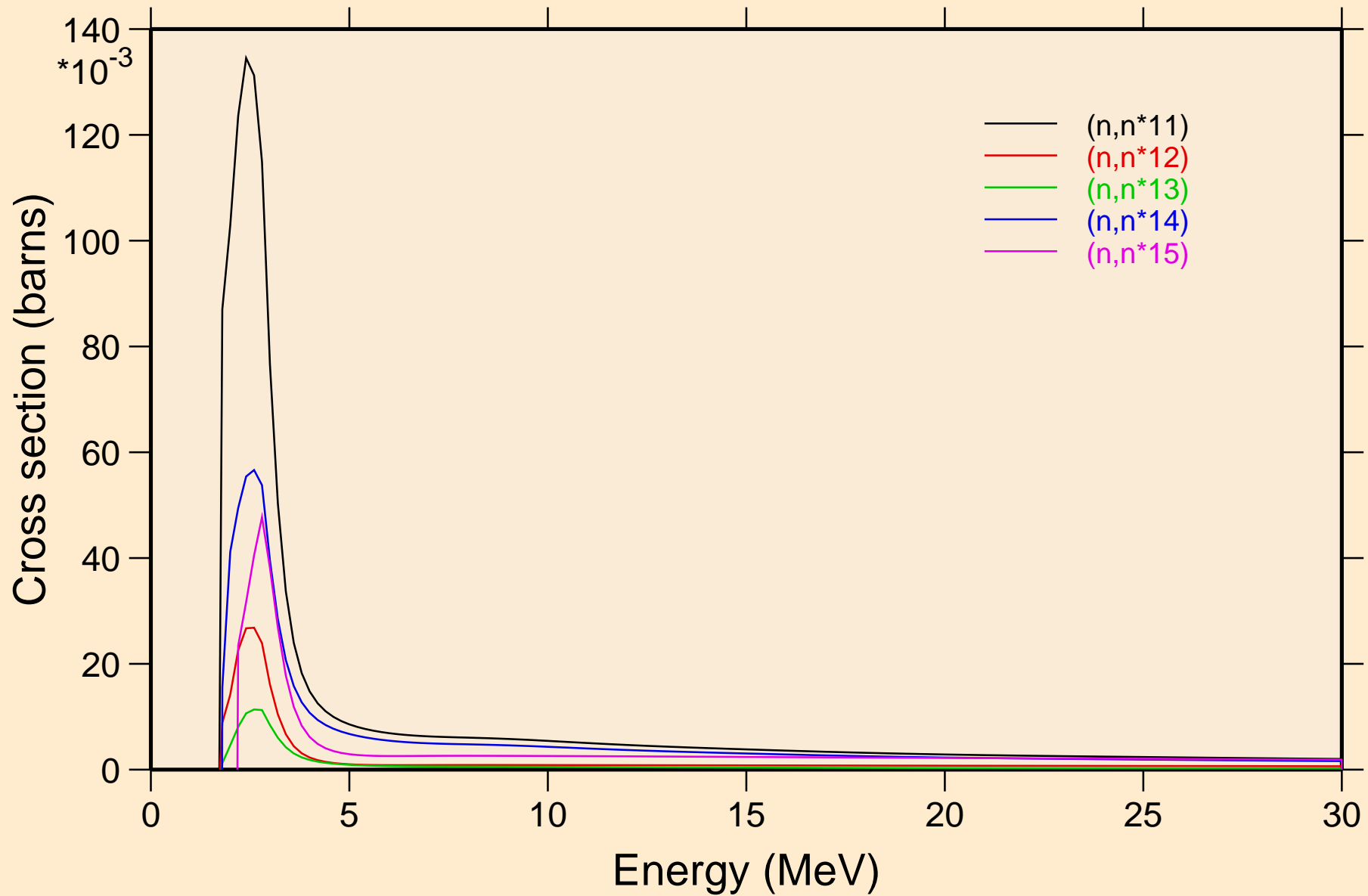

DY149 NEUTRON ACER TENDL-2024 LIBRARY; T=293.6K  
Inelastic levels

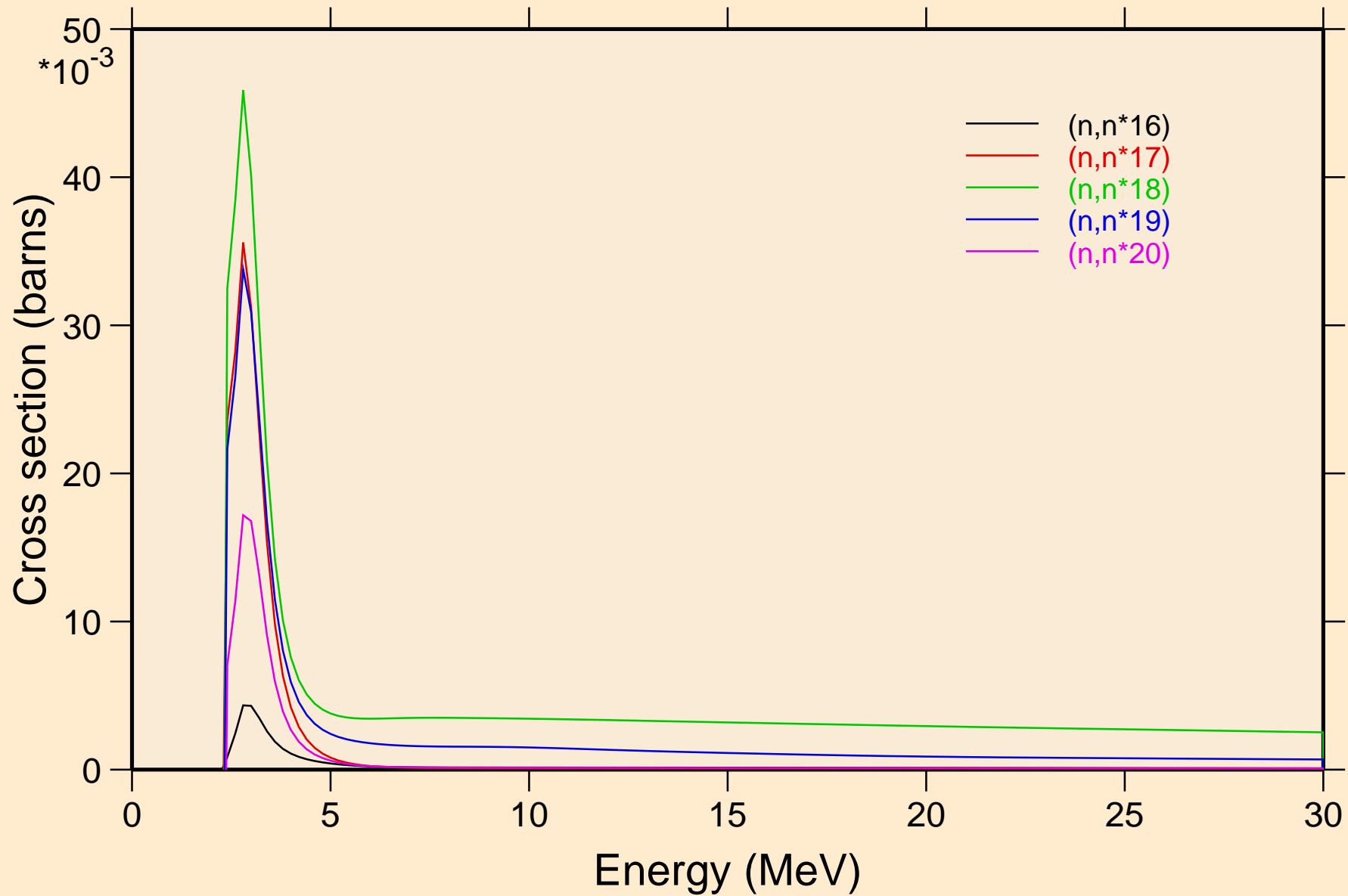

DY149 NEUTRON ACER TENDL-2024 LIBRARY; T=293.6K  
Inelastic levels

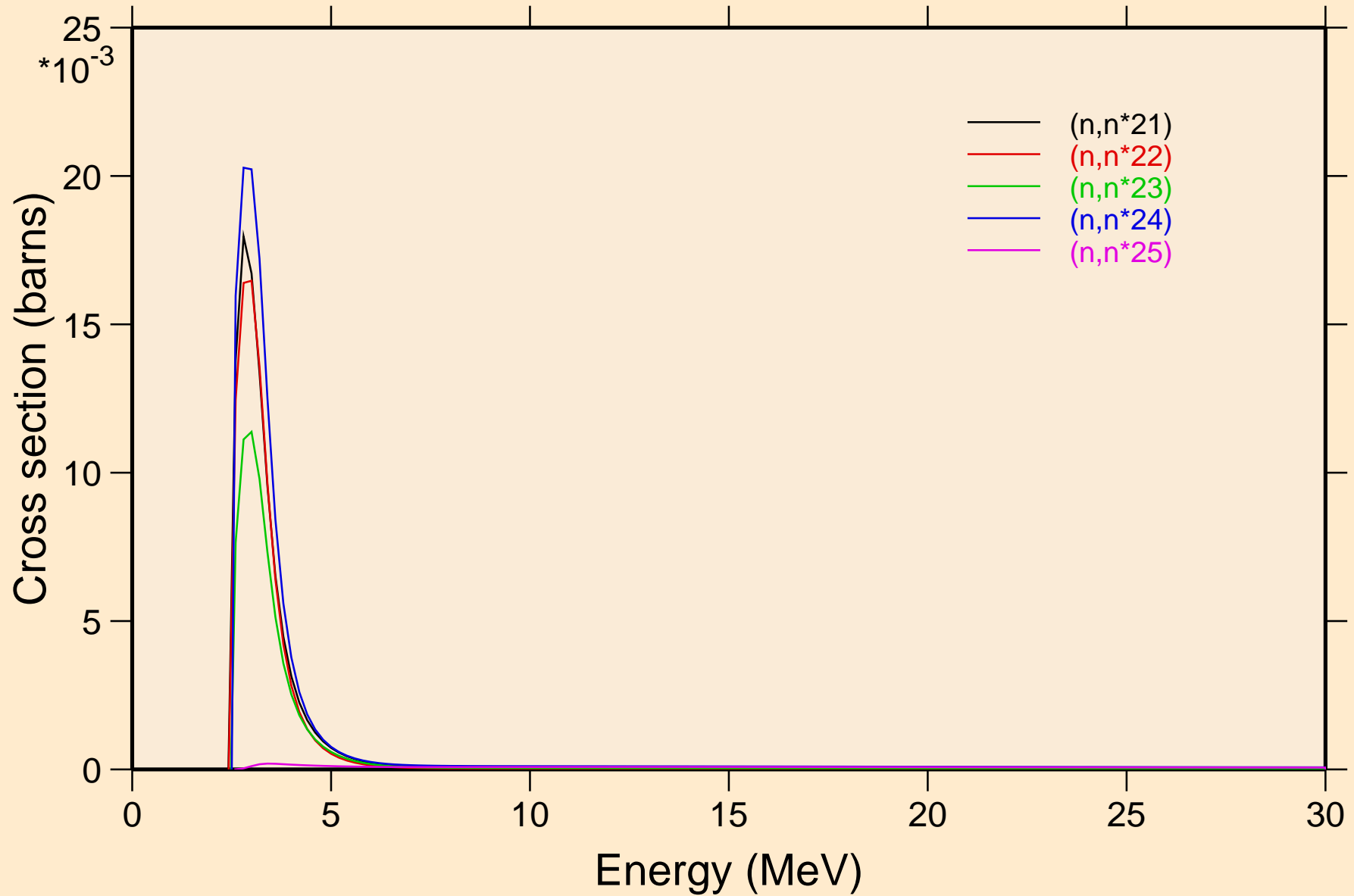

DY149 NEUTRON ACER TENDL-2024 LIBRARY; T=293.6K  
Inelastic levels

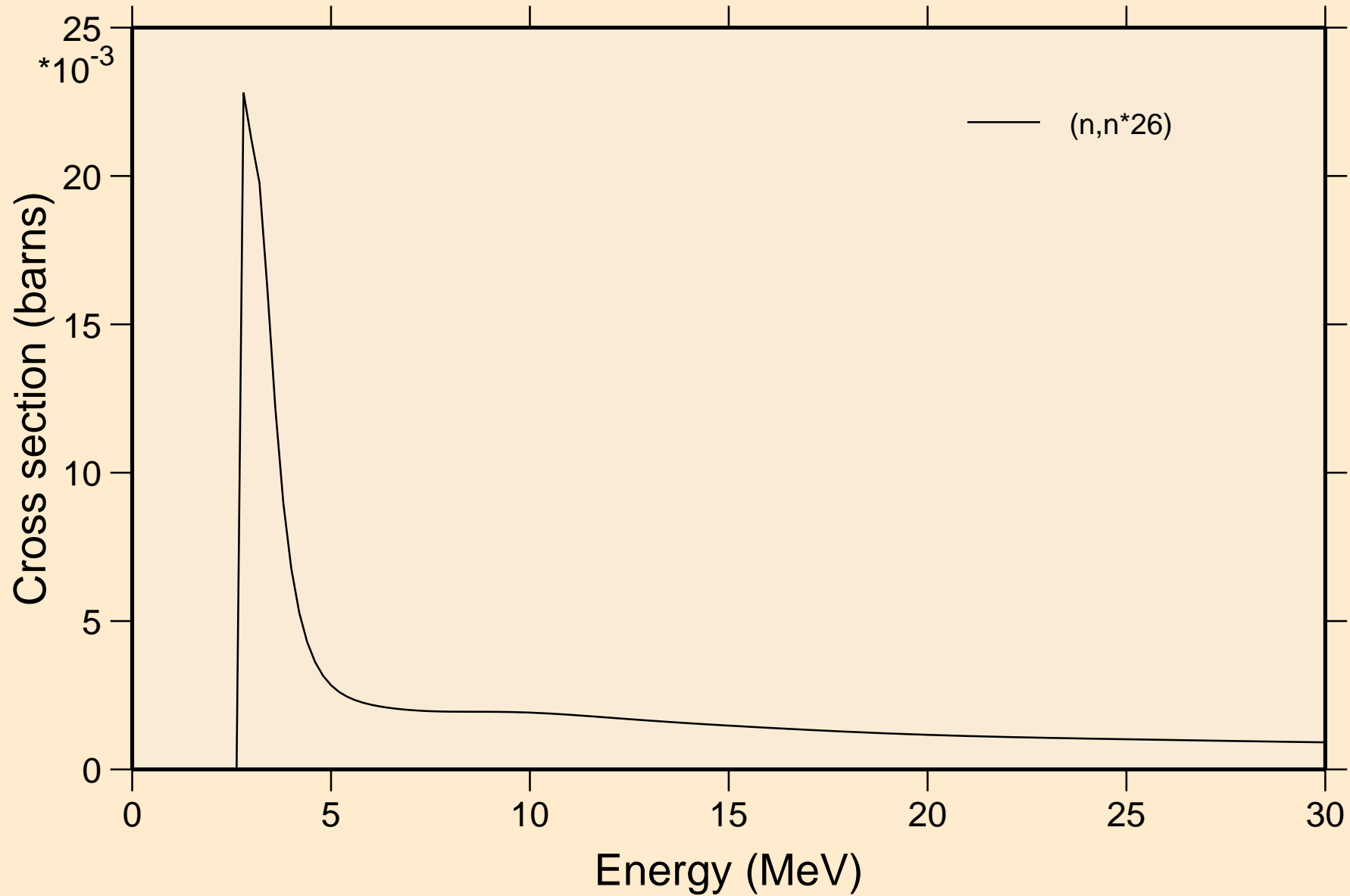

DY149 NEUTRON ACER TENDL-2024 LIBRARY; T=293.6K  
Threshold reactions

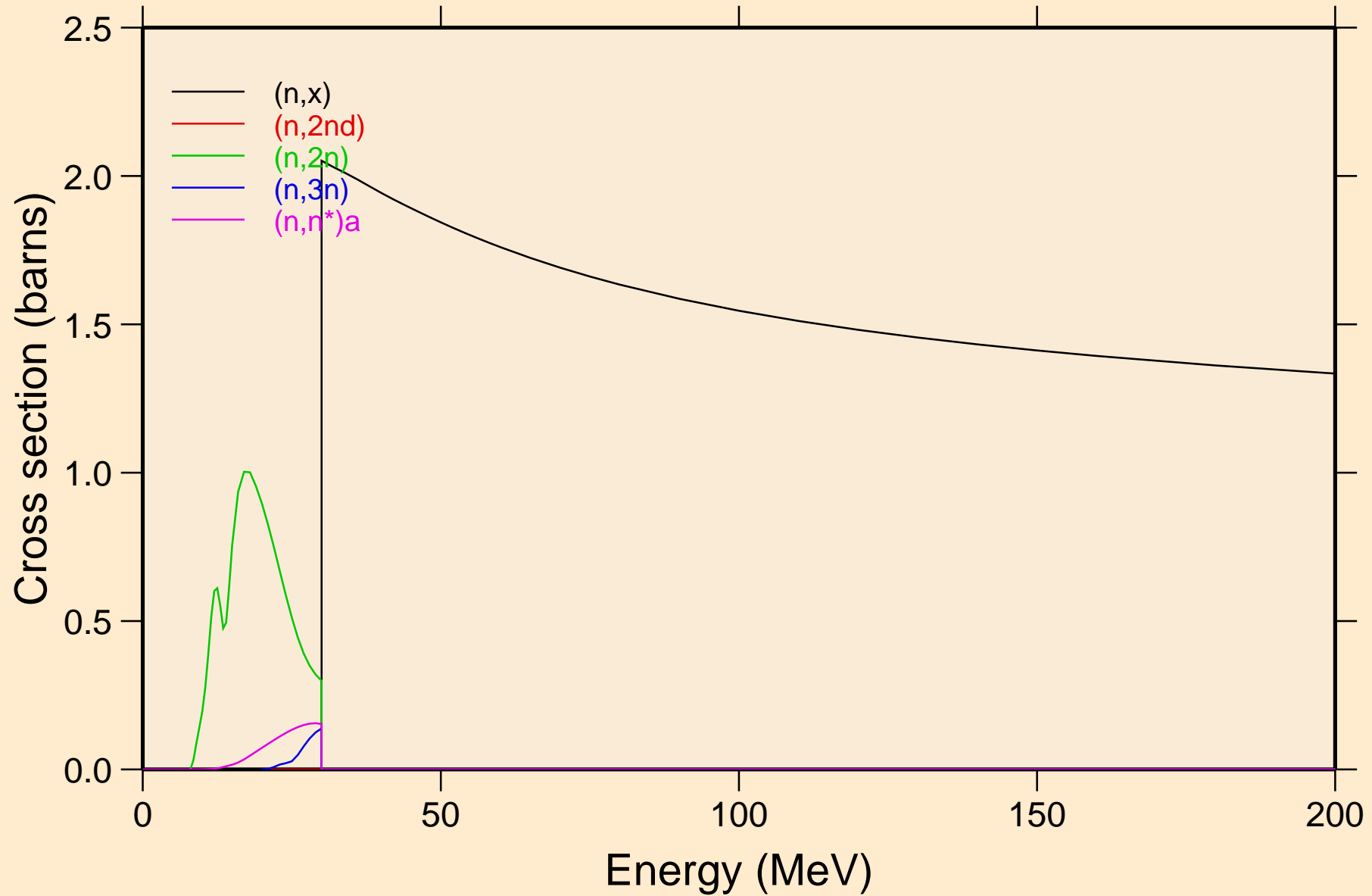

DY149 NEUTRON ACER TENDL-2024 LIBRARY; T=293.6K  
Threshold reactions

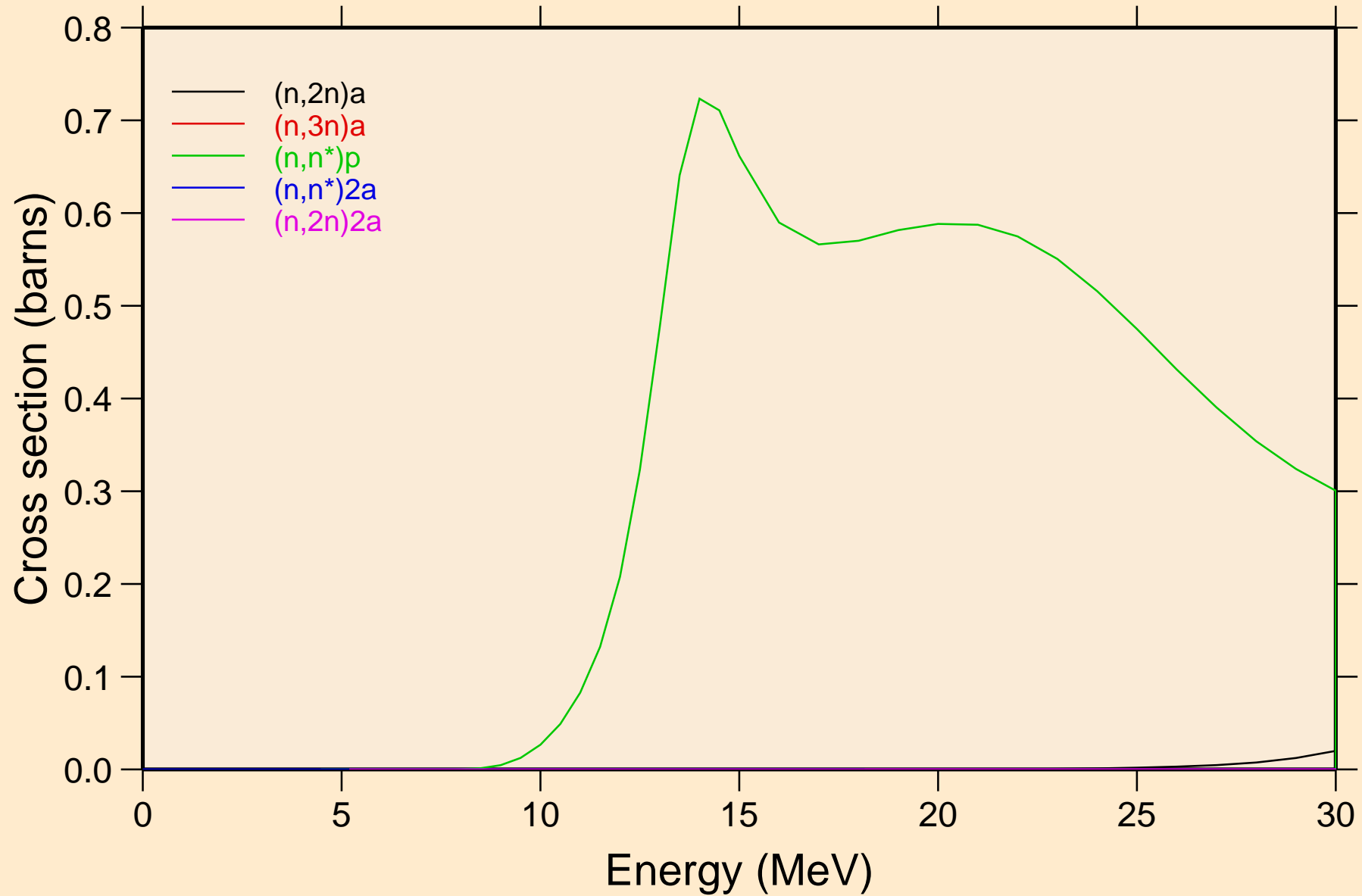

DY149 NEUTRON ACER TENDL-2024 LIBRARY; T=293.6K  
Threshold reactions

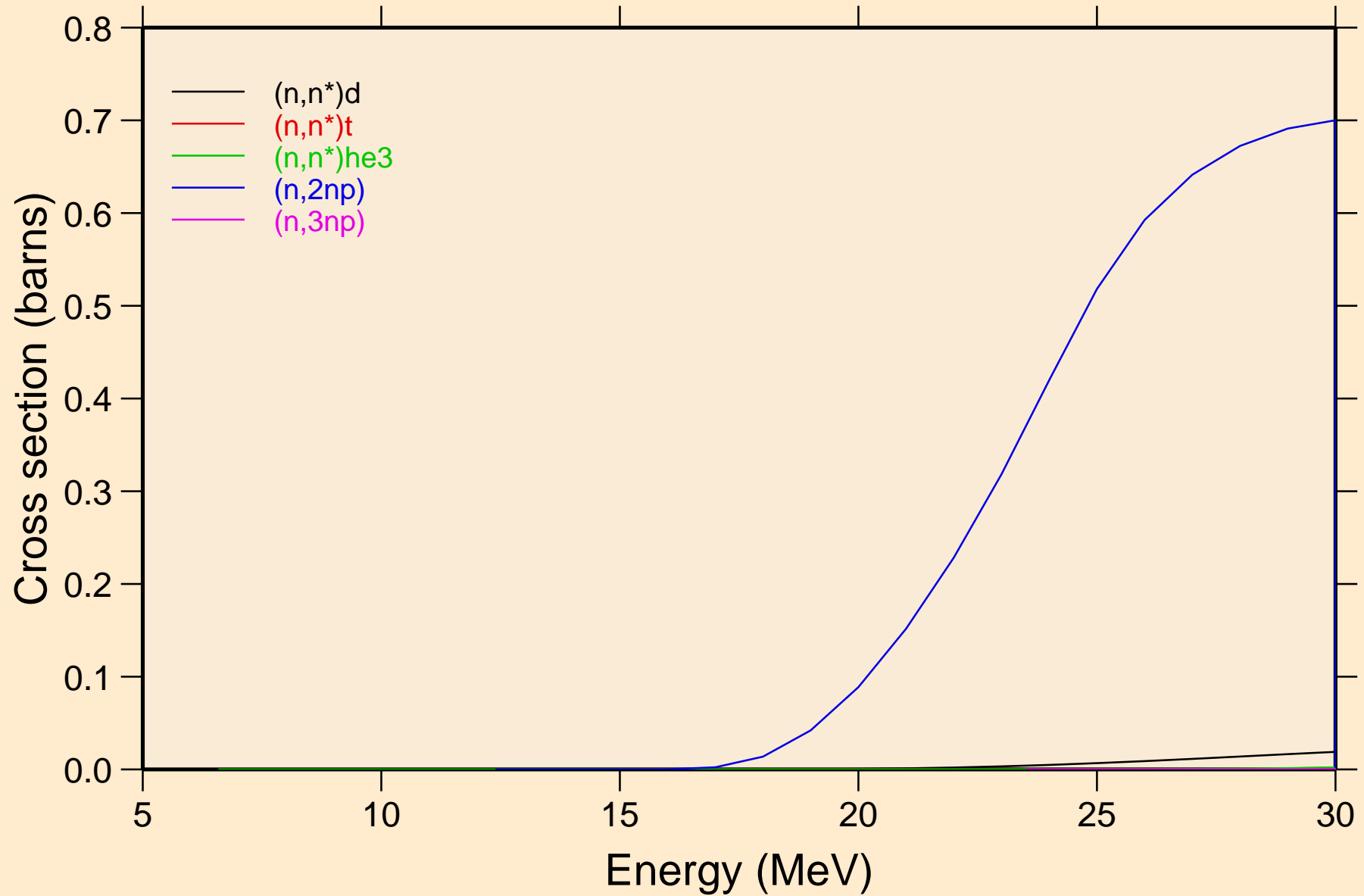

DY149 NEUTRON ACER TENDL-2024 LIBRARY; T=293.6K  
Threshold reactions

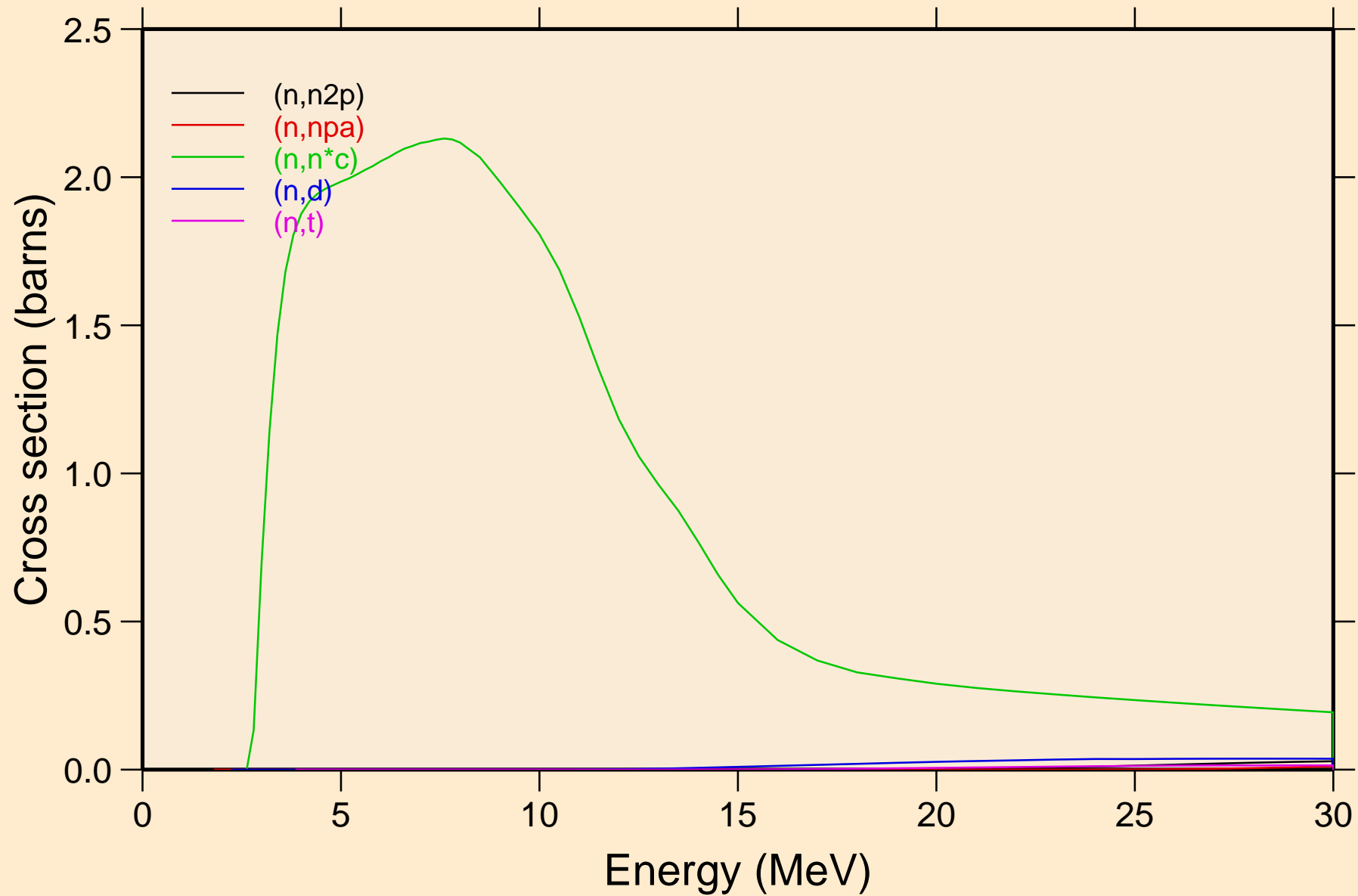

DY149 NEUTRON ACER TENDL-2024 LIBRARY; T=293.6K  
Threshold reactions

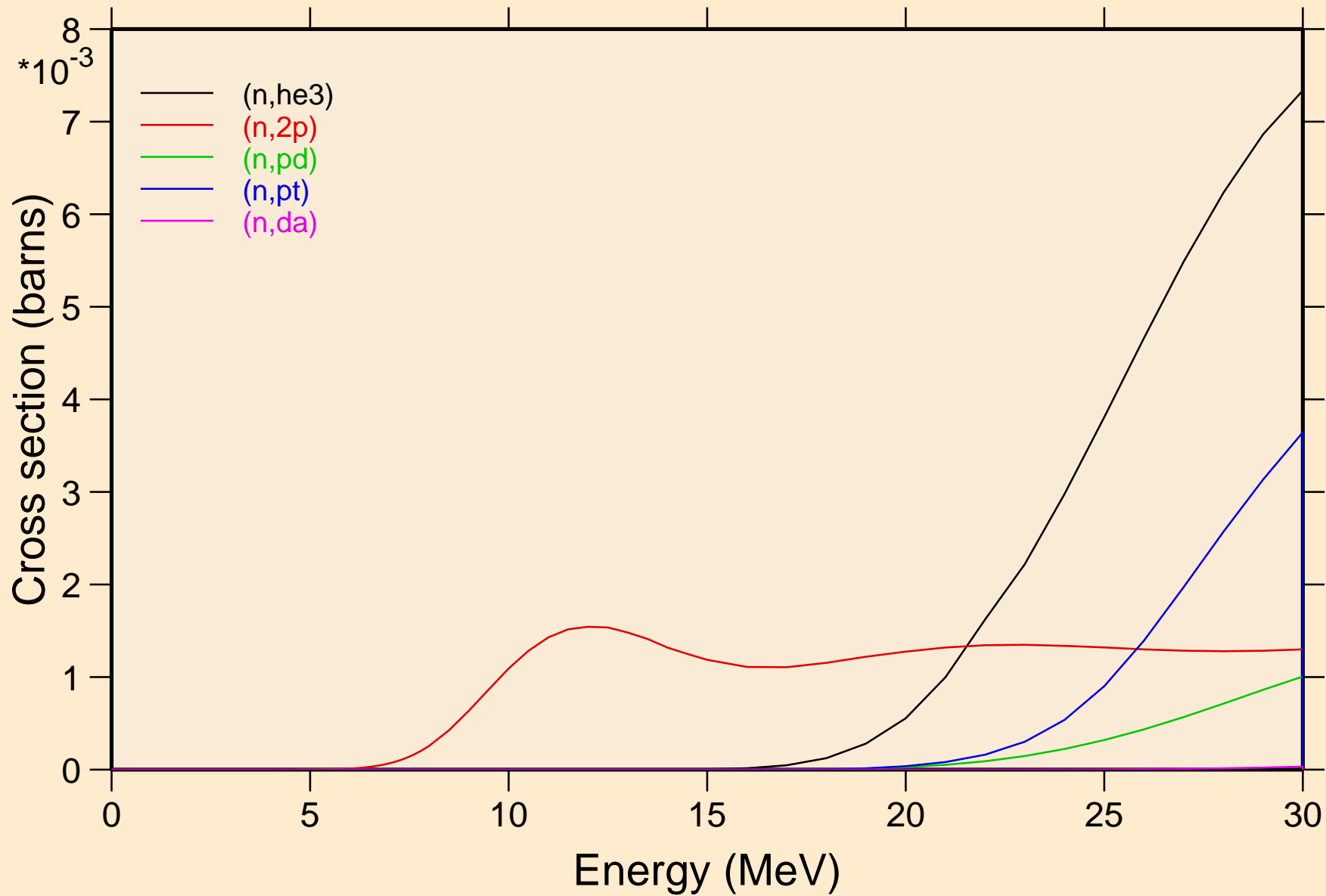

DY149 NEUTRON ACER TENDL-2024 LIBRARY; T=293.6K  
Threshold reactions

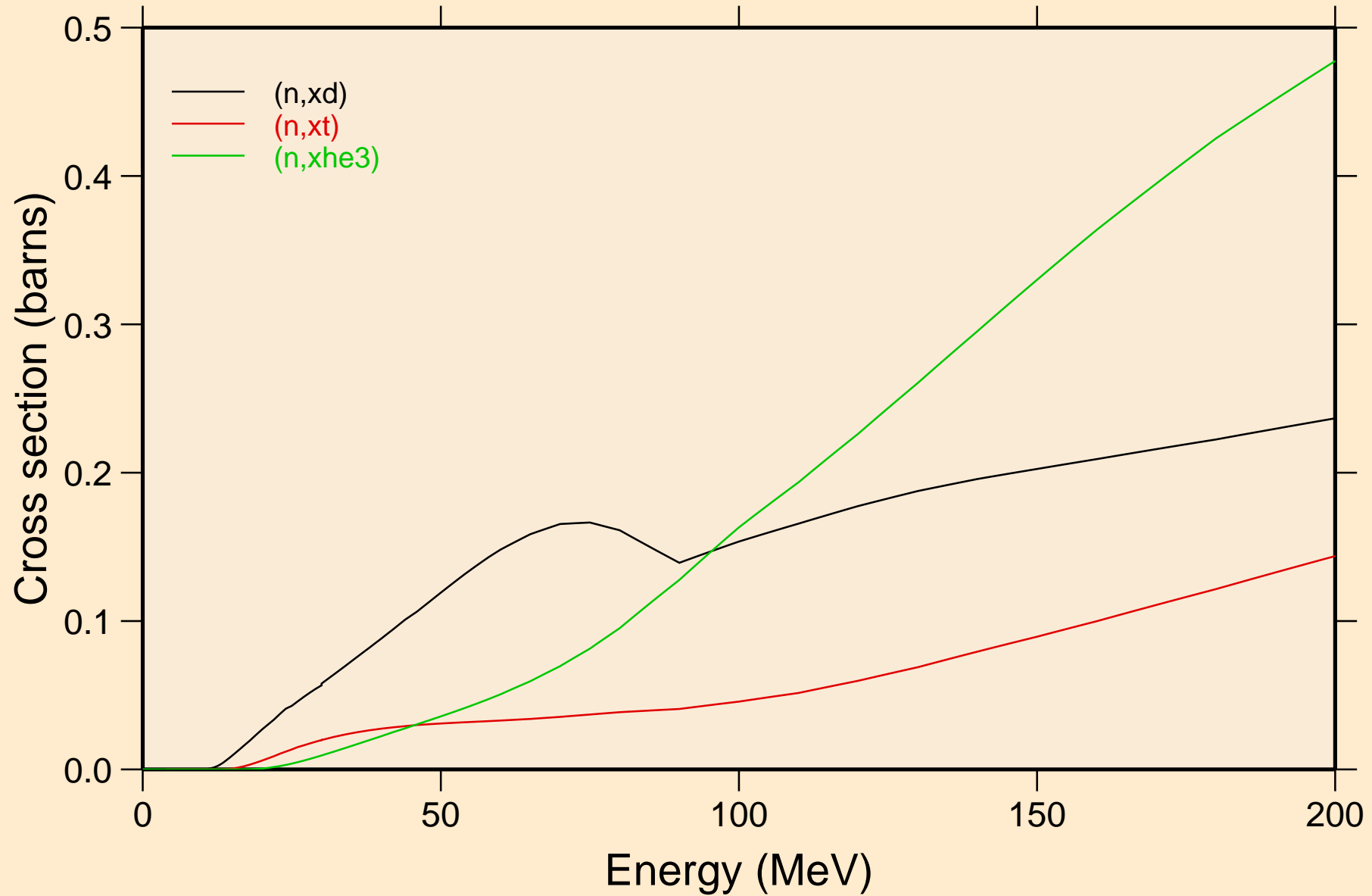

DY149 NEUTRON ACER TENDL-2024 LIBRARY; T=293.6K  
angular distribution for elastic

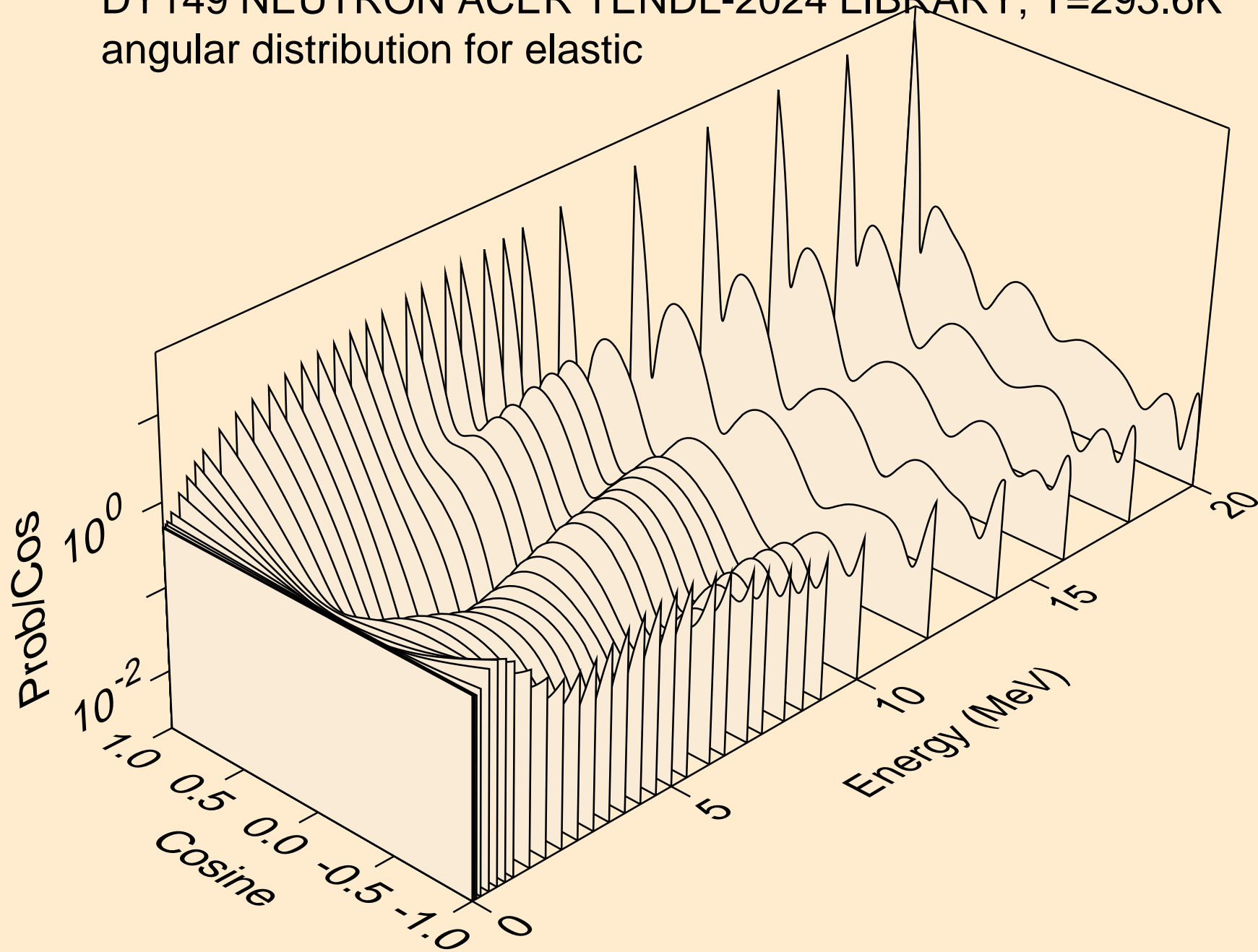

DY149 NEUTRON ACER TENDL-2024 LIBRARY; T=293.6K  
angular distribution for elastic

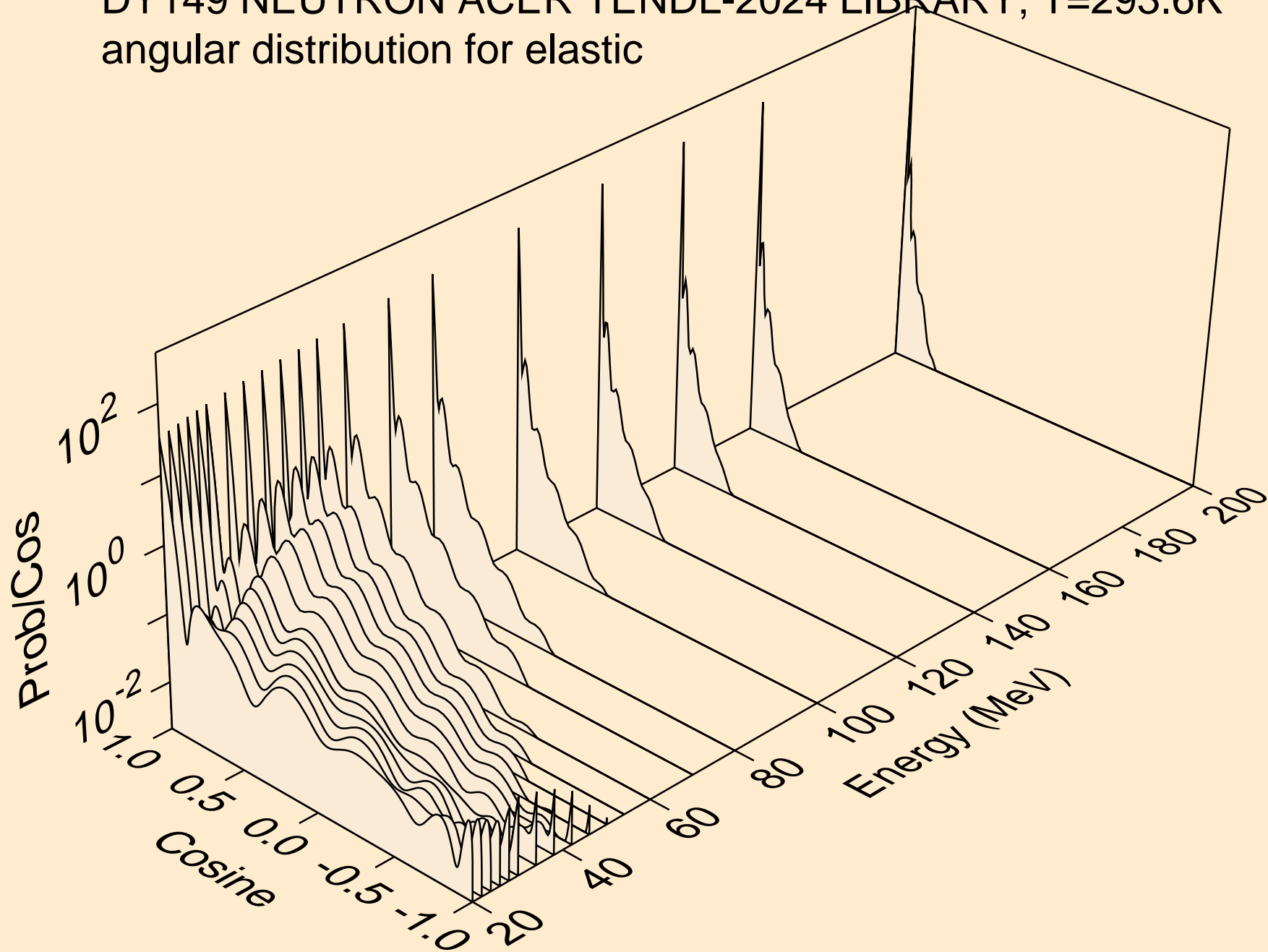

DY149 NEUTRON ACER TENDL-2024 LIBRARY; T=293.6K  
angular distribution for (n,n\*1)

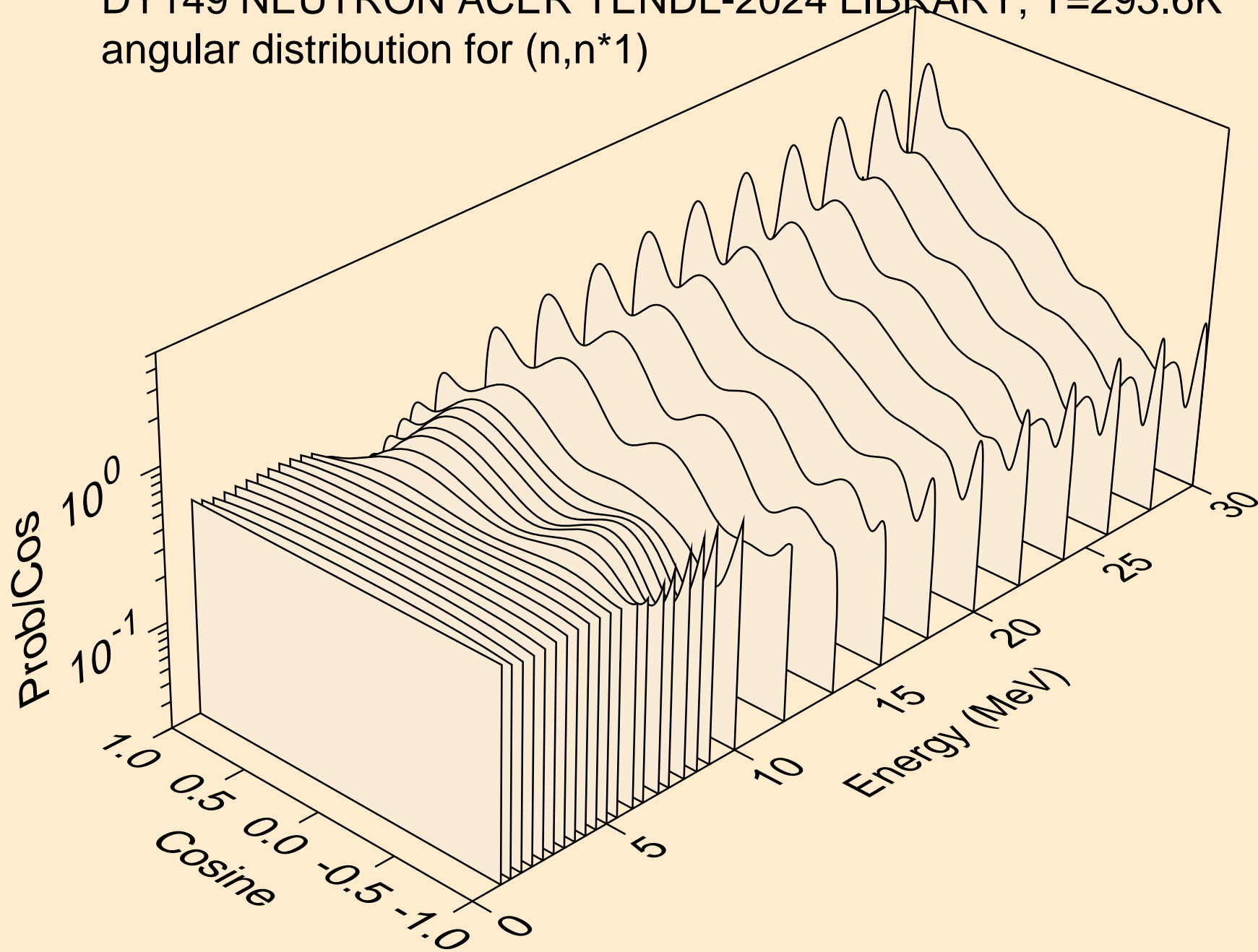

DY149 NEUTRON ACER TENDL-2024 LIBRARY; T=293.6K  
angular distribution for (n,n\*2)

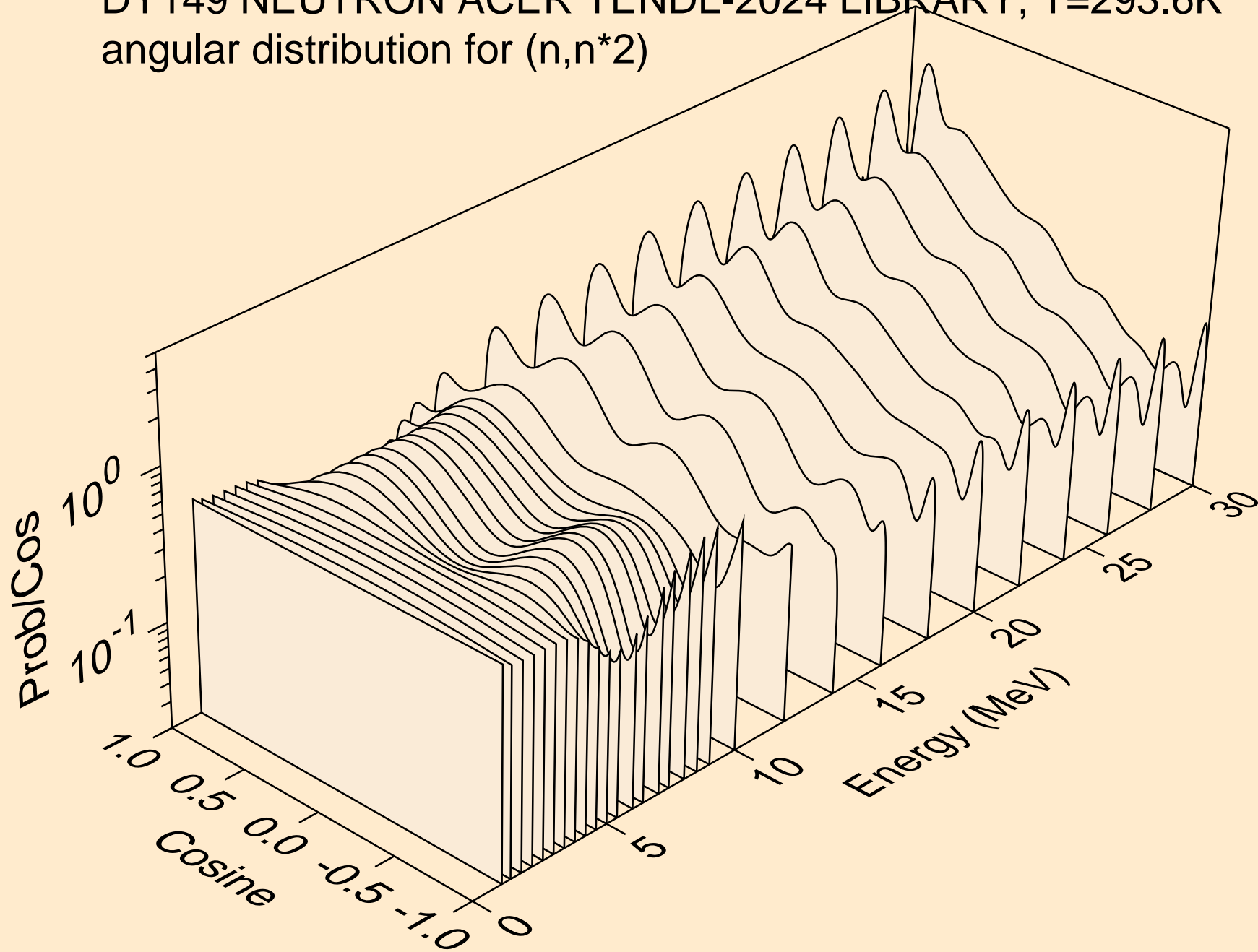

DY149 NEUTRON ACER TENDL-2024 LIBRARY; T=293.6K  
angular distribution for (n,n\*3)



DY149 NEUTRON ACER TENDL-2024 LIBRARY; T=293.6K  
angular distribution for (n,n\*4)

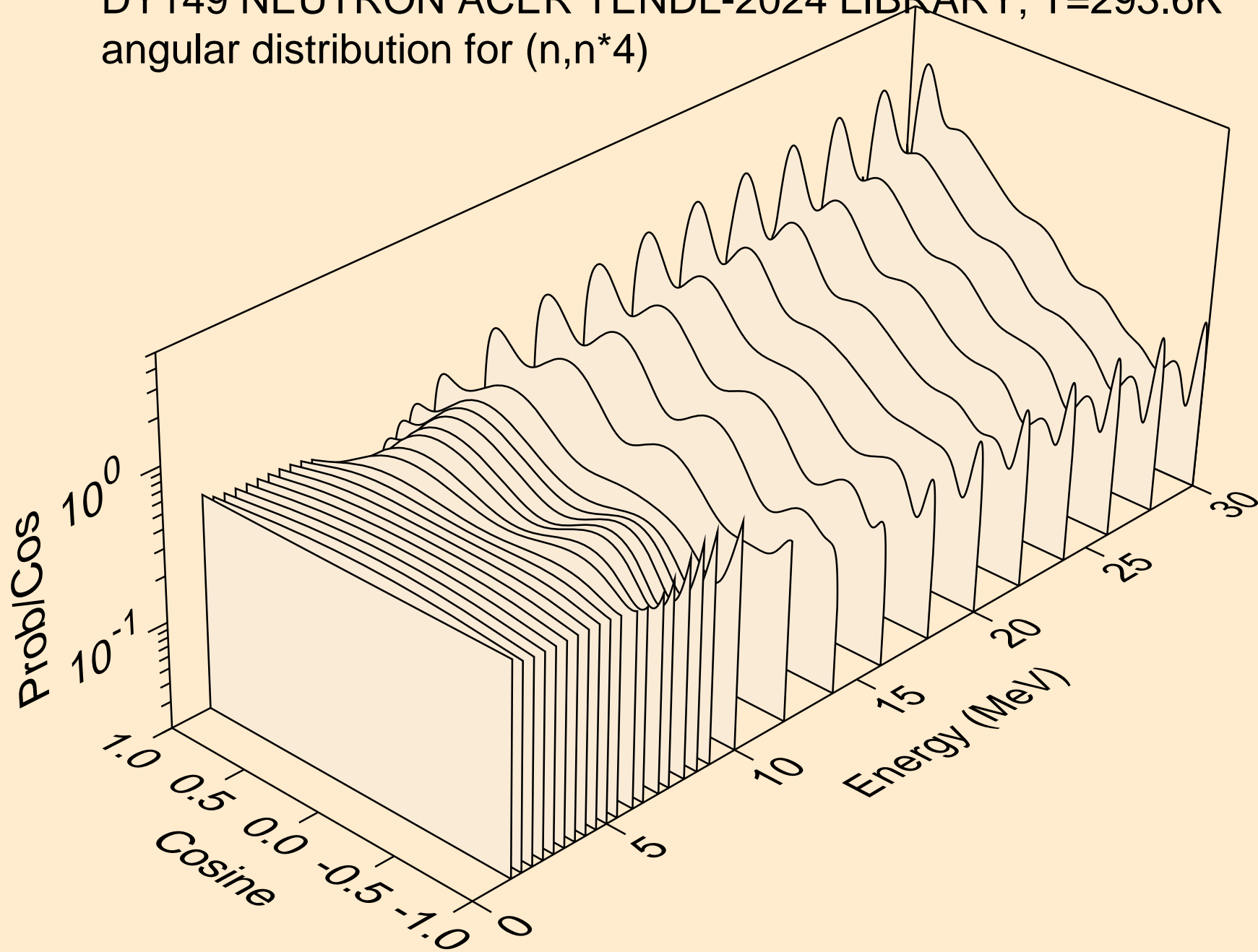

DY149 NEUTRON ACER TENDL-2024 LIBRARY; T=293.6K  
angular distribution for (n,n\*5)

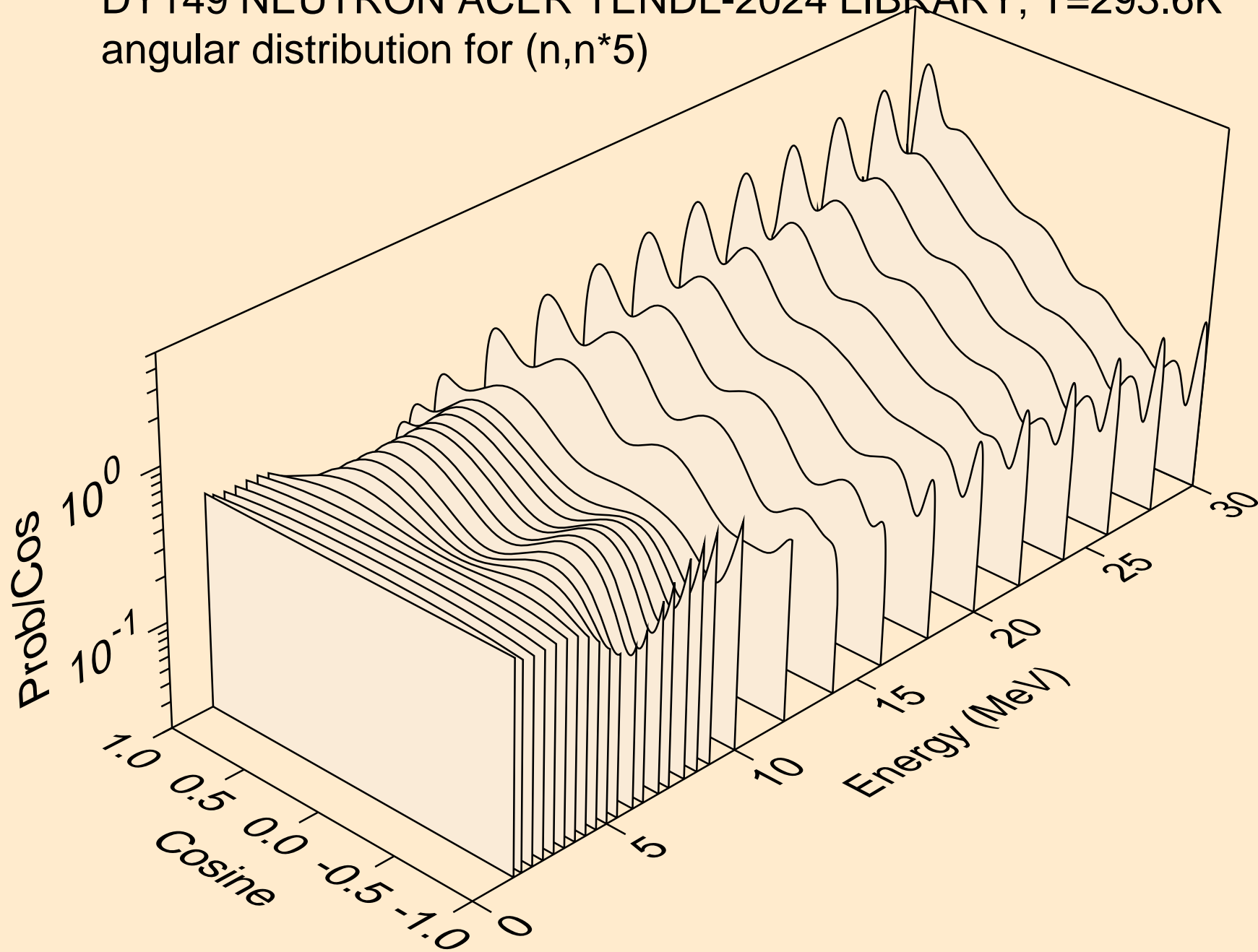

DY149 NEUTRON ACER TENDL-2024 LIBRARY; T=293.6K  
angular distribution for (n,n\*6)

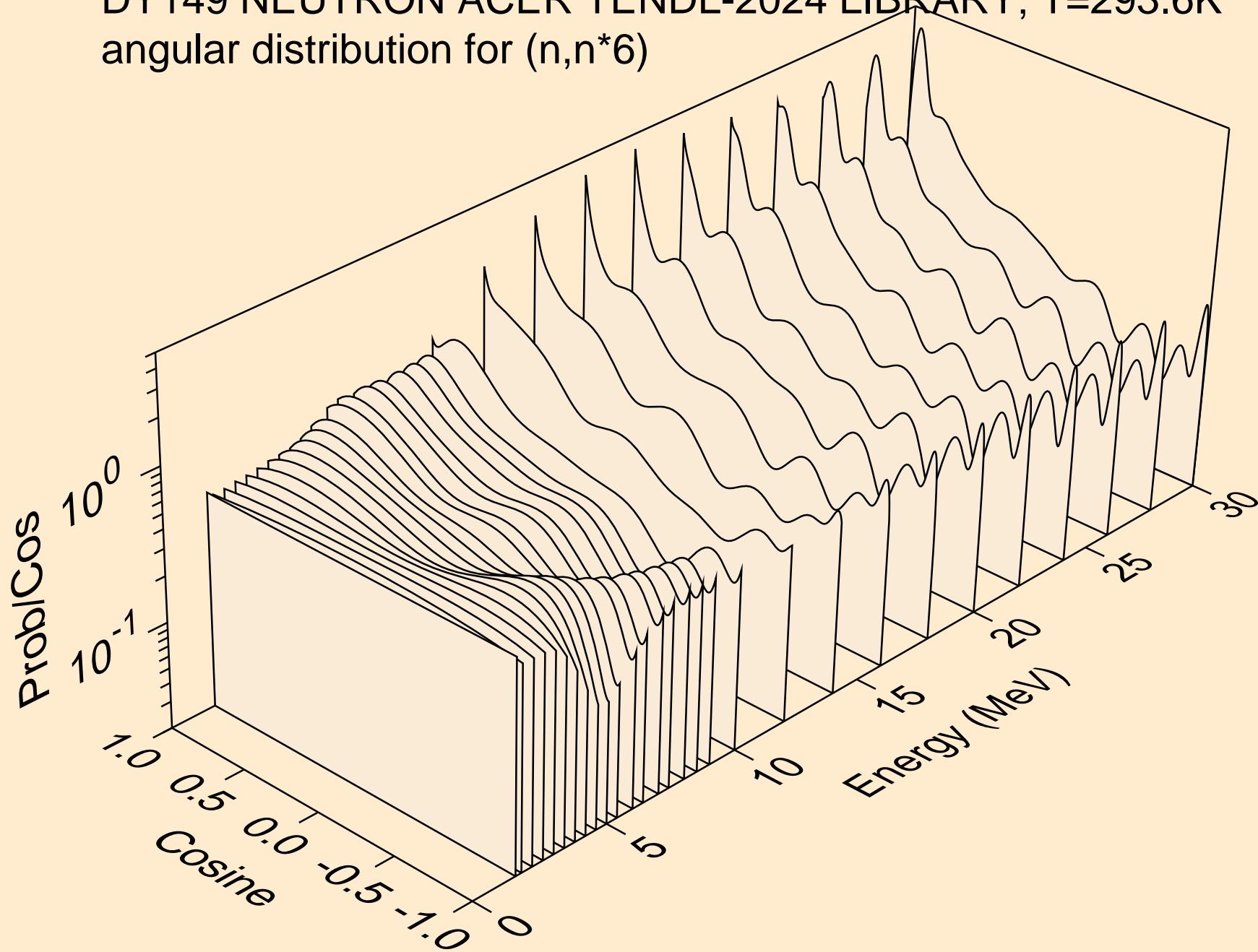

DY149 NEUTRON ACER TENDL-2024 LIBRARY; T=293.6K  
angular distribution for (n,n\*7)

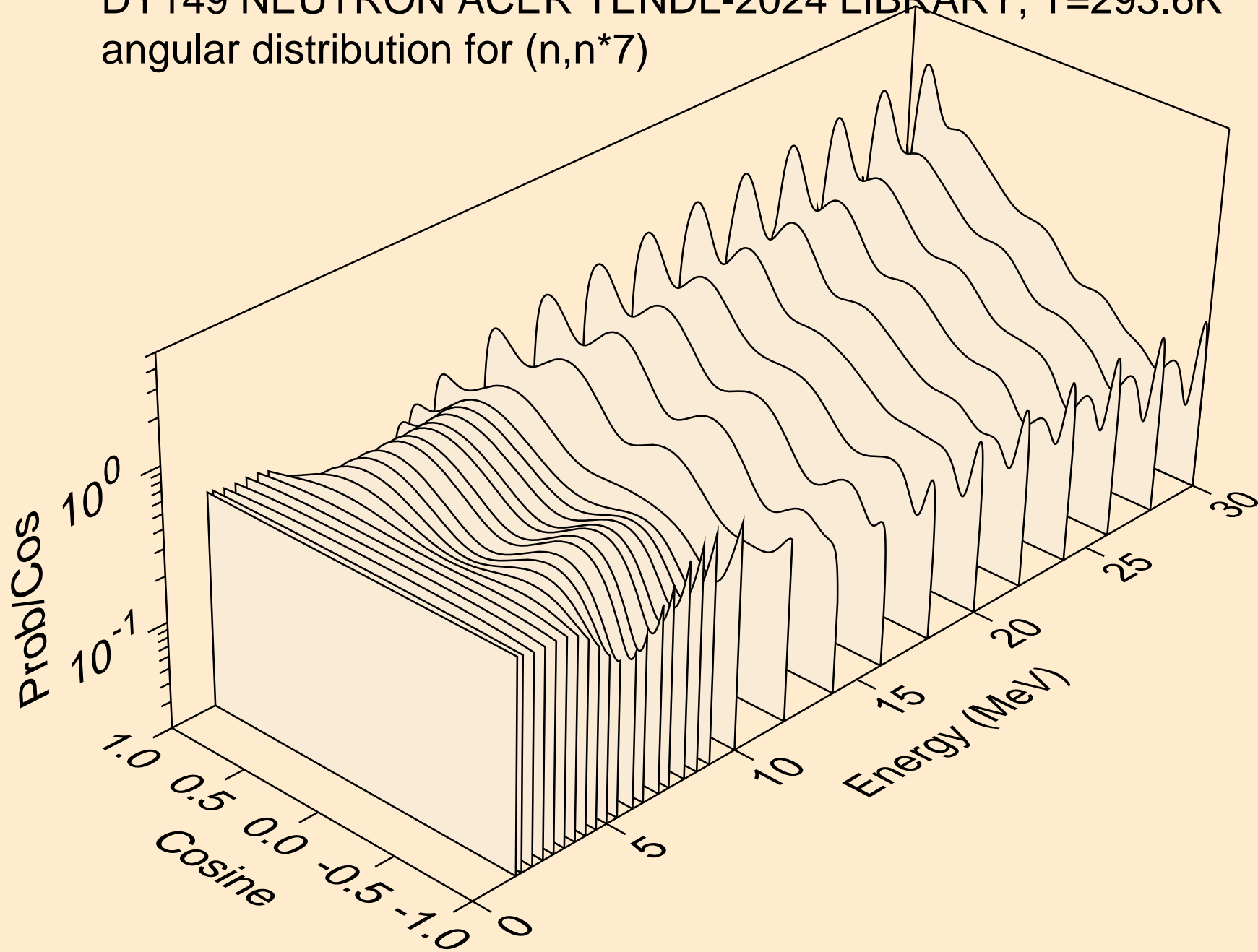

DY149 NEUTRON ACER TENDL-2024 LIBRARY; T=293.6K  
angular distribution for (n,n\*8)

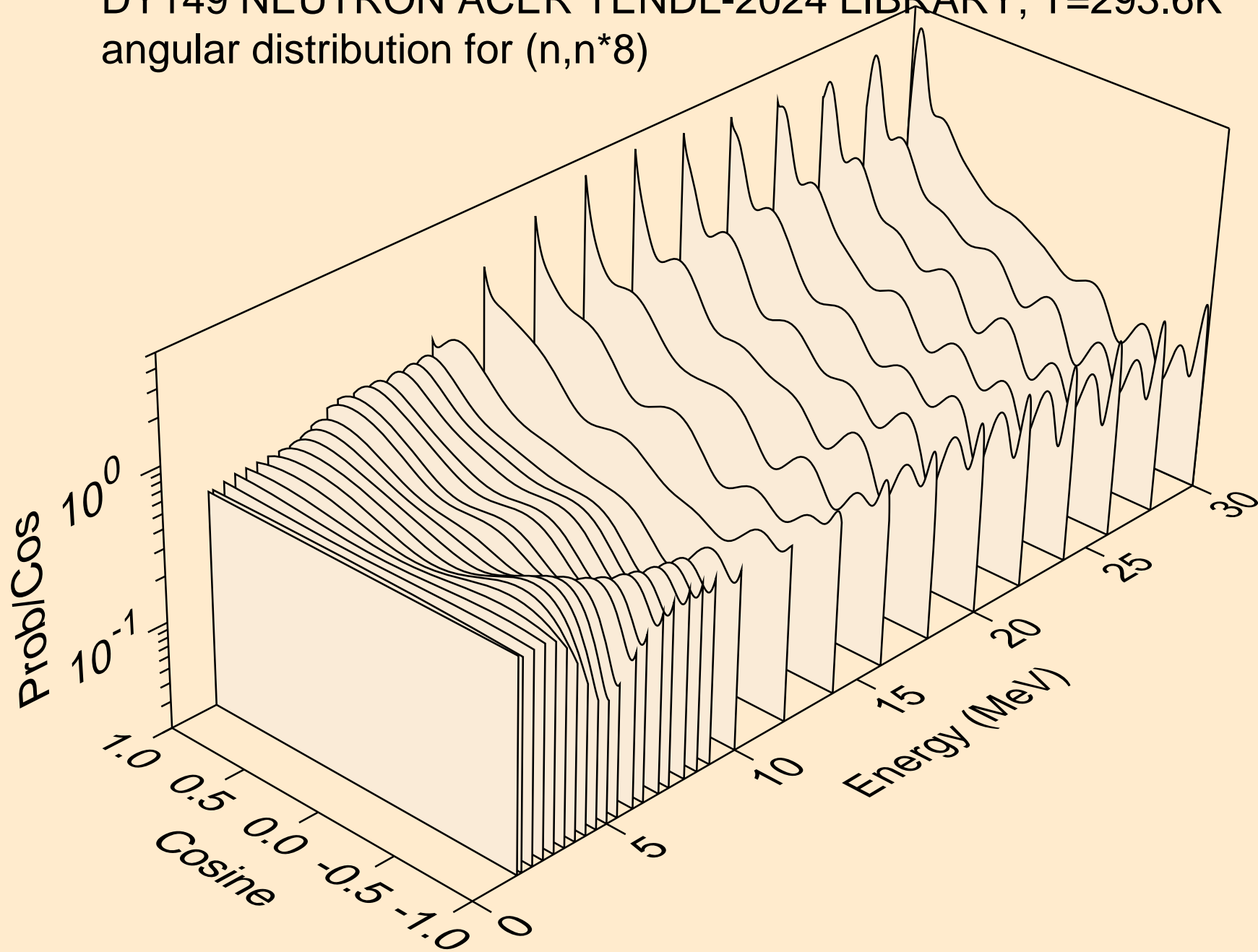

DY149 NEUTRON ACER TENDL-2024 LIBRARY; T=293.6K  
angular distribution for (n,n\*9)

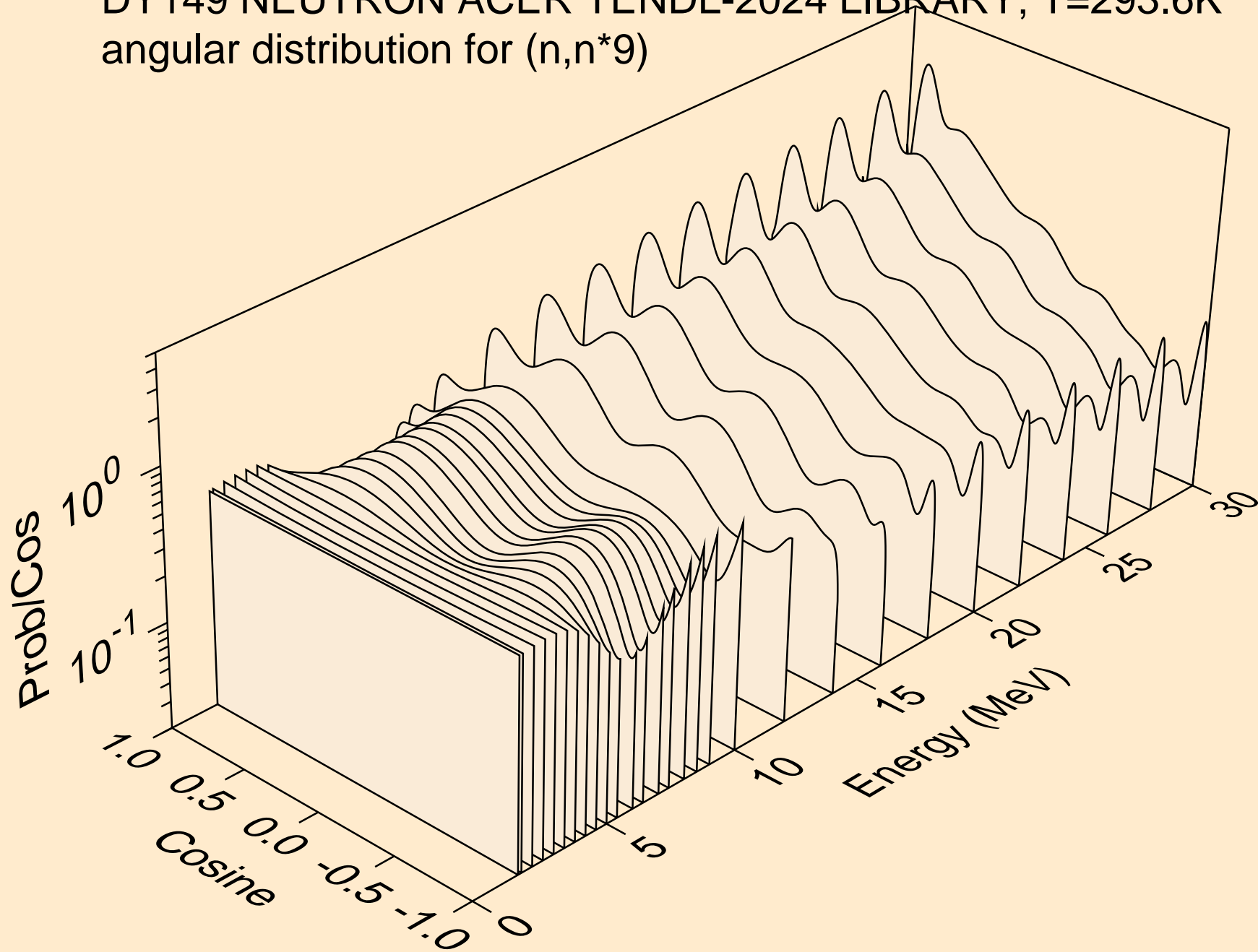

DY149 NEUTRON ACER TENDL-2024 LIBRARY; T=293.6K  
angular distribution for (n,n\*10)

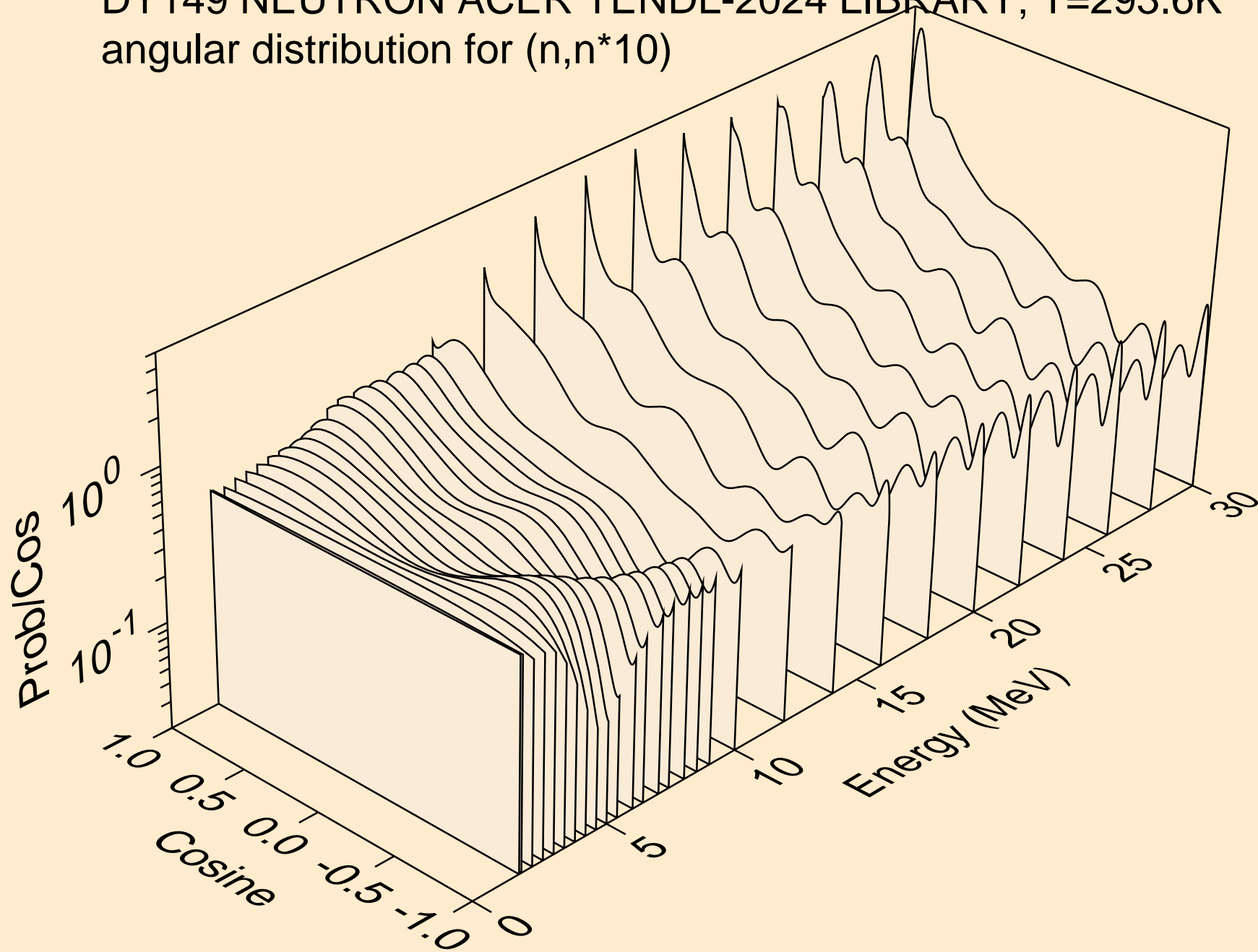

DY149 NEUTRON ACER TENDL-2024 LIBRARY; T=293.6K  
angular distribution for (n,n\*11)

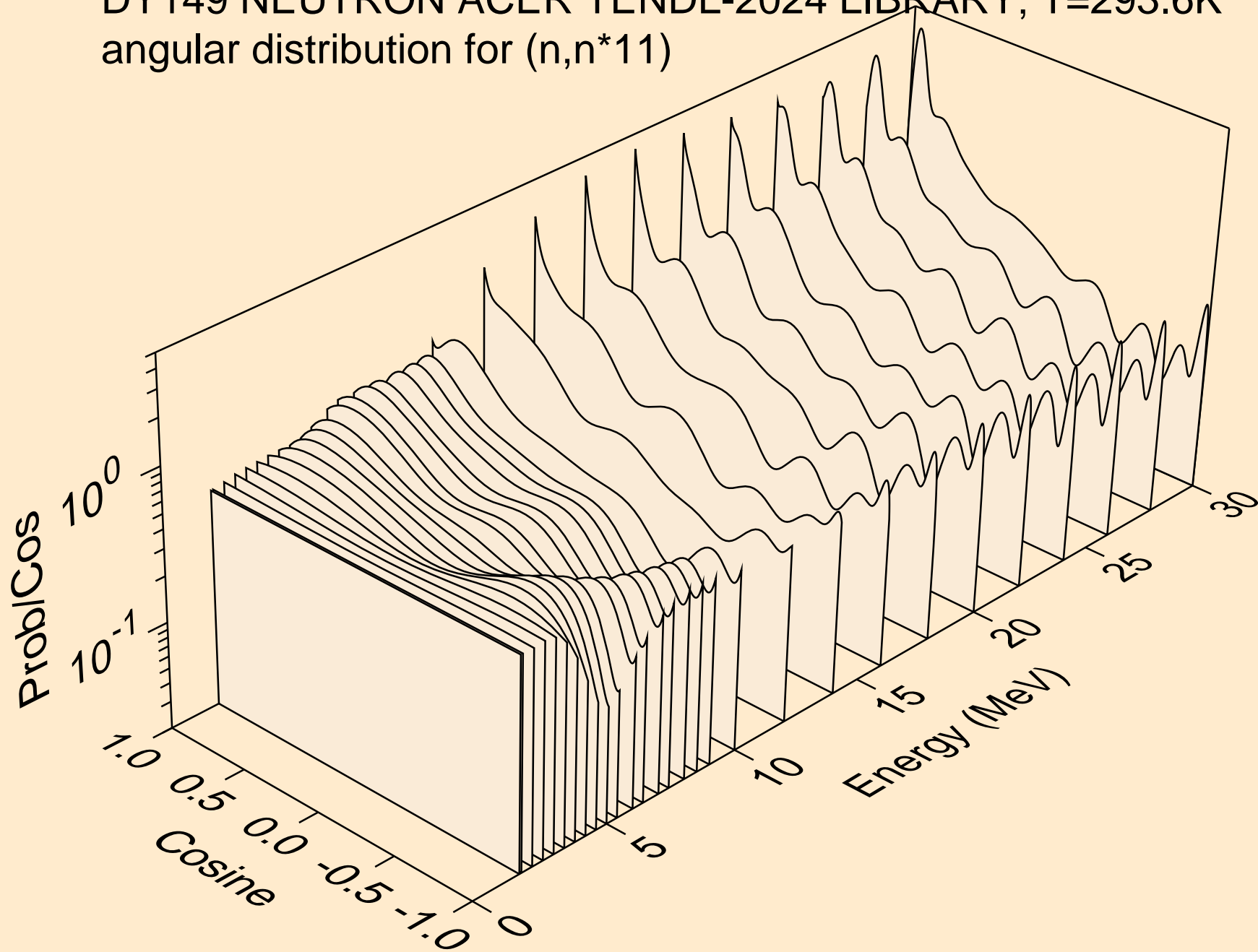

DY149 NEUTRON ACER TENDL-2024 LIBRARY; T=293.6K  
angular distribution for (n,n\*12)

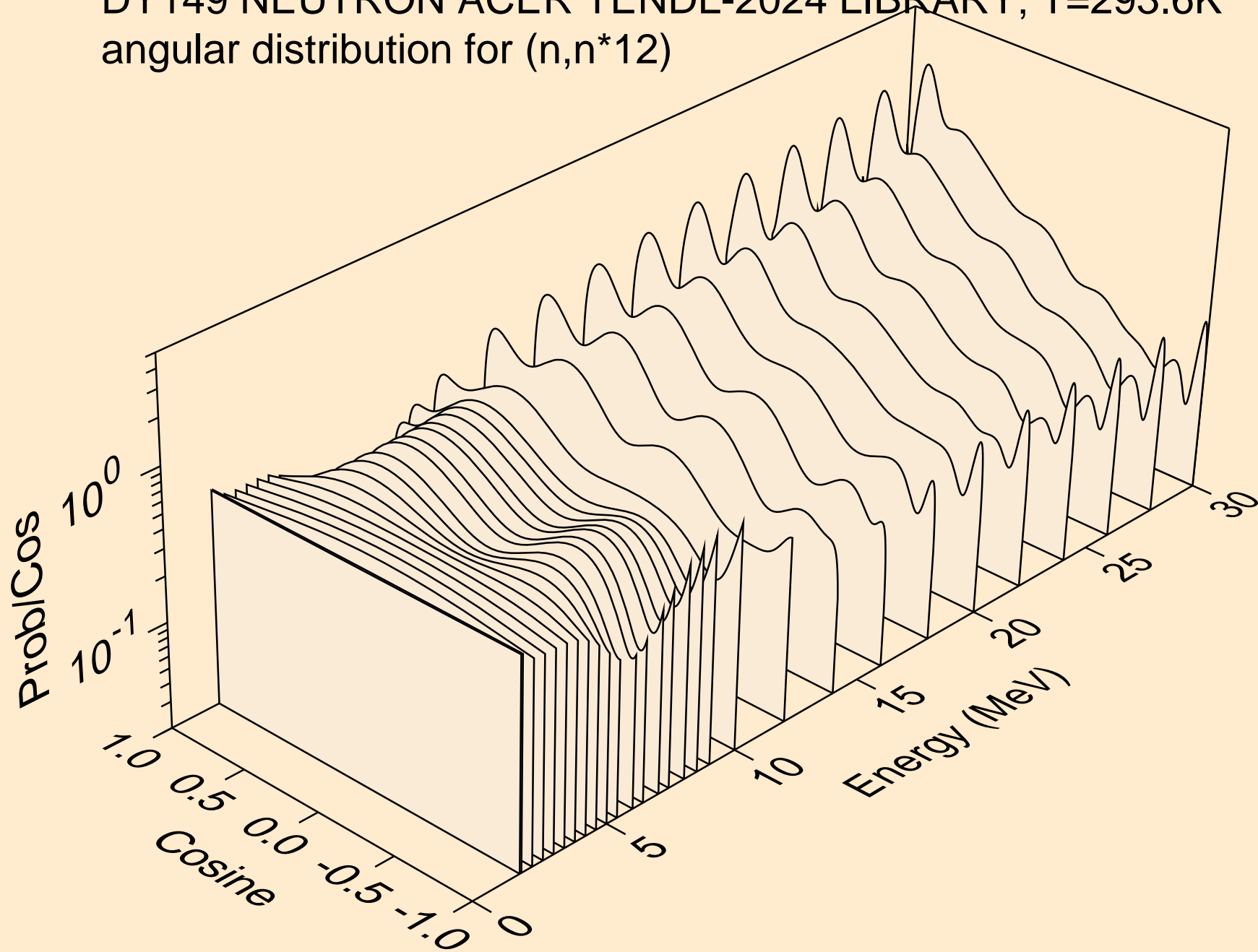

DY149 NEUTRON ACER TENDL-2024 LIBRARY; T=293.6K  
angular distribution for (n,n\*13)

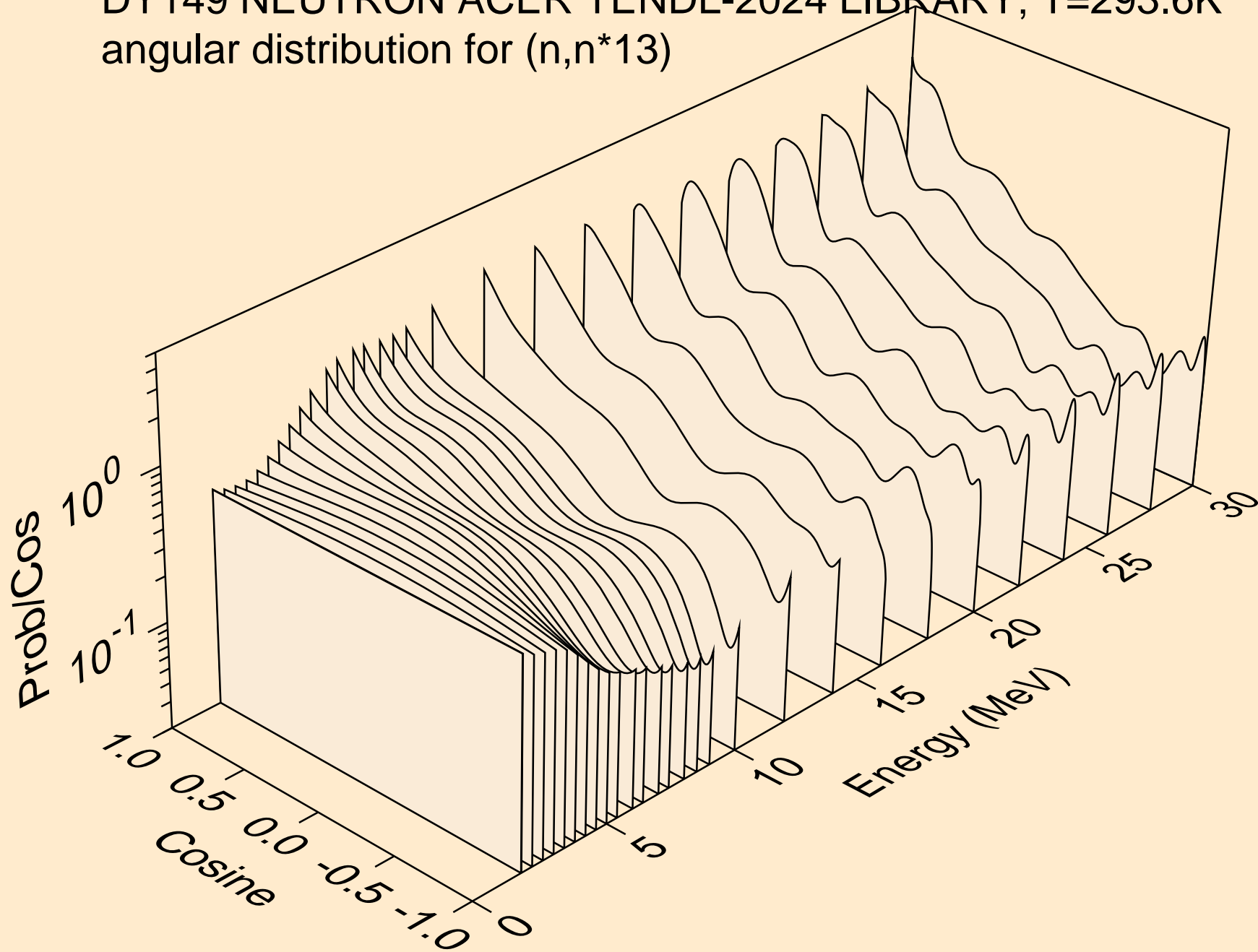

DY149 NEUTRON ACER TENDL-2024 LIBRARY; T=293.6K  
angular distribution for (n,n\*14)

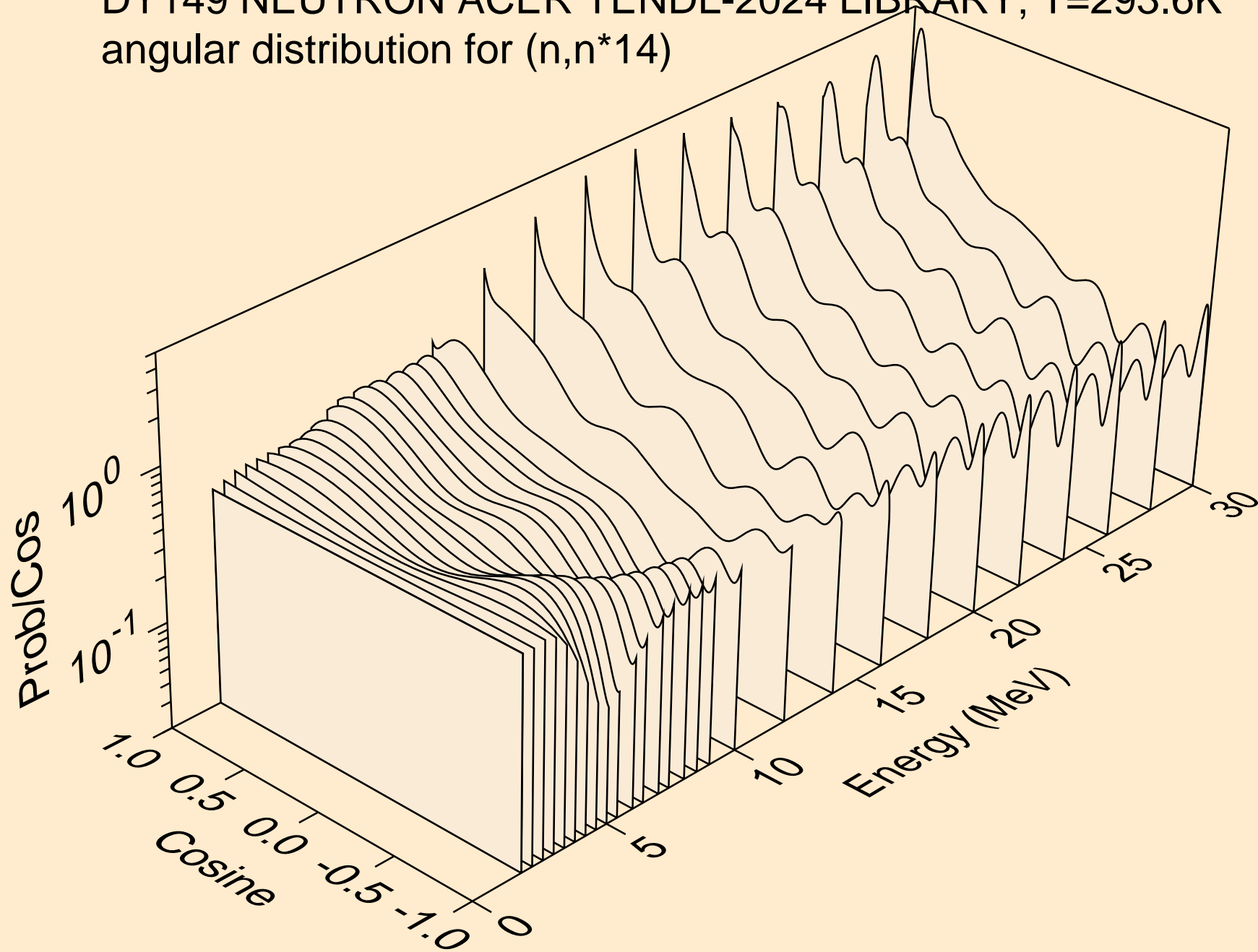

DY149 NEUTRON ACER TENDL-2024 LIBRARY; T=293.6K  
angular distribution for (n,n\*15)

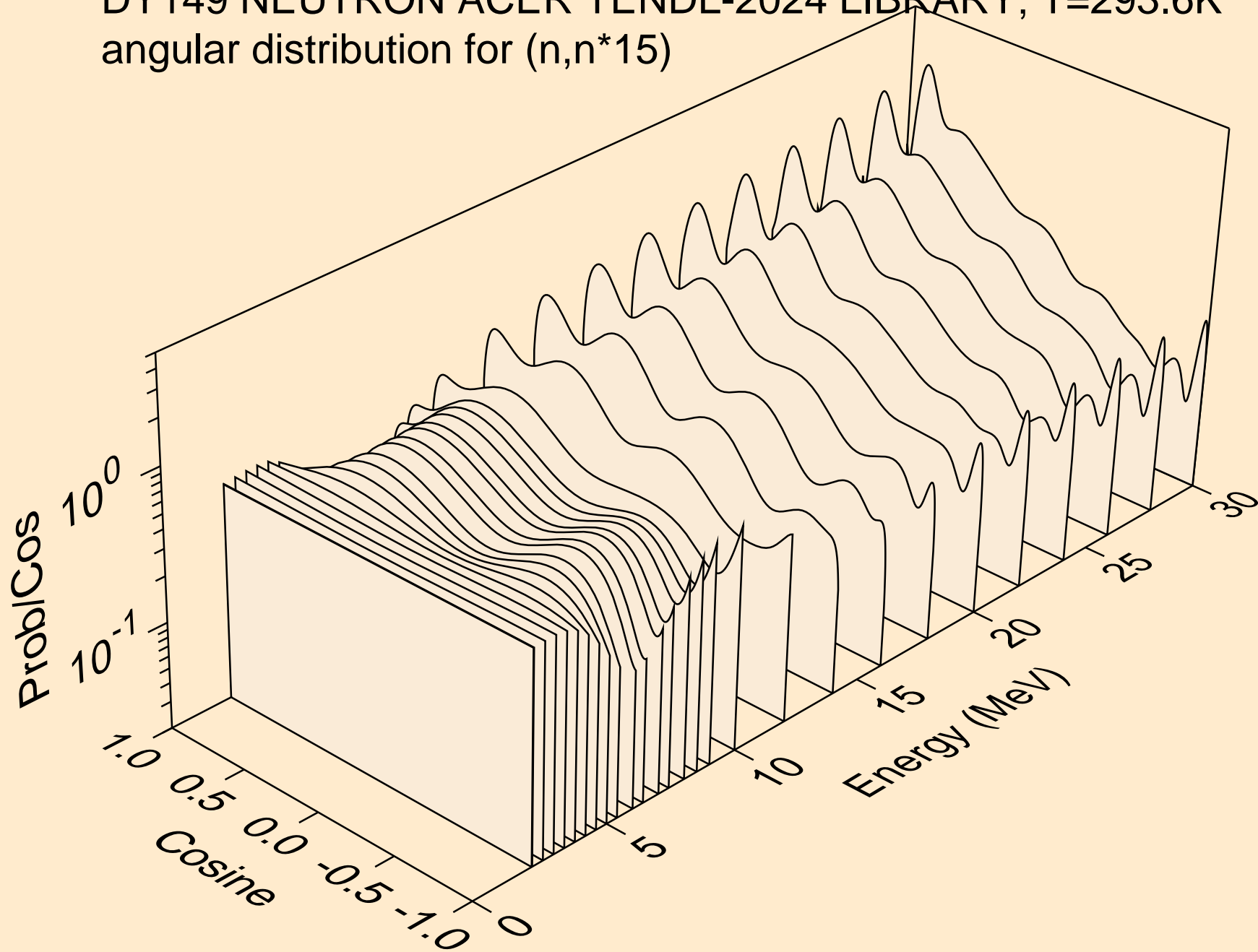

DY149 NEUTRON ACER TENDL-2024 LIBRARY; T=293.6K  
angular distribution for (n,n\*16)

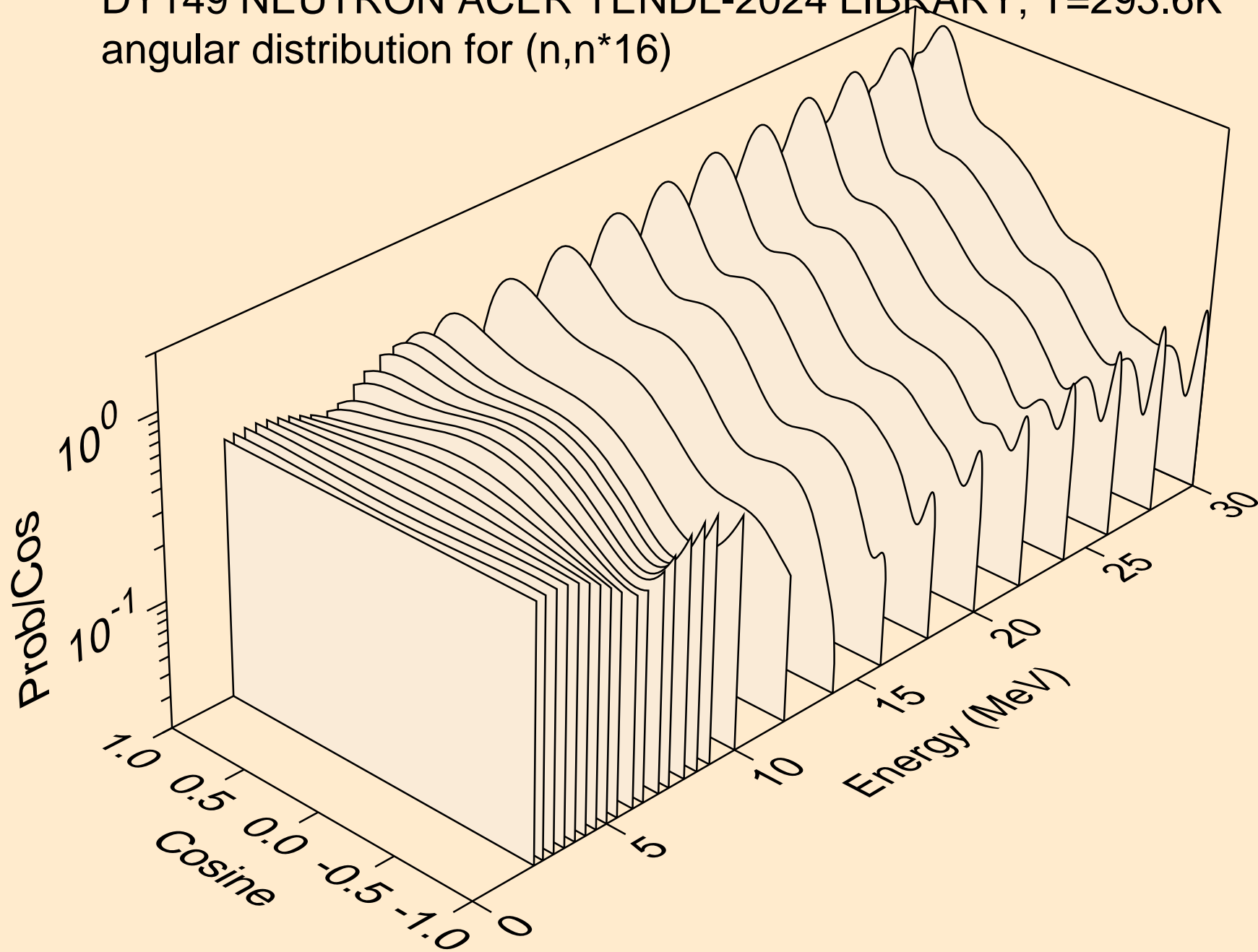

DY149 NEUTRON ACER TENDL-2024 LIBRARY; T=293.6K  
angular distribution for (n,n\*17)

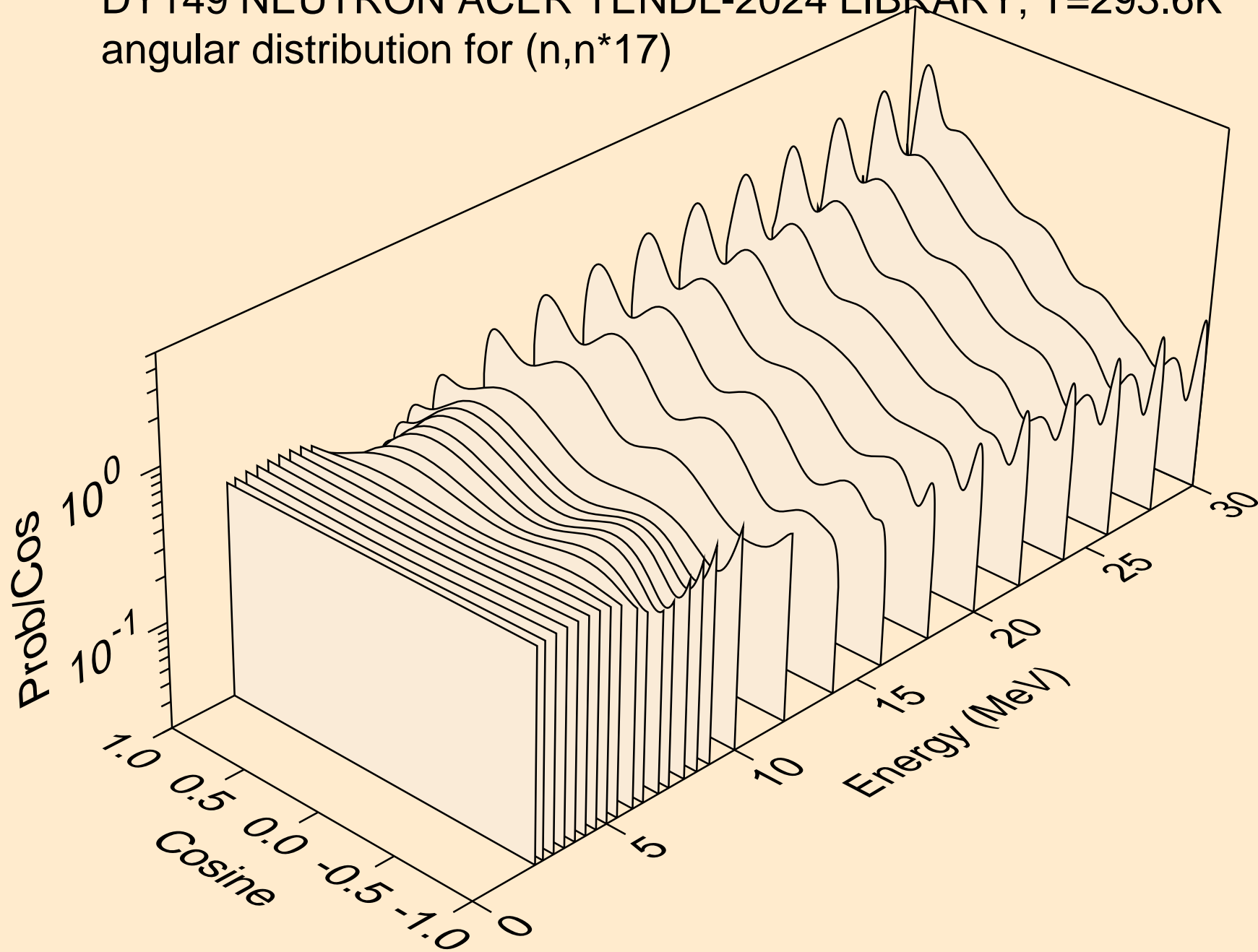

DY149 NEUTRON ACER TENDL-2024 LIBRARY; T=293.6K  
angular distribution for (n,n\*18)

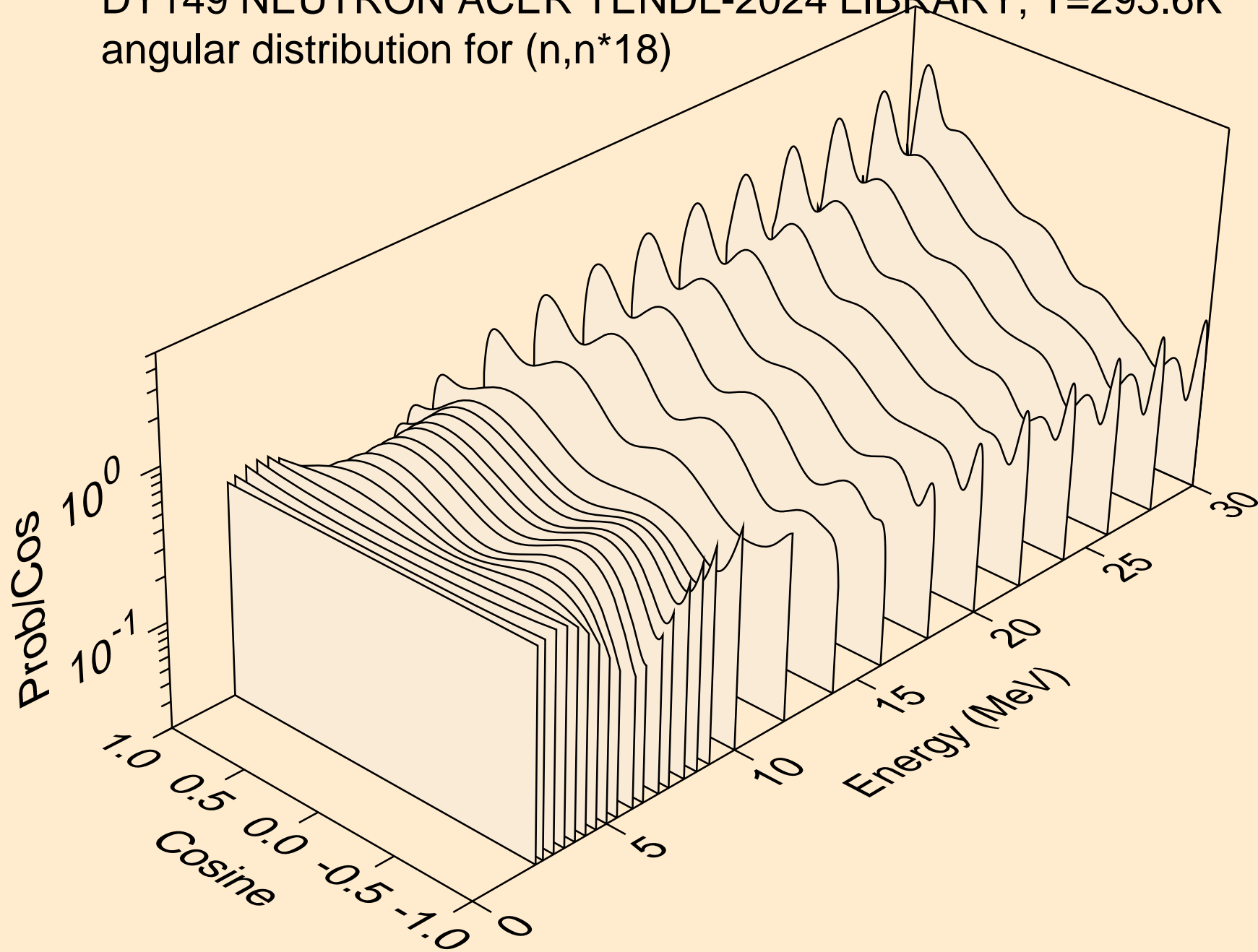

DY149 NEUTRON ACER TENDL-2024 LIBRARY; T=293.6K  
angular distribution for (n,n\*19)

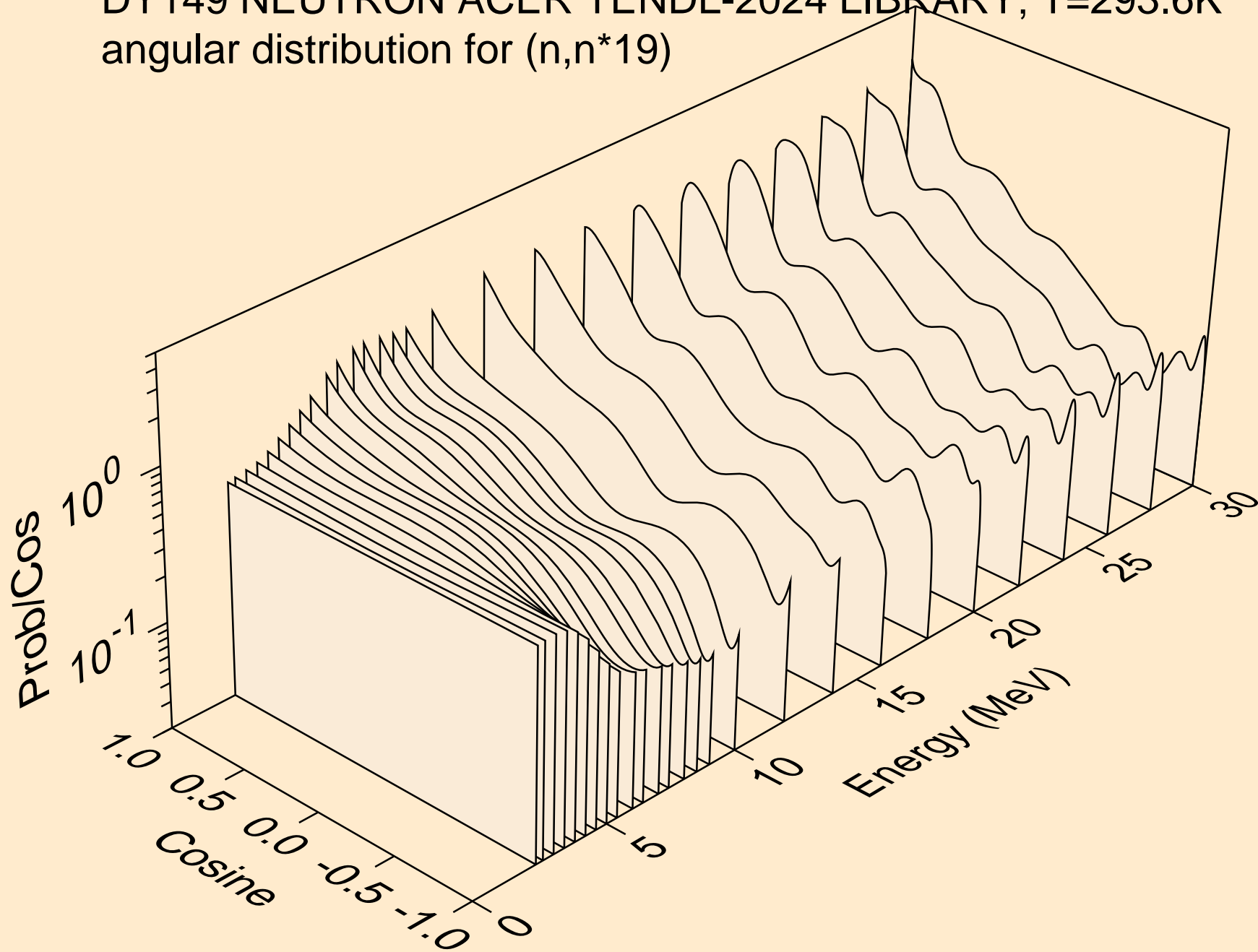

DY149 NEUTRON ACER TENDL-2024 LIBRARY; T=293.6K  
angular distribution for (n,n\*20)

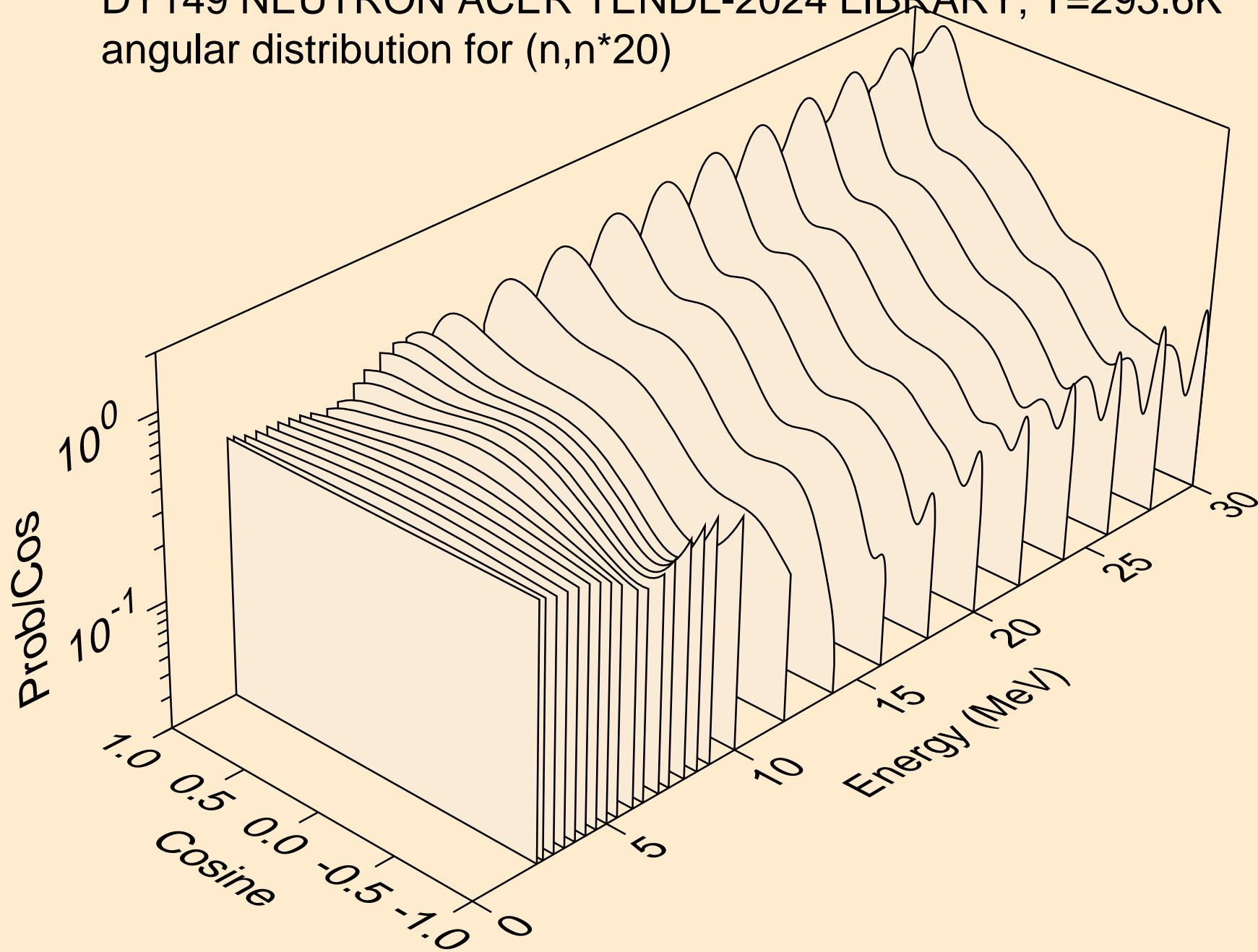

DY149 NEUTRON ACER TENDL-2024 LIBRARY; T=293.6K  
angular distribution for (n,n\*21)

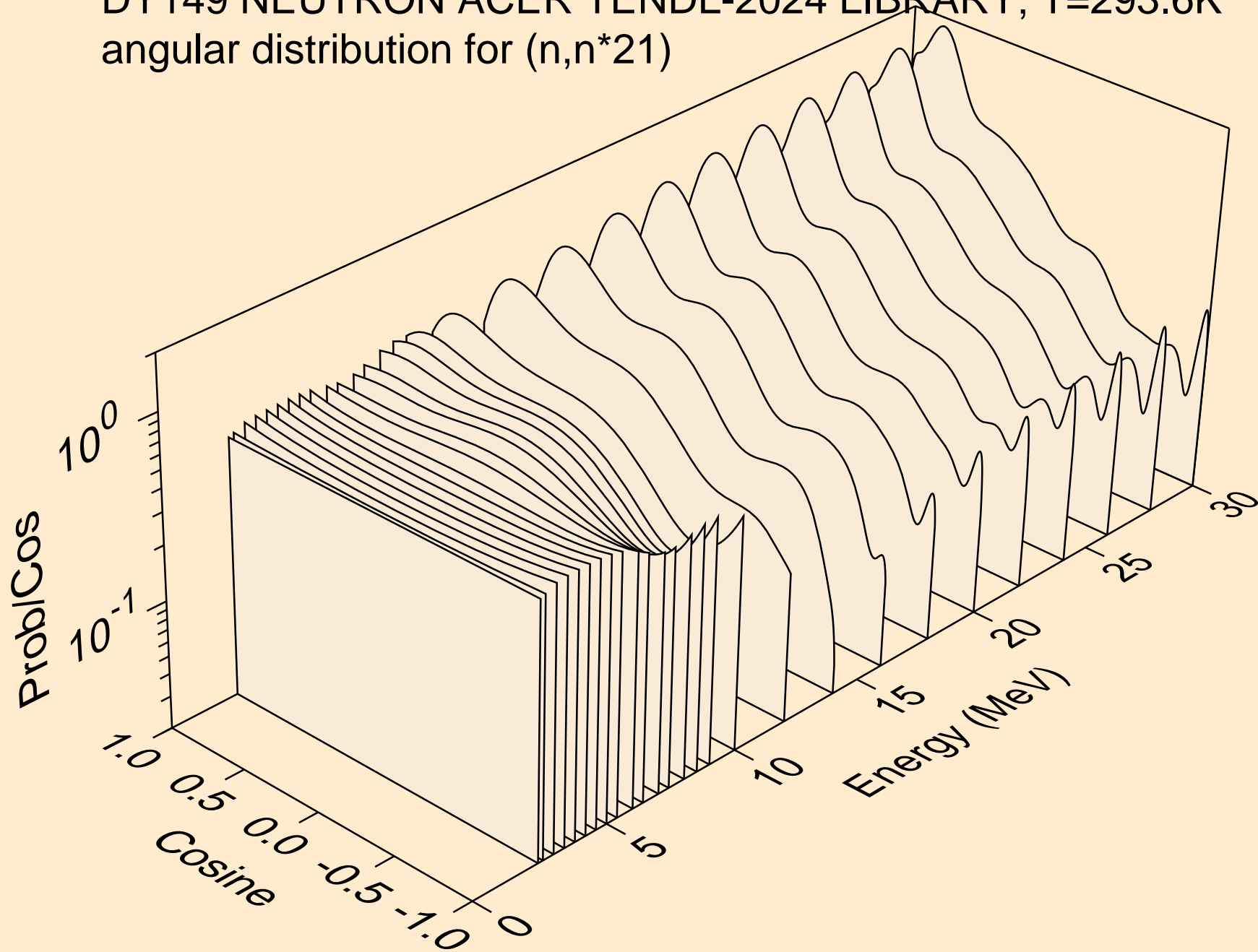

DY149 NEUTRON ACER TENDL-2024 LIBRARY; T=293.6K  
angular distribution for (n,n\*22)

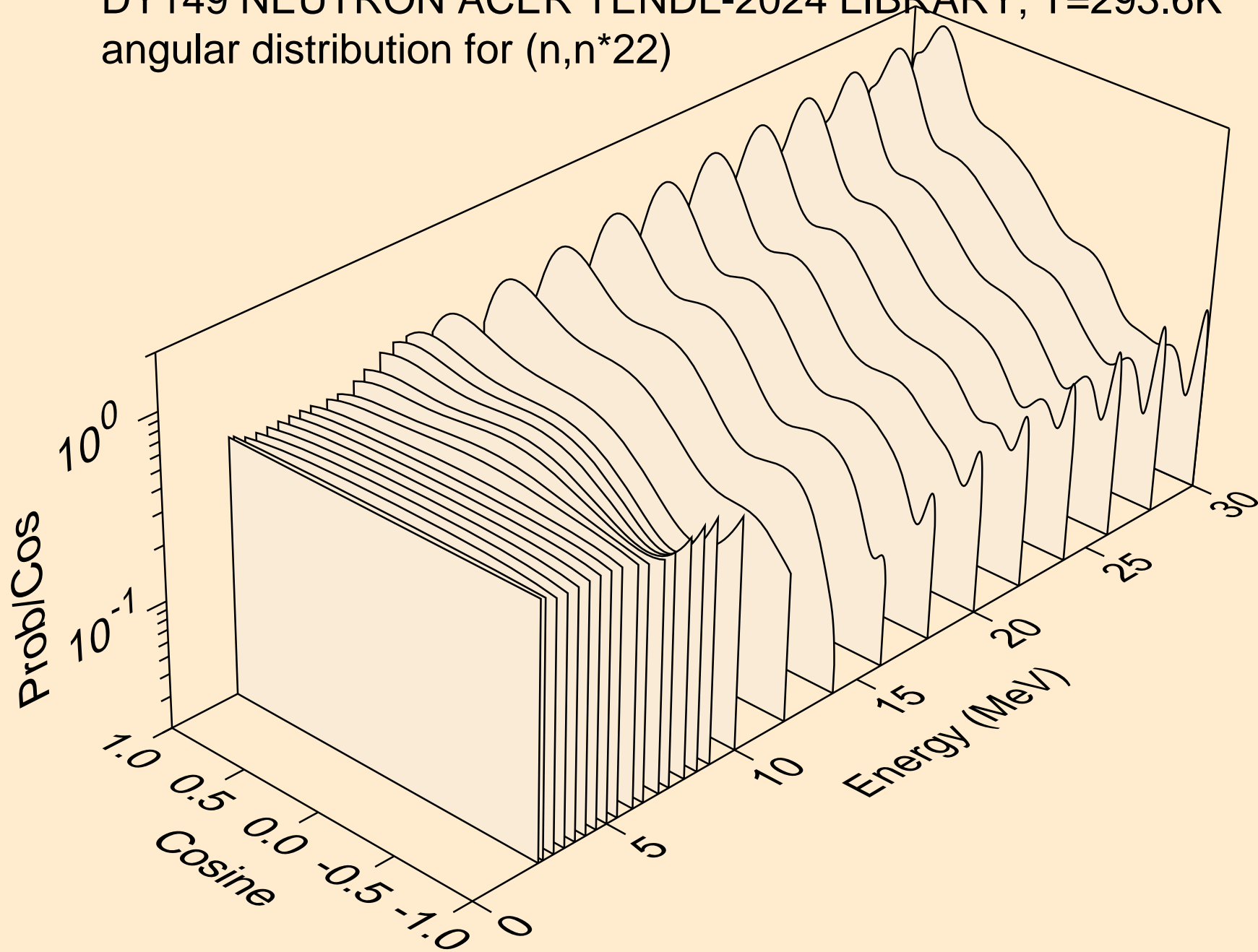

DY149 NEUTRON ACER TENDL-2024 LIBRARY; T=293.6K  
angular distribution for (n,n\*23)

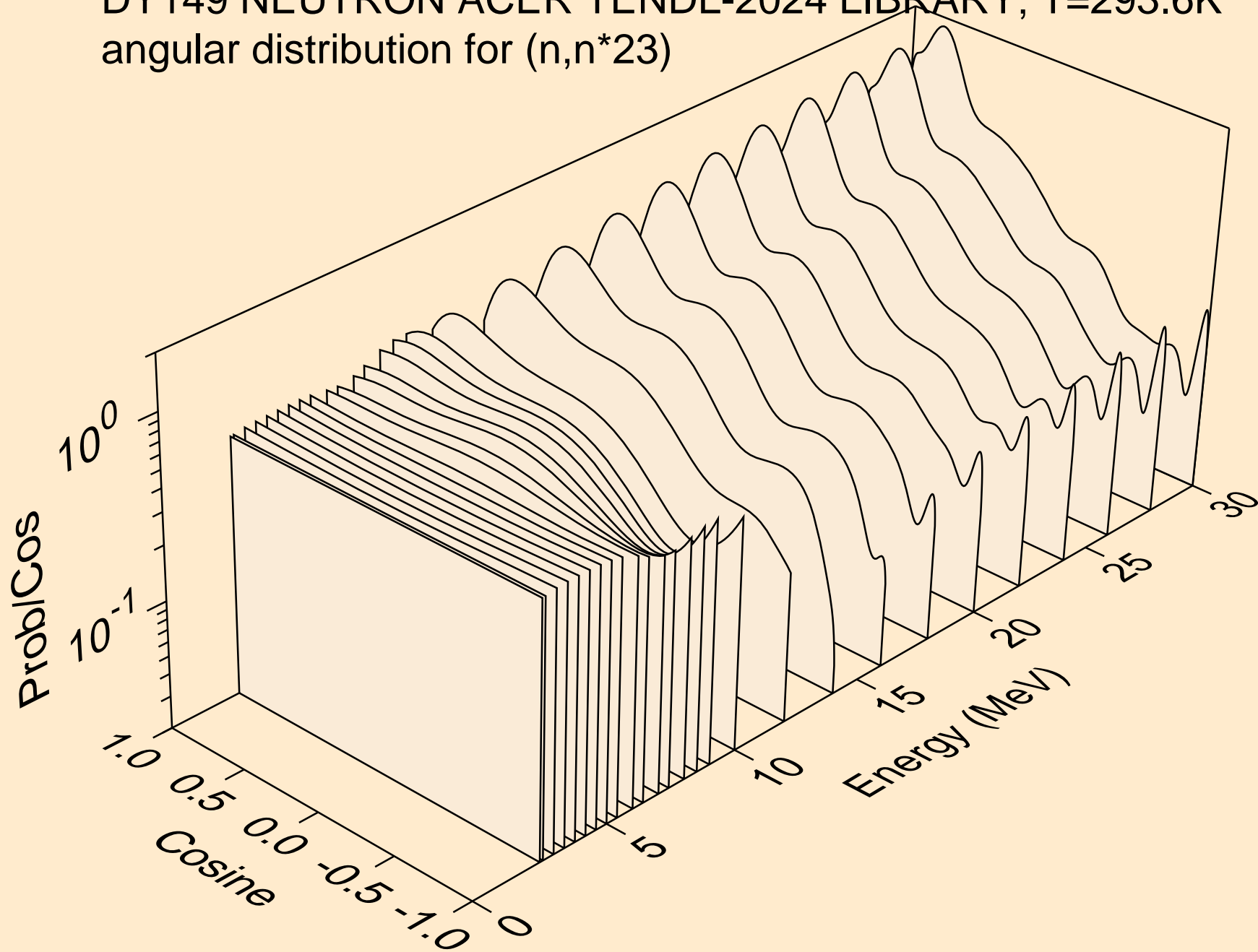

DY149 NEUTRON ACER TENDL-2024 LIBRARY; T=293.6K  
angular distribution for (n,n\*24)

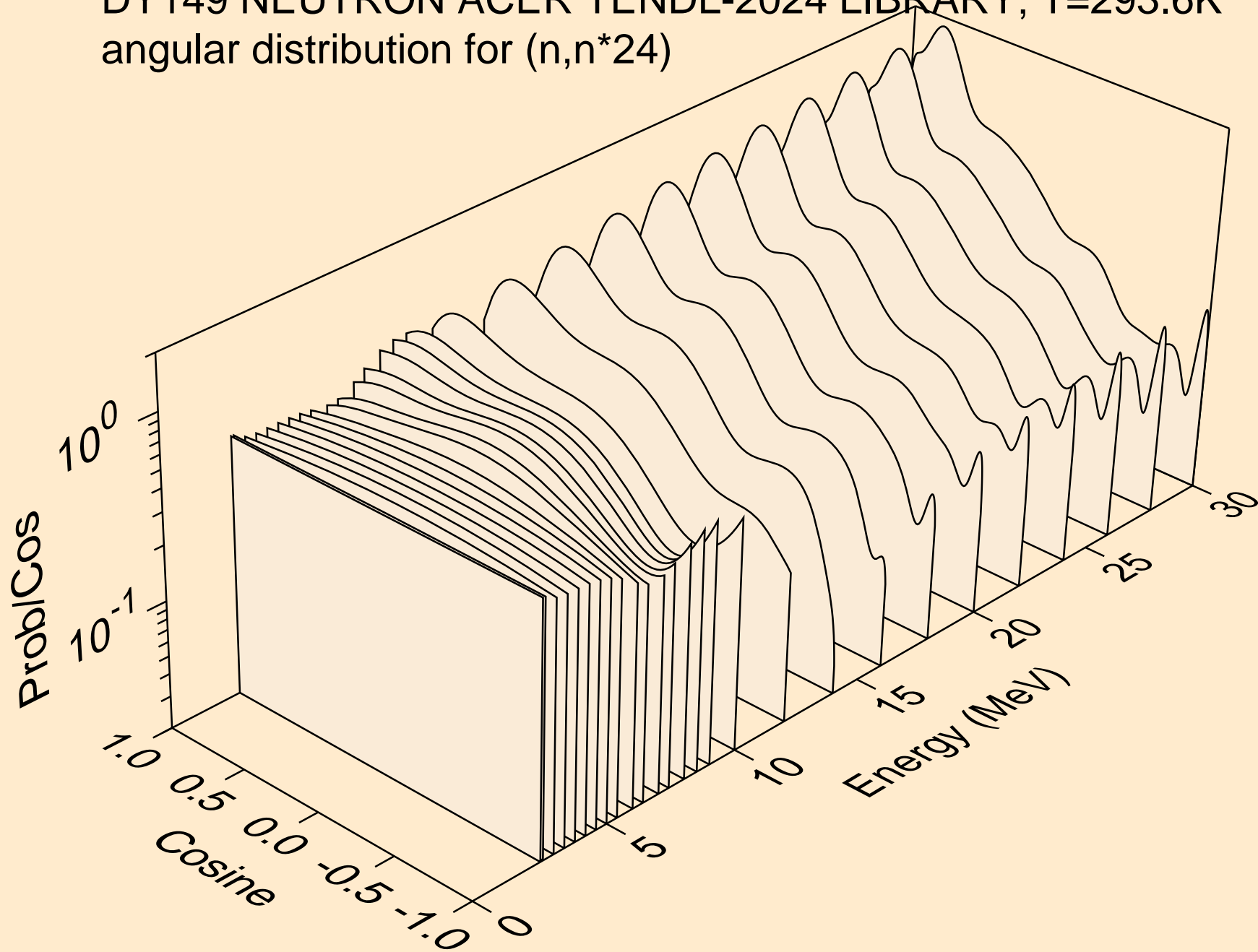

DY149 NEUTRON ACER TENDL-2024 LIBRARY; T=293.6K  
angular distribution for (n,n\*25)

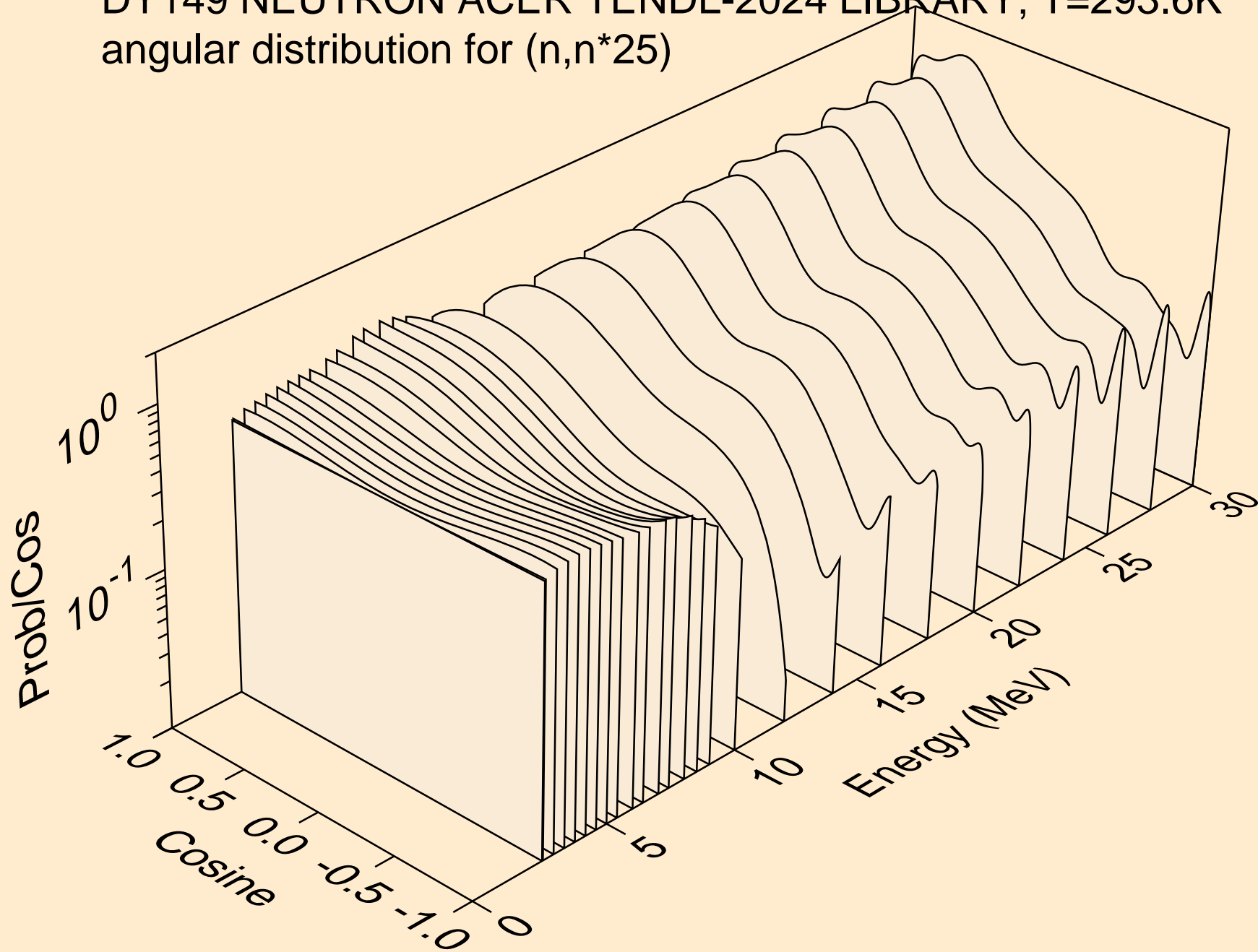

DY149 NEUTRON ACER TENDL-2024 LIBRARY; T=293.6K  
angular distribution for (n,n\*26)

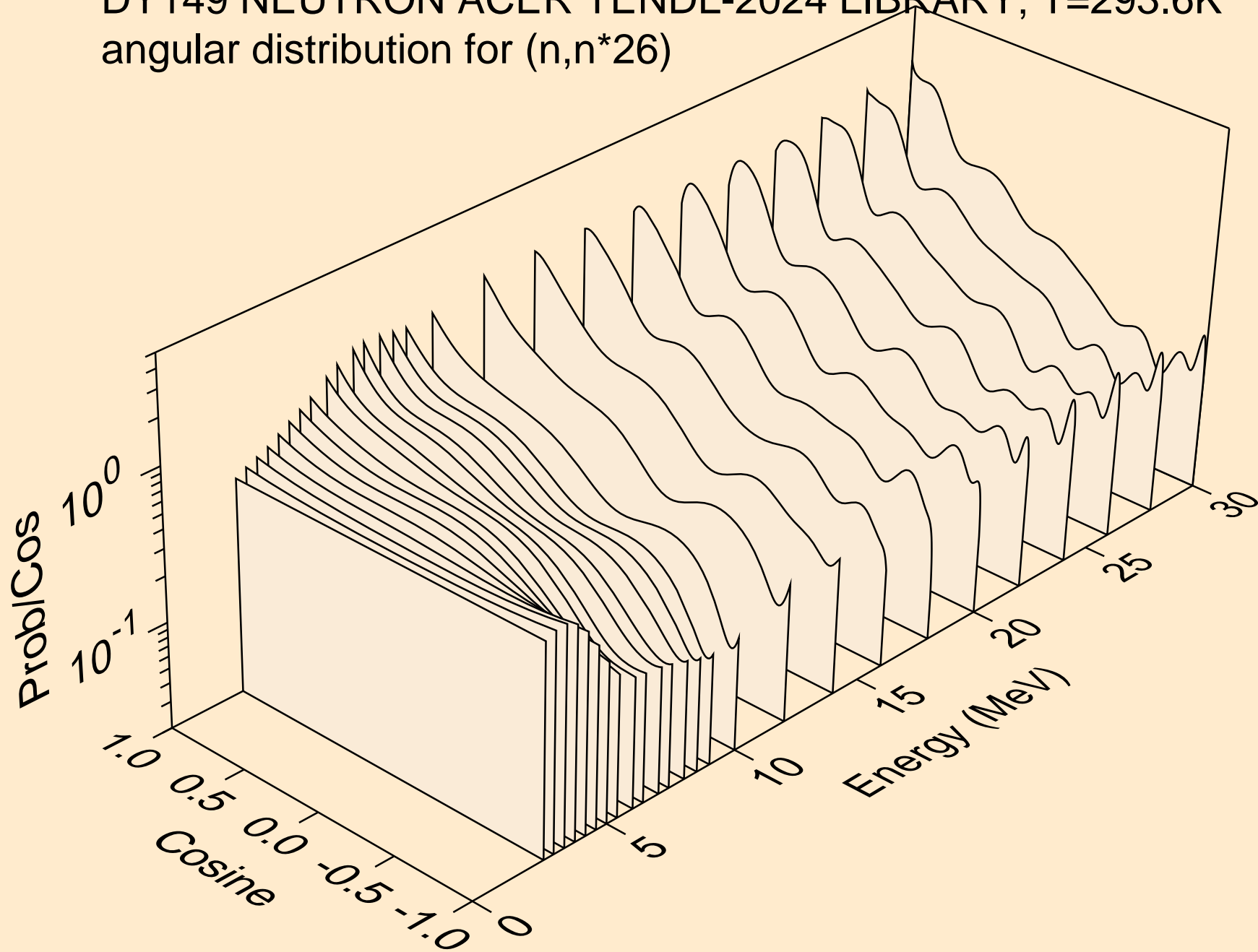

DY149 NEUTRON ACER TENDL-2024 LIBRARY; T=293.6K  
Neutron emission for (n,x)

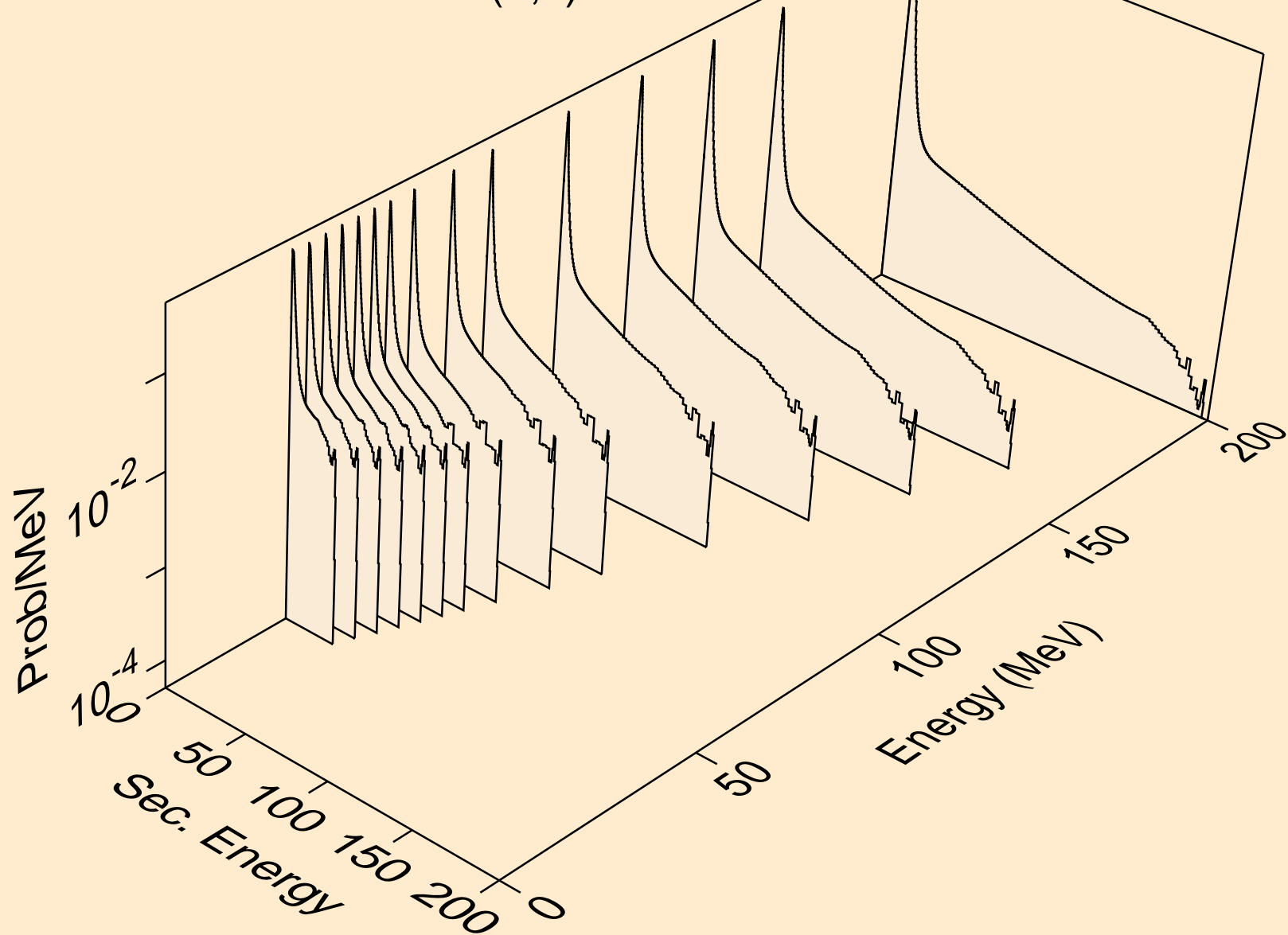

DY149 NEUTRON ACER TENDL-2024 LIBRARY; T=293.6K  
Neutron emission for (n,2nd)

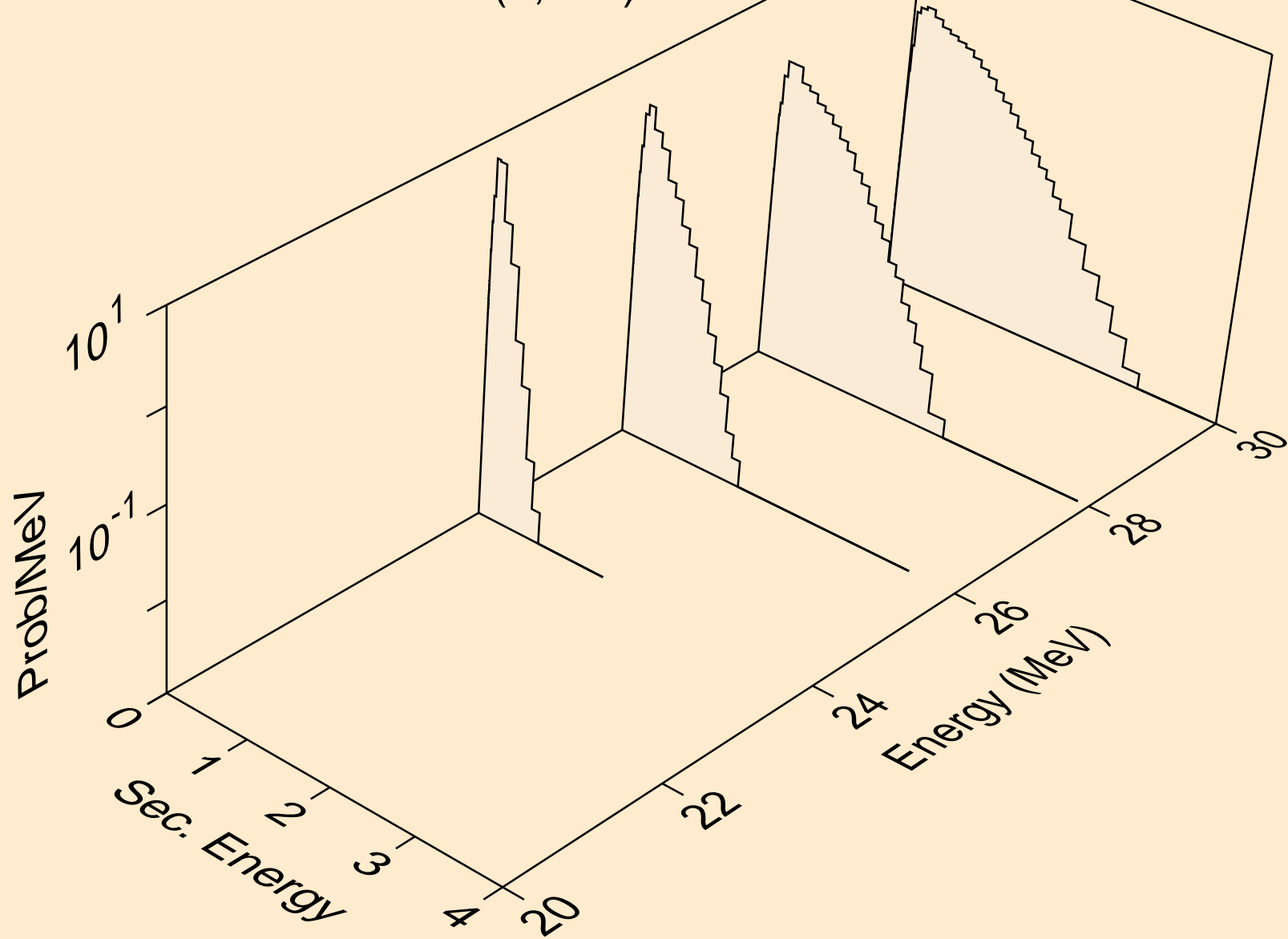

DY149 NEUTRON ACER TENDL-2024 LIBRARY; T=293.6K  
Neutron emission for (n,2n)

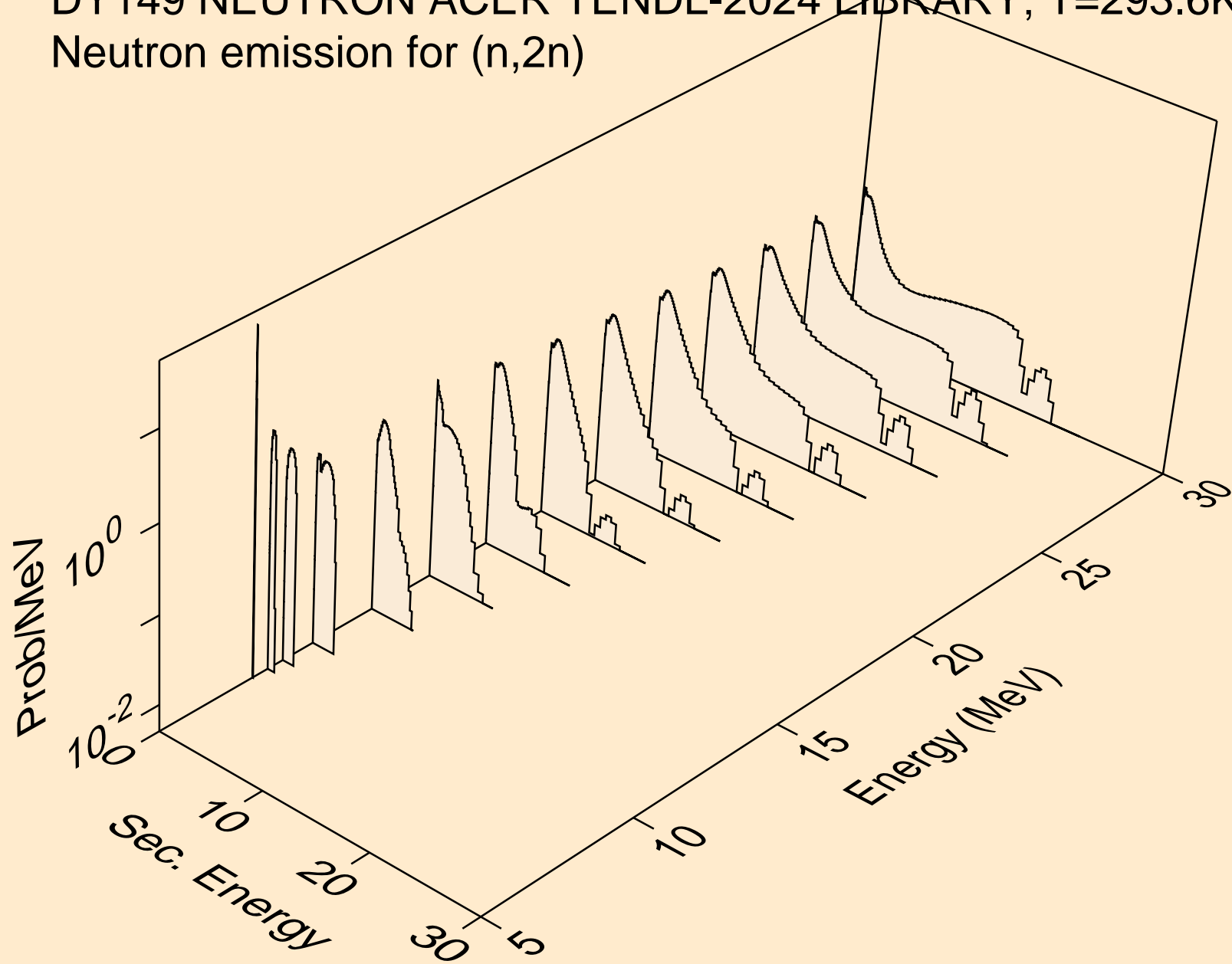

DY149 NEUTRON ACER TENDL-2024 LIBRARY; T=293.6K  
Neutron emission for (n,3n)

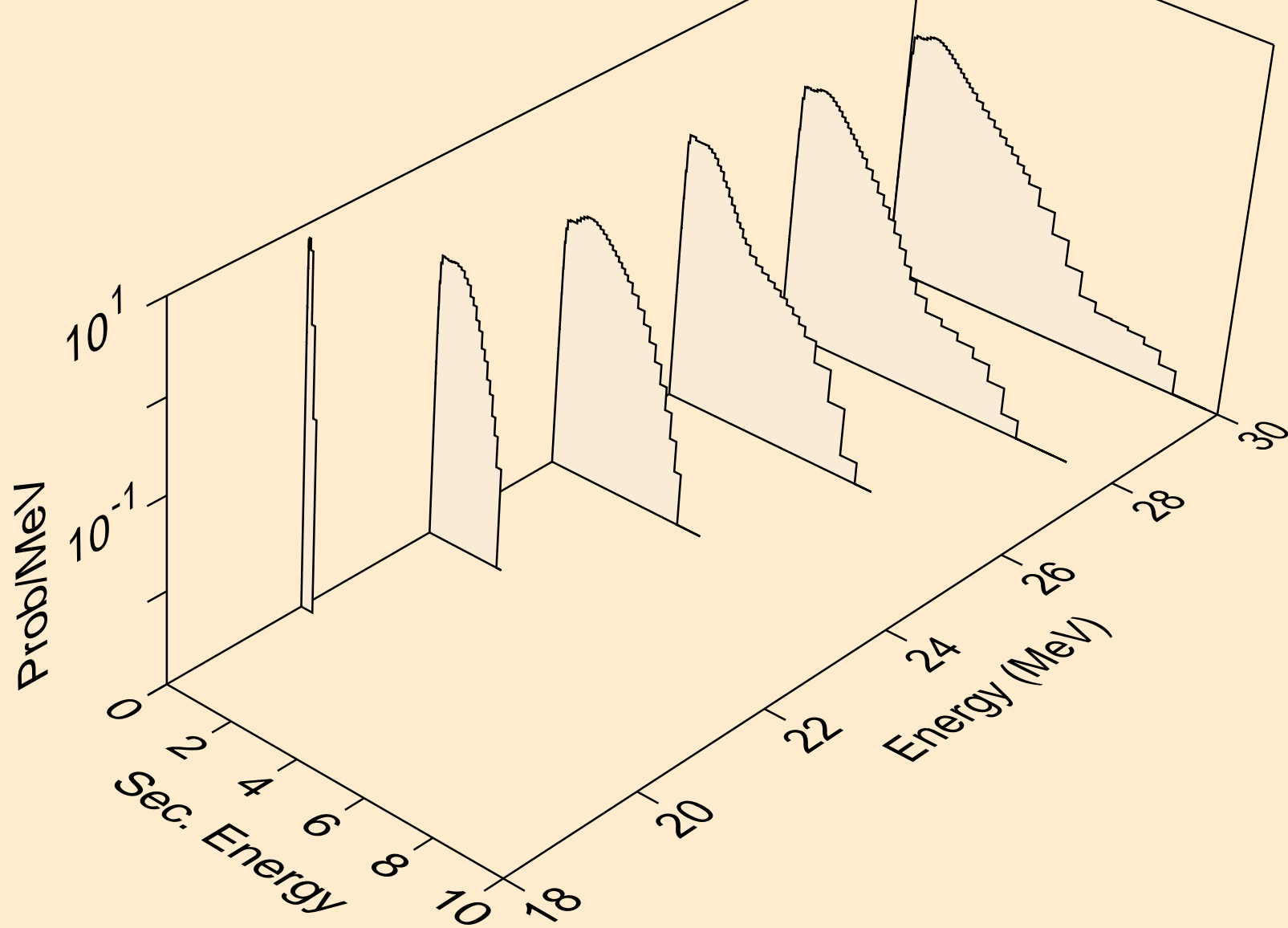

DY149 NEUTRON ACER TENDL-2024 LIBRARY; T=293.6K  
Neutron emission for (n,n\*)a

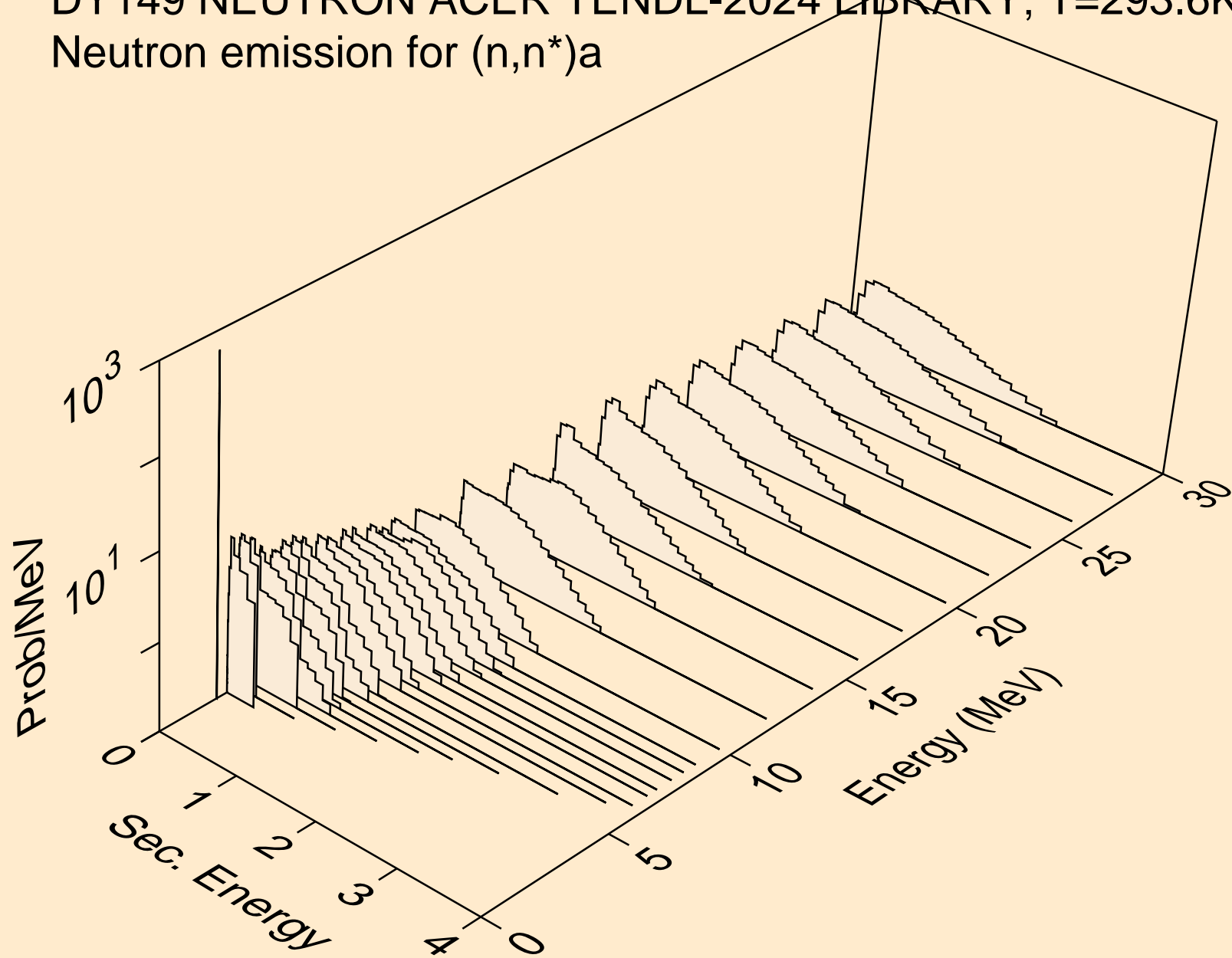

DY149 NEUTRON ACER TENDL-2024 LIBRARY; T=293.6K  
Neutron emission for (n,2n)a

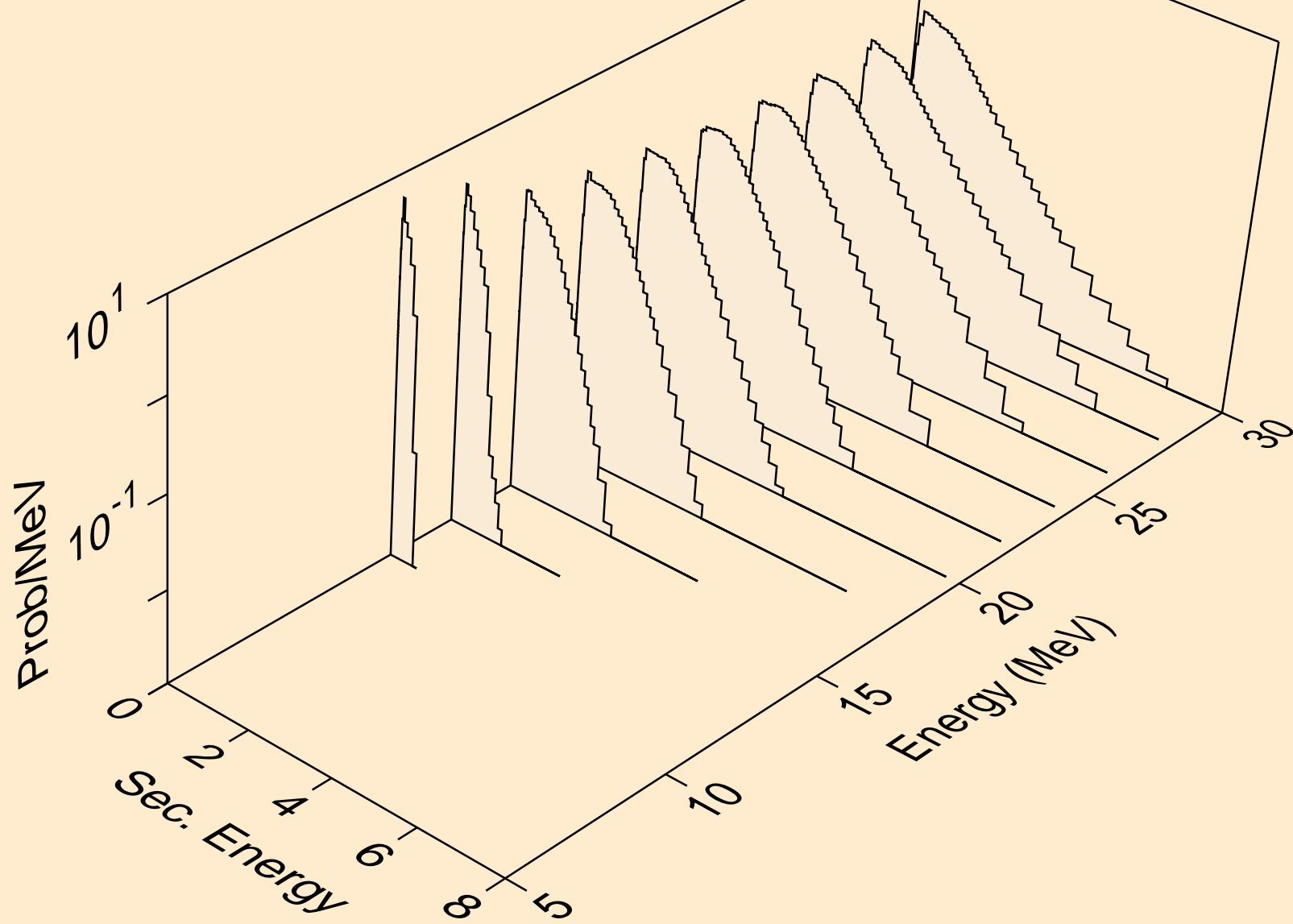

DY149 NEUTRON ACER TENDL-2024 LIBRARY; T=293.6K  
Neutron emission for (n,3n)a

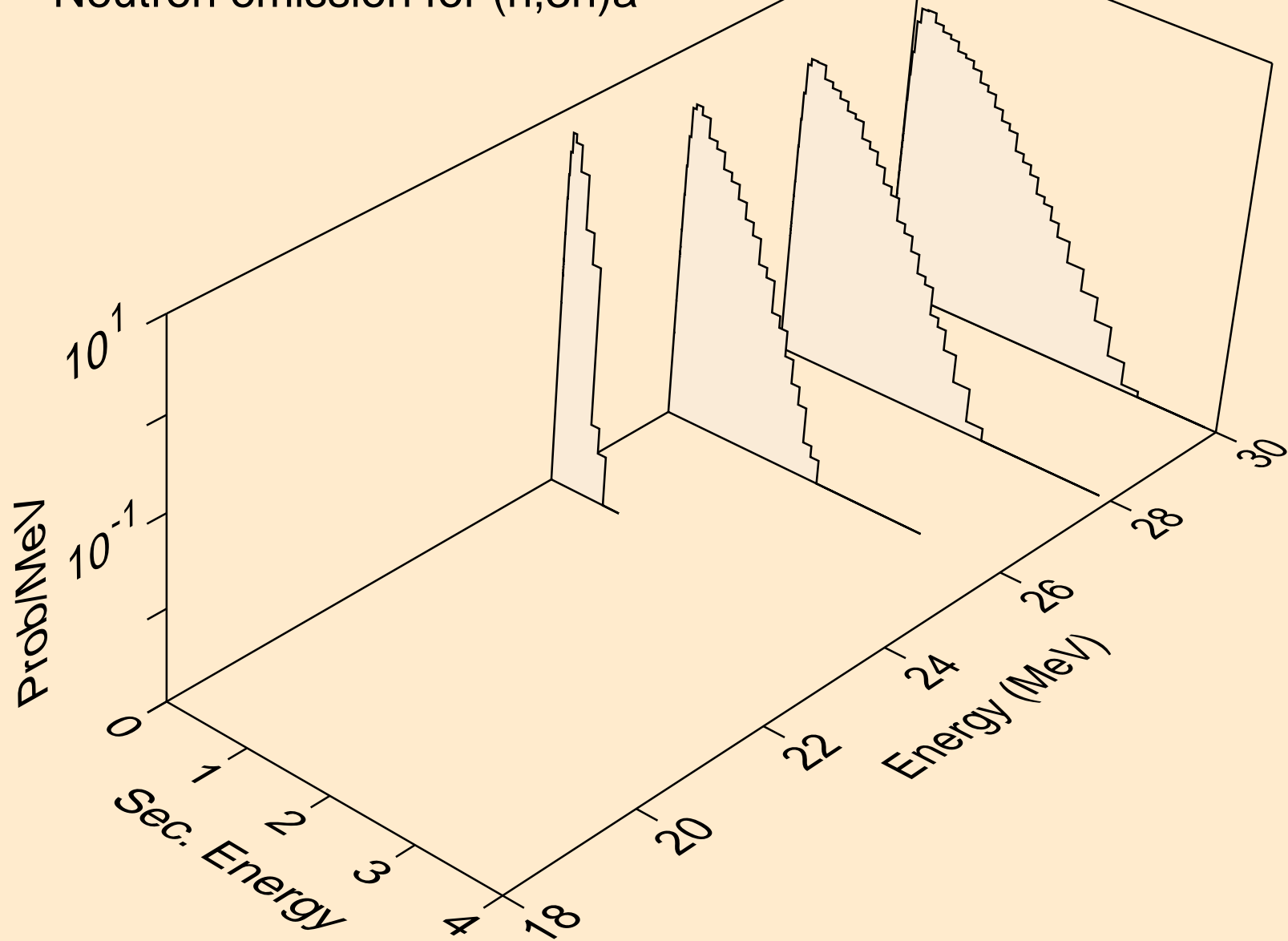

DY149 NEUTRON ACER TENDL-2024 LIBRARY; T=293.6K  
Neutron emission for (n,n\*)p

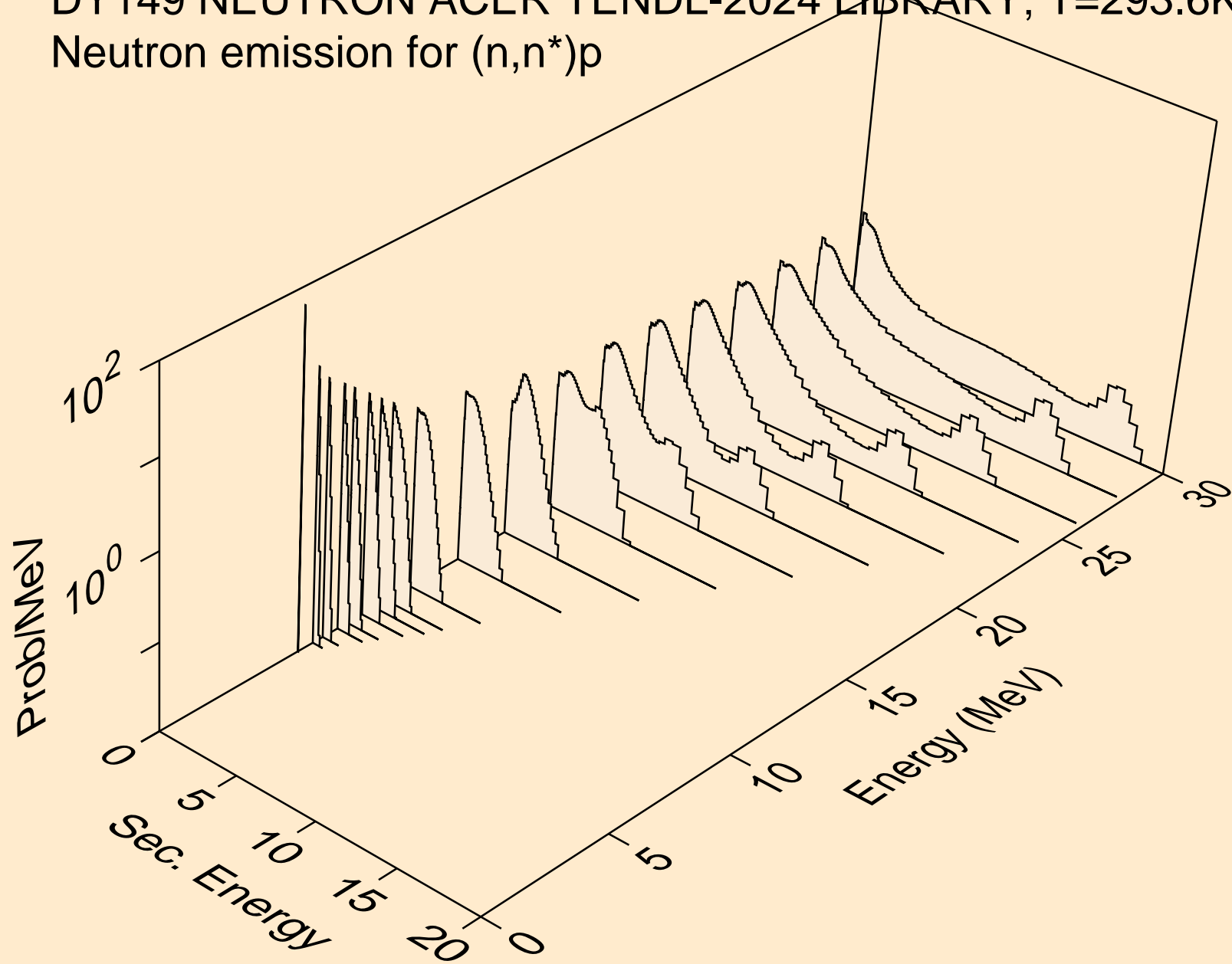

DY149 NEUTRON ACER TENDL-2024 LIBRARY; T=293.6K  
Neutron emission for (n,n\*)2a

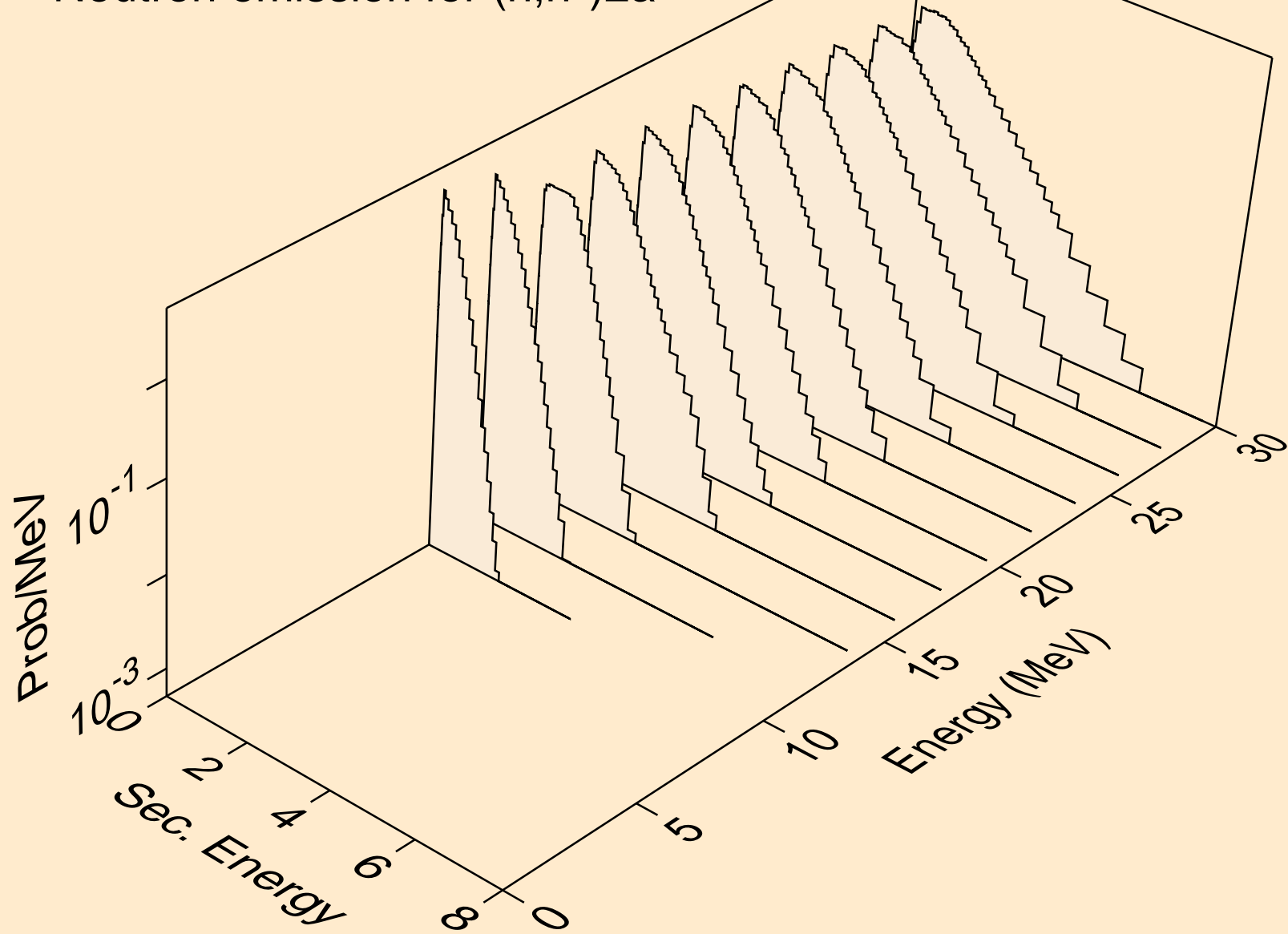

DY149 NEUTRON ACER TENDL-2024 LIBRARY; T=293.6K  
Neutron emission for (n,2n)2a

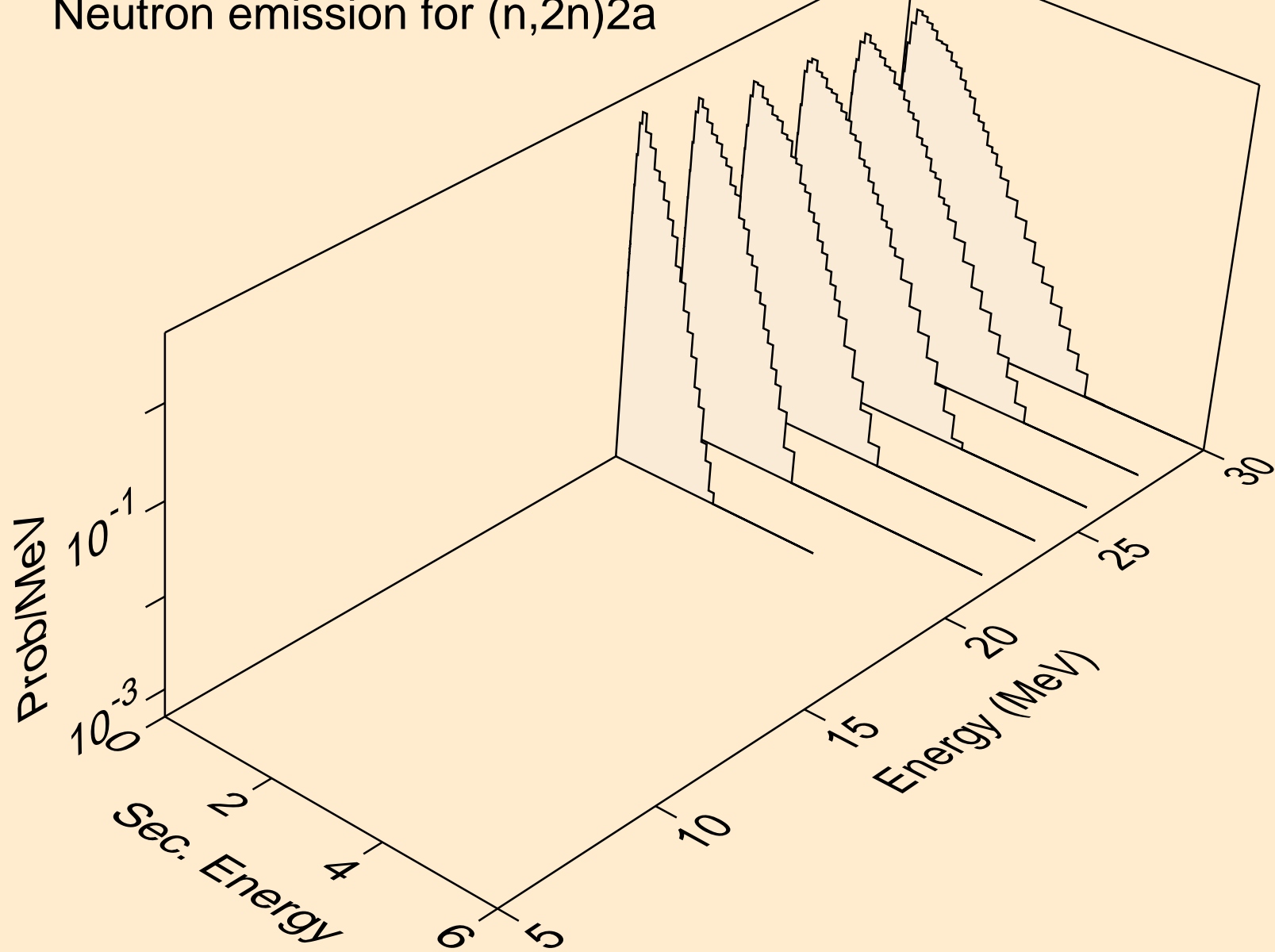

DY149 NEUTRON ACER TENDL-2024 LIBRARY; T=293.6K  
Neutron emission for (n,n\*)d

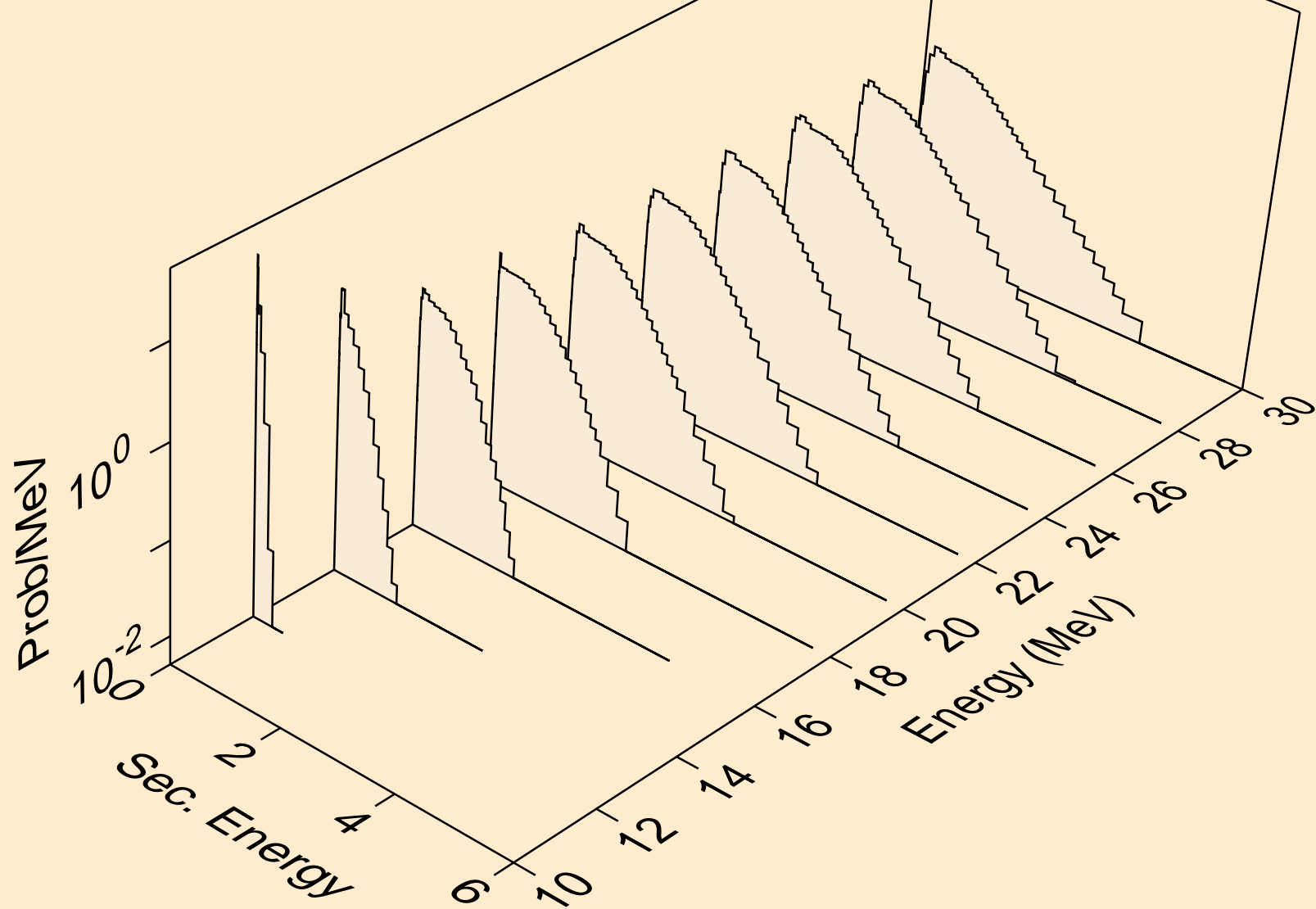

DY149 NEUTRON ACER TENDL-2024 LIBRARY; T=293.6K  
Neutron emission for (n,n\*)t

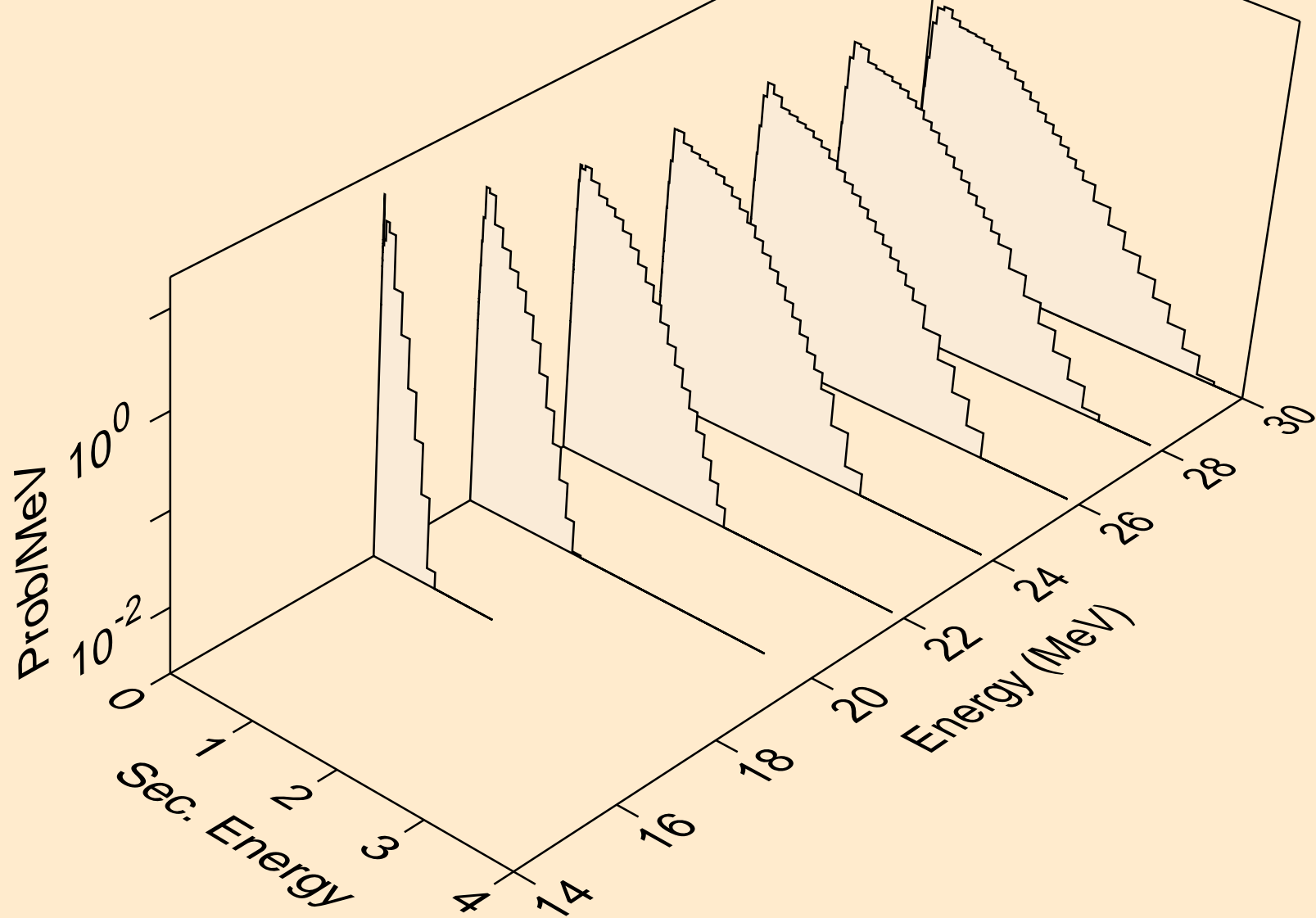

DY149 NEUTRON ACER TENDL-2024 LIBRARY; T=293.6K  
Neutron emission for (n,n\*)he3

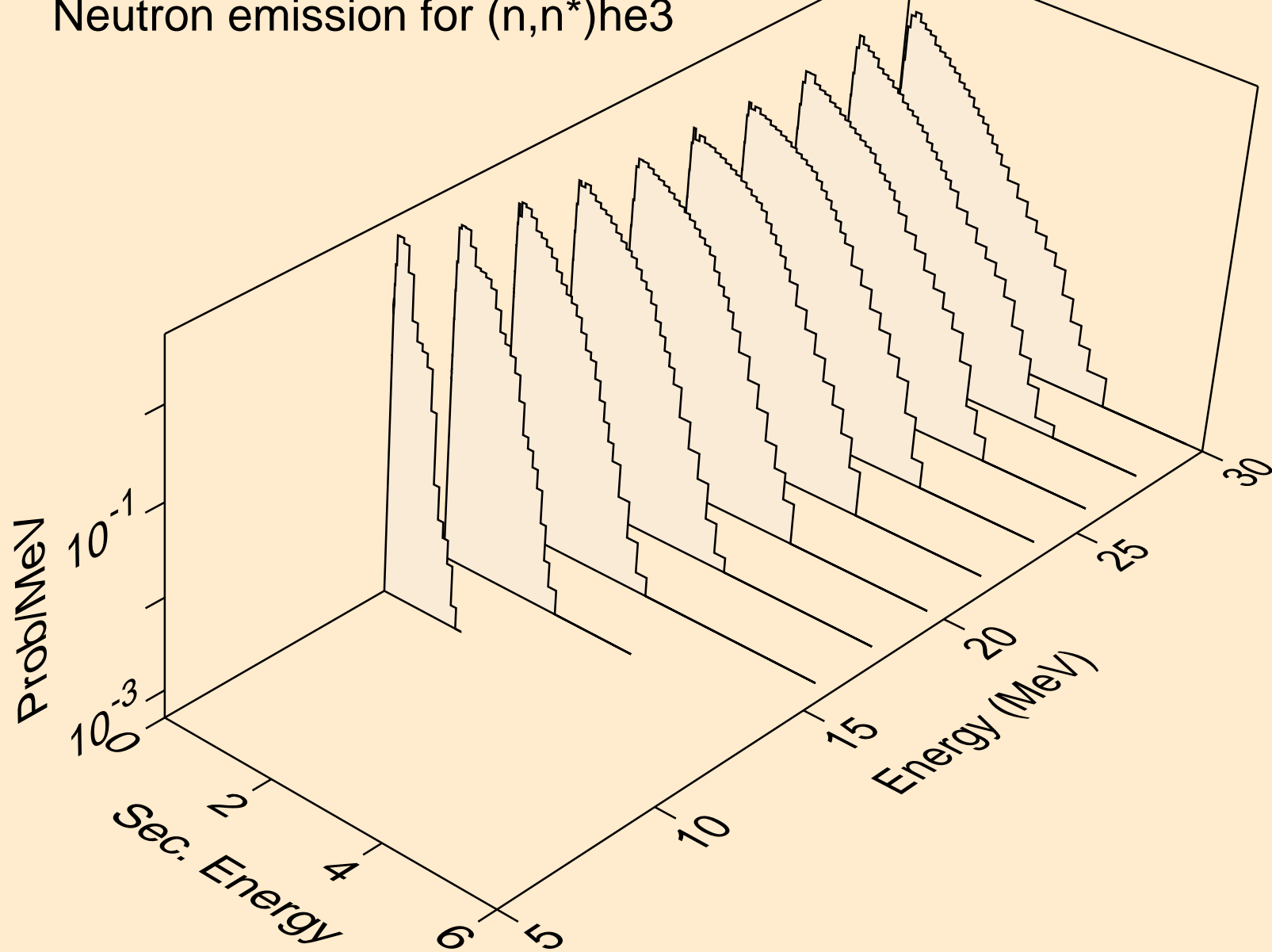

DY149 NEUTRON ACER TENDL-2024 LIBRARY; T=293.6K  
Neutron emission for (n,2np)

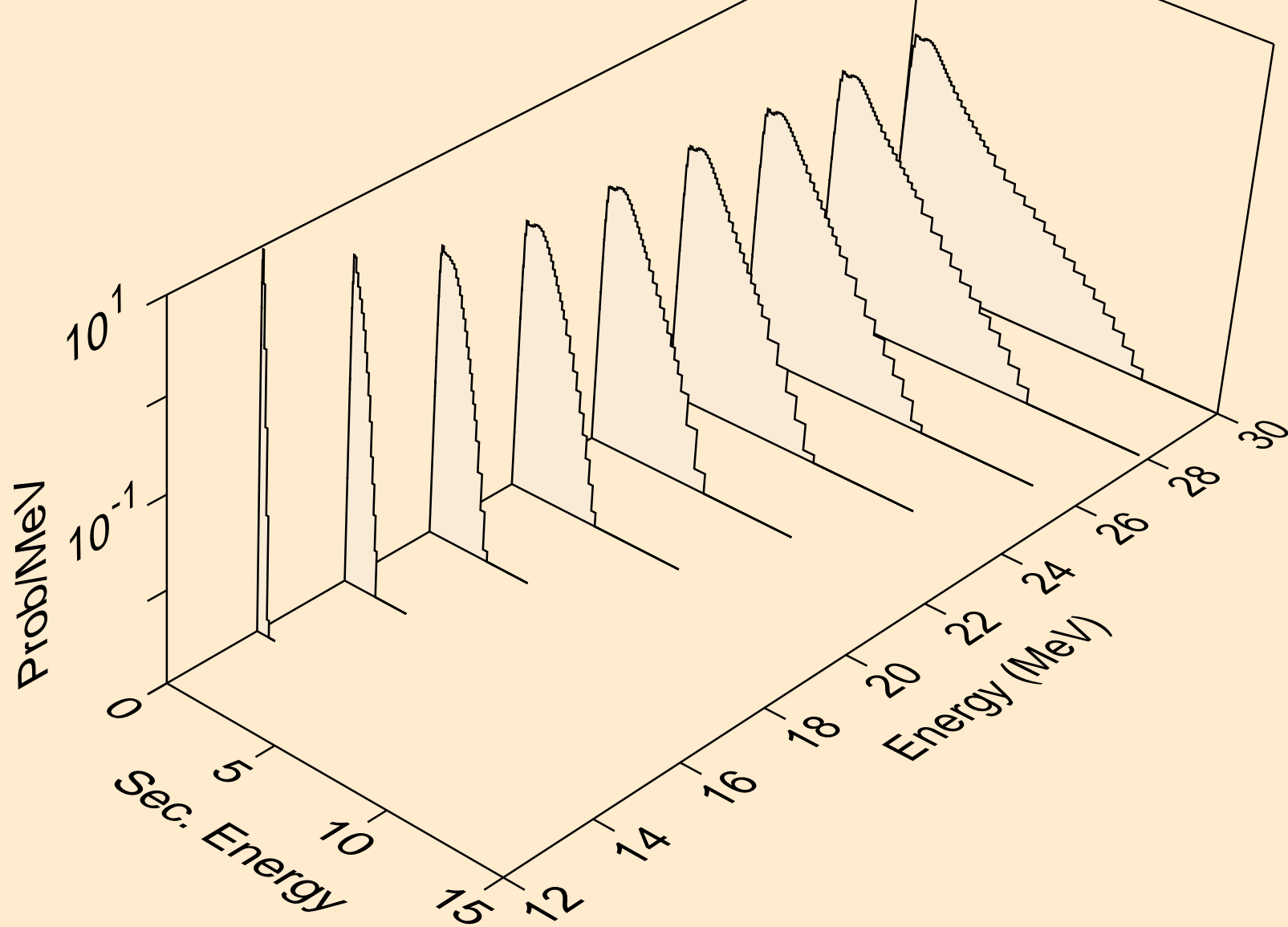

DY149 NEUTRON ACER TENDL-2024 LIBRARY; T=293.6K  
Neutron emission for (n,3np)

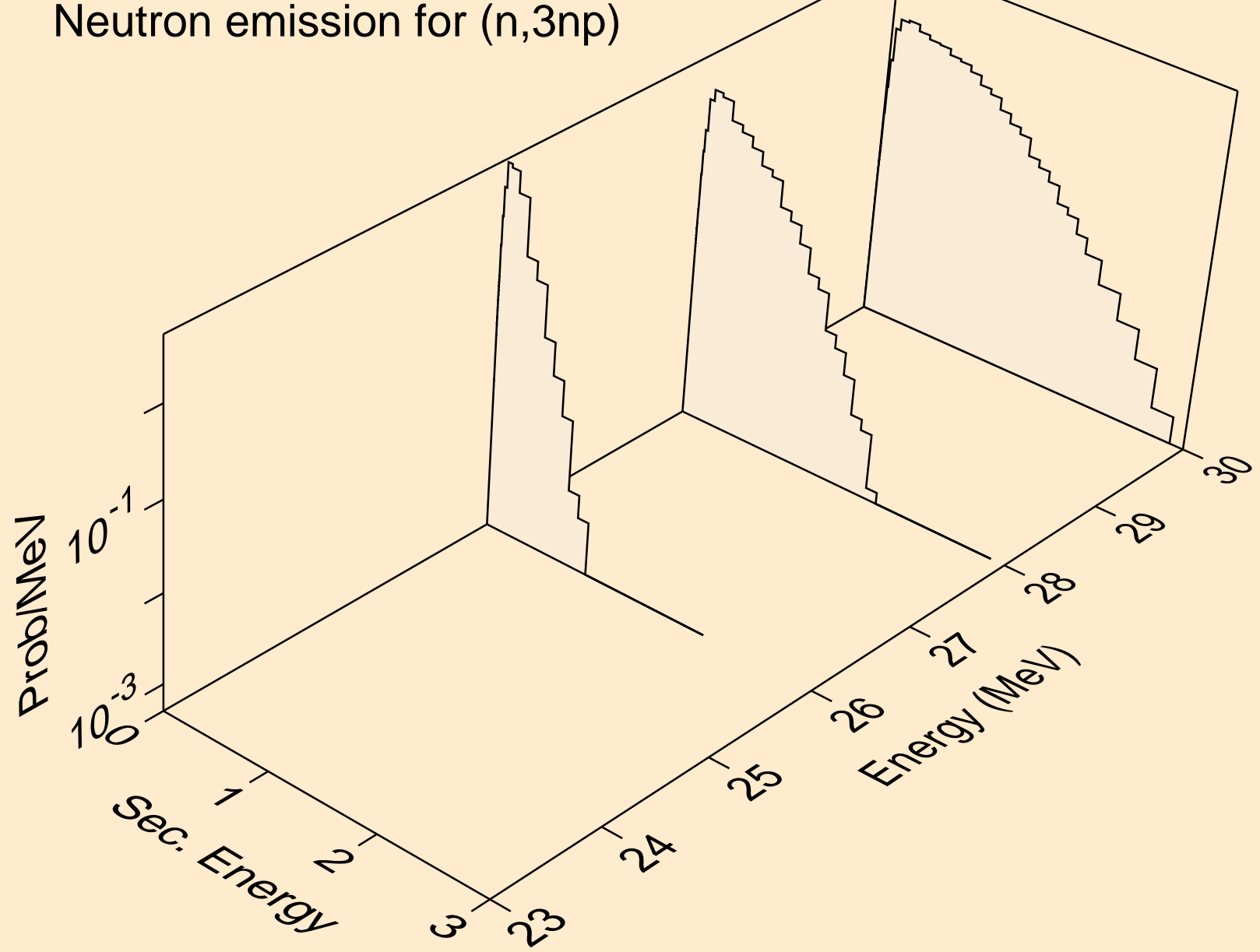

DY149 NEUTRON ACER TENDL-2024 LIBRARY; T=293.6K  
Neutron emission for (n,n2p)

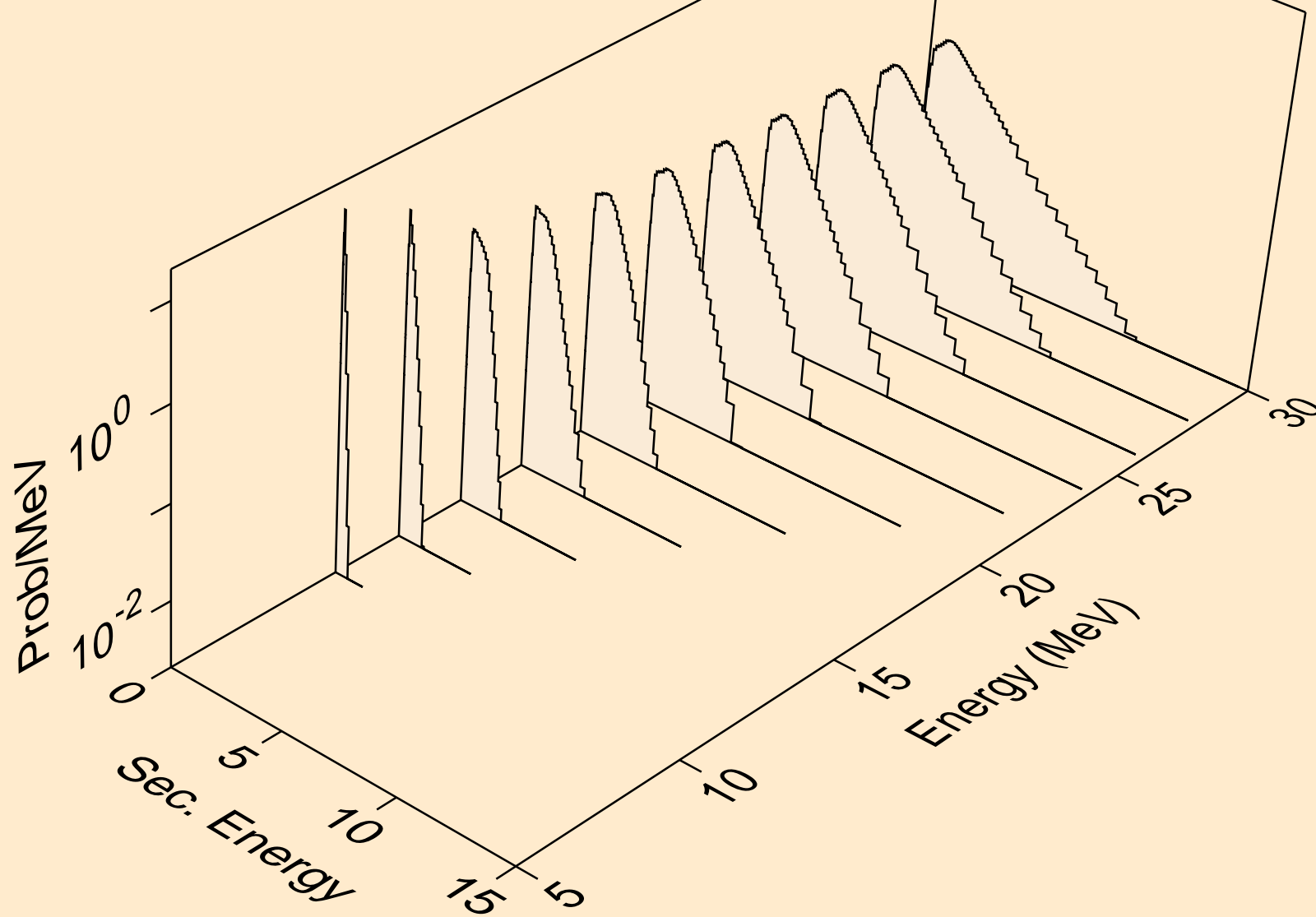

DY149 NEUTRON ACER TENDL-2024 LIBRARY; T=293.6K  
Neutron emission for (n,npa)

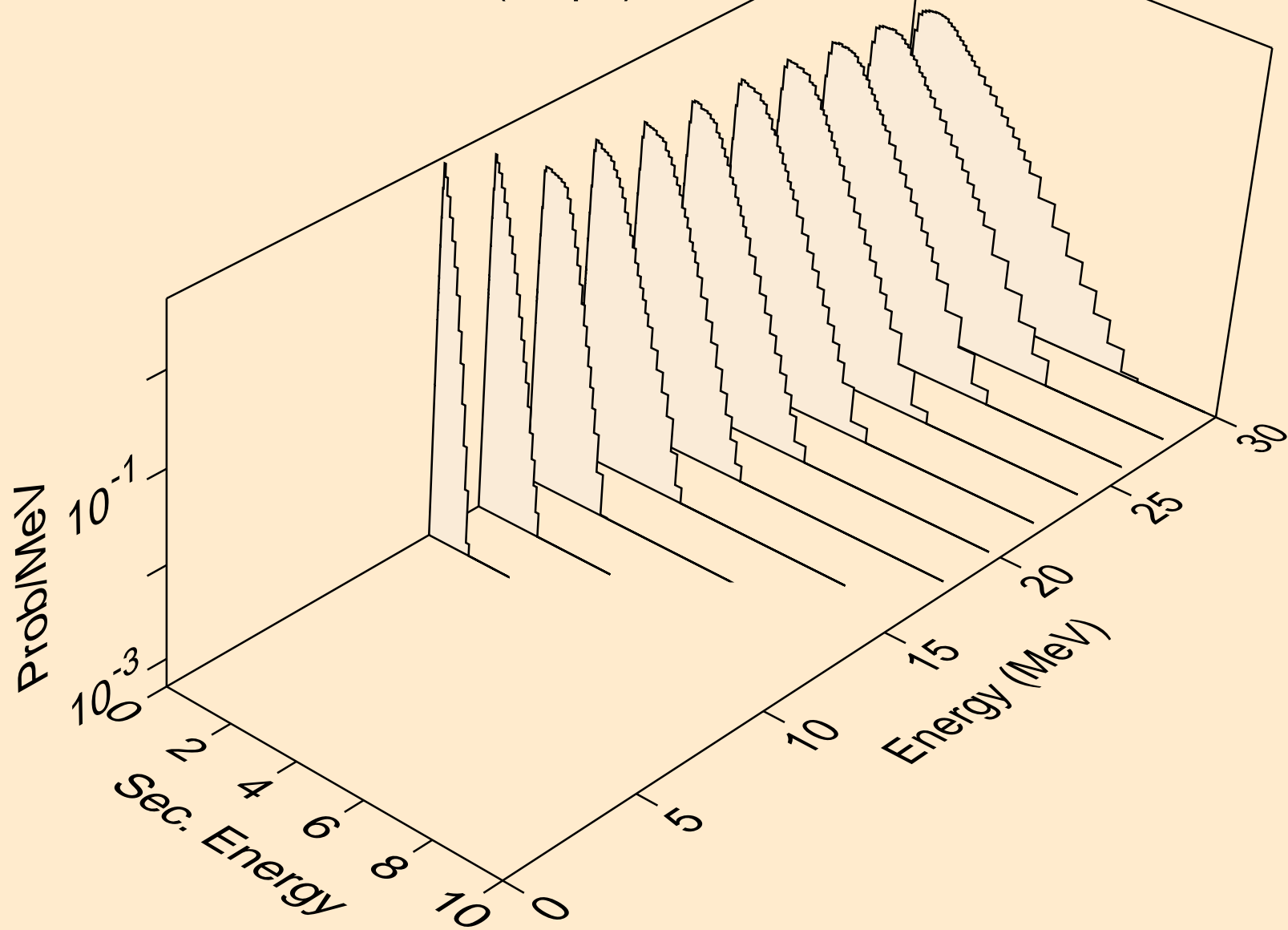

DY149 NEUTRON ACER TENDL-2024 LIBRARY; T=293.6K  
Neutron emission for (n,n\*c)

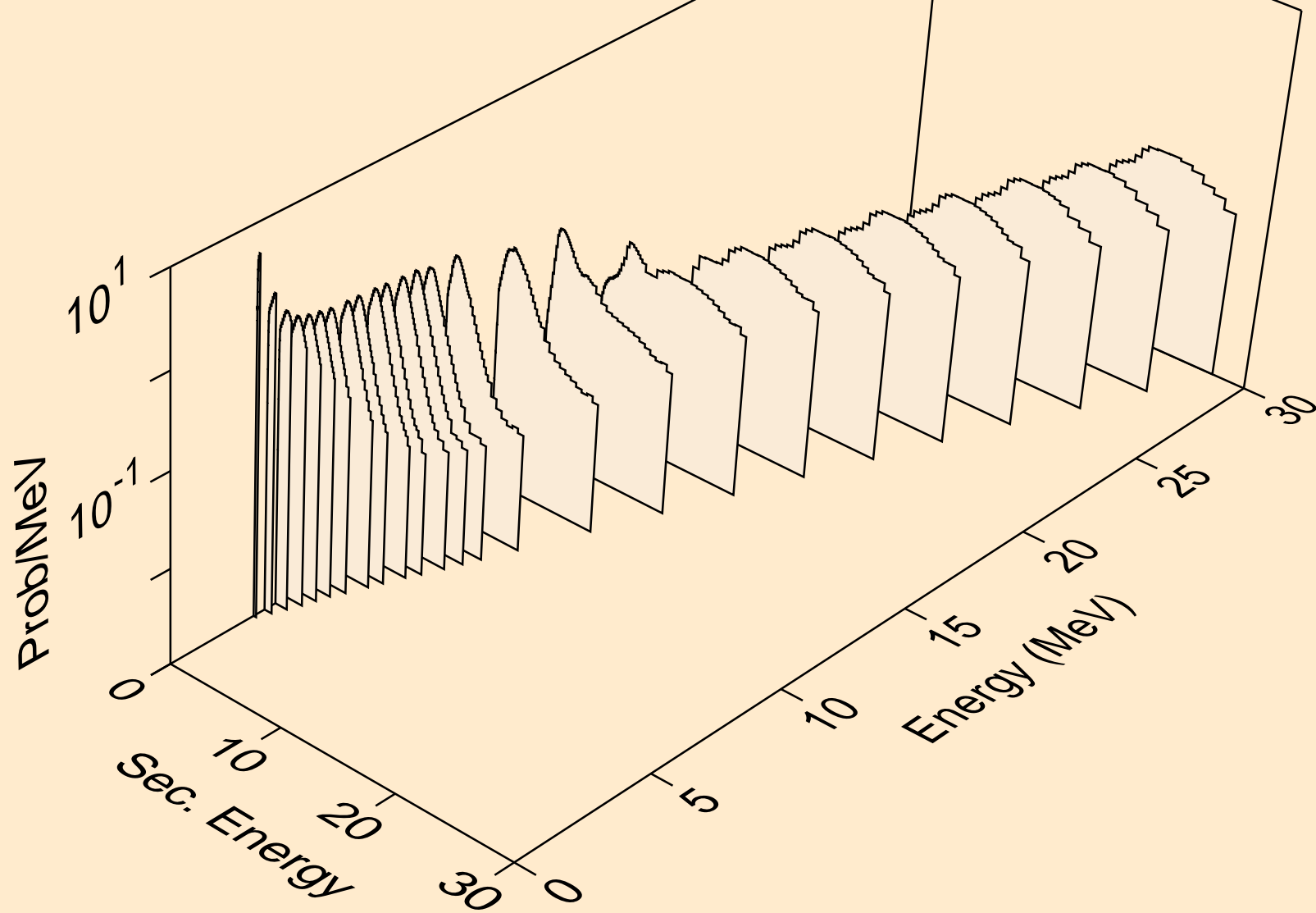

DY149 NEUTRON ACER TENDL-2024 LIBRARY; T=293.6K  
Photon emission for (n,x)

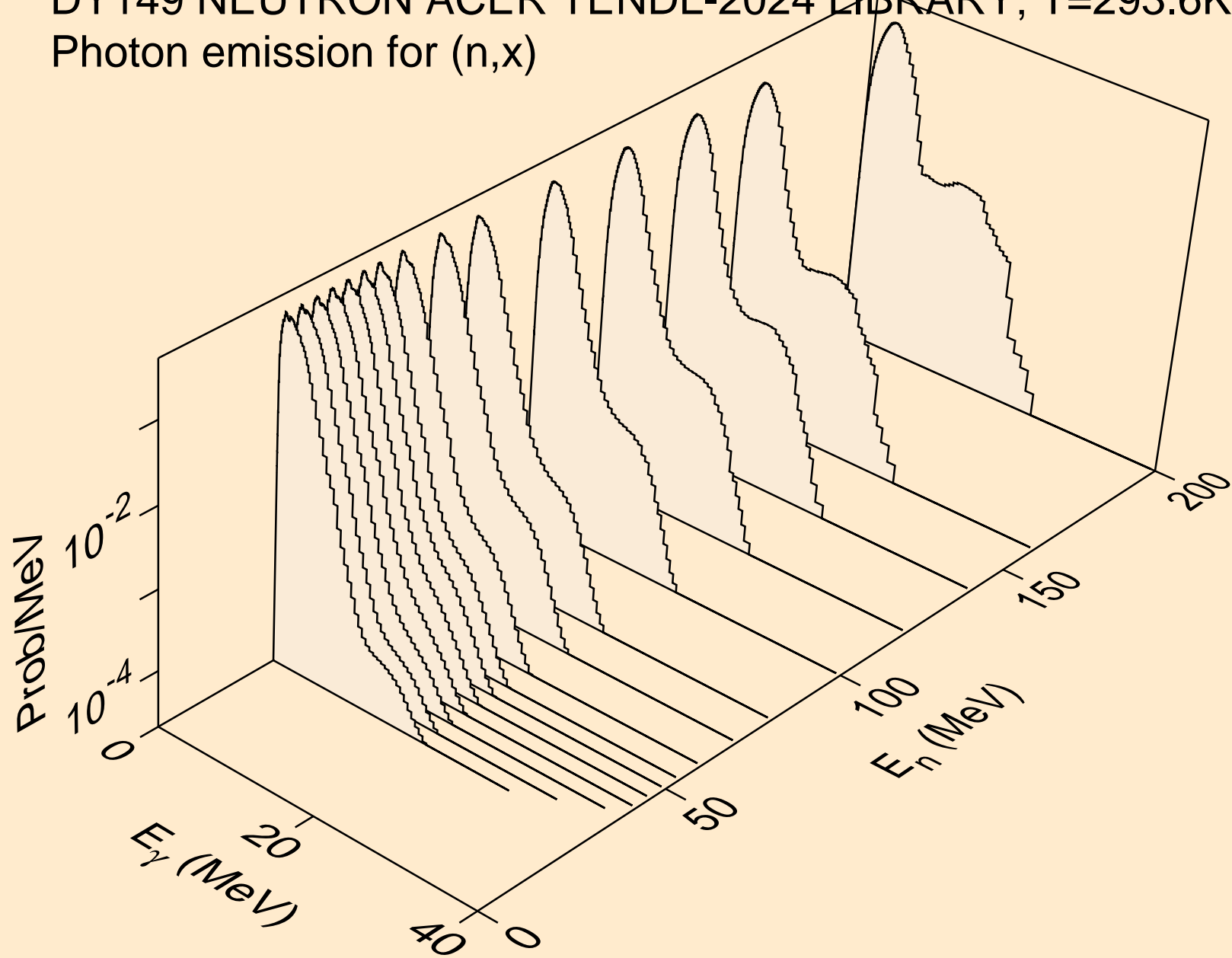

DY149 NEUTRON ACER TENDL-2024 LIBRARY; T=293.6K  
Photon emission for (n,2nd)

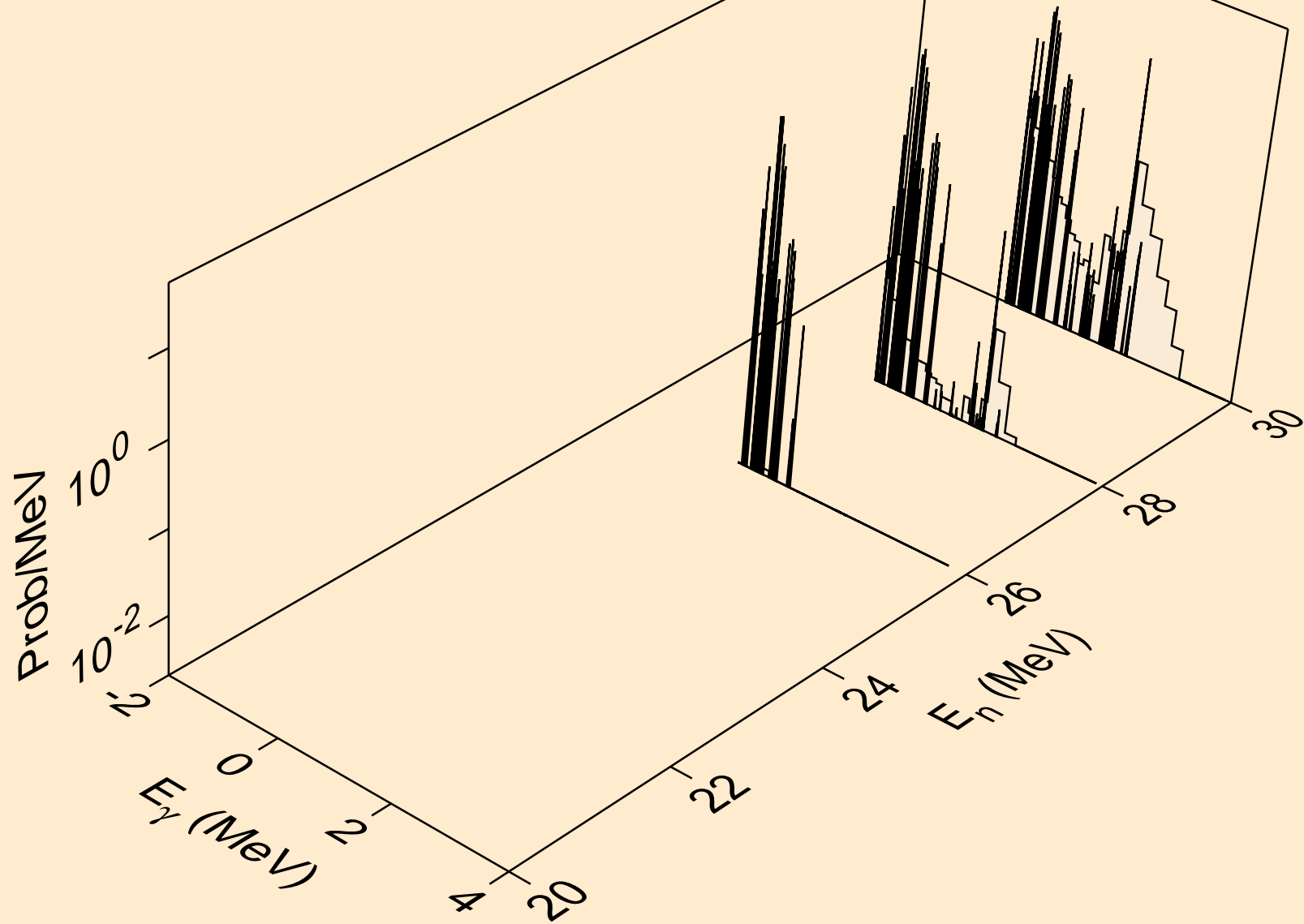

DY149 NEUTRON ACER TENDL-2024 LIBRARY; T=293.6K  
Photon emission for (n,2n)

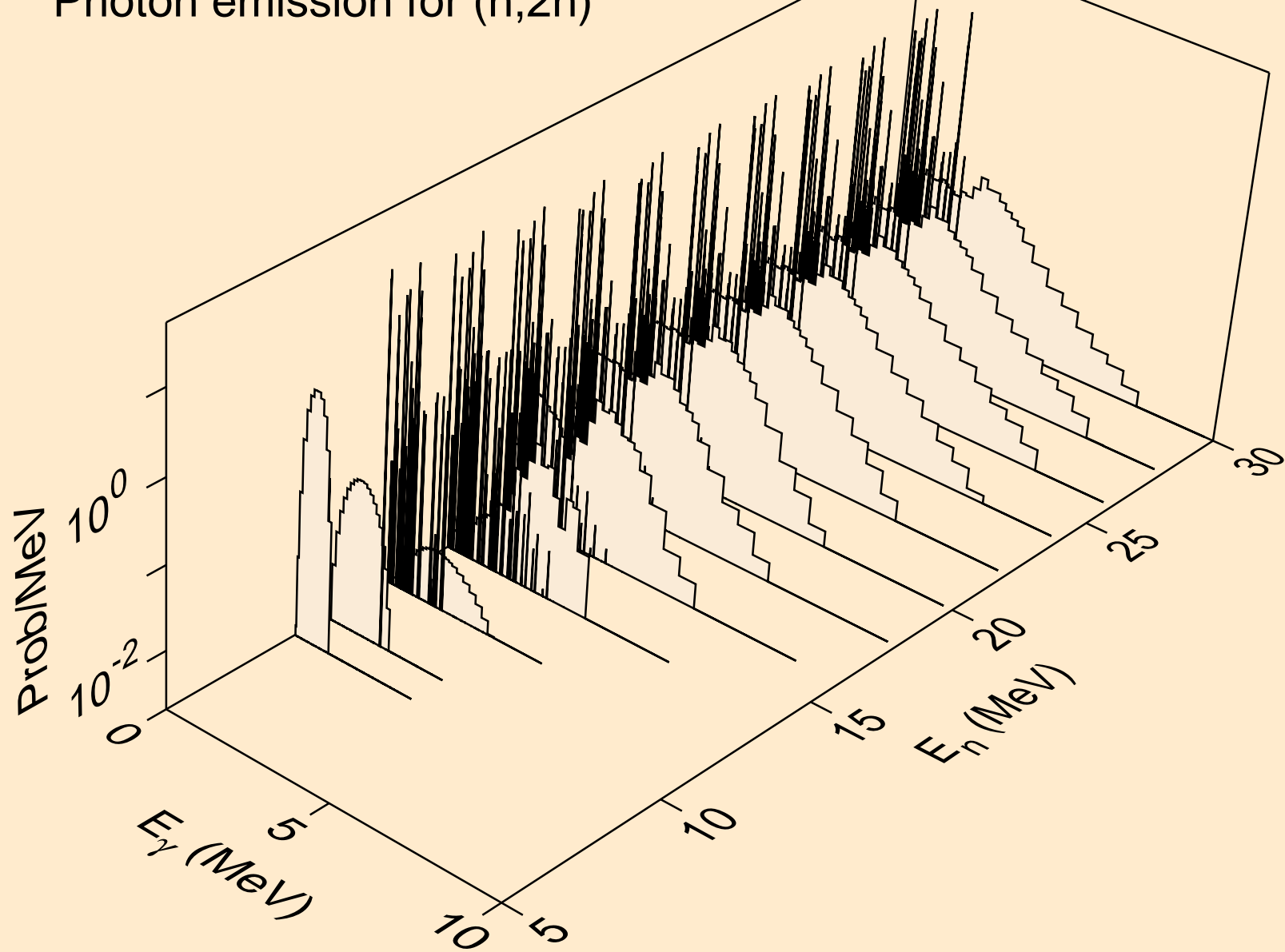

DY149 NEUTRON ACER TENDL-2024 LIBRARY; T=293.6K  
Photon emission for (n,3n)

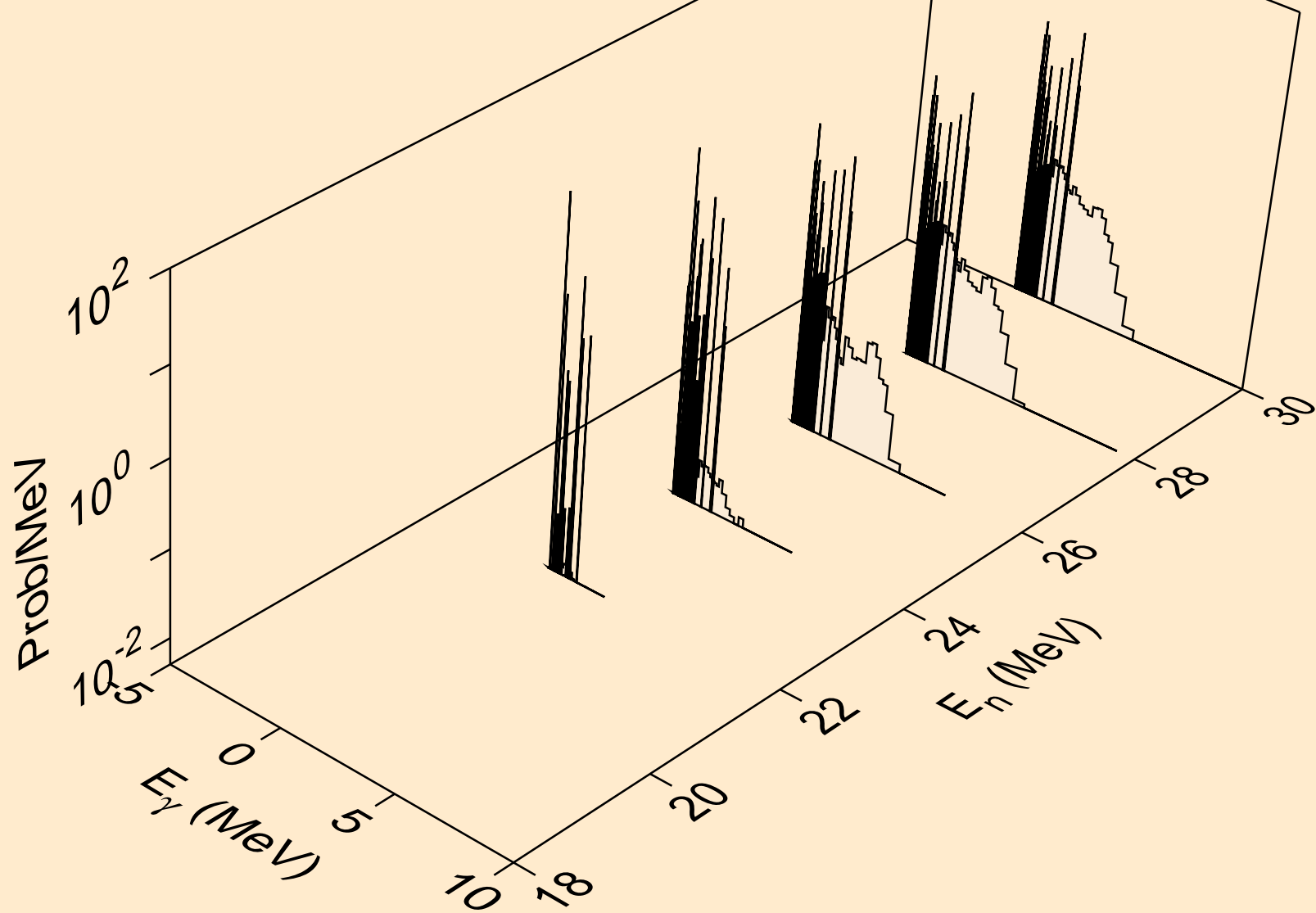

DY149 NEUTRON ACER TENDL-2024 LIBRARY; T=293.6K  
Photon emission for (n,n\*)a

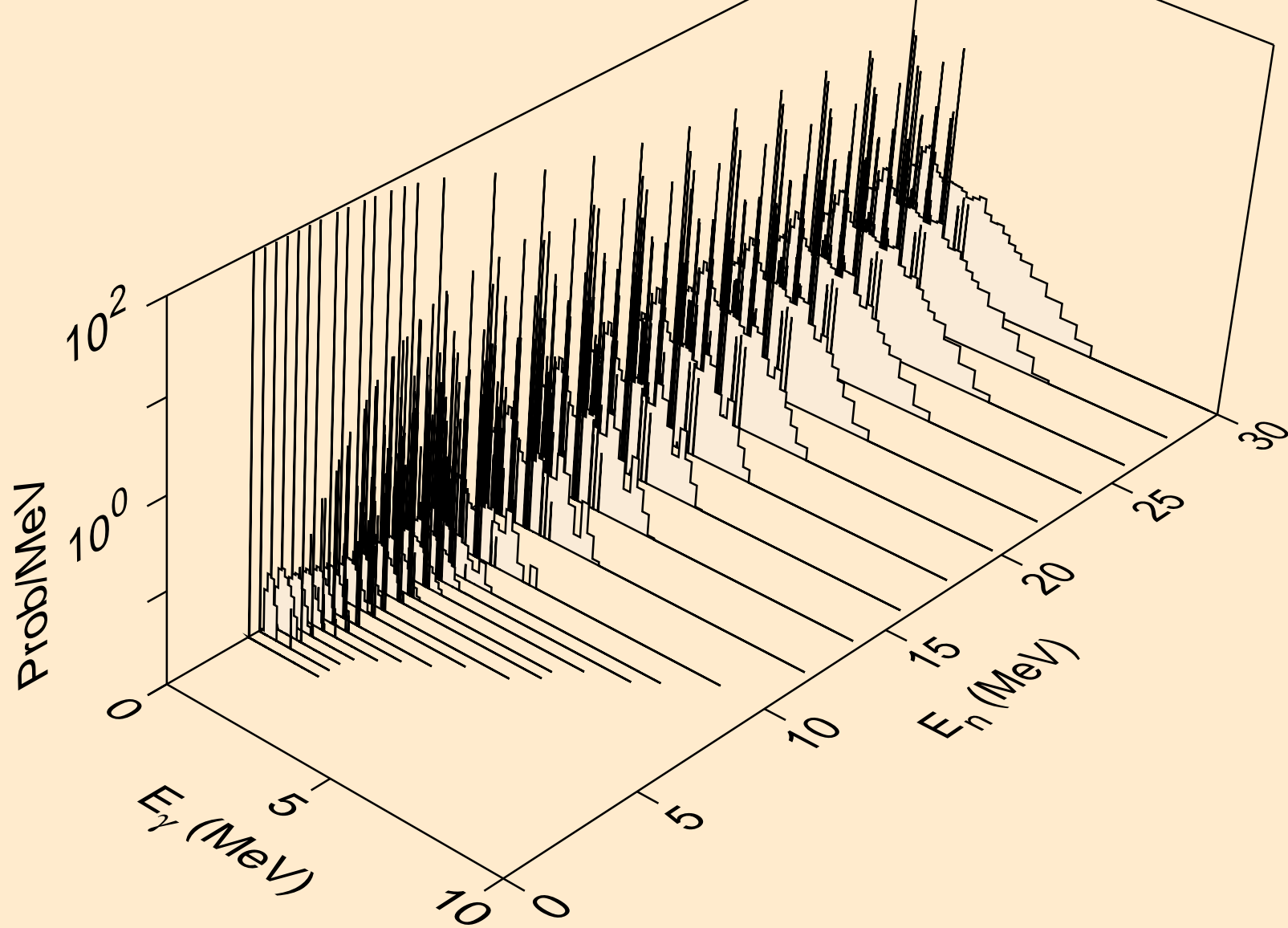

DY149 NEUTRON ACER TENDL-2024 LIBRARY; T=293.6K  
Photon emission for (n,2n)a

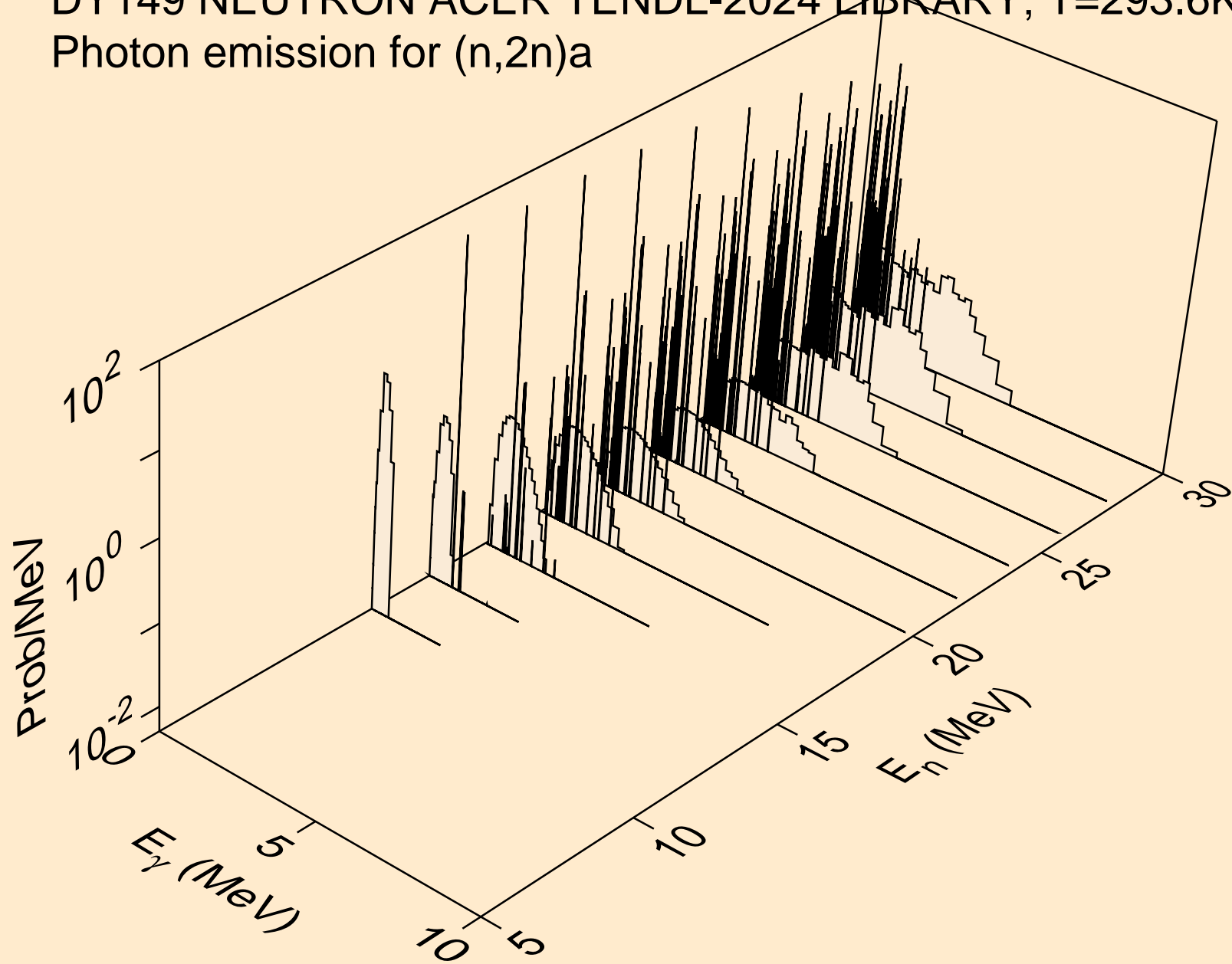

DY149 NEUTRON ACER TENDL-2024 LIBRARY; T=293.6K  
Photon emission for (n,3n)a

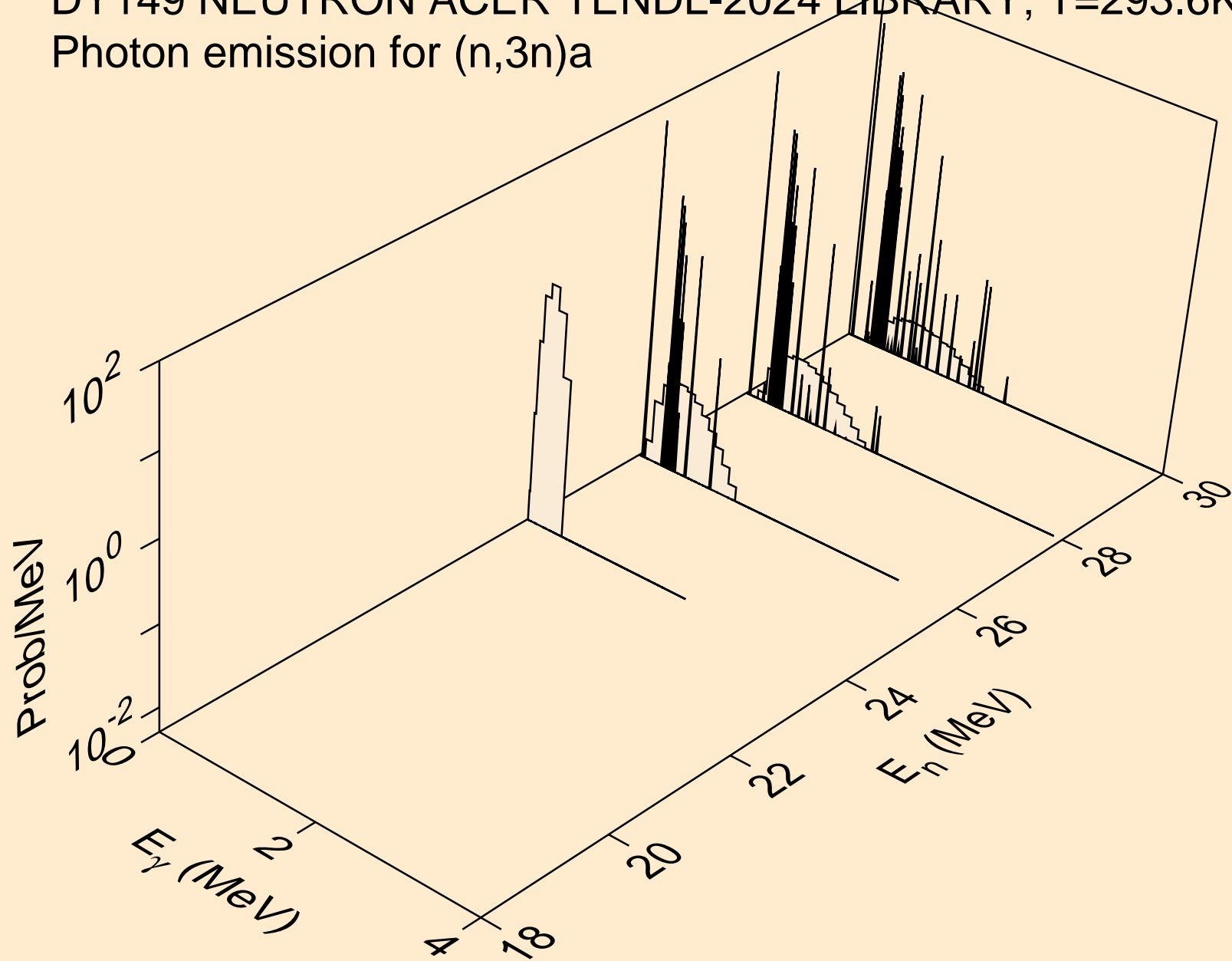

DY149 NEUTRON ACER TENDL-2024 LIBRARY; T=293.6K  
Photon emission for (n,n\*)p

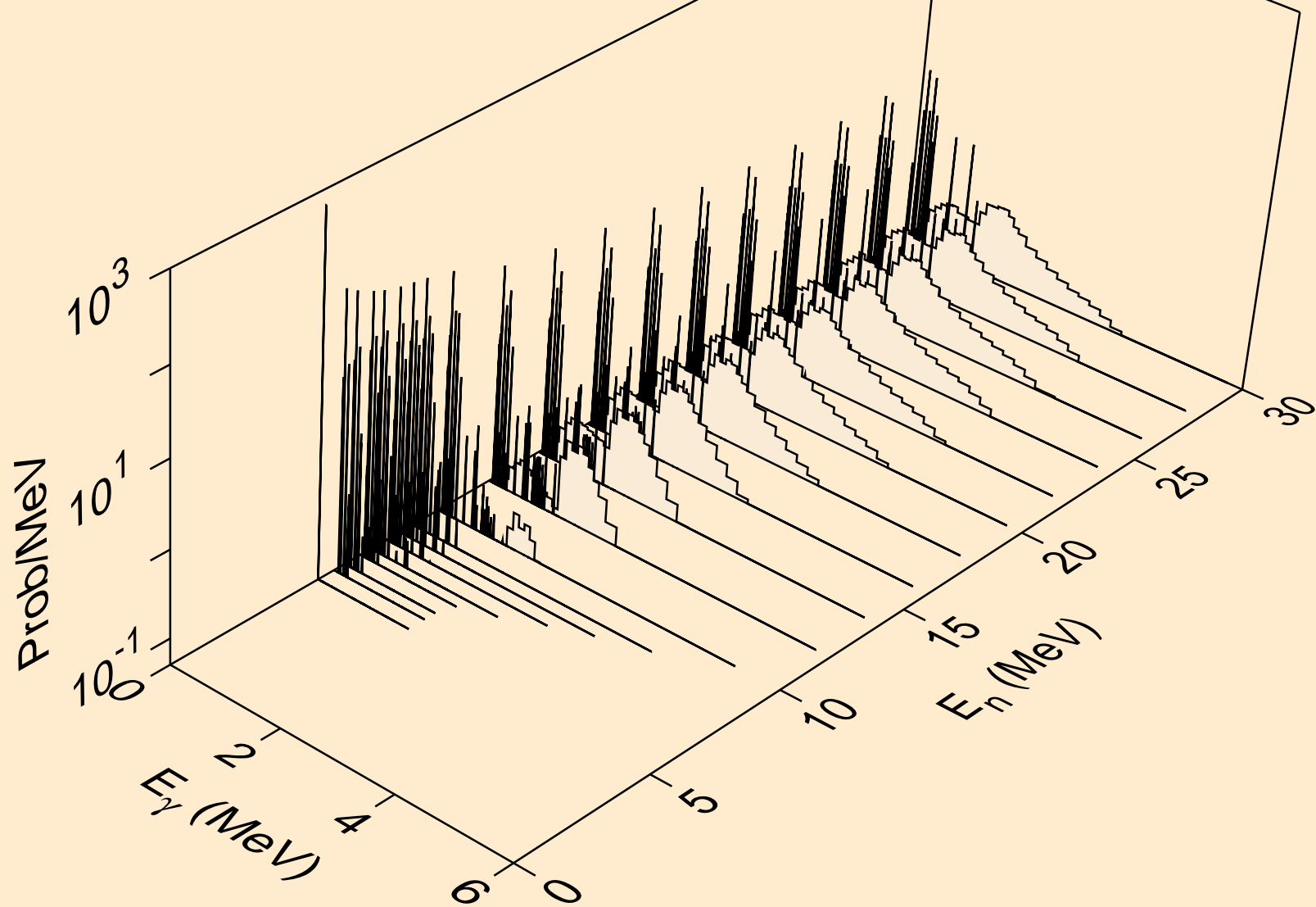

DY149 NEUTRON ACER TENDL-2024 LIBRARY; T=293.6K  
Photon emission for (n,n\*)2a

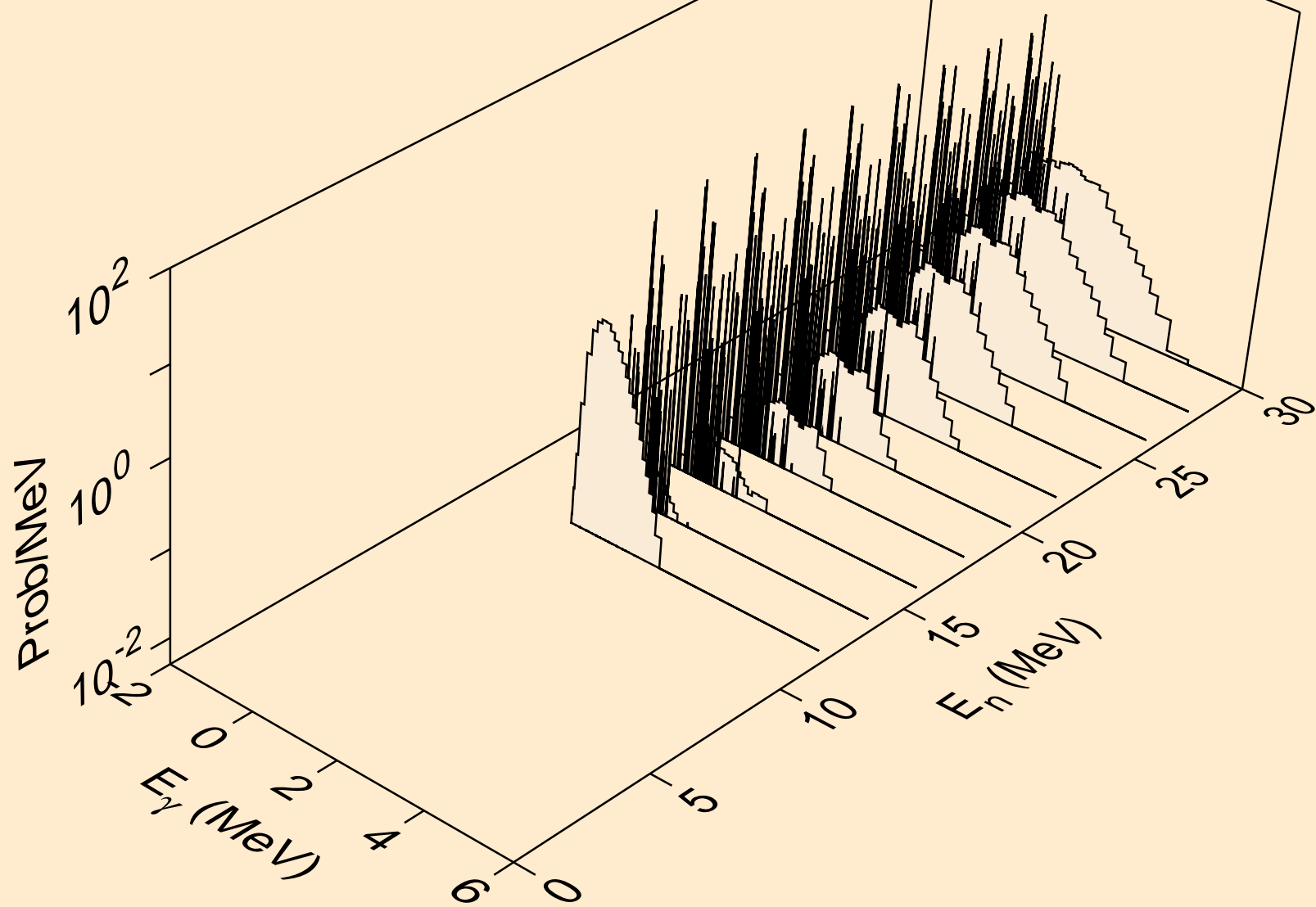

DY149 NEUTRON ACER TENDL-2024 LIBRARY; T=293.6K  
Photon emission for (n,2n)2a

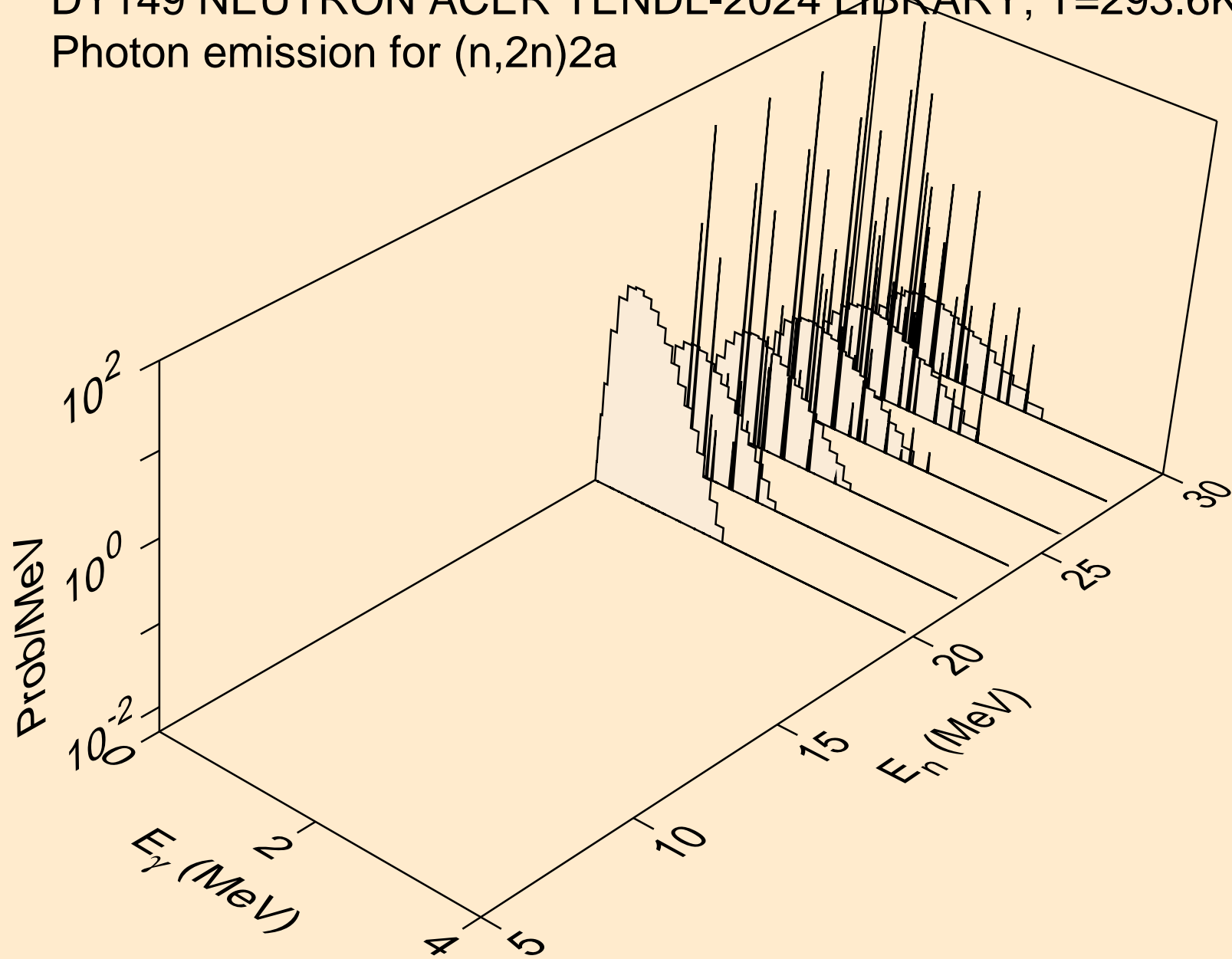

DY149 NEUTRON ACER TENDL-2024 LIBRARY; T=293.6K  
Photon emission for (n,n\*)d

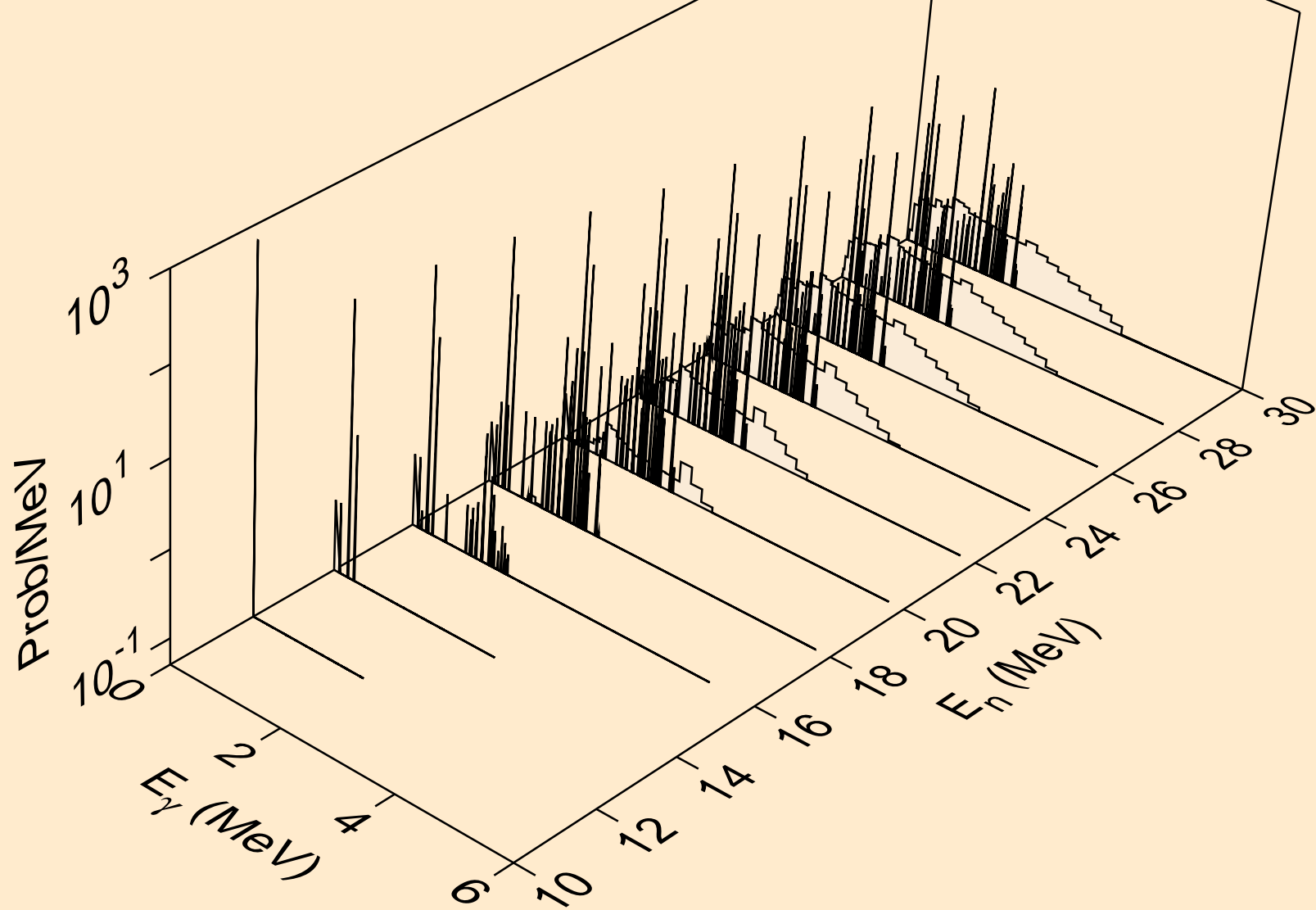

DY149 NEUTRON ACER TENDL-2024 LIBRARY; T=293.6K  
Photon emission for (n,n\*)t

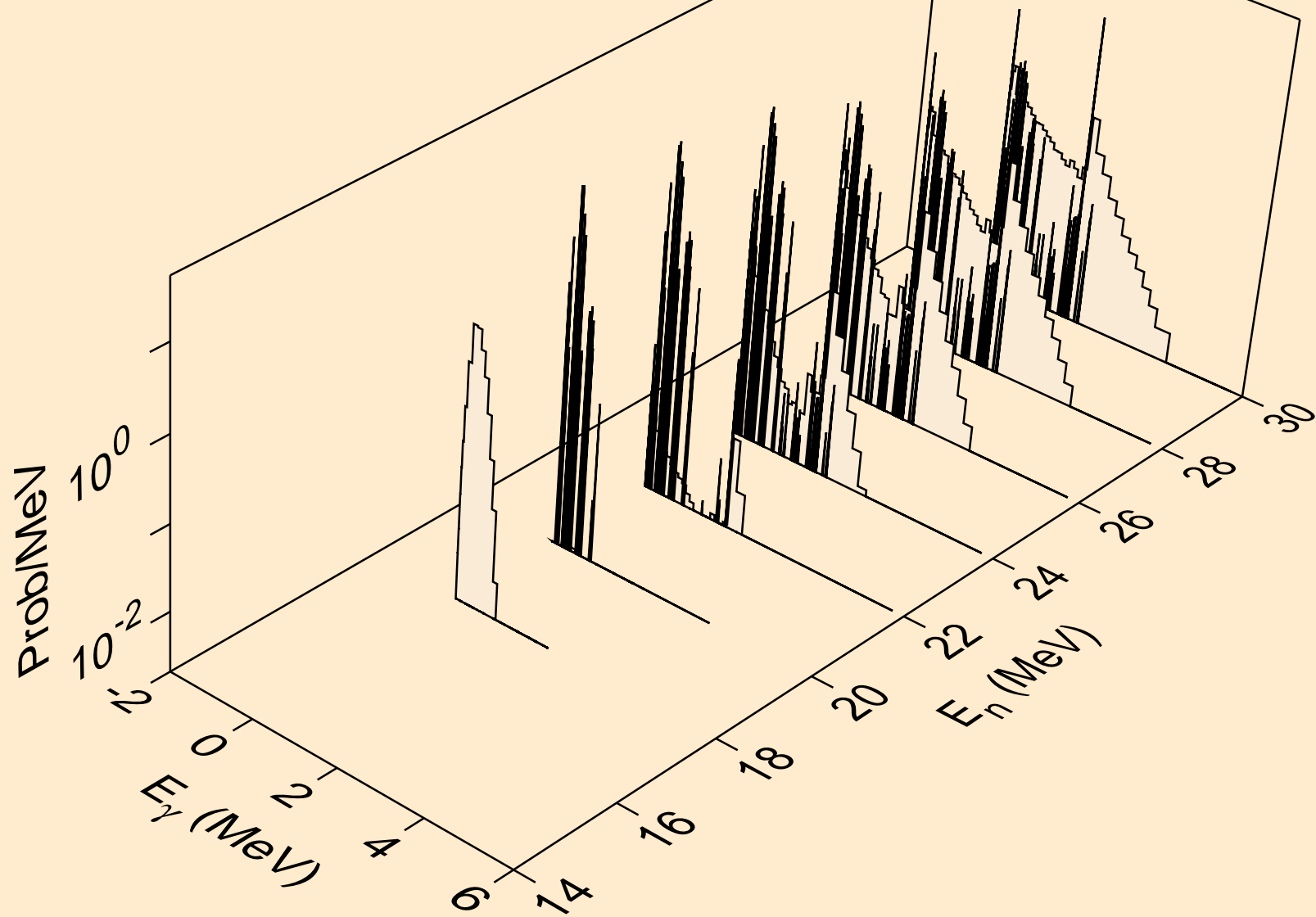

DY149 NEUTRON ACER TENDL-2024 LIBRARY; T=293.6K  
Photon emission for (n,n\*)he3

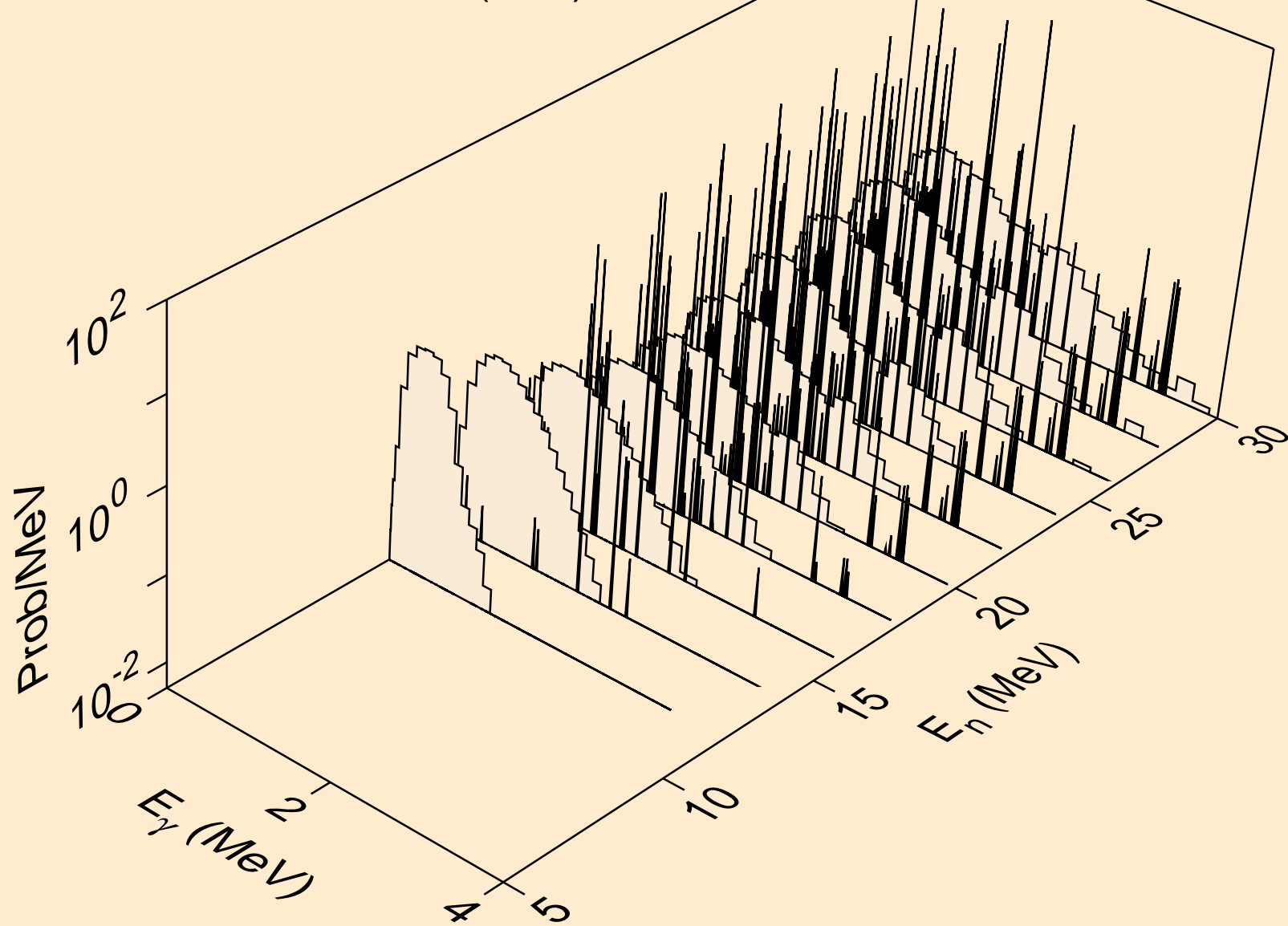

DY149 NEUTRON ACER TENDL-2024 LIBRARY; T=293.6K  
Photon emission for (n,2np)

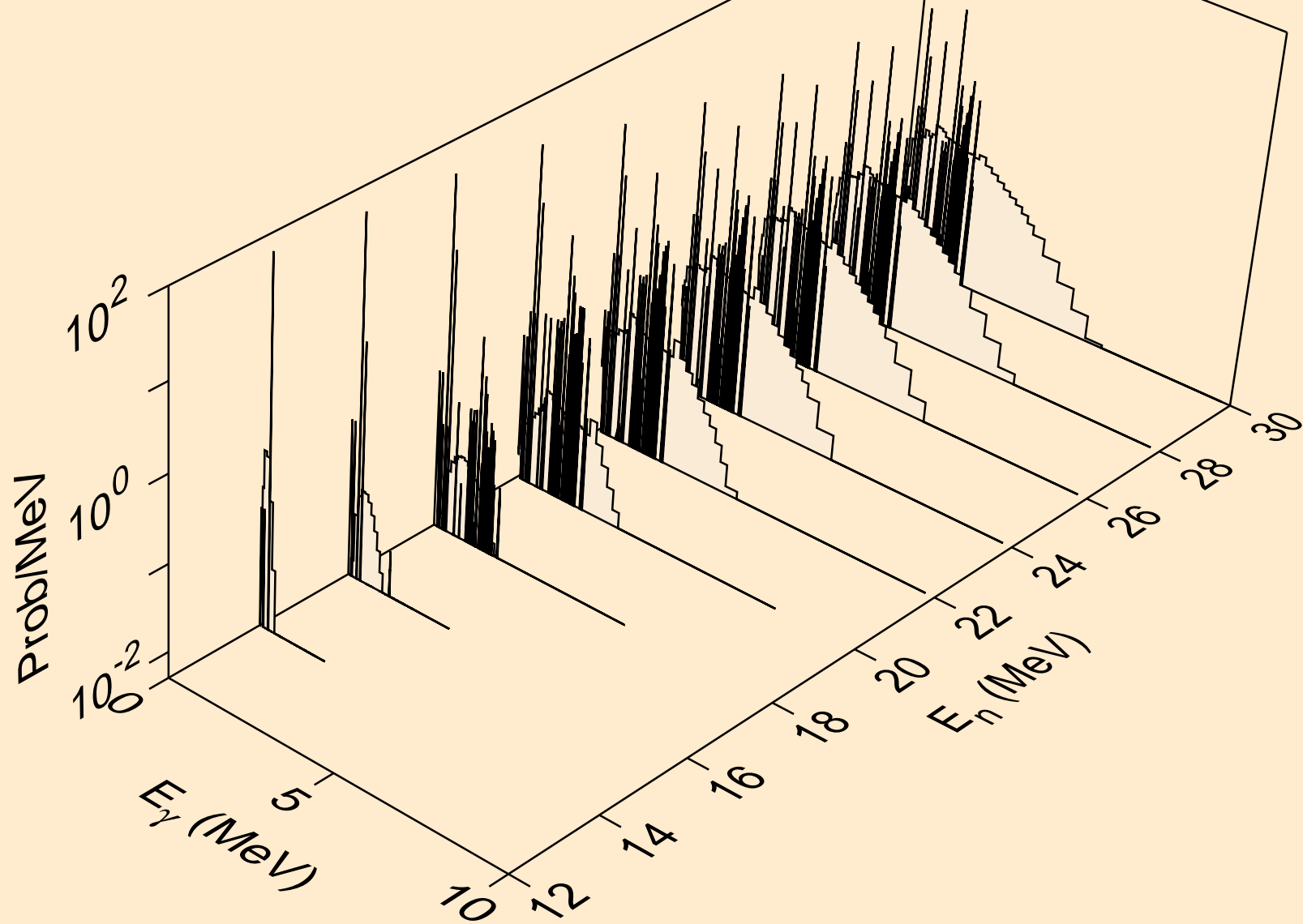

DY149 NEUTRON ACER TENDL-2024 LIBRARY; T=293.6K  
Photon emission for (n,3np)

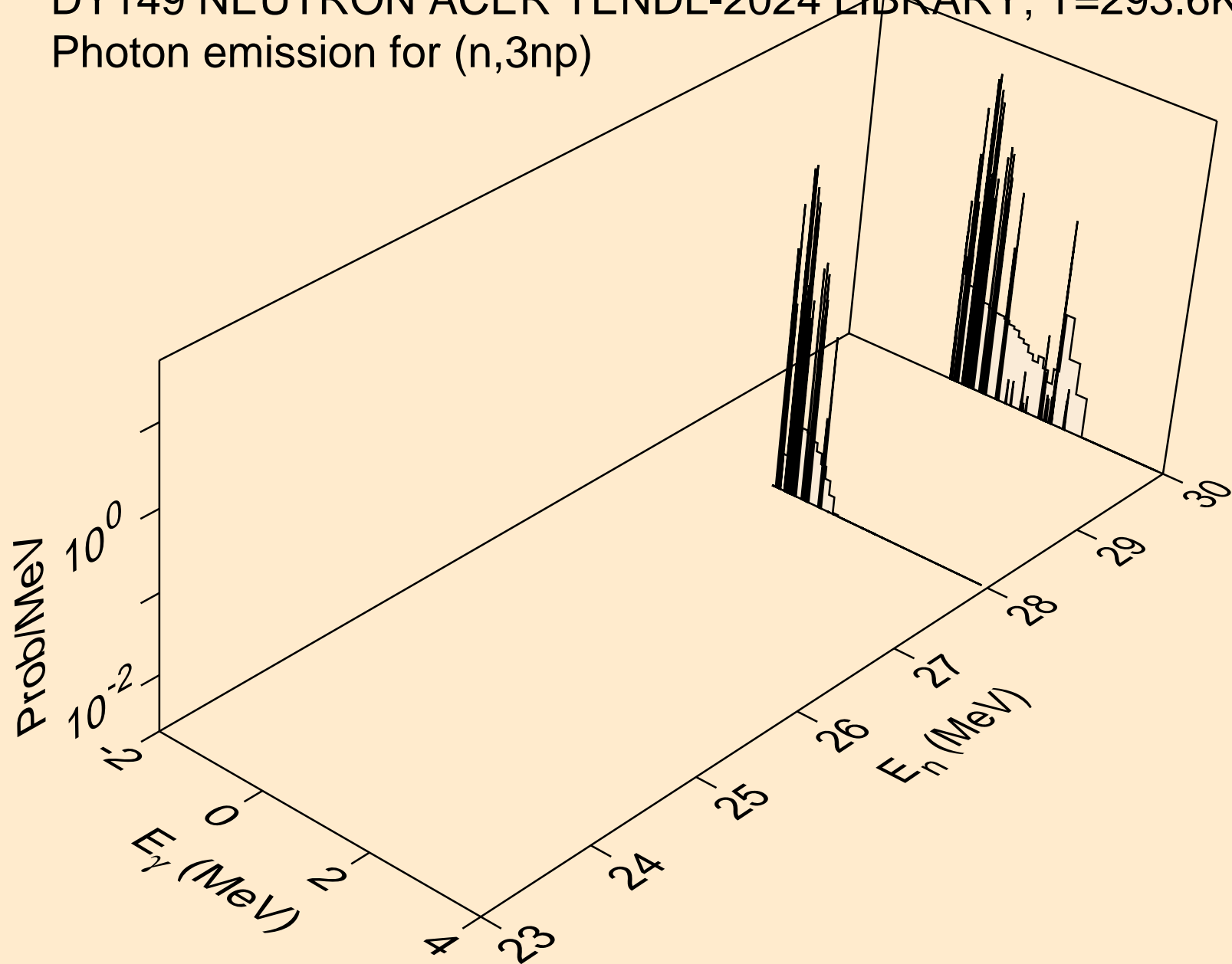

DY149 NEUTRON ACER TENDL-2024 LIBRARY; T=293.6K  
Photon emission for (n,n2p)

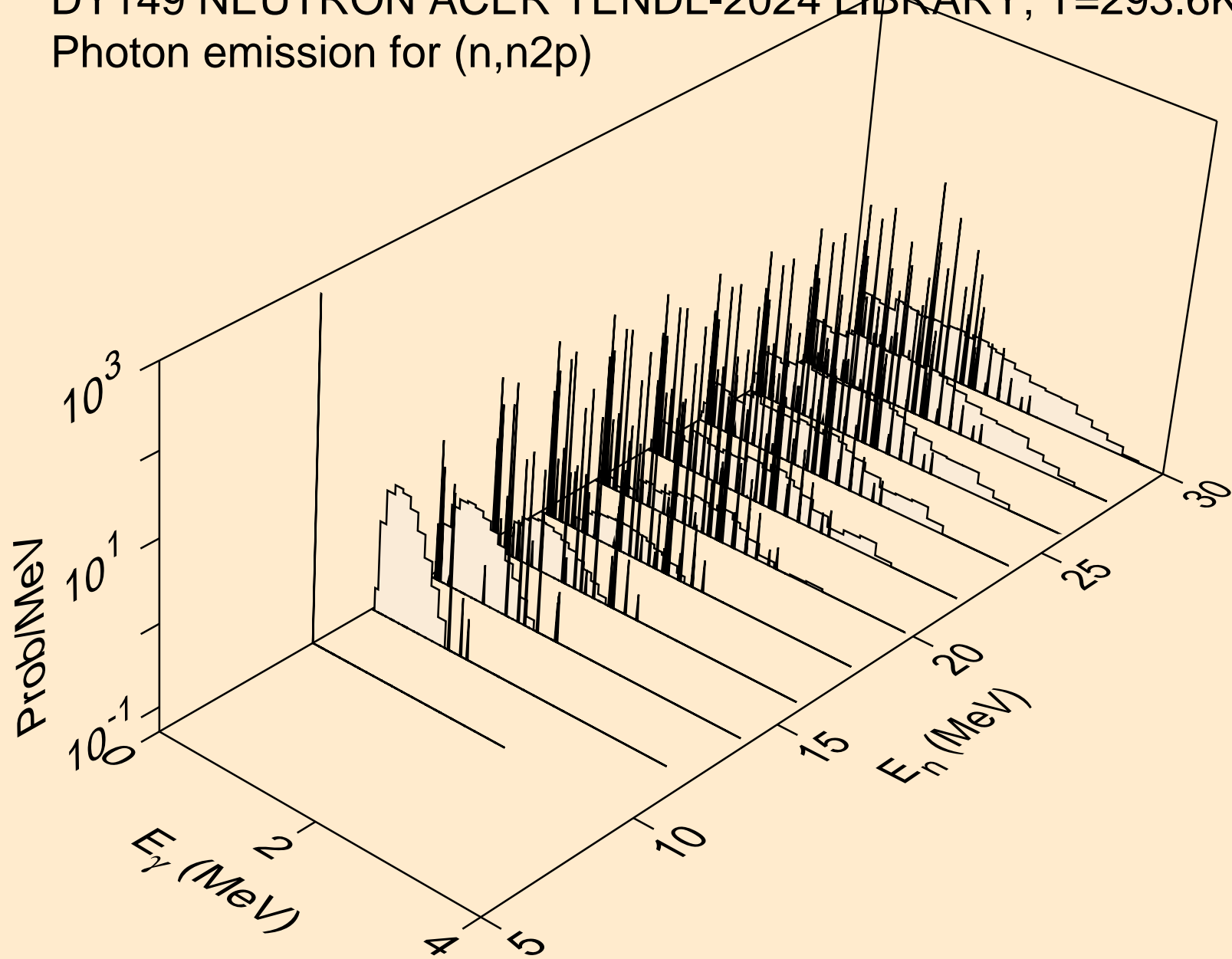

DY149 NEUTRON ACER TENDL-2024 LIBRARY; T=293.6K  
Photon emission for (n,npa)

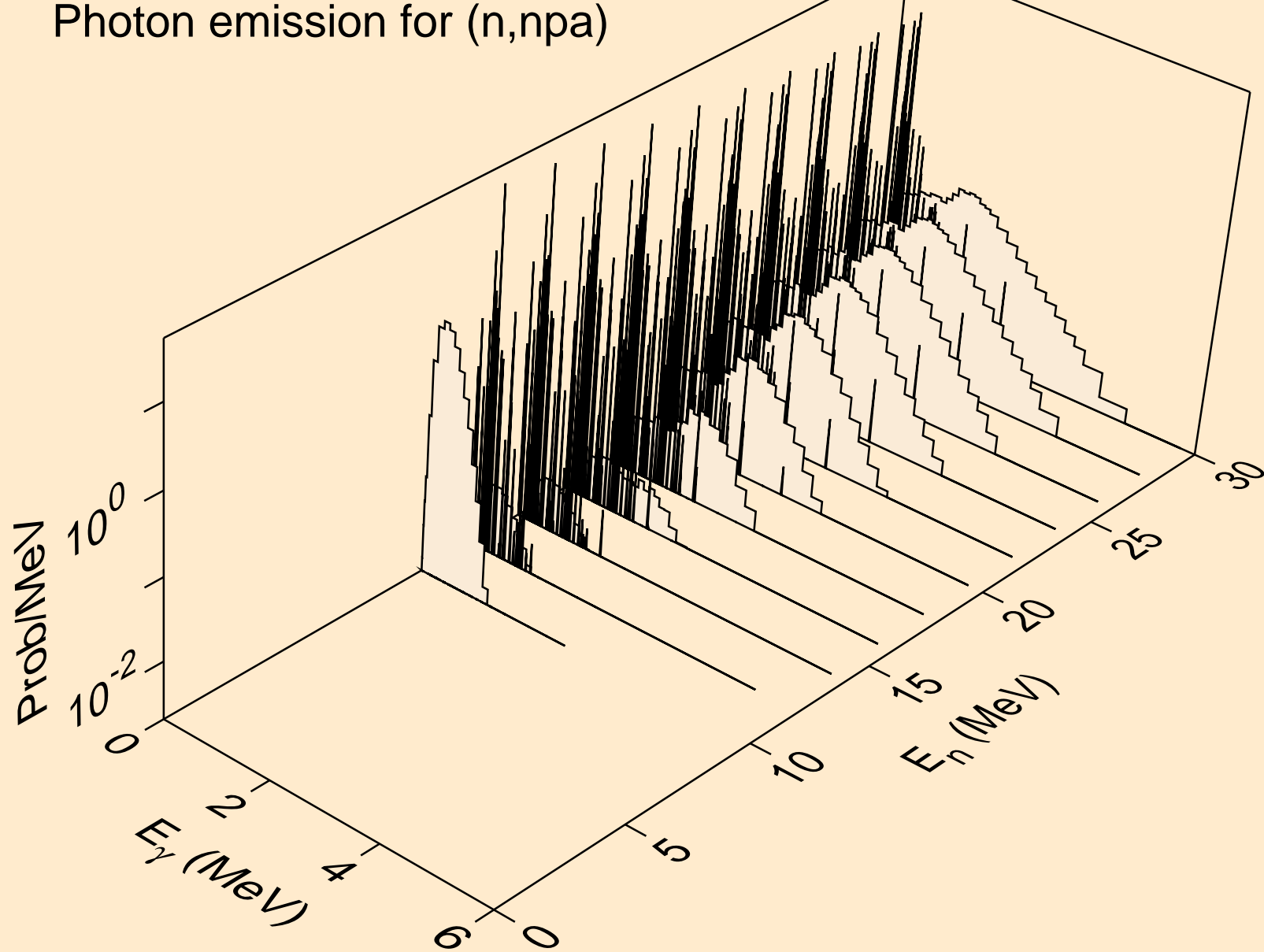

DY149 NEUTRON ACER TENDL-2024 LIBRARY; T=293.6K  
Photon emission for (n,n\*c)

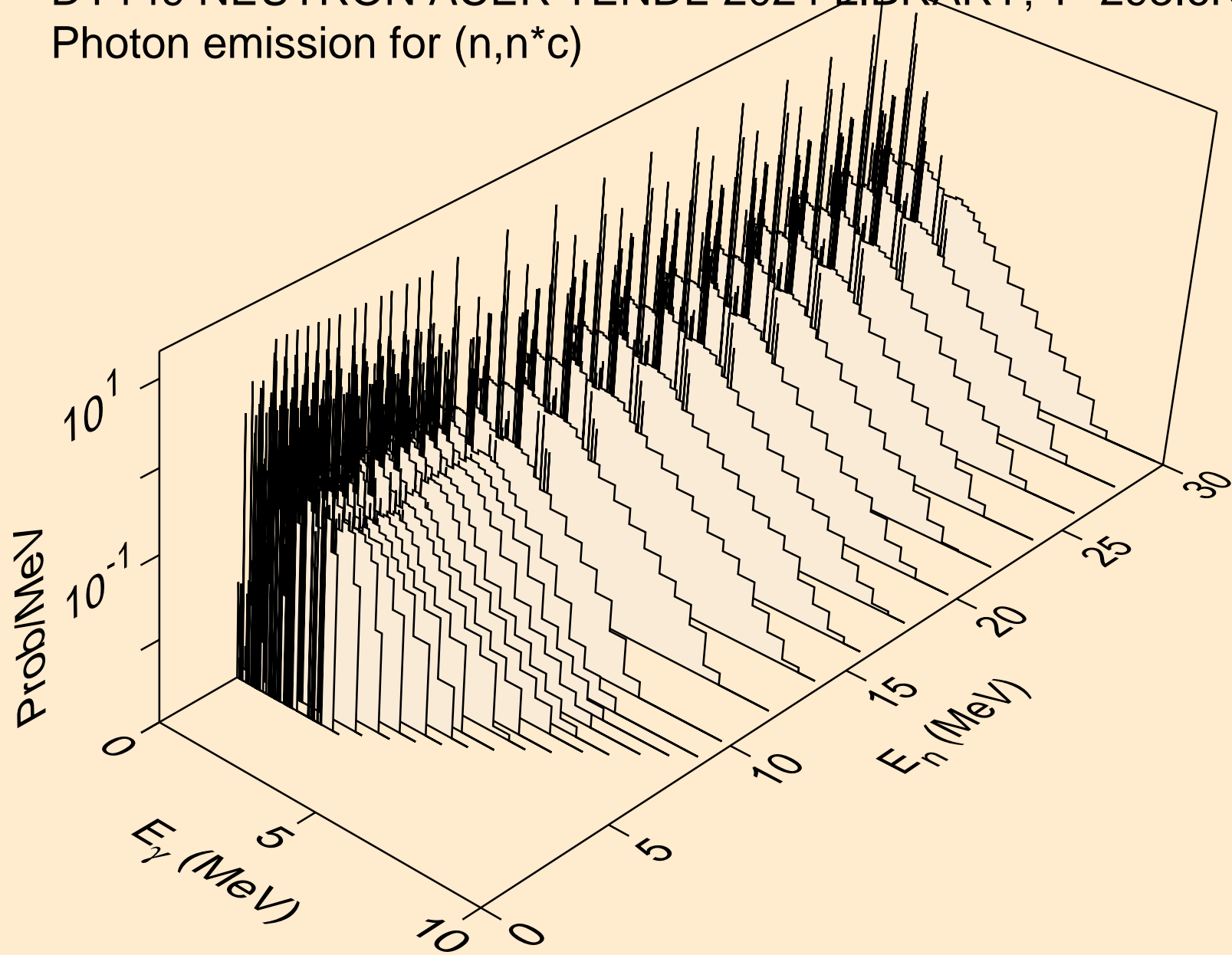

DY149 NEUTRON ACER TENDL-2024 LIBRARY; T=293.6K  
Photon emission for (n,gma)

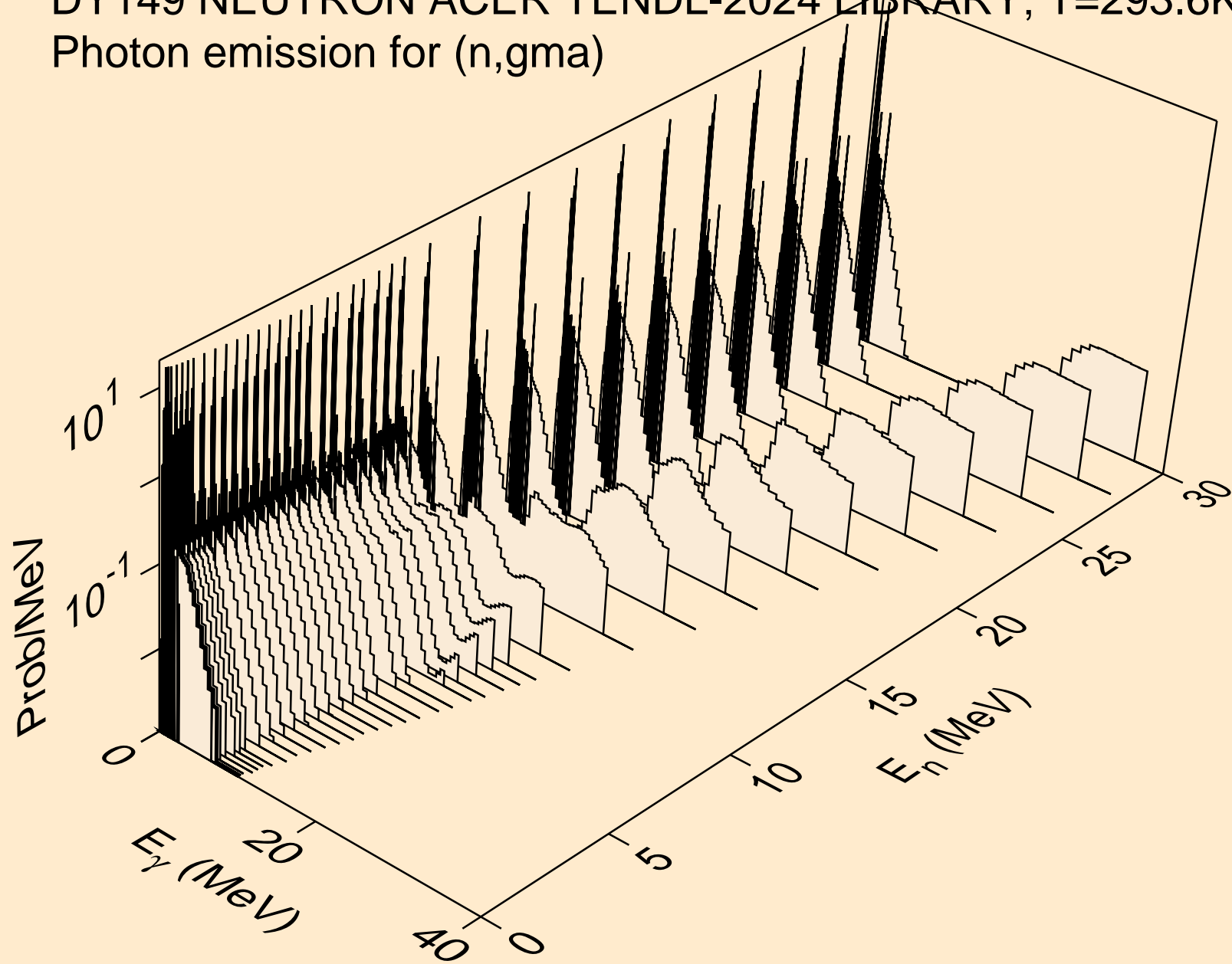

DY149 NEUTRON ACER TENDL-2024 LIBRARY; T=293.6K  
Photon emission for (n,p)

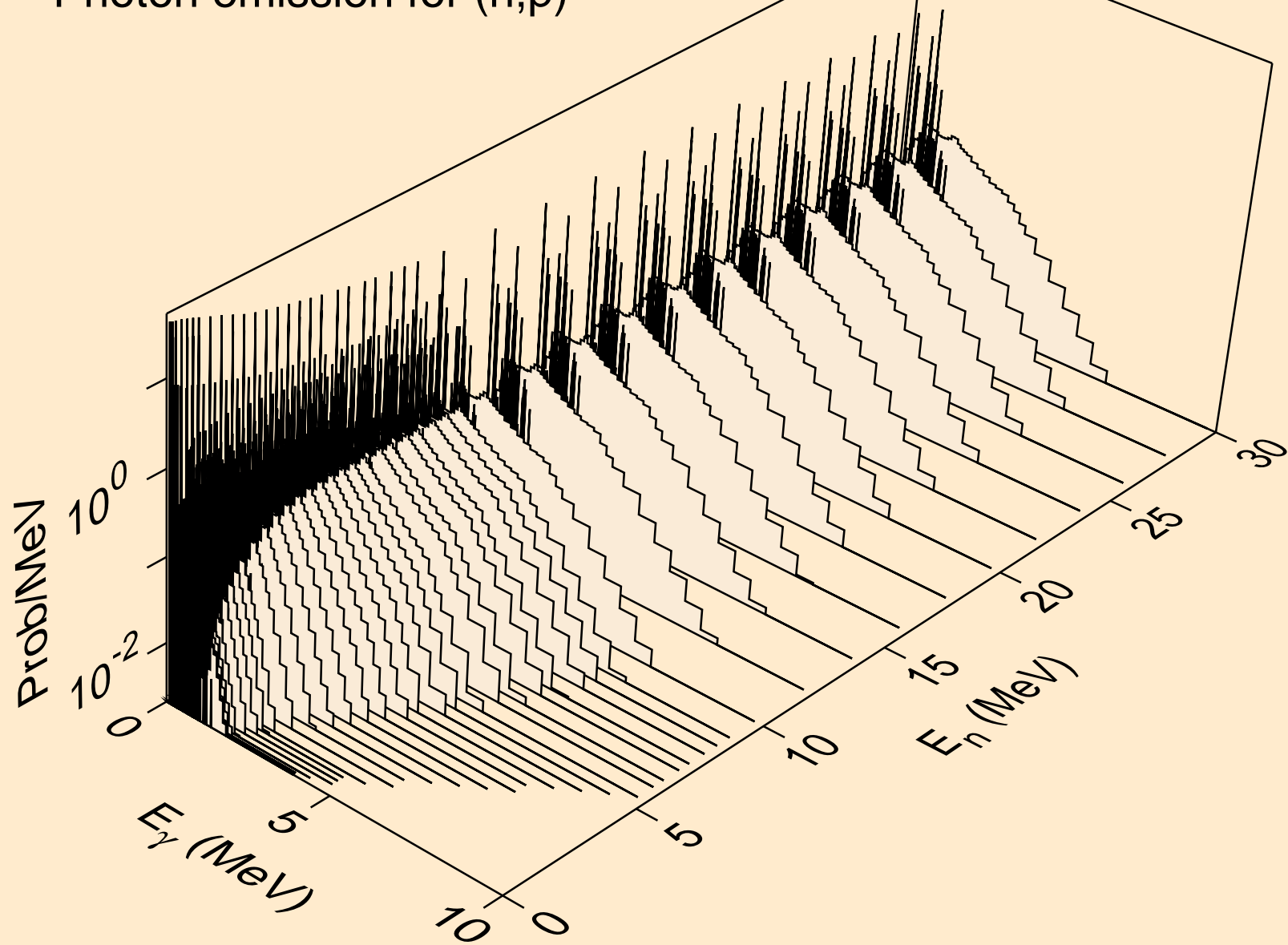

DY149 NEUTRON ACER TENDL-2024 LIBRARY; T=293.6K  
Photon emission for (n,d)

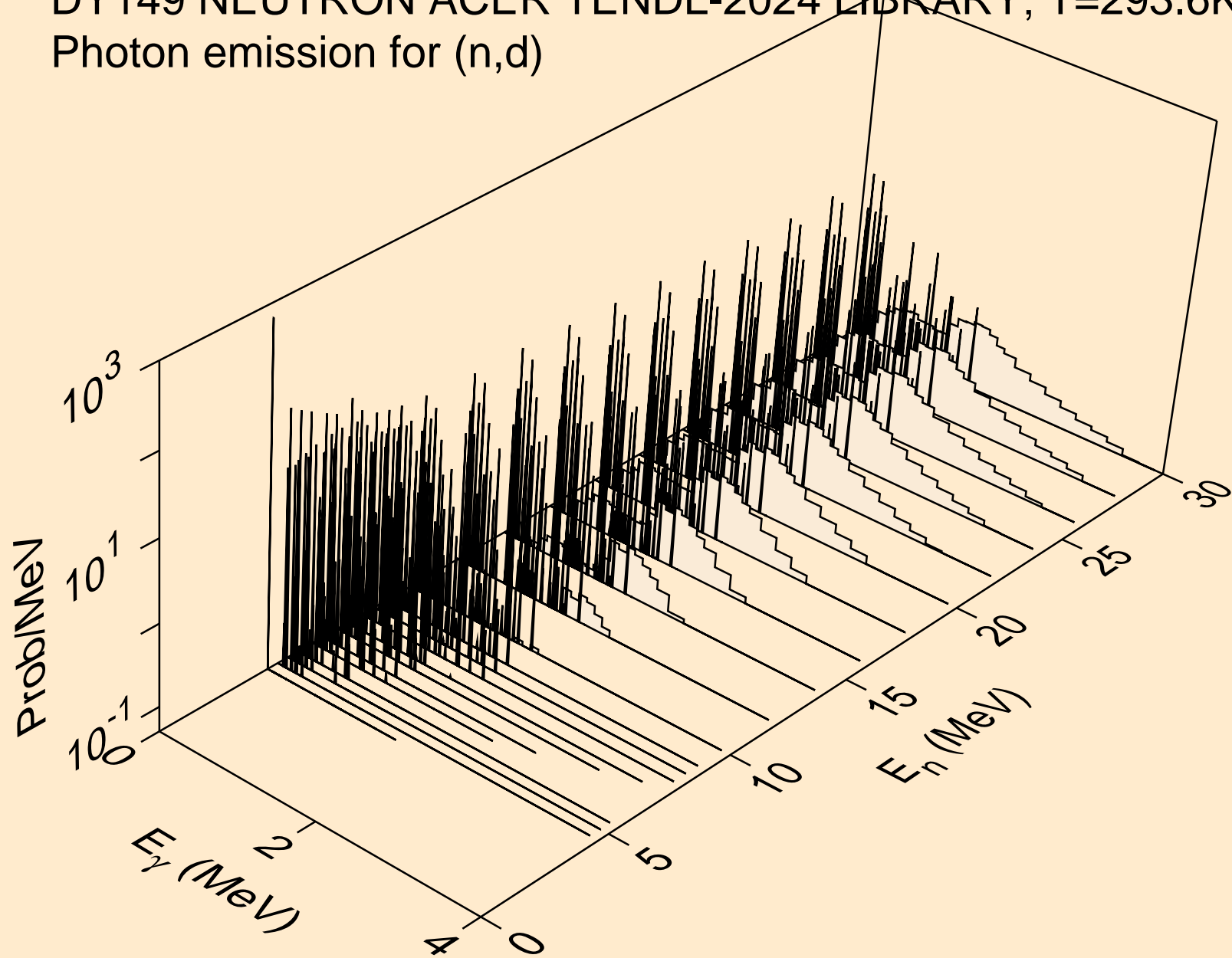

DY149 NEUTRON ACER TENDL-2024 LIBRARY; T=293.6K  
Photon emission for (n,t)

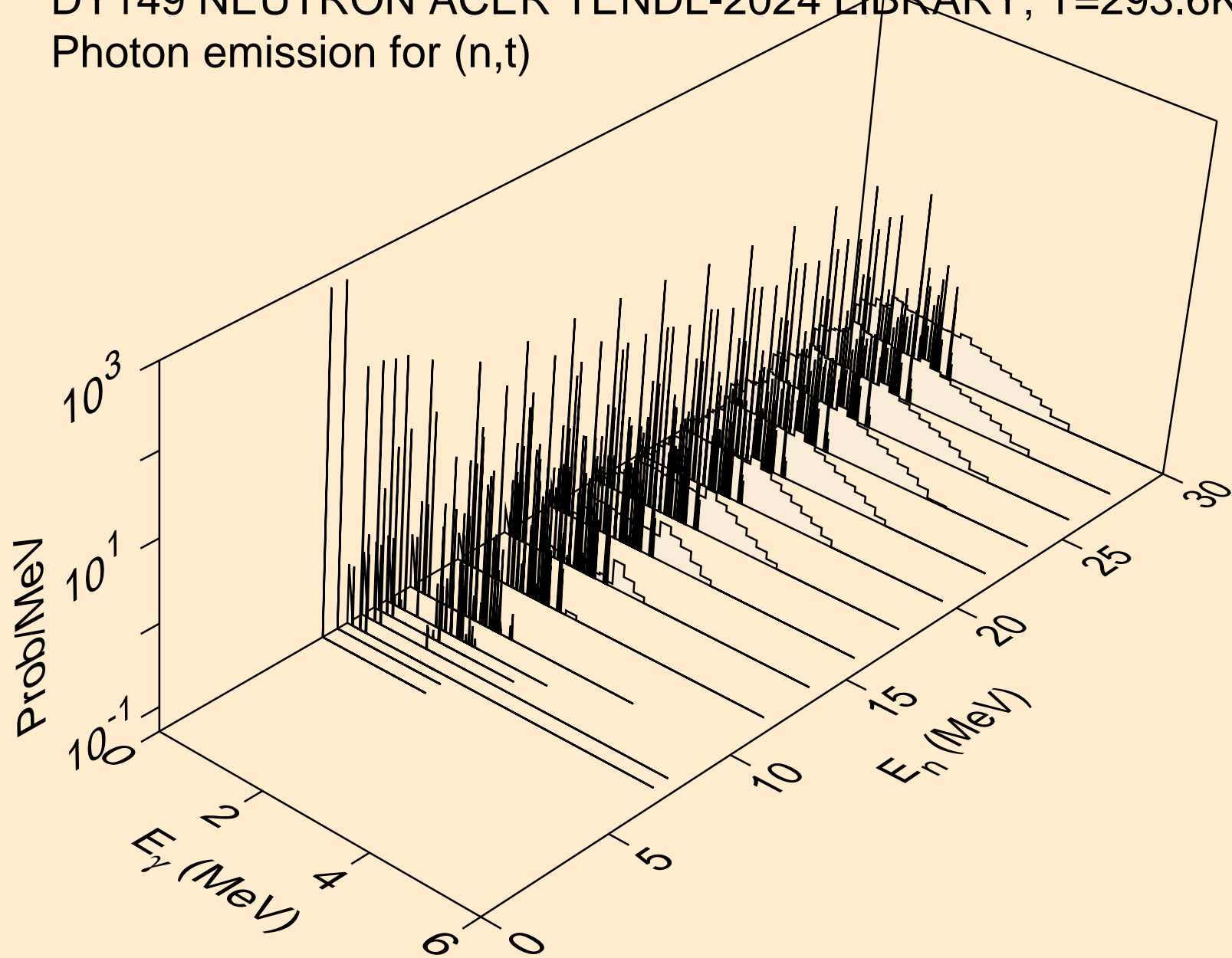

DY149 NEUTRON ACER TENDL-2024 LIBRARY; T=293.6K  
Photon emission for (n,he3)

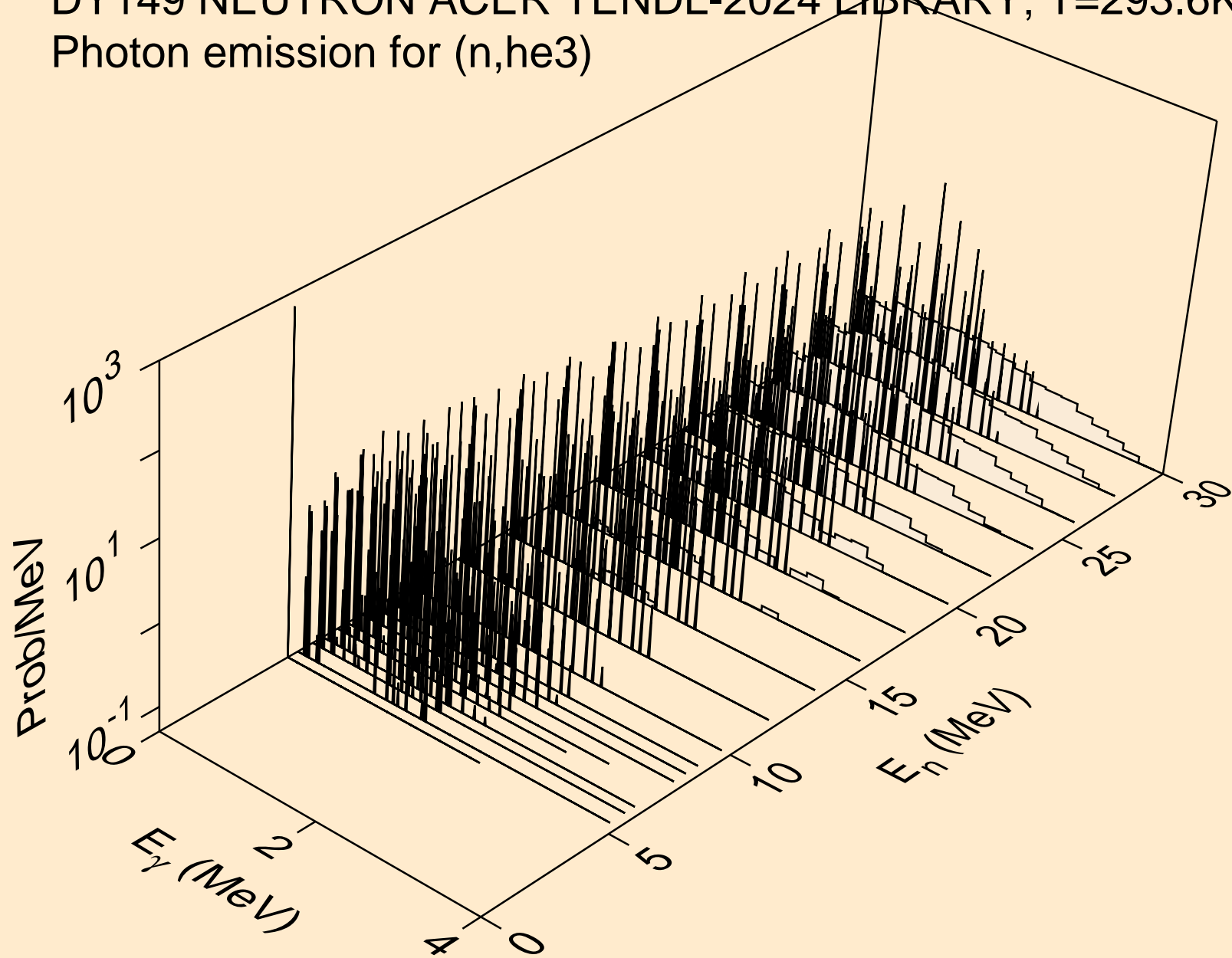

DY149 NEUTRON ACER TENDL-2024 LIBRARY; T=293.6K  
Photon emission for (n,a)

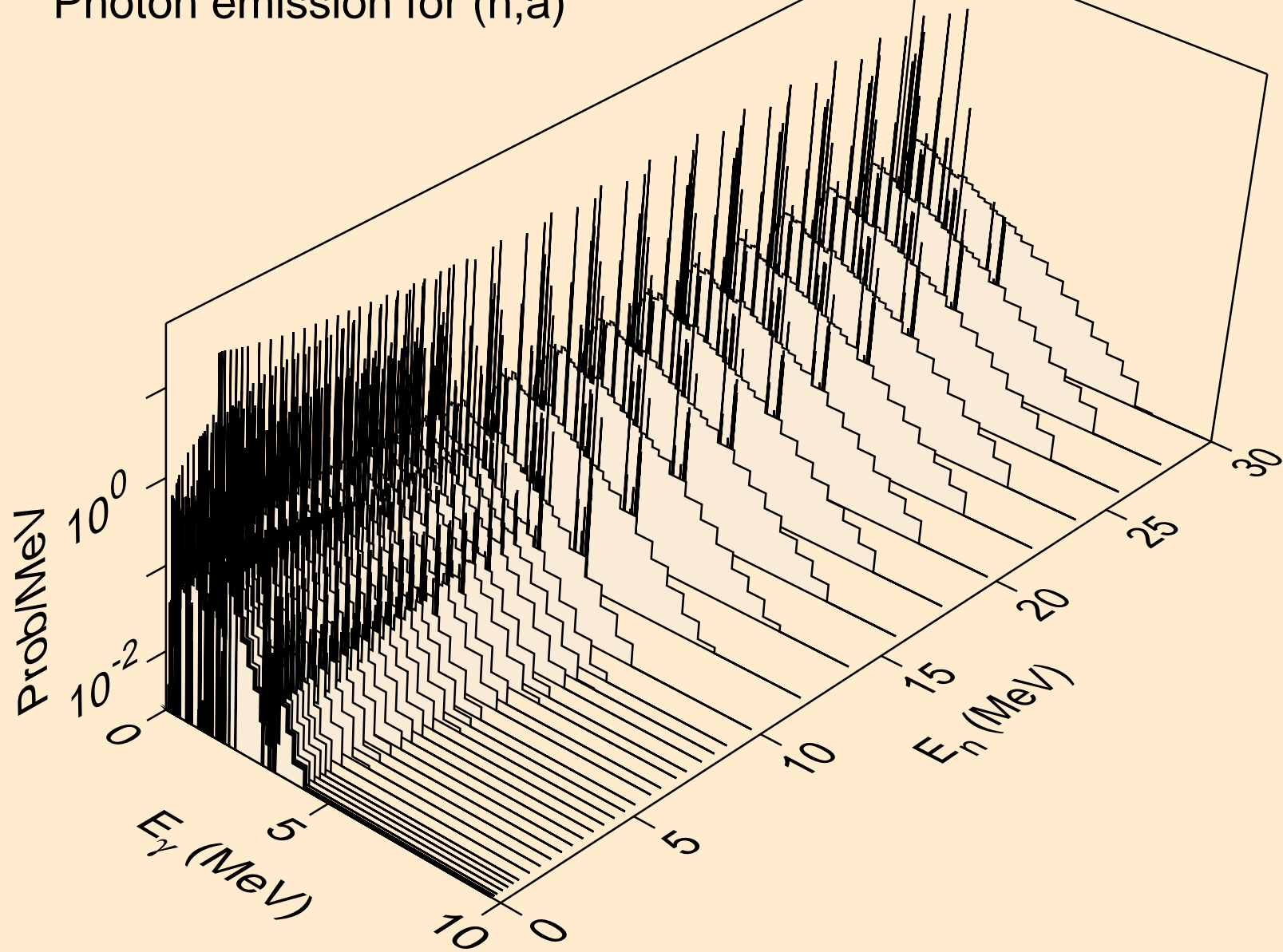

DY149 NEUTRON ACER TENDL-2024 LIBRARY; T=293.6K  
Photon emission for (n,2a)

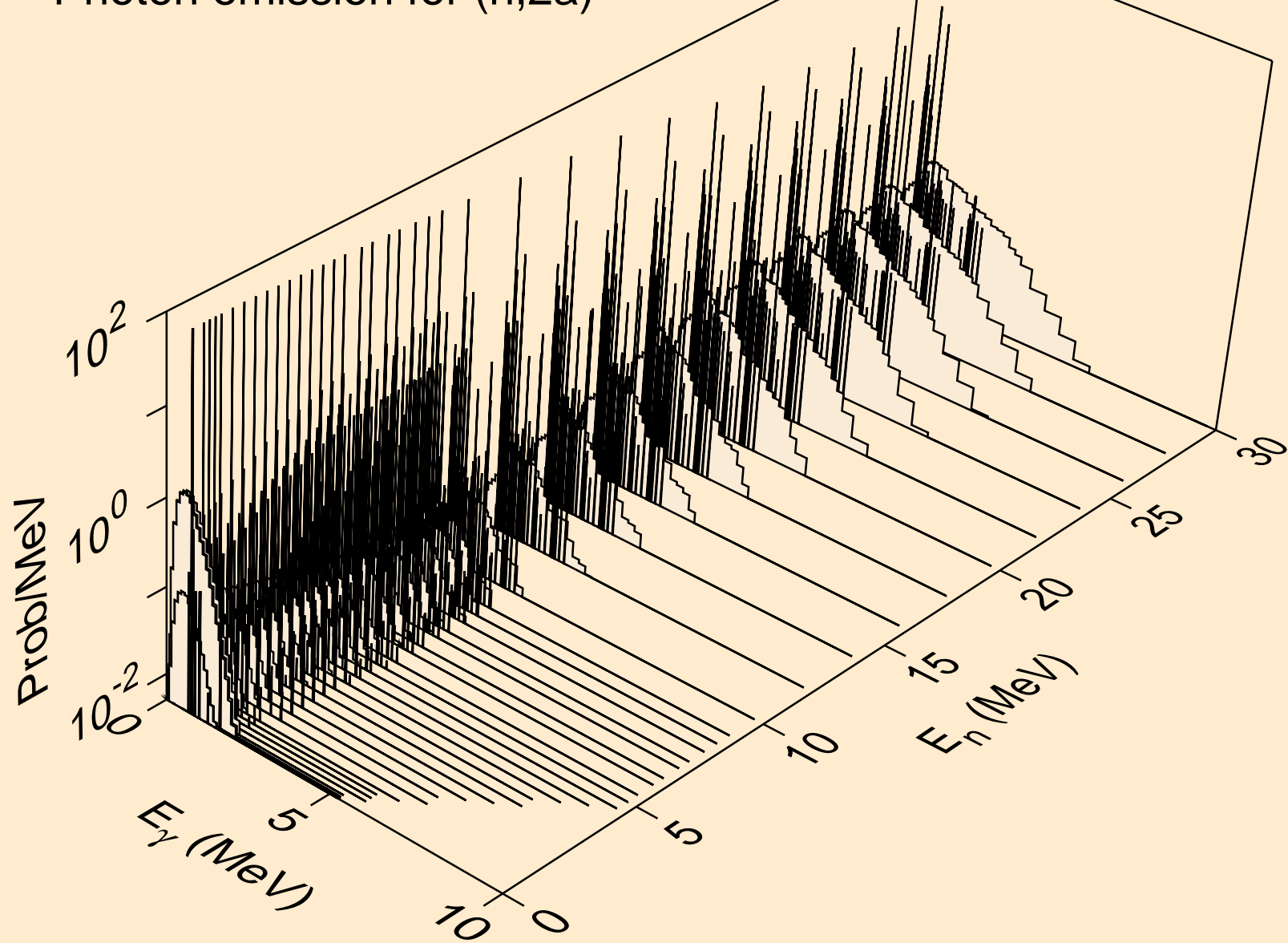

DY149 NEUTRON ACER TENDL-2024 LIBRARY; T=293.6K  
Photon emission for (n,2p)

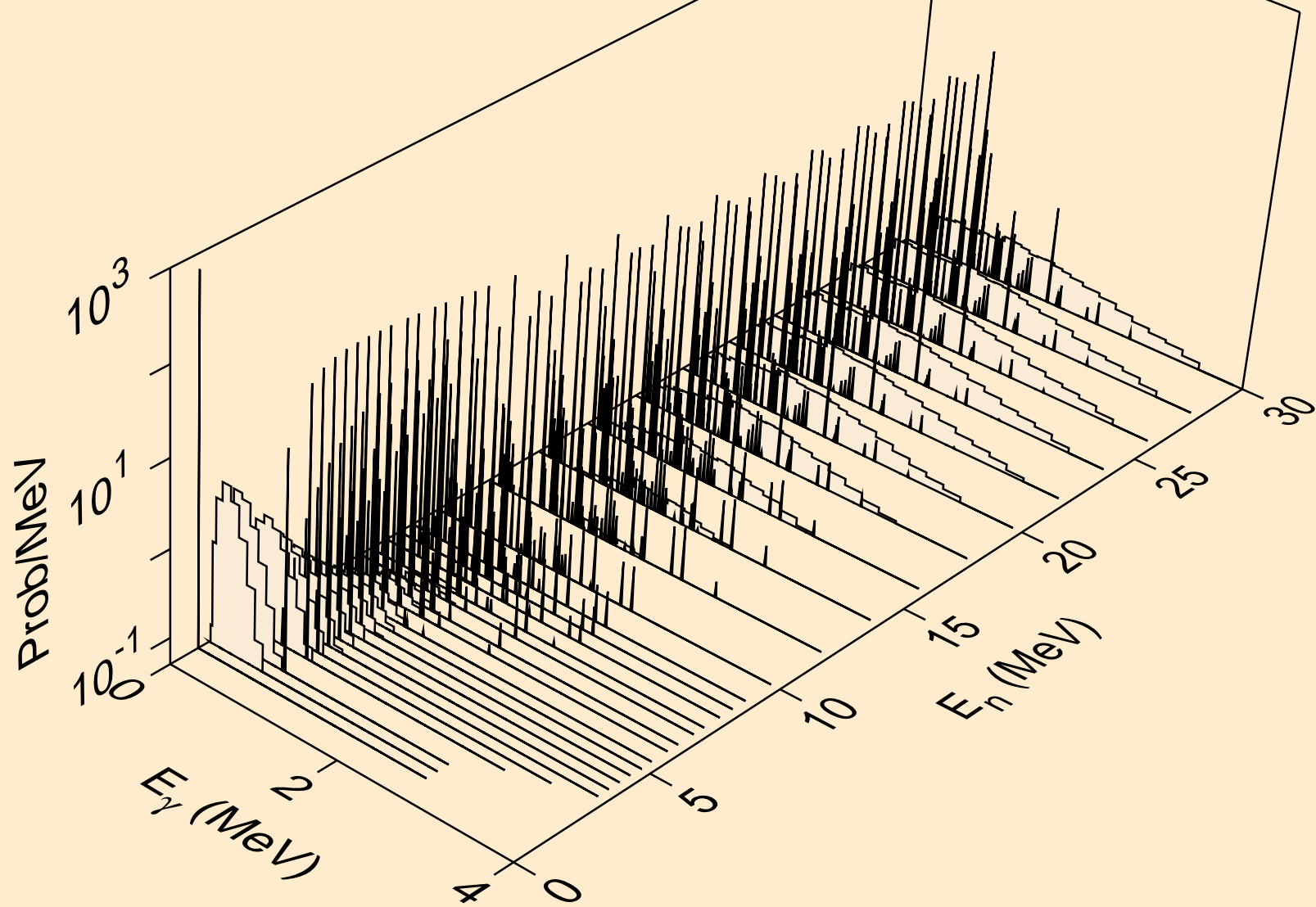

DY149 NEUTRON ACER TENDL-2024 LIBRARY; T=293.6K  
Photon emission for (n,p)

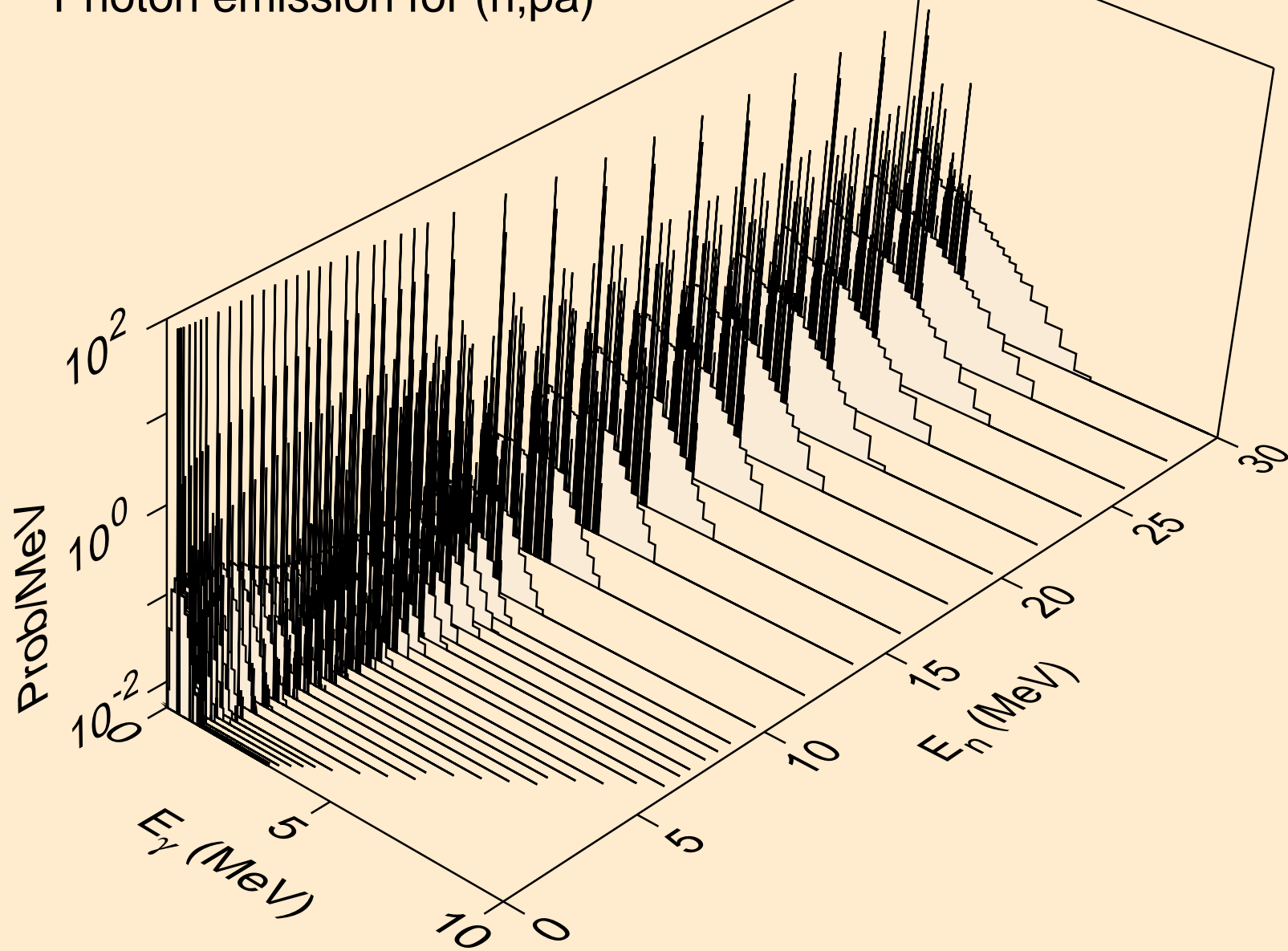

DY149 NEUTRON ACER TENDL-2024 LIBRARY; T=293.6K  
Photon emission for (n,pd)

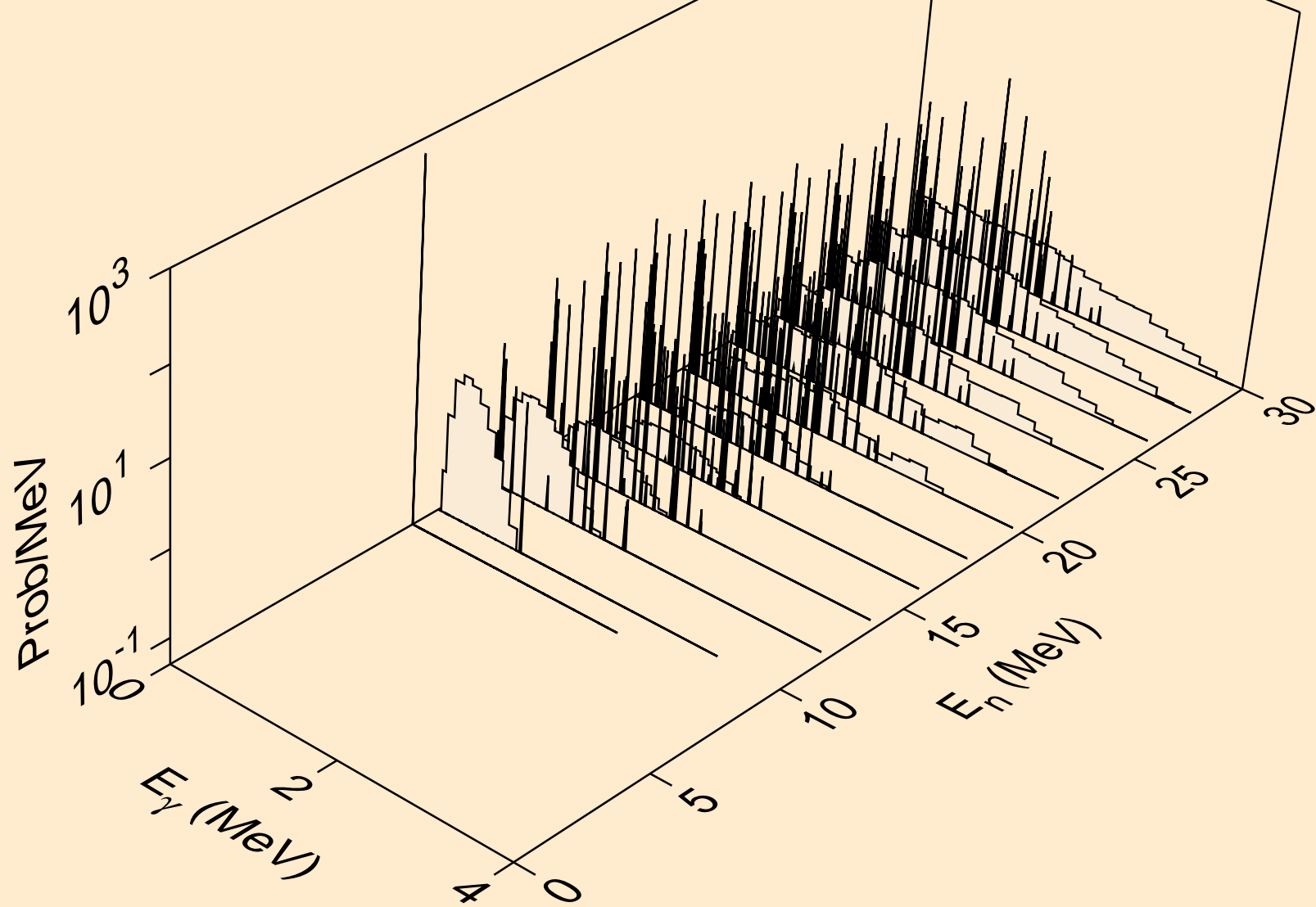

DY149 NEUTRON ACER TENDL-2024 LIBRARY; T=293.6K  
Photon emission for (n,pt)

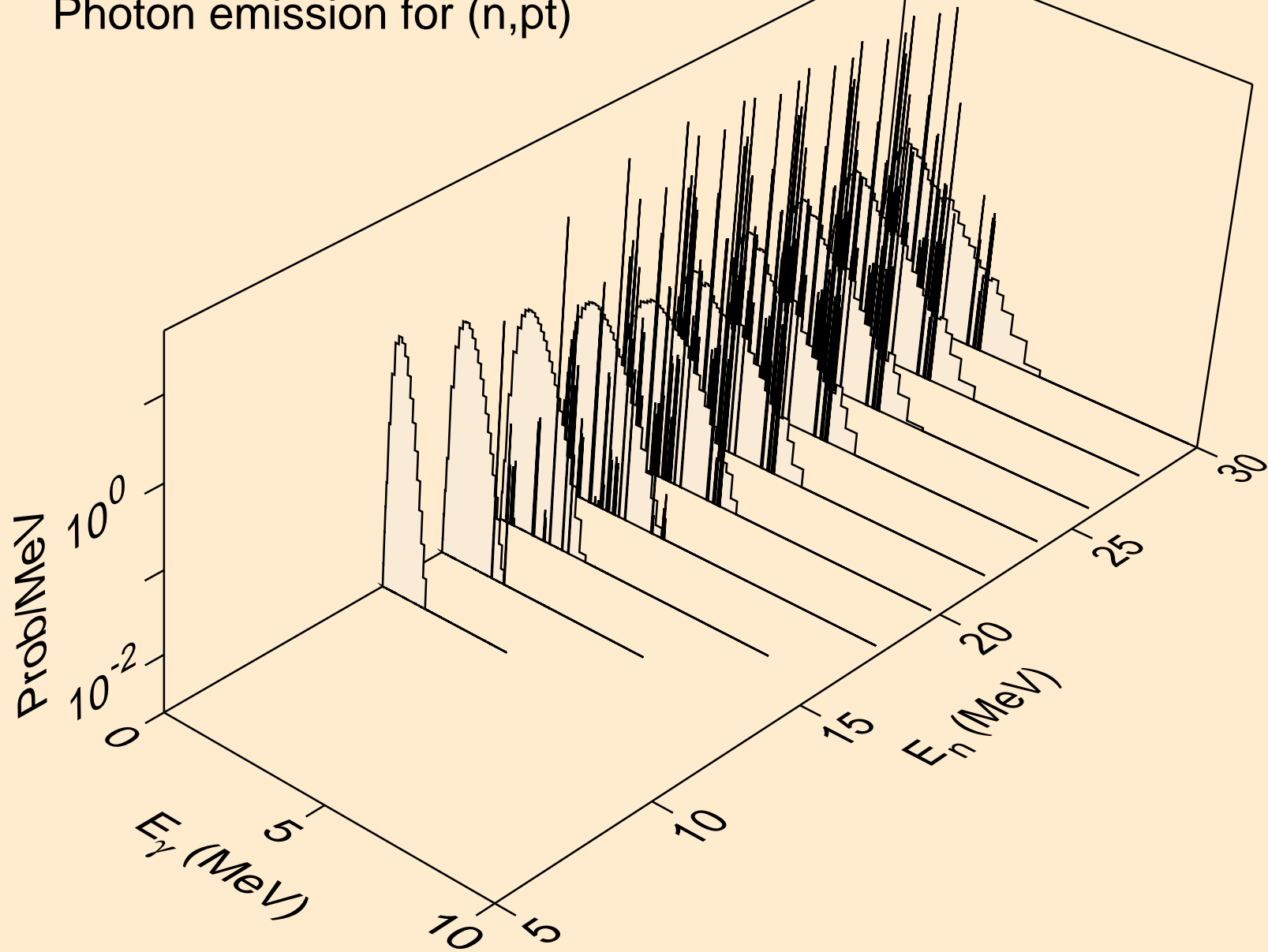

DY149 NEUTRON ACER TENDL-2024 LIBRARY; T=293.6K  
Photon emission for (n,da)

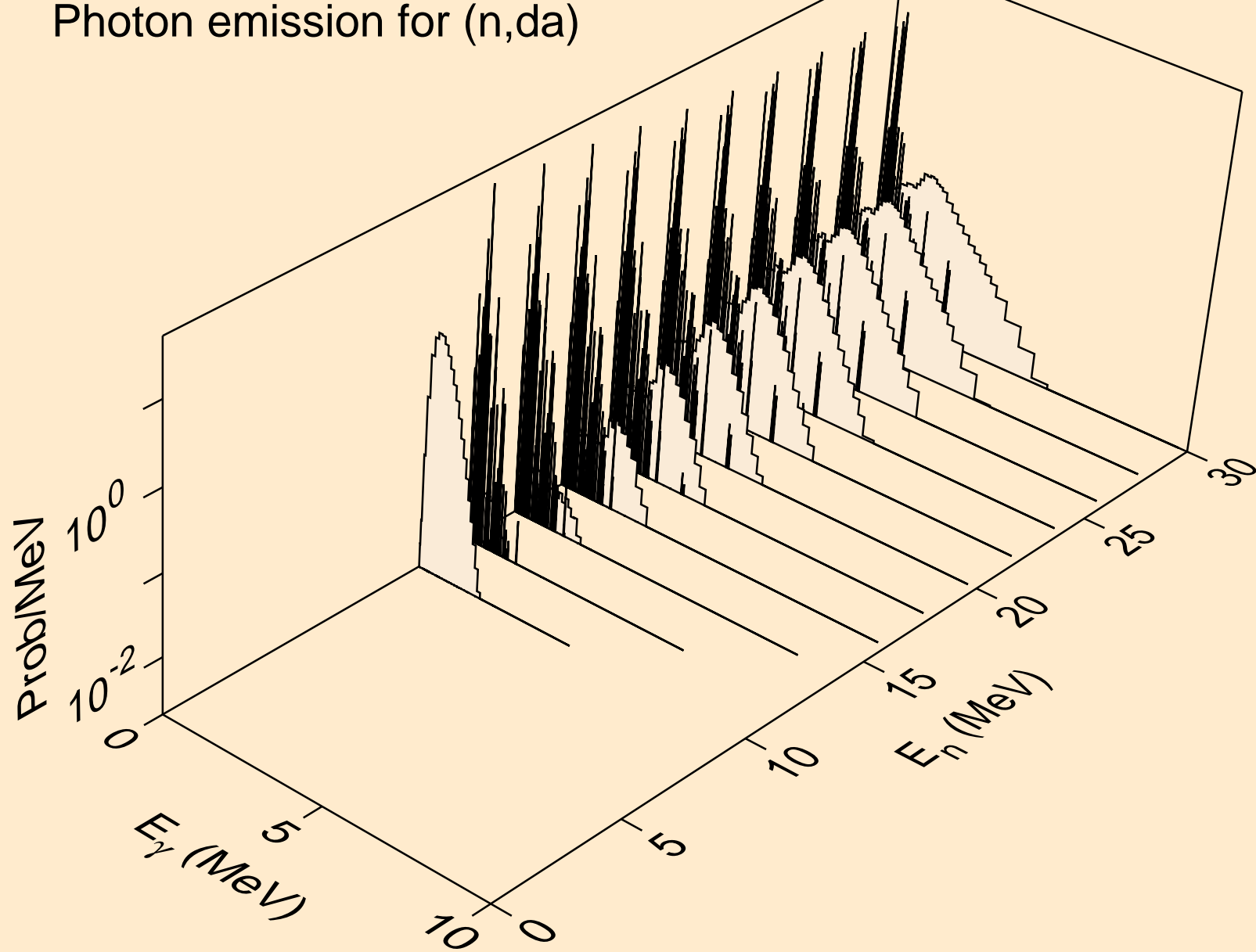

DY149 NEUTRON ACER TENDL-2024 LIBRARY; T=293.6K  
thermal capture photon spectrum

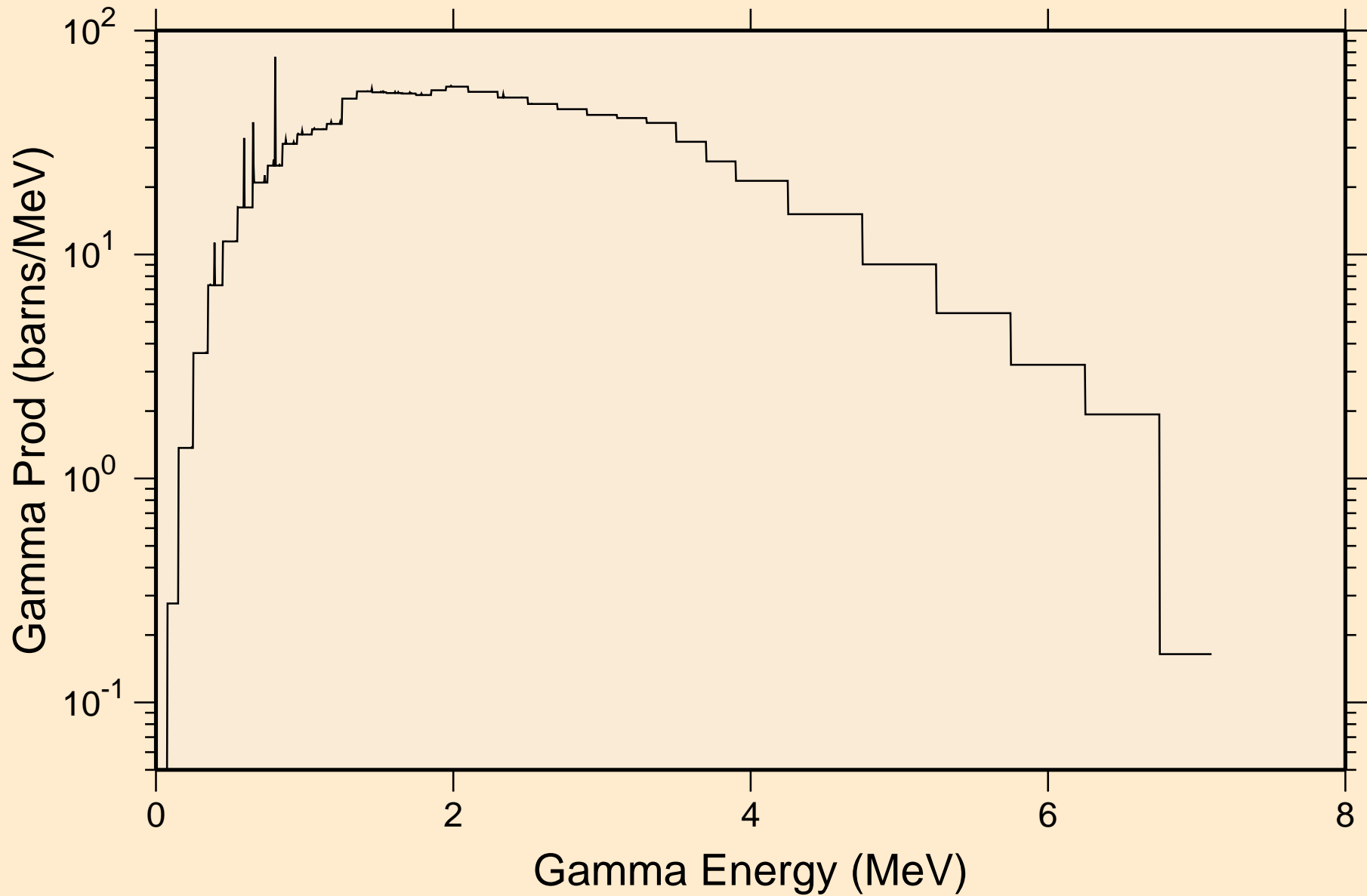

DY149 NEUTRON ACER TENDL-2024 LIBRARY; T=293.6K  
14 MeV photon spectrum

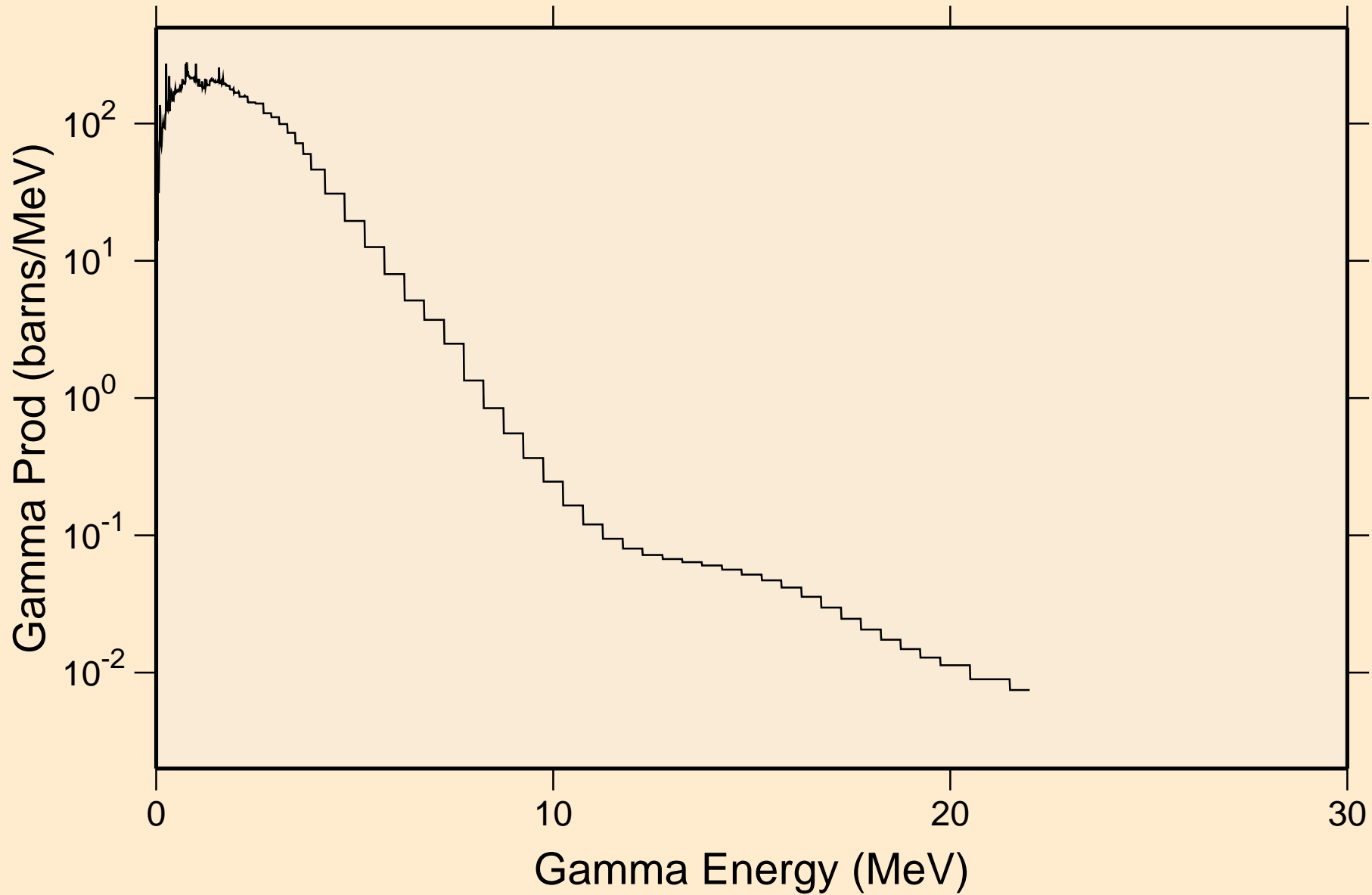

DY149 NEUTRON ACER TENDL-2024 LIBRARY; T=293.6K  
Particle heating contributions

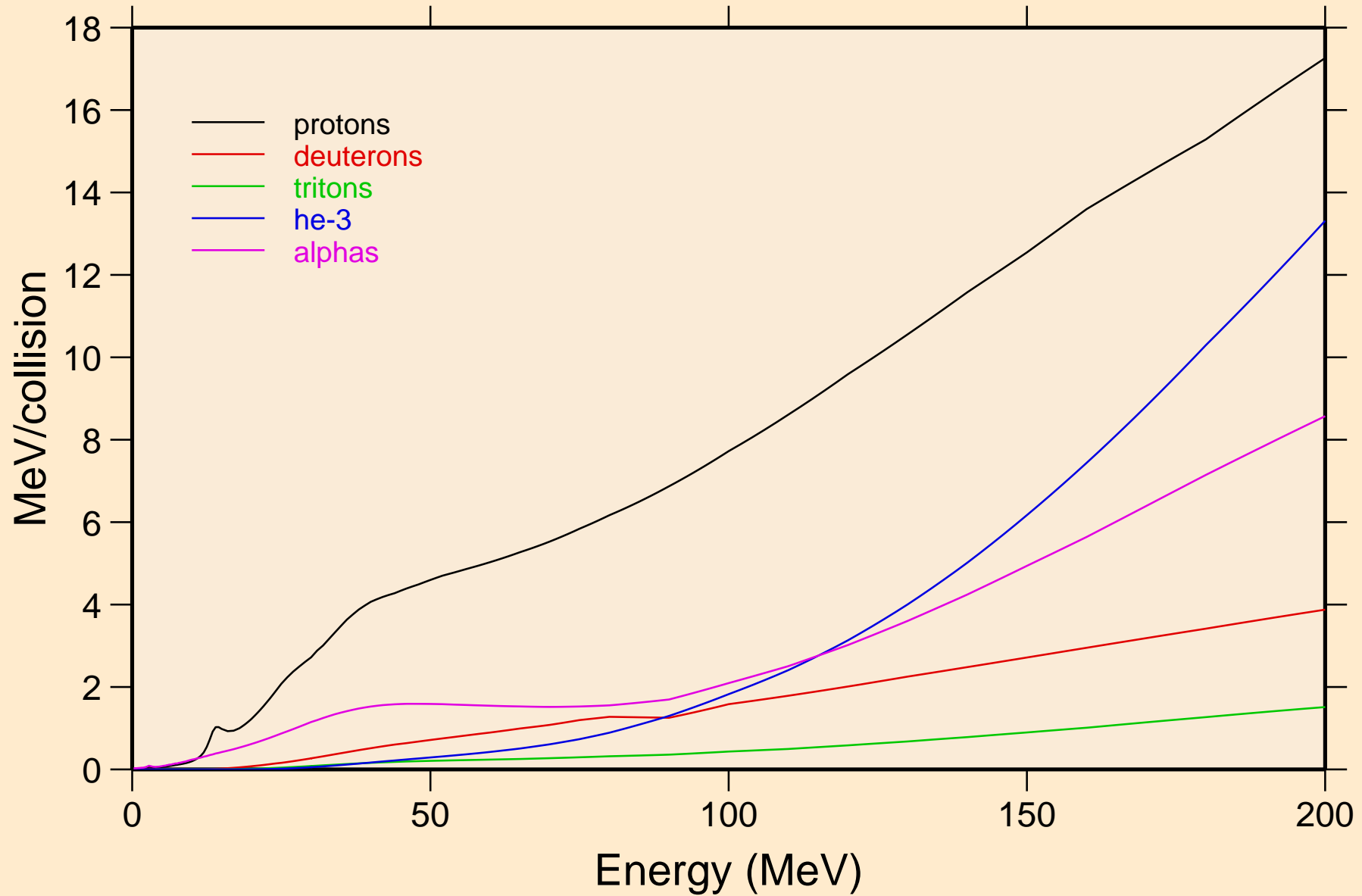

DY149 NEUTRON ACER TENDL-2024 LIBRARY; T=293.6K  
Recoil Heating

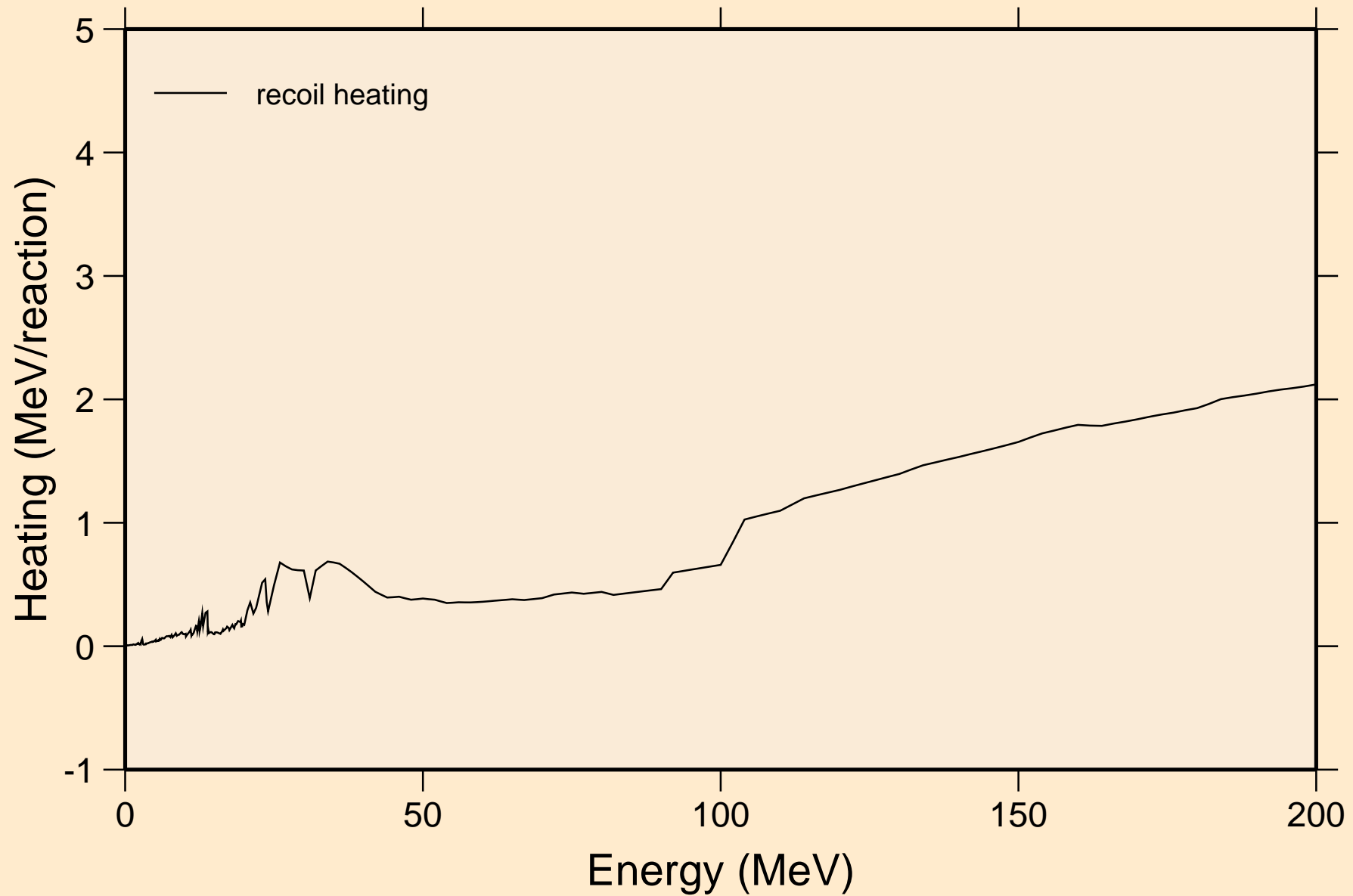

DY149 NEUTRON ACER TENDL-2024 LIBRARY; T=293.6K  
Particle production cross sections

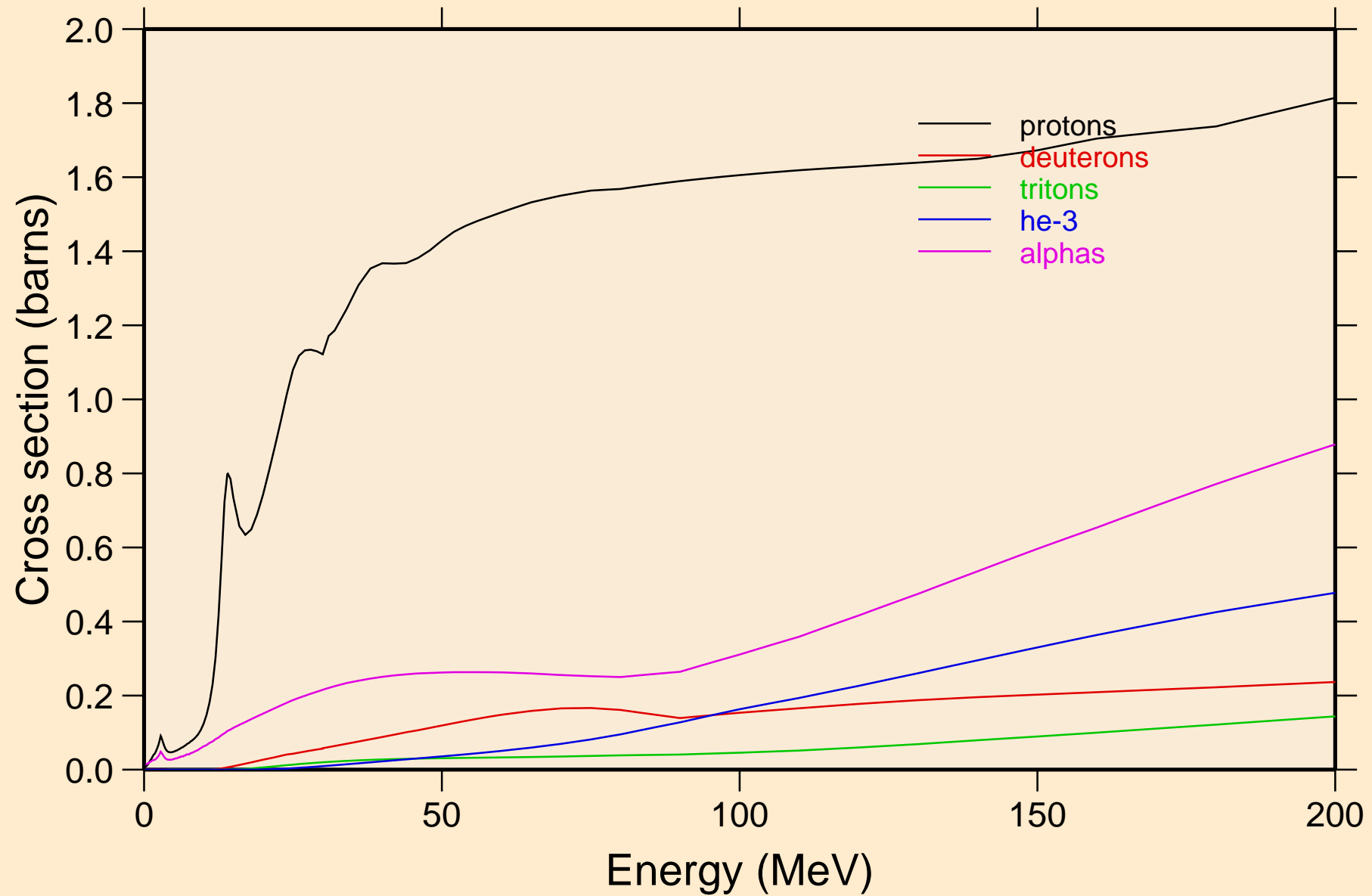

DY149 NEUTRON ACER TENDL-2024 LIBRARY; T=293.6K  
protons from (n,x)

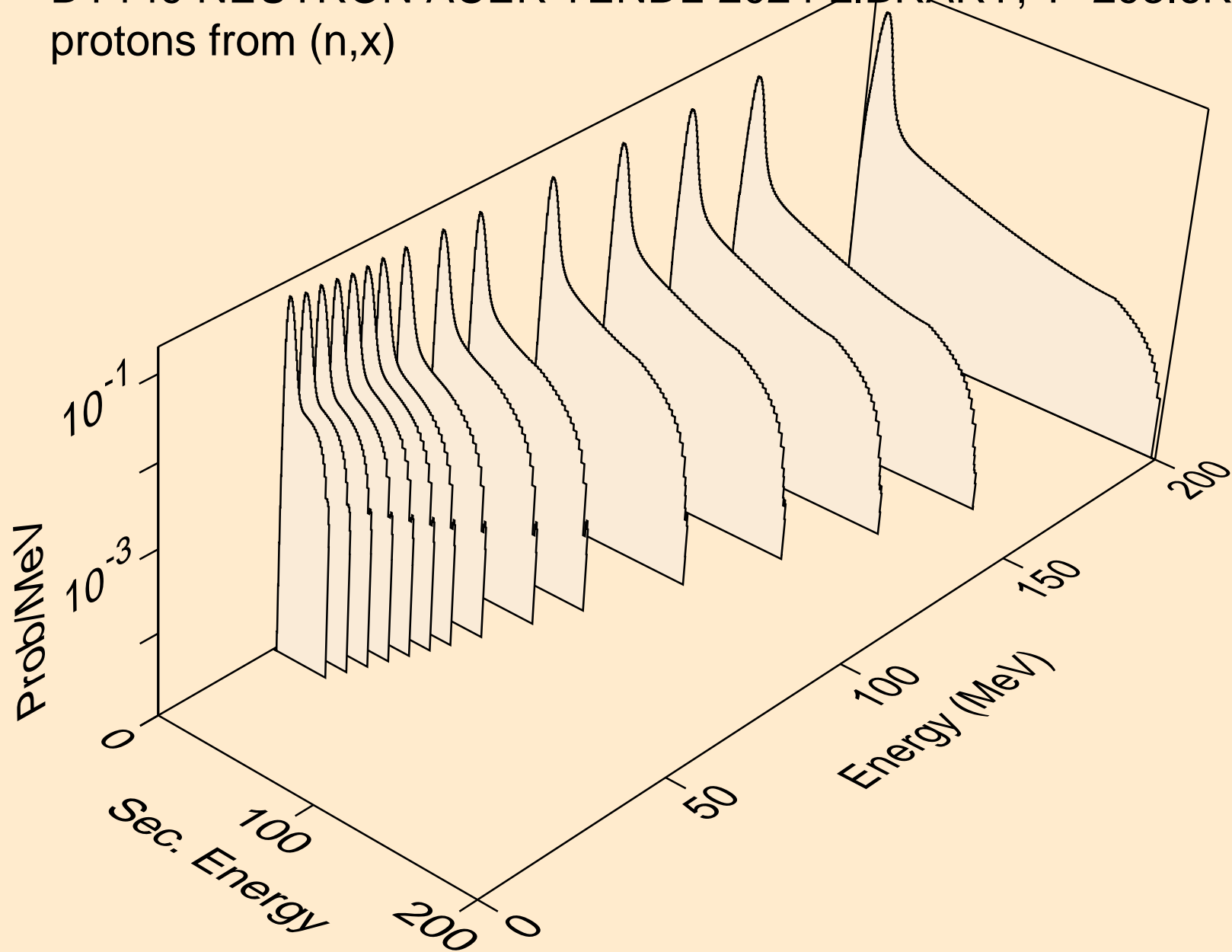

DY149 NEUTRON ACER TENDL-2024 LIBRARY; T=293.6K  
protons from (n,n\*)p

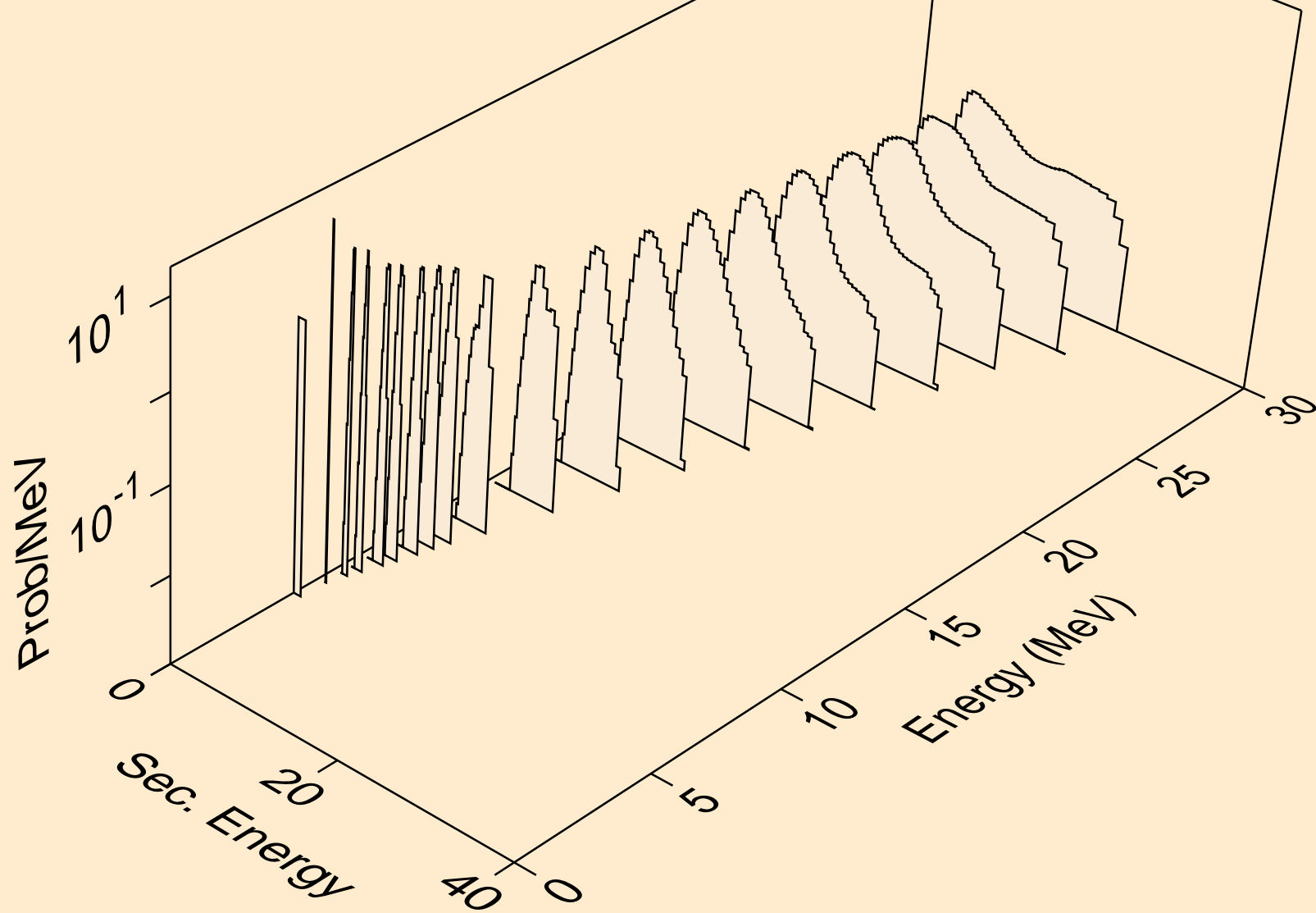

DY149 NEUTRON ACER TENDL-2024 LIBRARY; T=293.6K  
protons from (n,2np)

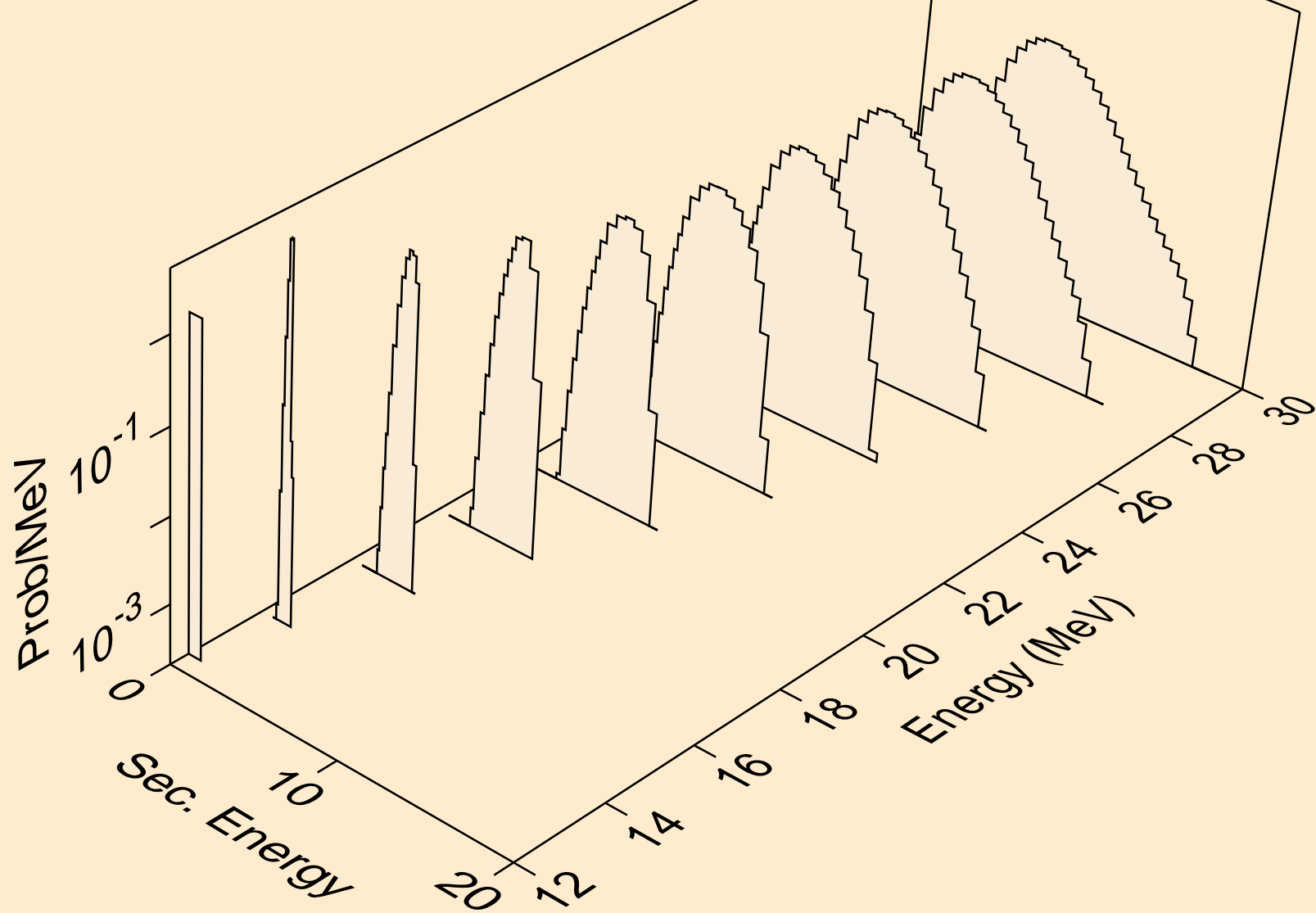

DY149 NEUTRON ACER TENDL-2024 LIBRARY; T=293.6K  
protons from (n,3np)

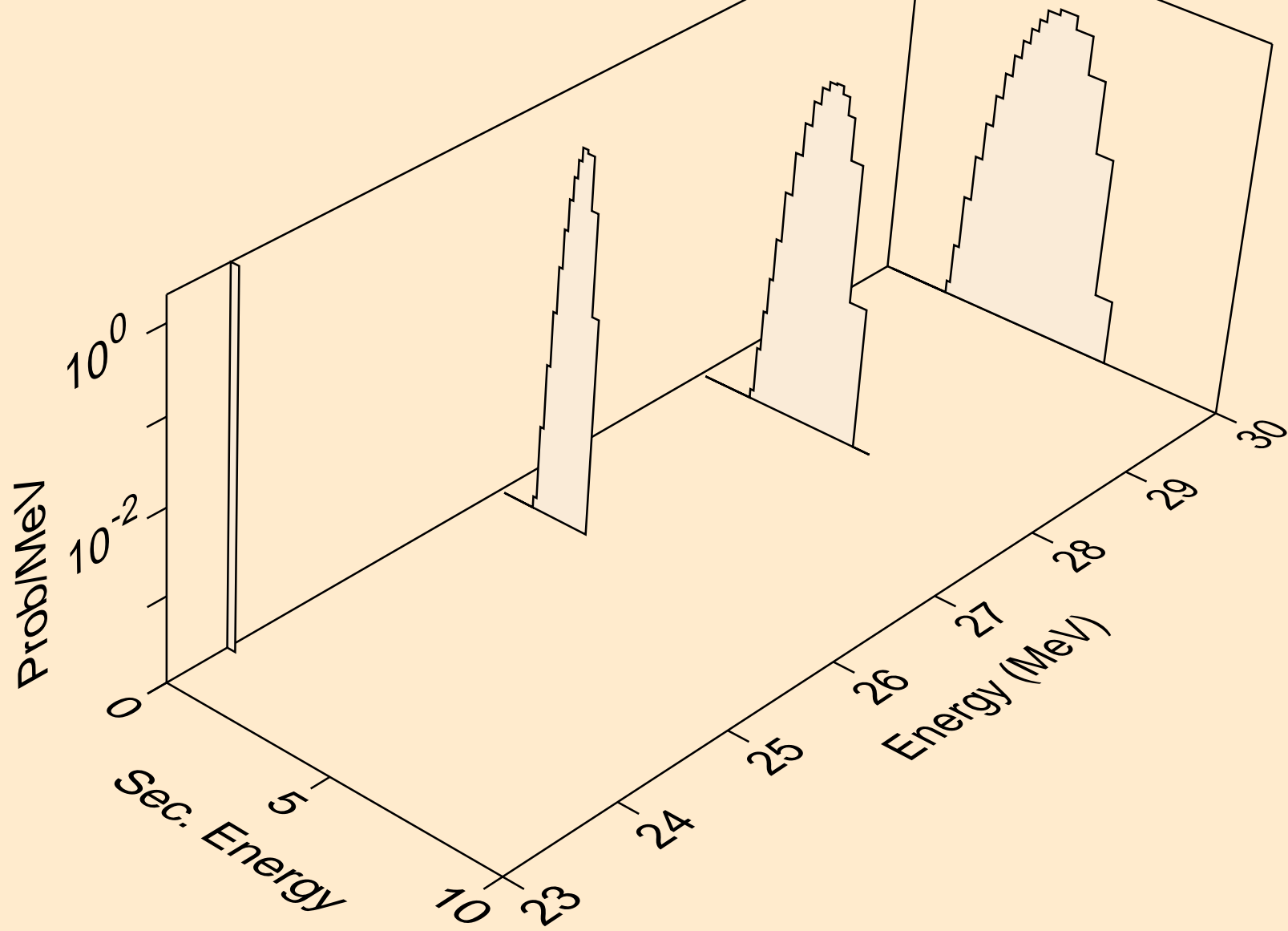

DY149 NEUTRON ACER TENDL-2024 LIBRARY; T=293.6K  
protons from (n,n2p)

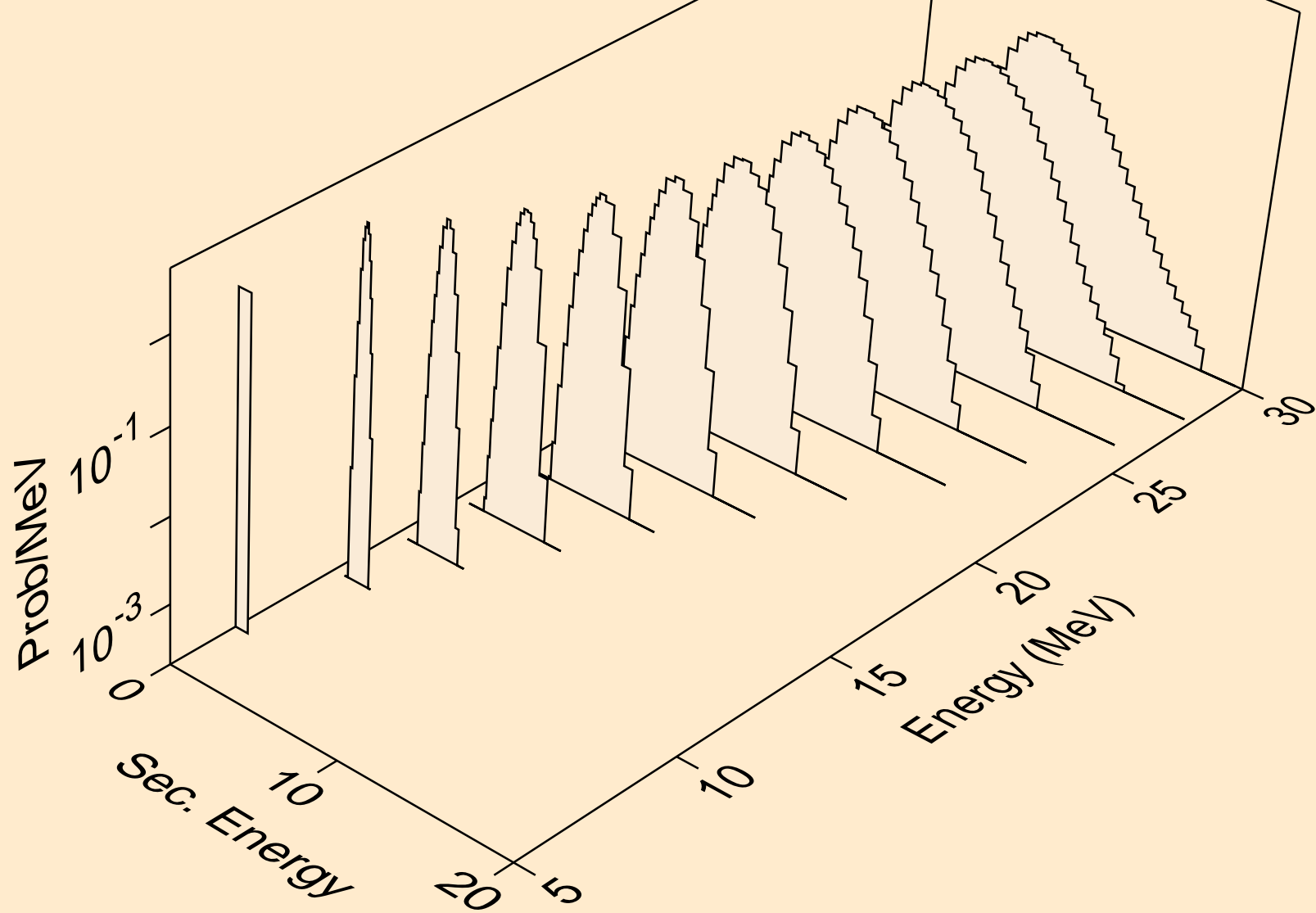

DY149 NEUTRON ACER TENDL-2024 LIBRARY; T=293.6K  
protons from (n,npa)

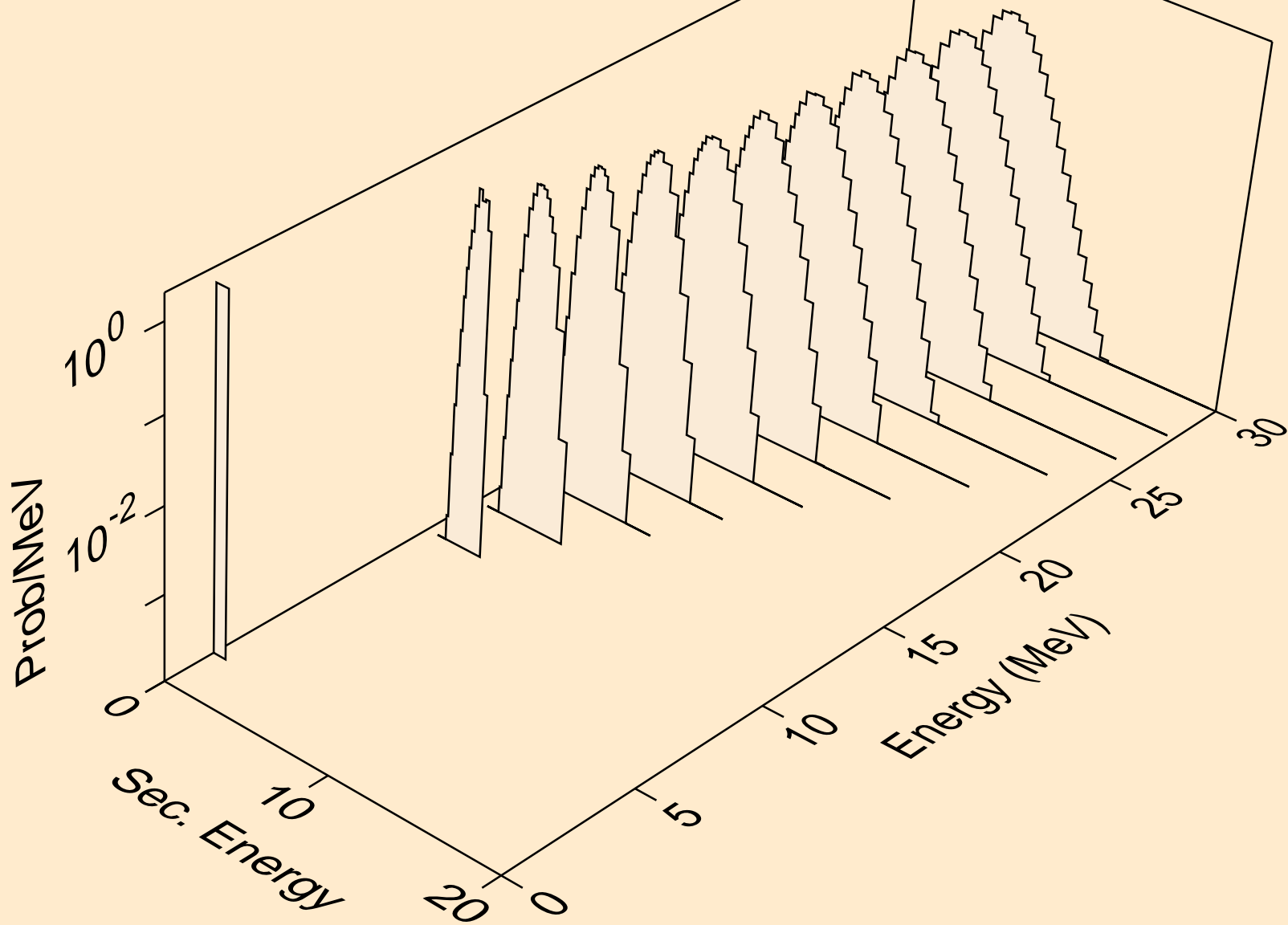

DY149 NEUTRON ACER TENDL-2024 LIBRARY; T=293.6K  
protons from (n,p)

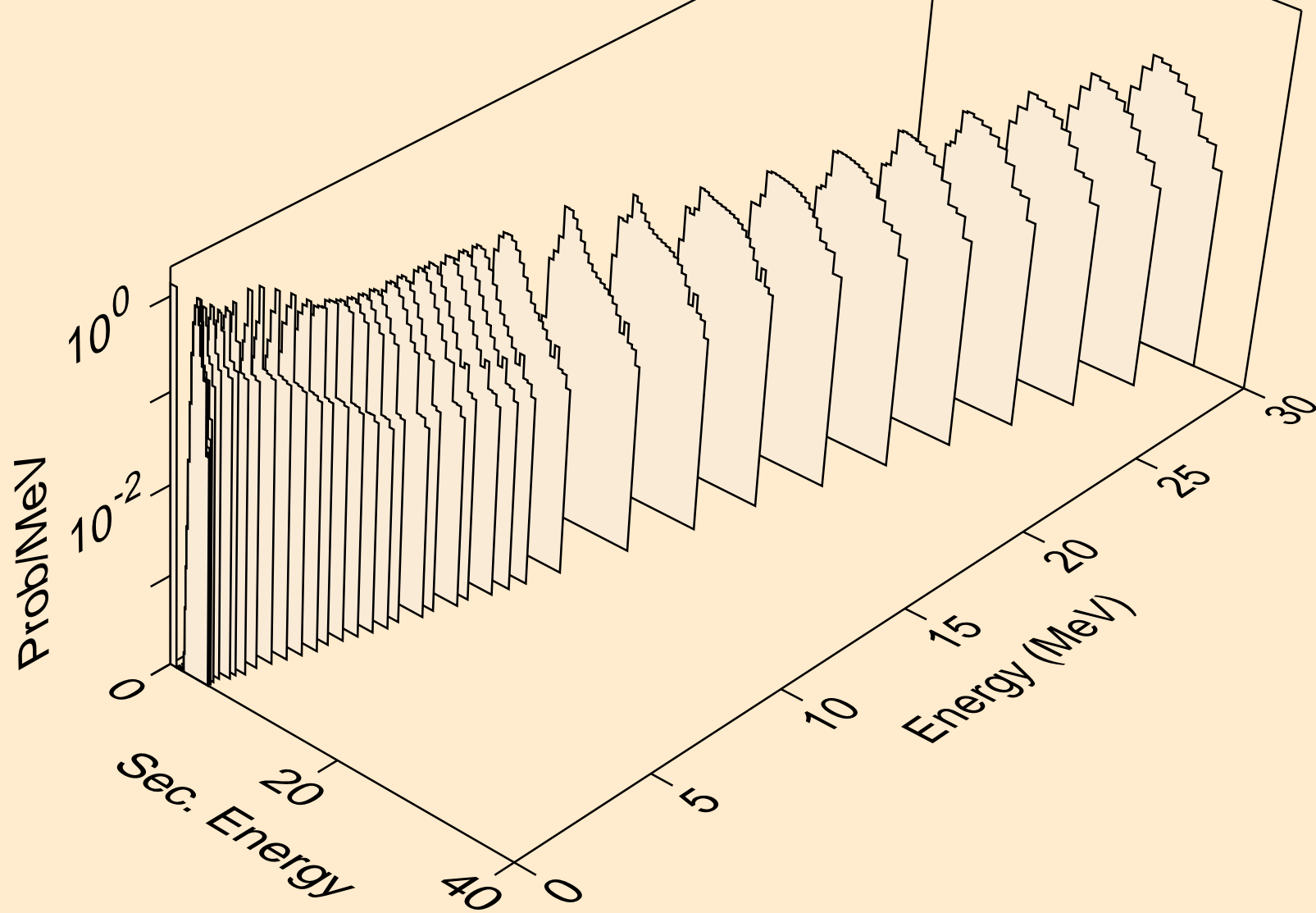

DY149 NEUTRON ACER TENDL-2024 LIBRARY; T=293.6K  
protons from (n,2p)

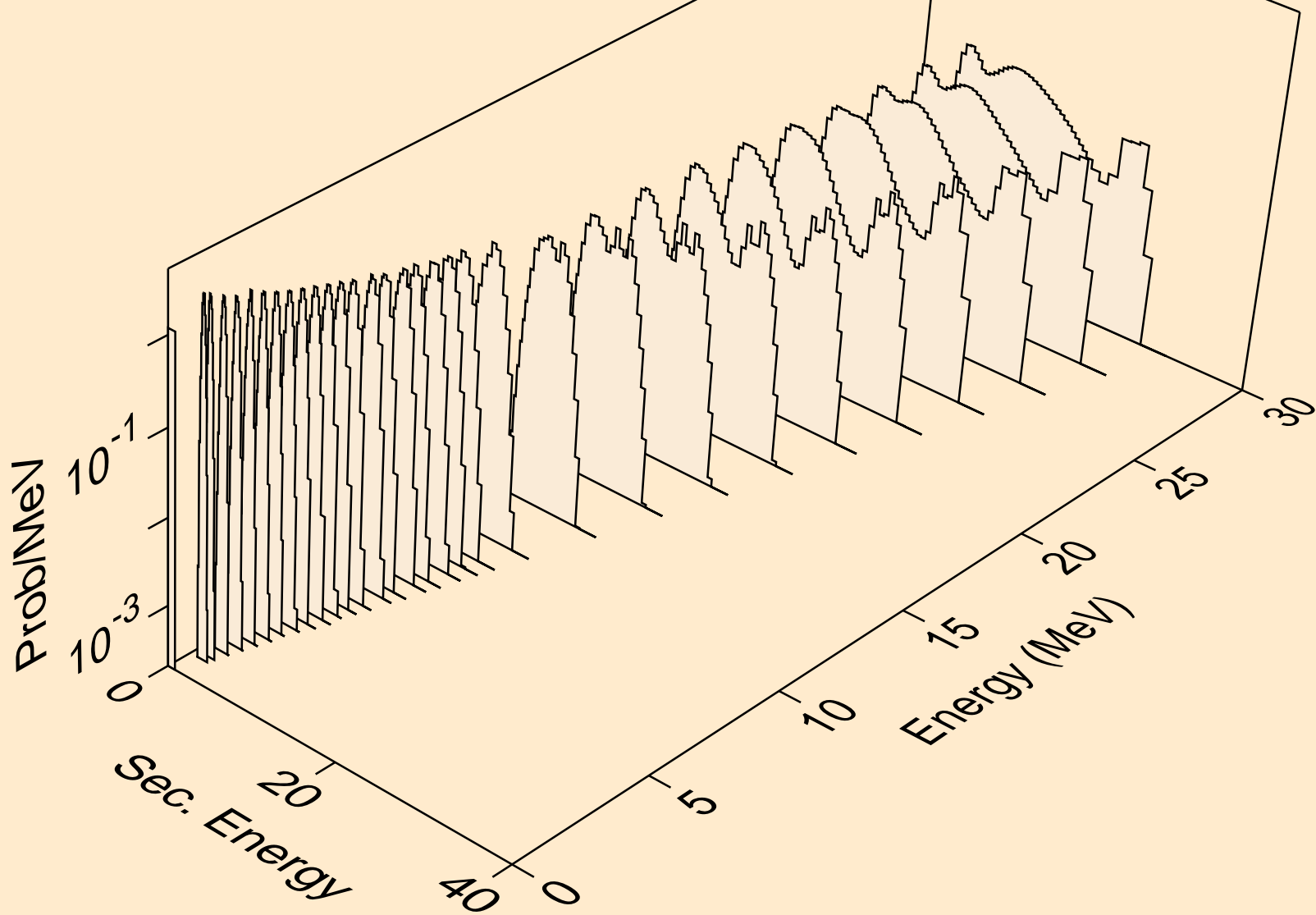

DY149 NEUTRON ACER TENDL-2024 LIBRARY; T=293.6K  
protons from (n,p)

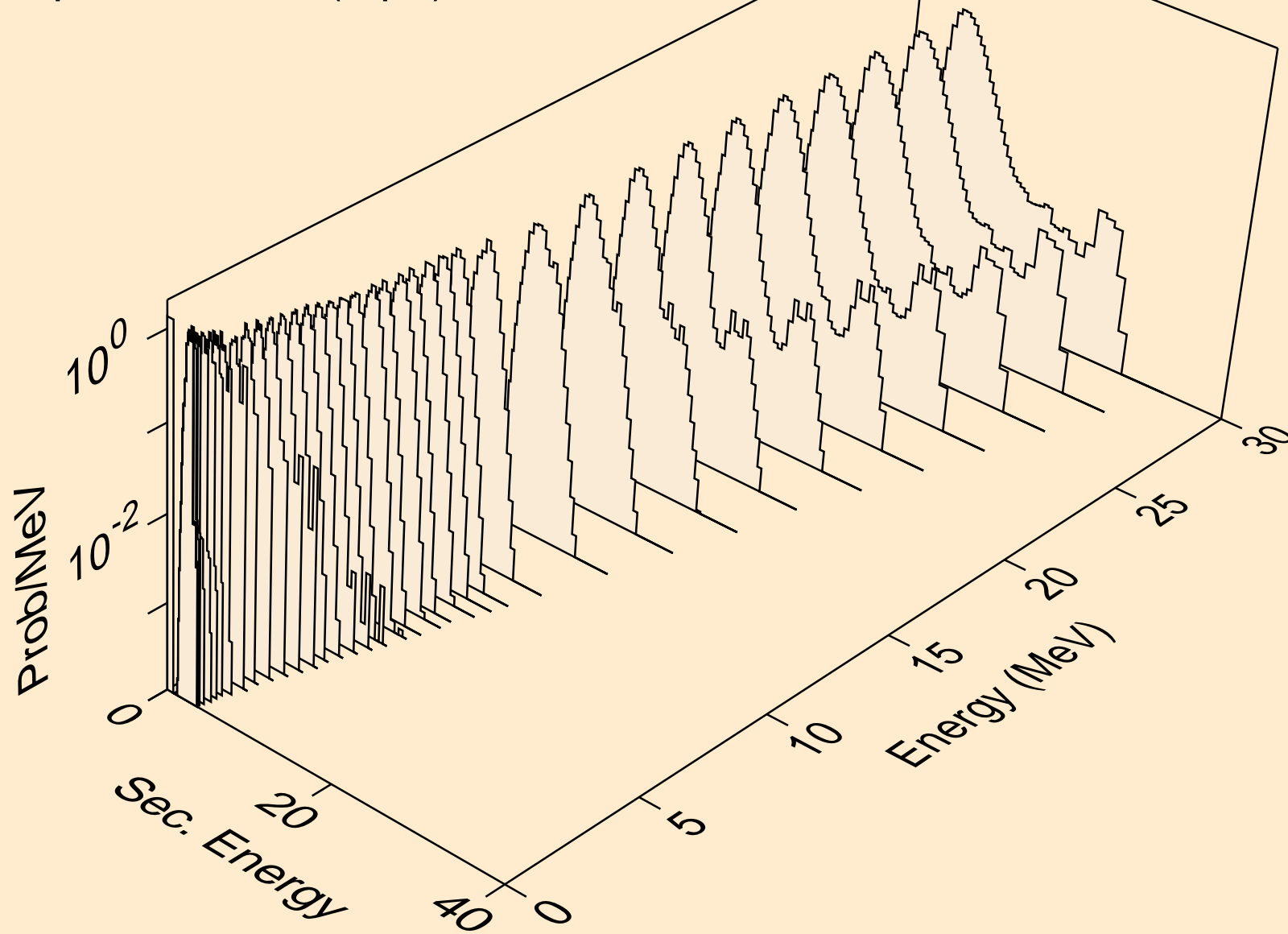

DY149 NEUTRON ACER TENDL-2024 LIBRARY; T=293.6K  
protons from (n,pd)

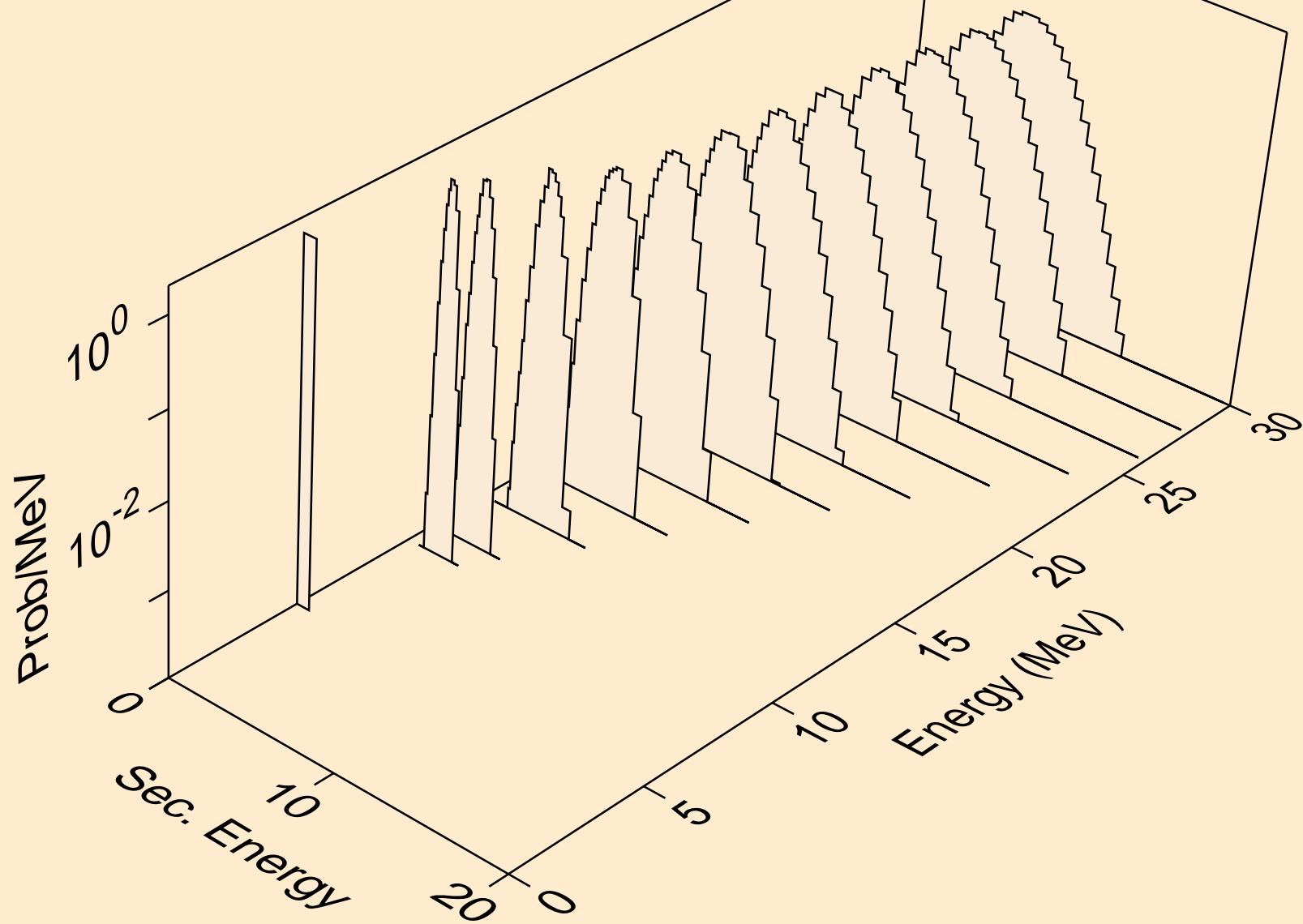

DY149 NEUTRON ACER TENDL-2024 LIBRARY; T=293.6K  
protons from (n,pt)

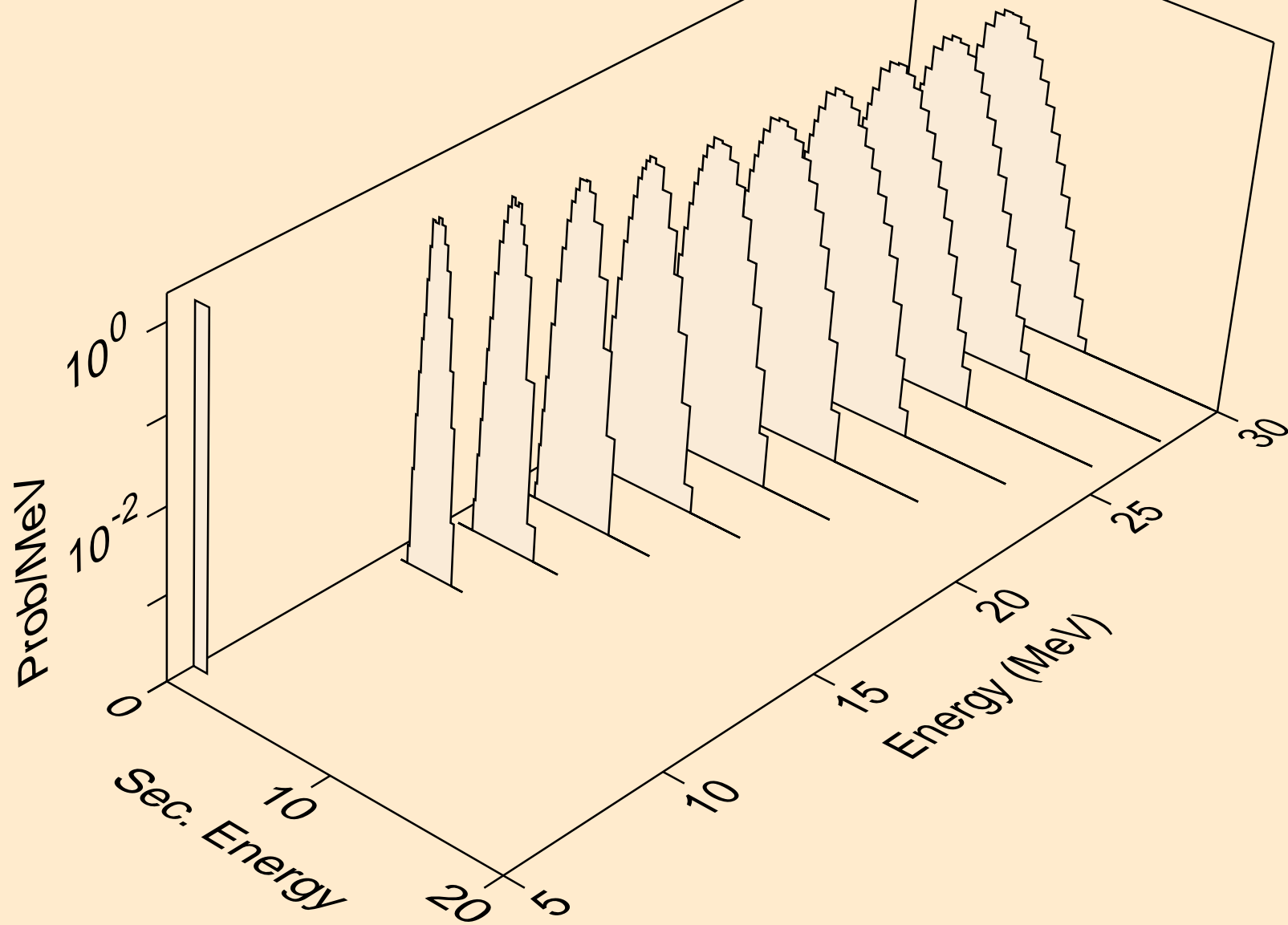

DY149 NEUTRON ACER TENDL-2024 LIBRARY; T=293.6K  
deuterons from (n,x)

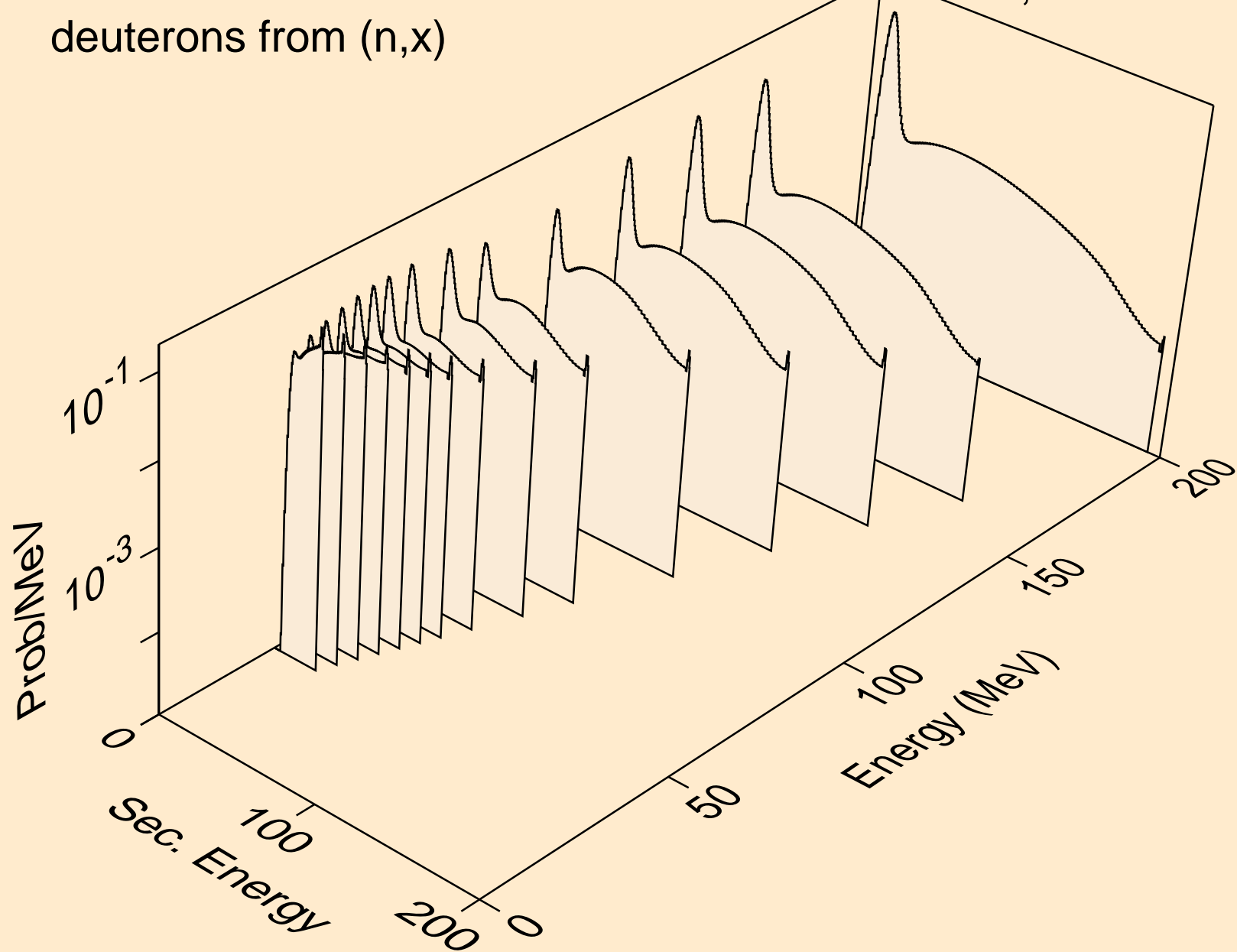

DY149 NEUTRON ACER TENDL-2024 LIBRARY; T=293.6K  
deuterons from (n,2nd)

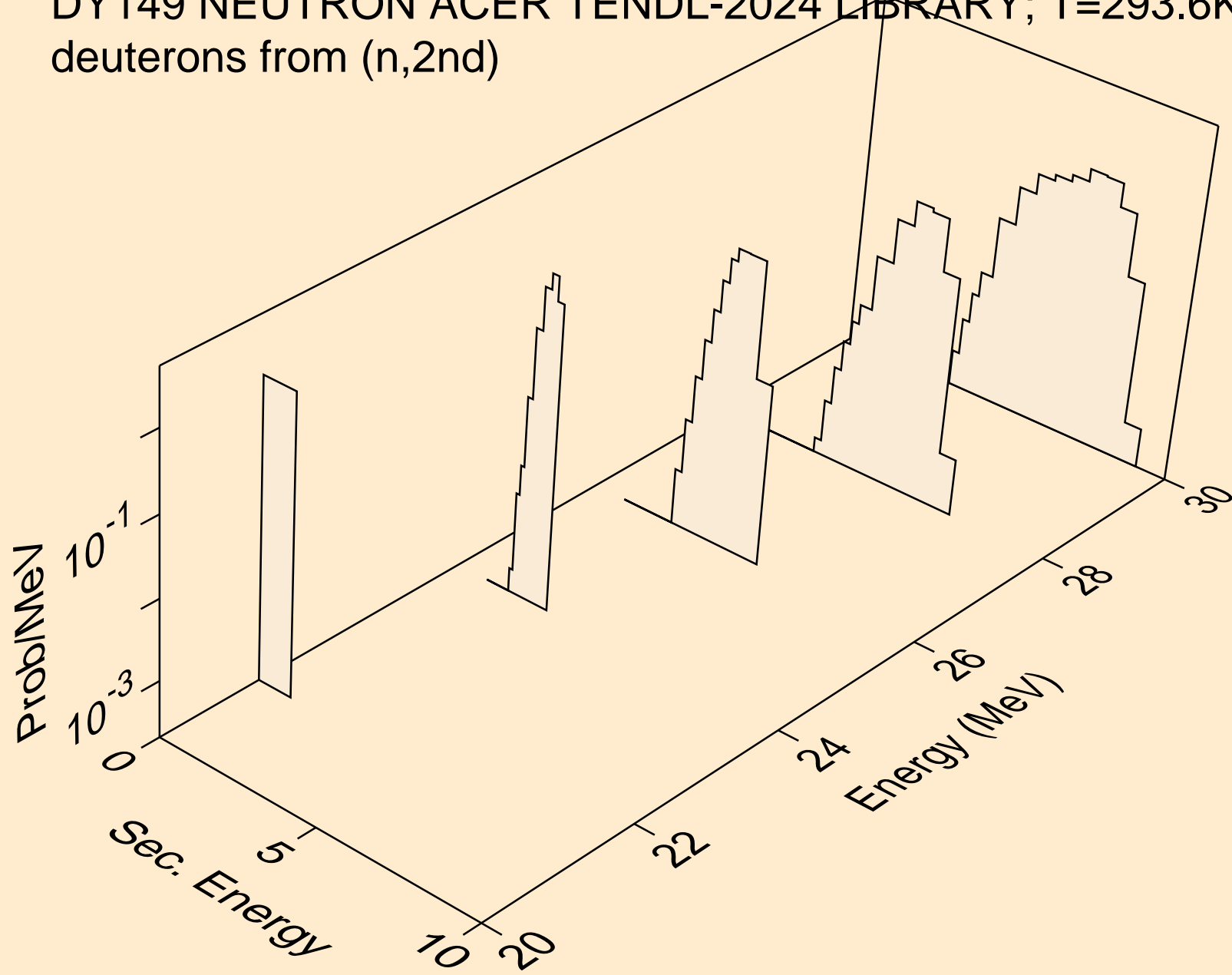

DY149 NEUTRON ACER TENDL-2024 LIBRARY; T=293.6K  
deuterons from (n,n\*)d

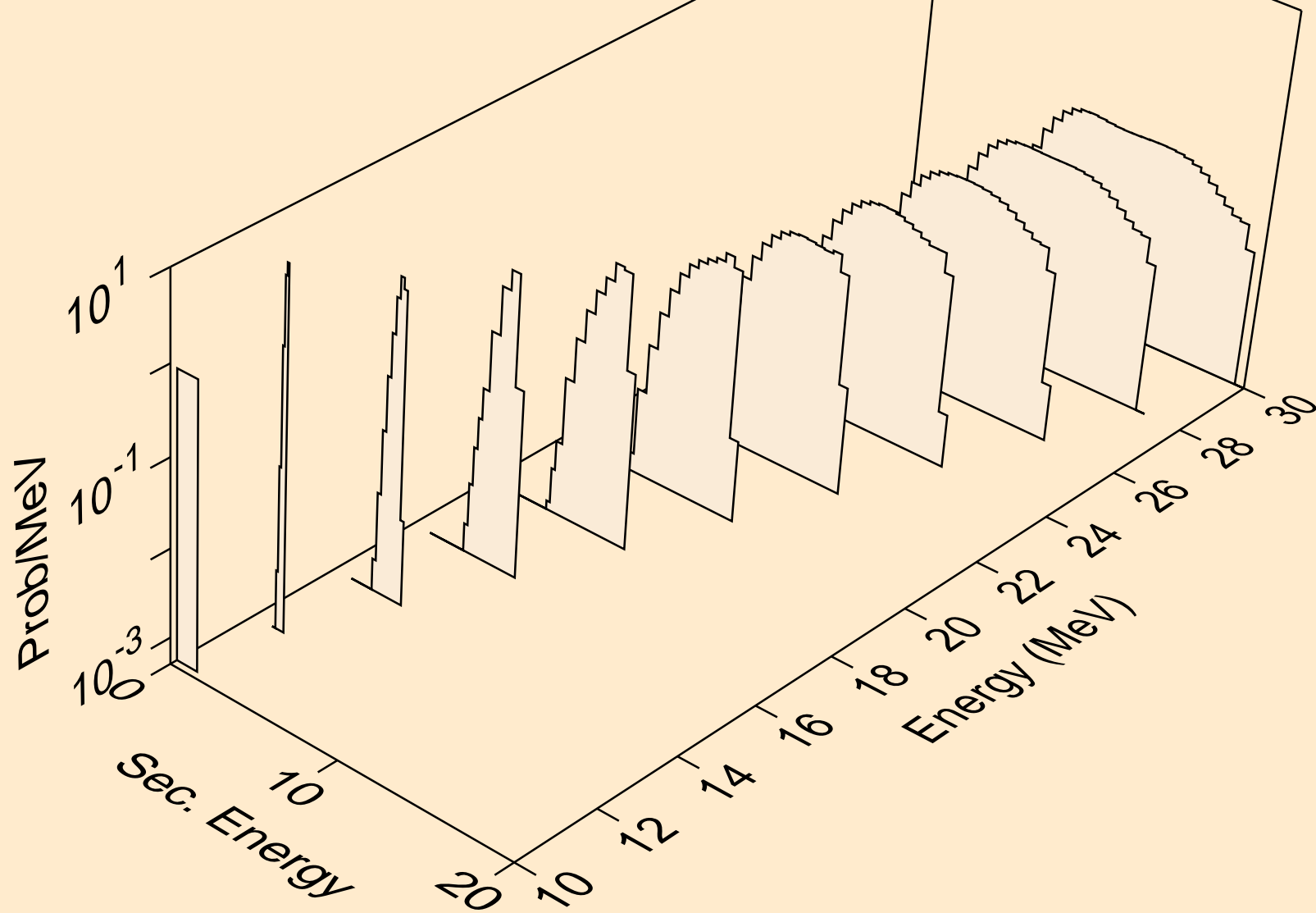

DY149 NEUTRON ACER TENDL-2024 LIBRARY; T=293.6K  
deuterons from (n,d)

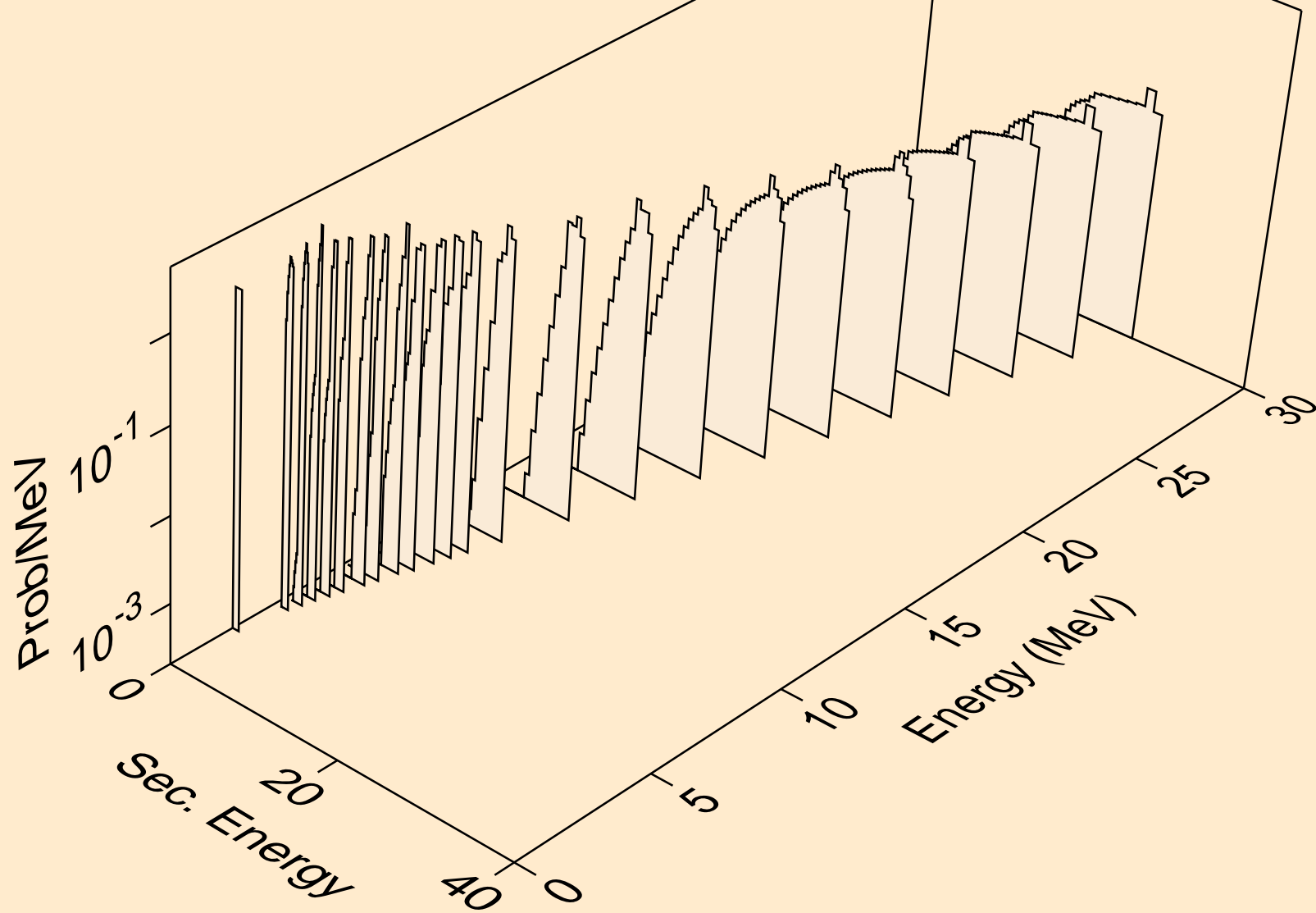

DY149 NEUTRON ACER TENDL-2024 LIBRARY; T=293.6K  
deuterons from (n,pd)

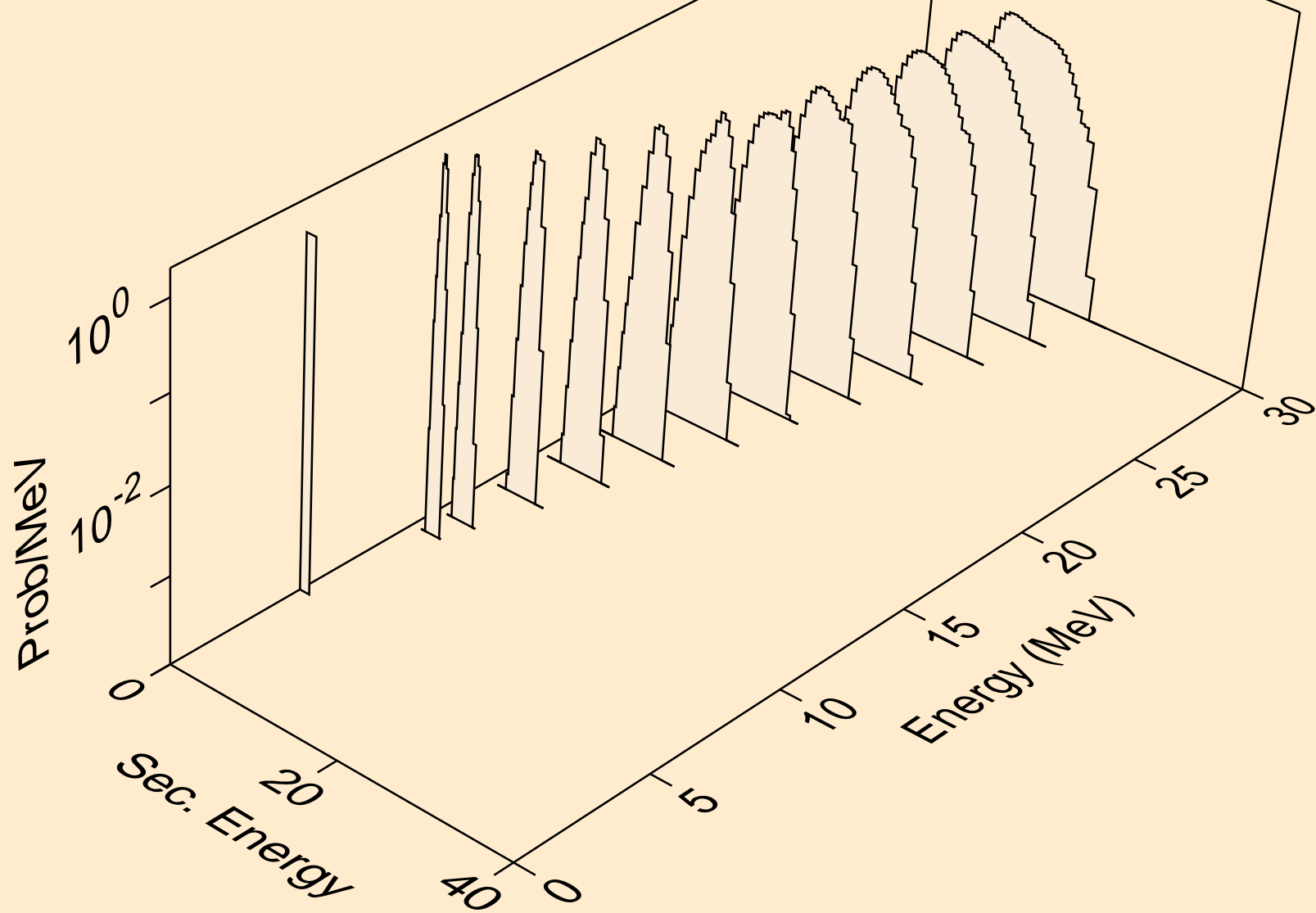

DY149 NEUTRON ACER TENDL-2024 LIBRARY; T=293.6K  
deuterons from (n,da)

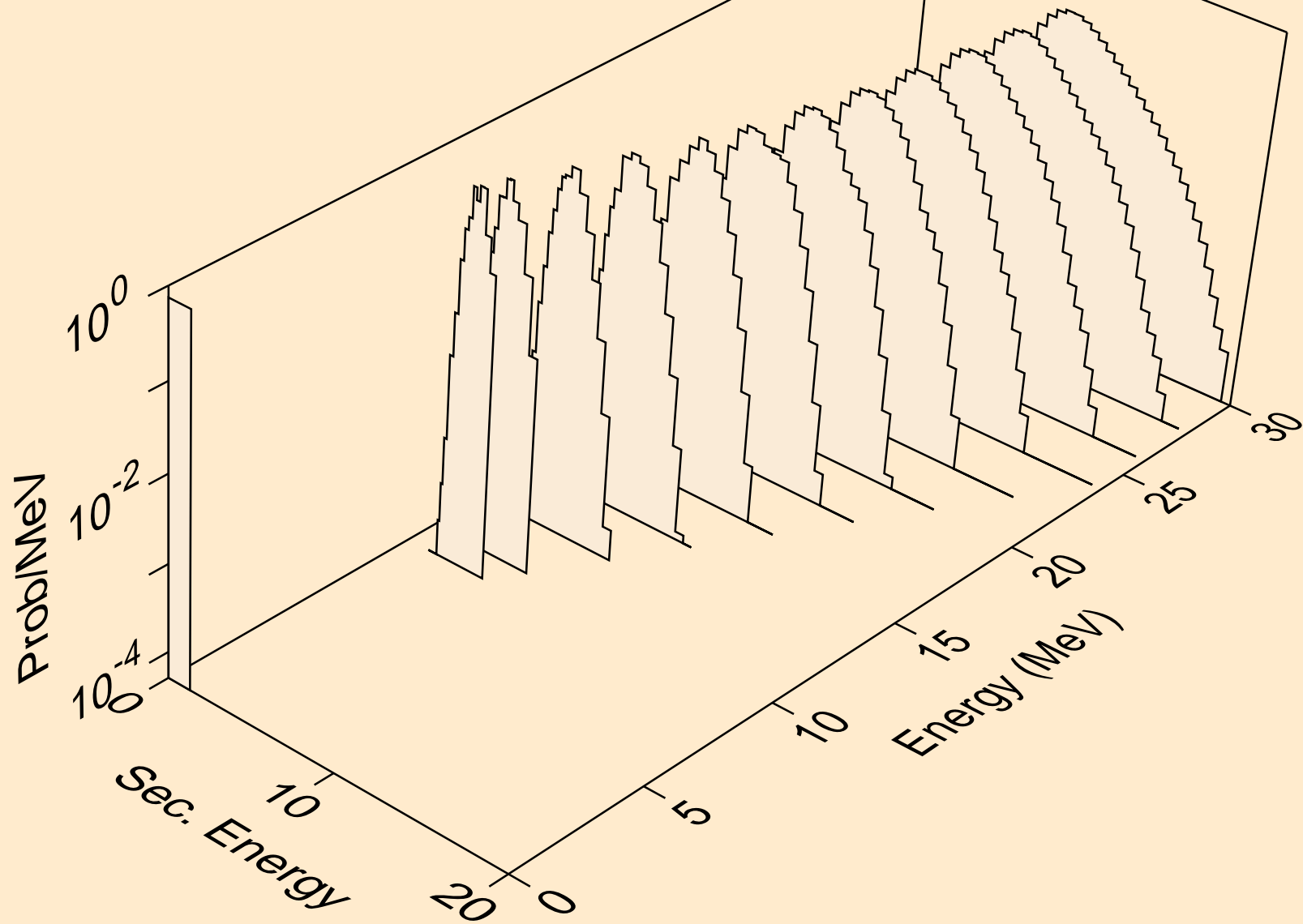

DY149 NEUTRON ACER TENDL-2024 LIBRARY; T=293.6K  
tritons from (n,x)

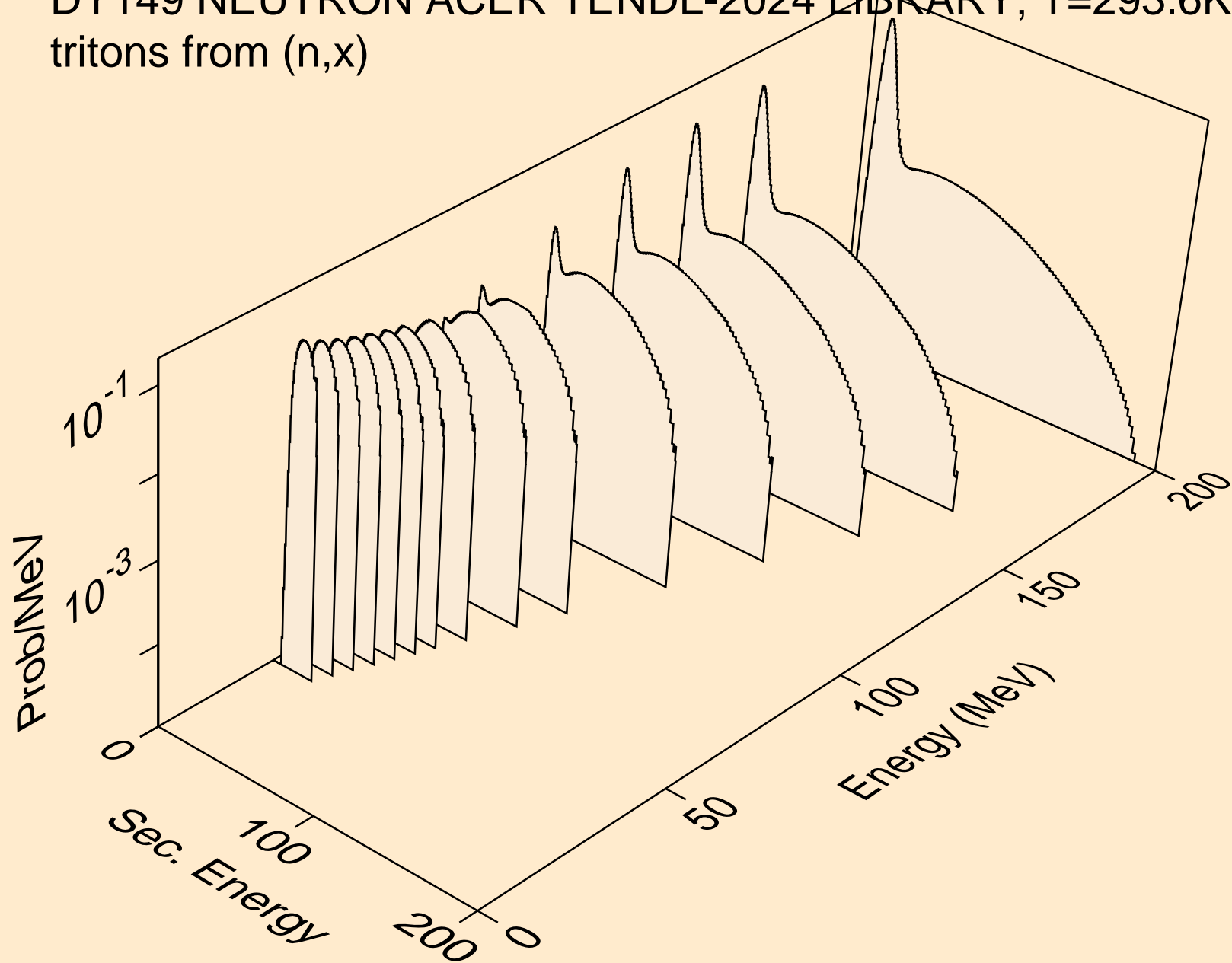

DY149 NEUTRON ACER TENDL-2024 LIBRARY; T=293.6K  
tritons from (n,n\*)t

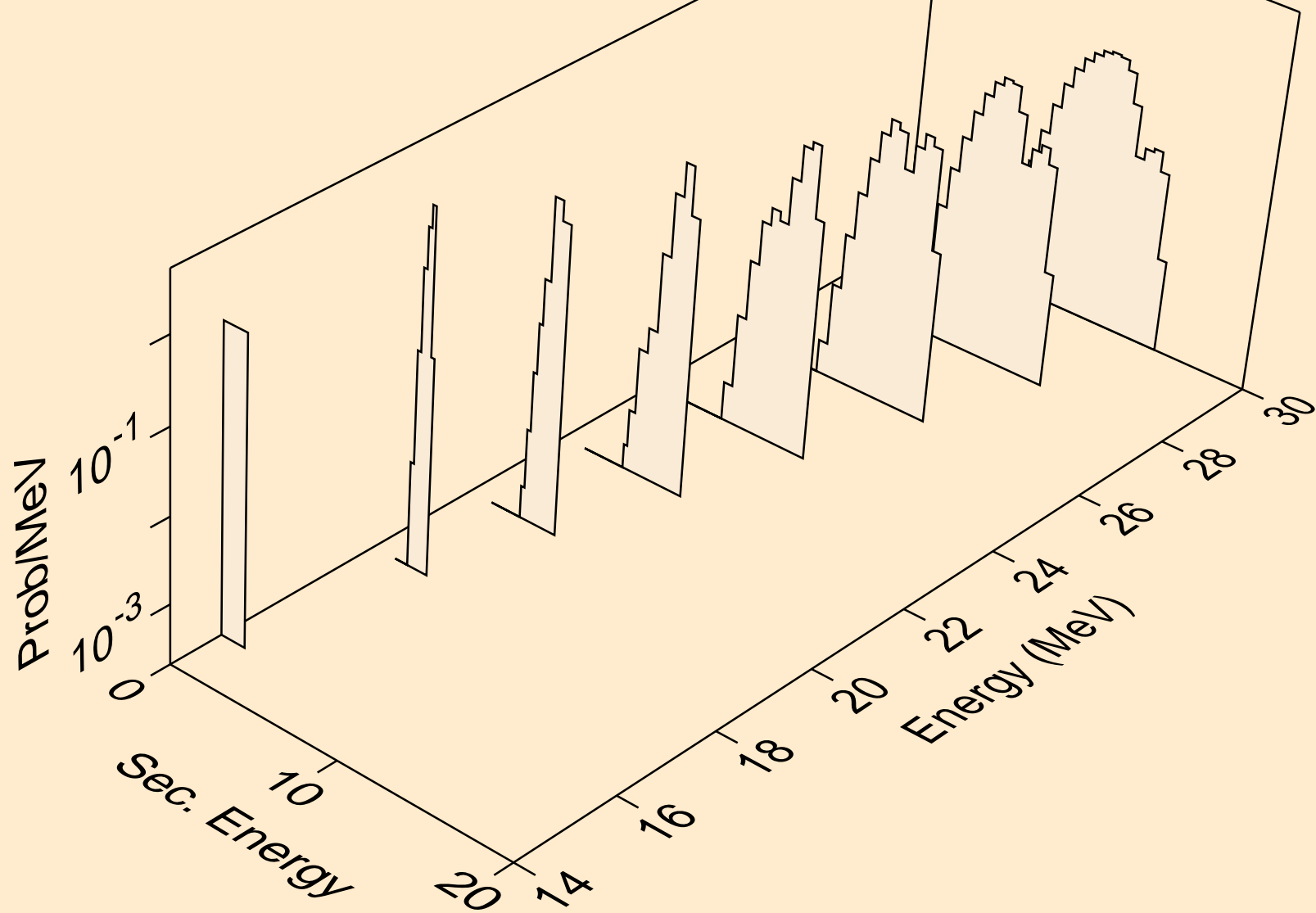

DY149 NEUTRON ACER TENDL-2024 LIBRARY; T=293.6K  
tritons from (n,t)

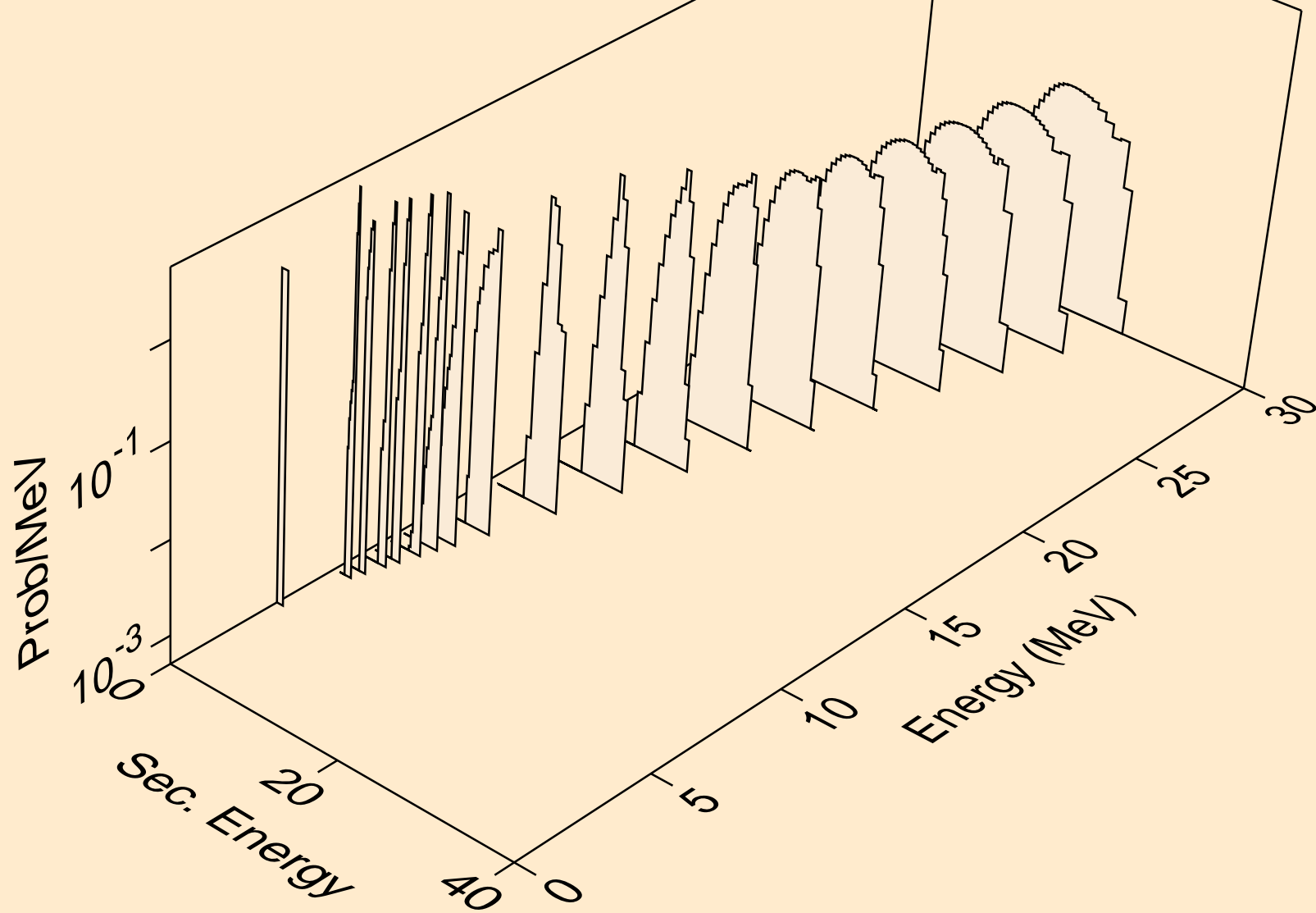

DY149 NEUTRON ACER TENDL-2024 LIBRARY; T=293.6K  
tritons from (n,pt)

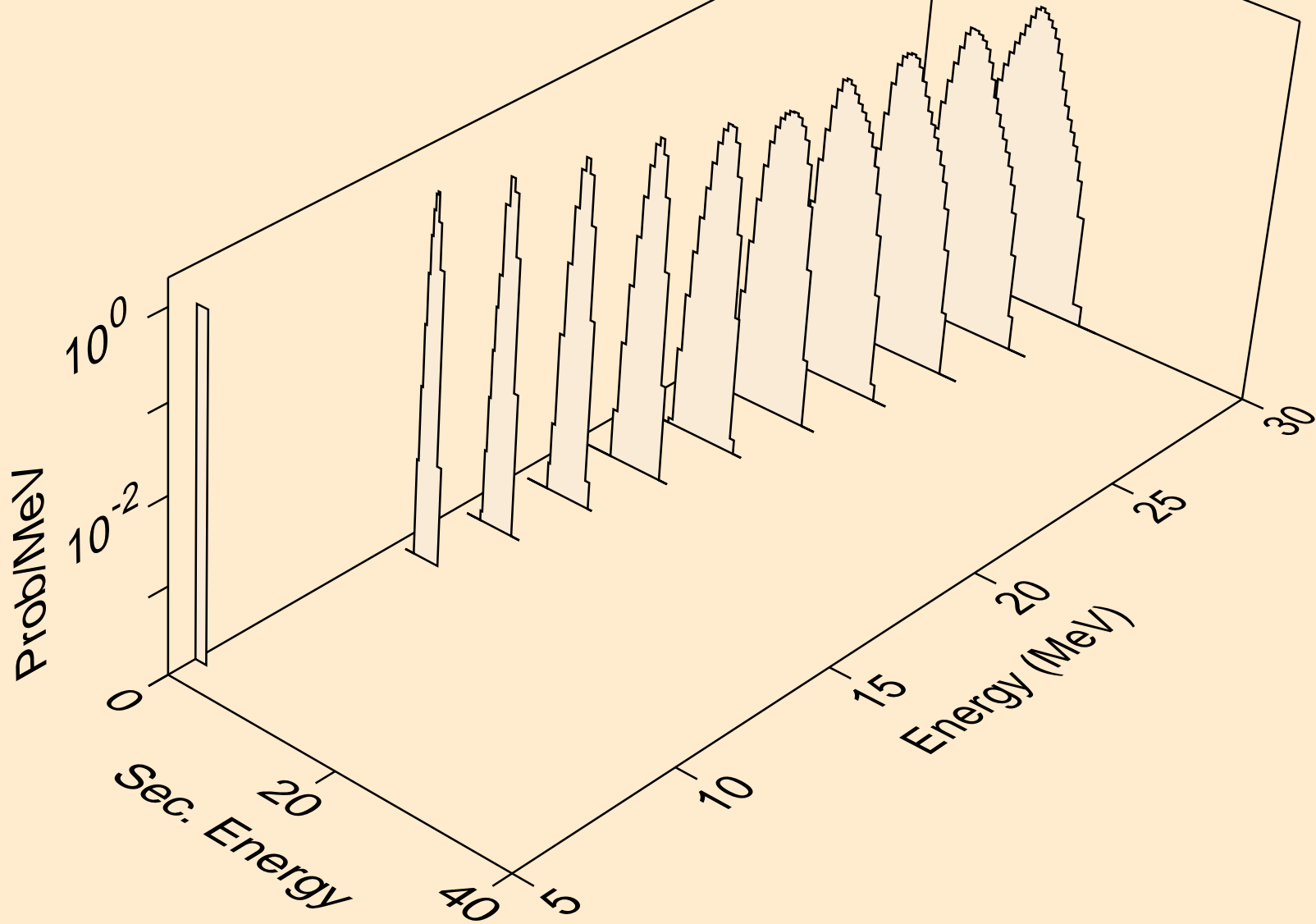

DY149 NEUTRON ACER TENDL-2024 LIBRARY; T=293.6K  
he3s from (n,x)

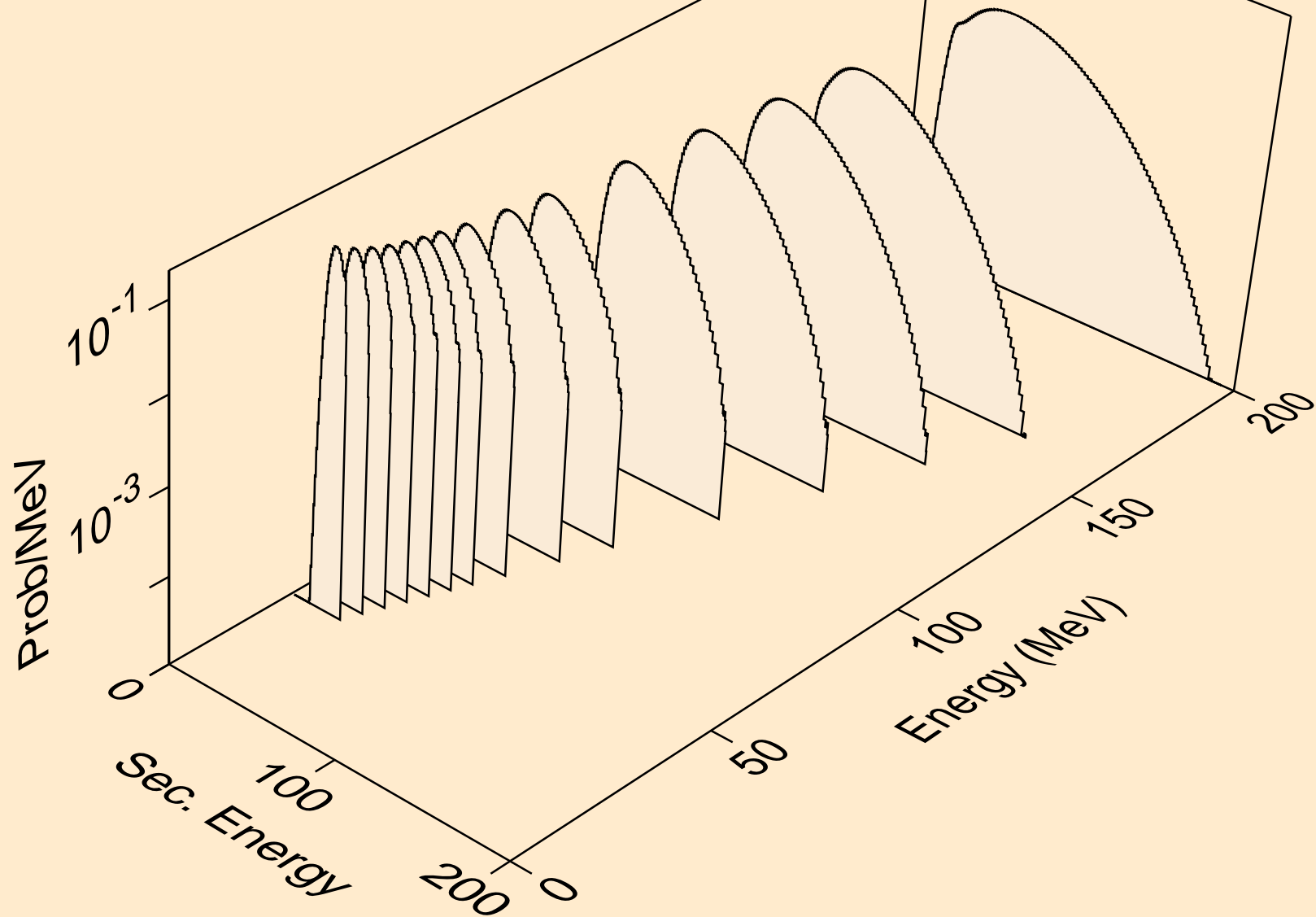

DY149 NEUTRON ACER TENDL-2024 LIBRARY; T=293.6K  
he3s from (n,n\*)he3

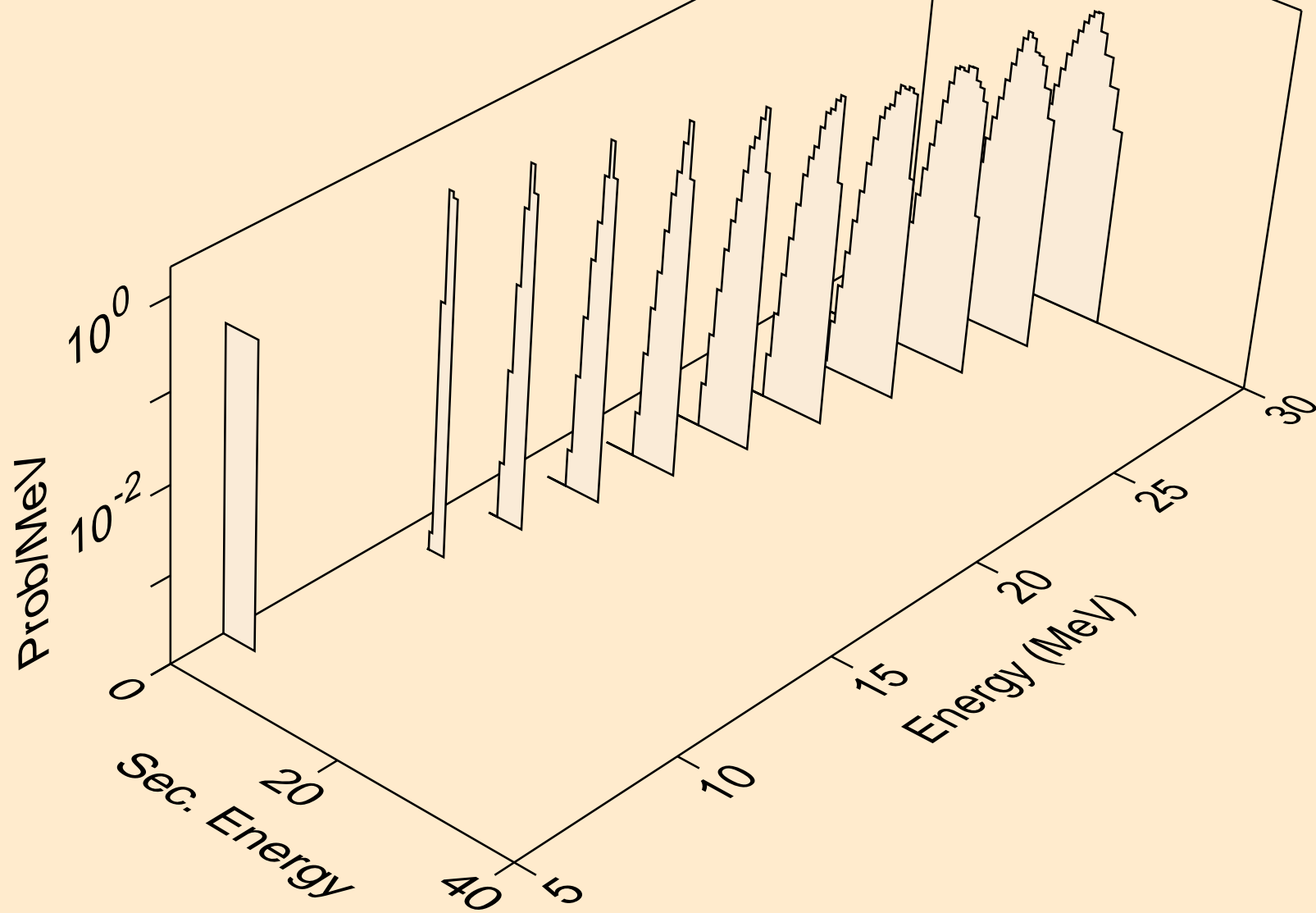

DY149 NEUTRON ACER TENDL-2024 LIBRARY; T=293.6K  
he3s from (n,he3)

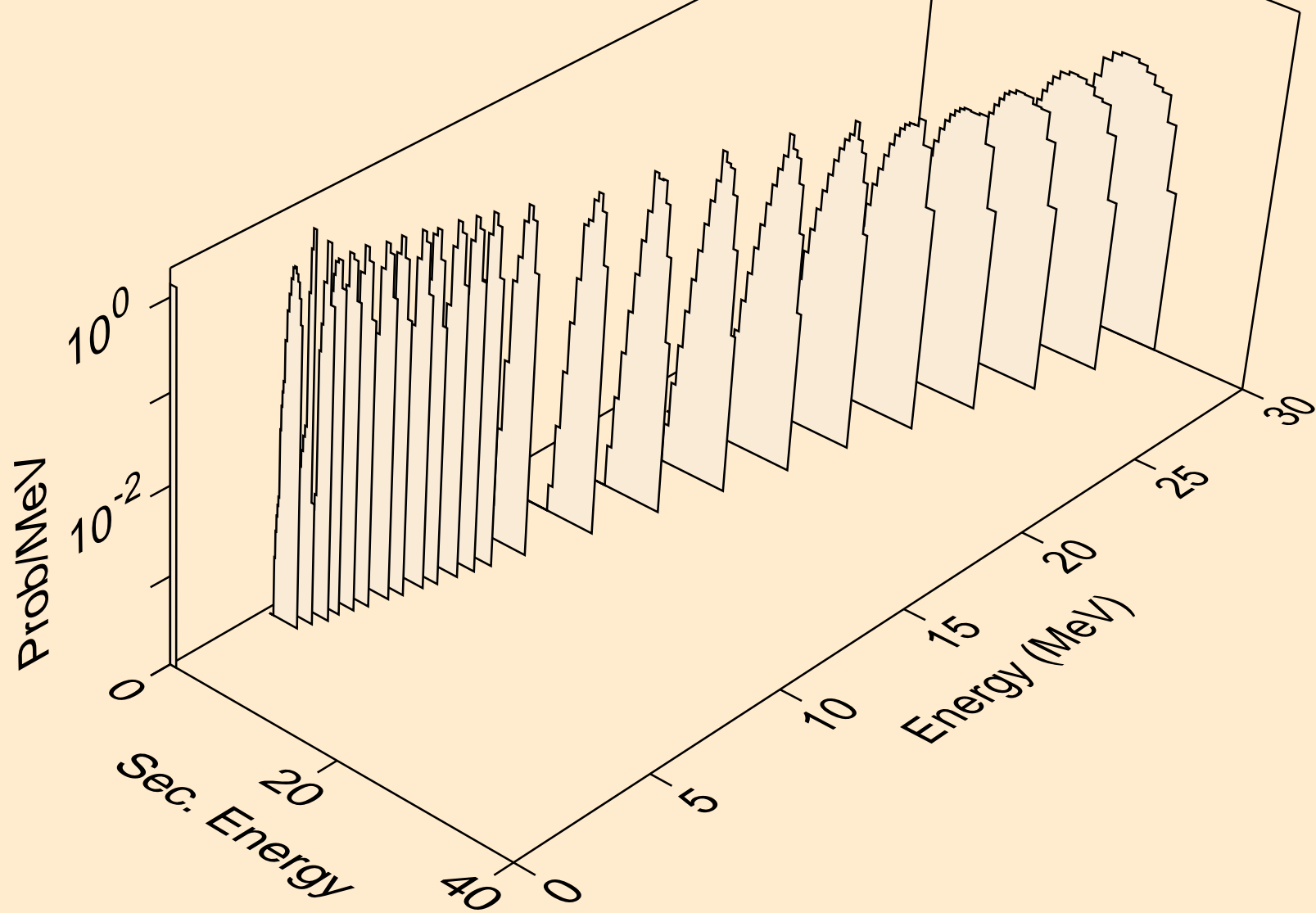

DY149 NEUTRON ACER TENDL-2024 LIBRARY; T=293.6K  
alphas from (n,x)

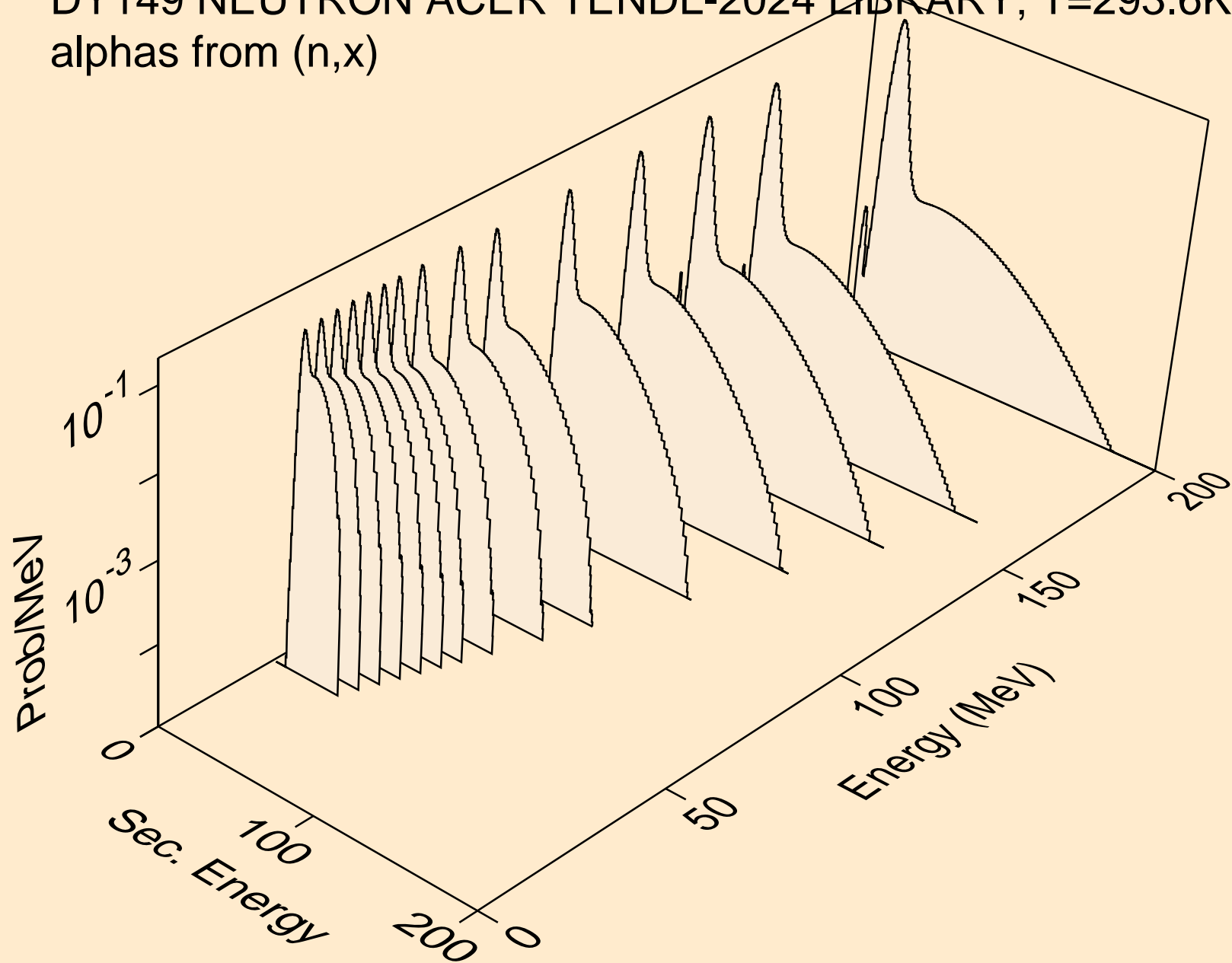

DY149 NEUTRON ACER TENDL-2024 LIBRARY; T=293.6K  
alphas from (n,n\*)a

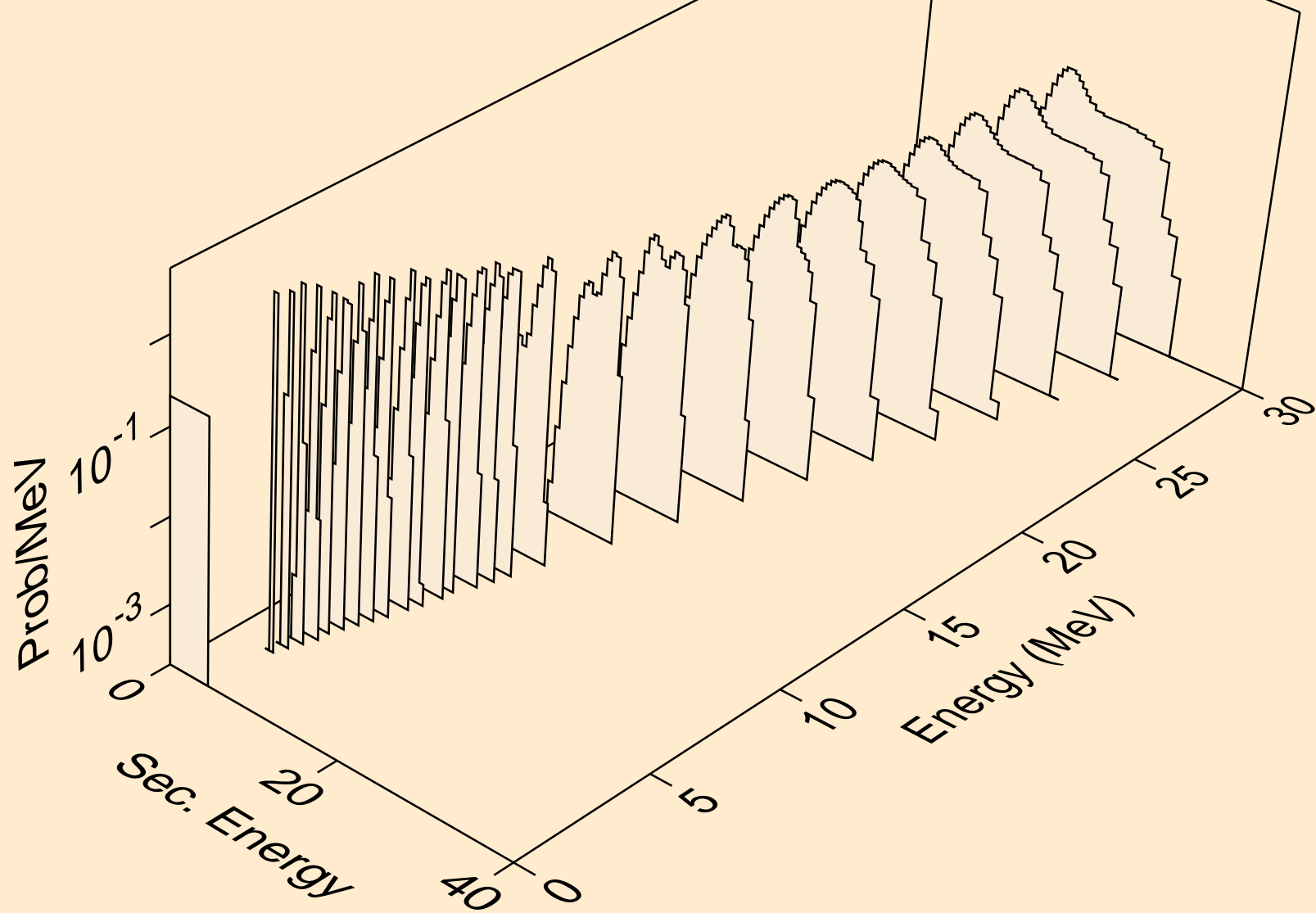

DY149 NEUTRON ACER TENDL-2024 LIBRARY; T=293.6K  
alphas from (n,2n)a

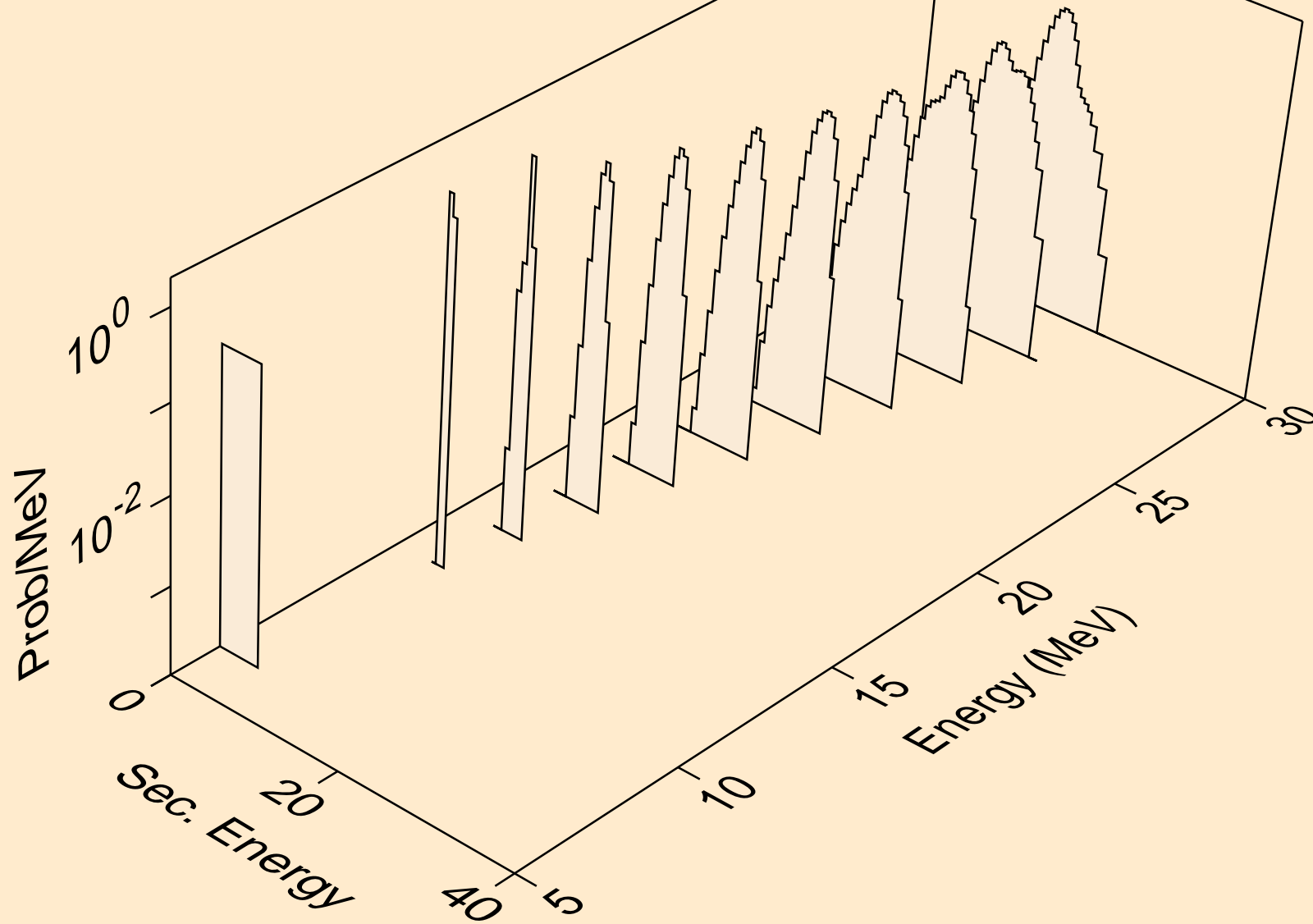

DY149 NEUTRON ACER TENDL-2024 LIBRARY; T=293.6K  
alphas from (n,3n)a

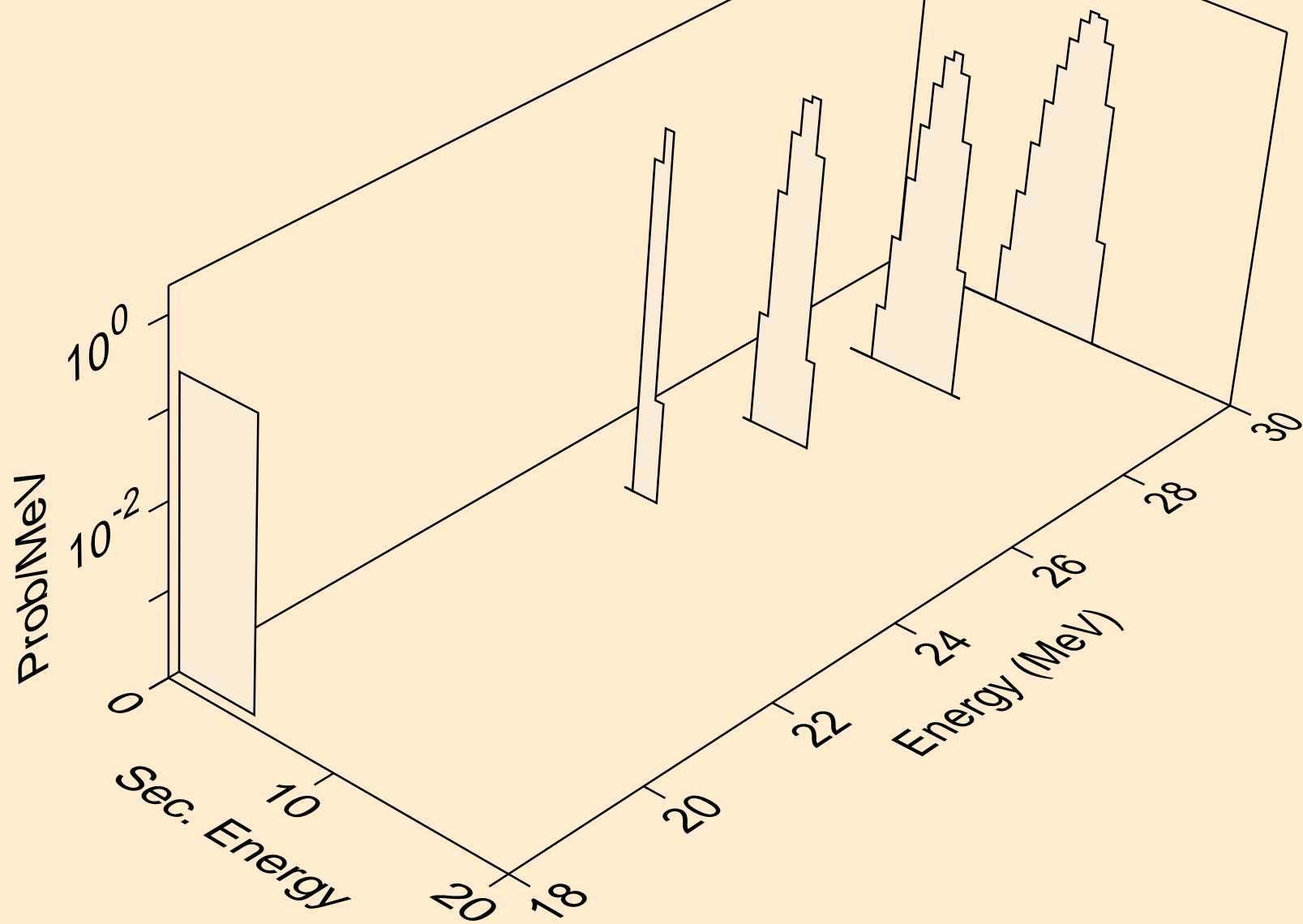

DY149 NEUTRON ACER TENDL-2024 LIBRARY; T=293.6K  
alphas from (n,n\*)2a

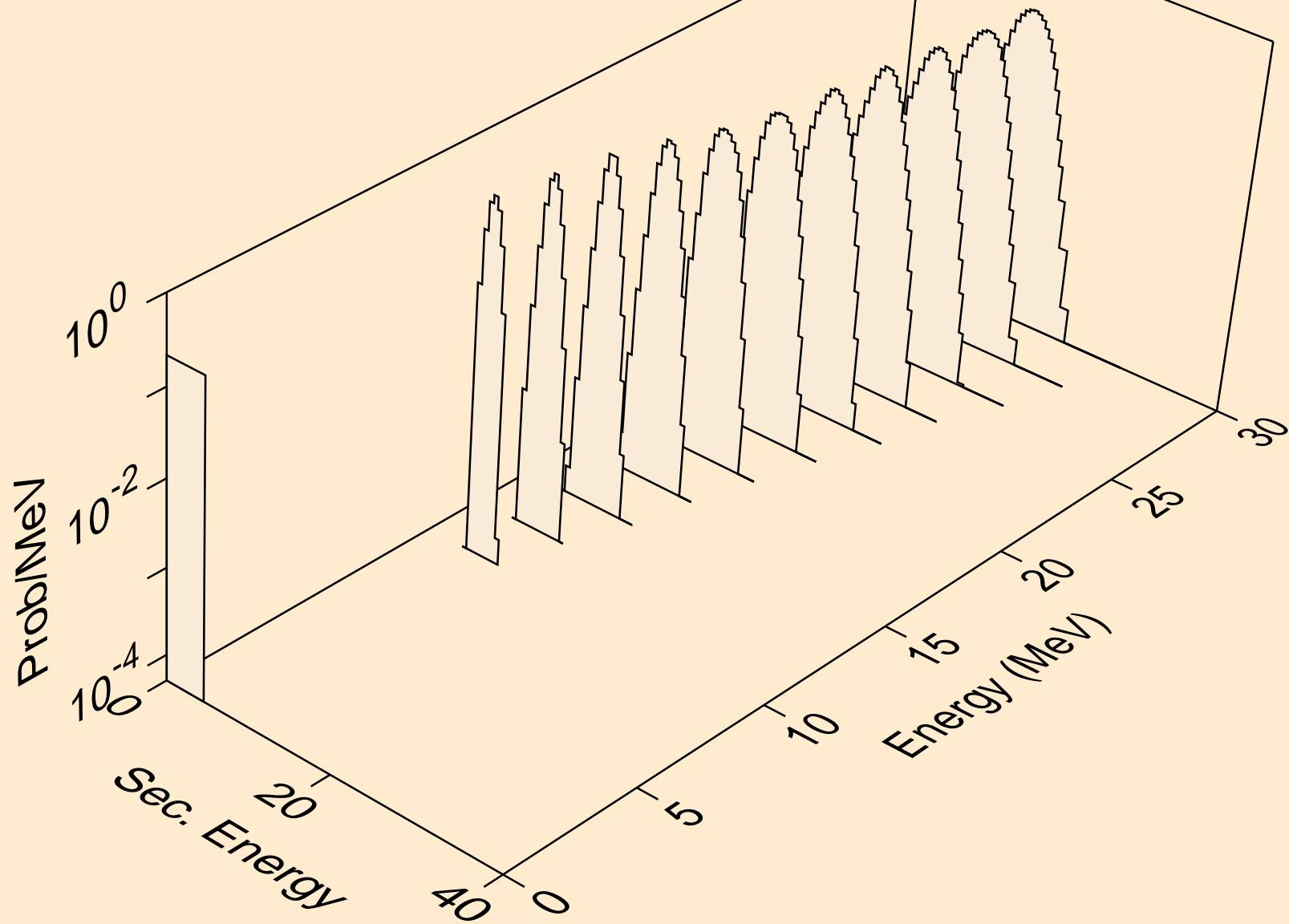

DY149 NEUTRON ACER TENDL-2024 LIBRARY; T=293.6K  
alphas from (n,2n)2a

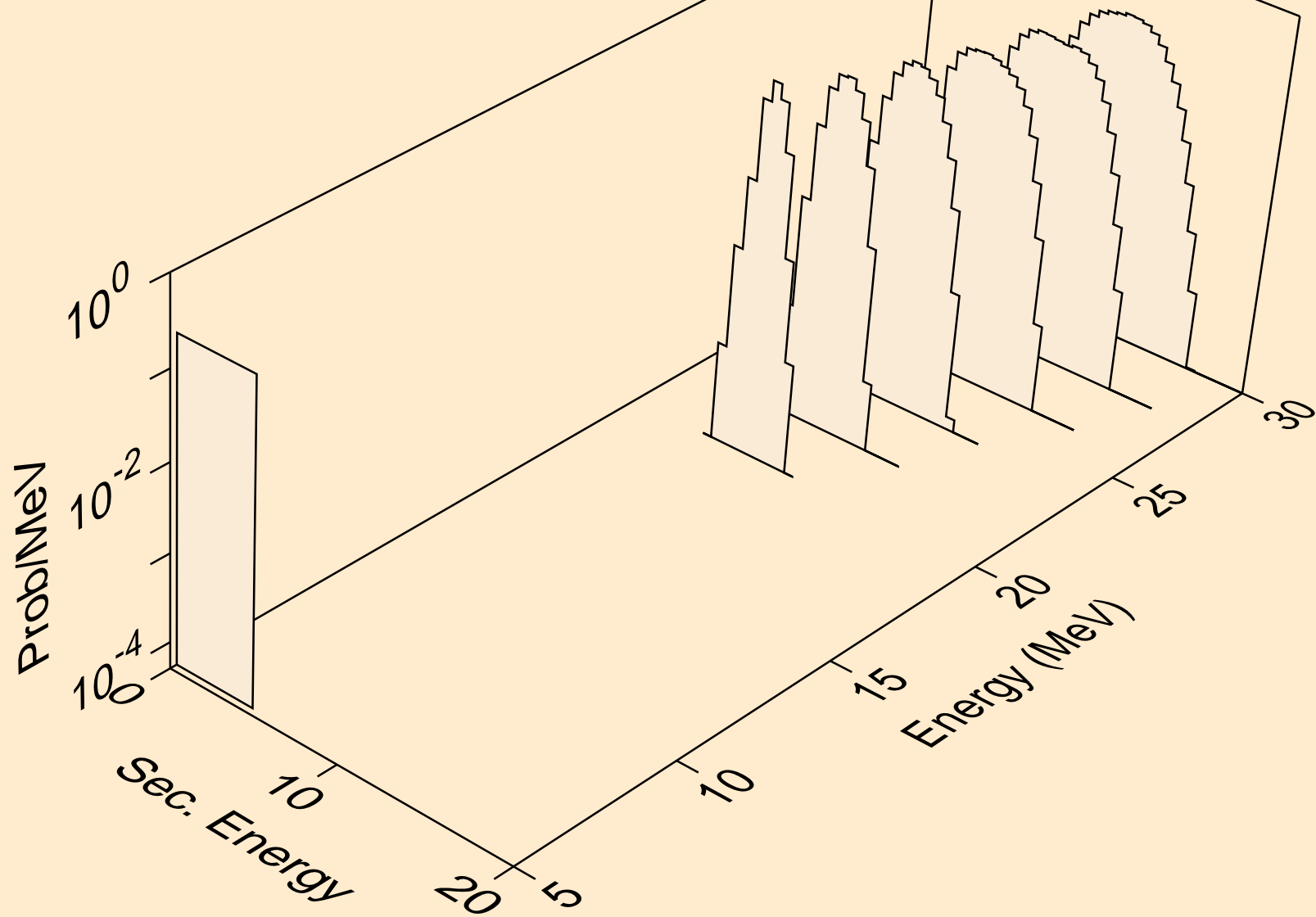

DY149 NEUTRON ACER TENDL-2024 LIBRARY; T=293.6K  
alphas from (n,npa)

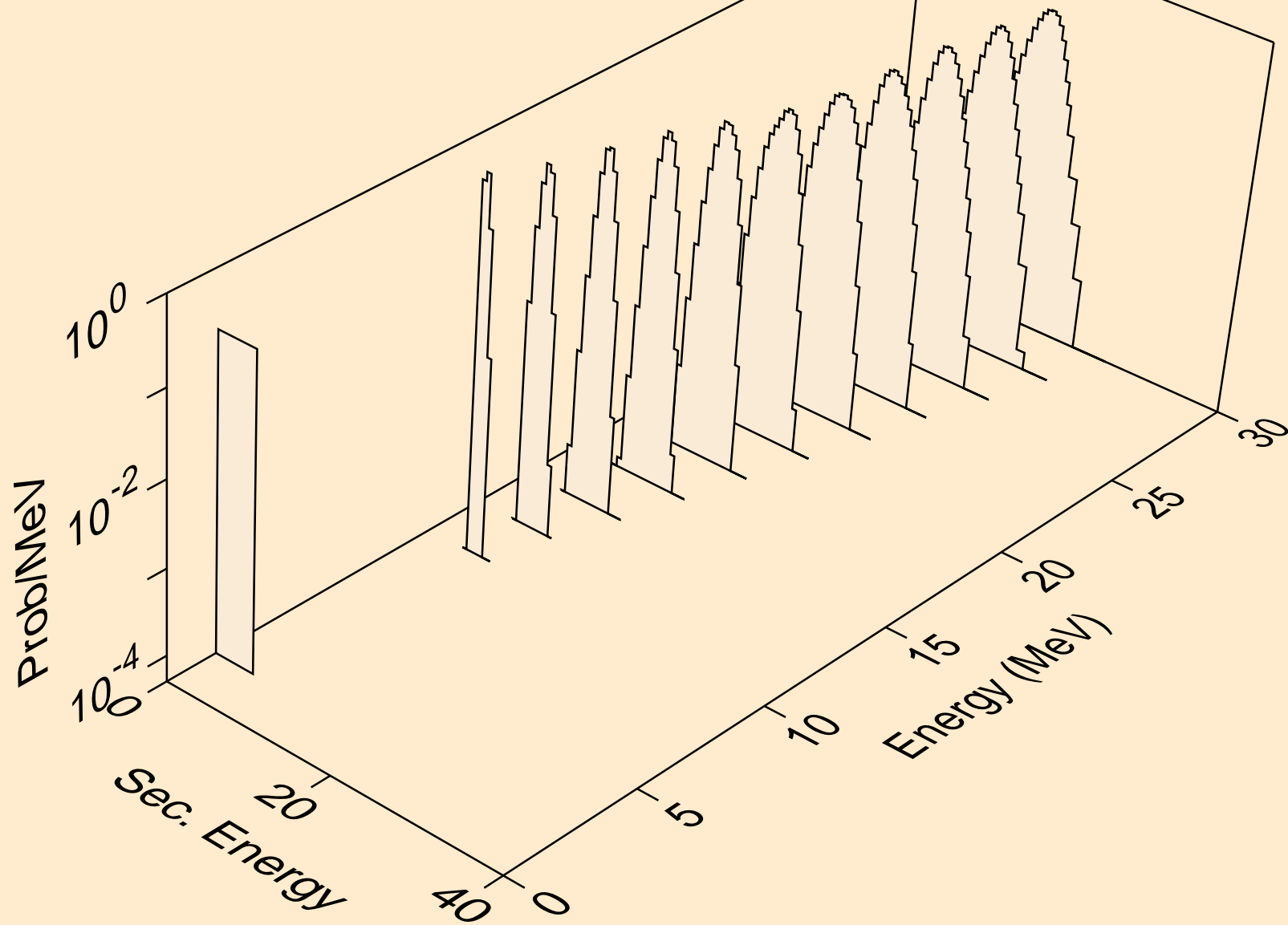

DY149 NEUTRON ACER TENDL-2024 LIBRARY; T=293.6K  
alphas from (n,a)

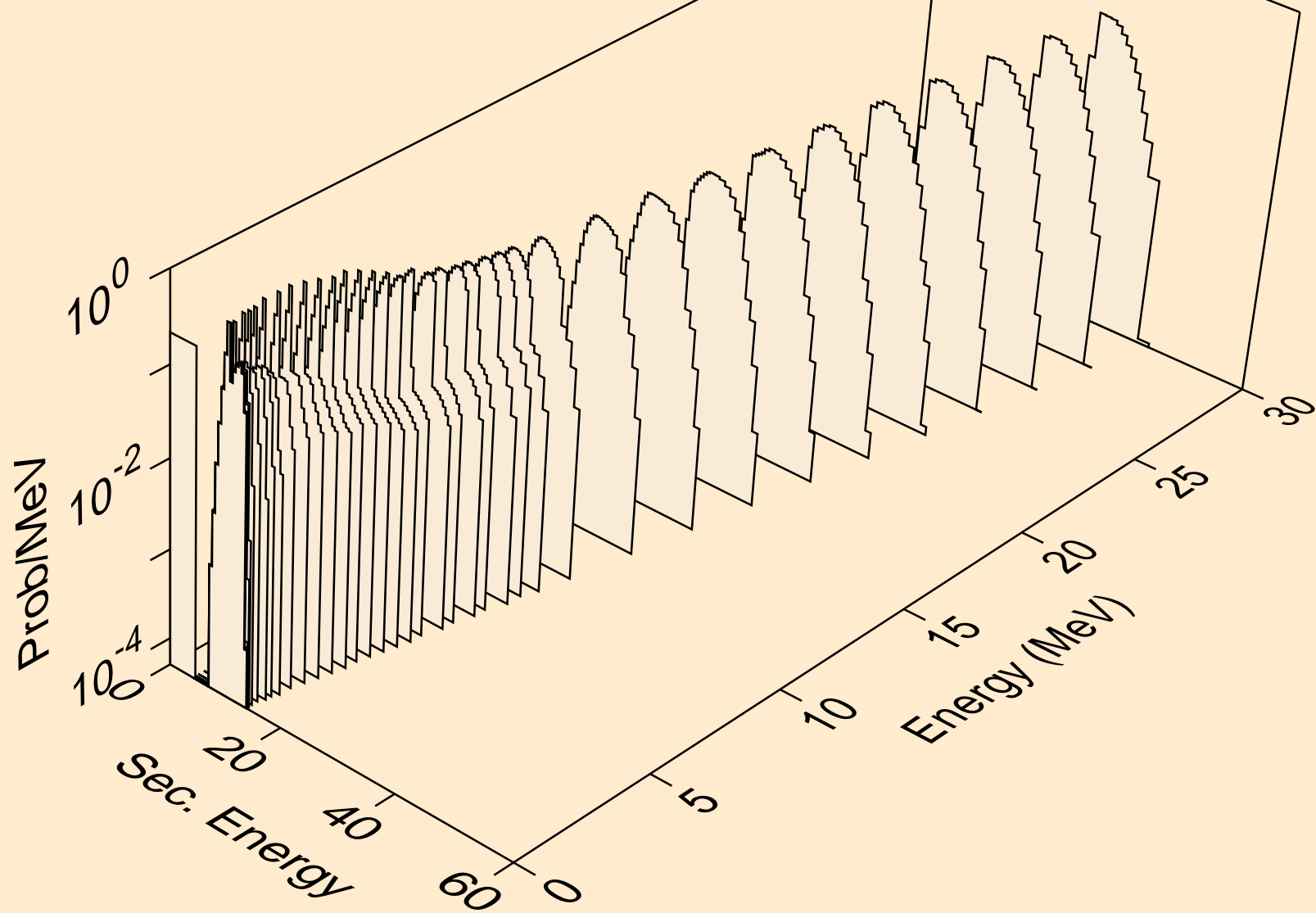

DY149 NEUTRON ACER TENDL-2024 LIBRARY; T=293.6K  
alphas from (n,2a)

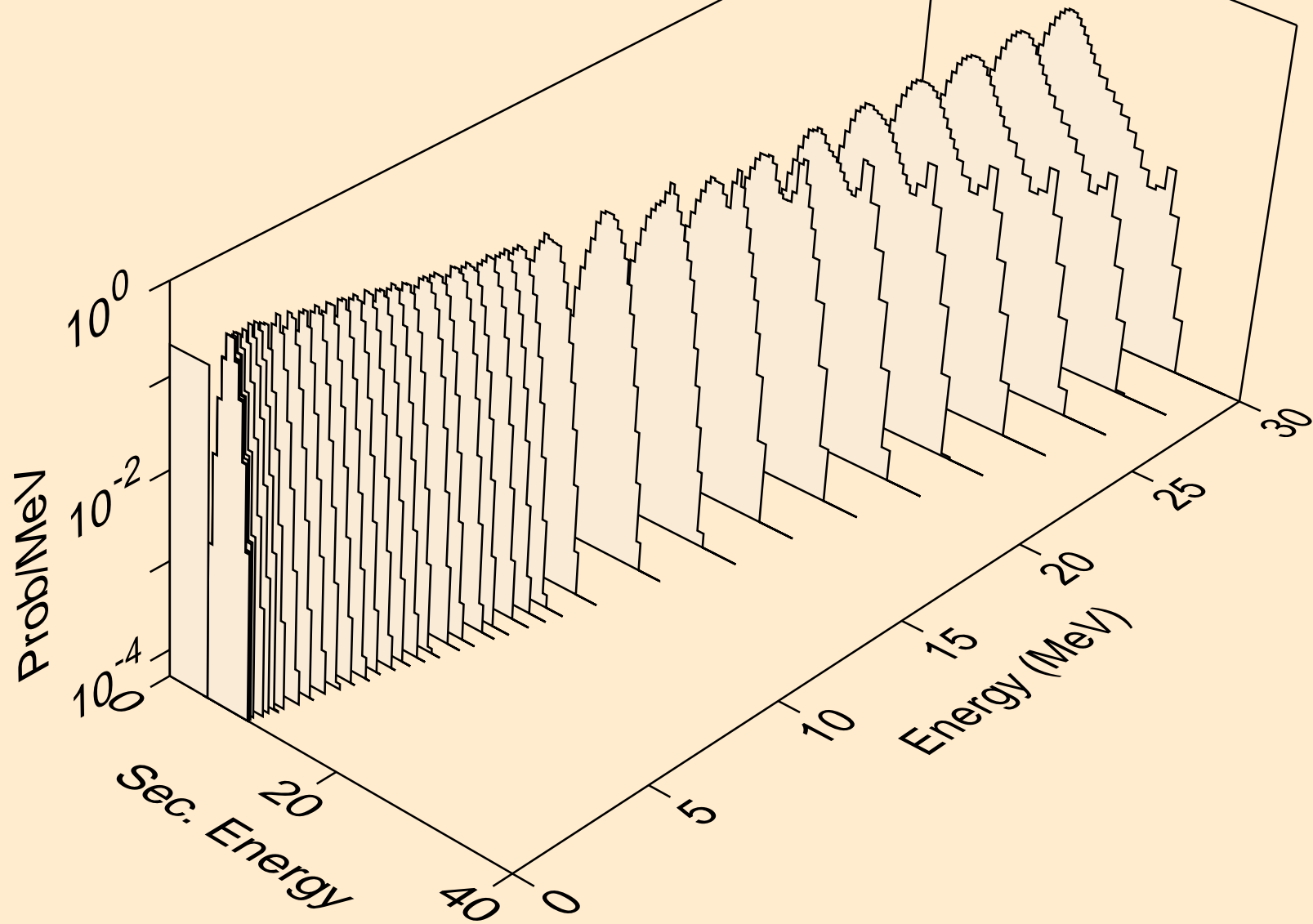

DY149 NEUTRON ACER TENDL-2024 LIBRARY; T=293.6K  
alphas from (n,pa)

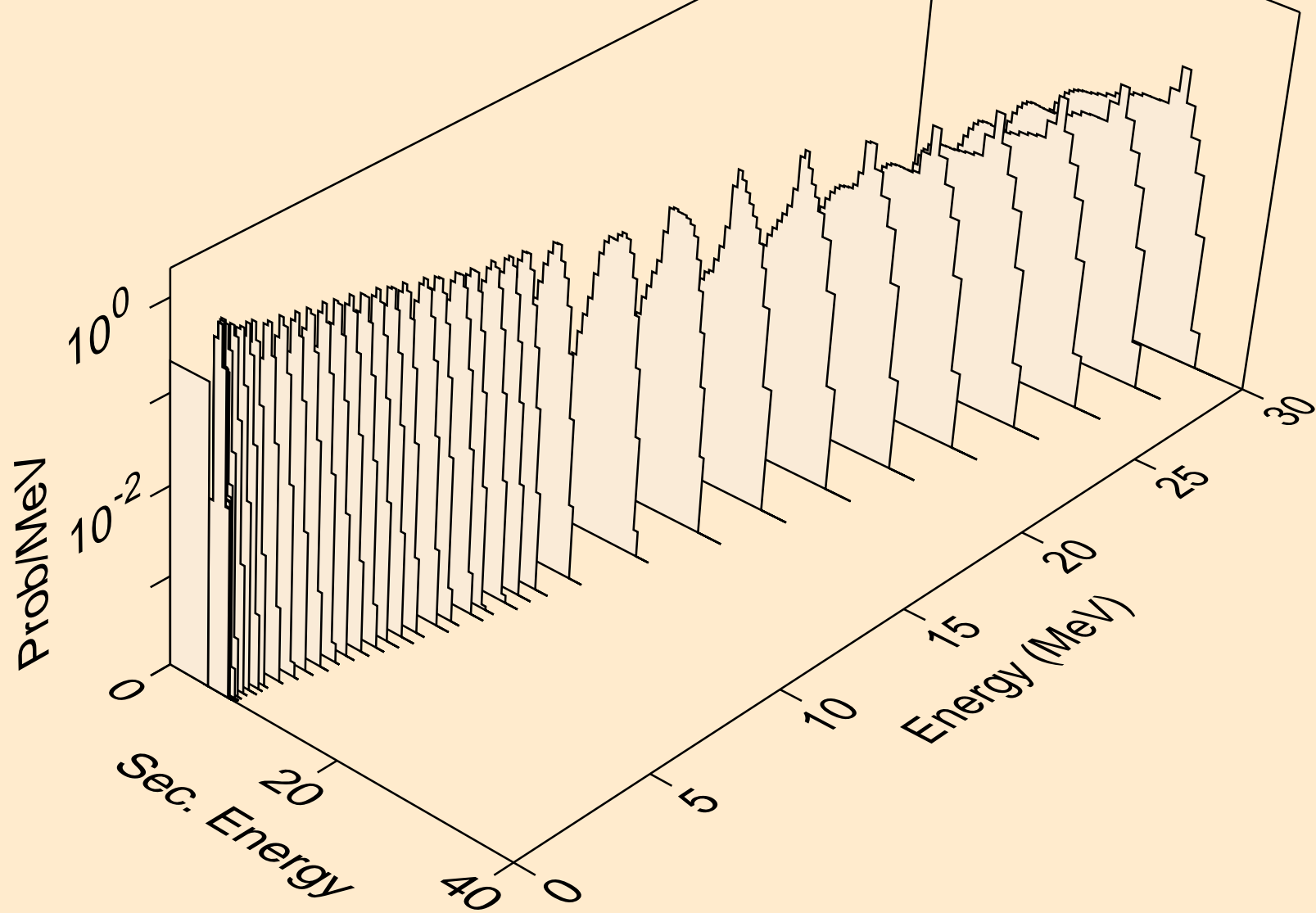

DY149 NEUTRON ACER TENDL-2024 LIBRARY; T=293.6K  
alphas from (n,da)

