

ER147 NEUTRON ACER TENDL-2024 LIBRARY; T=293.6K

Principal cross sections

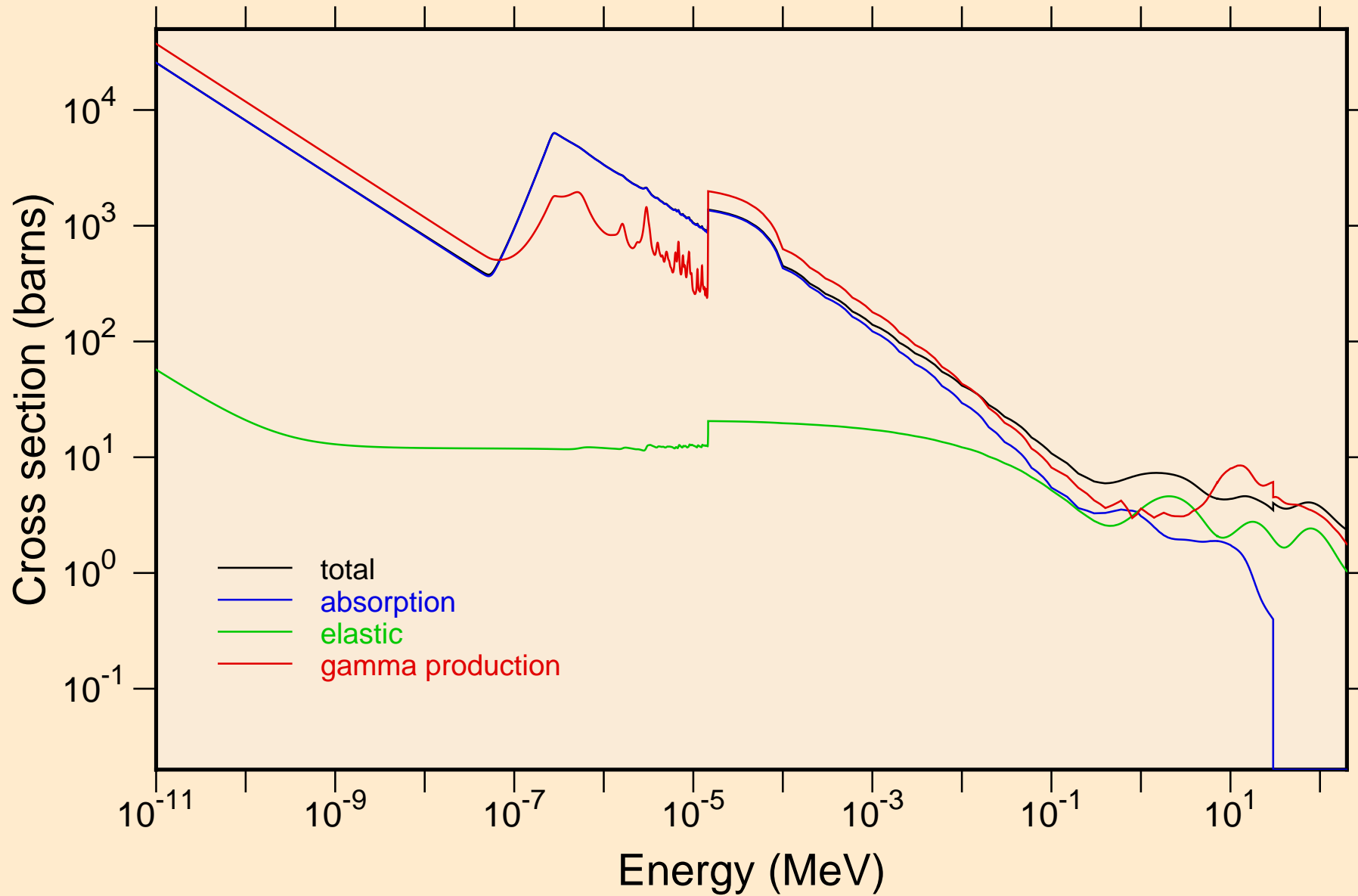

ER147 NEUTRON ACER TENDL-2024 LIBRARY; T=293.6K
resonance total cross section

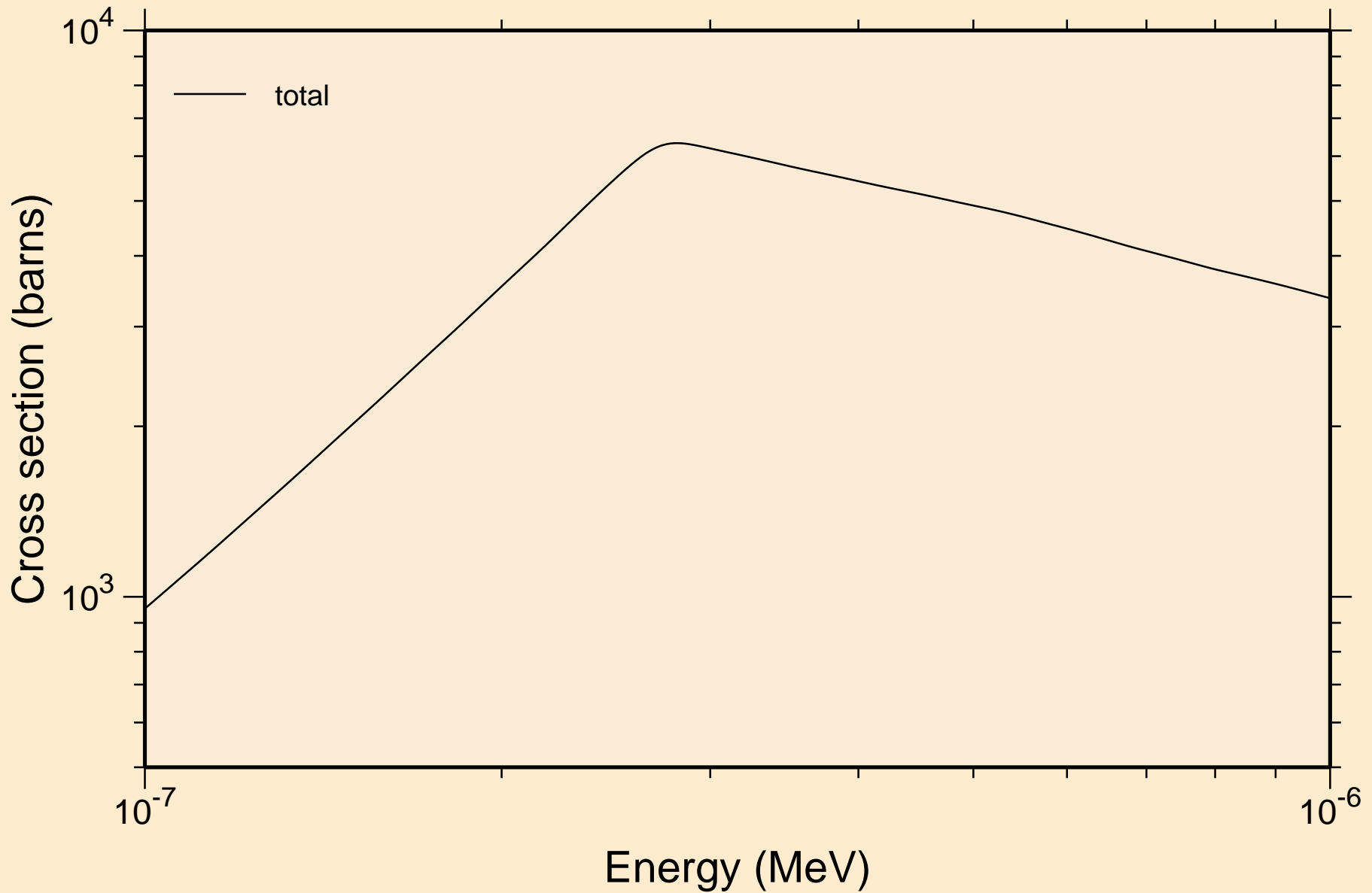

ER147 NEUTRON ACER TENDL-2024 LIBRARY; T=293.6K
resonance total cross section

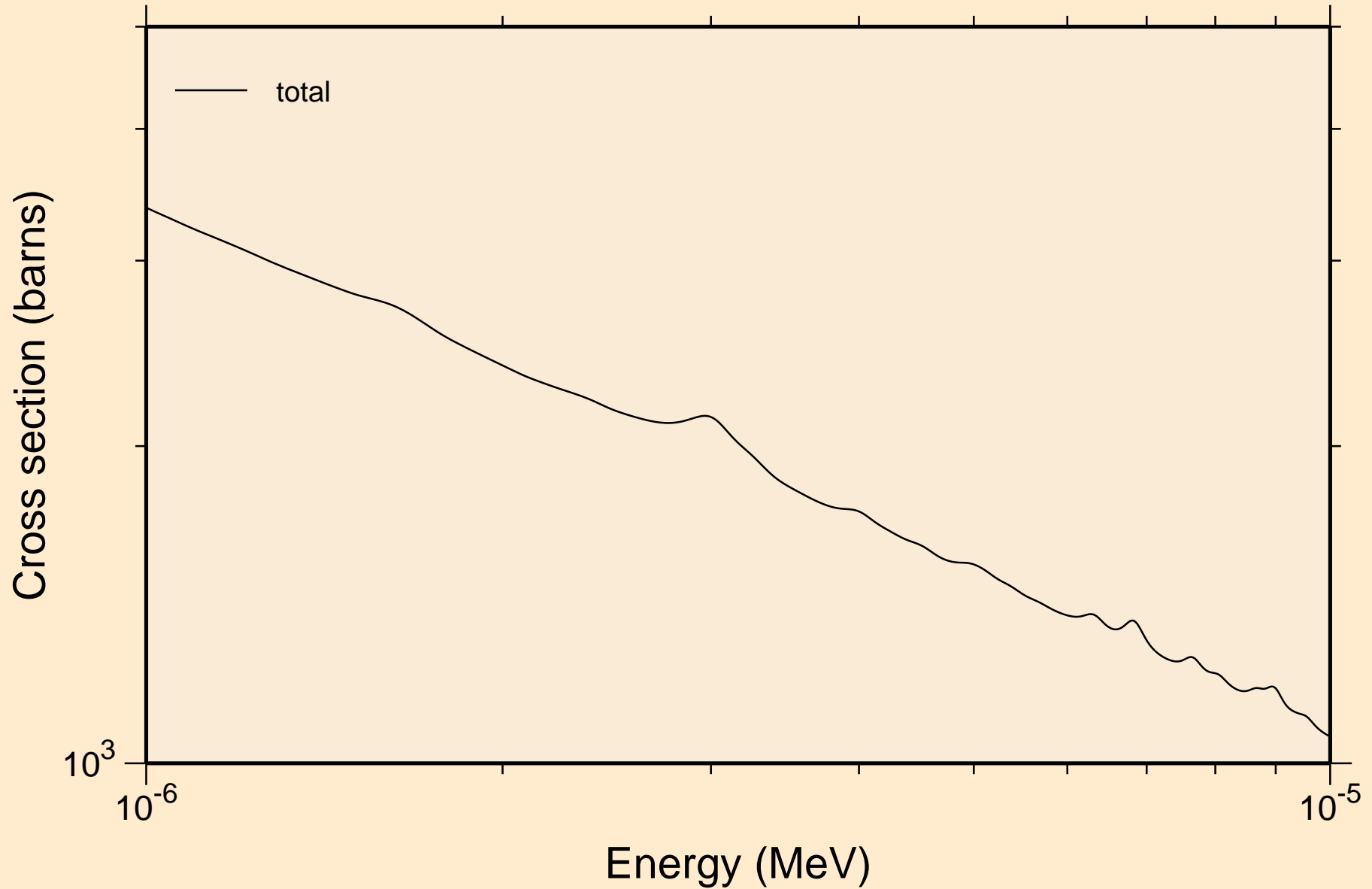

ER147 NEUTRON ACER TENDL-2024 LIBRARY; T=293.6K
resonance total cross section

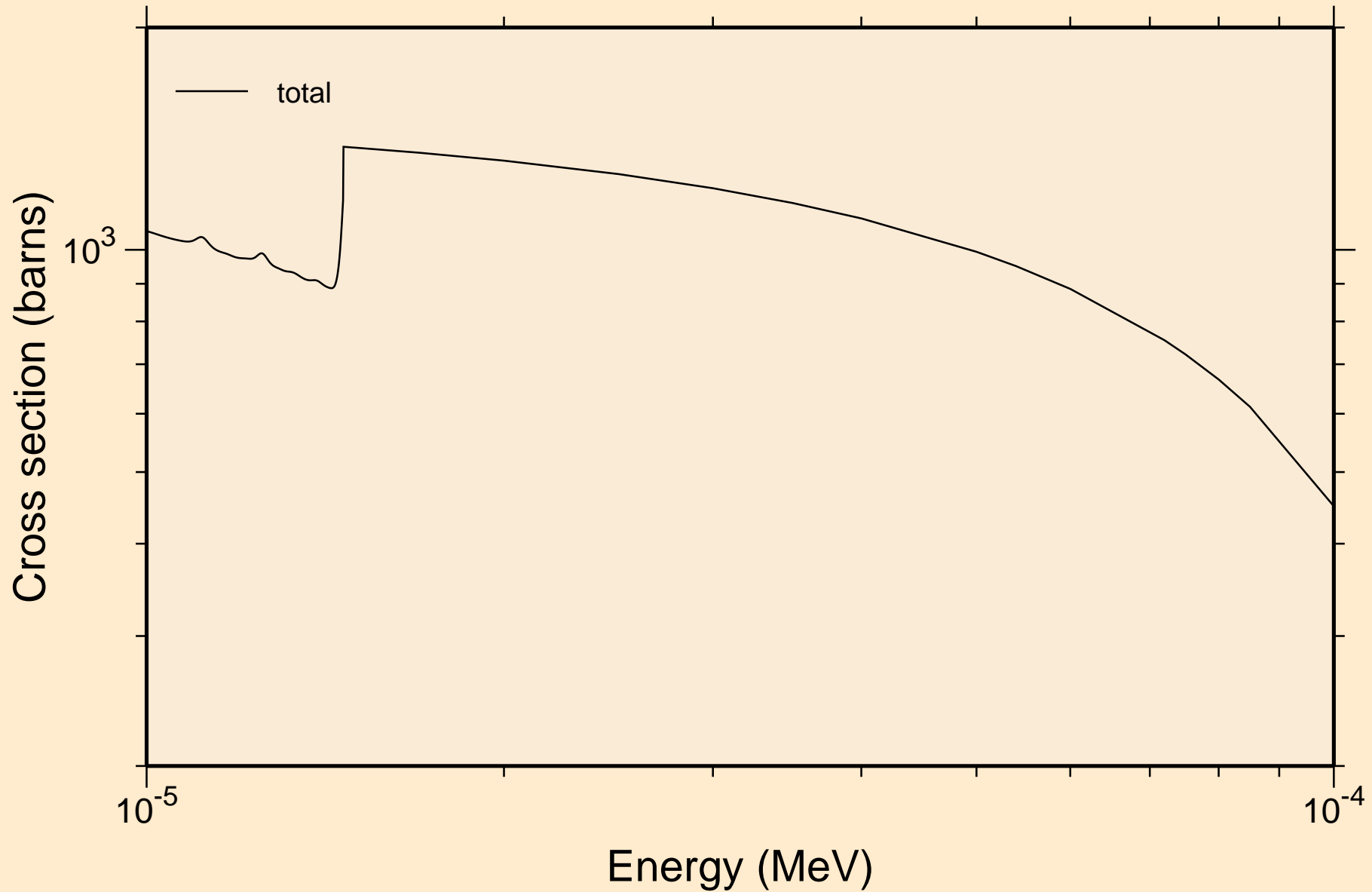

ER147 NEUTRON ACER TENDL-2024 LIBRARY; T=293.6K
resonance total cross section

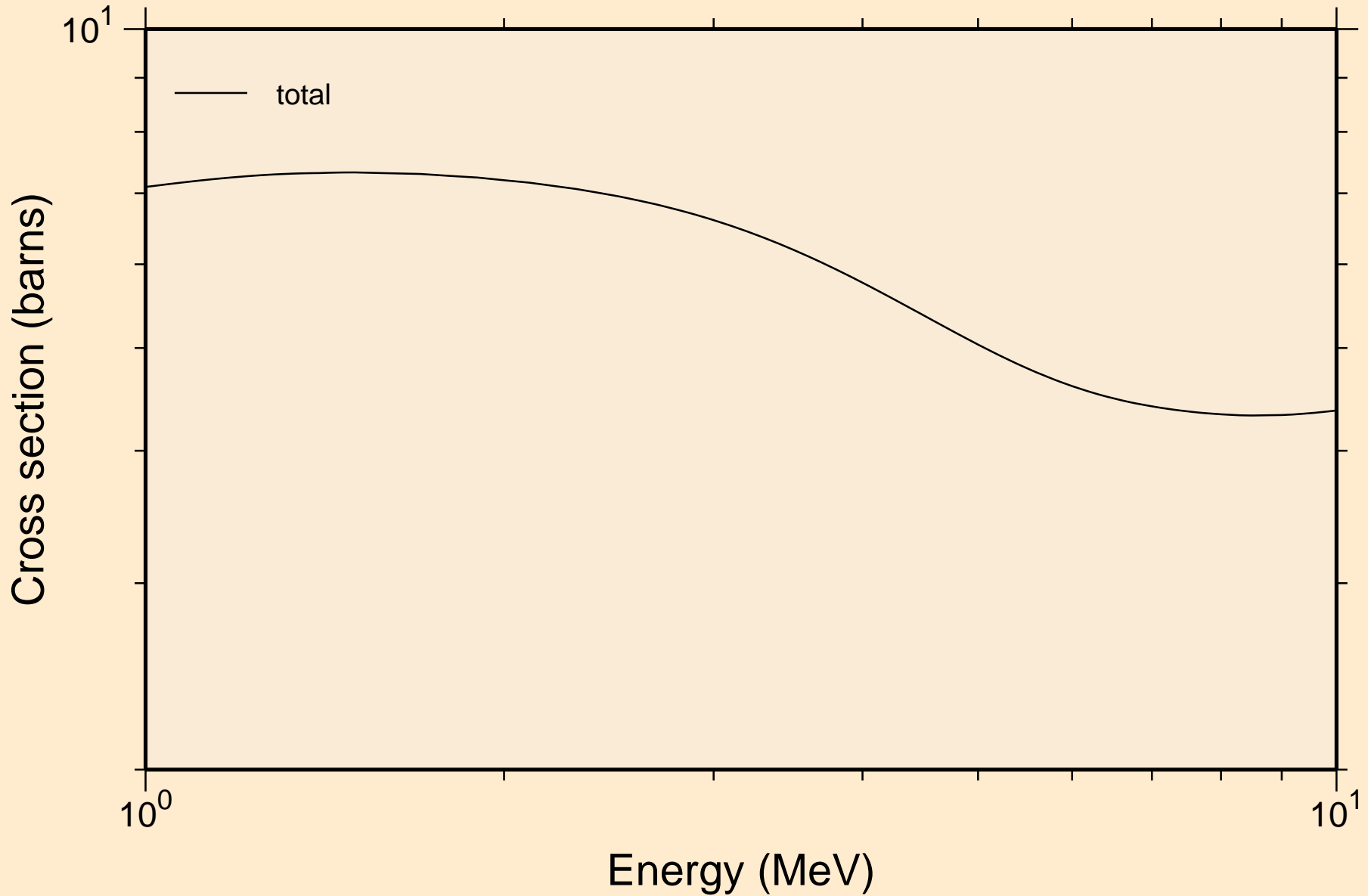

ER147 NEUTRON ACER TENDL-2024 LIBRARY; T=293.6K
resonance absorption cross sections

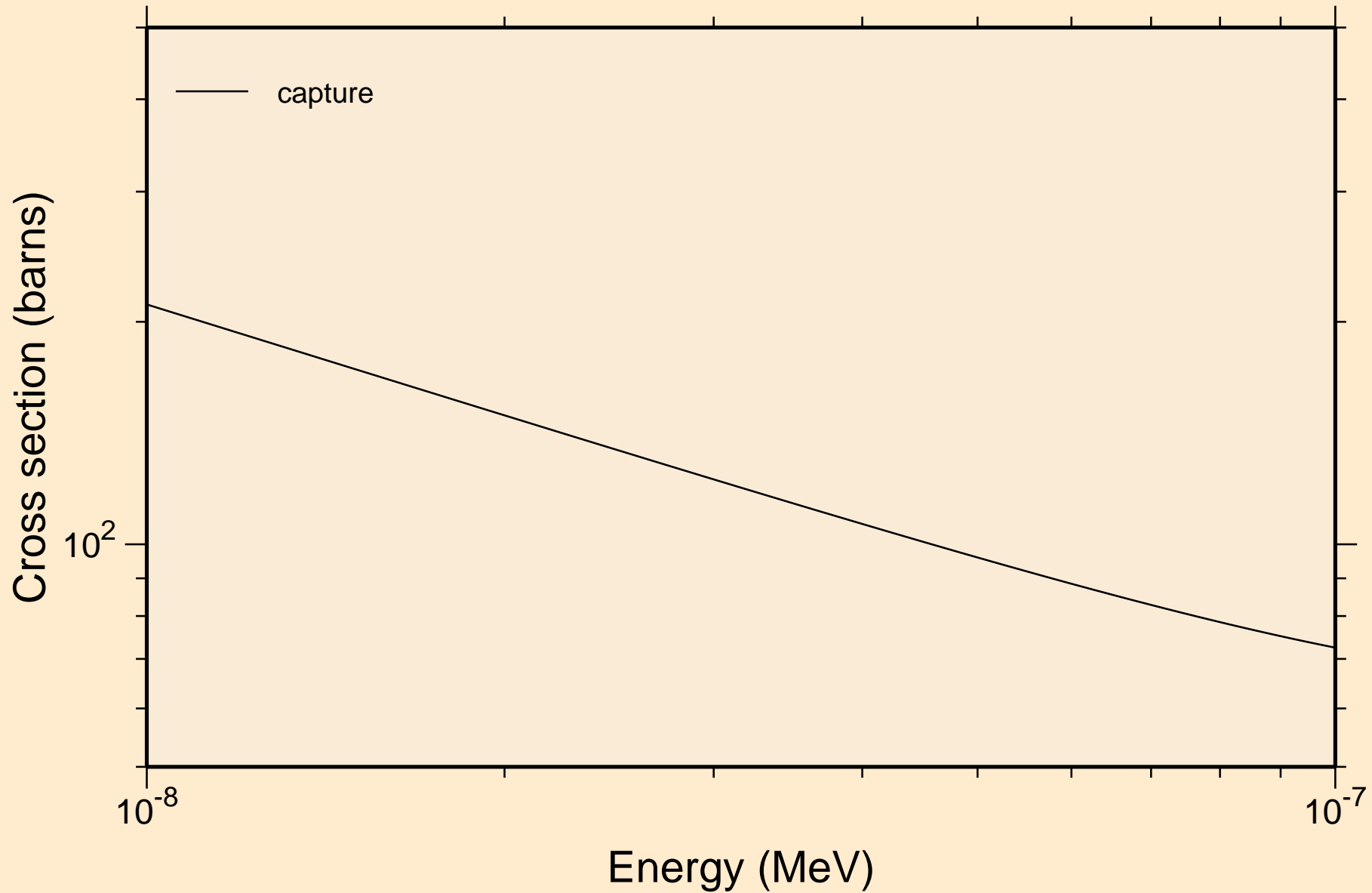

ER147 NEUTRON ACER TENDL-2024 LIBRARY; T=293.6K
resonance absorption cross sections

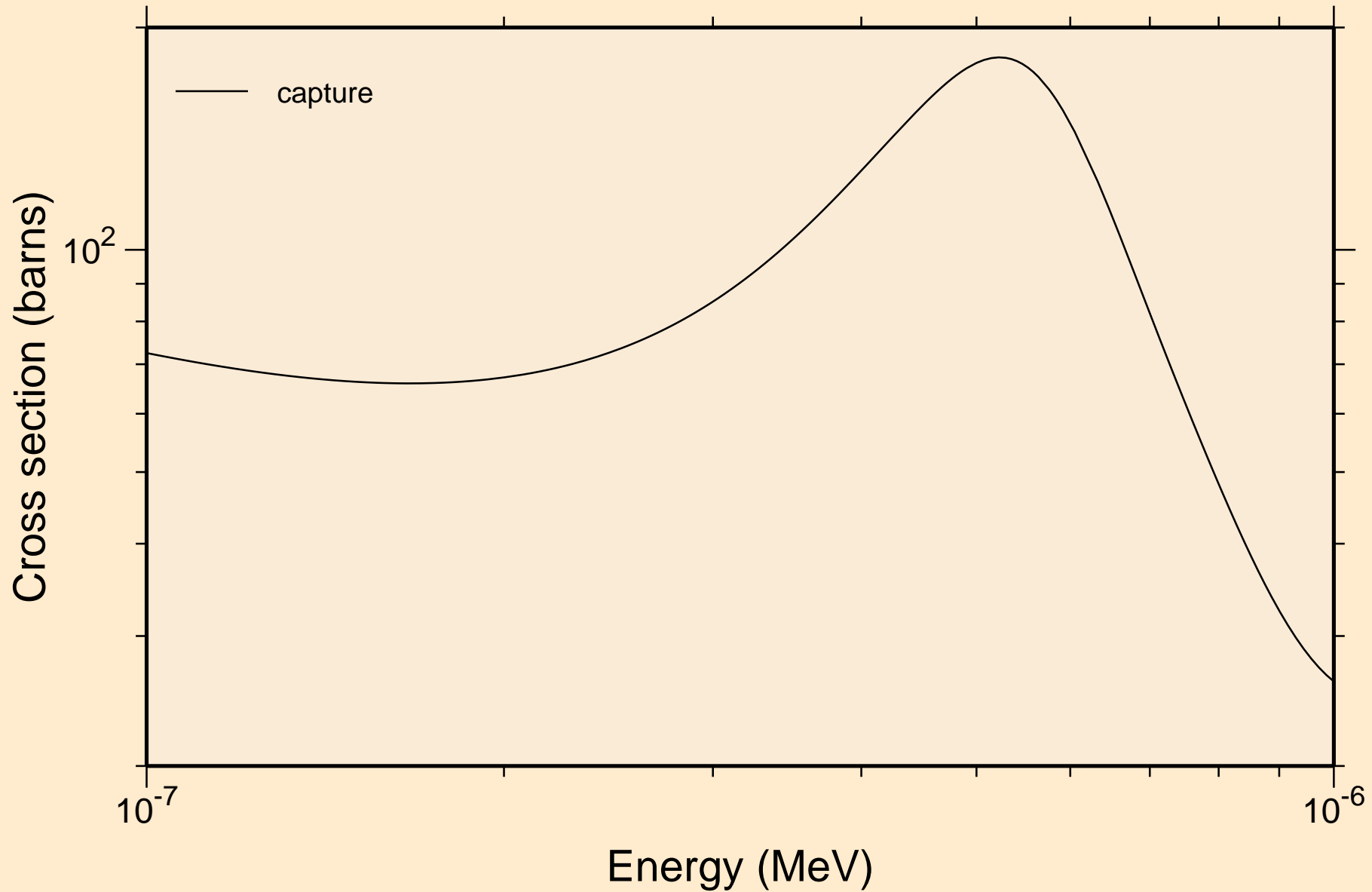

ER147 NEUTRON ACER TENDL-2024 LIBRARY; T=293.6K
resonance absorption cross sections

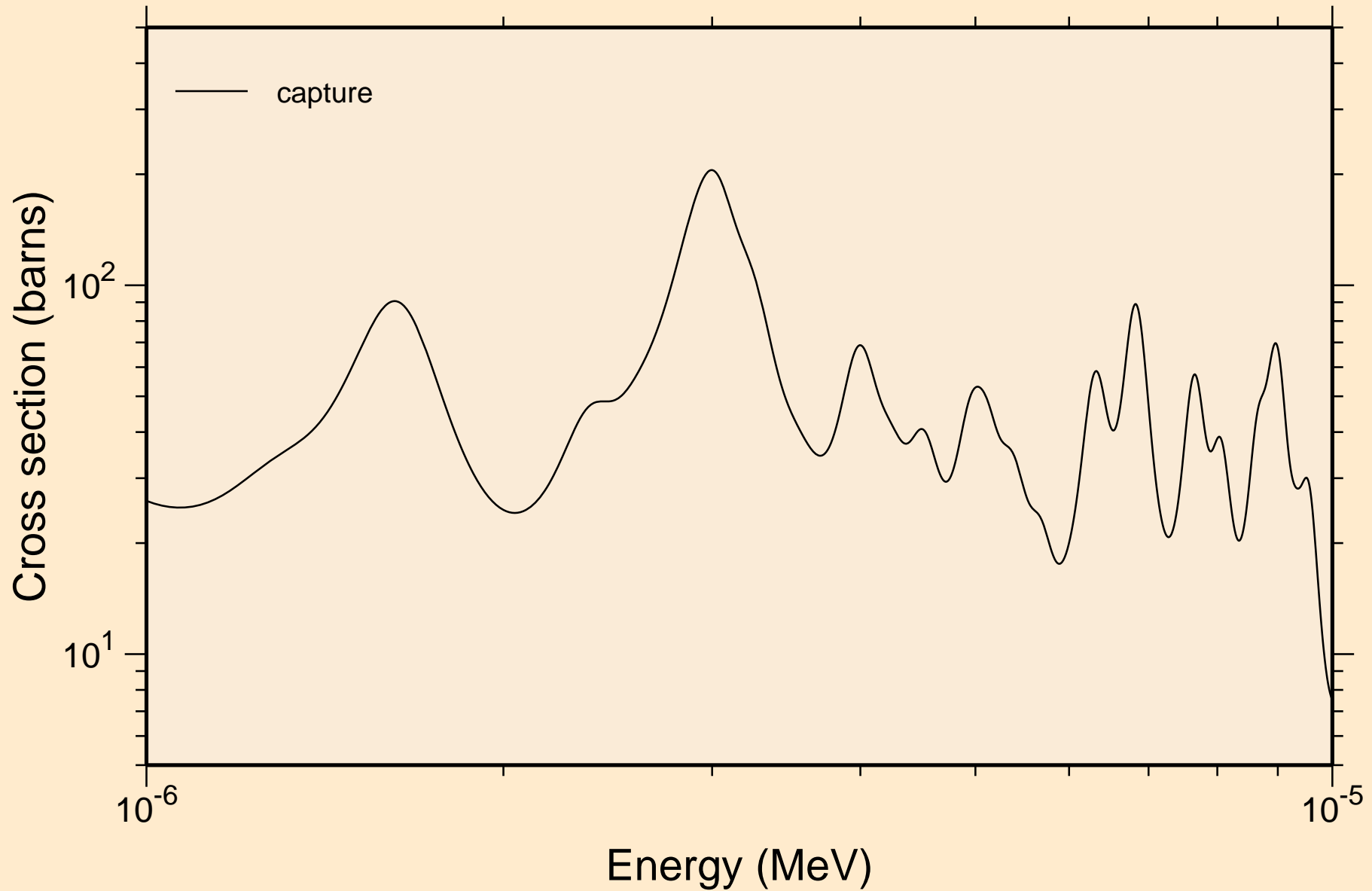

ER147 NEUTRON ACER TENDL-2024 LIBRARY; T=293.6K
resonance absorption cross sections

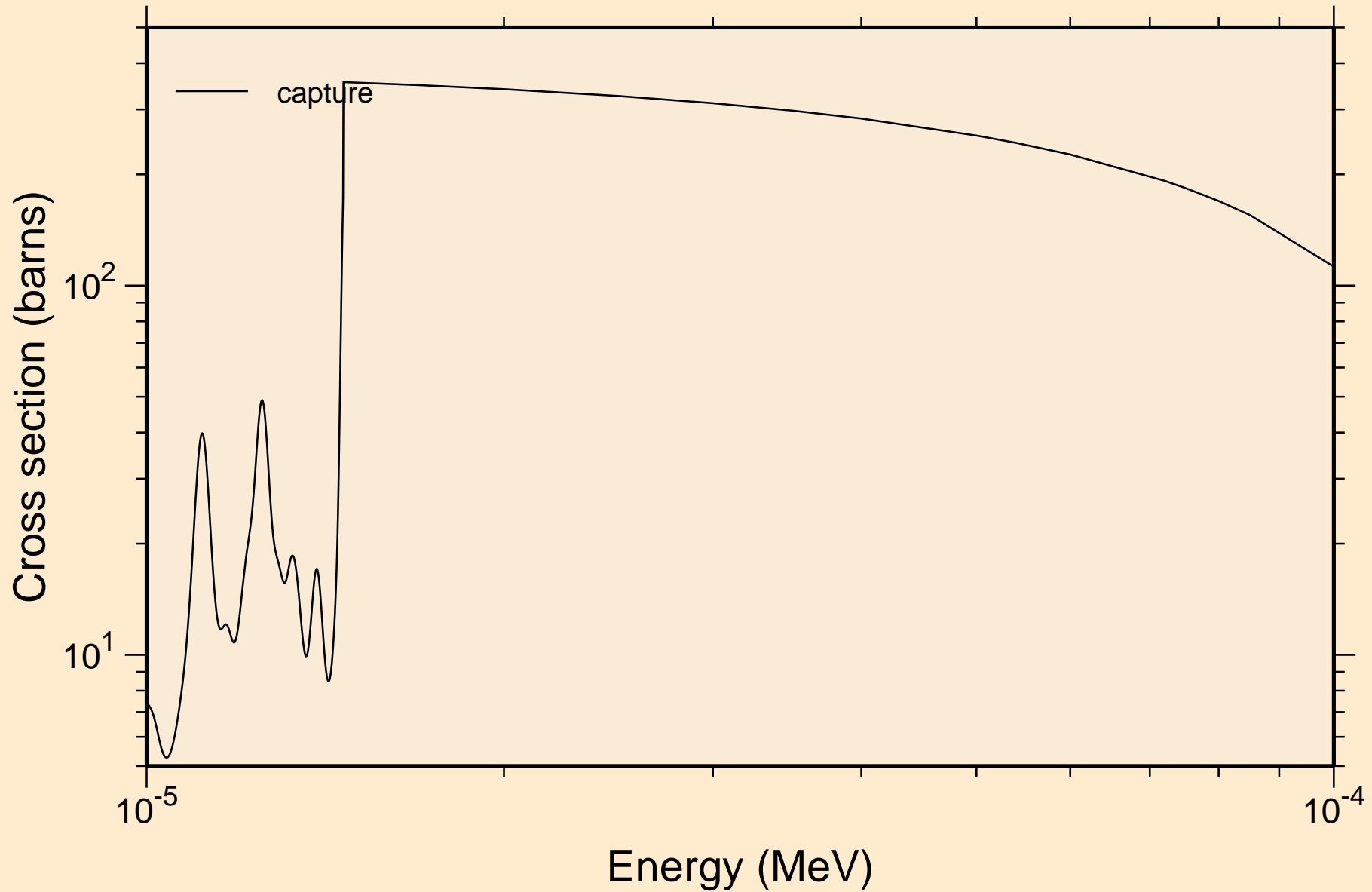

ER147 NEUTRON ACER TENDL-2024 LIBRARY; T=293.6K
resonance absorption cross sections

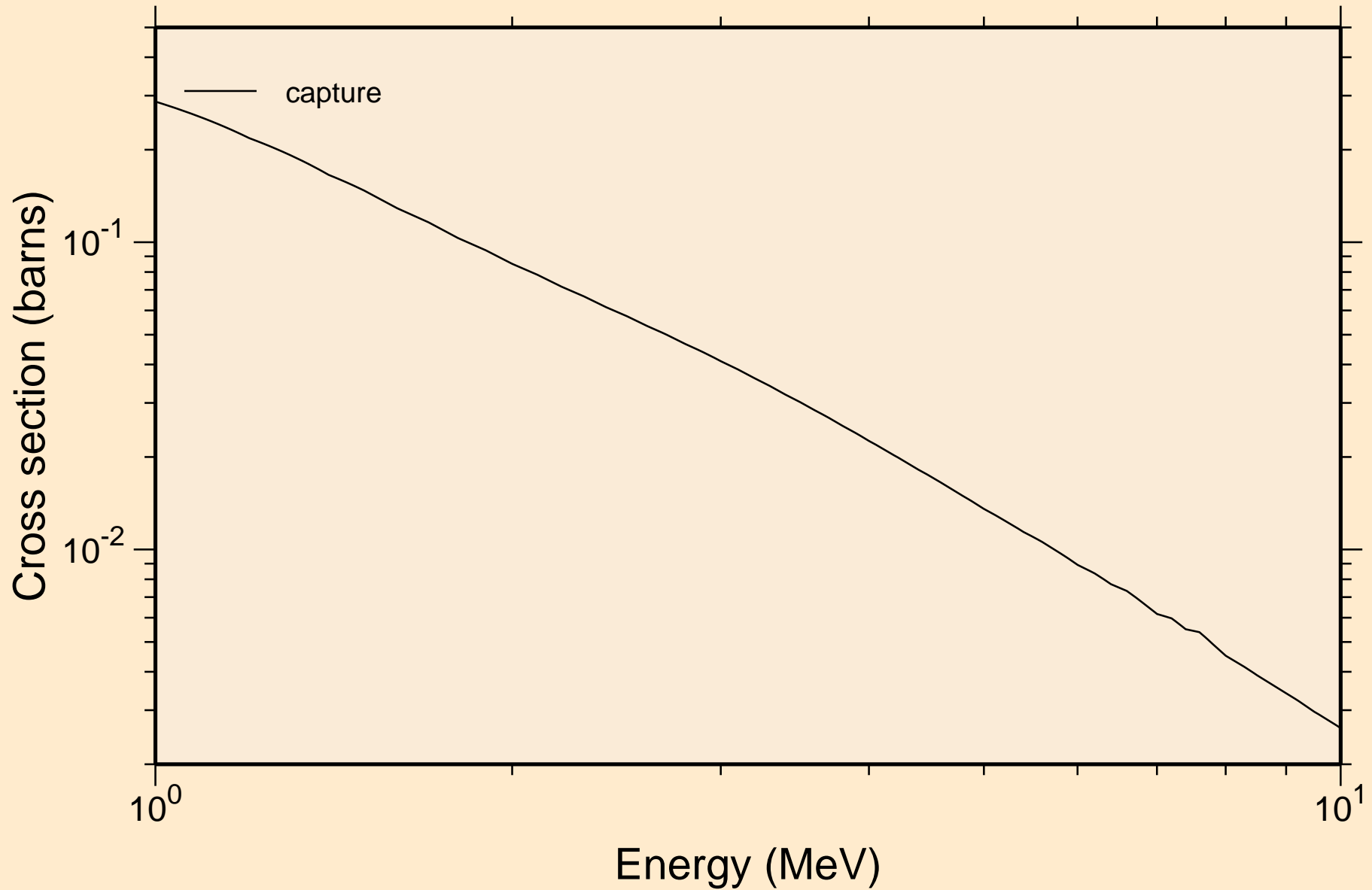

ER147 NEUTRON ACER TENDL-2024 LIBRARY; T=293.6K

Heating

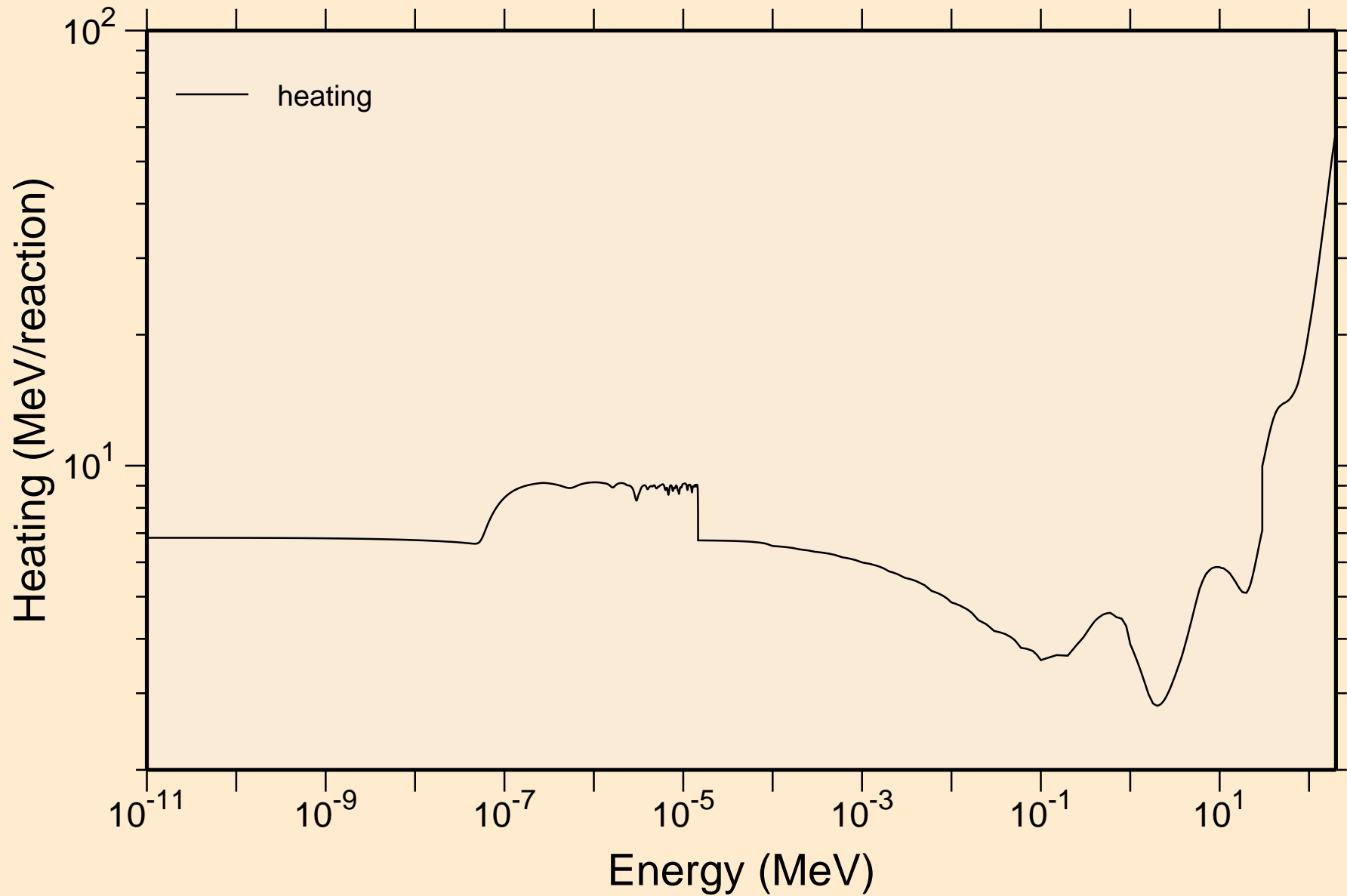

ER147 NEUTRON ACER TENDL-2024 LIBRARY; T=293.6K
Damage

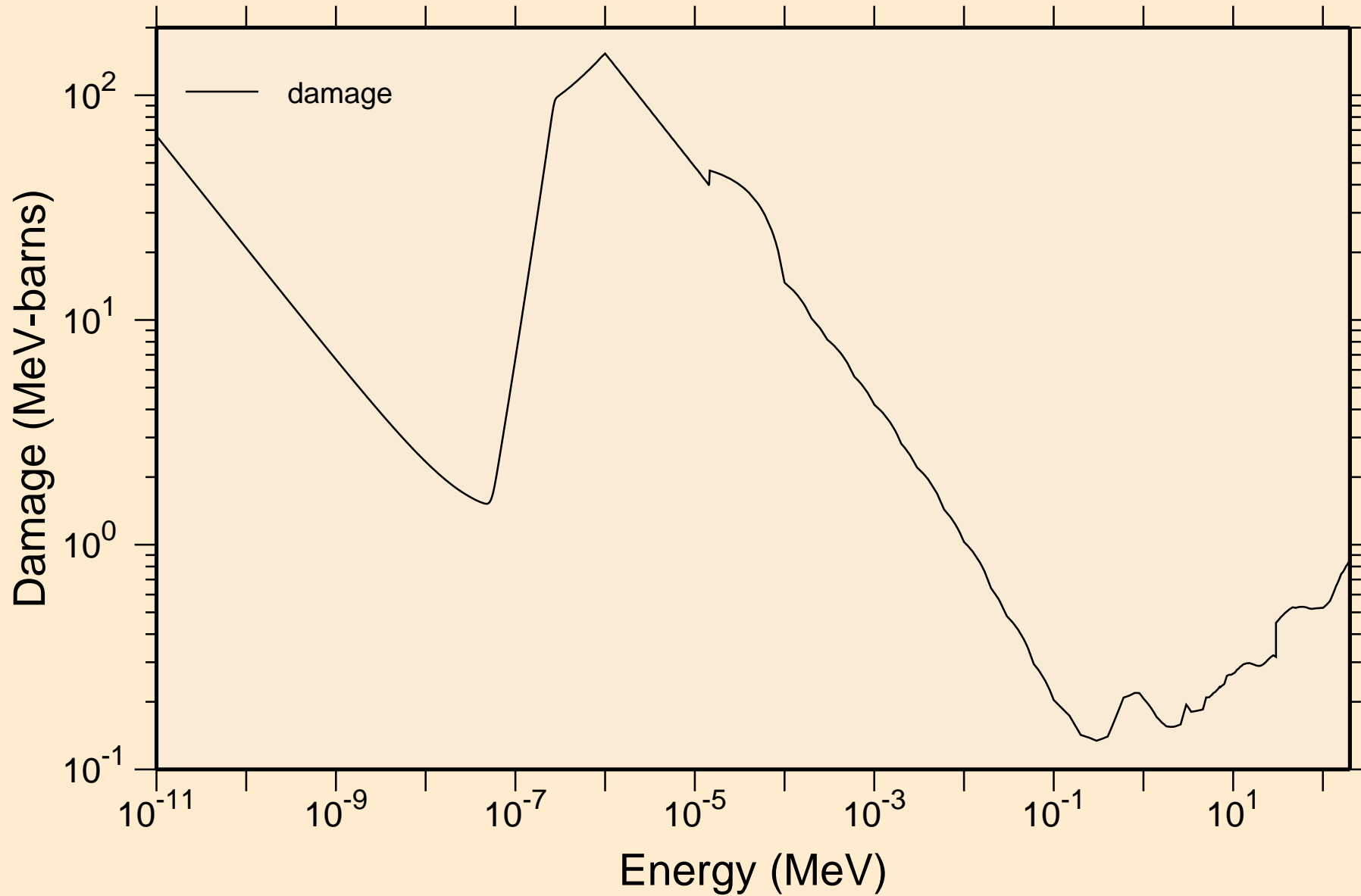

ER147 NEUTRON ACER TENDL-2024 LIBRARY; T=293.6K
Non-threshold reactions

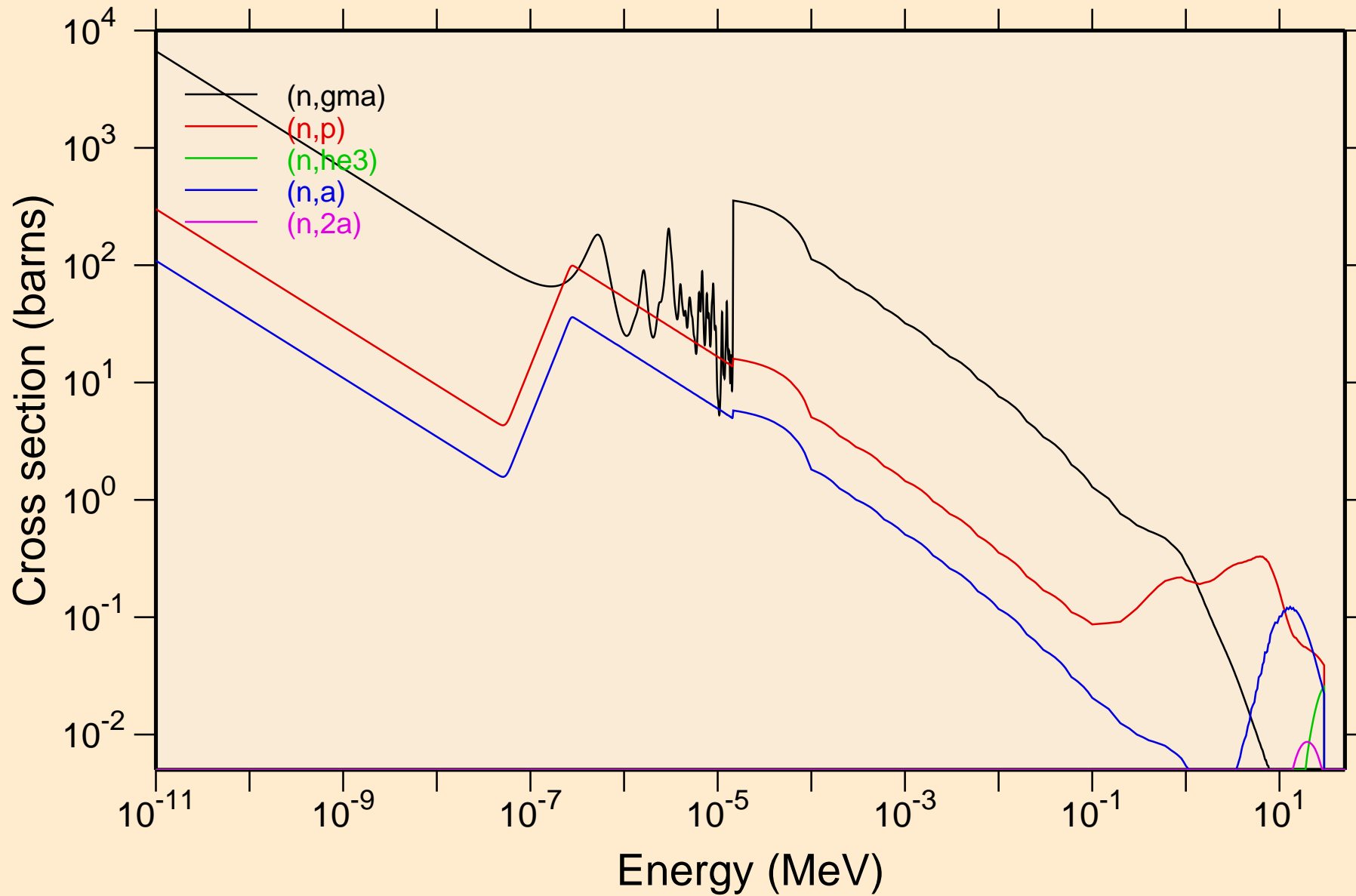

ER147 NEUTRON ACER TENDL-2024 LIBRARY; T=293.6K

Non-threshold reactions

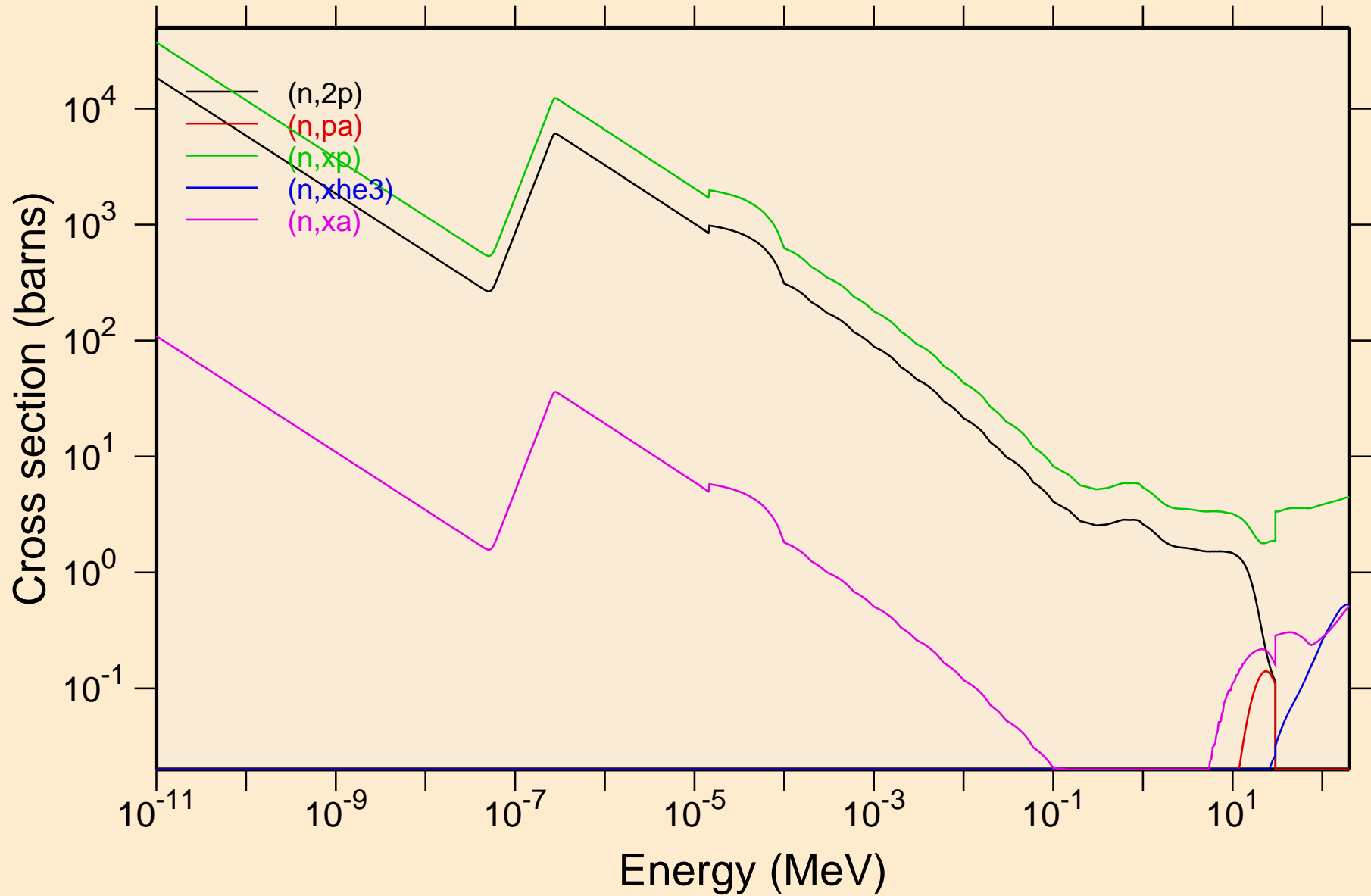

ER147 NEUTRON ACER TENDL-2024 LIBRARY; T=293.6K

Principal cross sections

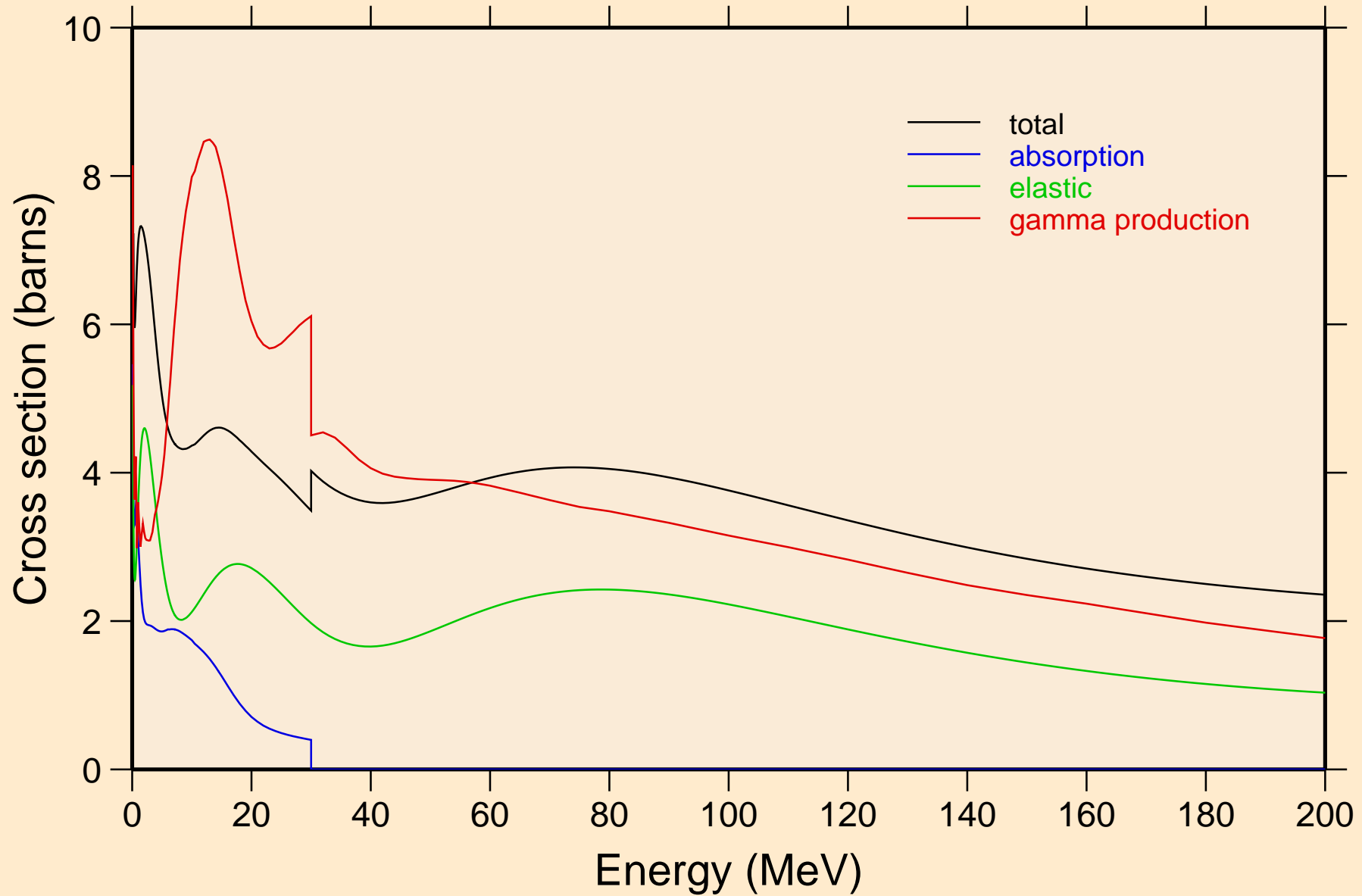

ER147 NEUTRON ACER TENDL-2024 LIBRARY; T=293.6K

Heating

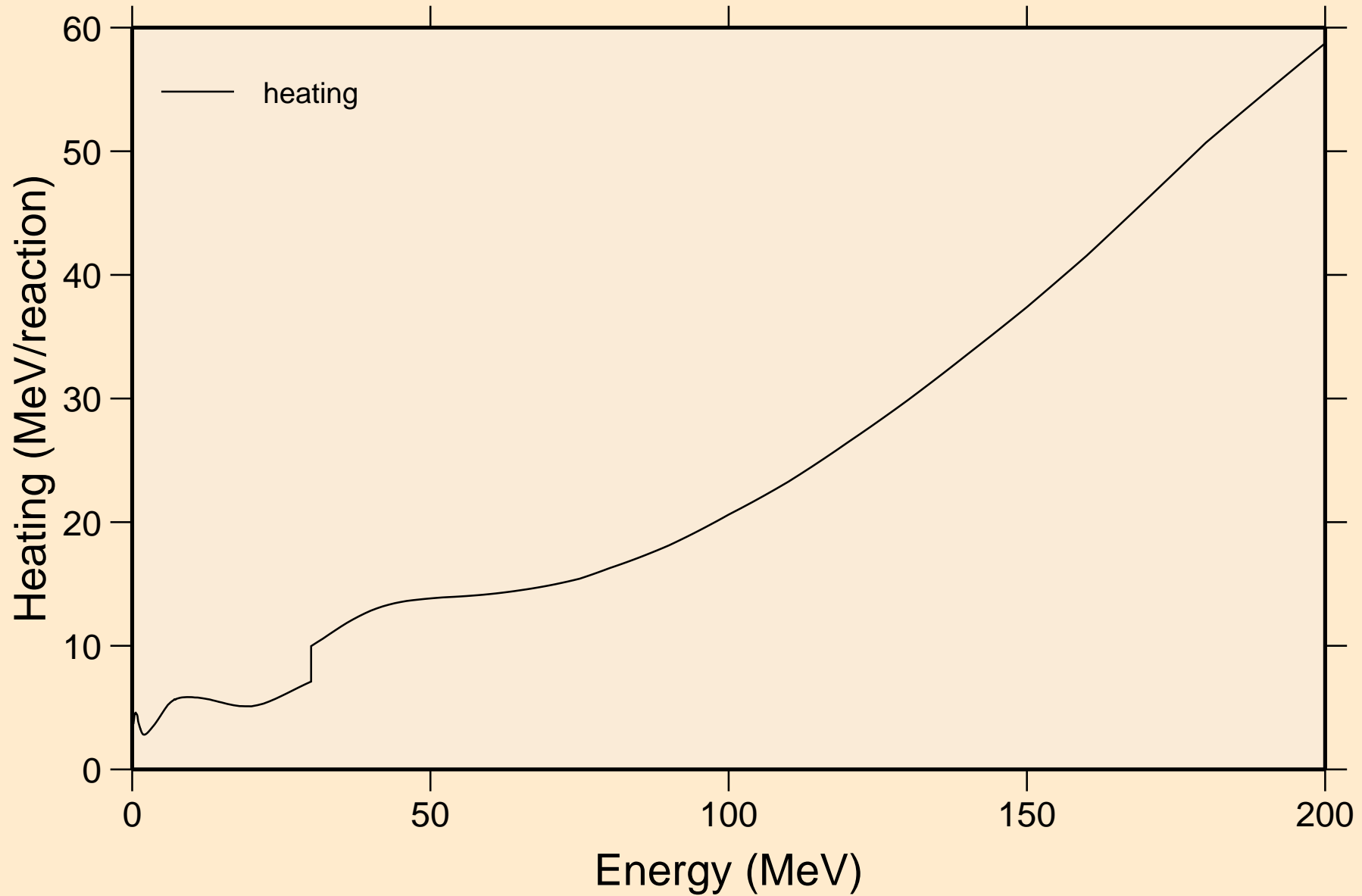

ER147 NEUTRON ACER TENDL-2024 LIBRARY; T=293.6K

Damage

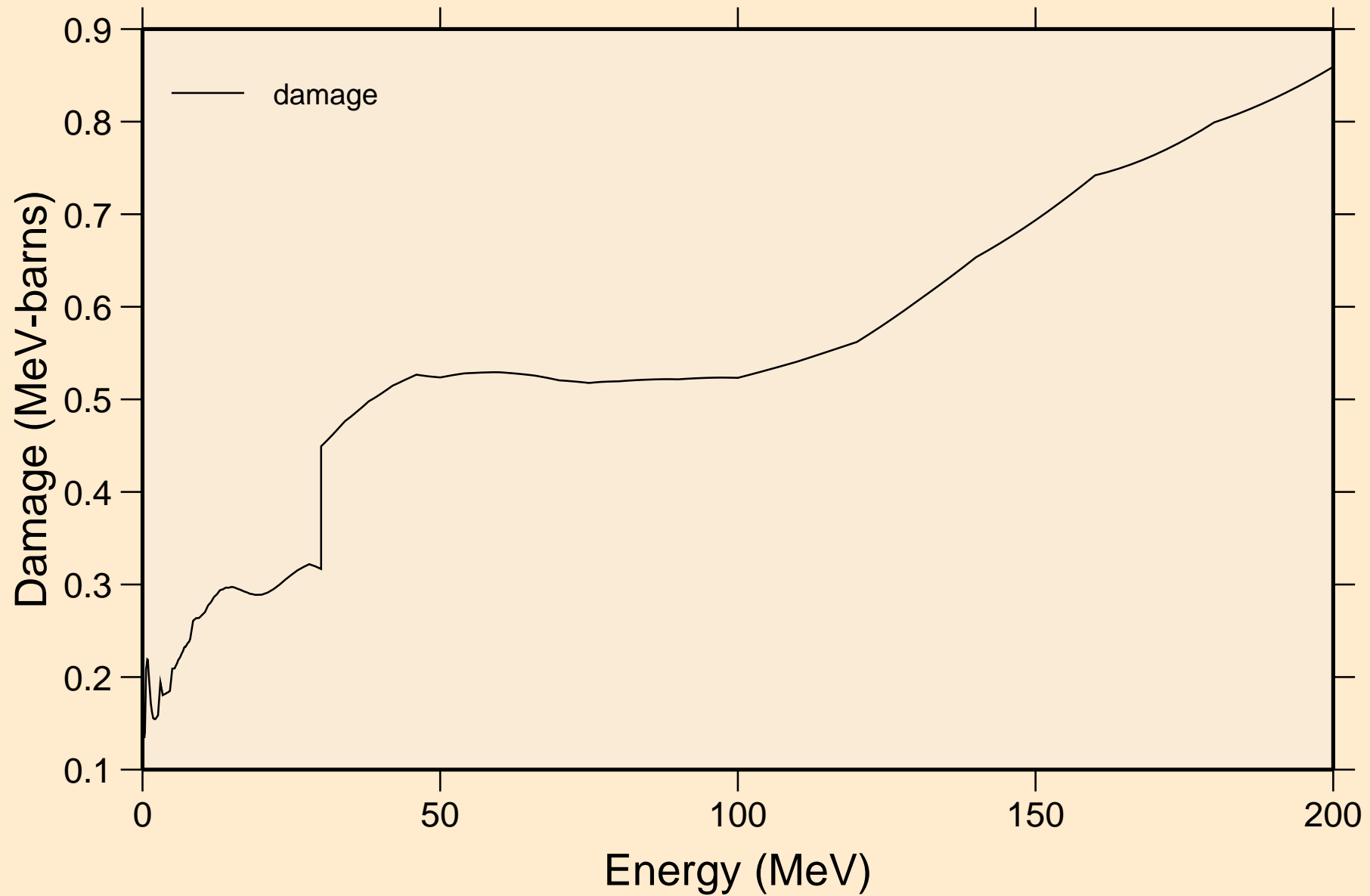

ER147 NEUTRON ACER TENDL-2024 LIBRARY; T=293.6K

Non-threshold reactions

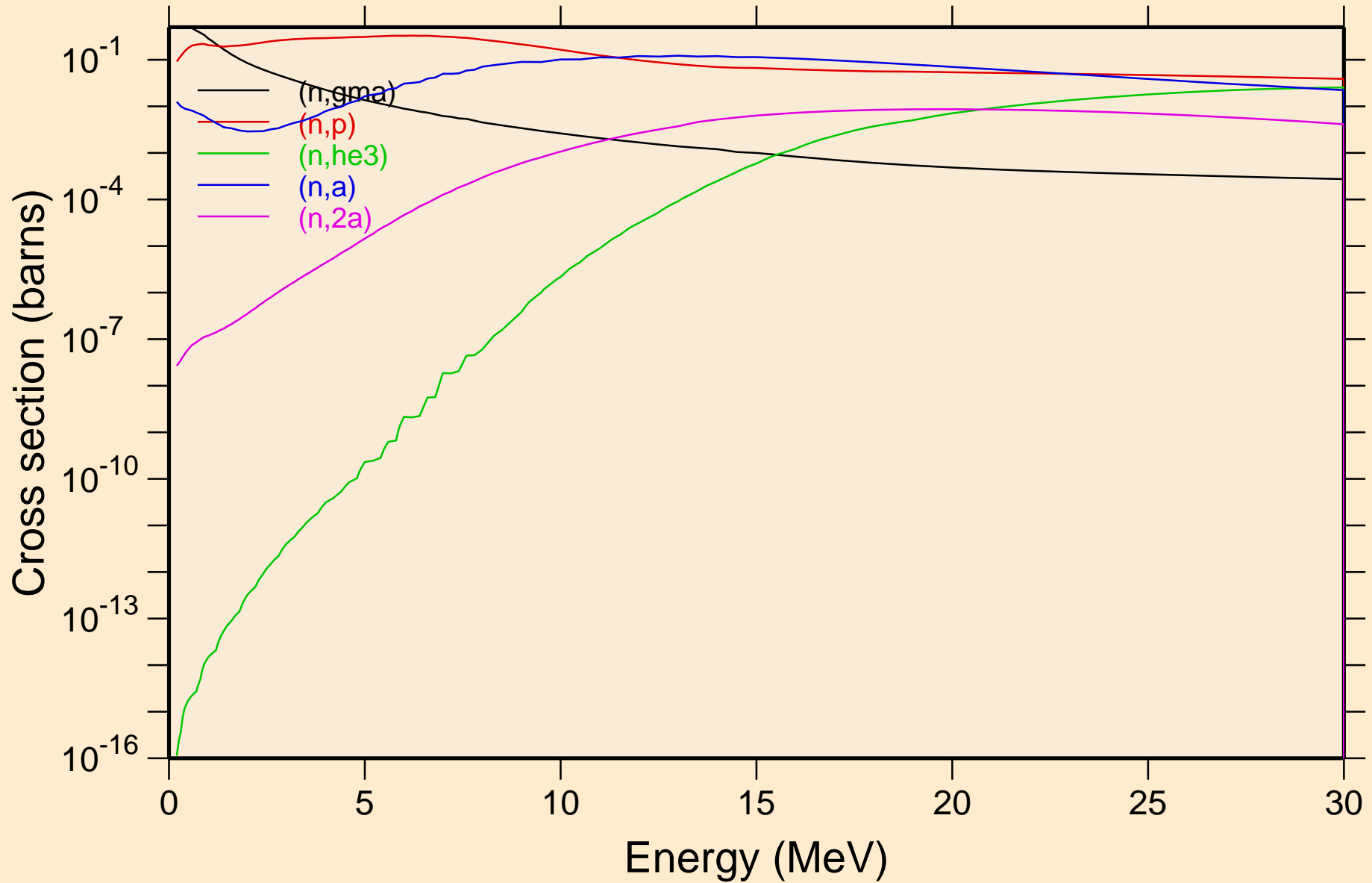

ER147 NEUTRON ACER TENDL-2024 LIBRARY; T=293.6K
Non-threshold reactions

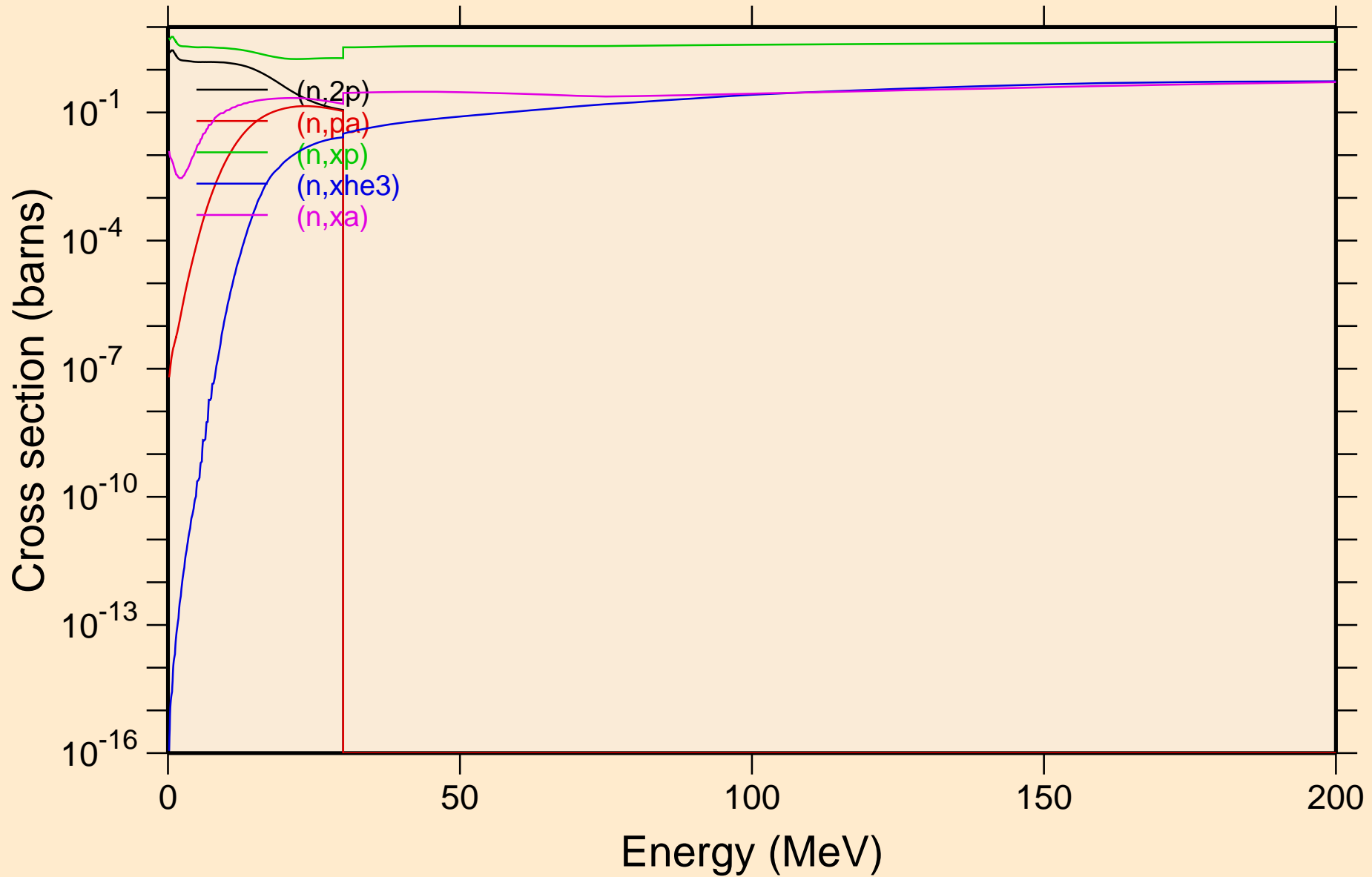

ER147 NEUTRON ACER TENDL-2024 LIBRARY; T=293.6K

Inelastic levels

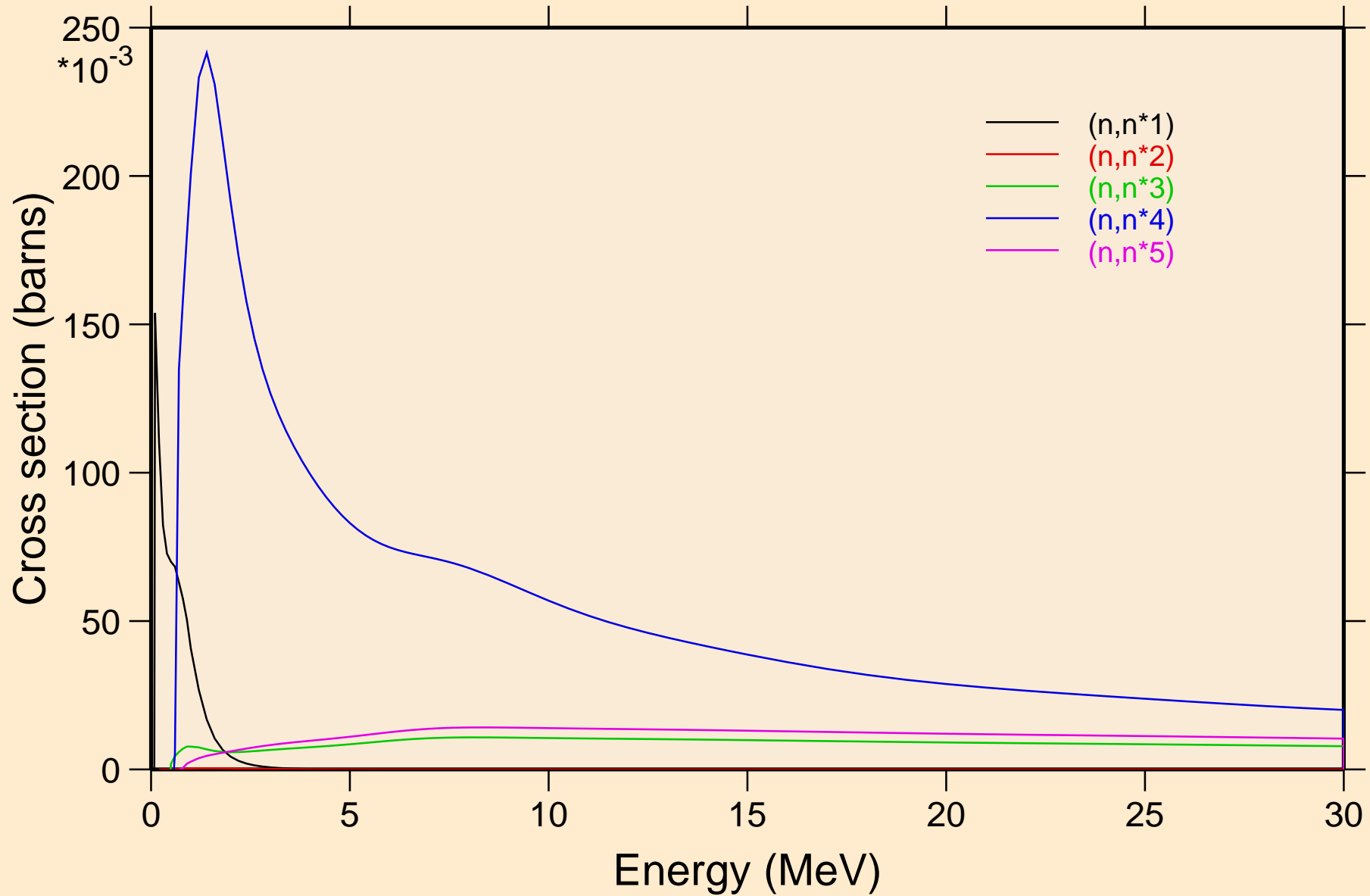

ER147 NEUTRON ACER TENDL-2024 LIBRARY; T=293.6K
Inelastic levels

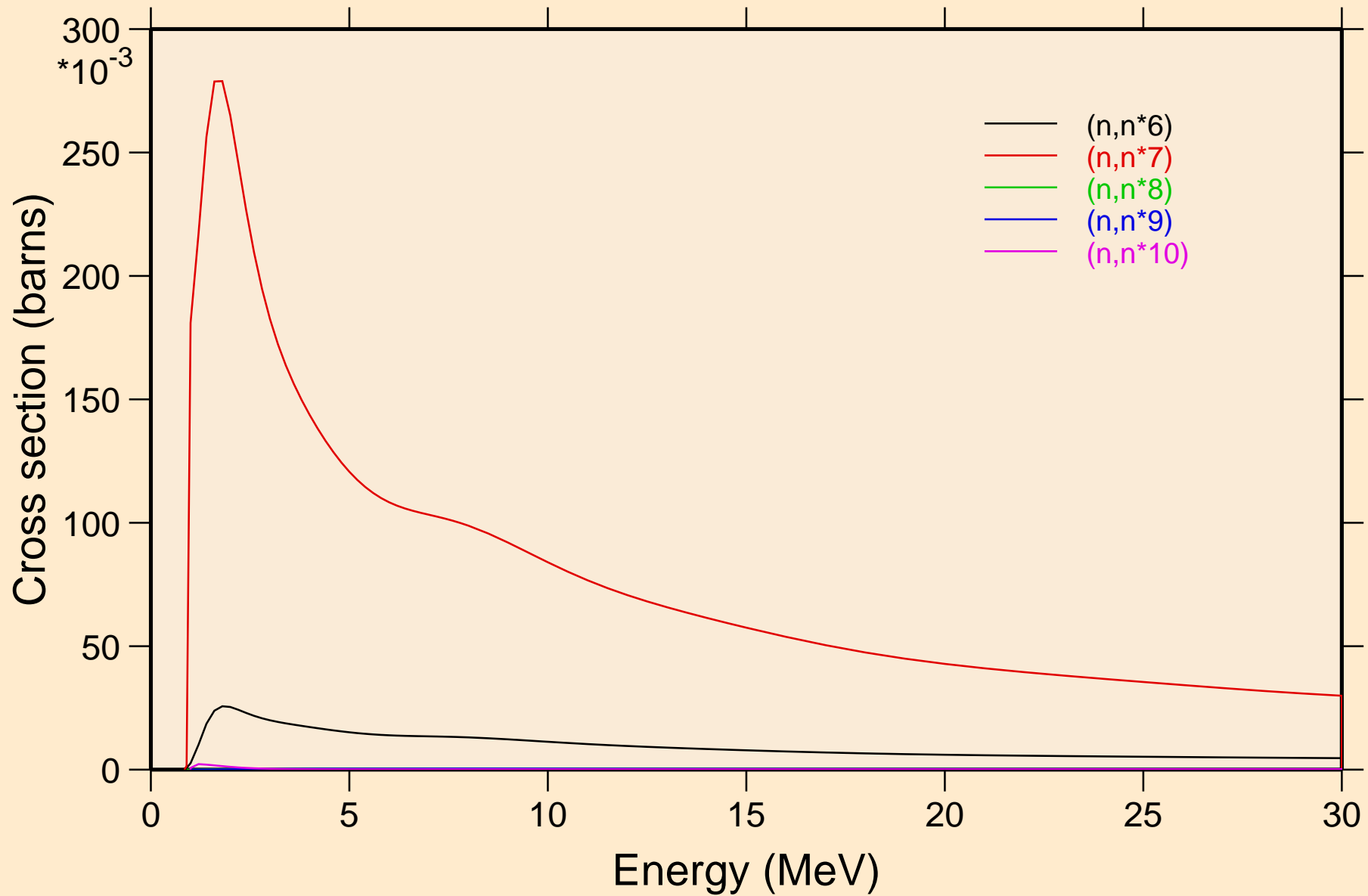

ER147 NEUTRON ACER TENDL-2024 LIBRARY; T=293.6K
Inelastic levels

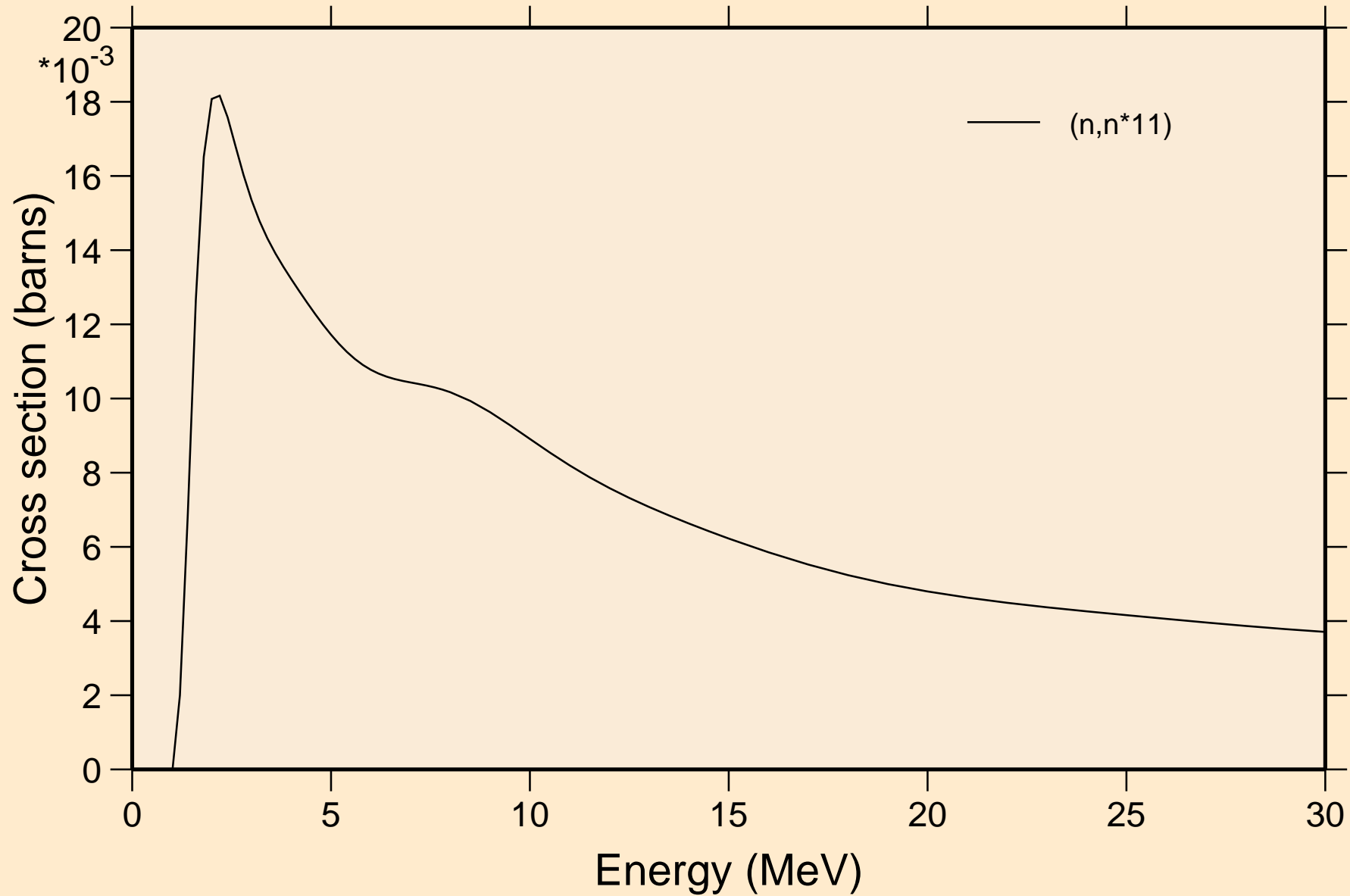

ER147 NEUTRON ACER TENDL-2024 LIBRARY; T=293.6K
Threshold reactions

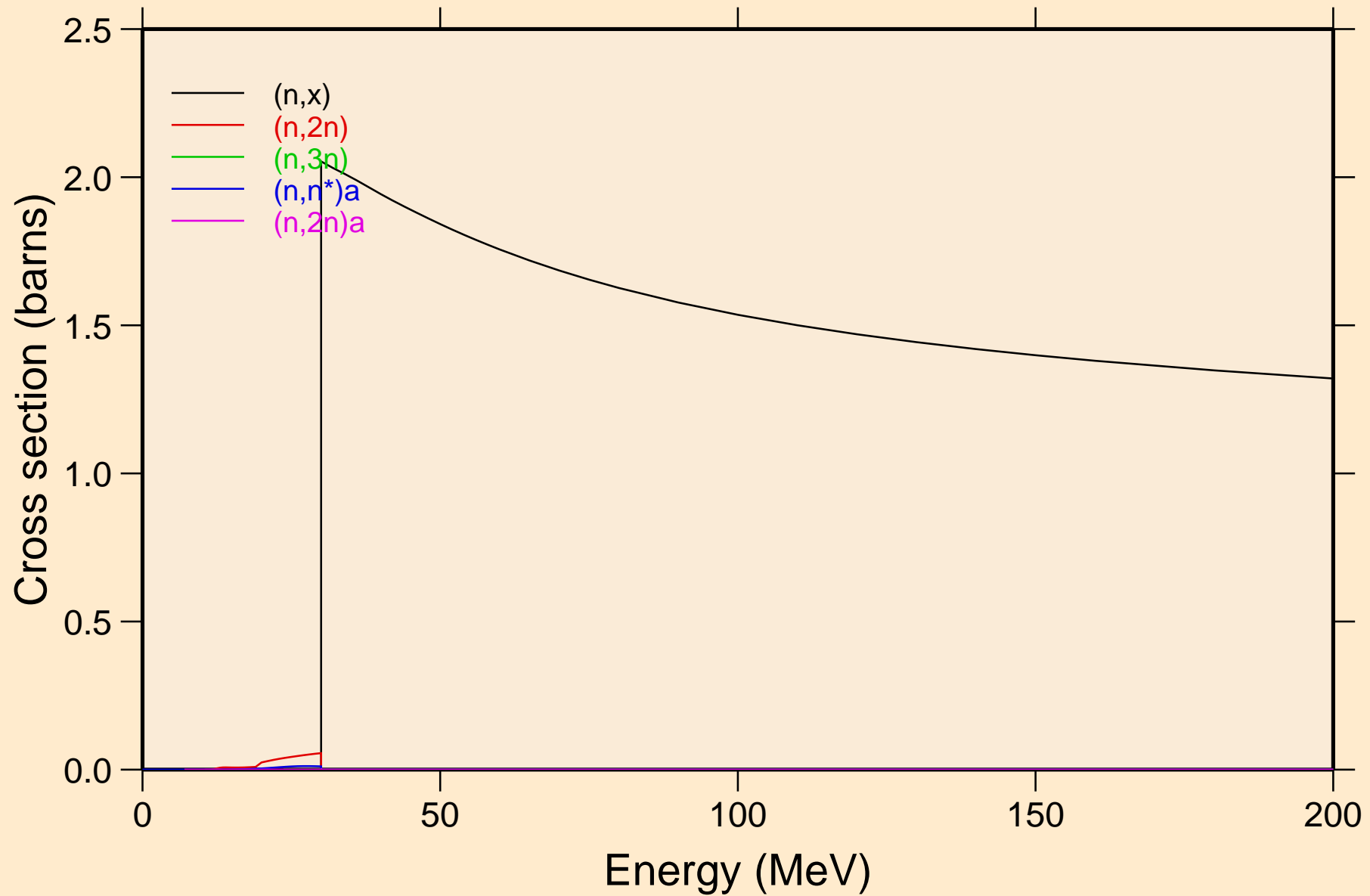

ER147 NEUTRON ACER TENDL-2024 LIBRARY; T=293.6K

Threshold reactions

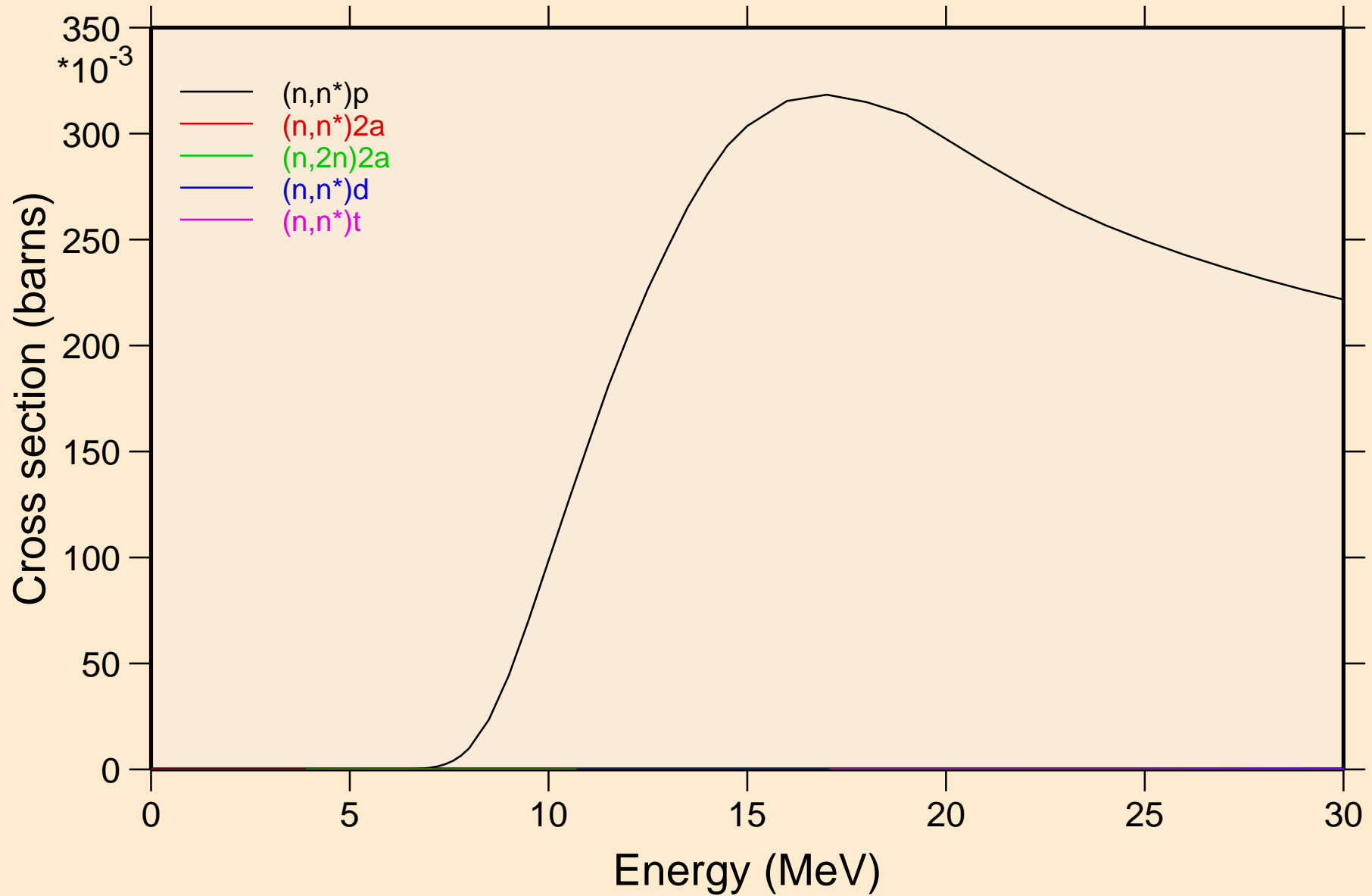

ER147 NEUTRON ACER TENDL-2024 LIBRARY; T=293.6K
Threshold reactions

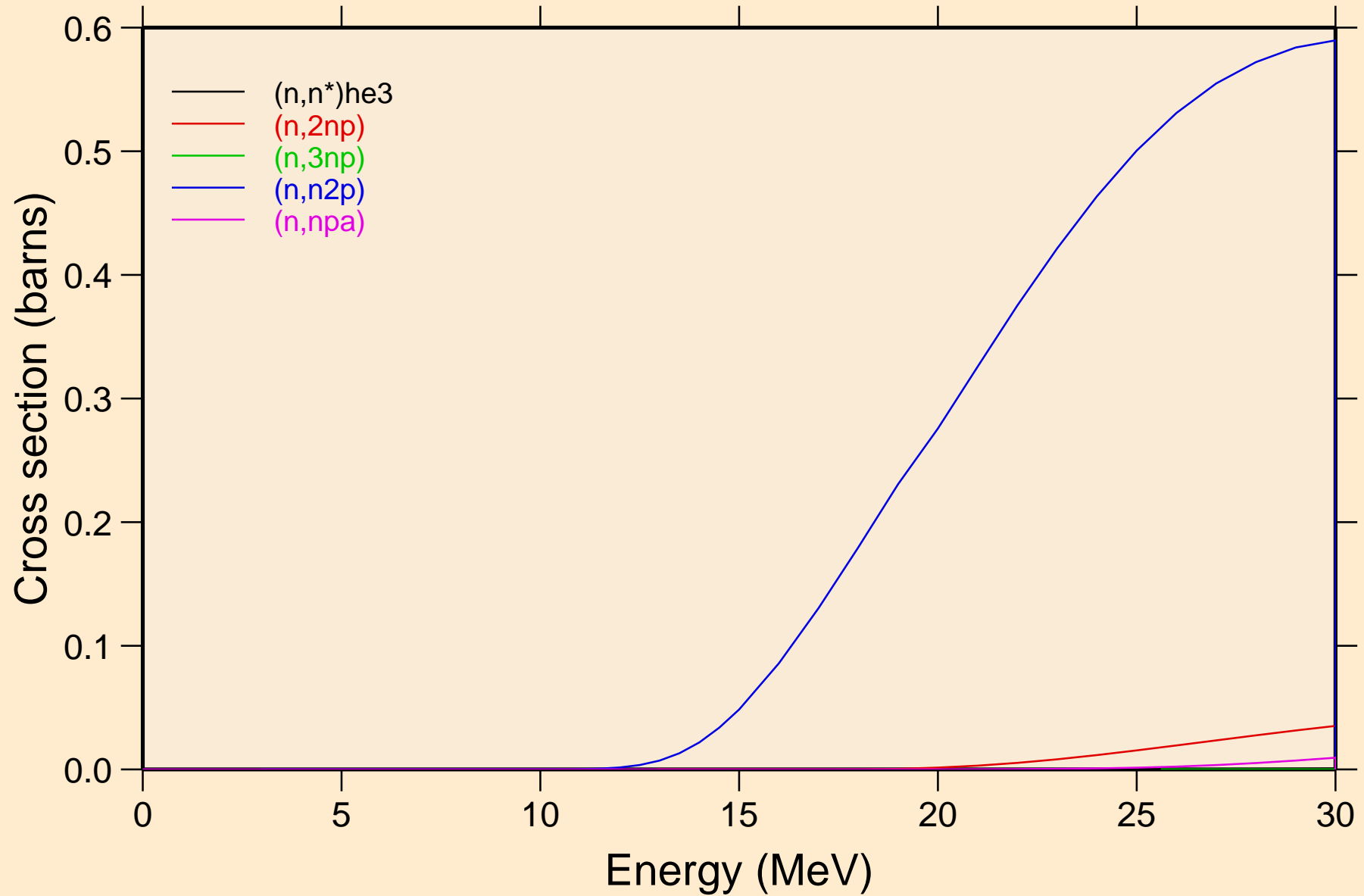

ER147 NEUTRON ACER TENDL-2024 LIBRARY; T=293.6K

Threshold reactions

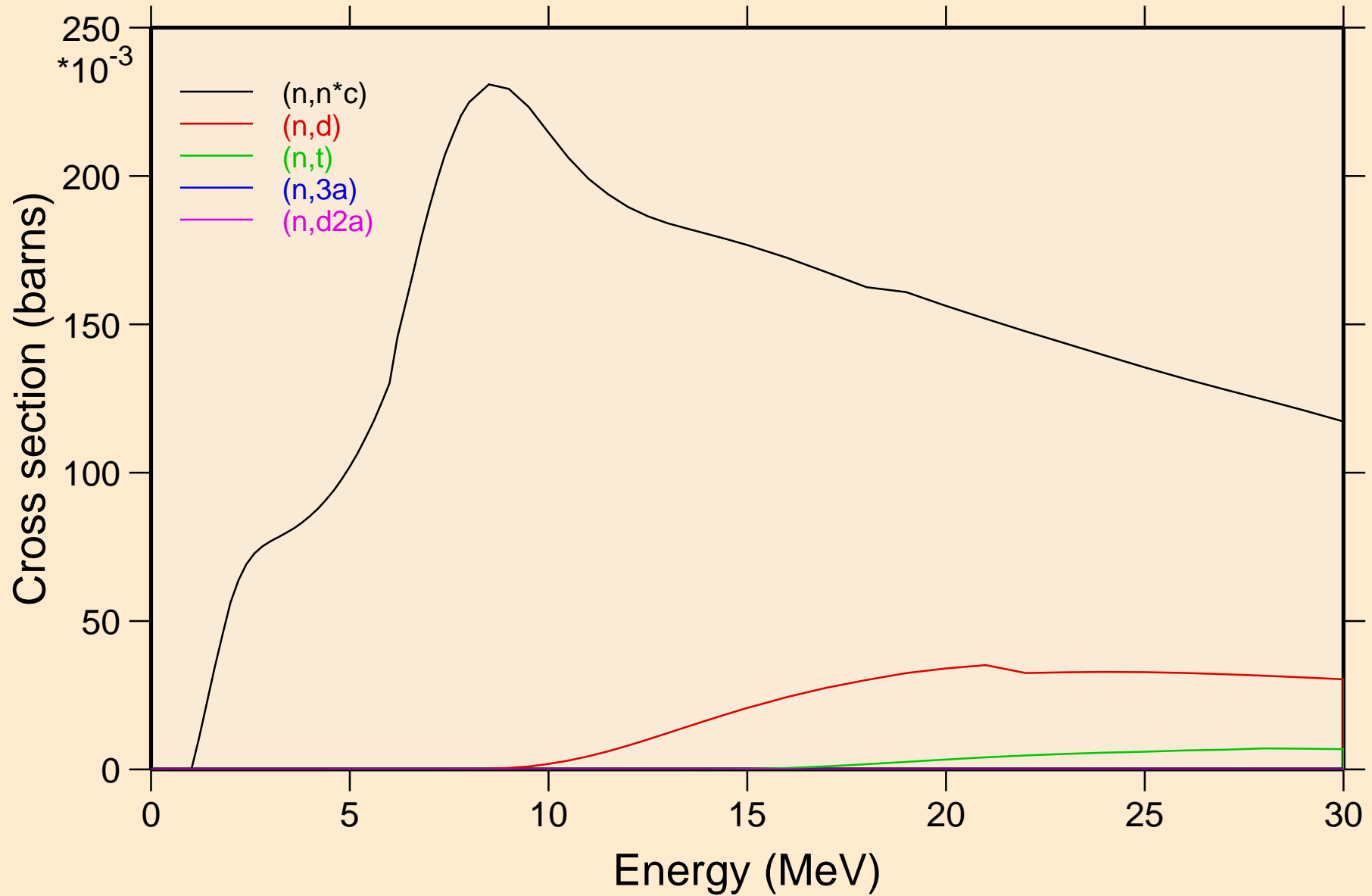

ER147 NEUTRON ACER TENDL-2024 LIBRARY; T=293.6K
Threshold reactions

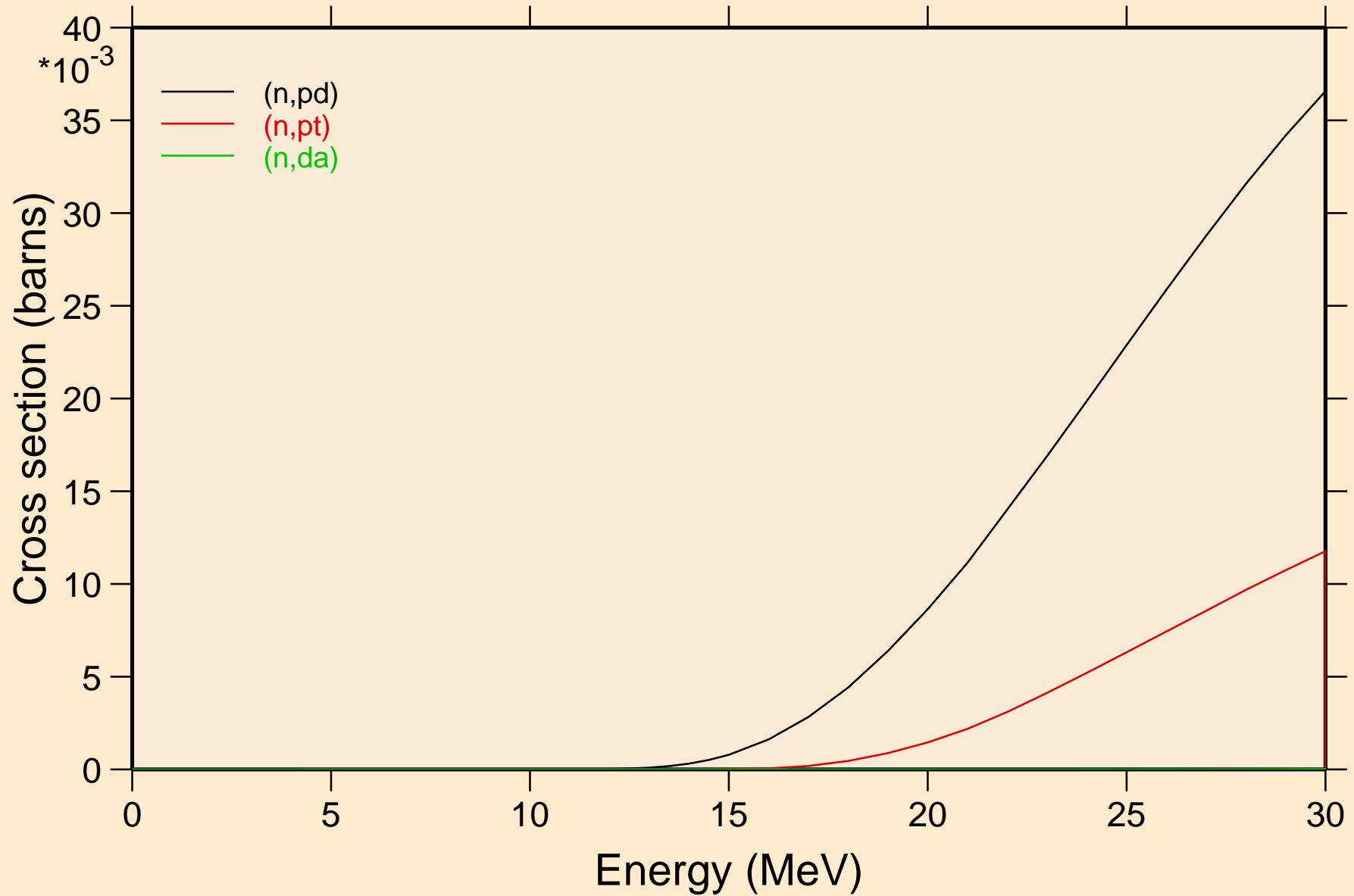

ER147 NEUTRON ACER TENDL-2024 LIBRARY; T=293.6K
Threshold reactions

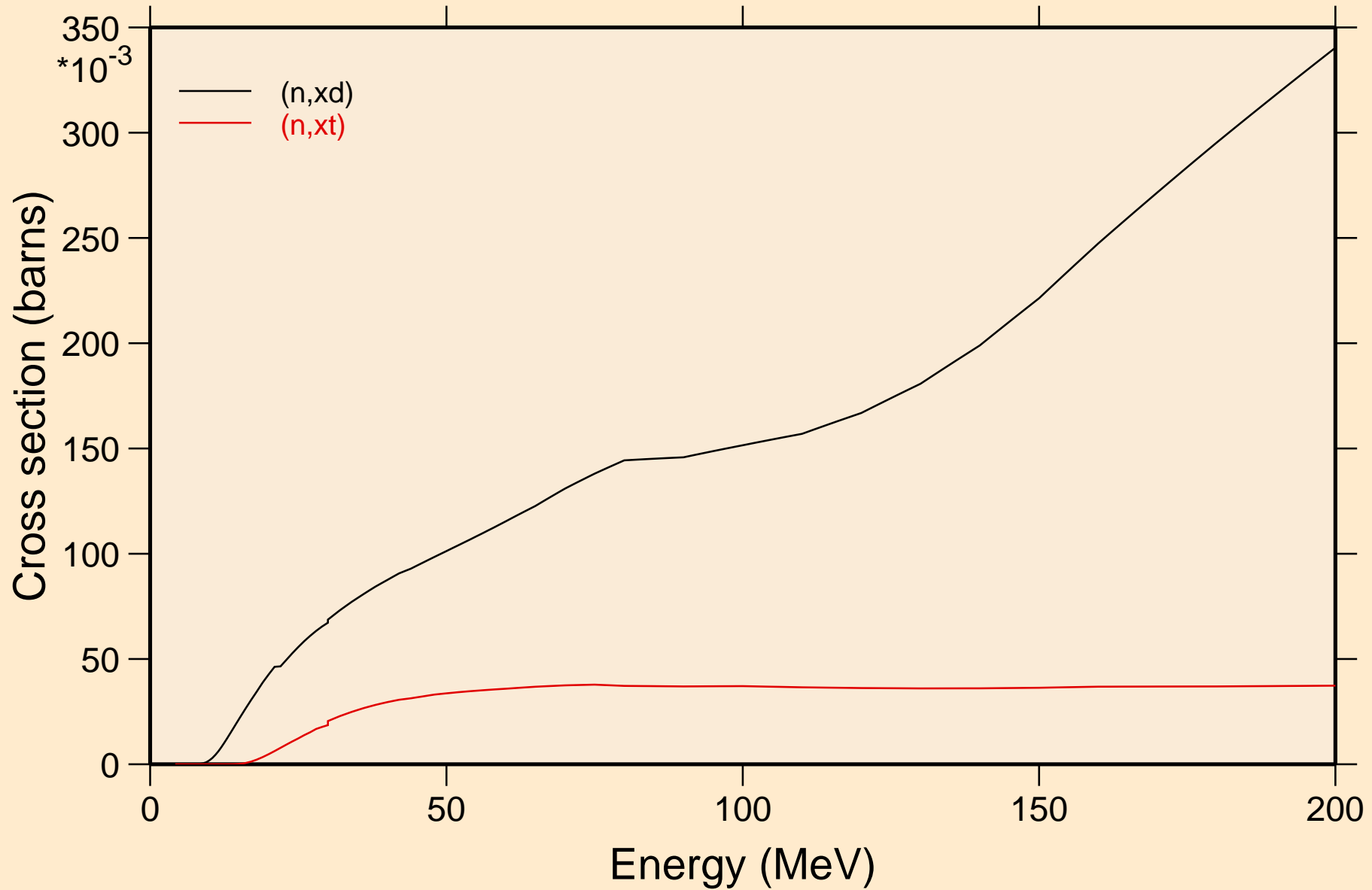

ER147 NEUTRON ACER TENDL-2024 LIBRARY; T=293.6K
angular distribution for elastic

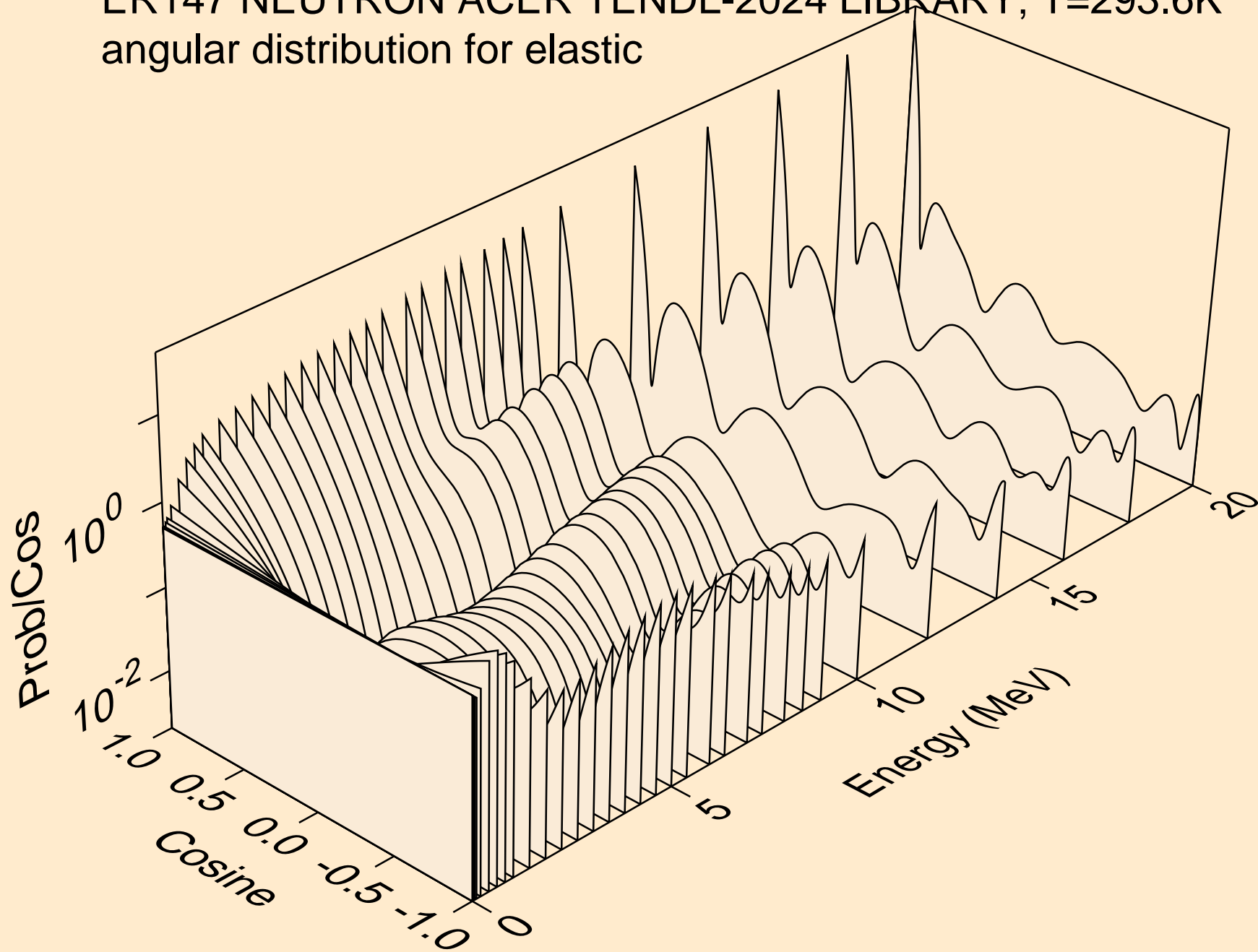

ER147 NEUTRON ACER TENDL-2024 LIBRARY; T=293.6K
angular distribution for elastic

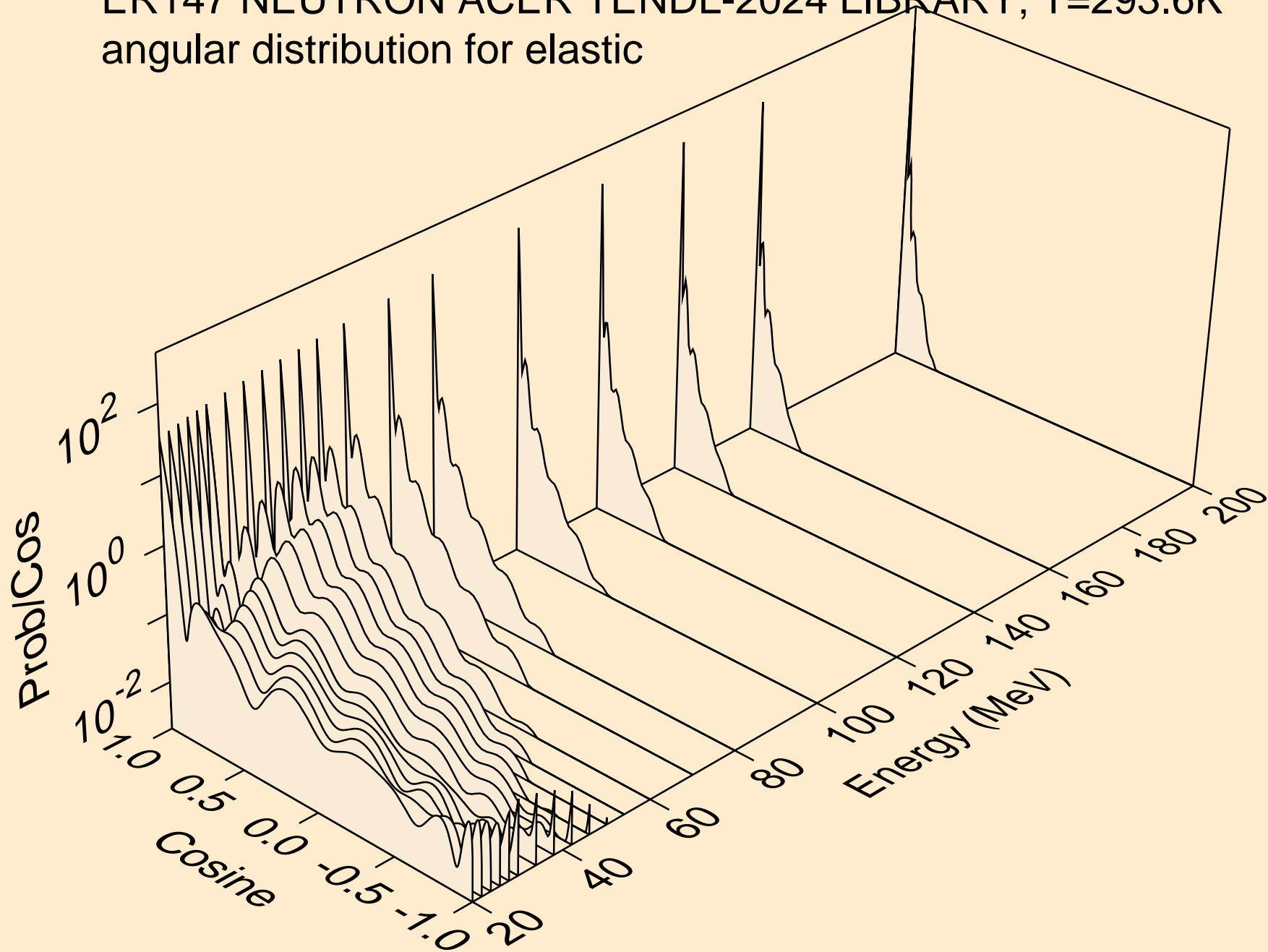

ER147 NEUTRON ACER TENDL-2024 LIBRARY; T=293.6K
angular distribution for (n,n*1)

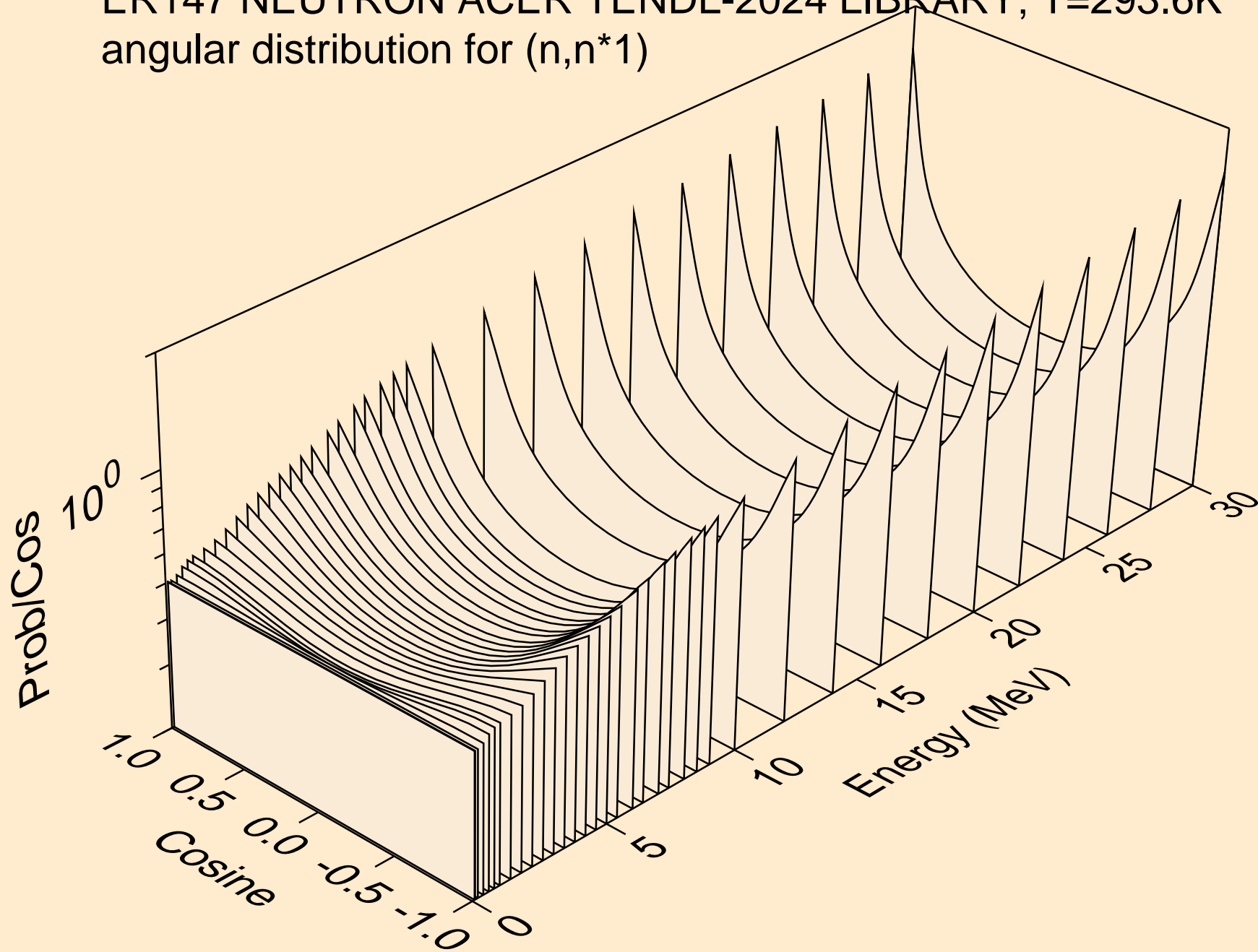

ER147 NEUTRON ACER TENDL-2024 LIBRARY; T=293.6K
angular distribution for (n,n*2)

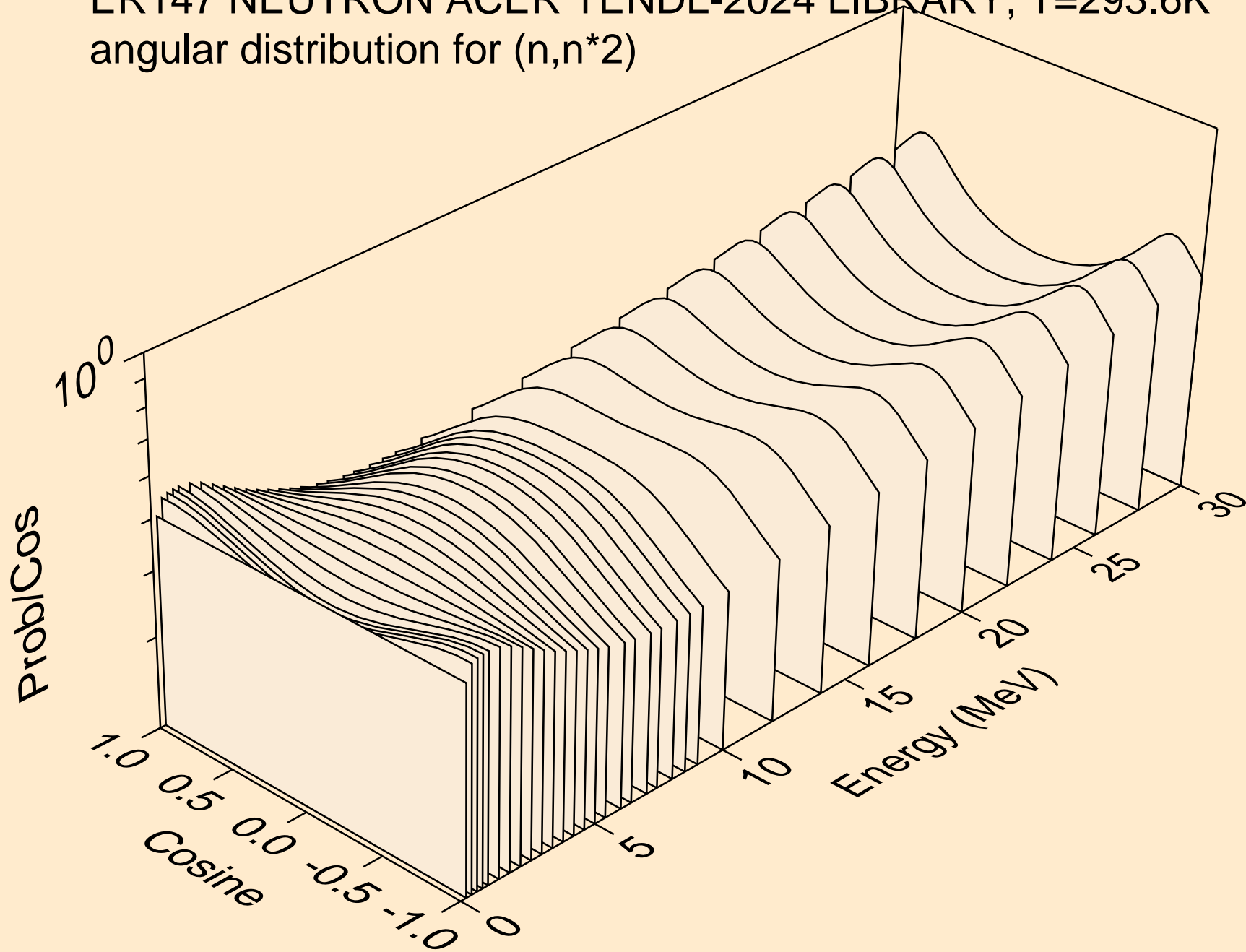

ER147 NEUTRON ACER TENDL-2024 LIBRARY; T=293.6K
angular distribution for (n,n*3)

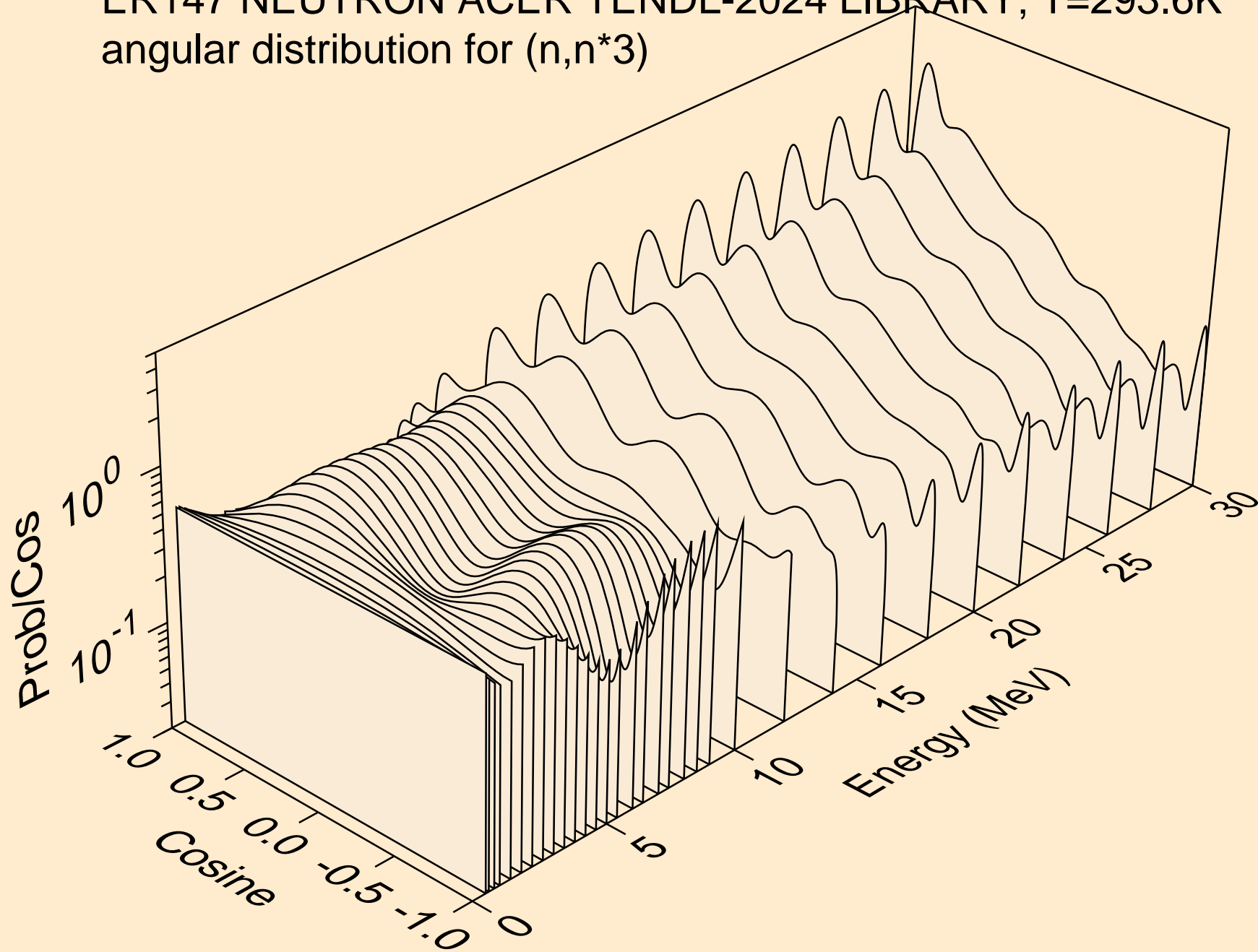

ER147 NEUTRON ACER TENDL-2024 LIBRARY; T=293.6K
angular distribution for (n,n*4)

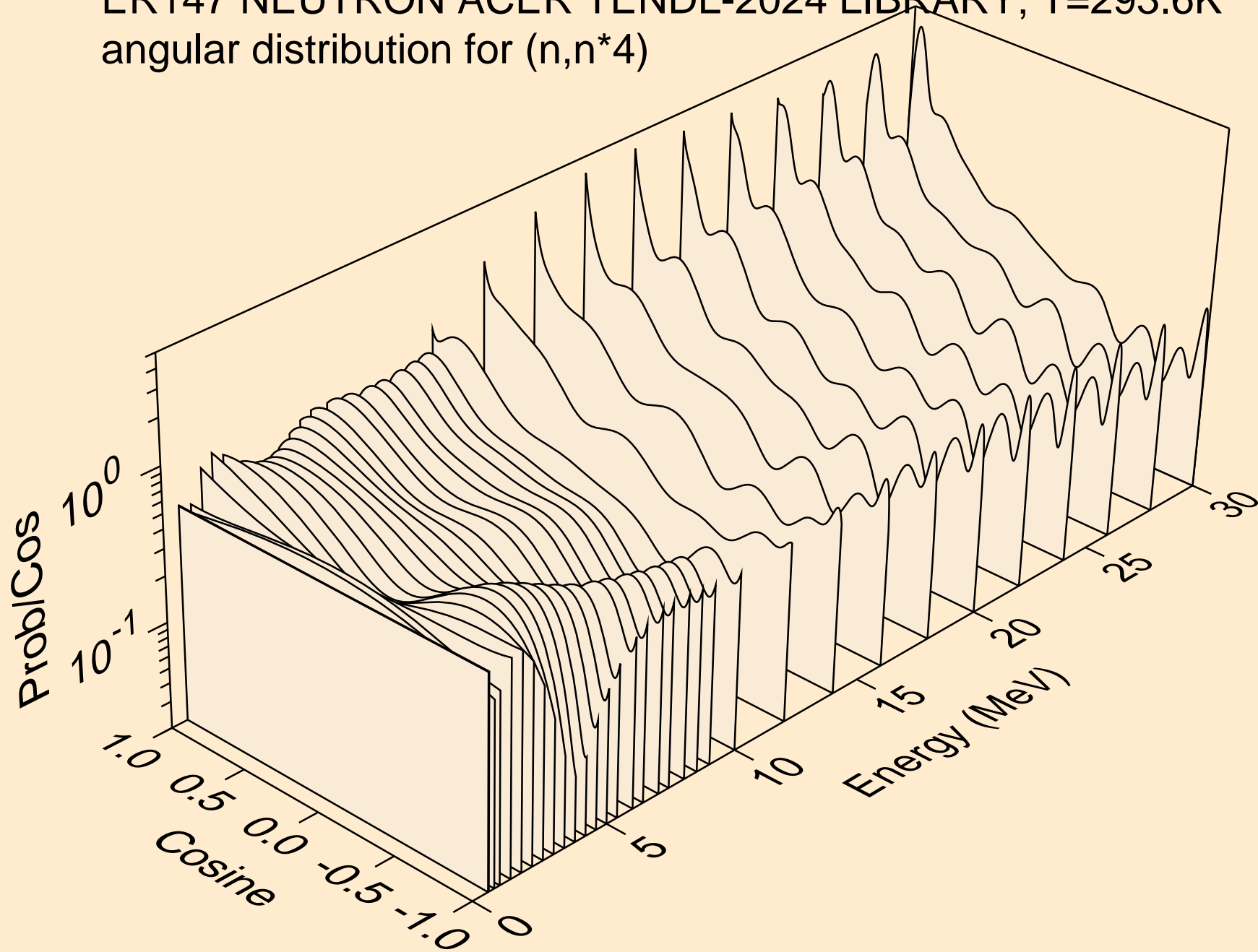

ER147 NEUTRON ACER TENDL-2024 LIBRARY; T=293.6K
angular distribution for (n,n*5)

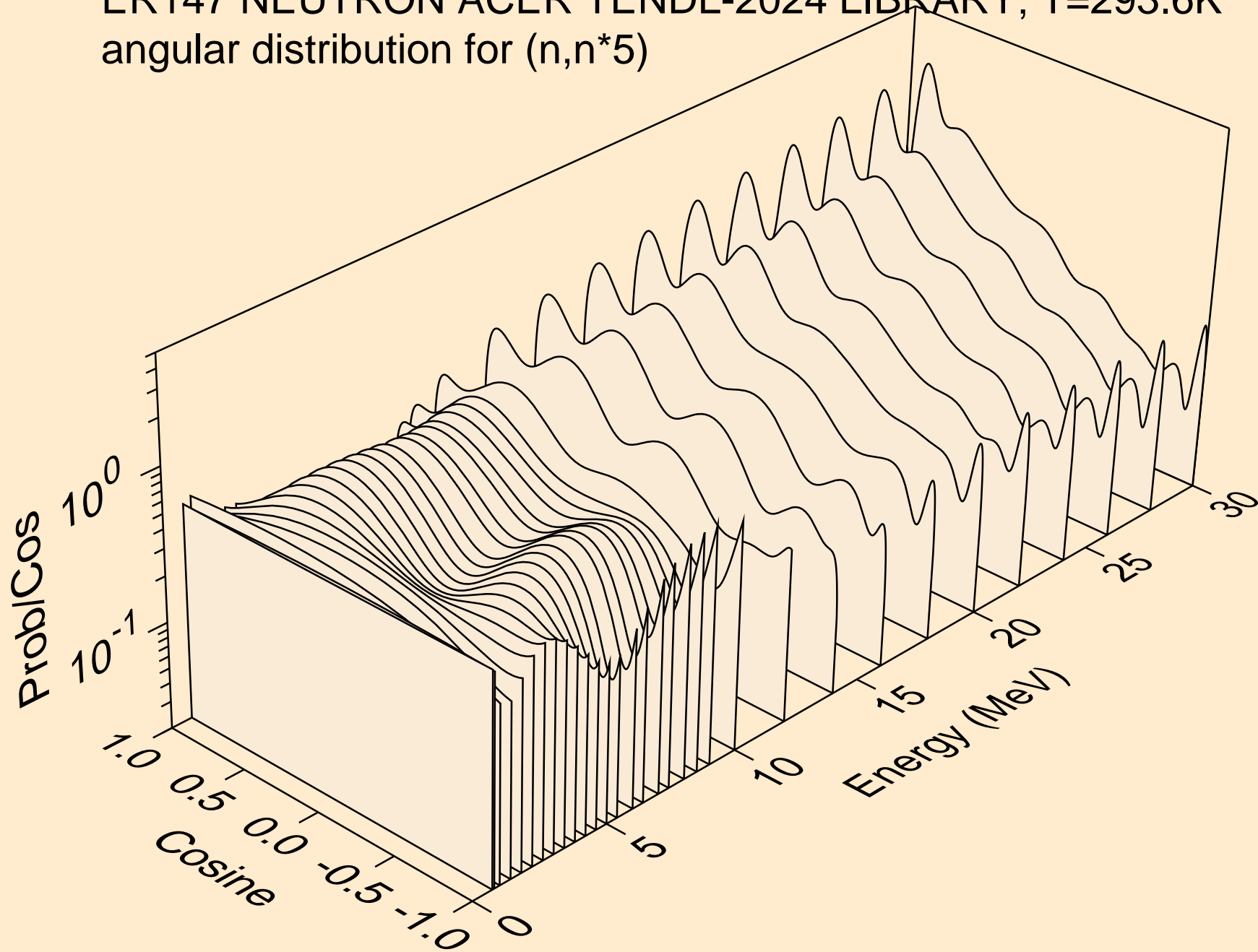

ER147 NEUTRON ACER TENDL-2024 LIBRARY; T=293.6K
angular distribution for (n,n*6)

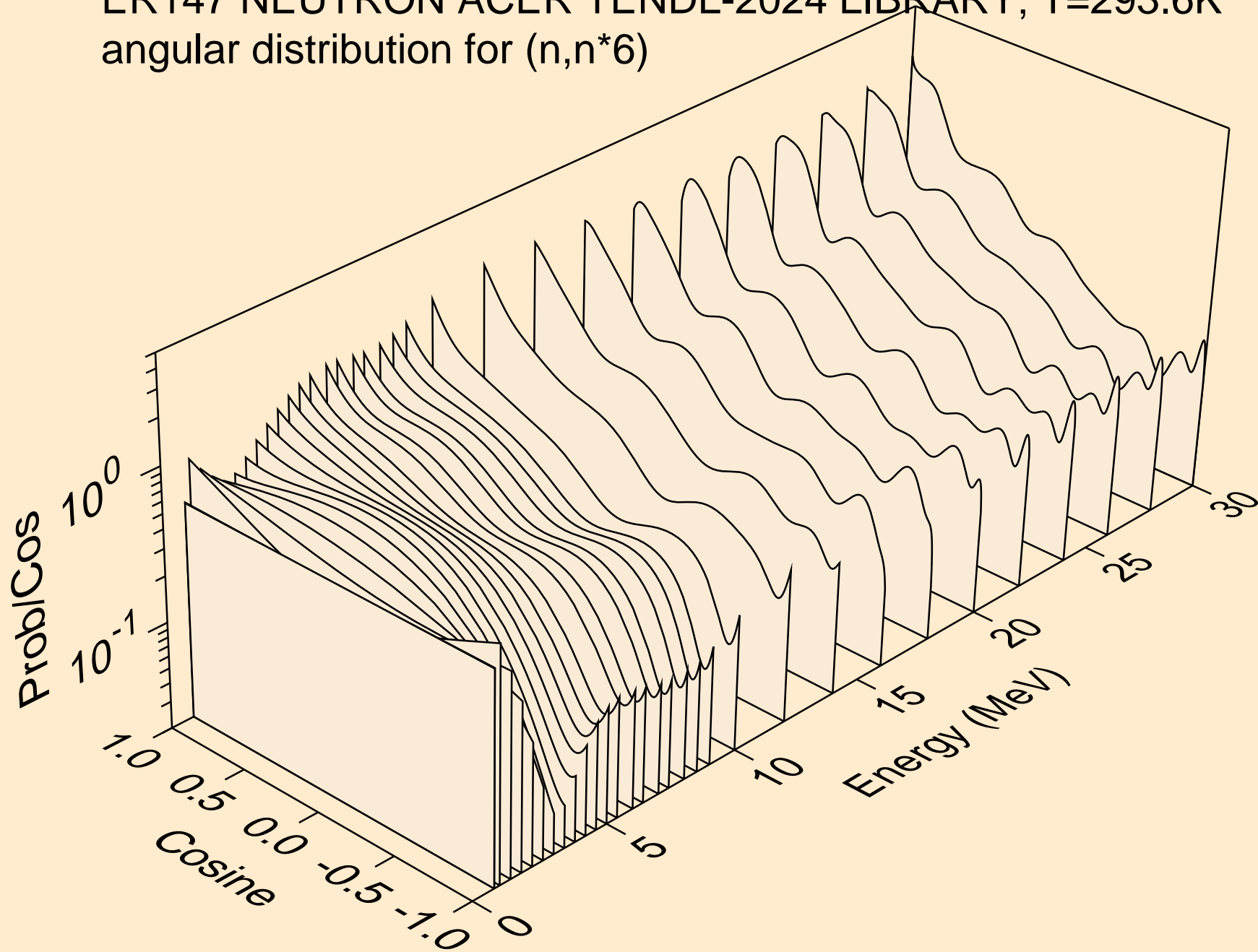

ER147 NEUTRON ACER TENDL-2024 LIBRARY; T=293.6K
angular distribution for (n,n*7)

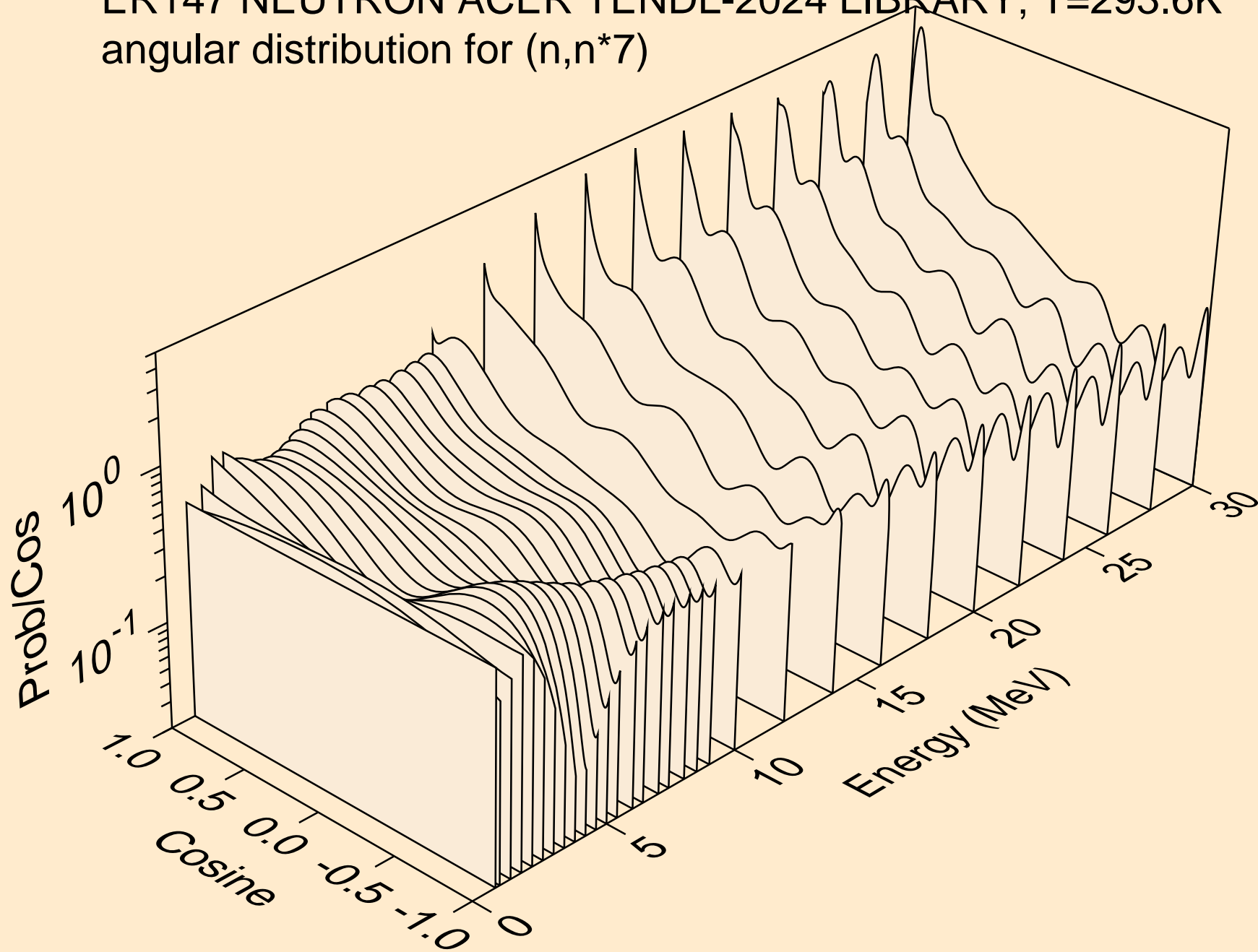

ER147 NEUTRON ACER TENDL-2024 LIBRARY; T=293.6K
angular distribution for (n,n*8)

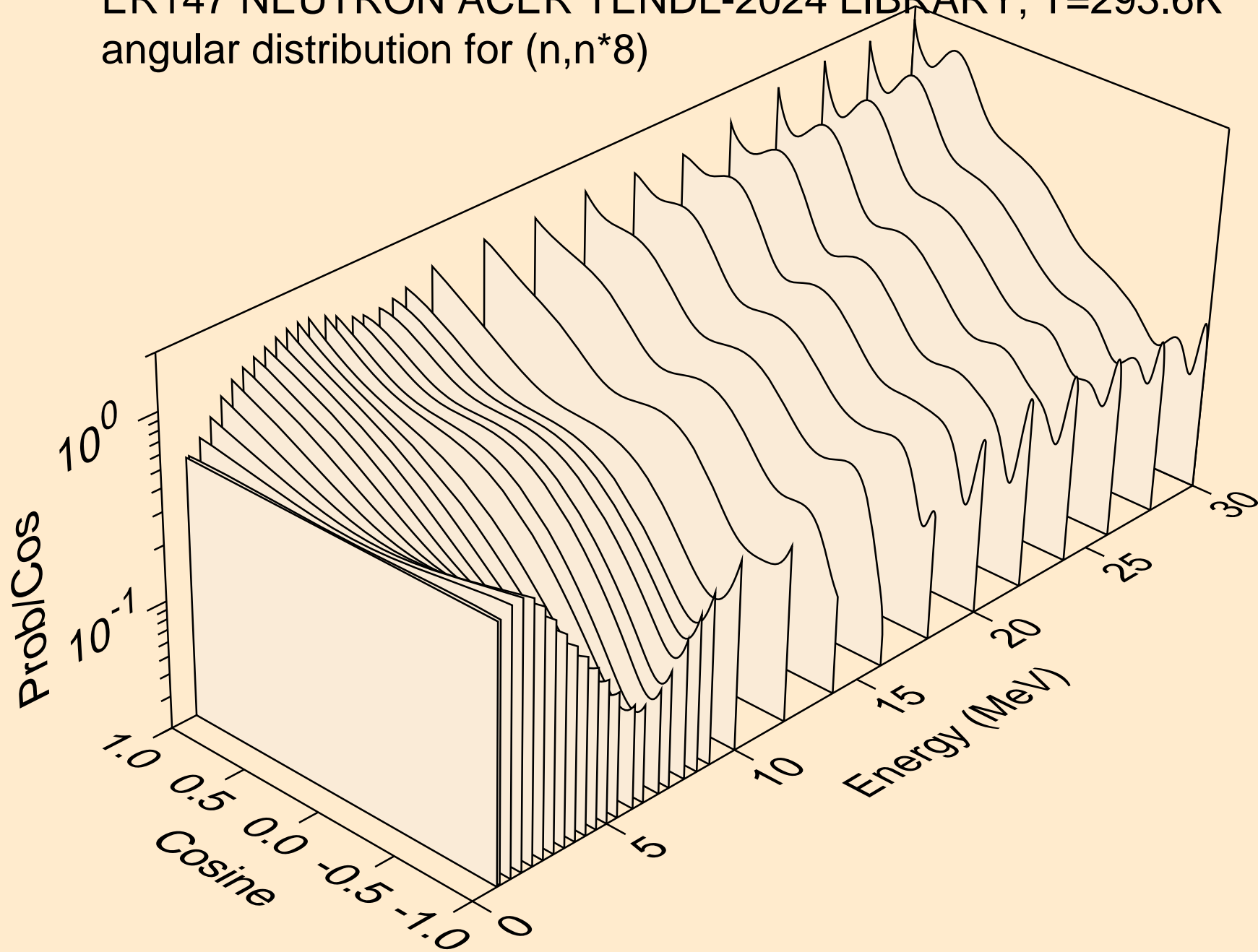

ER147 NEUTRON ACER TENDL-2024 LIBRARY; T=293.6K
angular distribution for (n,n*9)

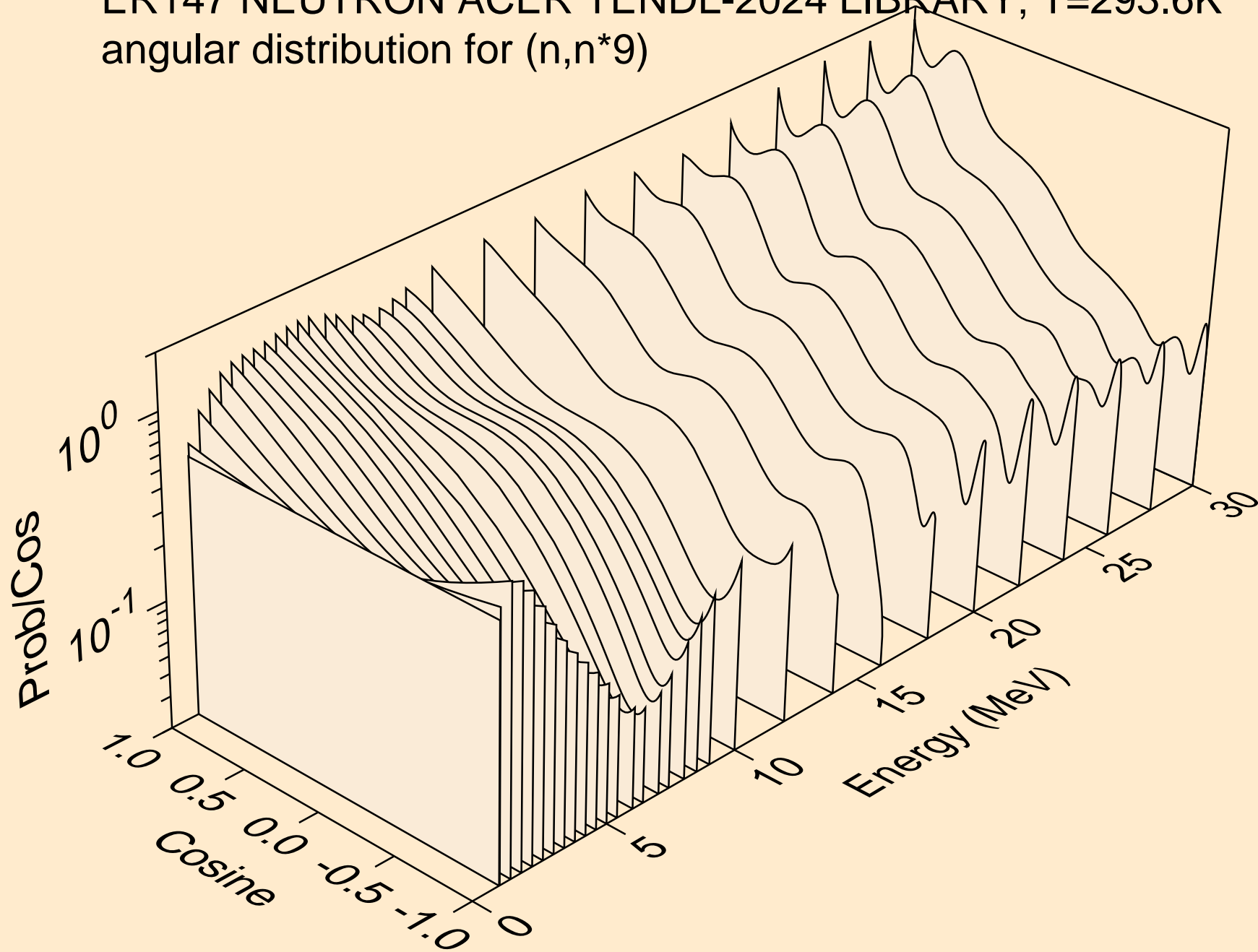

ER147 NEUTRON ACER TENDL-2024 LIBRARY; T=293.6K
angular distribution for (n,n*10)

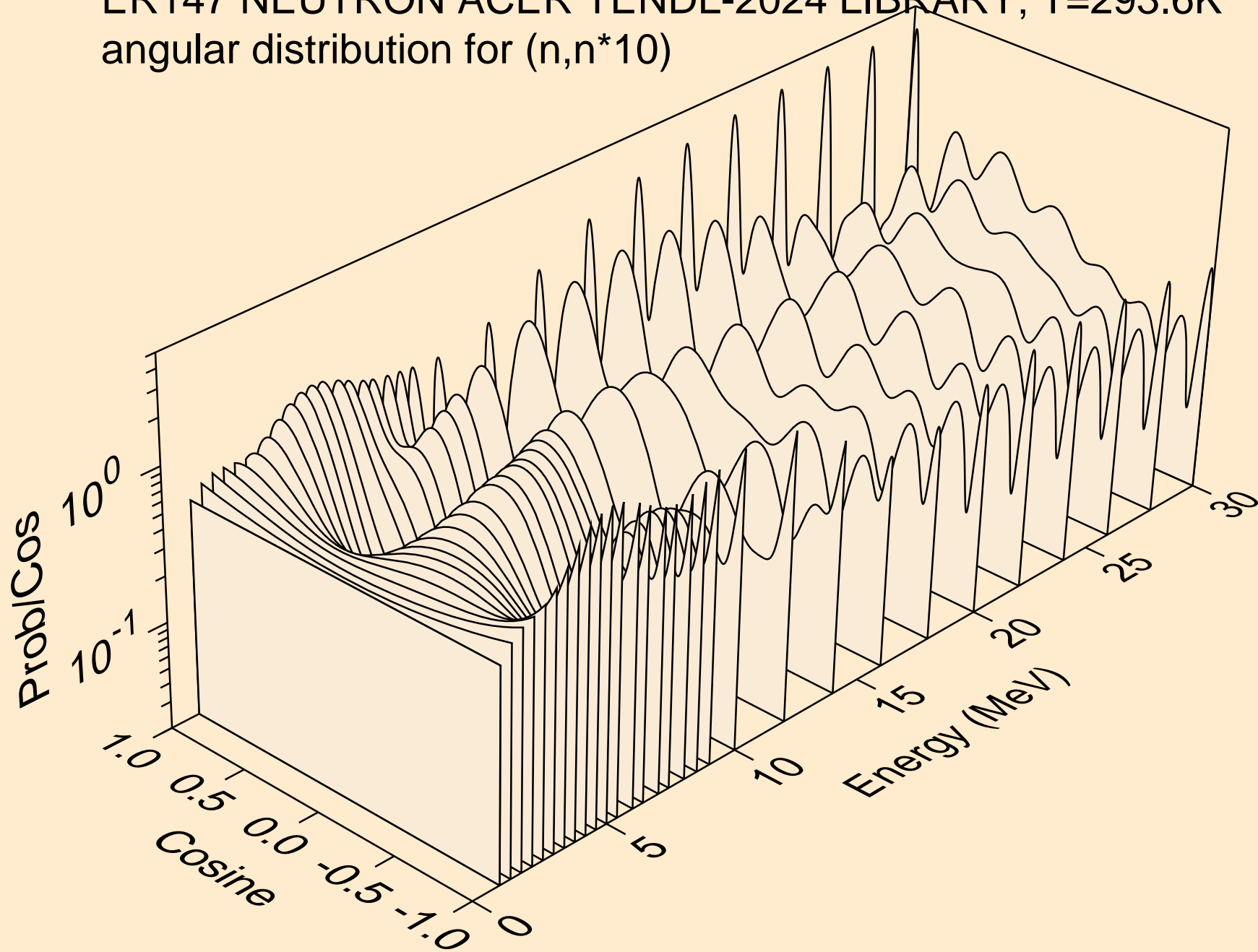

ER147 NEUTRON ACER TENDL-2024 LIBRARY; T=293.6K
angular distribution for (n,n*11)

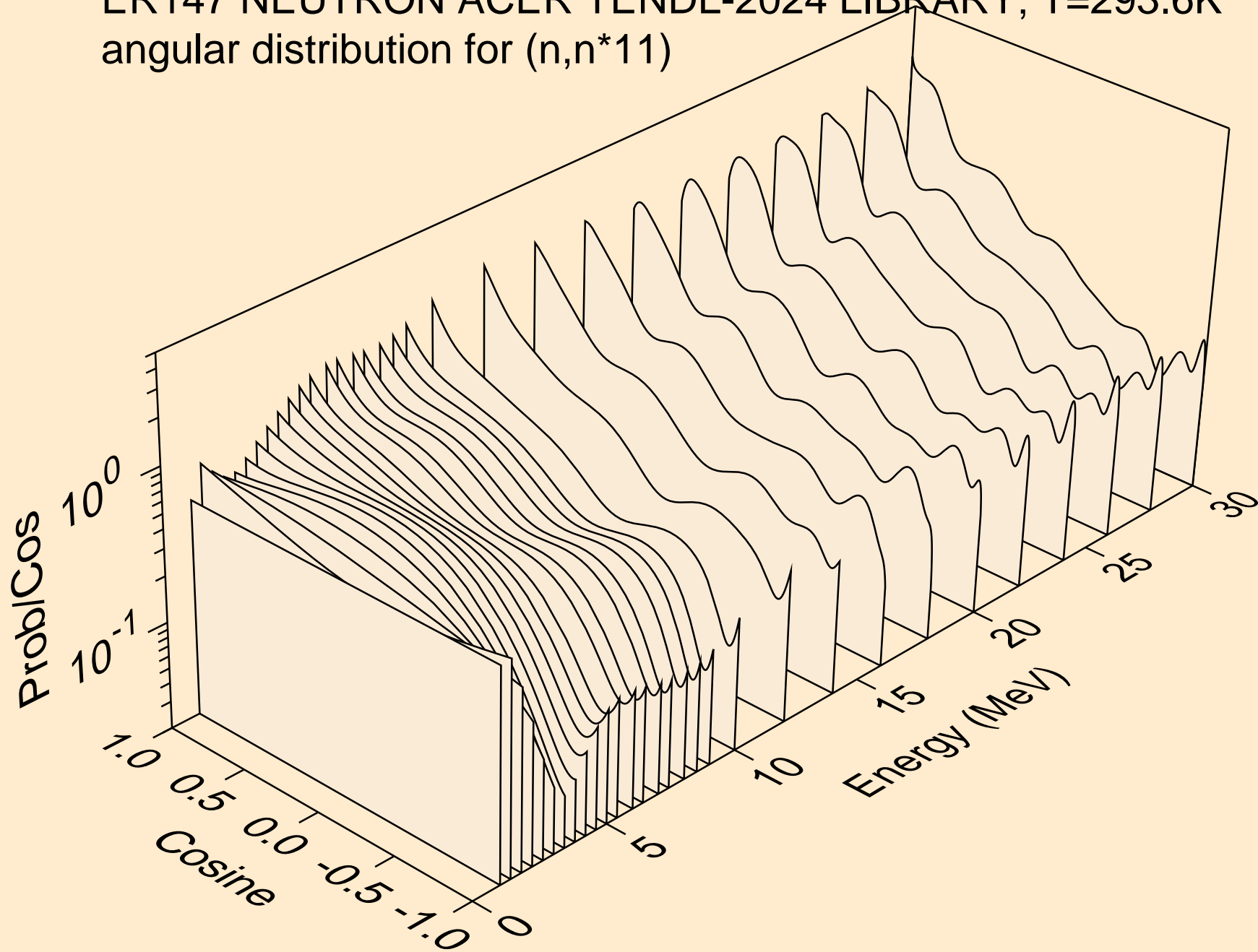

ER147 NEUTRON ACER TENDL-2024 LIBRARY; T=293.6K
Neutron emission for (n,x)

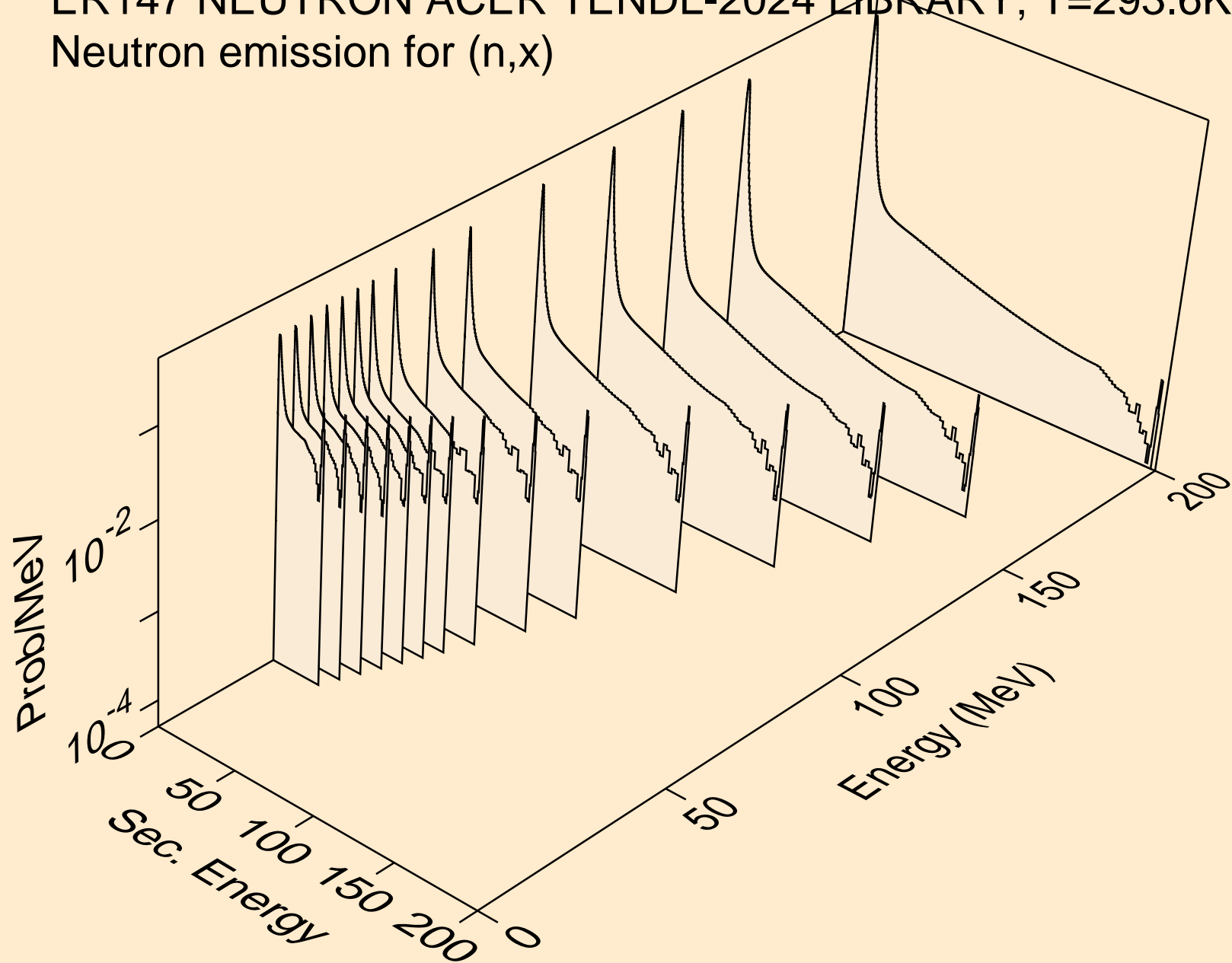

ER147 NEUTRON ACER TENDL-2024 LIBRARY; T=293.6K
Neutron emission for (n,2n)

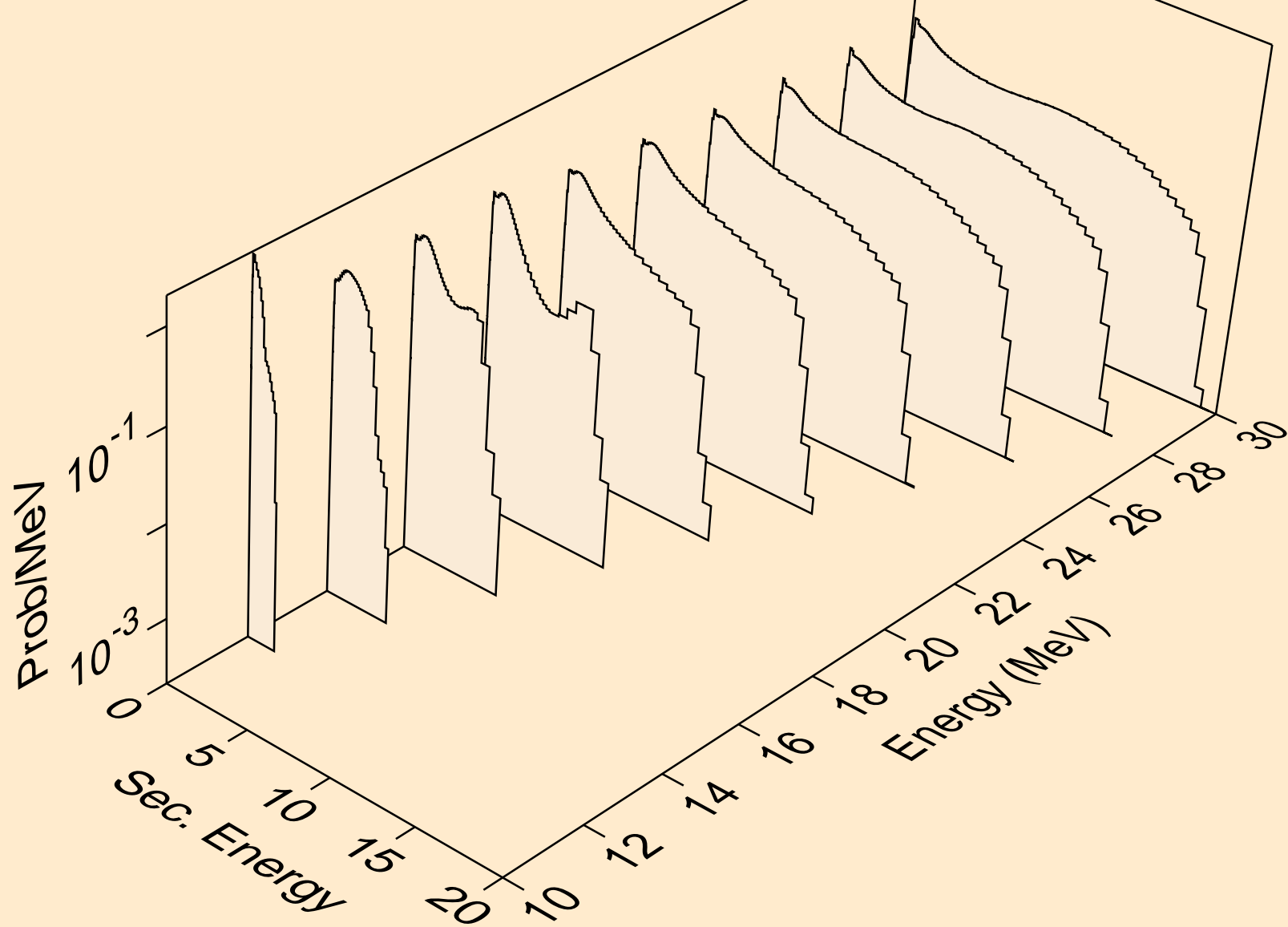

ER147 NEUTRON ACER TENDL-2024 LIBRARY; T=293.6K
Neutron emission for (n,3n)

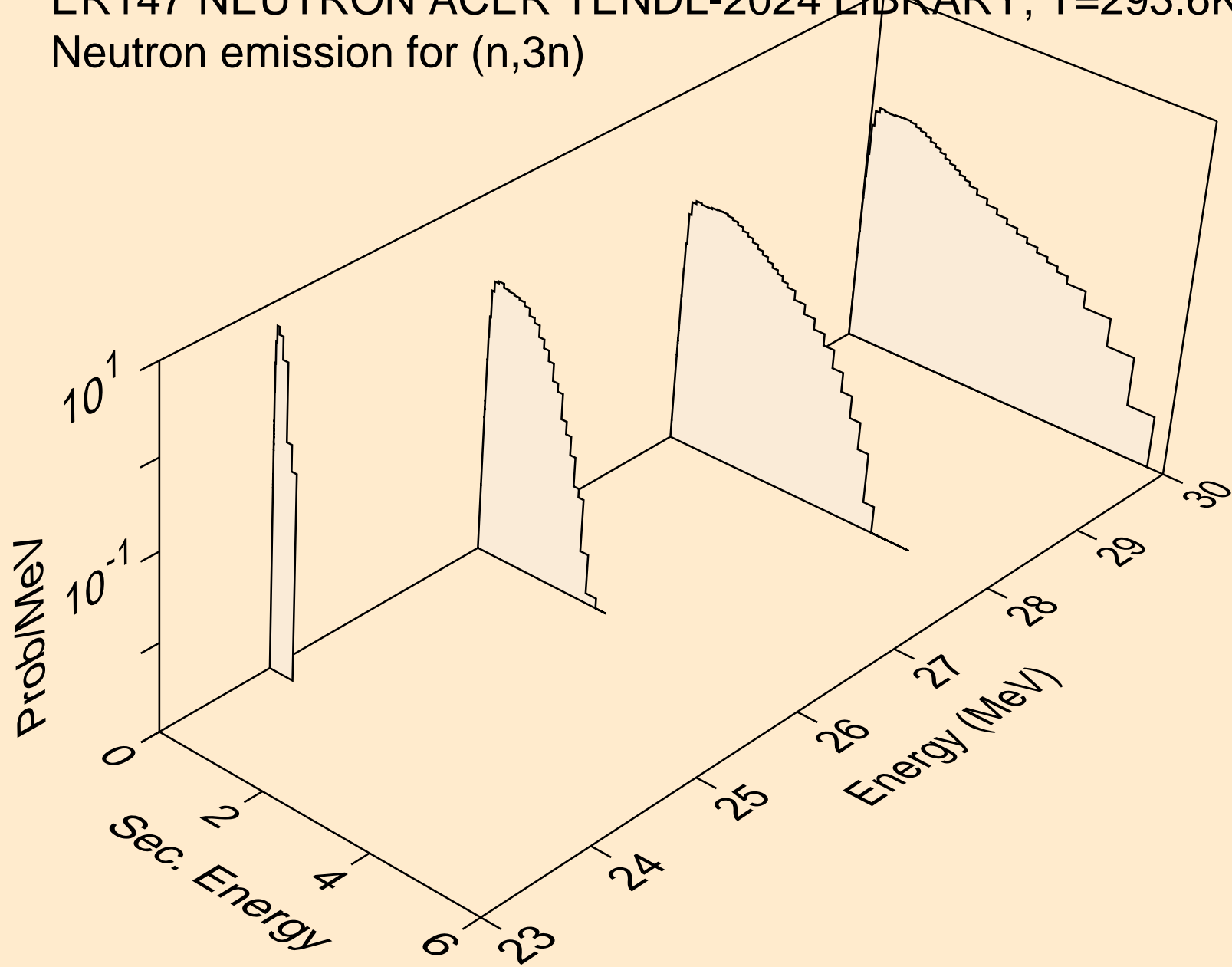

ER147 NEUTRON ACER TENDL-2024 LIBRARY; T=293.6K
Neutron emission for (n,n*)a

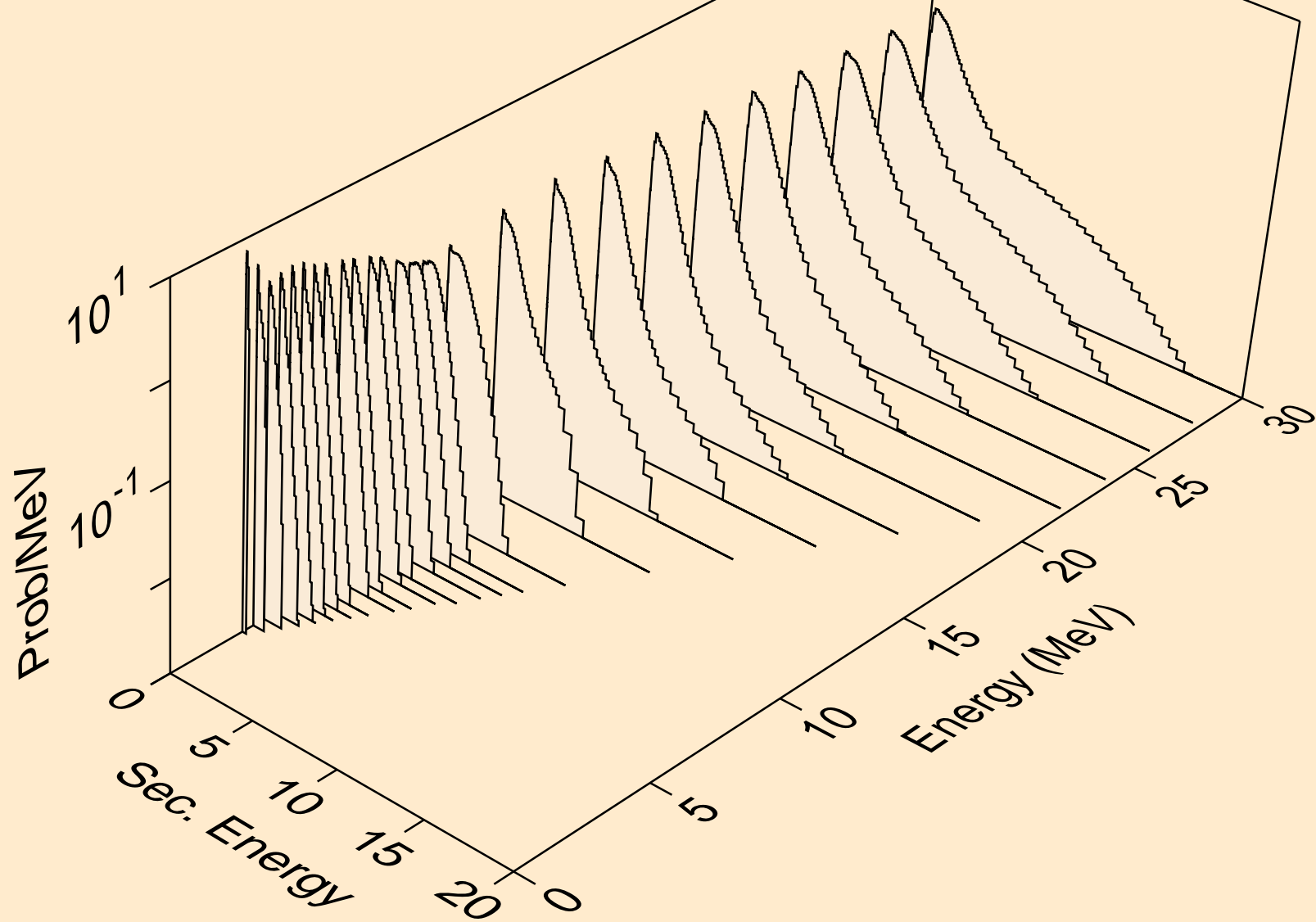

ER147 NEUTRON ACER TENDL-2024 LIBRARY; T=293.6K
Neutron emission for (n,2n)_a

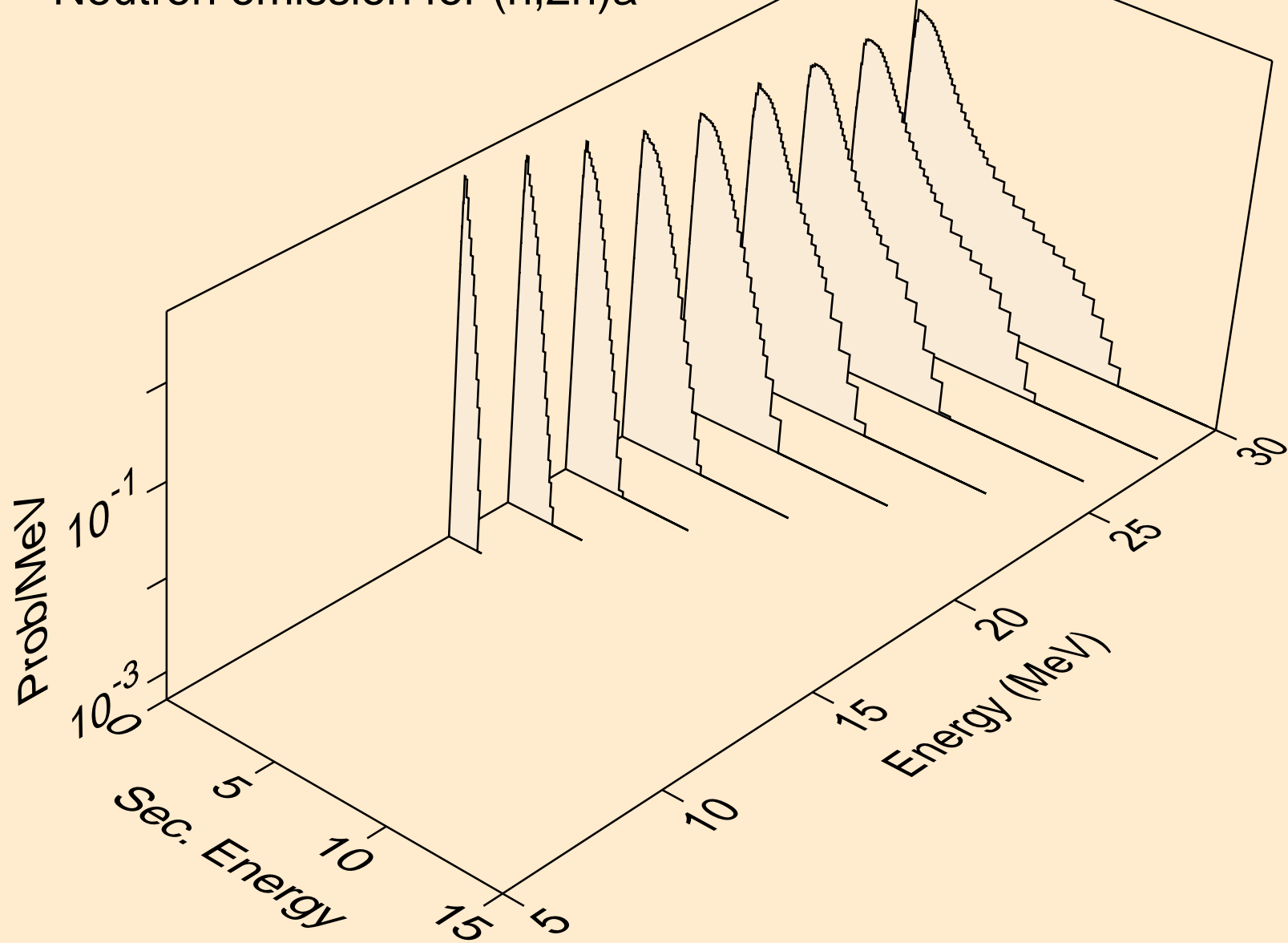

ER147 NEUTRON ACER TENDL-2024 LIBRARY; T=293.6K
Neutron emission for (n,n*)p

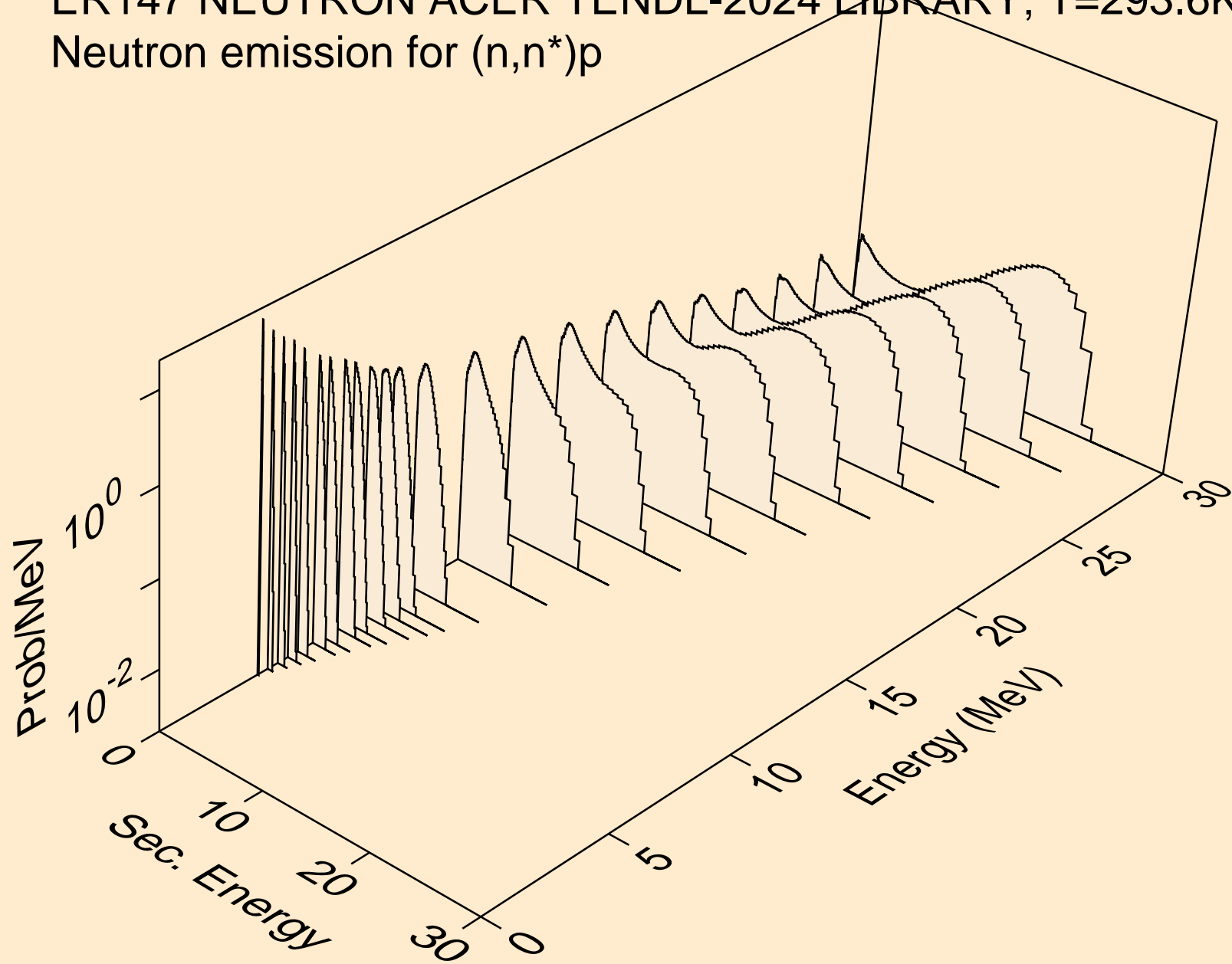

ER147 NEUTRON ACER TENDL-2024 LIBRARY; T=293.6K
Neutron emission for (n,n*)2a

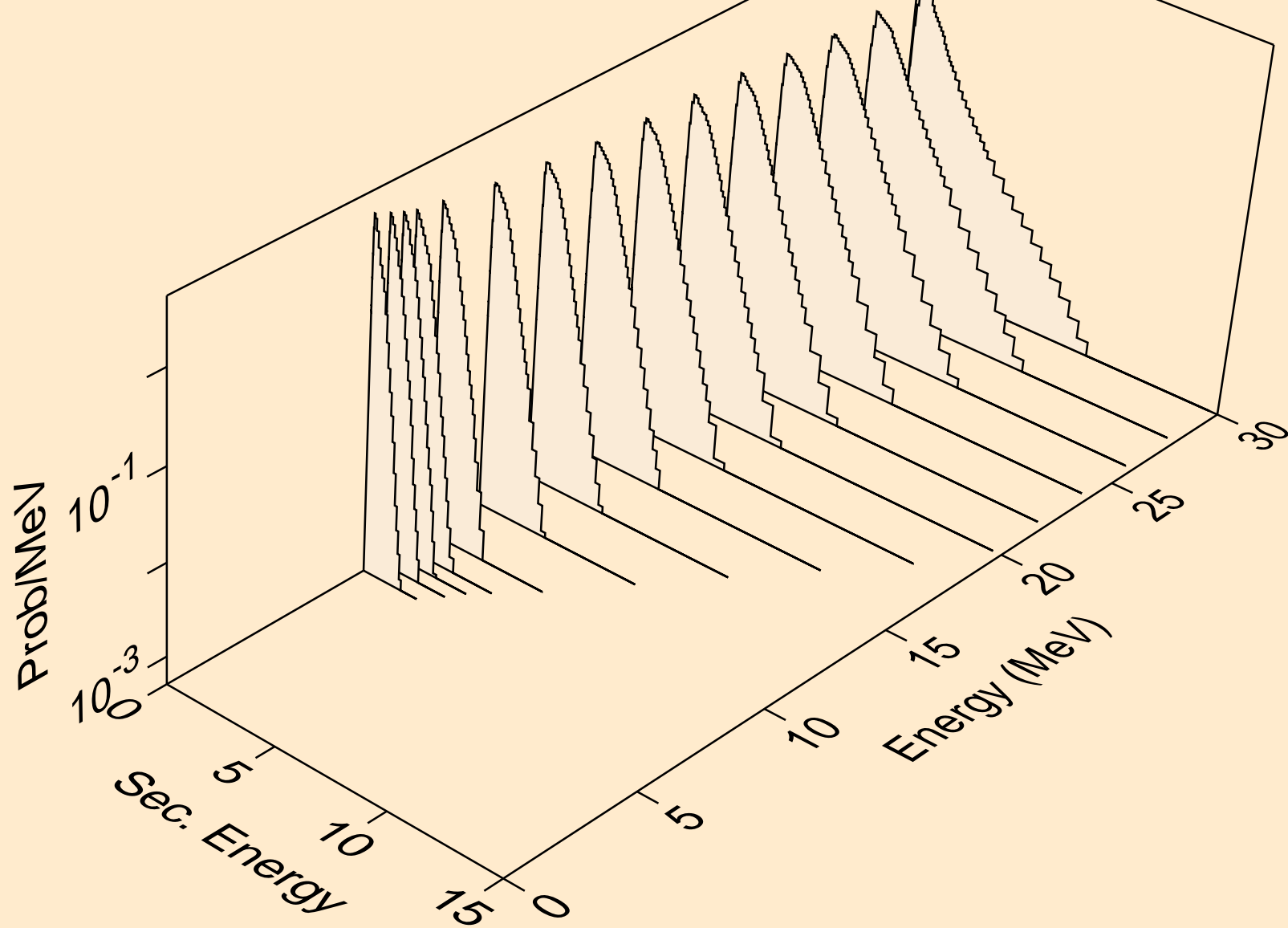

ER147 NEUTRON ACER TENDL-2024 LIBRARY; T=293.6K
Neutron emission for (n,2n)2a

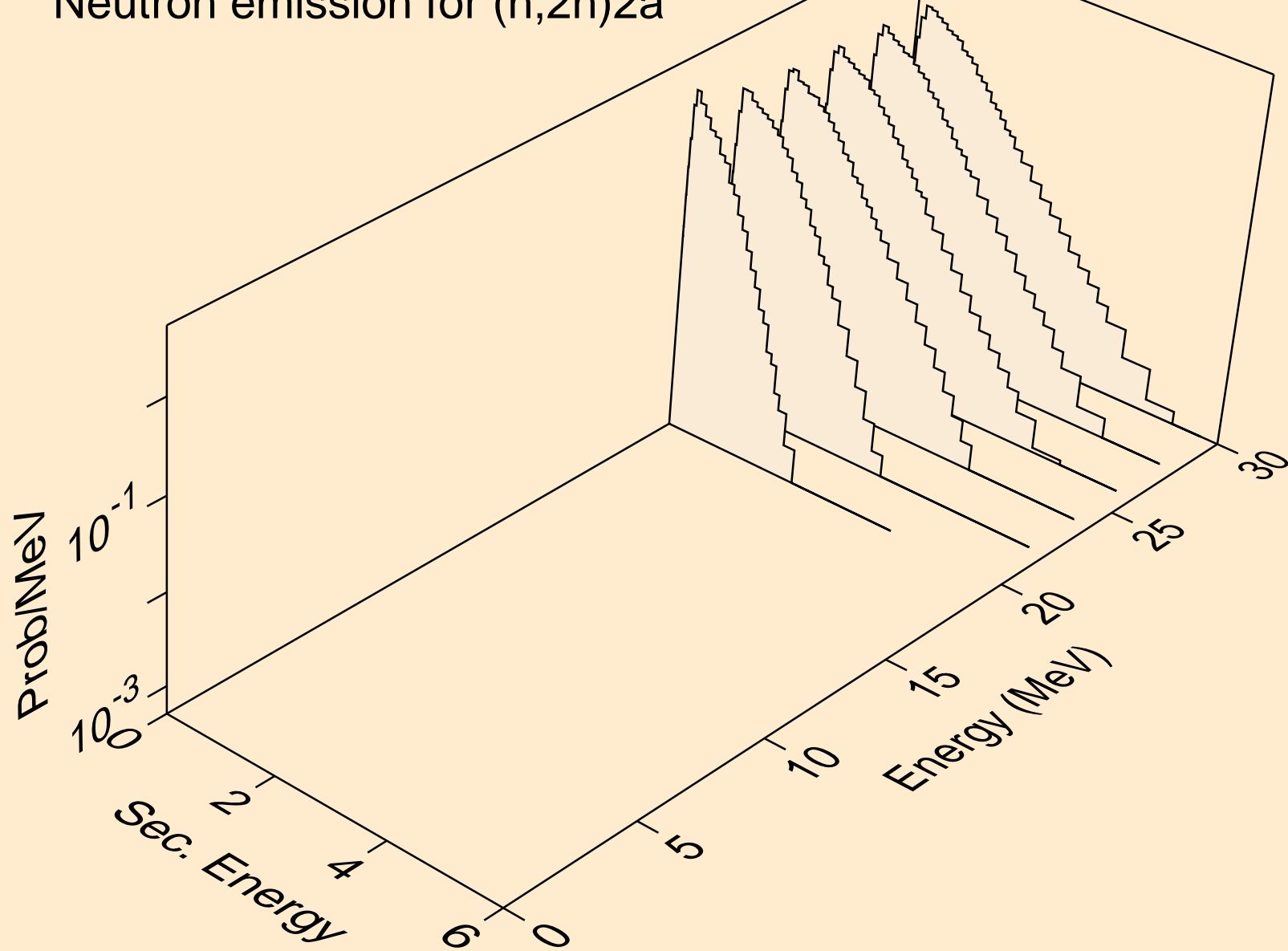

ER147 NEUTRON ACER TENDL-2024 LIBRARY; T=293.6K
Neutron emission for (n,n*)d

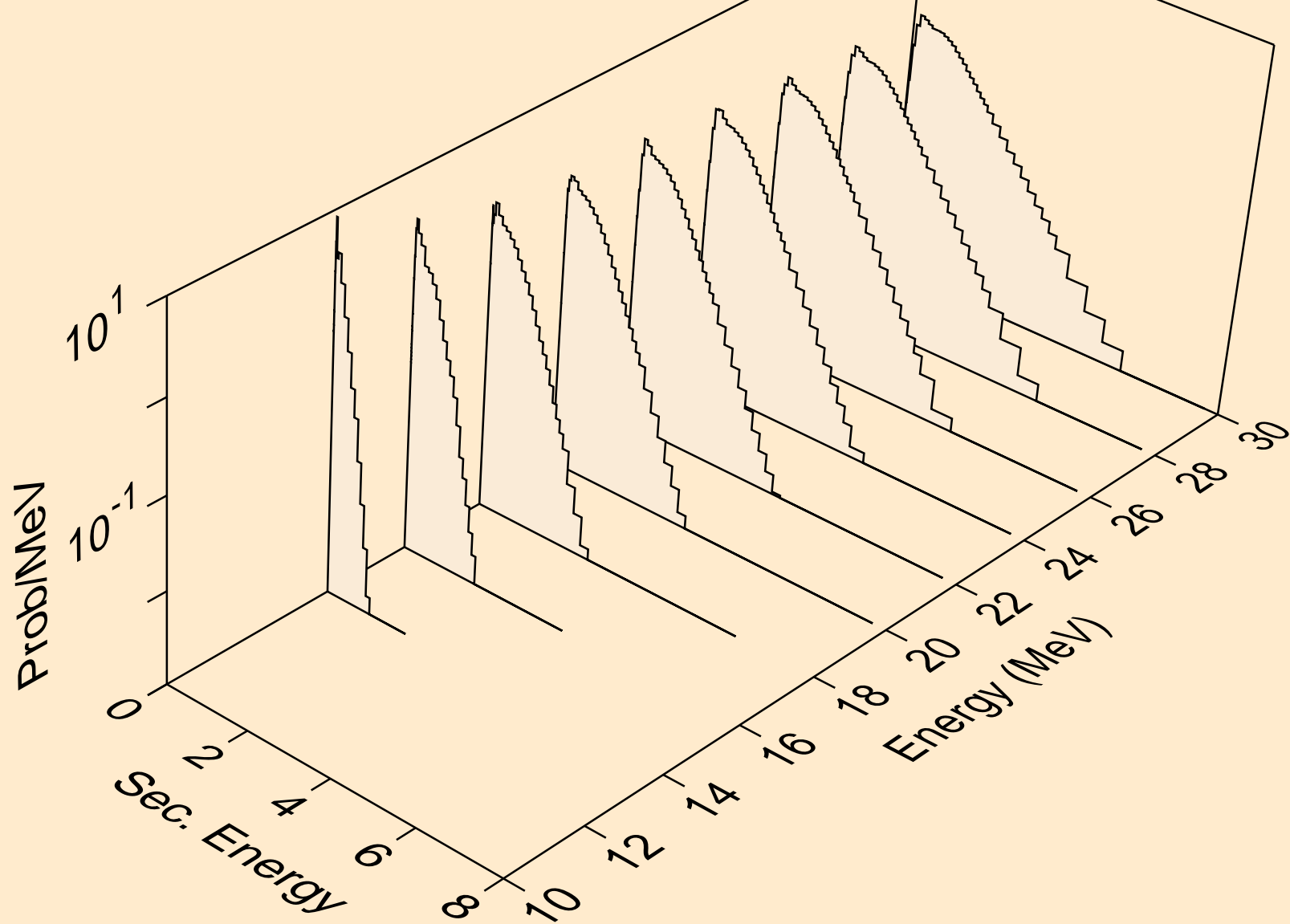

ER147 NEUTRON ACER TENDL-2024 LIBRARY; T=293.6K
Neutron emission for (n,n*)t

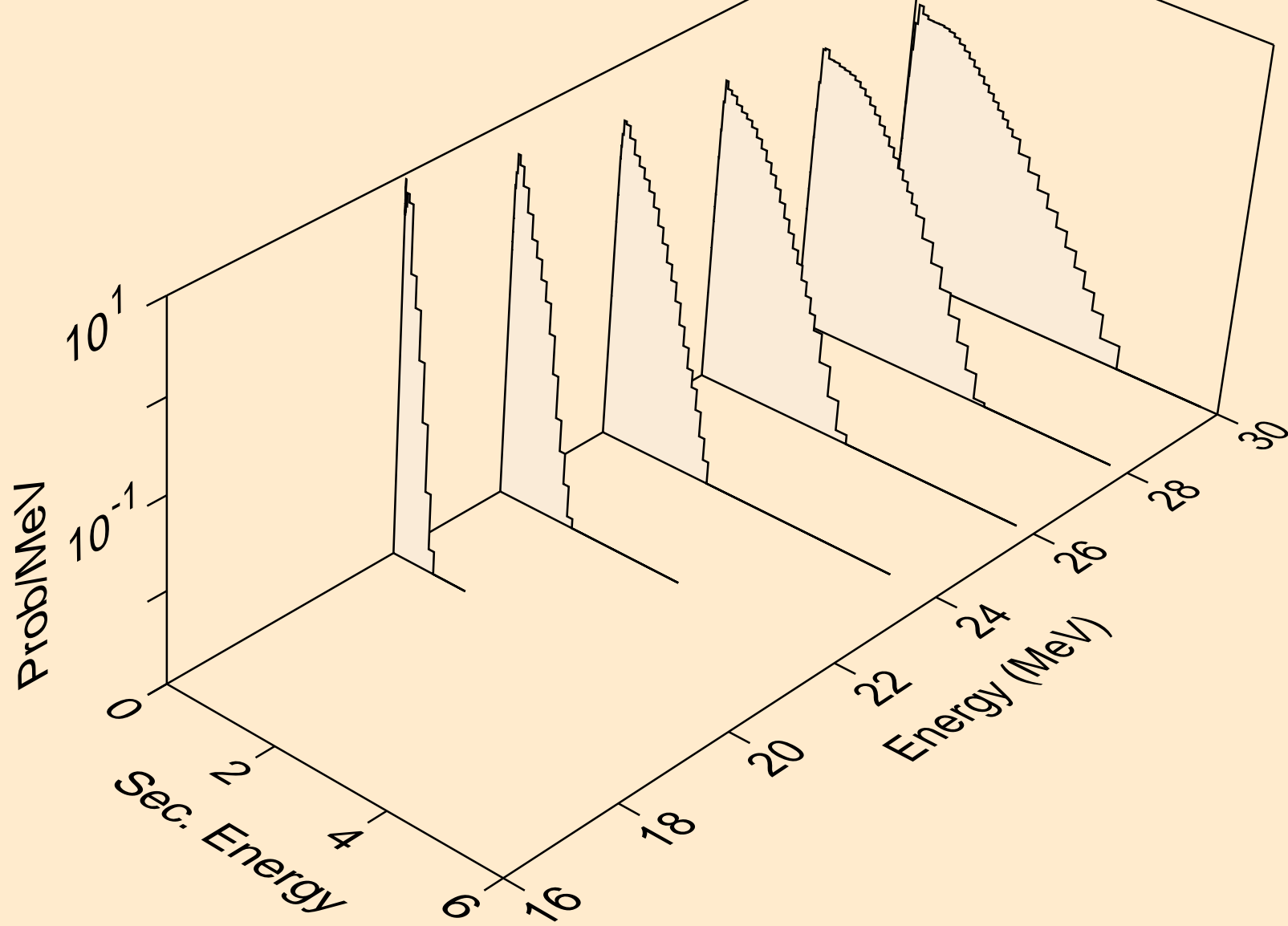

ER147 NEUTRON ACER TENDL-2024 LIBRARY; T=293.6K
Neutron emission for (n,n*)he3

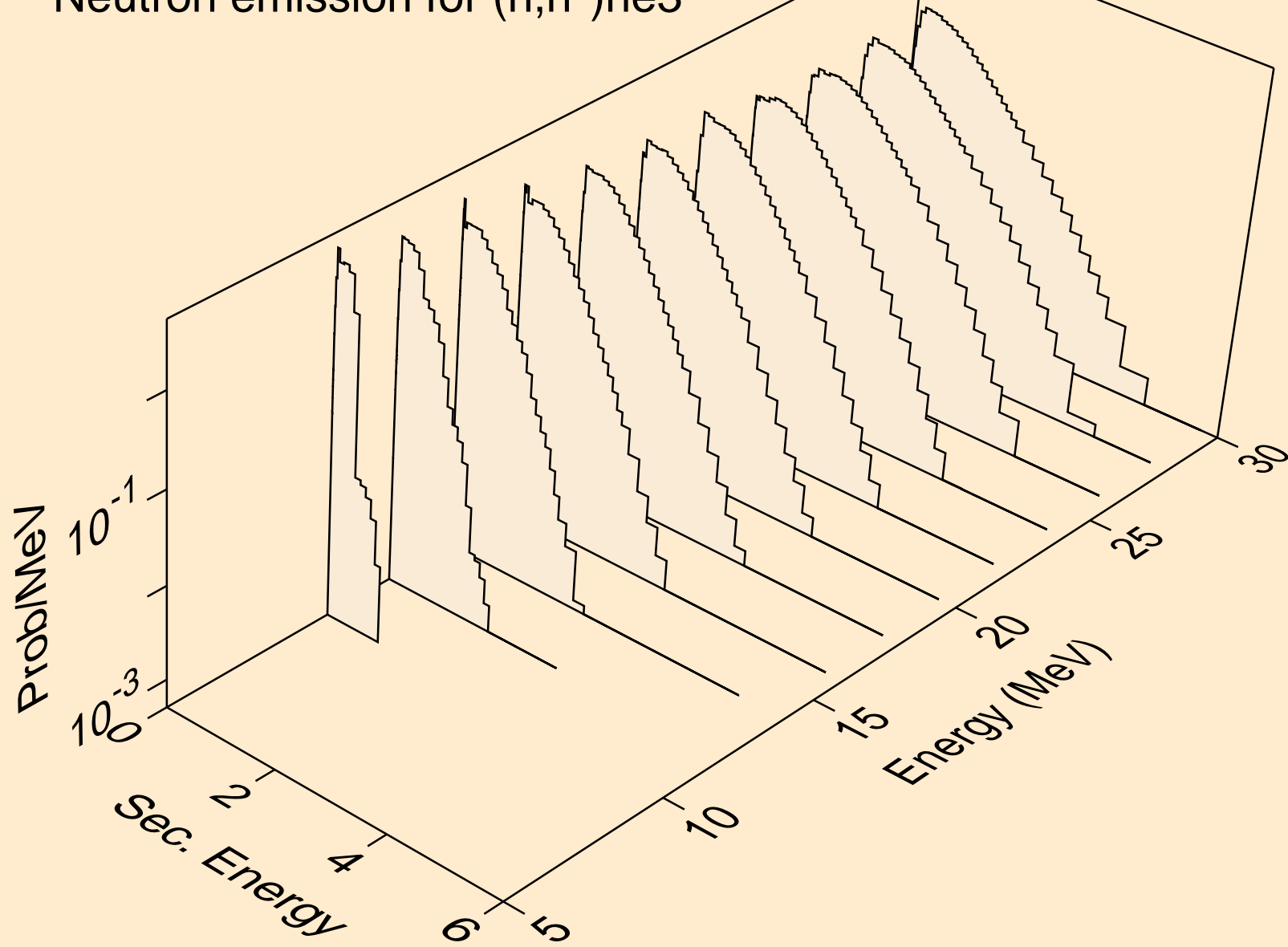

ER147 NEUTRON ACER TENDL-2024 LIBRARY; T=293.6K
Neutron emission for (n,2np)

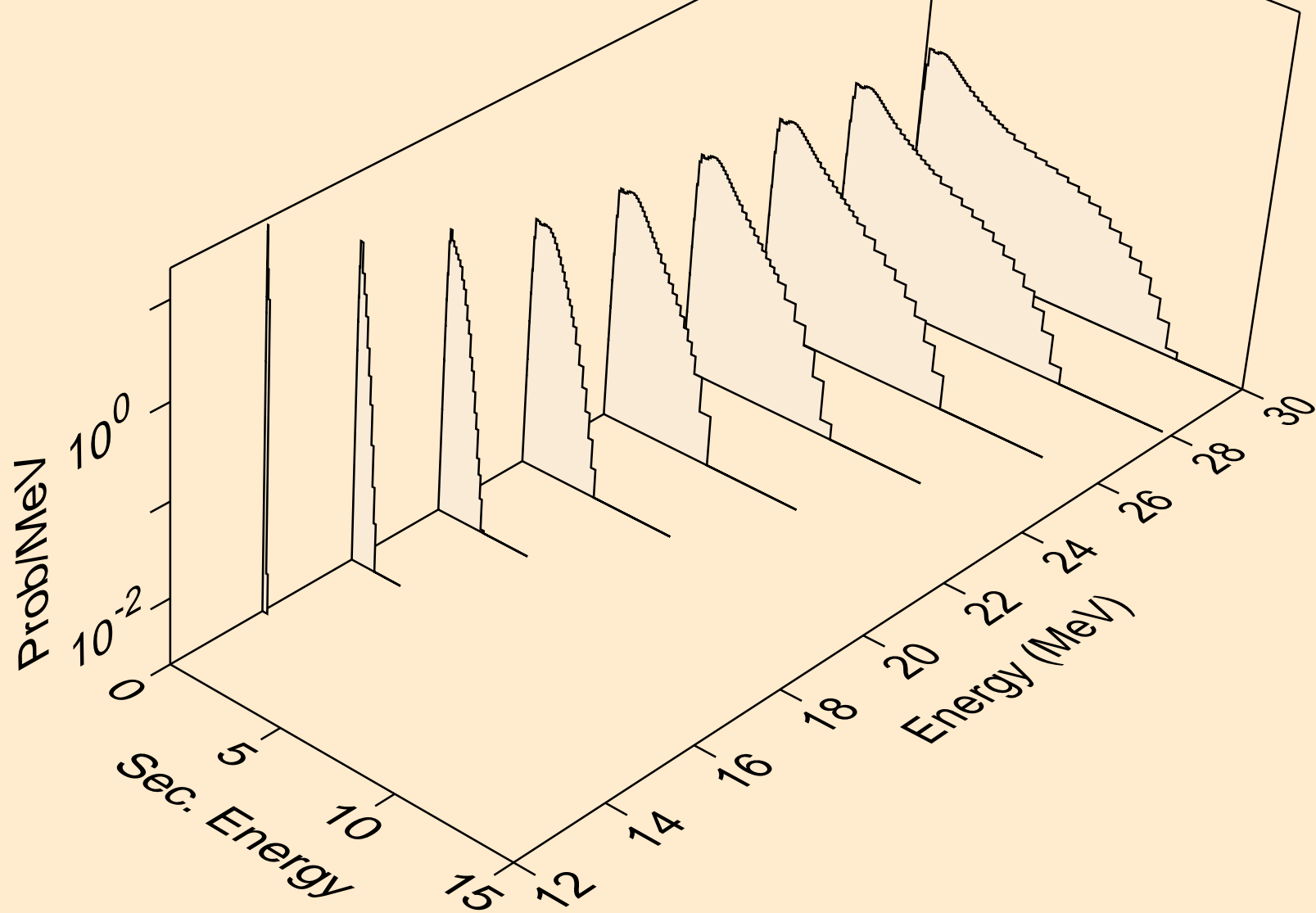

ER147 NEUTRON ACER TENDL-2024 LIBRARY; T=293.6K
Neutron emission for (n,3np)

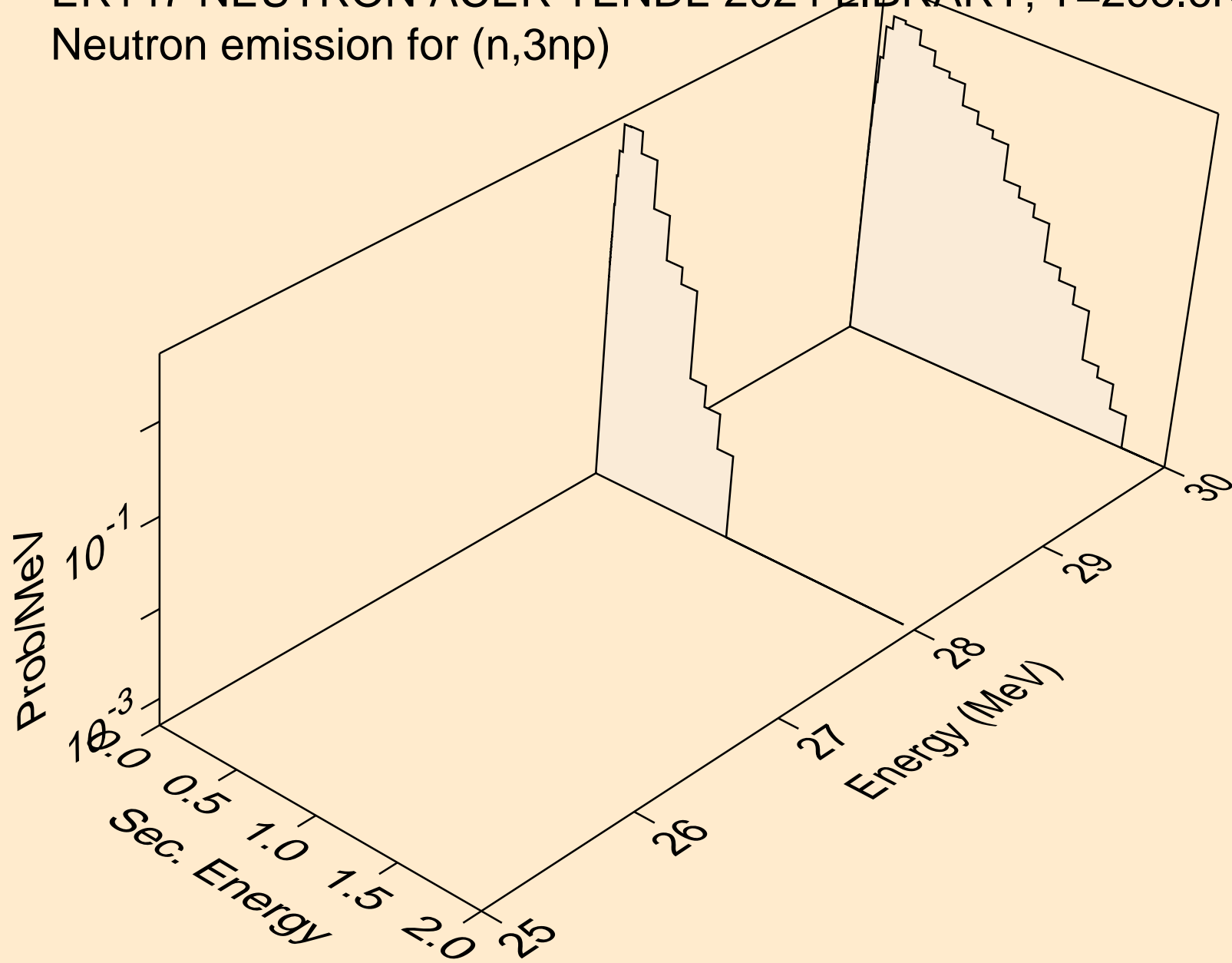

ER147 NEUTRON ACER TENDL-2024 LIBRARY; T=293.6K
Neutron emission for (n,n2p)

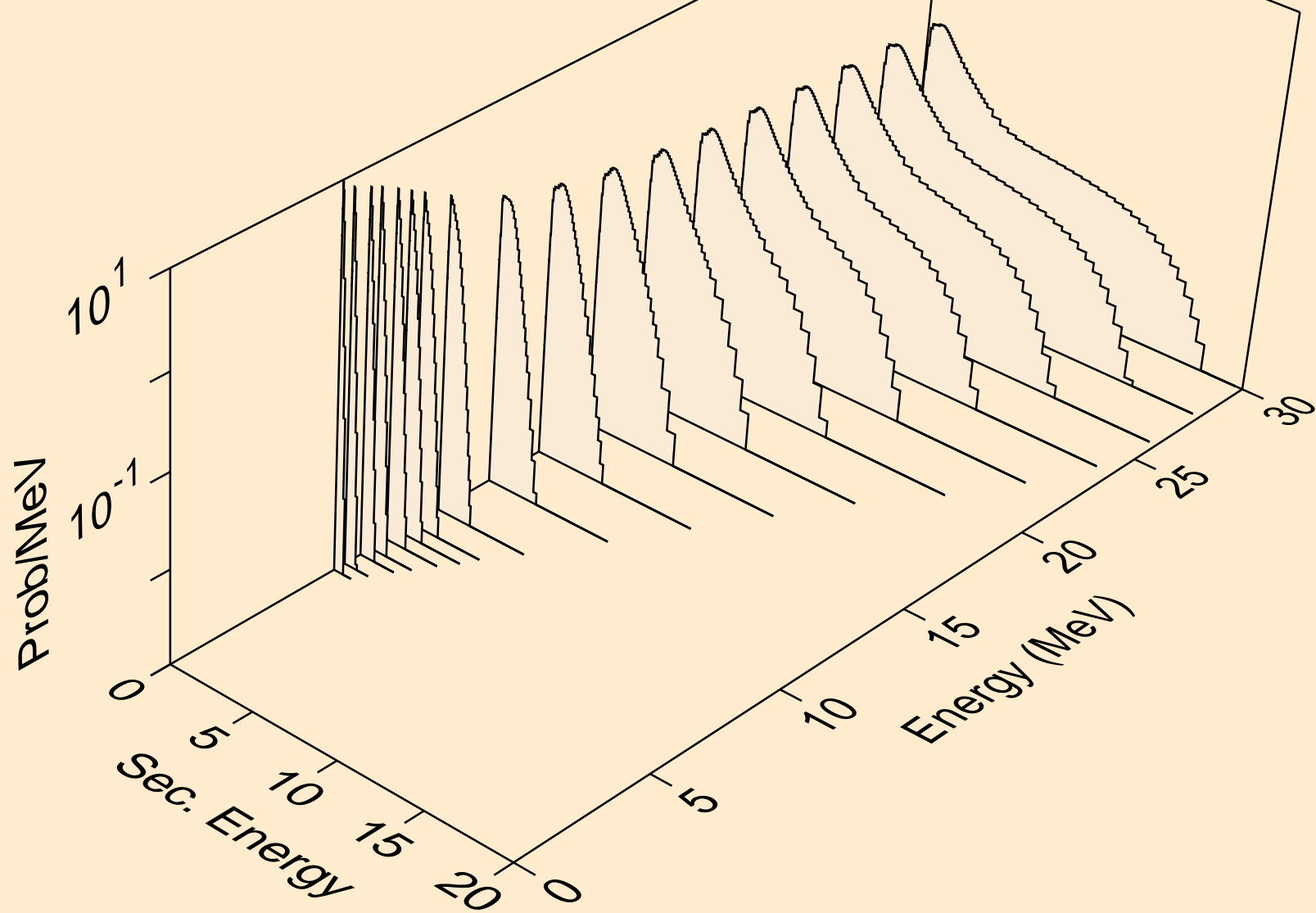

ER147 NEUTRON ACER TENDL-2024 LIBRARY; T=293.6K
Neutron emission for (n,npa)

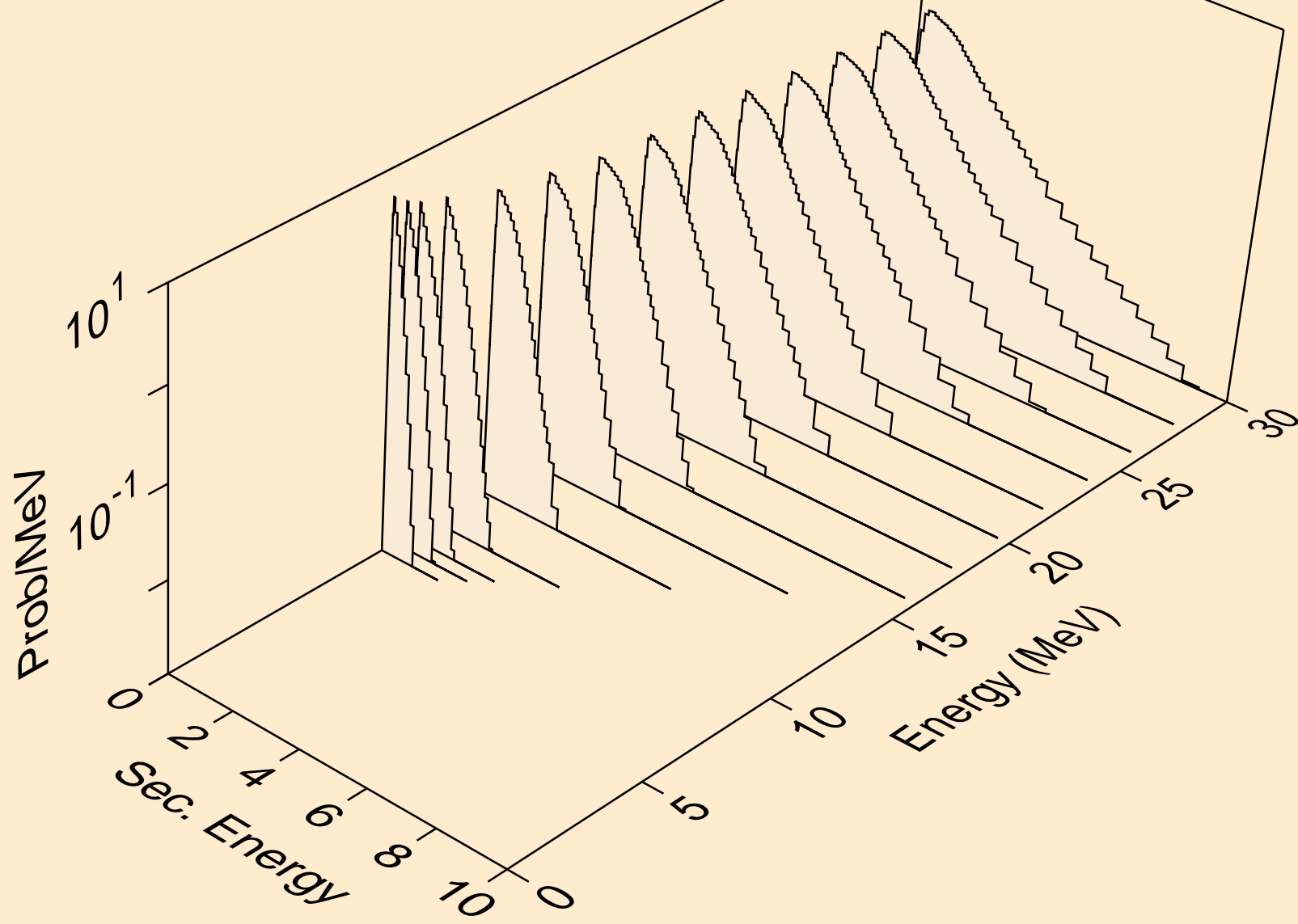

ER147 NEUTRON ACER TENDL-2024 LIBRARY; T=293.6K
Neutron emission for (n,n*c)

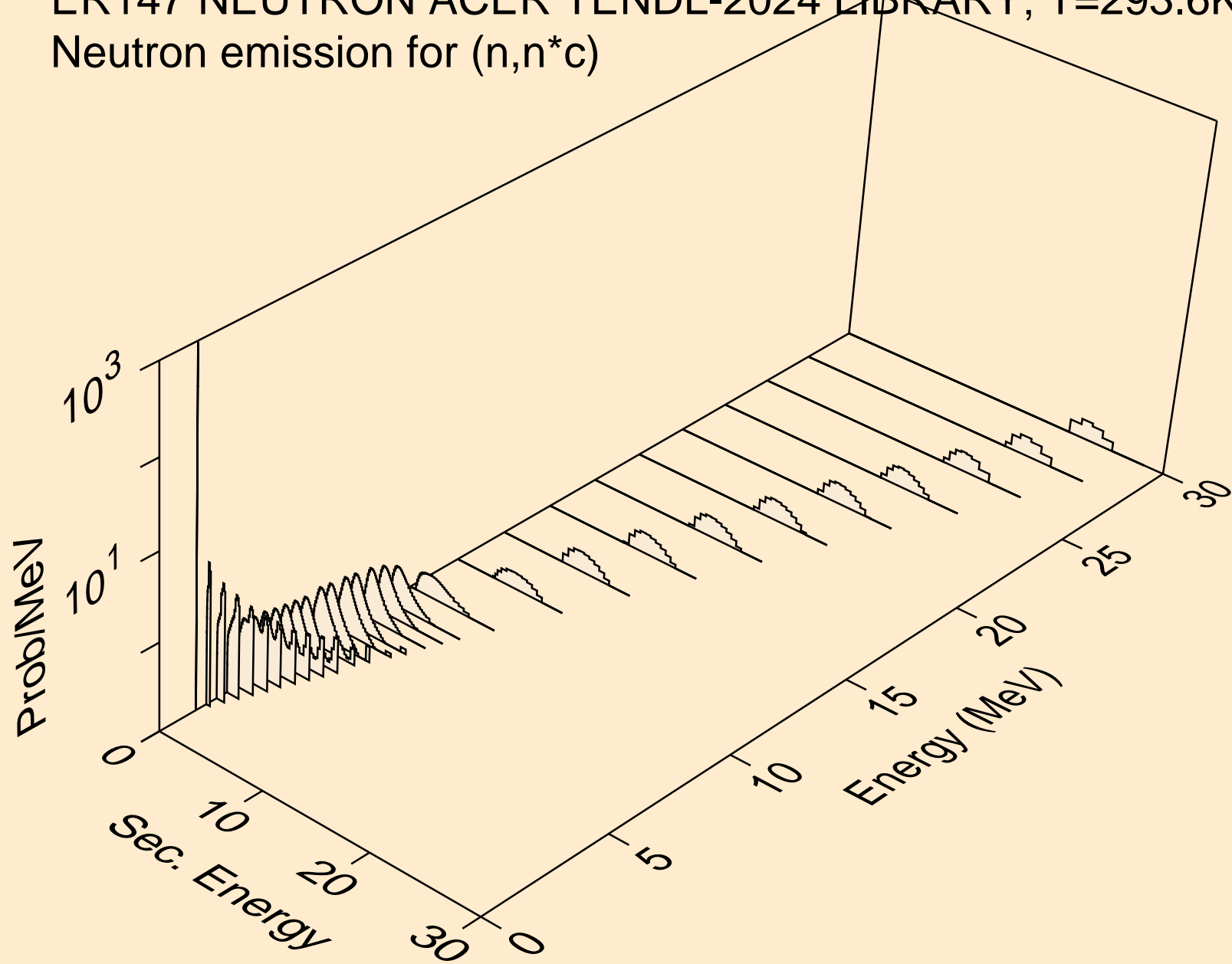

ER147 NEUTRON ACER TENDL-2024 LIBRARY; T=293.6K
Photon emission for (n,x)

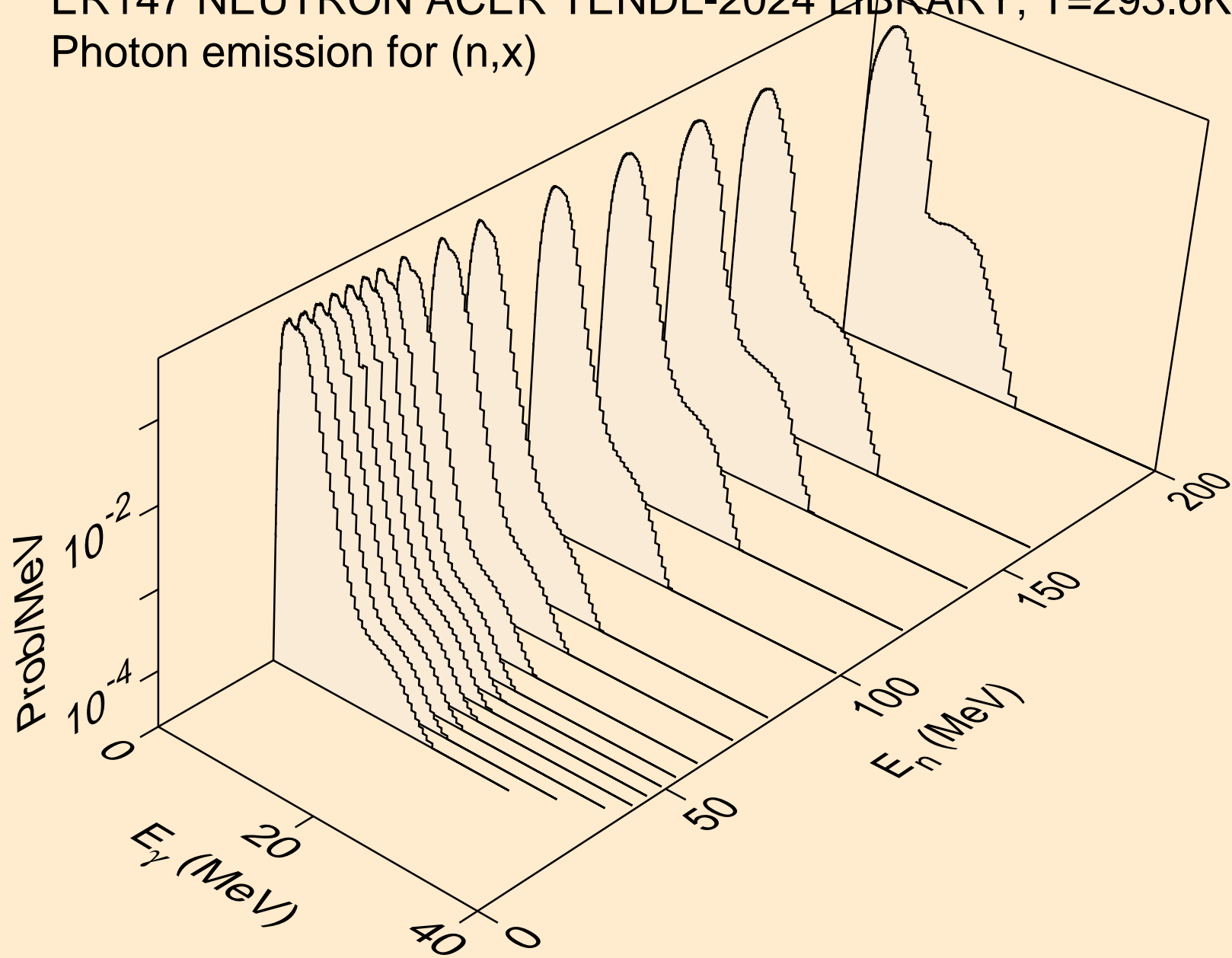

ER147 NEUTRON ACER TENDL-2024 LIBRARY; T=293.6K
Photon emission for (n,2n)

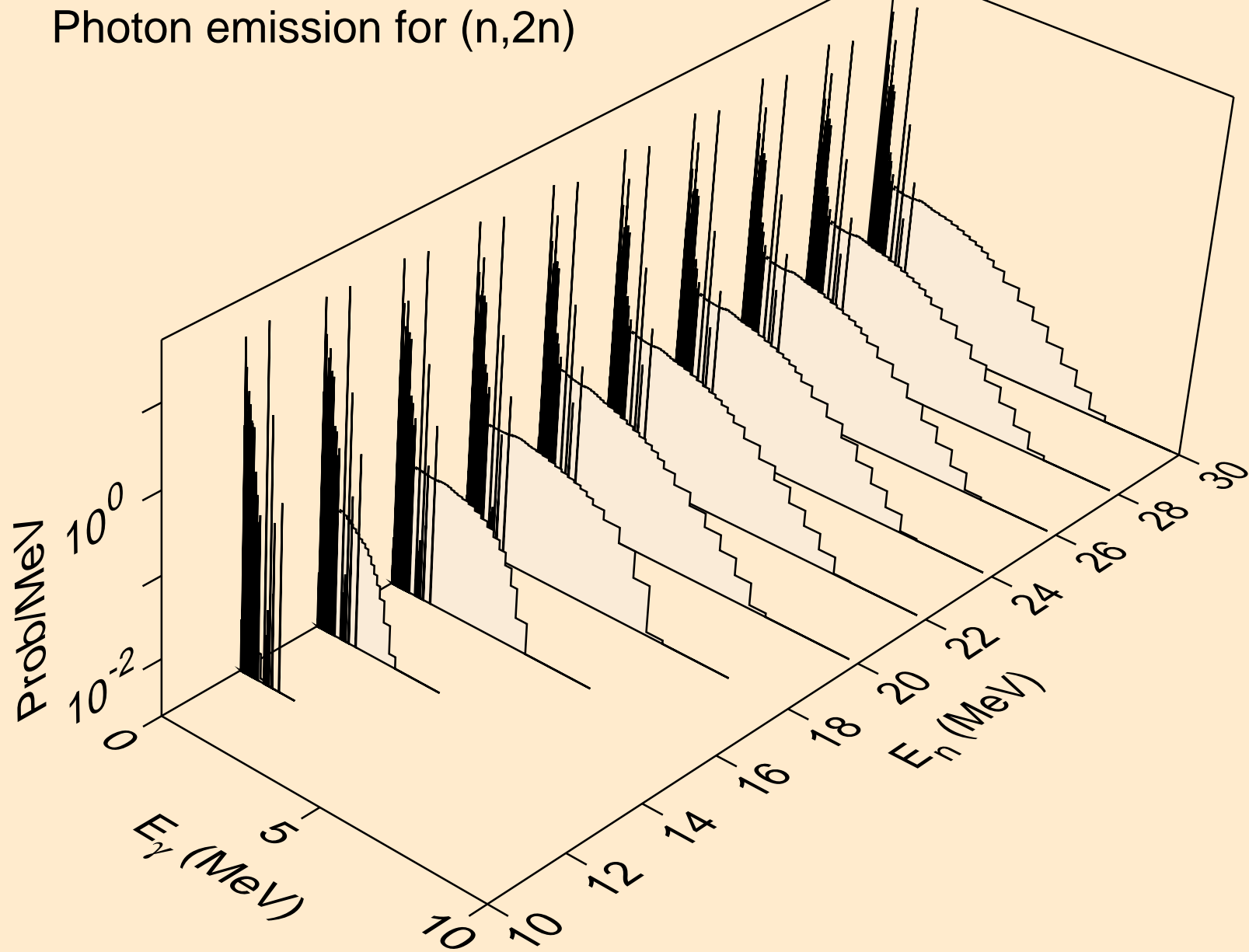

ER147 NEUTRON ACER TENDL-2024 LIBRARY; T=293.6K
Photon emission for (n,3n)

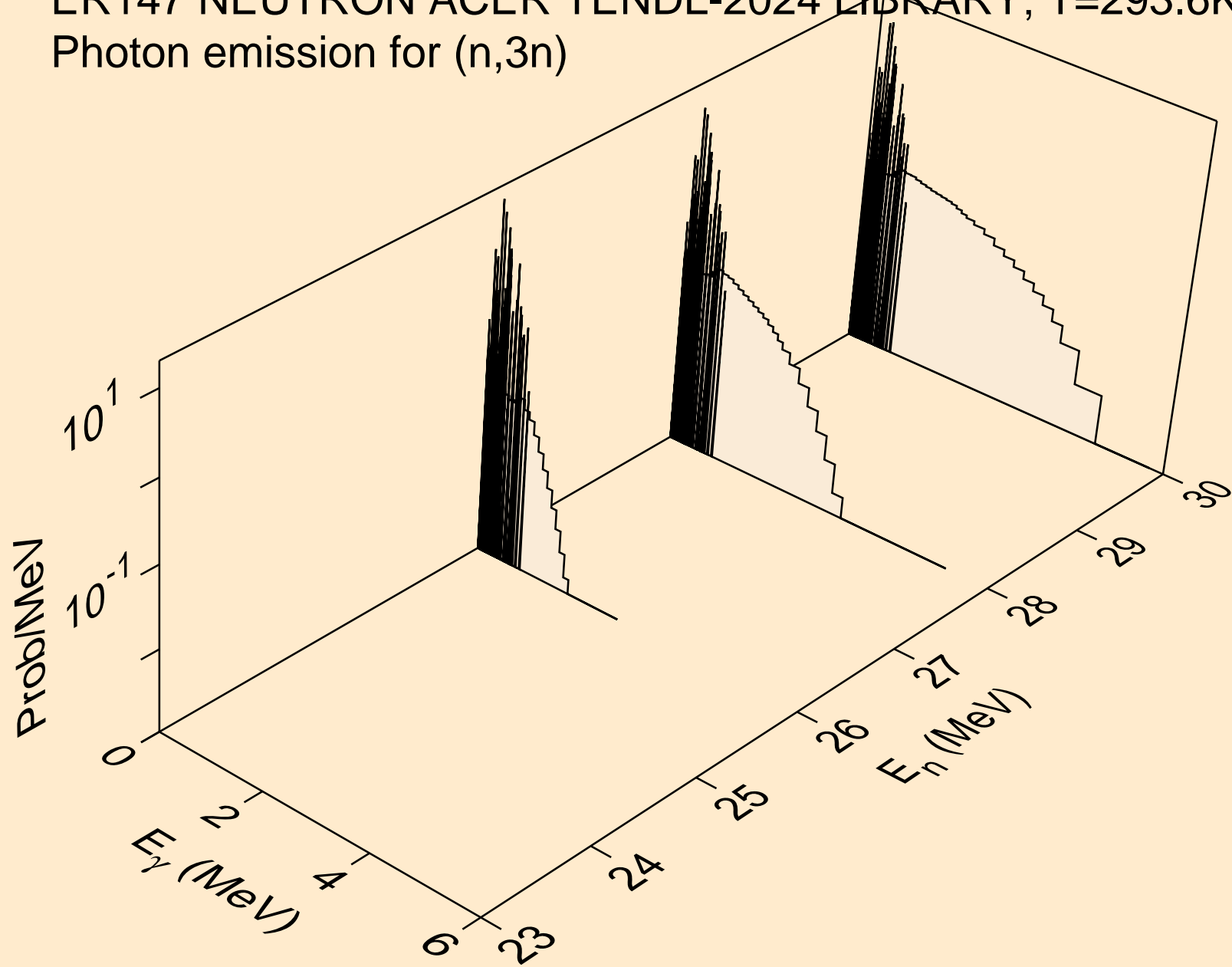

ER147 NEUTRON ACER TENDL-2024 LIBRARY; T=293.6K
Photon emission for (n,n*)a

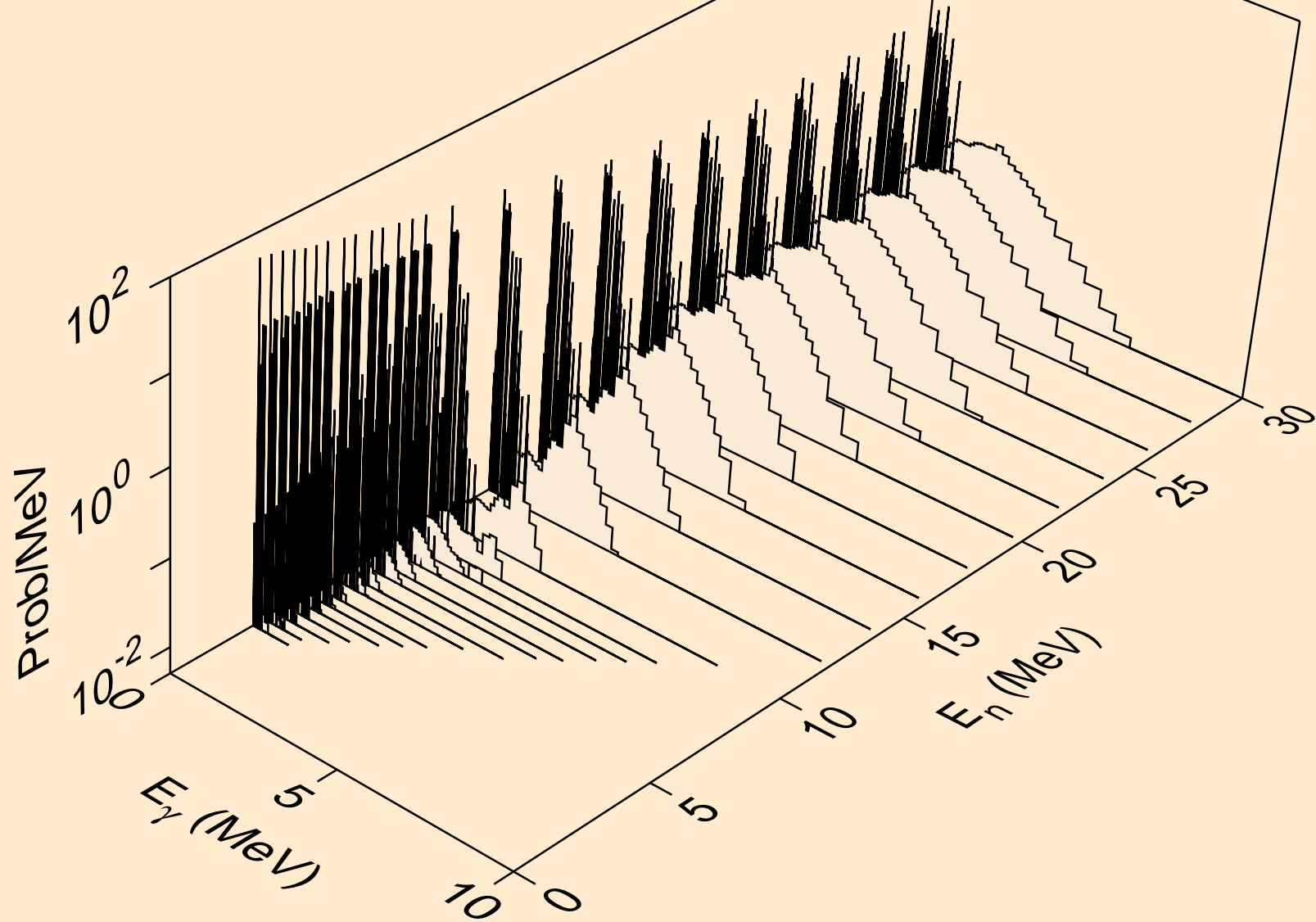

ER147 NEUTRON ACER TENDL-2024 LIBRARY; T=293.6K
Photon emission for (n,2n)a

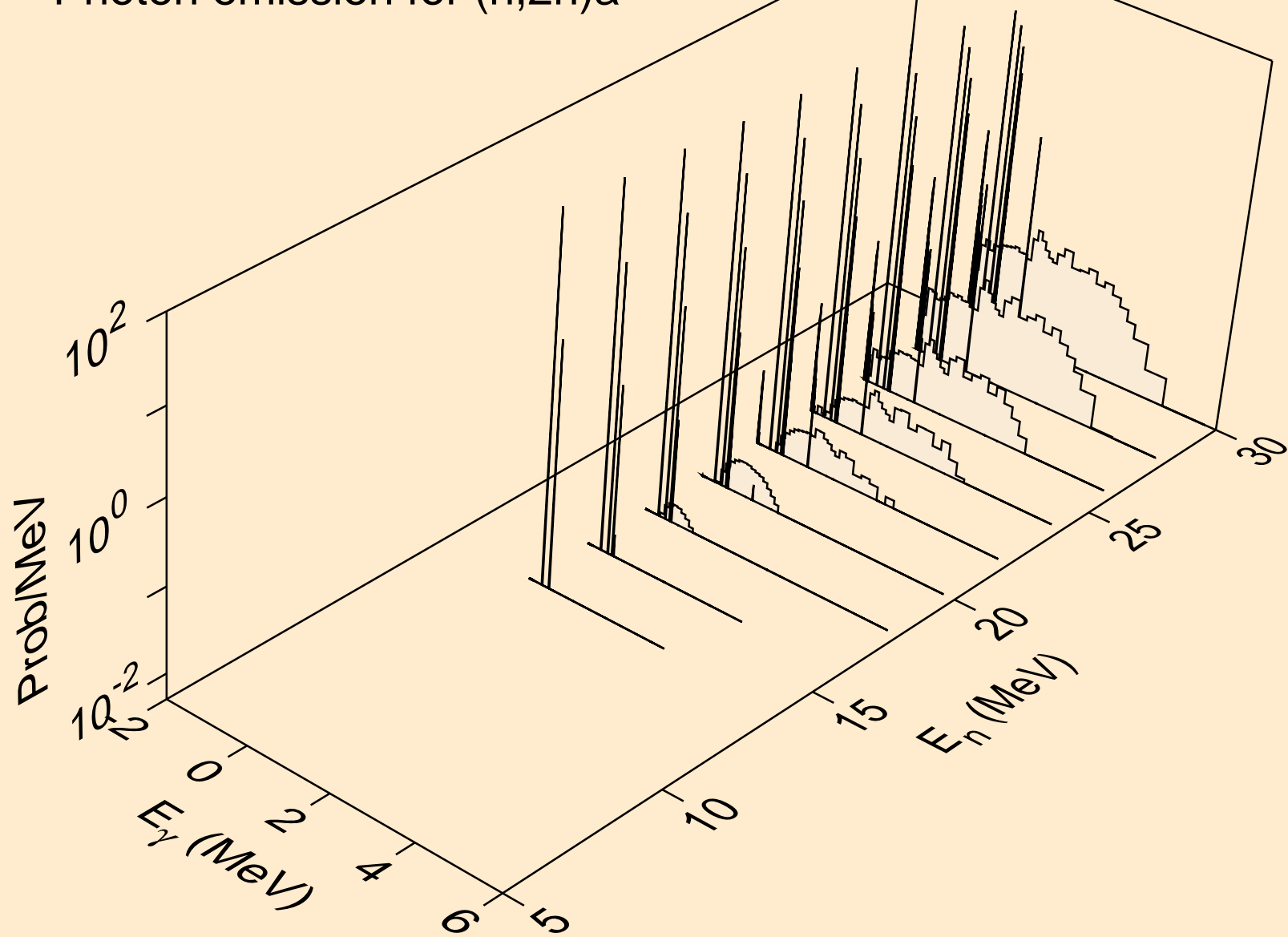

ER147 NEUTRON ACER TENDL-2024 LIBRARY; T=293.6K
Photon emission for (n,n*)p

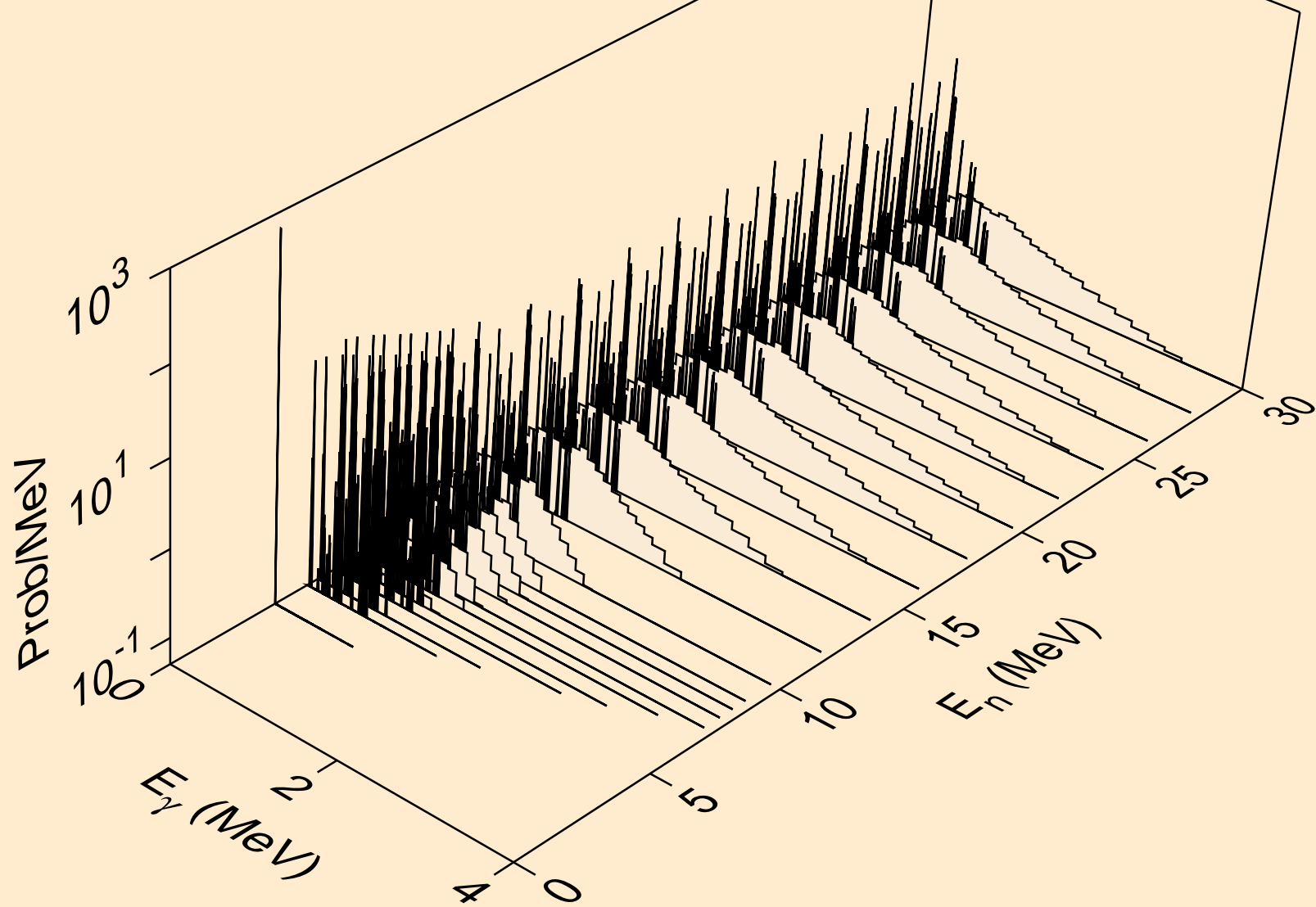

ER147 NEUTRON ACER TENDL-2024 LIBRARY; T=293.6K
Photon emission for (n,n*)2a

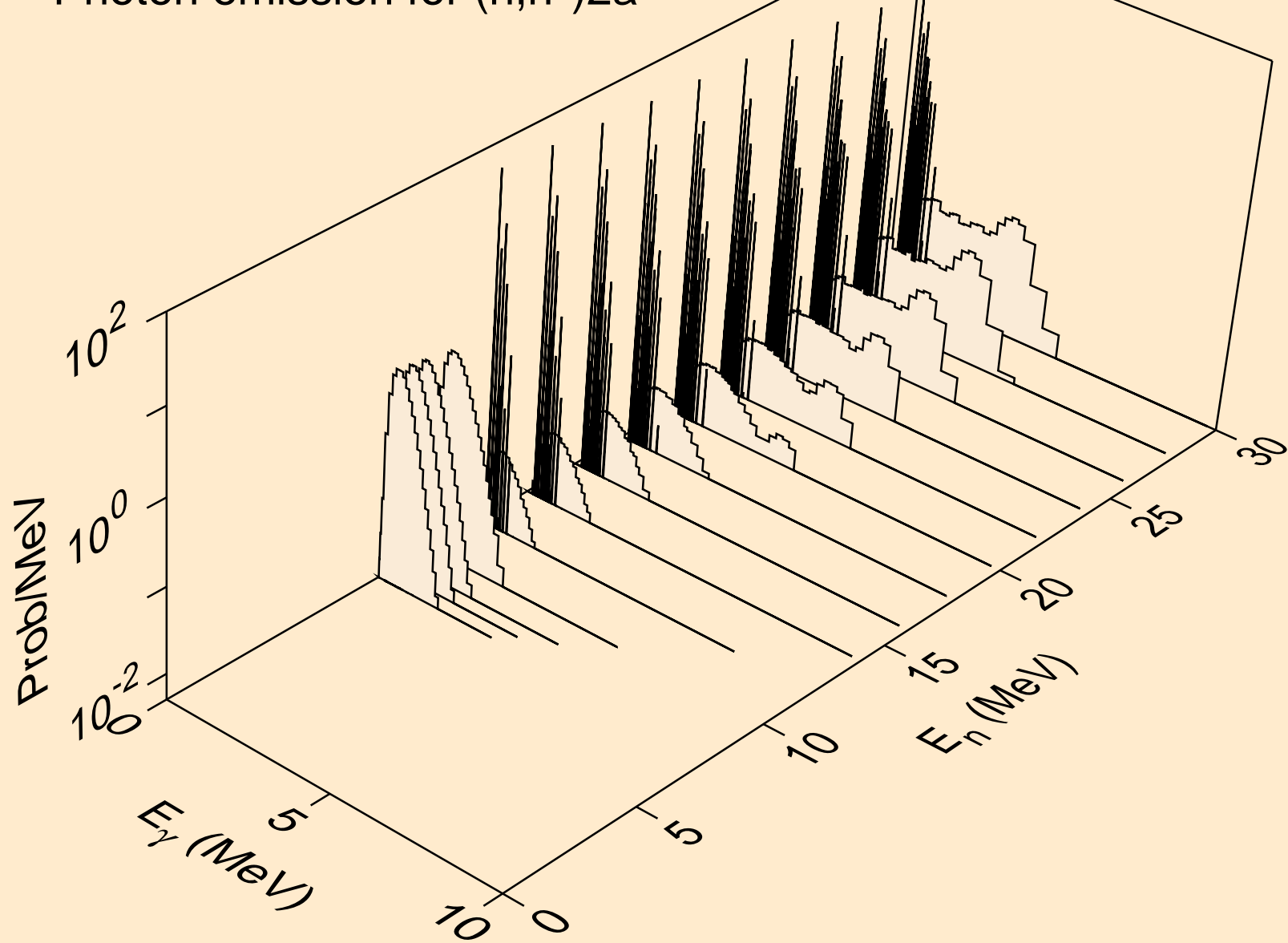

ER147 NEUTRON ACER TENDL-2024 LIBRARY; T=293.6K
Photon emission for (n,2n)2a

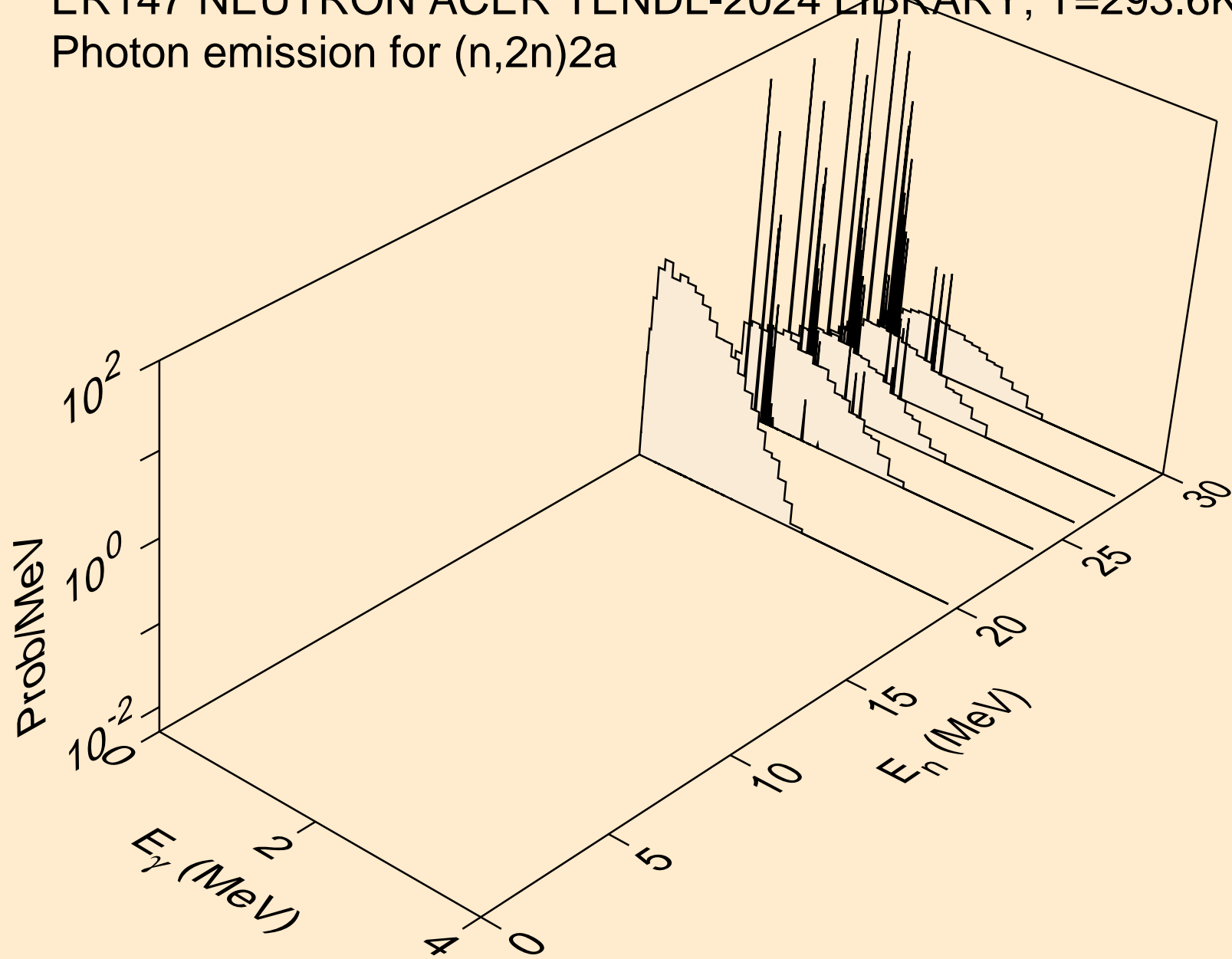

ER147 NEUTRON ACER TENDL-2024 LIBRARY; T=293.6K
Photon emission for (n,n*)d

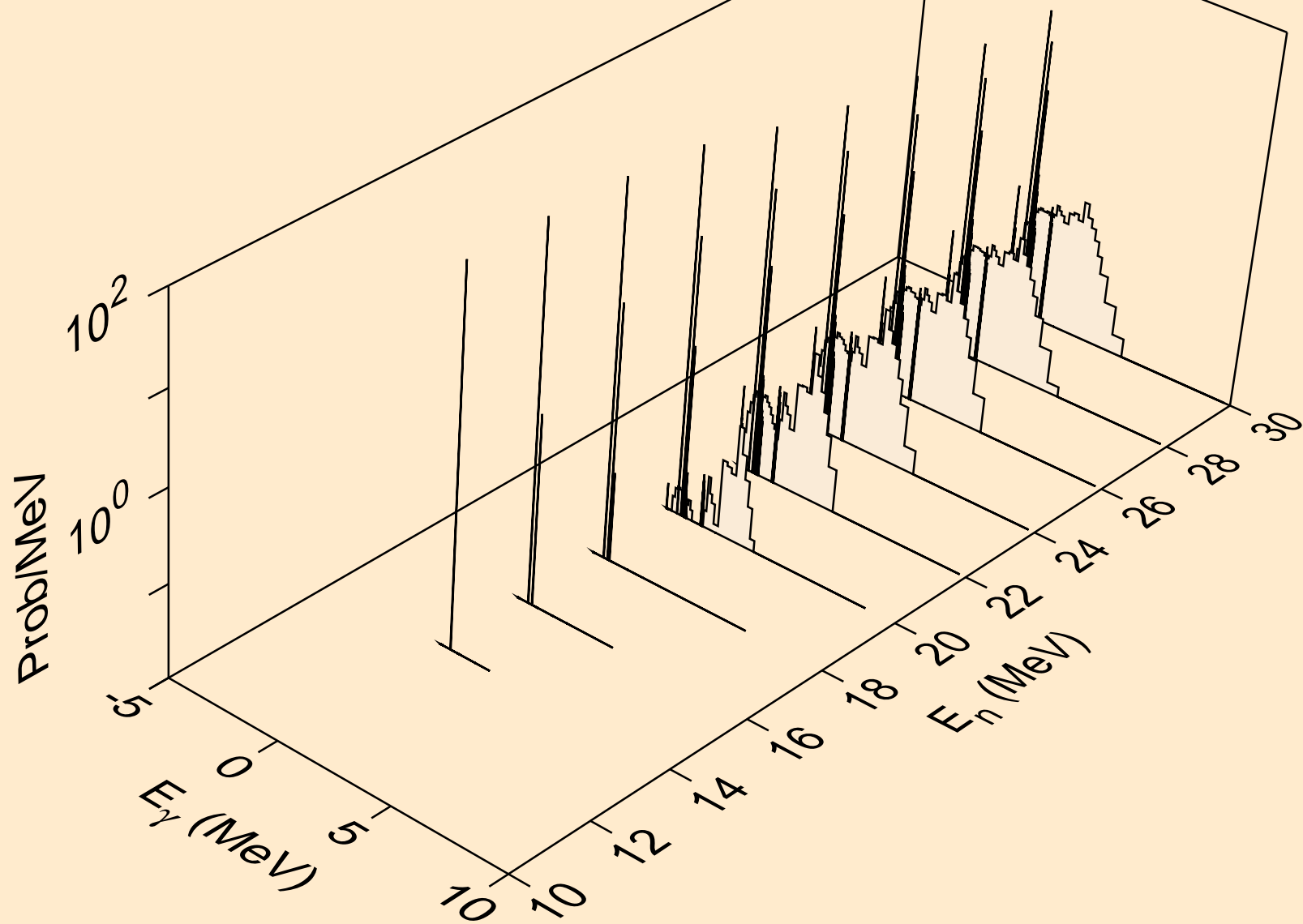

ER147 NEUTRON ACER TENDL-2024 LIBRARY; T=293.6K
Photon emission for (n,n*)t

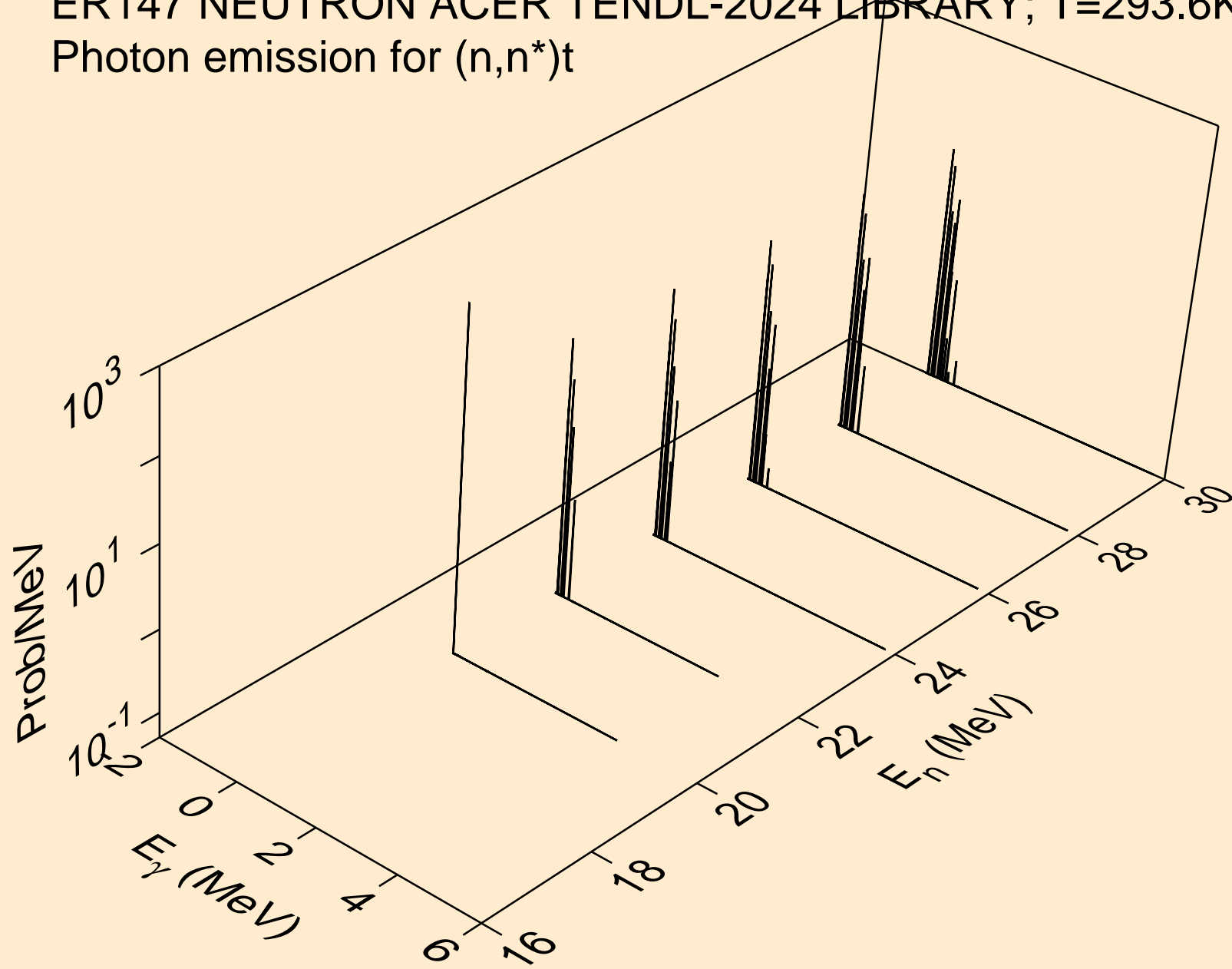

ER147 NEUTRON ACER TENDL-2024 LIBRARY; T=293.6K
Photon emission for (n,n*)he3

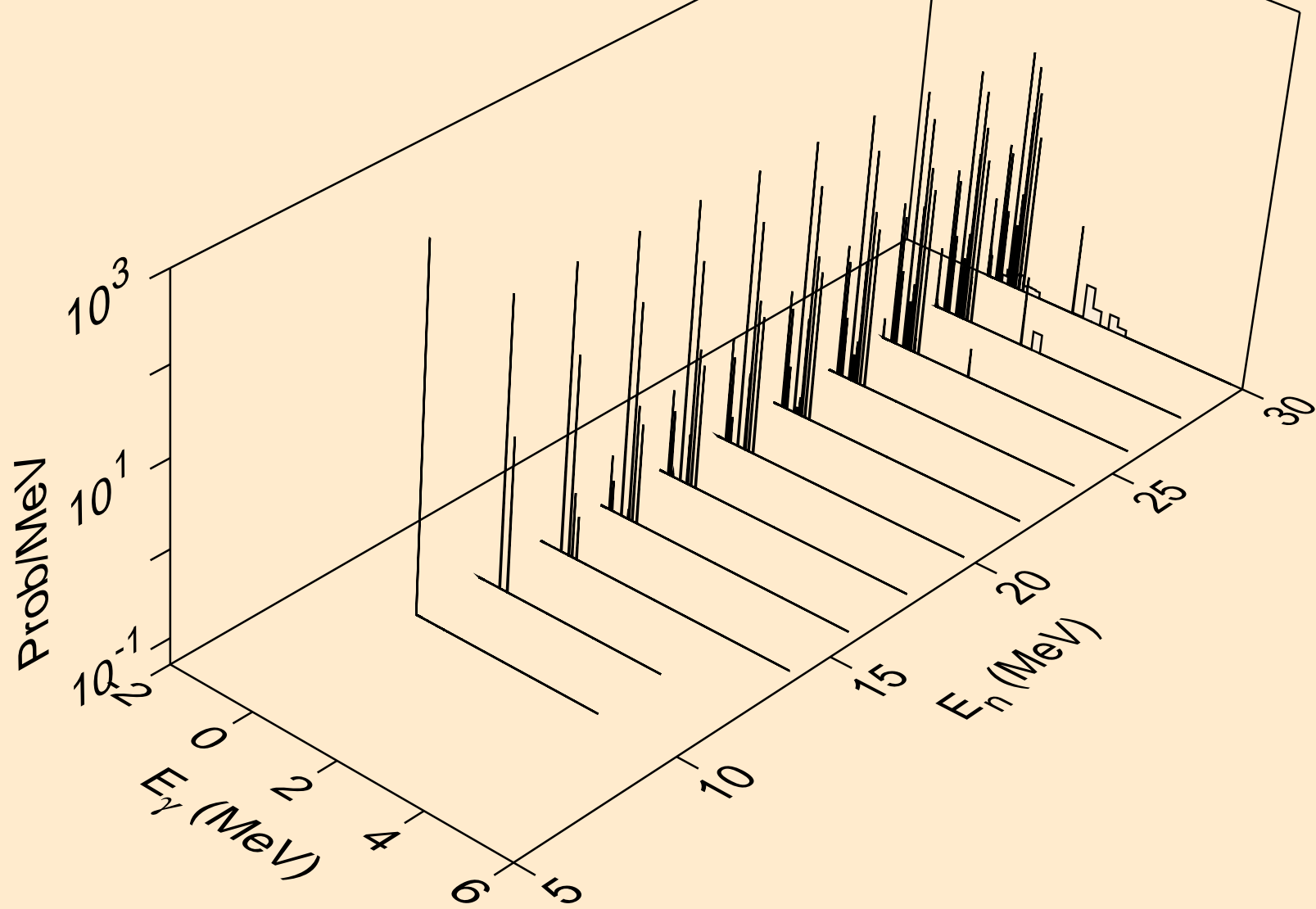

ER147 NEUTRON ACER TENDL-2024 LIBRARY; T=293.6K
Photon emission for (n,2np)

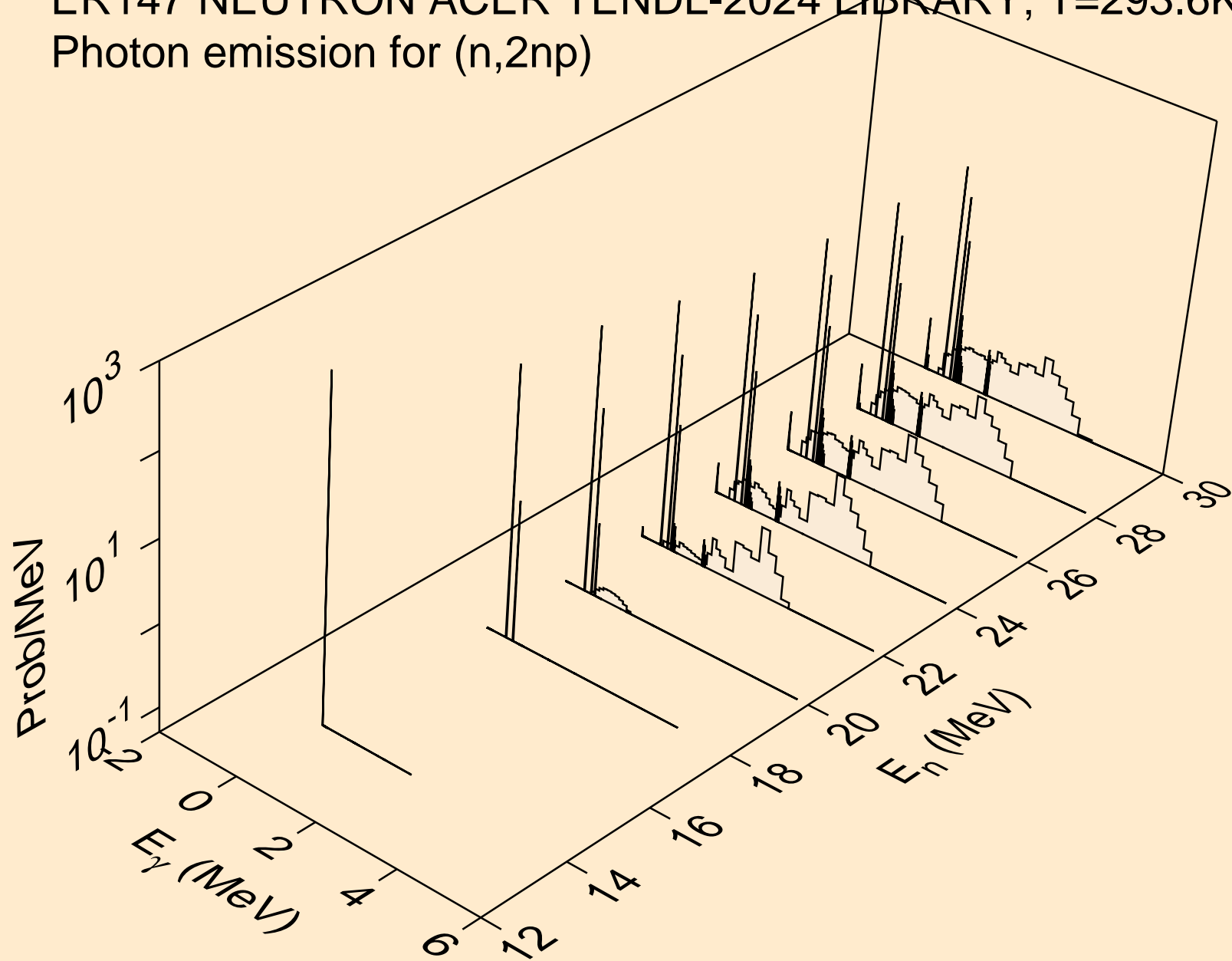

ER147 NEUTRON ACER TENDL-2024 LIBRARY; T=293.6K
Photon emission for (n,3np)

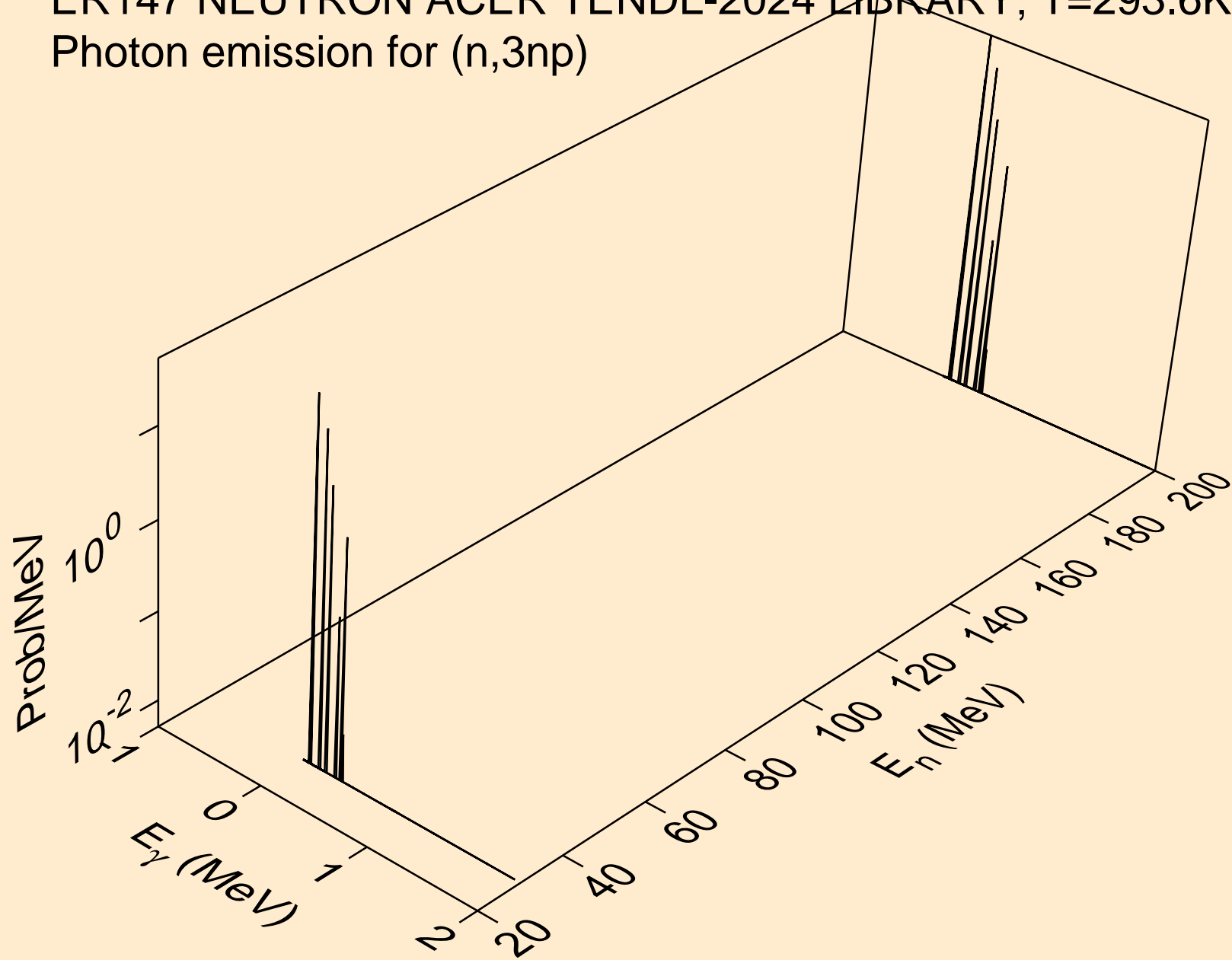

ER147 NEUTRON ACER TENDL-2024 LIBRARY; T=293.6K
Photon emission for (n,n2p)

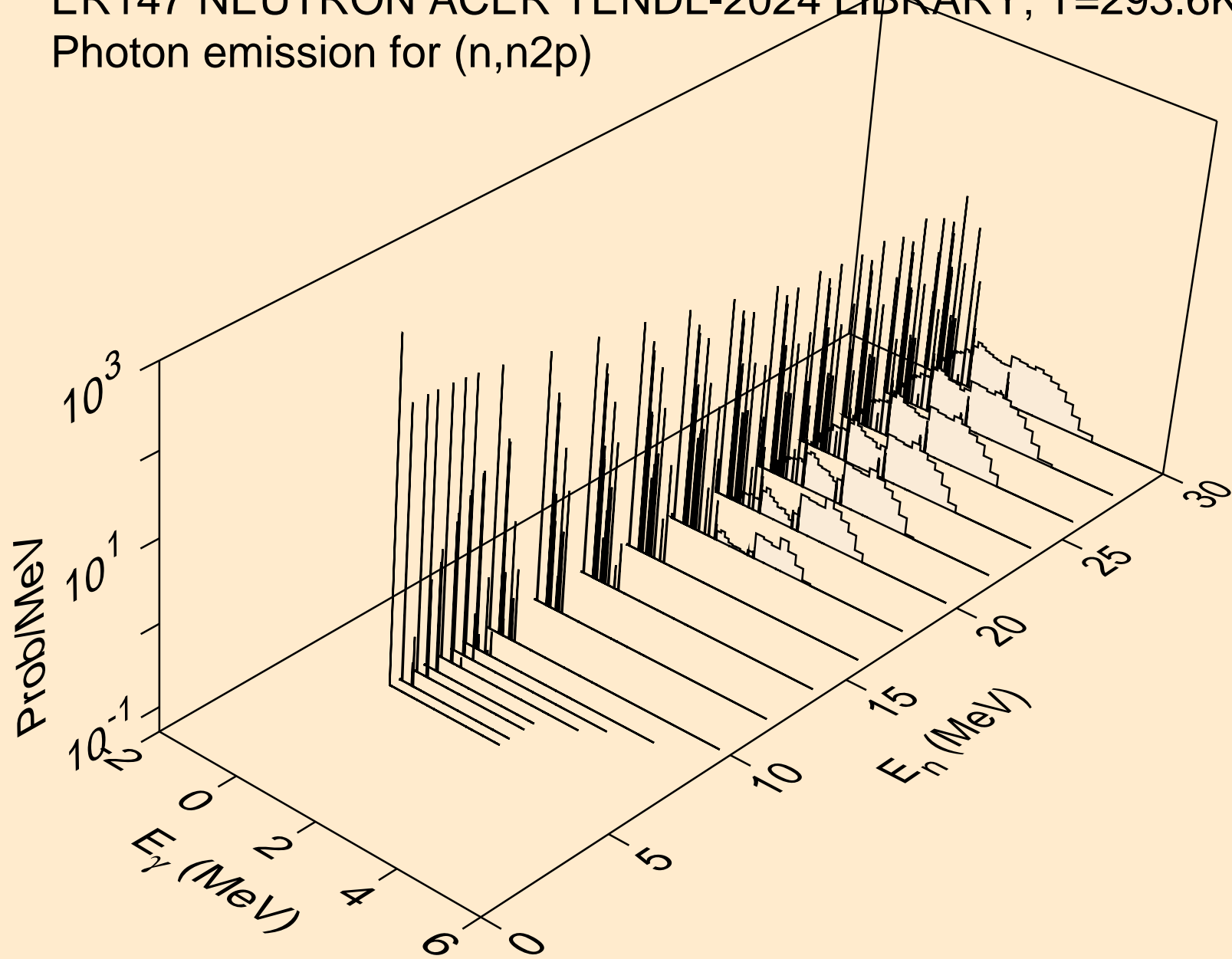

ER147 NEUTRON ACER TENDL-2024 LIBRARY; T=293.6K
Photon emission for (n,npa)

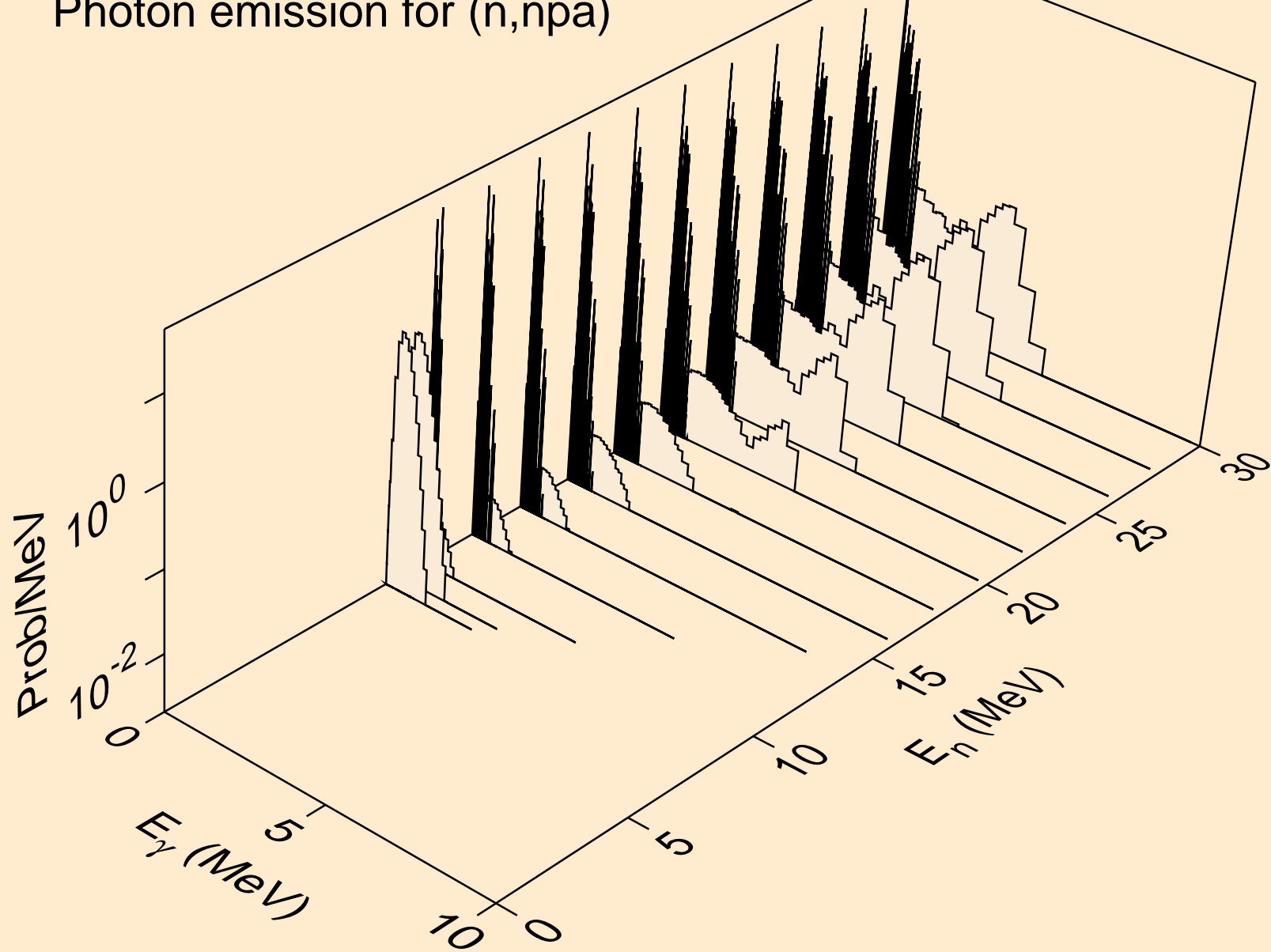

ER147 NEUTRON ACER TENDL-2024 LIBRARY; T=293.6K
Photon emission for (n,n*c)

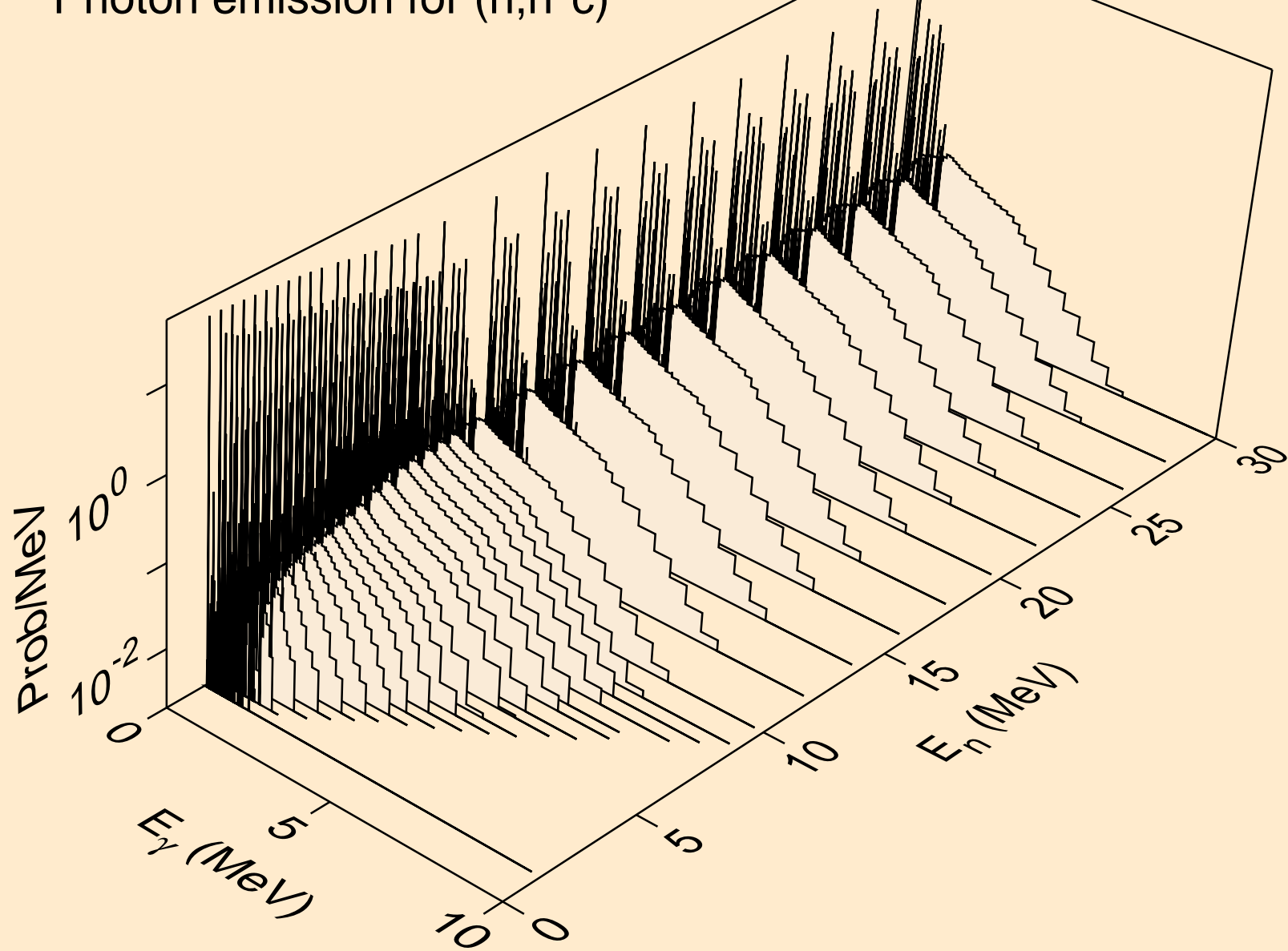

ER147 NEUTRON ACER TENDL-2024 LIBRARY; T=293.6K
Photon emission for (n,gma)

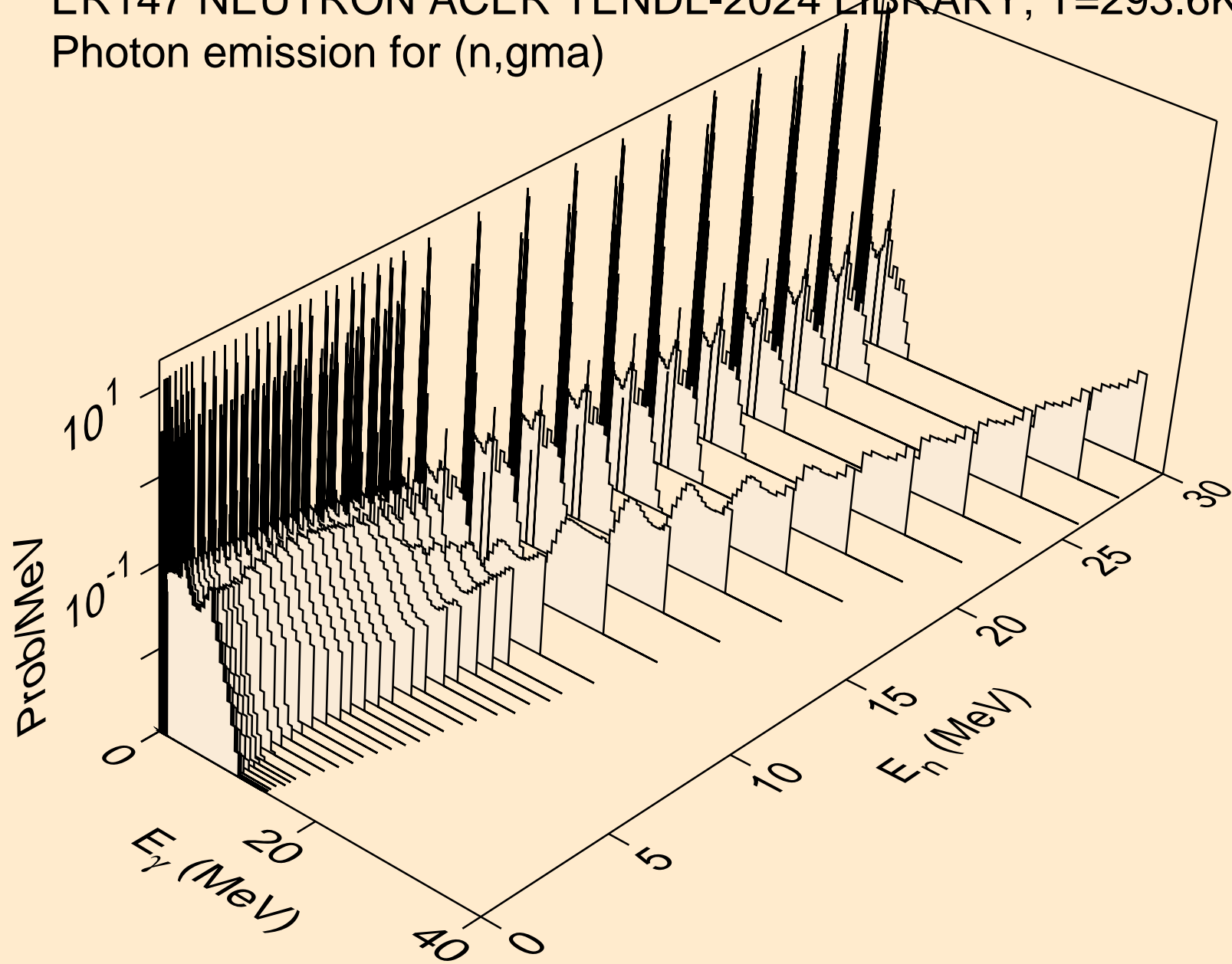

ER147 NEUTRON ACER TENDL-2024 LIBRARY; T=293.6K
Photon emission for (n,p)

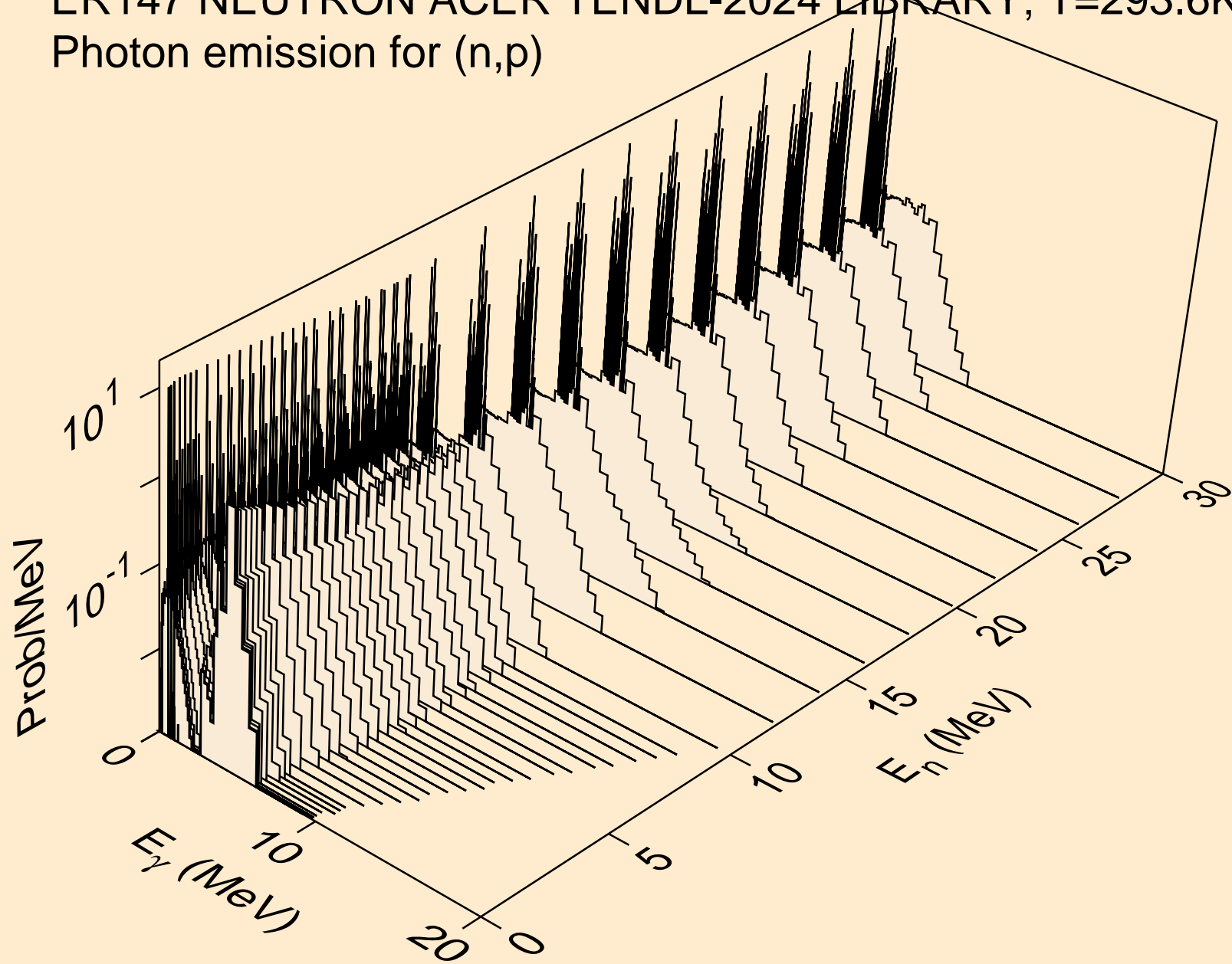

ER147 NEUTRON ACER TENDL-2024 LIBRARY; T=293.6K
Photon emission for (n,d)

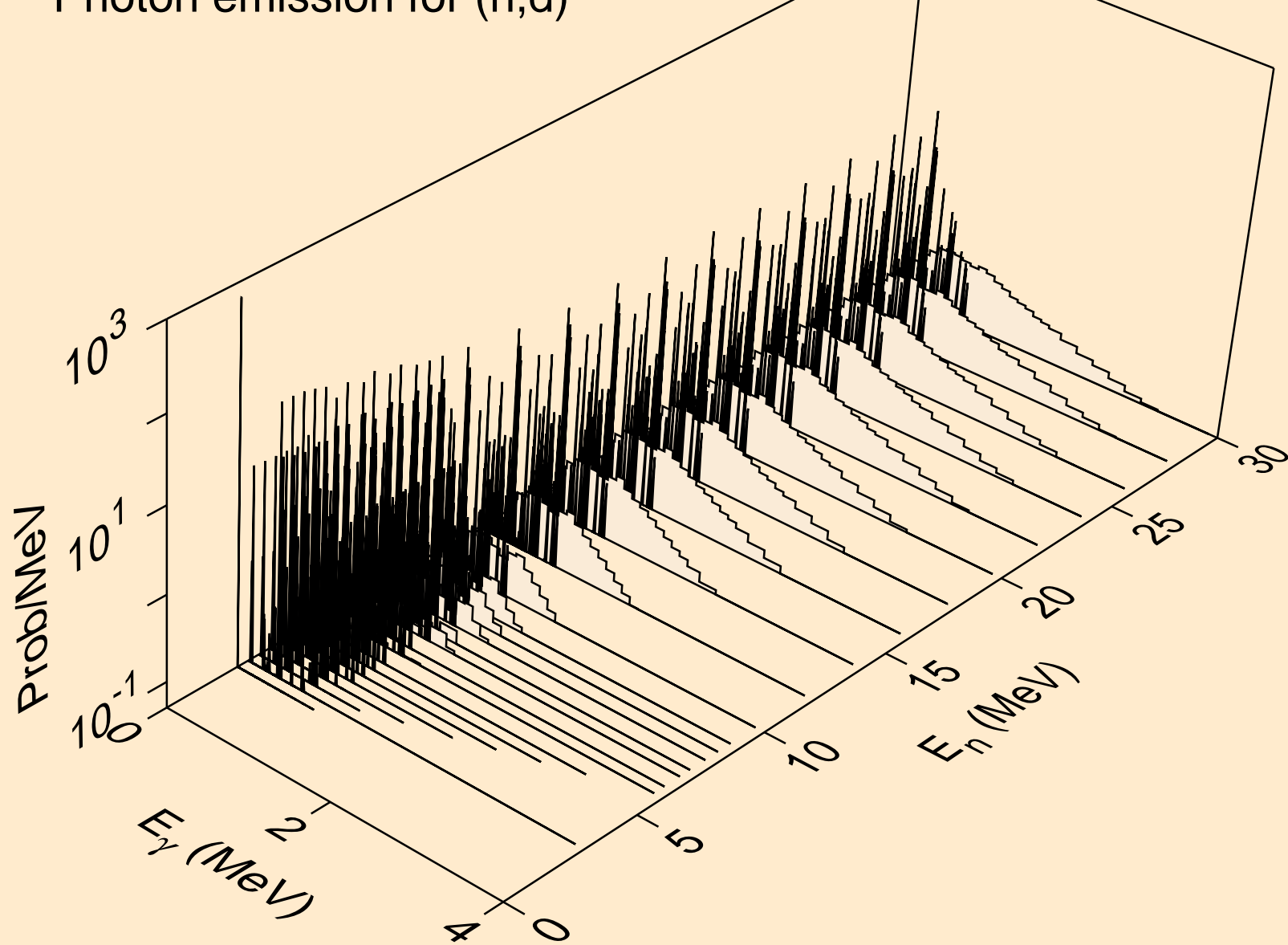

ER147 NEUTRON ACER TENDL-2024 LIBRARY; T=293.6K
Photon emission for (n,t)

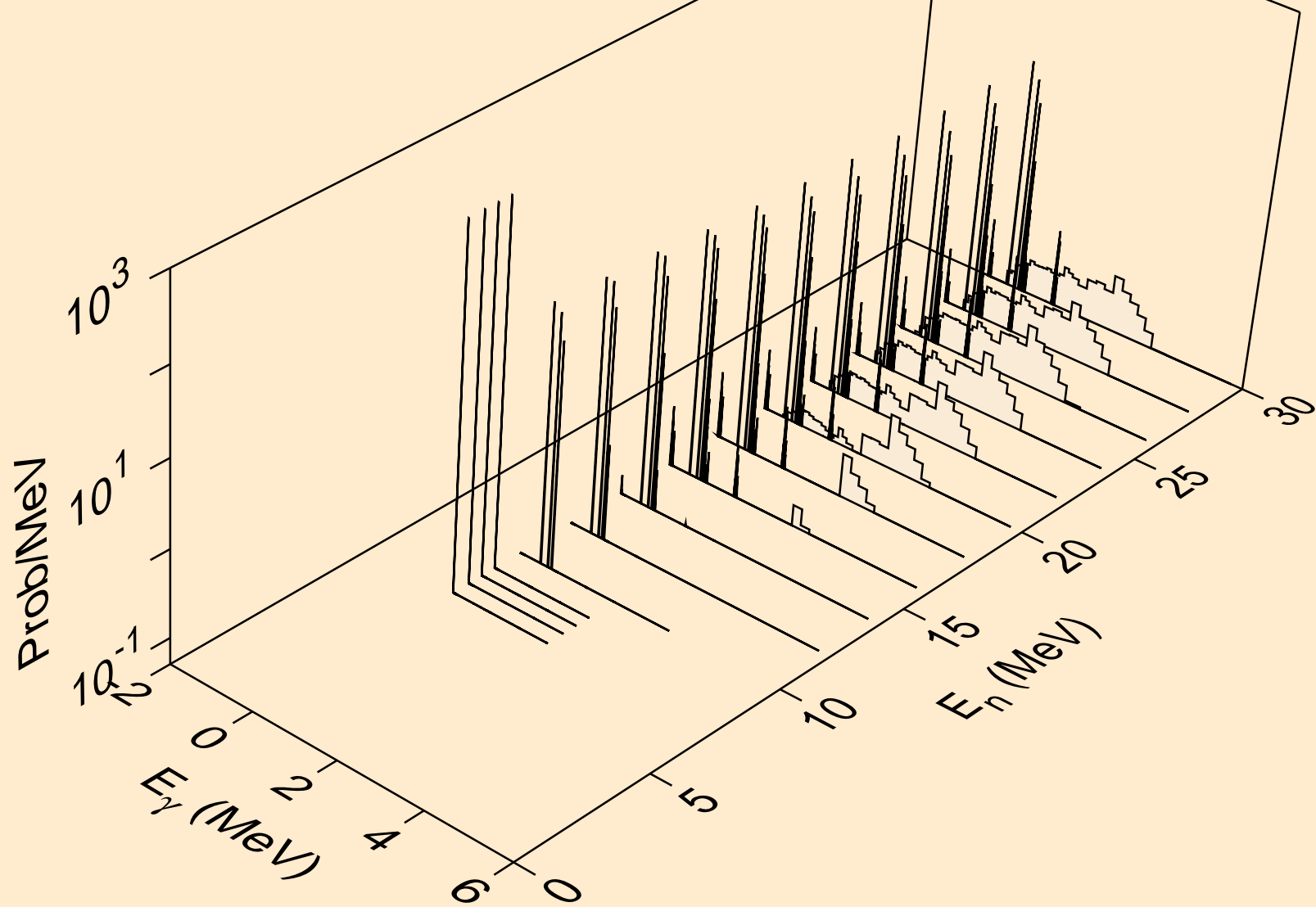

ER147 NEUTRON ACER TENDL-2024 LIBRARY; T=293.6K
Photon emission for (n,he3)

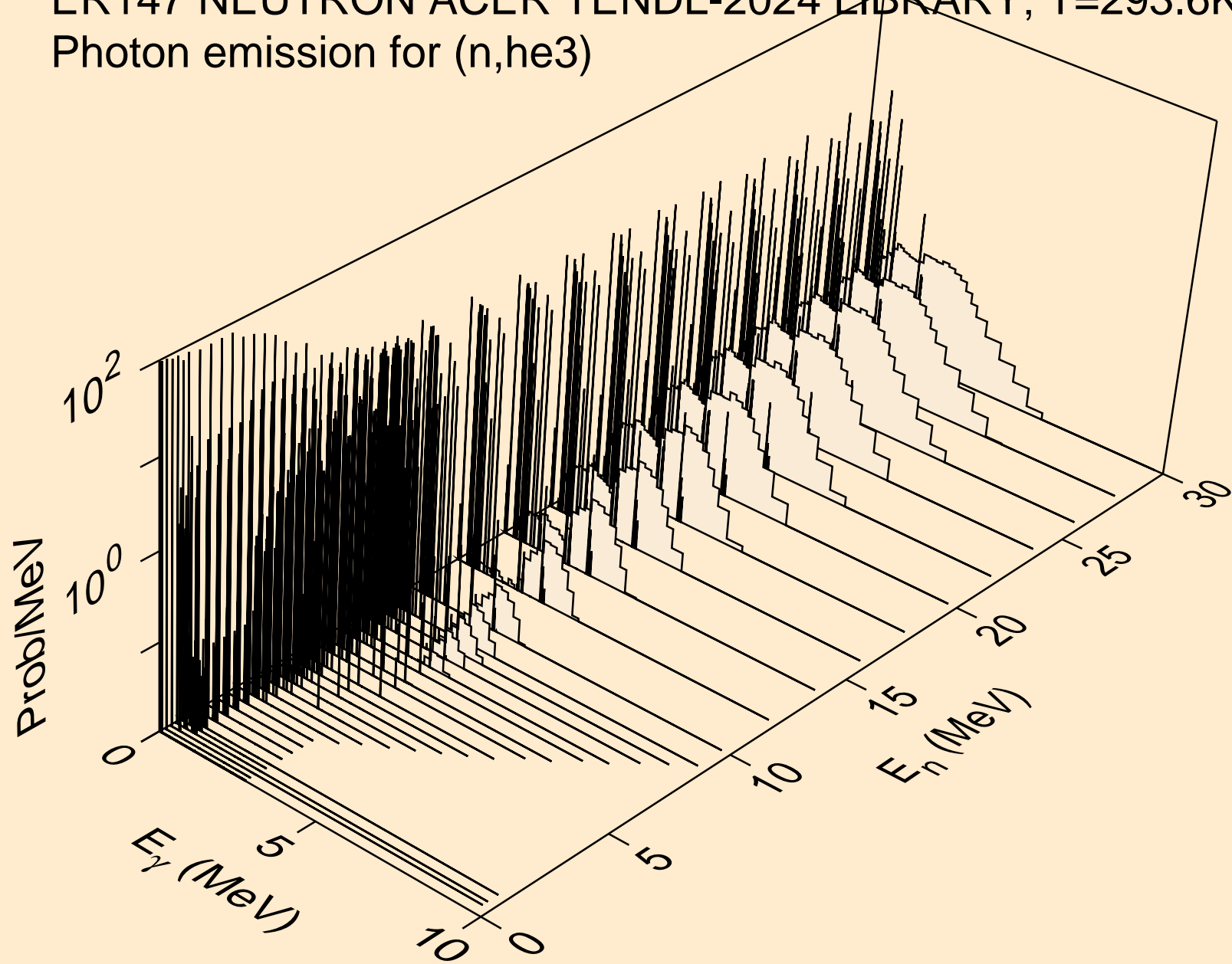

ER147 NEUTRON ACER TENDL-2024 LIBRARY; T=293.6K
Photon emission for (n,a)

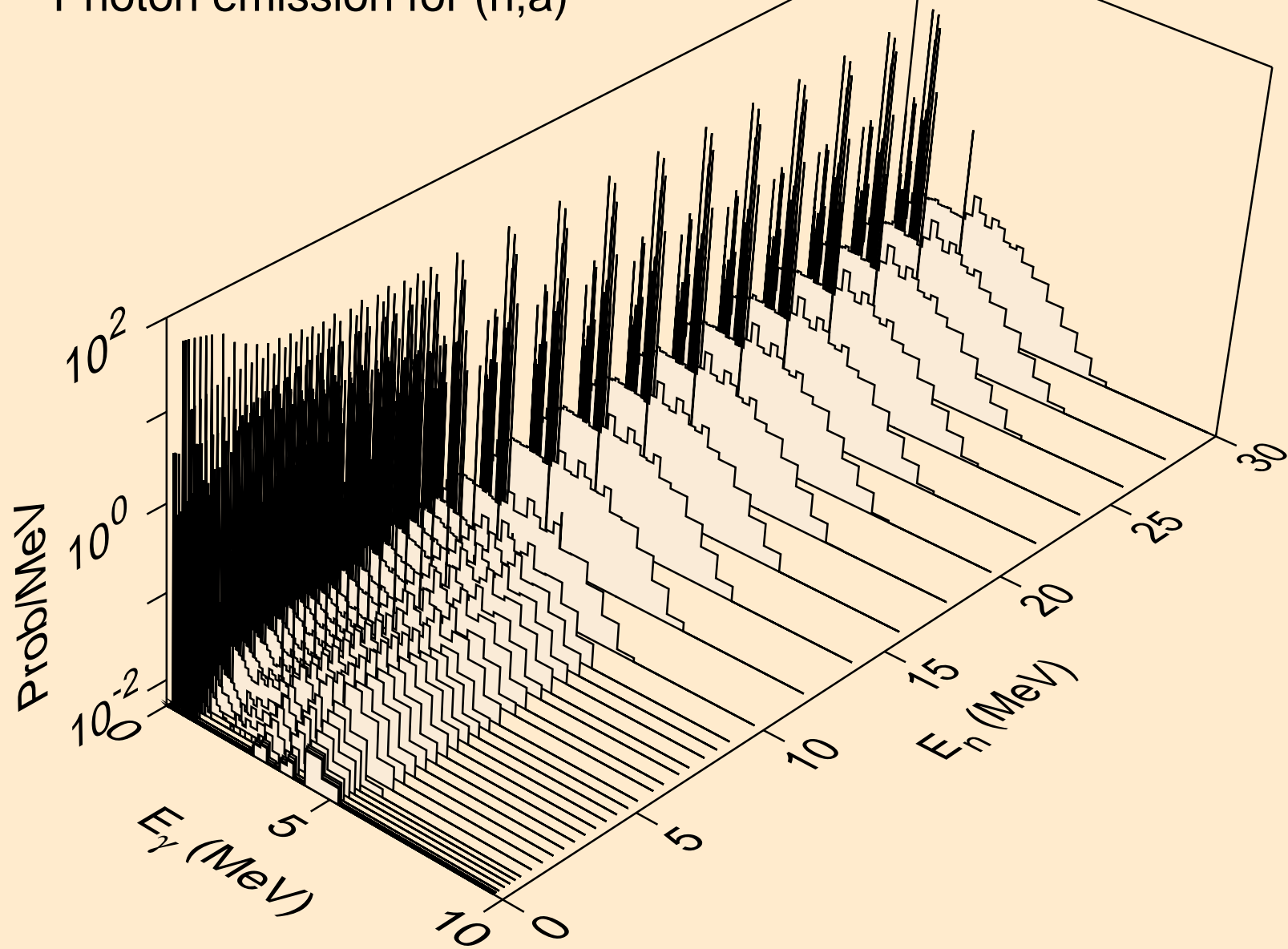

ER147 NEUTRON ACER TENDL-2024 LIBRARY; T=293.6K
Photon emission for (n,2a)

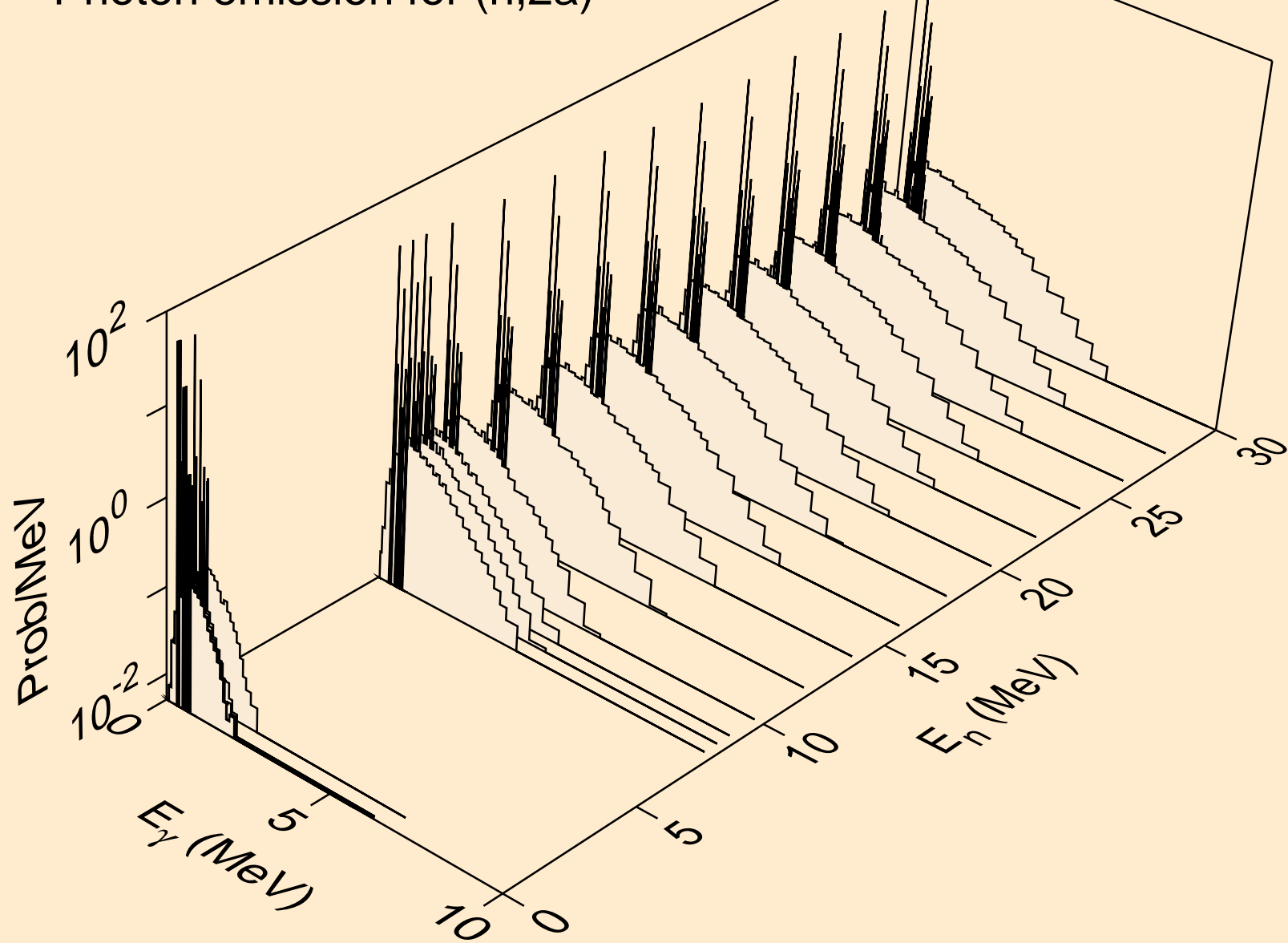

ER147 NEUTRON ACER TENDL-2024 LIBRARY; T=293.6K
Photon emission for (n,3a)

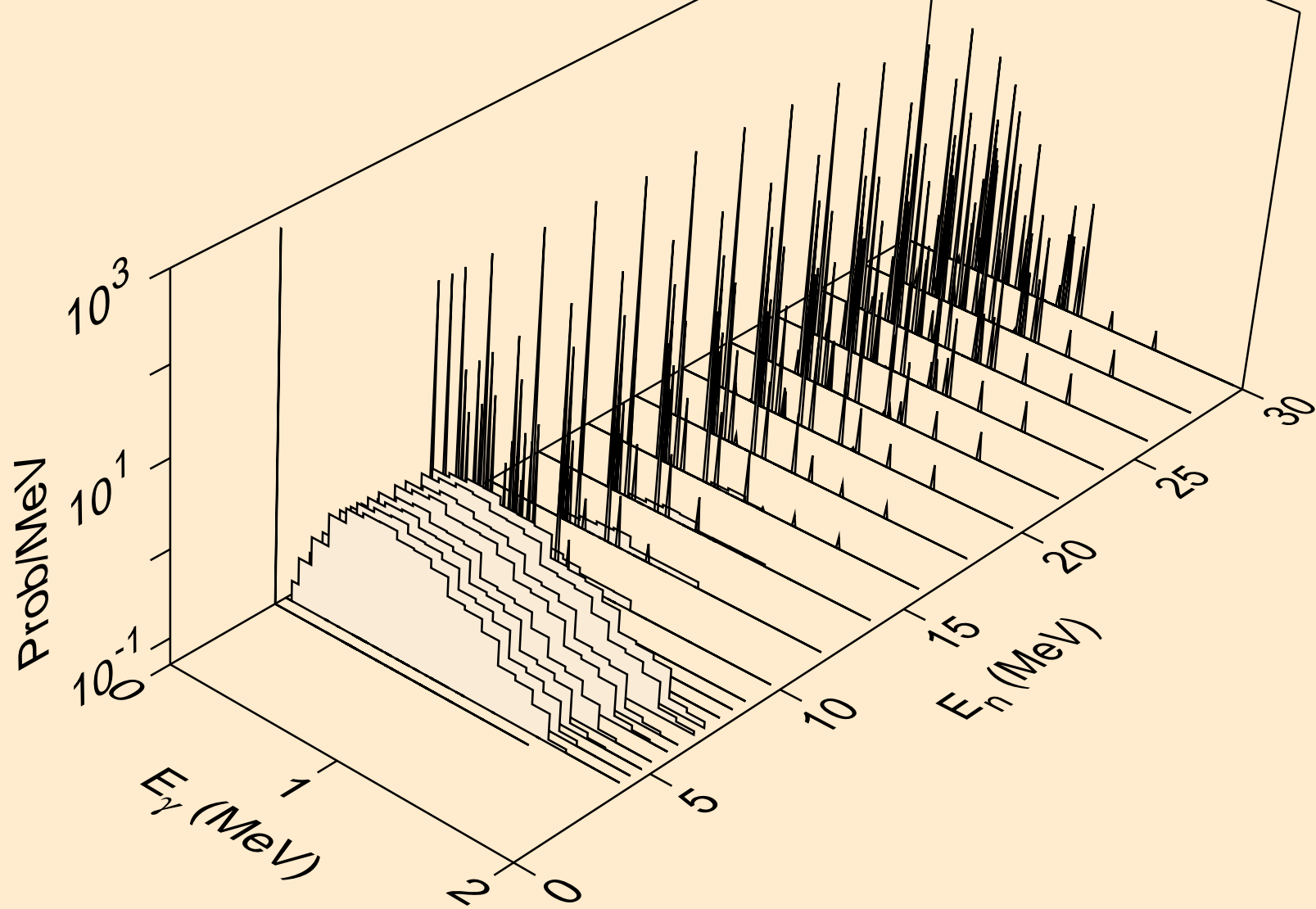

ER147 NEUTRON ACER TENDL-2024 LIBRARY; T=293.6K
Photon emission for (n,2p)

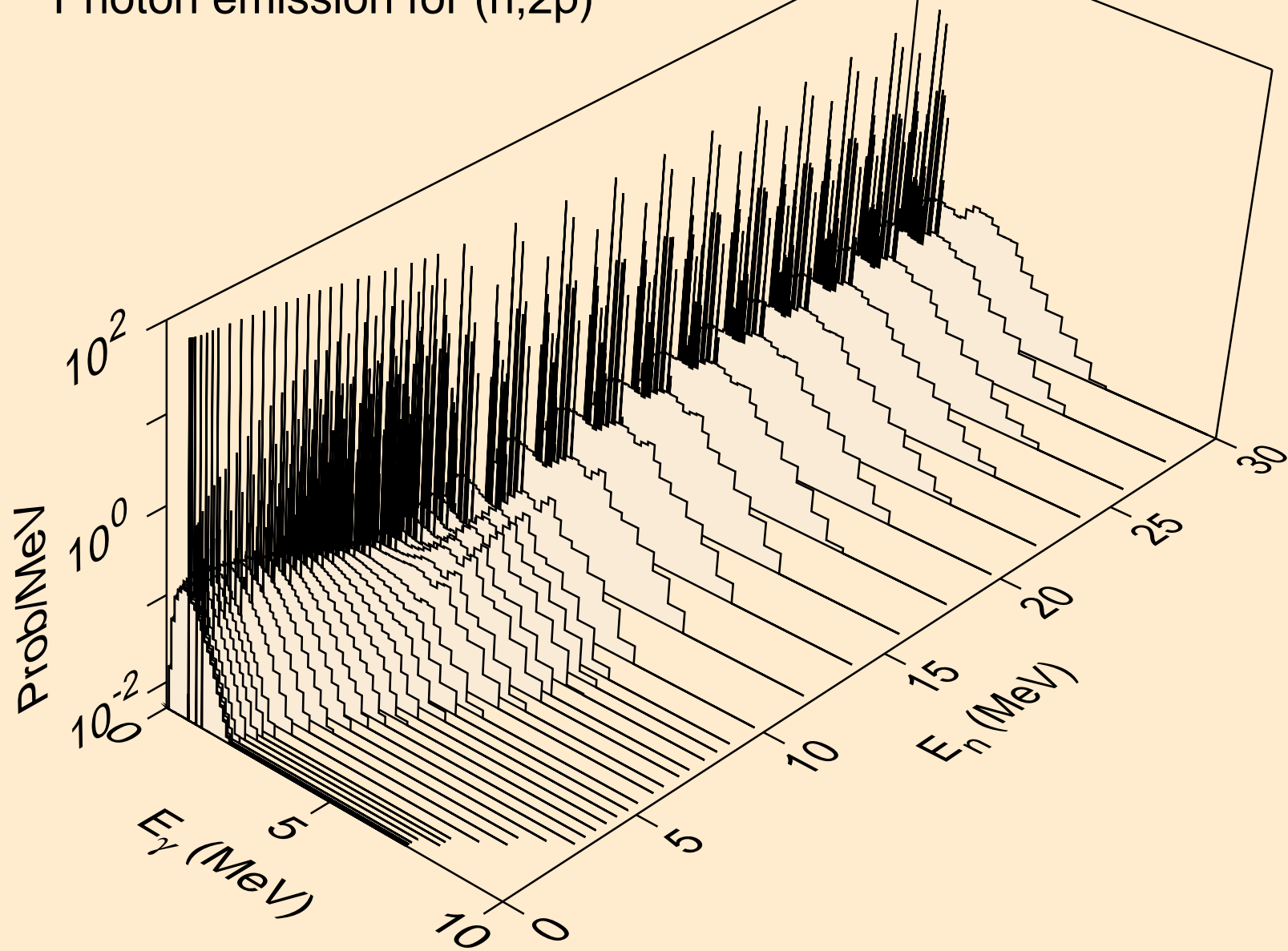

ER147 NEUTRON ACER TENDL-2024 LIBRARY; T=293.6K
Photon emission for (n,p)

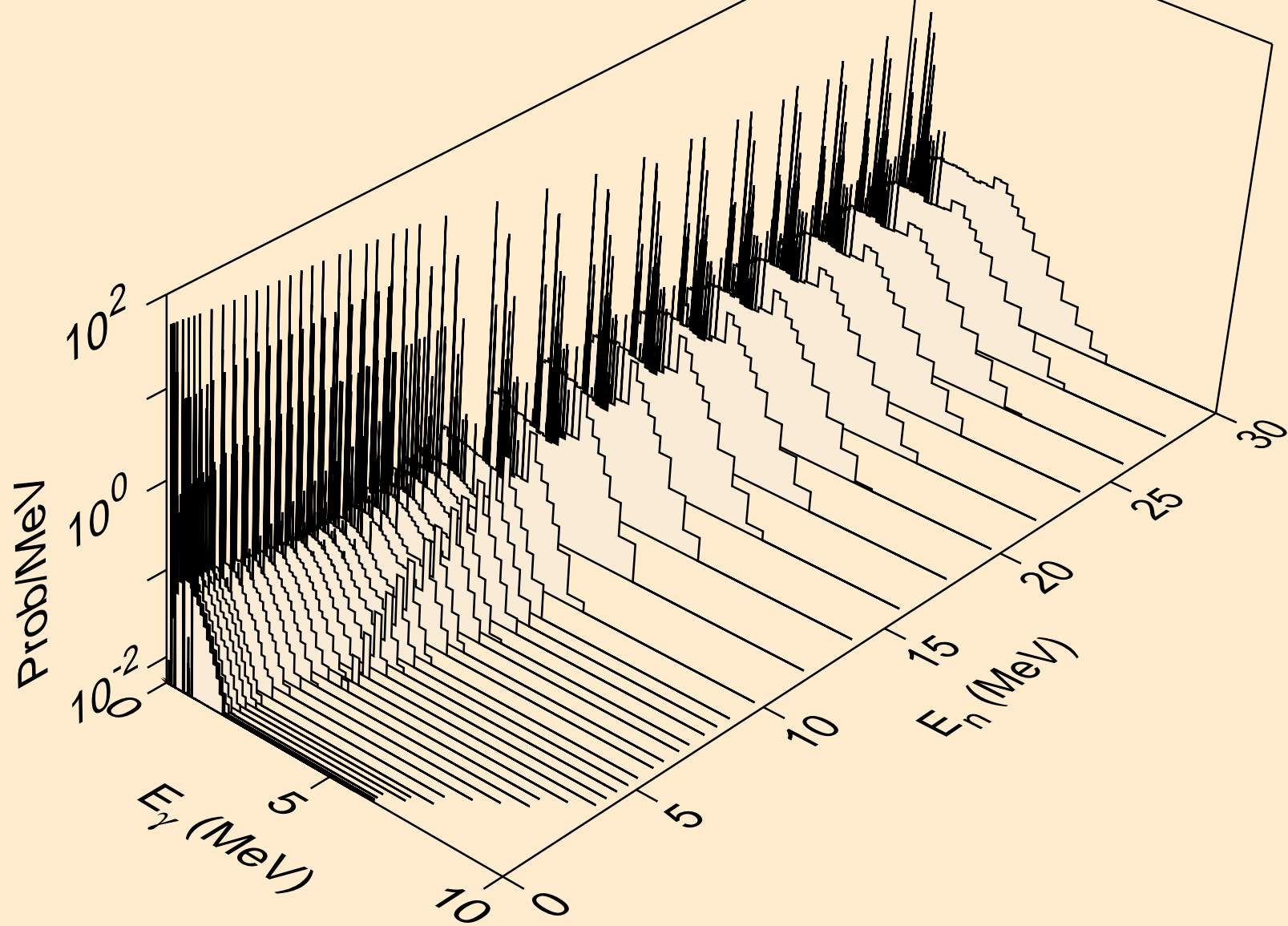

ER147 NEUTRON ACER TENDL-2024 LIBRARY; T=293.6K
Photon emission for (n,d2a)

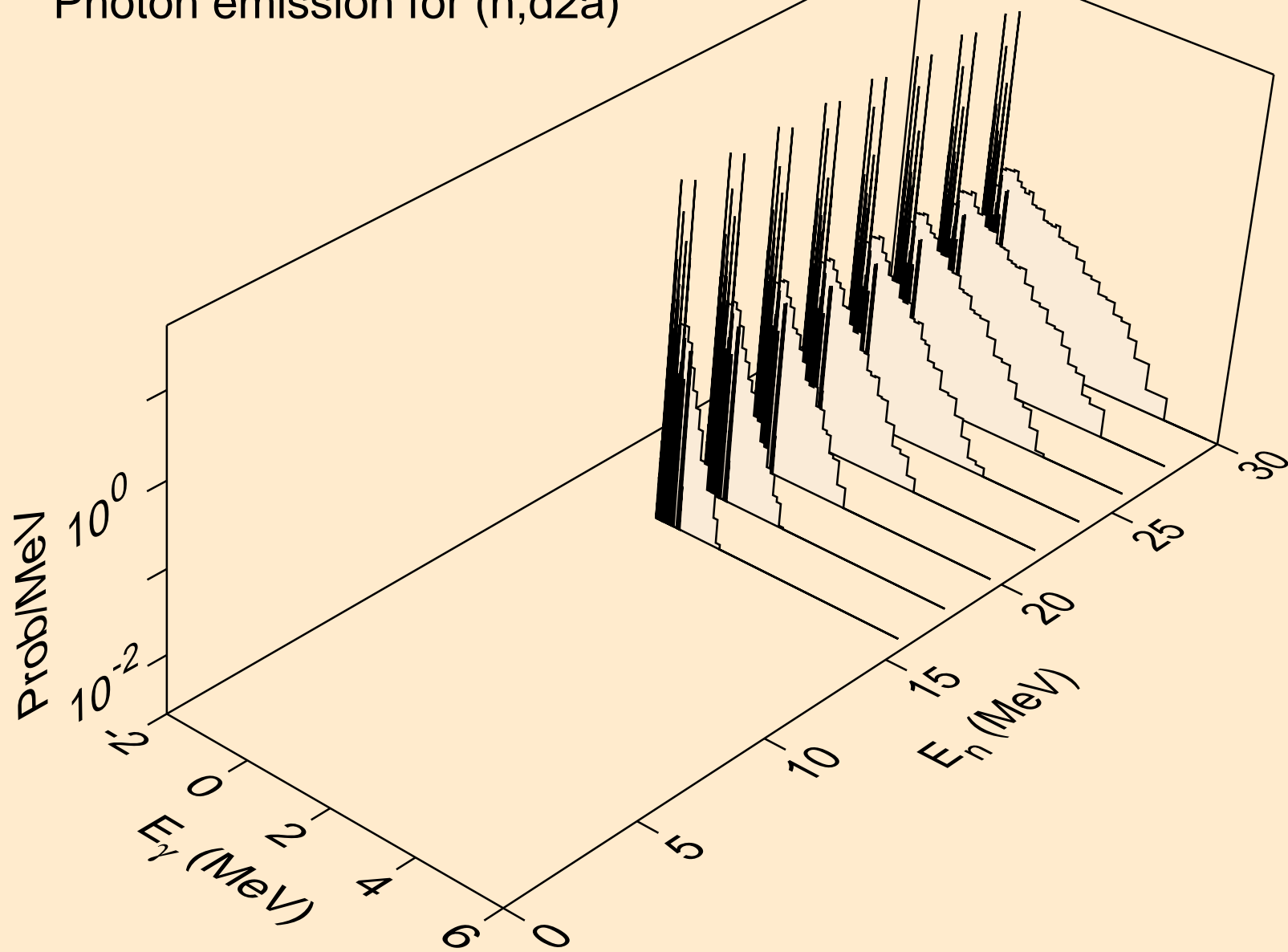

ER147 NEUTRON ACER TENDL-2024 LIBRARY; T=293.6K
Photon emission for (n,pd)

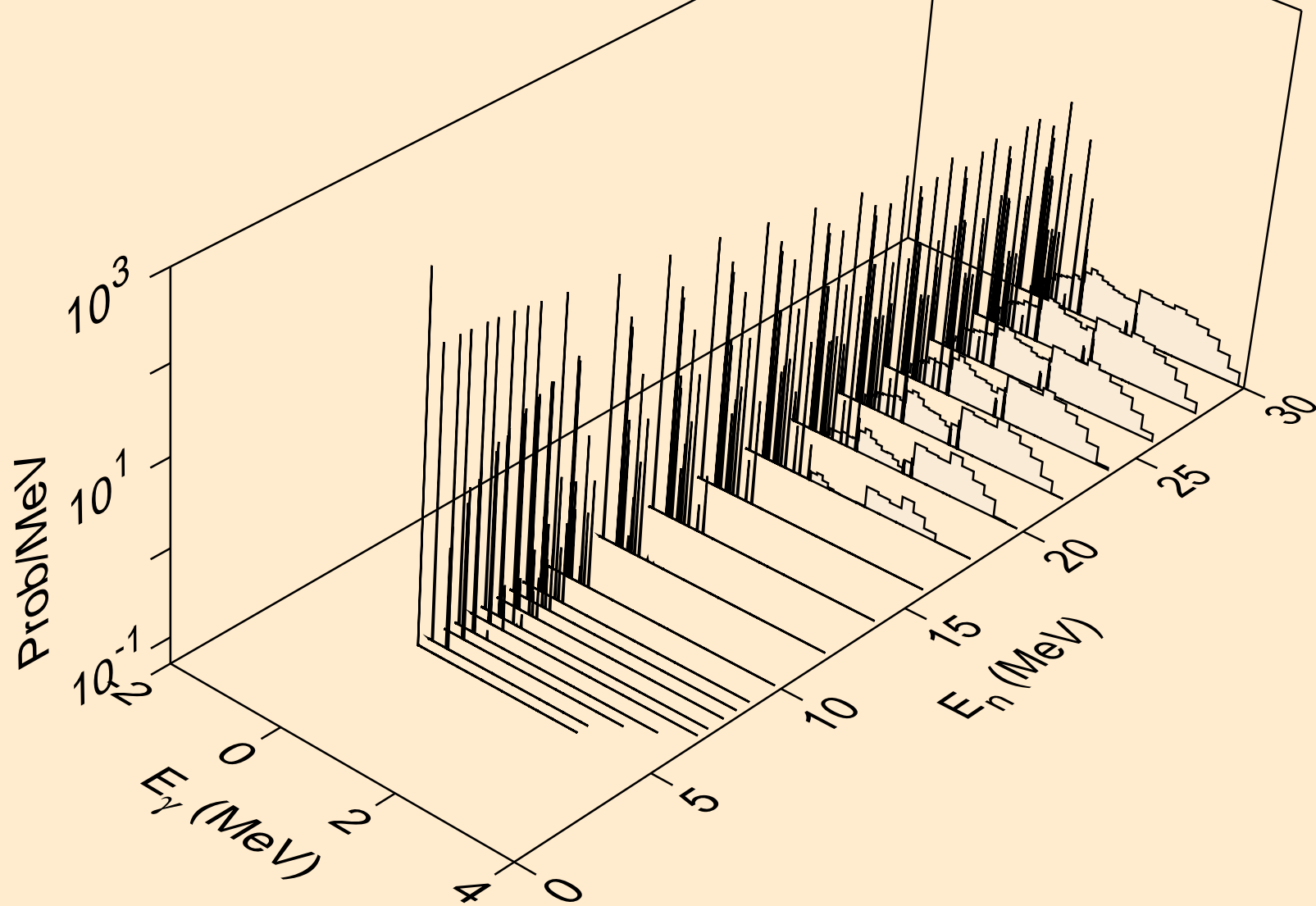

ER147 NEUTRON ACER TENDL-2024 LIBRARY; T=293.6K
Photon emission for (n,pt)

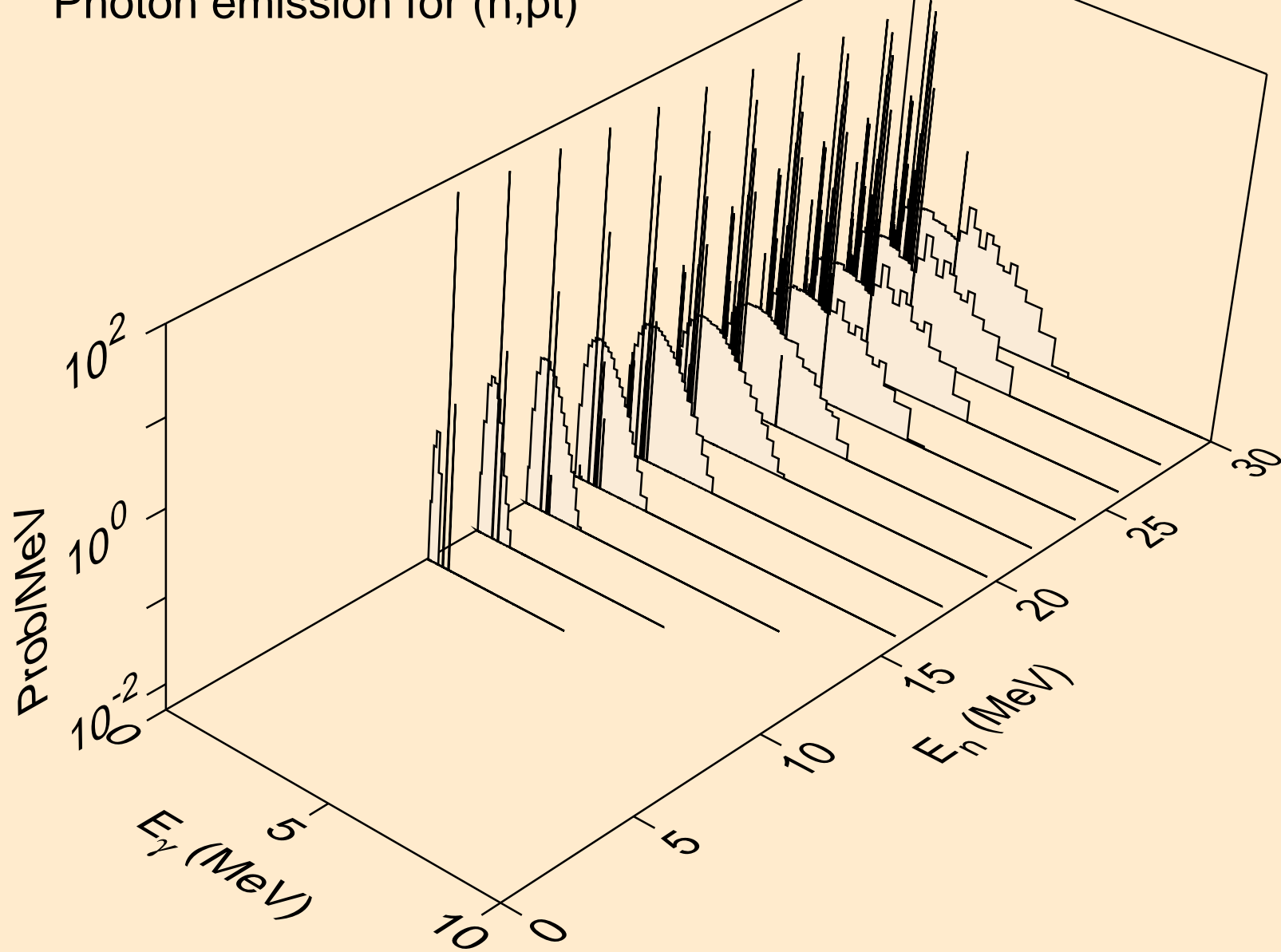

ER147 NEUTRON ACER TENDL-2024 LIBRARY; T=293.6K
Photon emission for (n,da)

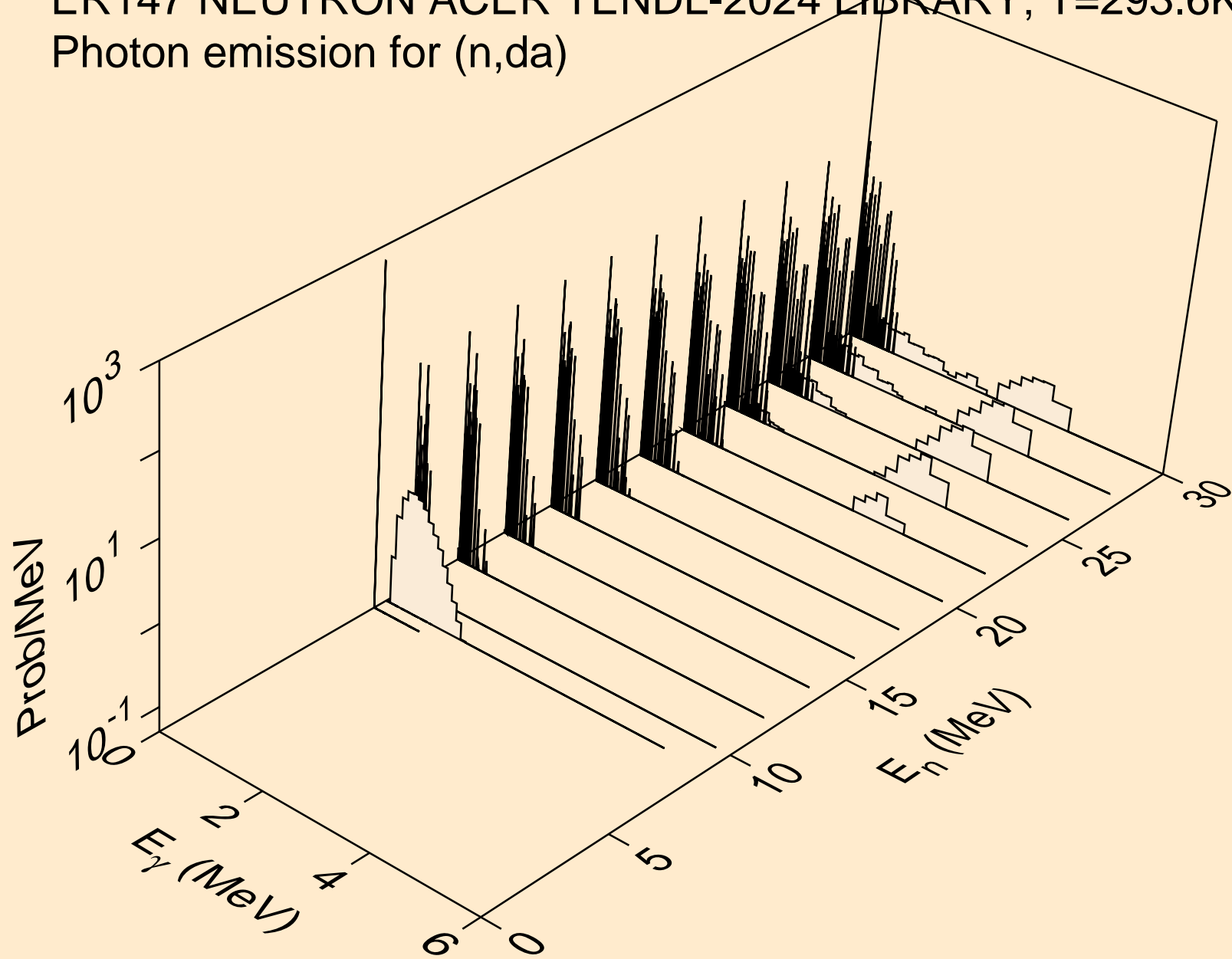

ER147 NEUTRON ACER TENDL-2024 LIBRARY; T=293.6K
thermal capture photon spectrum

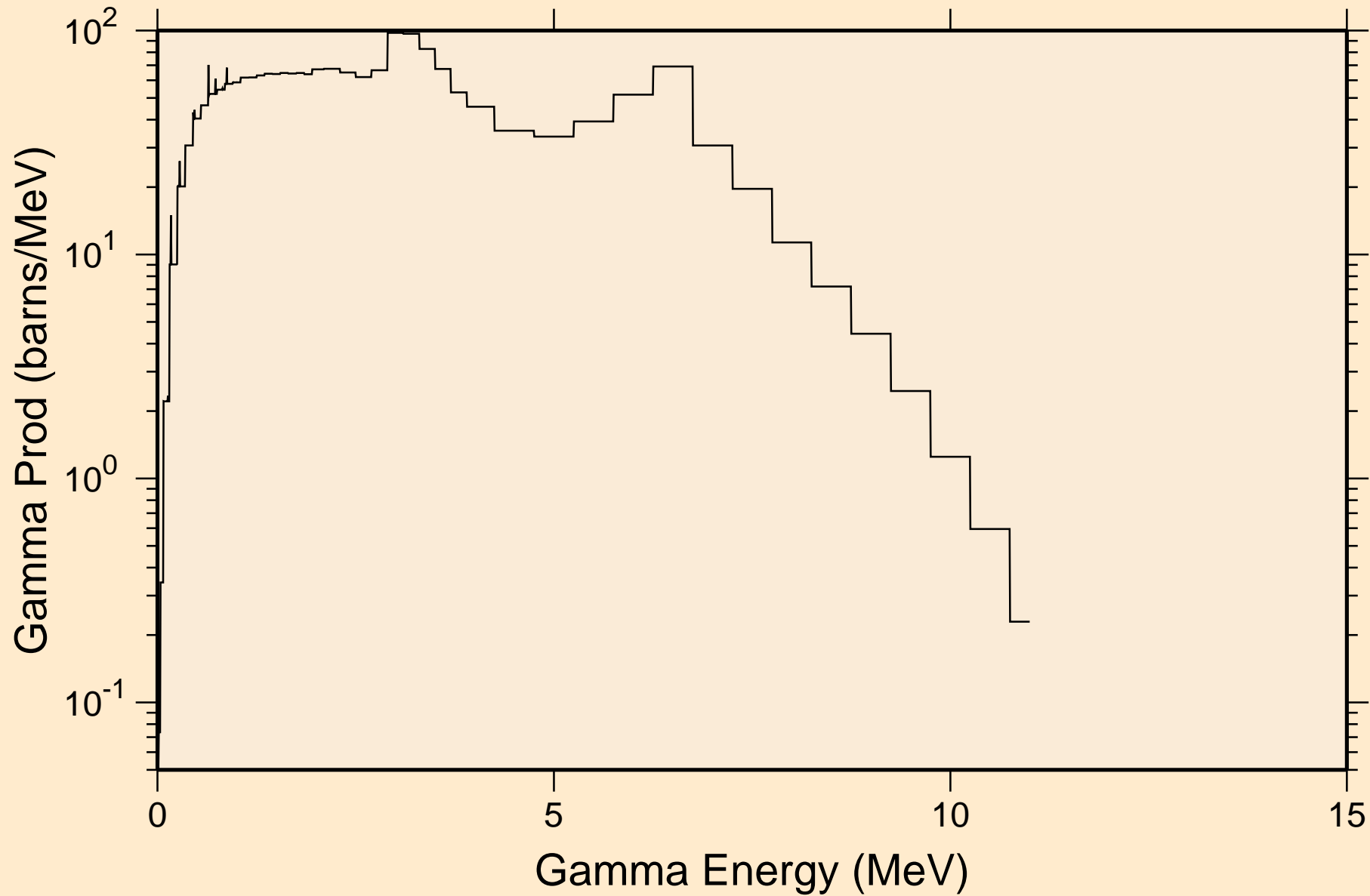

ER147 NEUTRON ACER TENDL-2024 LIBRARY; T=293.6K
14 MeV photon spectrum

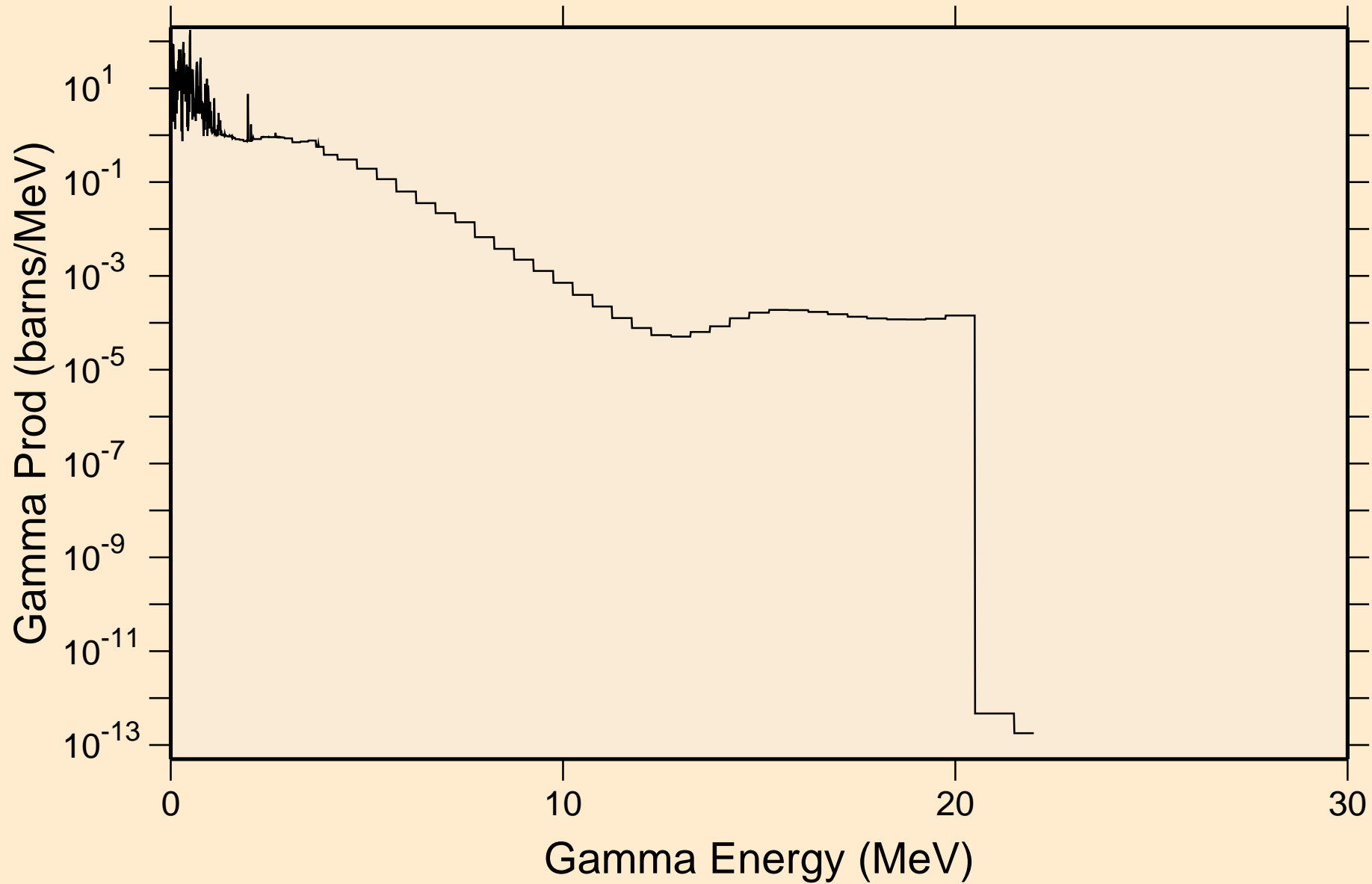

ER147 NEUTRON ACER TENDL-2024 LIBRARY; T=293.6K
Particle heating contributions

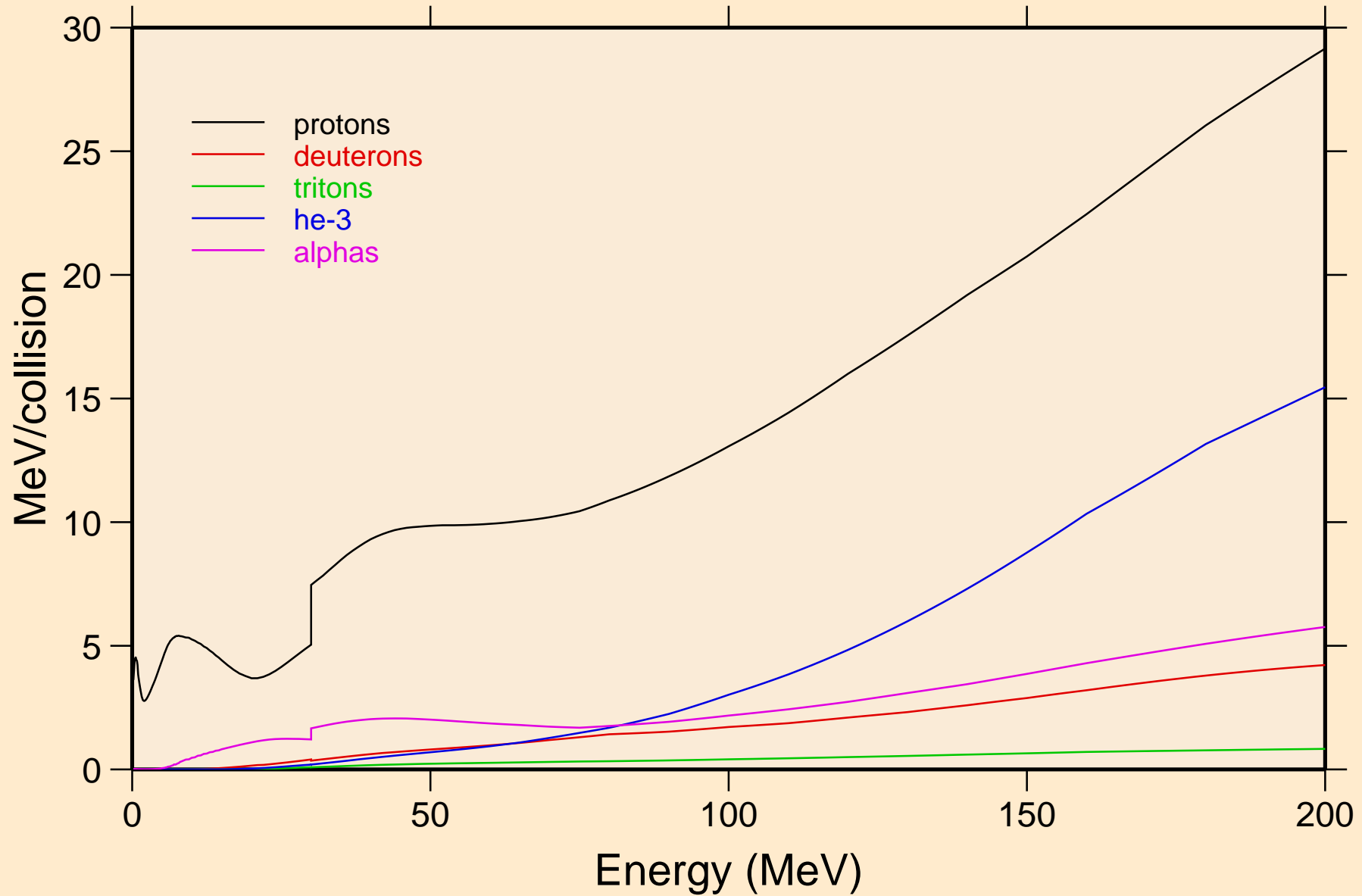

ER147 NEUTRON ACER TENDL-2024 LIBRARY; T=293.6K
Recoil Heating

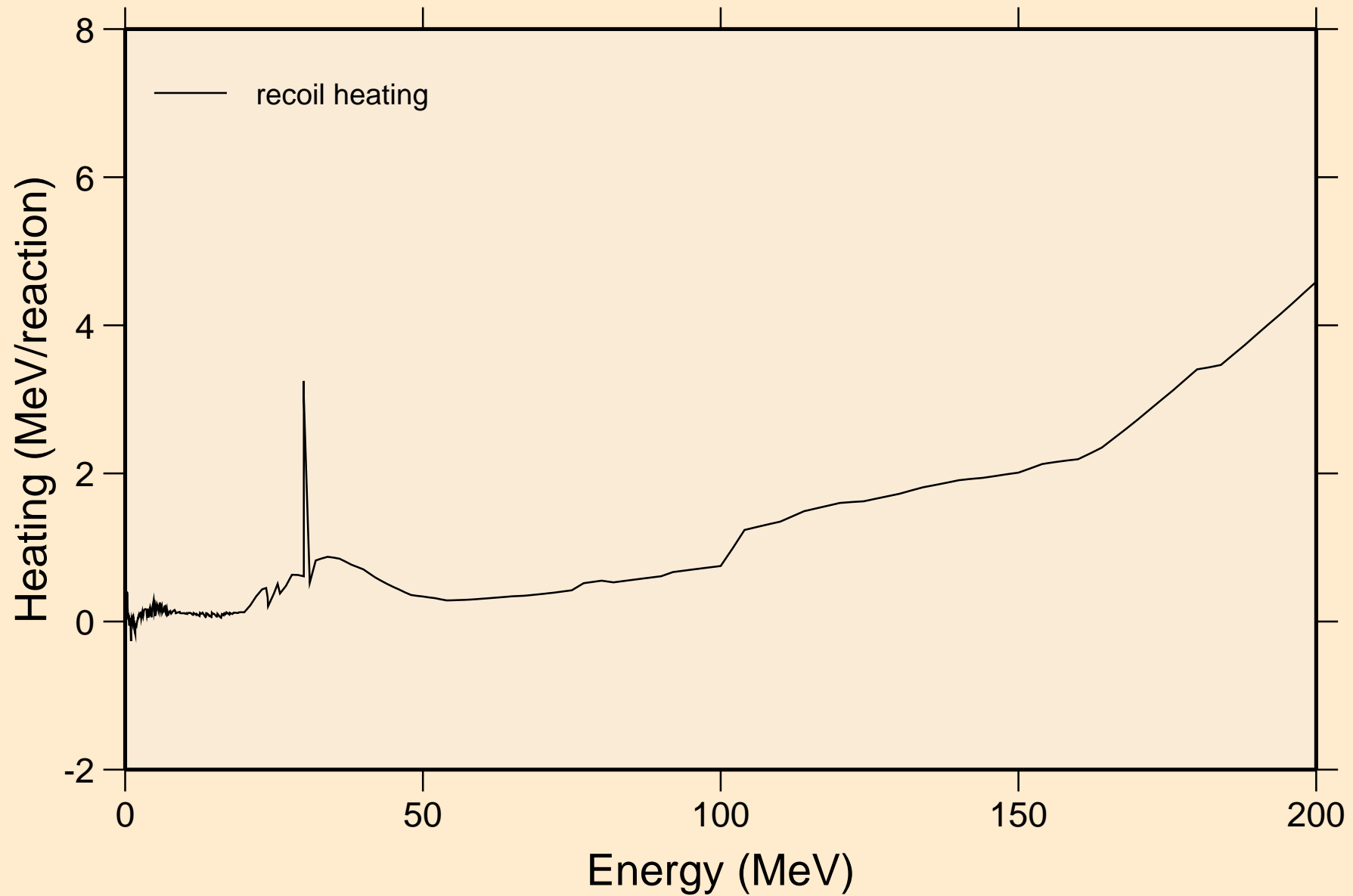

ER147 NEUTRON ACER TENDL-2024 LIBRARY; T=293.6K
Particle production cross sections

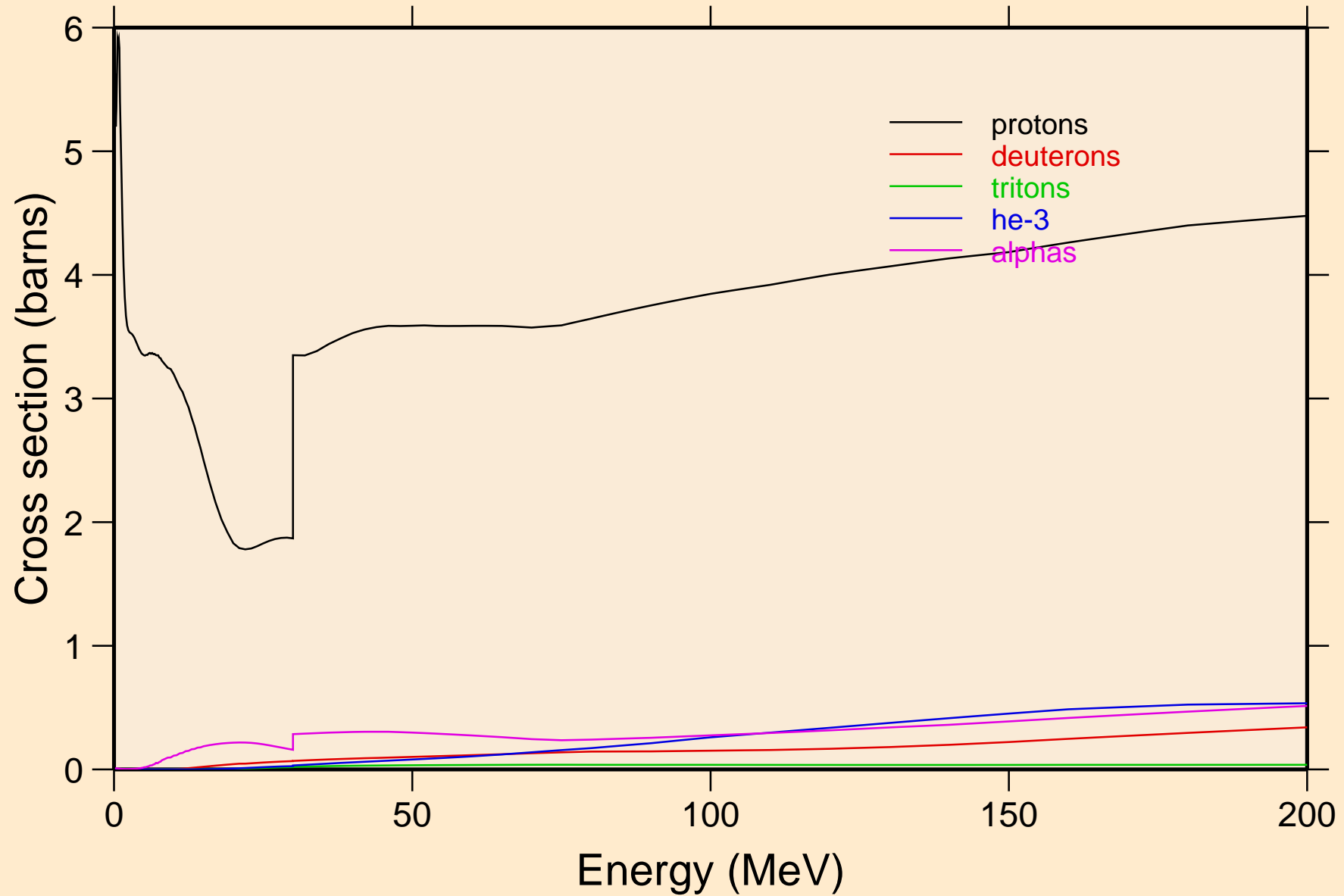

ER147 NEUTRON ACER TENDL-2024 LIBRARY; T=293.6K
protons from (n,x)

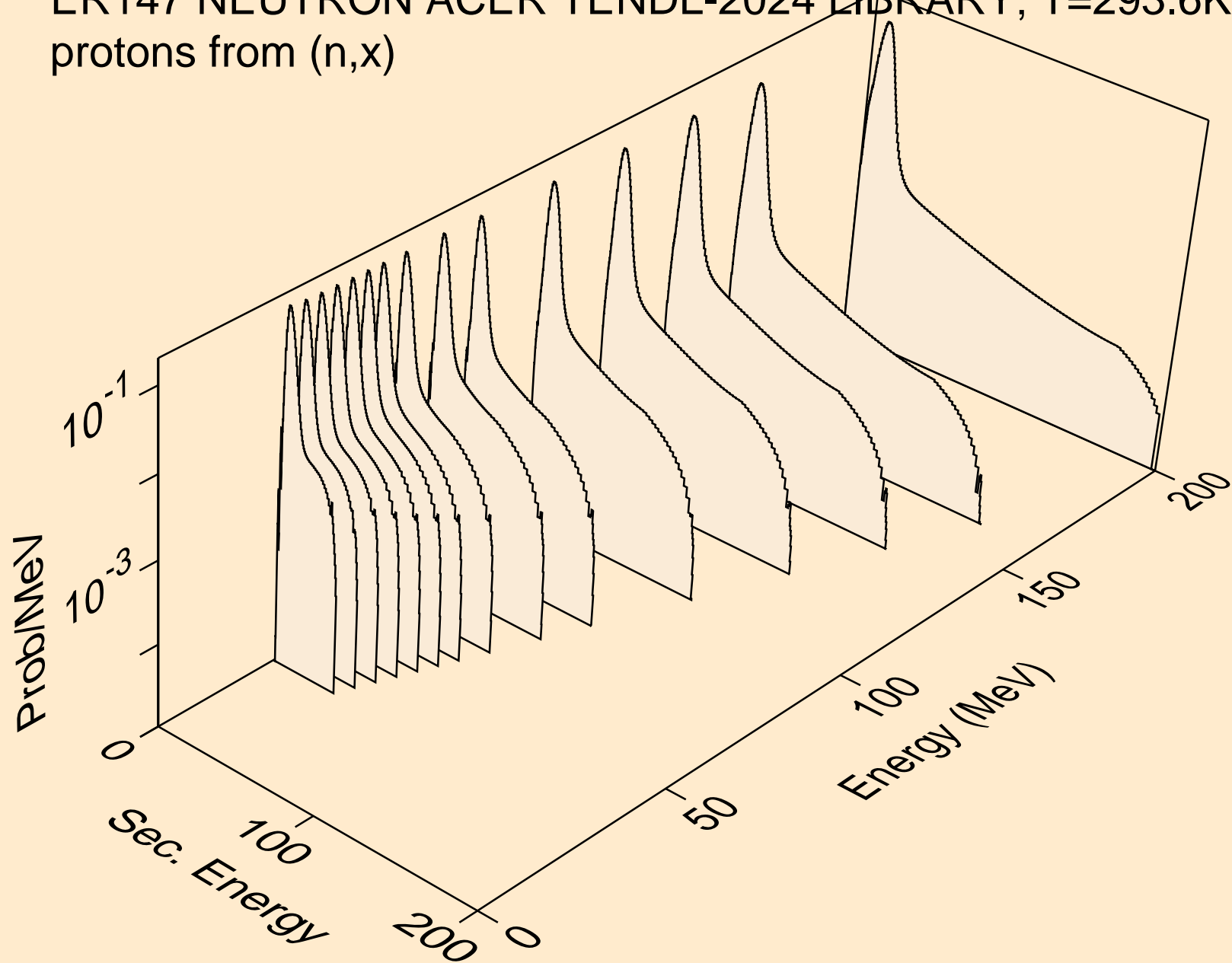

ER147 NEUTRON ACER TENDL-2024 LIBRARY; T=293.6K
protons from (n,n*)p

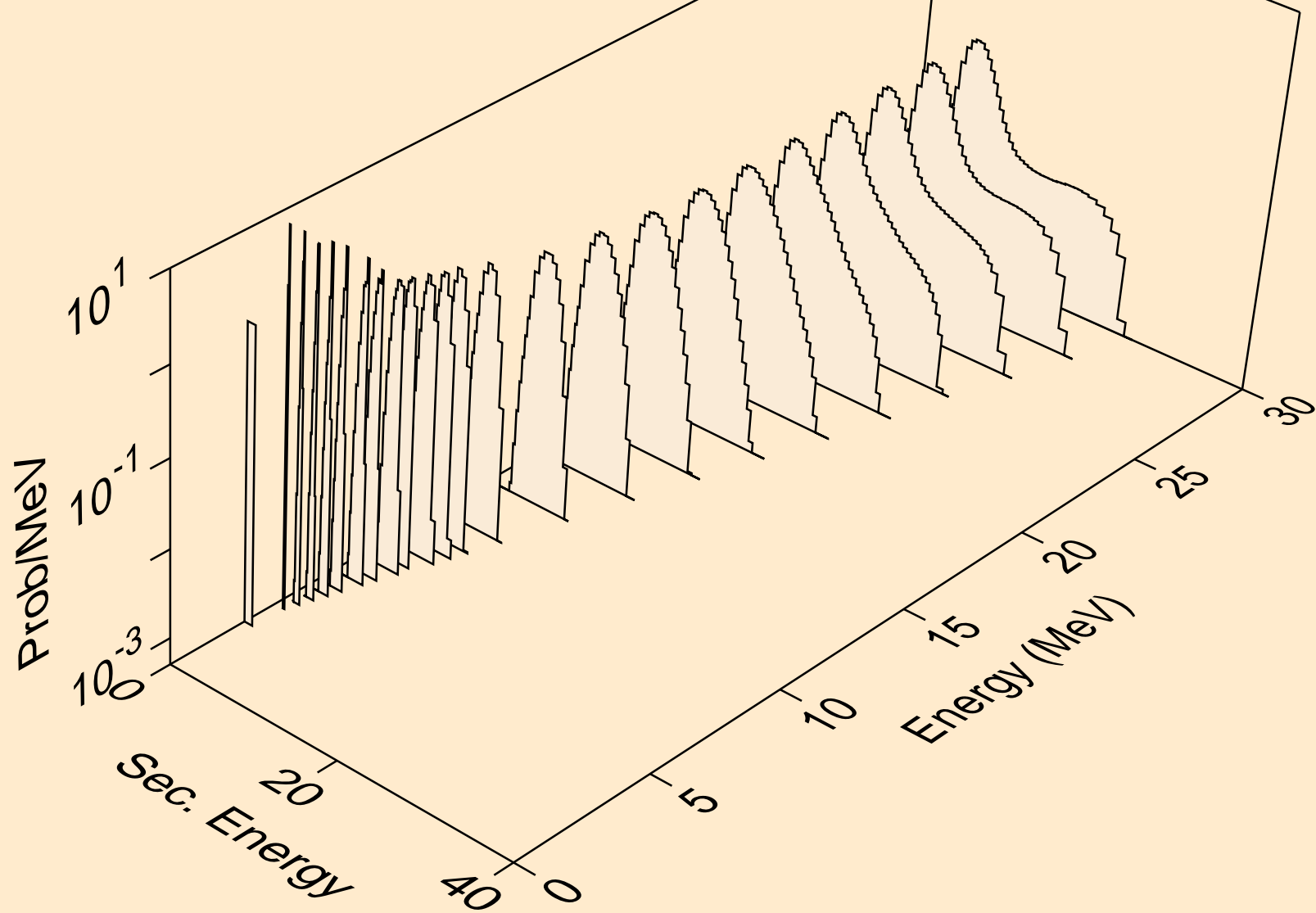

ER147 NEUTRON ACER TENDL-2024 LIBRARY; T=293.6K
protons from (n,2np)

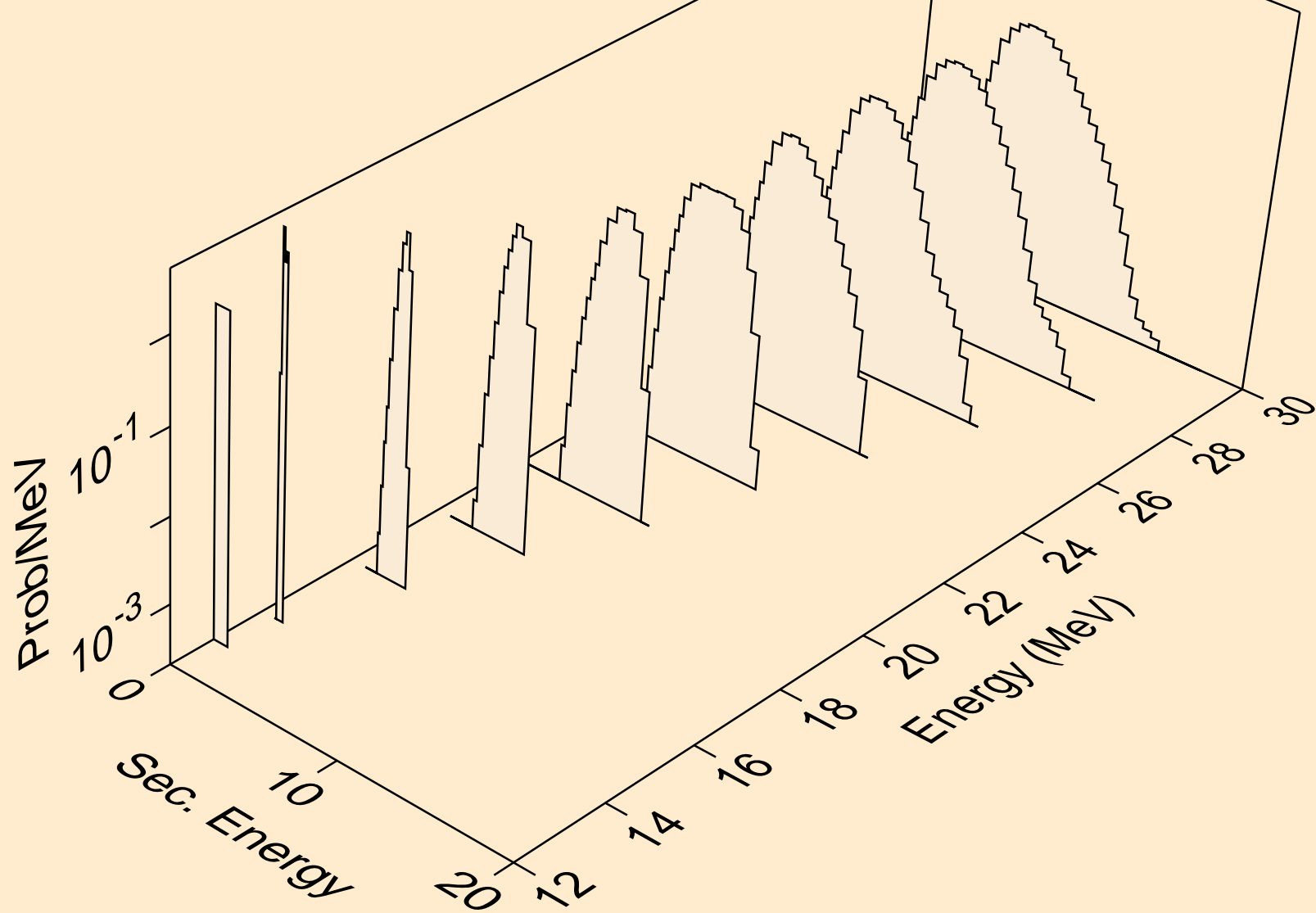

ER147 NEUTRON ACER TENDL-2024 LIBRARY; T=293.6K
protons from (n,3np)

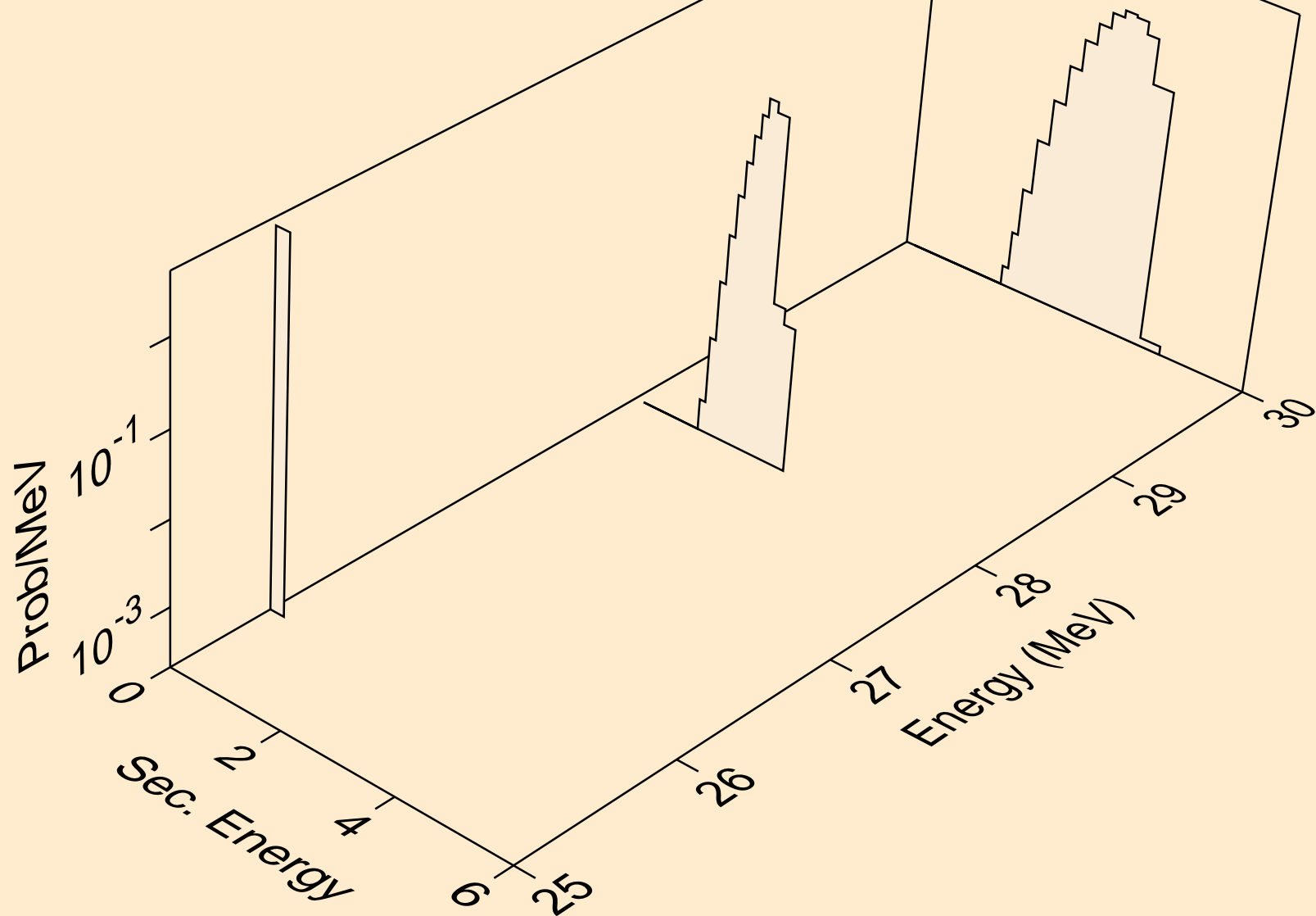

ER147 NEUTRON ACER TENDL-2024 LIBRARY; T=293.6K
protons from (n,n2p)

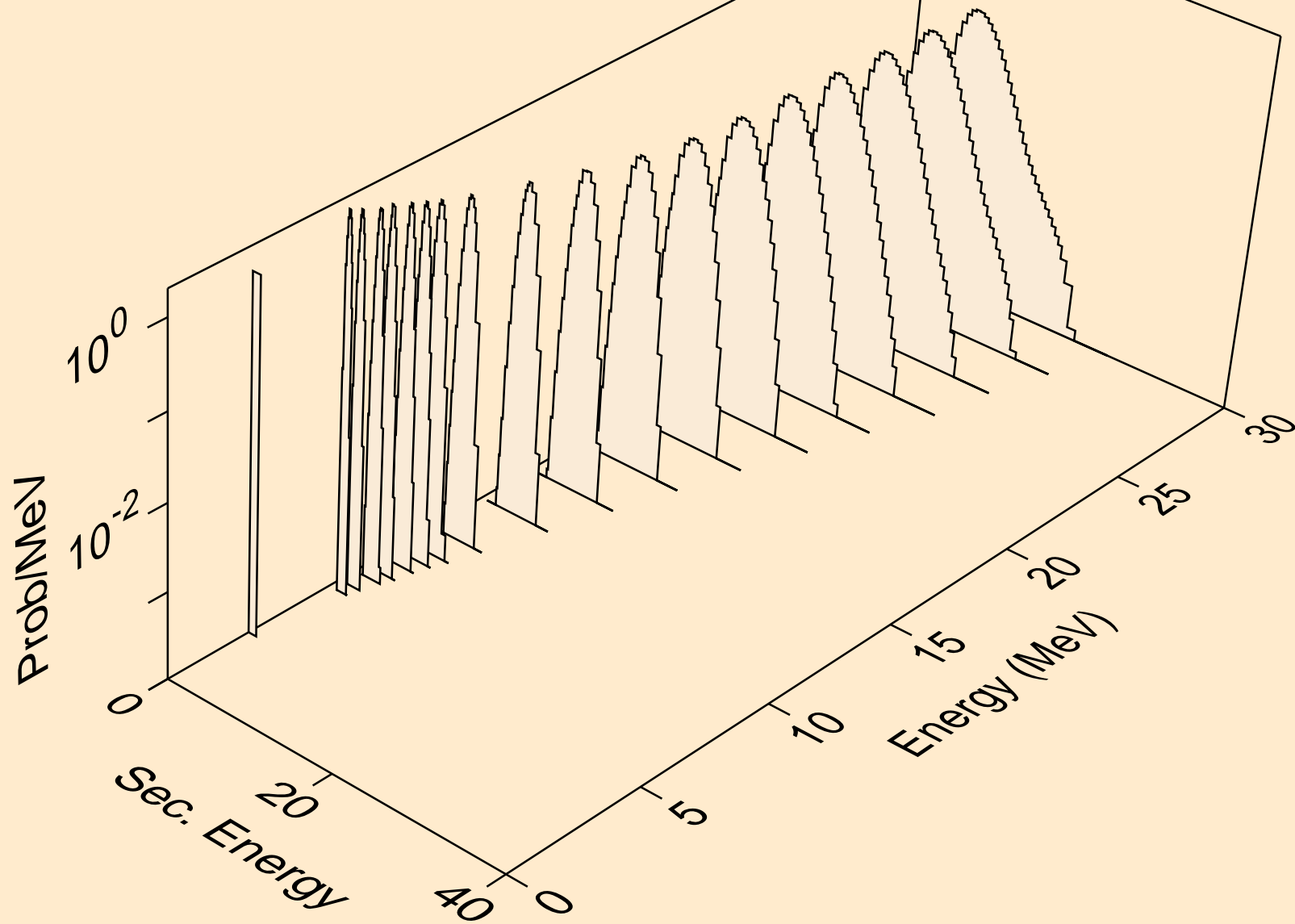

ER147 NEUTRON ACER TENDL-2024 LIBRARY; T=293.6K
protons from (n,npa)

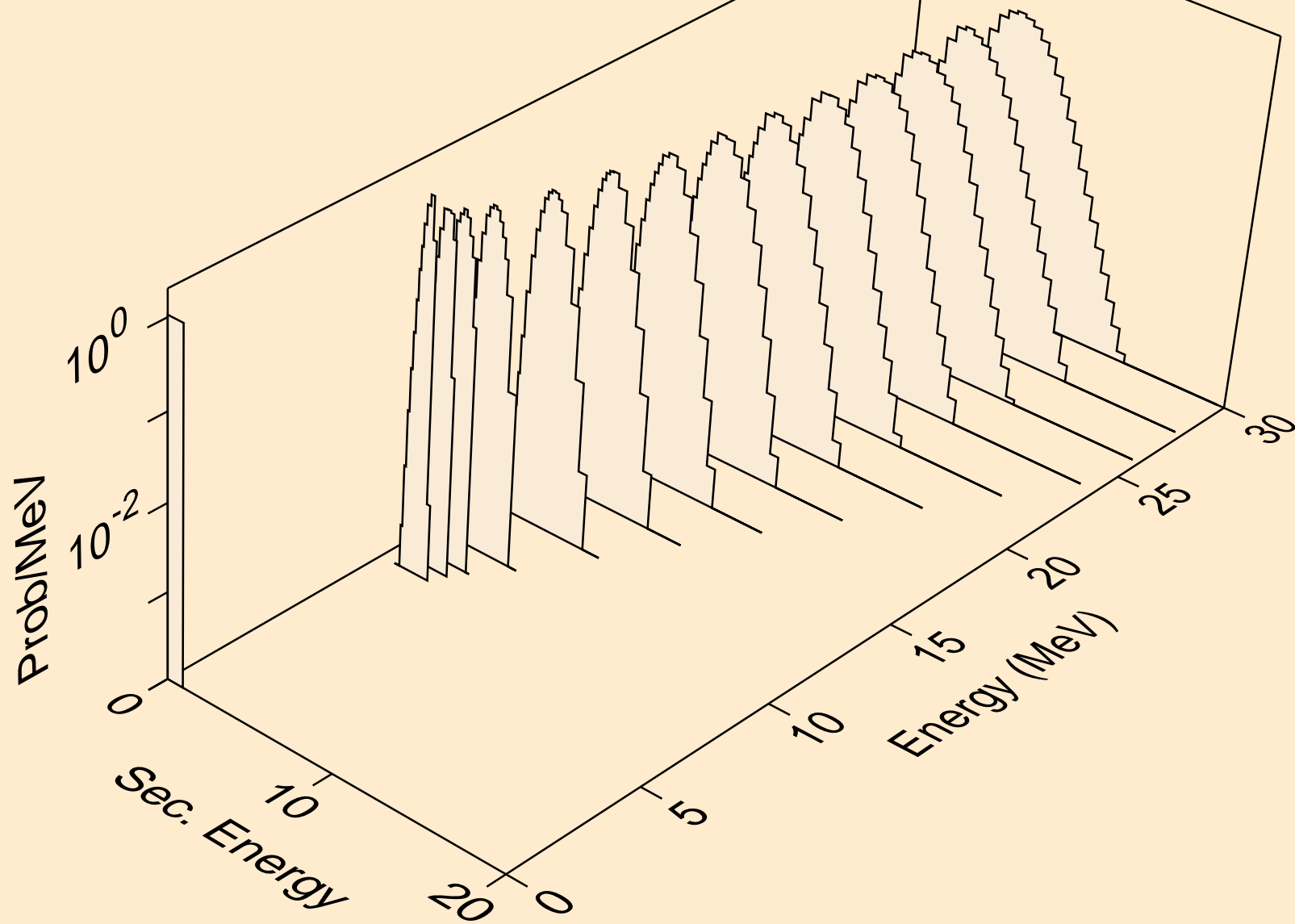

ER147 NEUTRON ACER TENDL-2024 LIBRARY; T=293.6K
protons from (n,p)

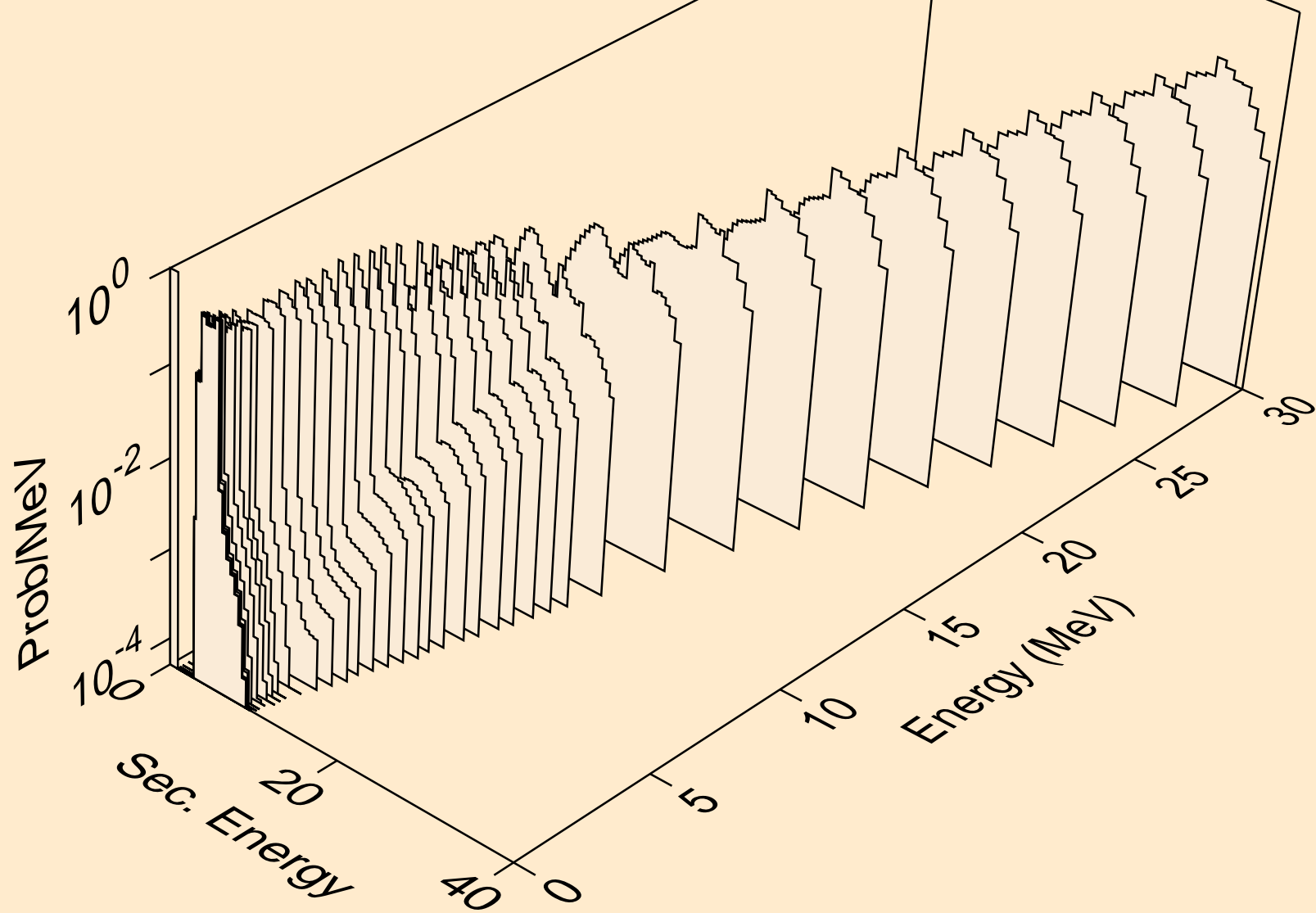

ER147 NEUTRON ACER TENDL-2024 LIBRARY; T=293.6K
protons from (n,2p)

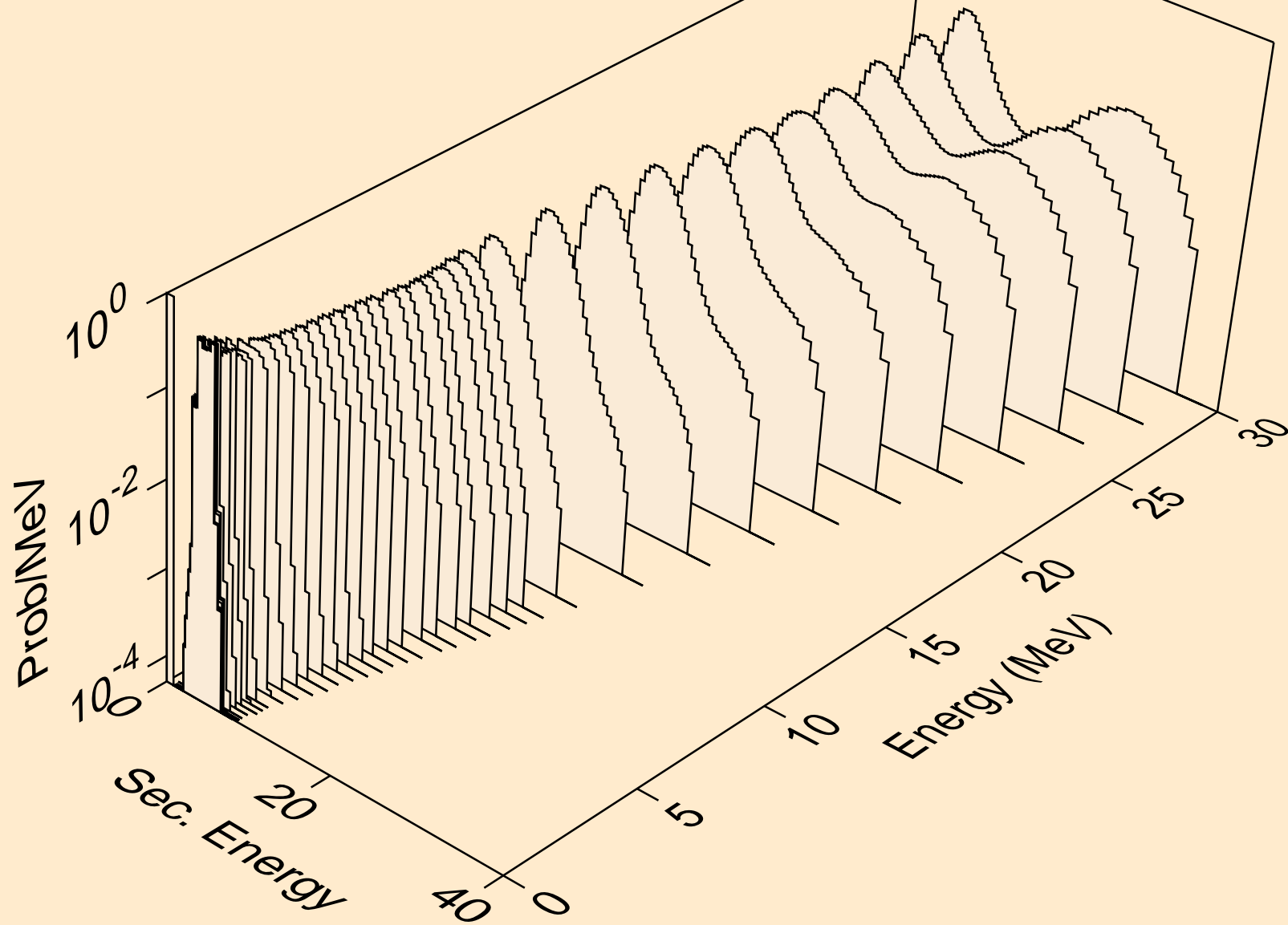

ER147 NEUTRON ACER TENDL-2024 LIBRARY; T=293.6K
protons from (n,p)

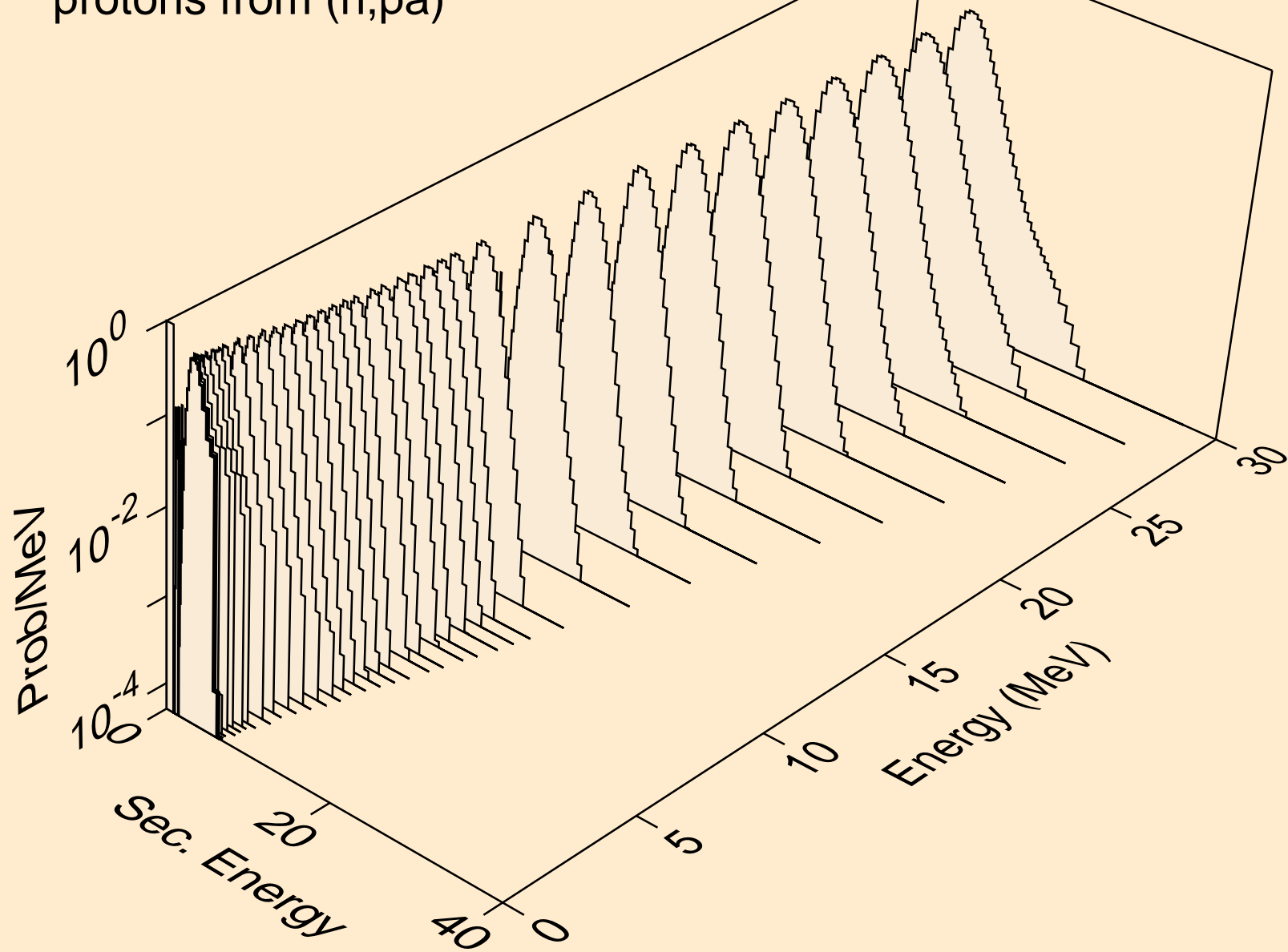

ER147 NEUTRON ACER TENDL-2024 LIBRARY; T=293.6K
protons from (n,pd)

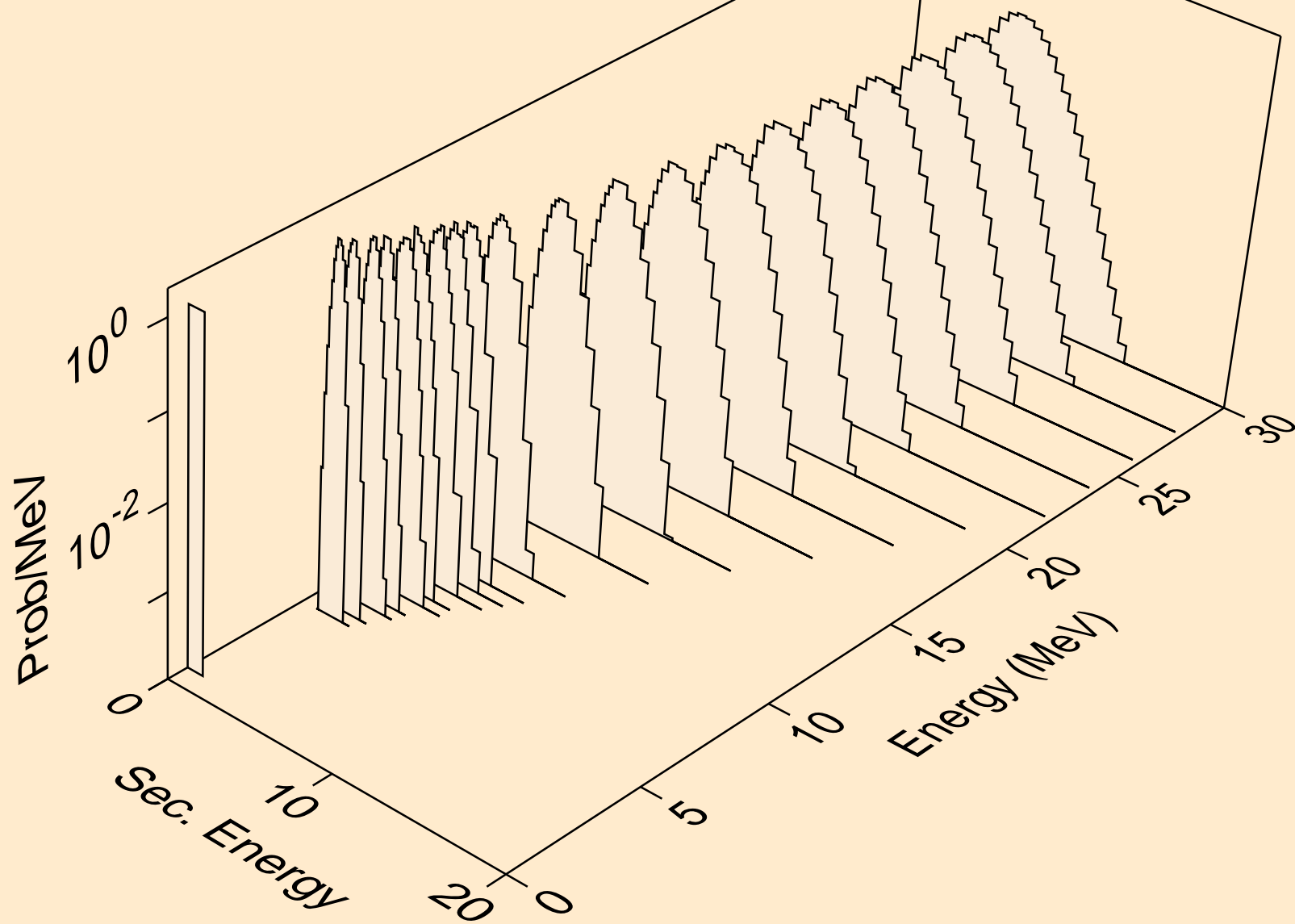

ER147 NEUTRON ACER TENDL-2024 LIBRARY; T=293.6K
protons from (n,pt)

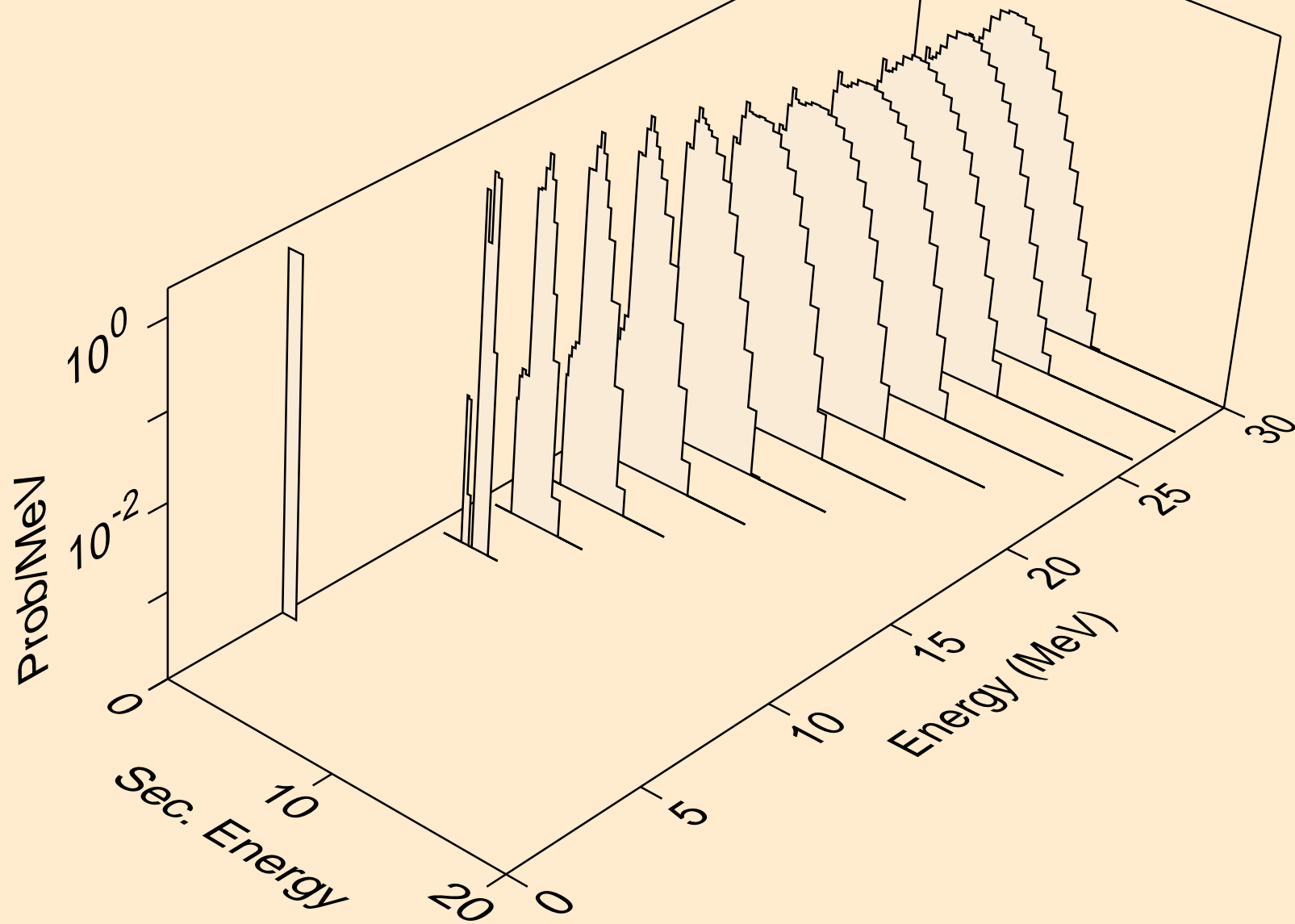

ER147 NEUTRON ACER TENDL-2024 LIBRARY; T=293.6K
deuterons from (n,x)

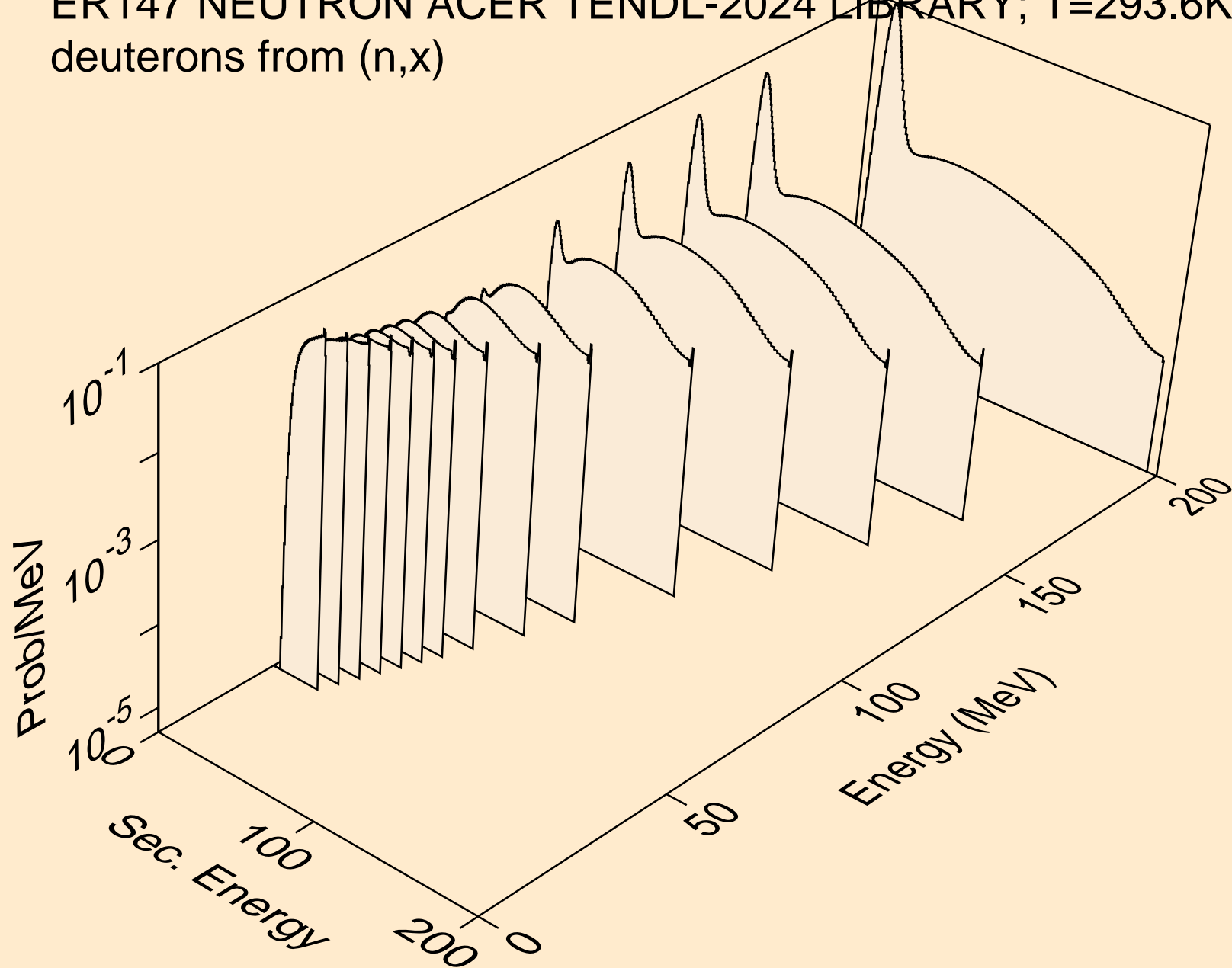

ER147 NEUTRON ACER TENDL-2024 LIBRARY; T=293.6K
deuterons from (n,n*)d

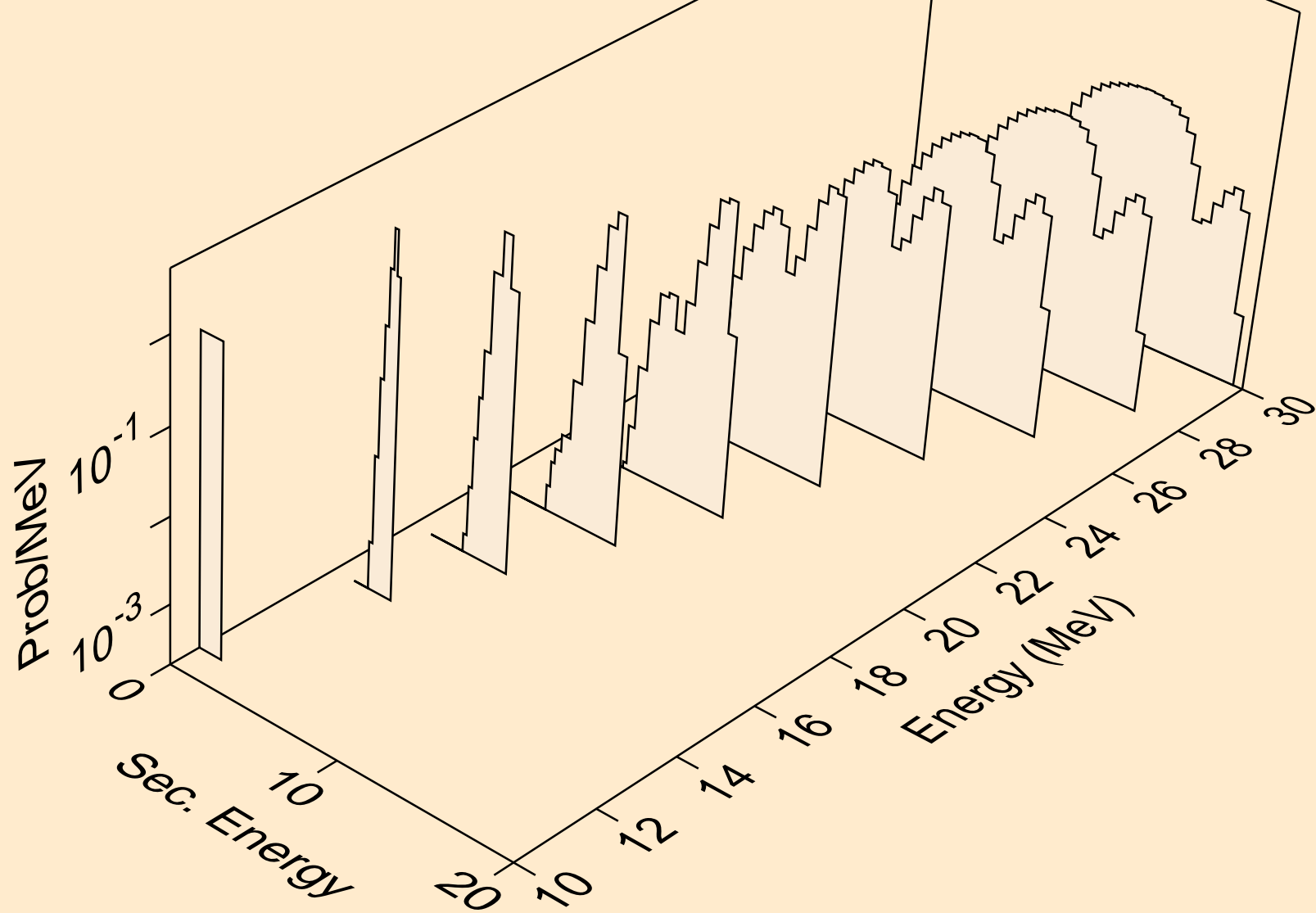

ER147 NEUTRON ACER TENDL-2024 LIBRARY; T=293.6K
deuterons from (n,d)

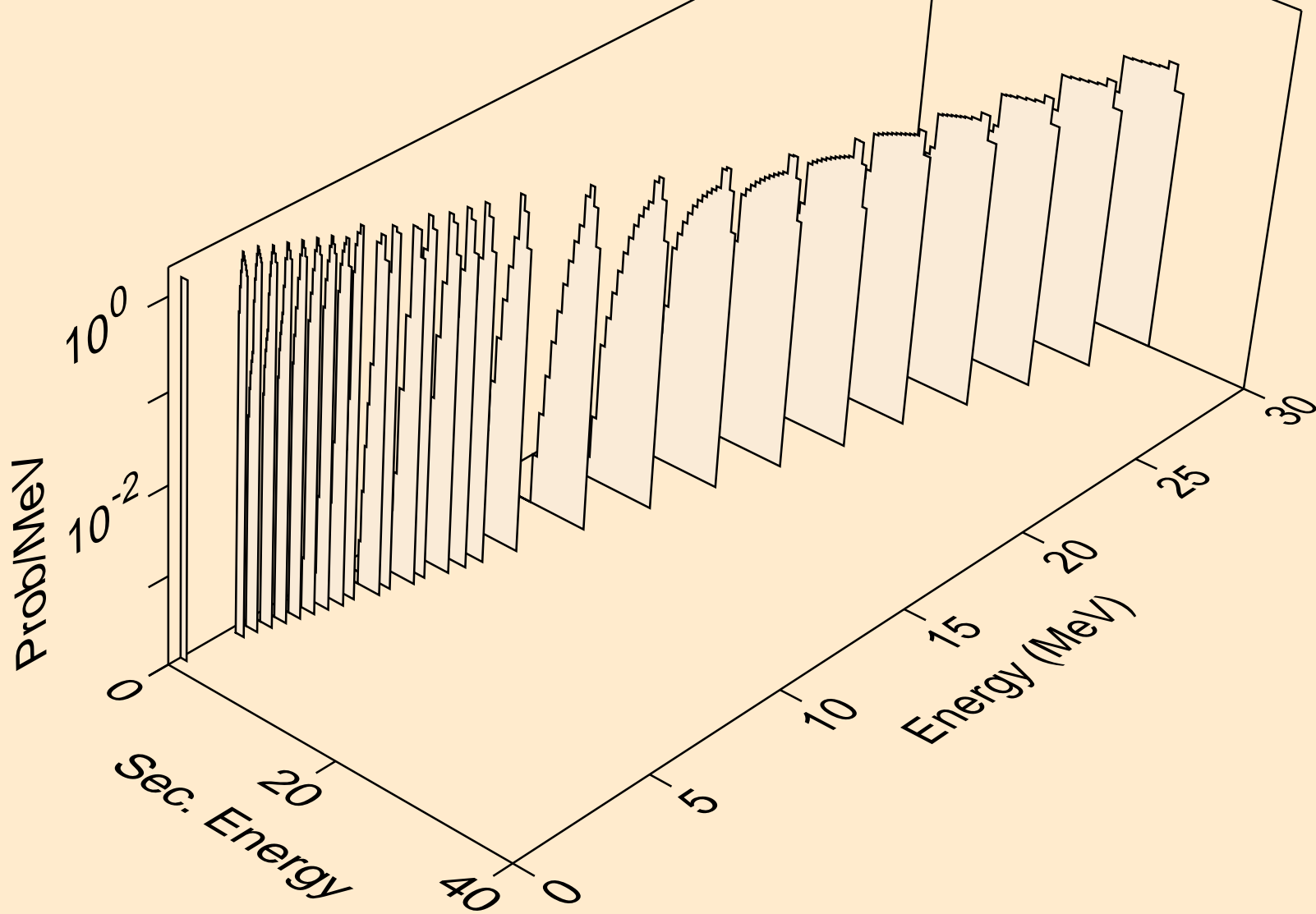

ER147 NEUTRON ACER TENDL-2024 LIBRARY; T=293.6K
deuterons from (n,d2a)

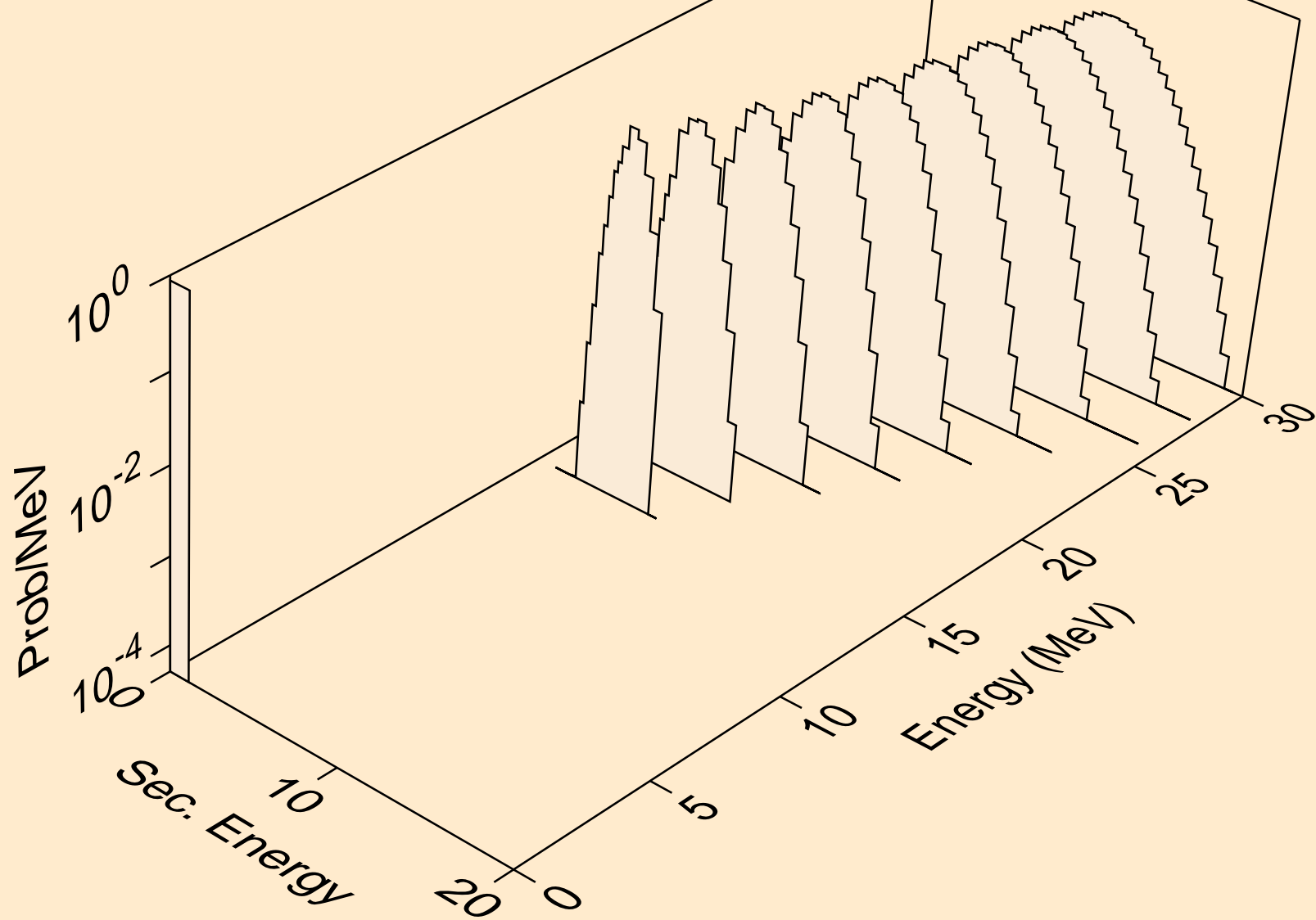

ER147 NEUTRON ACER TENDL-2024 LIBRARY; T=293.6K
deuterons from (n,pd)

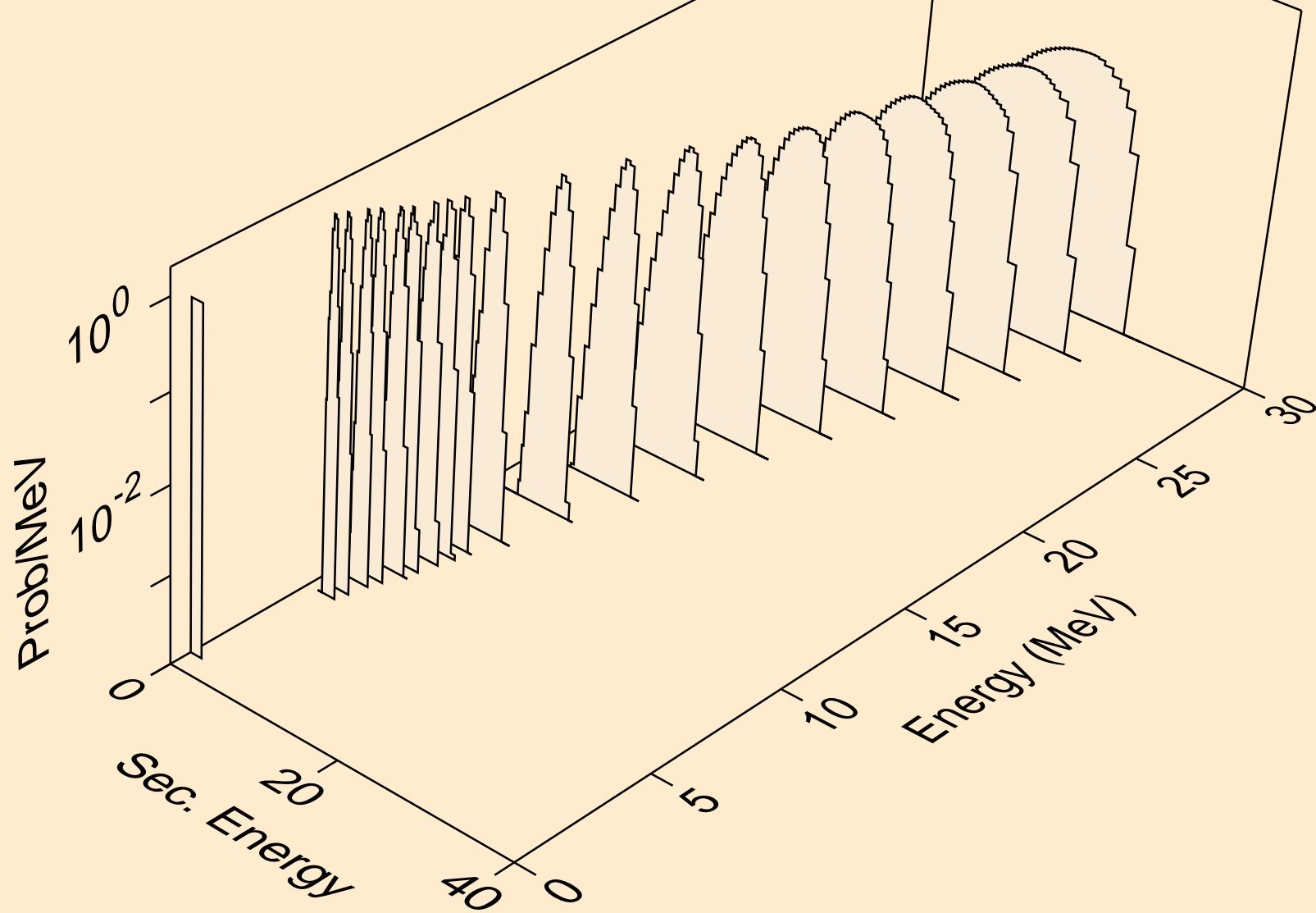

ER147 NEUTRON ACER TENDL-2024 LIBRARY; T=293.6K
deuterons from (n,da)

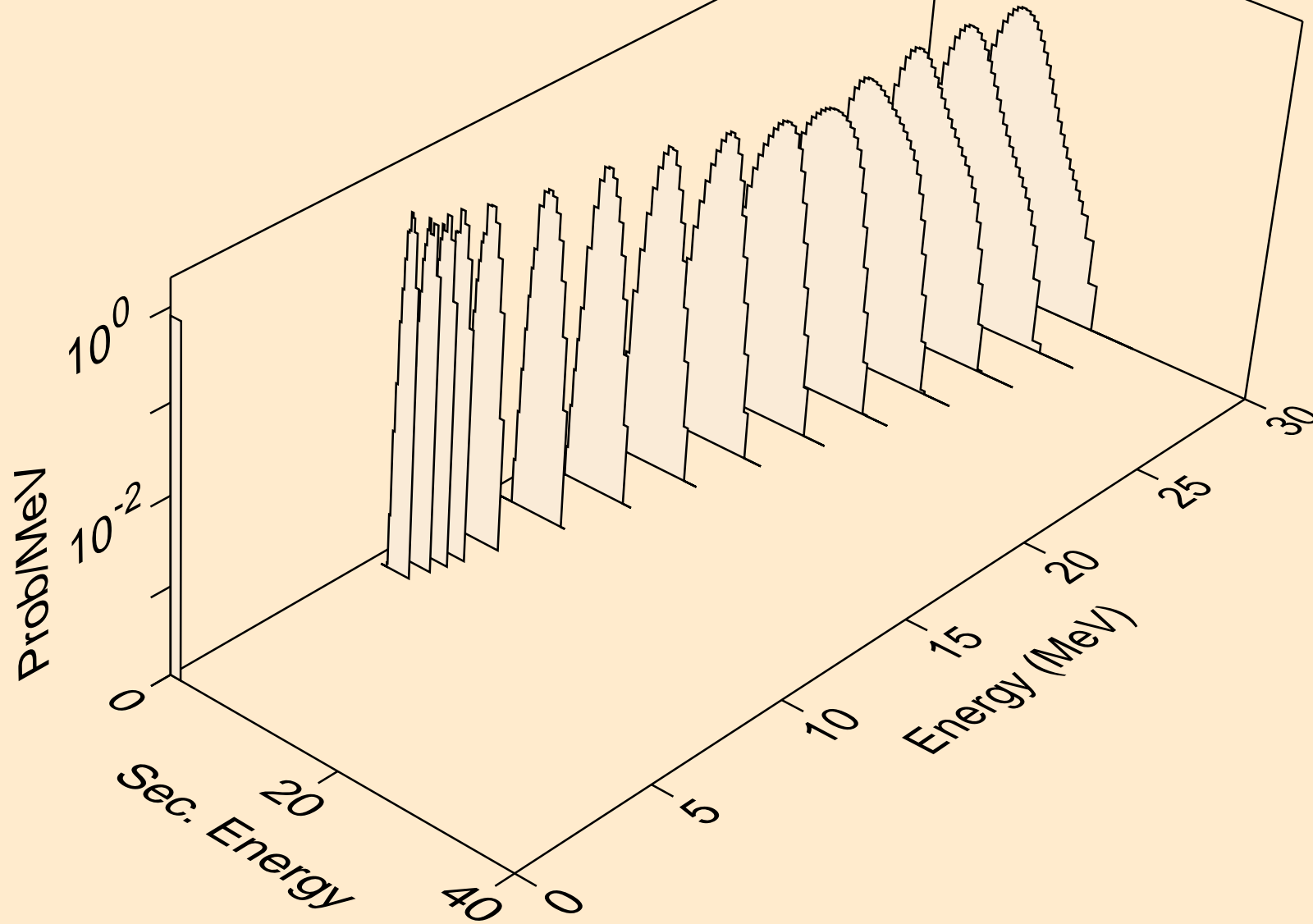

ER147 NEUTRON ACER TENDL-2024 LIBRARY; T=293.6K
tritons from (n,x)

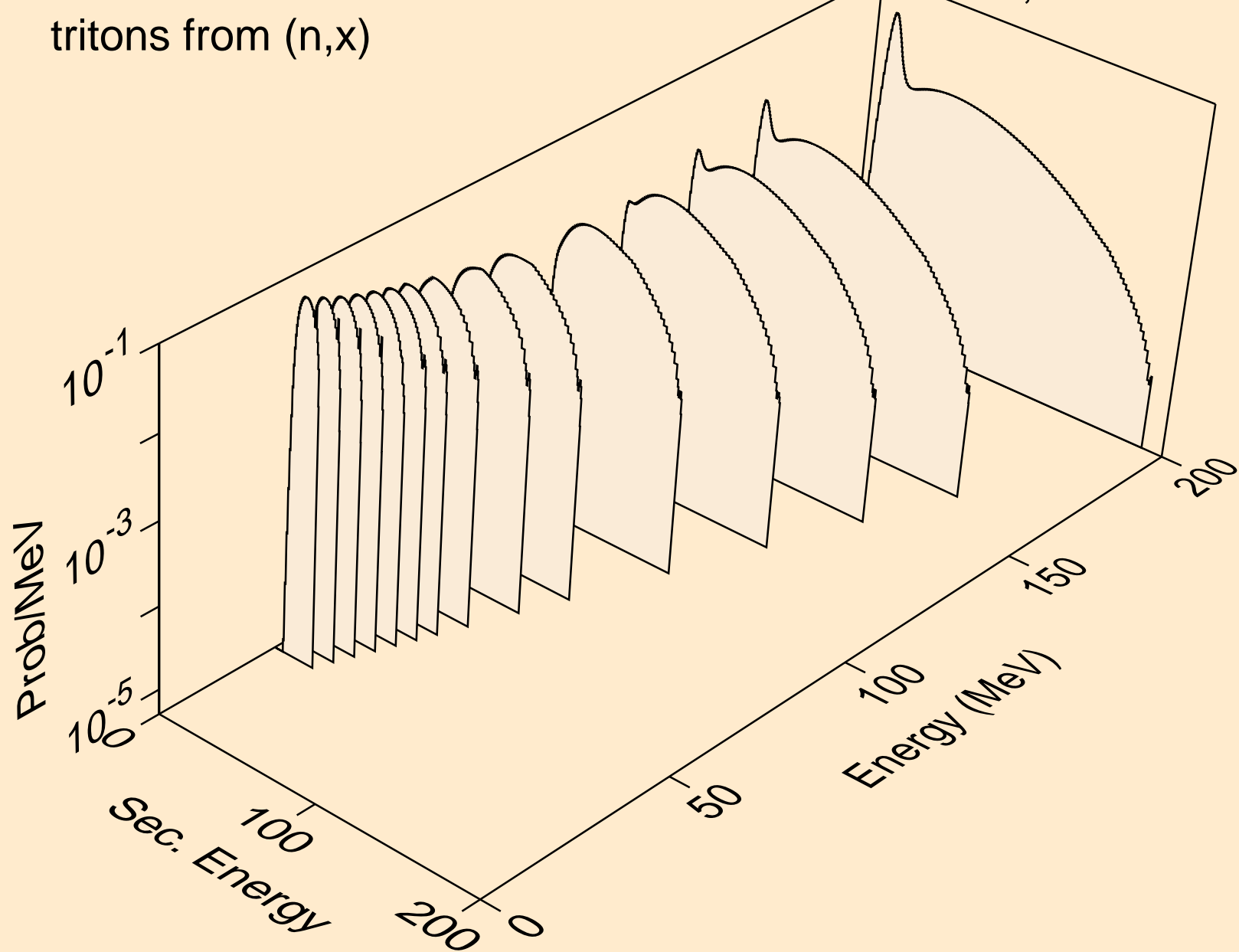

ER147 NEUTRON ACER TENDL-2024 LIBRARY; T=293.6K
tritons from (n,n*)t

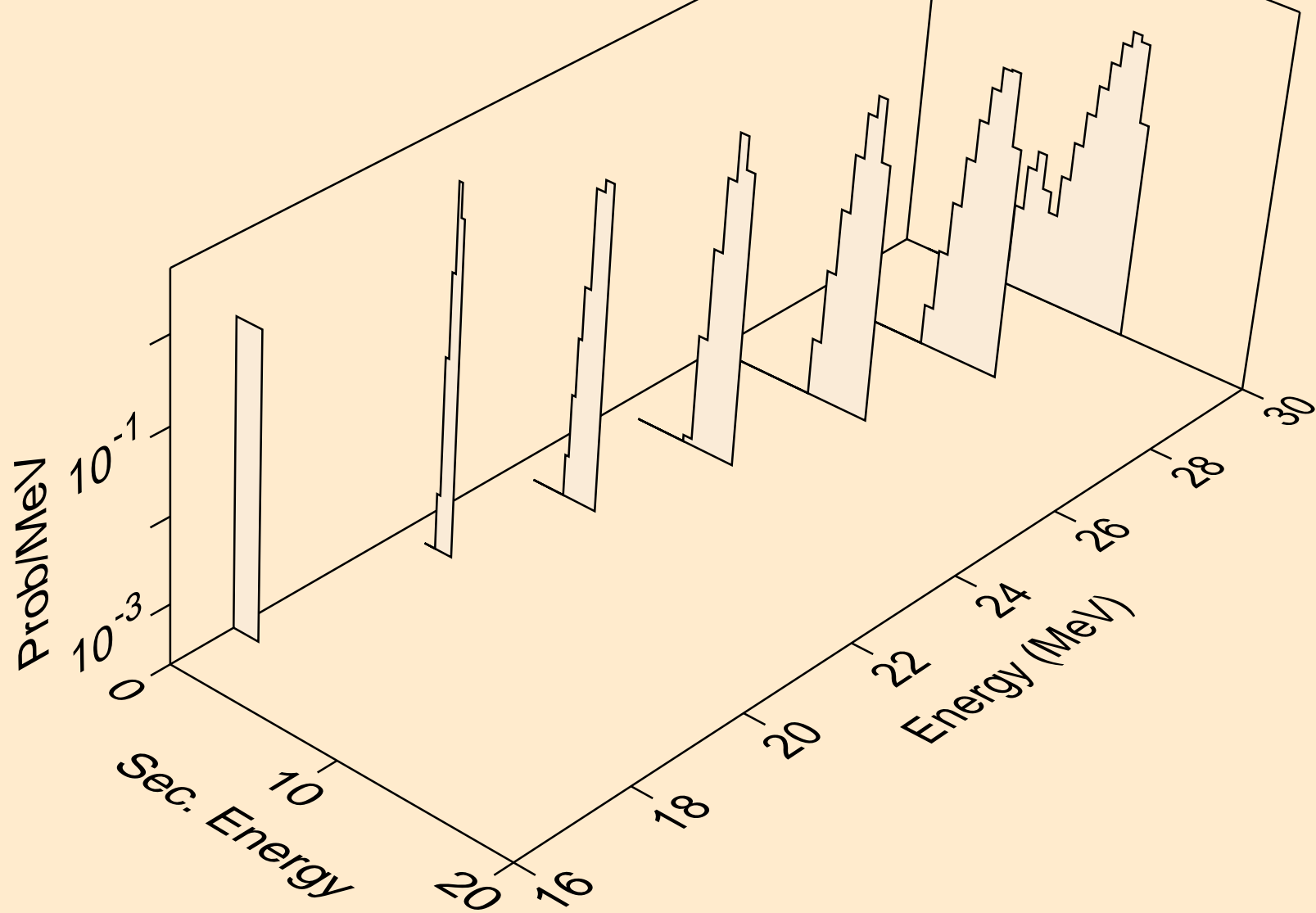

ER147 NEUTRON ACER TENDL-2024 LIBRARY; T=293.6K
tritons from (n,t)

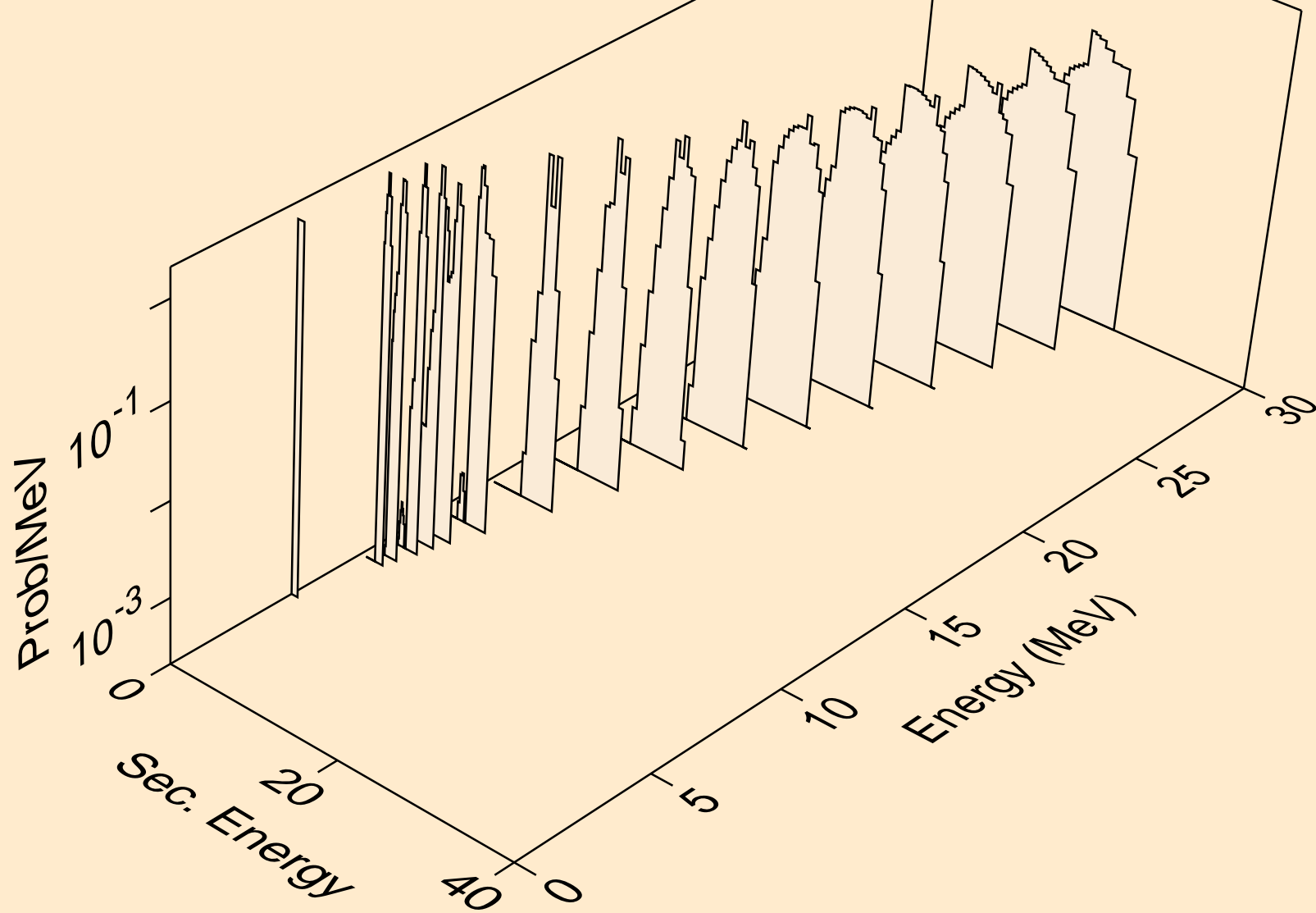

ER147 NEUTRON ACER TENDL-2024 LIBRARY; T=293.6K
tritons from (n,pt)

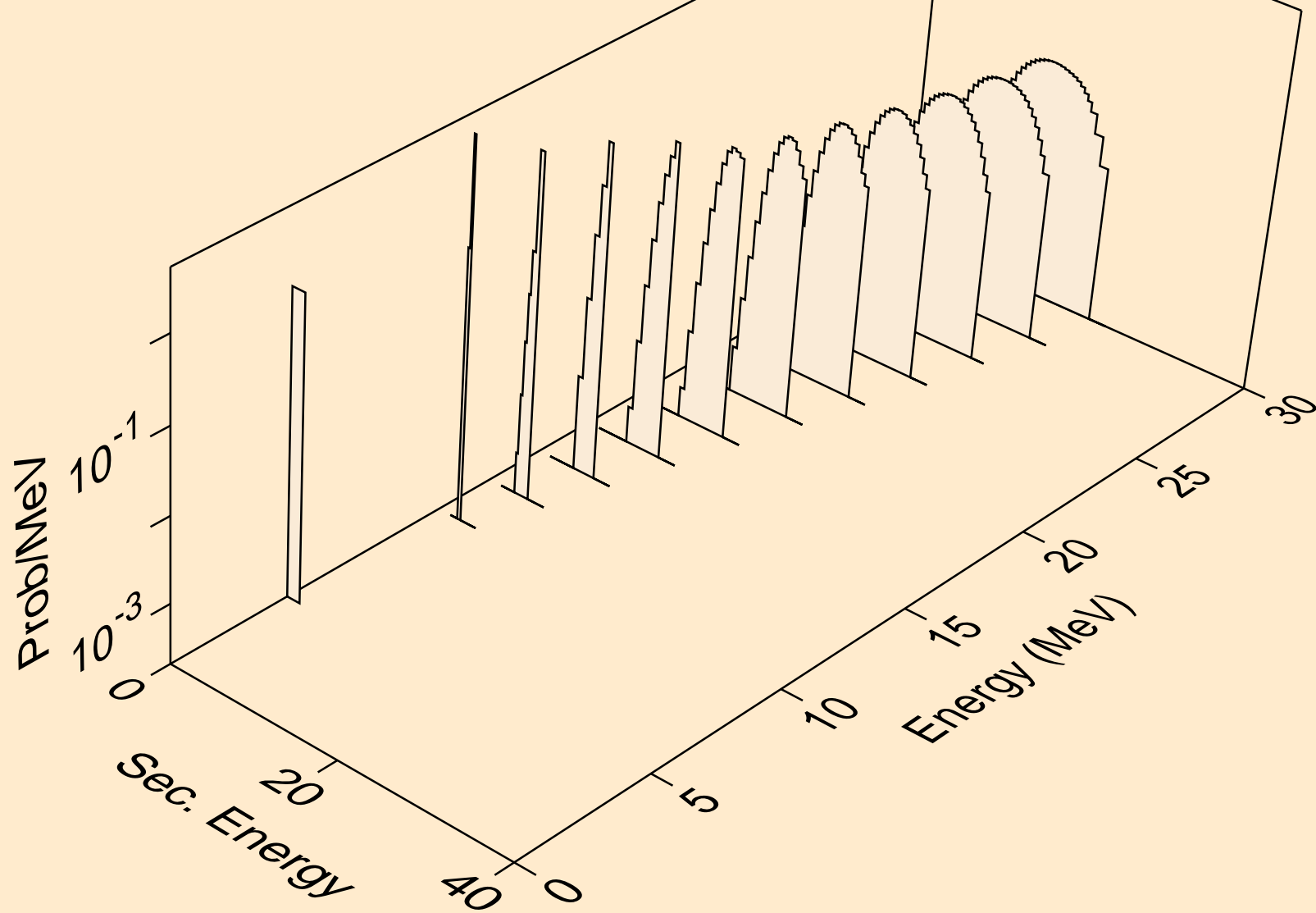

ER147 NEUTRON ACER TENDL-2024 LIBRARY; T=293.6K
he3s from (n,x)

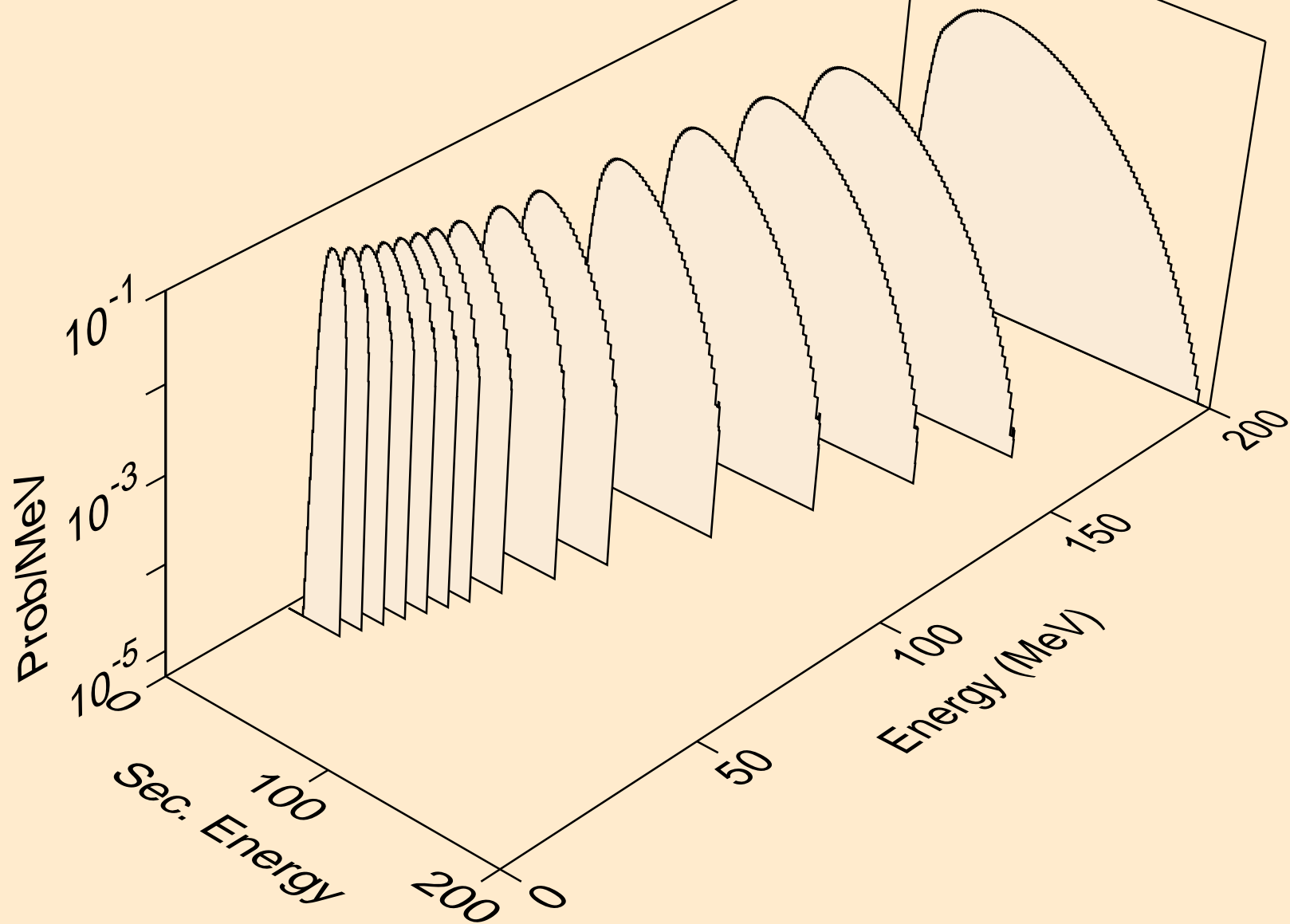

ER147 NEUTRON ACER TENDL-2024 LIBRARY; T=293.6K
he3s from (n,n*)he3

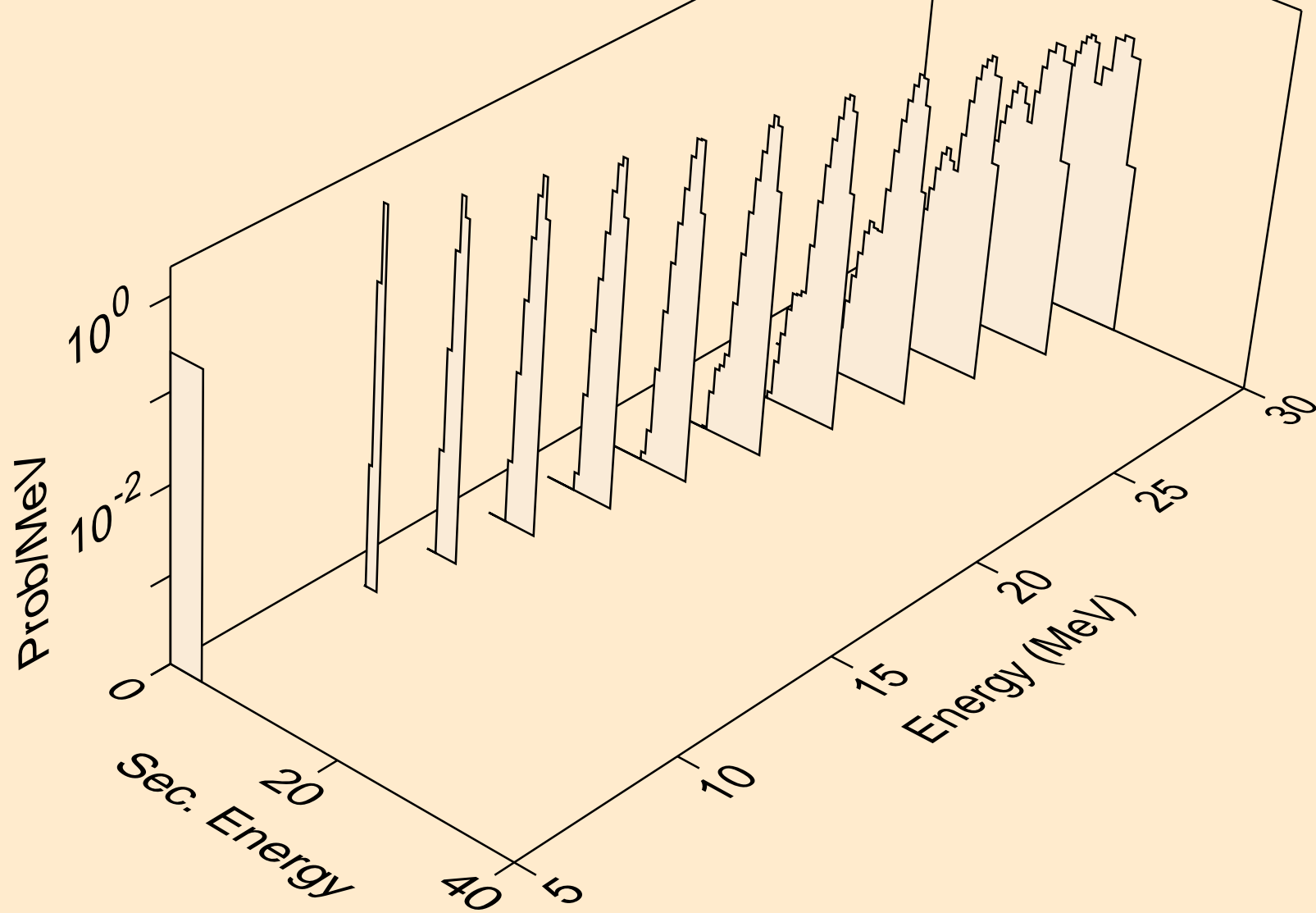

ER147 NEUTRON ACER TENDL-2024 LIBRARY; T=293.6K
he3s from (n,he3)

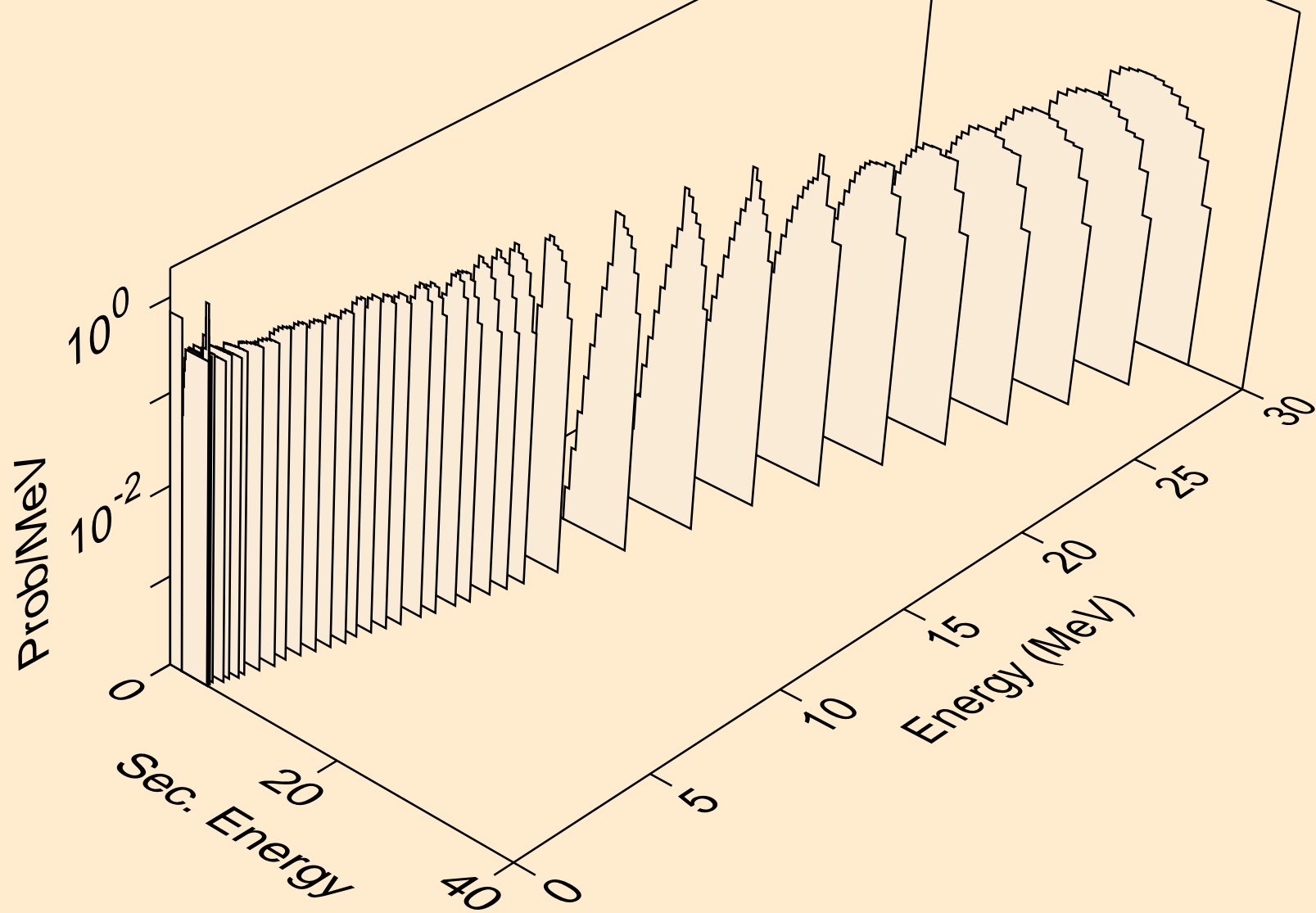

ER147 NEUTRON ACER TENDL-2024 LIBRARY; T=293.6K
alphas from (n,x)

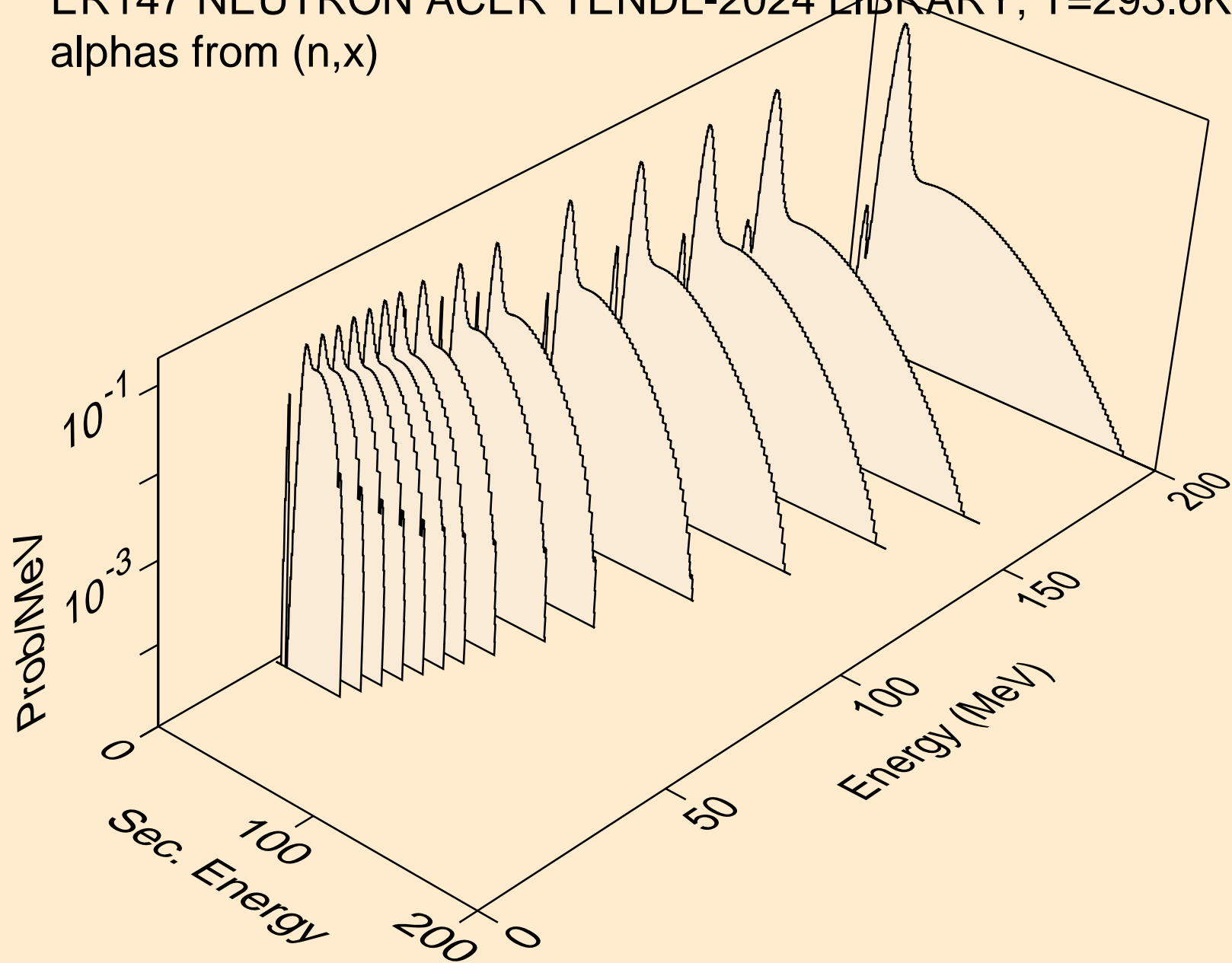

ER147 NEUTRON ACER TENDL-2024 LIBRARY; T=293.6K
alphas from (n,n*)a

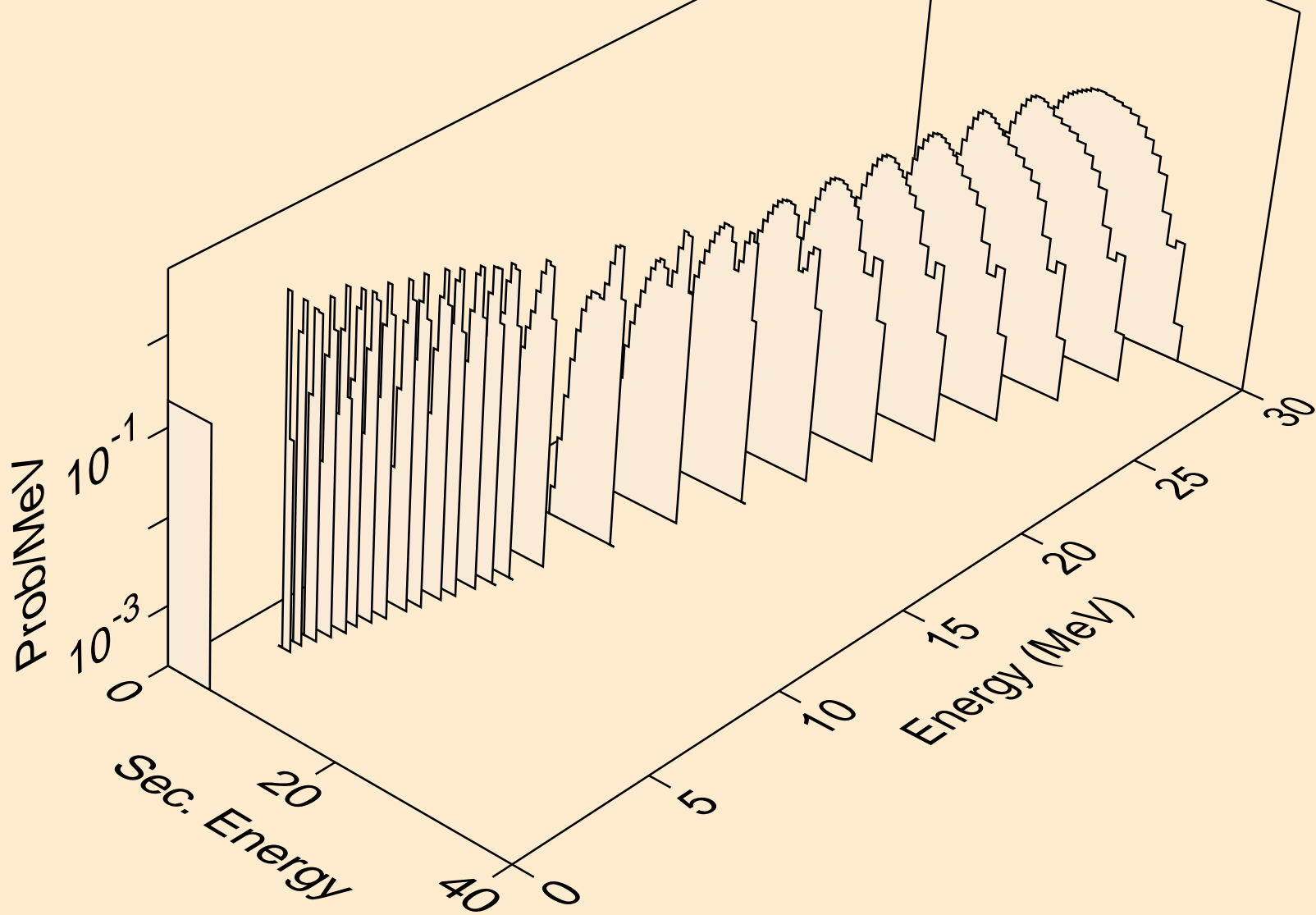

ER147 NEUTRON ACER TENDL-2024 LIBRARY; T=293.6K
alphas from (n,2n)a

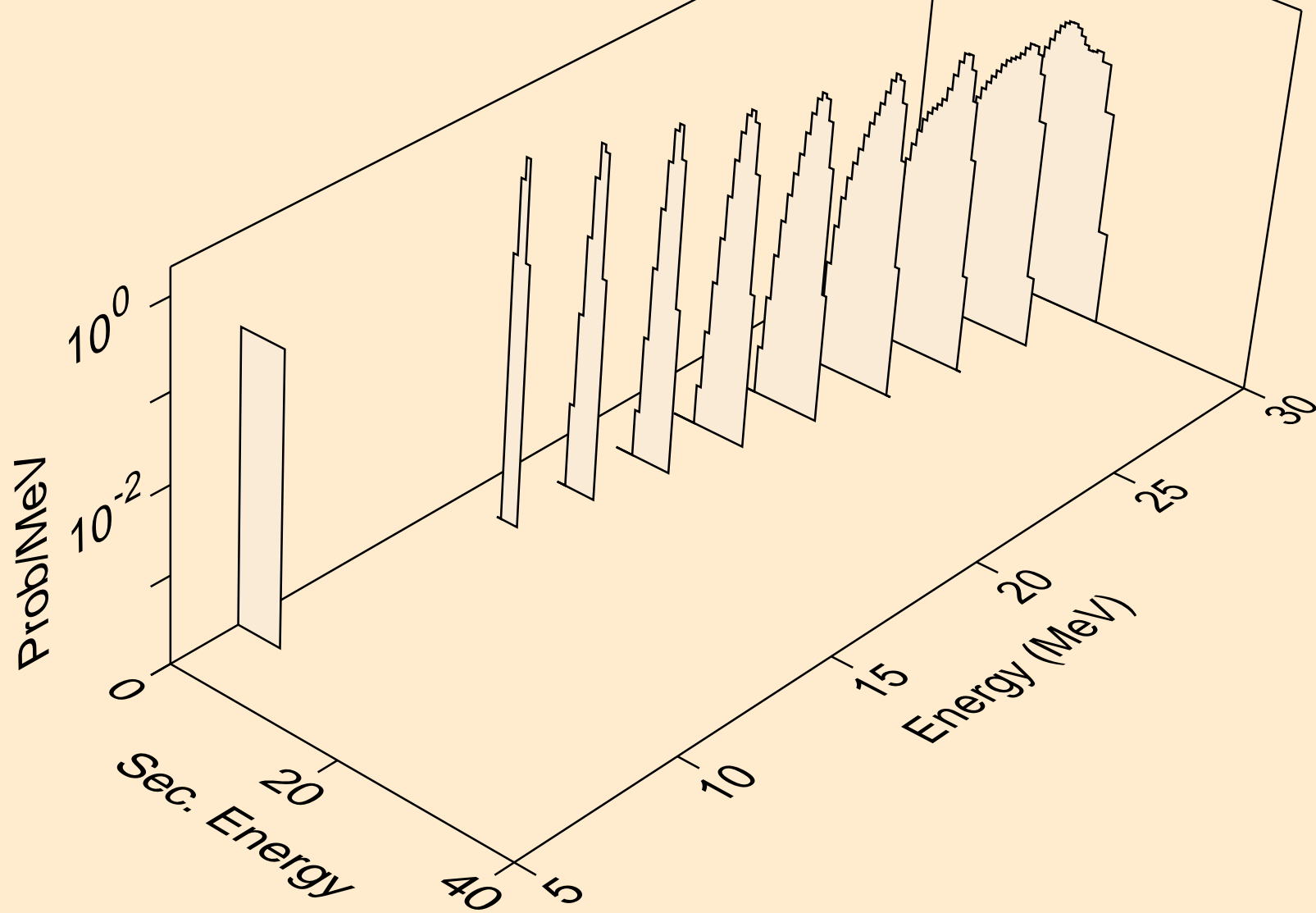

ER147 NEUTRON ACER TENDL-2024 LIBRARY; T=293.6K
alphas from (n,n*)2a

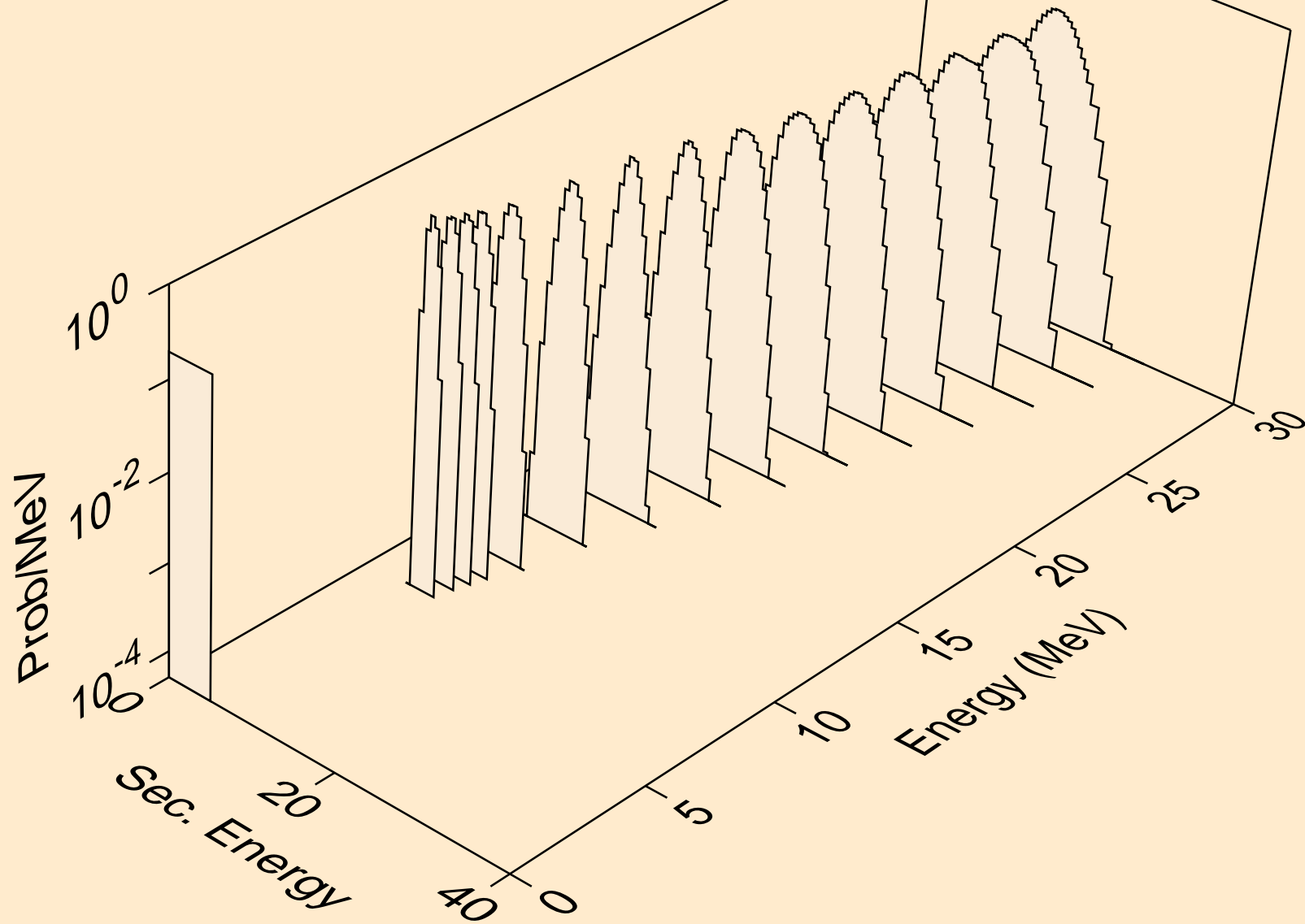

ER147 NEUTRON ACER TENDL-2024 LIBRARY; T=293.6K
alphas from (n,2n)2a

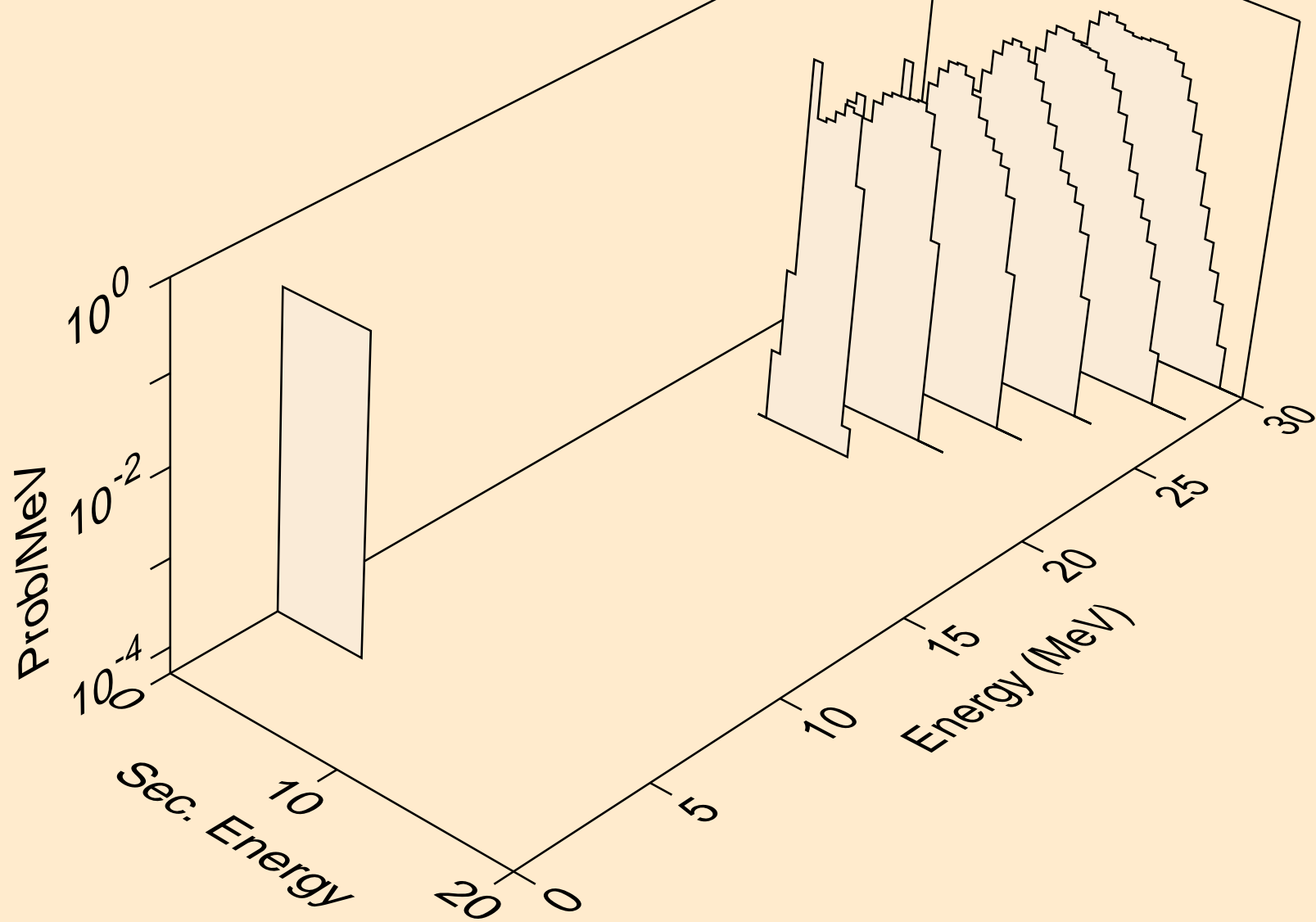

ER147 NEUTRON ACER TENDL-2024 LIBRARY; T=293.6K
alphas from (n,npa)

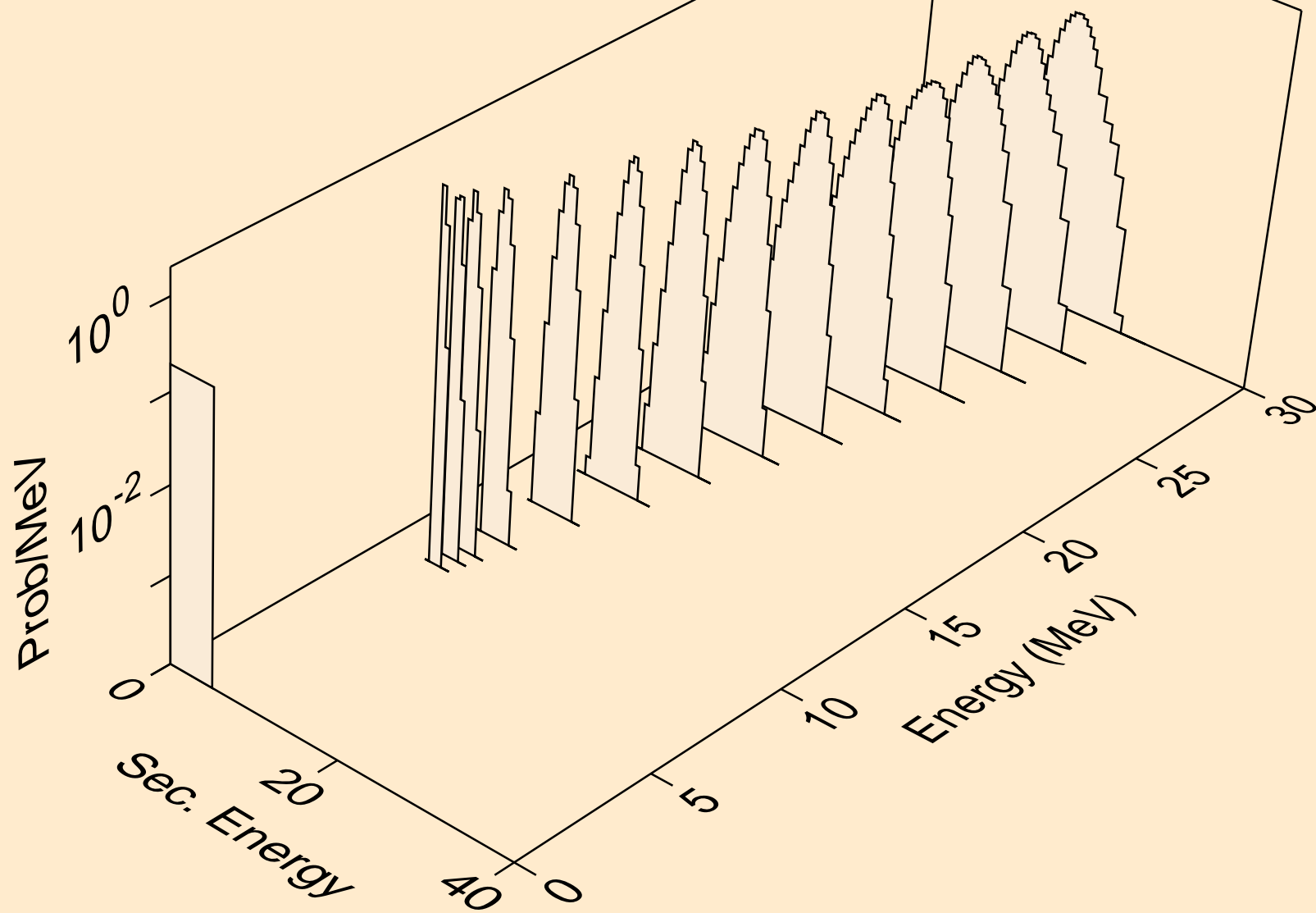

ER147 NEUTRON ACER TENDL-2024 LIBRARY; T=293.6K
alphas from (n,a)

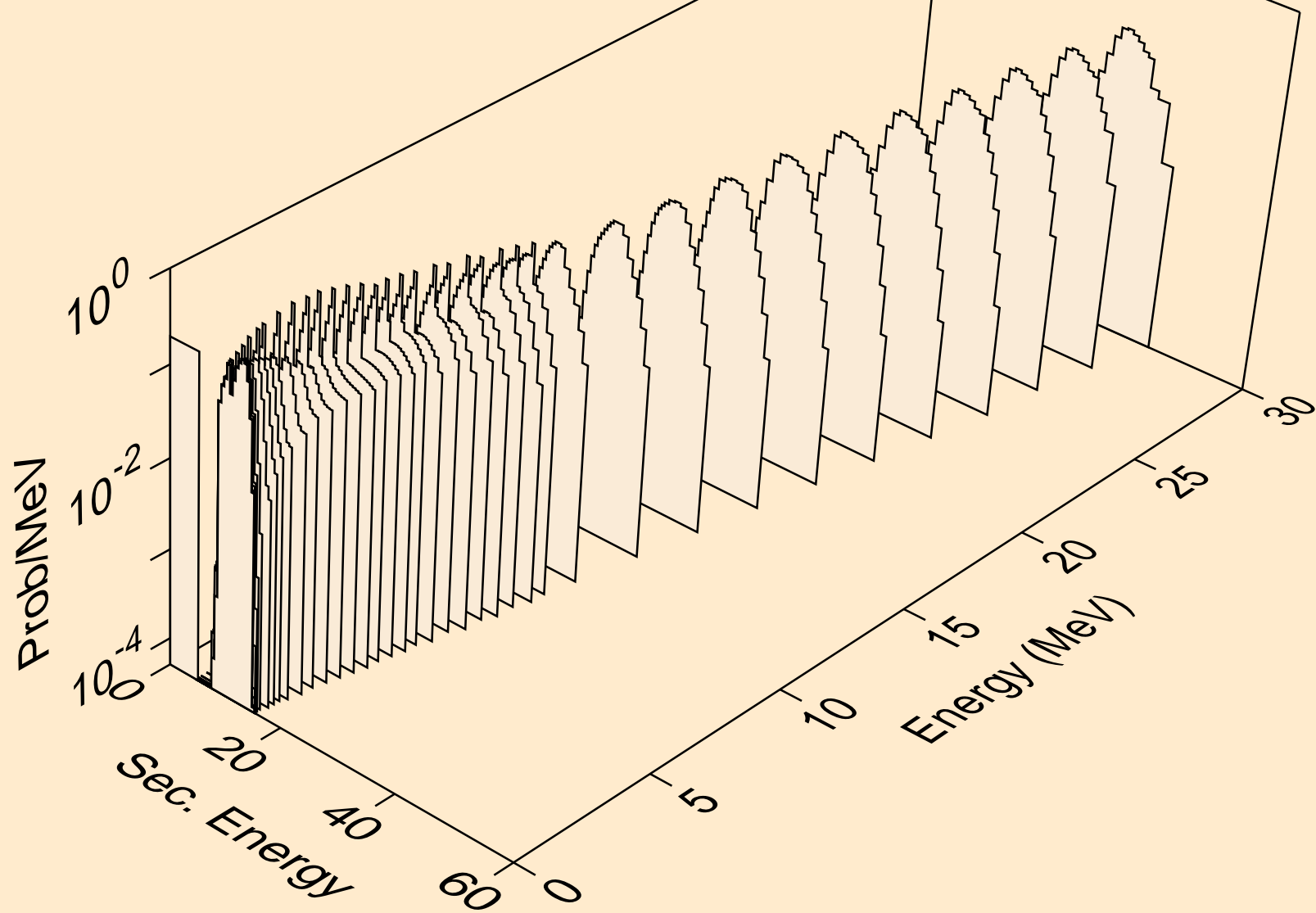

ER147 NEUTRON ACER TENDL-2024 LIBRARY; T=293.6K
alphas from (n,2a)

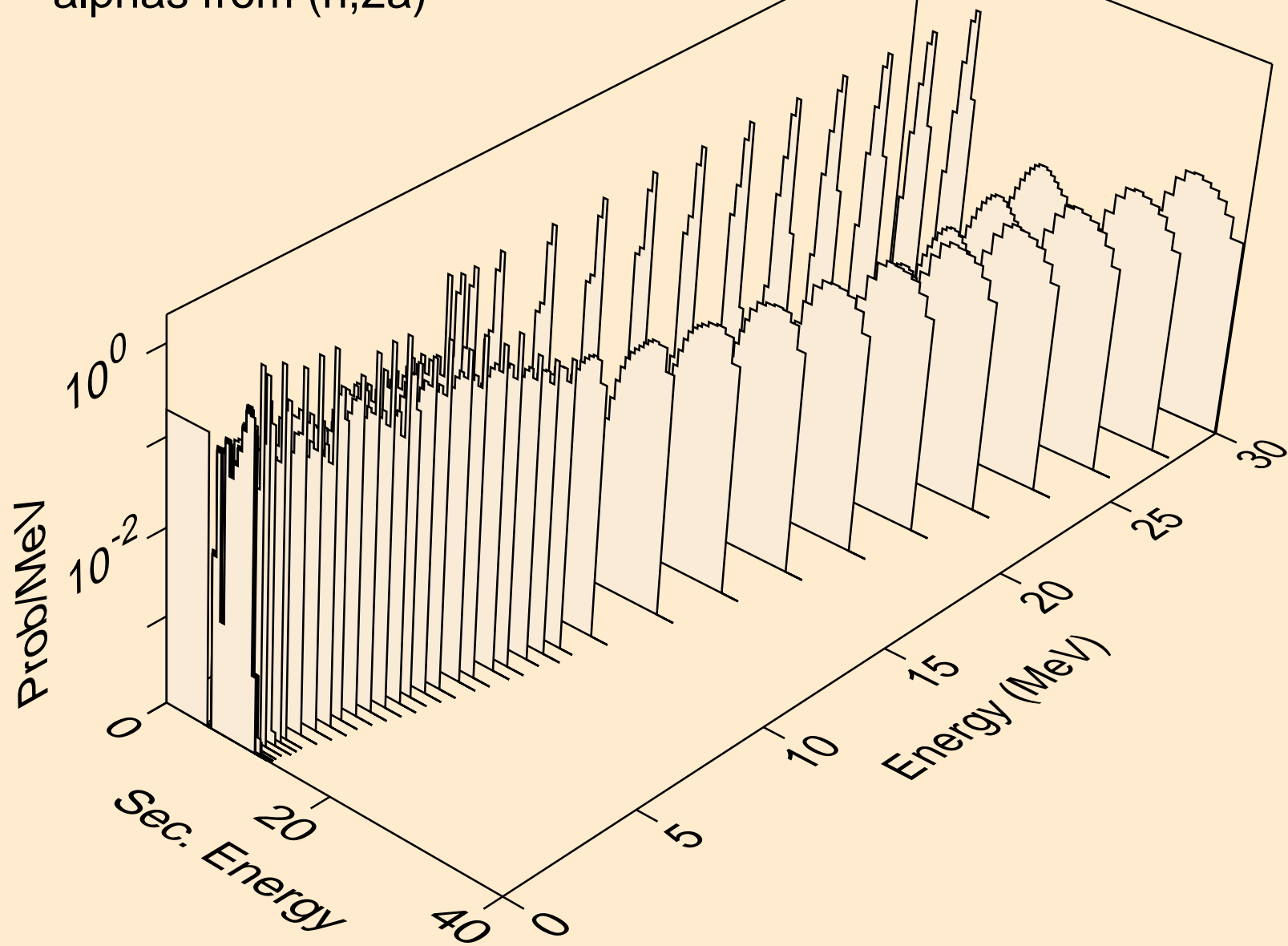

ER147 NEUTRON ACER TENDL-2024 LIBRARY; T=293.6K
alphas from (n,3a)

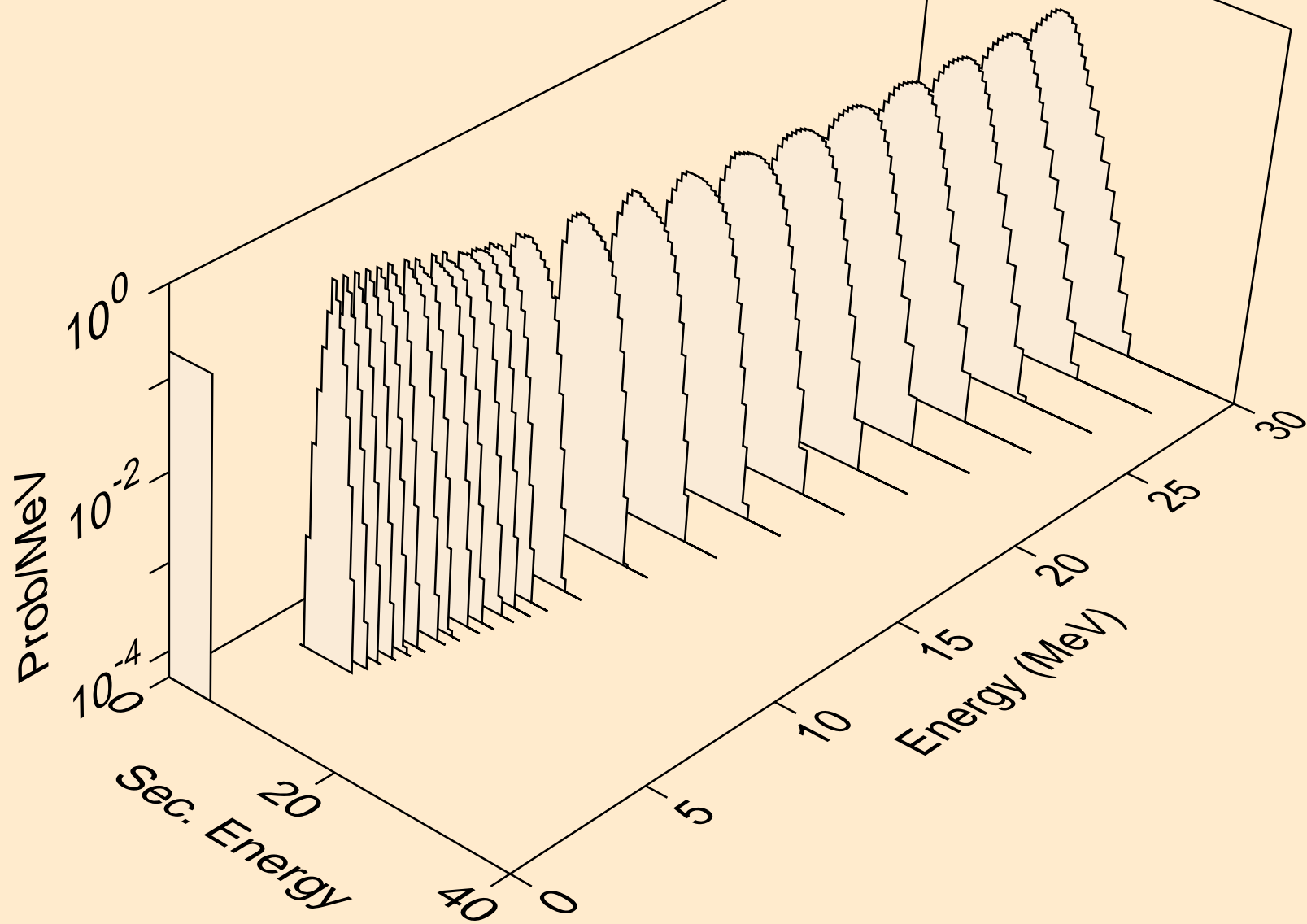

ER147 NEUTRON ACER TENDL-2024 LIBRARY; T=293.6K
alphas from (n,pa)

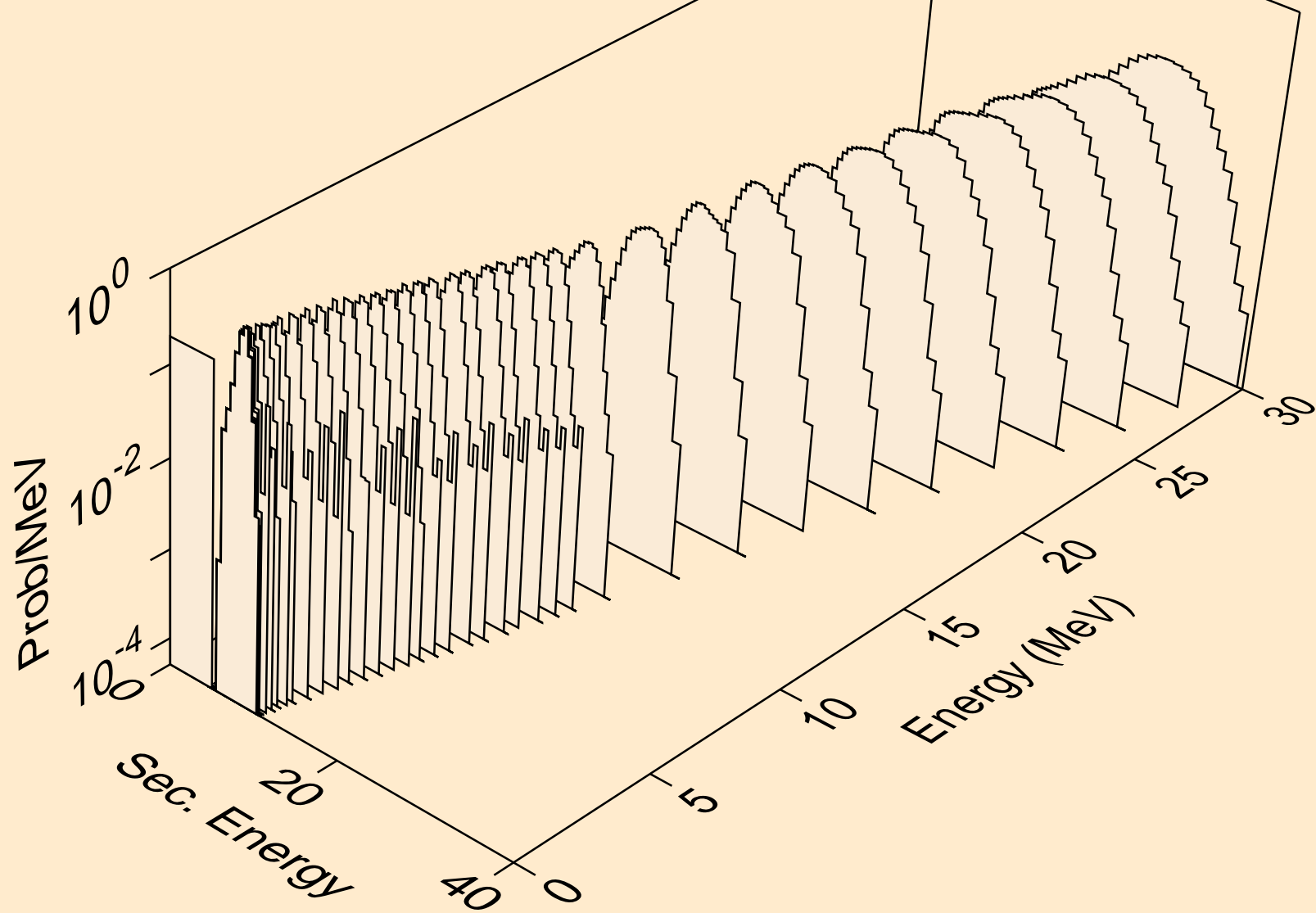

ER147 NEUTRON ACER TENDL-2024 LIBRARY; T=293.6K
alphas from (n,d2a)

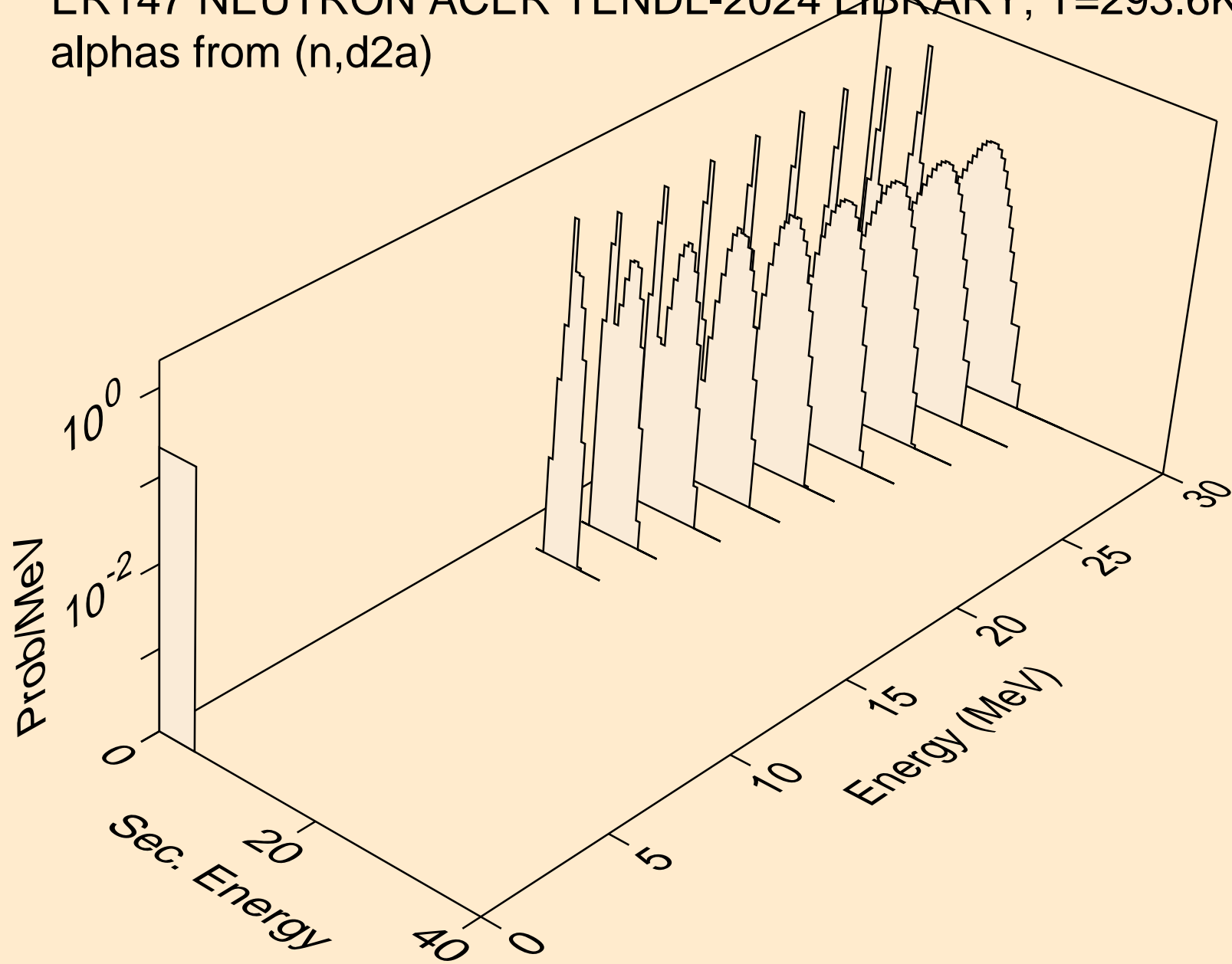

ER147 NEUTRON ACER TENDL-2024 LIBRARY; T=293.6K
alphas from (n,da)

