

Program EVALPLOT
(Version 2021-1)

by

Dermott E. Cullen
(Present Contact Information)

Dermott E. Cullen
1466 Hudson Way
Livermore, CA 94550
U.S.A.

Tele: 925-443-1911

E.Mail:redcullen1@comcast.net

Web:redcullen1.net/HOMEPAGE.NEW

Press Mouse Button to Start

MAT 6861

Neutron Major
293 Kelvin Cross Sections

68-Er-174

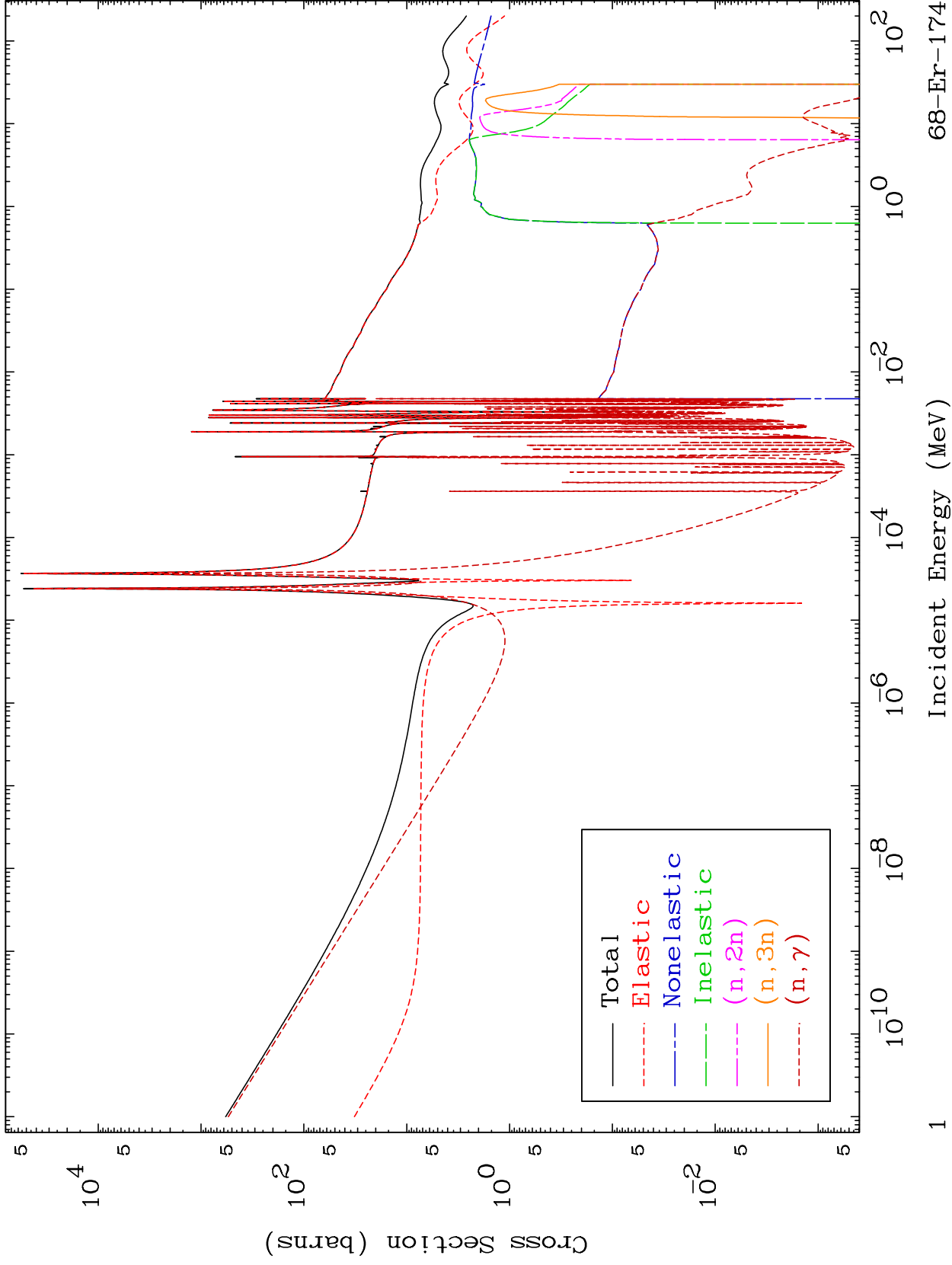

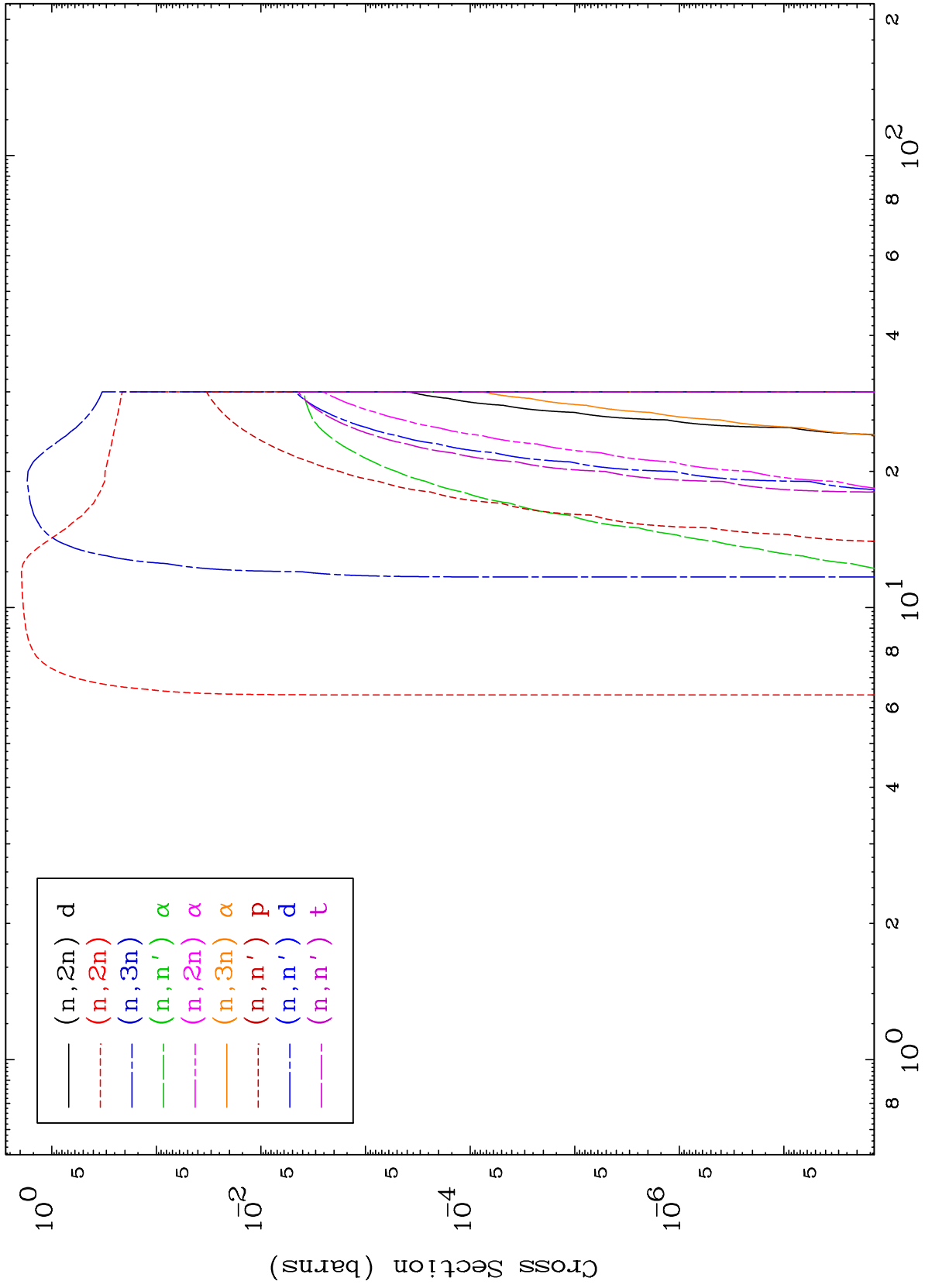

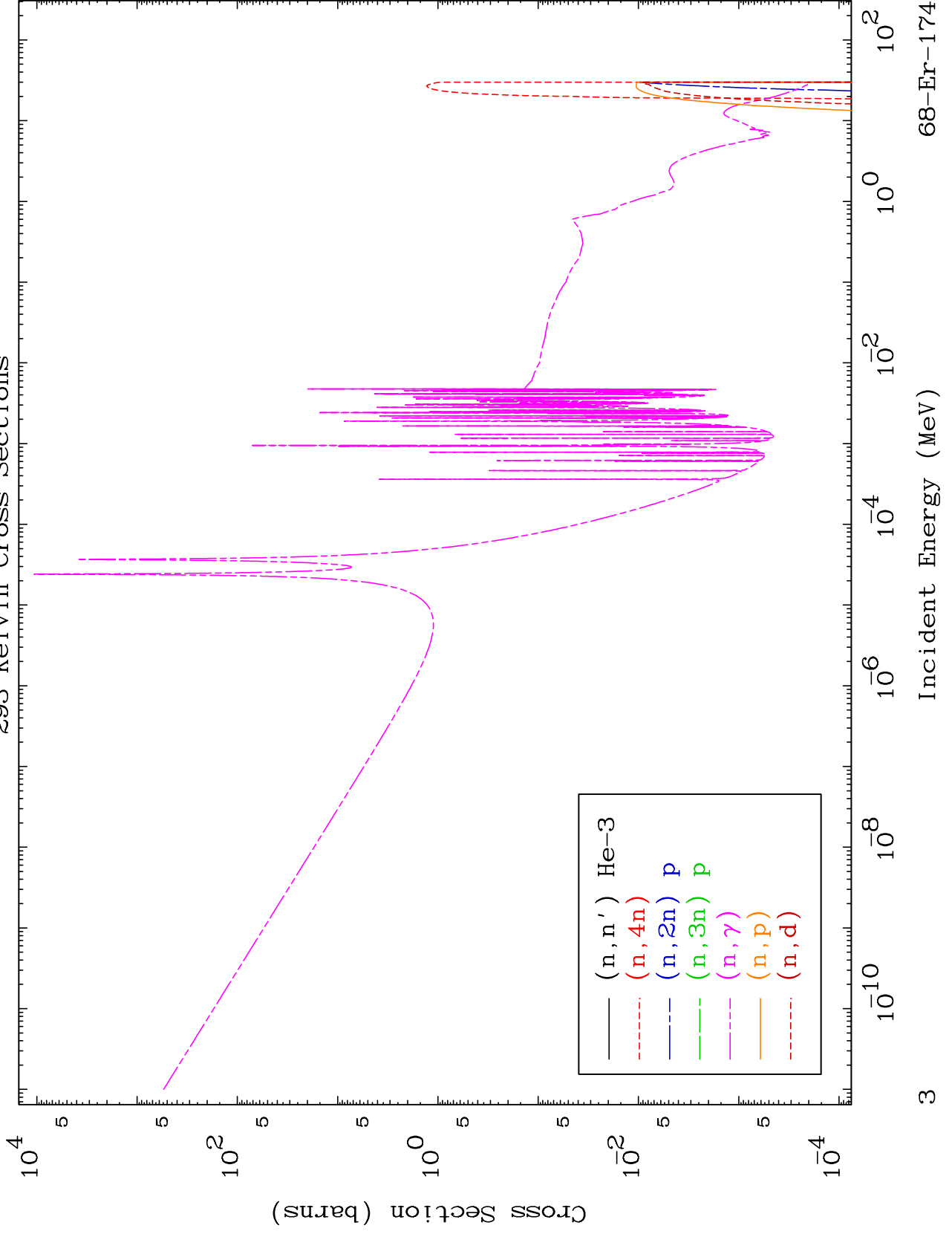

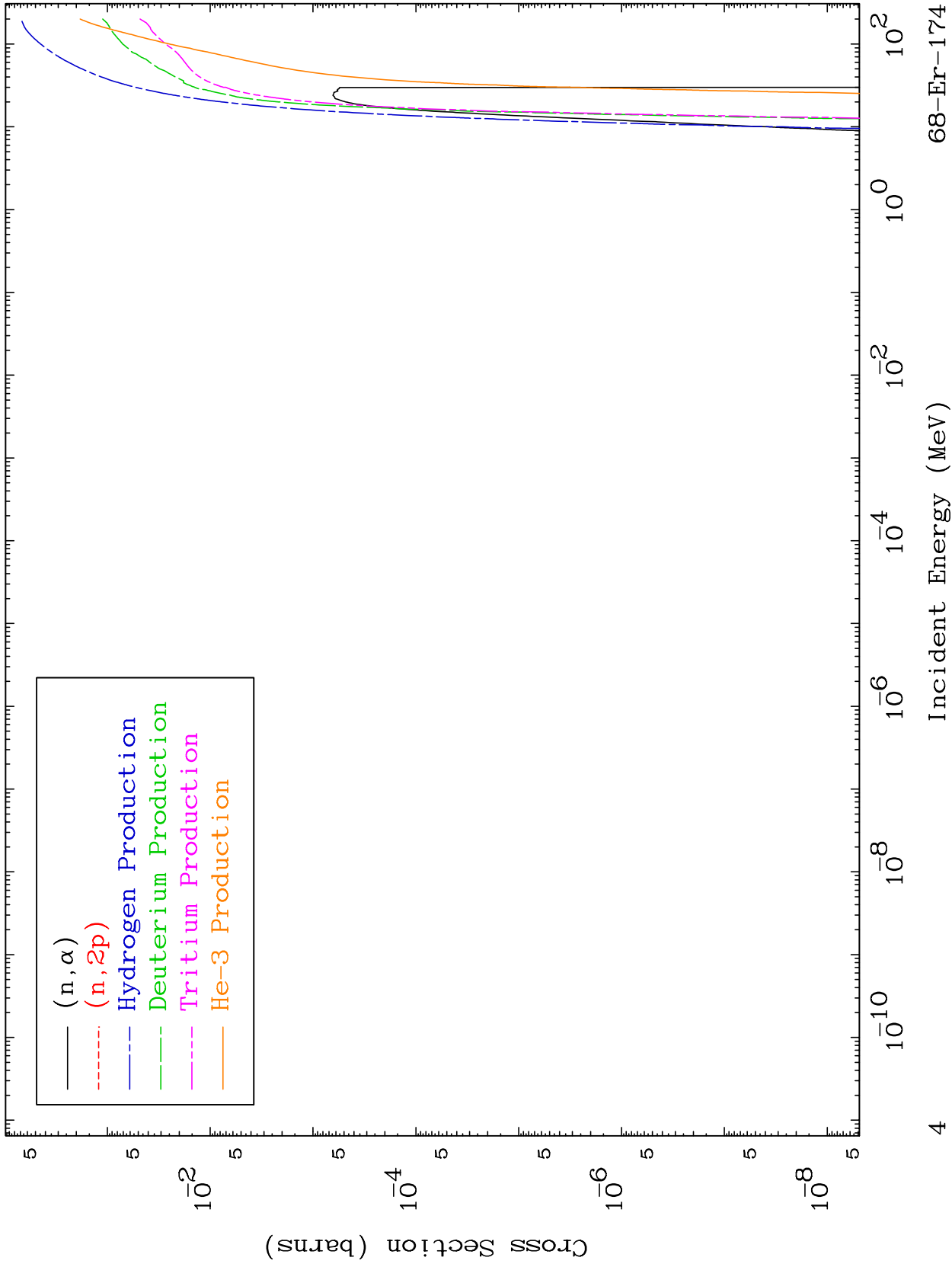

MAT 6861

Charged Particle
293 Kelvin Cross Sections

68-Er-174

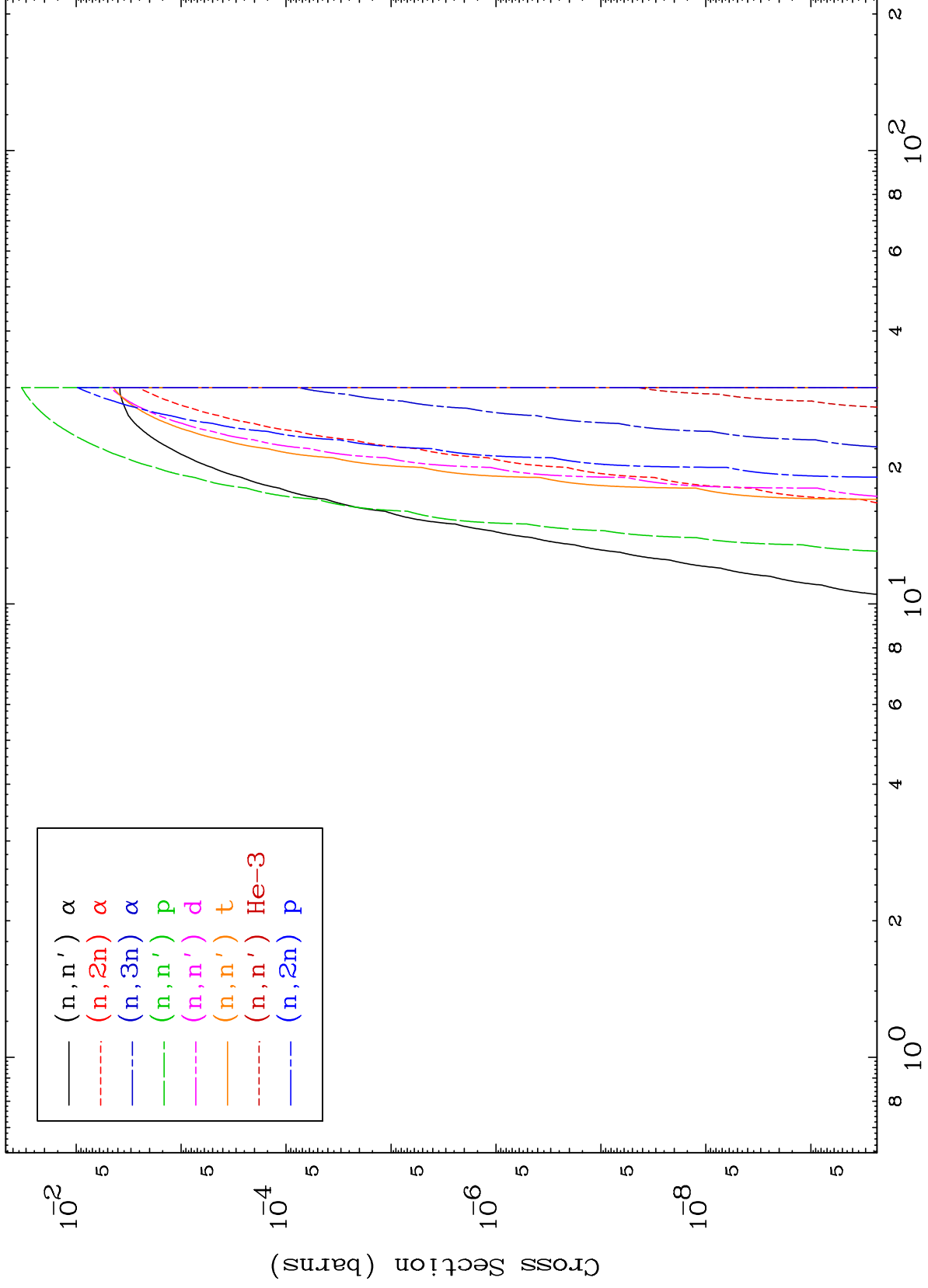

5

Incident Energy (MeV)

68-Er-174

MAT 6861

Charged Particle
293 Kelvin Cross Sections

68-Er-174

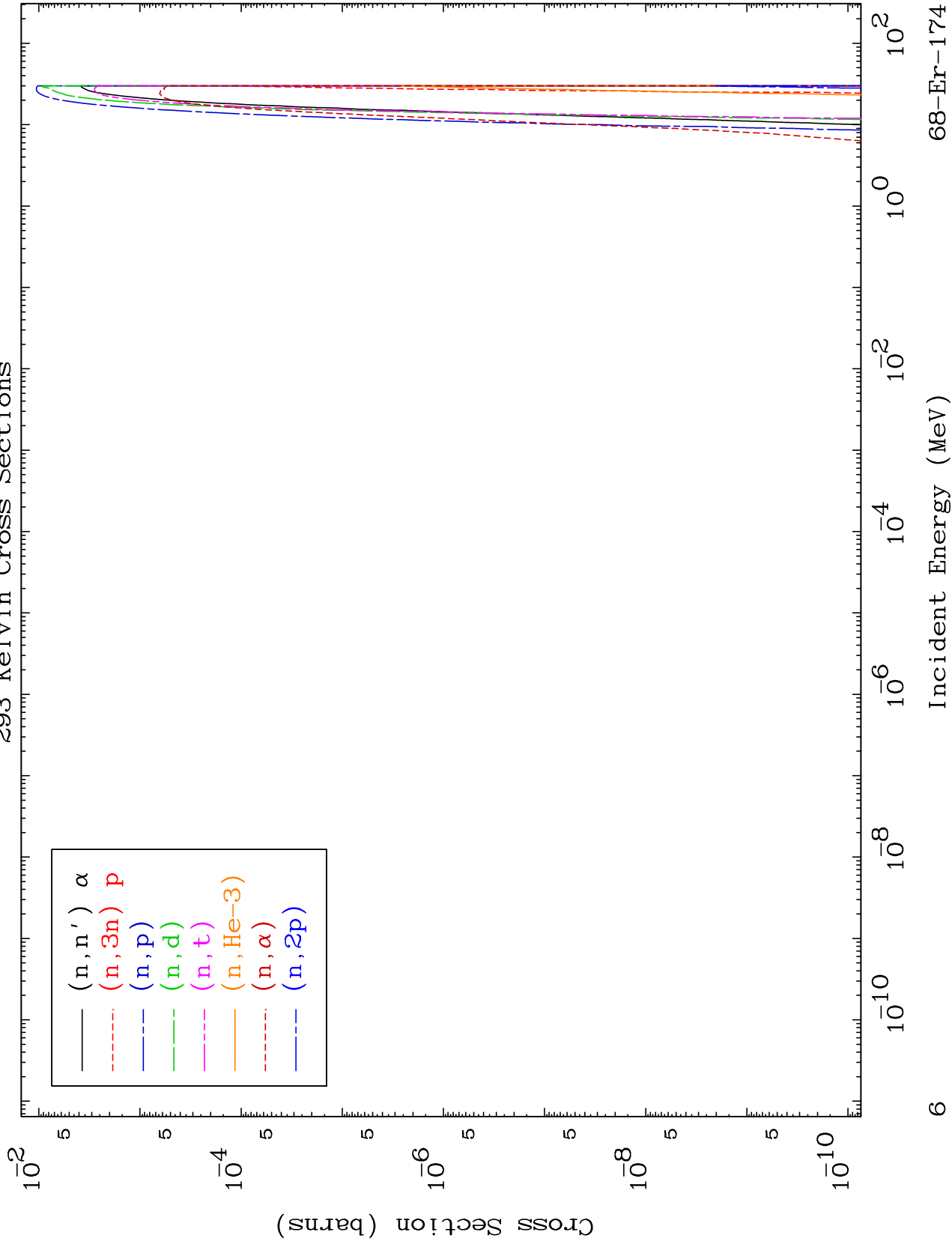

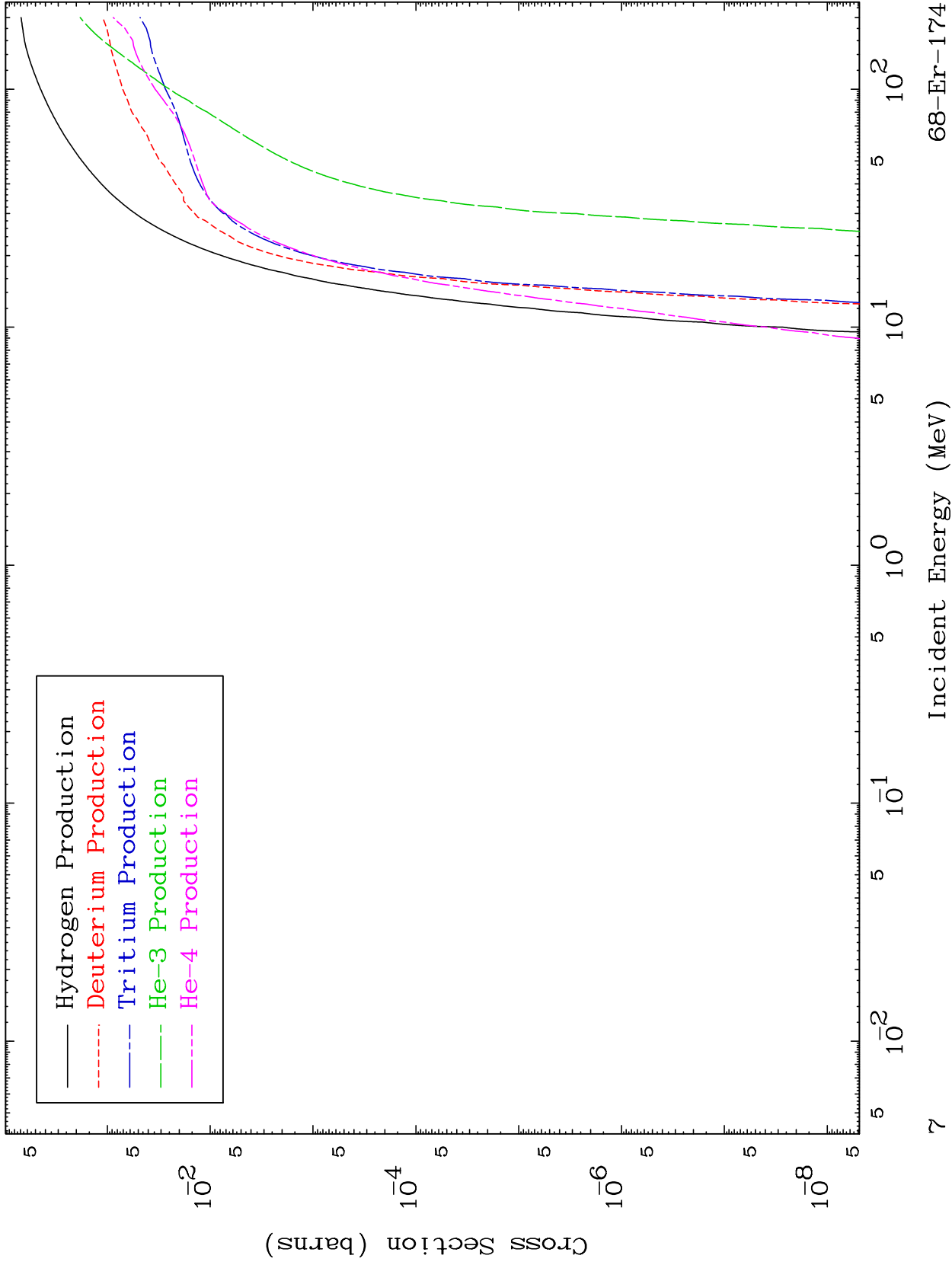

293 Kelvin Cross Sections

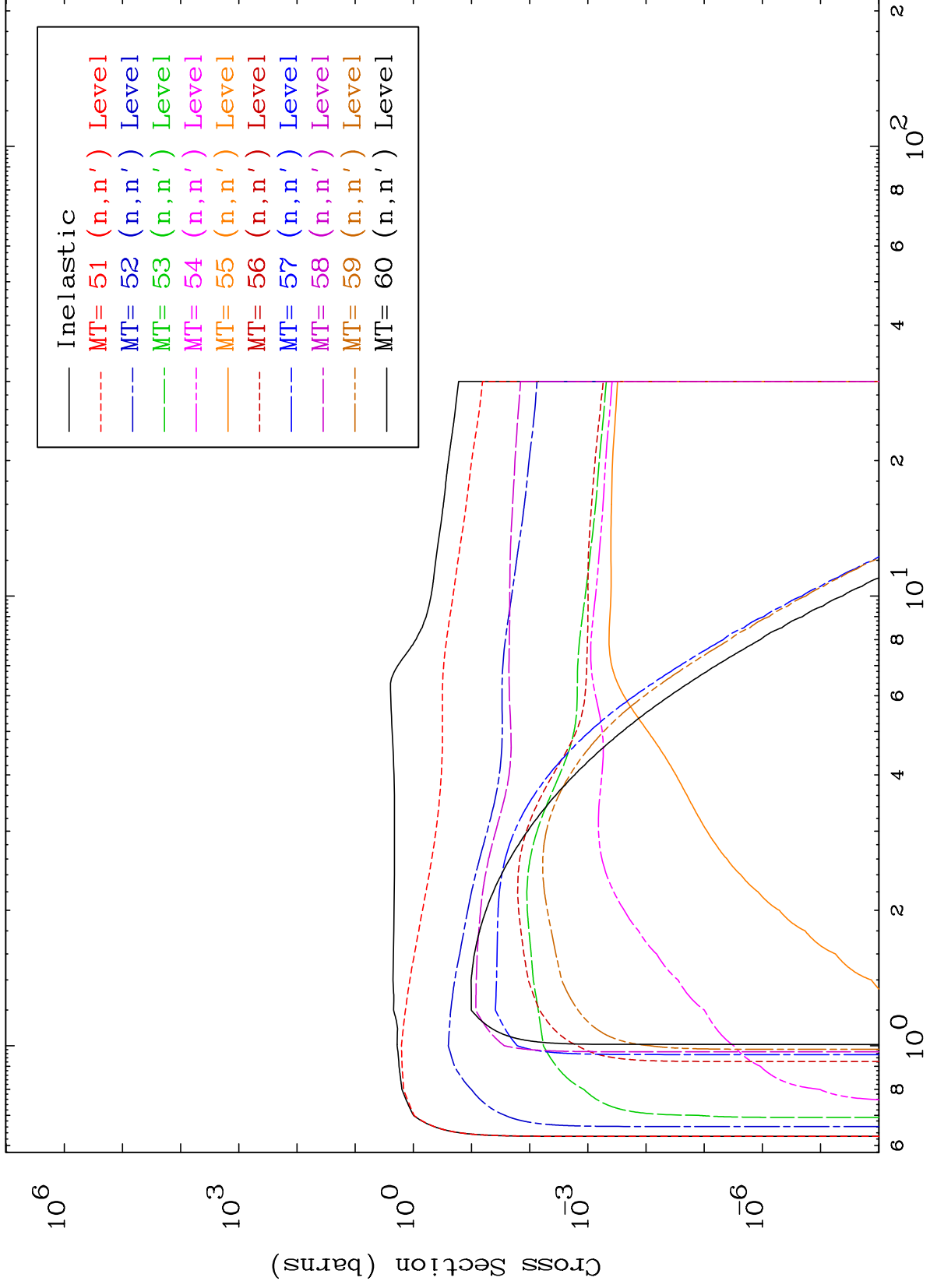

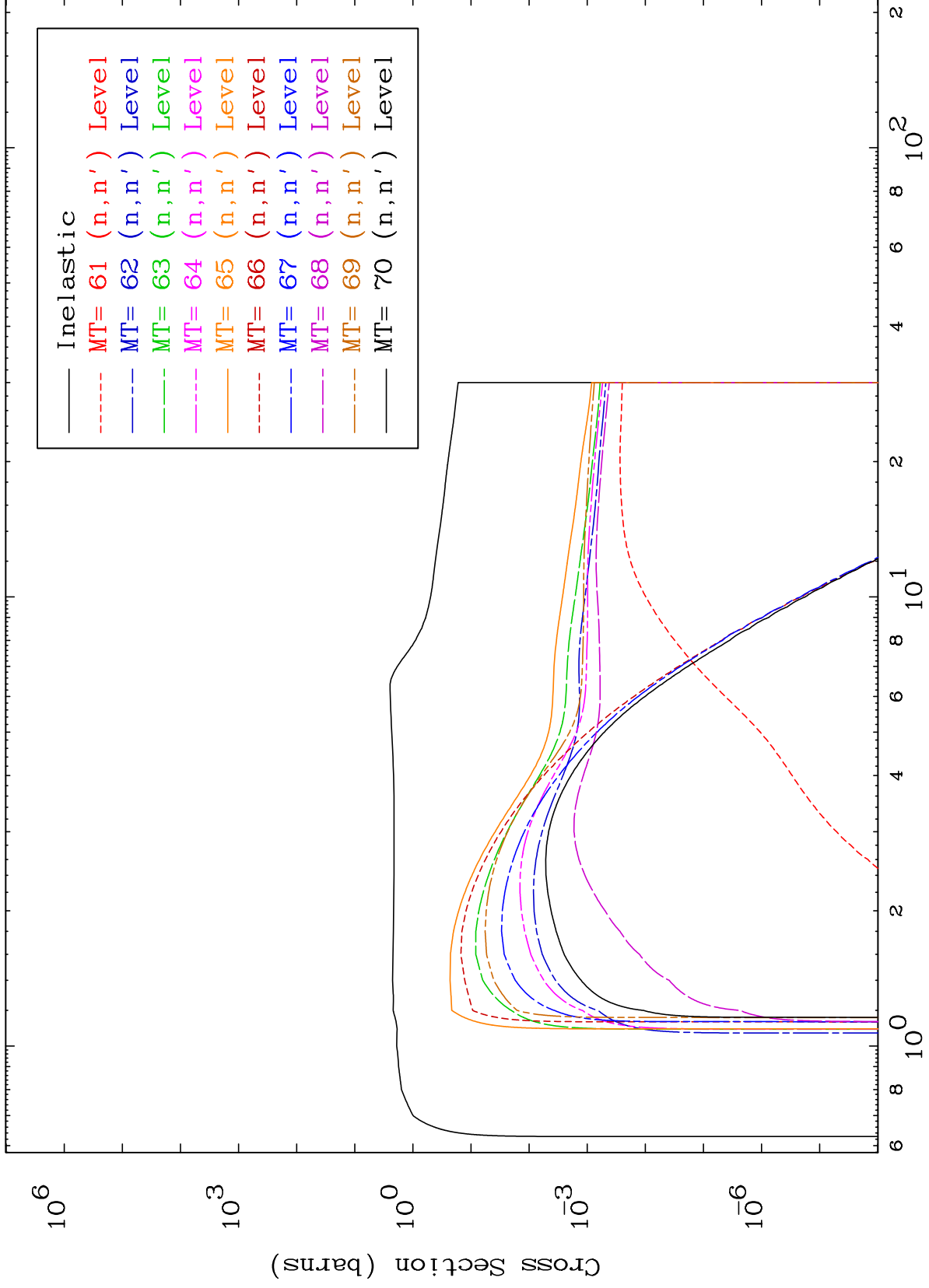

MAT 6861

(n,n') Levels

293 Kelvin Cross Sections

68-Er-174

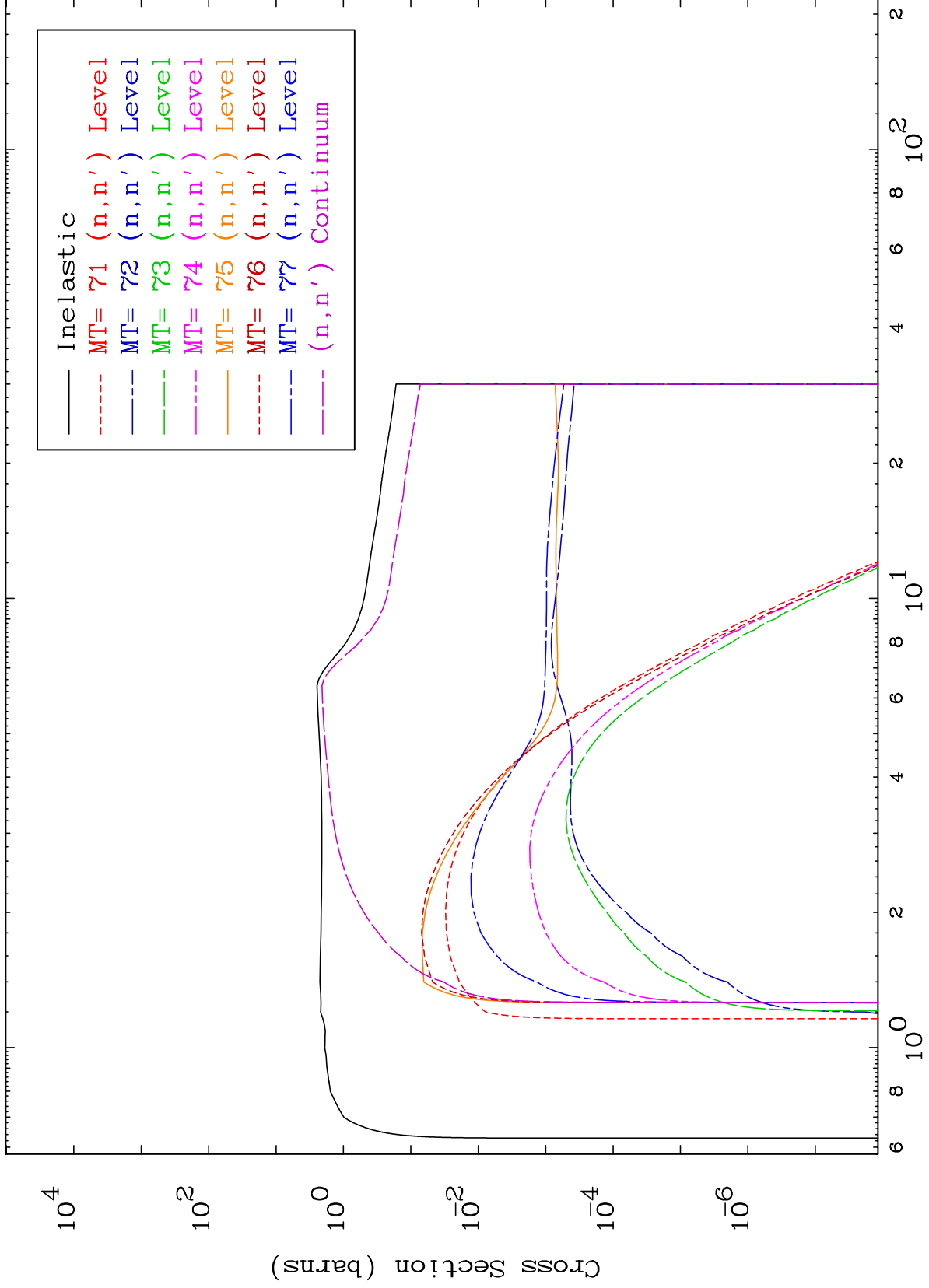

10

Incident Energy (MeV)

68-Er-174

MAT 6861

(n,p) Levels
293 Kelvin Cross Sections

68-Er-174

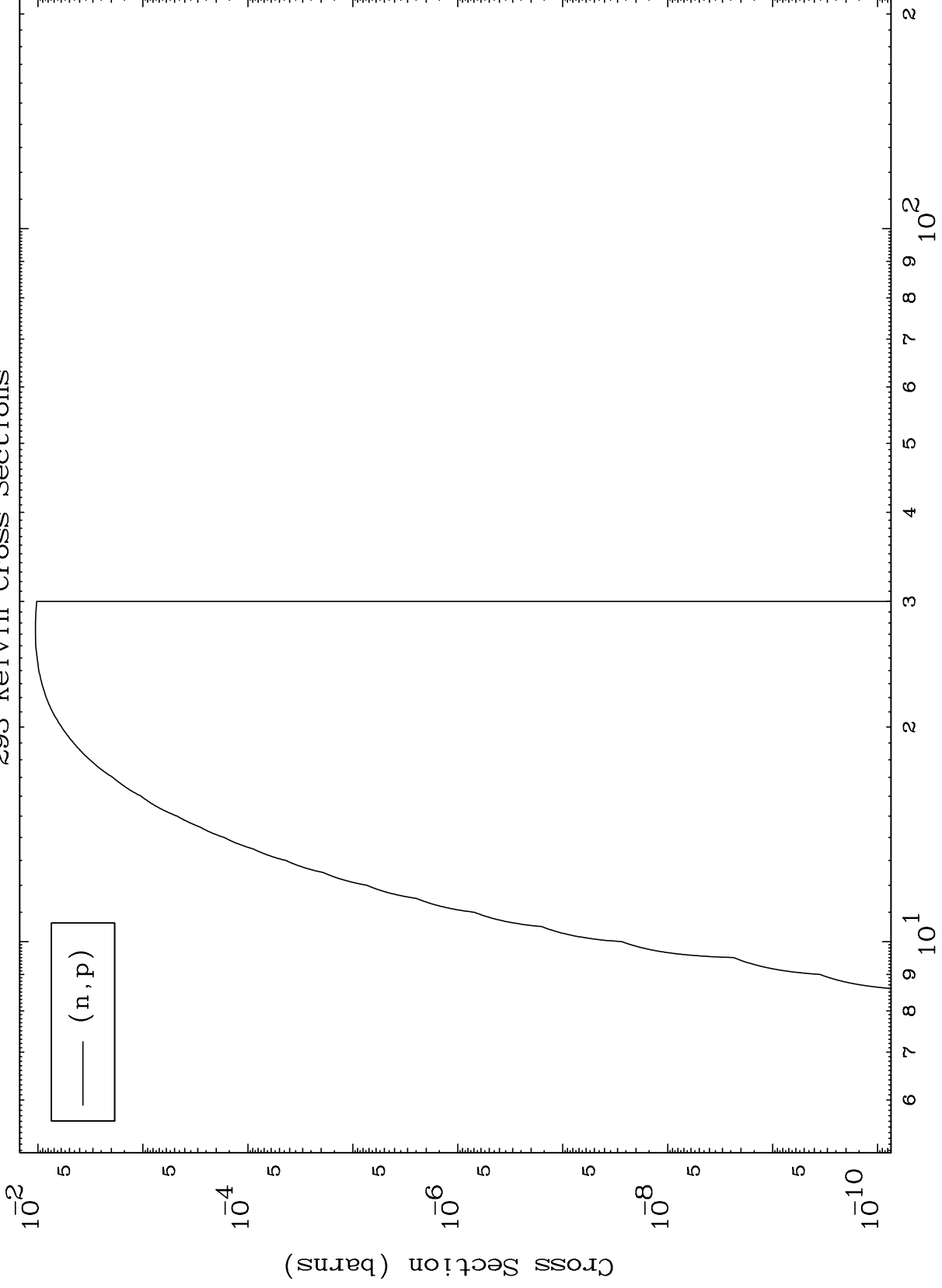

MAT 6861

(n,d) Levels
293 Kelvin Cross Sections

68-Er-174

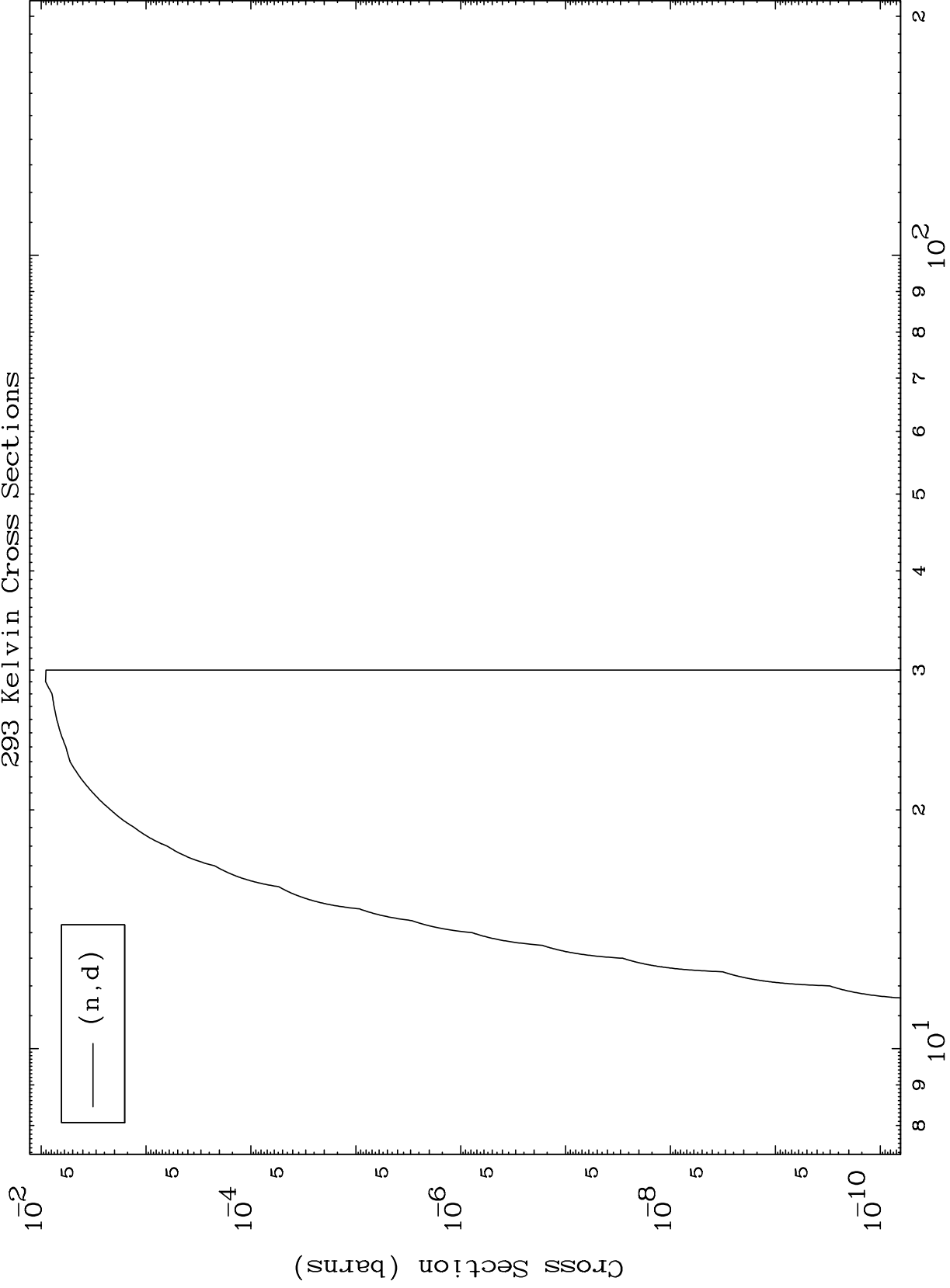

12

Incident Energy (MeV)

68-Er-174

MAT 6861

(n,t) Levels
293 Kelvin Cross Sections

68-Er-174

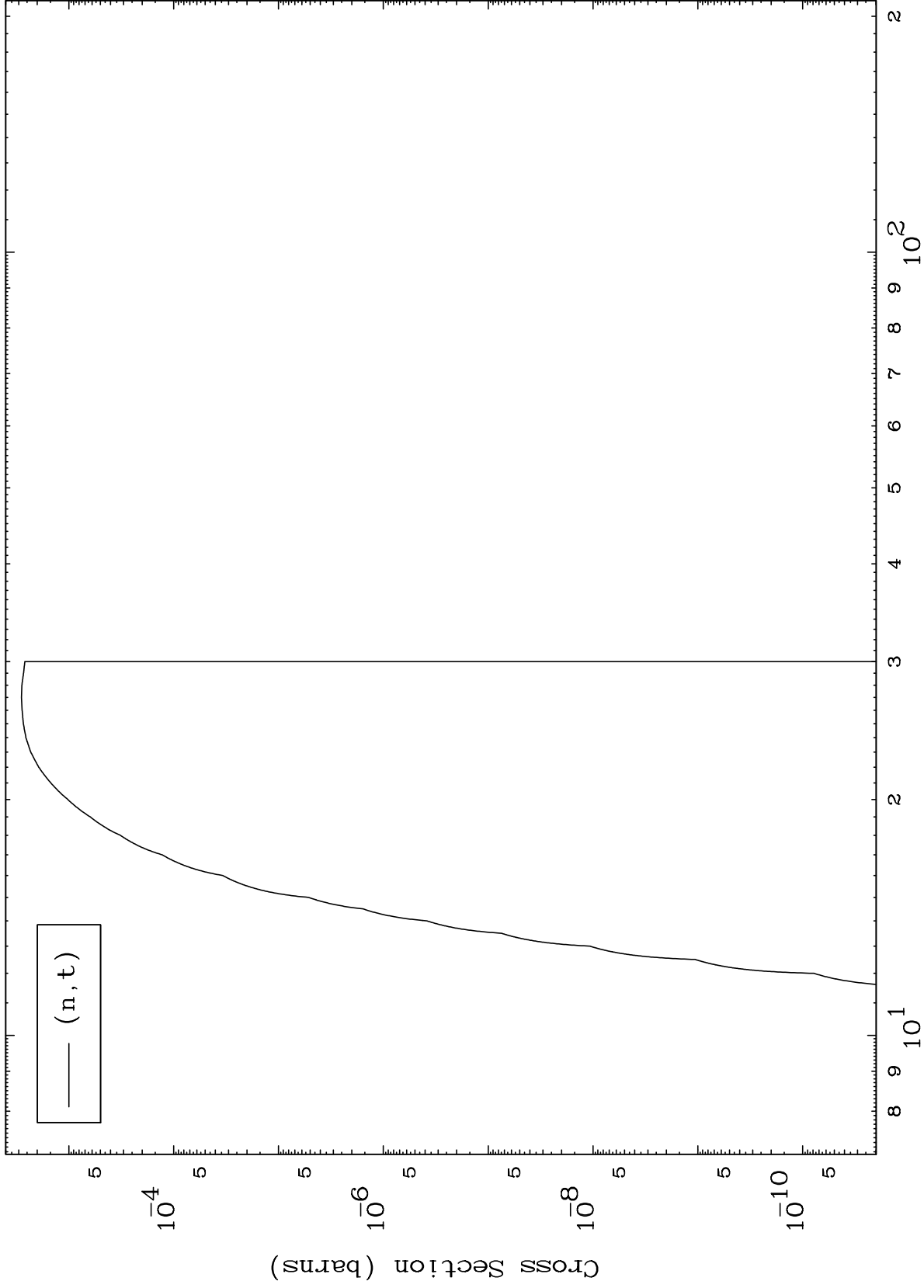

13

Incident Energy (MeV)

68-Er-174

MAT 6861

(n,He3) Levels
293 Kelvin Cross Sections

68-Er-174

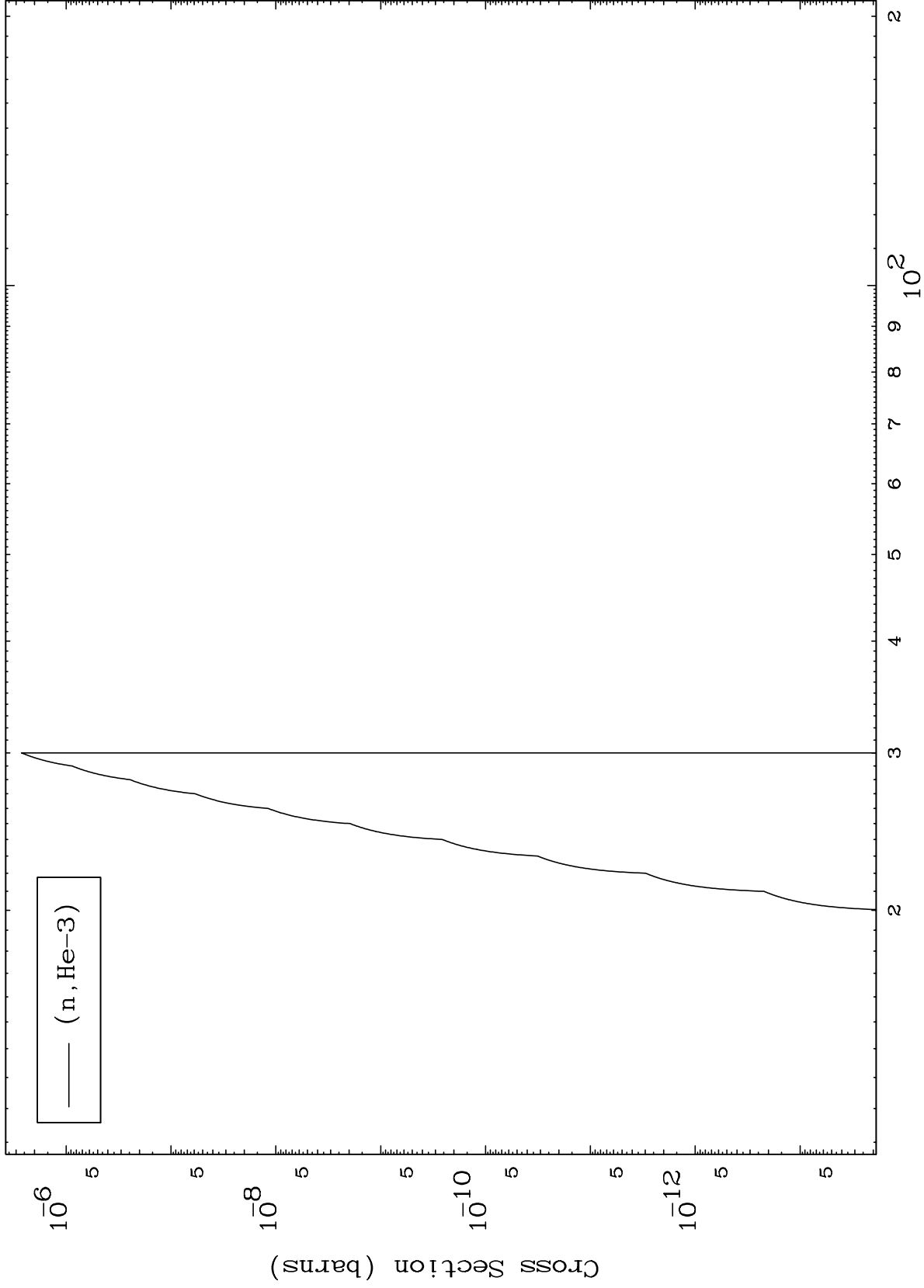

14

Incident Energy (MeV)

68-Er-174

MAT 6861

(n, α) Levels
293 Kelvin Cross Sections

68-Er-174

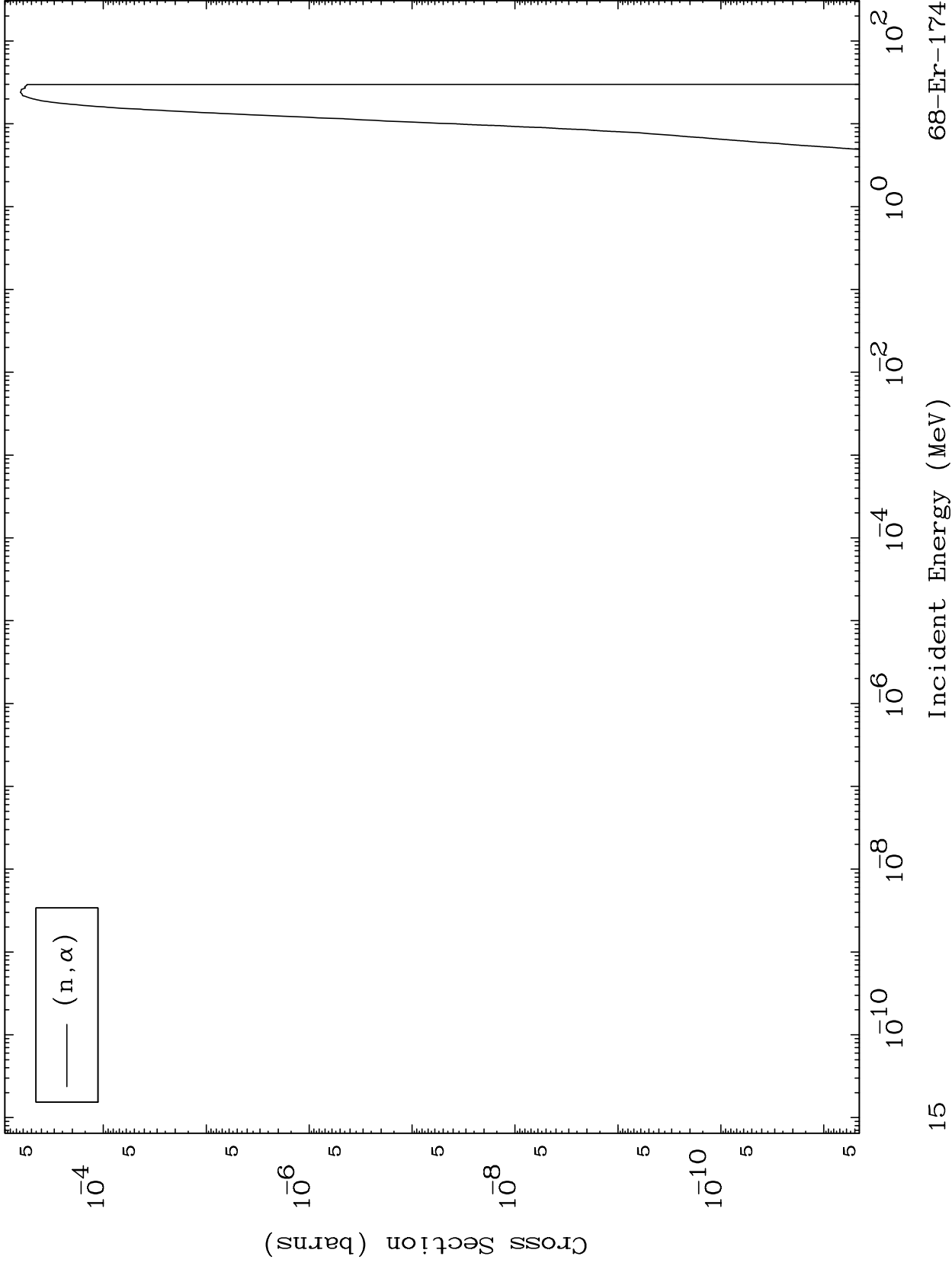

15

Incident Energy (MeV)

68-Er-174

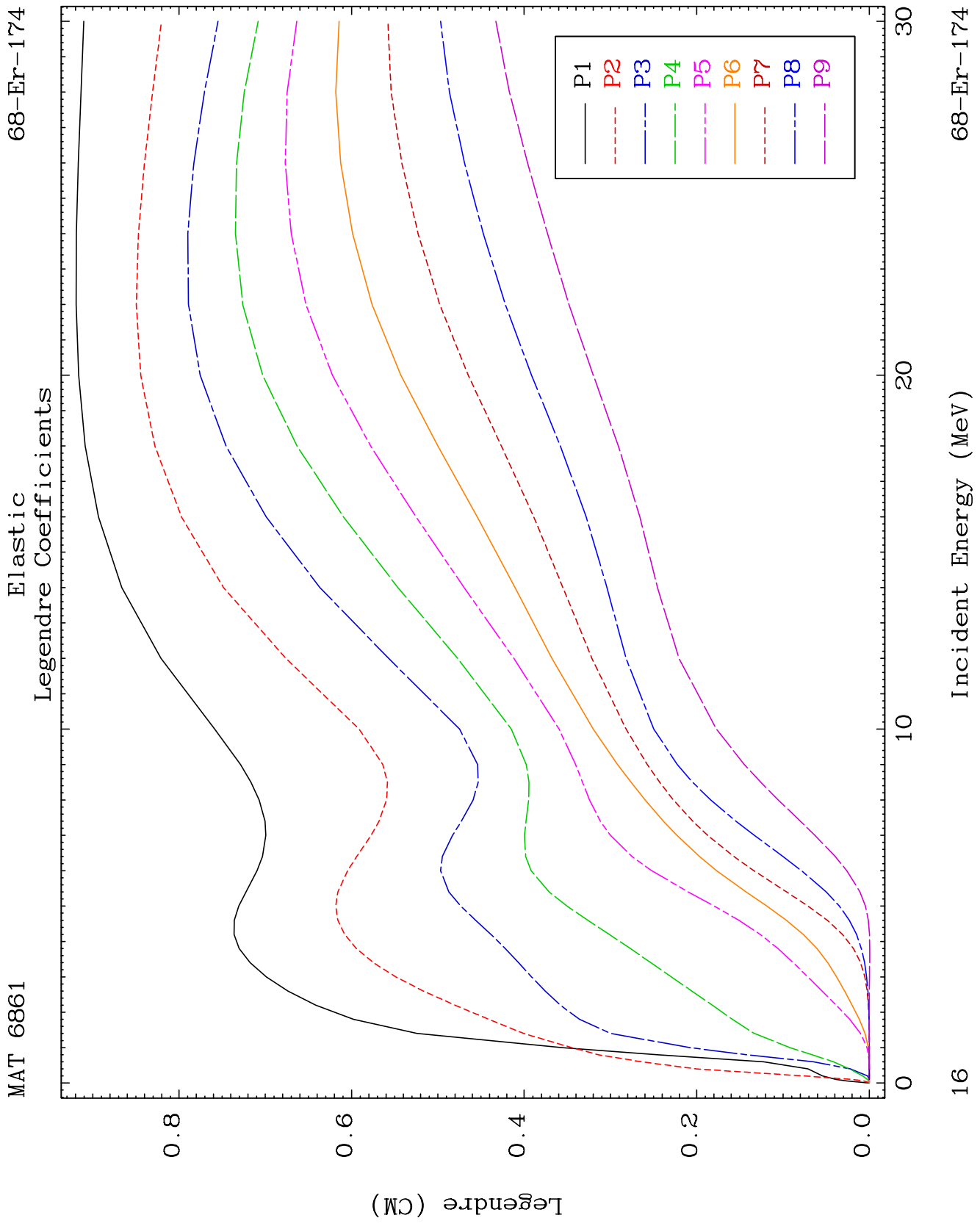

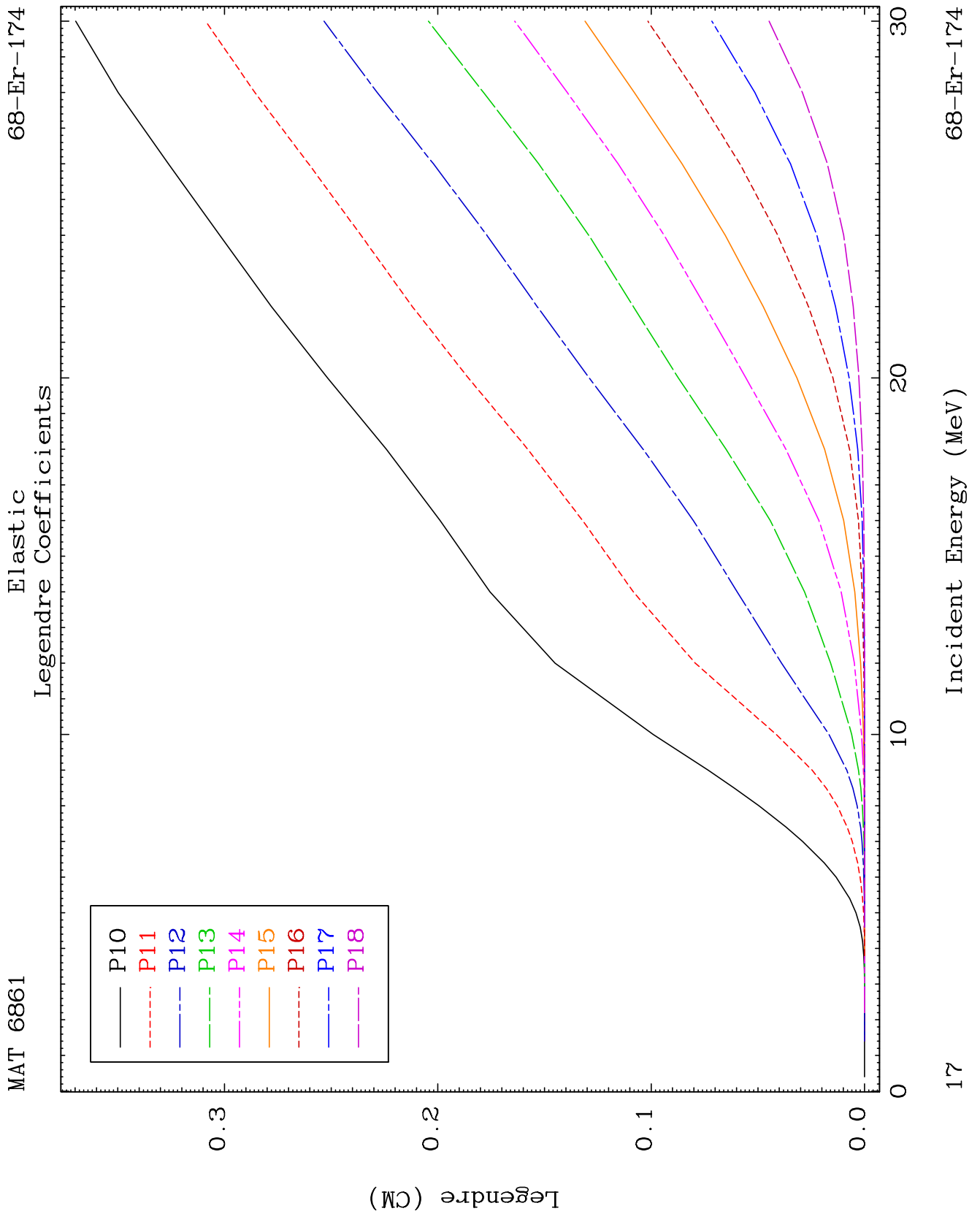

MAT 6861

Elastic
Legendre Coefficients

68-Er-174

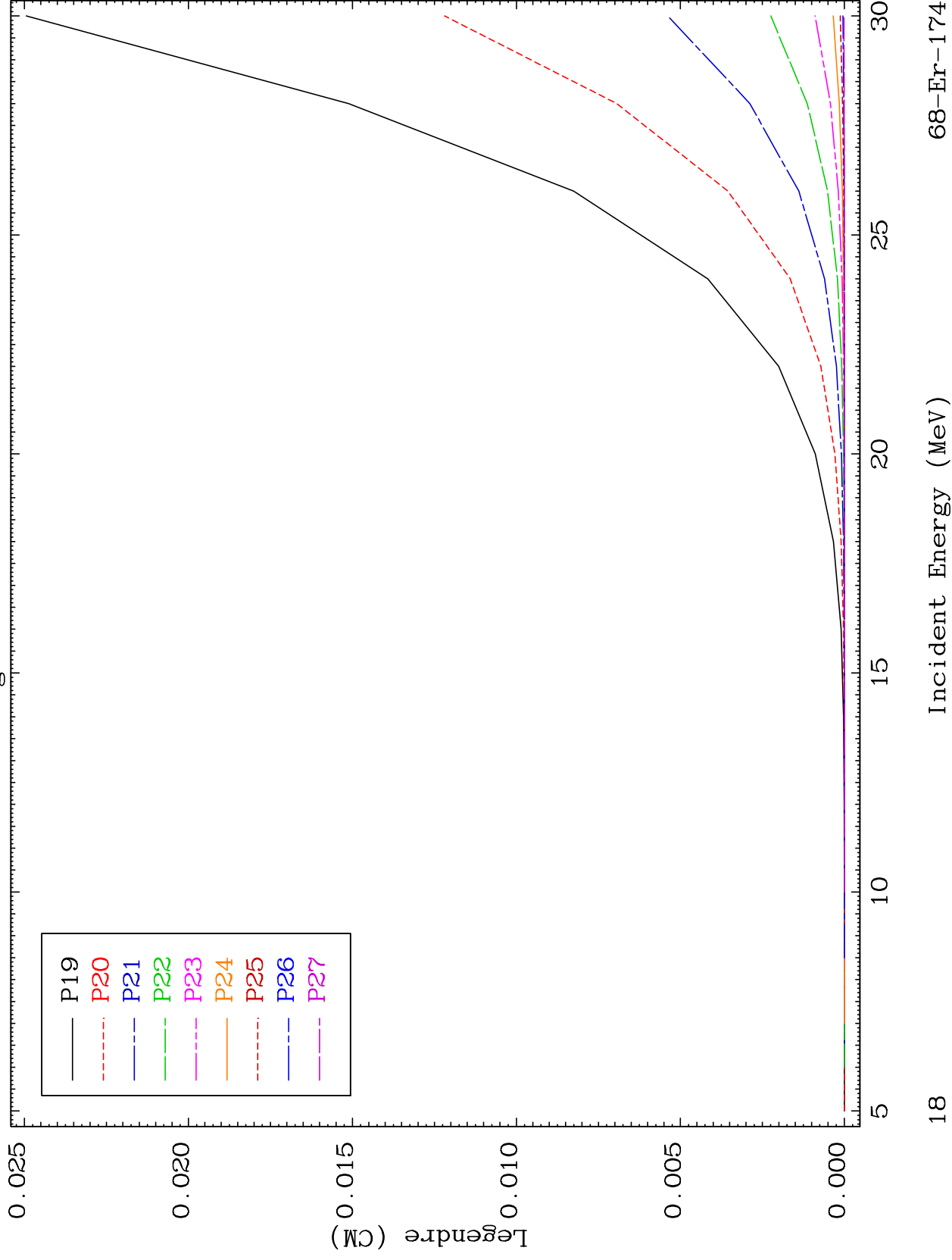

18

Incident Energy (MeV)

68-Er-174

MAT 6861

Elastic
Legendre Coefficients

68-Er-174

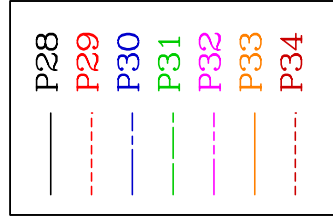

$\times 10^{-6}$

Legendre (CM)

10

15

20

25

30

Incident Energy (MeV)

68-Er-174

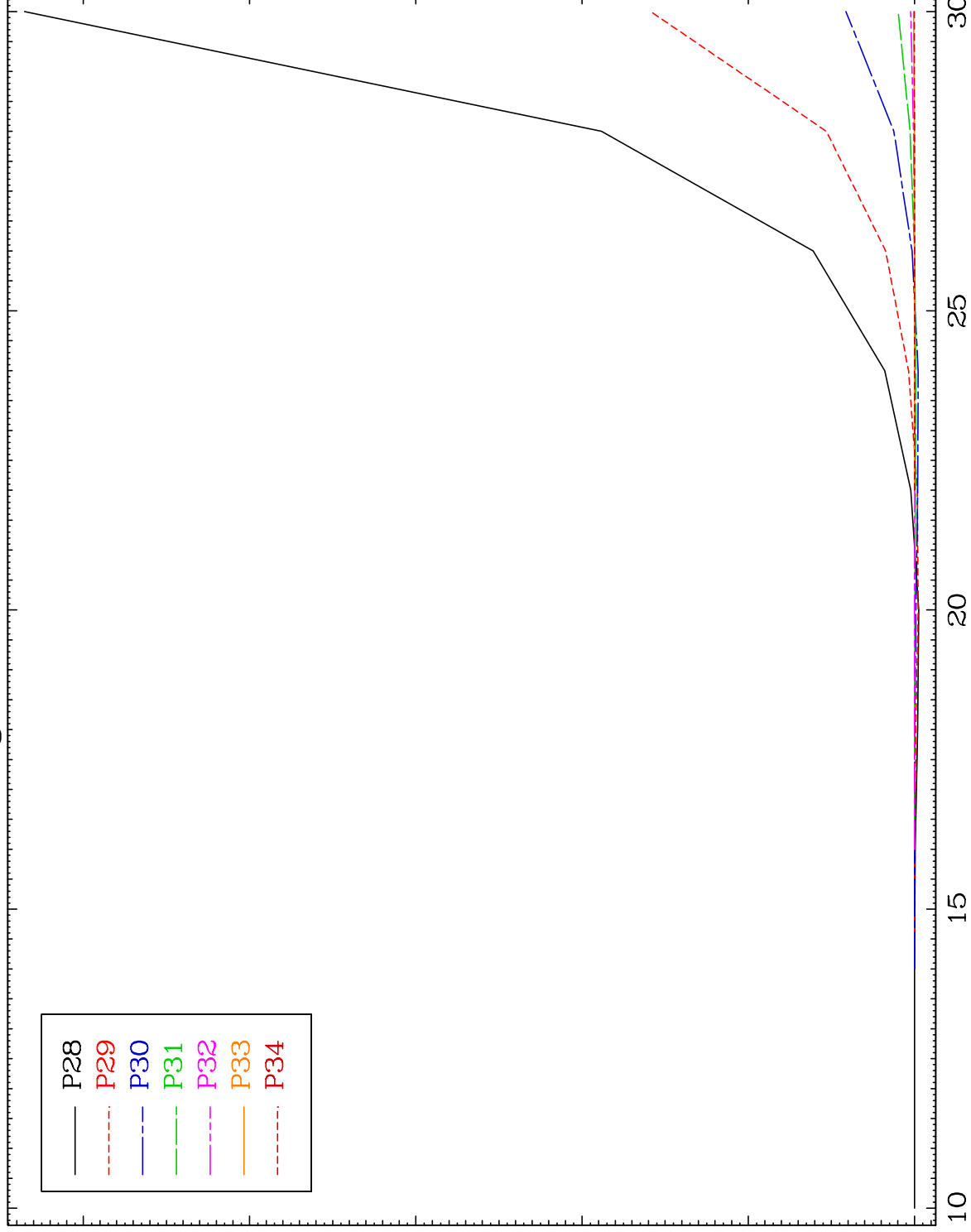

MAT 6861

MT= 51 (n,n') Level
Legendre Coefficients

68-Er-174

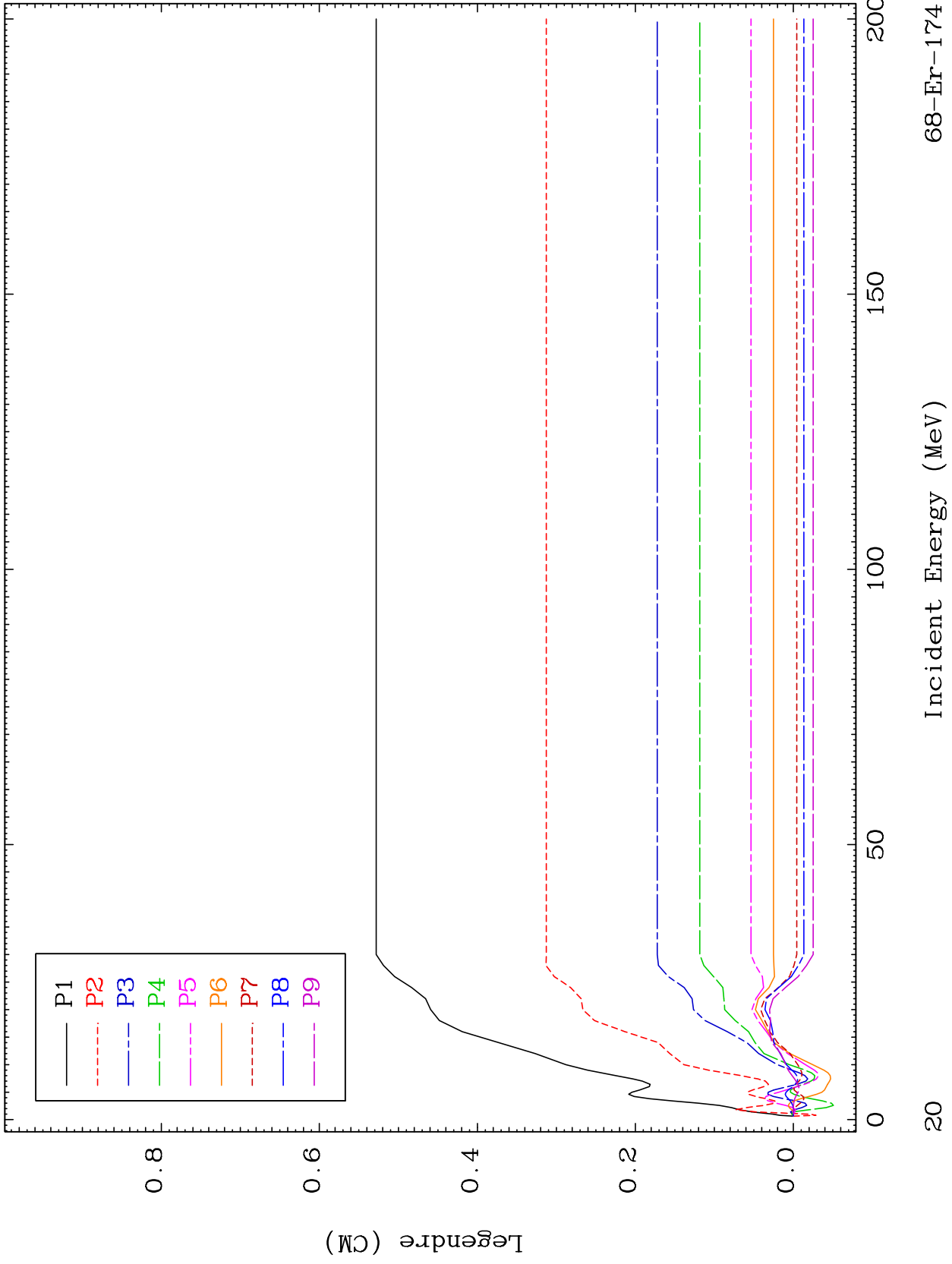

68-Er-174

Incident Energy (MeV)

0

MAT 6861

MT= 51 (n,n') Level
Legendre Coefficients

68-Er-174



21

Incident Energy (MeV)

68-Er-174

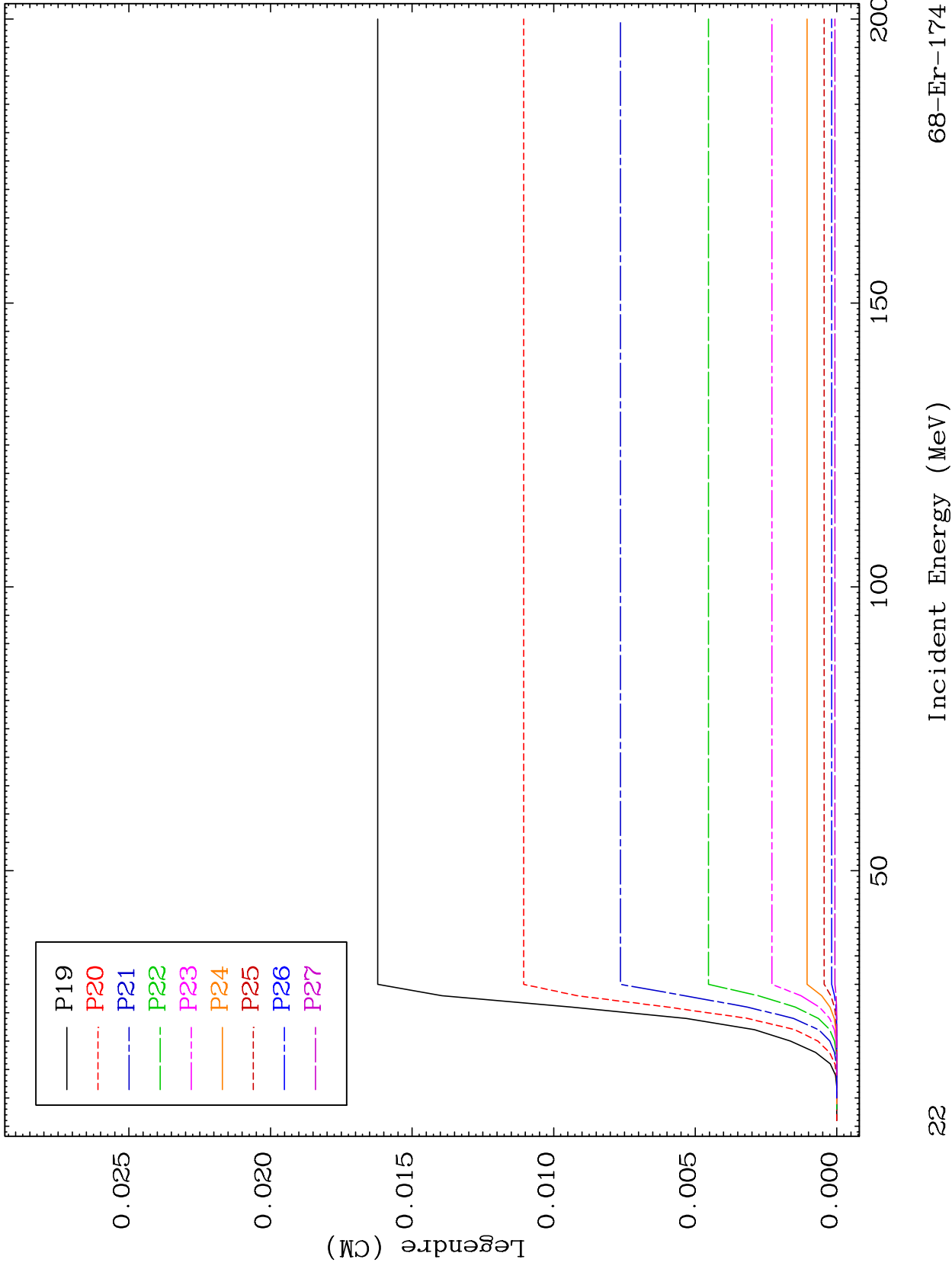

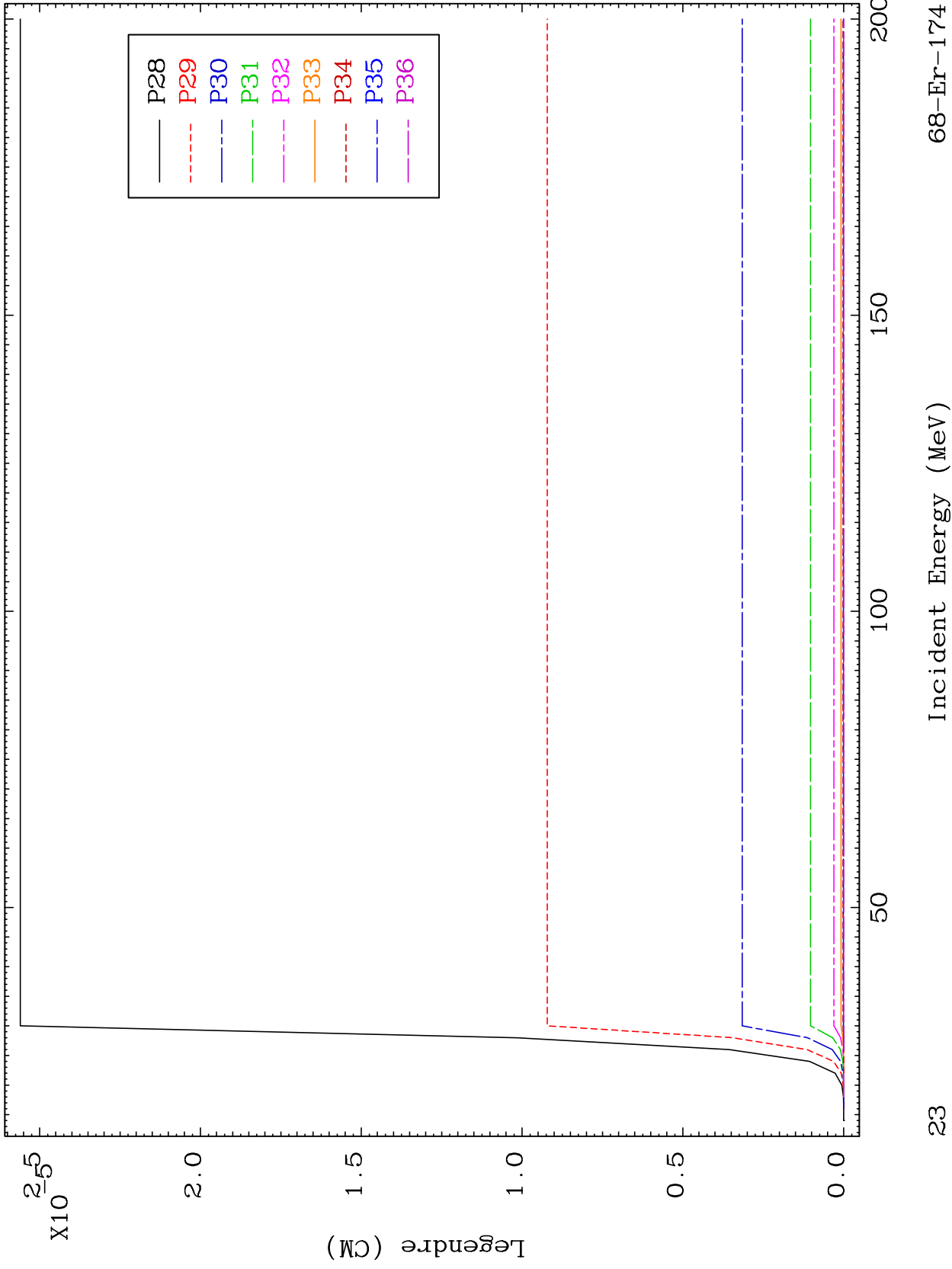

MAT 6861

MT= 52 (n,n') Level
Legendre Coefficients

68-Er-174

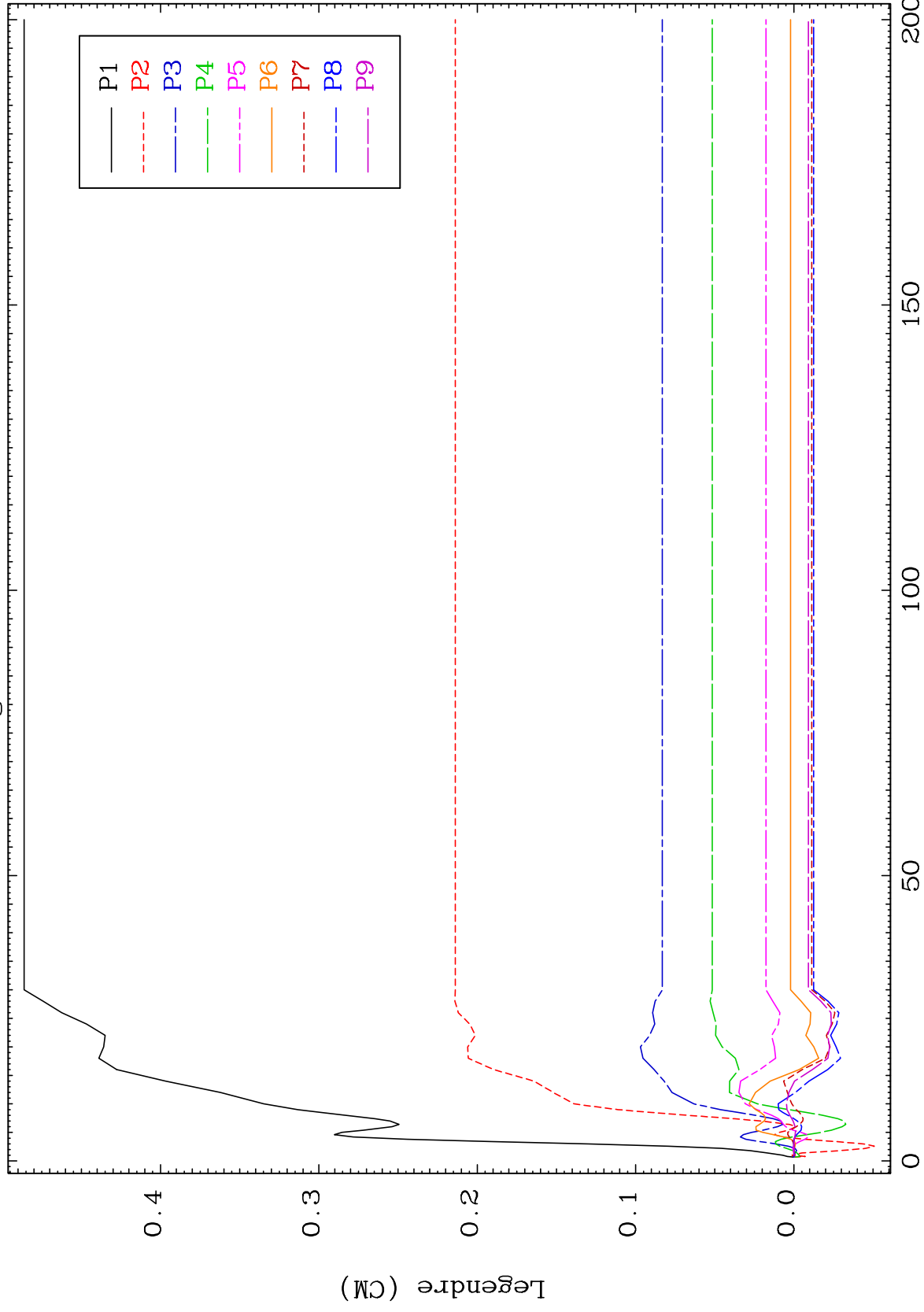

24

Incident Energy (MeV)

68-Er-174

MAT 6861

MT= 52 (n,n') Level
Legendre Coefficients

68-Er-174

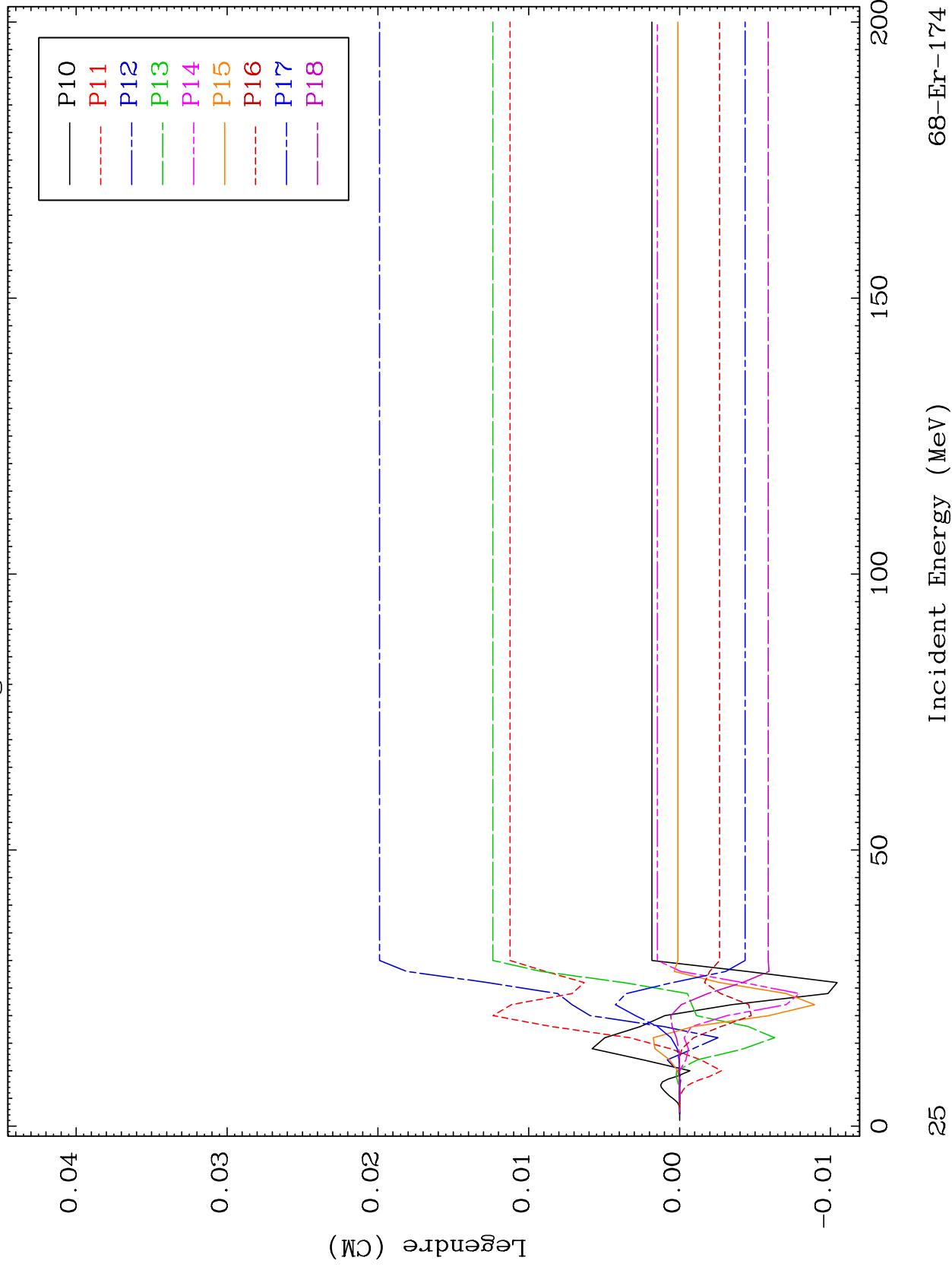

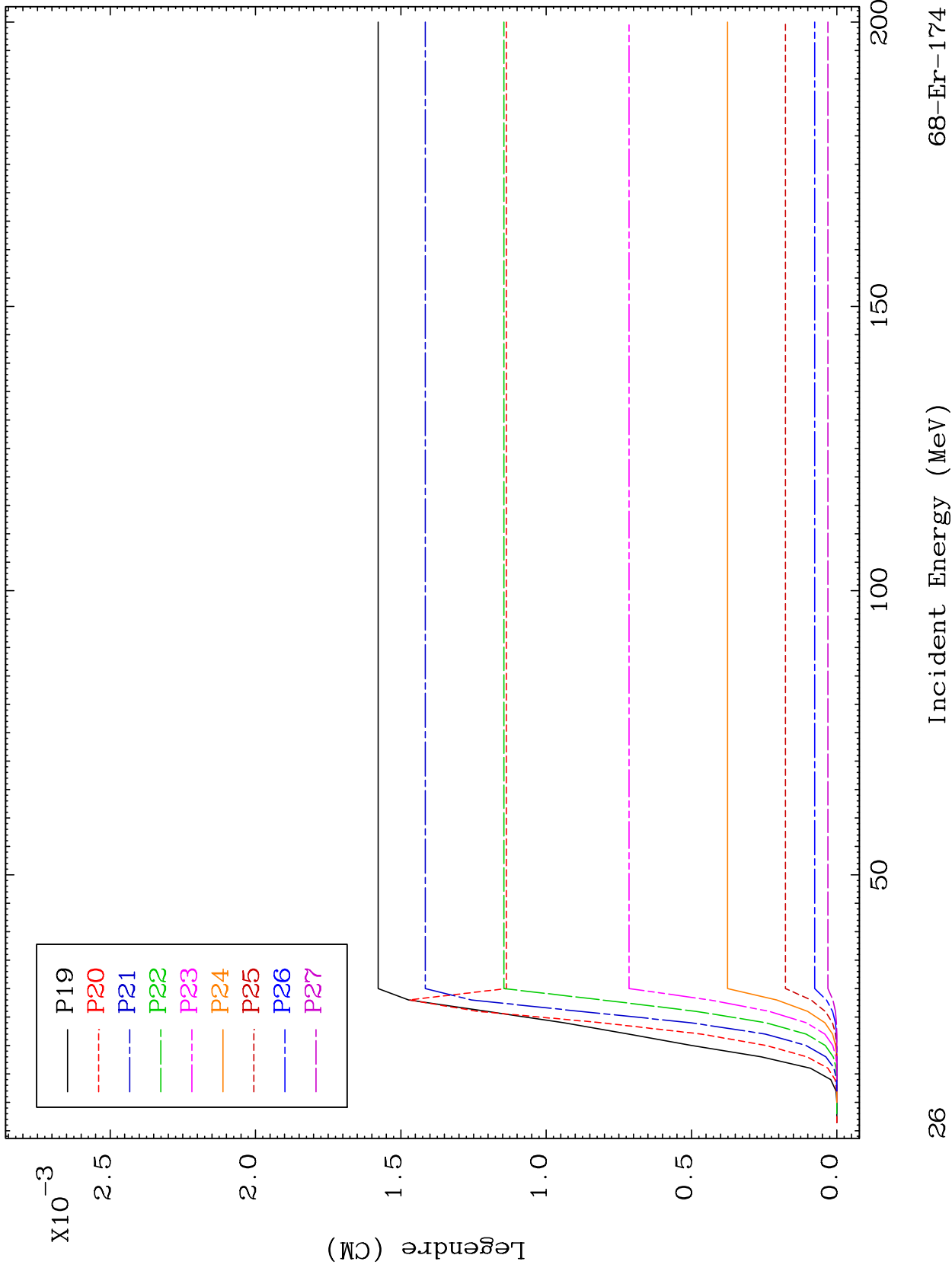

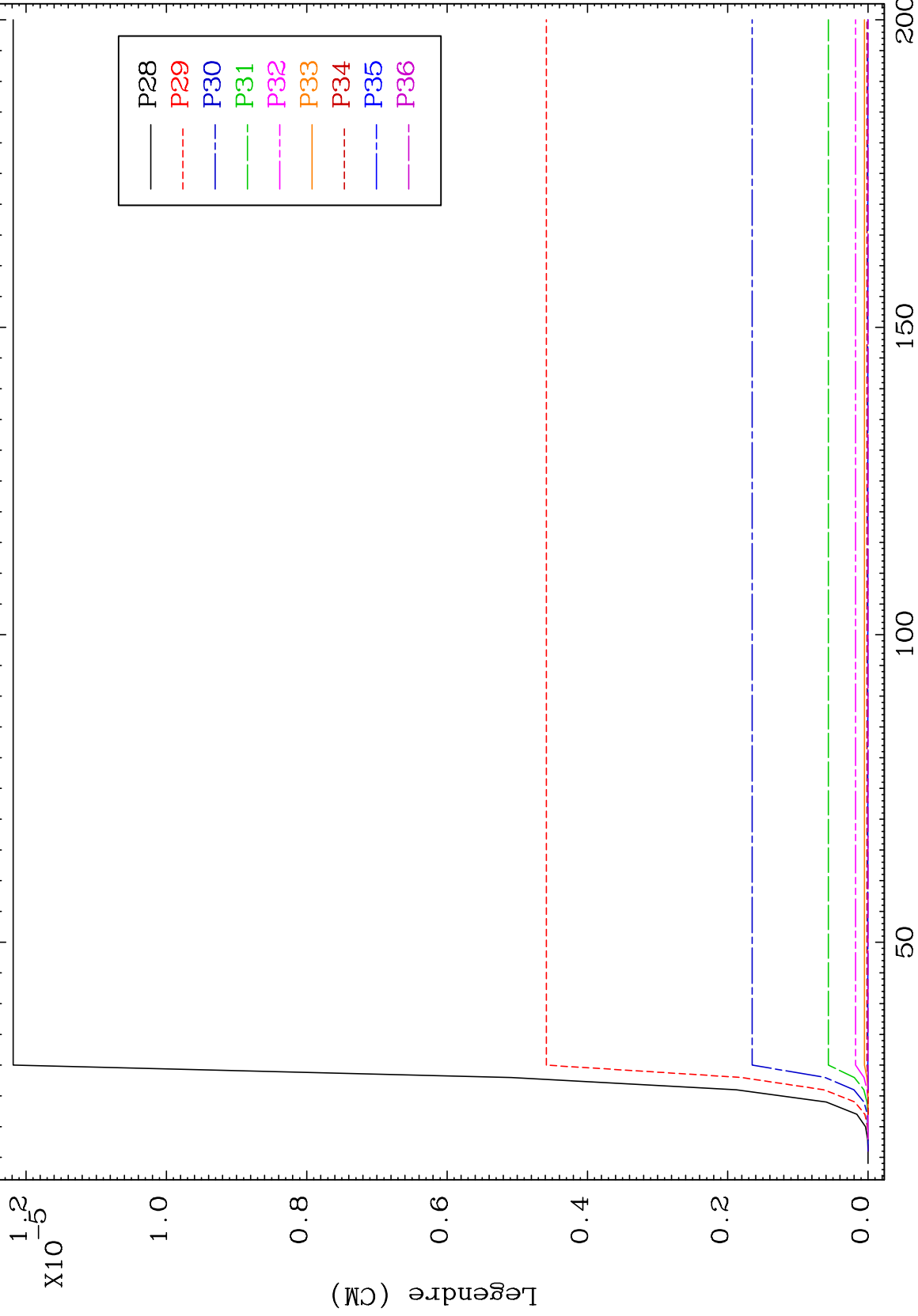

MAT 6861

MT= 53 (n,n') Level
Legendre Coefficients

68-Er-174

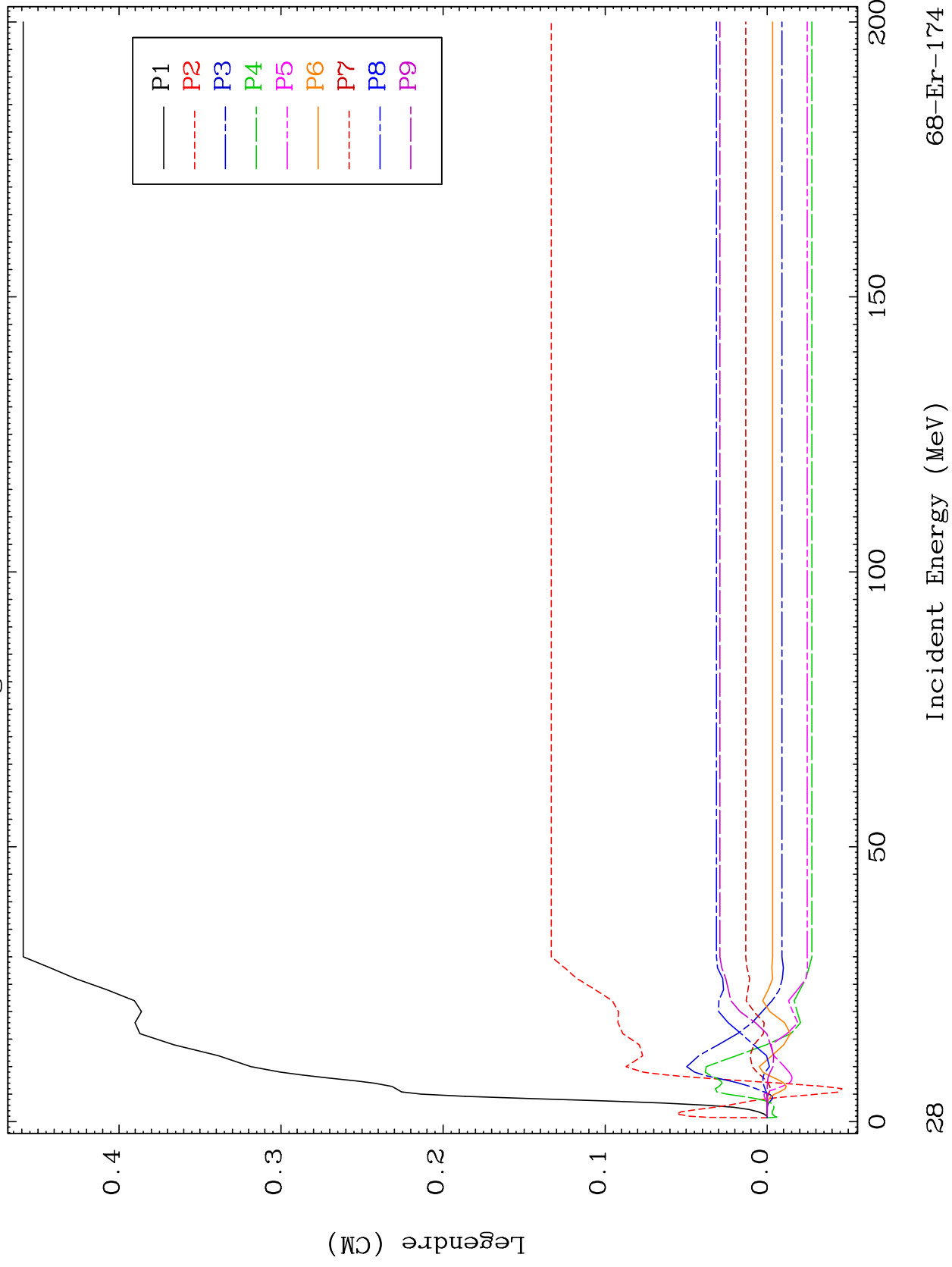

28

Incident Energy (MeV)

68-Er-174

MAT 6861

MT= 53 (n,n') Level
Legendre Coefficients

68-Er-174

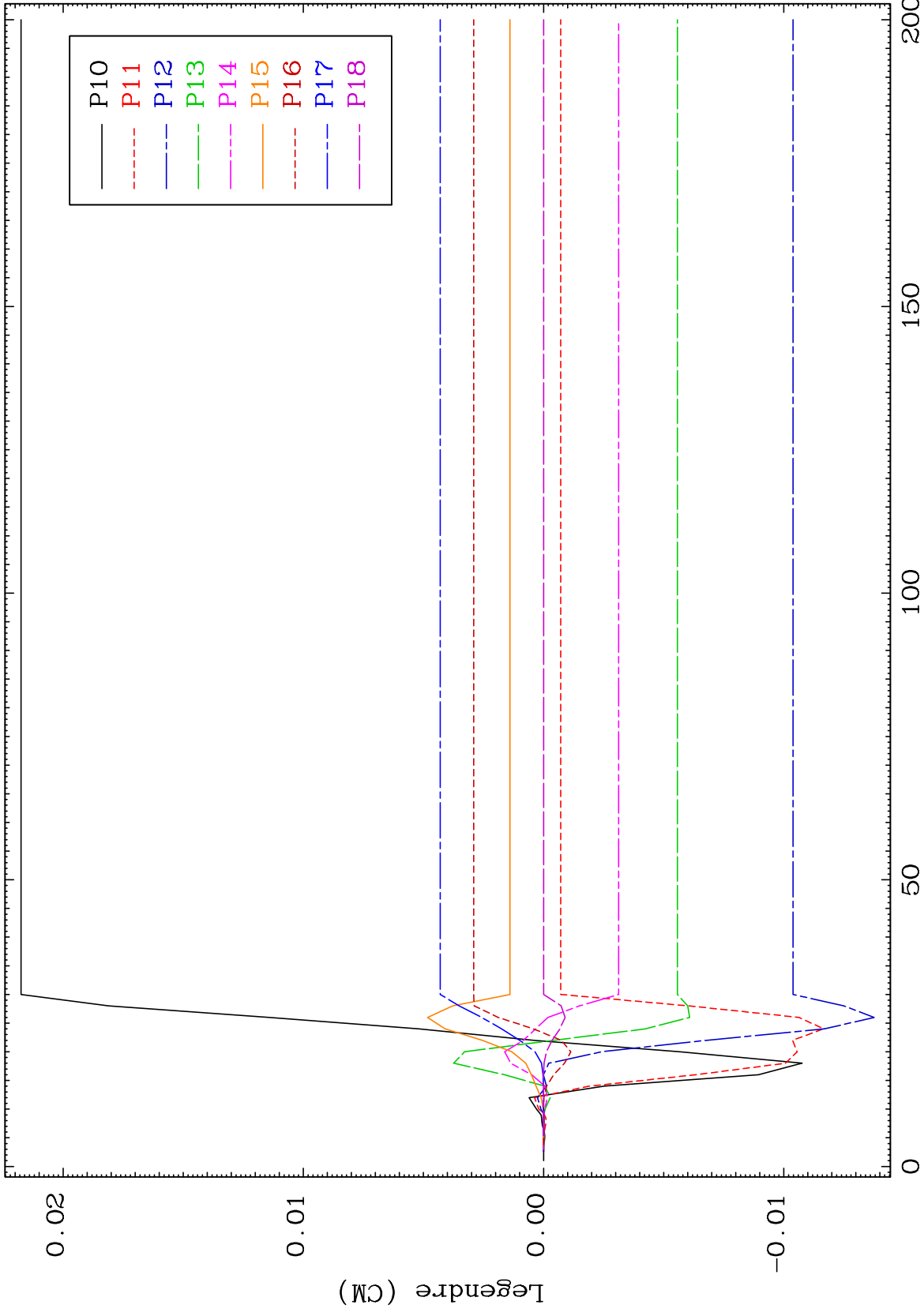

29

68-Er-174

MAT 6861

MT= 53 (n,n') Level
Legendre Coefficients

68-Er-174

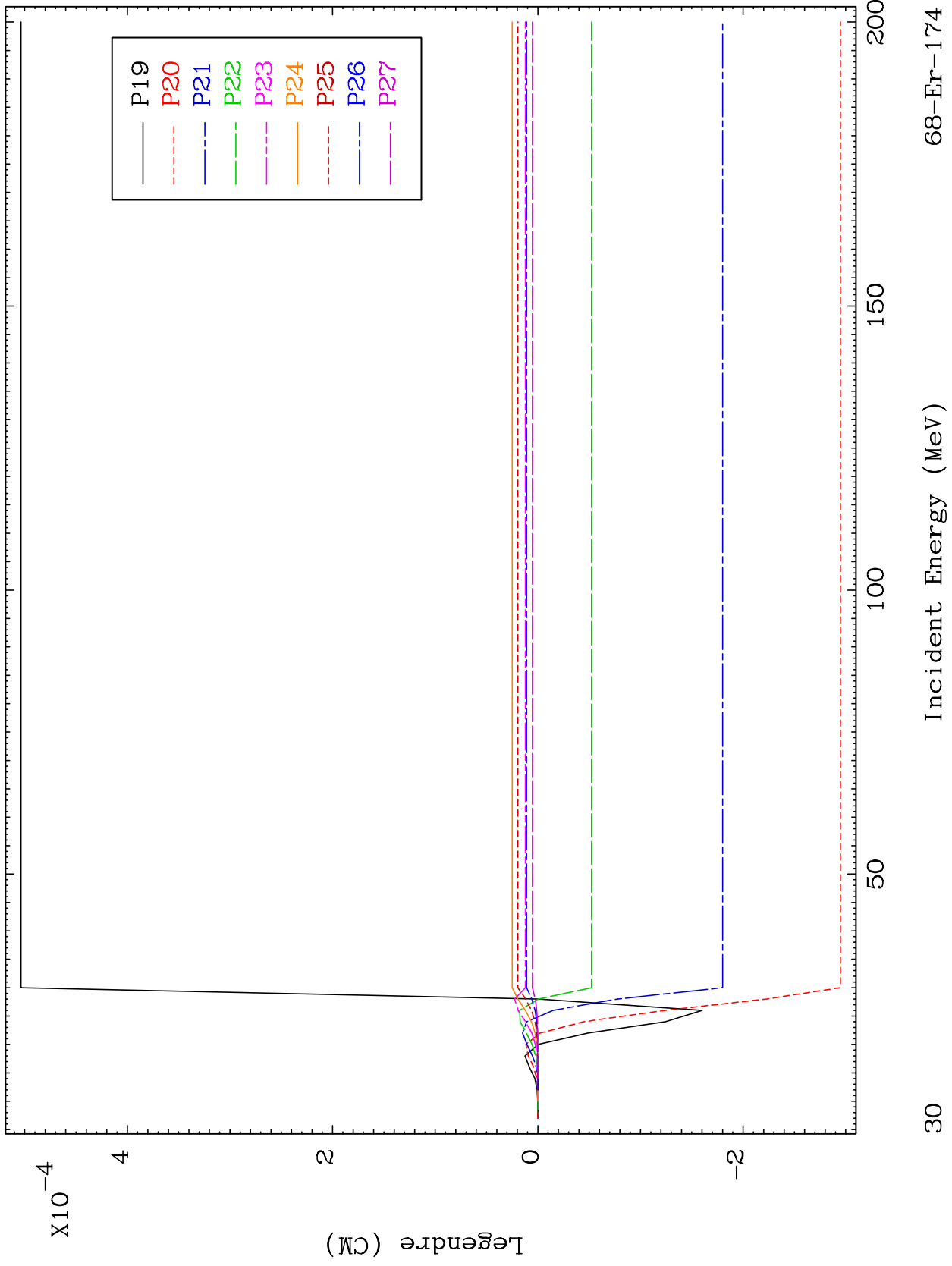

30

50

100

150

200

68-Er-174

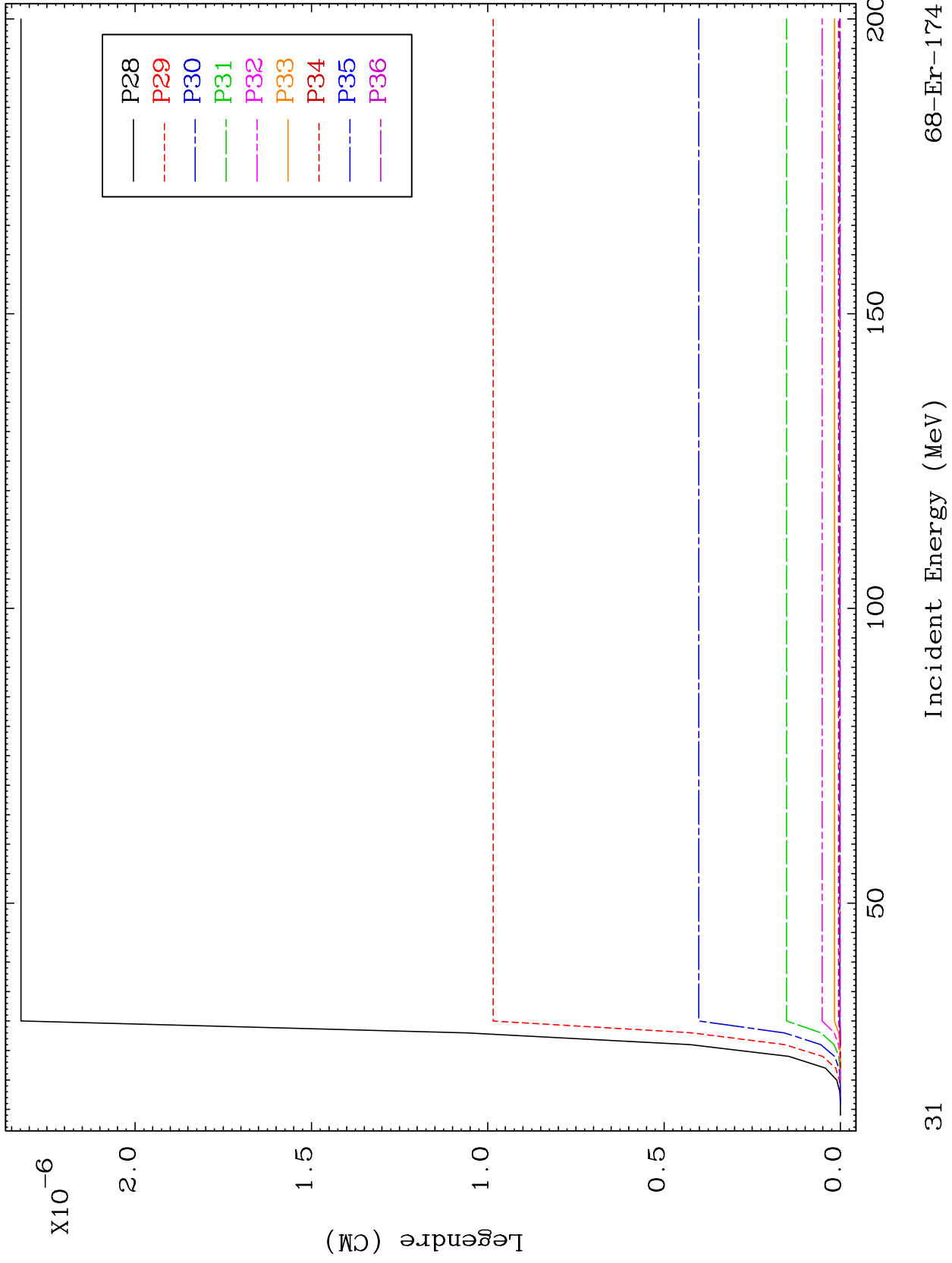

MAT 6861

MT= 54 (n,n') Level
Legendre Coefficients

68-Er-174

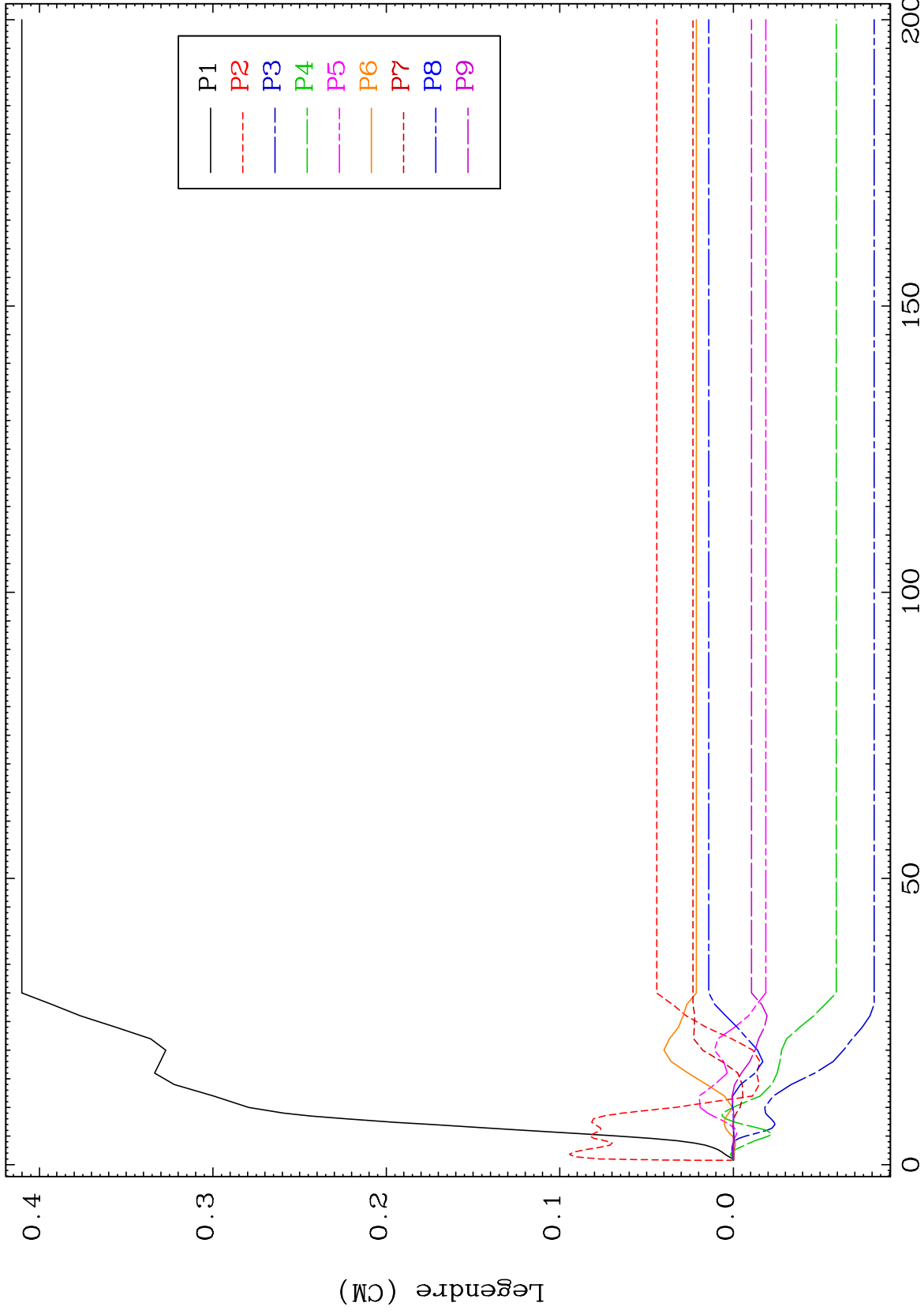

32

Incident Energy (MeV)

68-Er-174

MAT 6861

MT= 54 (n,n') Level
Legendre Coefficients

68-Er-174

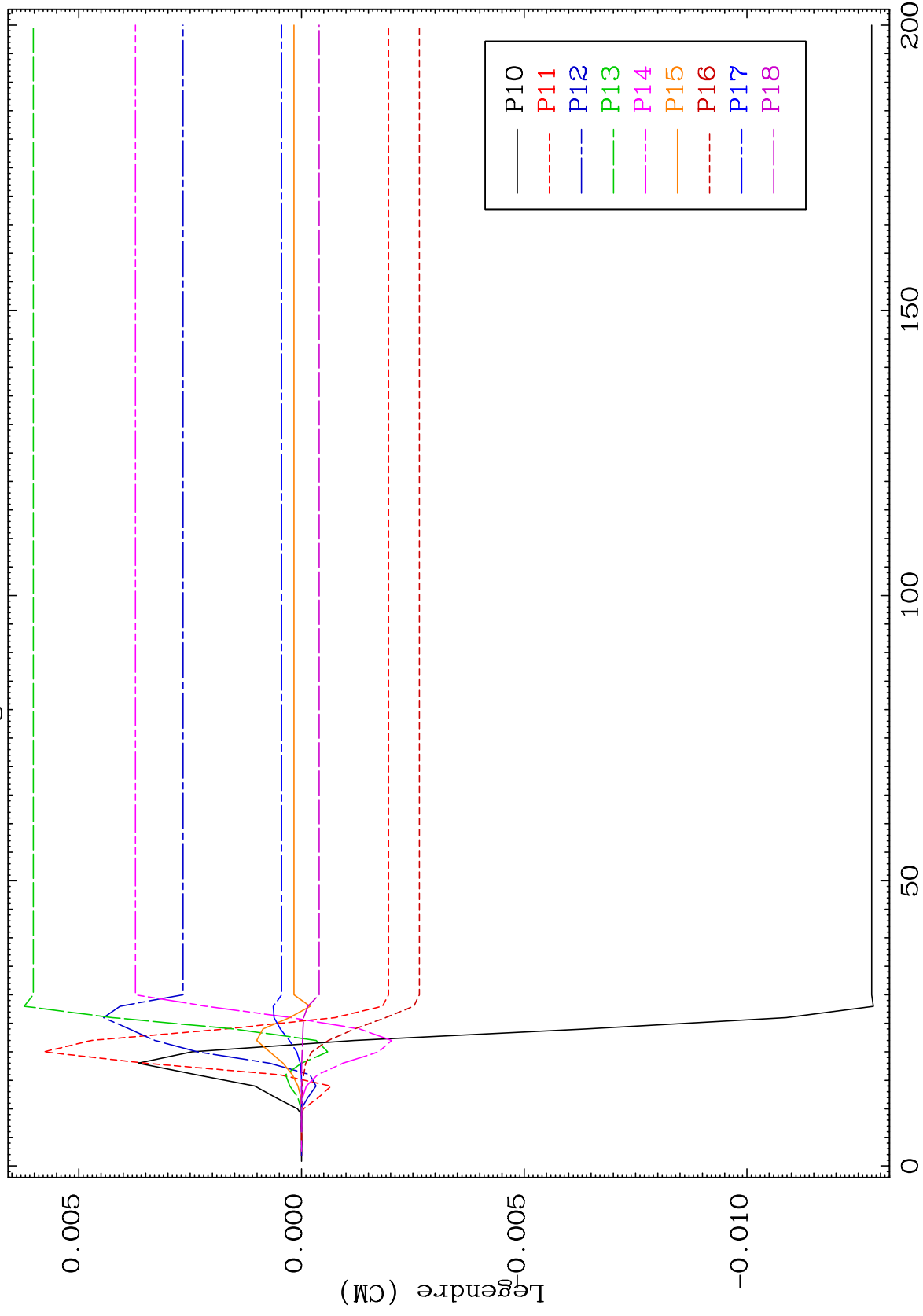

33

Incident Energy (MeV)

68-Er-174

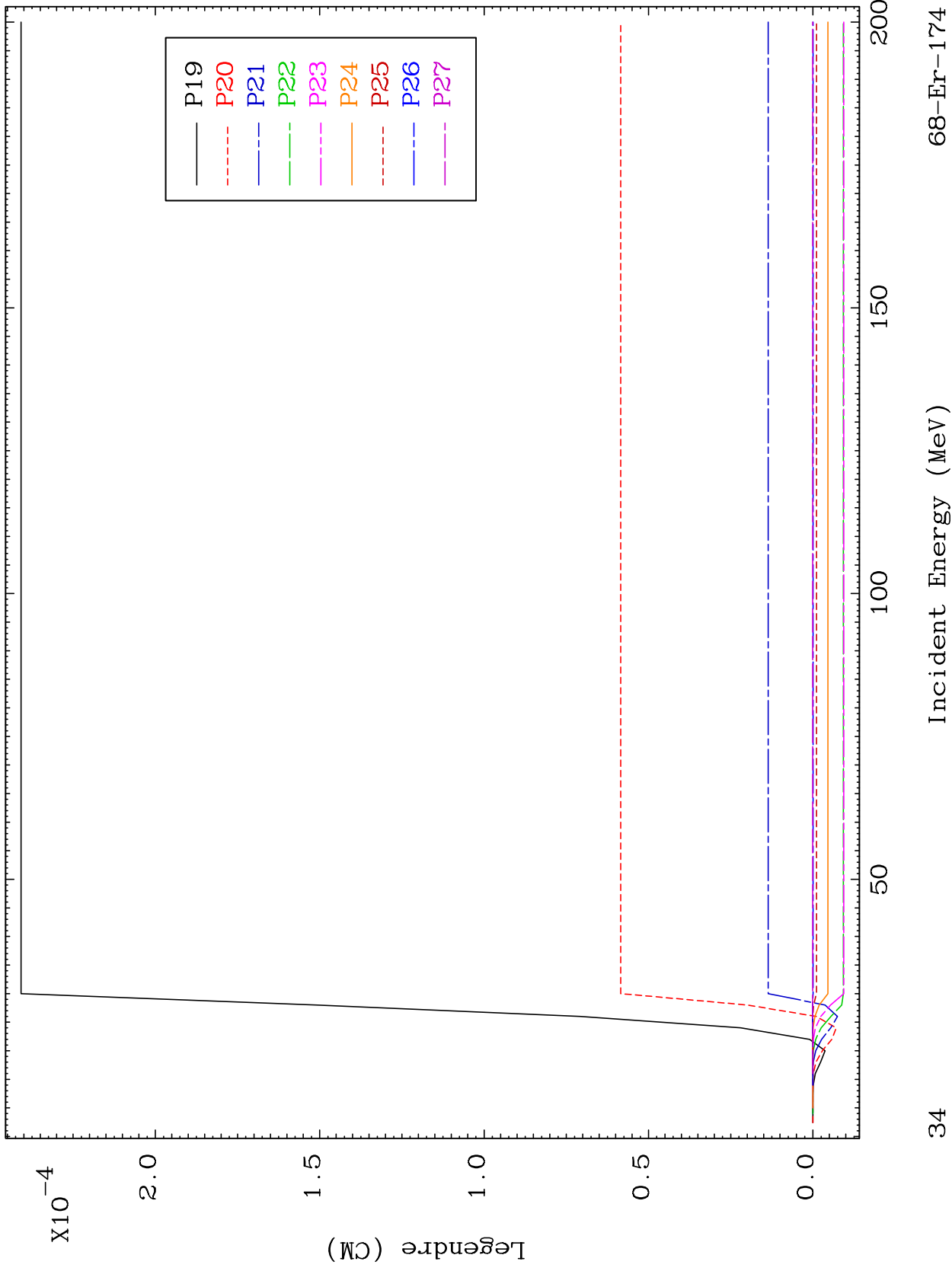

MAT 6861

MT= 54 (n,n') Level
Legendre Coefficients

68-Er-174

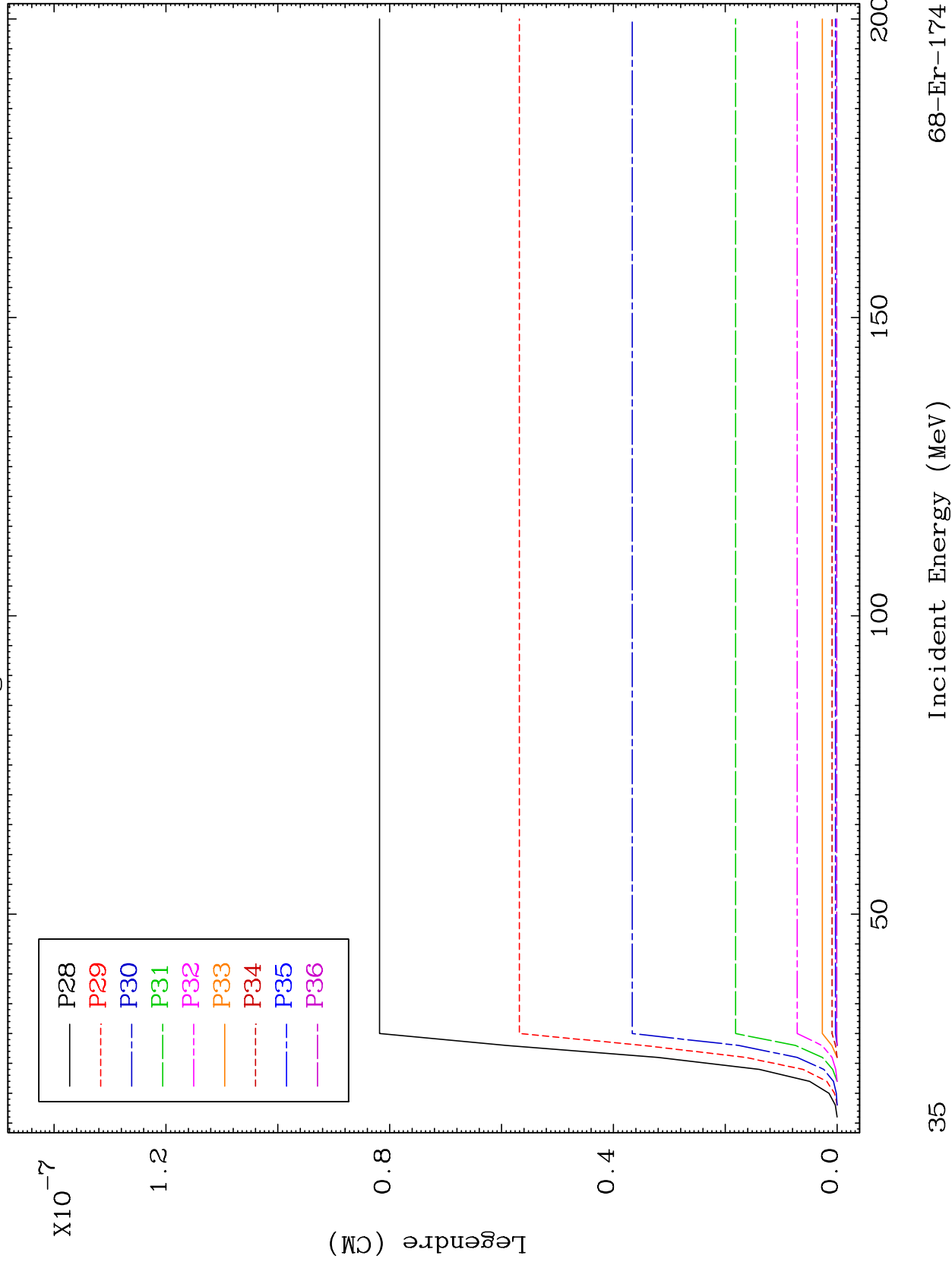

35

Incident Energy (MeV)

68-Er-174

MAT 6861

MT= 55 (n,n') Level
Legendre Coefficients

68-Er-174

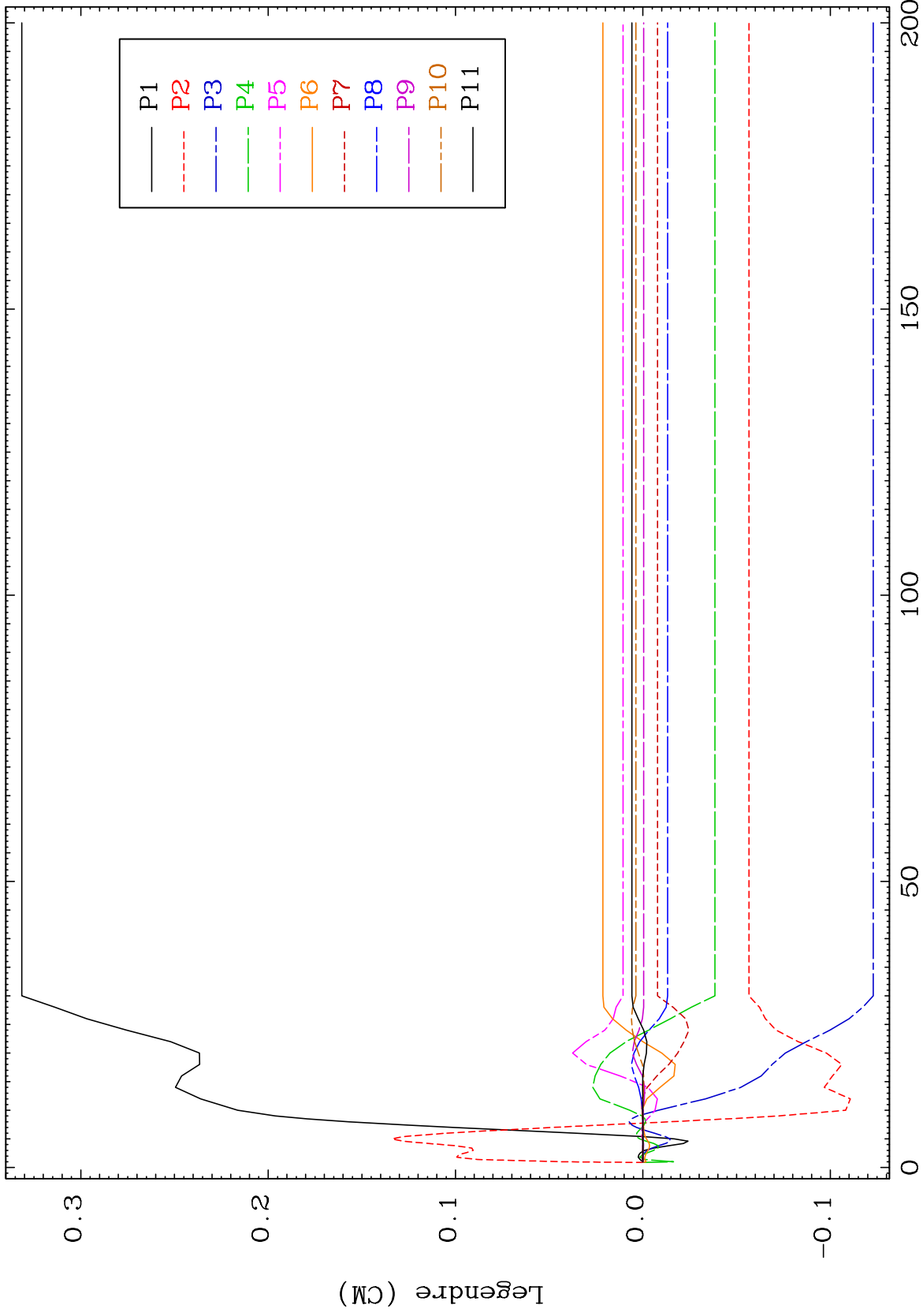

36

Incident Energy (MeV)

68-Er-174

MAT 6861

MT= 55 (n,n') Level
Legendre Coefficients

68-Er-174

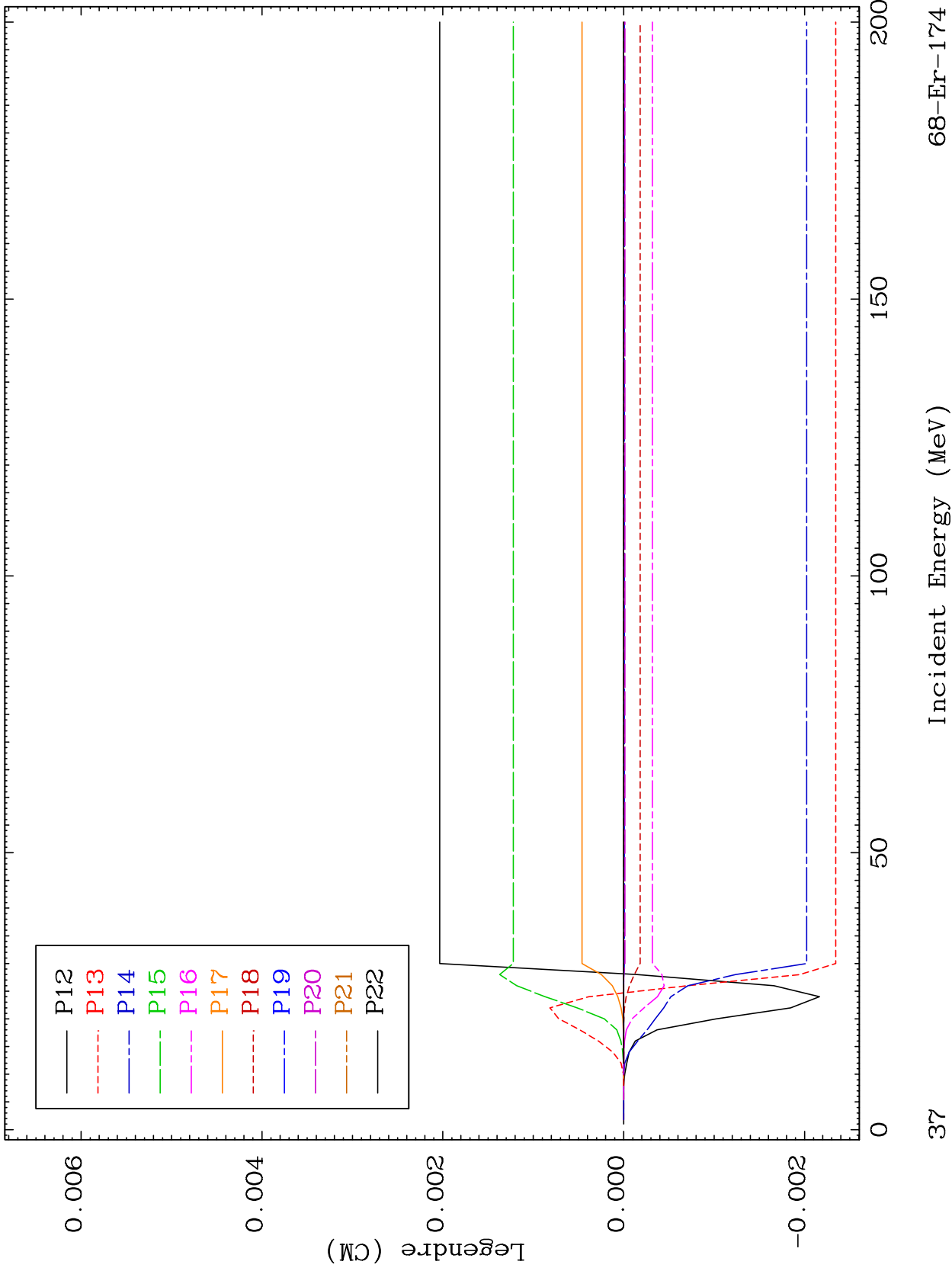

MAT 6861

MT= 55 (n,n') Level
Legendre Coefficients

68-Er-174

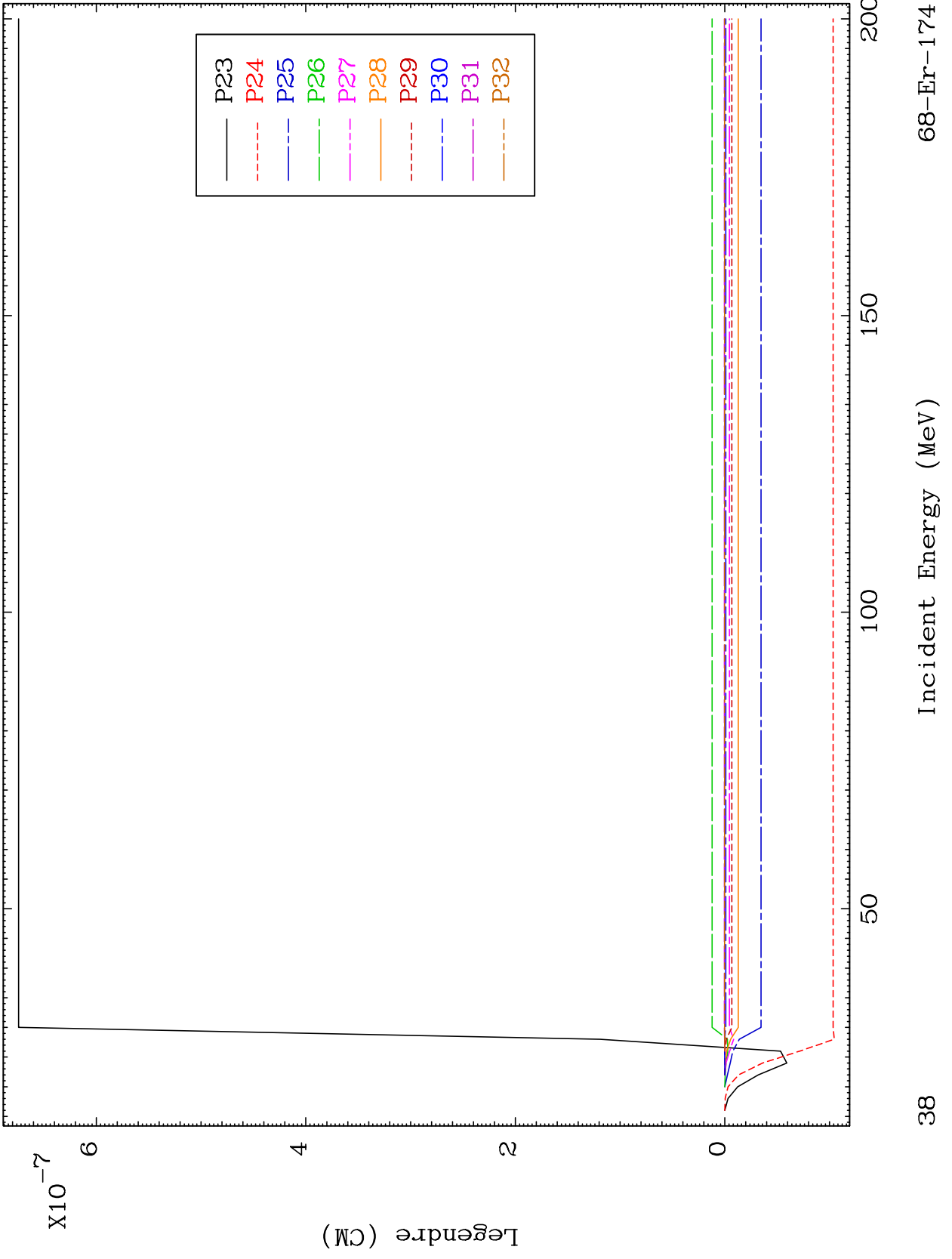

38

Incident Energy (MeV)

68-Er-174

MAT 6861

MT= 56 (n,n') Level
Legendre Coefficients

68-Er-174

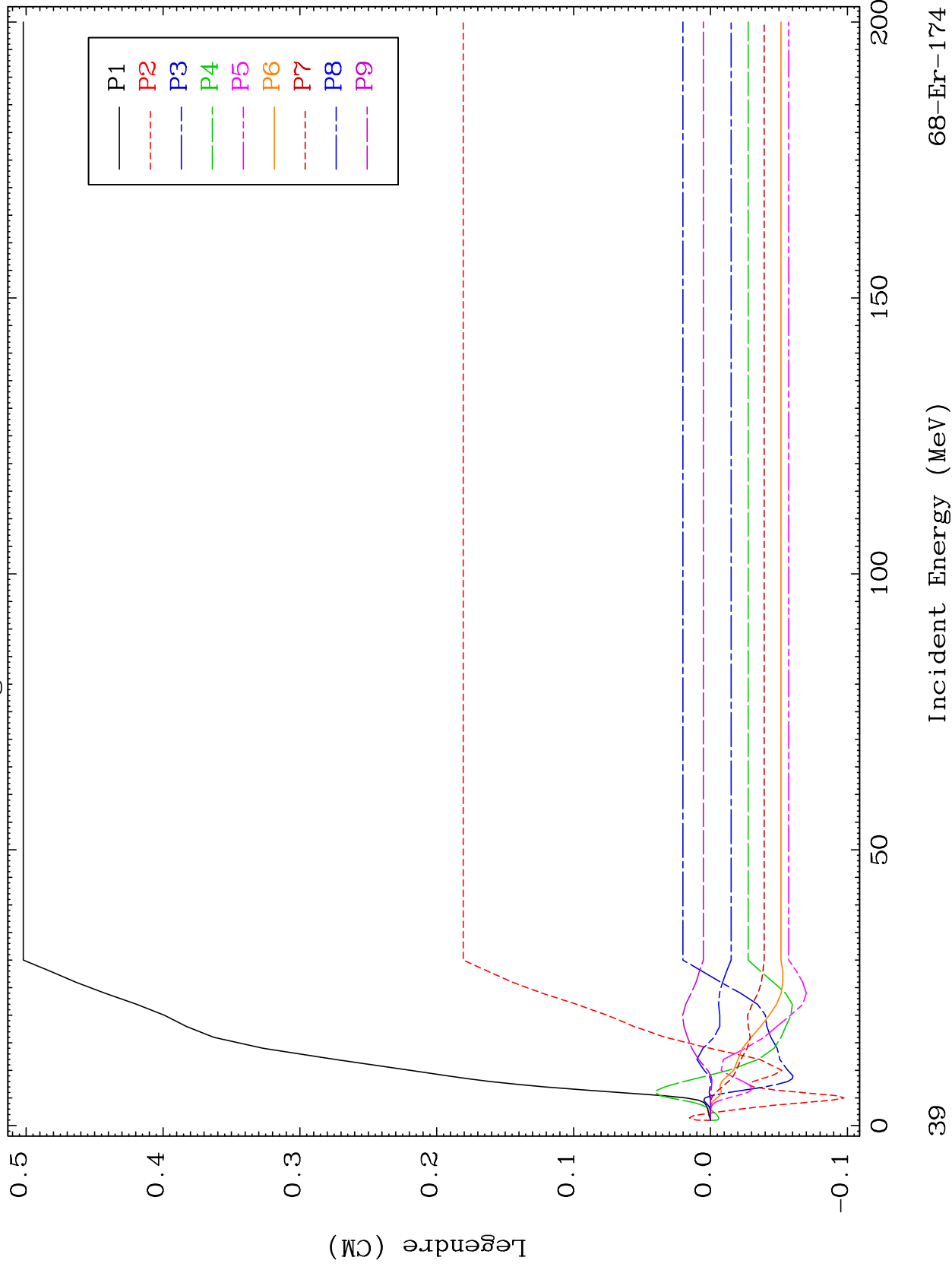

39

MAT 6861

MT= 56 (n,n') Level
Legendre Coefficients

68-Er-174

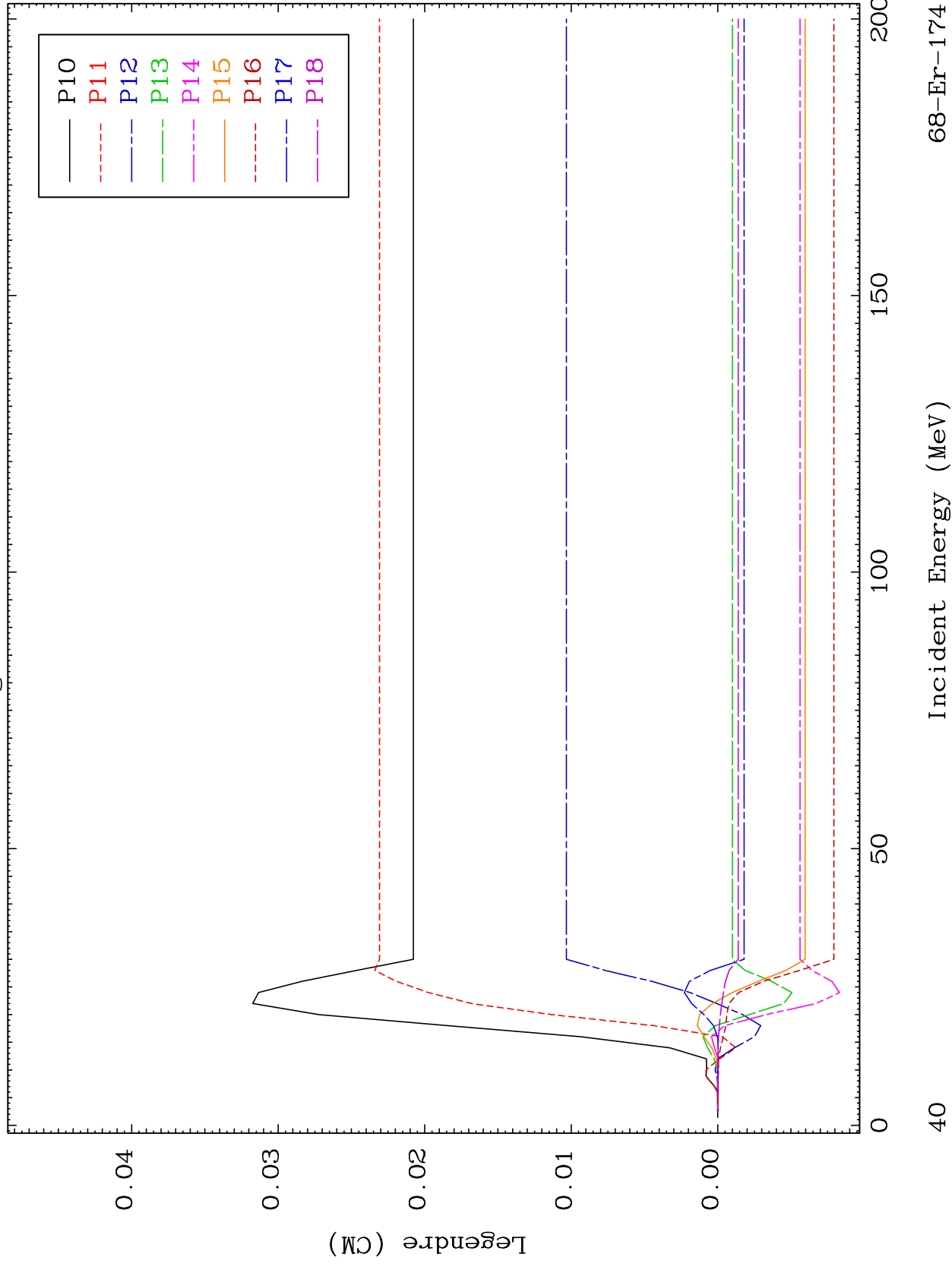

68-Er-174

Incident Energy (MeV)

40

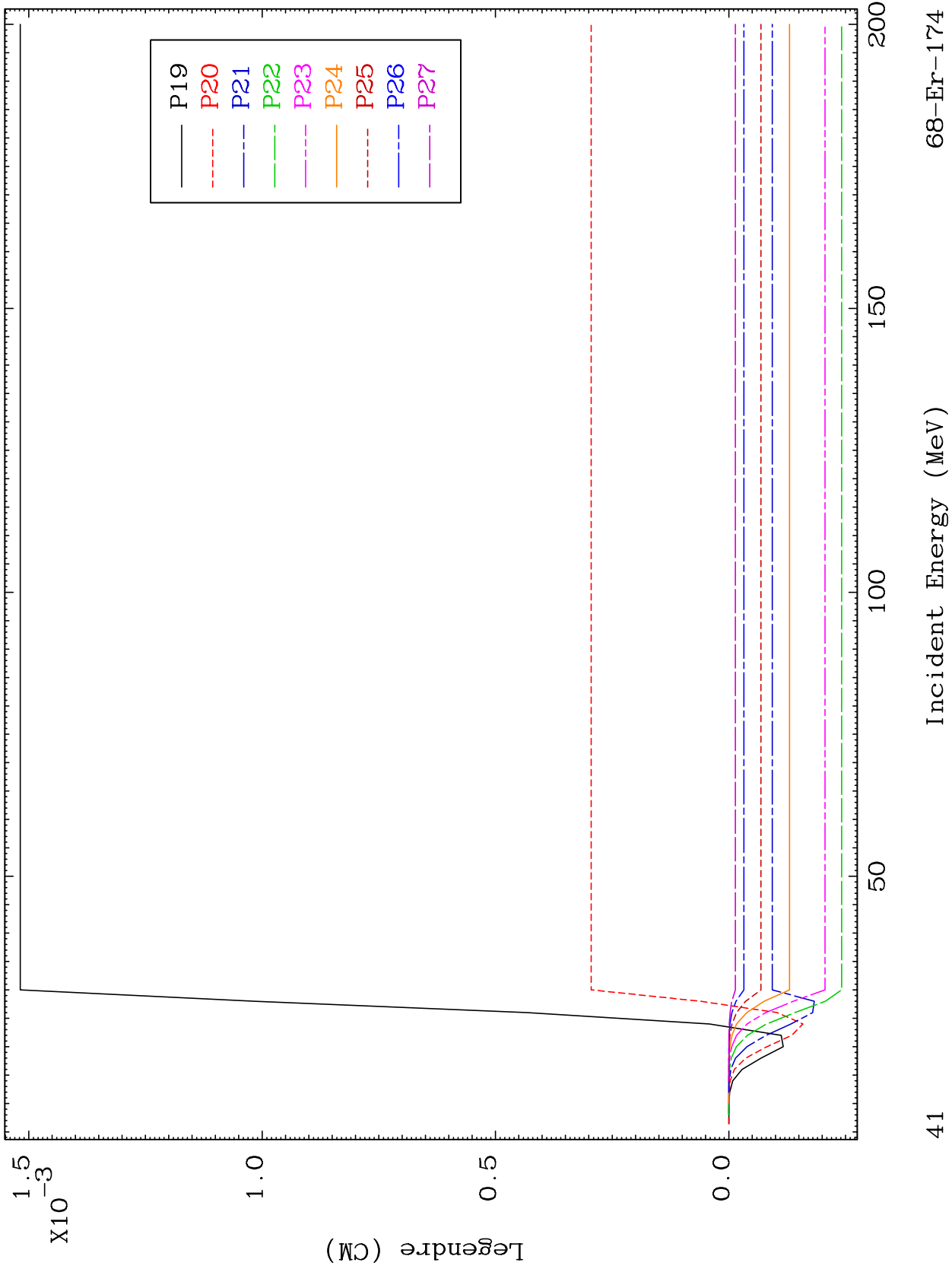

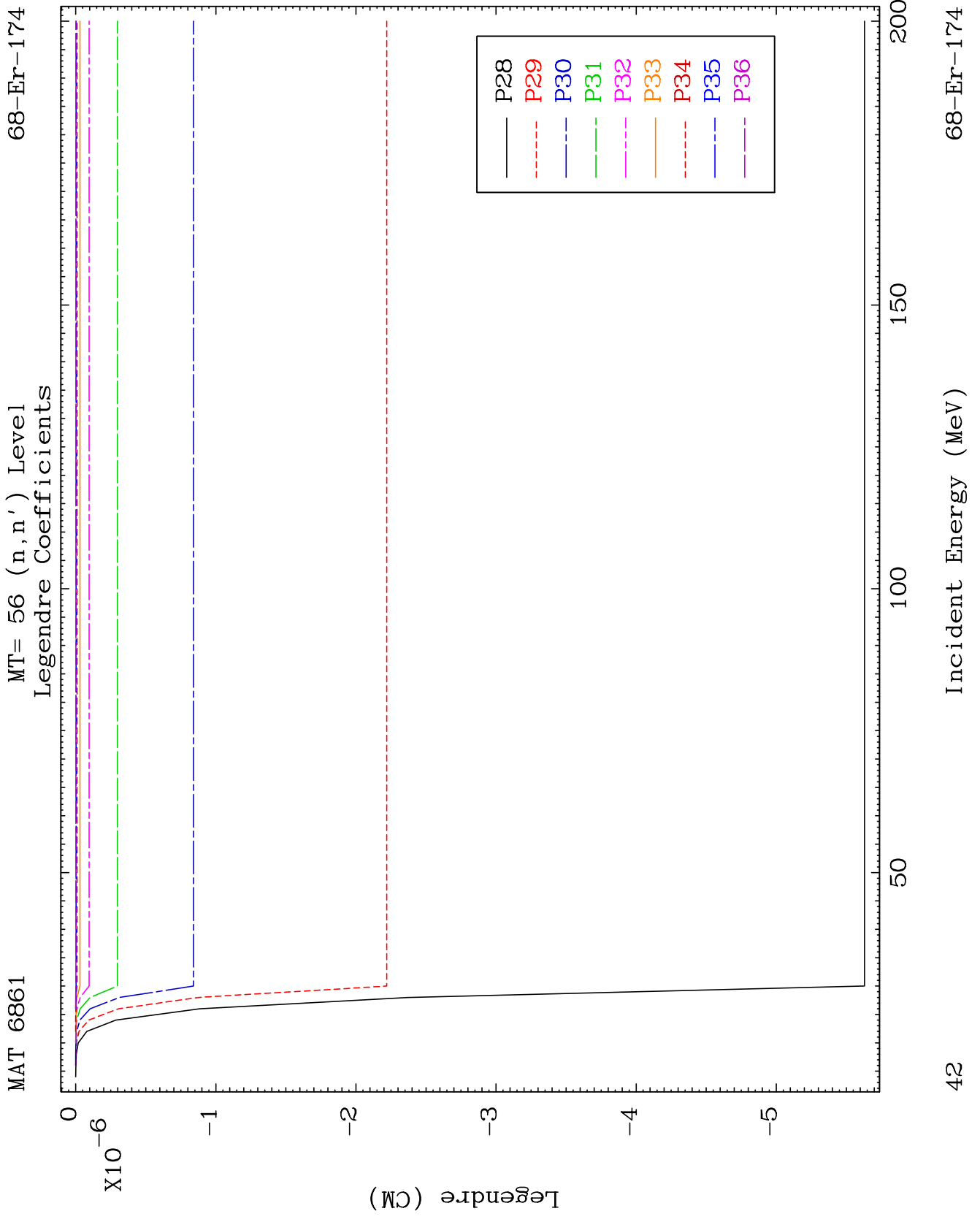

MAT 6861

MT= 57 (n,n') Level
Legendre Coefficients

68-Er-174

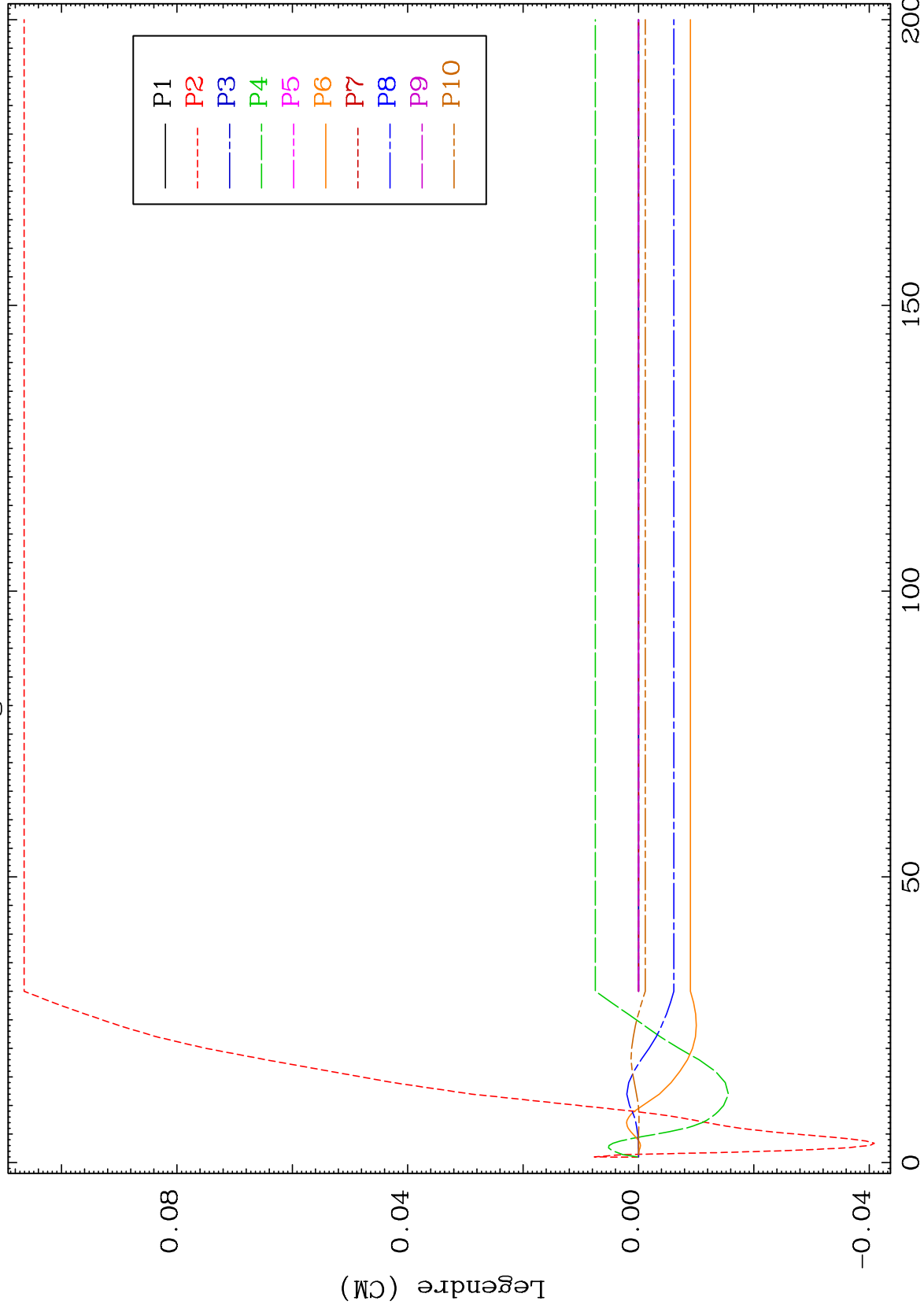

68-Er-174

Incident Energy (MeV)

43

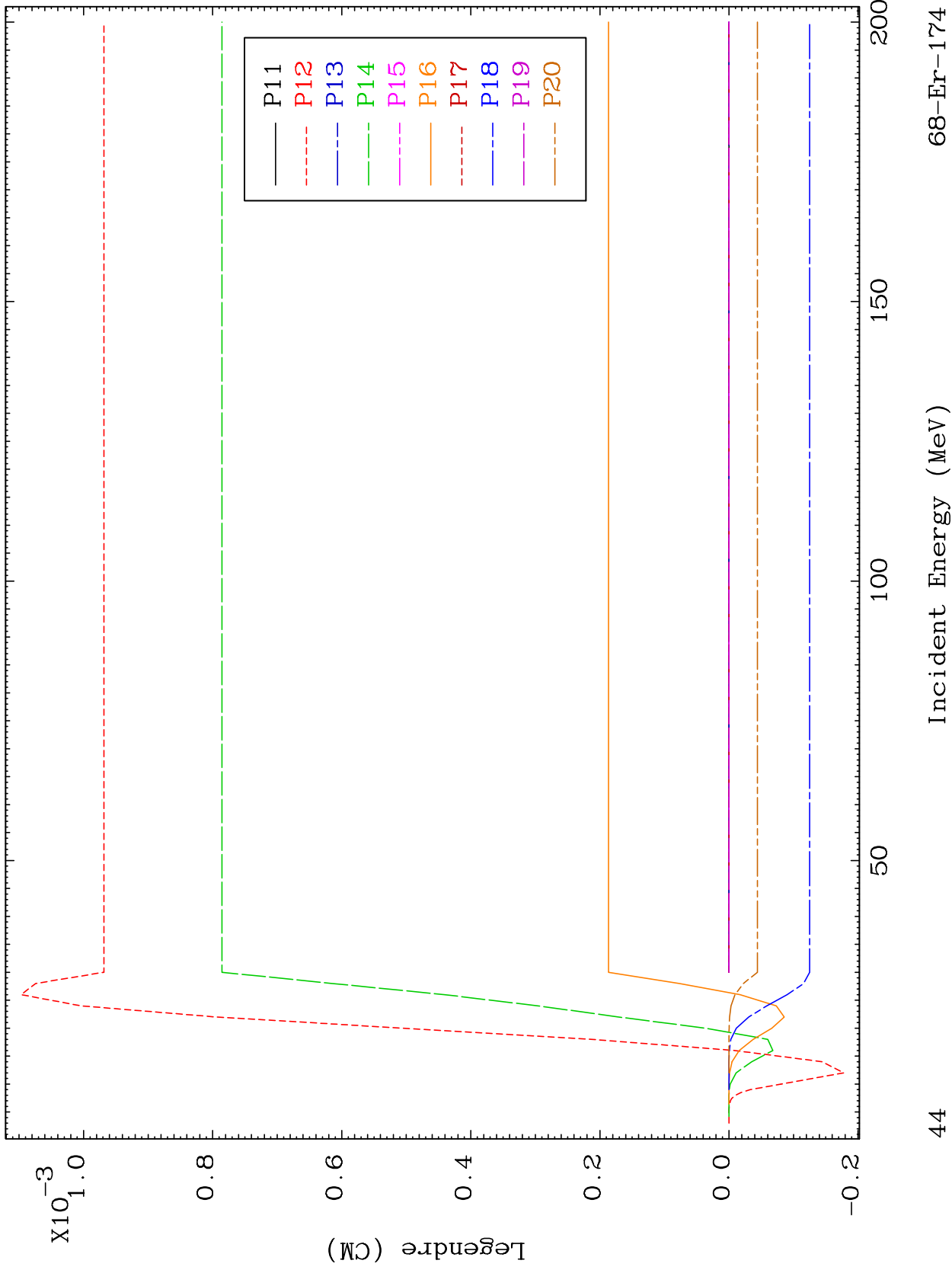

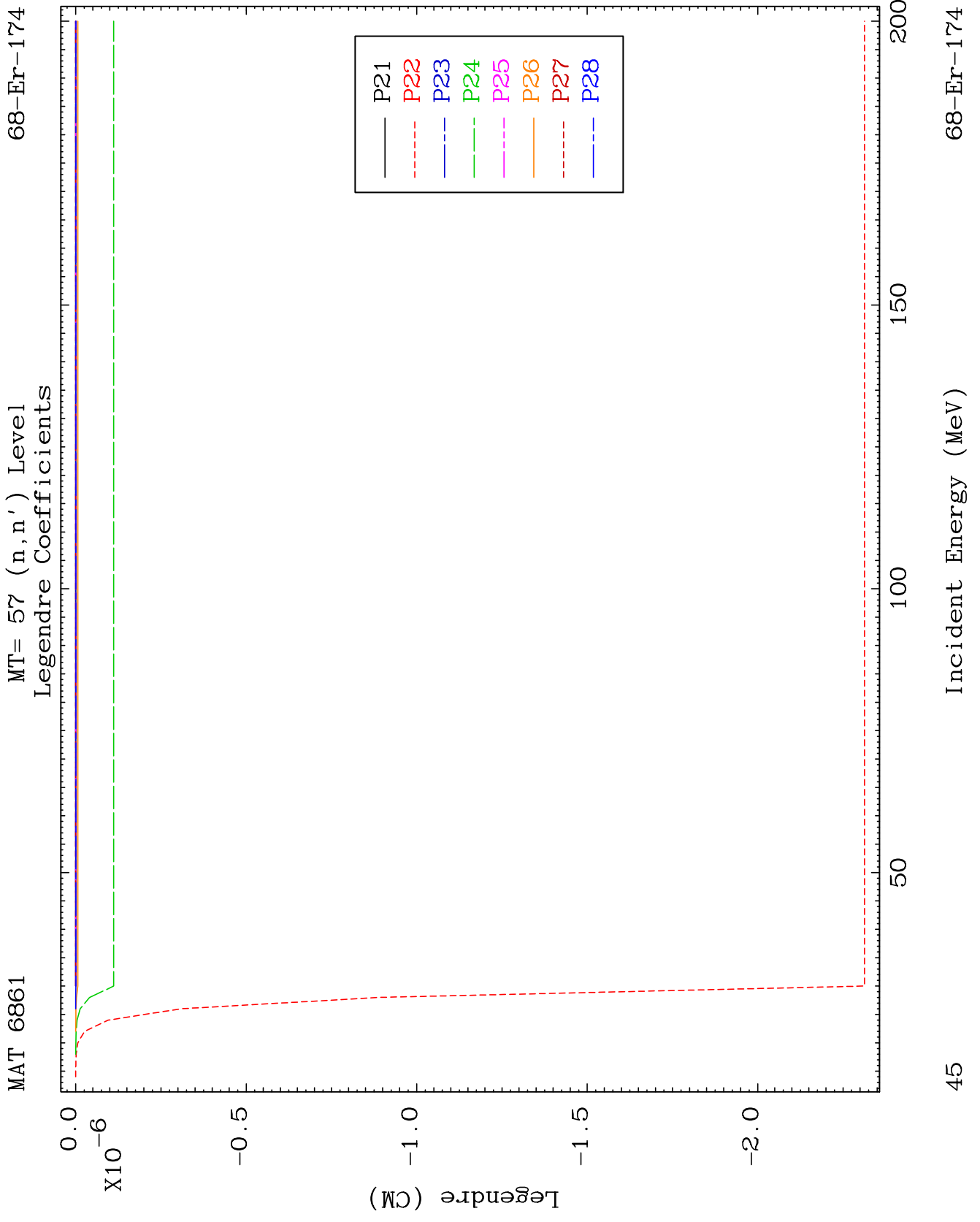

MAT 6861

MT= 58 (n,n') Level
Legendre Coefficients

68-Er-174

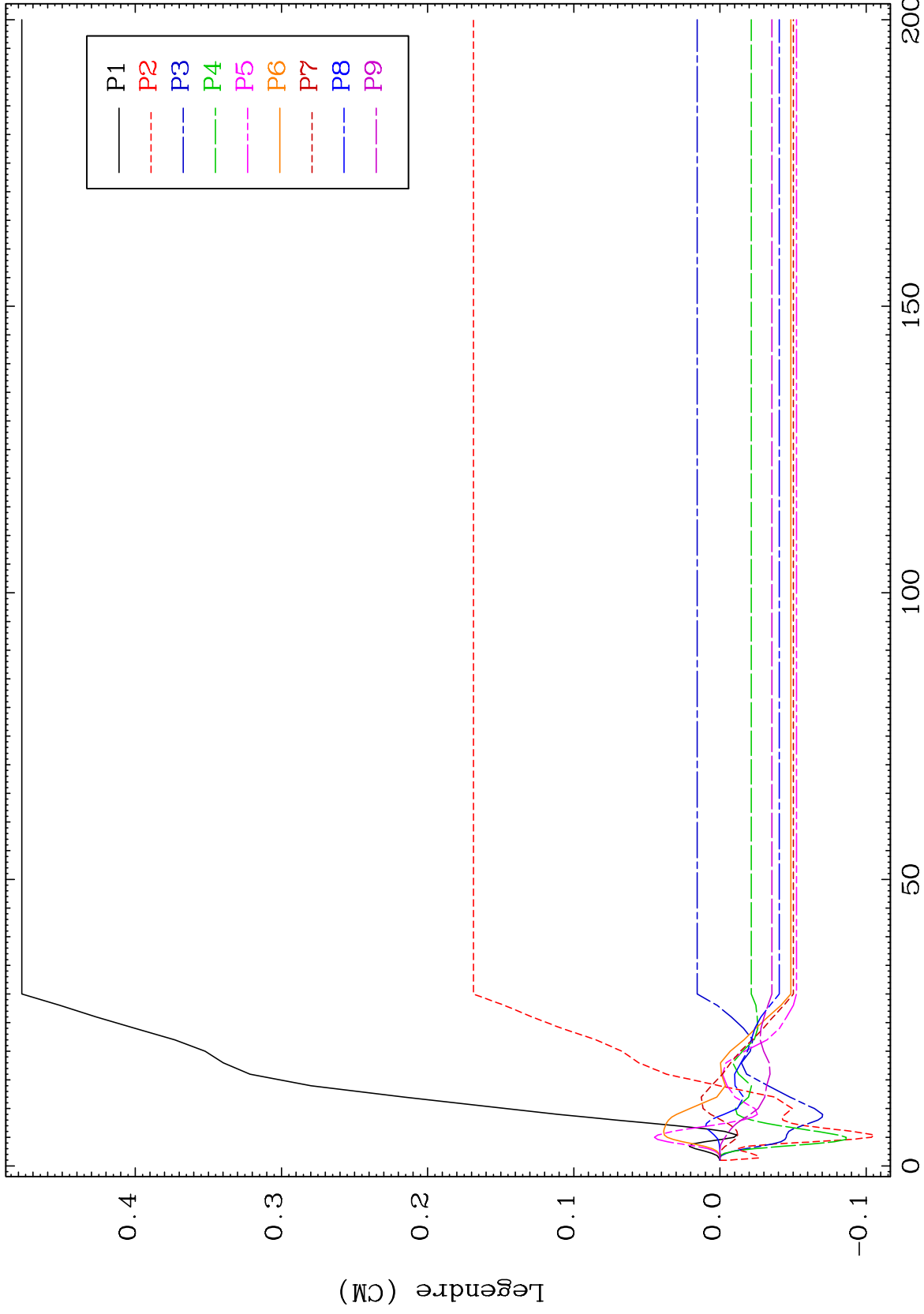

68-Er-174

Incident Energy (MeV)

46

MAT 6861

MT= 58 (n,n') Level
Legendre Coefficients

68-Er-174

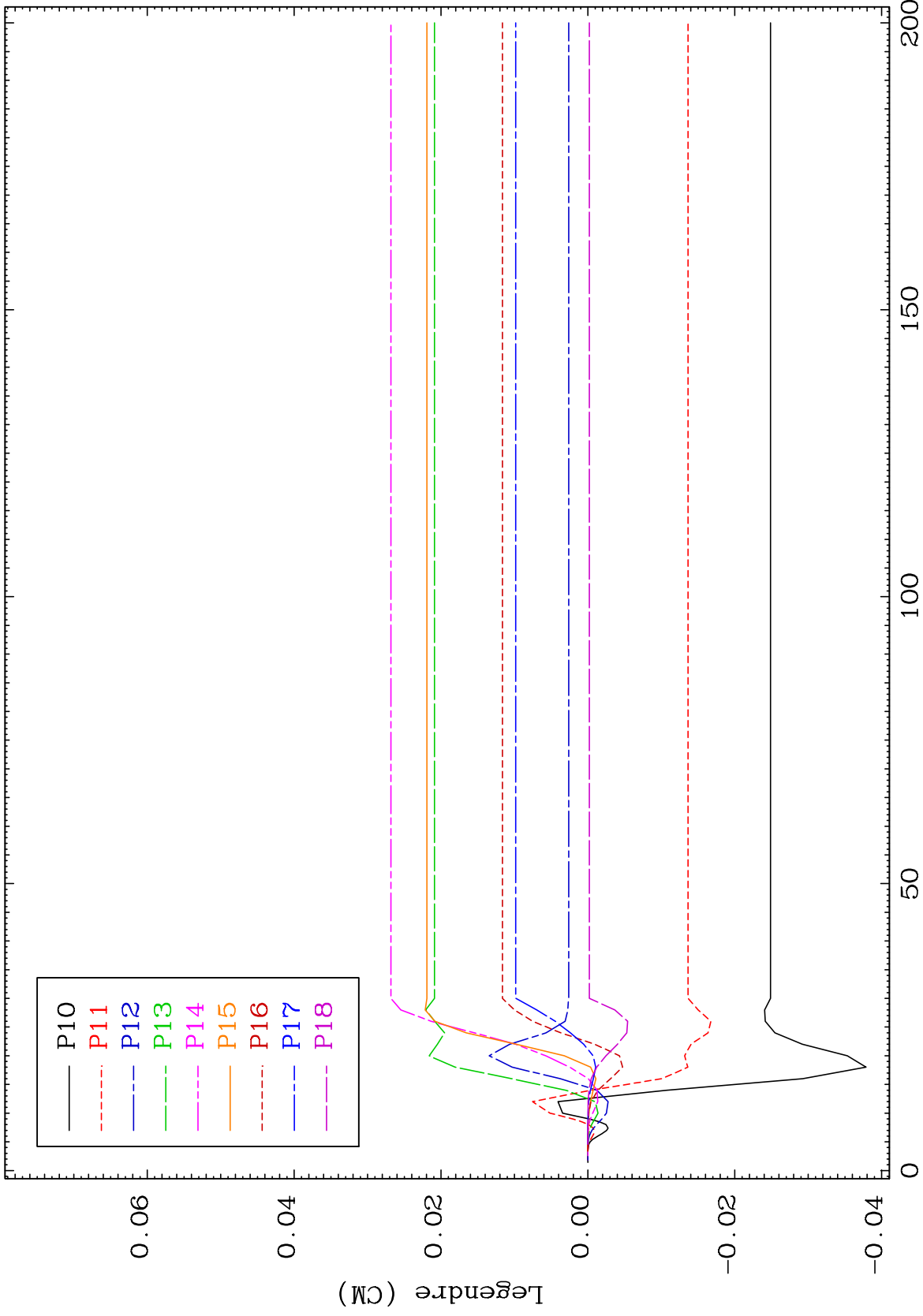

47

Incident Energy (MeV)

68-Er-174

MAT 6861

MT= 58 (n,n') Level
Legendre Coefficients

68-Er-174

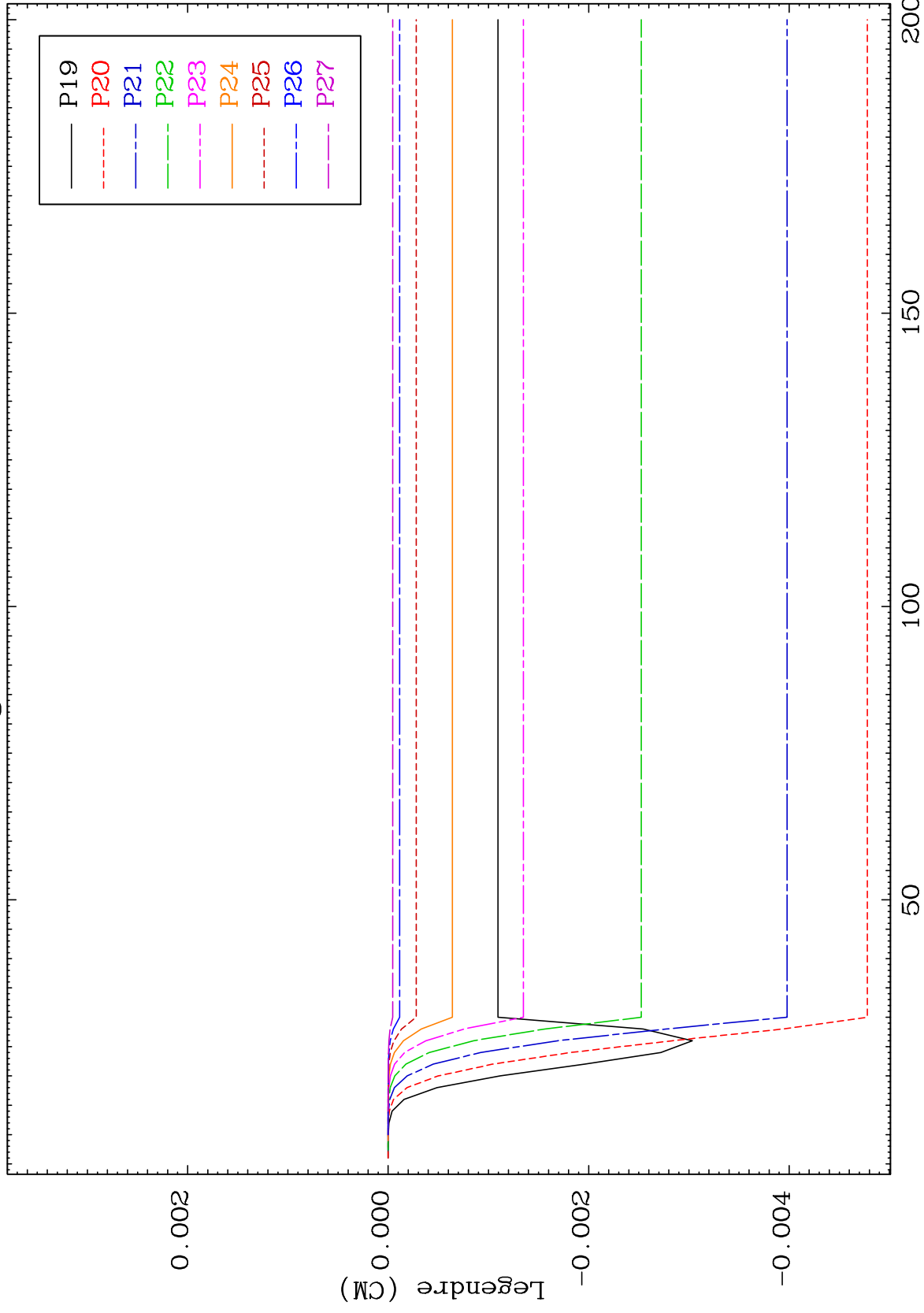

48

Incident Energy (MeV)

68-Er-174

MAT 6861

MT= 58 (n,n') Level
Legendre Coefficients

68-Er-174

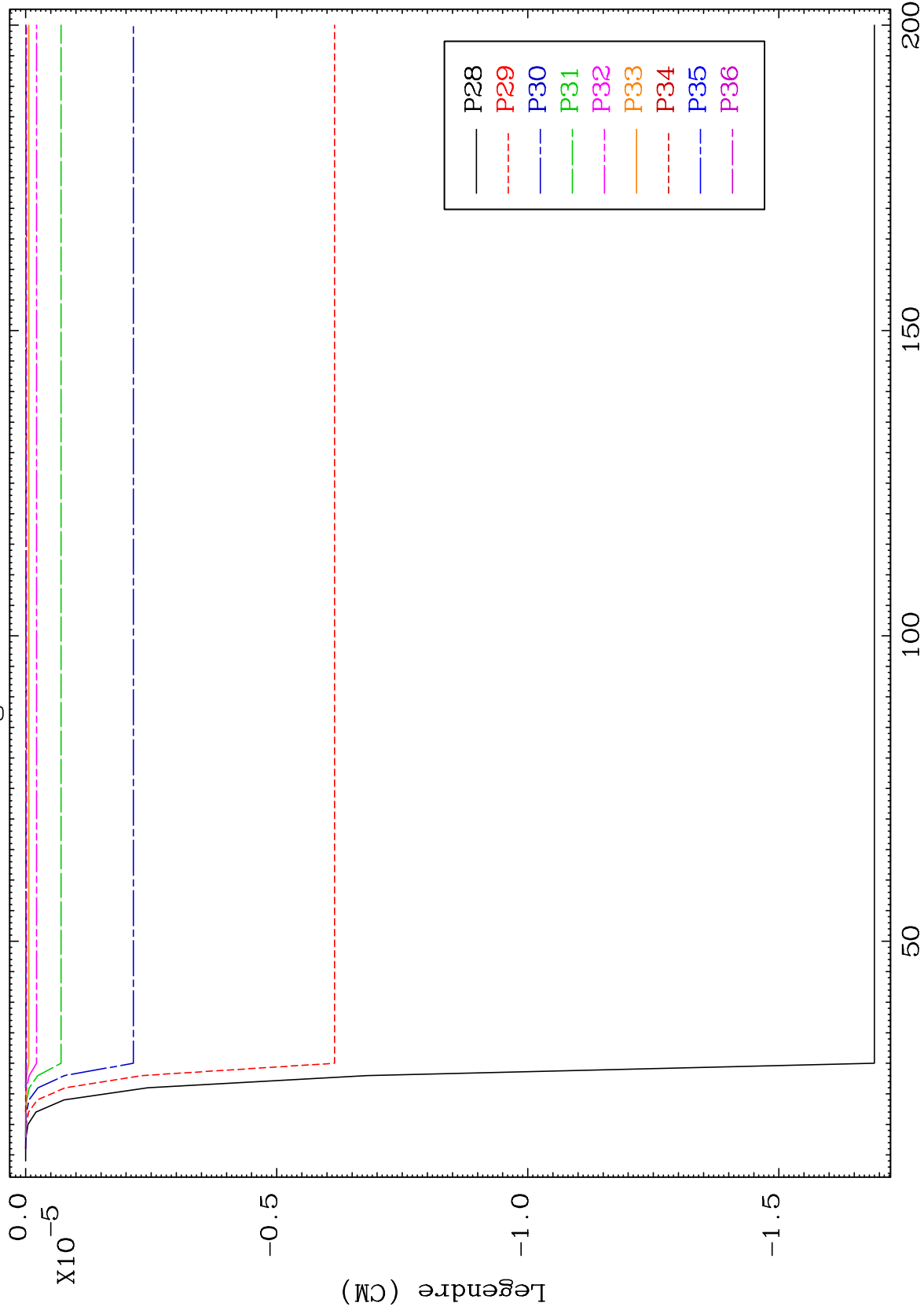

49

Incident Energy (MeV)

68-Er-174

MAT 6861

MT= 59 (n,n') Level
Legendre Coefficients

68-Er-174

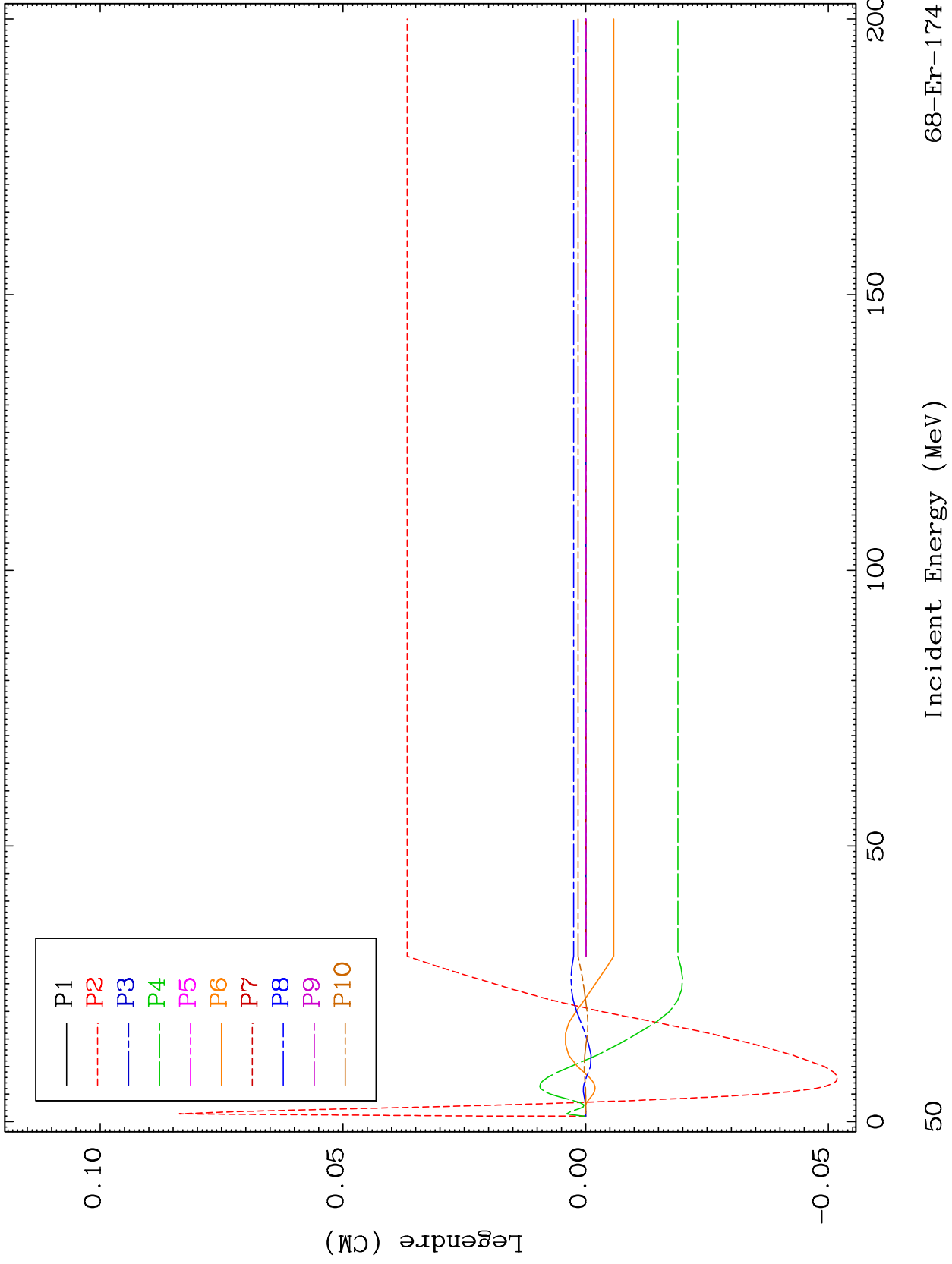

68-Er-174

Incident Energy (MeV)

50

MAT 6861

MT= 59 (n,n') Level
Legendre Coefficients

68-Er-174

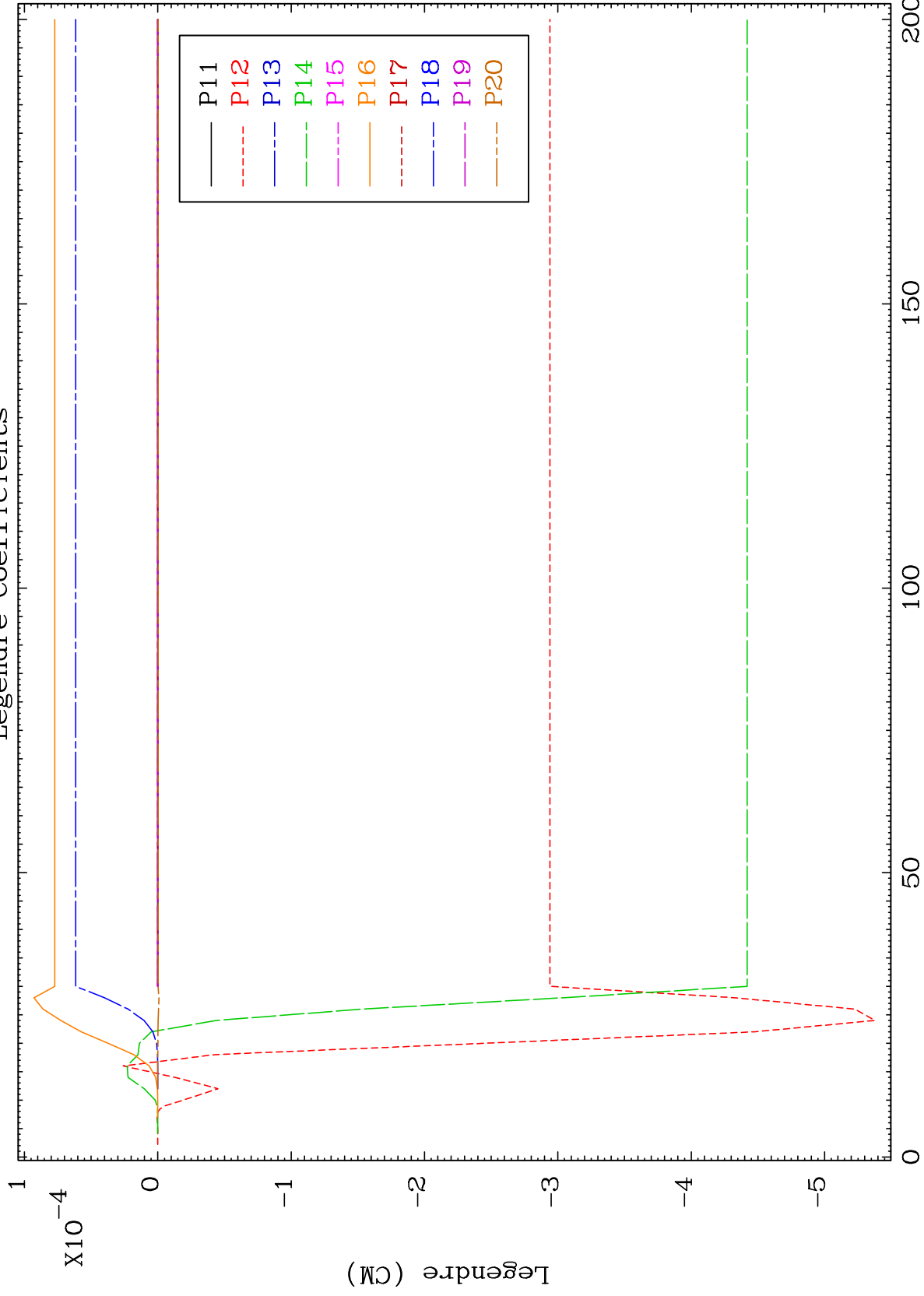

51

Incident Energy (MeV)

68-Er-174

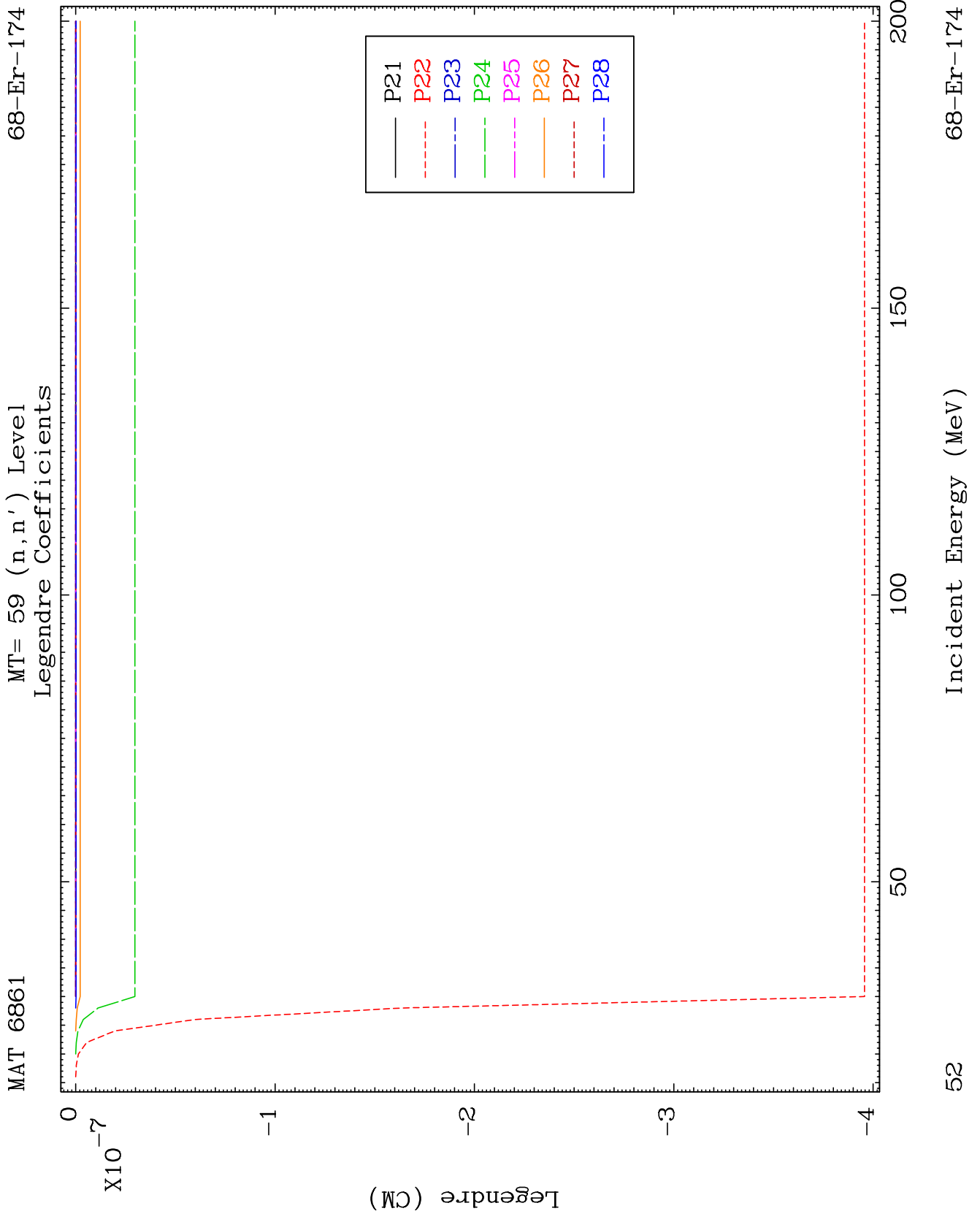

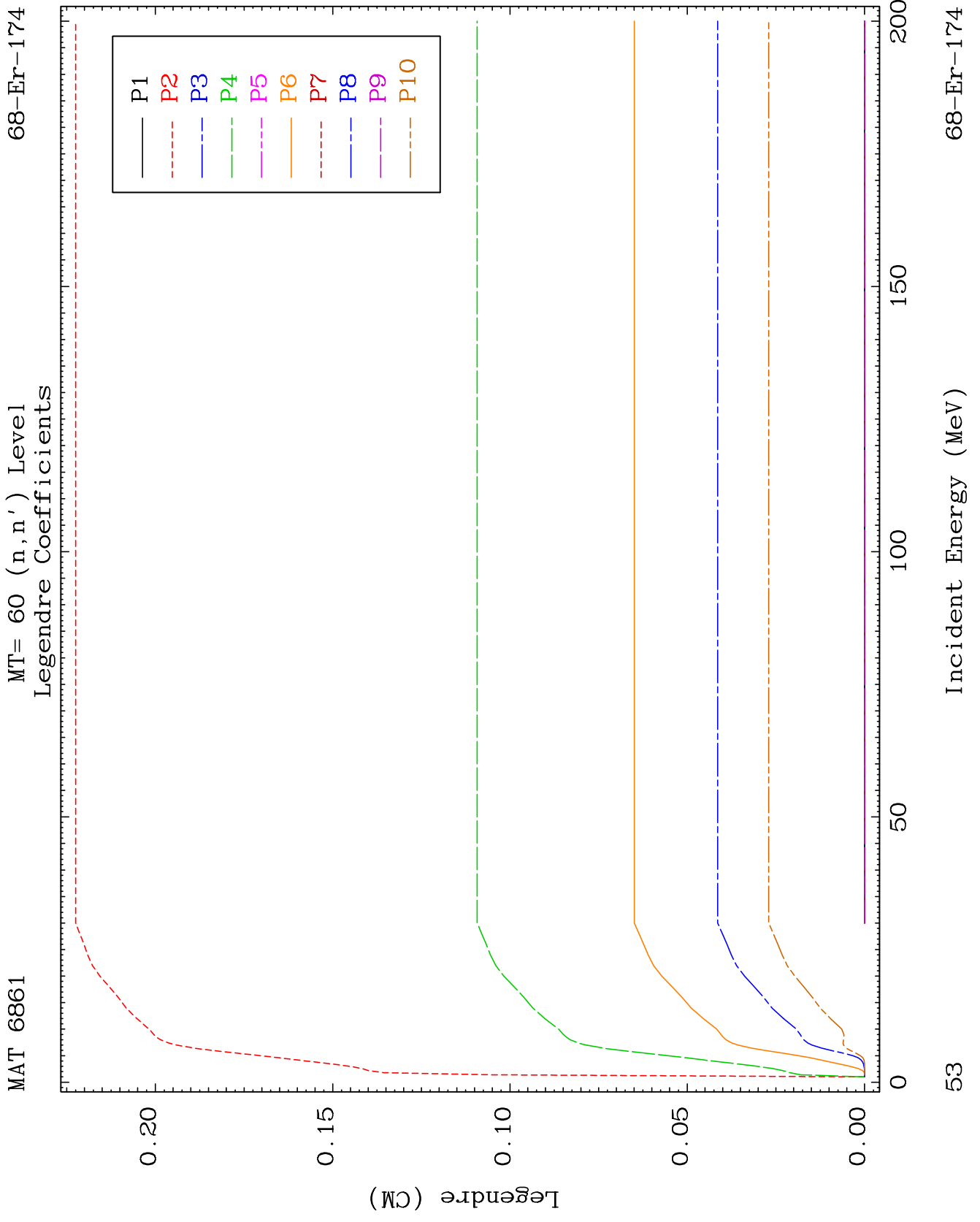

MAT 6861

MT= 60 (n,n') Level
Legendre Coefficients

68-Er-174

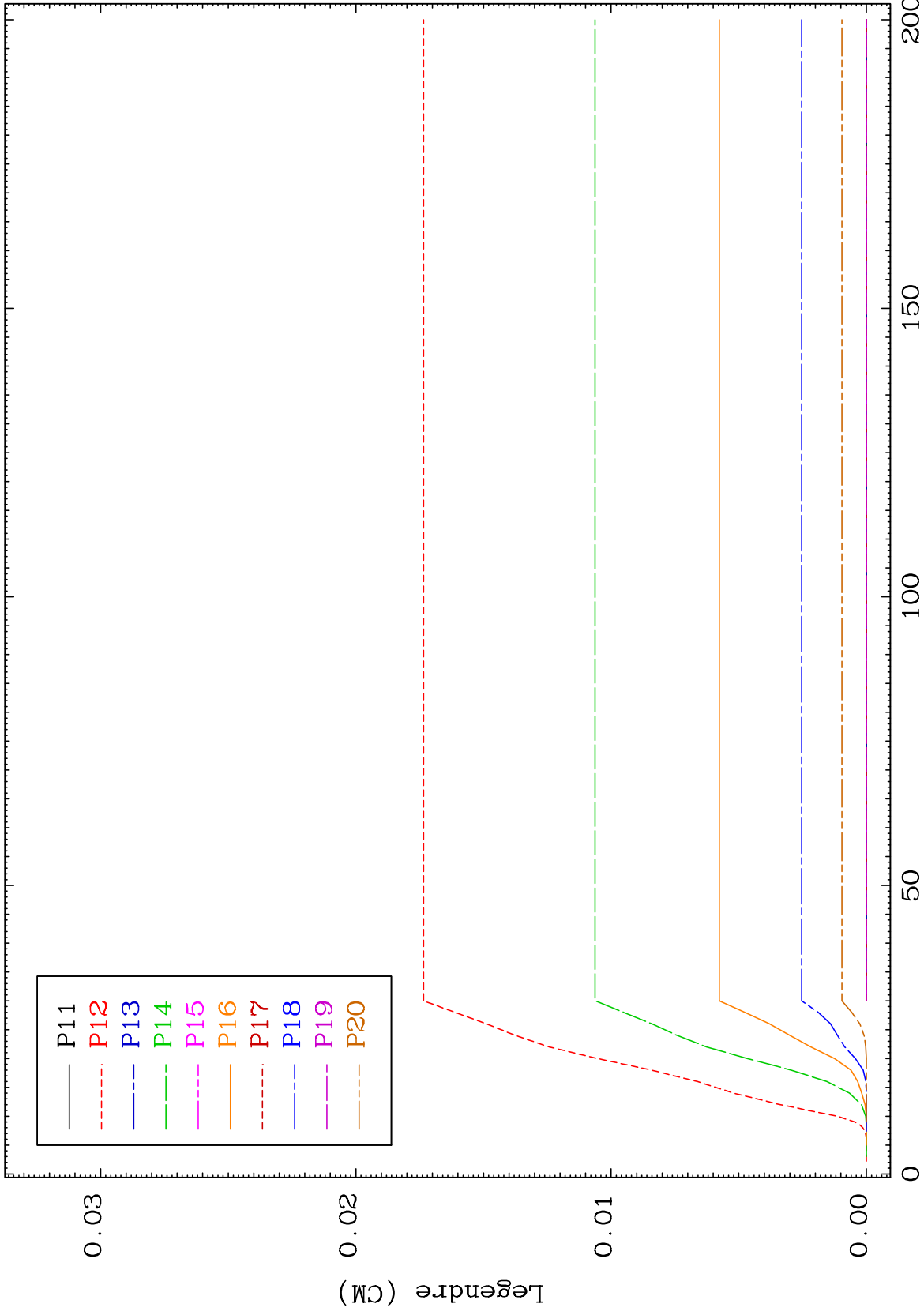

54

Incident Energy (MeV)

68-Er-174

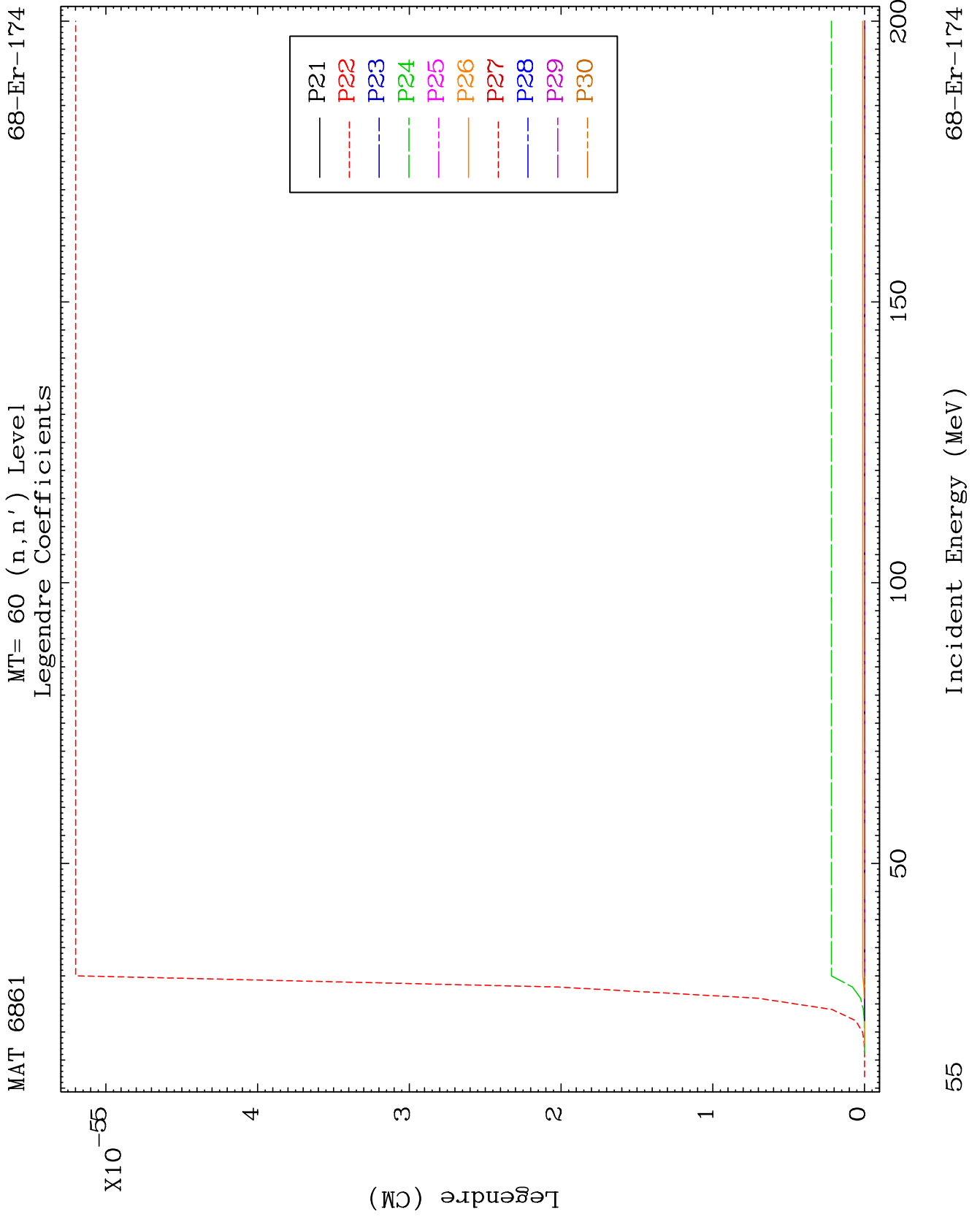

MAT 6861

MT= 61 (n,n') Level
Legendre Coefficients

68-Er-174

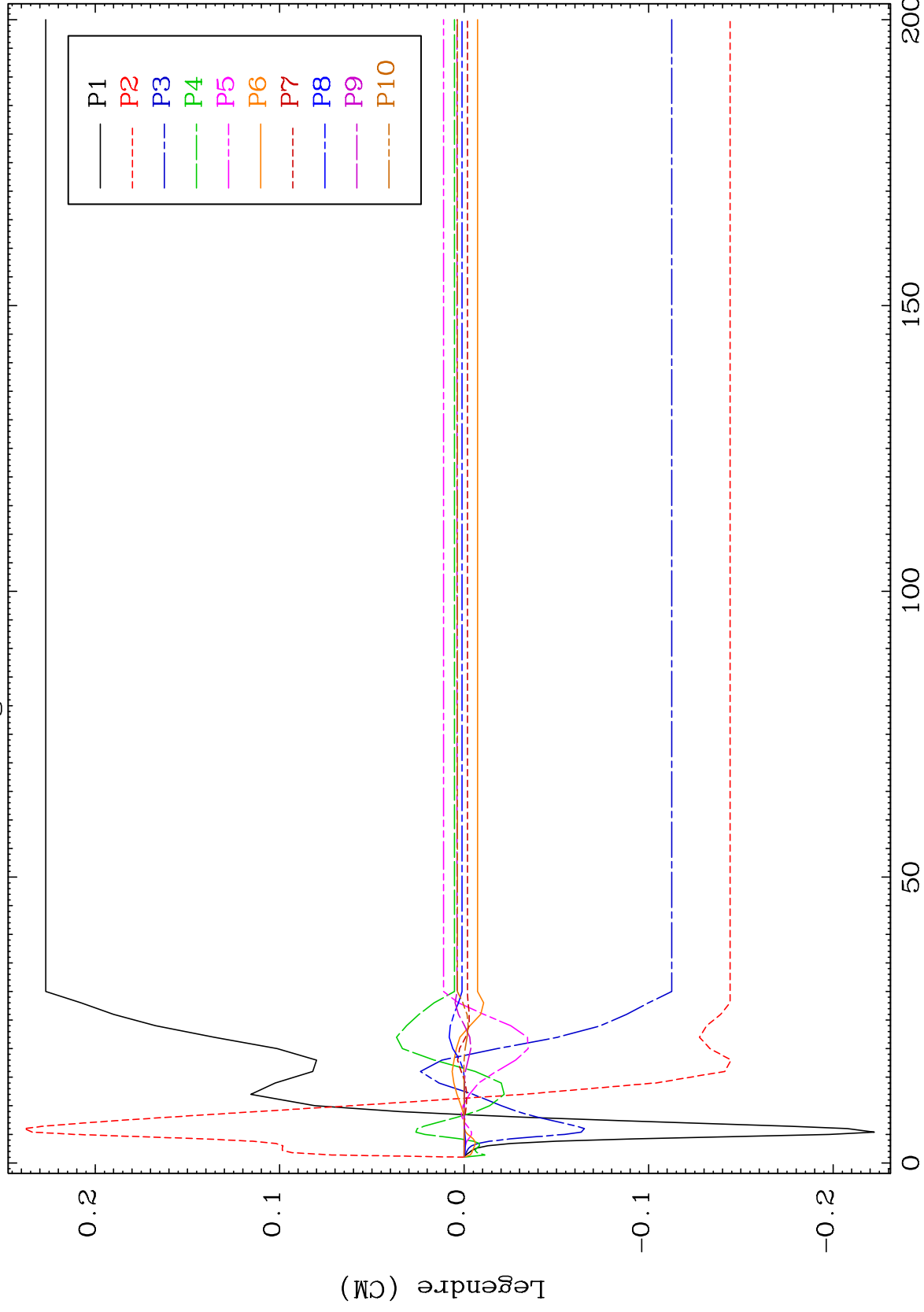

56

Incident Energy (MeV)

68-Er-174

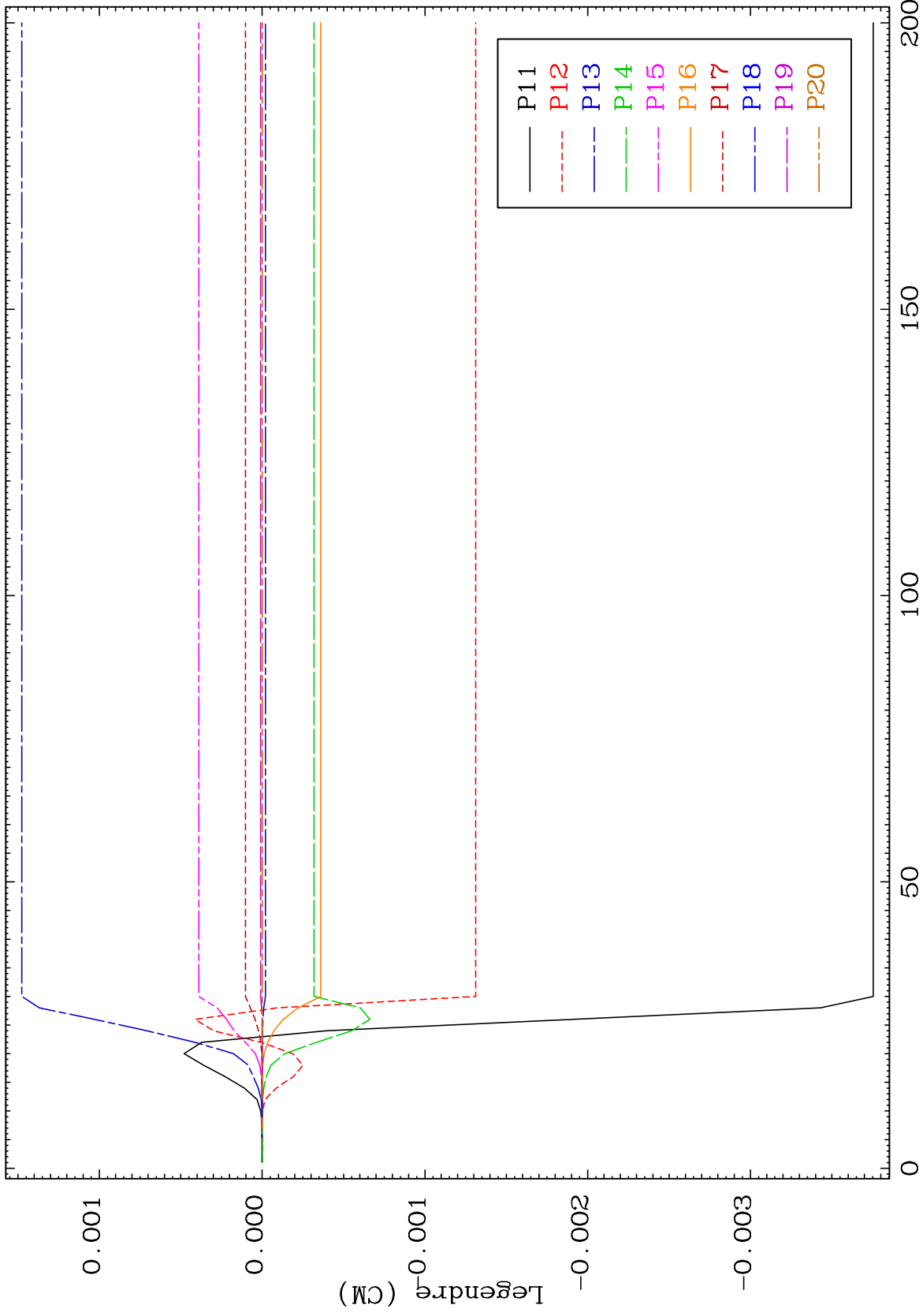

MAT 6861

MT= 61 (n,n') Level
Legendre Coefficients

68-Er-174

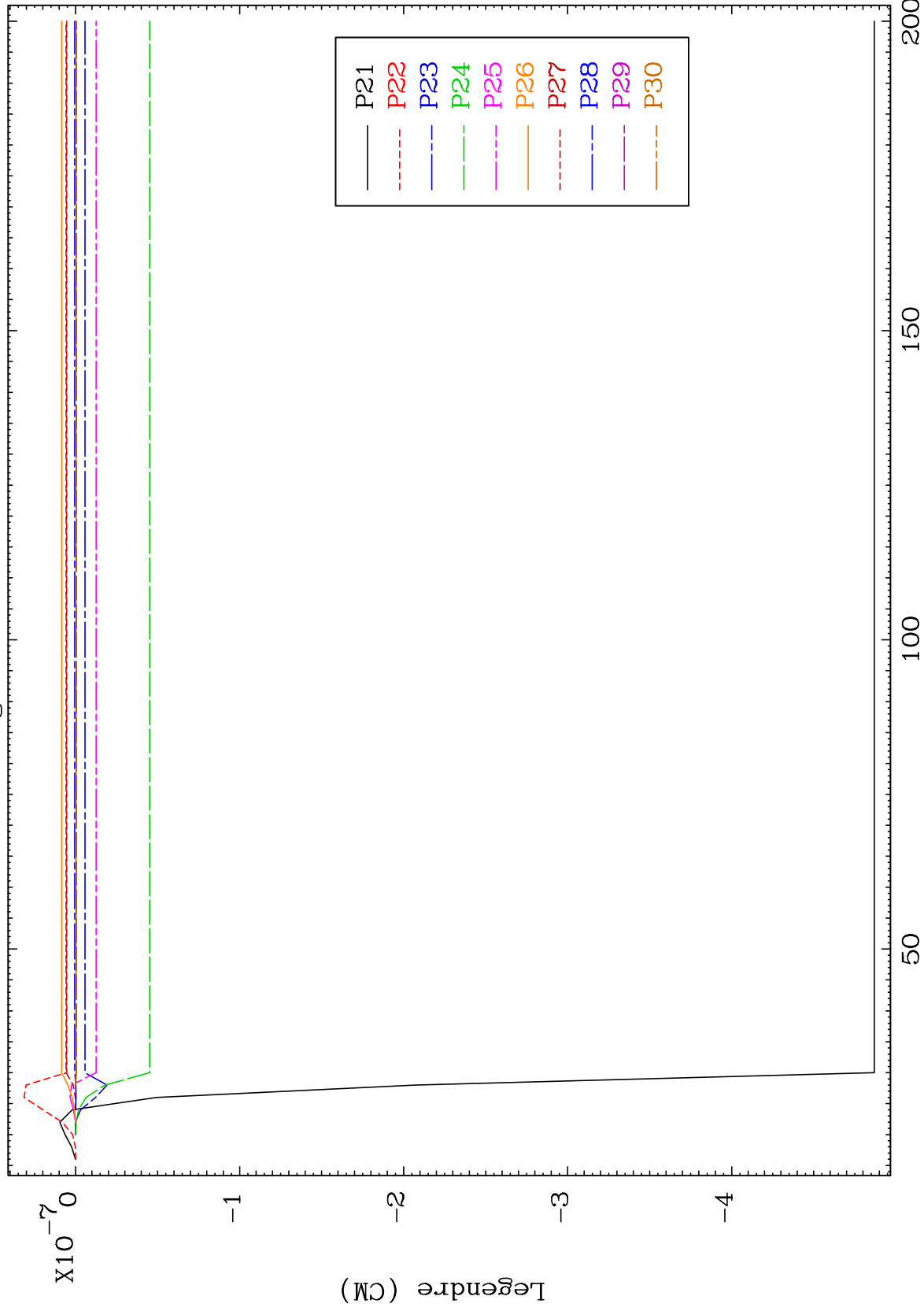

58

Incident Energy (MeV)

68-Er-174

MAT 6861

MT= 62 (n,n') Level
Legendre Coefficients

68-Er-174

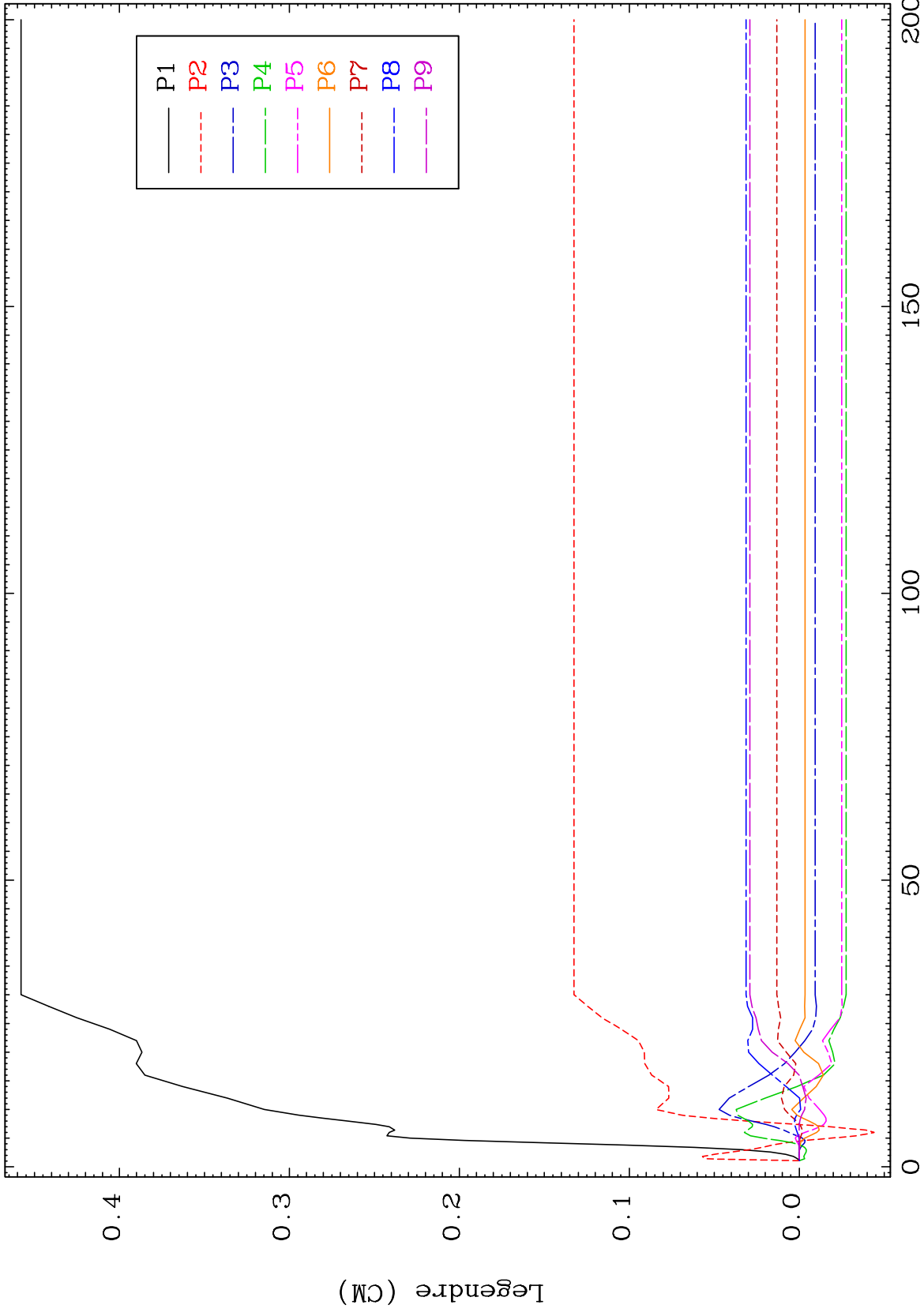

59

Incident Energy (MeV)

68-Er-174

MAT 6861

MT= 62 (n,n') Level
Legendre Coefficients

68-Er-174

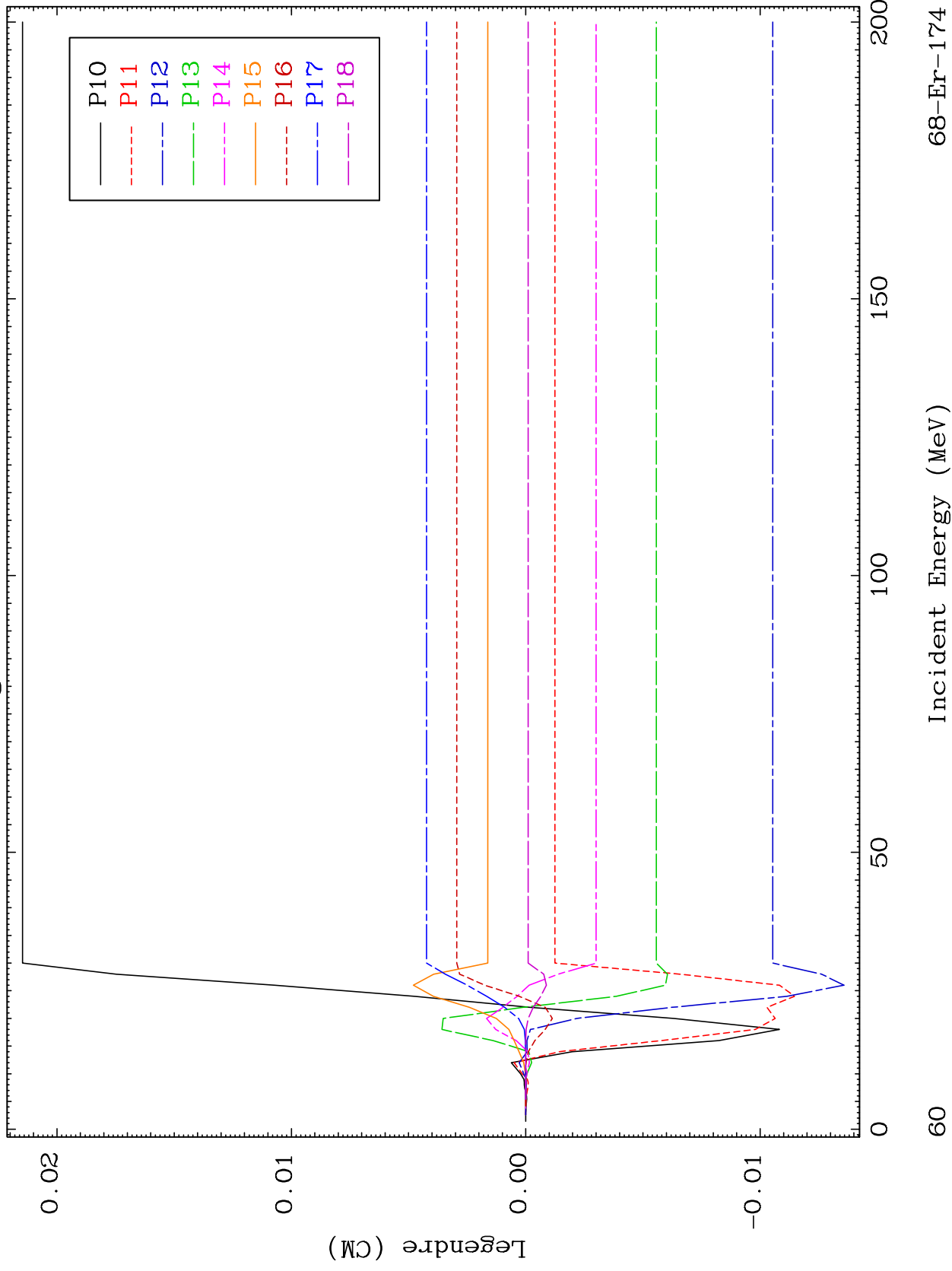

68-Er-174

Incident Energy (MeV)

MAT 6861

MT= 62 (n,n') Level
Legendre Coefficients

68-Er-174

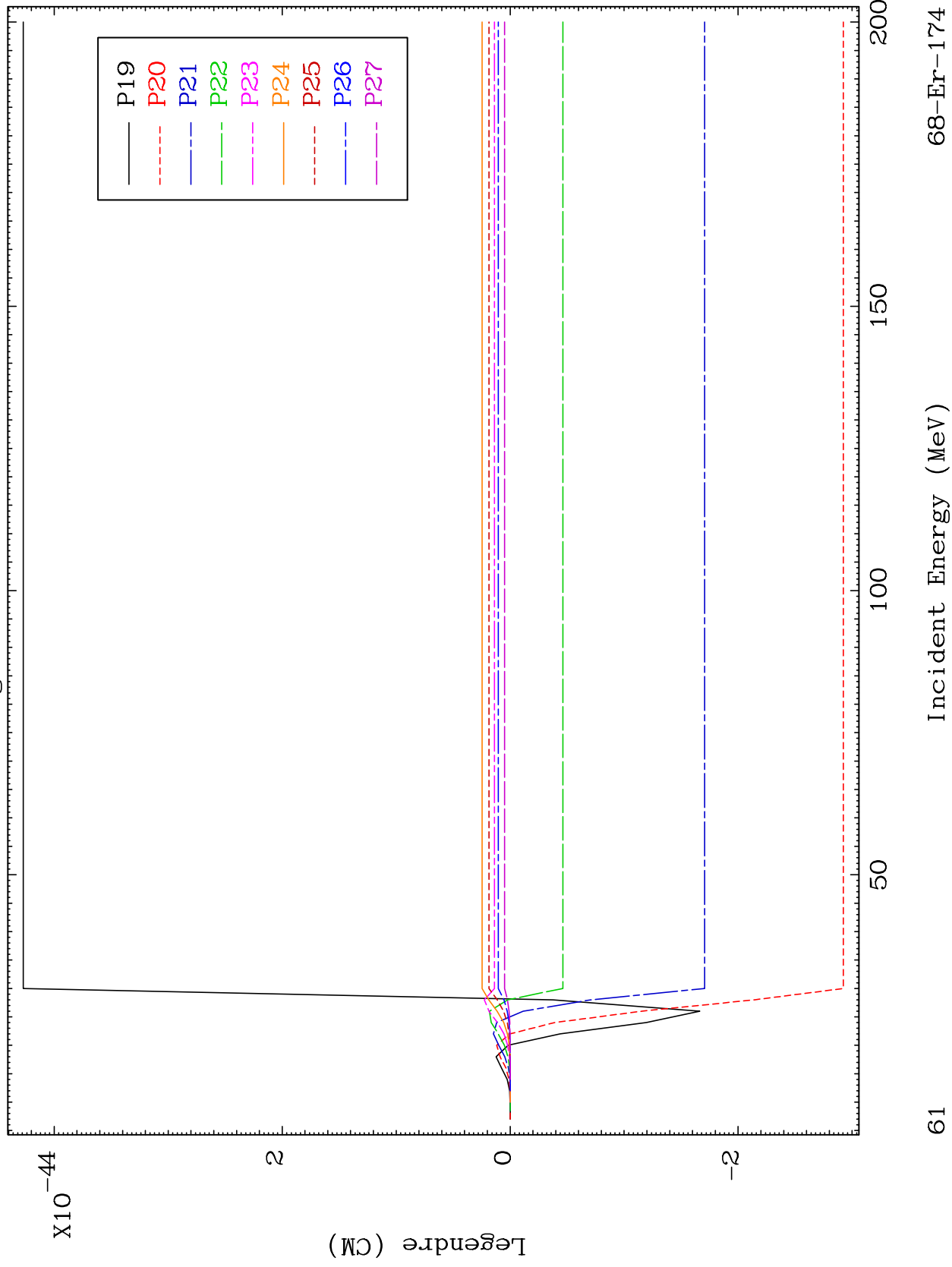

MAT 6861

MT= 62 (n,n') Level
Legendre Coefficients

68-Er-174

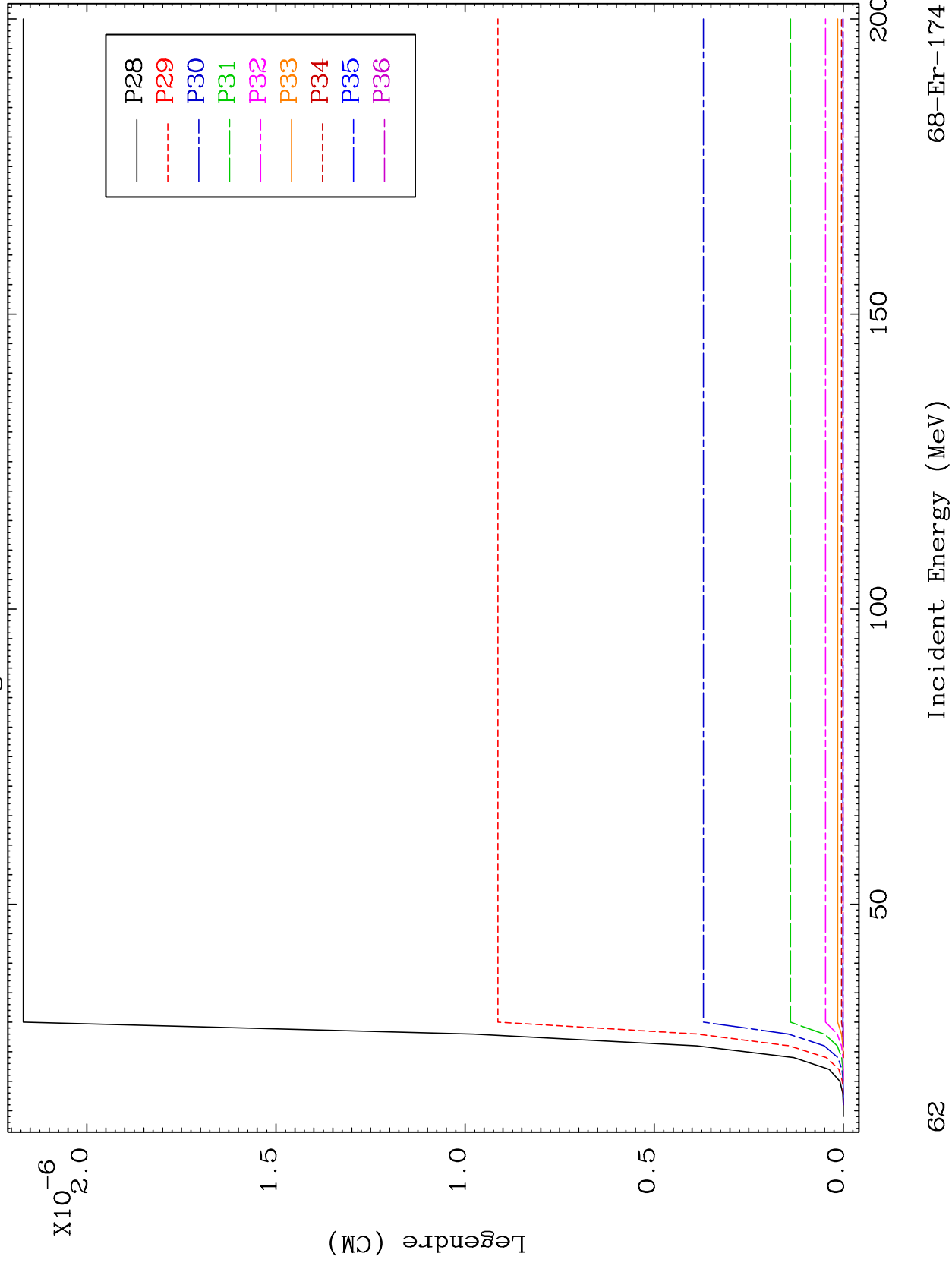

62

68-Er-174

MAT 6861

MT= 63 (n,n') Level
Legendre Coefficients

68-Er-174

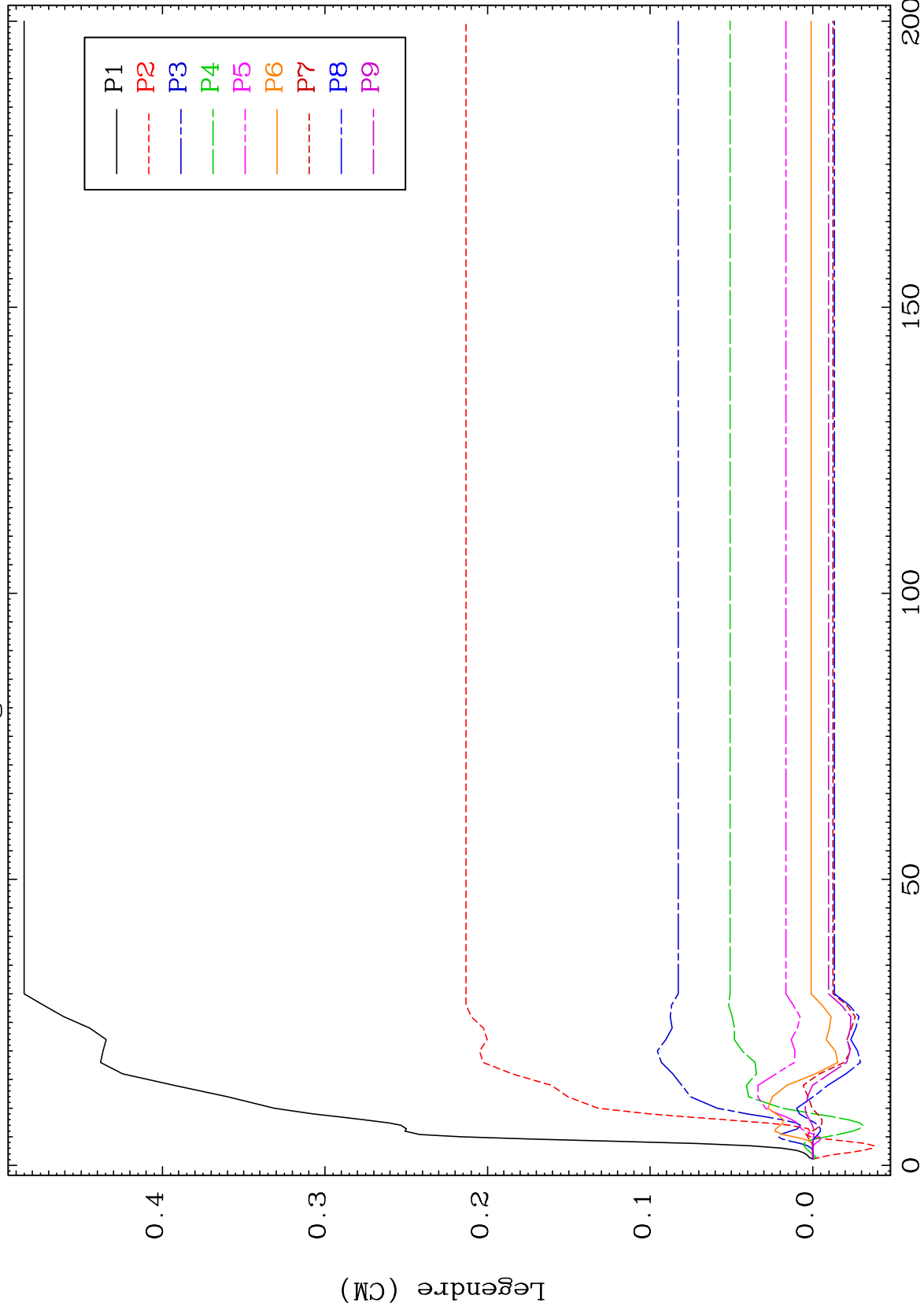

68-Er-174

Incident Energy (MeV)

63

MAT 6861

MT= 63 (n,n') Level
Legendre Coefficients

68-Er-174

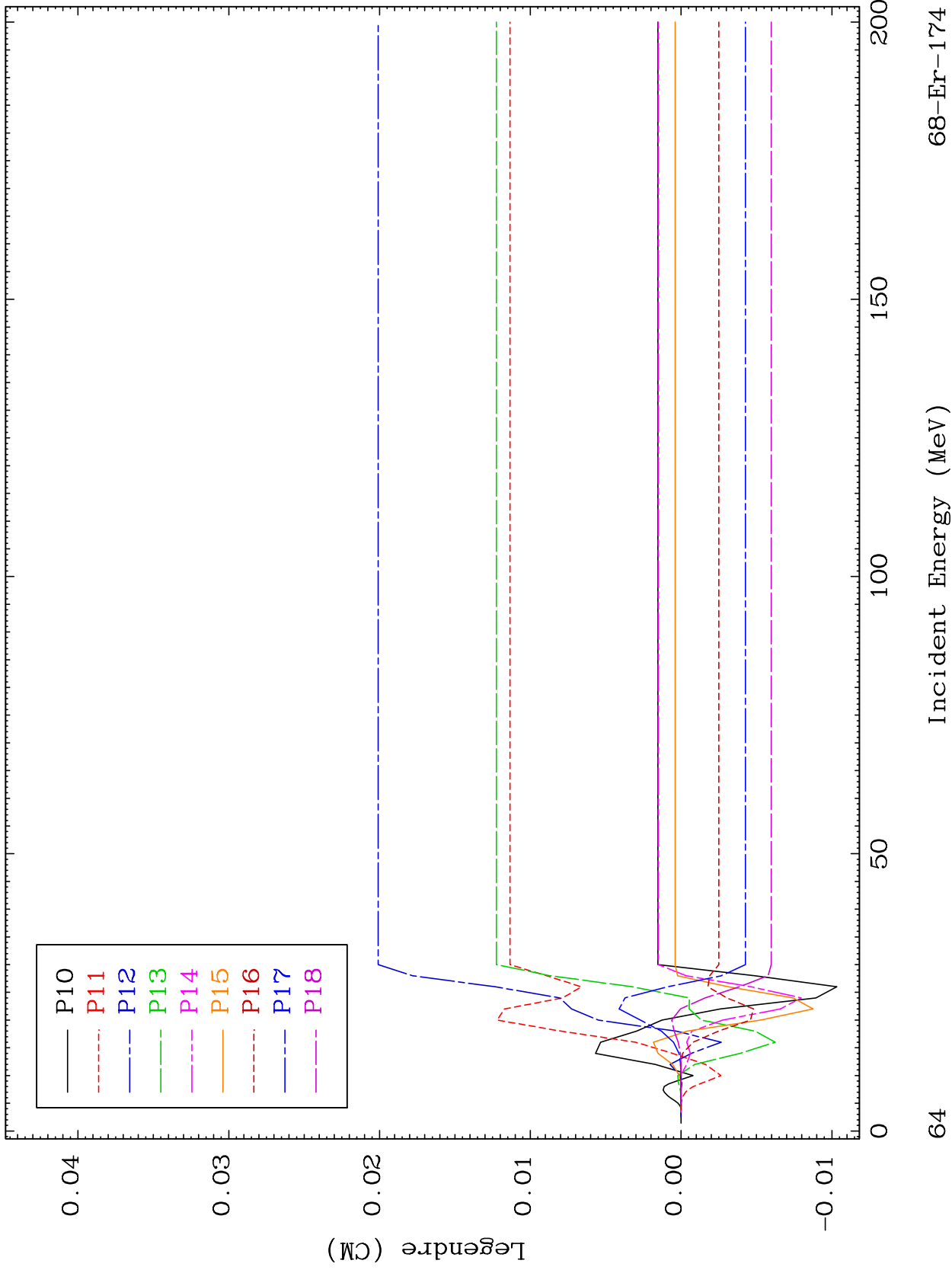

64

Incident Energy (MeV)

68-Er-174

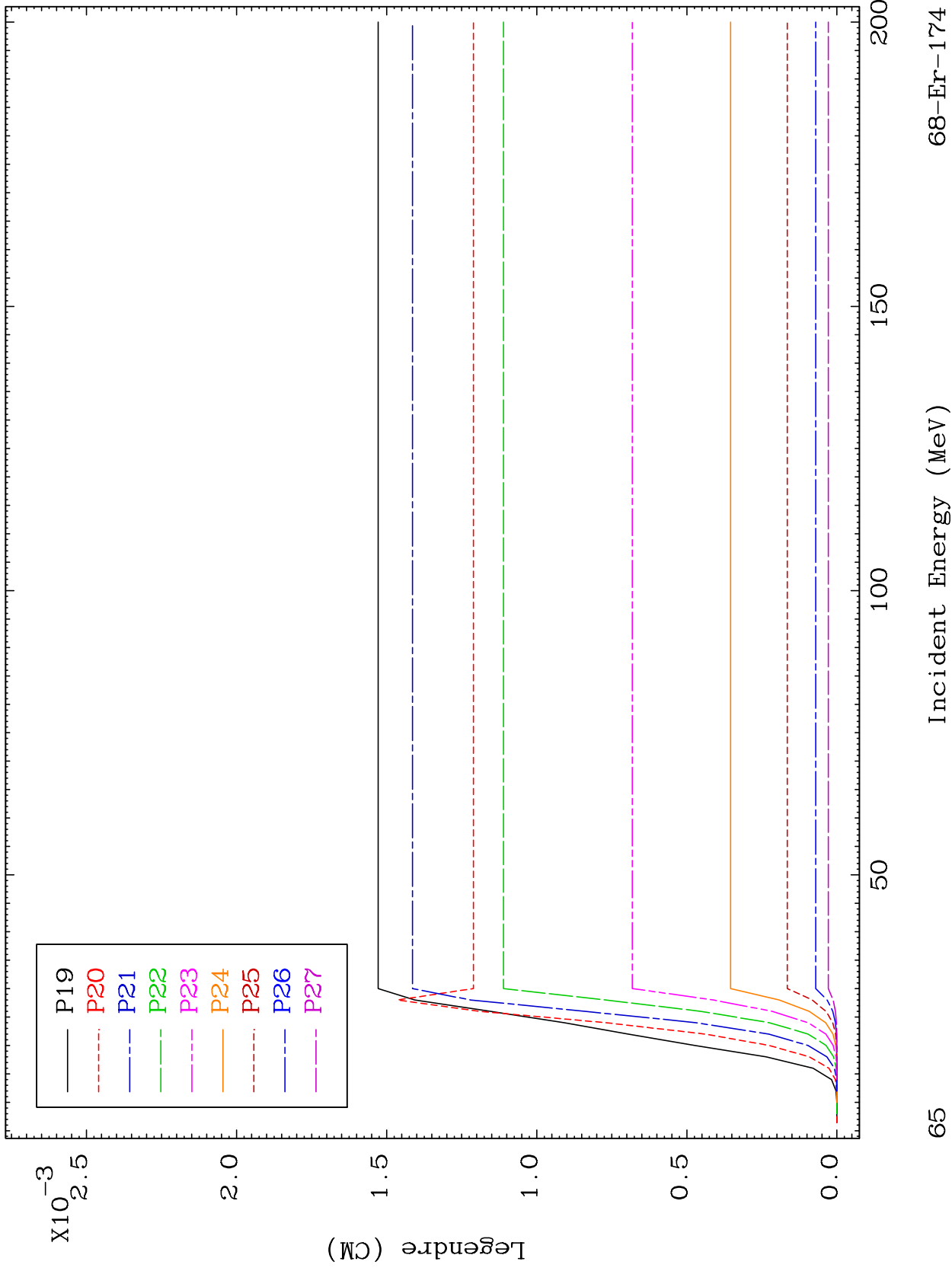

MAT 6861

MT= 63 (n,n') Level
Legendre Coefficients

68-Er-174

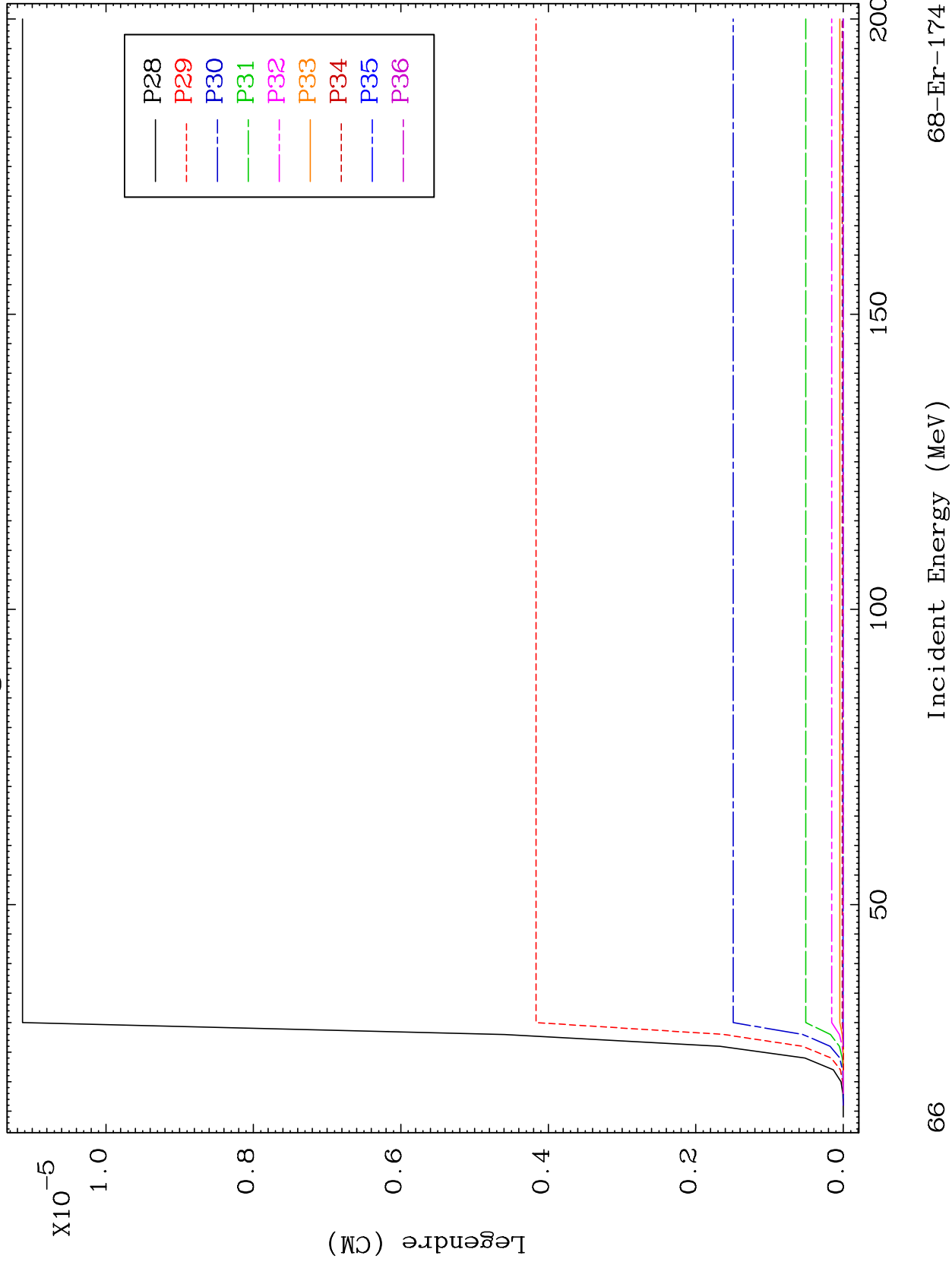

66

Incident Energy (MeV)

68-Er-174

MAT 6861

MT= 64 (n,n') Level
Legendre Coefficients

68-Er-174

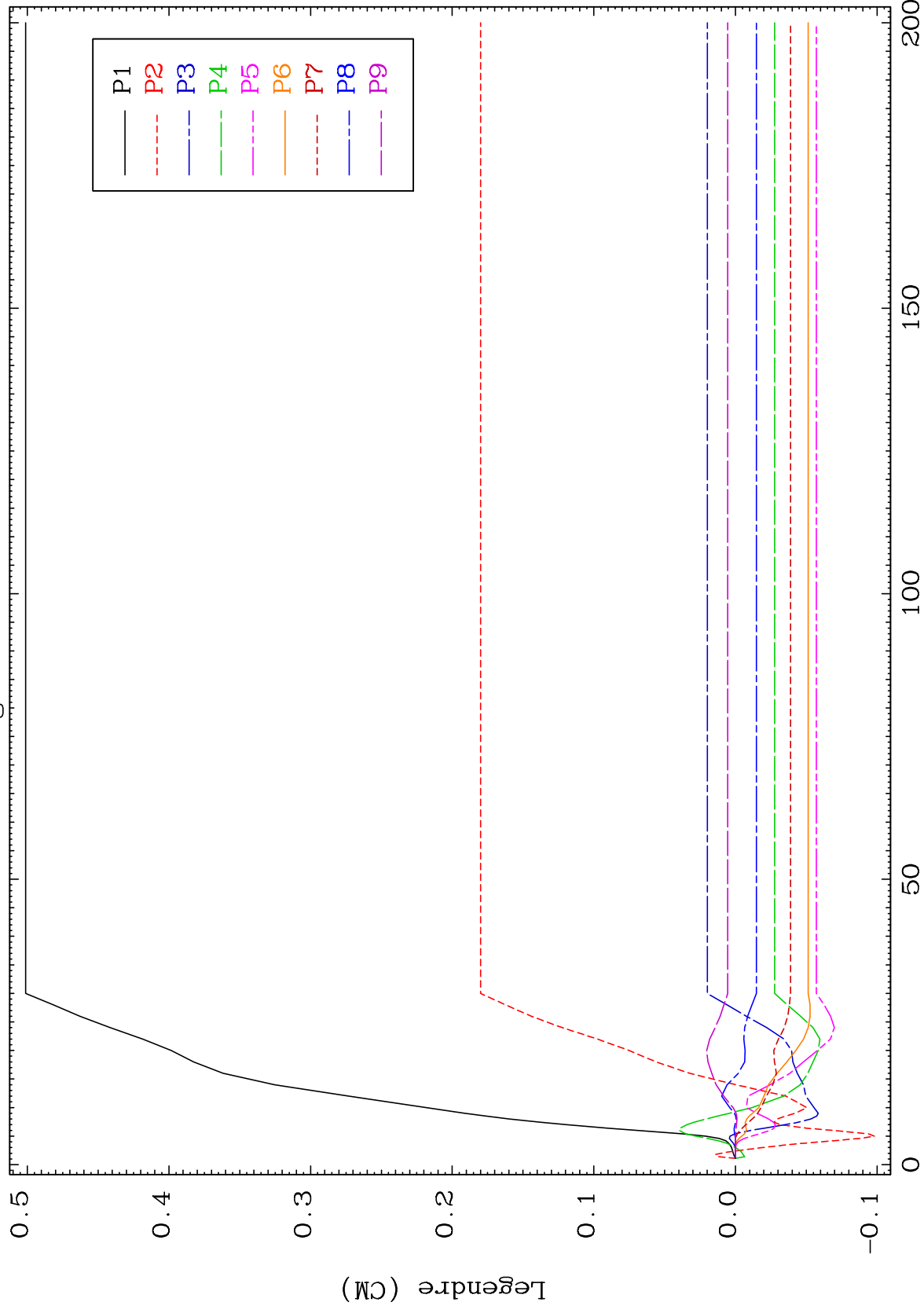

67

Incident Energy (MeV)

68-Er-174

MAT 6861

MT= 64 (n,n') Level
Legendre Coefficients

68-Er-174

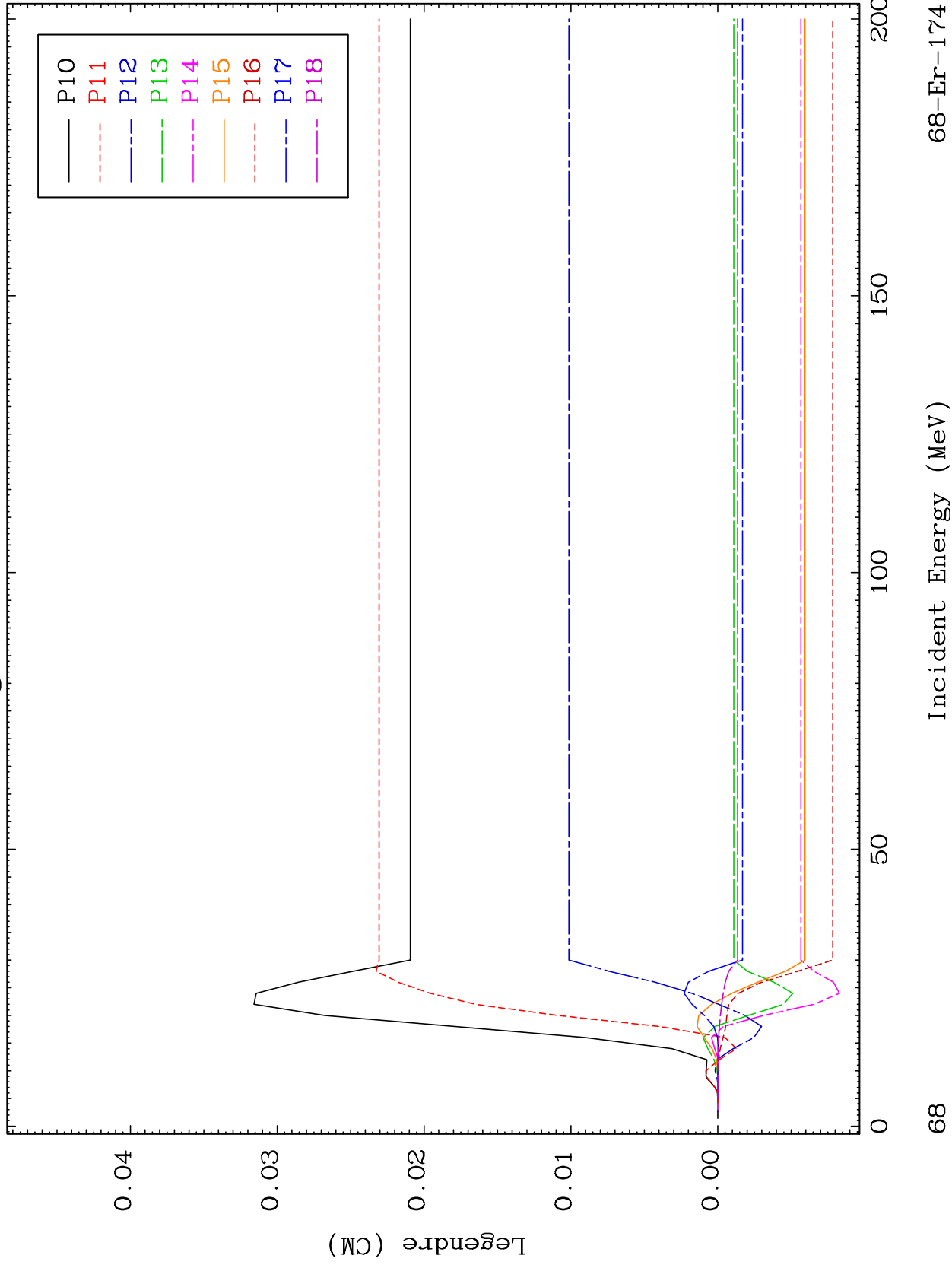

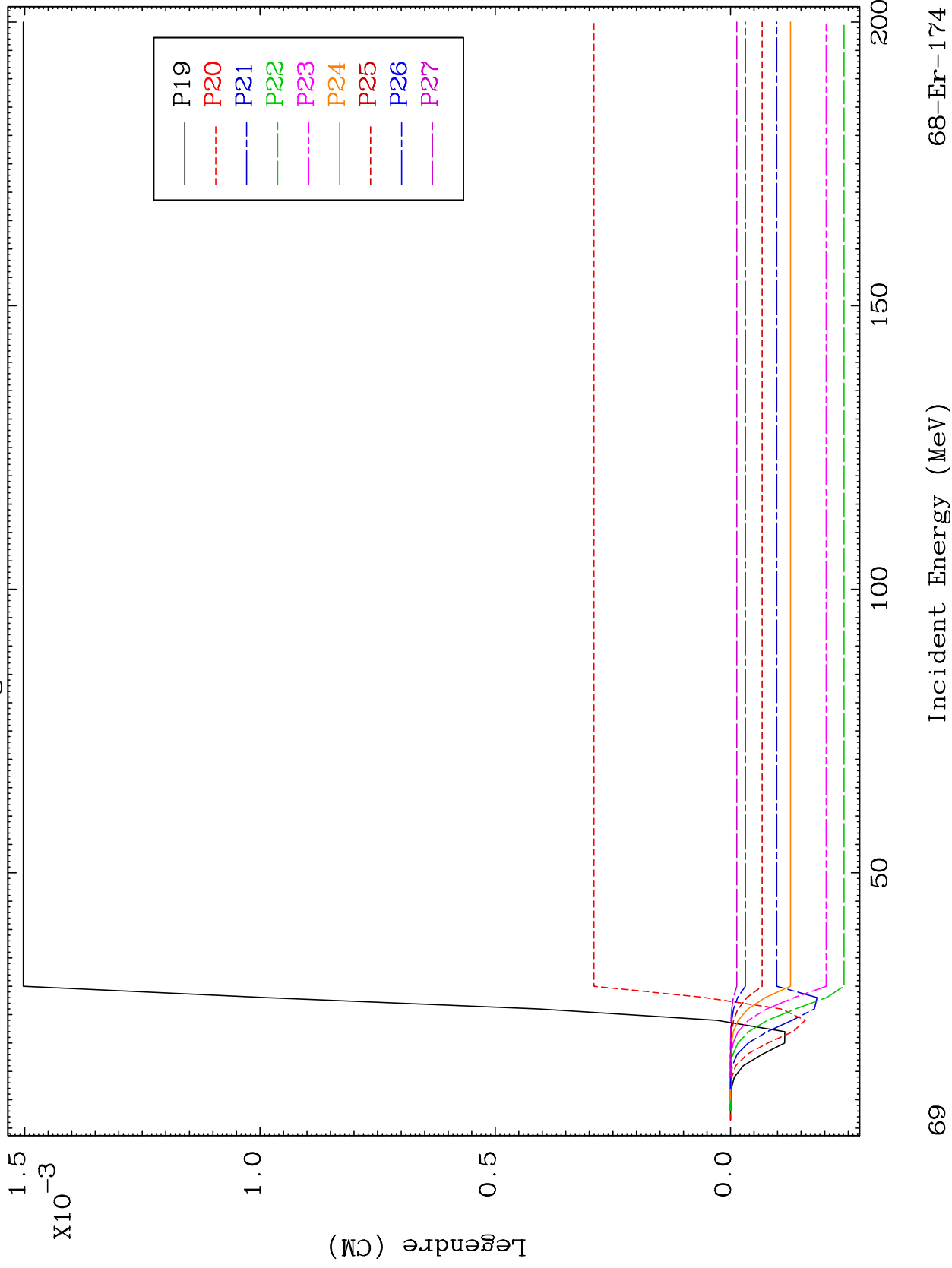

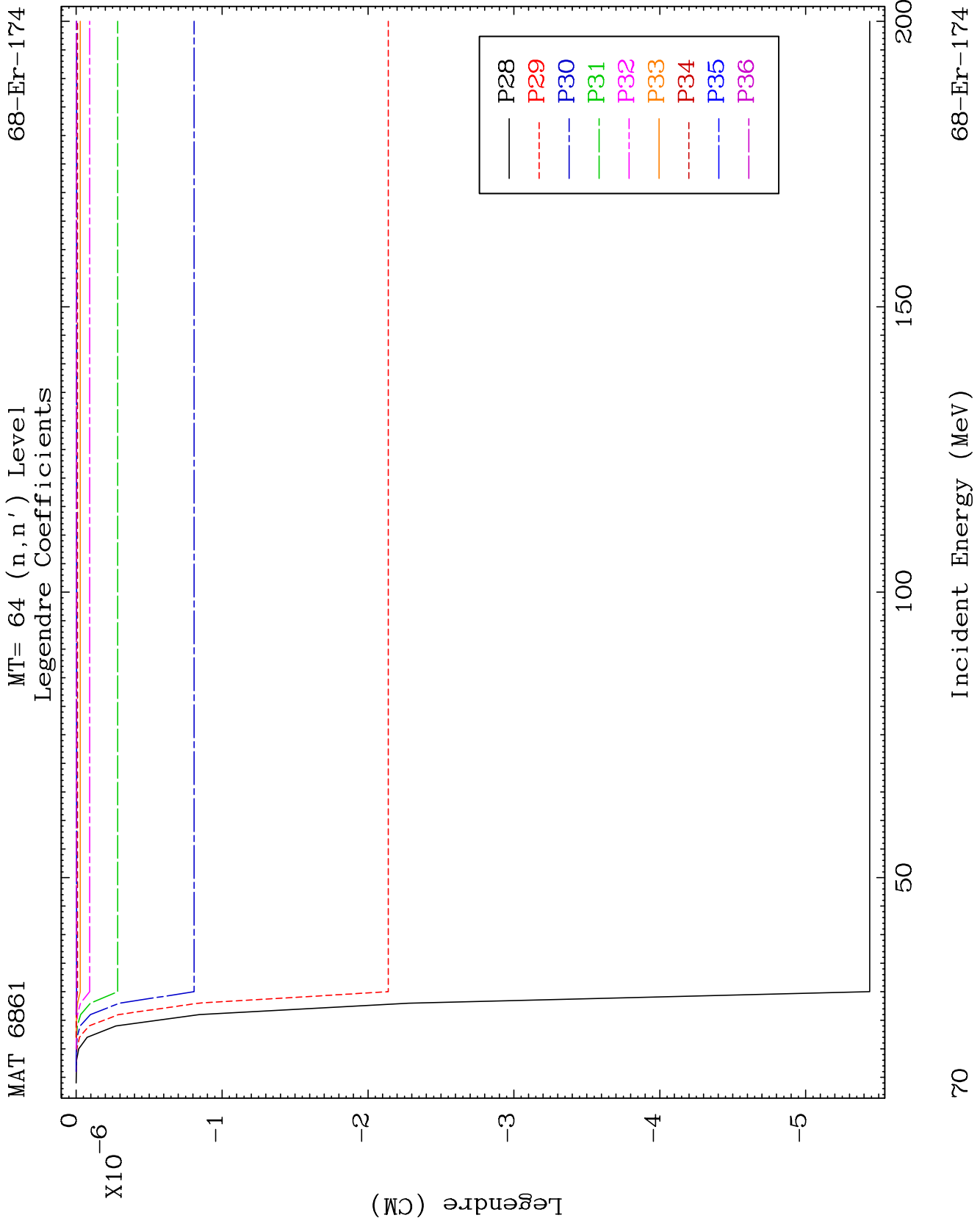

MAT 6861

MT= 65 (n,n') Level
Legendre Coefficients

68-Er-174

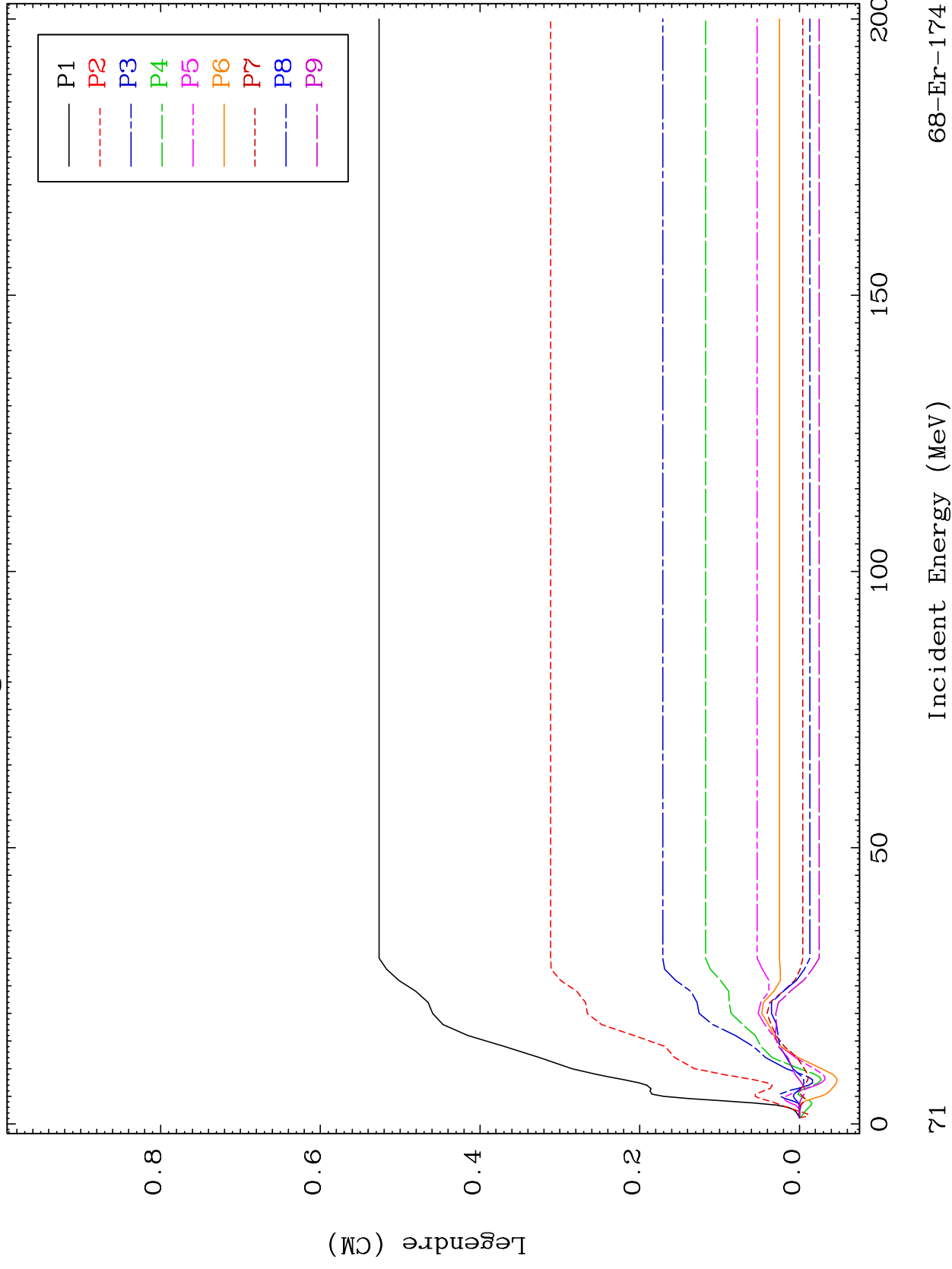

71

Incident Energy (MeV)

68-Er-174

MAT 6861

MT= 65 (n,n') Level
Legendre Coefficients

68-Er-174

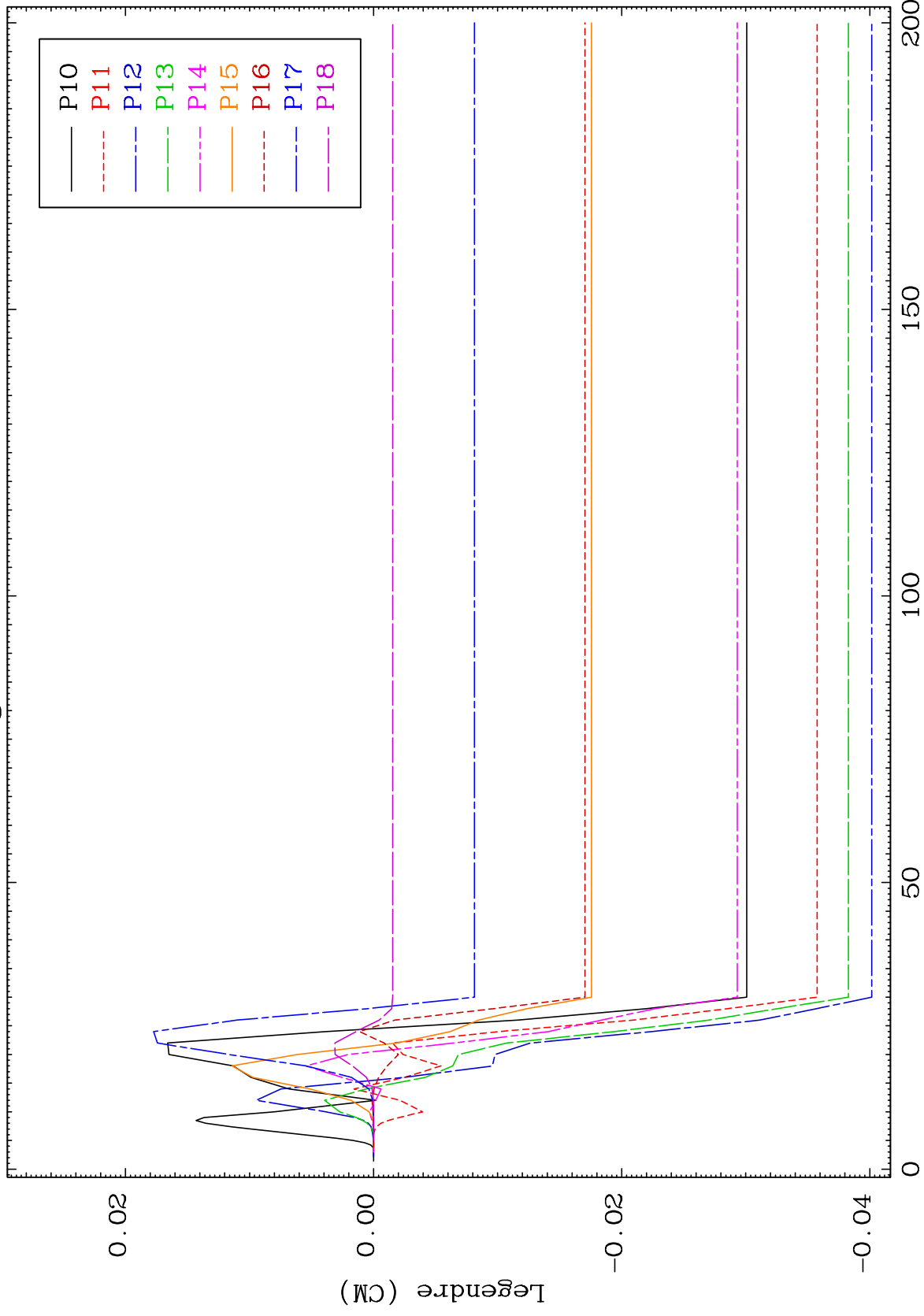

72

Incident Energy (MeV)

68-Er-174

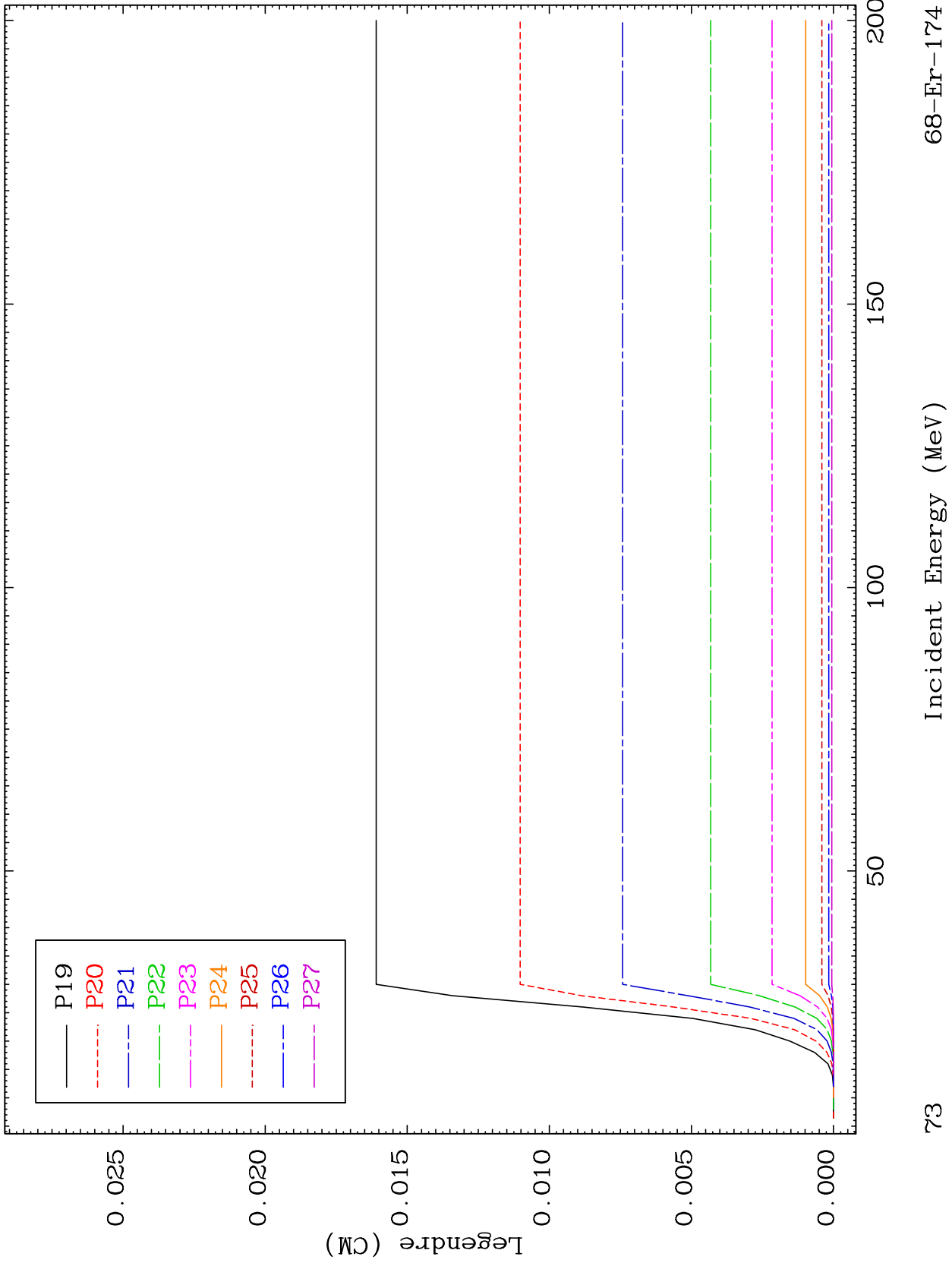

MAT 6861

MT= 65 (n,n') Level
Legendre Coefficients

68-Er-174

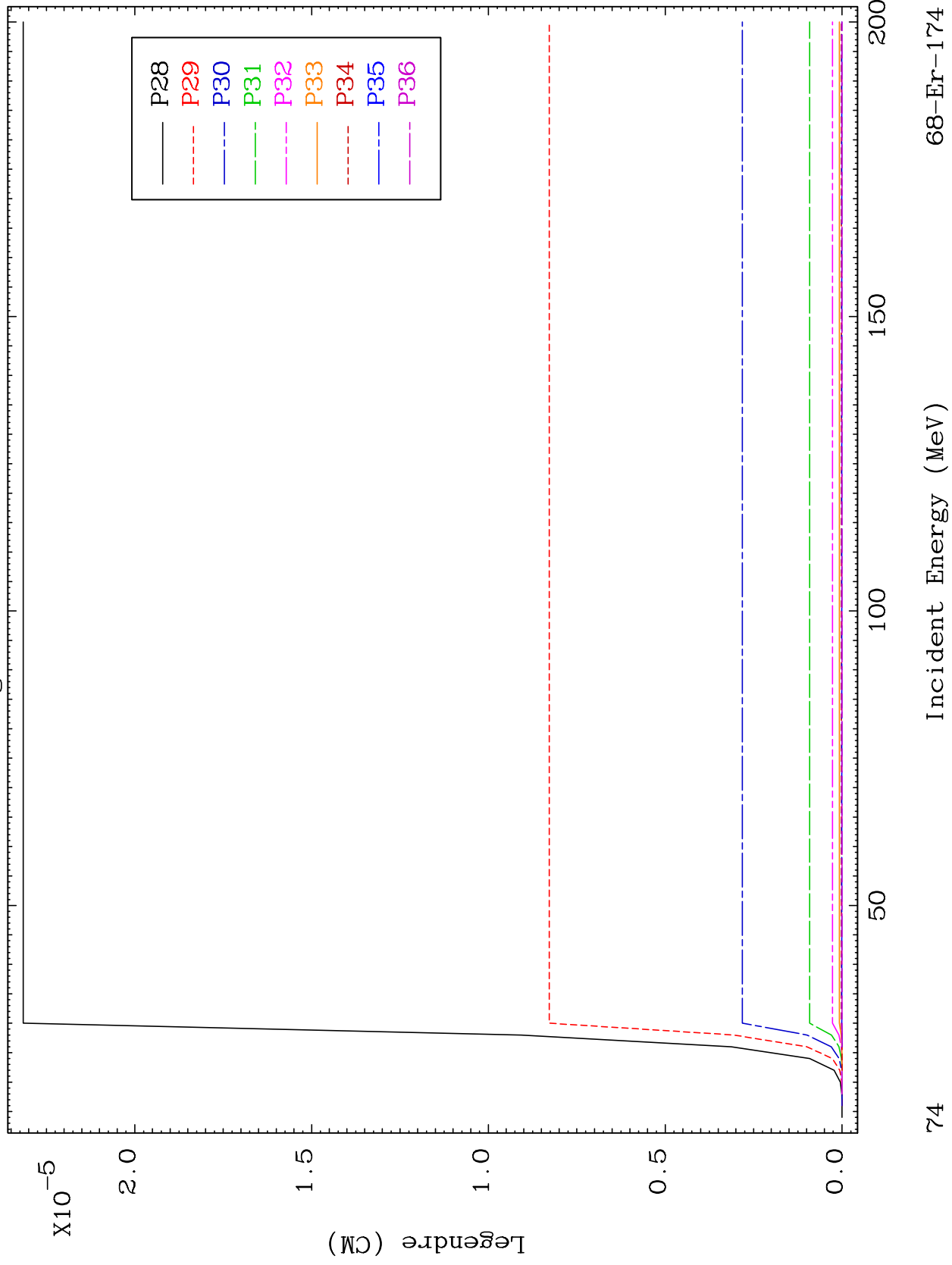

MAT 6861

MT= 66 (n,n') Level
Legendre Coefficients

68-Er-174

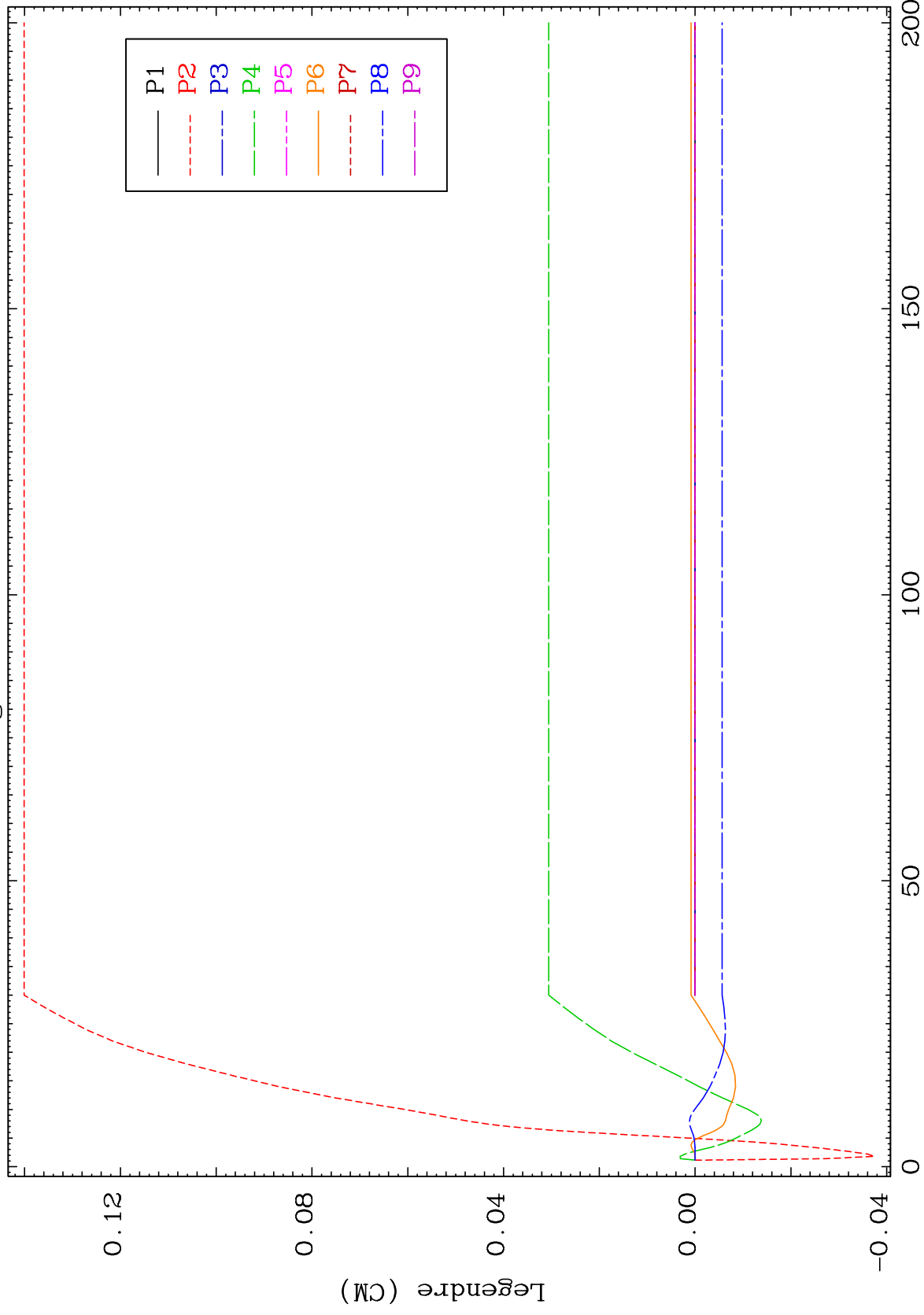

75

Incident Energy (MeV)

68-Er-174

MAT 6861

MT= 66 (n,n') Level
Legendre Coefficients

68-Er-174

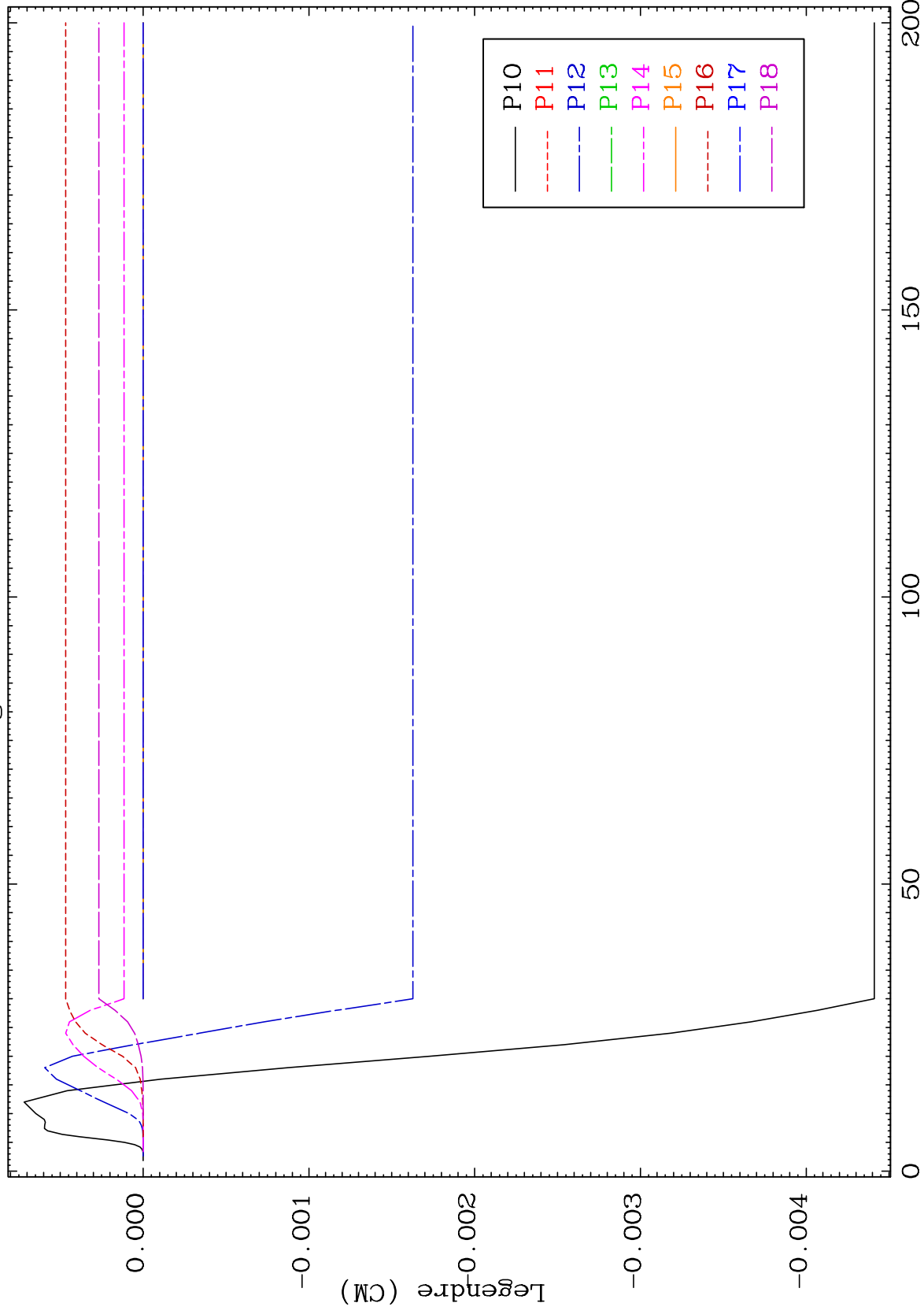

76

Incident Energy (MeV)

68-Er-174

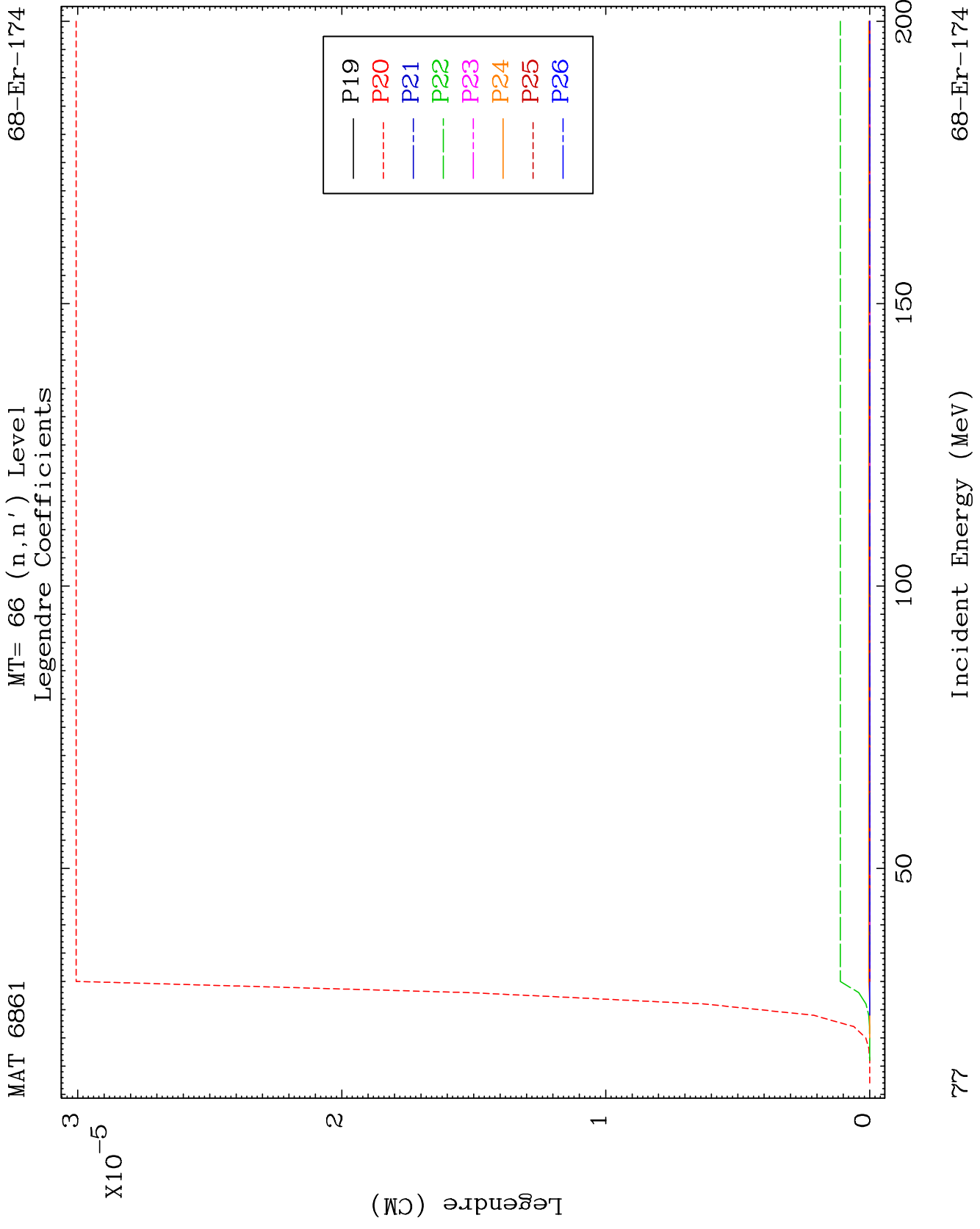

MAT 6861

MT= 67 (n,n') Level
Legendre Coefficients

68-Er-174

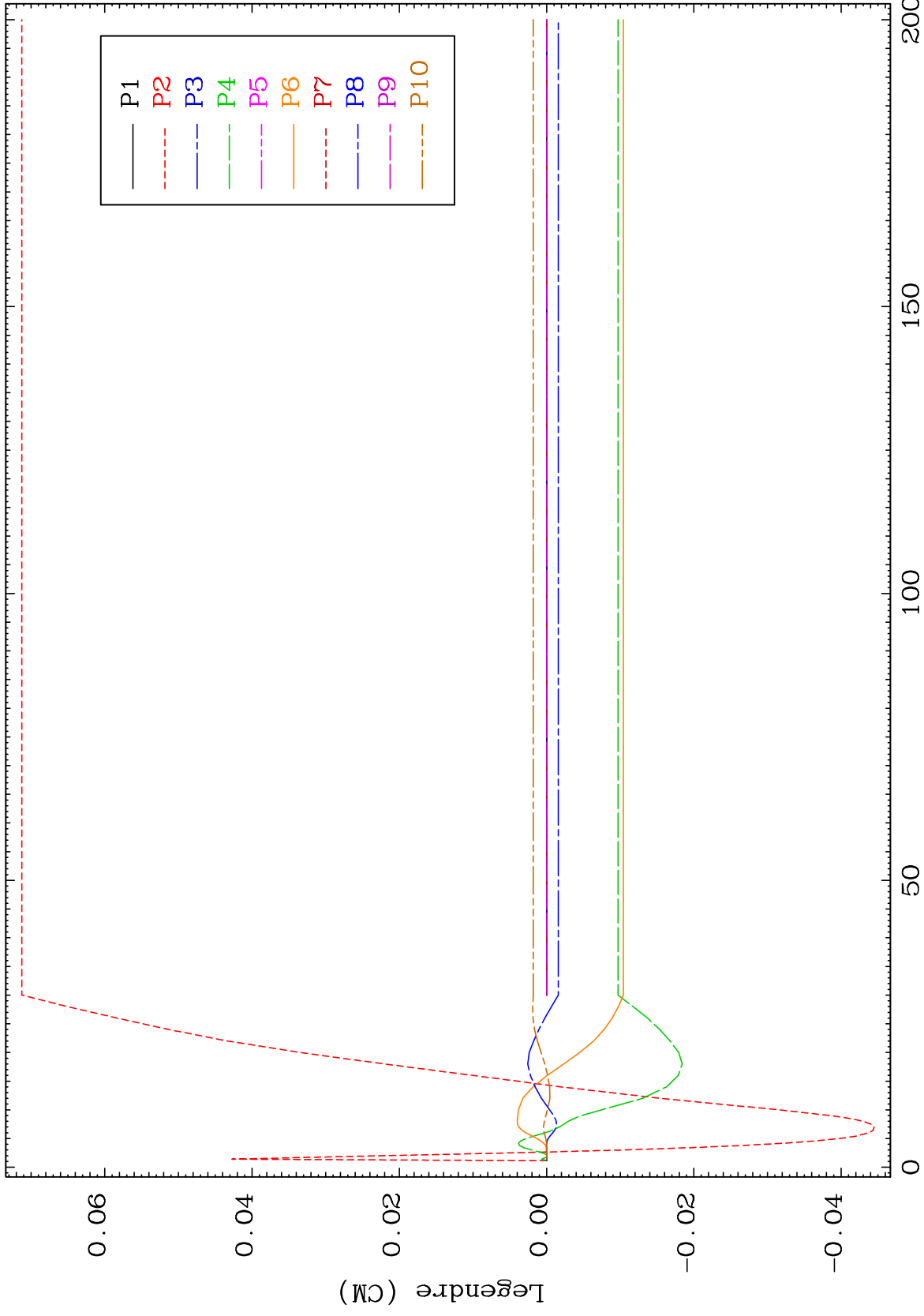

78

Incident Energy (MeV)

68-Er-174

MAT 6861

MT= 67 (n,n') Level
Legendre Coefficients

68-Er-174

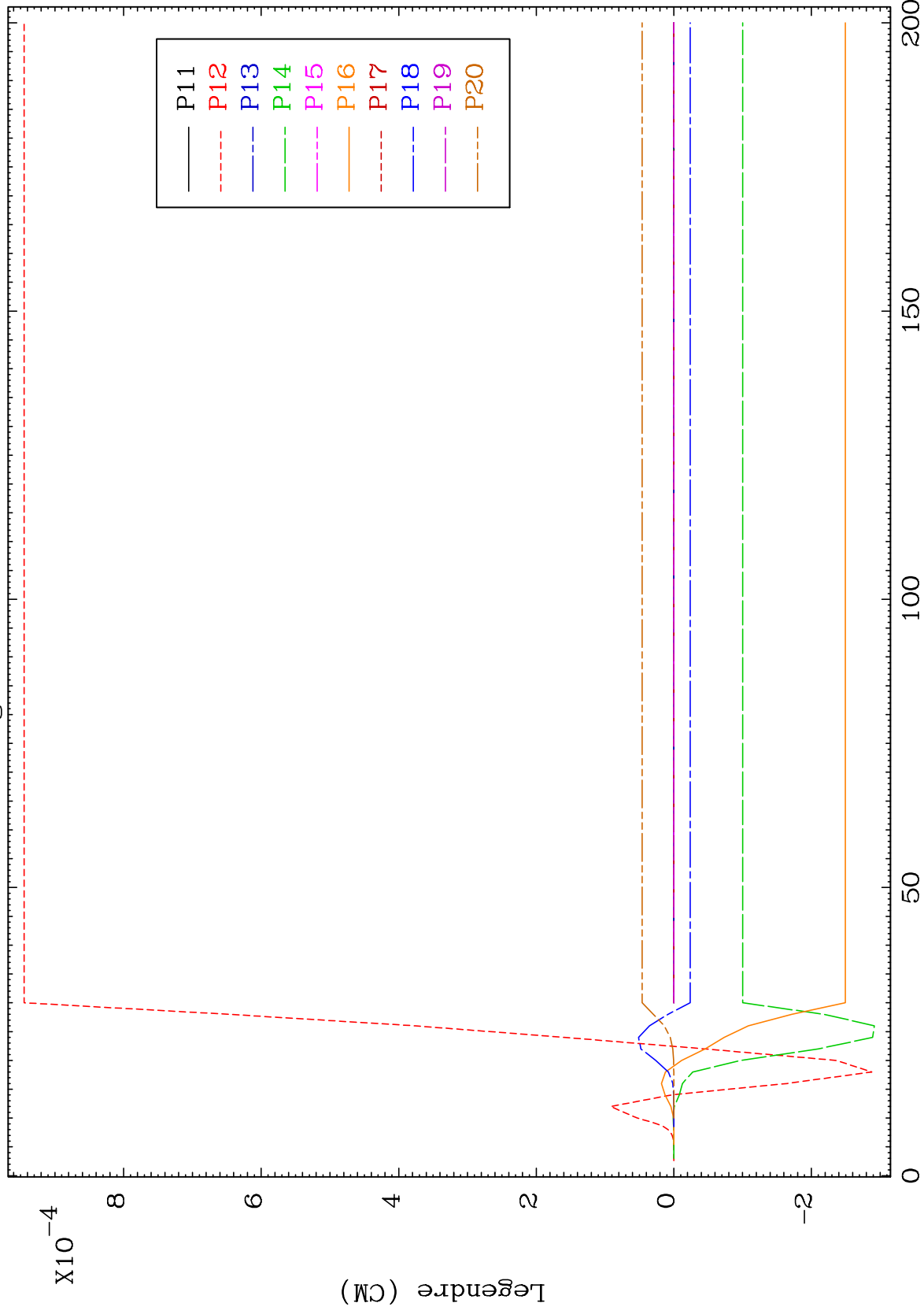

79

Incident Energy (MeV)

68-Er-174

MAT 6861

MT= 68 (n,n') Level
Legendre Coefficients

68-Er-174

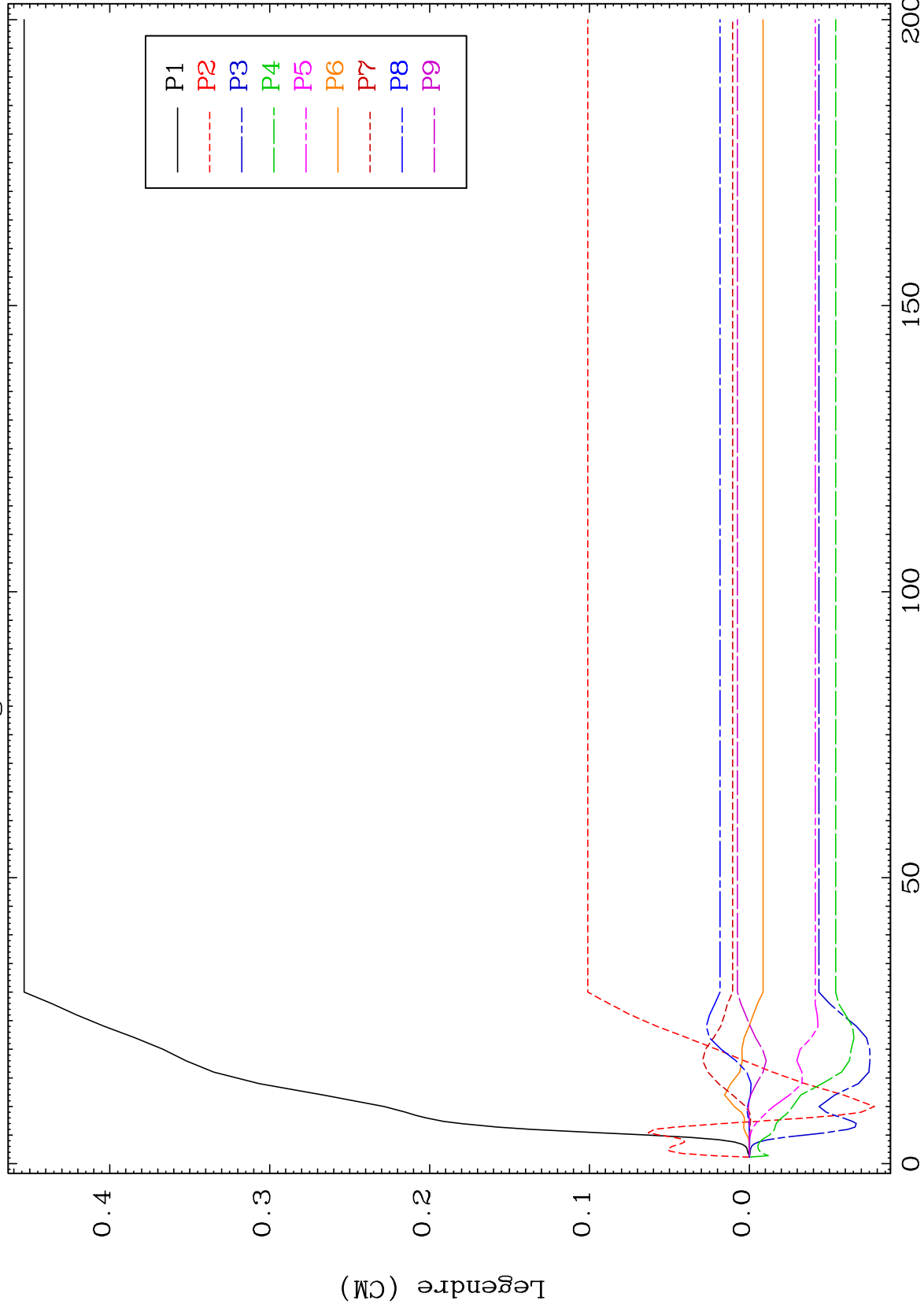

81

Incident Energy (MeV)

68-Er-174

MAT 6861

MT= 68 (n,n') Level
Legendre Coefficients

68-Er-174

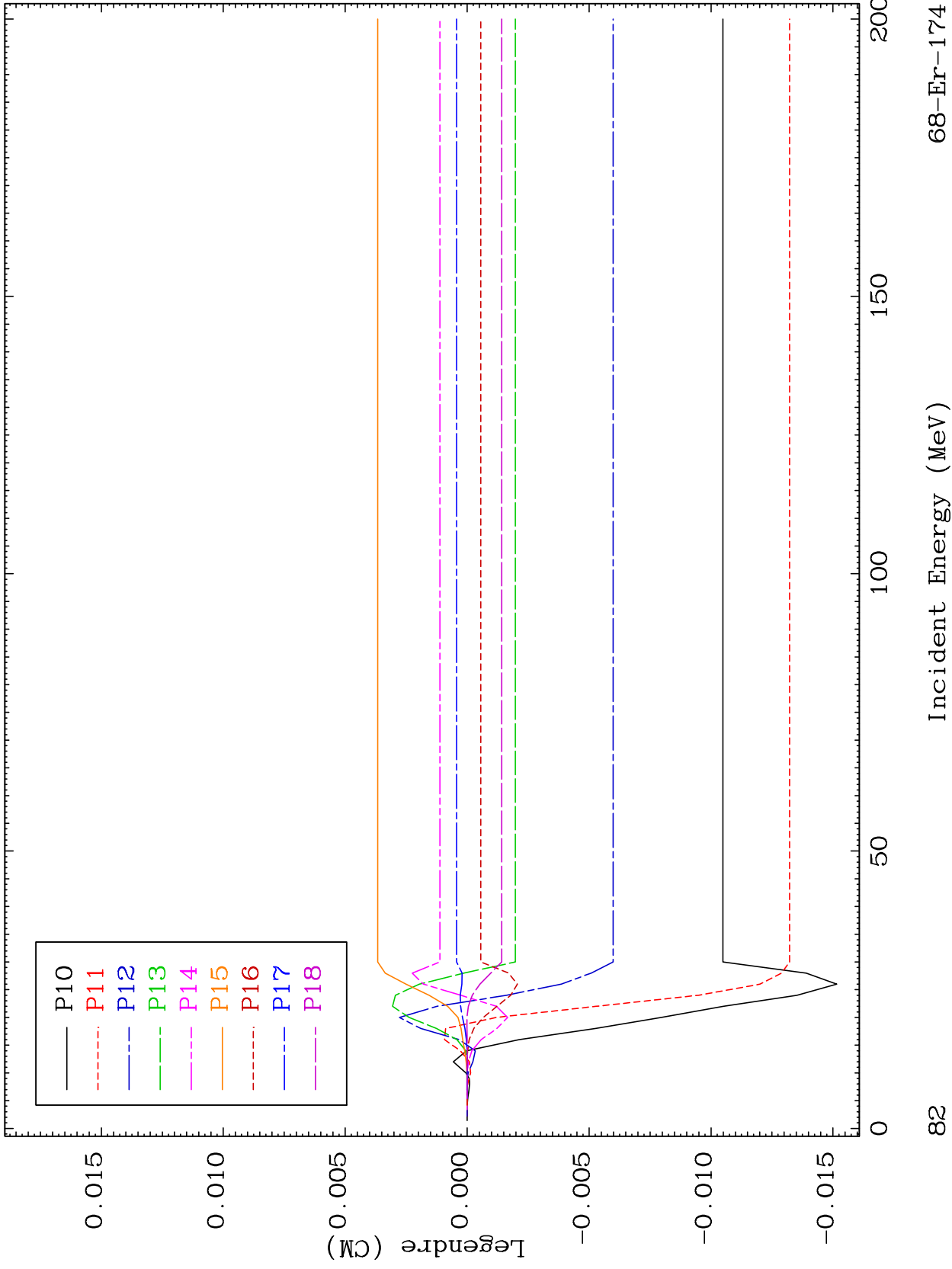

82

Incident Energy (MeV)

68-Er-174

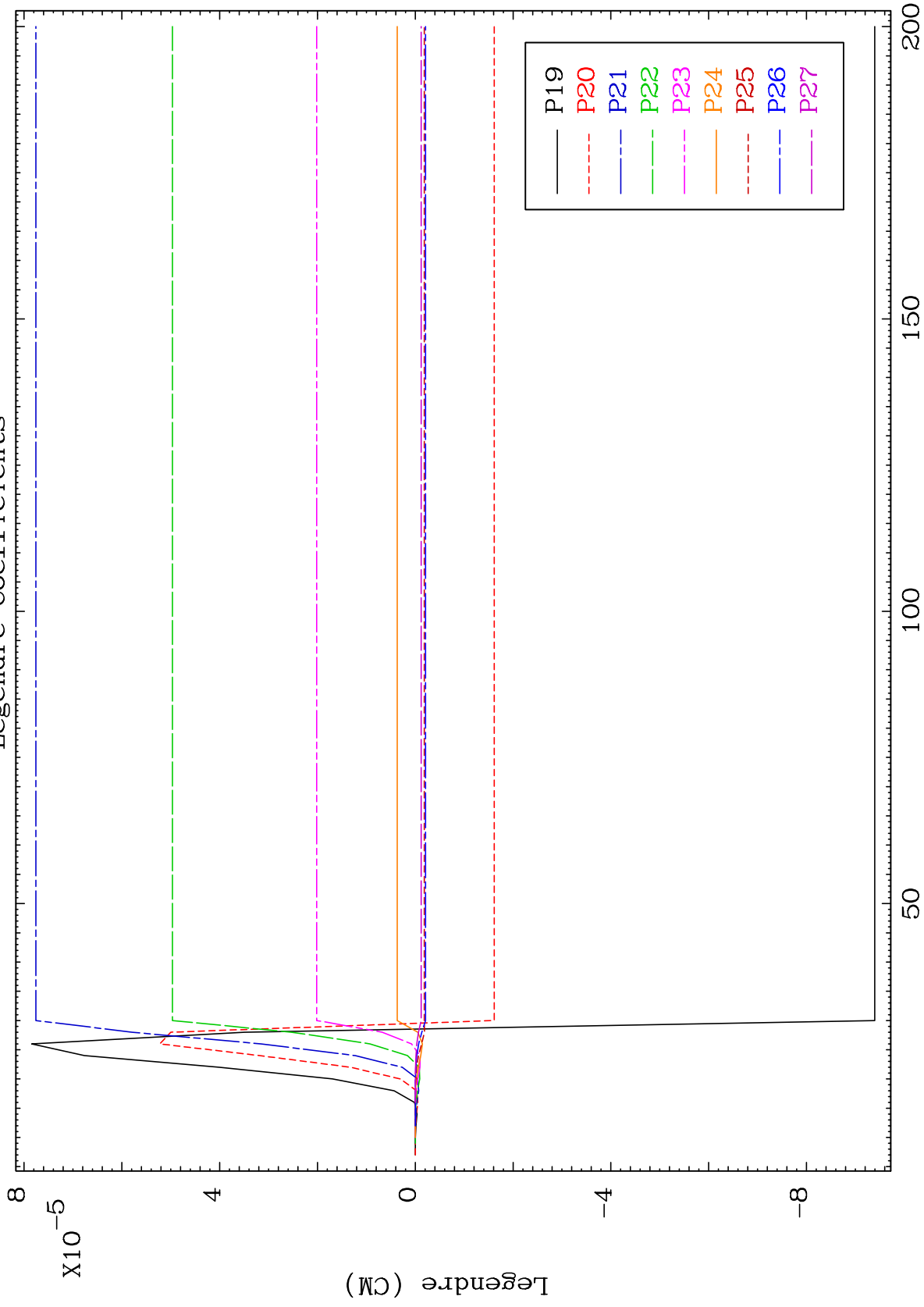

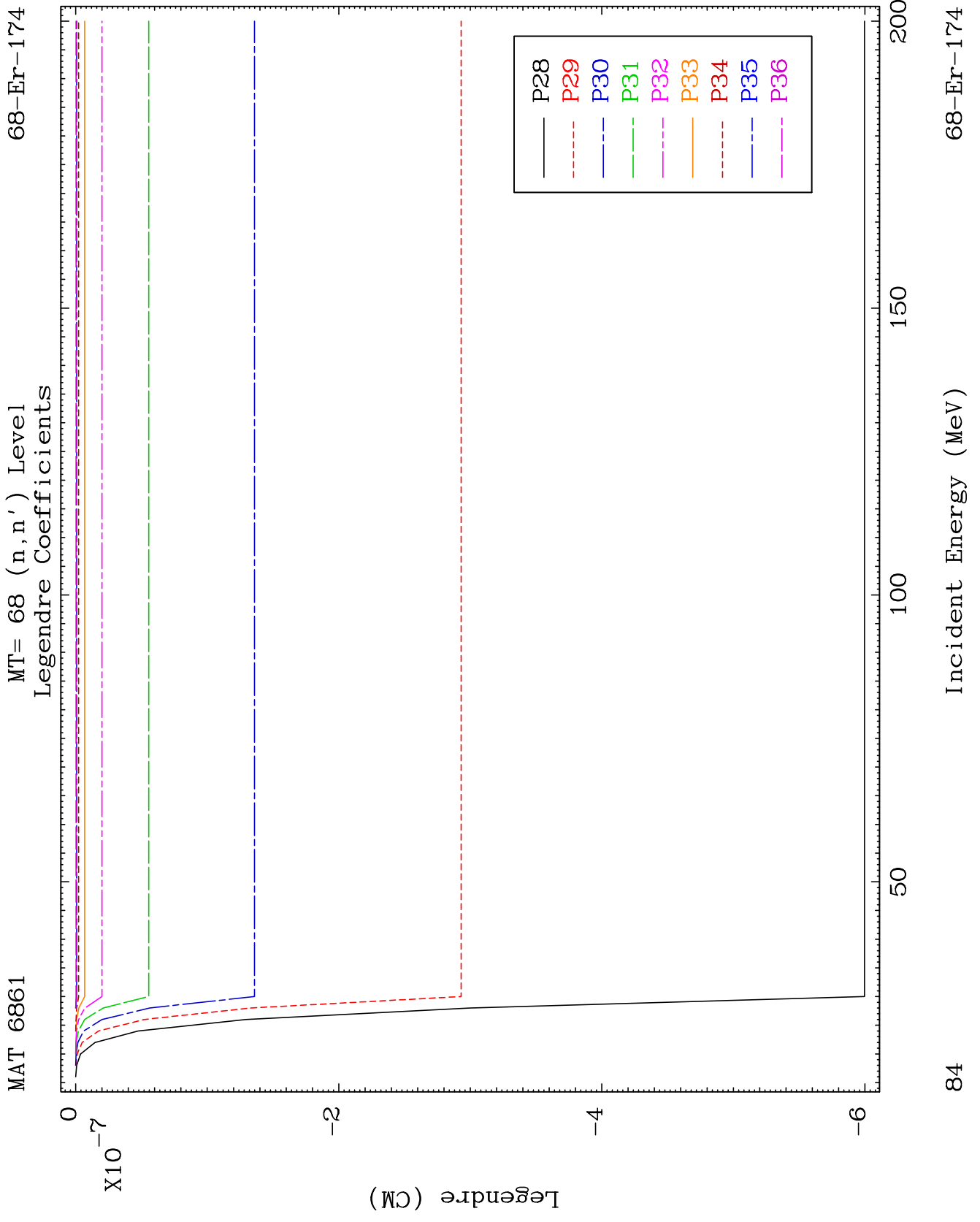

MAT 6861

MT= 69 (n,n') Level
Legendre Coefficients

68-Er-174

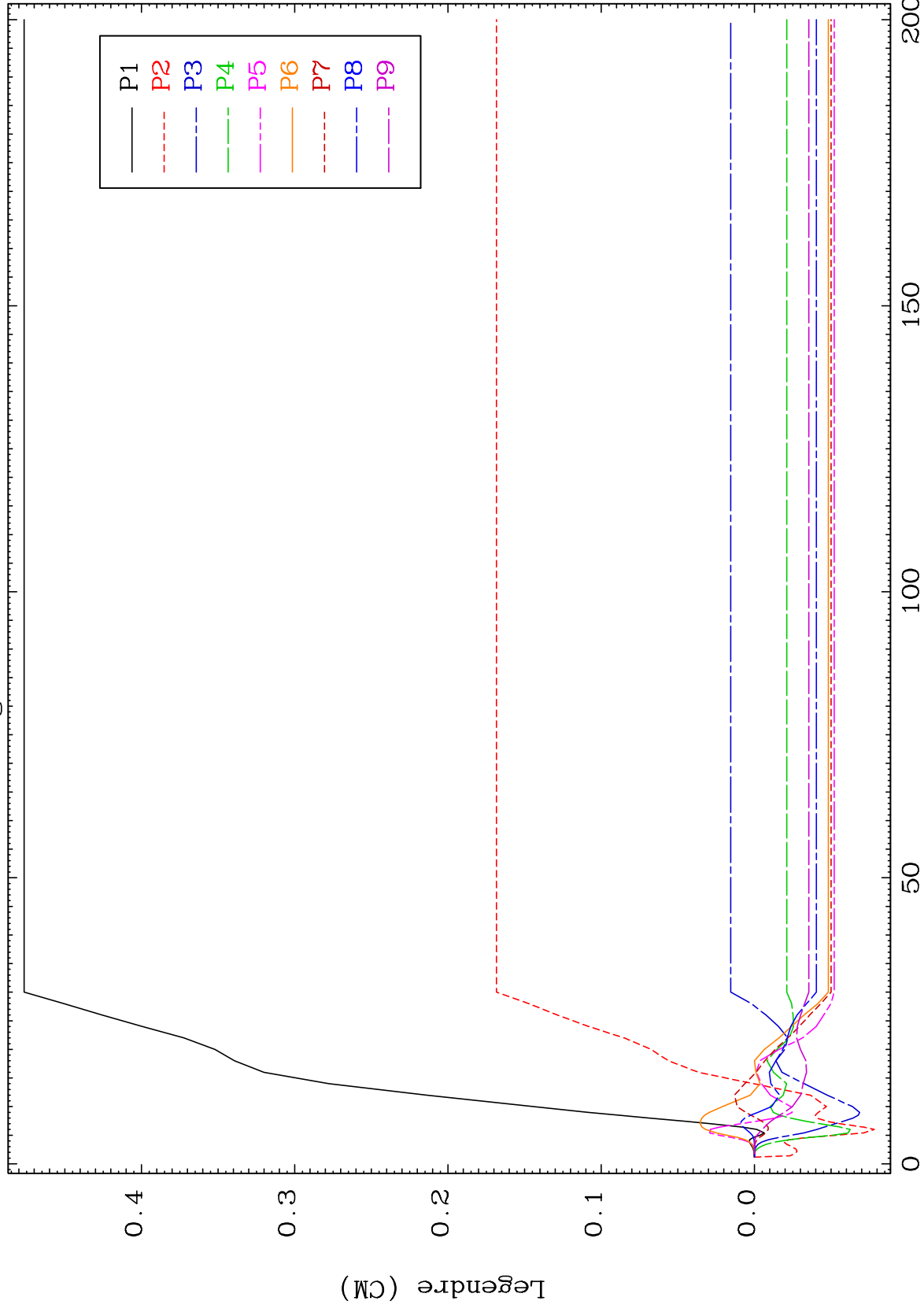

85

Incident Energy (MeV)

68-Er-174

MAT 6861

MT= 69 (n,n') Level
Legendre Coefficients

68-Er-174

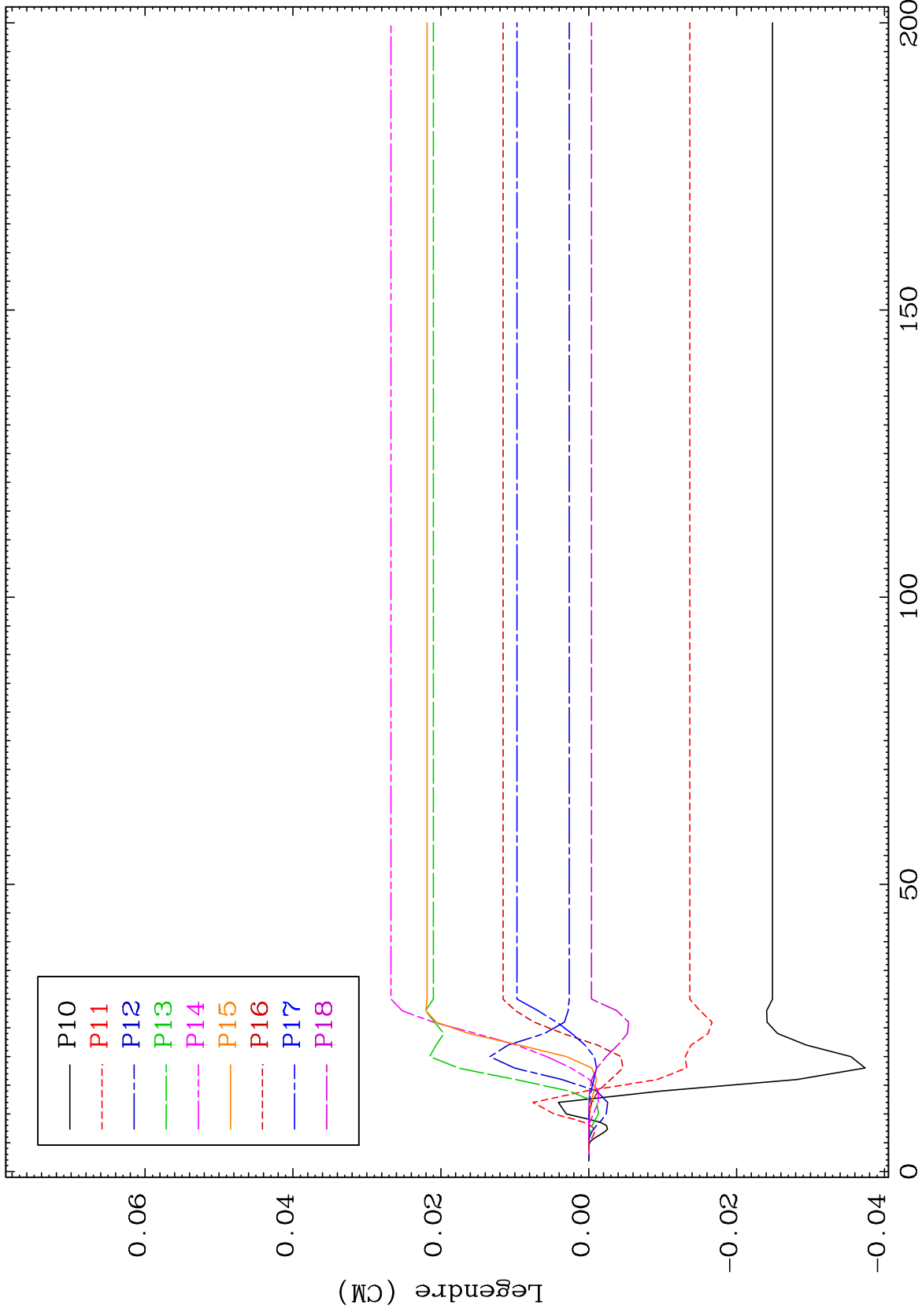

86

Incident Energy (MeV)

68-Er-174

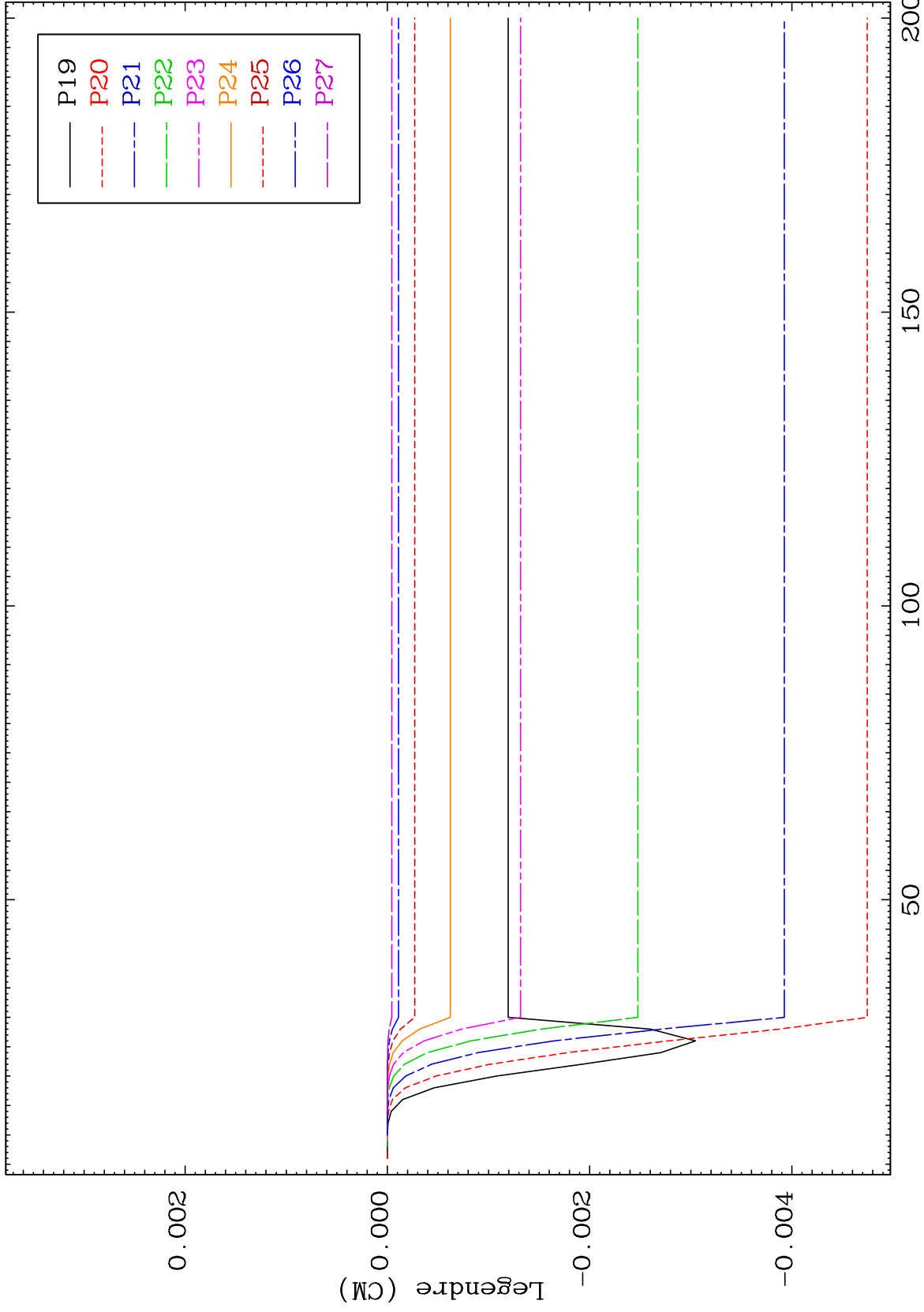

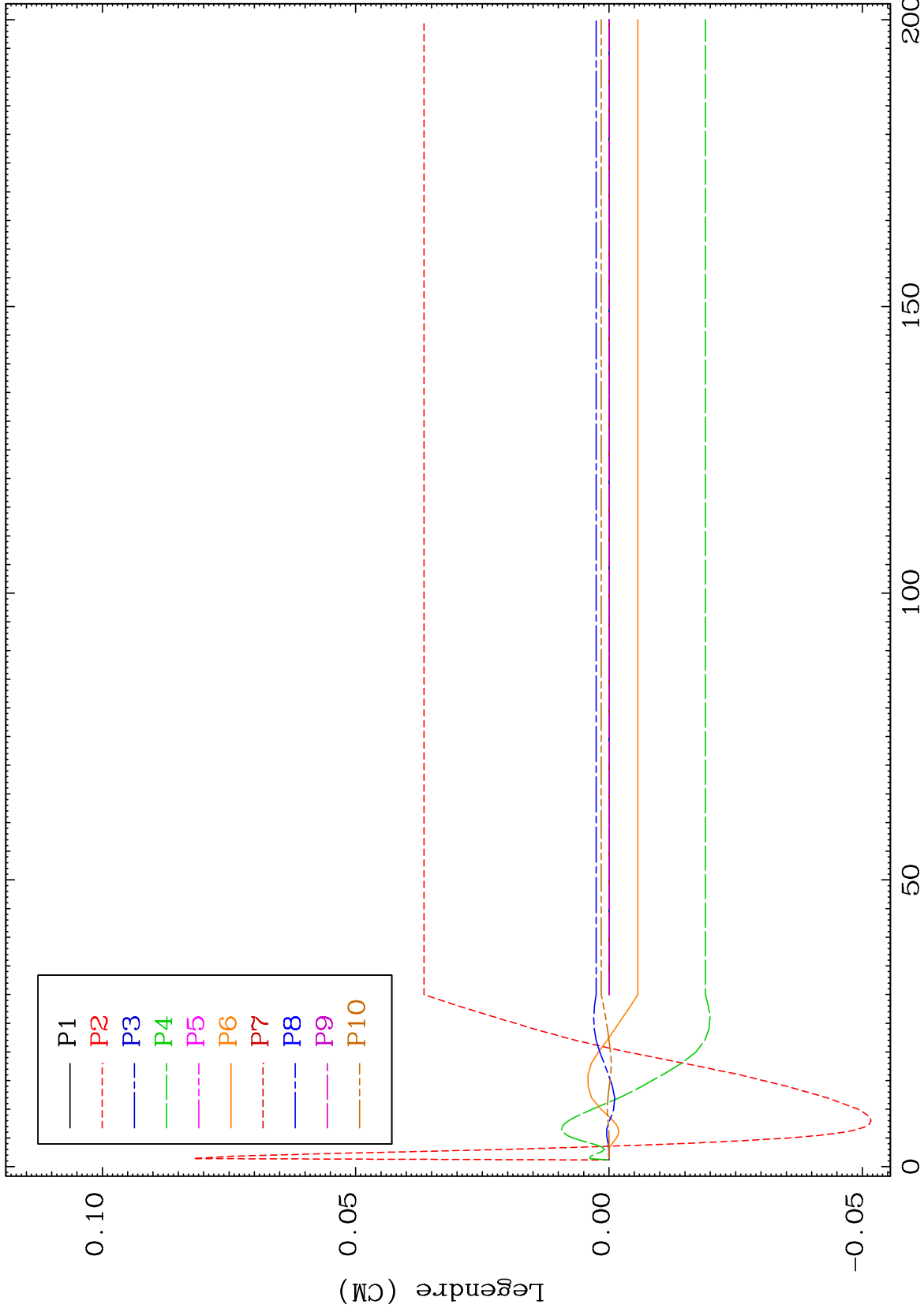

MAT 6861

MT= 70 (n,n') Level

68-Er-174

Legendre Coefficients

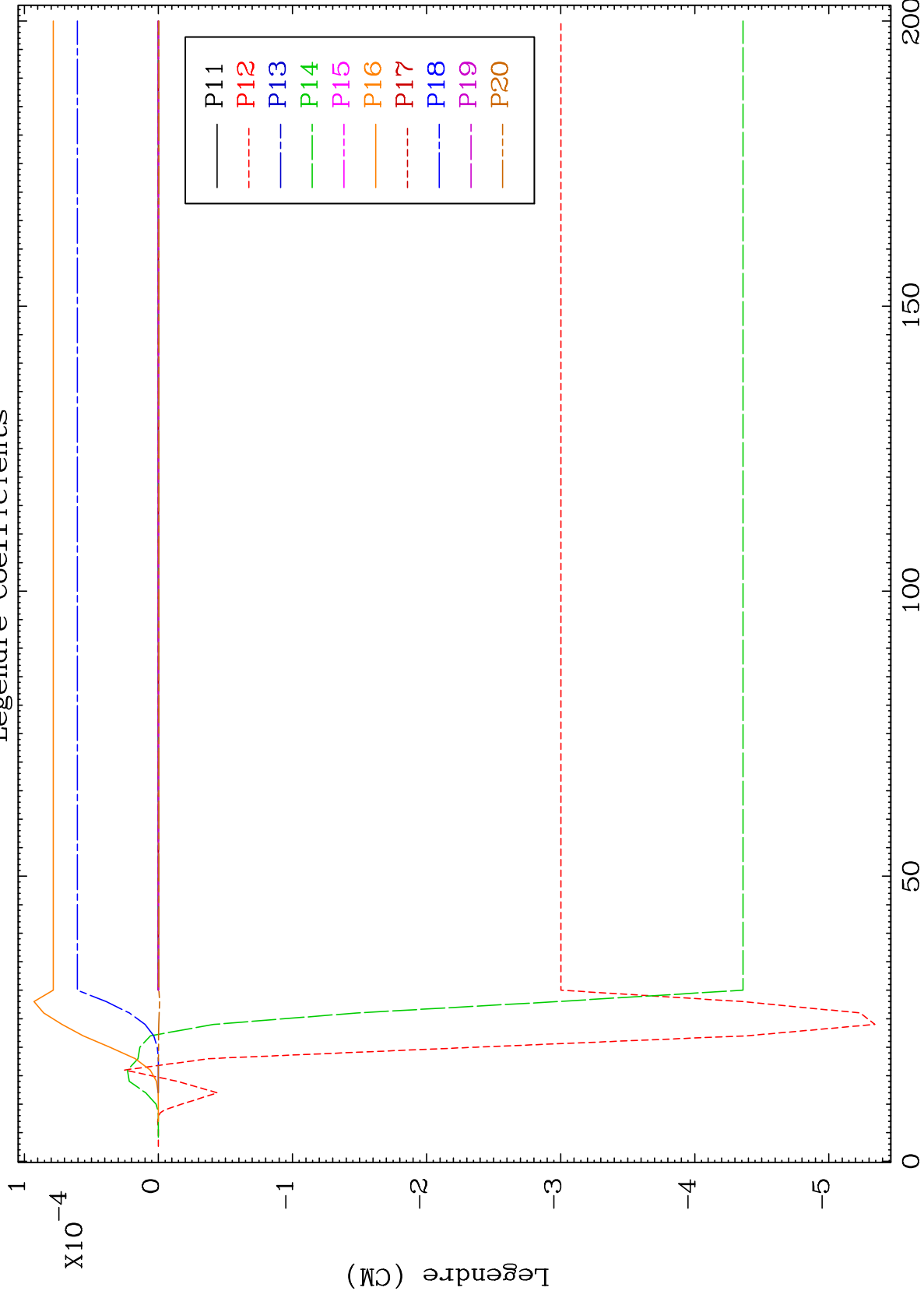

90

Incident Energy (MeV)

68-Er-174

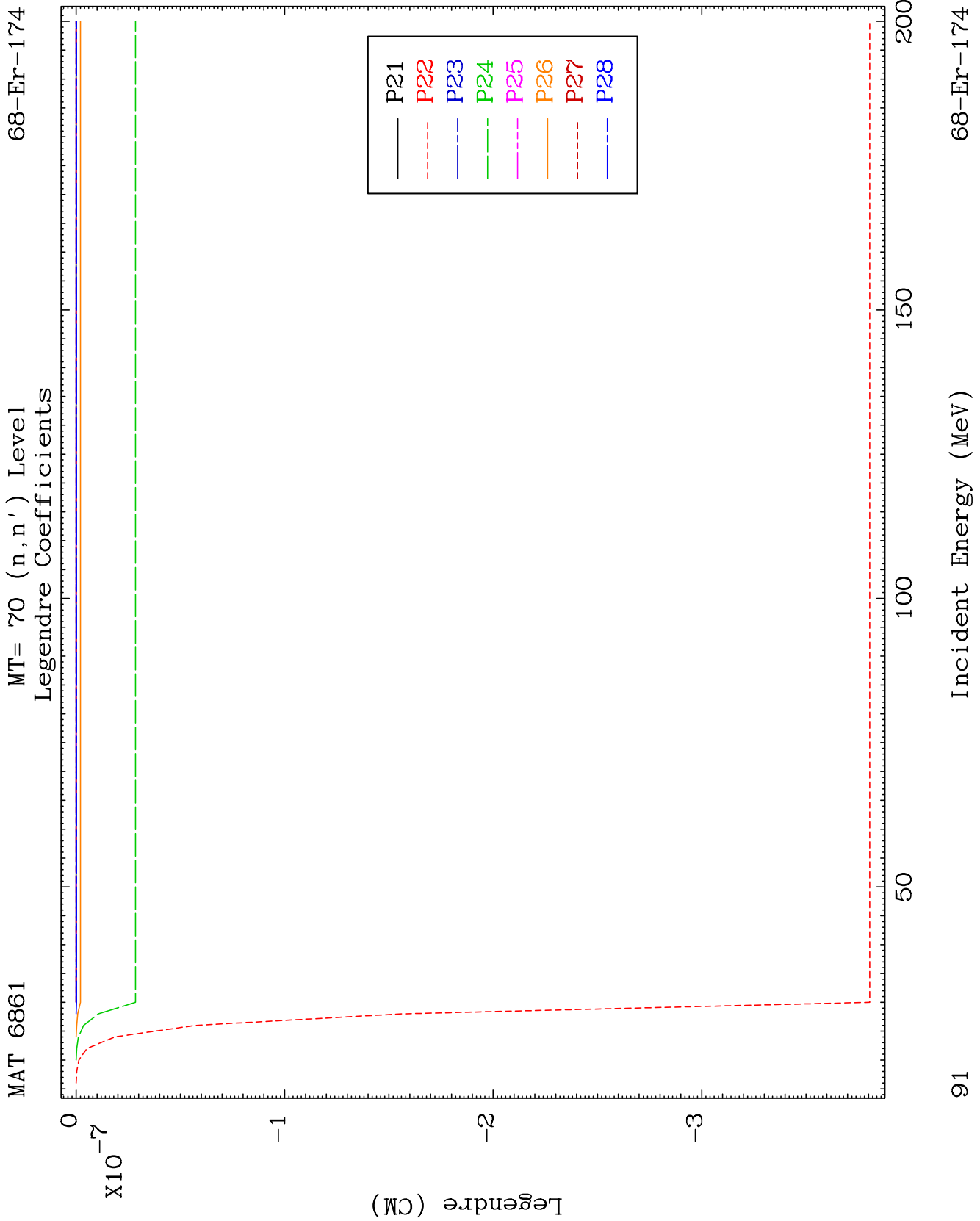

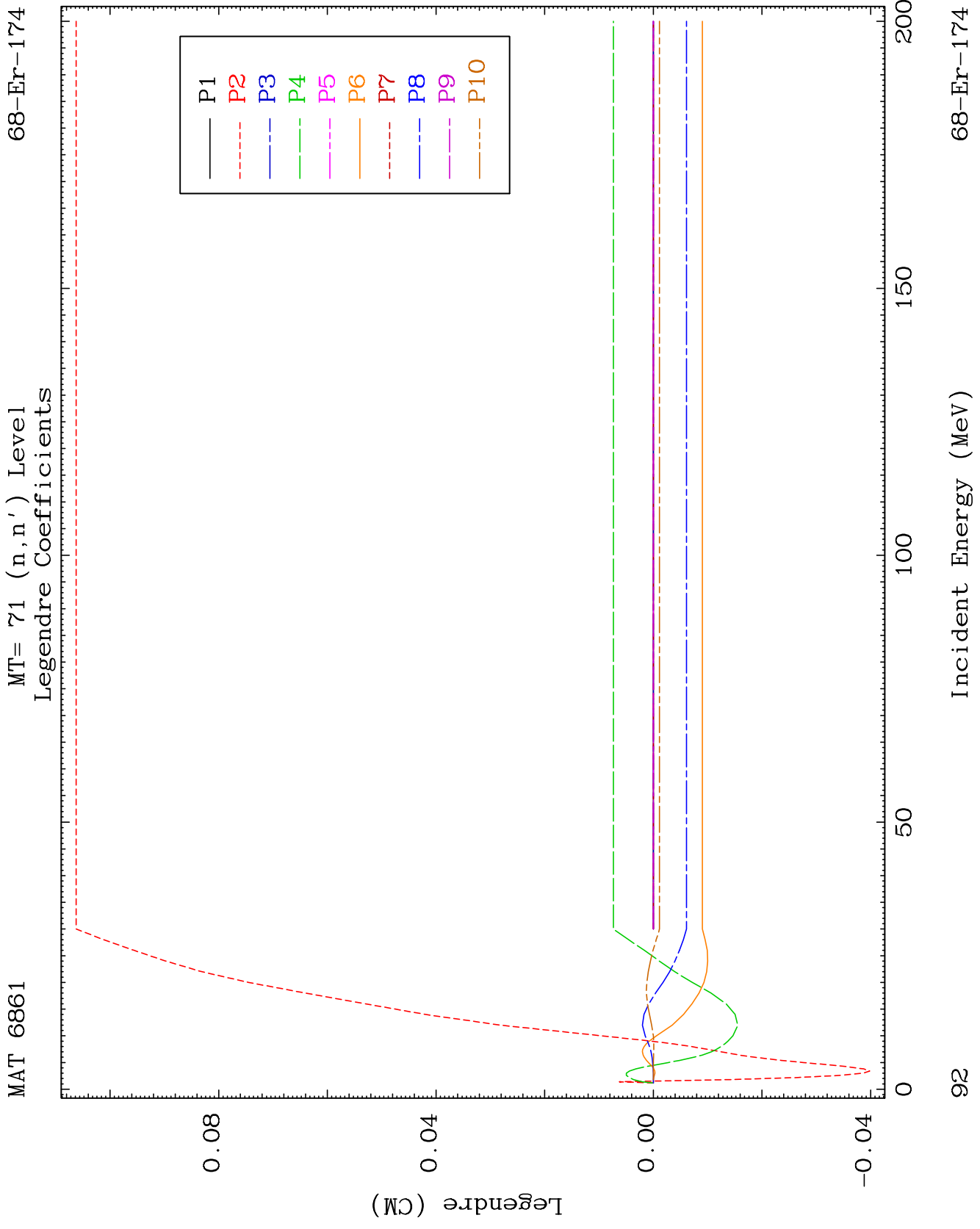

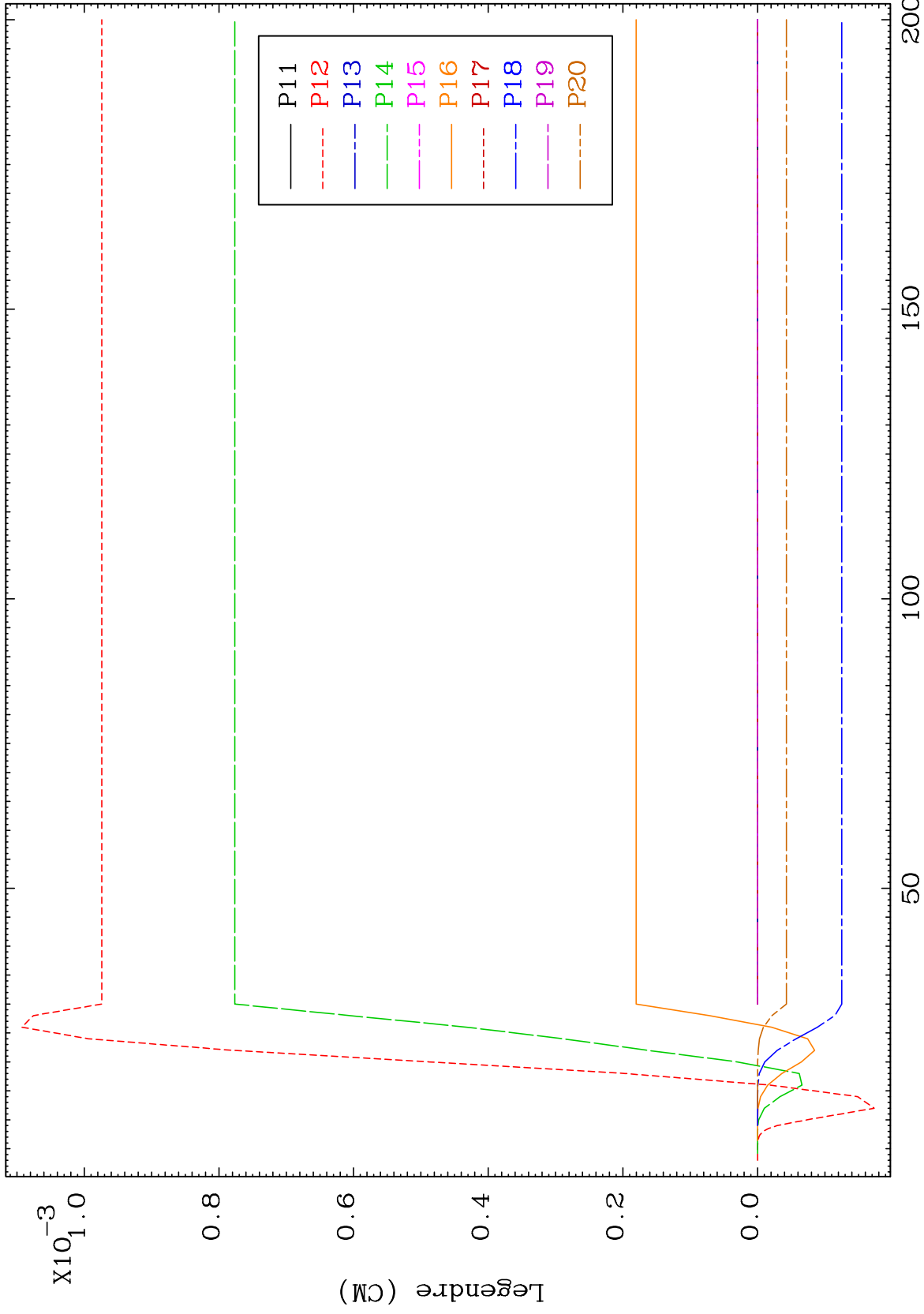

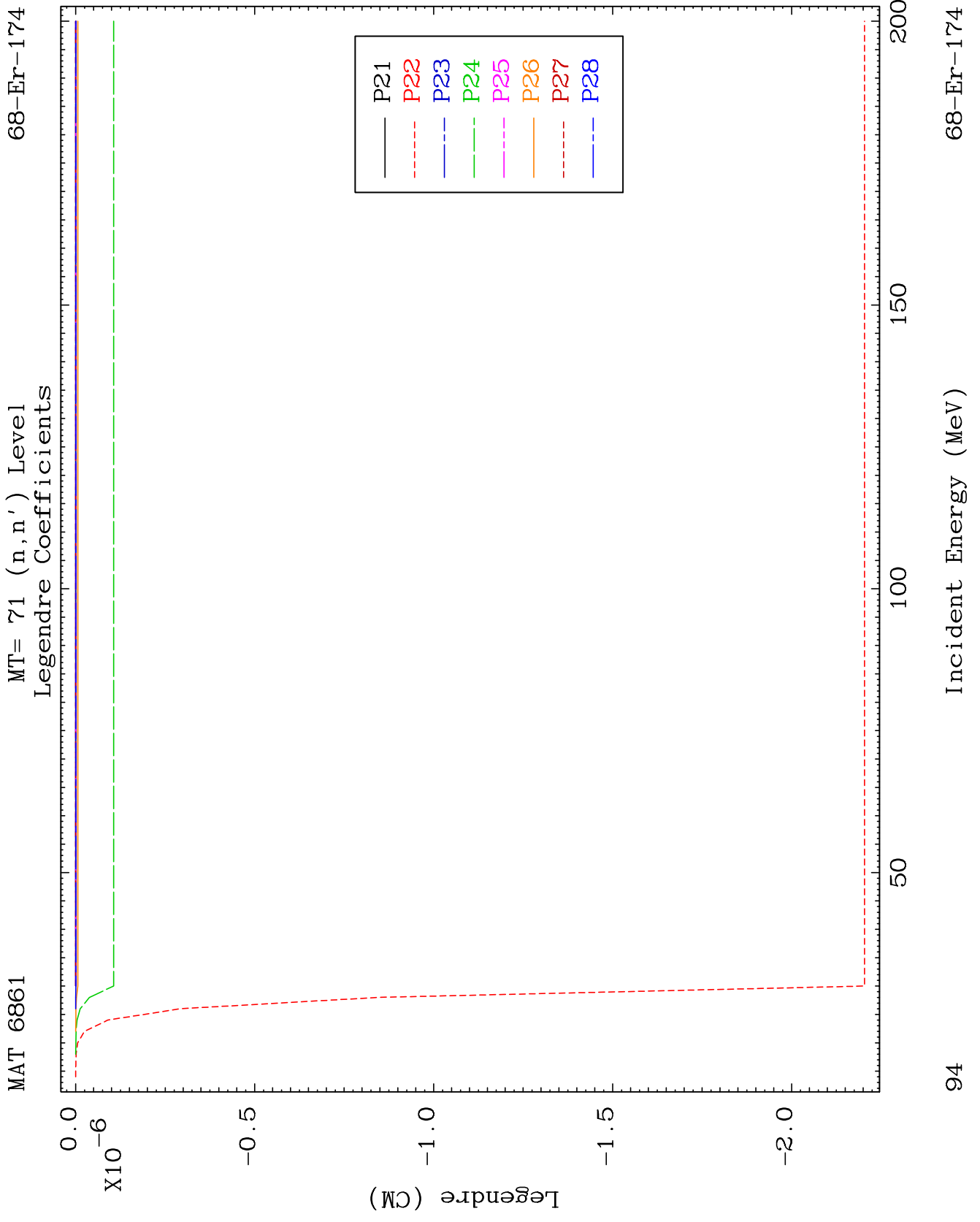

MAT 6861

MT= 72 (n,n') Level
Legendre Coefficients

68-Er-174

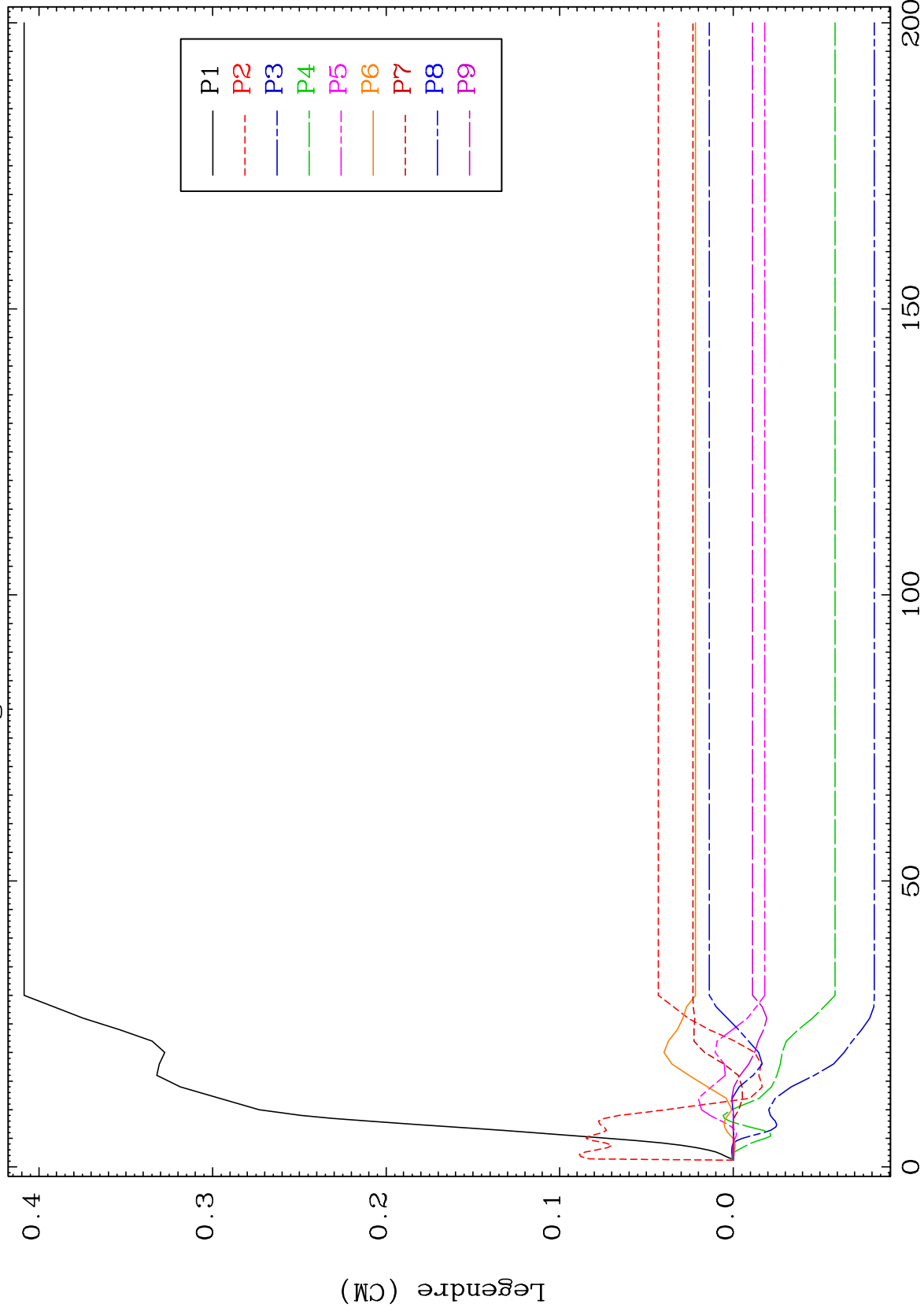

95

Incident Energy (MeV)

68-Er-174

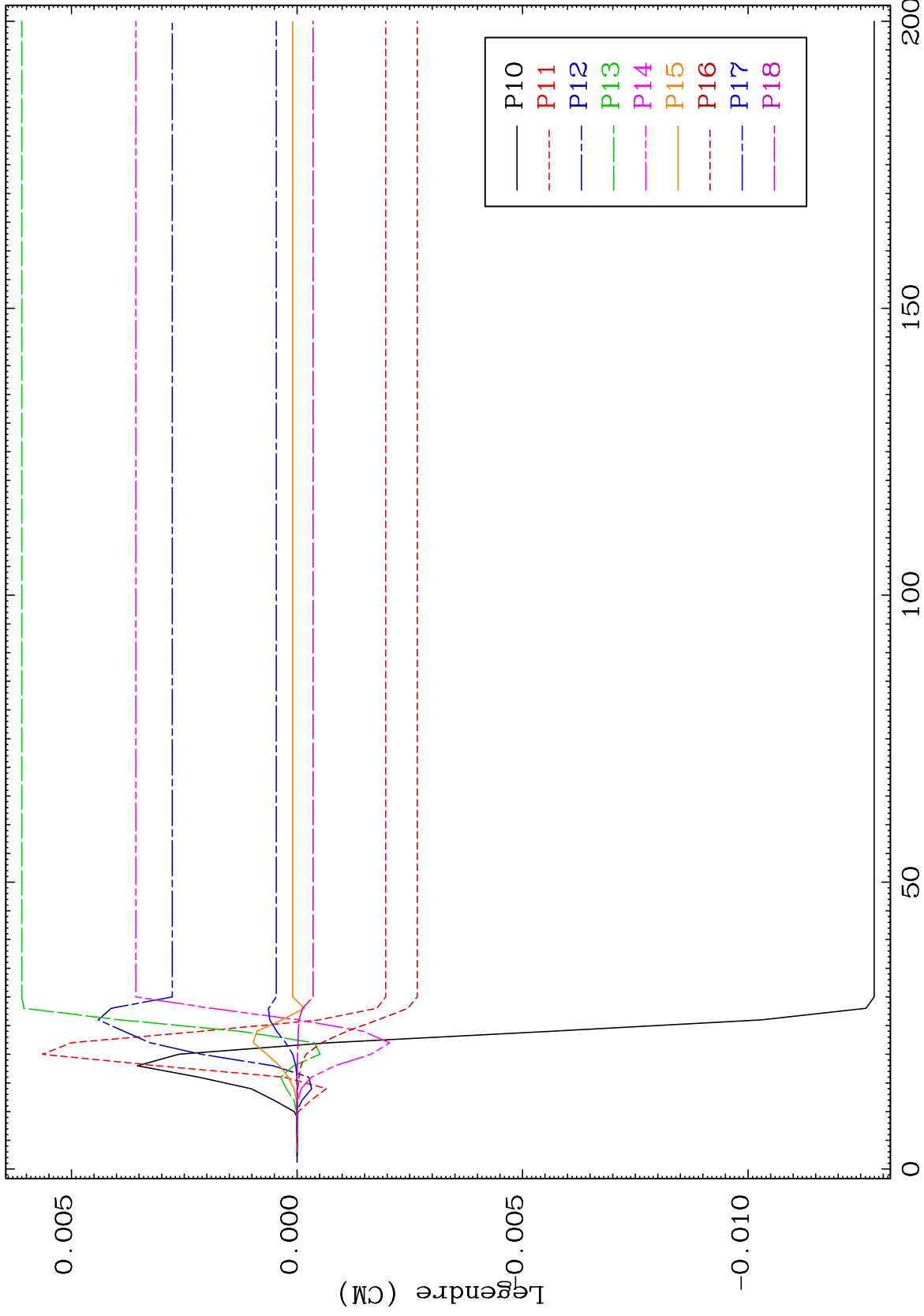

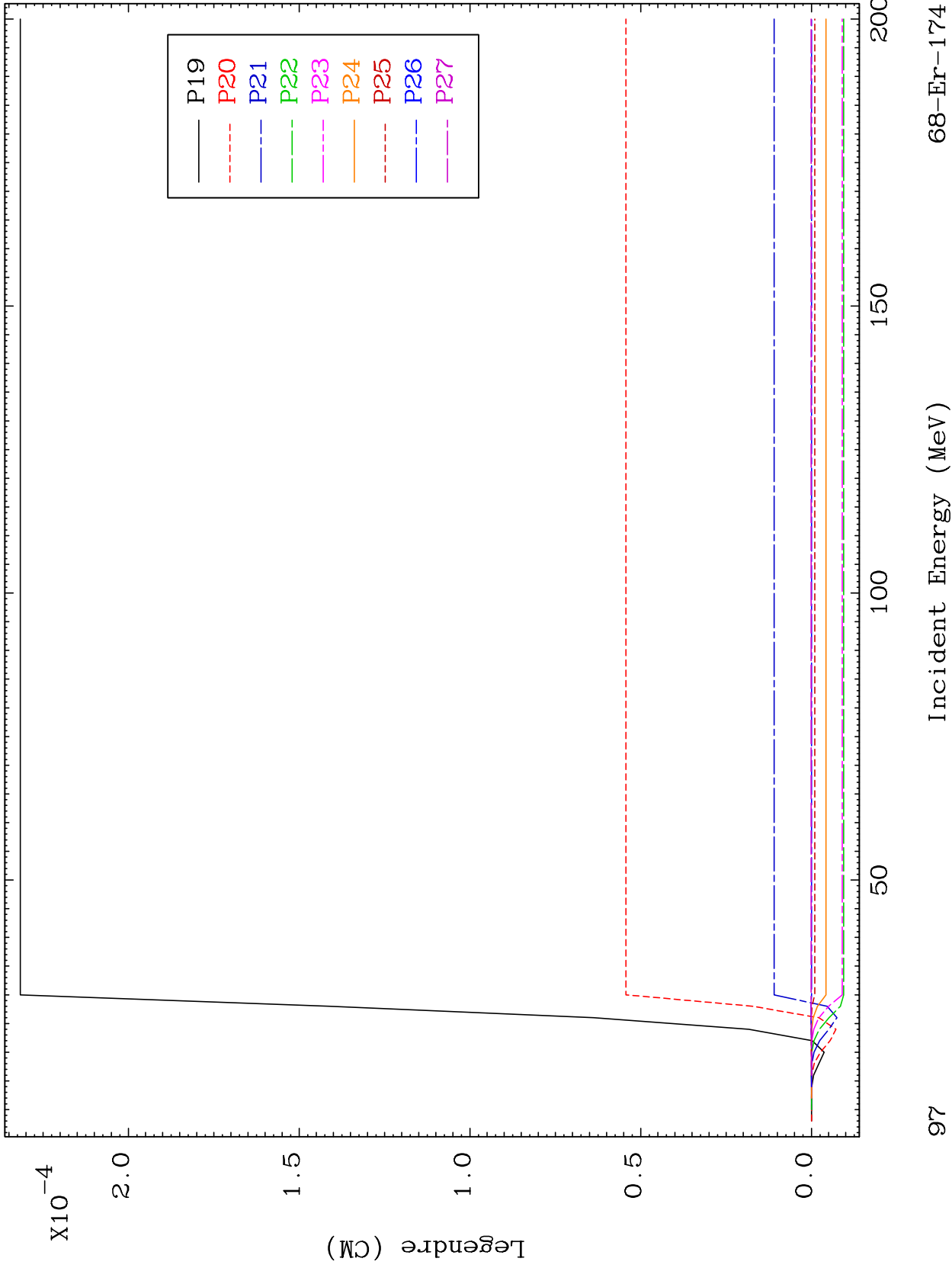

MAT 6861

MT= 72 (n,n') Level
Legendre Coefficients

68-Er-174

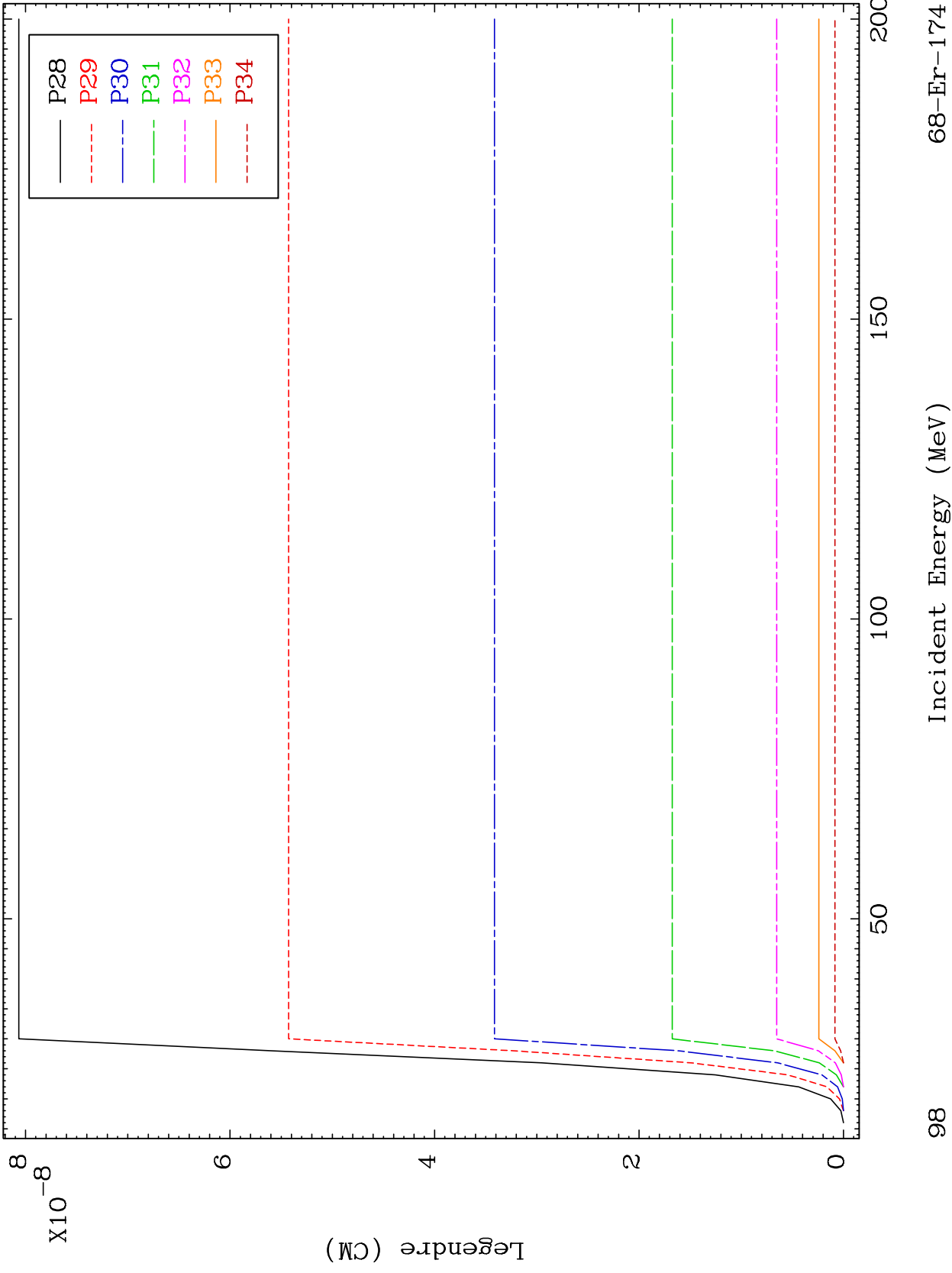

MAT 6861

MT= 73 (n,n') Level
Legendre Coefficients

68-Er-174

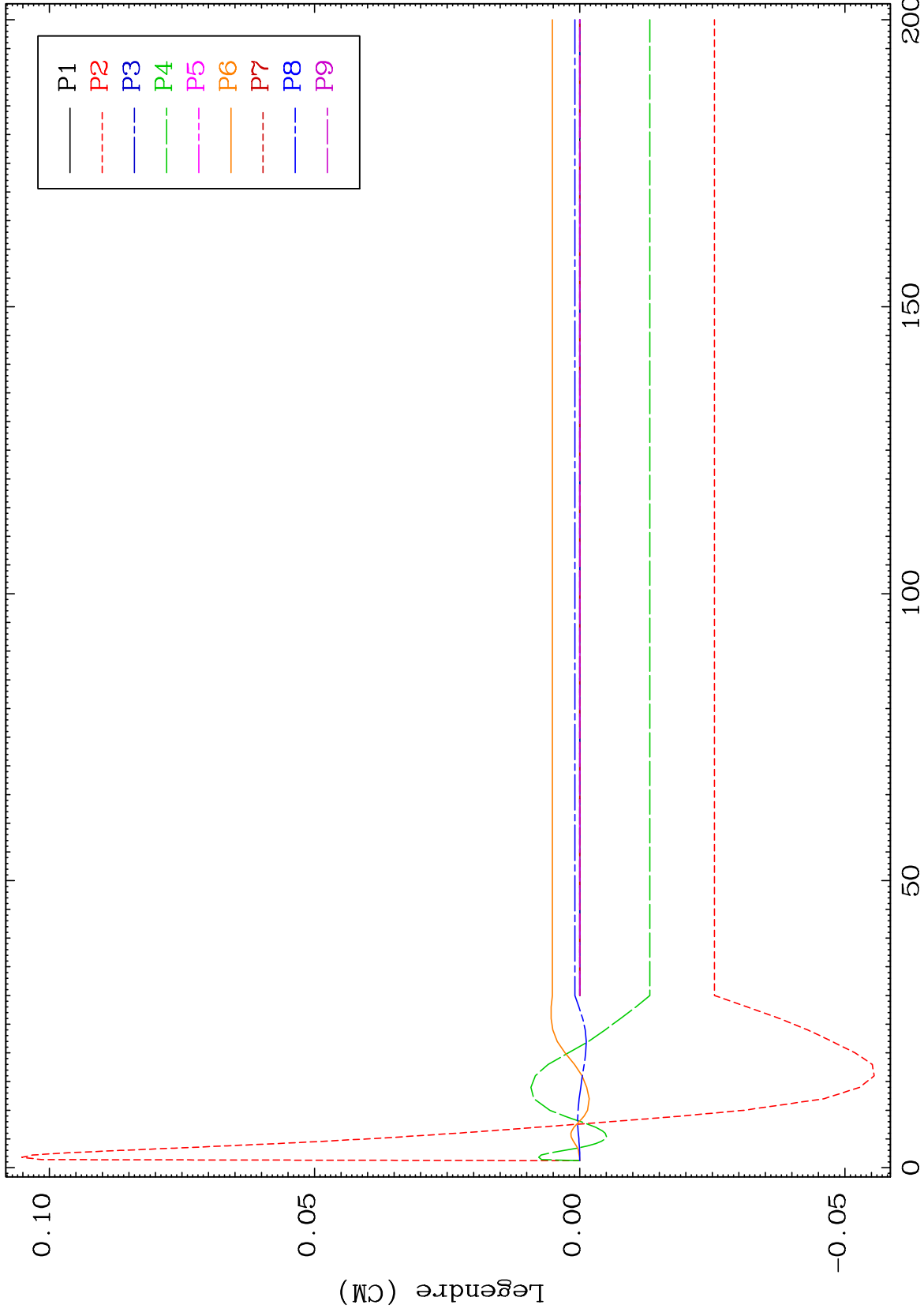

99

Incident Energy (MeV)

68-Er-174

MAT 6861

MT= 73 (n,n') Level
Legendre Coefficients

68-Er-174

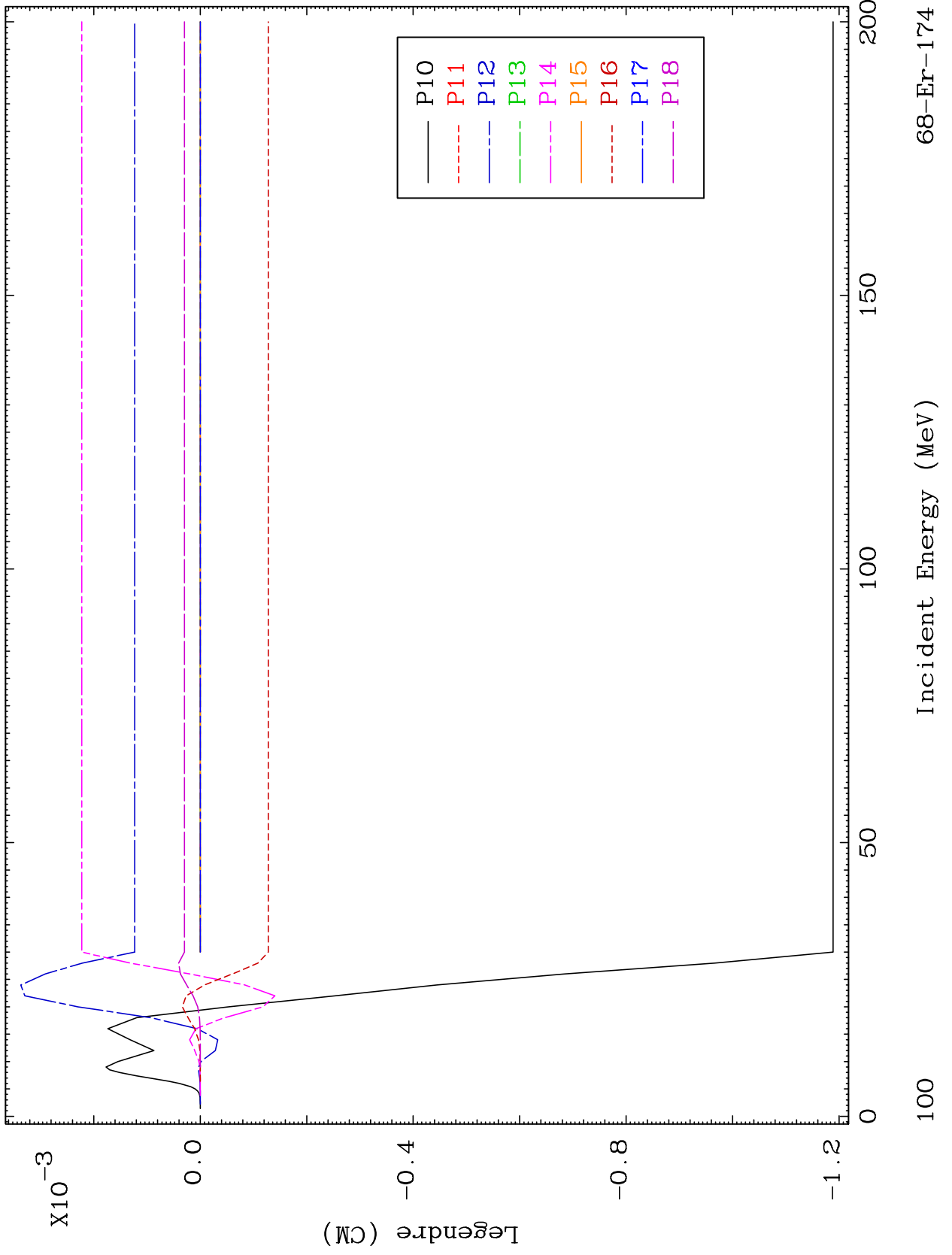

68-Er-174

MAT 6861

MT= 74 (n,n') Level
Legendre Coefficients

68-Er-174

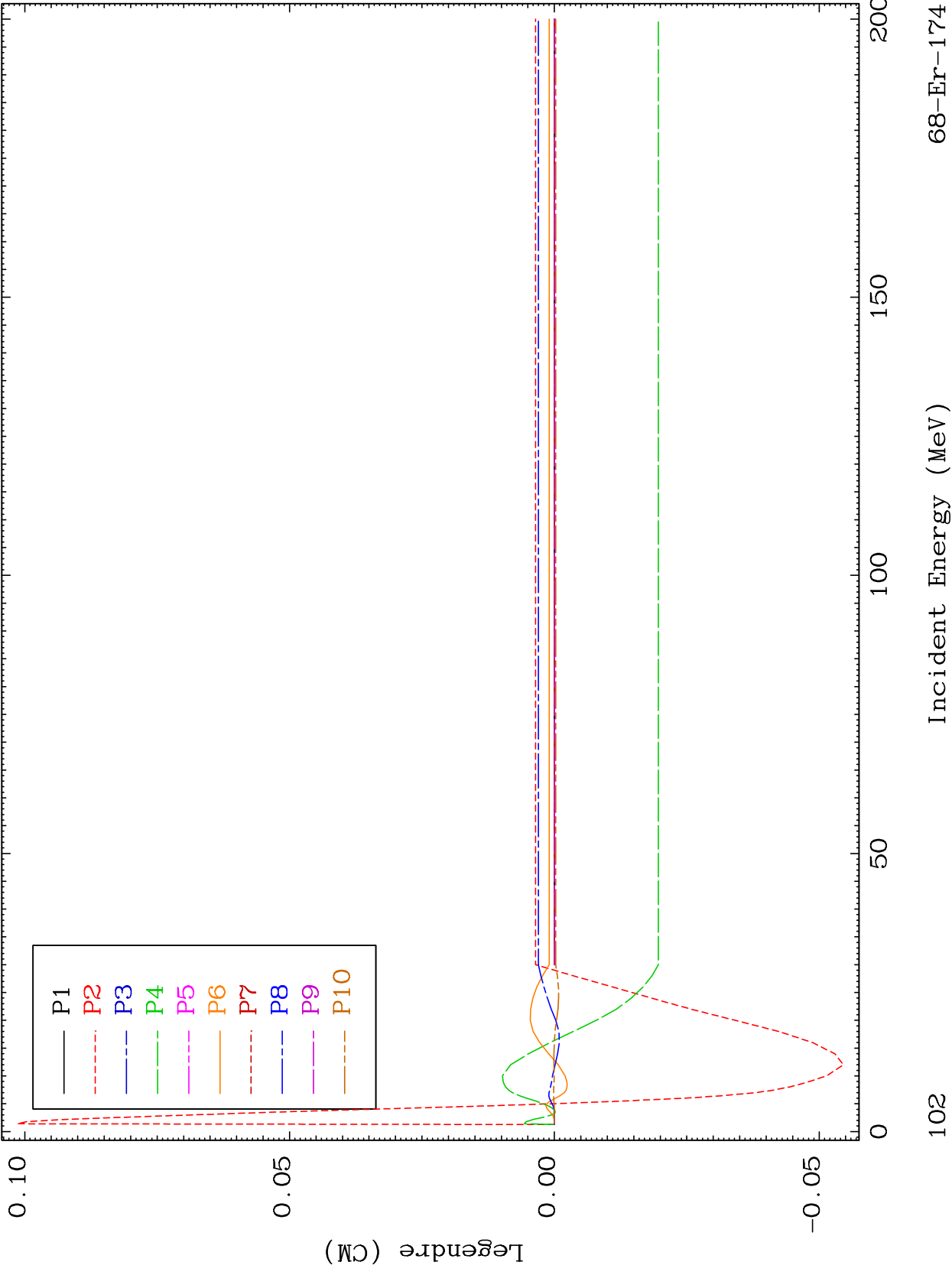

102

Incident Energy (MeV)

68-Er-174

MAT 6861

MT= 74 (n,n') Level

68-Er-174

Legendre Coefficients

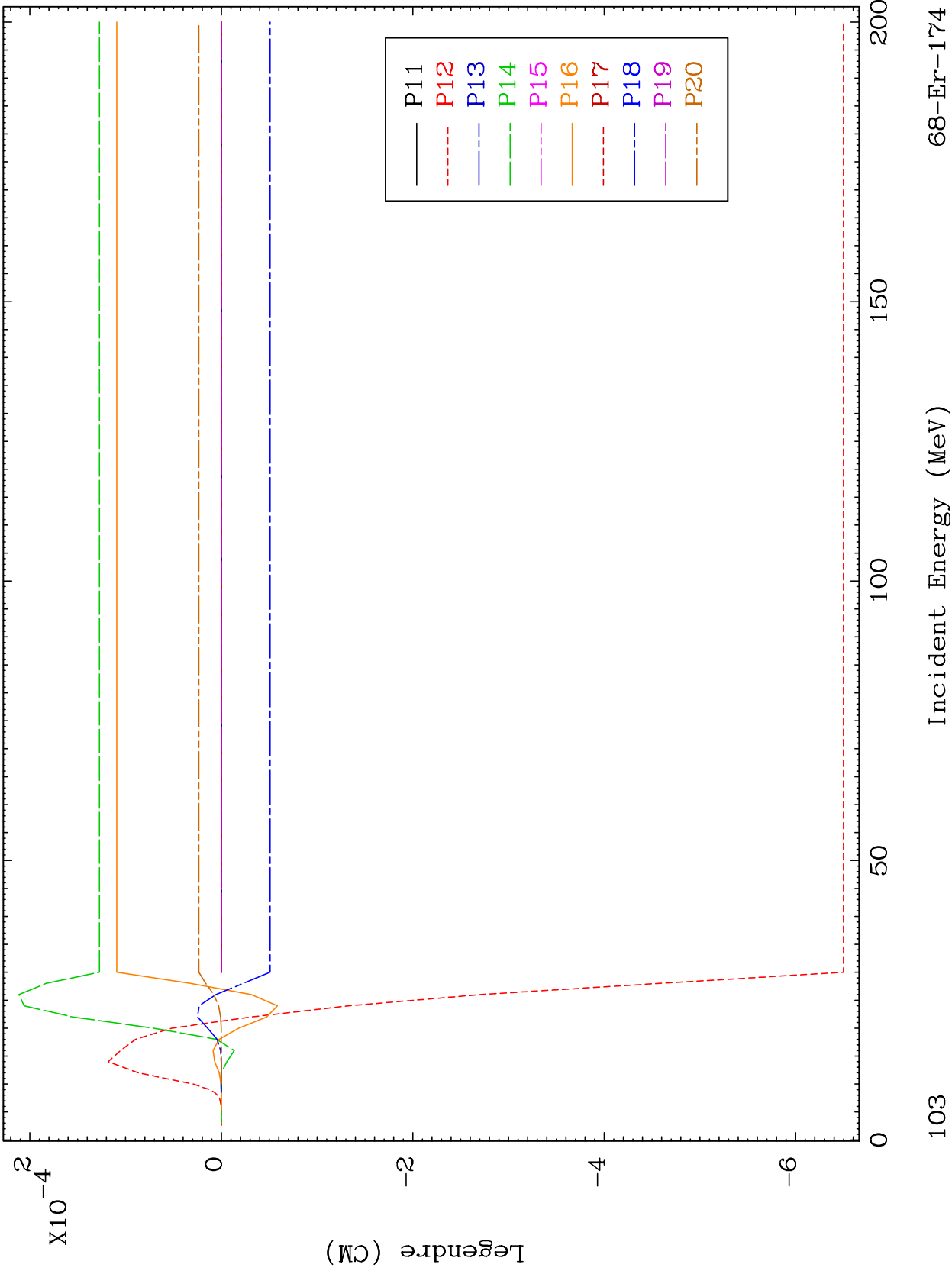

103

Incident Energy (MeV)

68-Er-174

MAT 6861

MT= 75 (n,n') Level
Legendre Coefficients

68-Er-174

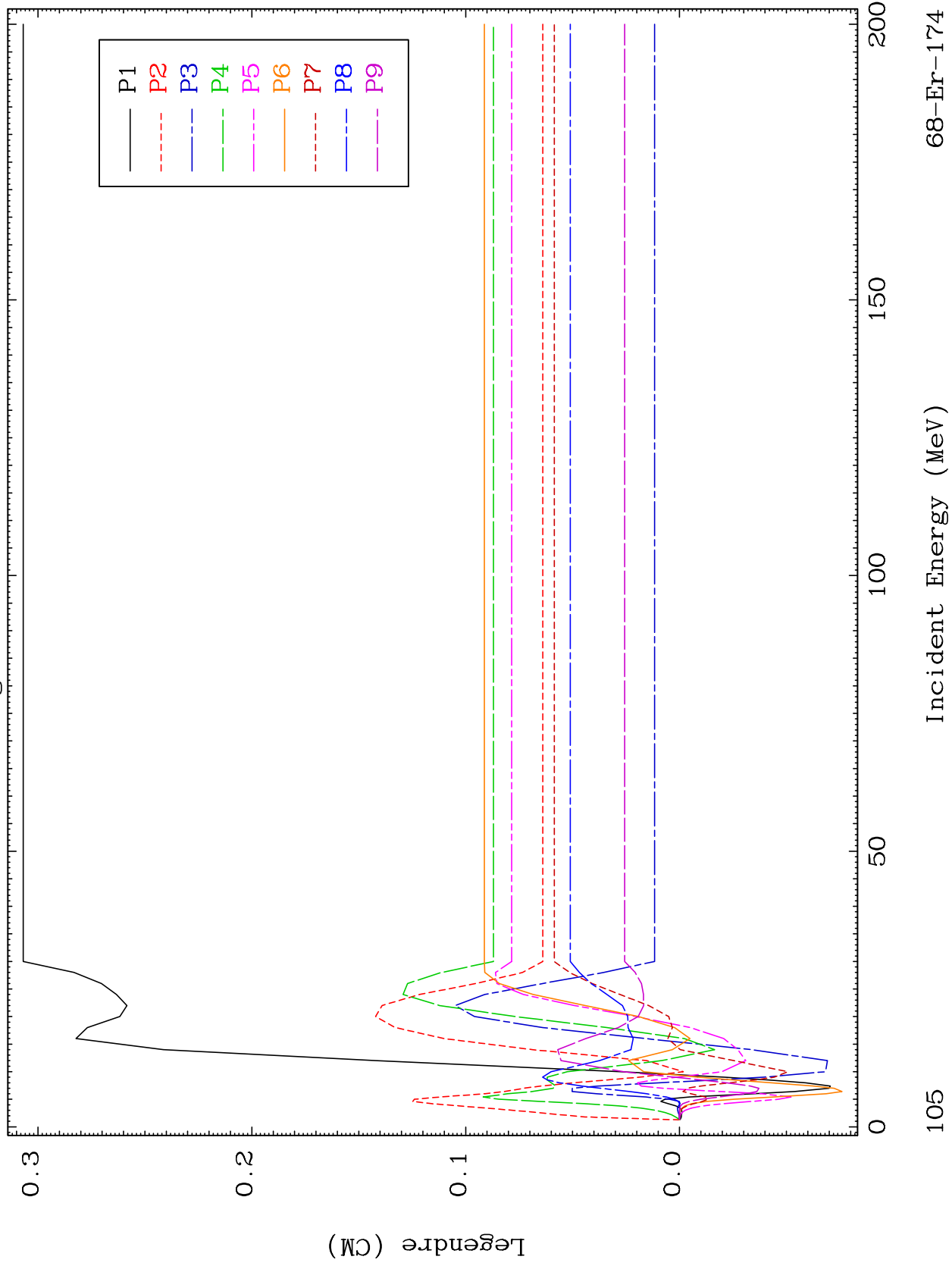

68-Er-174

Incident Energy (MeV)

105

MAT 6861

MT= 75 (n,n') Level
Legendre Coefficients

68-Er-174

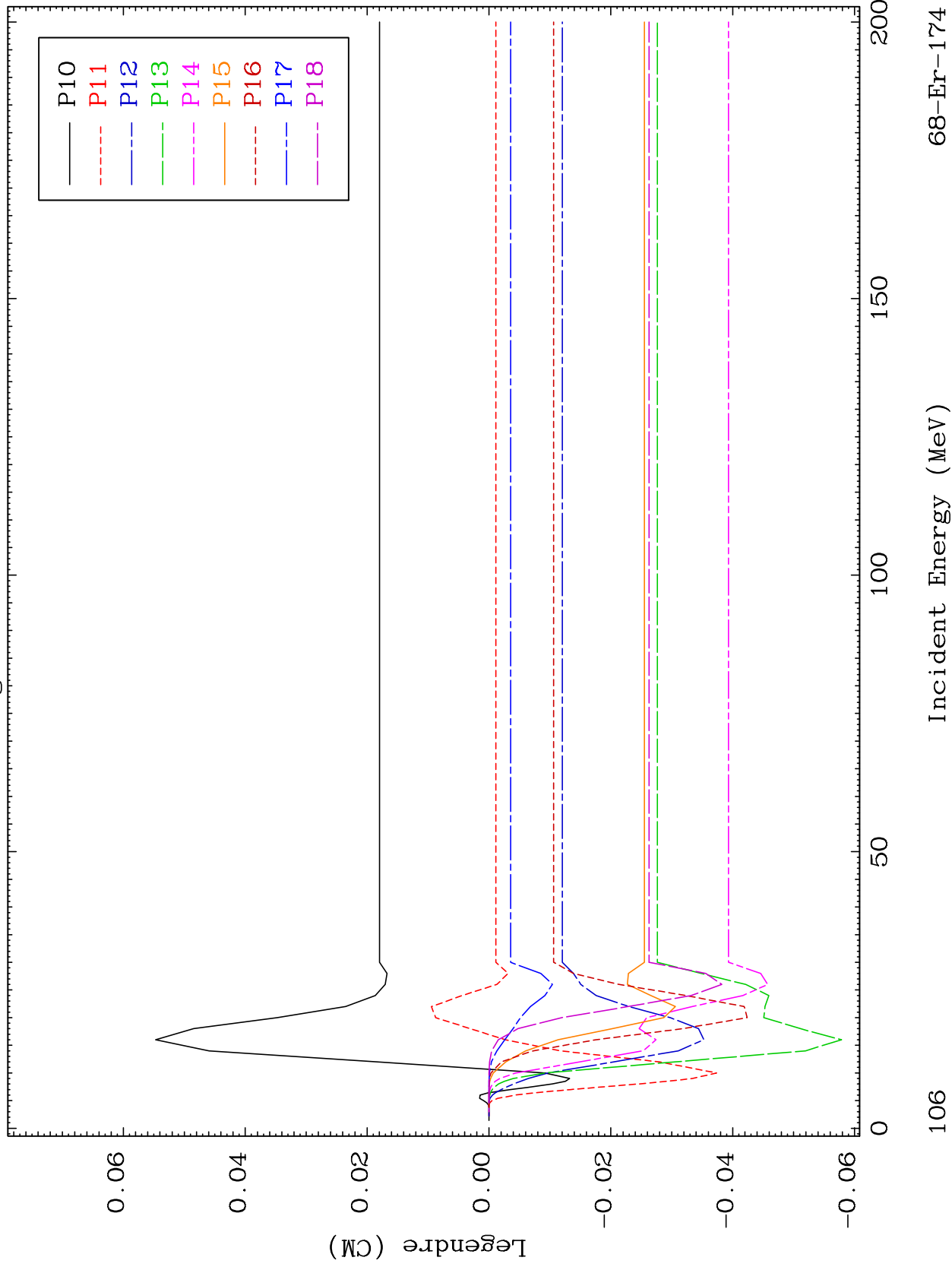

68-Er-174

Incident Energy (MeV)

106

MAT 6861

MT= 75 (n,n') Level
Legendre Coefficients

68-Er-174

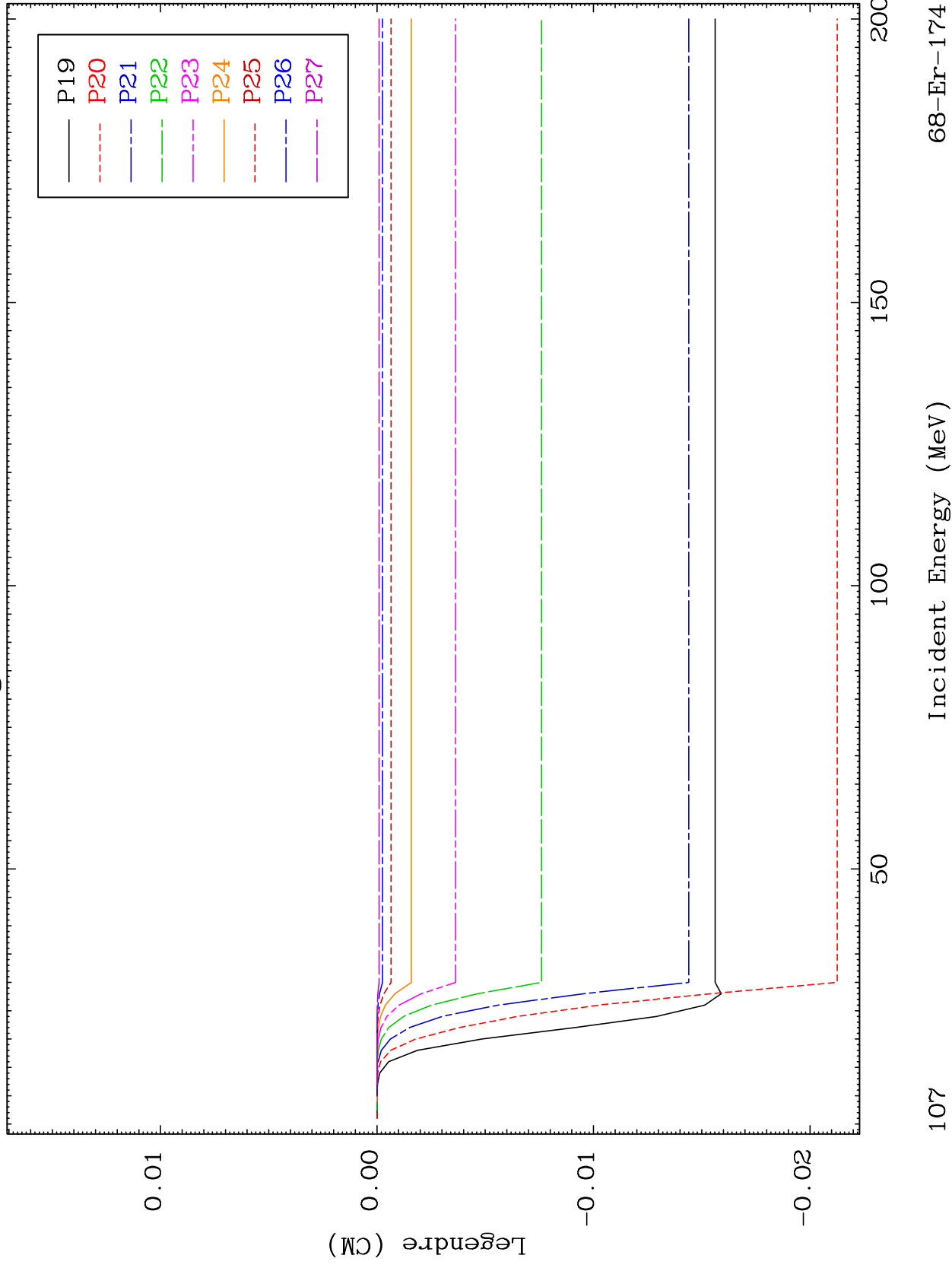

107

Incident Energy (MeV)

68-Er-174

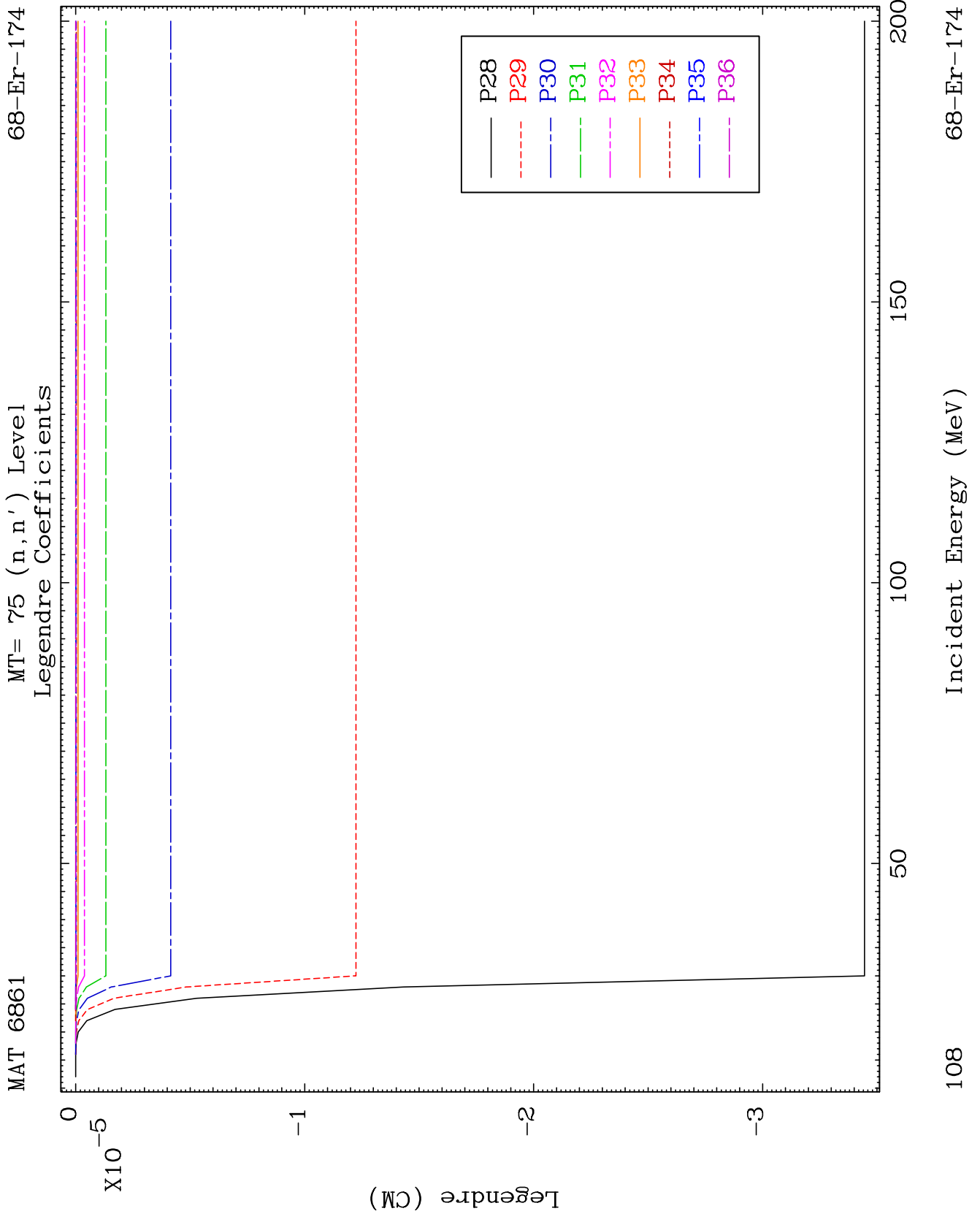

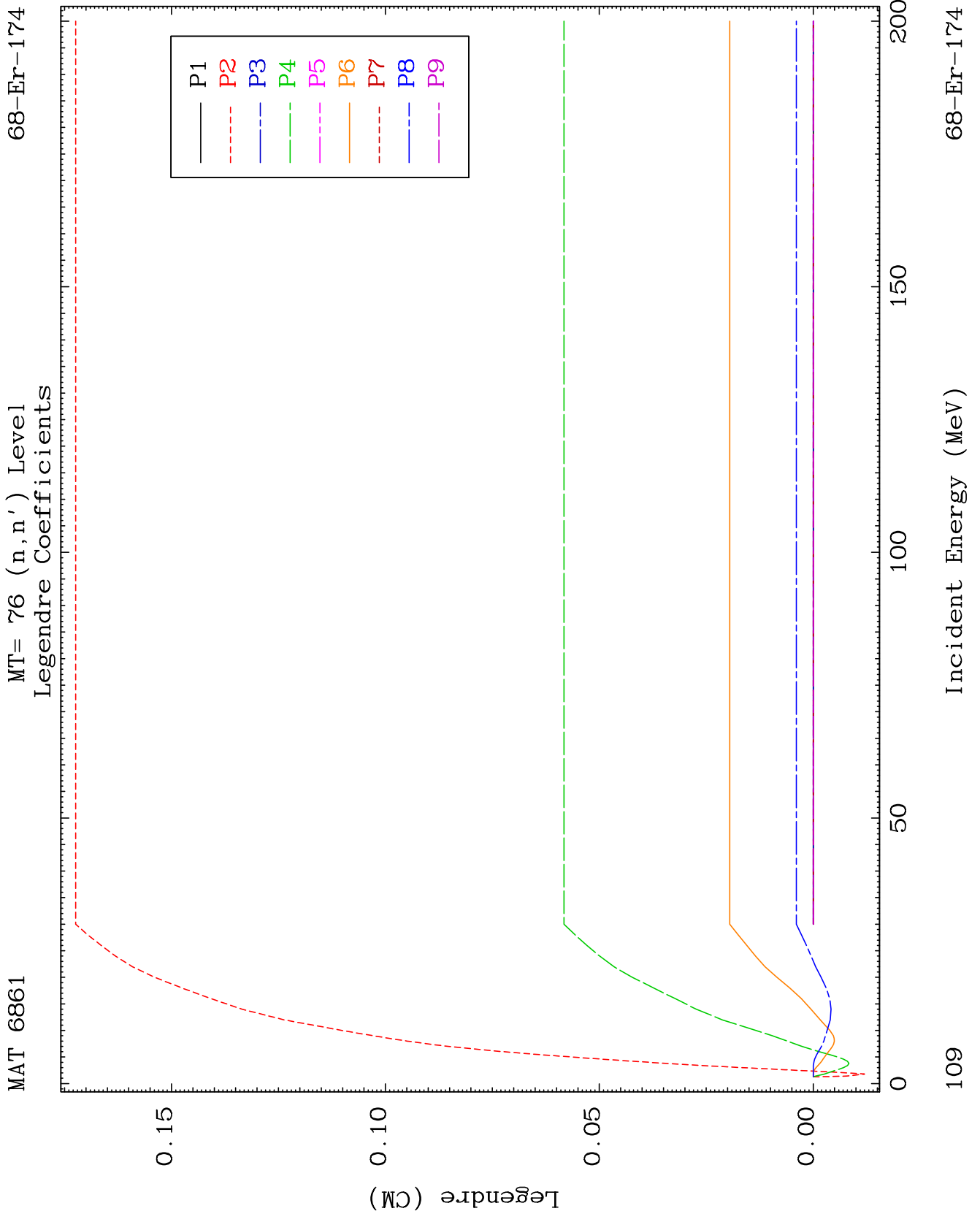

MAT 6861

MT= 76 (n,n') Level
Legendre Coefficients

68-Er-174

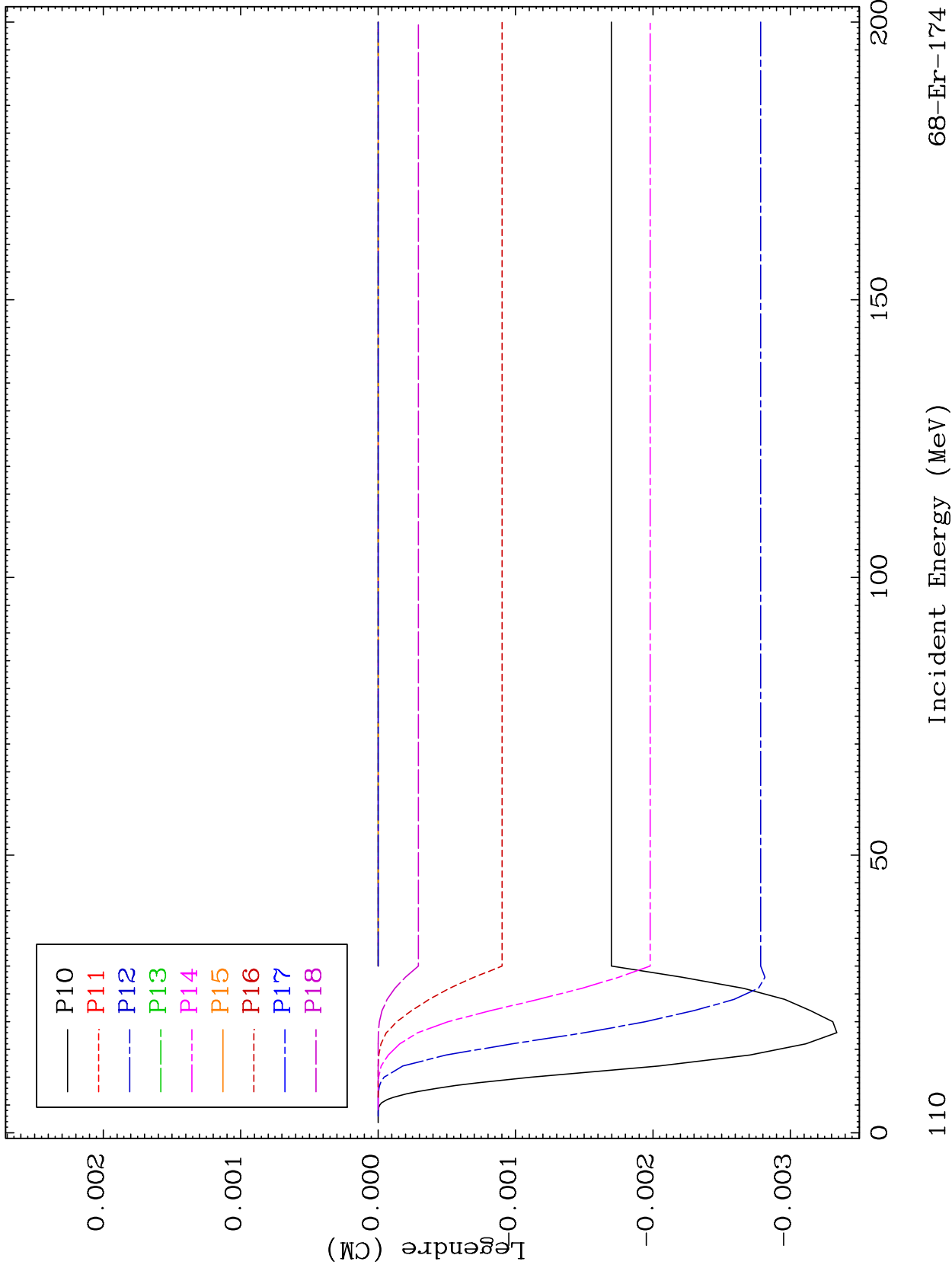

110

Incident Energy (MeV)

68-Er-174

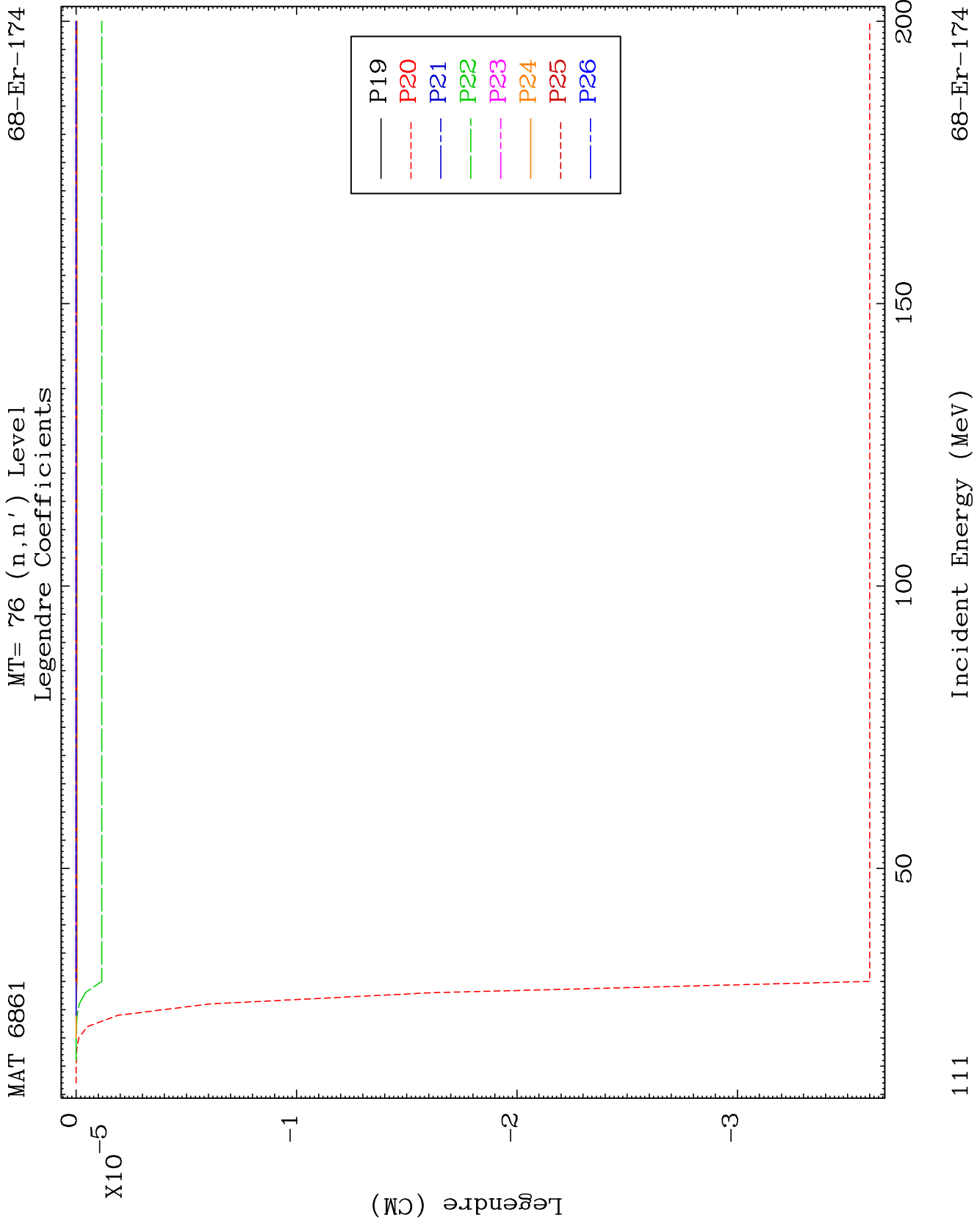

MAT 6861

MT= 77 (n,n') Level
Legendre Coefficients

68-Er-174

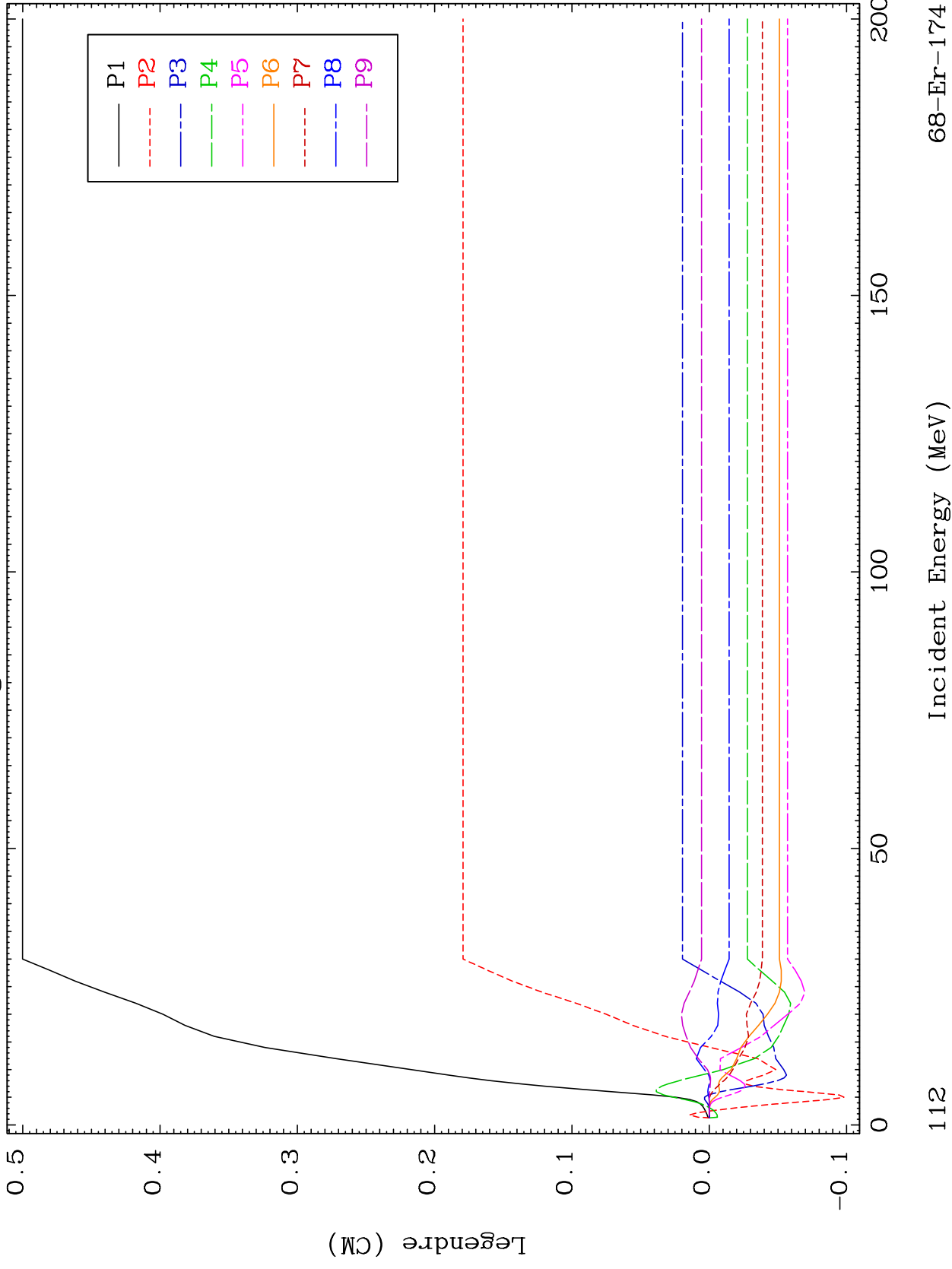

68-Er-174

Incident Energy (MeV)

112

MAT 6861

MT= 77 (n,n') Level
Legendre Coefficients

68-Er-174

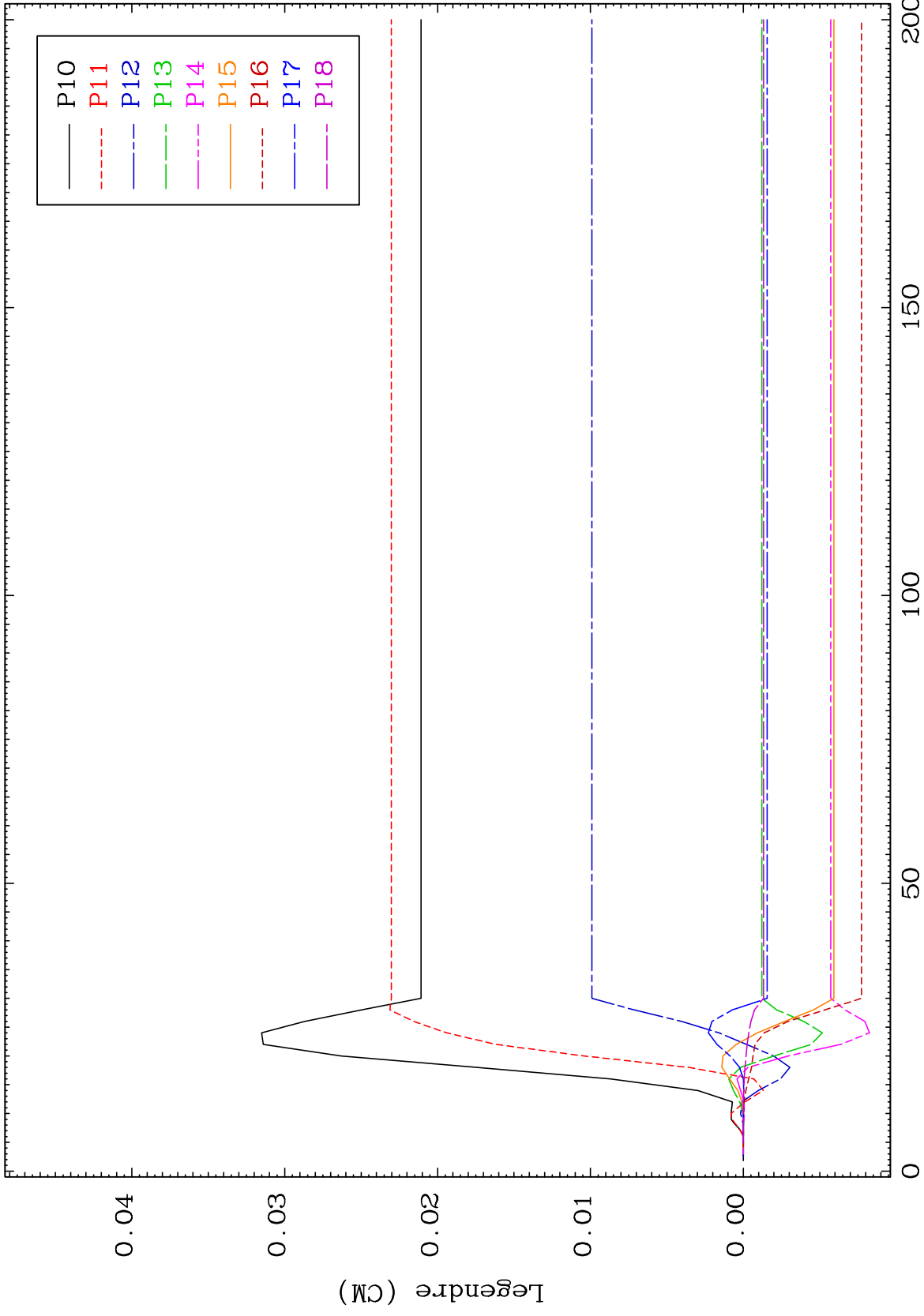

113

Incident Energy (MeV)

68-Er-174

