

ER180 NEUTRON ACER TENDL-2024 LIBRARY; T=293.6K

Principal cross sections

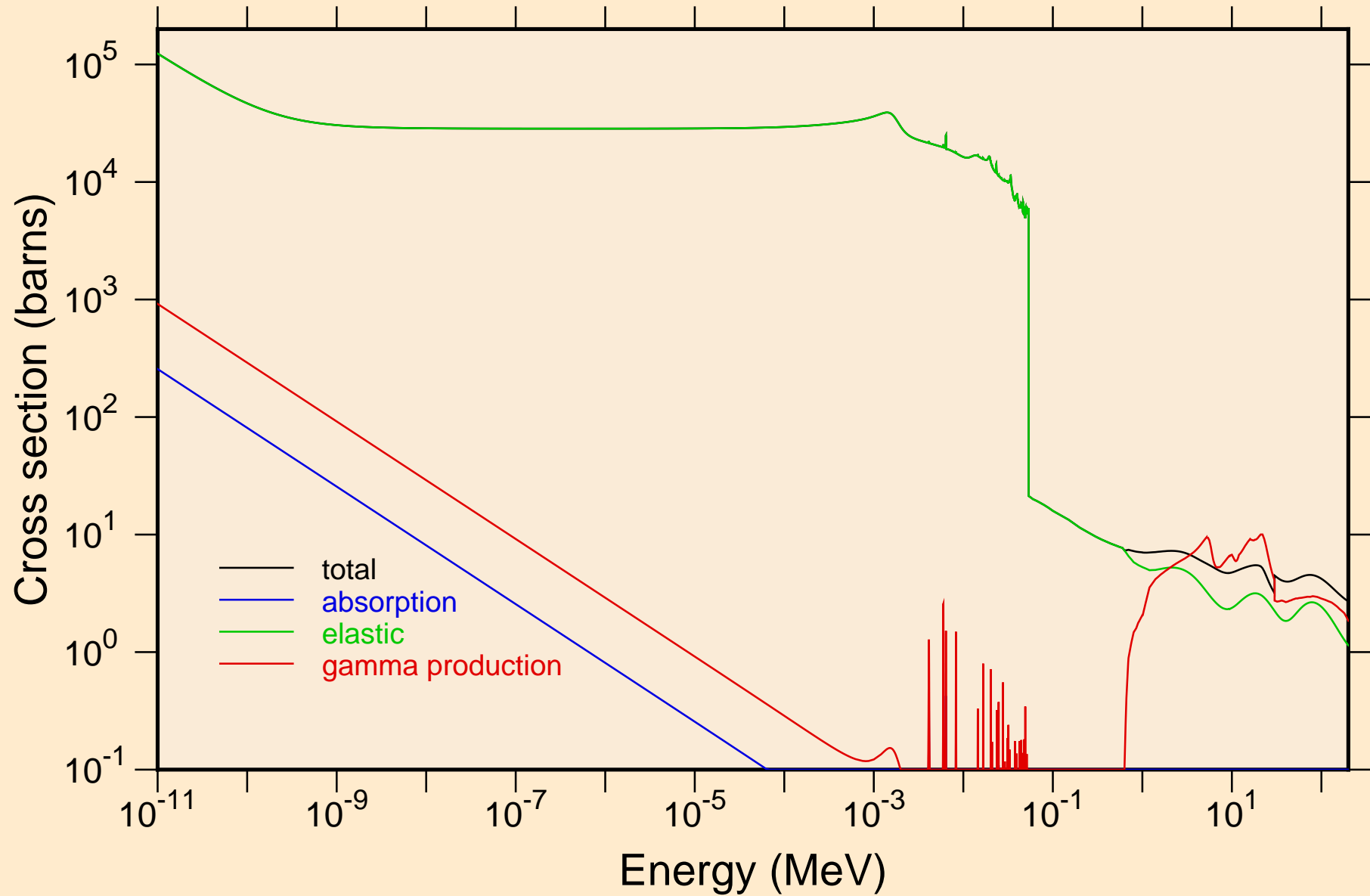

ER180 NEUTRON ACER TENDL-2024 LIBRARY; T=293.6K
resonance total cross section

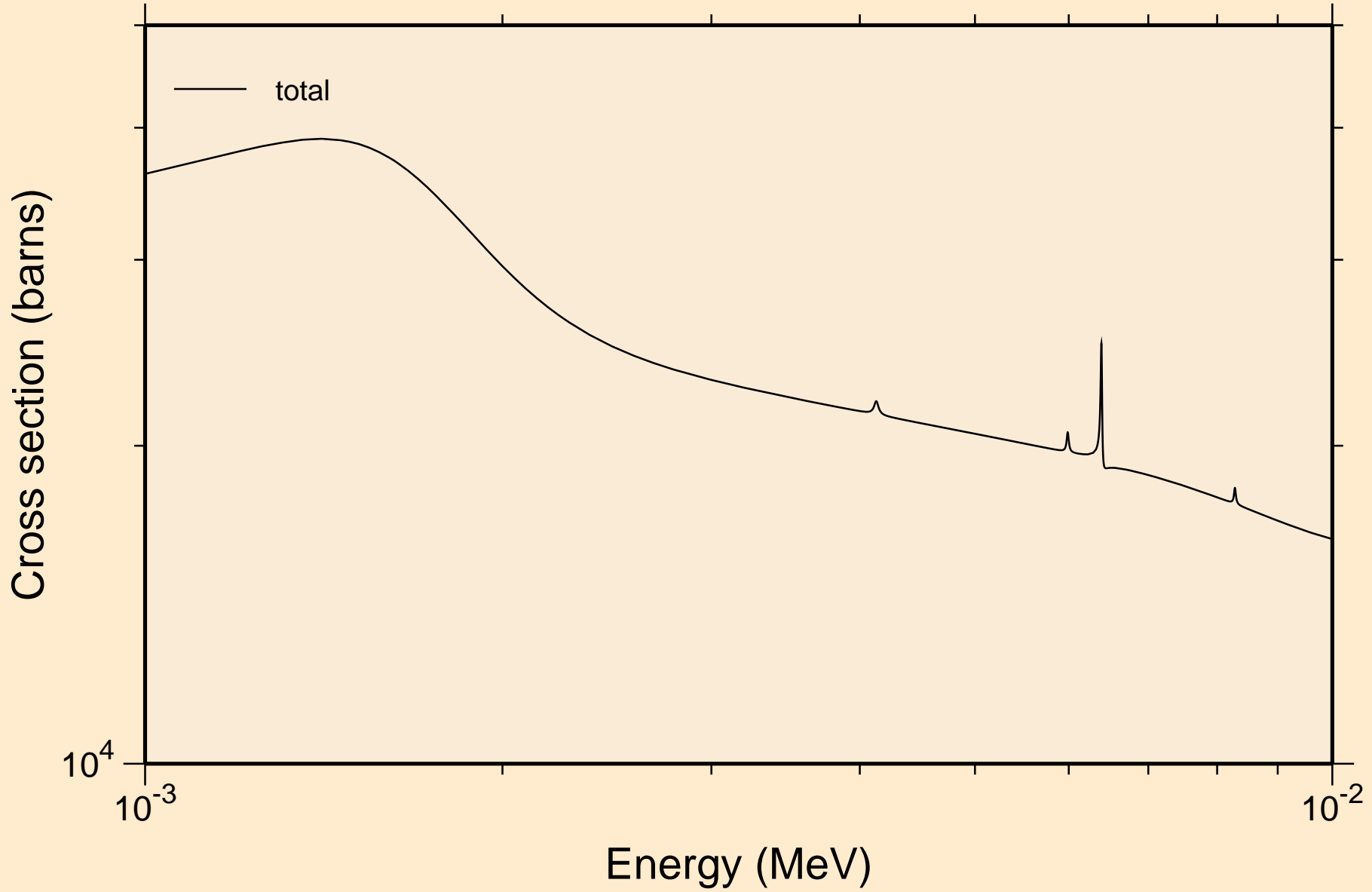

ER180 NEUTRON ACER TENDL-2024 LIBRARY; T=293.6K
resonance total cross section

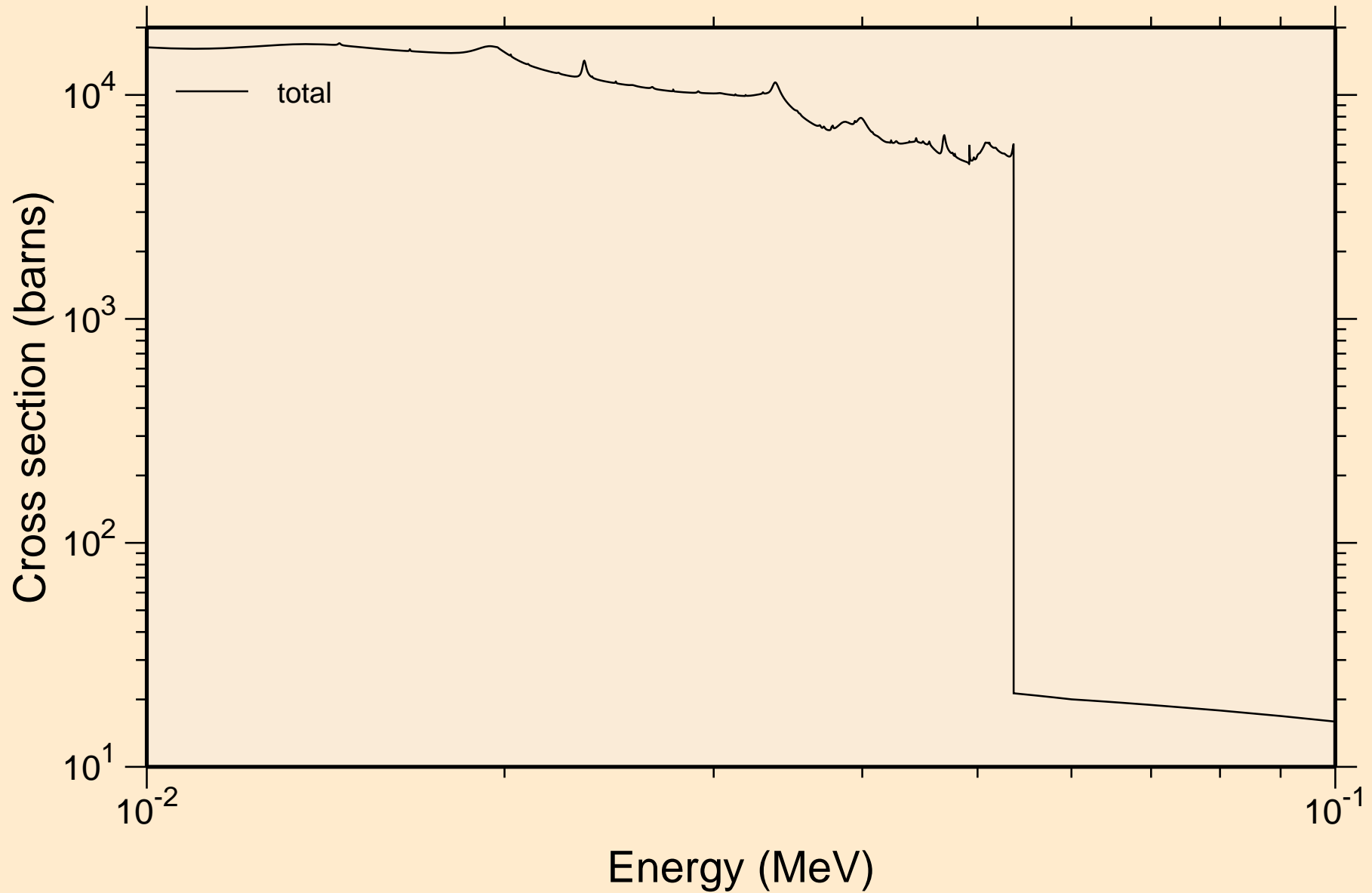

ER180 NEUTRON ACER TENDL-2024 LIBRARY; T=293.6K
resonance total cross section

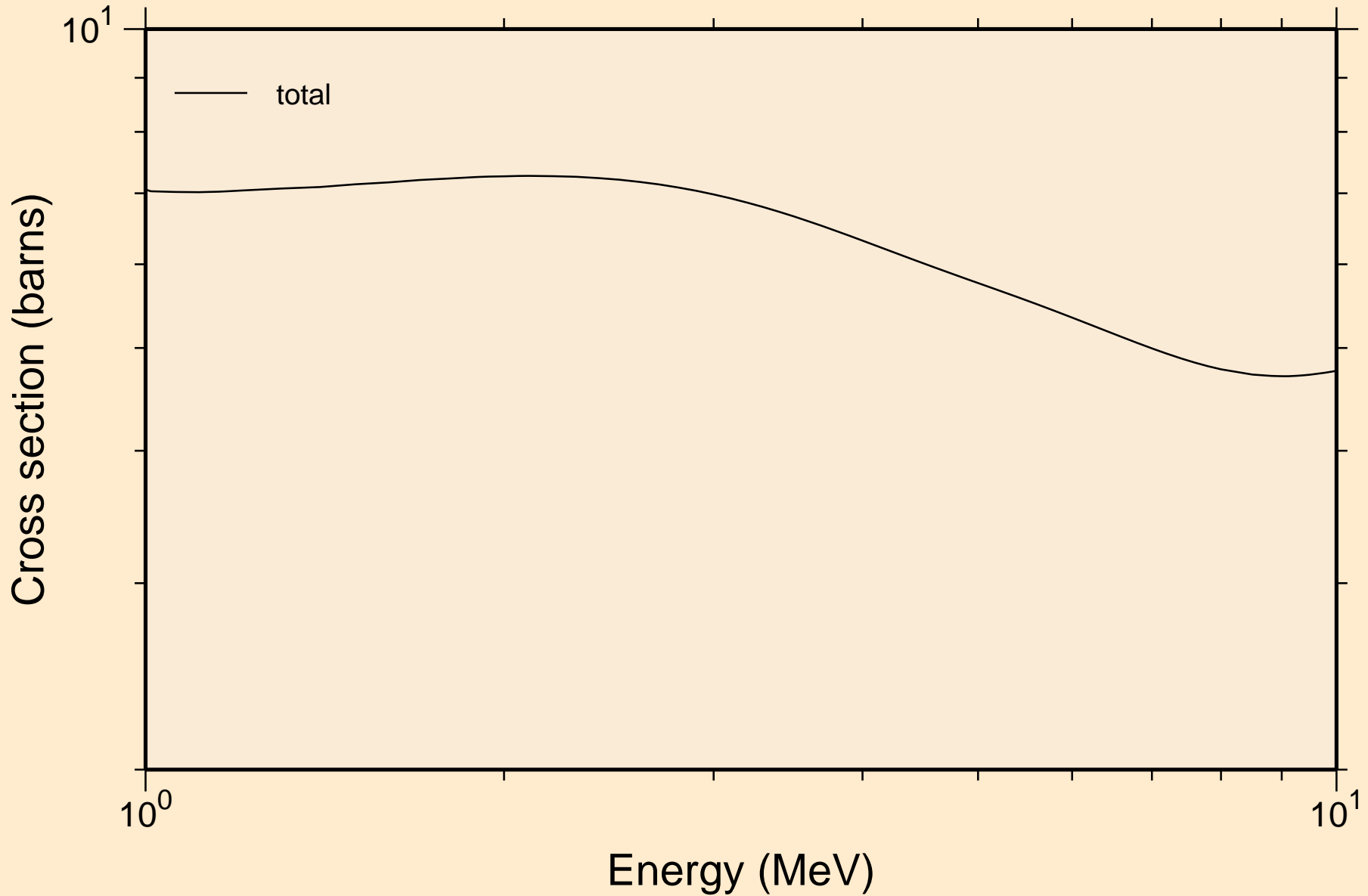

ER180 NEUTRON ACER TENDL-2024 LIBRARY; T=293.6K
resonance absorption cross sections

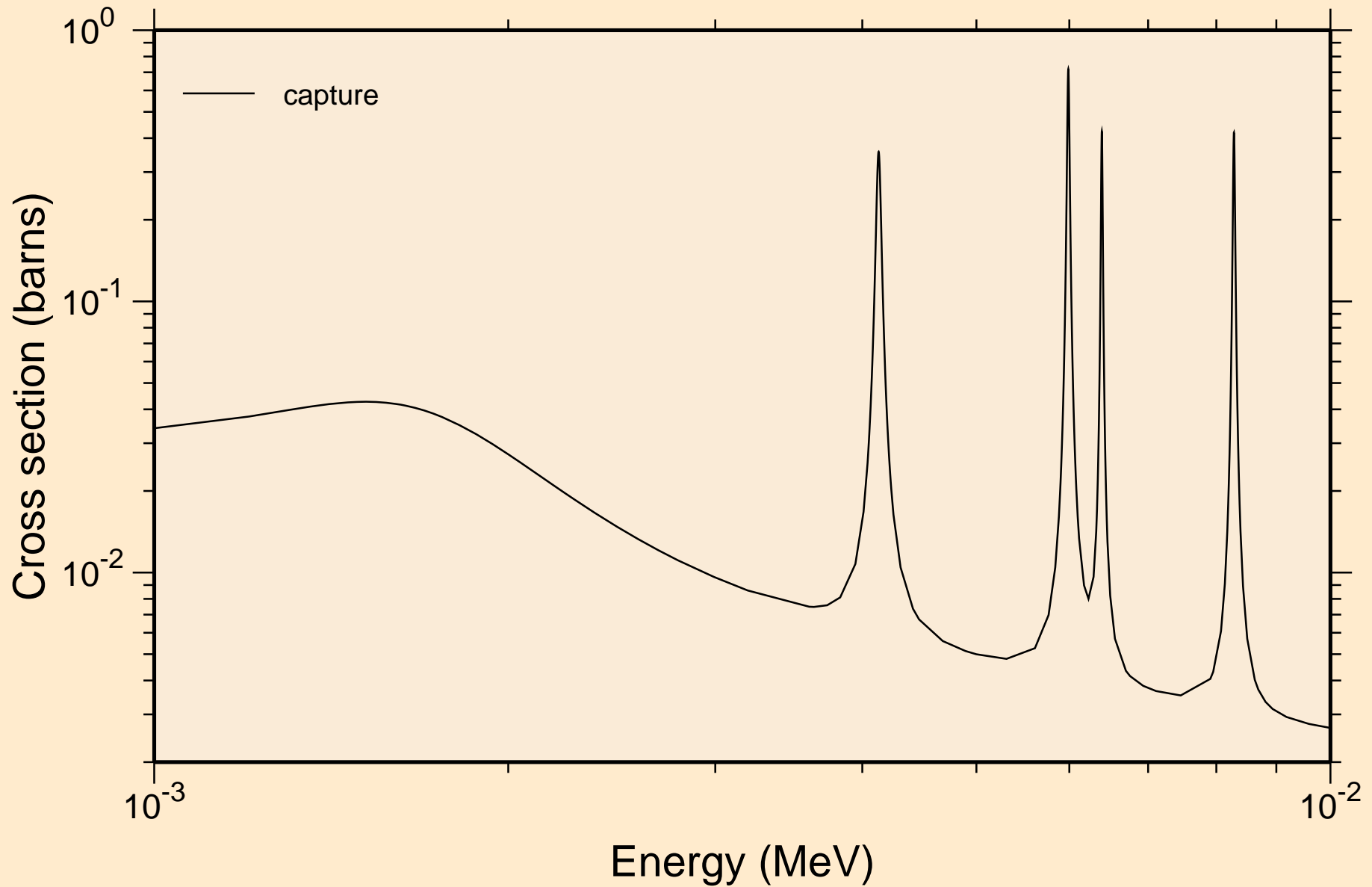

ER180 NEUTRON ACER TENDL-2024 LIBRARY; T=293.6K
resonance absorption cross sections

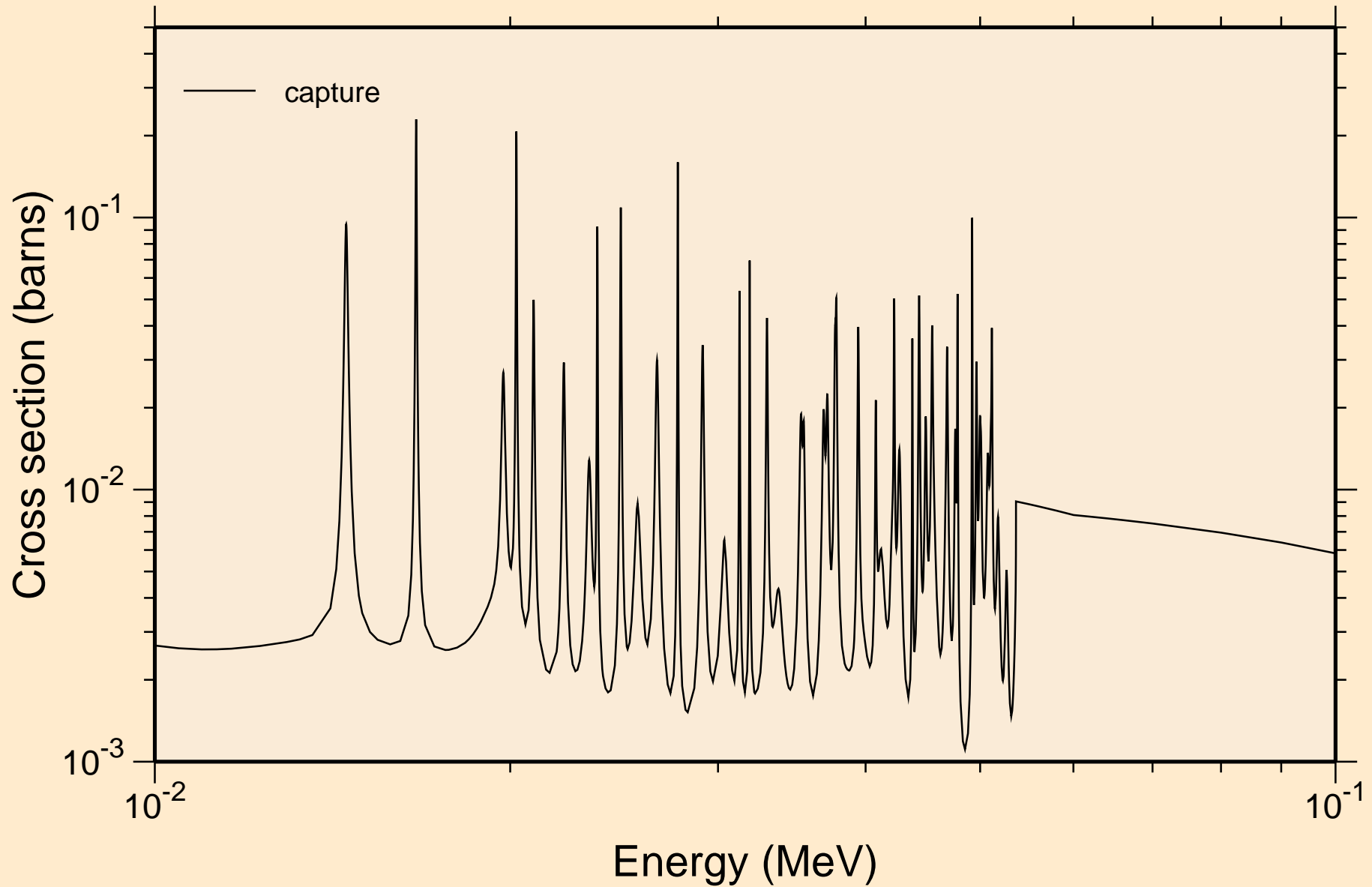

ER180 NEUTRON ACER TENDL-2024 LIBRARY; T=293.6K
resonance absorption cross sections

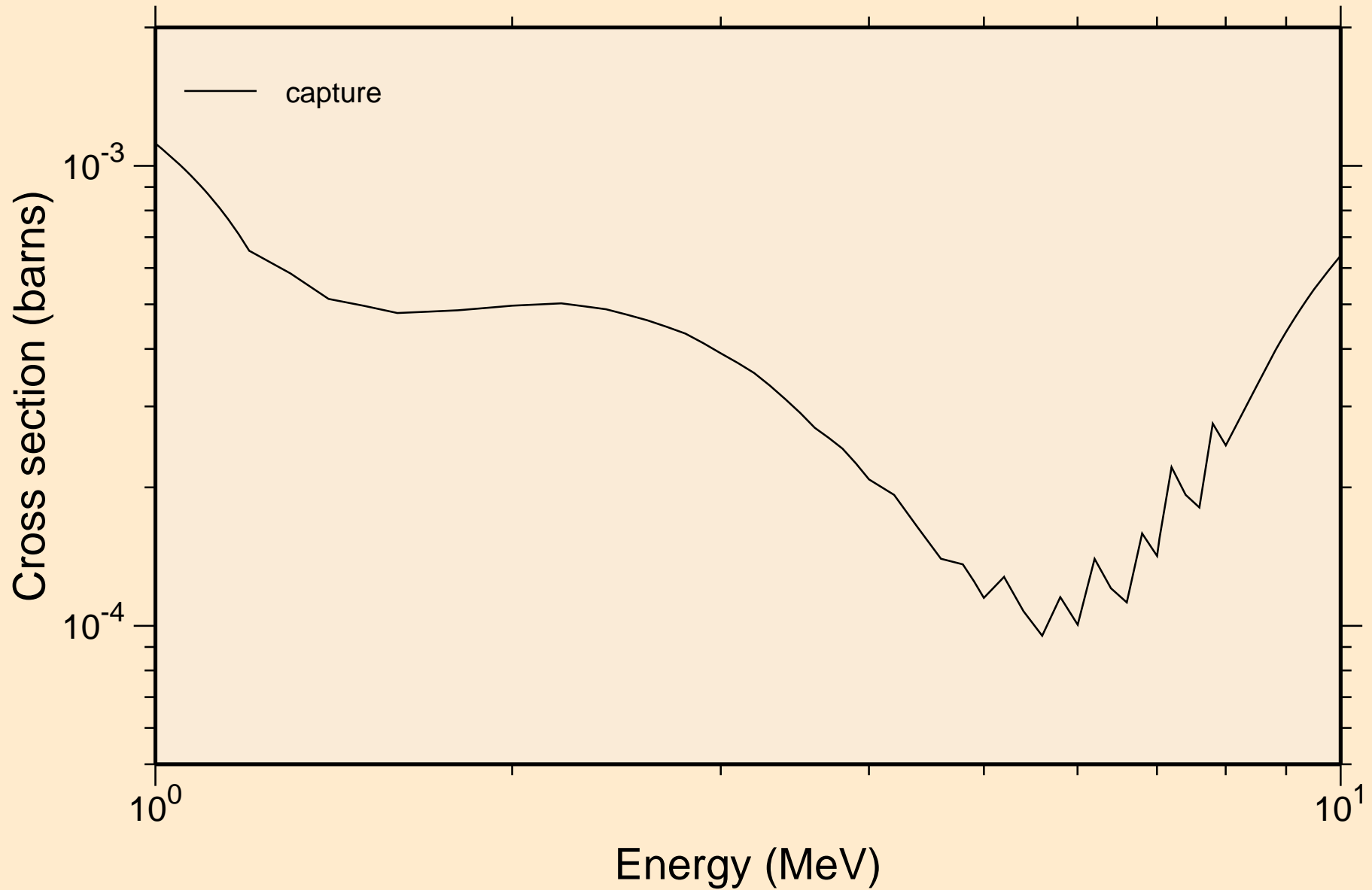

ER180 NEUTRON ACER TENDL-2024 LIBRARY; T=293.6K
Heating

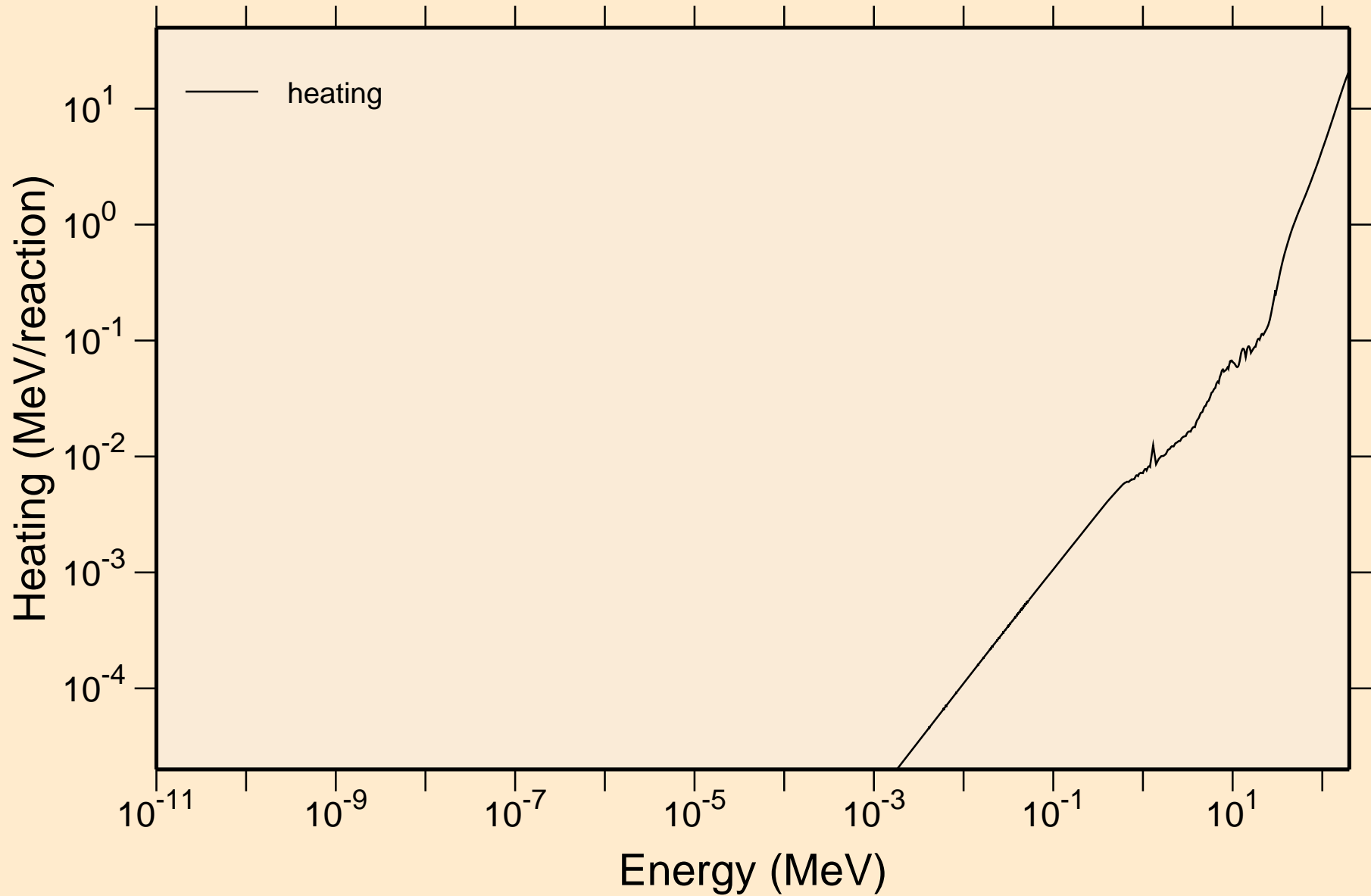

ER180 NEUTRON ACER TENDL-2024 LIBRARY; T=293.6K

Damage

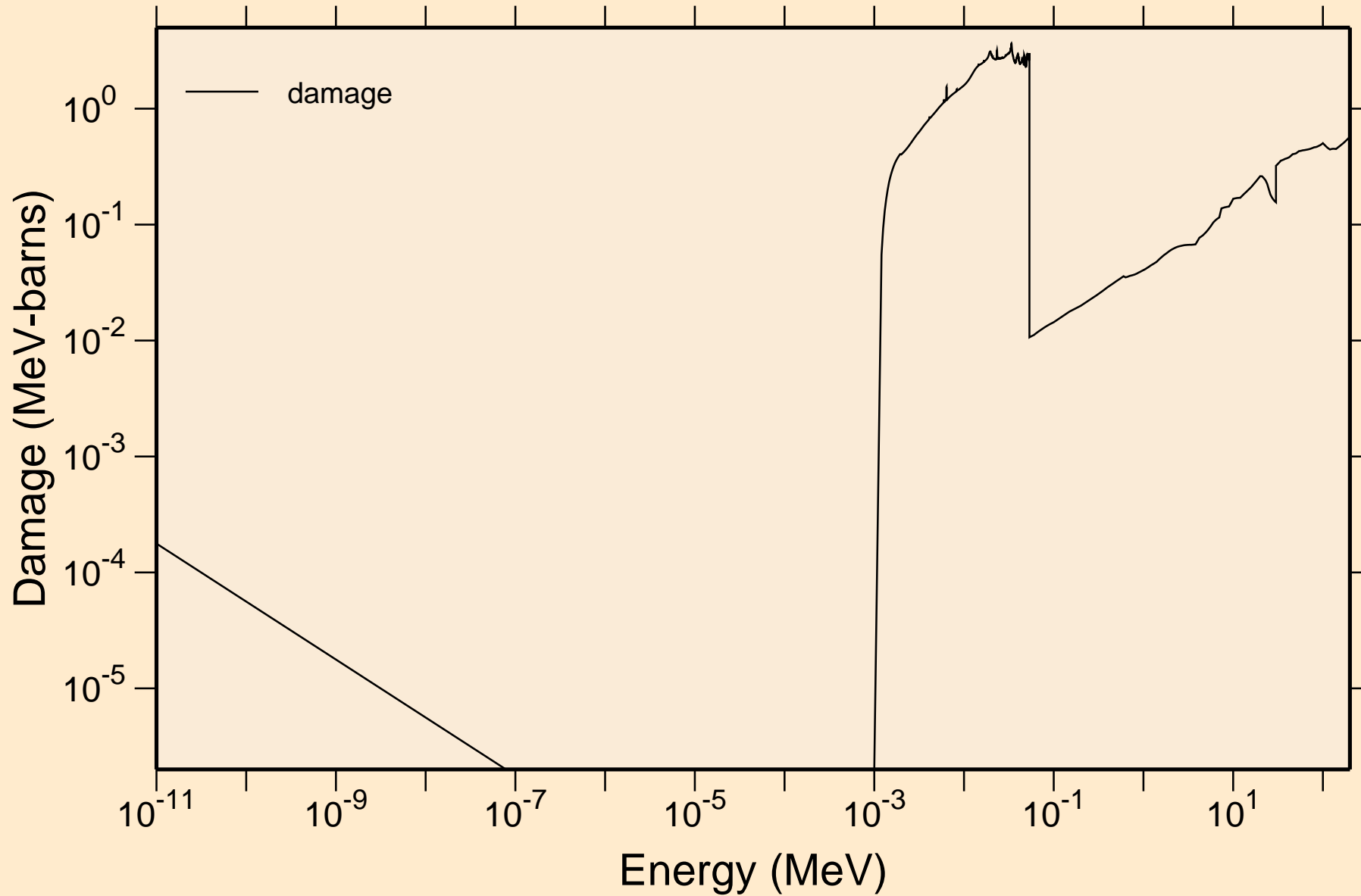

ER180 NEUTRON ACER TENDL-2024 LIBRARY; T=293.6K
Non-threshold reactions

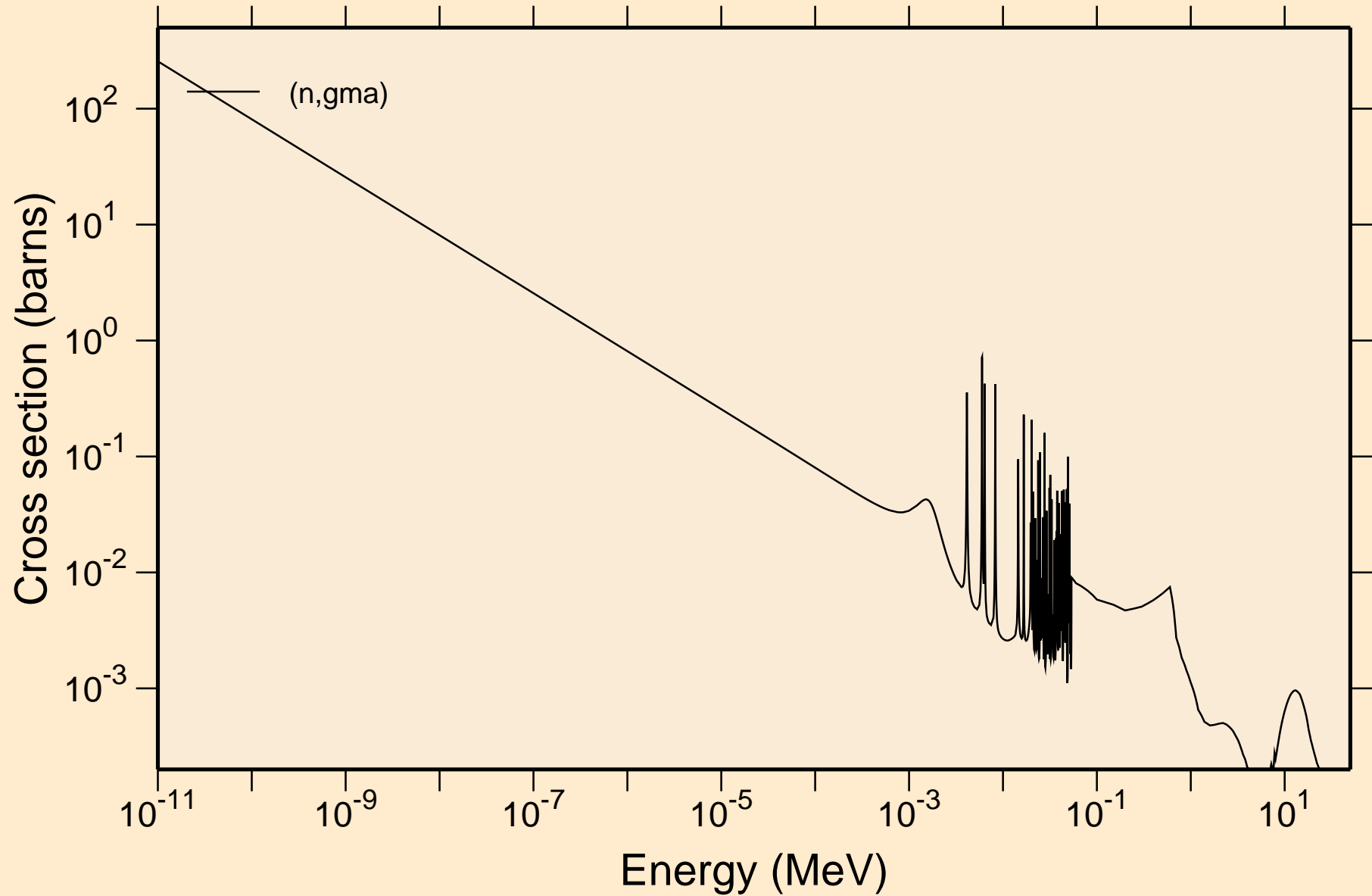

ER180 NEUTRON ACER TENDL-2024 LIBRARY; T=293.6K
Principal cross sections

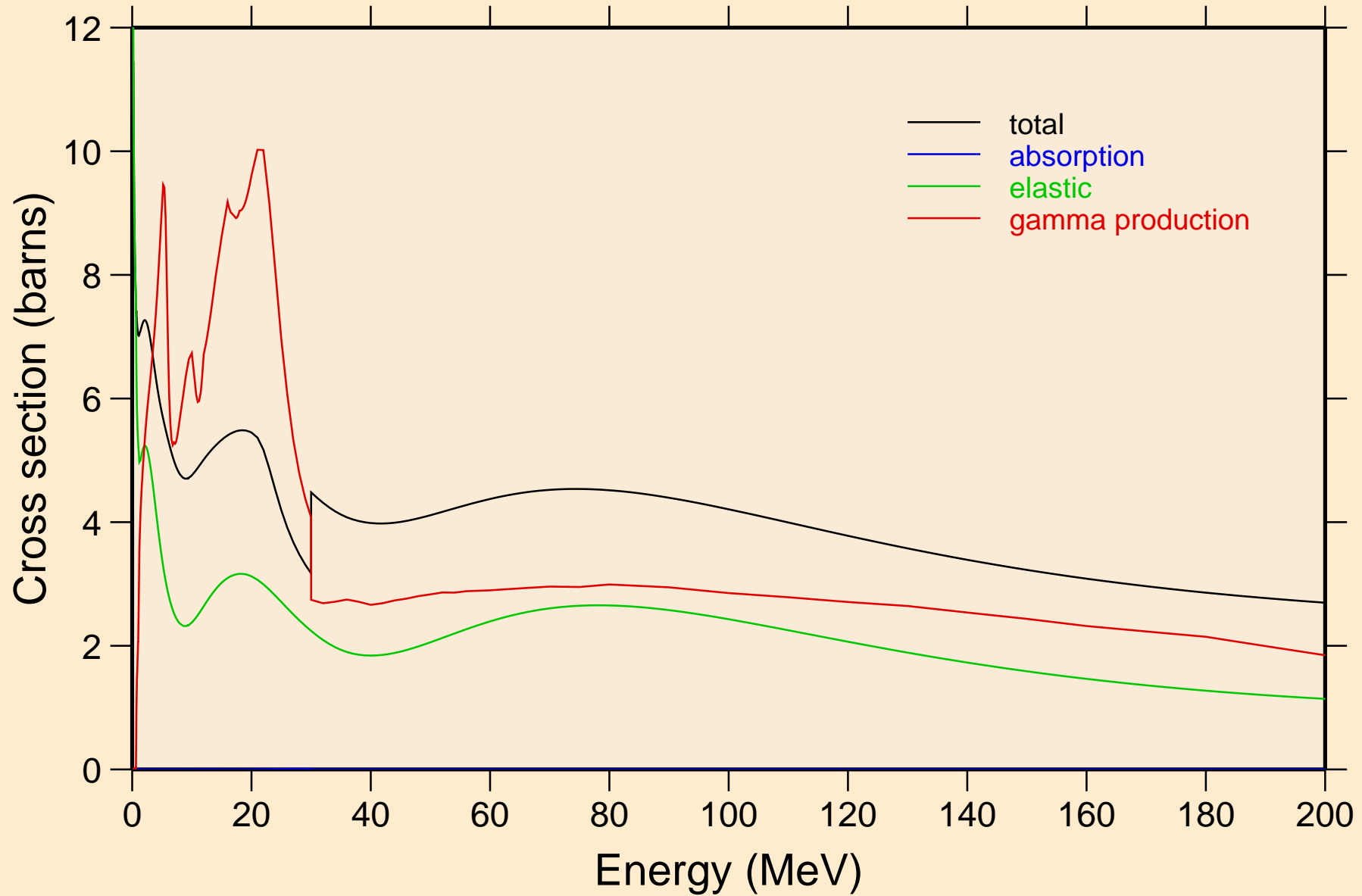

ER180 NEUTRON ACER TENDL-2024 LIBRARY; T=293.6K

Heating

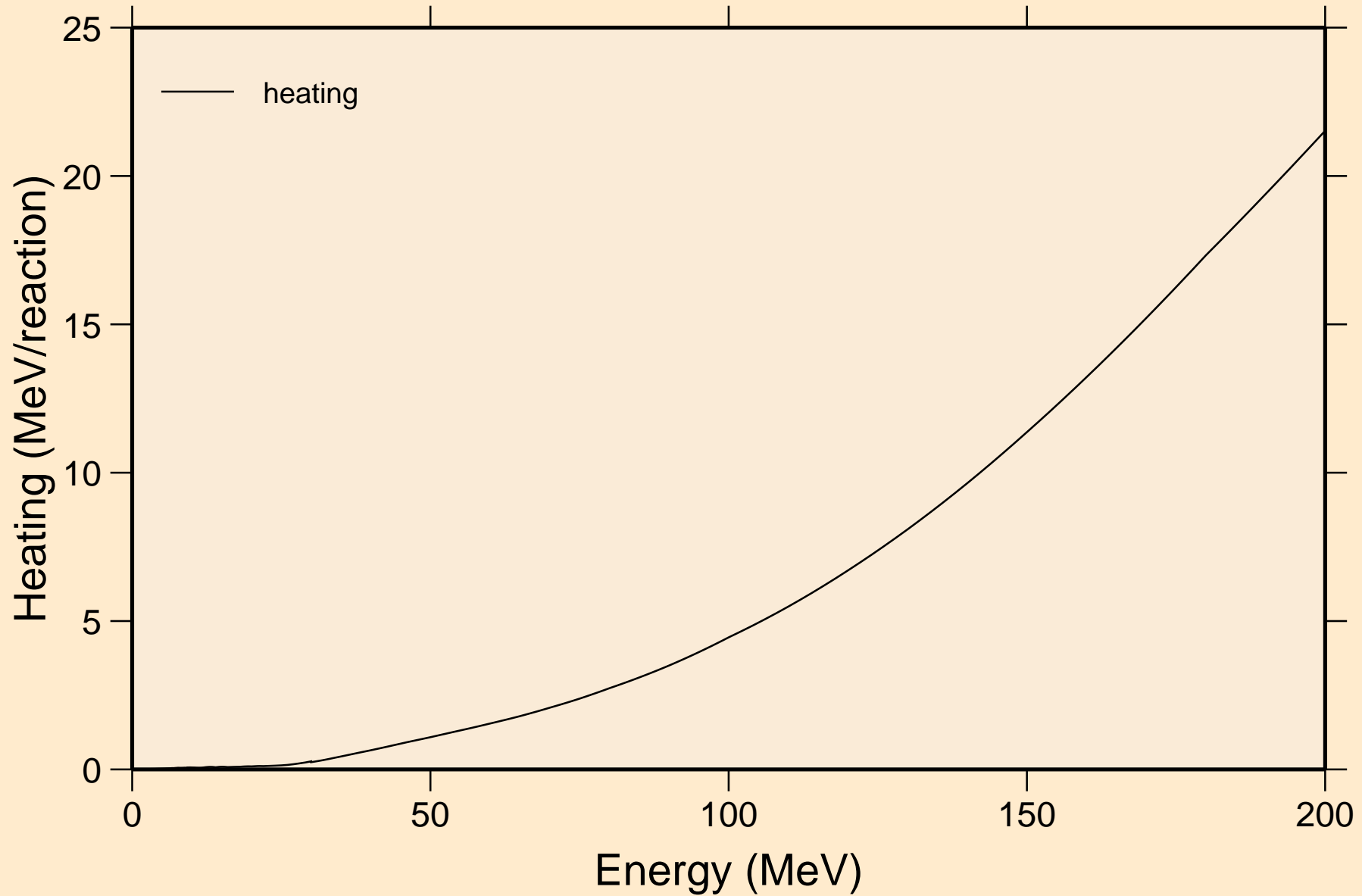

ER180 NEUTRON ACER TENDL-2024 LIBRARY; T=293.6K
Damage

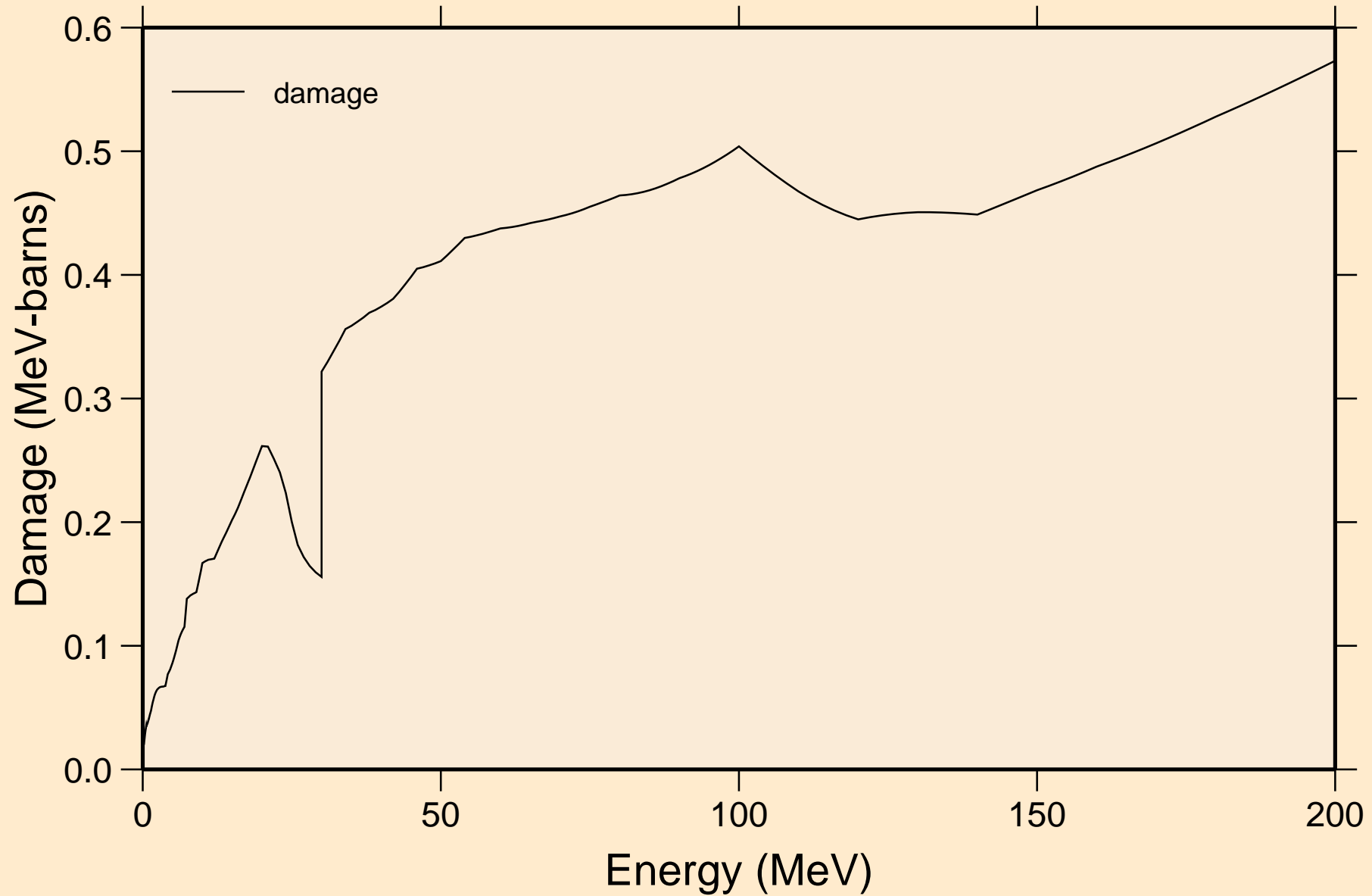

ER180 NEUTRON ACER TENDL-2024 LIBRARY; T=293.6K
Non-threshold reactions

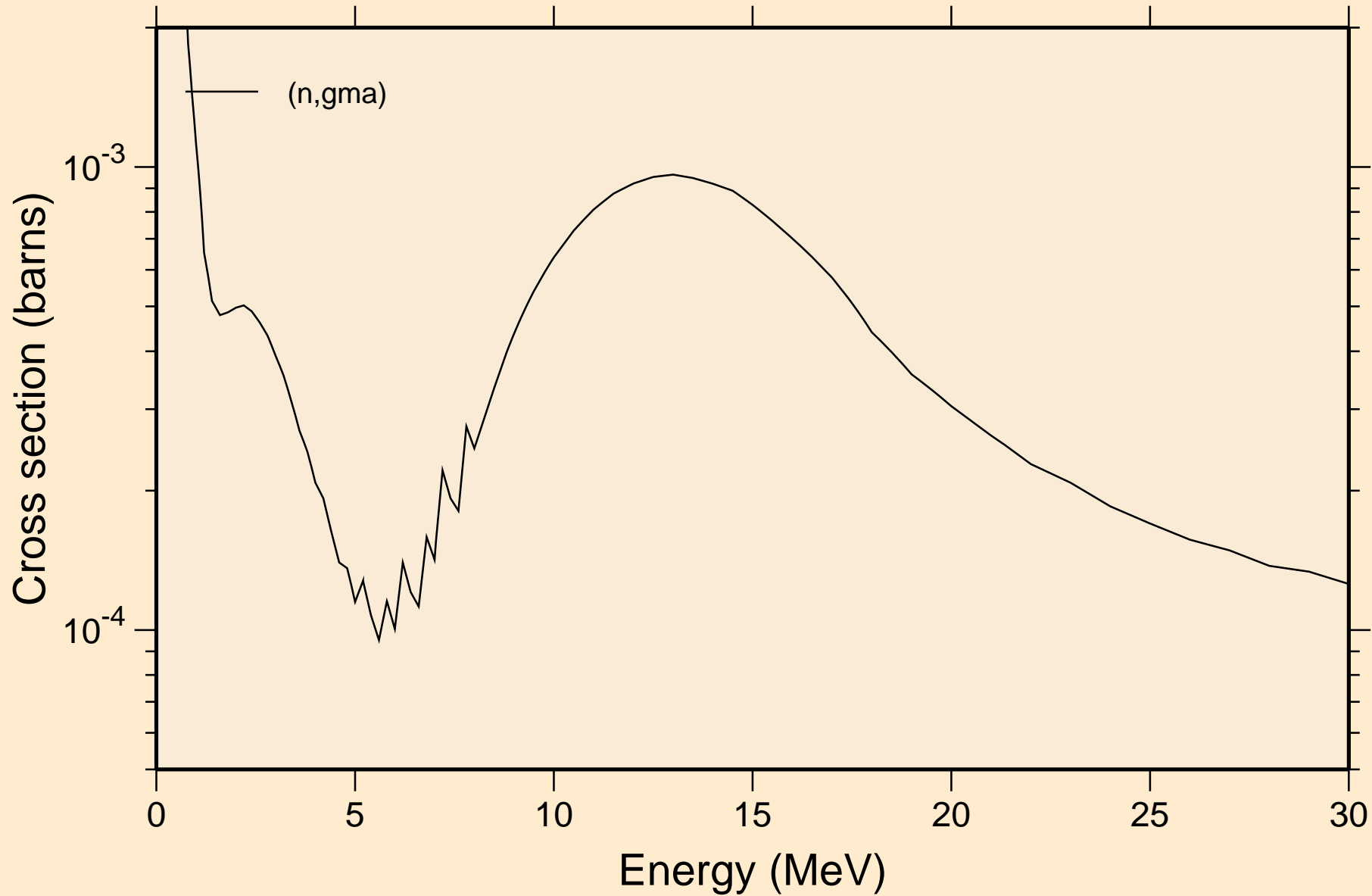

ER180 NEUTRON ACER TENDL-2024 LIBRARY; T=293.6K
Inelastic levels

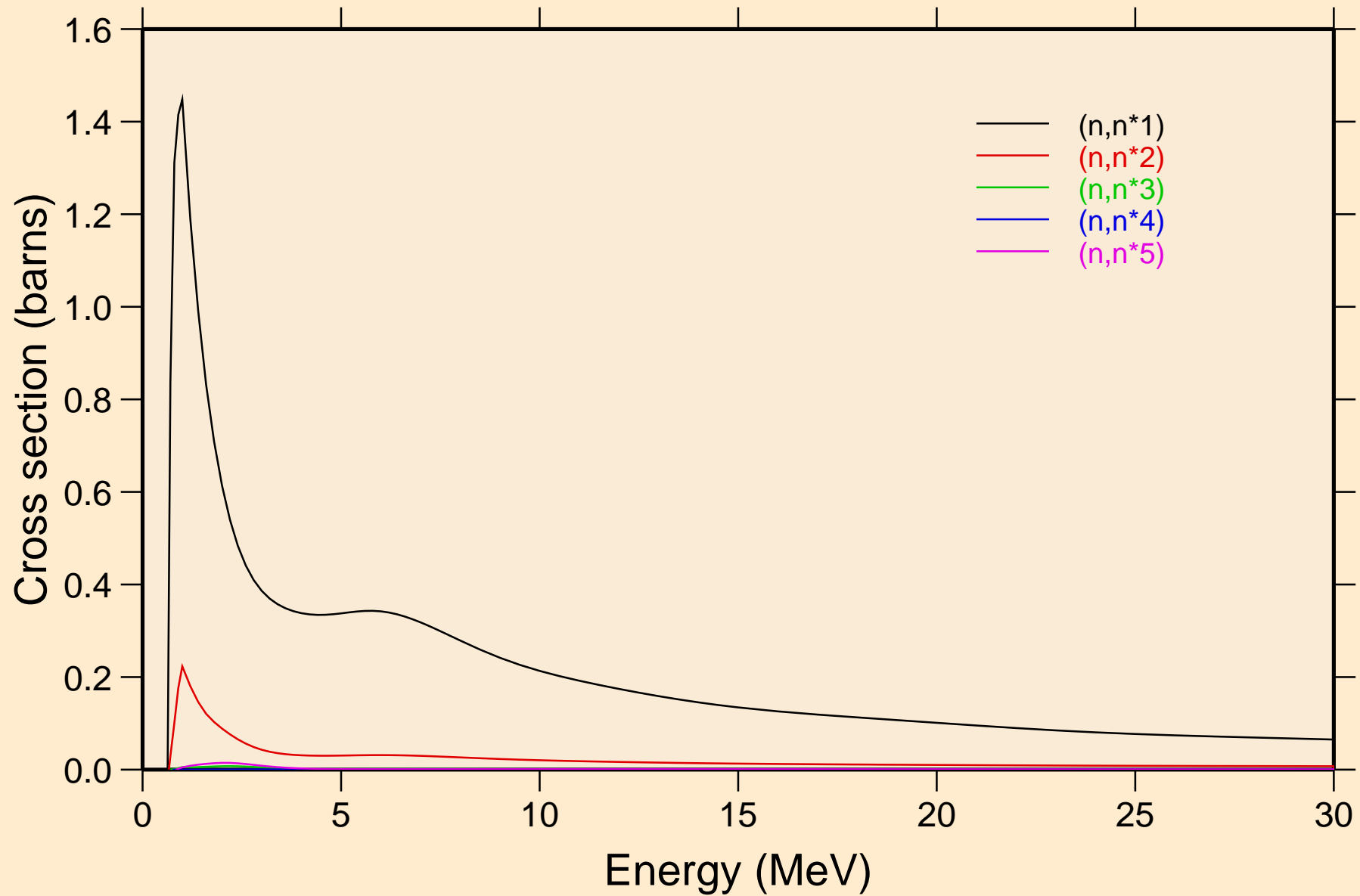

ER180 NEUTRON ACER TENDL-2024 LIBRARY; T=293.6K
Inelastic levels

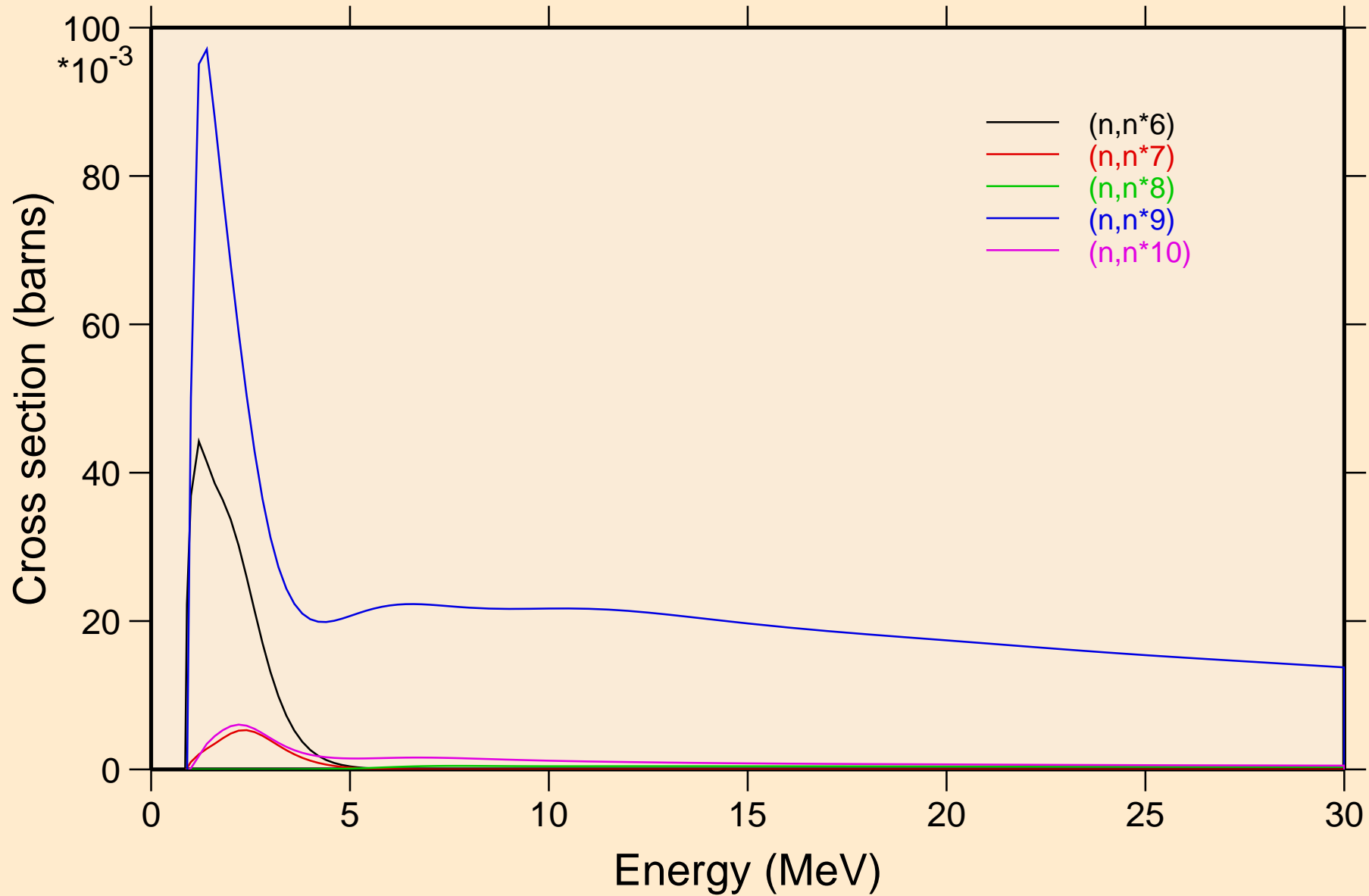

ER180 NEUTRON ACER TENDL-2024 LIBRARY; T=293.6K
Inelastic levels

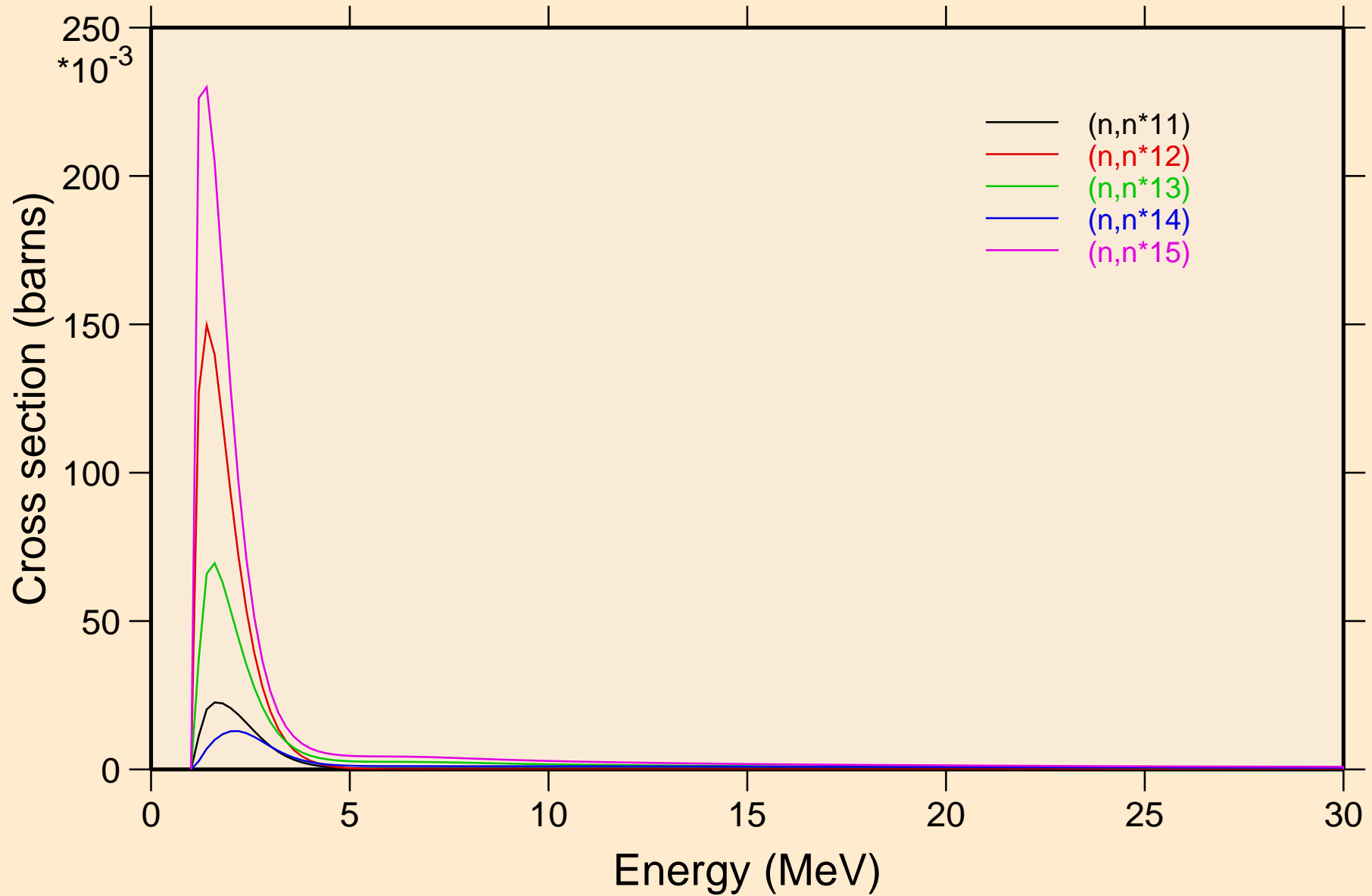

ER180 NEUTRON ACER TENDL-2024 LIBRARY; T=293.6K
Inelastic levels

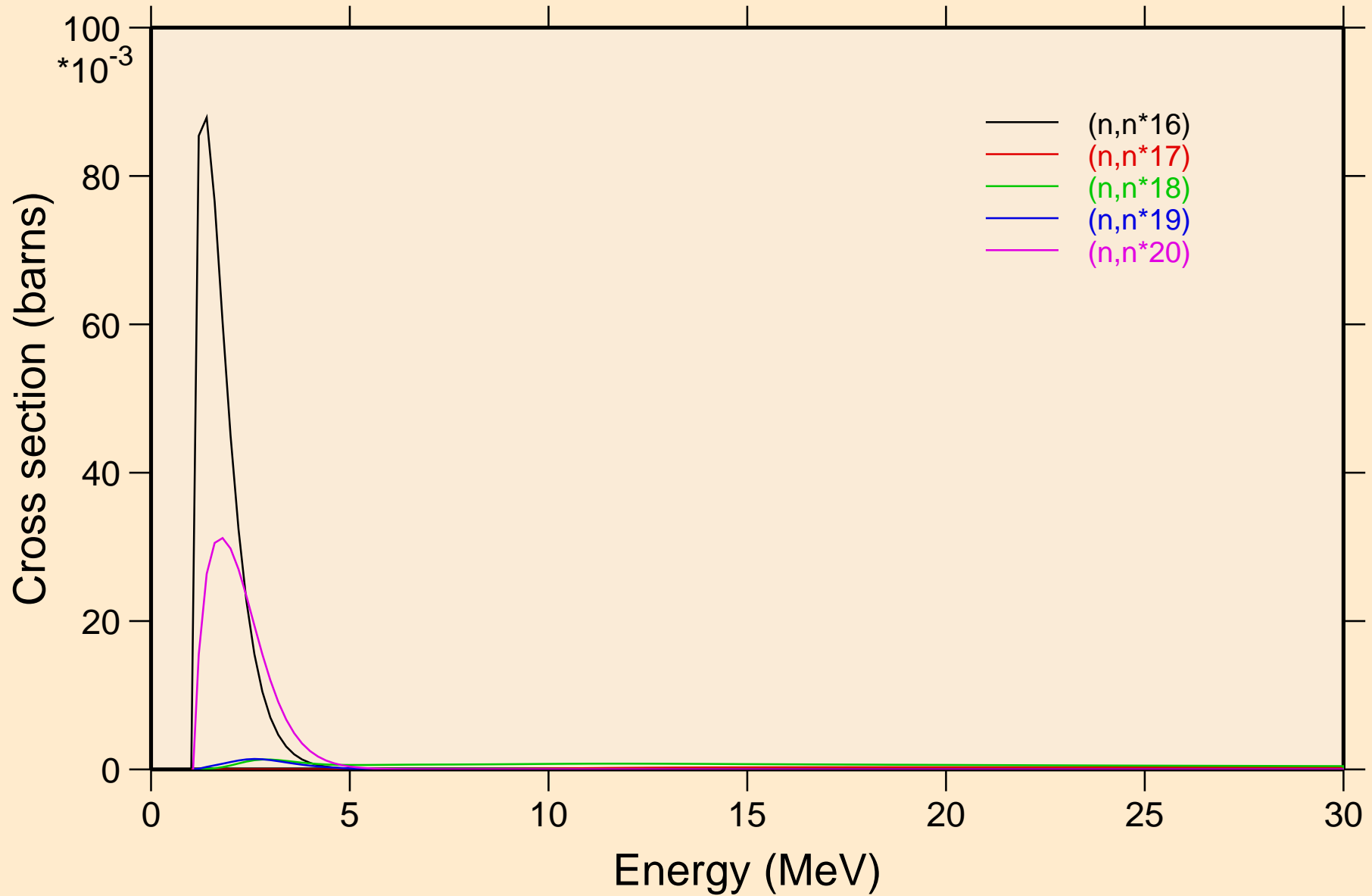

ER180 NEUTRON ACER TENDL-2024 LIBRARY; T=293.6K
Inelastic levels

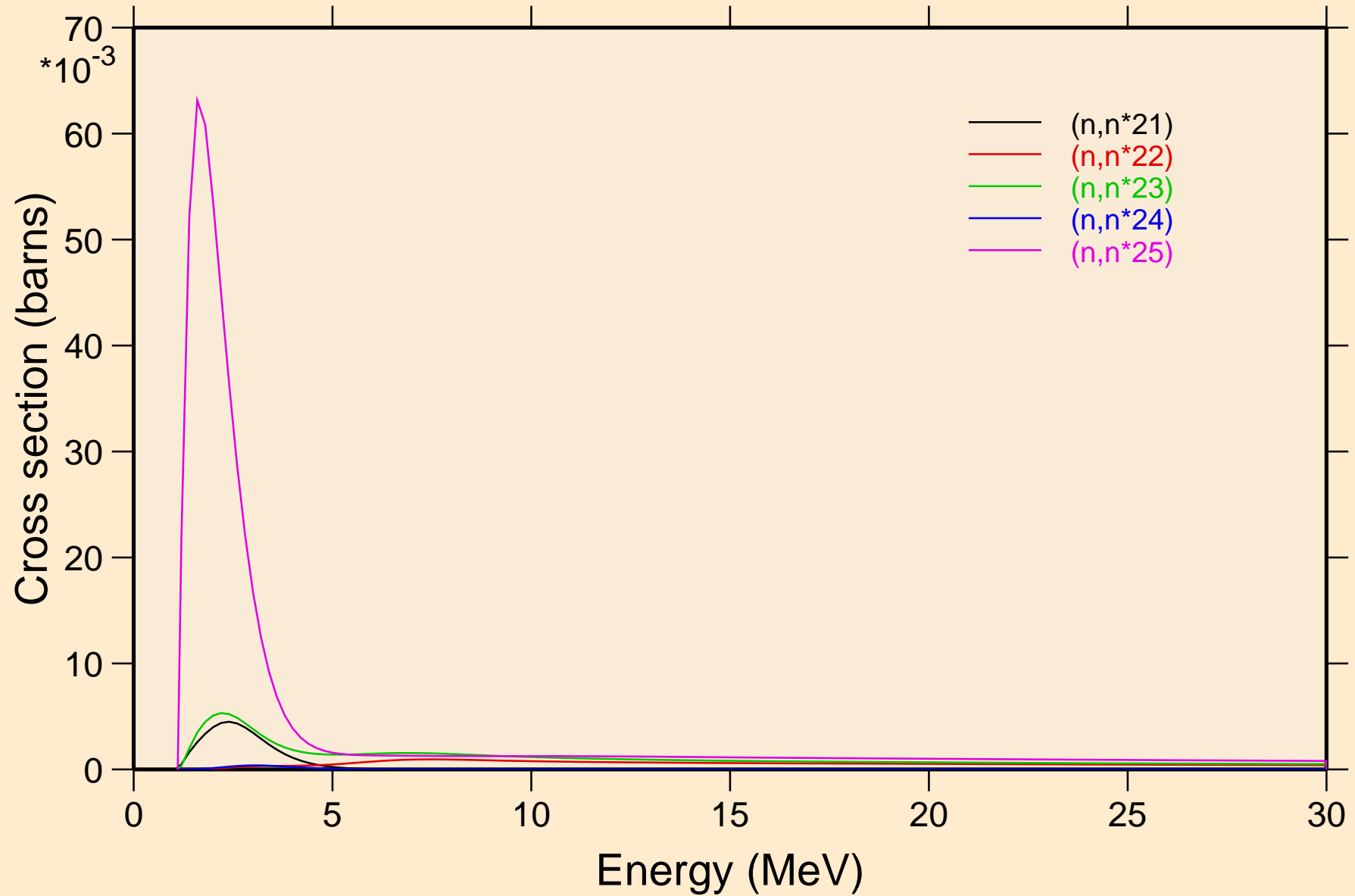

ER180 NEUTRON ACER TENDL-2024 LIBRARY; T=293.6K
Inelastic levels

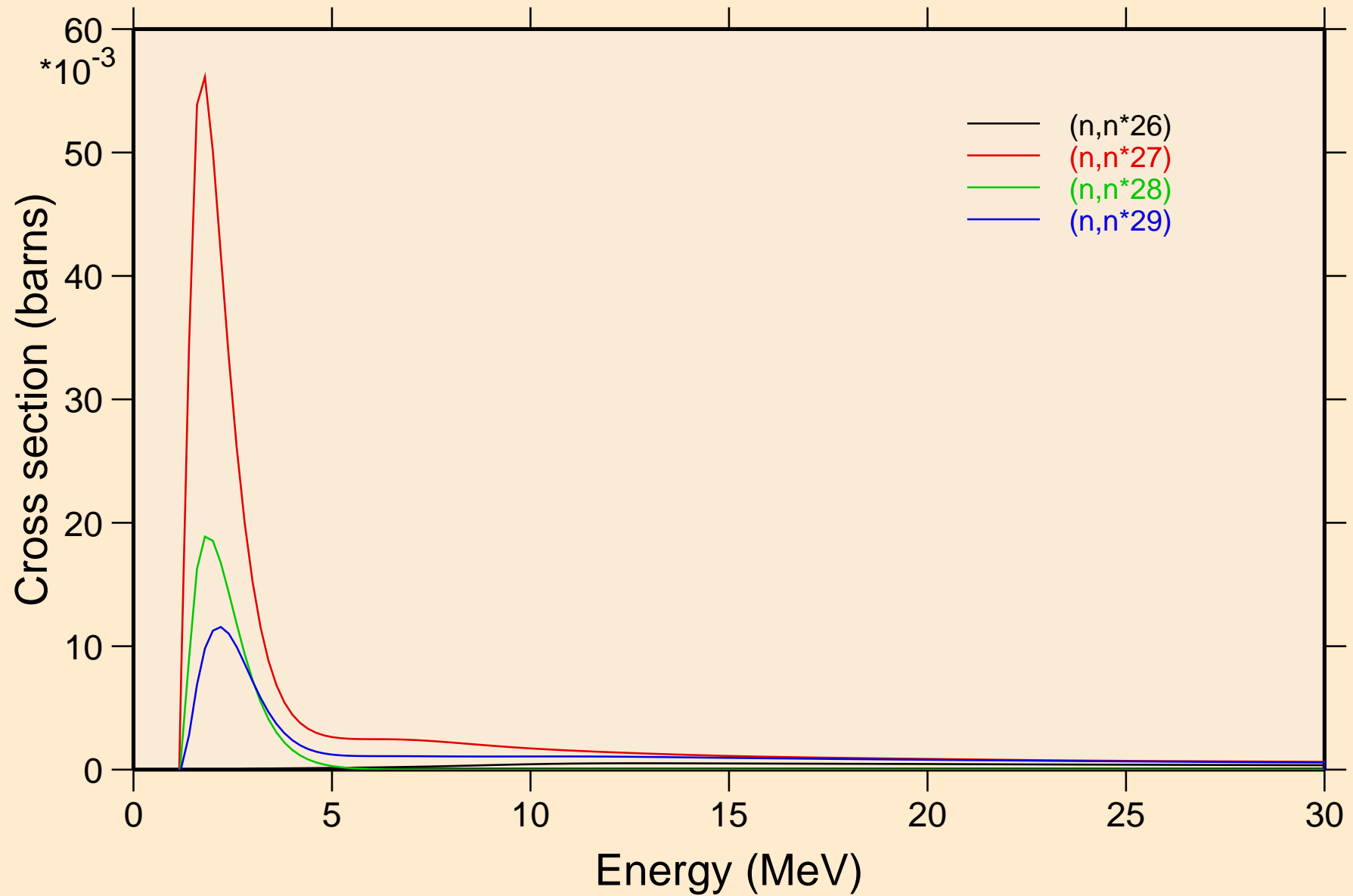

ER180 NEUTRON ACER TENDL-2024 LIBRARY; T=293.6K
Threshold reactions

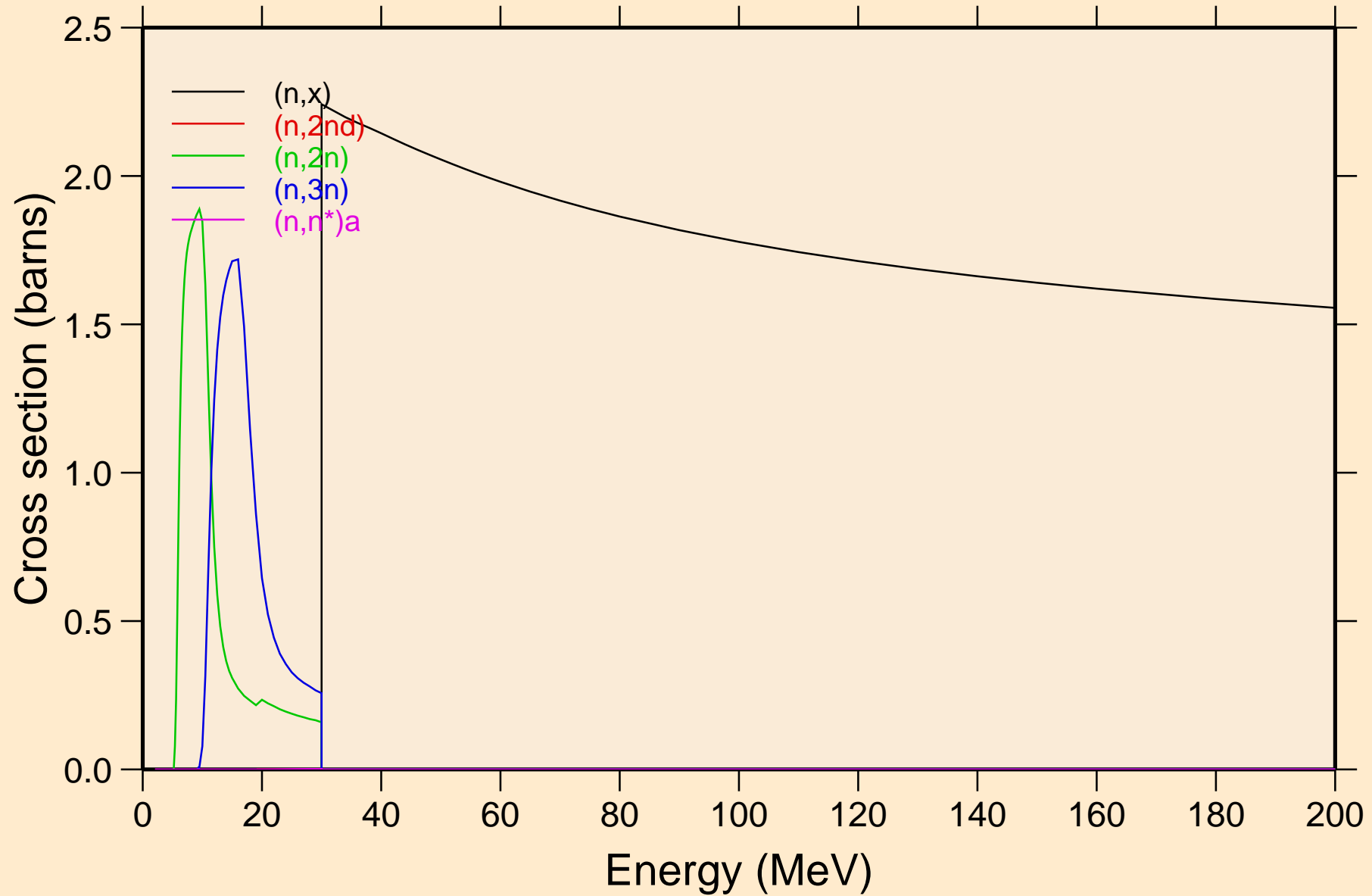

ER180 NEUTRON ACER TENDL-2024 LIBRARY; T=293.6K
Threshold reactions

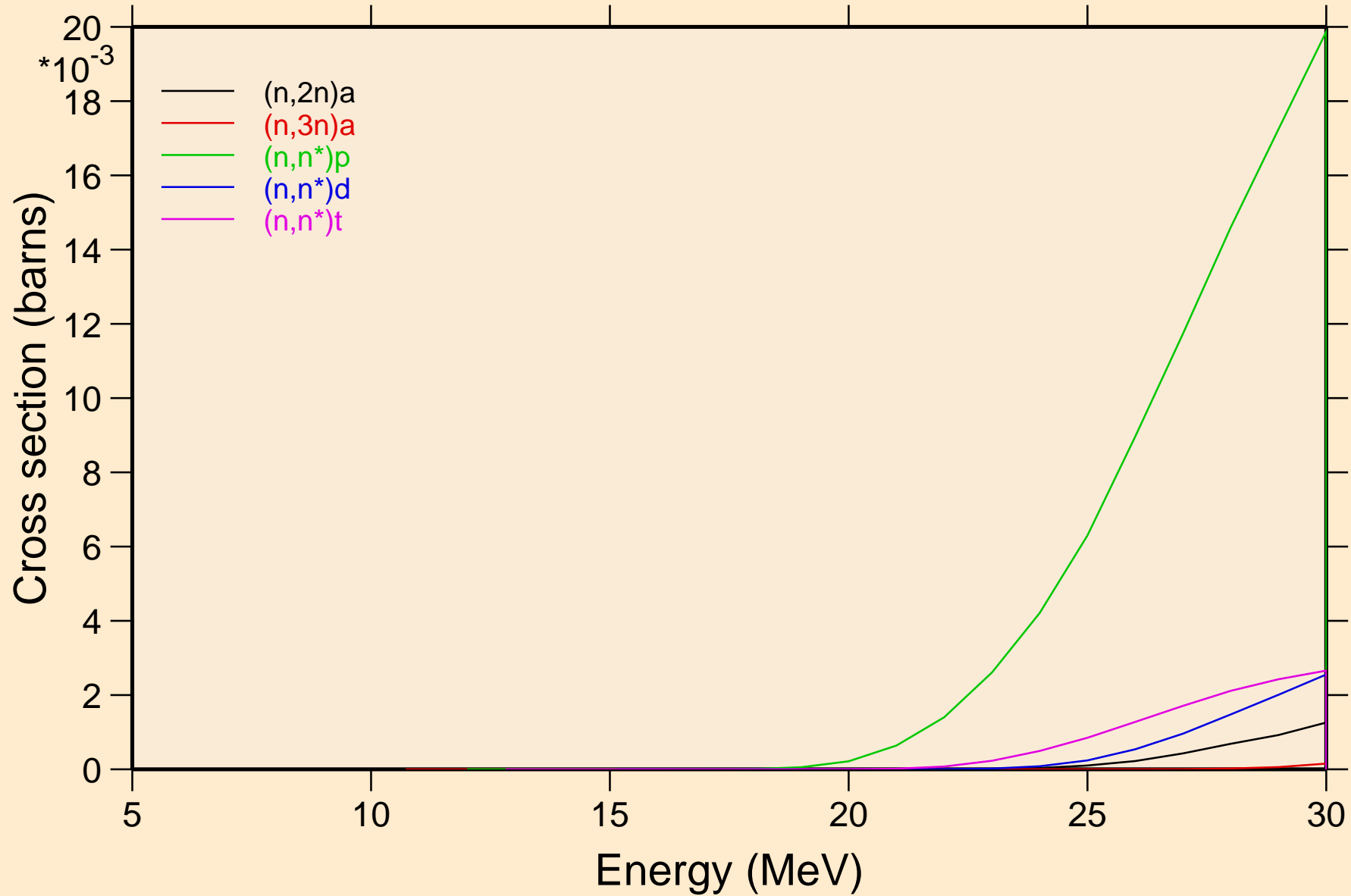

ER180 NEUTRON ACER TENDL-2024 LIBRARY; T=293.6K
Threshold reactions

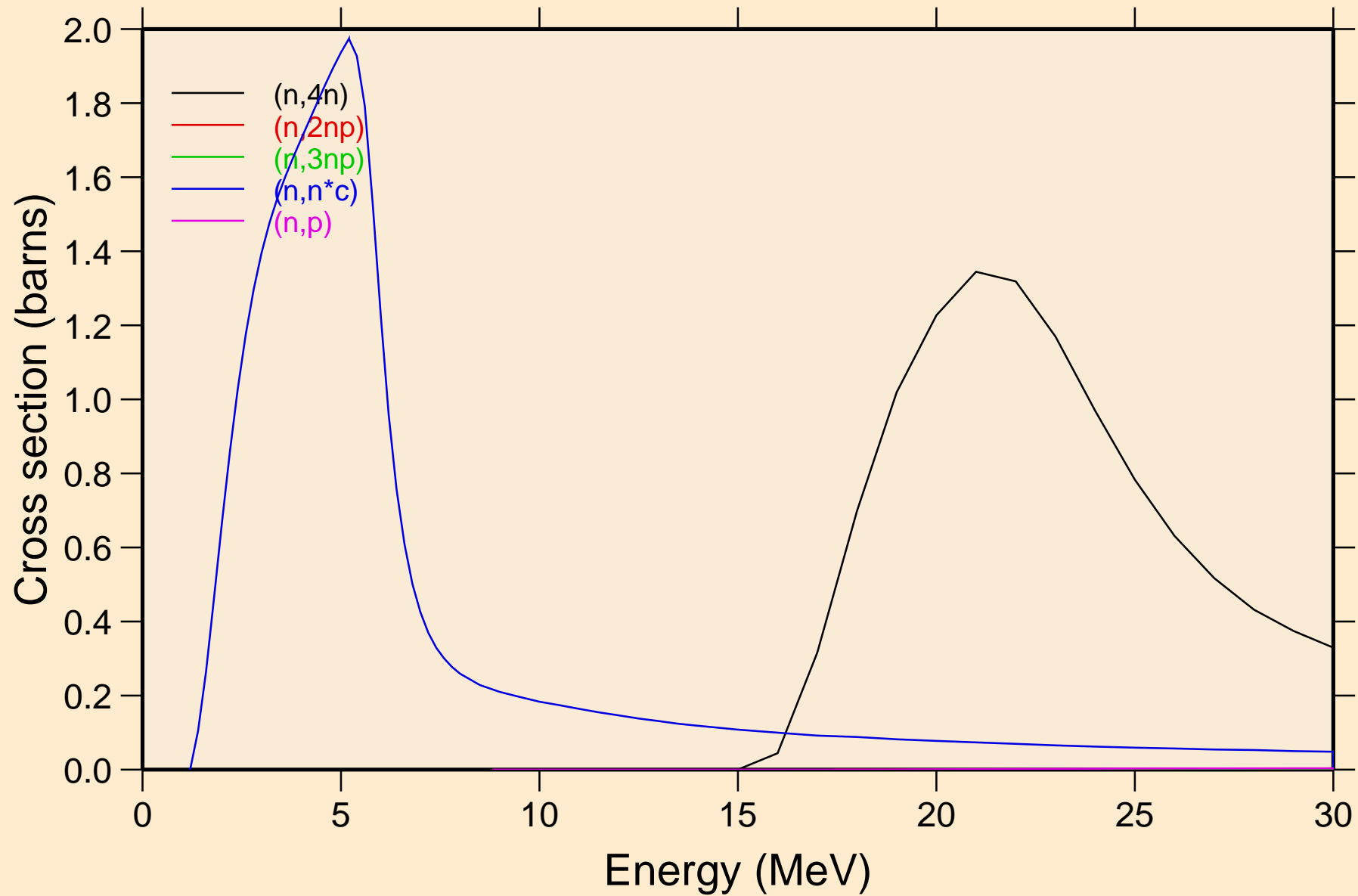

ER180 NEUTRON ACER TENDL-2024 LIBRARY; T=293.6K
Threshold reactions

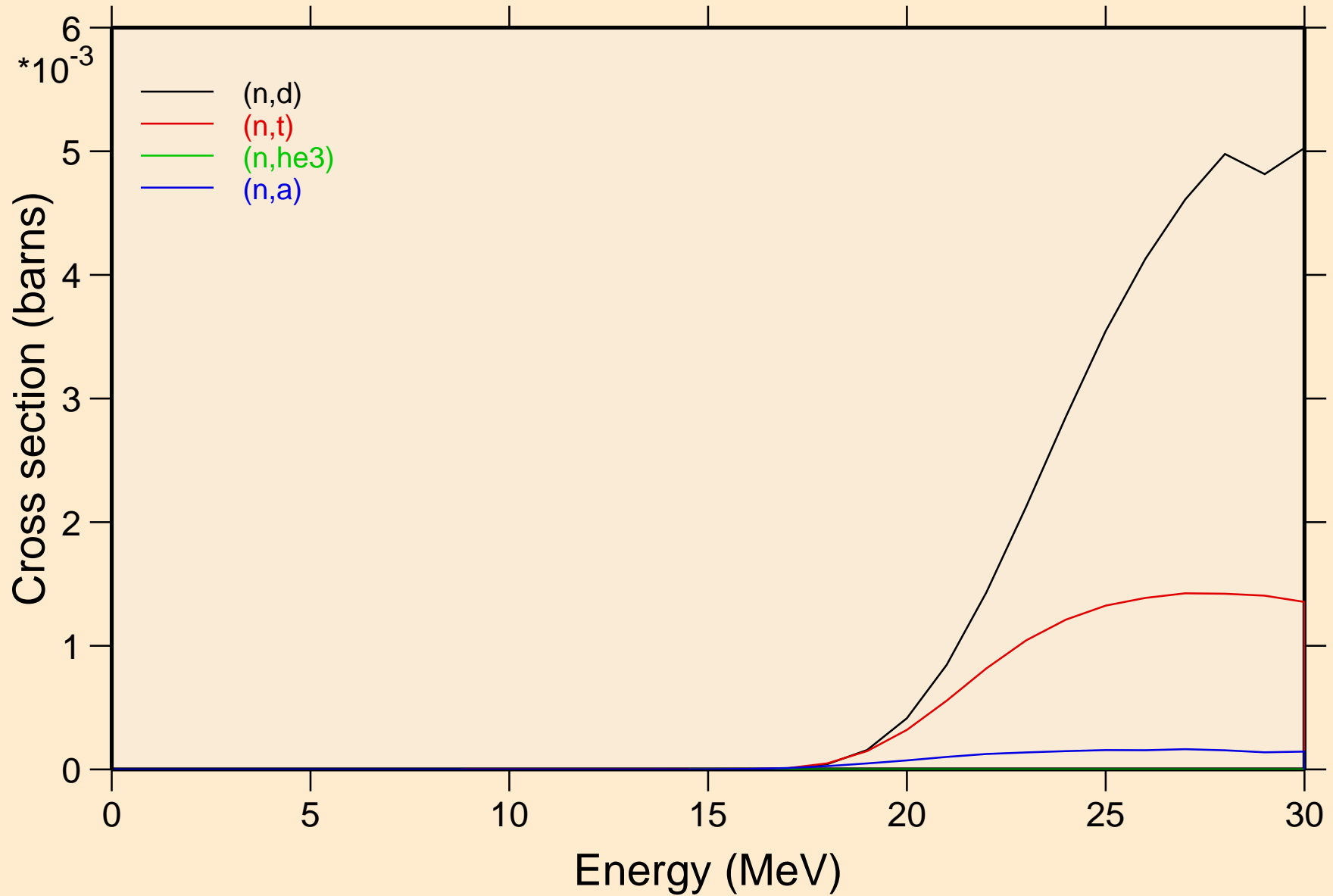

ER180 NEUTRON ACER TENDL-2024 LIBRARY; T=293.6K
Threshold reactions

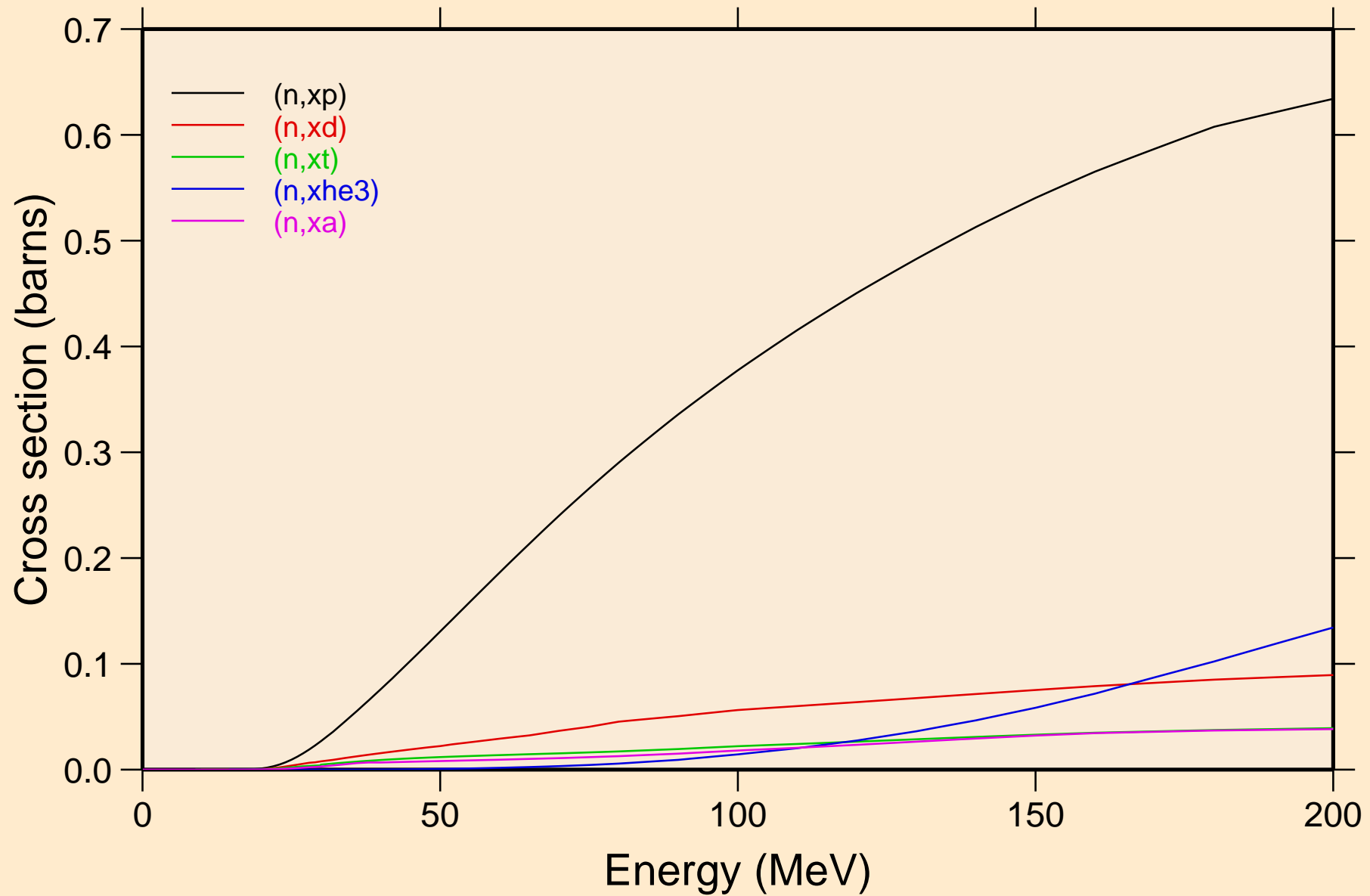

ER180 NEUTRON ACER TENDL-2024 LIBRARY; T=293.6K
angular distribution for elastic

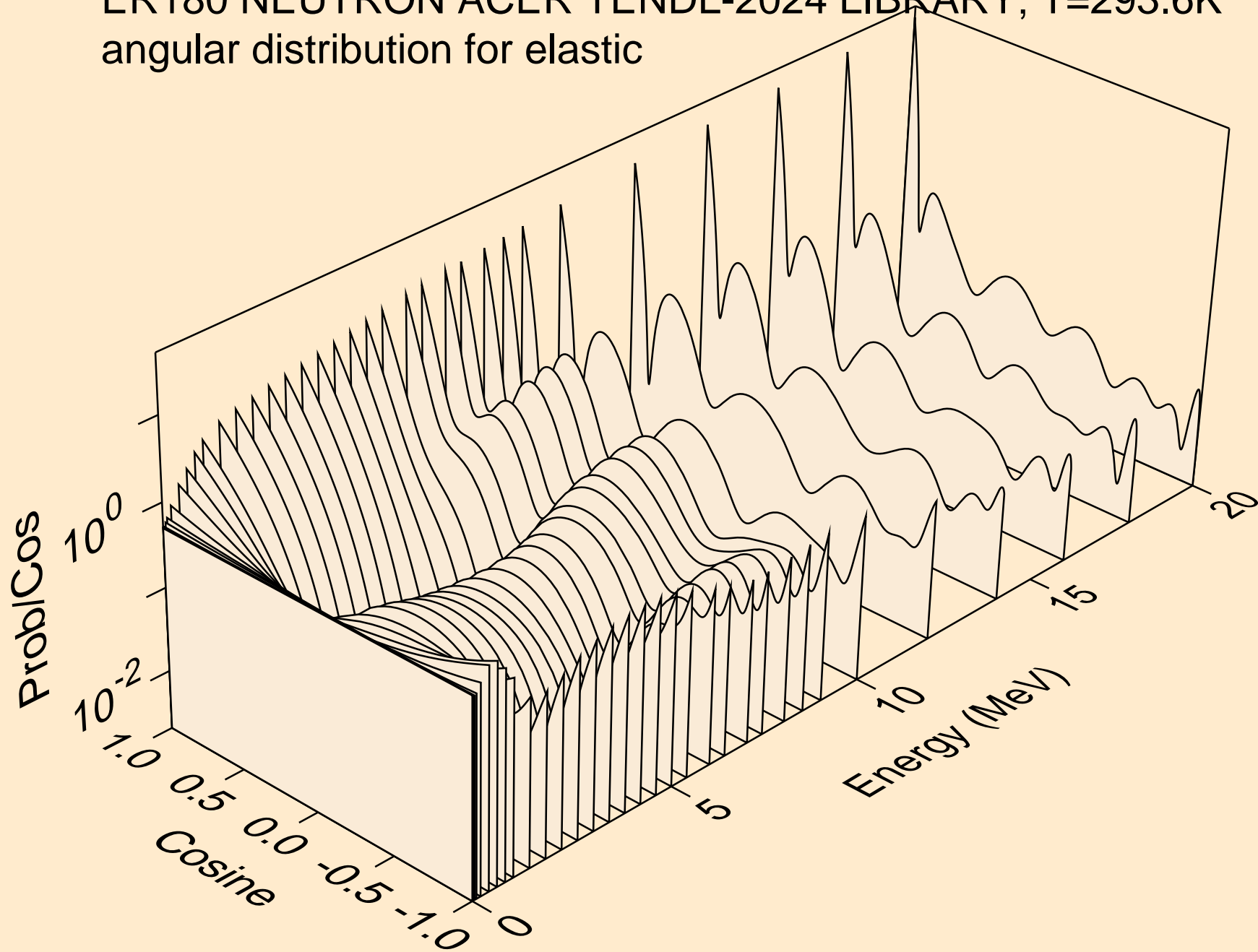

ER180 NEUTRON ACER TENDL-2024 LIBRARY; T=293.6K
angular distribution for elastic

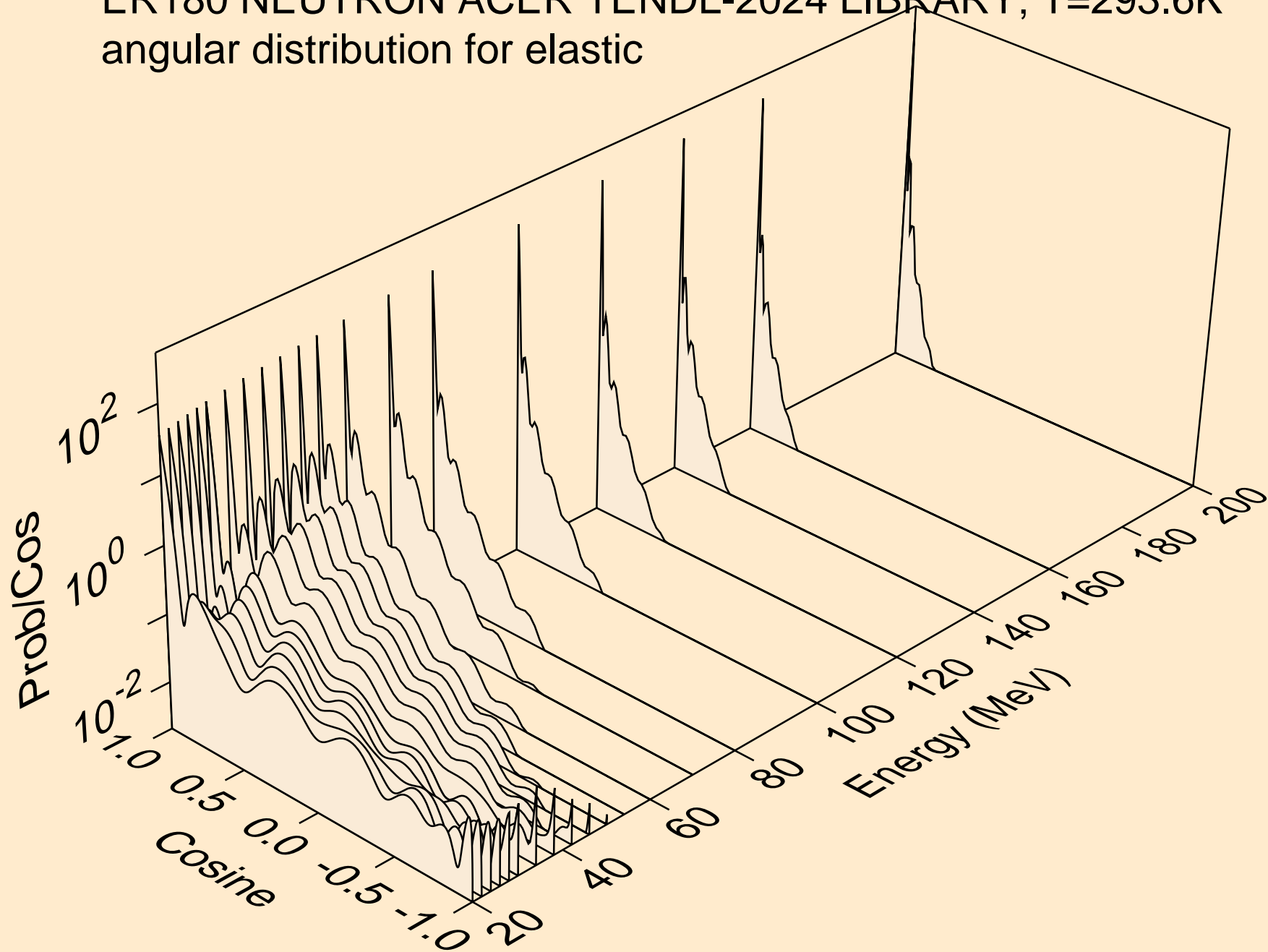

ER180 NEUTRON ACER TENDL-2024 LIBRARY; T=293.6K
angular distribution for (n,n*1)

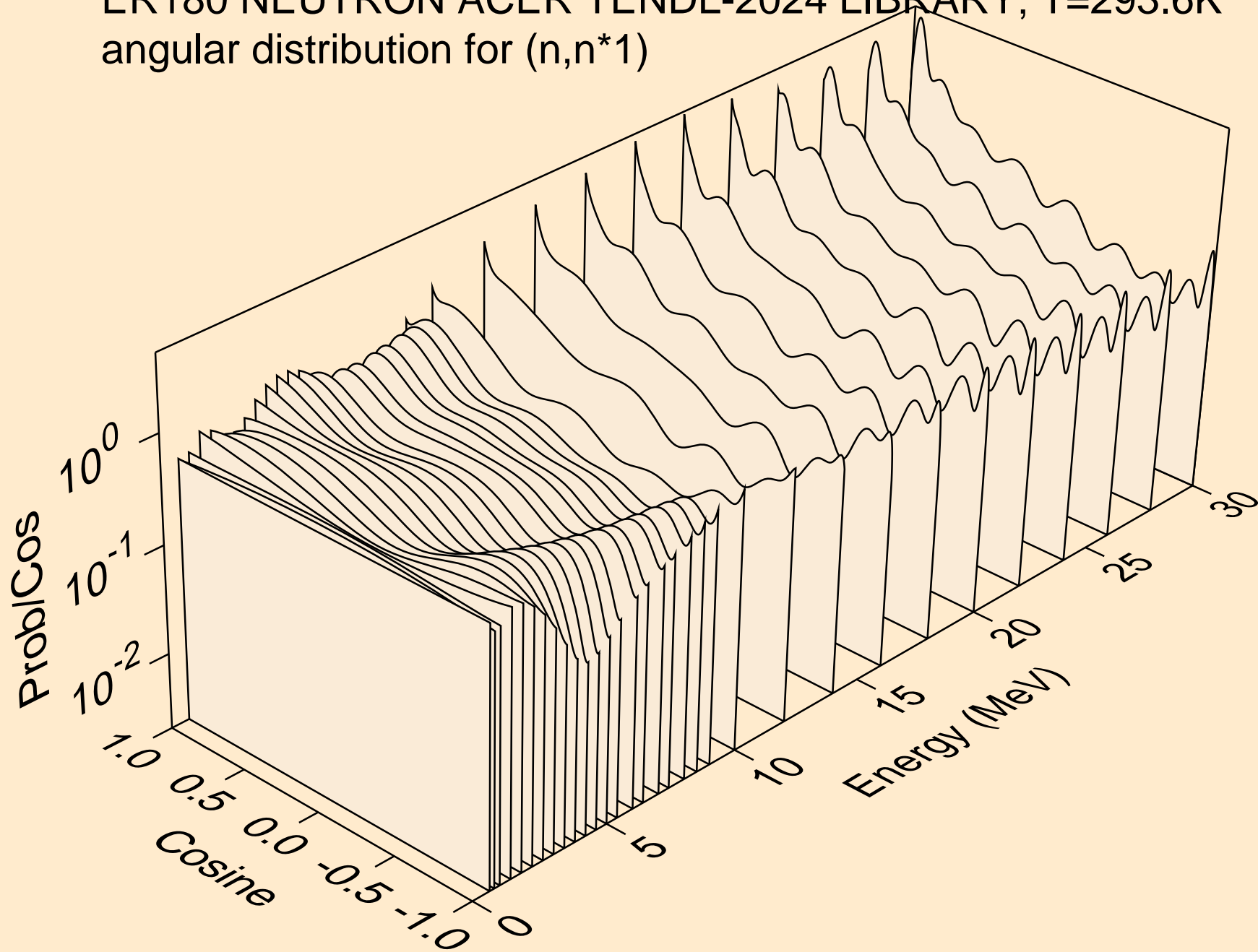

ER180 NEUTRON ACER TENDL-2024 LIBRARY; T=293.6K
angular distribution for (n,n*2)

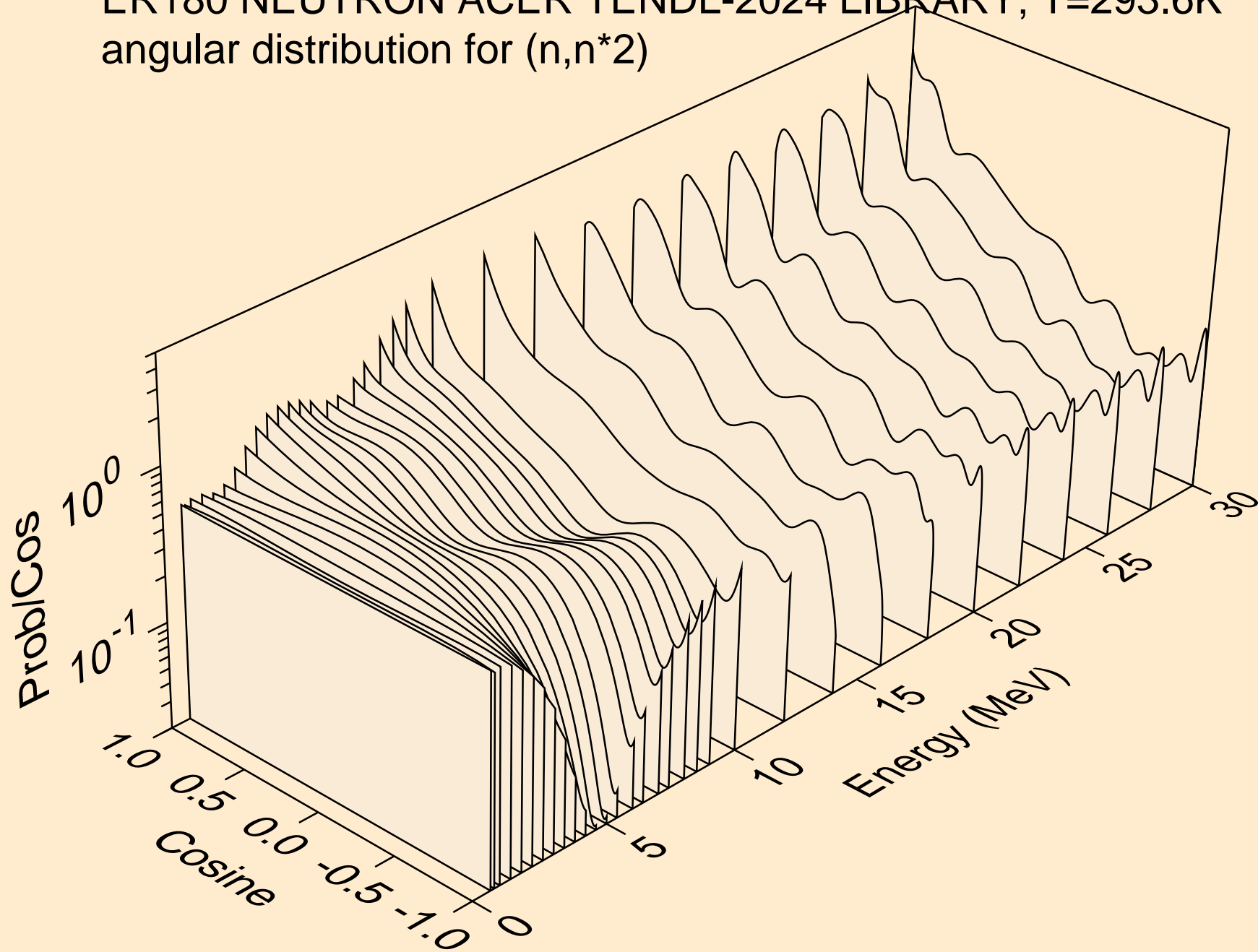

ER180 NEUTRON ACER TENDL-2024 LIBRARY; T=293.6K
angular distribution for (n,n*3)

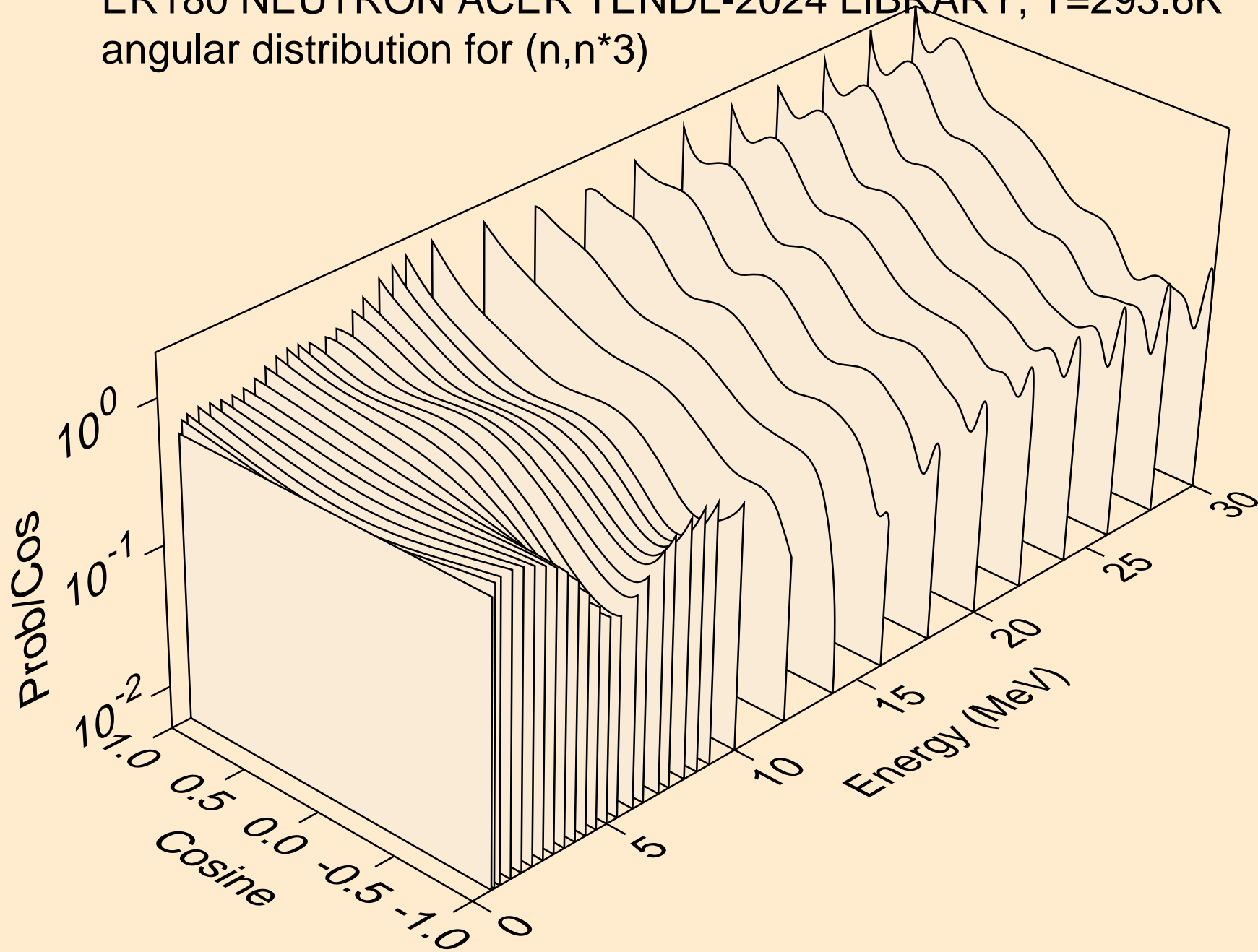

ER180 NEUTRON ACER TENDL-2024 LIBRARY; T=293.6K
angular distribution for (n,n*4)

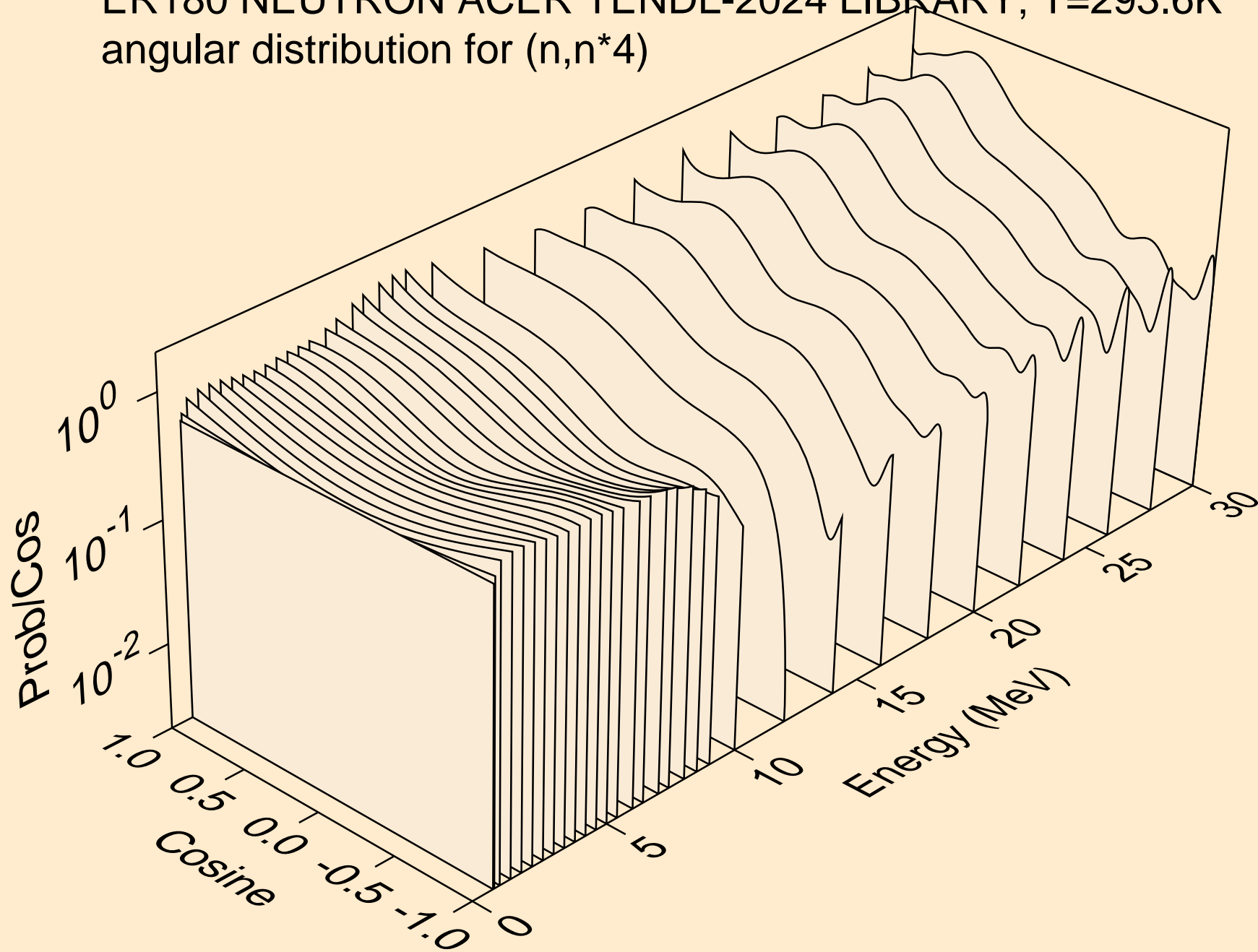

ER180 NEUTRON ACER TENDL-2024 LIBRARY; T=293.6K
angular distribution for (n,n*5)

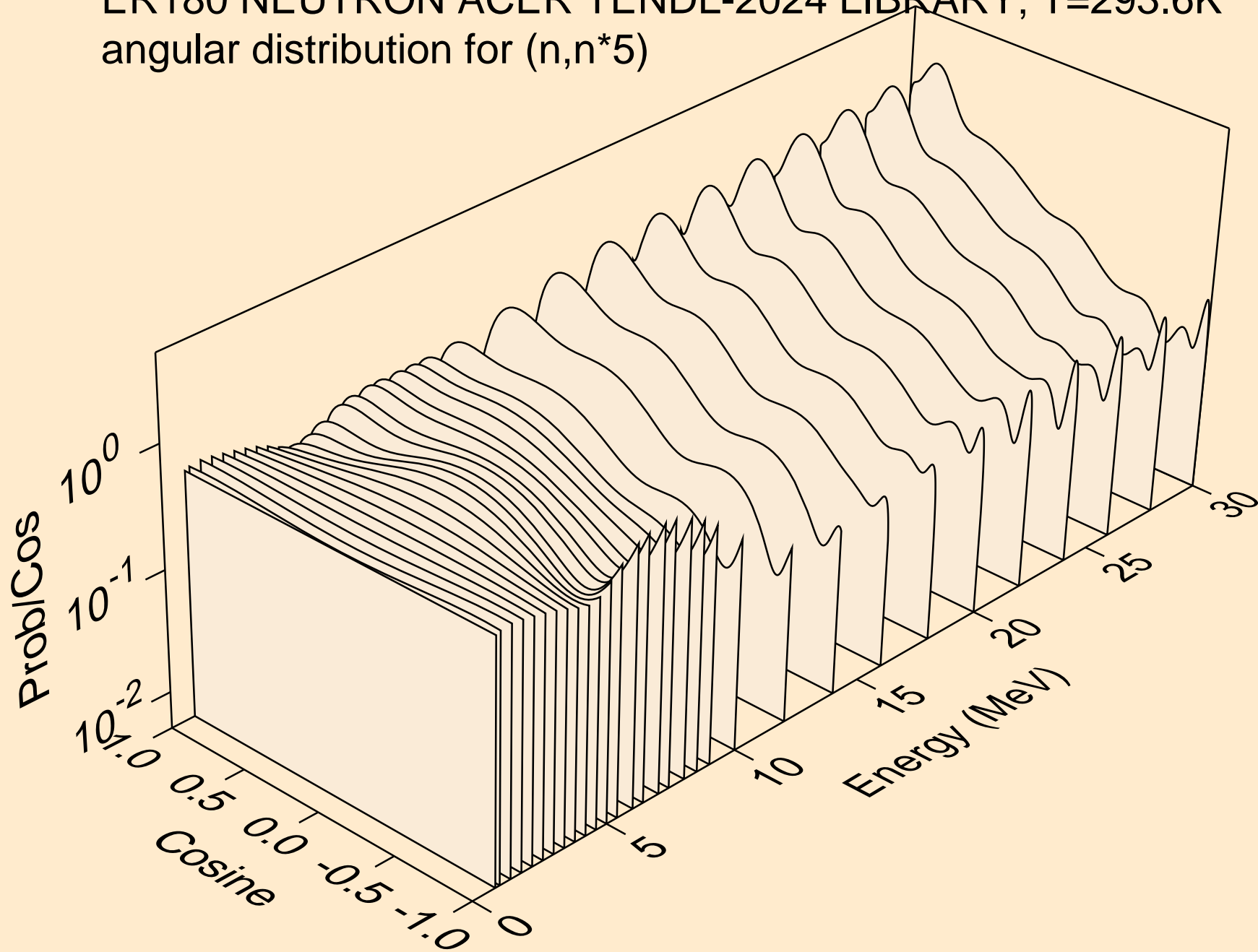

ER180 NEUTRON ACER TENDL-2024 LIBRARY; T=293.6K
angular distribution for (n,n*6)

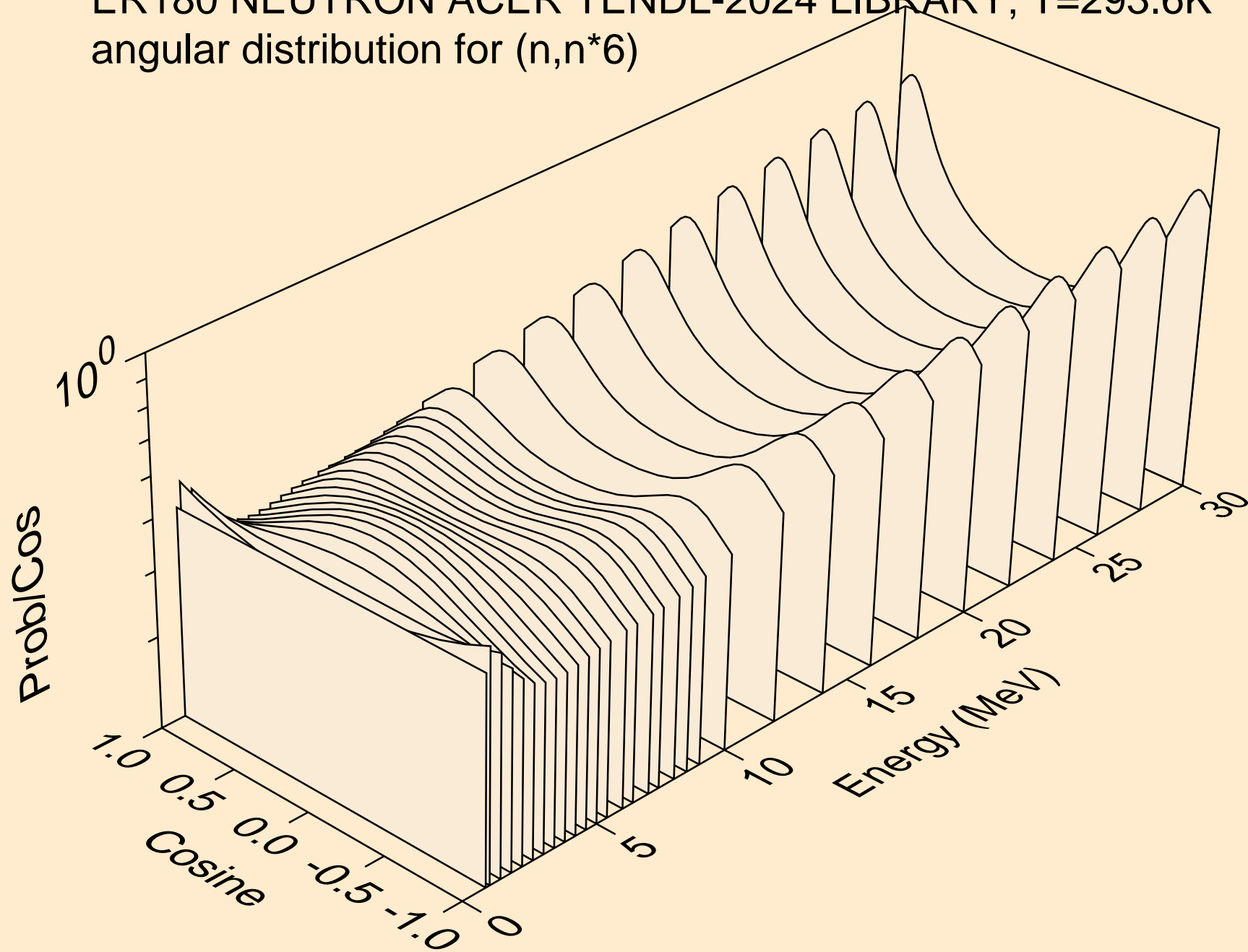

ER180 NEUTRON ACER TENDL-2024 LIBRARY; T=293.6K
angular distribution for (n,n*7)

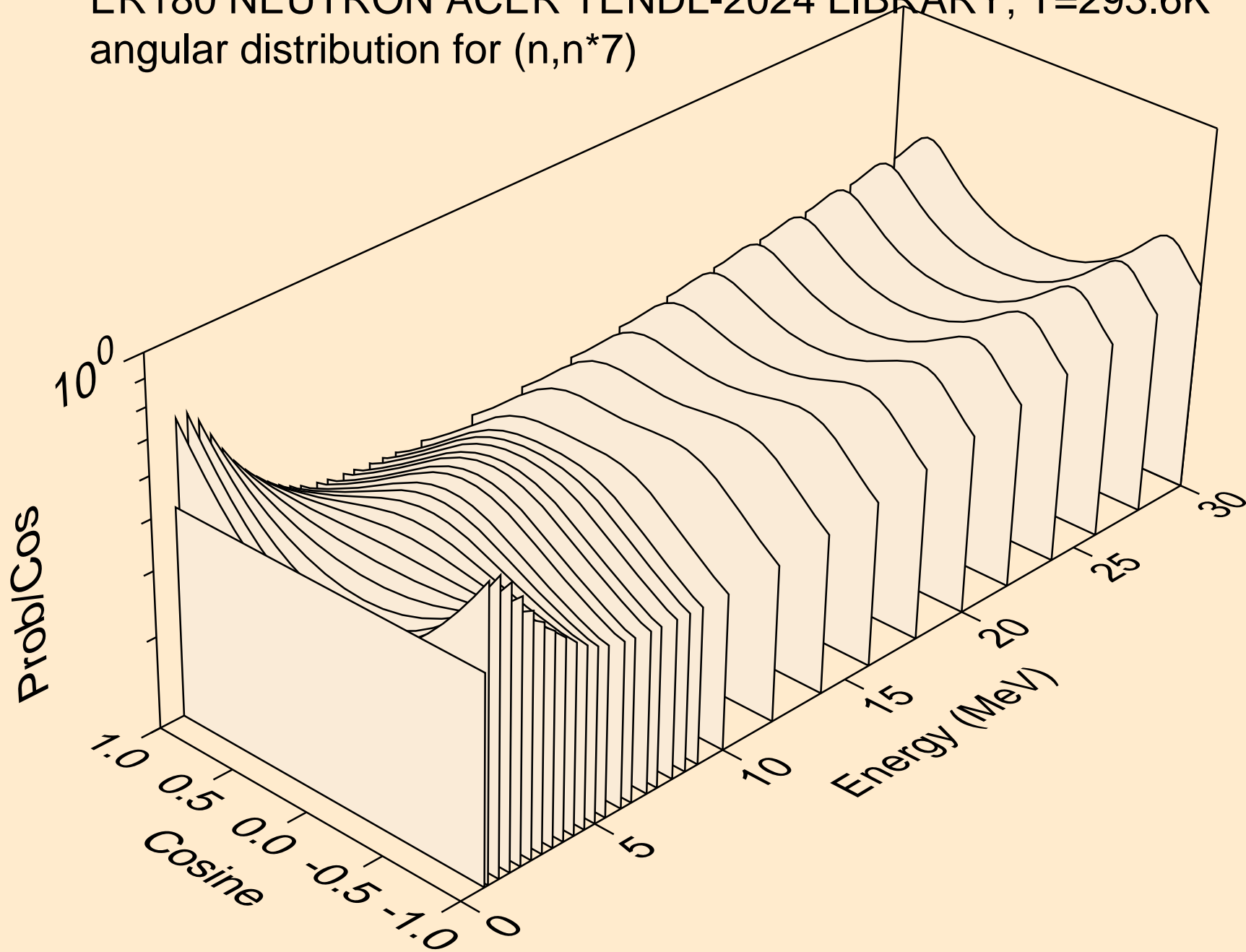

ER180 NEUTRON ACER TENDL-2024 LIBRARY; T=293.6K
angular distribution for (n,n*8)

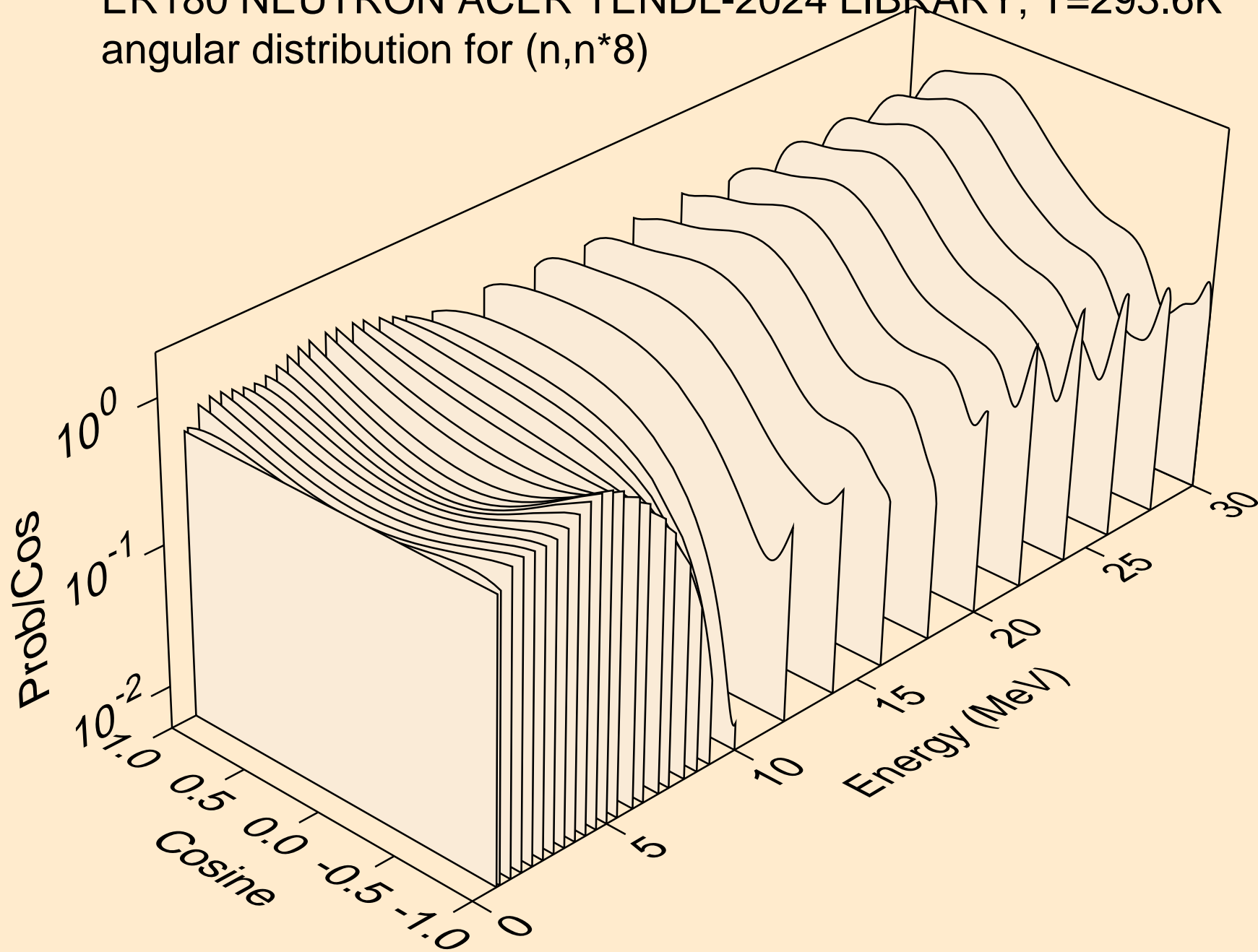

ER180 NEUTRON ACER TENDL-2024 LIBRARY; T=293.6K
angular distribution for (n,n*9)

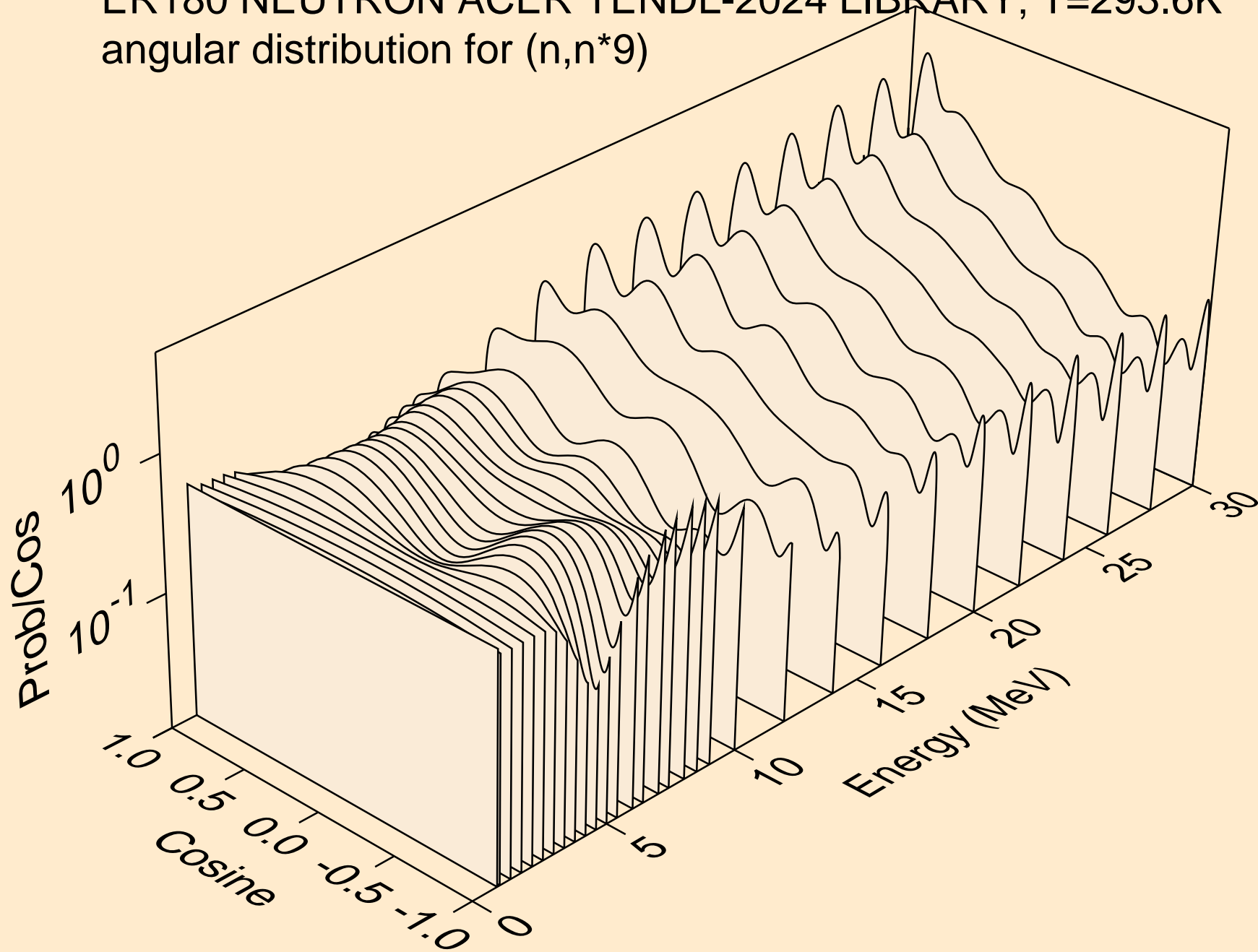

ER180 NEUTRON ACER TENDL-2024 LIBRARY; T=293.6K
angular distribution for (n,n*10)

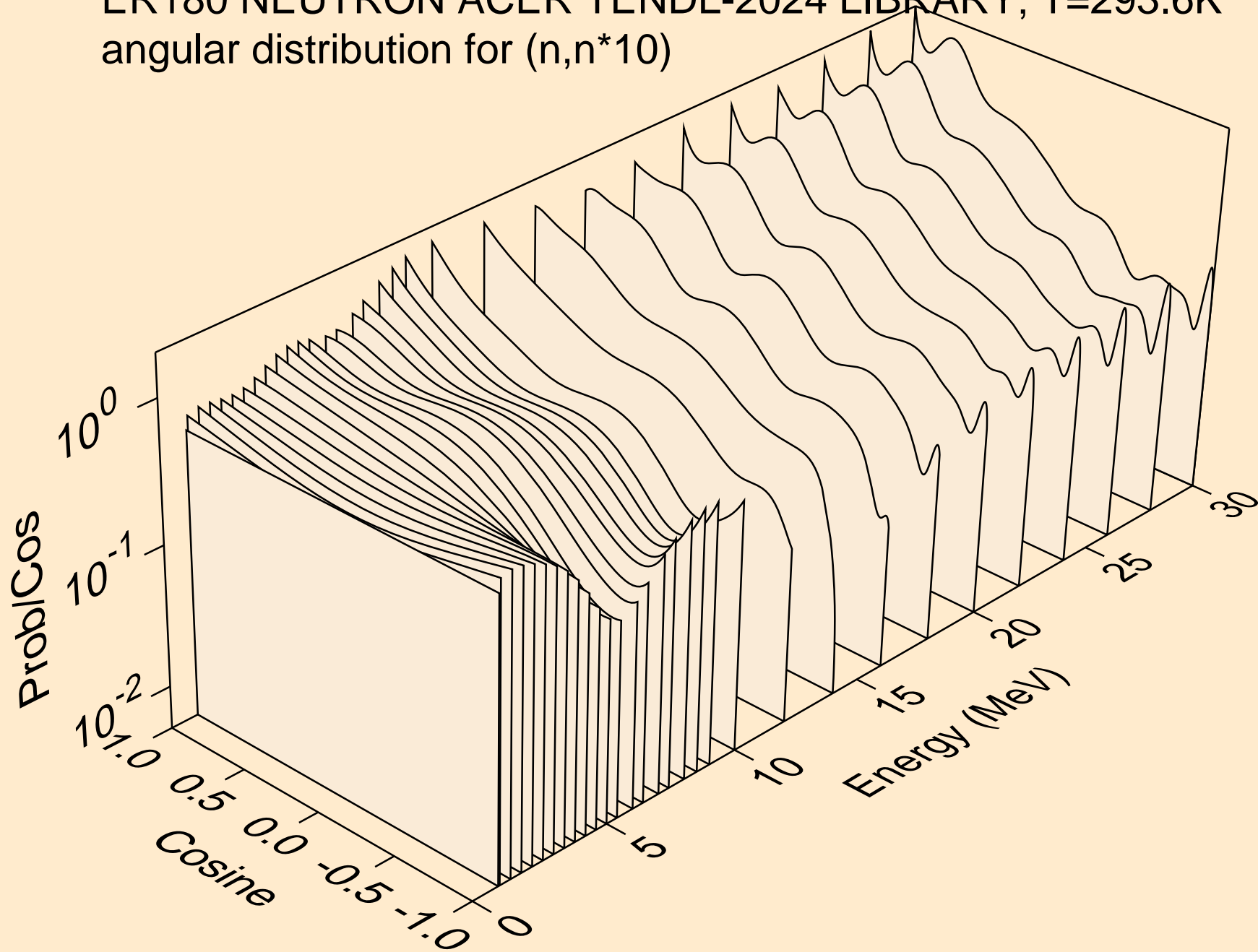

ER180 NEUTRON ACER TENDL-2024 LIBRARY; T=293.6K
angular distribution for (n,n*11)

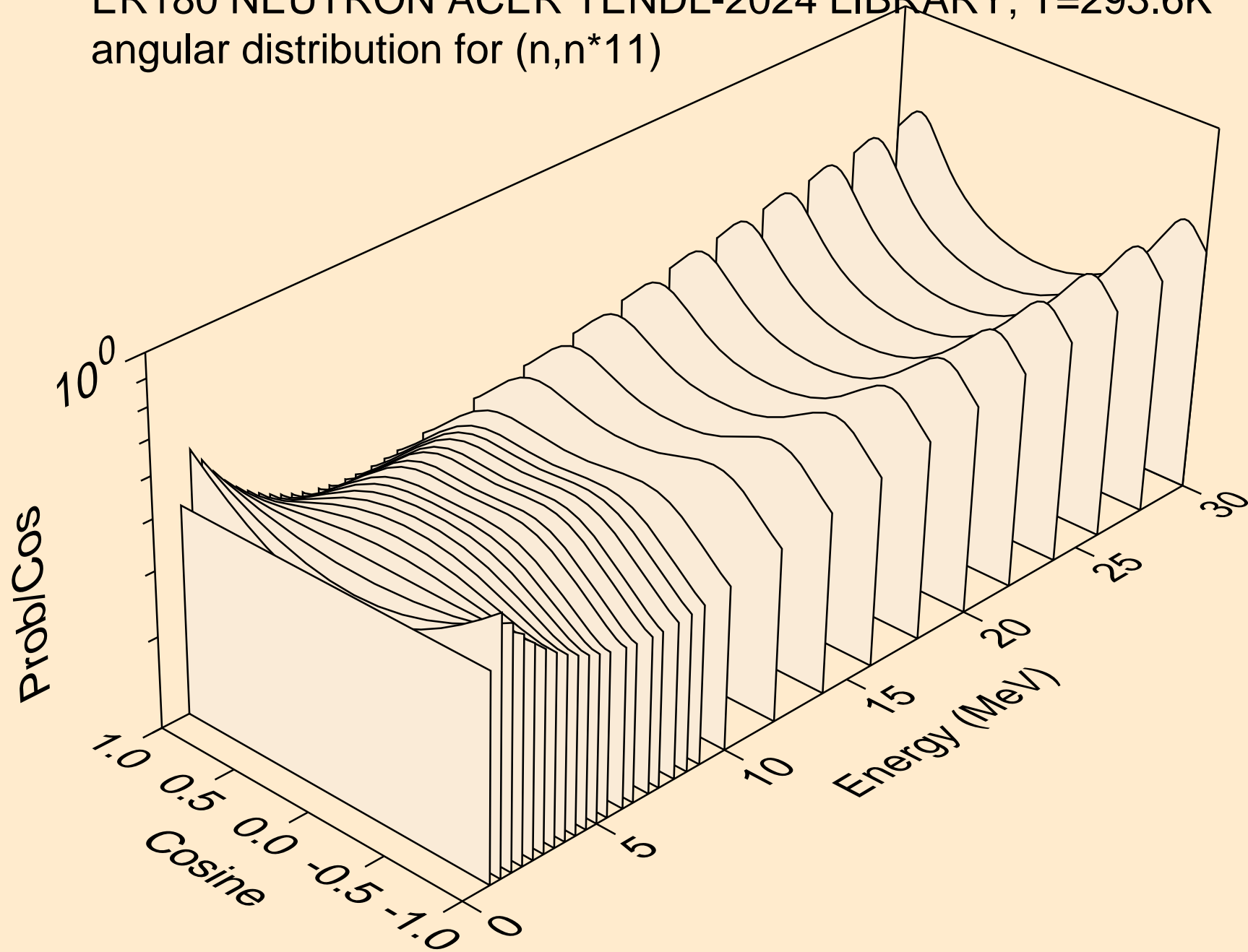

ER180 NEUTRON ACER TENDL-2024 LIBRARY; T=293.6K
angular distribution for (n,n*12)

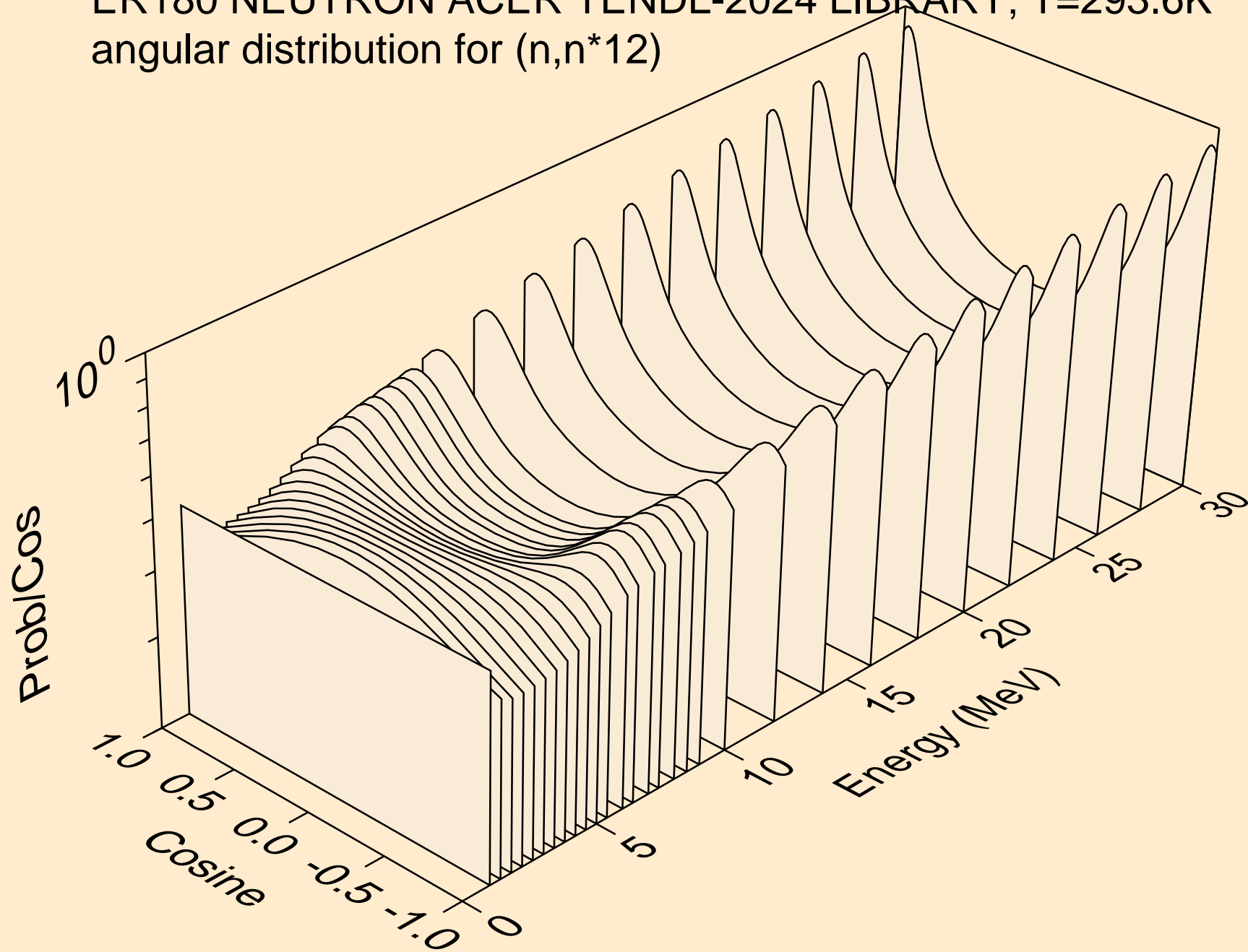

ER180 NEUTRON ACER TENDL-2024 LIBRARY; T=293.6K
angular distribution for (n,n*13)

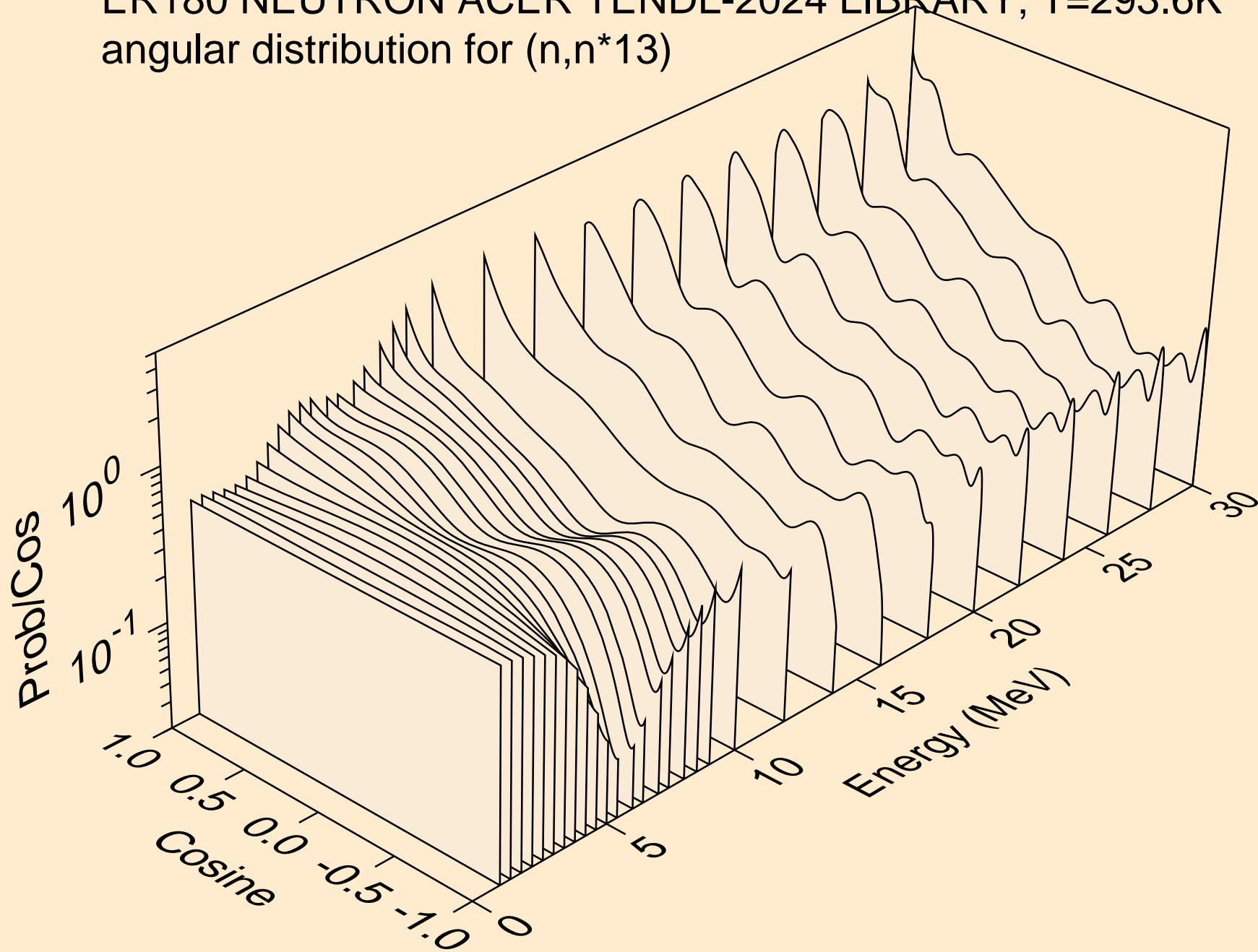

ER180 NEUTRON ACER TENDL-2024 LIBRARY; T=293.6K
angular distribution for (n,n*14)

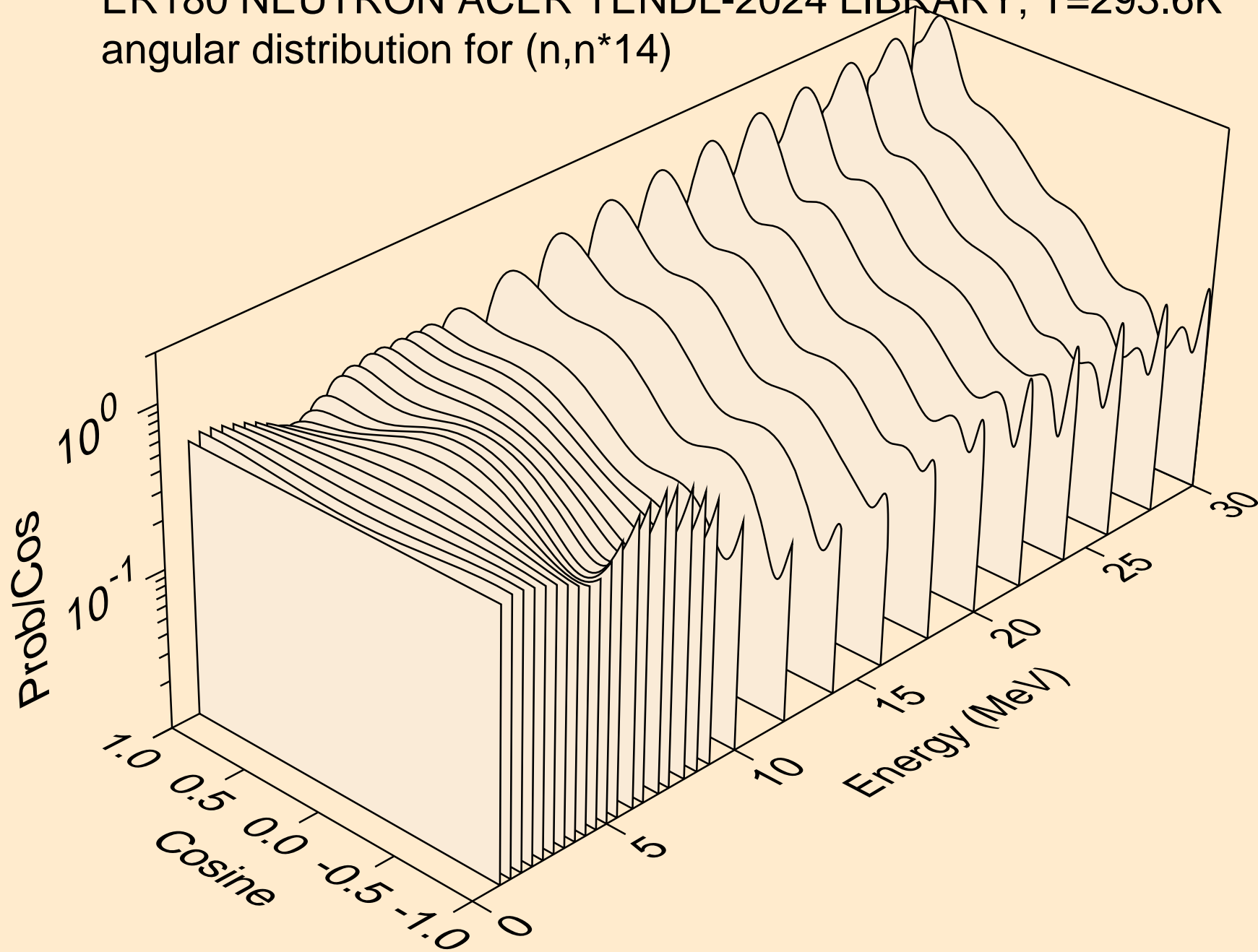

ER180 NEUTRON ACER TENDL-2024 LIBRARY; T=293.6K
angular distribution for (n,n*15)

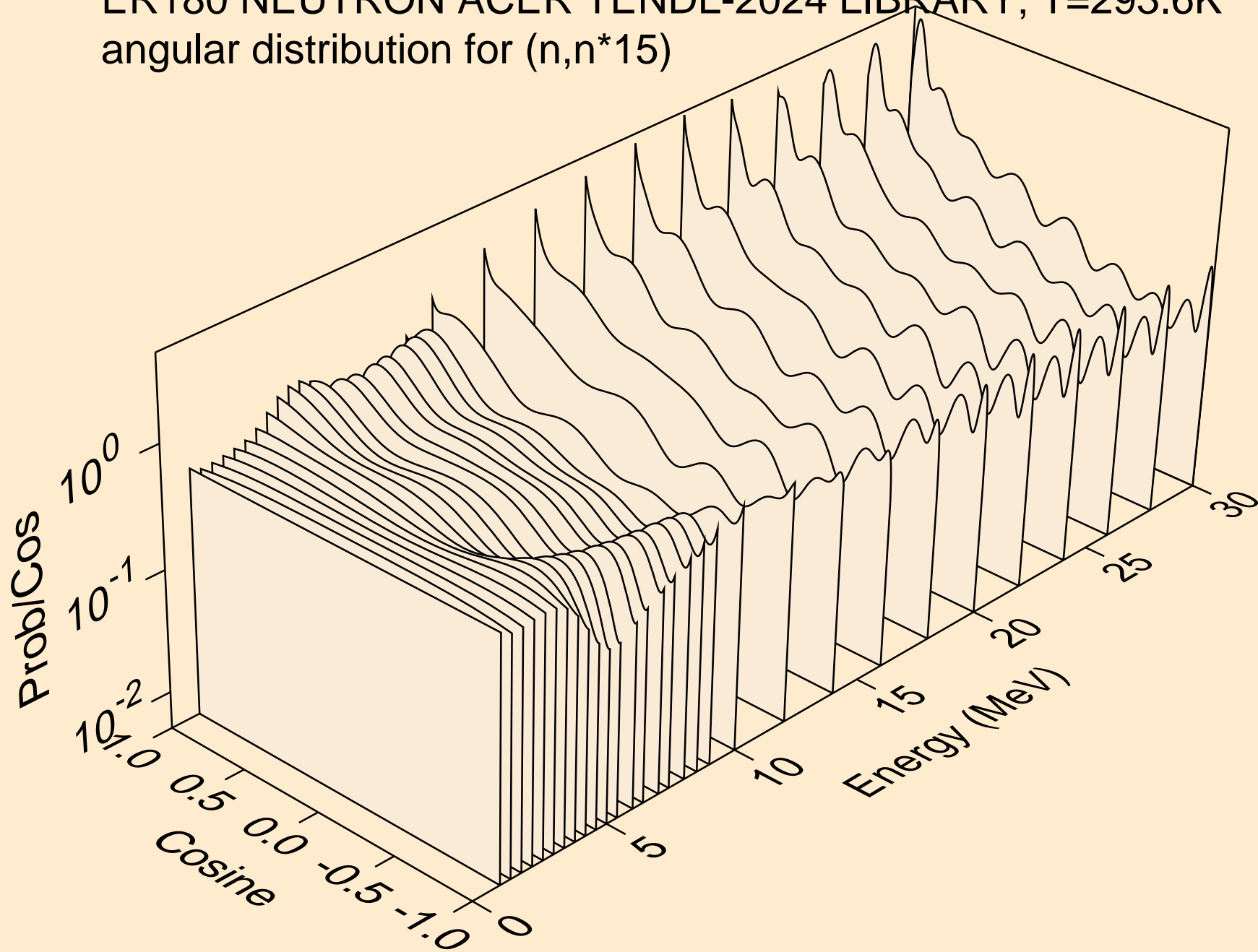

ER180 NEUTRON ACER TENDL-2024 LIBRARY; T=293.6K
angular distribution for (n,n*16)

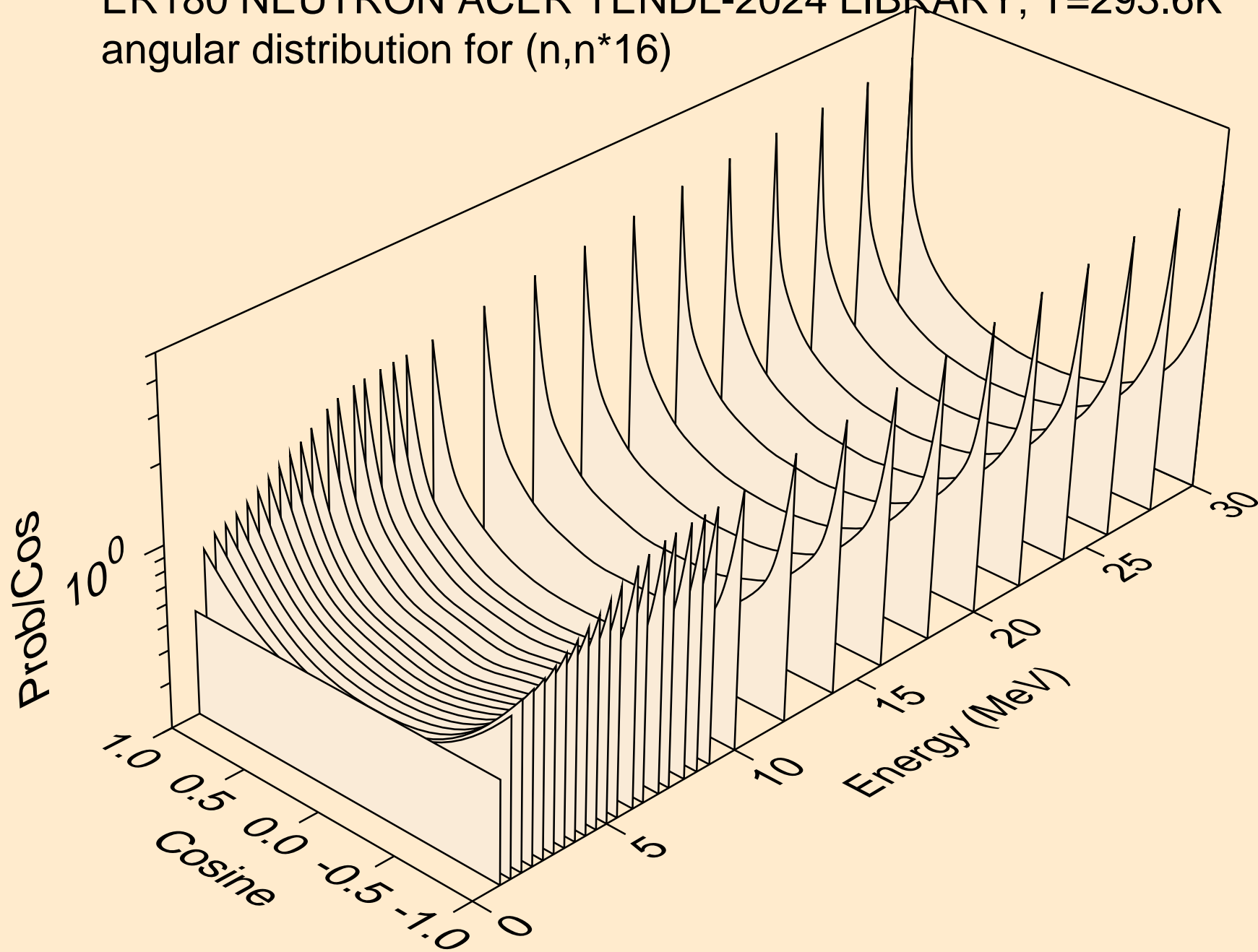

ER180 NEUTRON ACER TENDL-2024 LIBRARY; T=293.6K
angular distribution for (n,n*17)

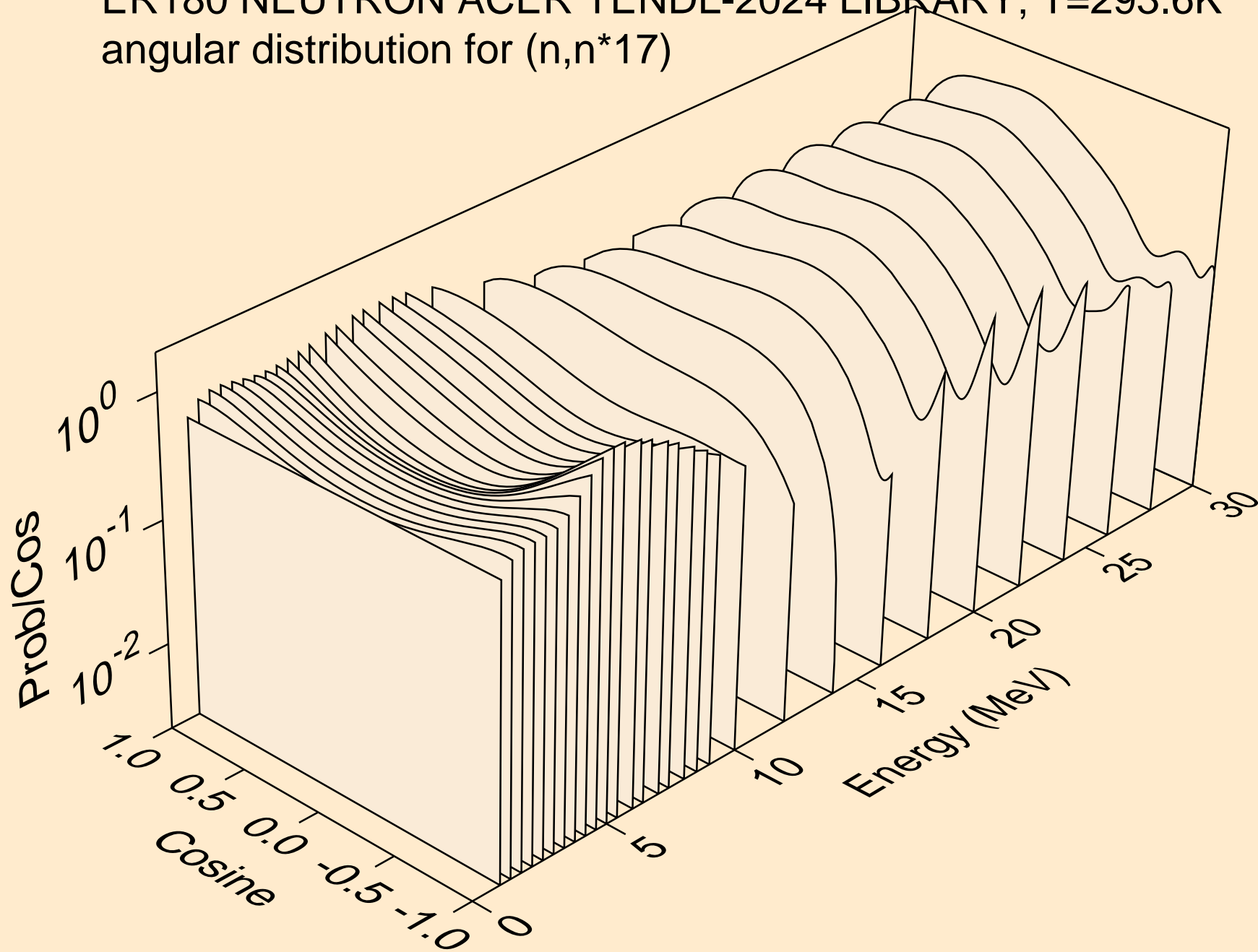

ER180 NEUTRON ACER TENDL-2024 LIBRARY; T=293.6K
angular distribution for (n,n*18)

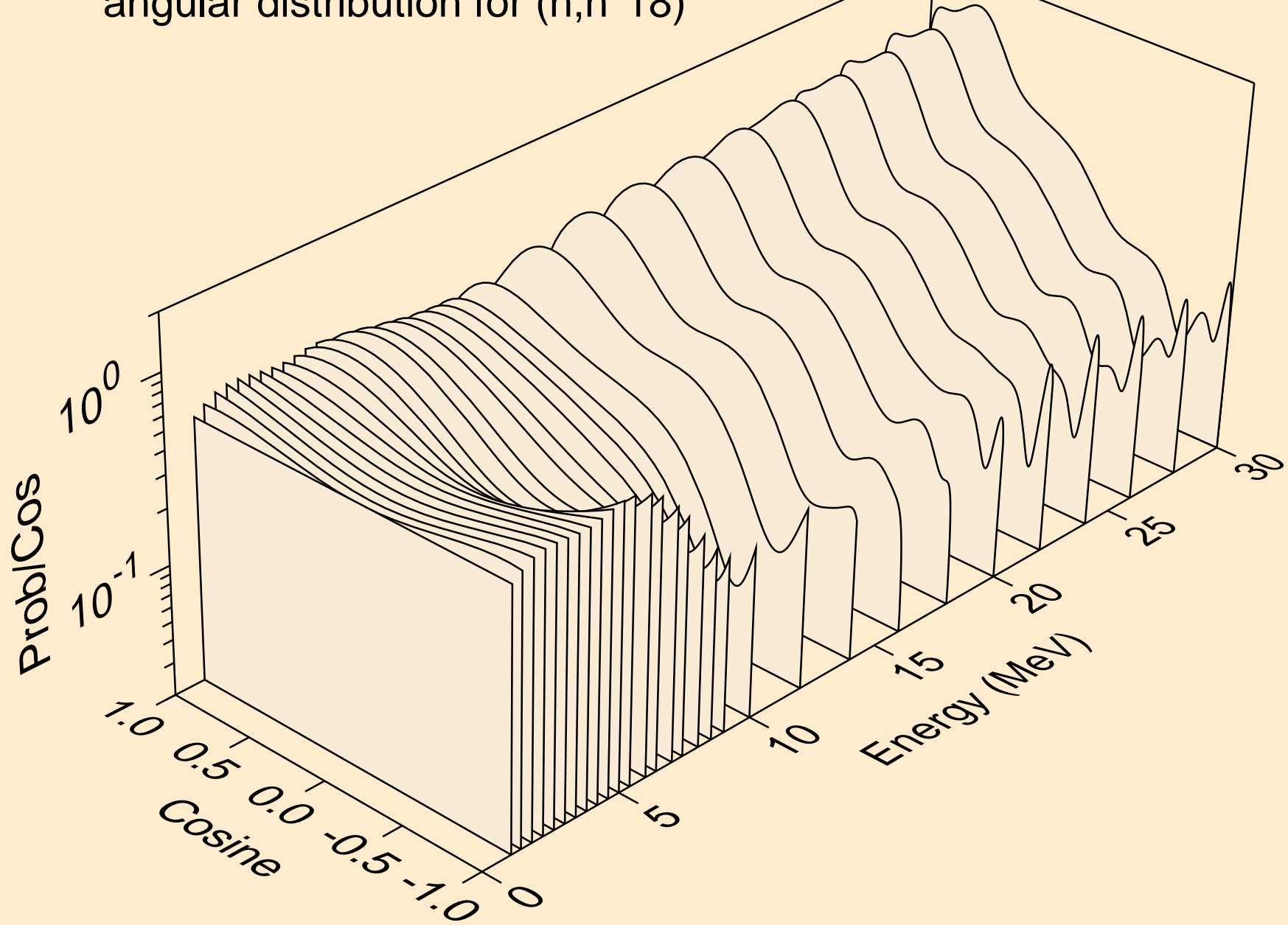

ER180 NEUTRON ACER TENDL-2024 LIBRARY; T=293.6K
angular distribution for (n,n*19)

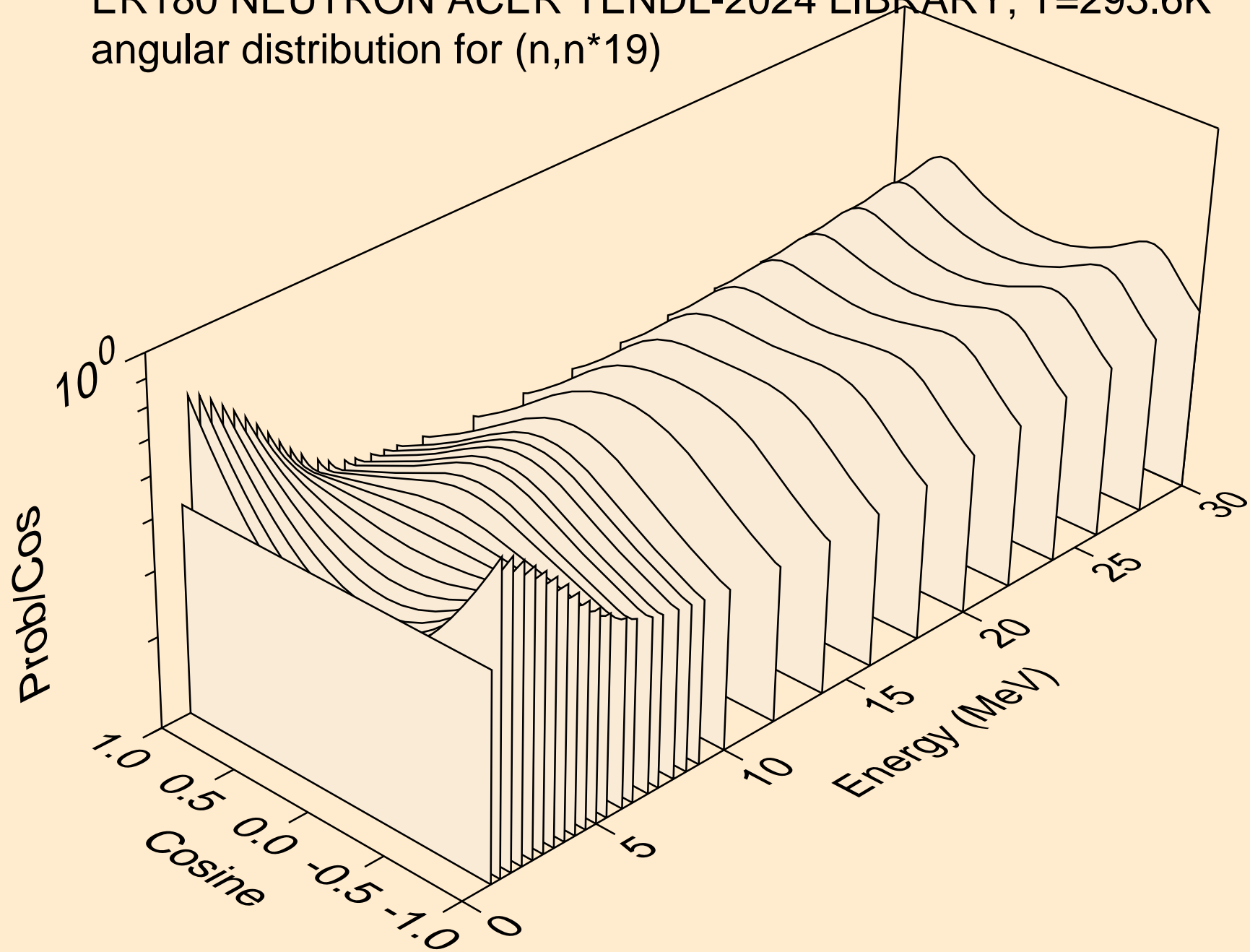

ER180 NEUTRON ACER TENDL-2024 LIBRARY; T=293.6K
angular distribution for (n,n*20)

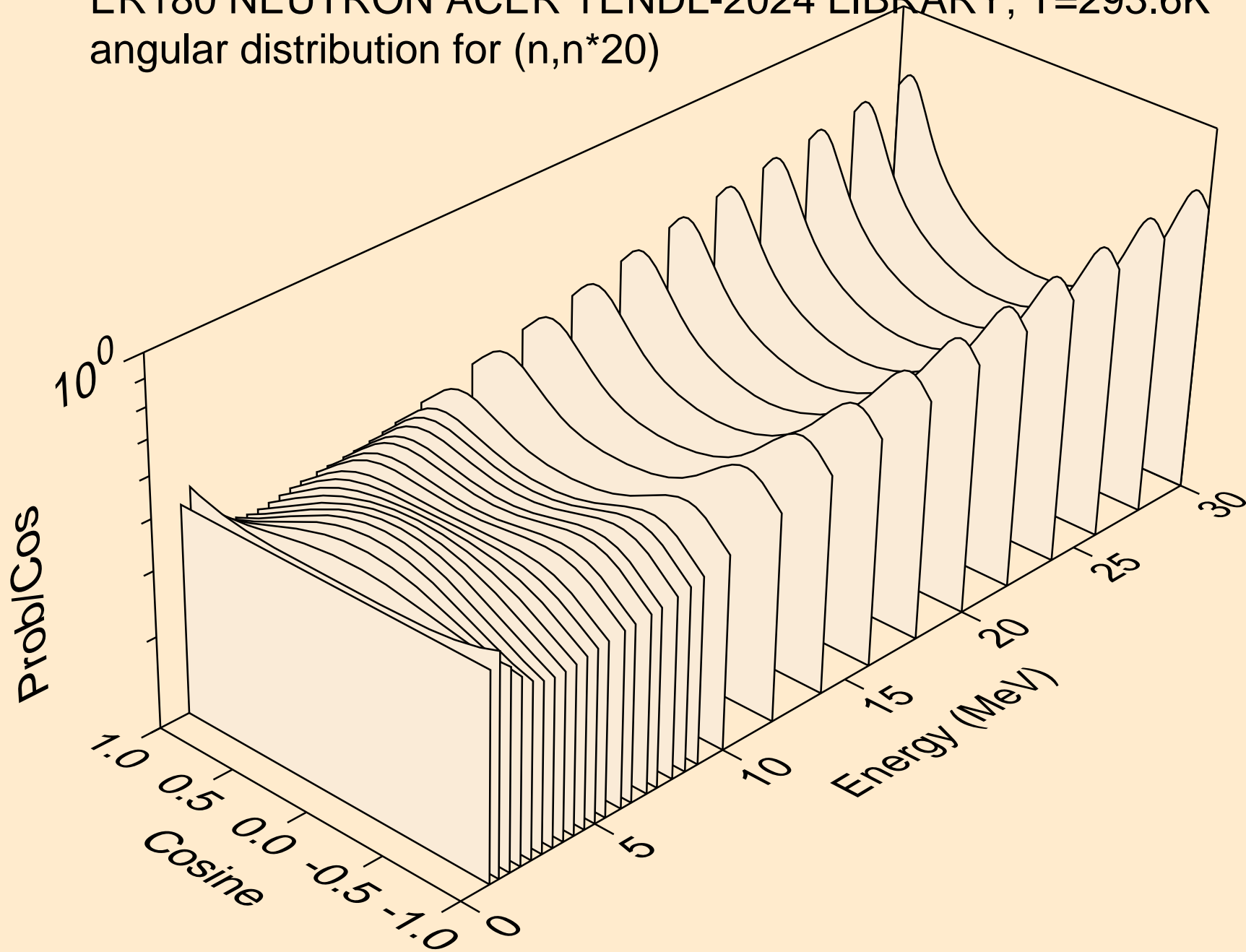

ER180 NEUTRON ACER TENDL-2024 LIBRARY; T=293.6K
angular distribution for (n,n*21)

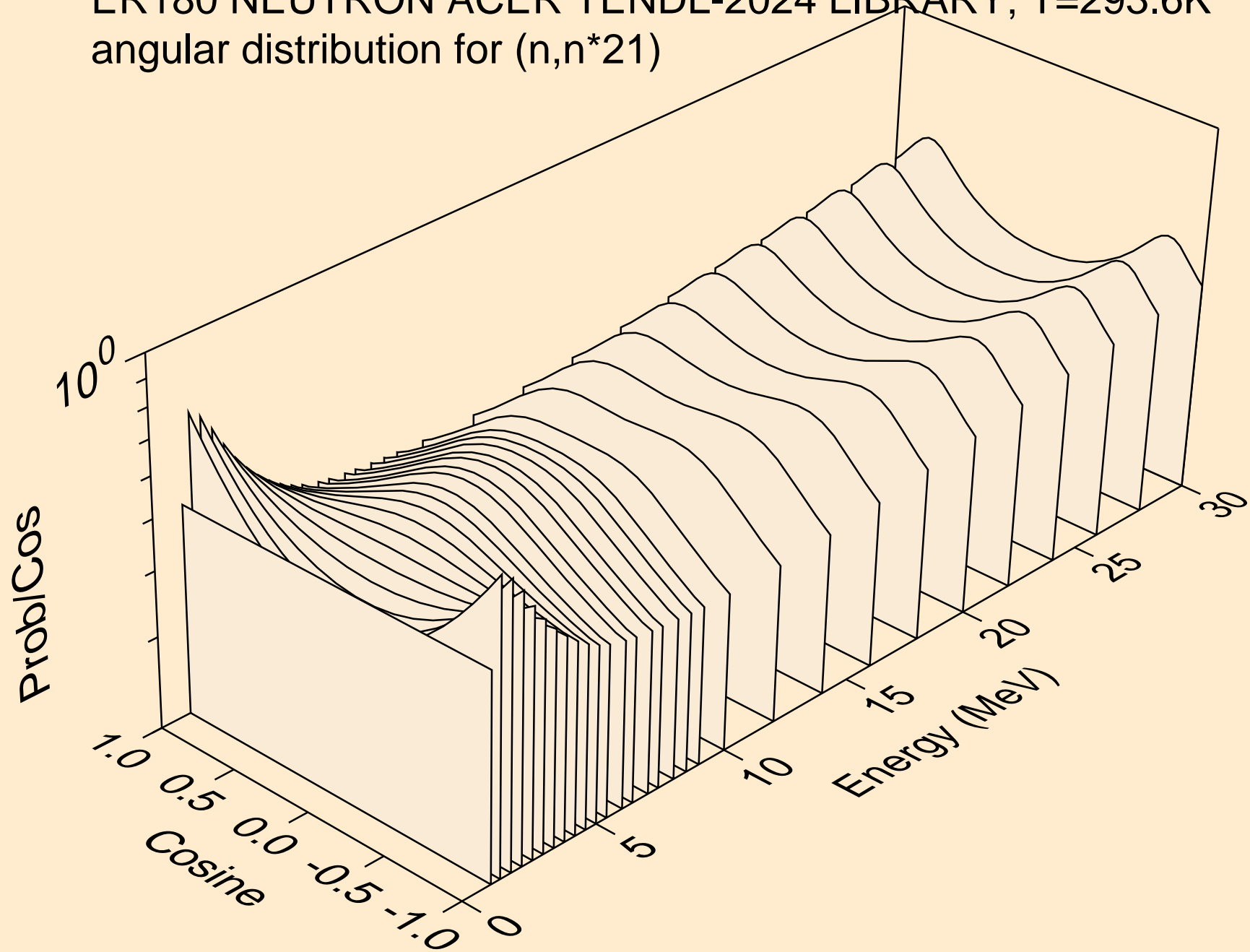

ER180 NEUTRON ACER TENDL-2024 LIBRARY; T=293.6K
angular distribution for (n,n*22)

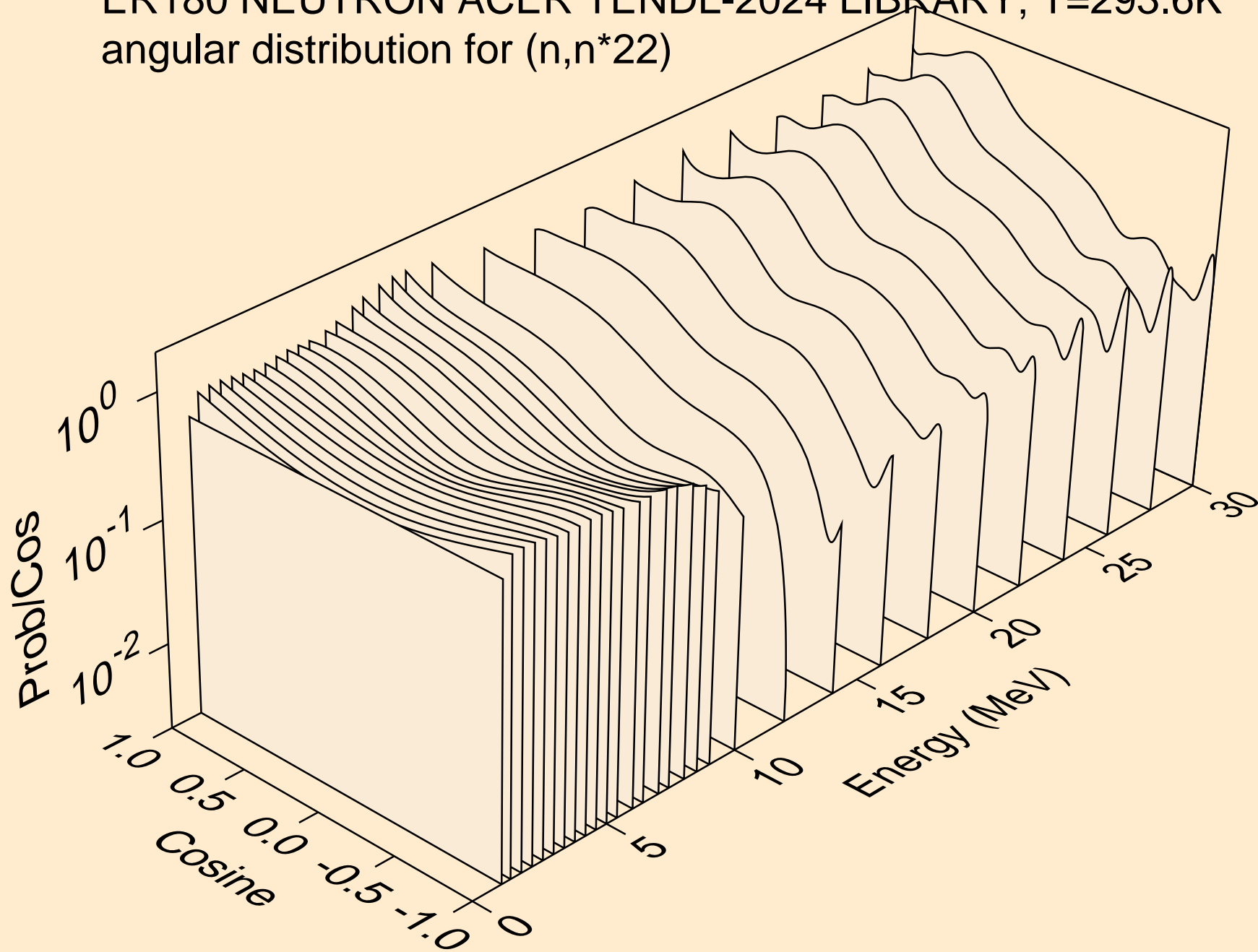

ER180 NEUTRON ACER TENDL-2024 LIBRARY; T=293.6K
angular distribution for (n,n*23)

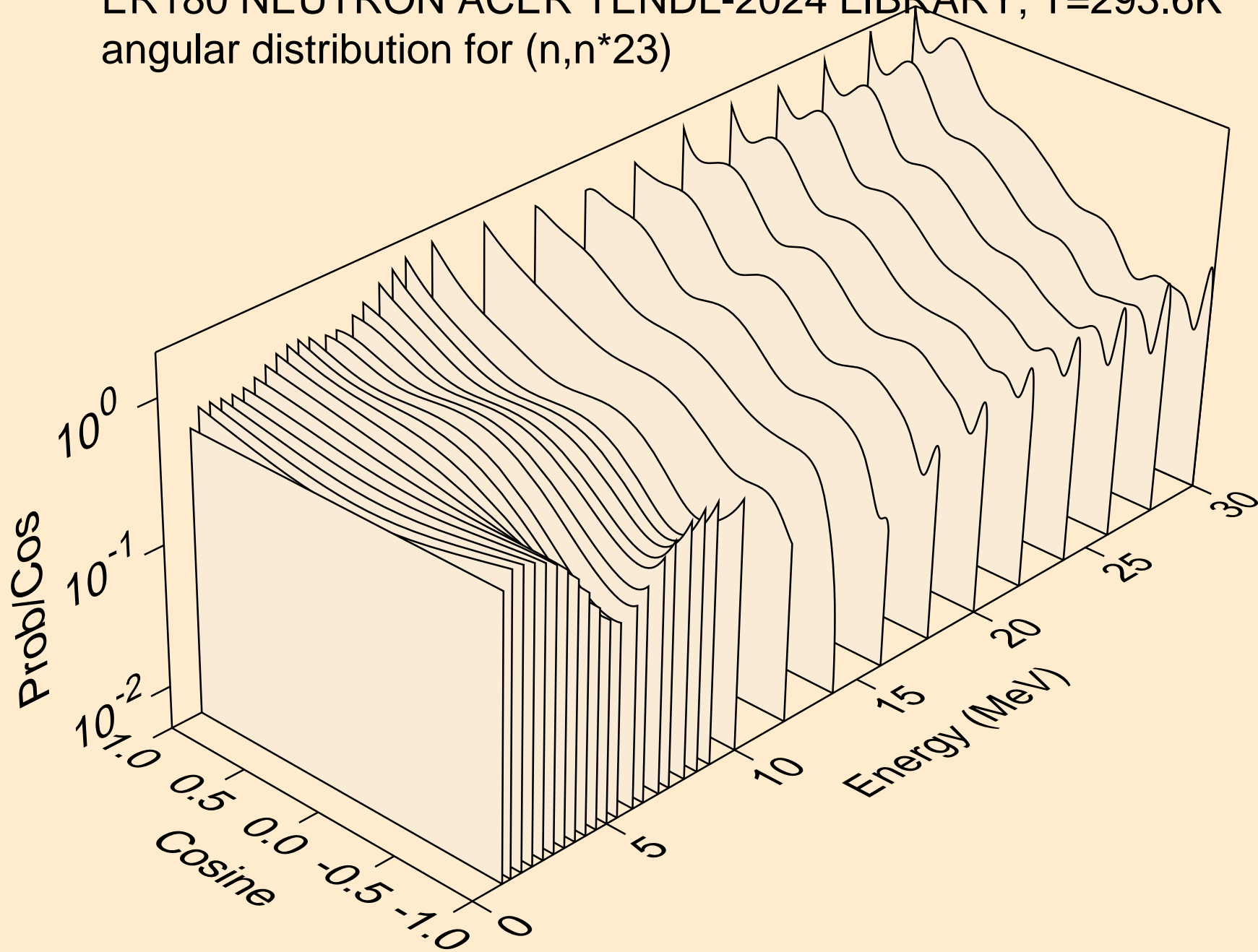

ER180 NEUTRON ACER TENDL-2024 LIBRARY; T=293.6K
angular distribution for (n,n*24)

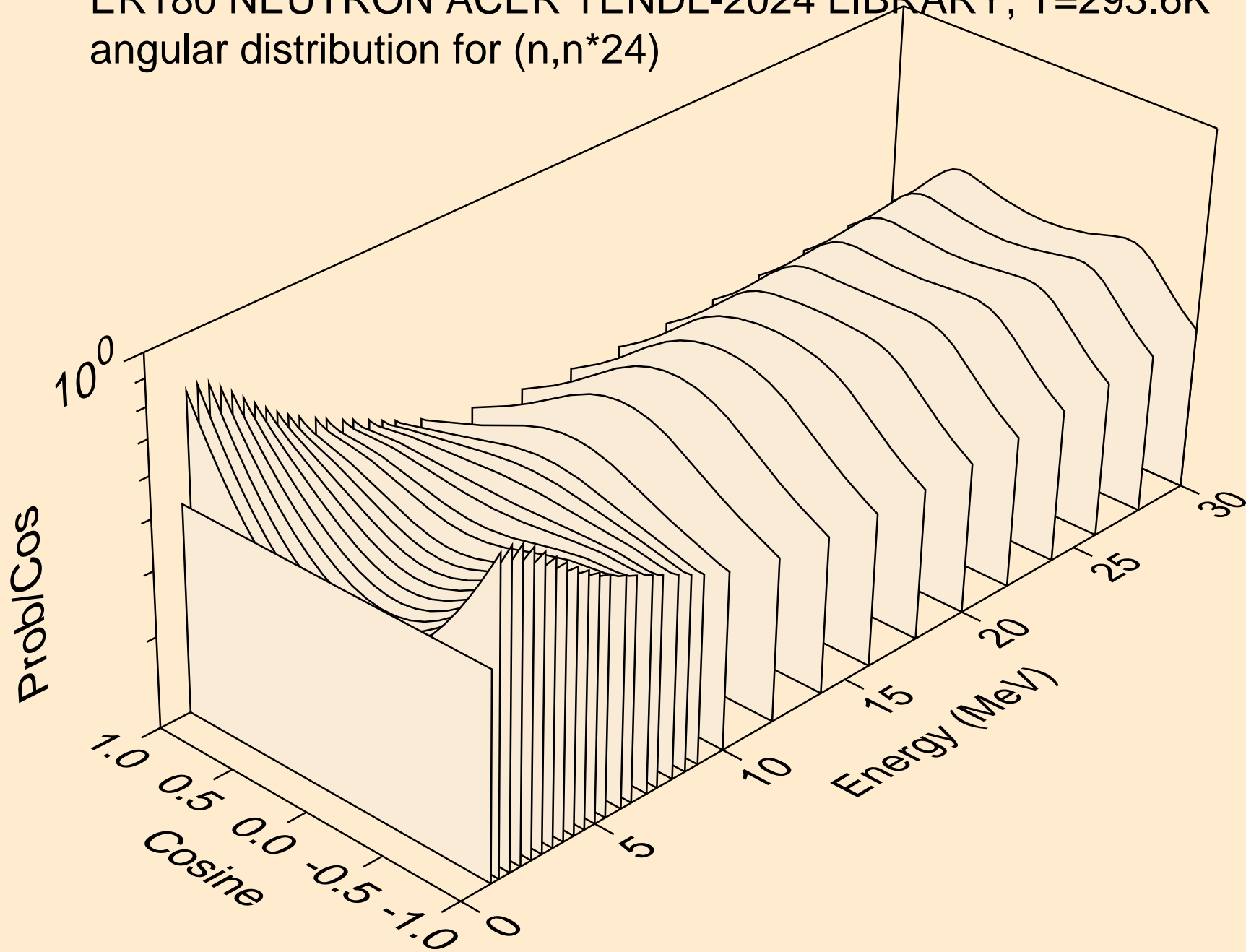

ER180 NEUTRON ACER TENDL-2024 LIBRARY; T=293.6K
angular distribution for (n,n*25)

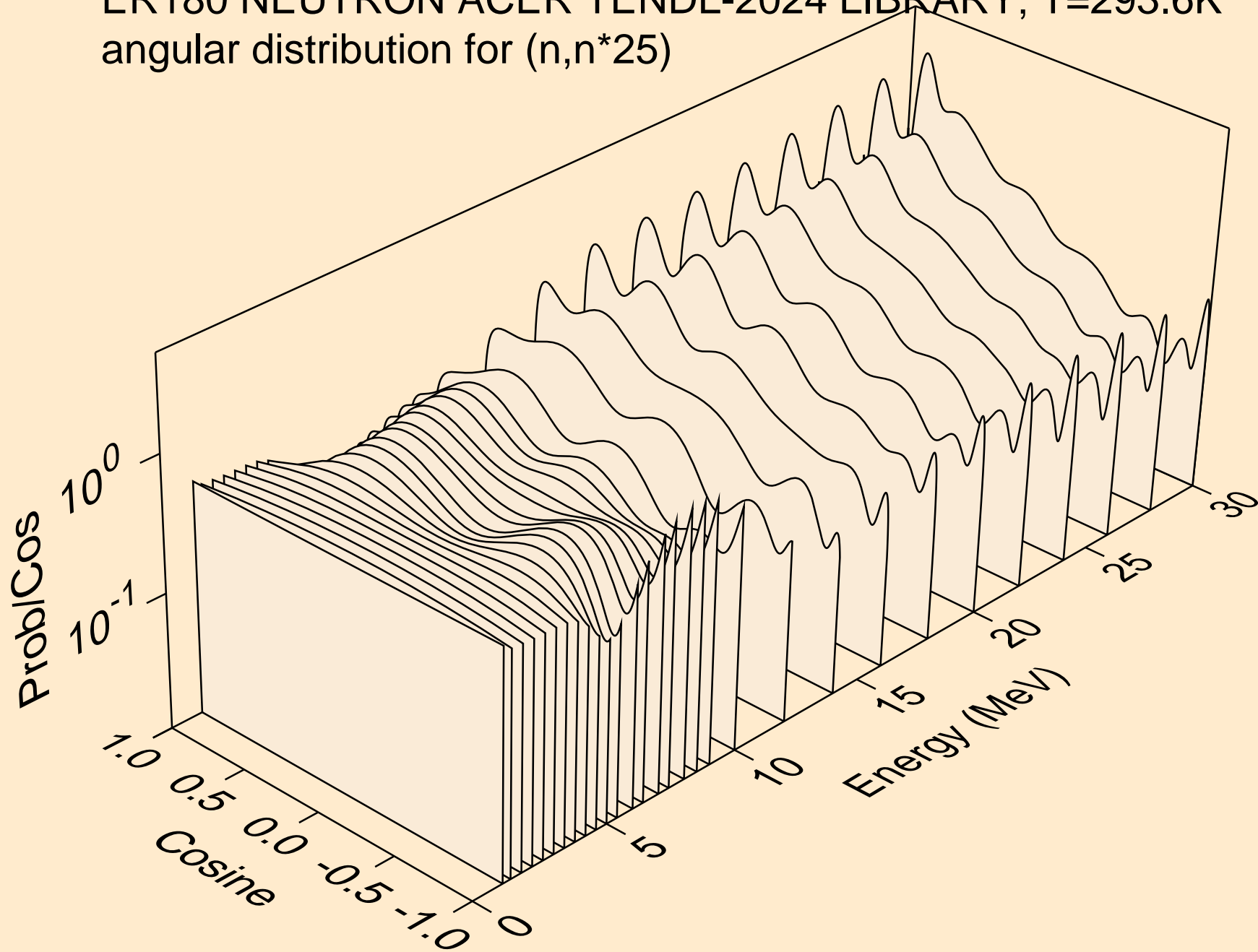

ER180 NEUTRON ACER TENDL-2024 LIBRARY; T=293.6K
angular distribution for (n,n*26)

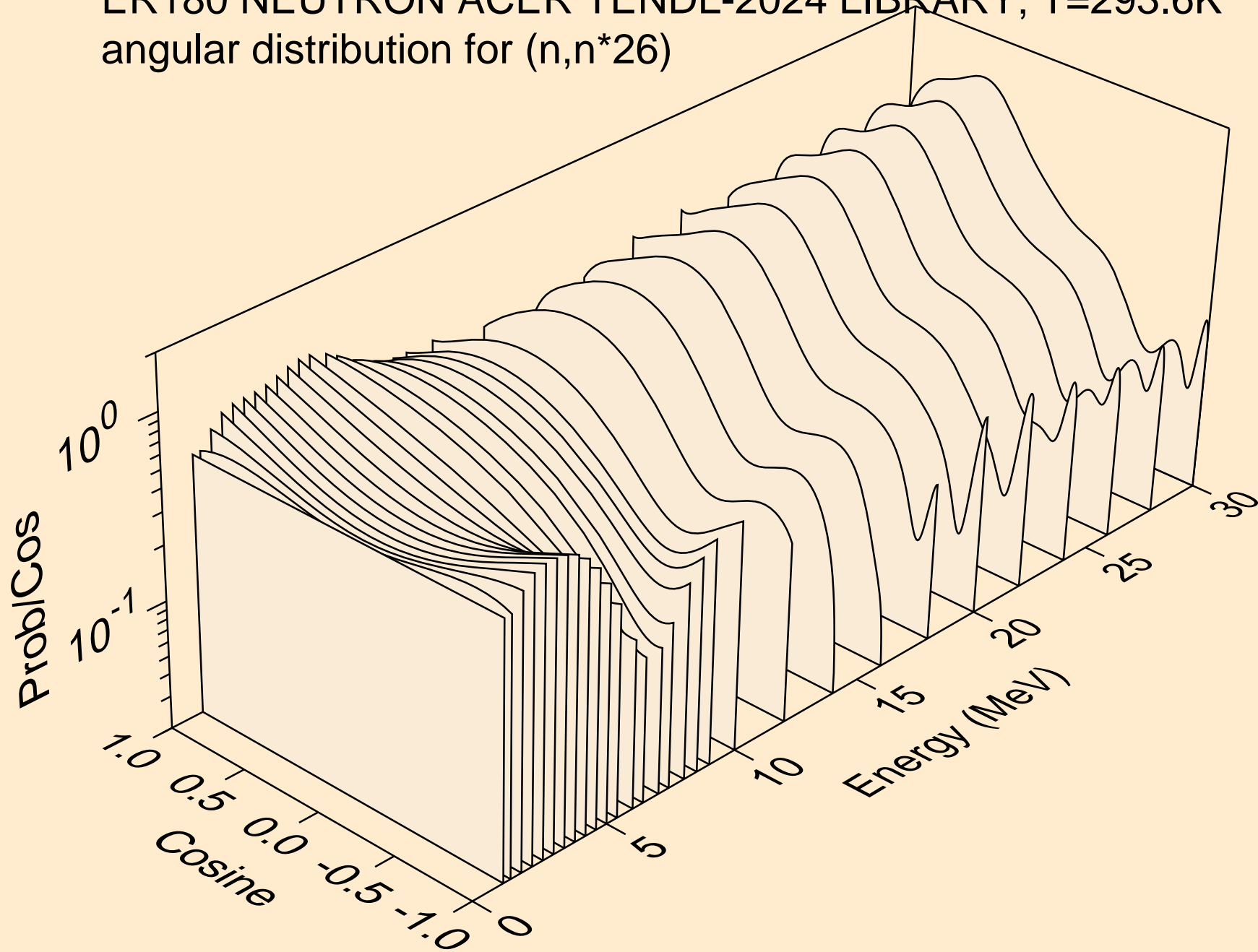

ER180 NEUTRON ACER TENDL-2024 LIBRARY; T=293.6K
angular distribution for (n,n*27)

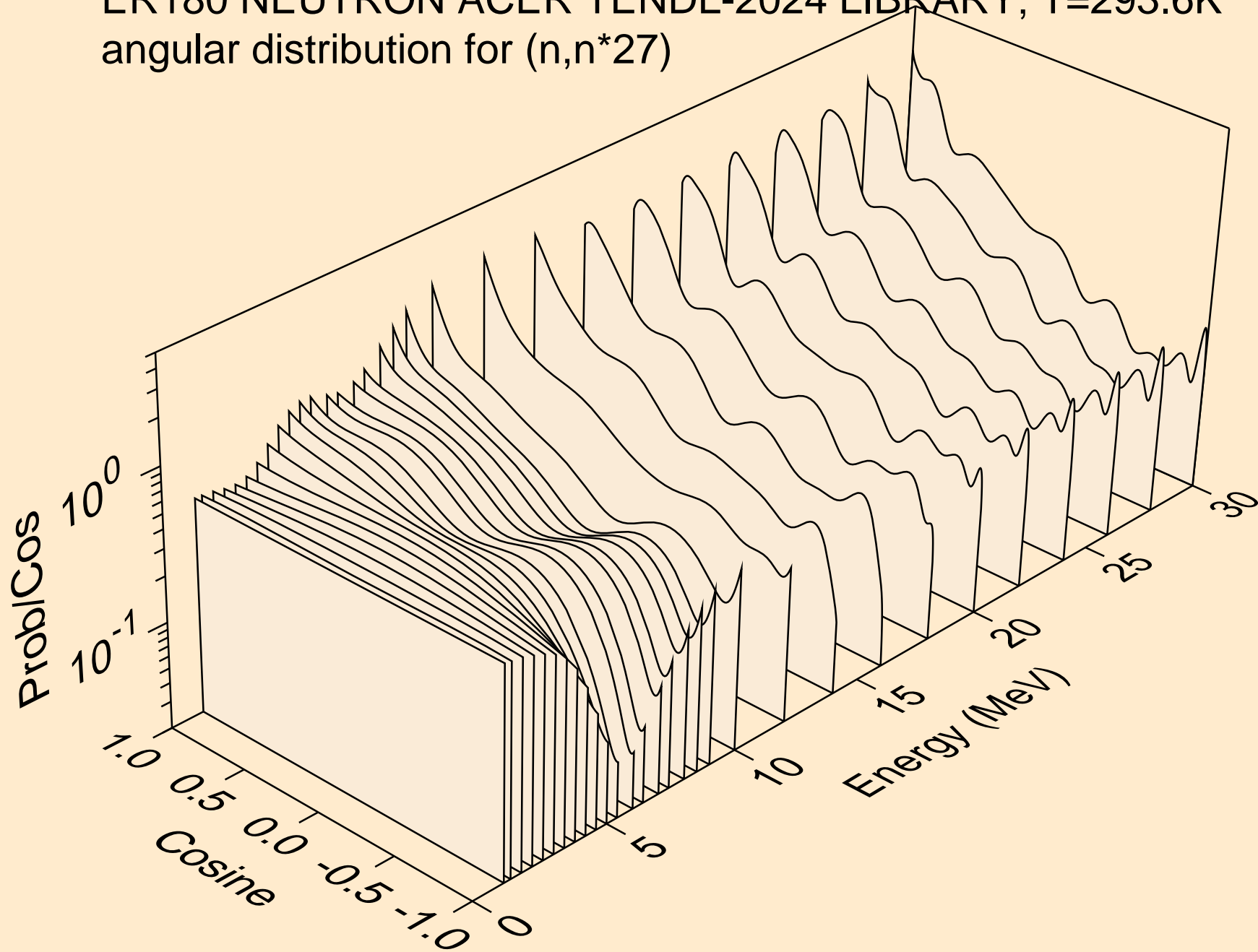

ER180 NEUTRON ACER TENDL-2024 LIBRARY; T=293.6K
angular distribution for (n,n*28)

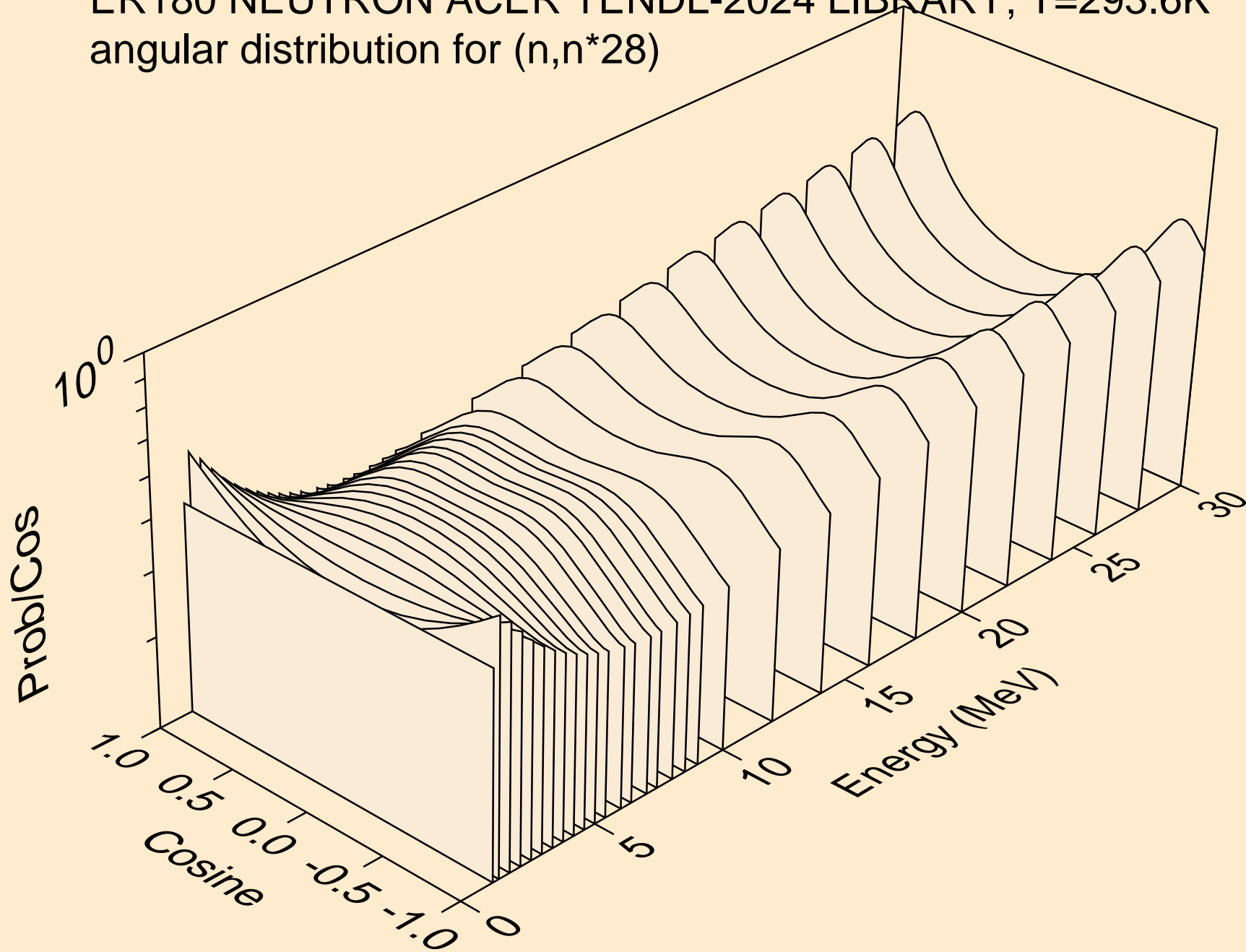

ER180 NEUTRON ACER TENDL-2024 LIBRARY; T=293.6K
angular distribution for (n,n*29)

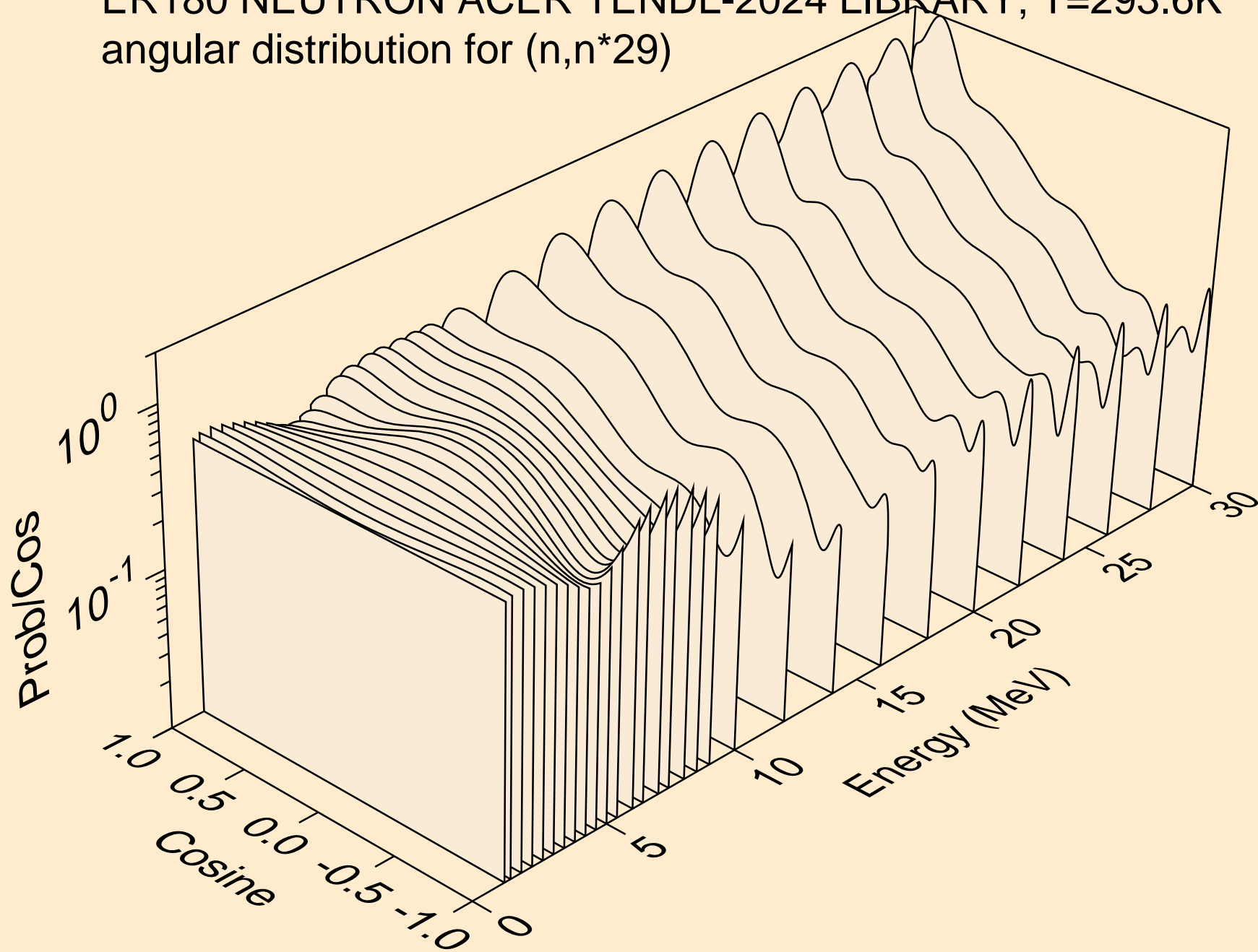

ER180 NEUTRON ACER TENDL-2024 LIBRARY; T=293.6K
Neutron emission for (n,x)

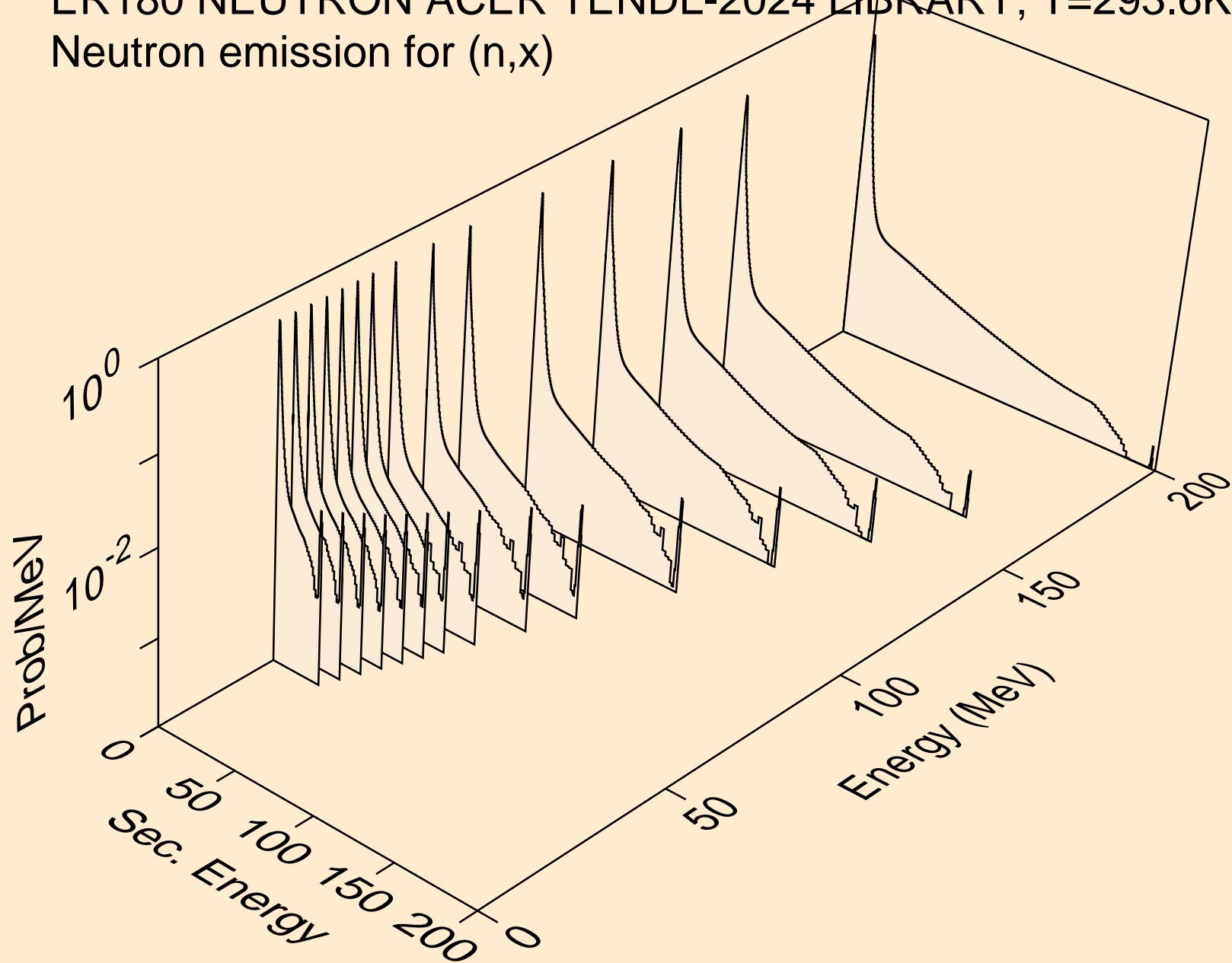

ER180 NEUTRON ACER TENDL-2024 LIBRARY; T=293.6K
Neutron emission for (n,2nd)

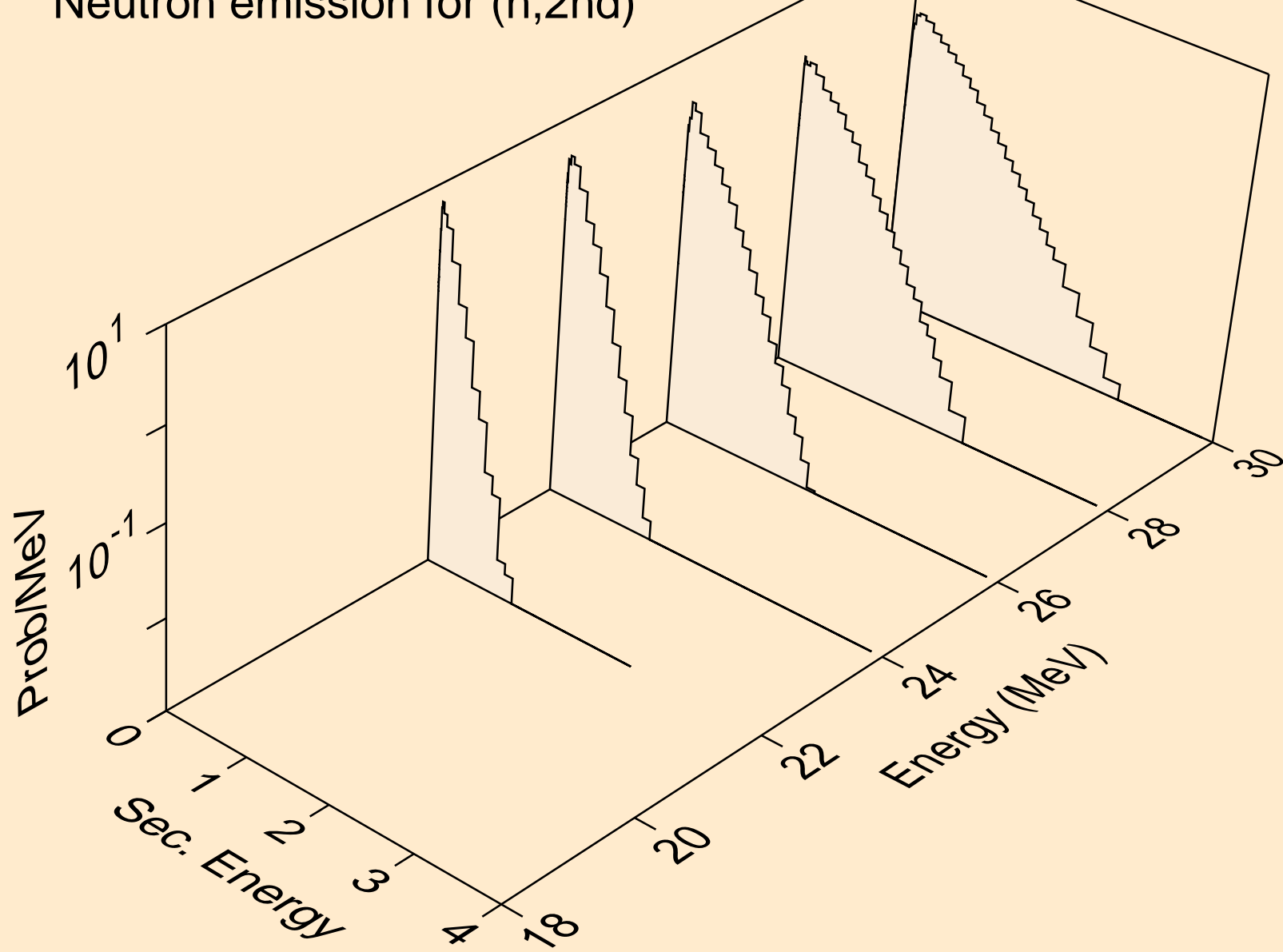

ER180 NEUTRON ACER TENDL-2024 LIBRARY; T=293.6K
Neutron emission for (n,2n)

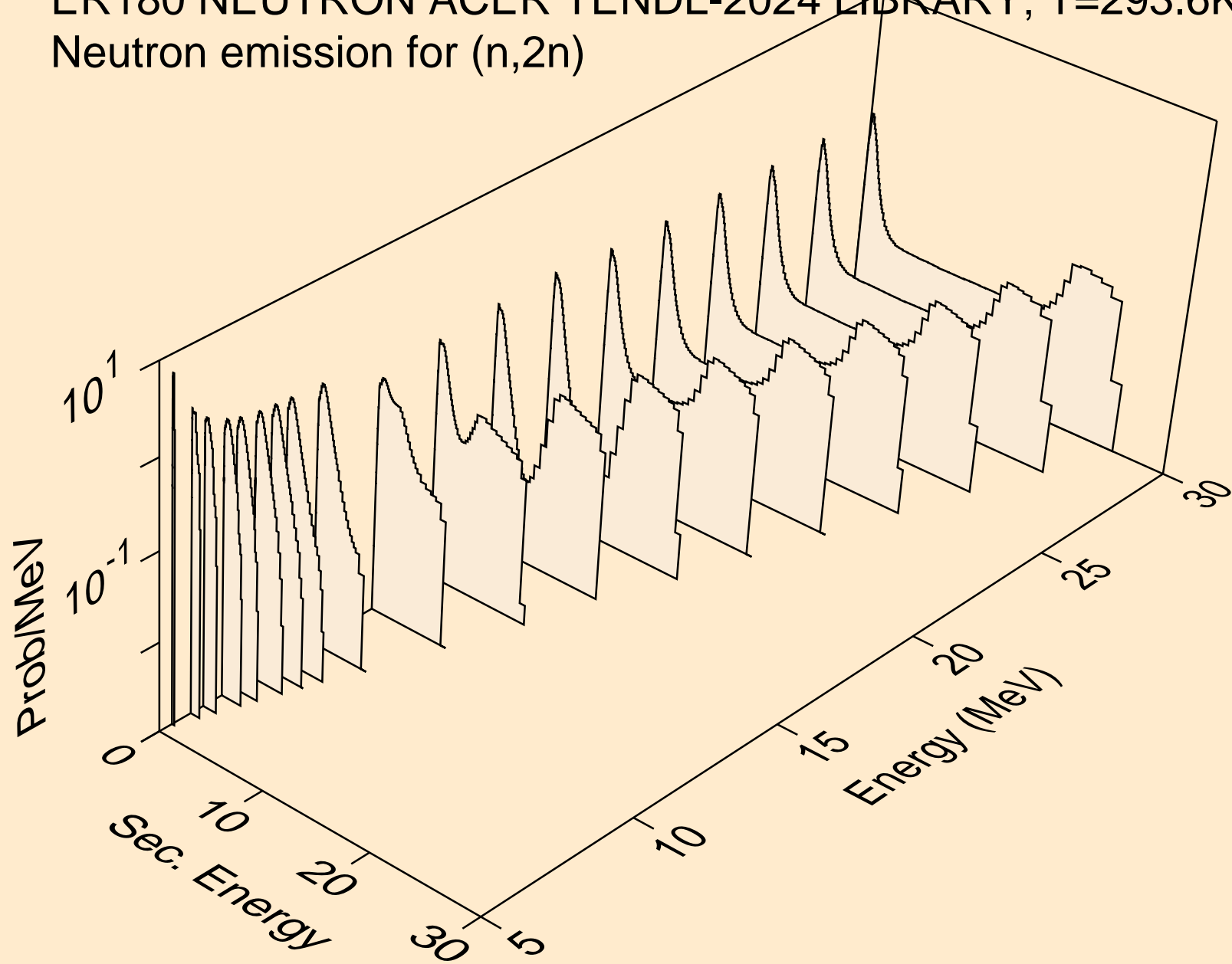

ER180 NEUTRON ACER TENDL-2024 LIBRARY; T=293.6K
Neutron emission for (n,3n)

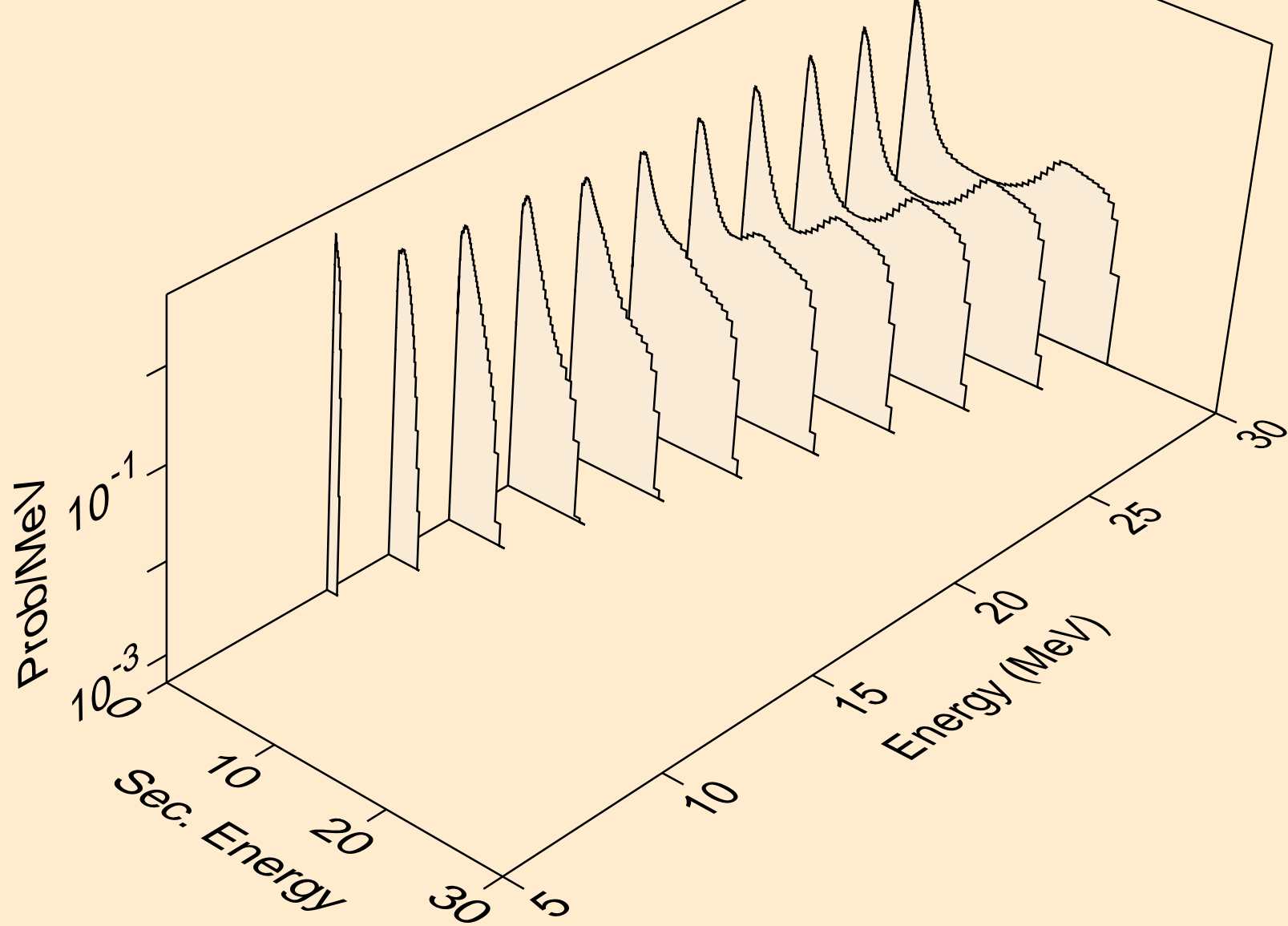

ER180 NEUTRON ACER TENDL-2024 LIBRARY; T=293.6K
Neutron emission for (n,n*)a

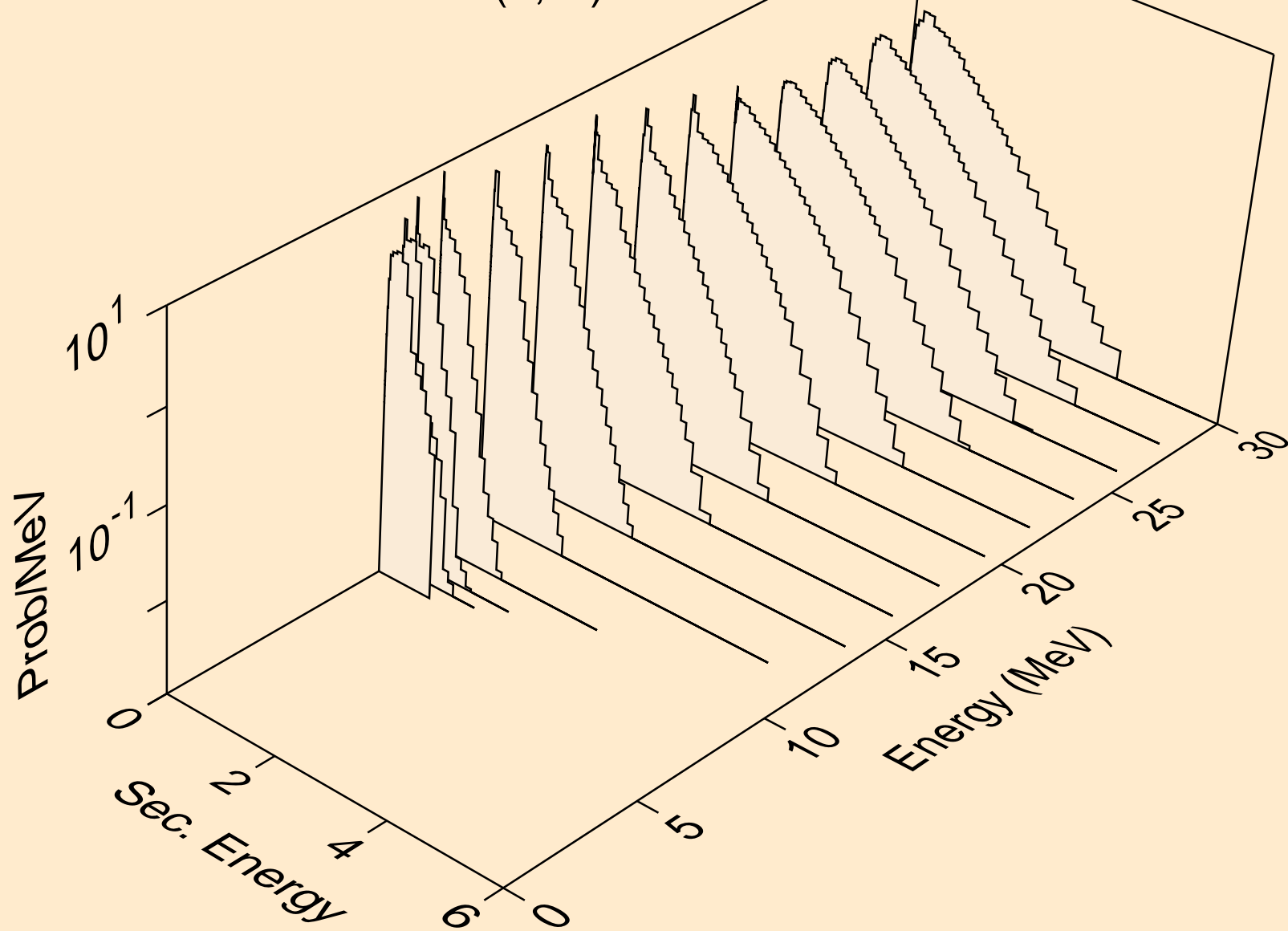

ER180 NEUTRON ACER TENDL-2024 LIBRARY; T=293.6K
Neutron emission for (n,2n)_a

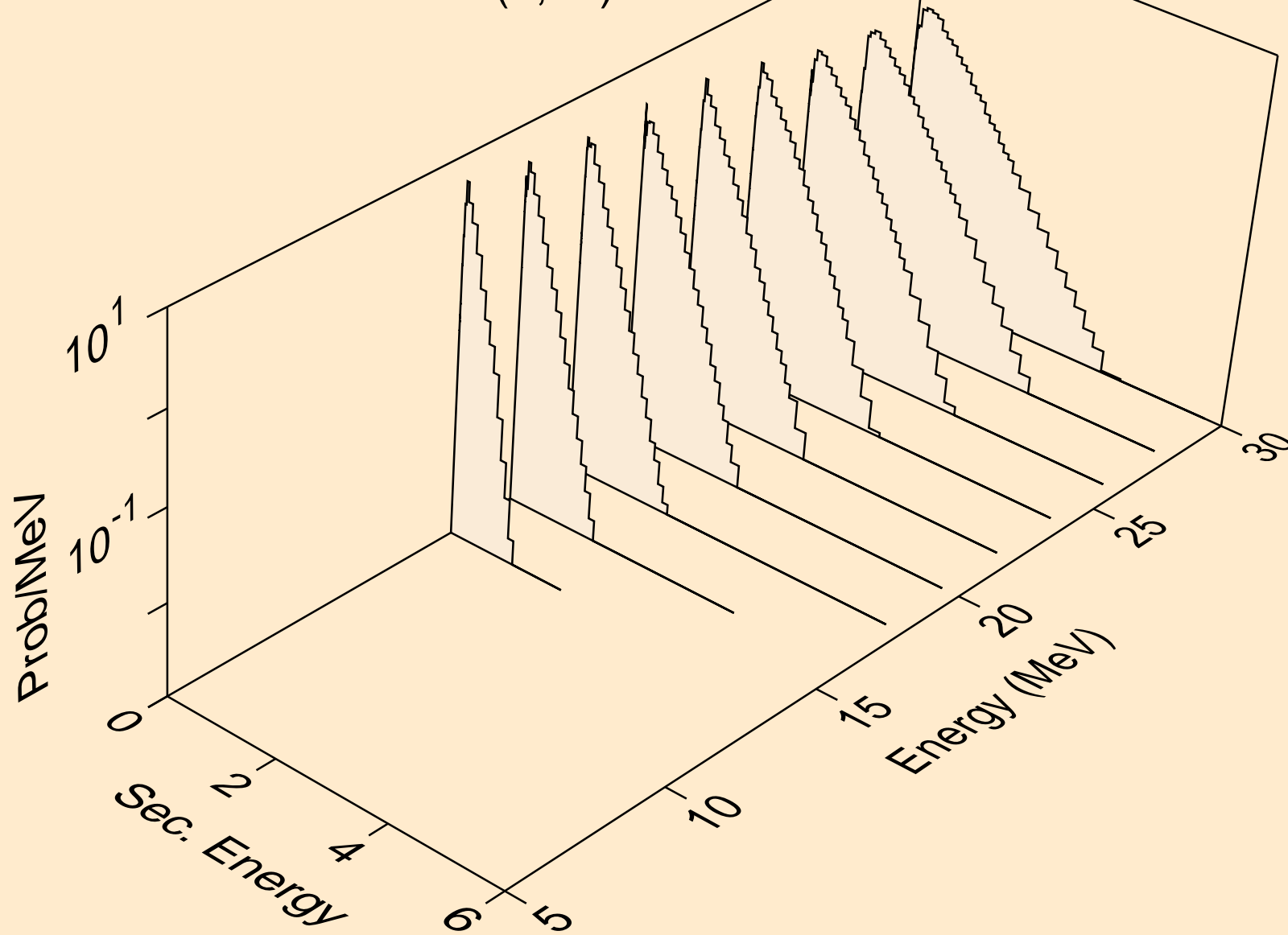

ER180 NEUTRON ACER TENDL-2024 LIBRARY; T=293.6K
Neutron emission for (n,3n)a

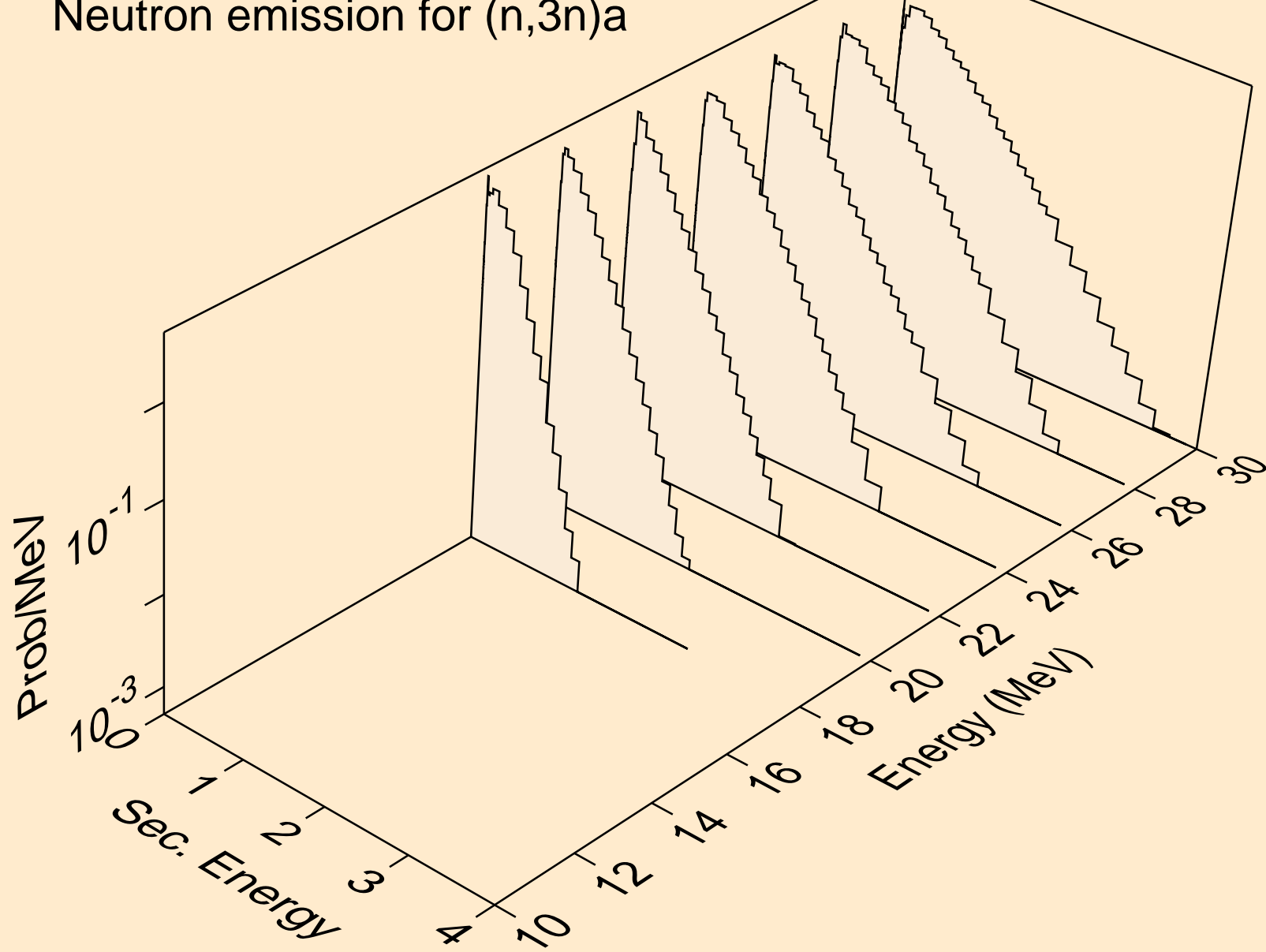

ER180 NEUTRON ACER TENDL-2024 LIBRARY; T=293.6K
Neutron emission for (n,n*)p

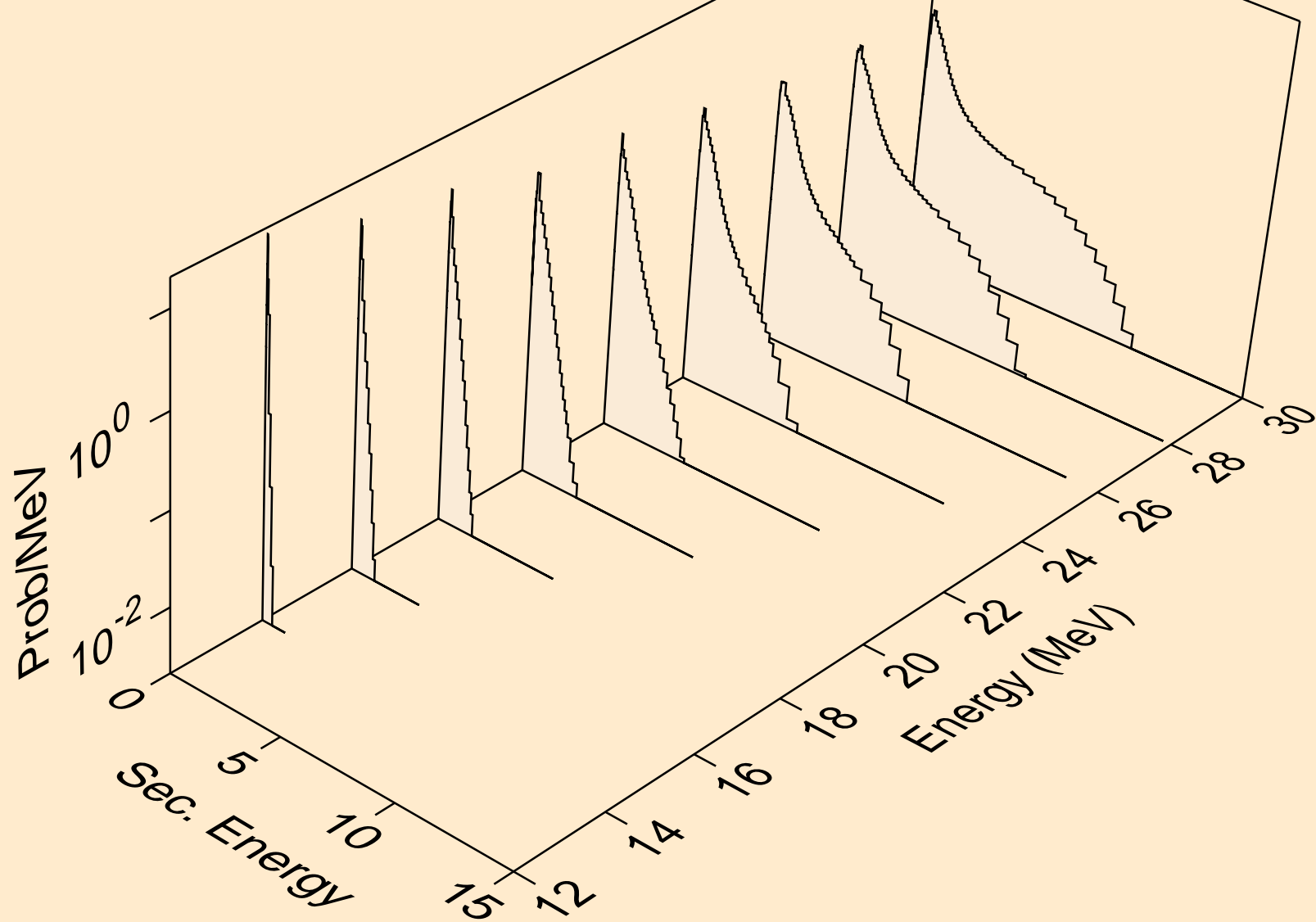

ER180 NEUTRON ACER TENDL-2024 LIBRARY; T=293.6K
Neutron emission for (n,n*)d

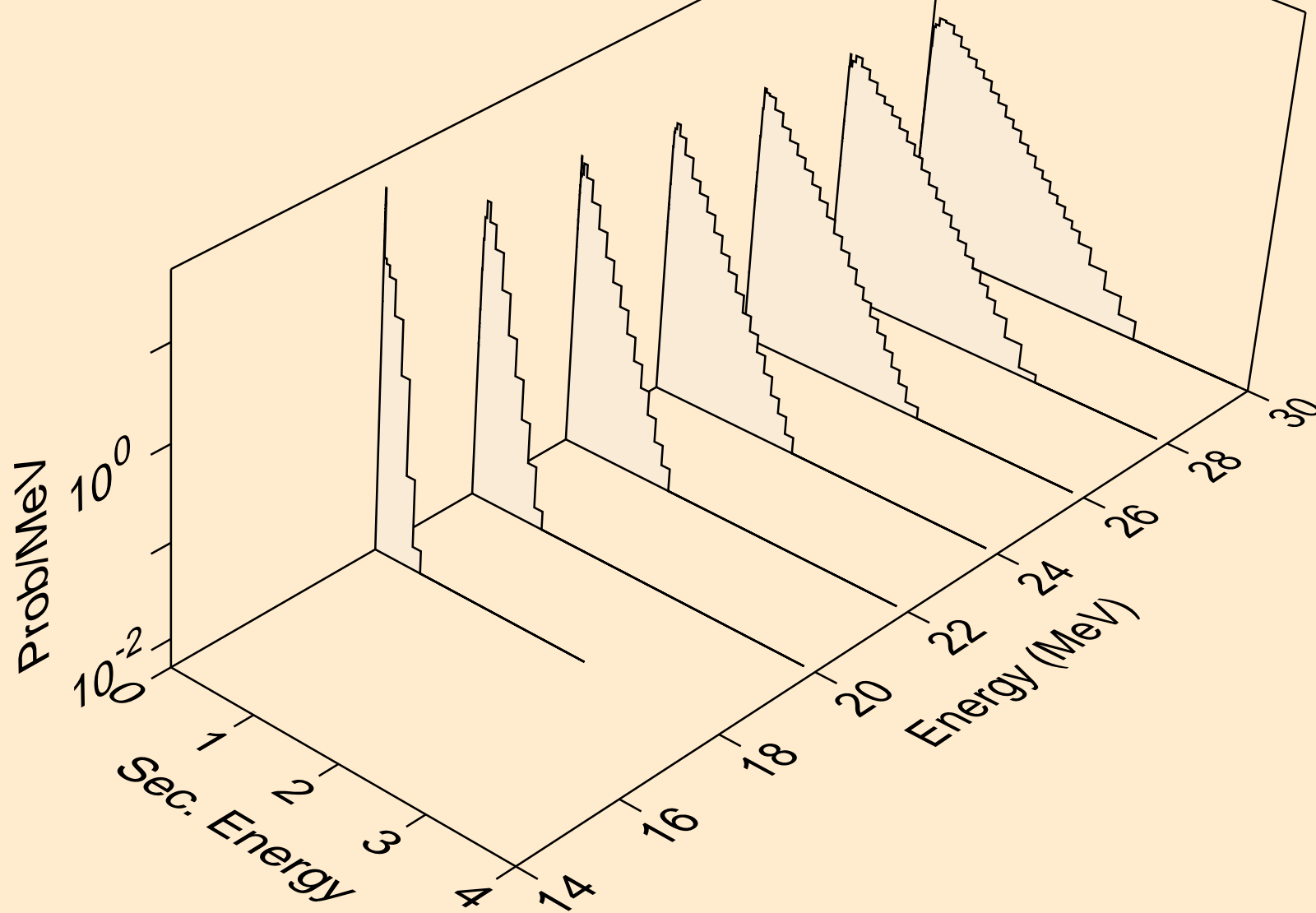

ER180 NEUTRON ACER TENDL-2024 LIBRARY; T=293.6K
Neutron emission for (n,n*)t

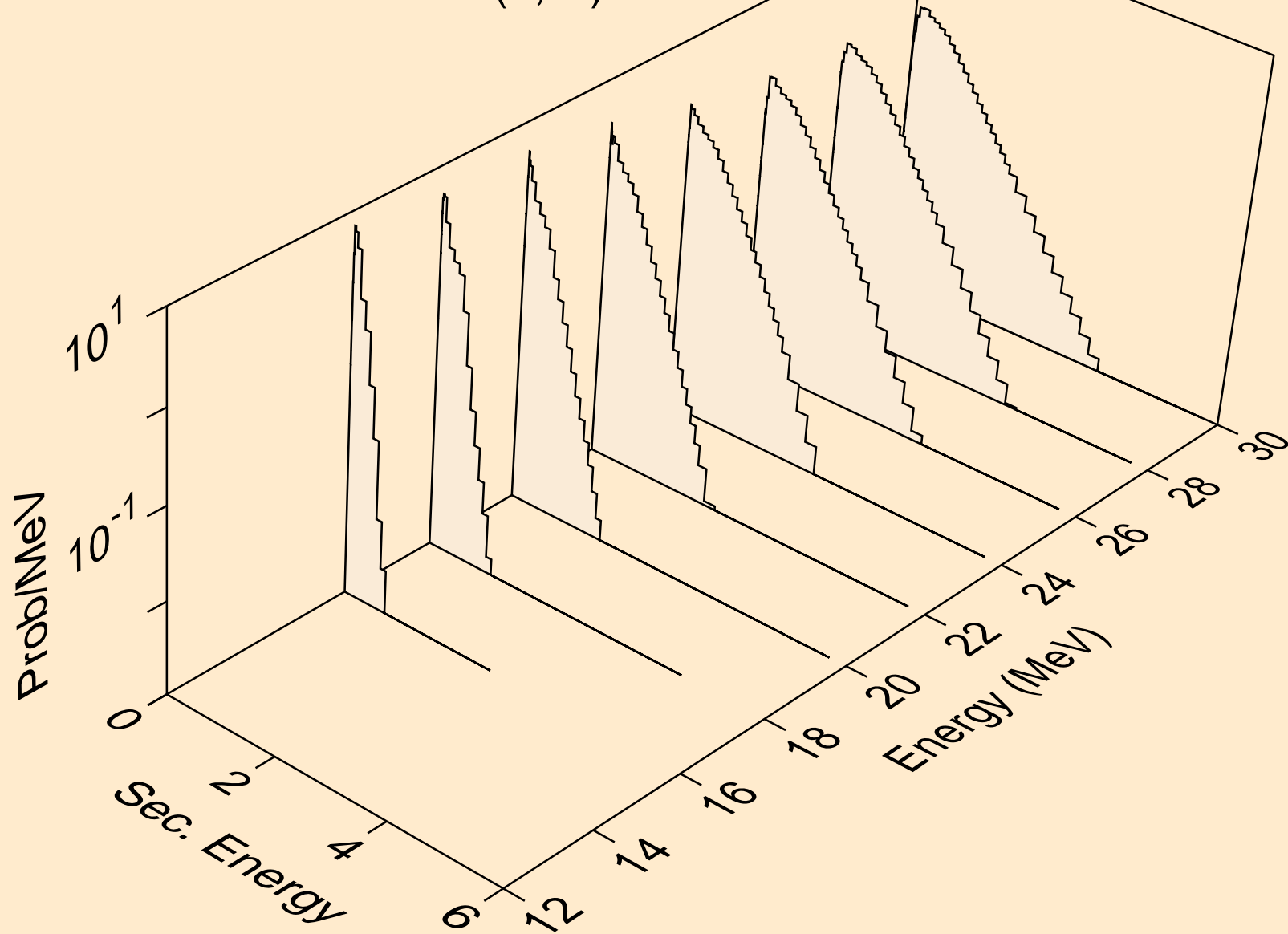

ER180 NEUTRON ACER TENDL-2024 LIBRARY; T=293.6K
Neutron emission for (n,4n)

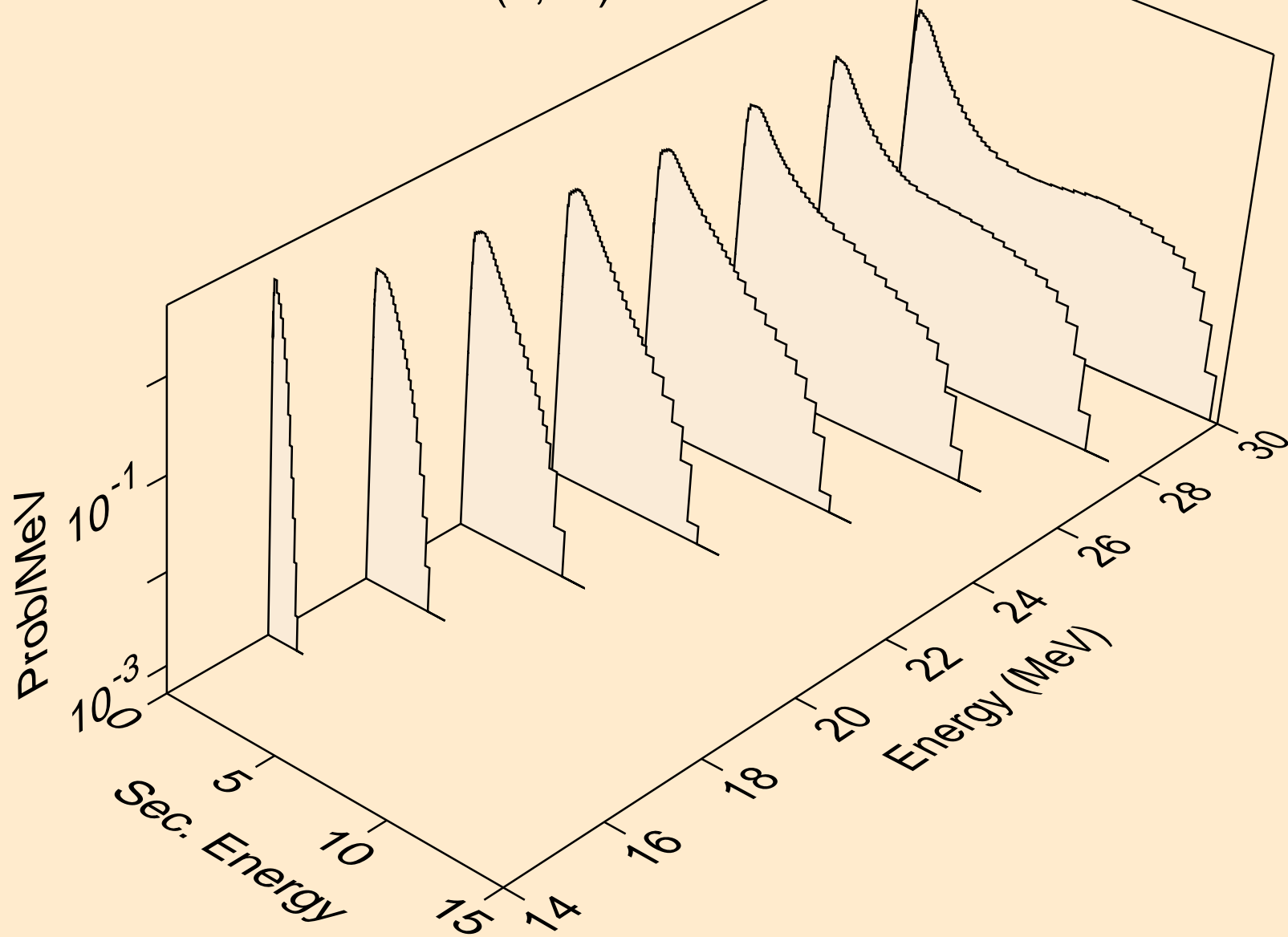

ER180 NEUTRON ACER TENDL-2024 LIBRARY; T=293.6K
Neutron emission for (n,2np)

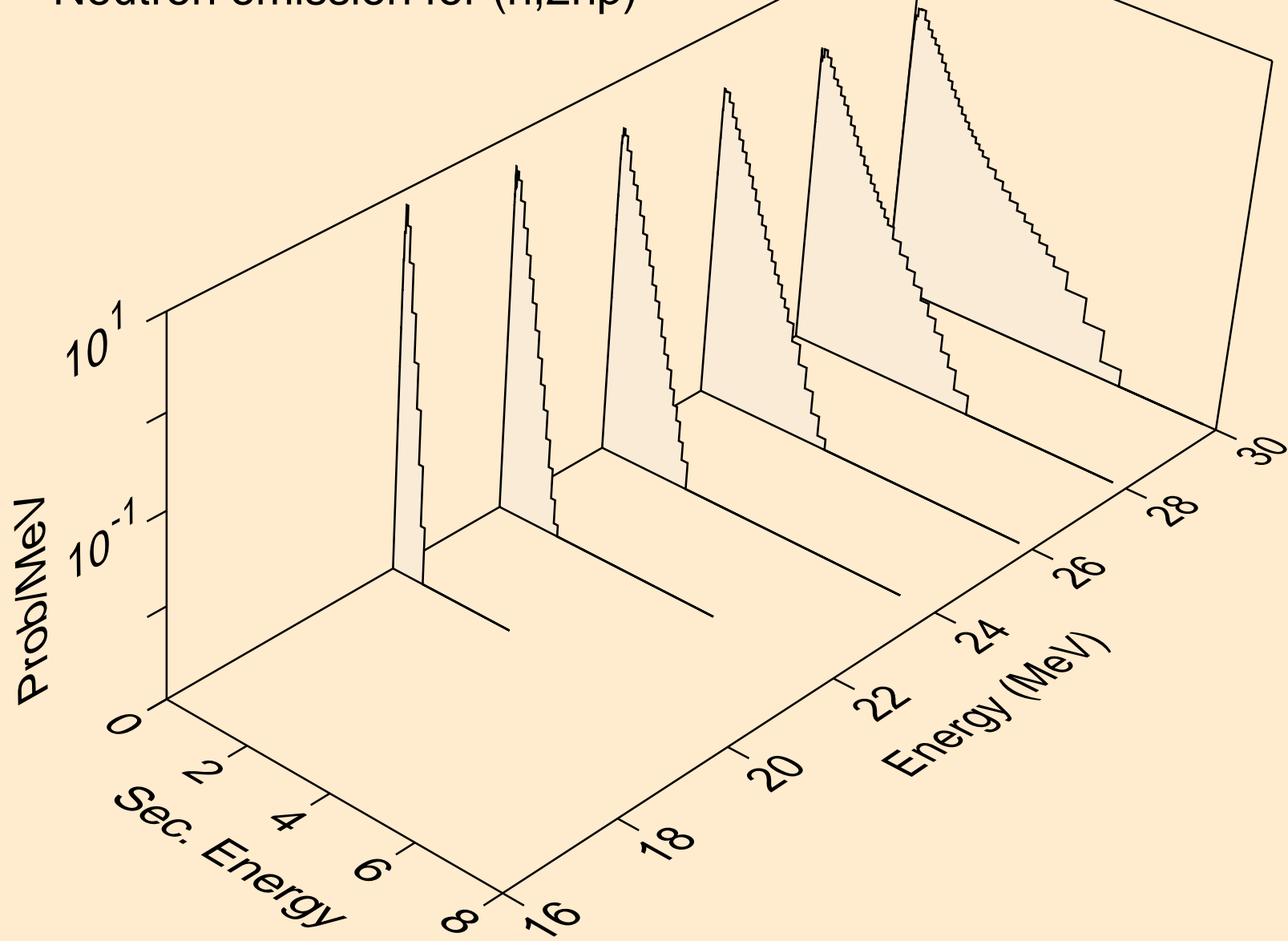

ER180 NEUTRON ACER TENDL-2024 LIBRARY; T=293.6K
Neutron emission for (n,3np)

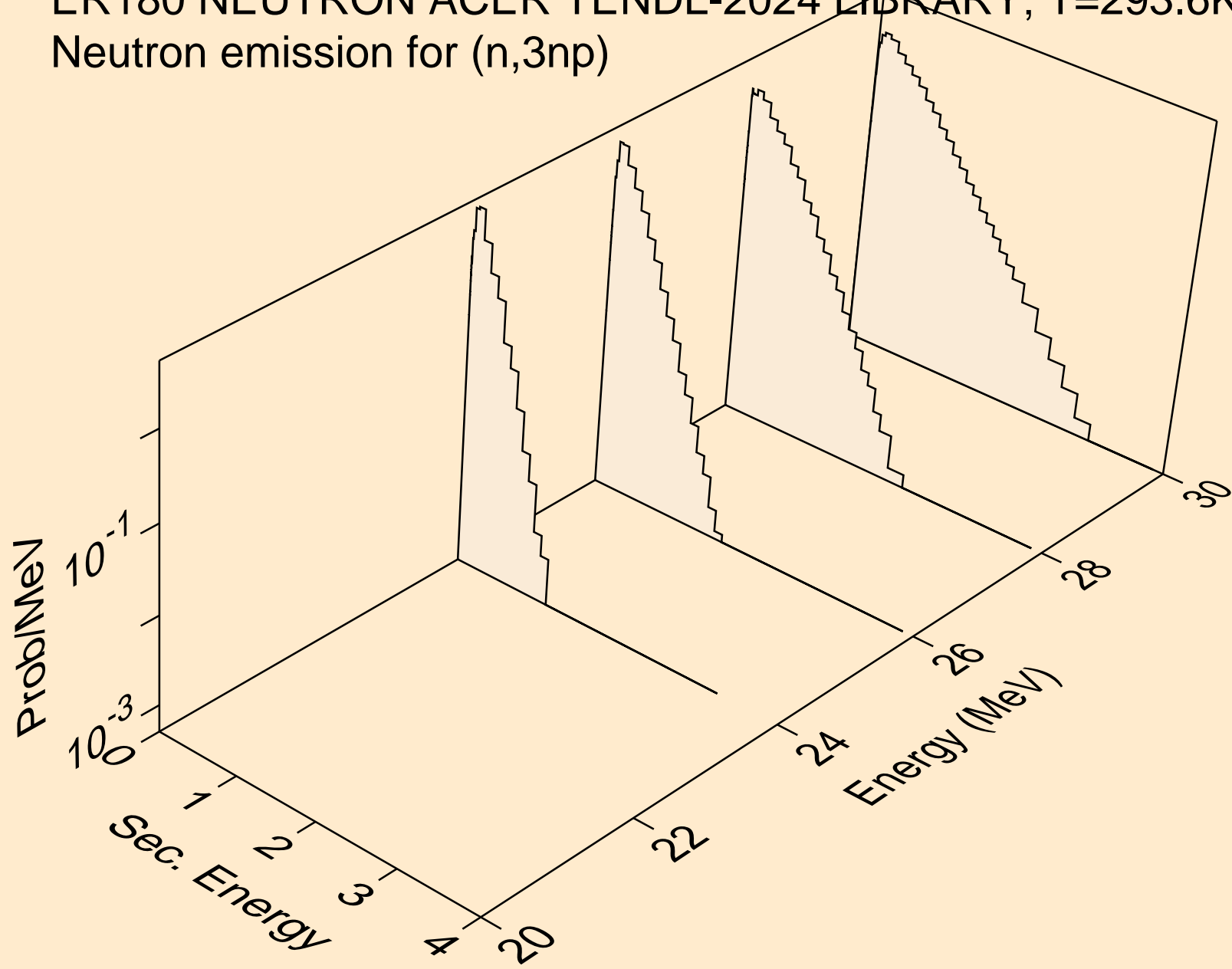

ER180 NEUTRON ACER TENDL-2024 LIBRARY; T=293.6K
Neutron emission for (n,n*c)

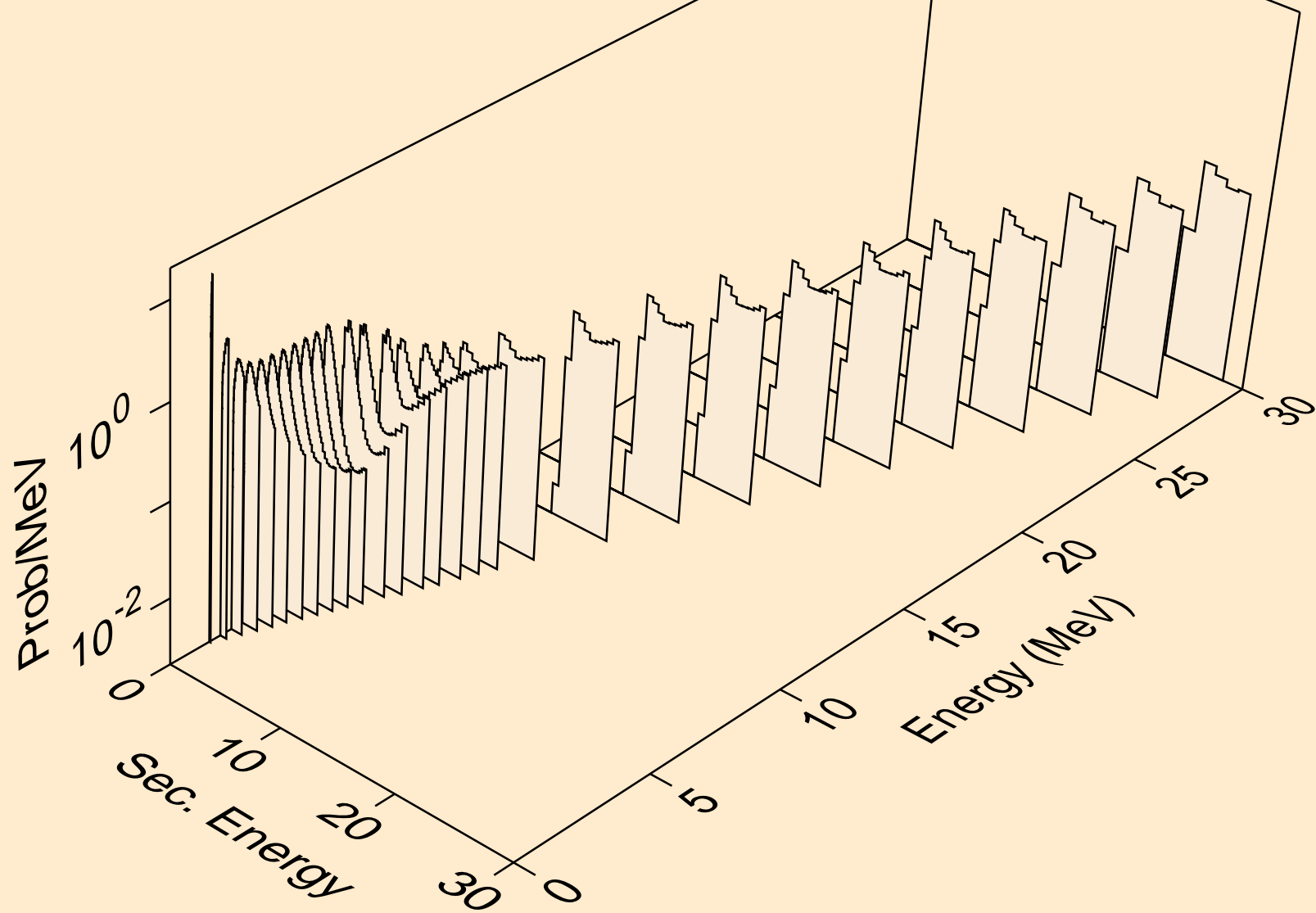

ER180 NEUTRON ACER TENDL-2024 LIBRARY; T=293.6K
Photon emission for (n,x)

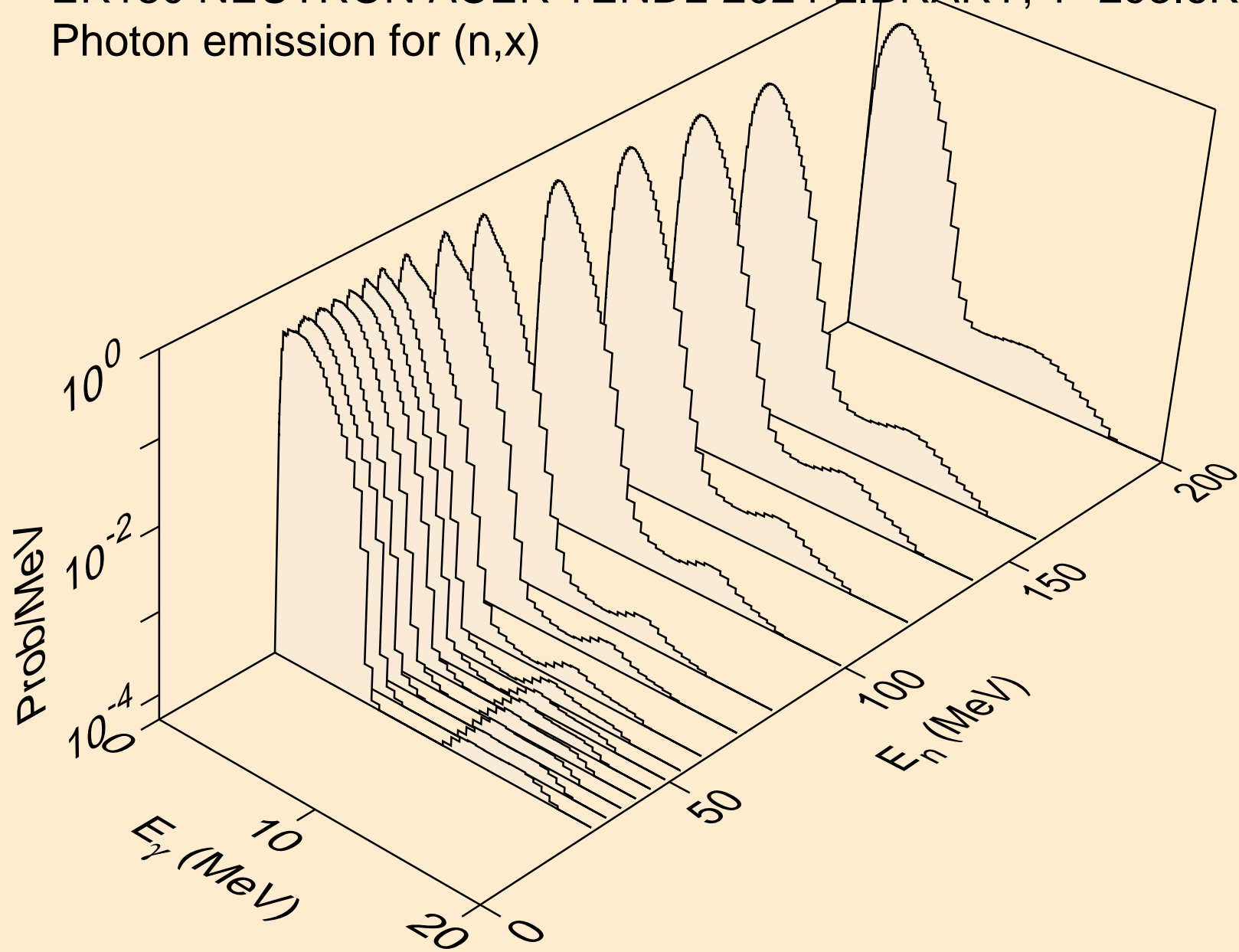

ER180 NEUTRON ACER TENDL-2024 LIBRARY; T=293.6K
Photon emission for (n,2nd)

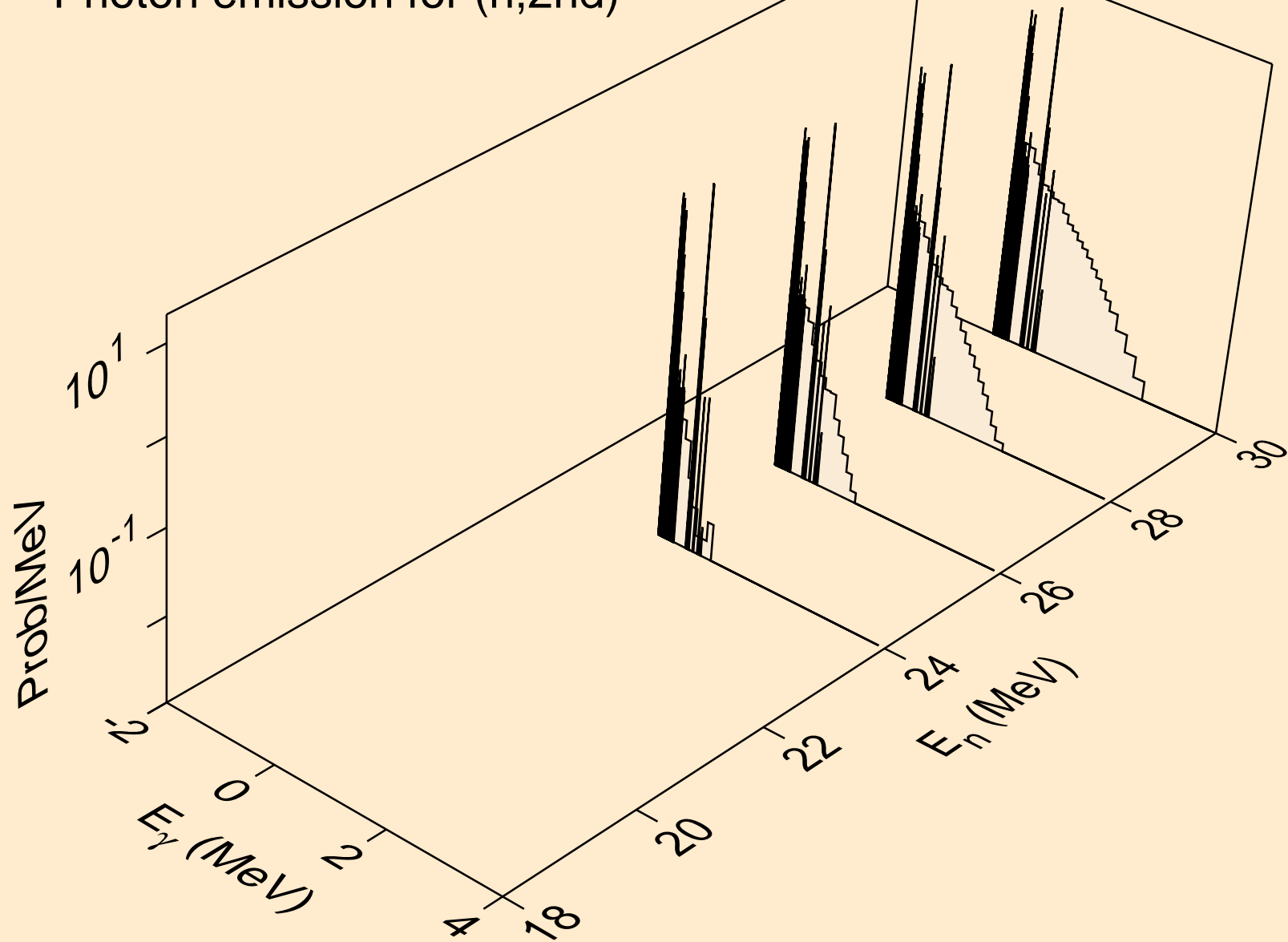

ER180 NEUTRON ACER TENDL-2024 LIBRARY; T=293.6K
Photon emission for (n,2n)

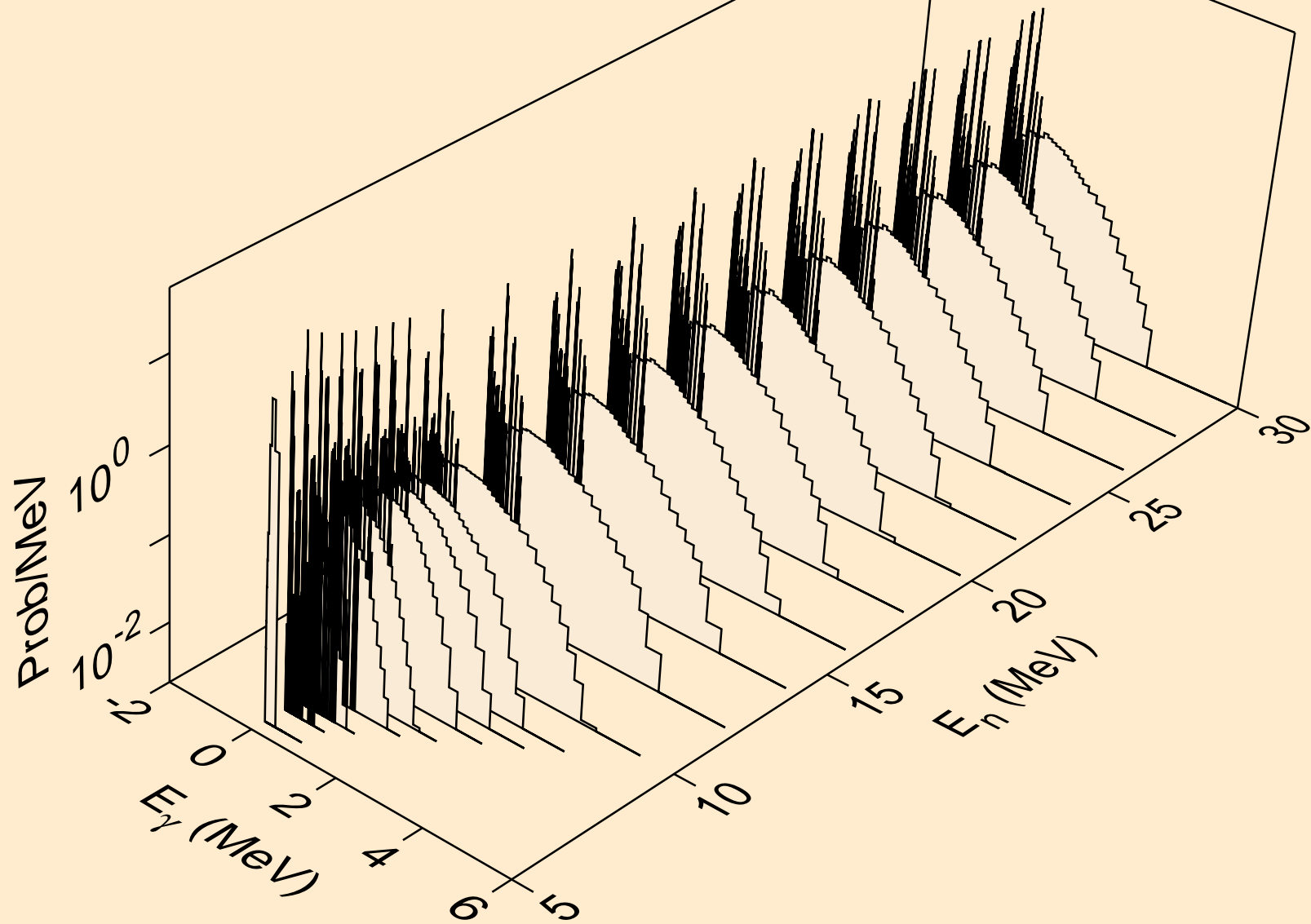

ER180 NEUTRON ACER TENDL-2024 LIBRARY; T=293.6K
Photon emission for (n,3n)

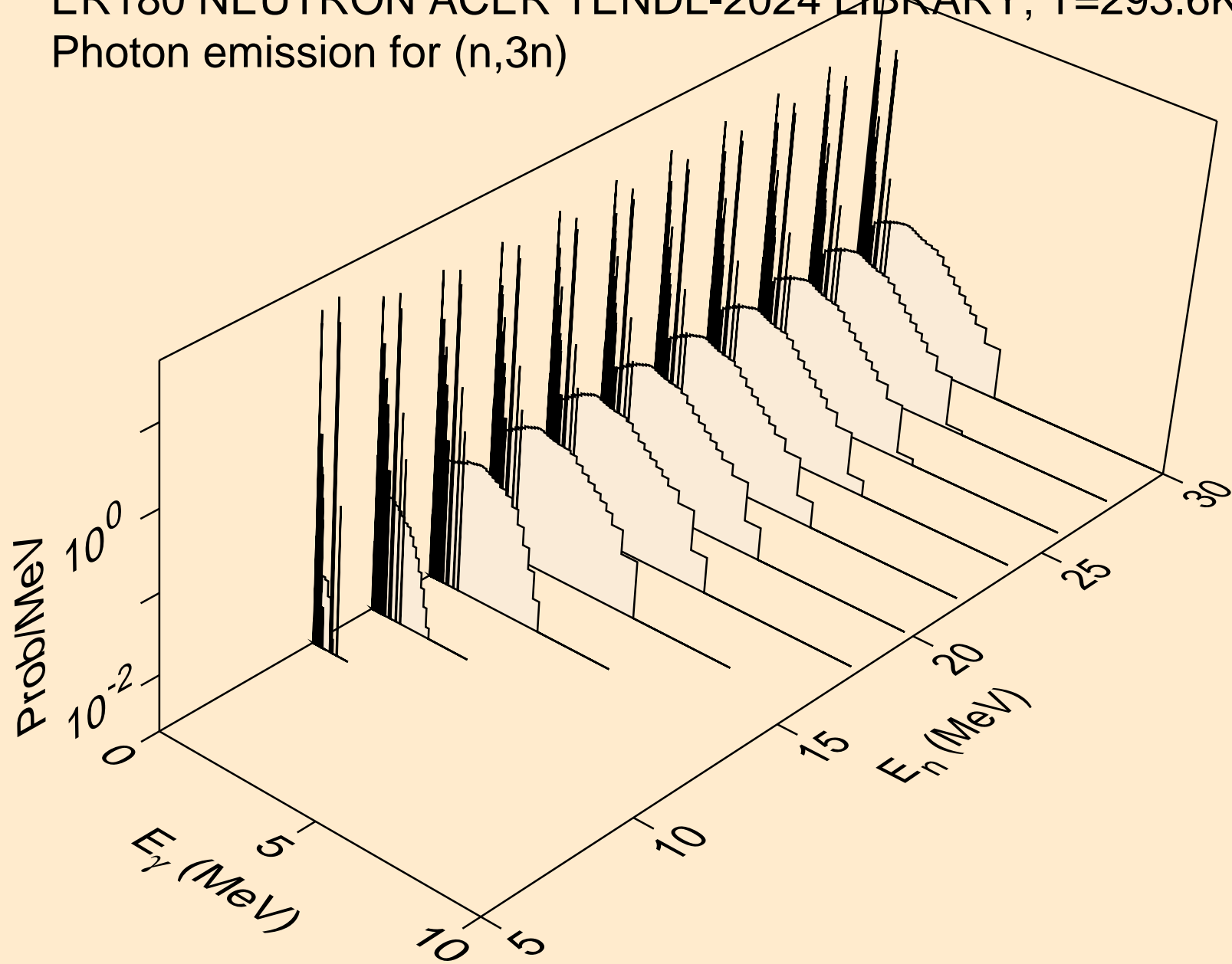

ER180 NEUTRON ACER TENDL-2024 LIBRARY; T=293.6K
Photon emission for (n,n*)a

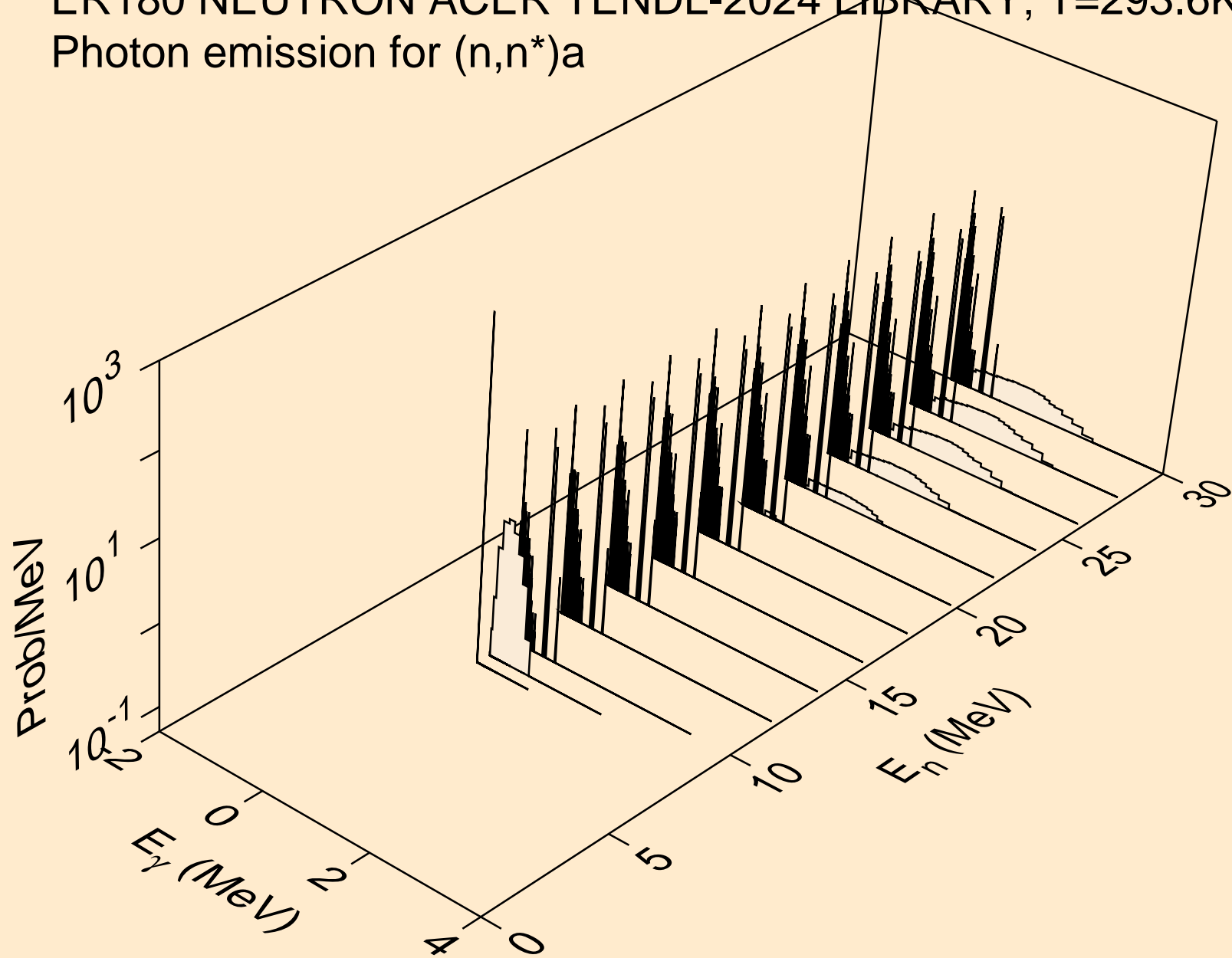

ER180 NEUTRON ACER TENDL-2024 LIBRARY; T=293.6K
Photon emission for (n,2n)a

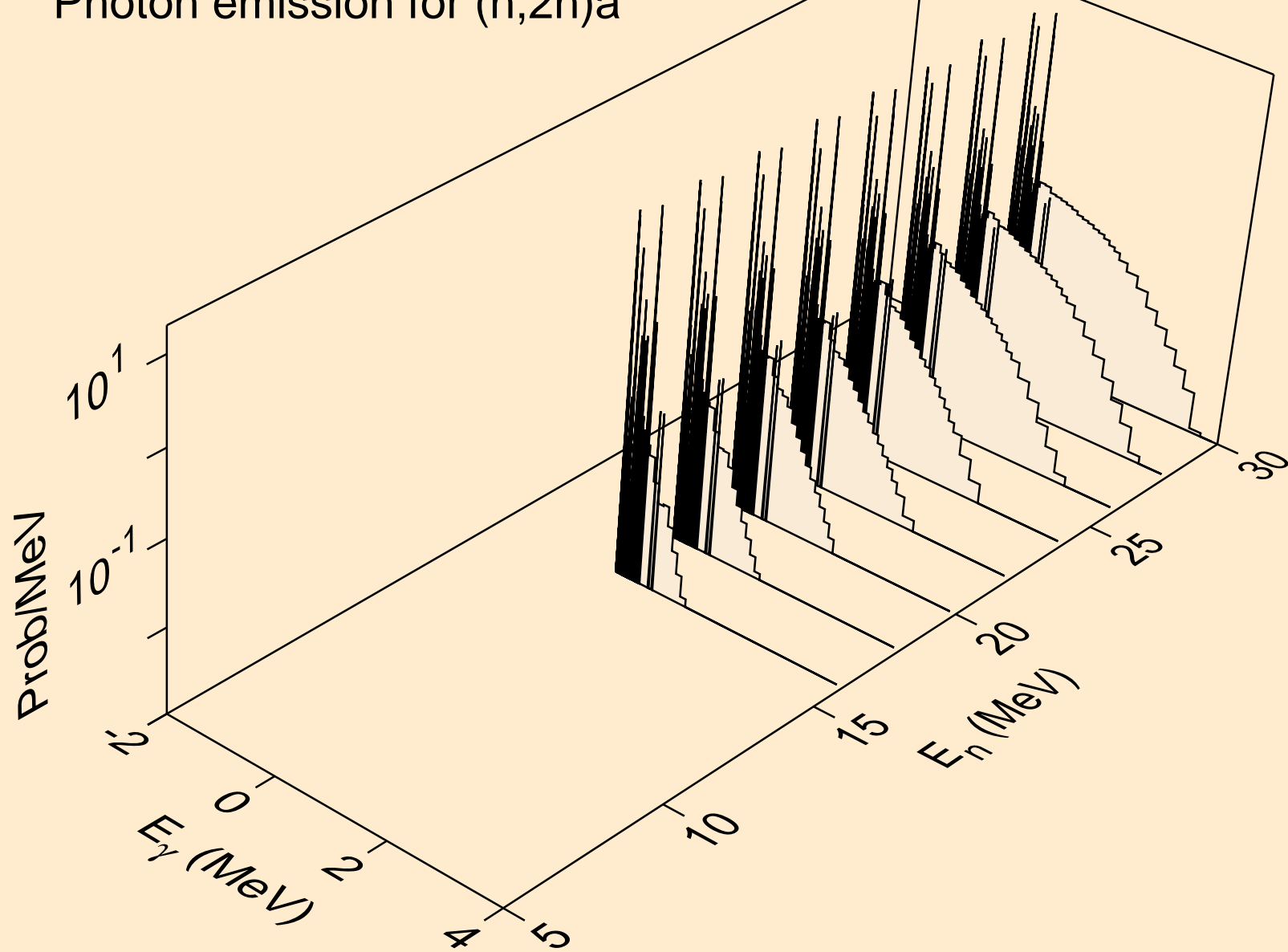

ER180 NEUTRON ACER TENDL-2024 LIBRARY; T=293.6K
Photon emission for (n,3n)a

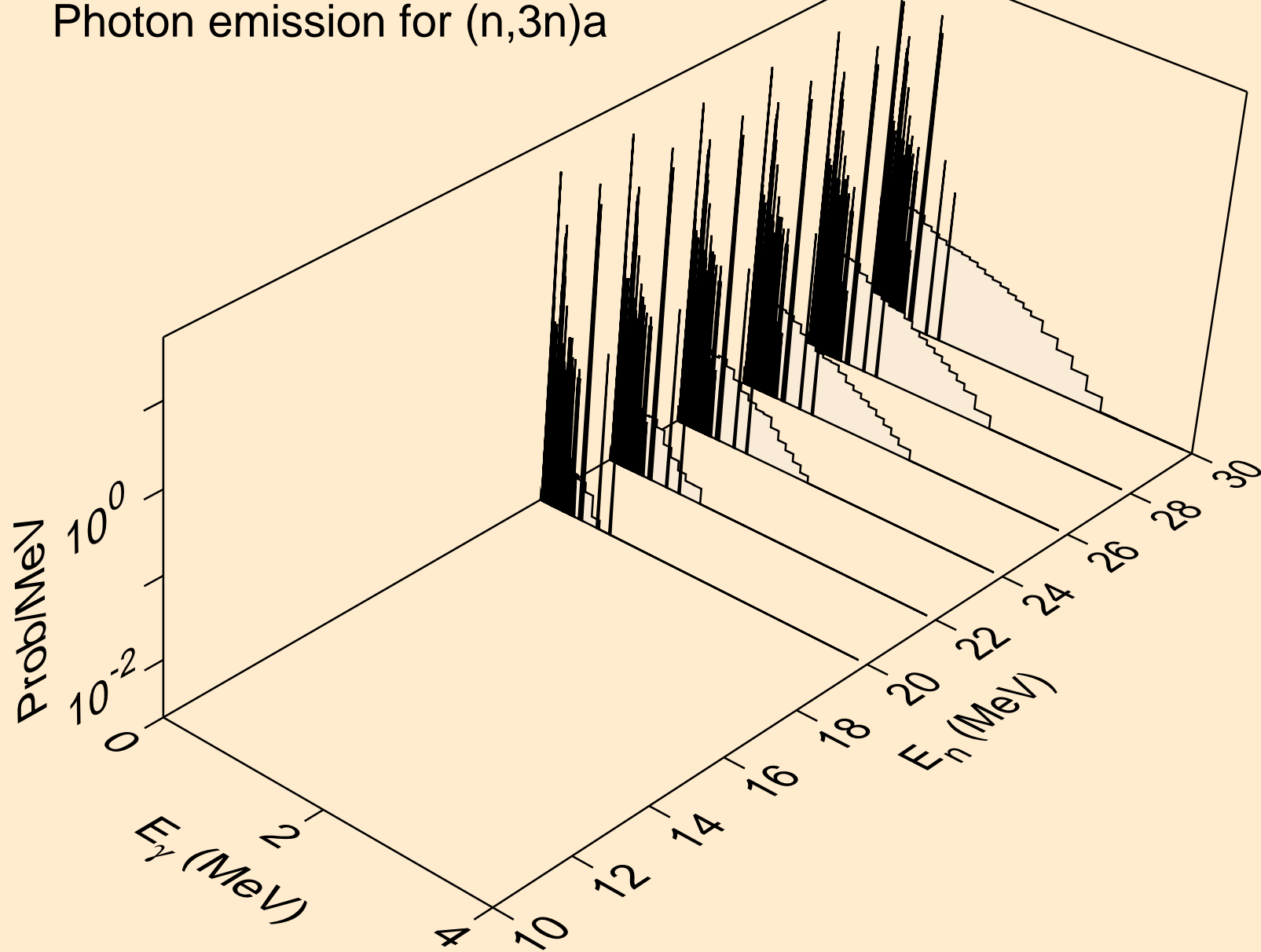

ER180 NEUTRON ACER TENDL-2024 LIBRARY; T=293.6K
Photon emission for (n,n*)p

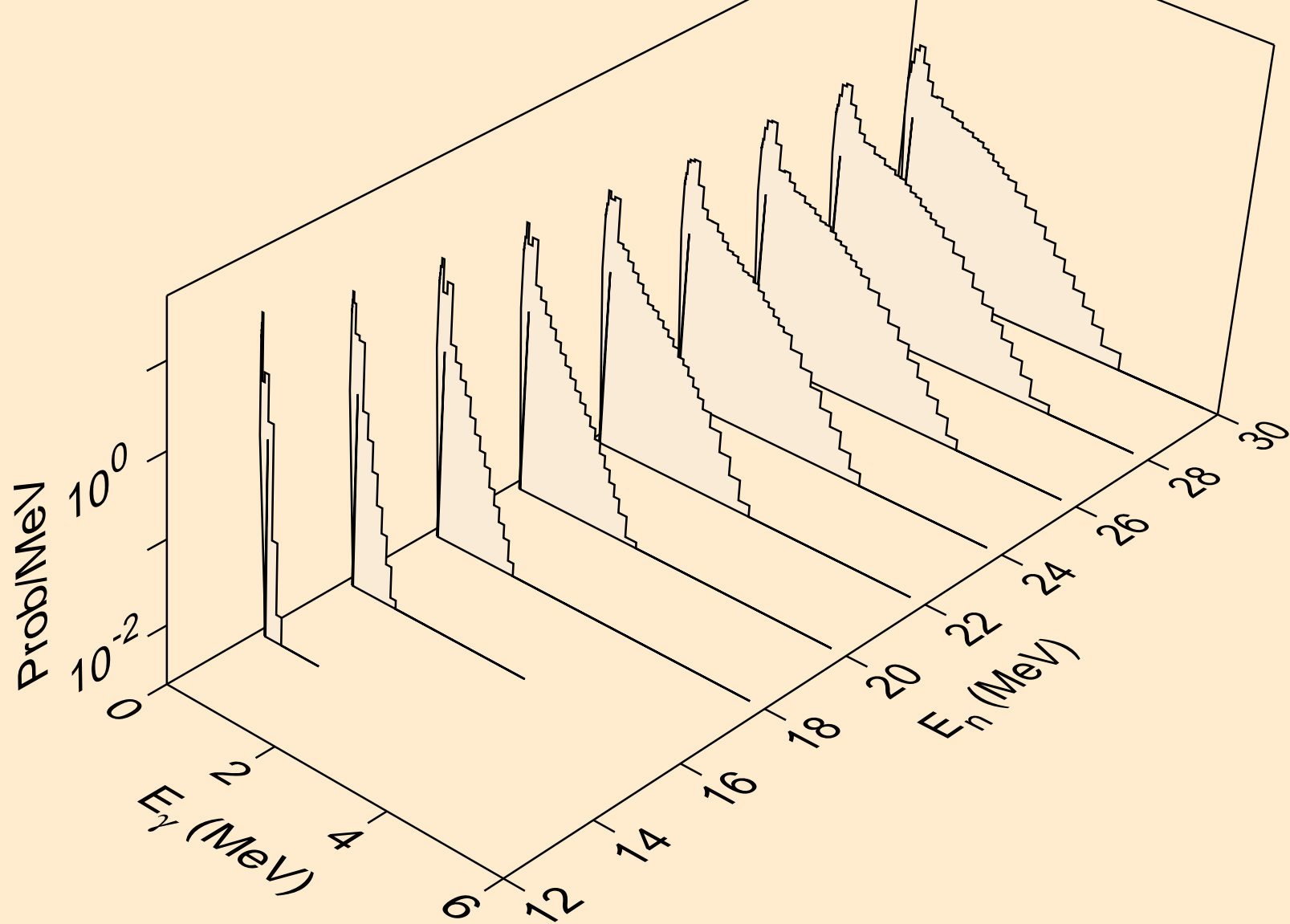

ER180 NEUTRON ACER TENDL-2024 LIBRARY; T=293.6K
Photon emission for (n,n*)d

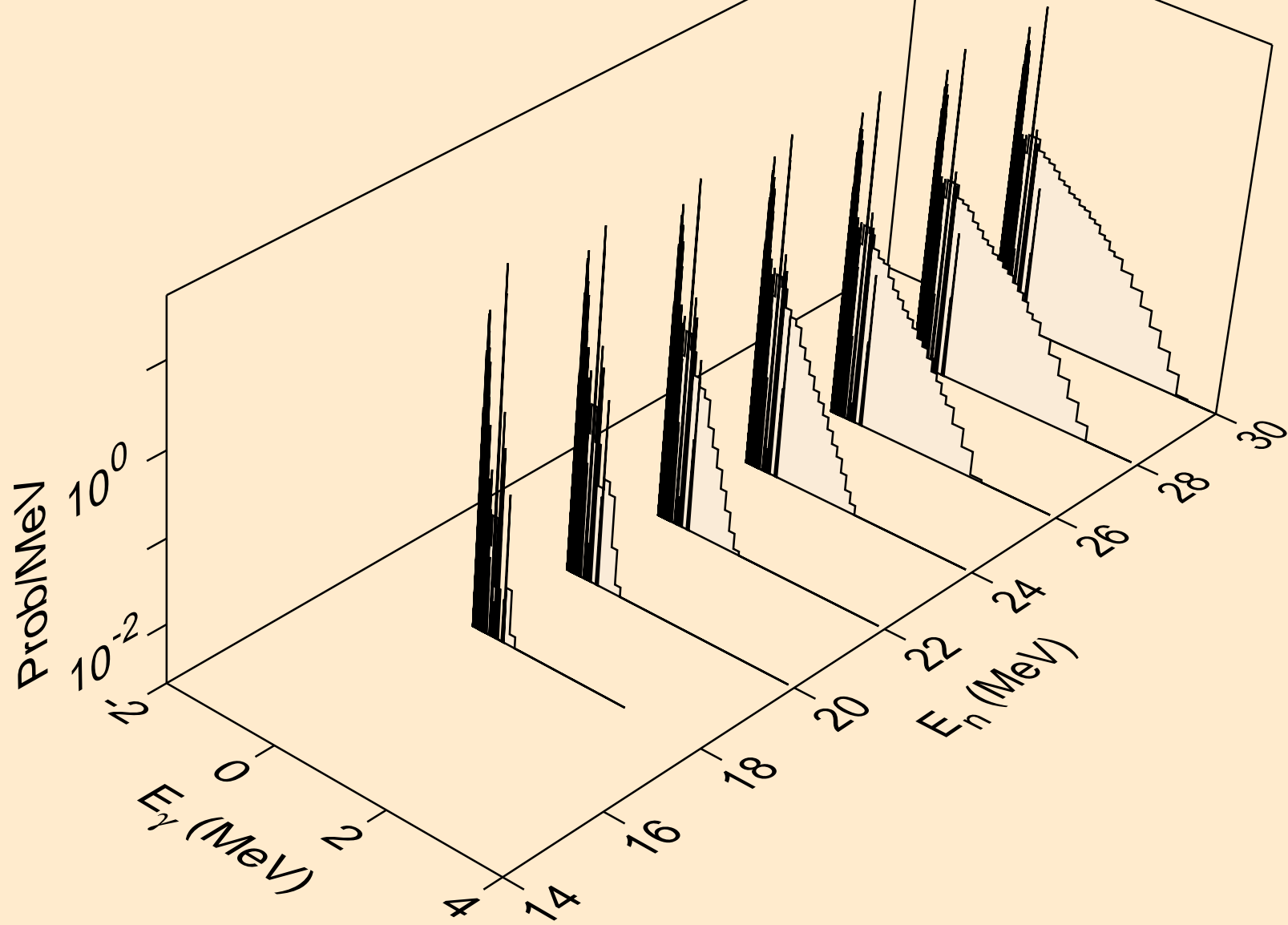

ER180 NEUTRON ACER TENDL-2024 LIBRARY; T=293.6K
Photon emission for (n,n*)t

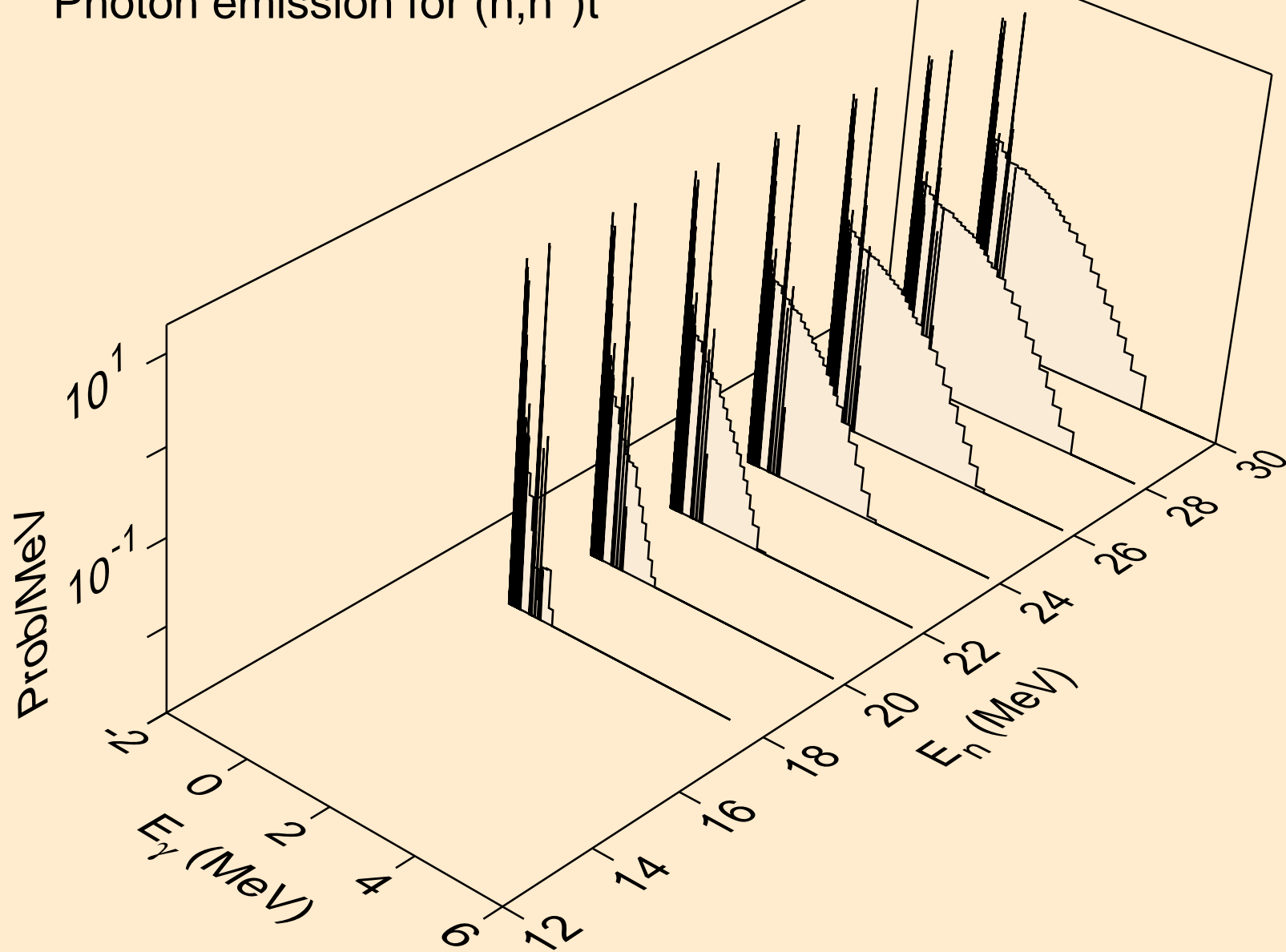

ER180 NEUTRON ACER TENDL-2024 LIBRARY; T=293.6K
Photon emission for (n,4n)

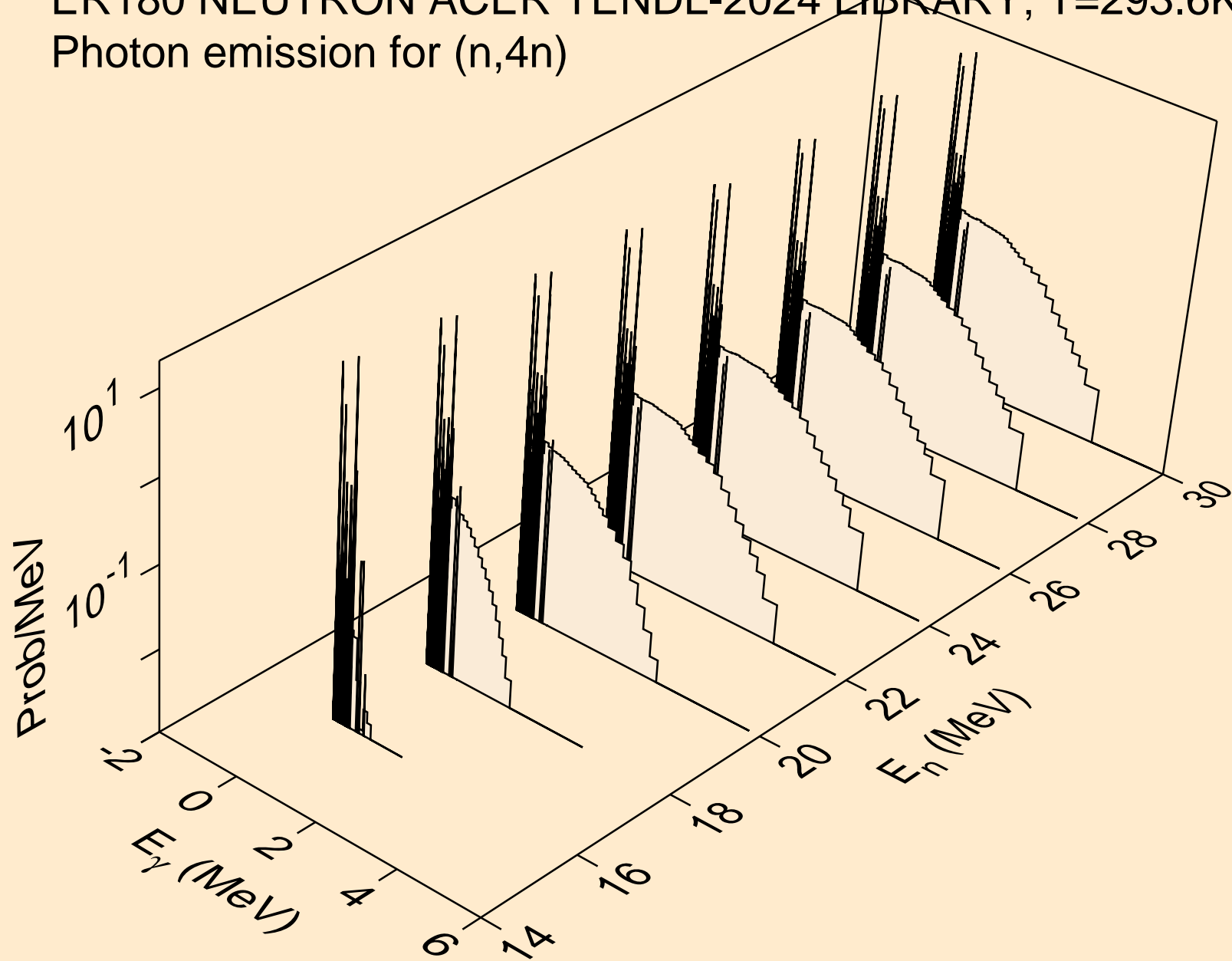

ER180 NEUTRON ACER TENDL-2024 LIBRARY; T=293.6K
Photon emission for (n,2np)

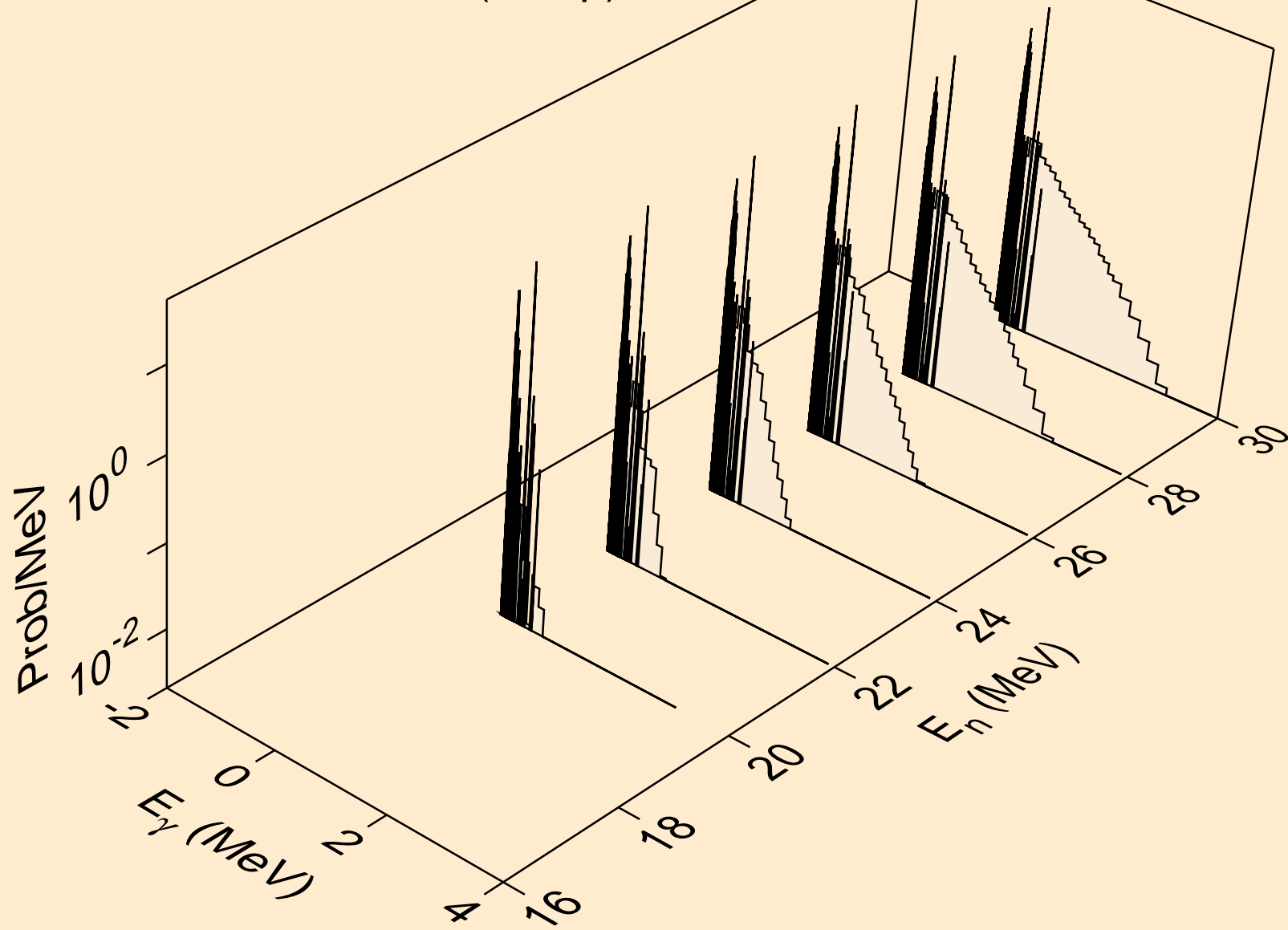

ER180 NEUTRON ACER TENDL-2024 LIBRARY; T=293.6K
Photon emission for (n,3np)

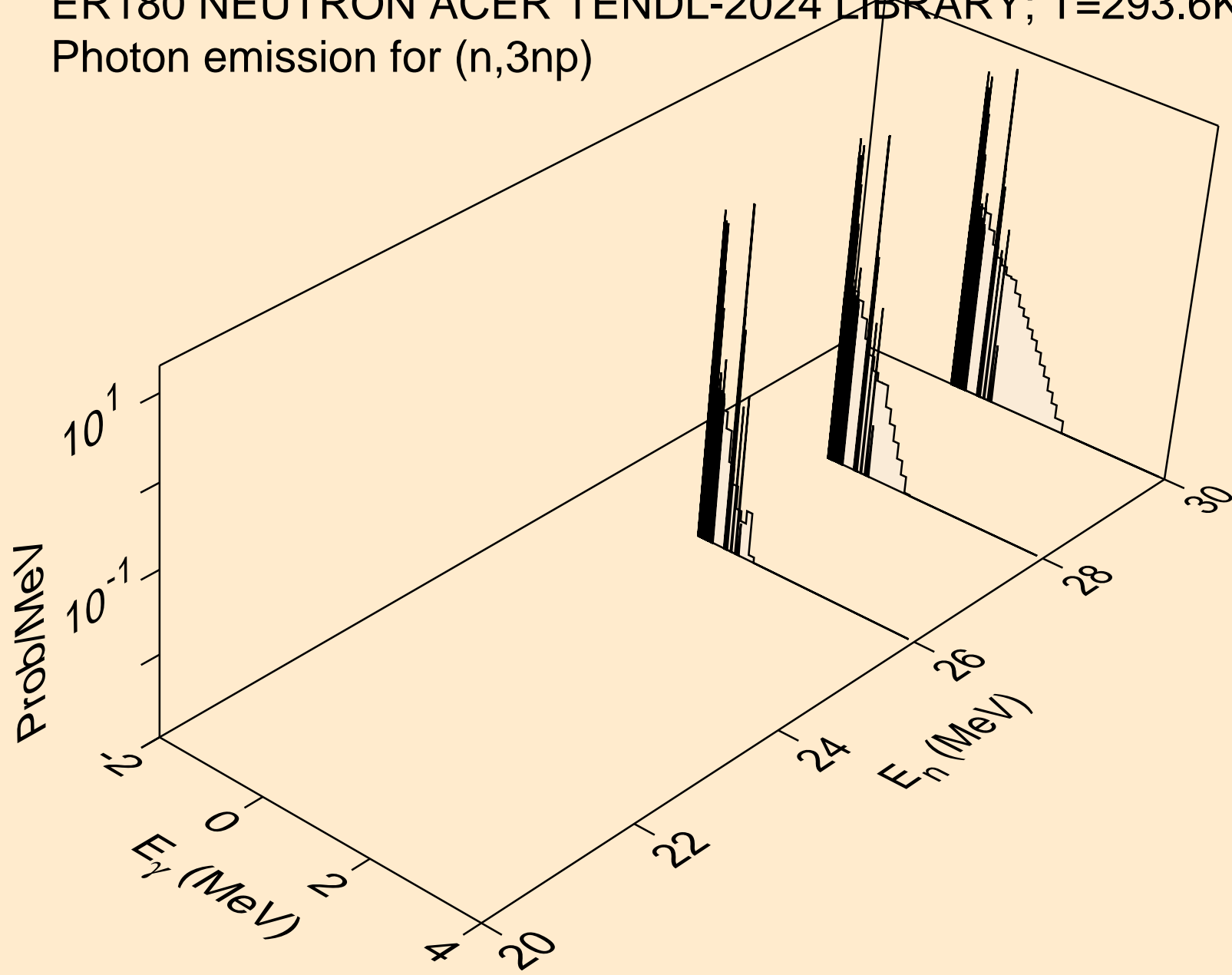

ER180 NEUTRON ACER TENDL-2024 LIBRARY; T=293.6K
Photon emission for (n,n*c)

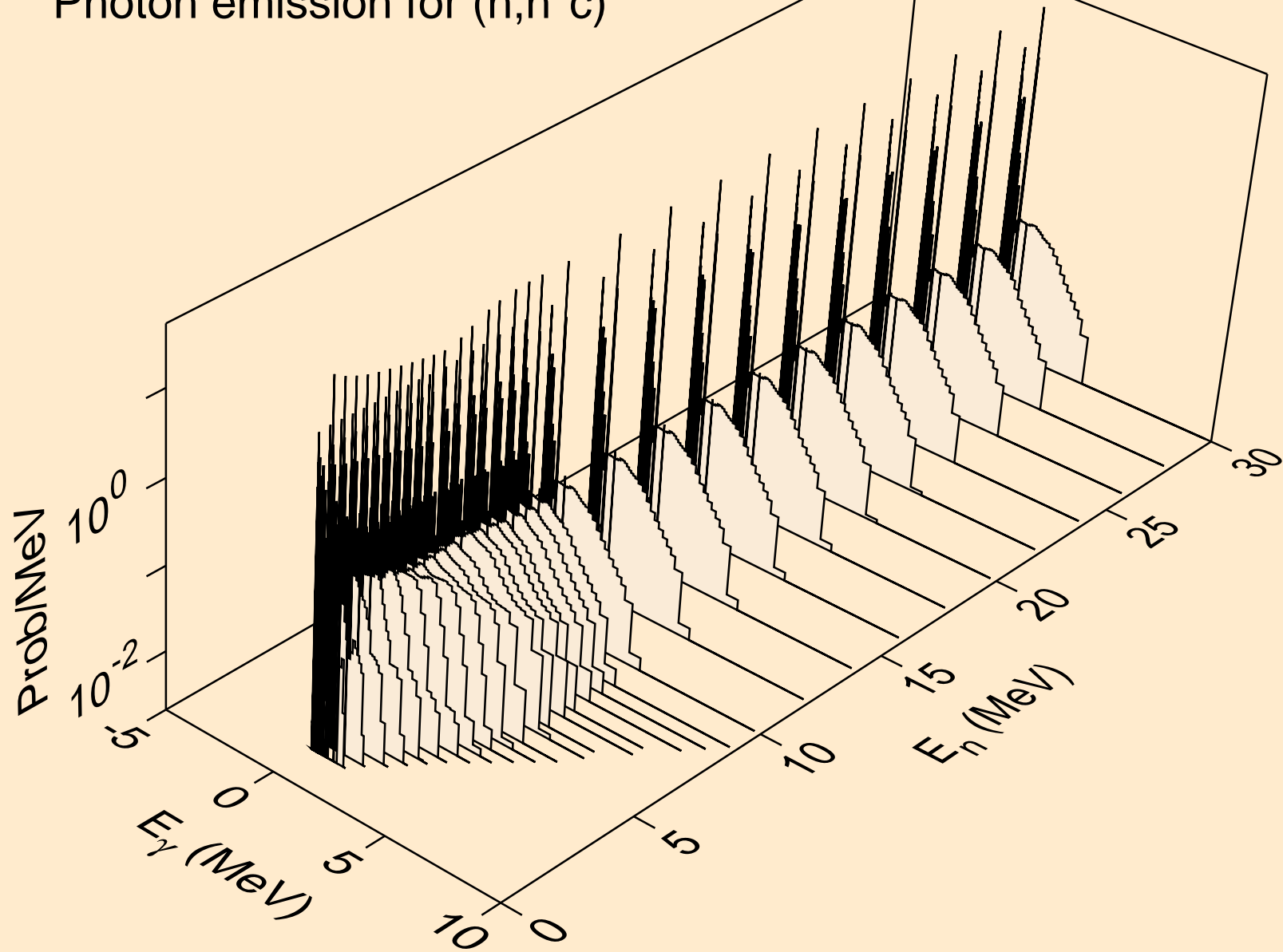

ER180 NEUTRON ACER TENDL-2024 LIBRARY; T=293.6K
Photon emission for (n,gma)

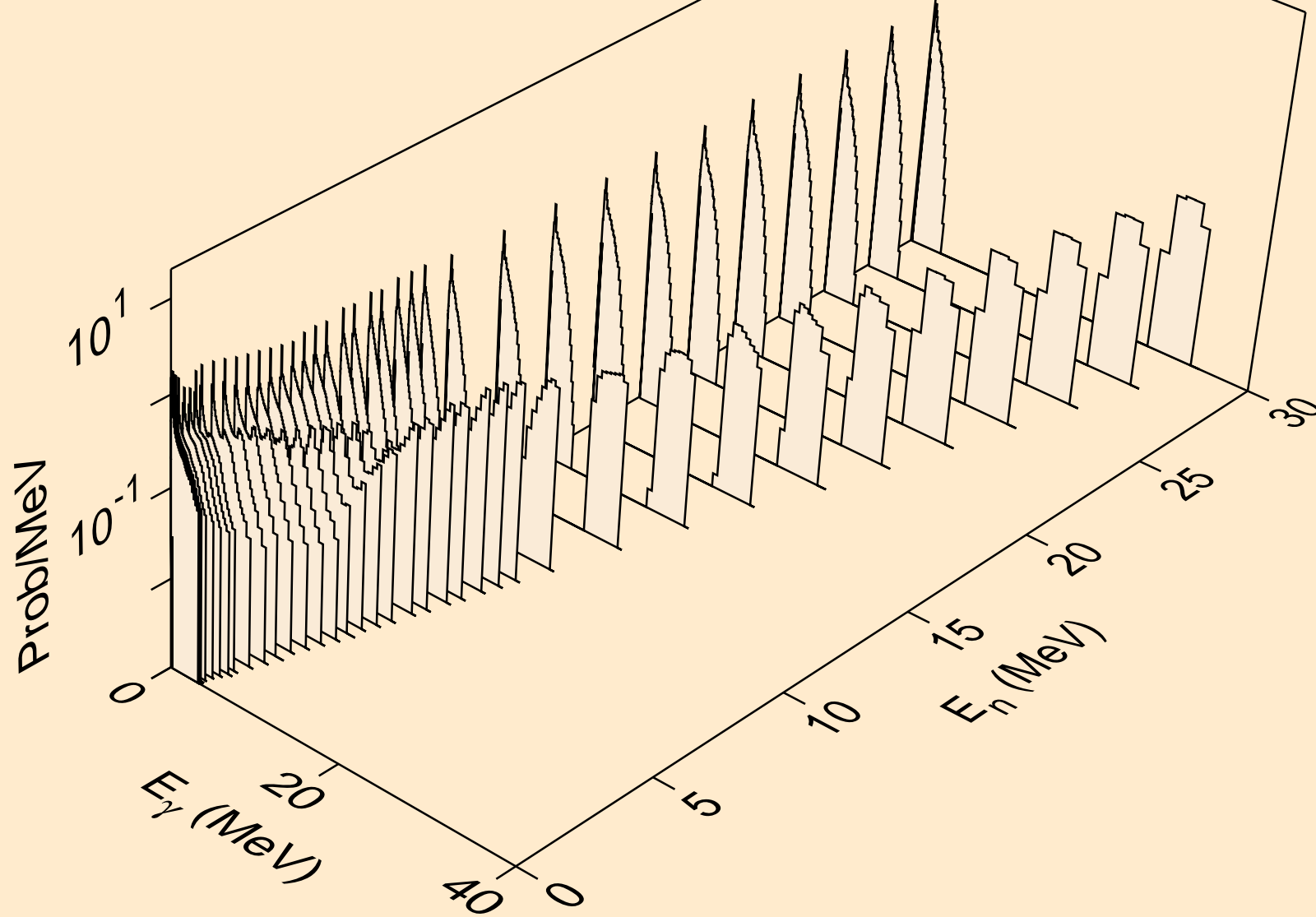

ER180 NEUTRON ACER TENDL-2024 LIBRARY; T=293.6K
Photon emission for (n,p)

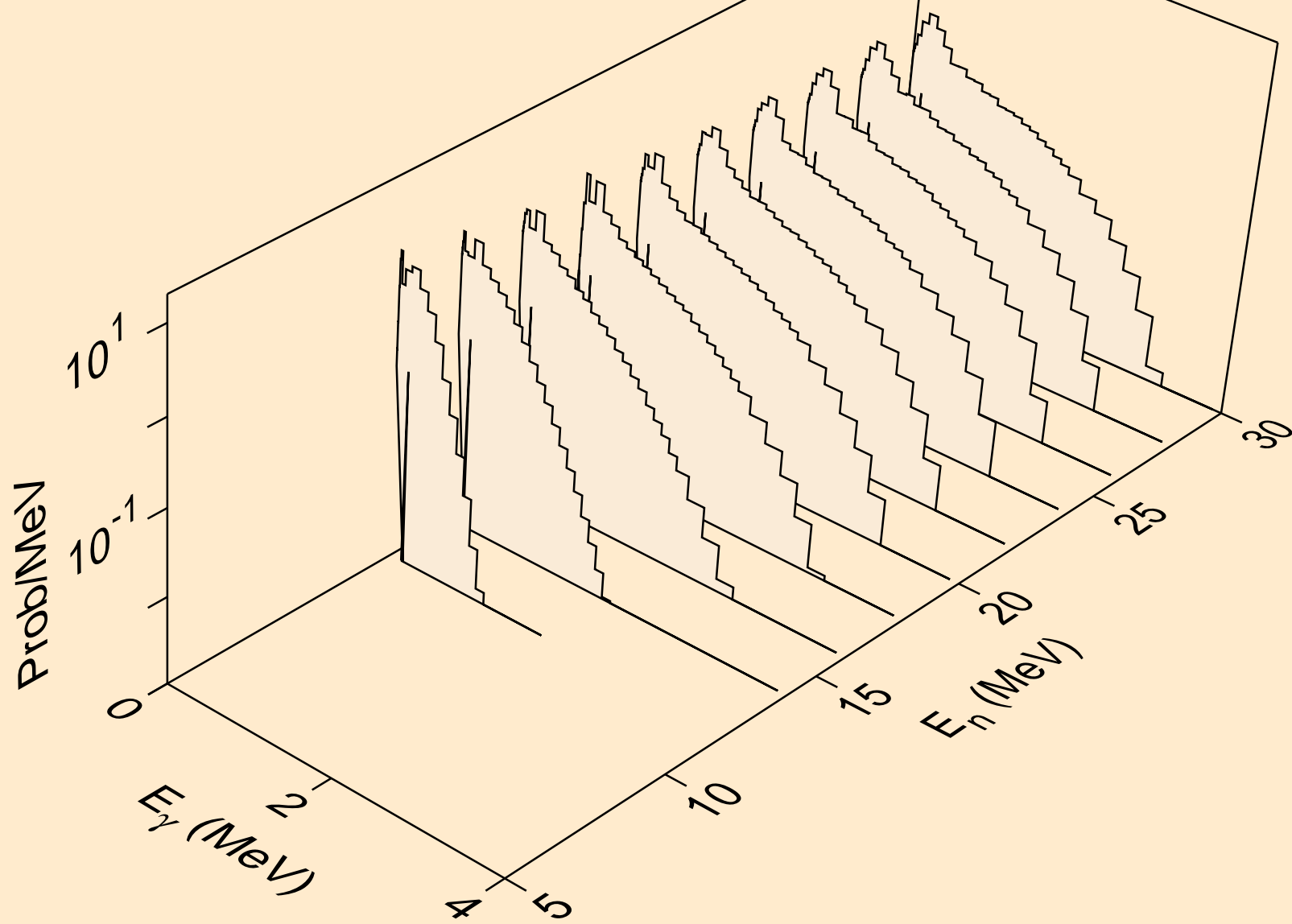

ER180 NEUTRON ACER TENDL-2024 LIBRARY; T=293.6K
Photon emission for (n,d)

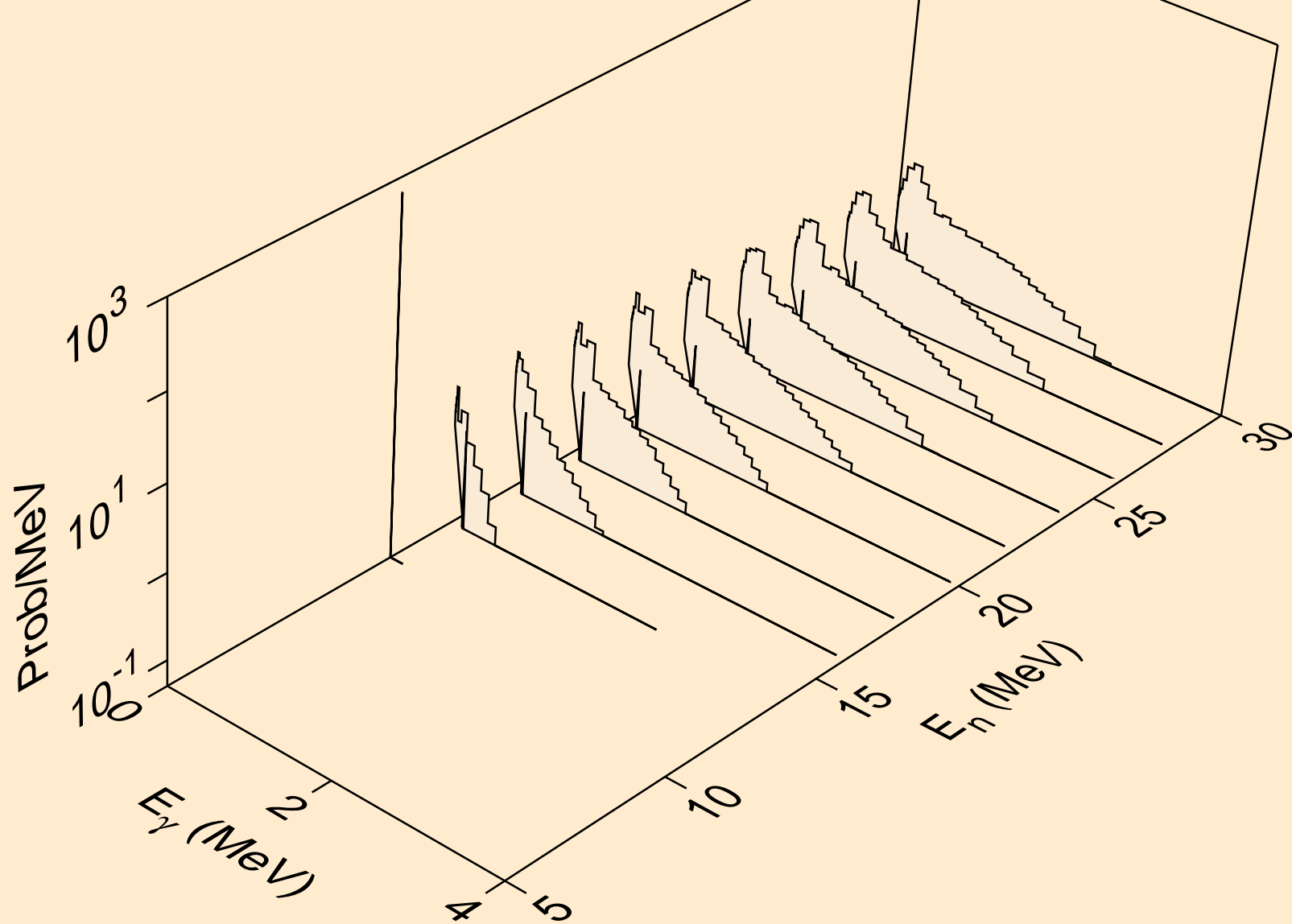

ER180 NEUTRON ACER TENDL-2024 LIBRARY; T=293.6K
Photon emission for (n,t)

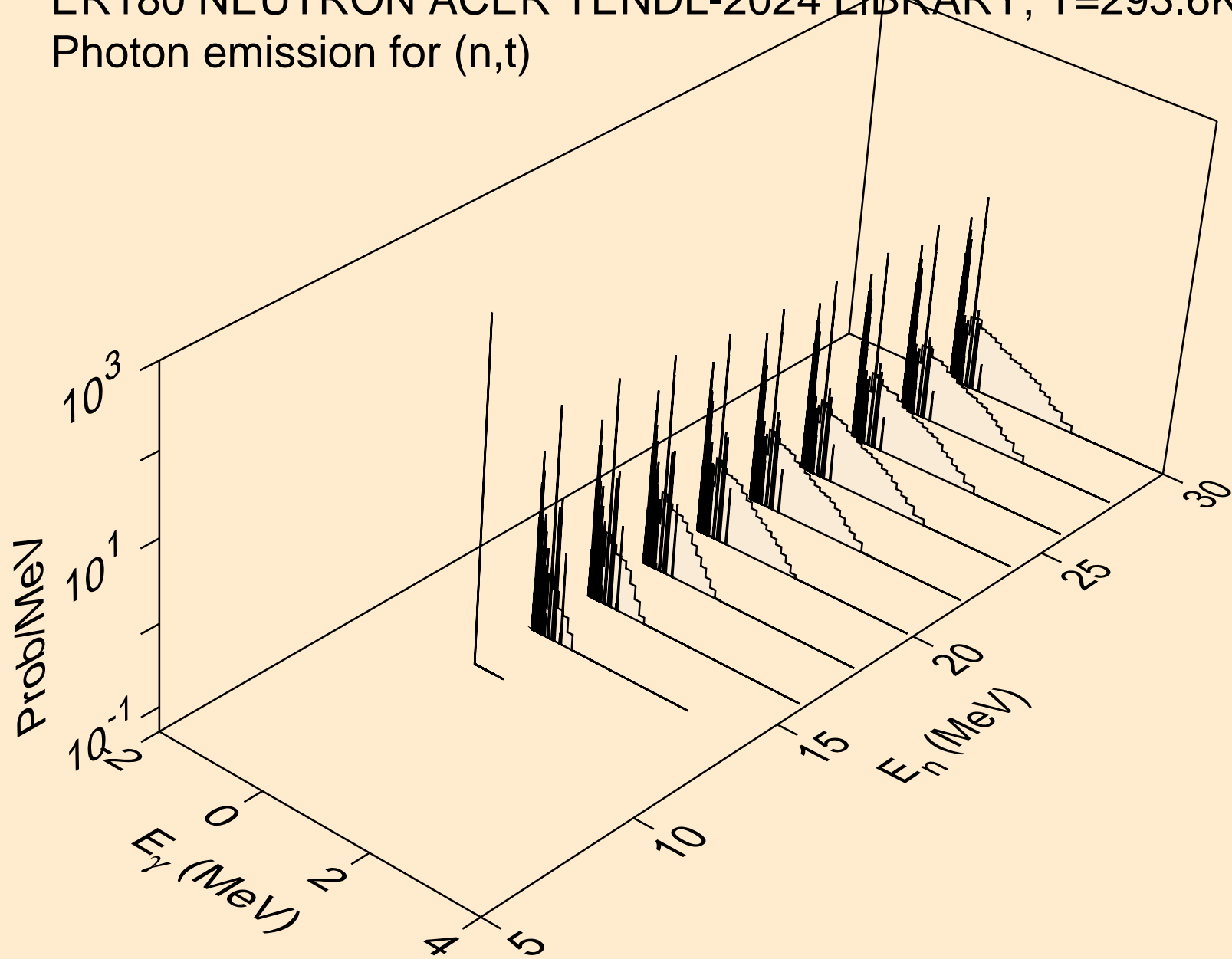

ER180 NEUTRON ACER TENDL-2024 LIBRARY; T=293.6K
Photon emission for (n,he3)

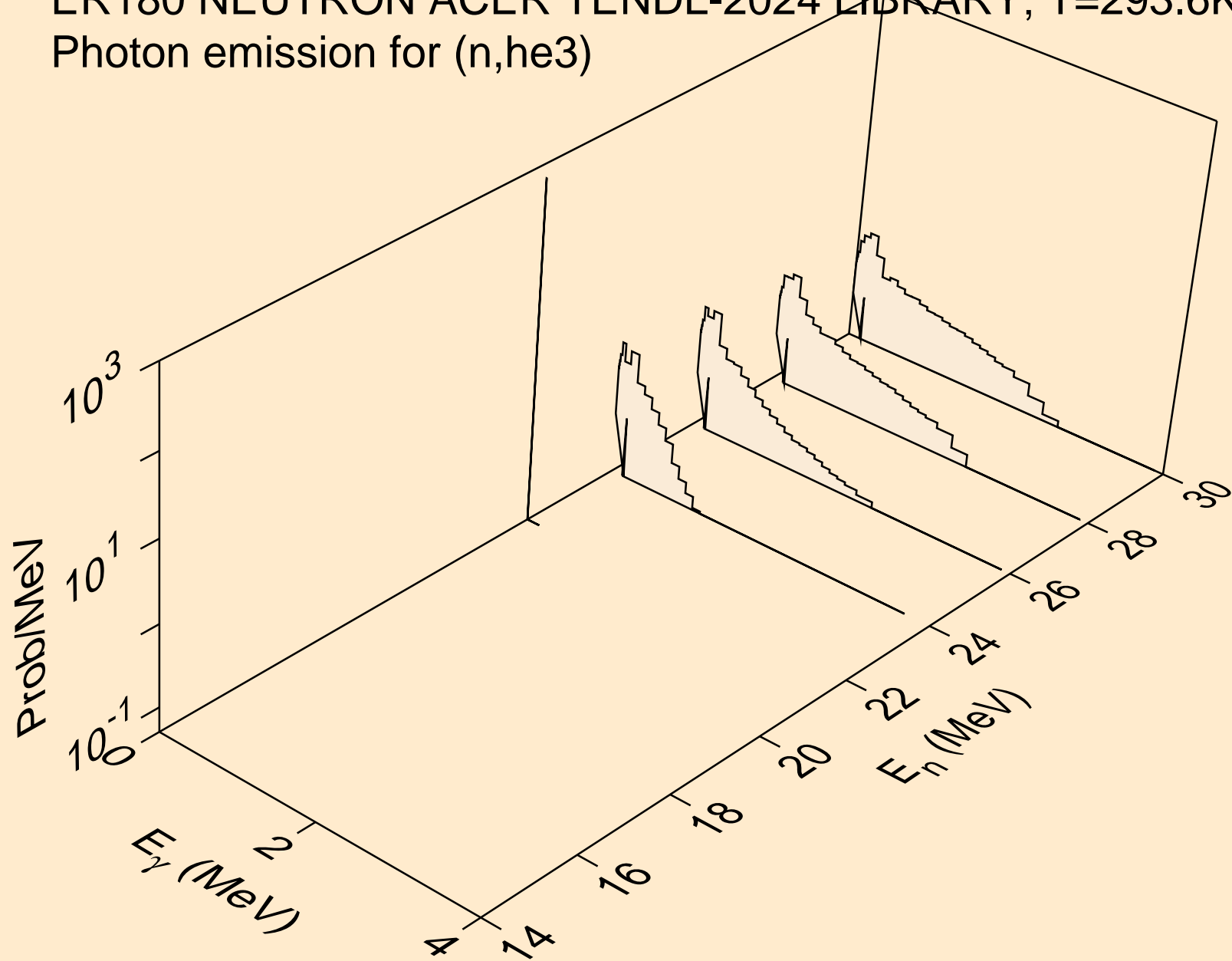

ER180 NEUTRON ACER TENDL-2024 LIBRARY; T=293.6K
Photon emission for (n,a)

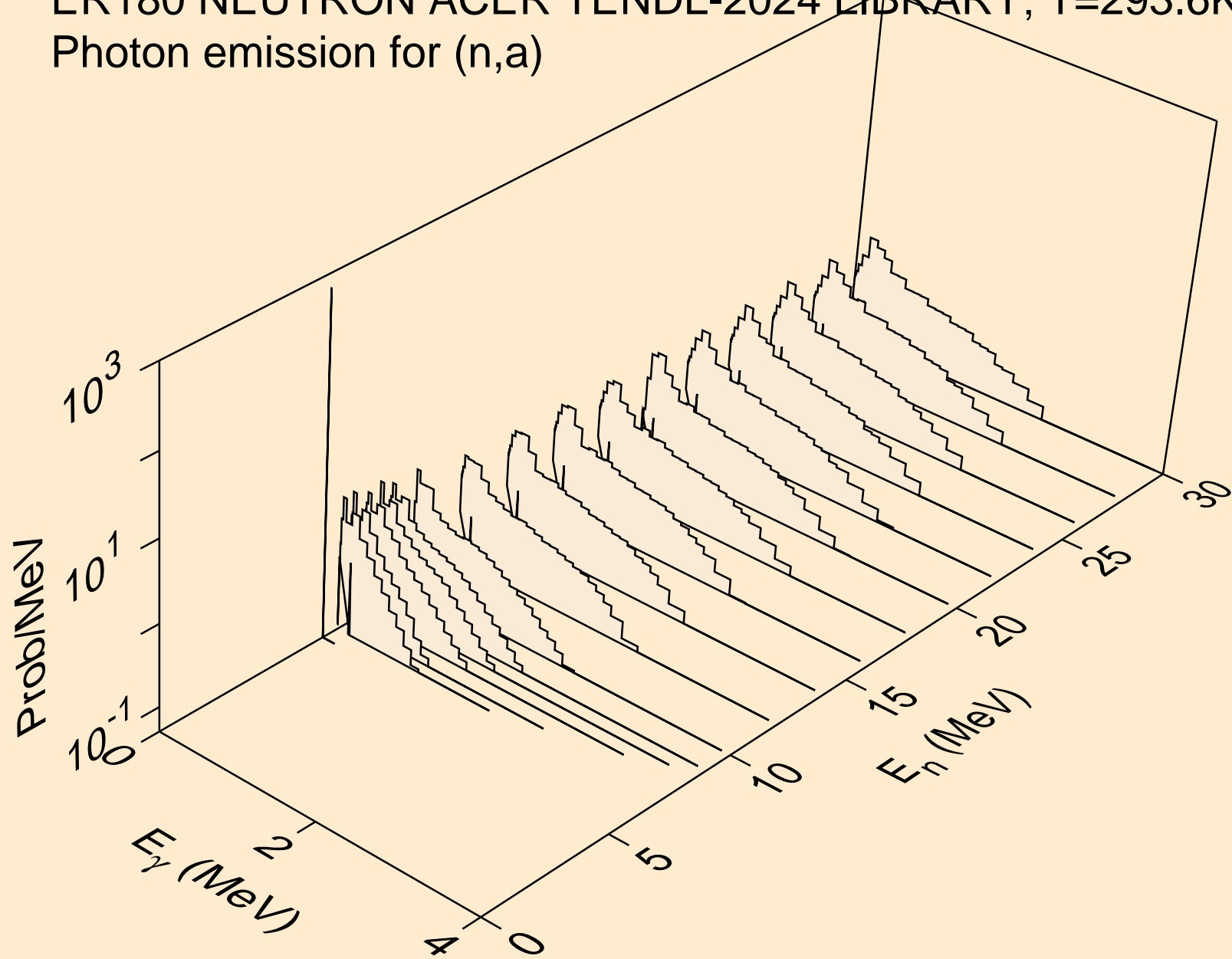

ER180 NEUTRON ACER TENDL-2024 LIBRARY; T=293.6K
thermal capture photon spectrum

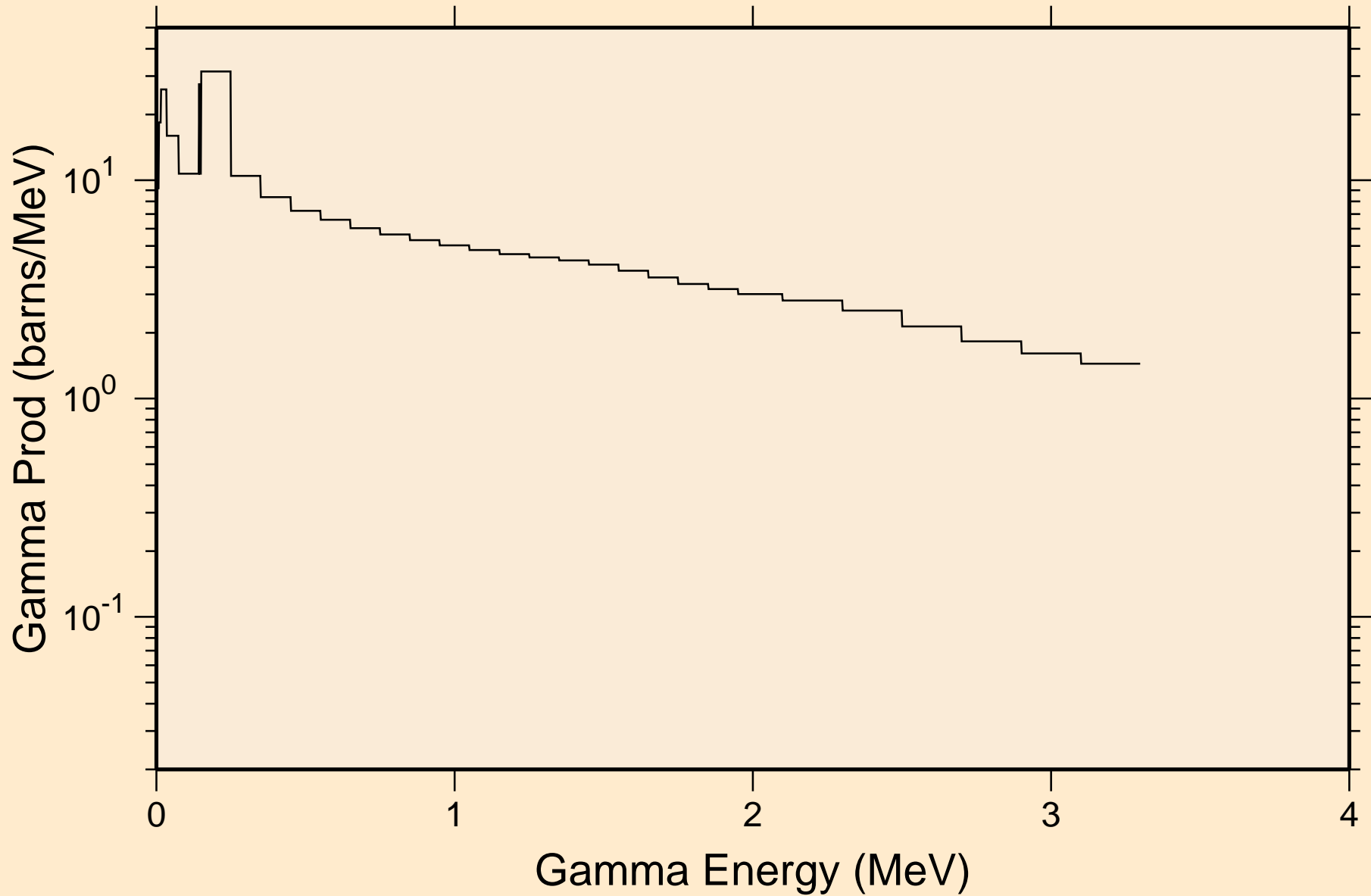

ER180 NEUTRON ACER TENDL-2024 LIBRARY; T=293.6K
14 MeV photon spectrum

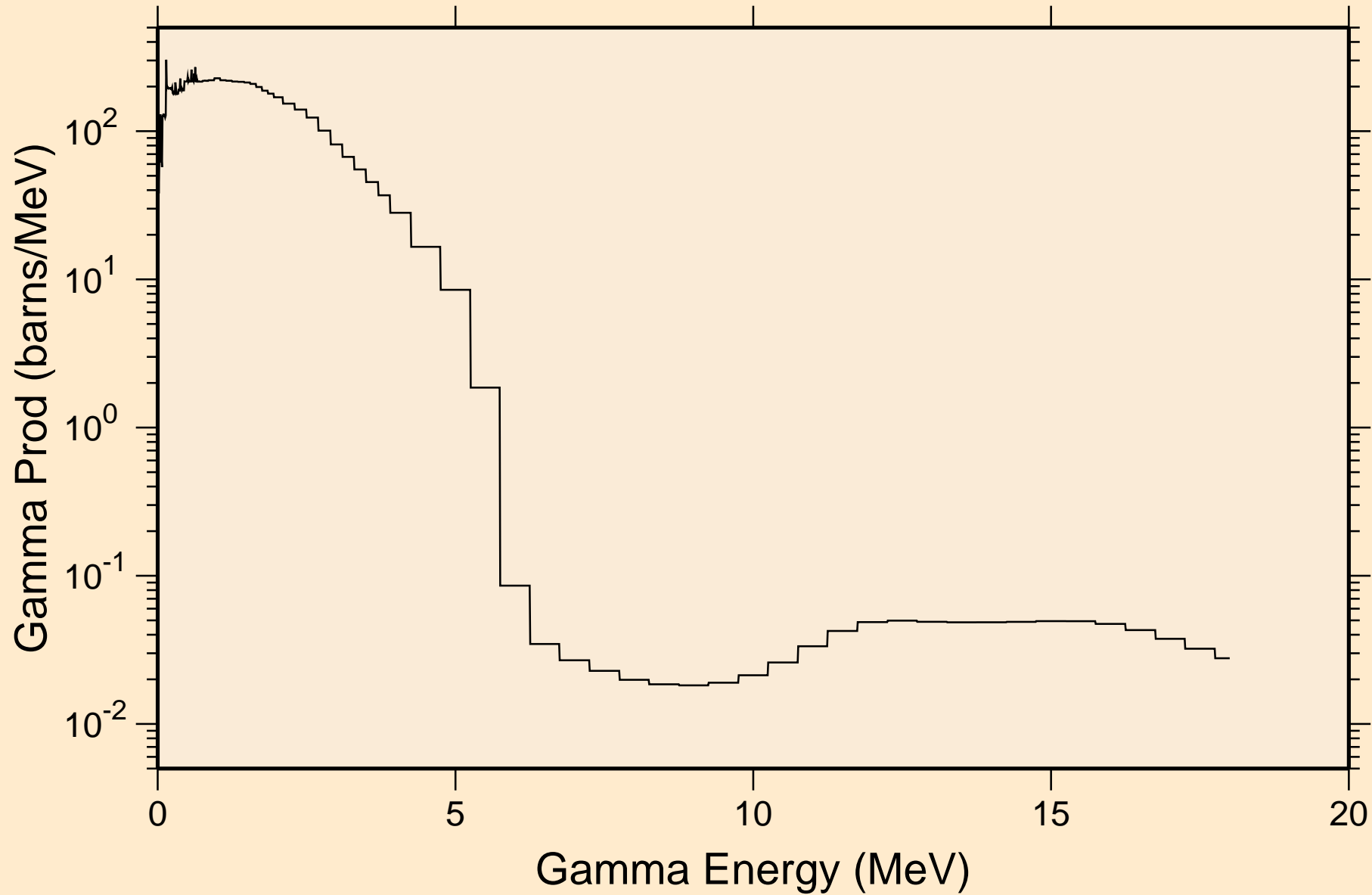

ER180 NEUTRON ACER TENDL-2024 LIBRARY; T=293.6K

Particle heating contributions

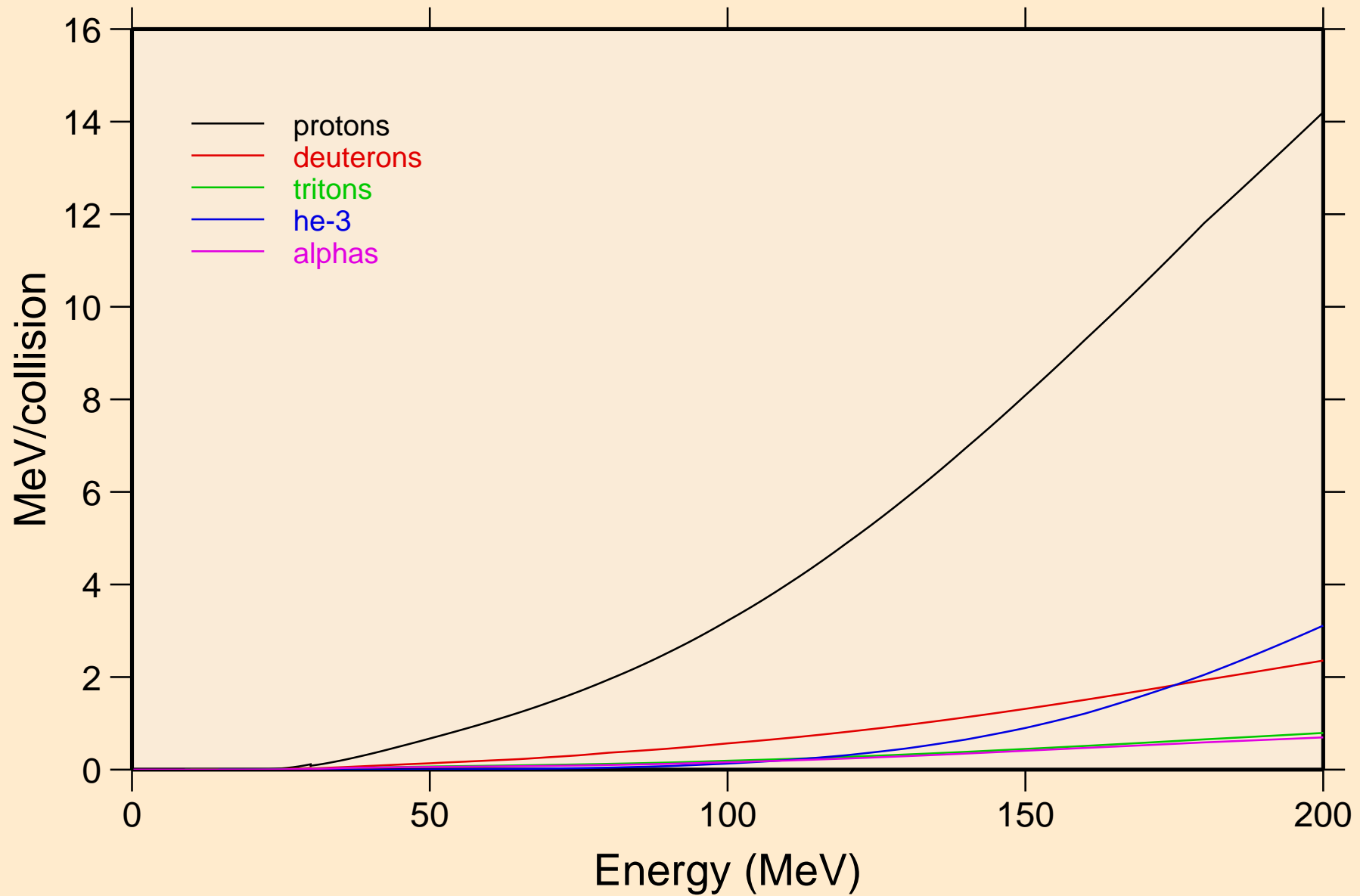

ER180 NEUTRON ACER TENDL-2024 LIBRARY; T=293.6K
Recoil Heating

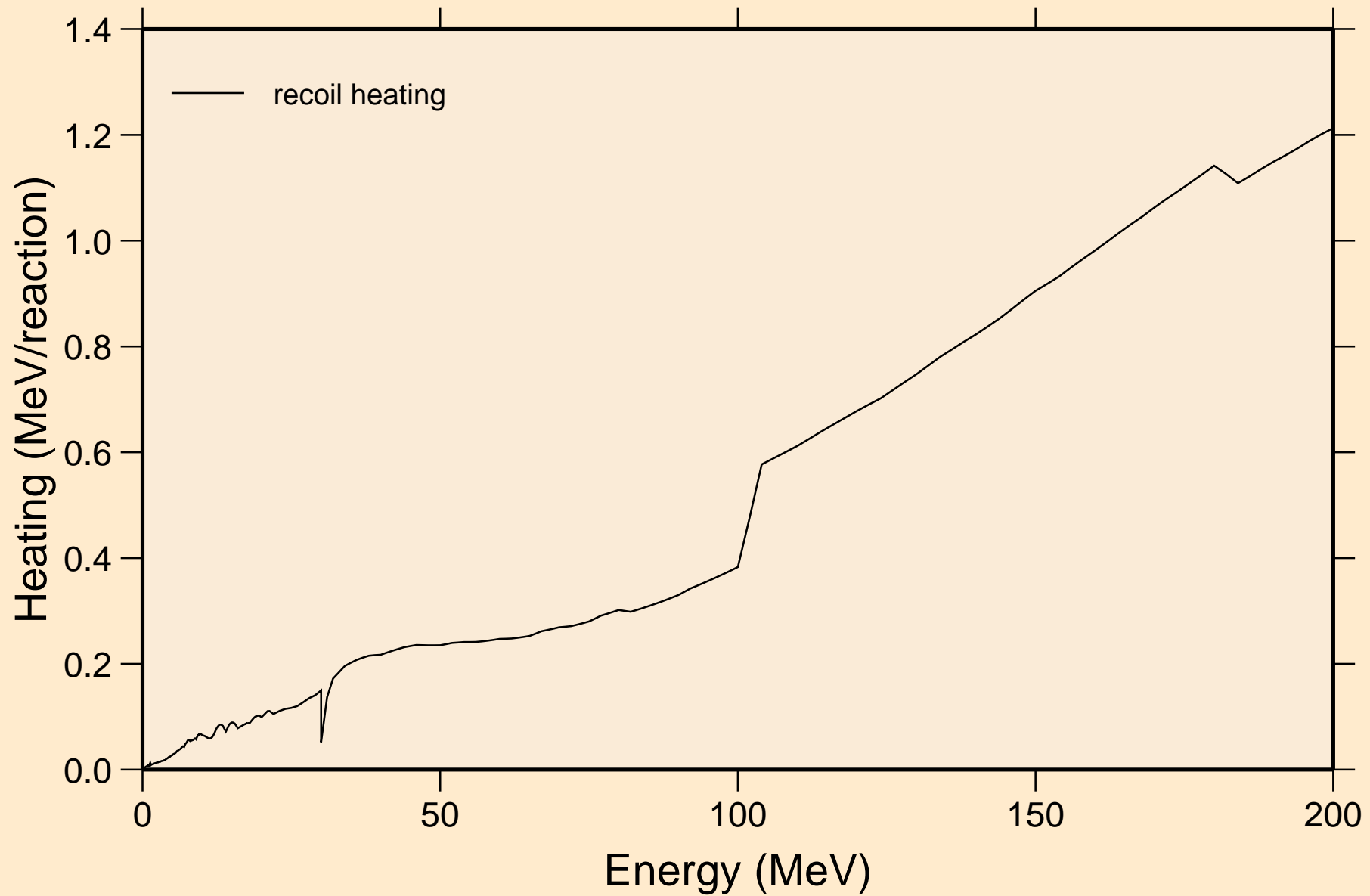

ER180 NEUTRON ACER TENDL-2024 LIBRARY; T=293.6K
Particle production cross sections

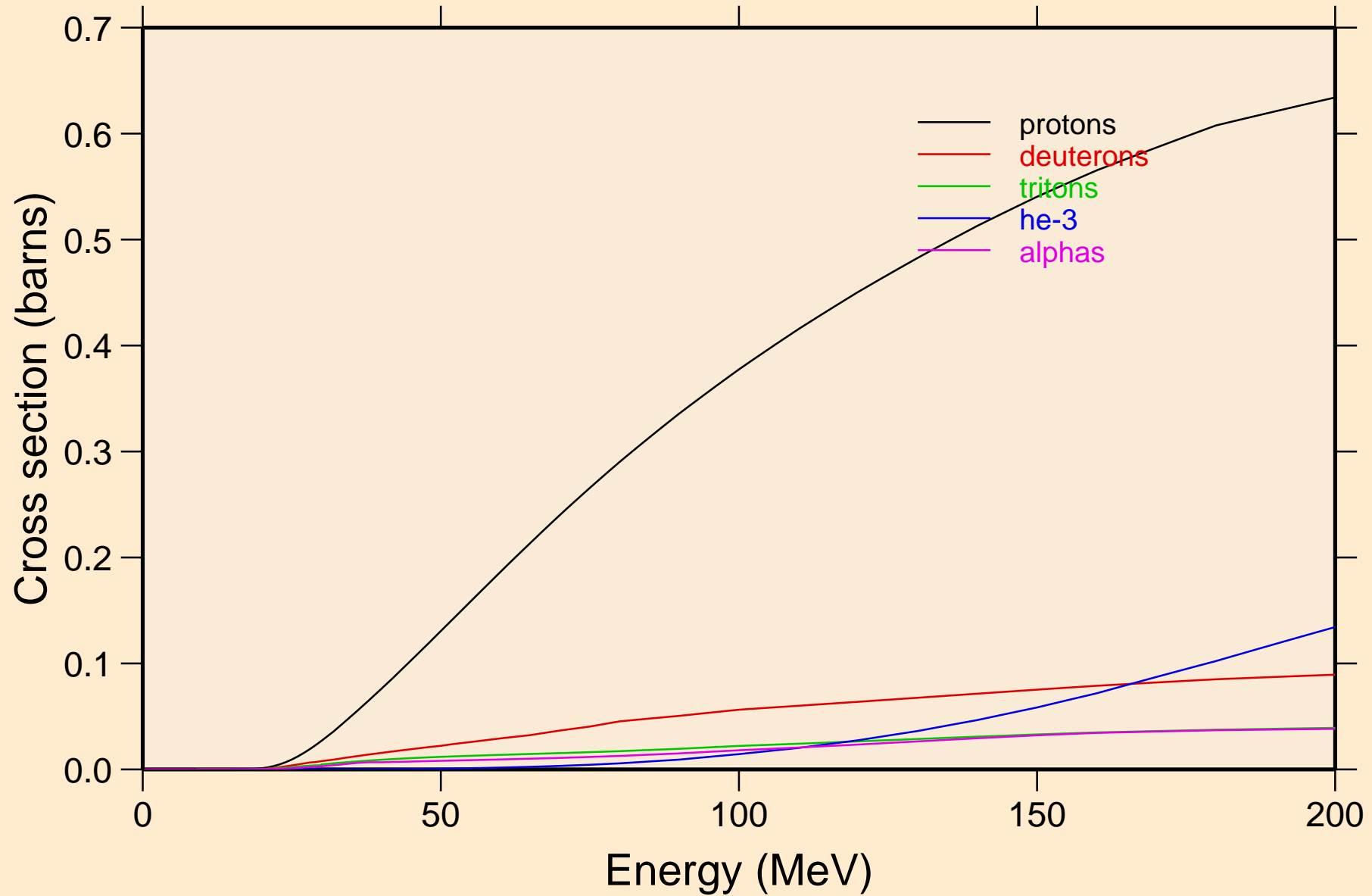

ER180 NEUTRON ACER TENDL-2024 LIBRARY; T=293.6K
protons from (n,x)

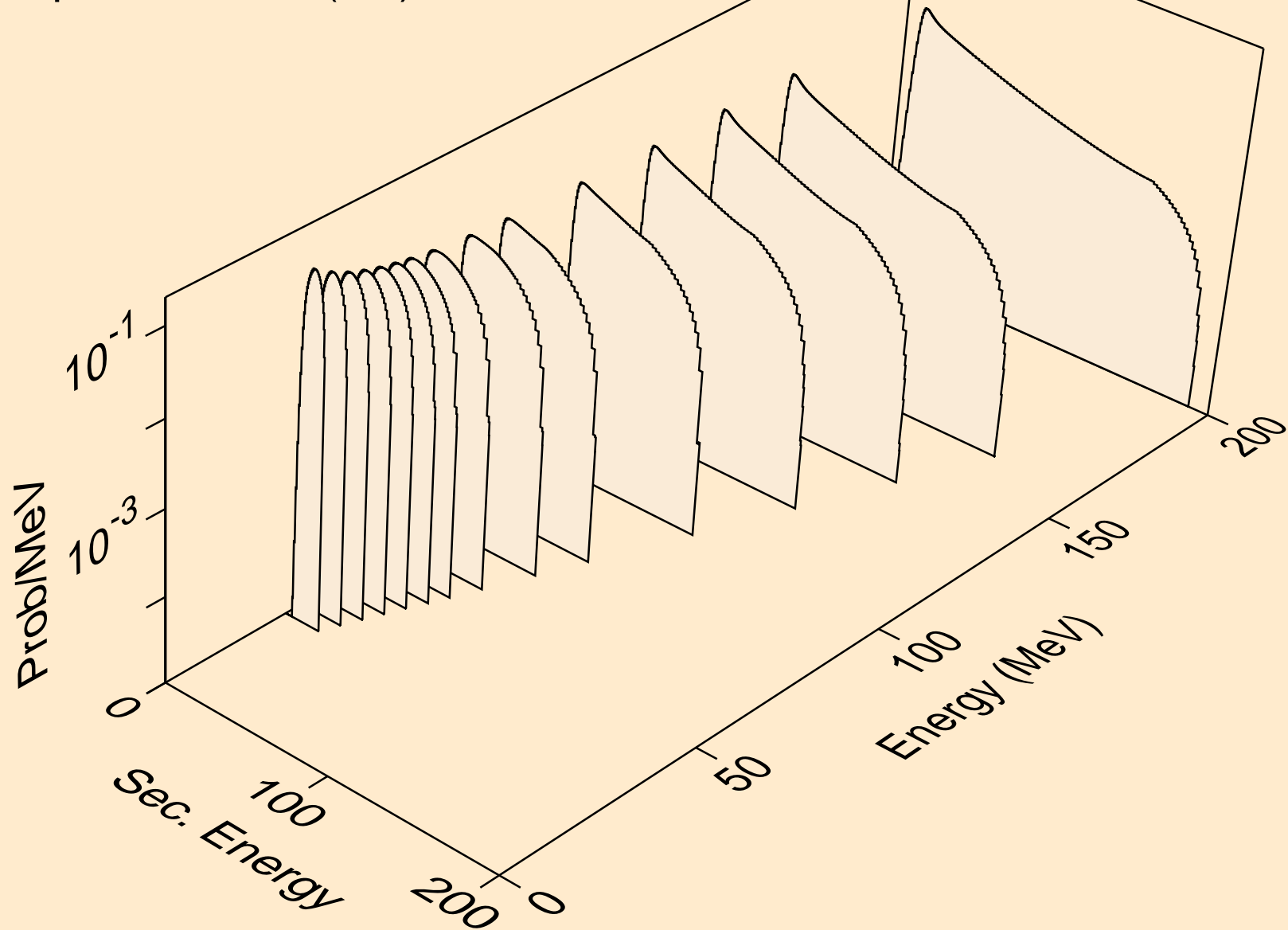

ER180 NEUTRON ACER TENDL-2024 LIBRARY; T=293.6K
protons from (n,n*)p

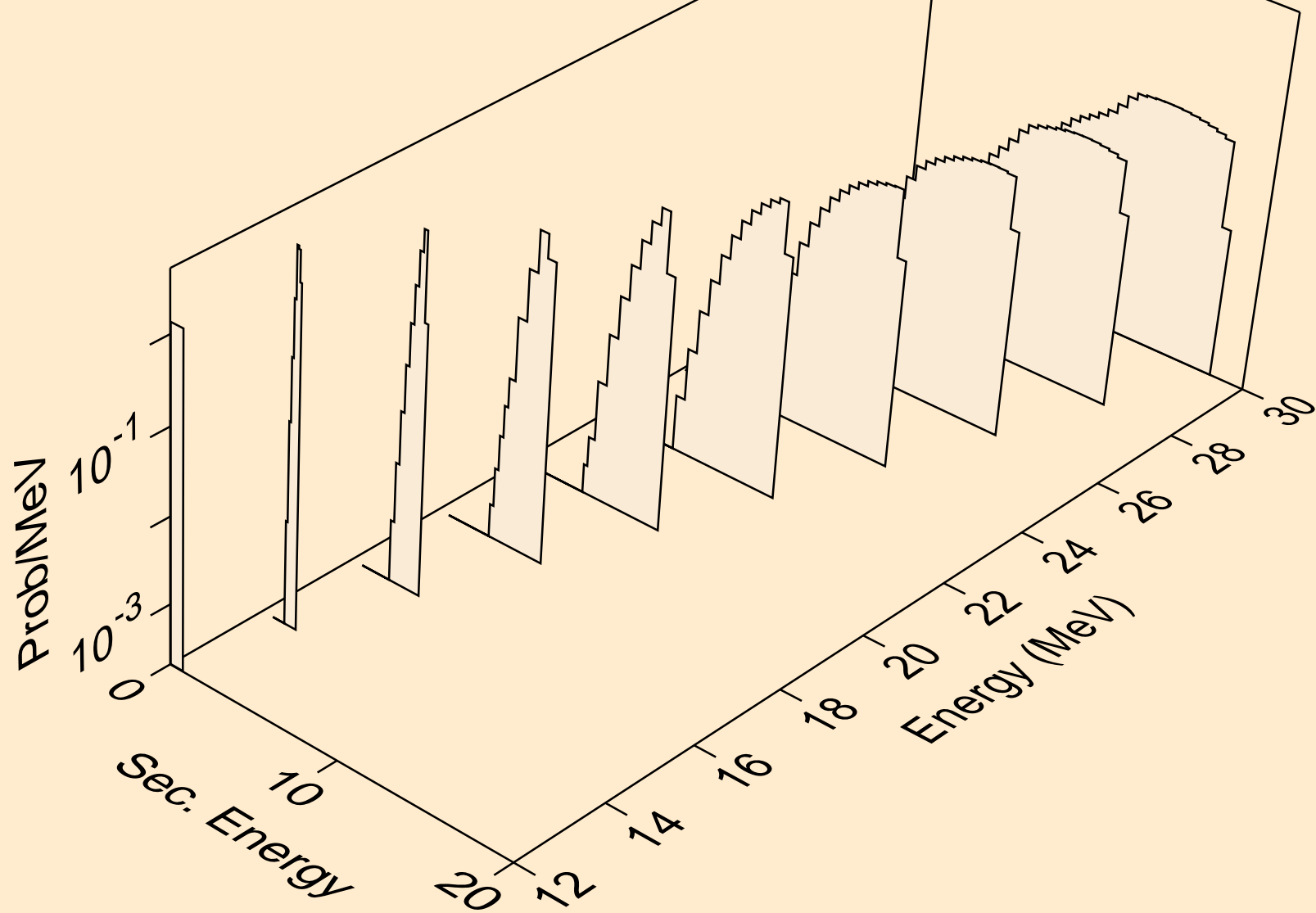

ER180 NEUTRON ACER TENDL-2024 LIBRARY; T=293.6K
protons from (n,2np)

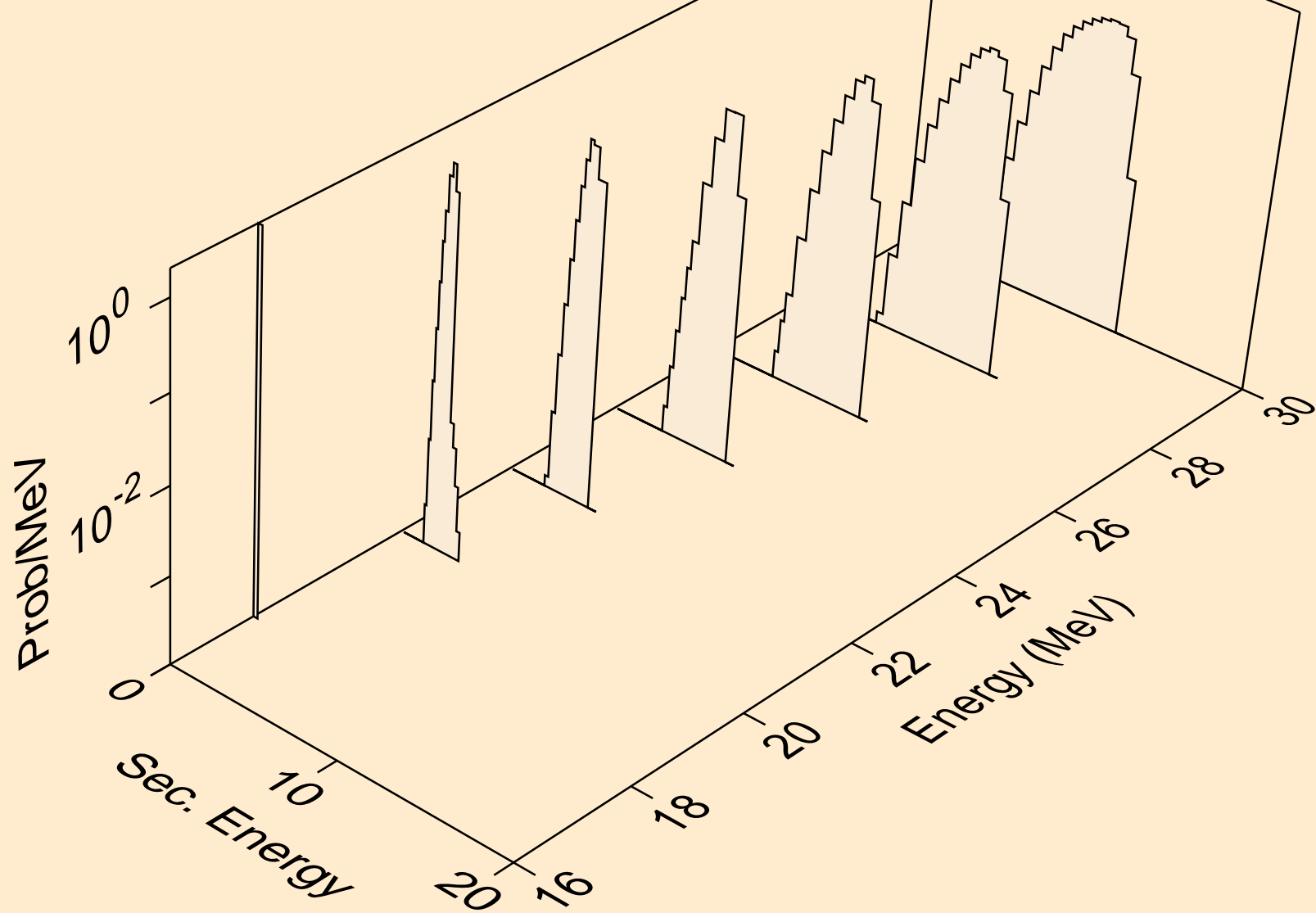

ER180 NEUTRON ACER TENDL-2024 LIBRARY; T=293.6K
protons from (n,3np)

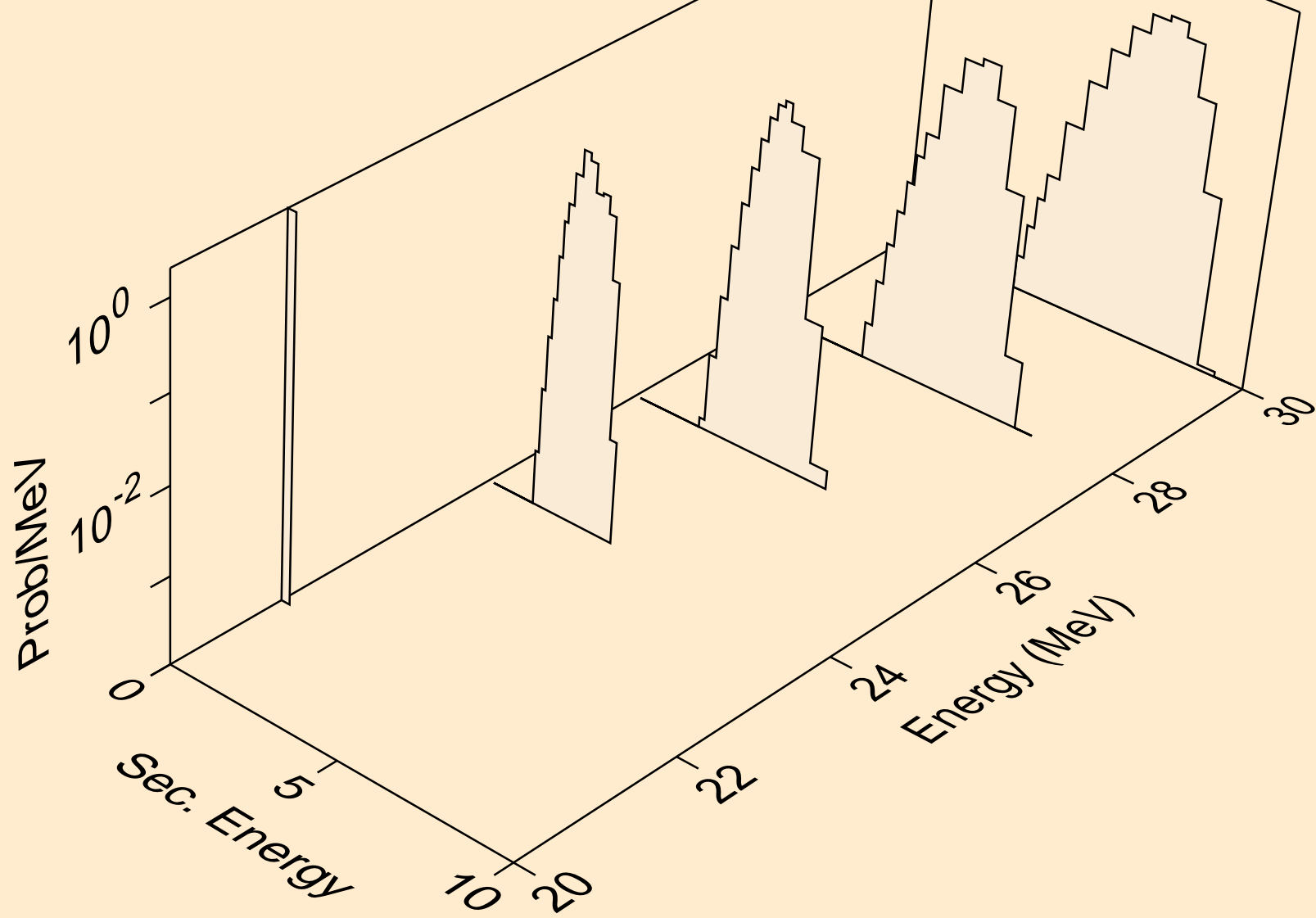

ER180 NEUTRON ACER TENDL-2024 LIBRARY; T=293.6K
protons from (n,p)

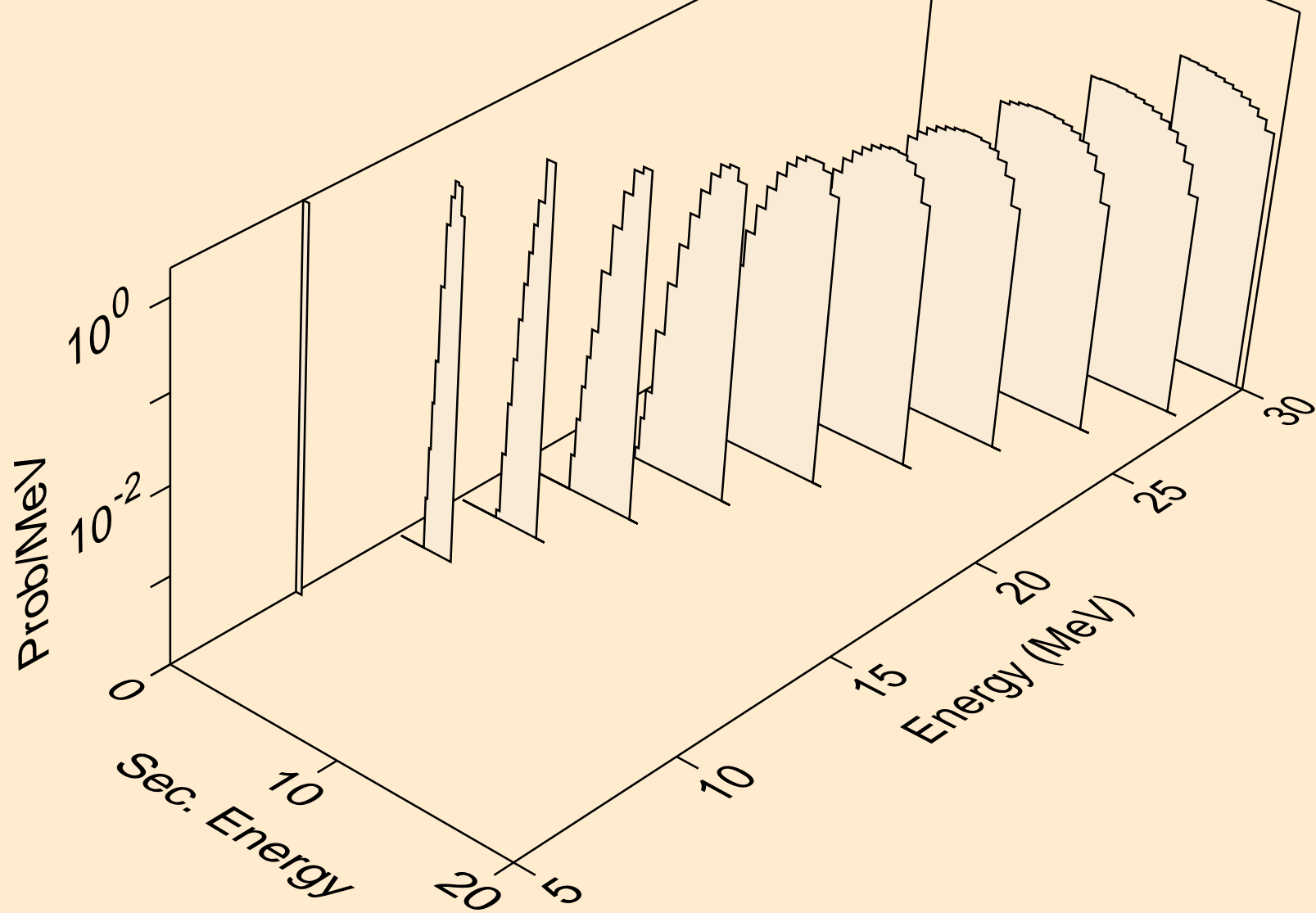

ER180 NEUTRON ACER TENDL-2024 LIBRARY; T=293.6K
deuterons from (n,x)

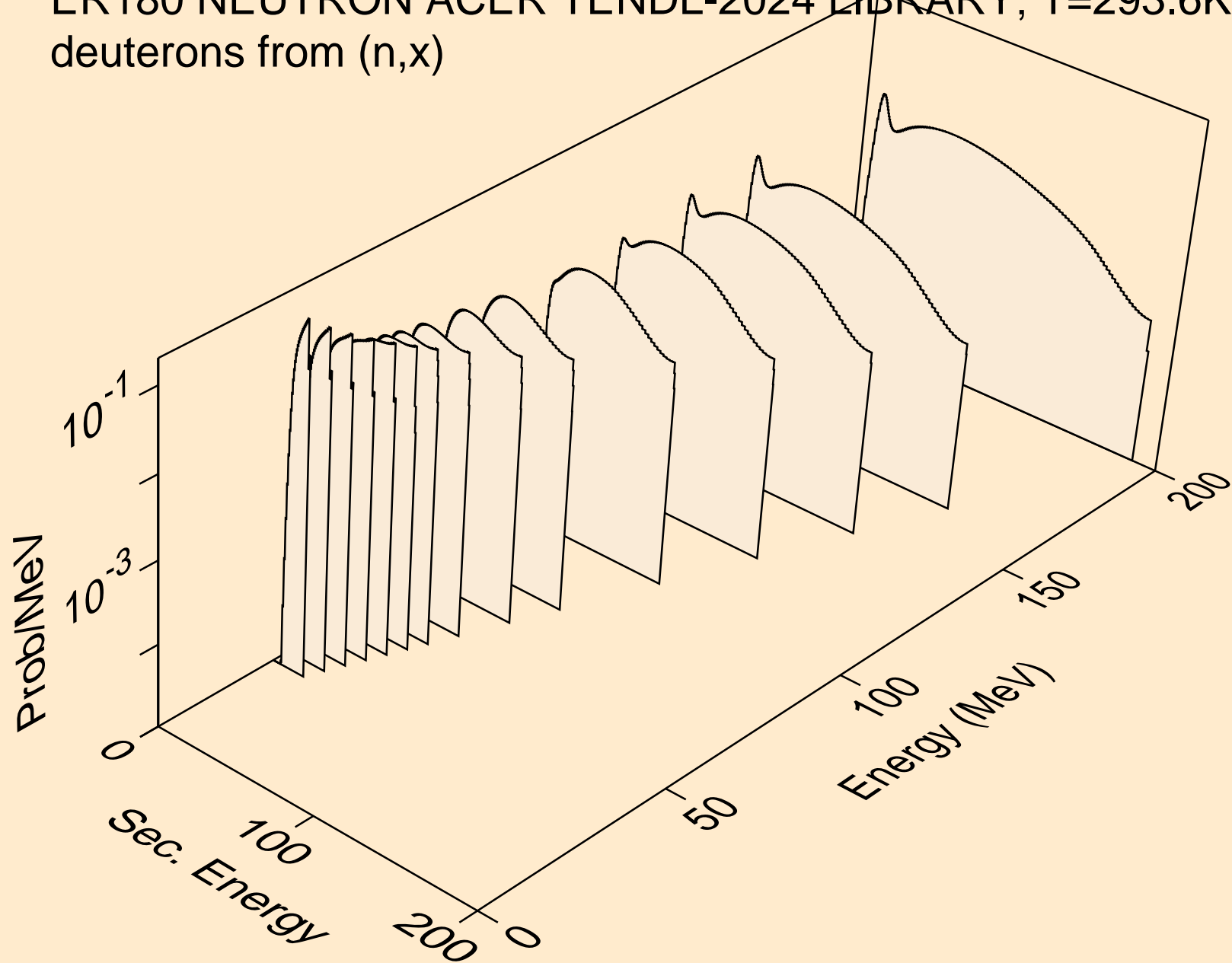

ER180 NEUTRON ACER TENDL-2024 LIBRARY; T=293.6K
deuterons from (n,2nd)

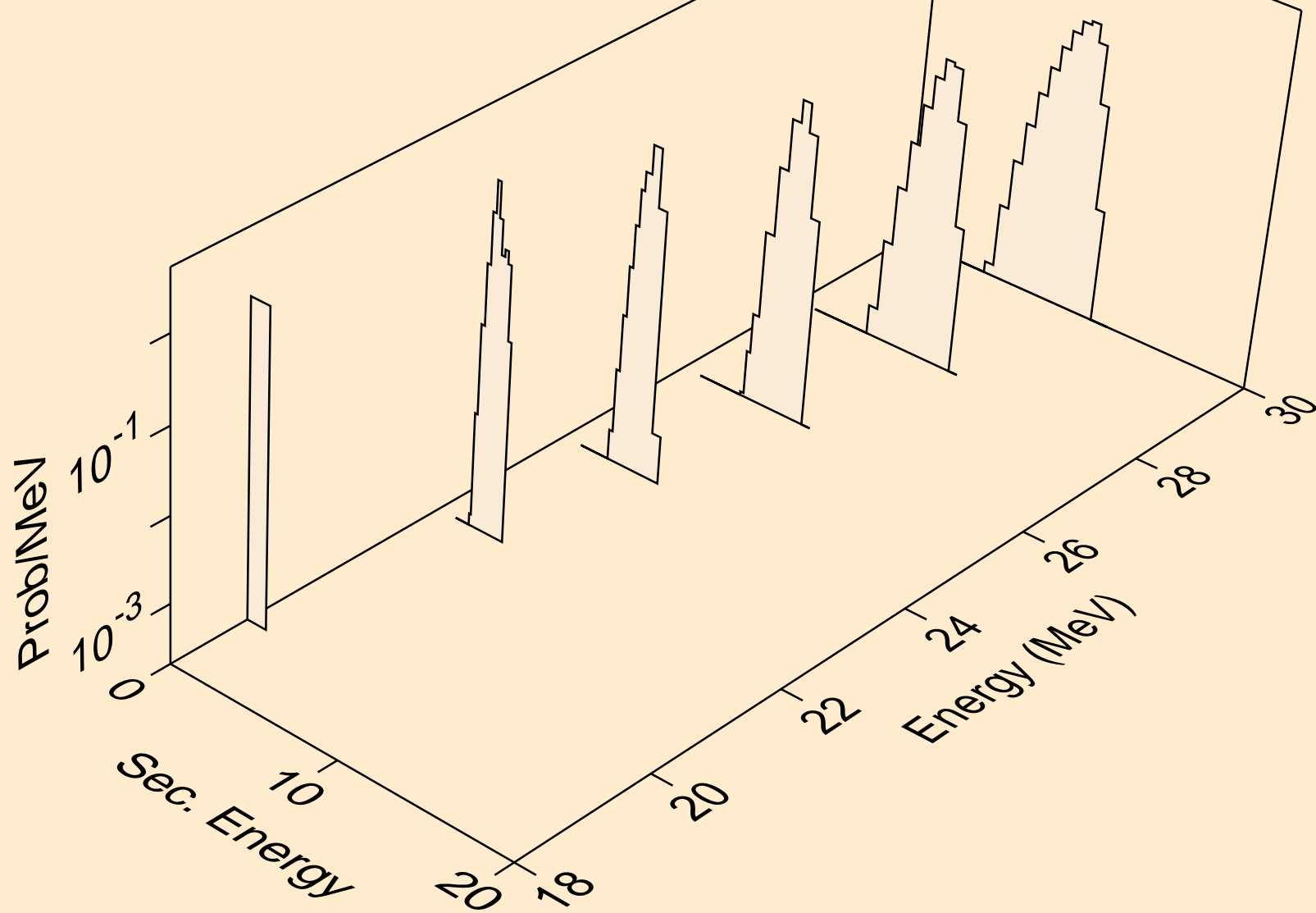

ER180 NEUTRON ACER TENDL-2024 LIBRARY; T=293.6K
deuterons from (n,n*)d

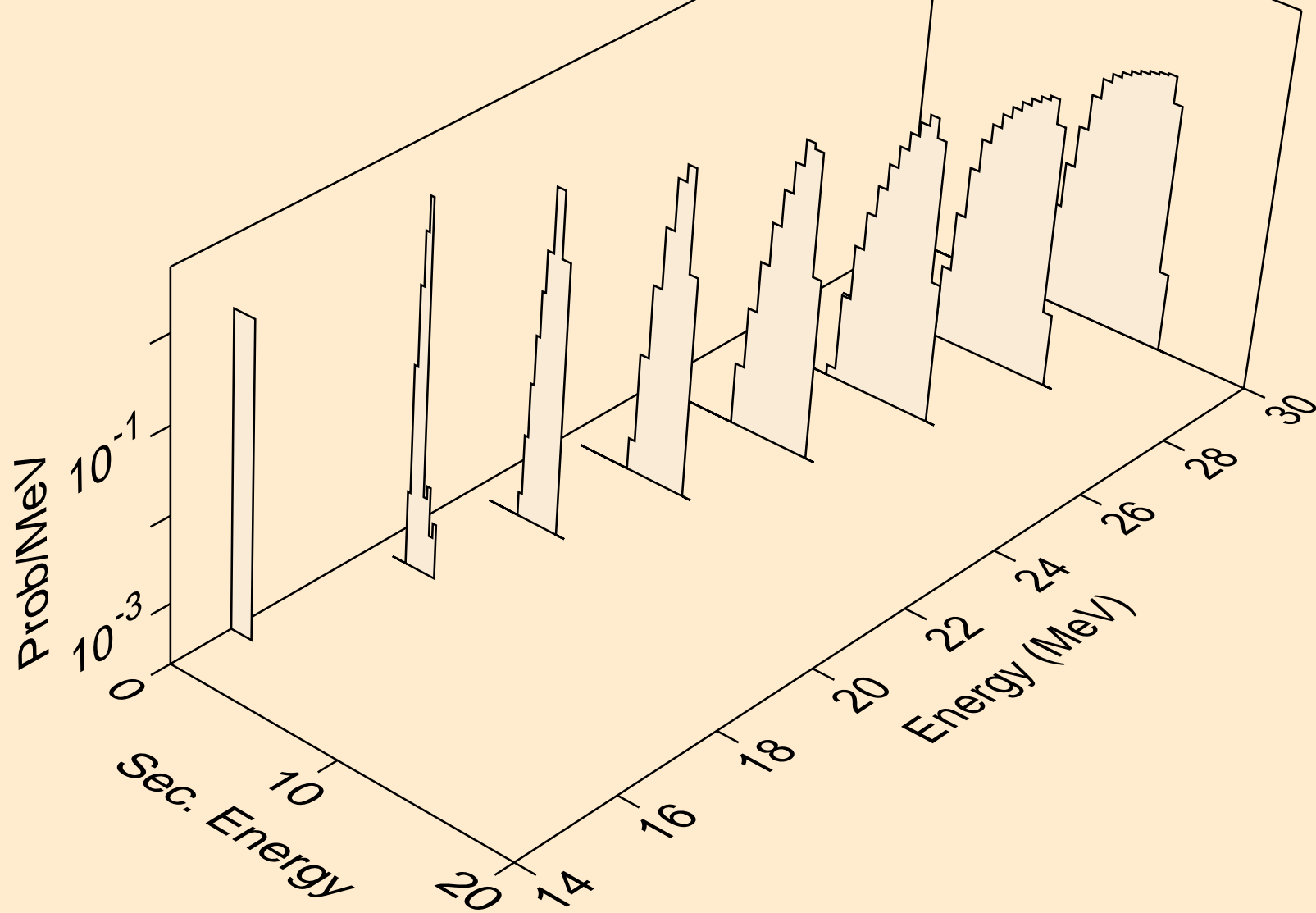

ER180 NEUTRON ACER TENDL-2024 LIBRARY; T=293.6K
deuterons from (n,d)

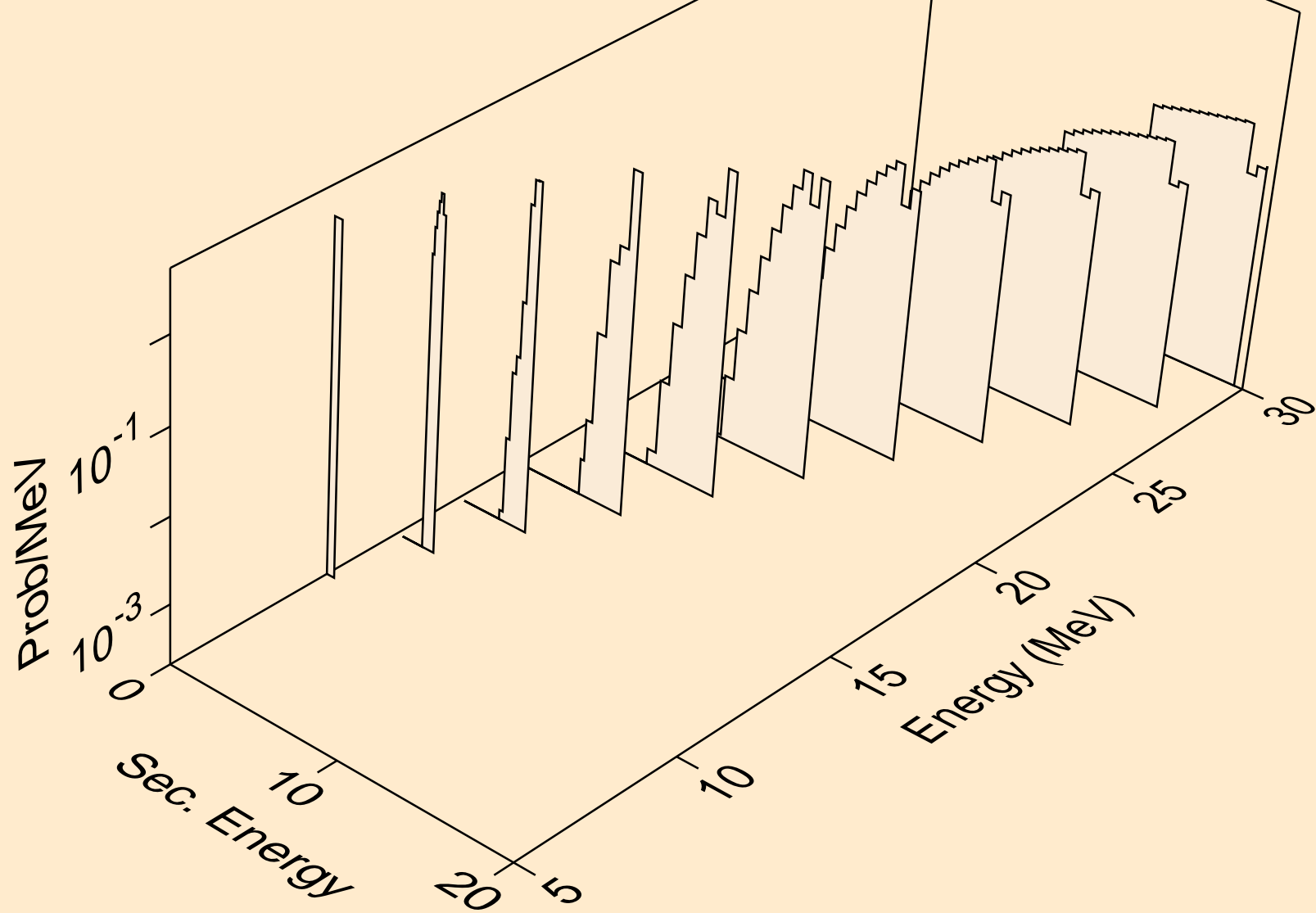

ER180 NEUTRON ACER TENDL-2024 LIBRARY; T=293.6K
tritons from (n,x)

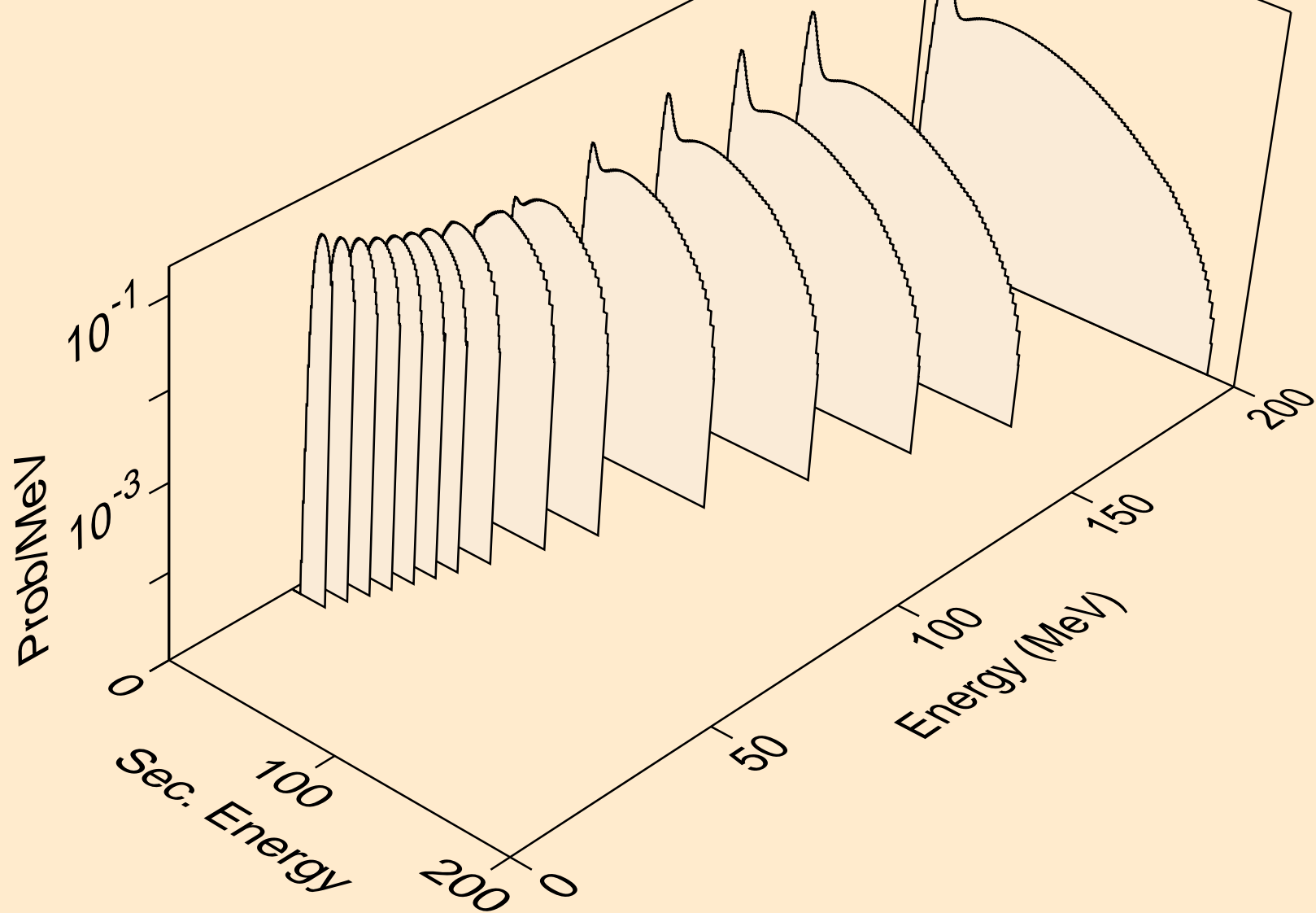

ER180 NEUTRON ACER TENDL-2024 LIBRARY; T=293.6K
tritons from (n,n*)t

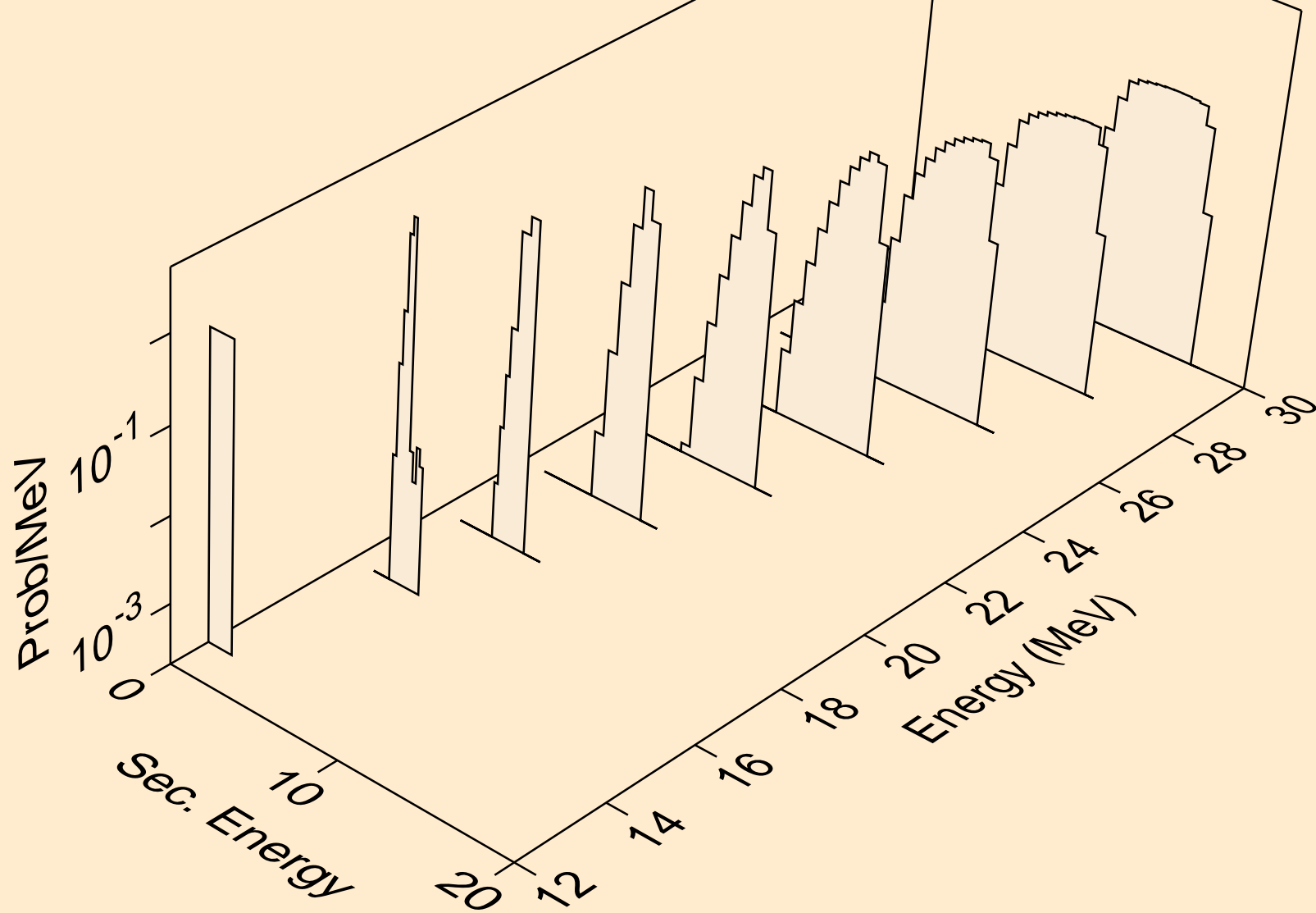

ER180 NEUTRON ACER TENDL-2024 LIBRARY; T=293.6K
tritons from (n,t)

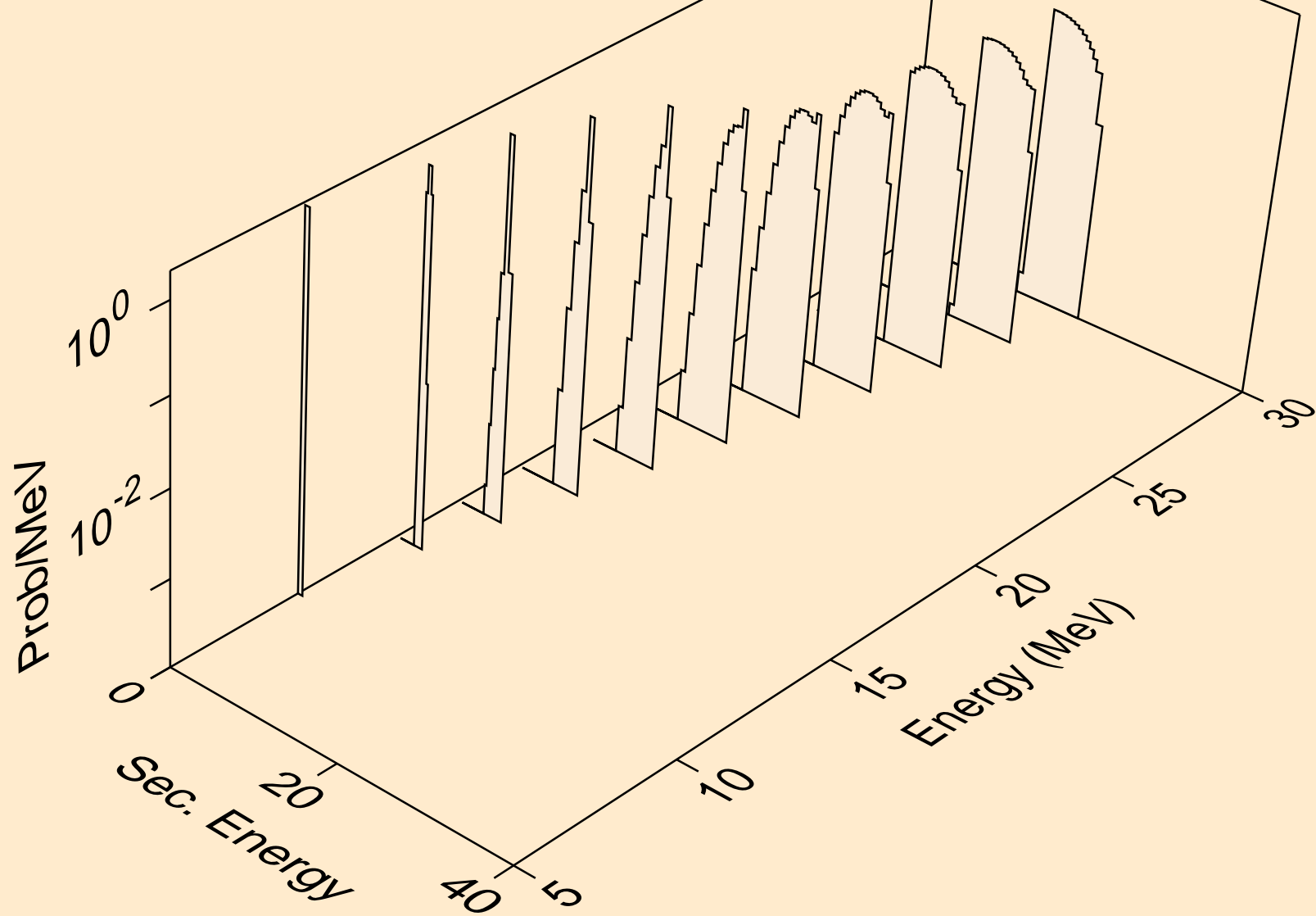

ER180 NEUTRON ACER TENDL-2024 LIBRARY; T=293.6K
he3s from (n,x)

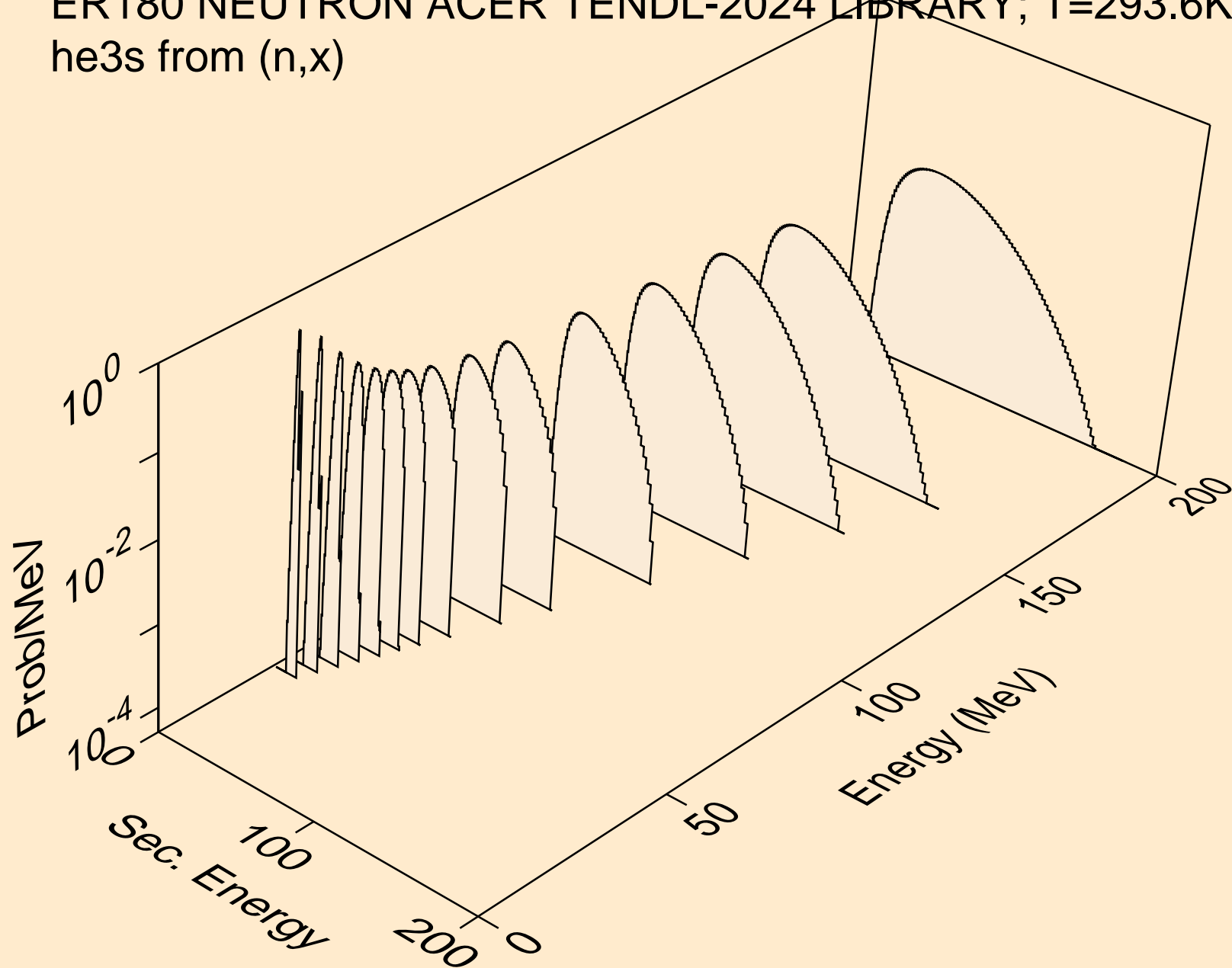

ER180 NEUTRON ACER TENDL-2024 LIBRARY; T=293.6K
he3s from (n,he3)

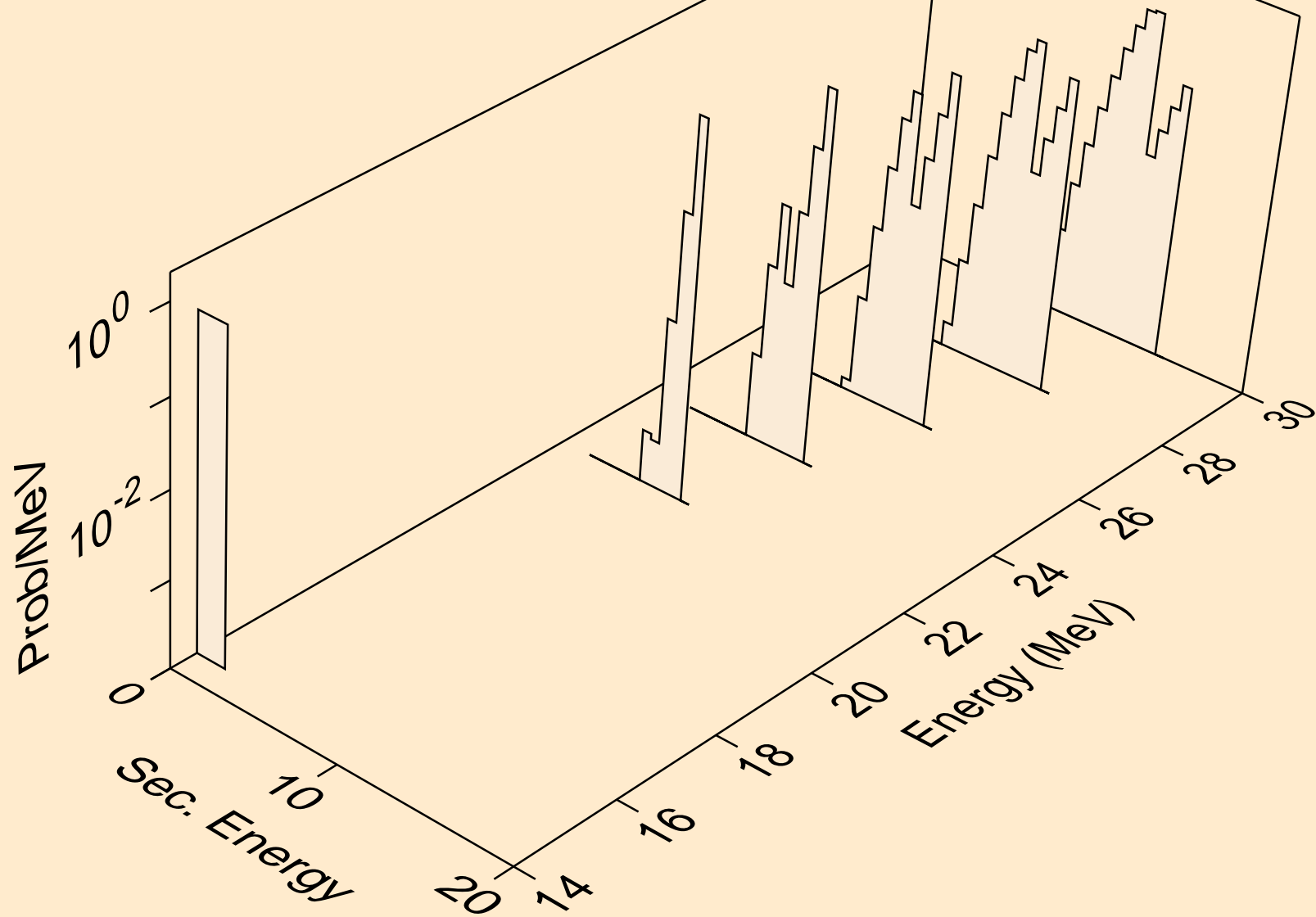

ER180 NEUTRON ACER TENDL-2024 LIBRARY; T=293.6K
alphas from (n,x)

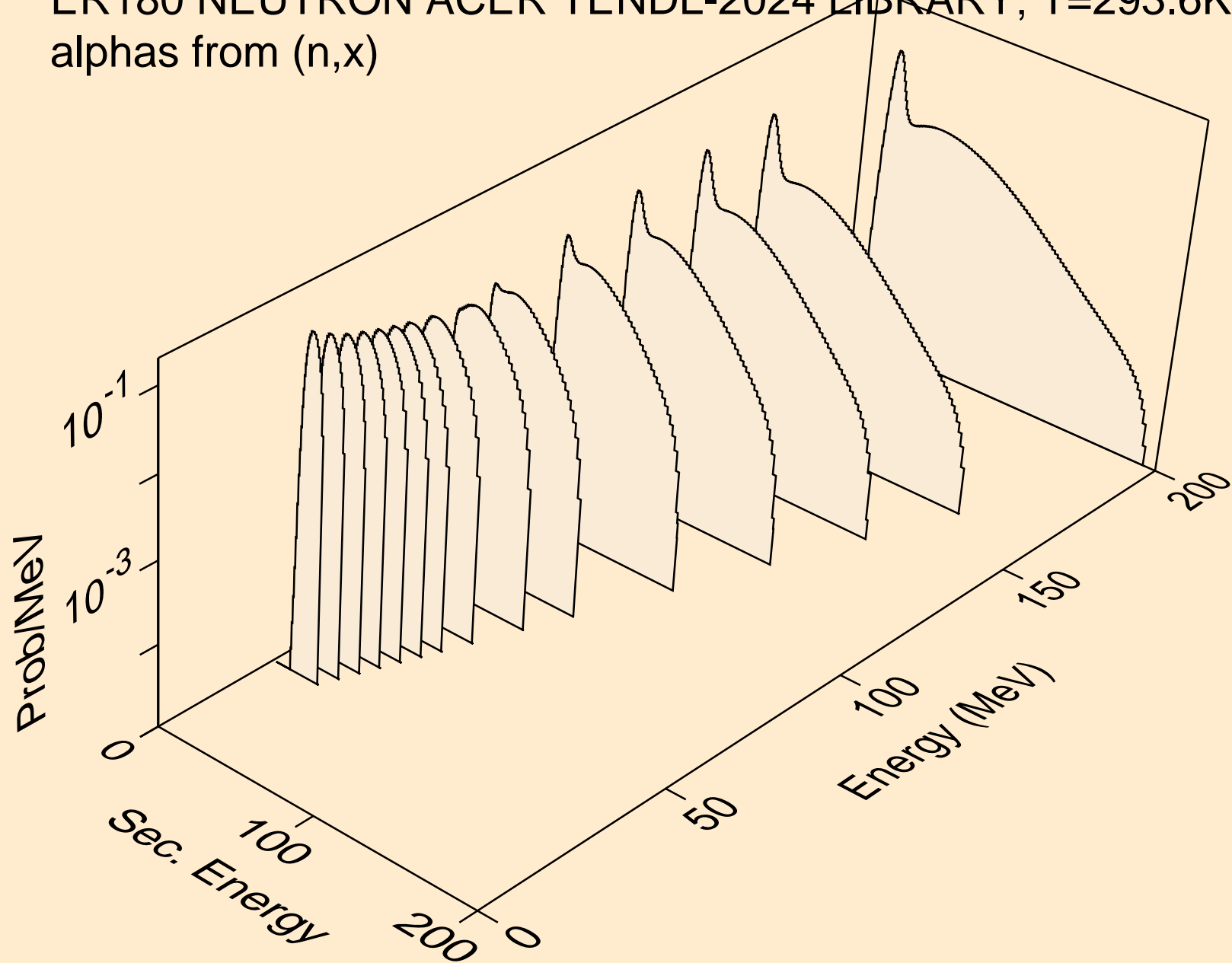

ER180 NEUTRON ACER TENDL-2024 LIBRARY; T=293.6K
alphas from (n,n*)a

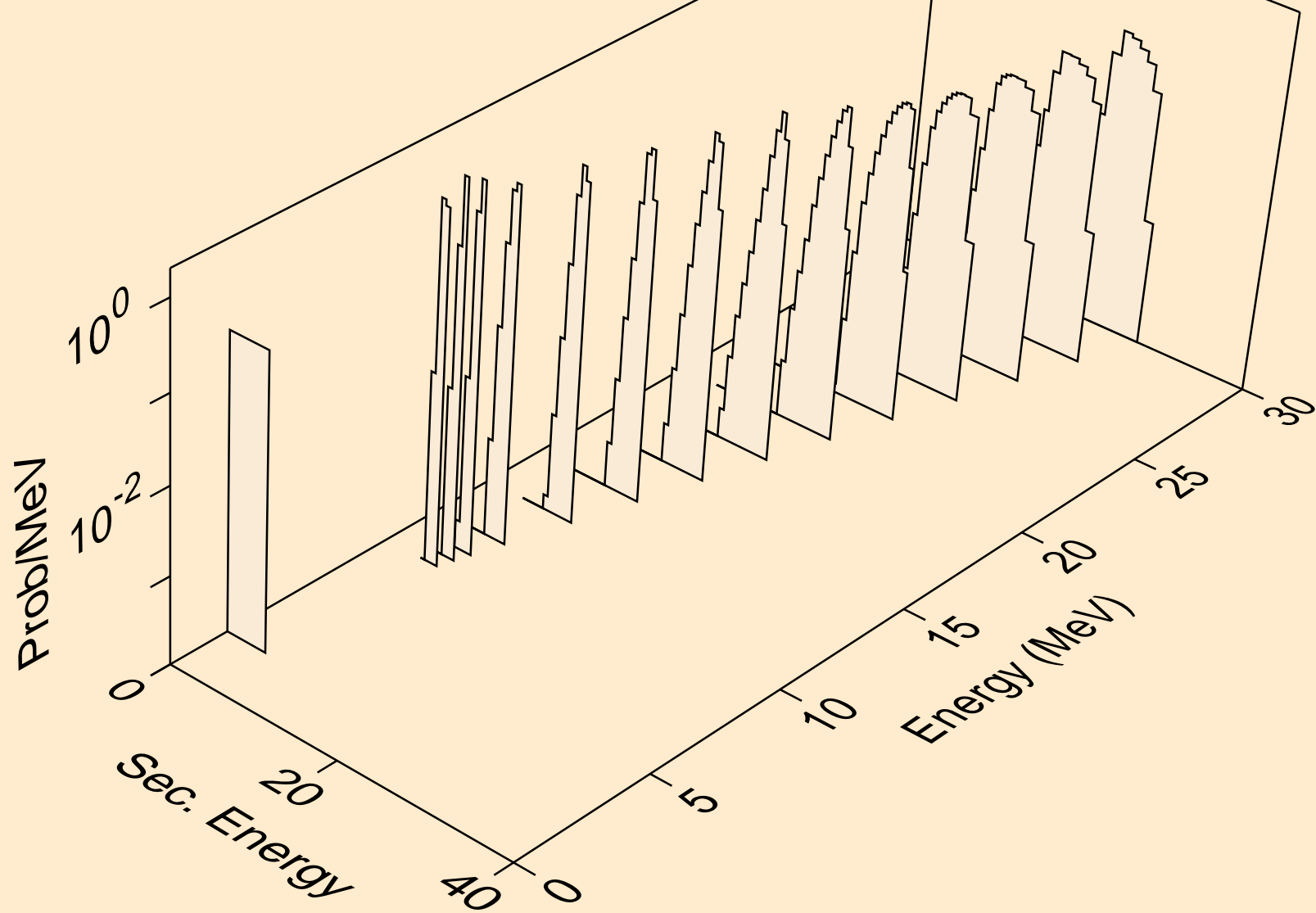

ER180 NEUTRON ACER TENDL-2024 LIBRARY; T=293.6K
alphas from (n,2n)a

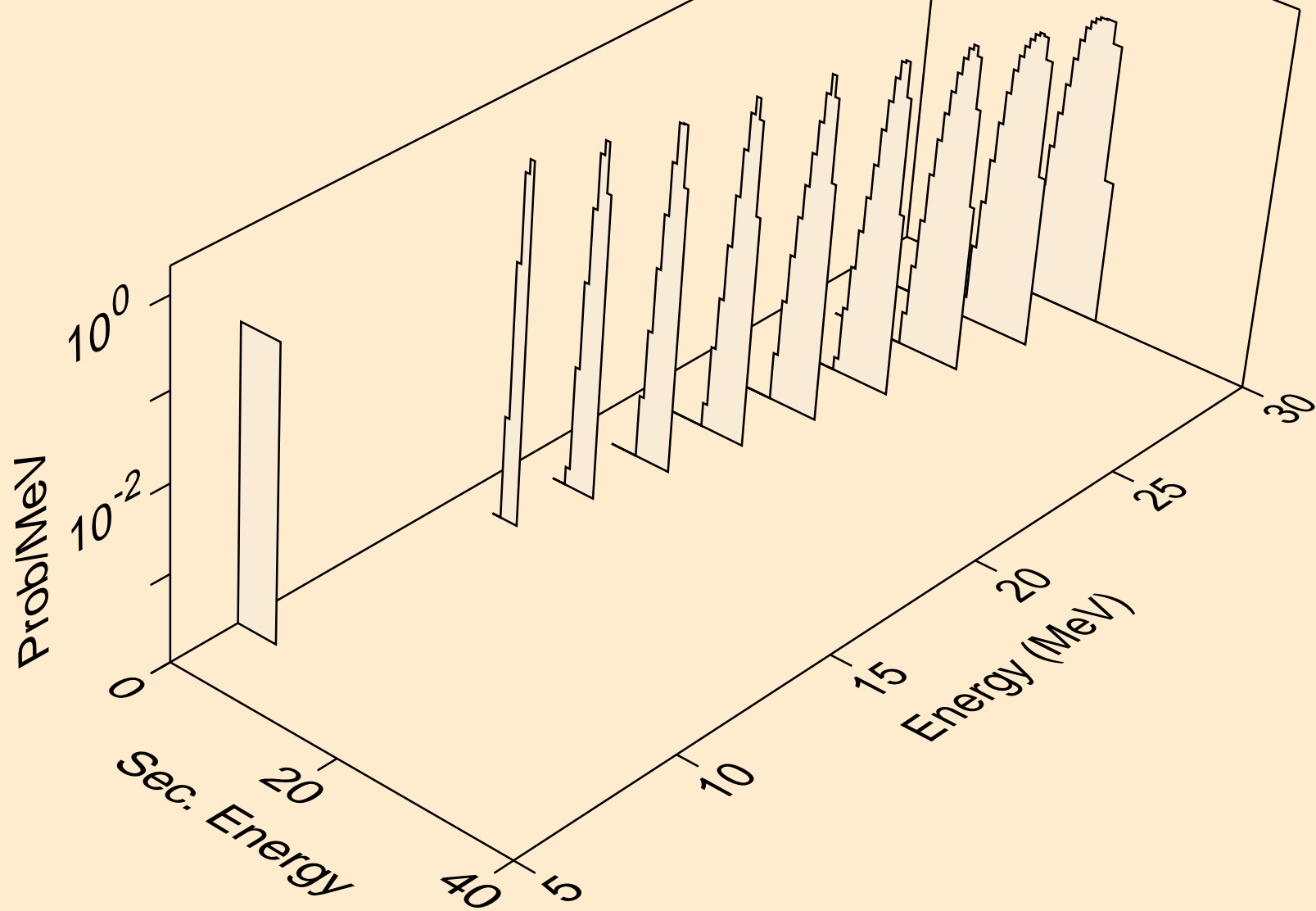

ER180 NEUTRON ACER TENDL-2024 LIBRARY; T=293.6K
alphas from (n,3n)a

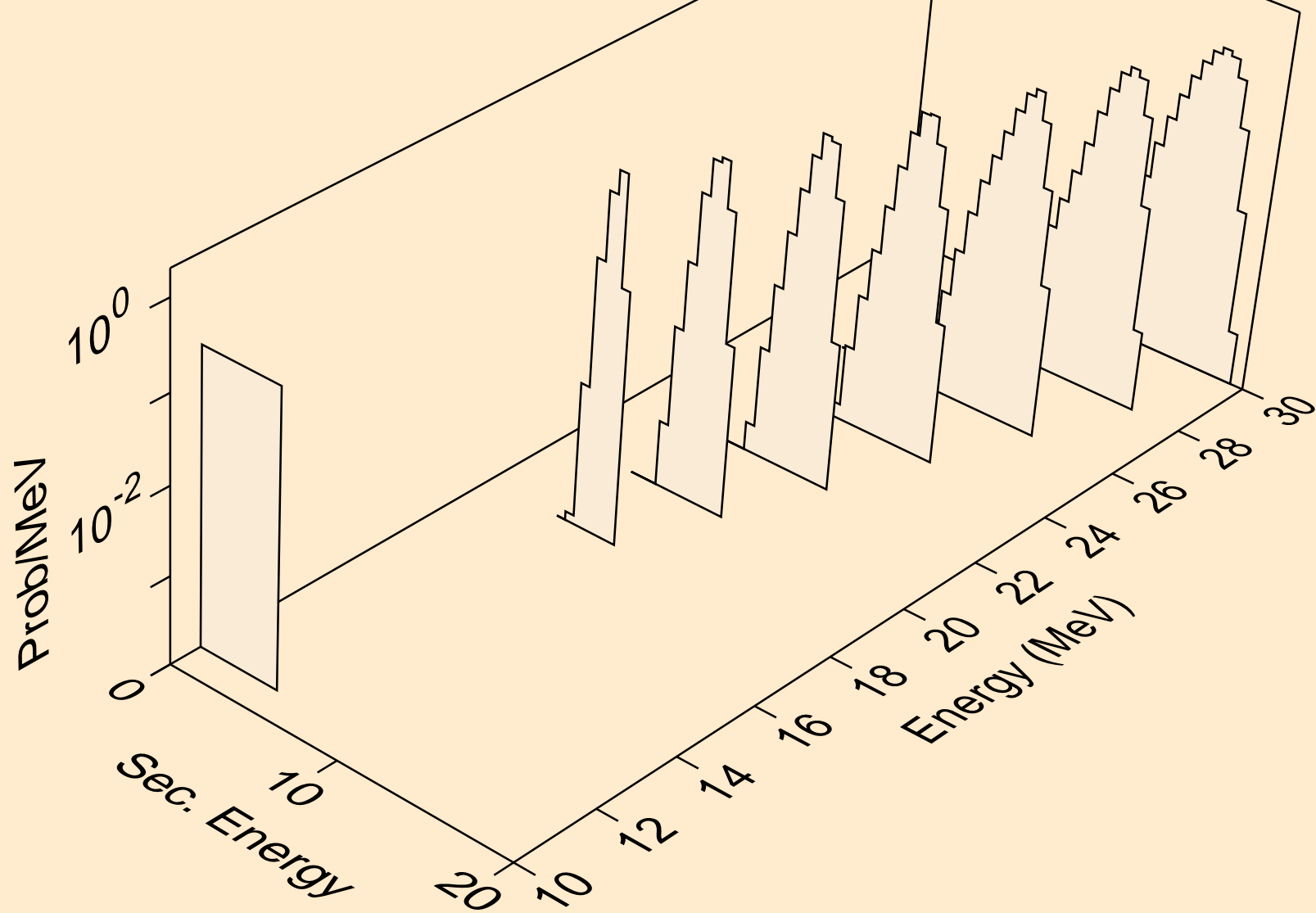

ER180 NEUTRON ACER TENDL-2024 LIBRARY; T=293.6K
alphas from (n,a)

