

FR229 NEUTRON ACER TENDL-2024 LIBRARY; T=293.6K

Principal cross sections

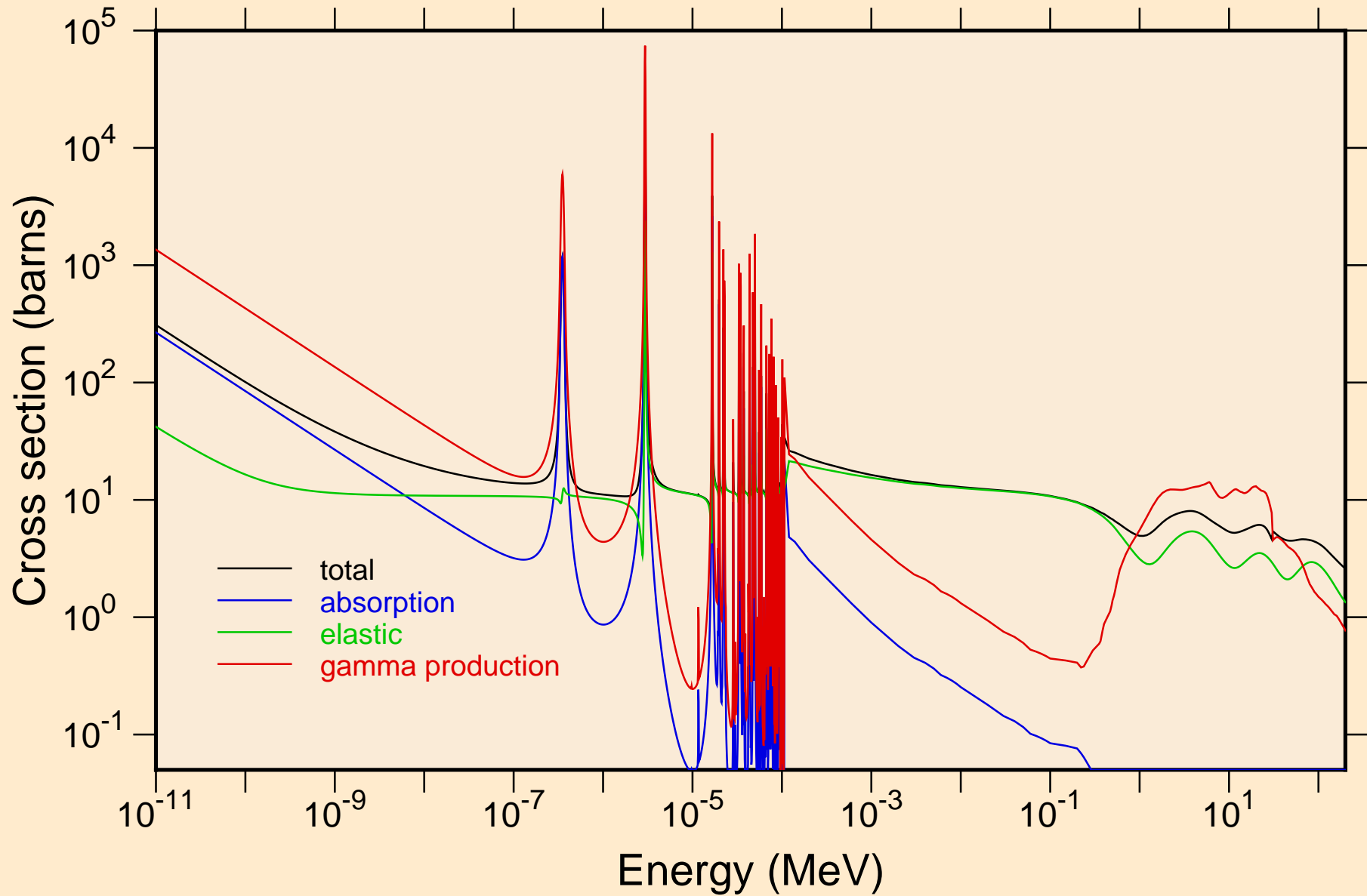

FR229 NEUTRON ACER TENDL-2024 LIBRARY; T=293.6K
resonance total cross section

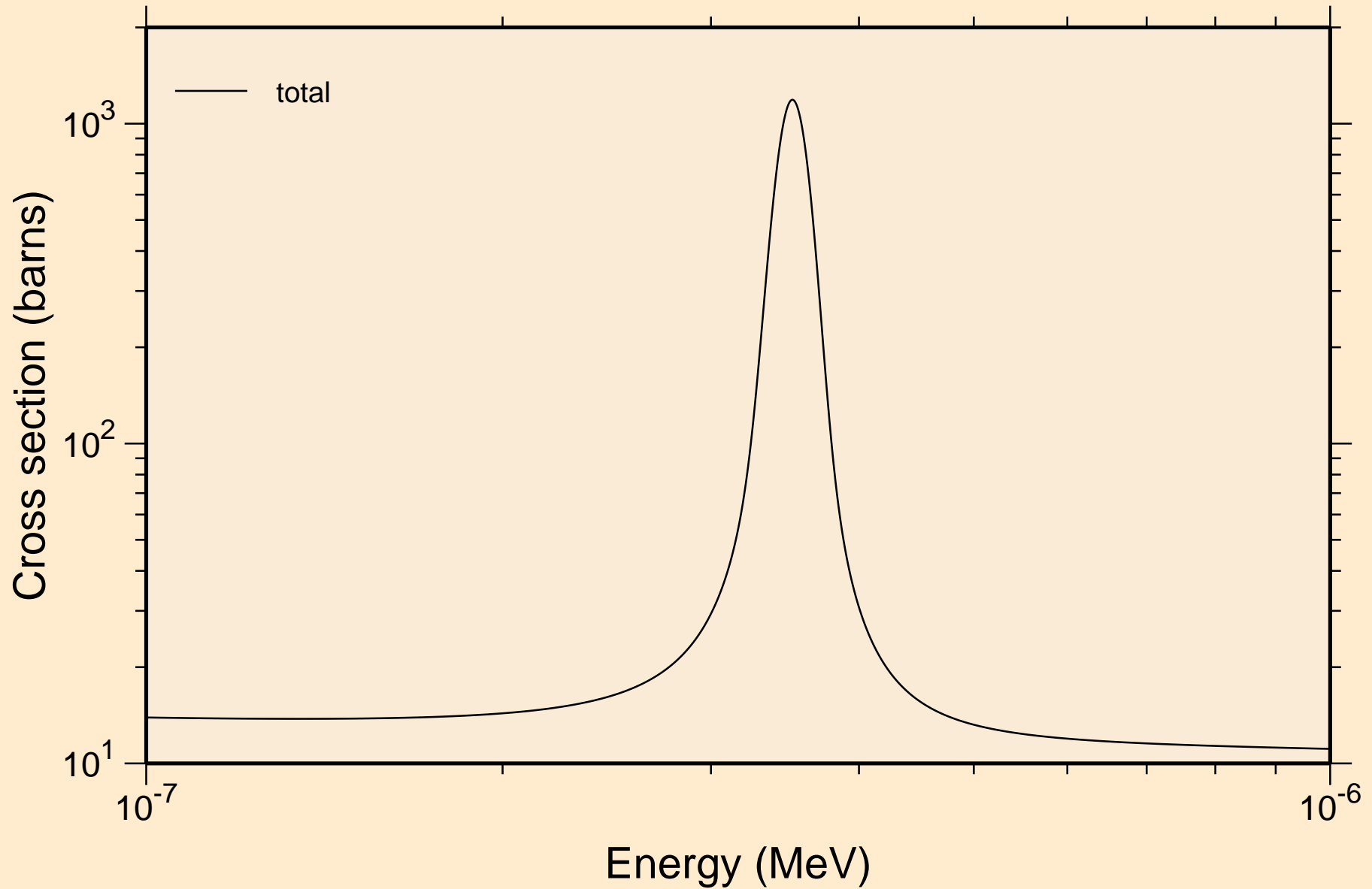

FR229 NEUTRON ACER TENDL-2024 LIBRARY; T=293.6K
resonance total cross section

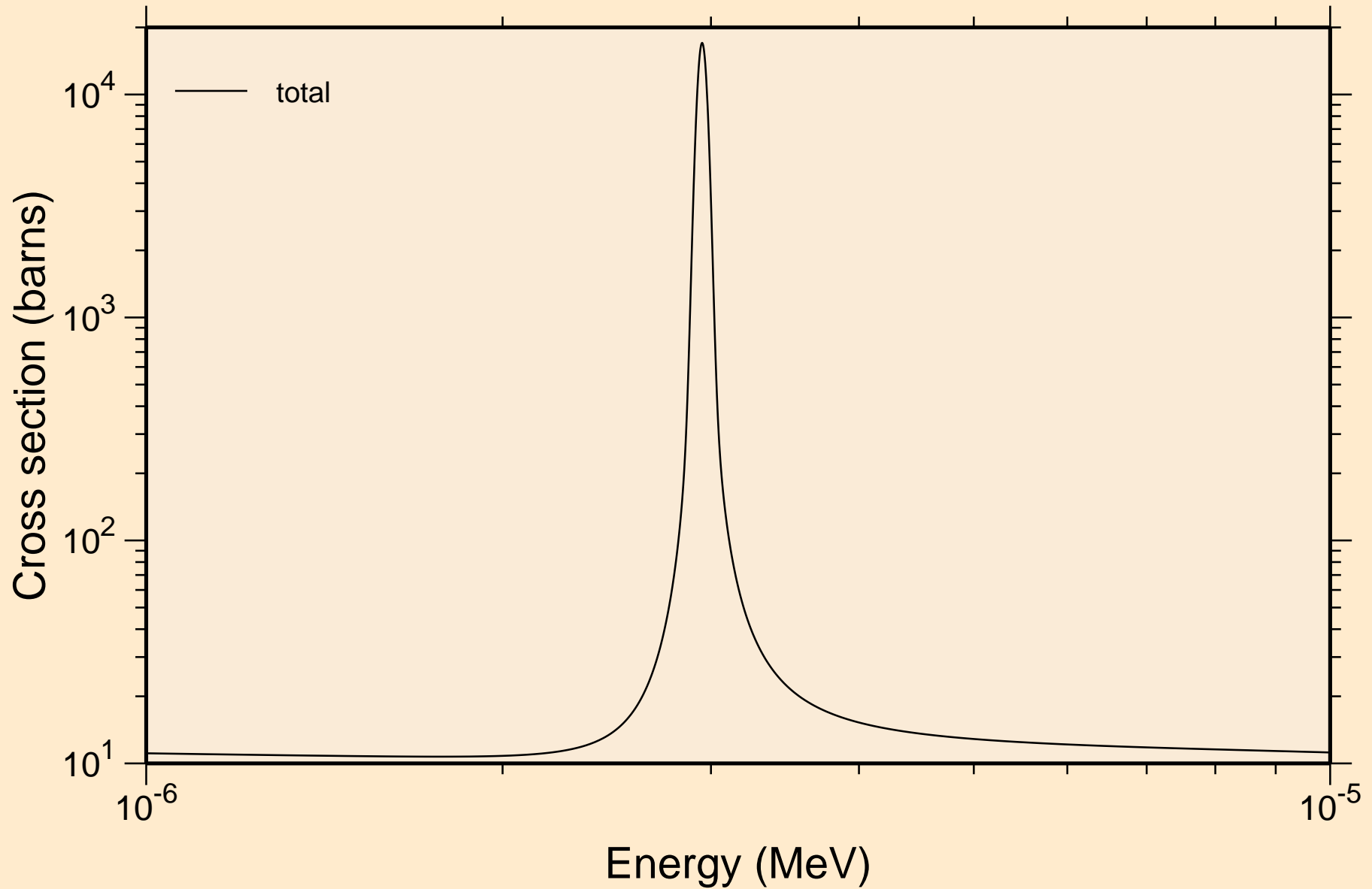

FR229 NEUTRON ACER TENDL-2024 LIBRARY; T=293.6K
resonance total cross section

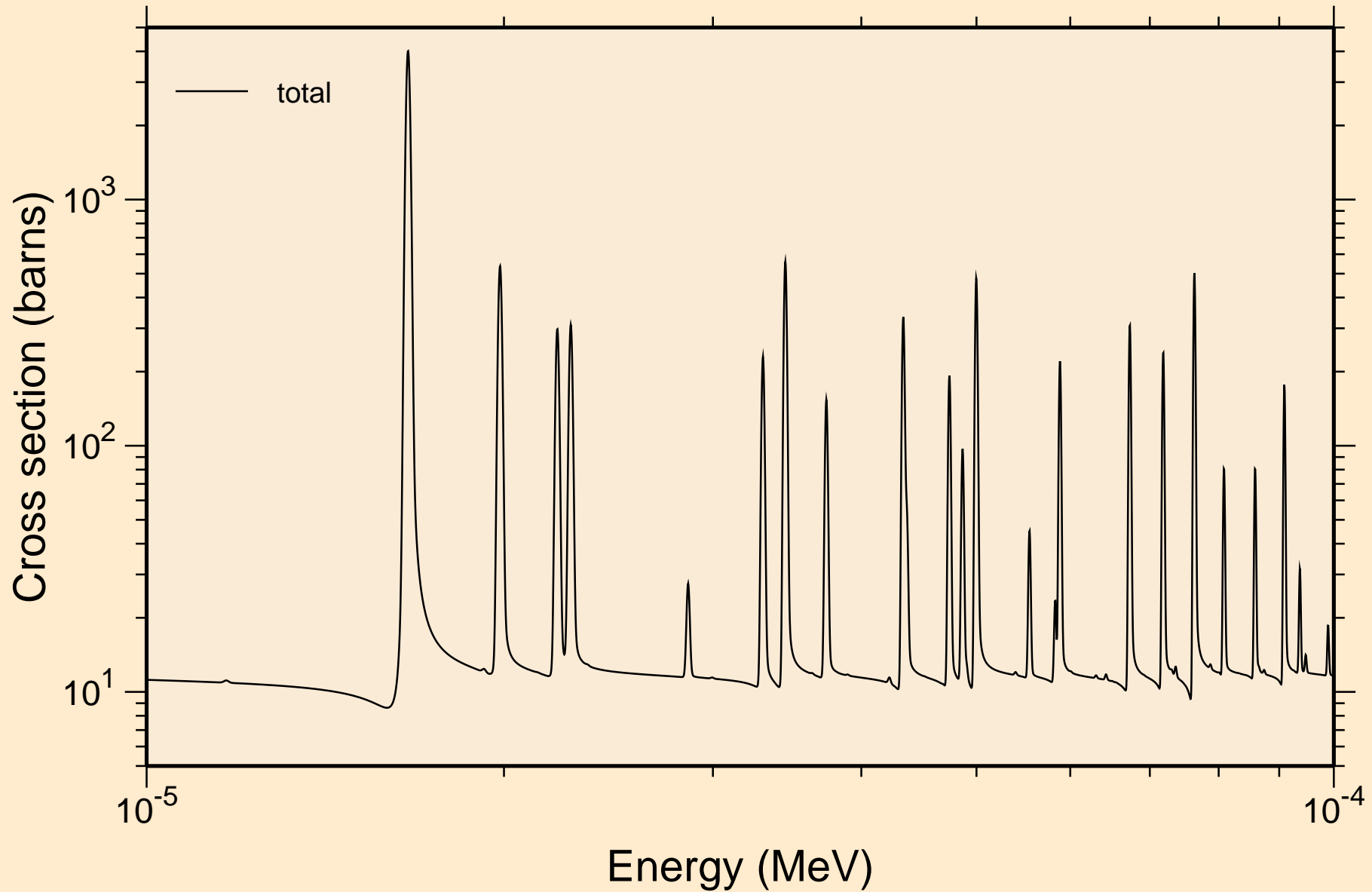

FR229 NEUTRON ACER TENDL-2024 LIBRARY; T=293.6K
resonance total cross section

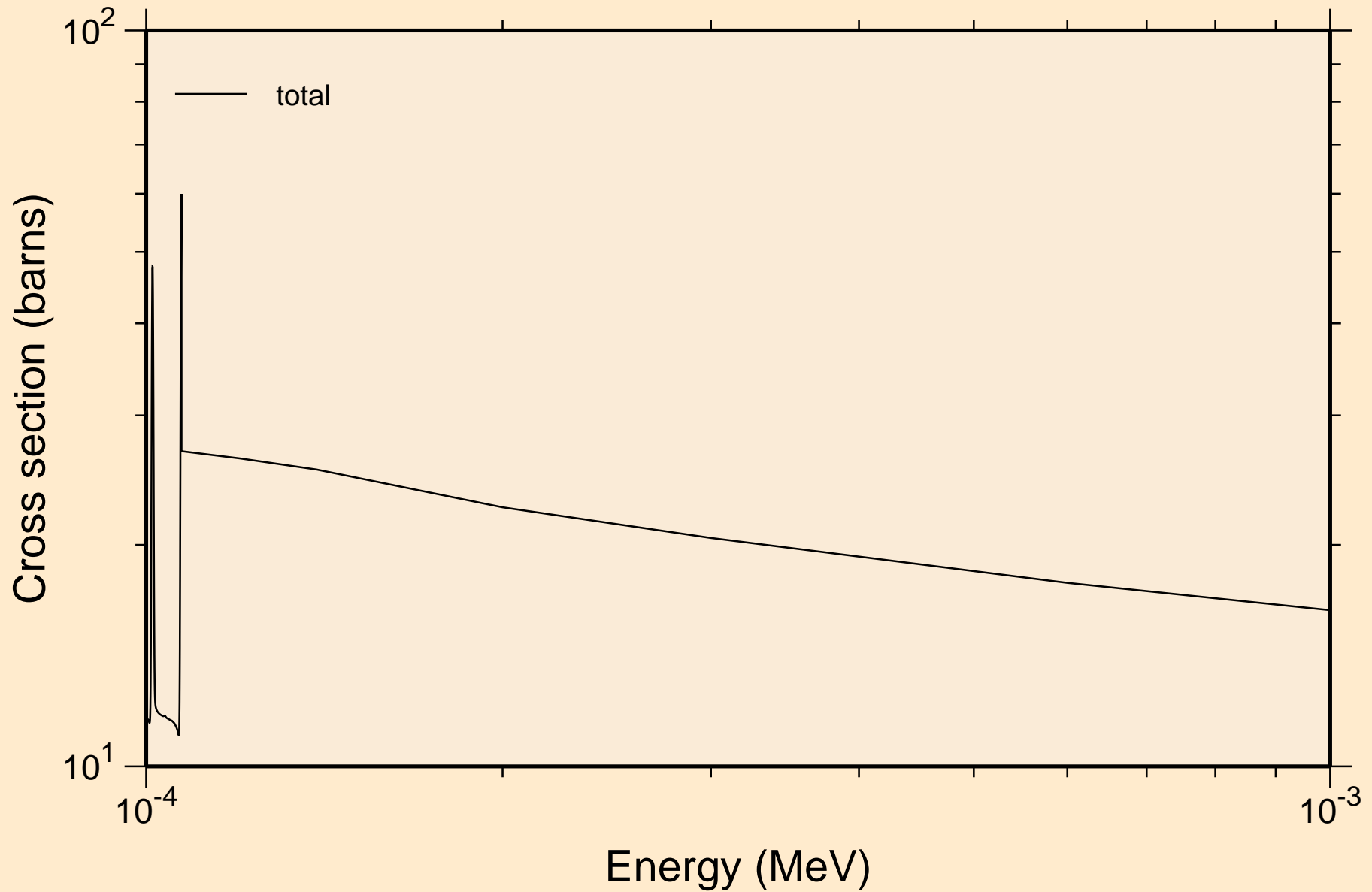

FR229 NEUTRON ACER TENDL-2024 LIBRARY; T=293.6K
resonance total cross section

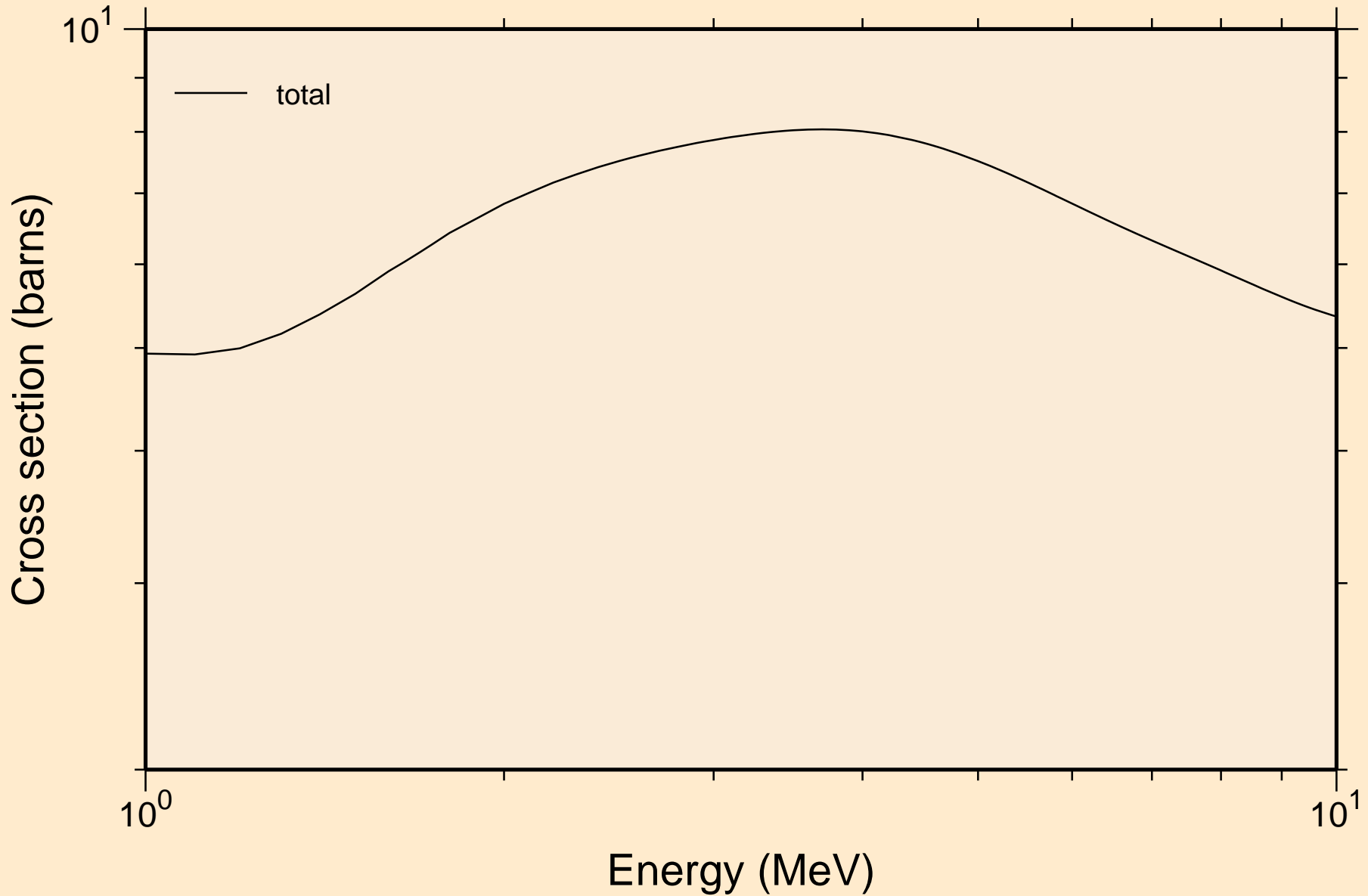

FR229 NEUTRON ACER TENDL-2024 LIBRARY; T=293.6K
resonance absorption cross sections

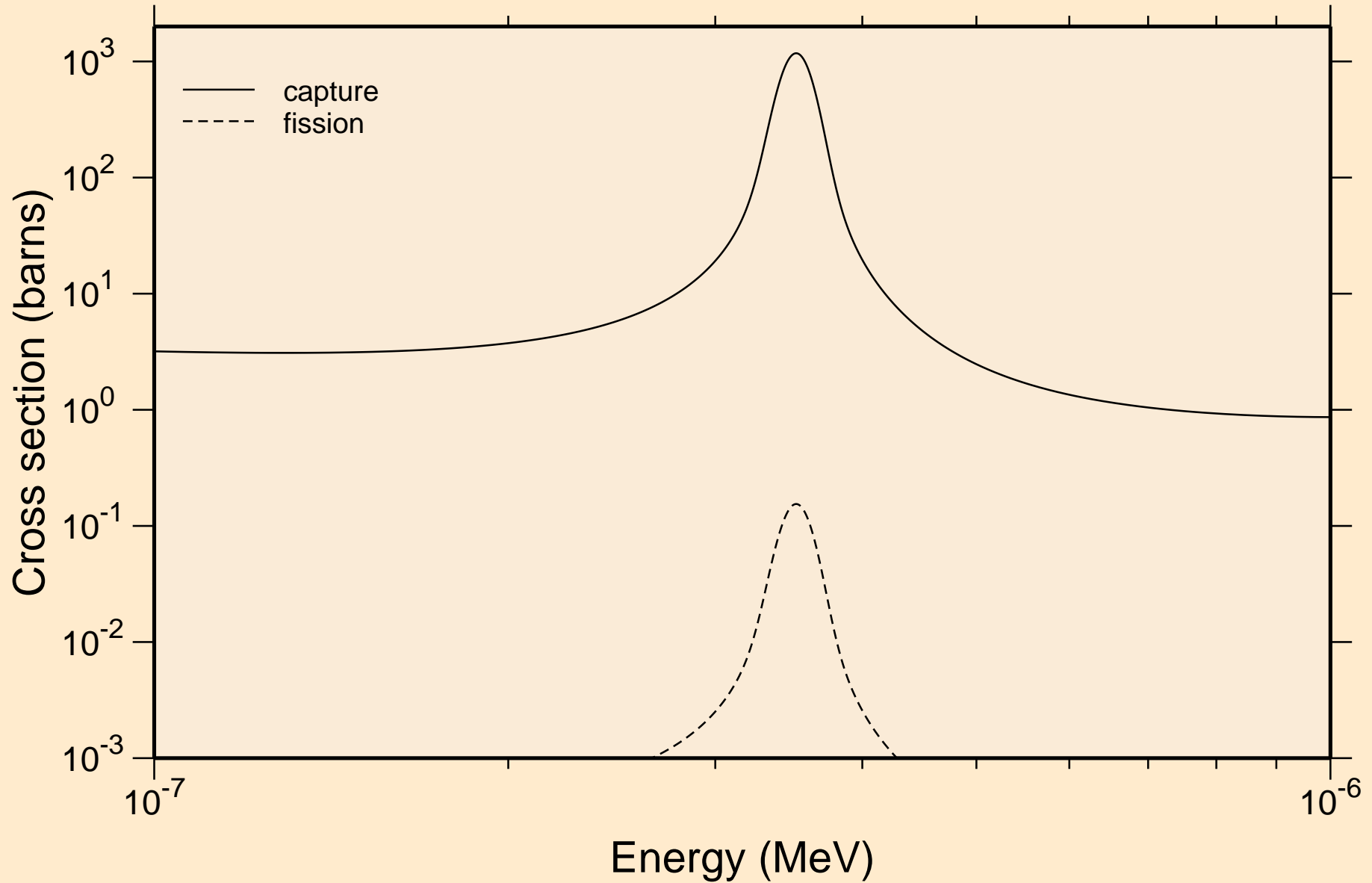

FR229 NEUTRON ACER TENDL-2024 LIBRARY; T=293.6K
resonance absorption cross sections

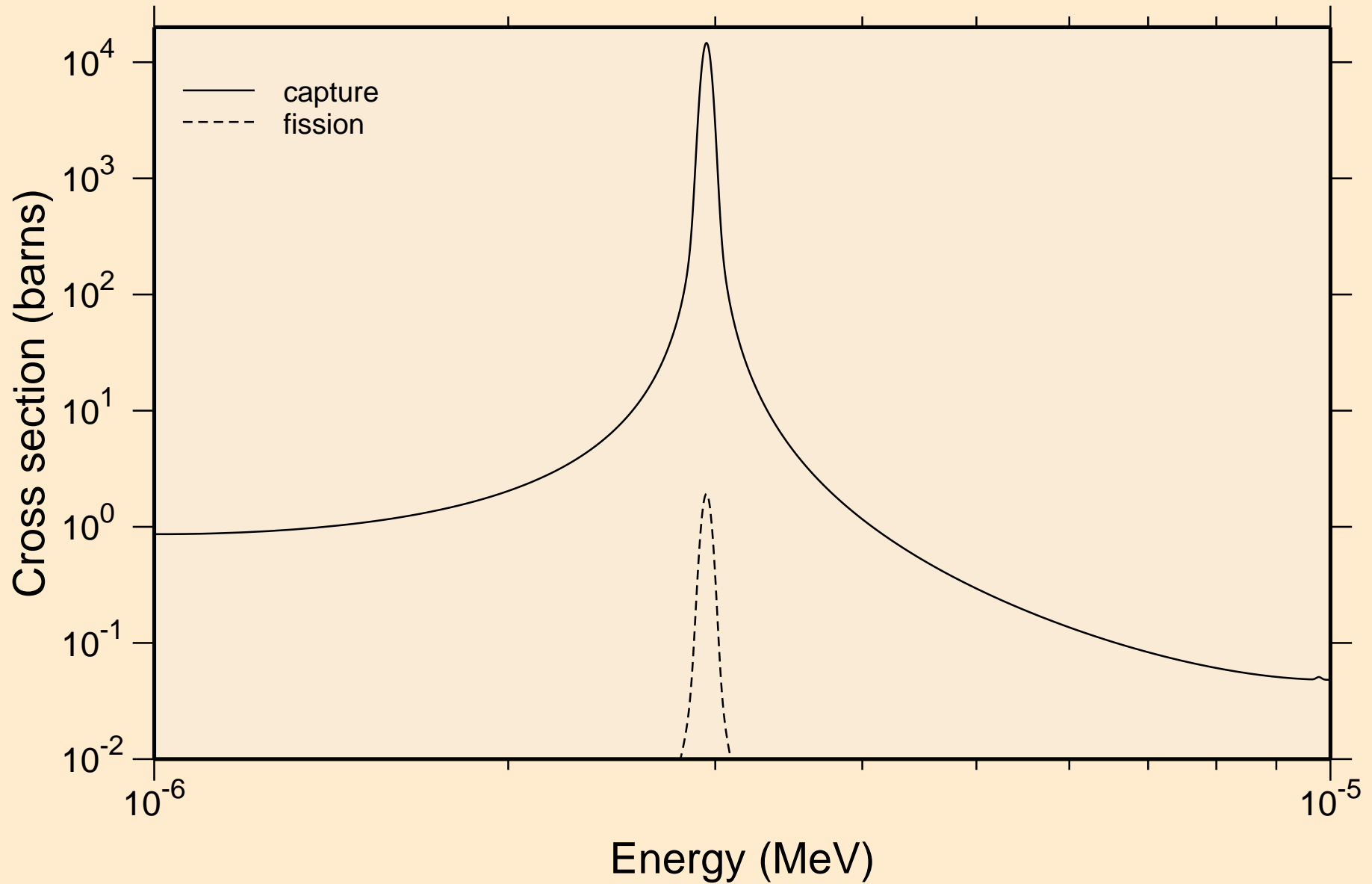

FR229 NEUTRON ACER TENDL-2024 LIBRARY; T=293.6K
resonance absorption cross sections

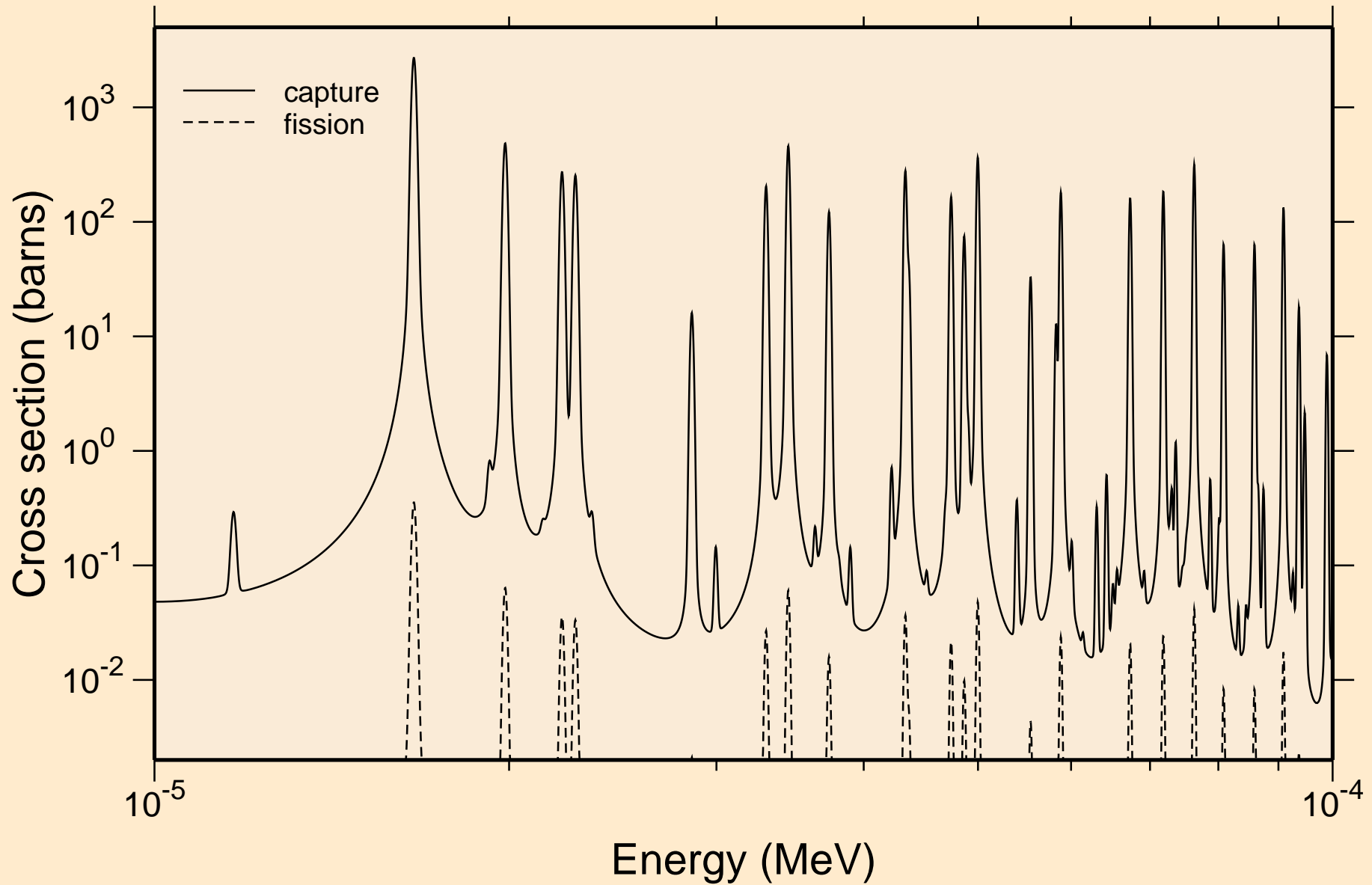

FR229 NEUTRON ACER TENDL-2024 LIBRARY; T=293.6K
resonance absorption cross sections

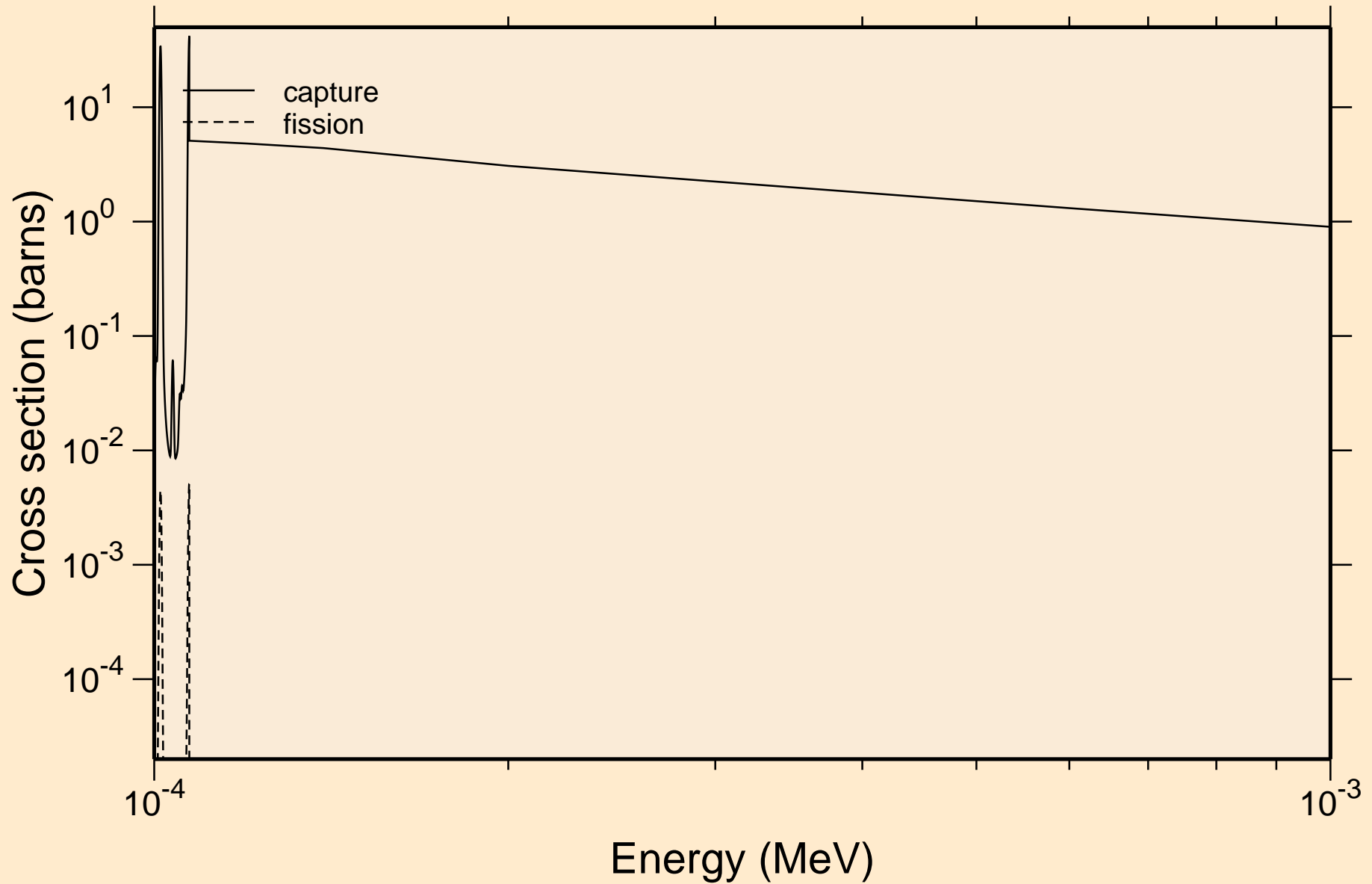

FR229 NEUTRON ACER TENDL-2024 LIBRARY; T=293.6K
resonance absorption cross sections

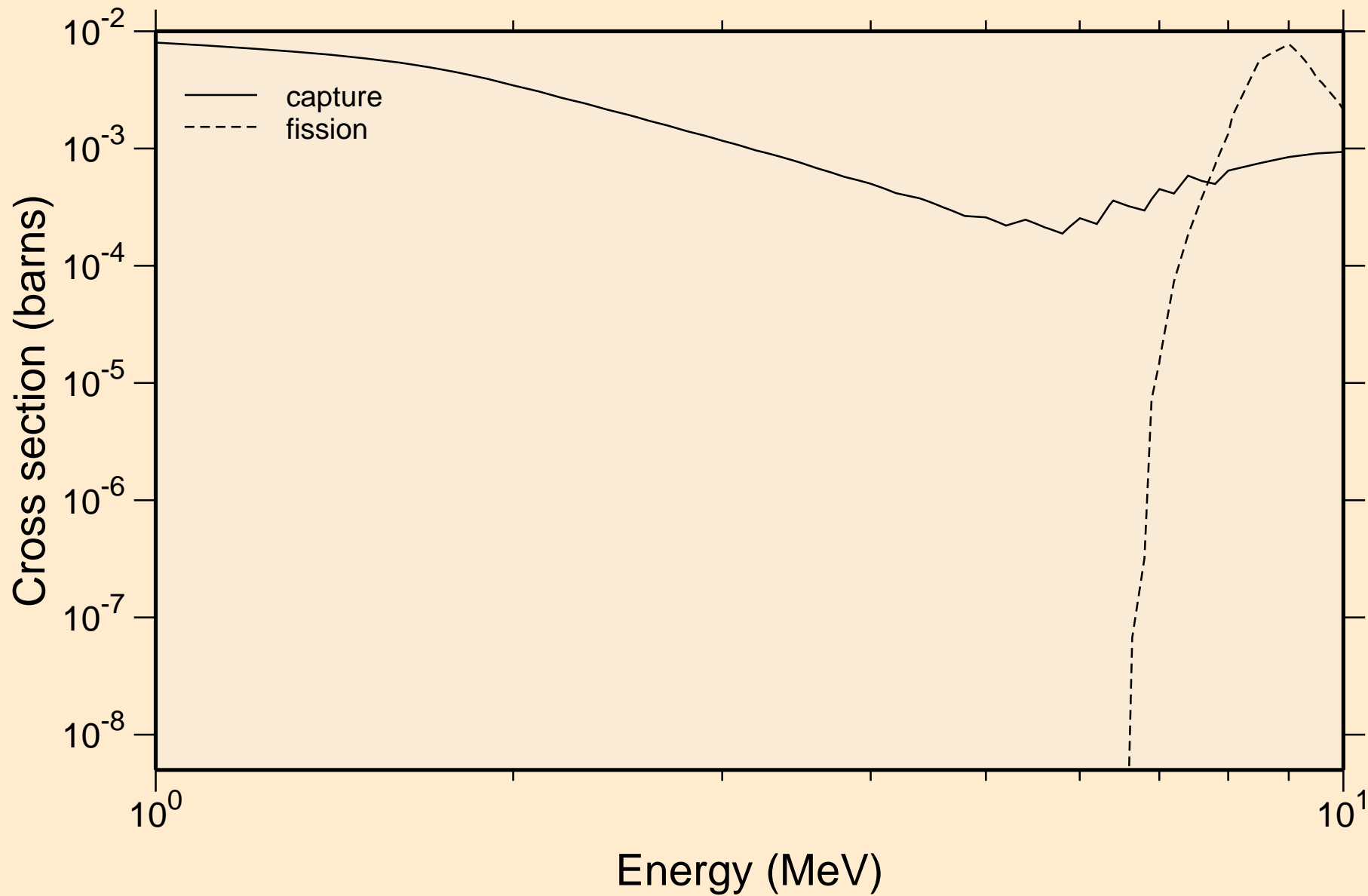

FR229 NEUTRON ACER TENDL-2024 LIBRARY; T=293.6K
Heating

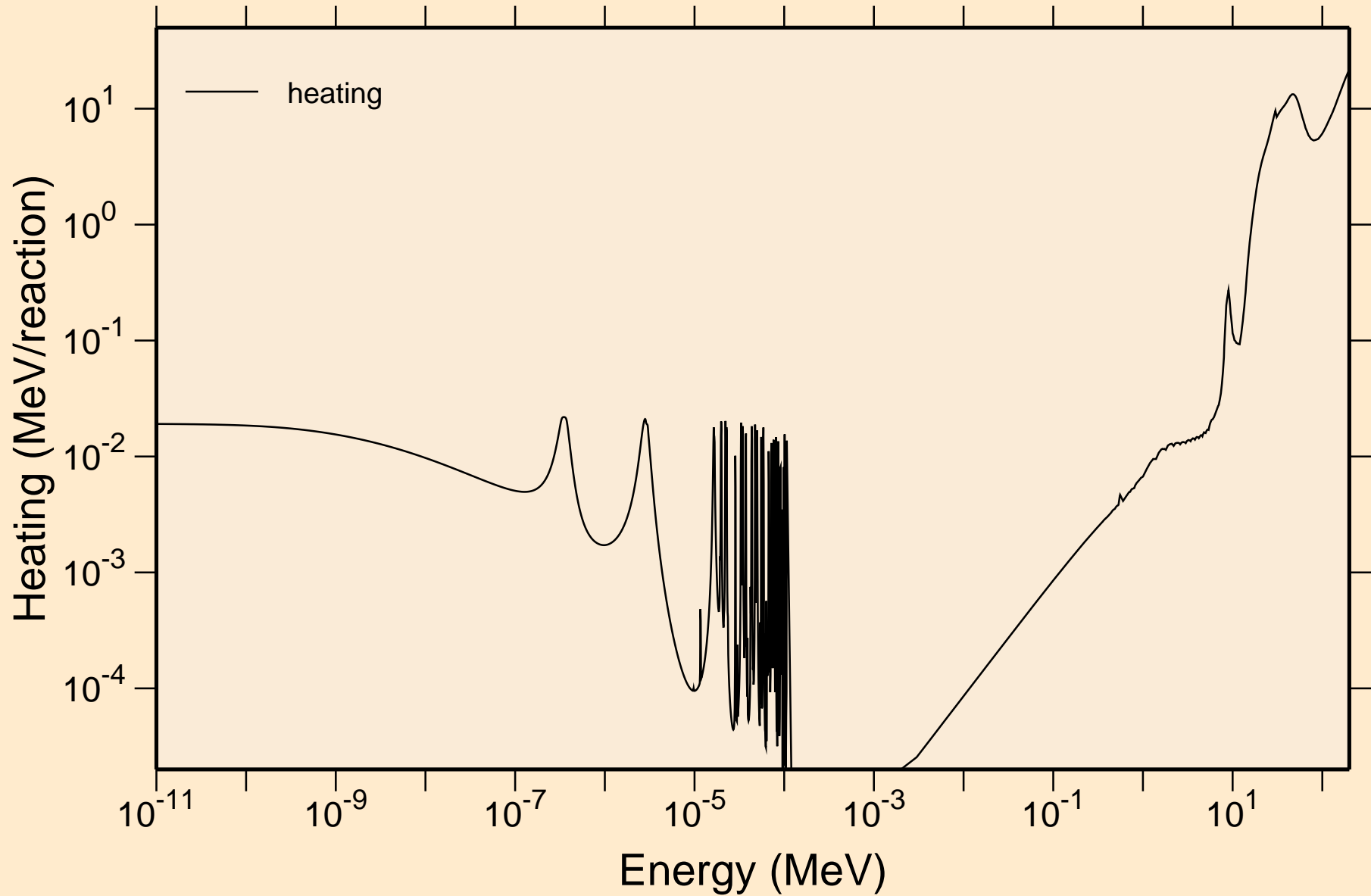

FR229 NEUTRON ACER TENDL-2024 LIBRARY; T=293.6K

Damage

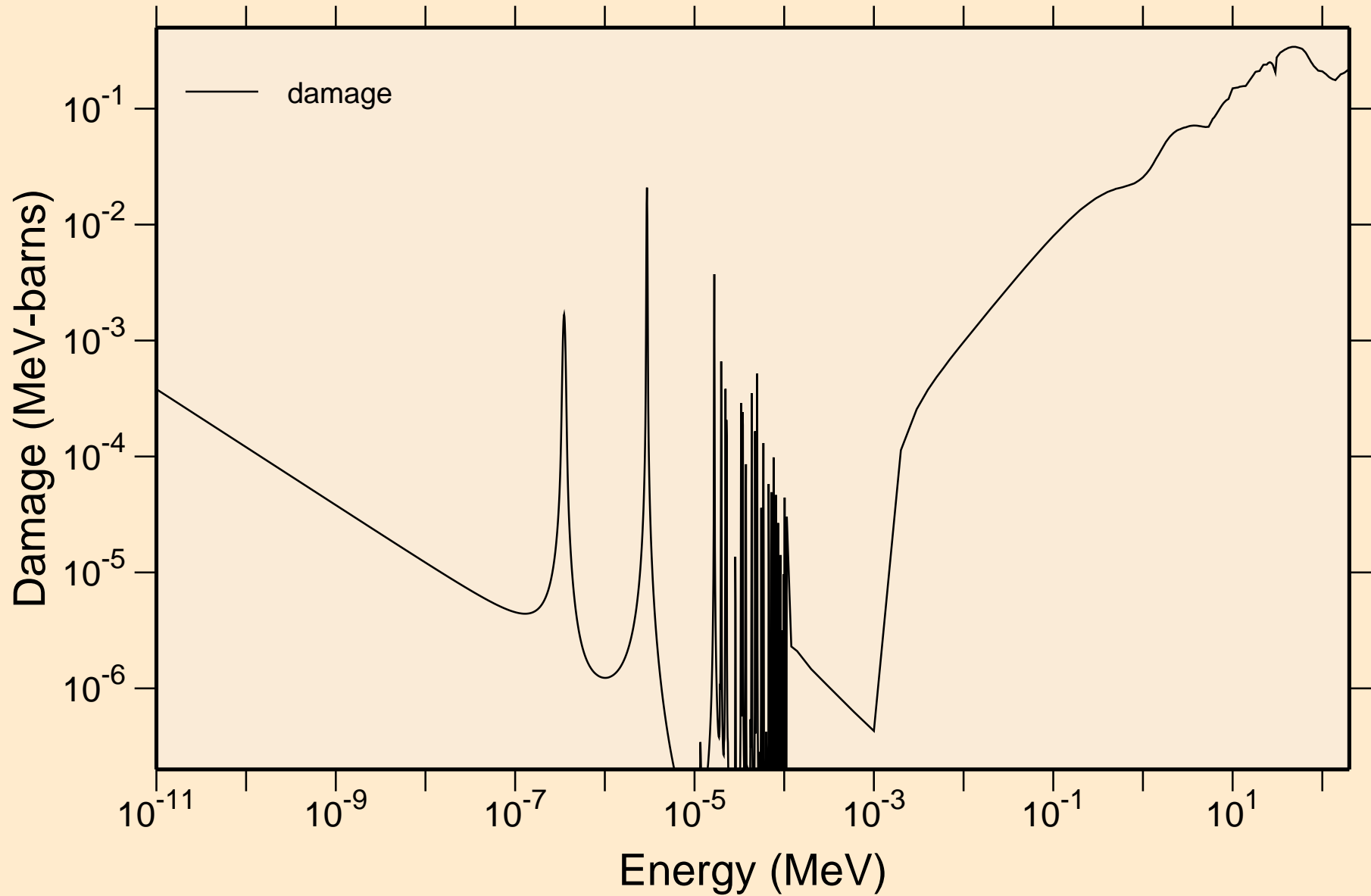

FR229 NEUTRON ACER TENDL-2024 LIBRARY; T=293.6K
Non-threshold reactions

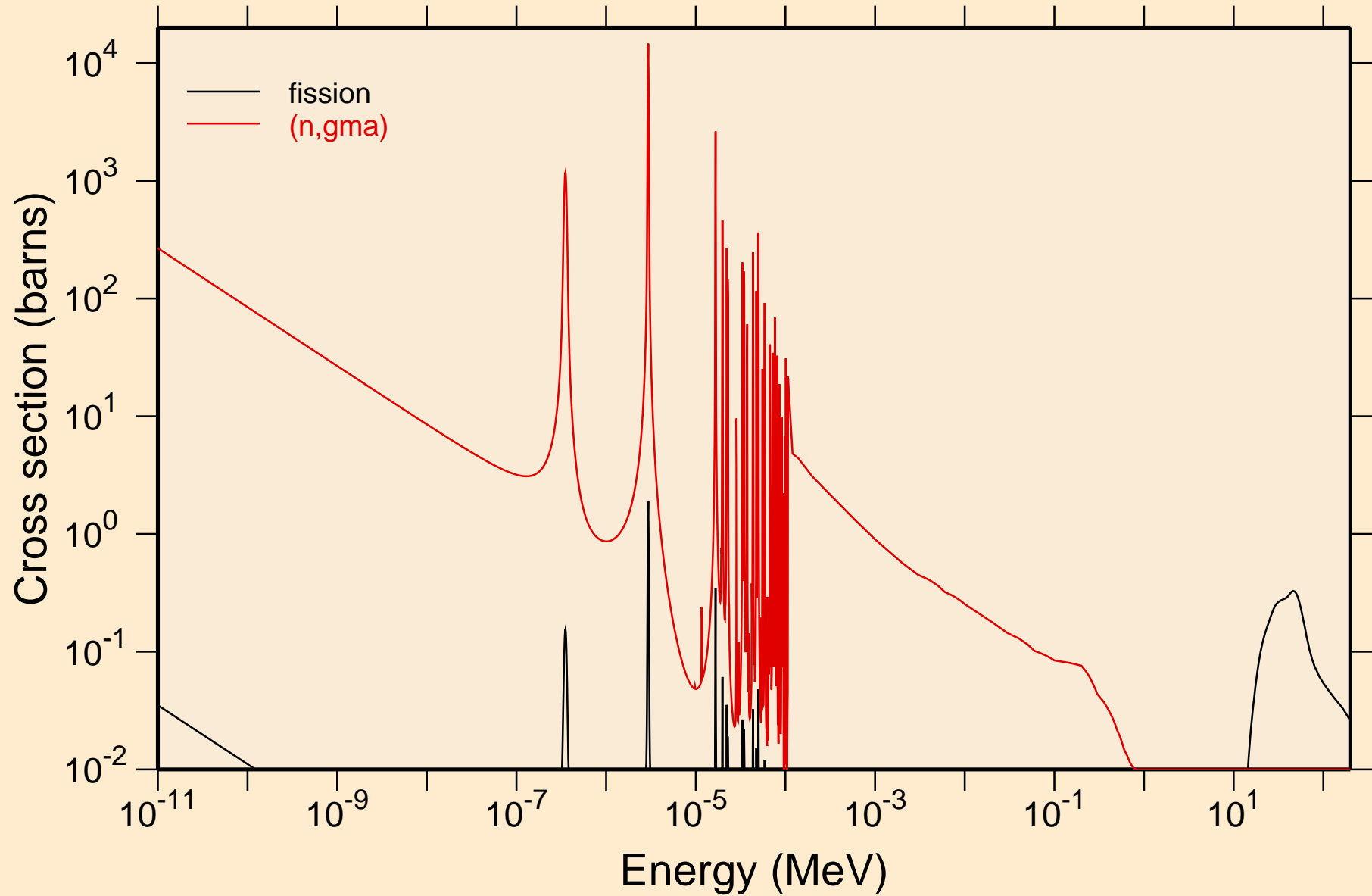

FR229 NEUTRON ACER TENDL-2024 LIBRARY; T=293.6K

Principal cross sections

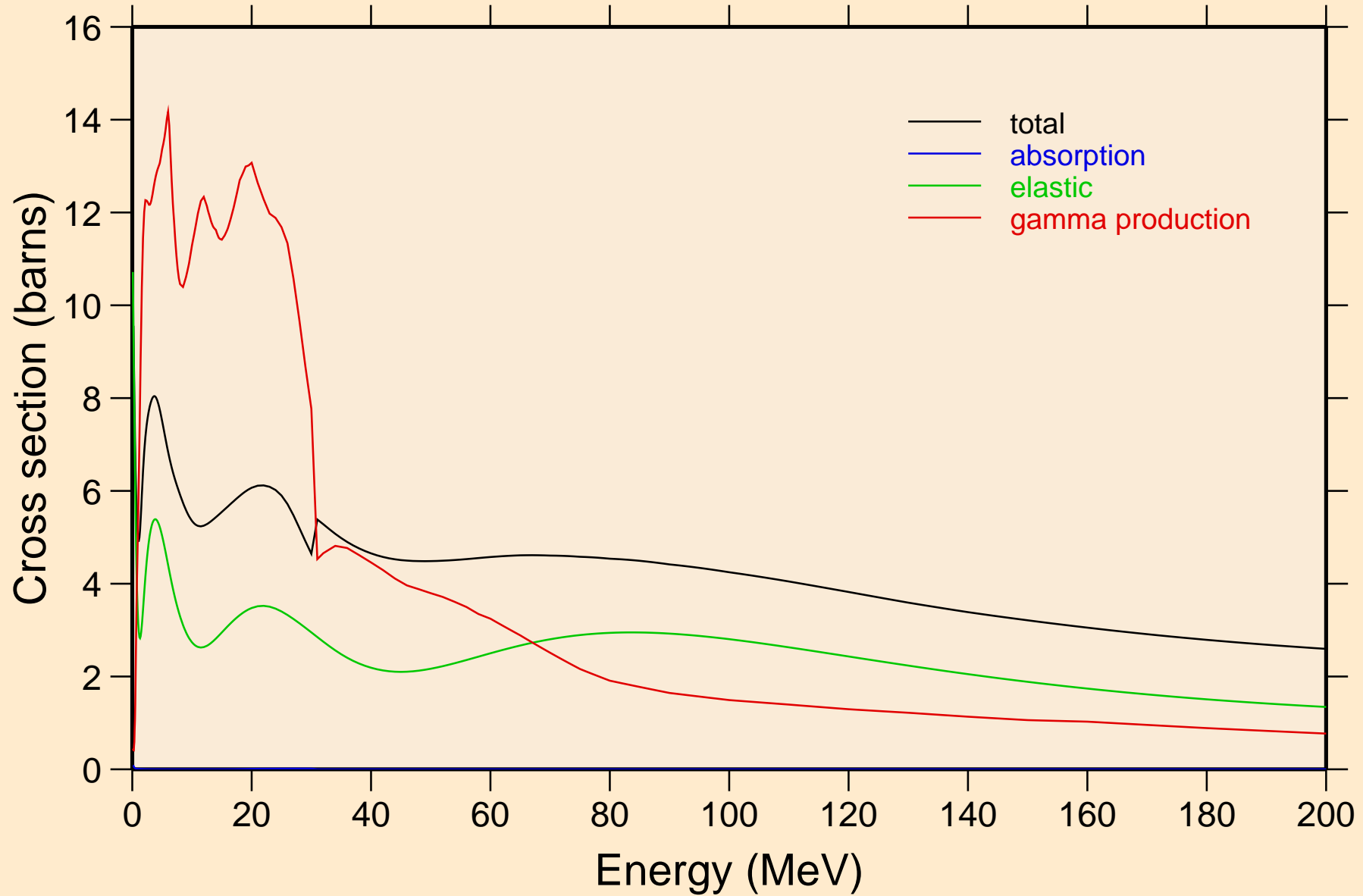

FR229 NEUTRON ACER TENDL-2024 LIBRARY; T=293.6K
Heating

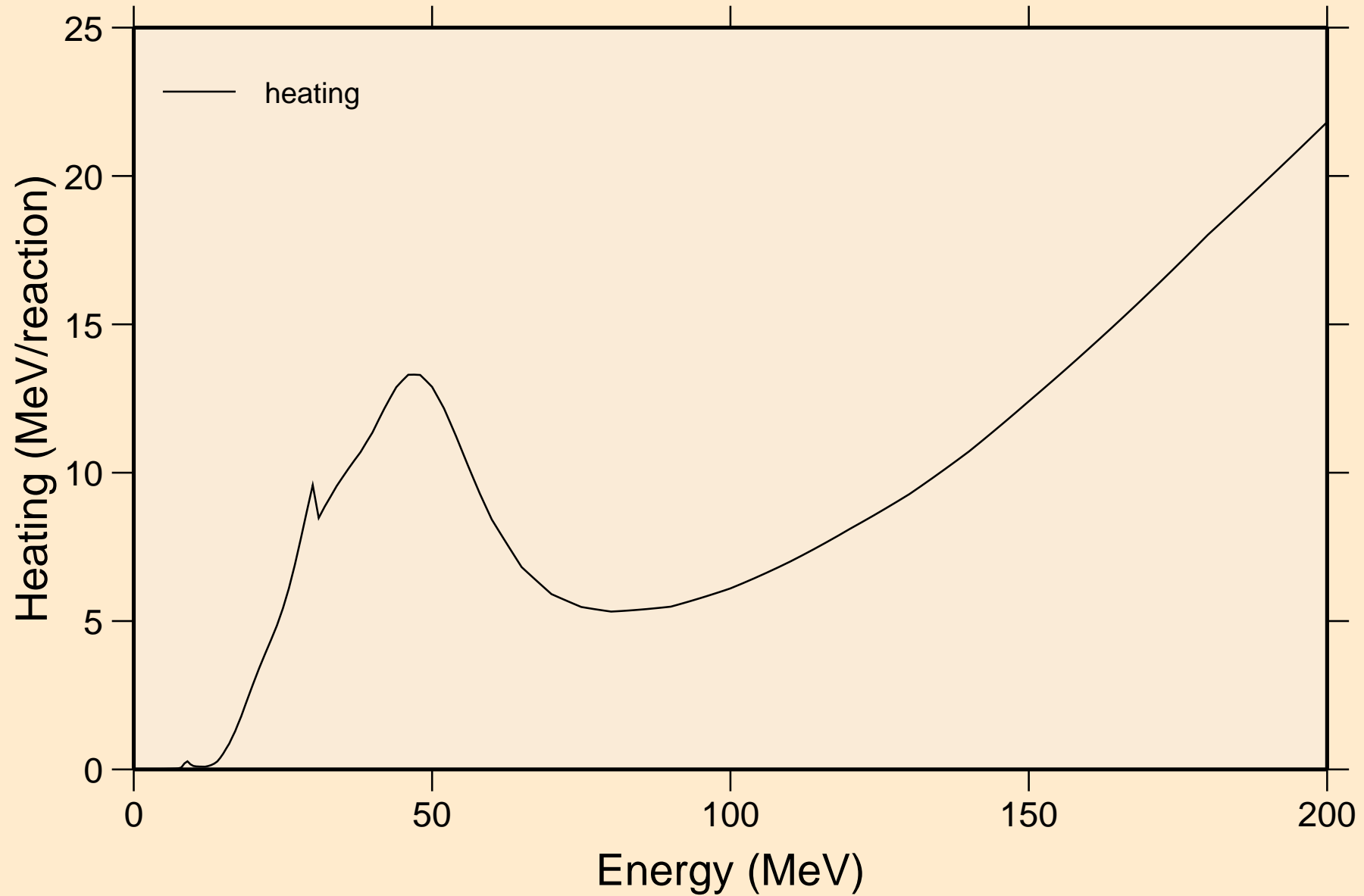

FR229 NEUTRON ACER TENDL-2024 LIBRARY; T=293.6K
Damage

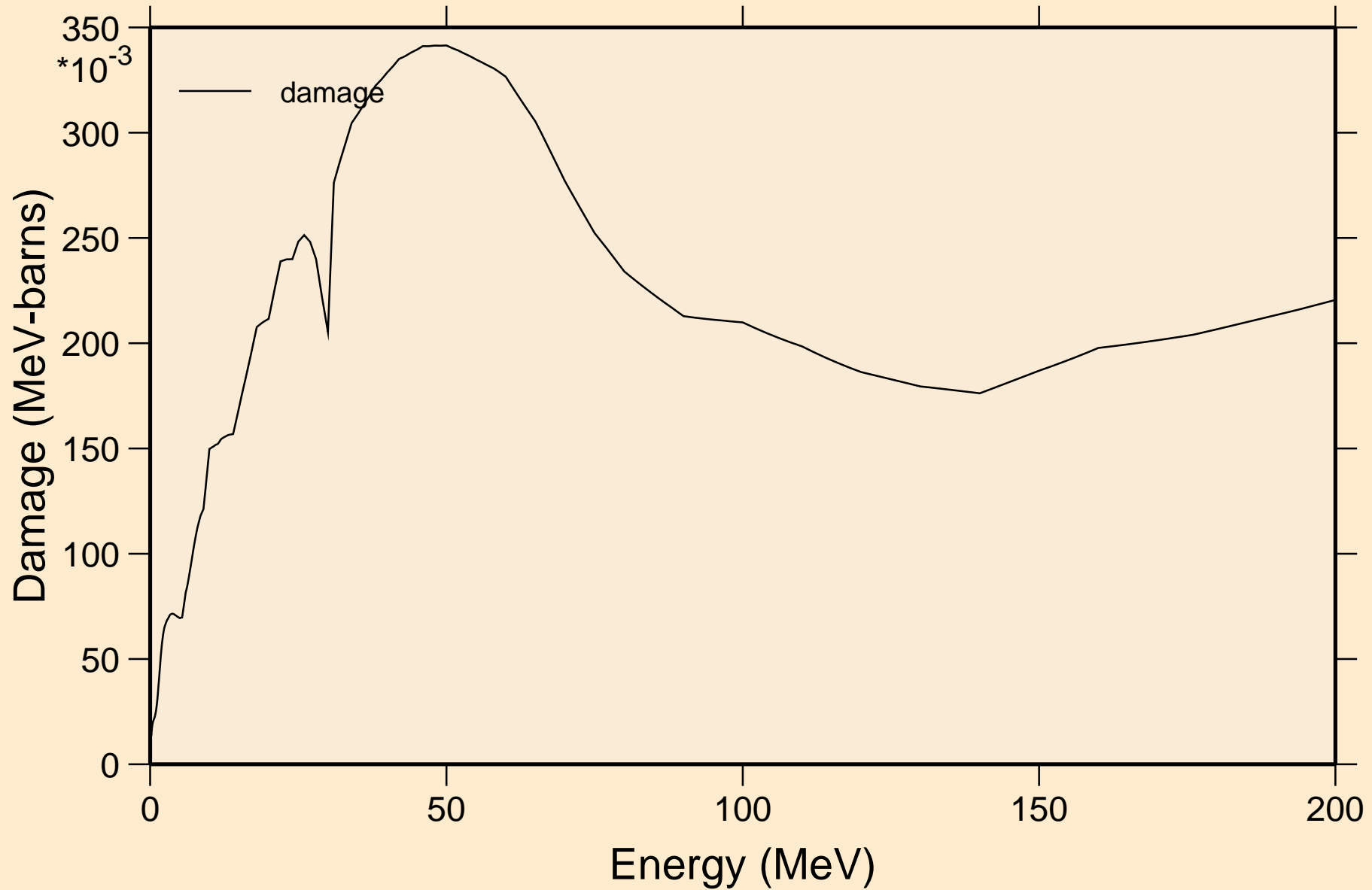

FR229 NEUTRON ACER TENDL-2024 LIBRARY; T=293.6K
Non-threshold reactions

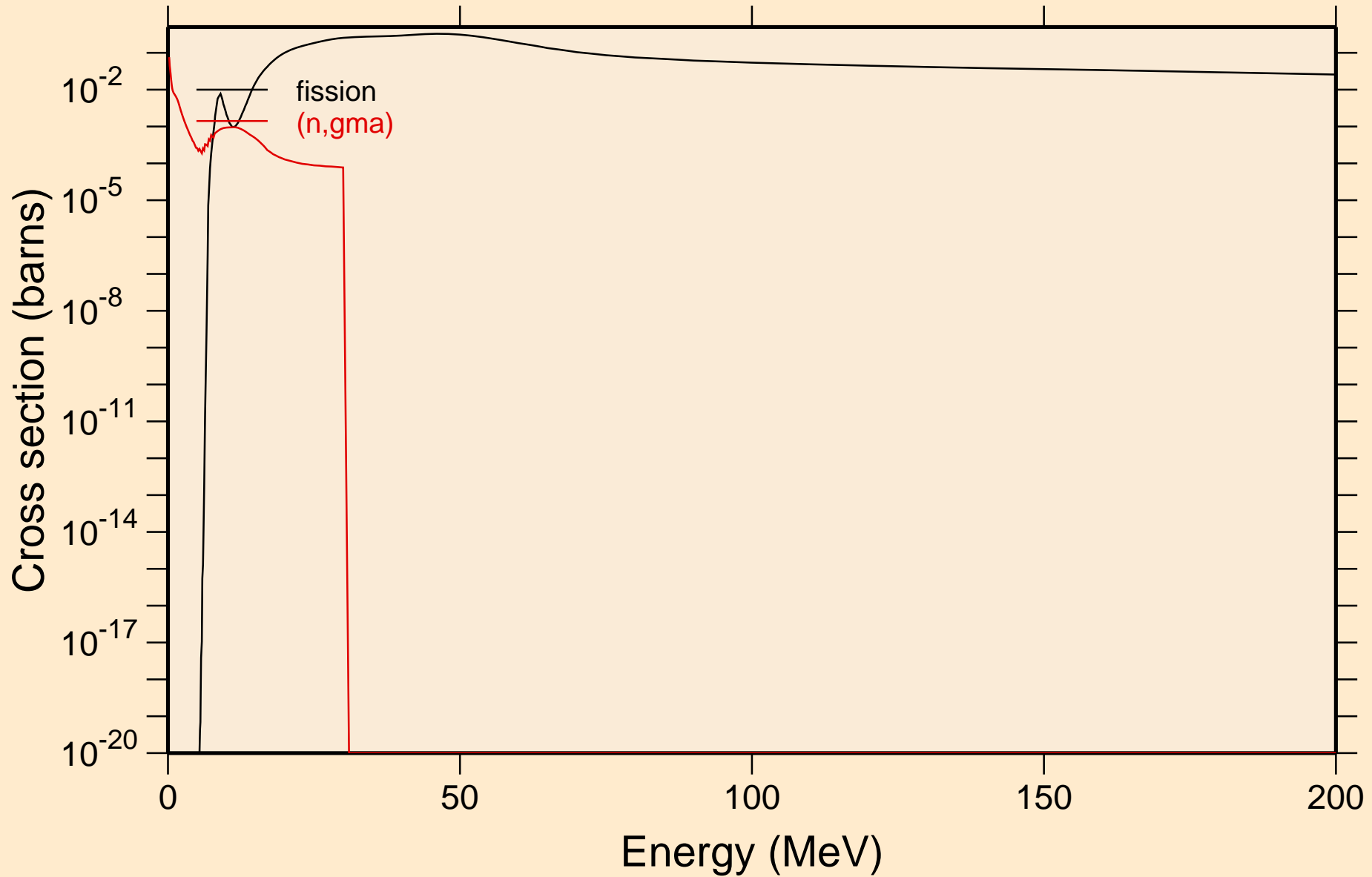

FR229 NEUTRON ACER TENDL-2024 LIBRARY; T=293.6K
Inelastic levels

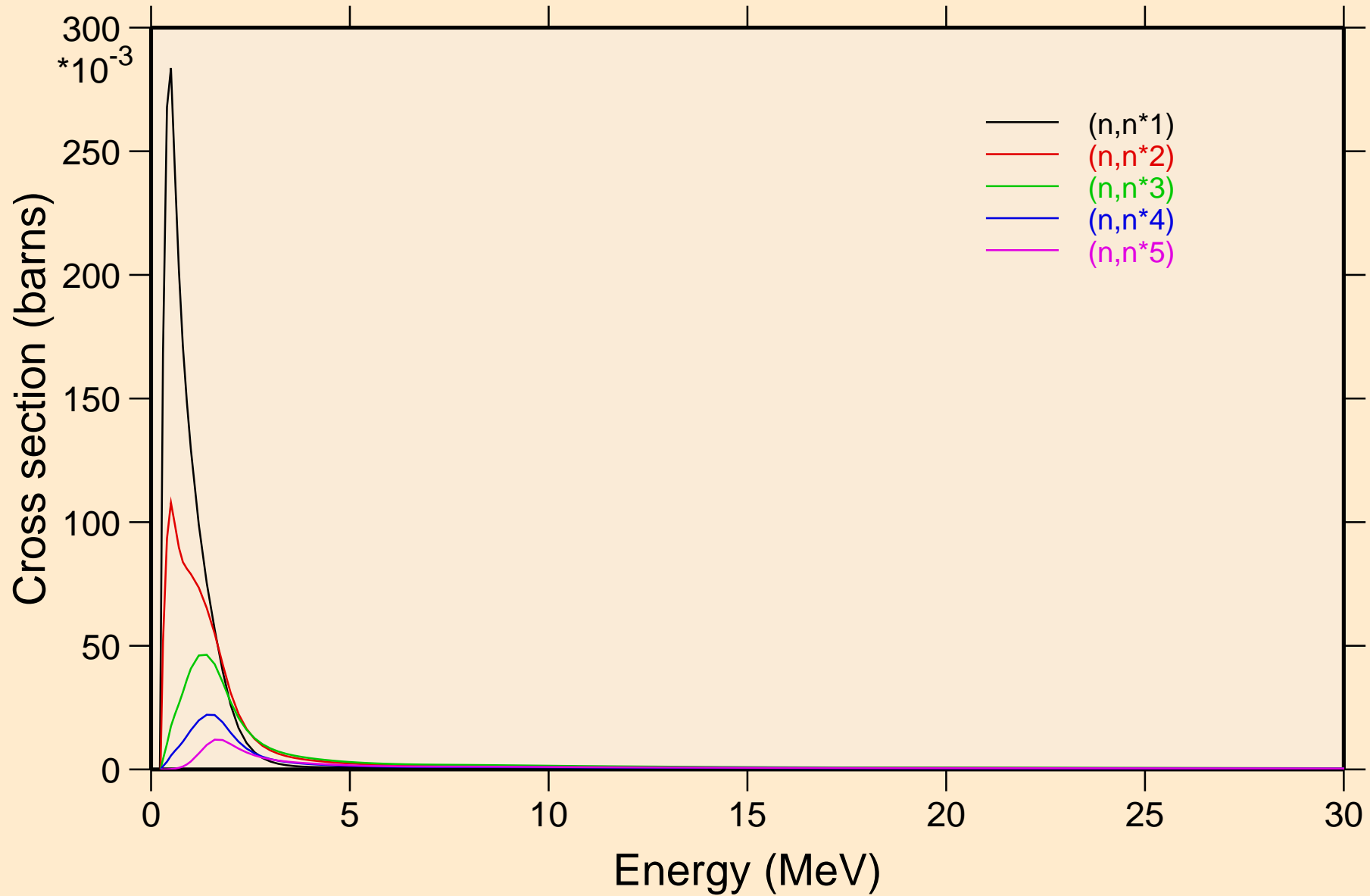

FR229 NEUTRON ACER TENDL-2024 LIBRARY; T=293.6K
Inelastic levels

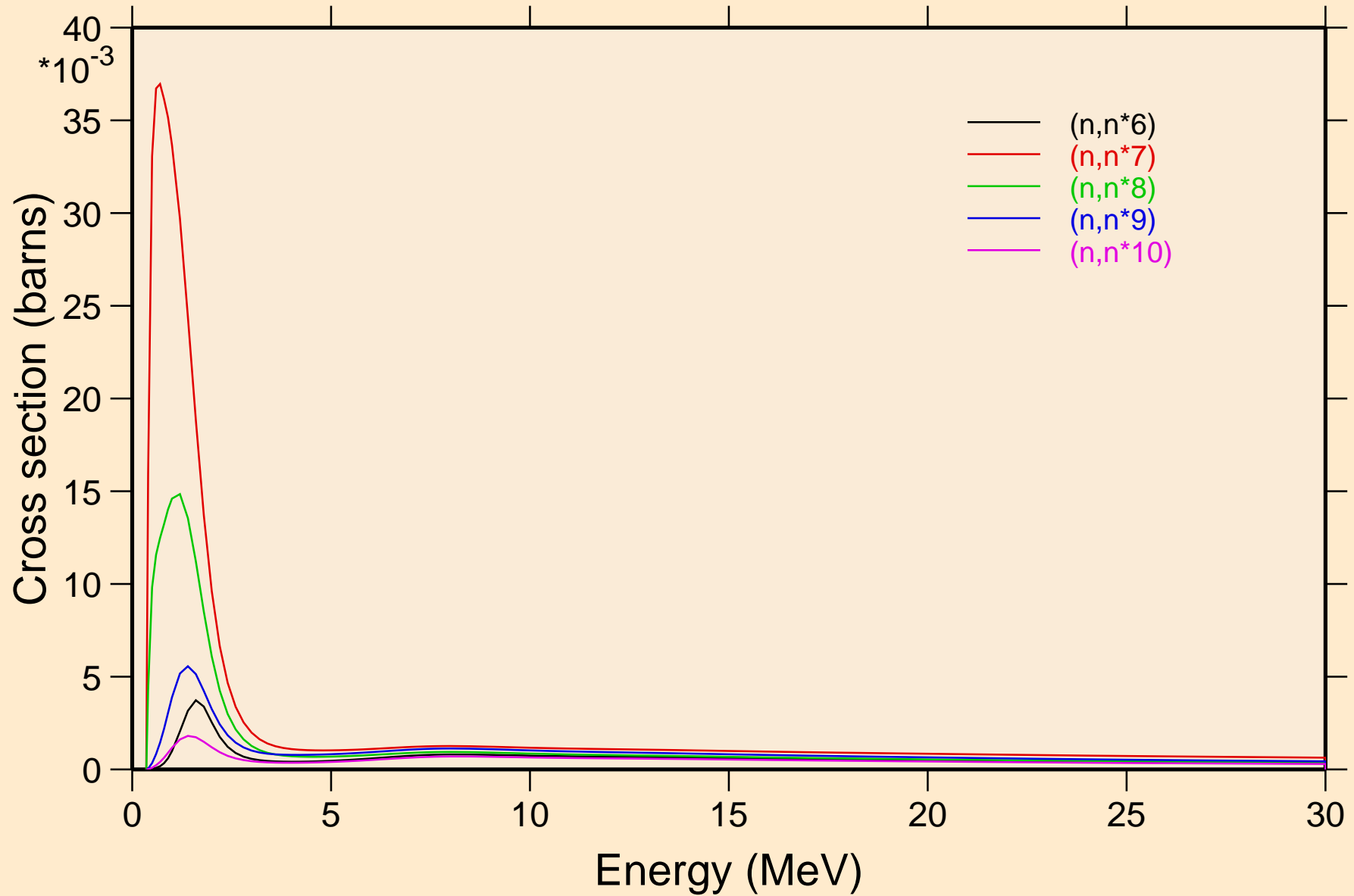

FR229 NEUTRON ACER TENDL-2024 LIBRARY; T=293.6K
Inelastic levels

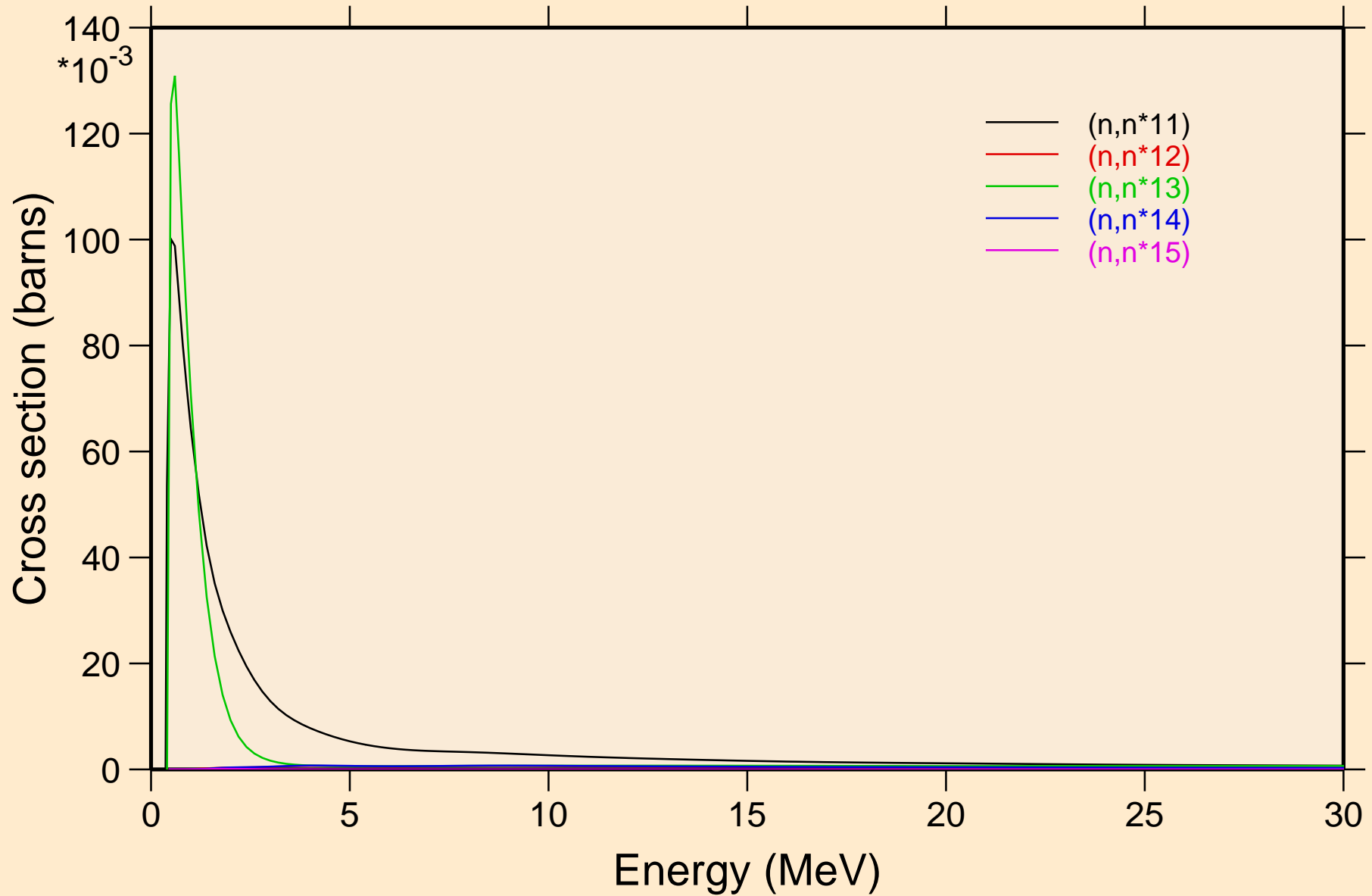

FR229 NEUTRON ACER TENDL-2024 LIBRARY; T=293.6K
Inelastic levels

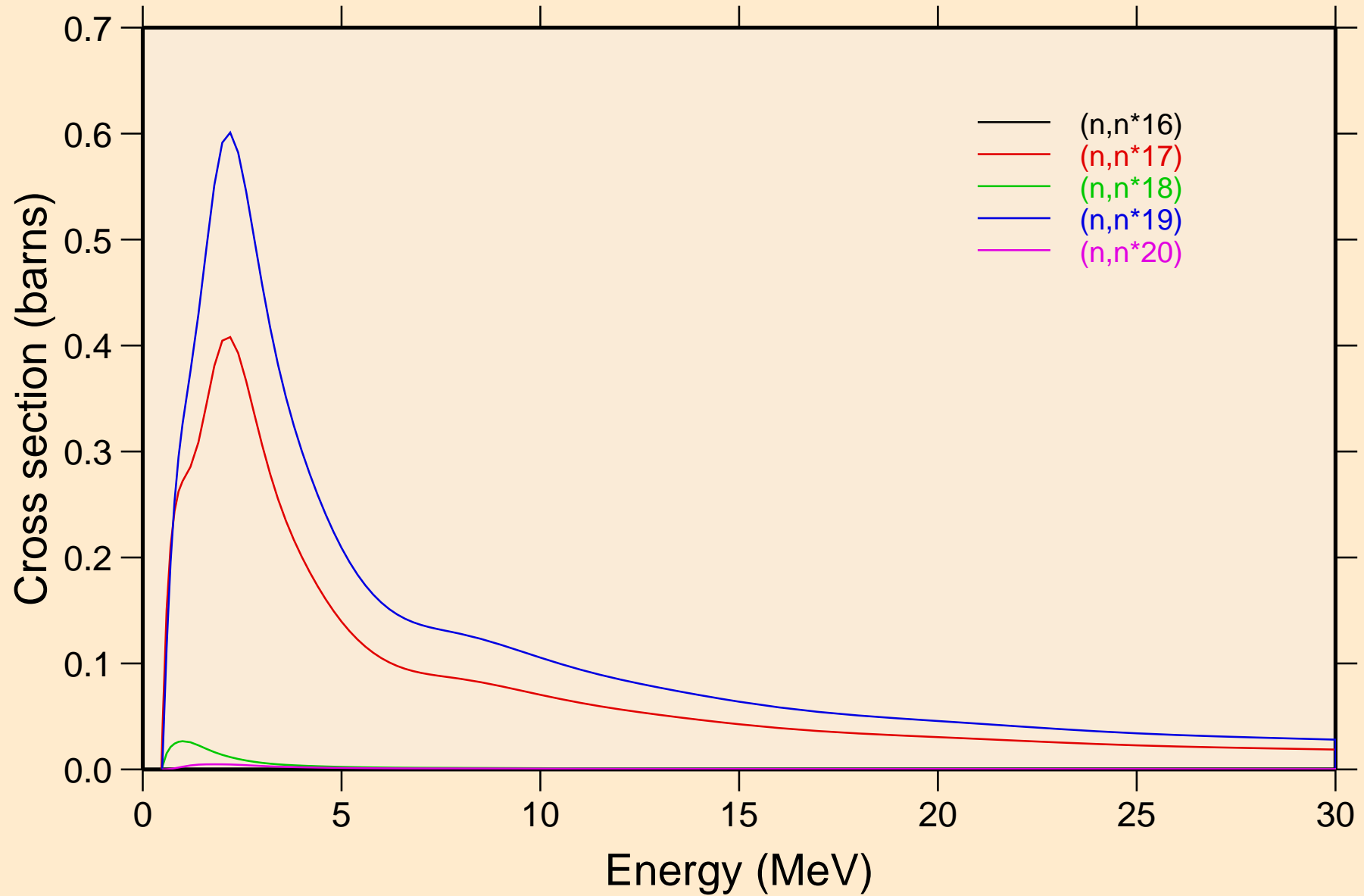

FR229 NEUTRON ACER TENDL-2024 LIBRARY; T=293.6K
Inelastic levels

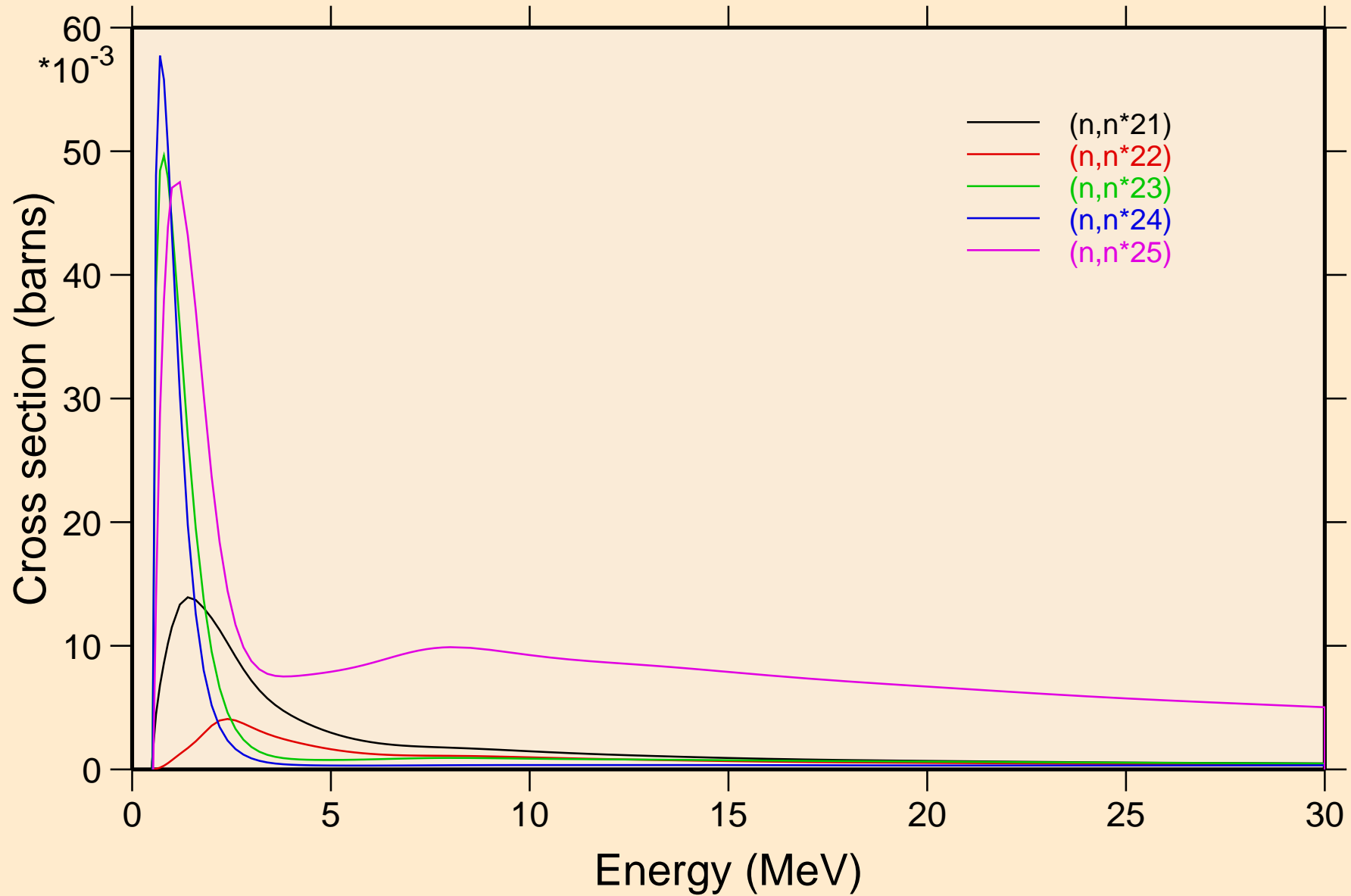

FR229 NEUTRON ACER TENDL-2024 LIBRARY; T=293.6K
Inelastic levels

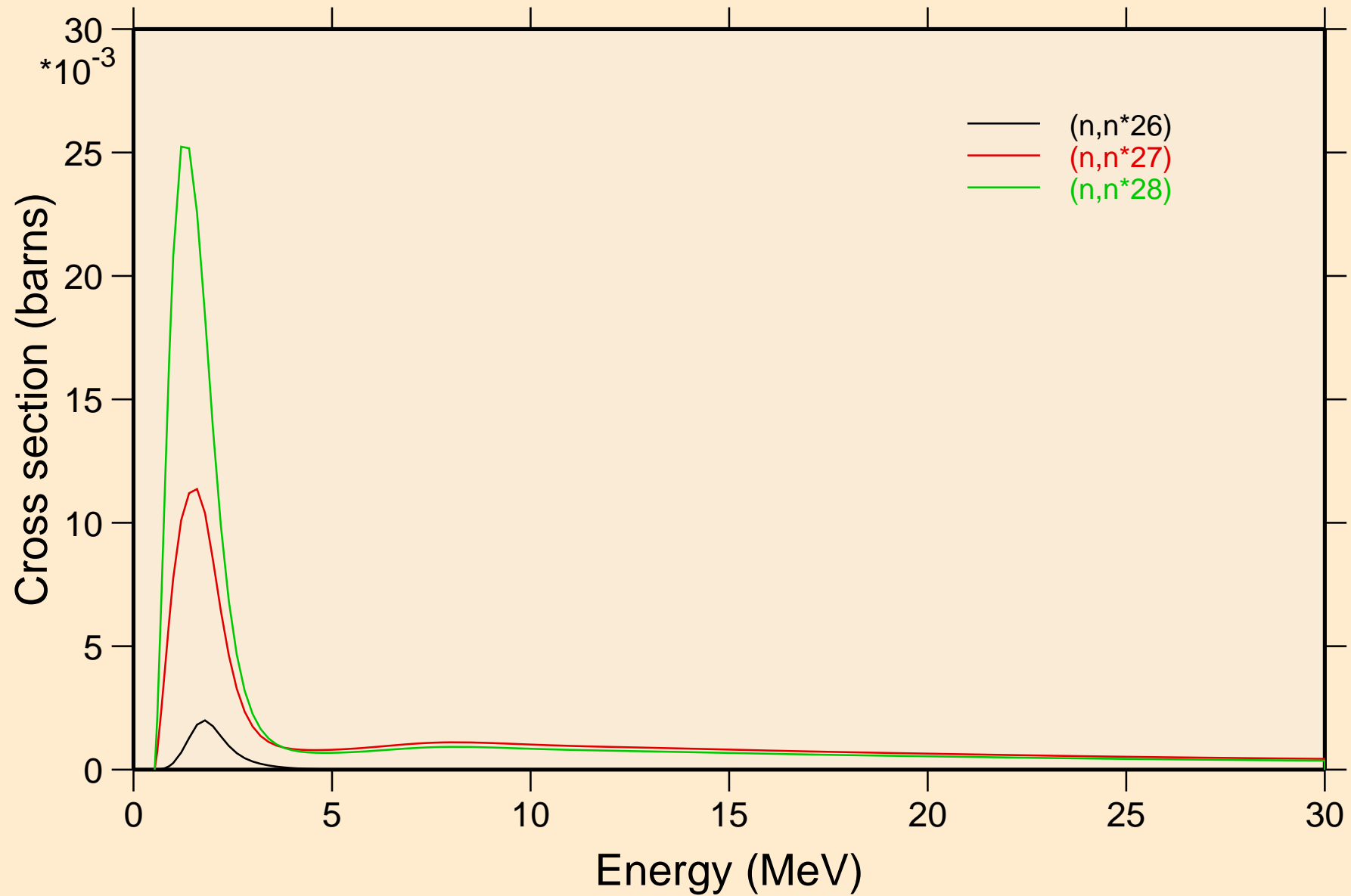

FR229 NEUTRON ACER TENDL-2024 LIBRARY; T=293.6K
Threshold reactions

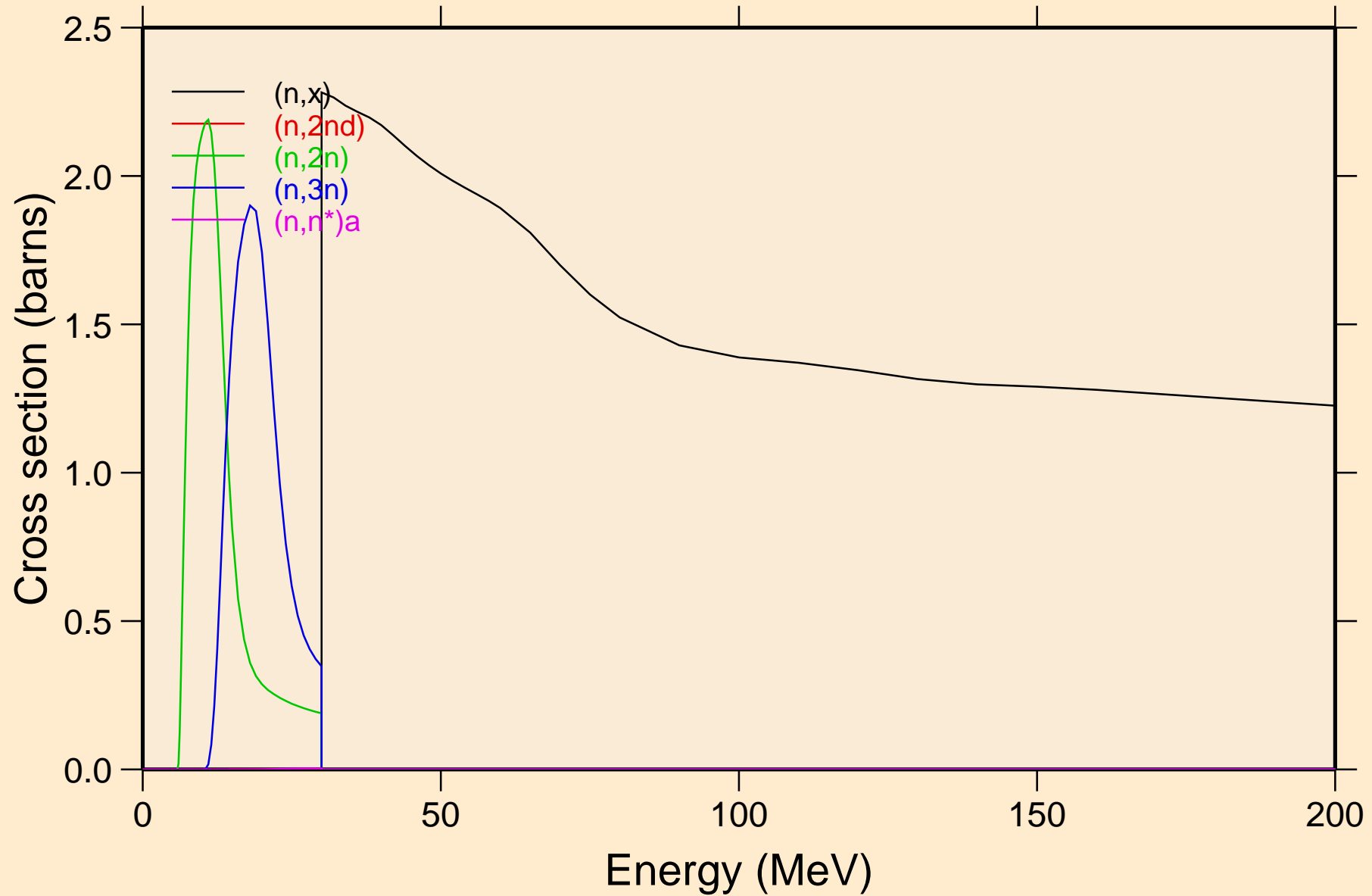

FR229 NEUTRON ACER TENDL-2024 LIBRARY; T=293.6K
Threshold reactions

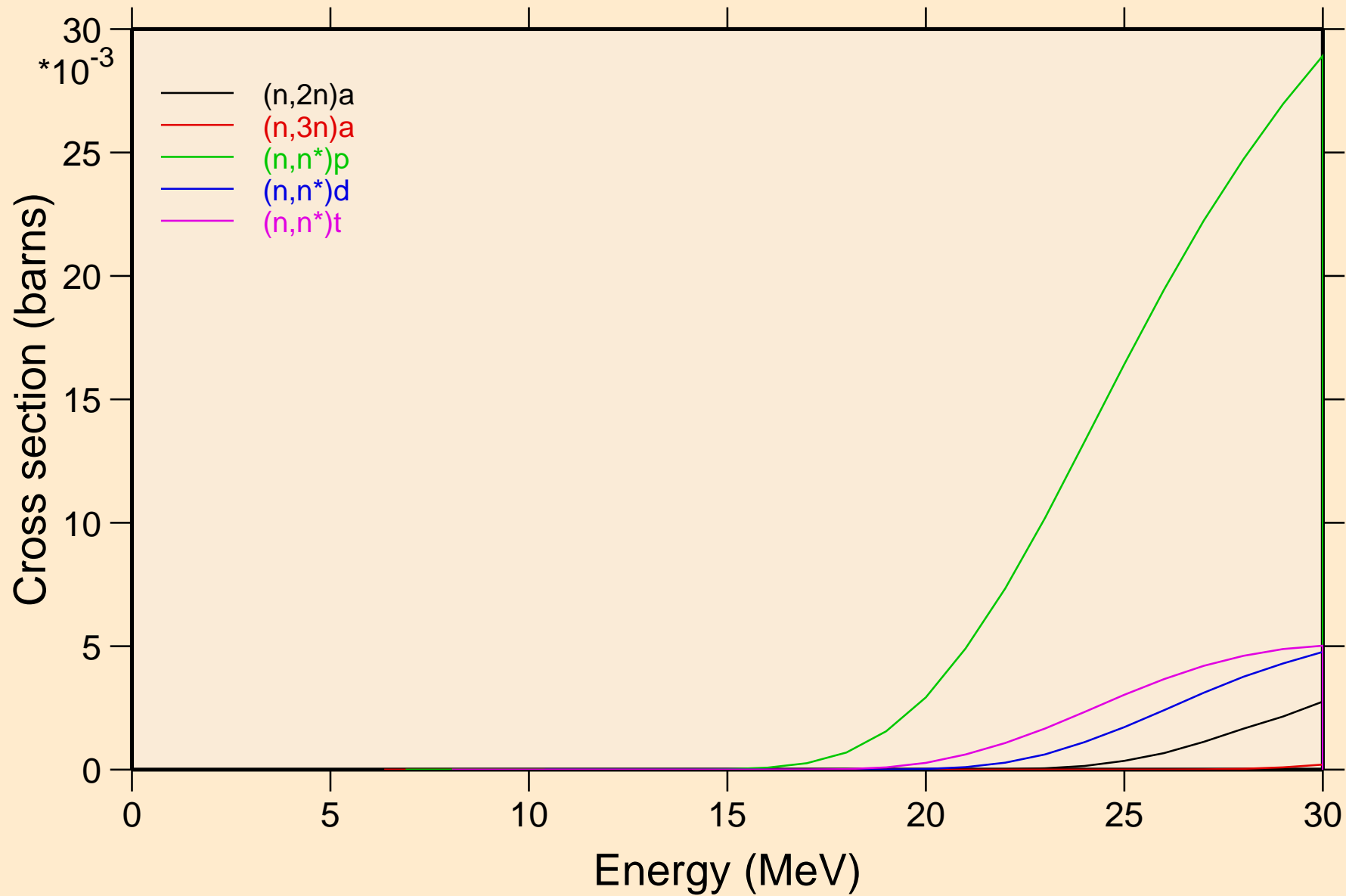

FR229 NEUTRON ACER TENDL-2024 LIBRARY; T=293.6K
Threshold reactions

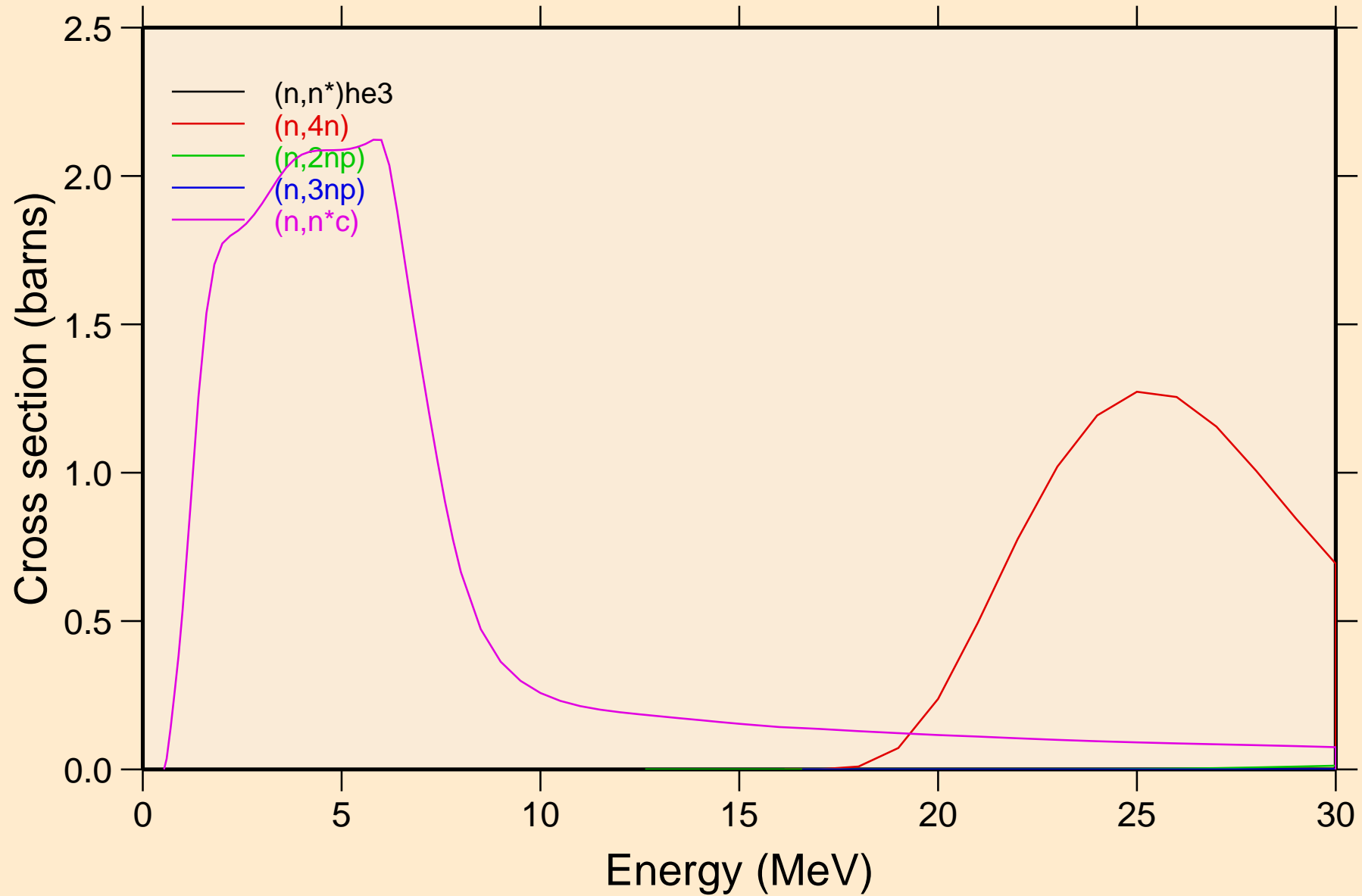

FR229 NEUTRON ACER TENDL-2024 LIBRARY; T=293.6K
Threshold reactions

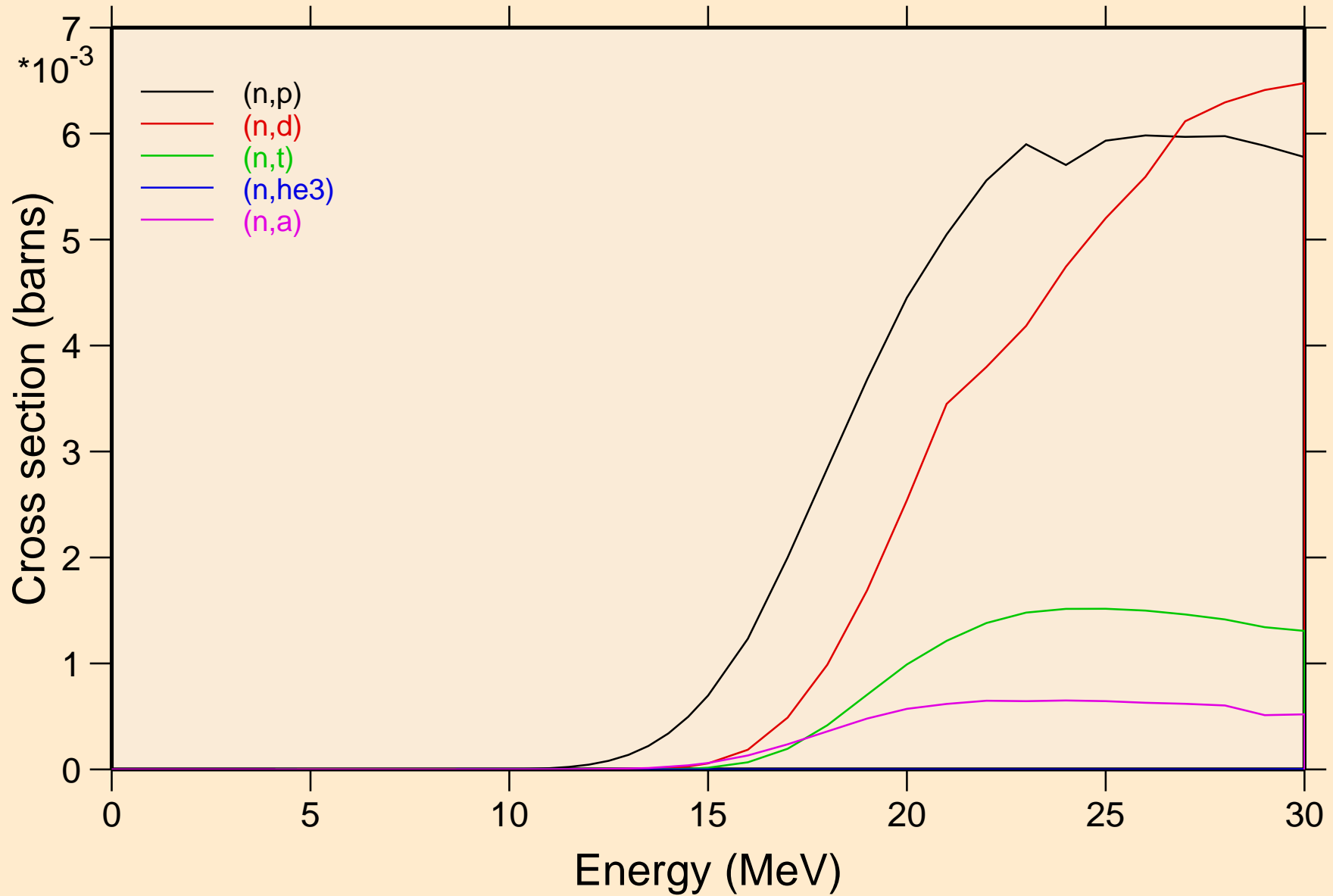

FR229 NEUTRON ACER TENDL-2024 LIBRARY; T=293.6K
Threshold reactions

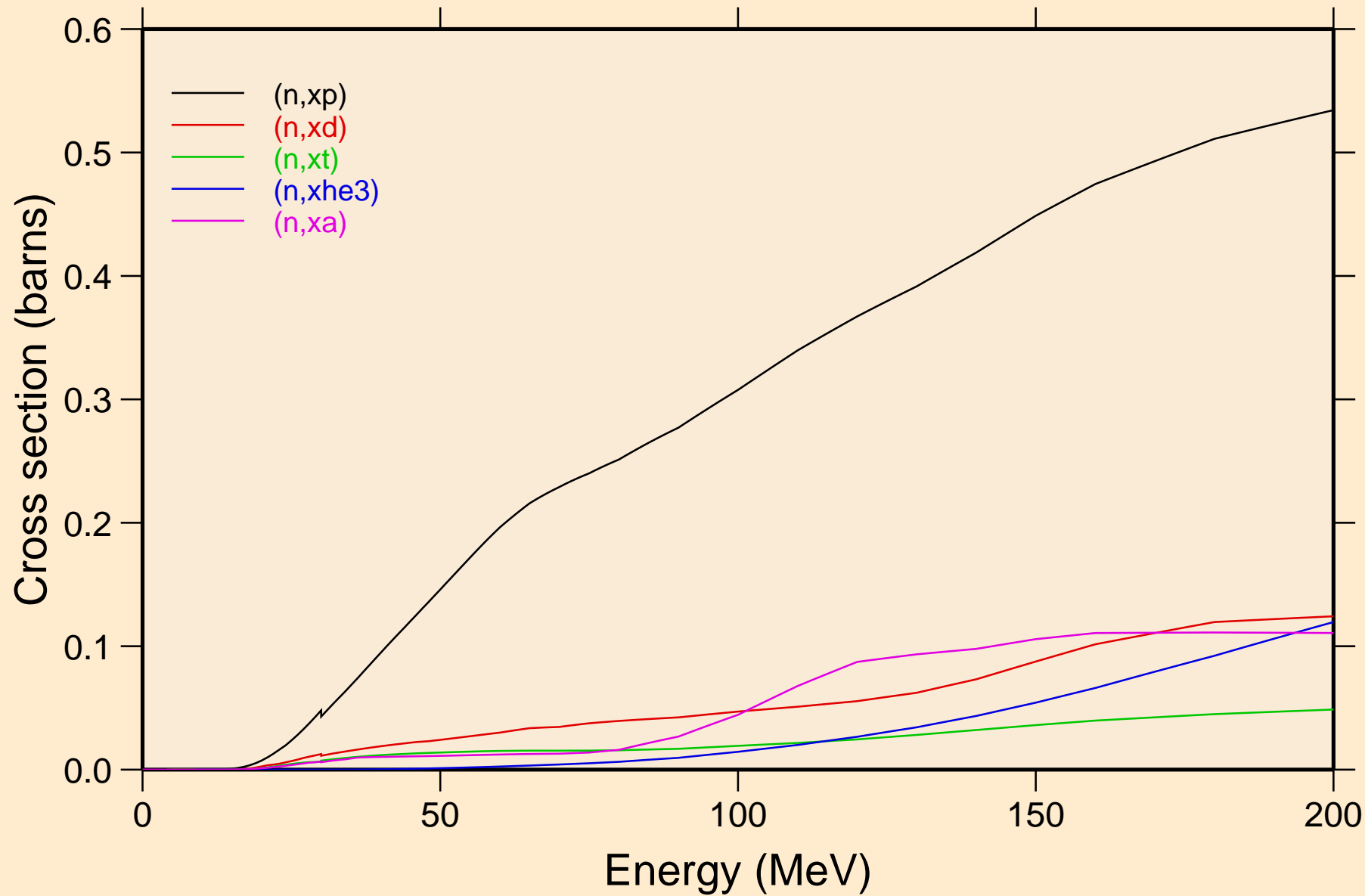

FR229 NEUTRON ACER TENDL-2024 LIBRARY; T=293.6K
angular distribution for elastic

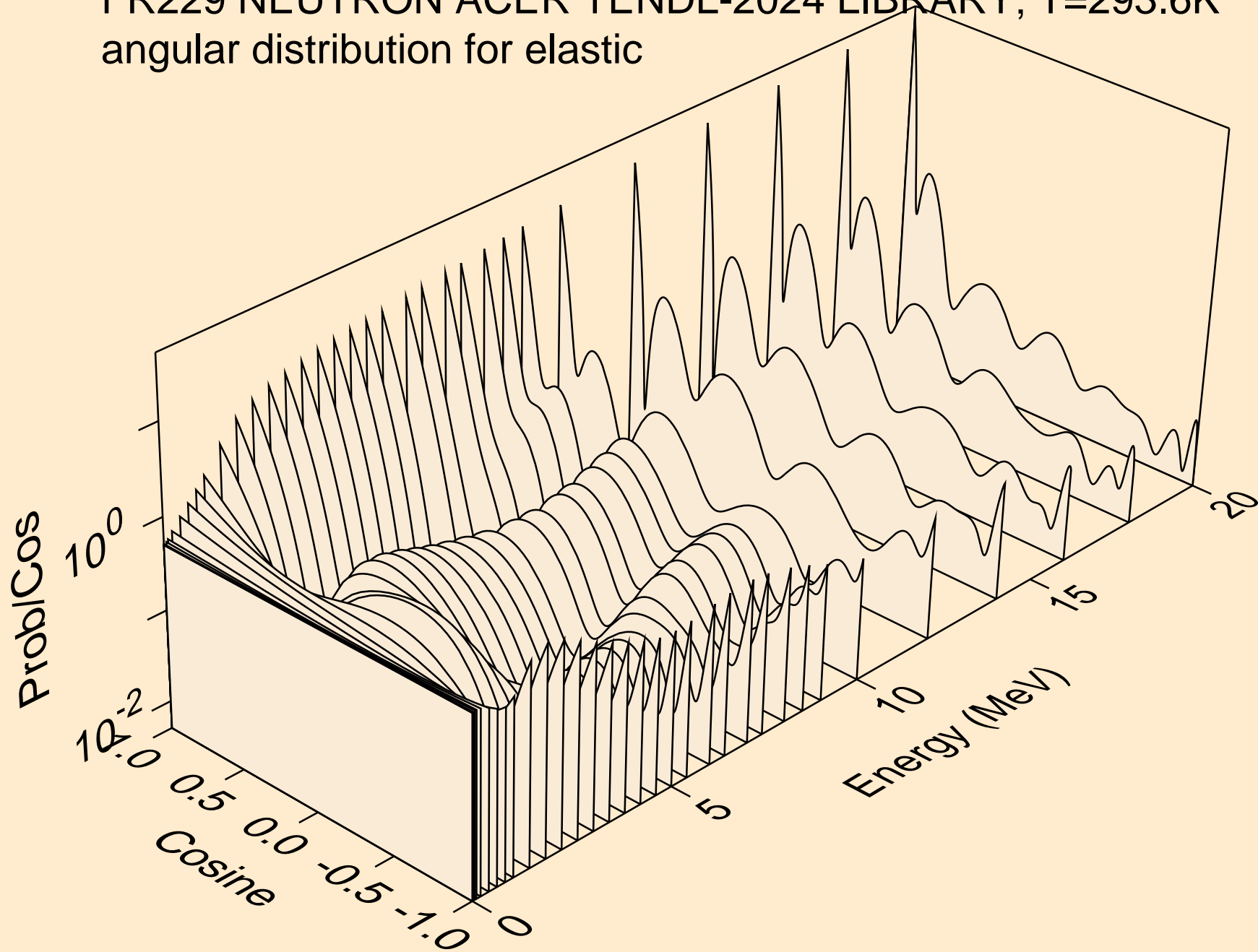

FR229 NEUTRON ACER TENDL-2024 LIBRARY; T=293.6K
angular distribution for elastic

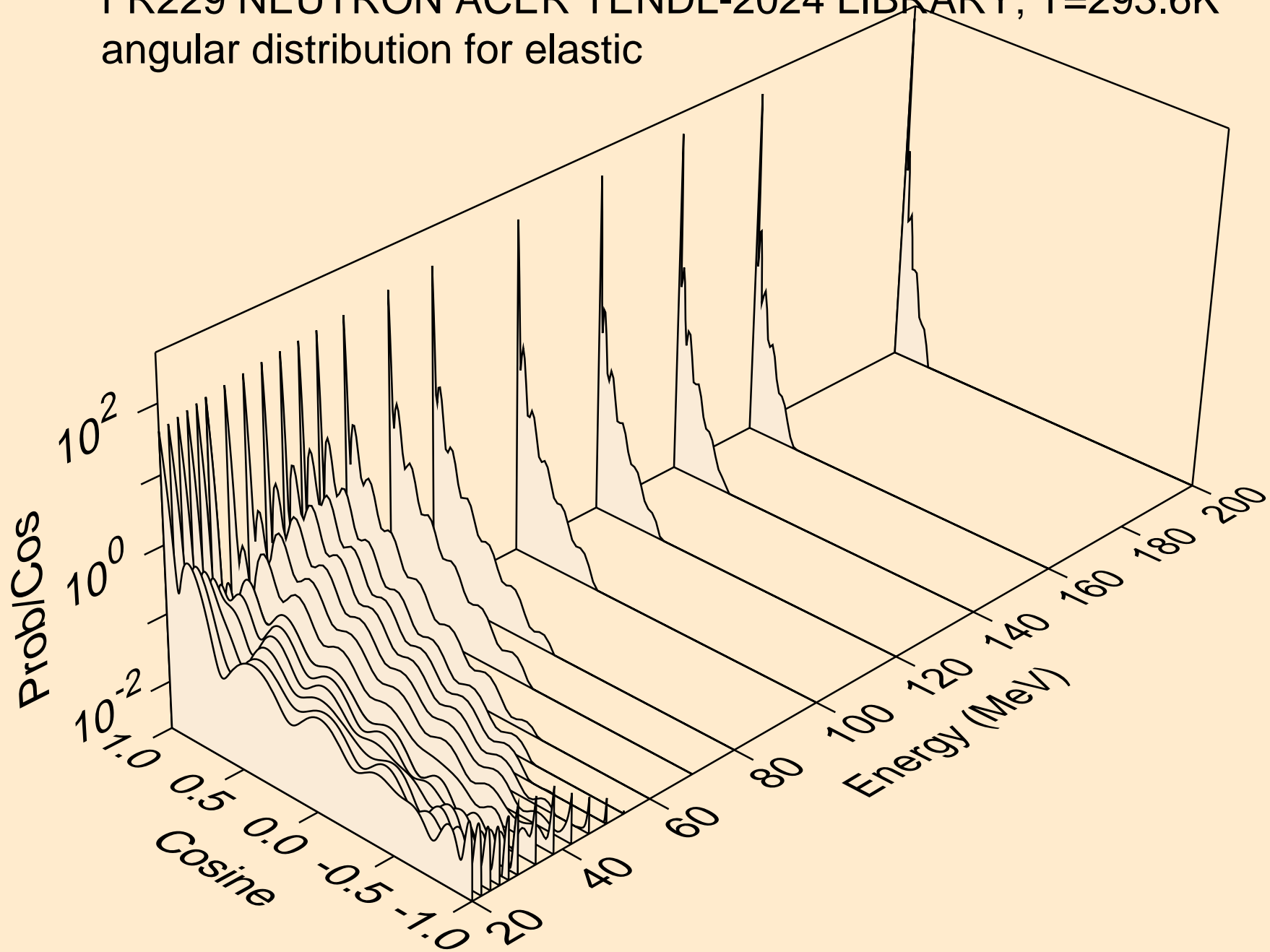

FR229 NEUTRON ACER TENDL-2024 LIBRARY; T=293.6K
angular distribution for (n,n*1)

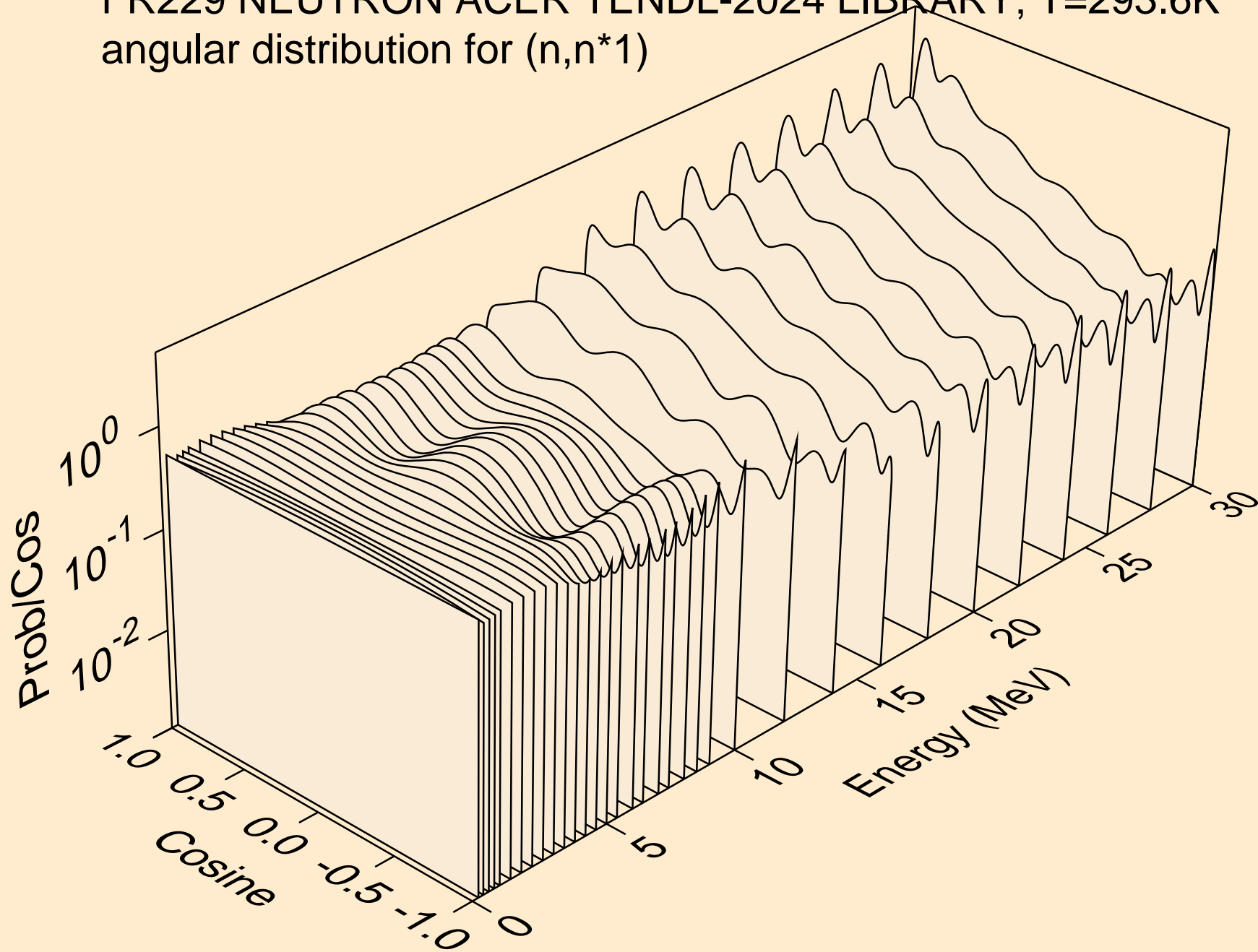

FR229 NEUTRON ACER TENDL-2024 LIBRARY; T=293.6K
angular distribution for (n,n*2)

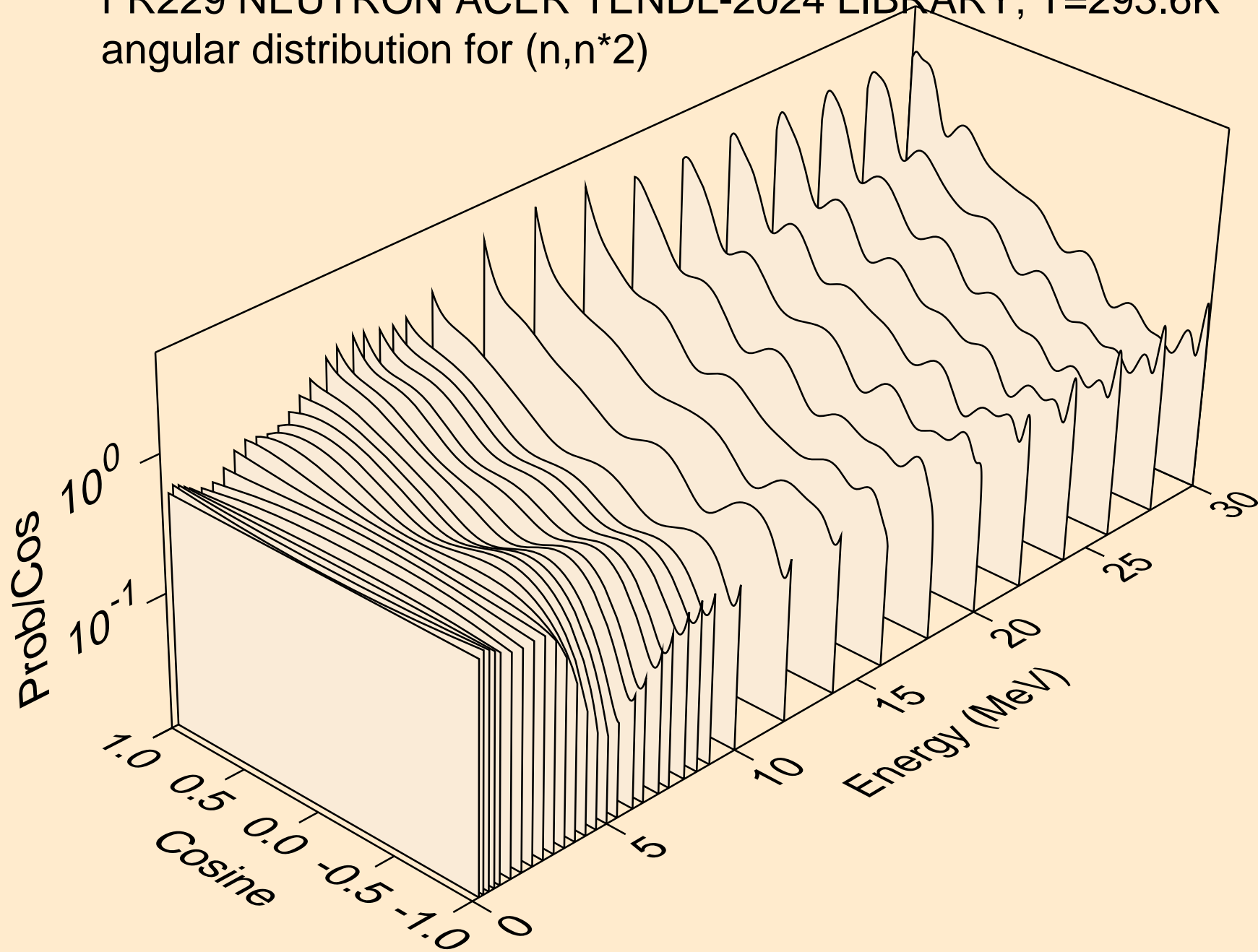

FR229 NEUTRON ACER TENDL-2024 LIBRARY; T=293.6K
angular distribution for (n,n*3)

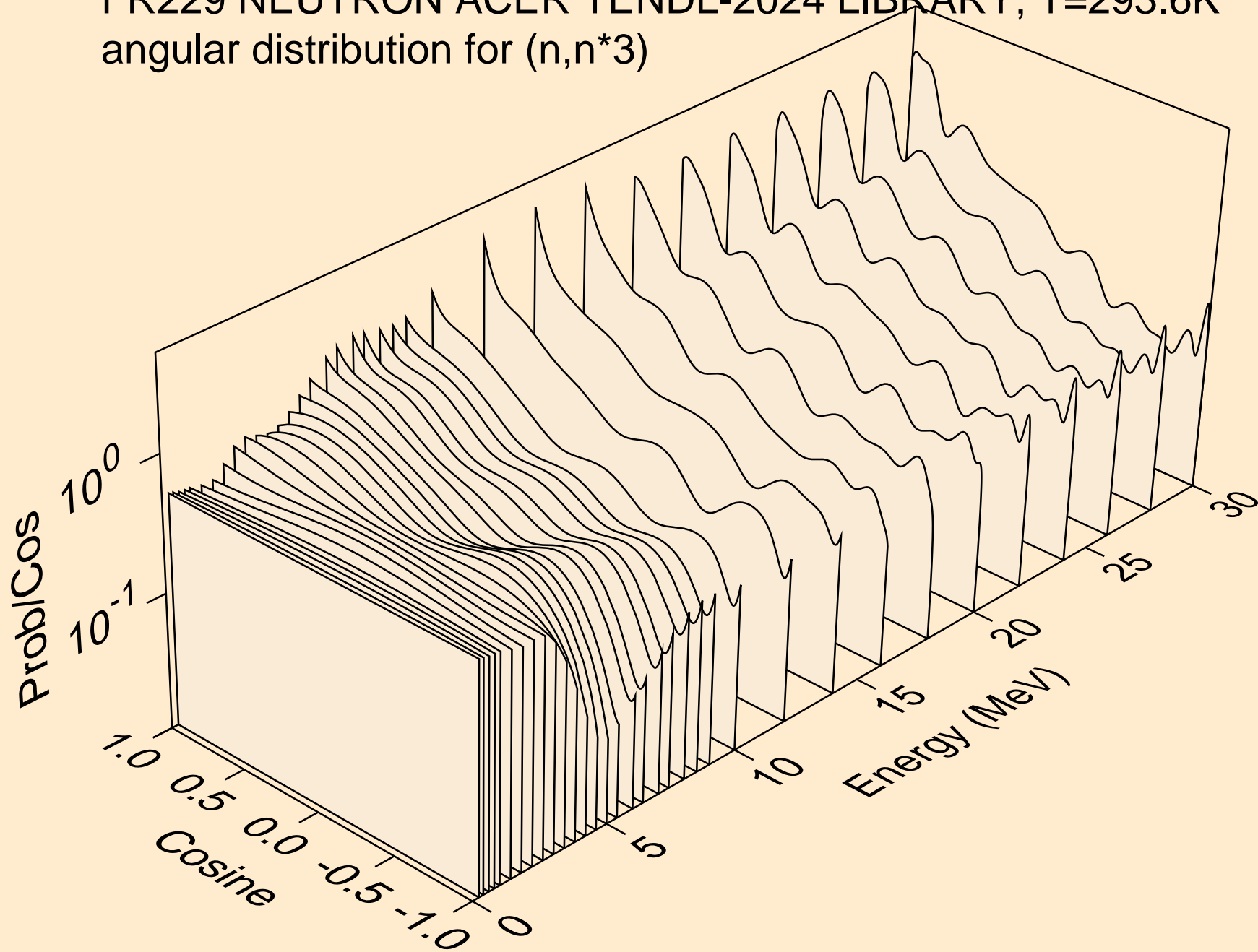

FR229 NEUTRON ACER TENDL-2024 LIBRARY; T=293.6K
angular distribution for (n,n*4)

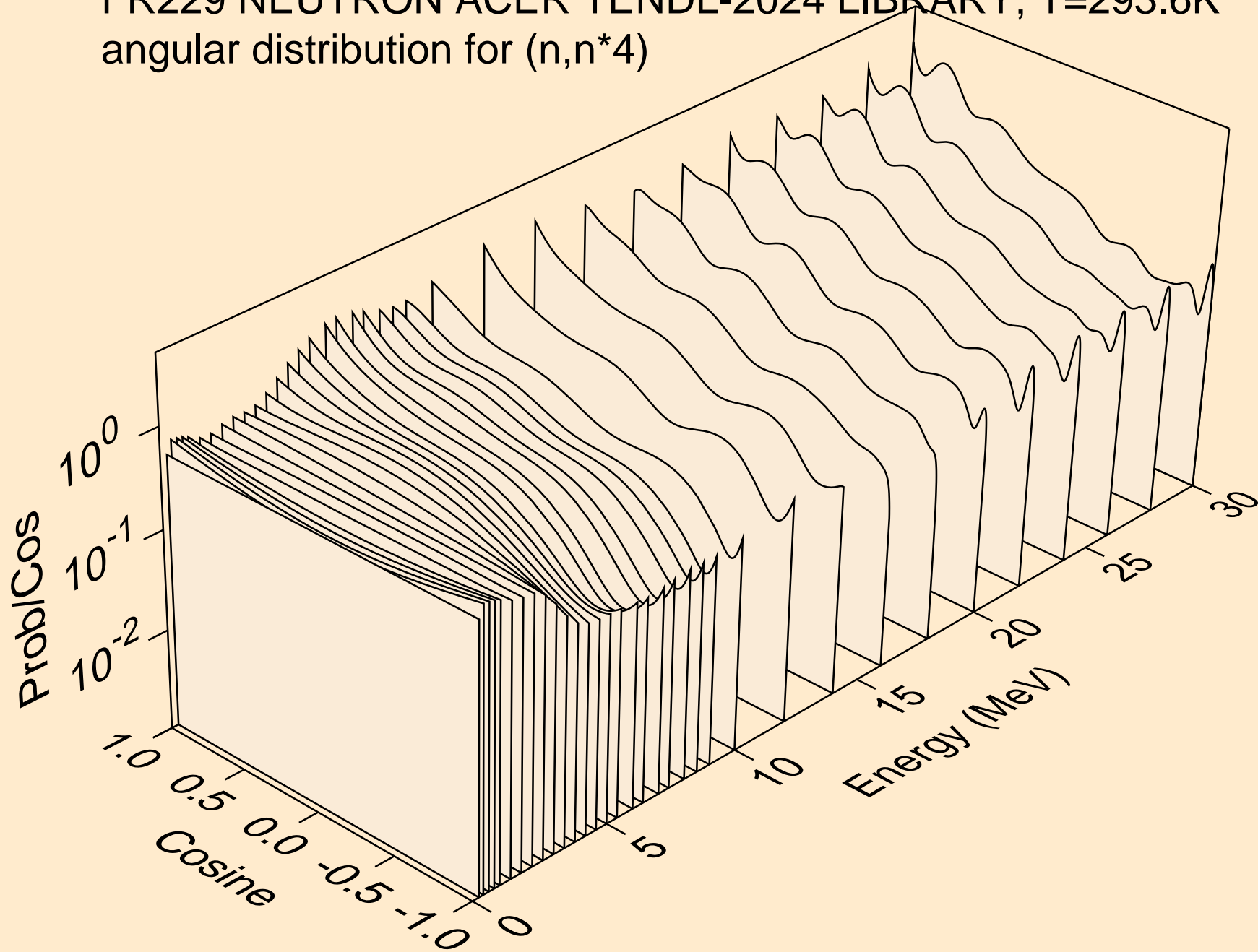

FR229 NEUTRON ACER TENDL-2024 LIBRARY; T=293.6K
angular distribution for (n,n*5)

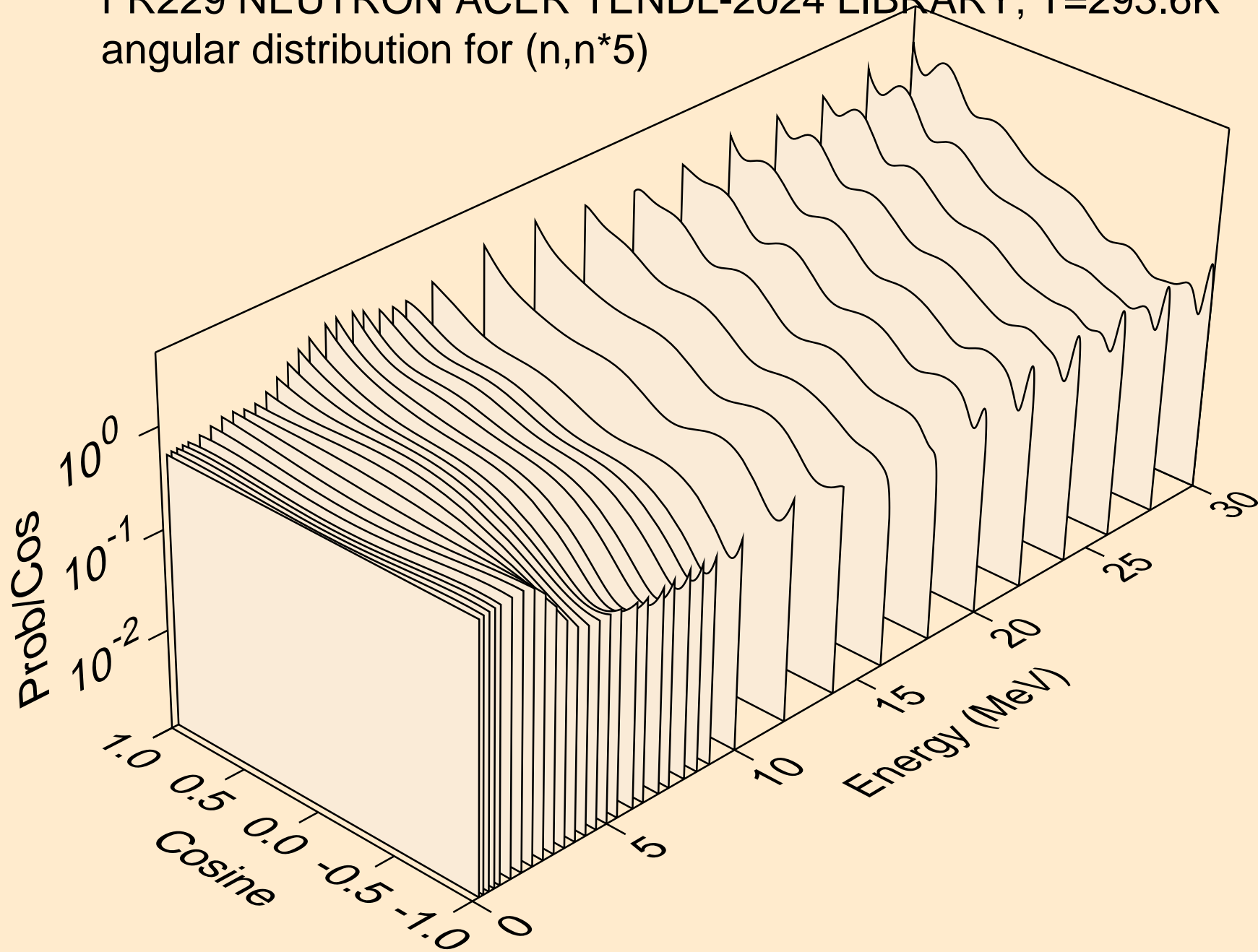

FR229 NEUTRON ACER TENDL-2024 LIBRARY; T=293.6K
angular distribution for (n,n*6)

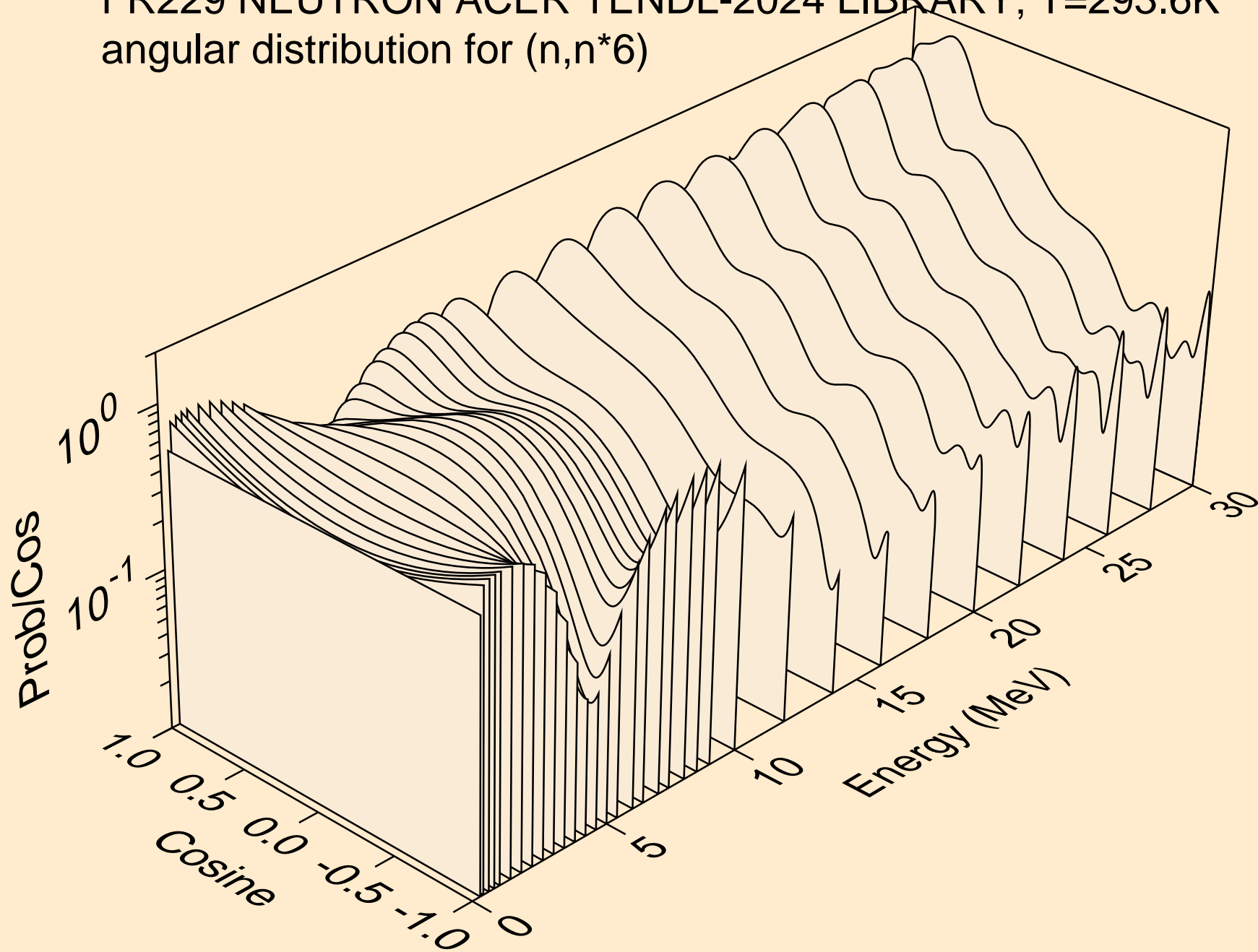

FR229 NEUTRON ACER TENDL-2024 LIBRARY; T=293.6K
angular distribution for (n,n*7)

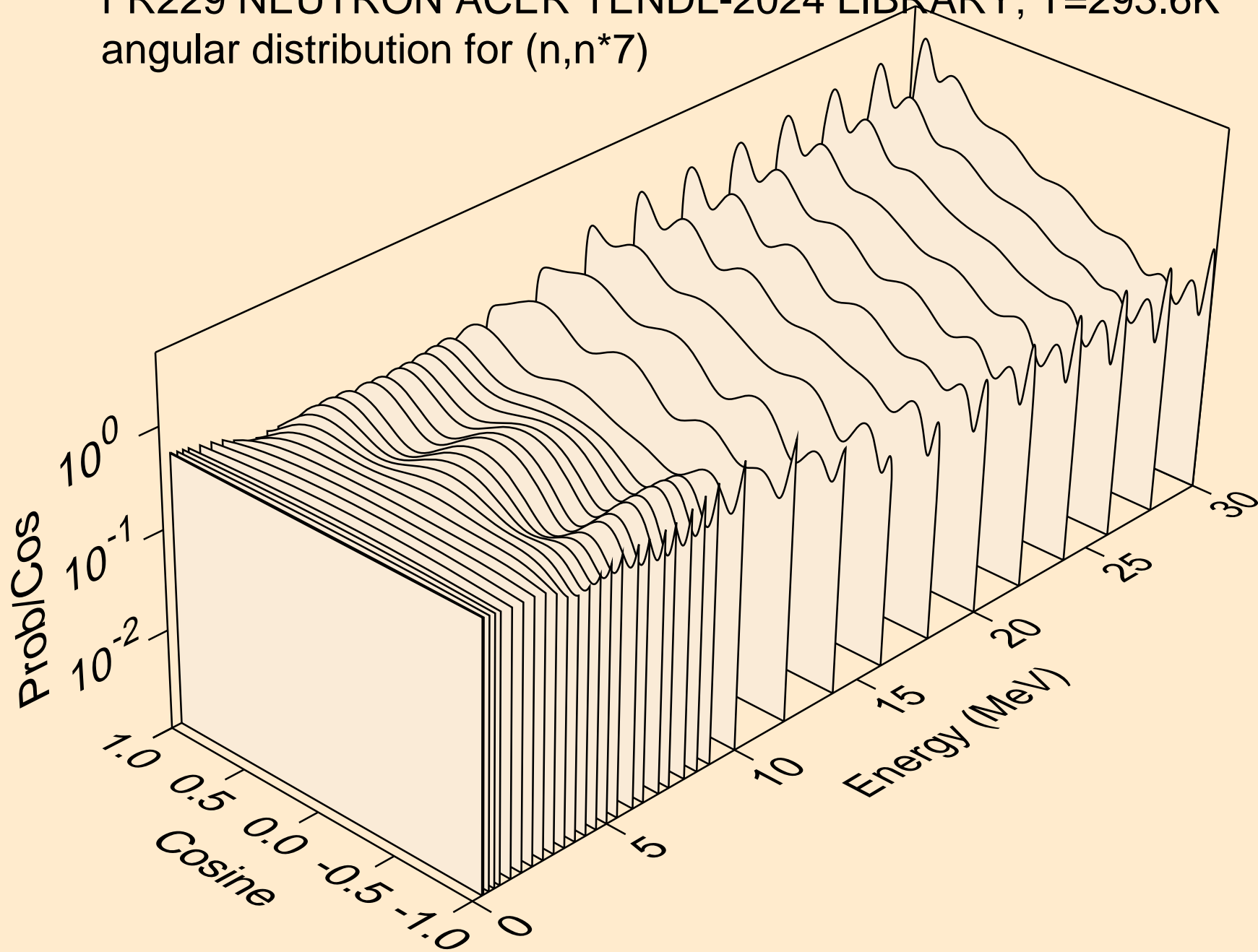

FR229 NEUTRON ACER TENDL-2024 LIBRARY; T=293.6K
angular distribution for (n,n*8)

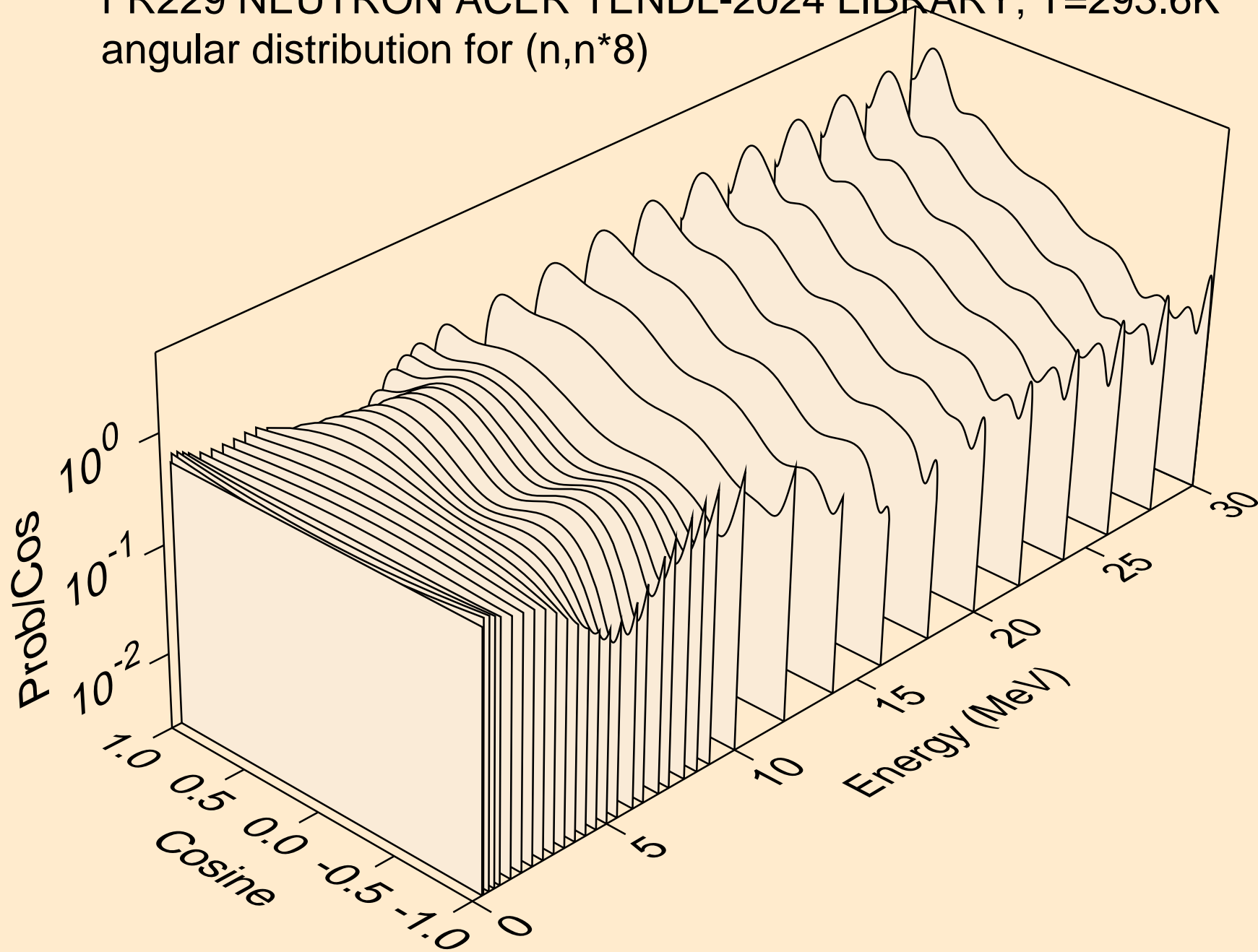

FR229 NEUTRON ACER TENDL-2024 LIBRARY; T=293.6K
angular distribution for (n,n*9)

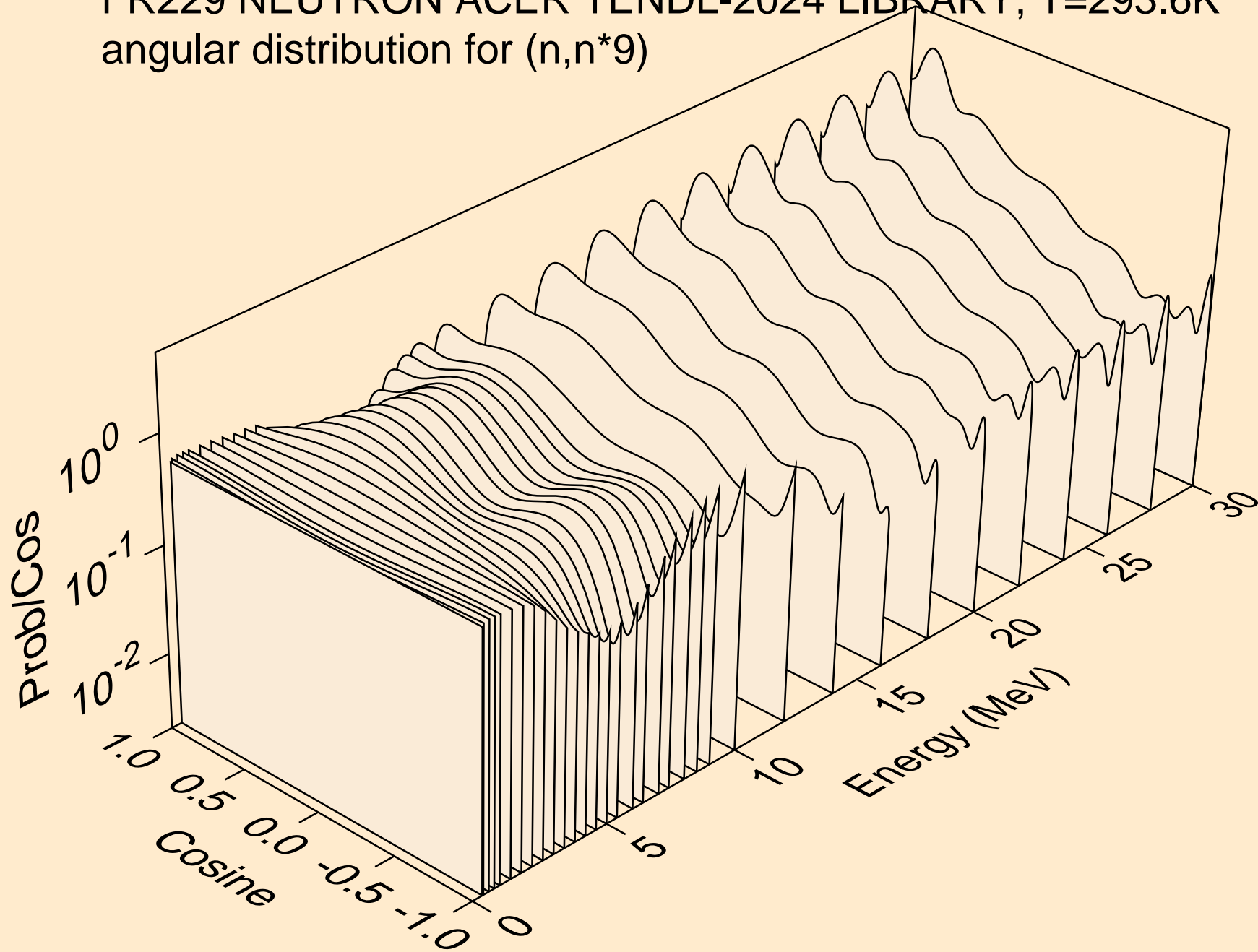

FR229 NEUTRON ACER TENDL-2024 LIBRARY; T=293.6K
angular distribution for (n,n*10)

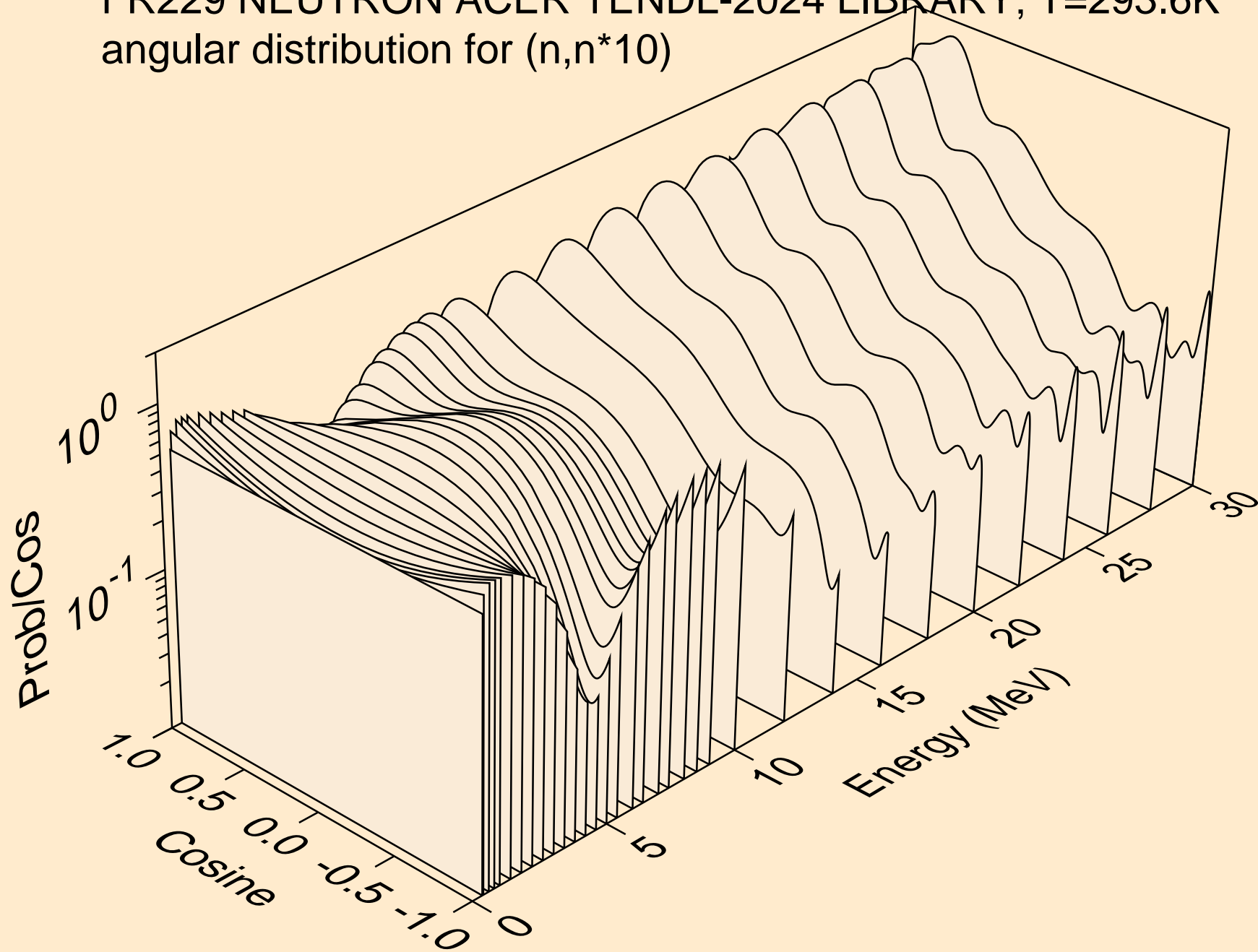

FR229 NEUTRON ACER TENDL-2024 LIBRARY; T=293.6K
angular distribution for (n,n*11)

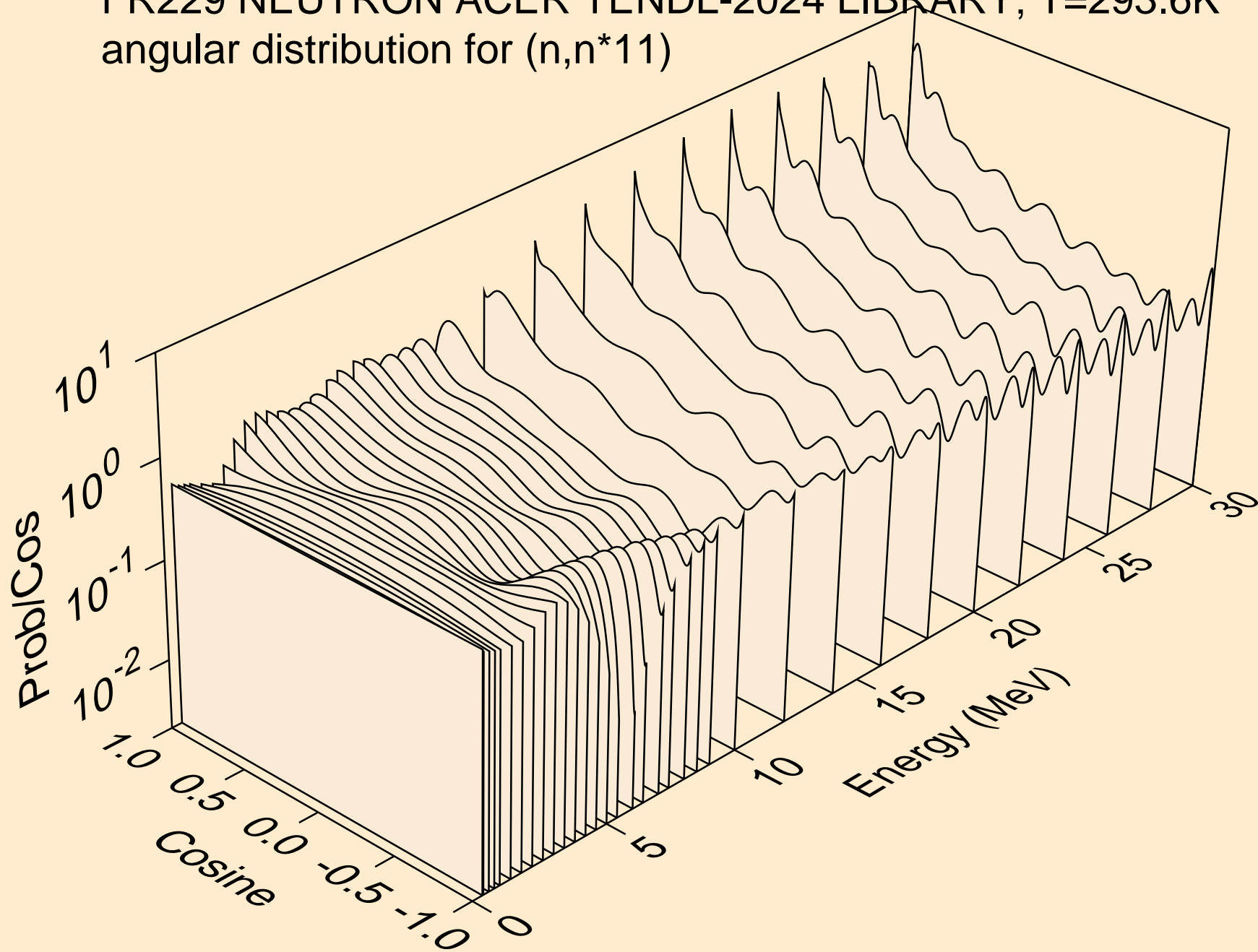

FR229 NEUTRON ACER TENDL-2024 LIBRARY; T=293.6K
angular distribution for (n,n*12)

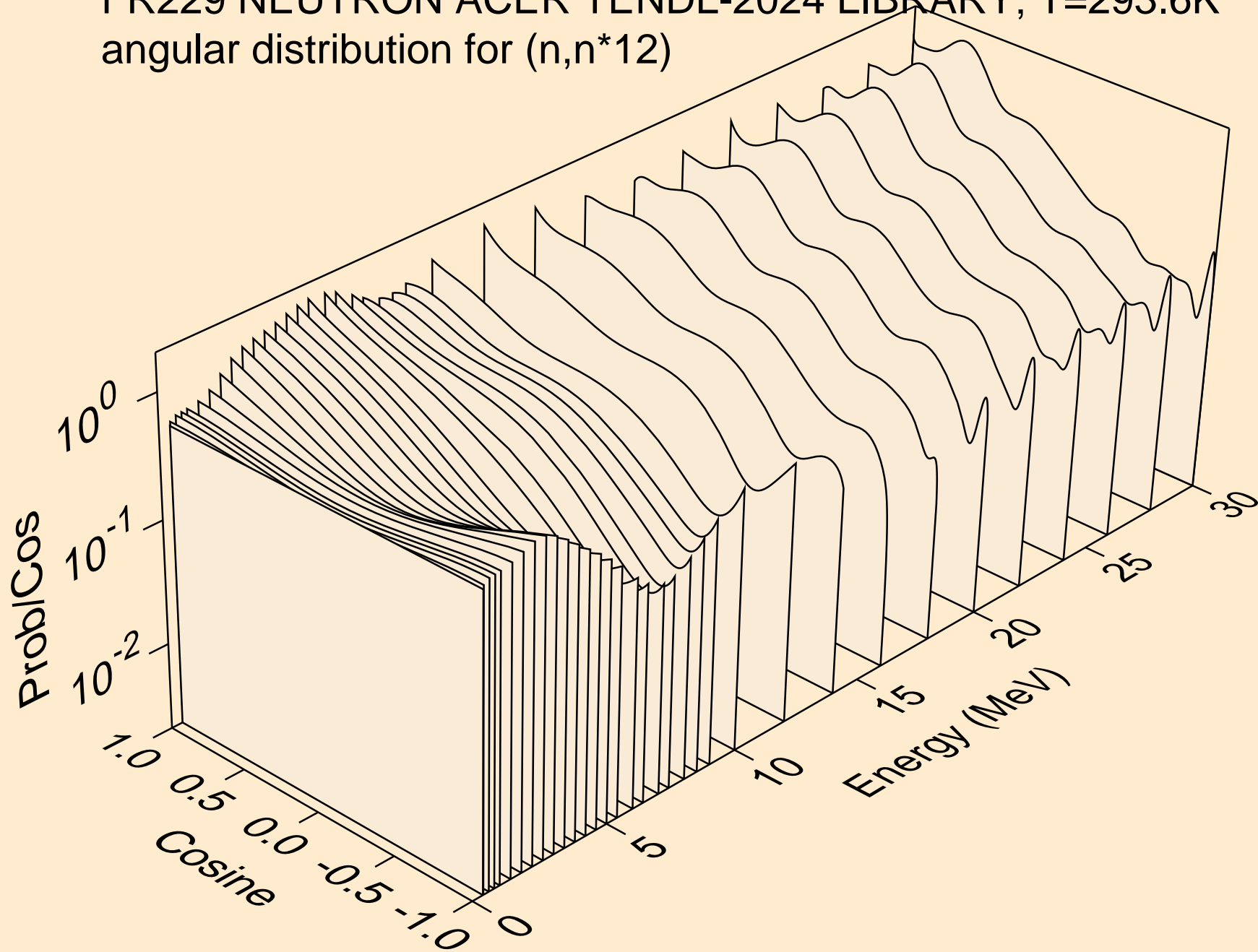

FR229 NEUTRON ACER TENDL-2024 LIBRARY; T=293.6K
angular distribution for (n,n*13)

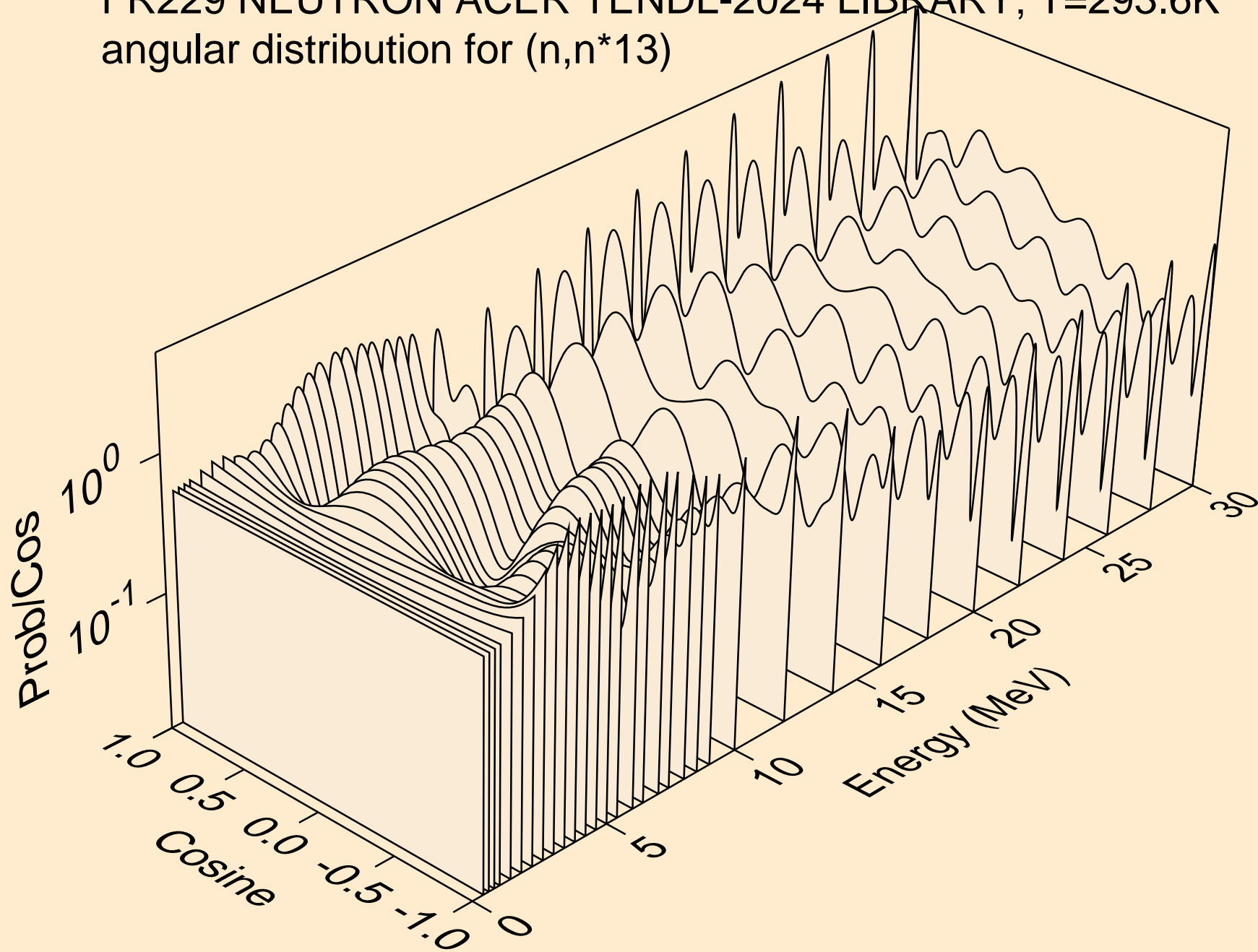

FR229 NEUTRON ACER TENDL-2024 LIBRARY; T=293.6K
angular distribution for (n,n*14)

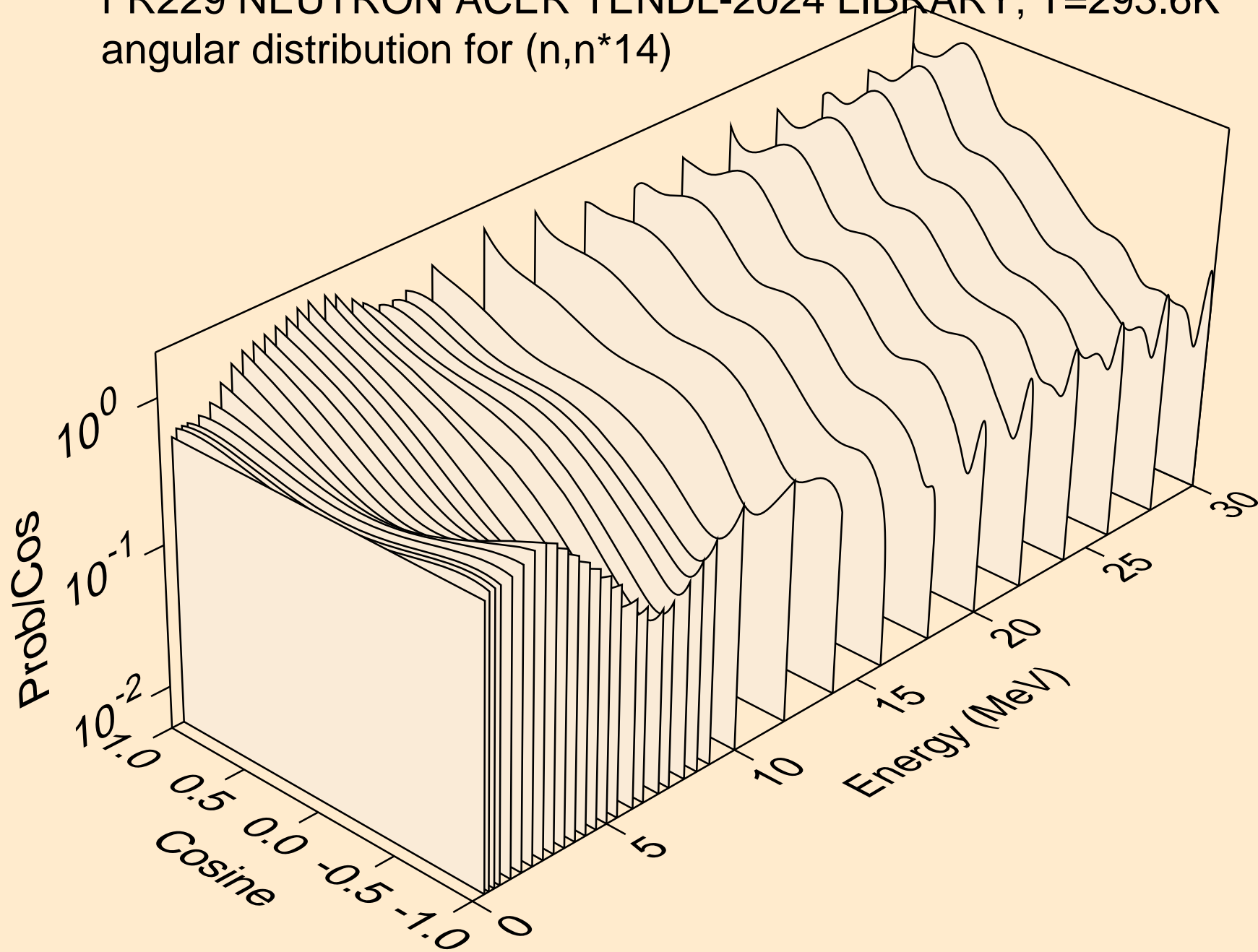

FR229 NEUTRON ACER TENDL-2024 LIBRARY; T=293.6K
angular distribution for (n,n*15)

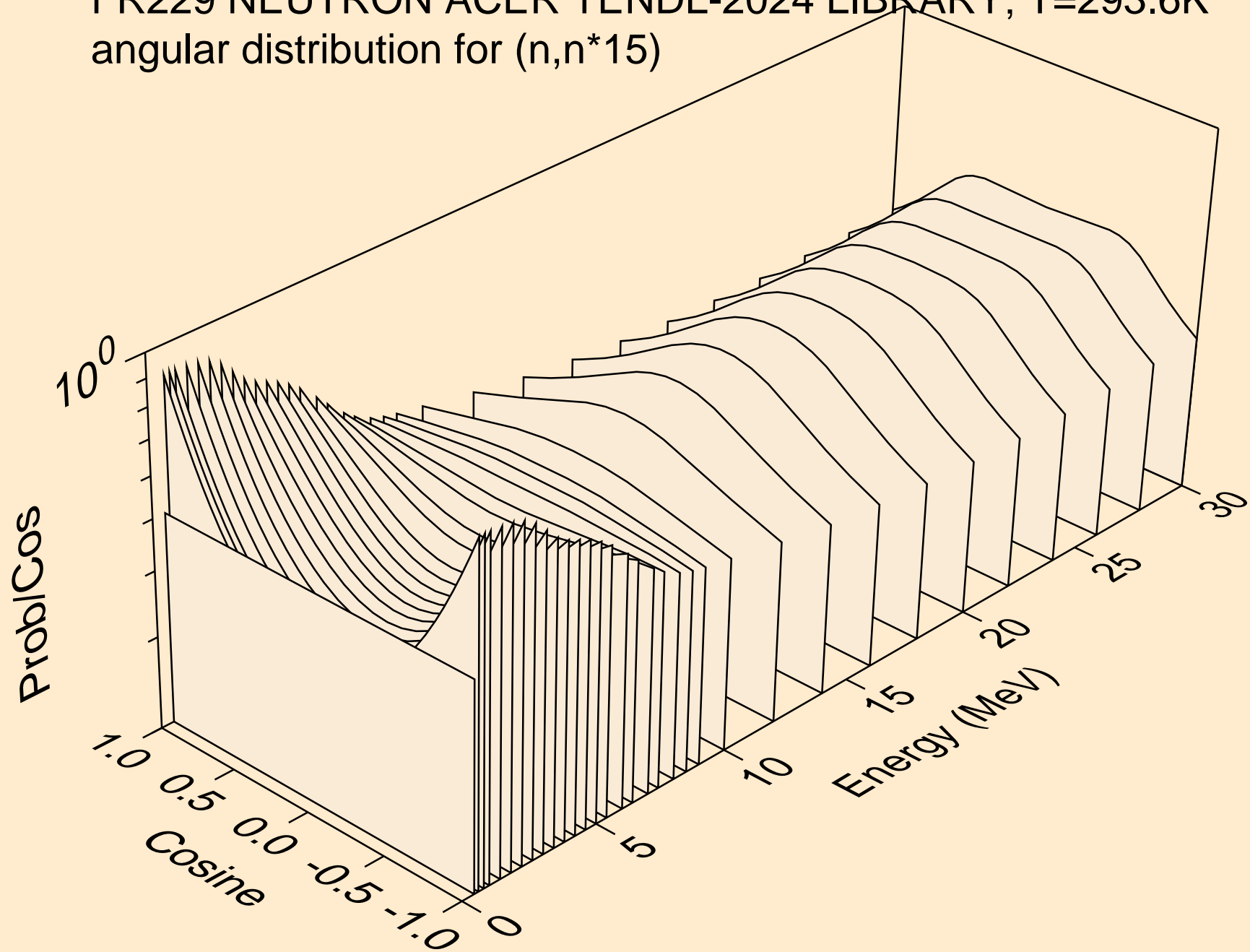

FR229 NEUTRON ACER TENDL-2024 LIBRARY; T=293.6K
angular distribution for (n,n*16)

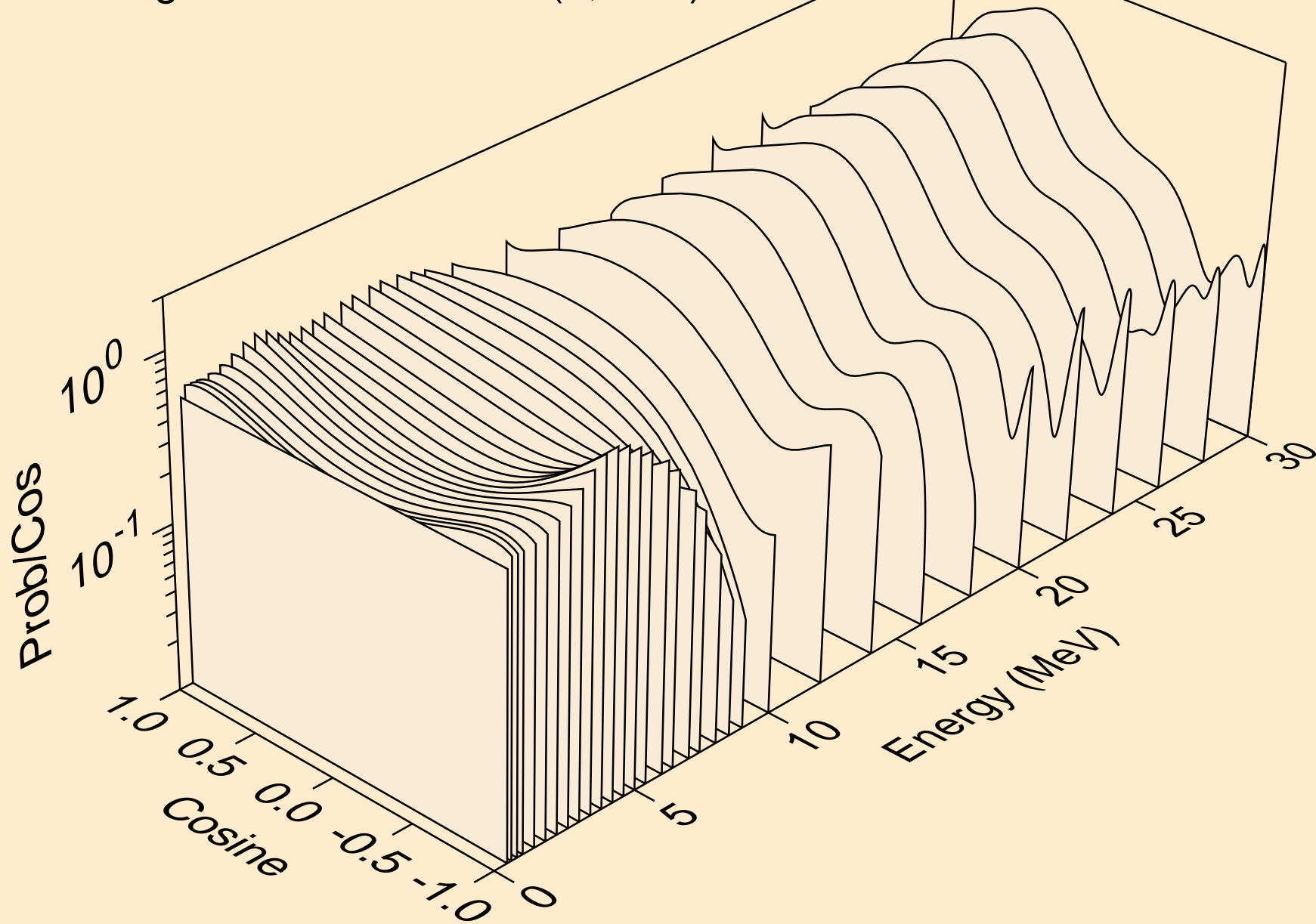

FR229 NEUTRON ACER TENDL-2024 LIBRARY; T=293.6K
angular distribution for (n,n*17)

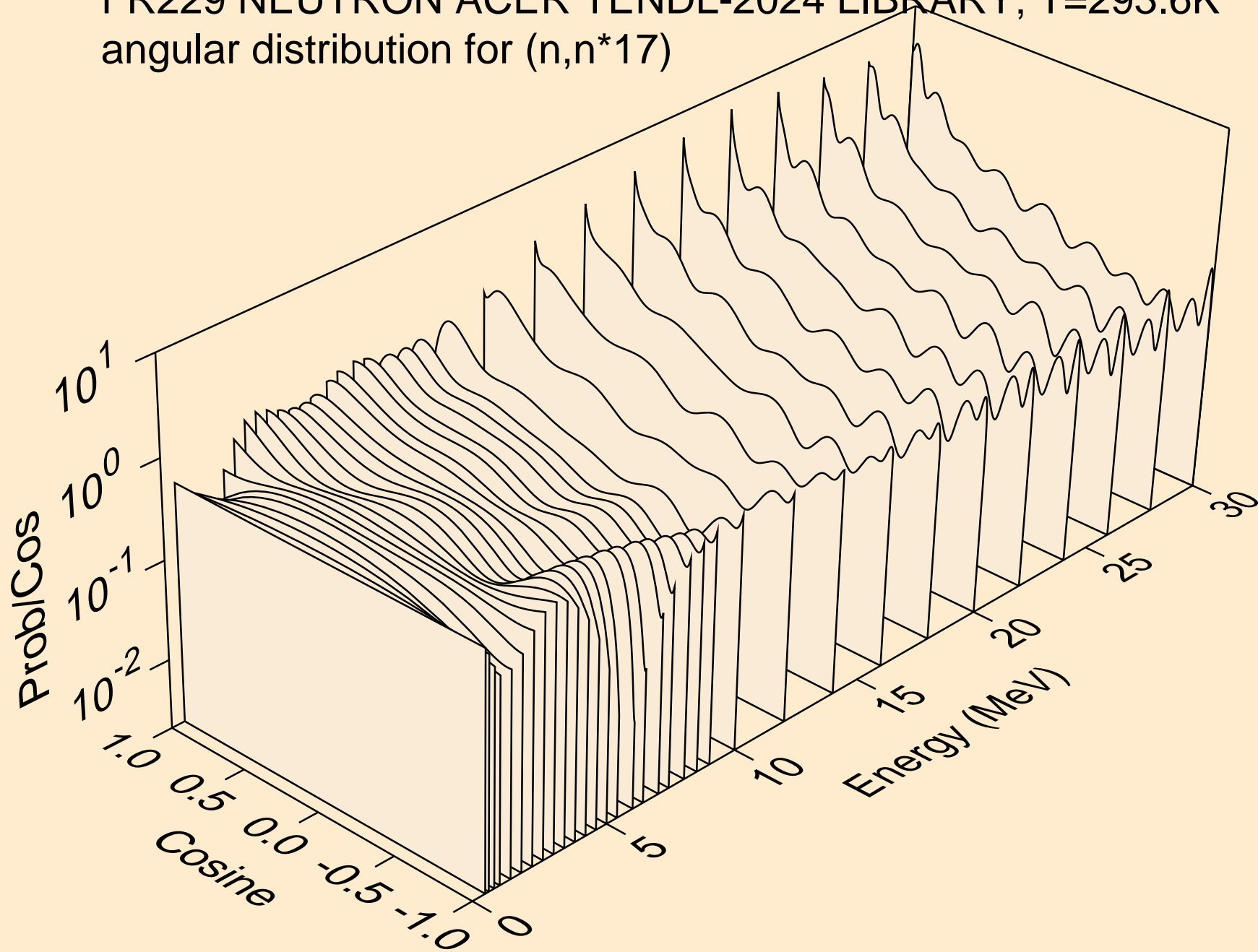

FR229 NEUTRON ACER TENDL-2024 LIBRARY; T=293.6K
angular distribution for (n,n*18)

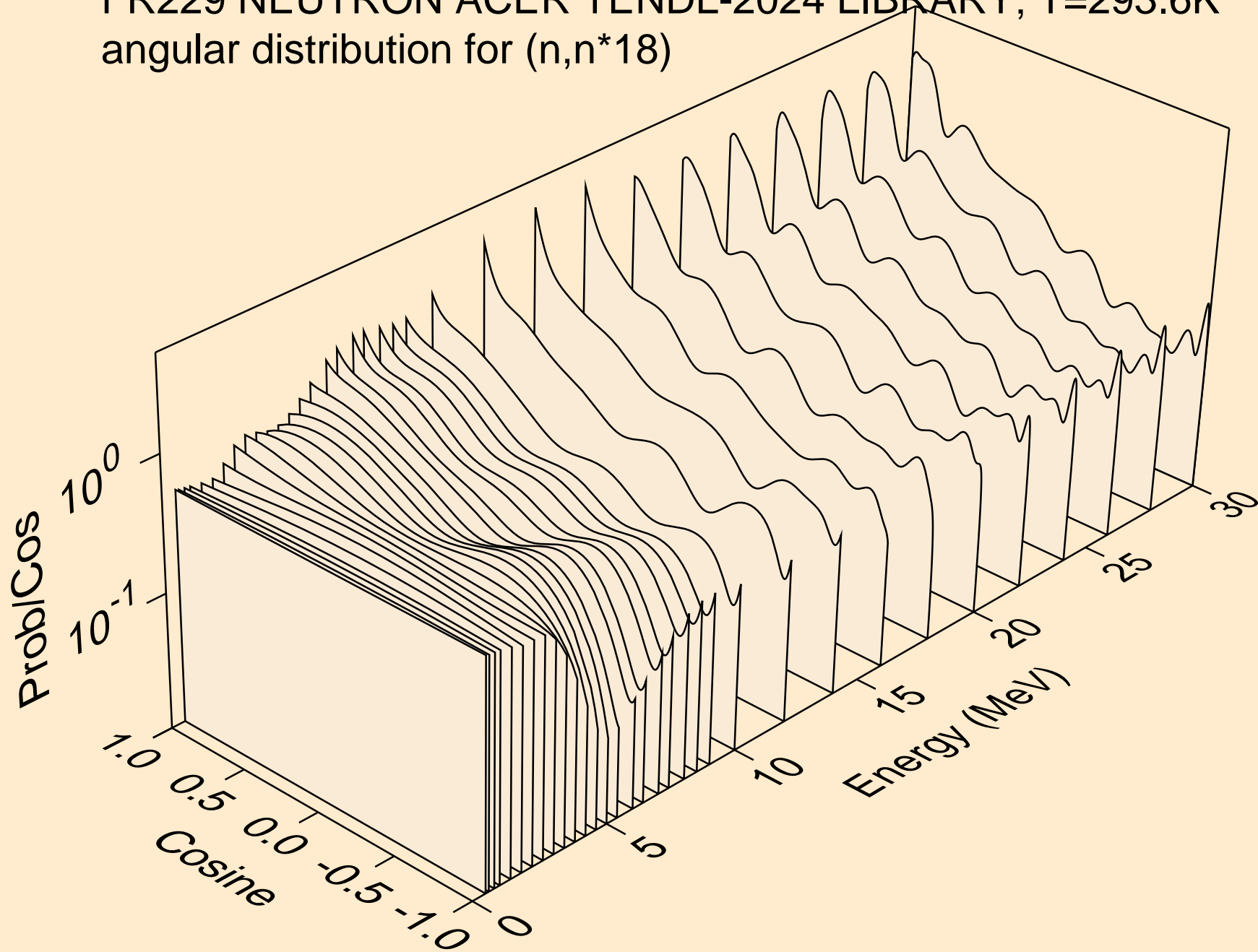

FR229 NEUTRON ACER TENDL-2024 LIBRARY; T=293.6K
angular distribution for (n,n*19)

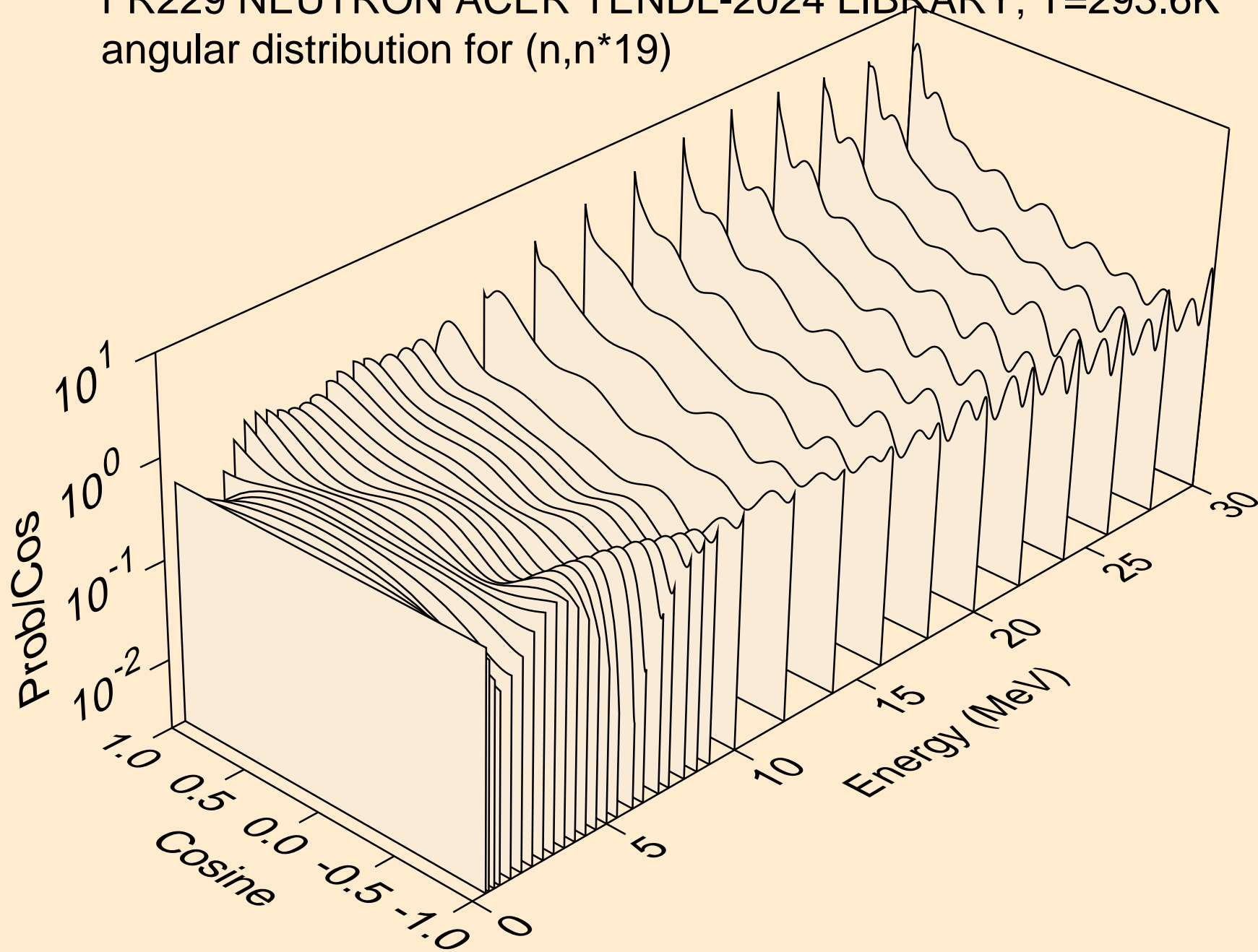

FR229 NEUTRON ACER TENDL-2024 LIBRARY; T=293.6K
angular distribution for (n,n*20)

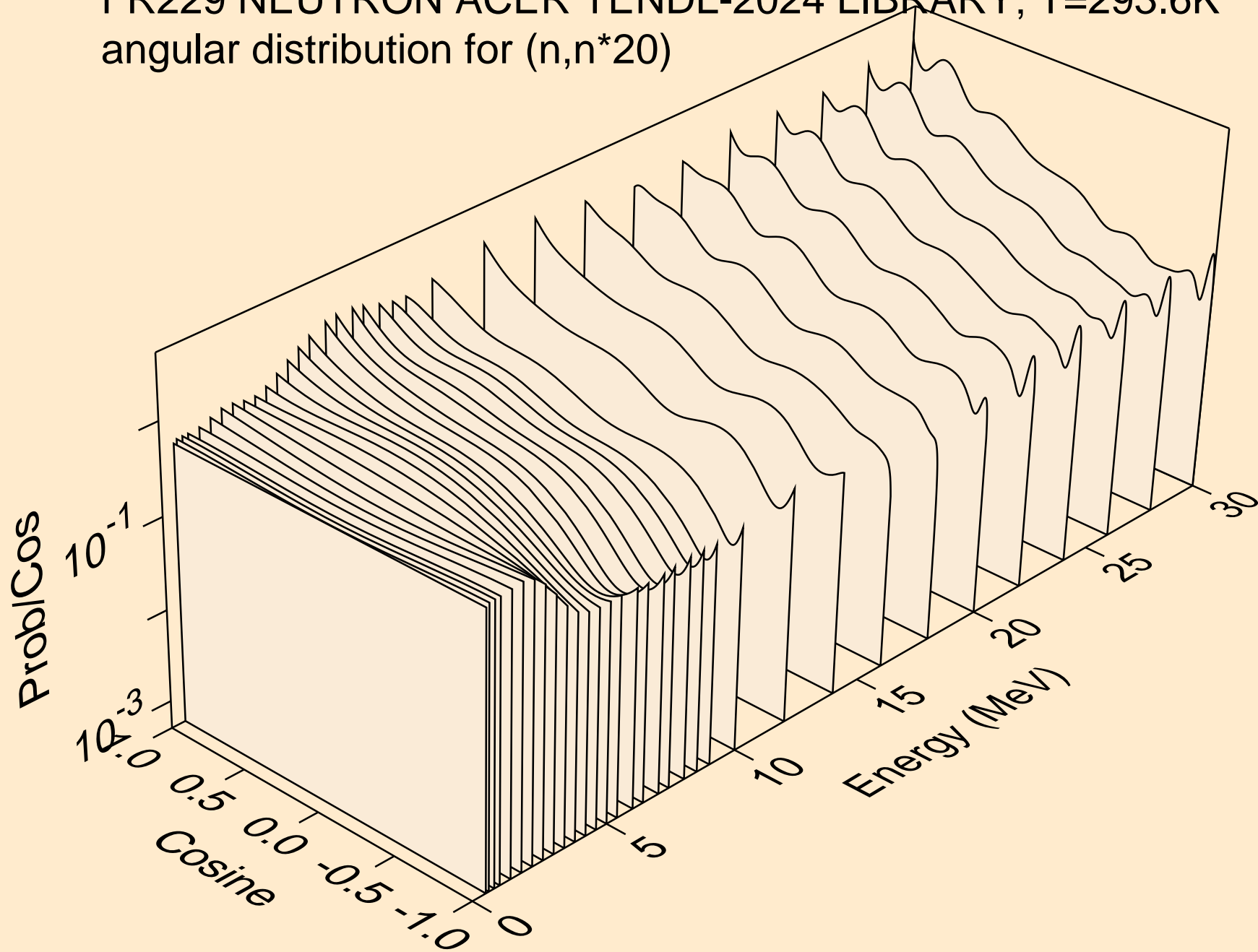

FR229 NEUTRON ACER TENDL-2024 LIBRARY; T=293.6K
angular distribution for (n,n*21)

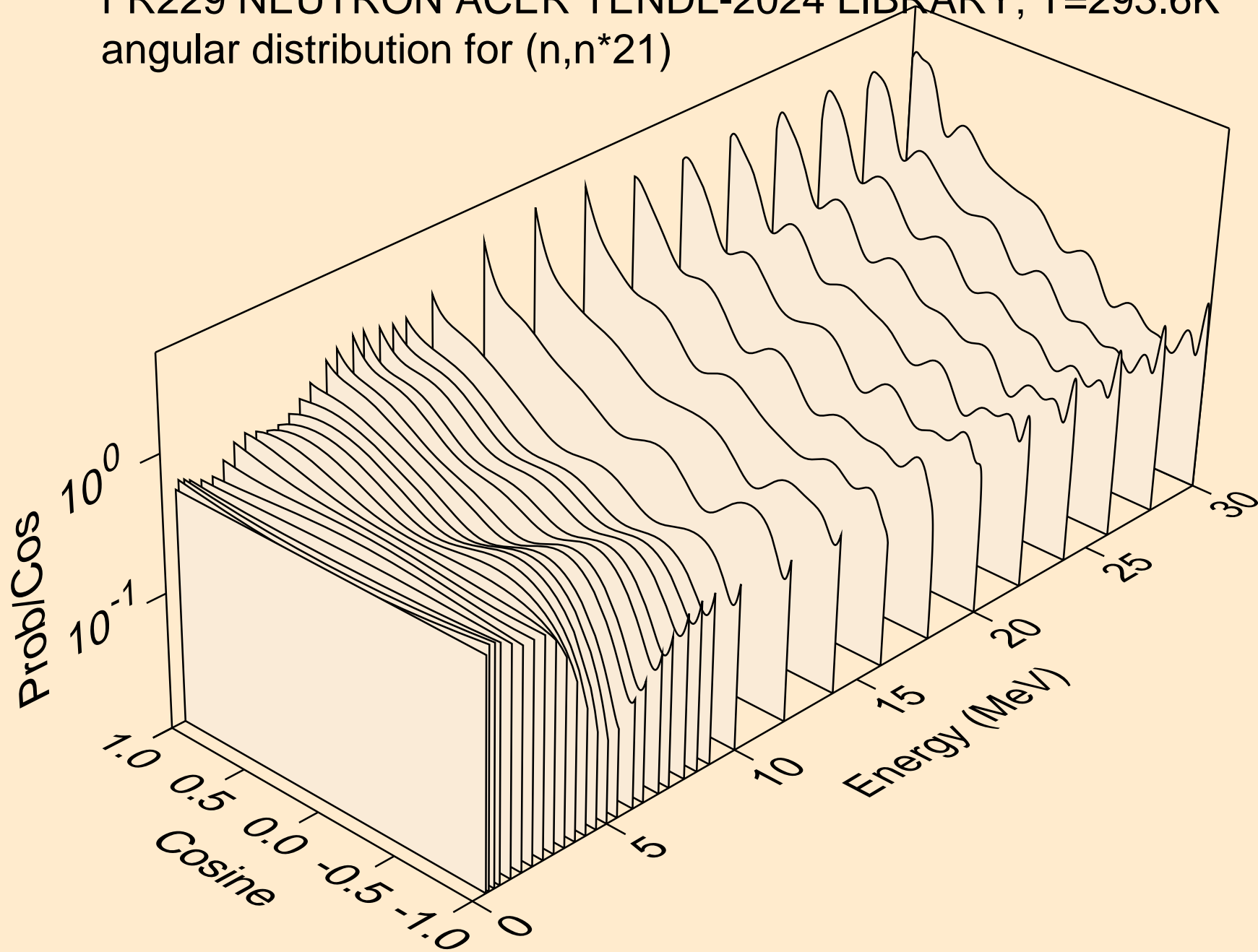

FR229 NEUTRON ACER TENDL-2024 LIBRARY; T=293.6K
angular distribution for (n,n*22)

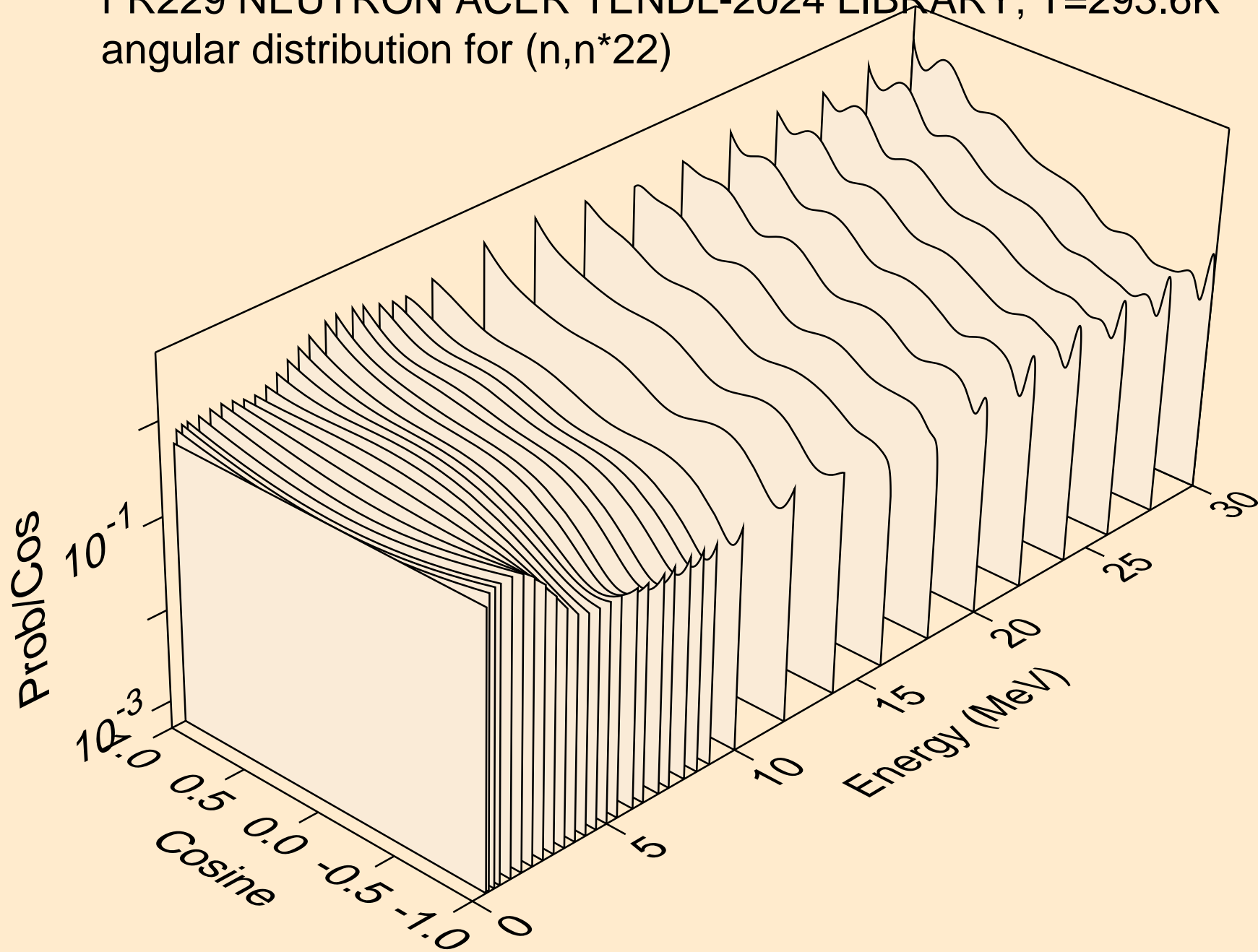

FR229 NEUTRON ACER TENDL-2024 LIBRARY; T=293.6K
angular distribution for (n,n*23)

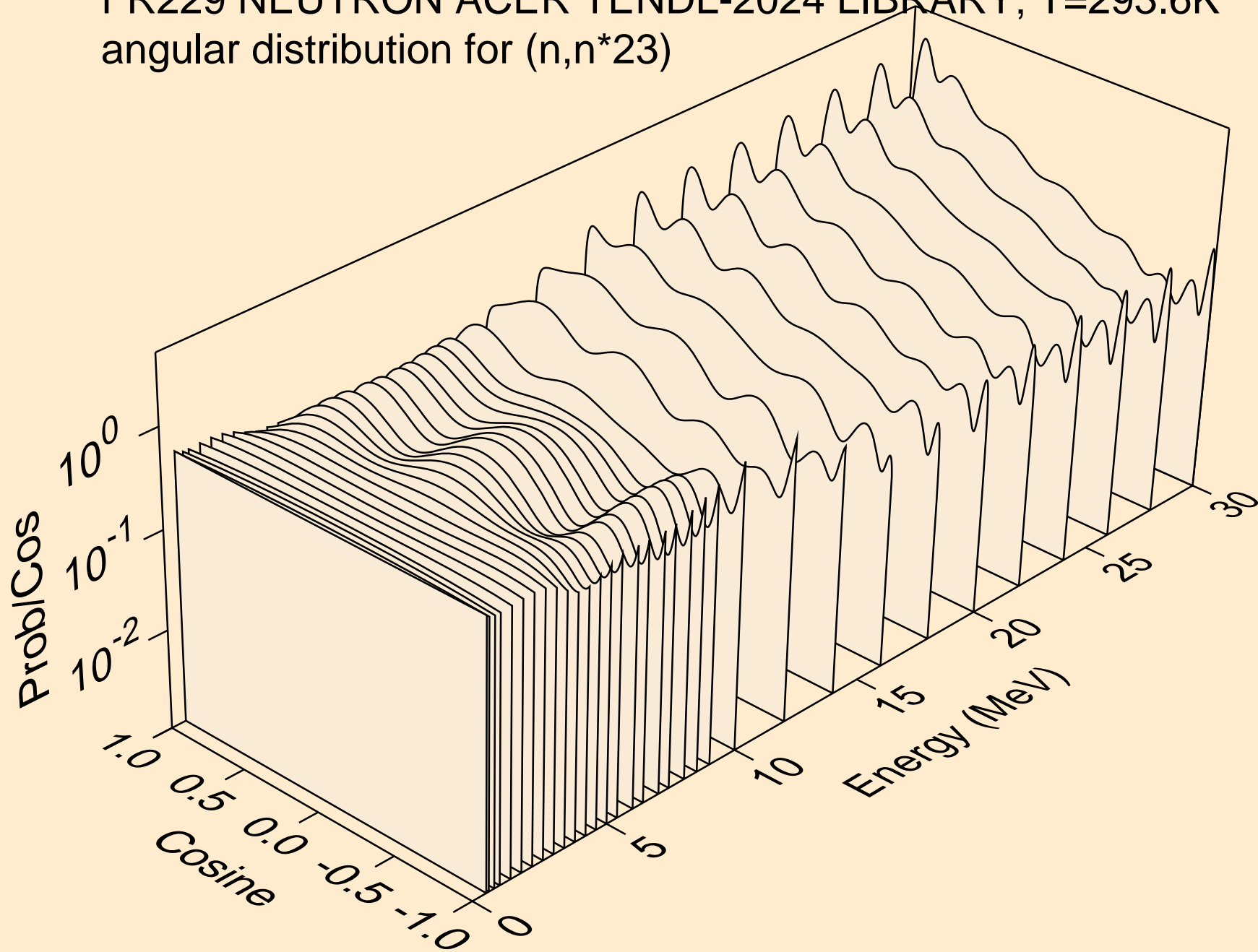

FR229 NEUTRON ACER TENDL-2024 LIBRARY; T=293.6K
angular distribution for (n,n*24)

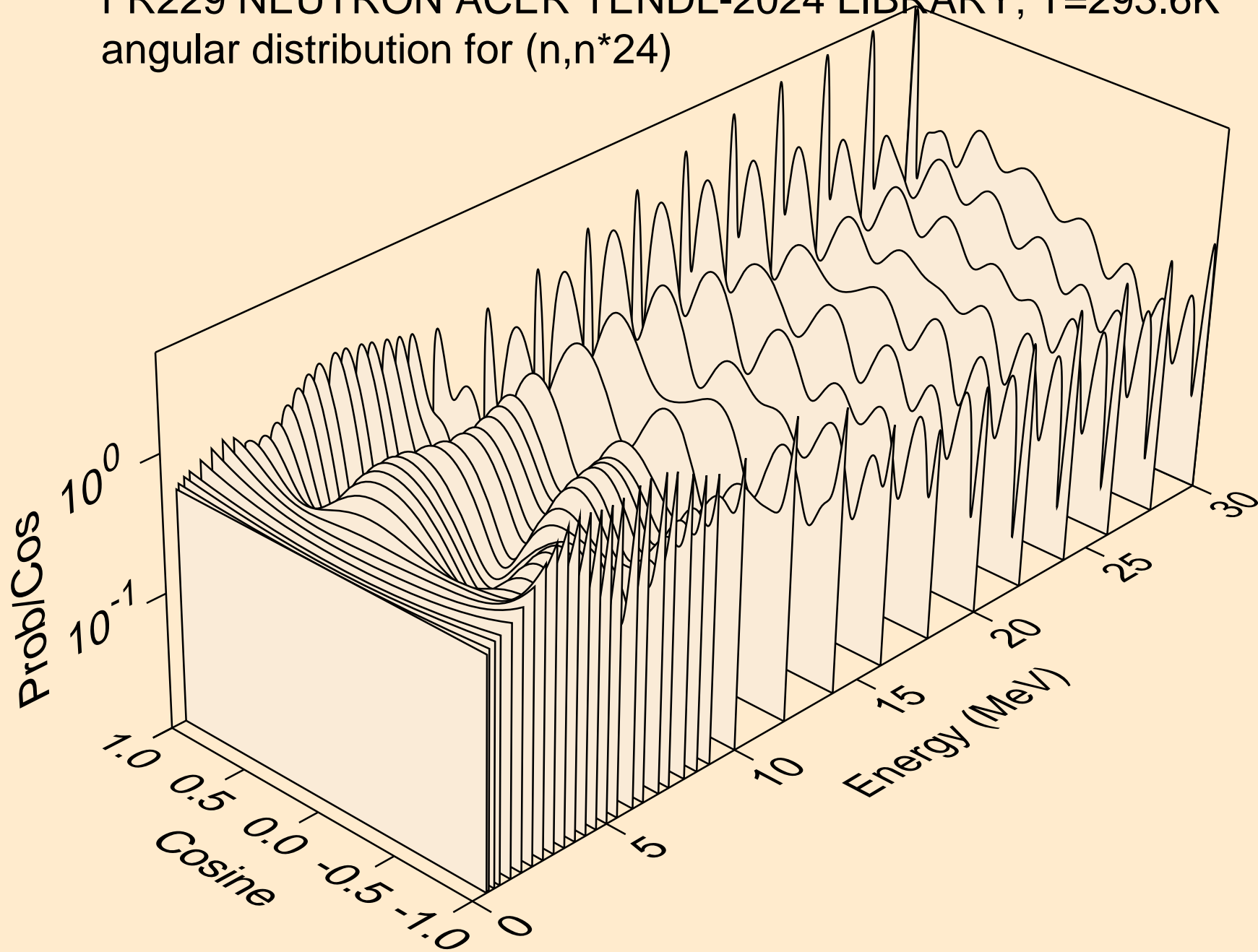

FR229 NEUTRON ACER TENDL-2024 LIBRARY; T=293.6K
angular distribution for (n,n*25)

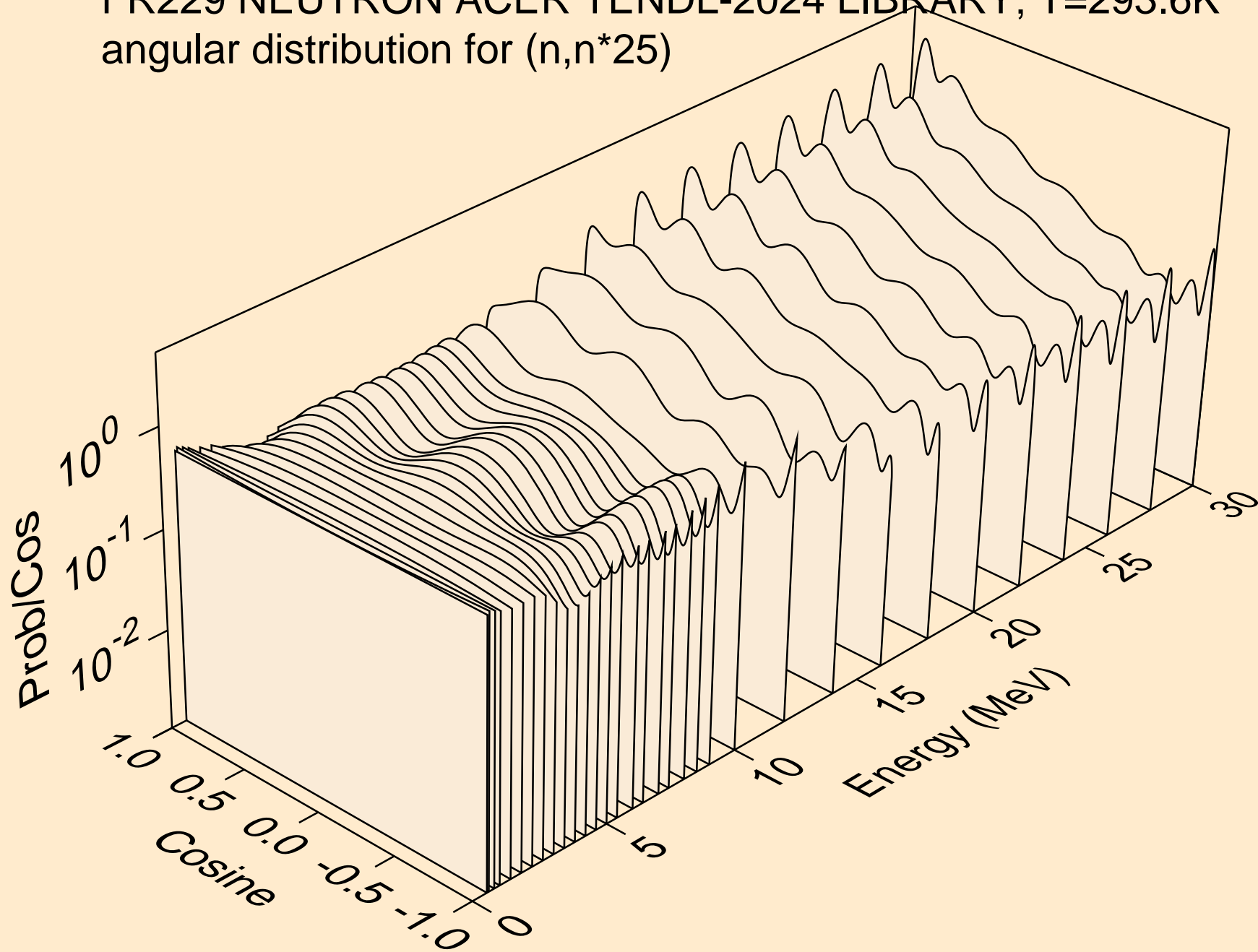

FR229 NEUTRON ACER TENDL-2024 LIBRARY; T=293.6K
angular distribution for (n,n*26)

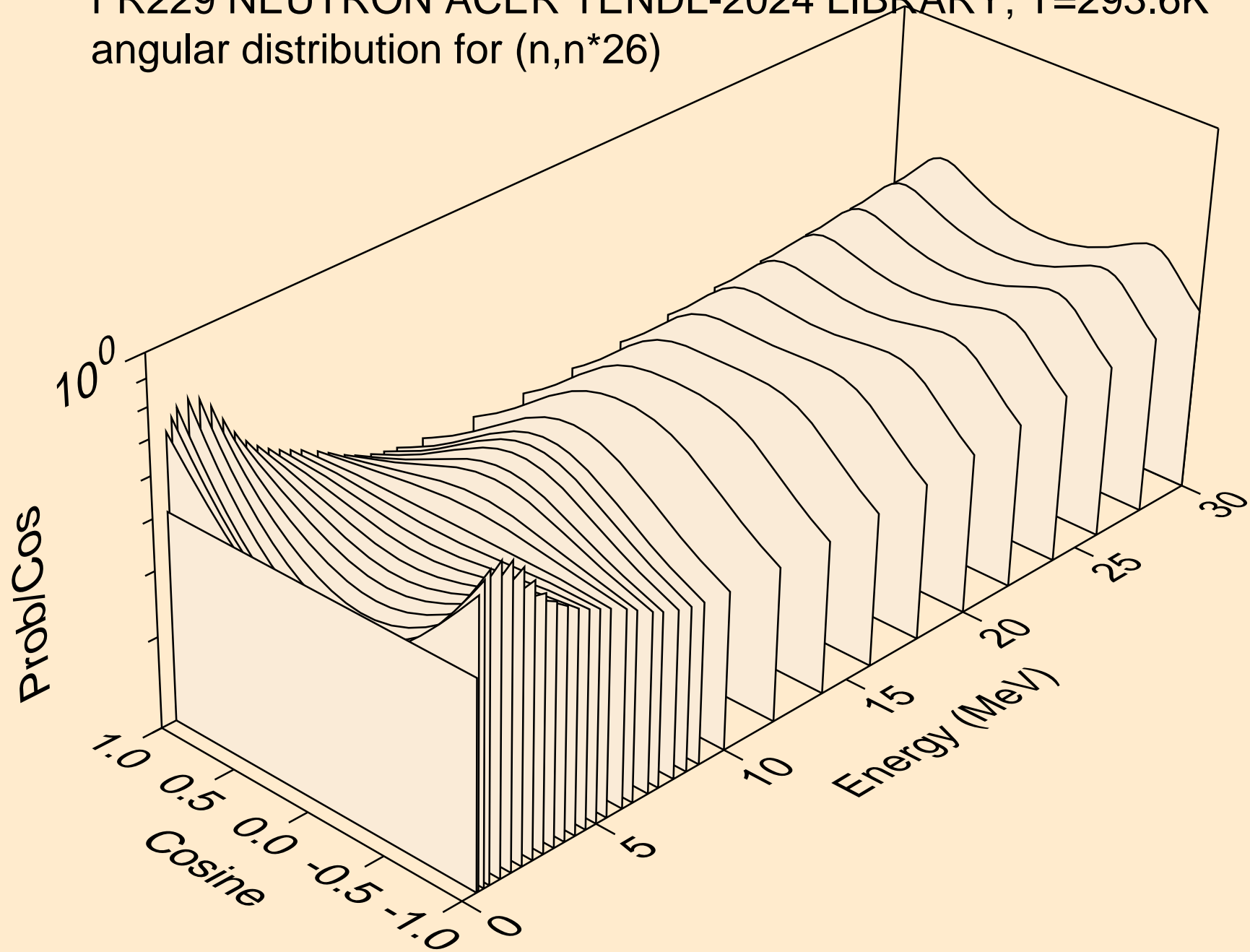

FR229 NEUTRON ACER TENDL-2024 LIBRARY; T=293.6K
angular distribution for (n,n*27)

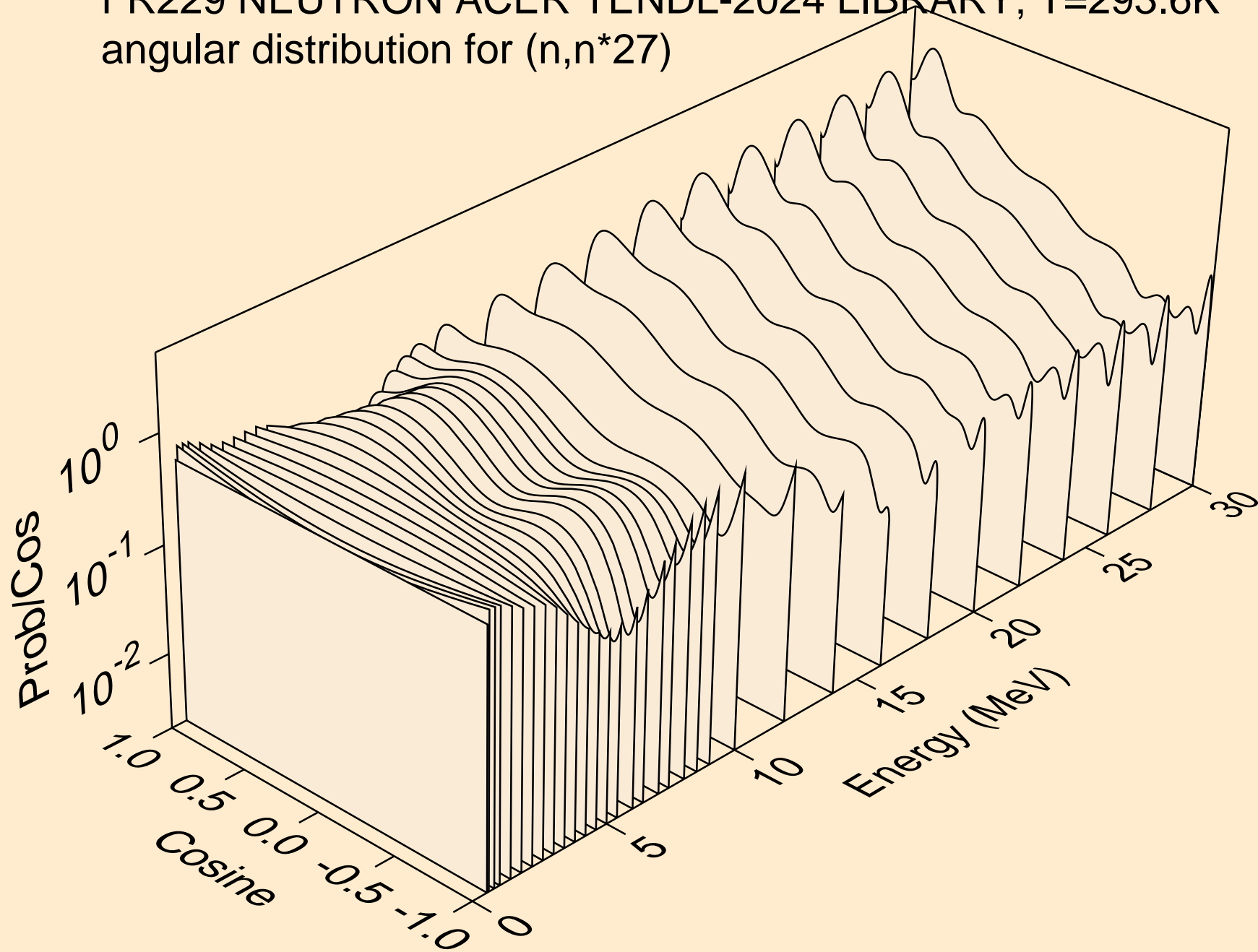

FR229 NEUTRON ACER TENDL-2024 LIBRARY; T=293.6K
angular distribution for (n,n*28)

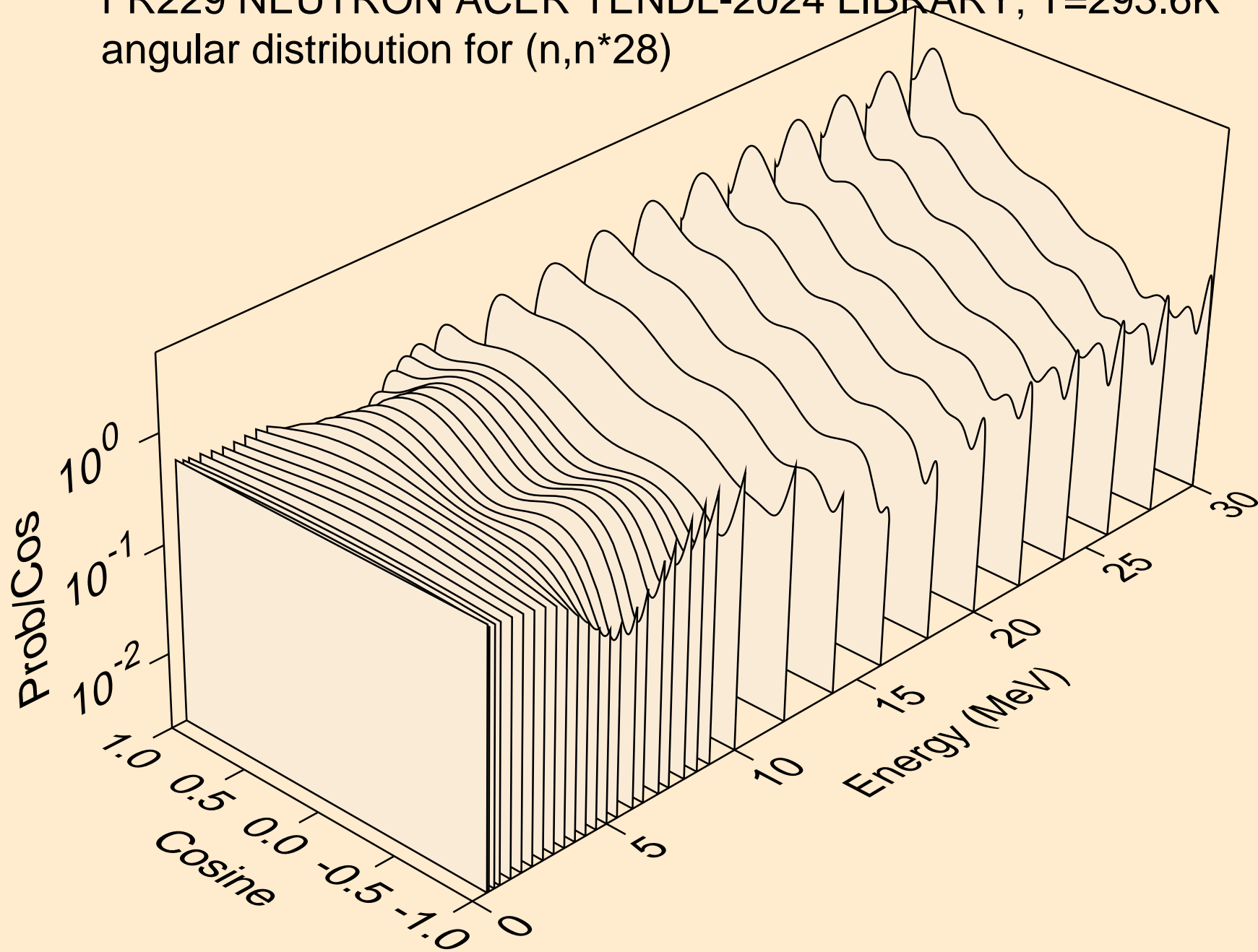

FR229 NEUTRON ACER TENDL-2024 LIBRARY; T=293.6K
Total fission nubar

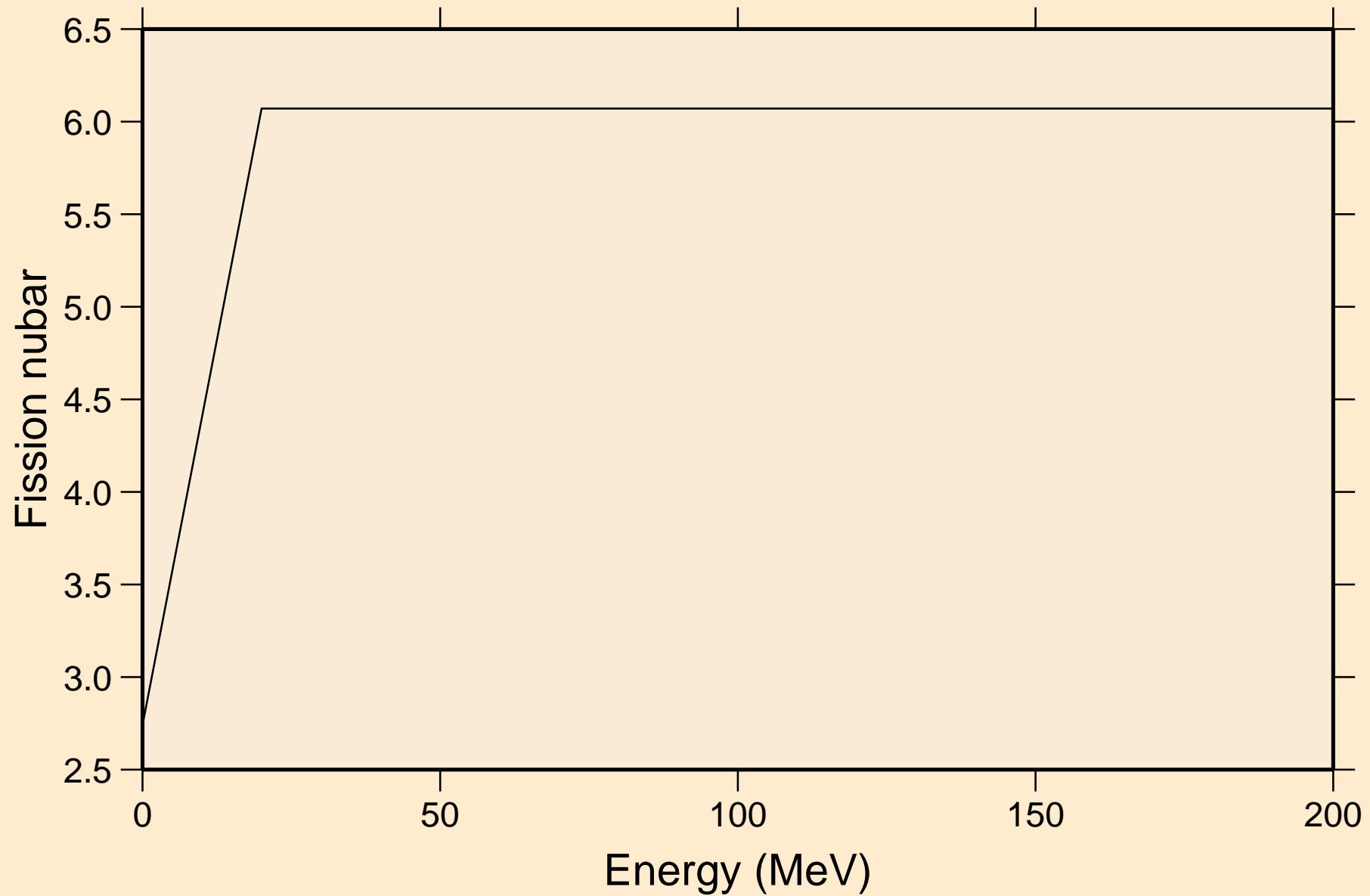

FR229 NEUTRON ACER TENDL-2024 LIBRARY; T=293.6K
Neutron emission for (n,x)

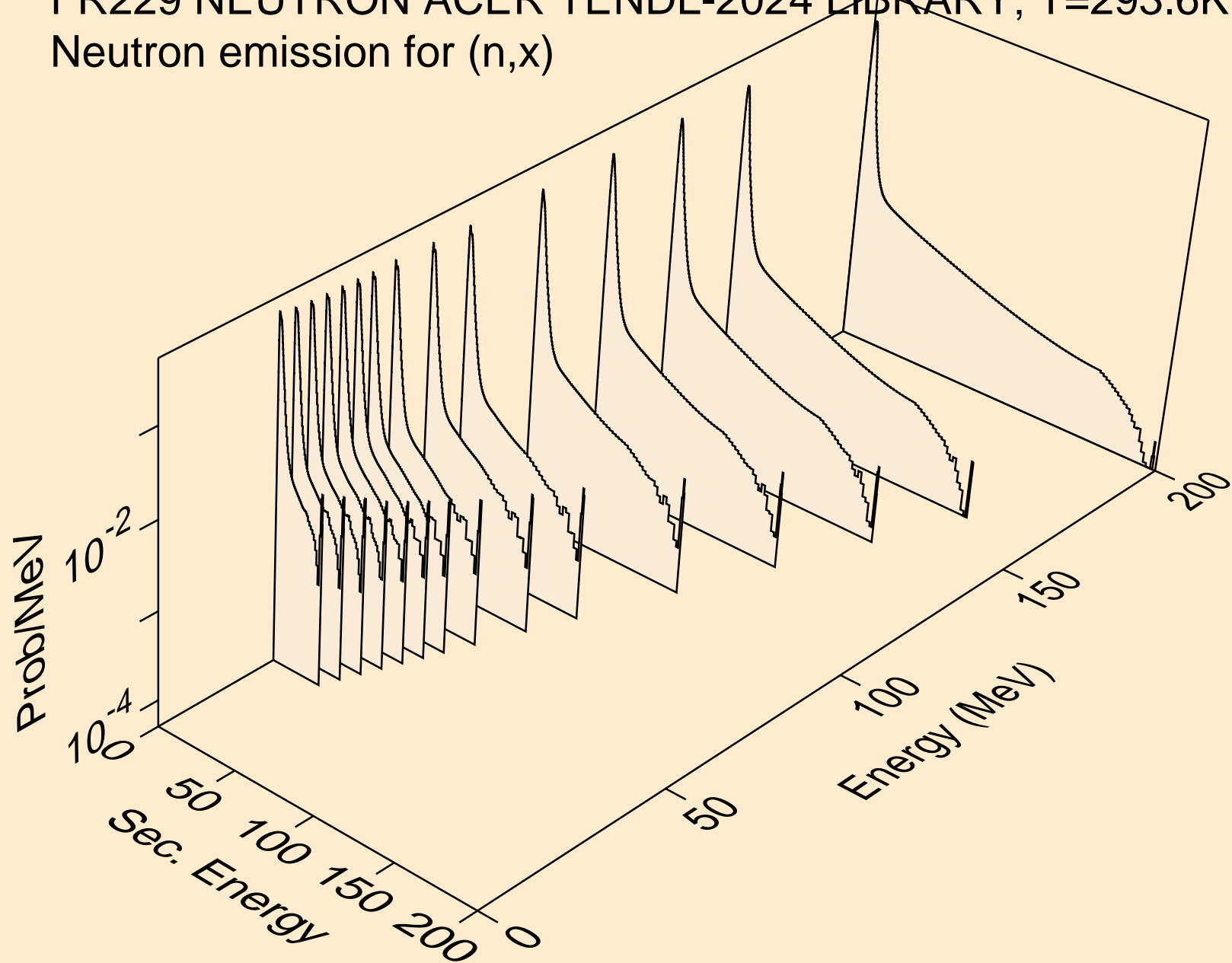

FR229 NEUTRON ACER TENDL-2024 LIBRARY; T=293.6K
Neutron emission for (n,2nd)

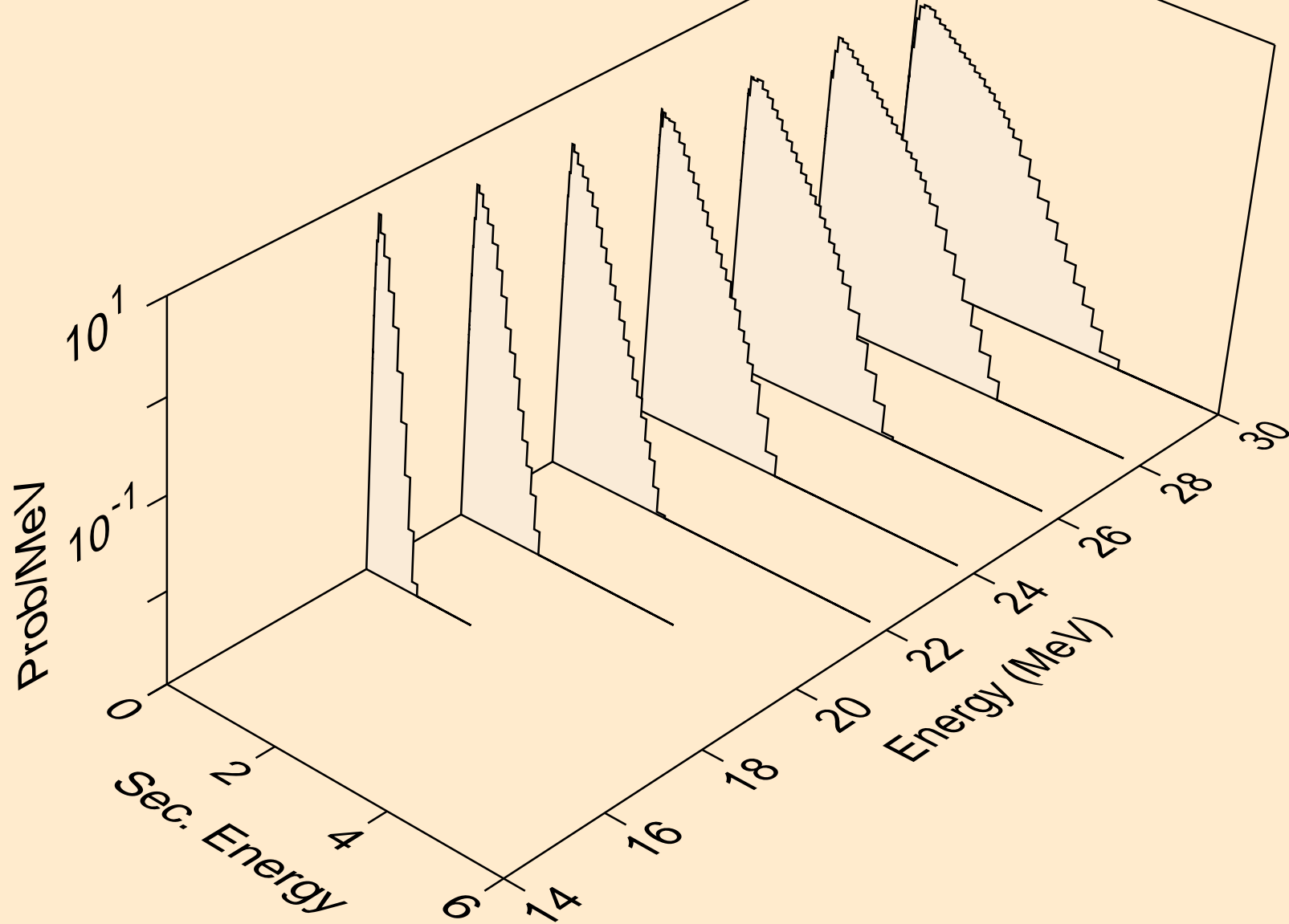

FR229 NEUTRON ACER TENDL-2024 LIBRARY; T=293.6K
Neutron emission for (n,2n)

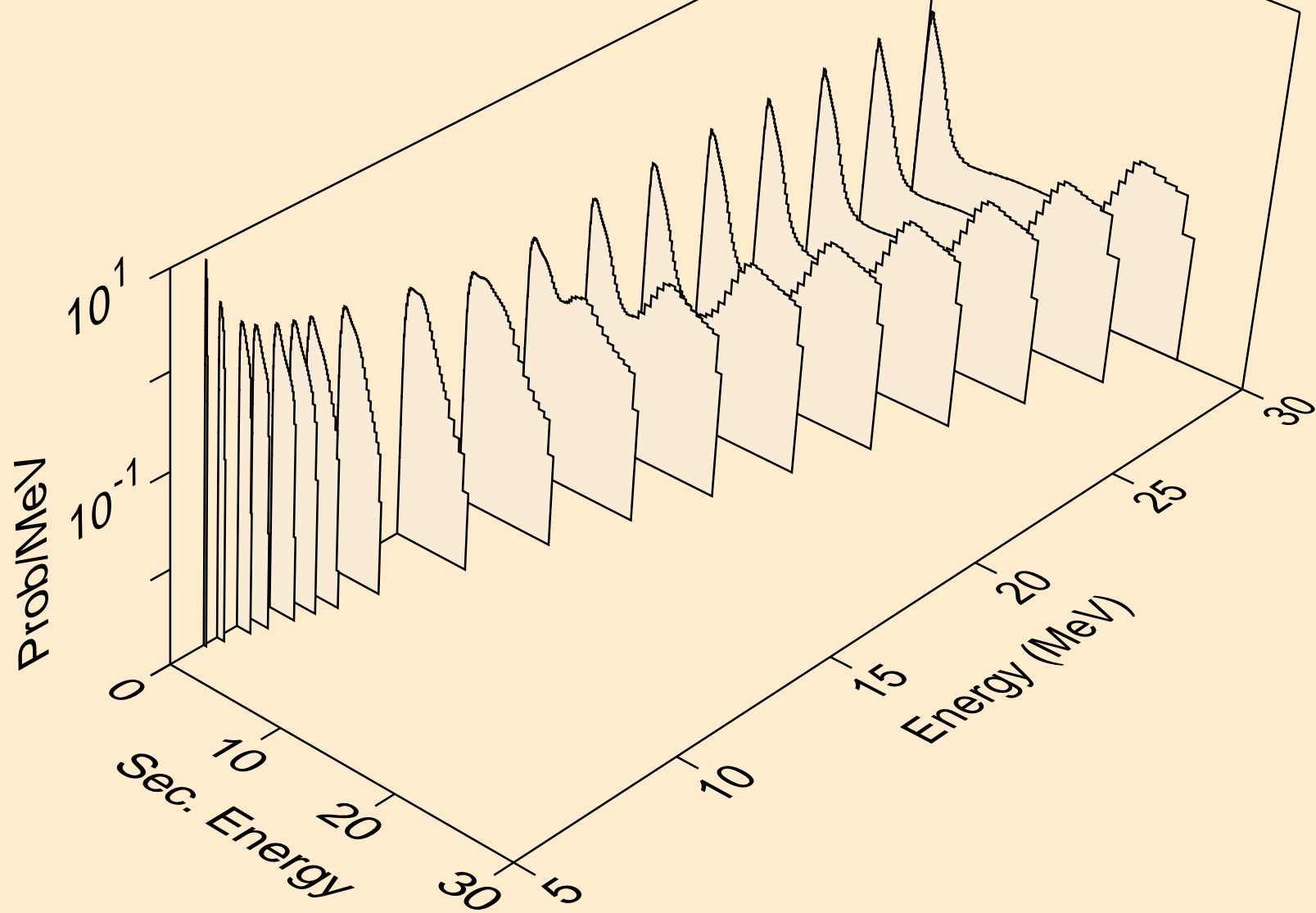

FR229 NEUTRON ACER TENDL-2024 LIBRARY; T=293.6K
Neutron emission for (n,3n)

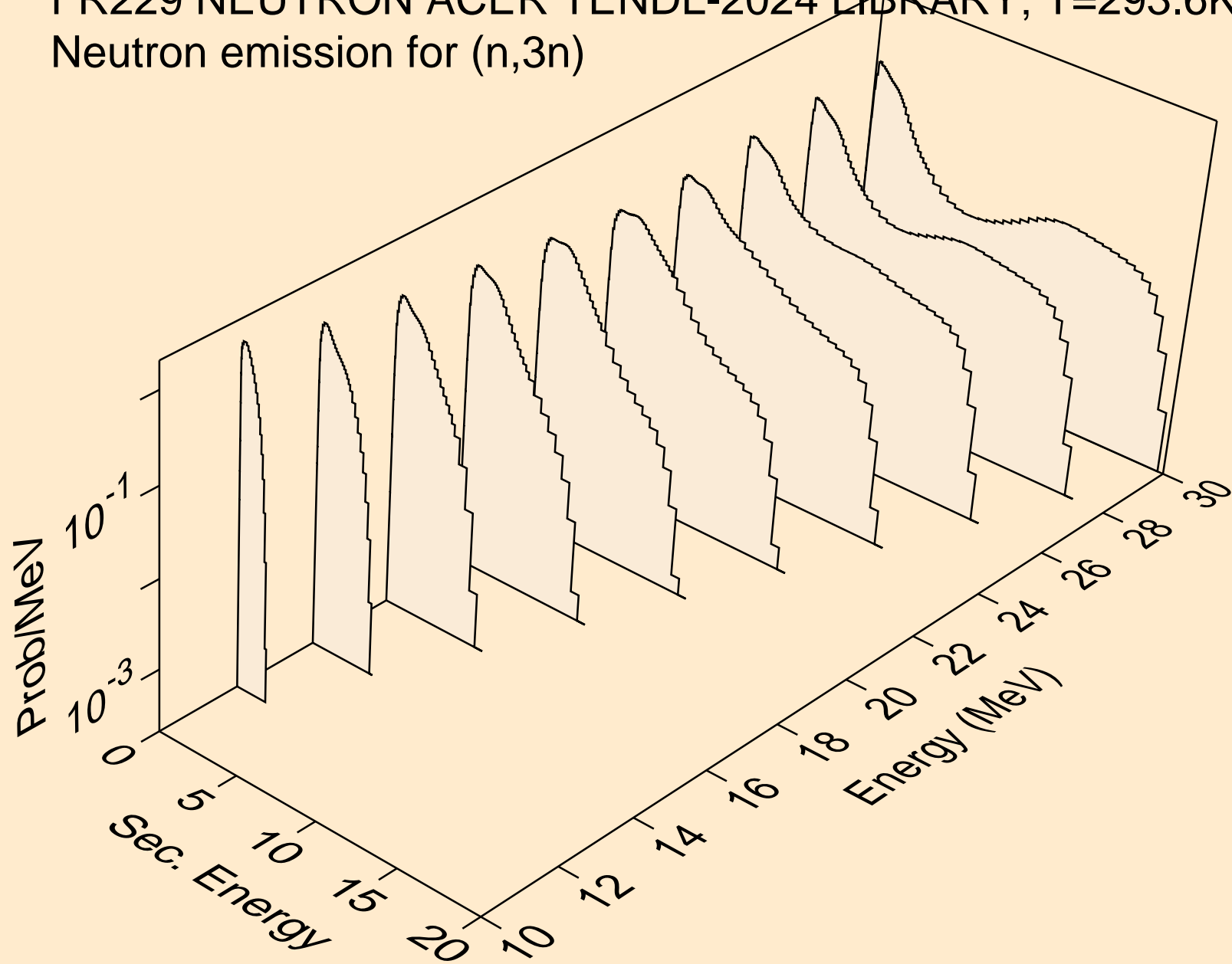

FR229 NEUTRON ACER TENDL-2024 LIBRARY; T=293.6K
Neutron emission for fission

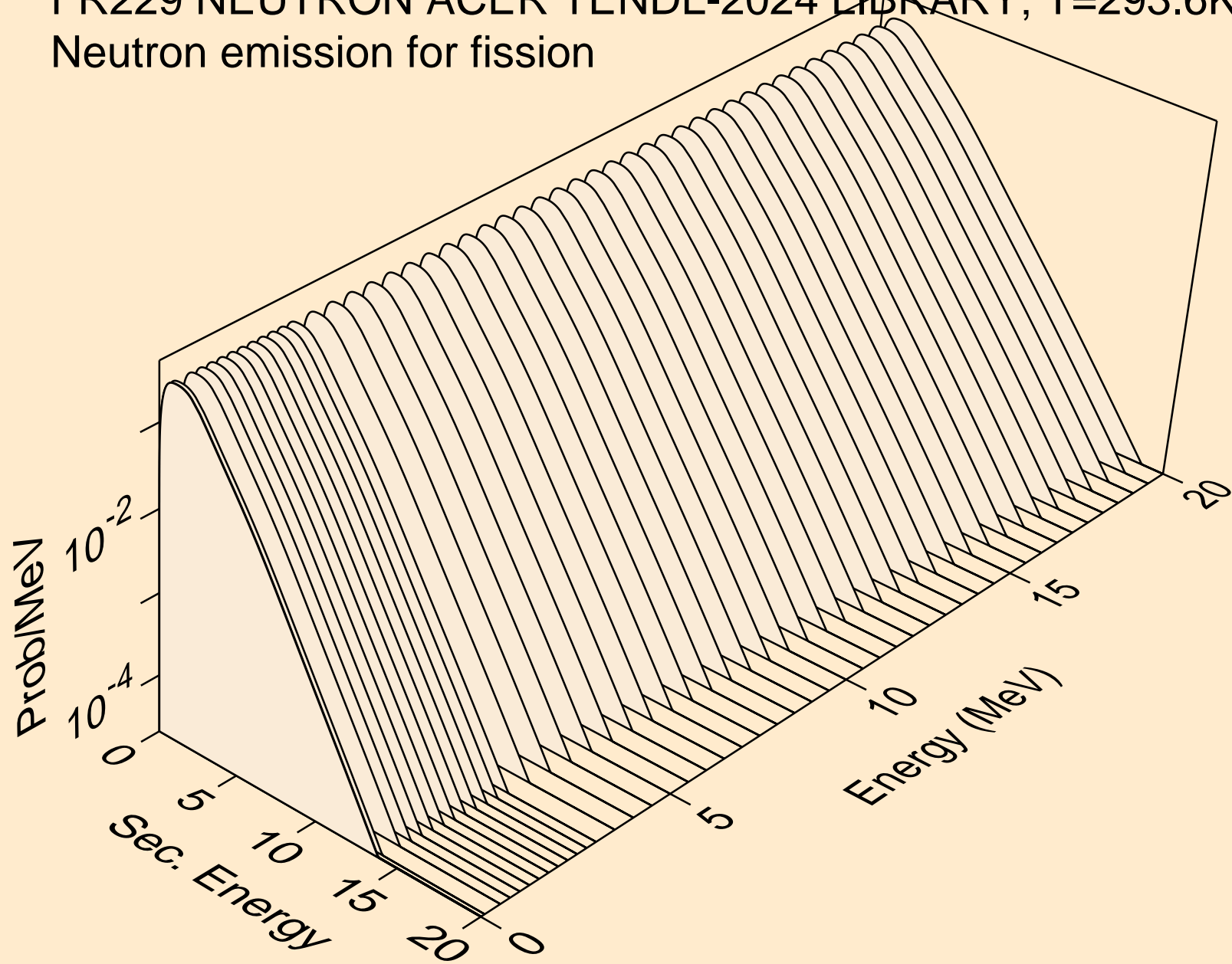

FR229 NEUTRON ACER TENDL-2024 LIBRARY; T=293.6K
Neutron emission for (n,n*)a

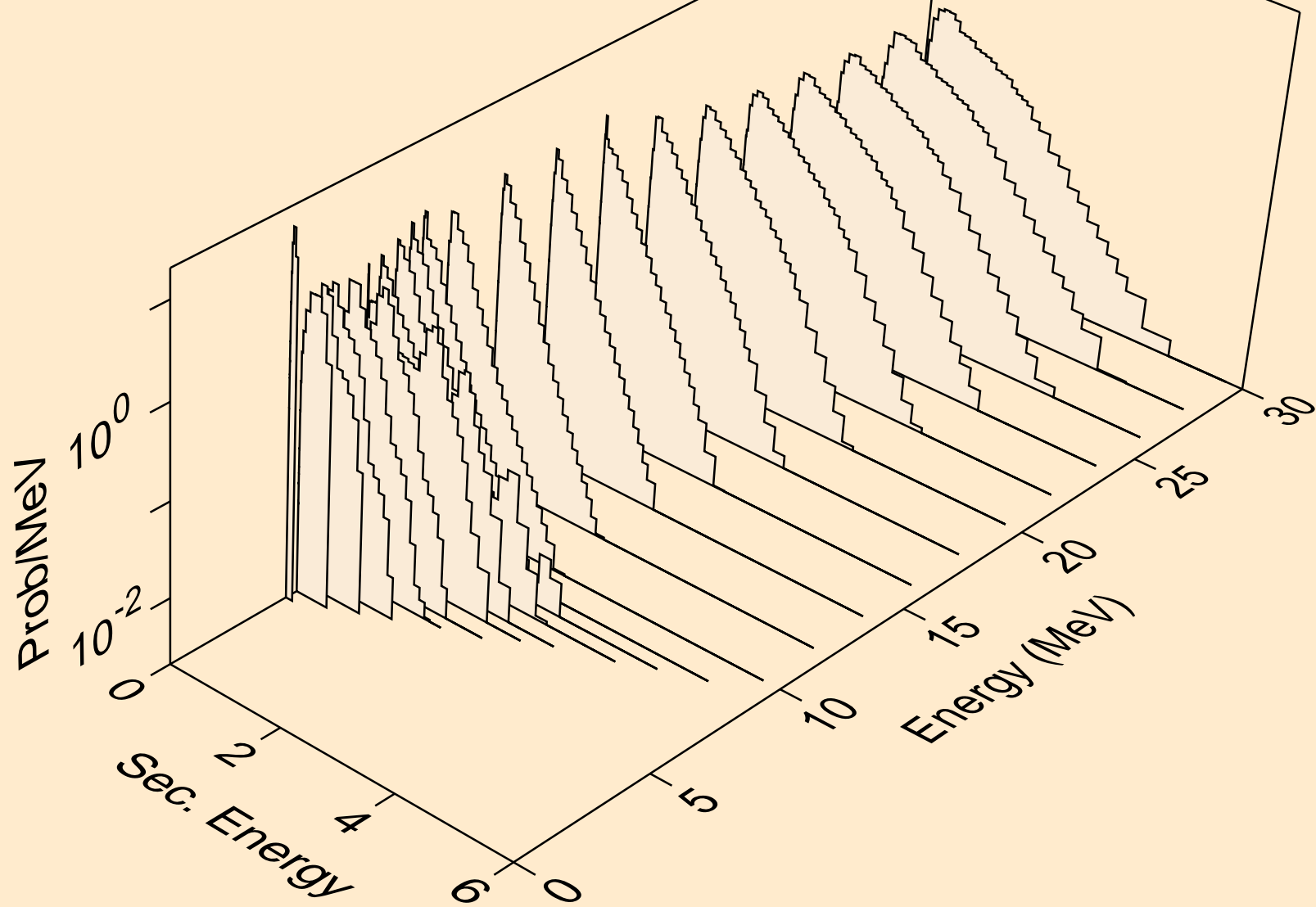

FR229 NEUTRON ACER TENDL-2024 LIBRARY; T=293.6K
Neutron emission for (n,2n)_a

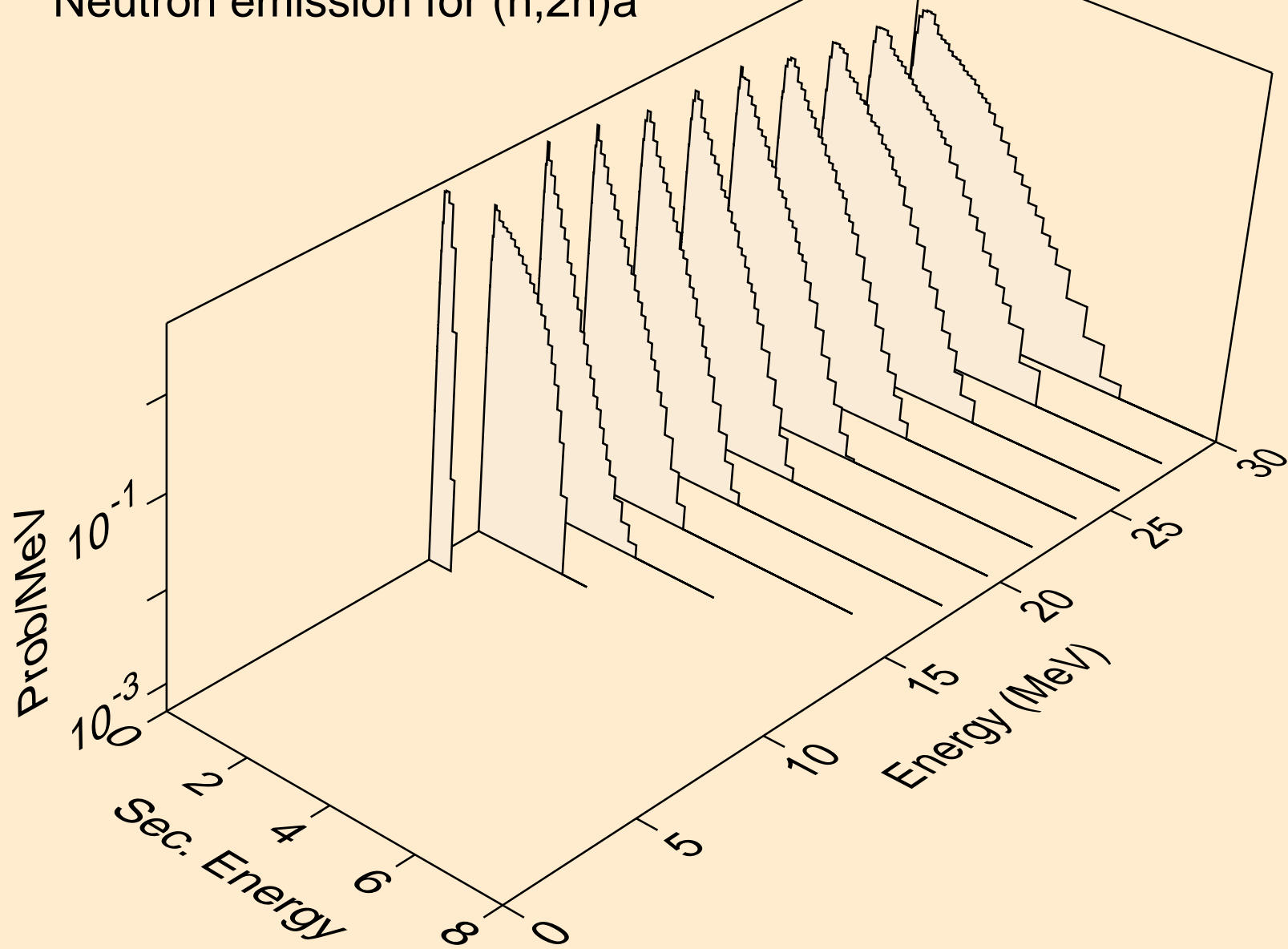

FR229 NEUTRON ACER TENDL-2024 LIBRARY; T=293.6K
Neutron emission for (n,3n)_a

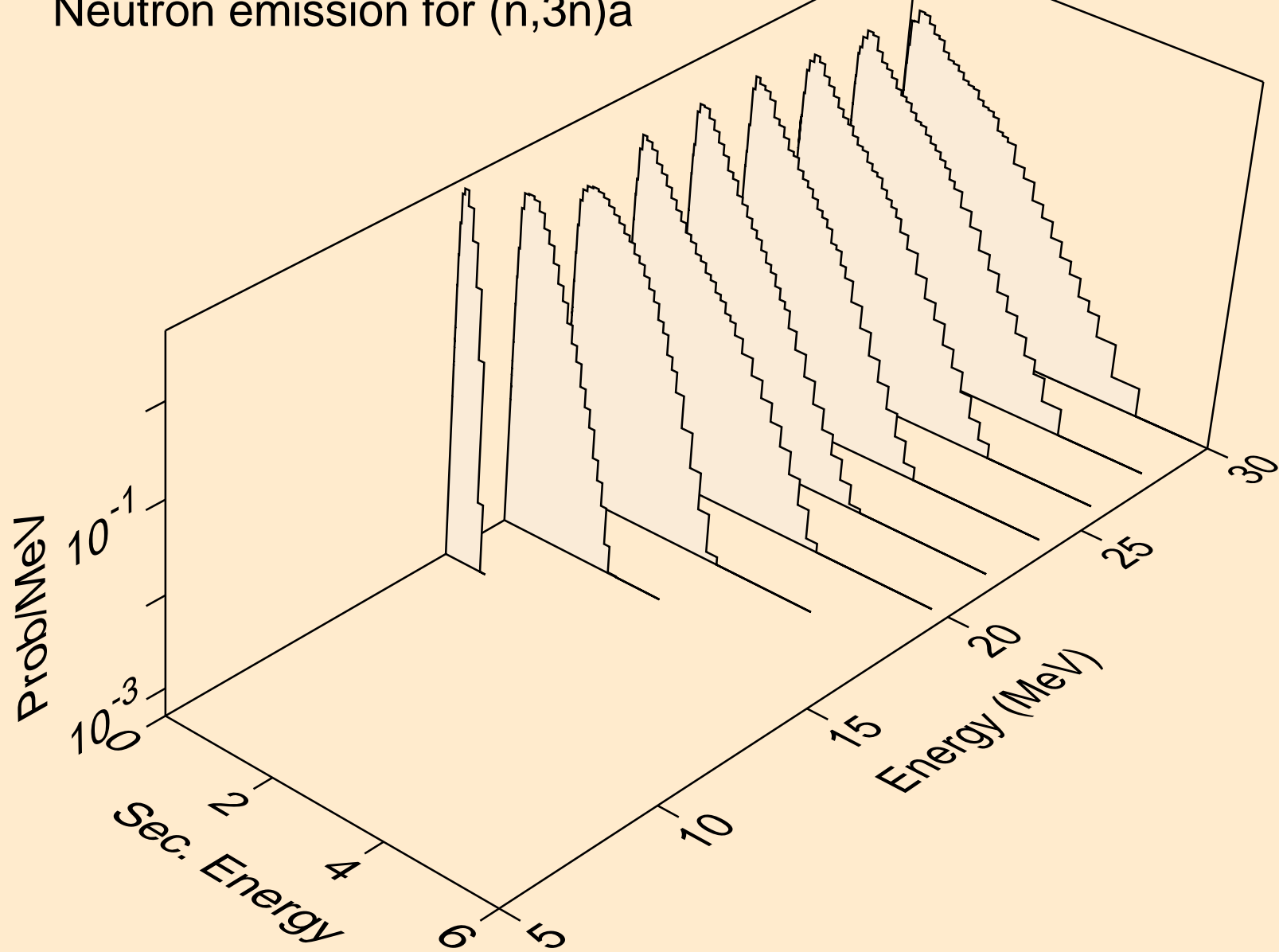

FR229 NEUTRON ACER TENDL-2024 LIBRARY; T=293.6K
Neutron emission for (n,n*)p

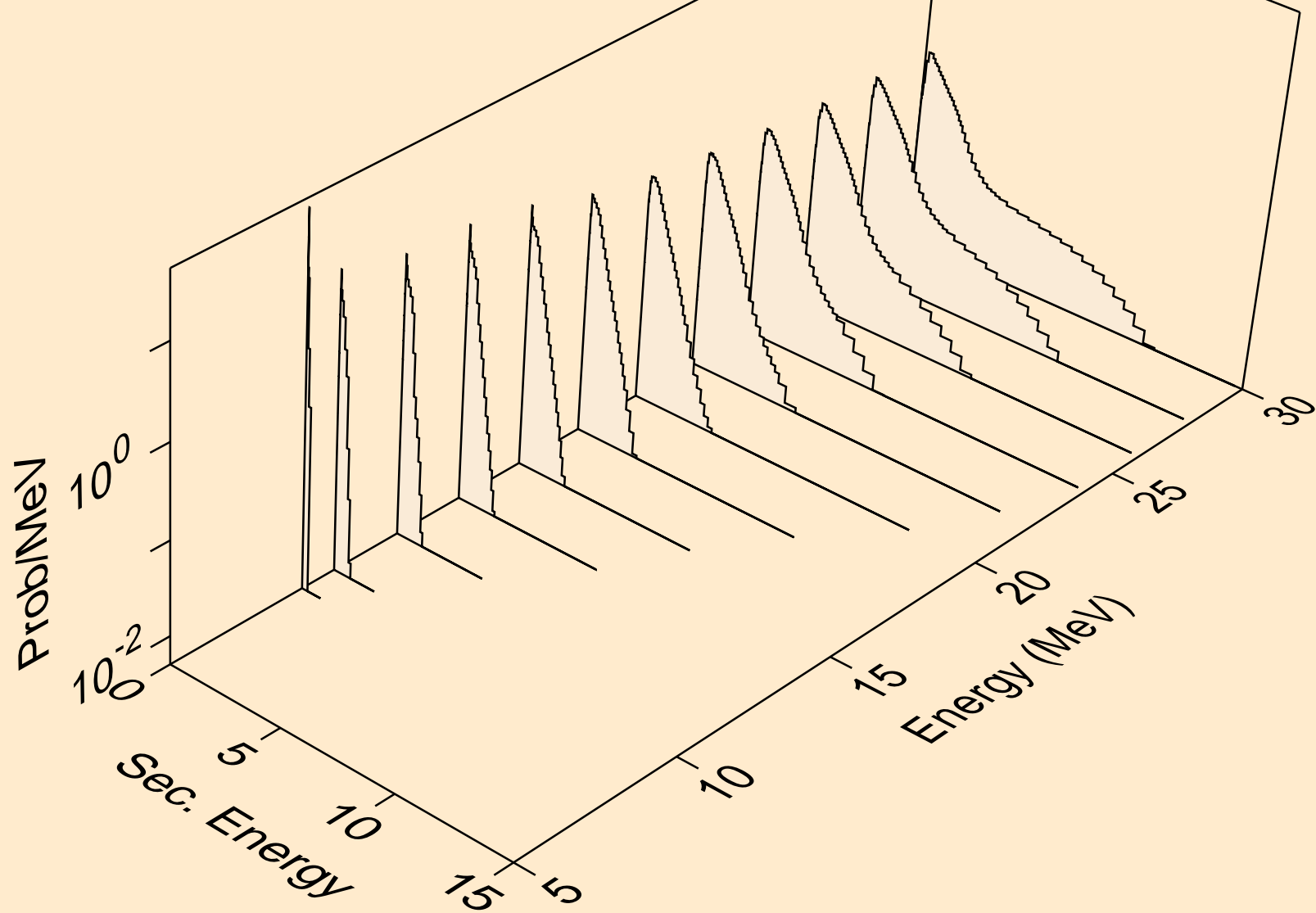

FR229 NEUTRON ACER TENDL-2024 LIBRARY; T=293.6K
Neutron emission for (n,n*)d

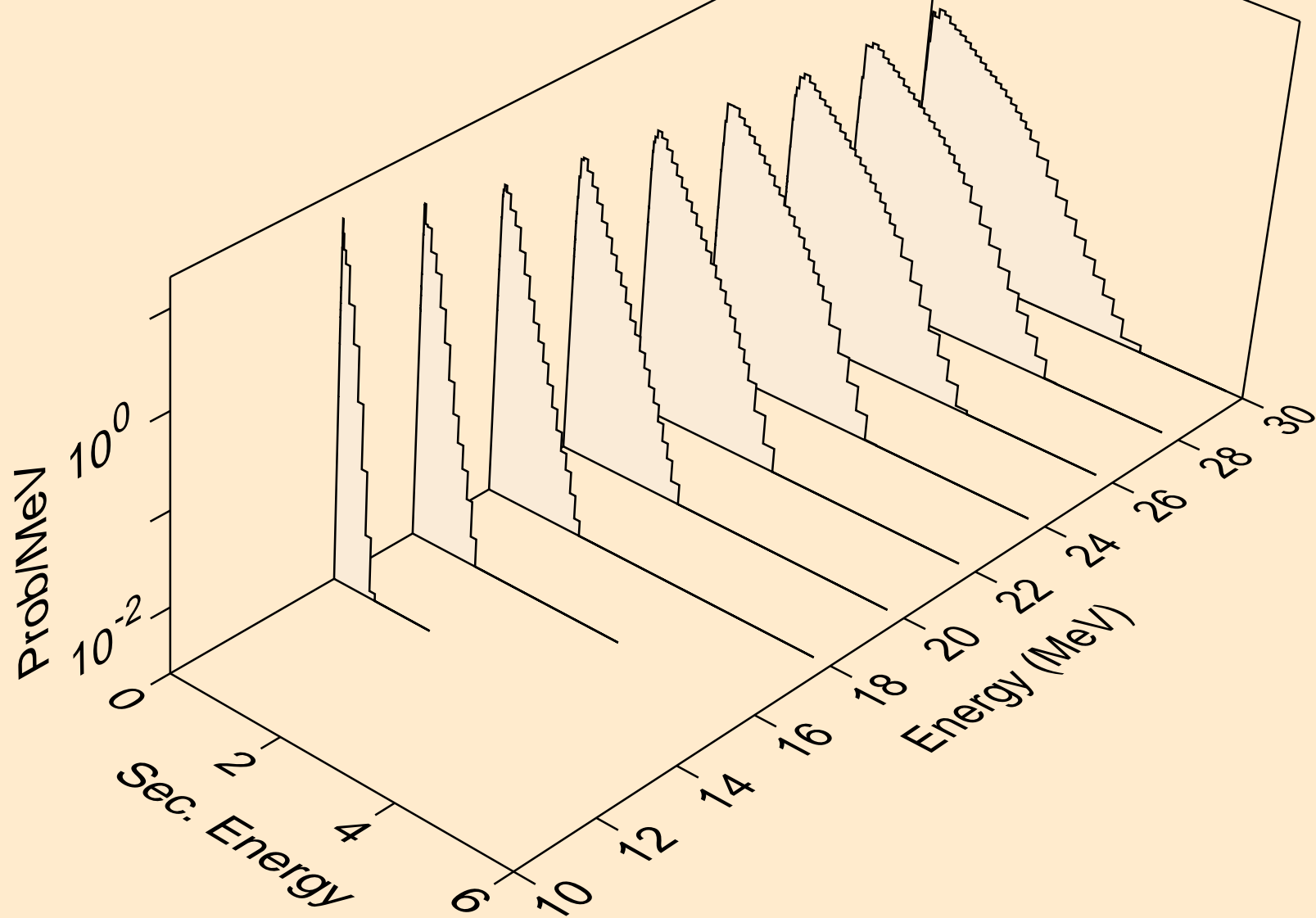

FR229 NEUTRON ACER TENDL-2024 LIBRARY; T=293.6K
Neutron emission for (n,n*)t

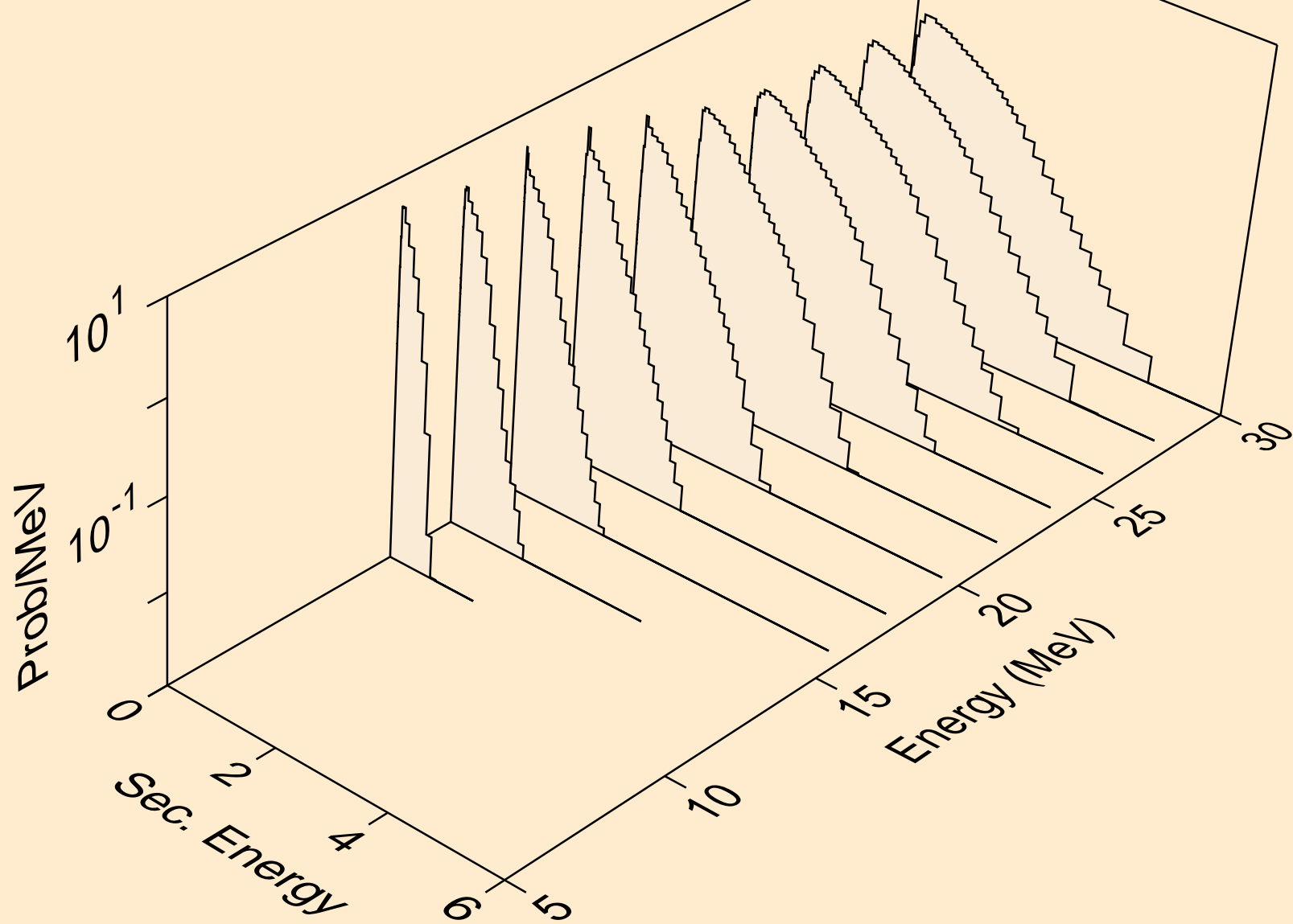

FR229 NEUTRON ACER TENDL-2024 LIBRARY; T=293.6K
Neutron emission for (n,n*)he3

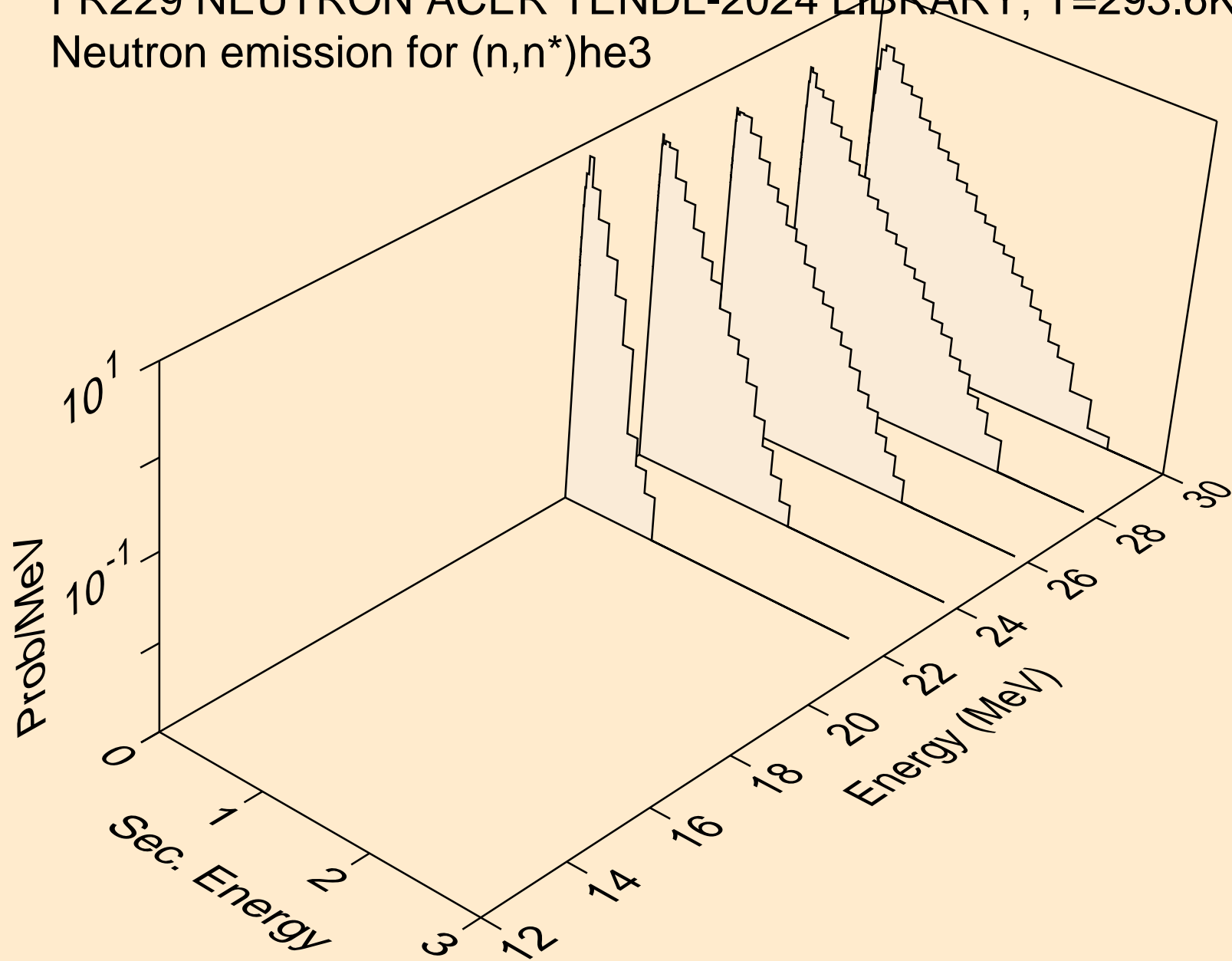

FR229 NEUTRON ACER TENDL-2024 LIBRARY; T=293.6K
Neutron emission for (n,4n)

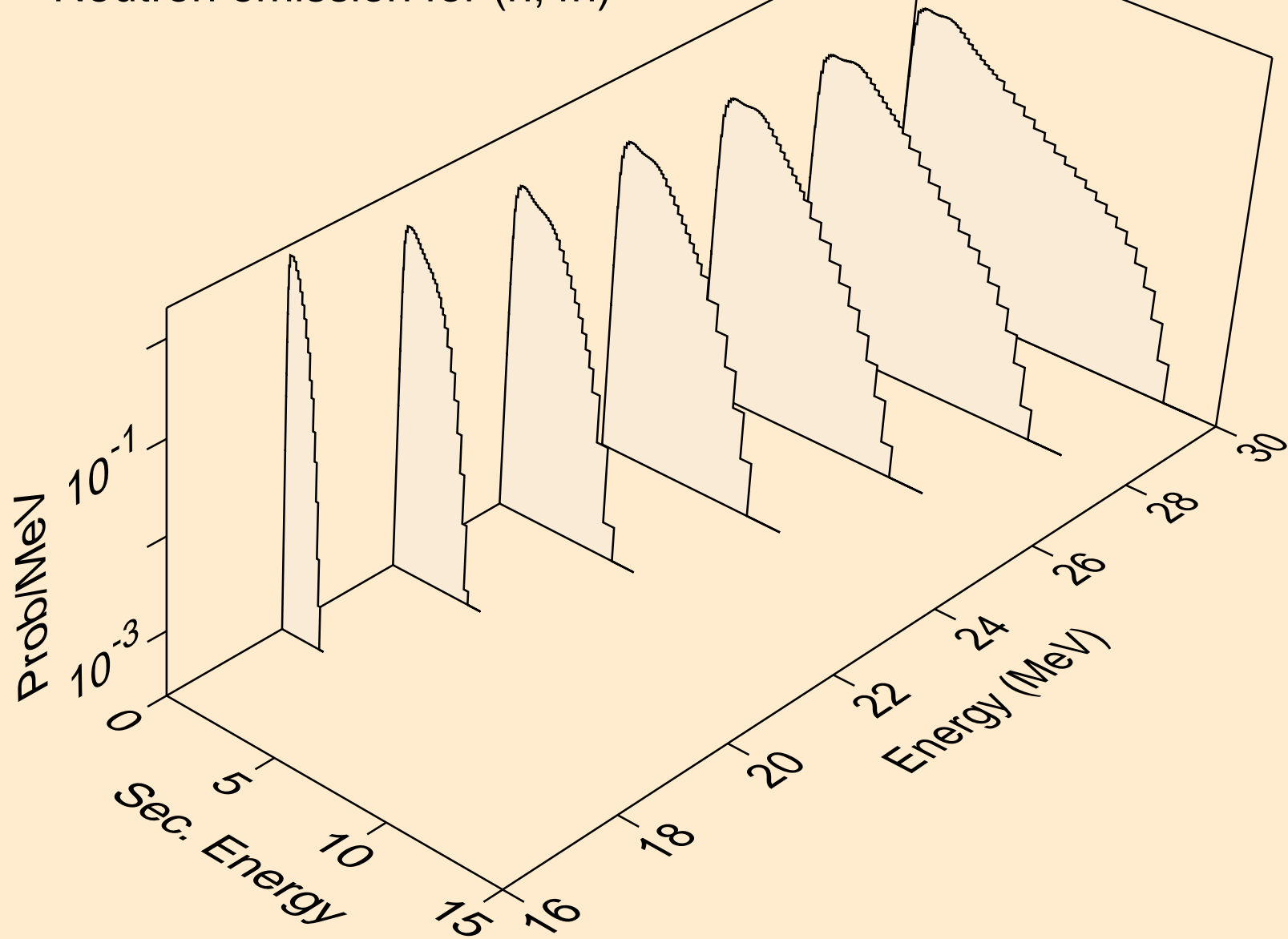

FR229 NEUTRON ACER TENDL-2024 LIBRARY; T=293.6K
Neutron emission for (n,2np)

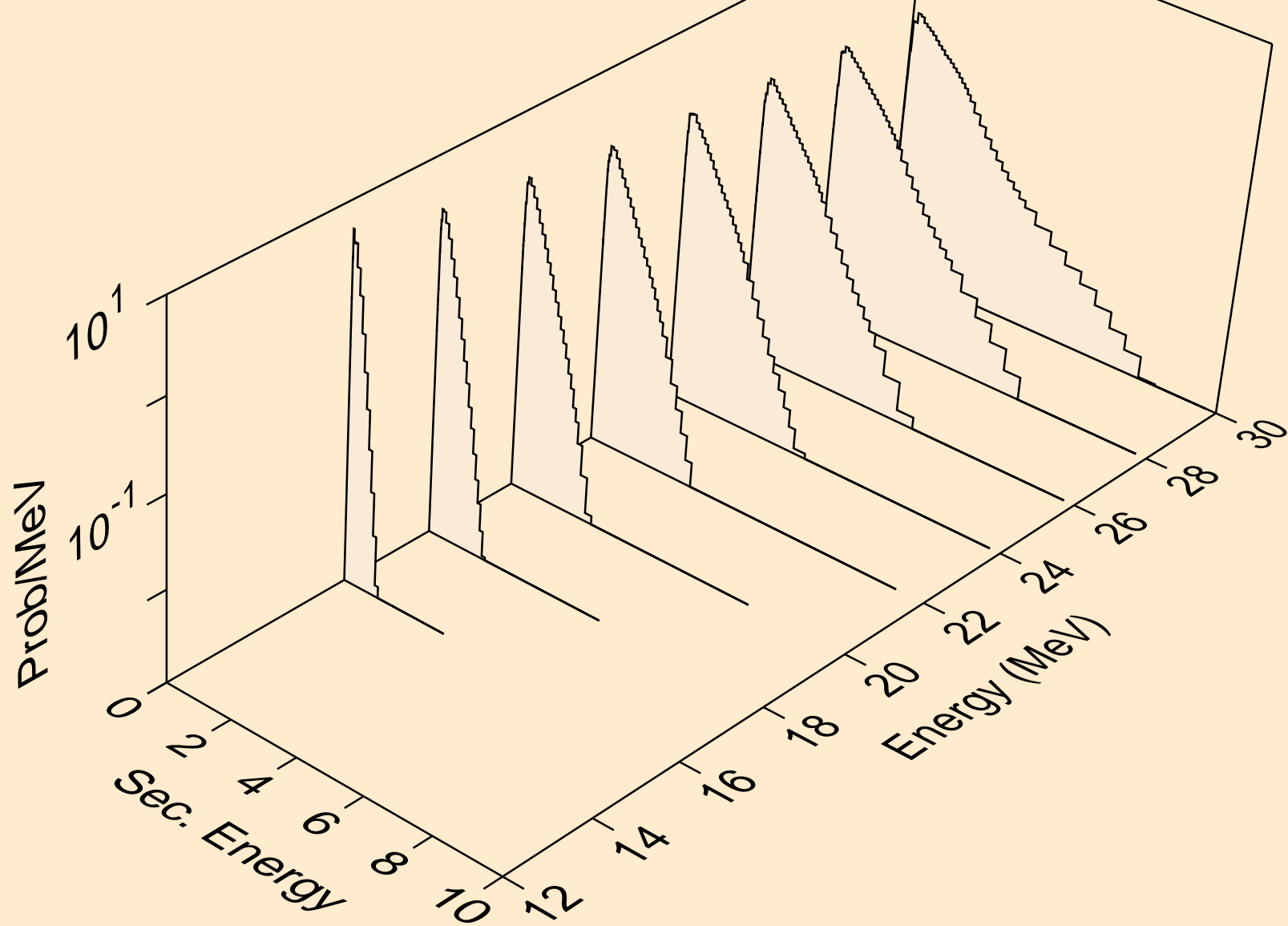

FR229 NEUTRON ACER TENDL-2024 LIBRARY; T=293.6K
Neutron emission for (n,3np)

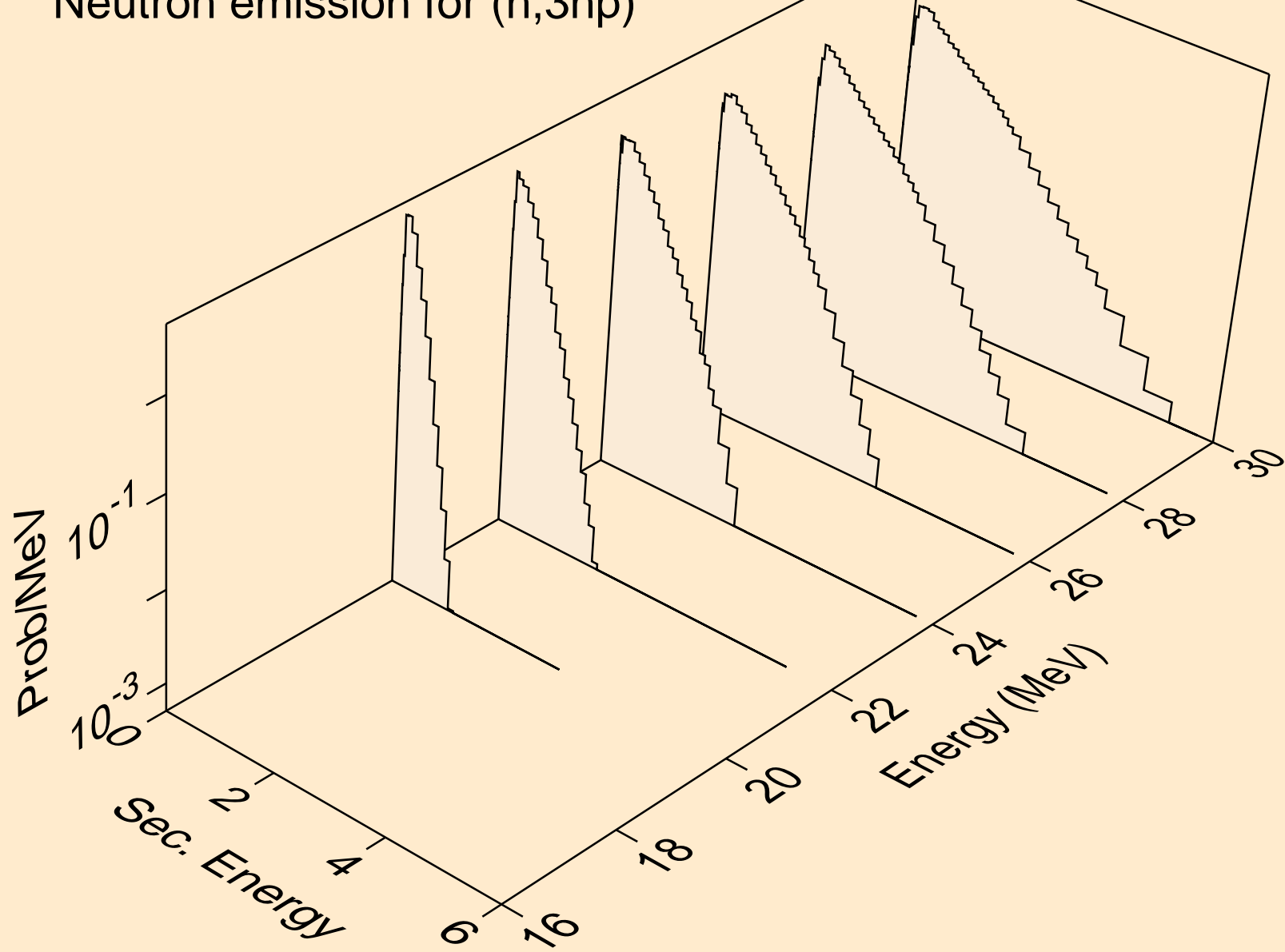

FR229 NEUTRON ACER TENDL-2024 LIBRARY; T=293.6K
Neutron emission for (n,n*c)

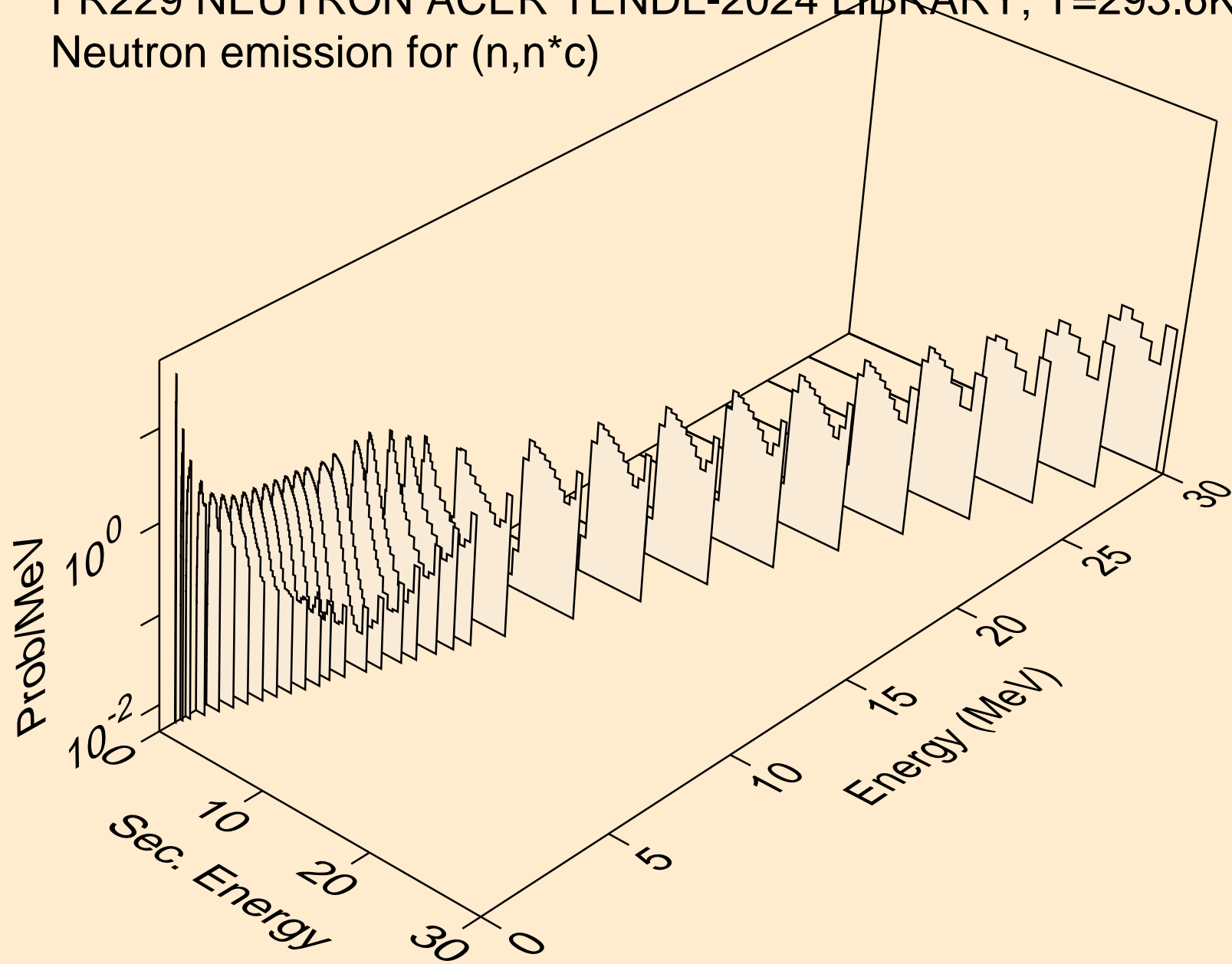

FR229 NEUTRON ACER TENDL-2024 LIBRARY; T=293.6K

Delayed nubar

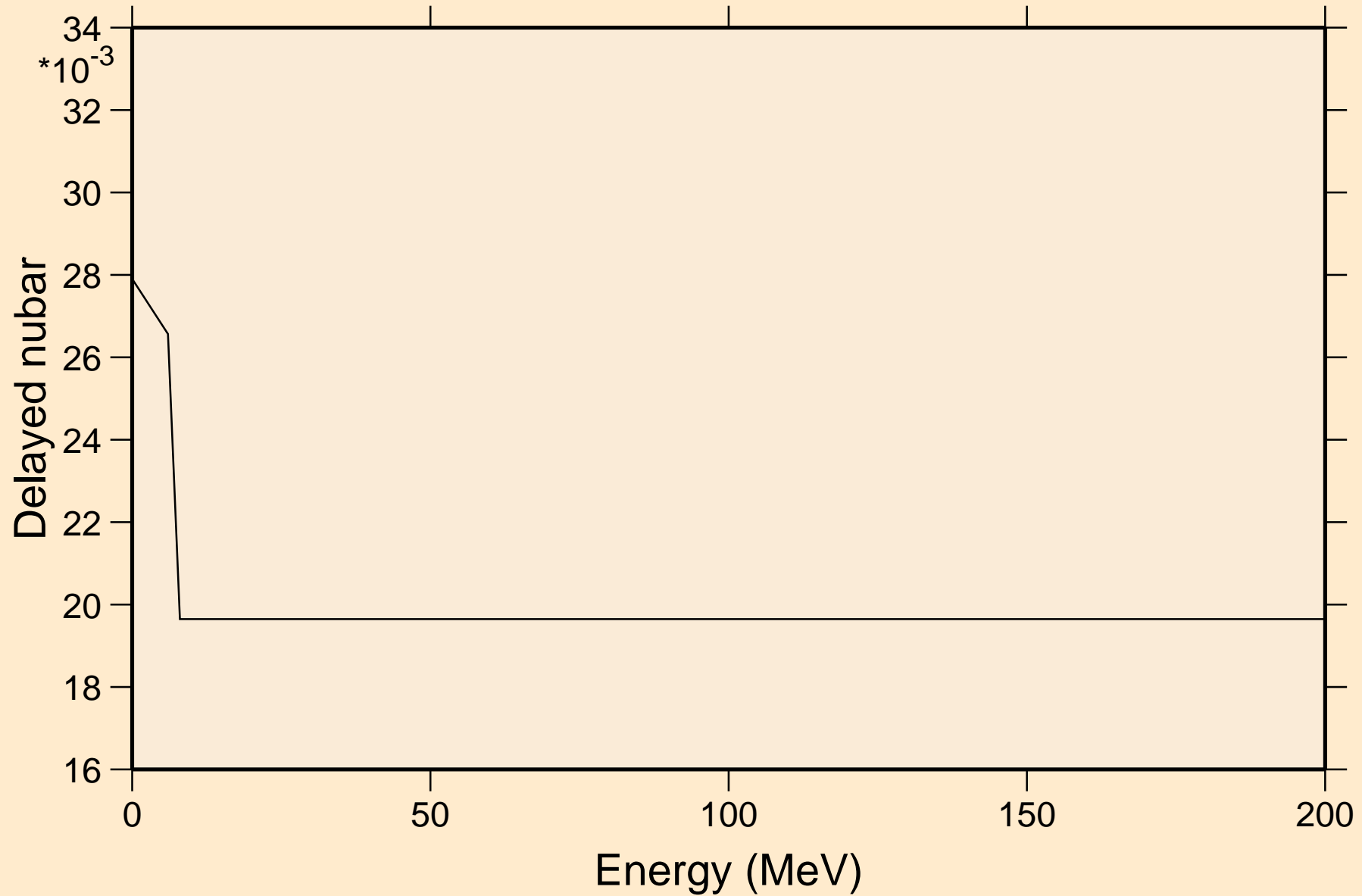

FR229 NEUTRON ACER TENDL-2024 LIBRARY; T=293.6K

Delayed neutron spectra

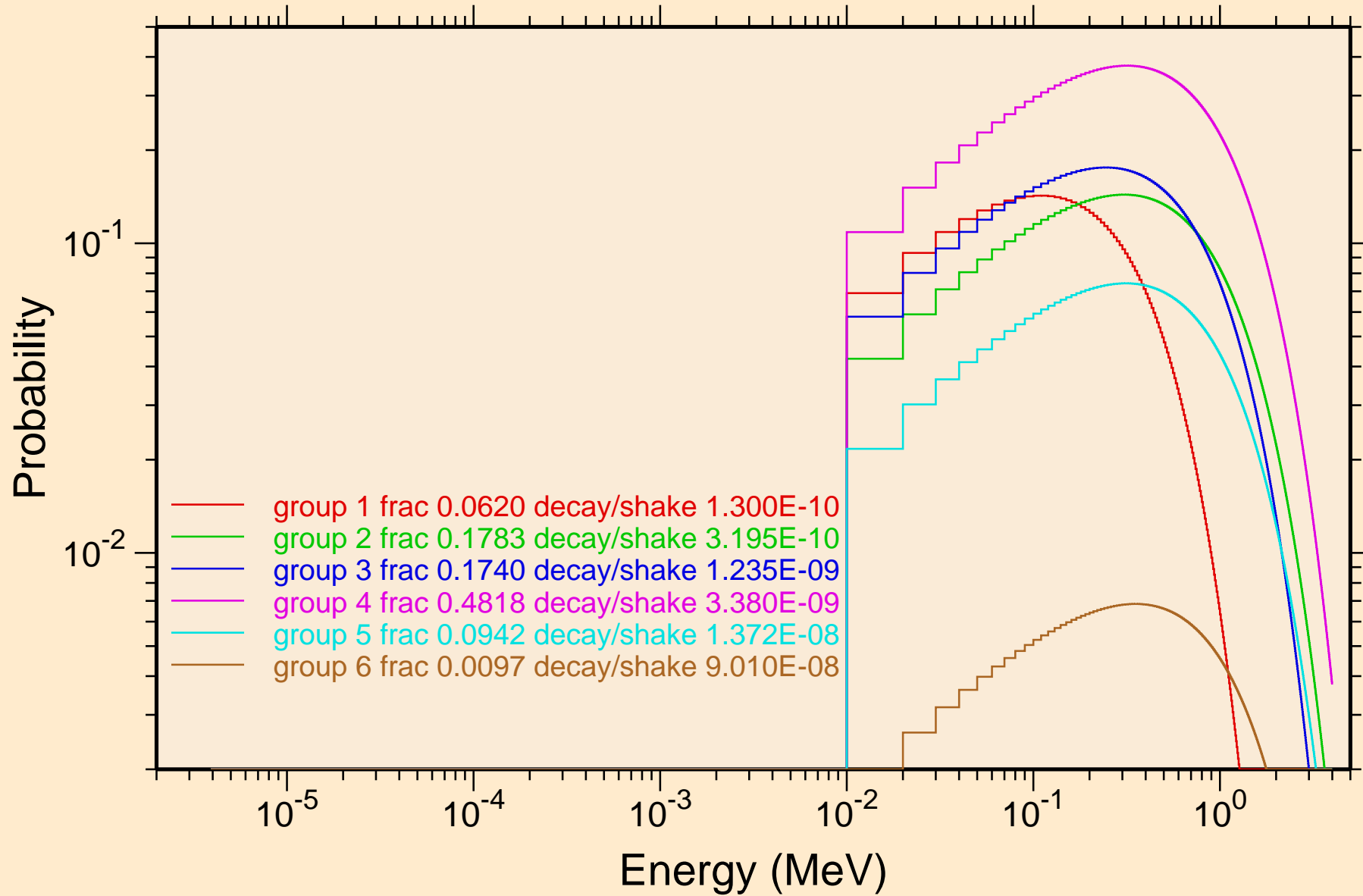

FR229 NEUTRON ACER TENDL-2024 LIBRARY; T=293.6K
Photon emission for (n,x)

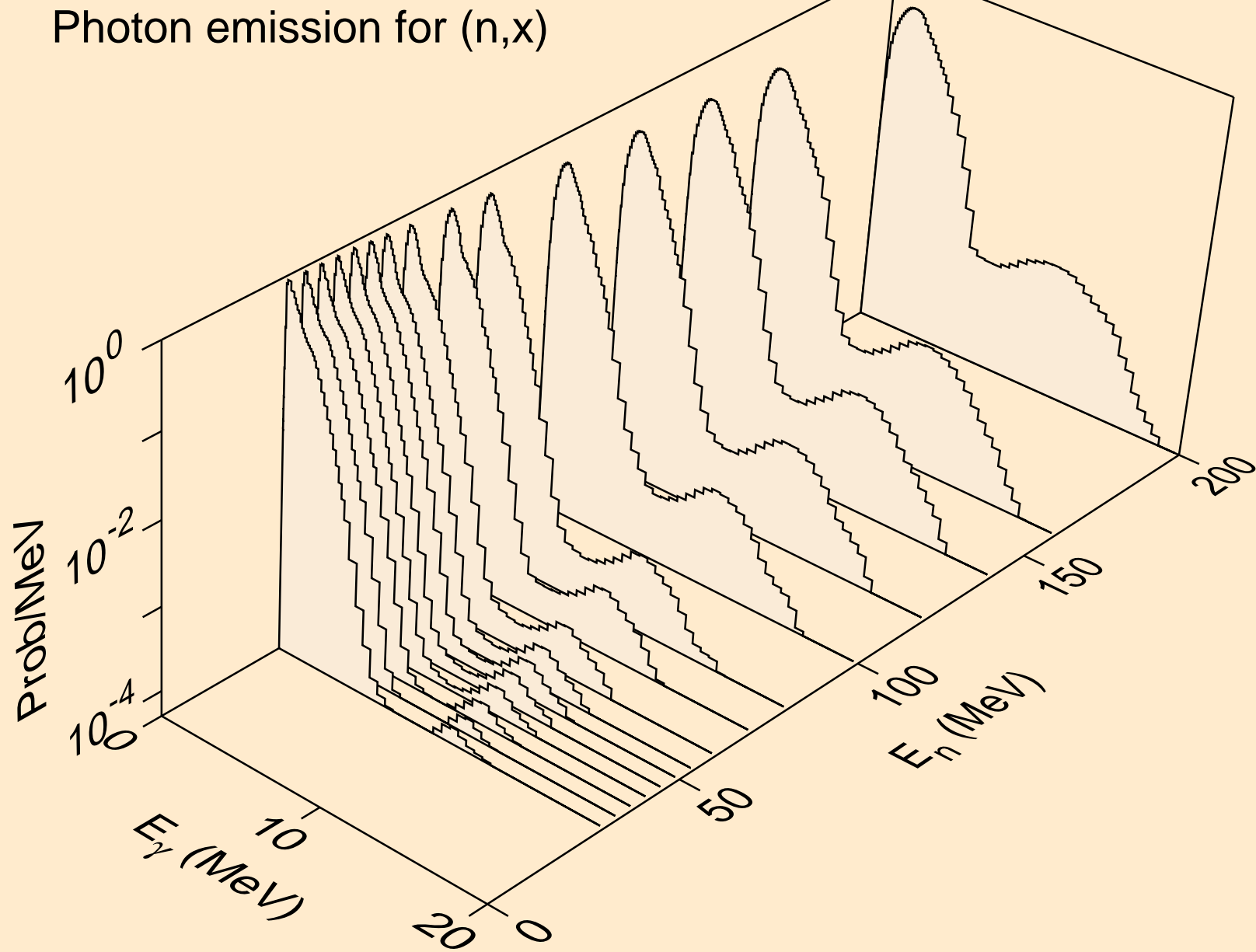

FR229 NEUTRON ACER TENDL-2024 LIBRARY; T=293.6K
Photon emission for (n,2nd)

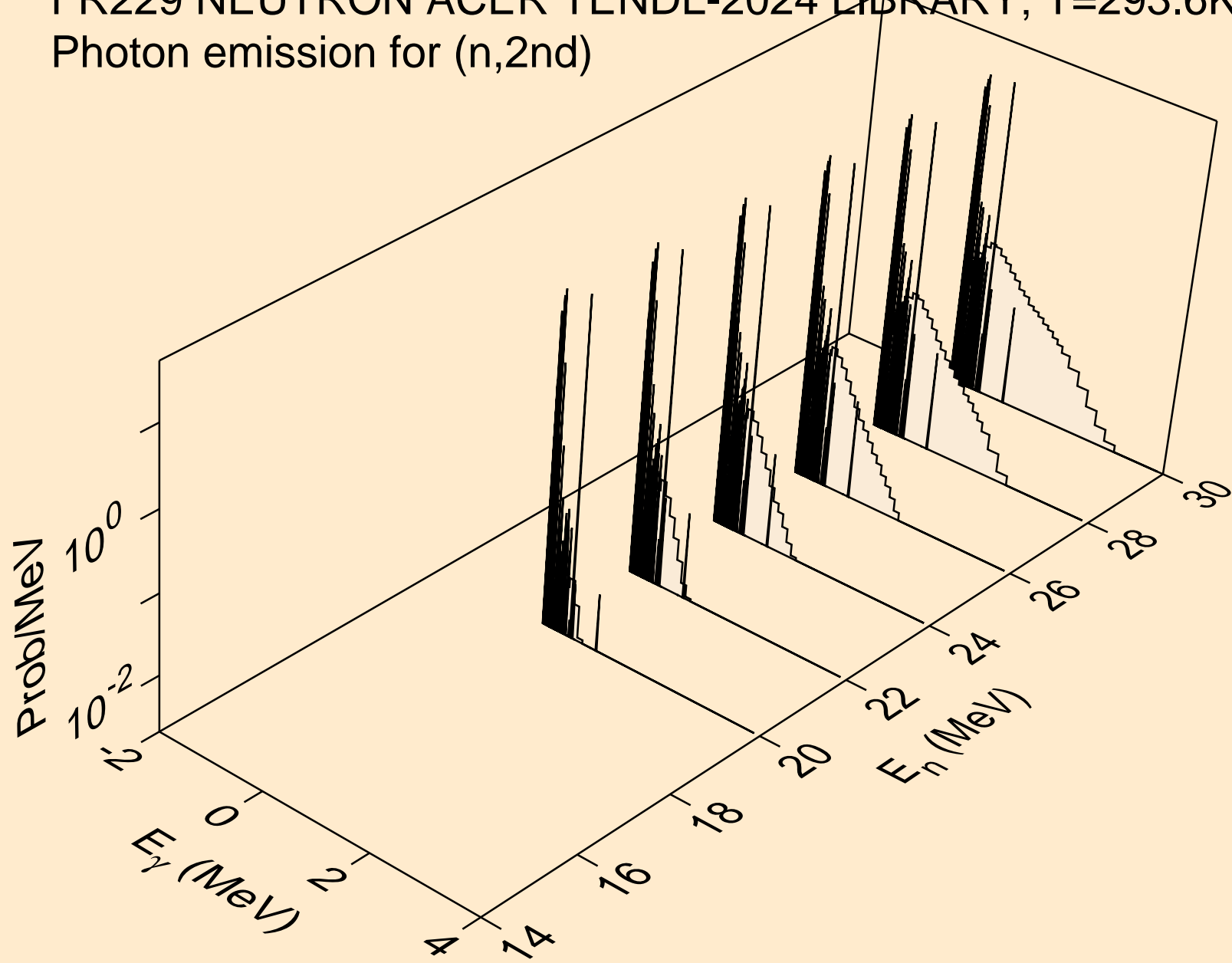

FR229 NEUTRON ACER TENDL-2024 LIBRARY; T=293.6K
Photon emission for (n,2n)

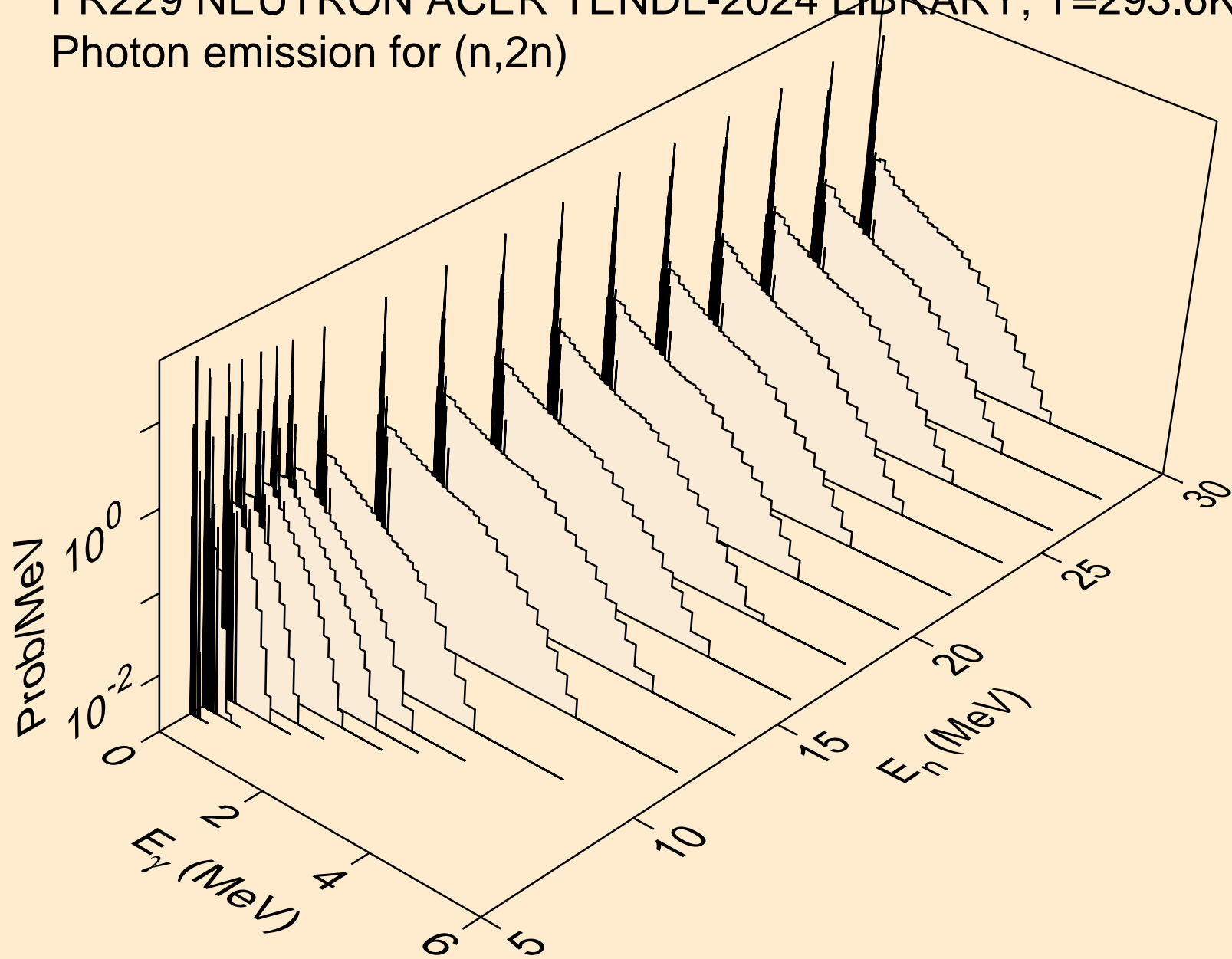

FR229 NEUTRON ACER TENDL-2024 LIBRARY; T=293.6K
Photon emission for (n,3n)

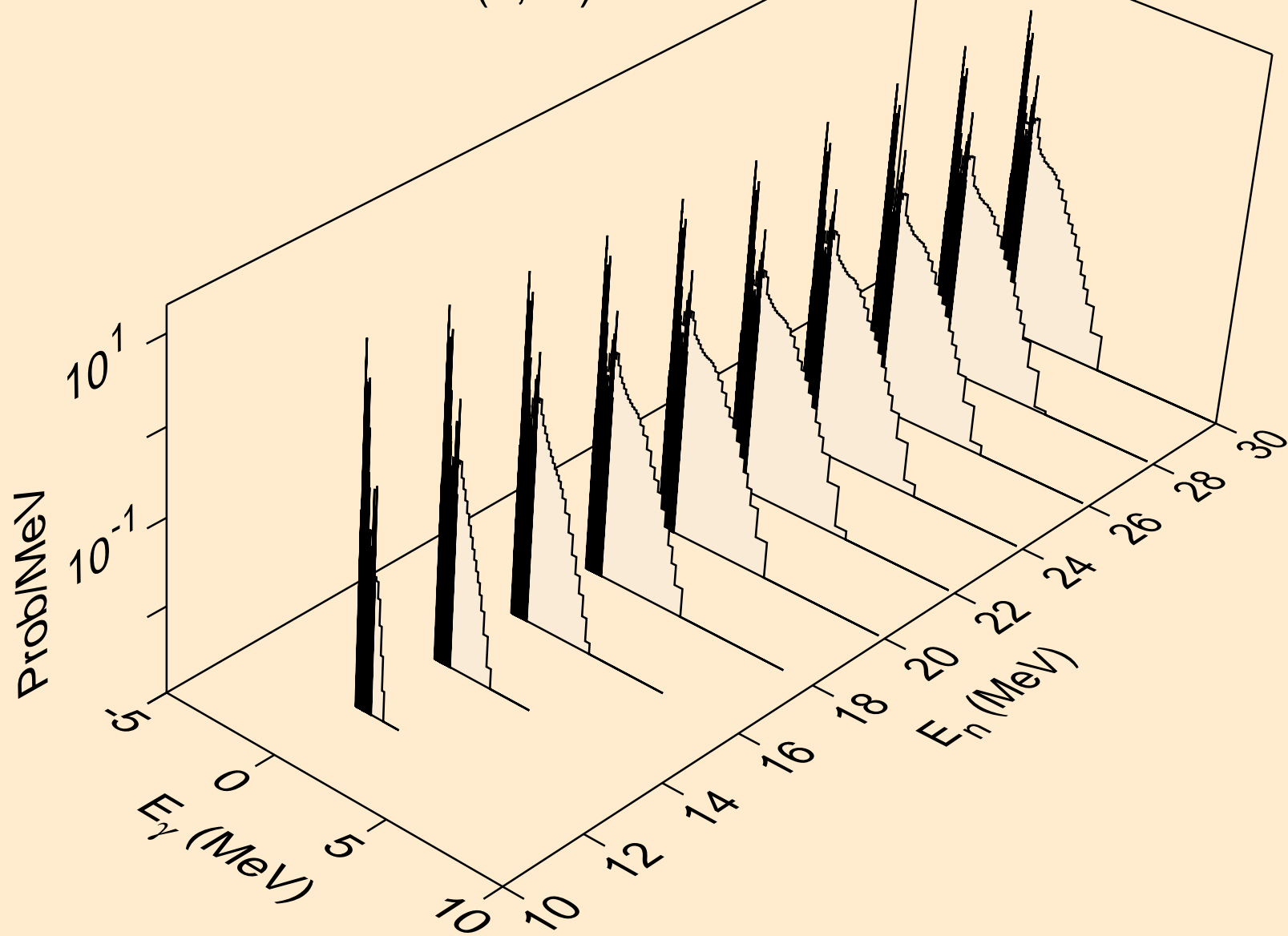

FR229 NEUTRON ACER TENDL-2024 LIBRARY; T=293.6K
Photon emission for (n,n*)a

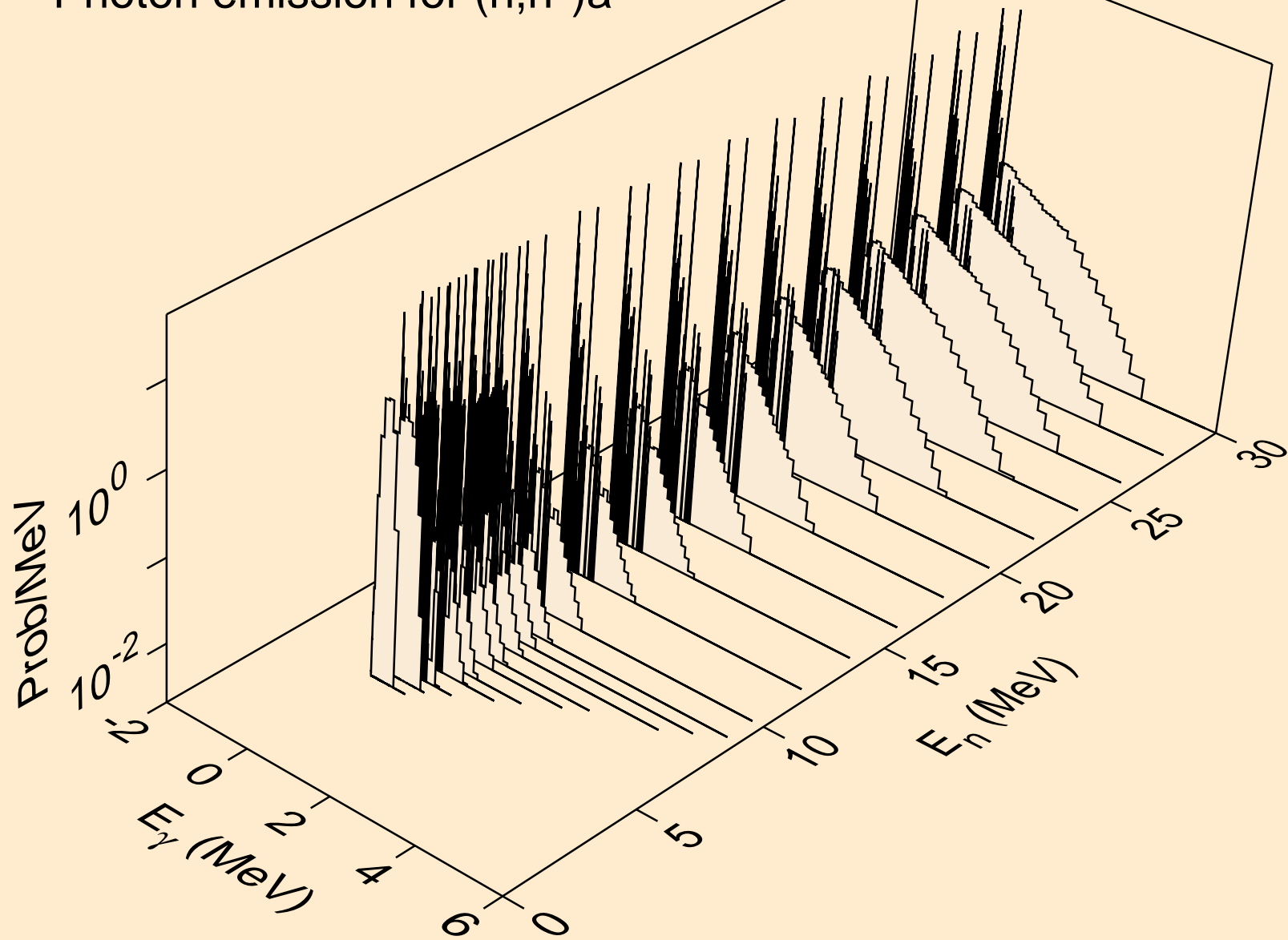

FR229 NEUTRON ACER TENDL-2024 LIBRARY; T=293.6K
Photon emission for (n,2n)a

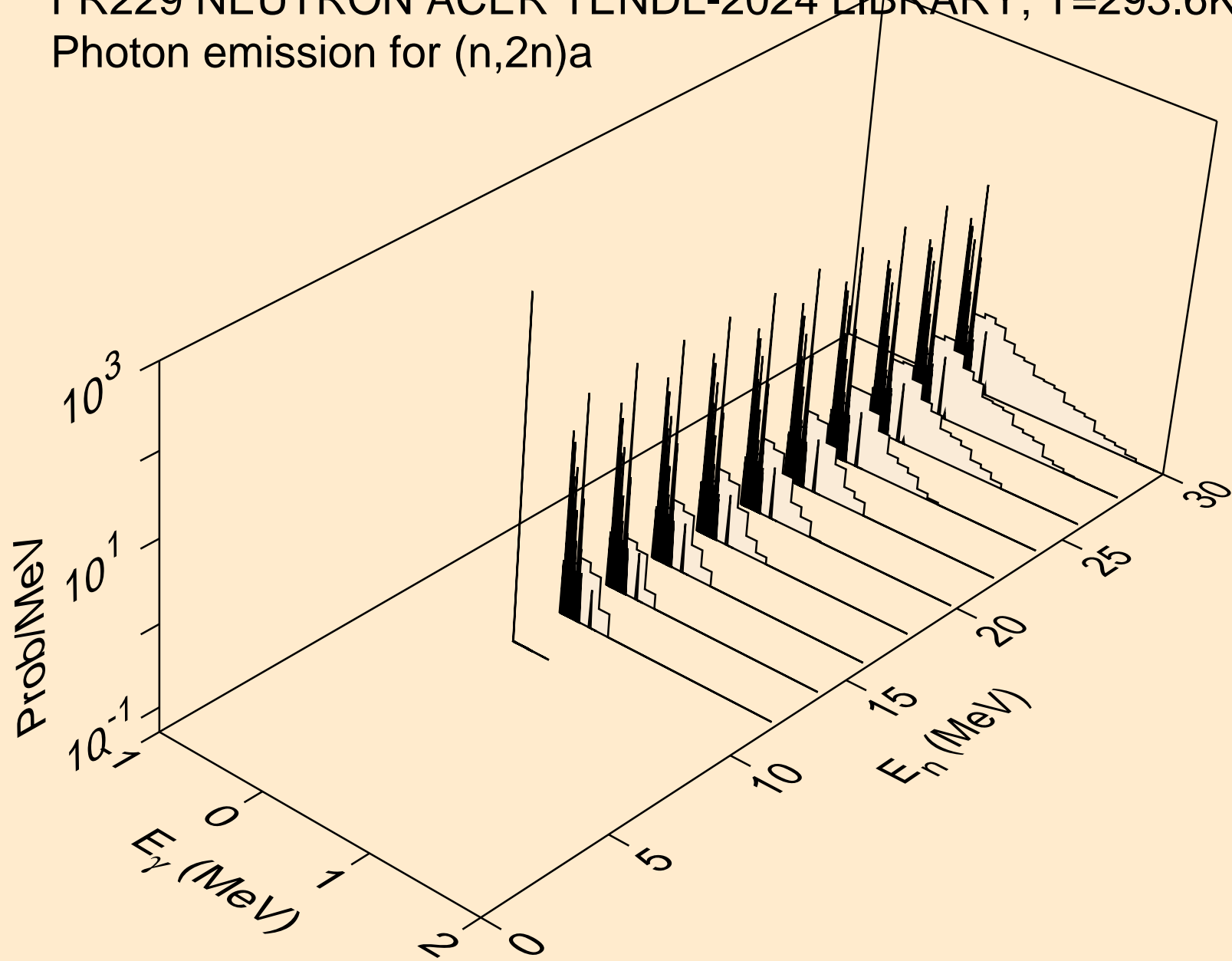

FR229 NEUTRON ACER TENDL-2024 LIBRARY; T=293.6K
Photon emission for (n,3n)a

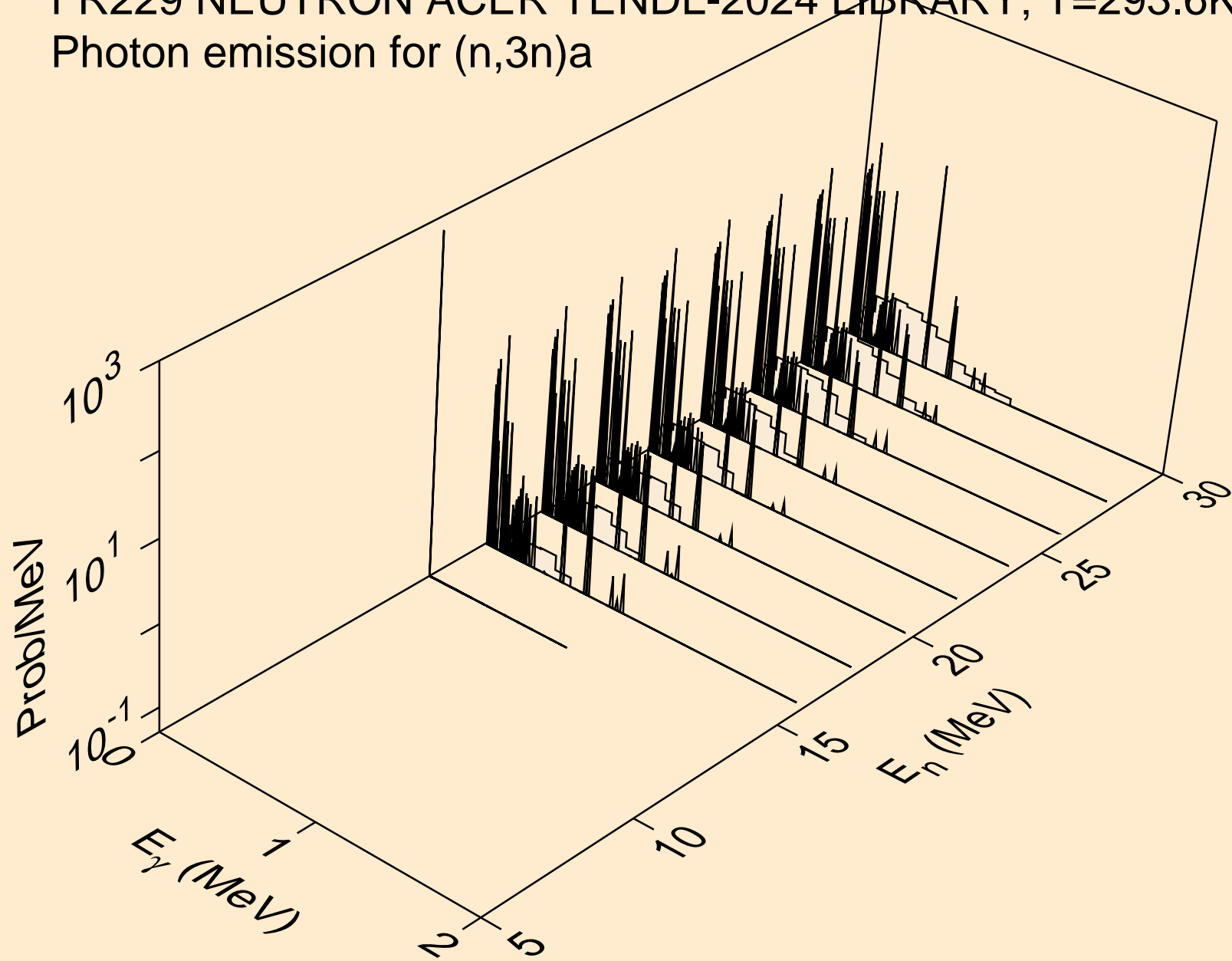

FR229 NEUTRON ACER TENDL-2024 LIBRARY; T=293.6K
Photon emission for (n,n*)p

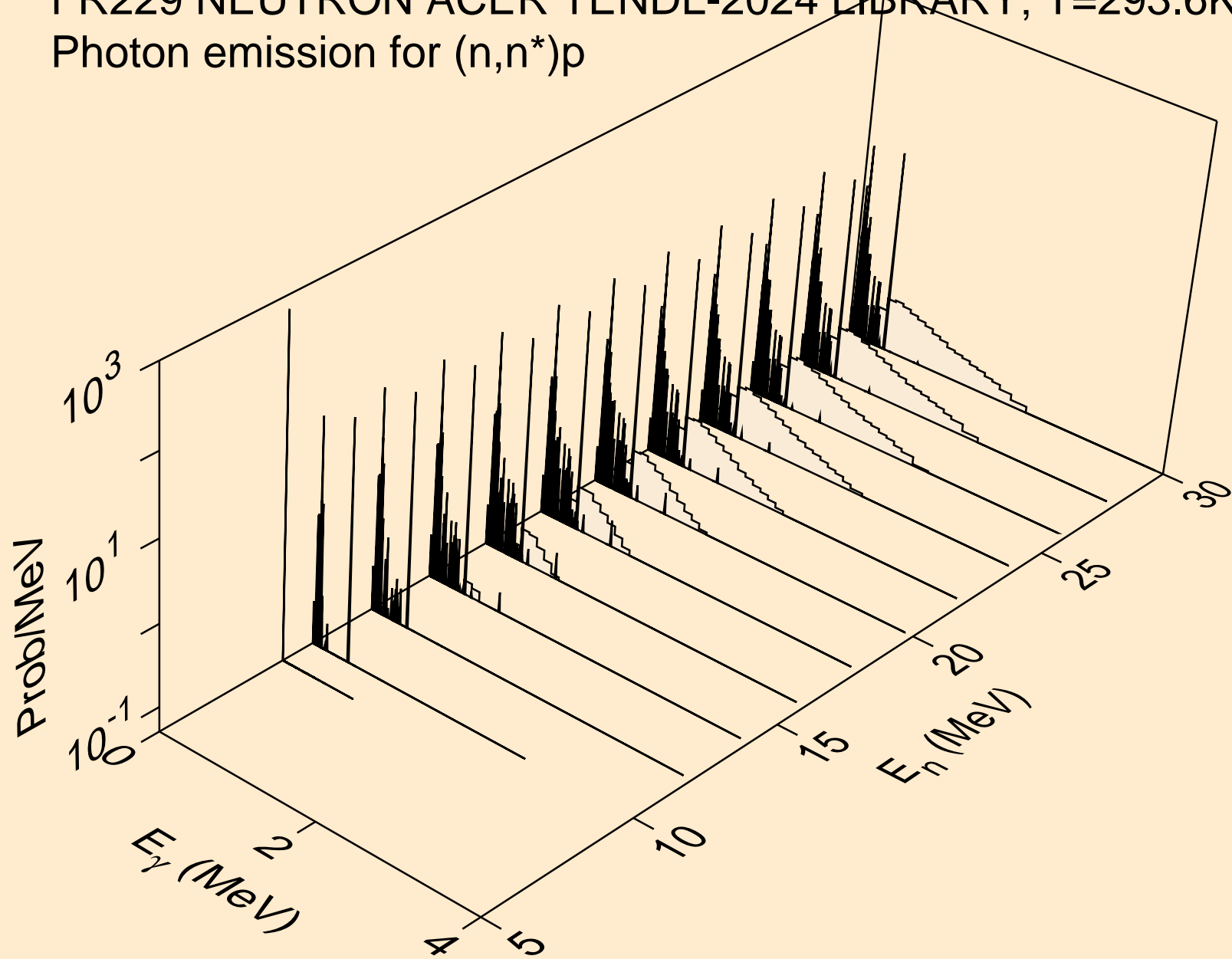

FR229 NEUTRON ACER TENDL-2024 LIBRARY; T=293.6K
Photon emission for (n,n*)d

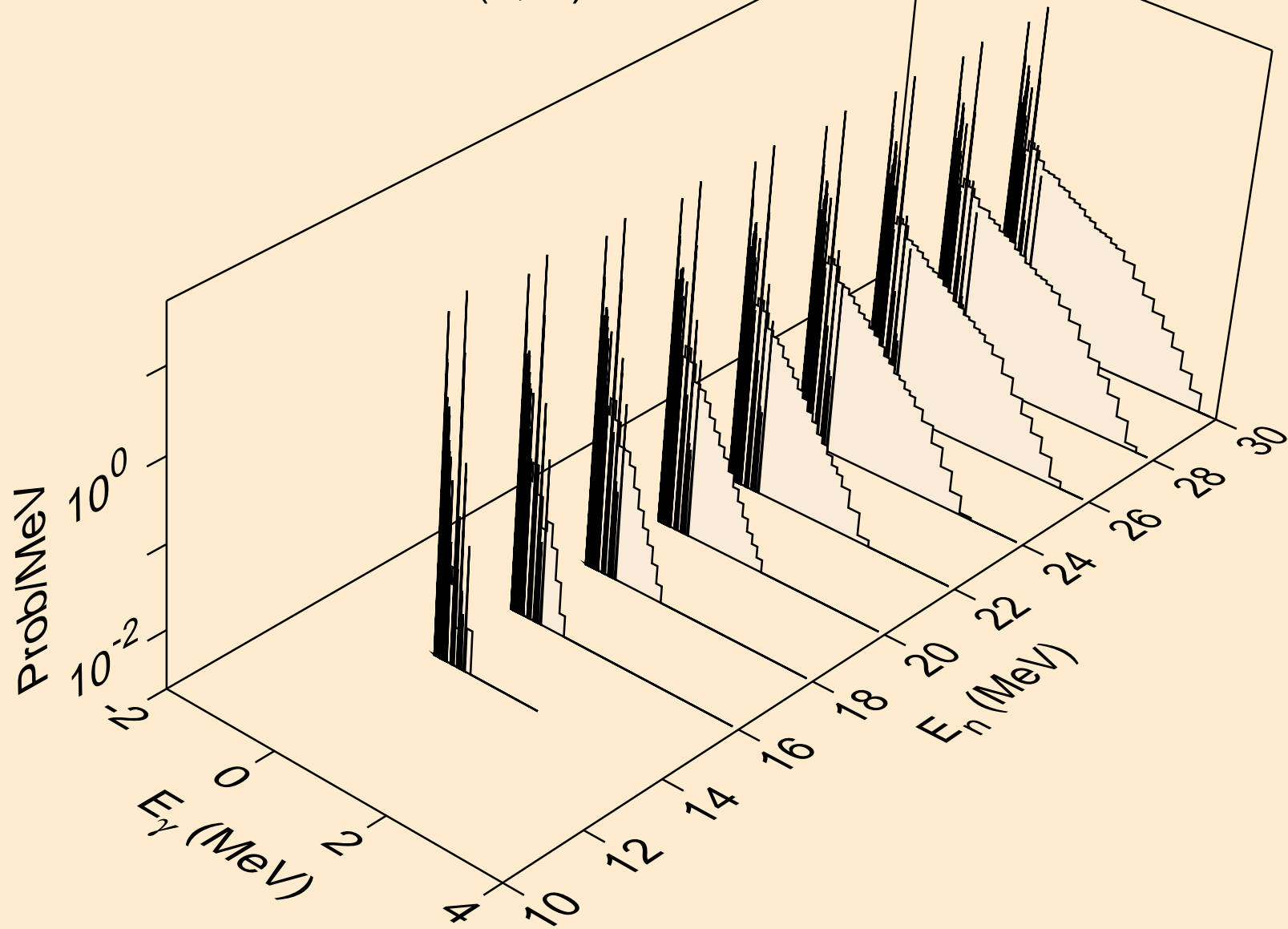

FR229 NEUTRON ACER TENDL-2024 LIBRARY; T=293.6K
Photon emission for (n,n*)t

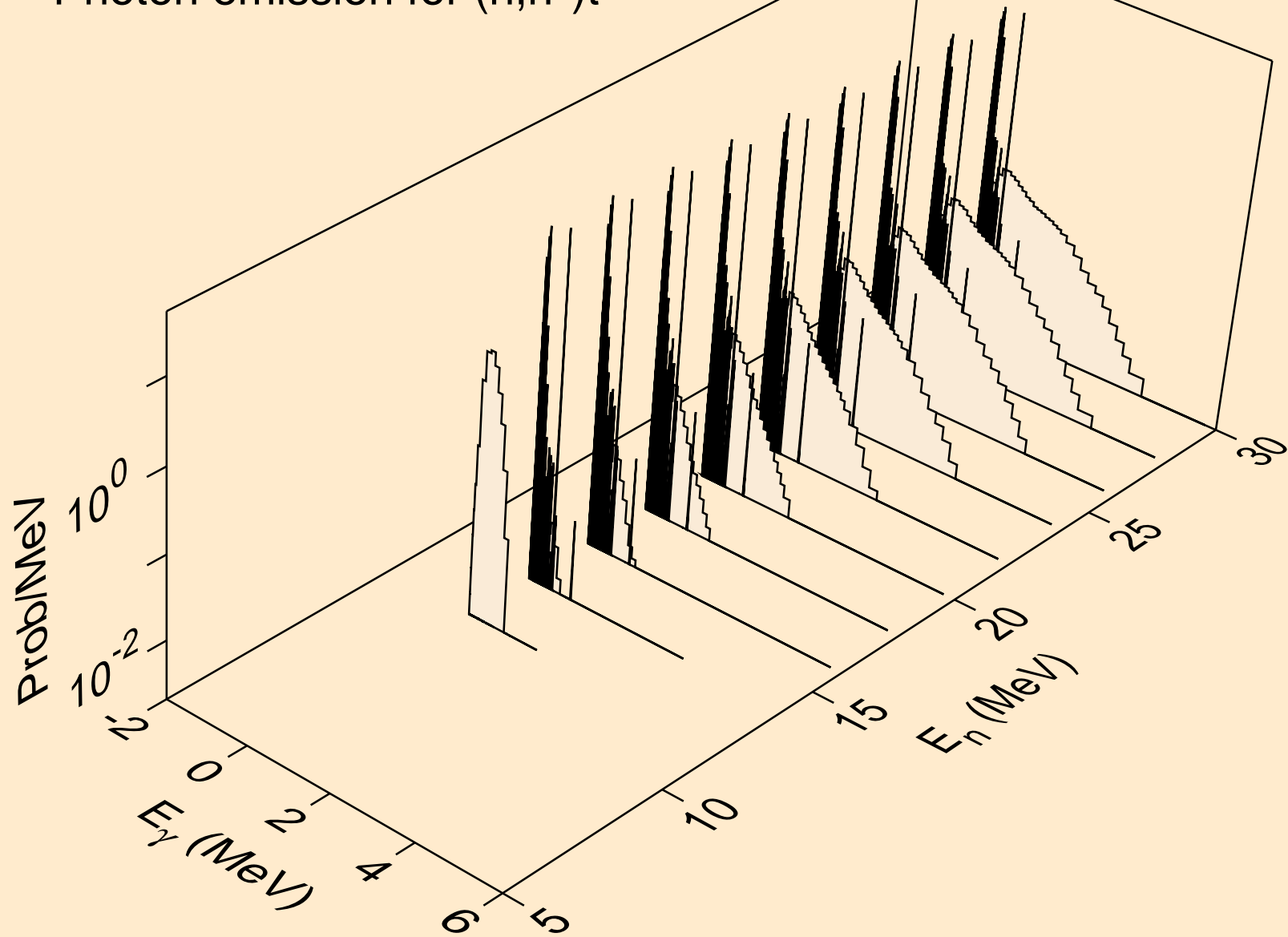

FR229 NEUTRON ACER TENDL-2024 LIBRARY; T=293.6K
Photon emission for (n,n*)he3

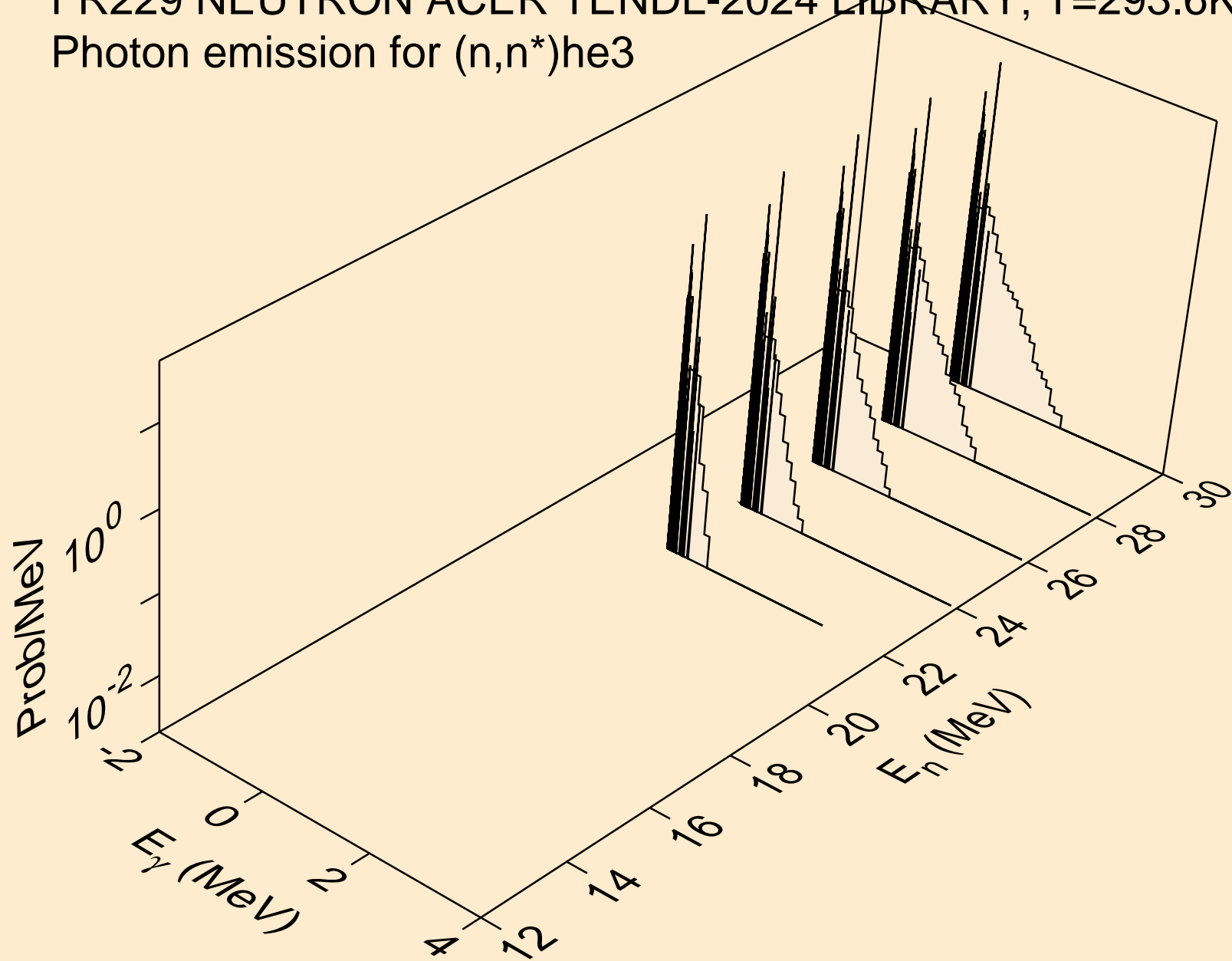

FR229 NEUTRON ACER TENDL-2024 LIBRARY; T=293.6K
Photon emission for (n,4n)

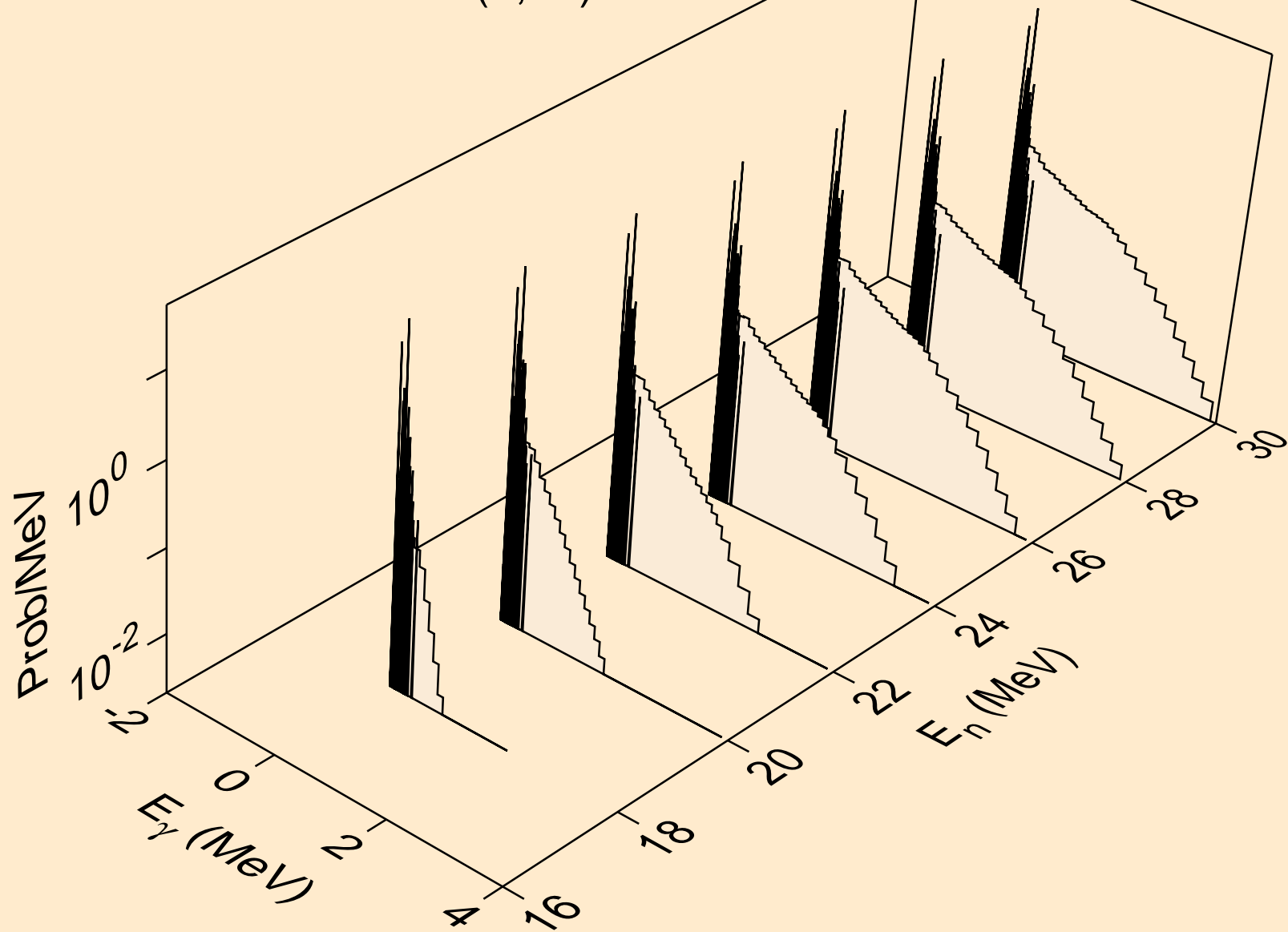

FR229 NEUTRON ACER TENDL-2024 LIBRARY; T=293.6K
Photon emission for (n,2np)

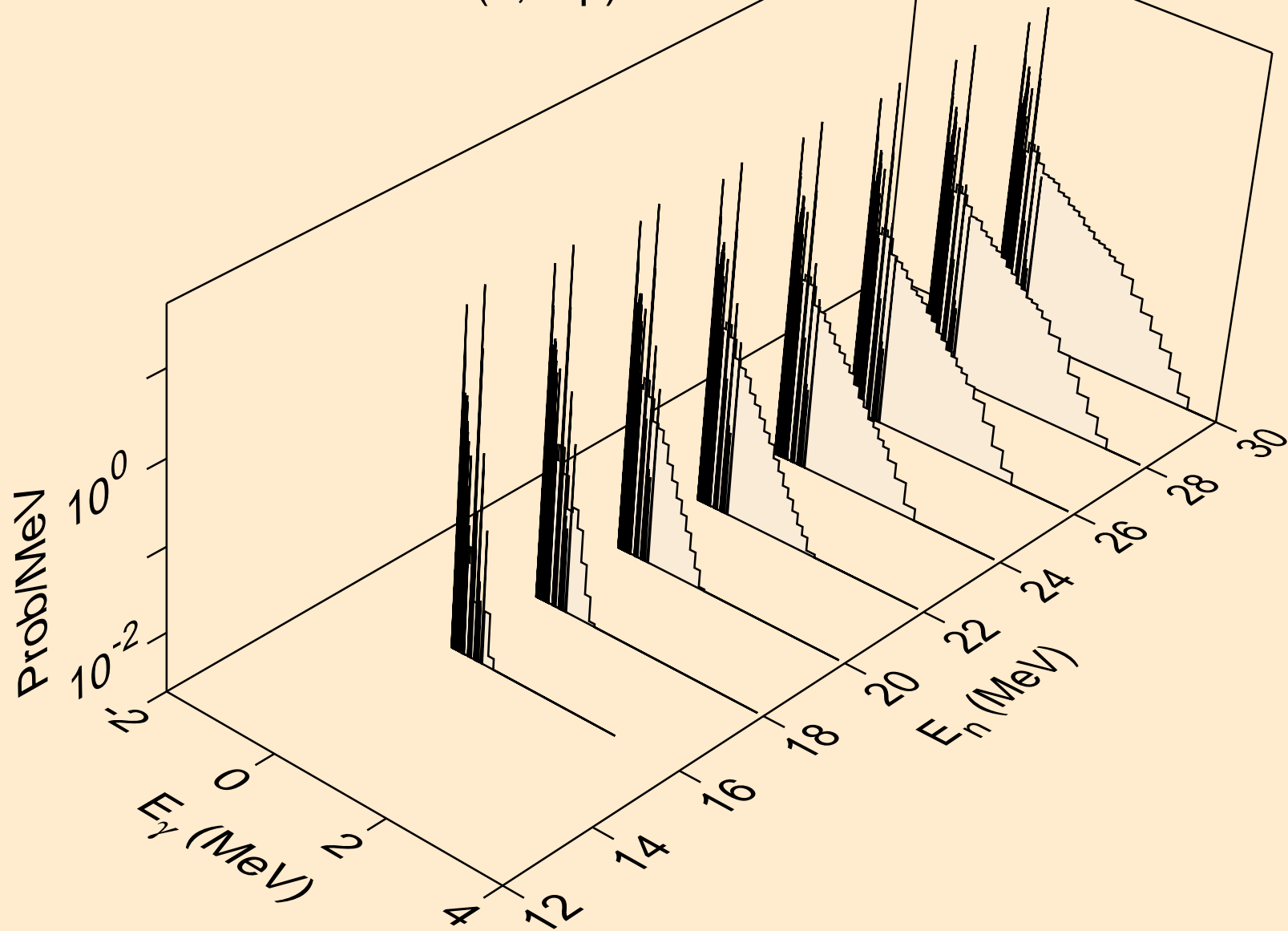

FR229 NEUTRON ACER TENDL-2024 LIBRARY; T=293.6K
Photon emission for (n,3np)

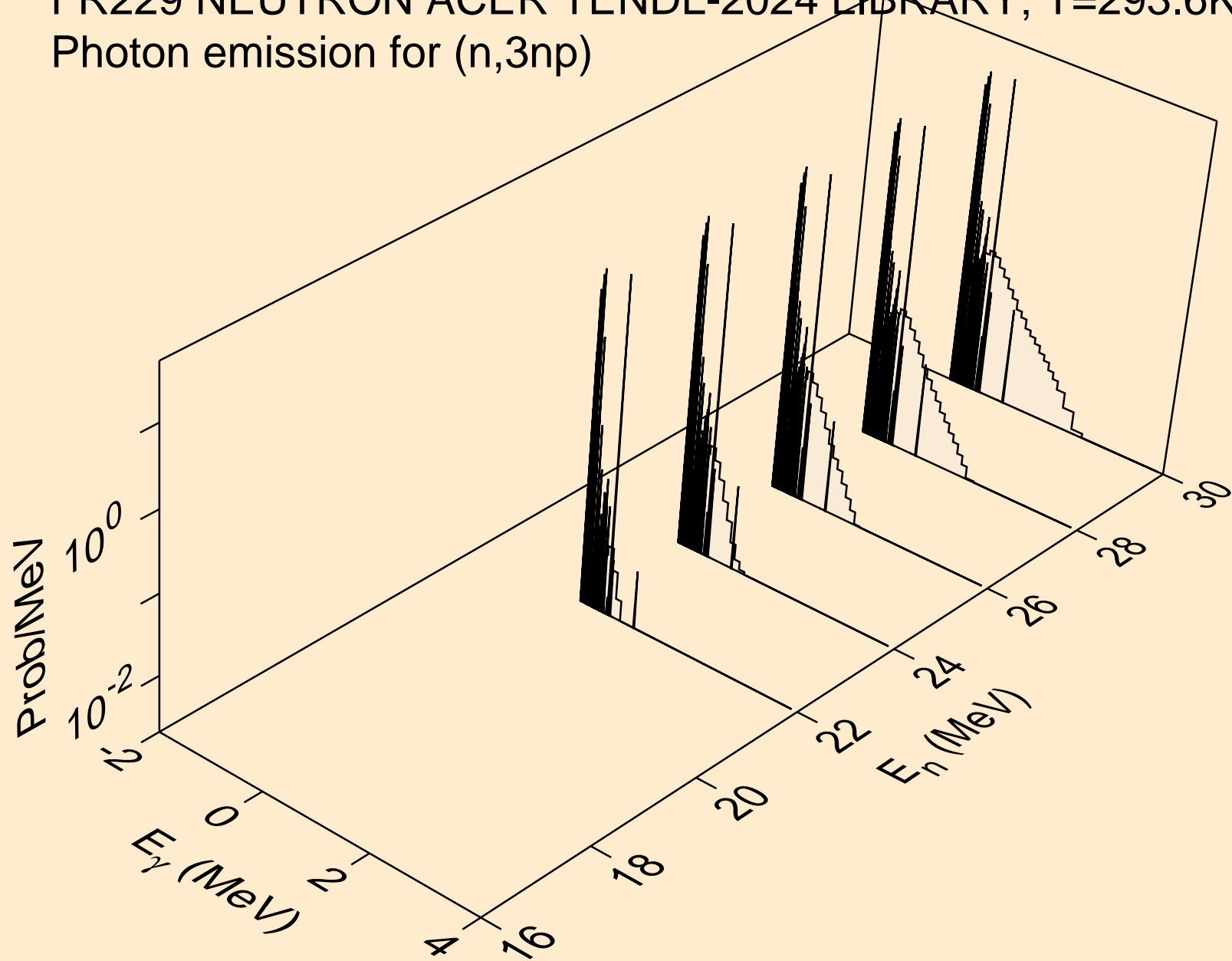

FR229 NEUTRON ACER TENDL-2024 LIBRARY; T=293.6K
Photon emission for (n,n*c)

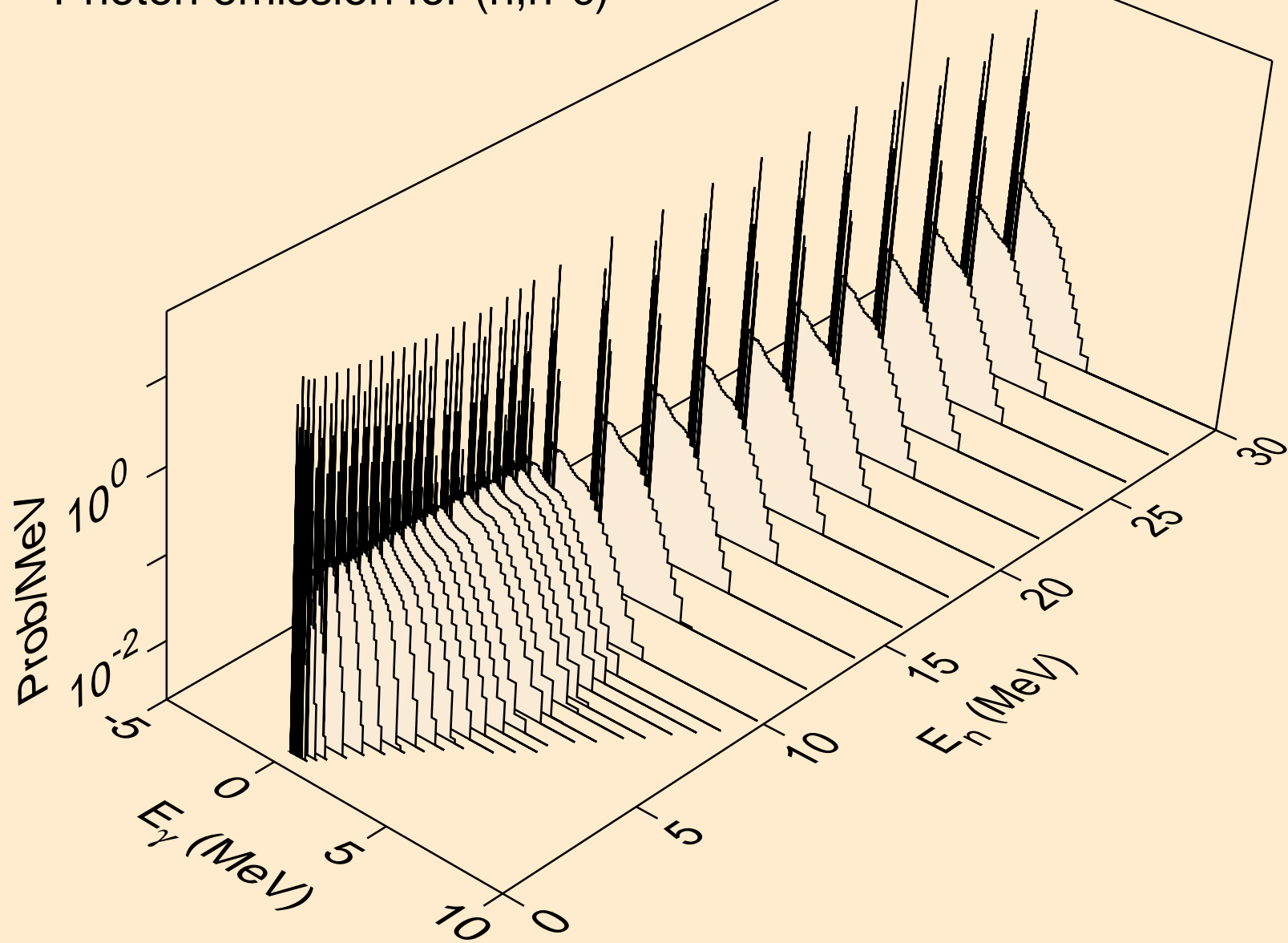

FR229 NEUTRON ACER TENDL-2024 LIBRARY; T=293.6K
Photon emission for (n,gma)

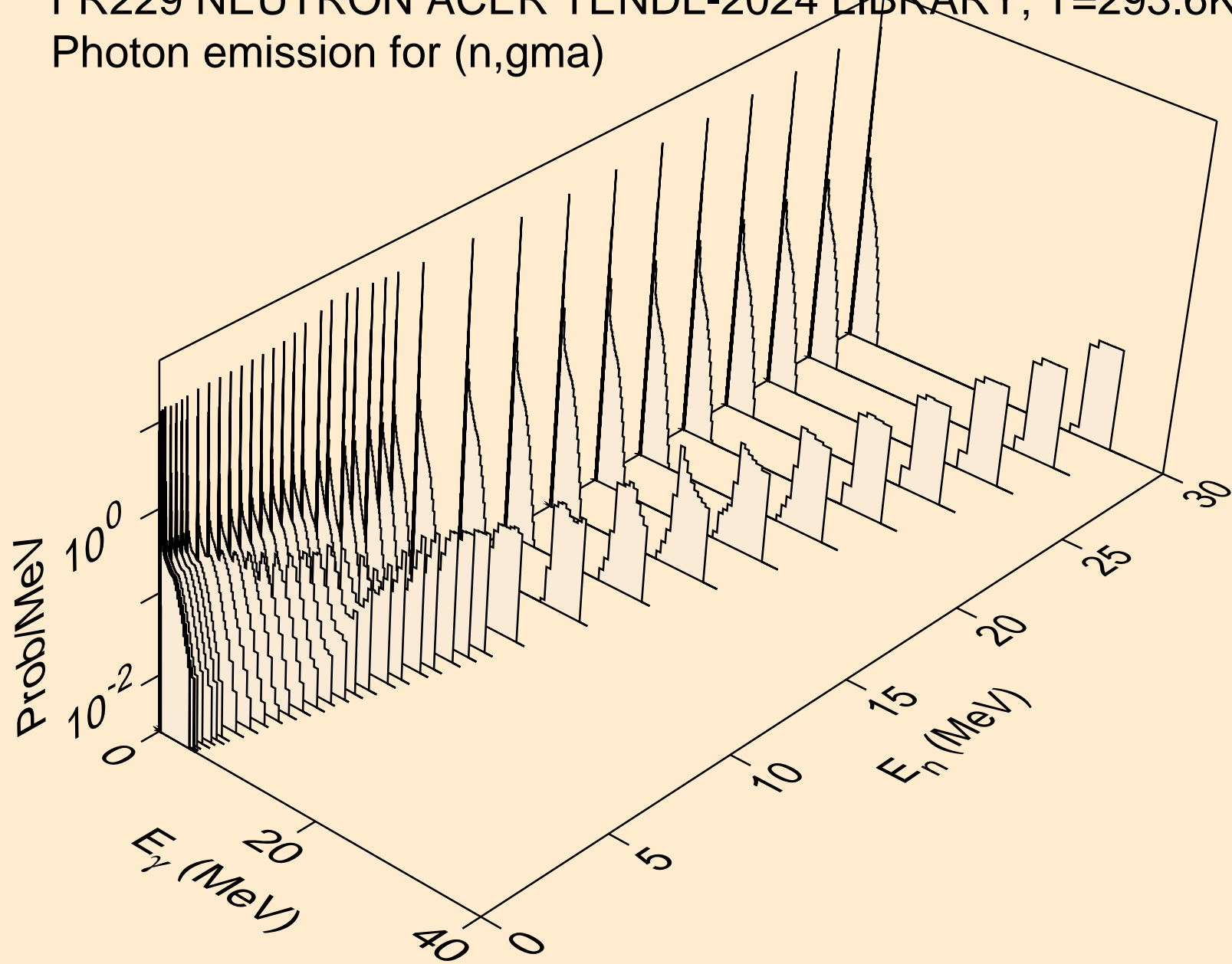

FR229 NEUTRON ACER TENDL-2024 LIBRARY; T=293.6K
Photon emission for (n,p)

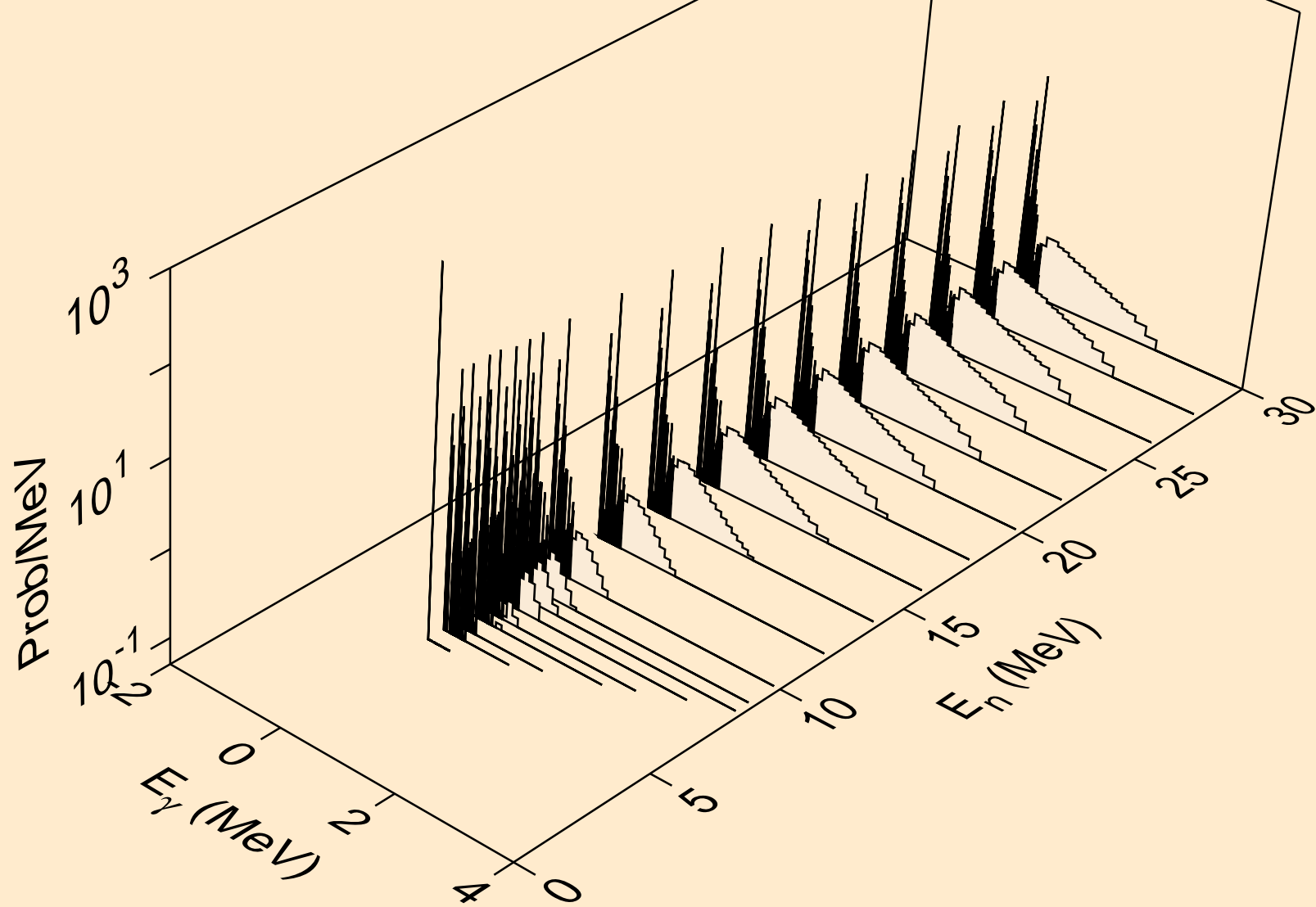

FR229 NEUTRON ACER TENDL-2024 LIBRARY; T=293.6K
Photon emission for (n,d)

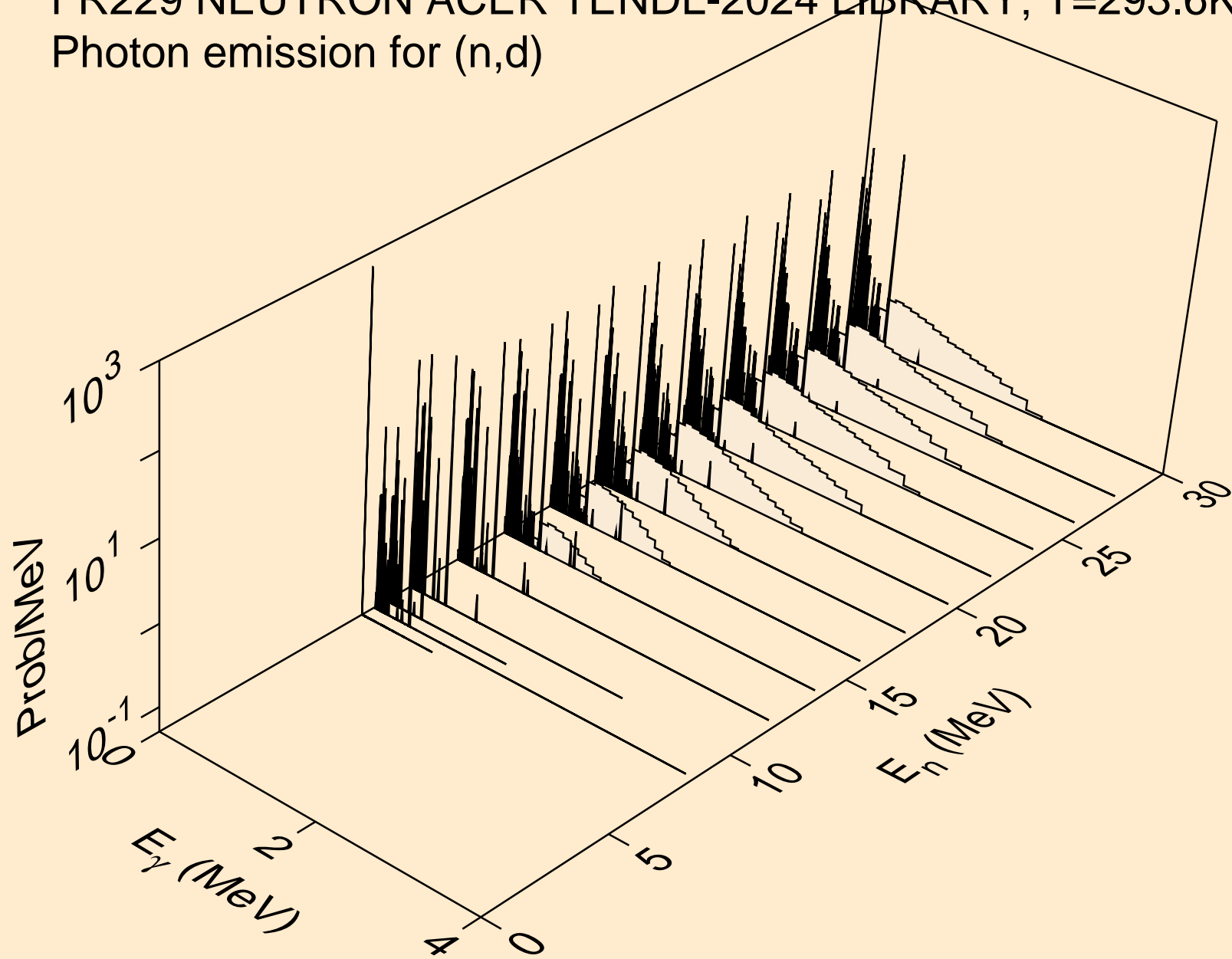

FR229 NEUTRON ACER TENDL-2024 LIBRARY; T=293.6K
Photon emission for (n,t)

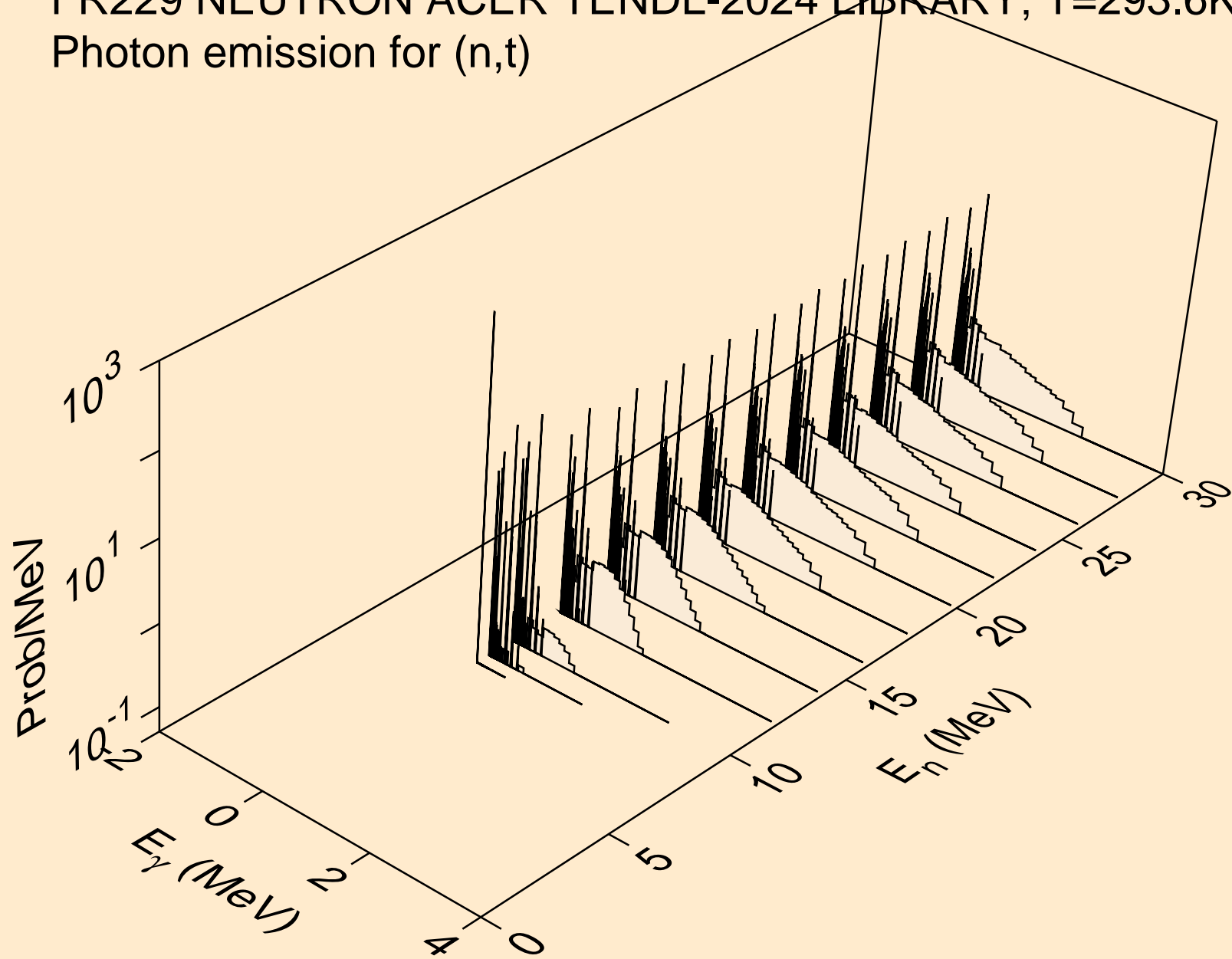

FR229 NEUTRON ACER TENDL-2024 LIBRARY; T=293.6K
Photon emission for (n,he3)

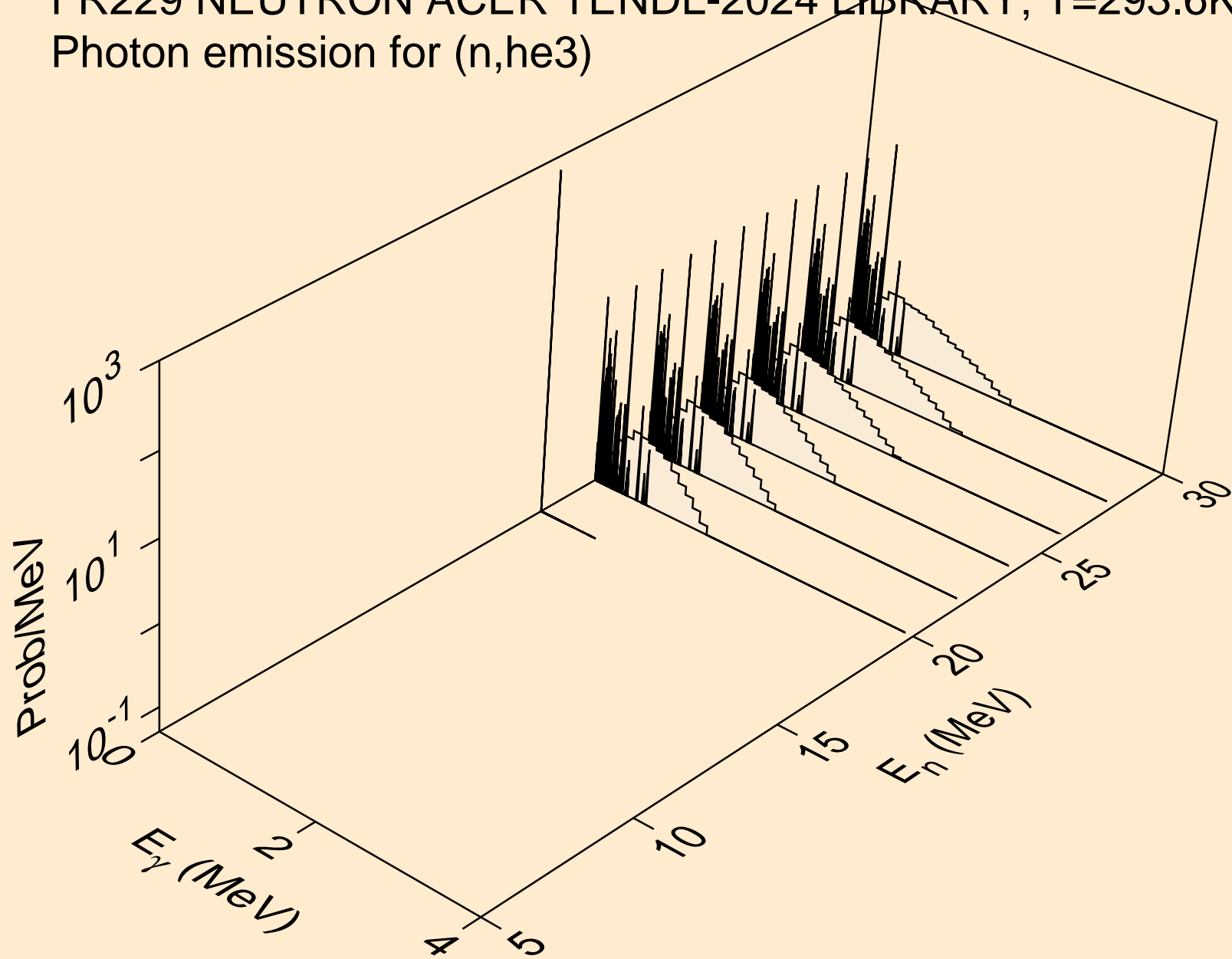

FR229 NEUTRON ACER TENDL-2024 LIBRARY; T=293.6K
Photon emission for (n,a)

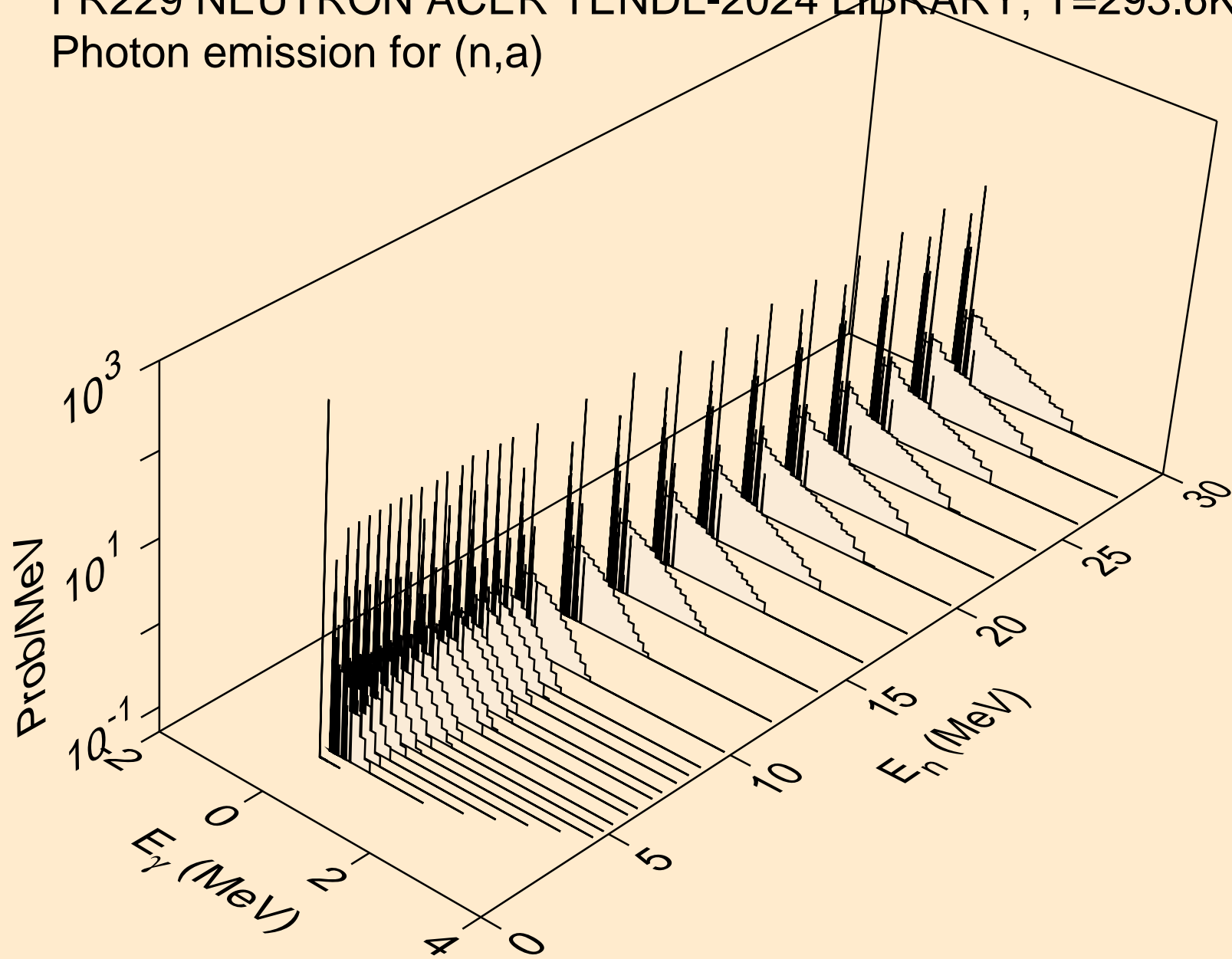

FR229 NEUTRON ACER TENDL-2024 LIBRARY; T=293.6K
thermal capture photon spectrum

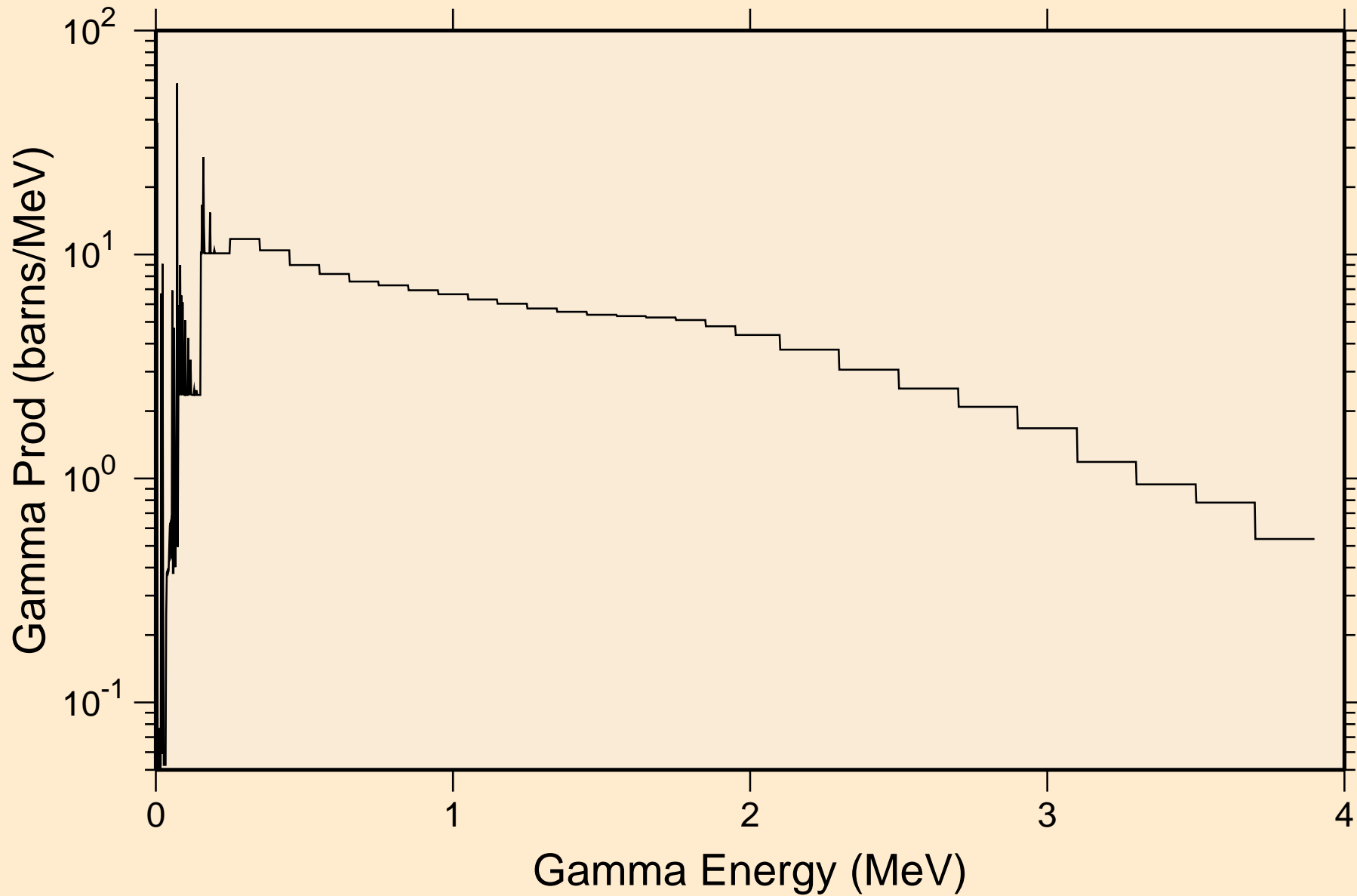

FR229 NEUTRON ACER TENDL-2024 LIBRARY; T=293.6K
14 MeV photon spectrum

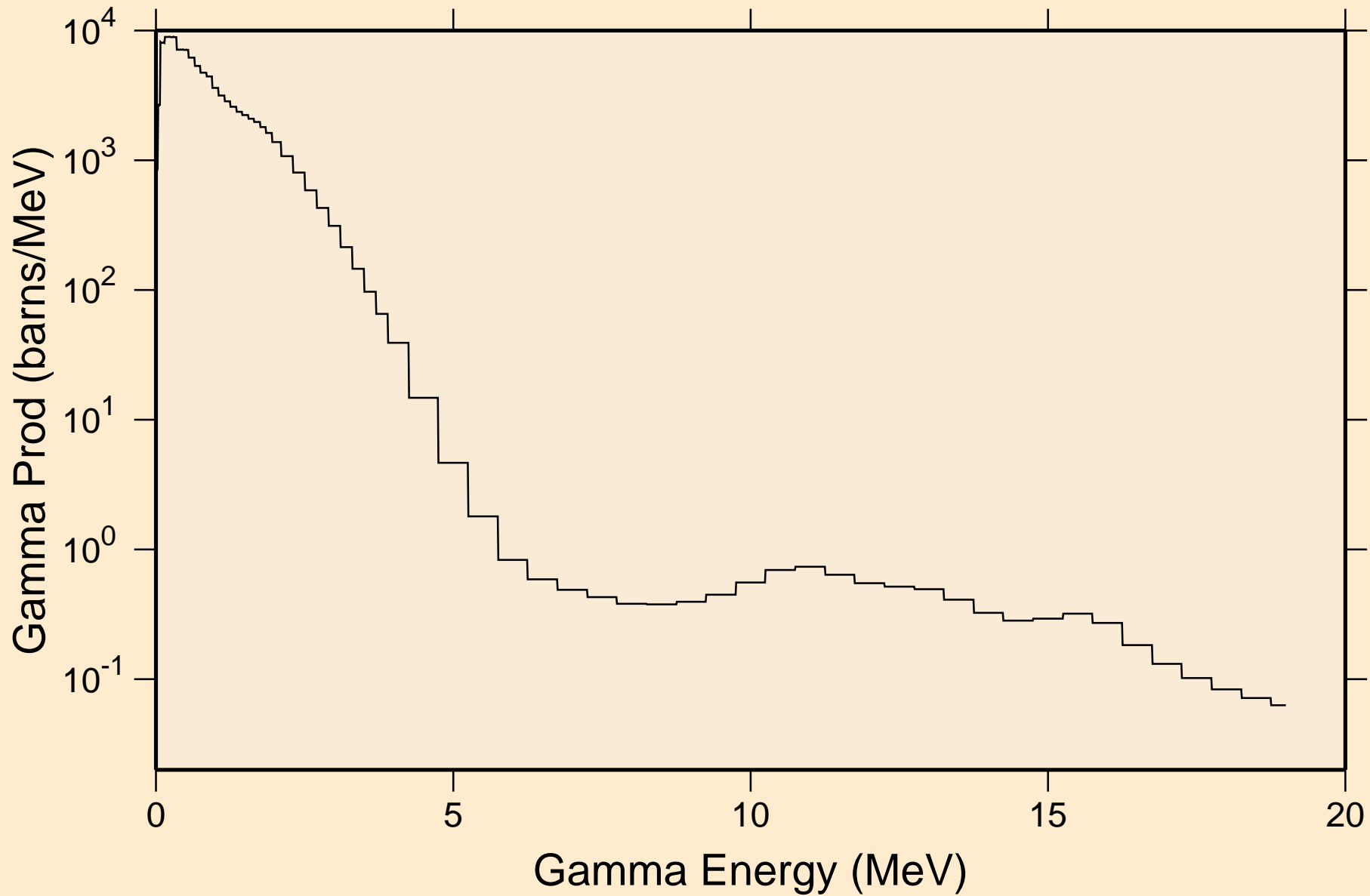

FR229 NEUTRON ACER TENDL-2024 LIBRARY; T=293.6K

Particle heating contributions

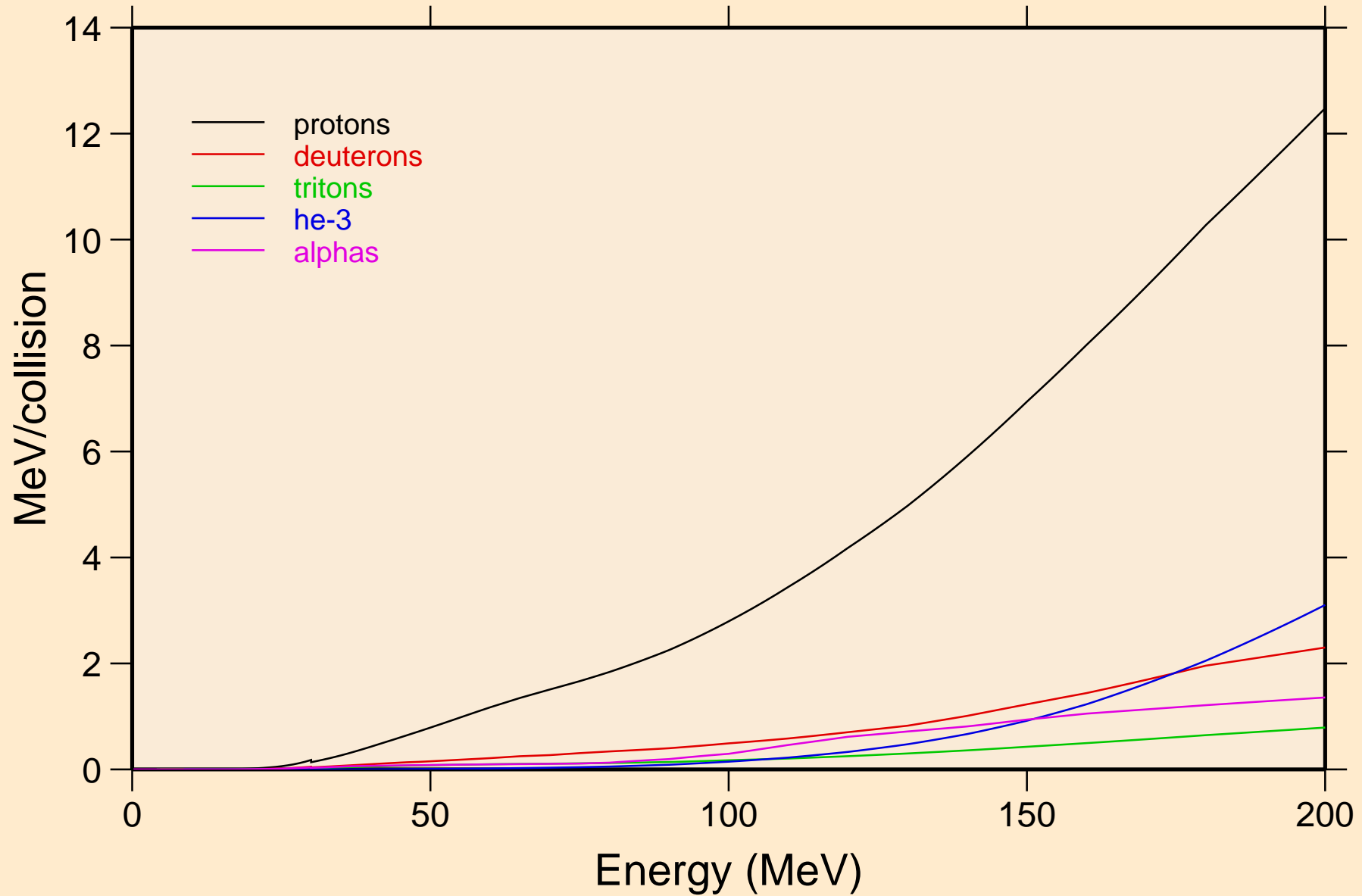

FR229 NEUTRON ACER TENDL-2024 LIBRARY; T=293.6K
Recoil Heating

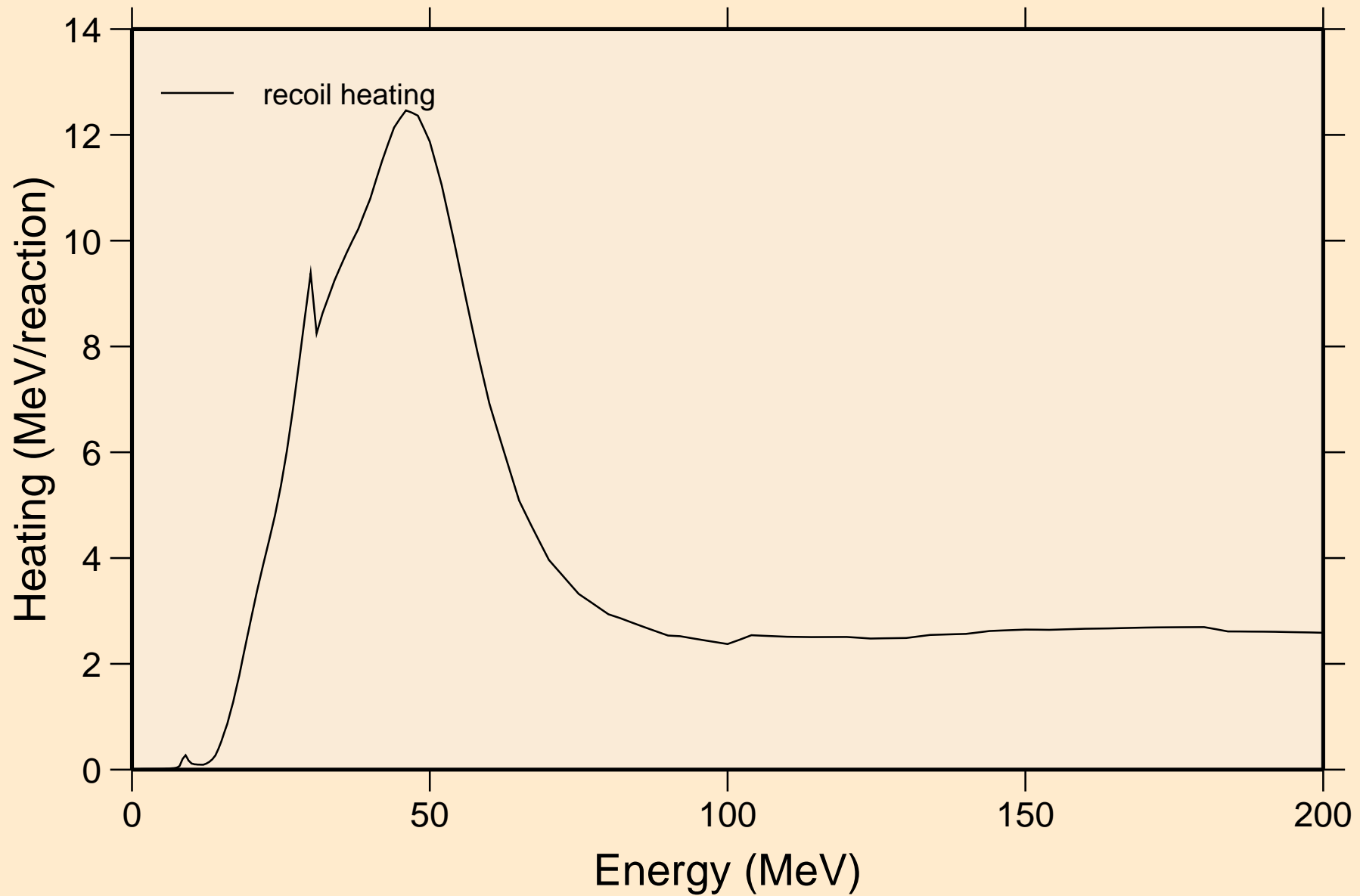

FR229 NEUTRON ACER TENDL-2024 LIBRARY; T=293.6K
Particle production cross sections

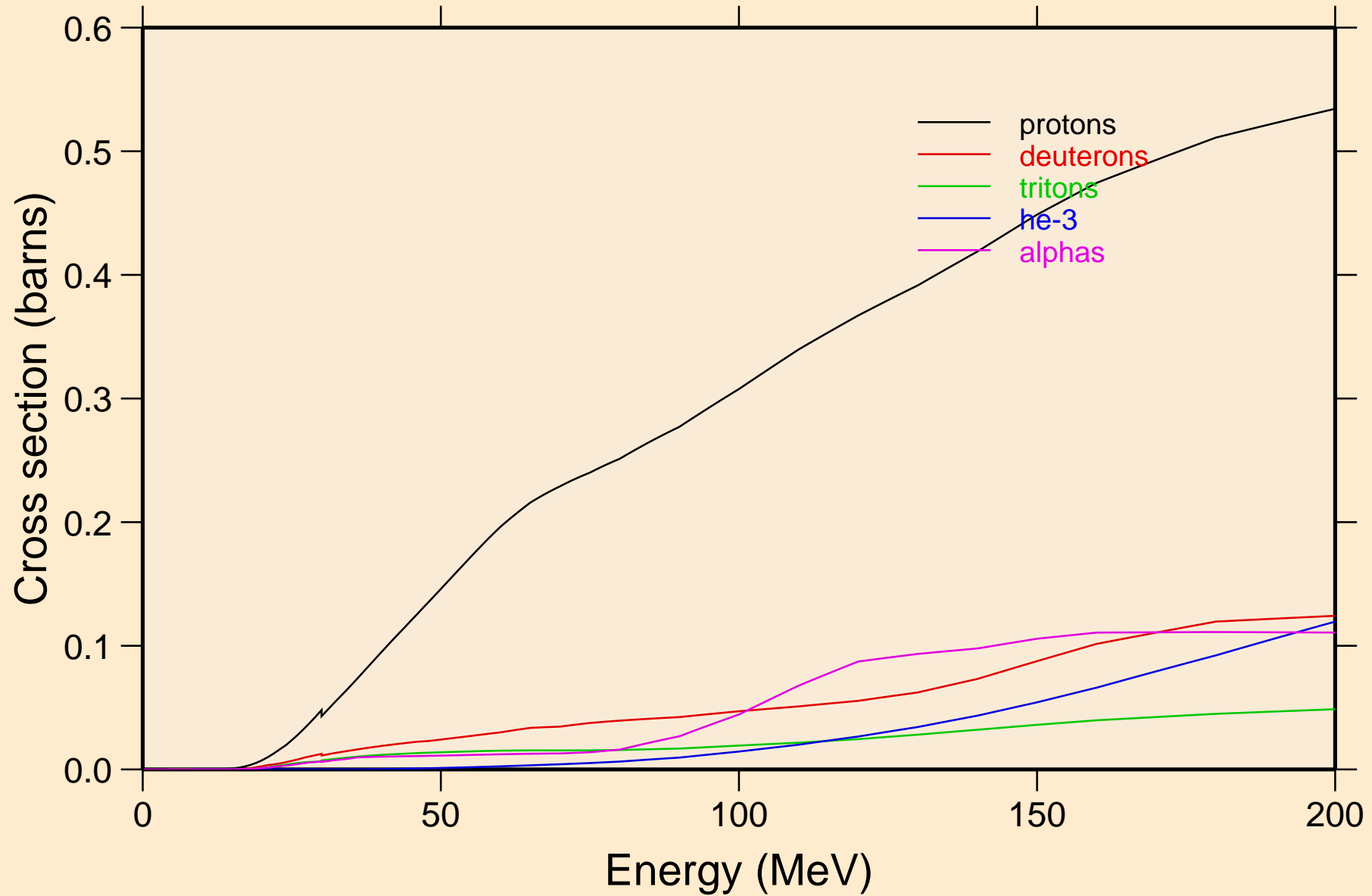

FR229 NEUTRON ACER TENDL-2024 LIBRARY; T=293.6K
protons from (n,x)

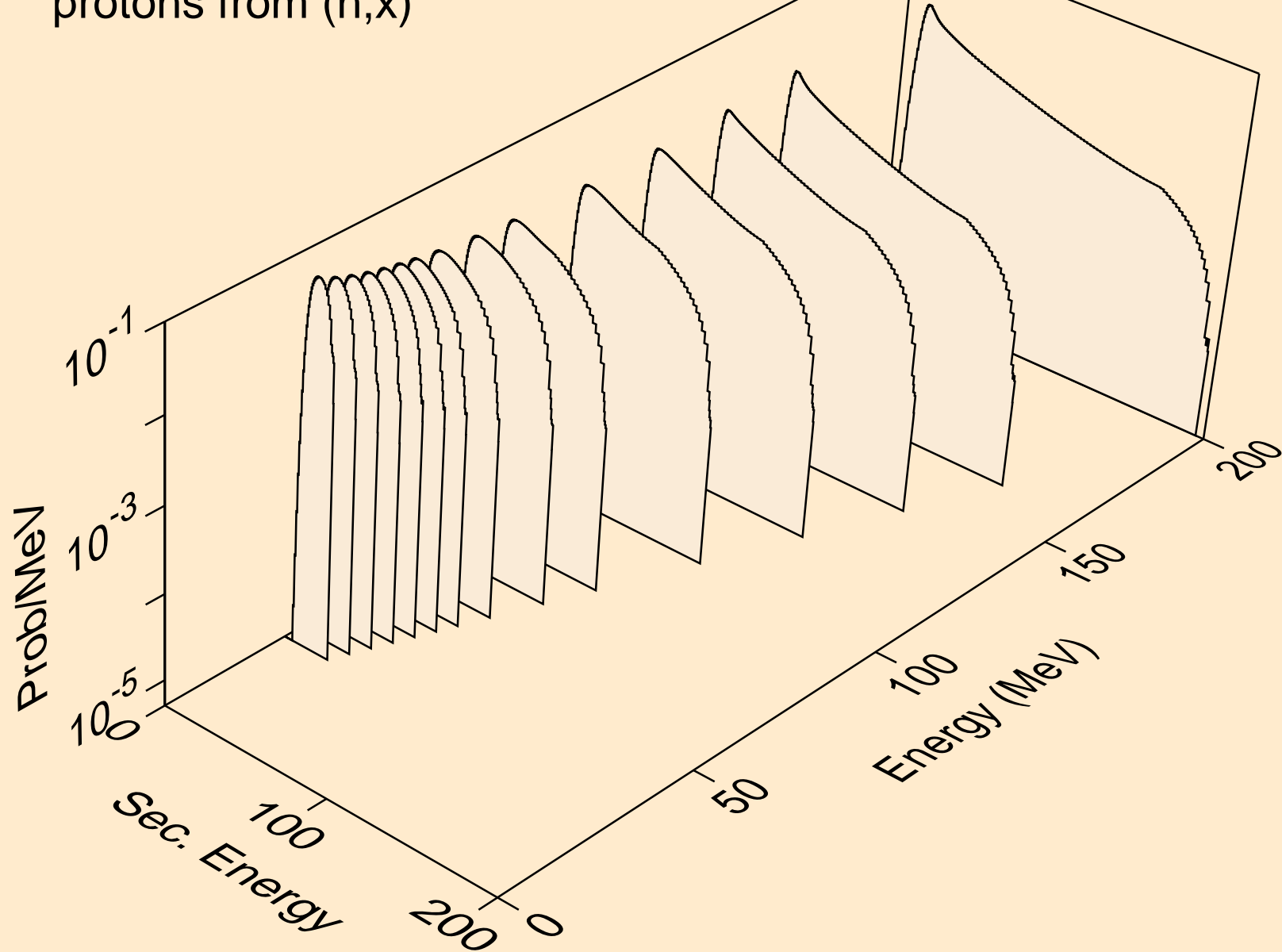

FR229 NEUTRON ACER TENDL-2024 LIBRARY; T=293.6K
protons from (n,n*)p

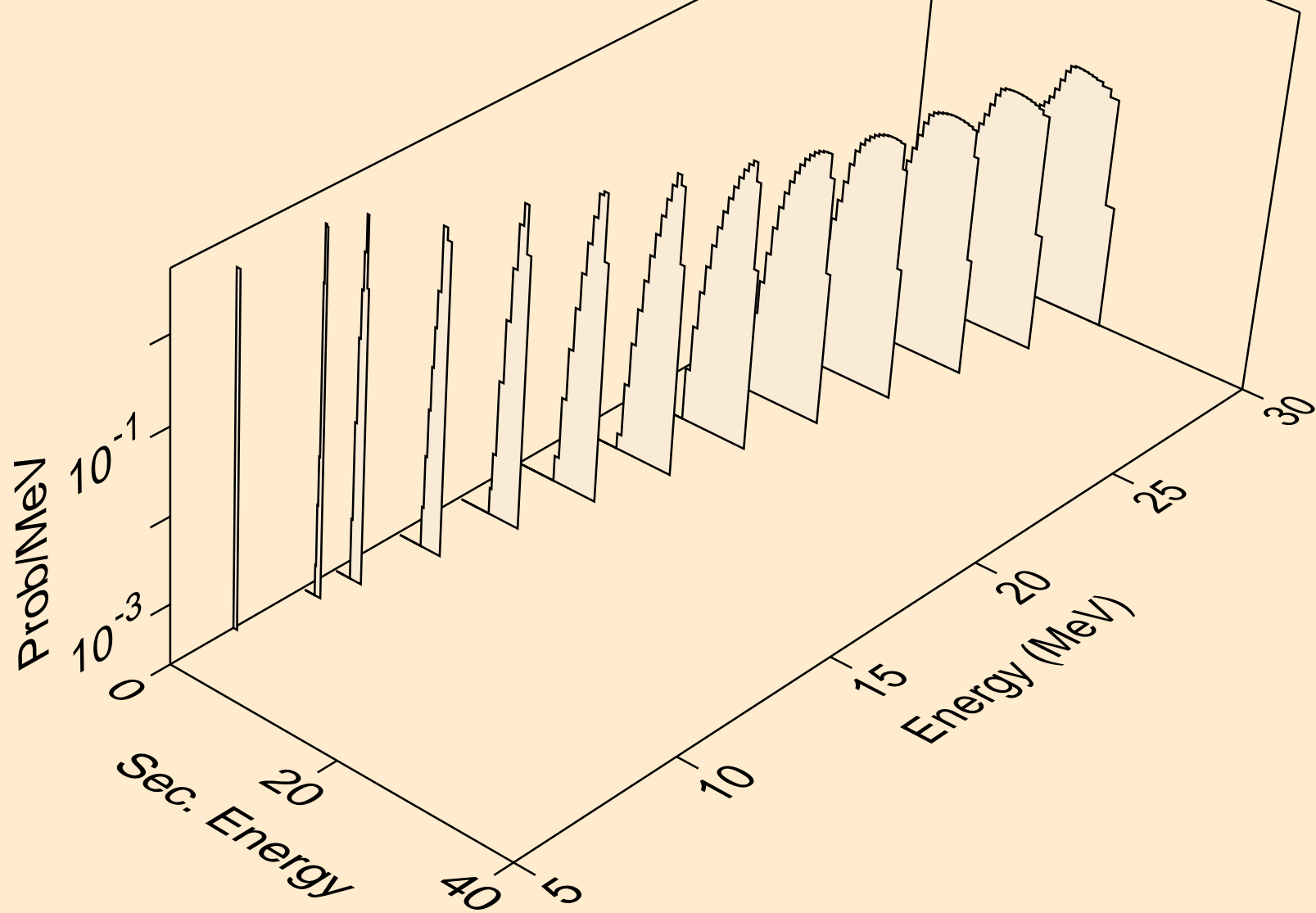

FR229 NEUTRON ACER TENDL-2024 LIBRARY; T=293.6K
protons from (n,2np)

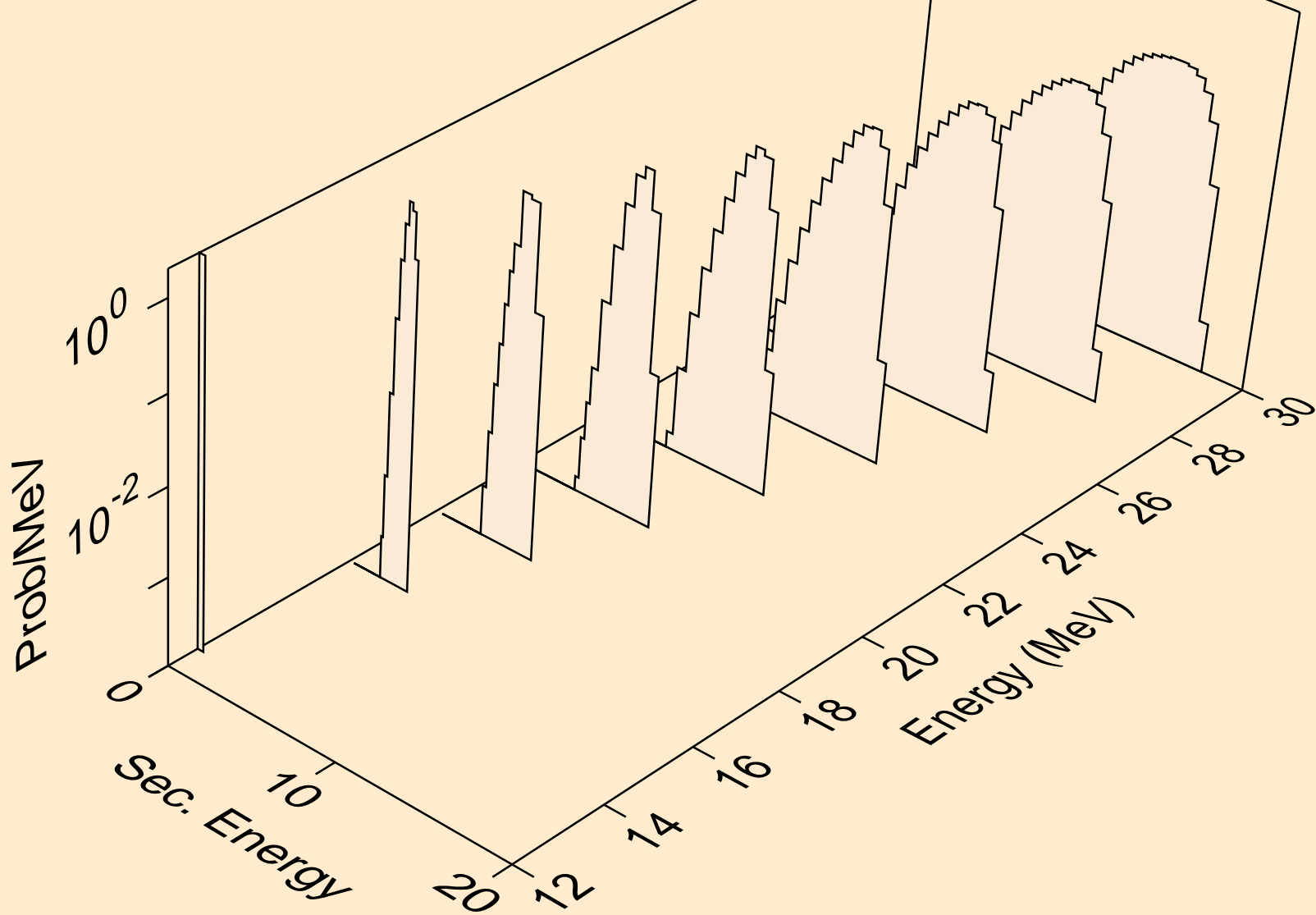

FR229 NEUTRON ACER TENDL-2024 LIBRARY; T=293.6K
protons from (n,3np)

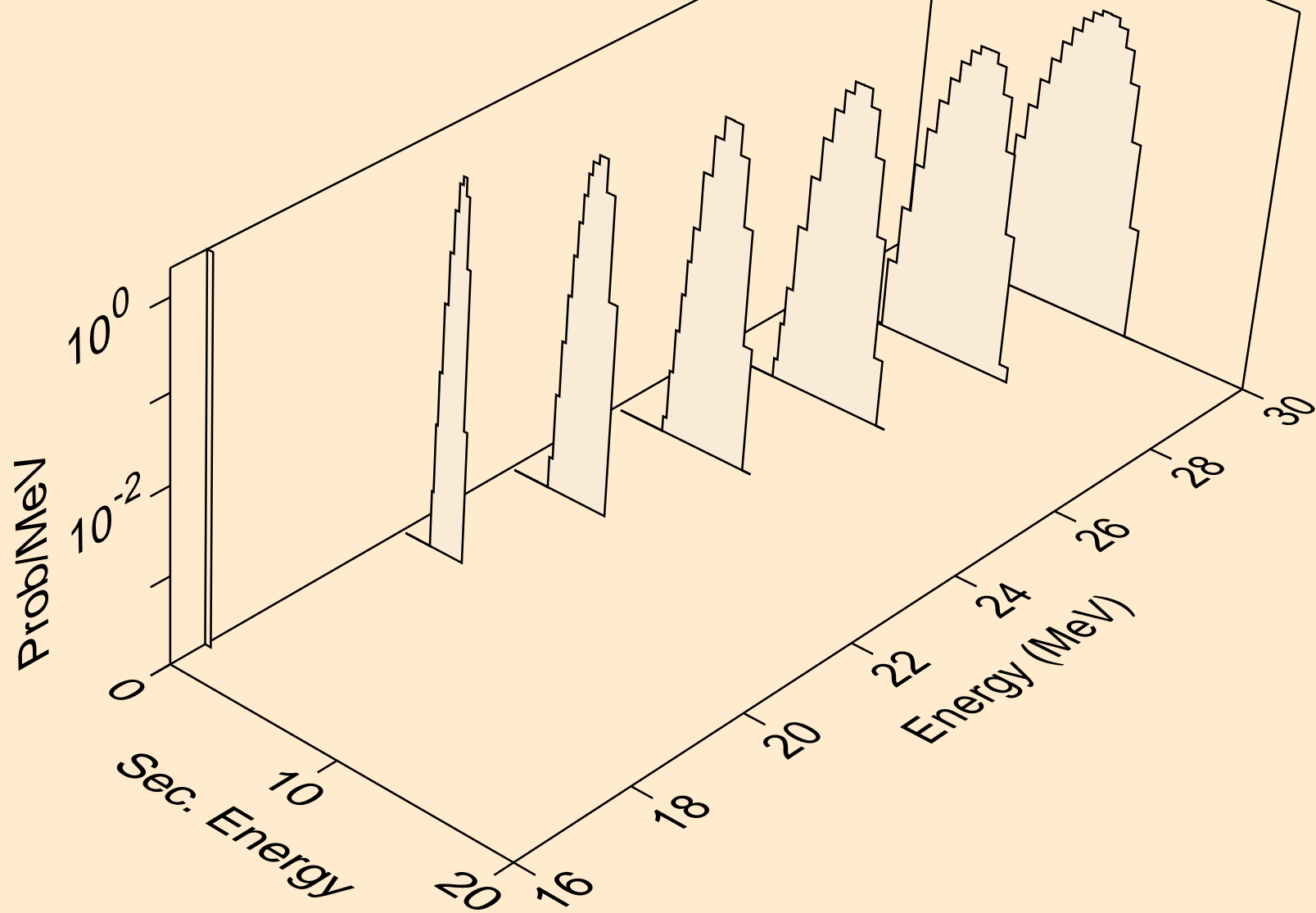

FR229 NEUTRON ACER TENDL-2024 LIBRARY; T=293.6K
protons from (n,p)

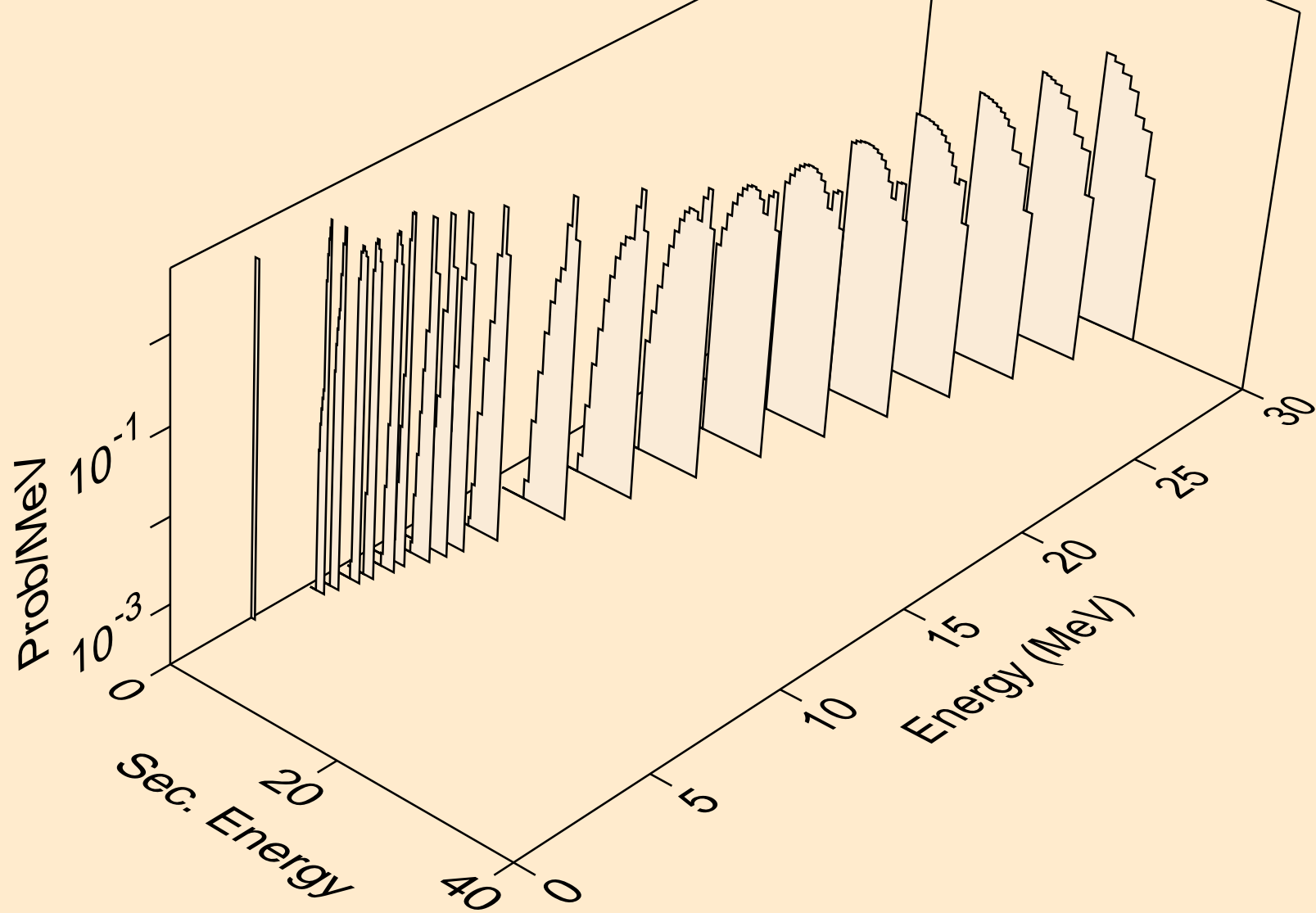

FR229 NEUTRON ACER TENDL-2024 LIBRARY; T=293.6K
deuterons from (n,x)

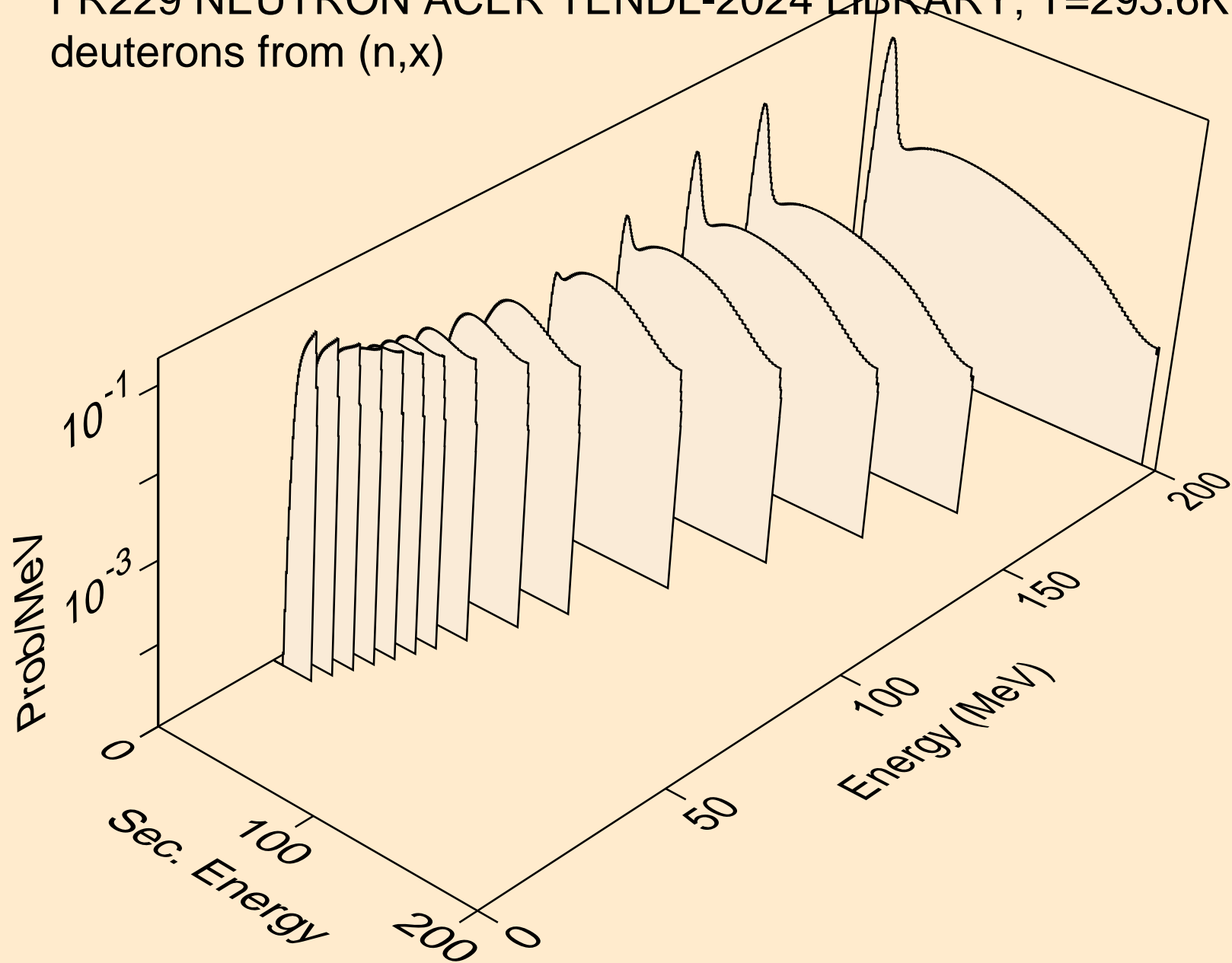

FR229 NEUTRON ACER TENDL-2024 LIBRARY; T=293.6K
deuterons from (n,2nd)

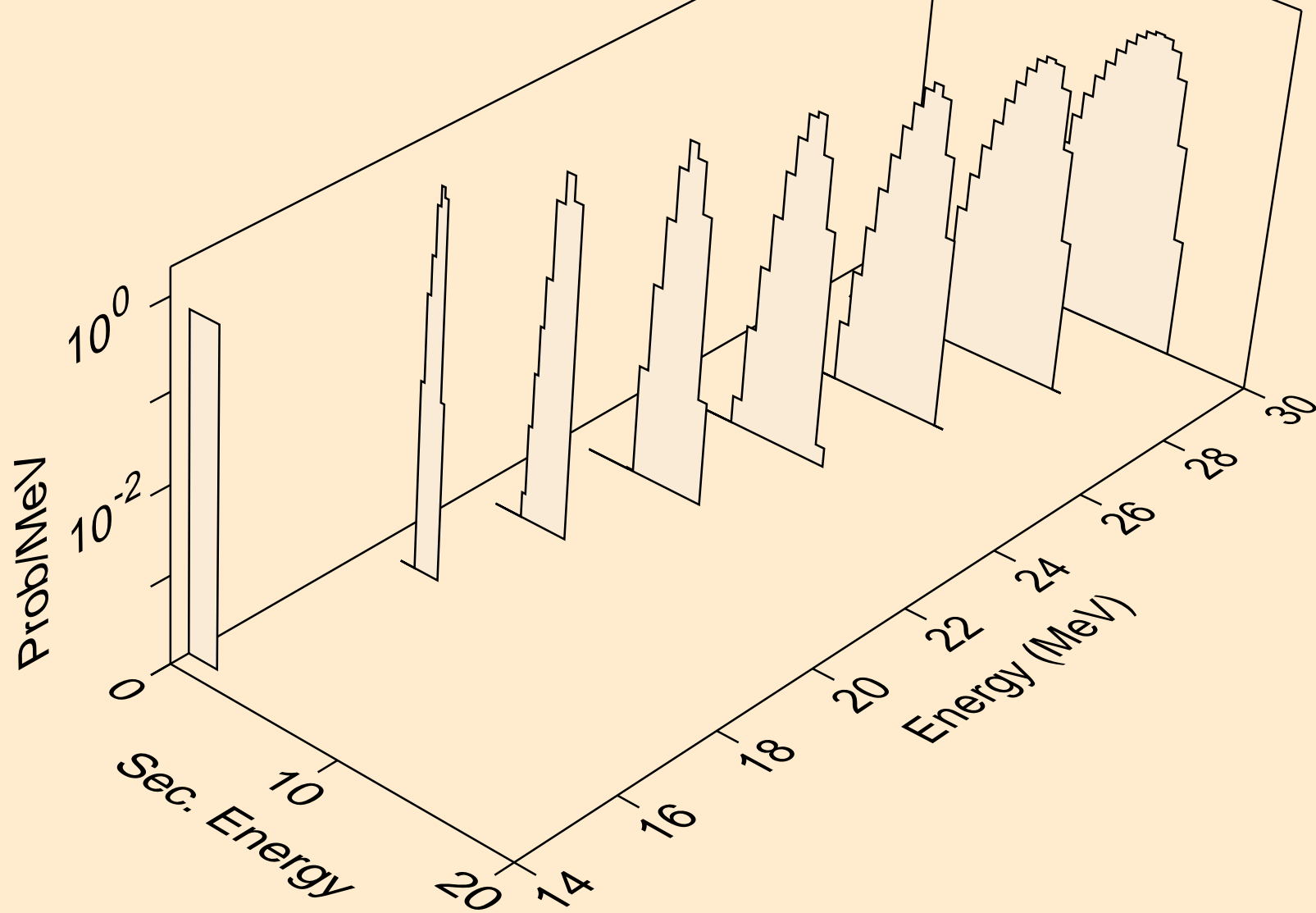

FR229 NEUTRON ACER TENDL-2024 LIBRARY; T=293.6K
deuterons from (n,n*)d

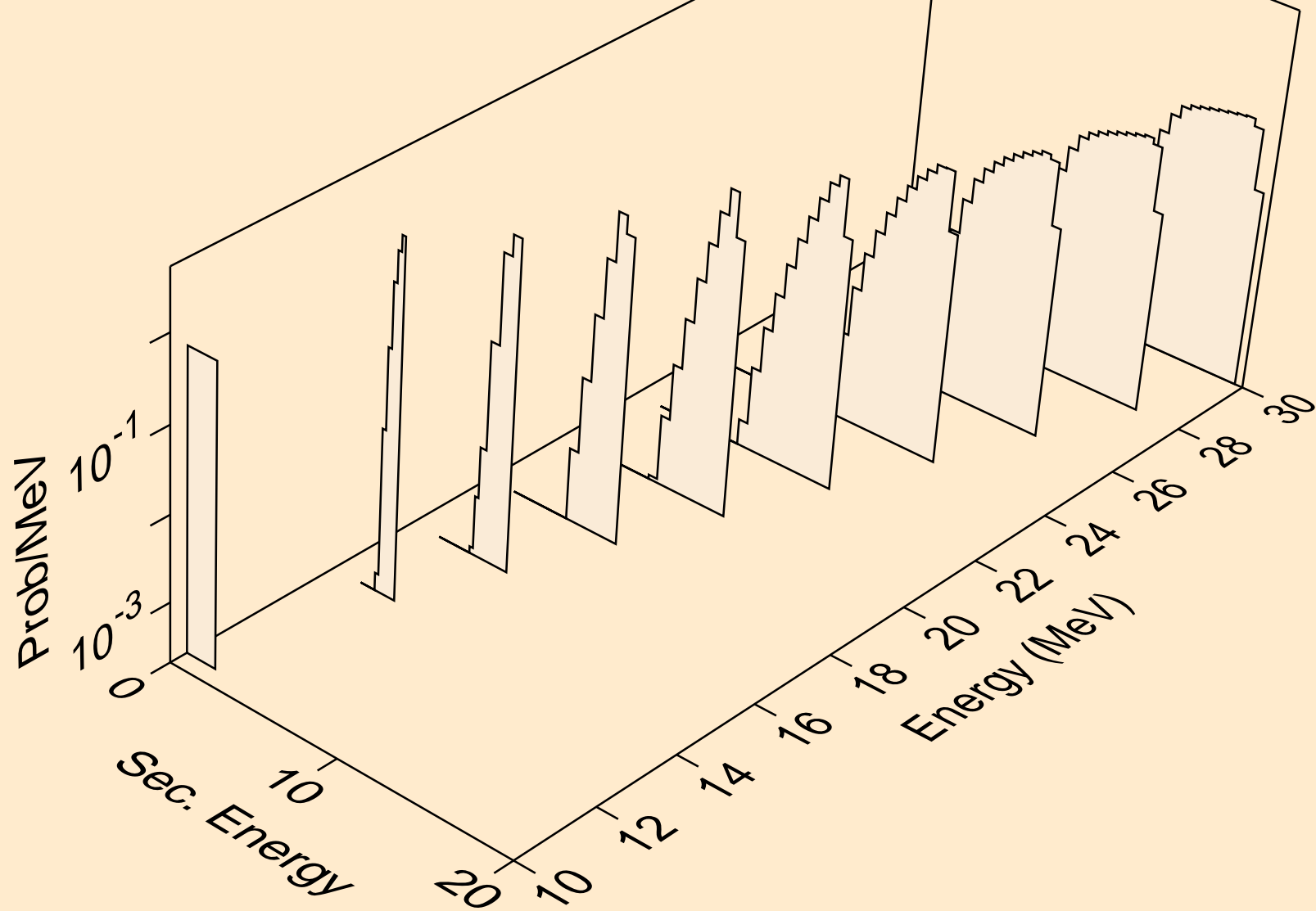

FR229 NEUTRON ACER TENDL-2024 LIBRARY; T=293.6K
deuterons from (n,d)

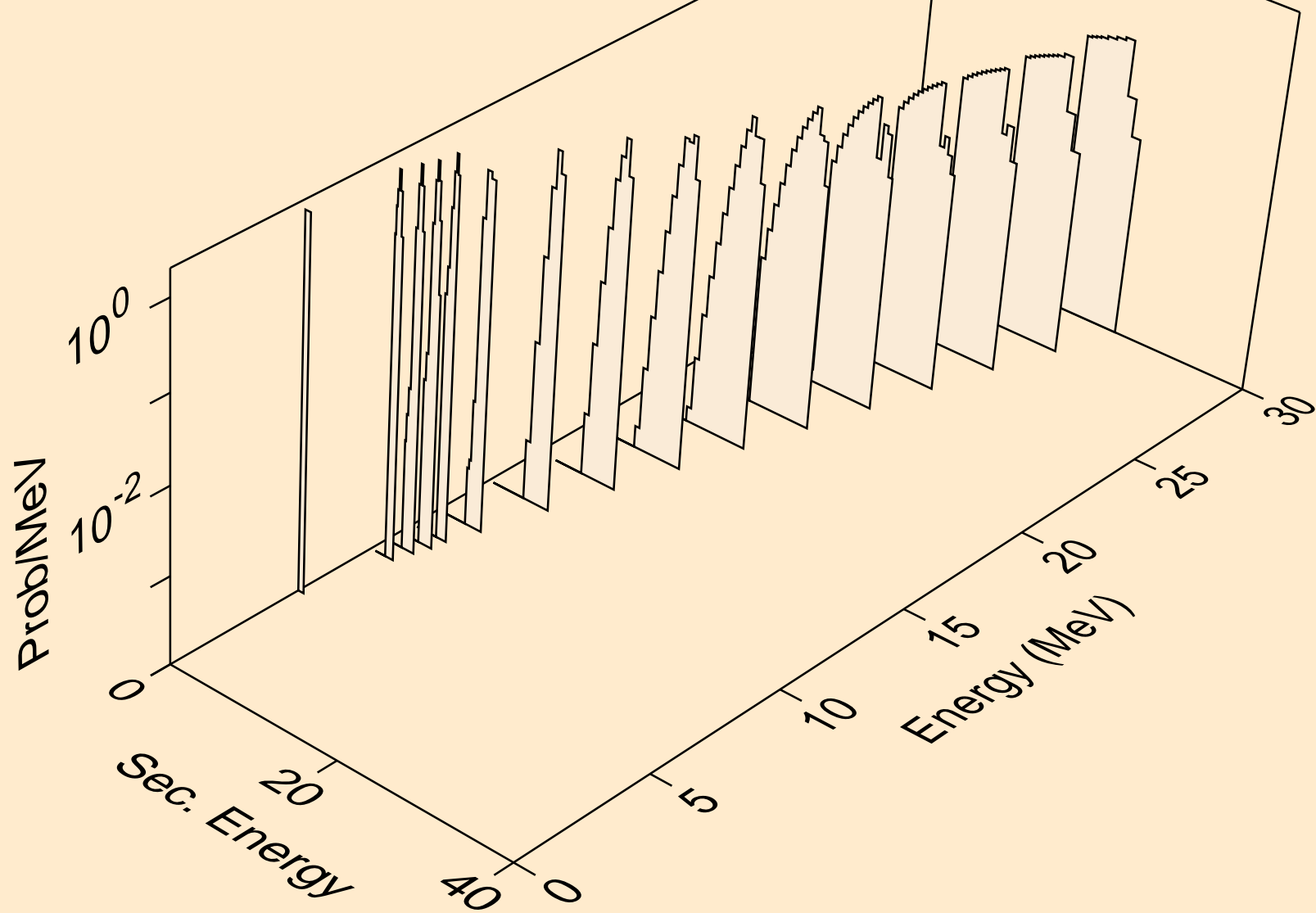

FR229 NEUTRON ACER TENDL-2024 LIBRARY; T=293.6K
tritons from (n,x)

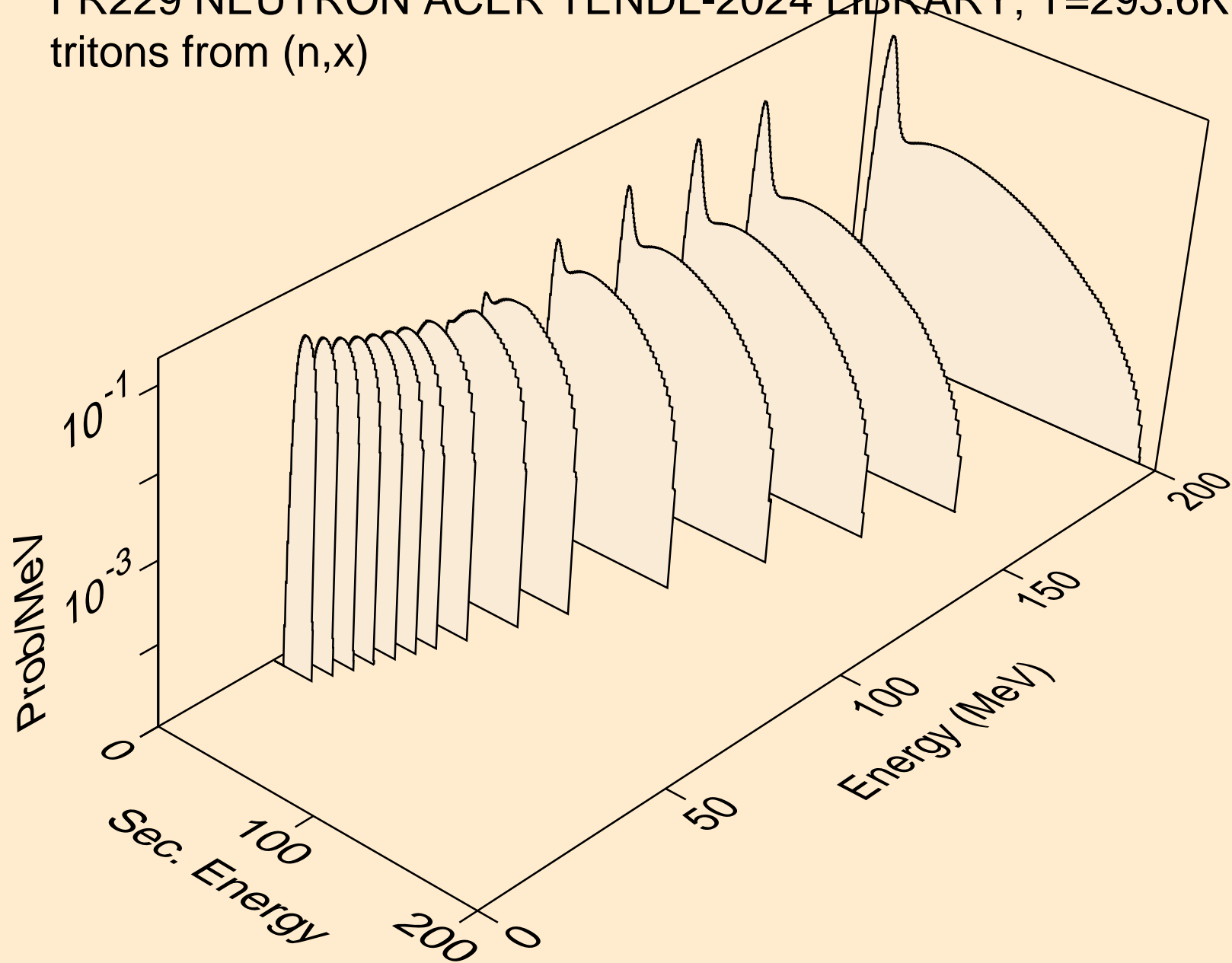

FR229 NEUTRON ACER TENDL-2024 LIBRARY; T=293.6K
tritons from (n,n*)t

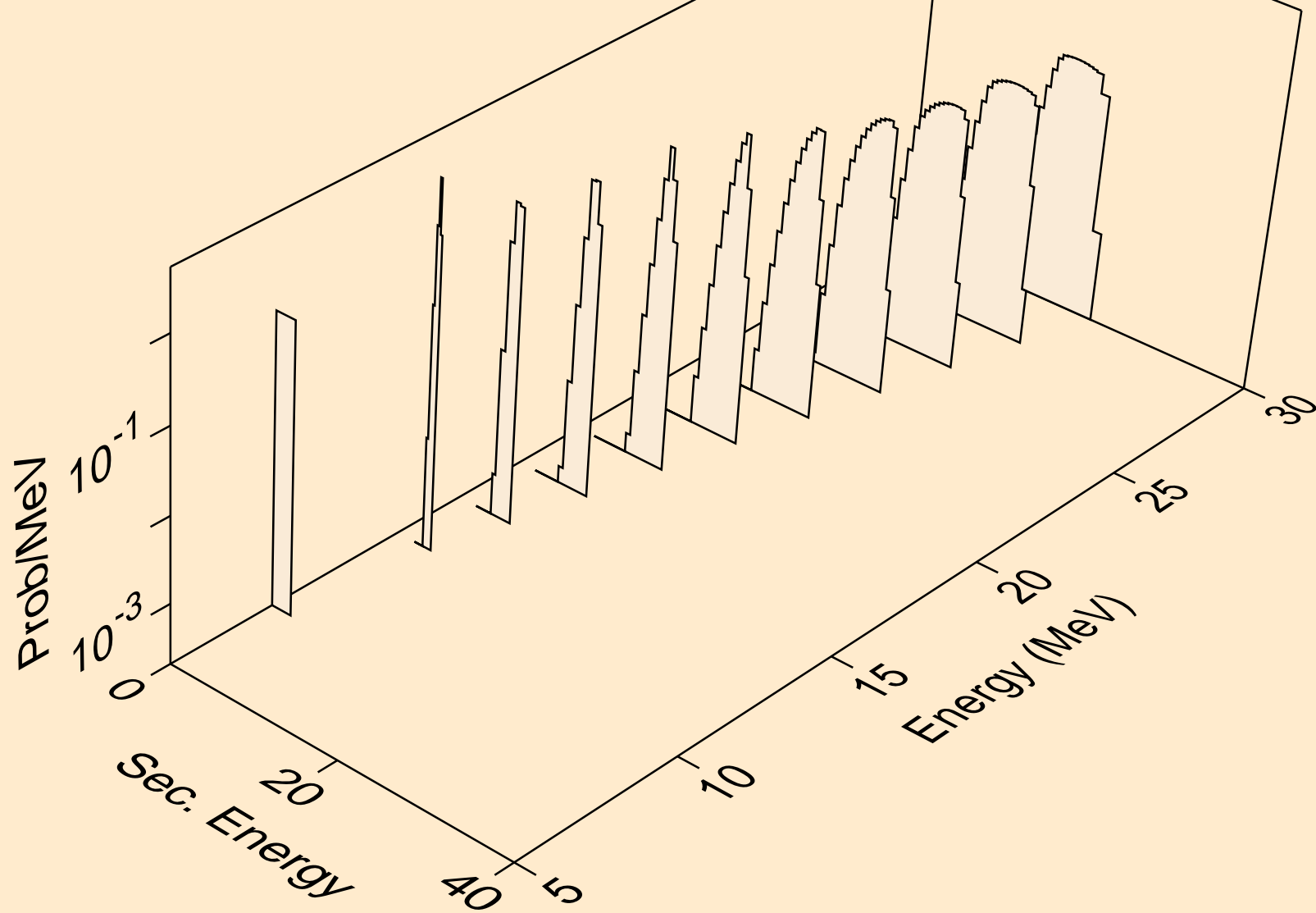

FR229 NEUTRON ACER TENDL-2024 LIBRARY; T=293.6K
tritons from (n,t)

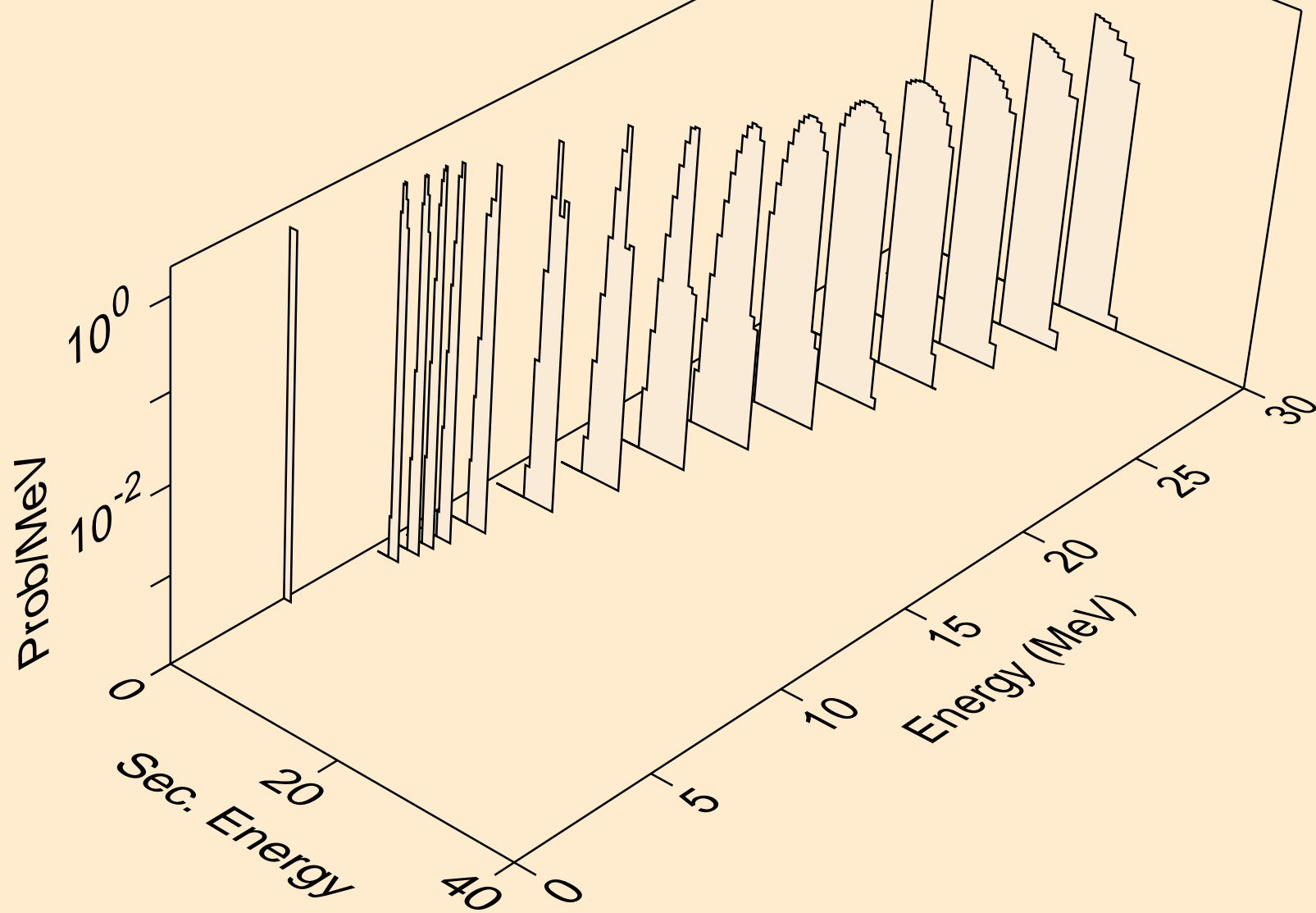

FR229 NEUTRON ACER TENDL-2024 LIBRARY; T=293.6K
he3s from (n,x)

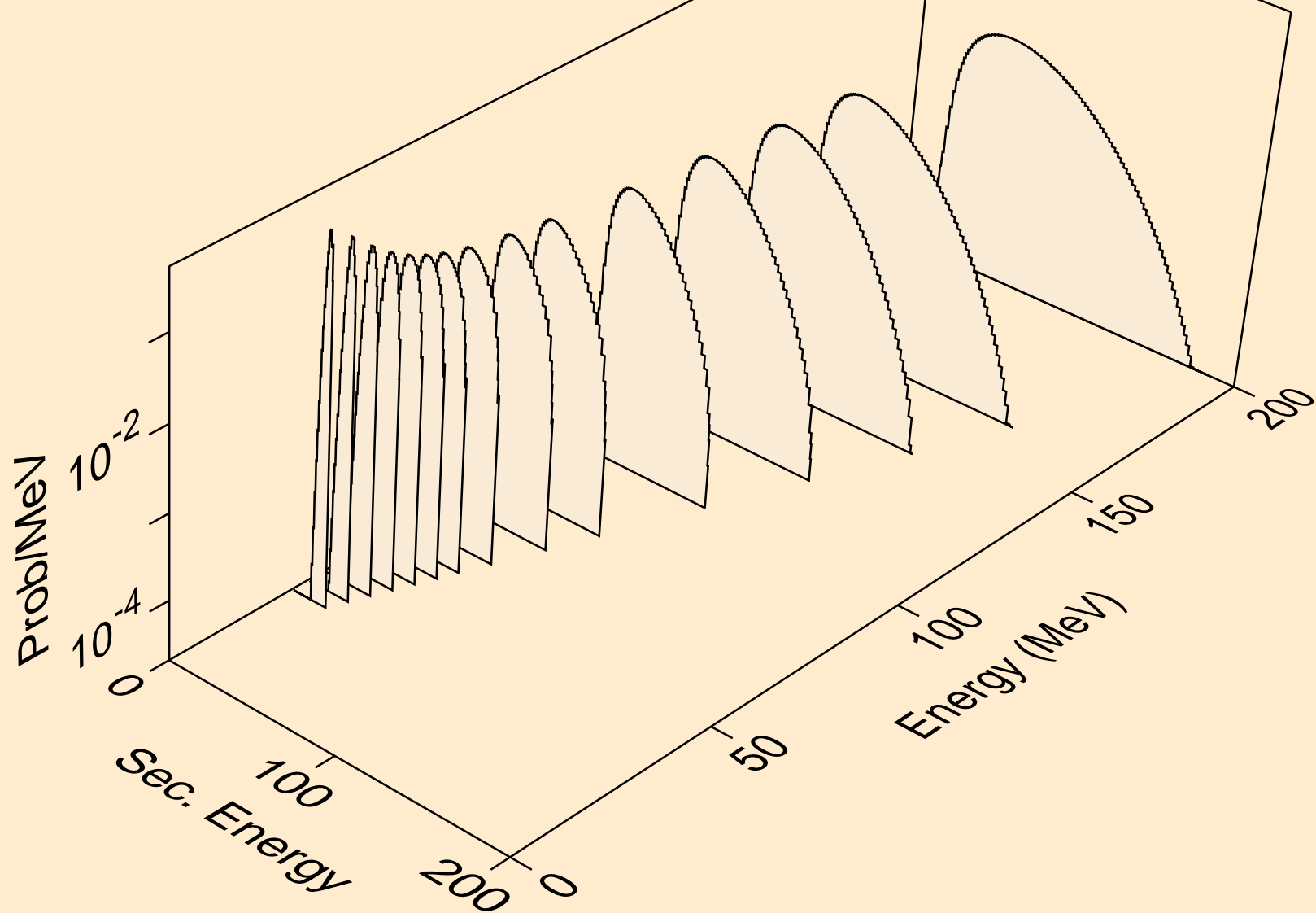

FR229 NEUTRON ACER TENDL-2024 LIBRARY; T=293.6K
he3s from (n,n*)he3

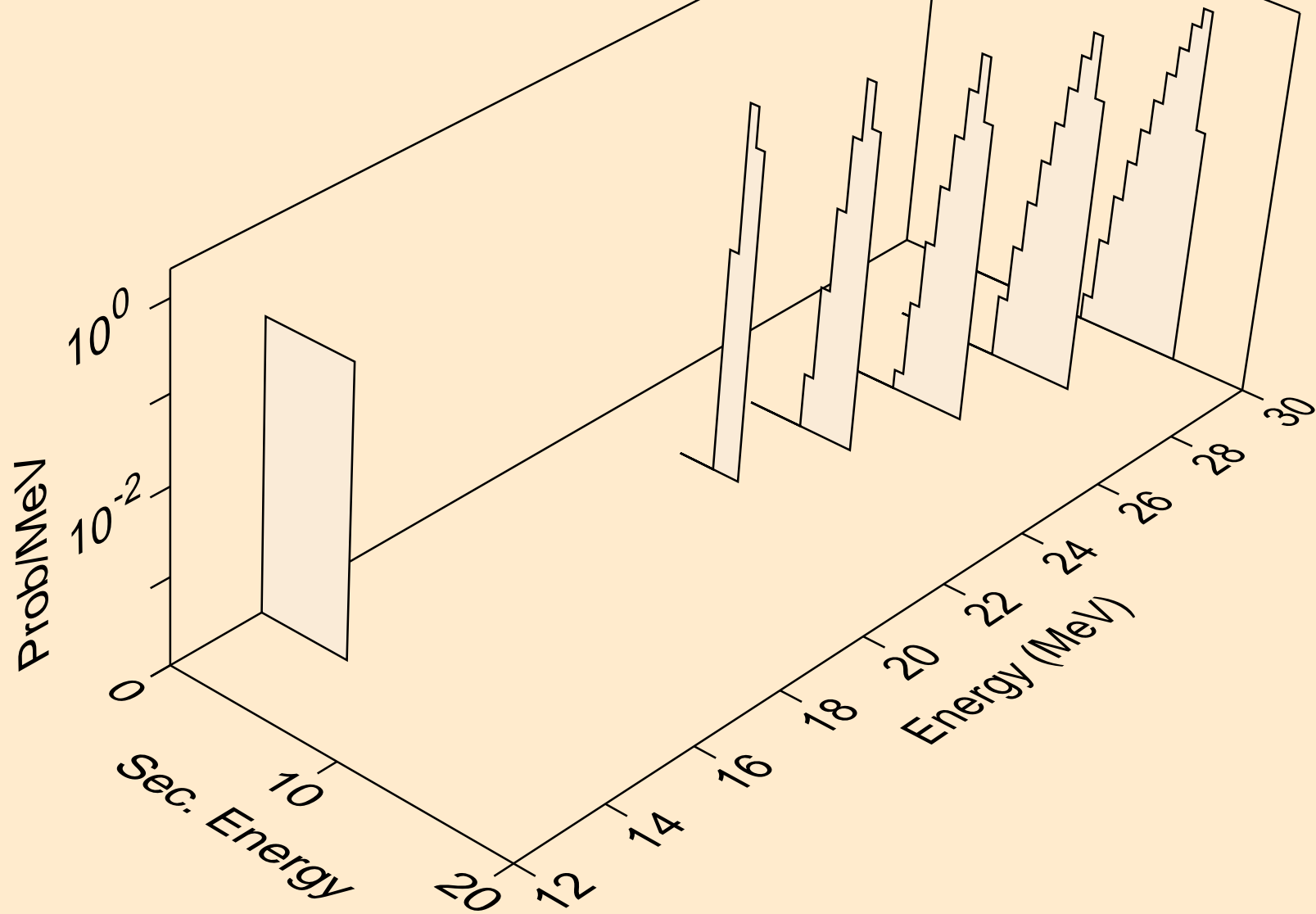

FR229 NEUTRON ACER TENDL-2024 LIBRARY; T=293.6K
he3s from (n,he3)

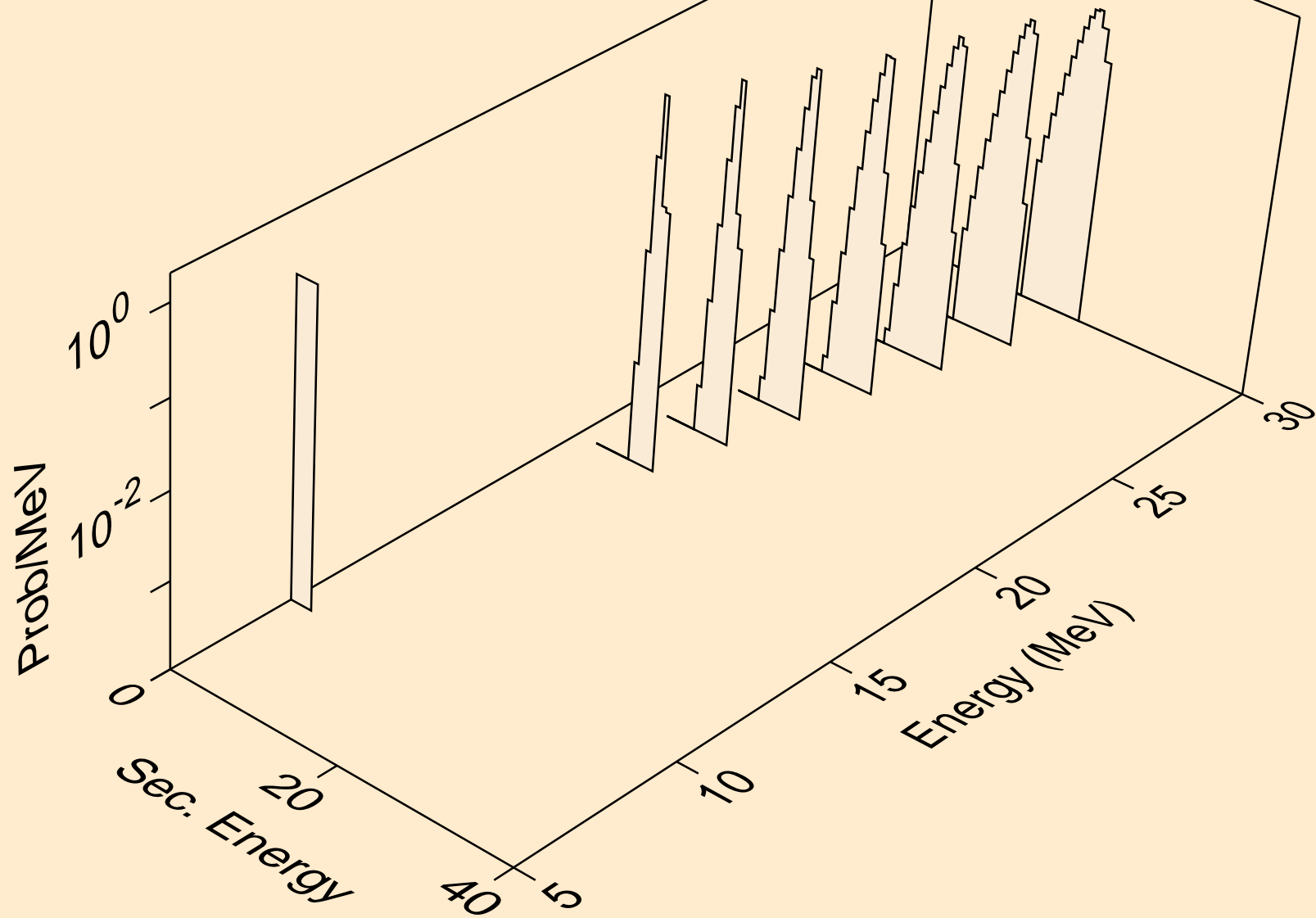

FR229 NEUTRON ACER TENDL-2024 LIBRARY; T=293.6K
alphas from (n,x)

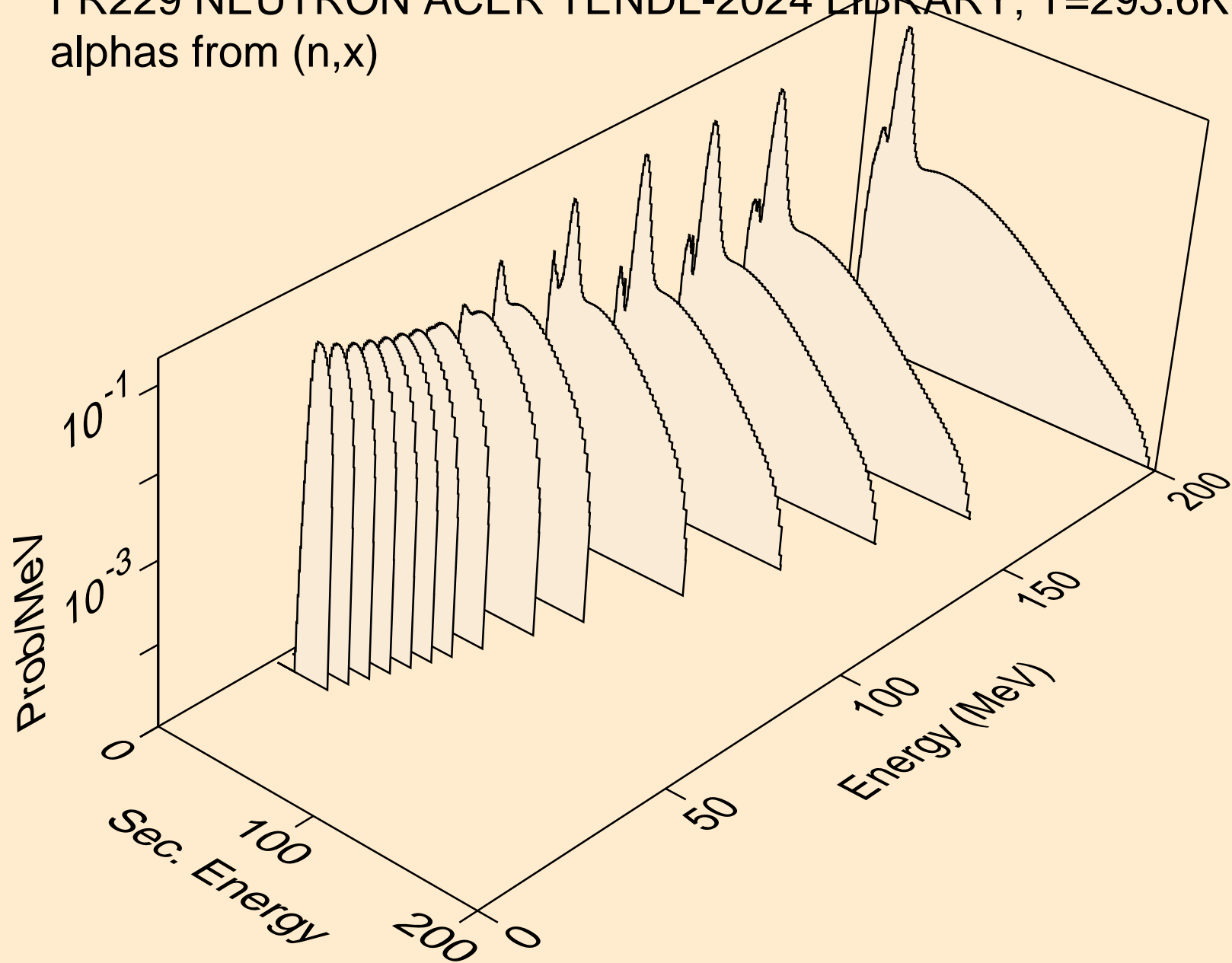

FR229 NEUTRON ACER TENDL-2024 LIBRARY; T=293.6K
alphas from (n,n*)a

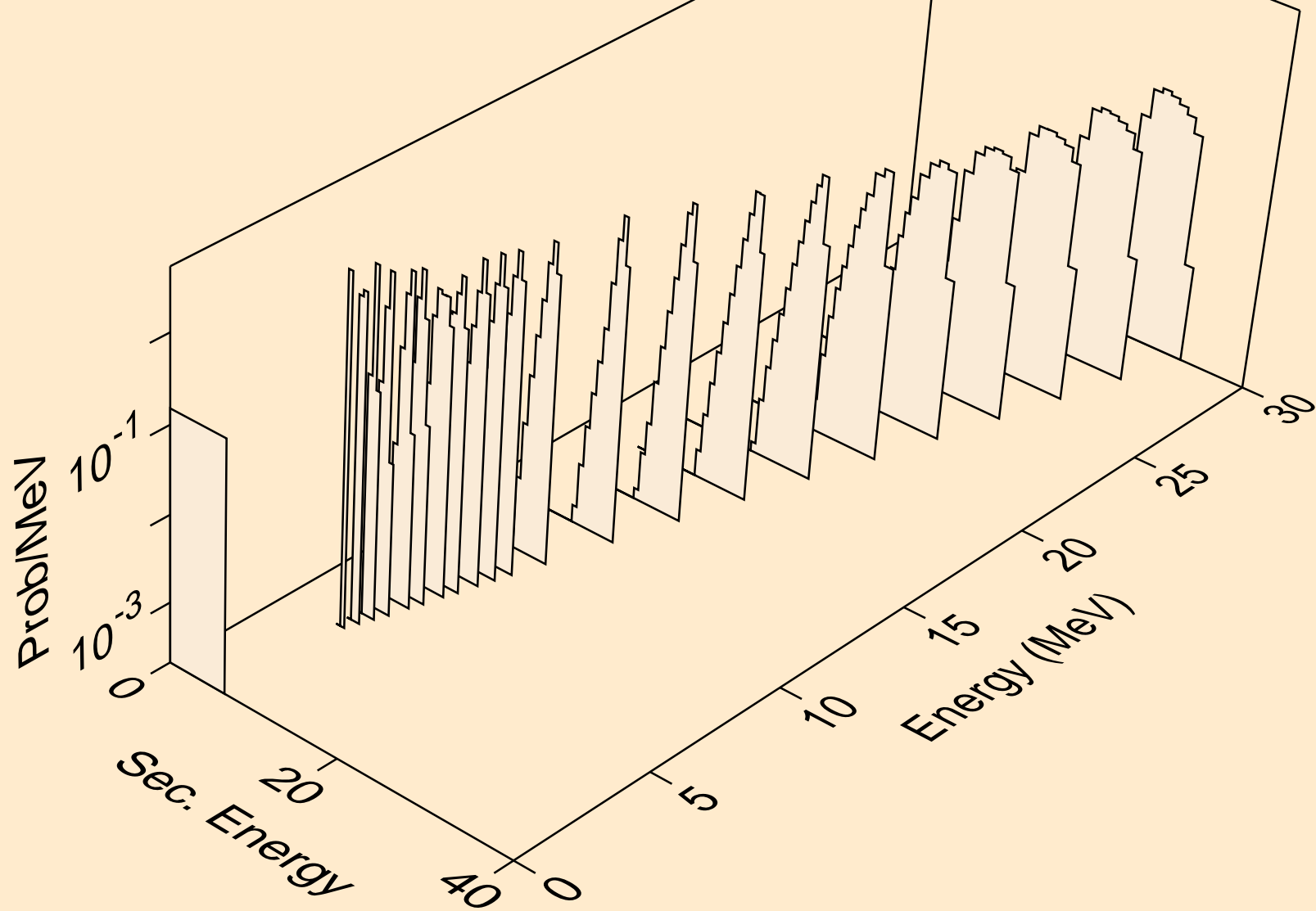

FR229 NEUTRON ACER TENDL-2024 LIBRARY; T=293.6K
alphas from (n,2n)a

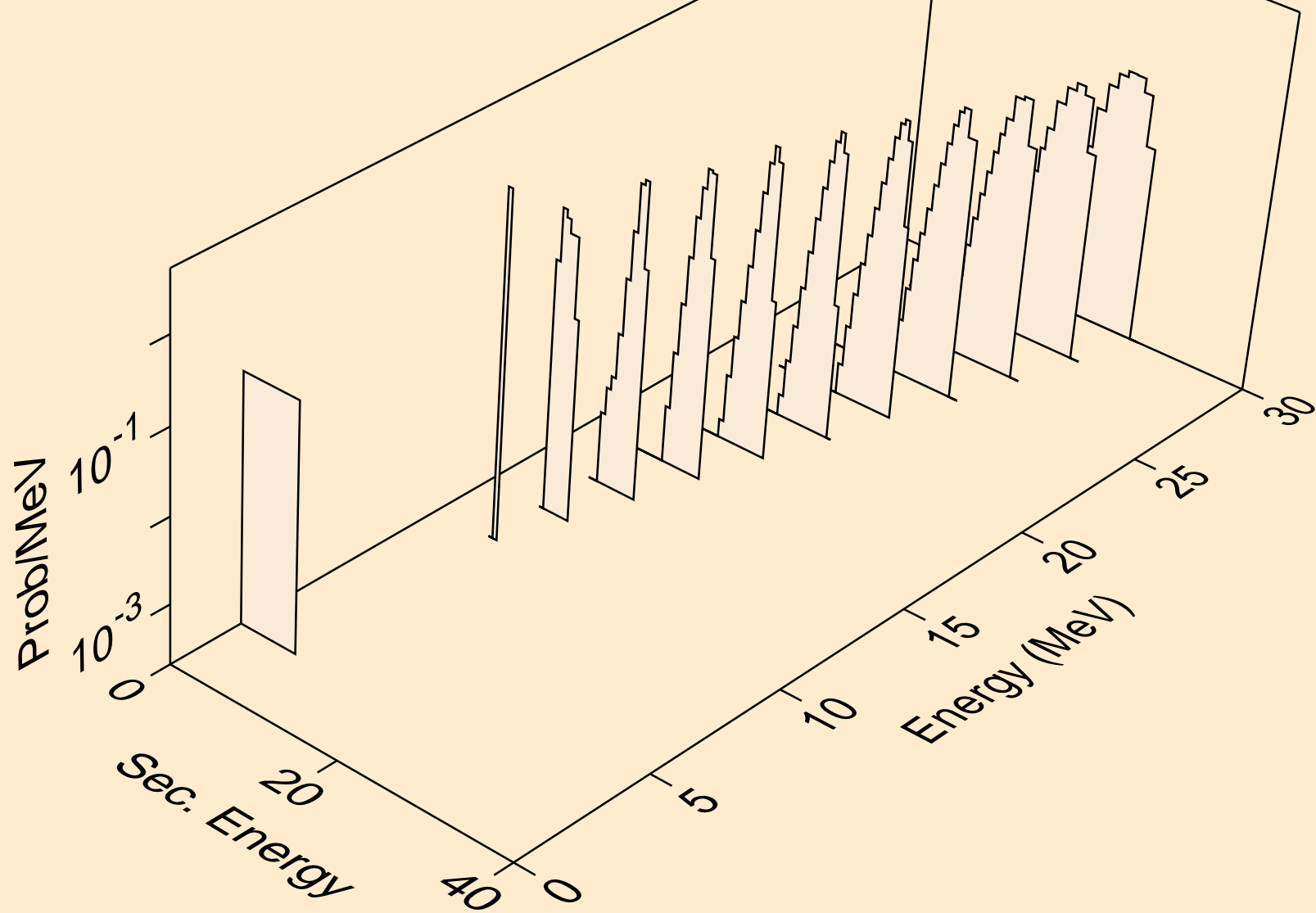

FR229 NEUTRON ACER TENDL-2024 LIBRARY; T=293.6K
alphas from (n,3n)a

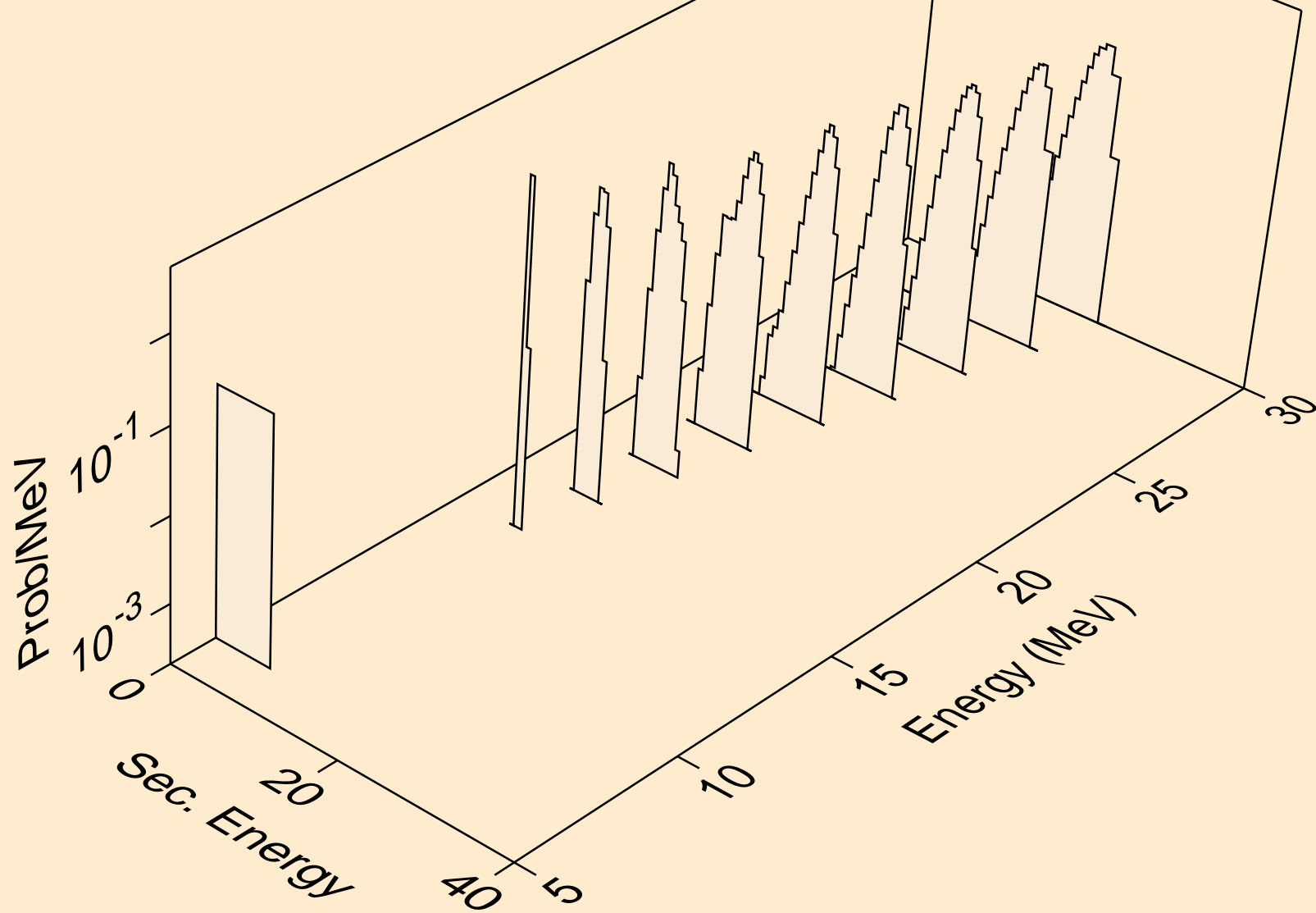

FR229 NEUTRON ACER TENDL-2024 LIBRARY; T=293.6K
alphas from (n,a)

