

GA064 NEUTRON ACER TENDL-2024 LIBRARY; T=293.6K

Principal cross sections

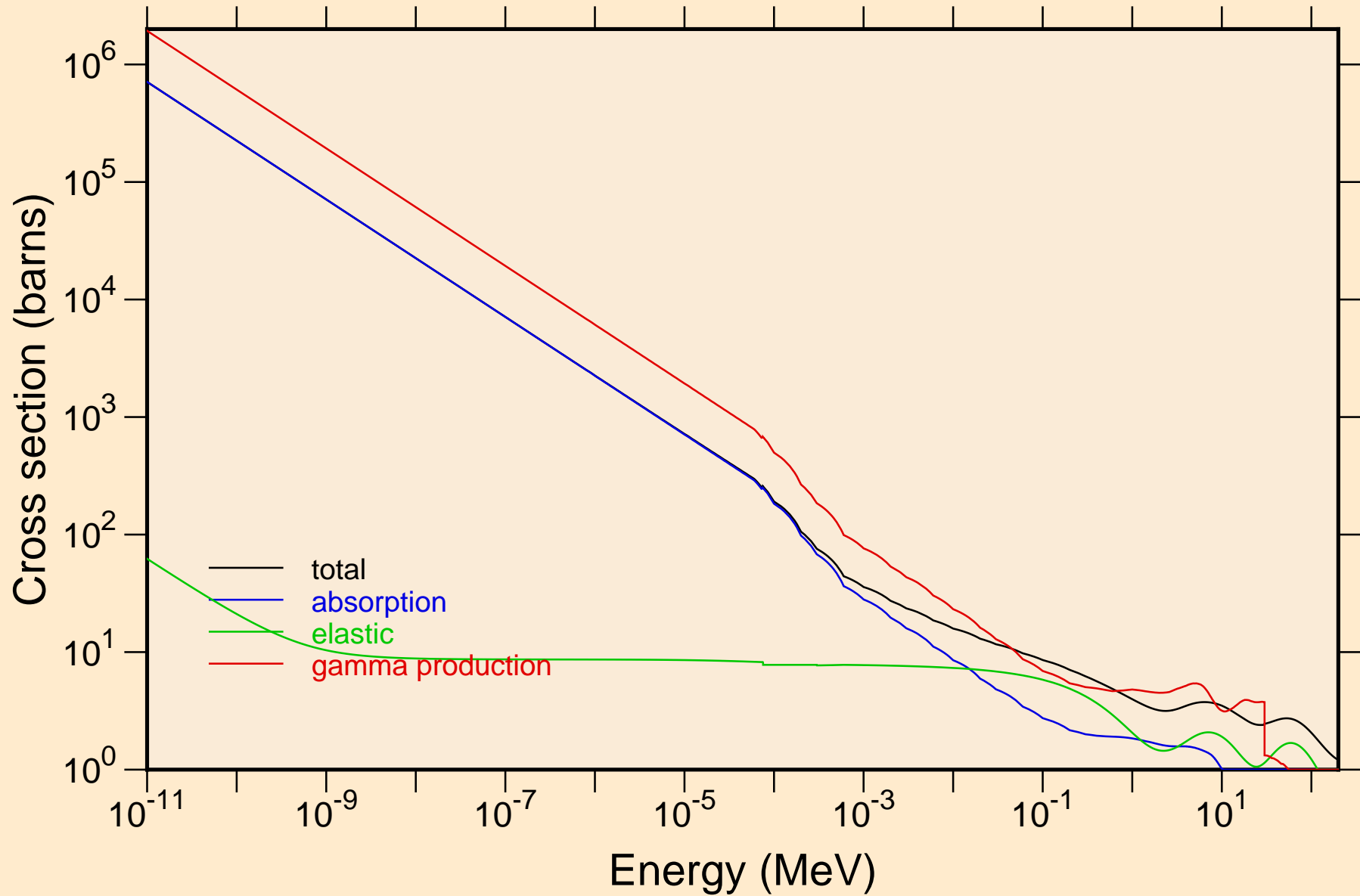

GA064 NEUTRON ACER TENDL-2024 LIBRARY; T=293.6K

Heating

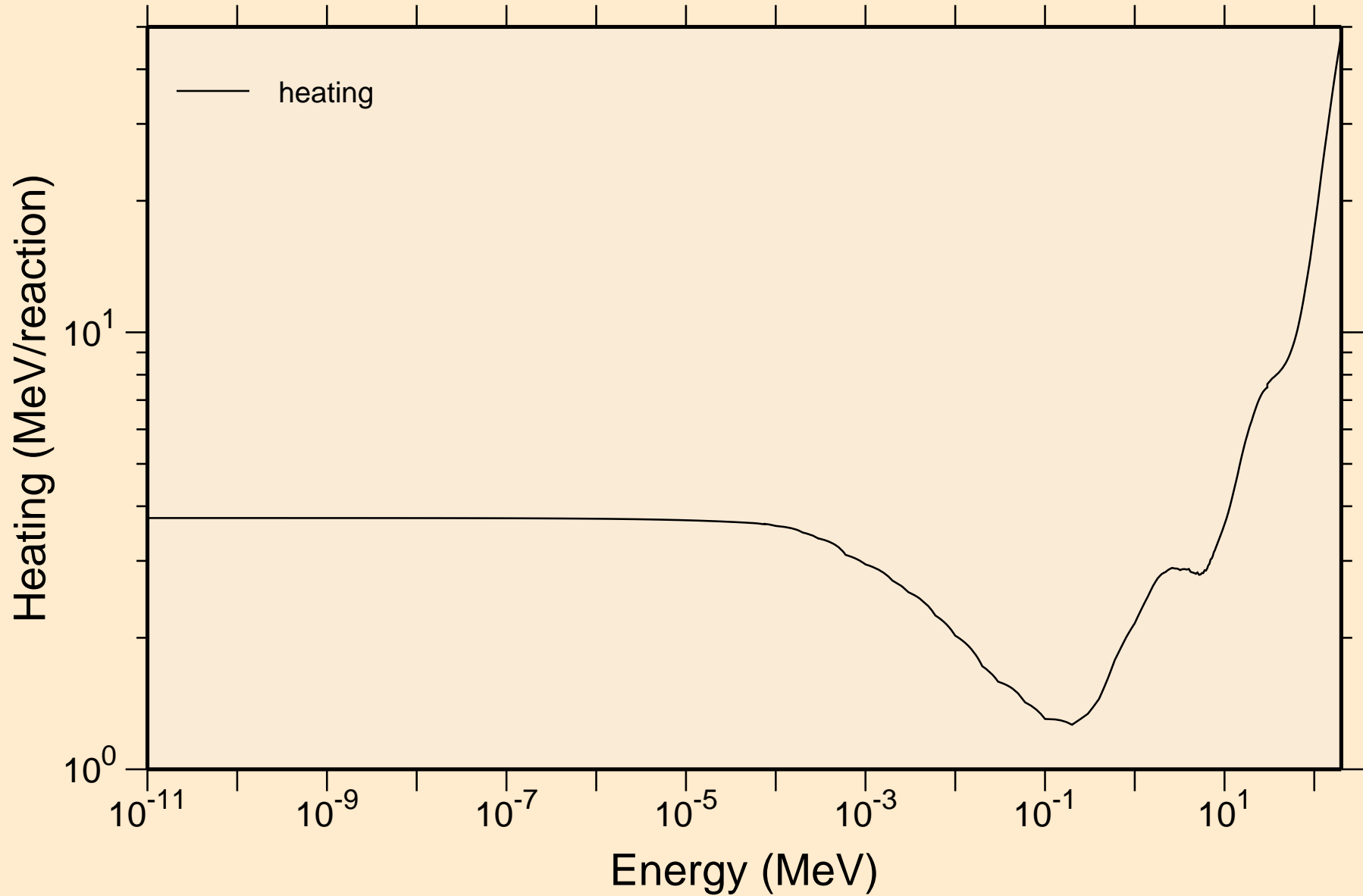

GA064 NEUTRON ACER TENDL-2024 LIBRARY; T=293.6K
Damage

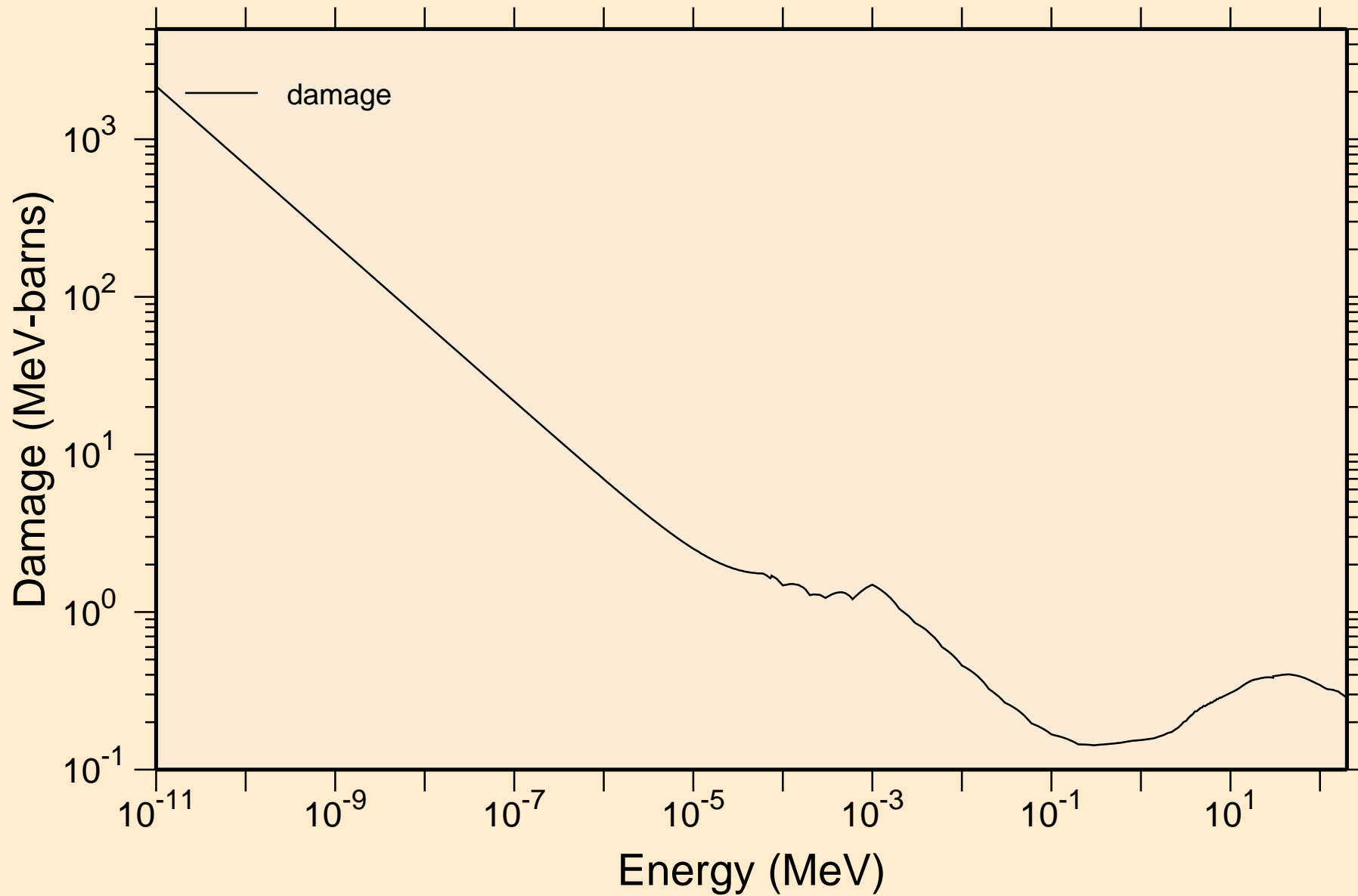

GA064 NEUTRON ACER TENDL-2024 LIBRARY; T=293.6K

Non-threshold reactions

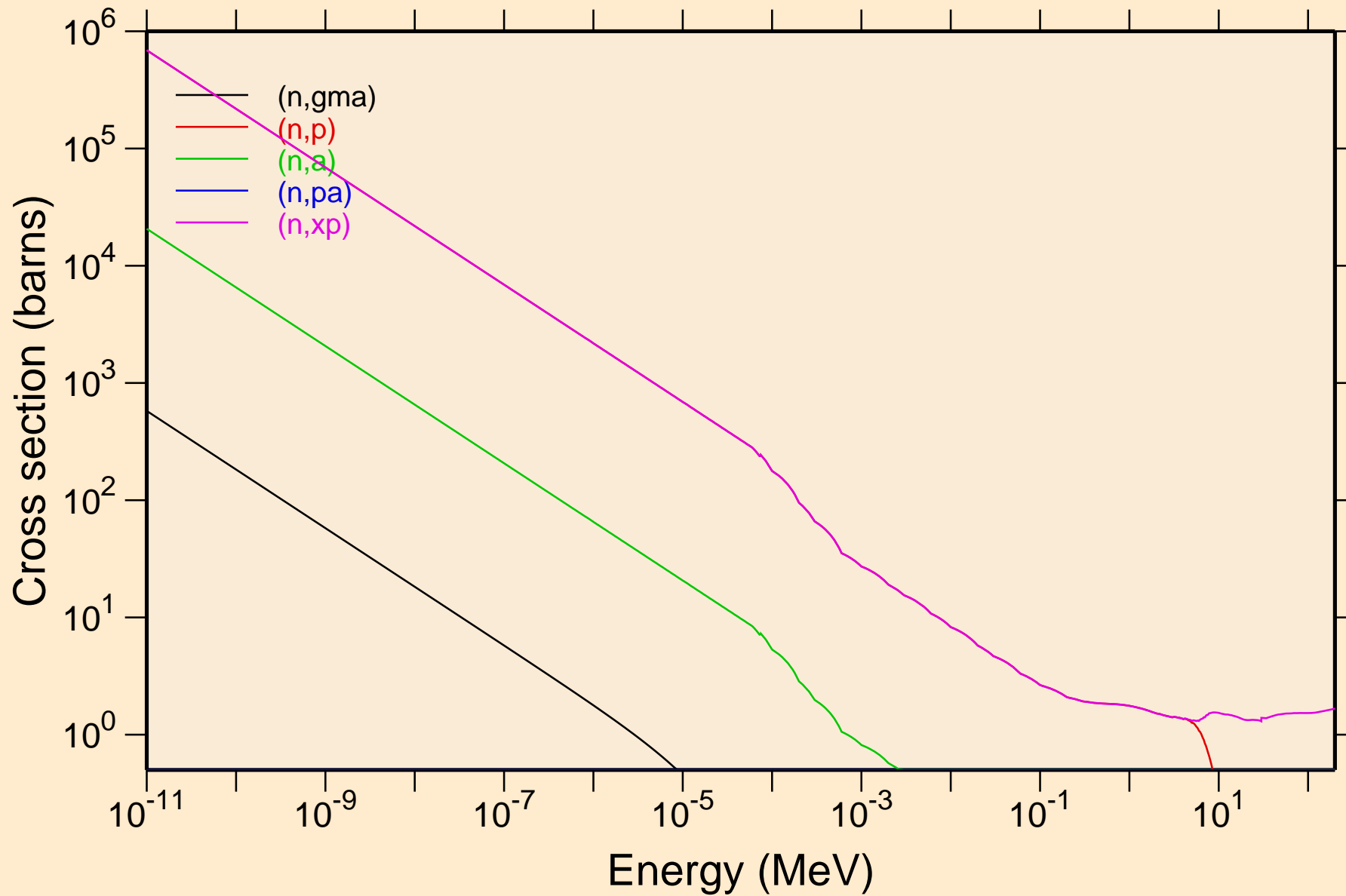

GA064 NEUTRON ACER TENDL-2024 LIBRARY; T=293.6K
Non-threshold reactions

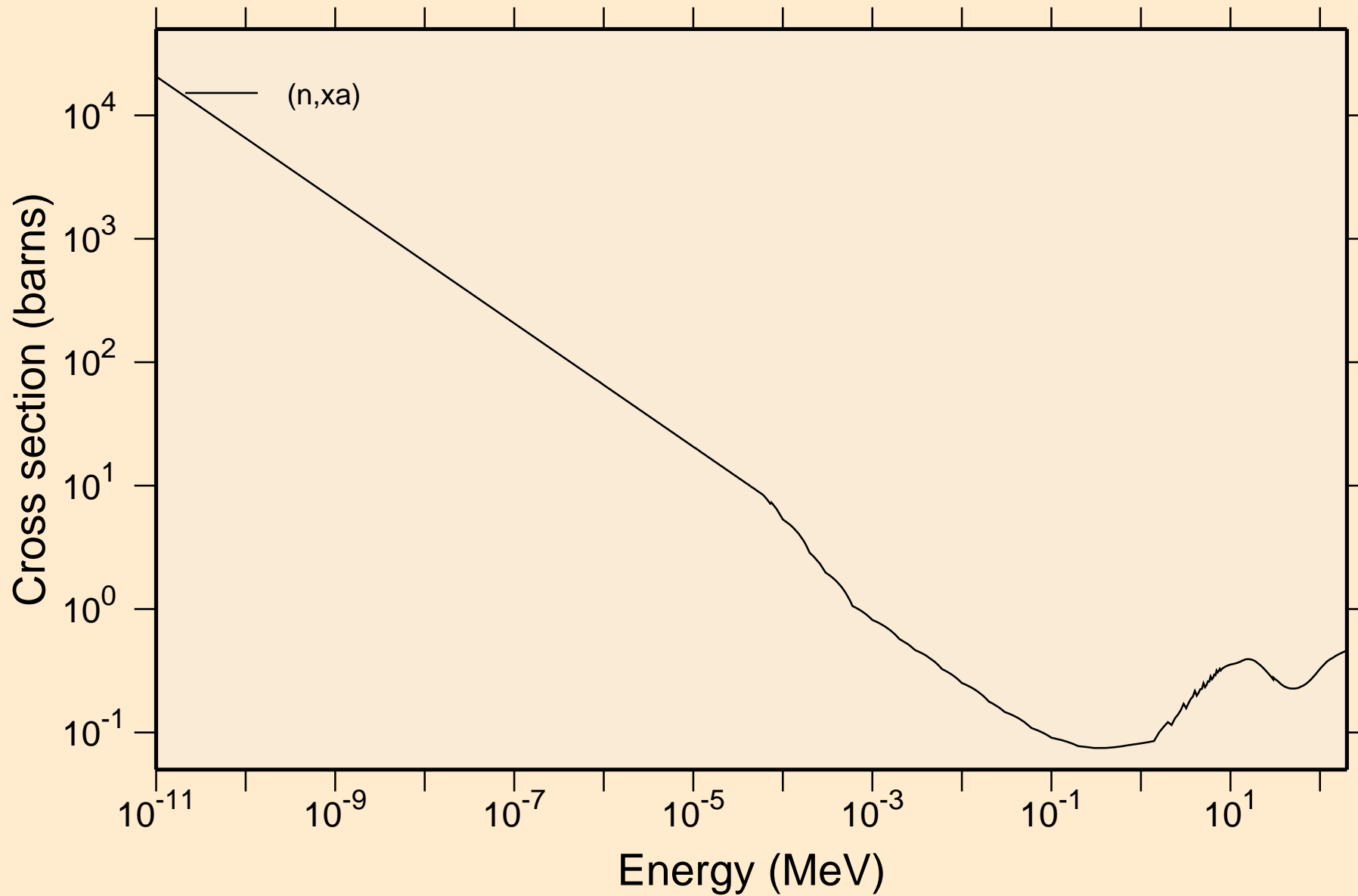

GA064 NEUTRON ACER TENDL-2024 LIBRARY; T=293.6K
Principal cross sections

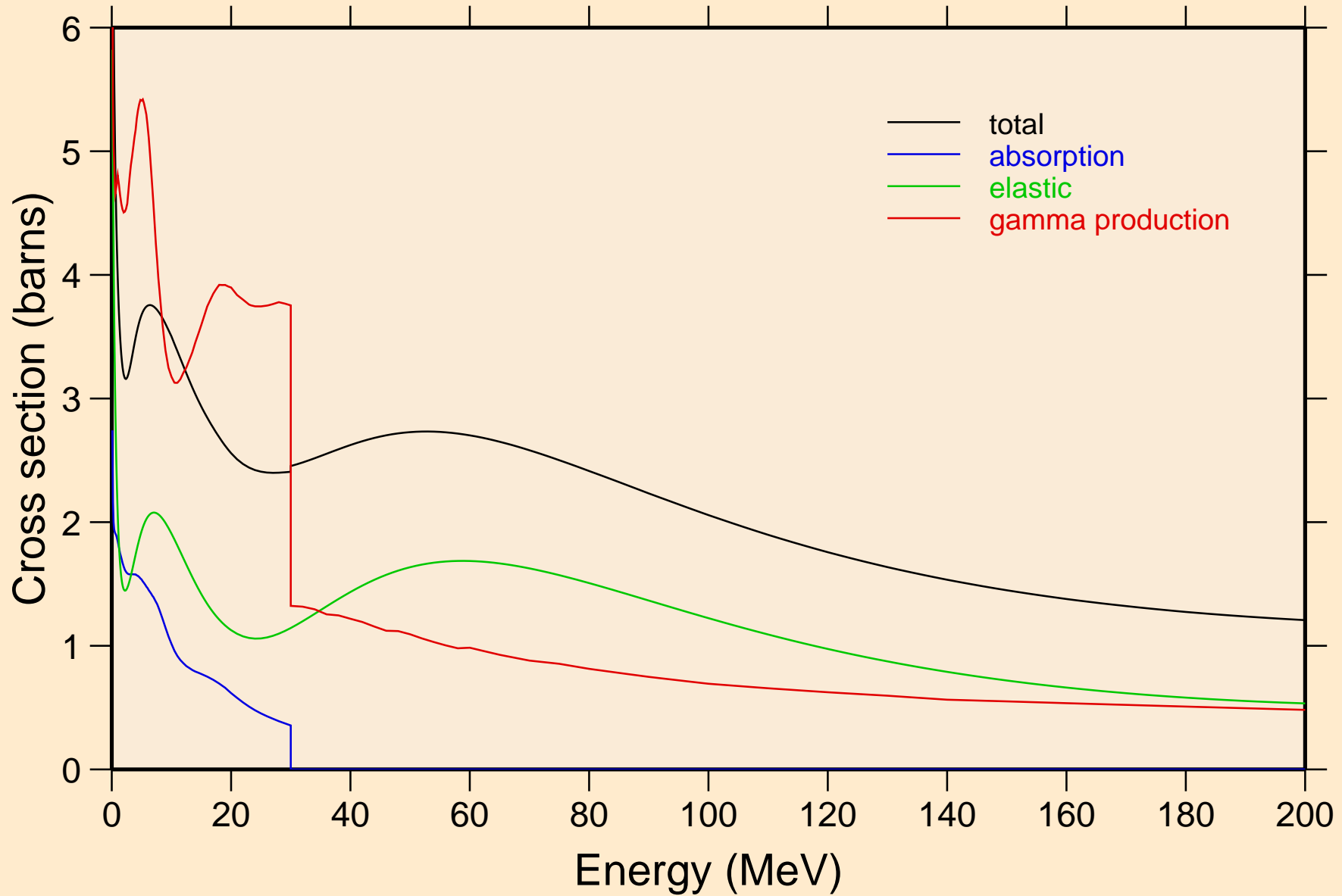

GA064 NEUTRON ACER TENDL-2024 LIBRARY; T=293.6K
Heating

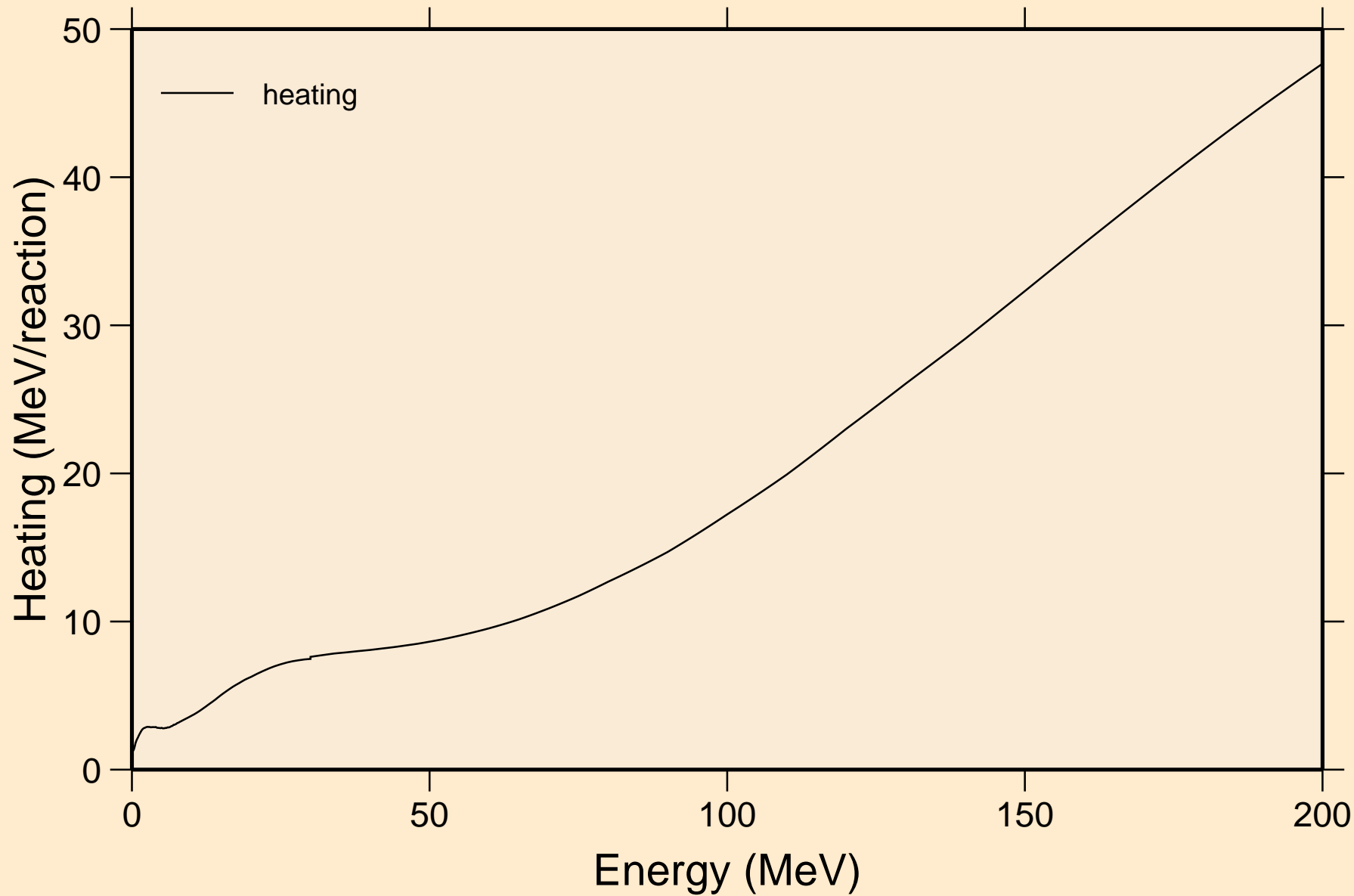

GA064 NEUTRON ACER TENDL-2024 LIBRARY; T=293.6K
Damage

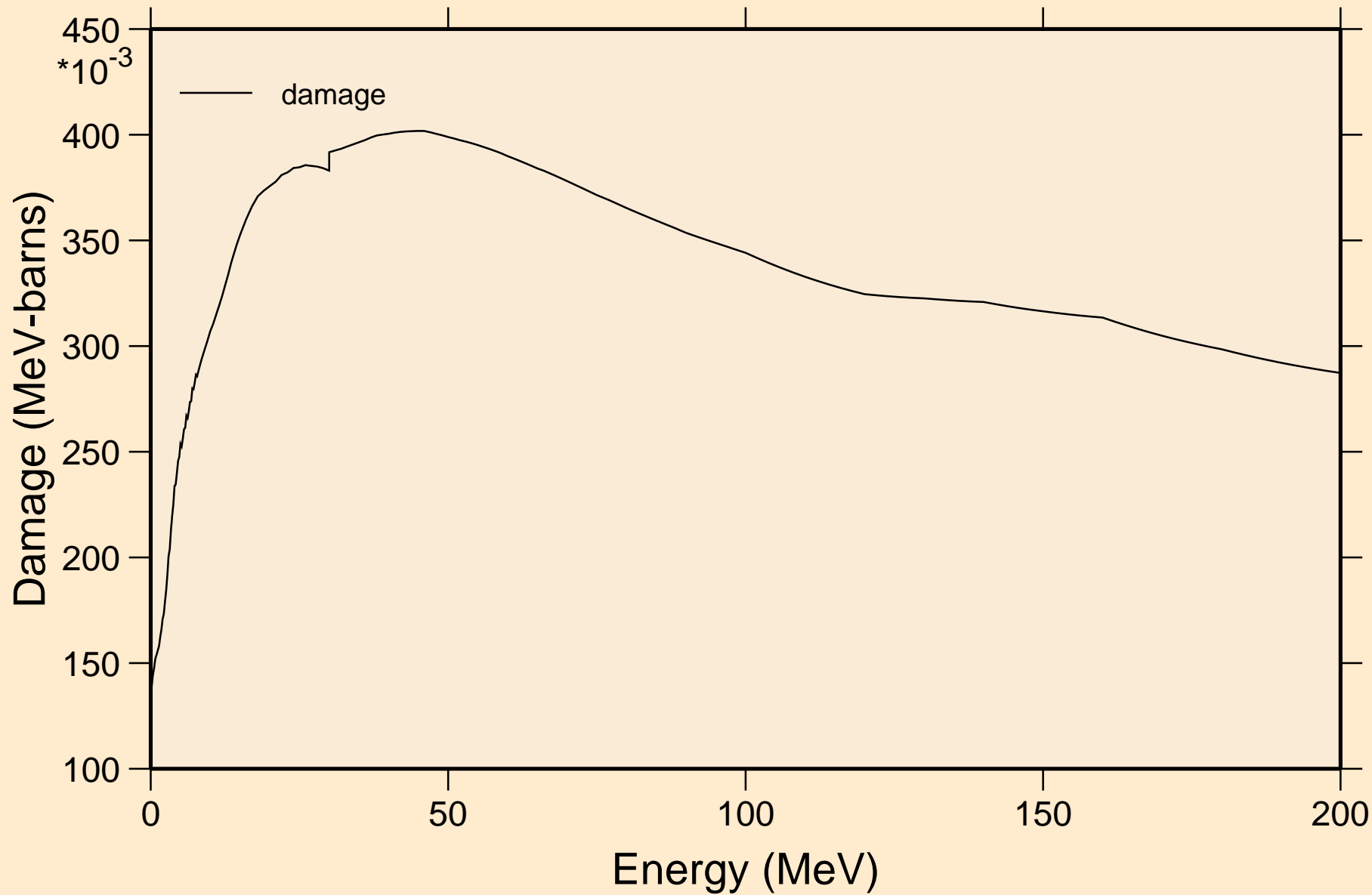

GA064 NEUTRON ACER TENDL-2024 LIBRARY; T=293.6K

Non-threshold reactions

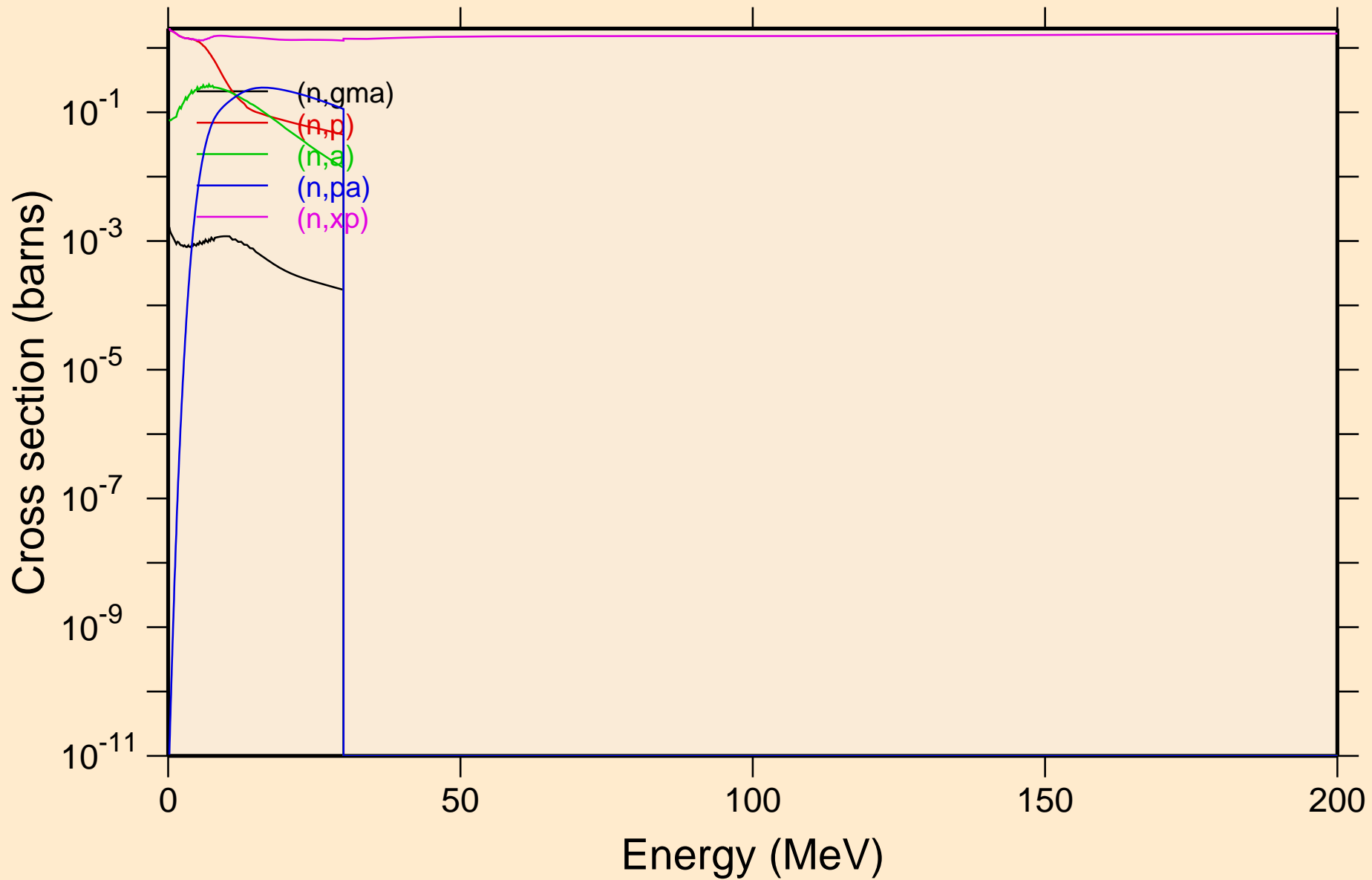

GA064 NEUTRON ACER TENDL-2024 LIBRARY; T=293.6K
Non-threshold reactions

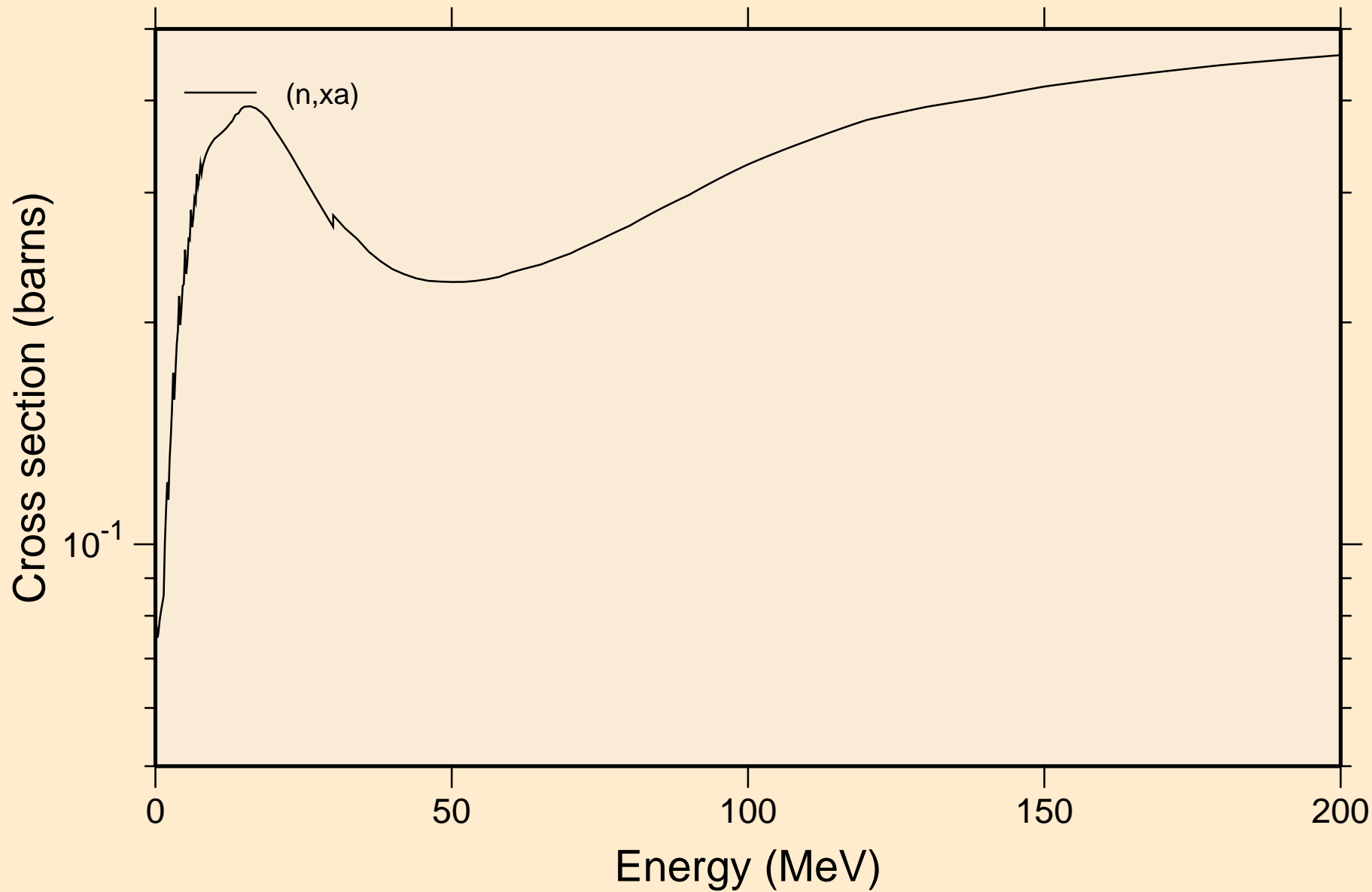

GA064 NEUTRON ACER TENDL-2024 LIBRARY; T=293.6K
Inelastic levels

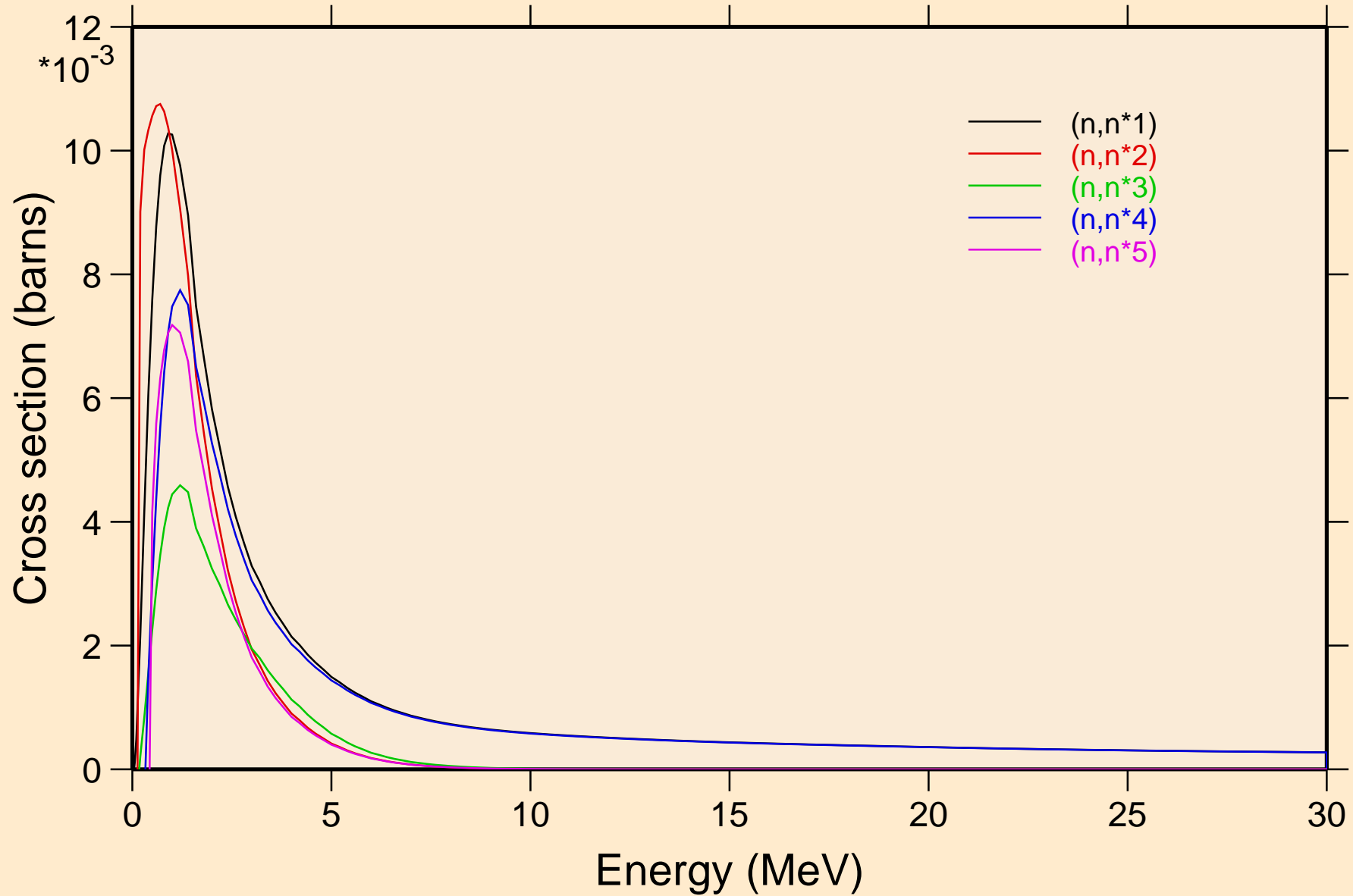

GA064 NEUTRON ACER TENDL-2024 LIBRARY; T=293.6K
Inelastic levels

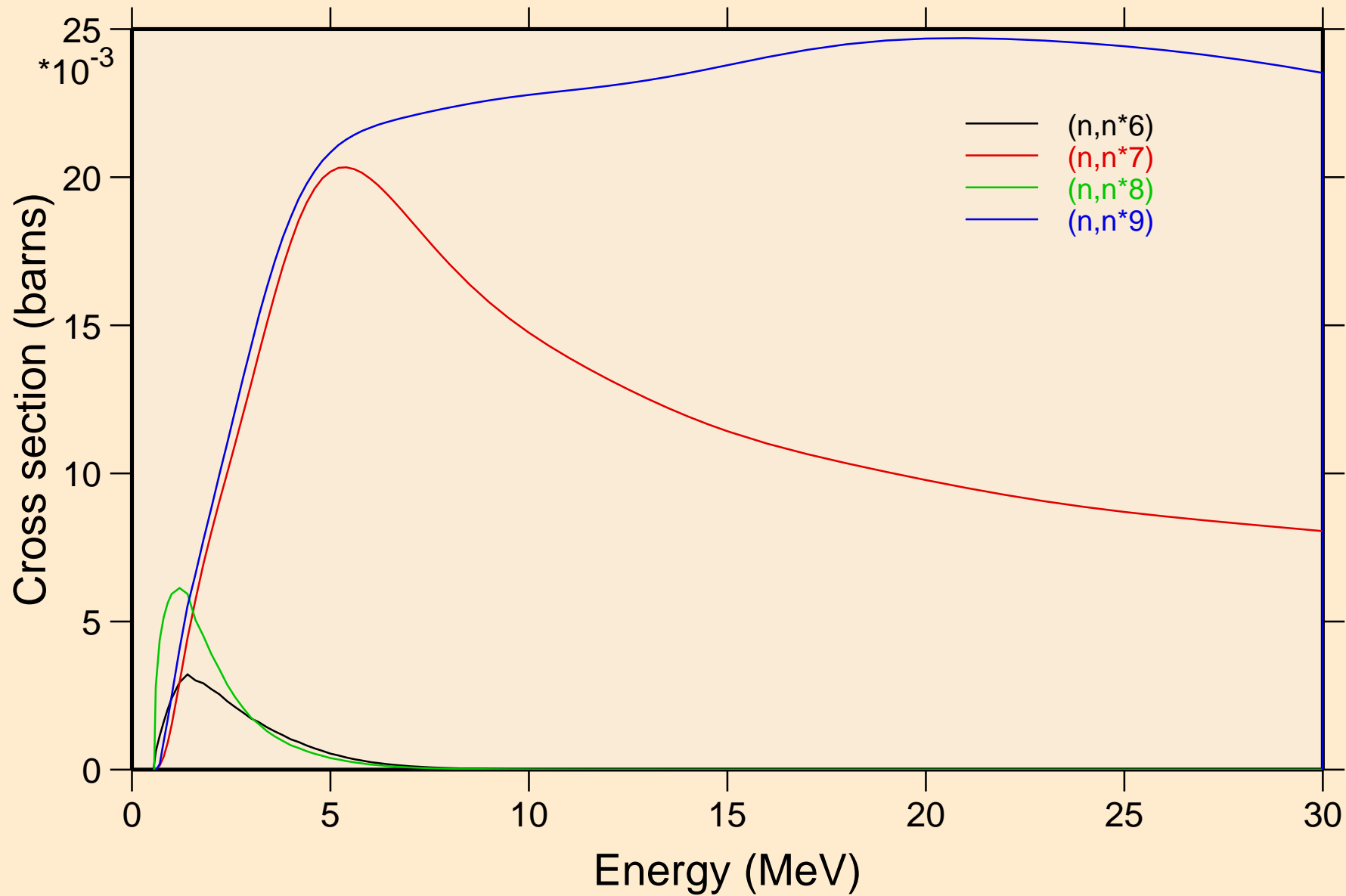

GA064 NEUTRON ACER TENDL-2024 LIBRARY; T=293.6K
Threshold reactions

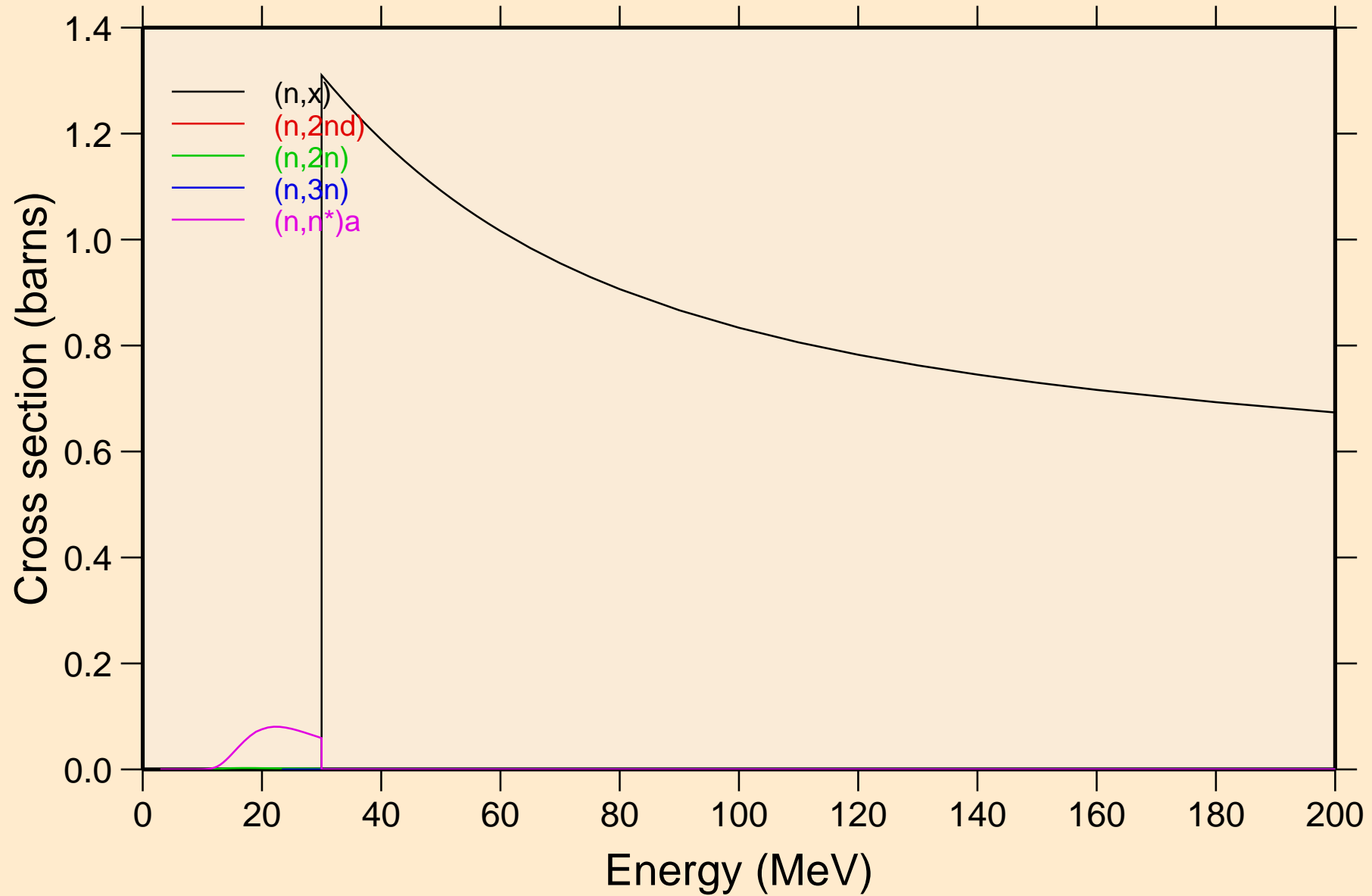

GA064 NEUTRON ACER TENDL-2024 LIBRARY; T=293.6K
Threshold reactions

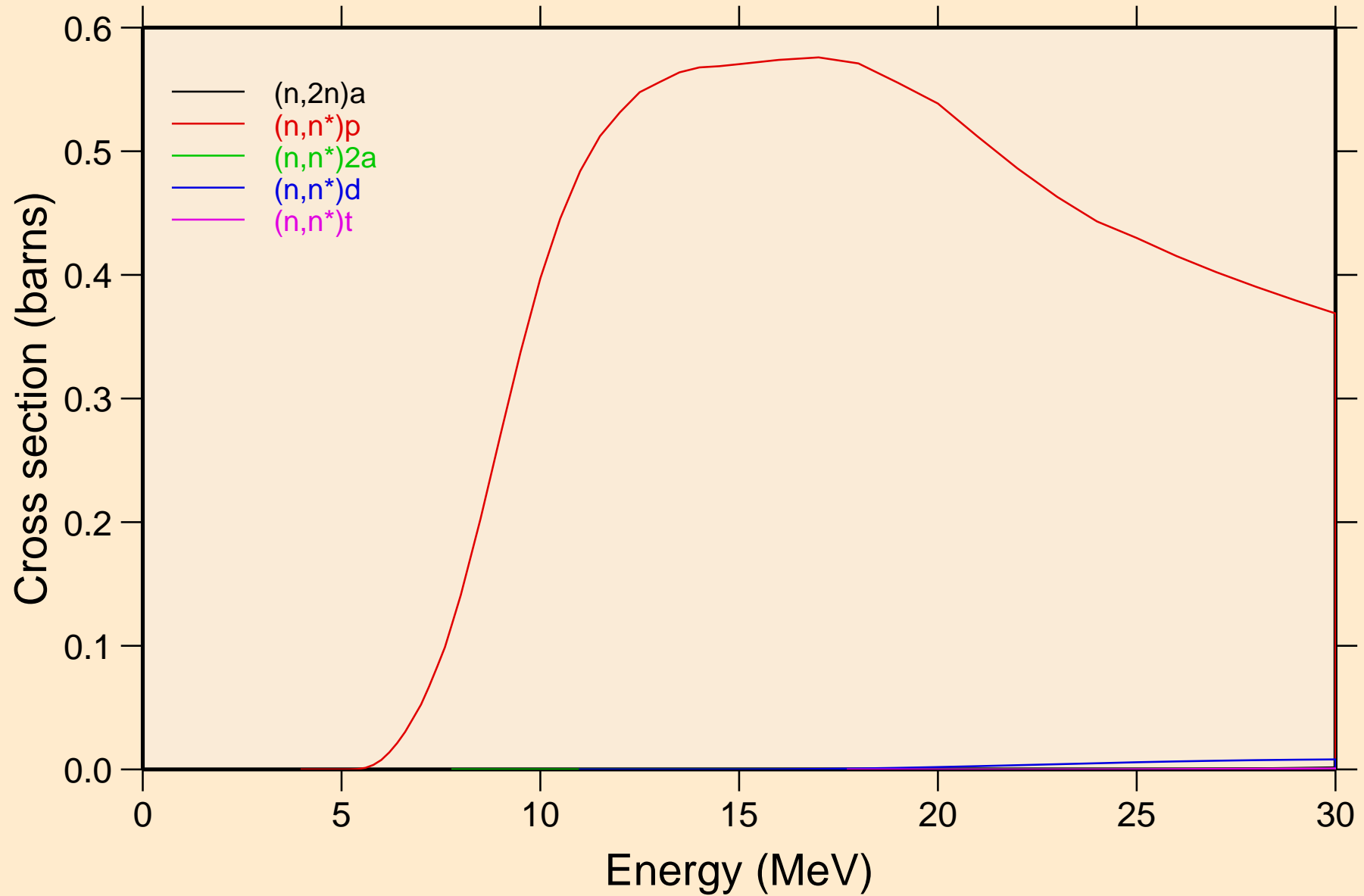

GA064 NEUTRON ACER TENDL-2024 LIBRARY; T=293.6K

Threshold reactions

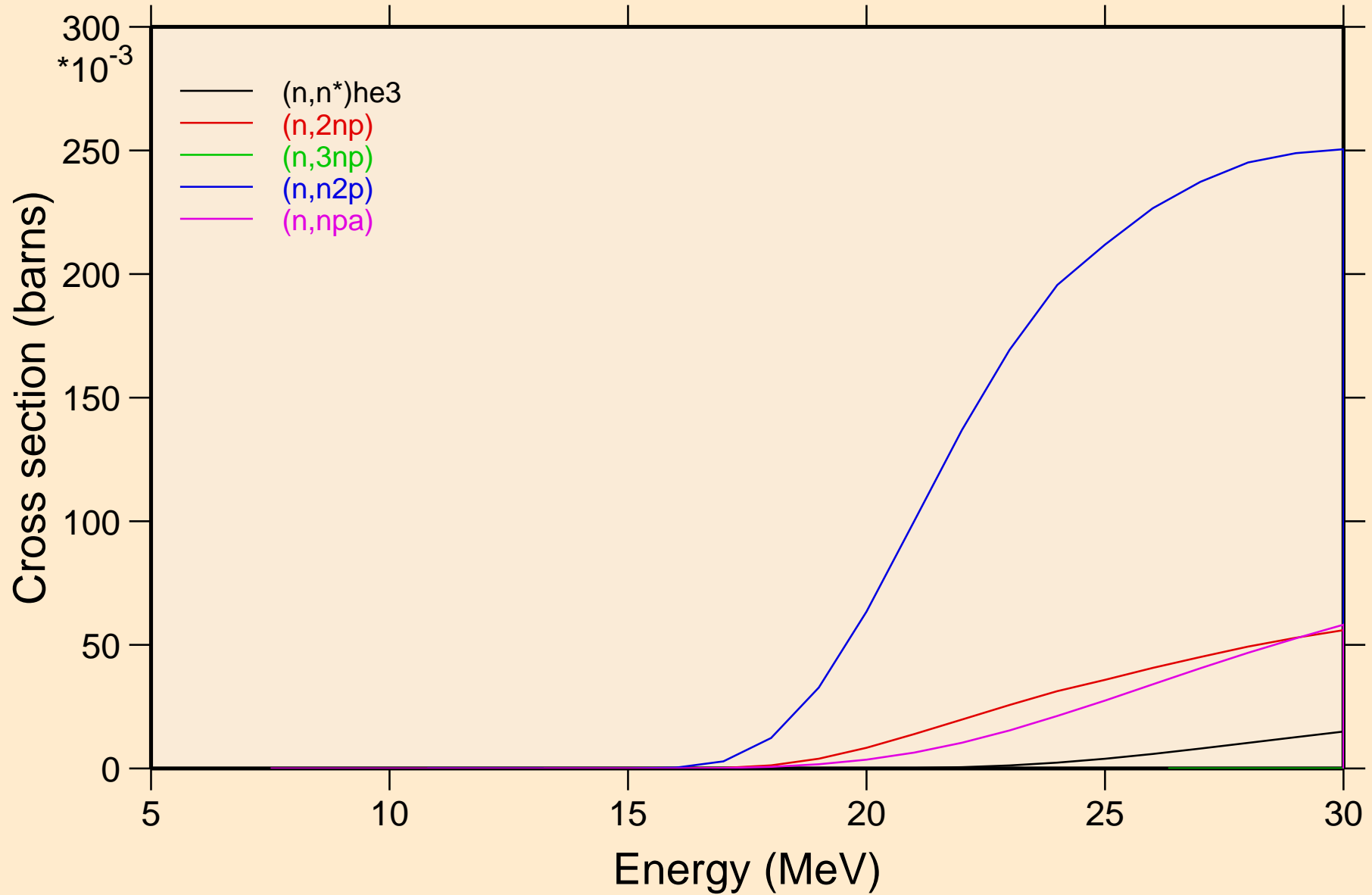

GA064 NEUTRON ACER TENDL-2024 LIBRARY; T=293.6K

Threshold reactions

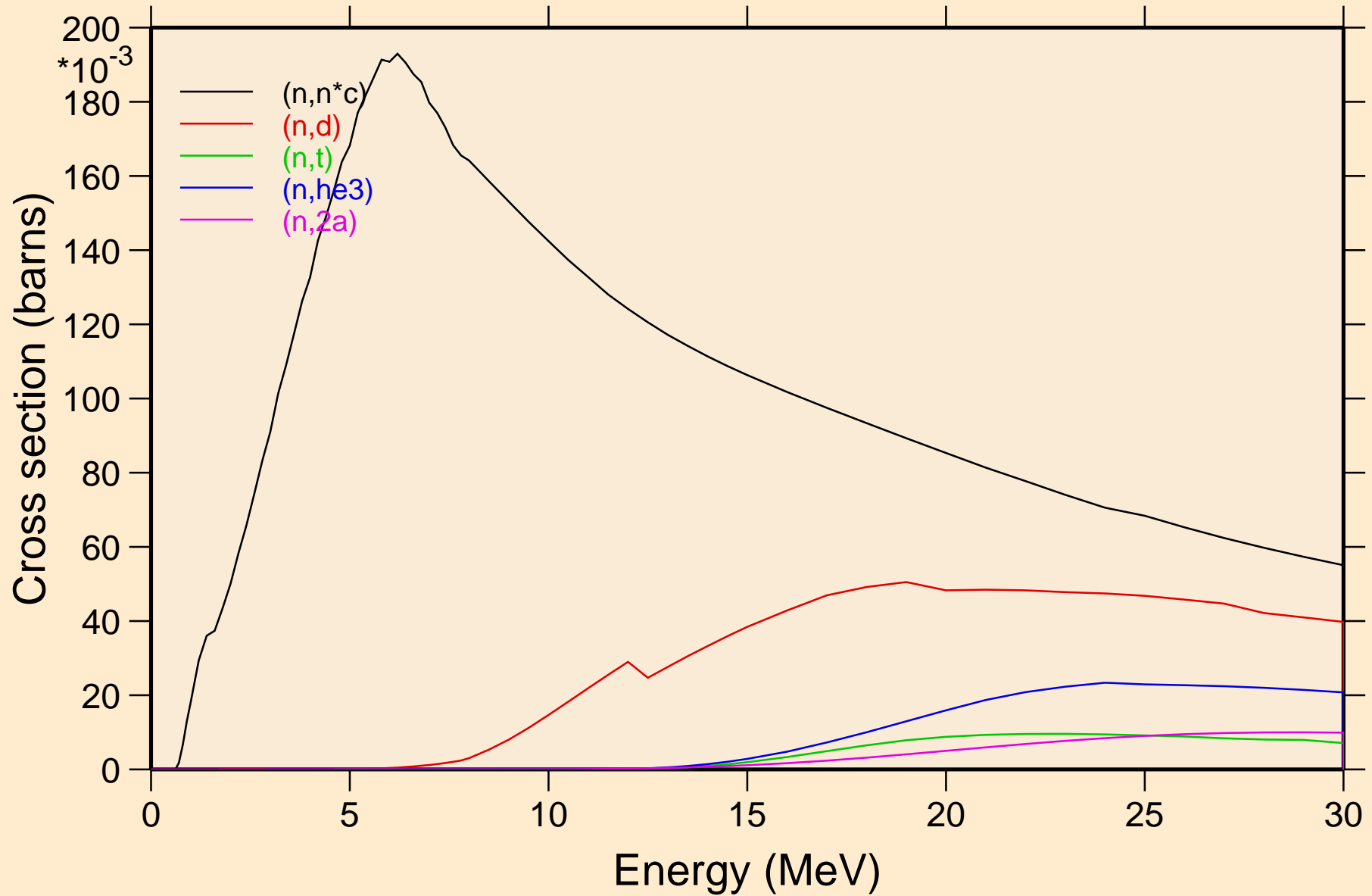

GA064 NEUTRON ACER TENDL-2024 LIBRARY; T=293.6K

Threshold reactions

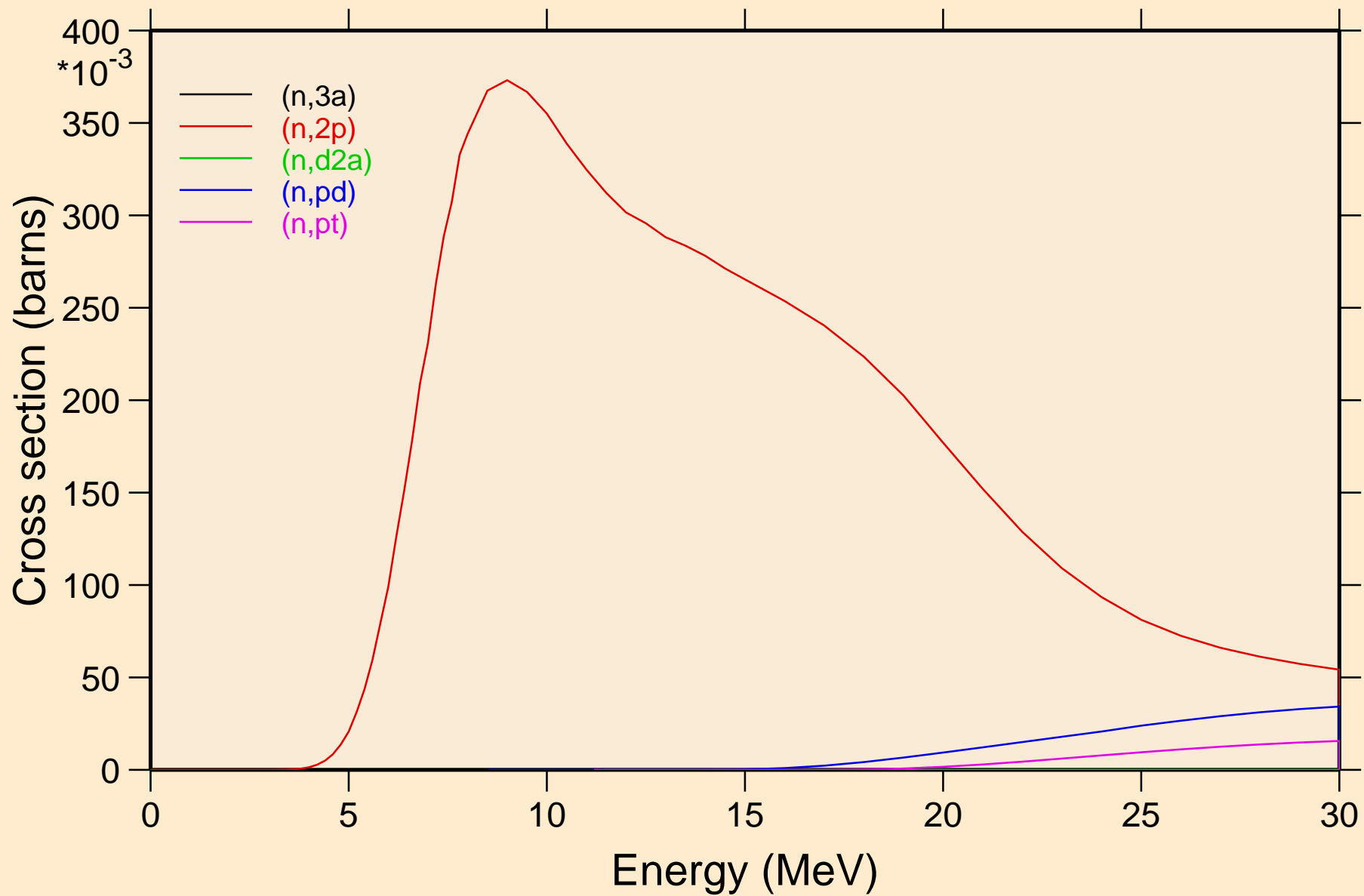

GA064 NEUTRON ACER TENDL-2024 LIBRARY; T=293.6K
Threshold reactions

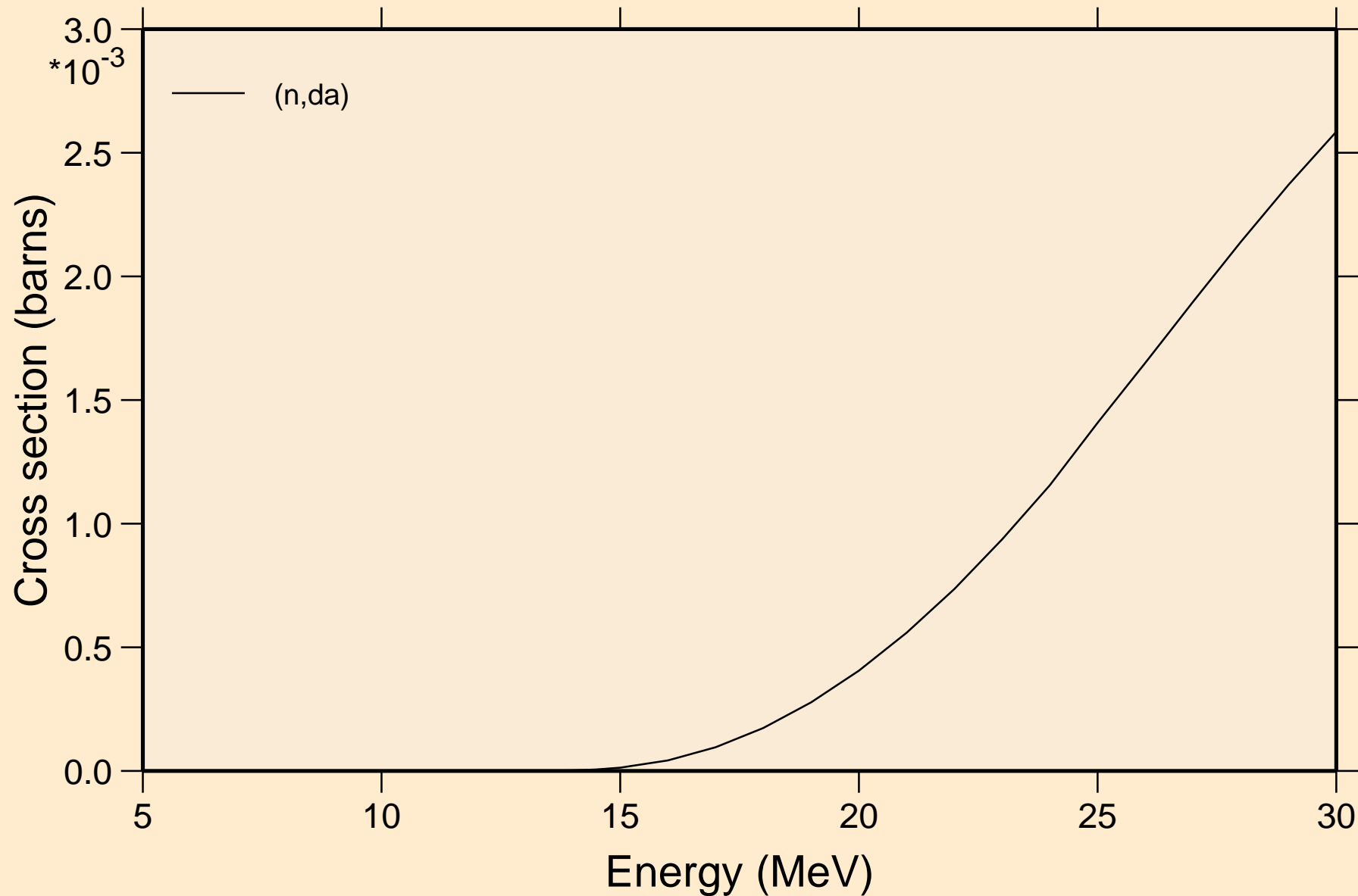

GA064 NEUTRON ACER TENDL-2024 LIBRARY; T=293.6K

Threshold reactions

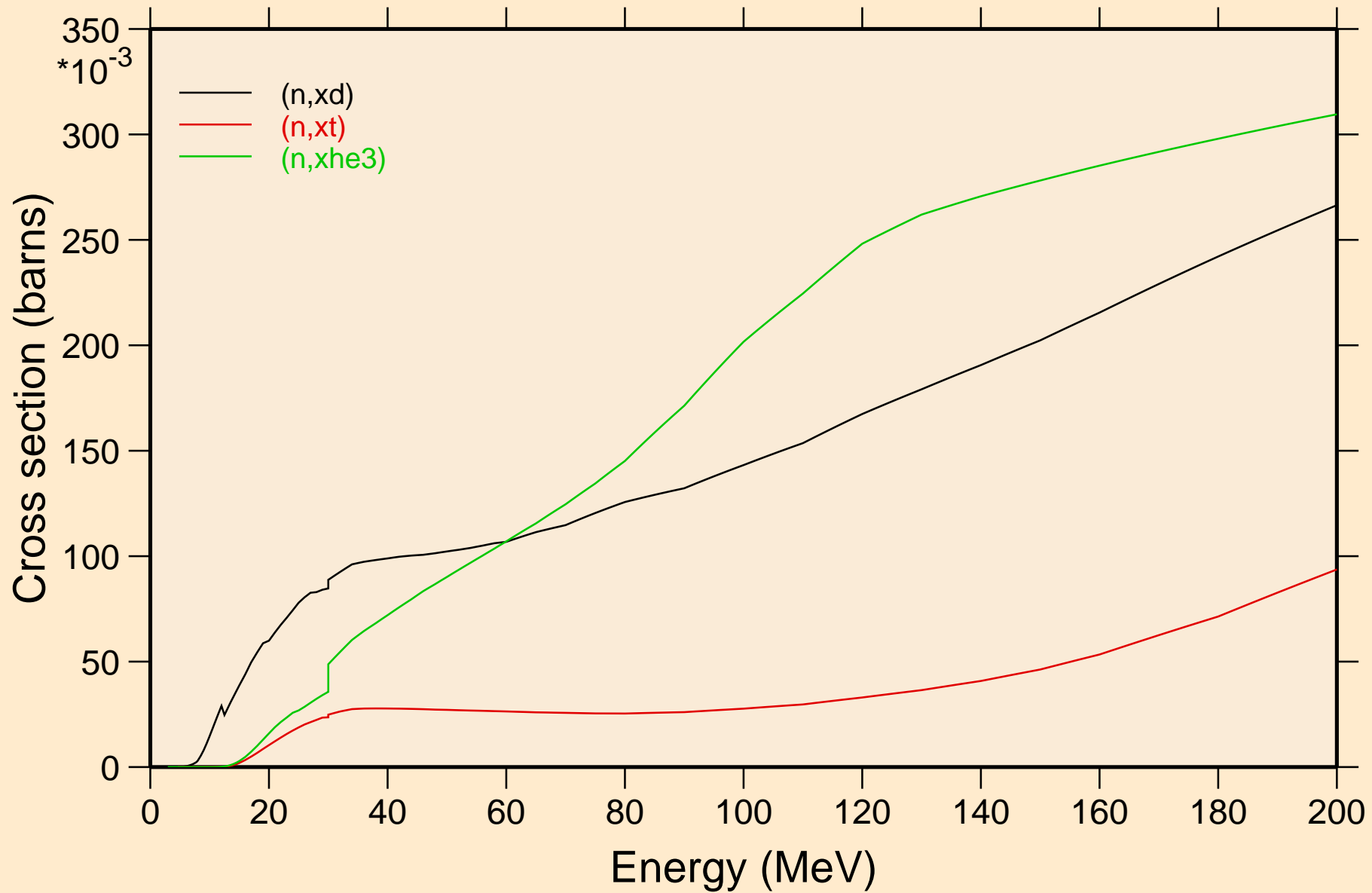

GA064 NEUTRON ACER TENDL-2024 LIBRARY; T=293.6K
angular distribution for elastic

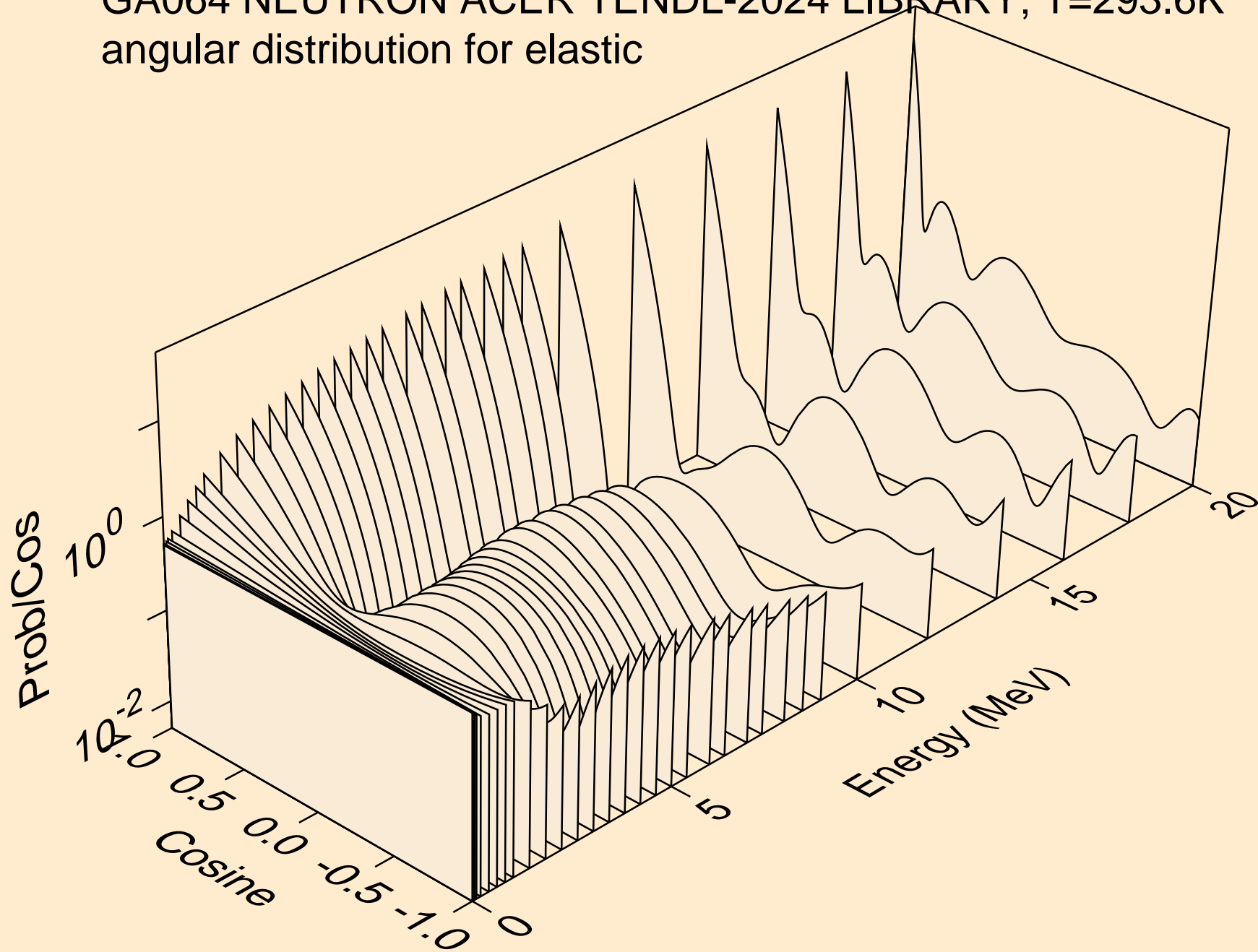

GA064 NEUTRON ACER TENDL-2024 LIBRARY; T=293.6K
angular distribution for elastic

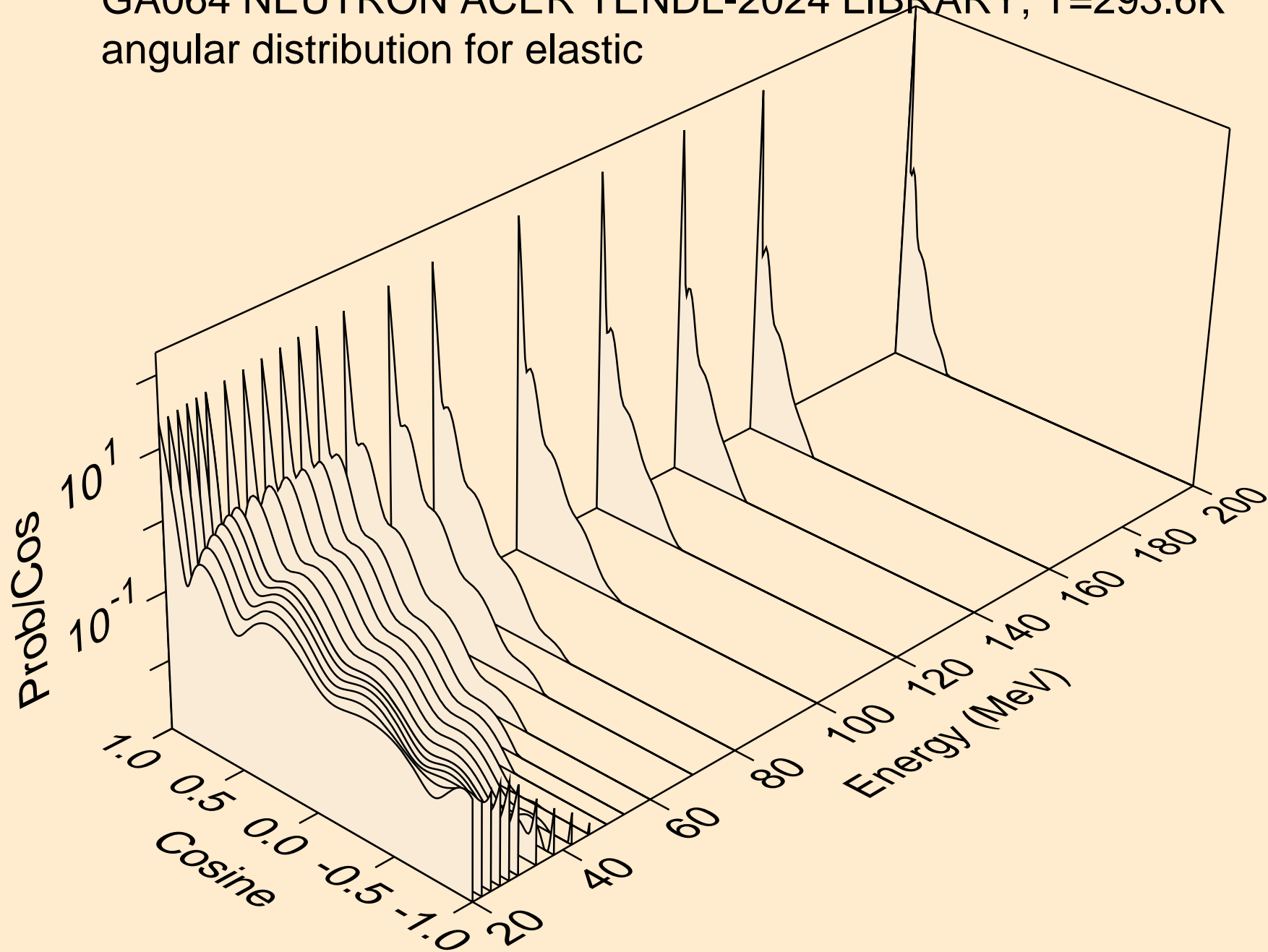

GA064 NEUTRON ACER TENDL-2024 LIBRARY; T=293.6K
angular distribution for (n,n*1)

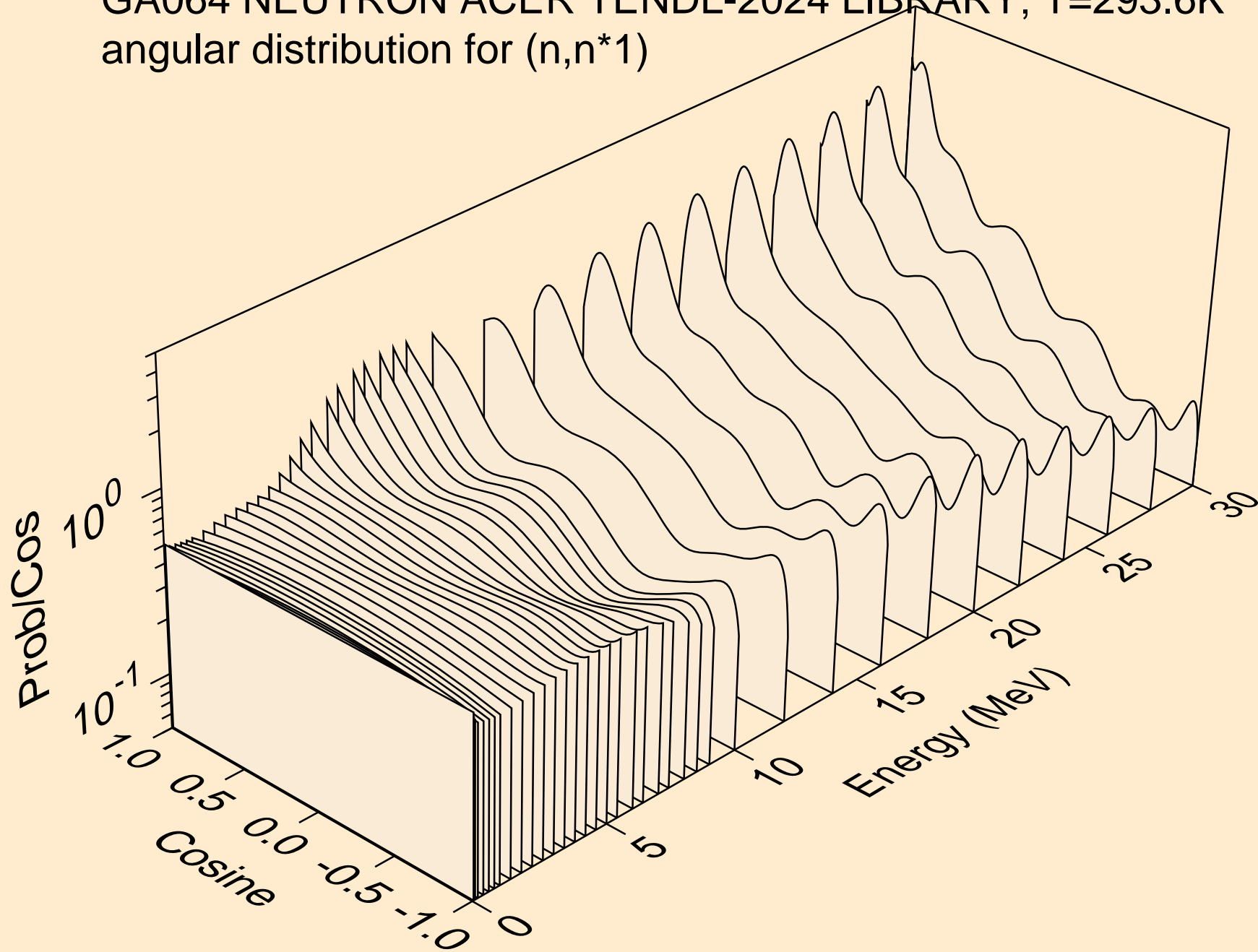

GA064 NEUTRON ACER TENDL-2024 LIBRARY; T=293.6K
angular distribution for (n,n*2)

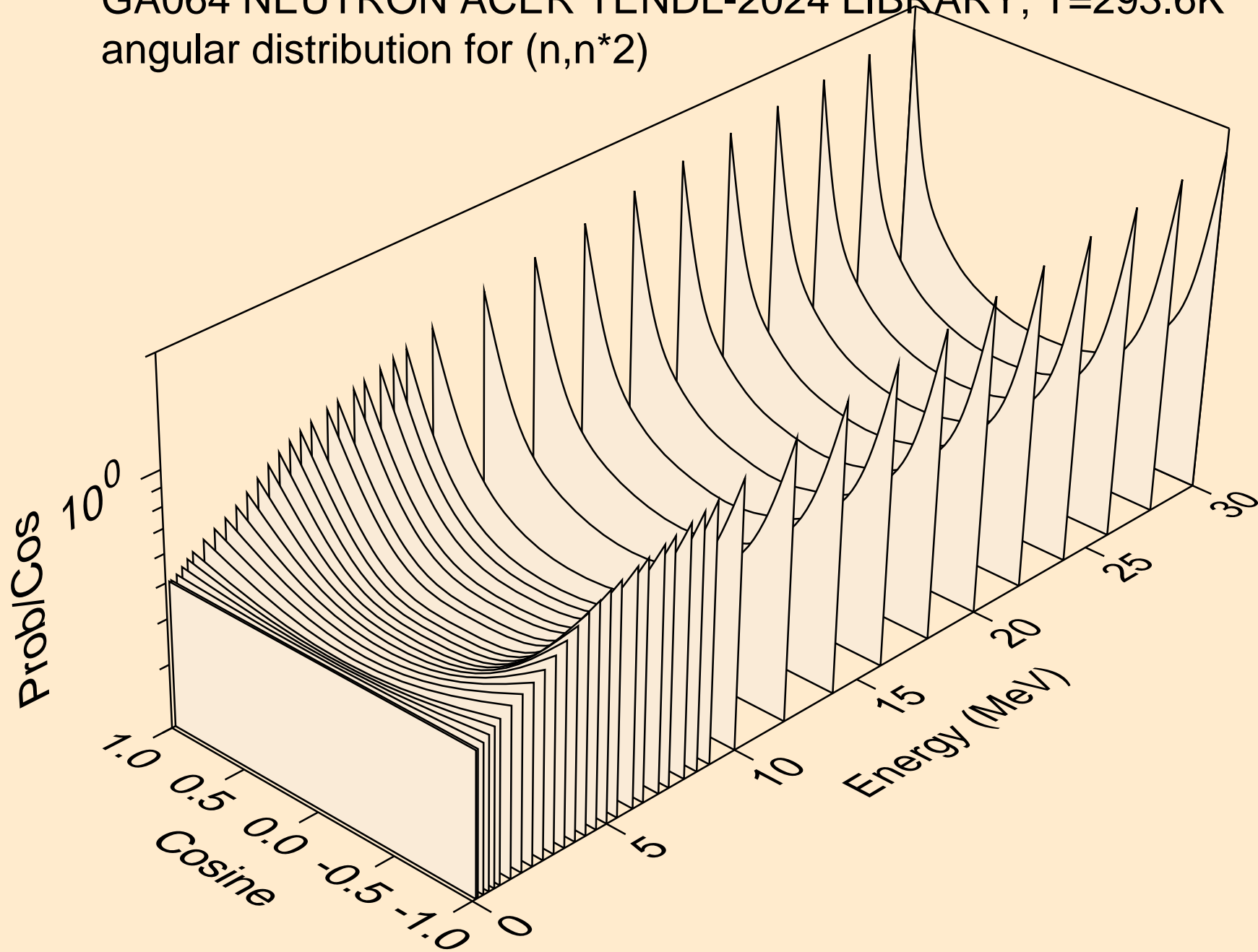

GA064 NEUTRON ACER TENDL-2024 LIBRARY; T=293.6K
angular distribution for (n,n*3)

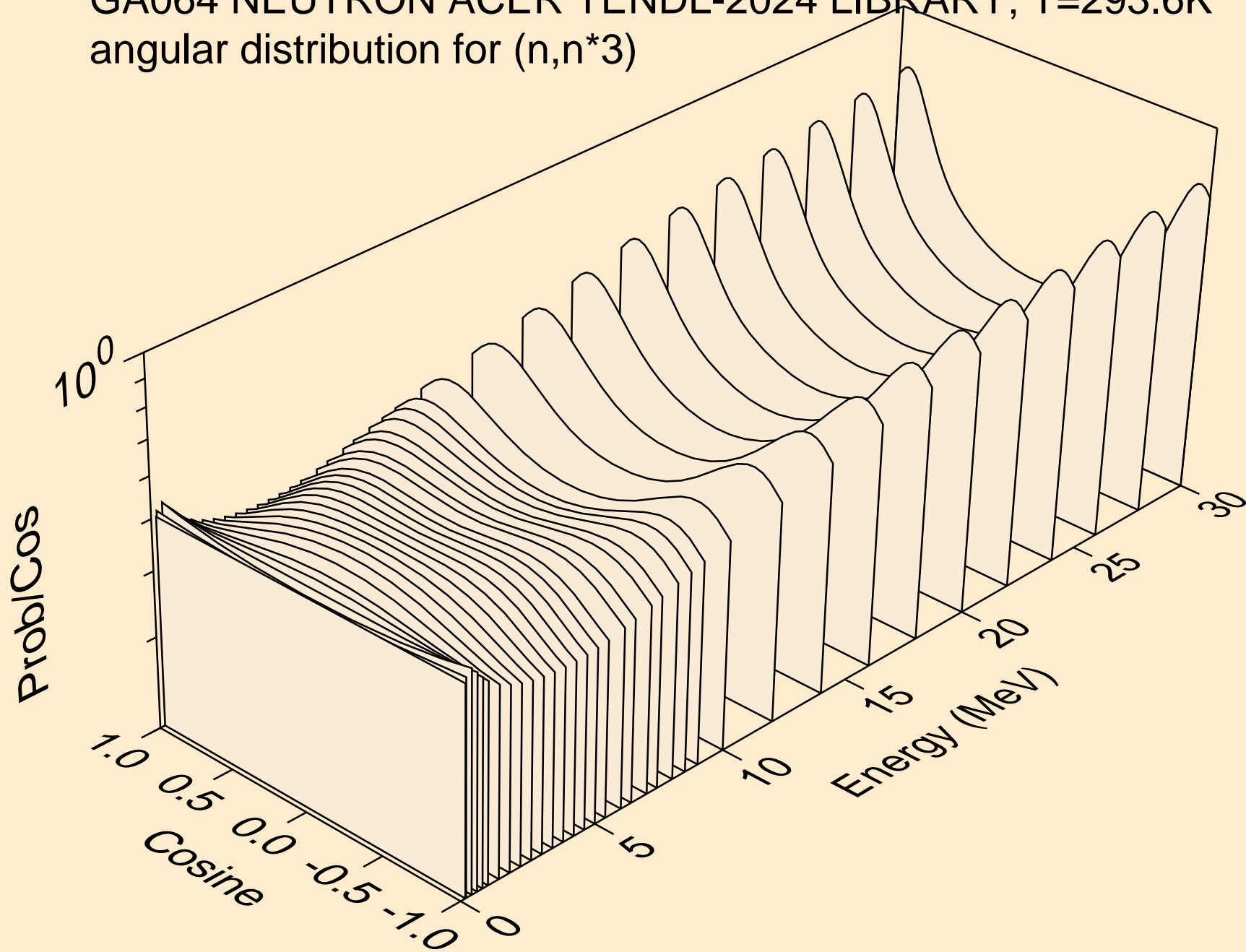

GA064 NEUTRON ACER TENDL-2024 LIBRARY; T=293.6K
angular distribution for (n,n*4)

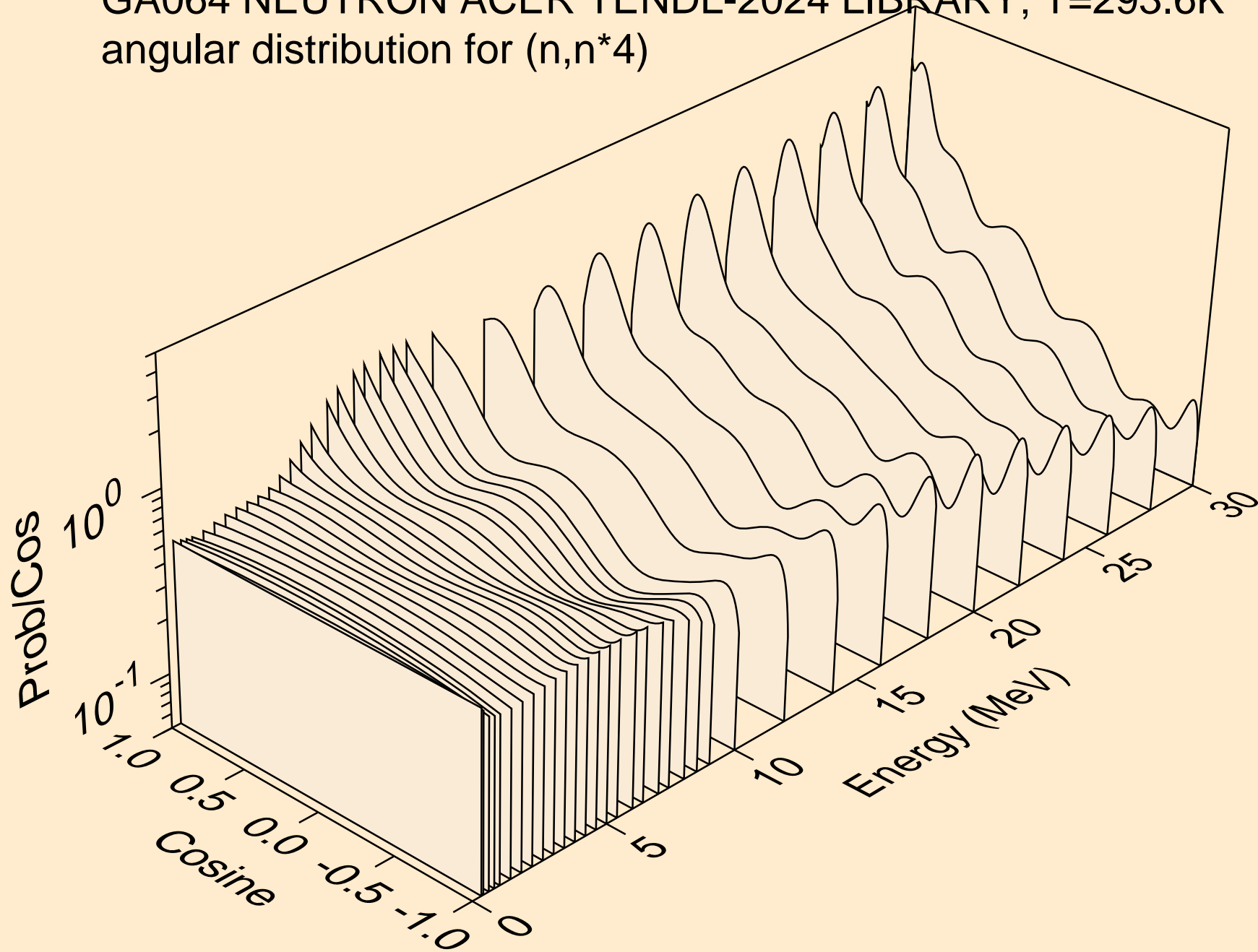

GA064 NEUTRON ACER TENDL-2024 LIBRARY; T=293.6K
angular distribution for (n,n*5)

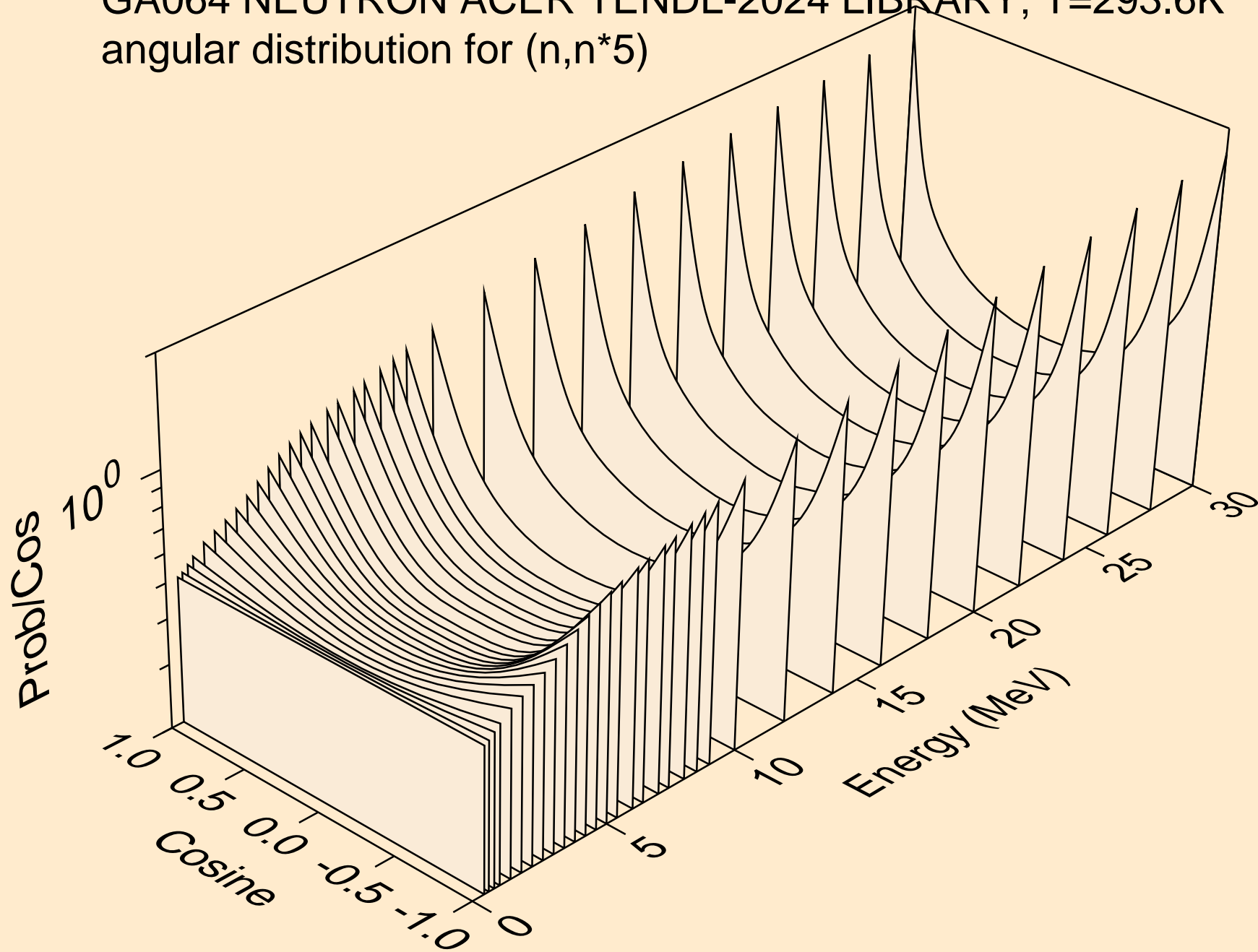

GA064 NEUTRON ACER TENDL-2024 LIBRARY; T=293.6K
angular distribution for (n,n*6)

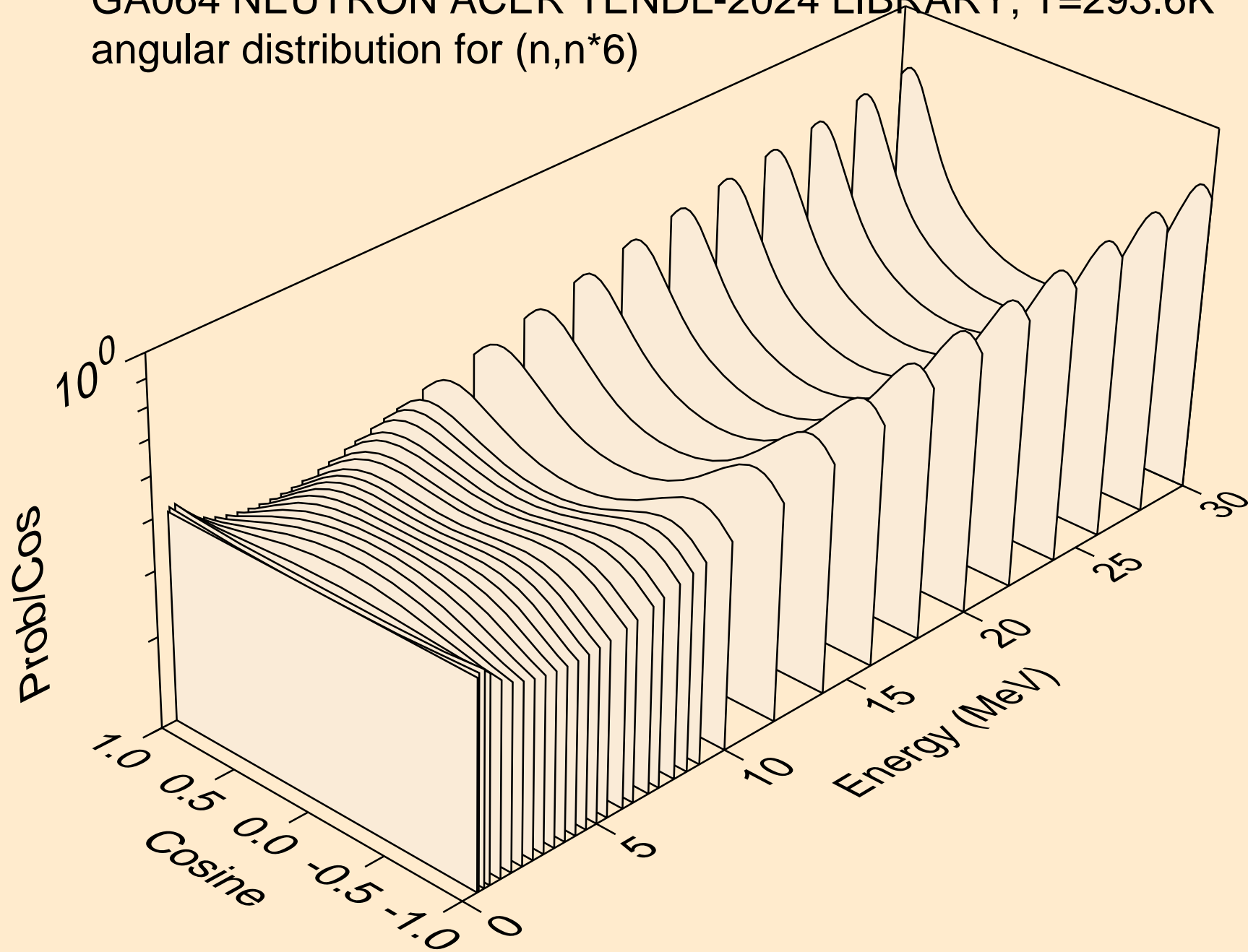

GA064 NEUTRON ACER TENDL-2024 LIBRARY; T=293.6K
angular distribution for (n,n*7)

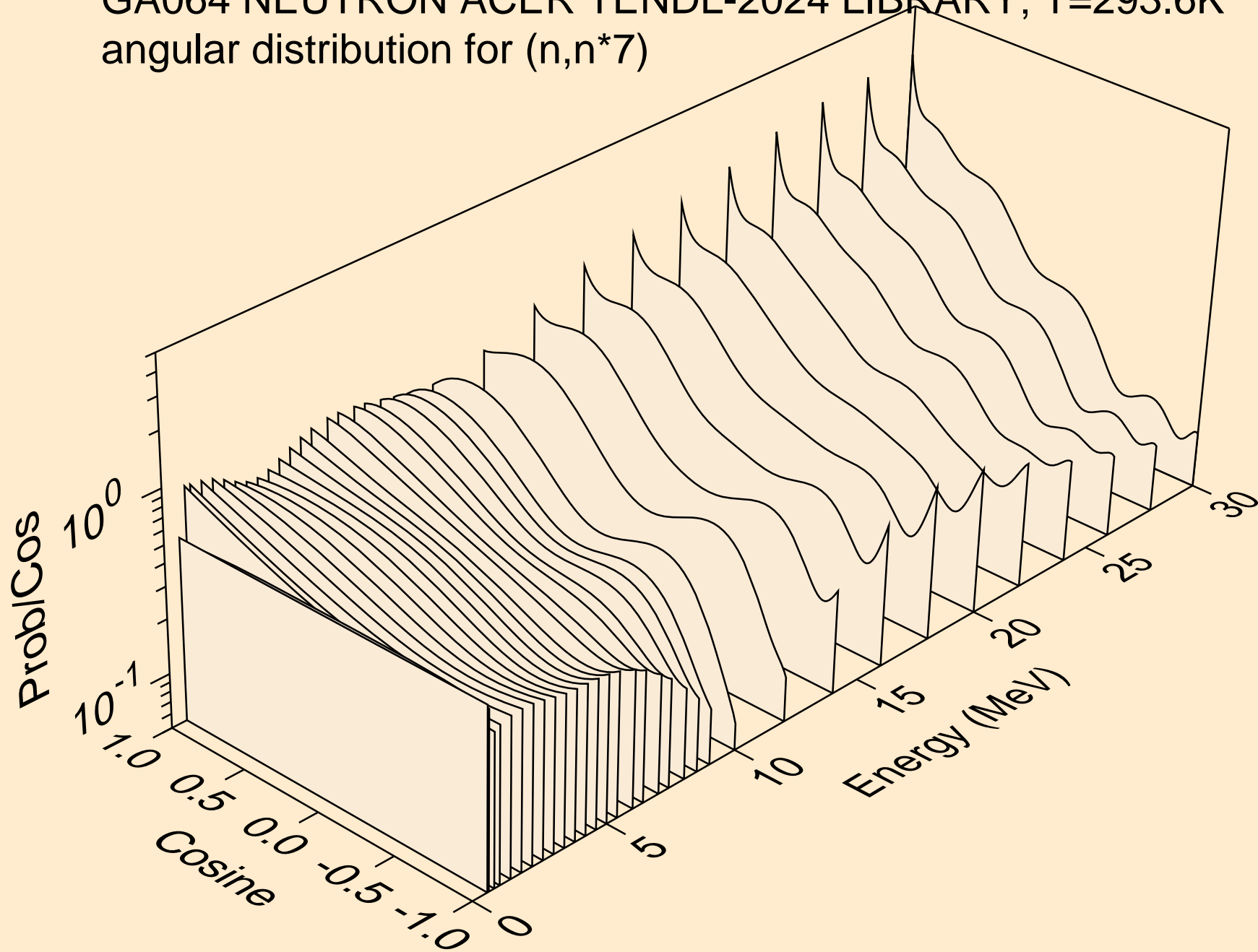

GA064 NEUTRON ACER TENDL-2024 LIBRARY; T=293.6K
angular distribution for (n,n*8)

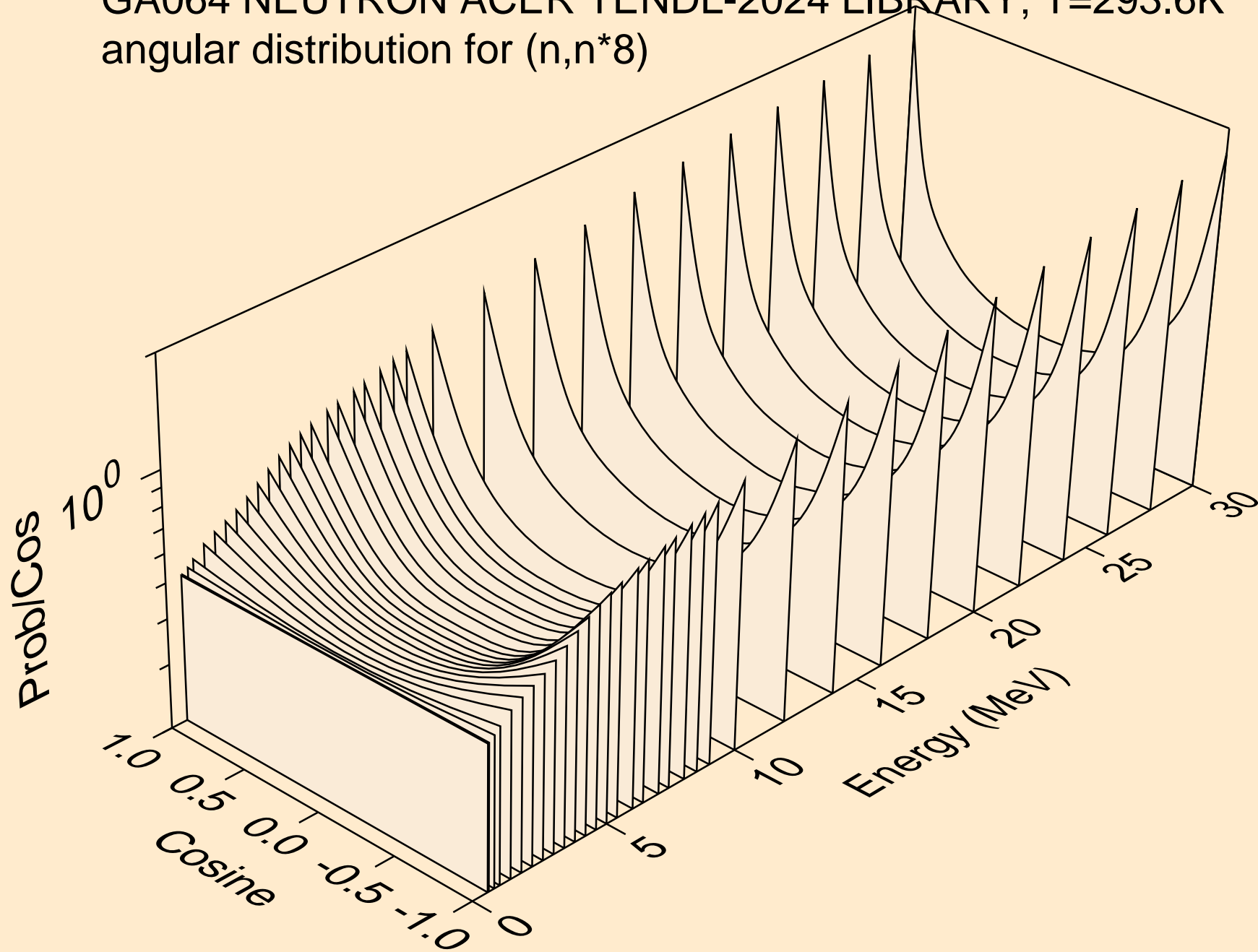

GA064 NEUTRON ACER TENDL-2024 LIBRARY; T=293.6K
angular distribution for (n,n*9)

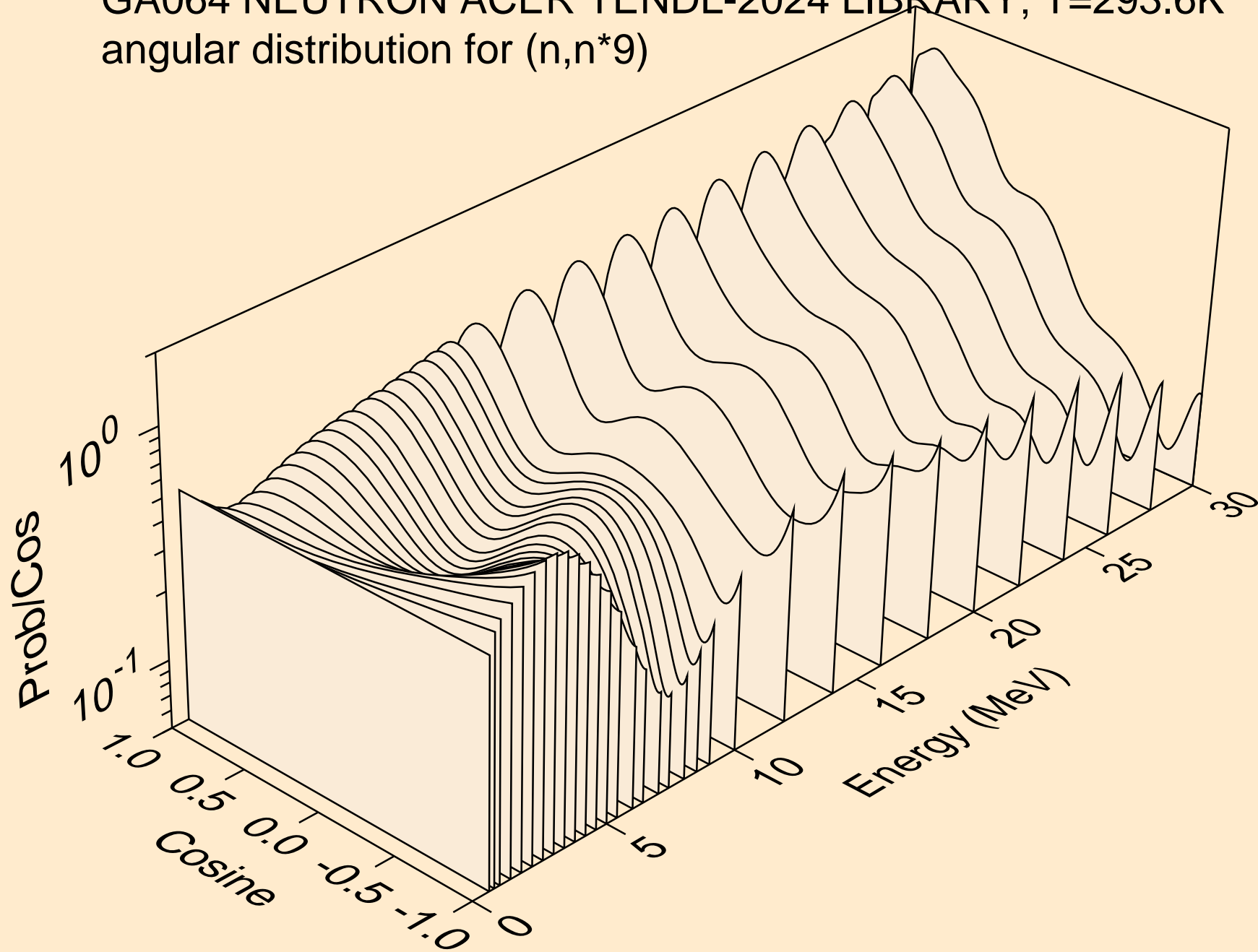

GA064 NEUTRON ACER TENDL-2024 LIBRARY; T=293.6K
Neutron emission for (n,x)

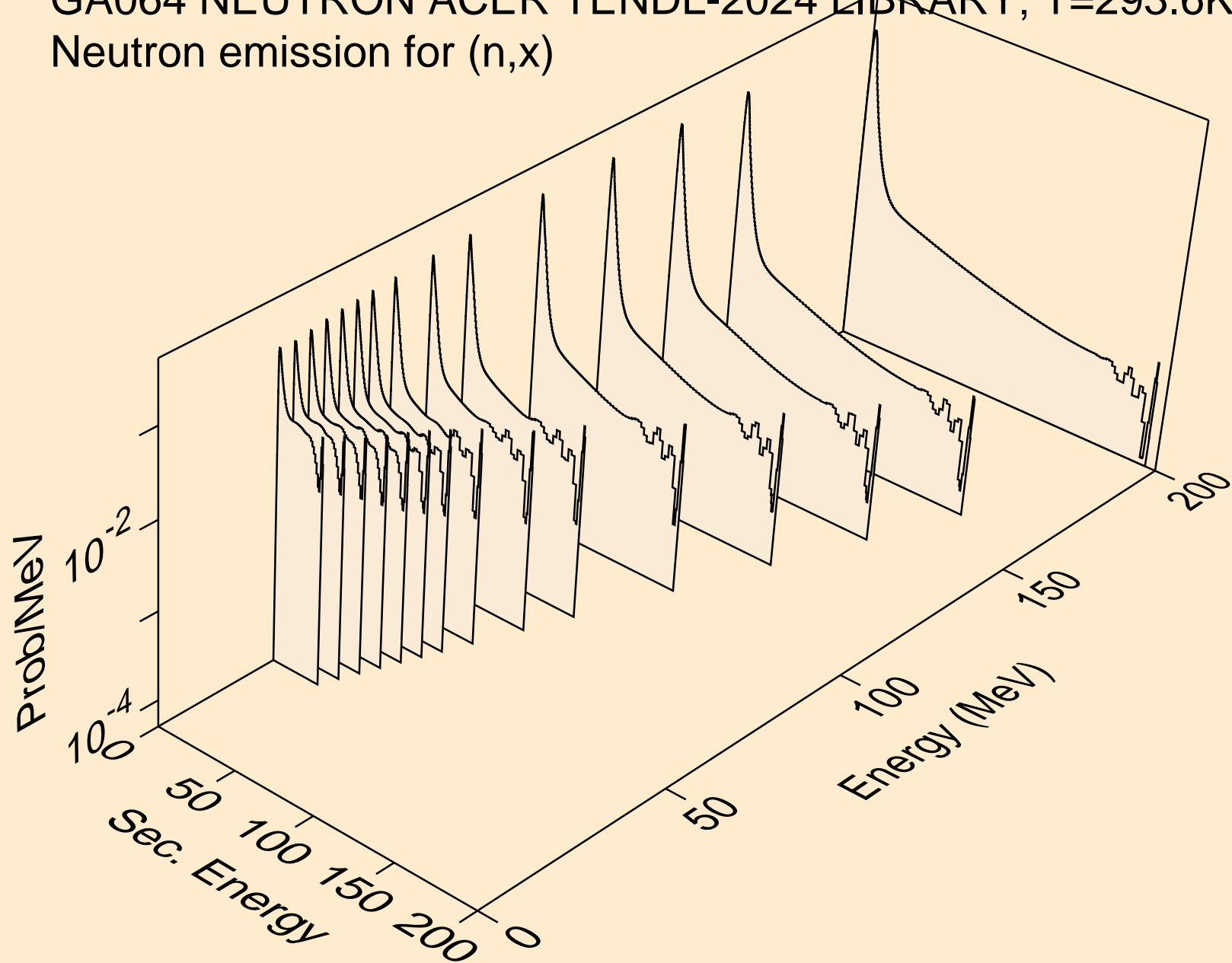

GA064 NEUTRON ACER TENDL-2024 LIBRARY; T=293.6K
Neutron emission for (n,2nd)

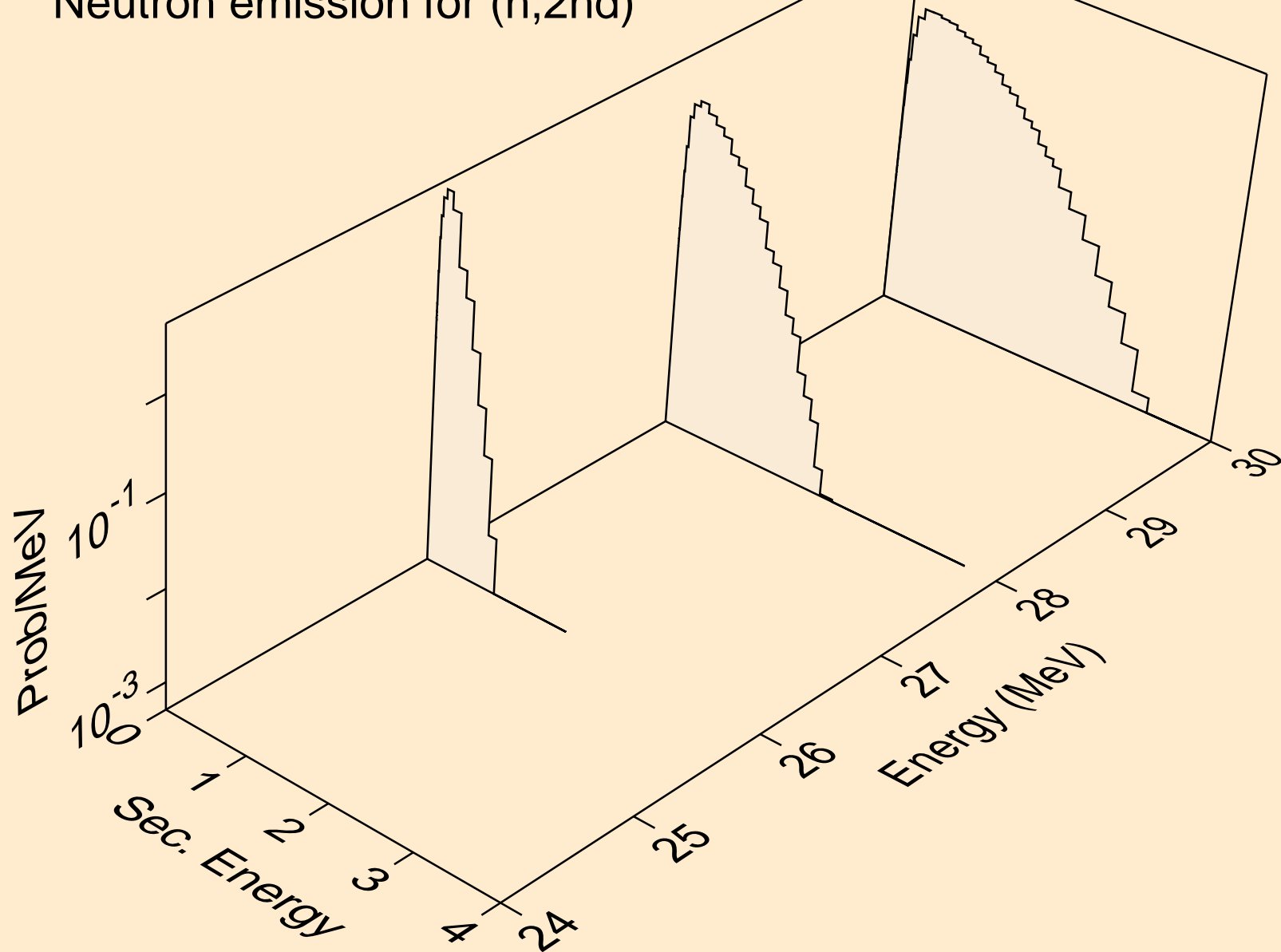

GA064 NEUTRON ACER TENDL-2024 LIBRARY; T=293.6K
Neutron emission for (n,2n)

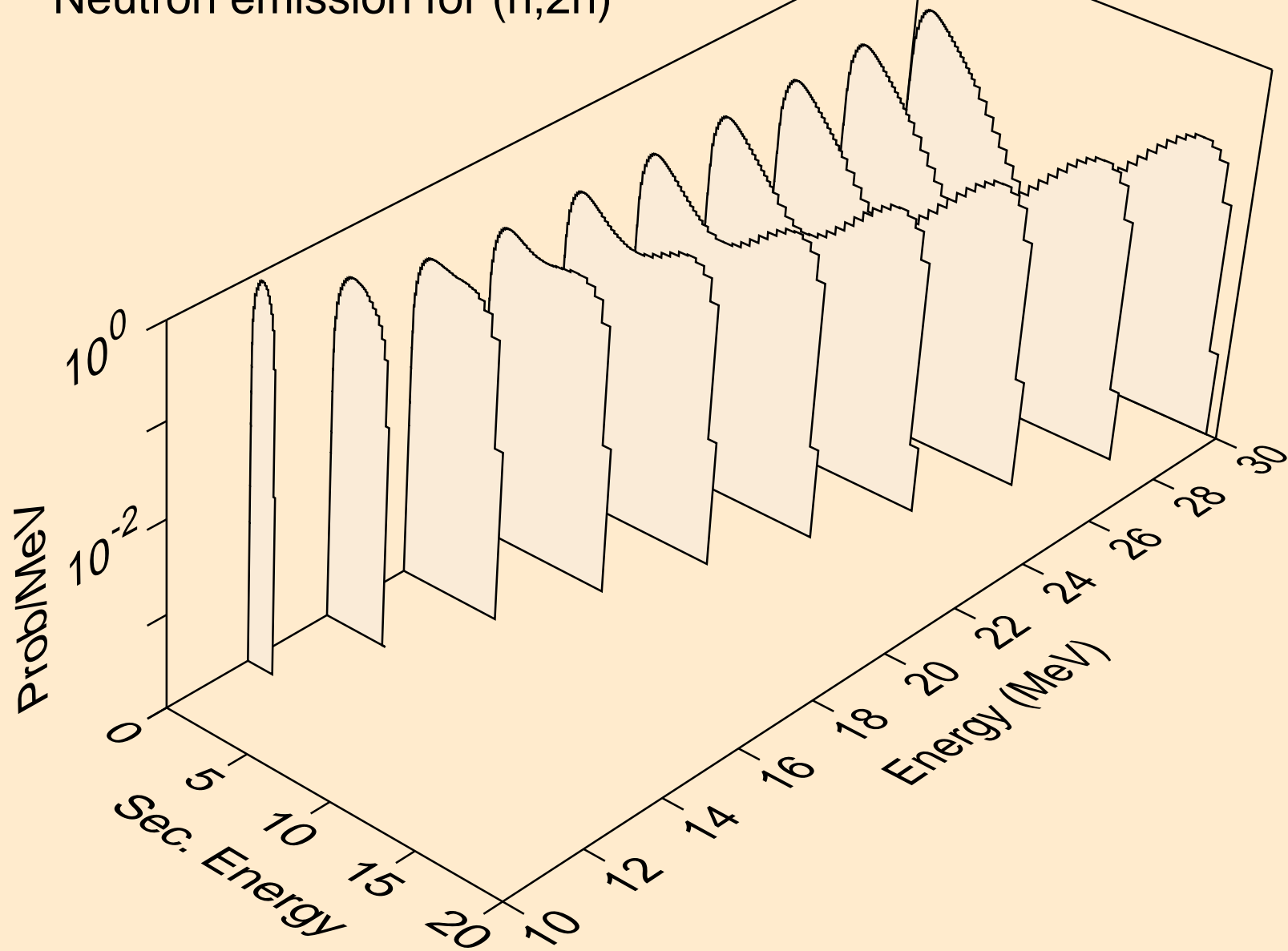

GA064 NEUTRON ACER TENDL-2024 LIBRARY; T=293.6K
Neutron emission for (n,3n)

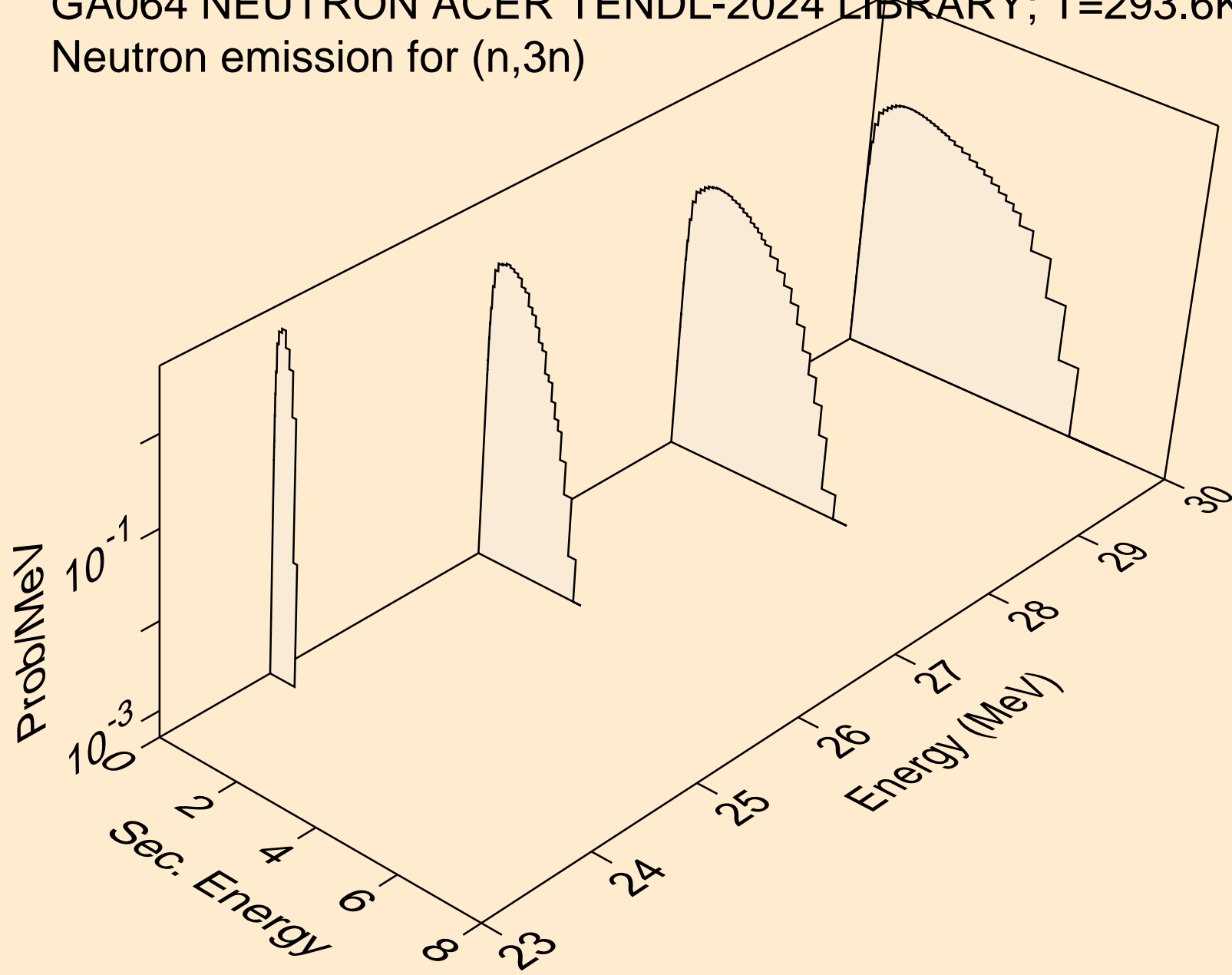

GA064 NEUTRON ACER TENDL-2024 LIBRARY; T=293.6K
Neutron emission for (n,n*)a

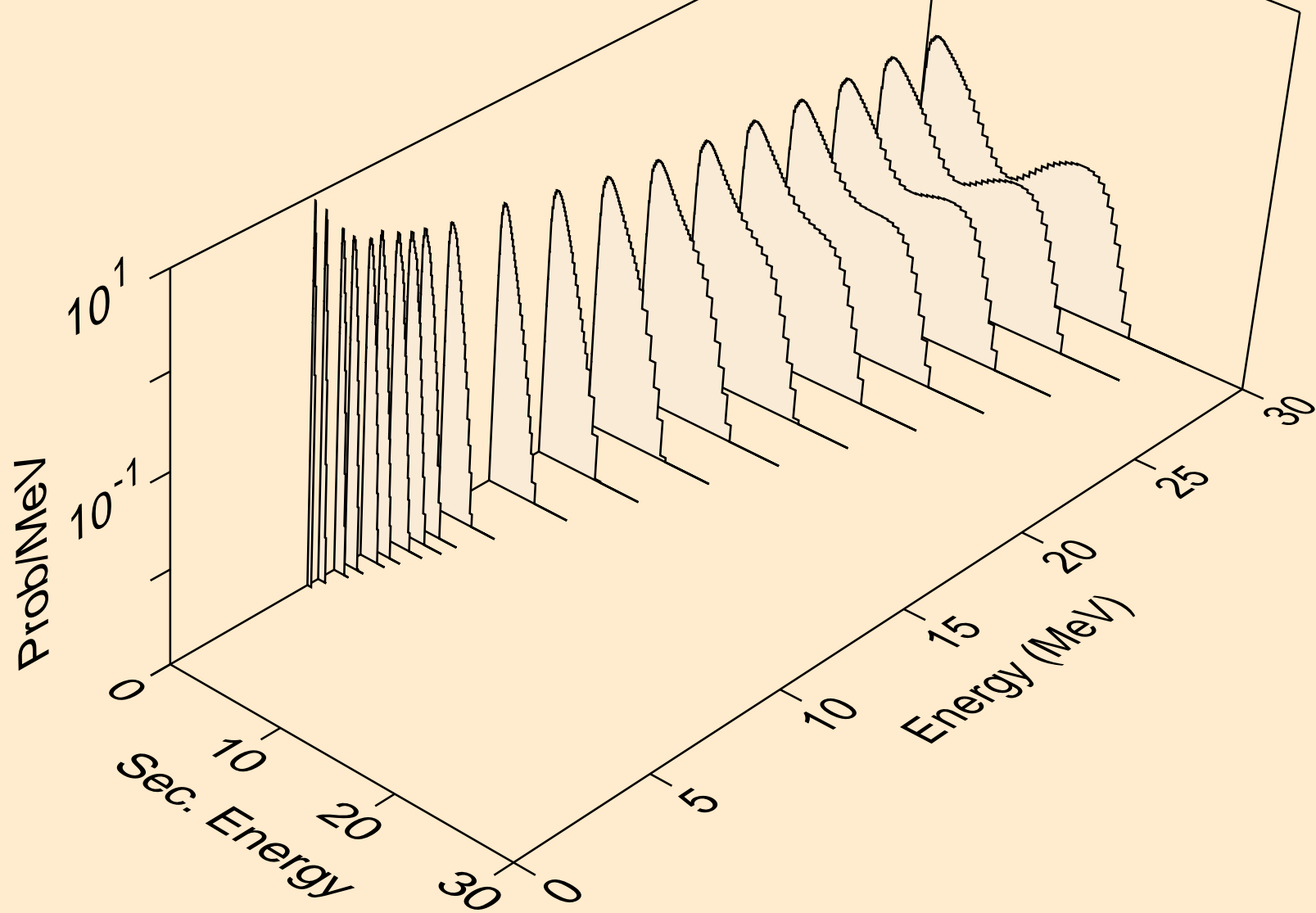

GA064 NEUTRON ACER TENDL-2024 LIBRARY; T=293.6K
Neutron emission for (n,2n)a

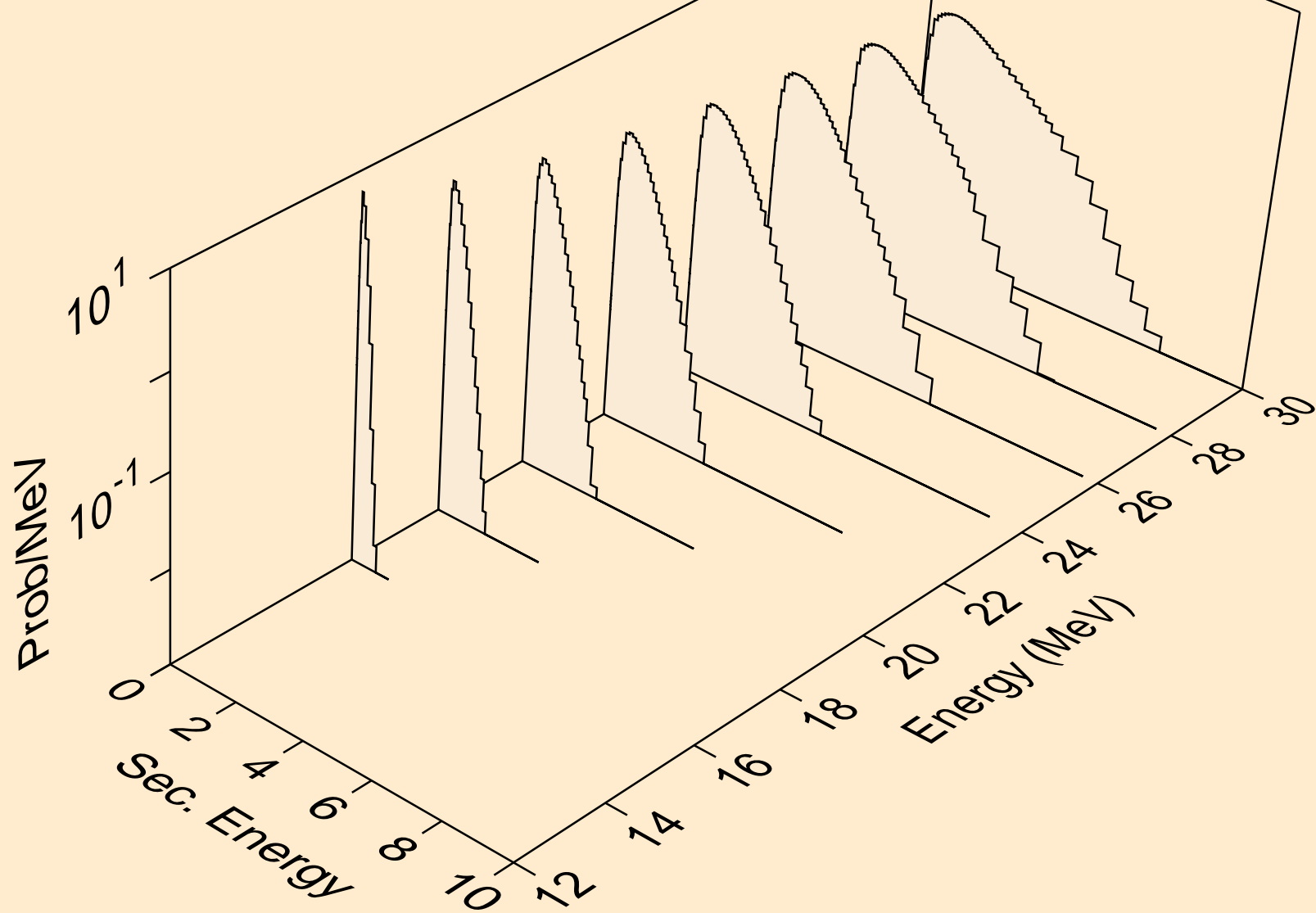

GA064 NEUTRON ACER TENDL-2024 LIBRARY; T=293.6K
Neutron emission for (n,n*)p

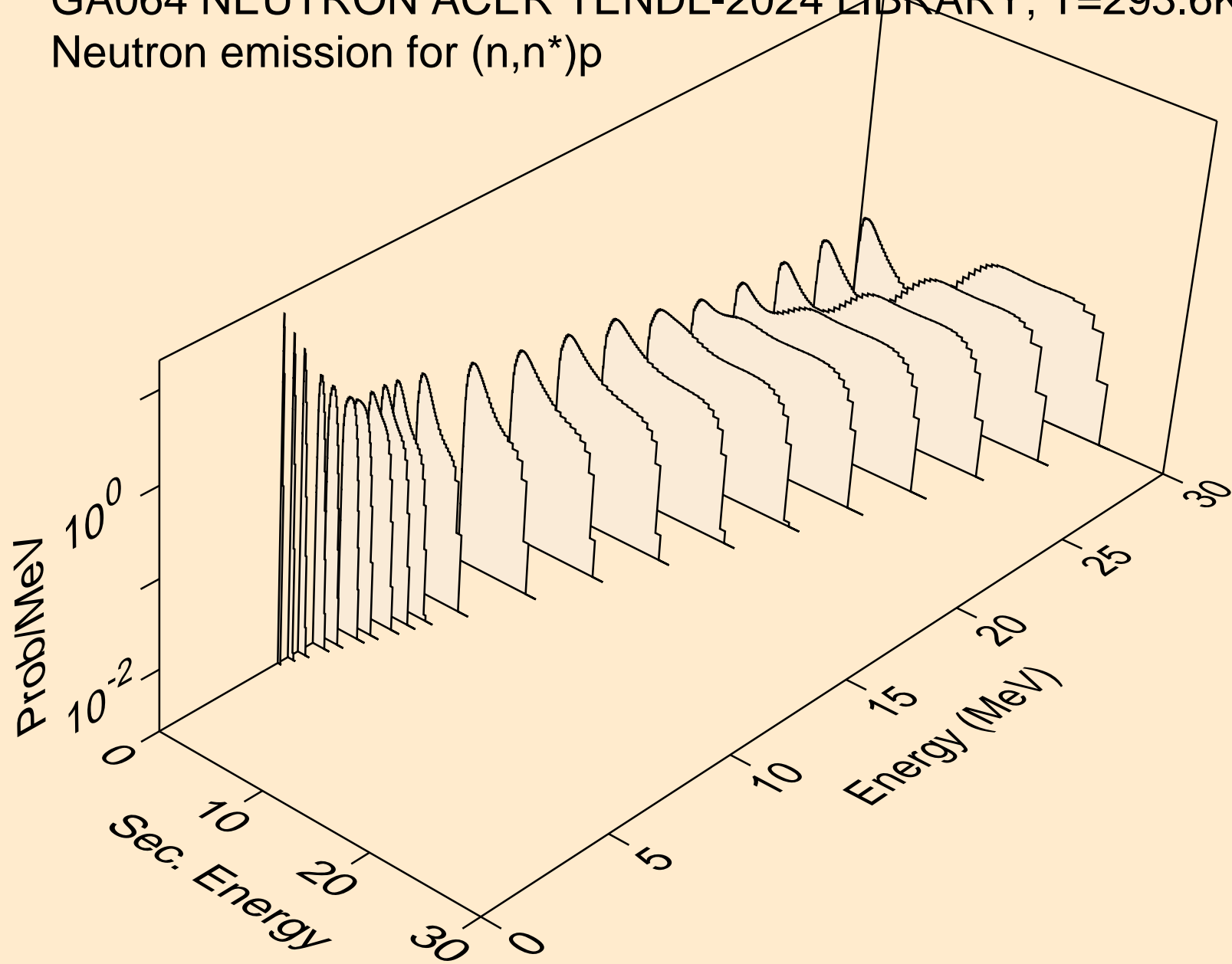

GA064 NEUTRON ACER TENDL-2024 LIBRARY; T=293.6K
Neutron emission for (n,n*)2a

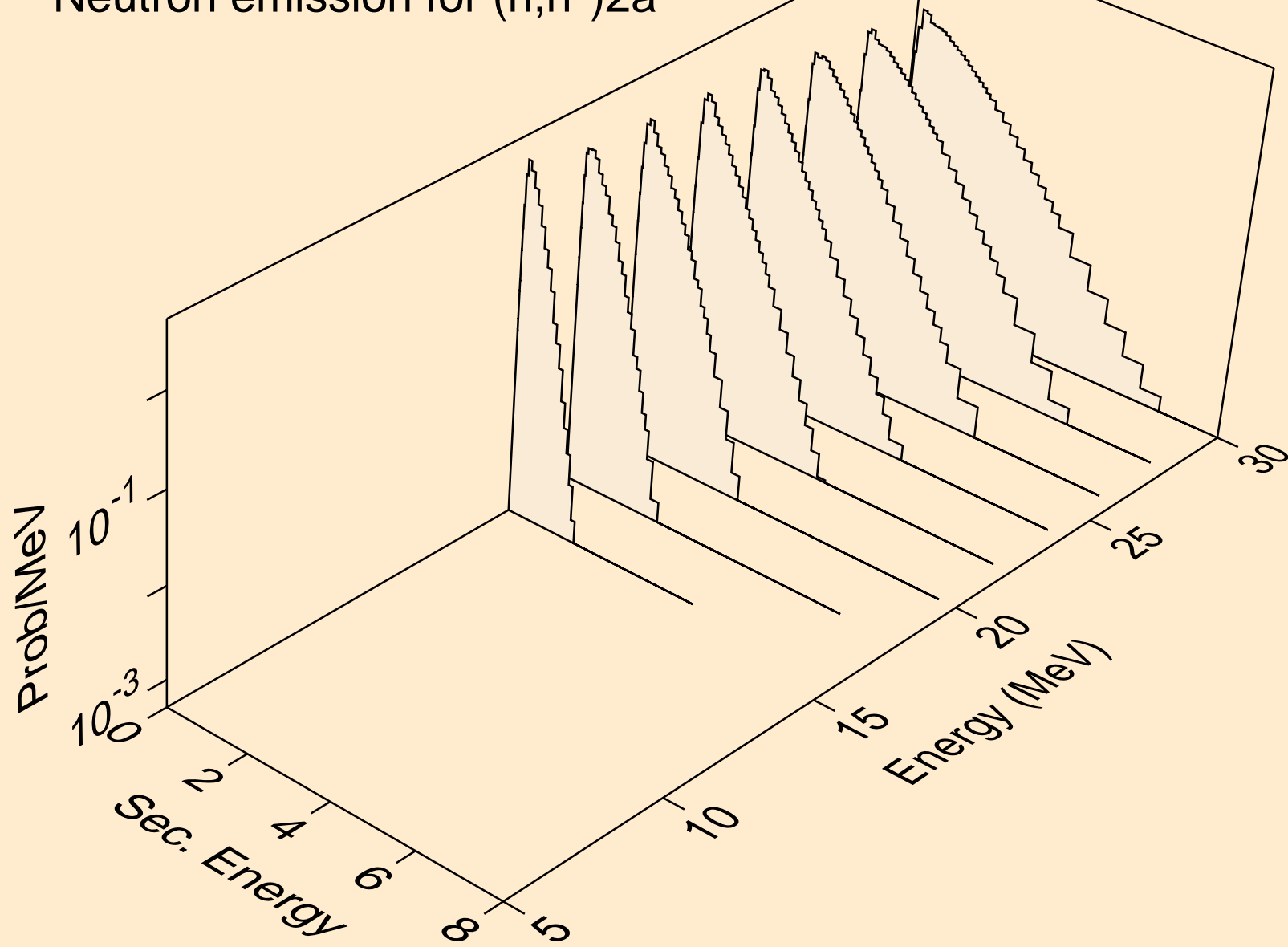

GA064 NEUTRON ACER TENDL-2024 LIBRARY; T=293.6K
Neutron emission for (n,n*)d

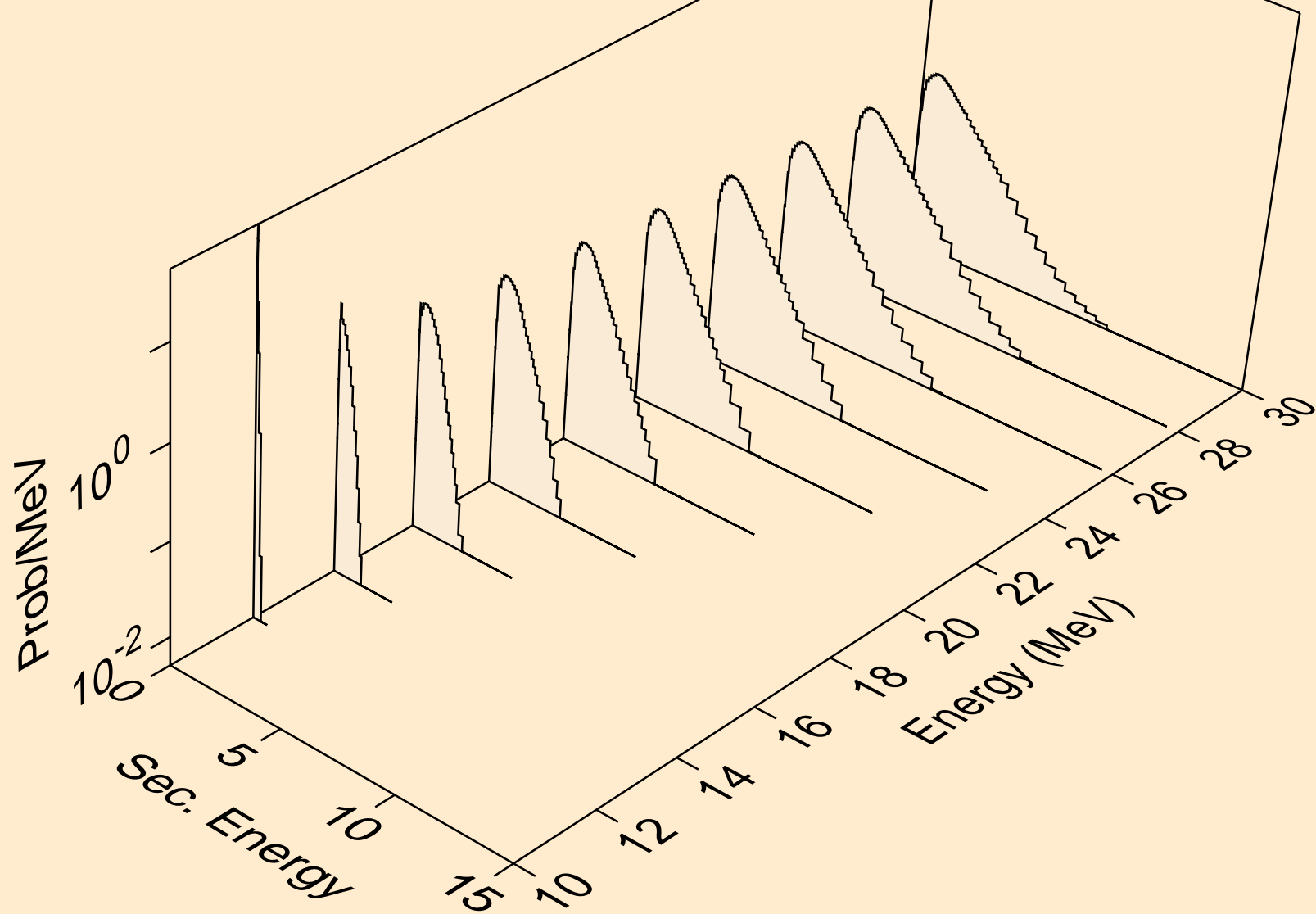

GA064 NEUTRON ACER TENDL-2024 LIBRARY; T=293.6K
Neutron emission for (n,n*)t

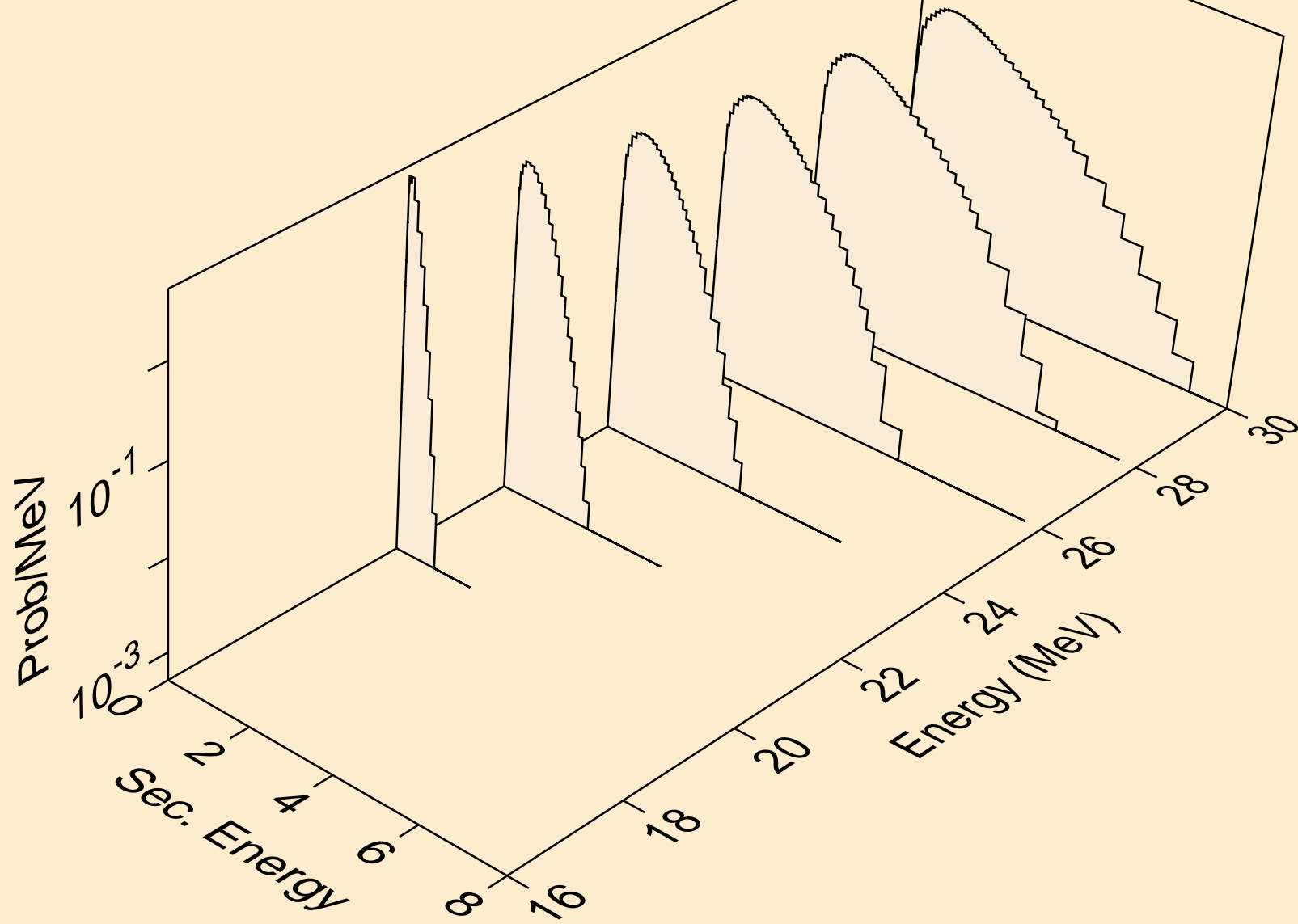

GA064 NEUTRON ACER TENDL-2024 LIBRARY; T=293.6K
Neutron emission for (n,n*)he3

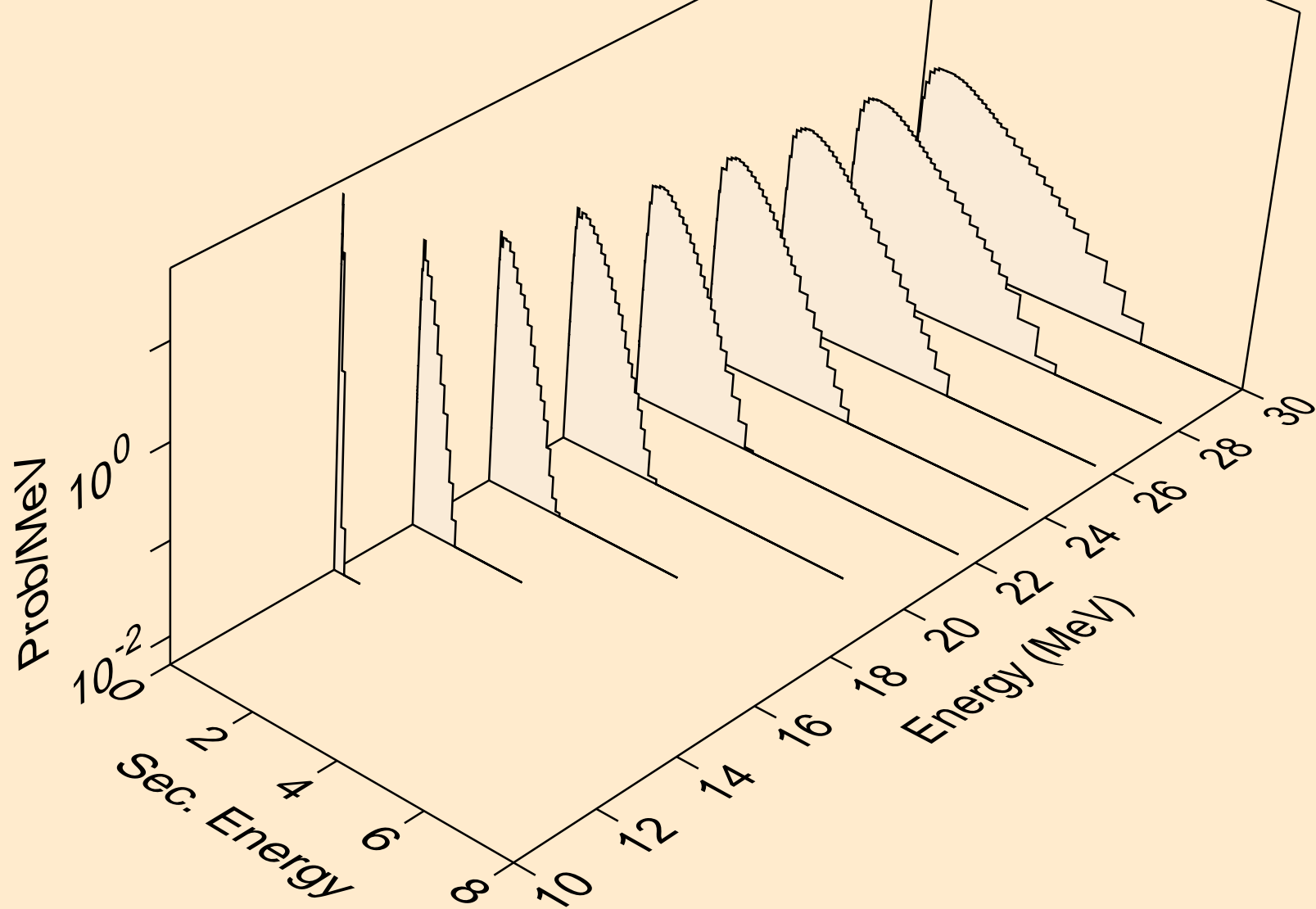

GA064 NEUTRON ACER TENDL-2024 LIBRARY; T=293.6K
Neutron emission for (n,2np)

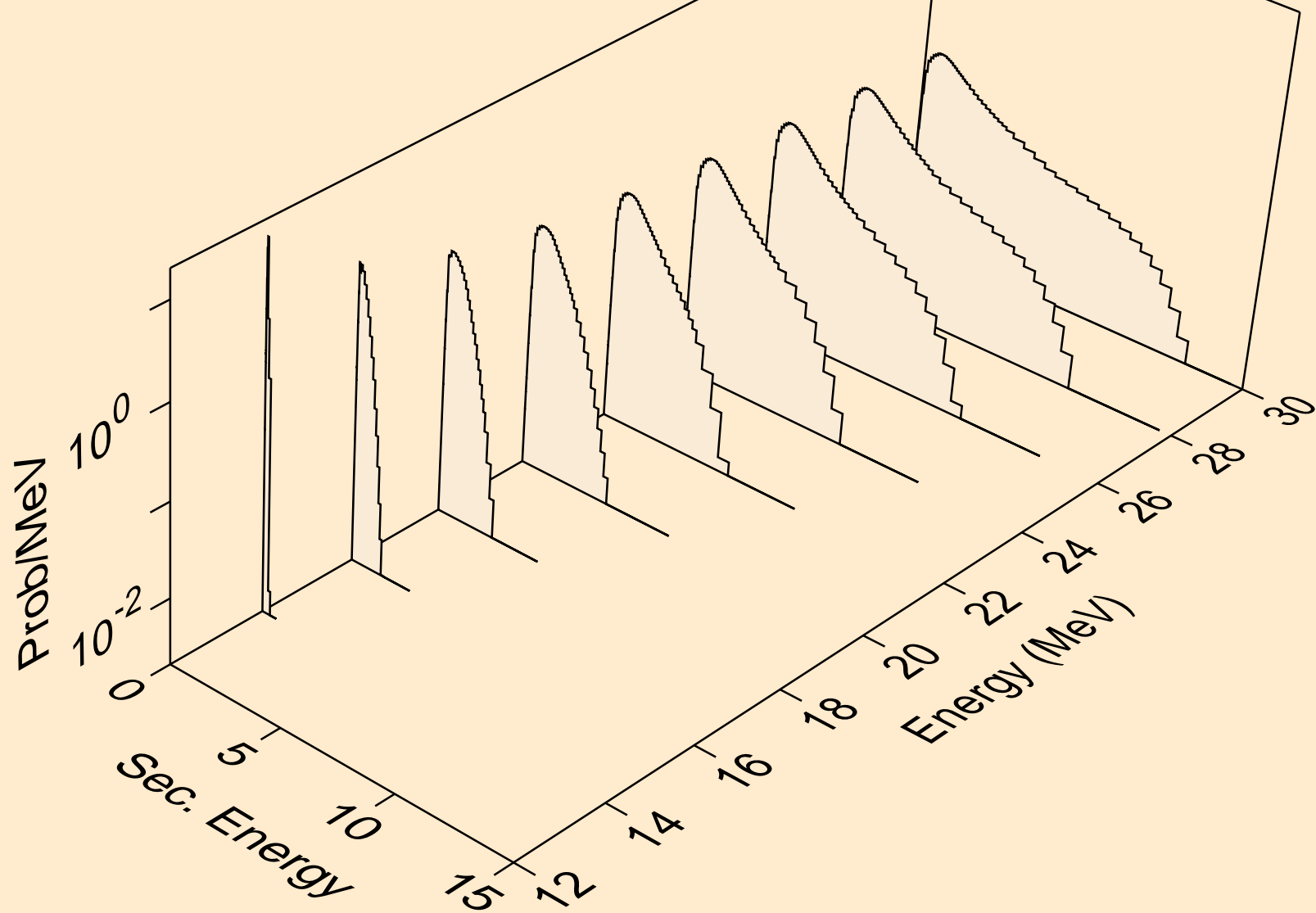

GA064 NEUTRON ACER TENDL-2024 LIBRARY; T=293.6K
Neutron emission for (n,3np)

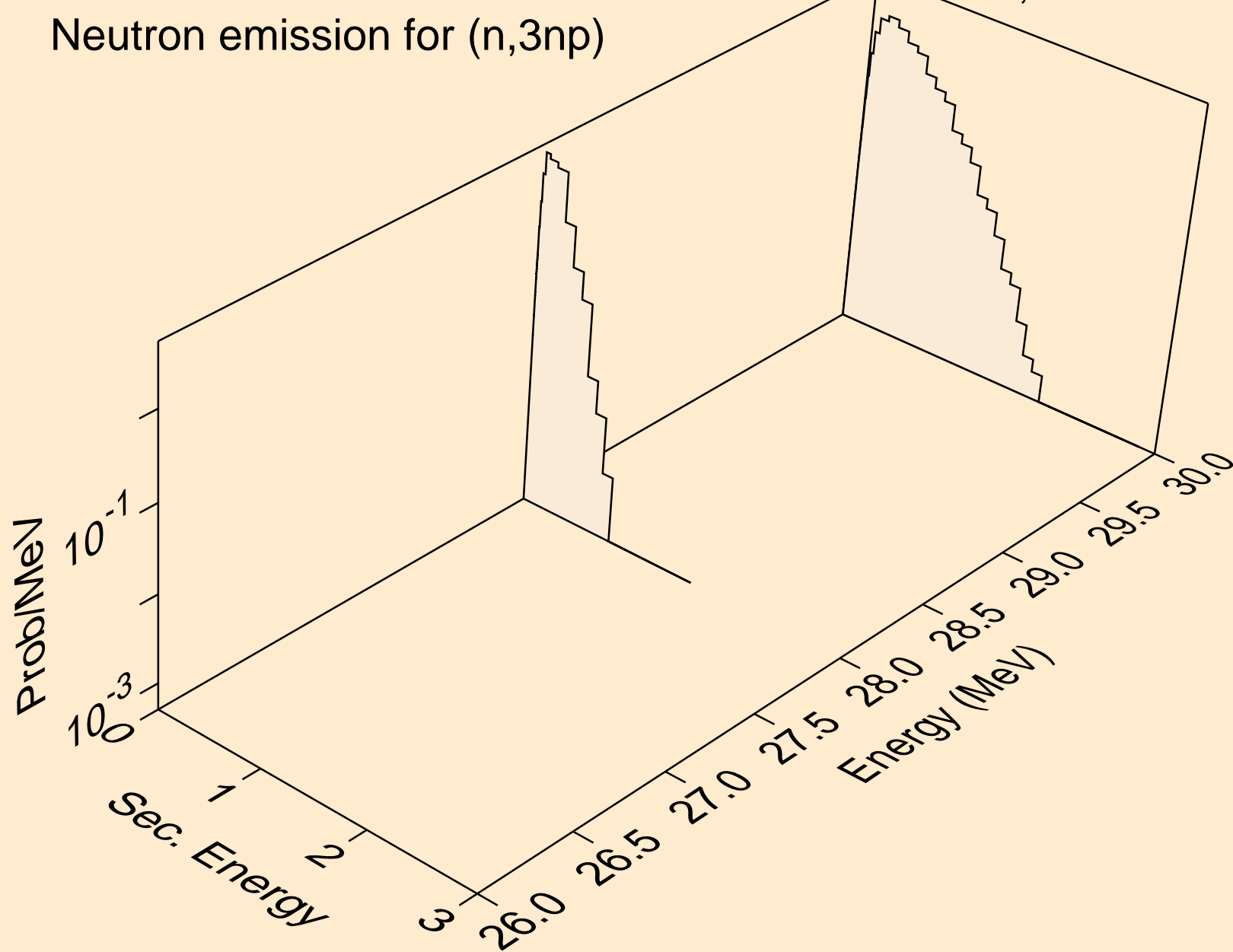

GA064 NEUTRON ACER TENDL-2024 LIBRARY; T=293.6K
Neutron emission for (n,n2p)

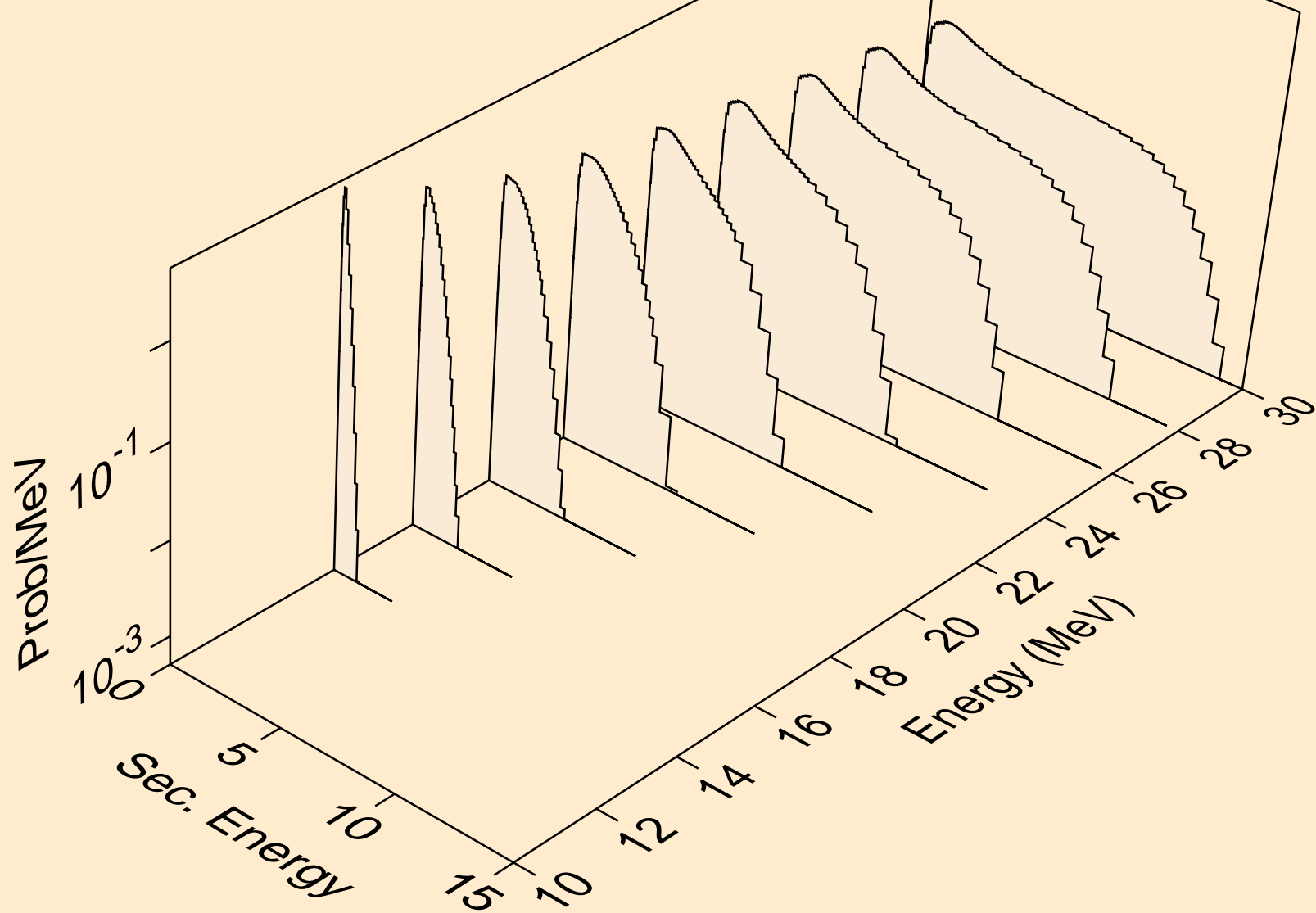

GA064 NEUTRON ACER TENDL-2024 LIBRARY; T=293.6K
Neutron emission for (n,npa)

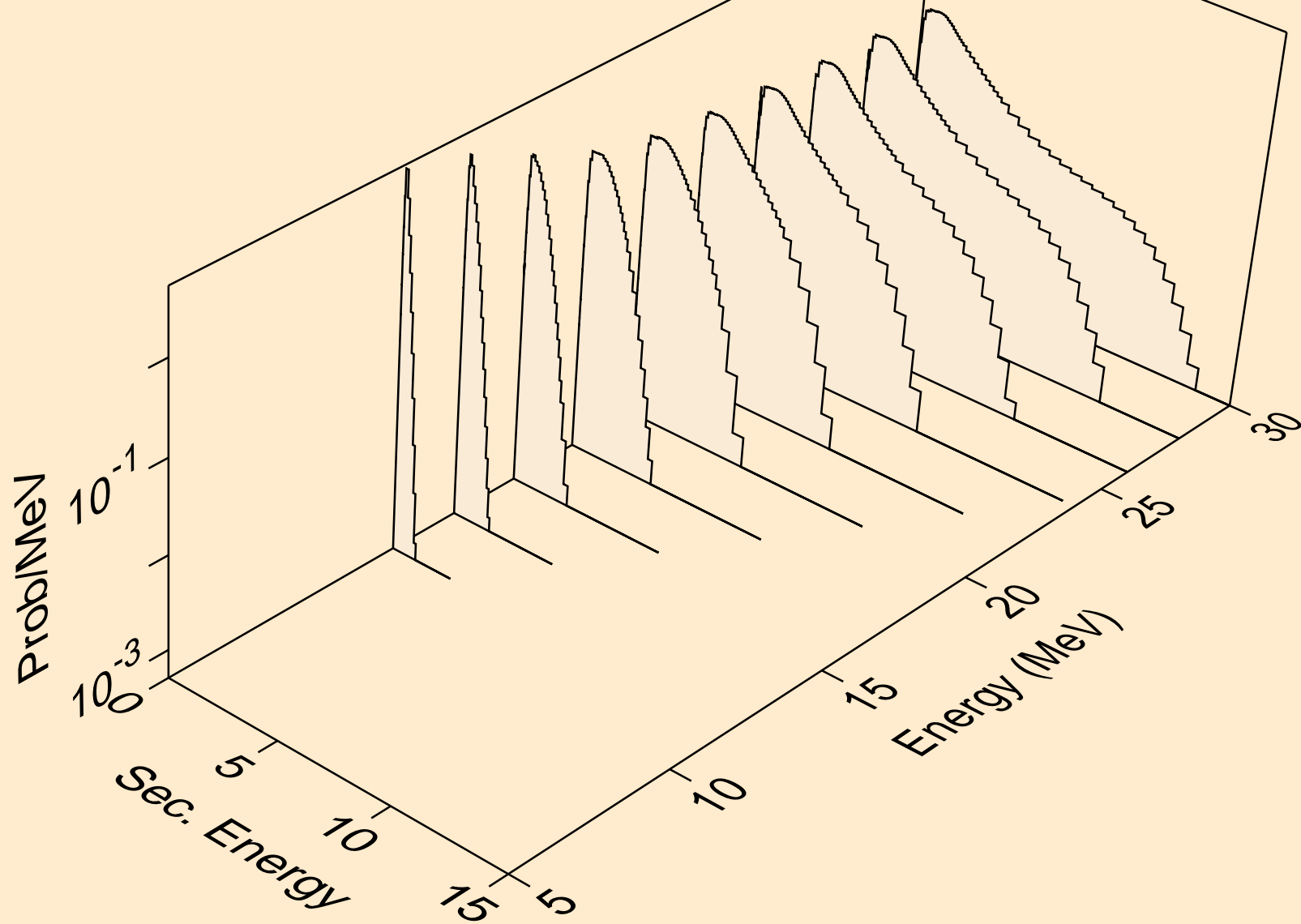

GA064 NEUTRON ACER TENDL-2024 LIBRARY; T=293.6K
Neutron emission for (n,n*c)

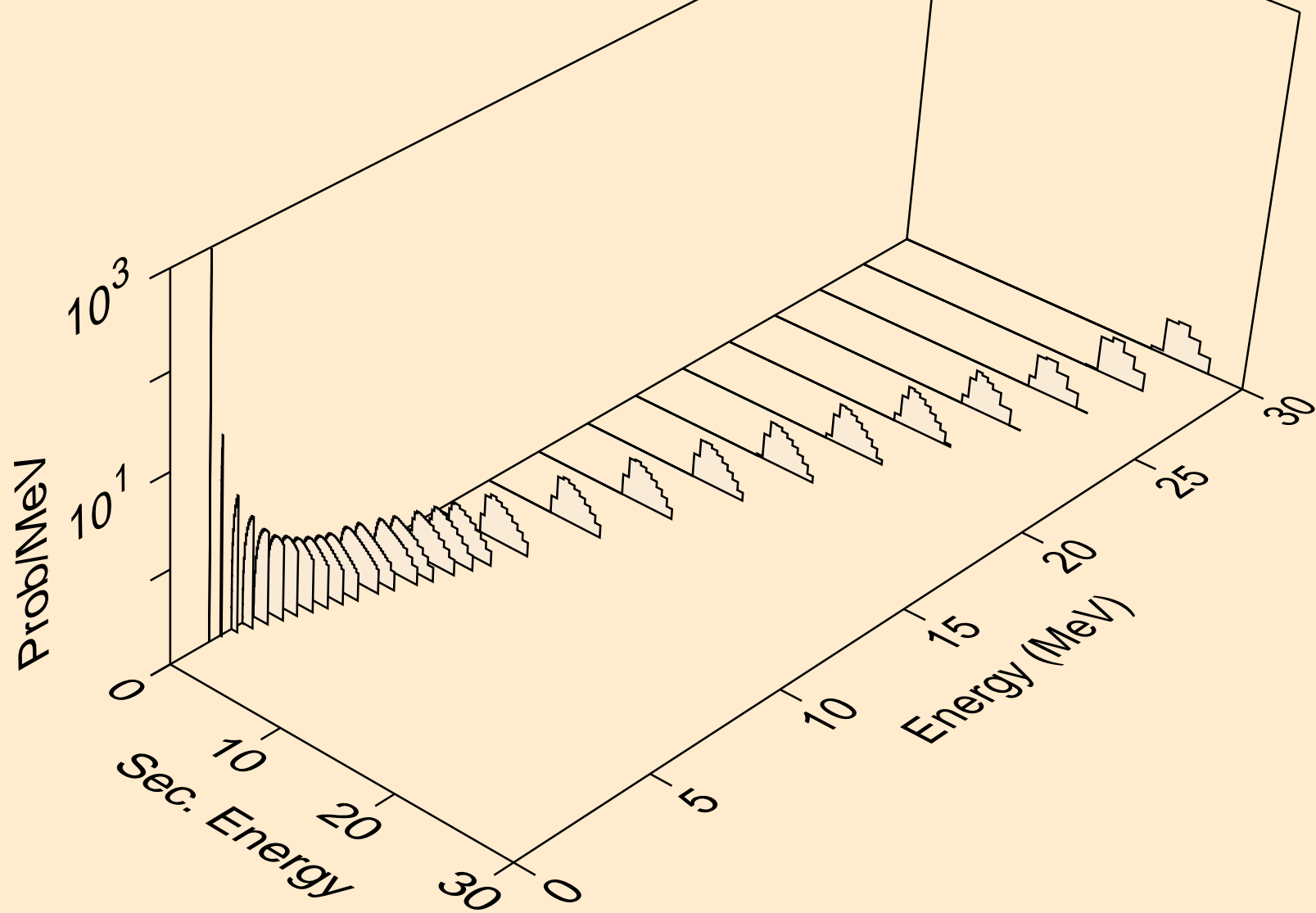

GA064 NEUTRON ACER TENDL-2024 LIBRARY; T=293.6K
Photon emission for (n,x)

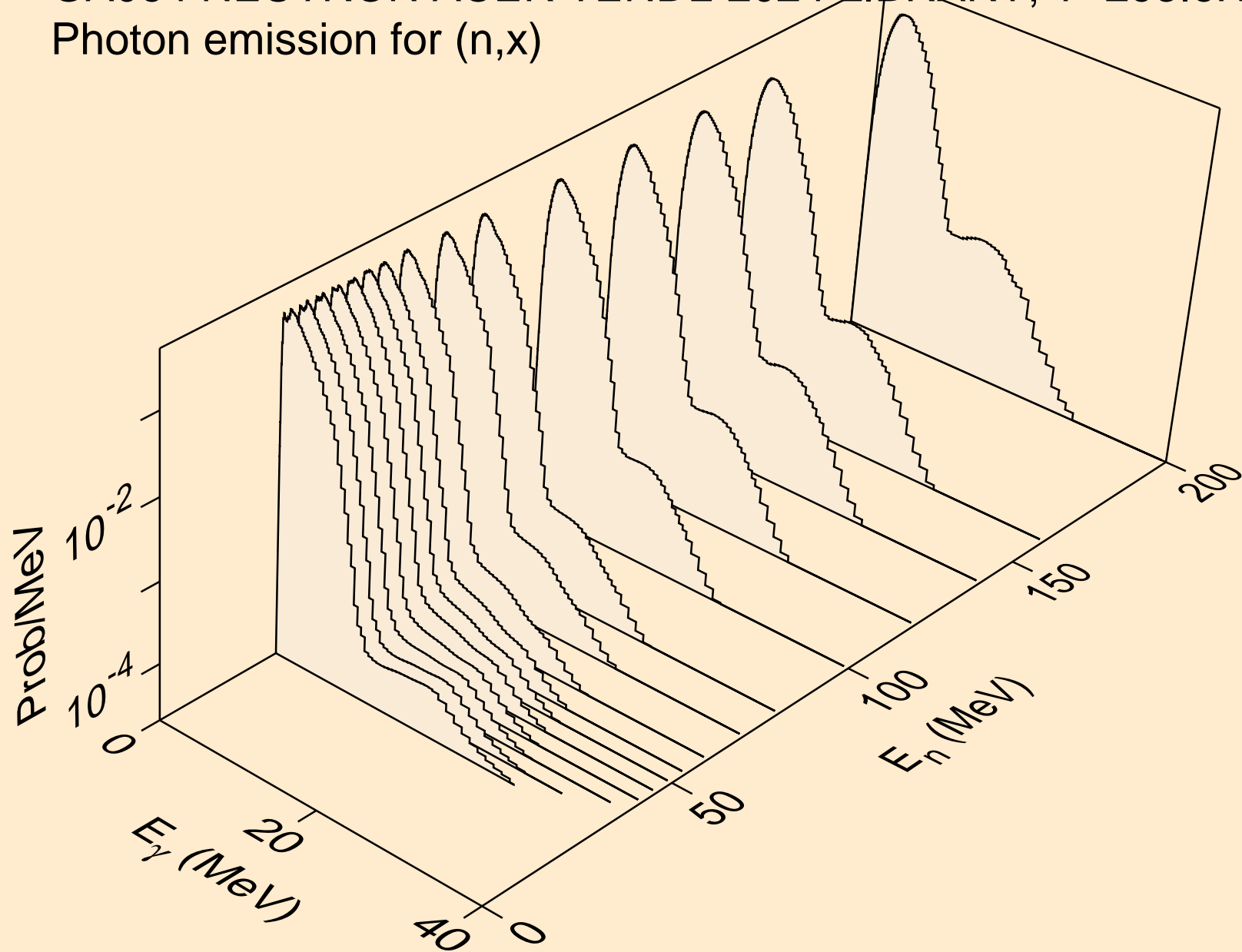

GA064 NEUTRON ACER TENDL-2024 LIBRARY; T=293.6K
Photon emission for (n,2nd)

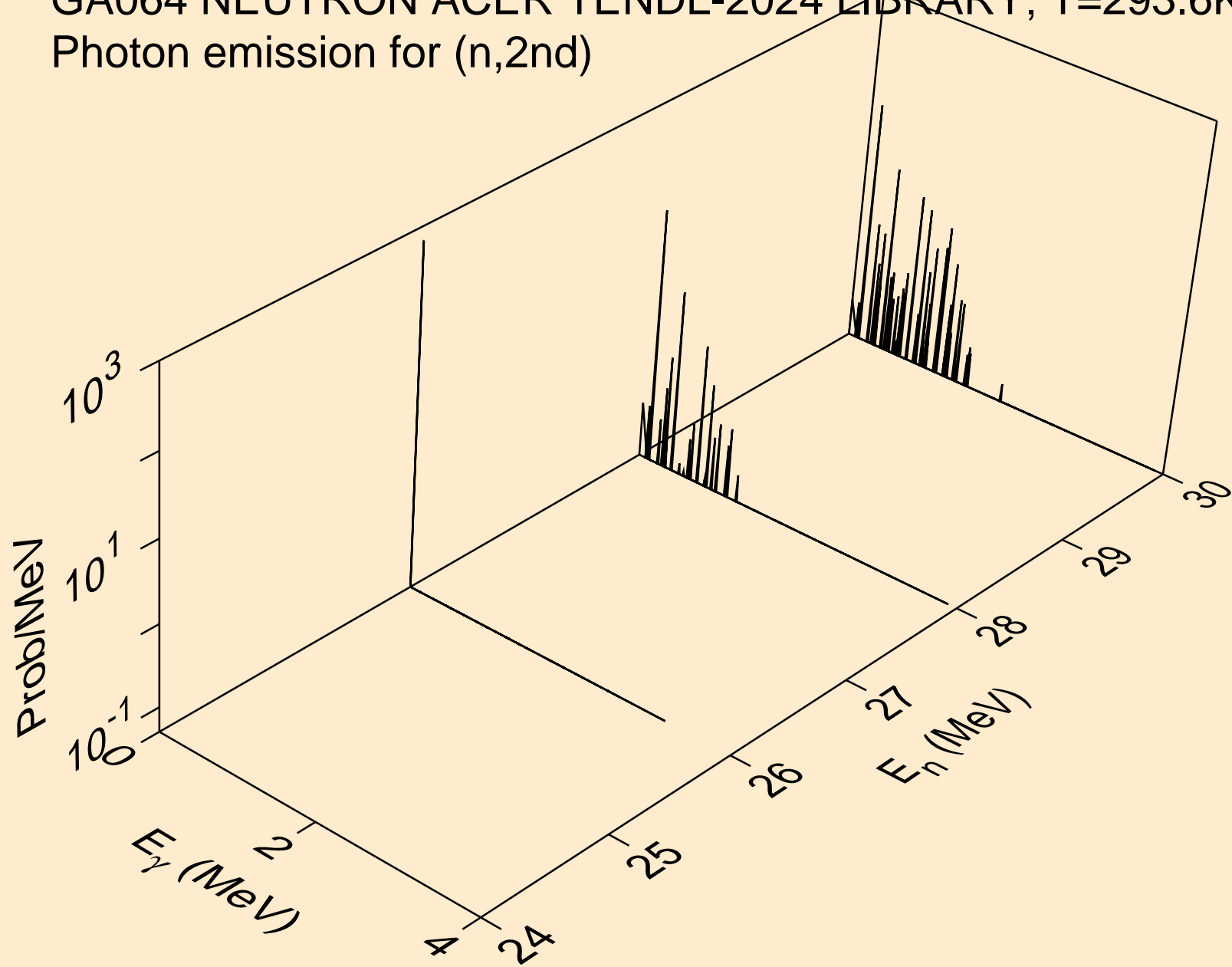

GA064 NEUTRON ACER TENDL-2024 LIBRARY; T=293.6K
Photon emission for (n,2n)

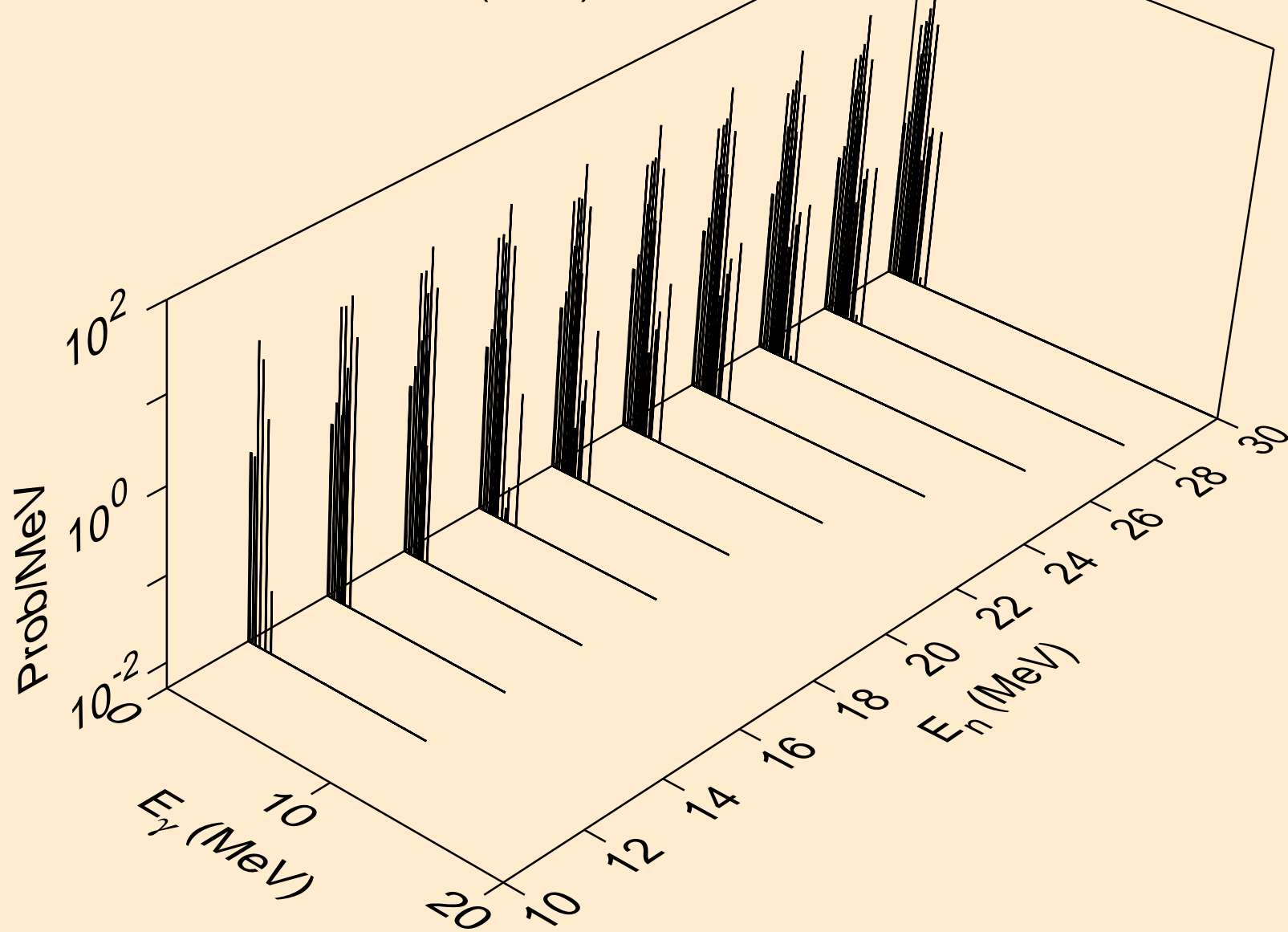

GA064 NEUTRON ACER TENDL-2024 LIBRARY; T=293.6K
Photon emission for (n,3n)

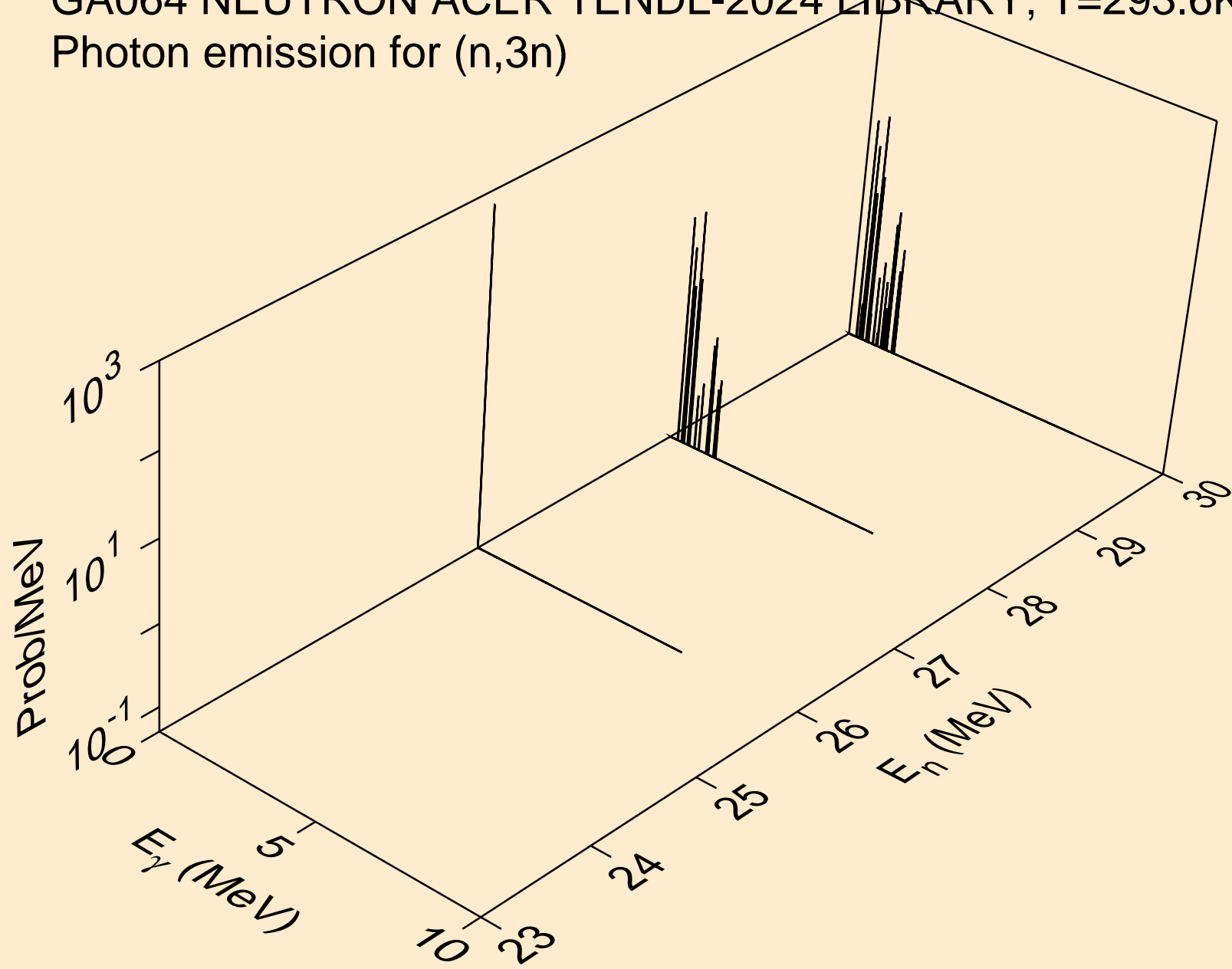

GA064 NEUTRON ACER TENDL-2024 LIBRARY; T=293.6K
Photon emission for (n,n*)a

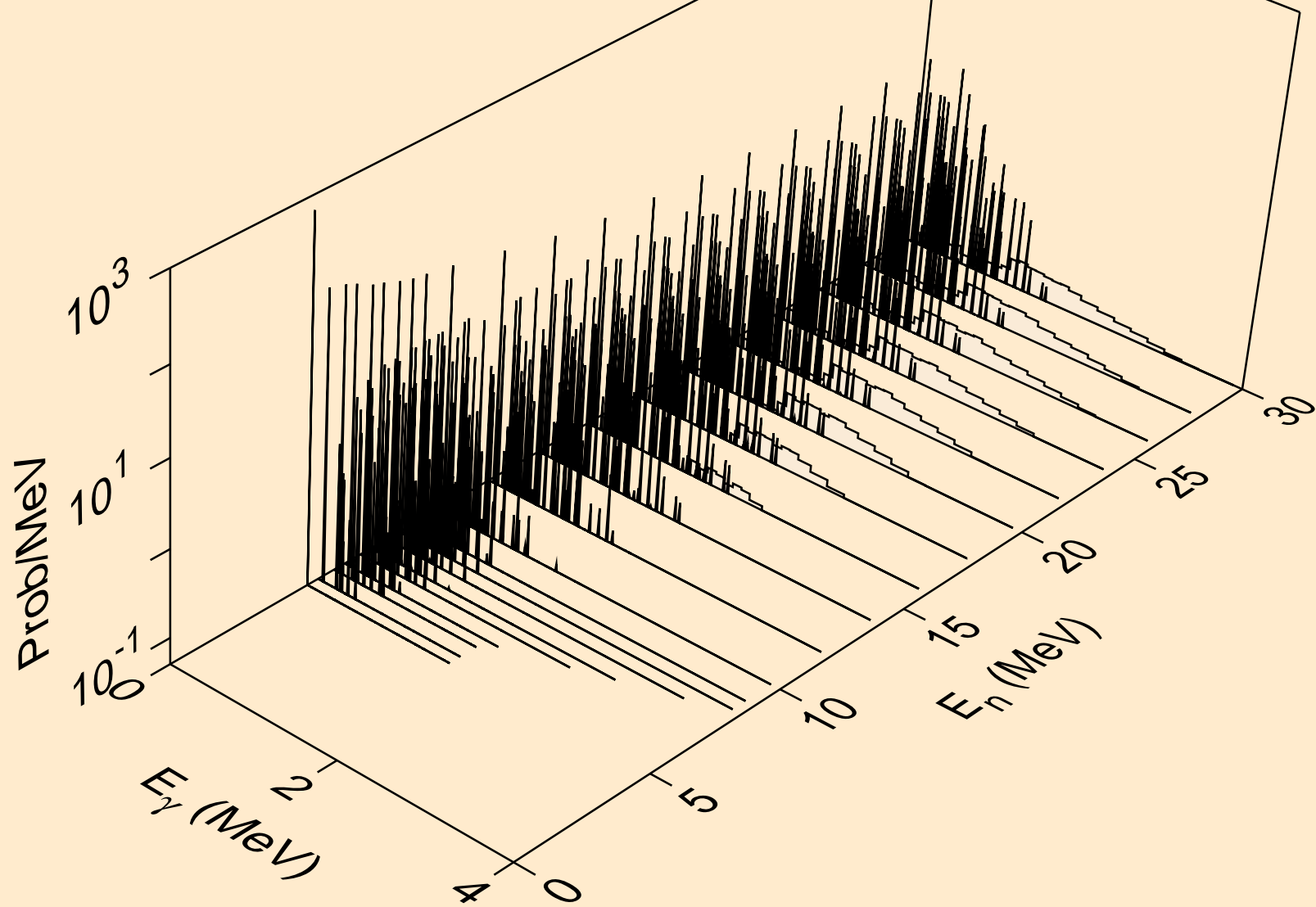

GA064 NEUTRON ACER TENDL-2024 LIBRARY; T=293.6K
Photon emission for (n,2n)a

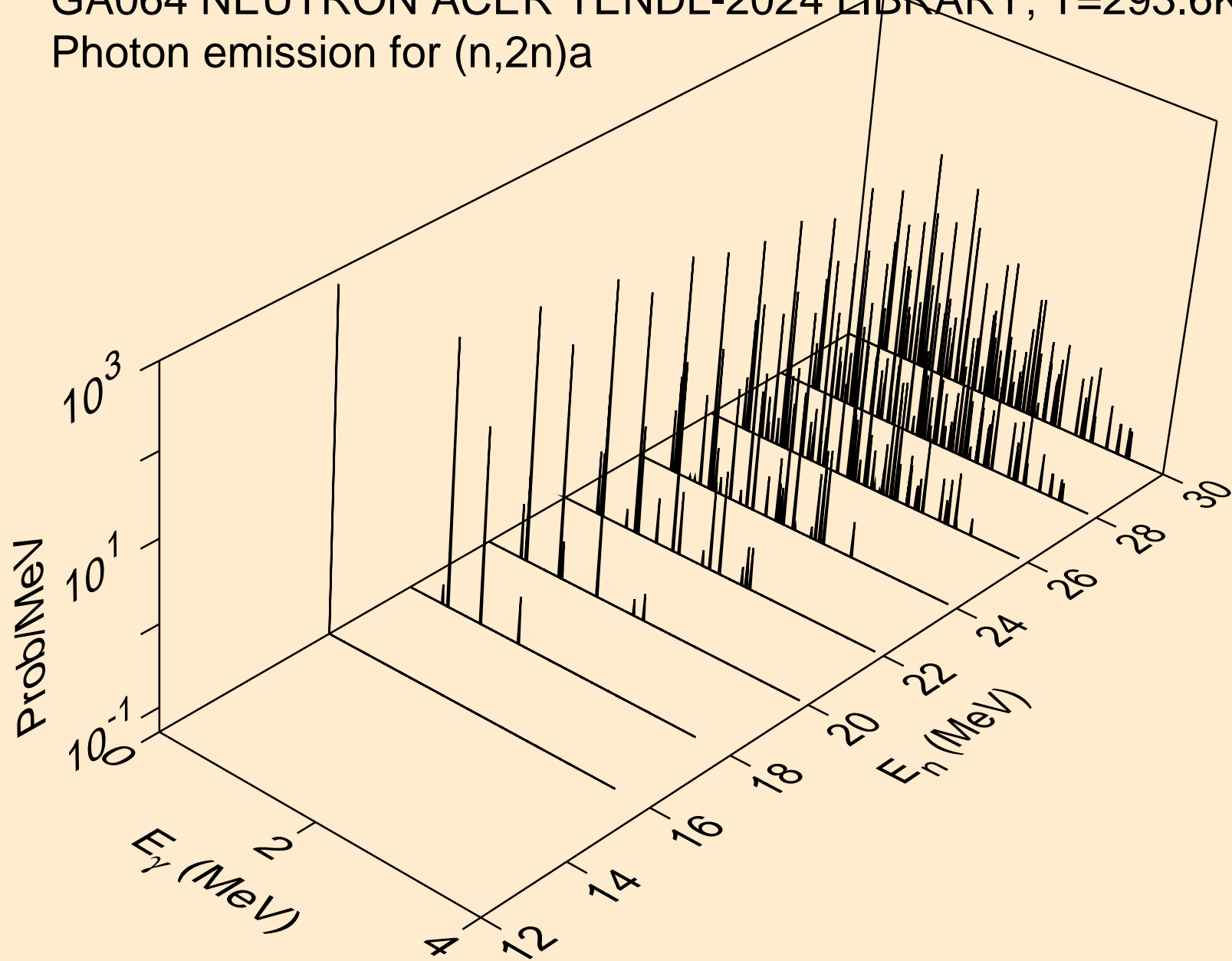

GA064 NEUTRON ACER TENDL-2024 LIBRARY; T=293.6K
Photon emission for (n,n*)p

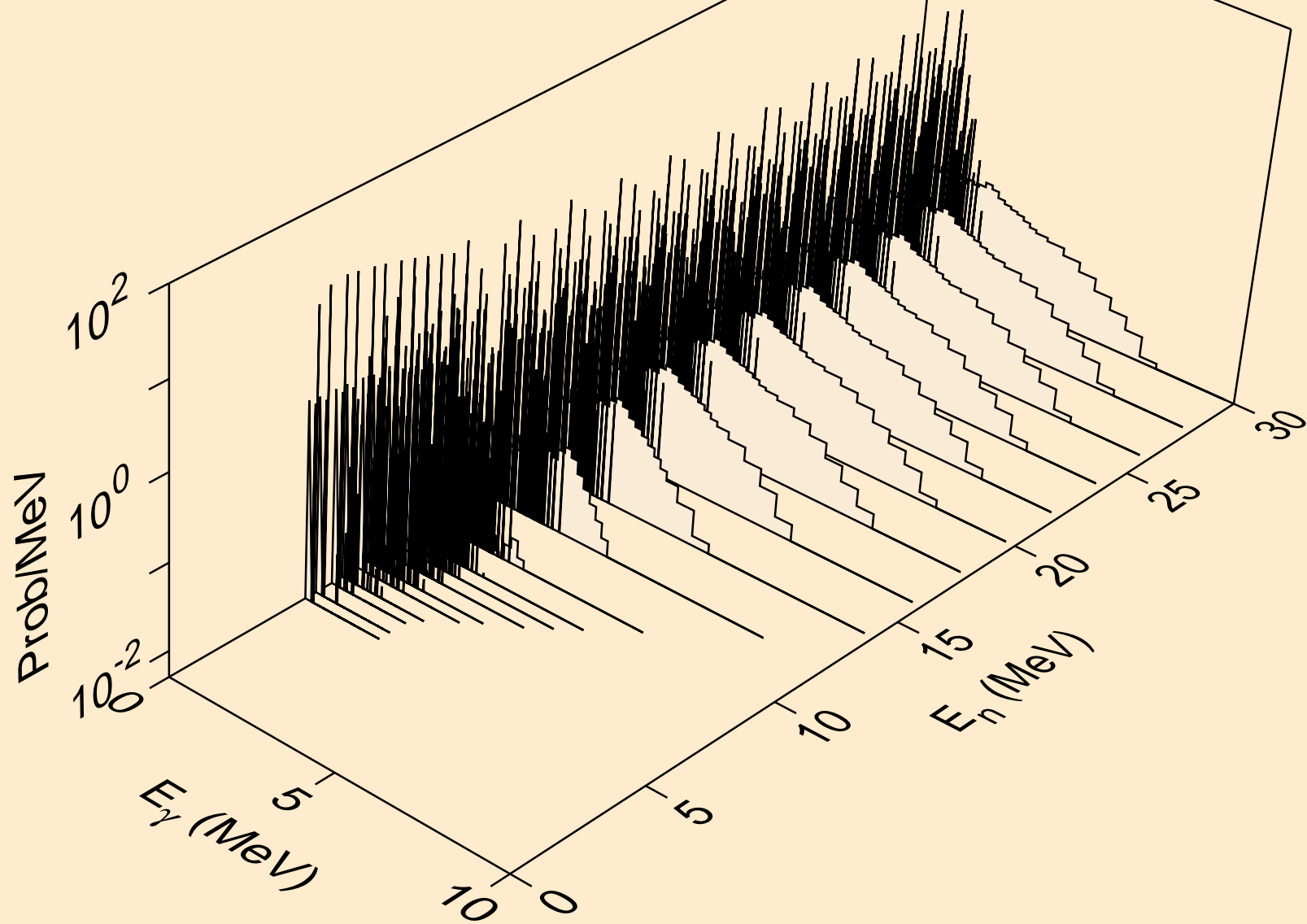

GA064 NEUTRON ACER TENDL-2024 LIBRARY; T=293.6K
Photon emission for (n,n*)2a

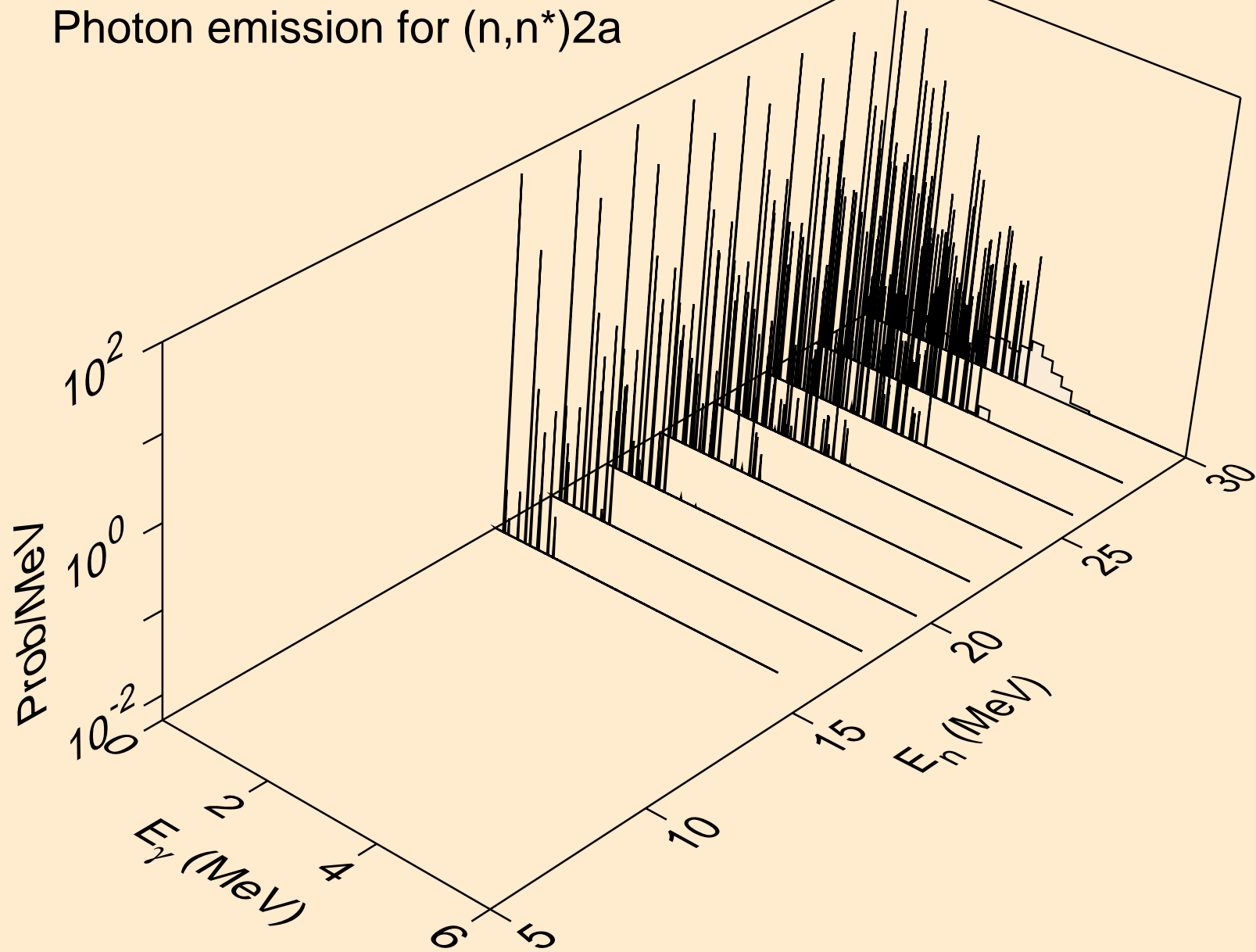

GA064 NEUTRON ACER TENDL-2024 LIBRARY; T=293.6K
Photon emission for (n,n*)d

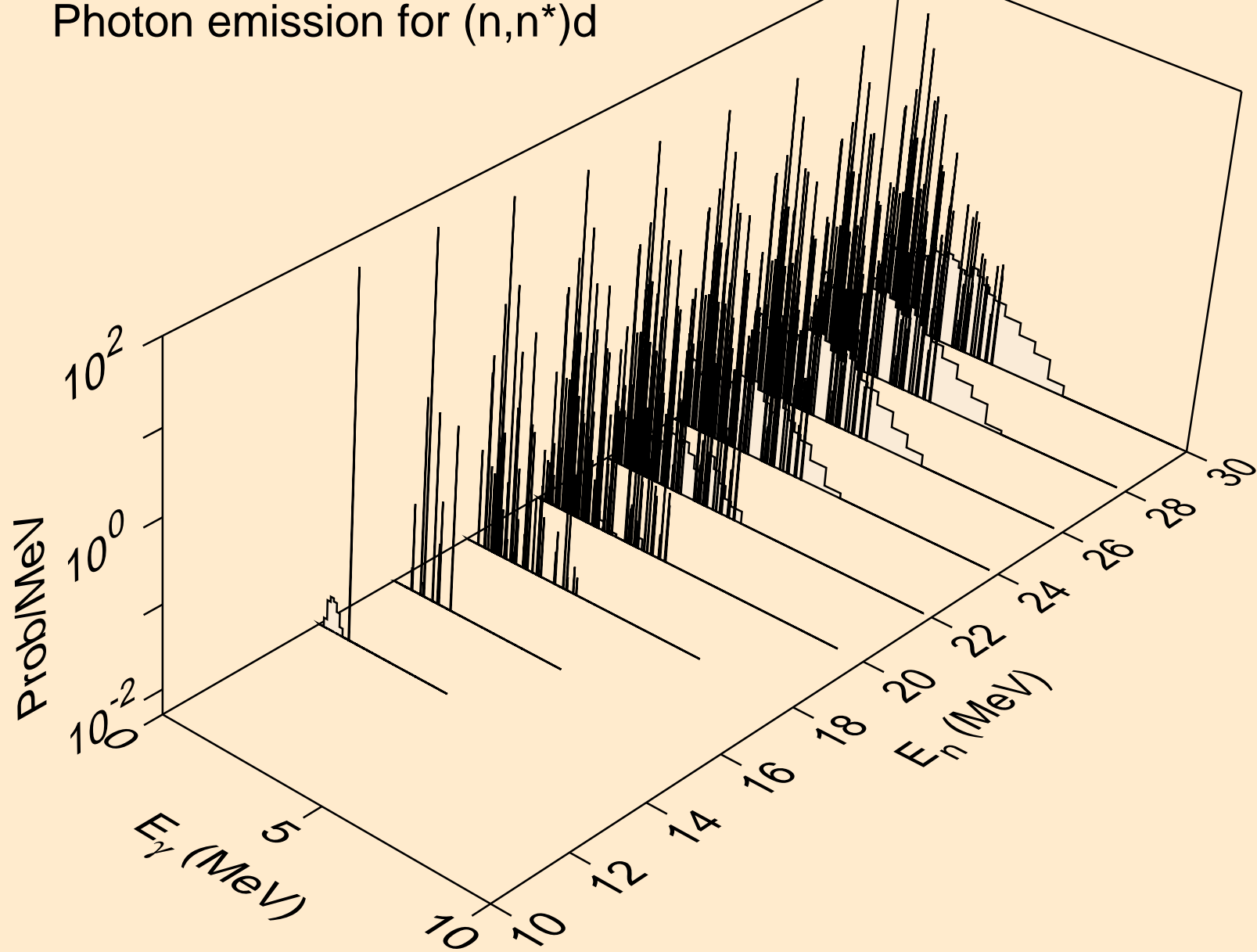

GA064 NEUTRON ACER TENDL-2024 LIBRARY; T=293.6K
Photon emission for (n,n*)t

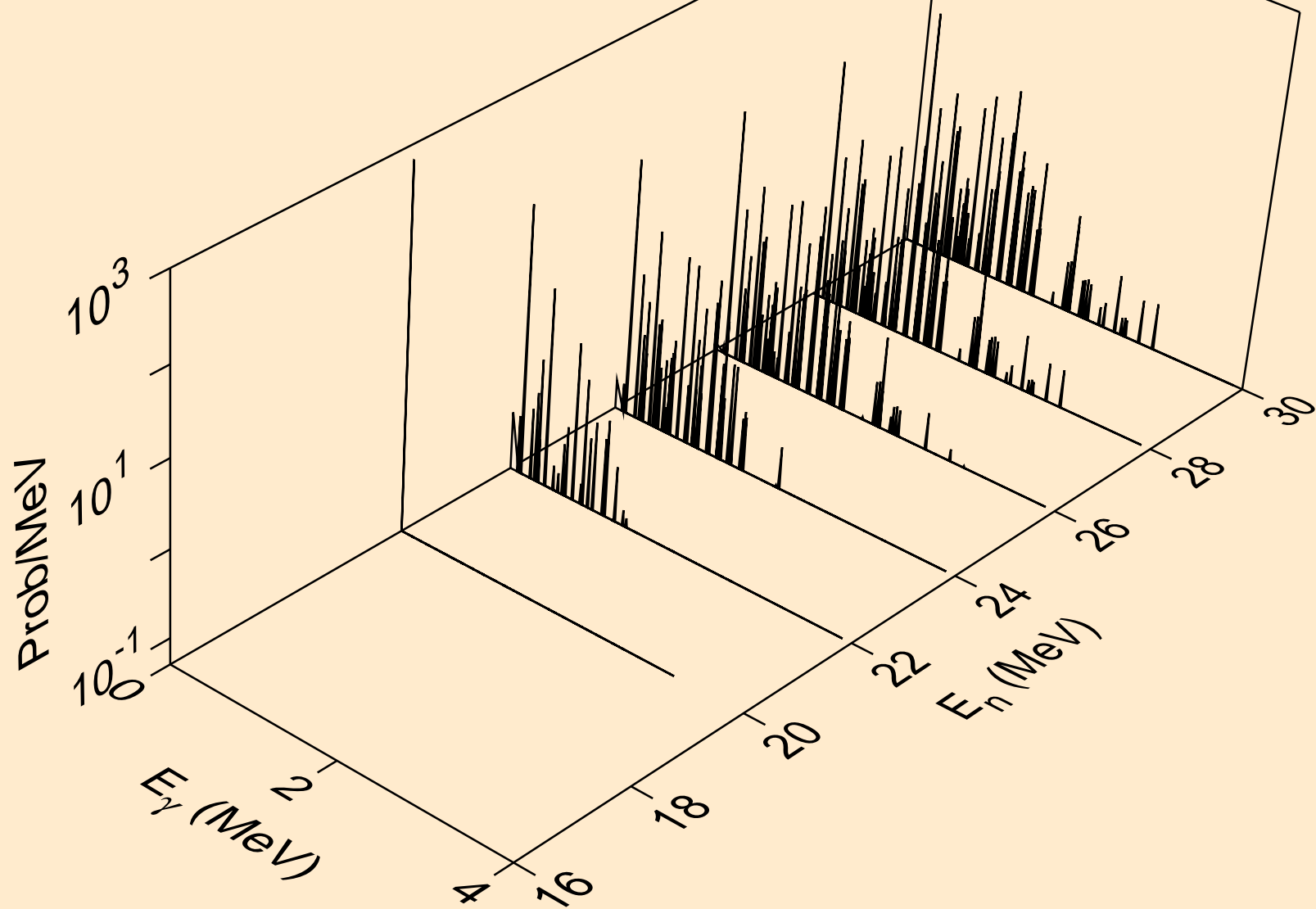

GA064 NEUTRON ACER TENDL-2024 LIBRARY; T=293.6K
Photon emission for (n,n*)he3

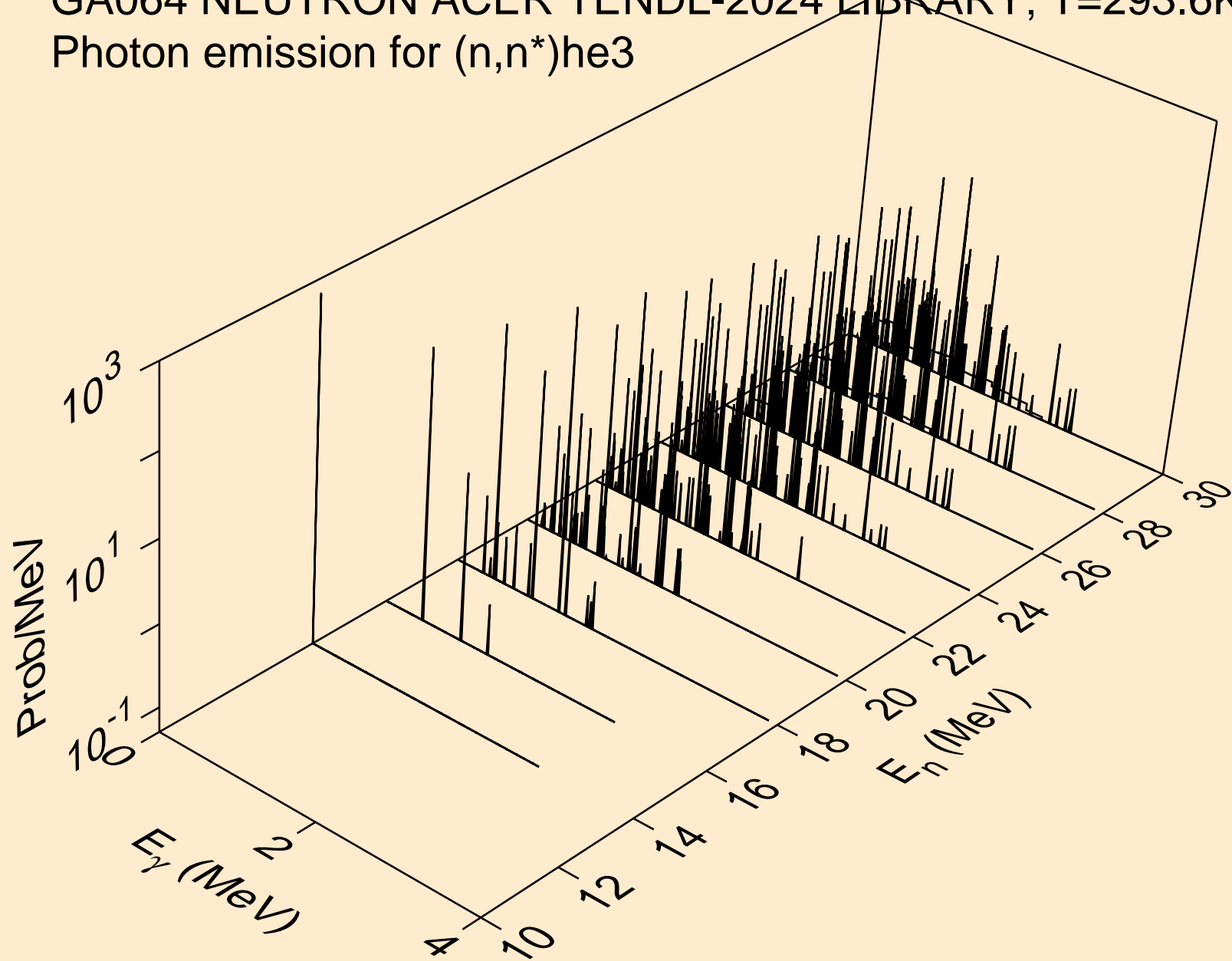

GA064 NEUTRON ACER TENDL-2024 LIBRARY; T=293.6K
Photon emission for (n,2np)

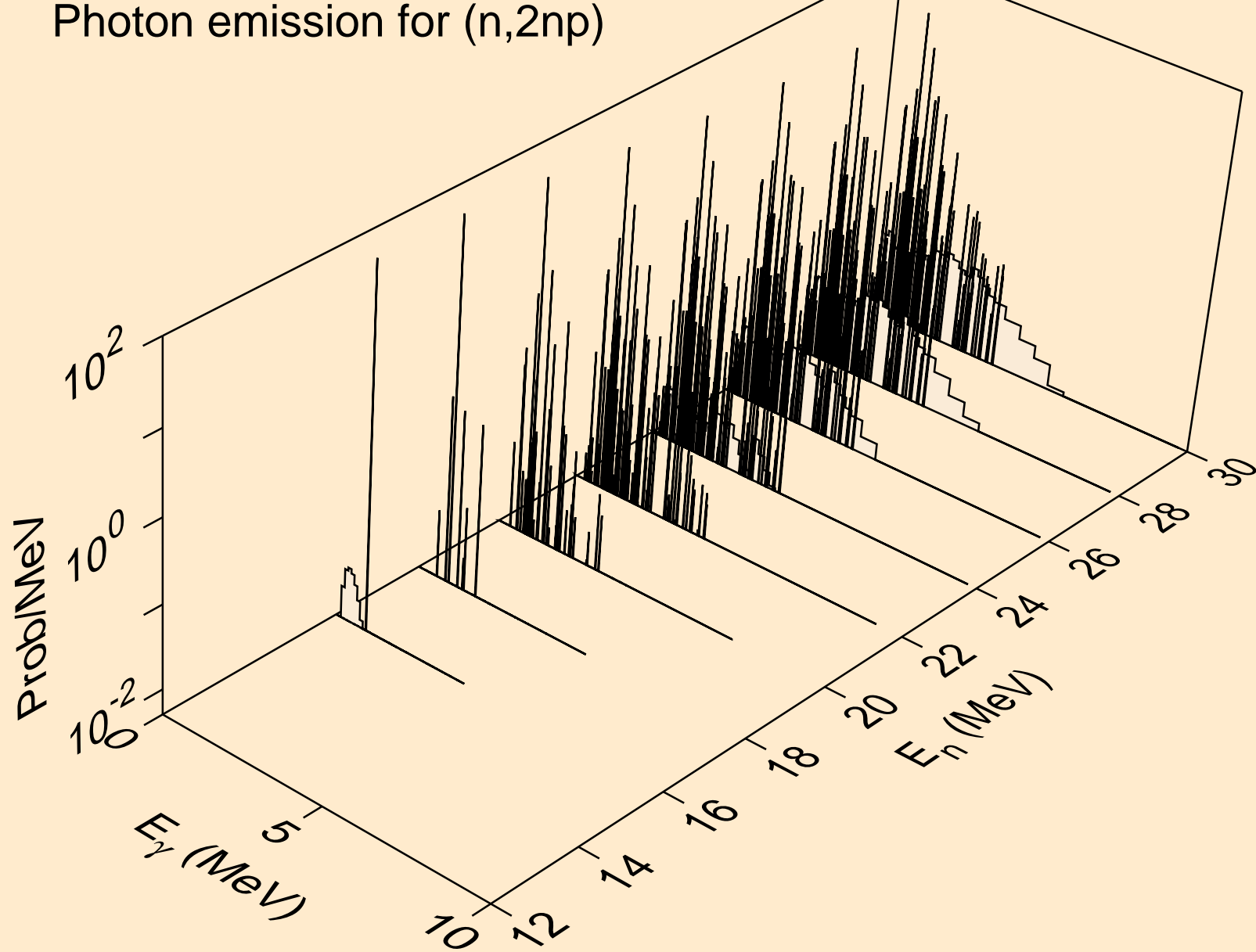

GA064 NEUTRON ACER TENDL-2024 LIBRARY; T=293.6K
Photon emission for (n,3np)

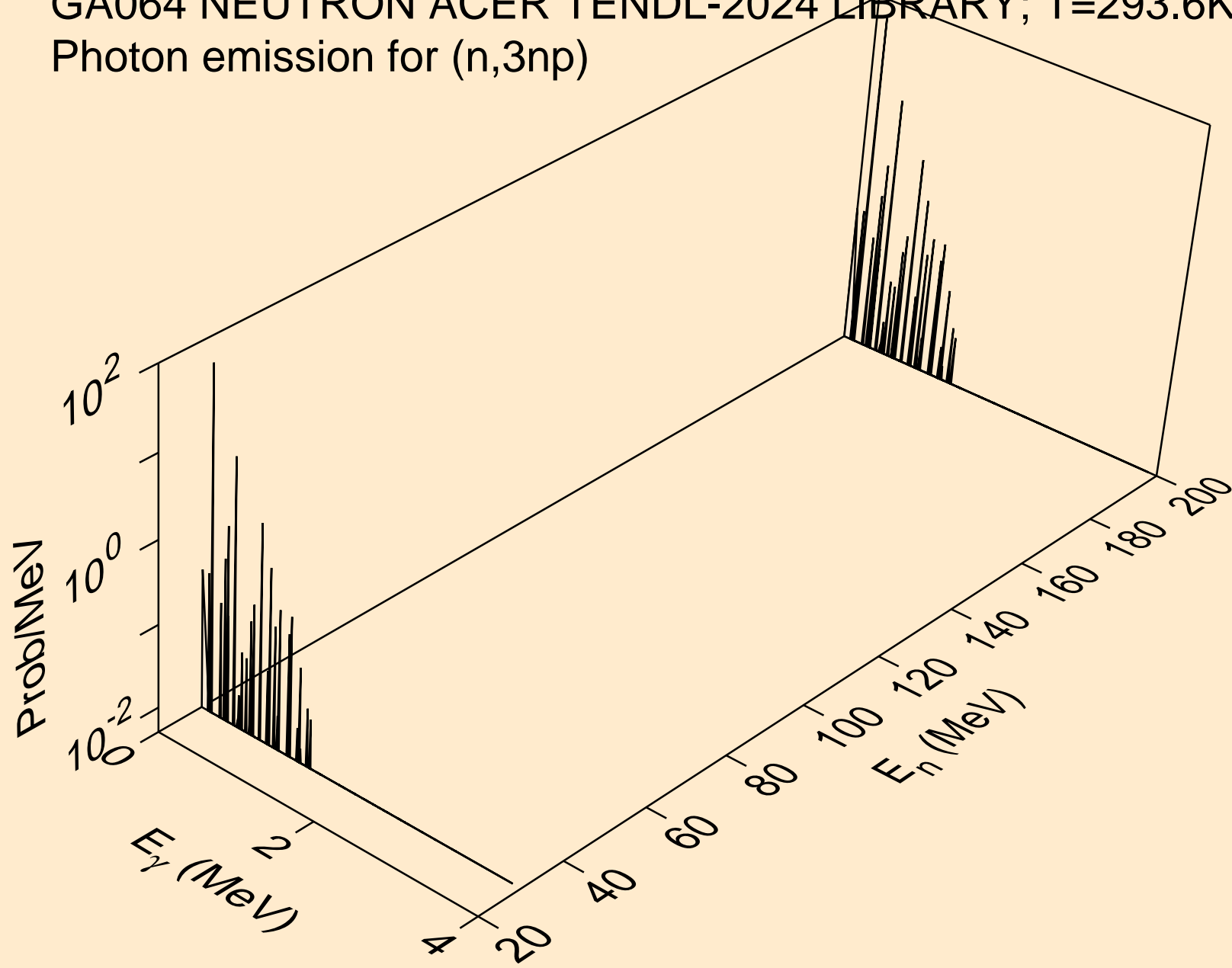

GA064 NEUTRON ACER TENDL-2024 LIBRARY; T=293.6K
Photon emission for (n,n2p)

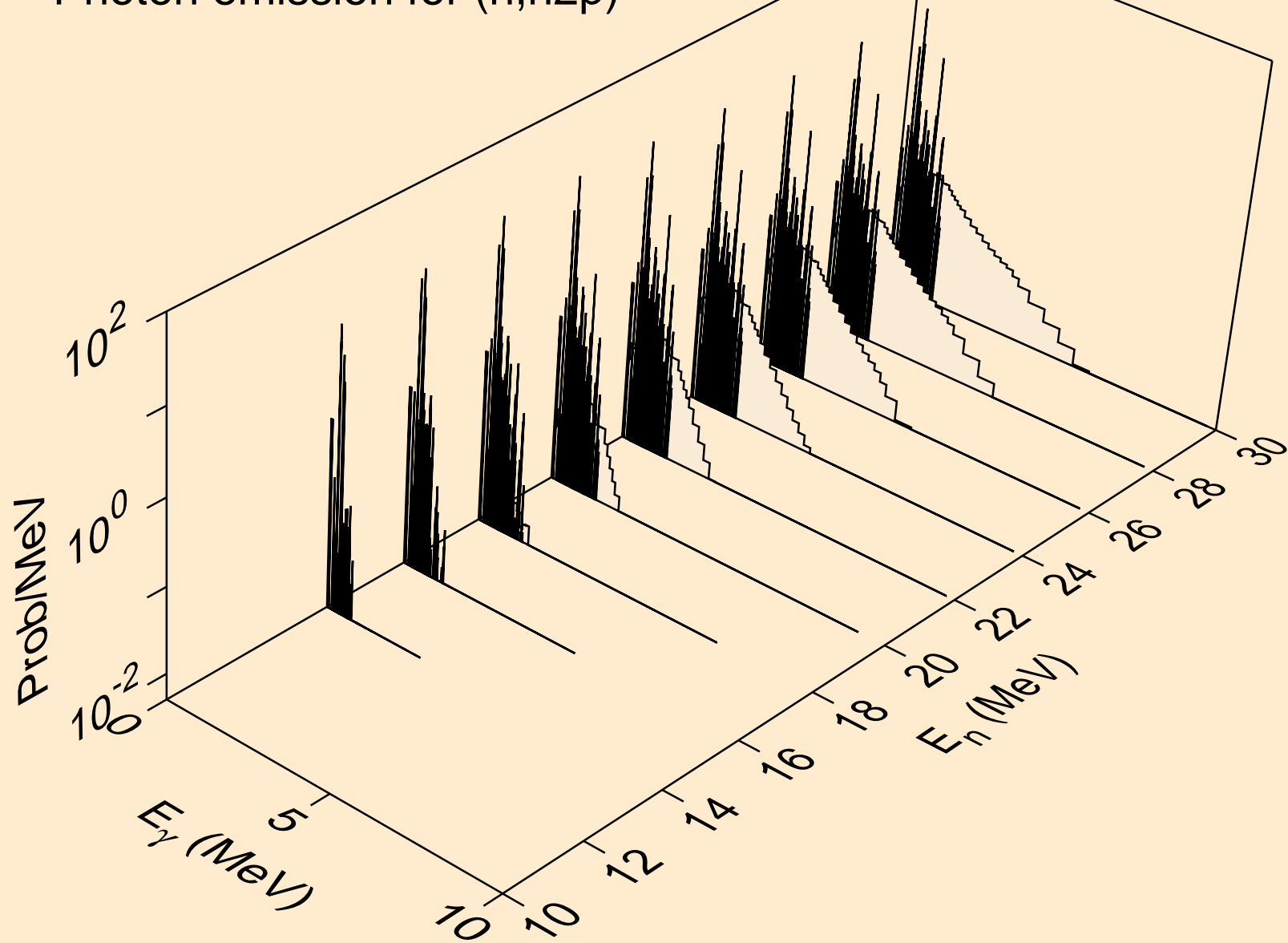

GA064 NEUTRON ACER TENDL-2024 LIBRARY; T=293.6K
Photon emission for (n,npa)

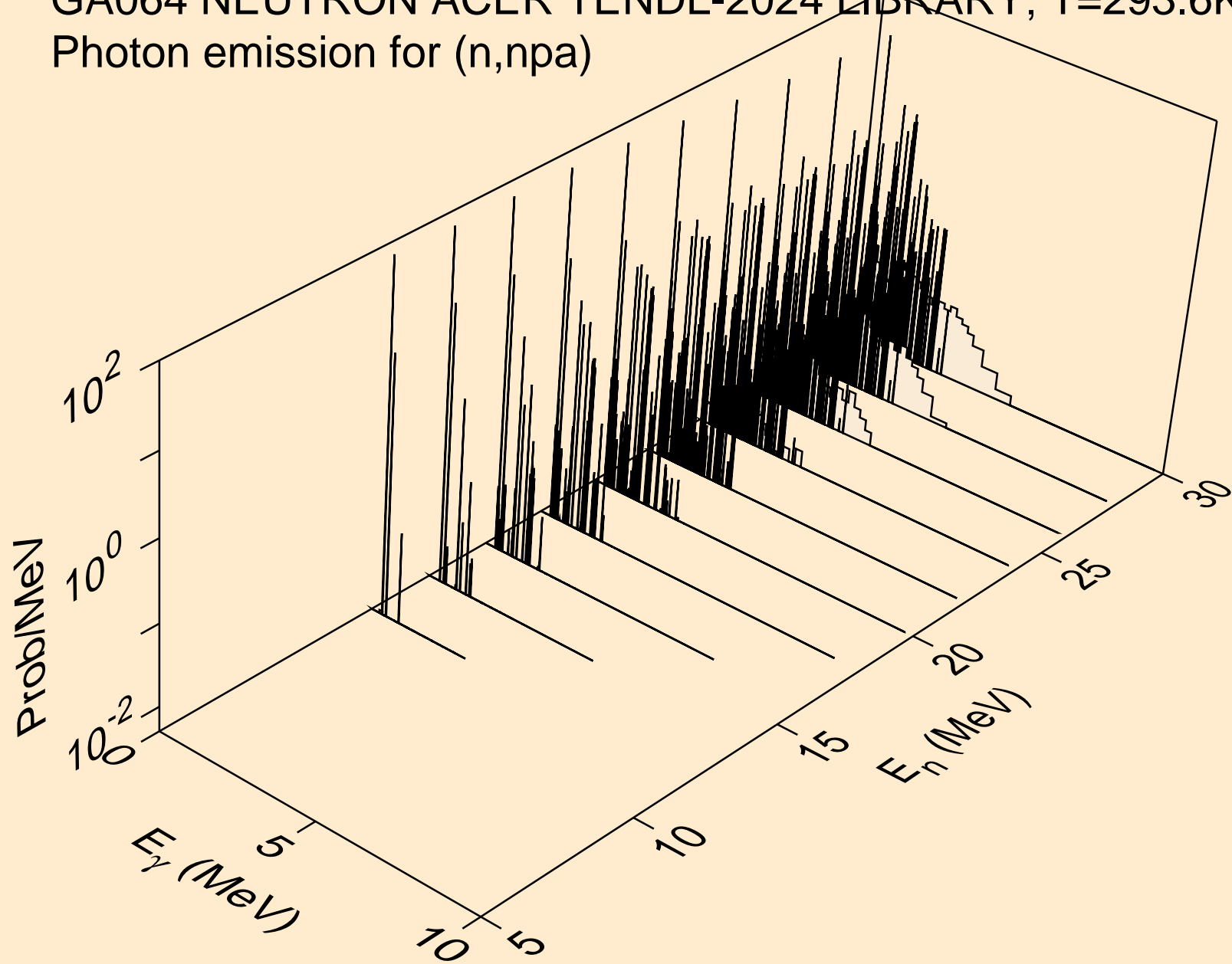

GA064 NEUTRON ACER TENDL-2024 LIBRARY; T=293.6K
Photon emission for (n,n*c)

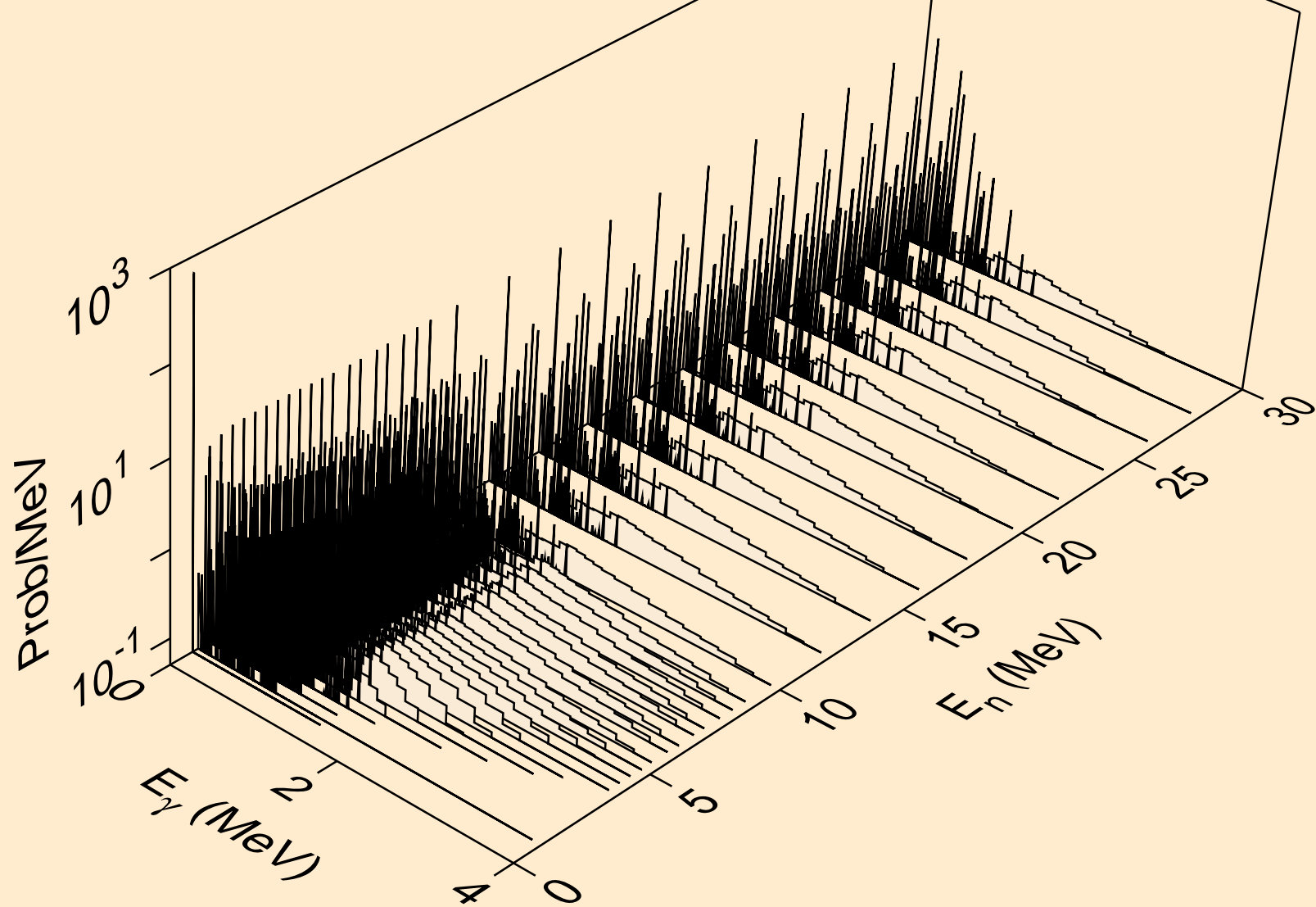

GA064 NEUTRON ACER TENDL-2024 LIBRARY; T=293.6K
Photon emission for (n,gma)

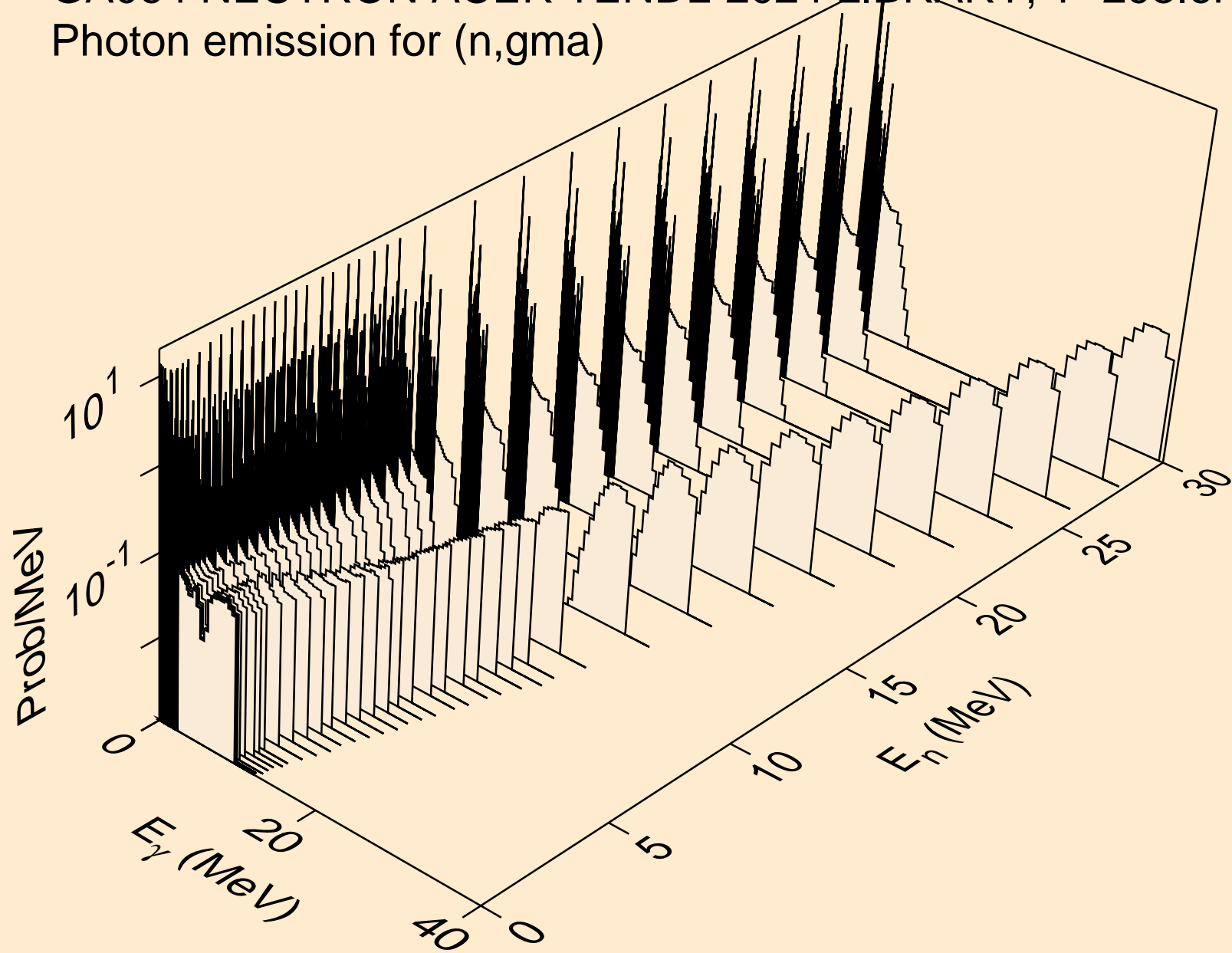

GA064 NEUTRON ACER TENDL-2024 LIBRARY; T=293.6K
Photon emission for (n,p)

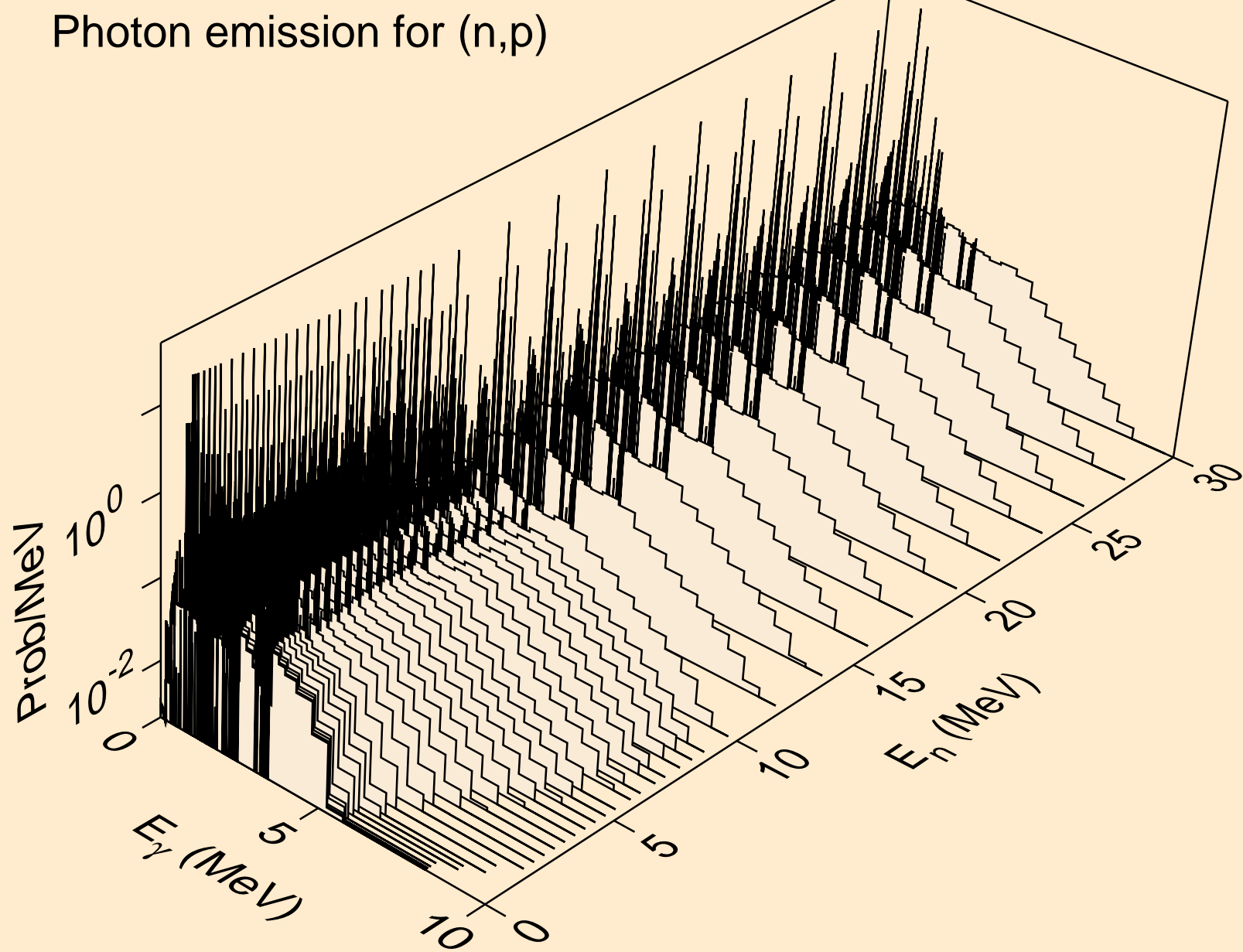

GA064 NEUTRON ACER TENDL-2024 LIBRARY; T=293.6K
Photon emission for (n,d)

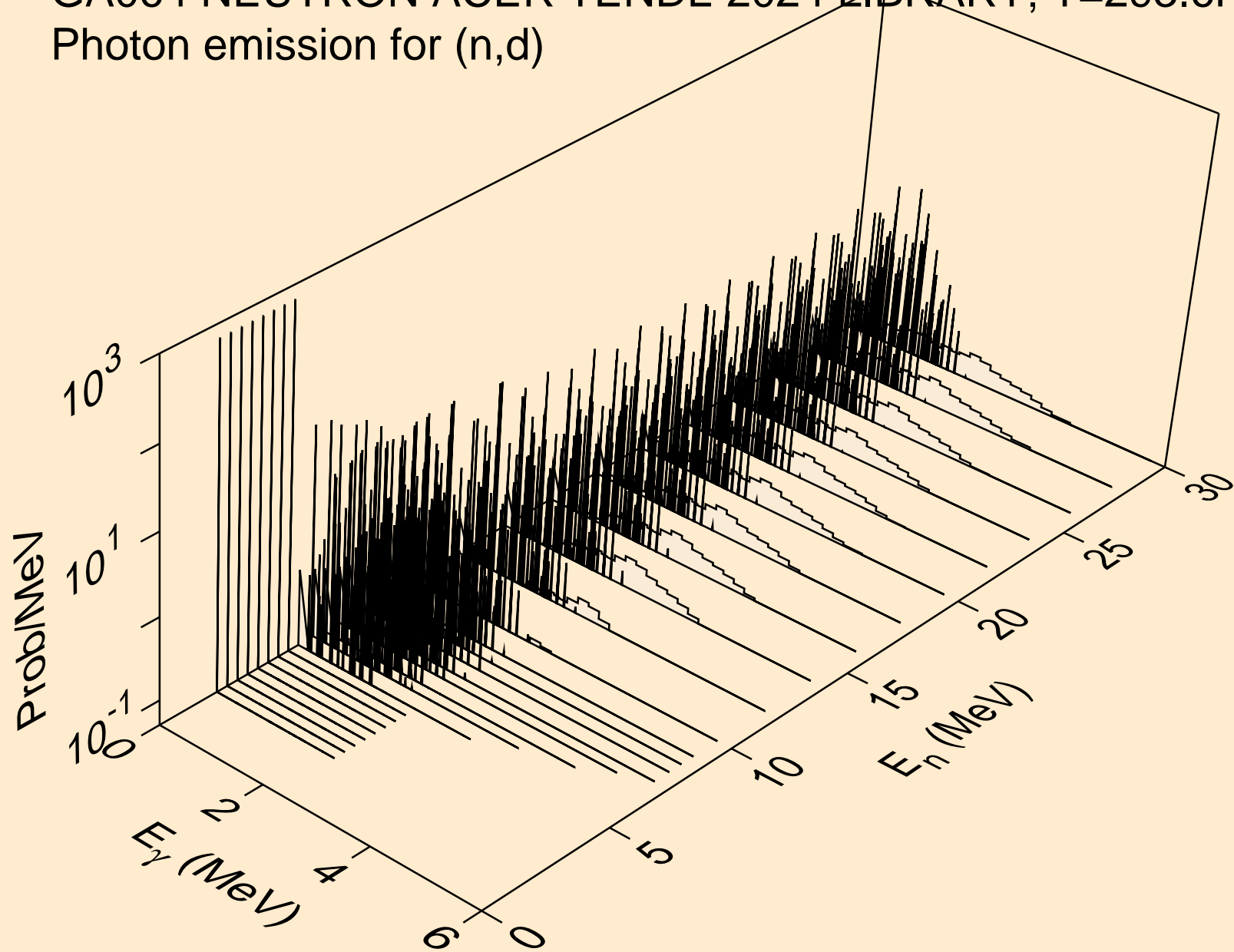

GA064 NEUTRON ACER TENDL-2024 LIBRARY; T=293.6K
Photon emission for (n,t)

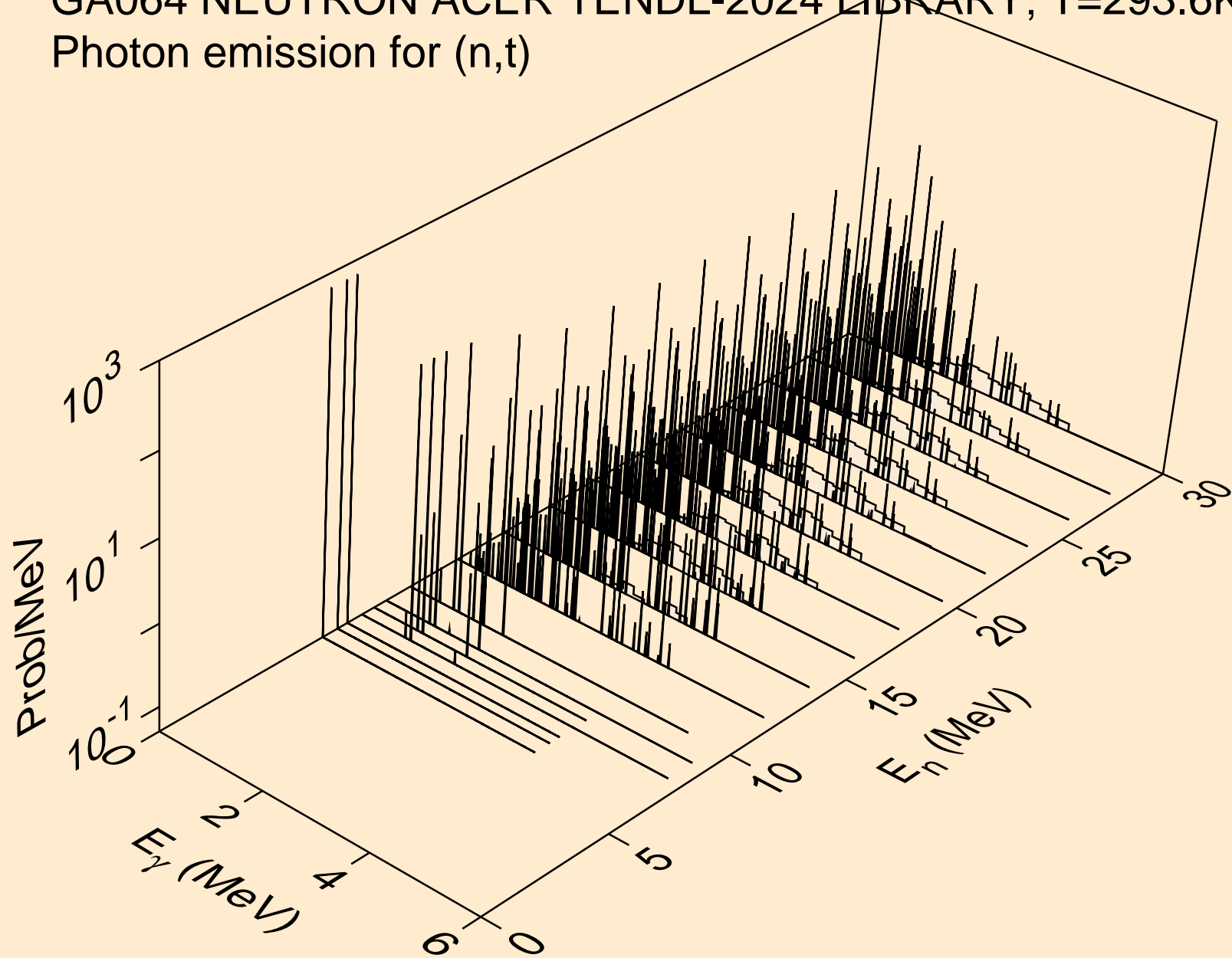

GA064 NEUTRON ACER TENDL-2024 LIBRARY; T=293.6K
Photon emission for (n,he3)

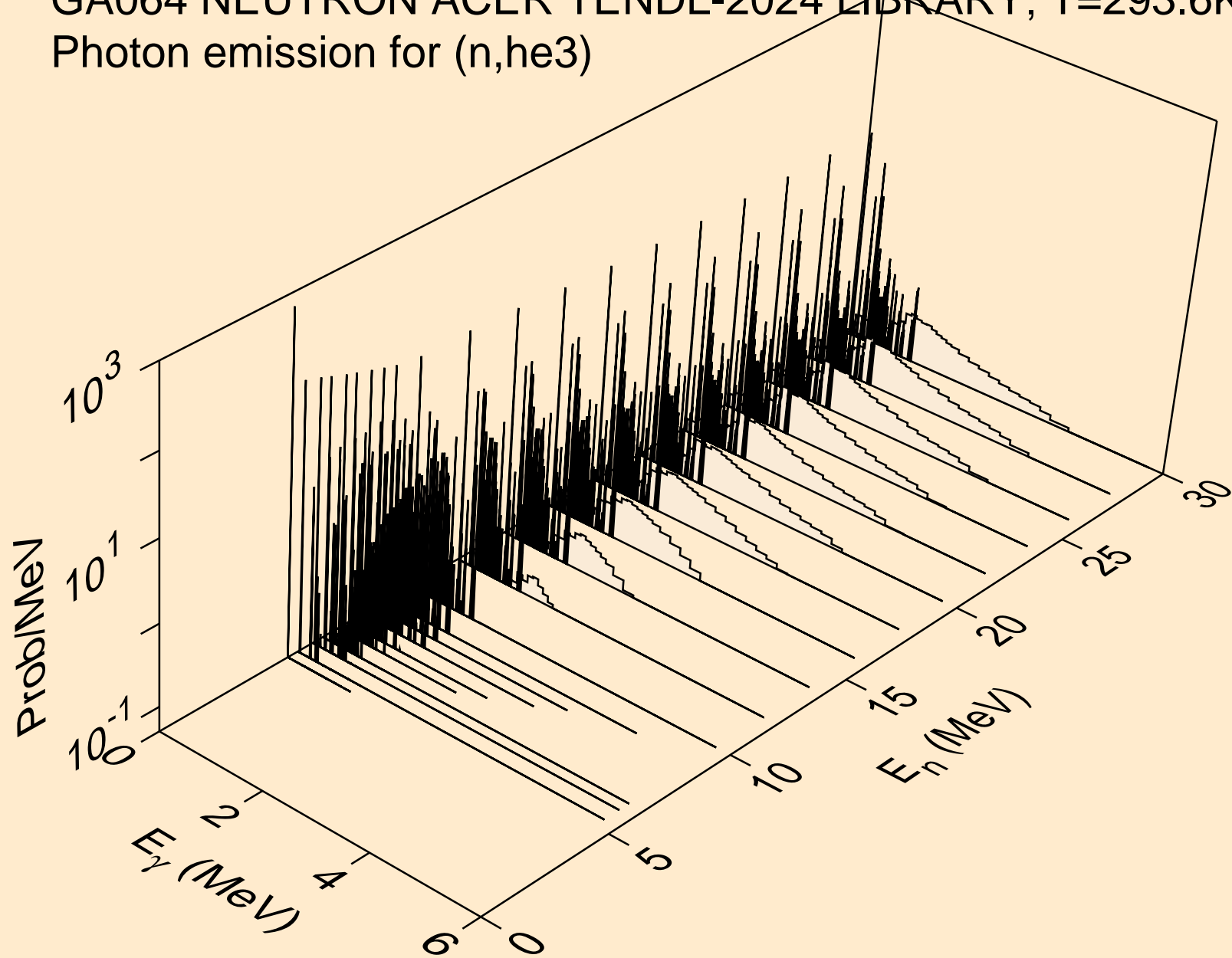

GA064 NEUTRON ACER TENDL-2024 LIBRARY; T=293.6K
Photon emission for (n,a)

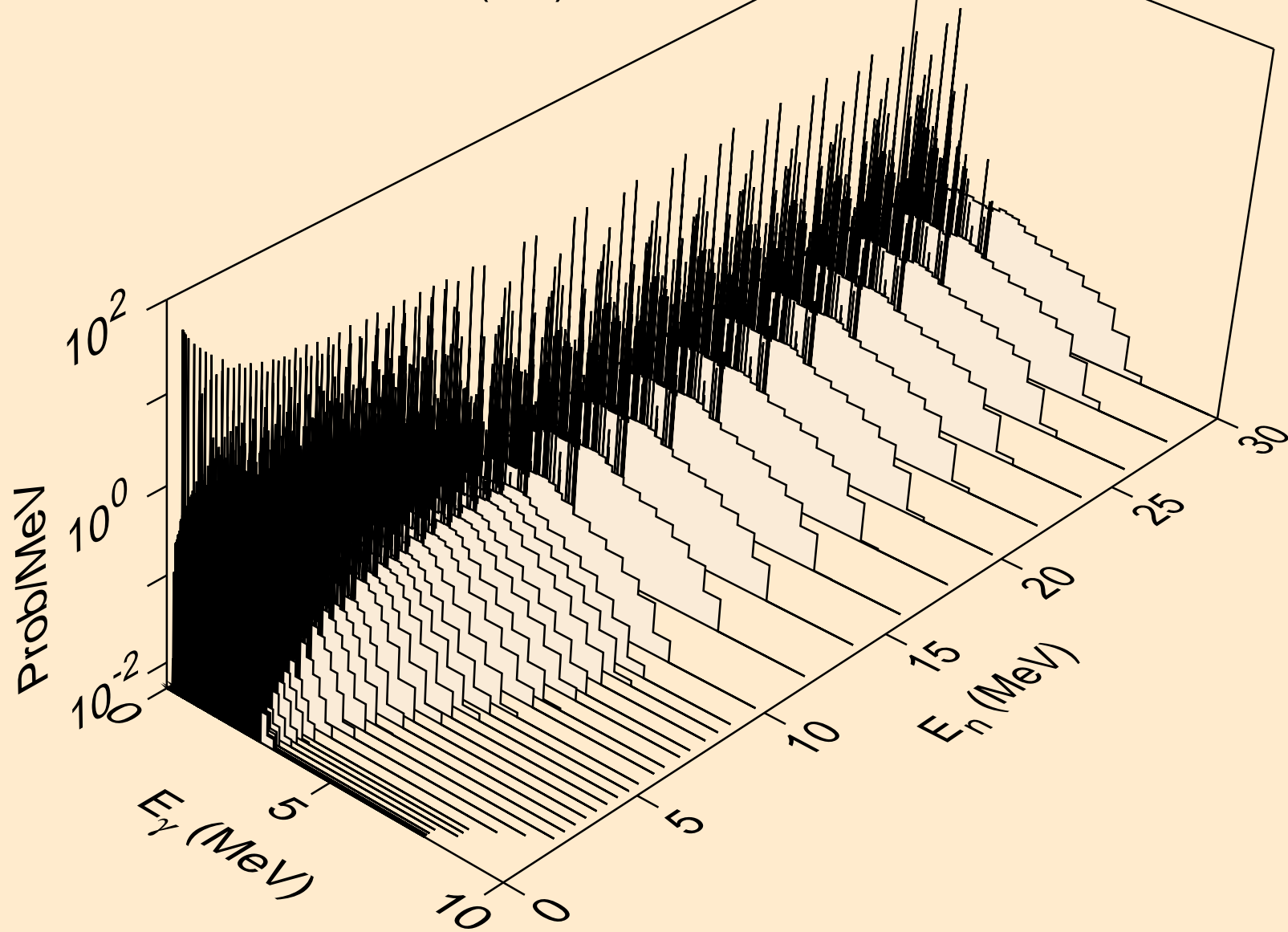

GA064 NEUTRON ACER TENDL-2024 LIBRARY; T=293.6K
Photon emission for (n,2a)

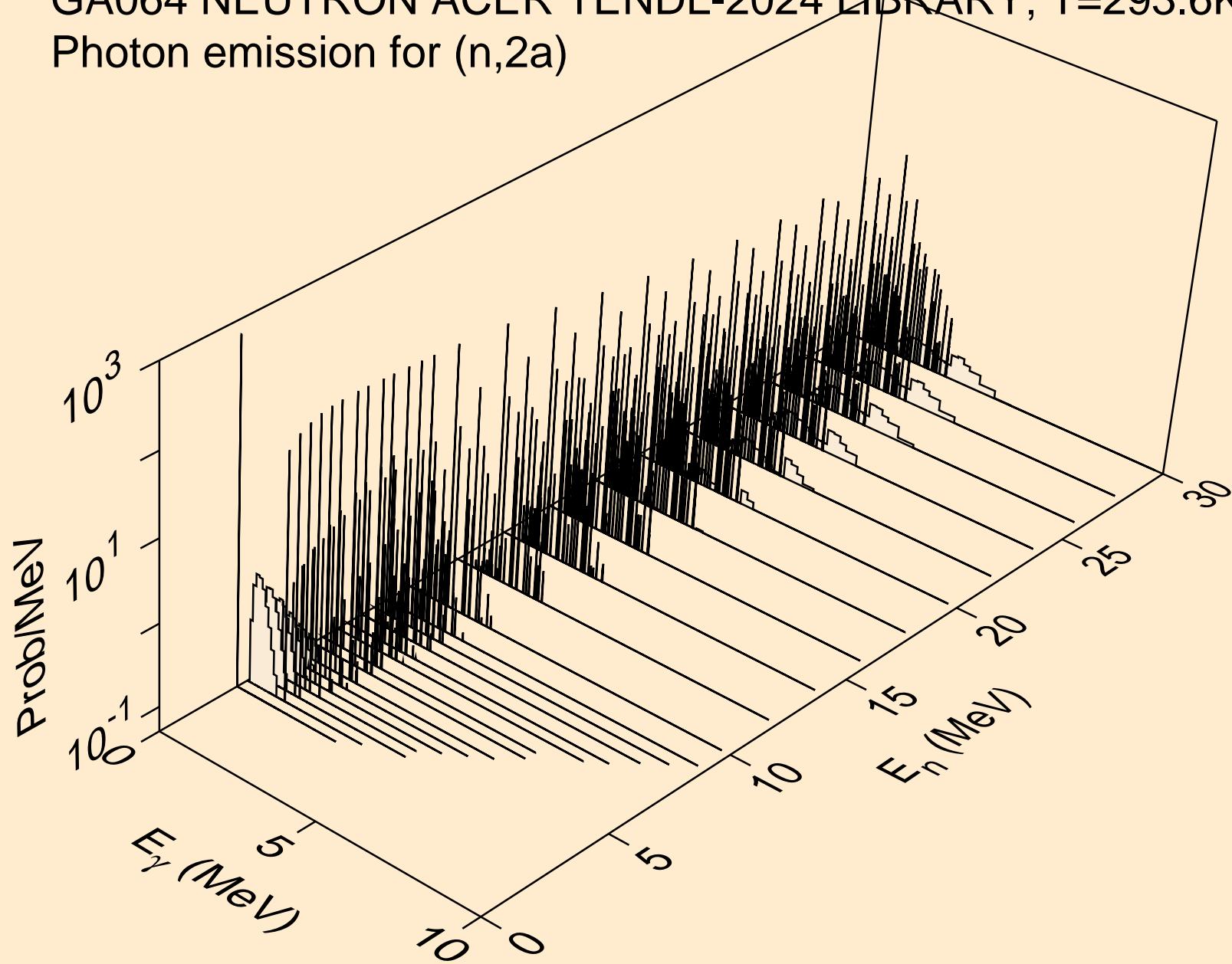

GA064 NEUTRON ACER TENDL-2024 LIBRARY; T=293.6K
Photon emission for (n,3a)

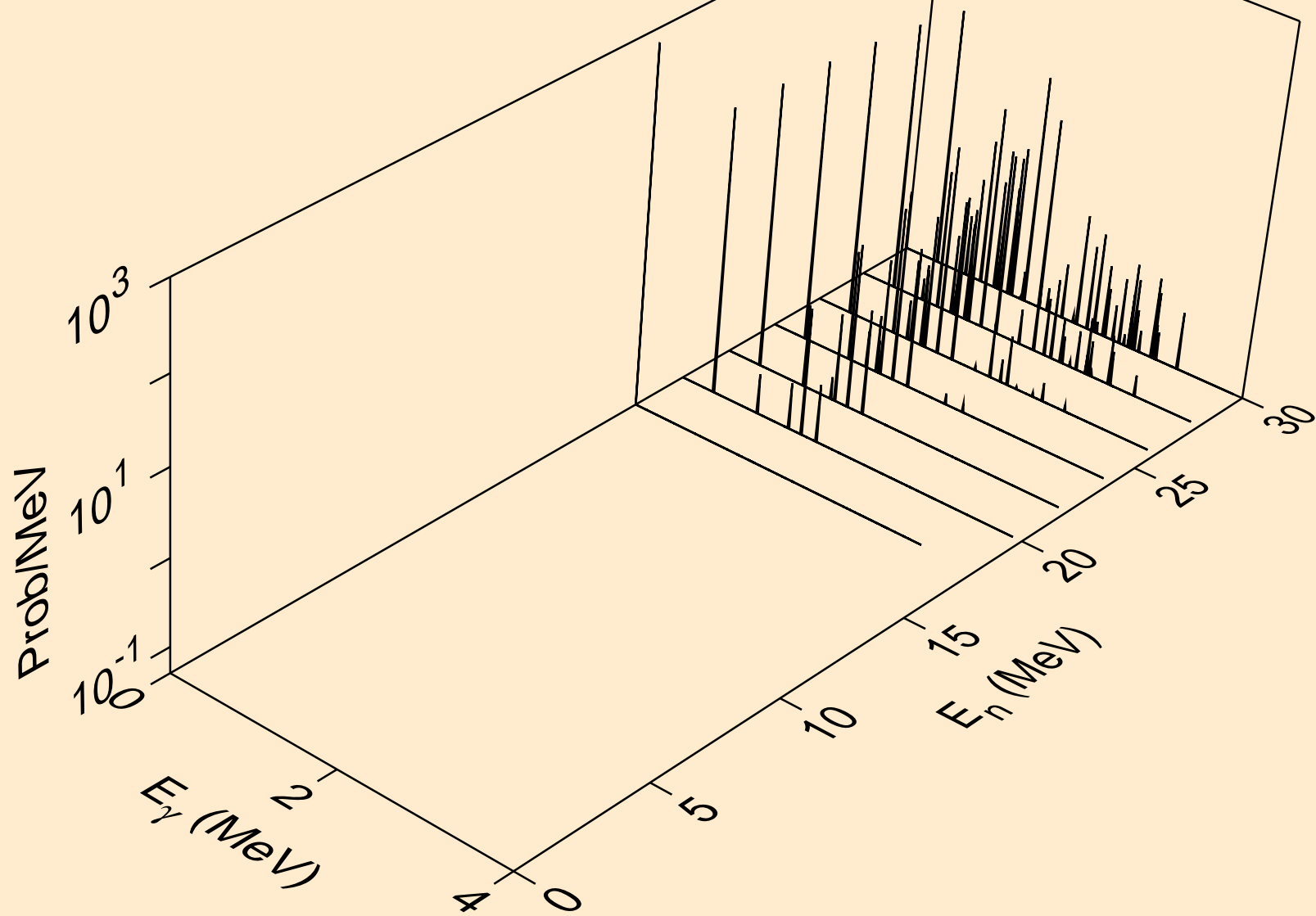

GA064 NEUTRON ACER TENDL-2024 LIBRARY; T=293.6K
Photon emission for (n,2p)

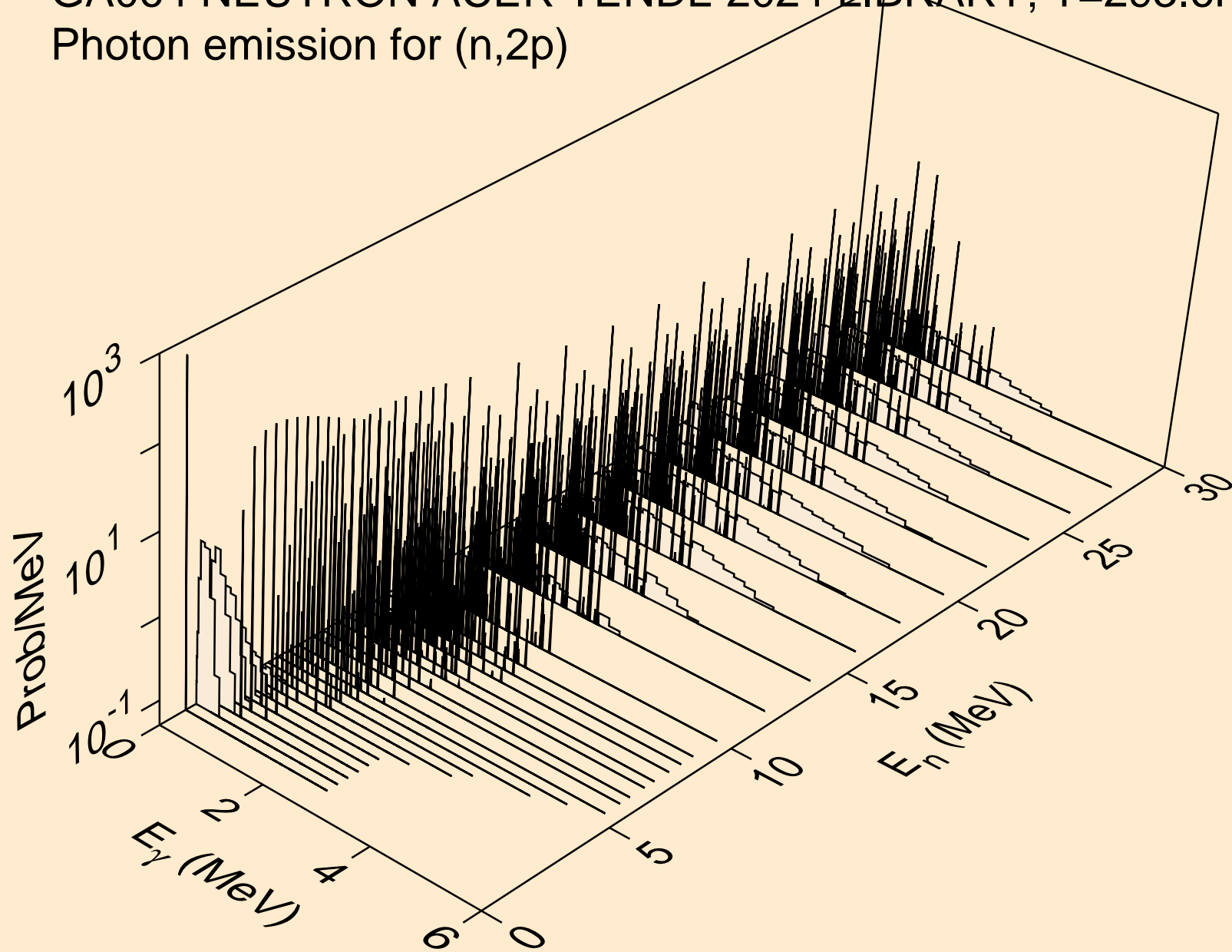

GA064 NEUTRON ACER TENDL-2024 LIBRARY; T=293.6K
Photon emission for (n,p α)

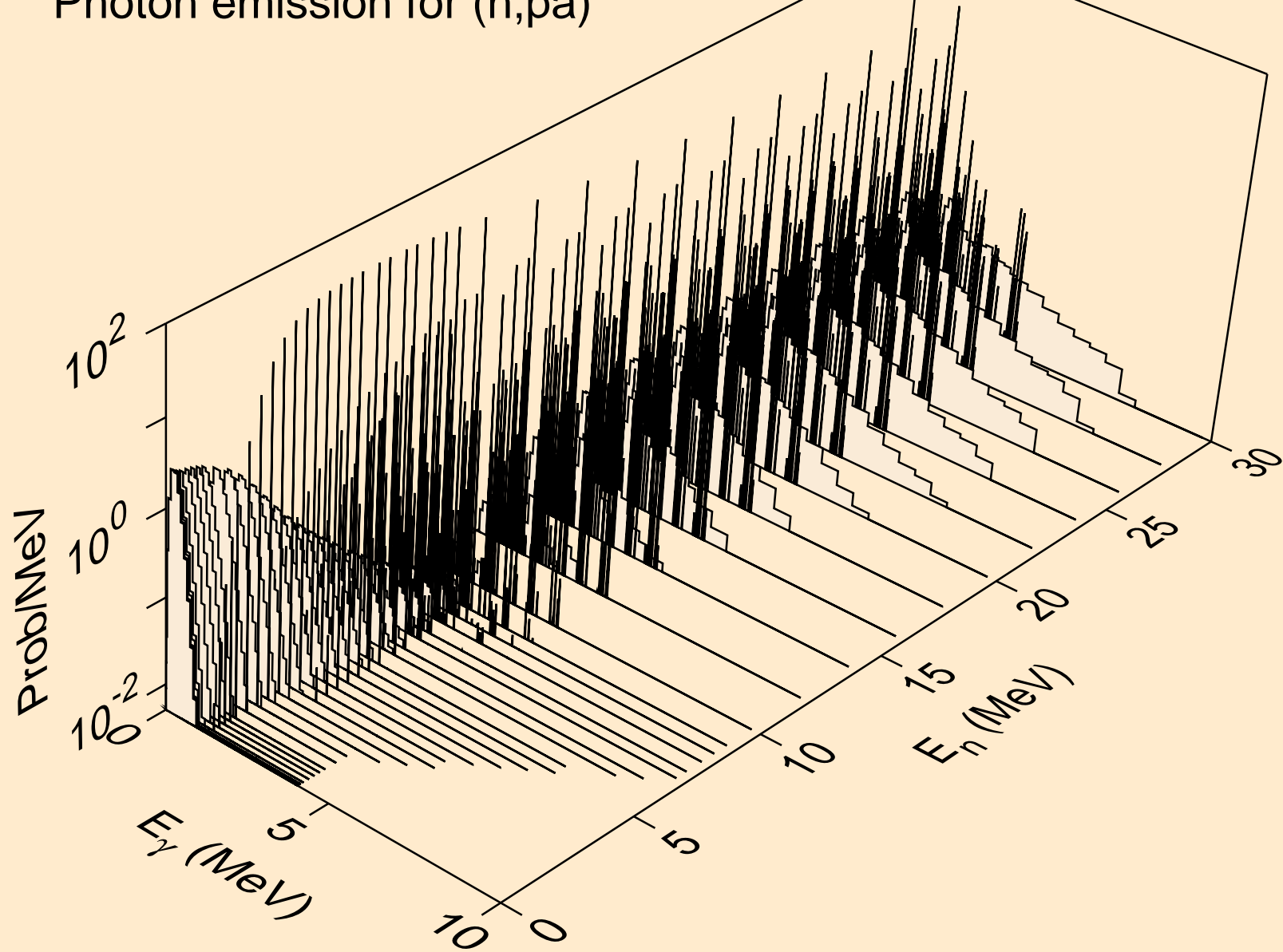

GA064 NEUTRON ACER TENDL-2024 LIBRARY; T=293.6K
Photon emission for (n,d2a)

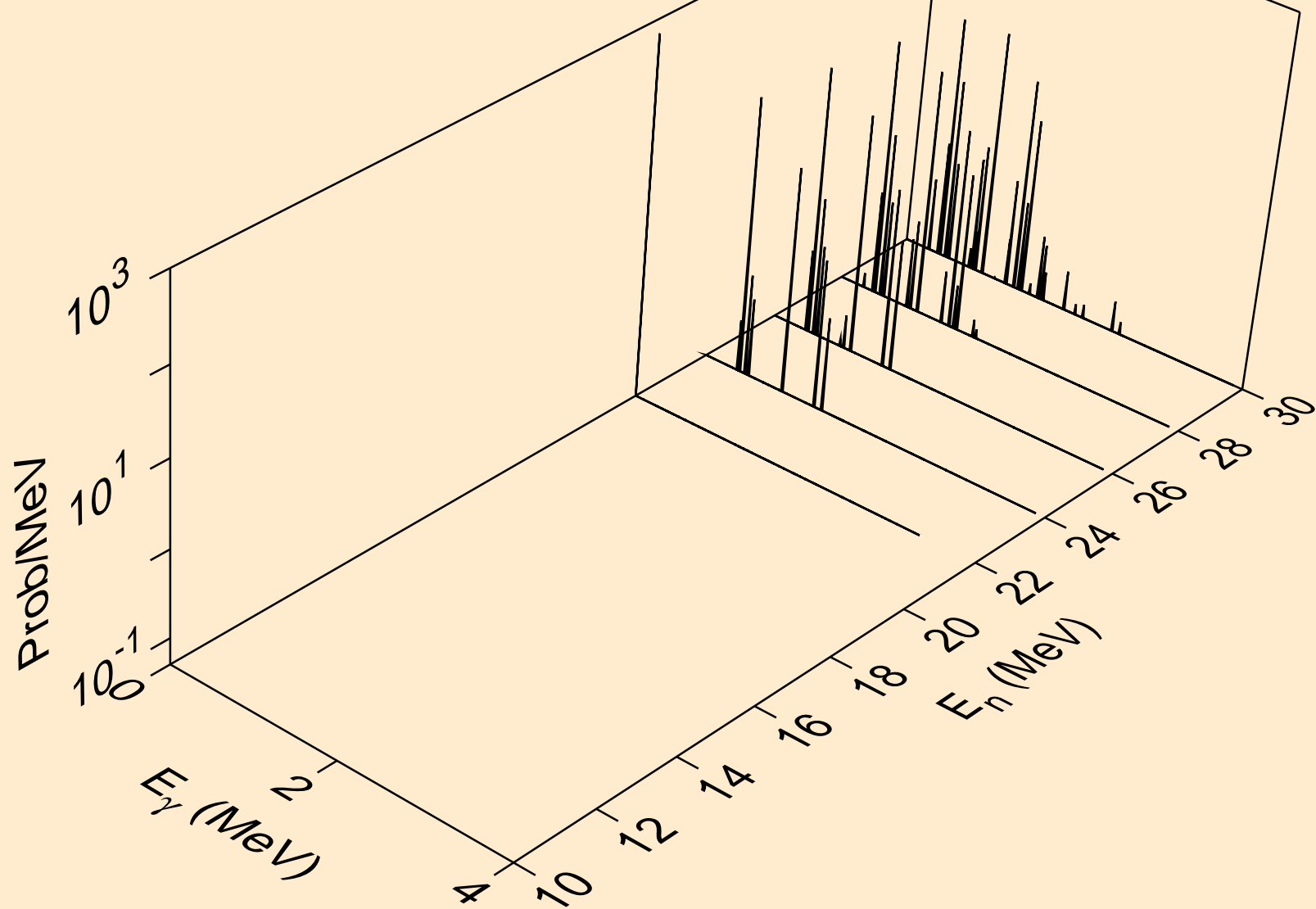

GA064 NEUTRON ACER TENDL-2024 LIBRARY; T=293.6K
Photon emission for (n,pd)

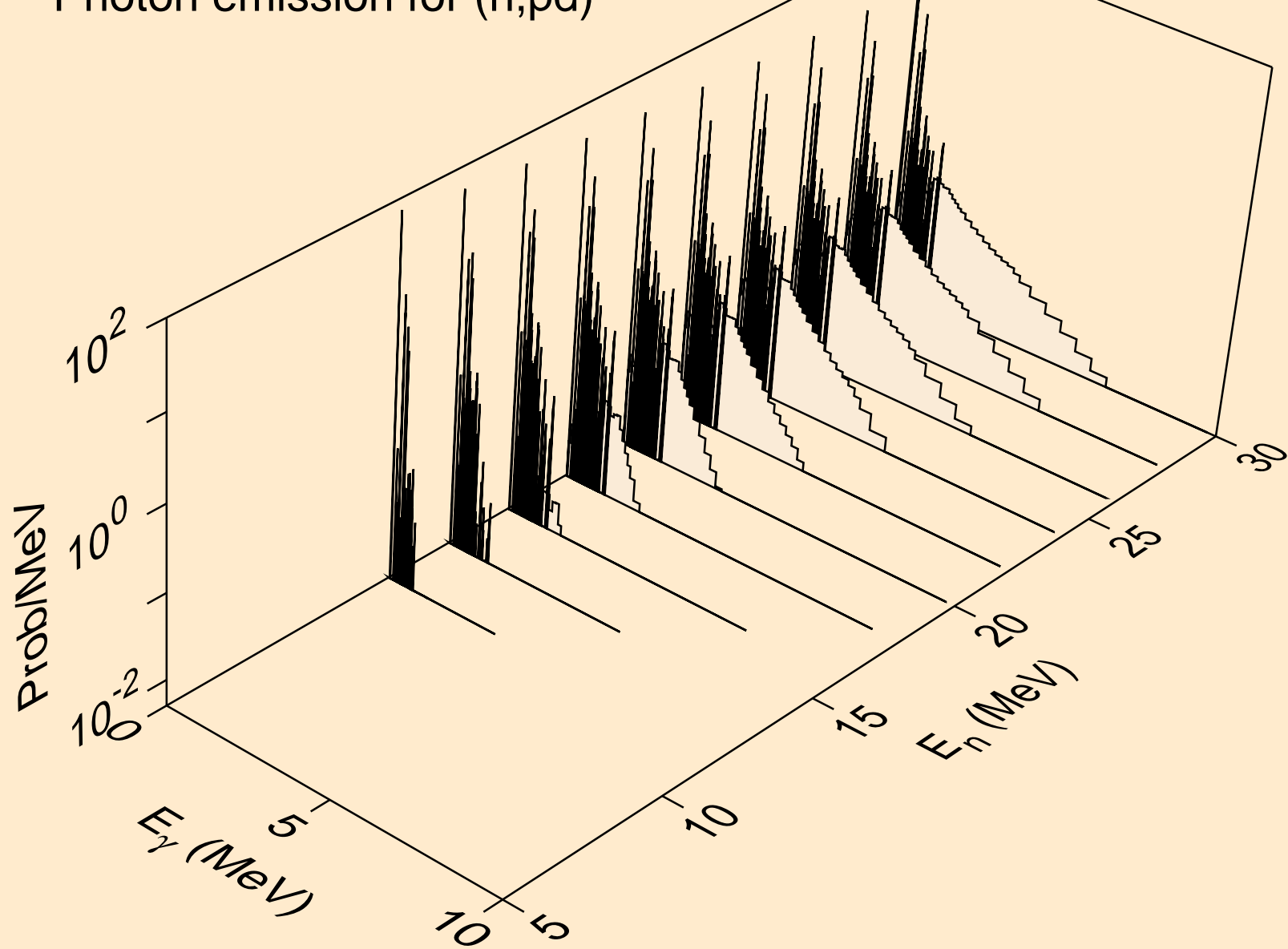

GA064 NEUTRON ACER TENDL-2024 LIBRARY; T=293.6K
Photon emission for (n,pt)

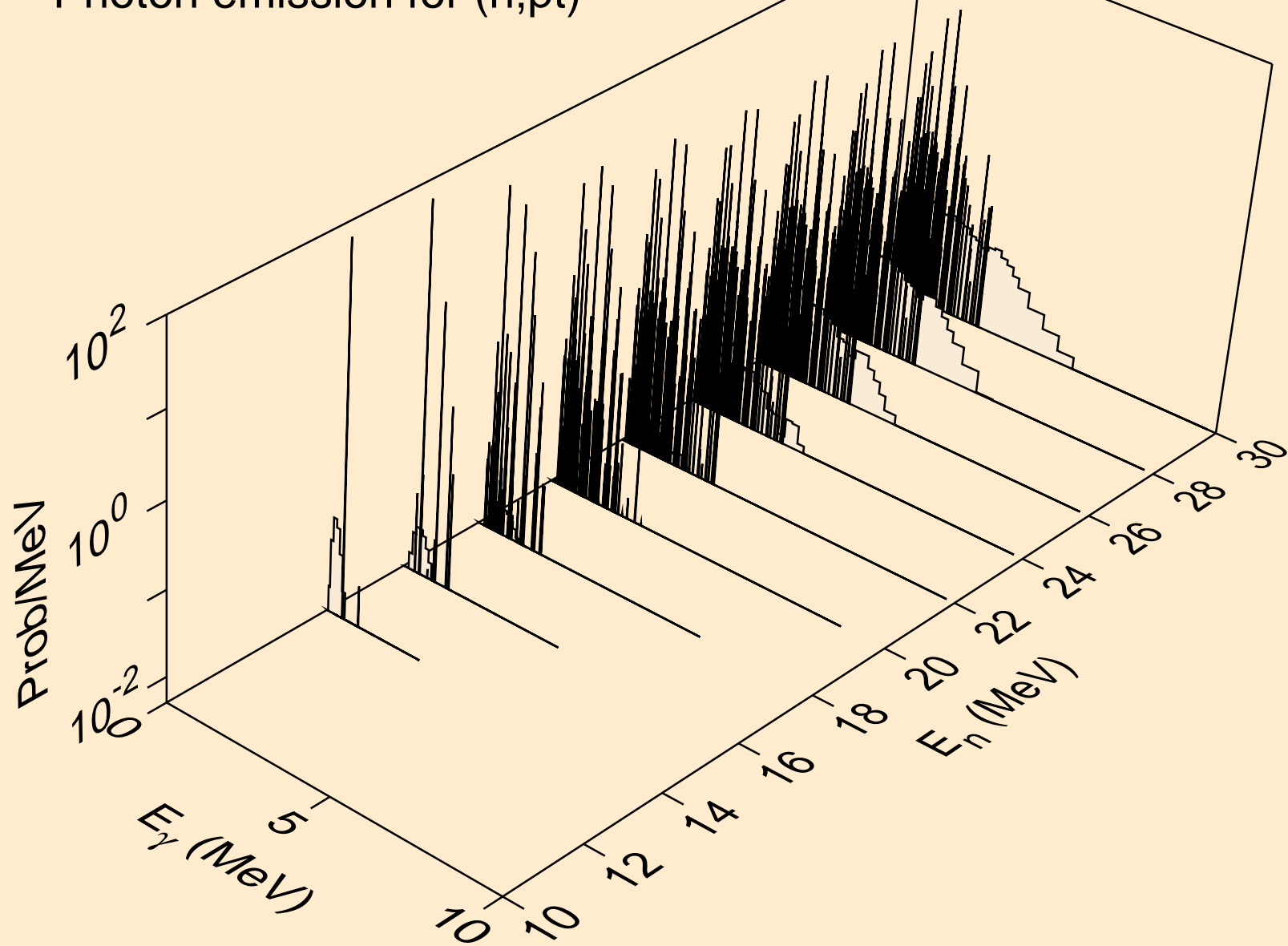

GA064 NEUTRON ACER TENDL-2024 LIBRARY; T=293.6K
Photon emission for (n,da)

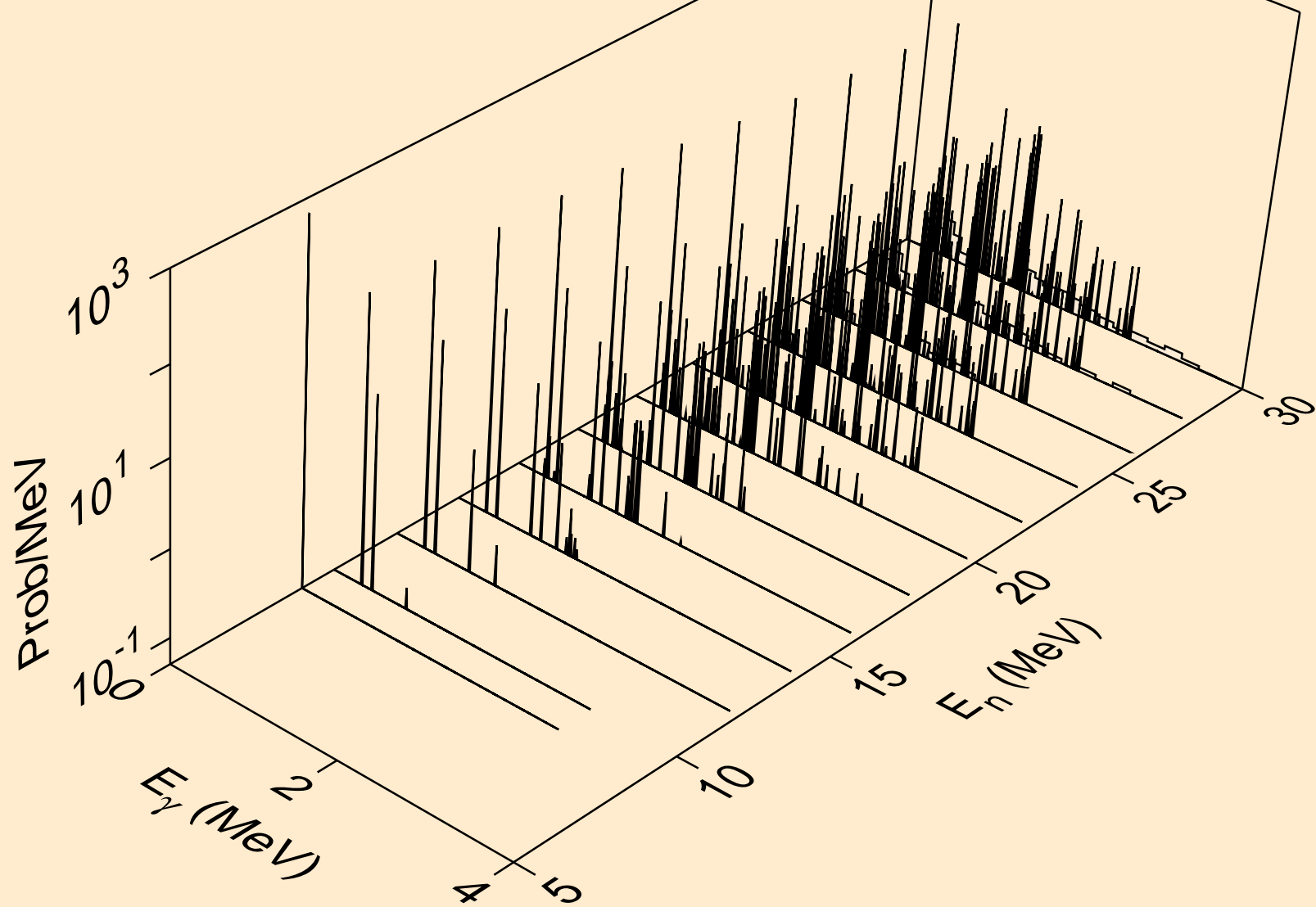

GA064 NEUTRON ACER TENDL-2024 LIBRARY; T=293.6K
thermal capture photon spectrum

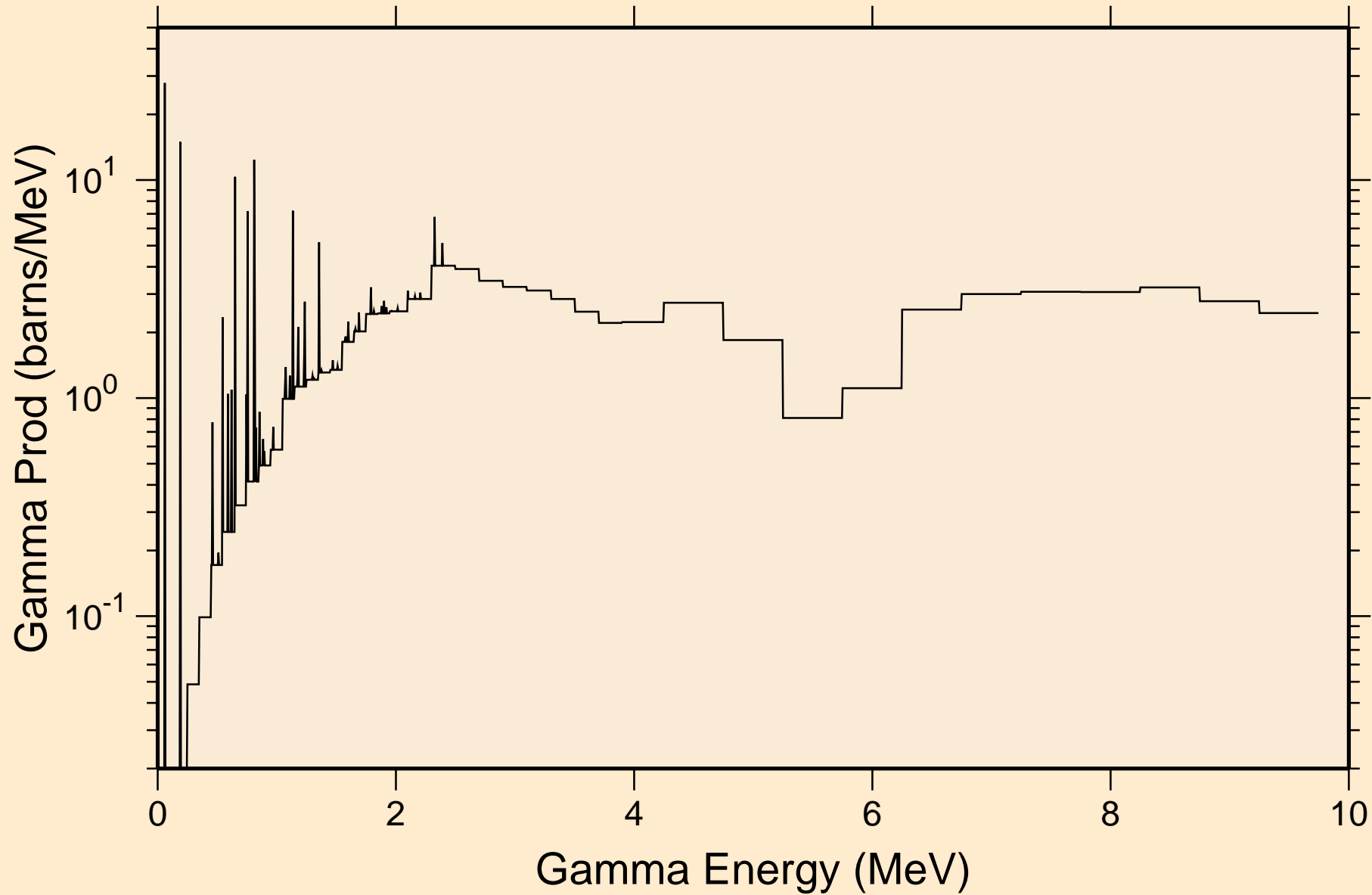

GA064 NEUTRON ACER TENDL-2024 LIBRARY; T=293.6K
14 MeV photon spectrum

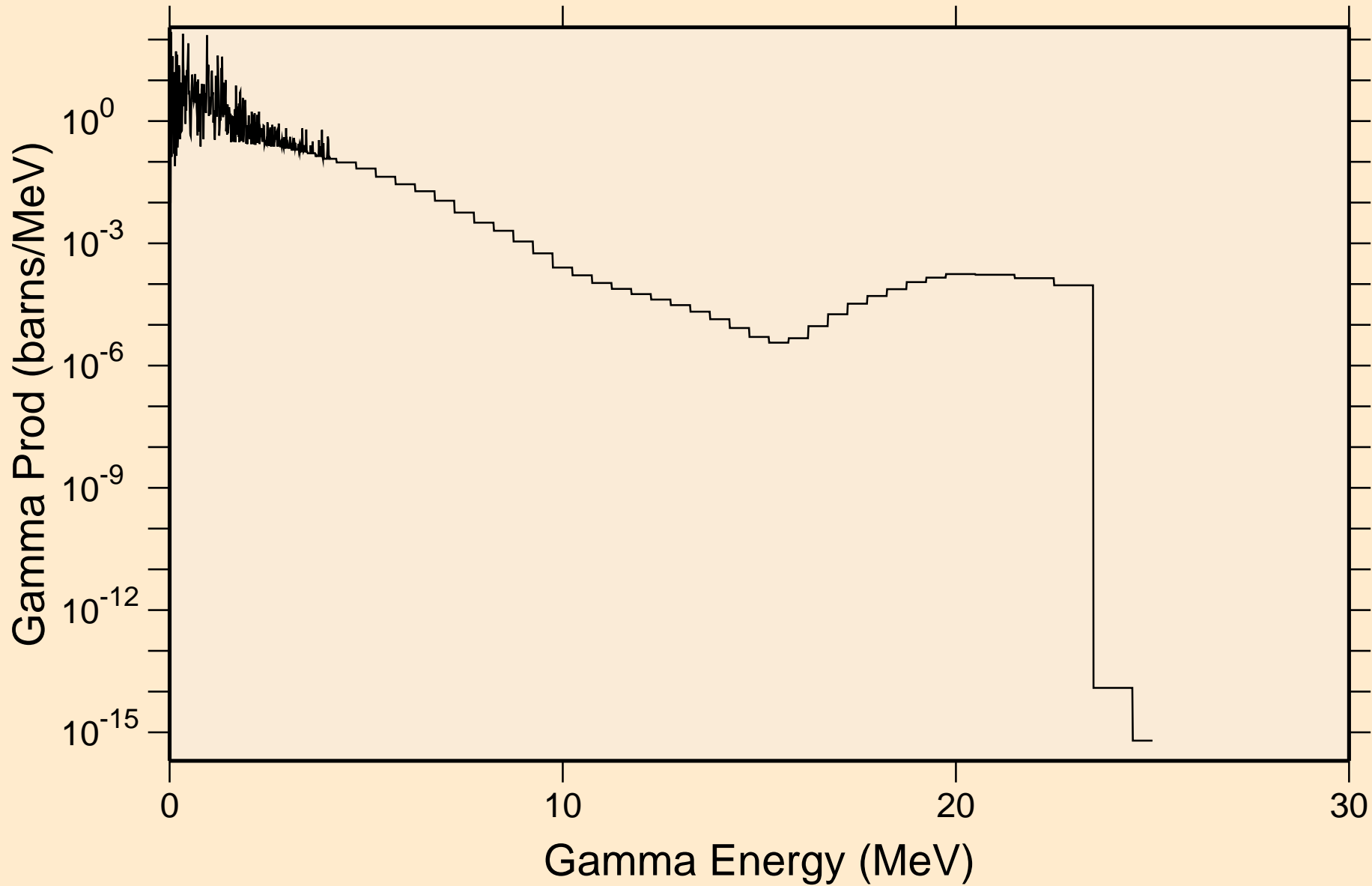

GA064 NEUTRON ACER TENDL-2024 LIBRARY; T=293.6K
Particle heating contributions

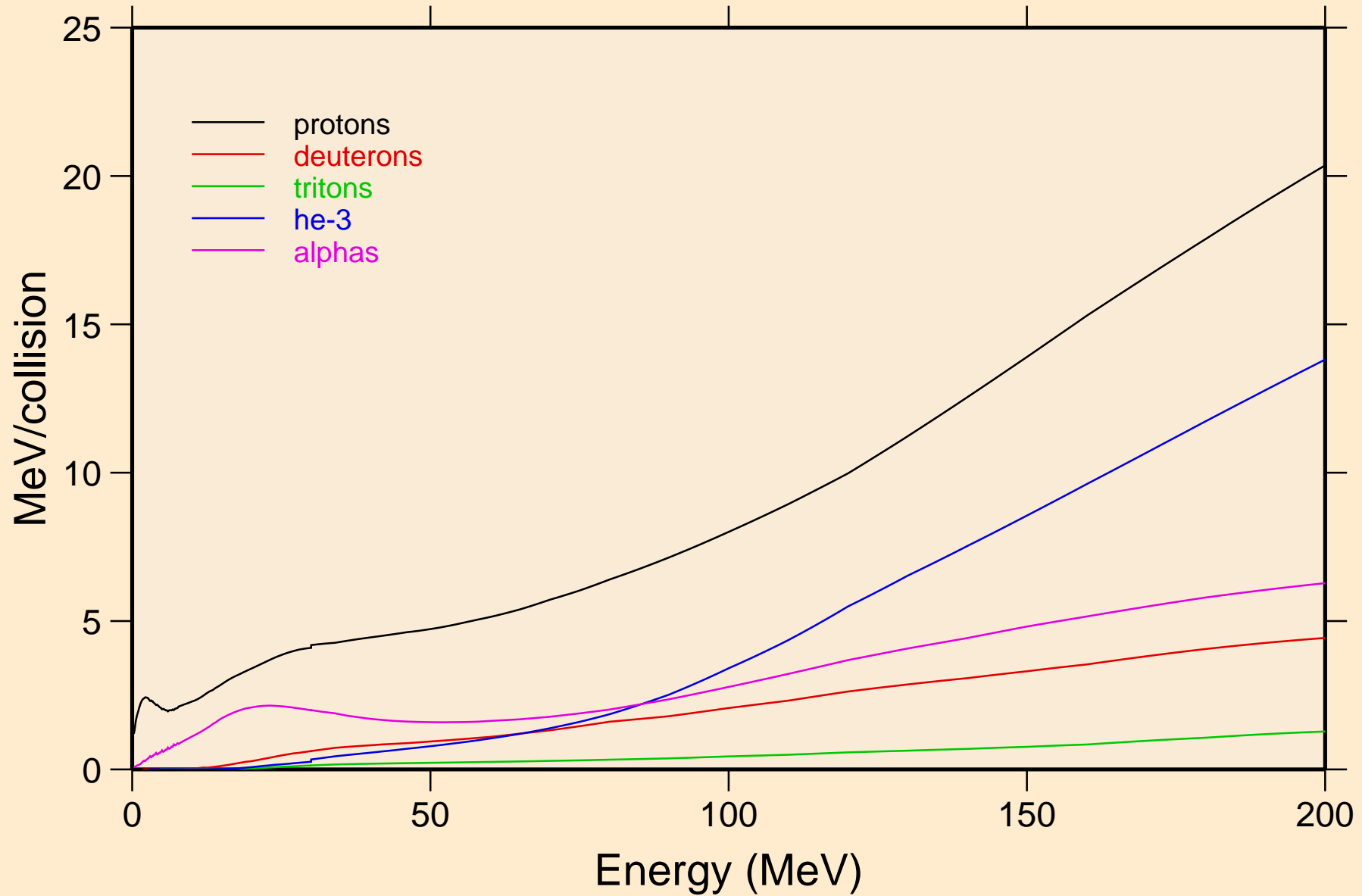

GA064 NEUTRON ACER TENDL-2024 LIBRARY; T=293.6K
Recoil Heating

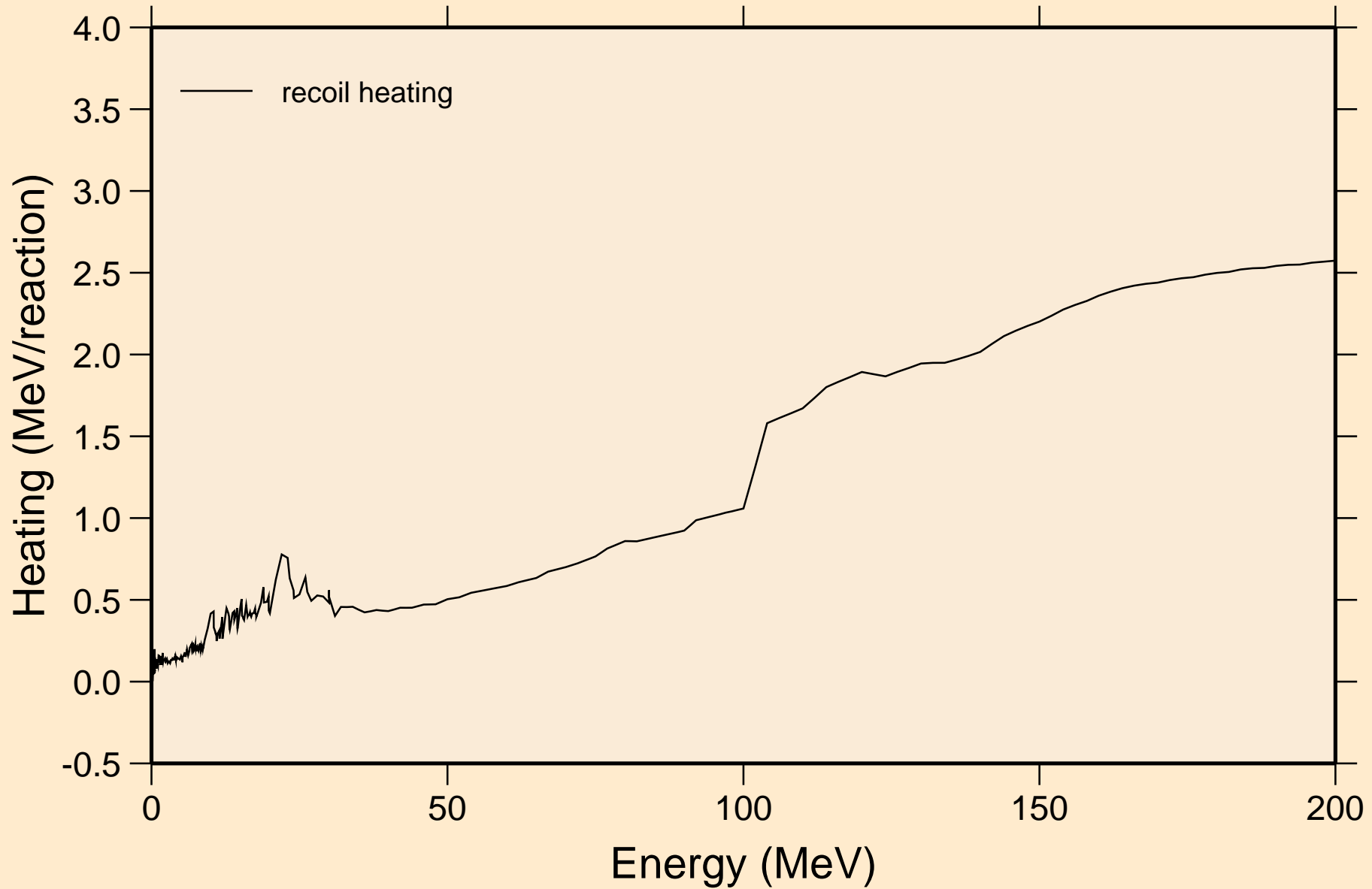

GA064 NEUTRON ACER TENDL-2024 LIBRARY; T=293.6K

Particle production cross sections

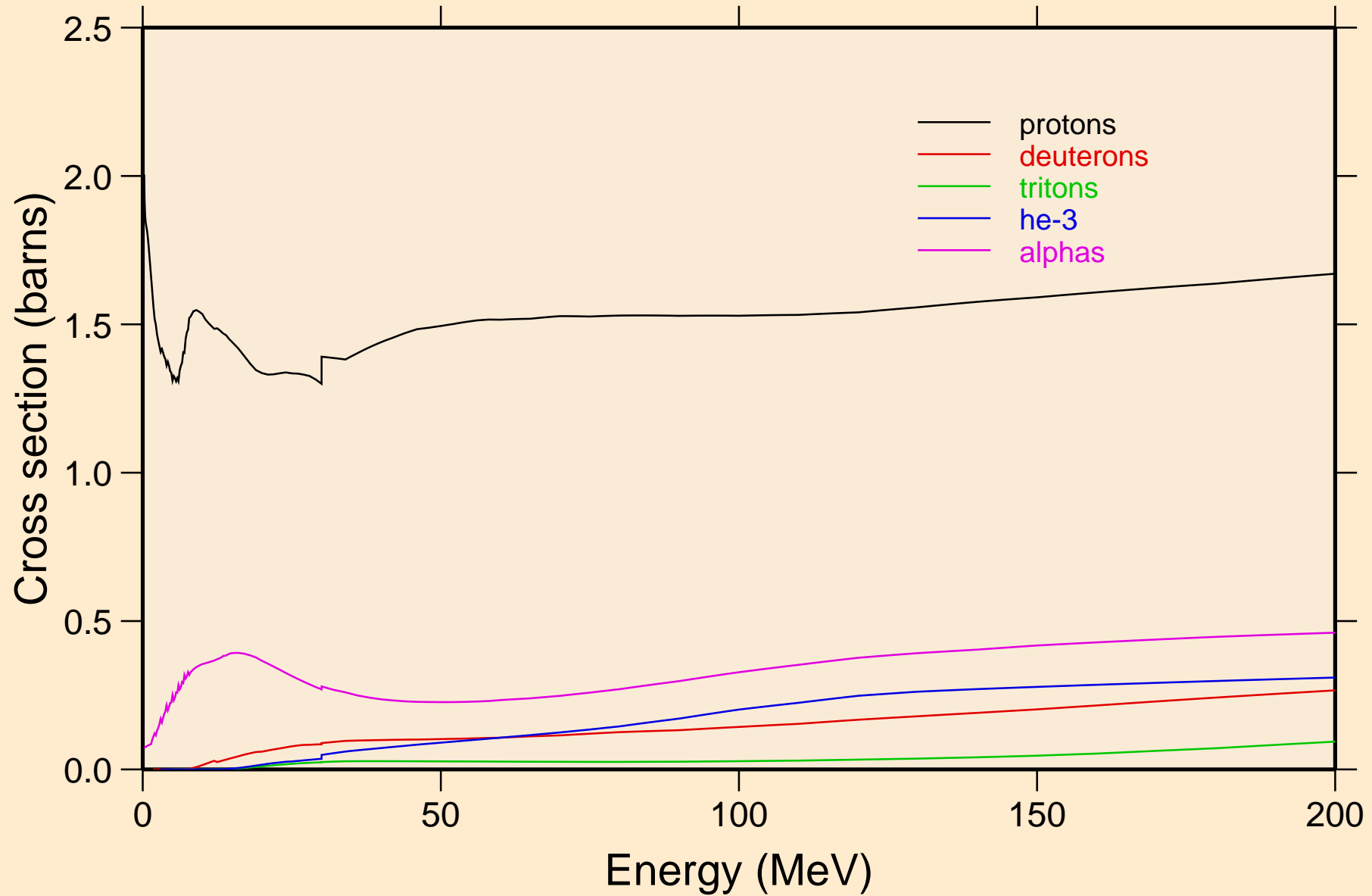

GA064 NEUTRON ACER TENDL-2024 LIBRARY; T=293.6K
protons from (n,x)

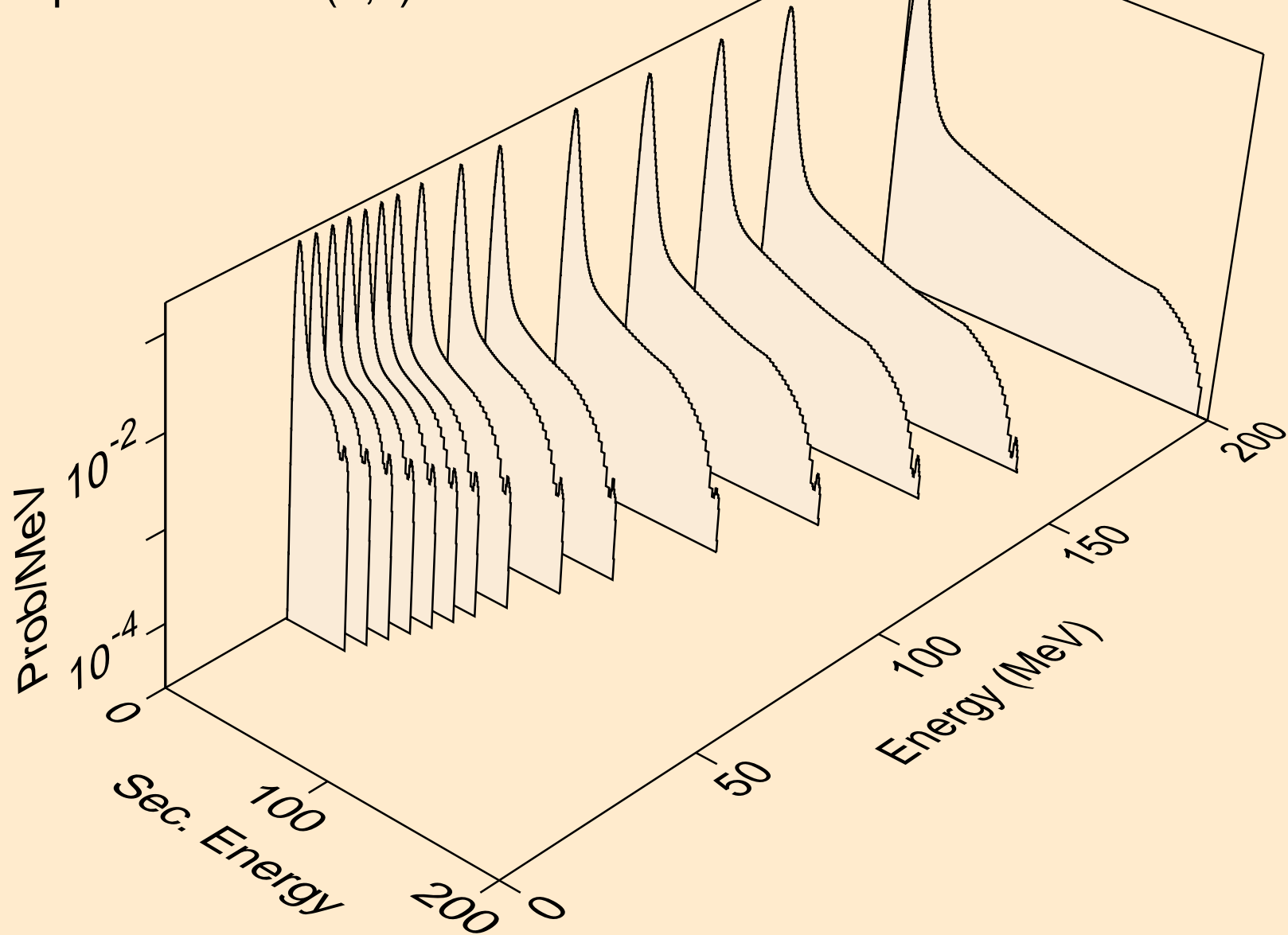

GA064 NEUTRON ACER TENDL-2024 LIBRARY; T=293.6K
protons from (n,n*)p

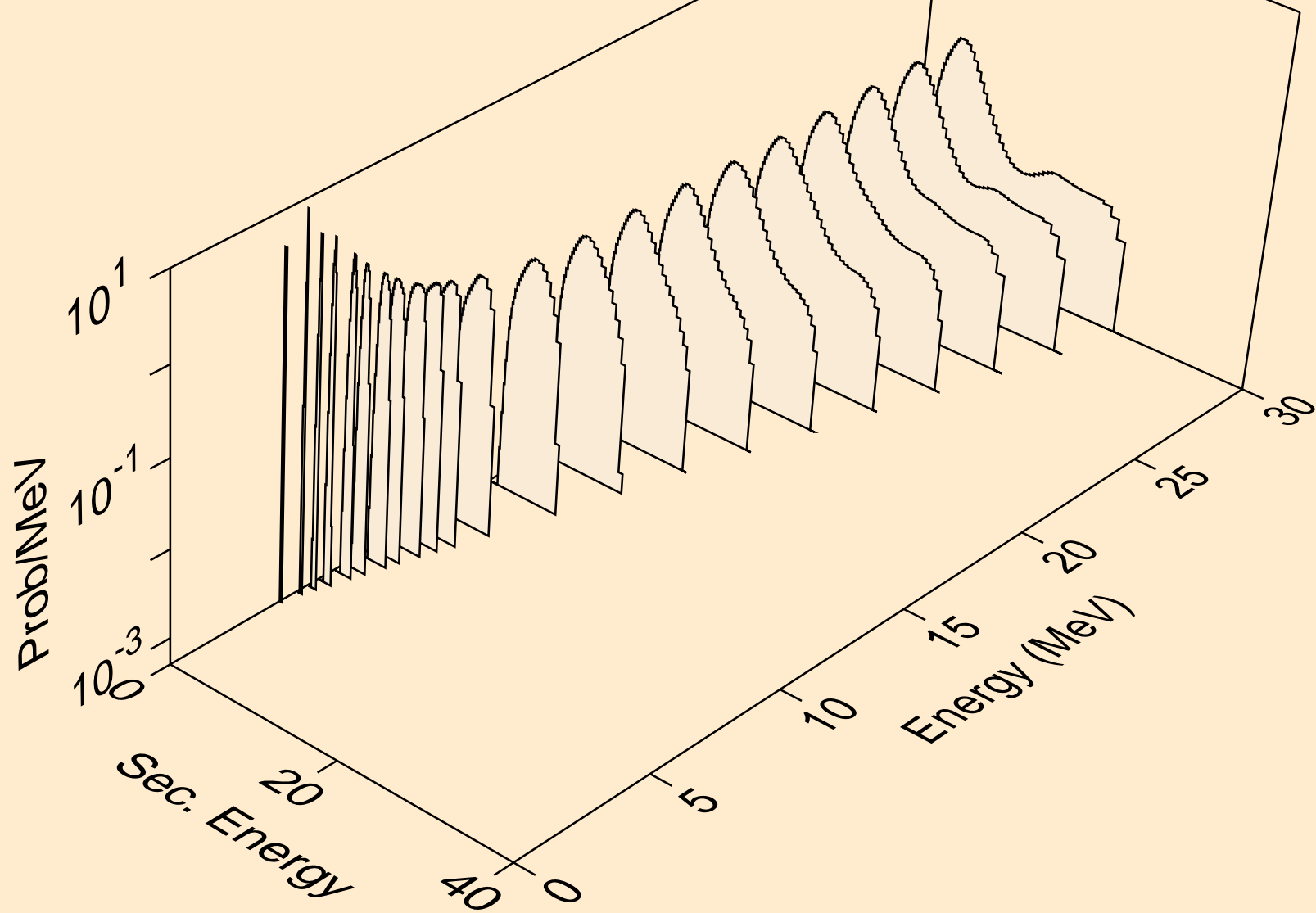

GA064 NEUTRON ACER TENDL-2024 LIBRARY; T=293.6K
protons from (n,2np)

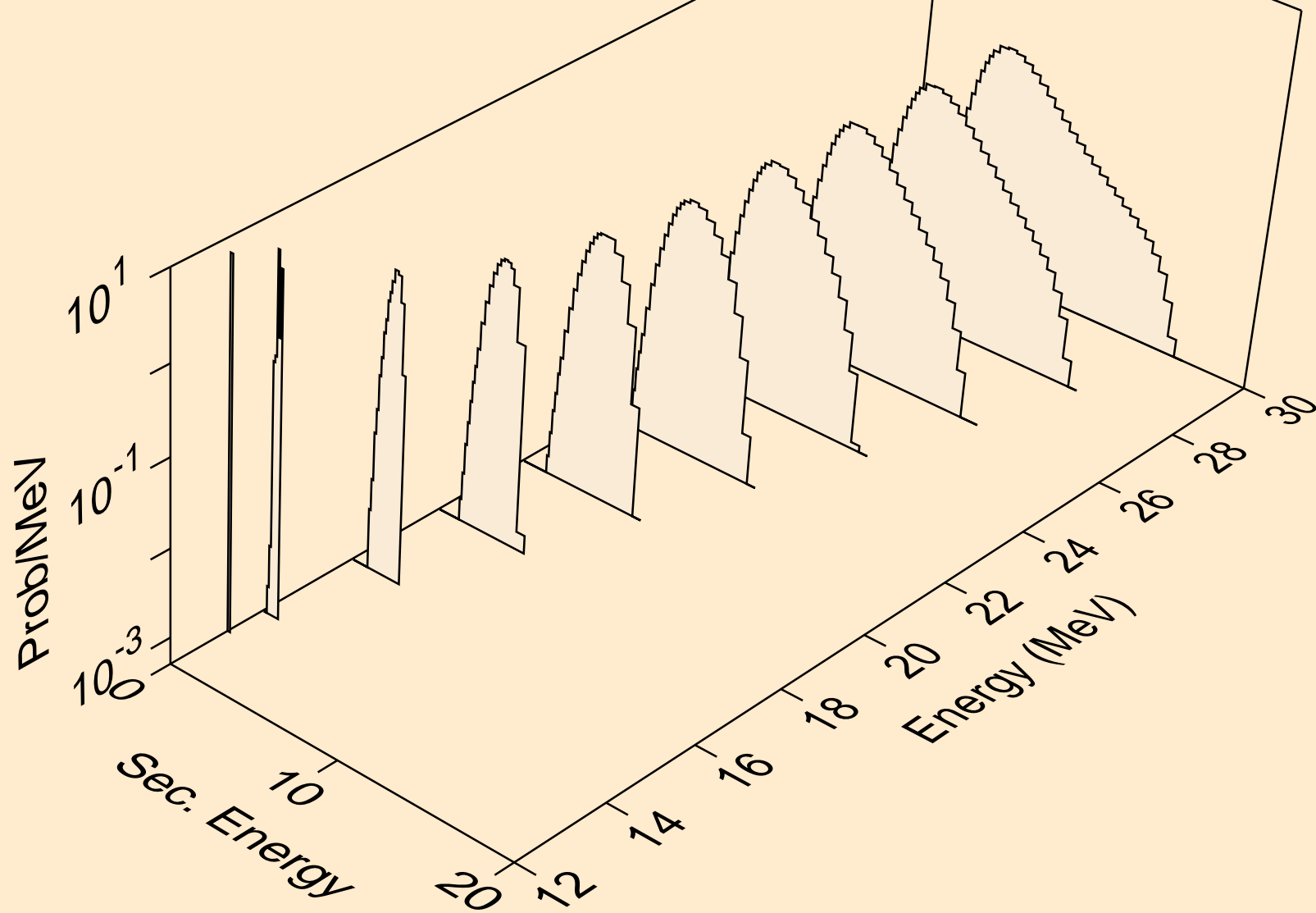

GA064 NEUTRON ACER TENDL-2024 LIBRARY; T=293.6K
protons from (n,3np)

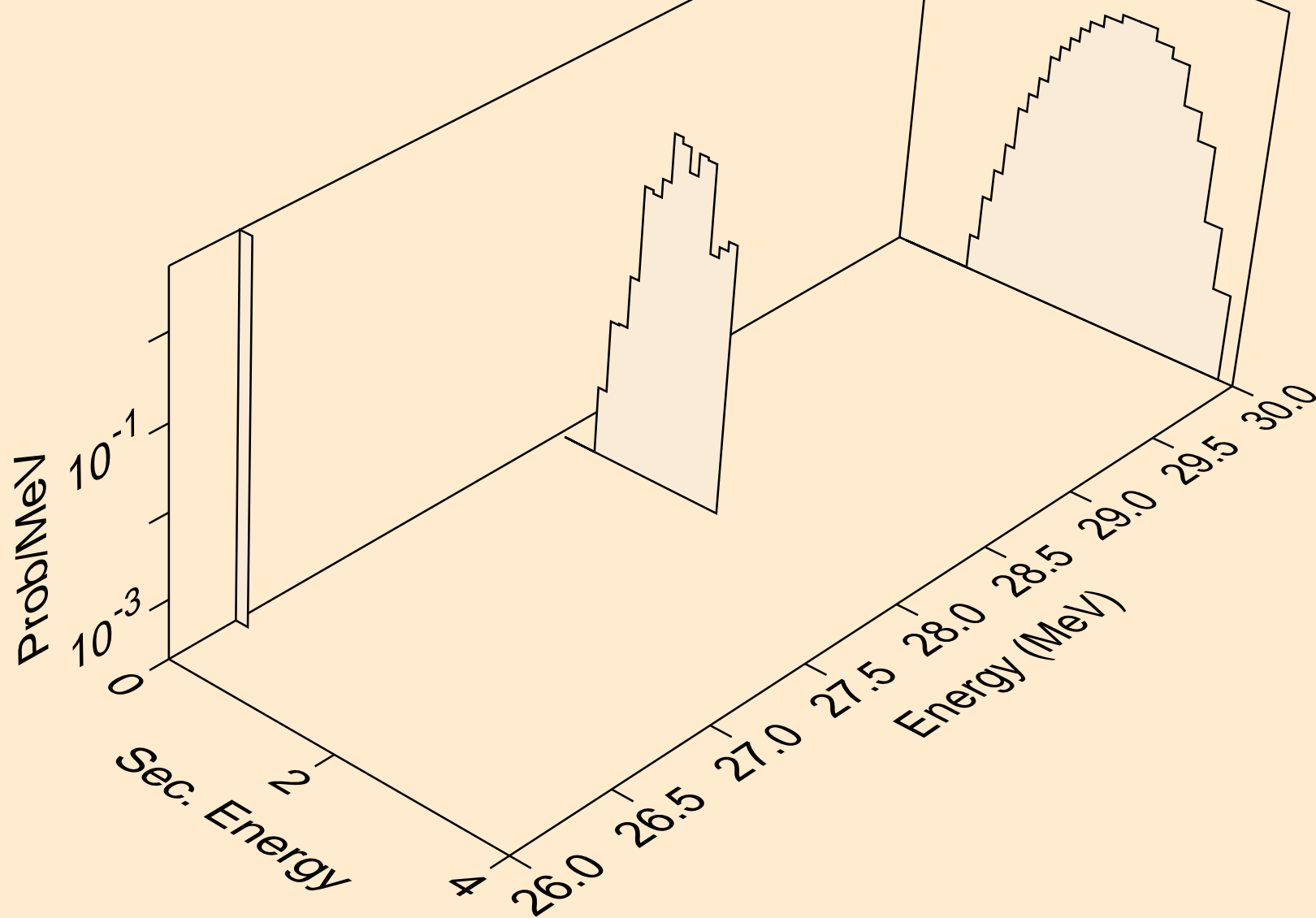

GA064 NEUTRON ACER TENDL-2024 LIBRARY; T=293.6K
protons from (n,n2p)

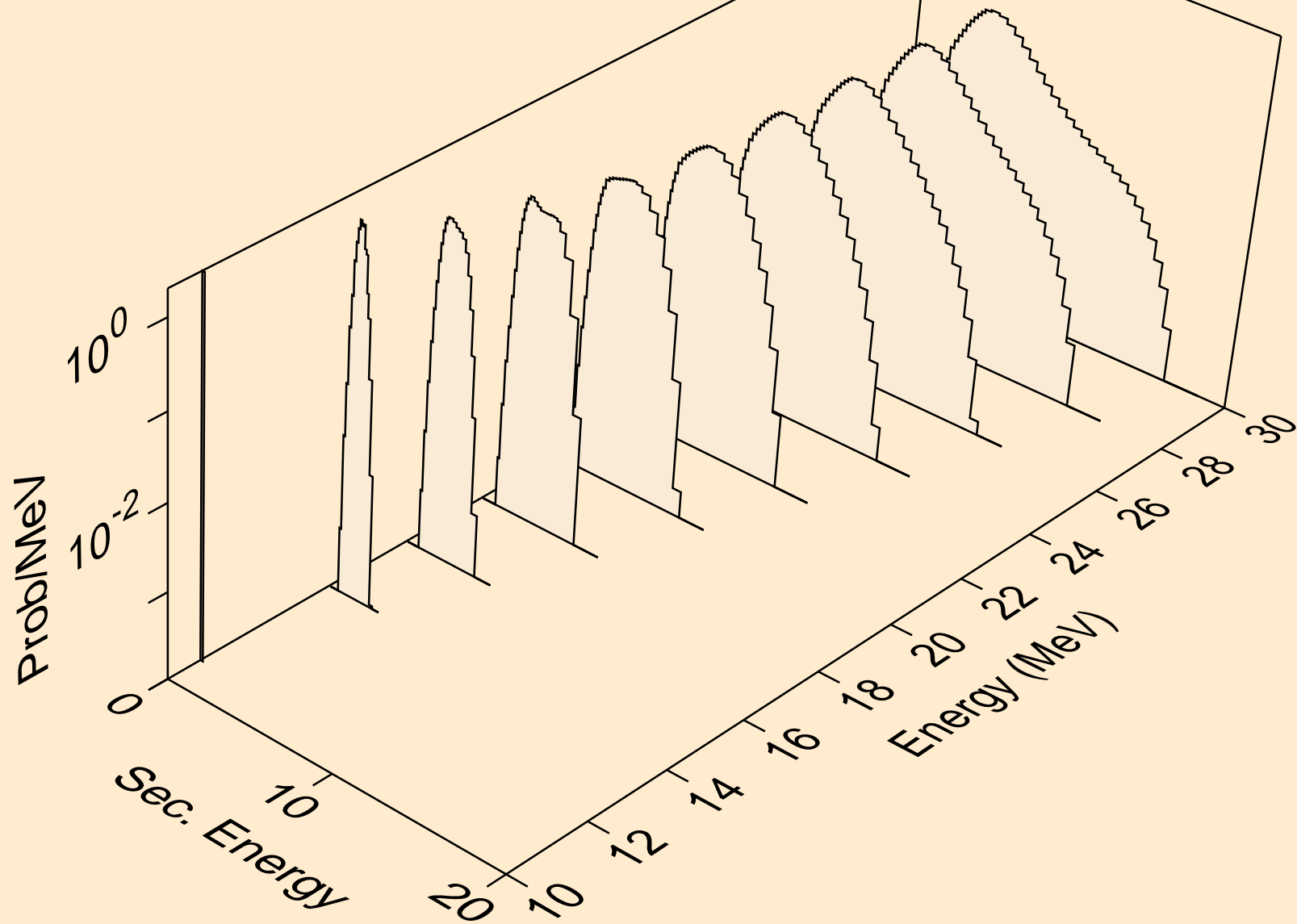

GA064 NEUTRON ACER TENDL-2024 LIBRARY; T=293.6K
protons from (n,npa)

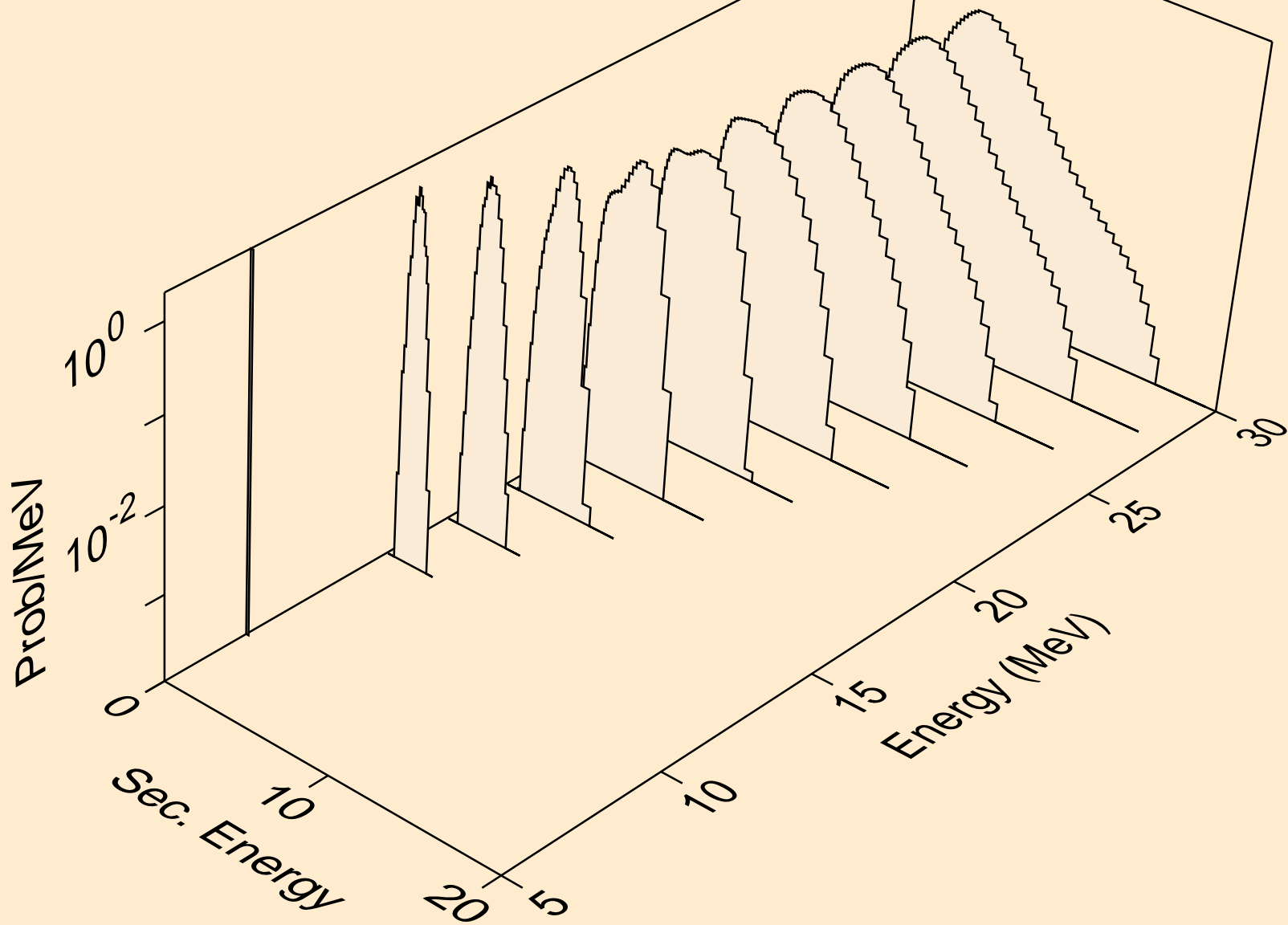

GA064 NEUTRON ACER TENDL-2024 LIBRARY; T=293.6K
protons from (n,p)

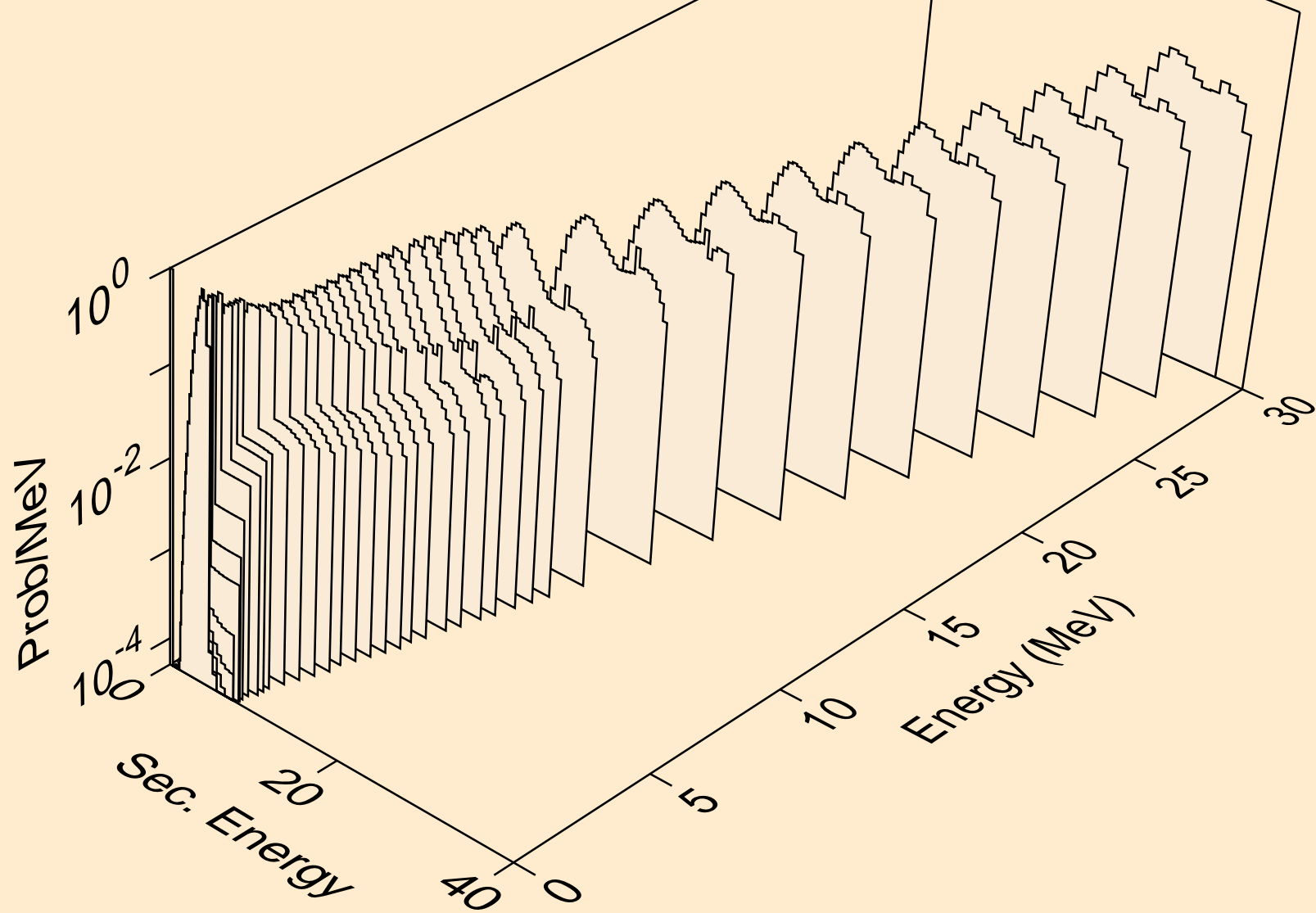

GA064 NEUTRON ACER TENDL-2024 LIBRARY; T=293.6K
protons from (n,2p)

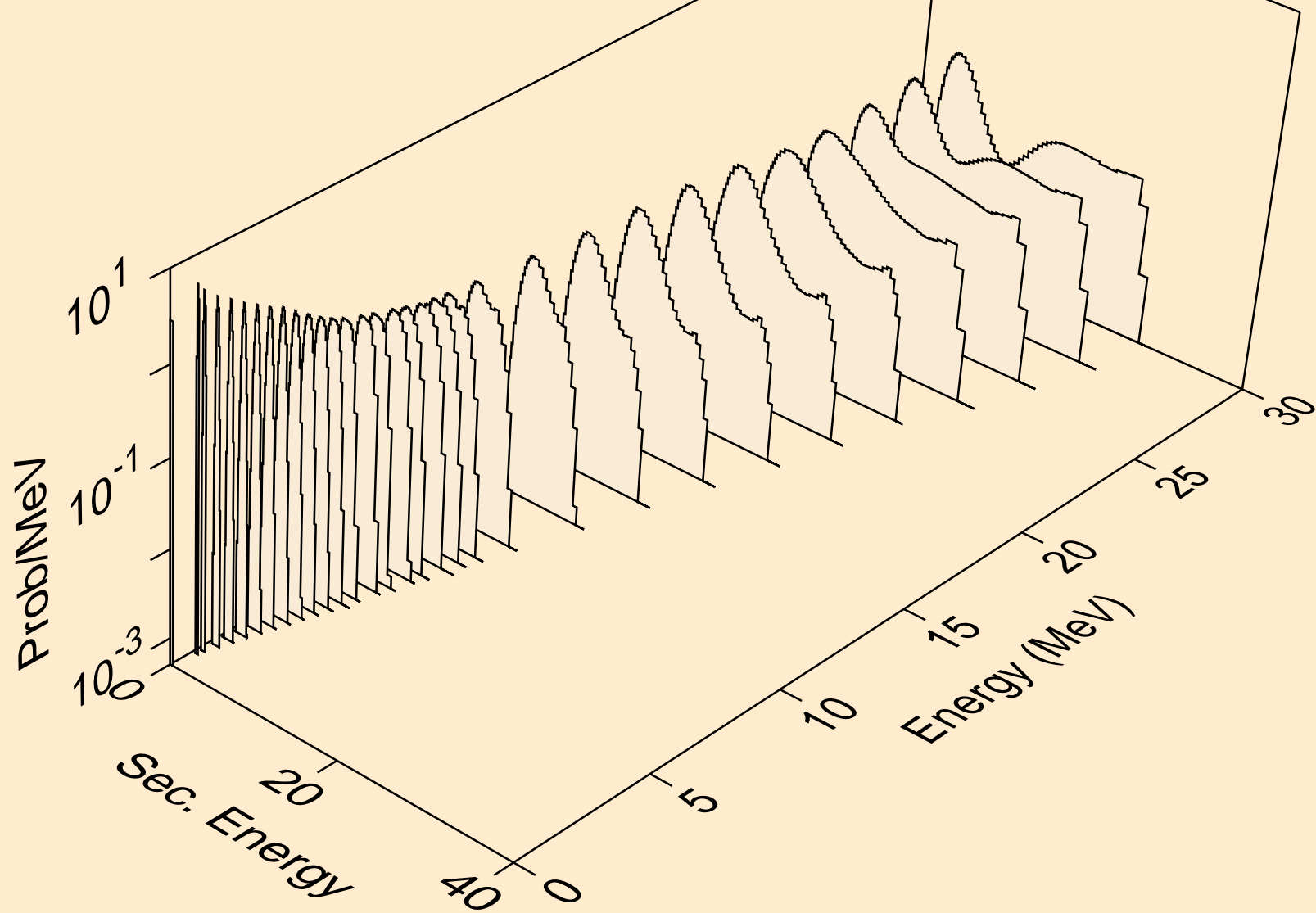

GA064 NEUTRON ACER TENDL-2024 LIBRARY; T=293.6K
protons from (n,p)

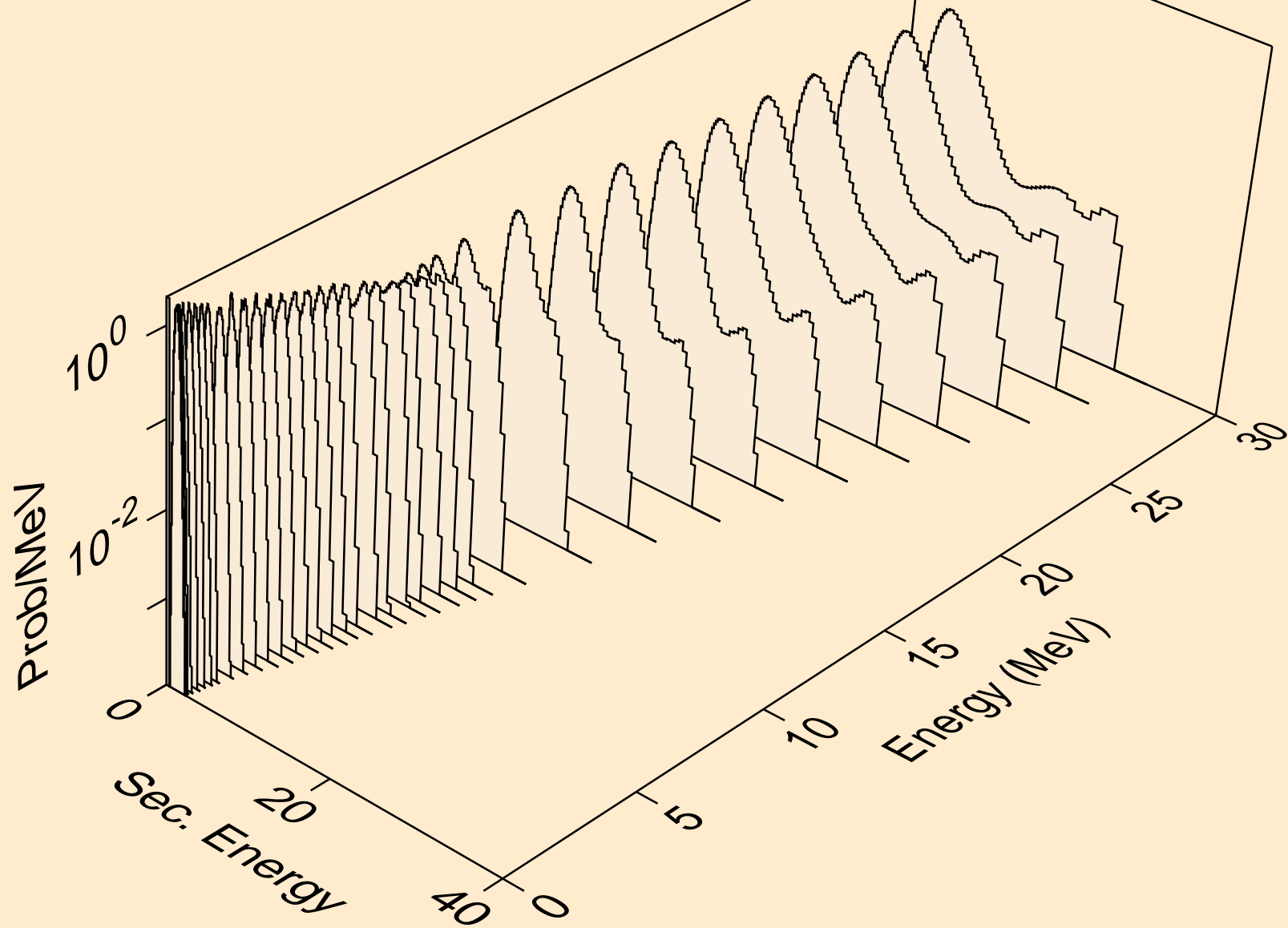

GA064 NEUTRON ACER TENDL-2024 LIBRARY; T=293.6K
protons from (n,pd)

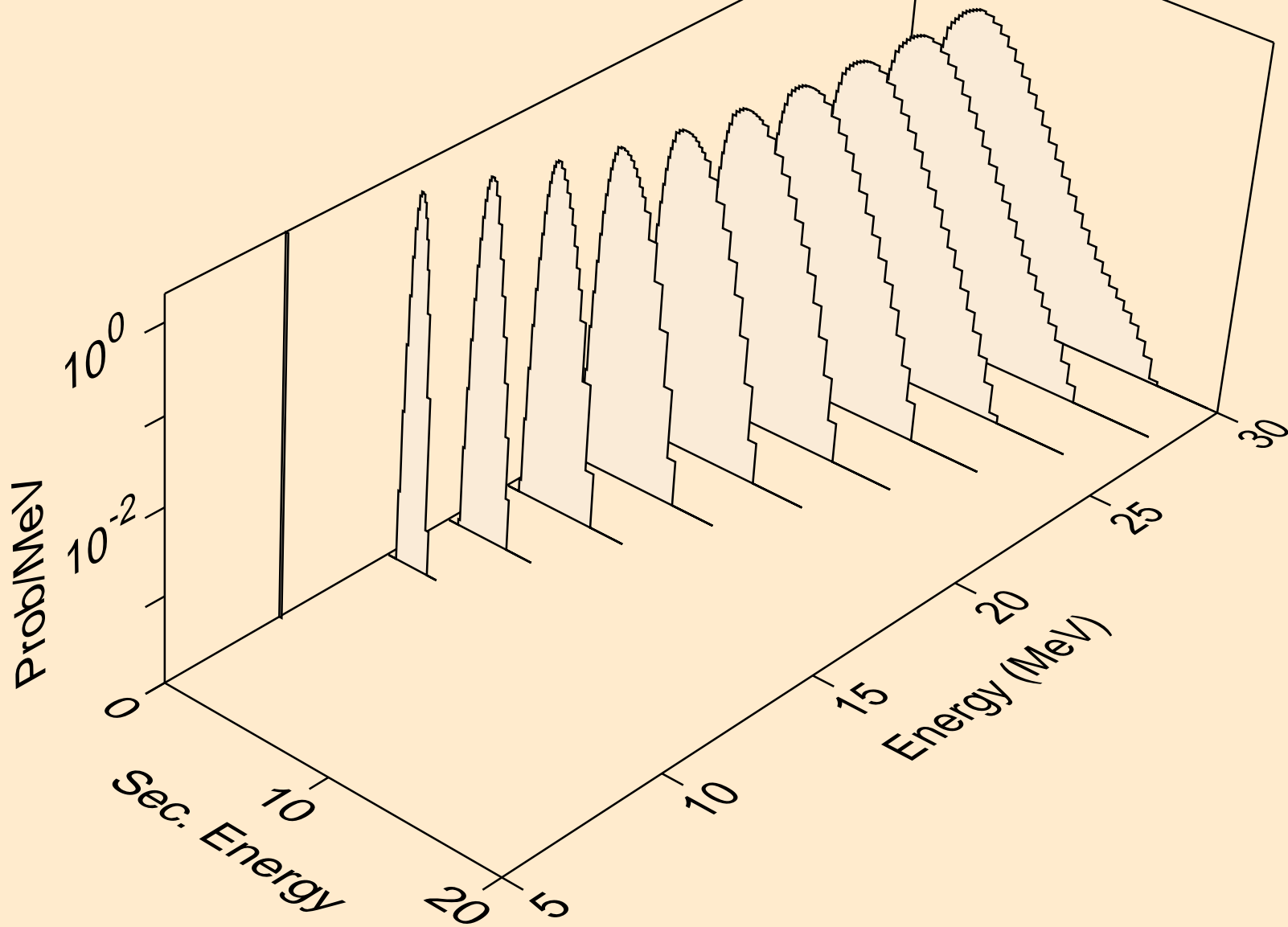

GA064 NEUTRON ACER TENDL-2024 LIBRARY; T=293.6K
protons from (n,pt)

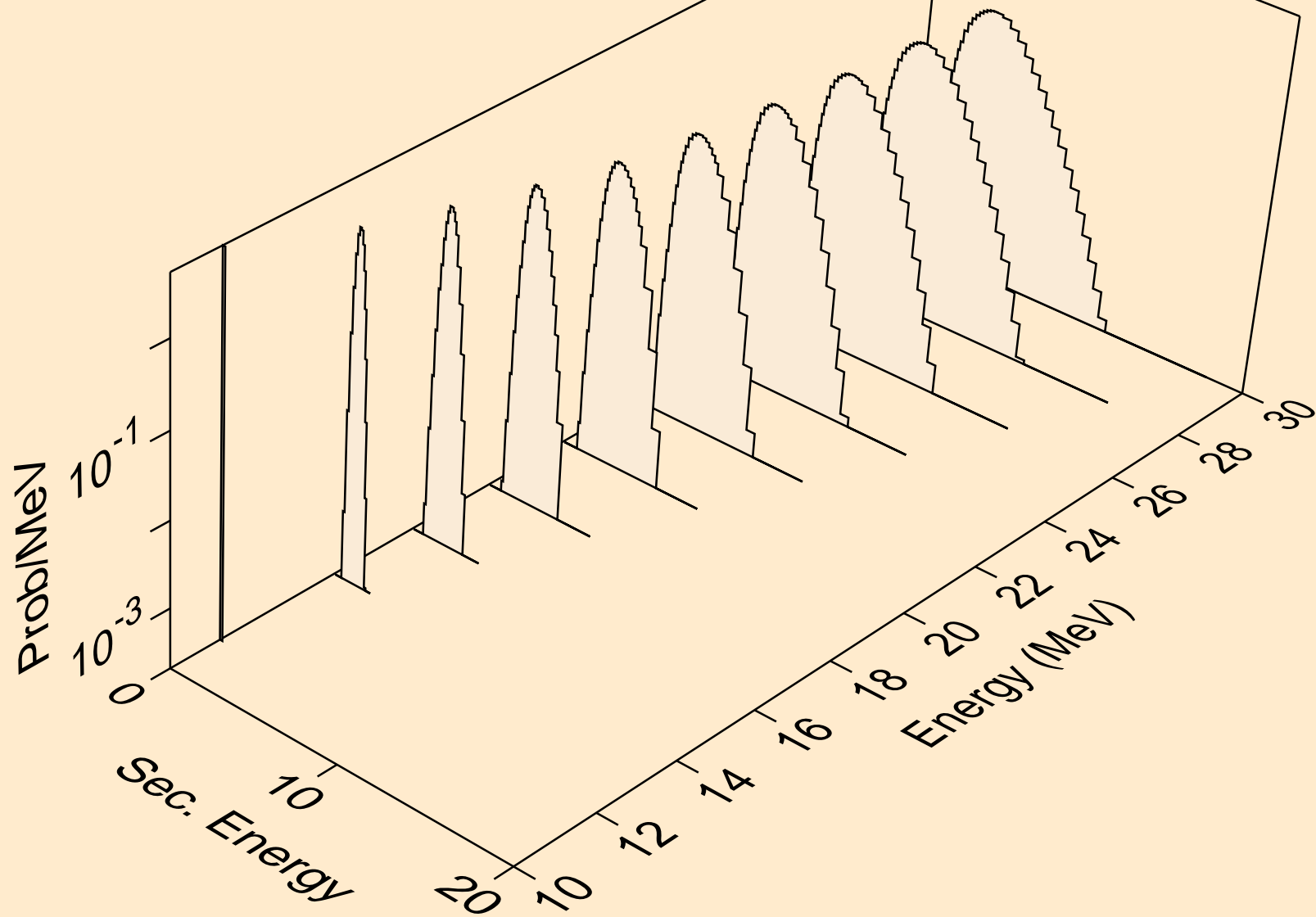

GA064 NEUTRON ACER TENDL-2024 LIBRARY; T=293.6K
deuterons from (n,x)

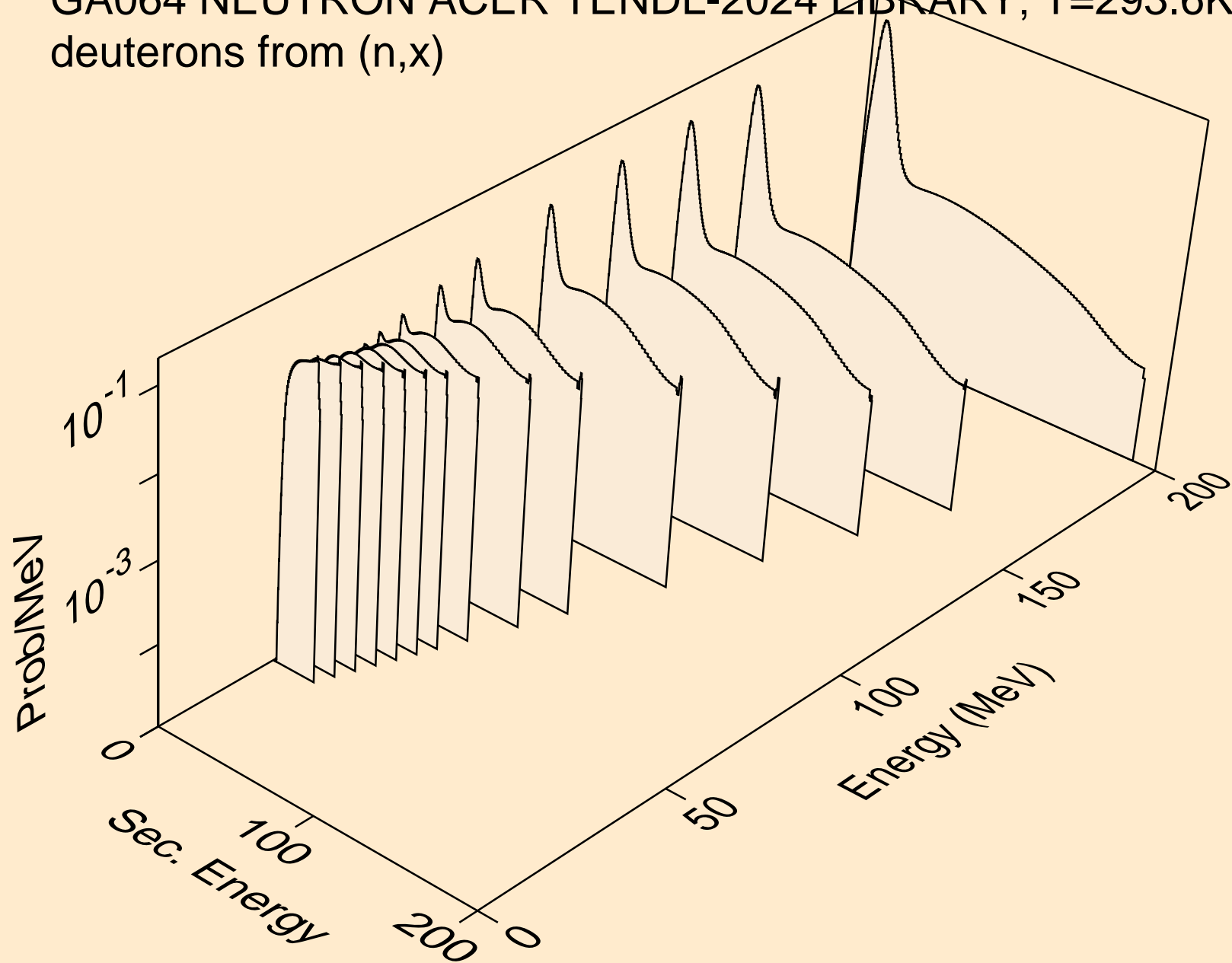

GA064 NEUTRON ACER TENDL-2024 LIBRARY; T=293.6K
deuterons from (n,2nd)

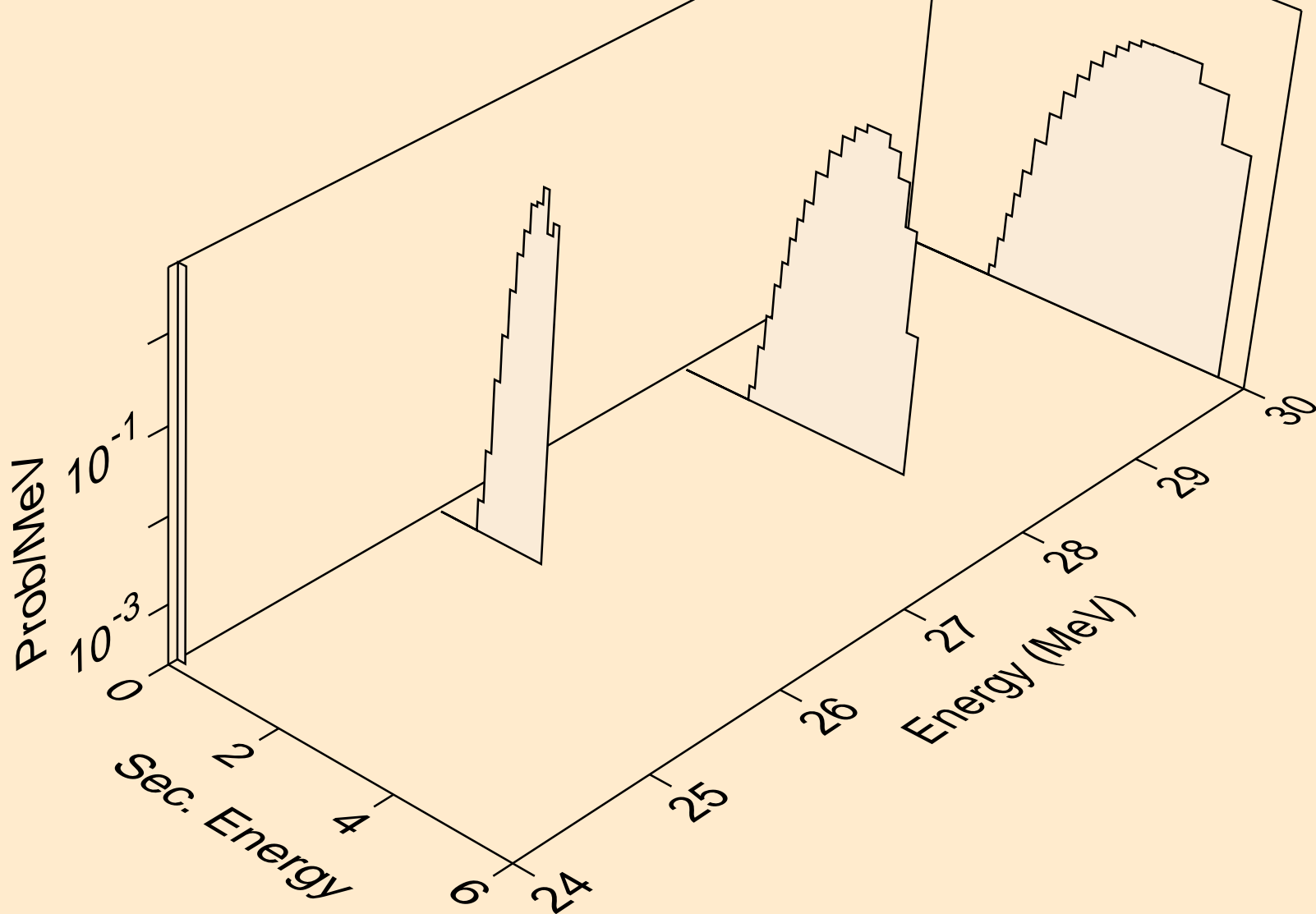

GA064 NEUTRON ACER TENDL-2024 LIBRARY; T=293.6K
deuterons from (n,n*)d

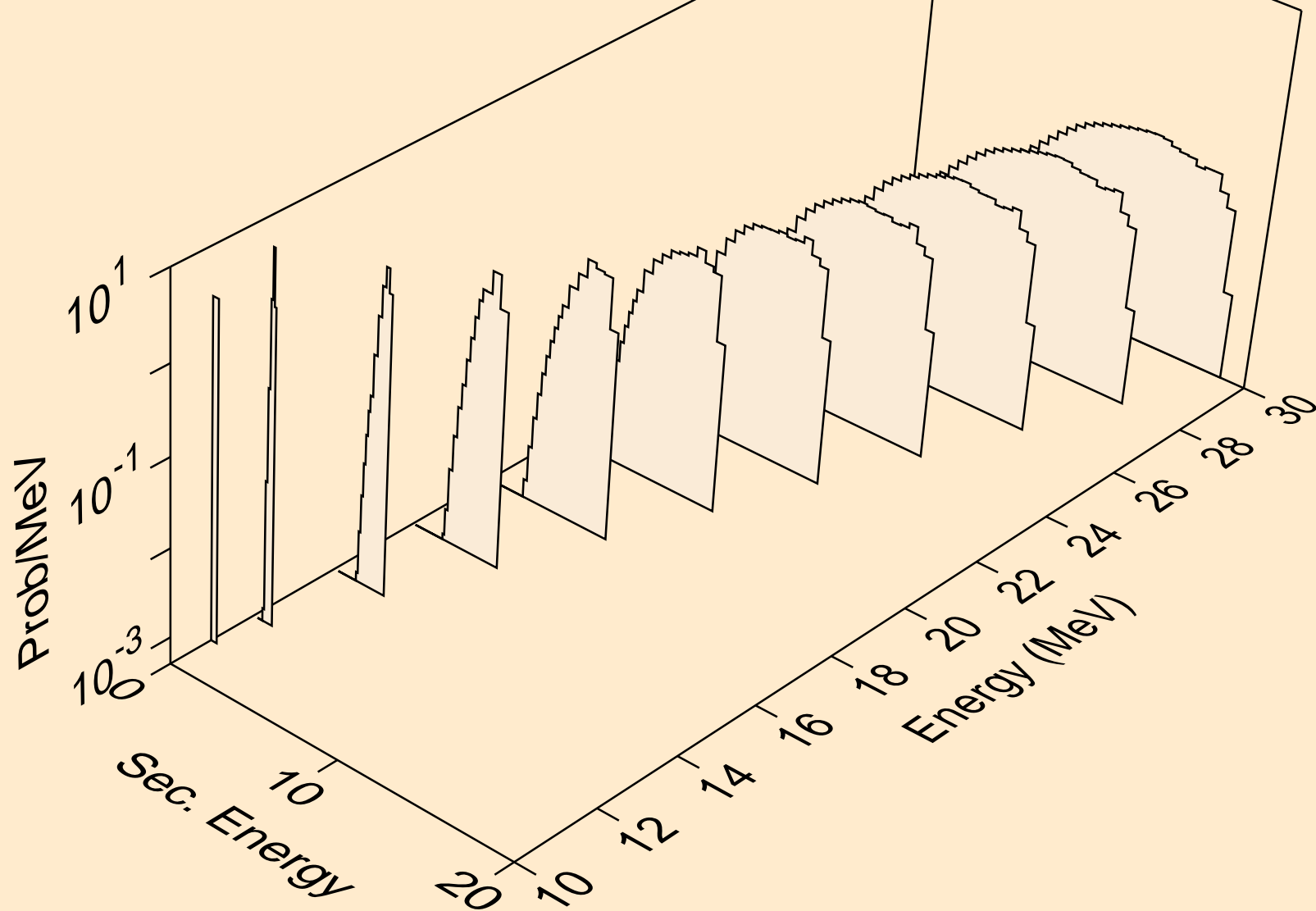

GA064 NEUTRON ACER TENDL-2024 LIBRARY; T=293.6K
deuterons from (n,d)

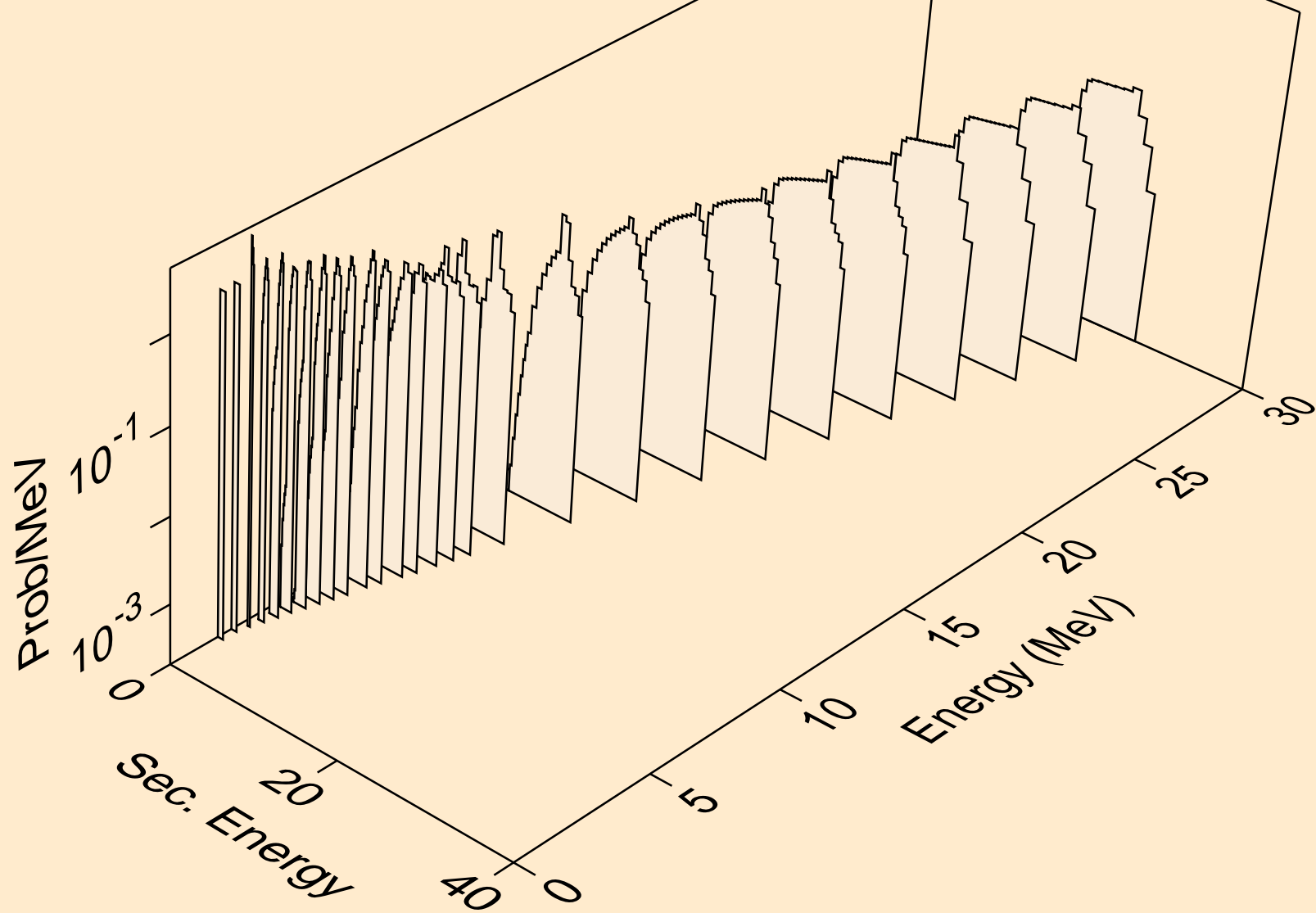

GA064 NEUTRON ACER TENDL-2024 LIBRARY; T=293.6K
deuterons from (n,d2a)

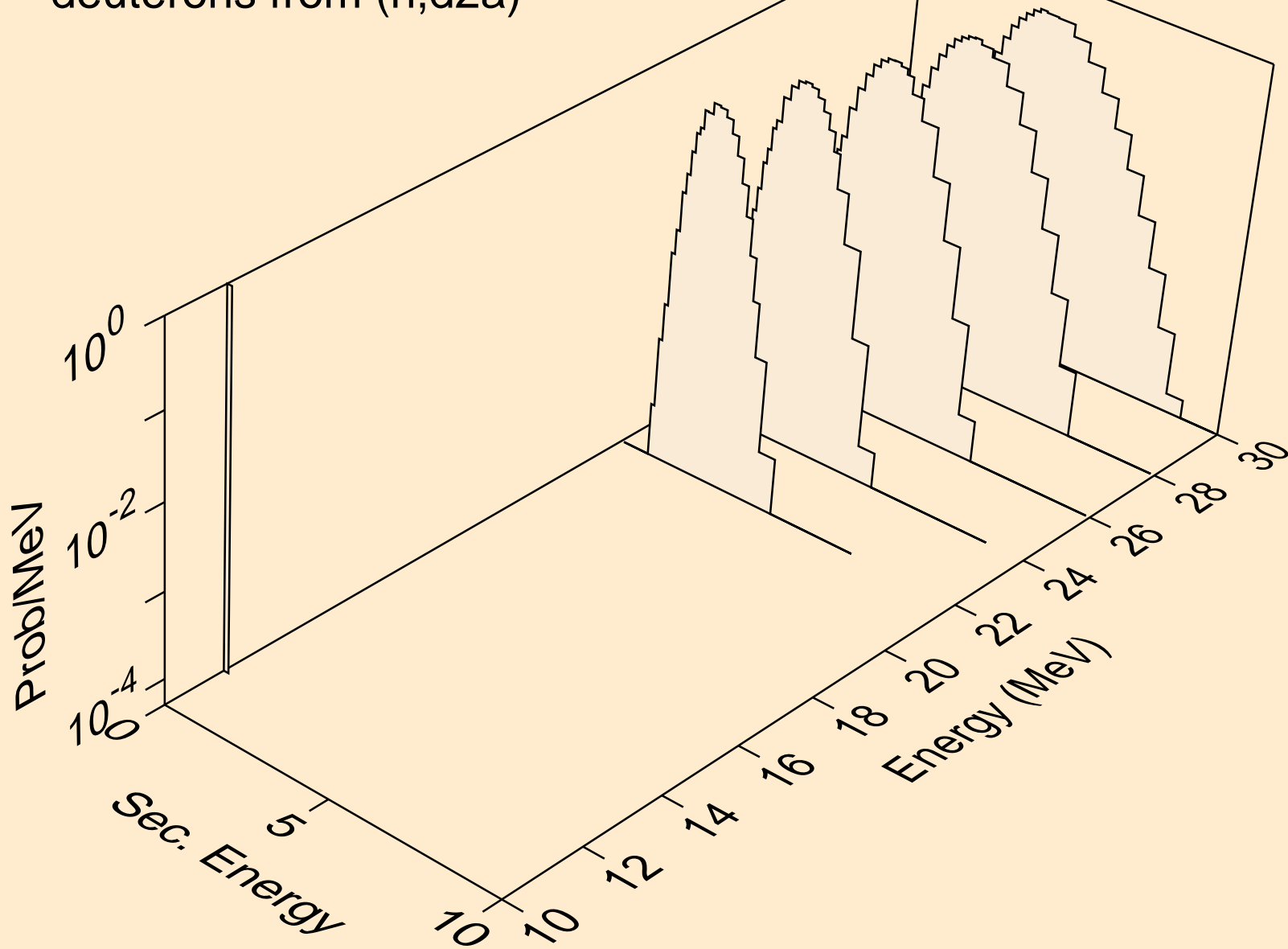

GA064 NEUTRON ACER TENDL-2024 LIBRARY; T=293.6K
deuterons from (n,pd)

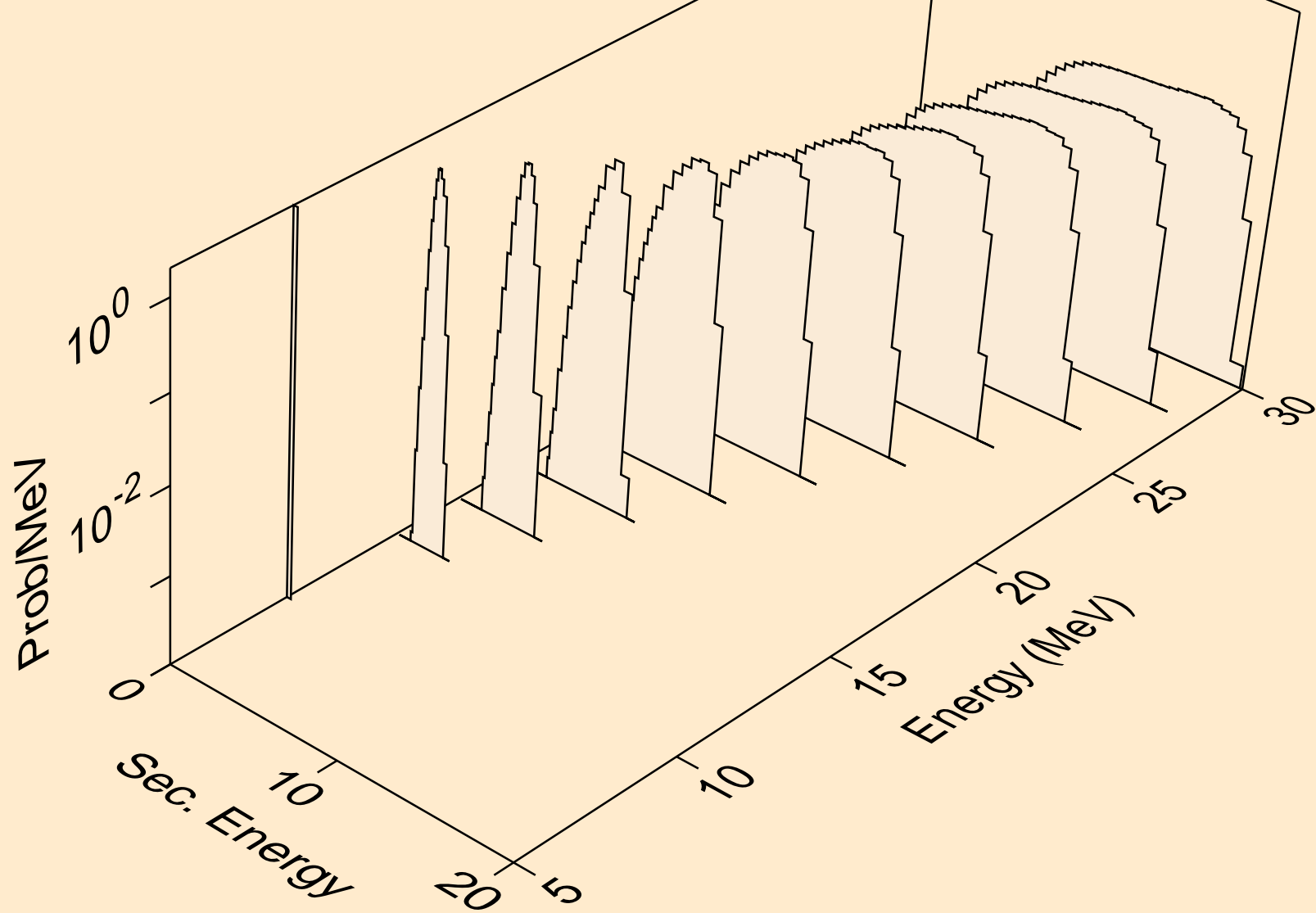

GA064 NEUTRON ACER TENDL-2024 LIBRARY; T=293.6K
deuterons from (n,da)

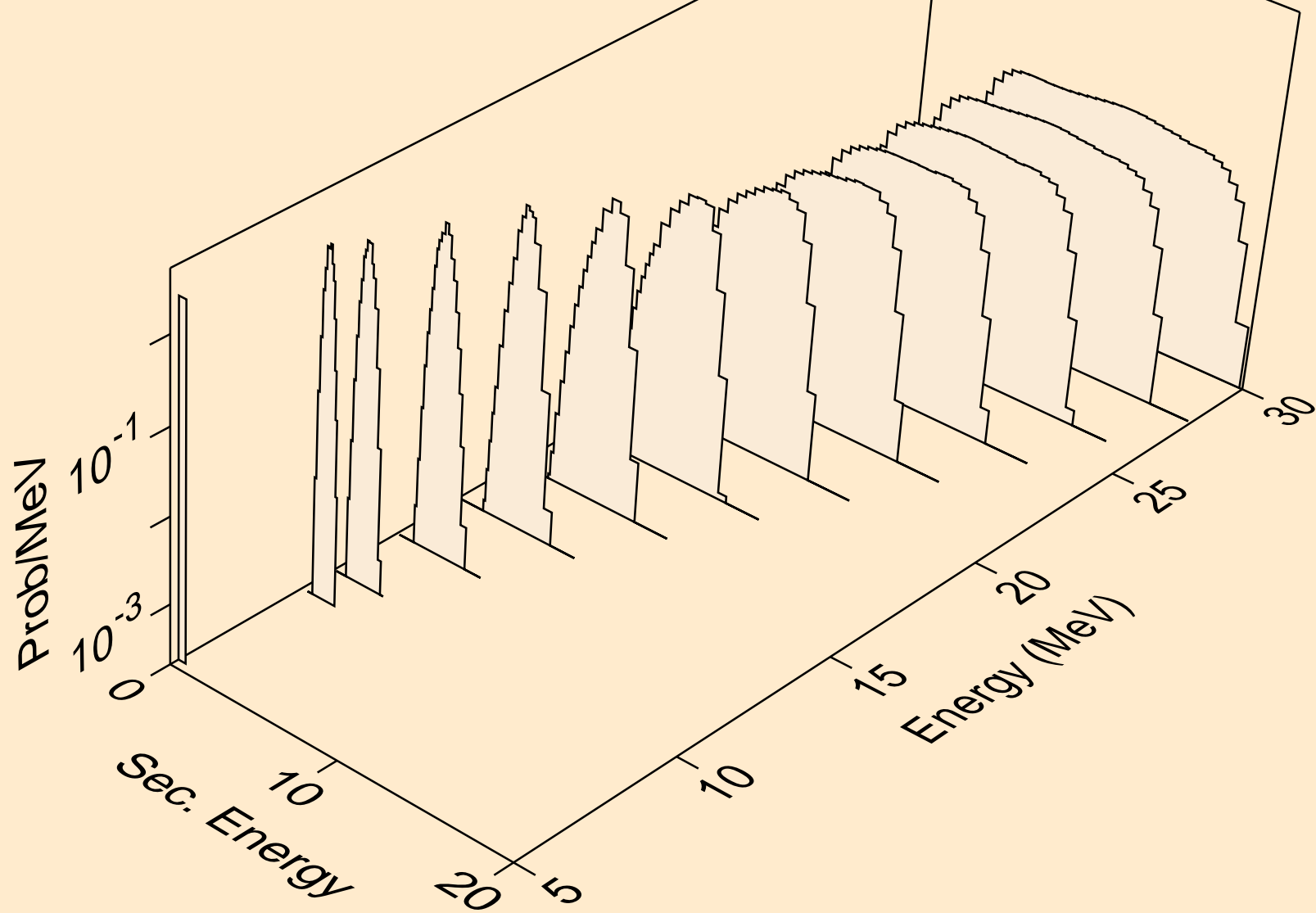

GA064 NEUTRON ACER TENDL-2024 LIBRARY; T=293.6K
tritons from (n,x)

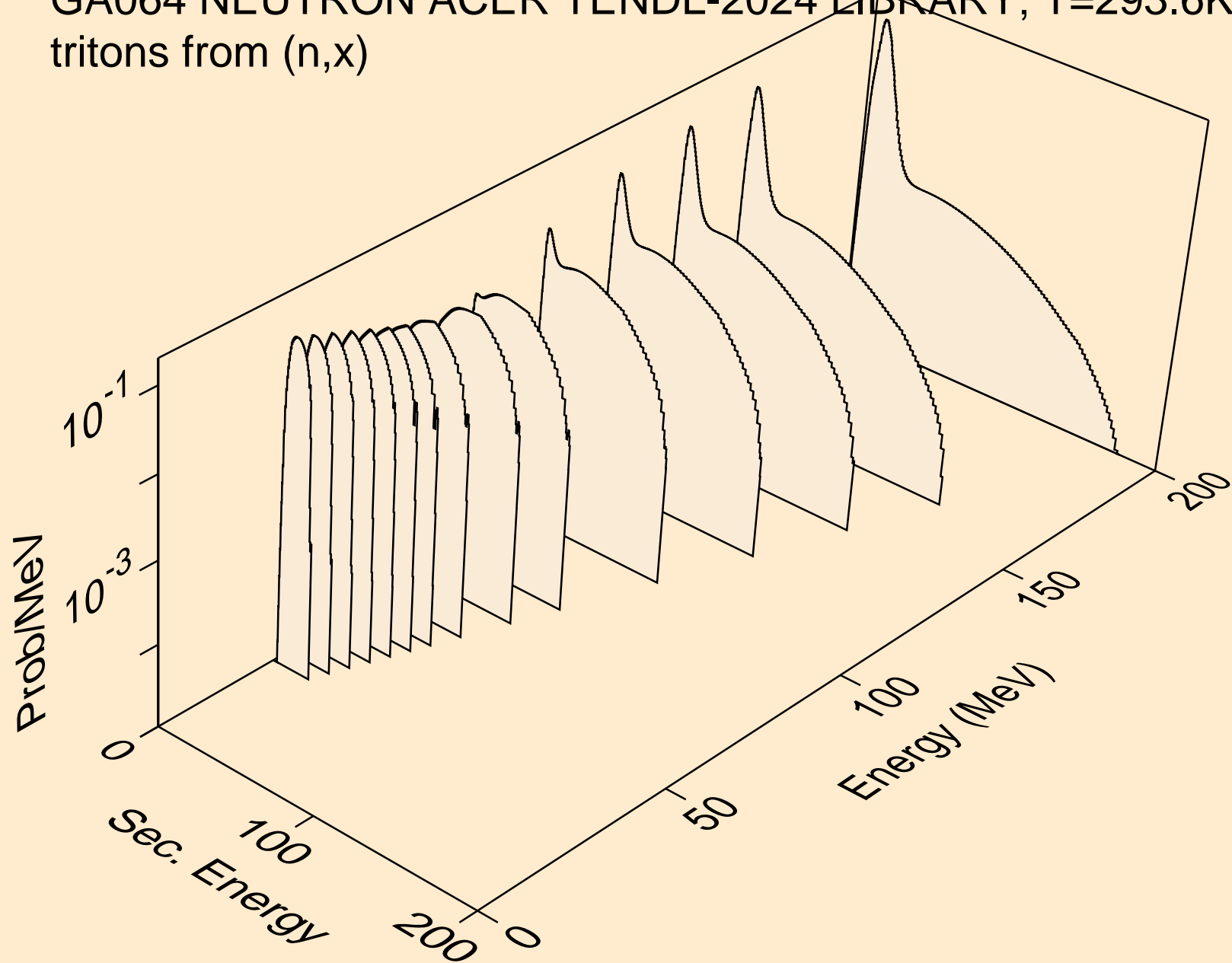

GA064 NEUTRON ACER TENDL-2024 LIBRARY; T=293.6K
tritons from (n,n*)t

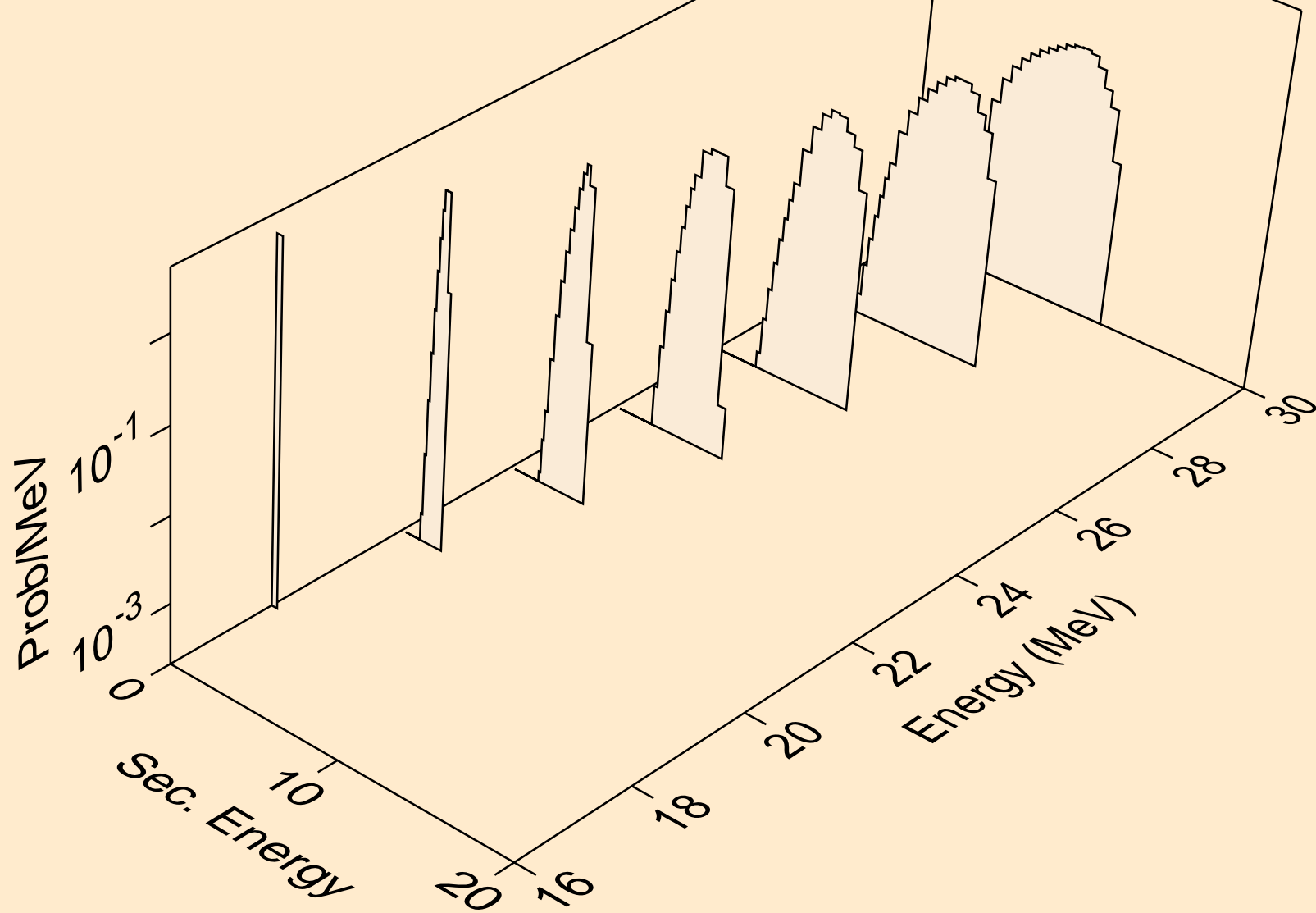

GA064 NEUTRON ACER TENDL-2024 LIBRARY; T=293.6K
tritons from (n,t)

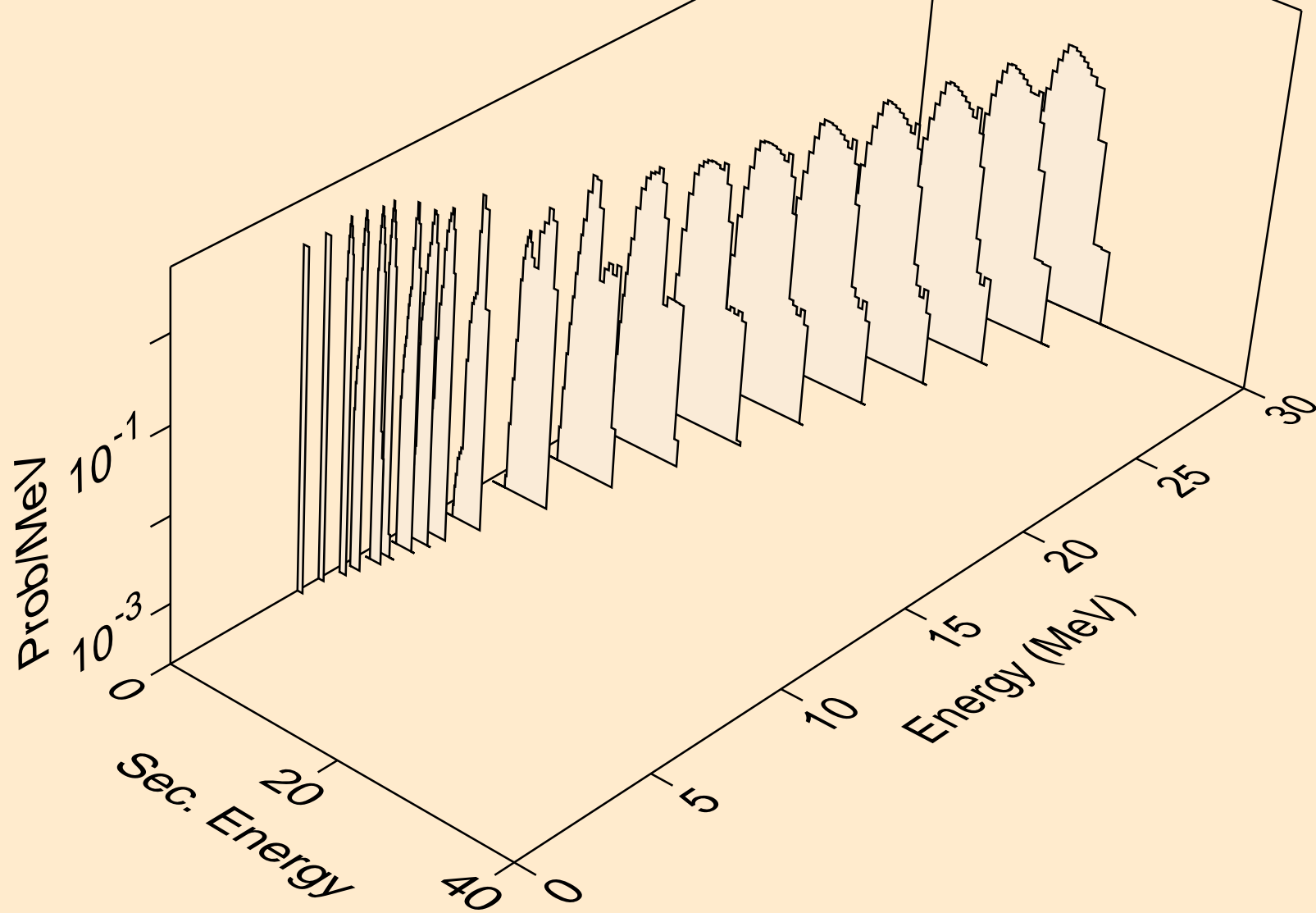

GA064 NEUTRON ACER TENDL-2024 LIBRARY; T=293.6K
tritons from (n,pt)

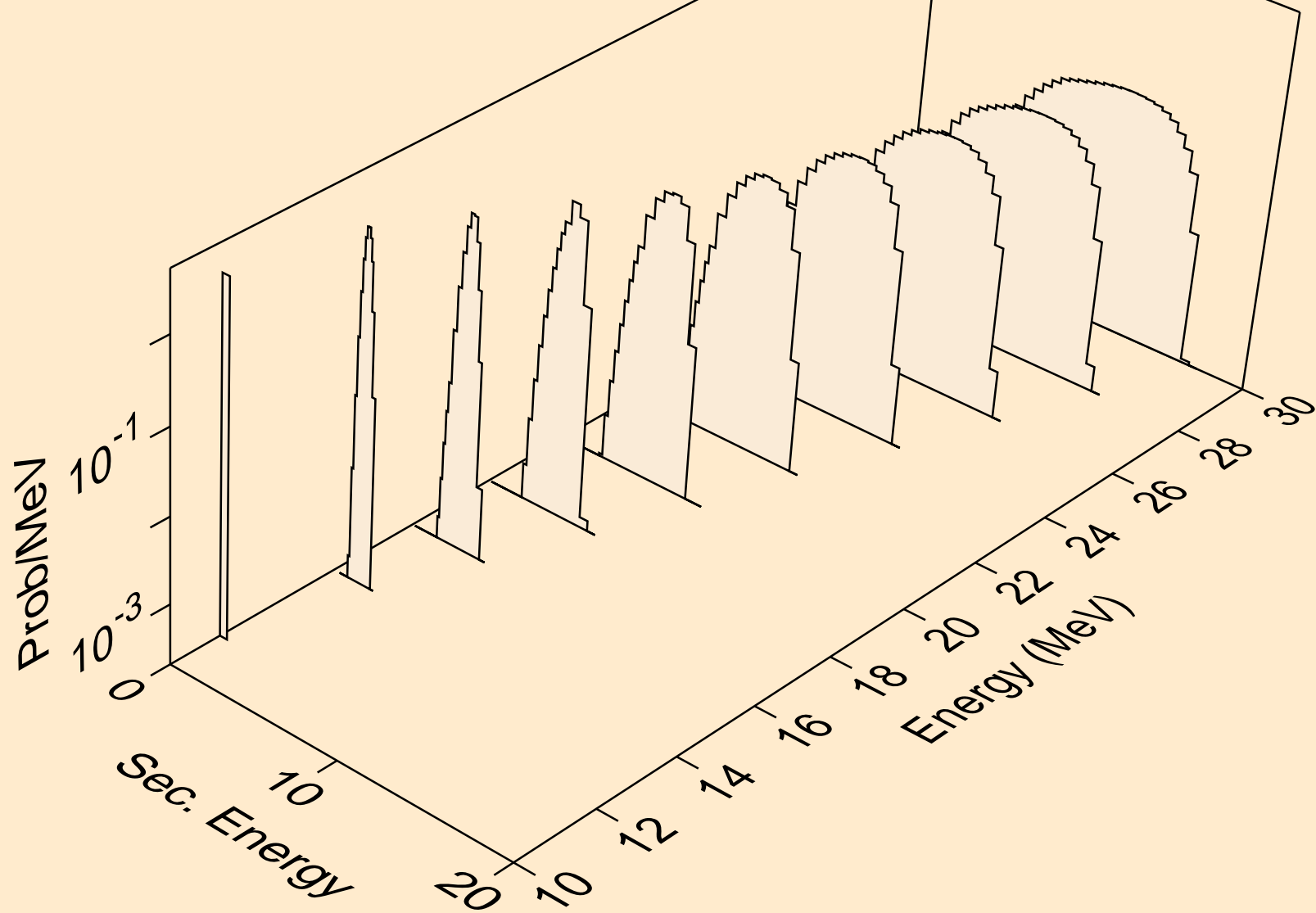

GA064 NEUTRON ACER TENDL-2024 LIBRARY; T=293.6K
he3s from (n,x)

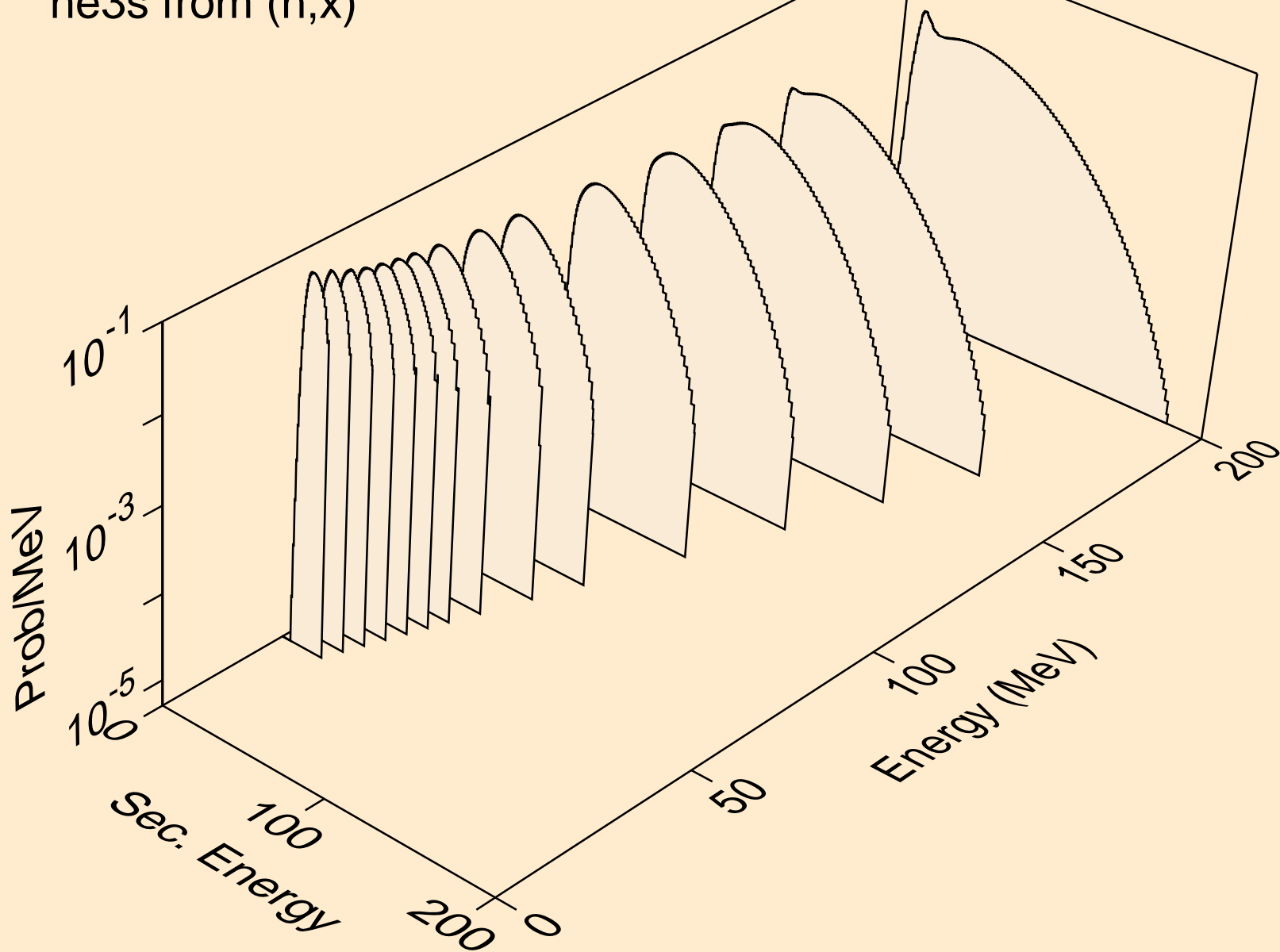

GA064 NEUTRON ACER TENDL-2024 LIBRARY; T=293.6K
he3s from (n,n*)he3

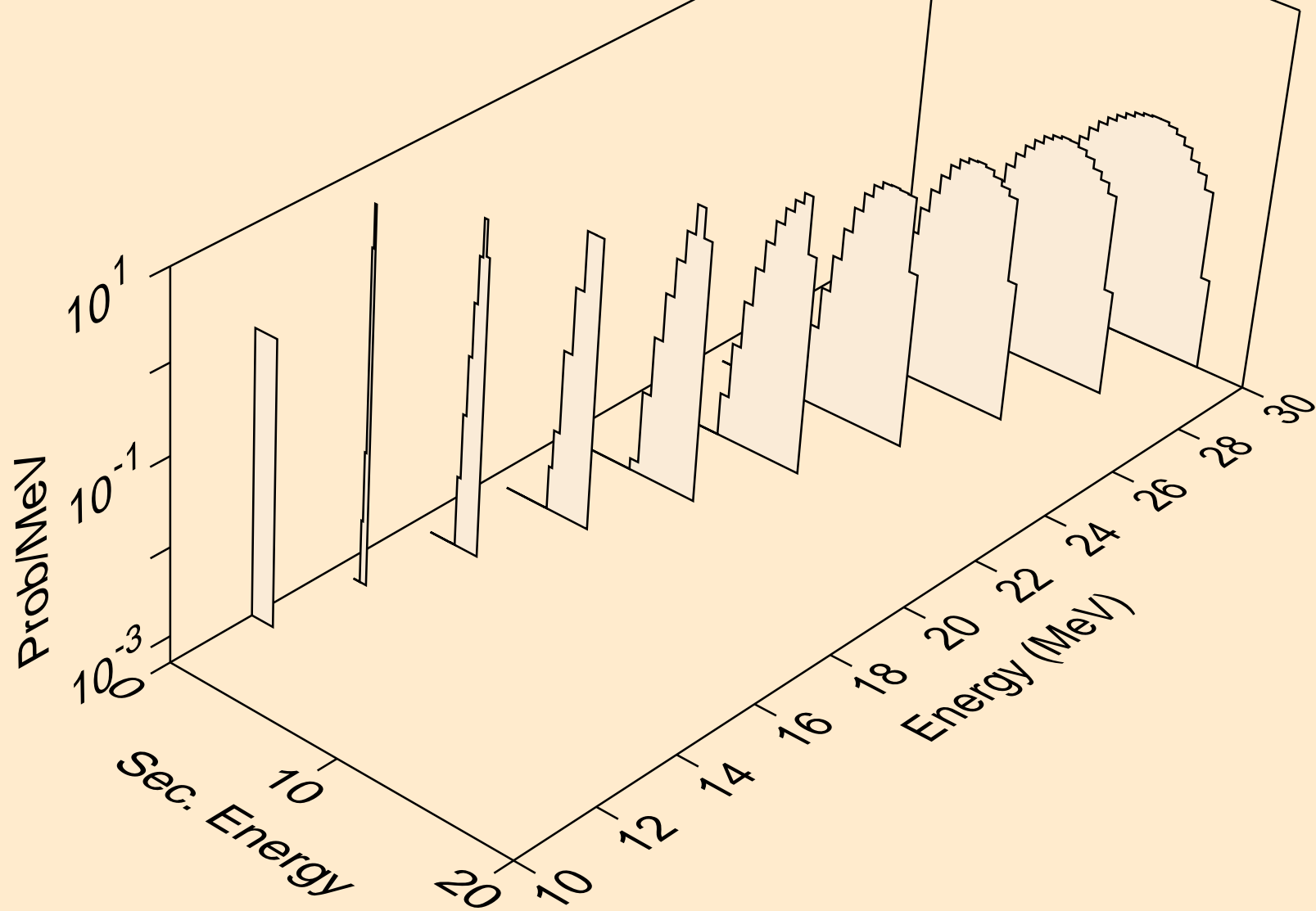

GA064 NEUTRON ACER TENDL-2024 LIBRARY; T=293.6K
he3s from (n,he3)

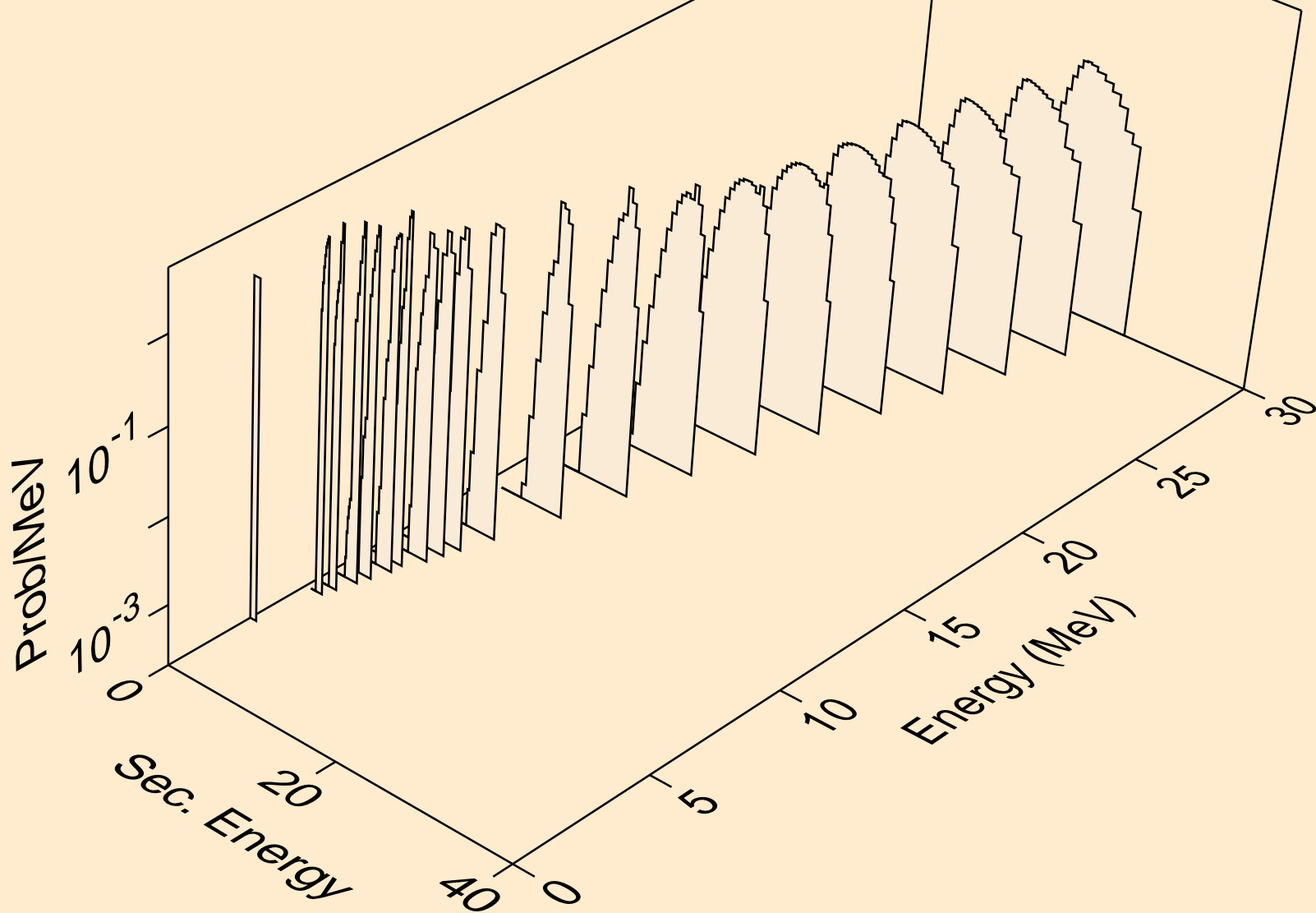

GA064 NEUTRON ACER TENDL-2024 LIBRARY; T=293.6K
alphas from (n,x)

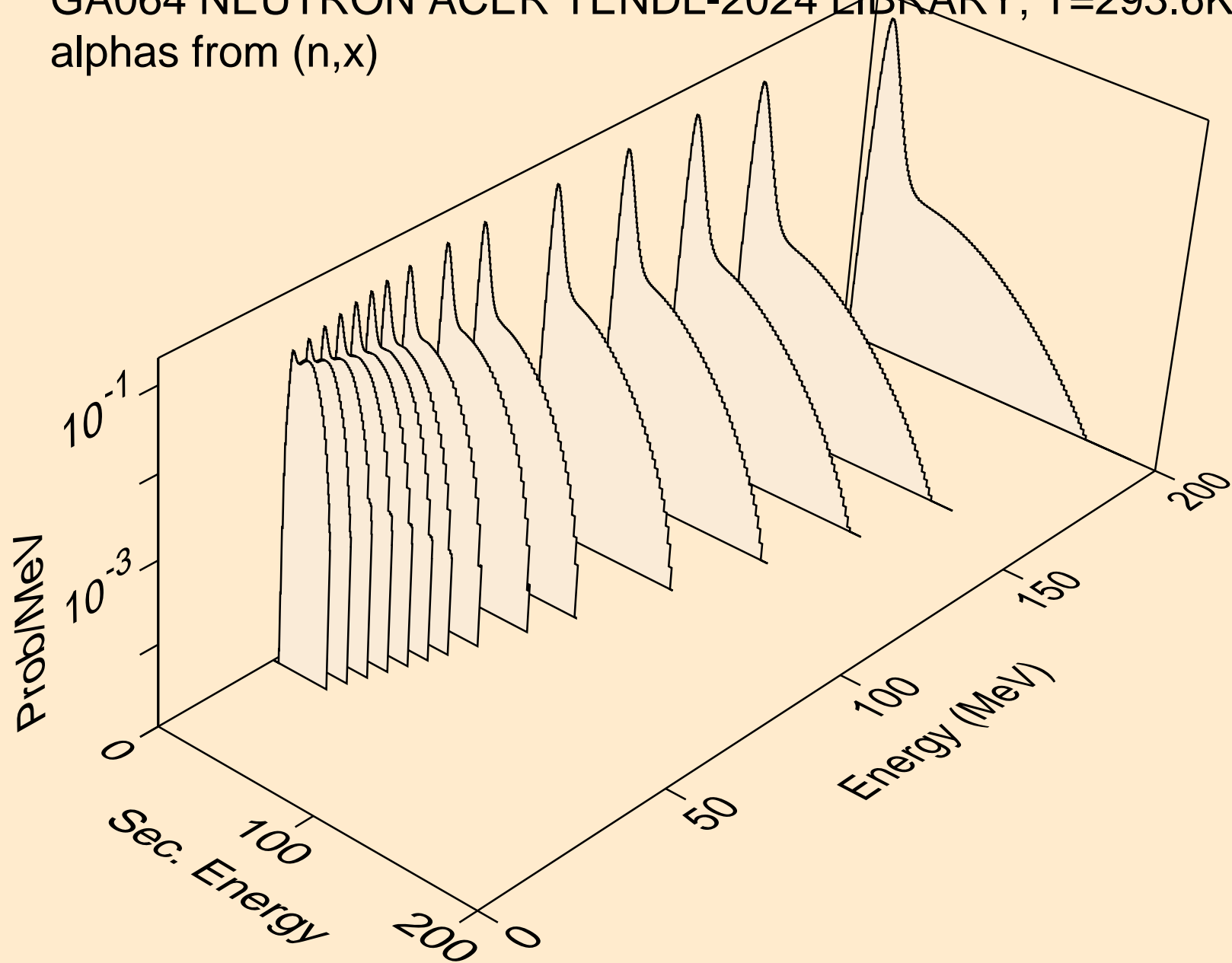

GA064 NEUTRON ACER TENDL-2024 LIBRARY; T=293.6K
alphas from (n,n*)a

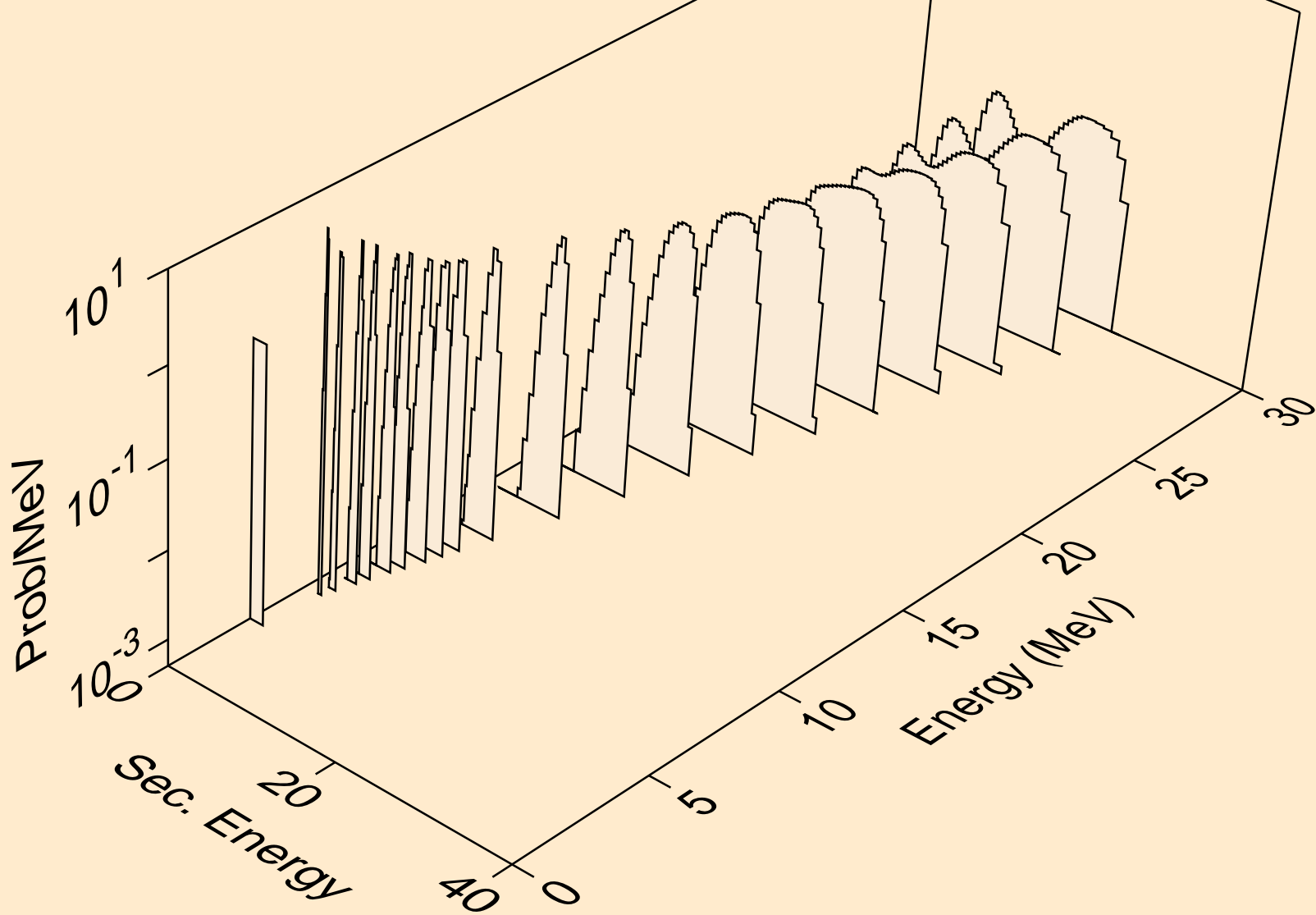

GA064 NEUTRON ACER TENDL-2024 LIBRARY; T=293.6K
alphas from (n,2n)a

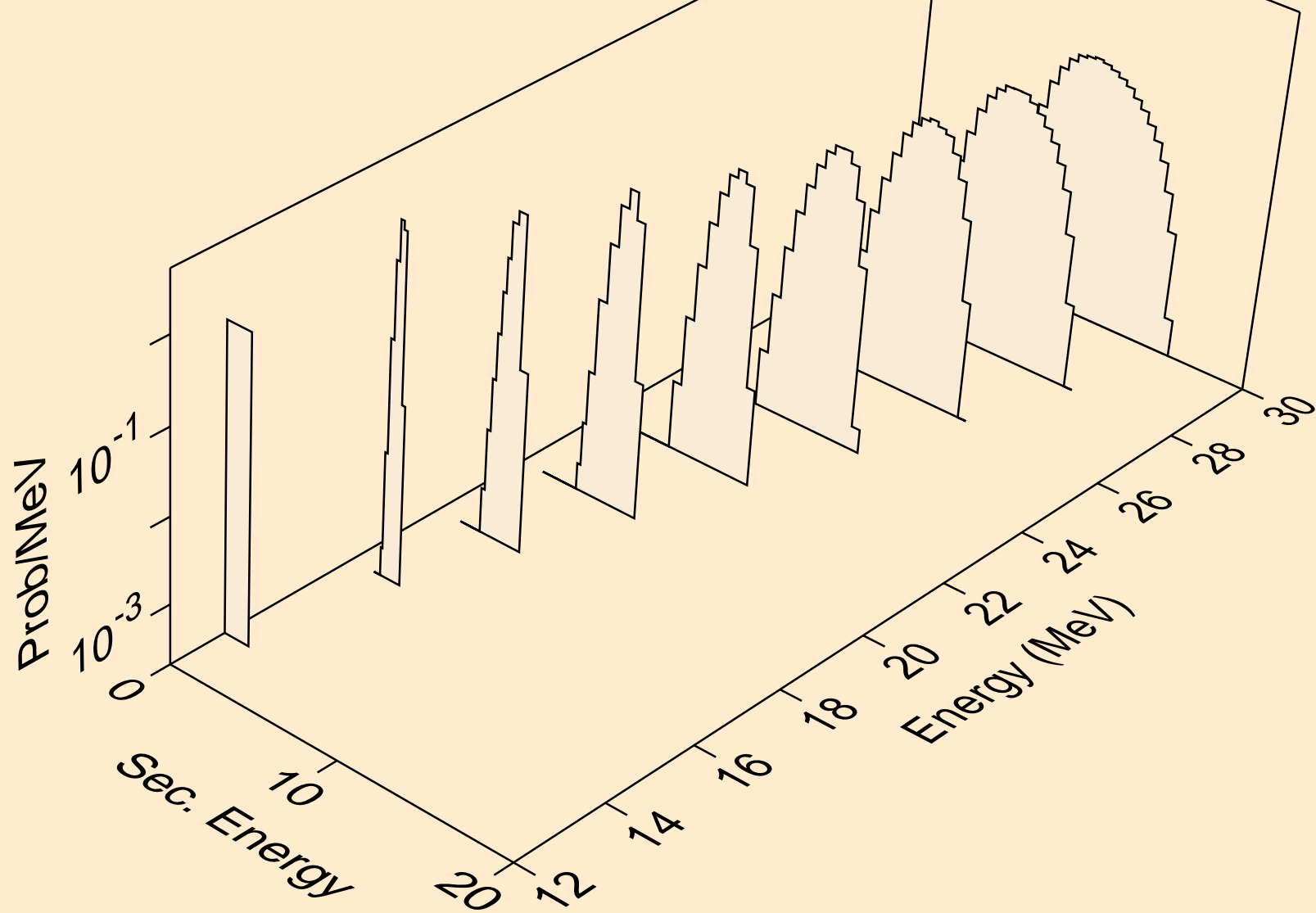

GA064 NEUTRON ACER TENDL-2024 LIBRARY; T=293.6K
alphas from (n,n*)2a

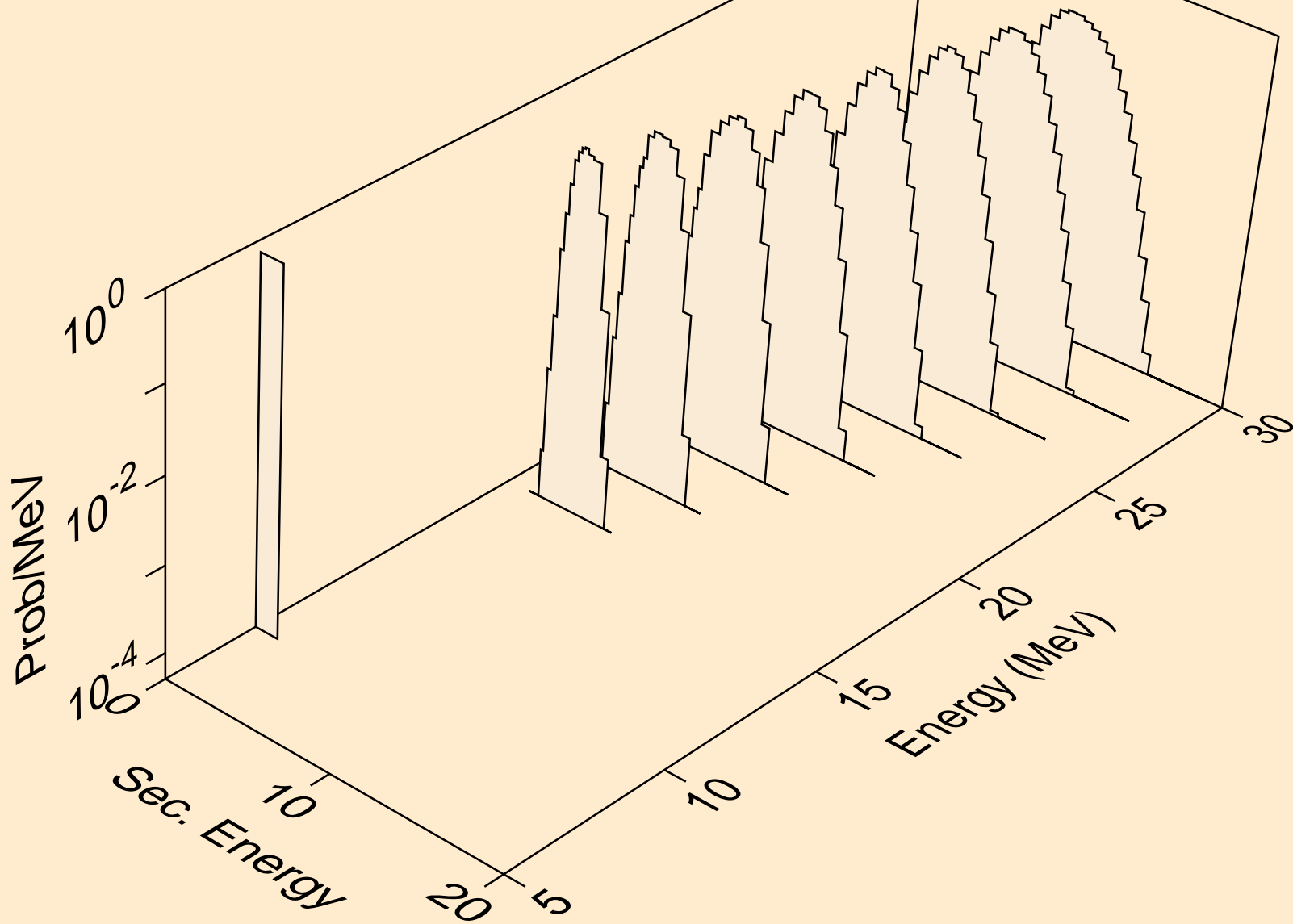

GA064 NEUTRON ACER TENDL-2024 LIBRARY; T=293.6K
alphas from (n,npa)

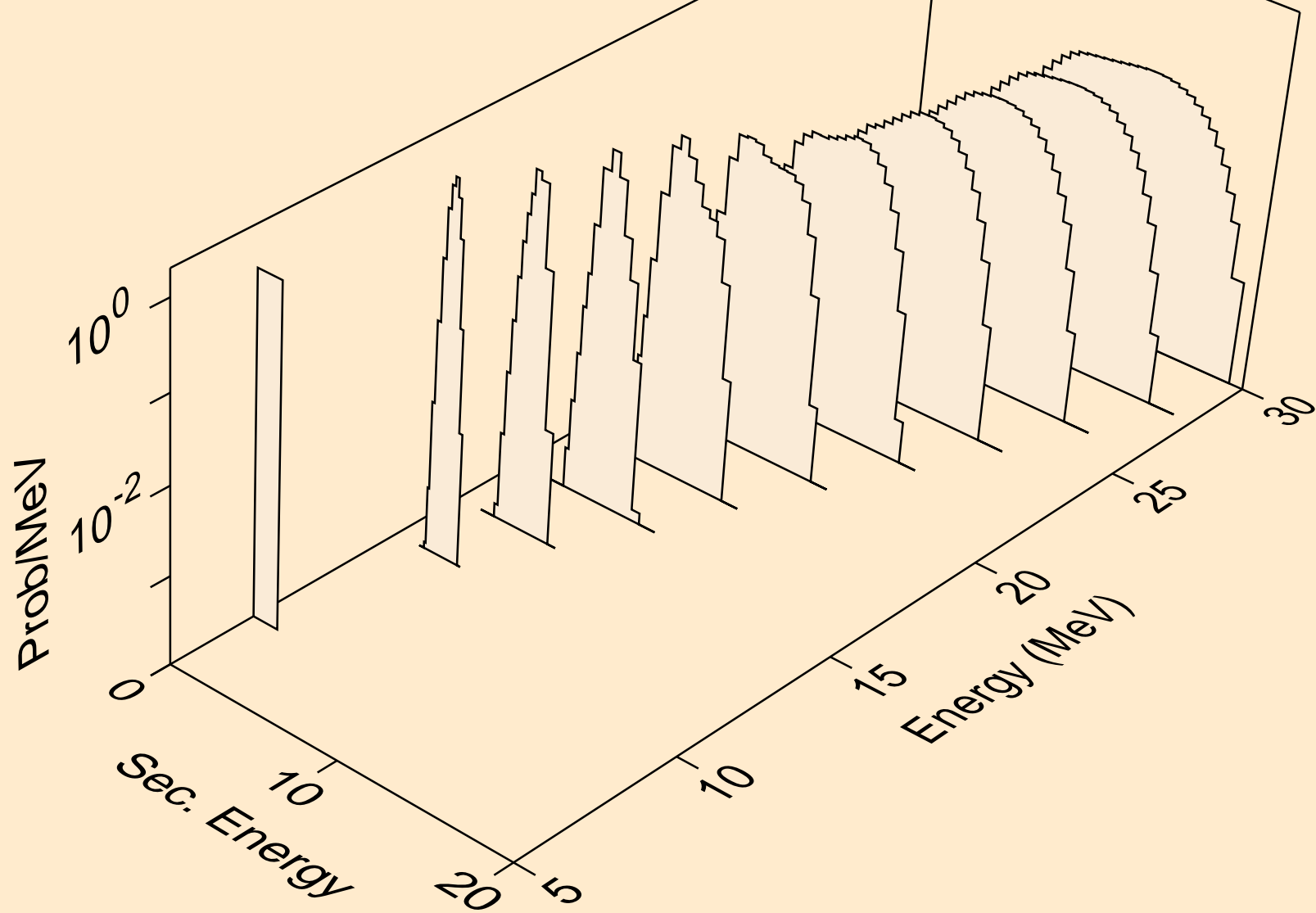

GA064 NEUTRON ACER TENDL-2024 LIBRARY; T=293.6K
alphas from (n,a)

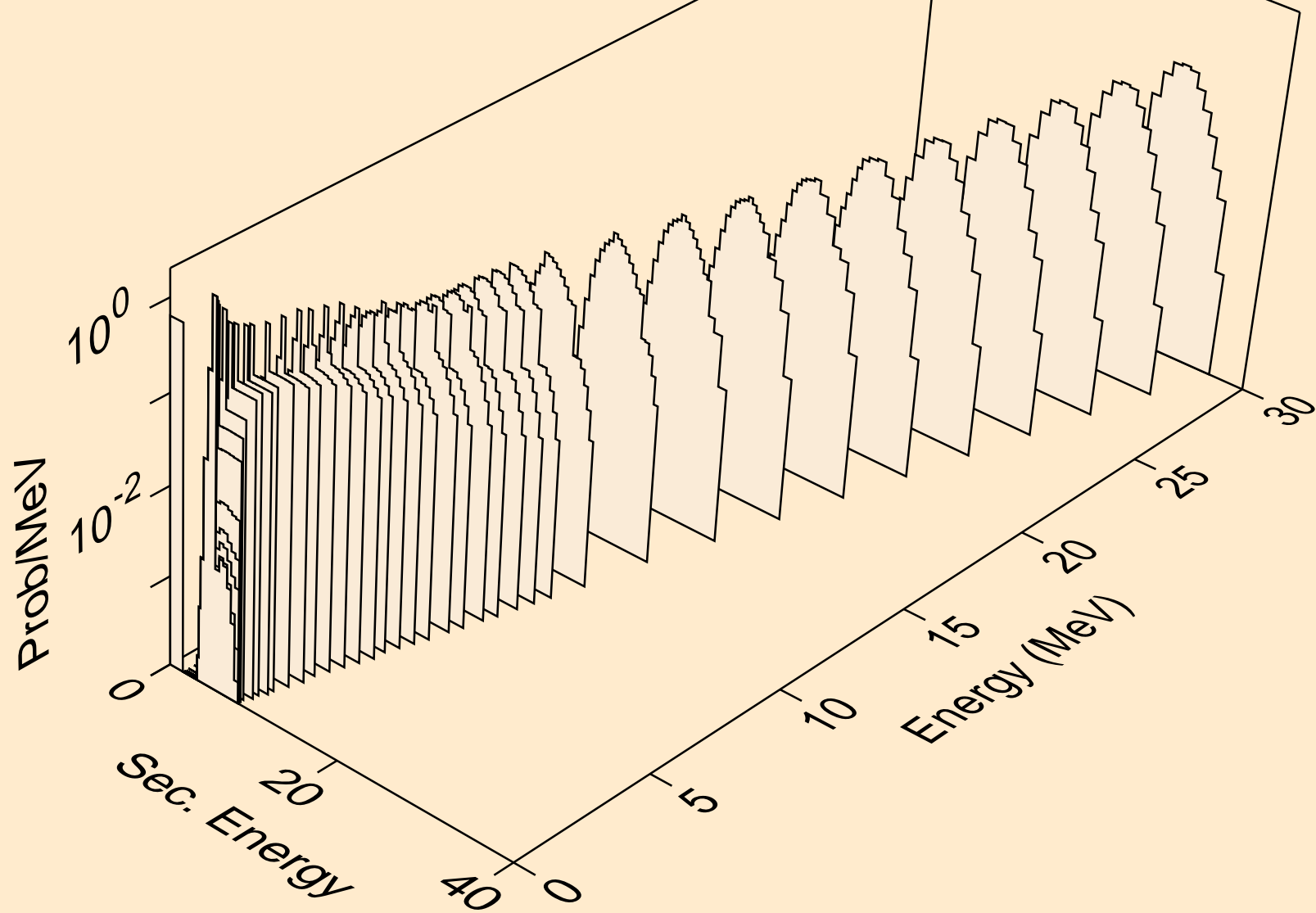

GA064 NEUTRON ACER TENDL-2024 LIBRARY; T=293.6K
alphas from (n,2a)

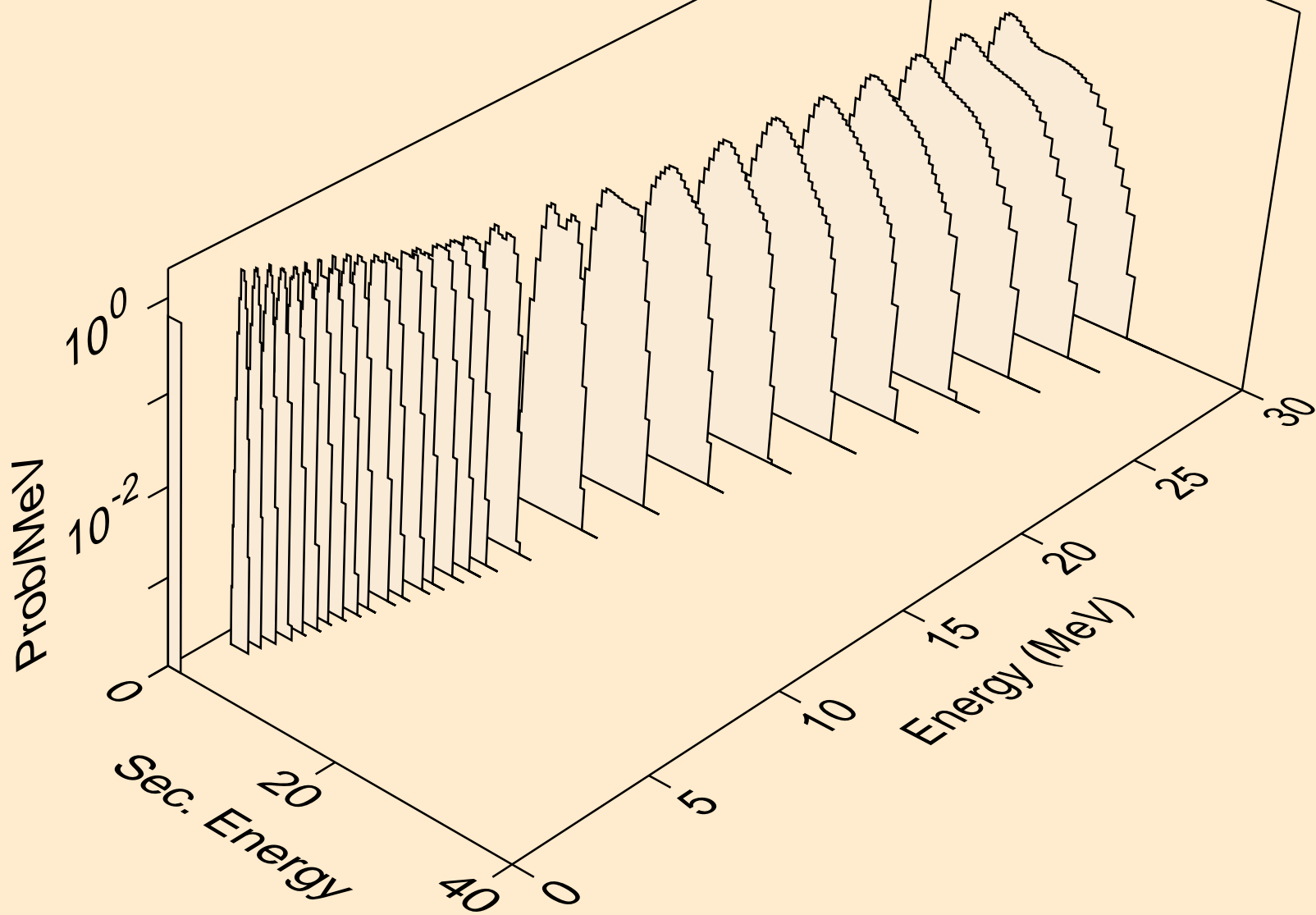

GA064 NEUTRON ACER TENDL-2024 LIBRARY; T=293.6K
alphas from (n,3a)

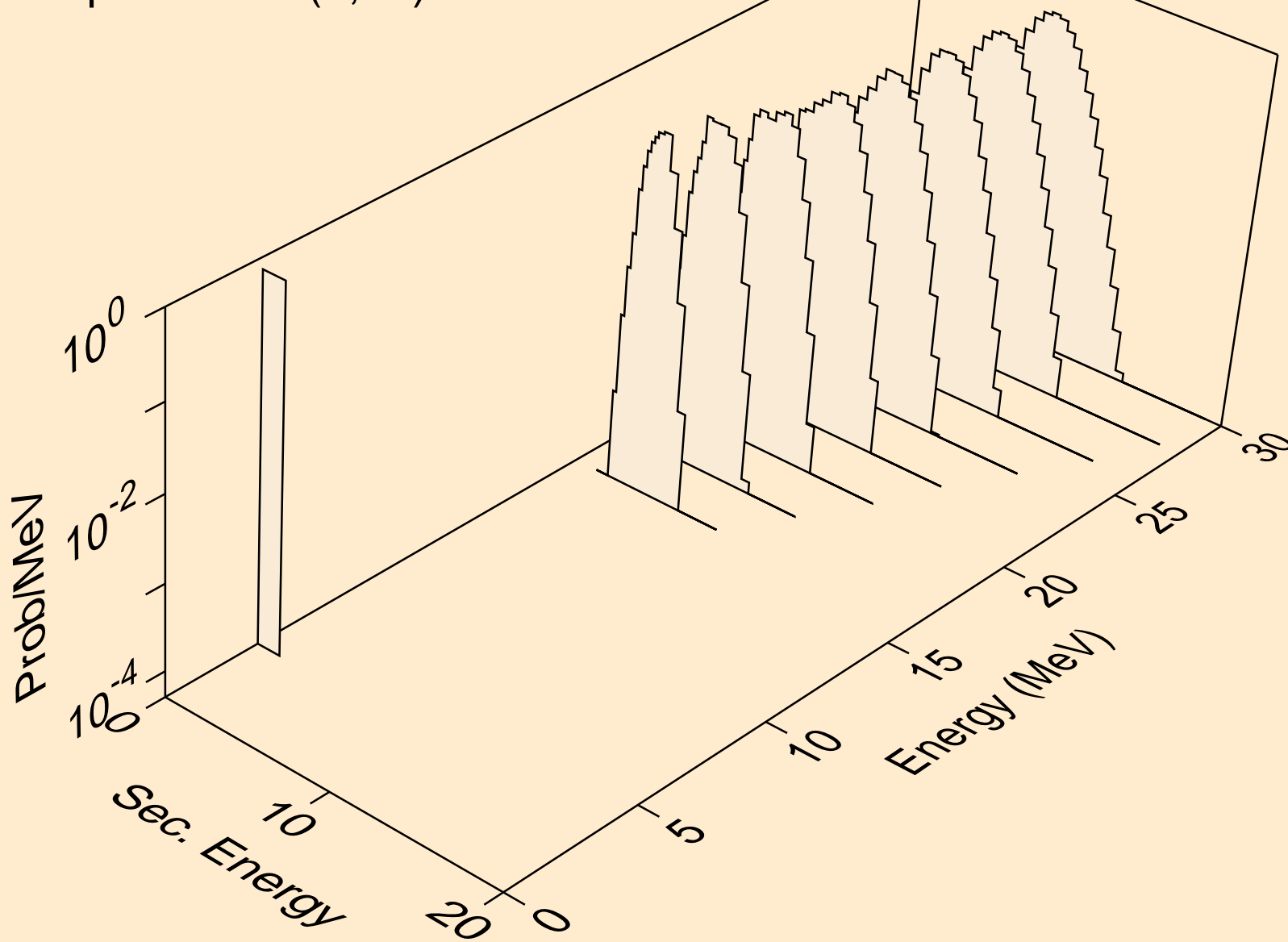

GA064 NEUTRON ACER TENDL-2024 LIBRARY; T=293.6K
alphas from (n,pa)

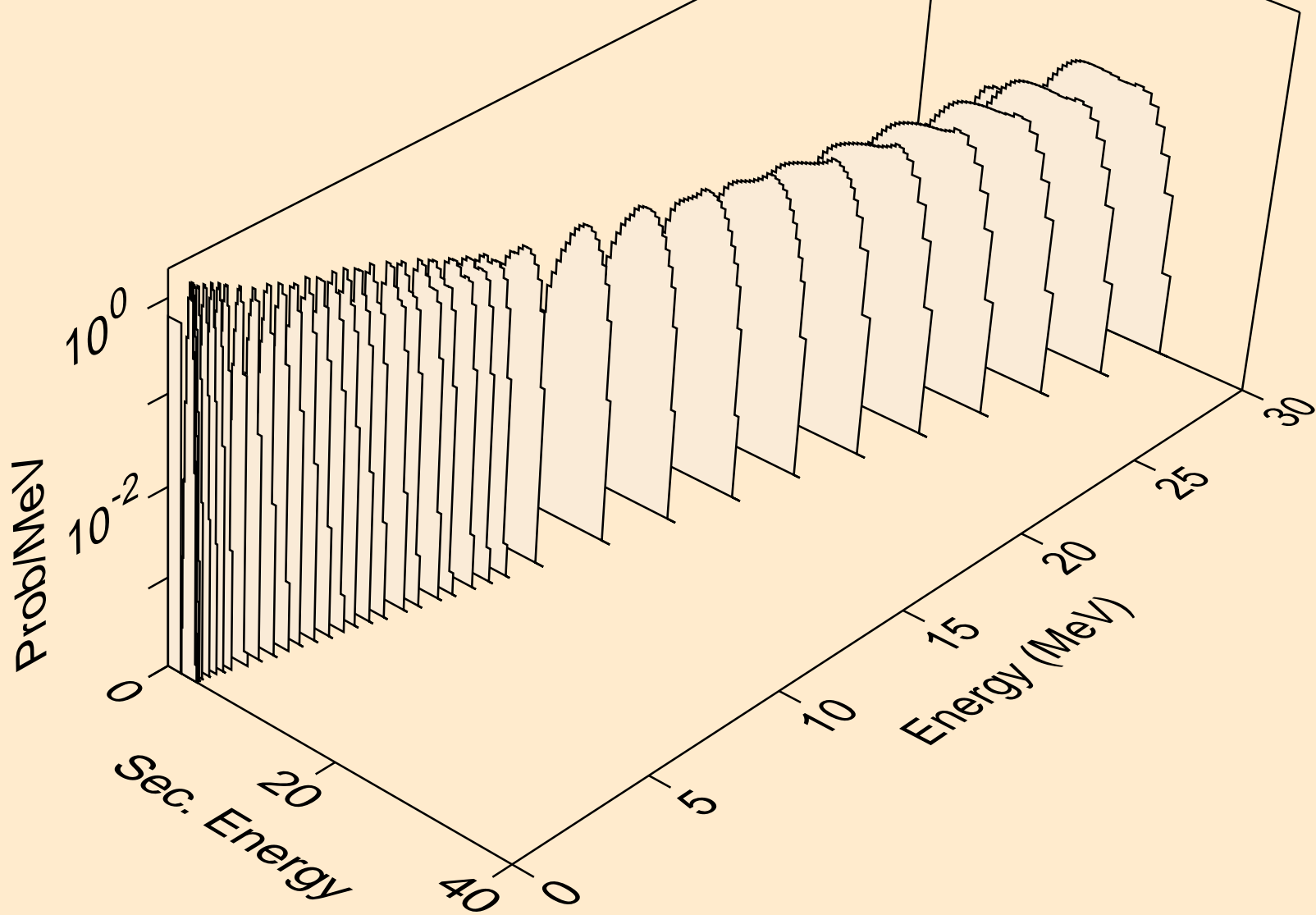

GA064 NEUTRON ACER TENDL-2024 LIBRARY; T=293.6K
alphas from (n,d2a)

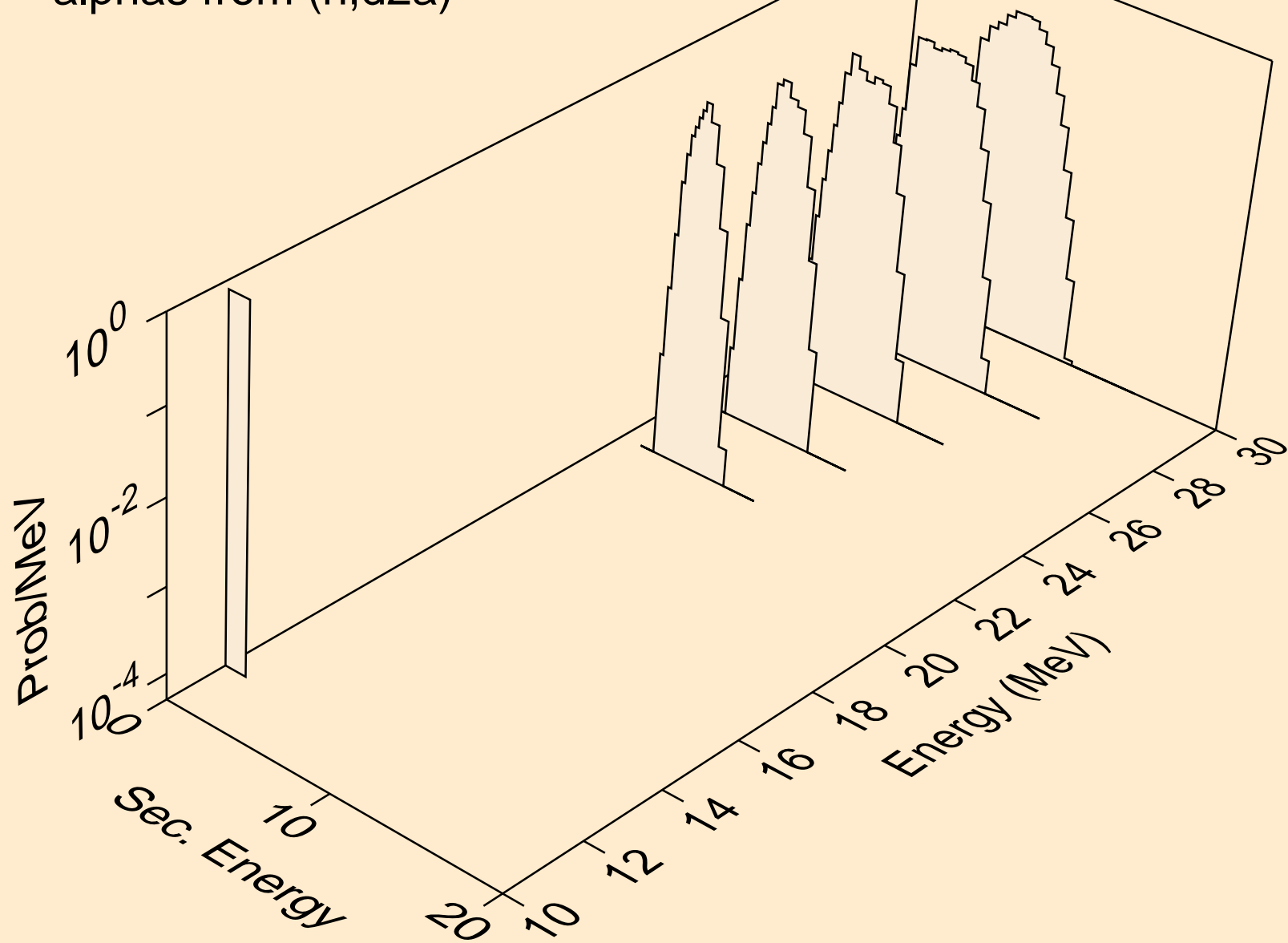

GA064 NEUTRON ACER TENDL-2024 LIBRARY; T=293.6K
alphas from (n,da)

