

HF178N NEUTRON ACER TENDL-2024 LIBRARY; T=293.6K

Principal cross sections

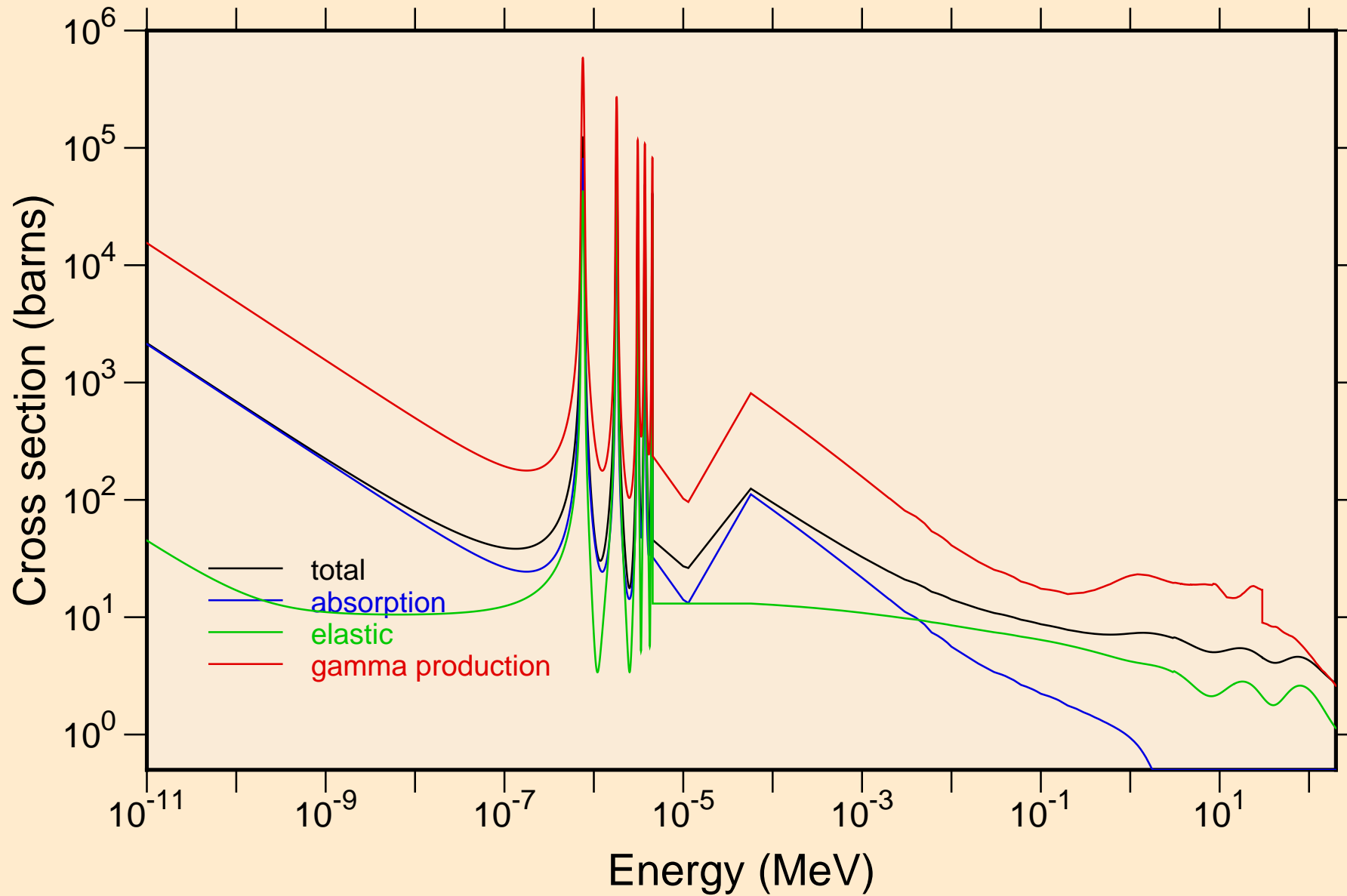

HF178N NEUTRON ACER TENDL-2024 LIBRARY; T=293.6K
resonance total cross section

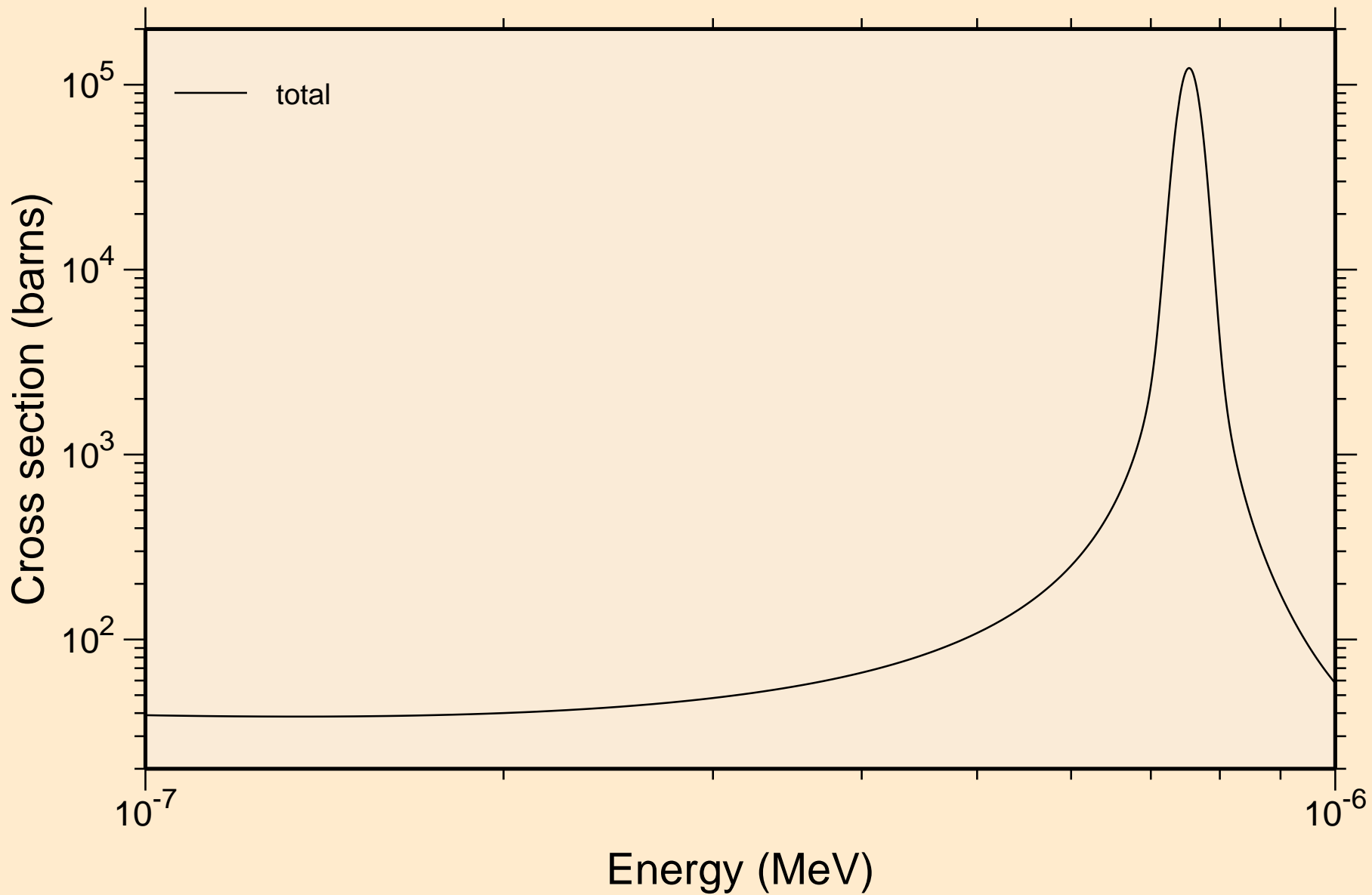

HF178N NEUTRON ACER TENDL-2024 LIBRARY; T=293.6K
resonance total cross section

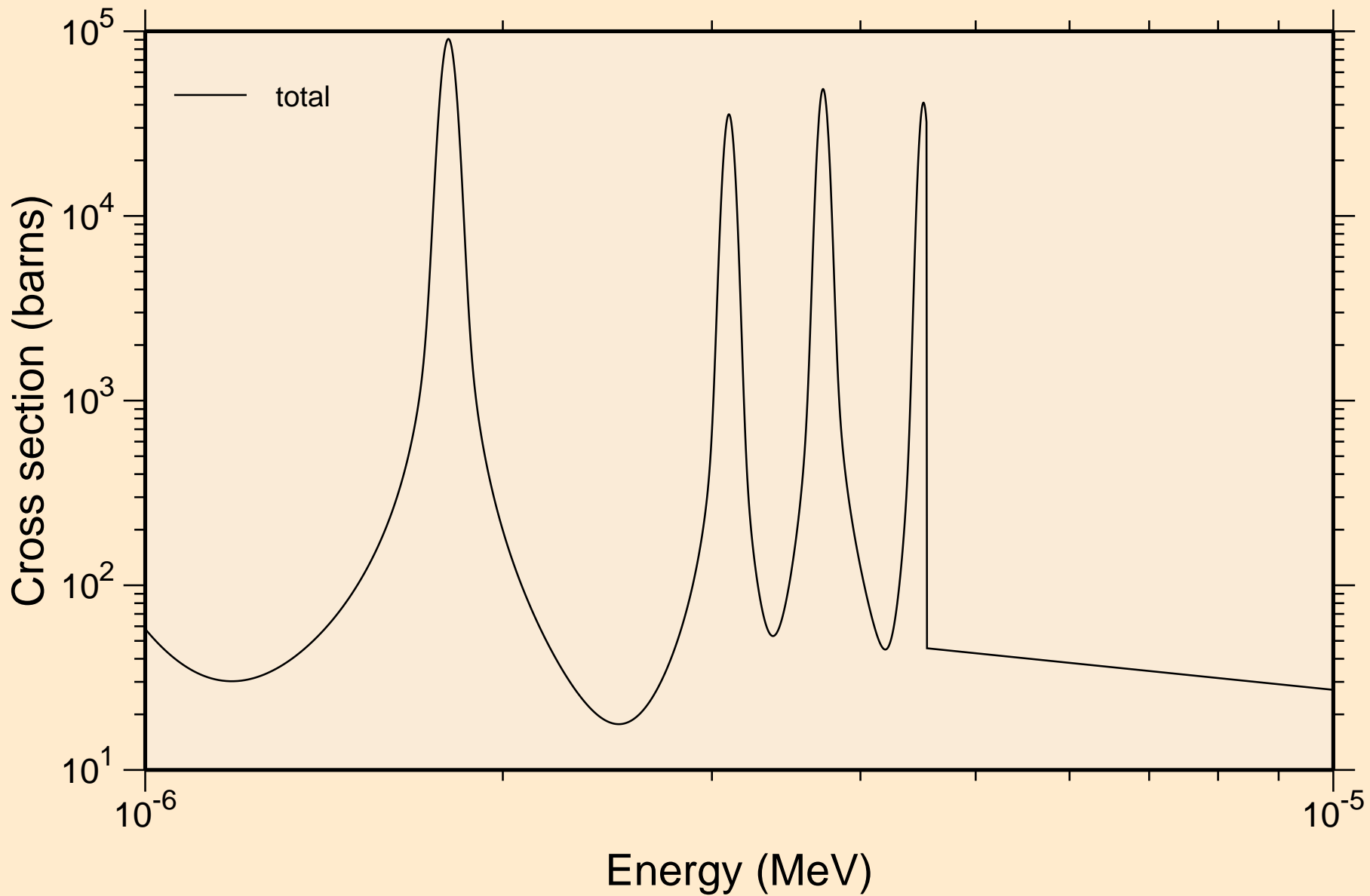

HF178N NEUTRON ACER TENDL-2024 LIBRARY; T=293.6K
resonance total cross section

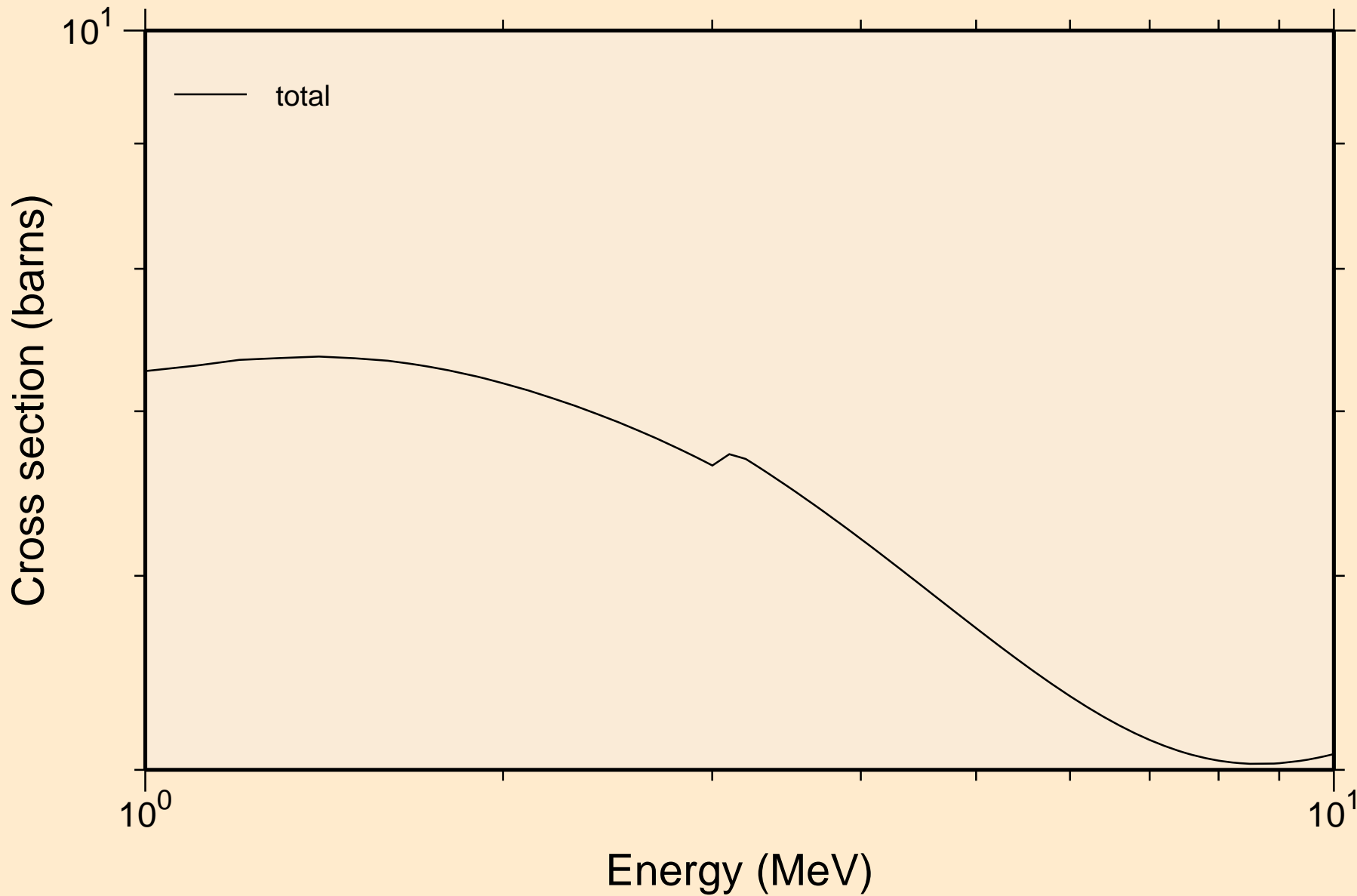

HF178N NEUTRON ACER TENDL-2024 LIBRARY; T=293.6K
resonance absorption cross sections

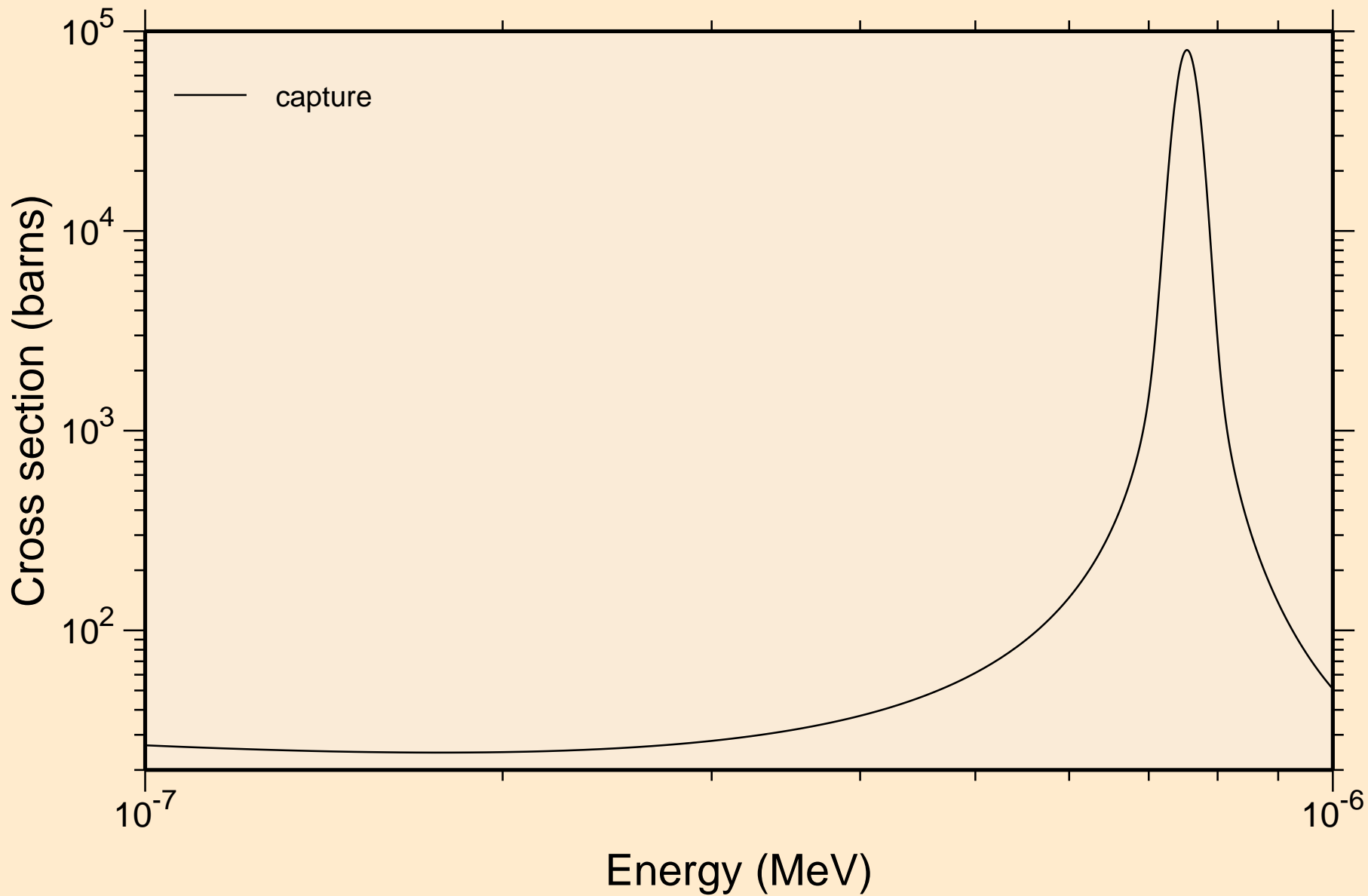

HF178N NEUTRON ACER TENDL-2024 LIBRARY; T=293.6K
resonance absorption cross sections

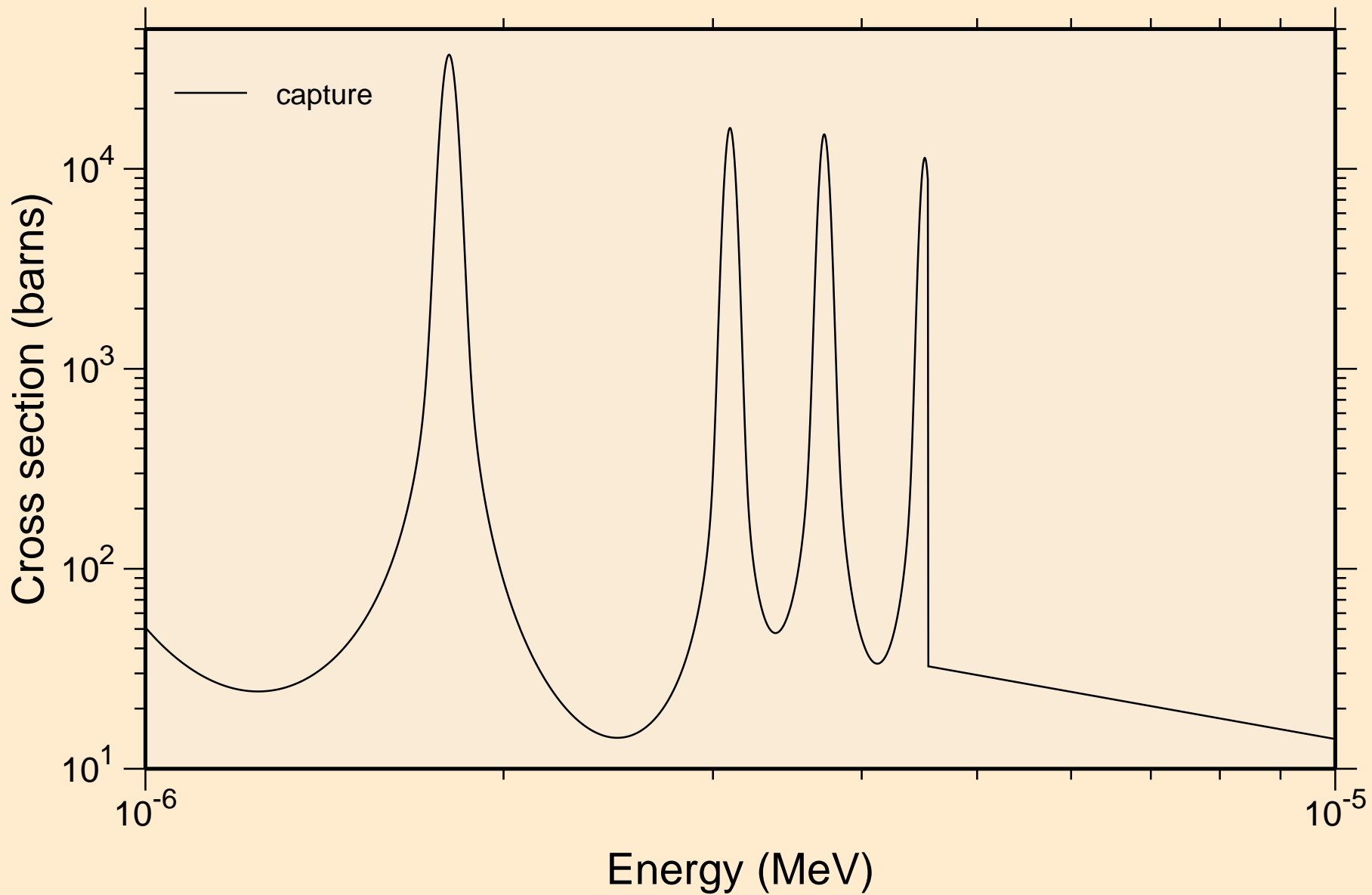

HF178N NEUTRON ACER TENDL-2024 LIBRARY; T=293.6K
resonance absorption cross sections

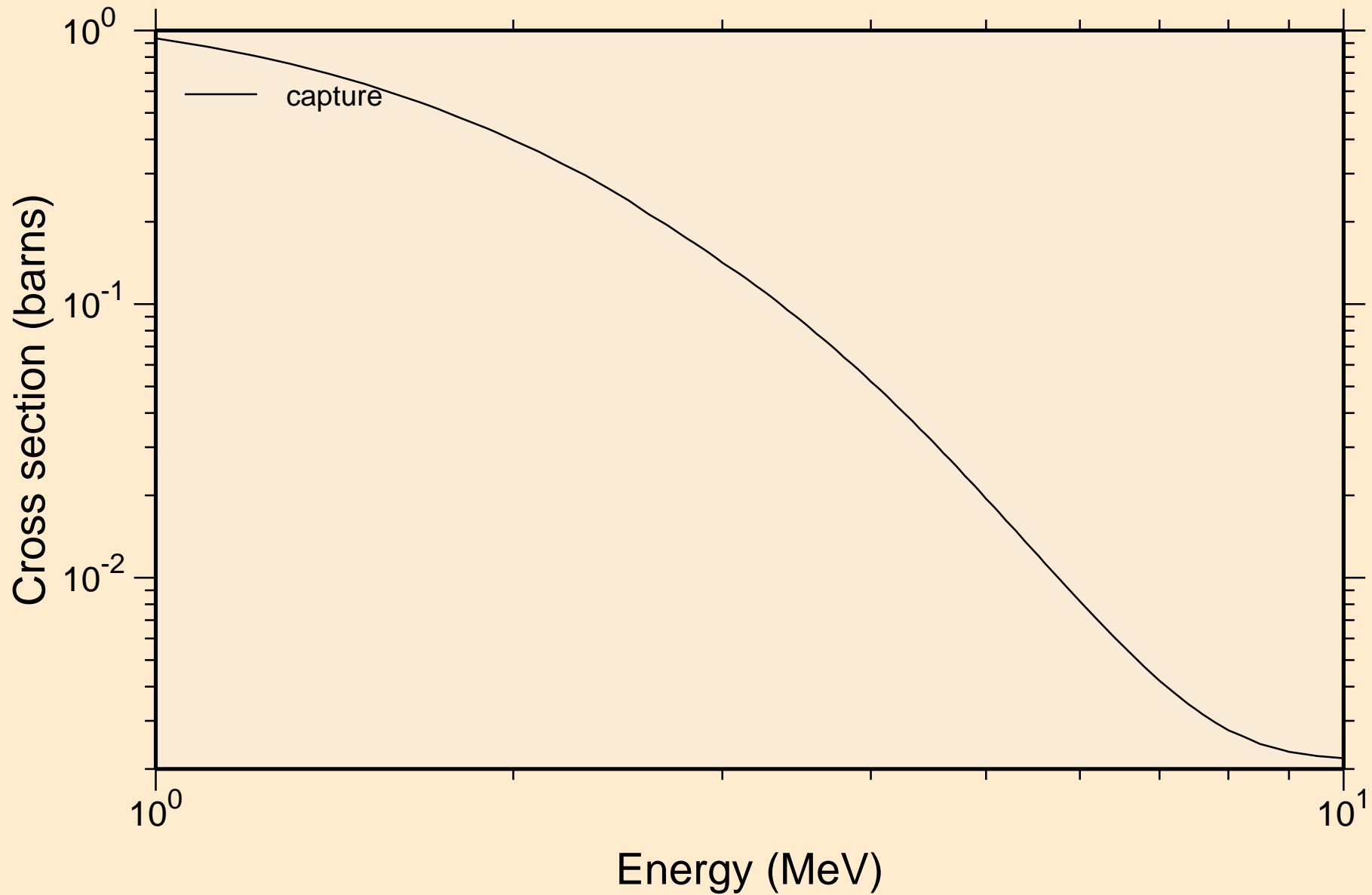

HF178N NEUTRON ACER TENDL-2024 LIBRARY; T=293.6K
Heating

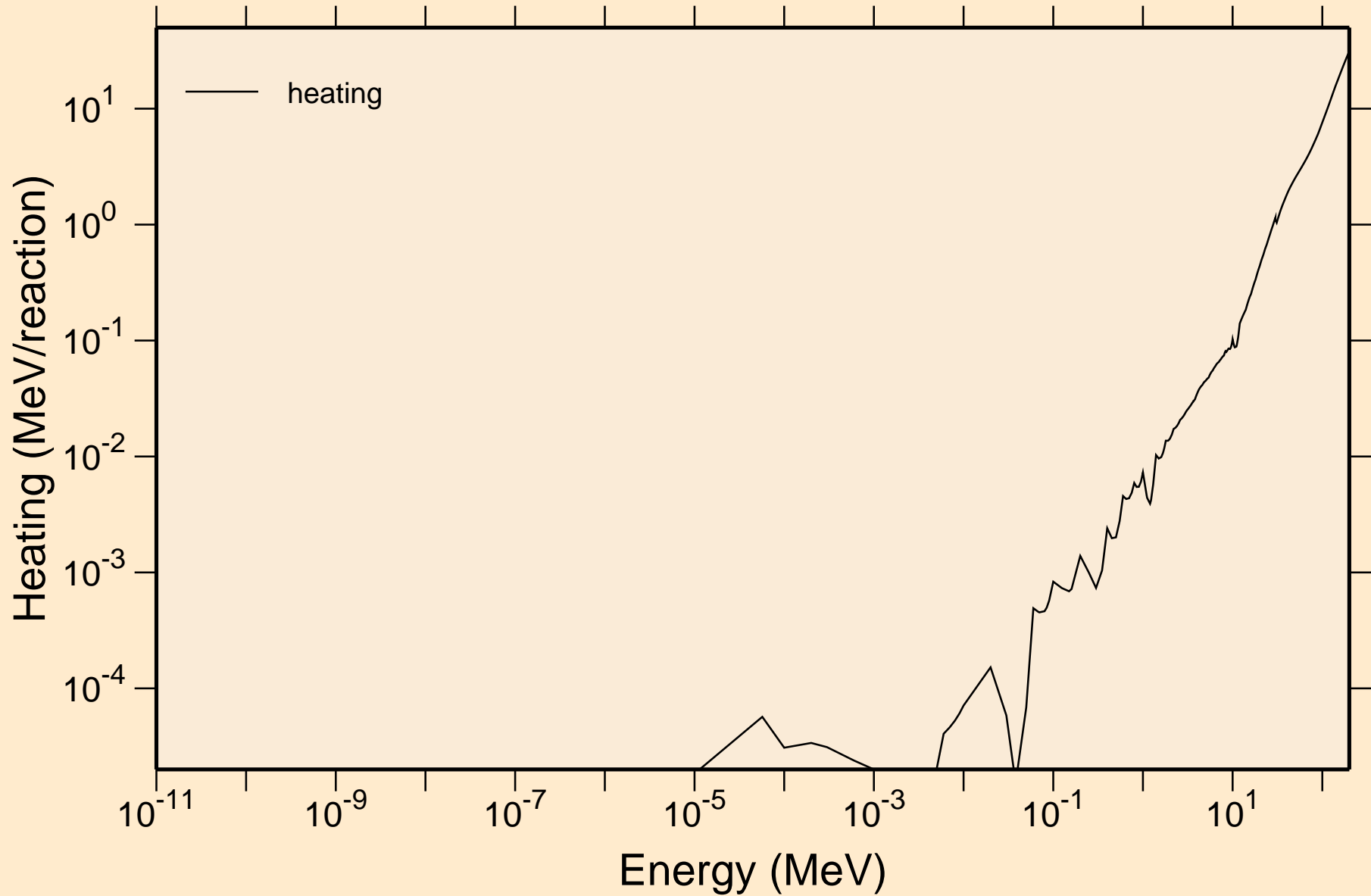

HF178N NEUTRON ACER TENDL-2024 LIBRARY; T=293.6K

Damage

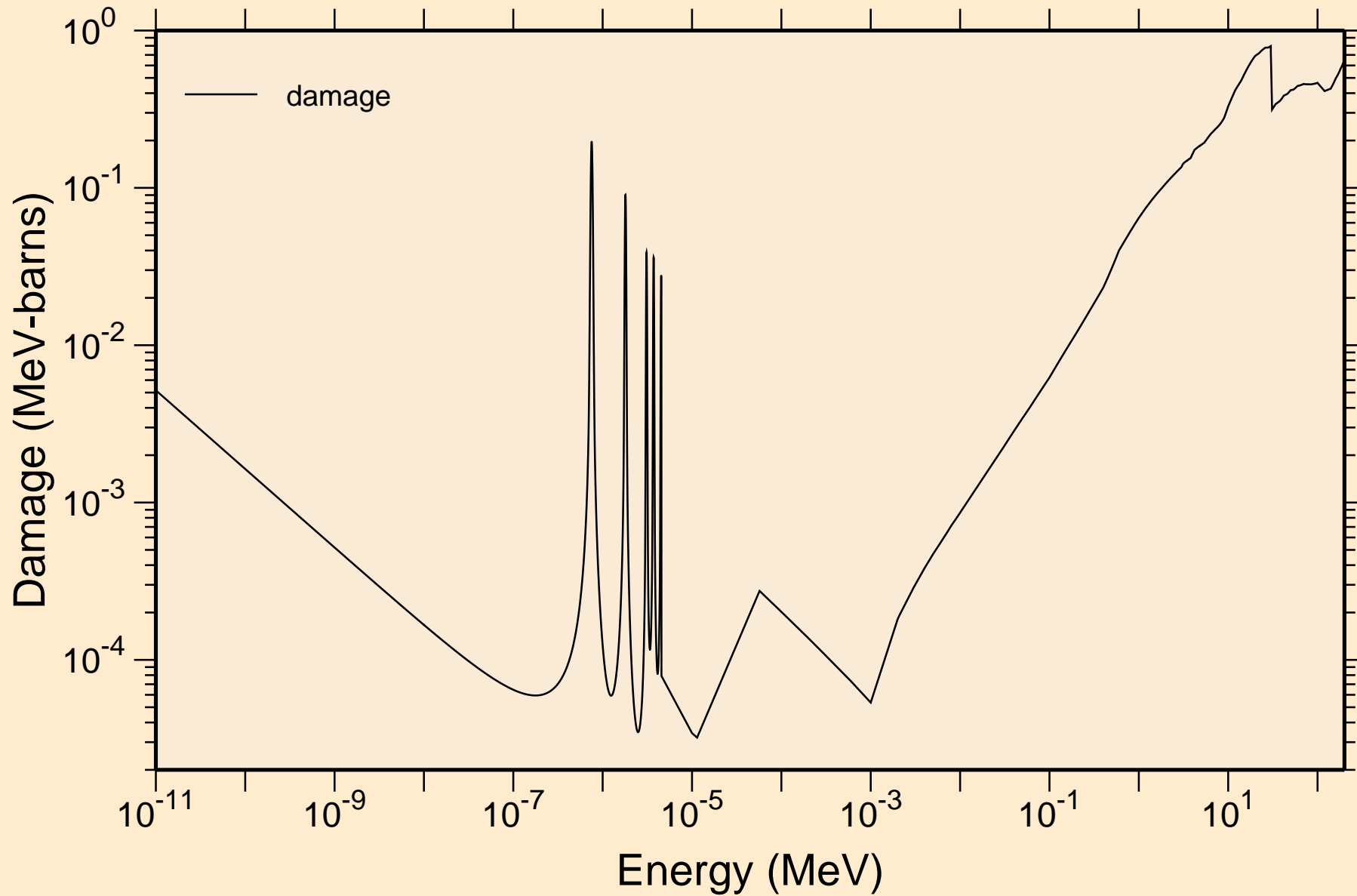

HF178N NEUTRON ACER TENDL-2024 LIBRARY; T=293.6K

Non-threshold reactions

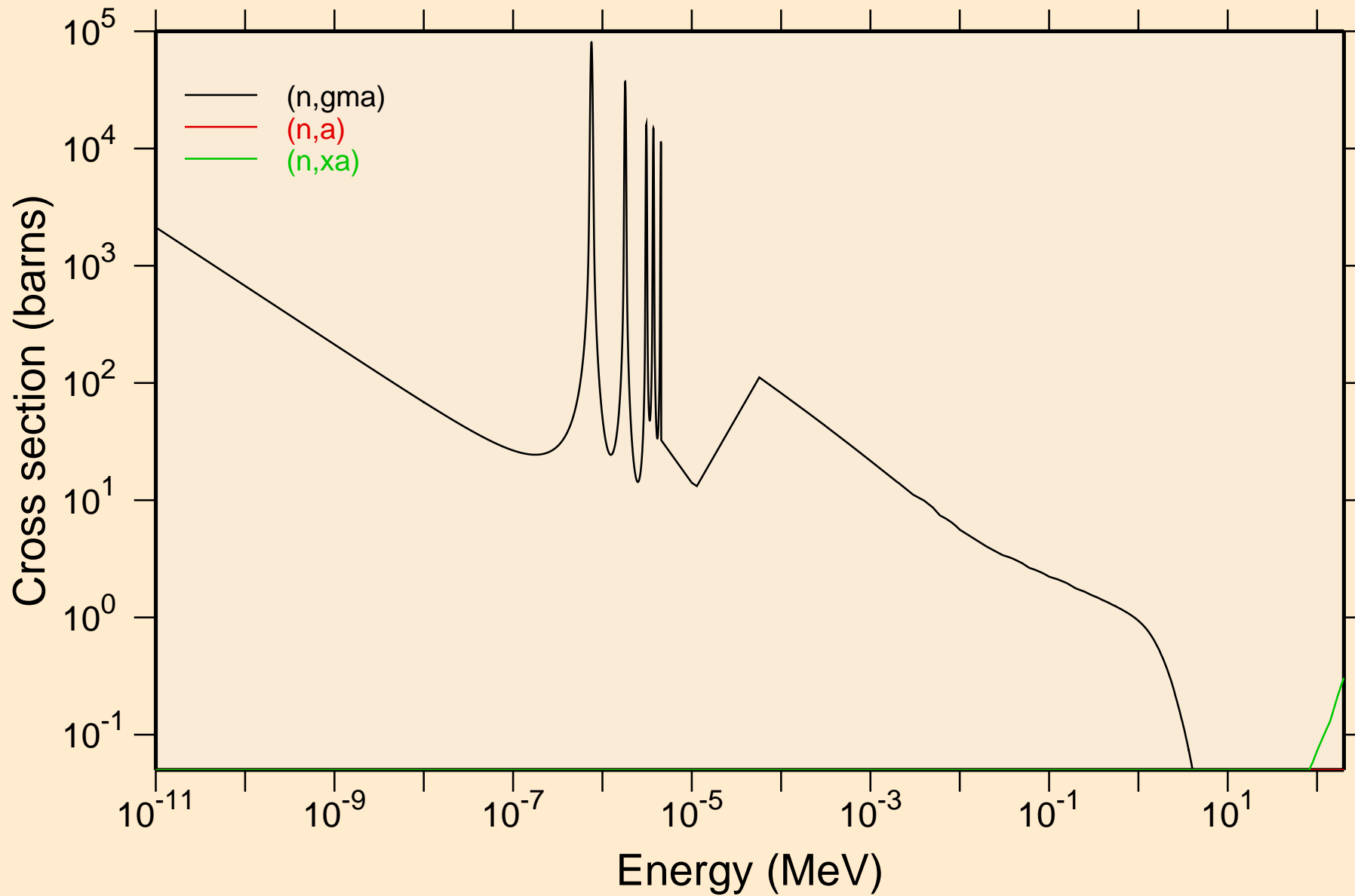

HF178N NEUTRON ACER TENDL-2024 LIBRARY; T=293.6K

Principal cross sections

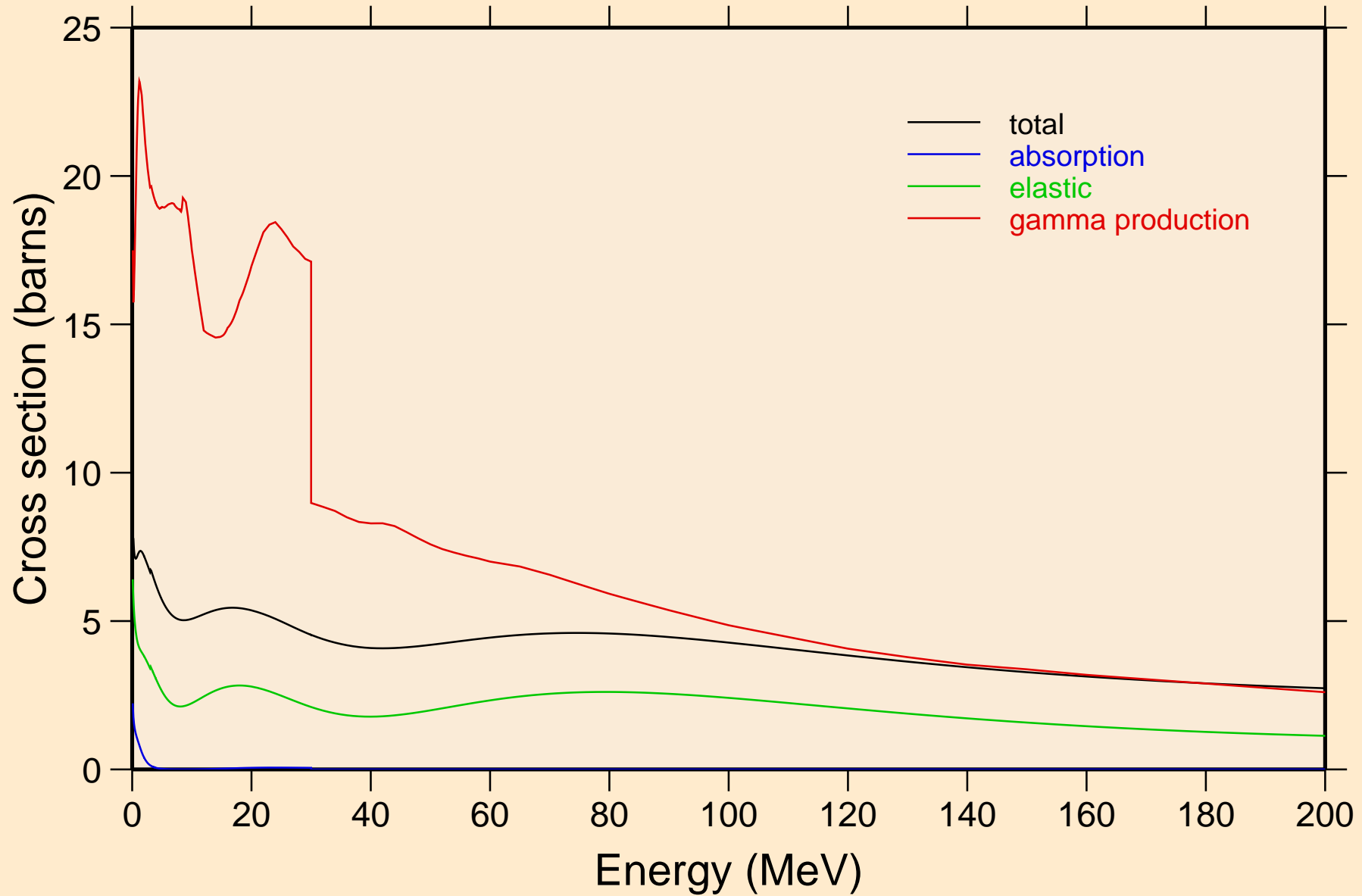

HF178N NEUTRON ACER TENDL-2024 LIBRARY; T=293.6K
Heating

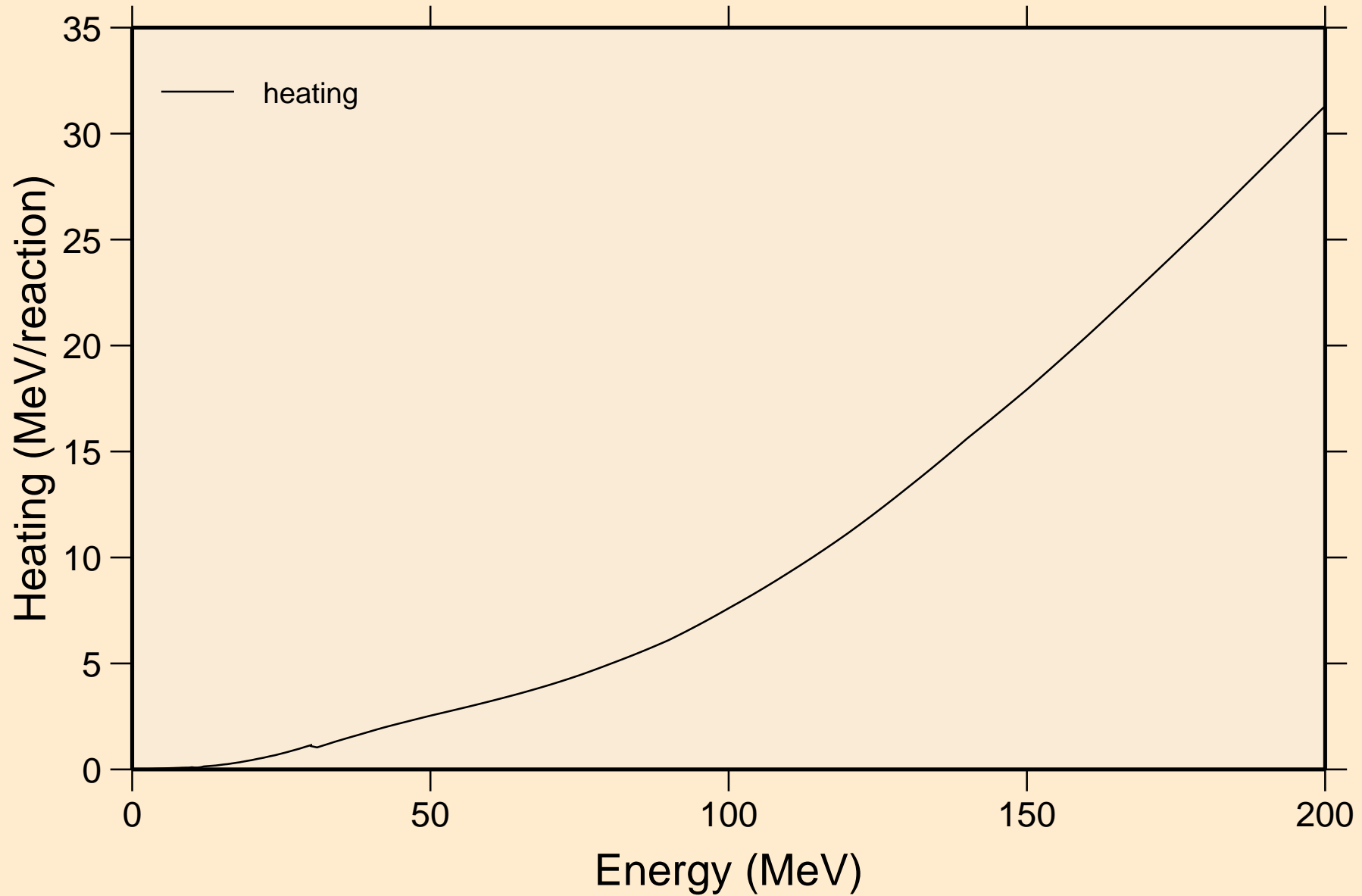

HF178N NEUTRON ACER TENDL-2024 LIBRARY; T=293.6K

Damage

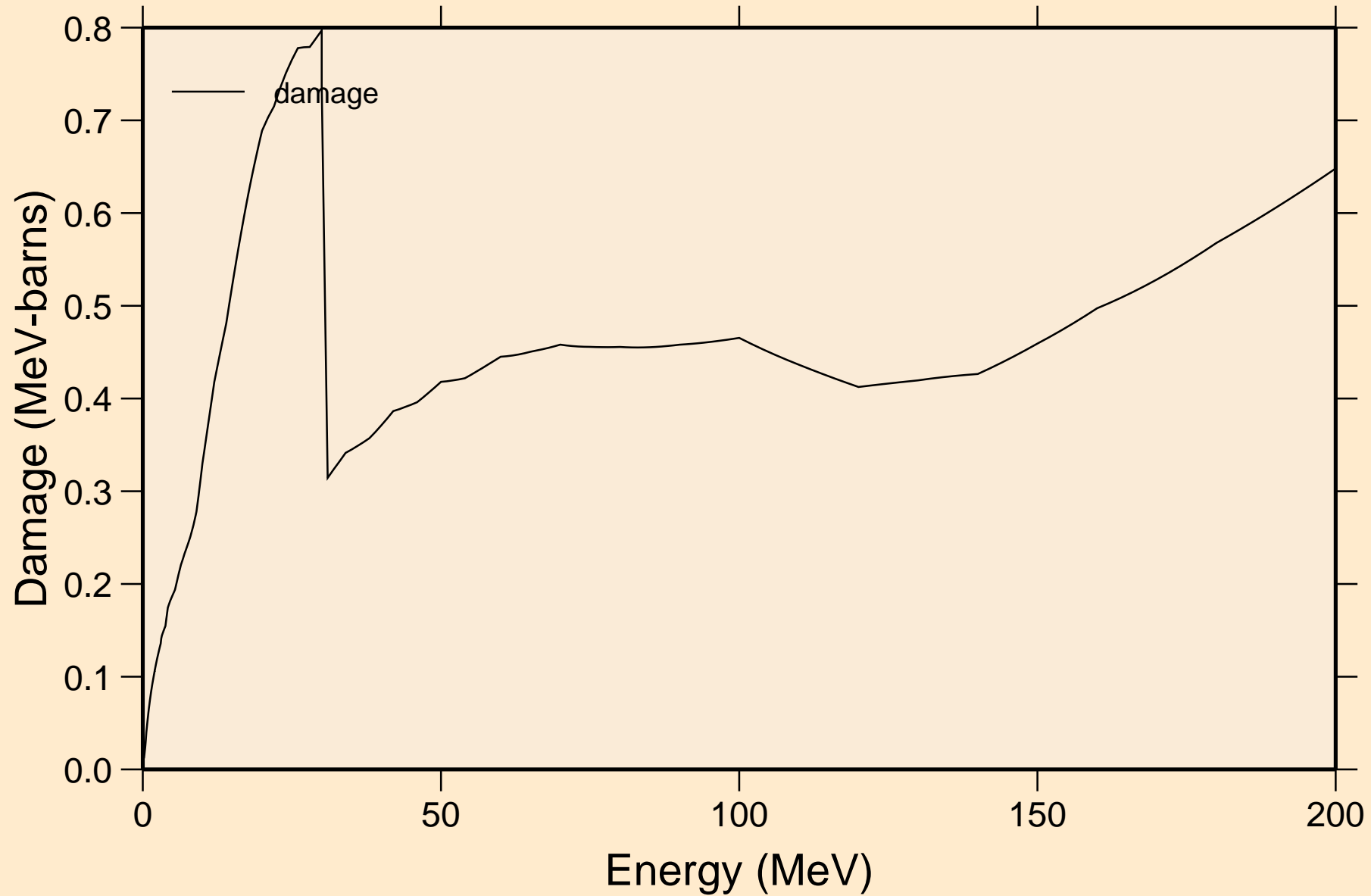

HF178N NEUTRON ACER TENDL-2024 LIBRARY; T=293.6K

Non-threshold reactions

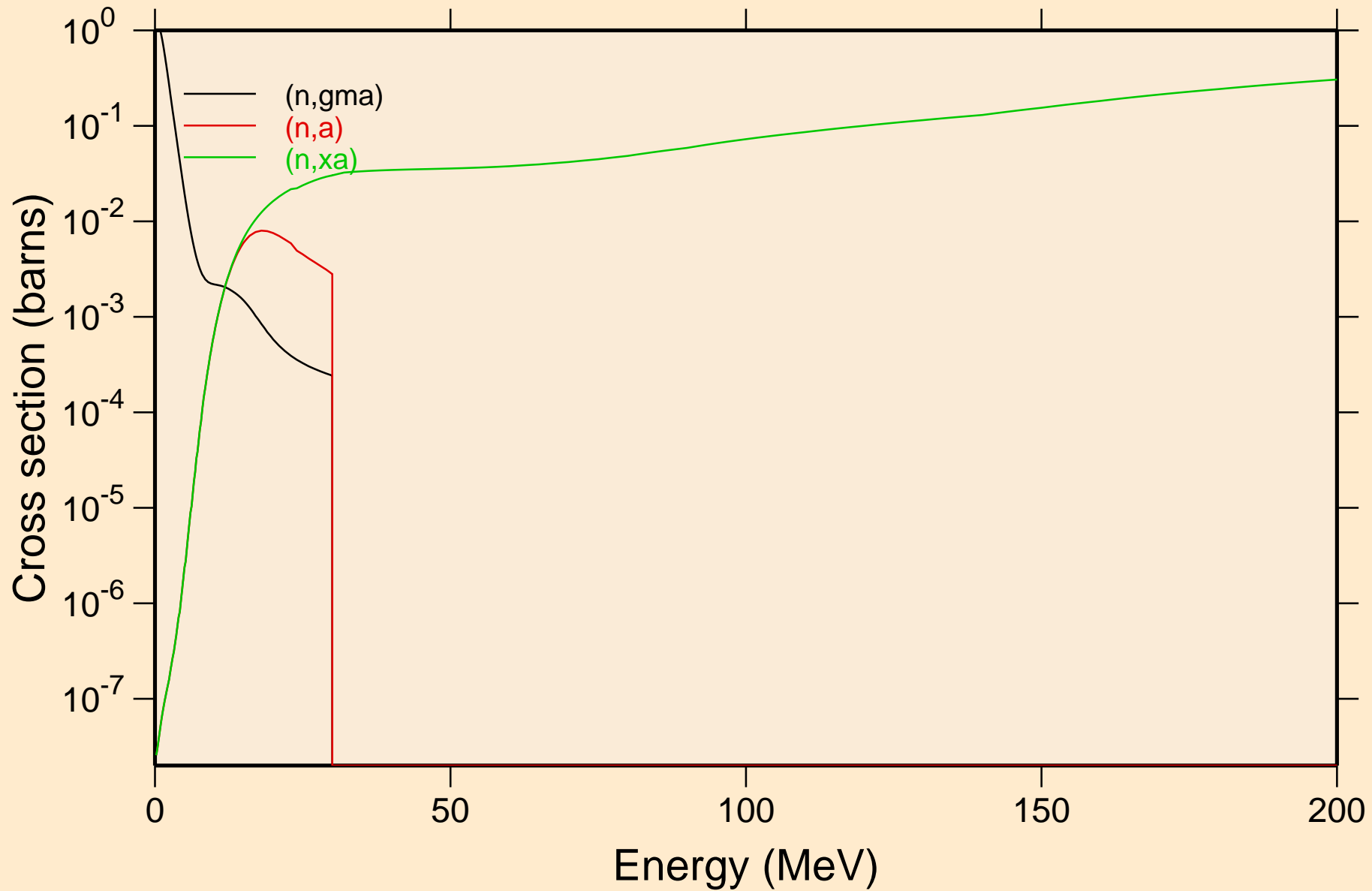

HF178N NEUTRON ACER TENDL-2024 LIBRARY; T=293.6K
Inelastic levels

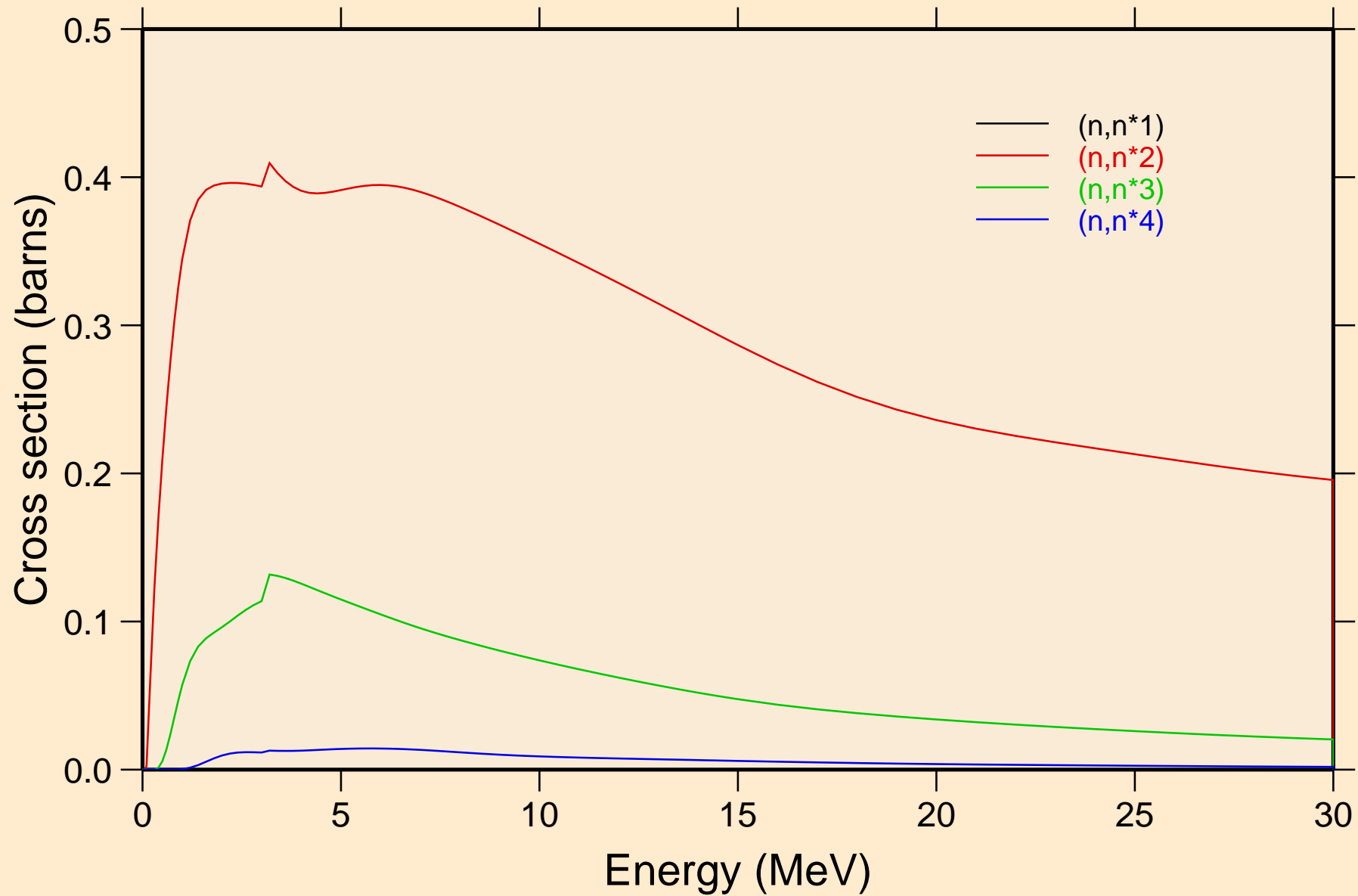

HF178N NEUTRON ACER TENDL-2024 LIBRARY; T=293.6K
Threshold reactions

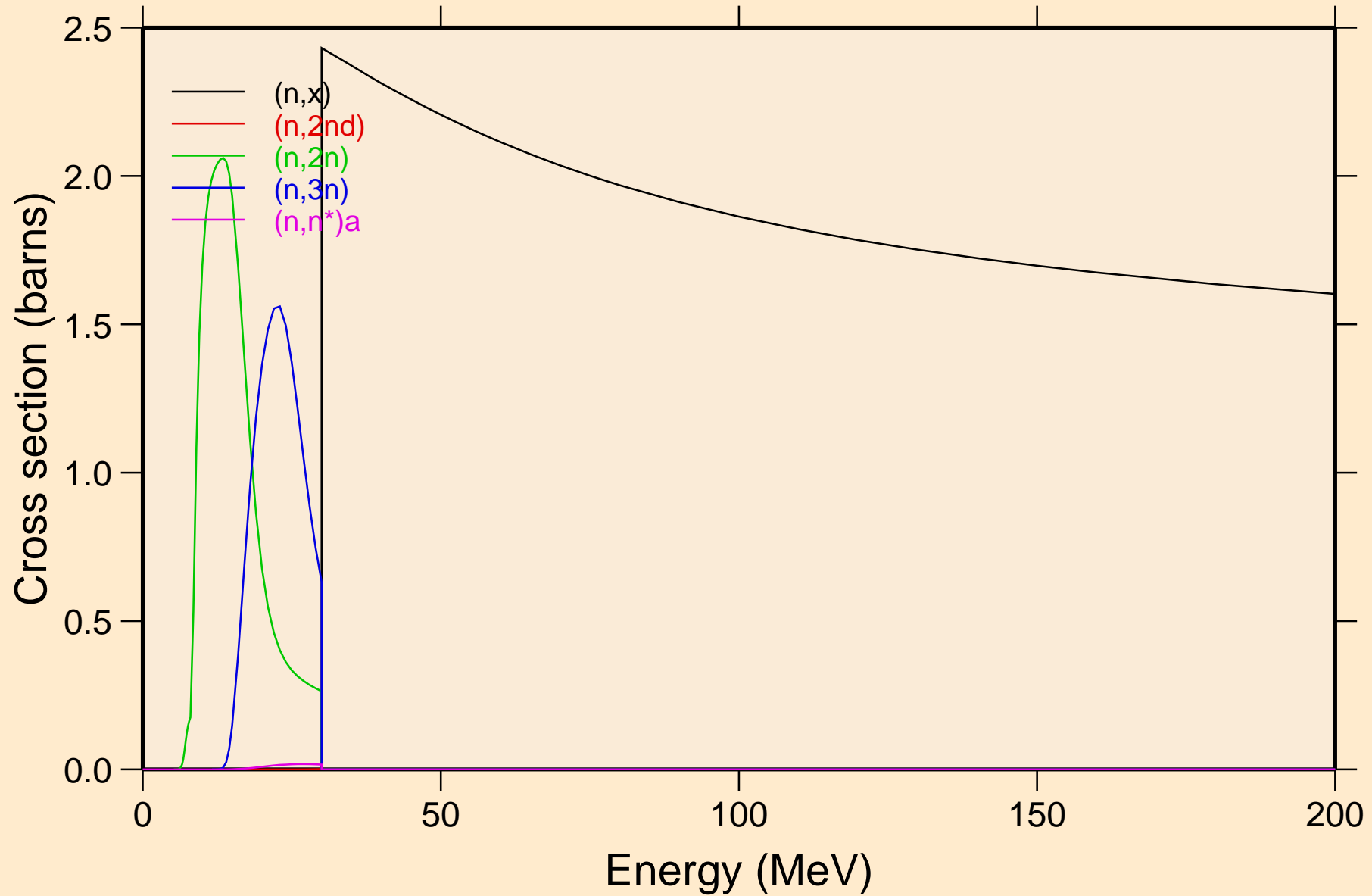

HF178N NEUTRON ACER TENDL-2024 LIBRARY; T=293.6K

Threshold reactions

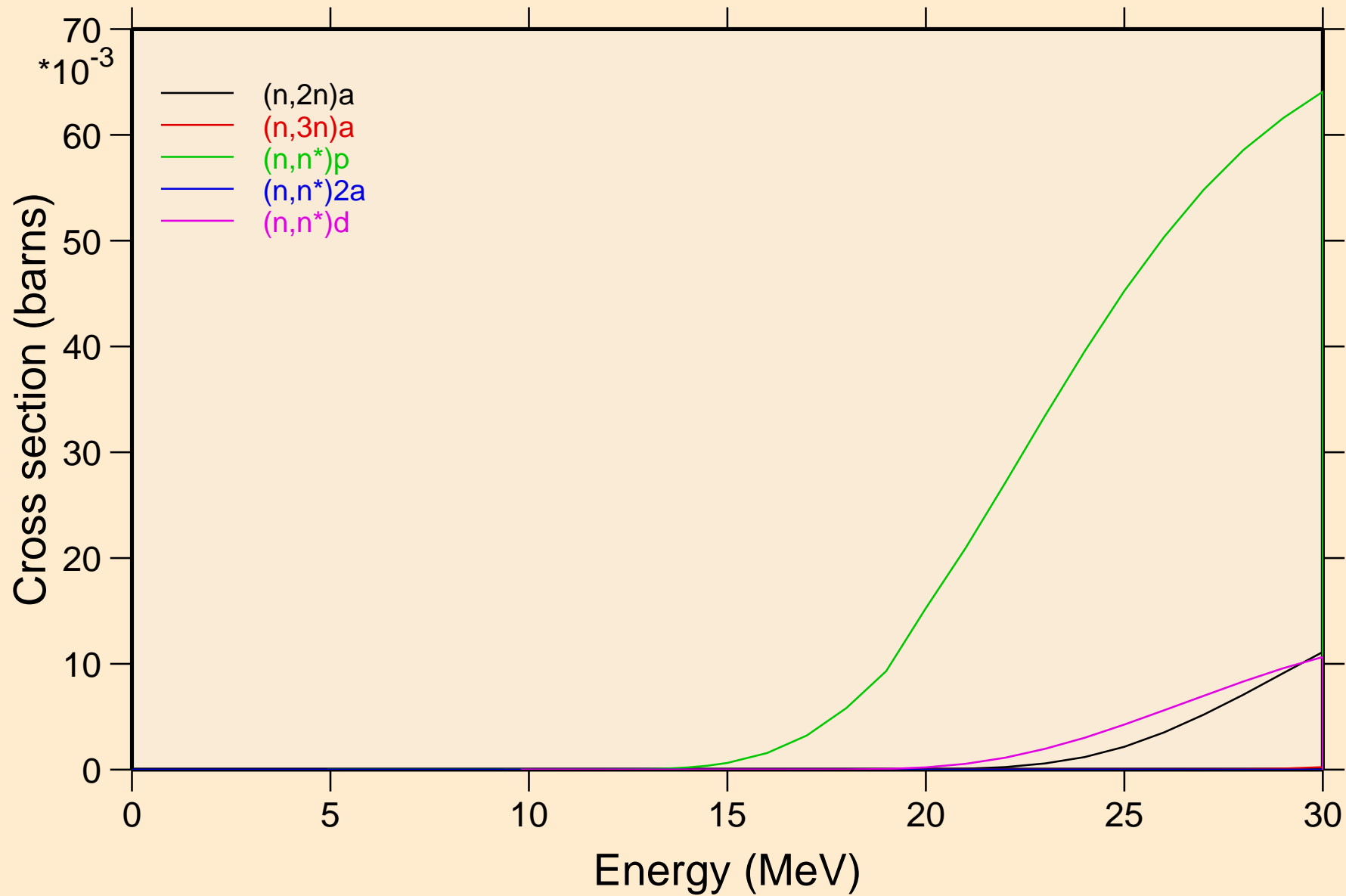

HF178N NEUTRON ACER TENDL-2024 LIBRARY; T=293.6K
Threshold reactions

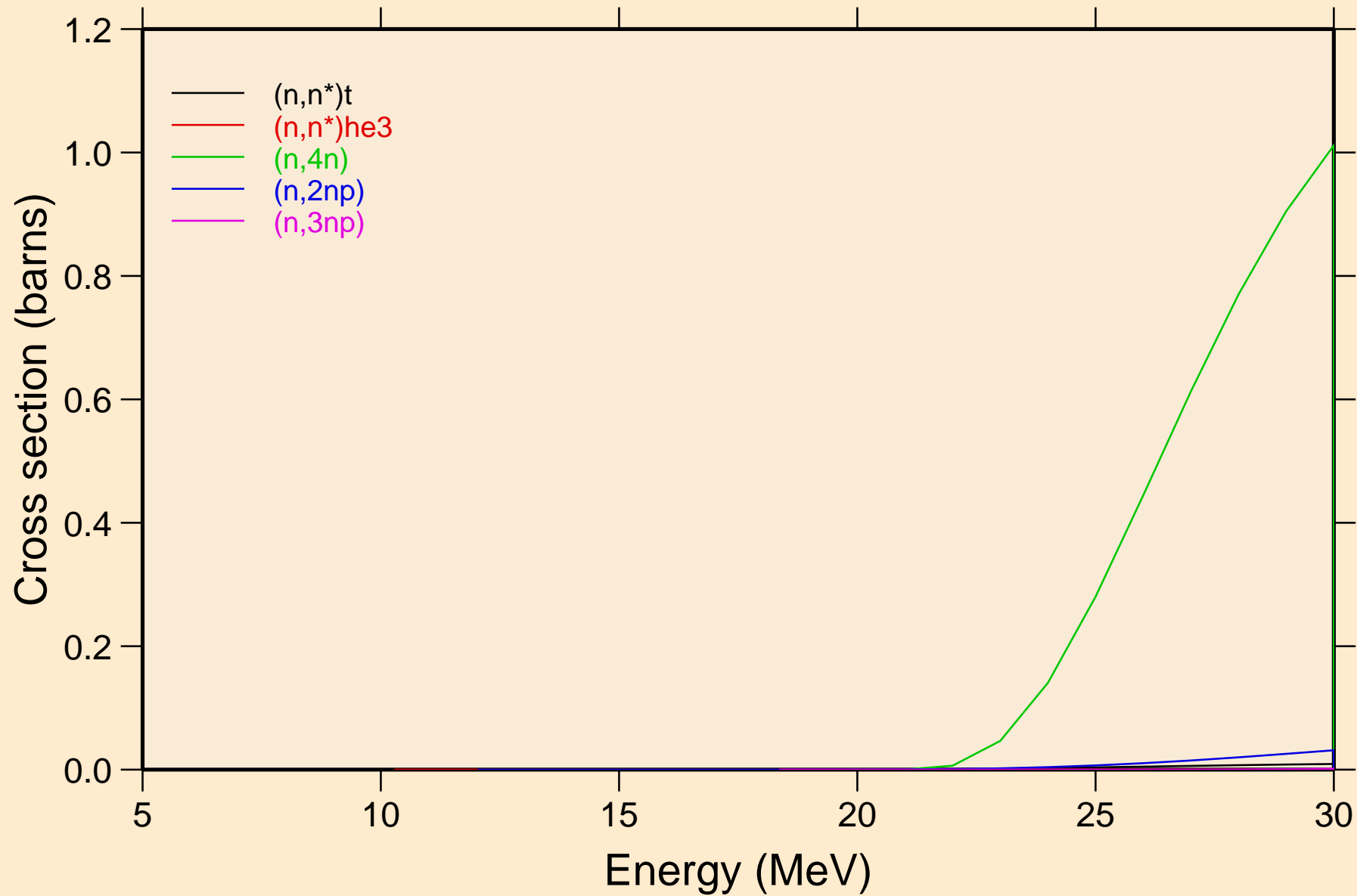

HF178N NEUTRON ACER TENDL-2024 LIBRARY; T=293.6K

Threshold reactions

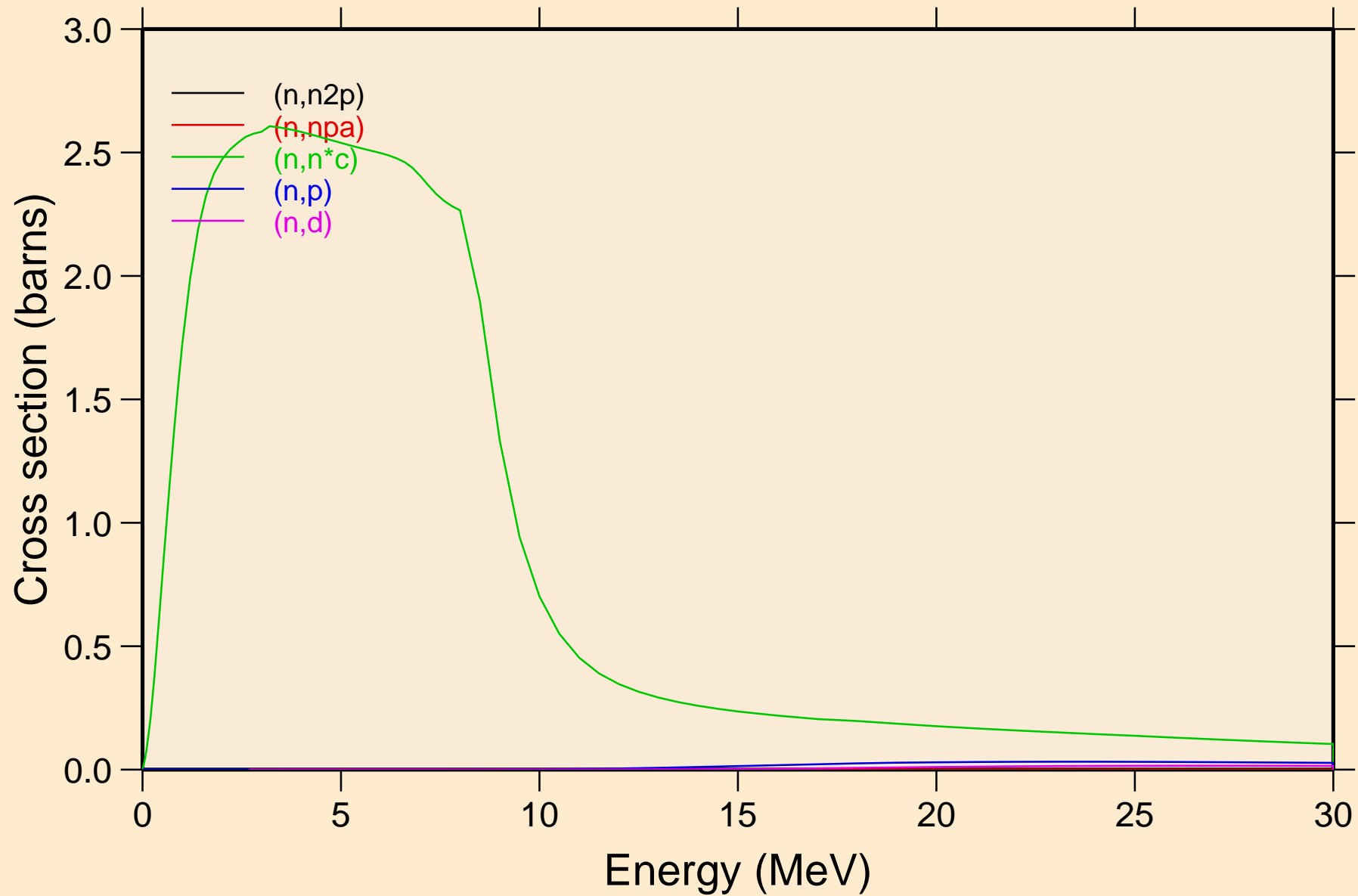

HF178N NEUTRON ACER TENDL-2024 LIBRARY; T=293.6K
Threshold reactions

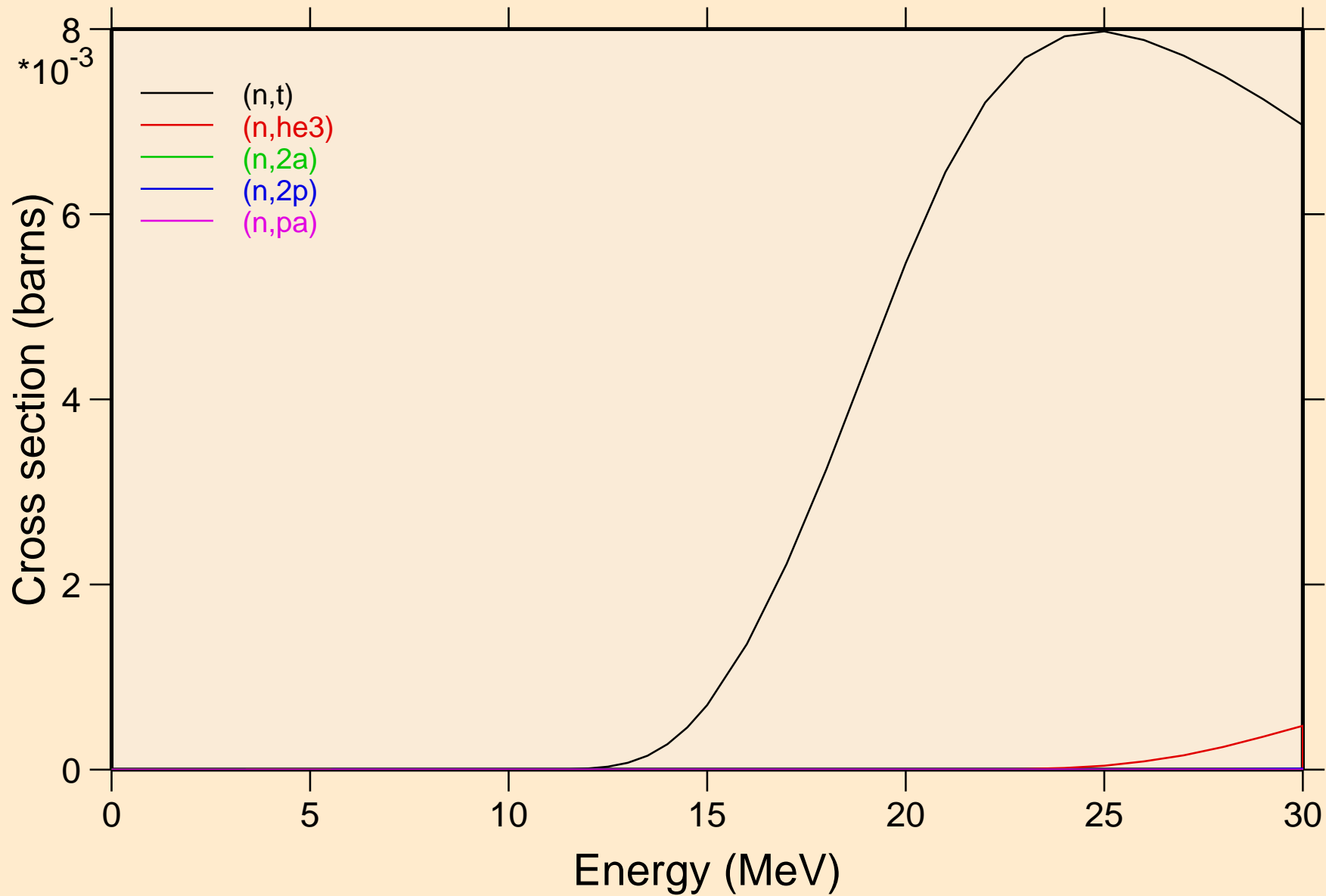

HF178N NEUTRON ACER TENDL-2024 LIBRARY; T=293.6K
Threshold reactions

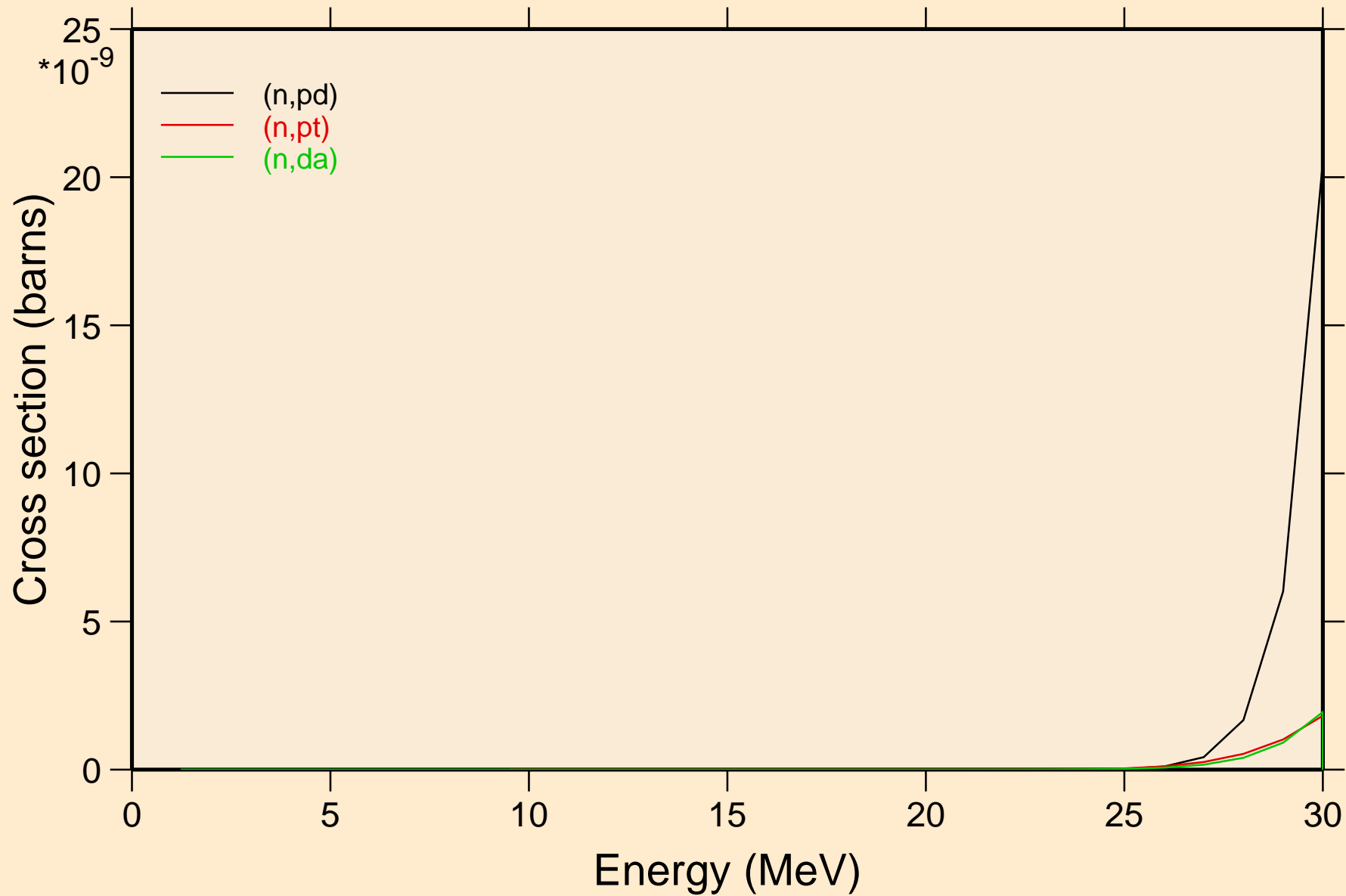

HF178N NEUTRON ACER TENDL-2024 LIBRARY; T=293.6K
Threshold reactions

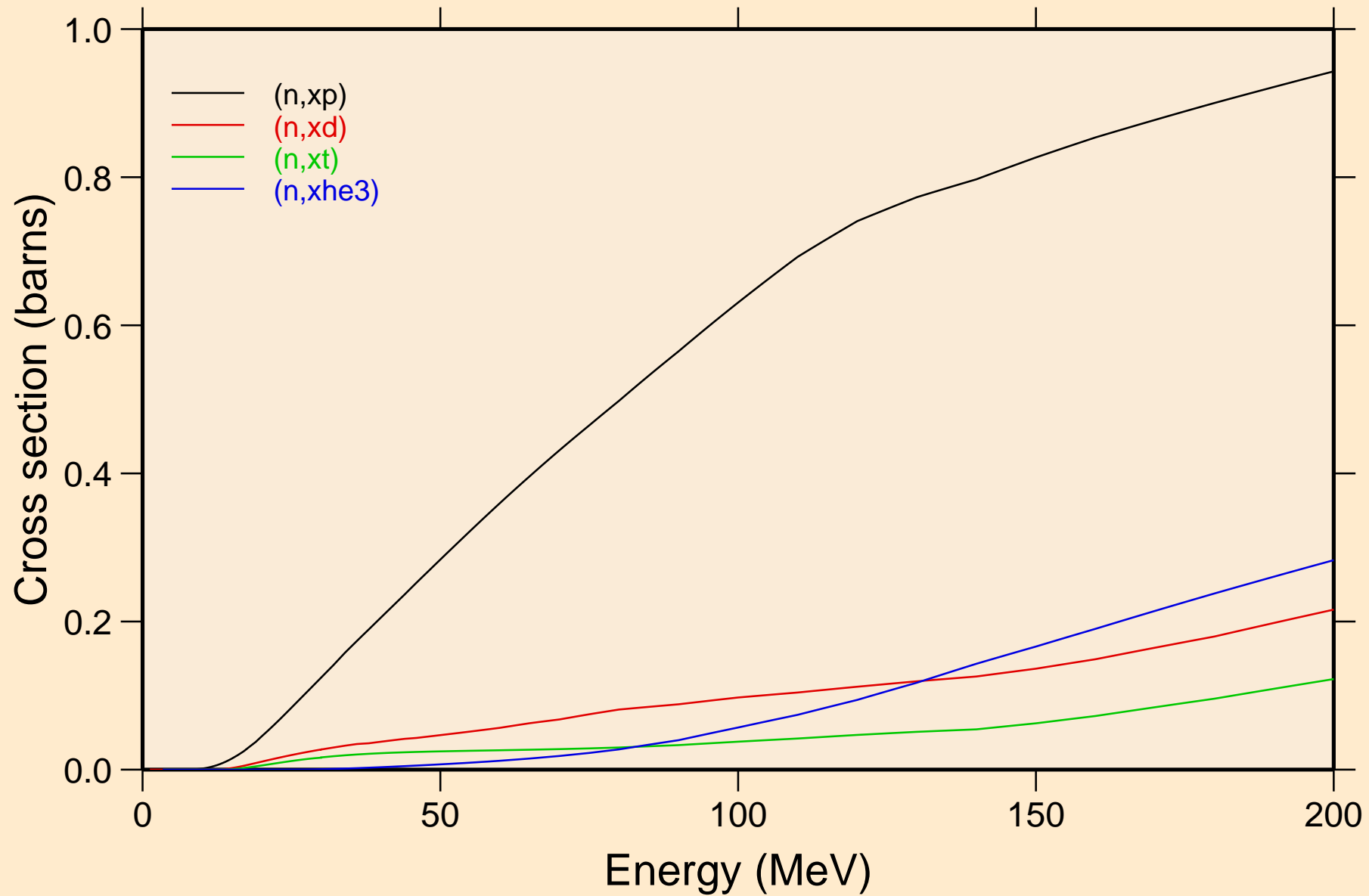

HF178N NEUTRON ACER TENDL-2024 LIBRARY; T=293.6K
angular distribution for elastic

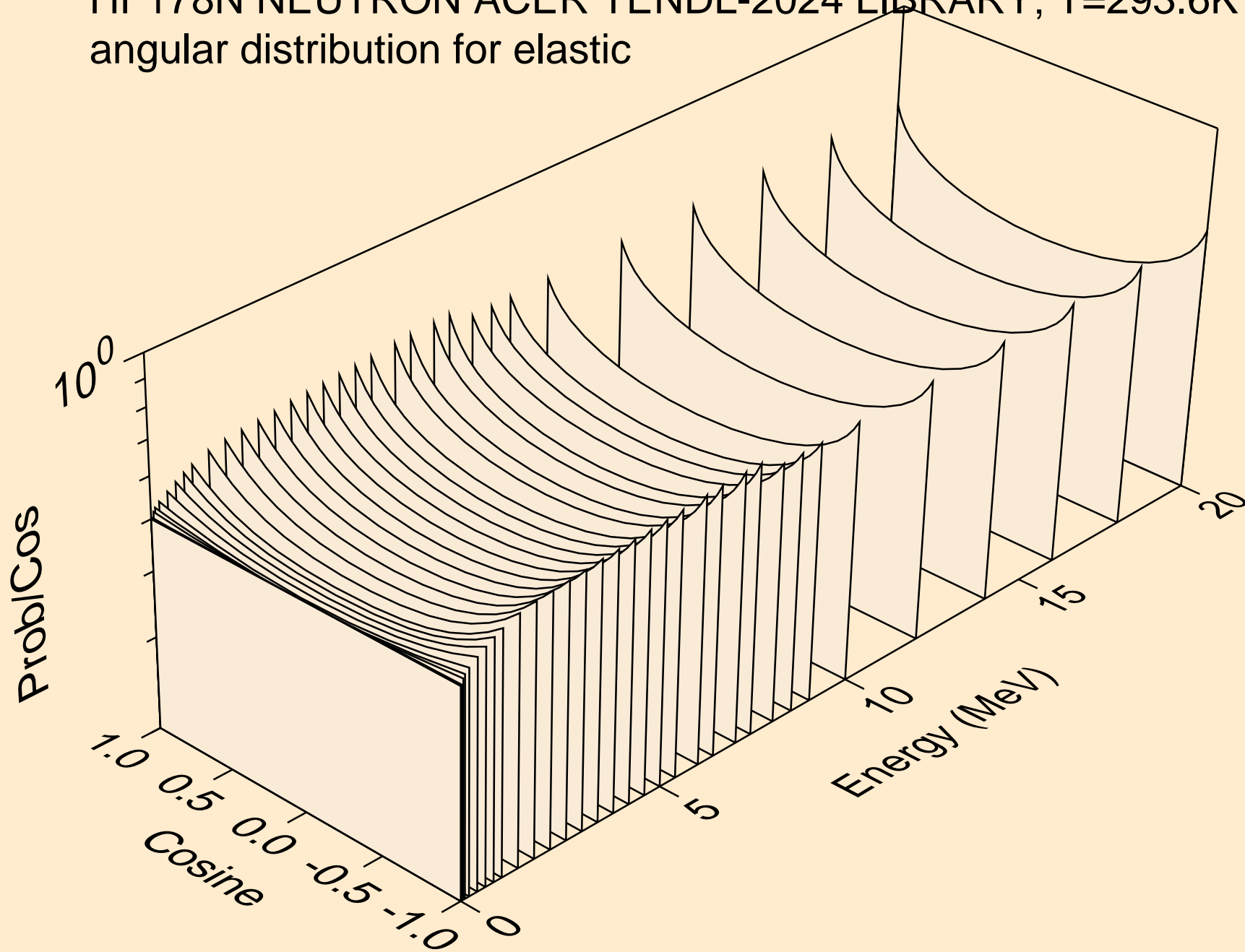

HF178N NEUTRON ACER TENDL-2024 LIBRARY; T=293.6K
angular distribution for elastic

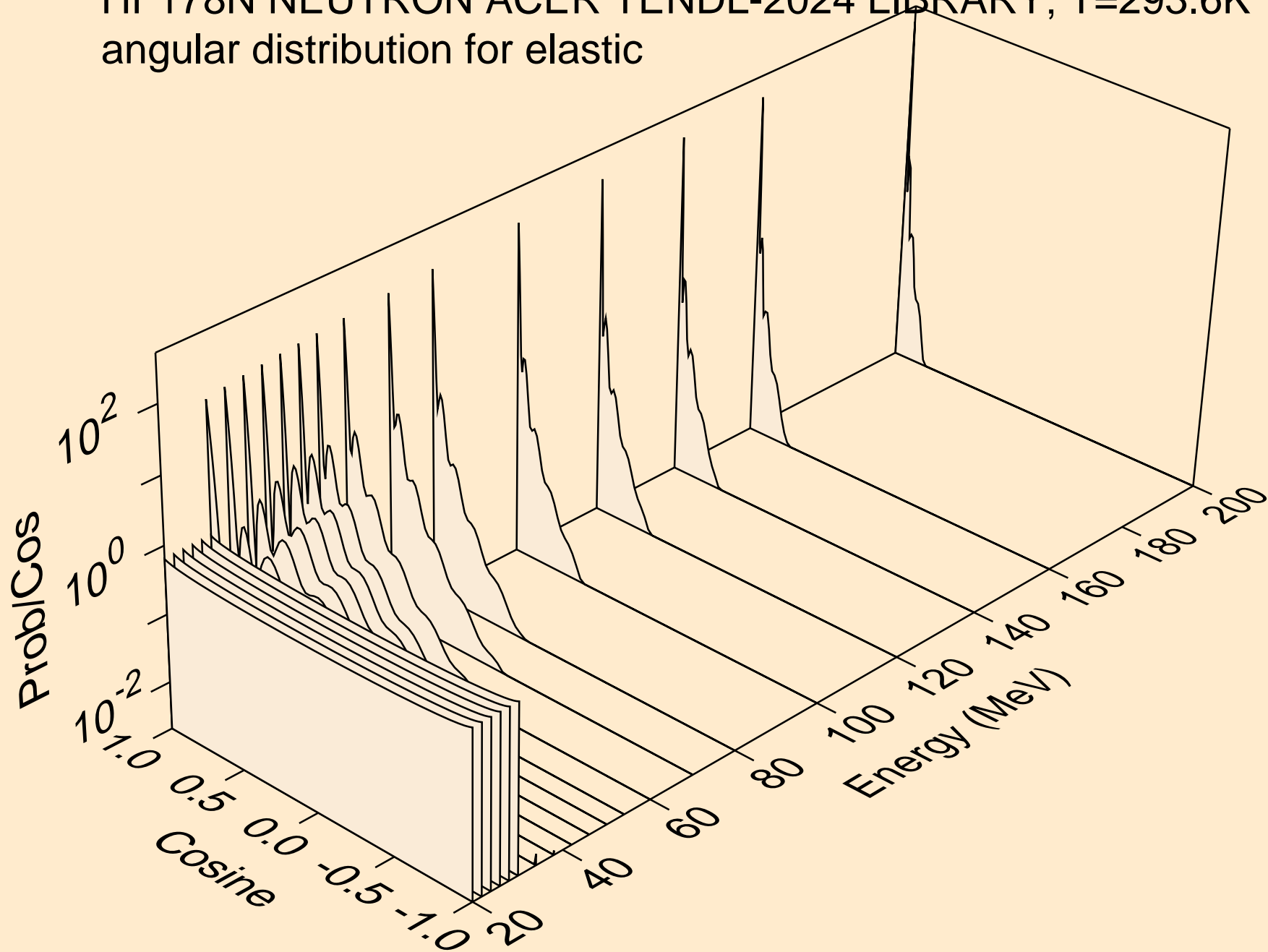

HF178N NEUTRON ACER TENDL-2024 LIBRARY; T=293.6K
angular distribution for (n,n*1)

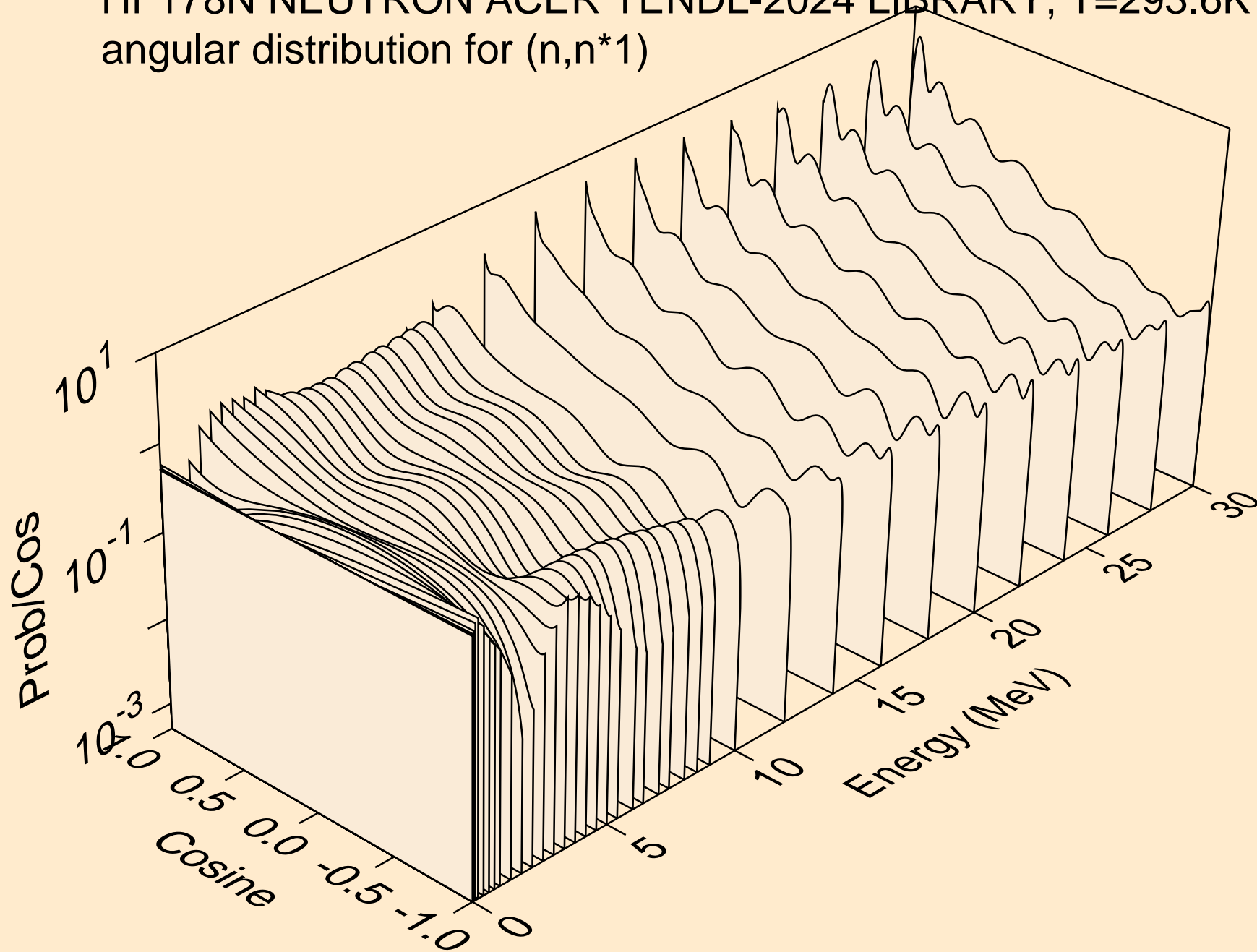

HF178N NEUTRON ACER TENDL-2024 LIBRARY; T=293.6K
angular distribution for (n,n*2)

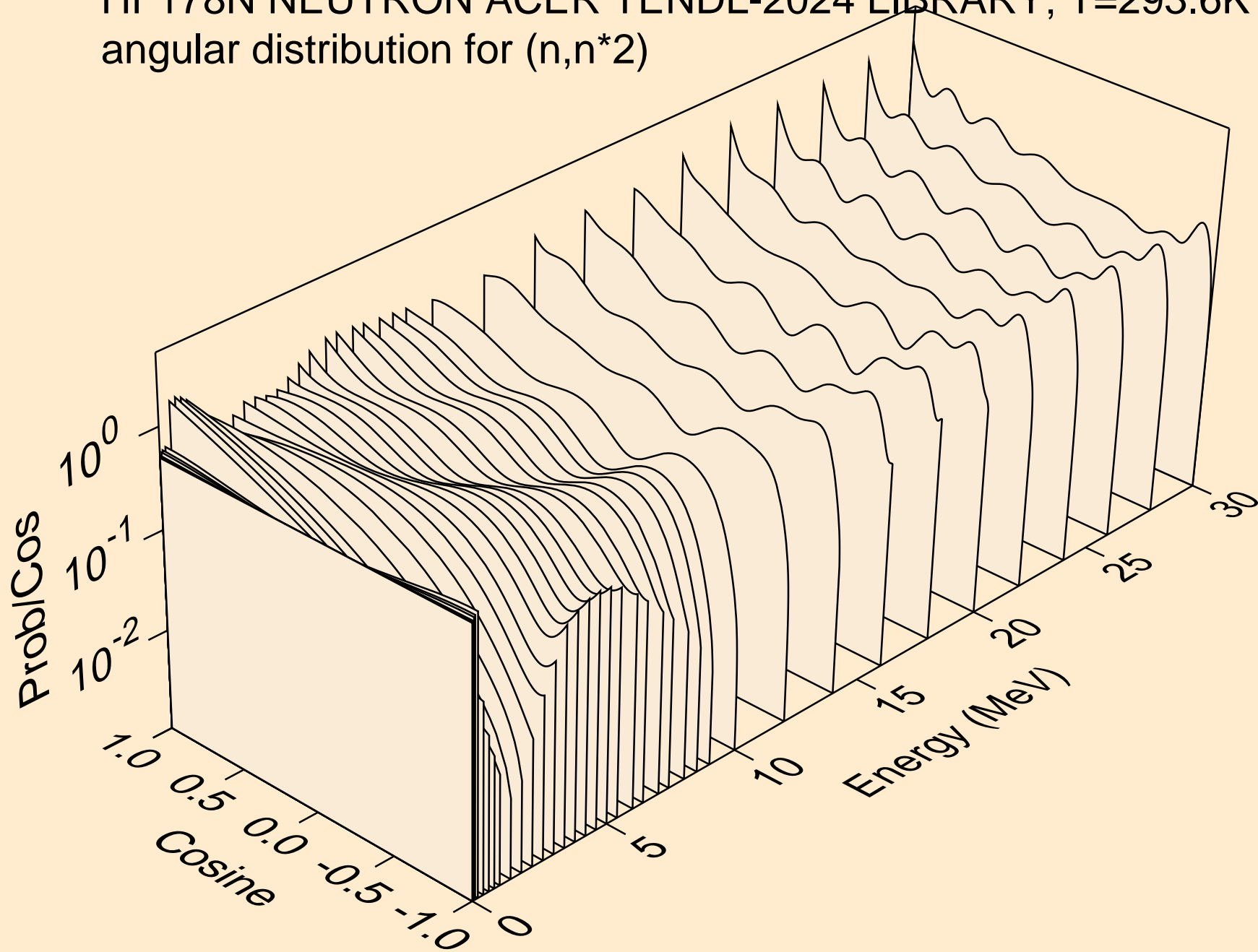

HF178N NEUTRON ACER TENDL-2024 LIBRARY; T=293.6K
angular distribution for (n,n*3)

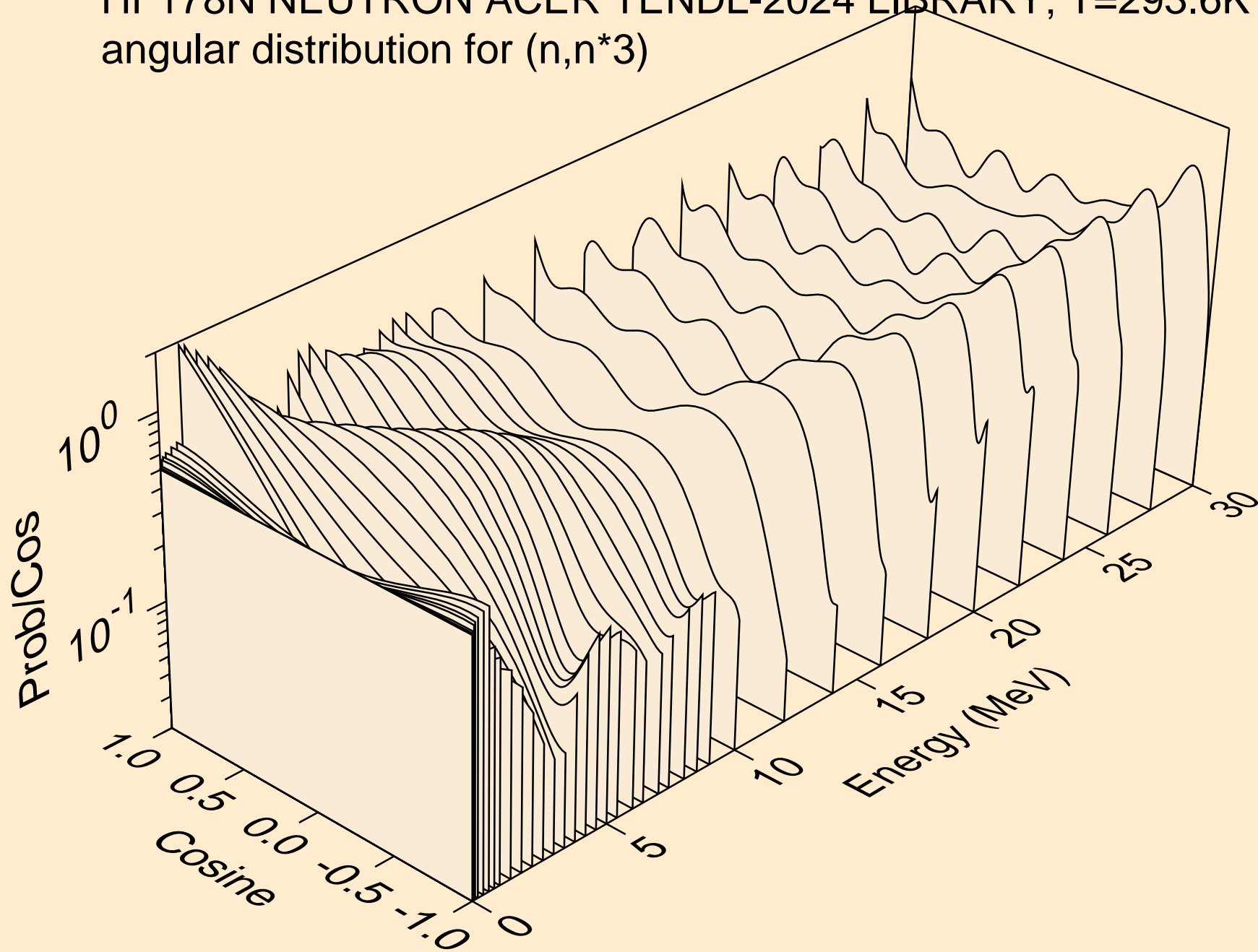

HF178N NEUTRON ACER TENDL-2024 LIBRARY; T=293.6K
angular distribution for (n,n*4)

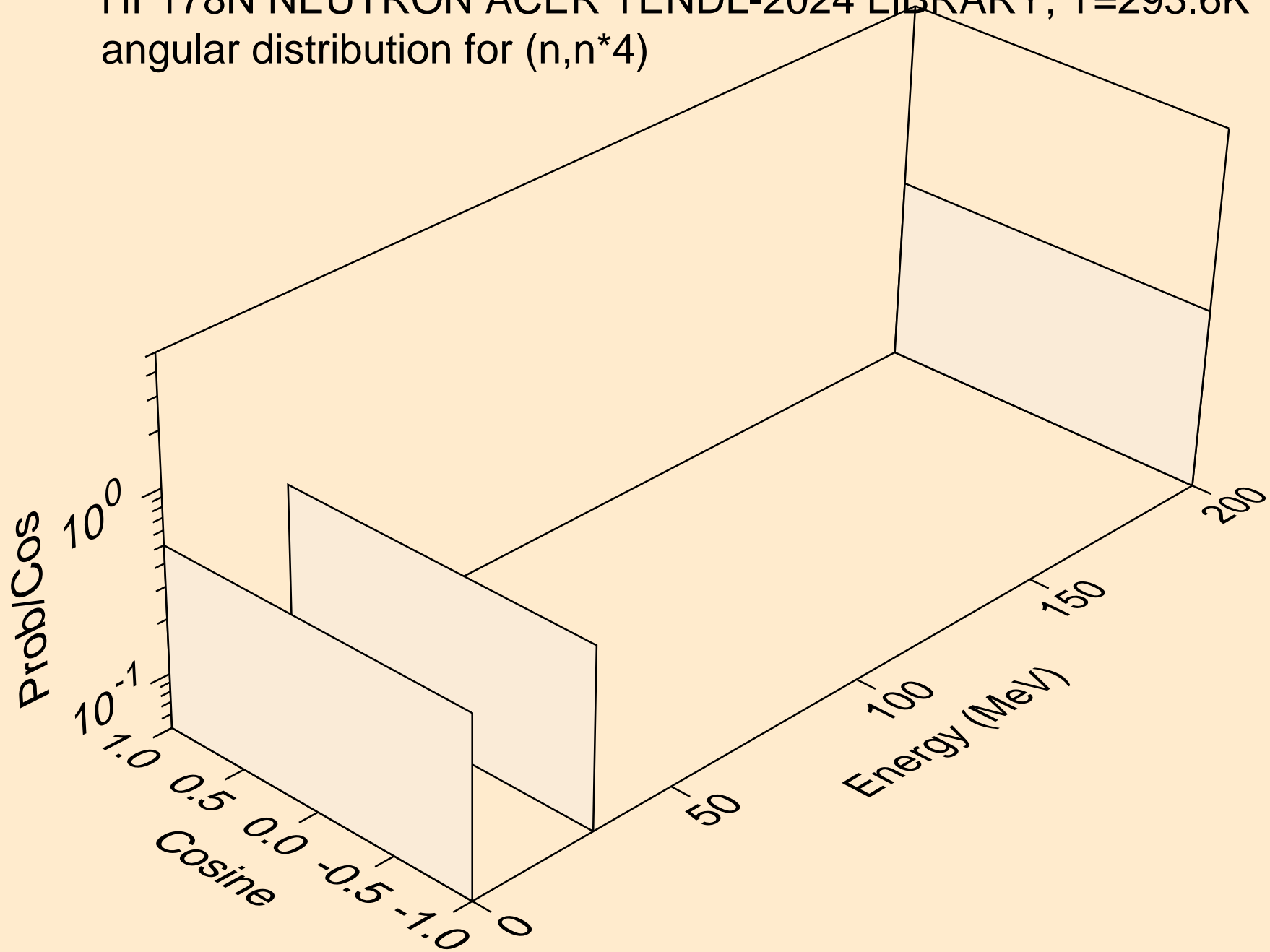

HF178N NEUTRON ACER TENDL-2024 LIBRARY; T=293.6K
Neutron emission for (n,x)

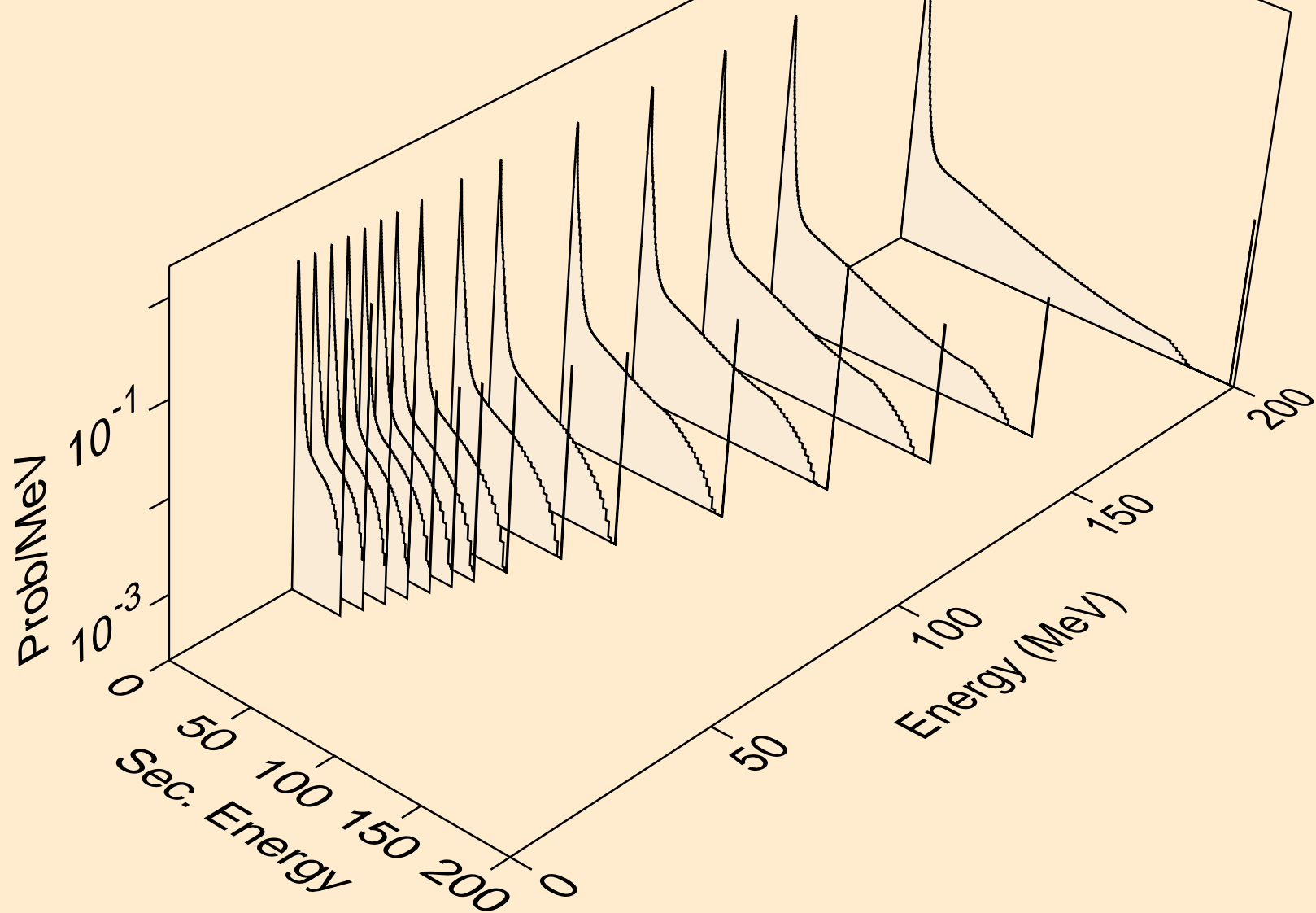

HF178N NEUTRON ACER TENDL-2024 LIBRARY; T=293.6K
Neutron emission for (n,2nd)

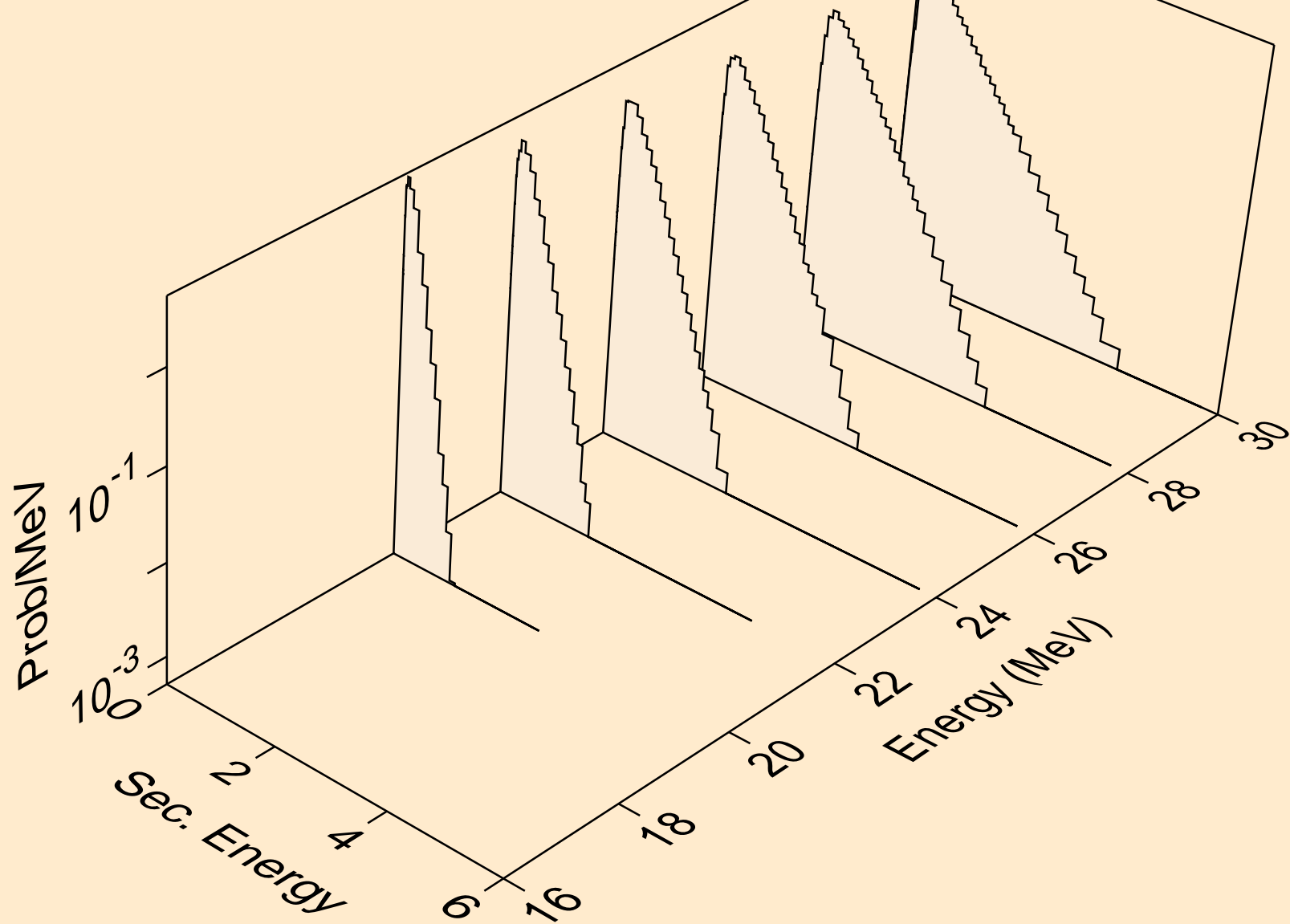

HF178N NEUTRON ACER TENDL-2024 LIBRARY; T=293.6K
Neutron emission for (n,2n)

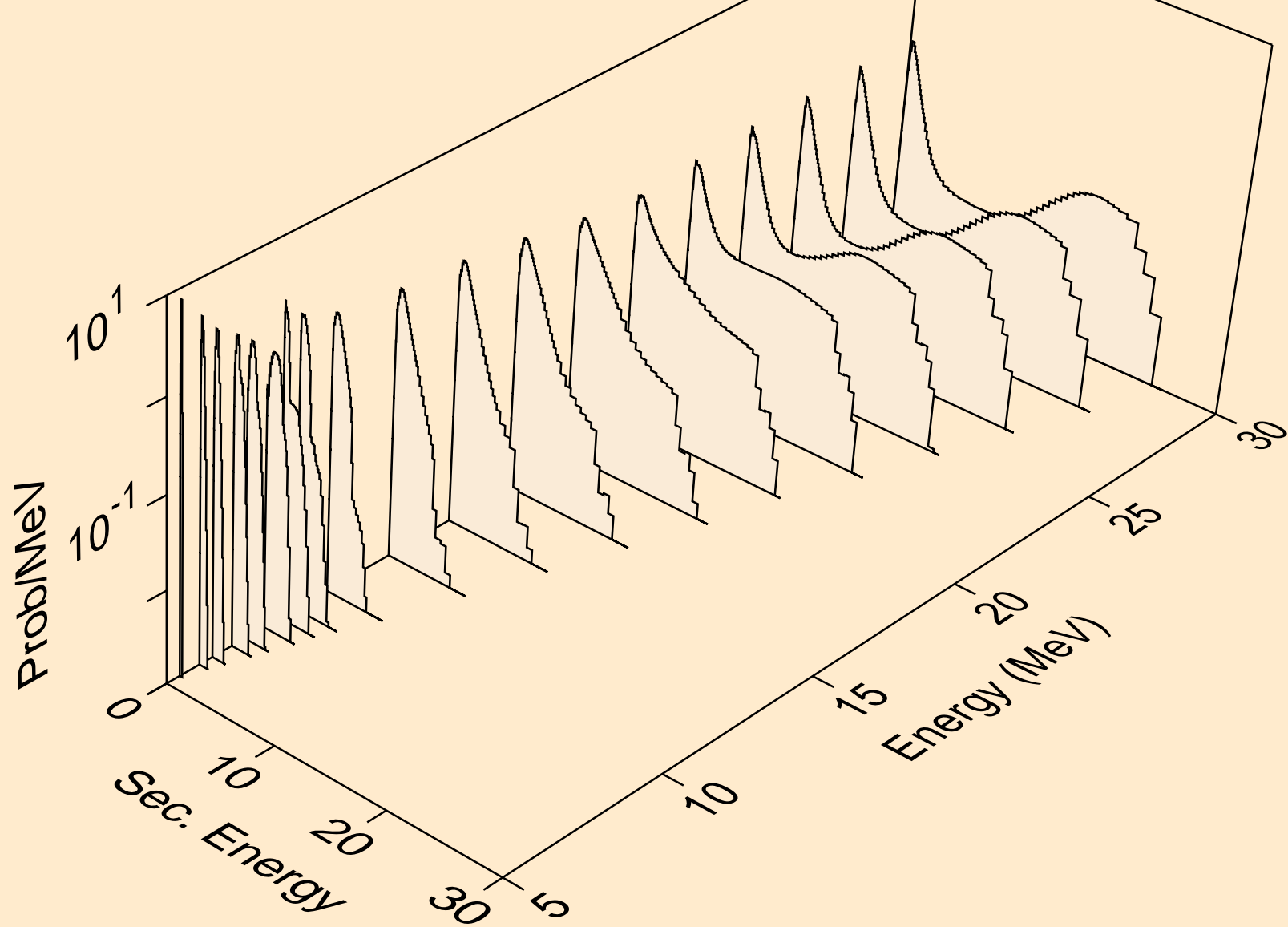

HF178N NEUTRON ACER TENDL-2024 LIBRARY; T=293.6K
Neutron emission for (n,3n)

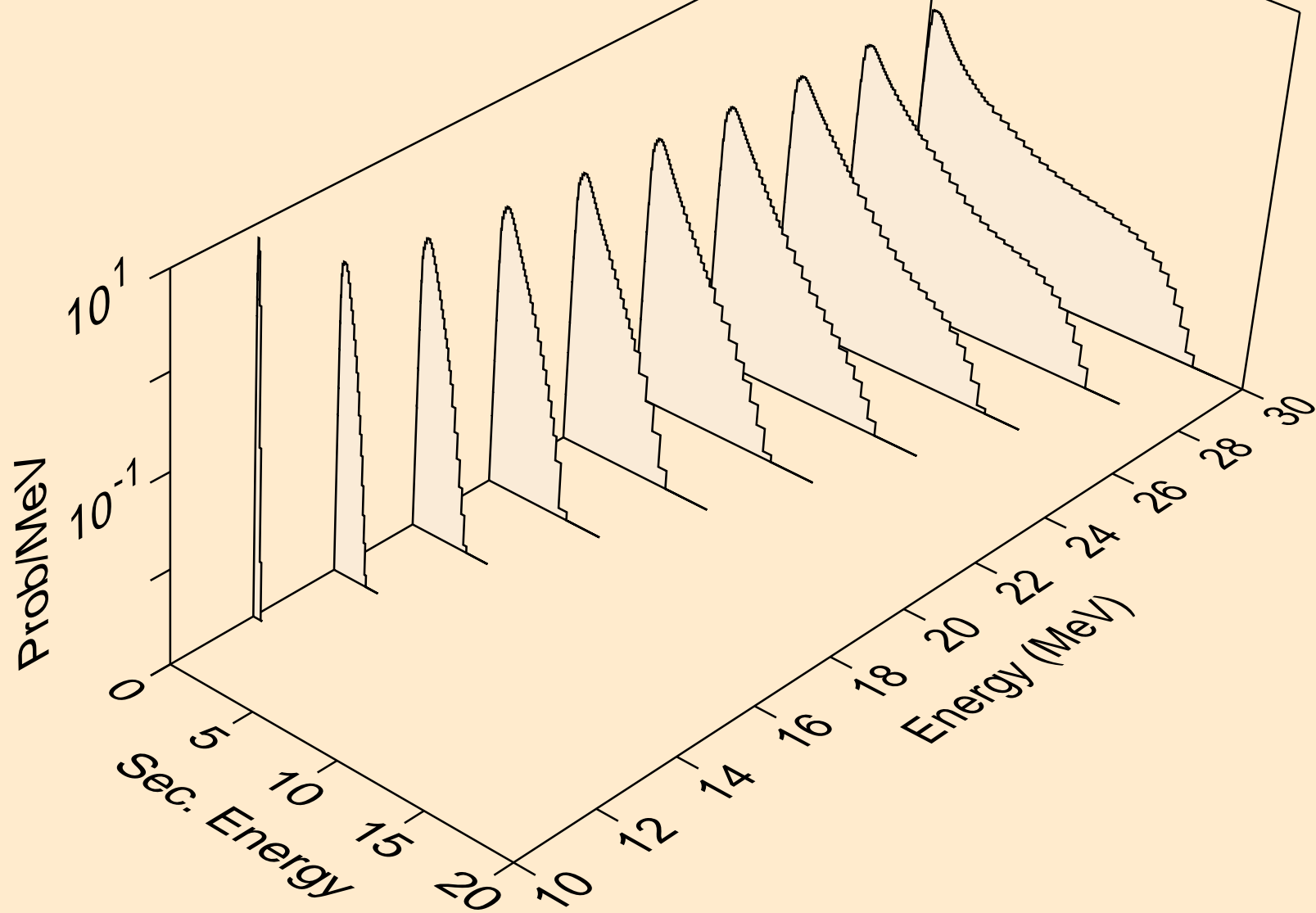

HF178N NEUTRON ACER TENDL-2024 LIBRARY; T=293.6K
Neutron emission for (n,n*)a

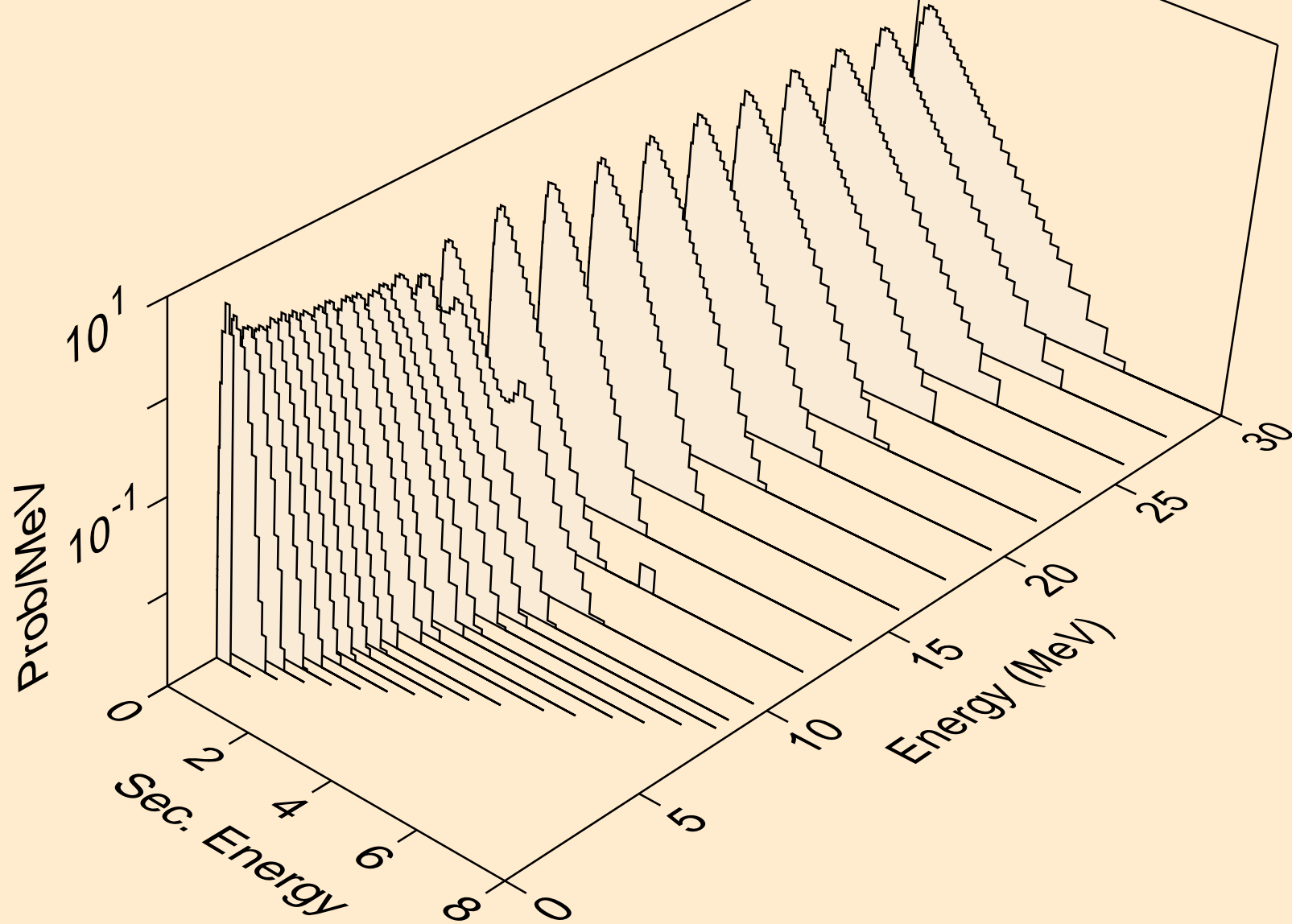

HF178N NEUTRON ACER TENDL-2024 LIBRARY; T=293.6K
Neutron emission for (n,2n)a

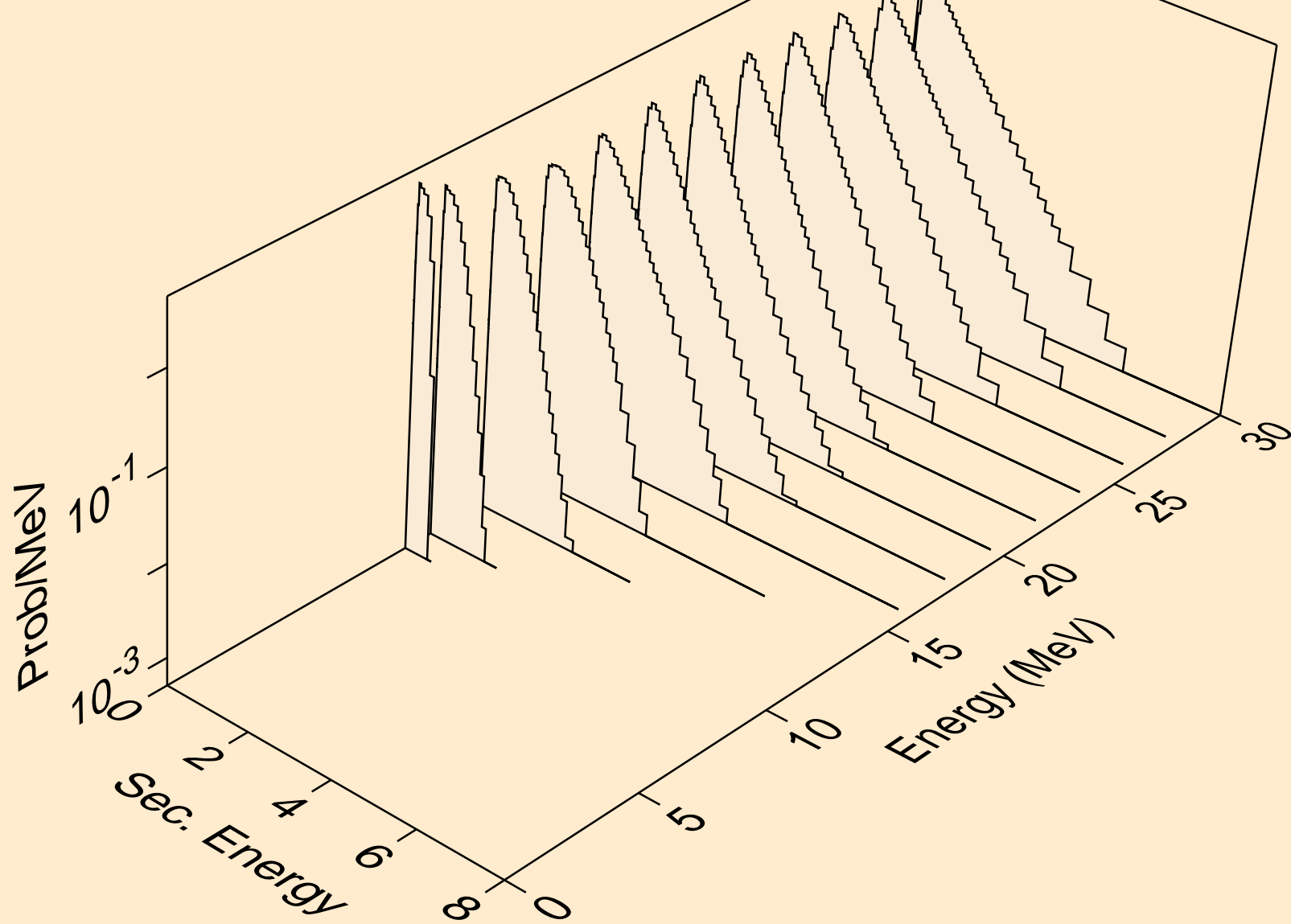

HF178N NEUTRON ACER TENDL-2024 LIBRARY; T=293.6K
Neutron emission for (n,3n)a

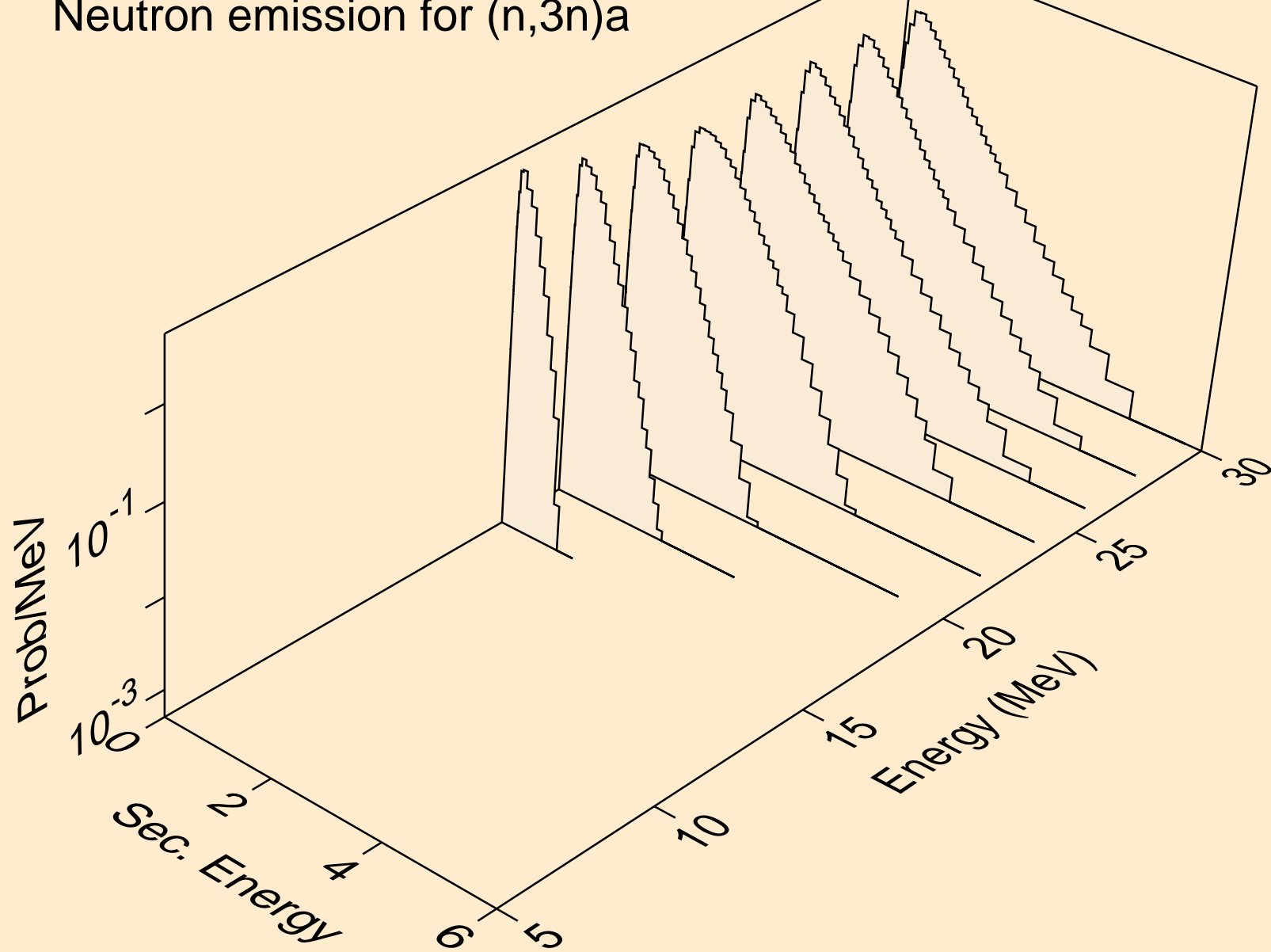

HF178N NEUTRON ACER TENDL-2024 LIBRARY; T=293.6K
Neutron emission for (n,n*)p

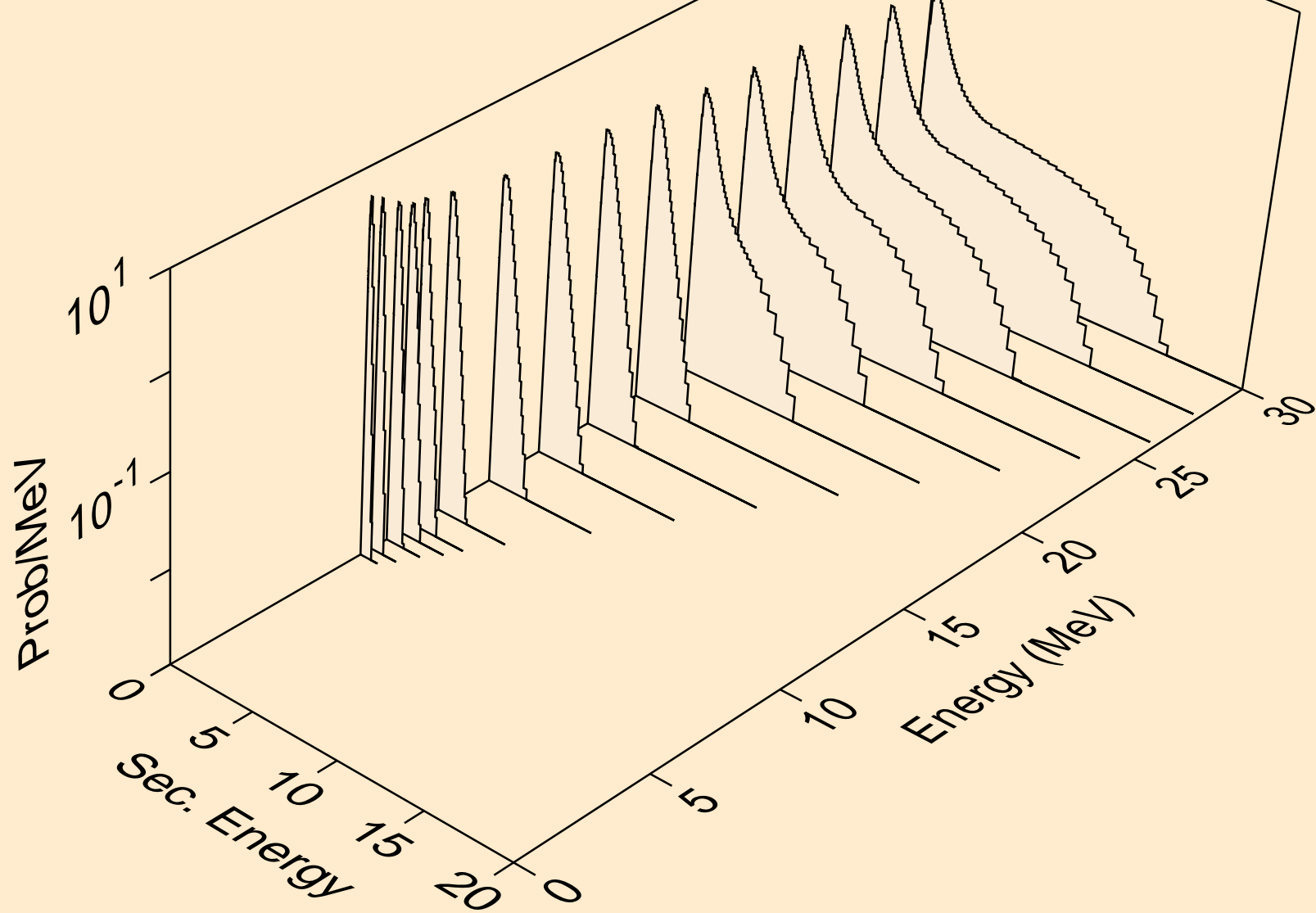

HF178N NEUTRON ACER TENDL-2024 LIBRARY; T=293.6K
Neutron emission for (n,n*)2a

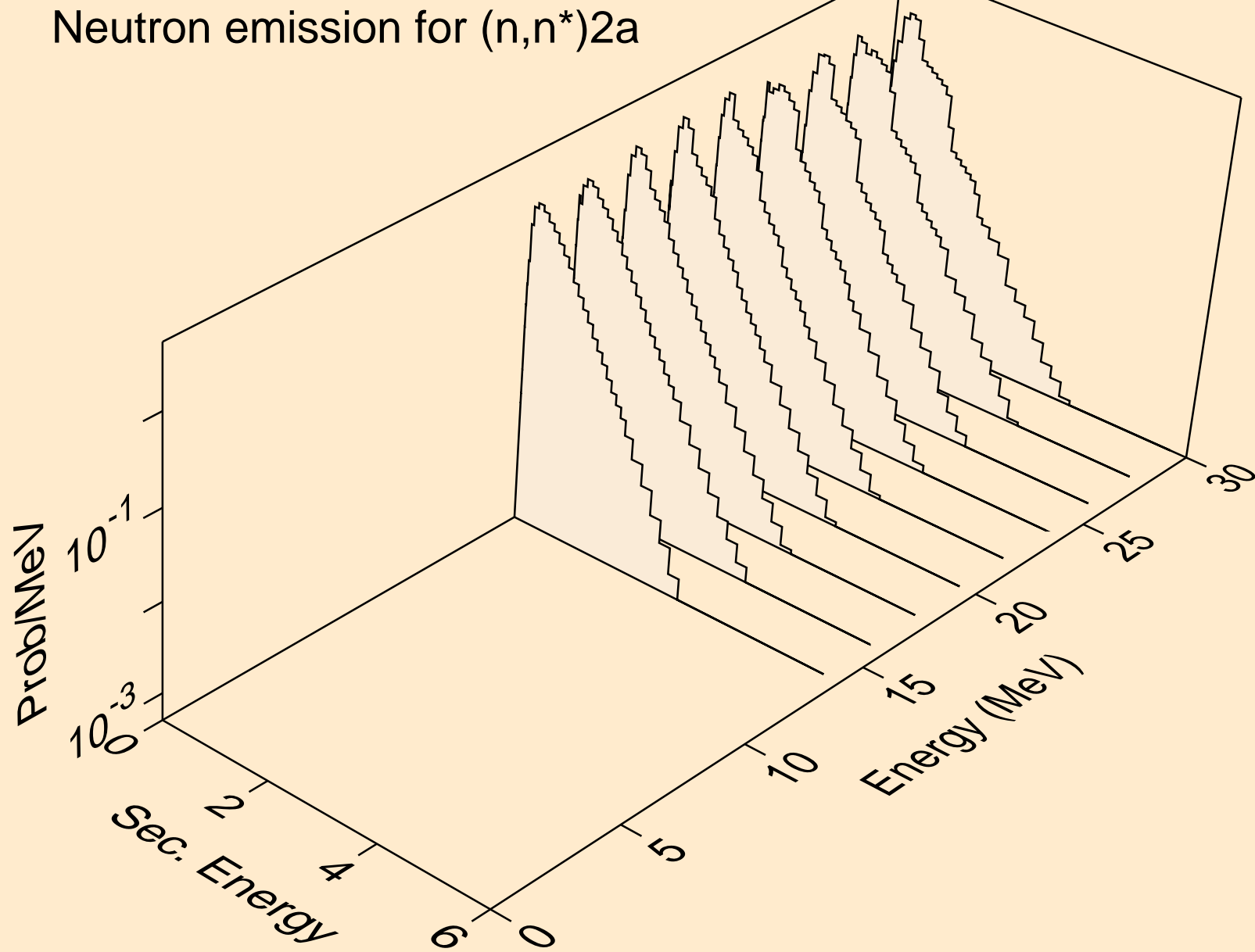

HF178N NEUTRON ACER TENDL-2024 LIBRARY; T=293.6K
Neutron emission for (n,n*)d

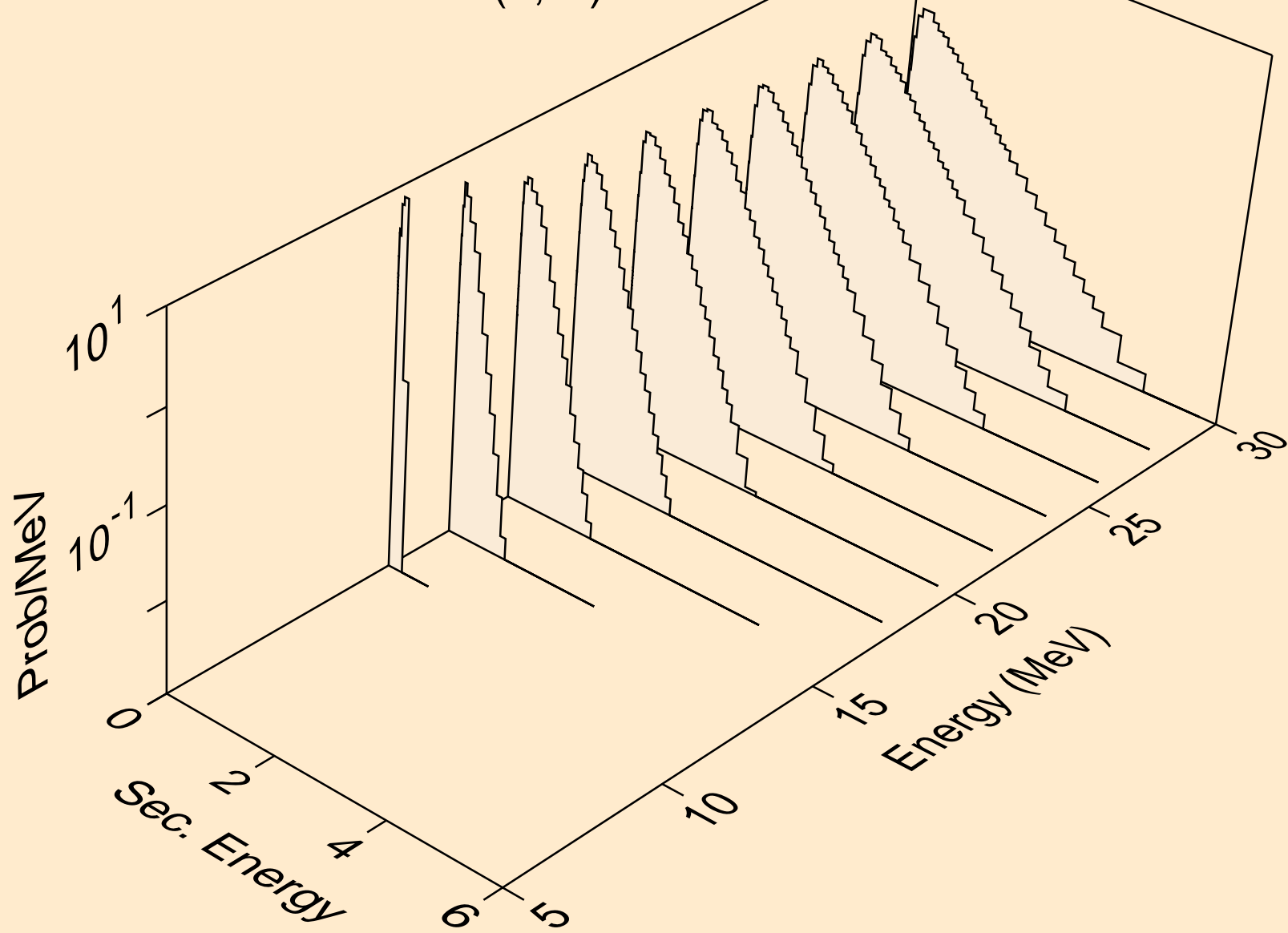

HF178N NEUTRON ACER TENDL-2024 LIBRARY; T=293.6K
Neutron emission for (n,n*)t

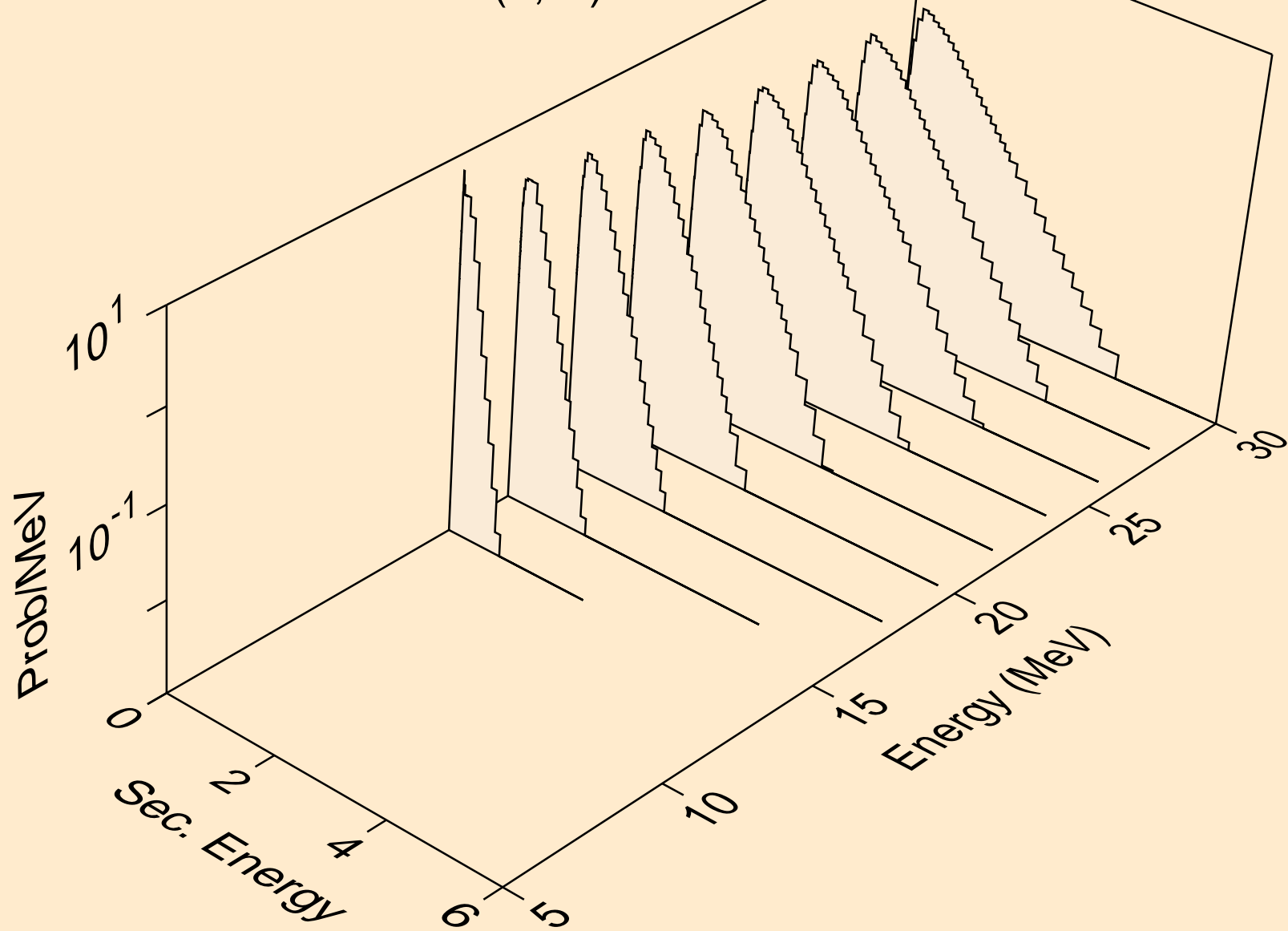

HF178N NEUTRON ACER TENDL-2024 LIBRARY; T=293.6K
Neutron emission for (n,n*)he3

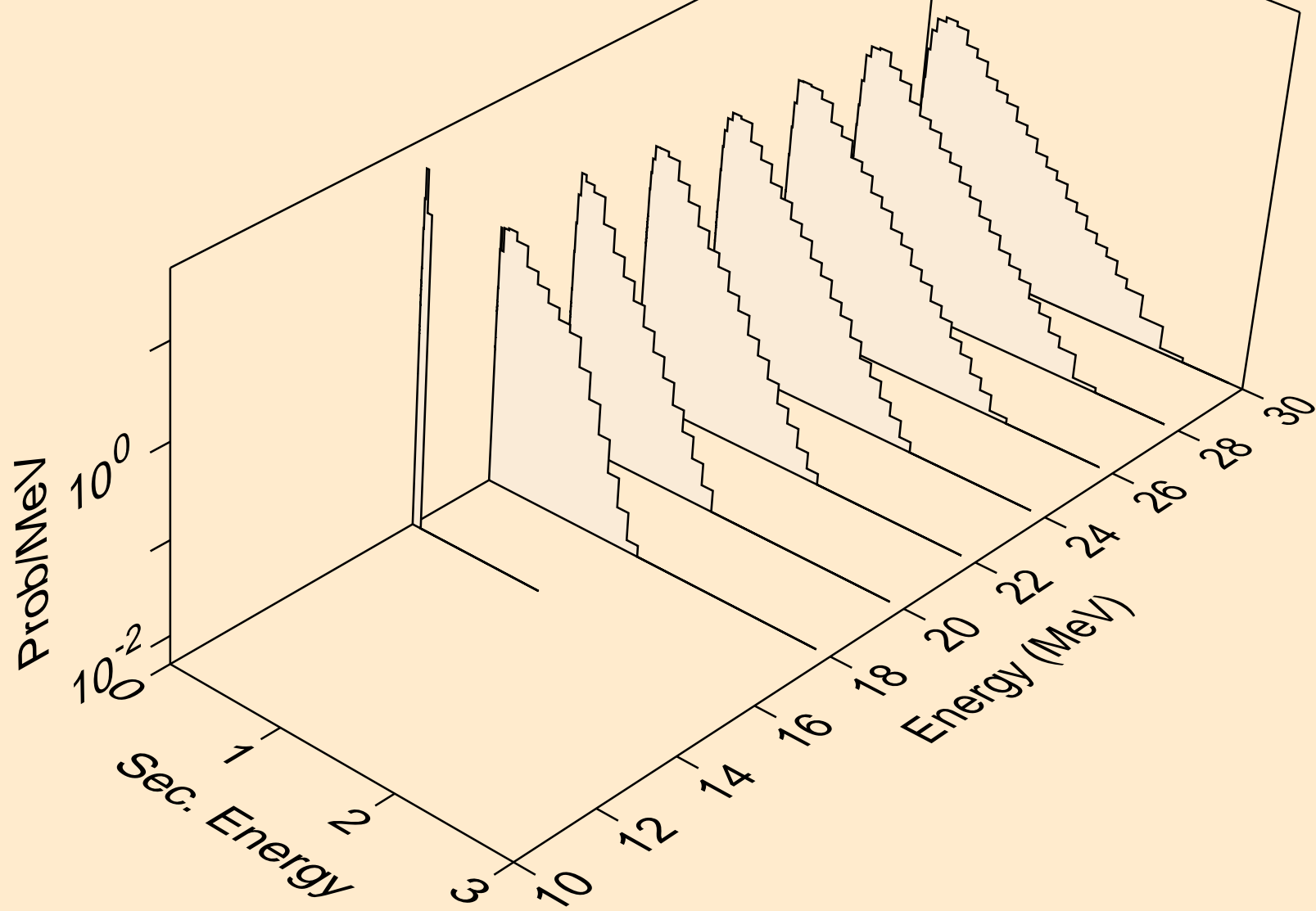

HF178N NEUTRON ACER TENDL-2024 LIBRARY; T=293.6K
Neutron emission for (n,4n)

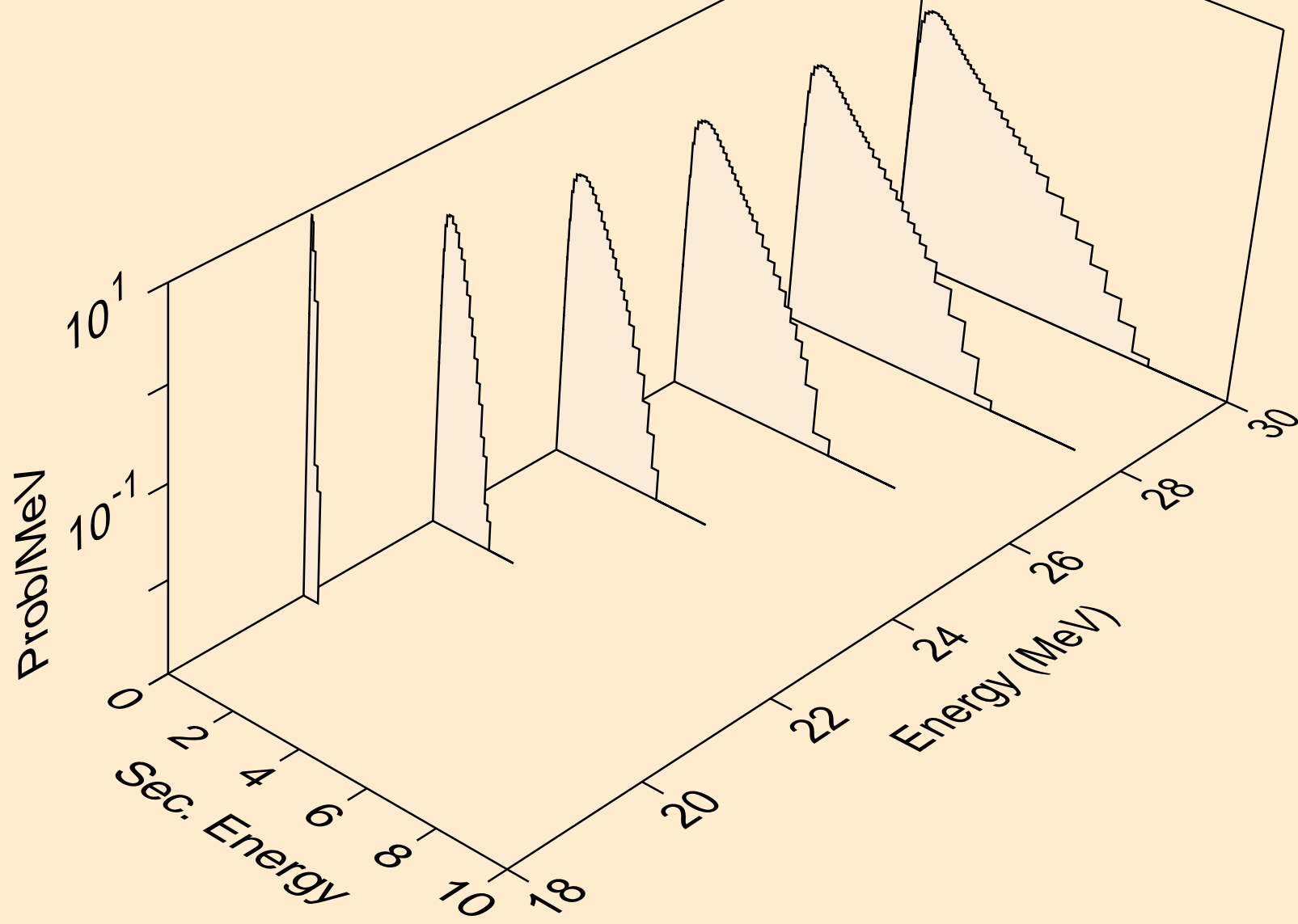

HF178N NEUTRON ACER TENDL-2024 LIBRARY; T=293.6K
Neutron emission for (n,2np)

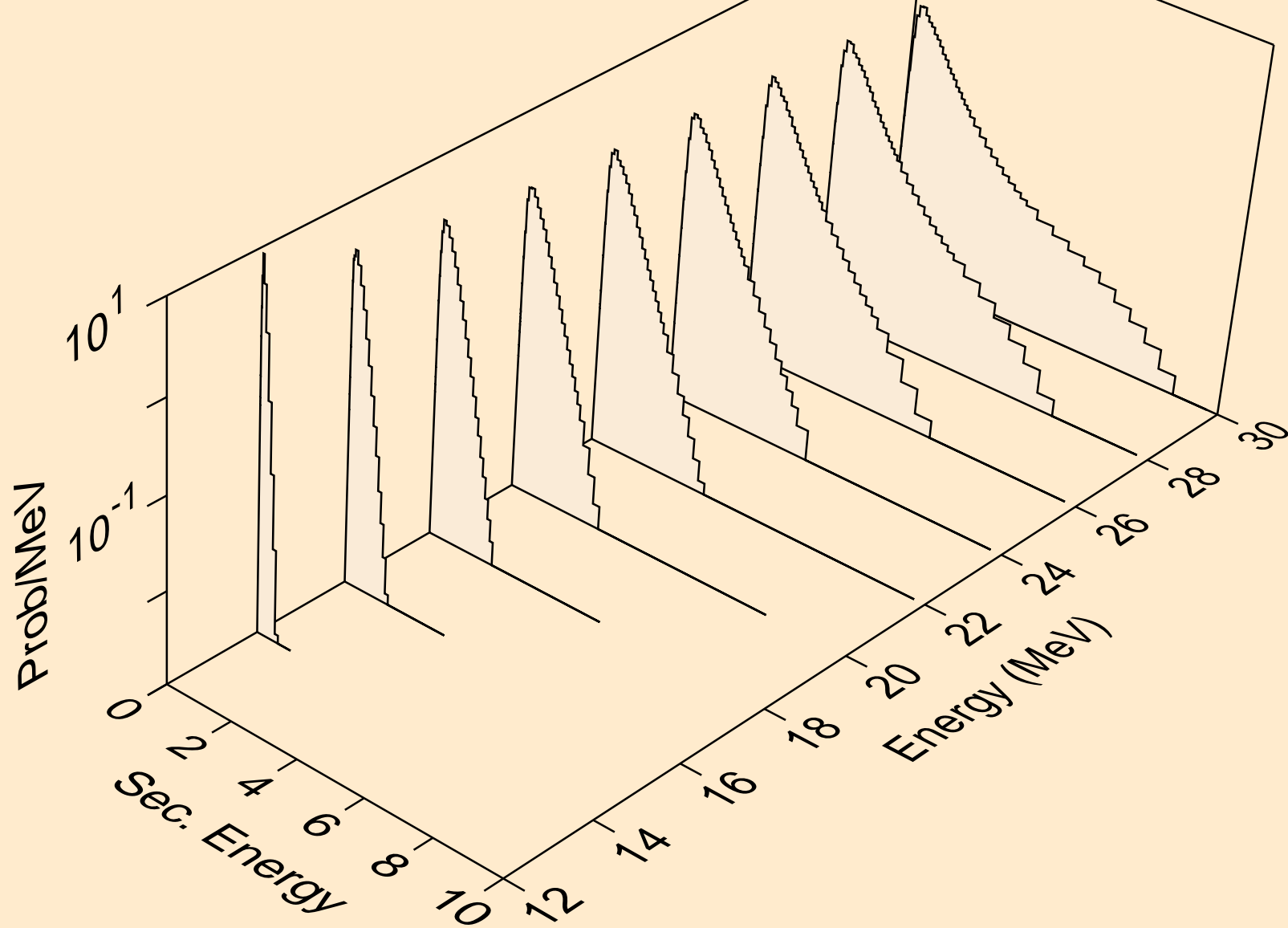

HF178N NEUTRON ACER TENDL-2024 LIBRARY; T=293.6K
Neutron emission for (n,3np)

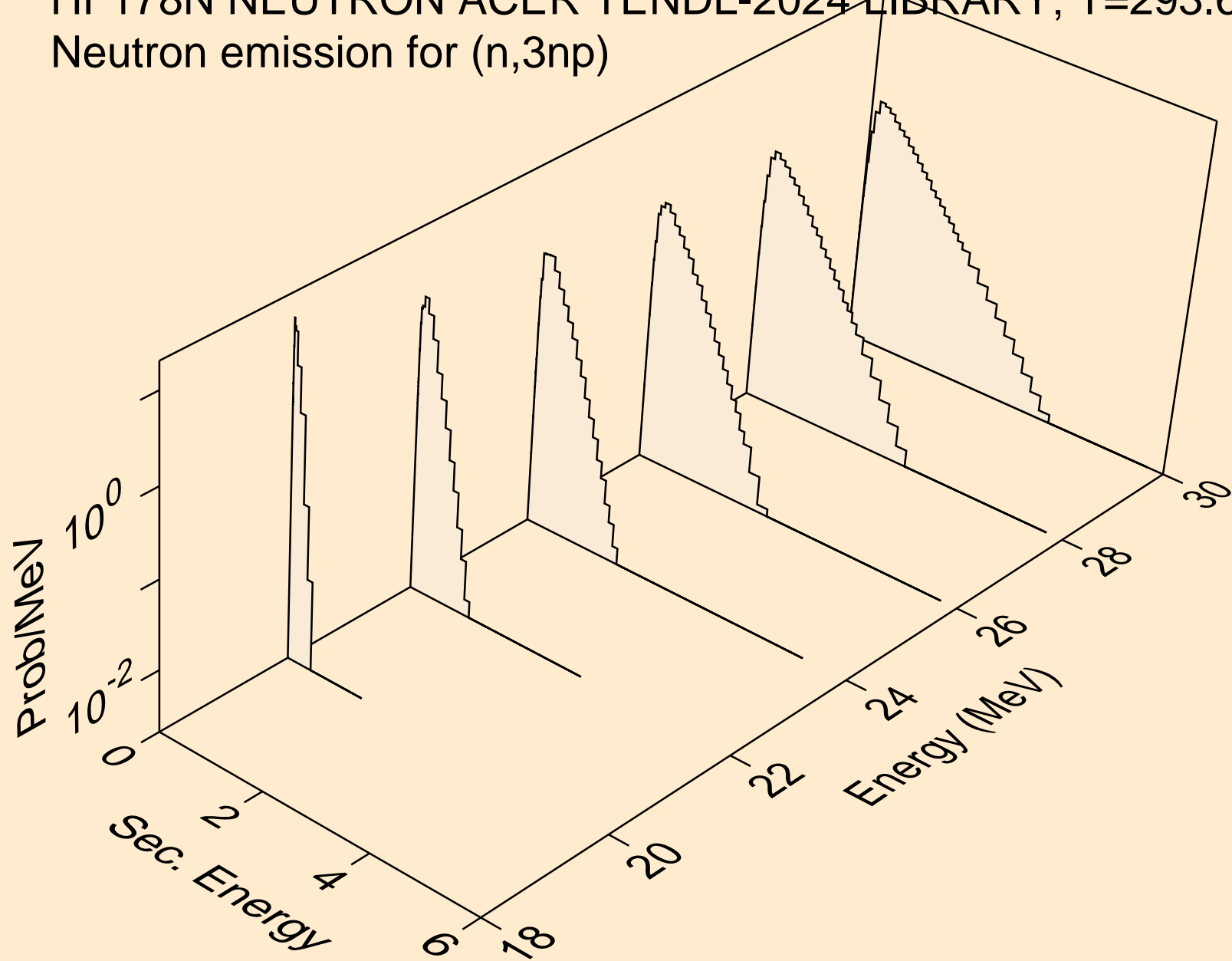

HF178N NEUTRON ACER TENDL-2024 LIBRARY; T=293.6K
Neutron emission for (n,n2p)

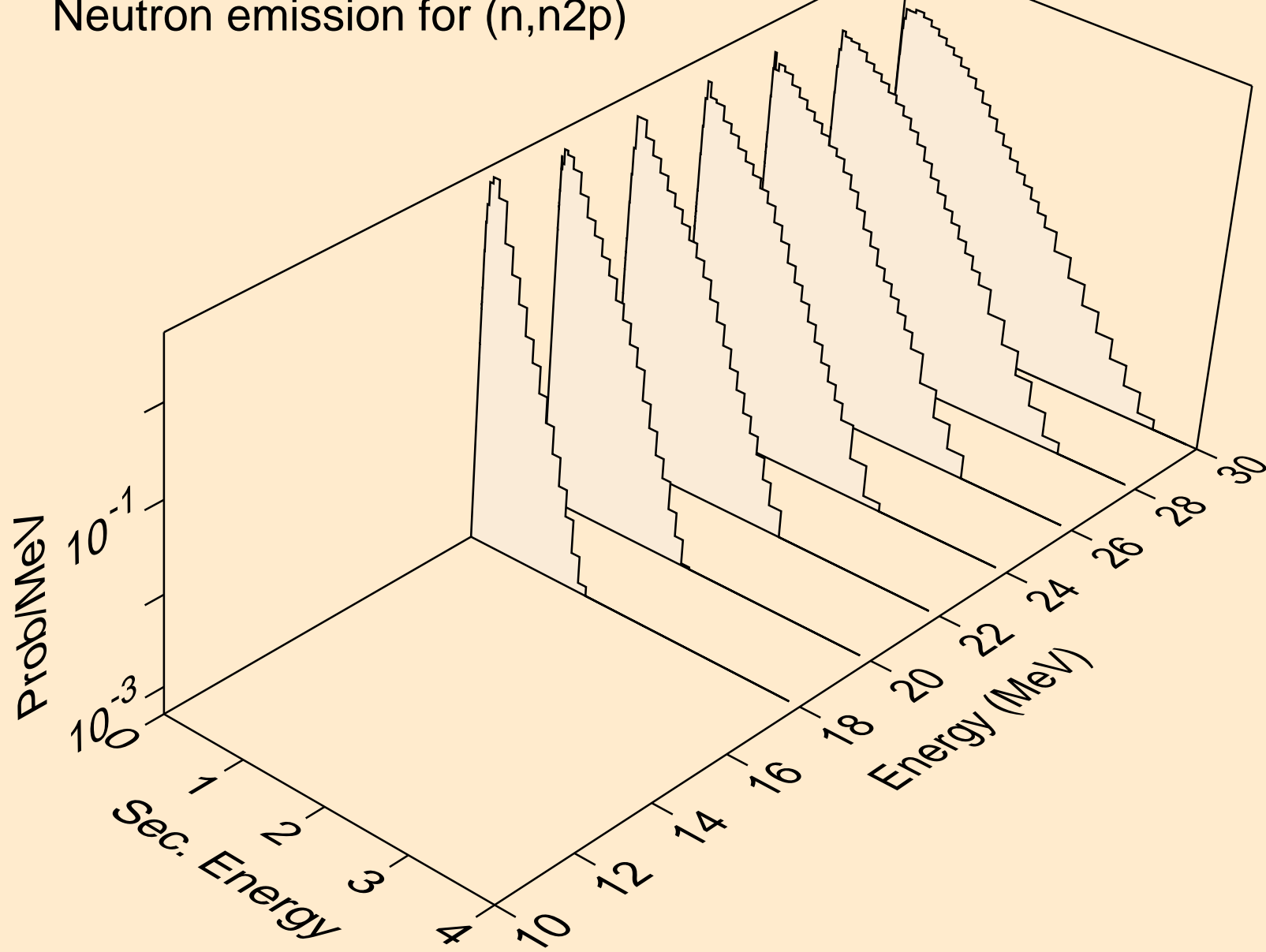

HF178N NEUTRON ACER TENDL-2024 LIBRARY; T=293.6K
Neutron emission for (n,npa)

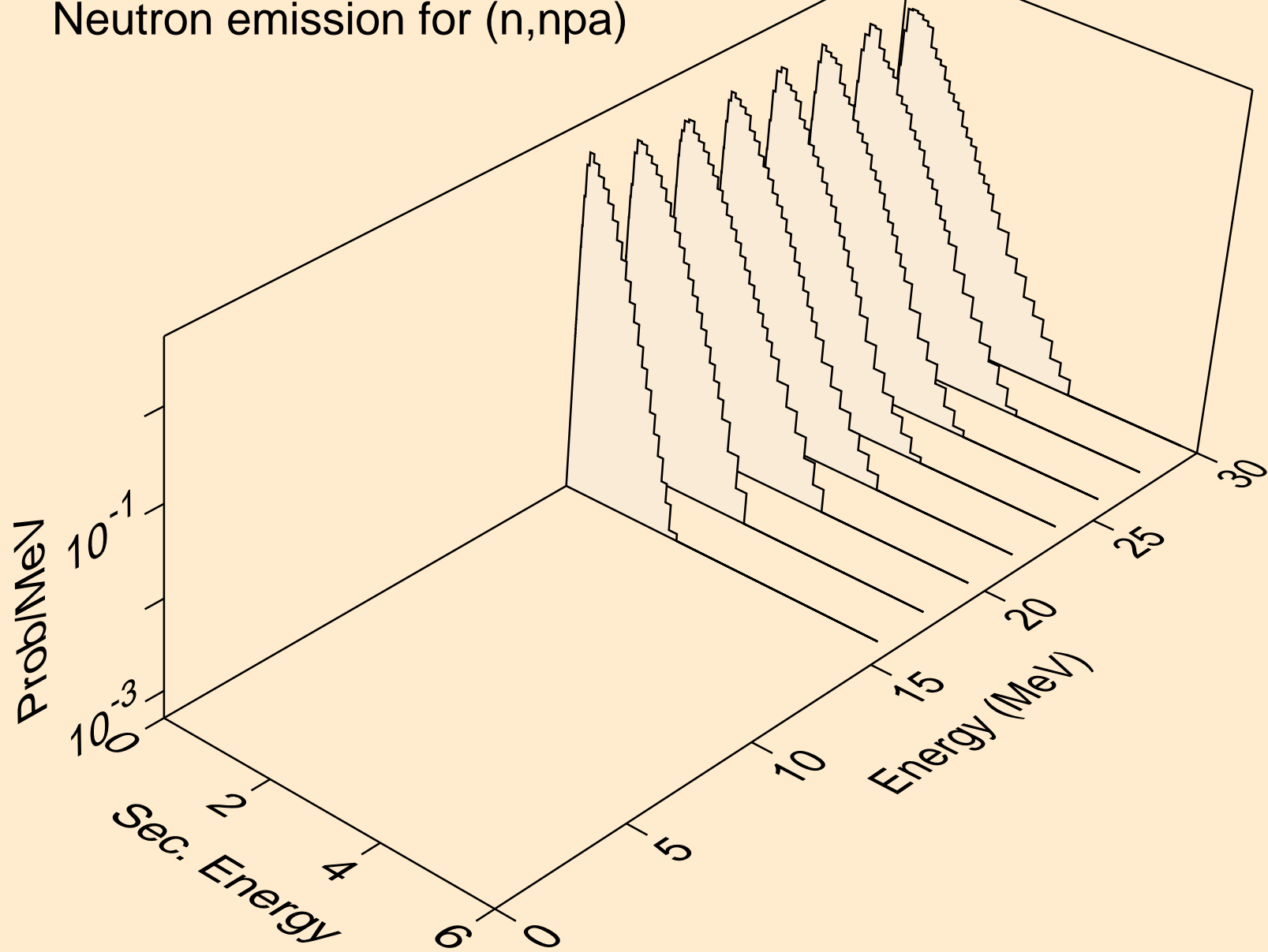

HF178N NEUTRON ACER TENDL-2024 LIBRARY; T=293.6K
Neutron emission for (n,n*c)

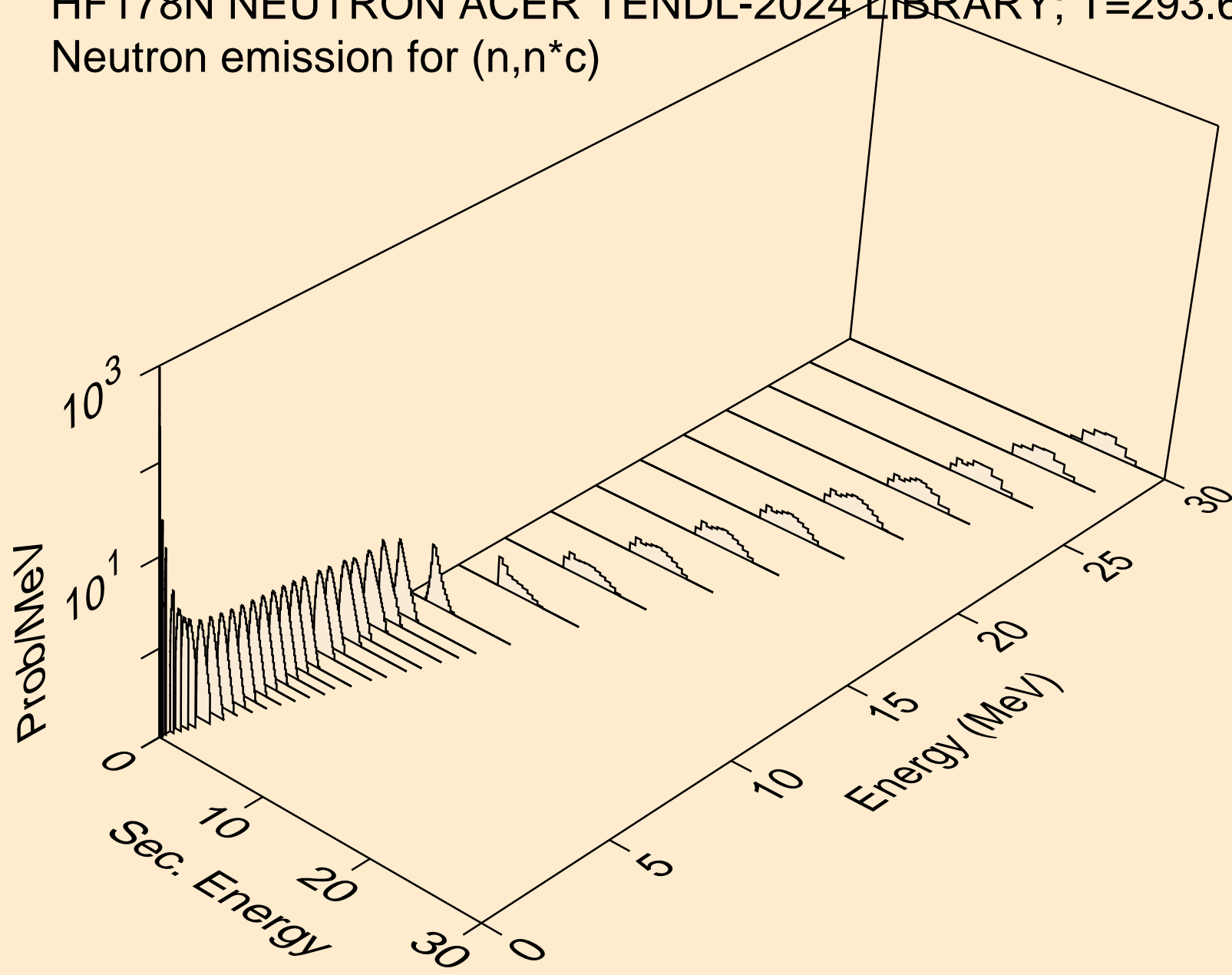

HF178N NEUTRON ACER TENDL-2024 LIBRARY; T=293.6K
Photon emission for (n,x)

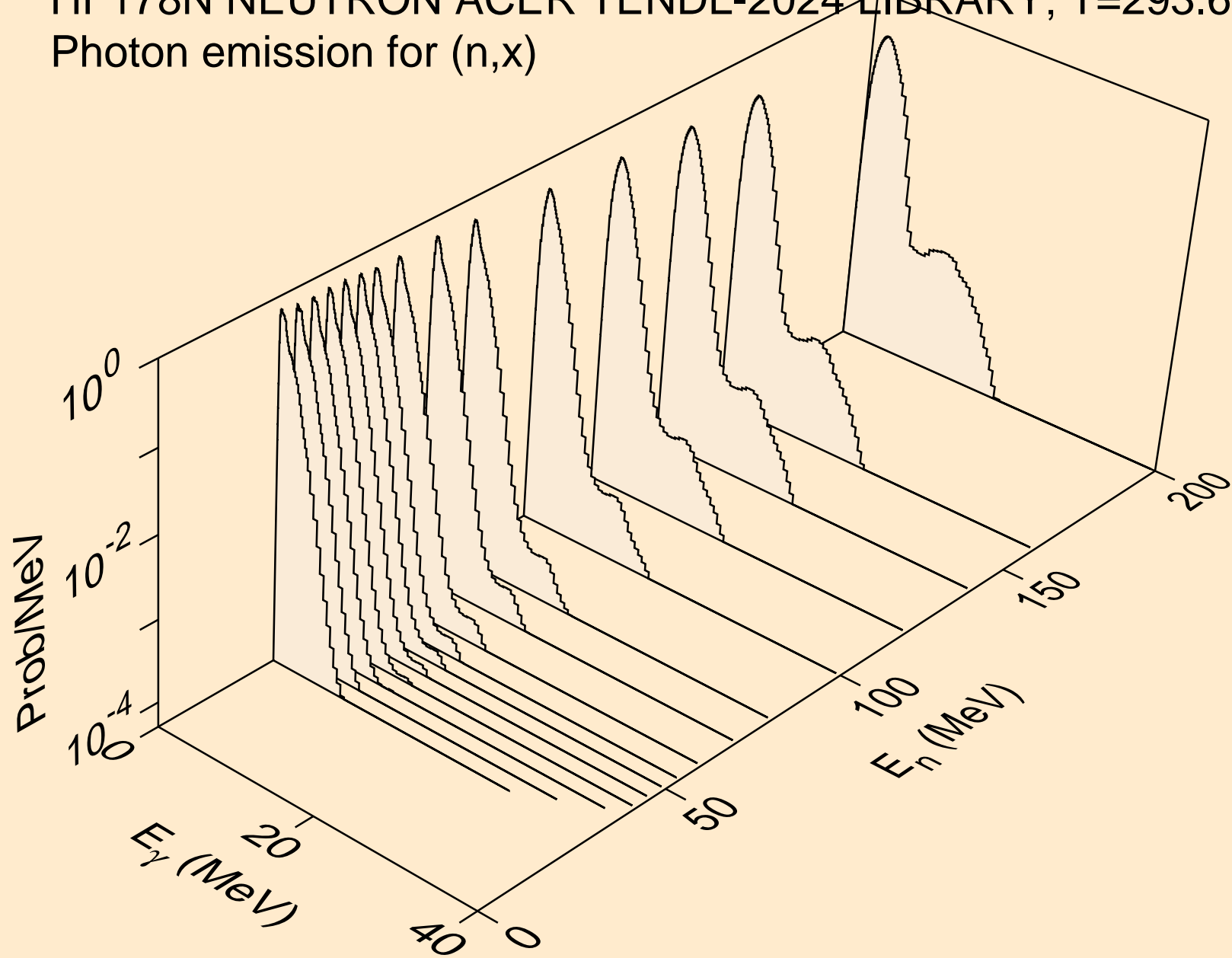

HF178N NEUTRON ACER TENDL-2024 LIBRARY; T=293.6K
Photon emission for (n,2nd)

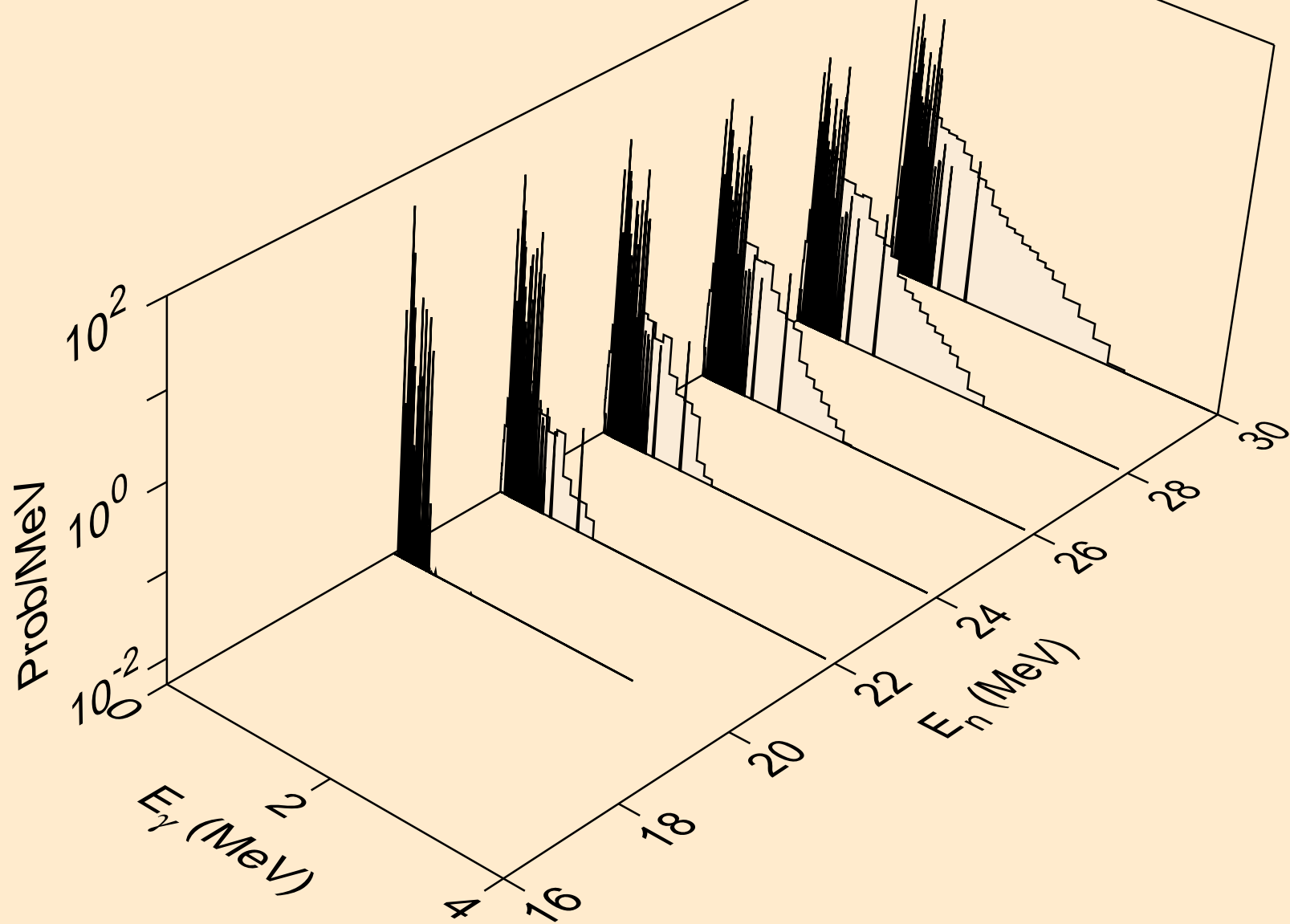

HF178N NEUTRON ACER TENDL-2024 LIBRARY; T=293.6K
Photon emission for (n,2n)

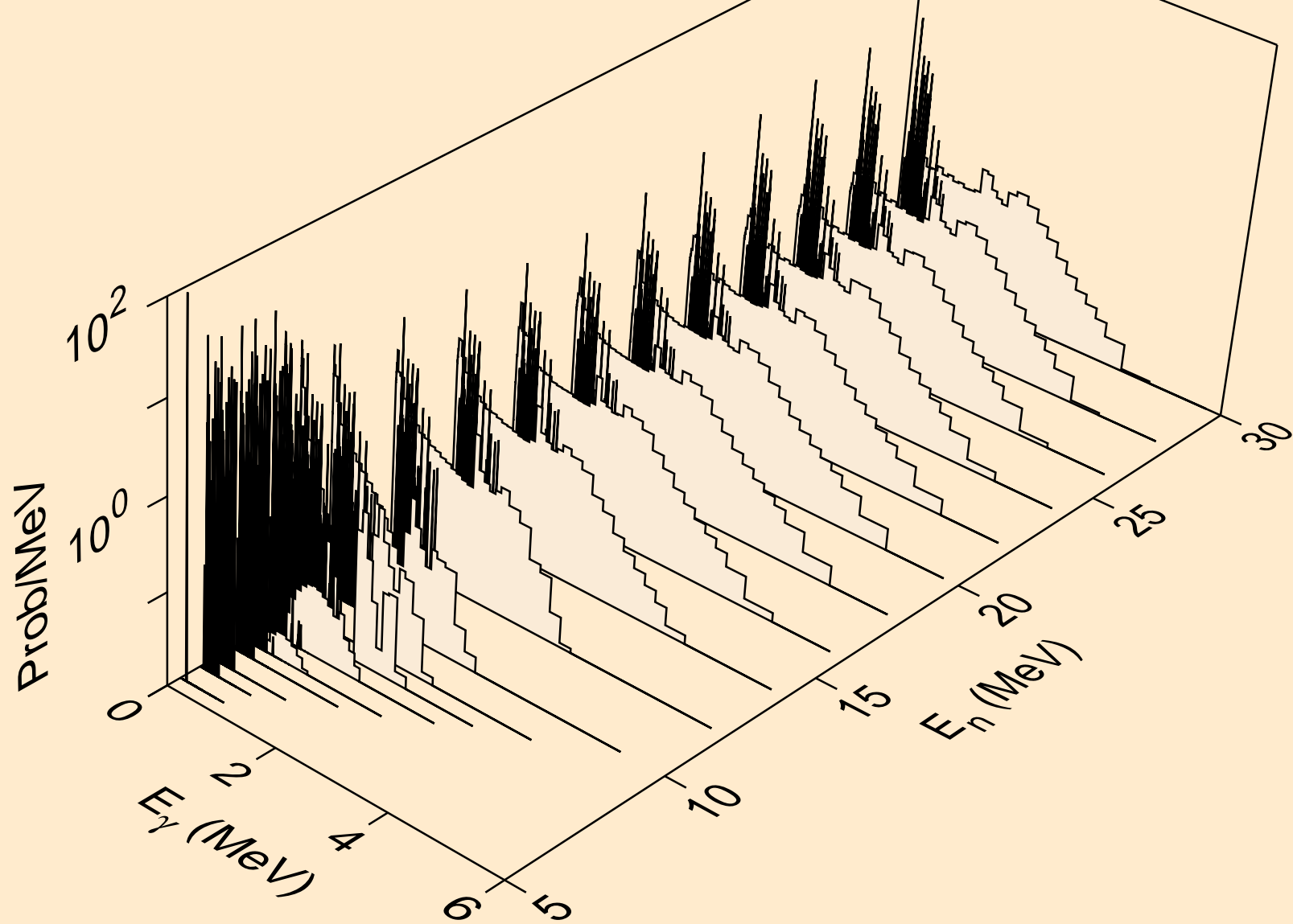

HF178N NEUTRON ACER TENDL-2024 LIBRARY; T=293.6K
Photon emission for (n,3n)

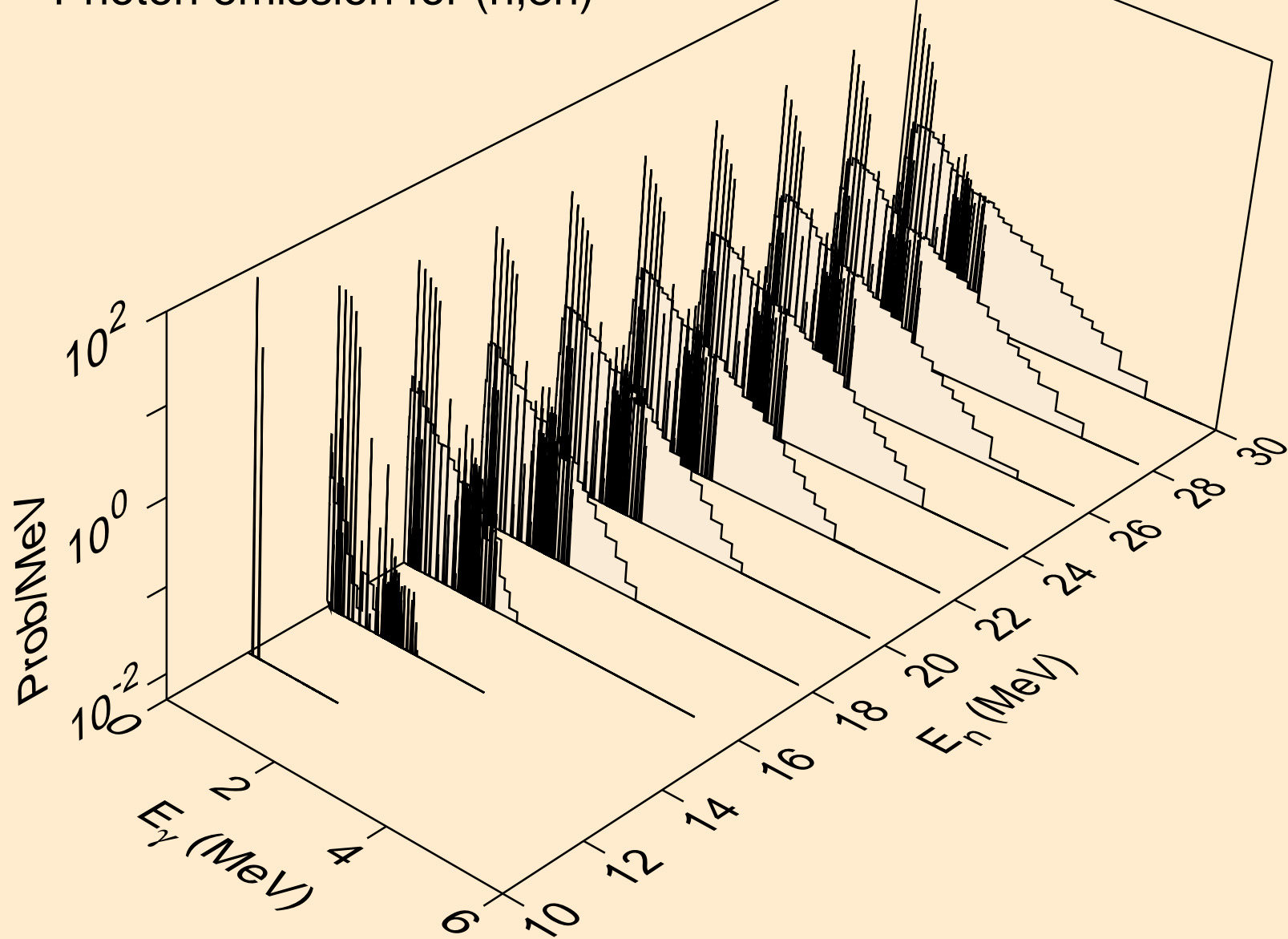

HF178N NEUTRON ACER TENDL-2024 LIBRARY; T=293.6K
Photon emission for (n,n*)a

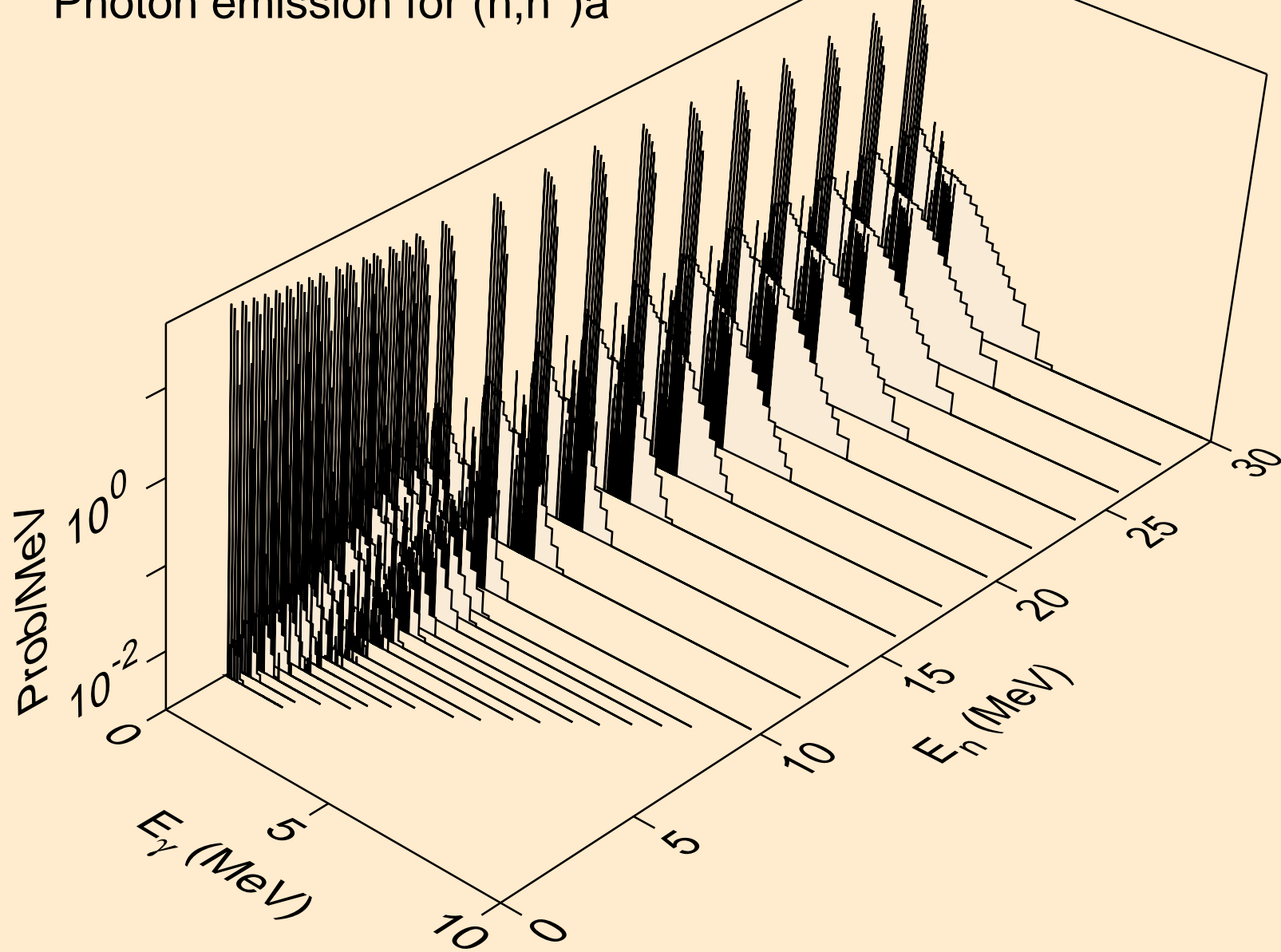

HF178N NEUTRON ACER TENDL-2024 LIBRARY; T=293.6K
Photon emission for (n,2n)a

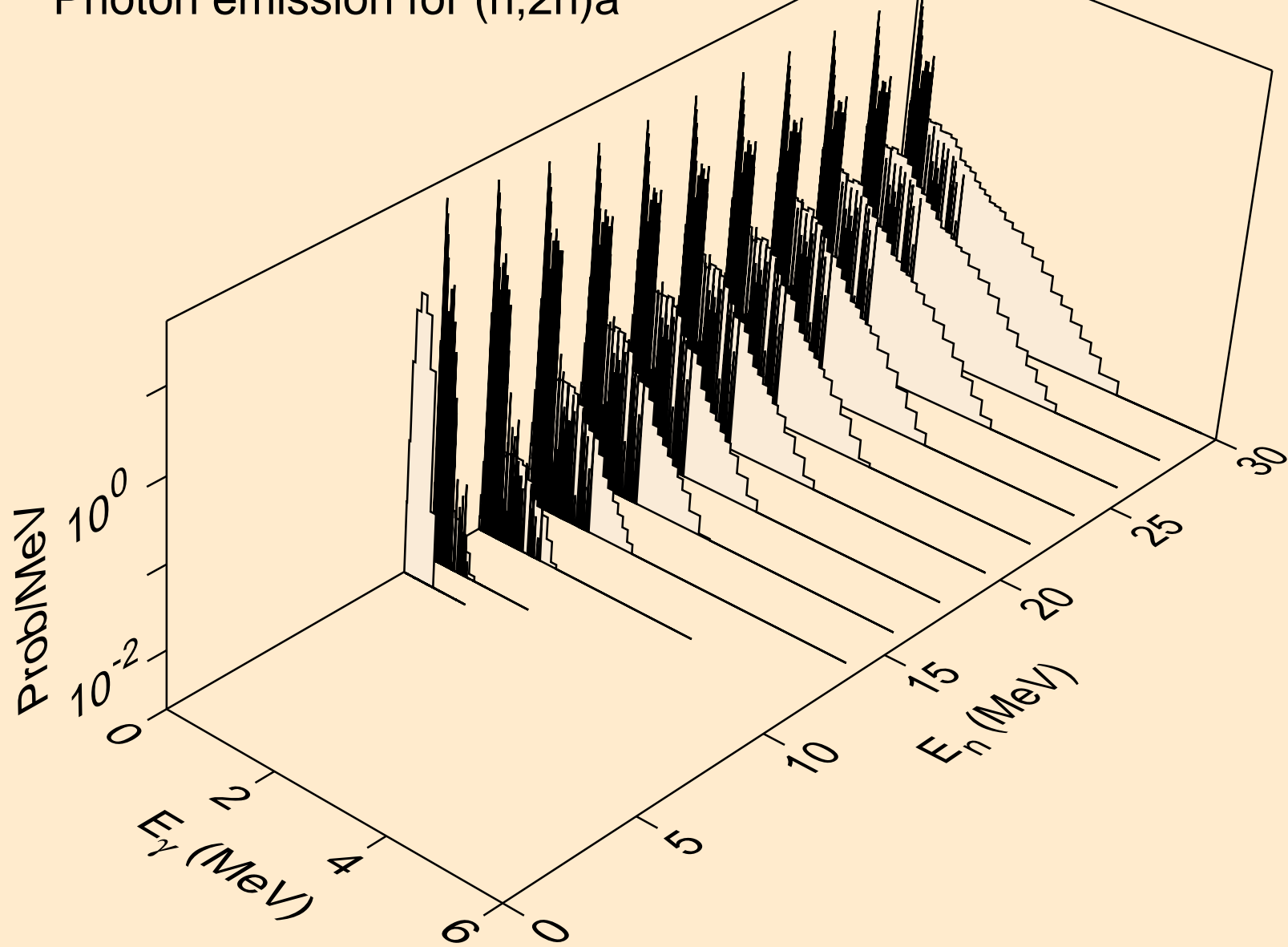

HF178N NEUTRON ACER TENDL-2024 LIBRARY; T=293.6K
Photon emission for (n,3n)a

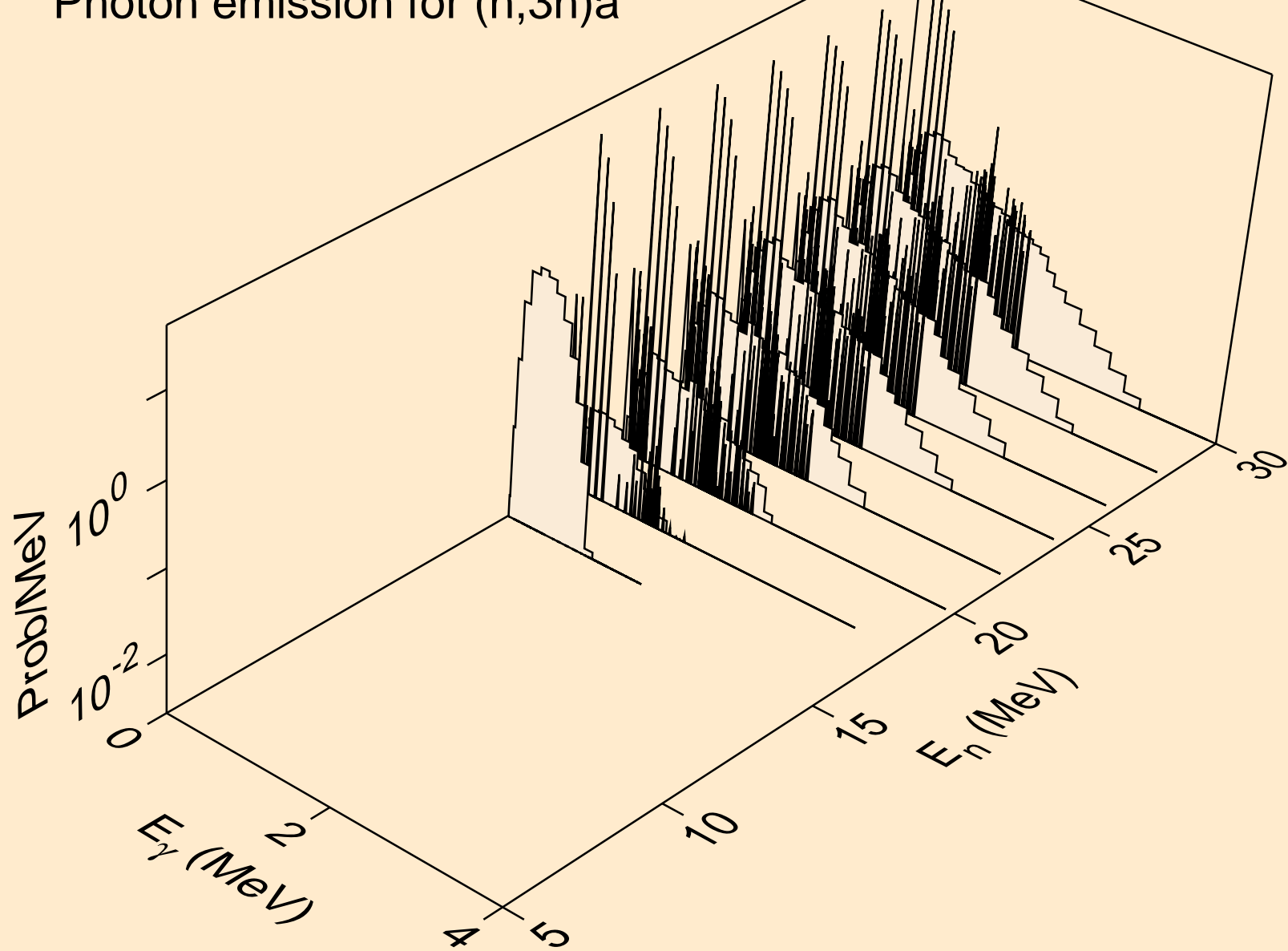

HF178N NEUTRON ACER TENDL-2024 LIBRARY; T=293.6K
Photon emission for (n,n*)p

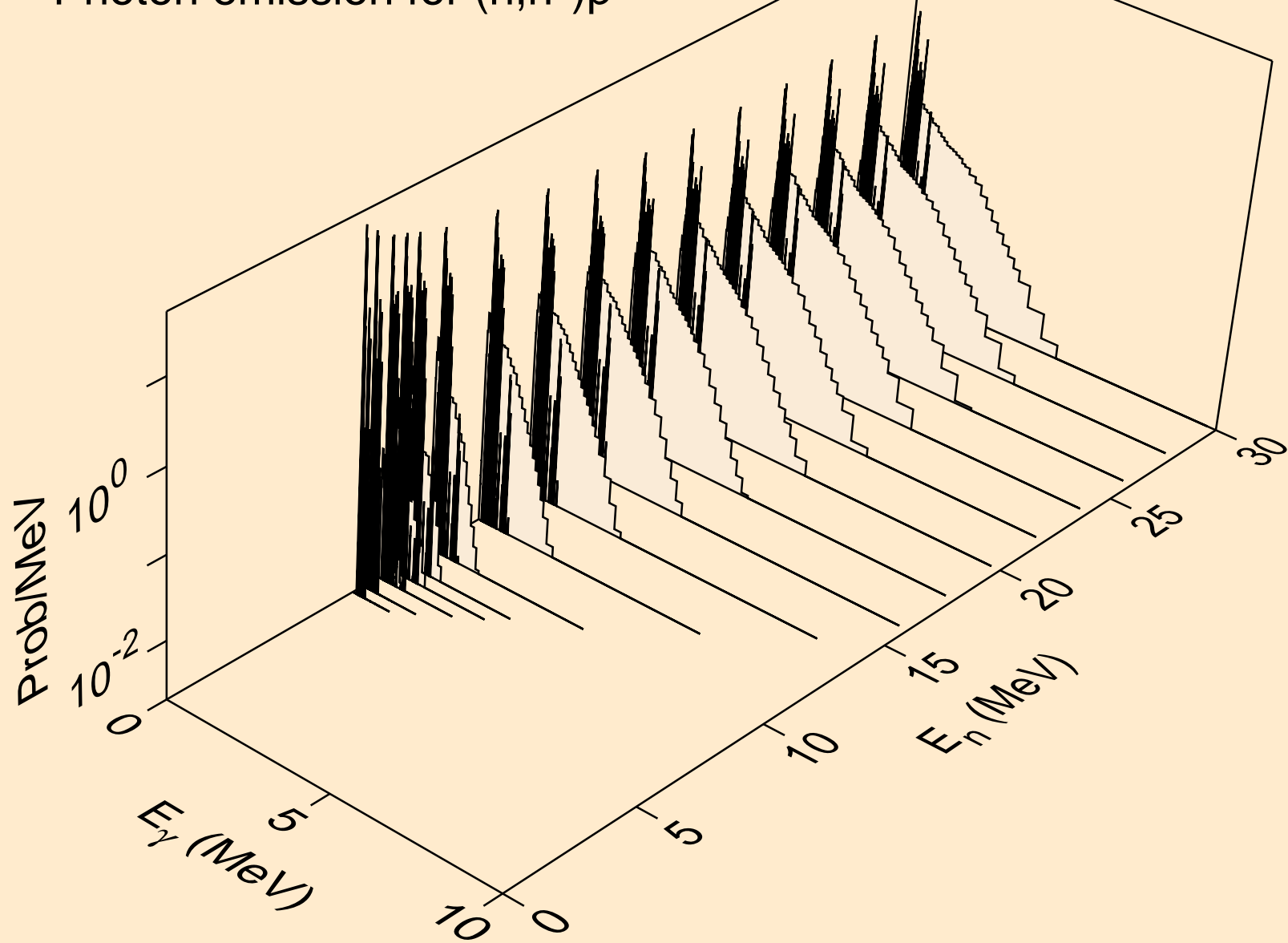

HF178N NEUTRON ACER TENDL-2024 LIBRARY; T=293.6K
Photon emission for (n,n*)2a

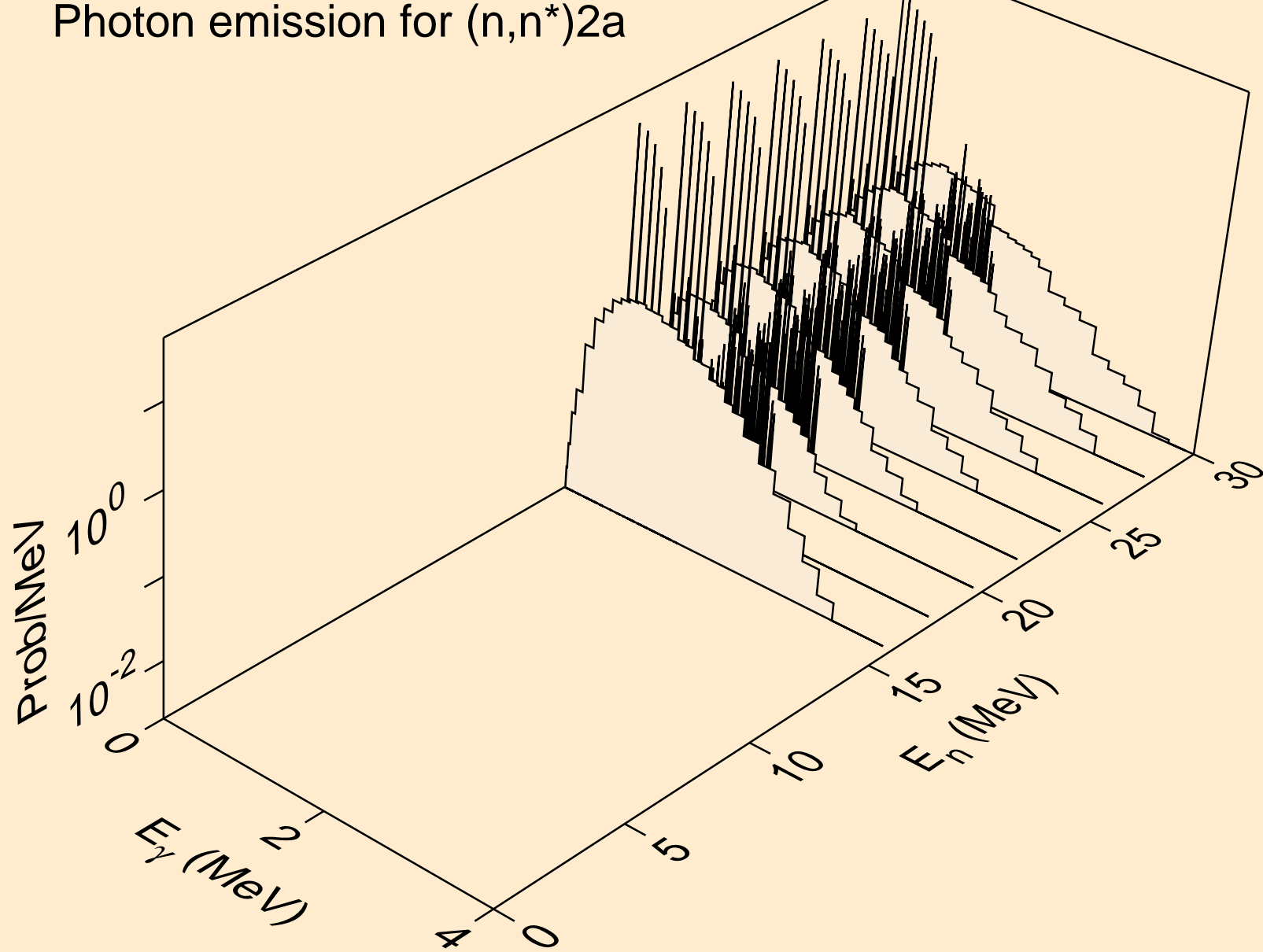

HF178N NEUTRON ACER TENDL-2024 LIBRARY; T=293.6K
Photon emission for (n,n*)d

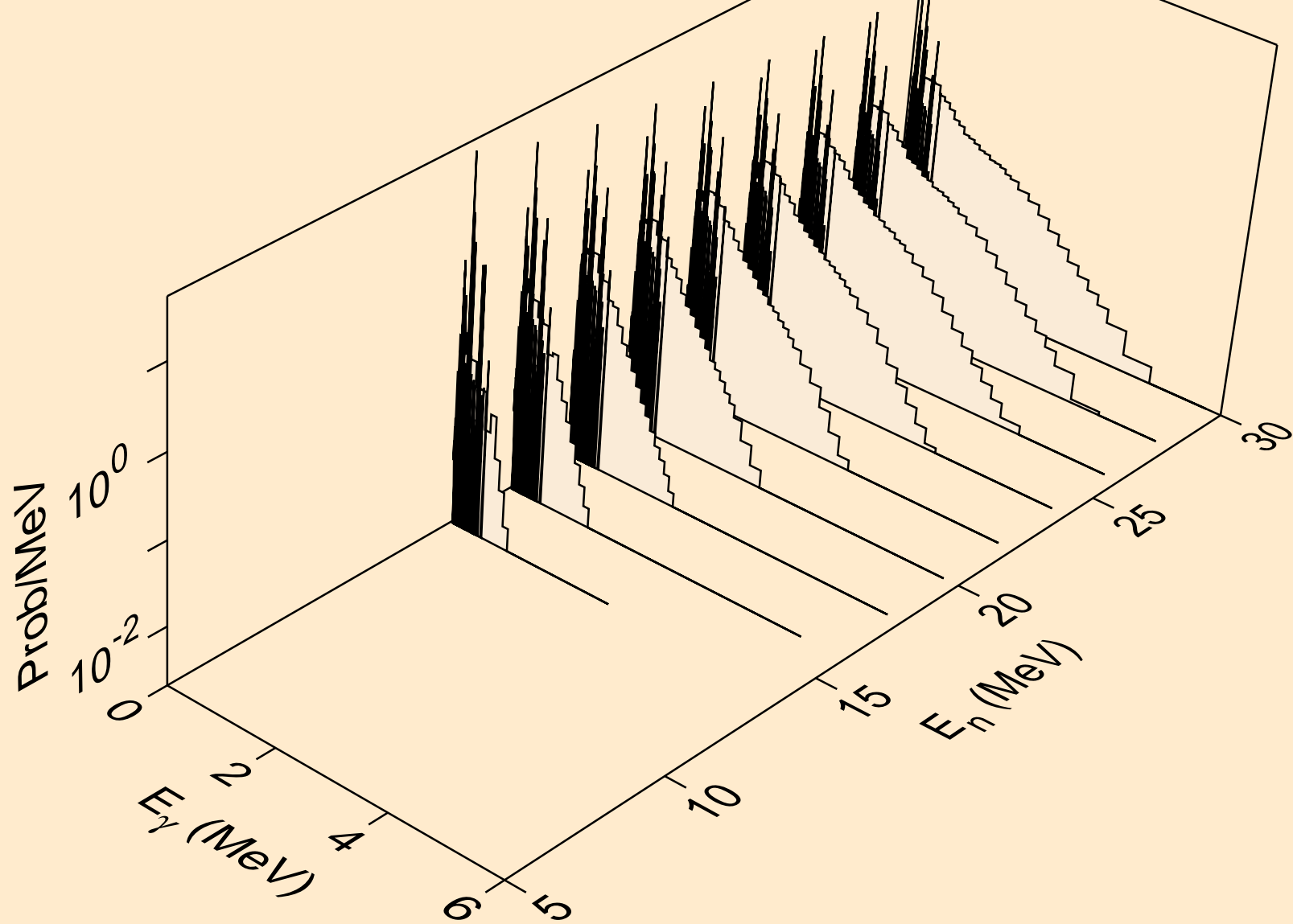

HF178N NEUTRON ACER TENDL-2024 LIBRARY; T=293.6K
Photon emission for (n,n*)t

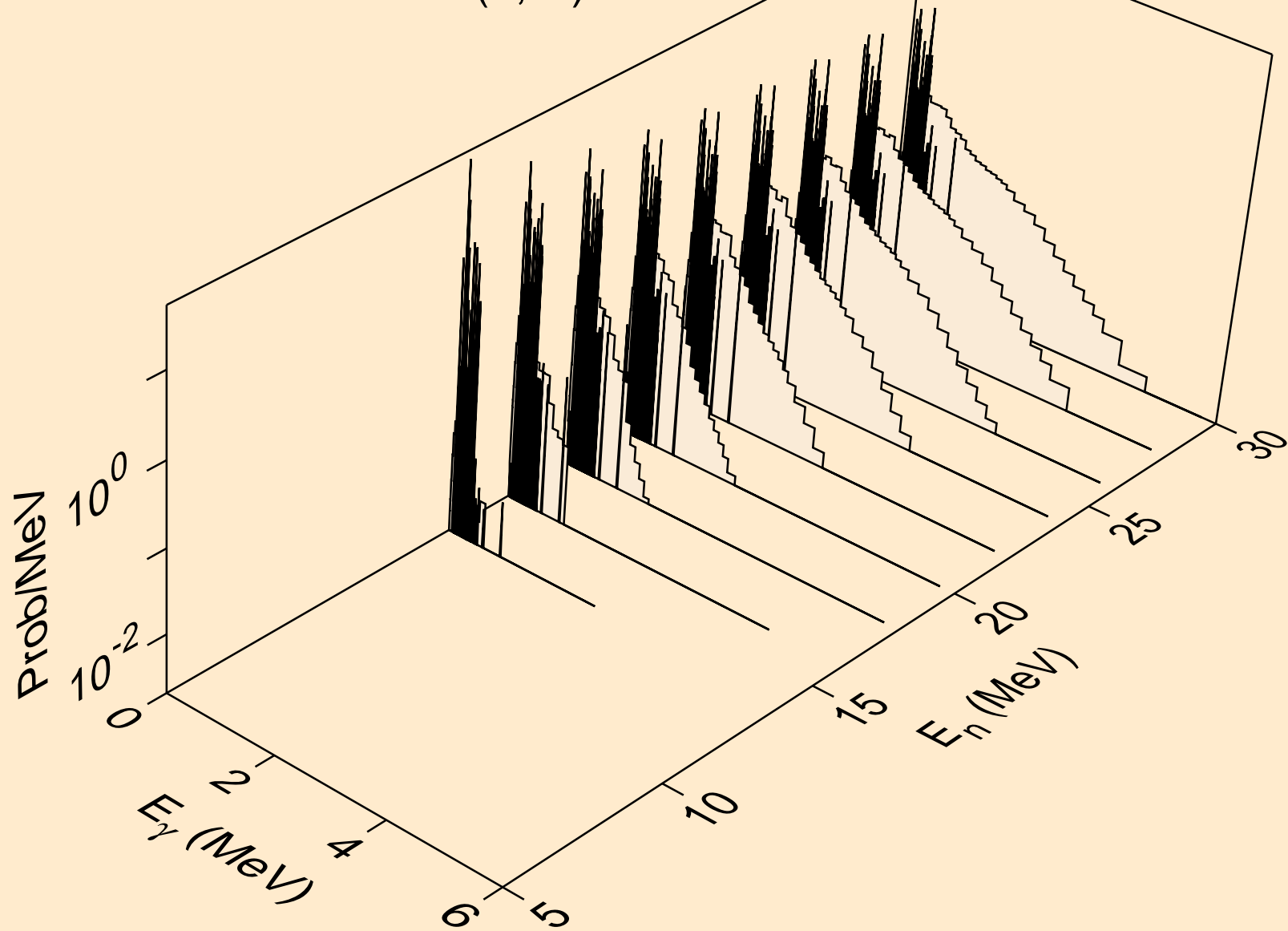

HF178N NEUTRON ACER TENDL-2024 LIBRARY; T=293.6K
Photon emission for (n,n*)he3

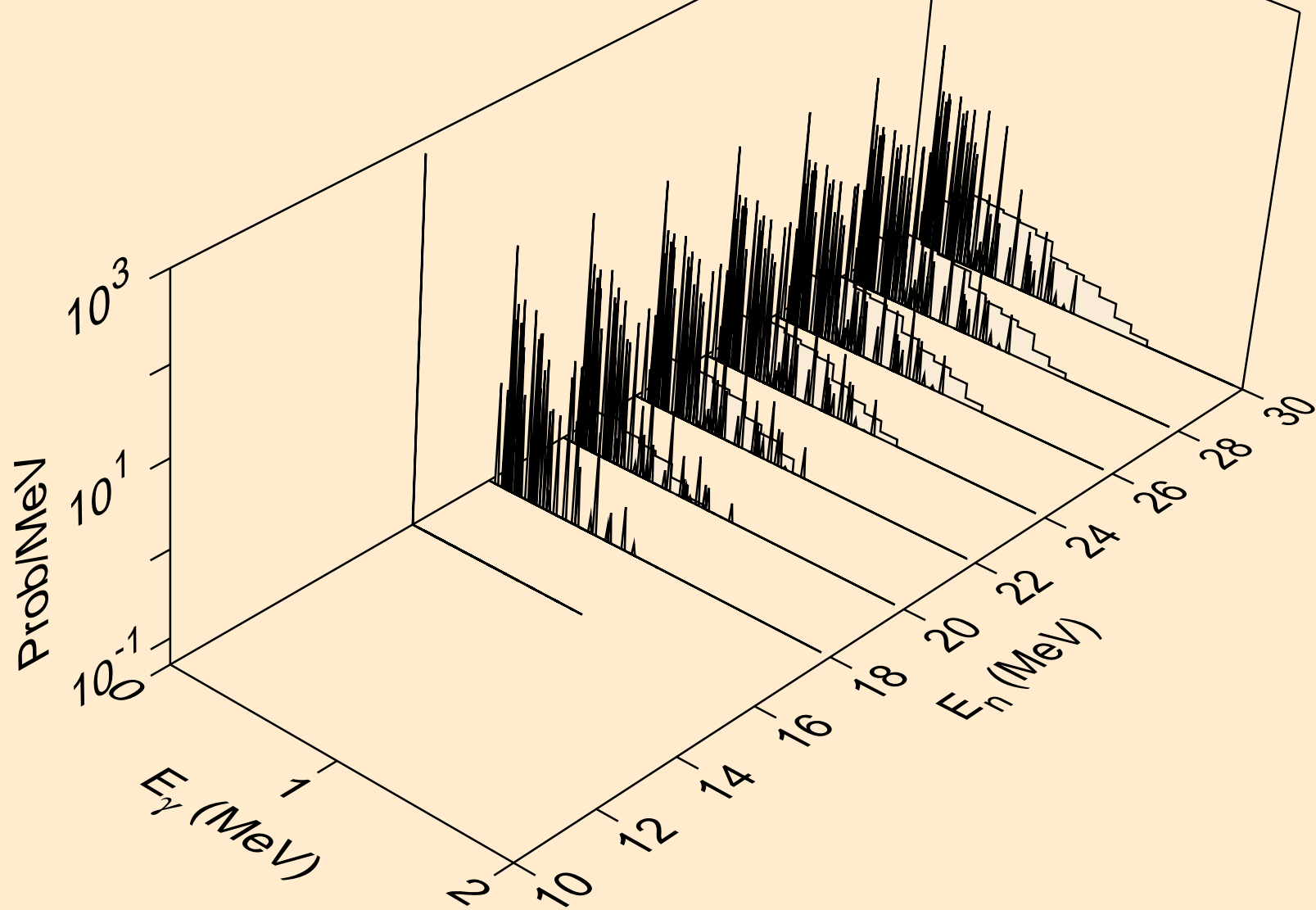

HF178N NEUTRON ACER TENDL-2024 LIBRARY; T=293.6K
Photon emission for (n,4n)

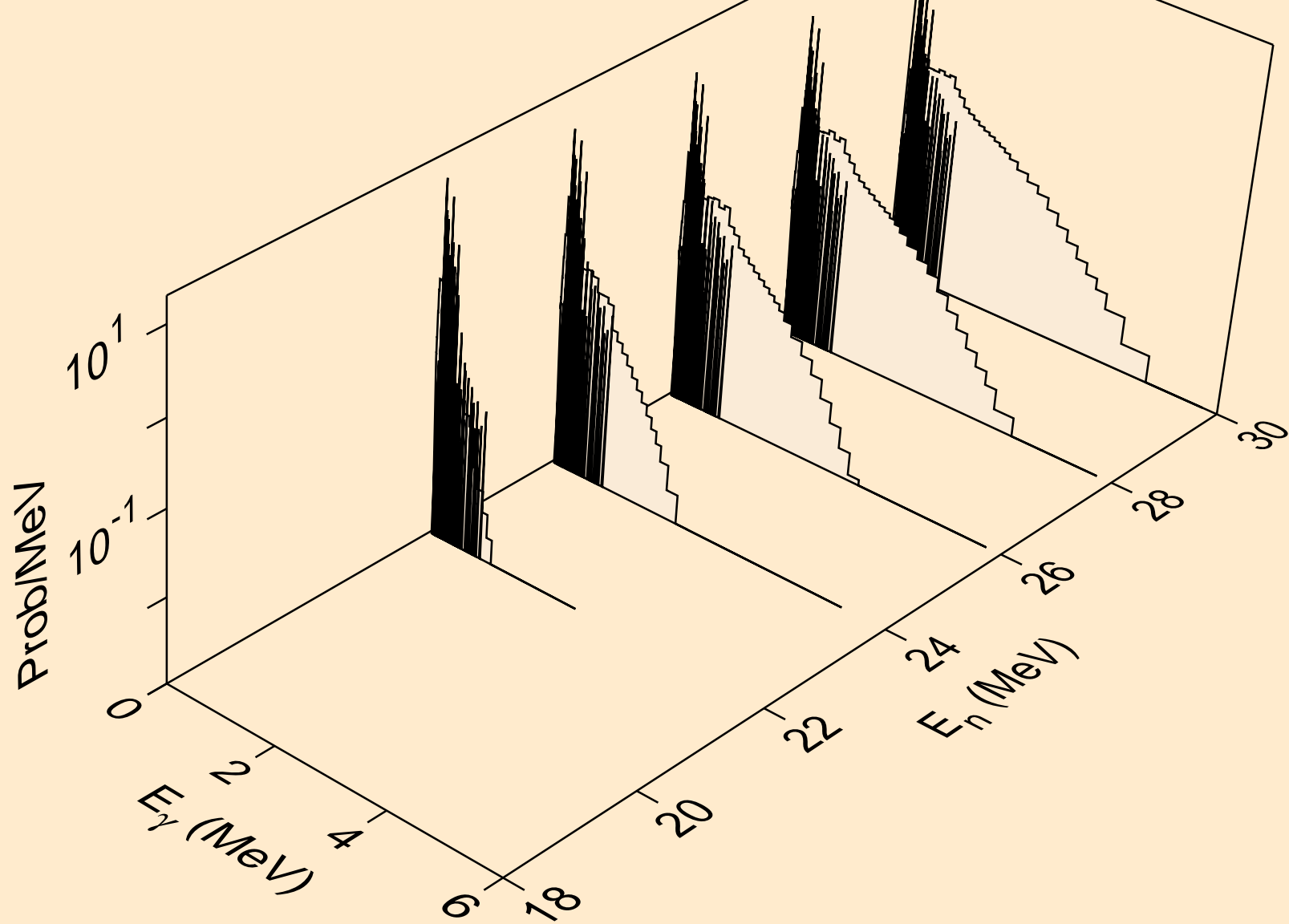

HF178N NEUTRON ACER TENDL-2024 LIBRARY; T=293.6K
Photon emission for (n,2np)

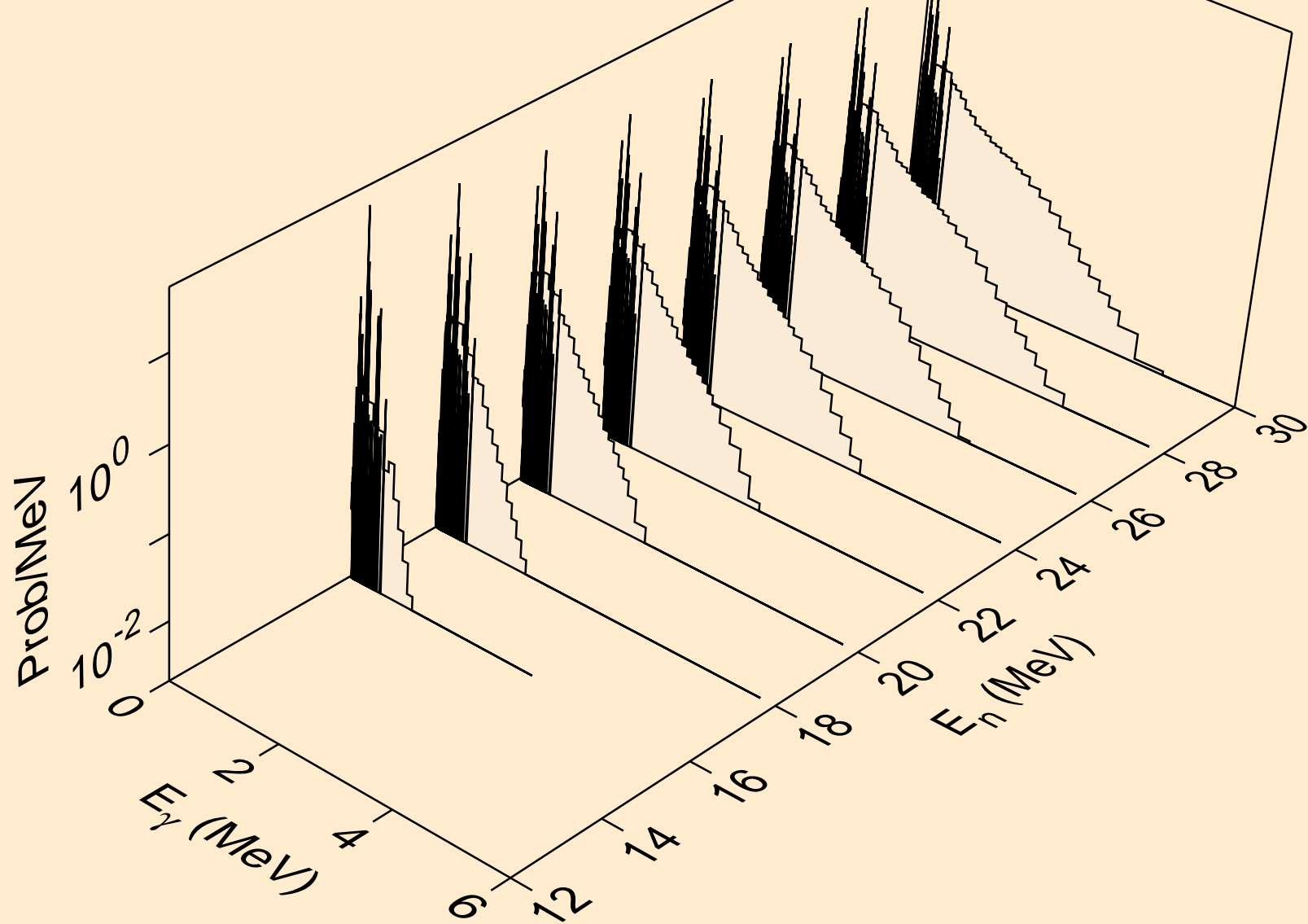

HF178N NEUTRON ACER TENDL-2024 LIBRARY; T=293.6K
Photon emission for (n,3np)

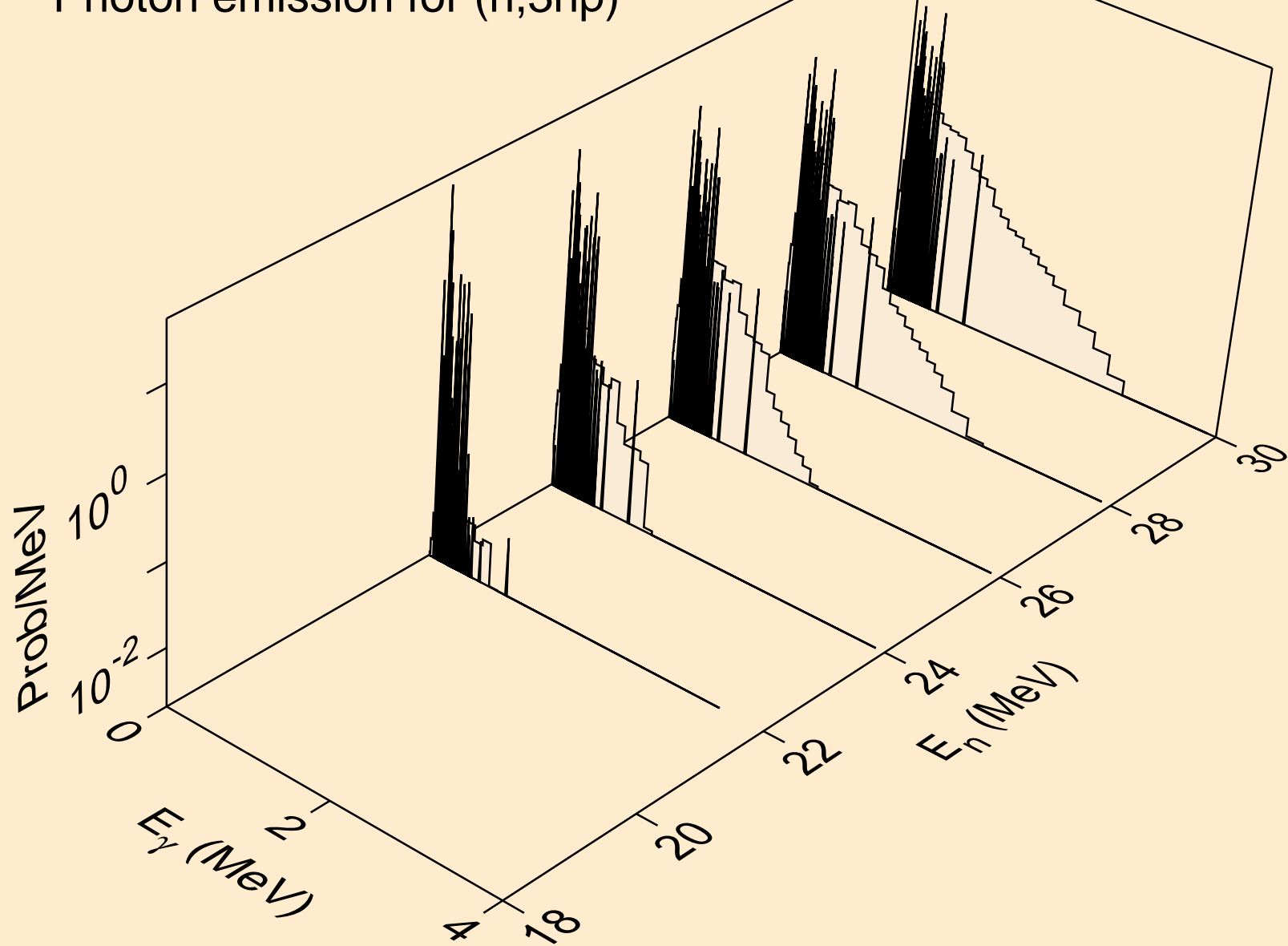

HF178N NEUTRON ACER TENDL-2024 LIBRARY; T=293.6K
Photon emission for (n,n2p)

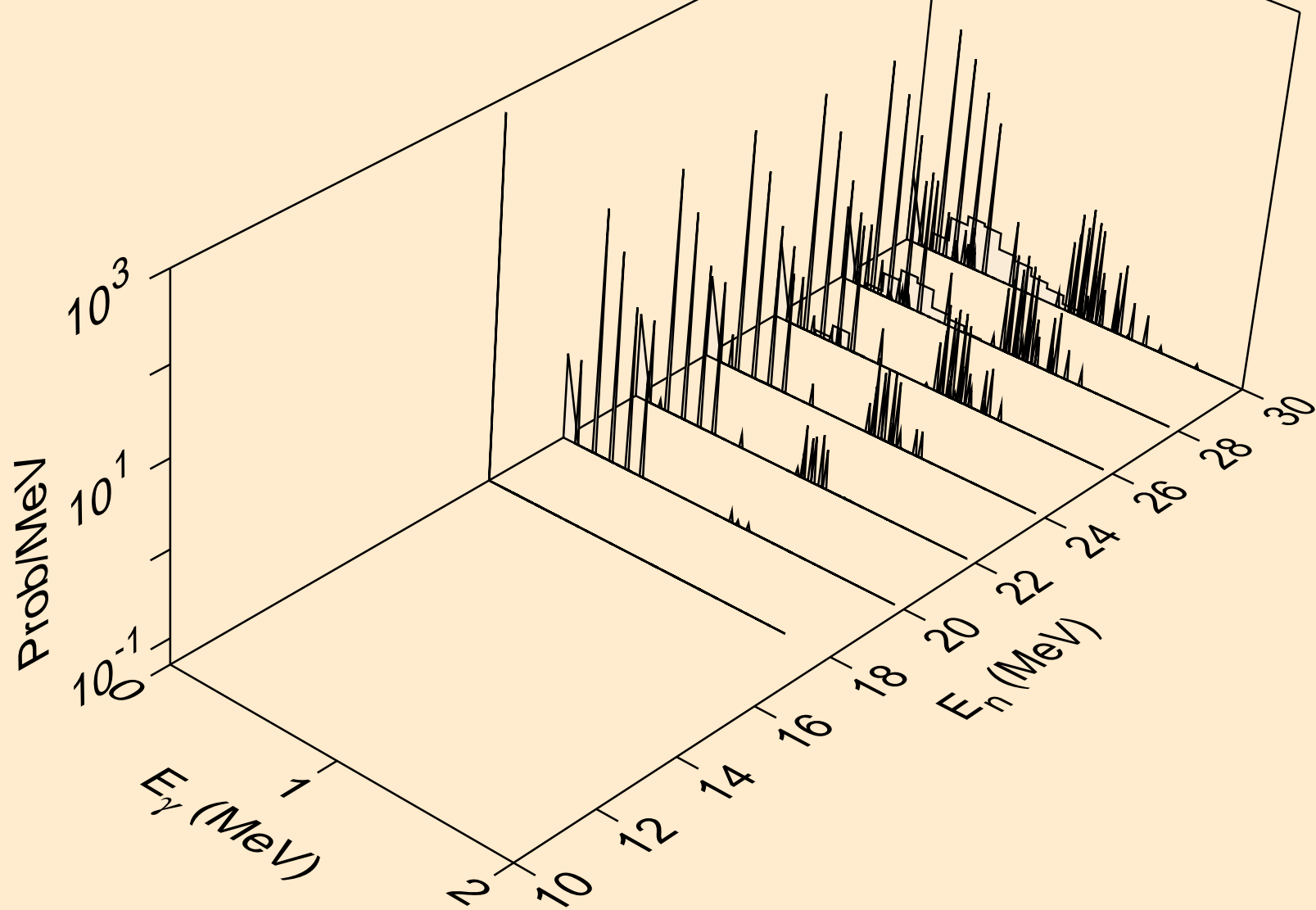

HF178N NEUTRON ACER TENDL-2024 LIBRARY; T=293.6K
Photon emission for (n,npa)

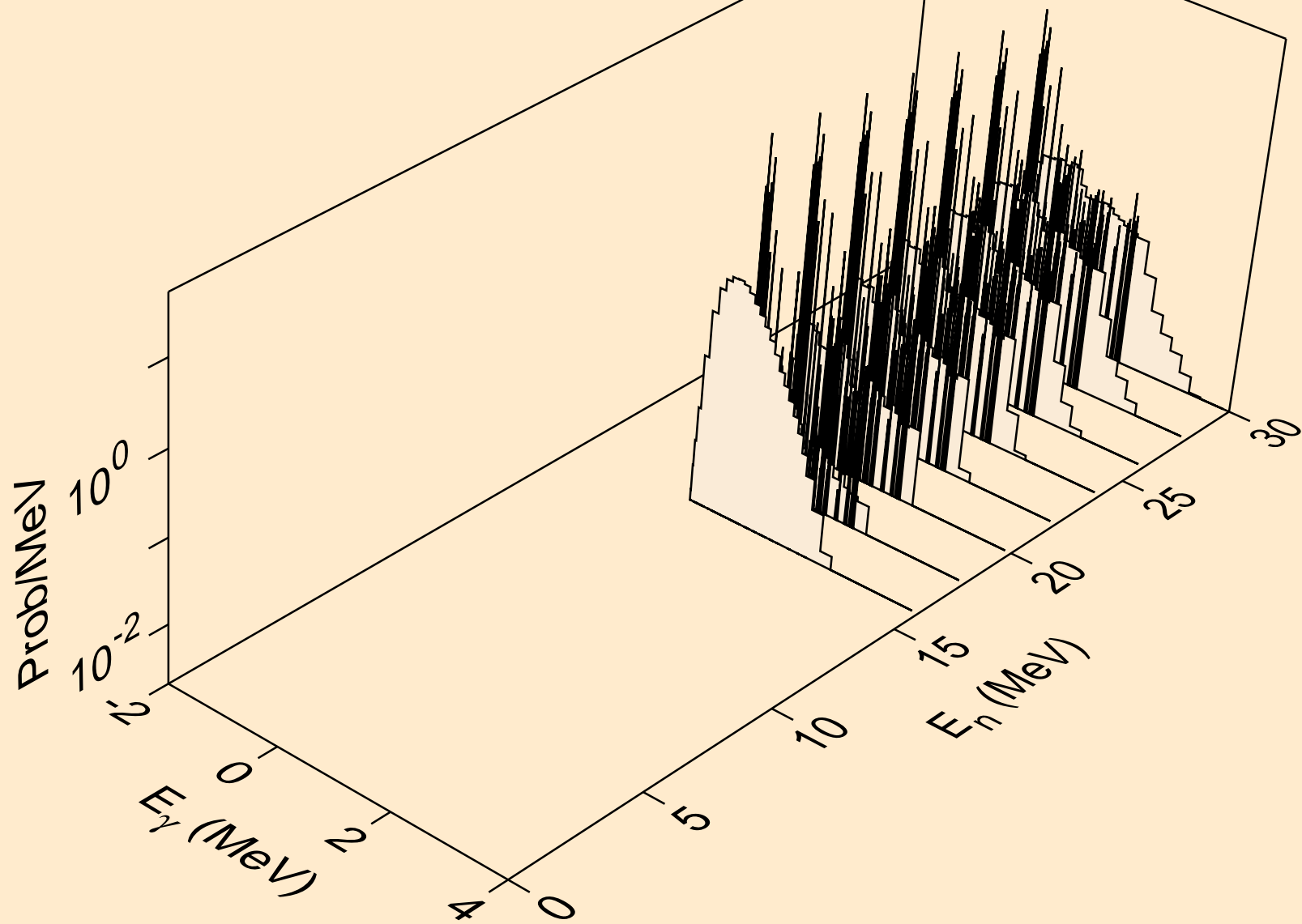

HF178N NEUTRON ACER TENDL-2024 LIBRARY; T=293.6K
Photon emission for (n,n*1)

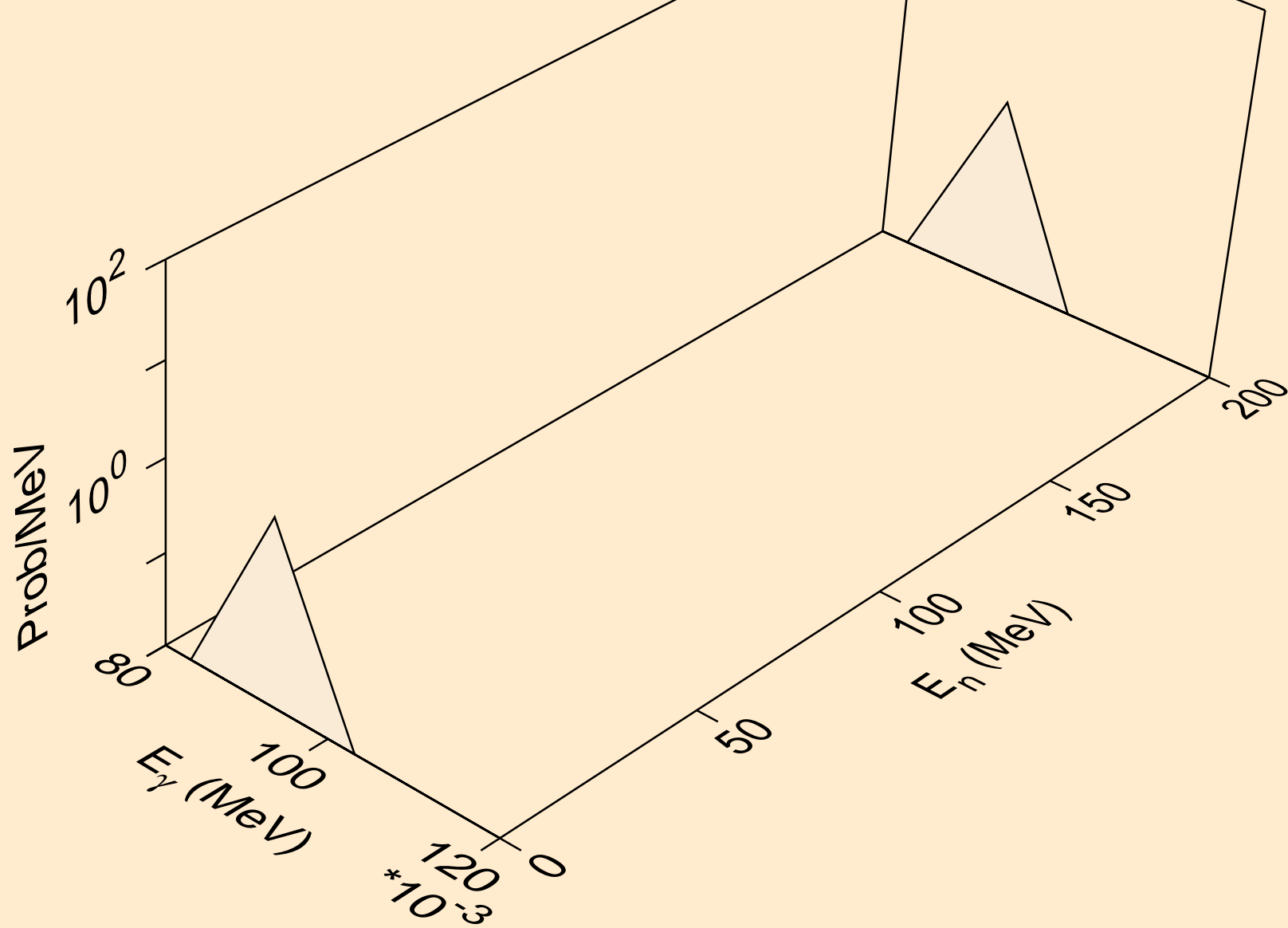

HF178N NEUTRON ACER TENDL-2024 LIBRARY; T=293.6K
Photon emission for (n,n*2)

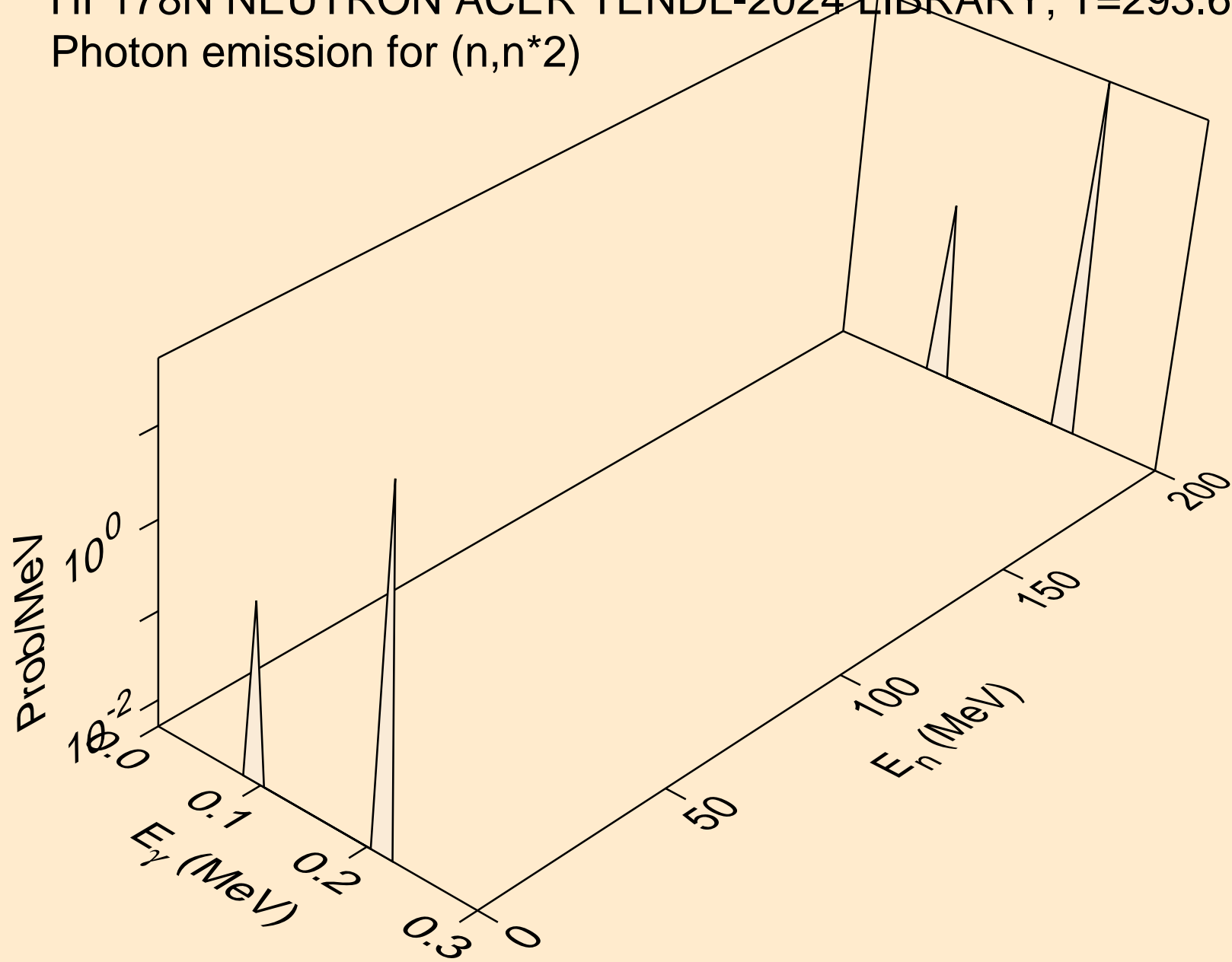

HF178N NEUTRON ACER TENDL-2024 LIBRARY; T=293.6K
Photon emission for (n,n*3)

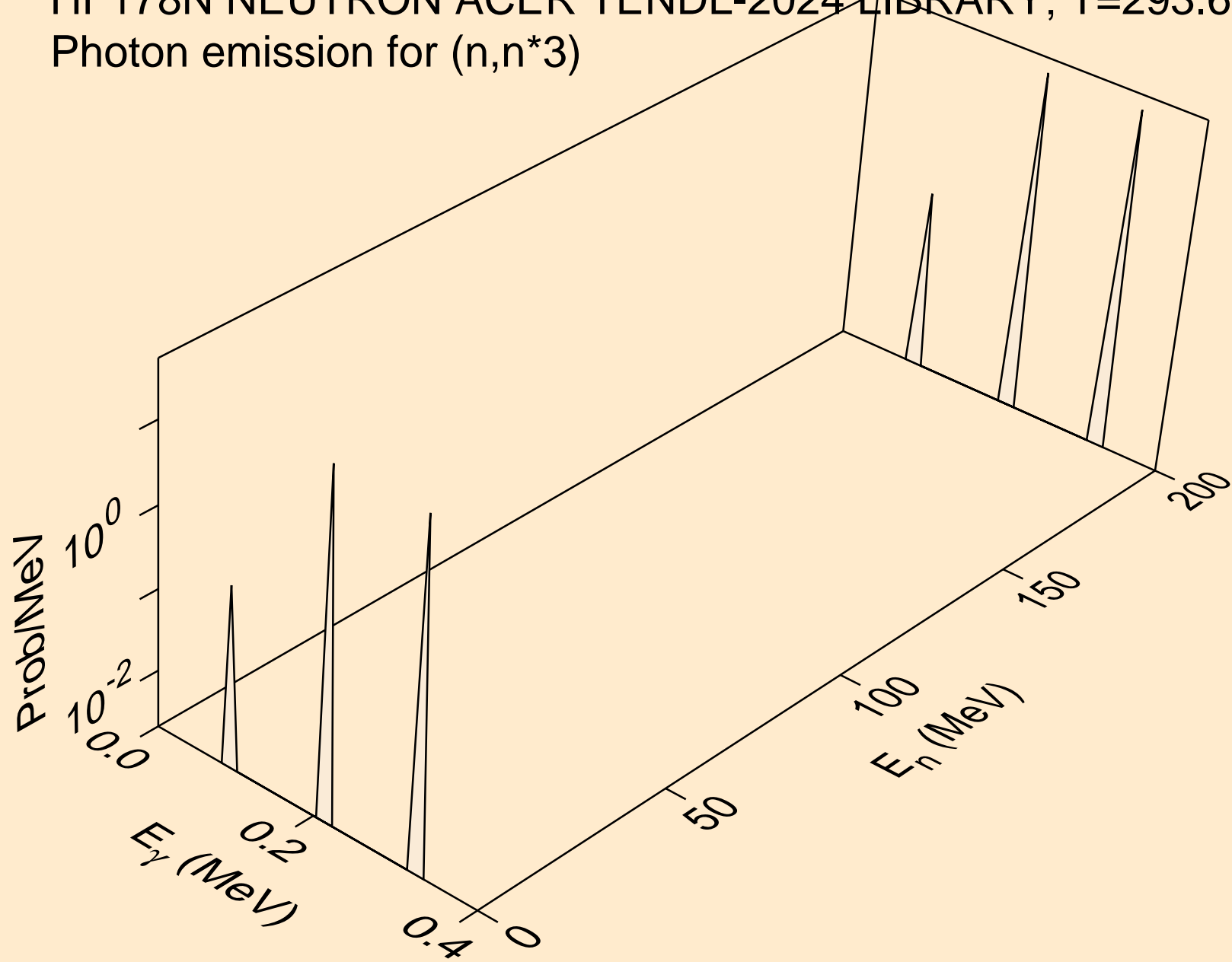

HF178N NEUTRON ACER TENDL-2024 LIBRARY; T=293.6K
Photon emission for (n,n*4)

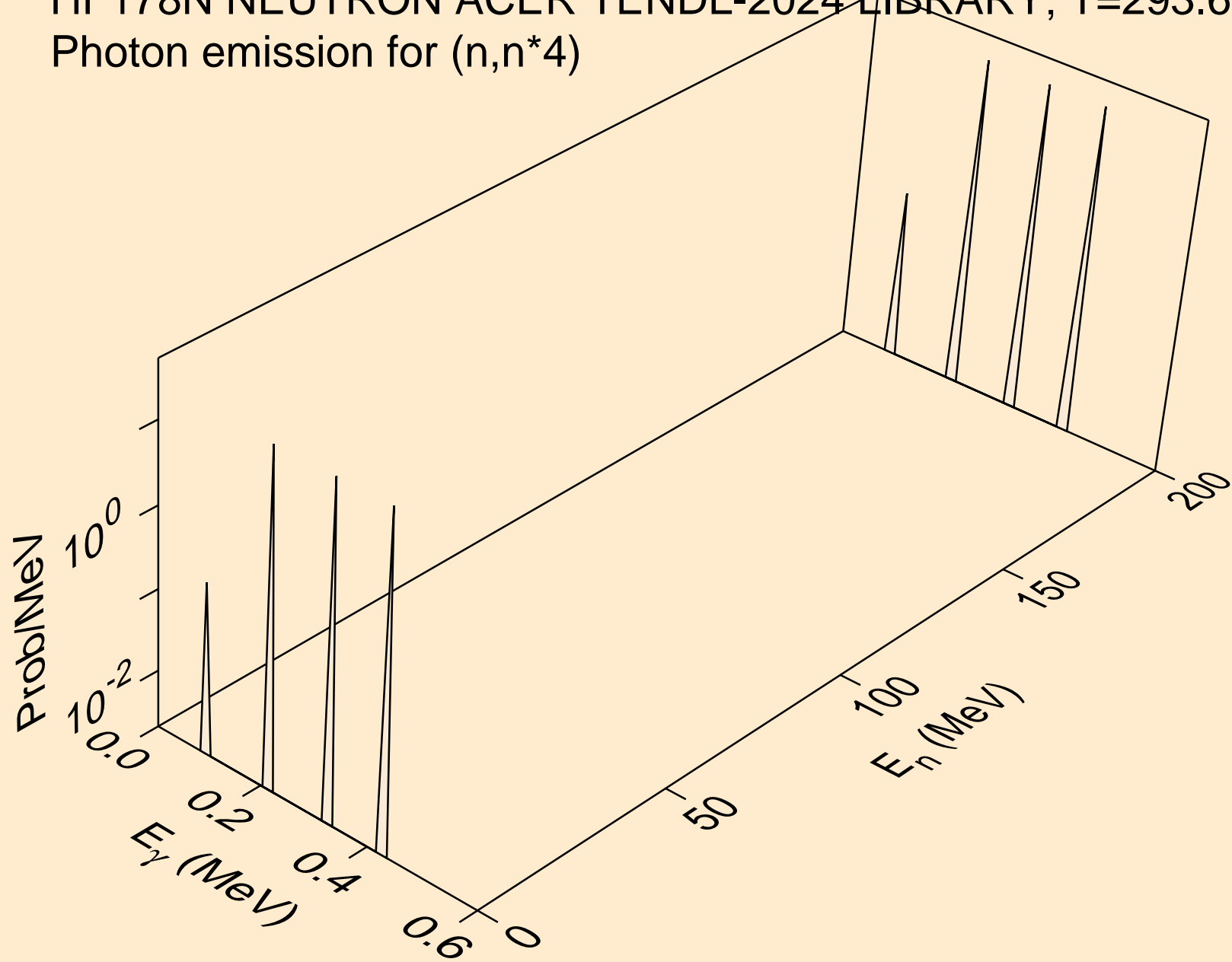

HF178N NEUTRON ACER TENDL-2024 LIBRARY; T=293.6K
Photon emission for (n,n*c)

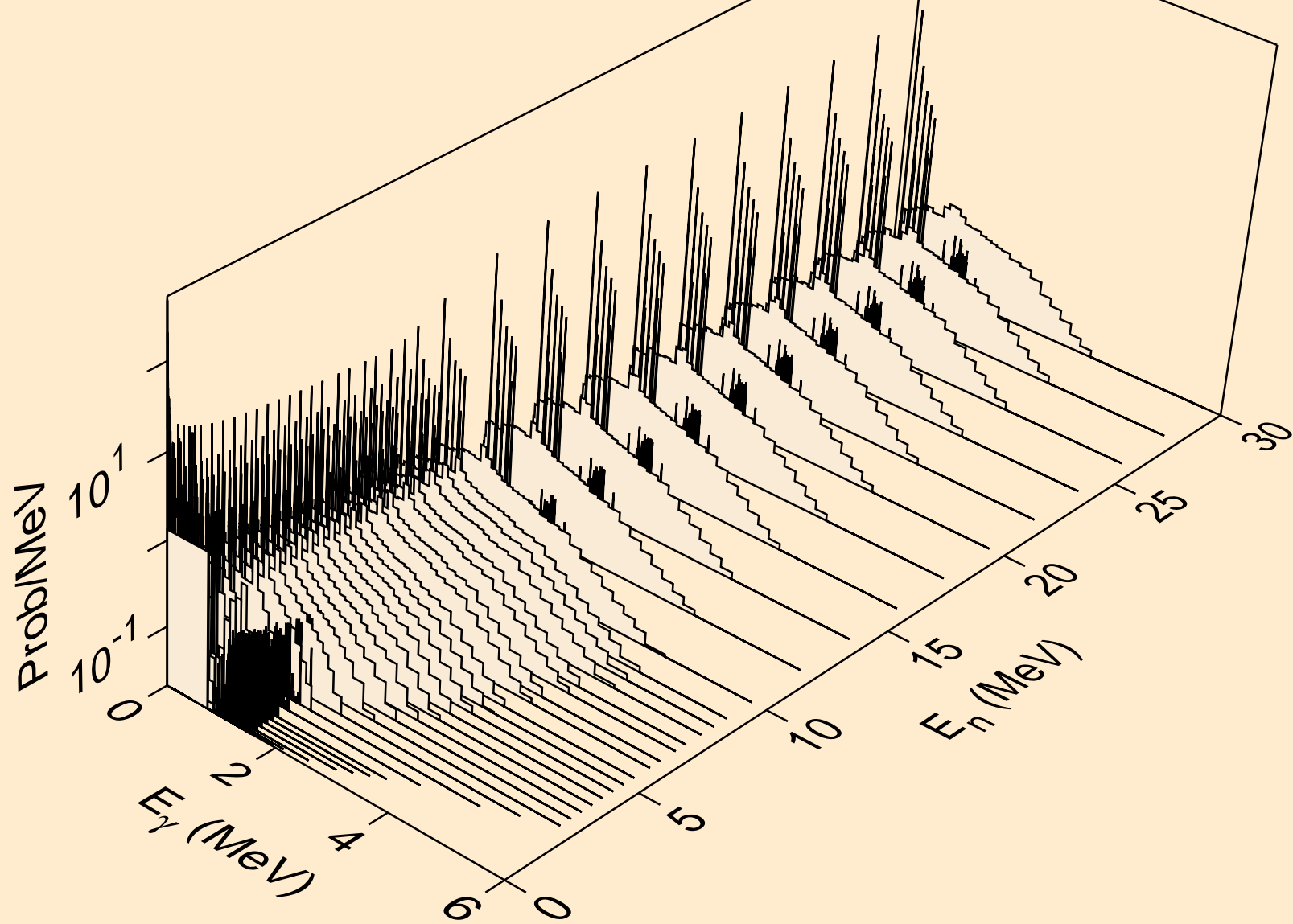

HF178N NEUTRON ACER TENDL-2024 LIBRARY; T=293.6K
Photon emission for (n,gma)

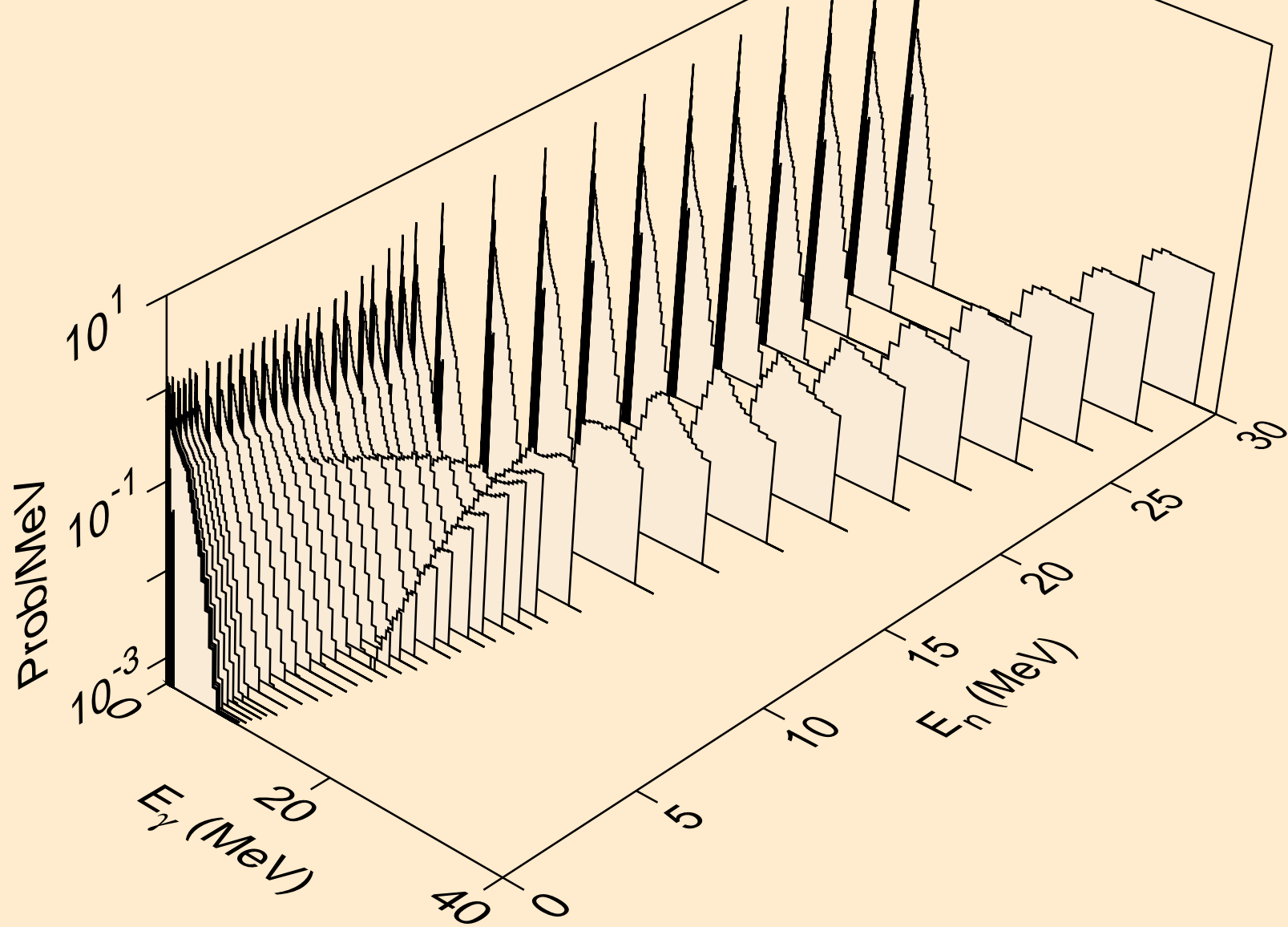

HF178N NEUTRON ACER TENDL-2024 LIBRARY; T=293.6K
Photon emission for (n,p)

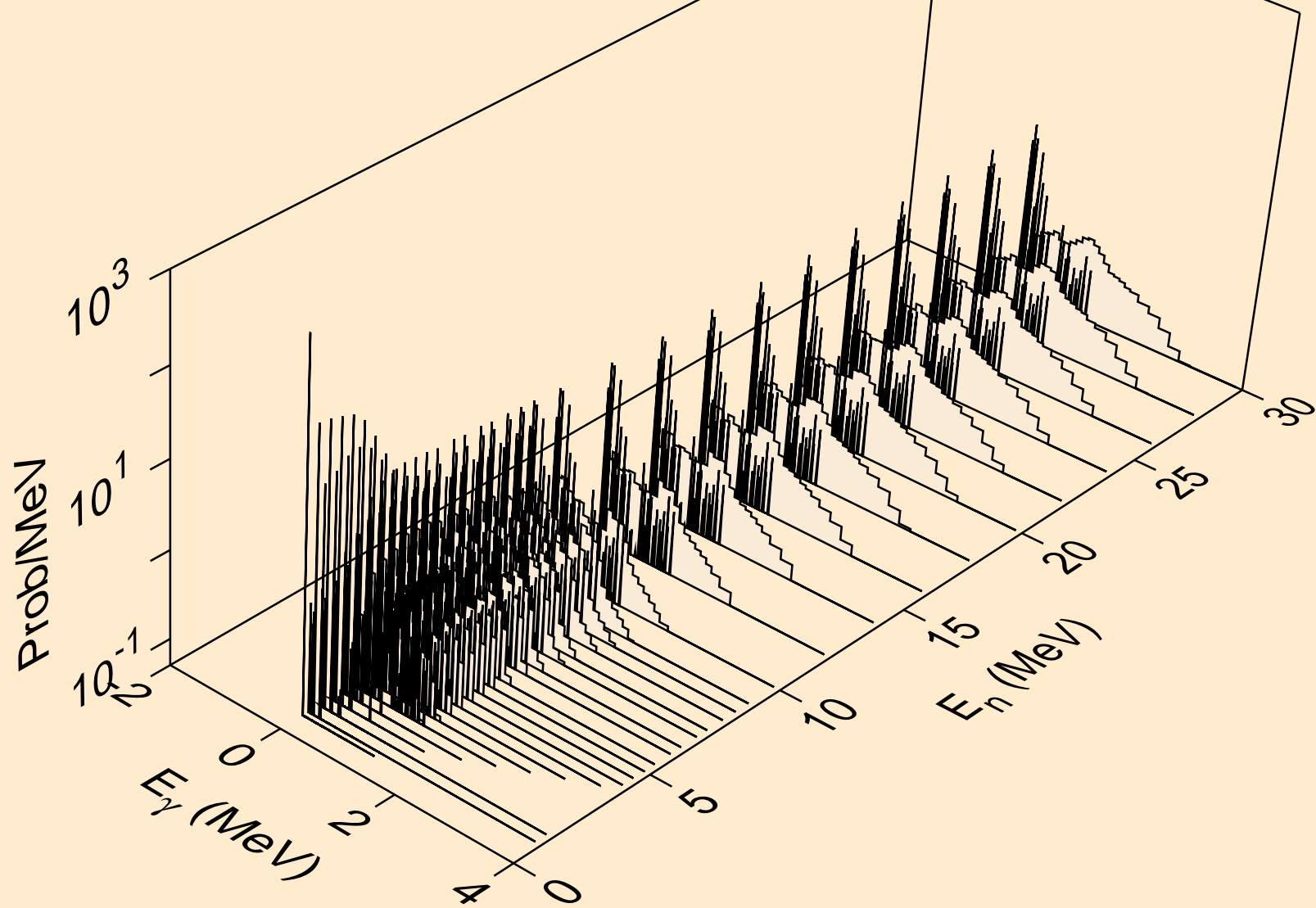

HF178N NEUTRON ACER TENDL-2024 LIBRARY; T=293.6K
Photon emission for (n,d)

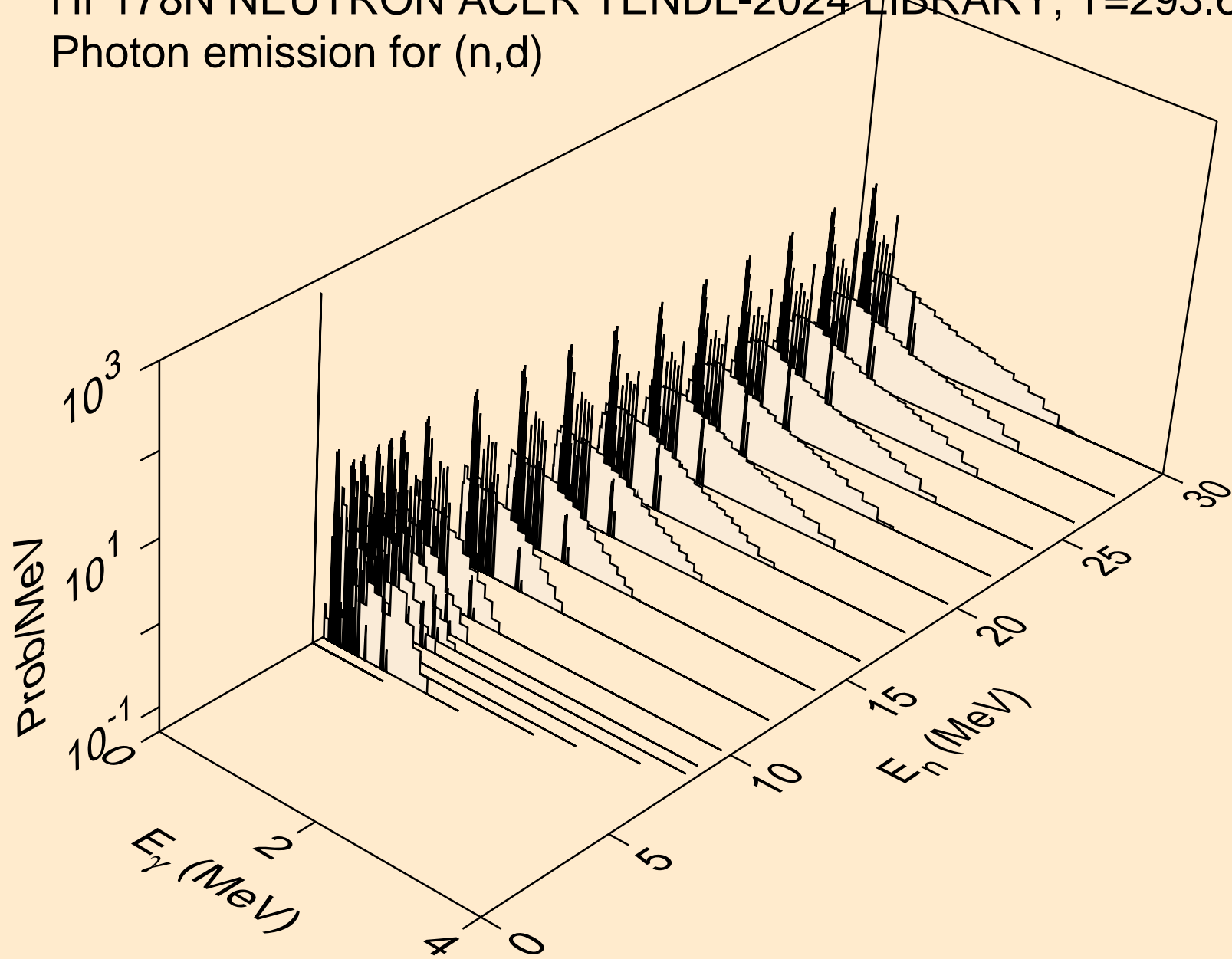

HF178N NEUTRON ACER TENDL-2024 LIBRARY; T=293.6K
Photon emission for (n,t)

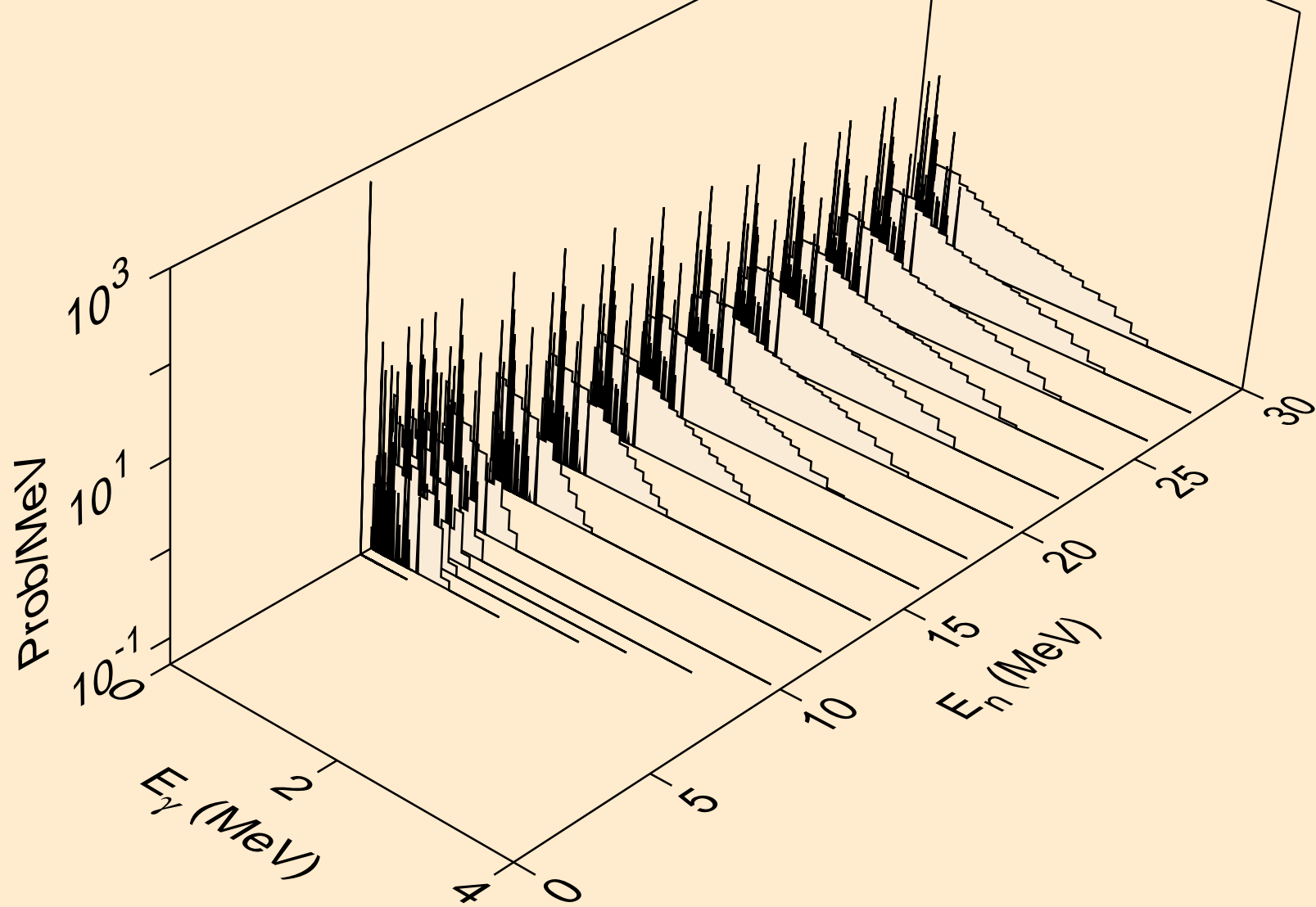

HF178N NEUTRON ACER TENDL-2024 LIBRARY; T=293.6K
Photon emission for (n,he3)

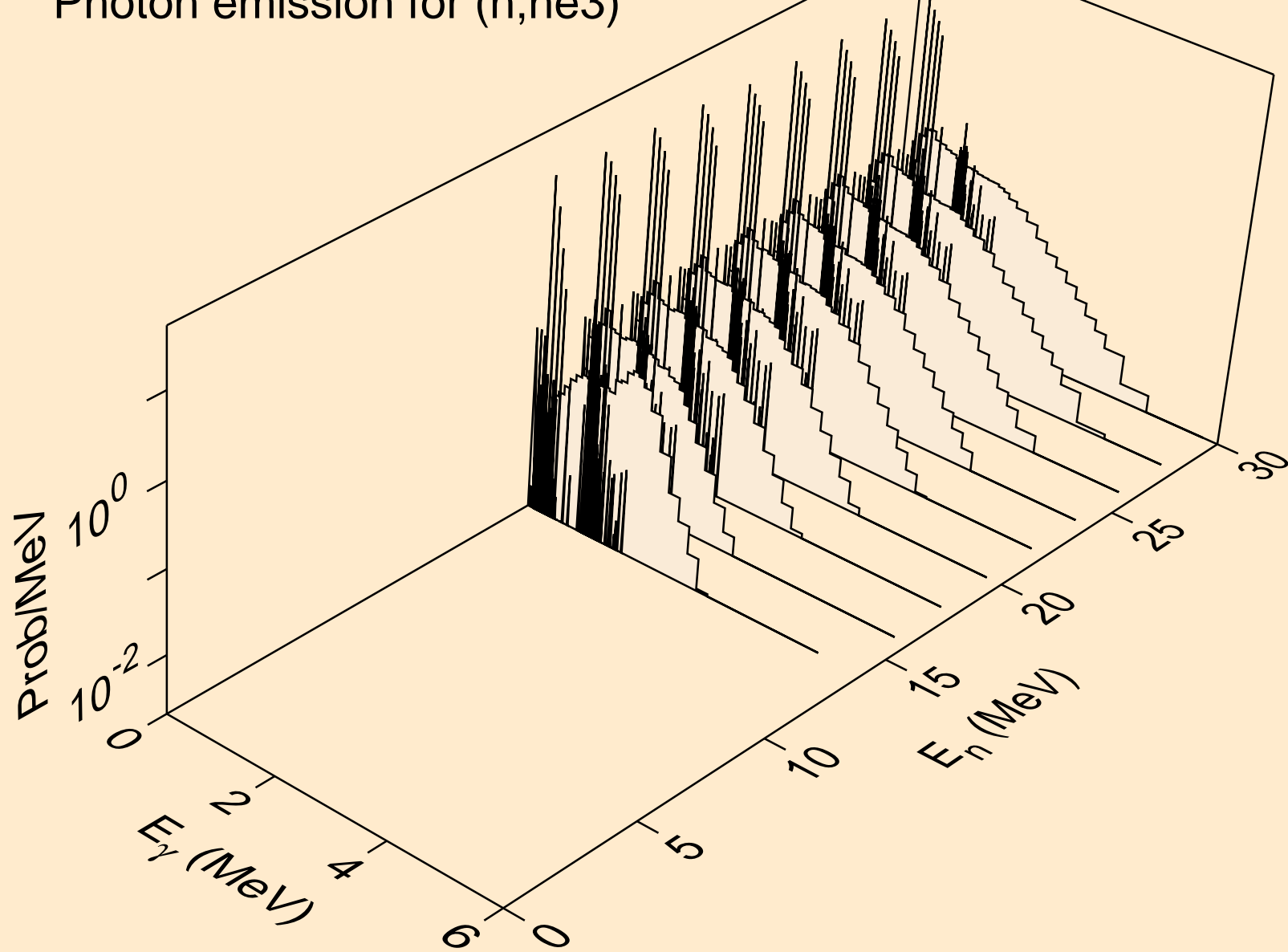

HF178N NEUTRON ACER TENDL-2024 LIBRARY; T=293.6K
Photon emission for (n,a)

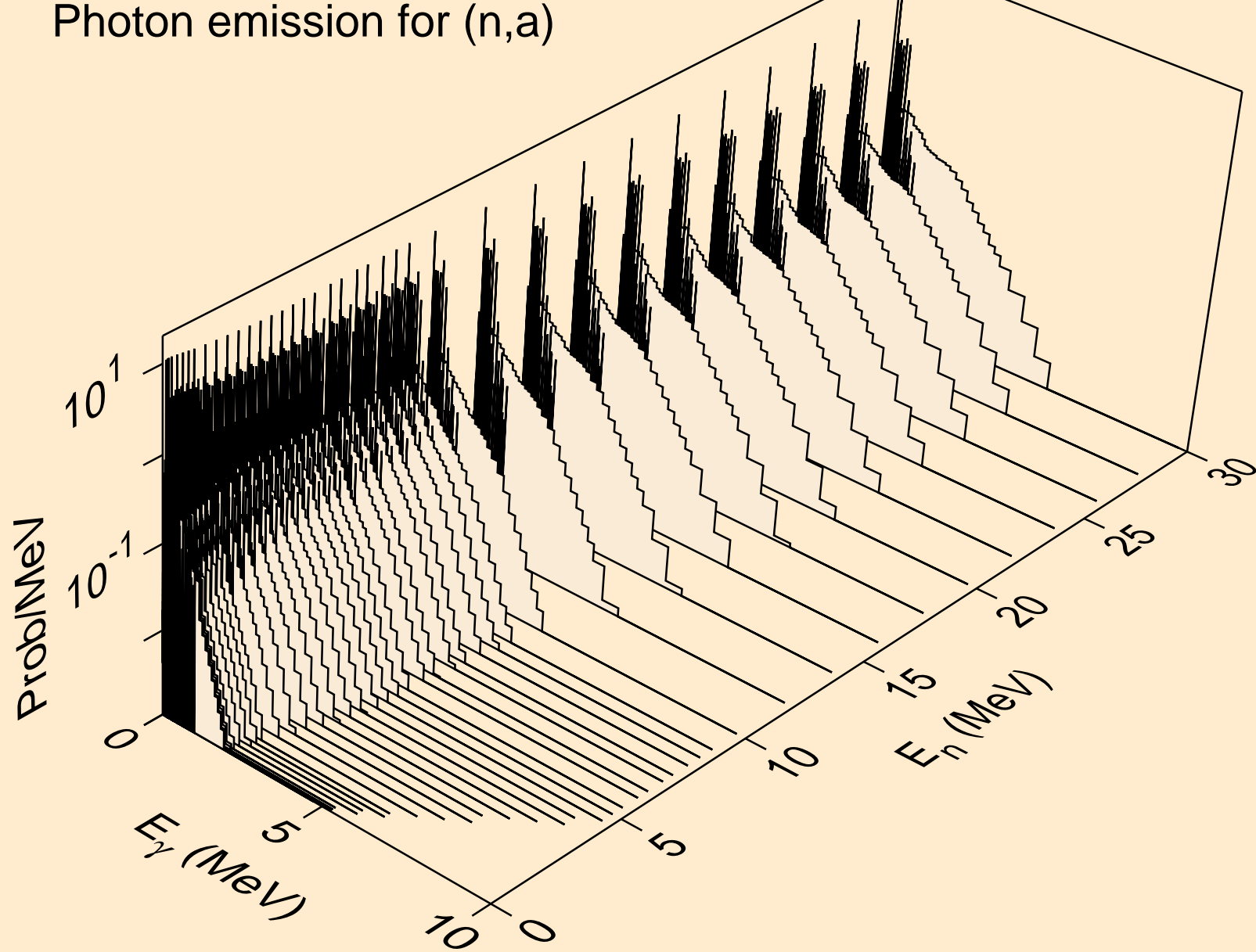

HF178N NEUTRON ACER TENDL-2024 LIBRARY; T=293.6K
Photon emission for (n,2a)

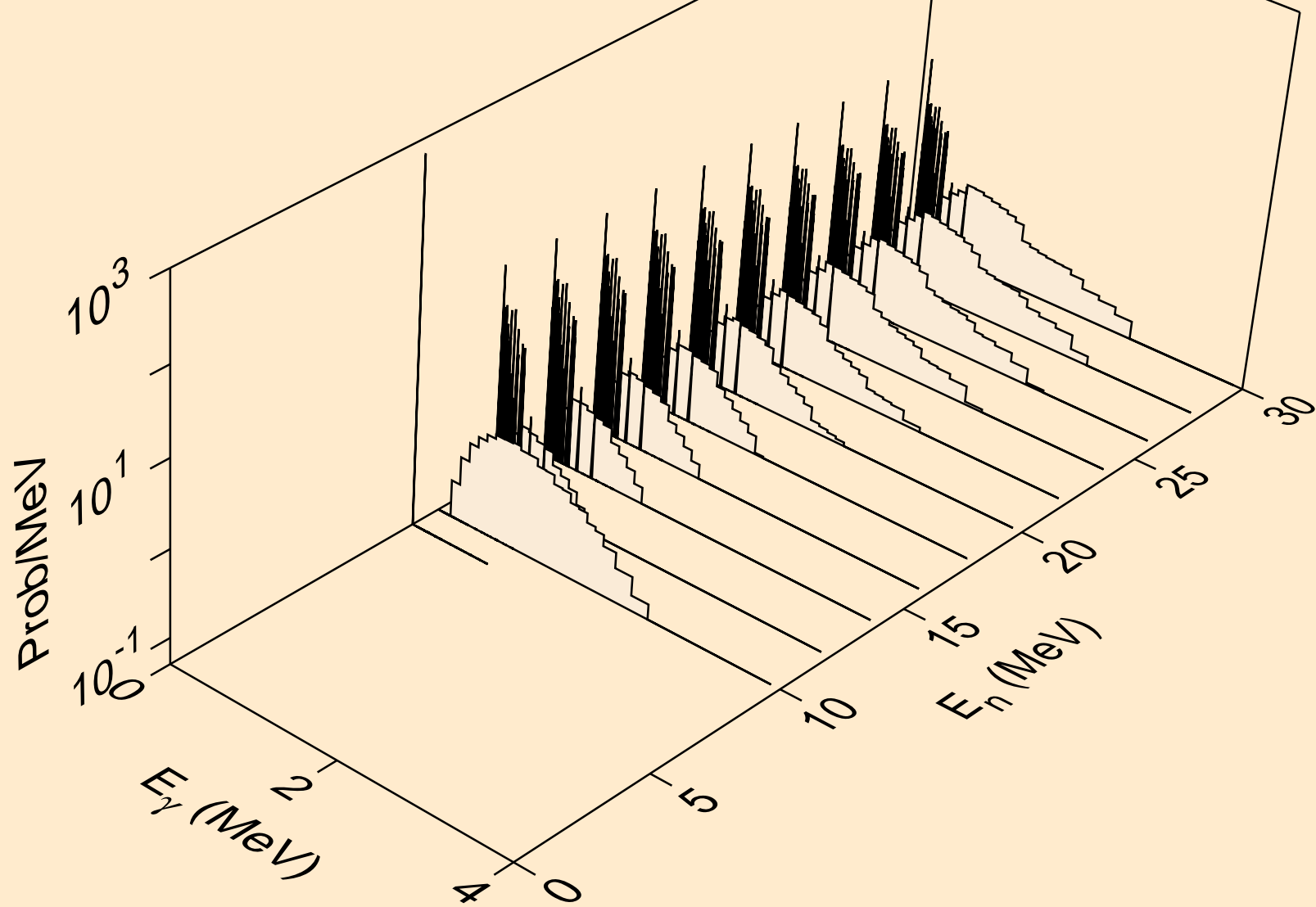

HF178N NEUTRON ACER TENDL-2024 LIBRARY; T=293.6K
Photon emission for (n,2p)

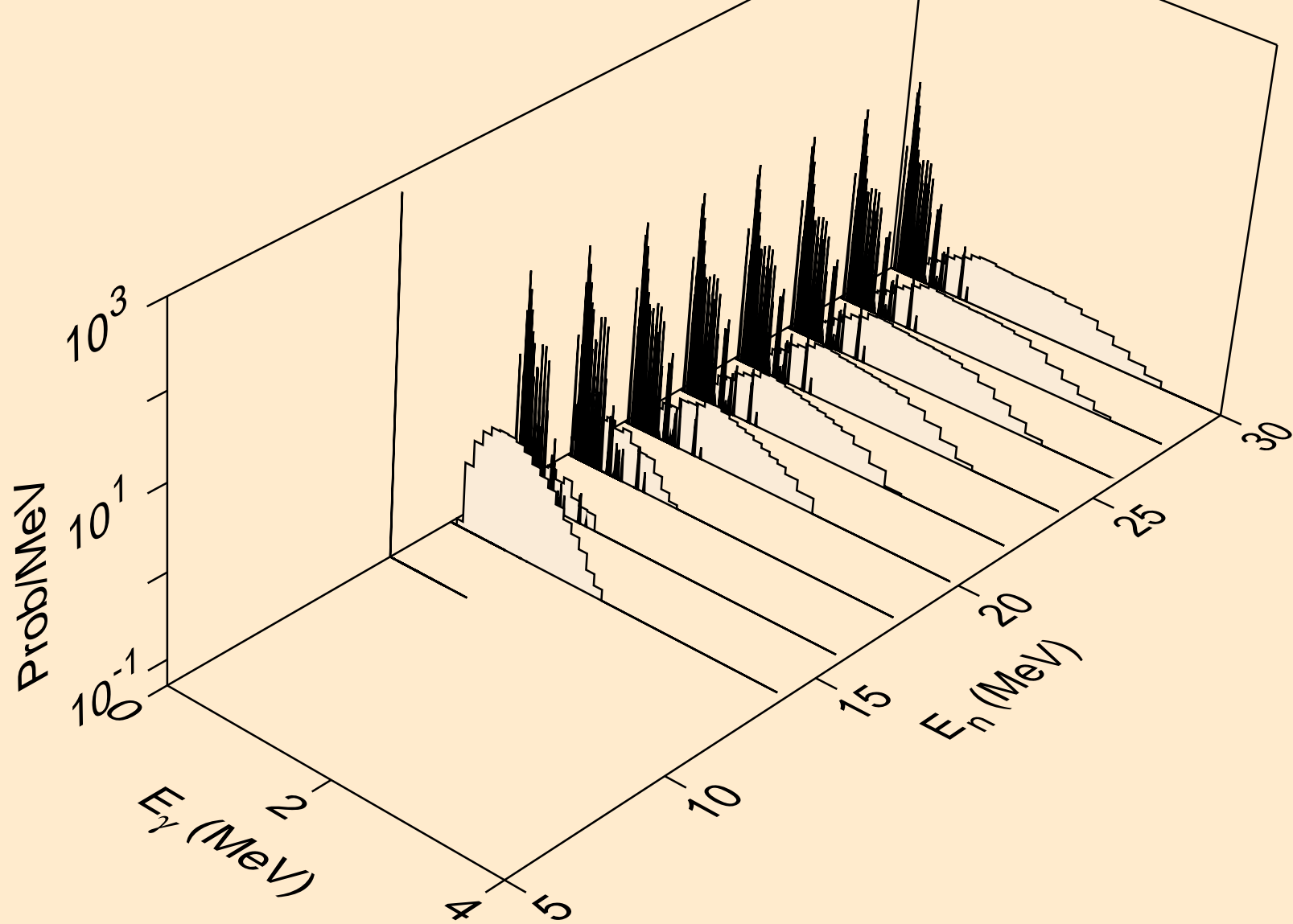

HF178N NEUTRON ACER TENDL-2024 LIBRARY; T=293.6K
Photon emission for (n,p)

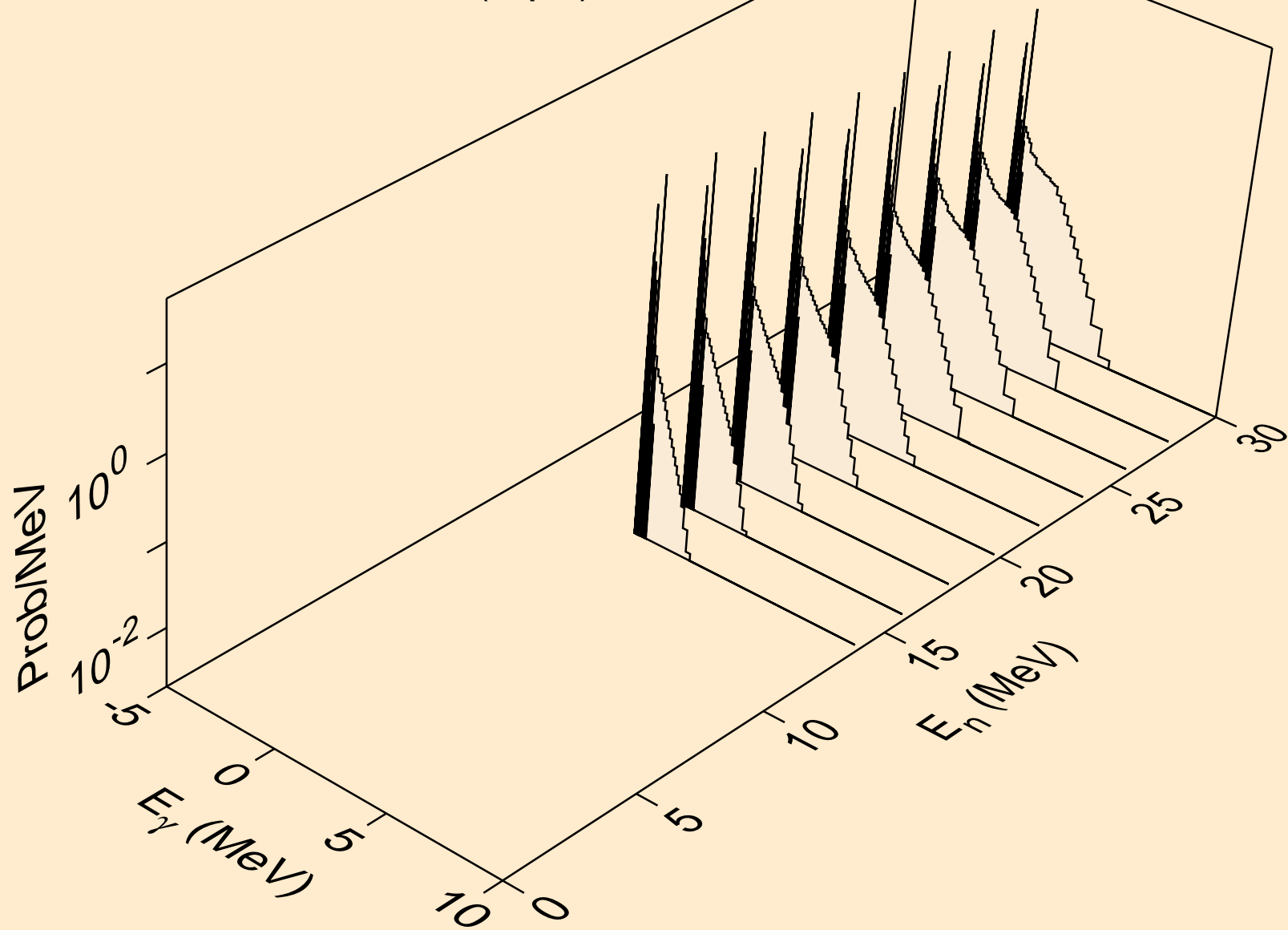

HF178N NEUTRON ACER TENDL-2024 LIBRARY; T=293.6K
Photon emission for (n,pd)

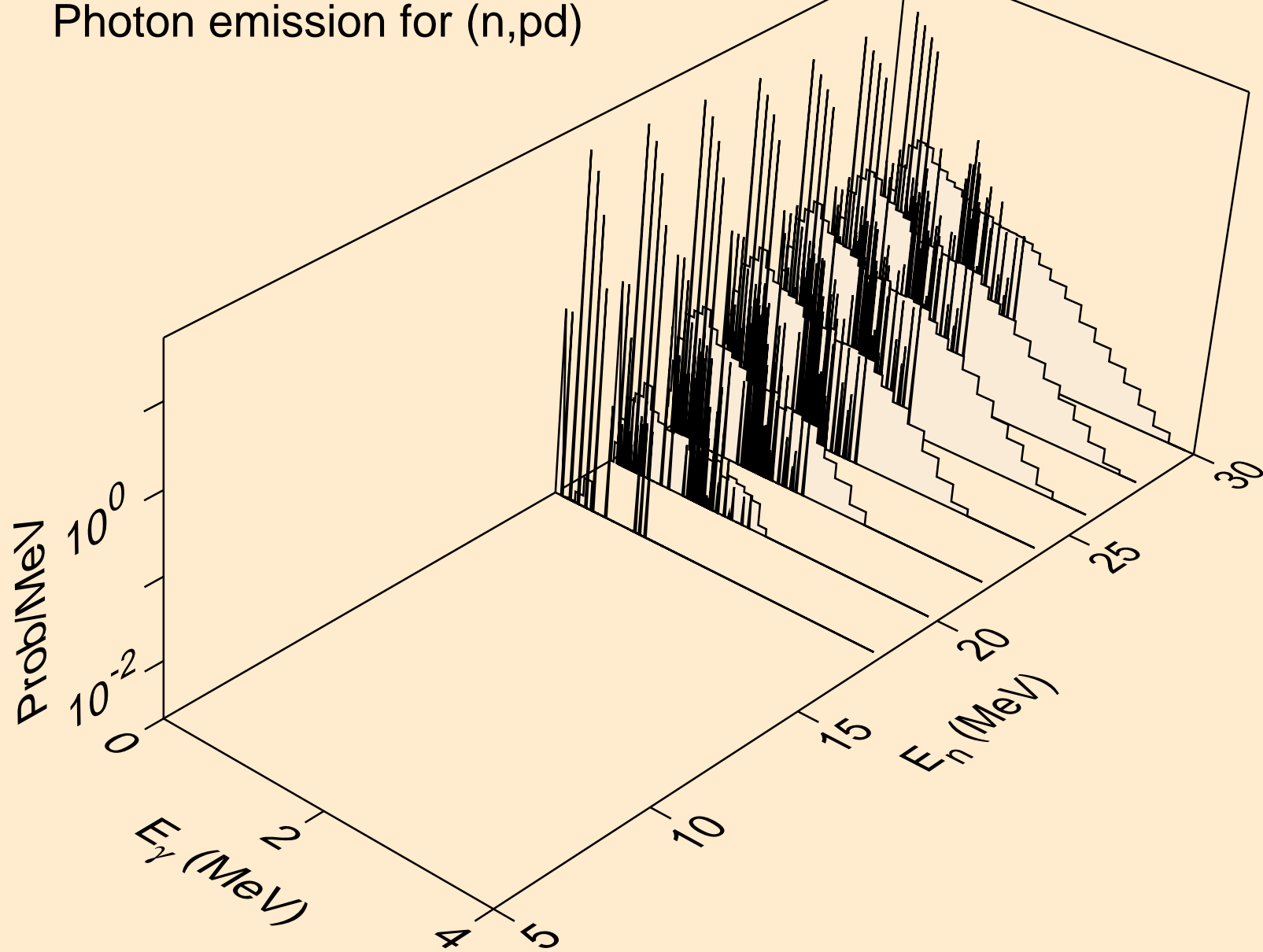

HF178N NEUTRON ACER TENDL-2024 LIBRARY; T=293.6K
Photon emission for (n,pt)

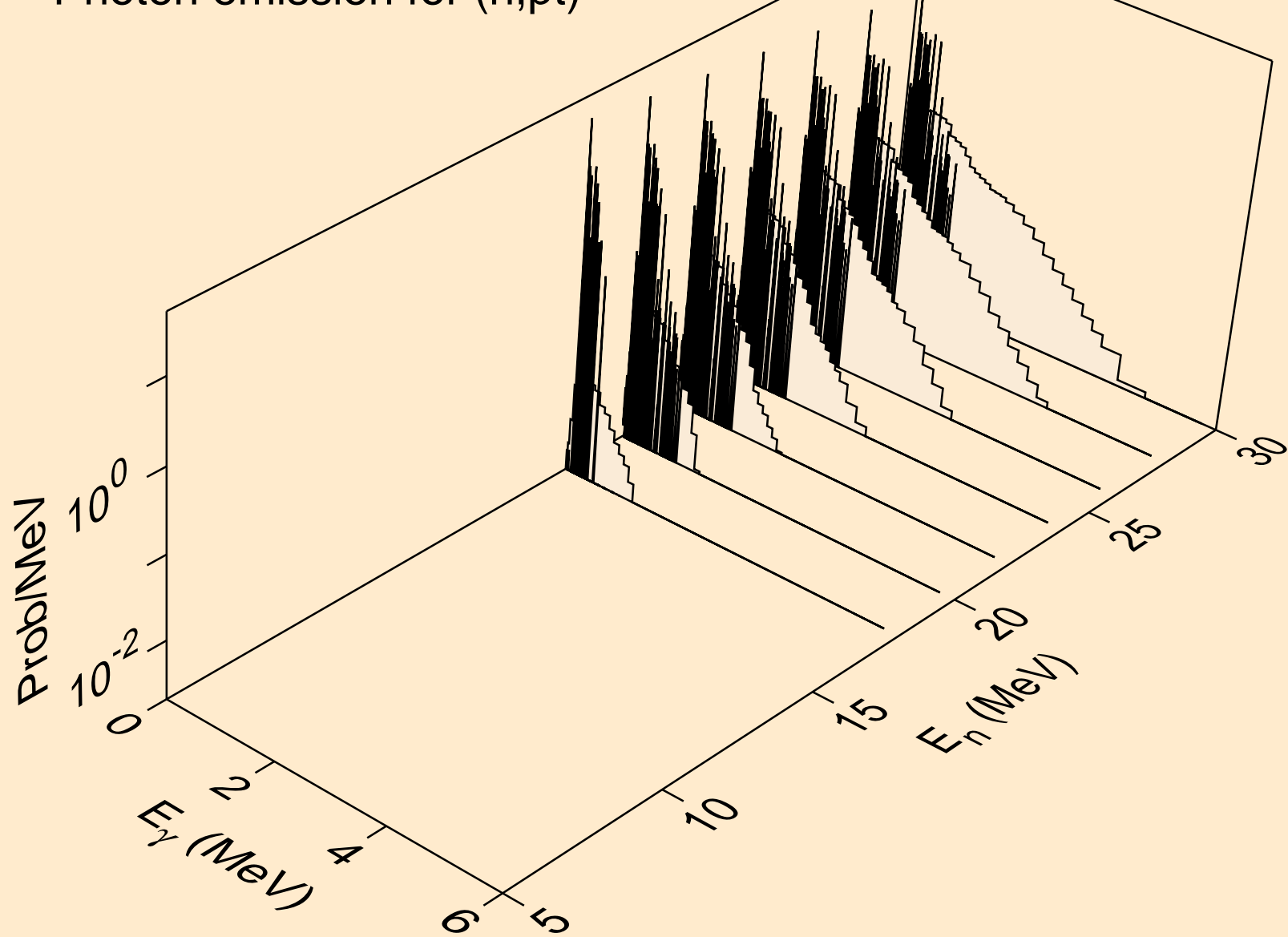

HF178N NEUTRON ACER TENDL-2024 LIBRARY; T=293.6K
Photon emission for (n,da)

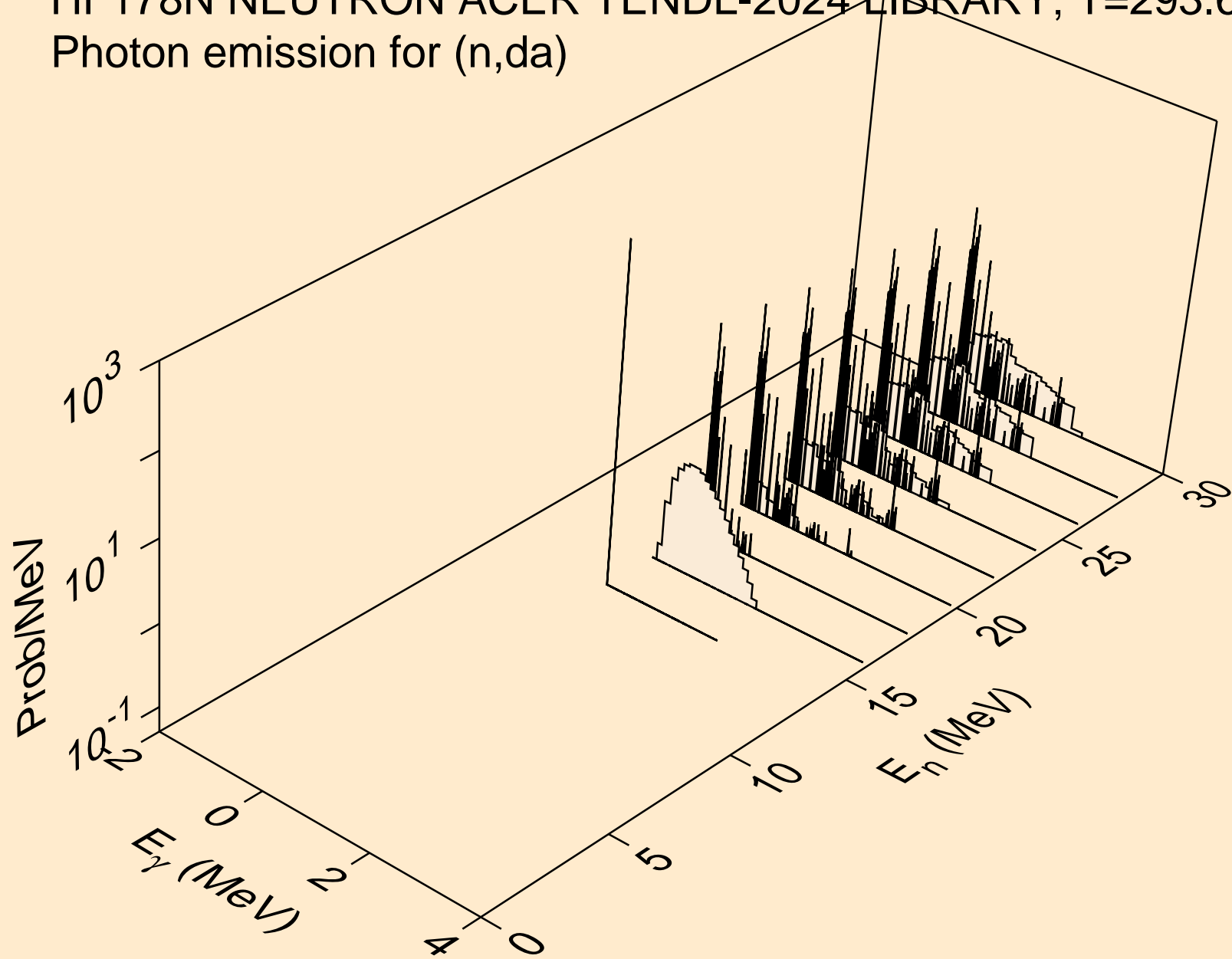

HF178N NEUTRON ACER TENDL-2024 LIBRARY; T=293.6K
thermal capture photon spectrum

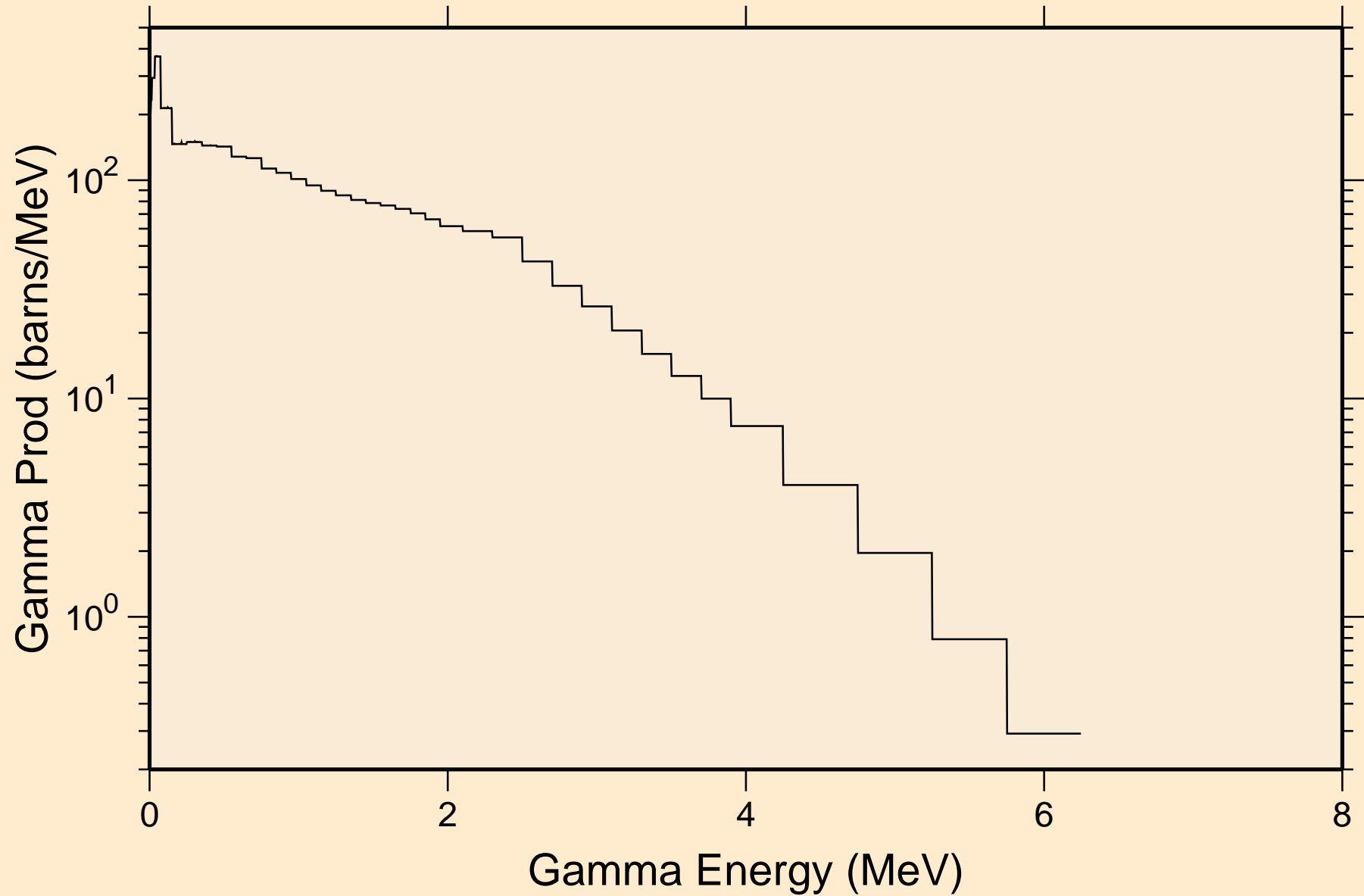

HF178N NEUTRON ACER TENDL-2024 LIBRARY; T=293.6K
14 MeV photon spectrum

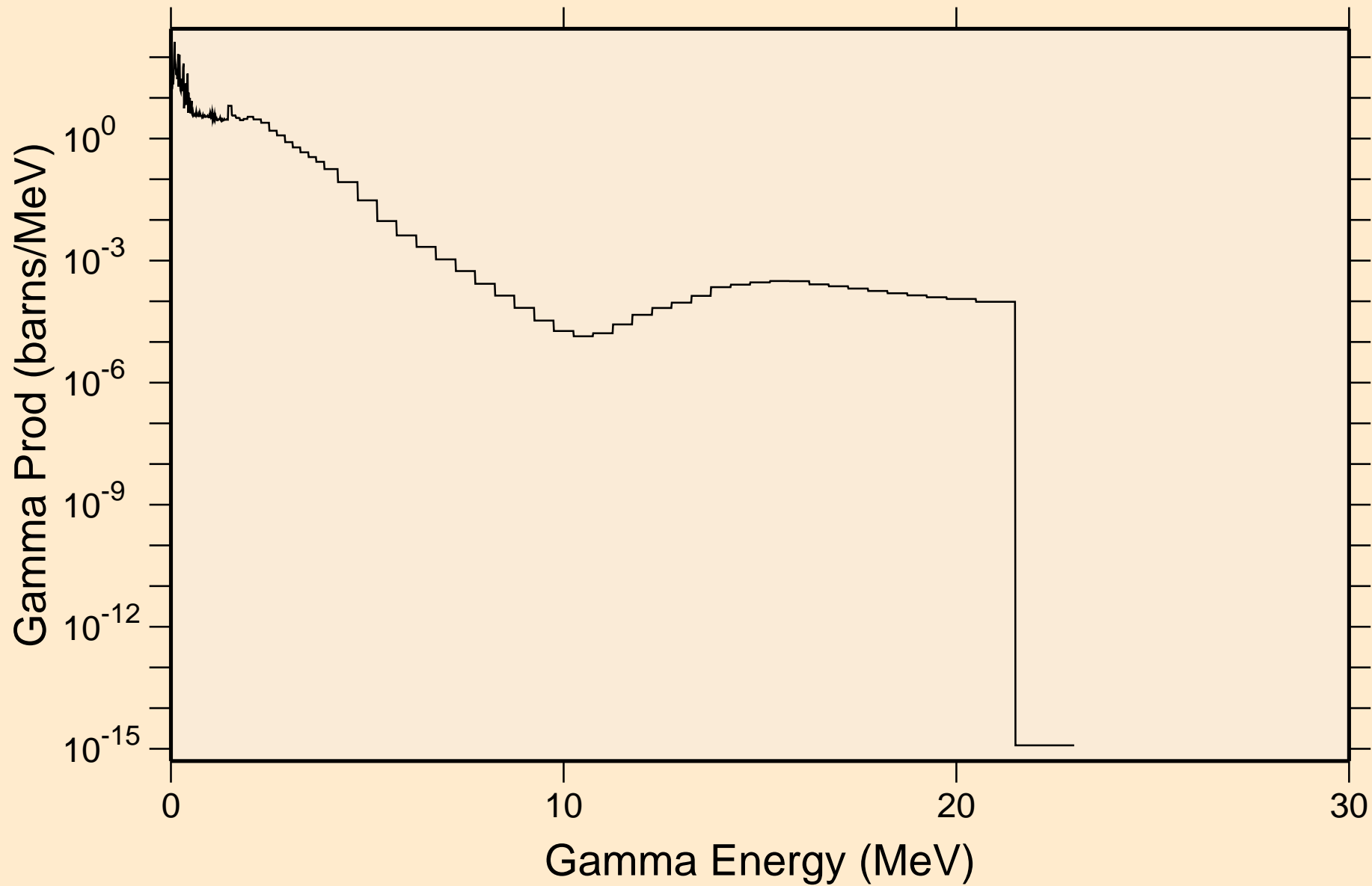

HF178N NEUTRON ACER TENDL-2024 LIBRARY; T=293.6K

Particle heating contributions

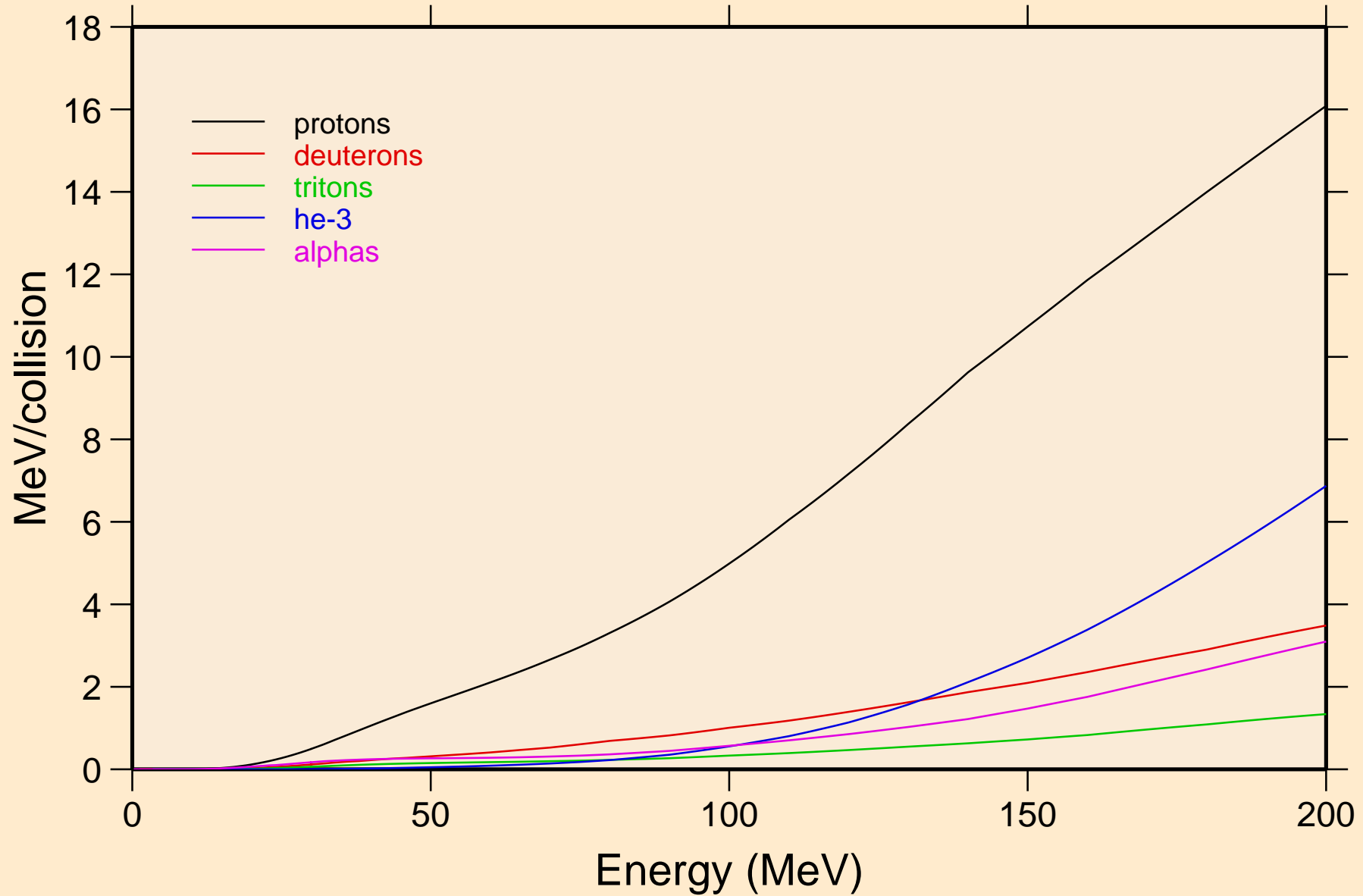

HF178N NEUTRON ACER TENDL-2024 LIBRARY; T=293.6K
Recoil Heating

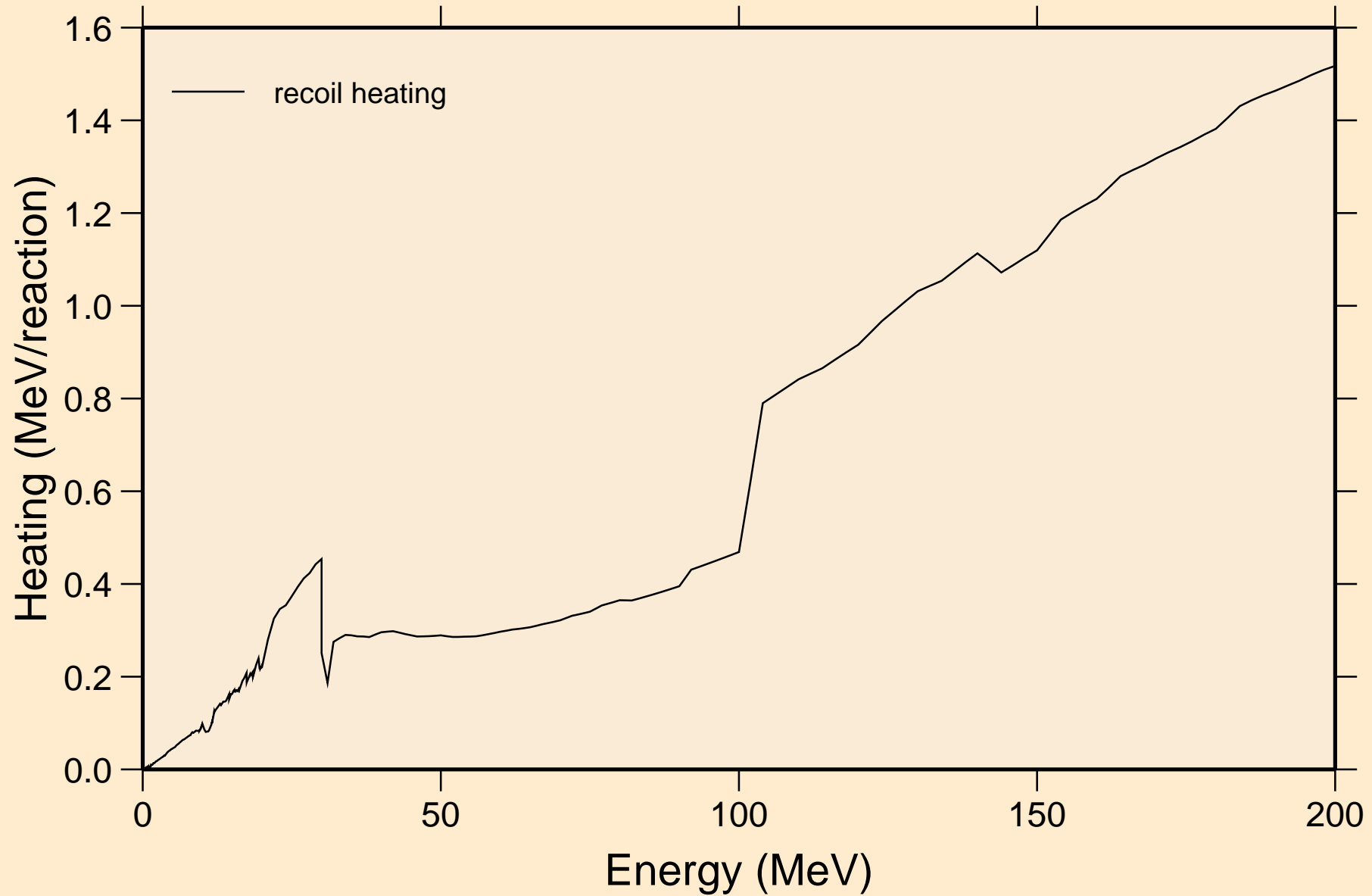

HF178N NEUTRON ACER TENDL-2024 LIBRARY; T=293.6K
Particle production cross sections

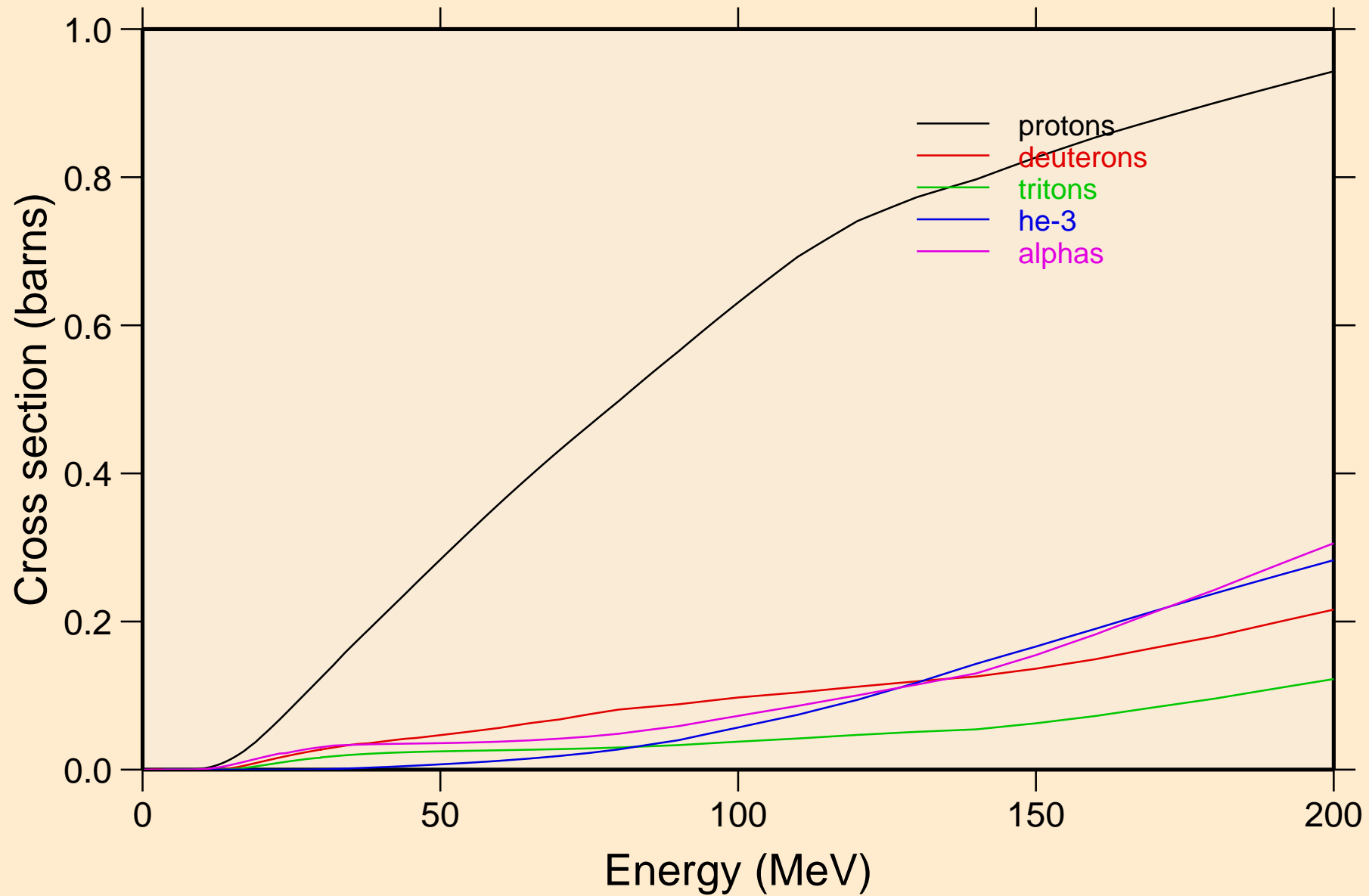

HF178N NEUTRON ACER TENDL-2024 LIBRARY; T=293.6K
protons from (n,x)

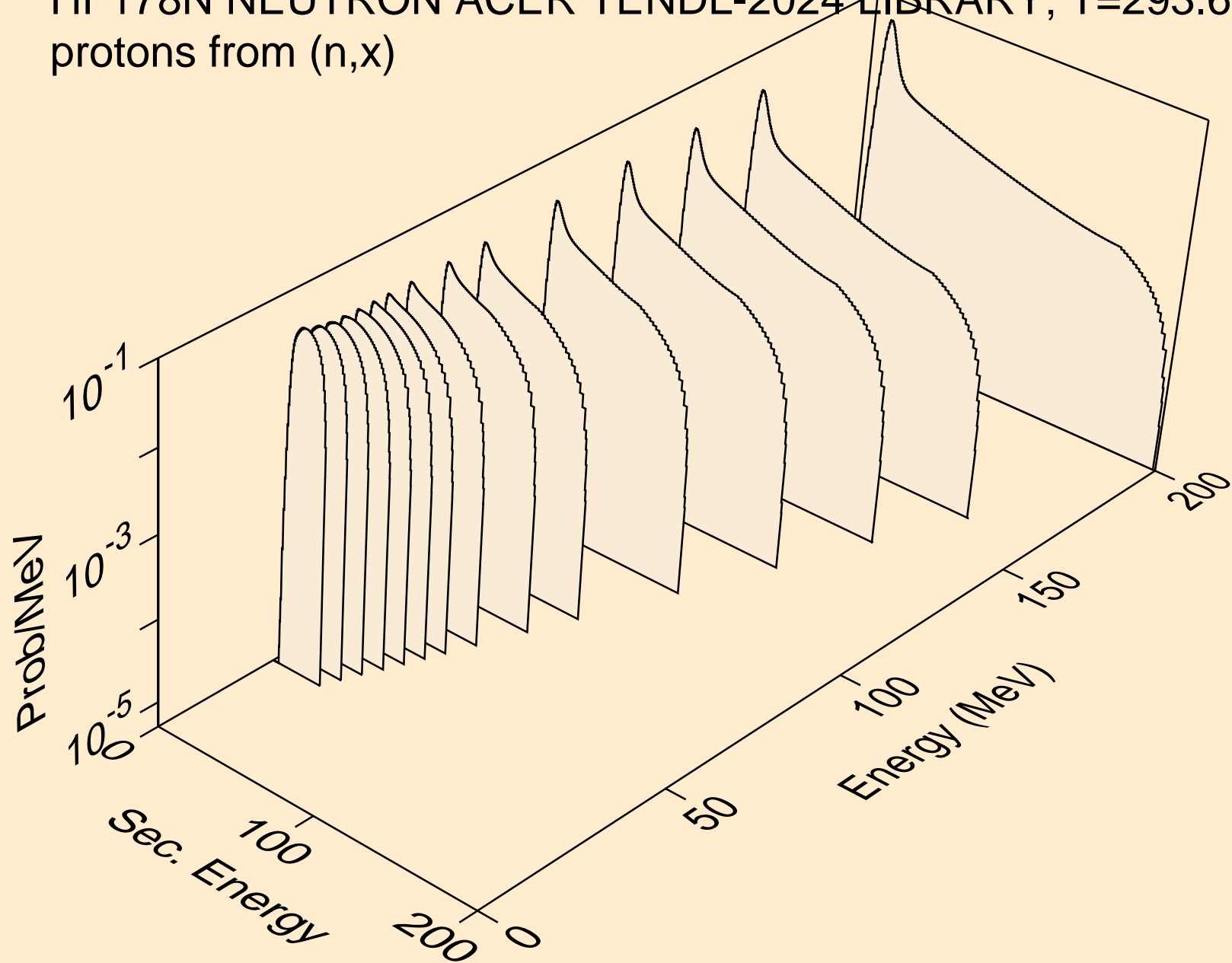

HF178N NEUTRON ACER TENDL-2024 LIBRARY; T=293.6K
protons from (n,n*)p

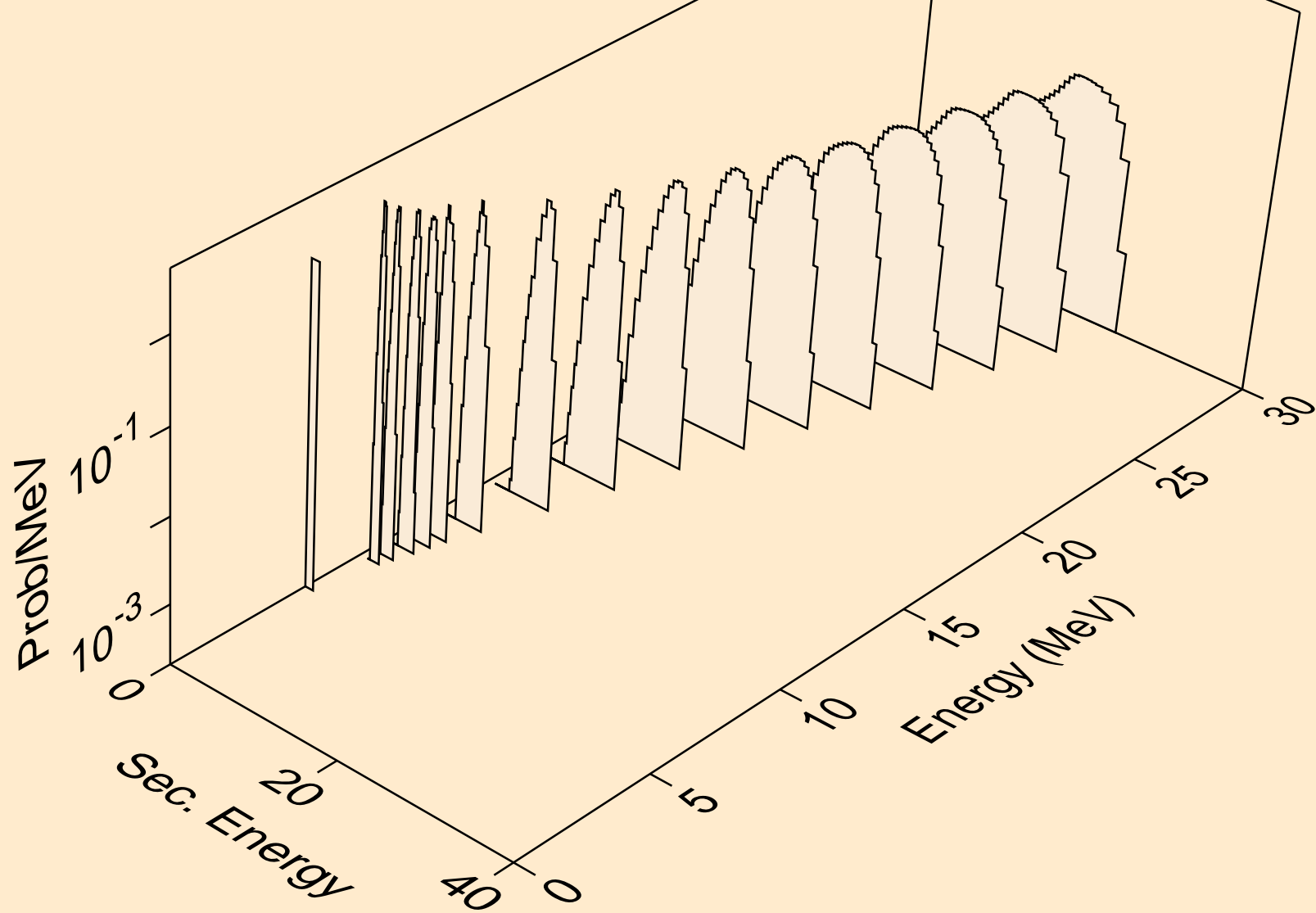

HF178N NEUTRON ACER TENDL-2024 LIBRARY; T=293.6K
protons from (n,2np)

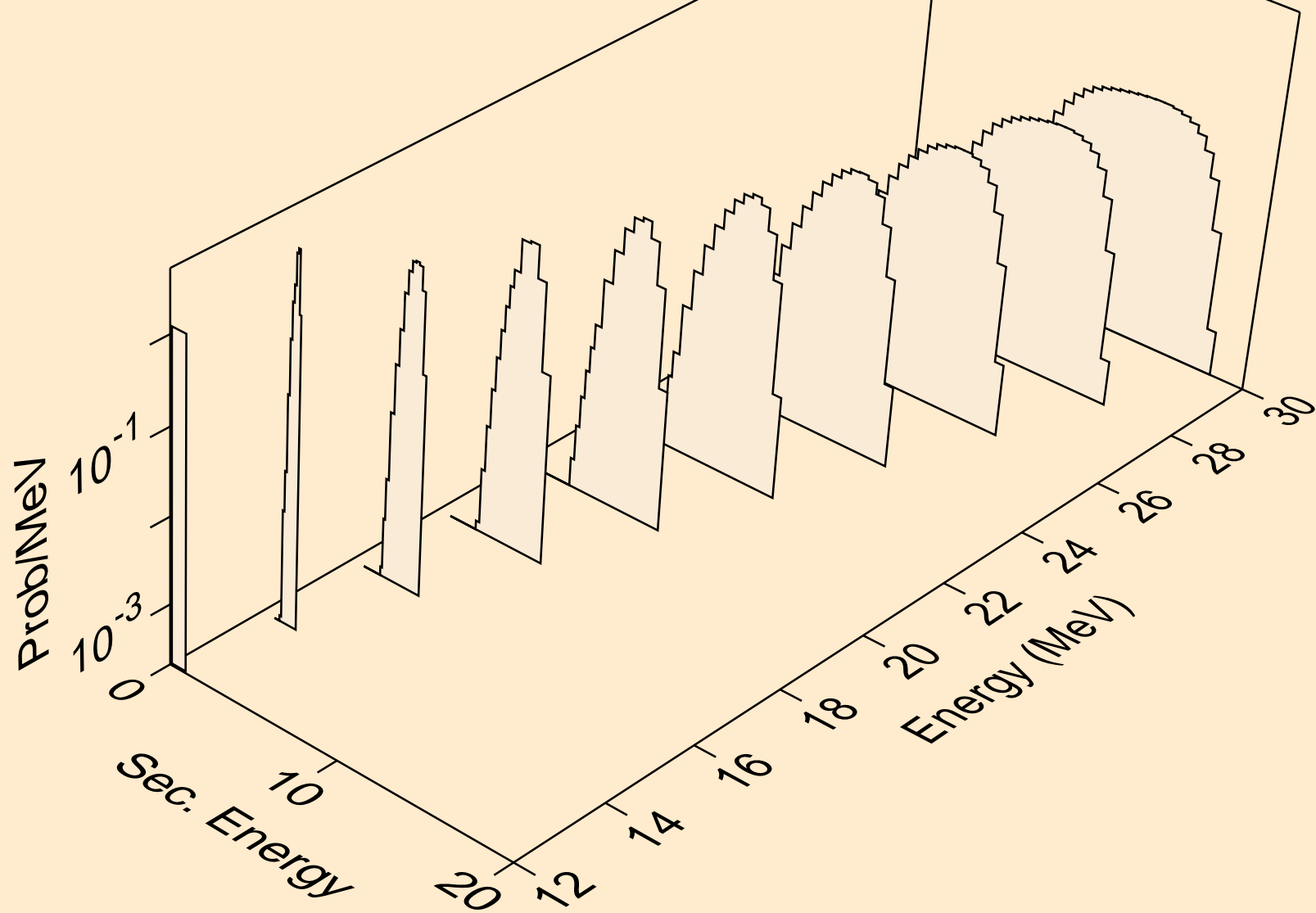

HF178N NEUTRON ACER TENDL-2024 LIBRARY; T=293.6K
protons from (n,3np)

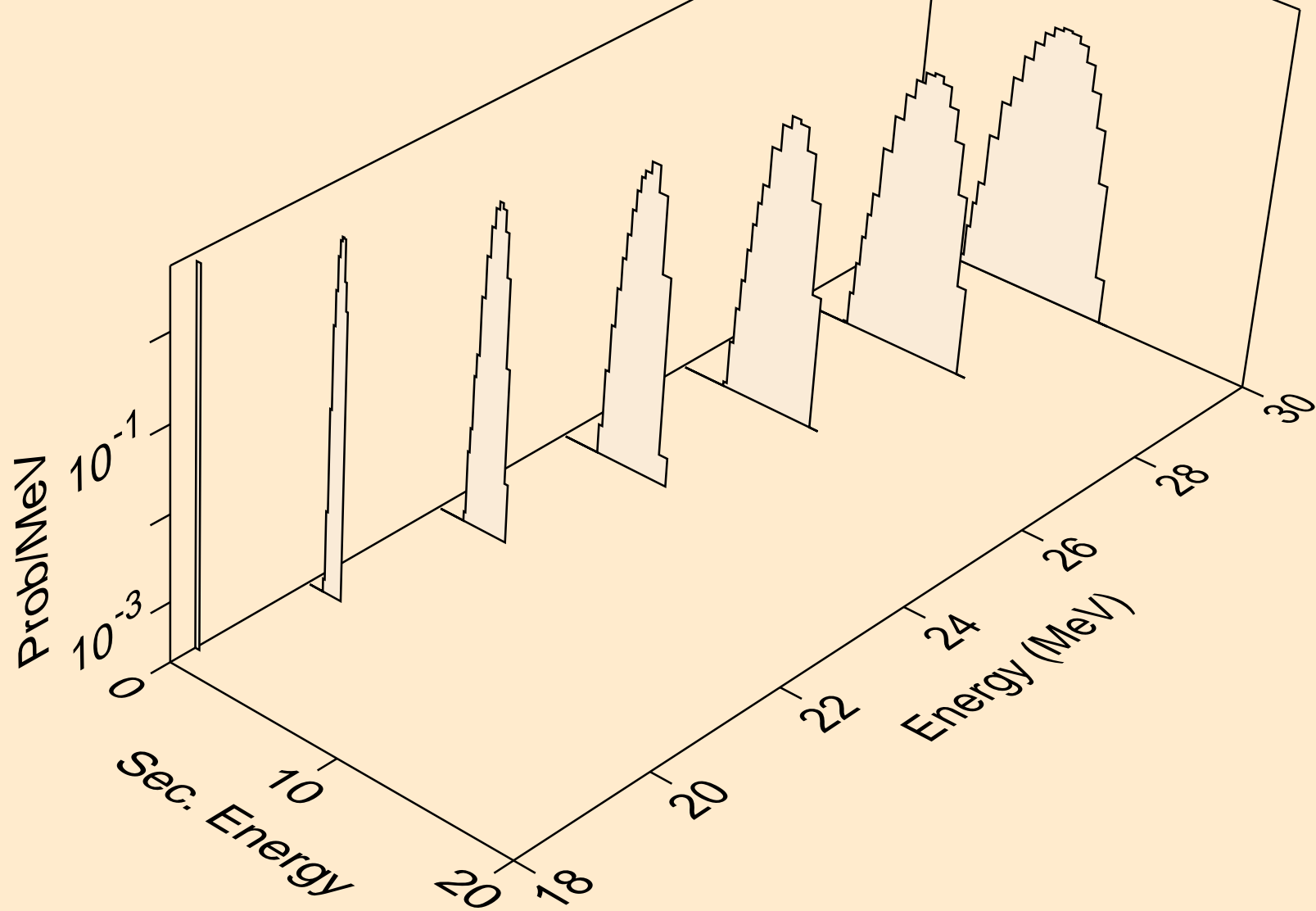

HF178N NEUTRON ACER TENDL-2024 LIBRARY; T=293.6K
protons from (n,n2p)

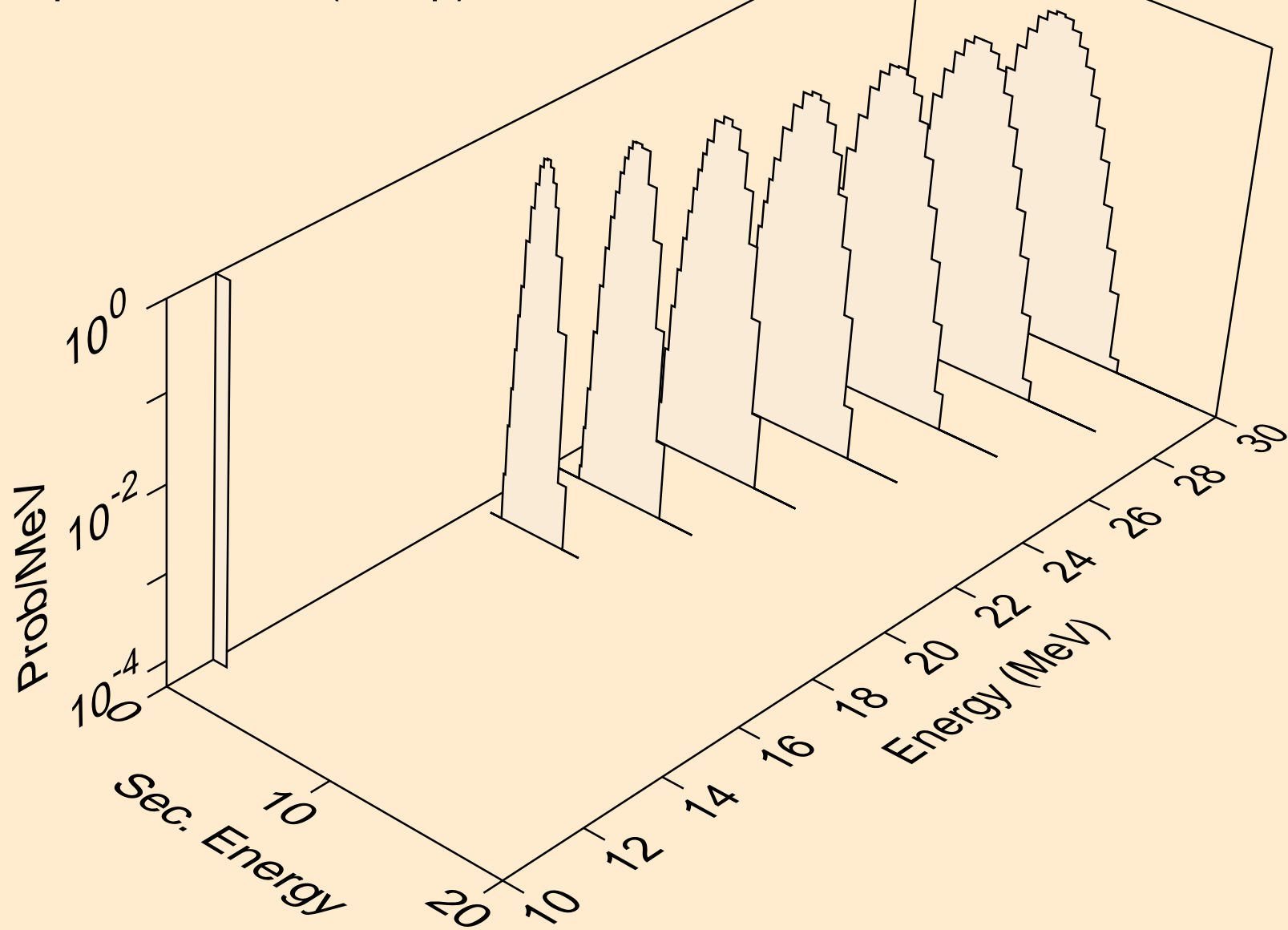

HF178N NEUTRON ACER TENDL-2024 LIBRARY; T=293.6K
protons from (n,npa)

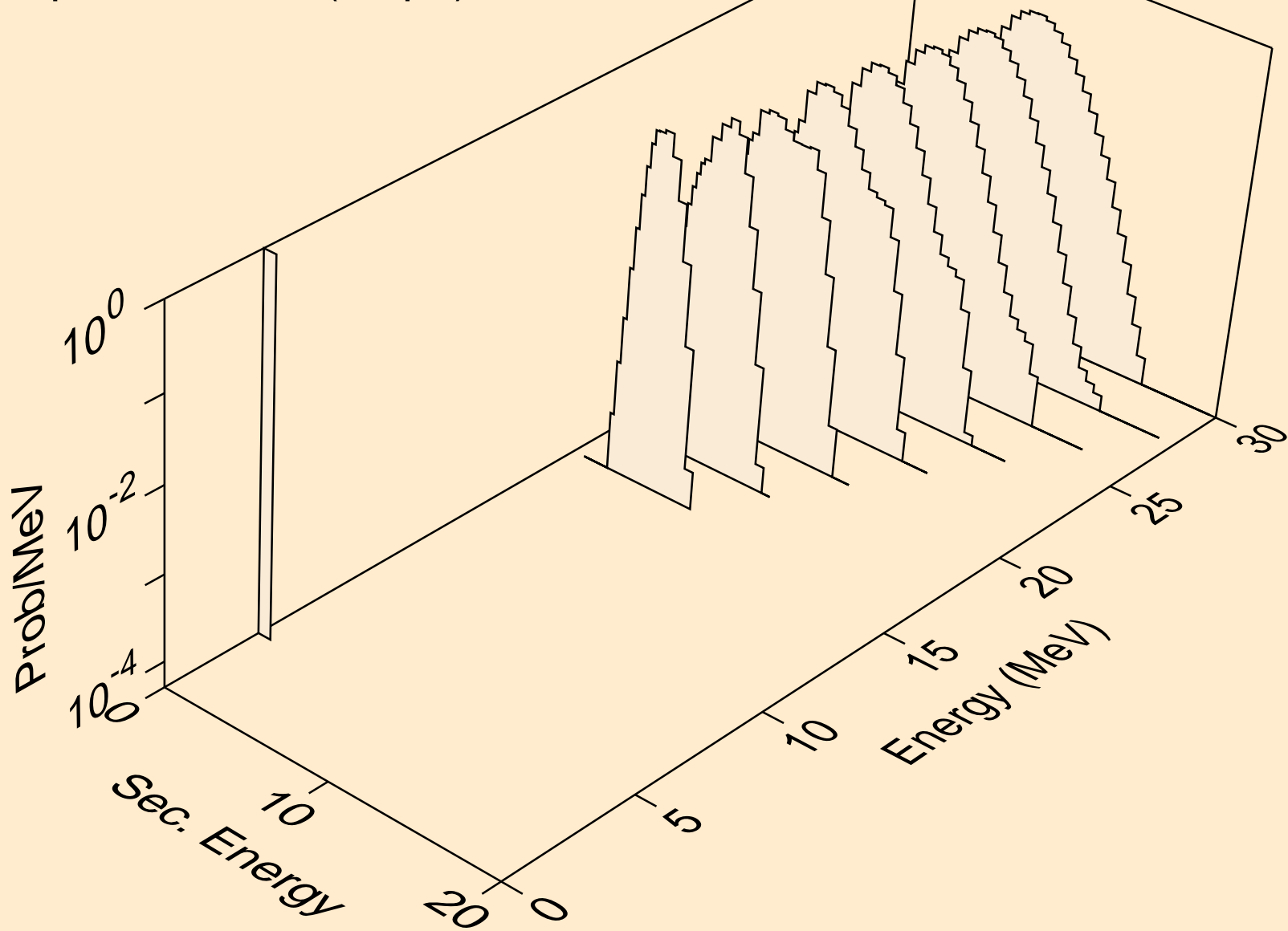

HF178N NEUTRON ACER TENDL-2024 LIBRARY; T=293.6K
protons from (n,p)

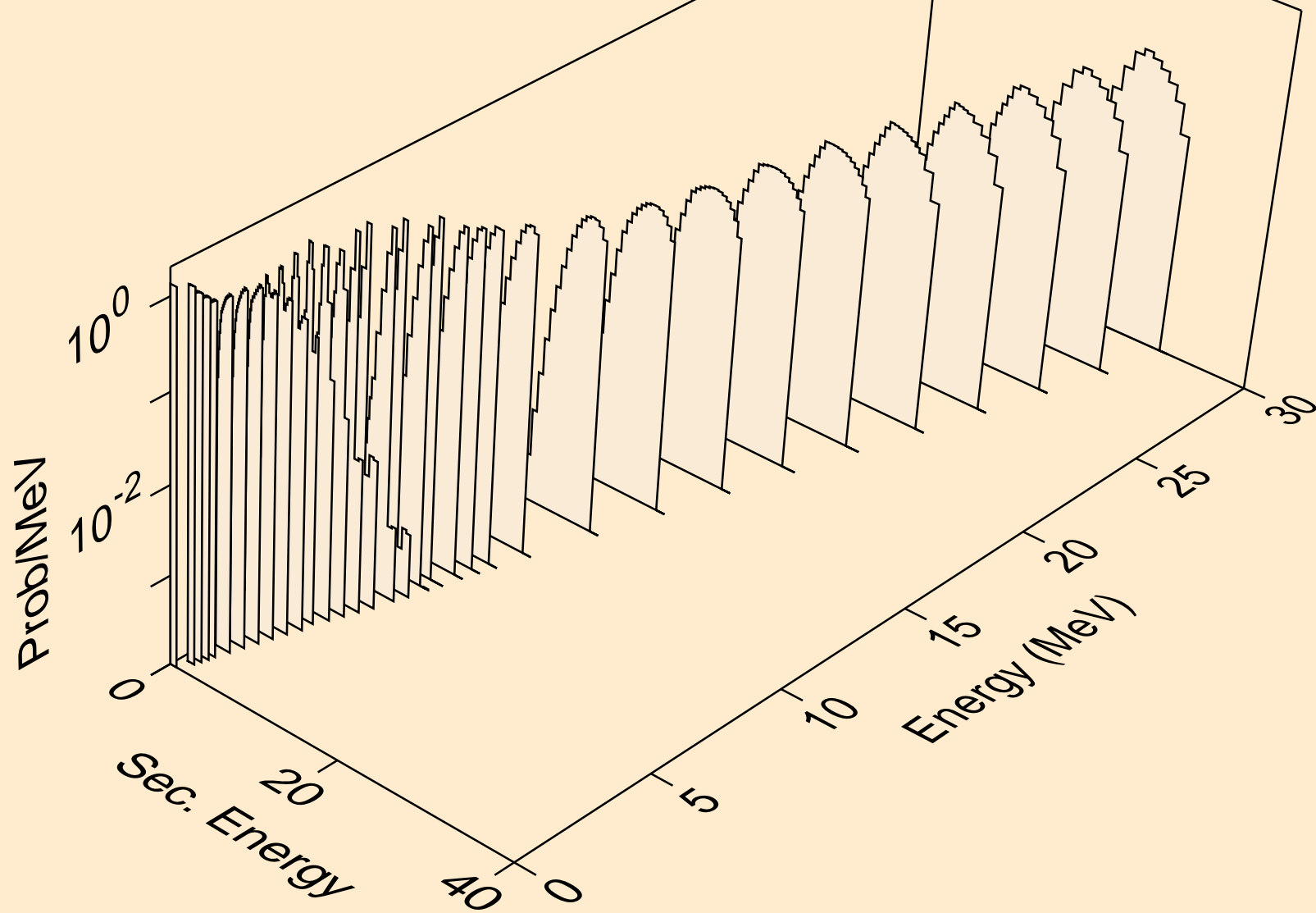

HF178N NEUTRON ACER TENDL-2024 LIBRARY; T=293.6K
protons from (n,2p)

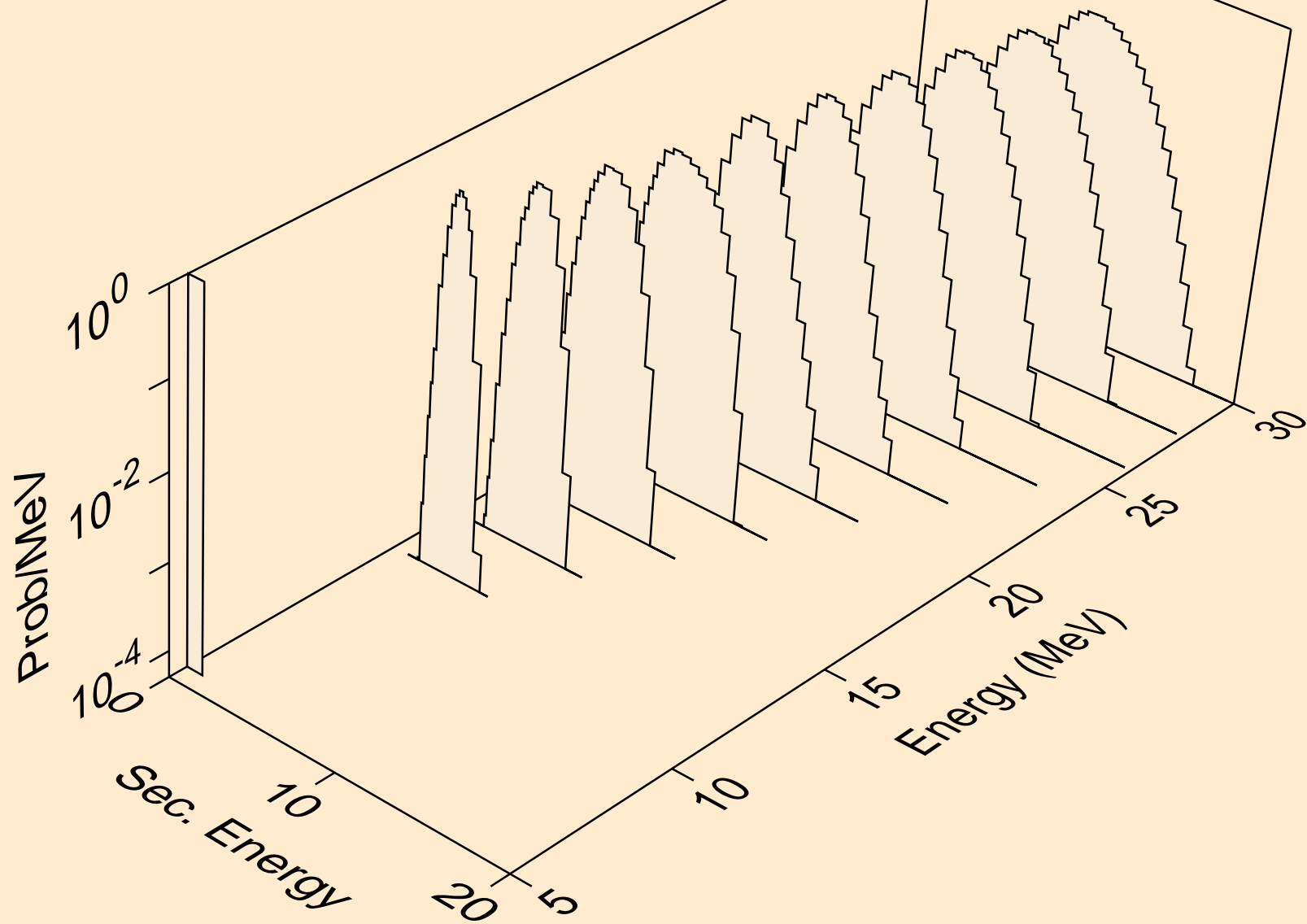

HF178N NEUTRON ACER TENDL-2024 LIBRARY; T=293.6K
protons from (n,p)

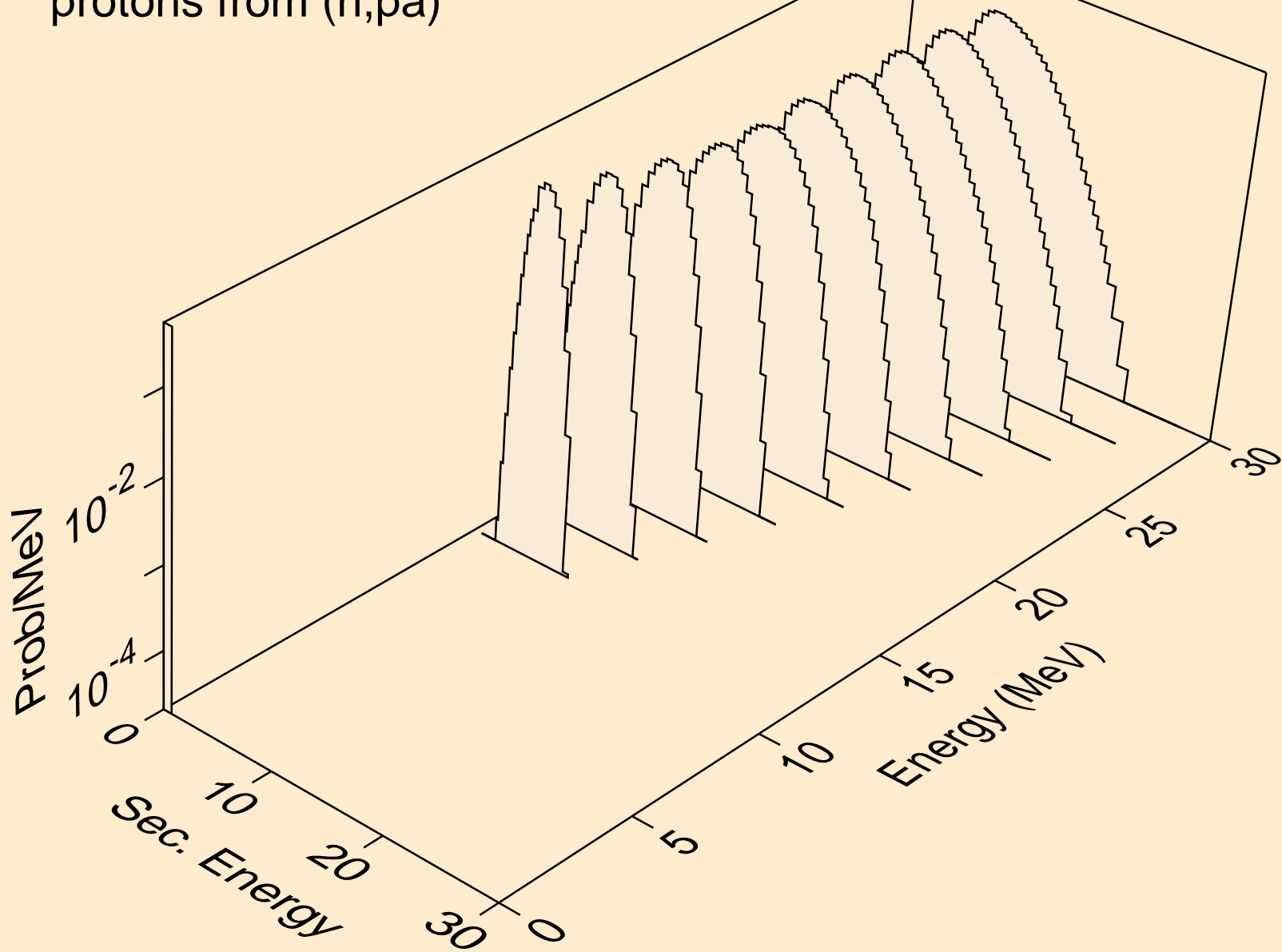

HF178N NEUTRON ACER TENDL-2024 LIBRARY; T=293.6K
protons from (n,pd)

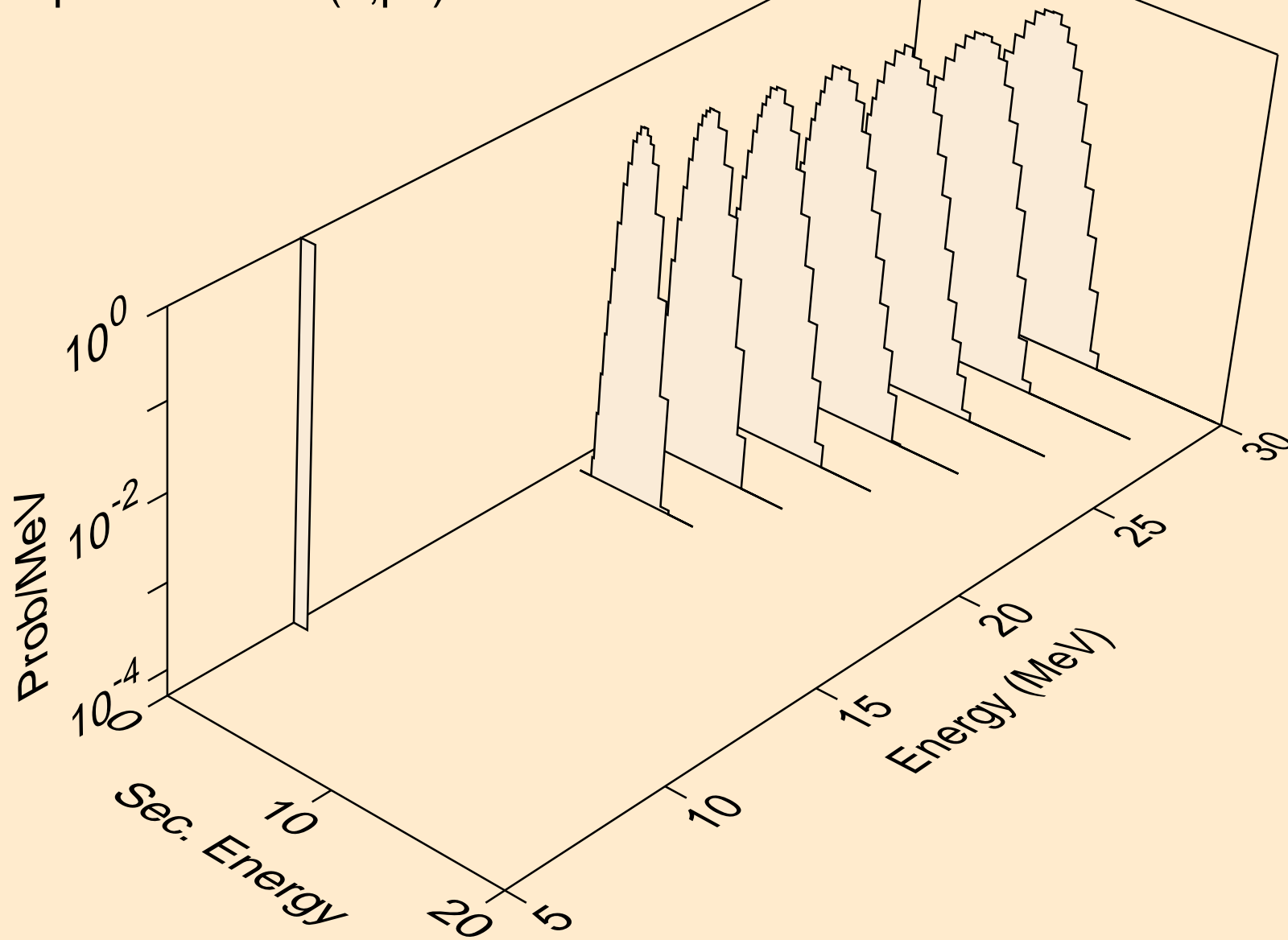

HF178N NEUTRON ACER TENDL-2024 LIBRARY; T=293.6K
protons from (n,pt)

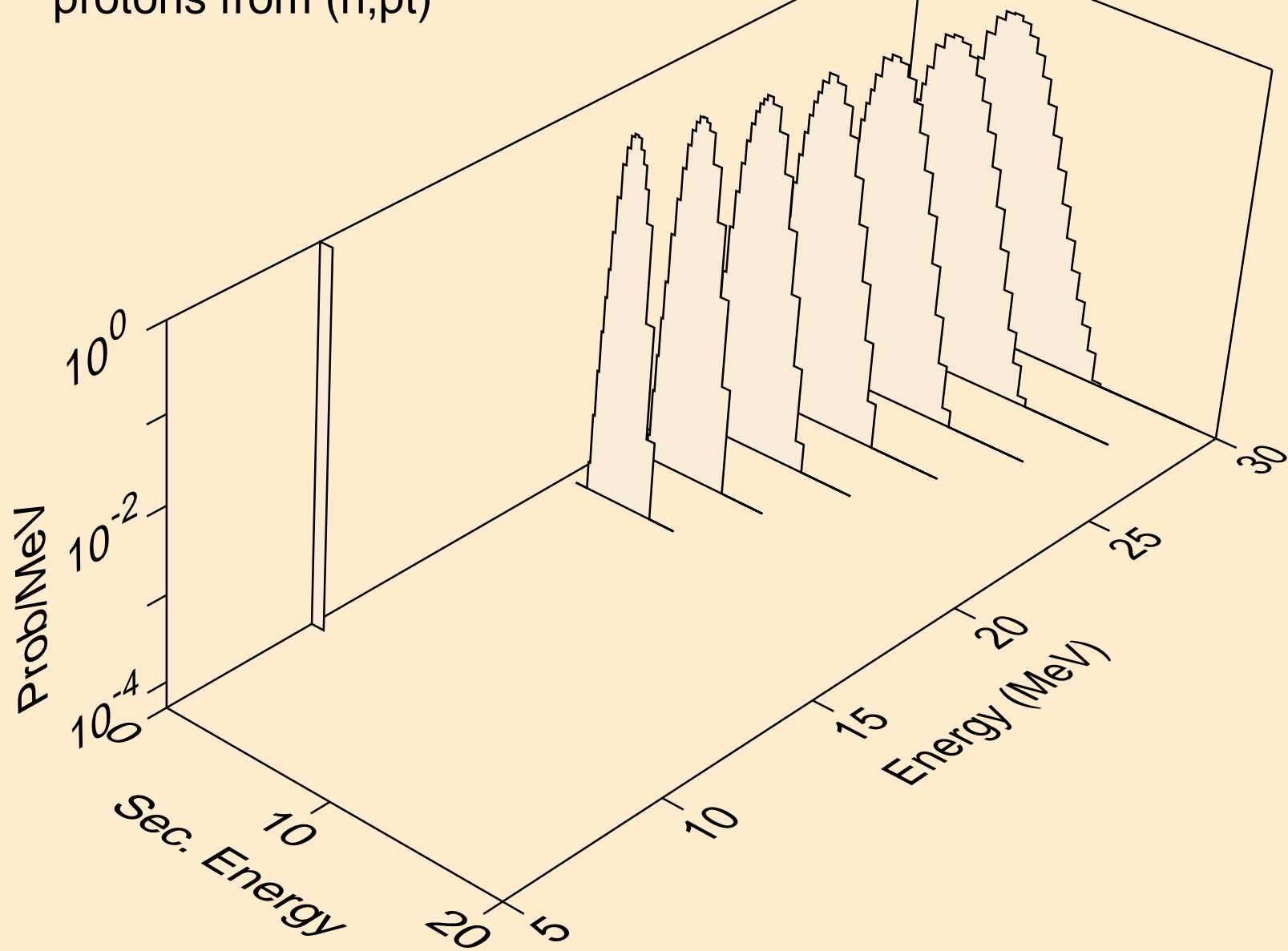

HF178N NEUTRON ACER TENDL-2024 LIBRARY; T=293.6K
deuterons from (n,x)

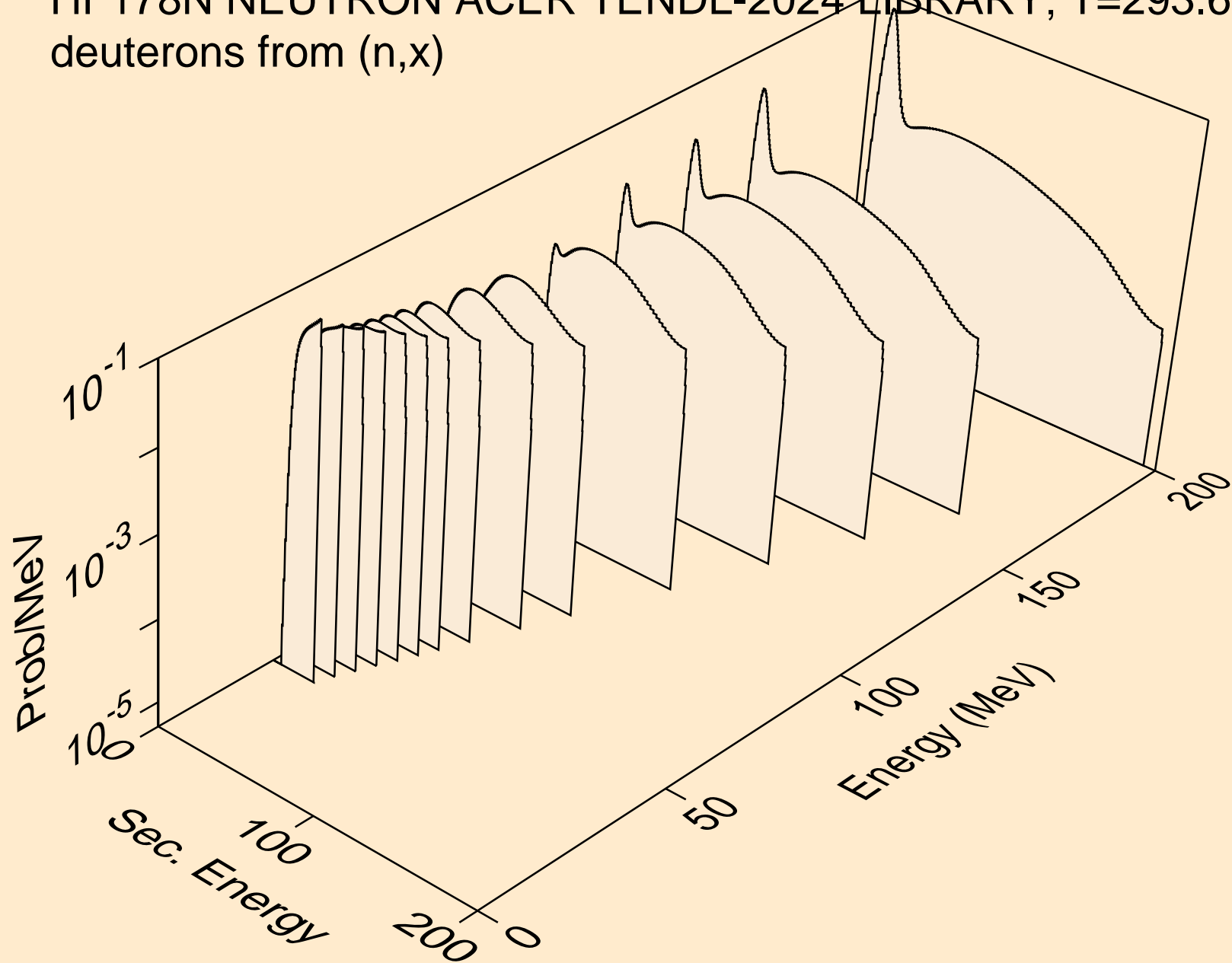

HF178N NEUTRON ACER TENDL-2024 LIBRARY; T=293.6K
deuterons from (n,2nd)

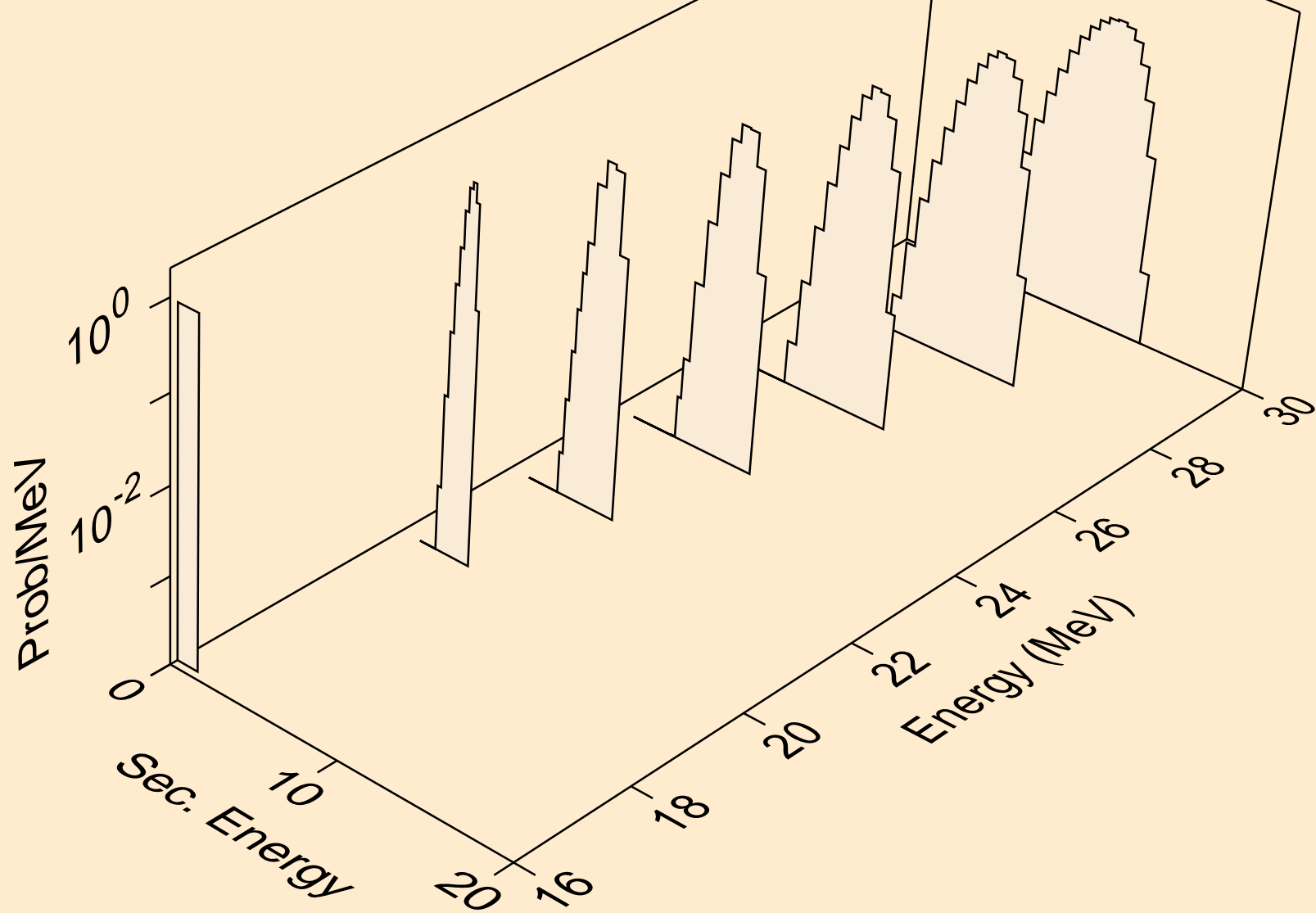

HF178N NEUTRON ACER TENDL-2024 LIBRARY; T=293.6K
deuterons from (n,n*)d

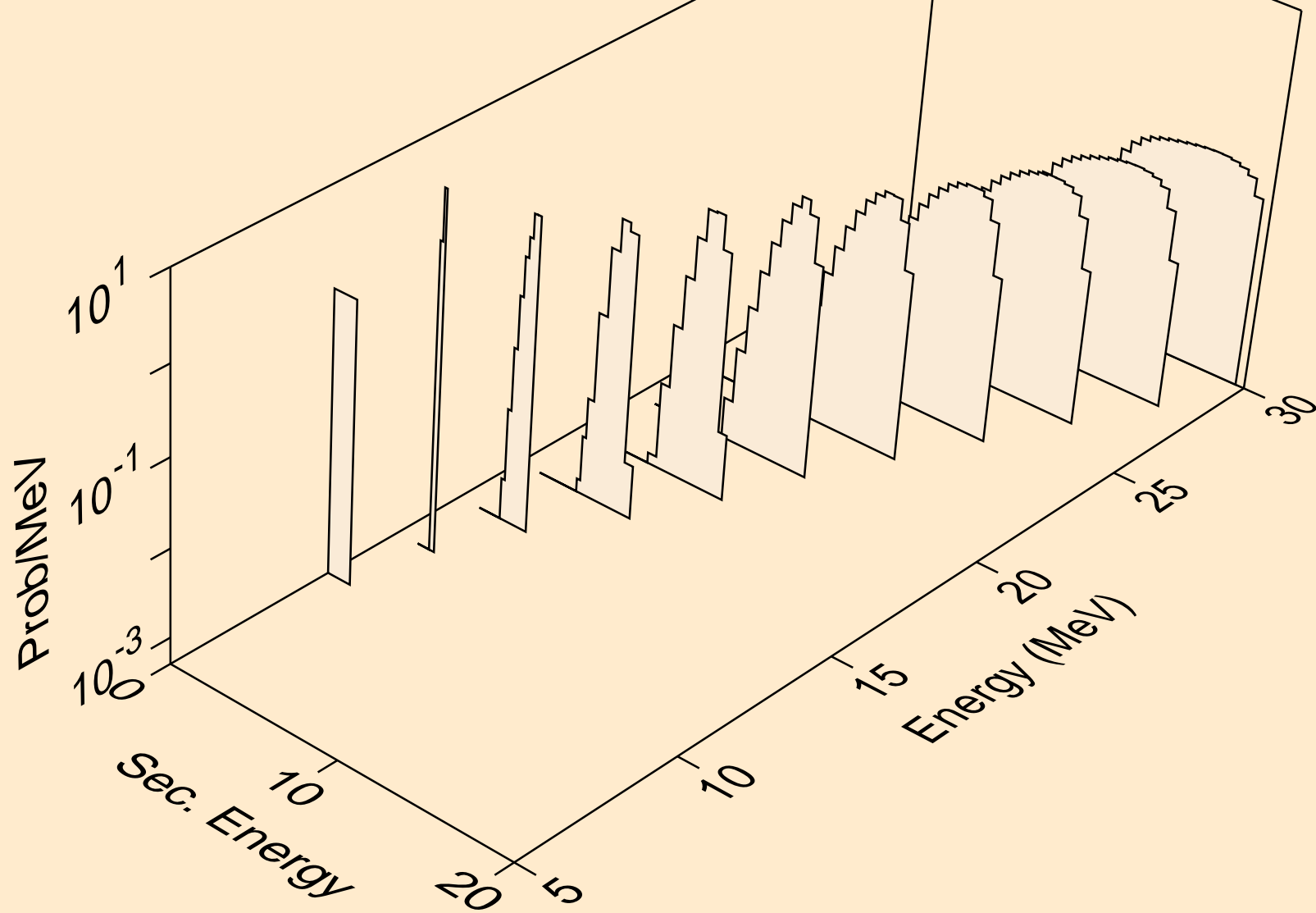

HF178N NEUTRON ACER TENDL-2024 LIBRARY; T=293.6K
deuterons from (n,d)

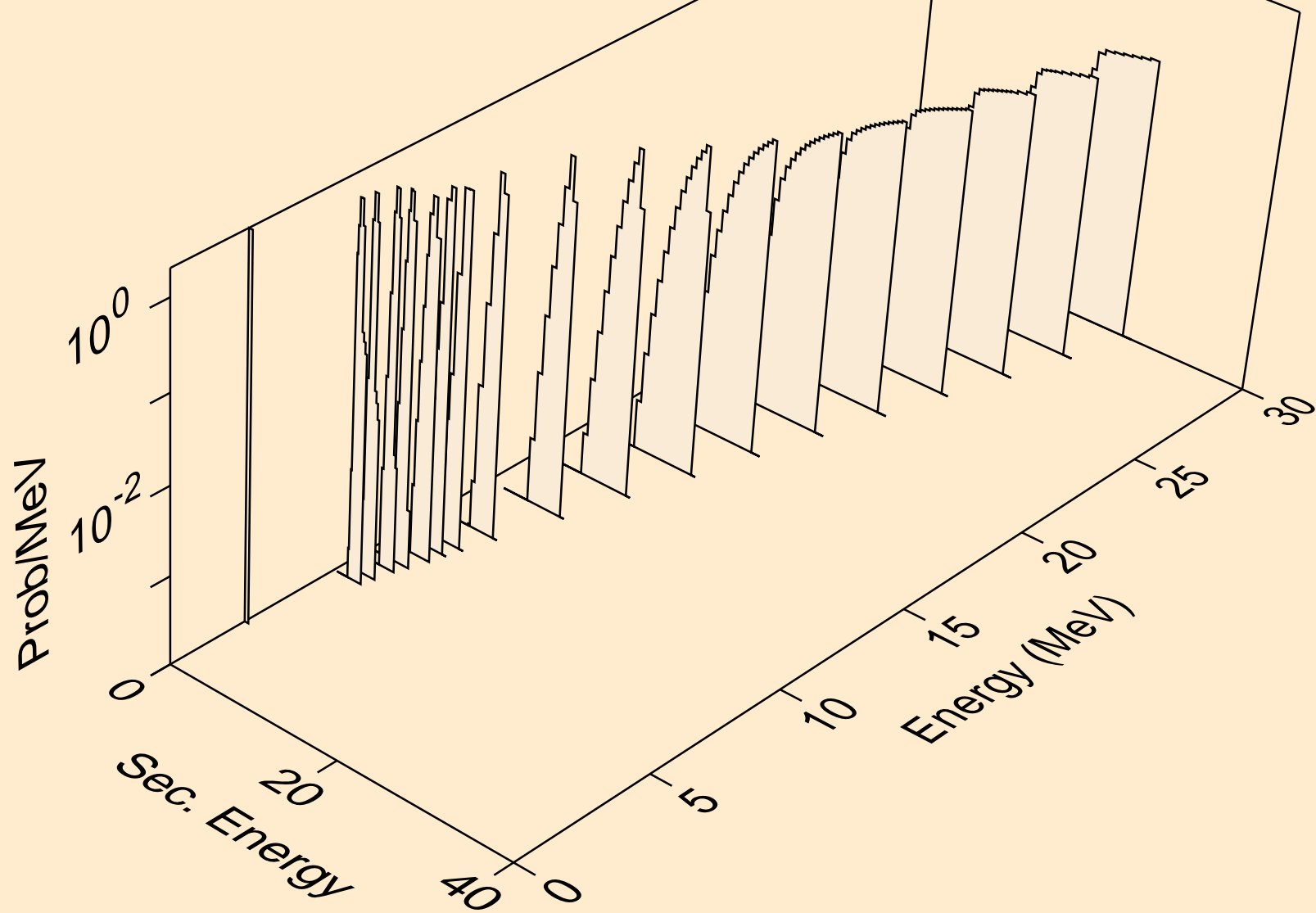

HF178N NEUTRON ACER TENDL-2024 LIBRARY; T=293.6K
deuterons from (n,pd)

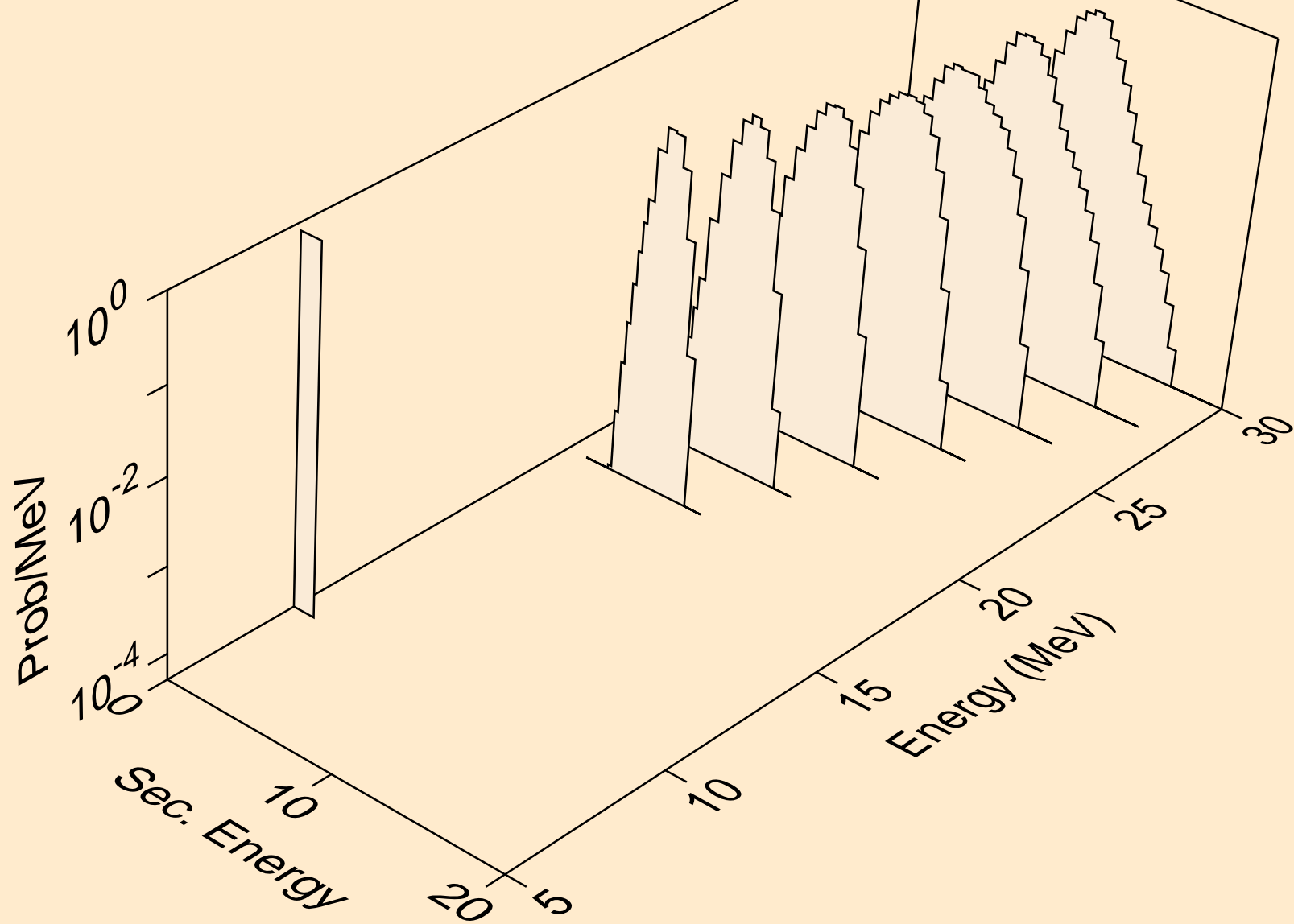

HF178N NEUTRON ACER TENDL-2024 LIBRARY; T=293.6K
deuterons from (n,da)

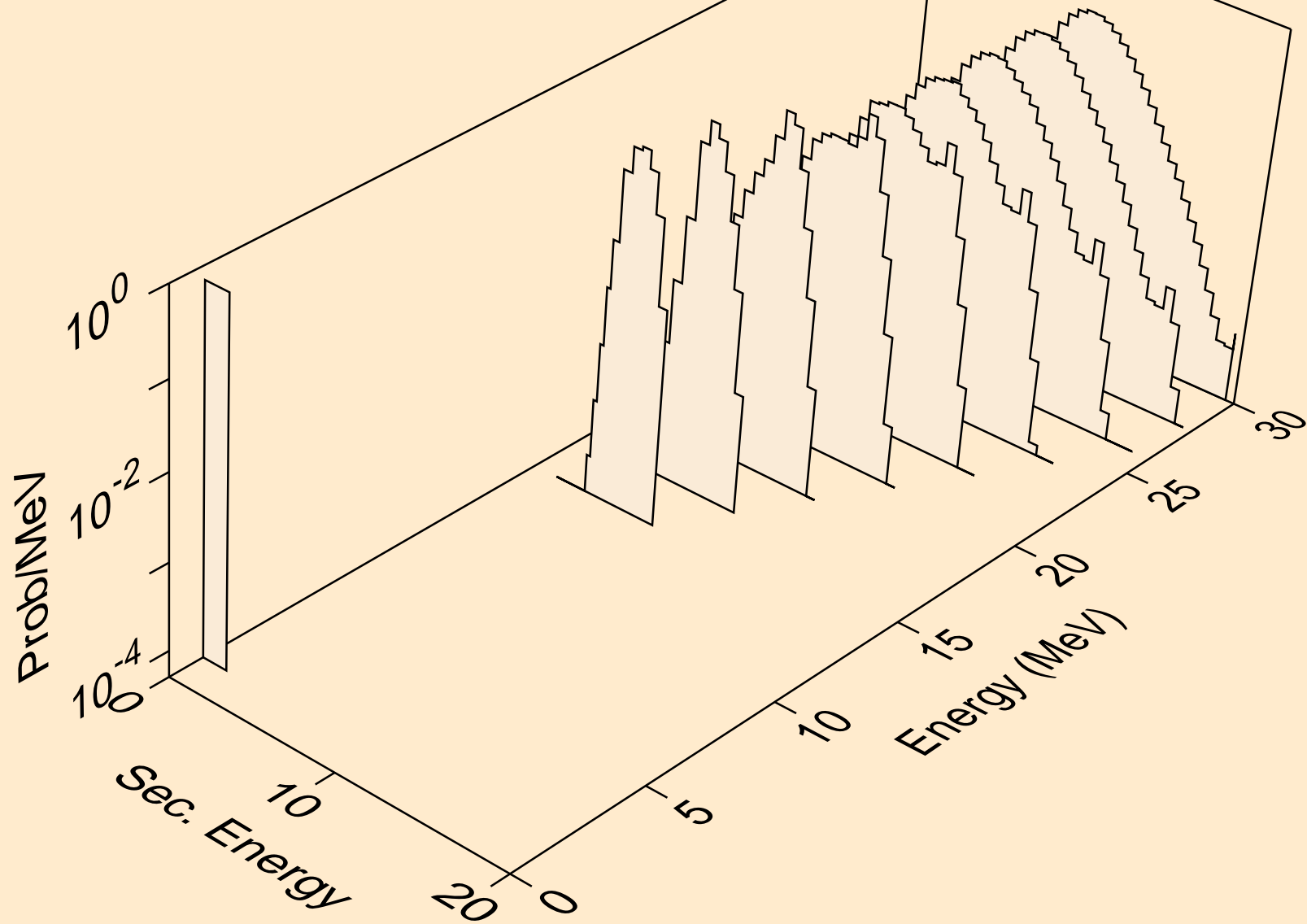

HF178N NEUTRON ACER TENDL-2024 LIBRARY; T=293.6K
tritons from (n,x)

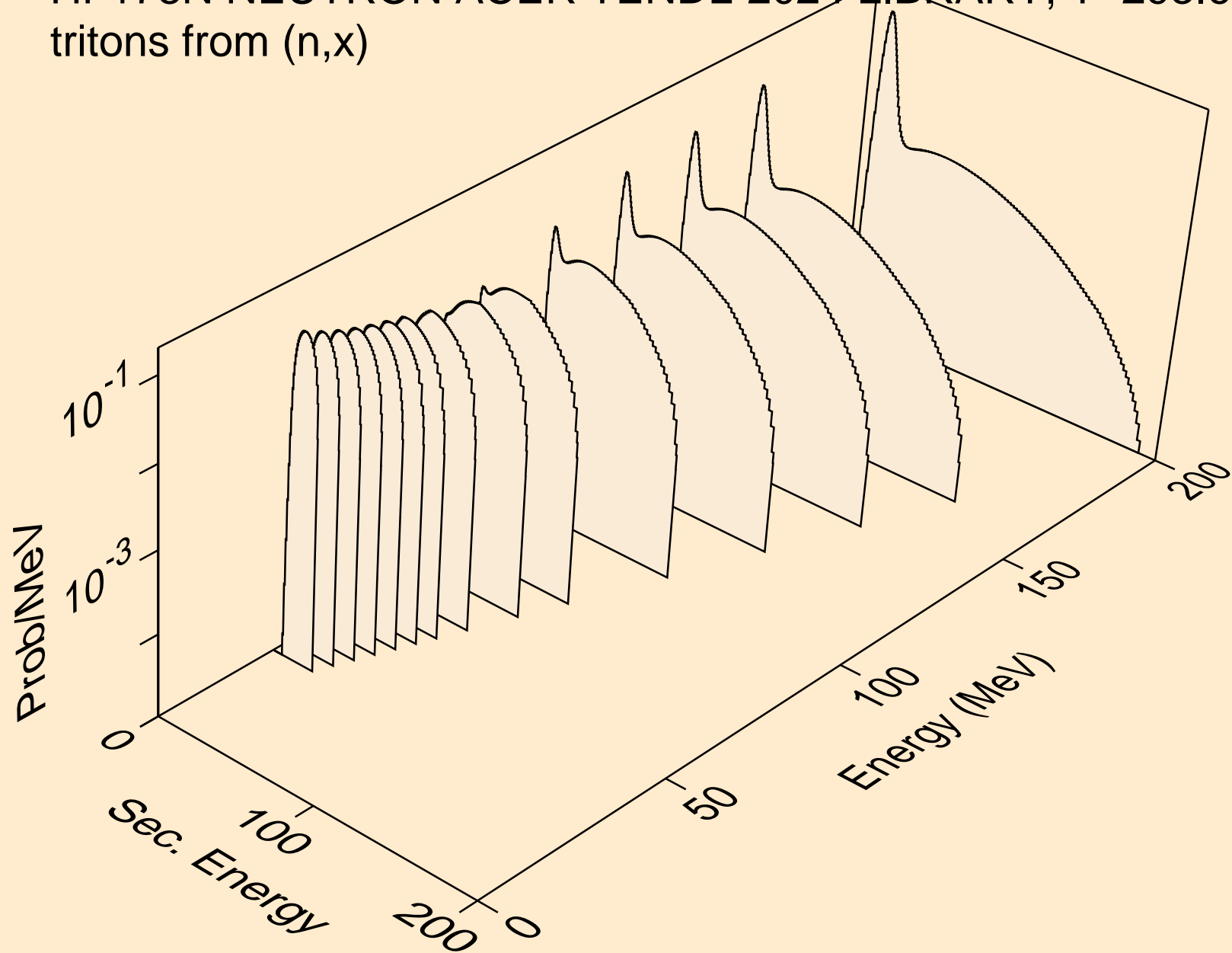

HF178N NEUTRON ACER TENDL-2024 LIBRARY; T=293.6K
tritons from (n,n*)t

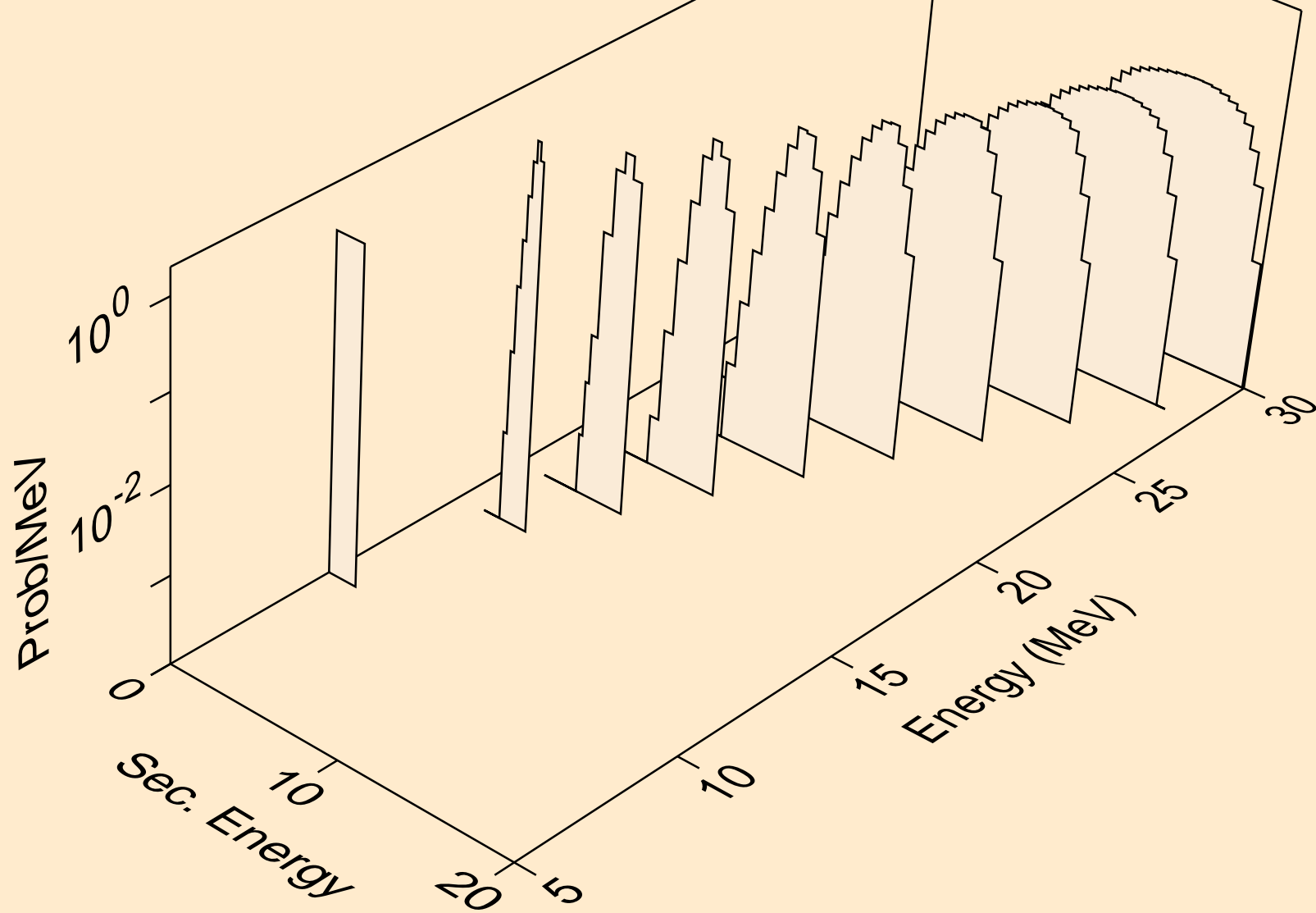

HF178N NEUTRON ACER TENDL-2024 LIBRARY; T=293.6K
tritons from (n,t)

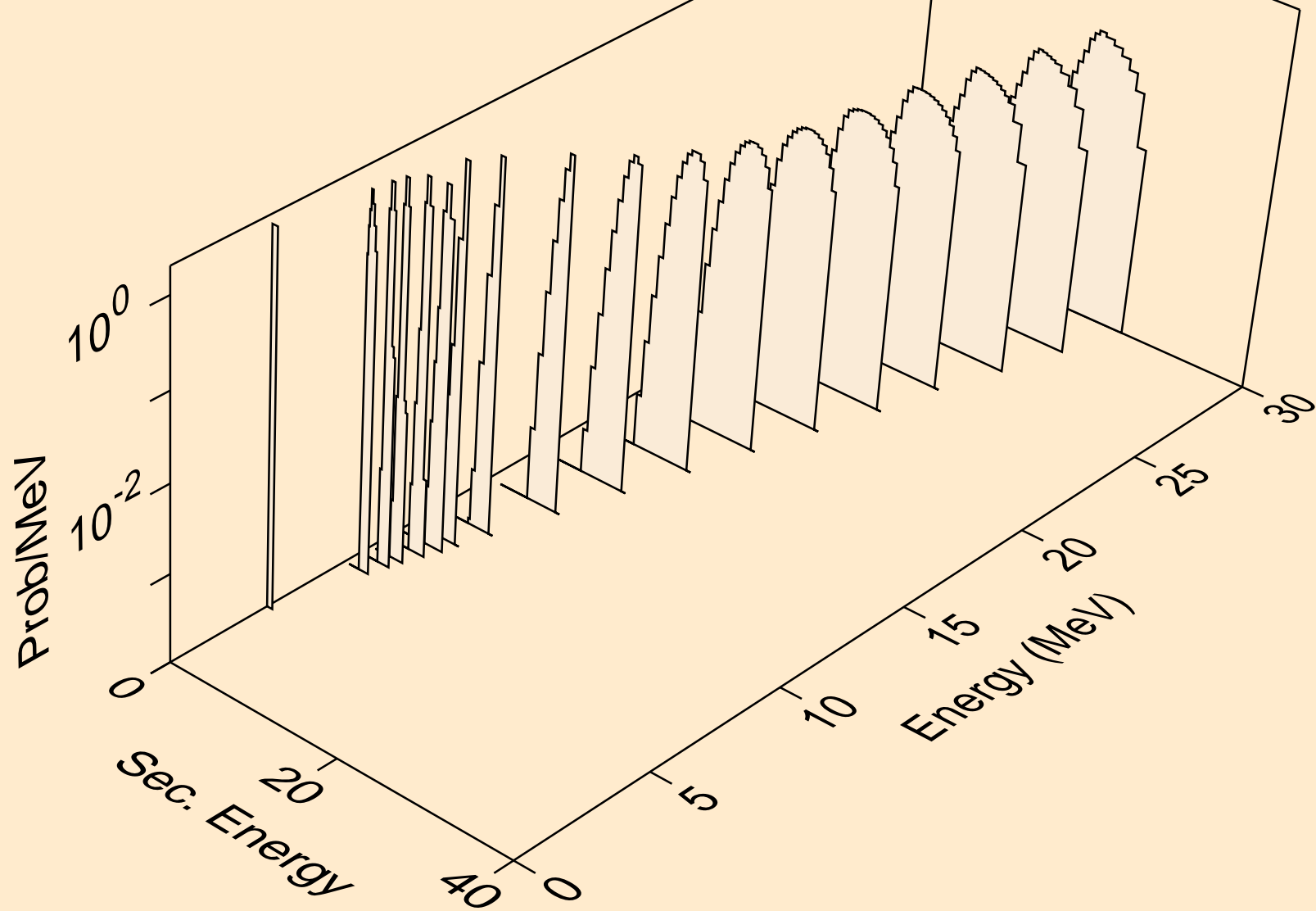

HF178N NEUTRON ACER TENDL-2024 LIBRARY; T=293.6K
tritons from (n,pt)

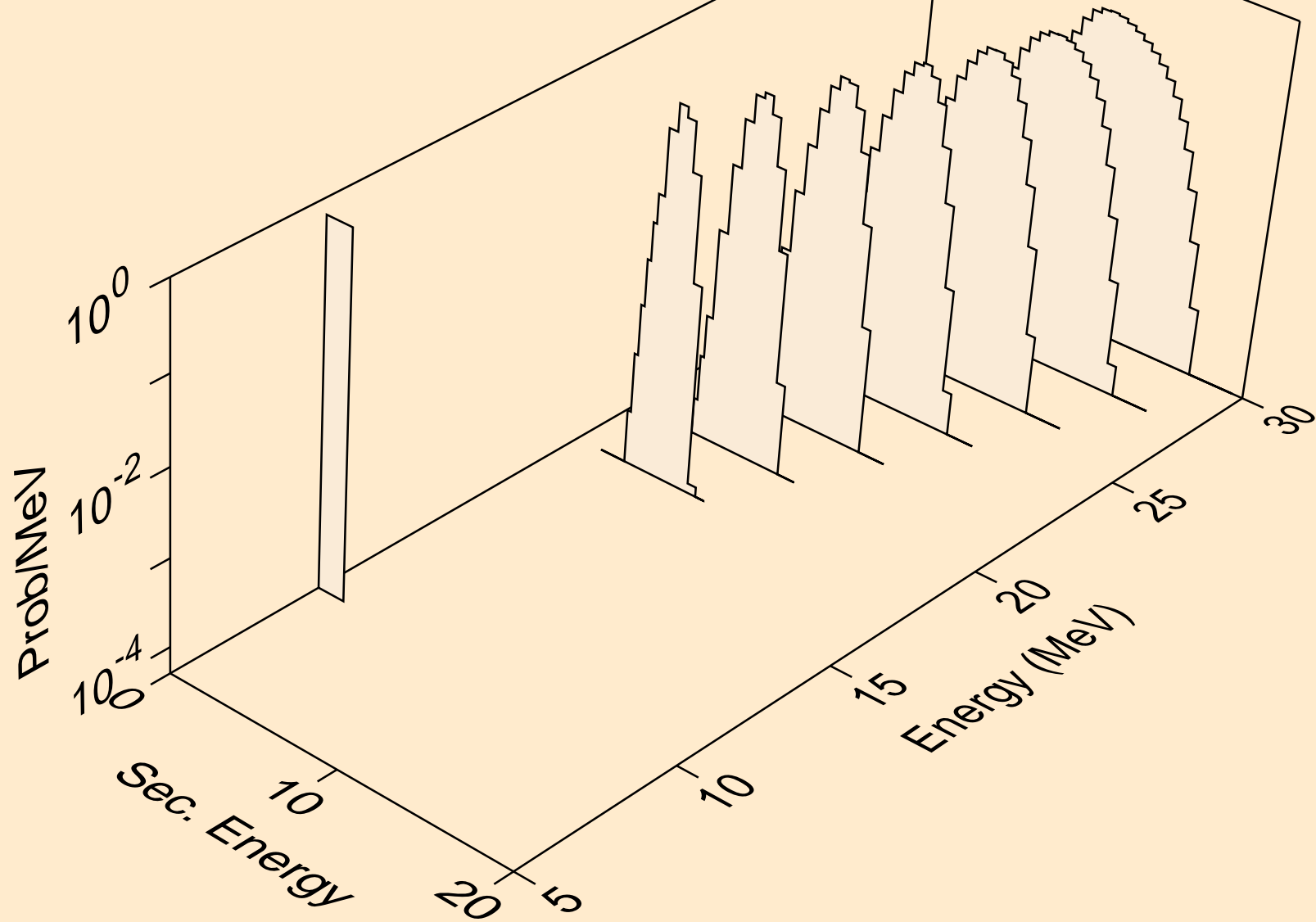

HF178N NEUTRON ACER TENDL-2024 LIBRARY; T=293.6K
he3s from (n,x)

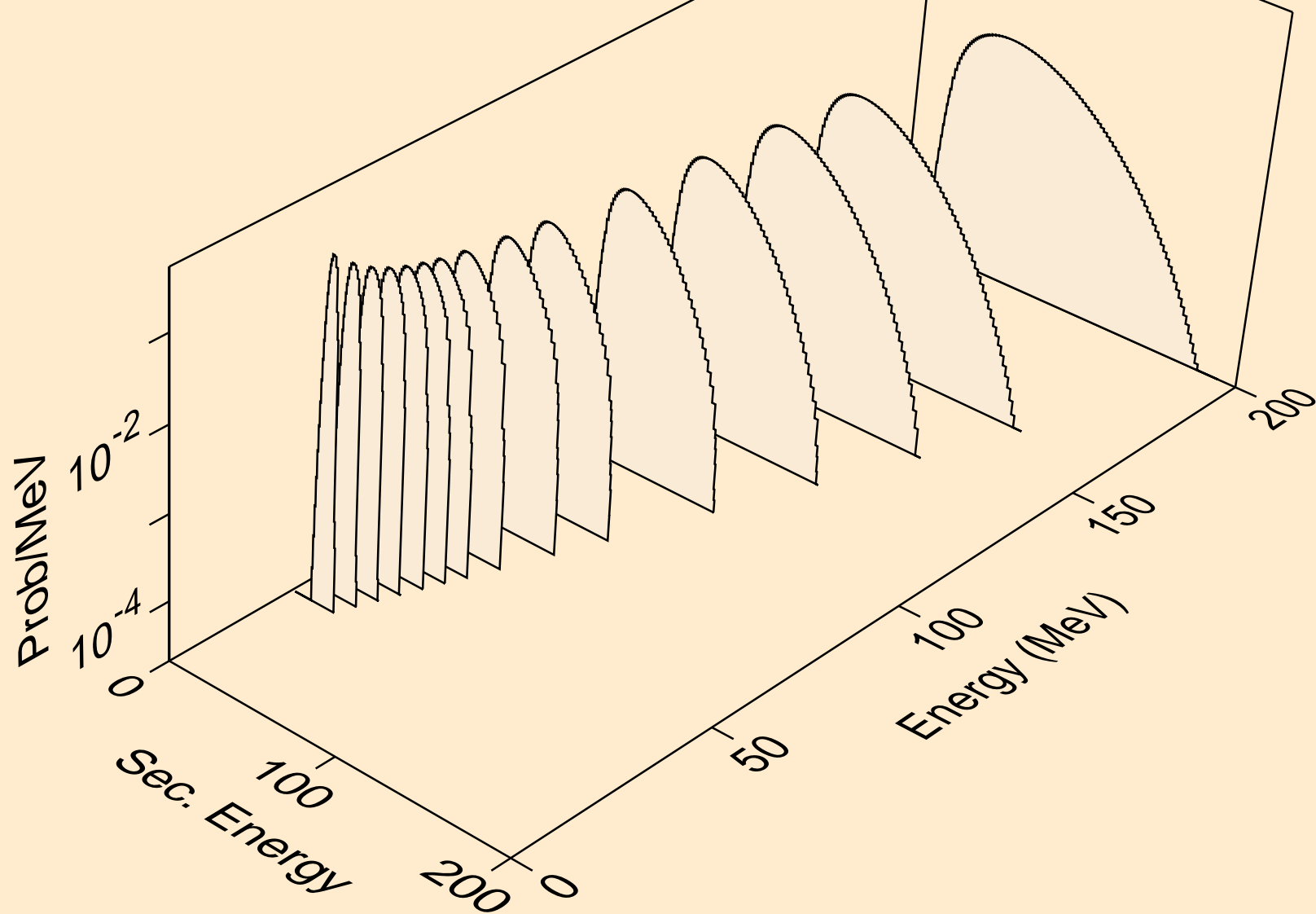

HF178N NEUTRON ACER TENDL-2024 LIBRARY; T=293.6K
he3s from (n,n*)he3

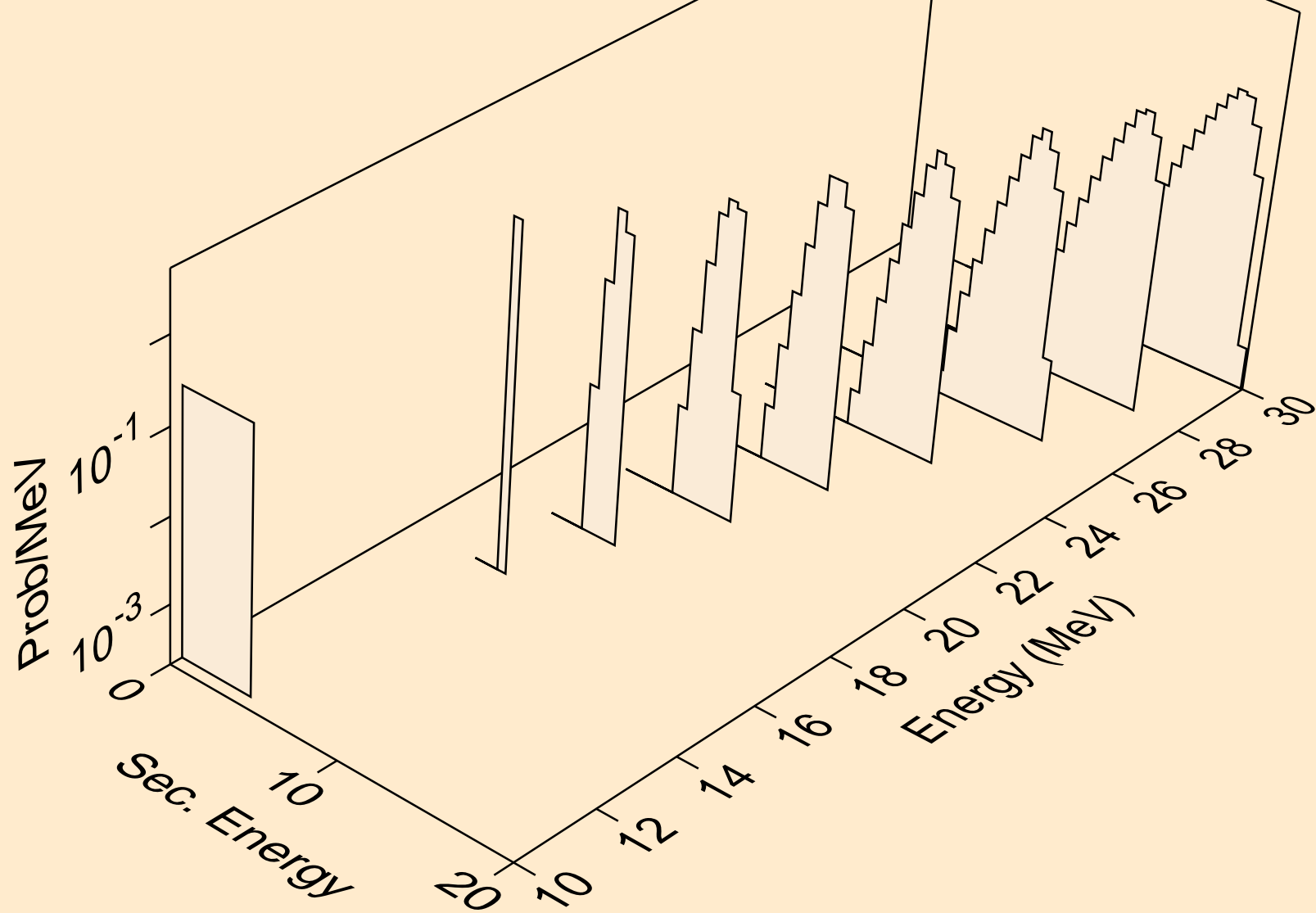

HF178N NEUTRON ACER TENDL-2024 LIBRARY; T=293.6K
he3s from (n,he3)

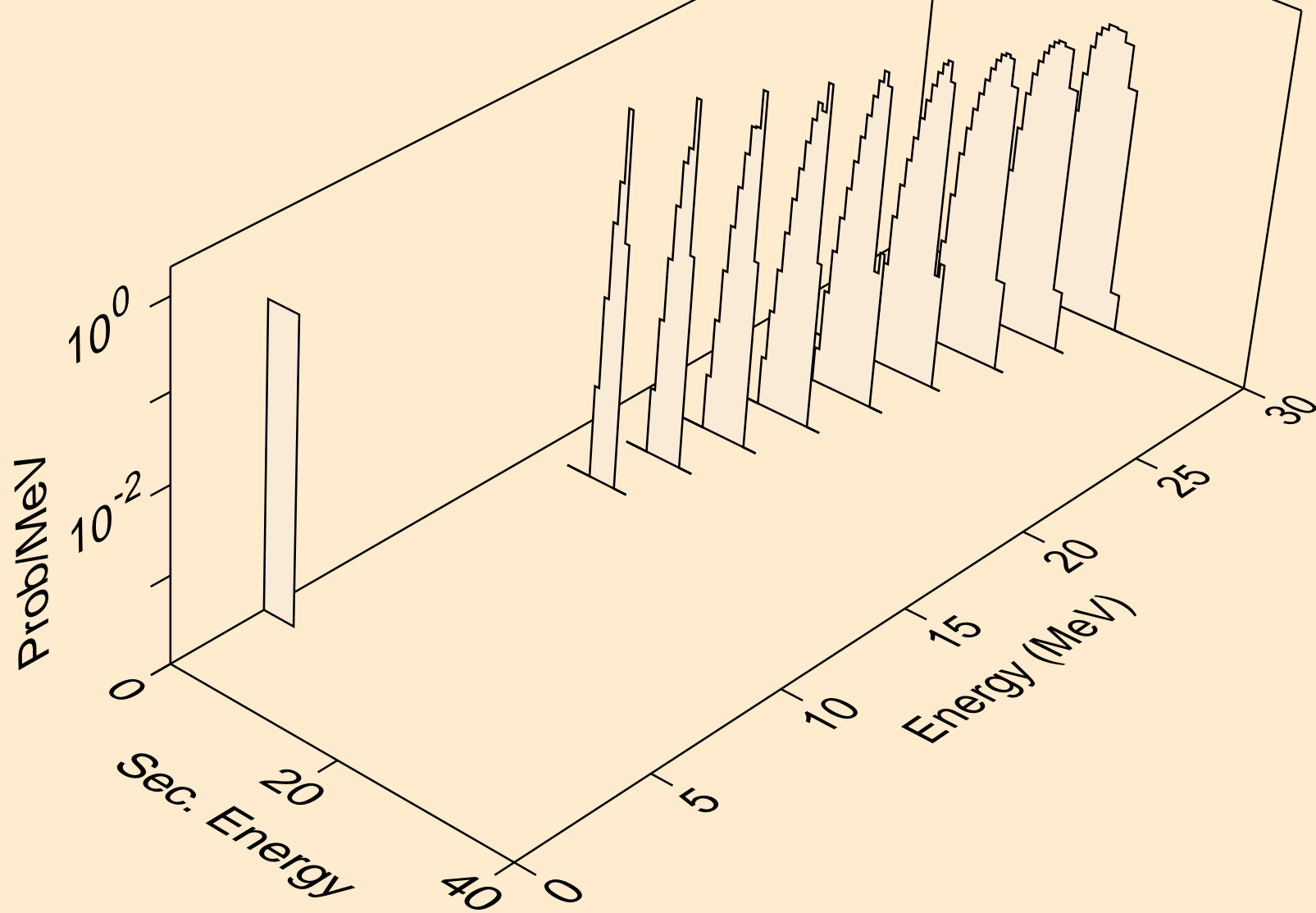

HF178N NEUTRON ACER TENDL-2024 LIBRARY; T=293.6K
alphas from (n,x)

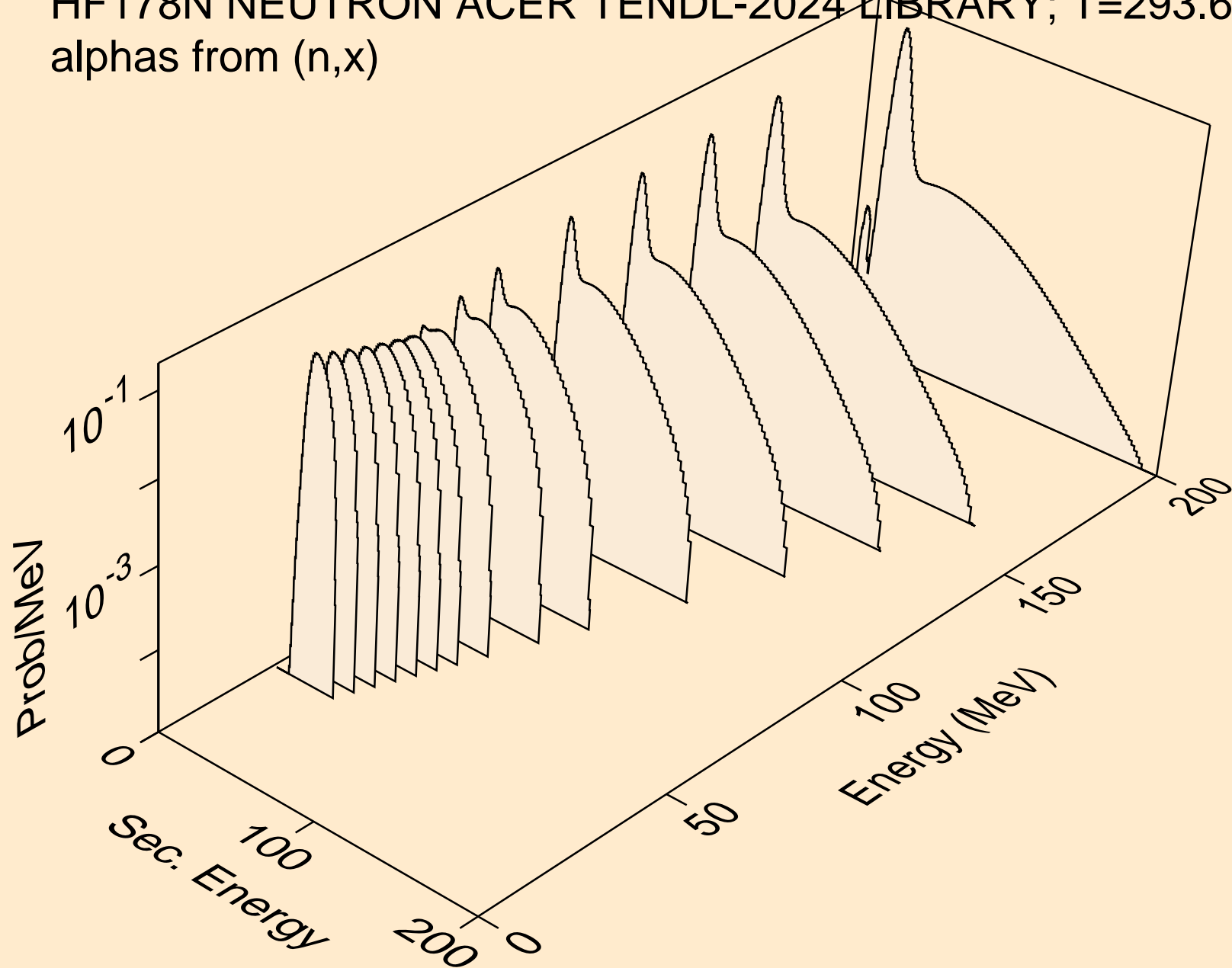

HF178N NEUTRON ACER TENDL-2024 LIBRARY; T=293.6K
alphas from (n,n*)a

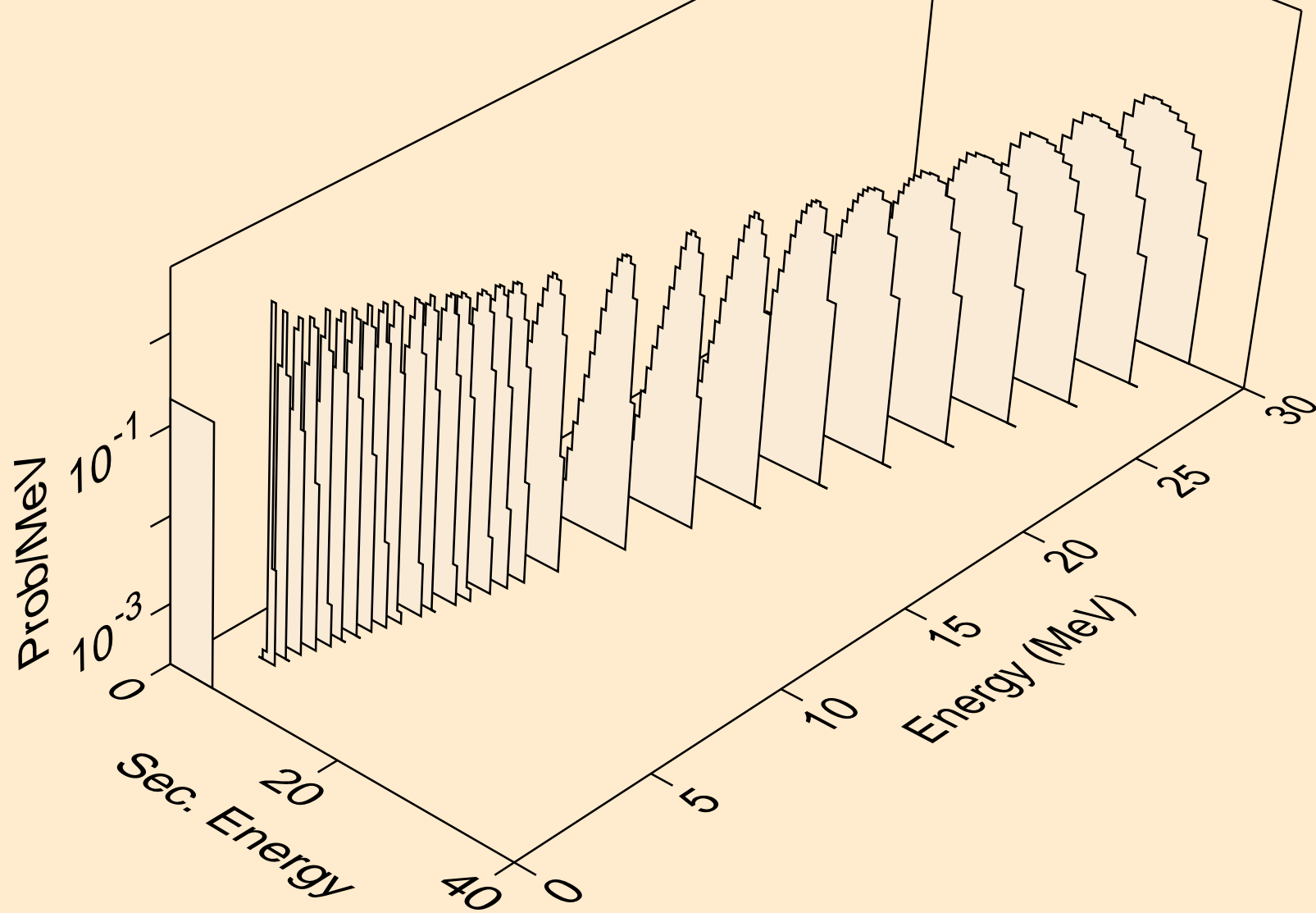

HF178N NEUTRON ACER TENDL-2024 LIBRARY; T=293.6K
alphas from (n,2n)a

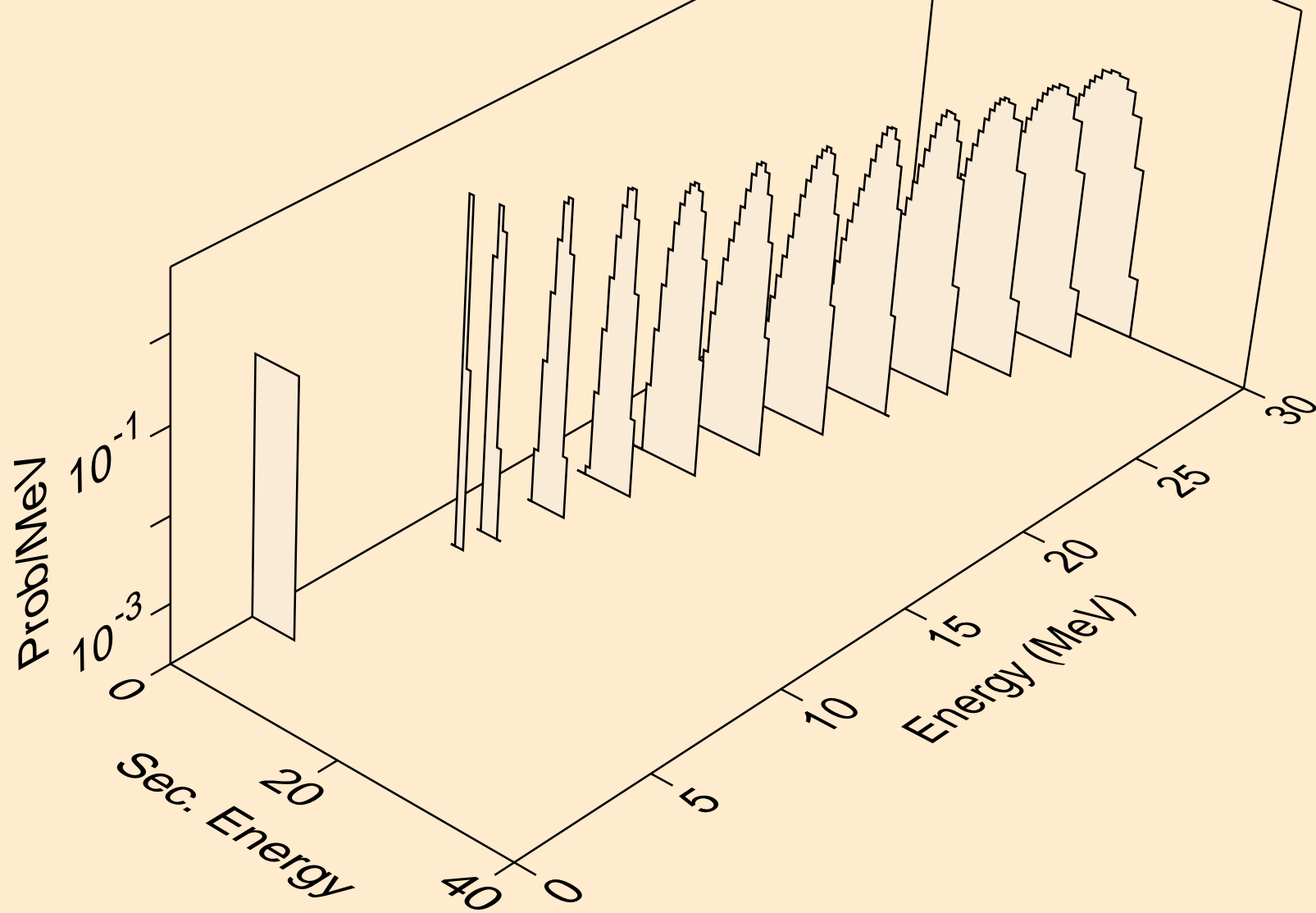

HF178N NEUTRON ACER TENDL-2024 LIBRARY; T=293.6K
alphas from (n,3n)a

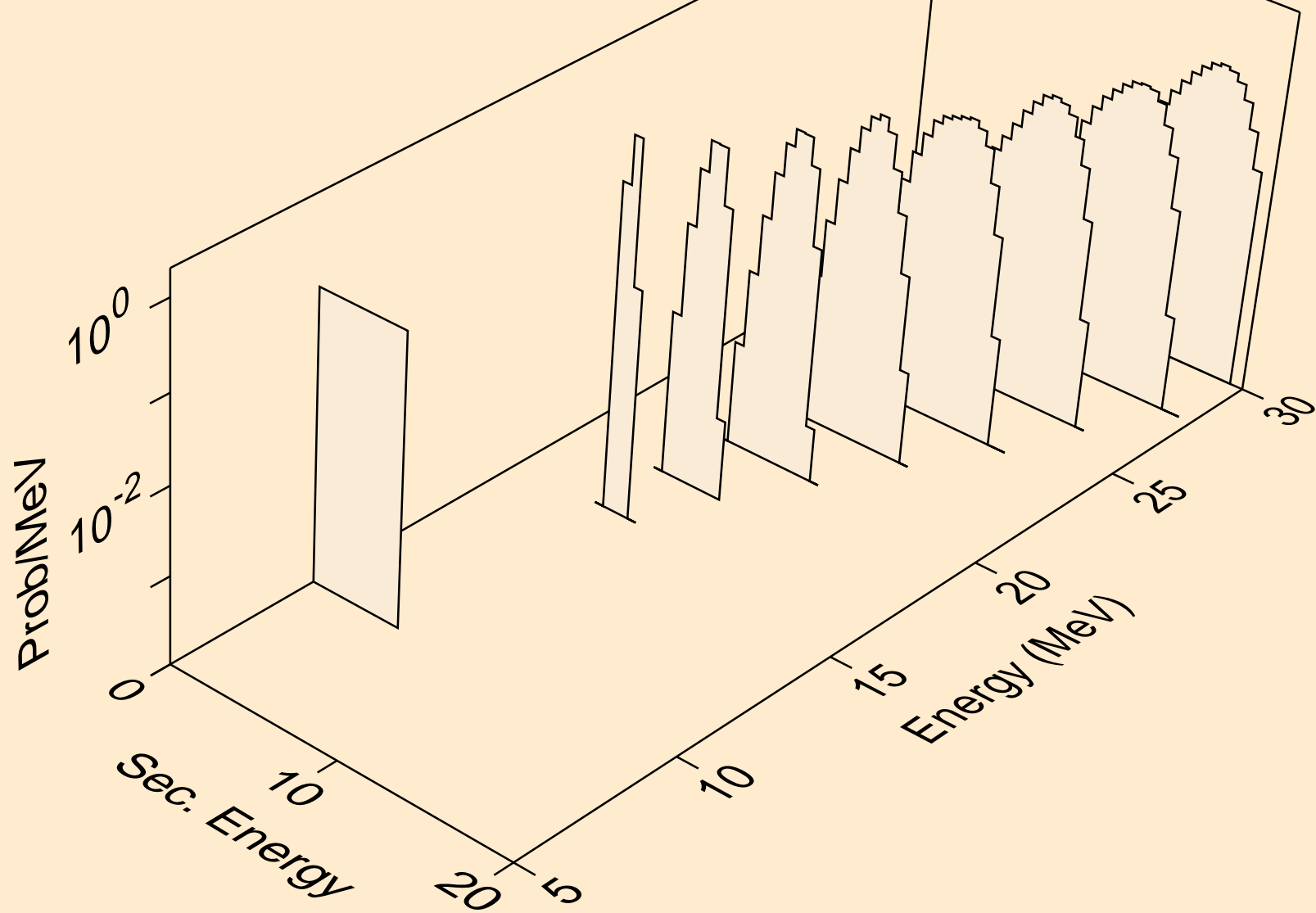

HF178N NEUTRON ACER TENDL-2024 LIBRARY; T=293.6K
alphas from (n,n*)2a

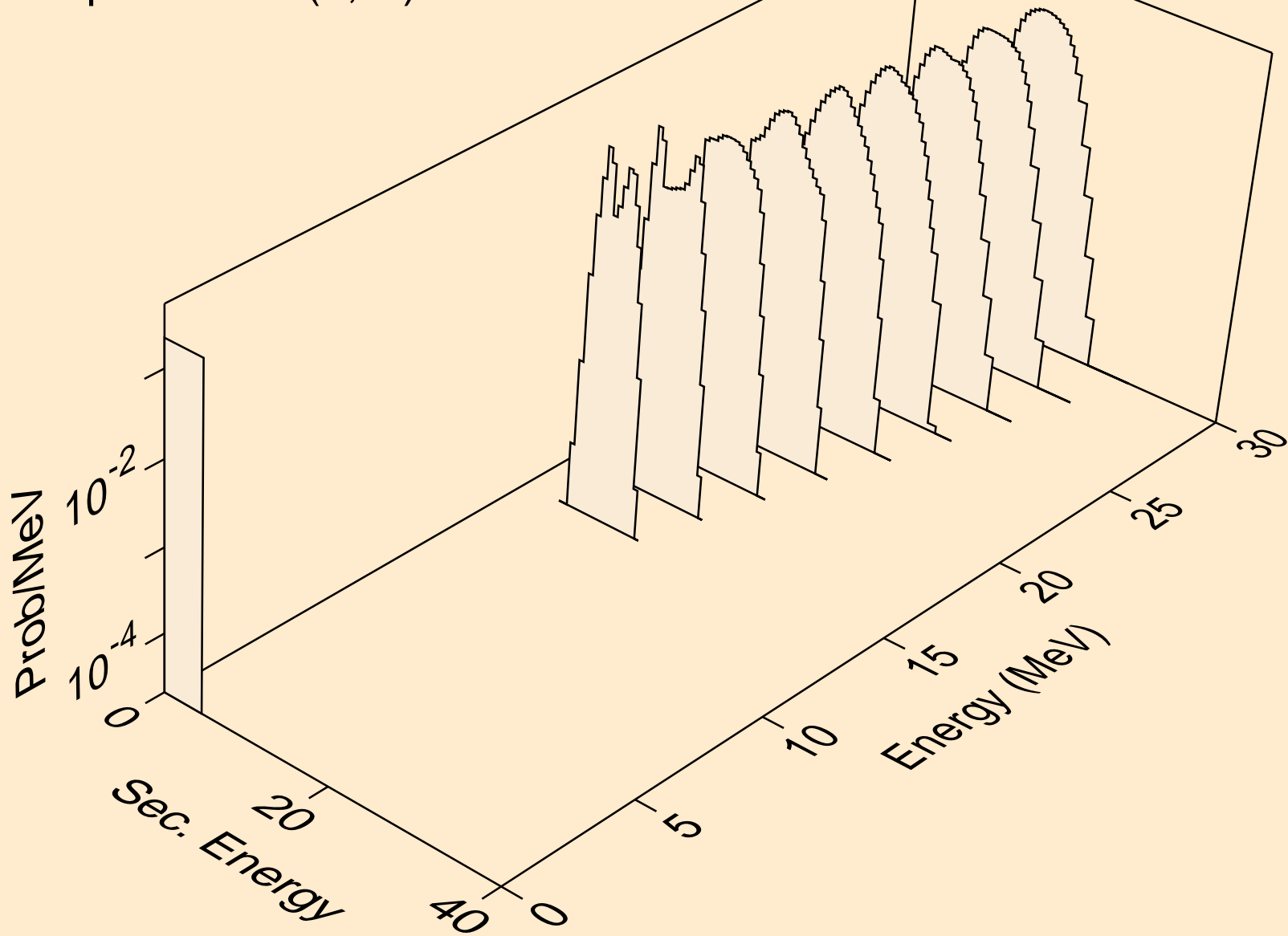

HF178N NEUTRON ACER TENDL-2024 LIBRARY; T=293.6K
alphas from (n,npa)

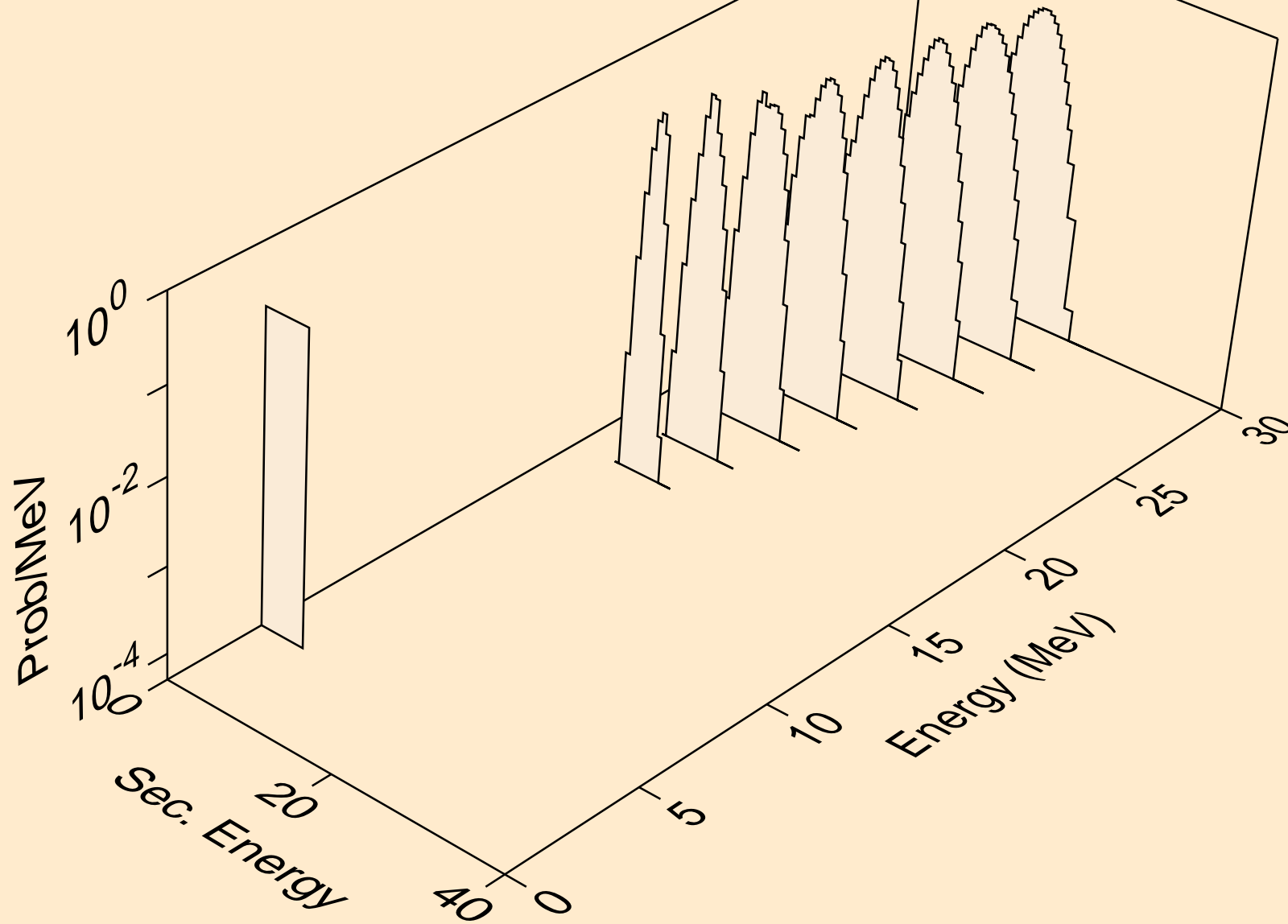

HF178N NEUTRON ACER TENDL-2024 LIBRARY; T=293.6K
alphas from (n,a)

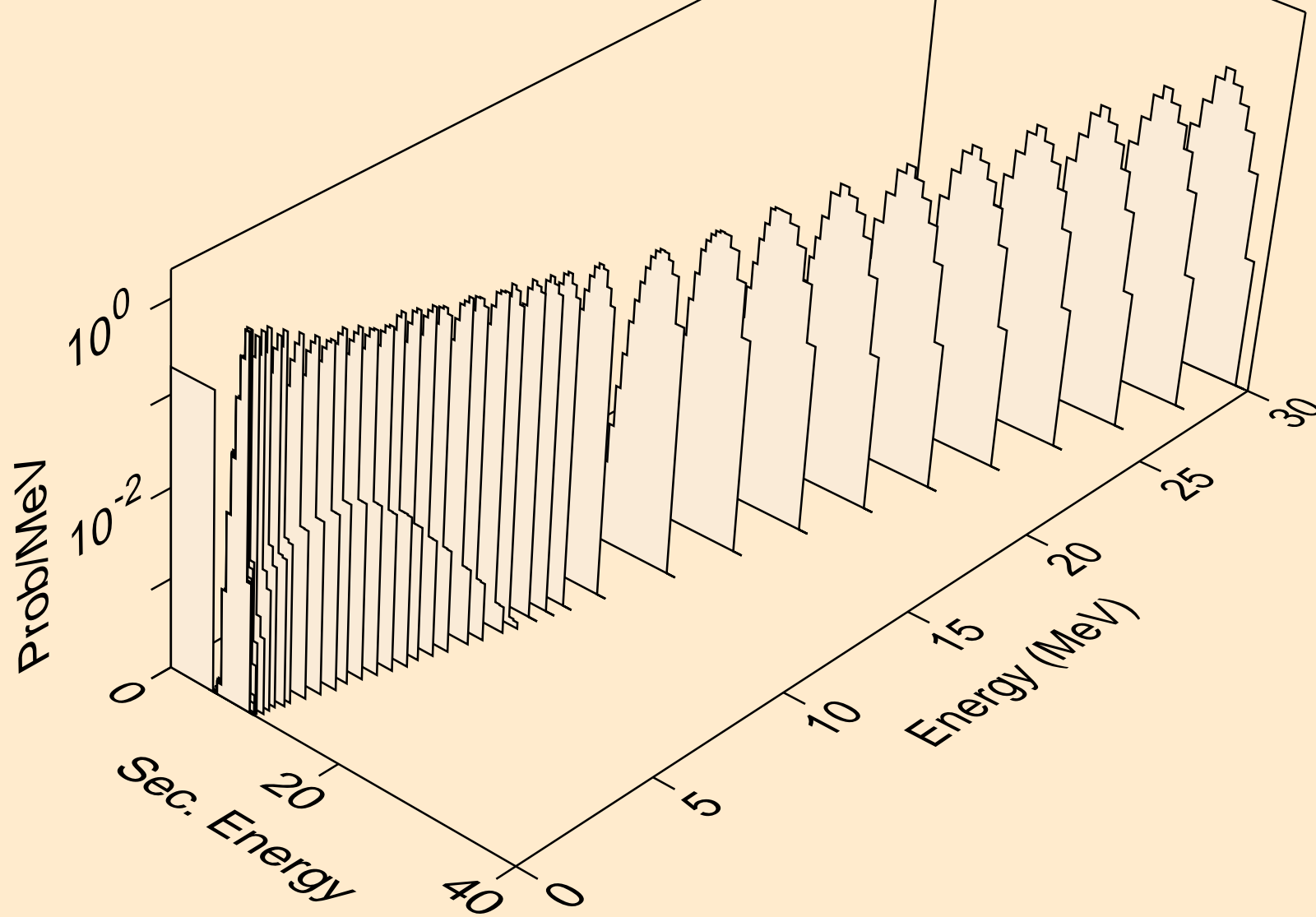

HF178N NEUTRON ACER TENDL-2024 LIBRARY; T=293.6K
alphas from (n,2a)

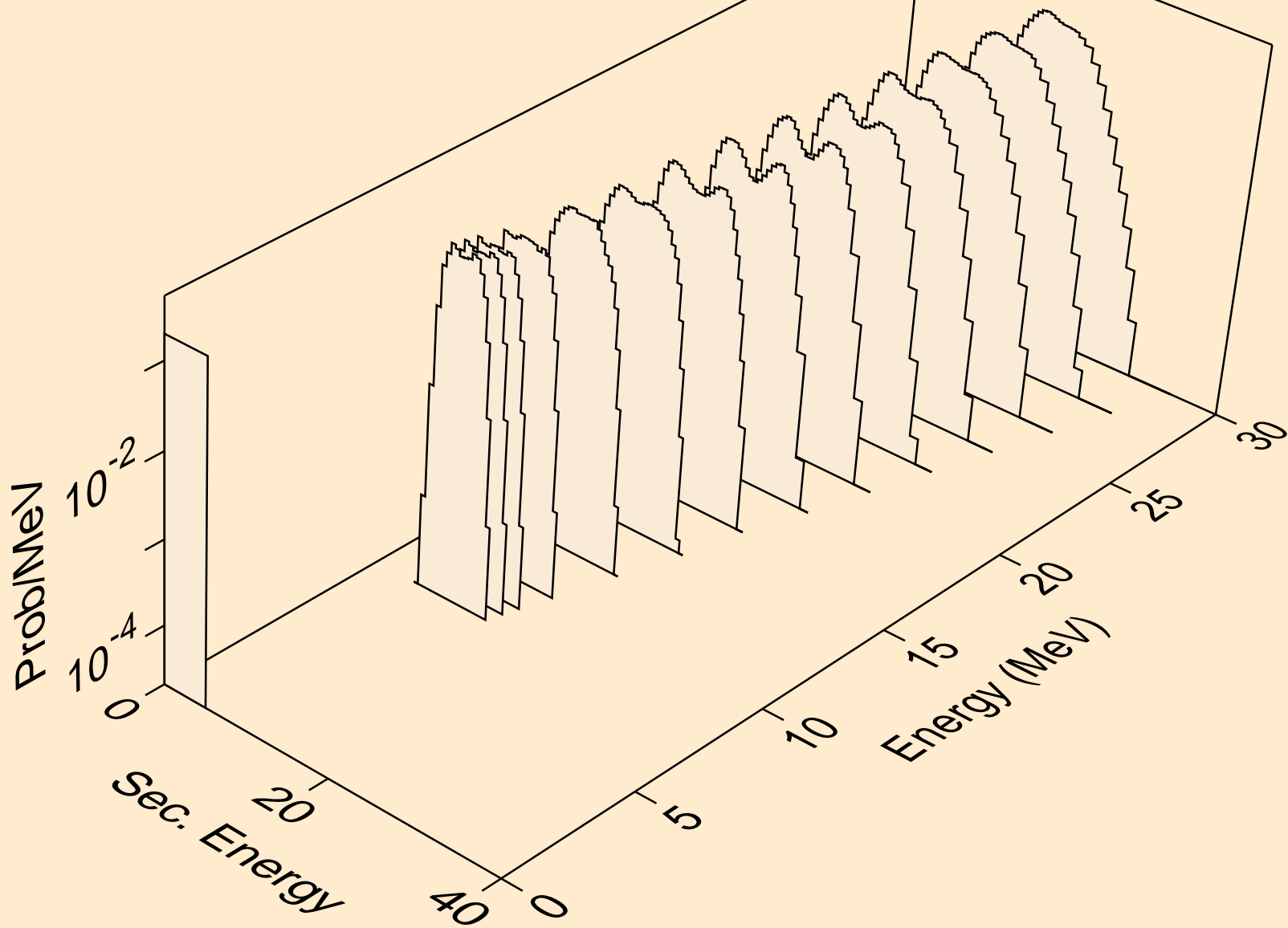

HF178N NEUTRON ACER TENDL-2024 LIBRARY; T=293.6K
alphas from (n,pa)

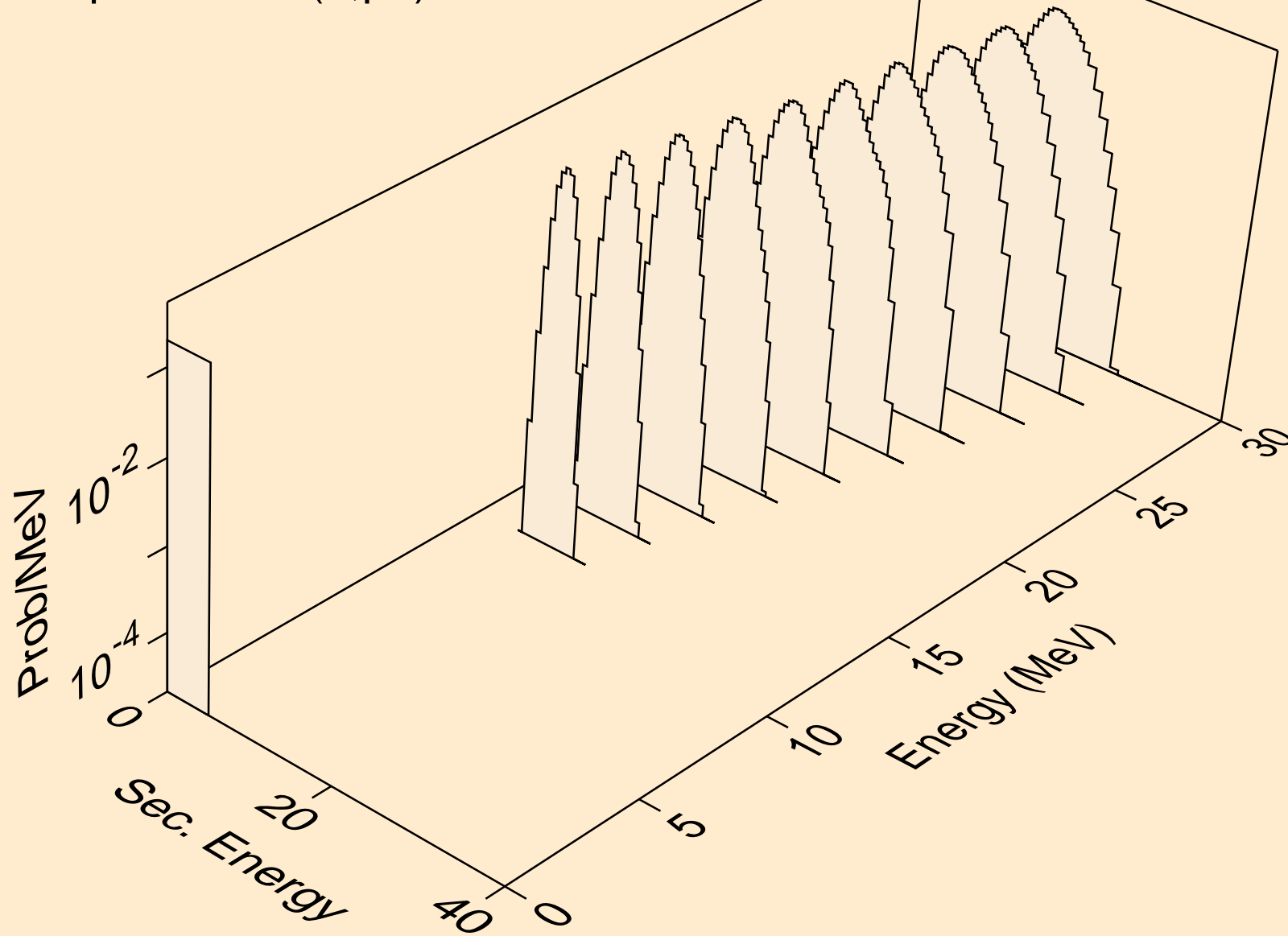

HF178N NEUTRON ACER TENDL-2024 LIBRARY; T=293.6K
alphas from (n,da)

