

# HG191 NEUTRON ACER TENDL-2024 LIBRARY; T=293.6K

## Principal cross sections

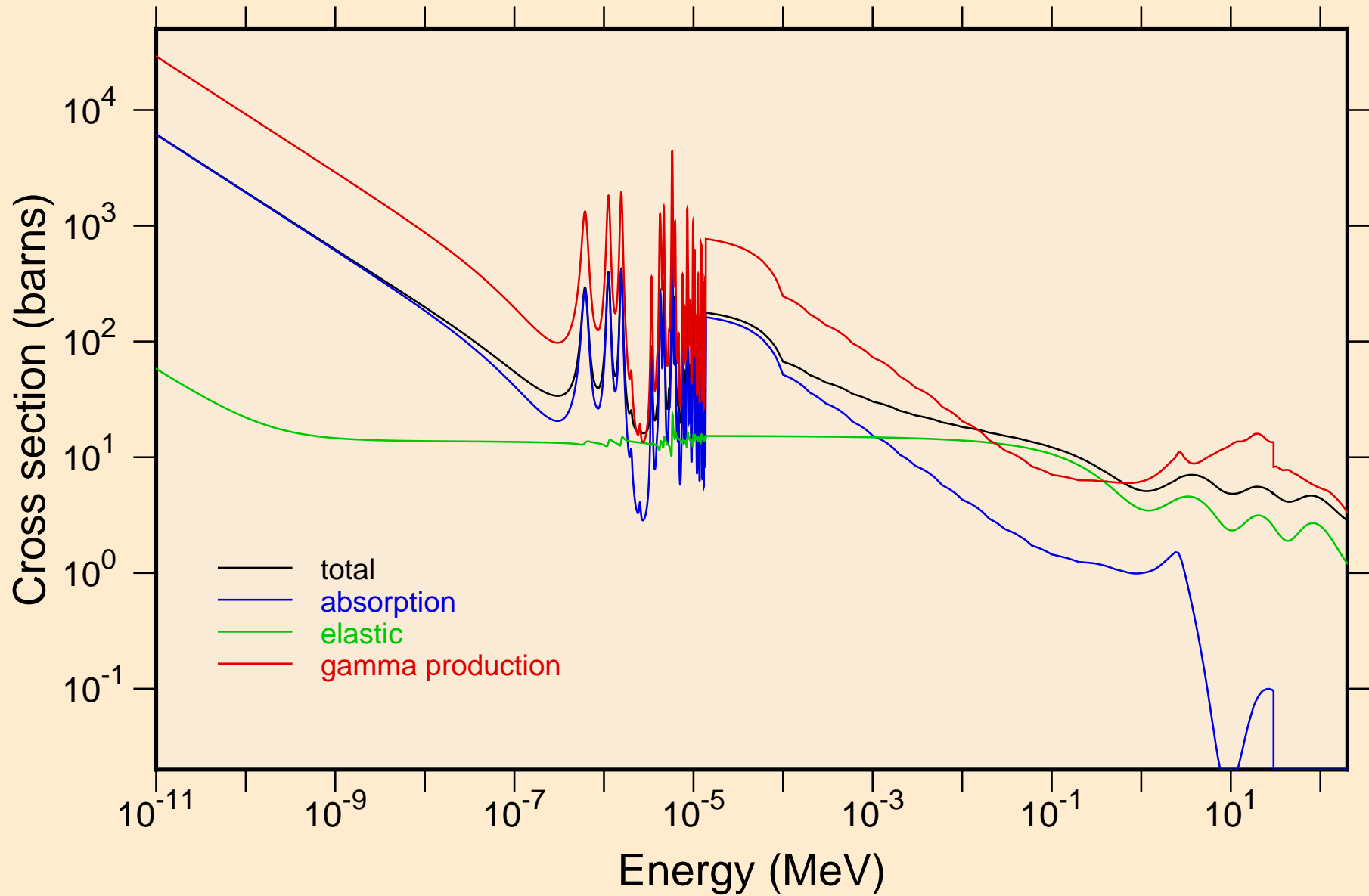

HG191 NEUTRON ACER TENDL-2024 LIBRARY; T=293.6K  
resonance total cross section

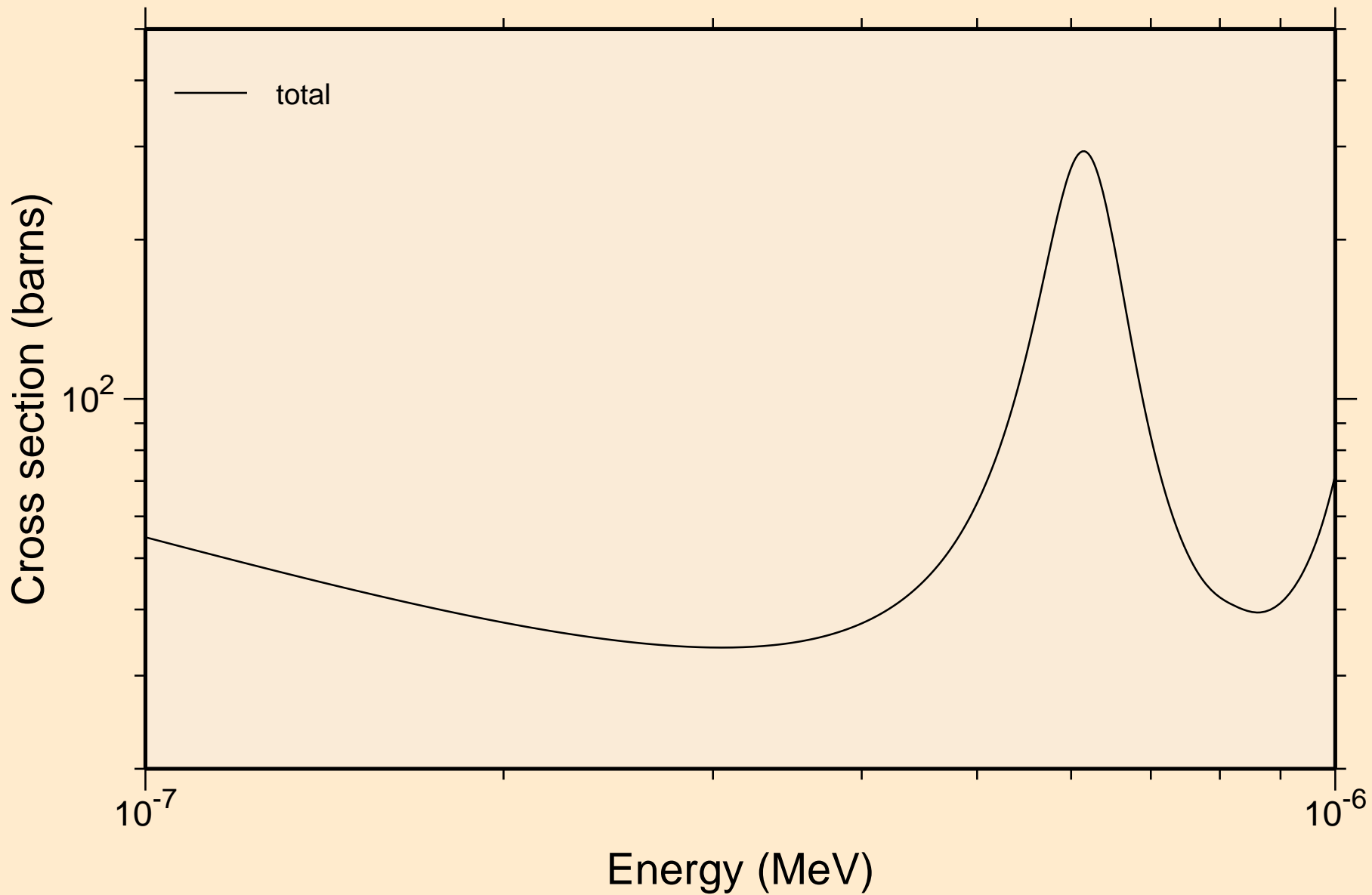

HG191 NEUTRON ACER TENDL-2024 LIBRARY; T=293.6K  
resonance total cross section

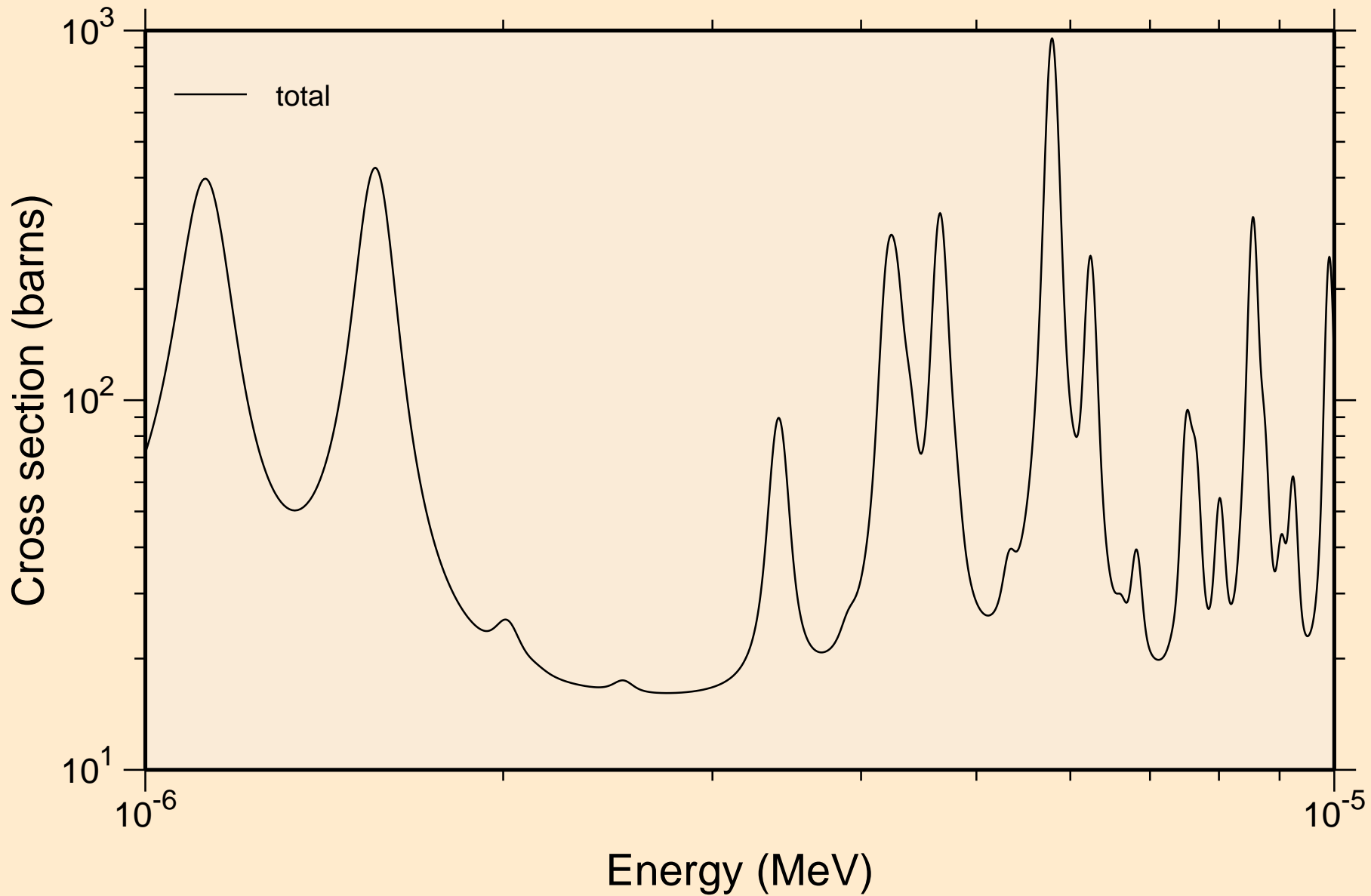

HG191 NEUTRON ACER TENDL-2024 LIBRARY; T=293.6K  
resonance total cross section

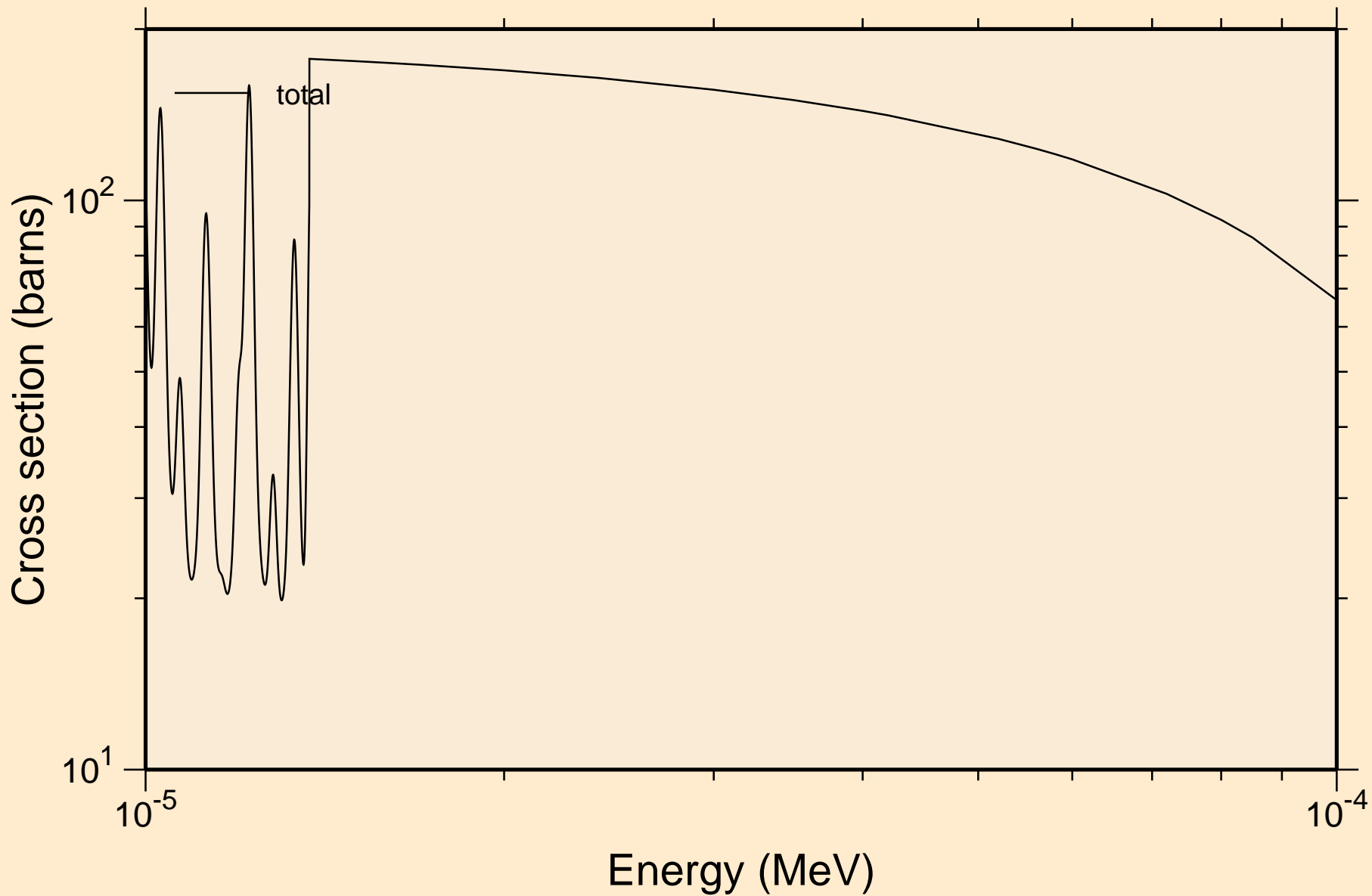

HG191 NEUTRON ACER TENDL-2024 LIBRARY; T=293.6K  
resonance total cross section

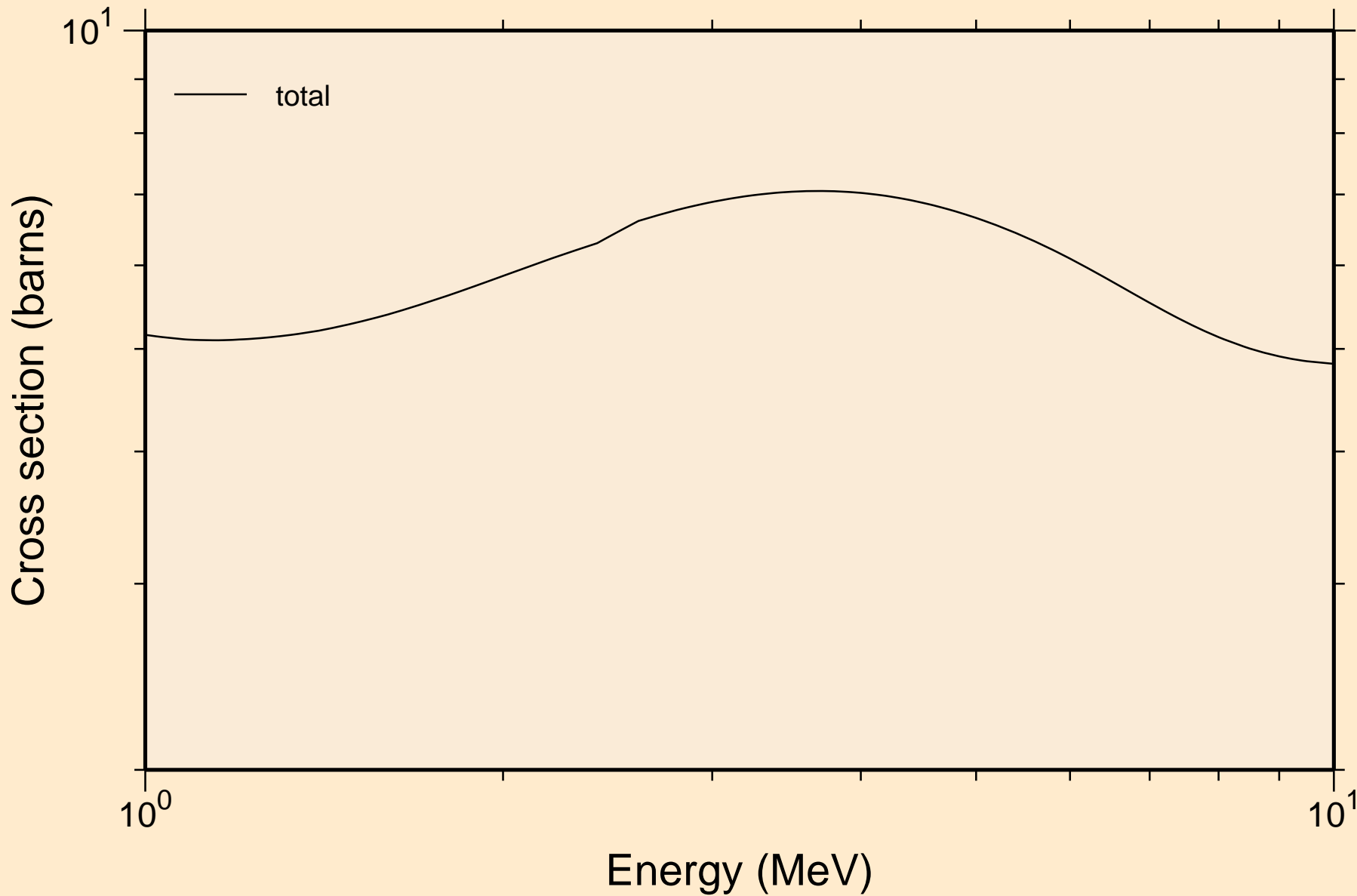

HG191 NEUTRON ACER TENDL-2024 LIBRARY; T=293.6K  
resonance absorption cross sections

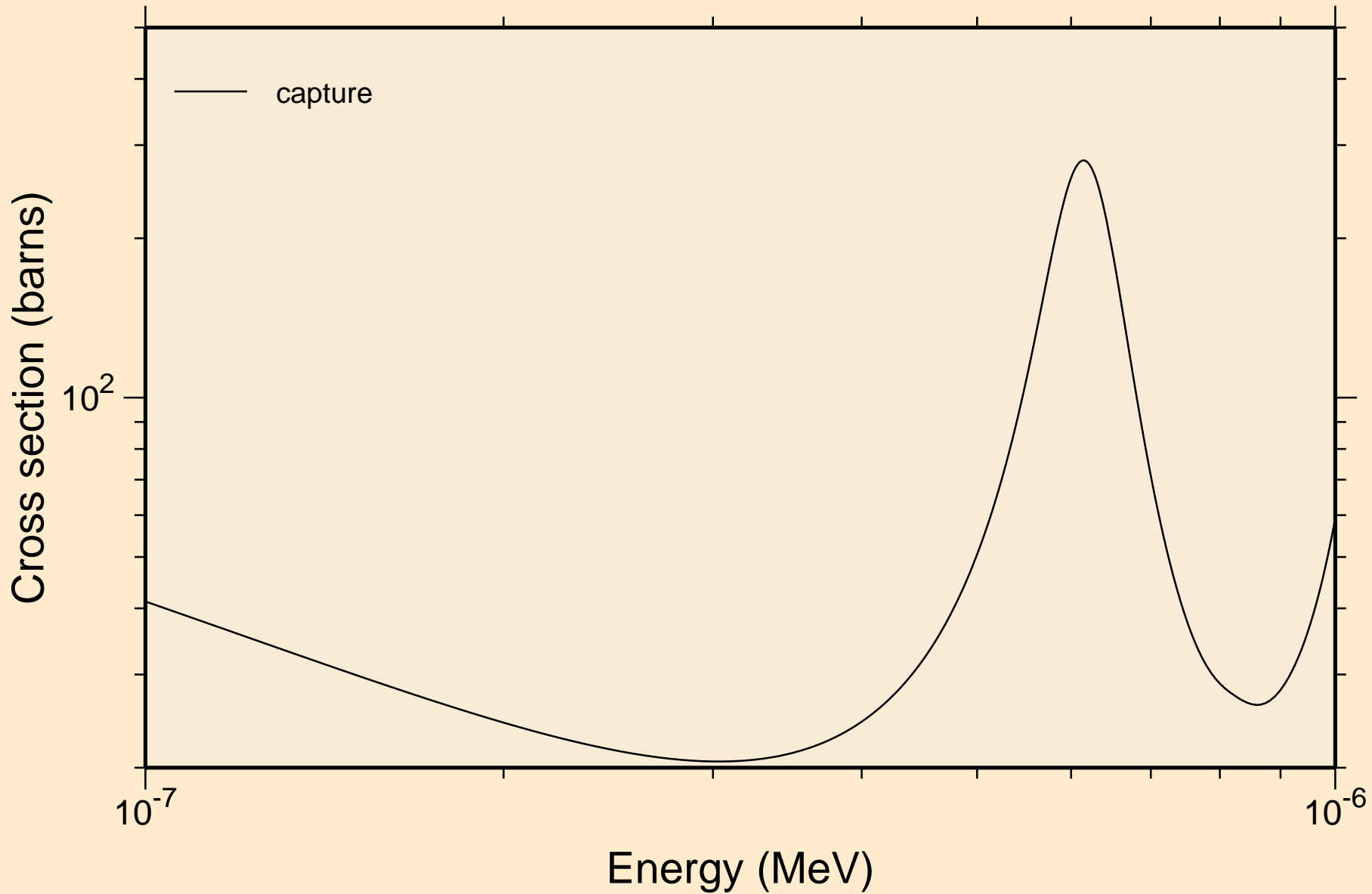

HG191 NEUTRON ACER TENDL-2024 LIBRARY; T=293.6K  
resonance absorption cross sections

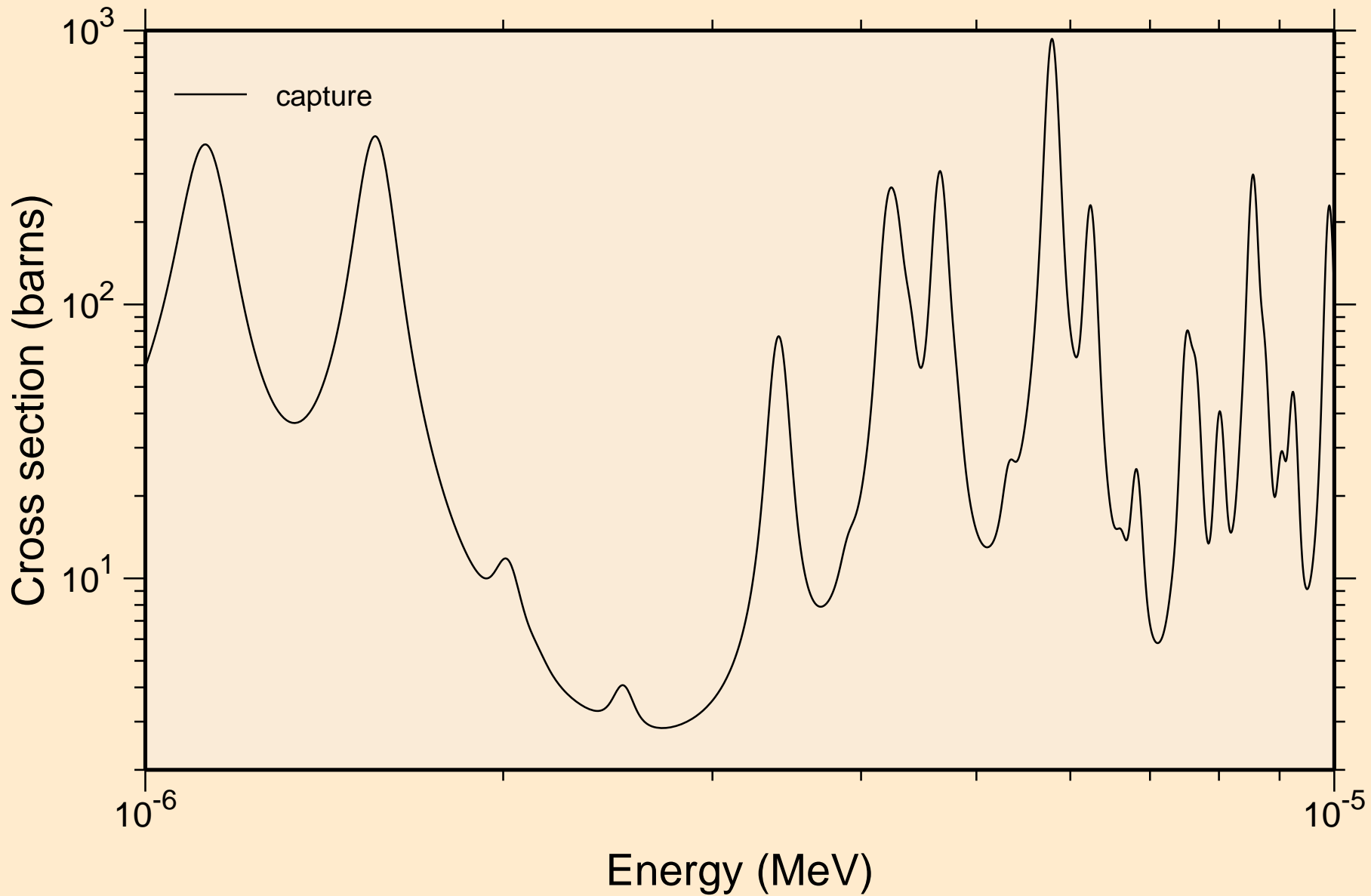

HG191 NEUTRON ACER TENDL-2024 LIBRARY; T=293.6K  
resonance absorption cross sections

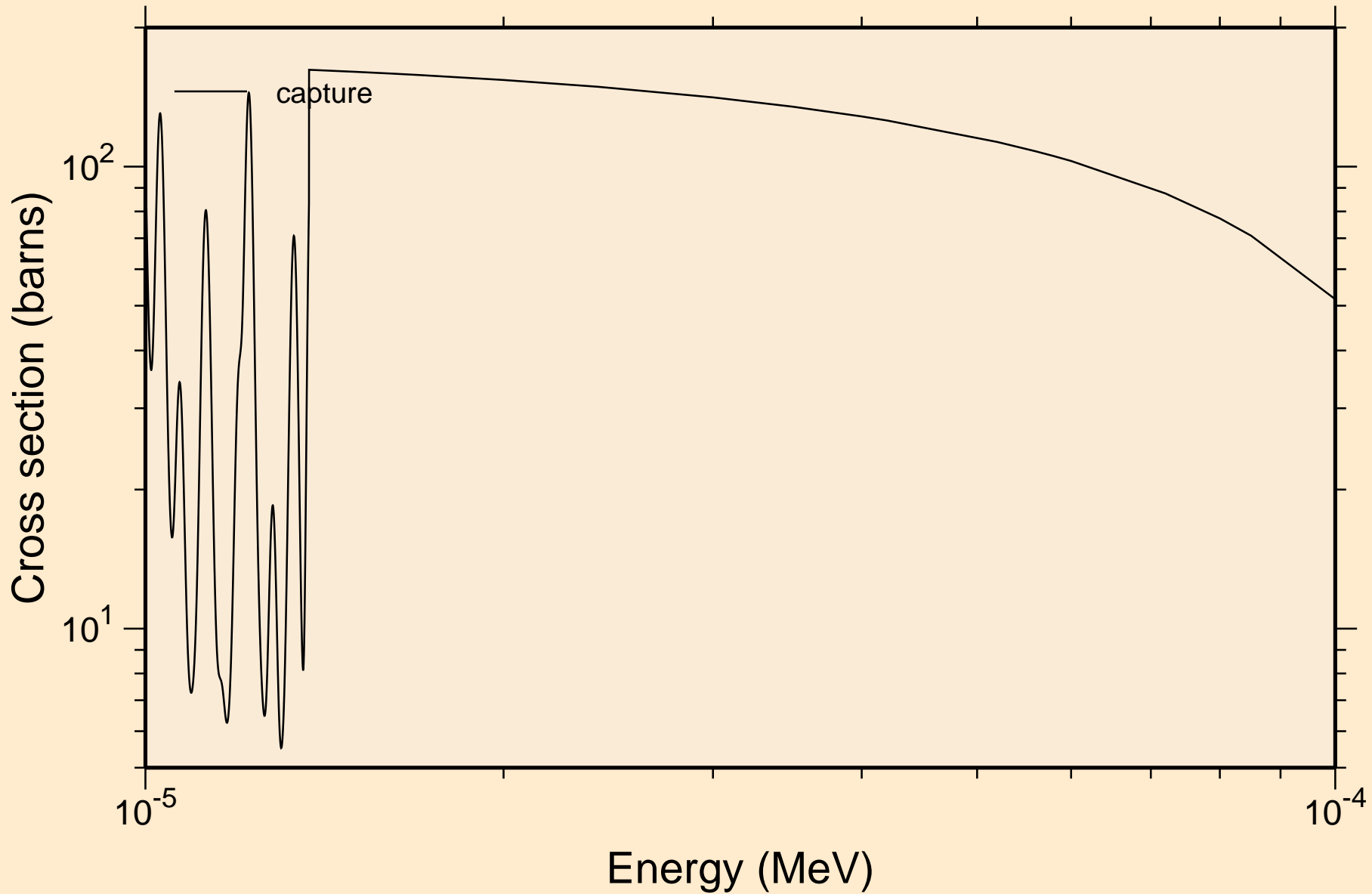

HG191 NEUTRON ACER TENDL-2024 LIBRARY; T=293.6K  
resonance absorption cross sections

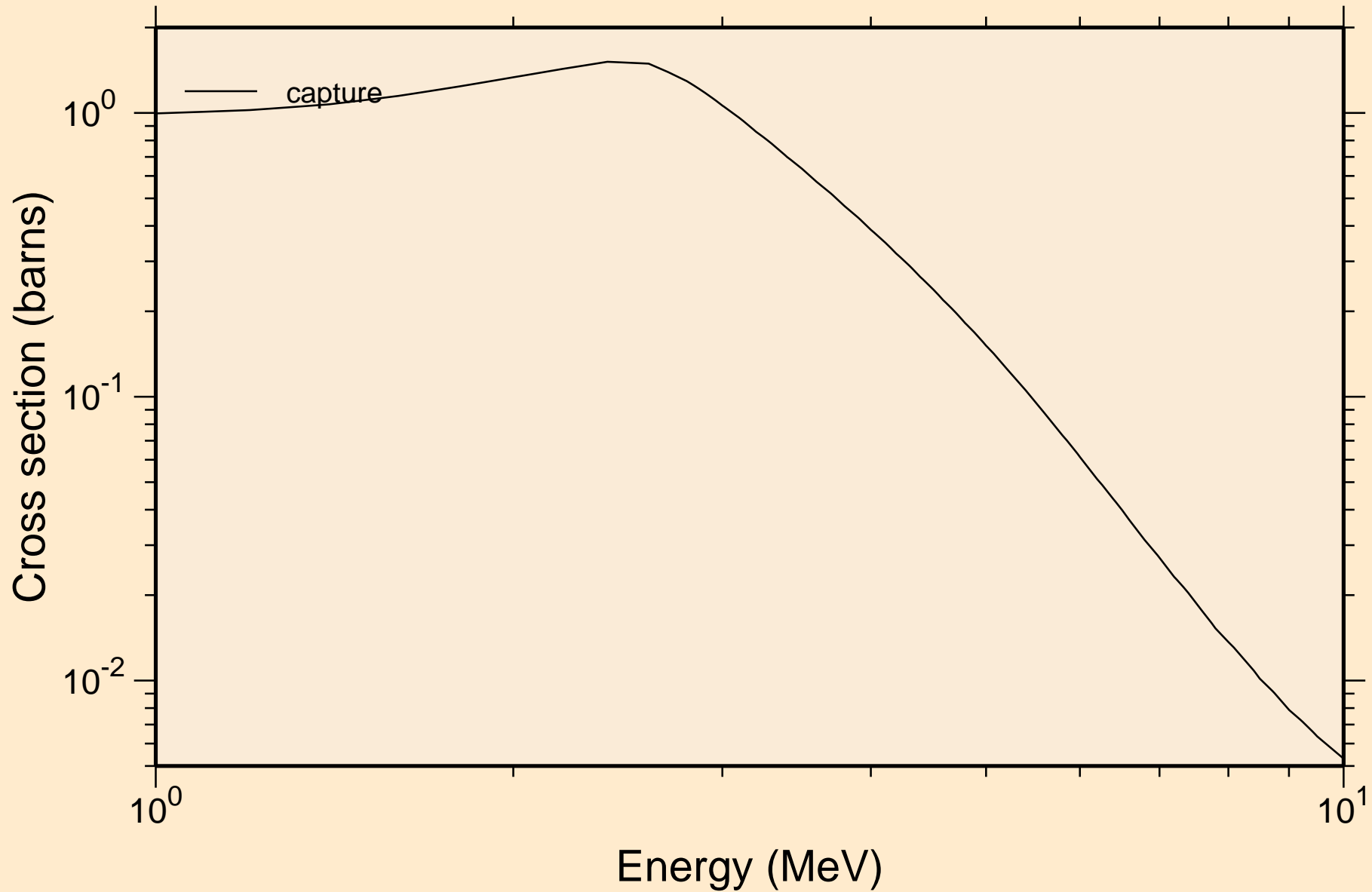

HG191 NEUTRON ACER TENDL-2024 LIBRARY; T=293.6K  
Heating

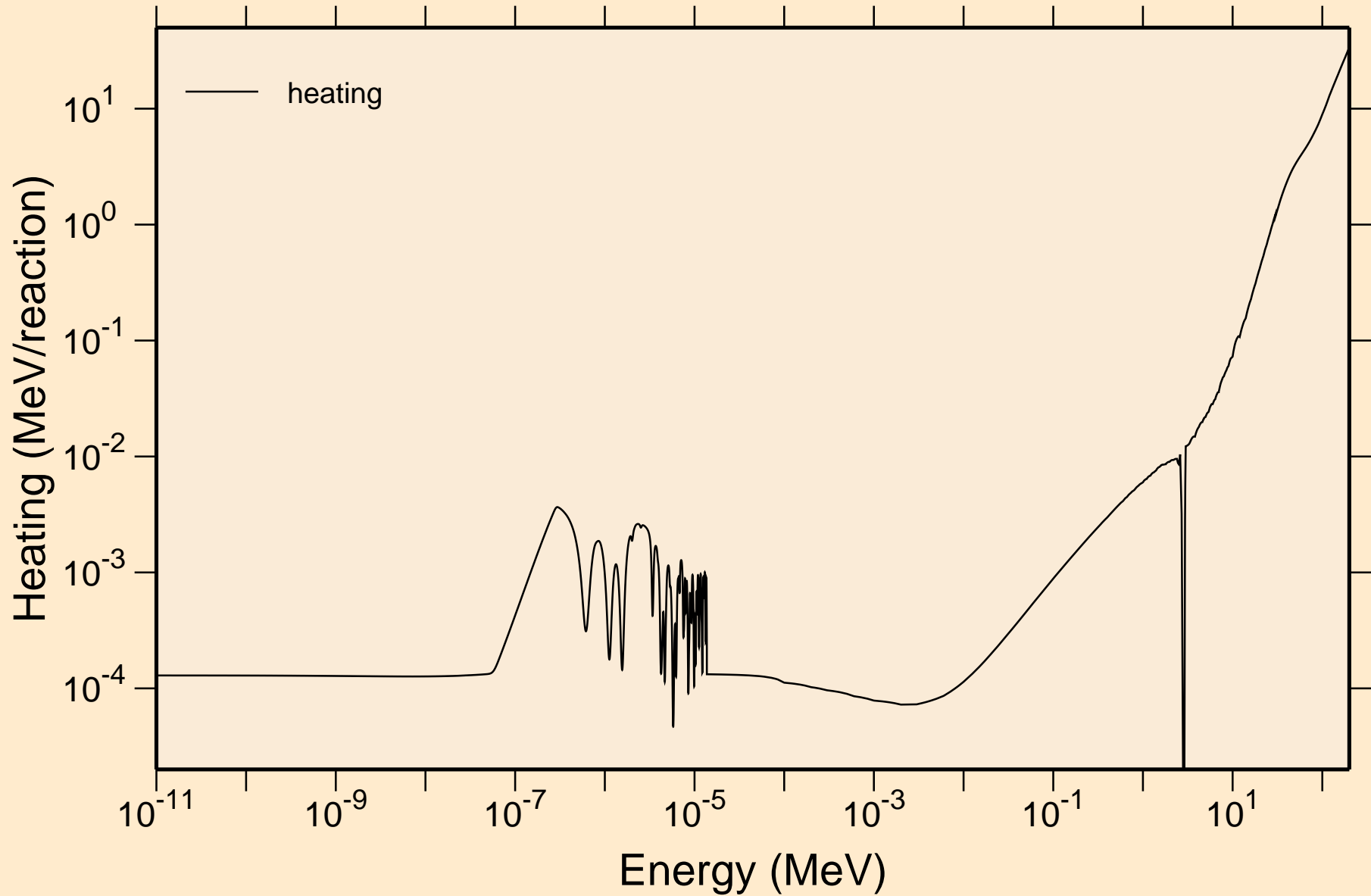

# HG191 NEUTRON ACER TENDL-2024 LIBRARY; T=293.6K

## Damage

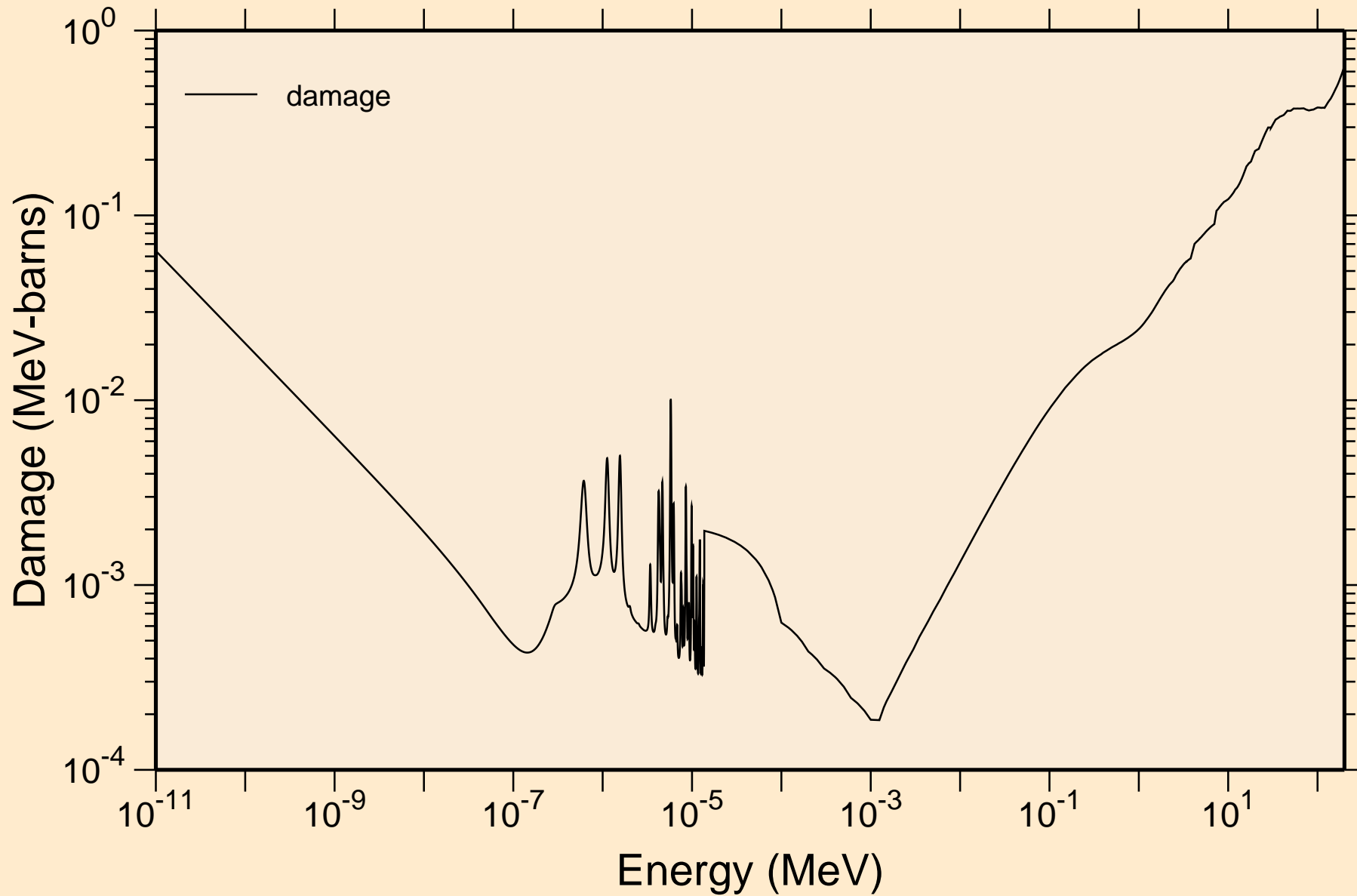

# HG191 NEUTRON ACER TENDL-2024 LIBRARY; T=293.6K

## Non-threshold reactions

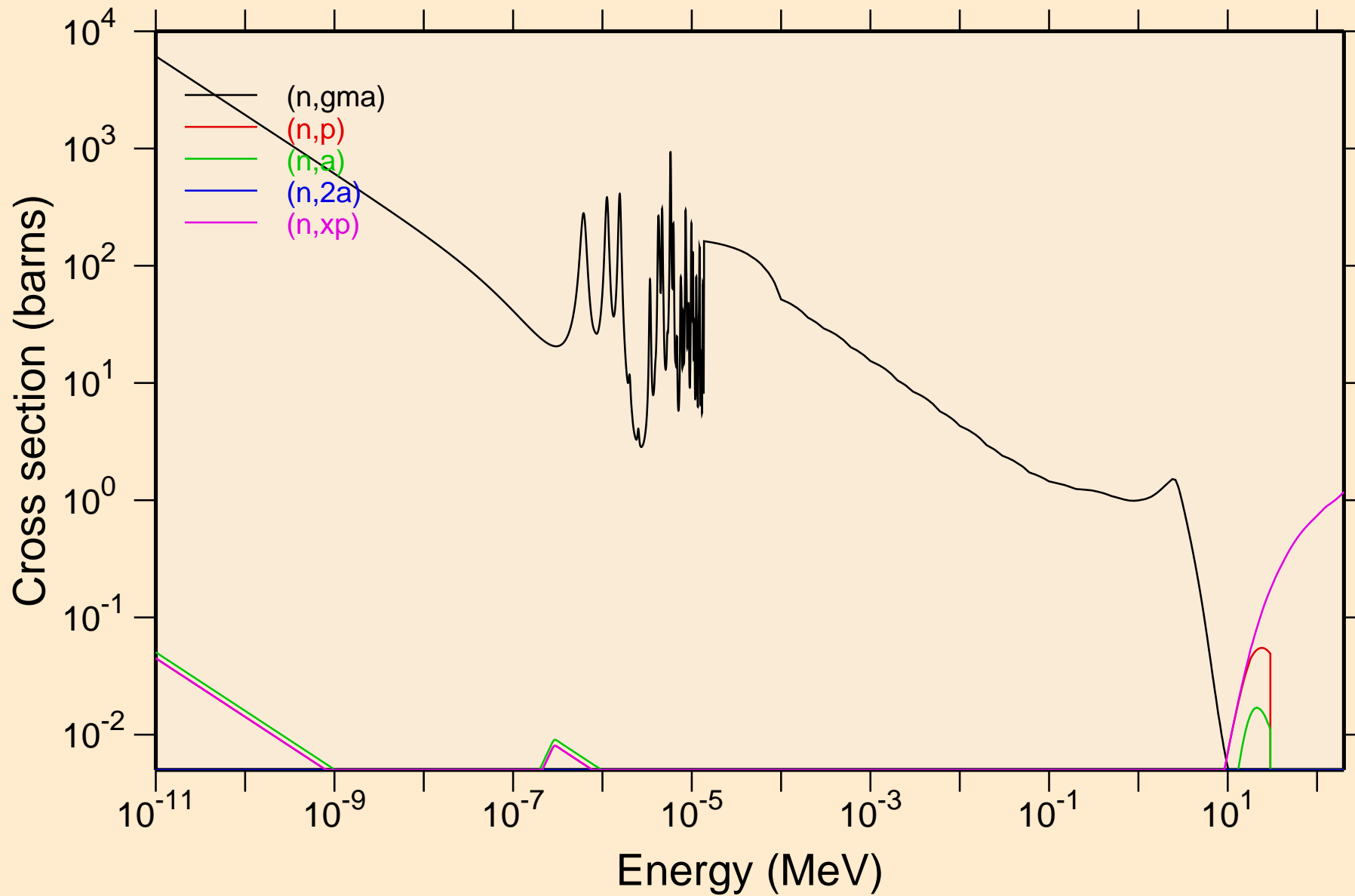

HG191 NEUTRON ACER TENDL-2024 LIBRARY; T=293.6K  
Non-threshold reactions

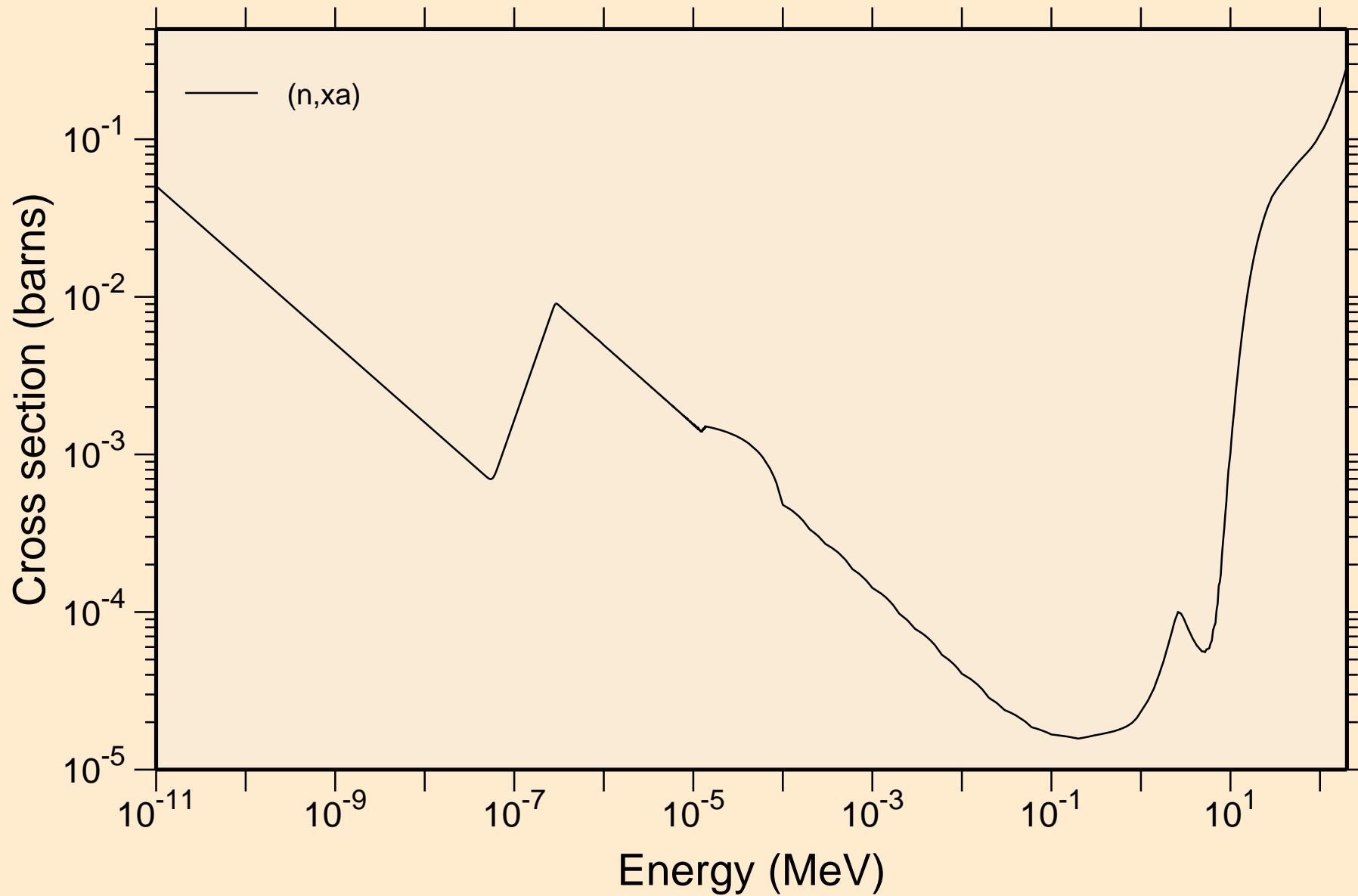

# HG191 NEUTRON ACER TENDL-2024 LIBRARY; T=293.6K

## Principal cross sections

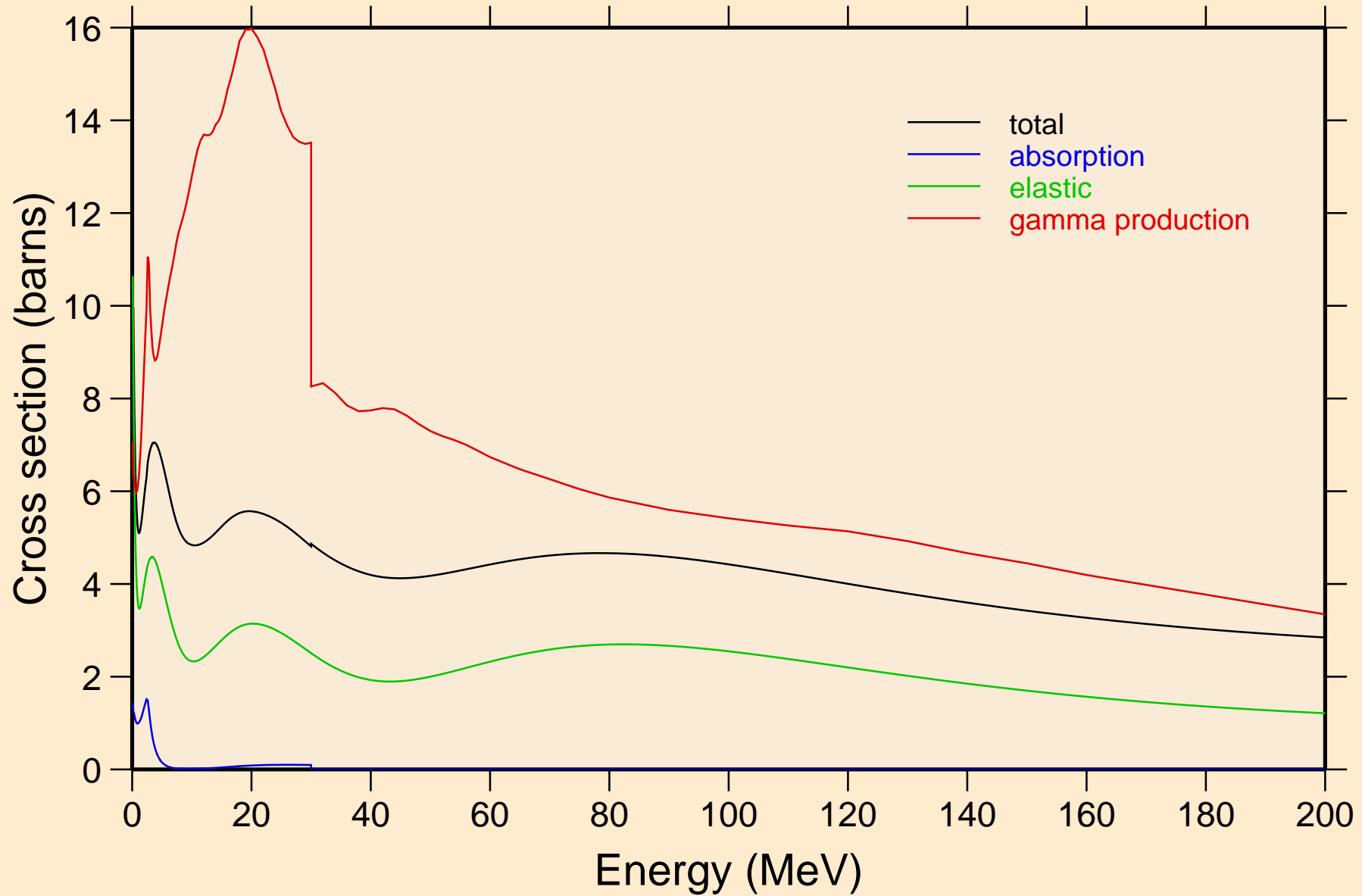

HG191 NEUTRON ACER TENDL-2024 LIBRARY; T=293.6K  
Heating

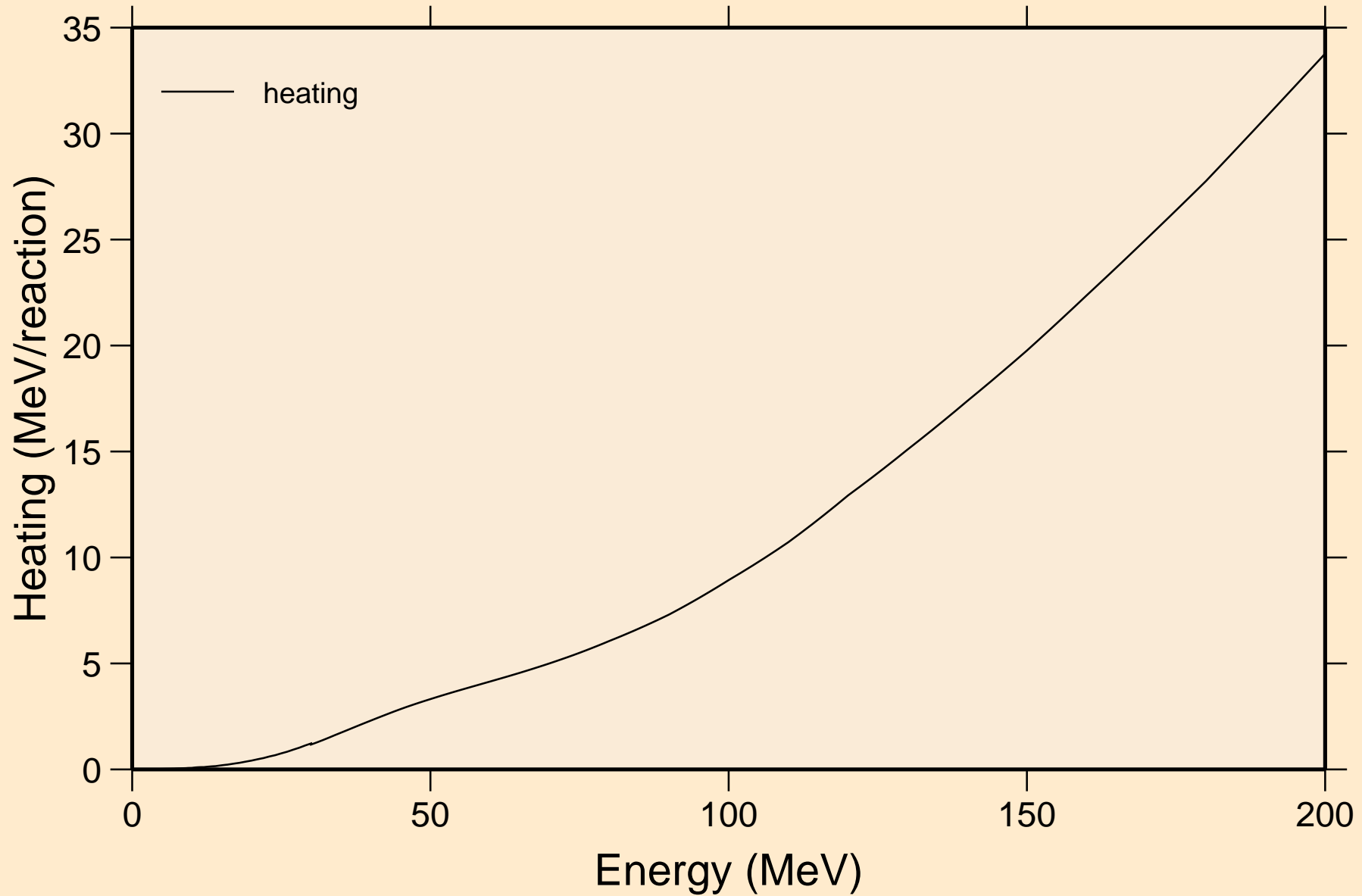

# HG191 NEUTRON ACER TENDL-2024 LIBRARY; T=293.6K

## Damage

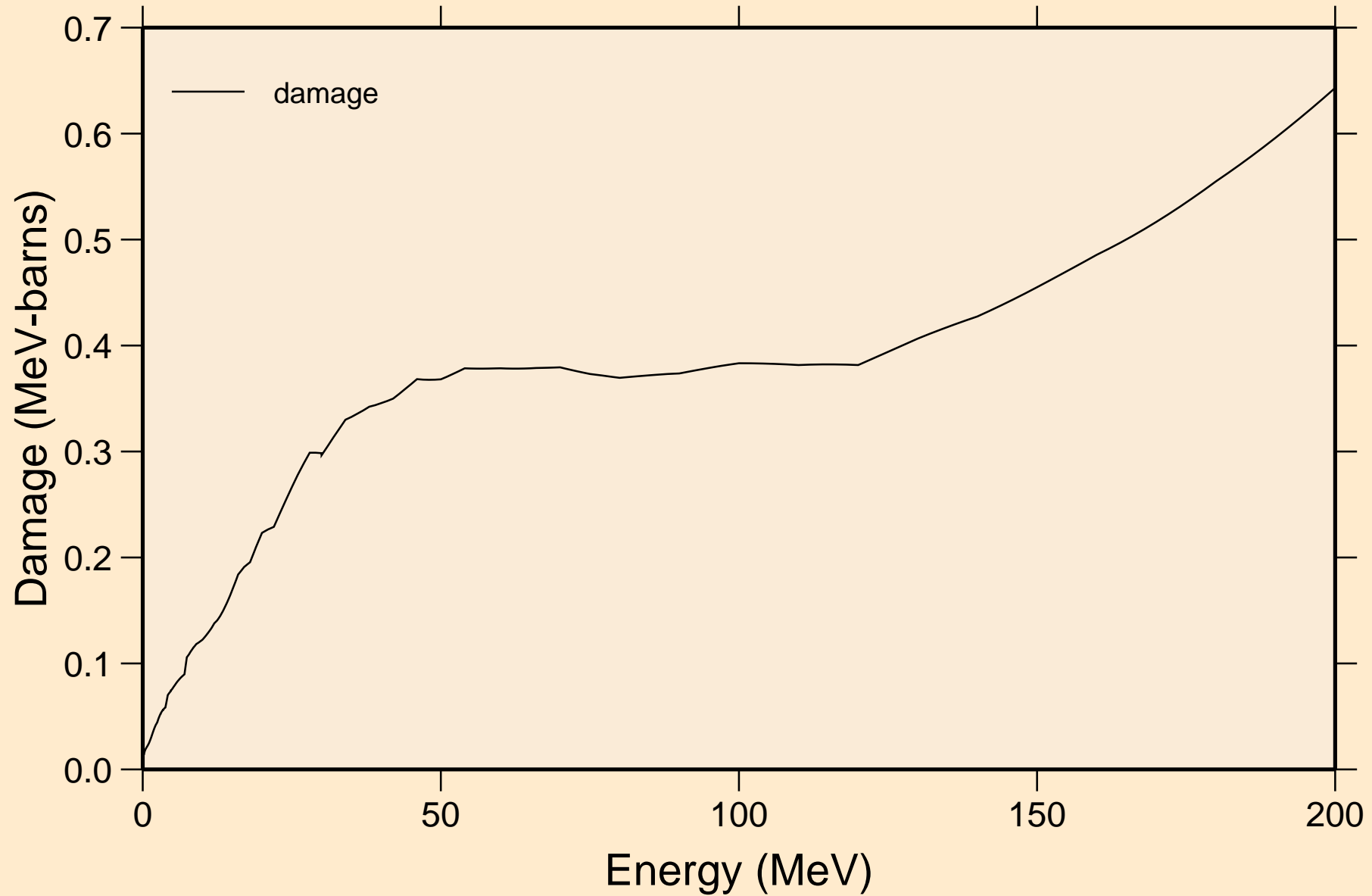

# HG191 NEUTRON ACER TENDL-2024 LIBRARY; T=293.6K

## Non-threshold reactions

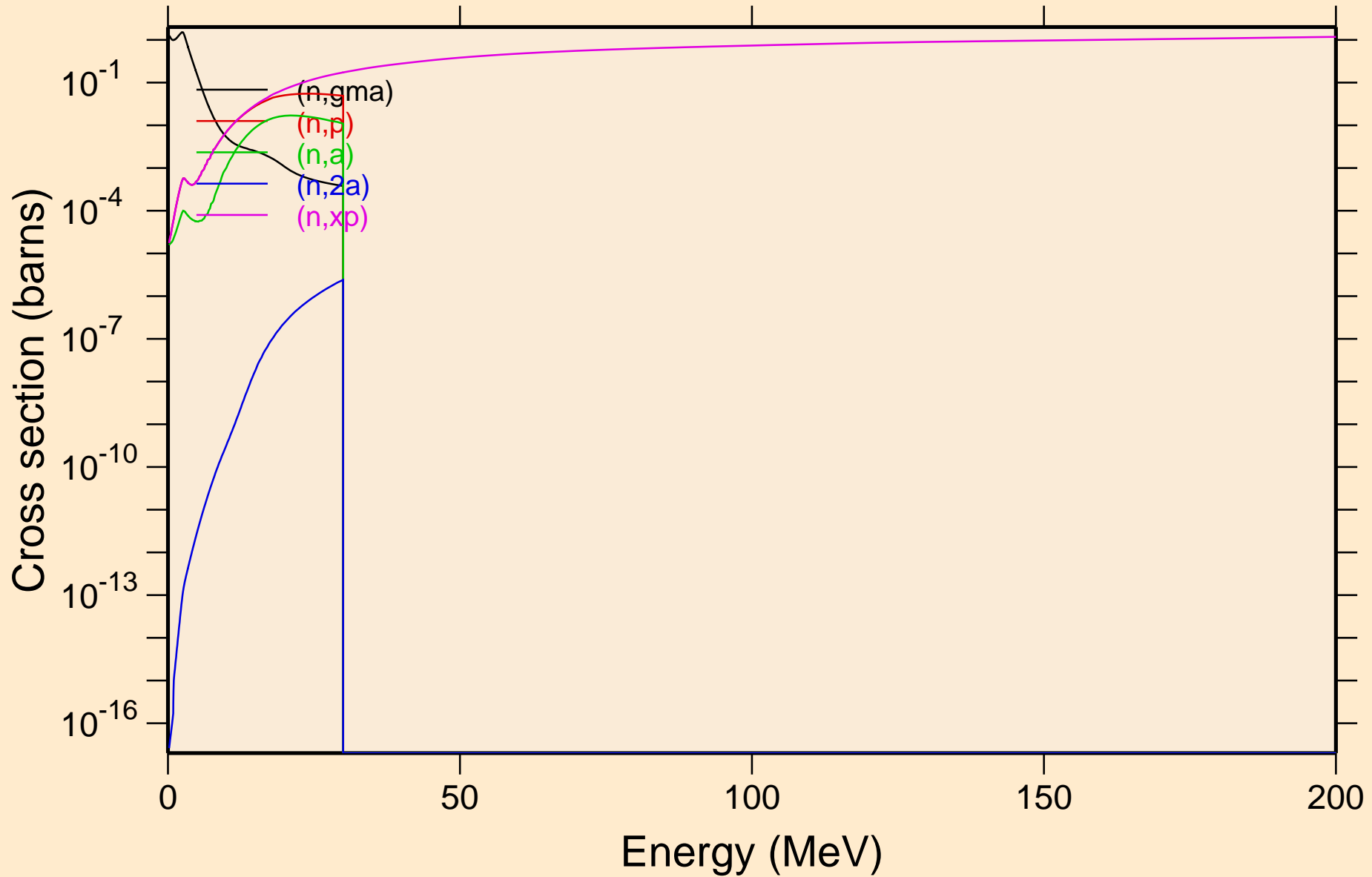

HG191 NEUTRON ACER TENDL-2024 LIBRARY; T=293.6K  
Non-threshold reactions

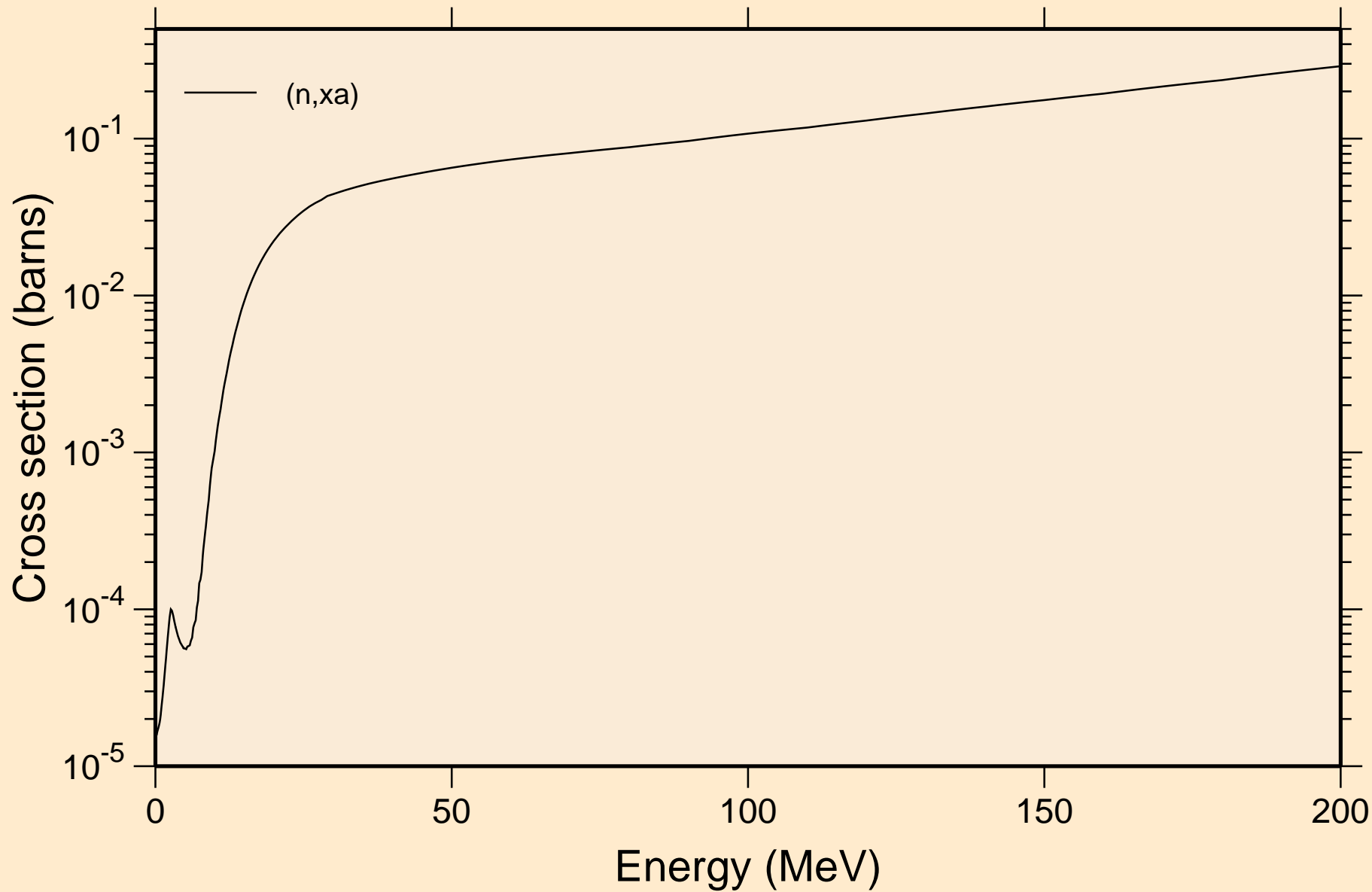

# HG191 NEUTRON ACER TENDL-2024 LIBRARY; T=293.6K

## Inelastic levels

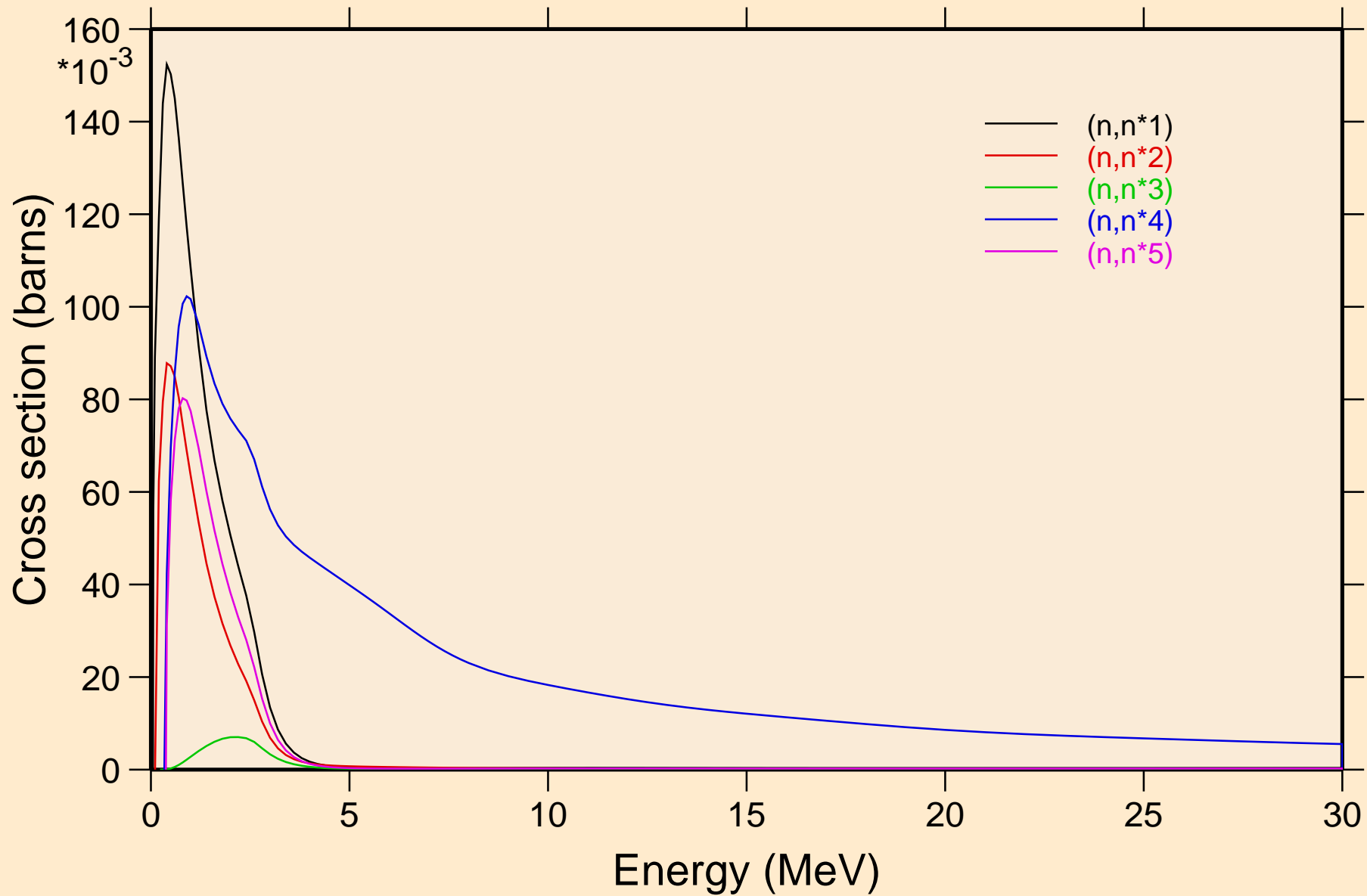

# HG191 NEUTRON ACER TENDL-2024 LIBRARY; T=293.6K

## Inelastic levels

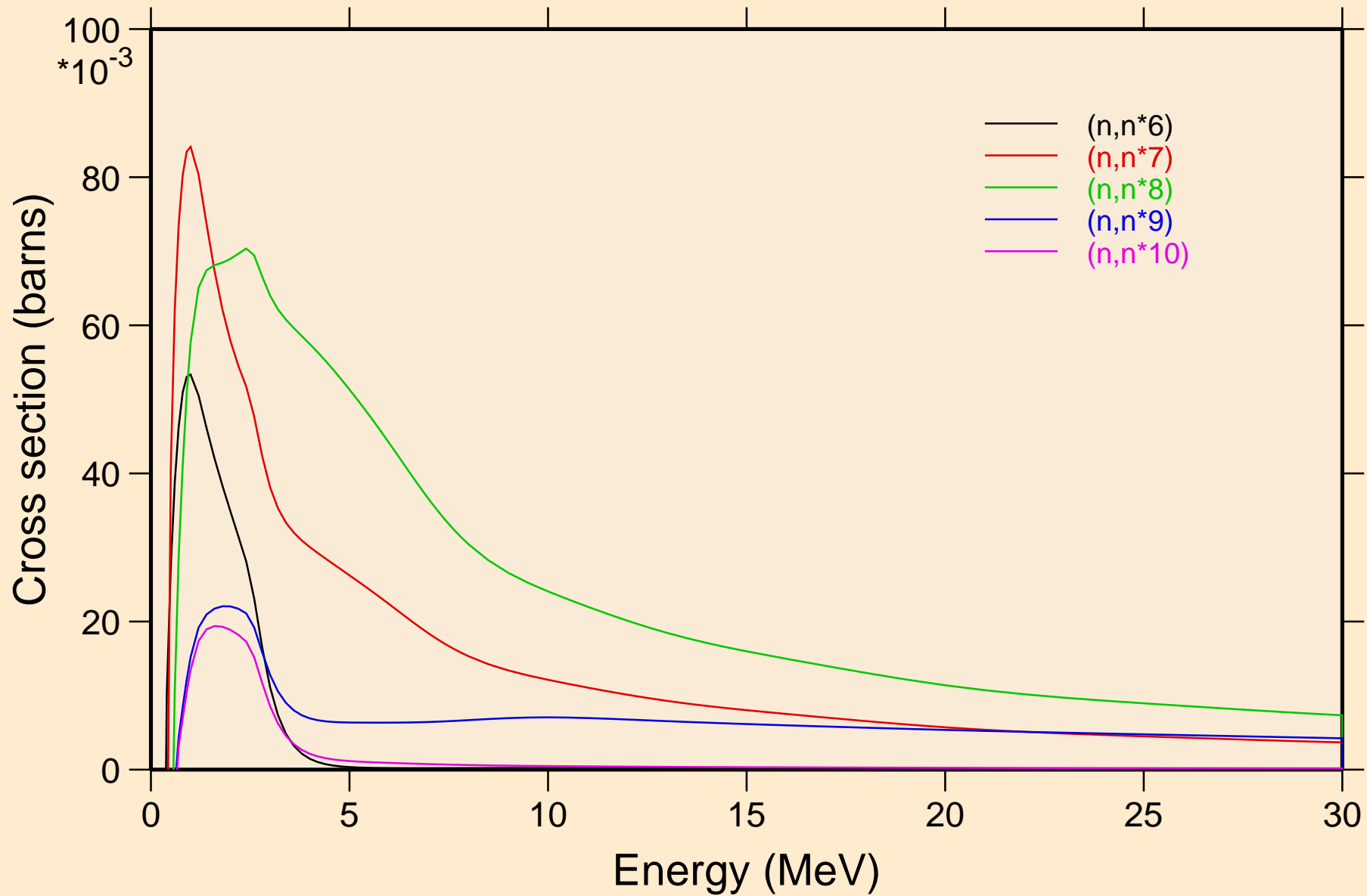

# HG191 NEUTRON ACER TENDL-2024 LIBRARY; T=293.6K

## Inelastic levels

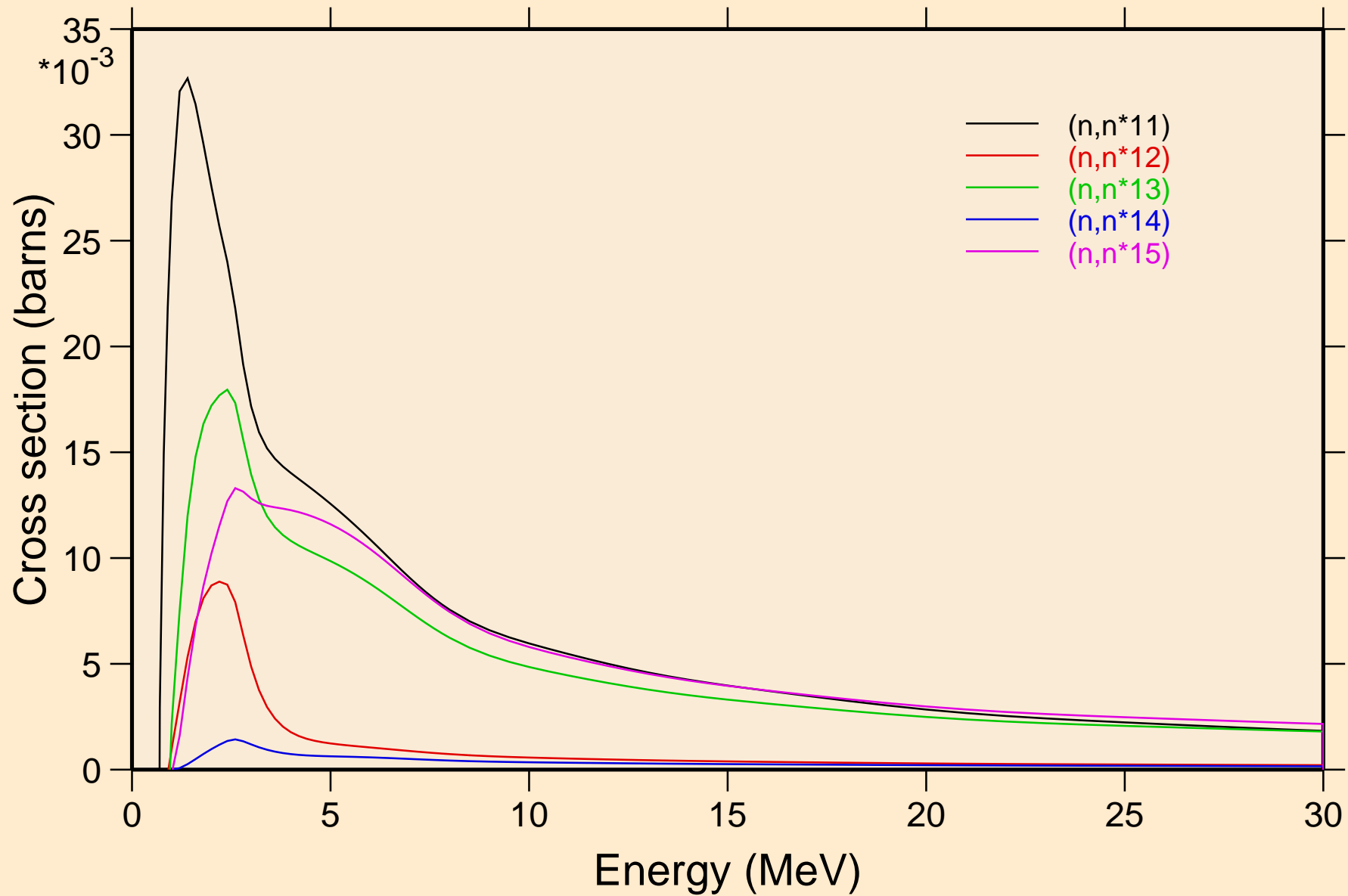

HG191 NEUTRON ACER TENDL-2024 LIBRARY; T=293.6K  
Inelastic levels

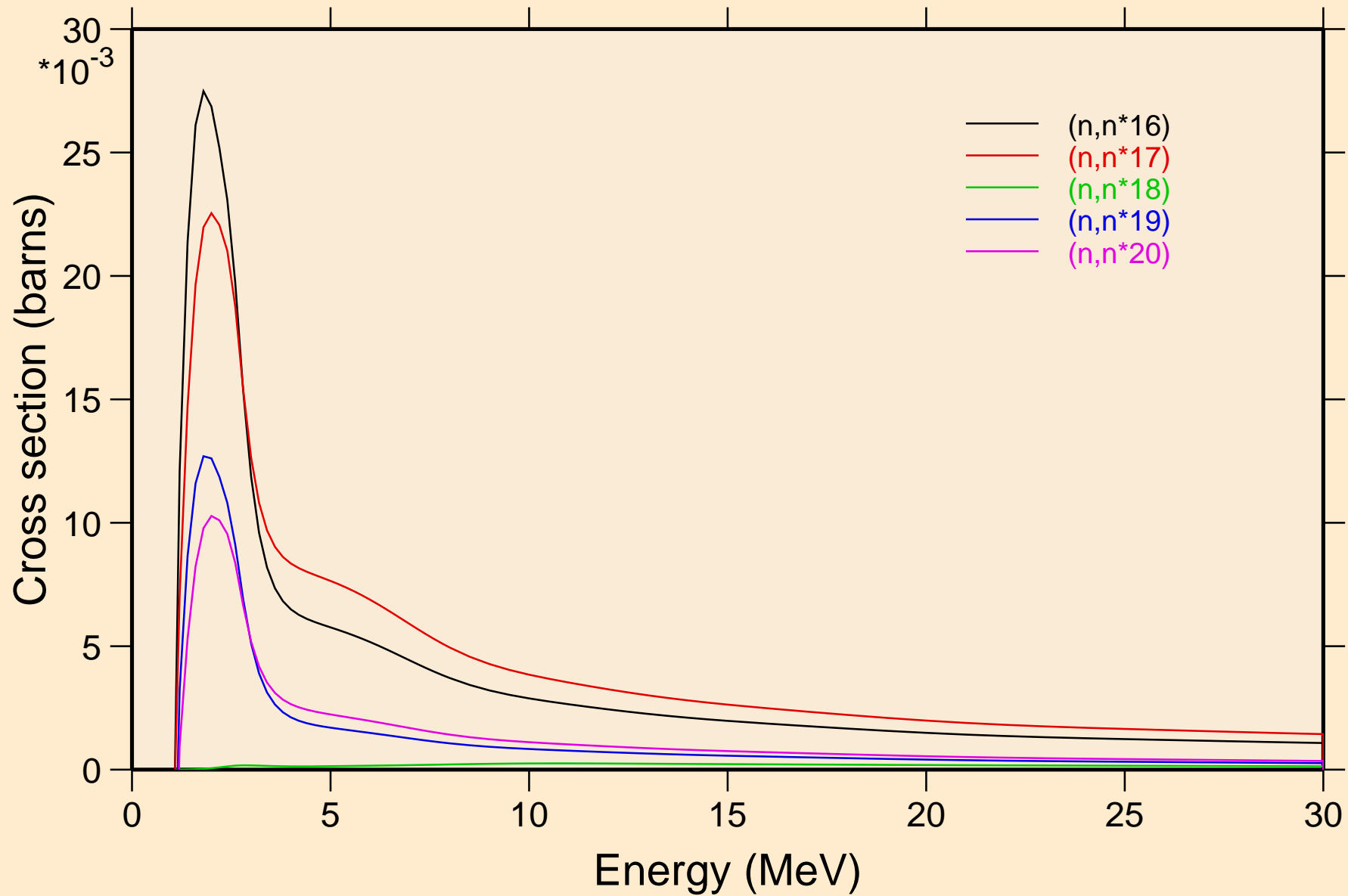

HG191 NEUTRON ACER TENDL-2024 LIBRARY; T=293.6K  
Inelastic levels

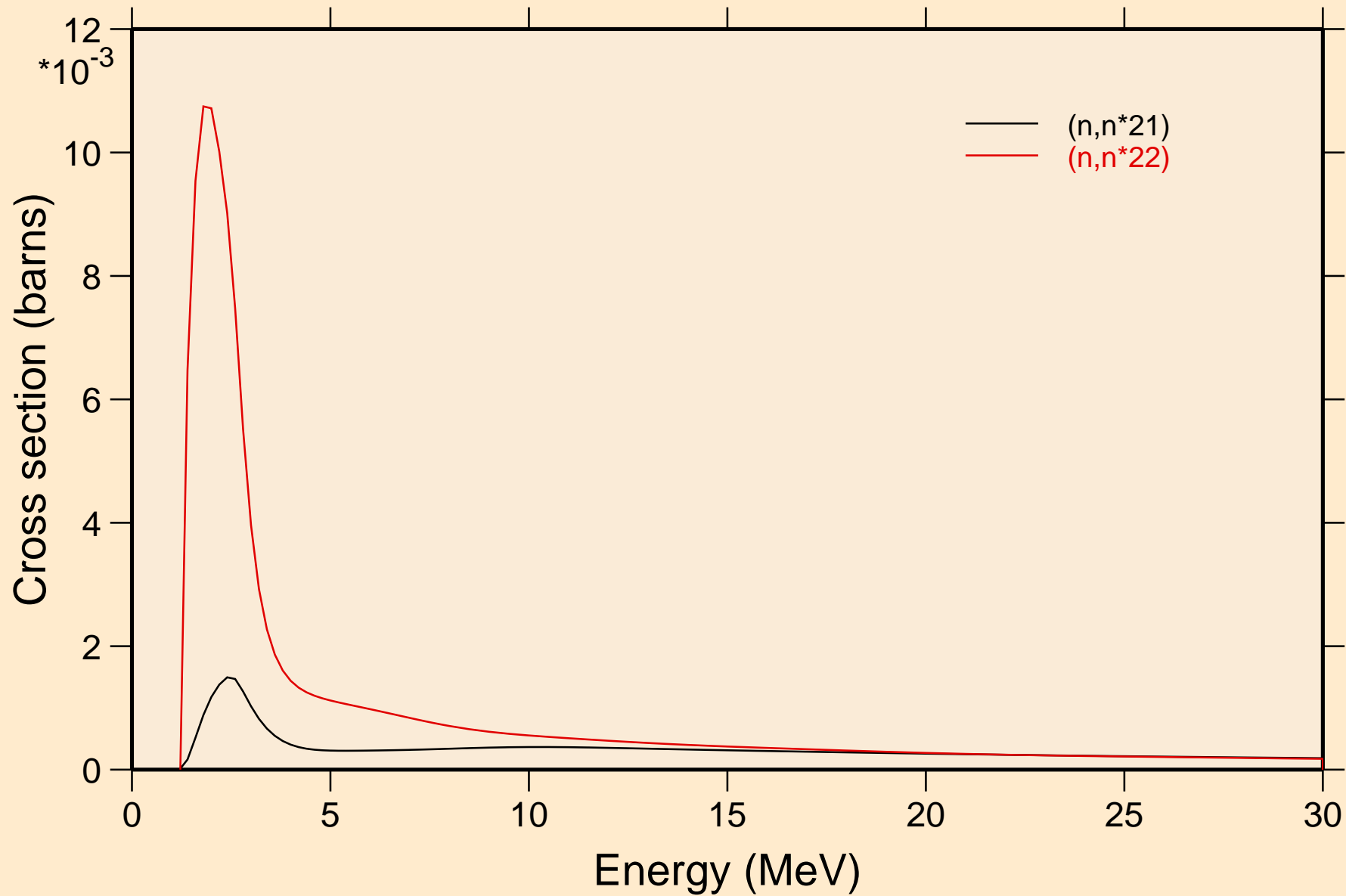

# HG191 NEUTRON ACER TENDL-2024 LIBRARY; T=293.6K

## Threshold reactions

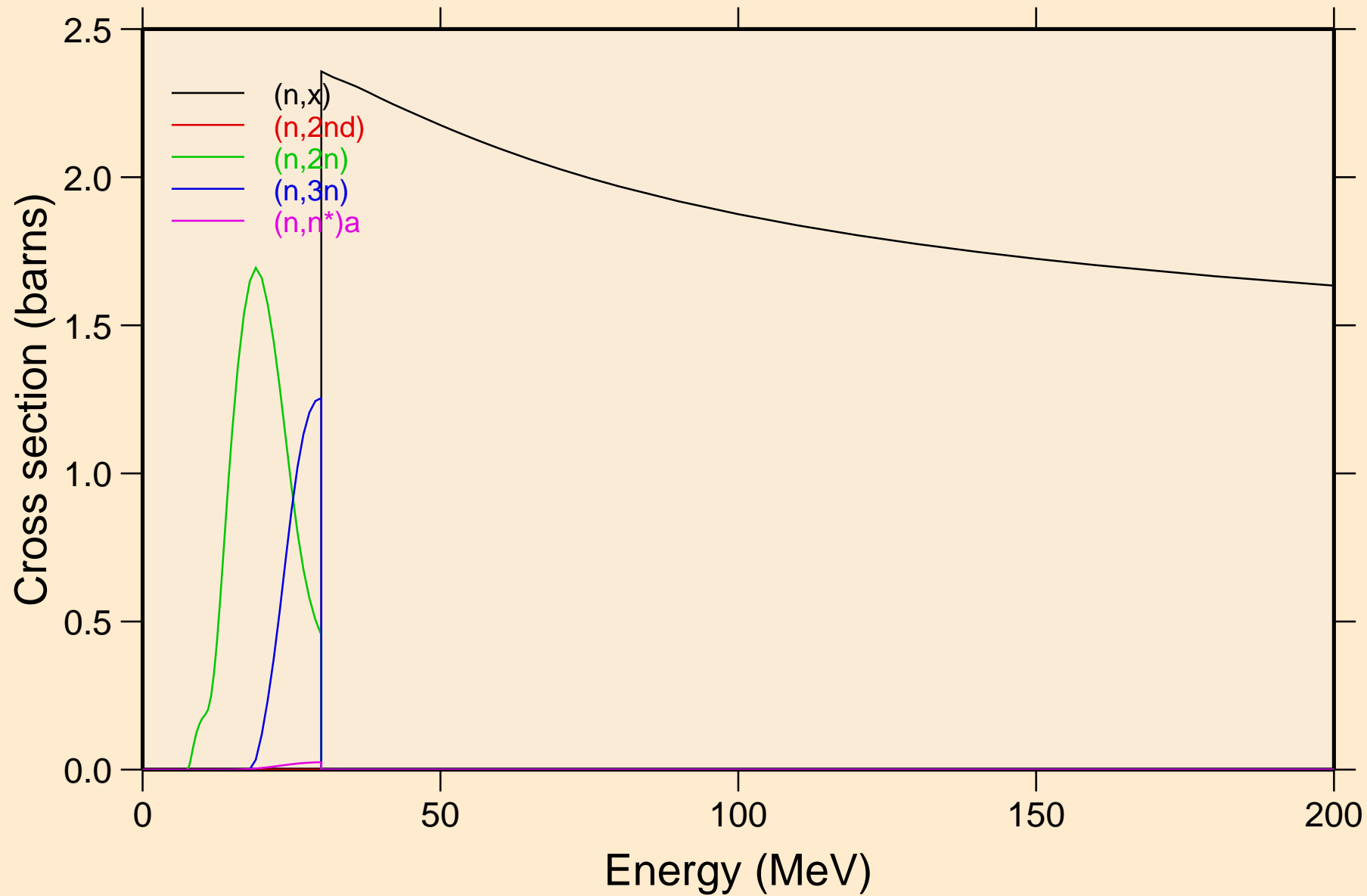

# HG191 NEUTRON ACER TENDL-2024 LIBRARY; T=293.6K

## Threshold reactions

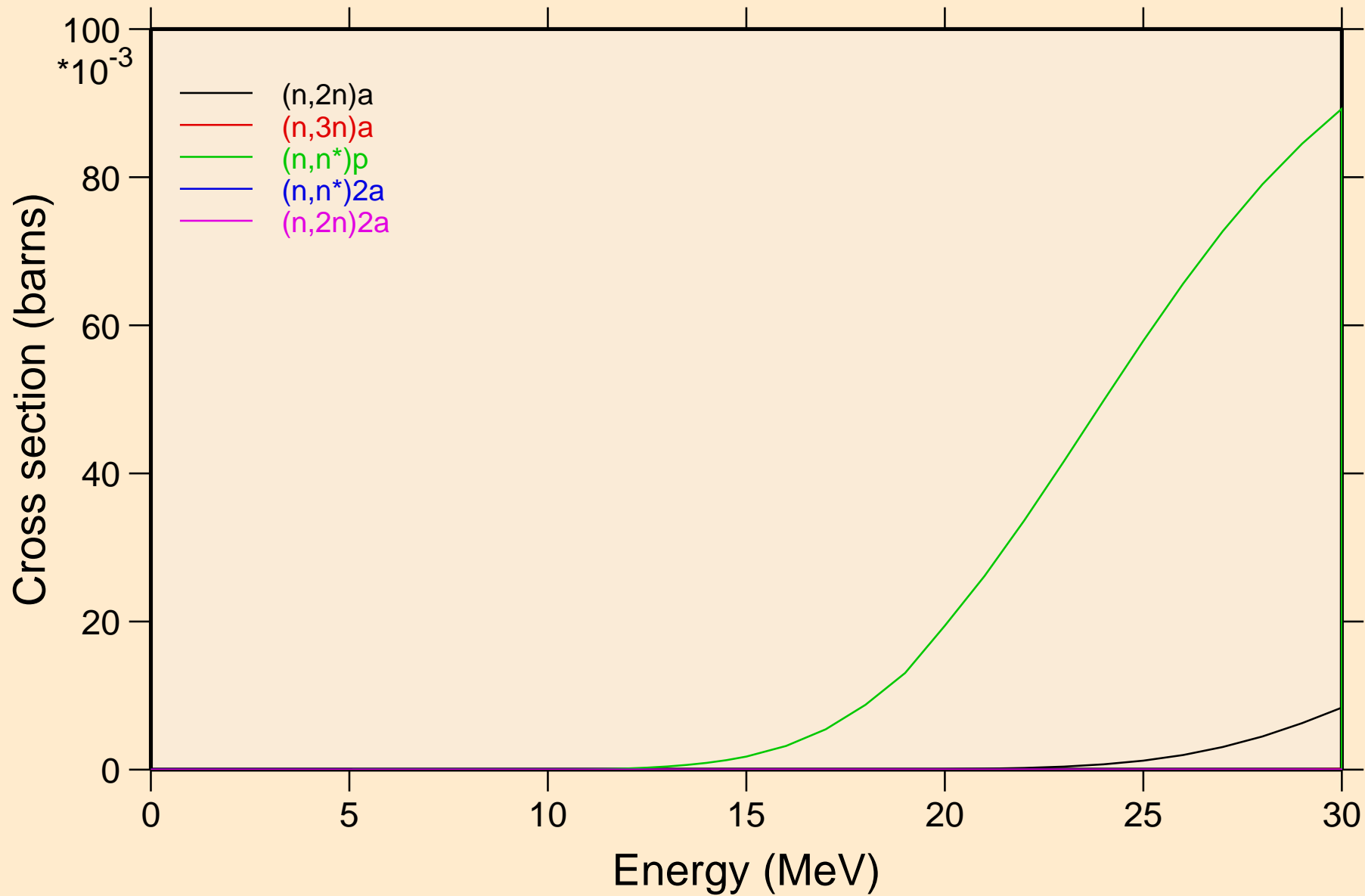

# HG191 NEUTRON ACER TENDL-2024 LIBRARY; T=293.6K

## Threshold reactions

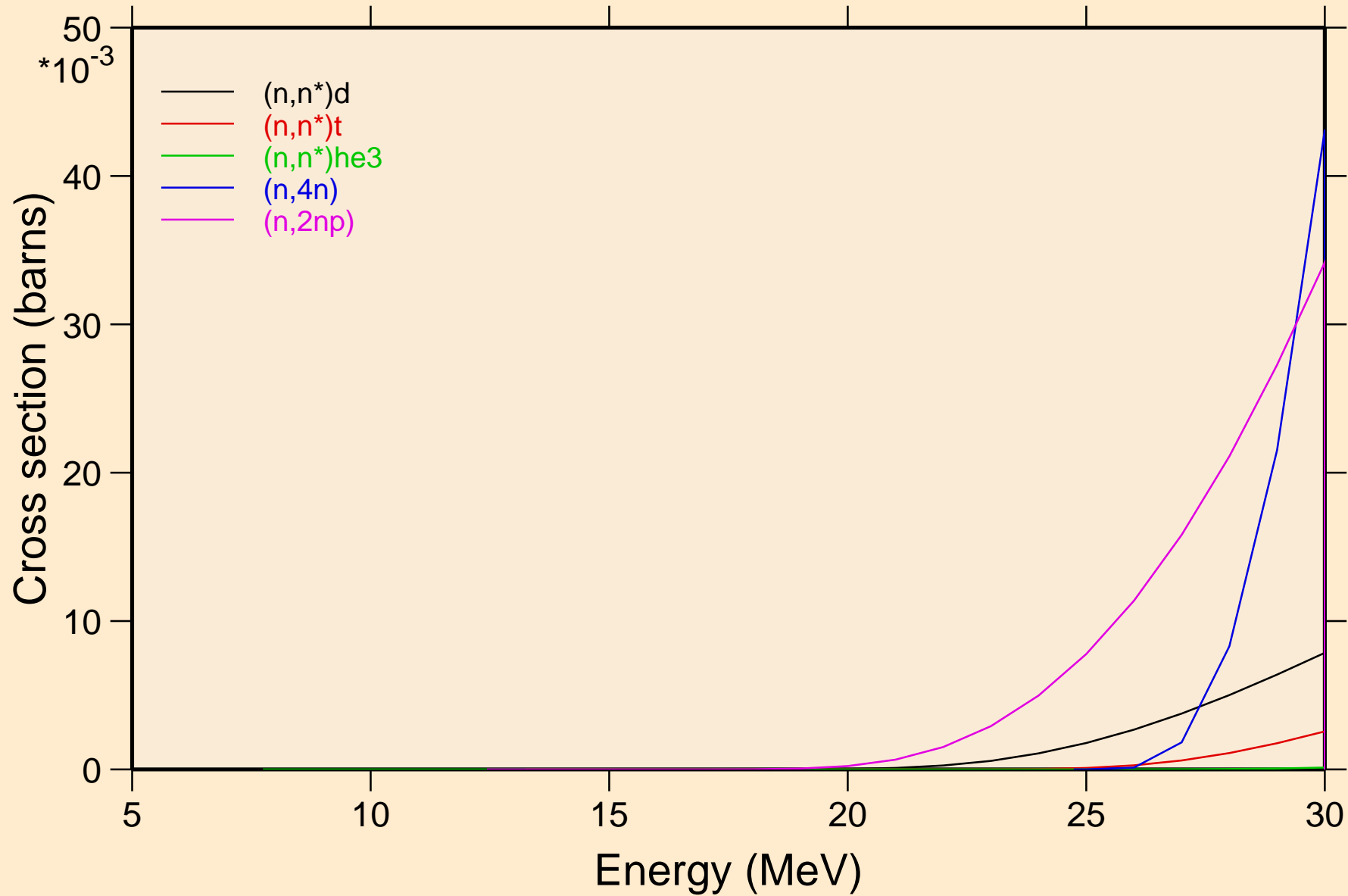

# HG191 NEUTRON ACER TENDL-2024 LIBRARY; T=293.6K

## Threshold reactions

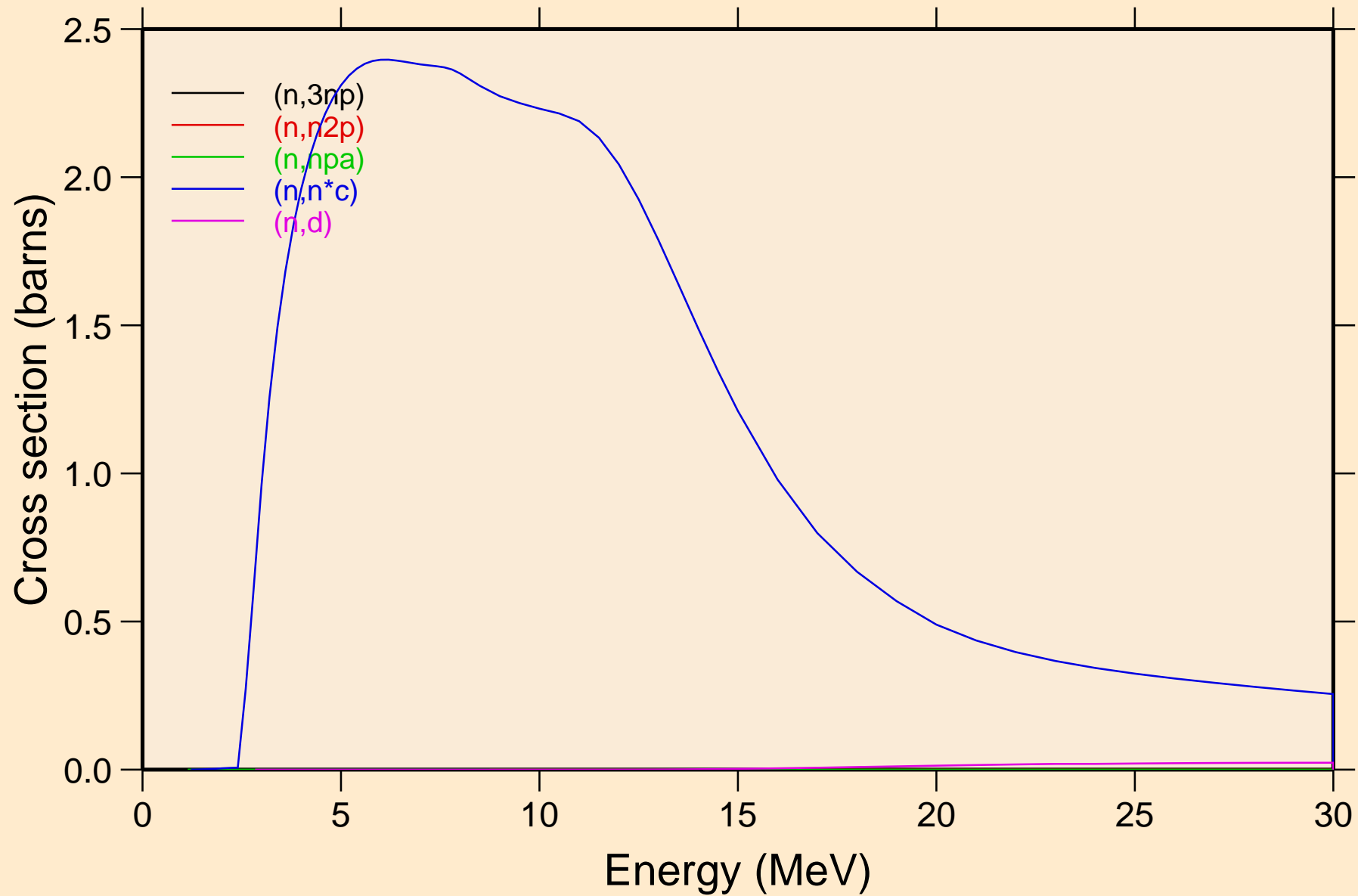

# HG191 NEUTRON ACER TENDL-2024 LIBRARY; T=293.6K

## Threshold reactions

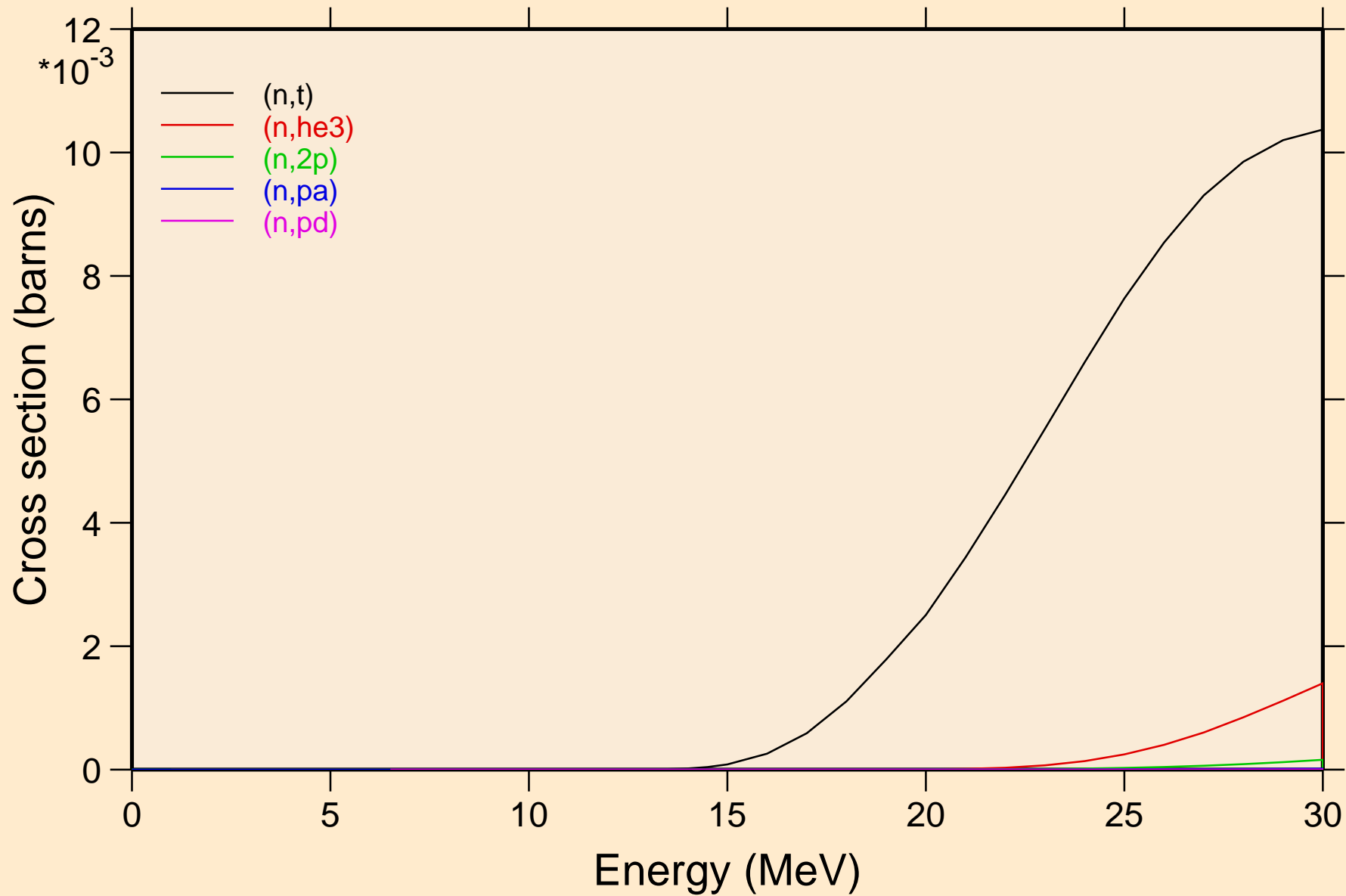

HG191 NEUTRON ACER TENDL-2024 LIBRARY; T=293.6K  
Threshold reactions

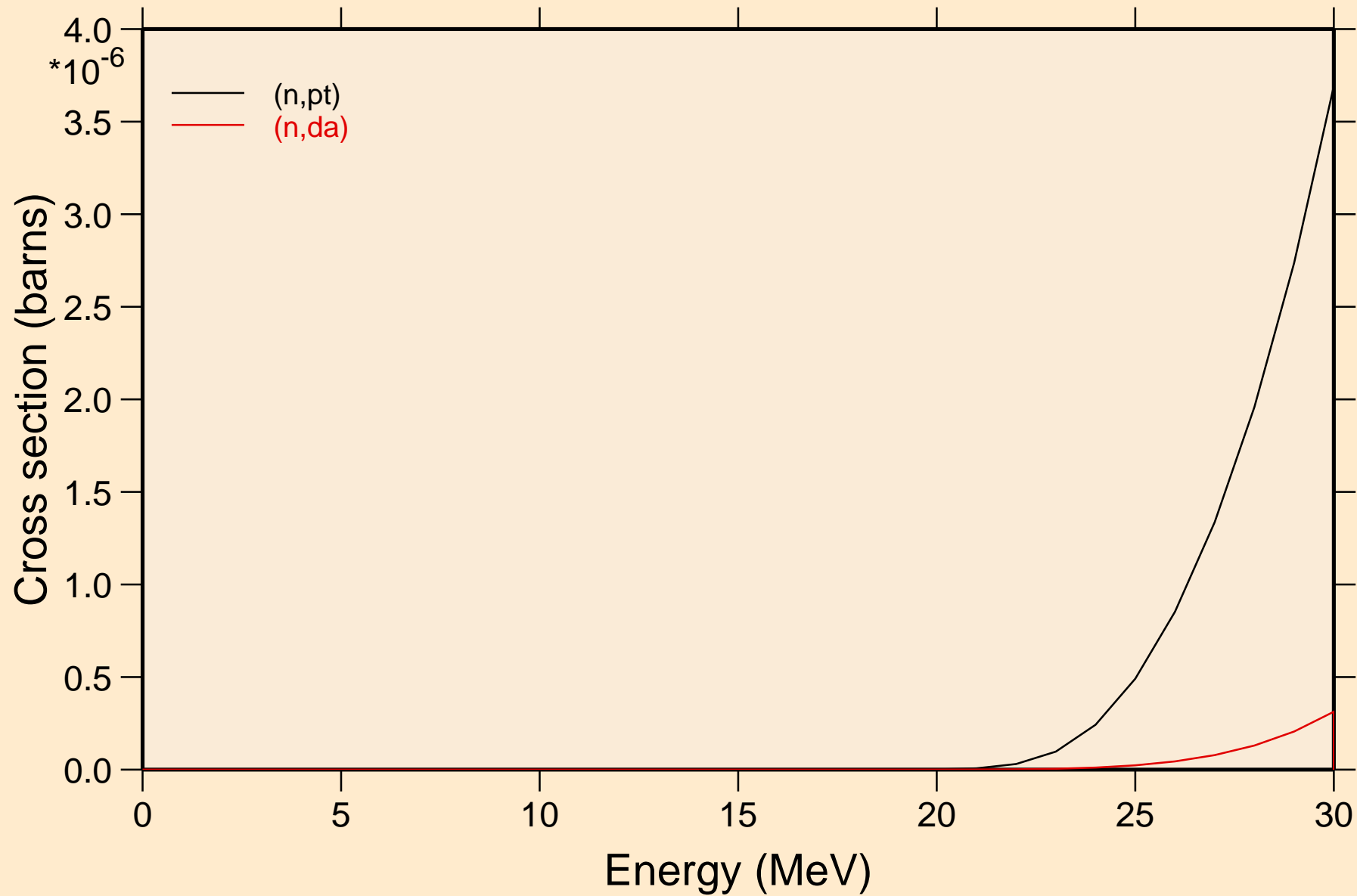

# HG191 NEUTRON ACER TENDL-2024 LIBRARY; T=293.6K

## Threshold reactions

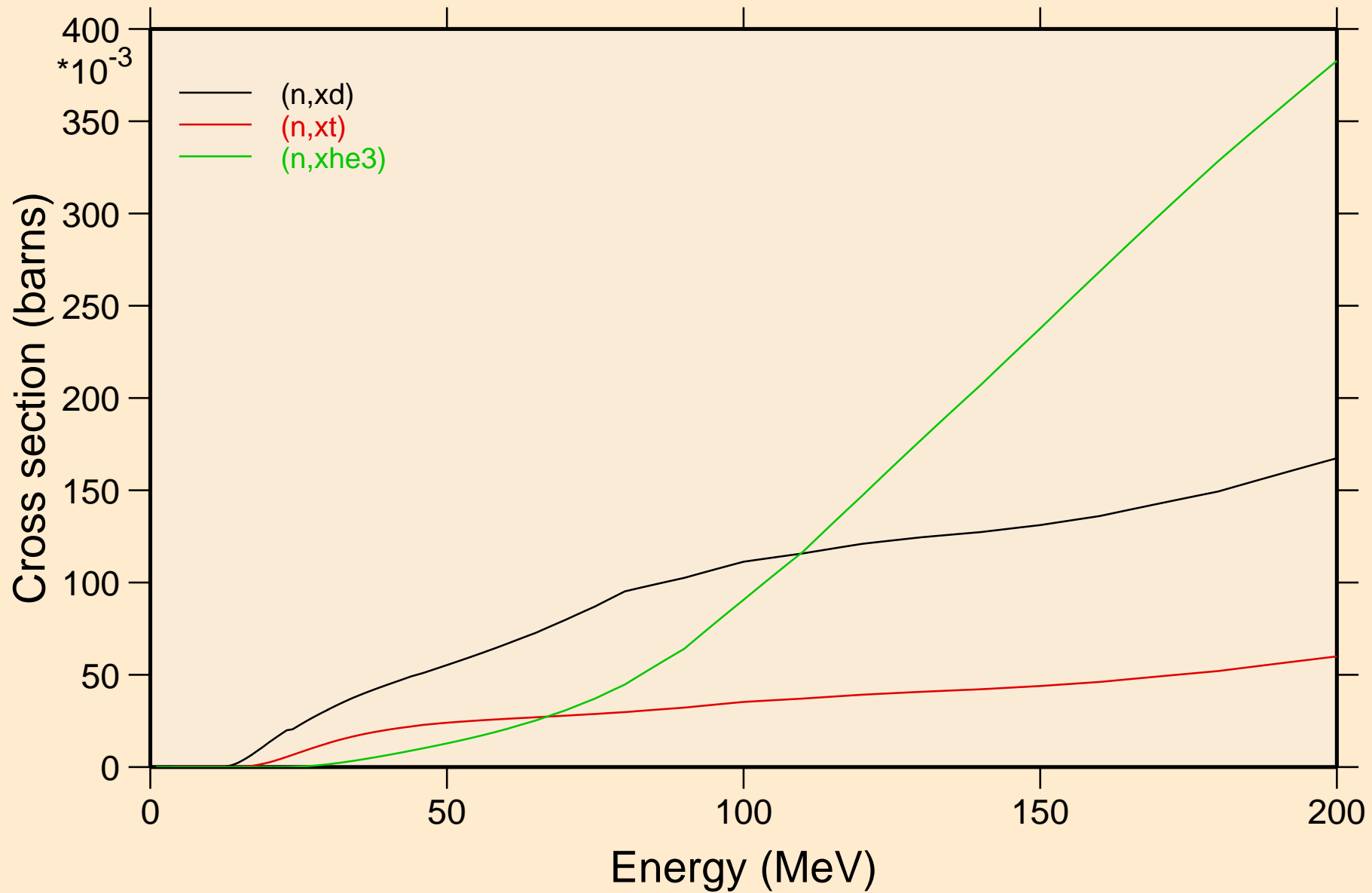

HG191 NEUTRON ACER TENDL-2024 LIBRARY; T=293.6K  
angular distribution for elastic

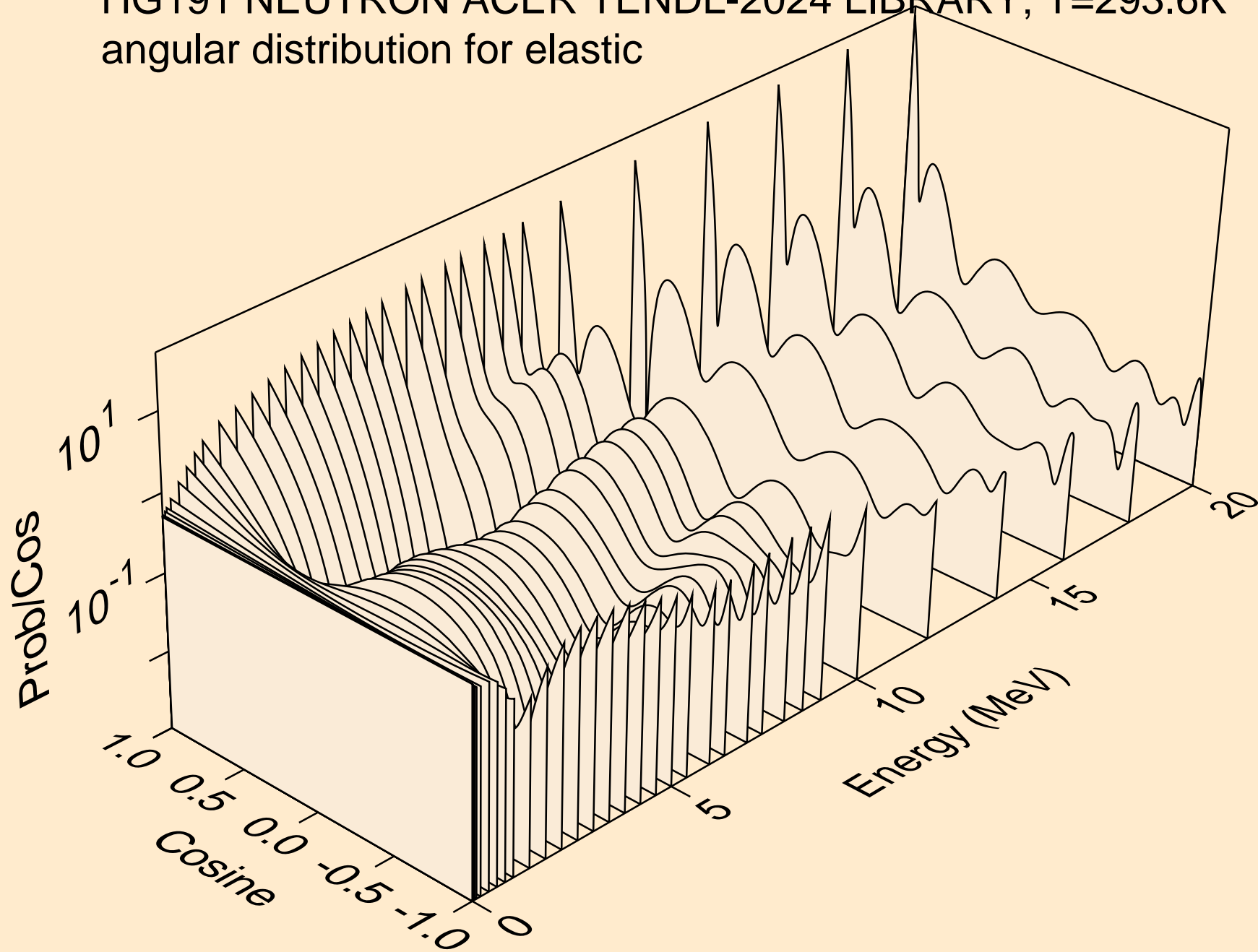

HG191 NEUTRON ACER TENDL-2024 LIBRARY; T=293.6K  
angular distribution for elastic

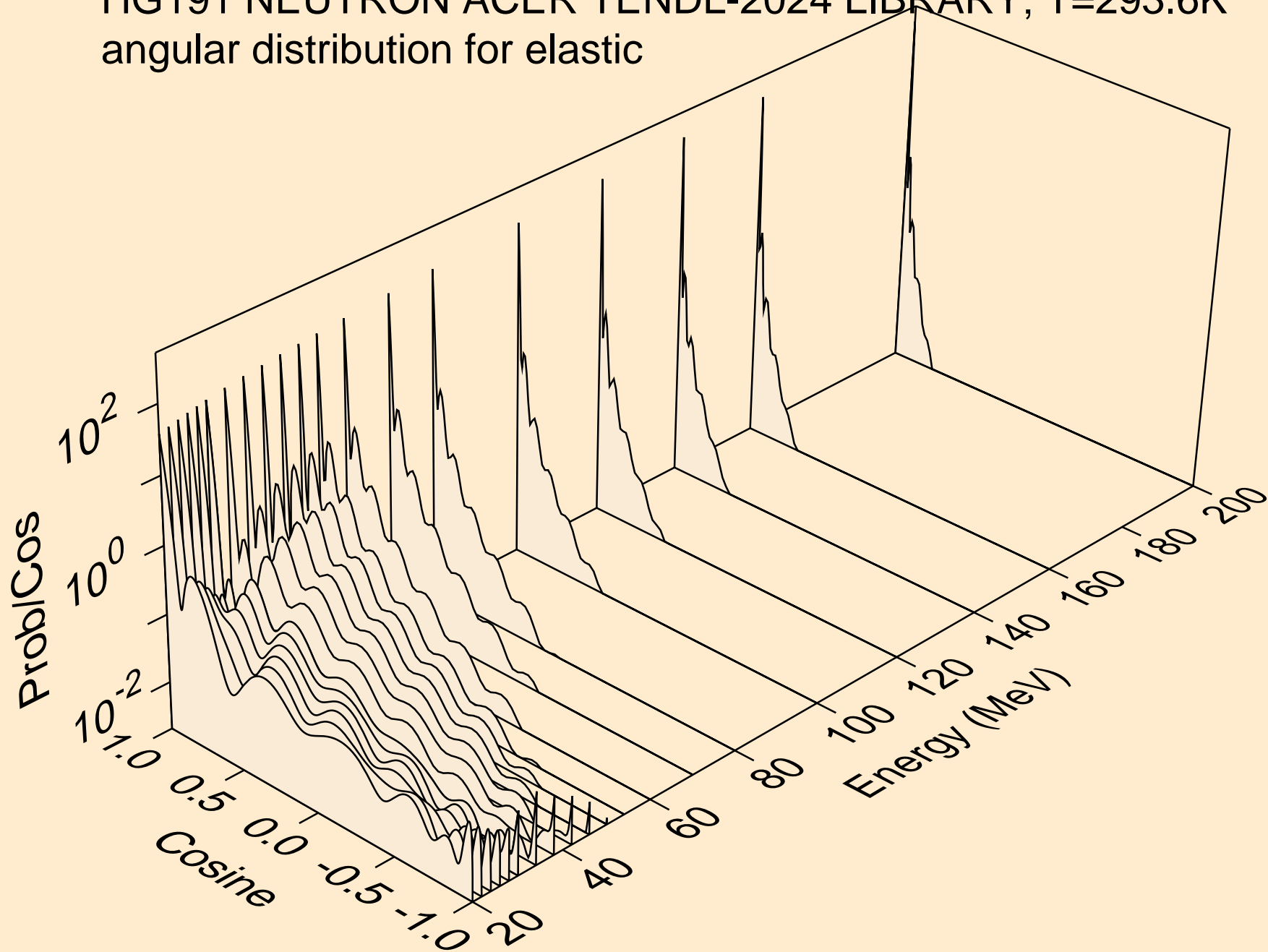

HG191 NEUTRON ACER TENDL-2024 LIBRARY; T=293.6K  
angular distribution for (n,n\*1)

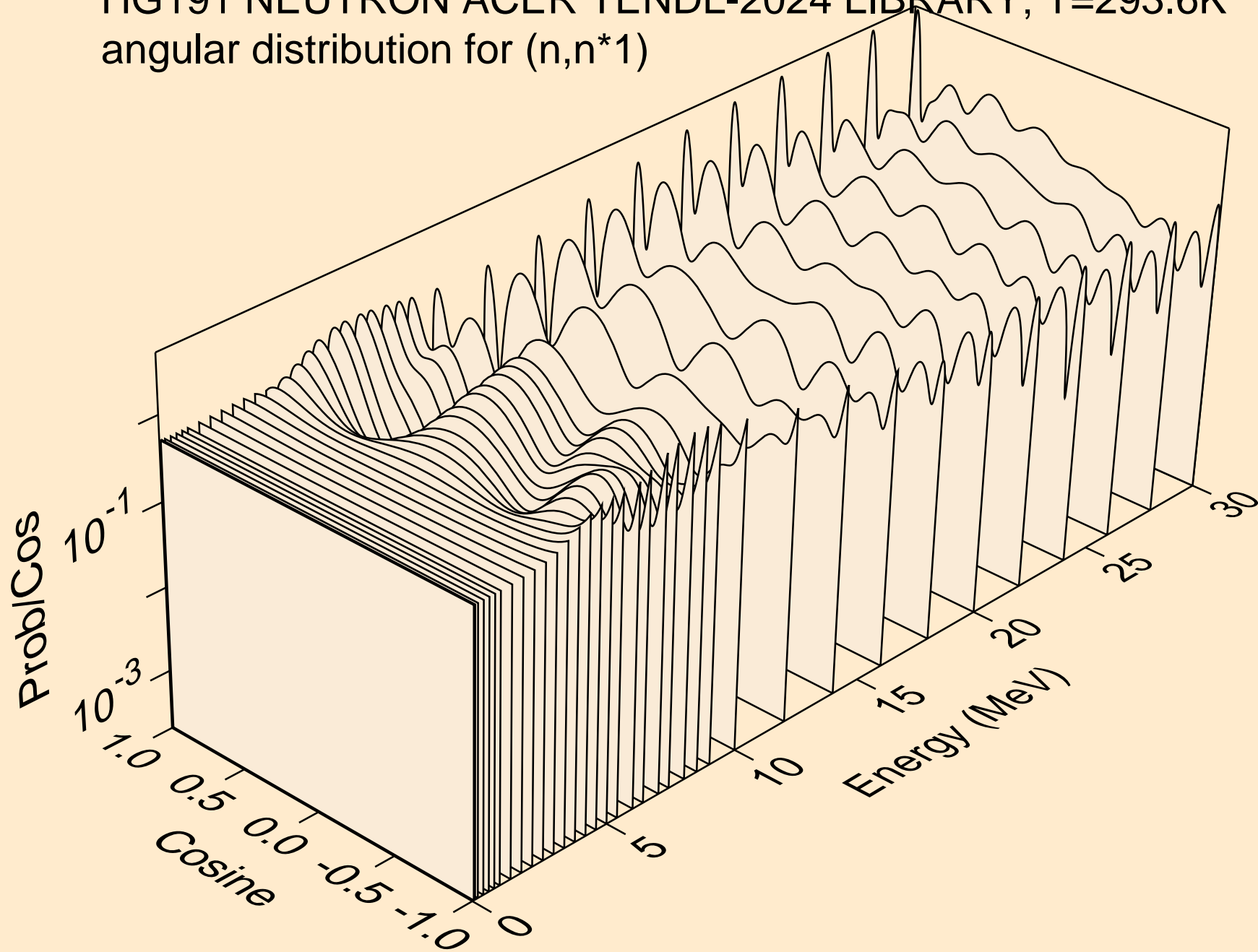

HG191 NEUTRON ACER TENDL-2024 LIBRARY; T=293.6K  
angular distribution for (n,n\*2)

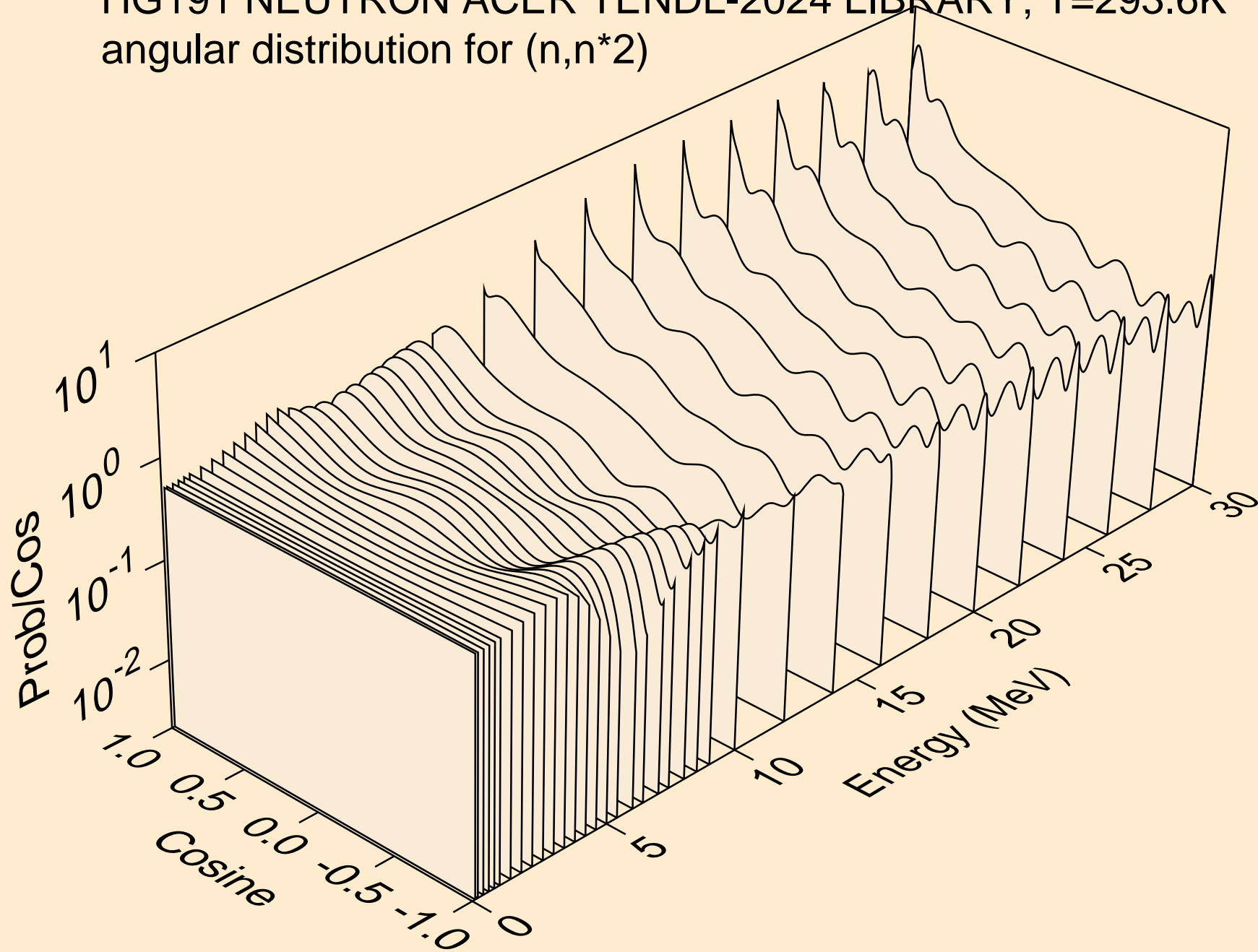

HG191 NEUTRON ACER TENDL-2024 LIBRARY; T=293.6K  
angular distribution for (n,n\*3)

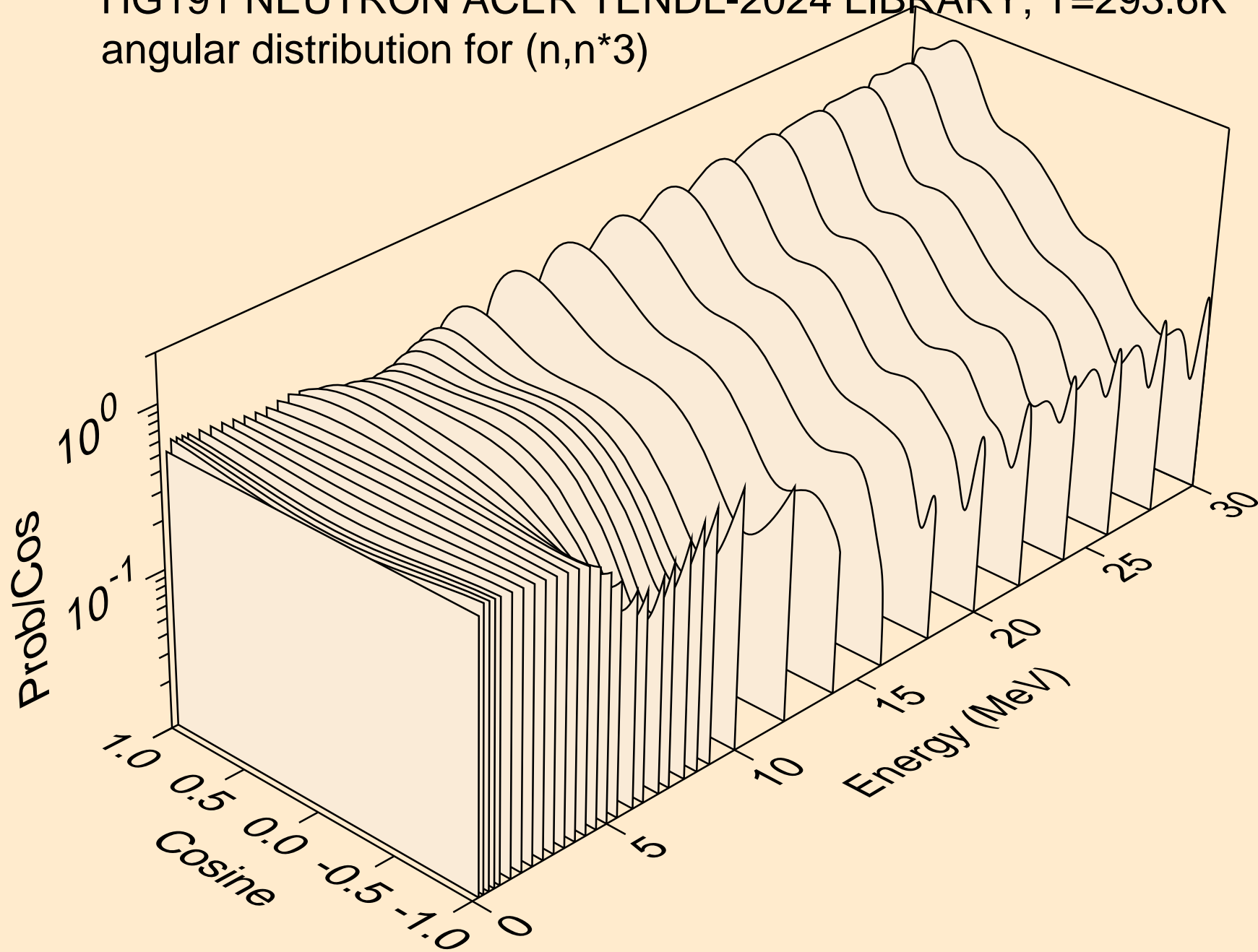

HG191 NEUTRON ACER TENDL-2024 LIBRARY; T=293.6K  
angular distribution for (n,n\*4)

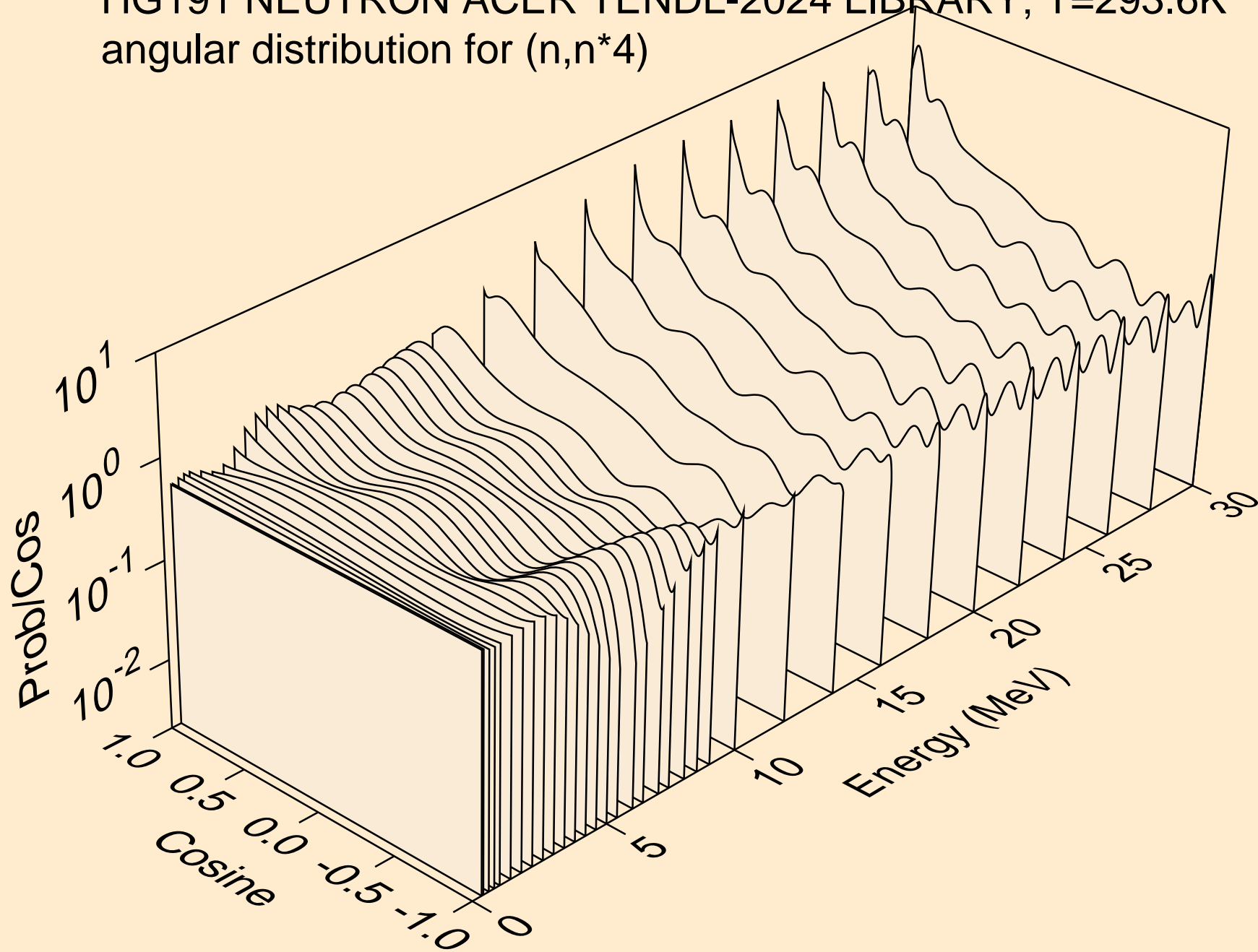

HG191 NEUTRON ACER TENDL-2024 LIBRARY; T=293.6K  
angular distribution for (n,n\*5)

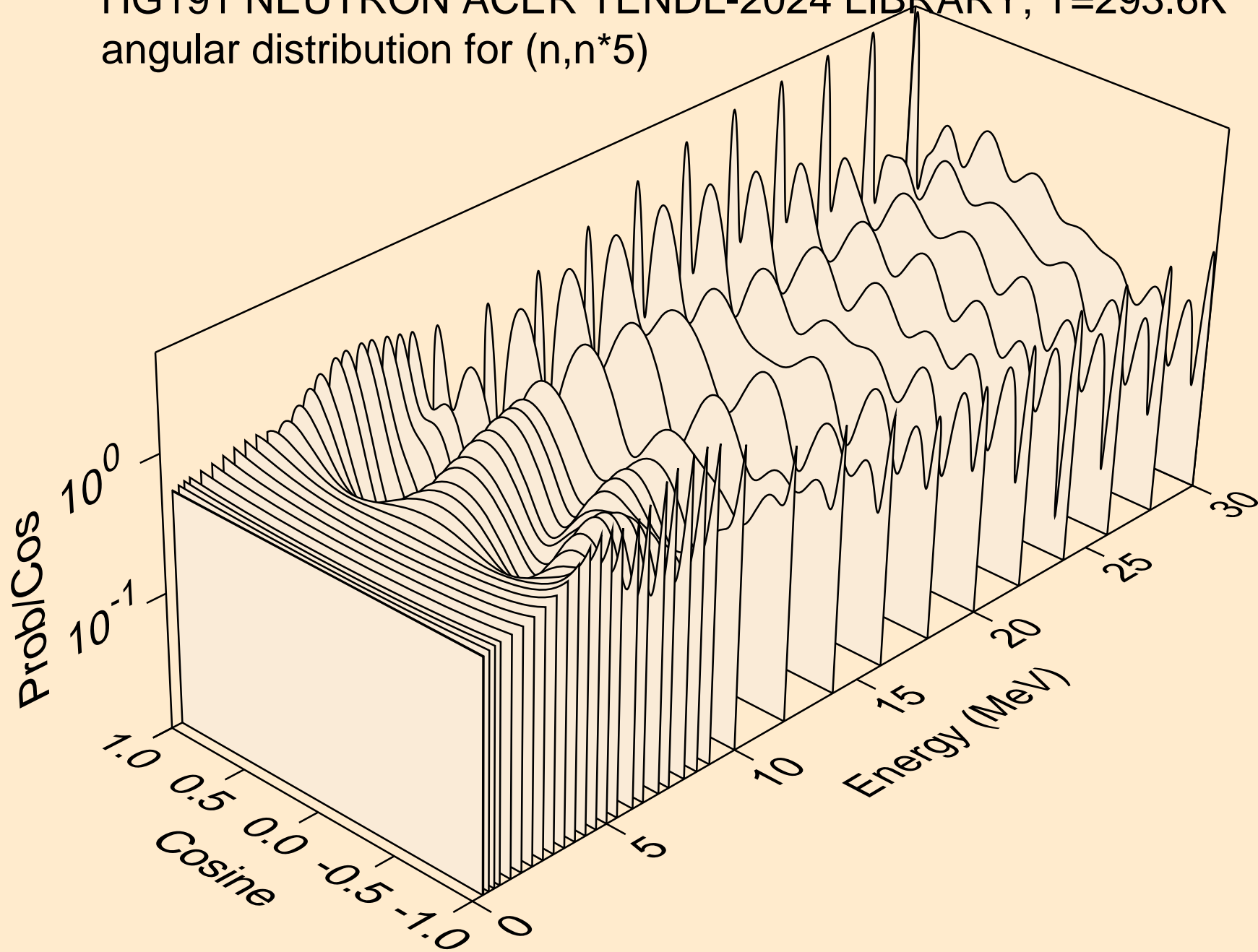

HG191 NEUTRON ACER TENDL-2024 LIBRARY; T=293.6K  
angular distribution for (n,n\*6)

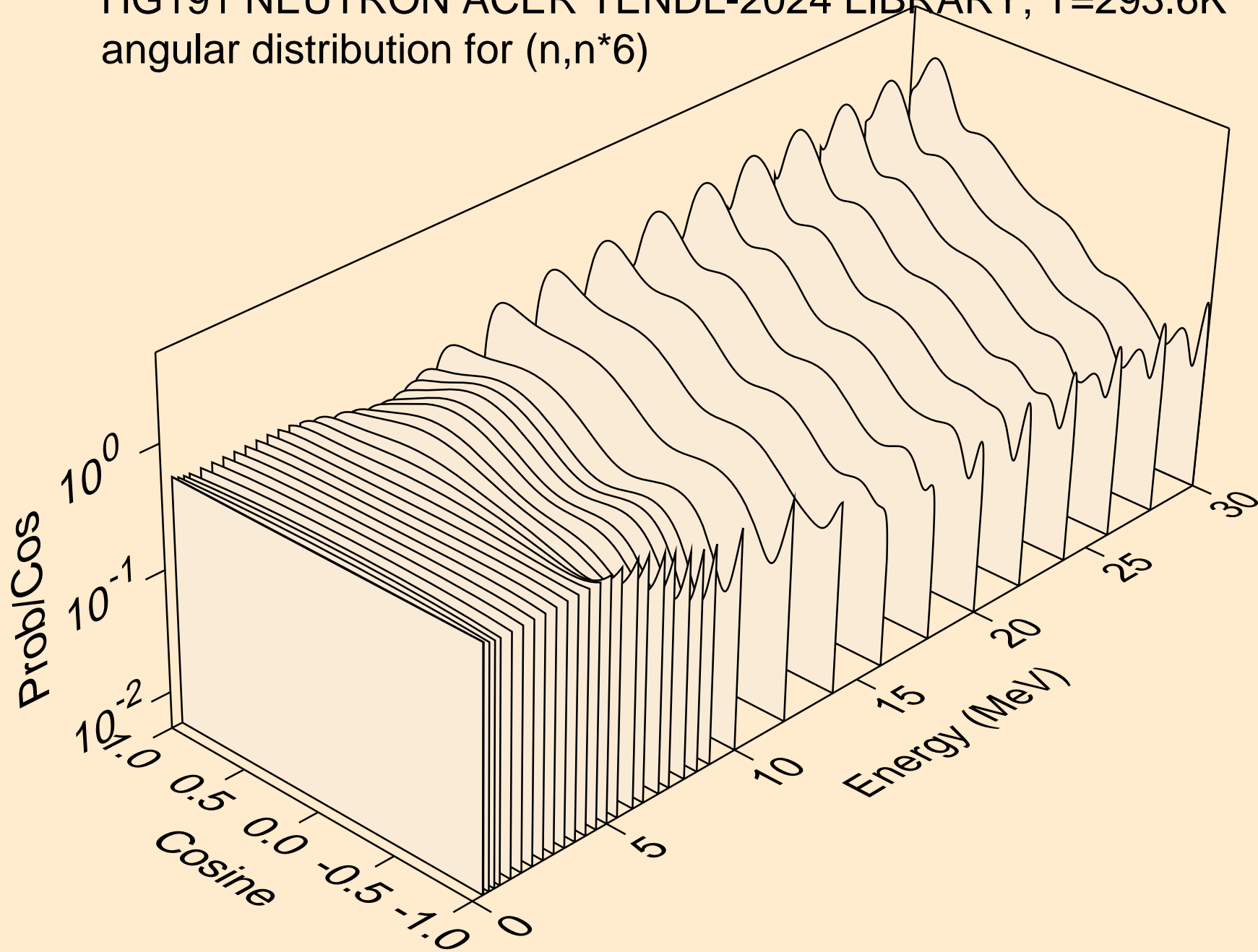

HG191 NEUTRON ACER TENDL-2024 LIBRARY; T=293.6K  
angular distribution for (n,n\*7)

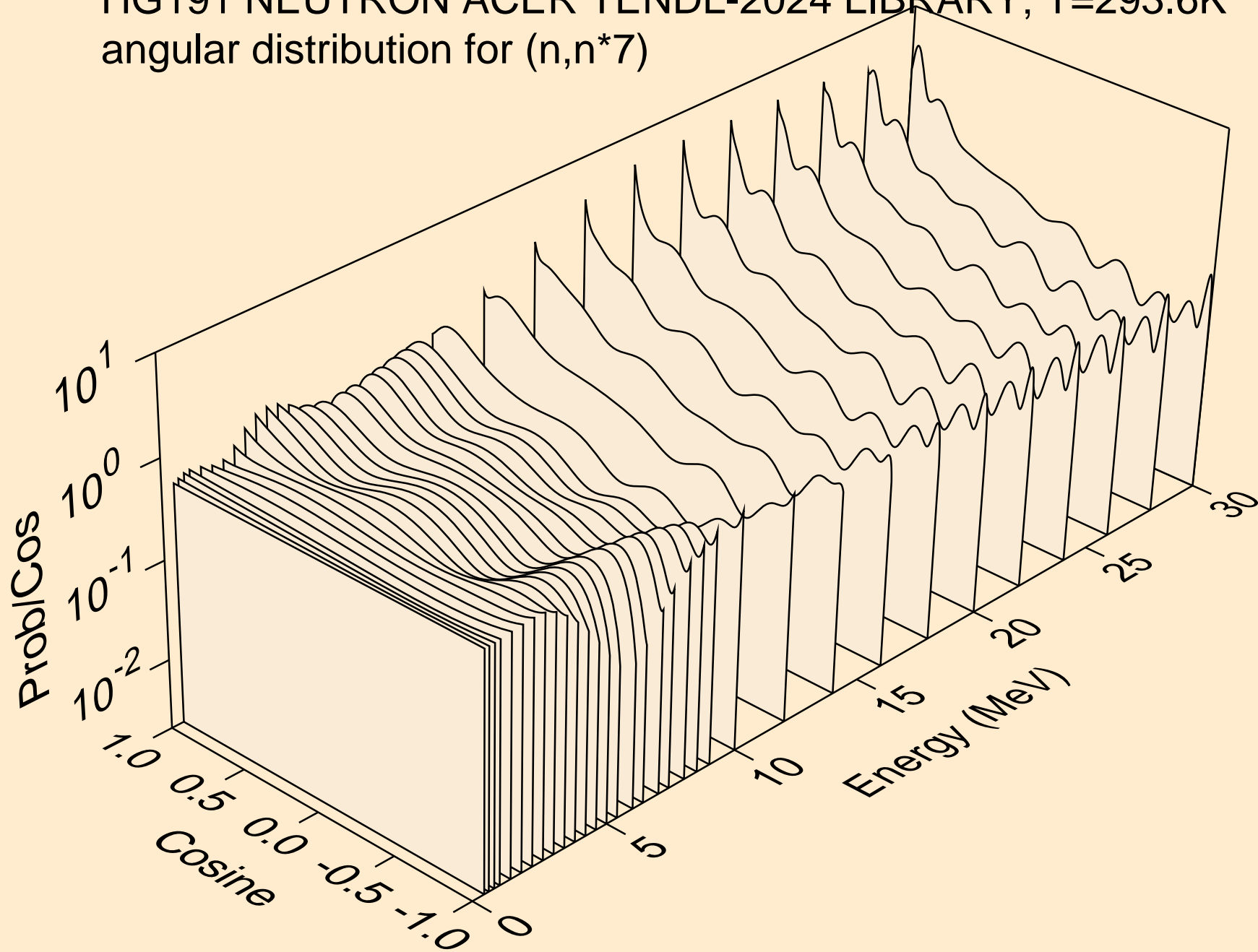

HG191 NEUTRON ACER TENDL-2024 LIBRARY; T=293.6K  
angular distribution for (n,n\*8)

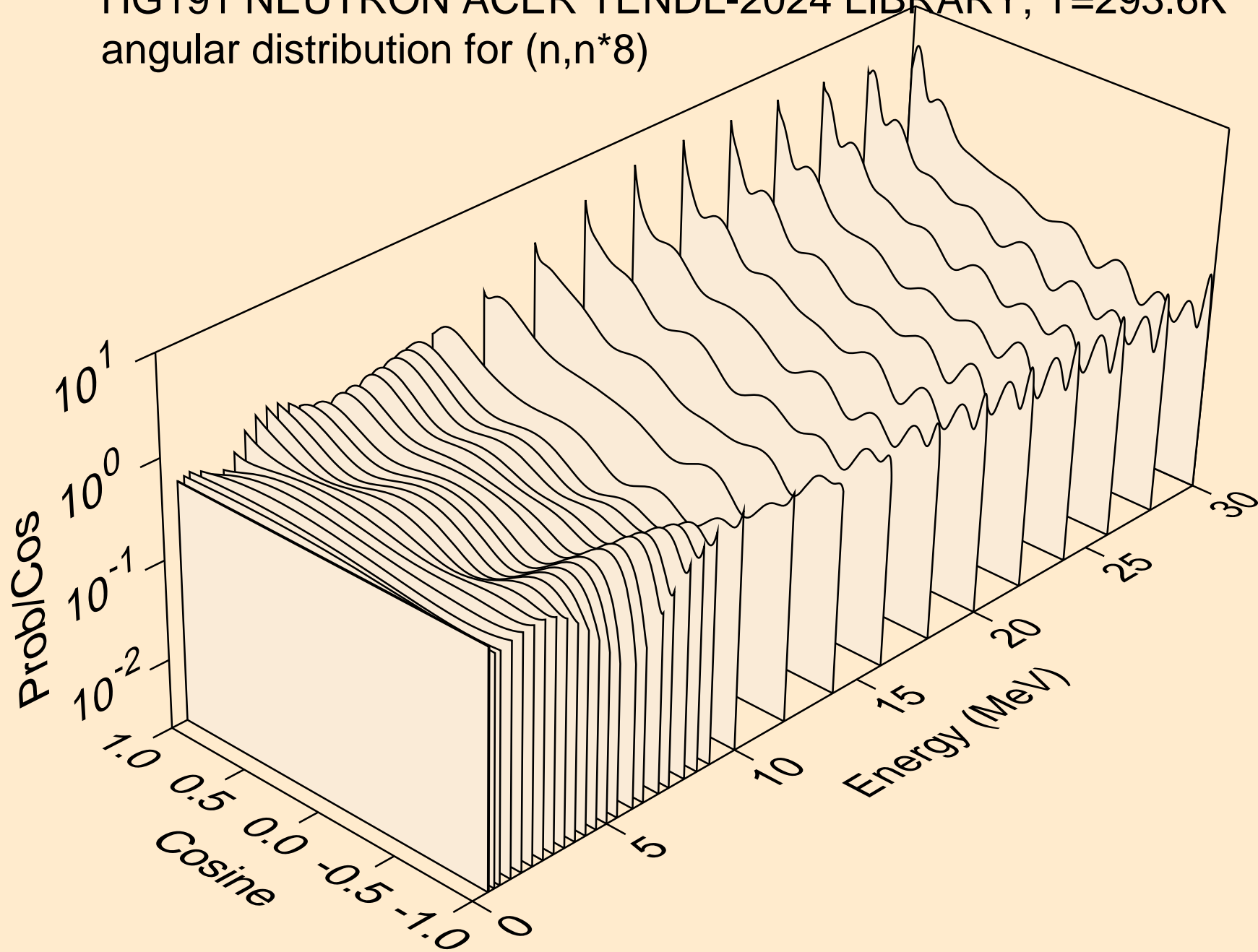

HG191 NEUTRON ACER TENDL-2024 LIBRARY; T=293.6K  
angular distribution for (n,n\*9)

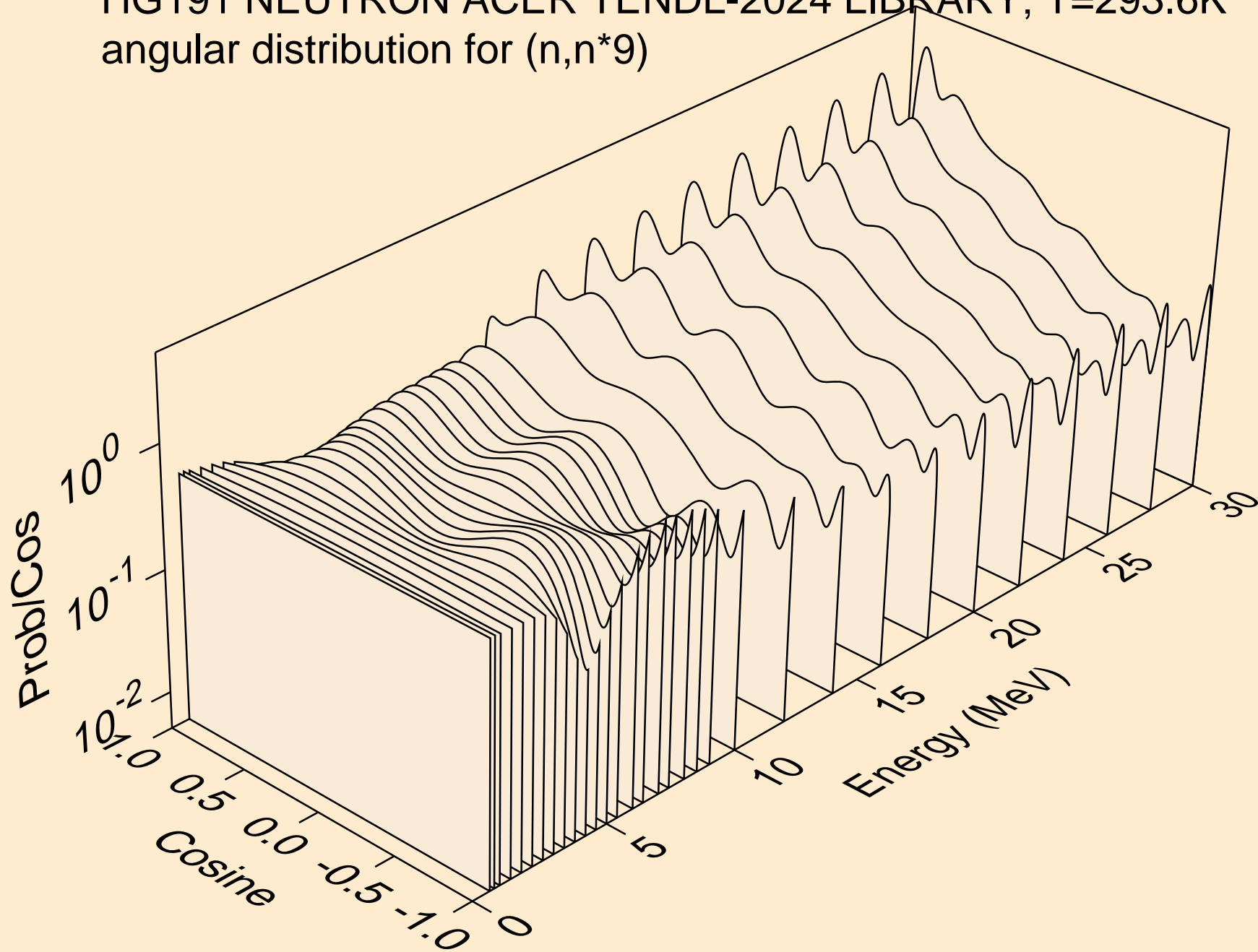

HG191 NEUTRON ACER TENDL-2024 LIBRARY; T=293.6K  
angular distribution for (n,n\*10)

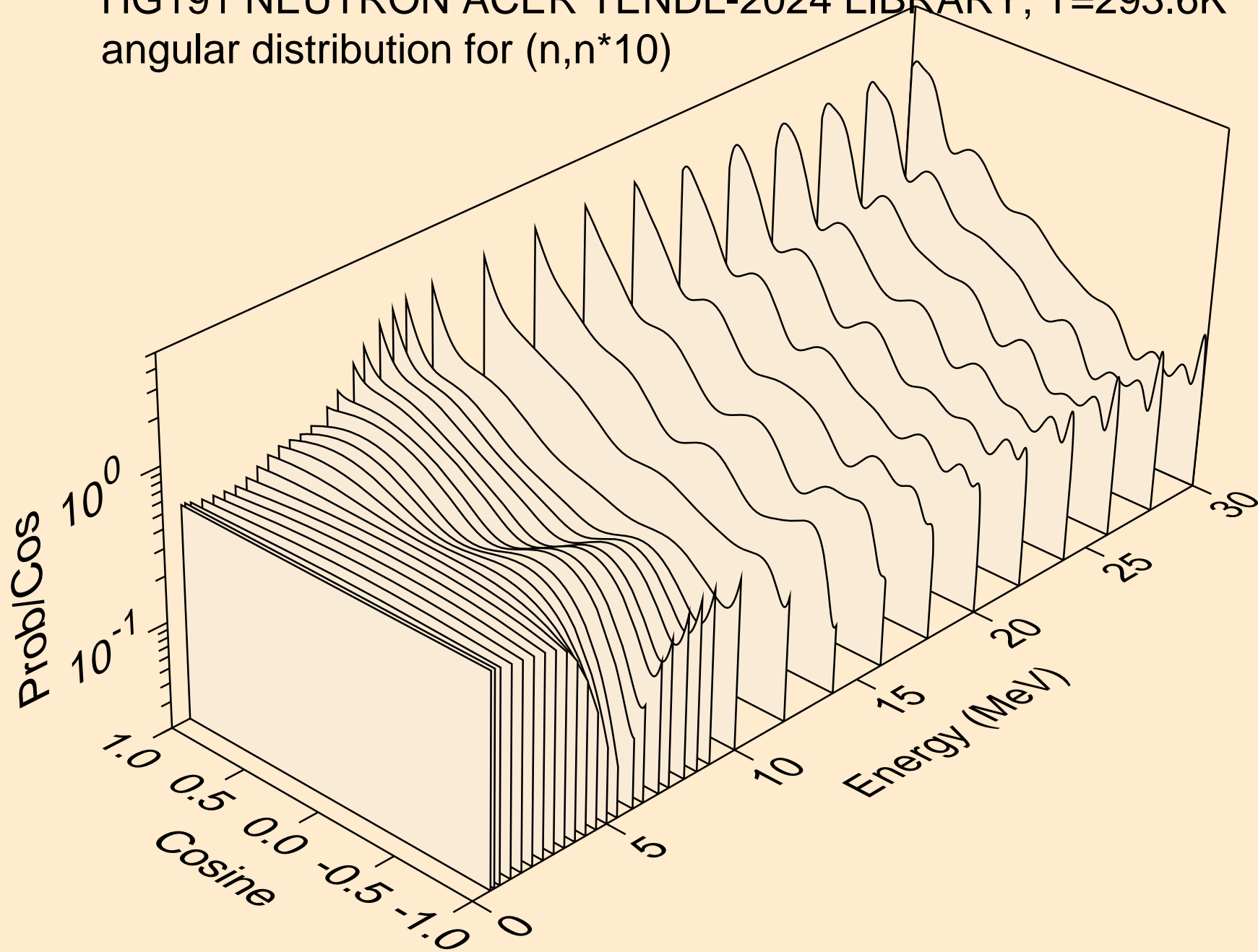

HG191 NEUTRON ACER TENDL-2024 LIBRARY; T=293.6K  
angular distribution for (n,n\*11)

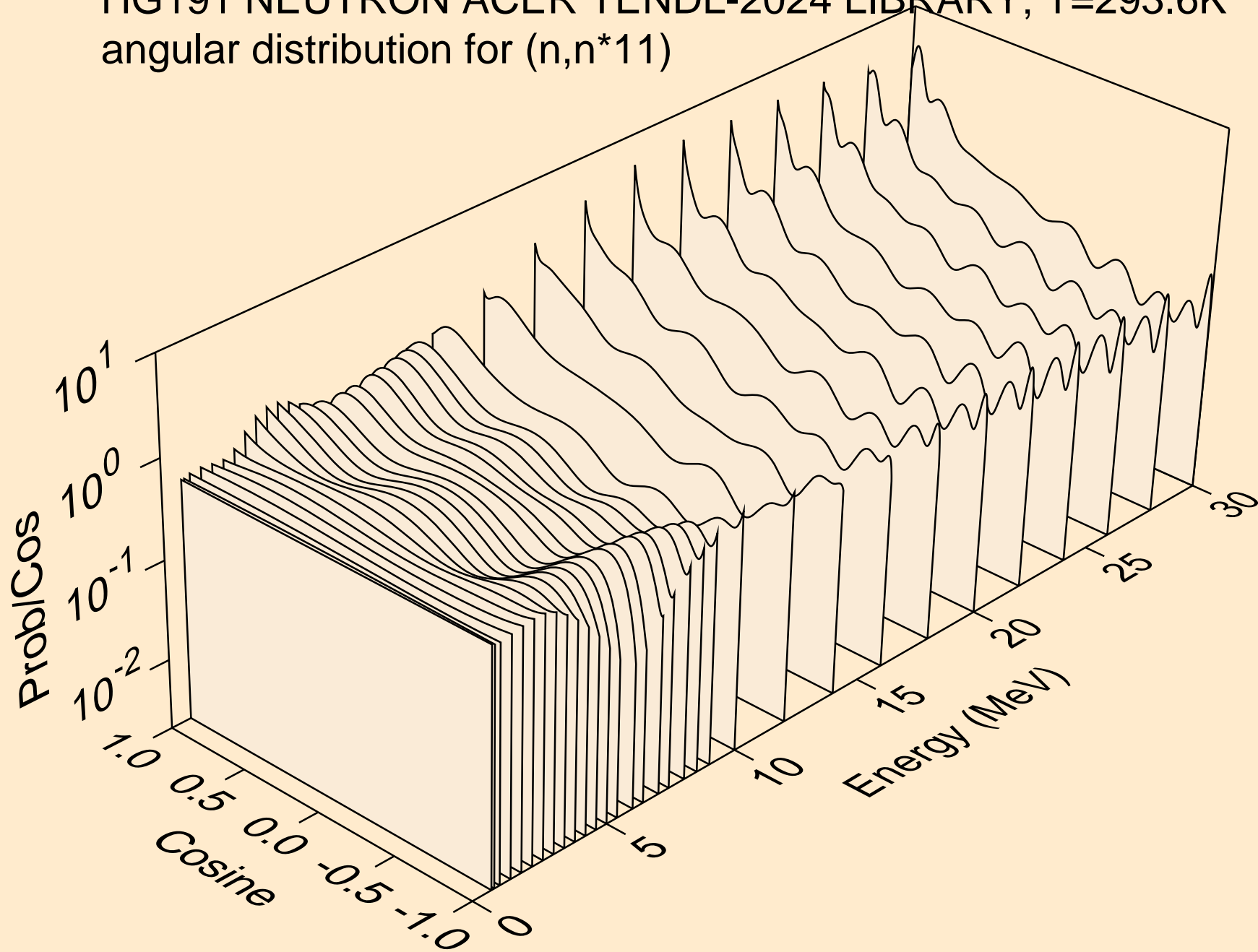

HG191 NEUTRON ACER TENDL-2024 LIBRARY; T=293.6K  
angular distribution for (n,n\*12)

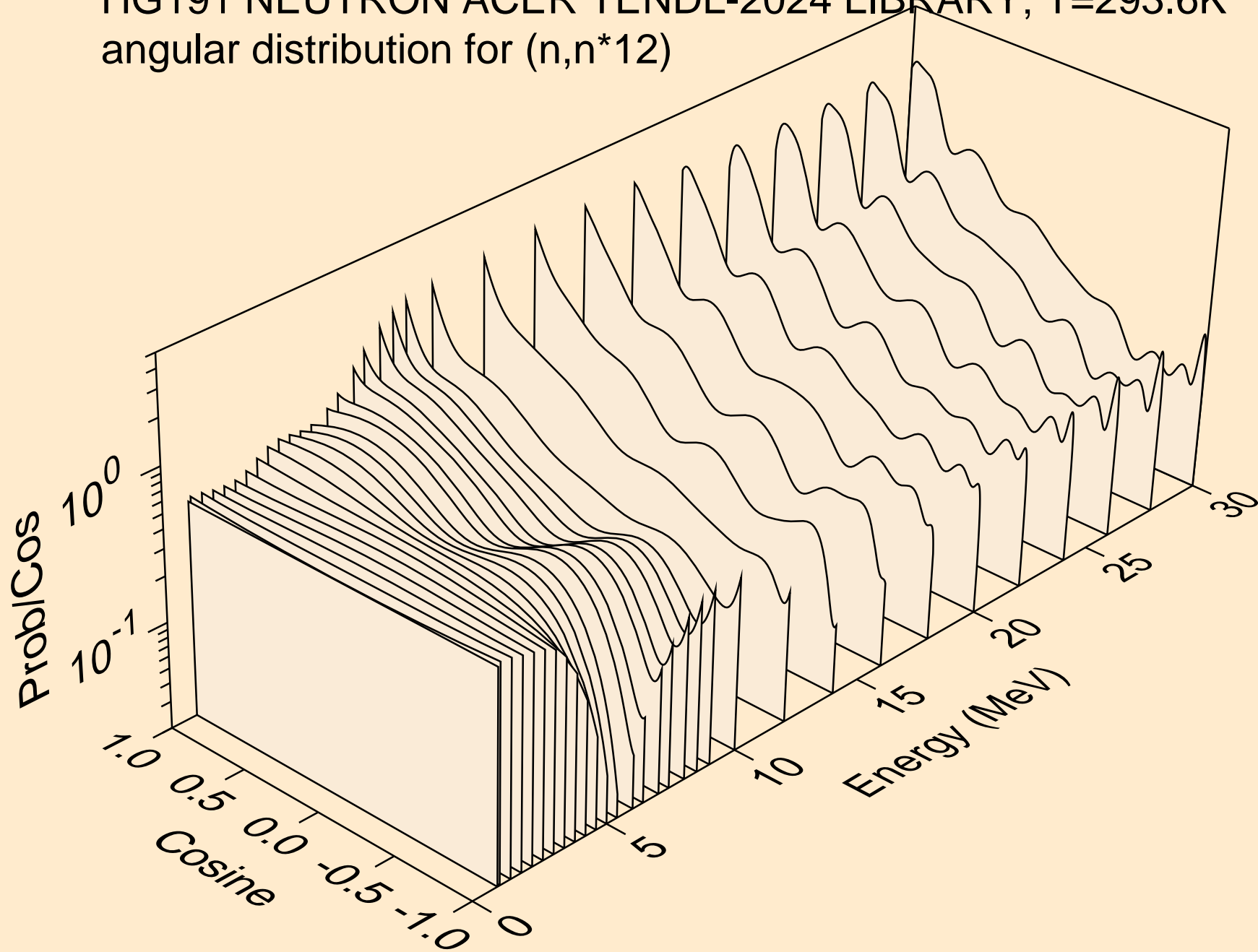

HG191 NEUTRON ACER TENDL-2024 LIBRARY; T=293.6K  
angular distribution for (n,n\*13)

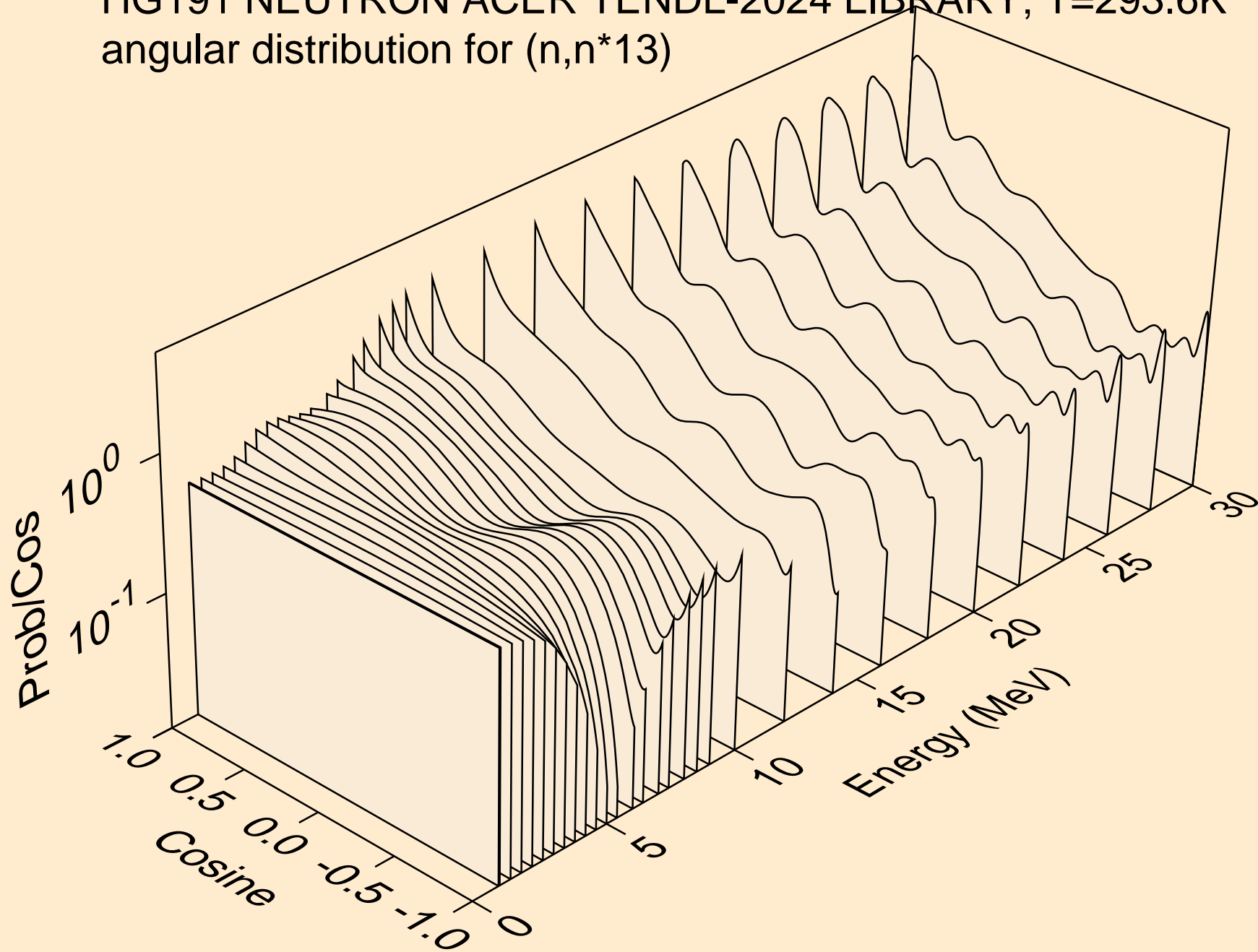

HG191 NEUTRON ACER TENDL-2024 LIBRARY; T=293.6K  
angular distribution for (n,n\*14)

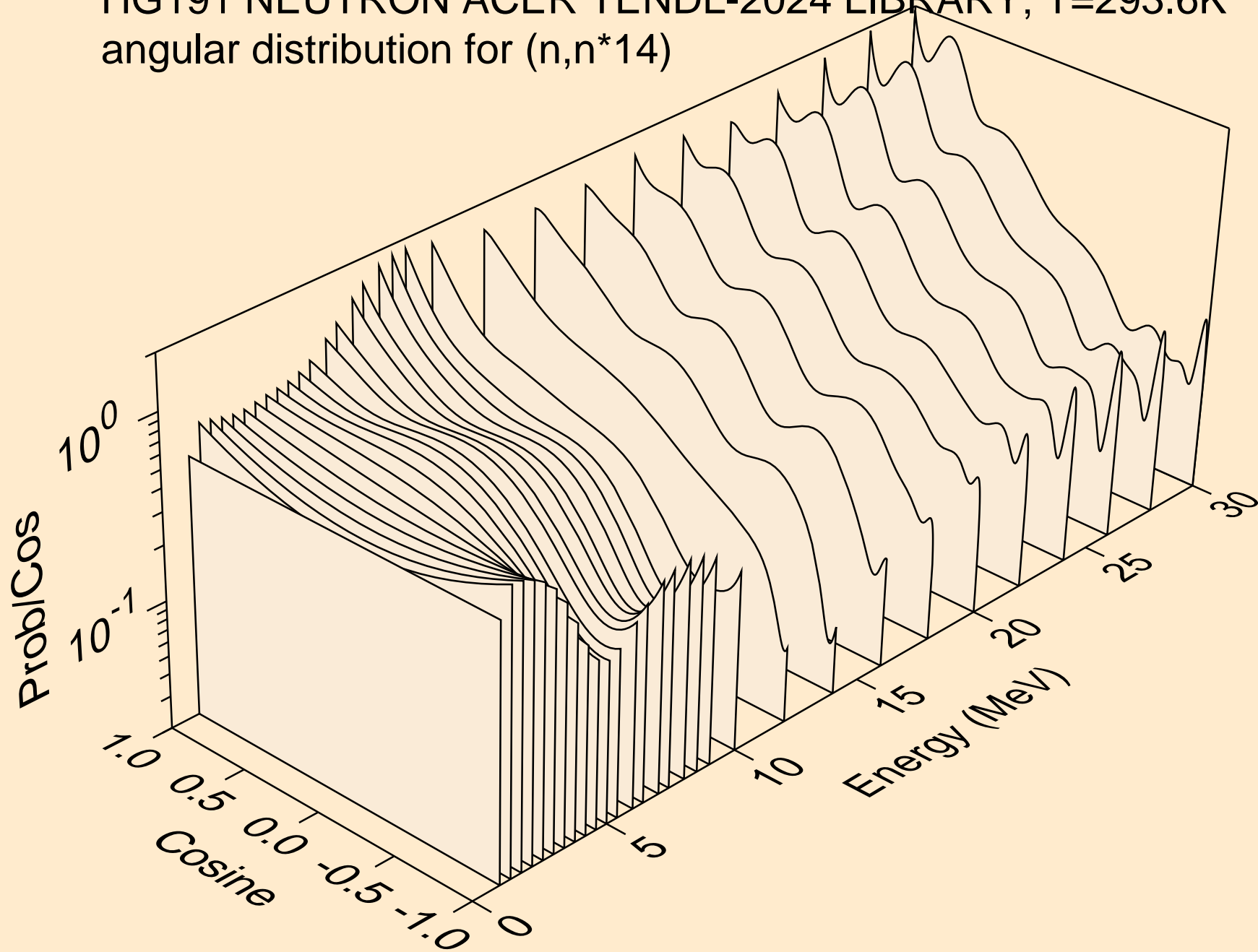

HG191 NEUTRON ACER TENDL-2024 LIBRARY; T=293.6K  
angular distribution for (n,n\*15)

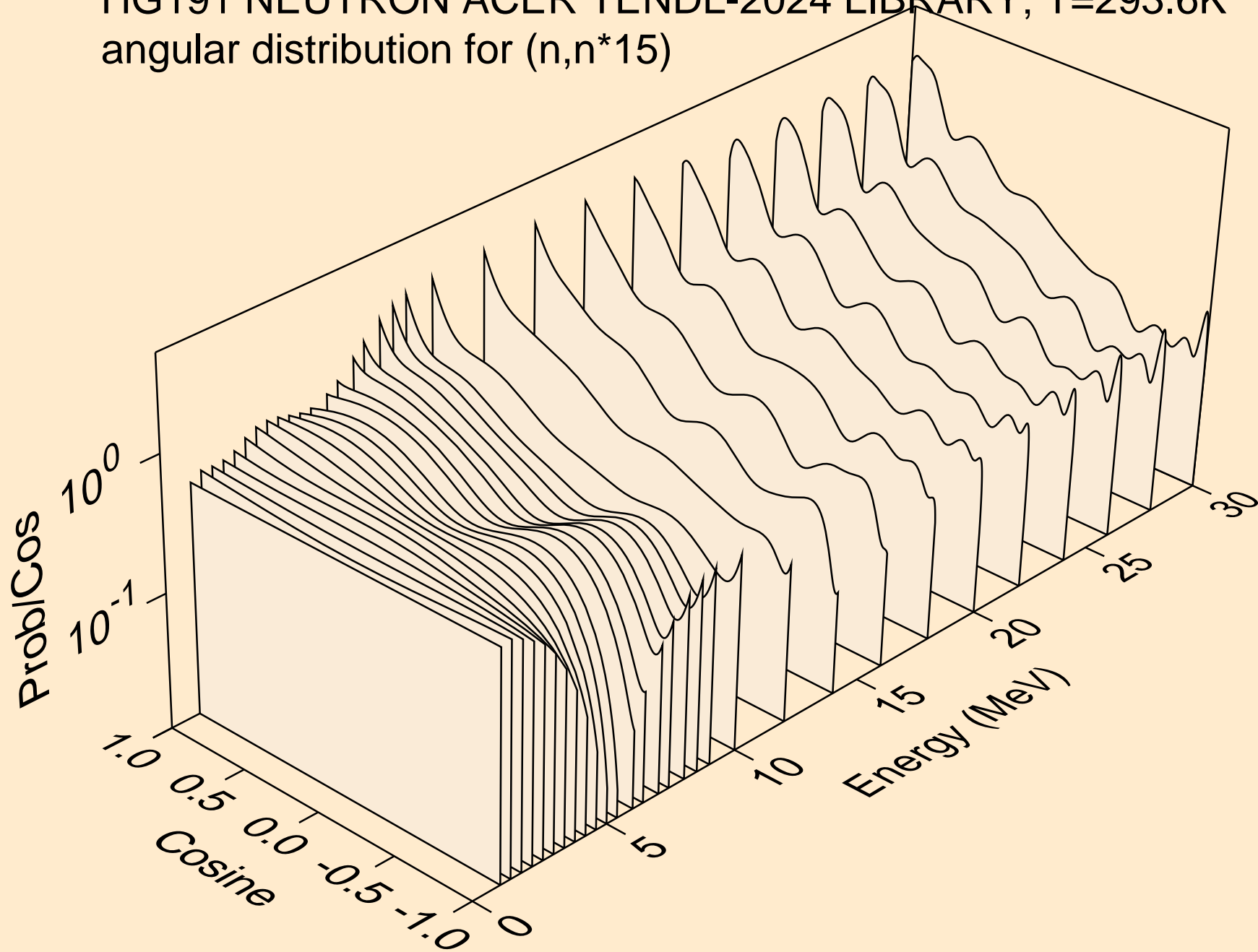

HG191 NEUTRON ACER TENDL-2024 LIBRARY; T=293.6K  
angular distribution for (n,n\*16)

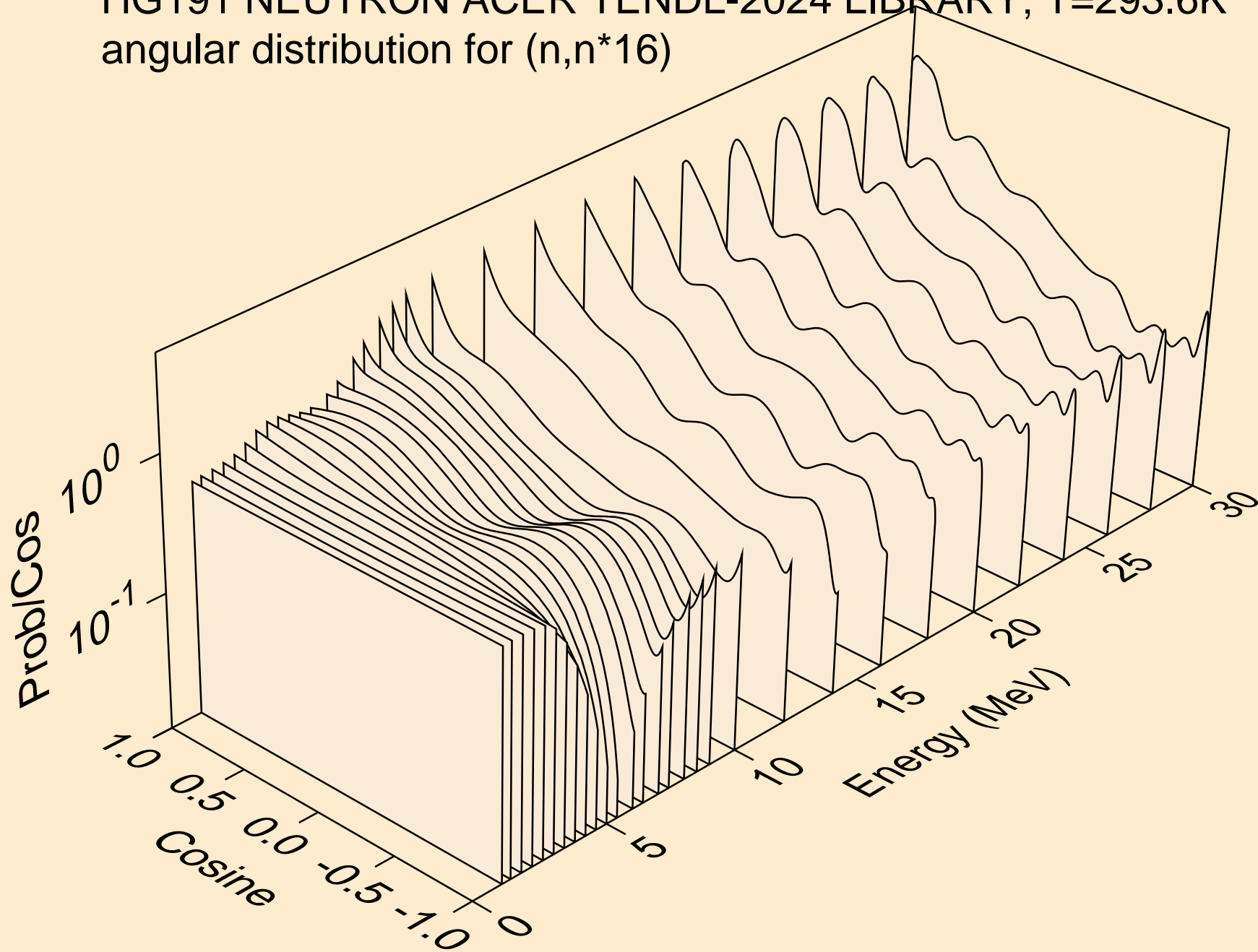

HG191 NEUTRON ACER TENDL-2024 LIBRARY; T=293.6K  
angular distribution for (n,n\*17)

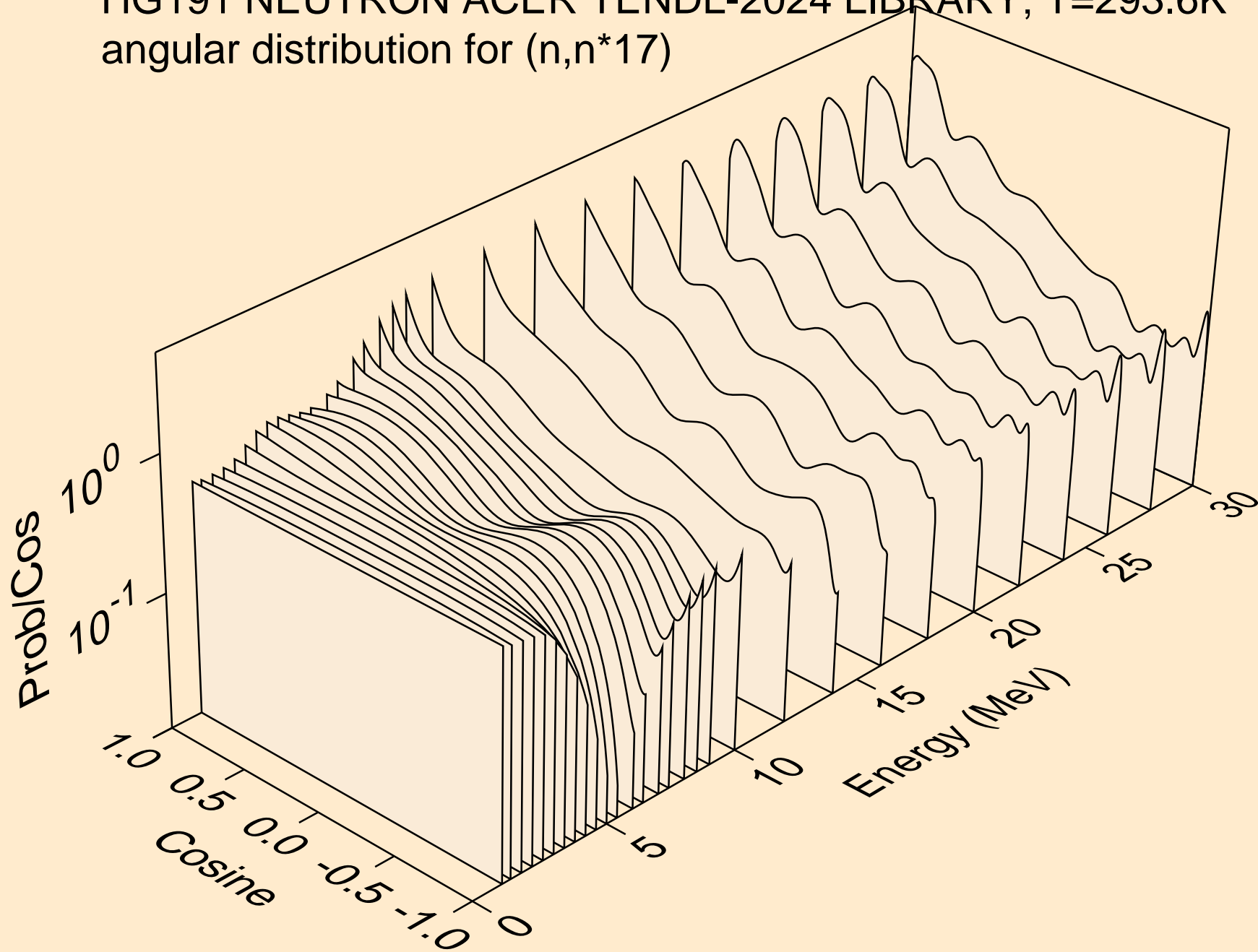

HG191 NEUTRON ACER TENDL-2024 LIBRARY; T=293.6K  
angular distribution for (n,n\*18)

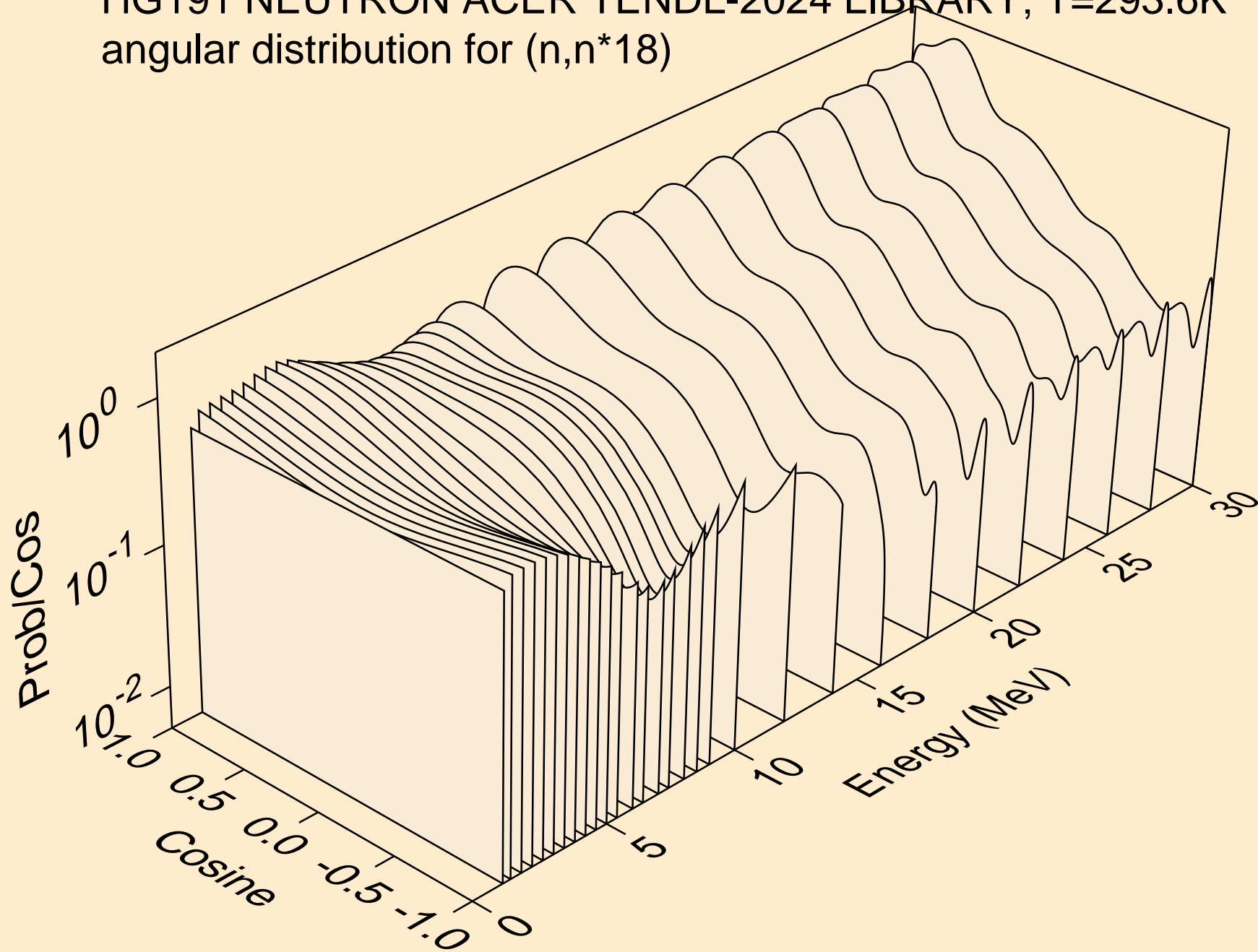

HG191 NEUTRON ACER TENDL-2024 LIBRARY; T=293.6K  
angular distribution for (n,n\*19)

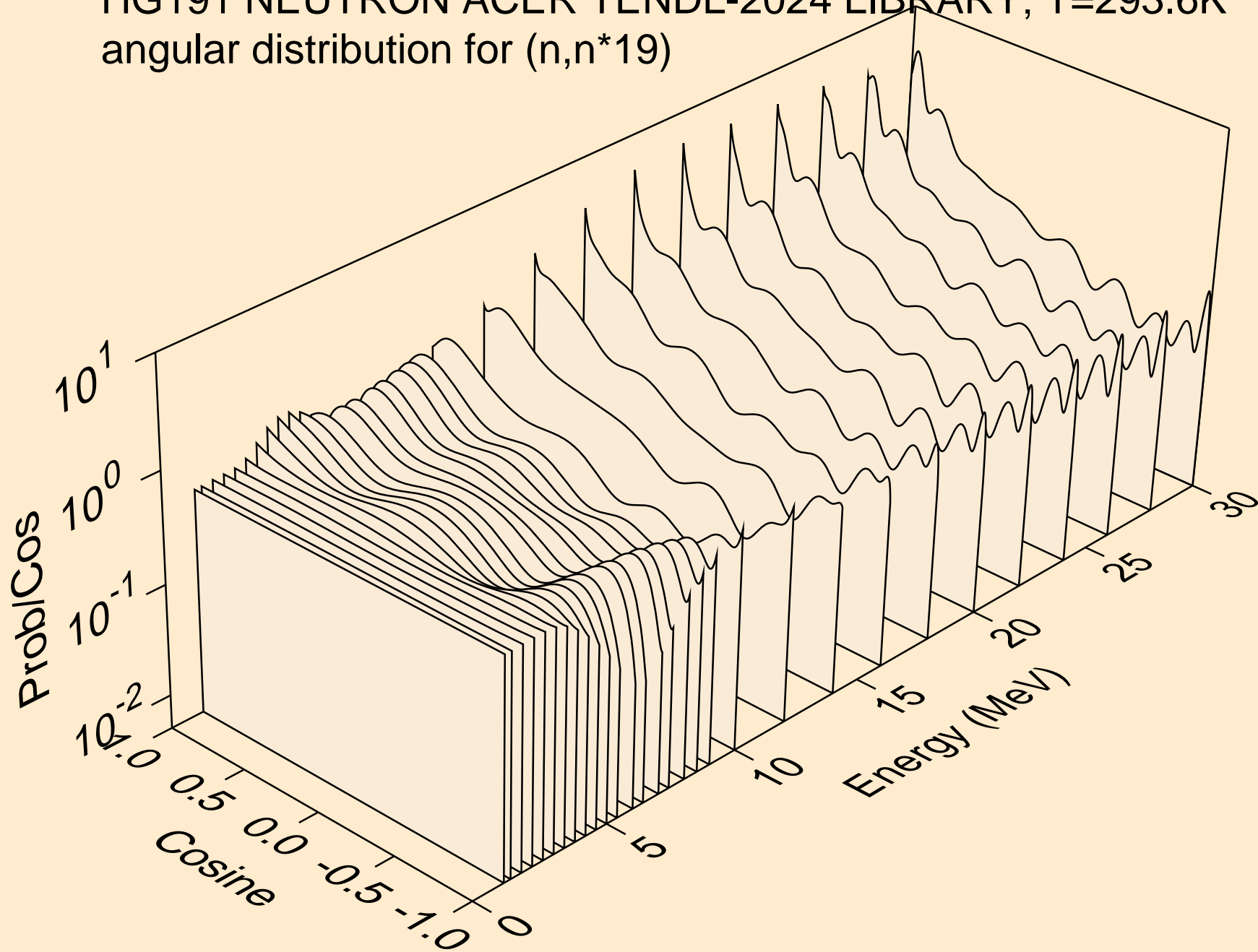

HG191 NEUTRON ACER TENDL-2024 LIBRARY; T=293.6K  
angular distribution for (n,n\*20)

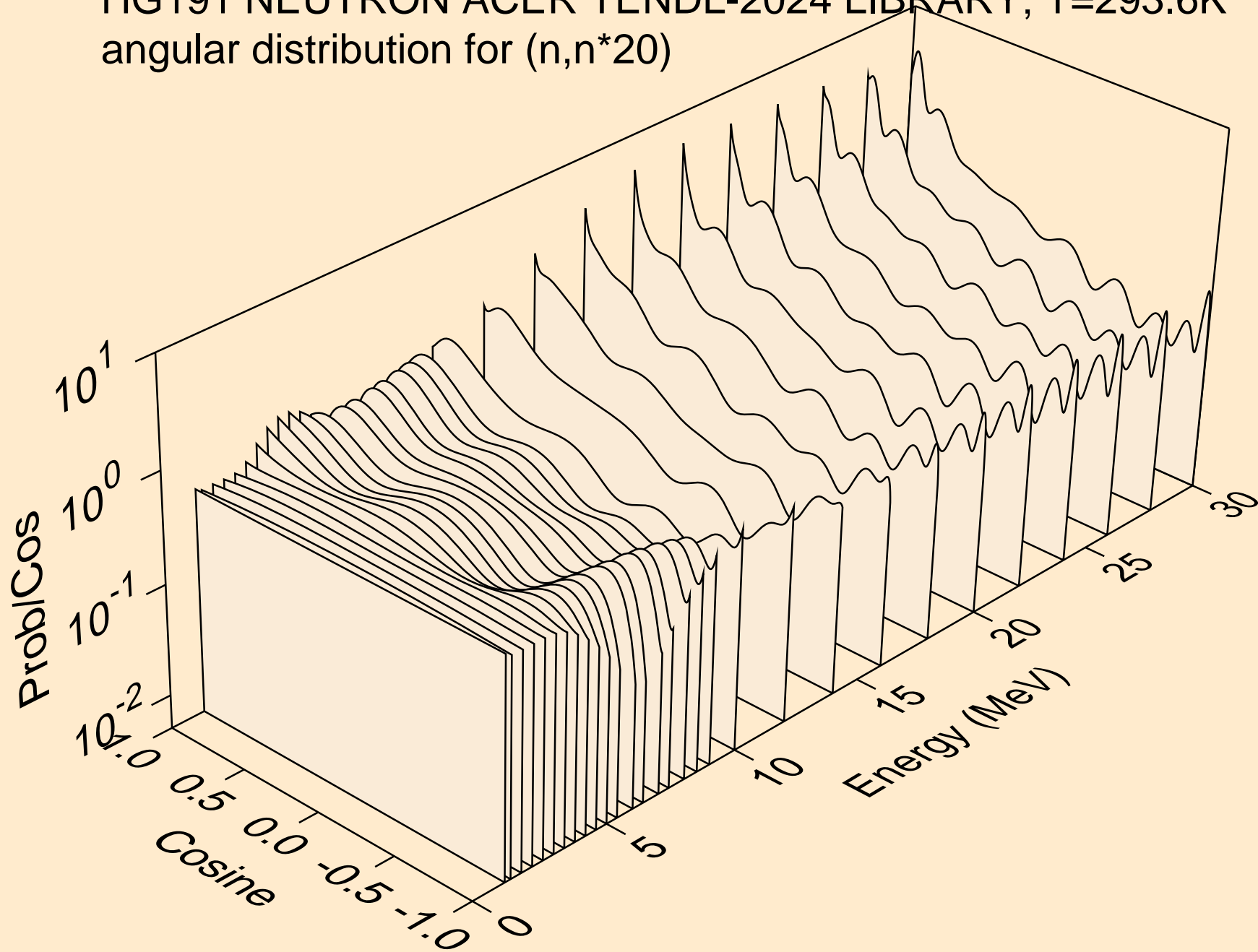

HG191 NEUTRON ACER TENDL-2024 LIBRARY; T=293.6K  
angular distribution for (n,n\*21)

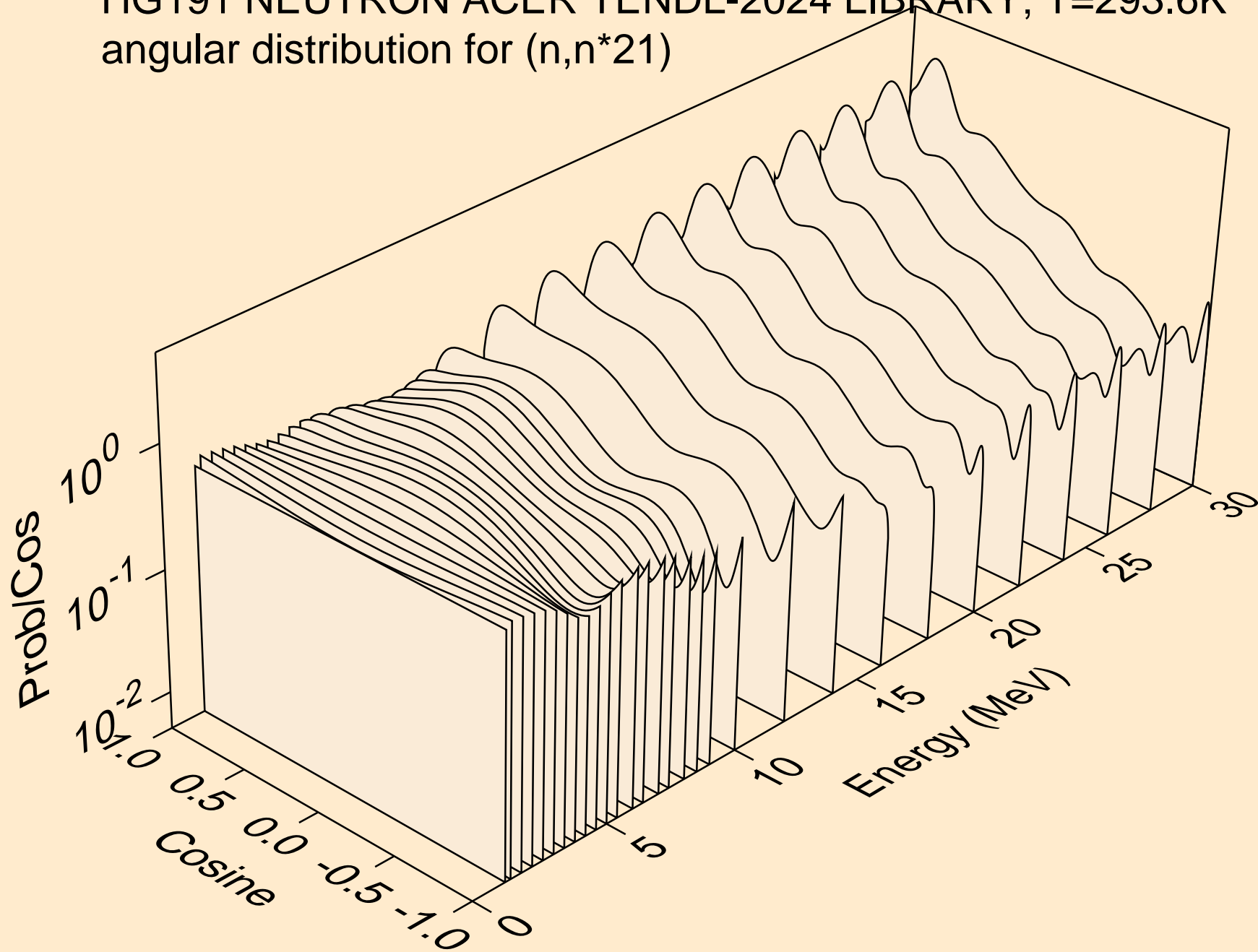

HG191 NEUTRON ACER TENDL-2024 LIBRARY; T=293.6K  
angular distribution for (n,n\*22)

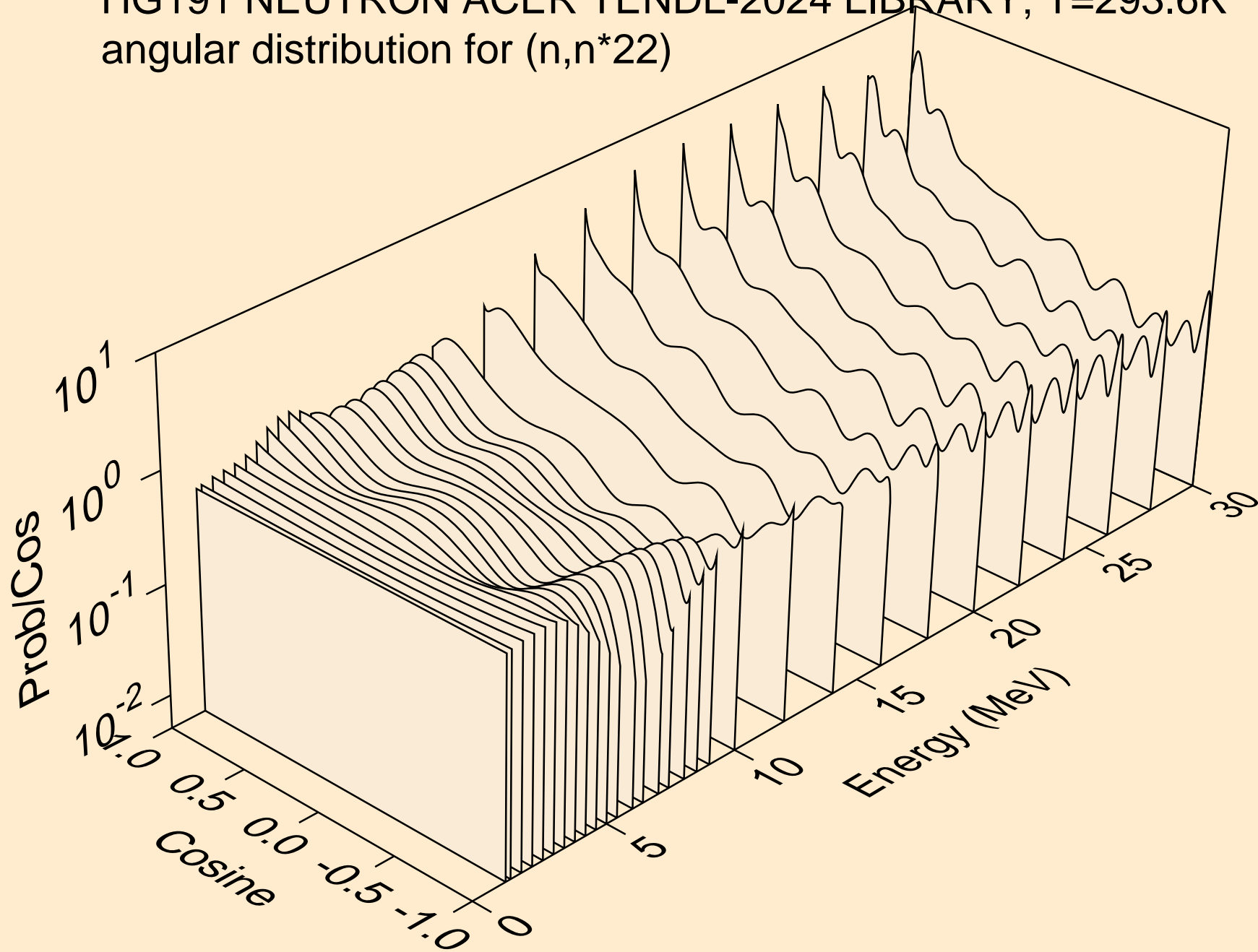

HG191 NEUTRON ACER TENDL-2024 LIBRARY; T=293.6K  
Neutron emission for (n,x)

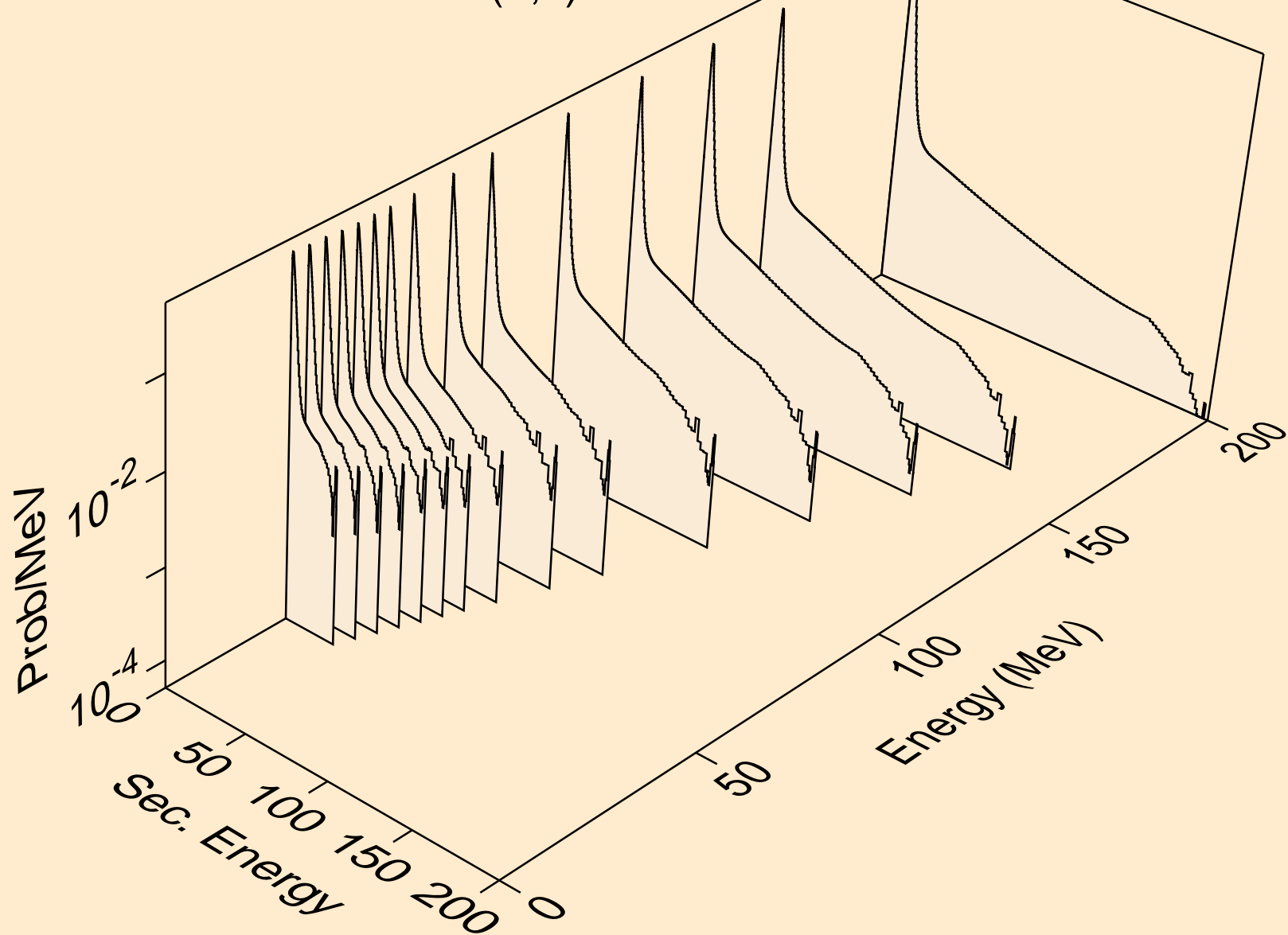

HG191 NEUTRON ACER TENDL-2024 LIBRARY; T=293.6K  
Neutron emission for (n,2nd)

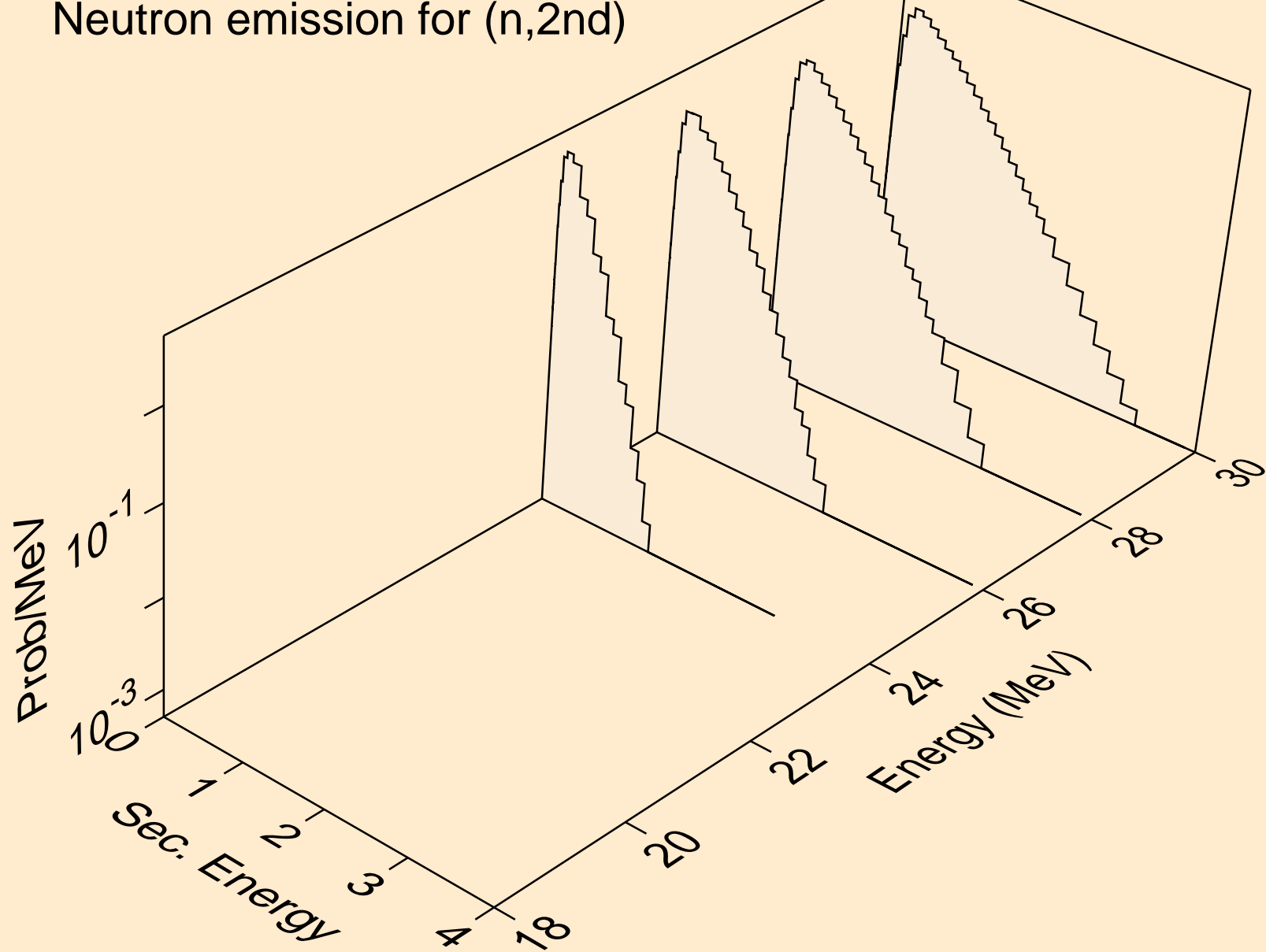

HG191 NEUTRON ACER TENDL-2024 LIBRARY; T=293.6K  
Neutron emission for (n,2n)

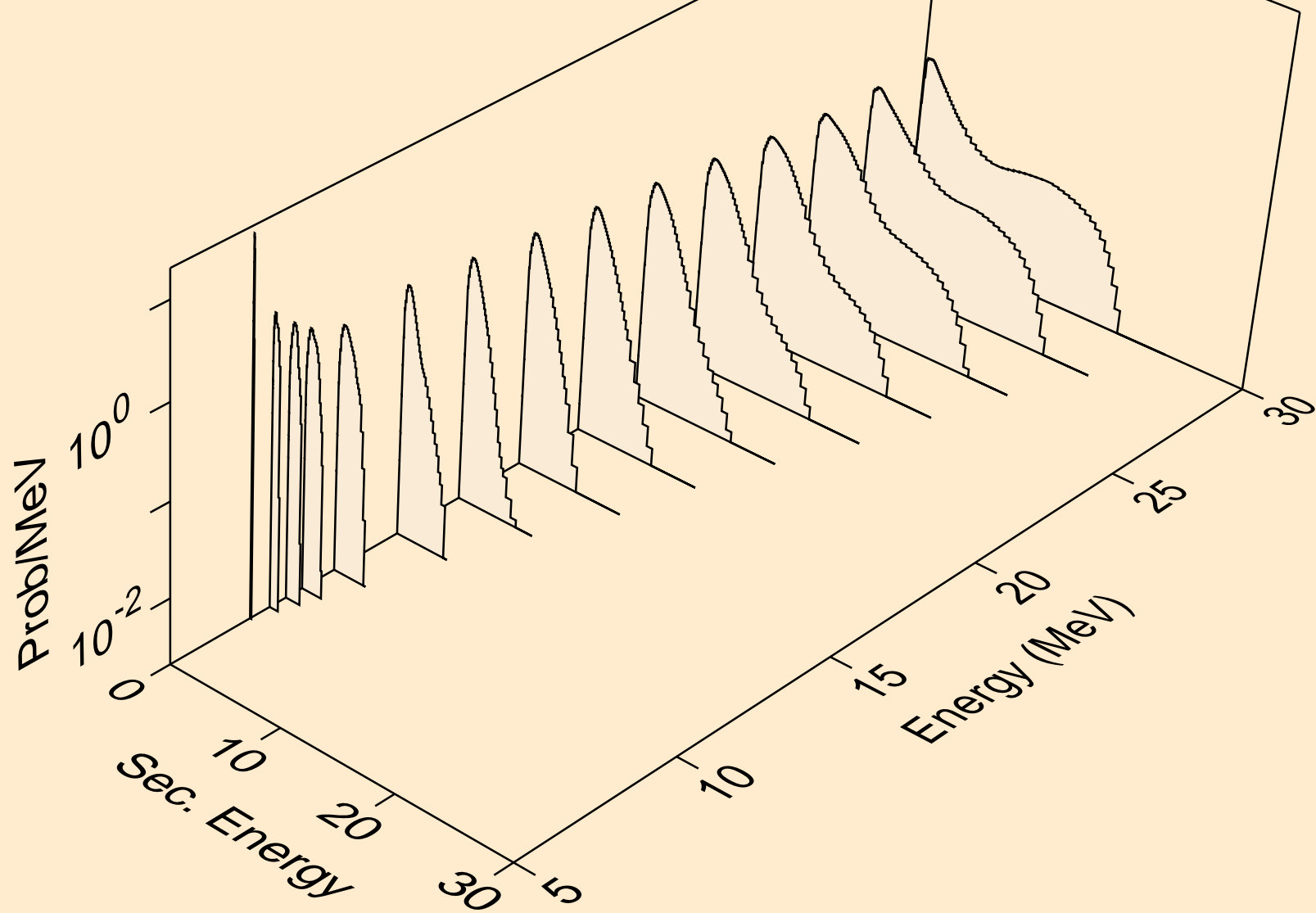

HG191 NEUTRON ACER TENDL-2024 LIBRARY; T=293.6K  
Neutron emission for (n,3n)

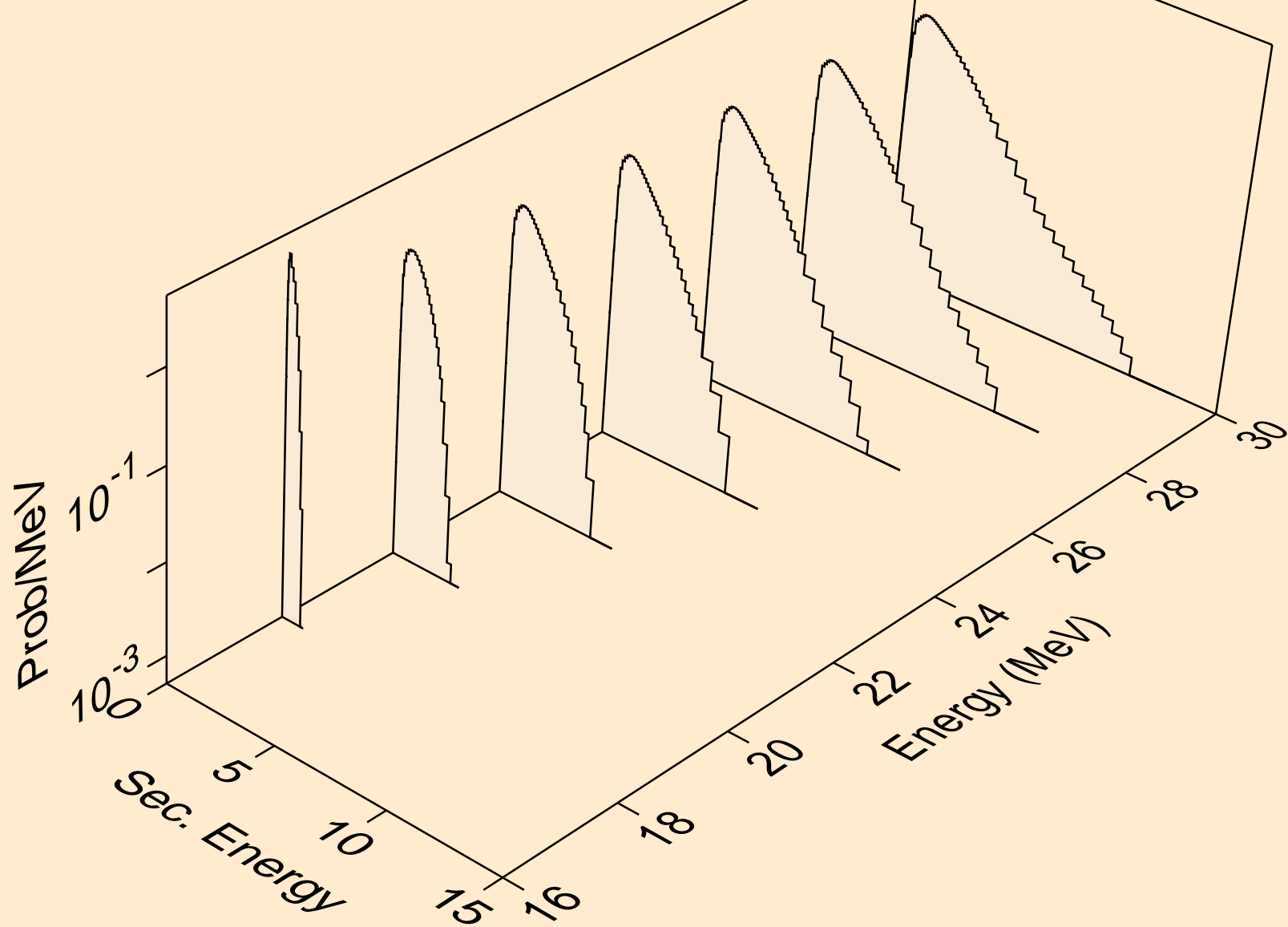

HG191 NEUTRON ACER TENDL-2024 LIBRARY; T=293.6K  
Neutron emission for (n,n\*)a

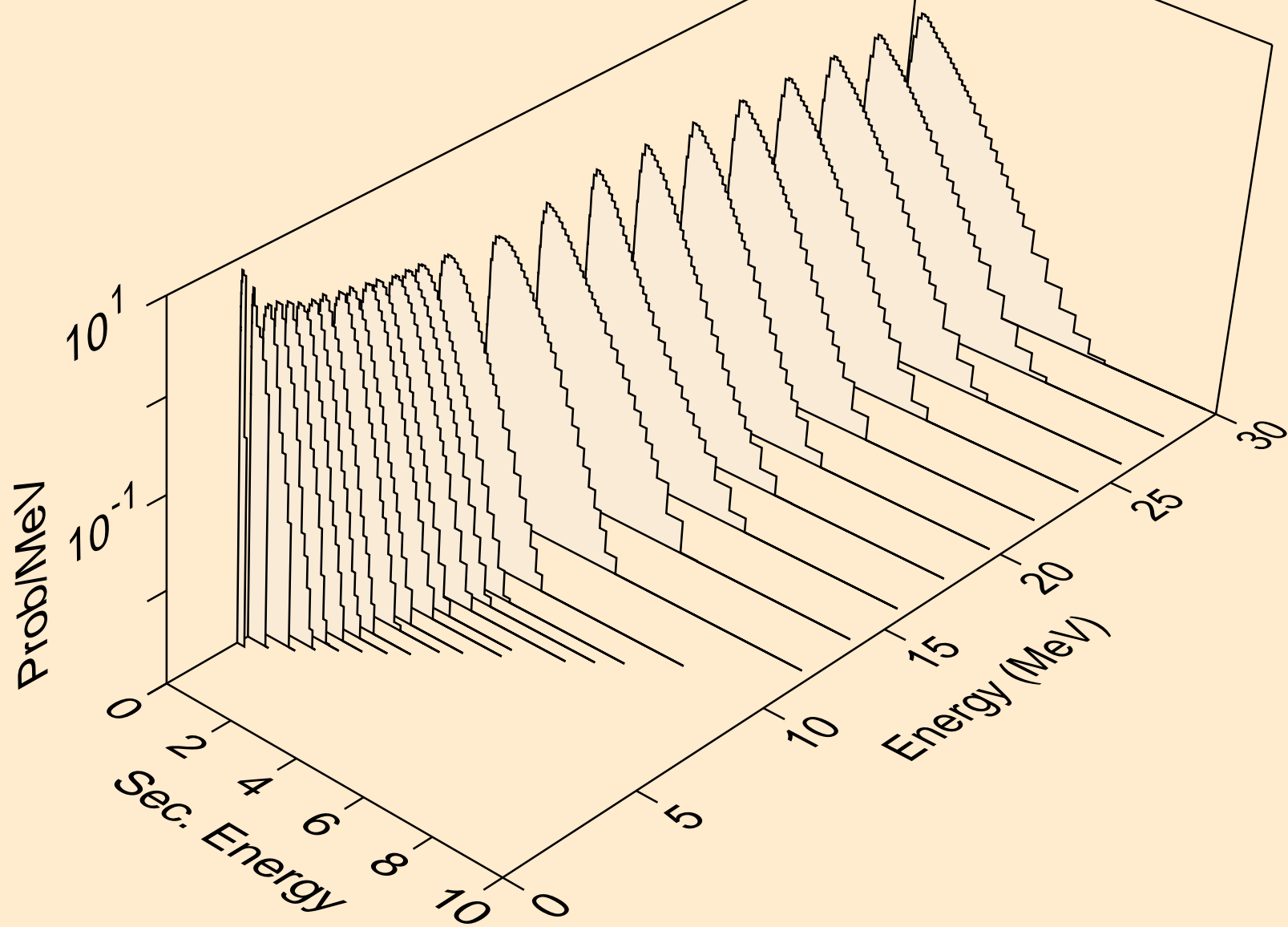

HG191 NEUTRON ACER TENDL-2024 LIBRARY; T=293.6K  
Neutron emission for (n,2n)a

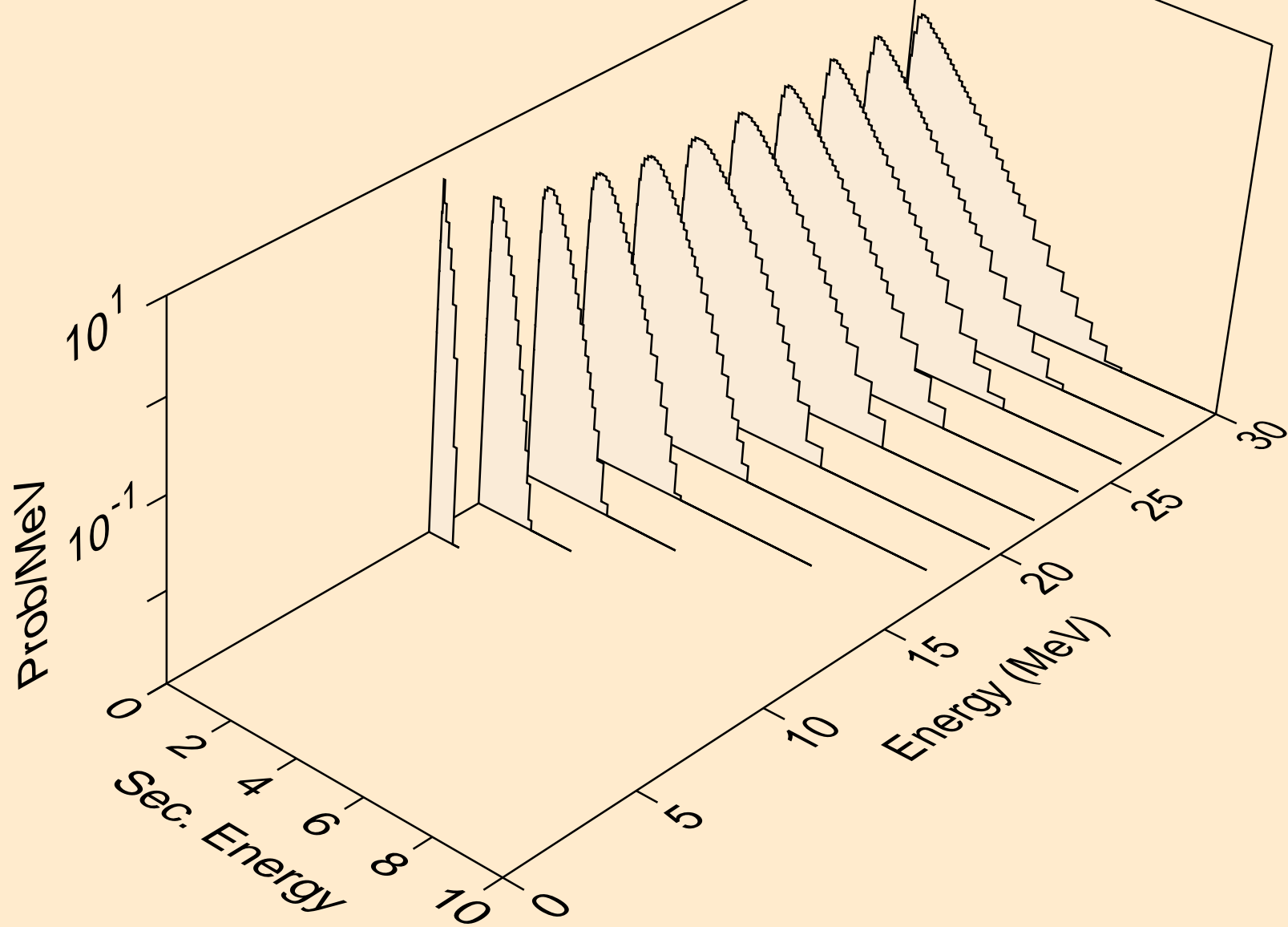

HG191 NEUTRON ACER TENDL-2024 LIBRARY; T=293.6K  
Neutron emission for (n,3n)a

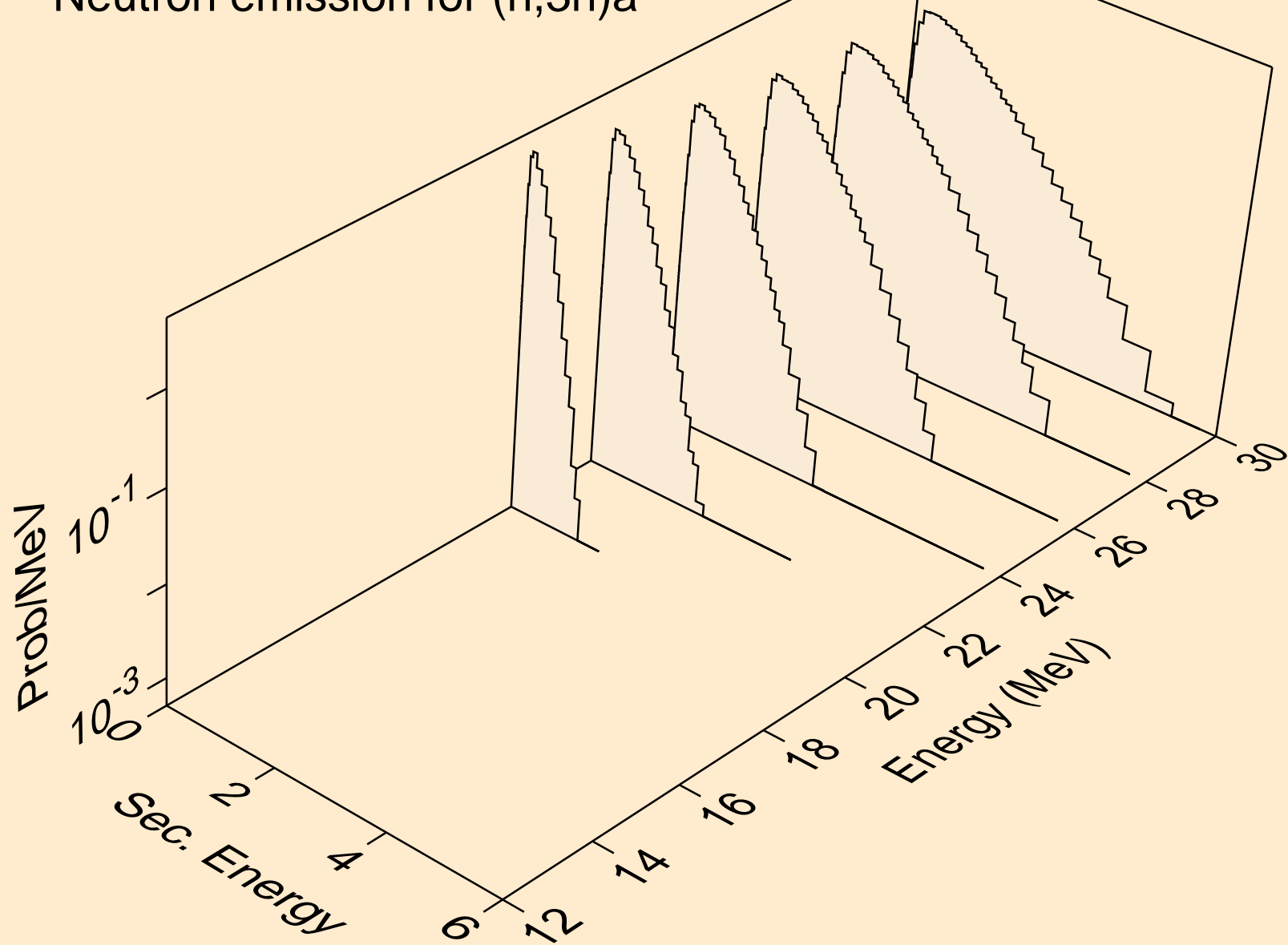

HG191 NEUTRON ACER TENDL-2024 LIBRARY; T=293.6K  
Neutron emission for (n,n\*)p

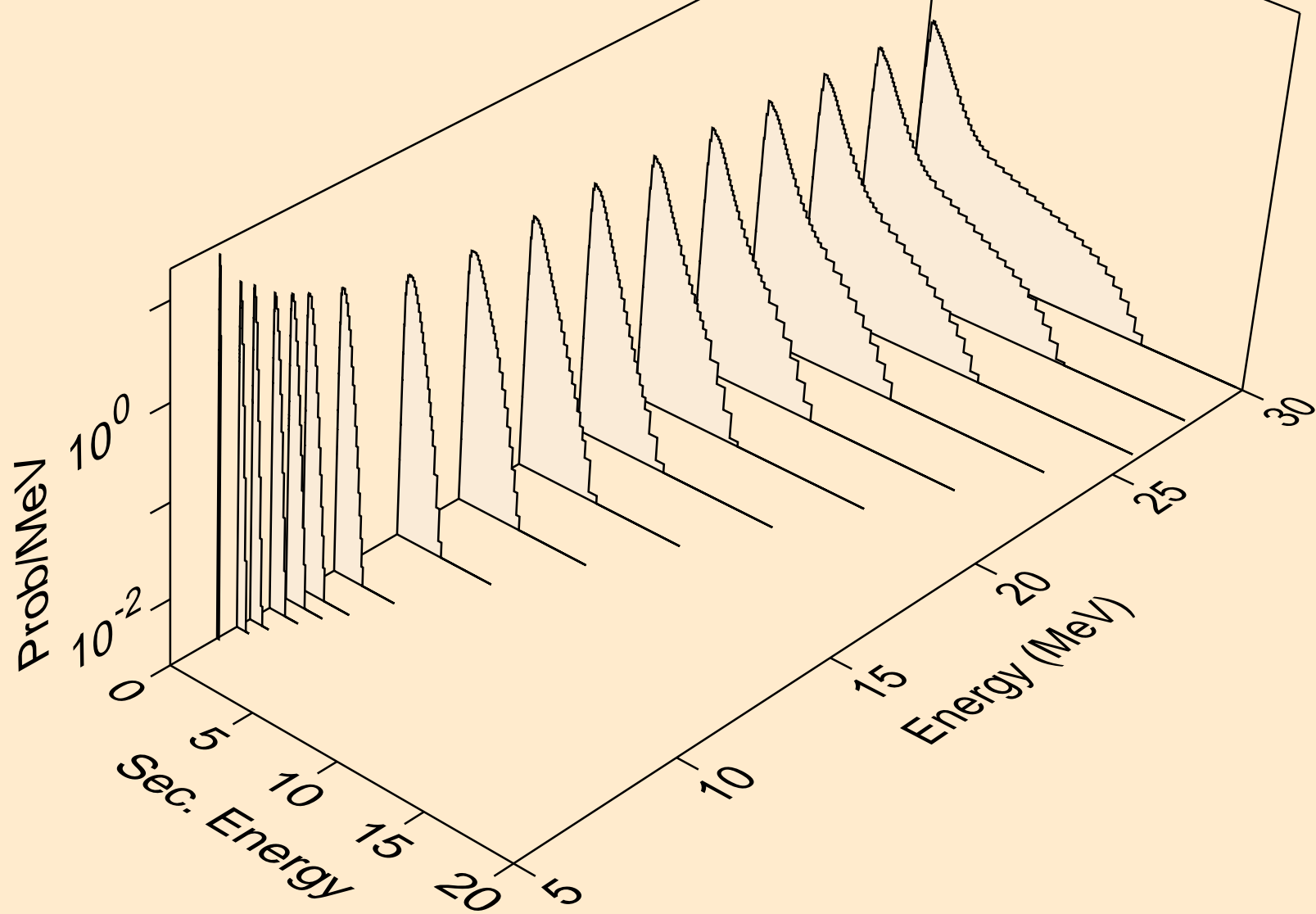

HG191 NEUTRON ACER TENDL-2024 LIBRARY; T=293.6K  
Neutron emission for (n,n\*)2a

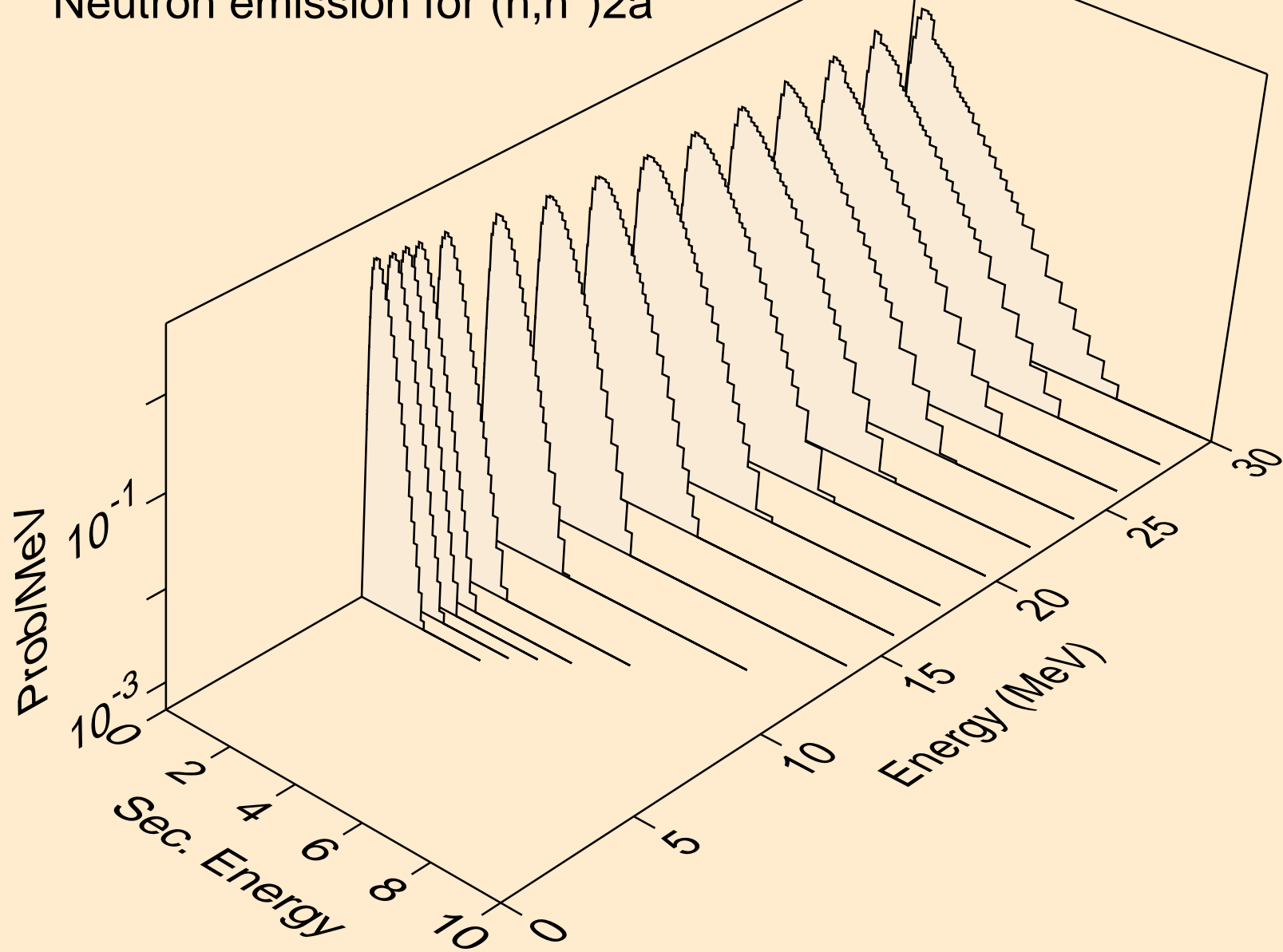

HG191 NEUTRON ACER TENDL-2024 LIBRARY; T=293.6K  
Neutron emission for (n,2n)2a

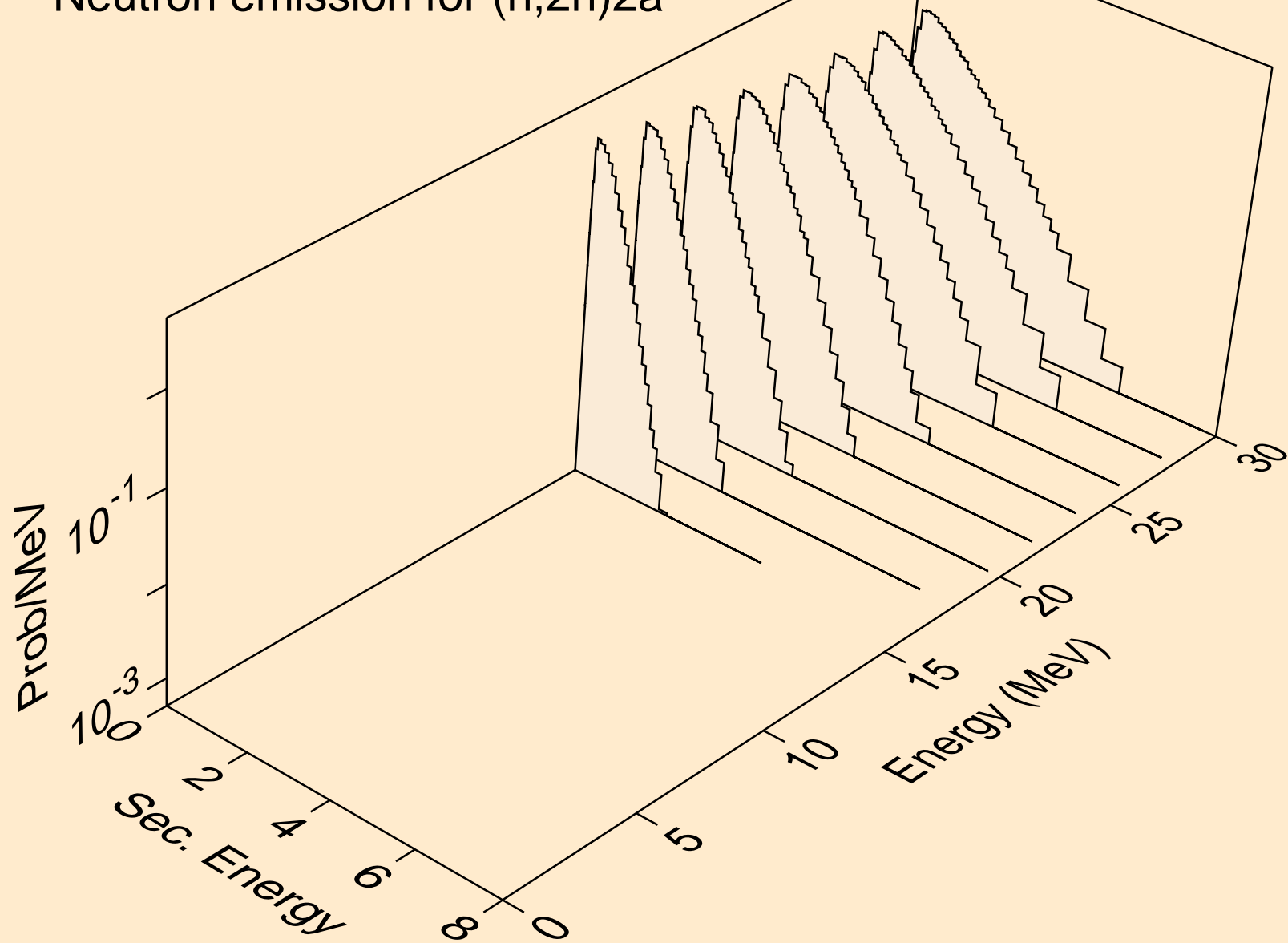

HG191 NEUTRON ACER TENDL-2024 LIBRARY; T=293.6K  
Neutron emission for (n,n\*)d

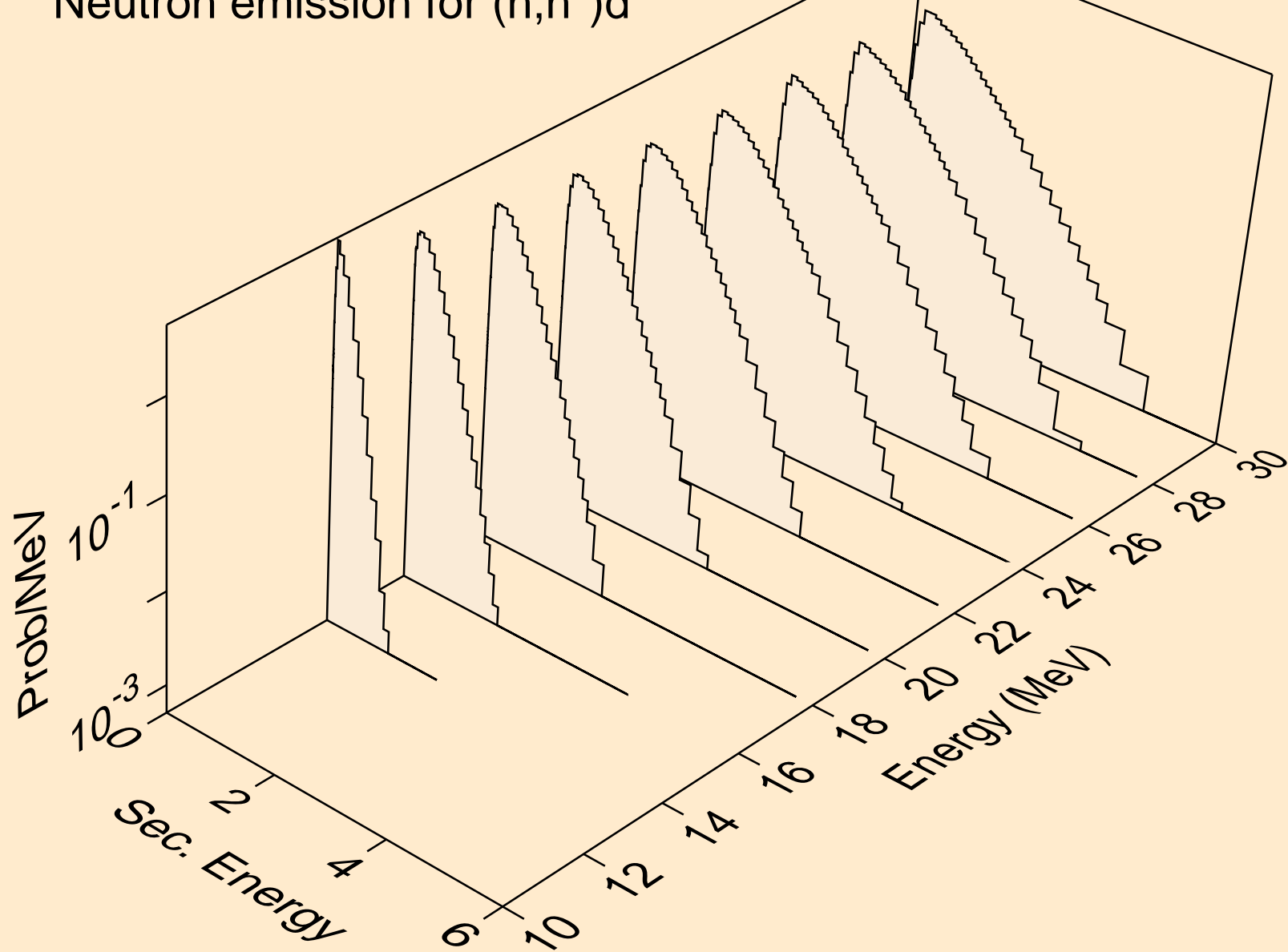

HG191 NEUTRON ACER TENDL-2024 LIBRARY; T=293.6K  
Neutron emission for (n,n\*)t

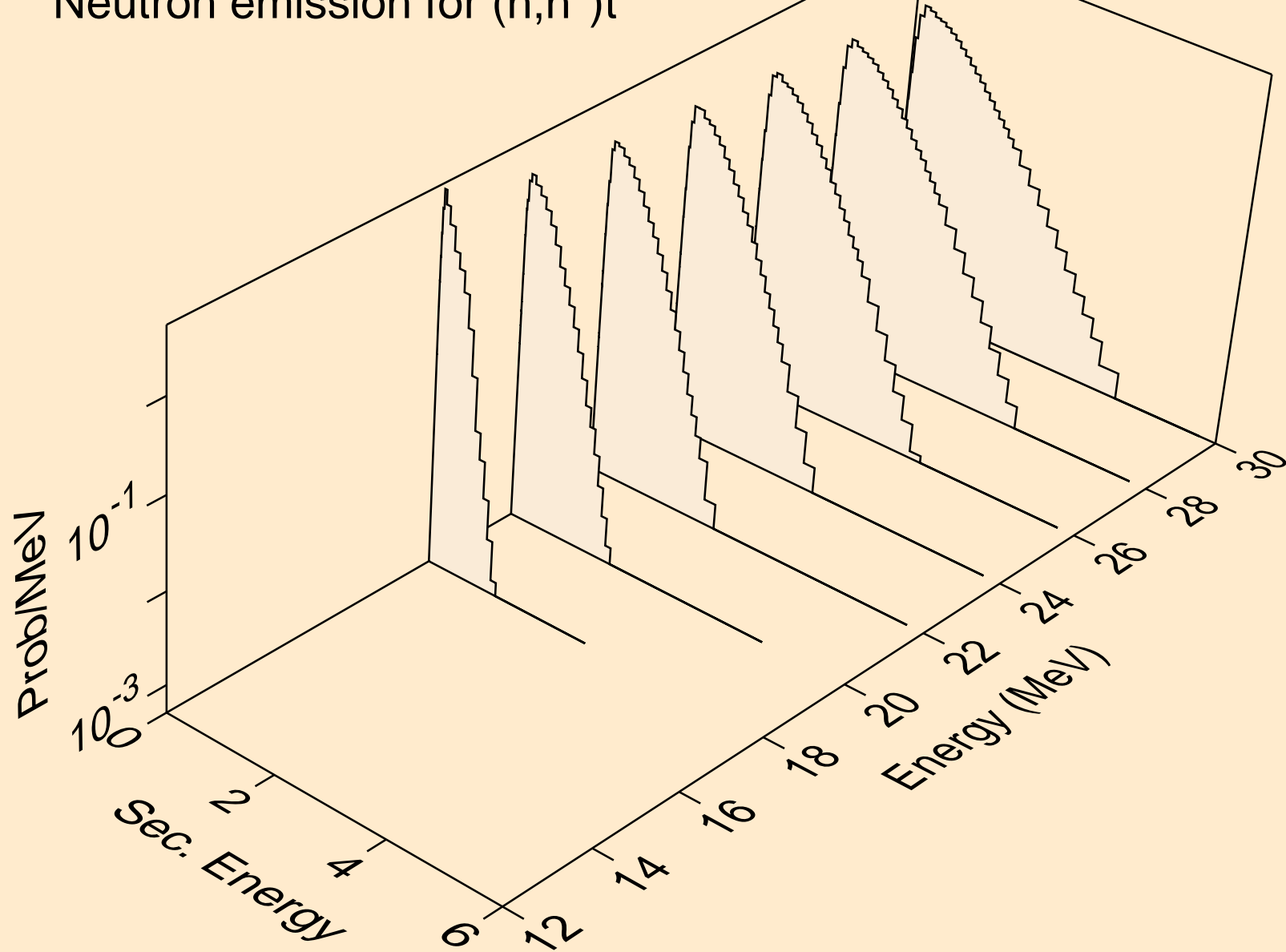

HG191 NEUTRON ACER TENDL-2024 LIBRARY; T=293.6K  
Neutron emission for (n,n\*)he3

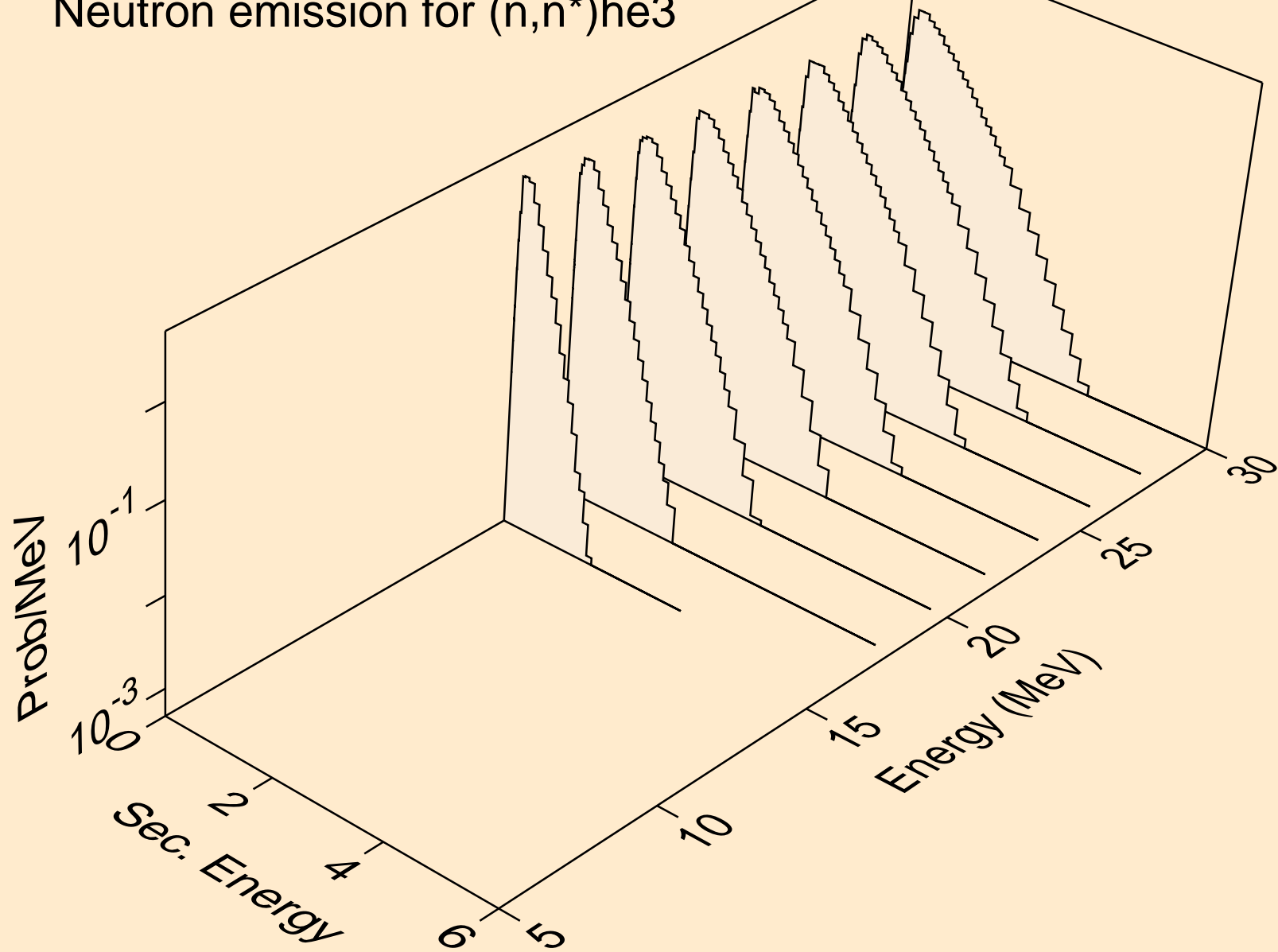

HG191 NEUTRON ACER TENDL-2024 LIBRARY; T=293.6K  
Neutron emission for (n,4n)

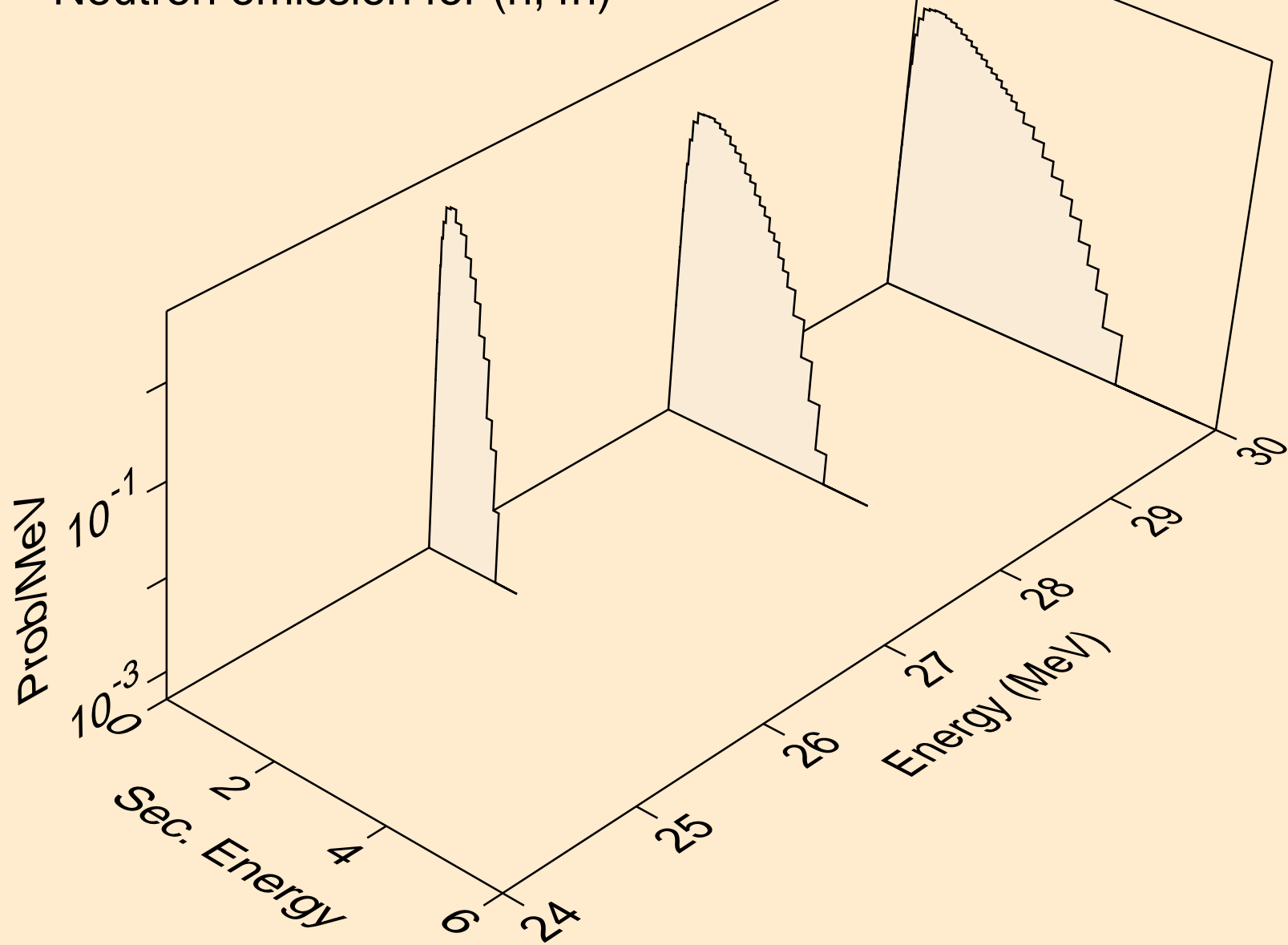

HG191 NEUTRON ACER TENDL-2024 LIBRARY; T=293.6K  
Neutron emission for (n,2np)

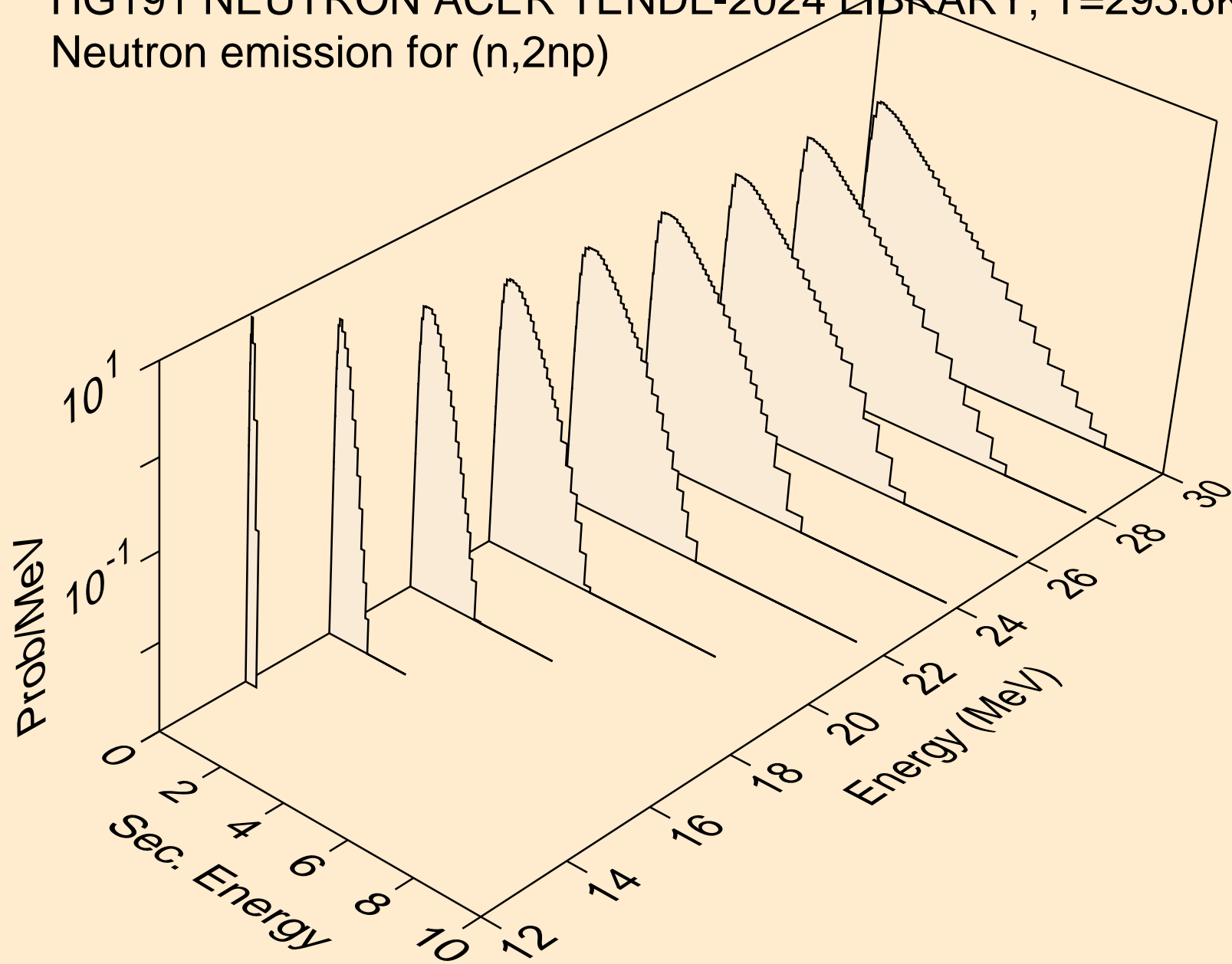

HG191 NEUTRON ACER TENDL-2024 LIBRARY; T=293.6K  
Neutron emission for (n,3np)

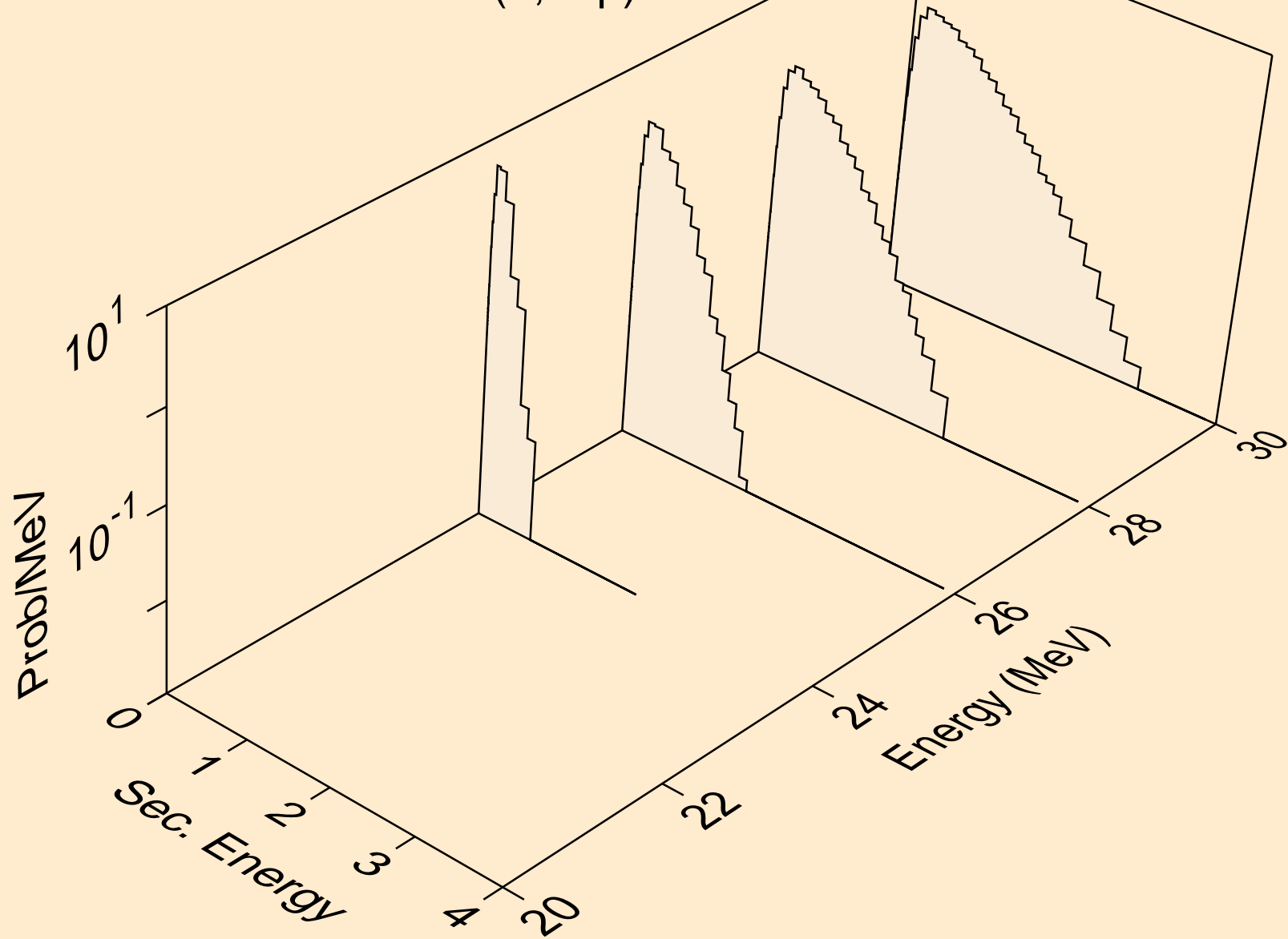

HG191 NEUTRON ACER TENDL-2024 LIBRARY; T=293.6K  
Neutron emission for (n,n2p)

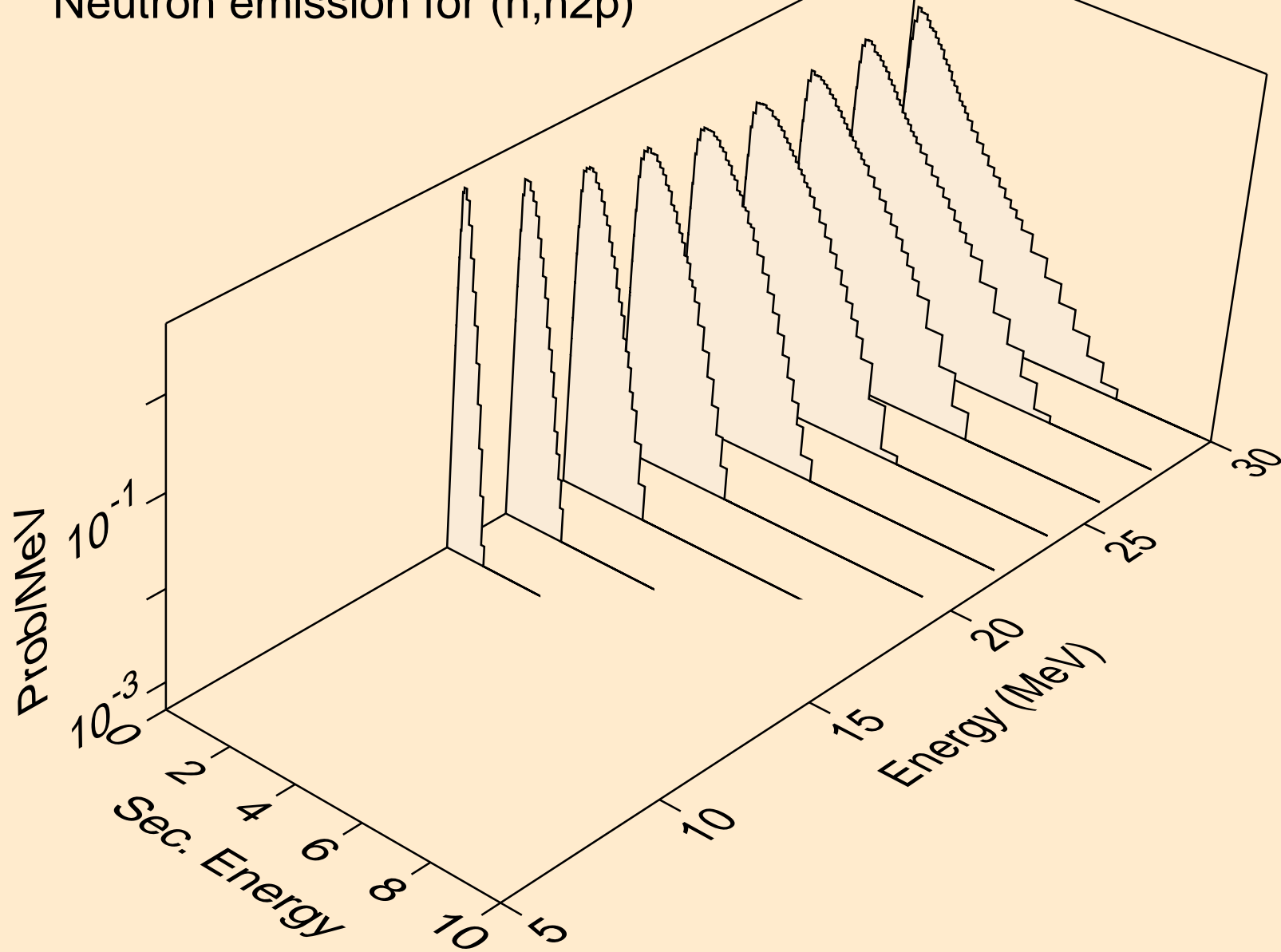

HG191 NEUTRON ACER TENDL-2024 LIBRARY; T=293.6K  
Neutron emission for (n,npa)

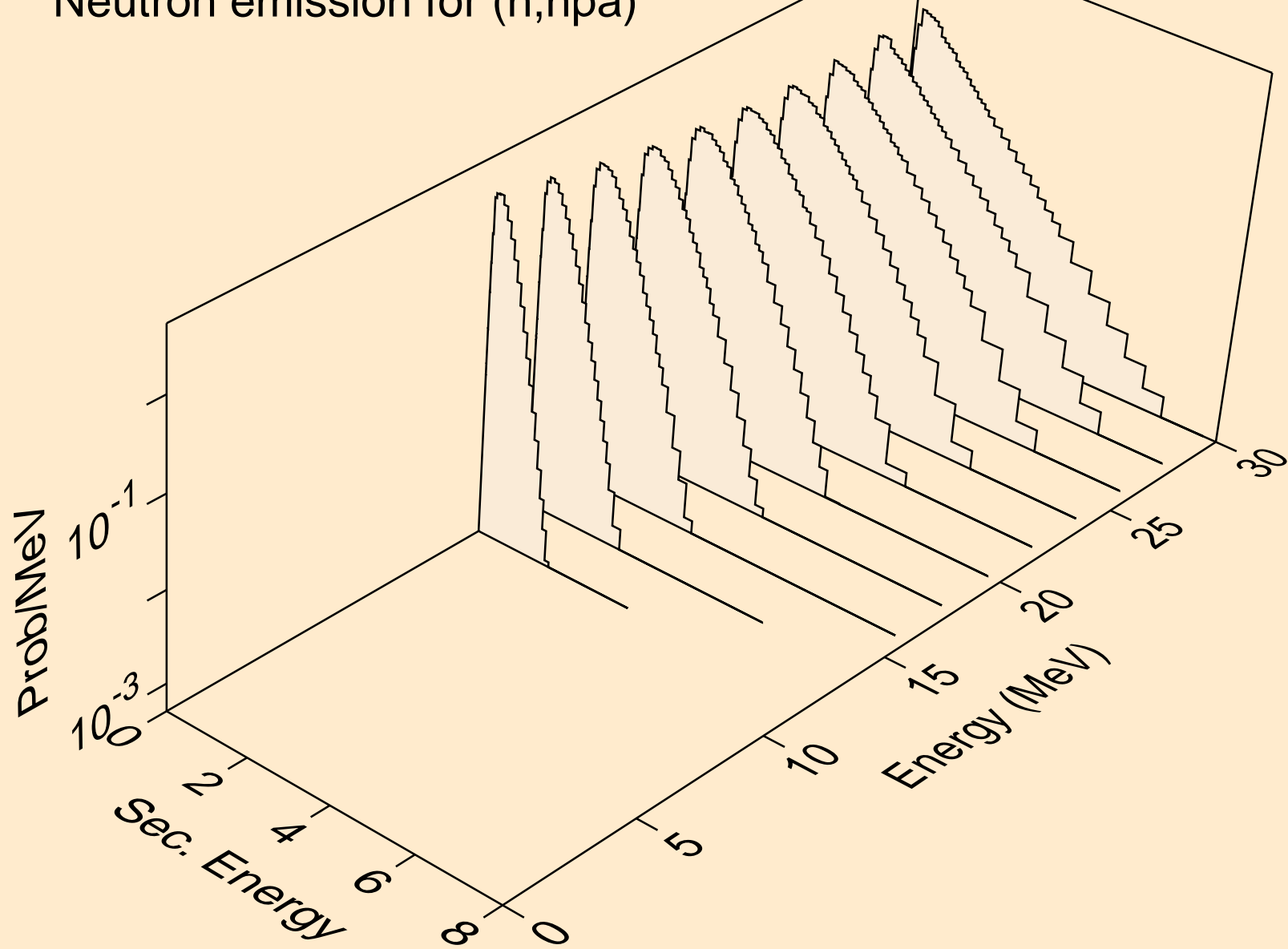

HG191 NEUTRON ACER TENDL-2024 LIBRARY; T=293.6K  
Neutron emission for (n,n\*c)

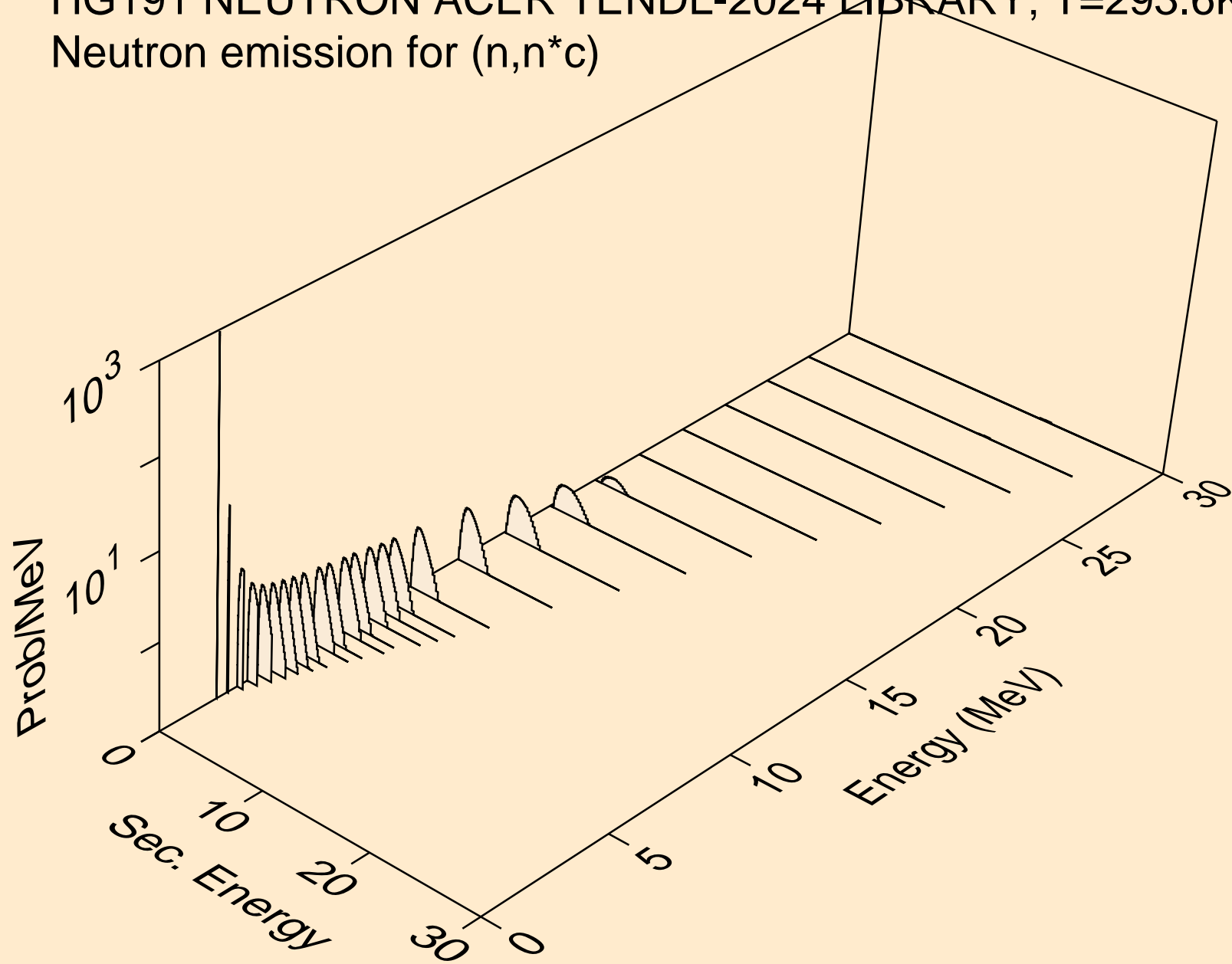

HG191 NEUTRON ACER TENDL-2024 LIBRARY; T=293.6K  
Photon emission for (n,x)

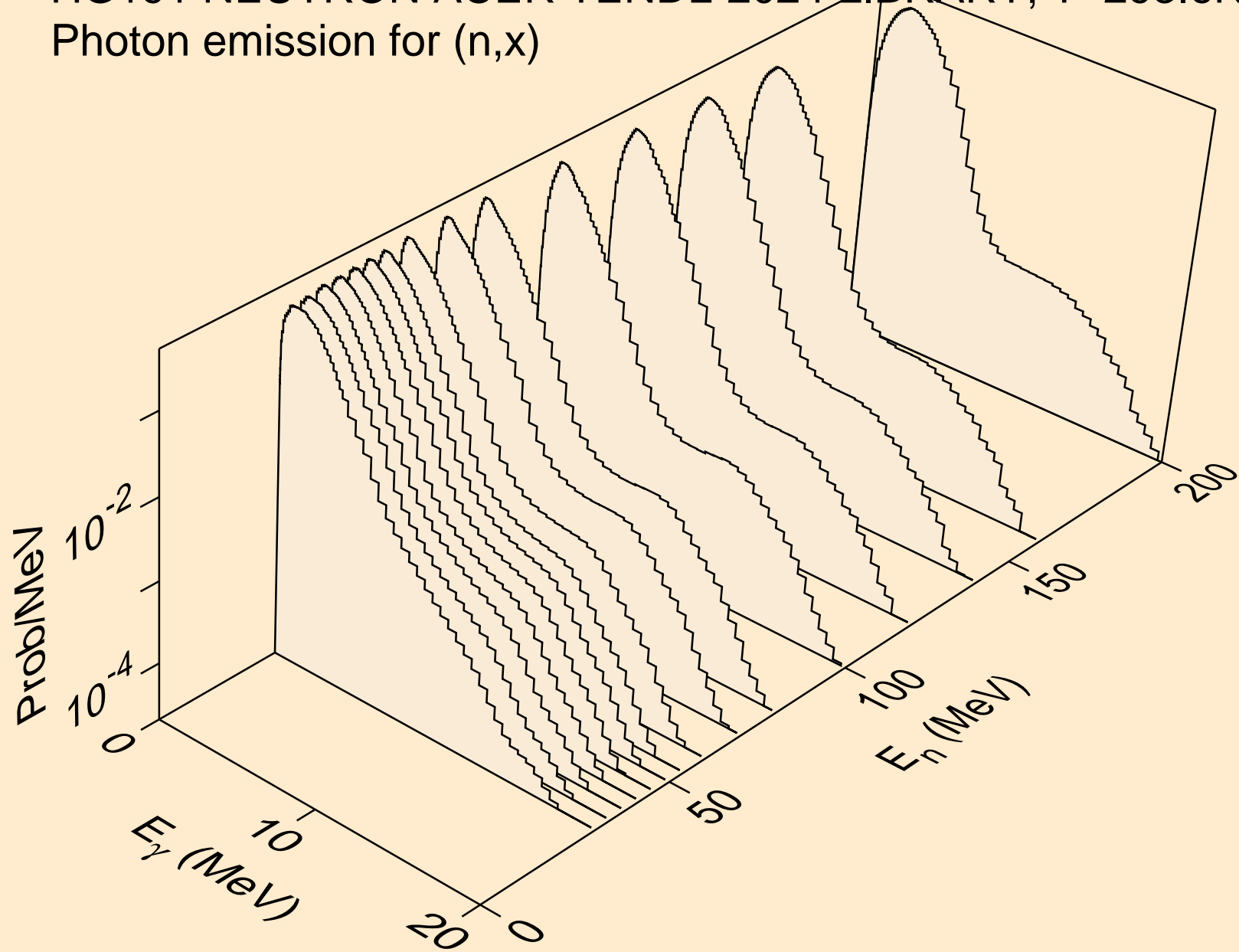

HG191 NEUTRON ACER TENDL-2024 LIBRARY; T=293.6K  
Photon emission for (n,2nd)

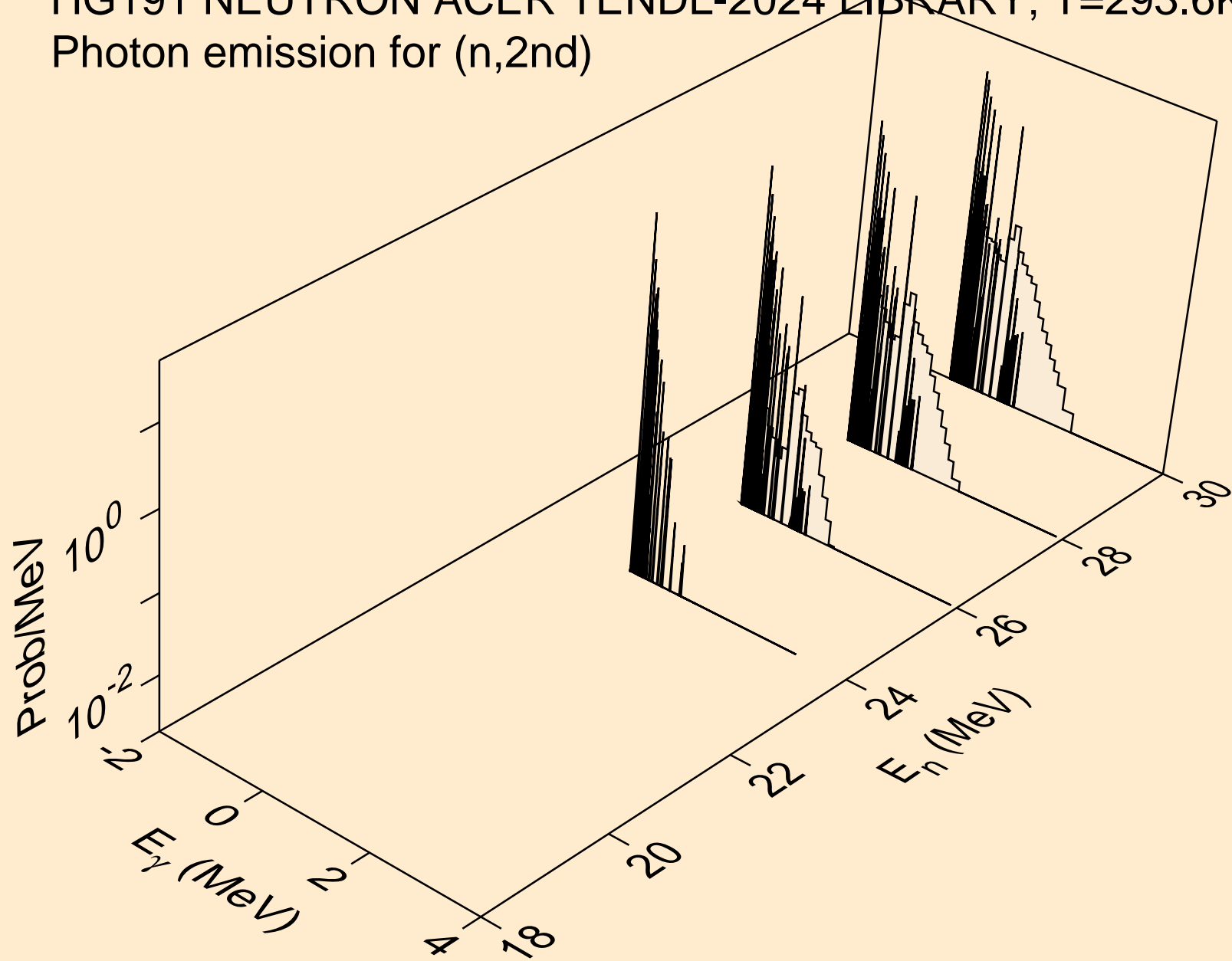

HG191 NEUTRON ACER TENDL-2024 LIBRARY; T=293.6K  
Photon emission for (n,2n)

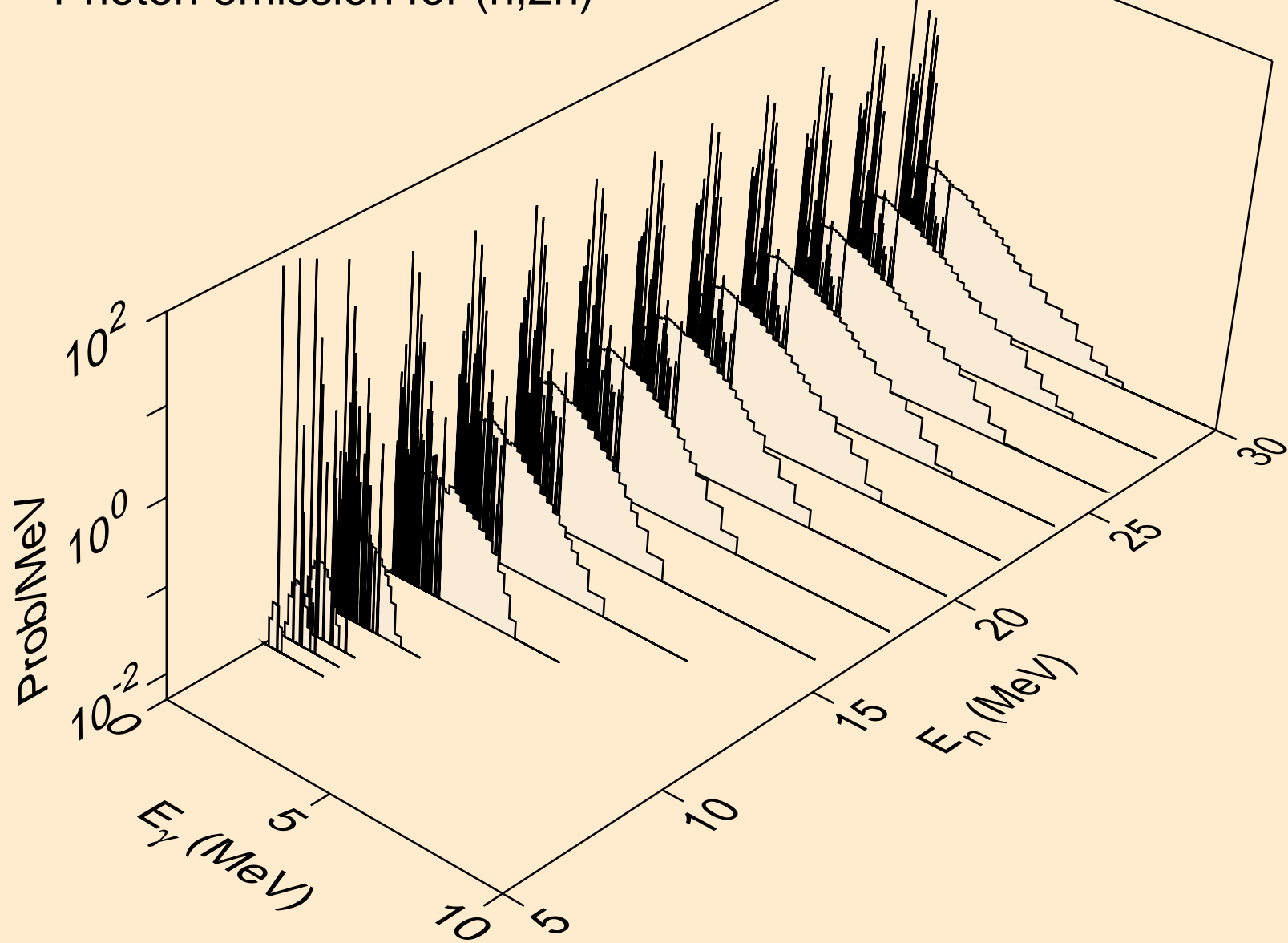

HG191 NEUTRON ACER TENDL-2024 LIBRARY; T=293.6K  
Photon emission for (n,3n)

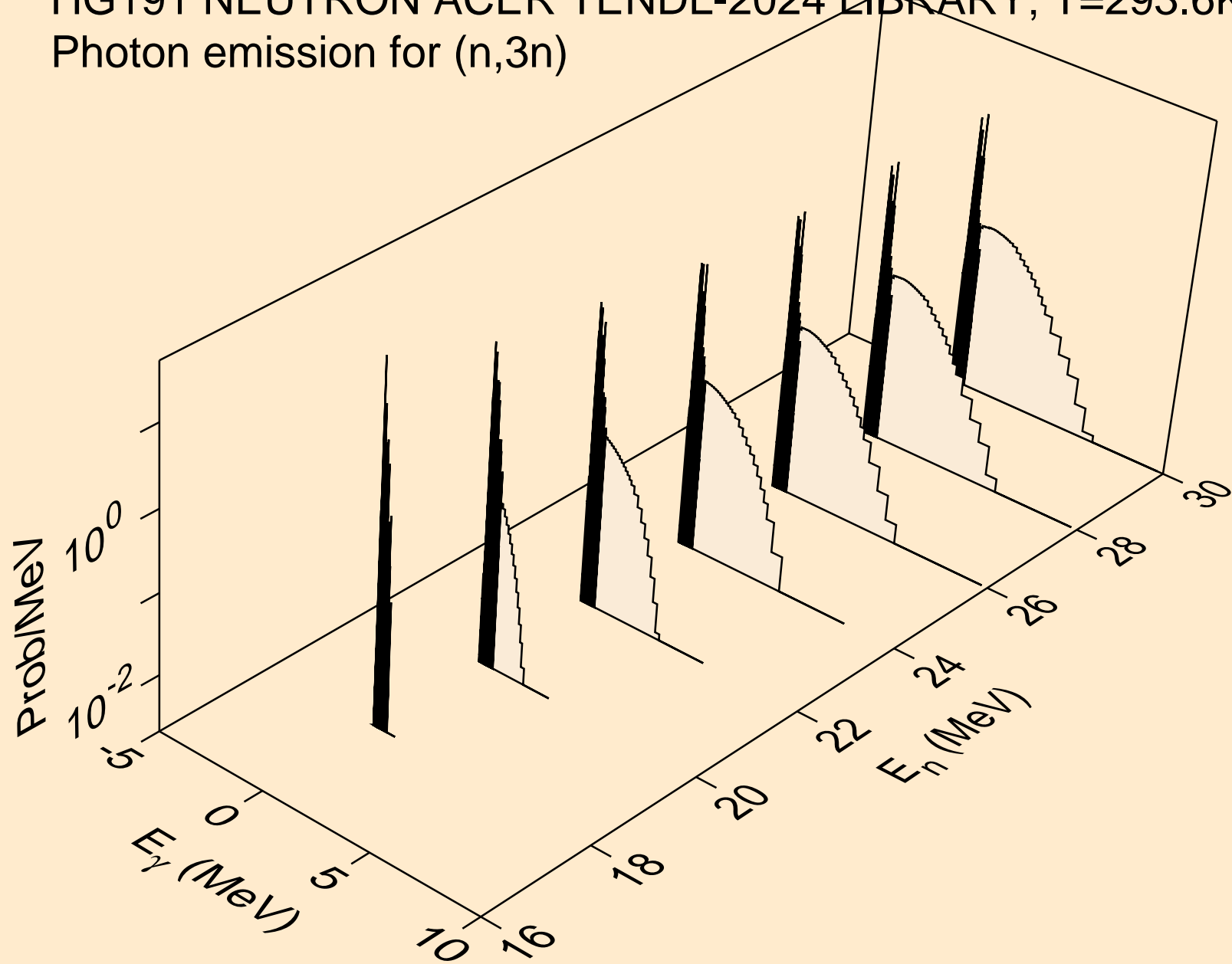

HG191 NEUTRON ACER TENDL-2024 LIBRARY; T=293.6K  
Photon emission for (n,n\*)a

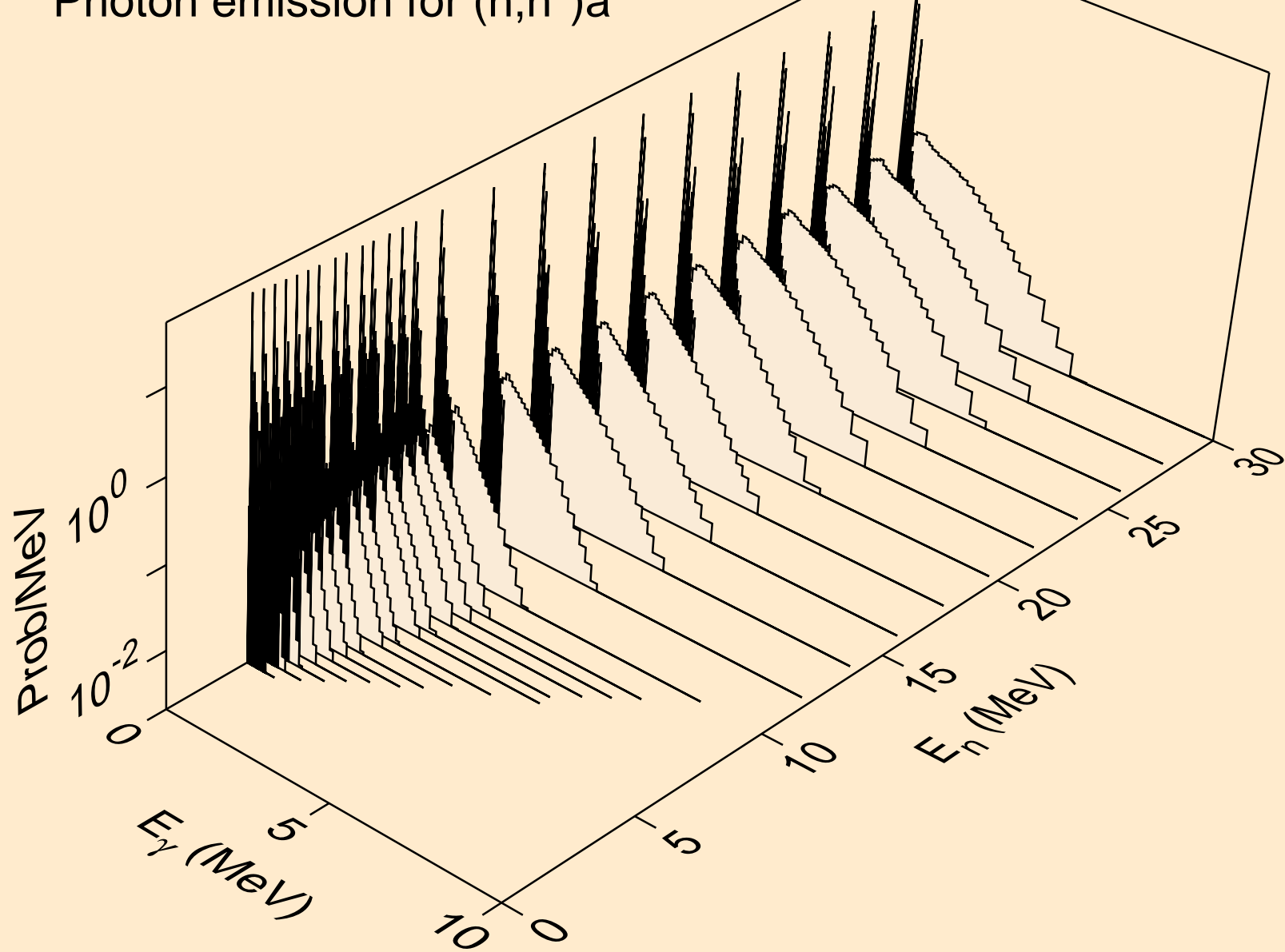

HG191 NEUTRON ACER TENDL-2024 LIBRARY; T=293.6K  
Photon emission for (n,2n)a

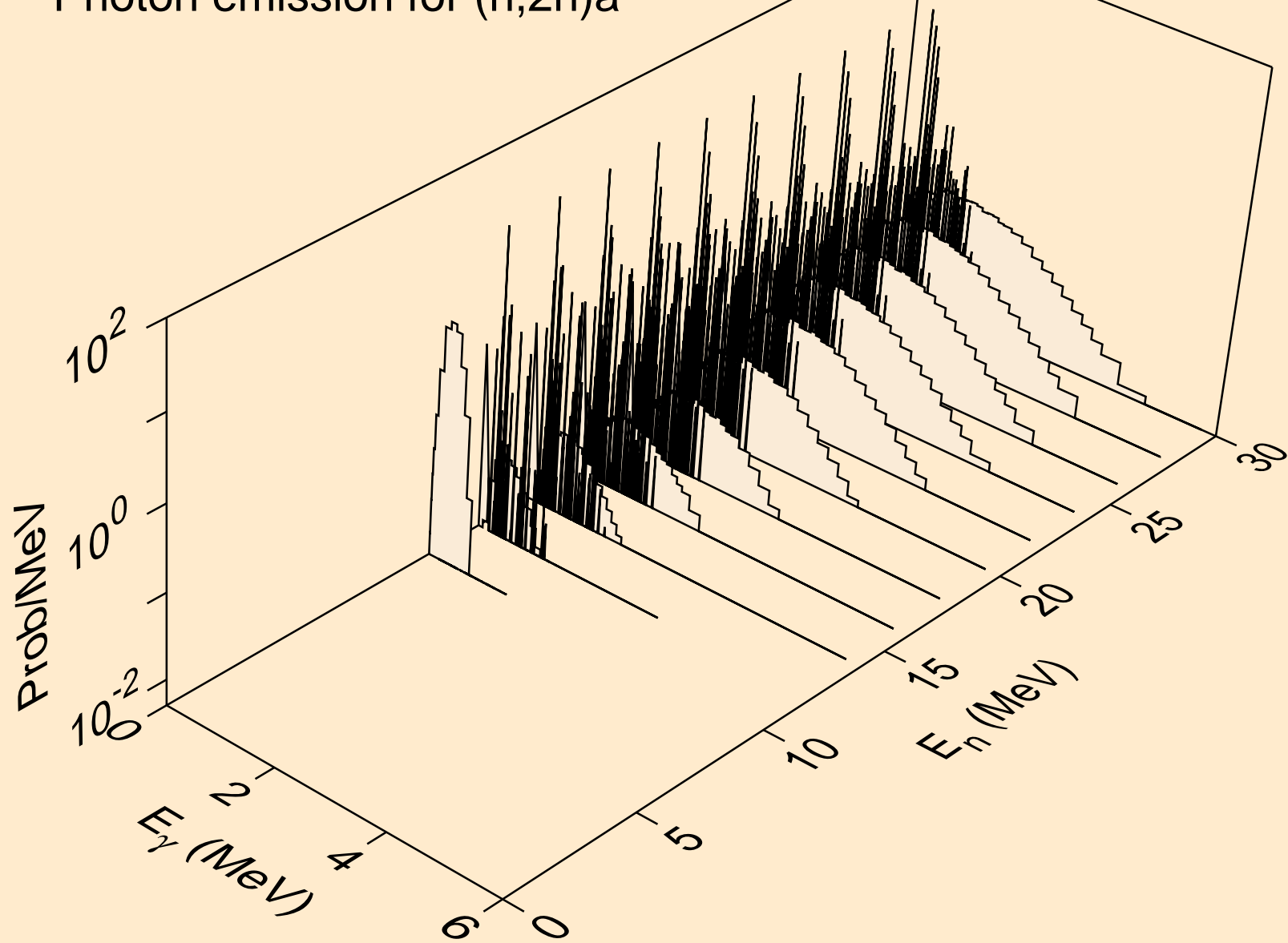

HG191 NEUTRON ACER TENDL-2024 LIBRARY; T=293.6K  
Photon emission for (n,3n)a

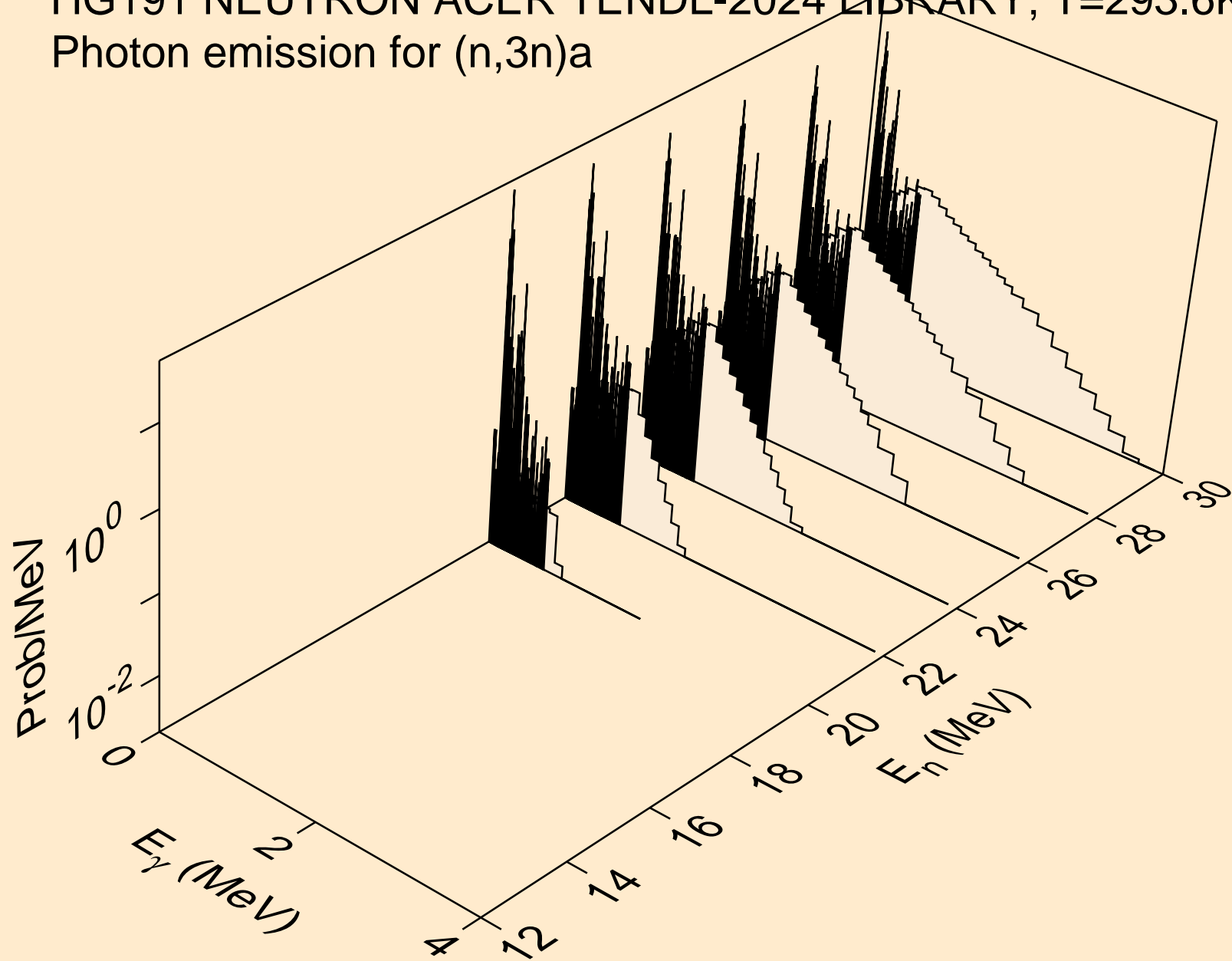

HG191 NEUTRON ACER TENDL-2024 LIBRARY; T=293.6K  
Photon emission for (n,n\*)p

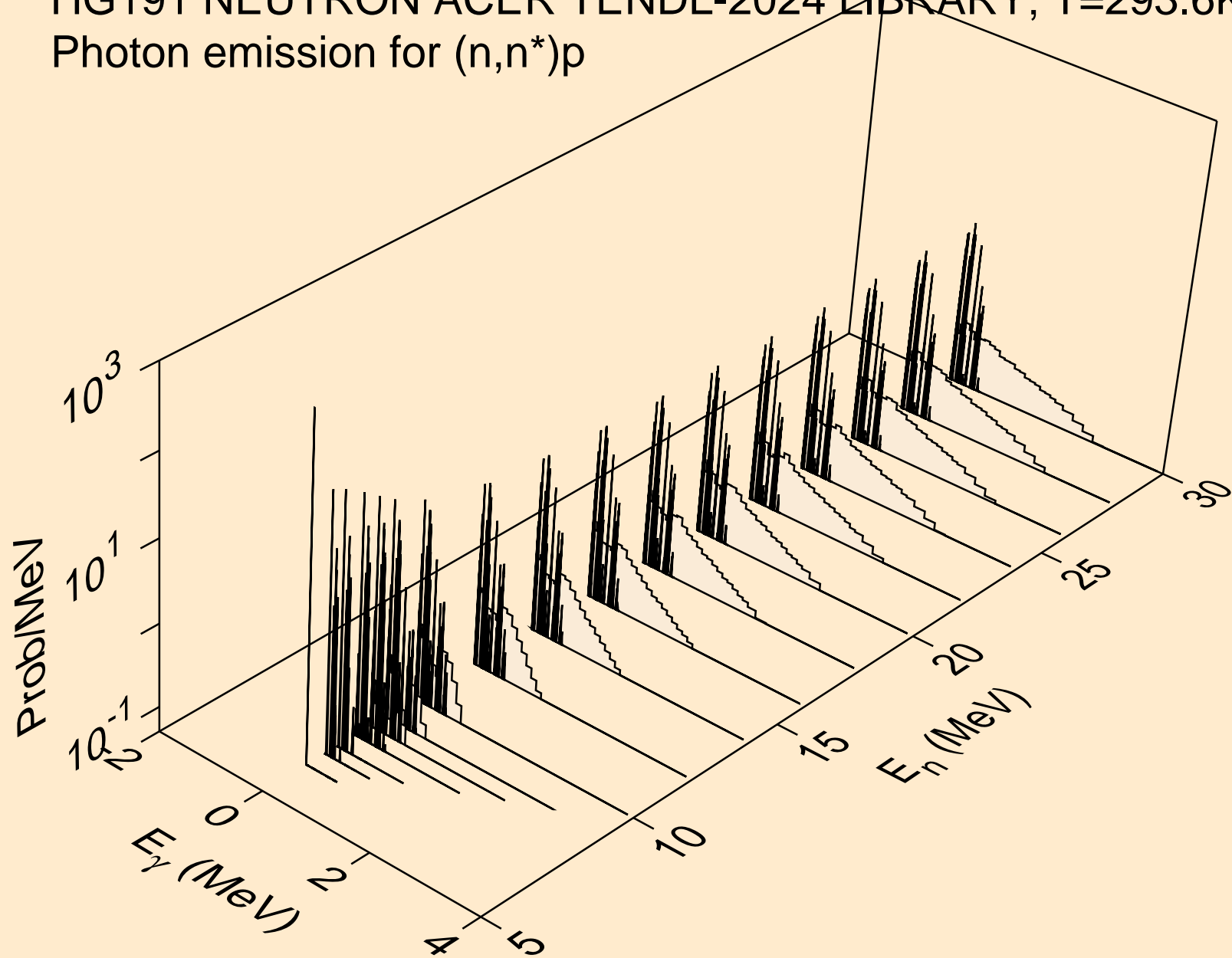

HG191 NEUTRON ACER TENDL-2024 LIBRARY; T=293.6K  
Photon emission for (n,n\*)2a

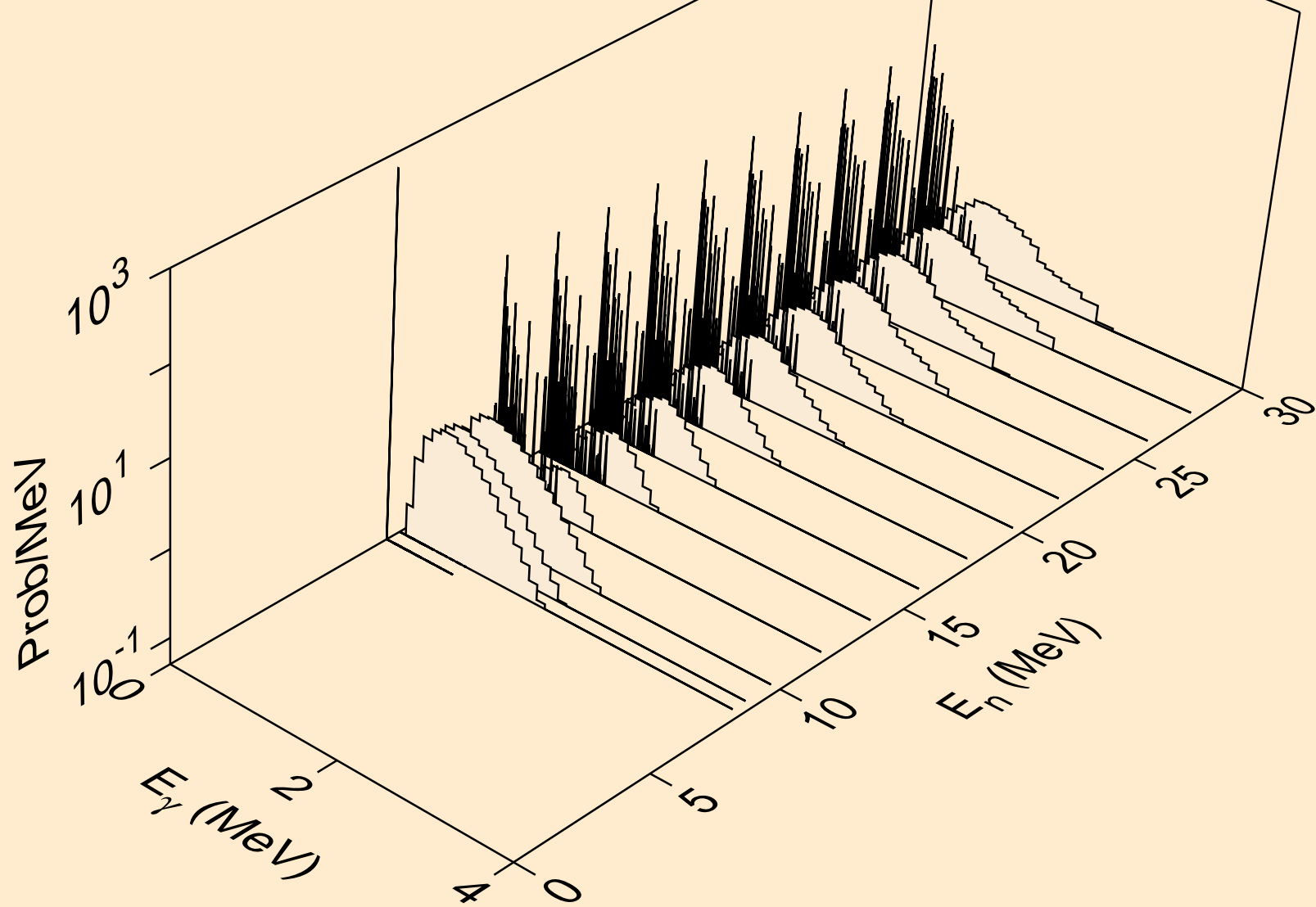

HG191 NEUTRON ACER TENDL-2024 LIBRARY; T=293.6K  
Photon emission for (n,2n)2a

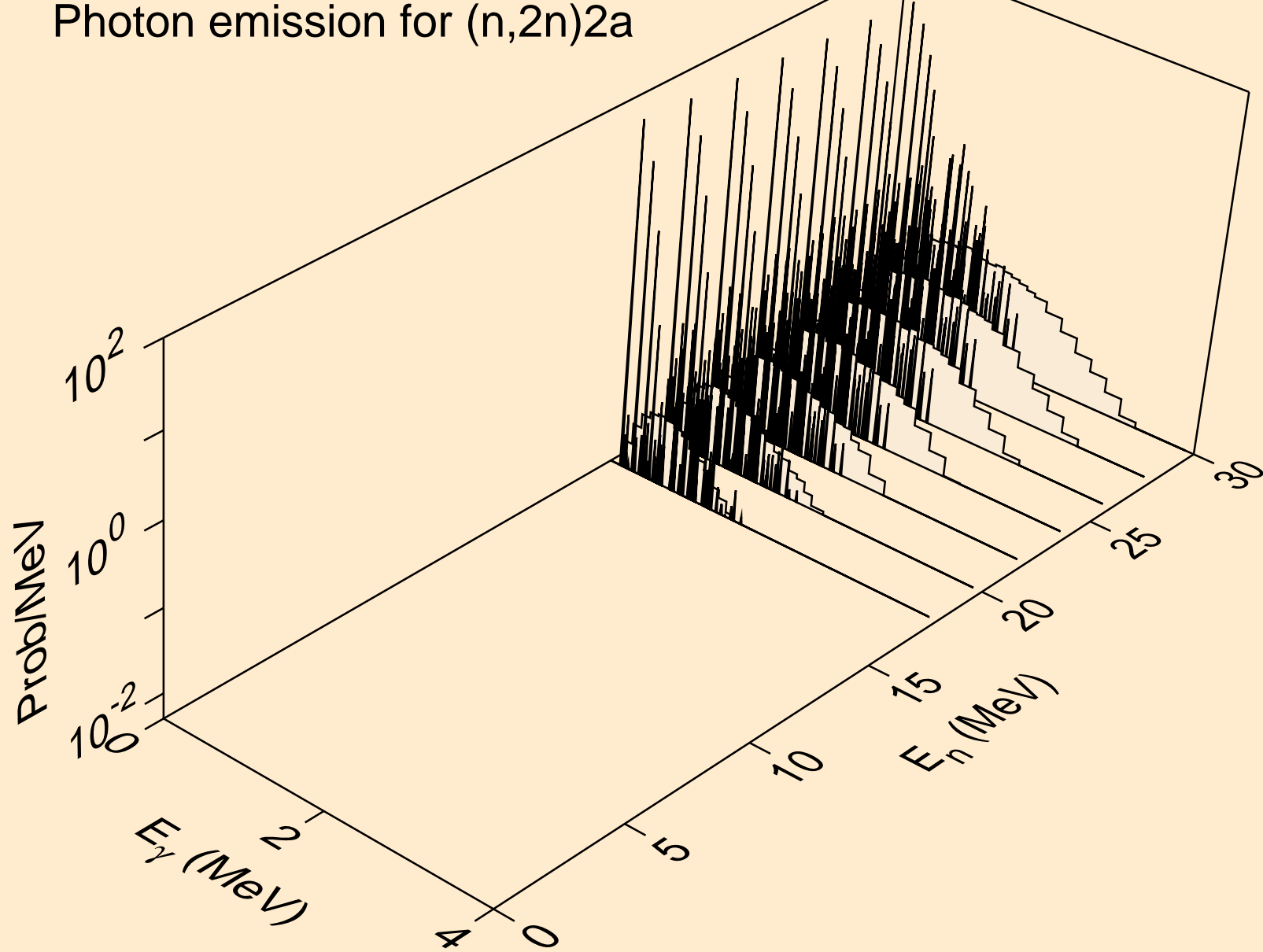

HG191 NEUTRON ACER TENDL-2024 LIBRARY; T=293.6K  
Photon emission for (n,n\*)d

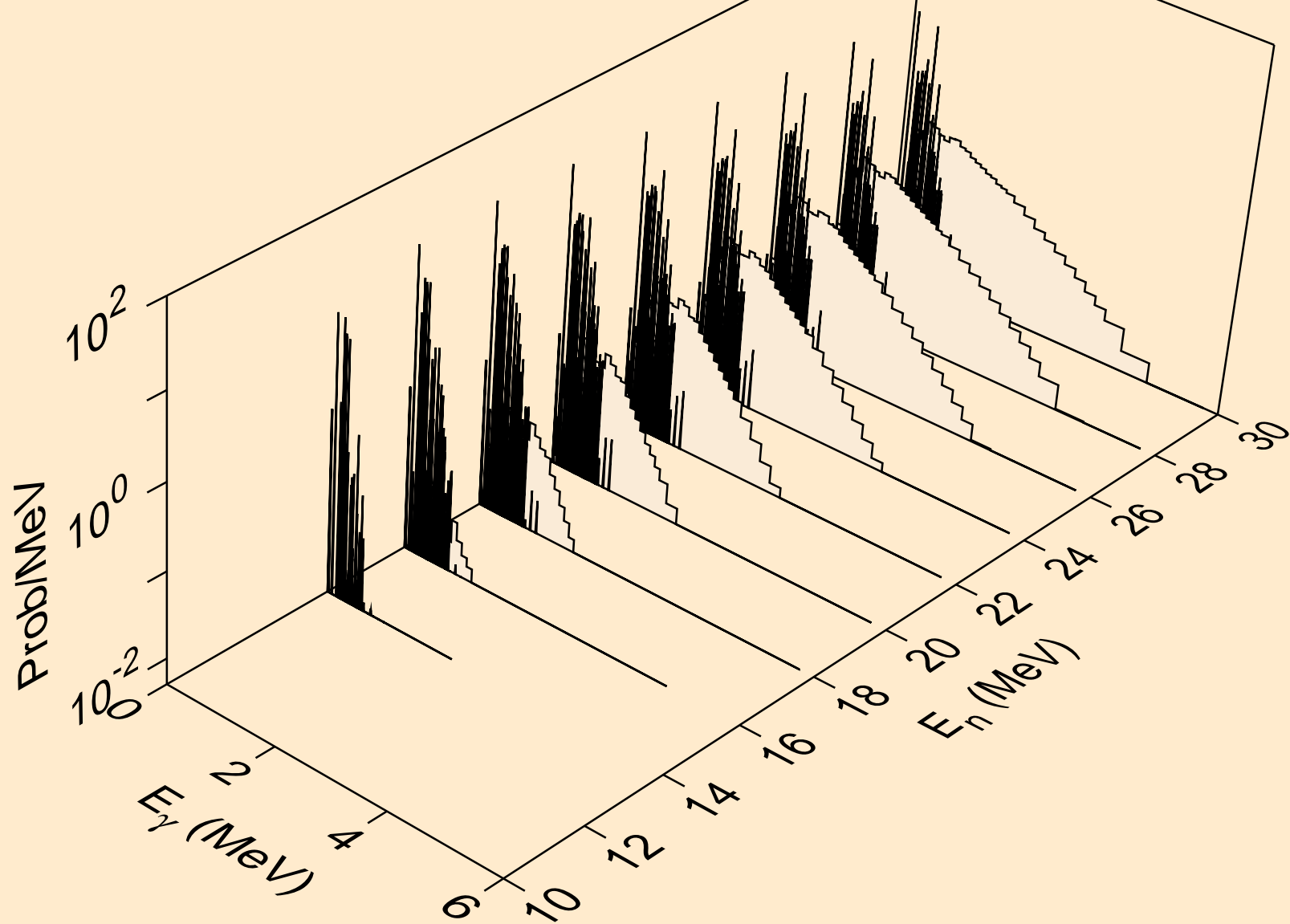

HG191 NEUTRON ACER TENDL-2024 LIBRARY; T=293.6K  
Photon emission for (n,n\*)t

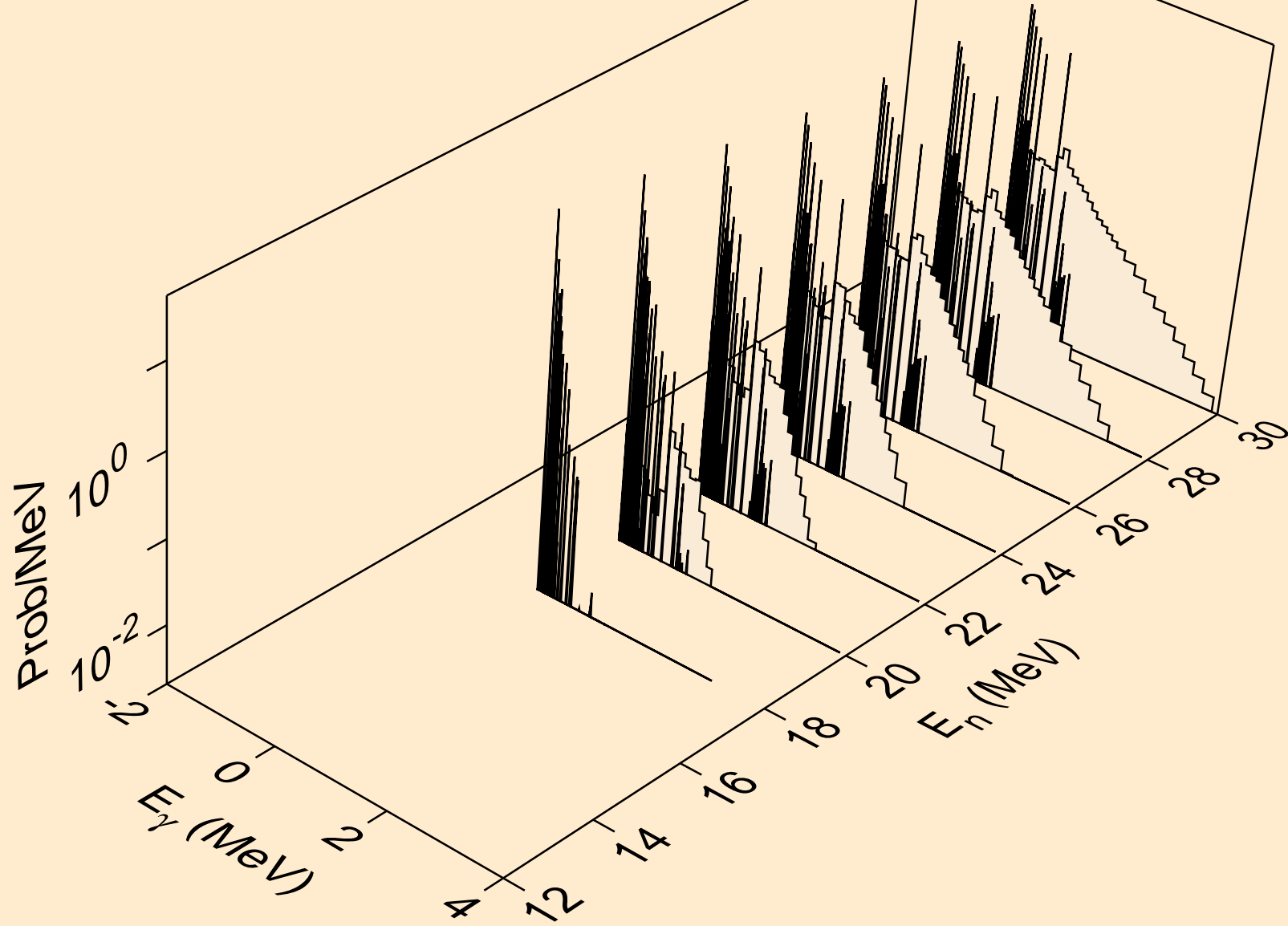

HG191 NEUTRON ACER TENDL-2024 LIBRARY; T=293.6K  
Photon emission for (n,n\*)he3

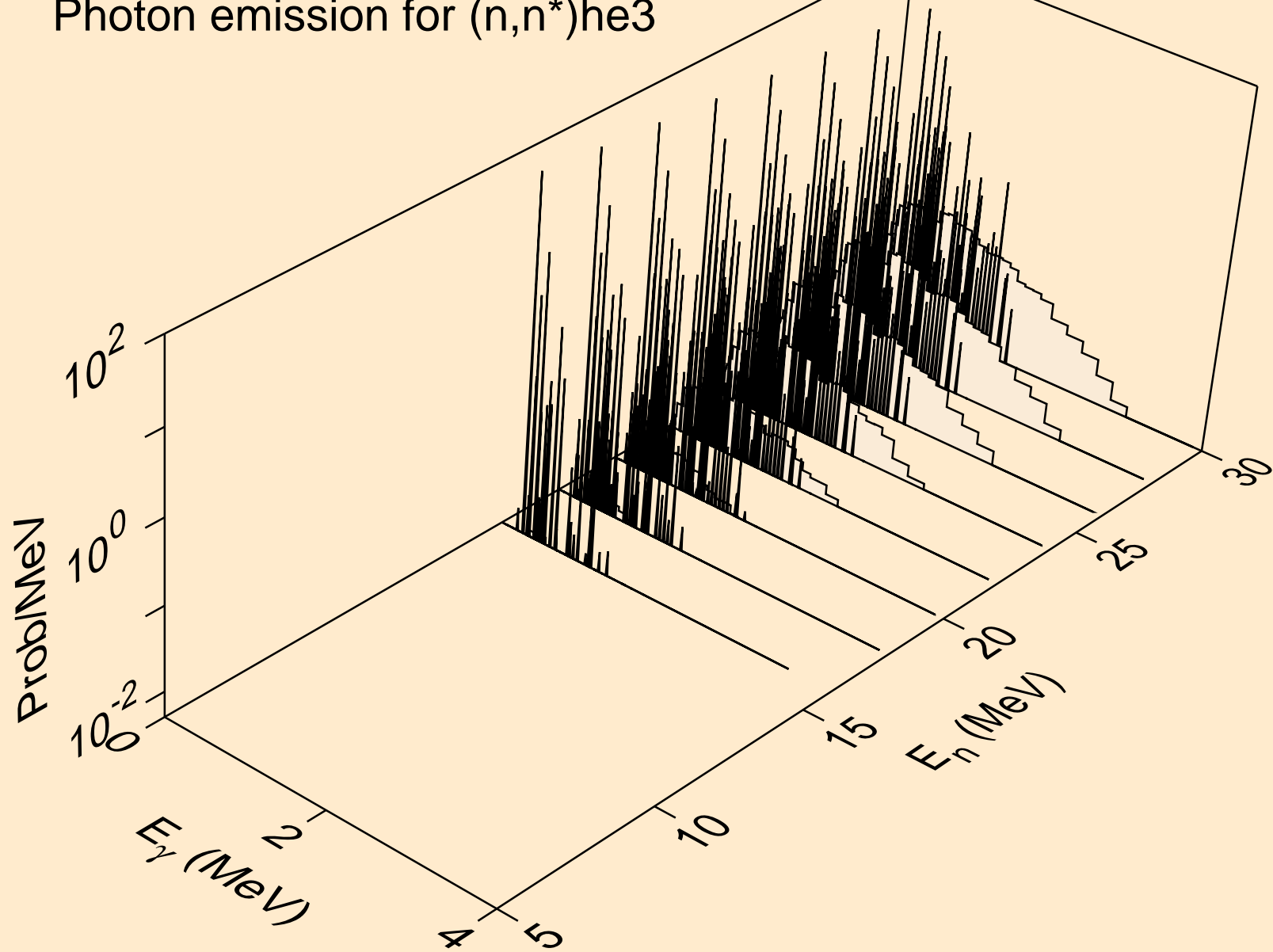

HG191 NEUTRON ACER TENDL-2024 LIBRARY; T=293.6K  
Photon emission for (n,4n)

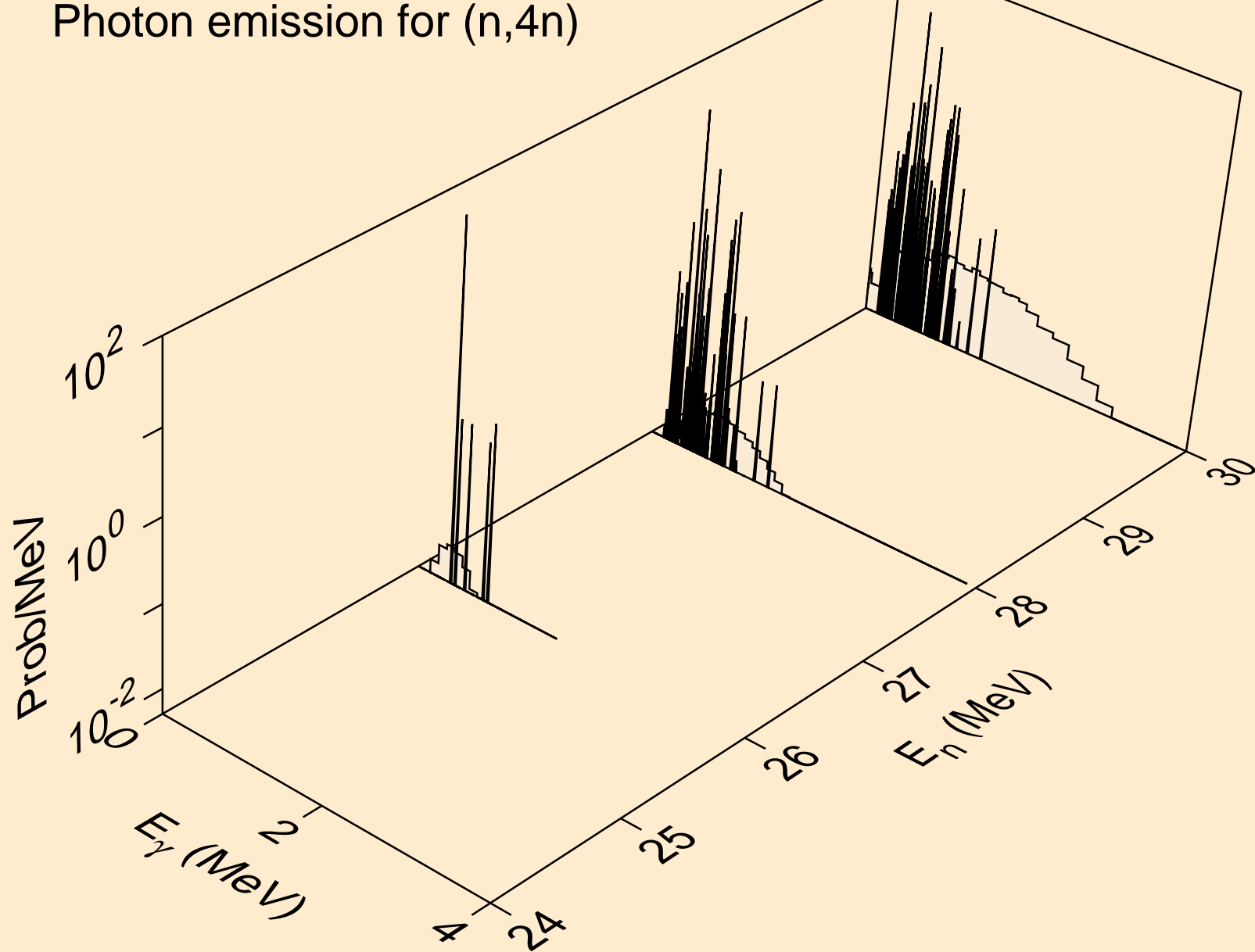

HG191 NEUTRON ACER TENDL-2024 LIBRARY; T=293.6K  
Photon emission for (n,2np)

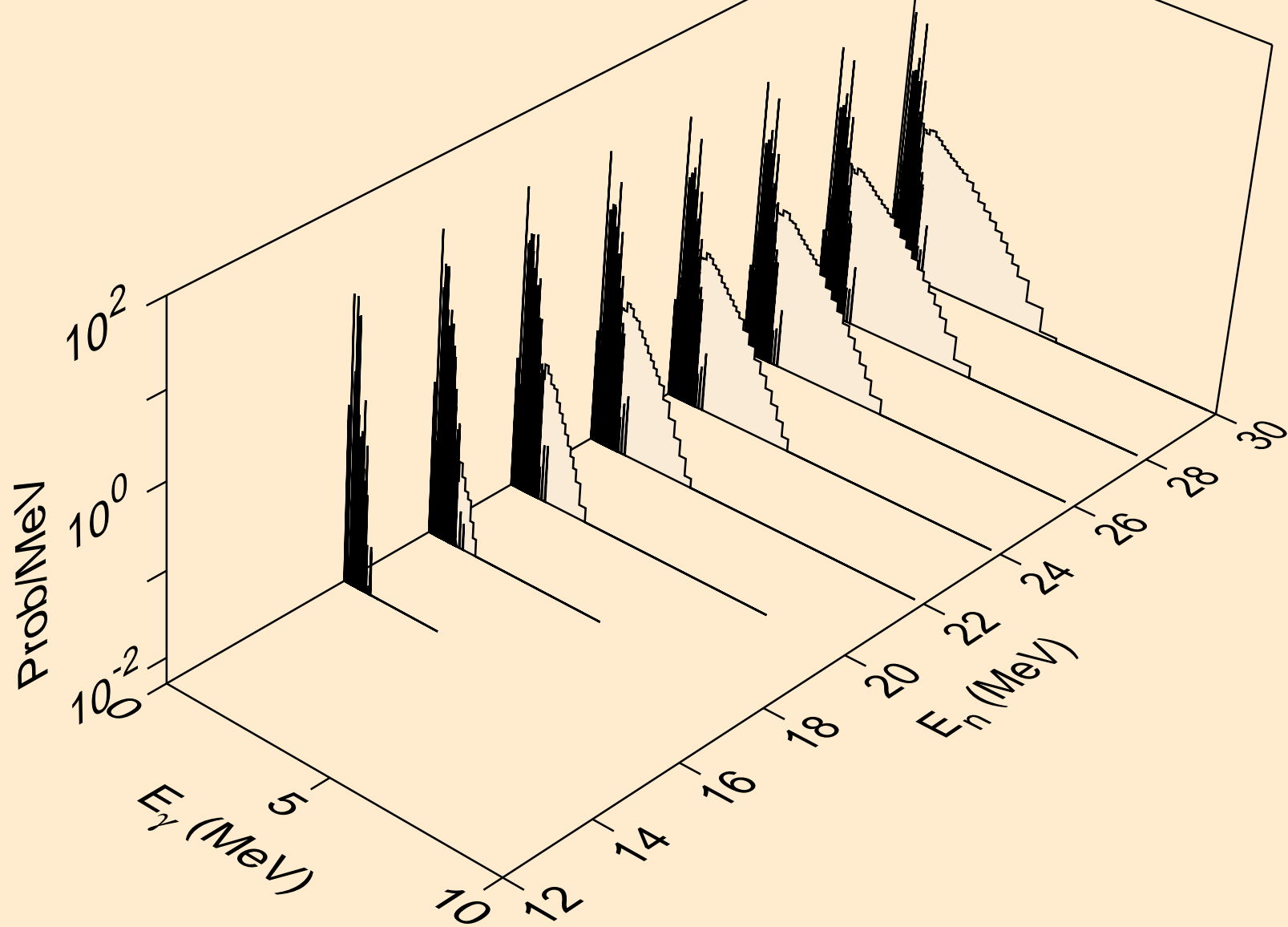

HG191 NEUTRON ACER TENDL-2024 LIBRARY; T=293.6K  
Photon emission for (n,3np)

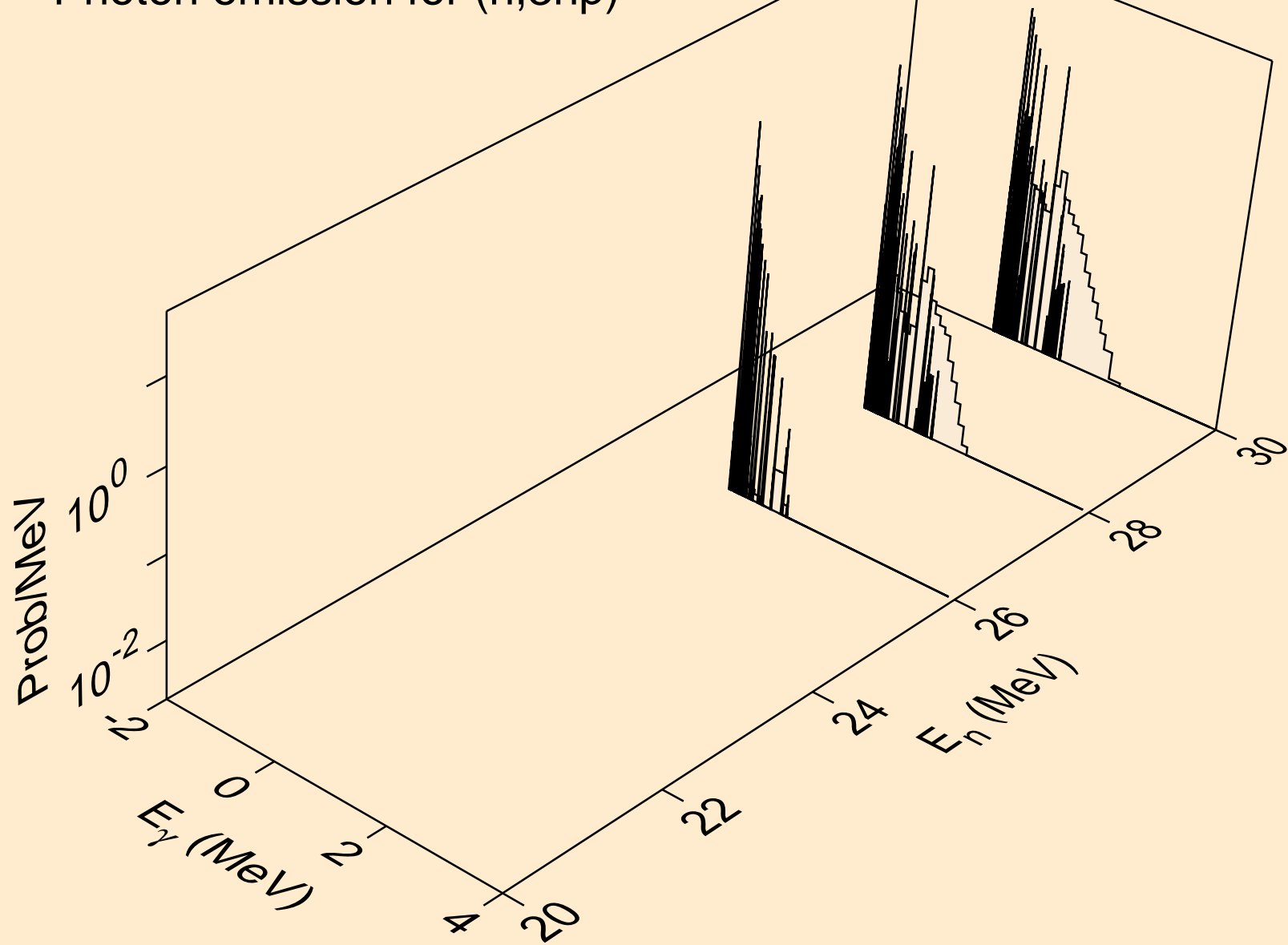

HG191 NEUTRON ACER TENDL-2024 LIBRARY; T=293.6K  
Photon emission for (n,n2p)

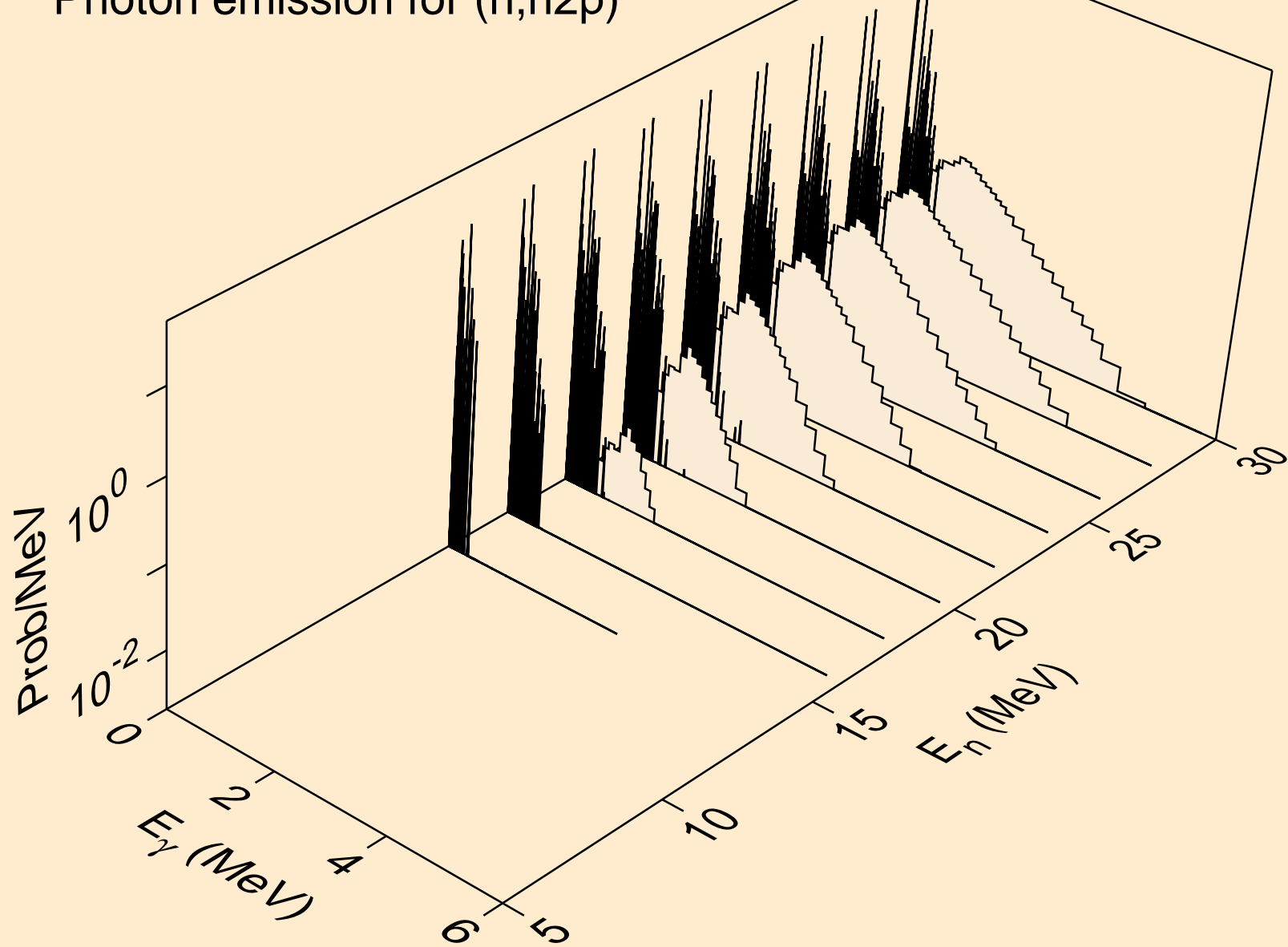

HG191 NEUTRON ACER TENDL-2024 LIBRARY; T=293.6K  
Photon emission for (n,npa)

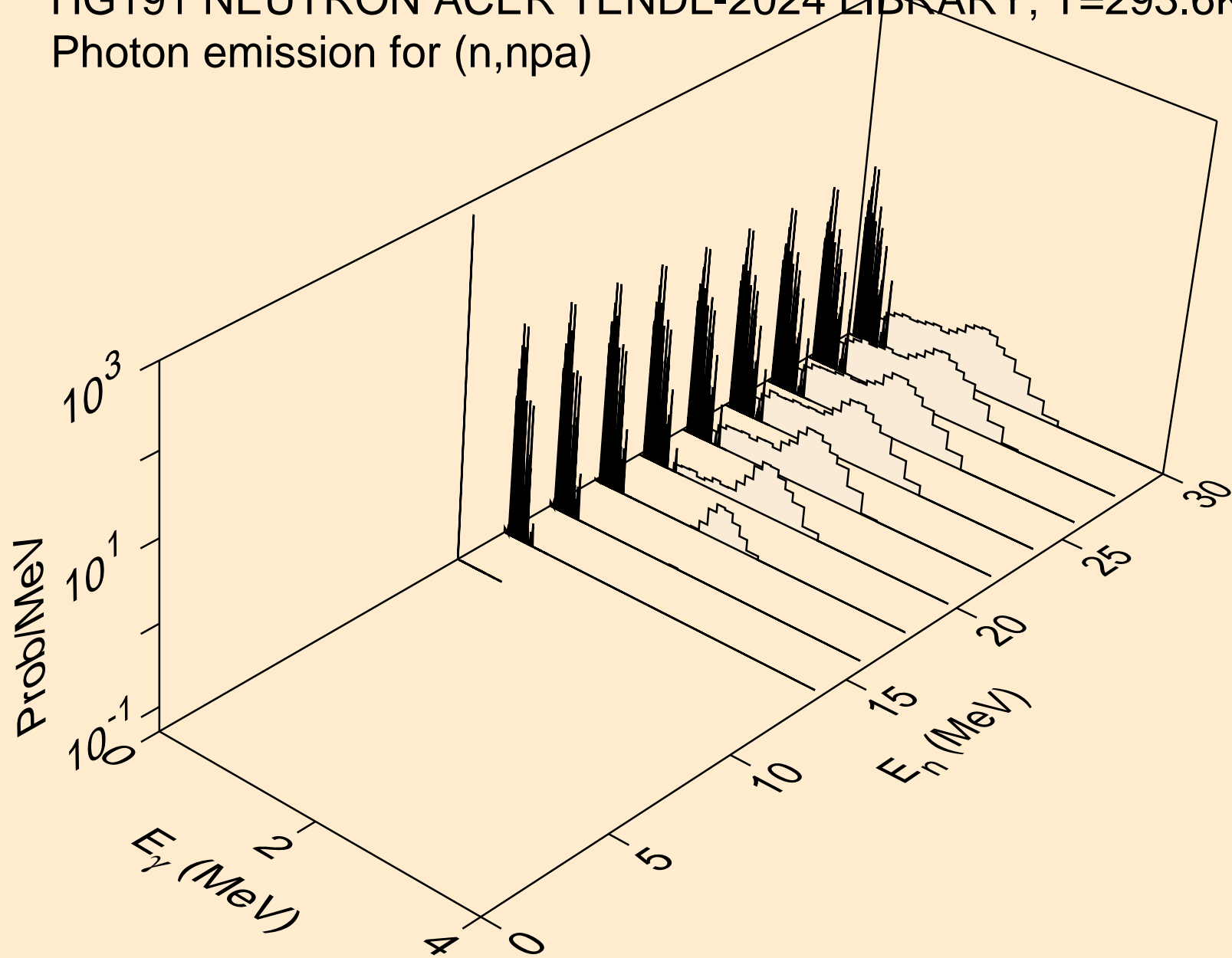

HG191 NEUTRON ACER TENDL-2024 LIBRARY; T=293.6K  
Photon emission for (n,n\*c)

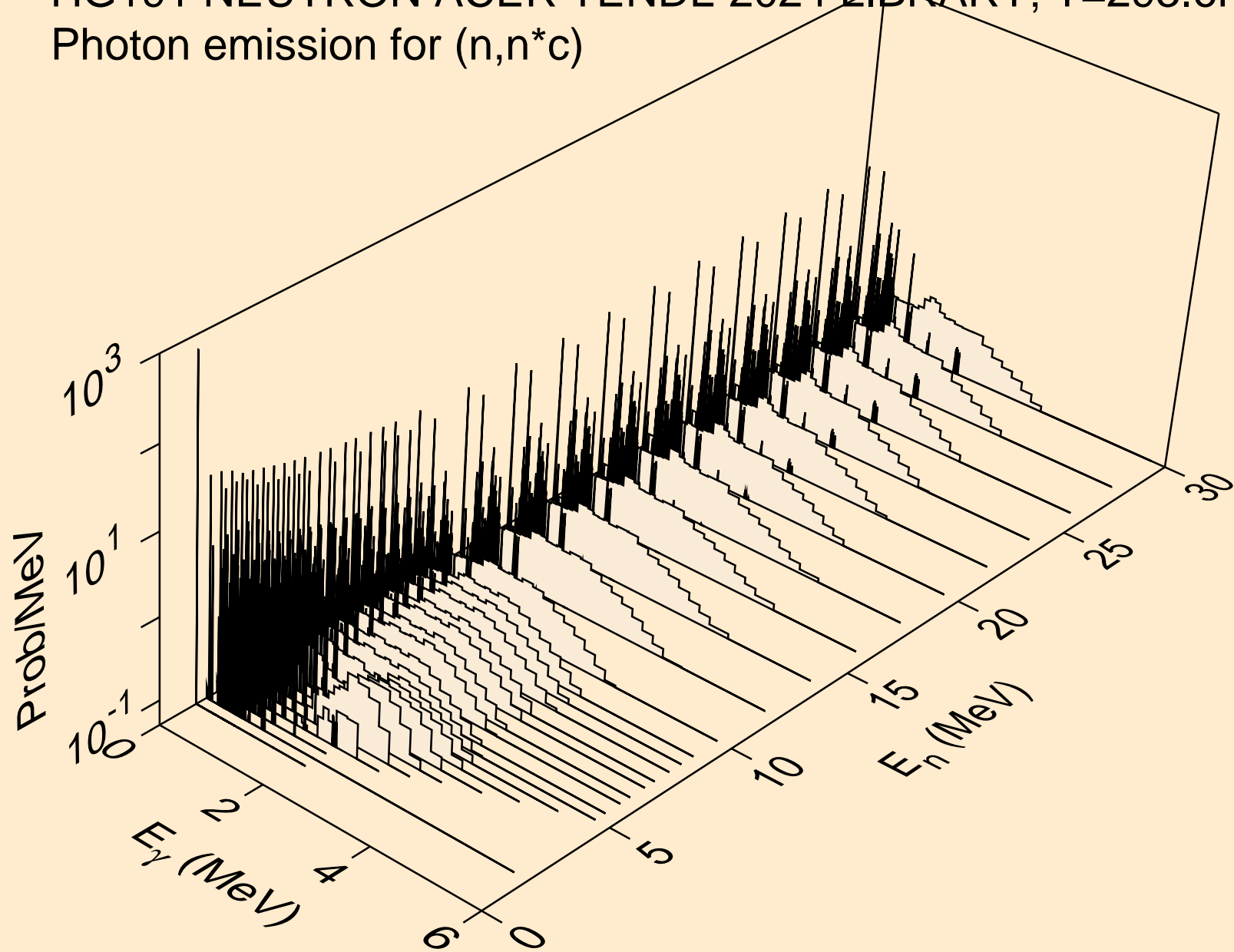

HG191 NEUTRON ACER TENDL-2024 LIBRARY; T=293.6K  
Photon emission for (n,gma)

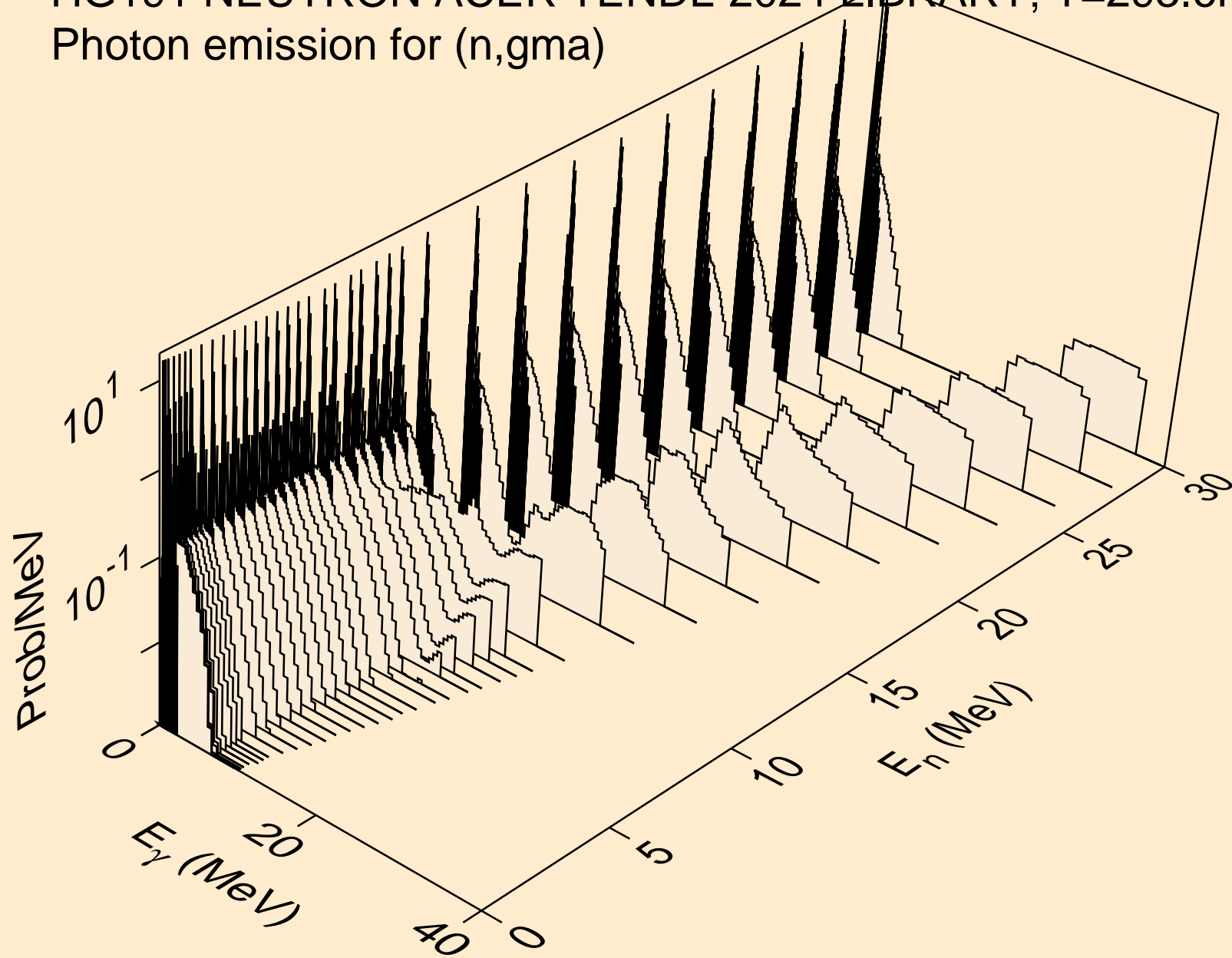

HG191 NEUTRON ACER TENDL-2024 LIBRARY; T=293.6K  
Photon emission for (n,p)

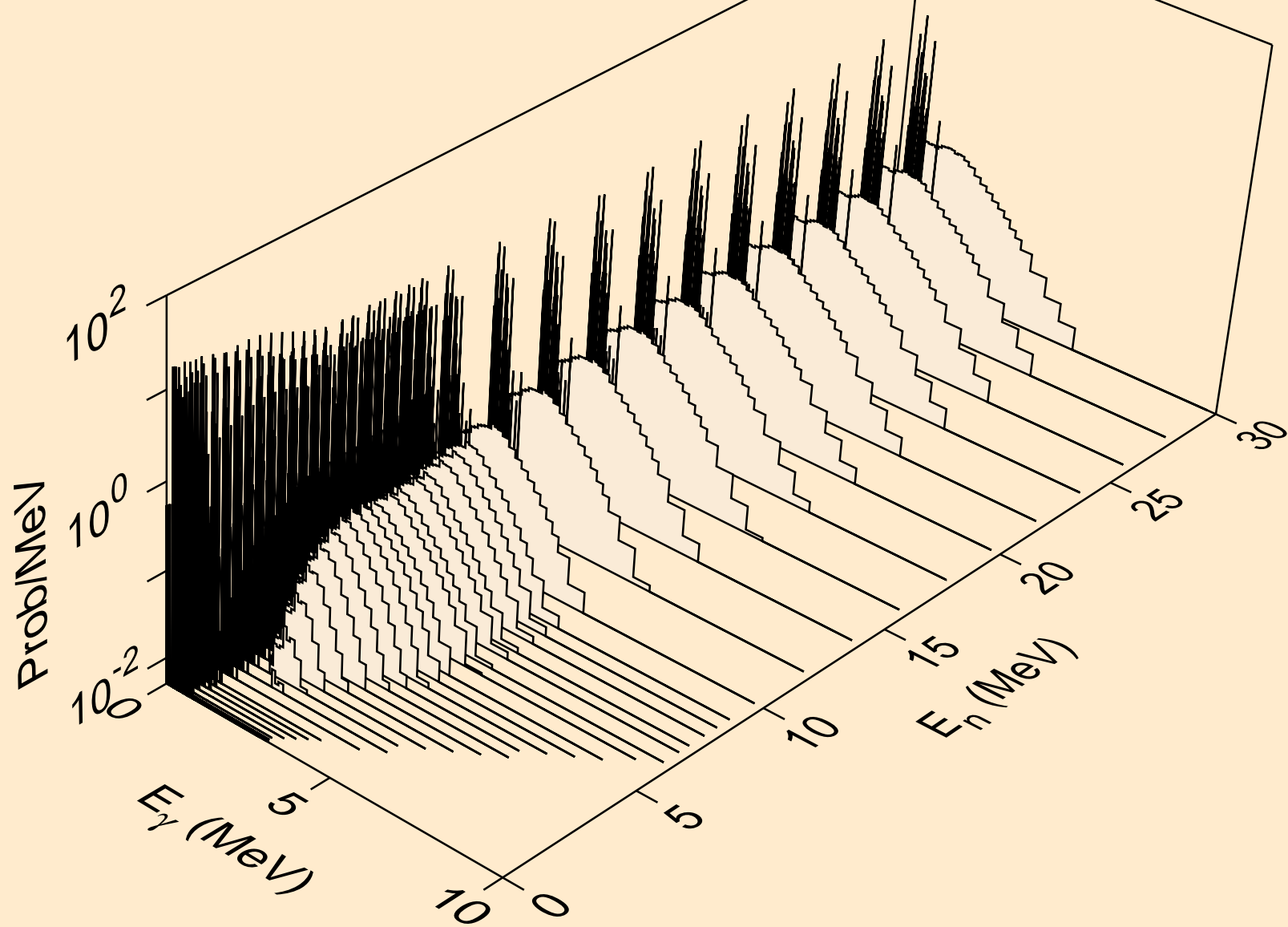

HG191 NEUTRON ACER TENDL-2024 LIBRARY; T=293.6K  
Photon emission for (n,d)

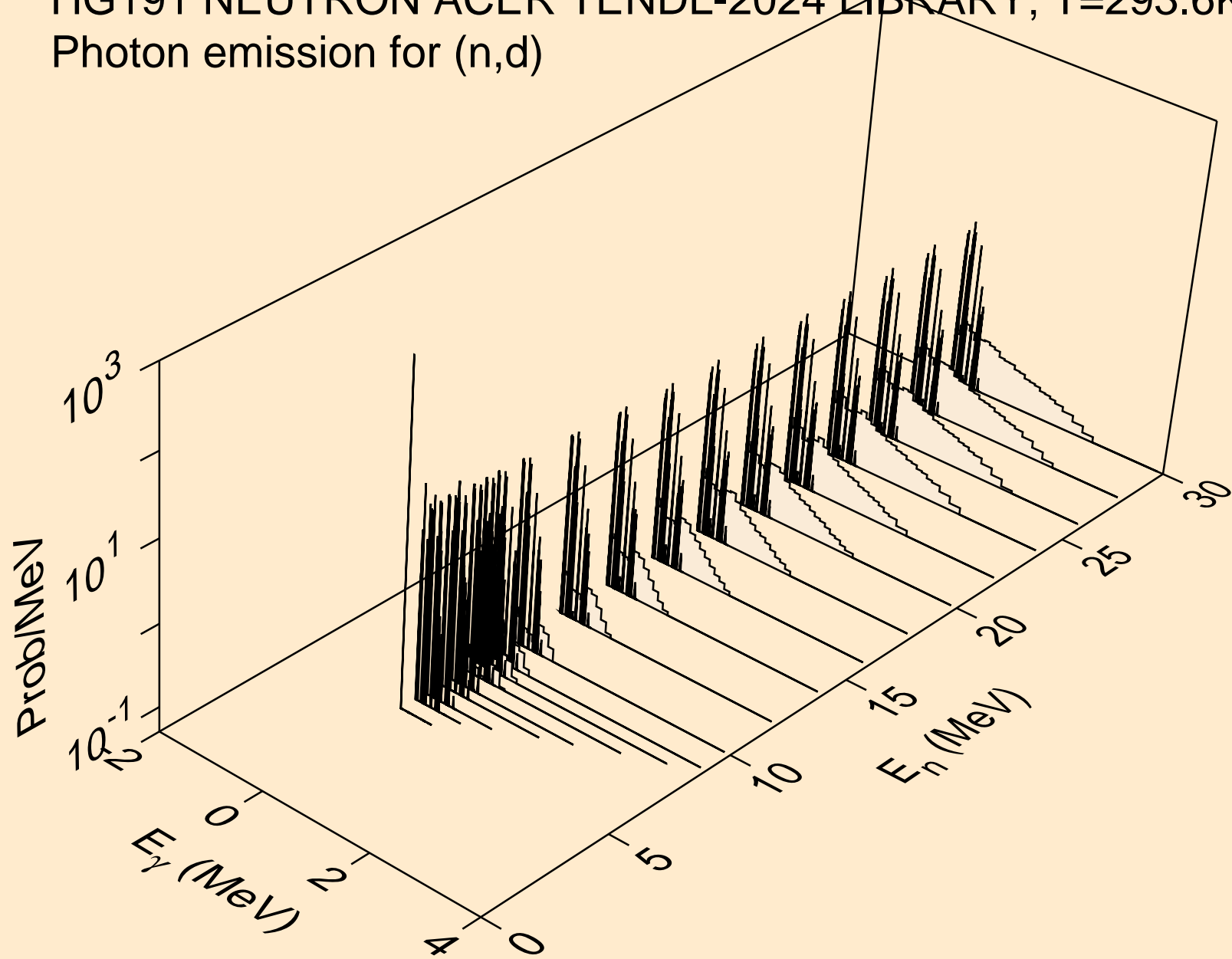

HG191 NEUTRON ACER TENDL-2024 LIBRARY; T=293.6K  
Photon emission for (n,t)

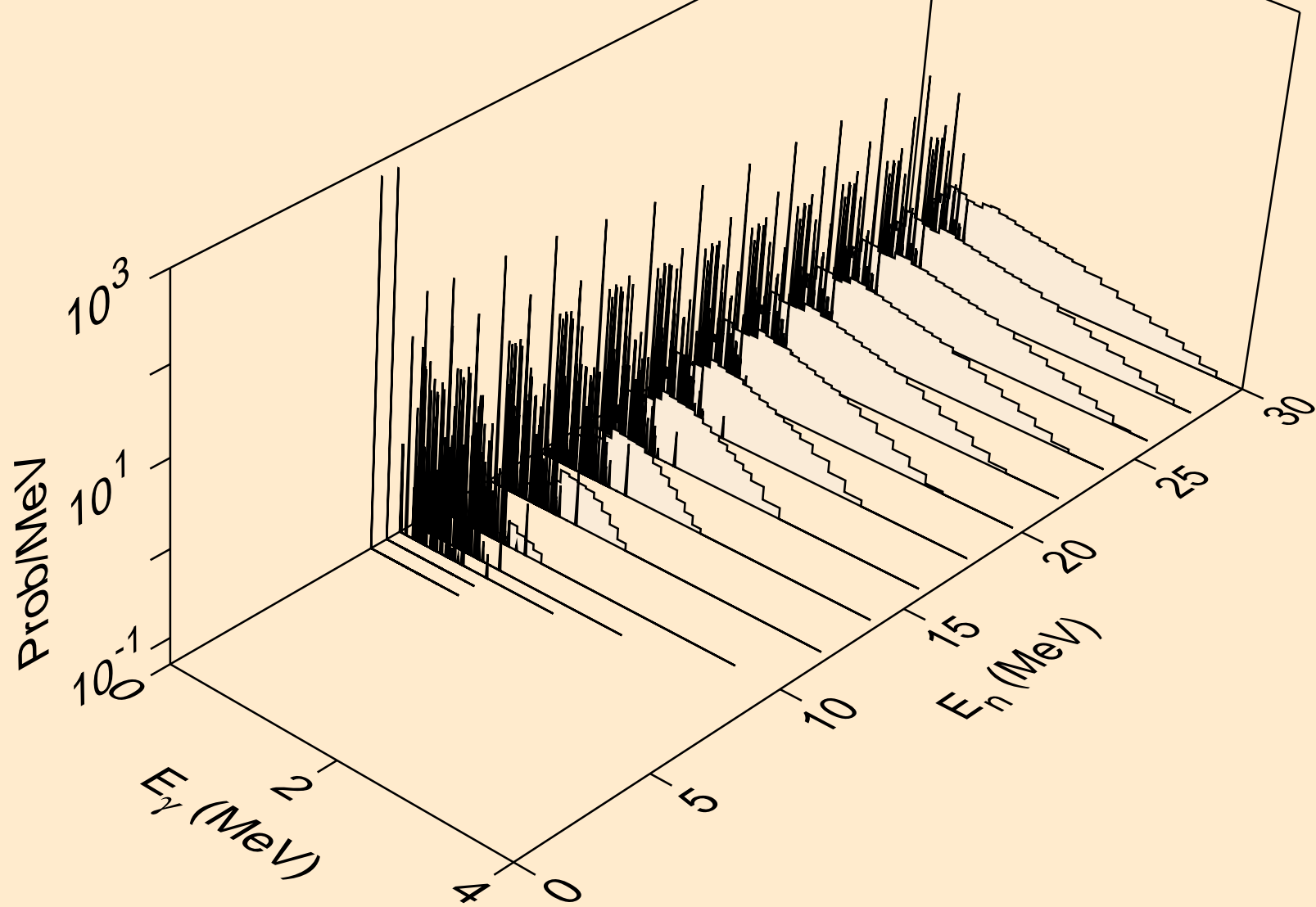

HG191 NEUTRON ACER TENDL-2024 LIBRARY; T=293.6K  
Photon emission for (n,he3)

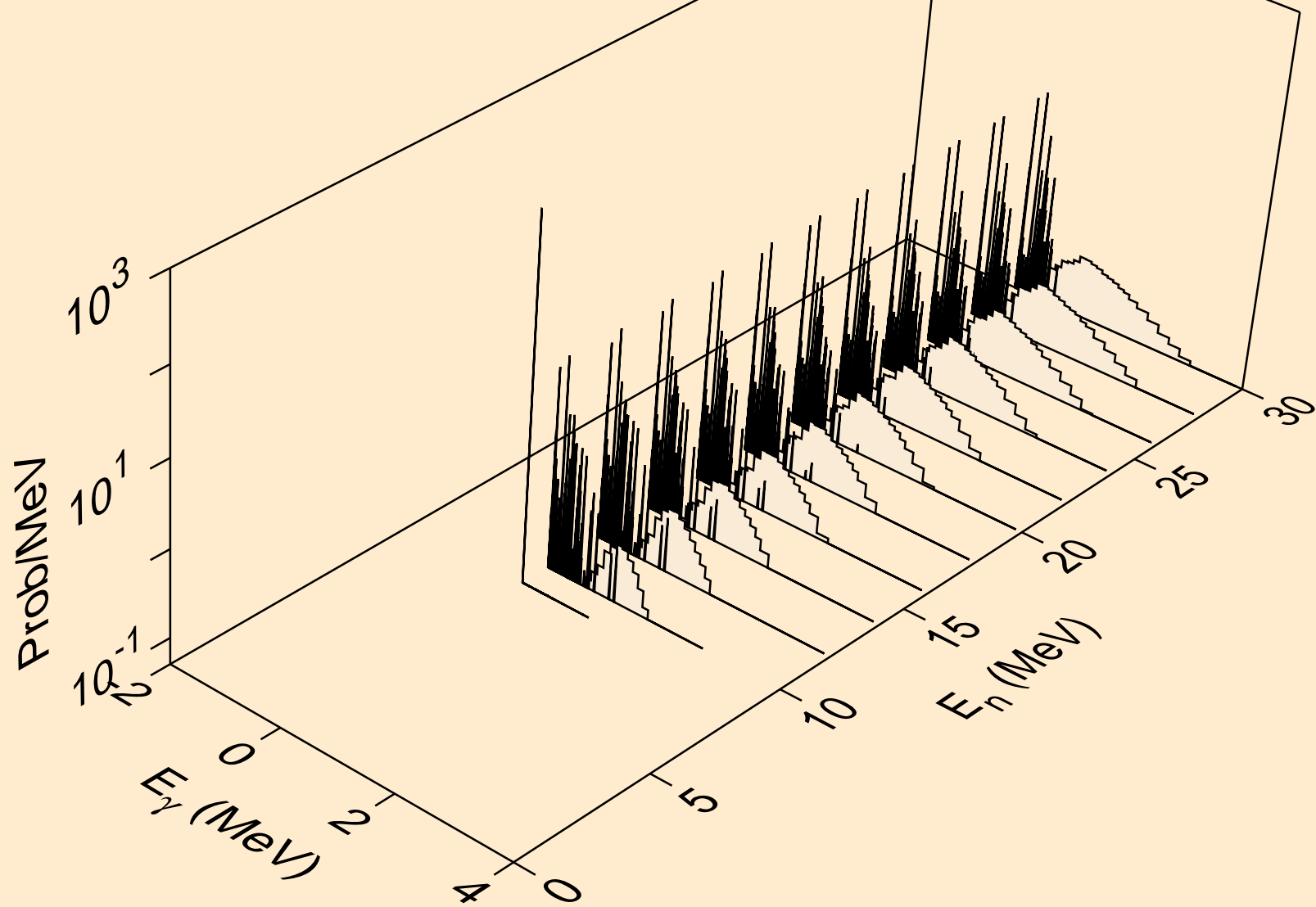

HG191 NEUTRON ACER TENDL-2024 LIBRARY; T=293.6K  
Photon emission for (n,a)

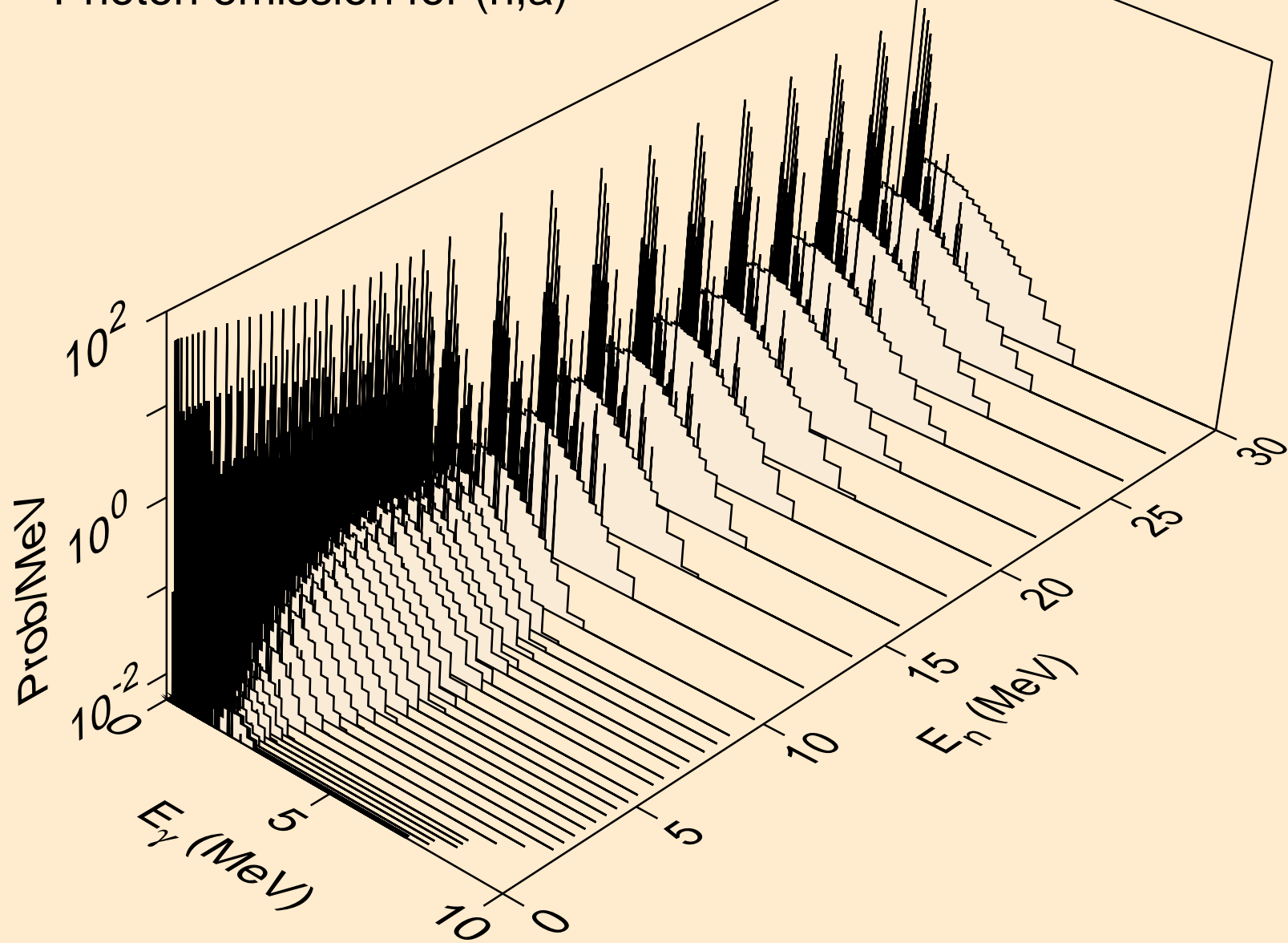

HG191 NEUTRON ACER TENDL-2024 LIBRARY; T=293.6K  
Photon emission for (n,2a)

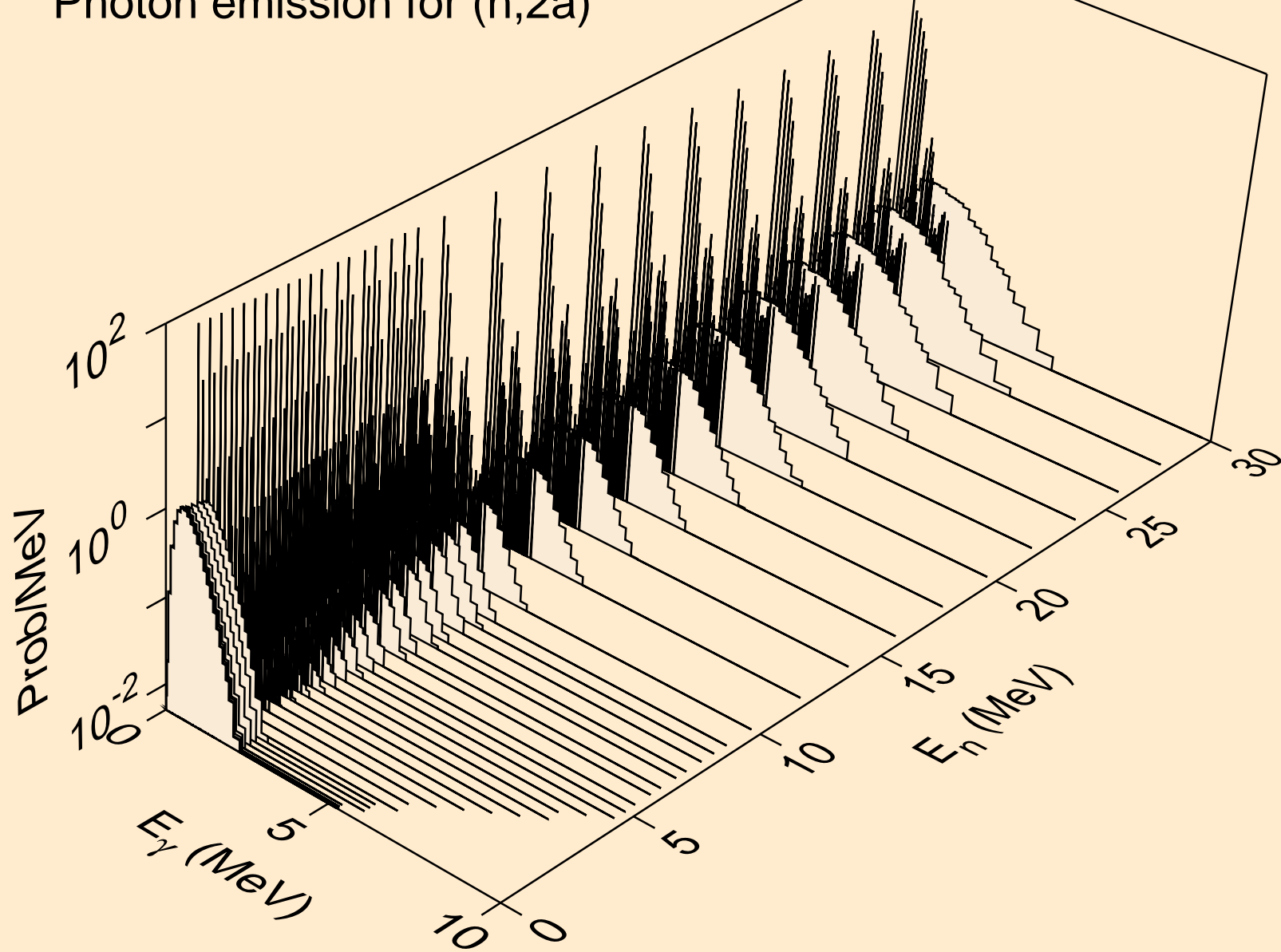

HG191 NEUTRON ACER TENDL-2024 LIBRARY; T=293.6K  
Photon emission for (n,2p)

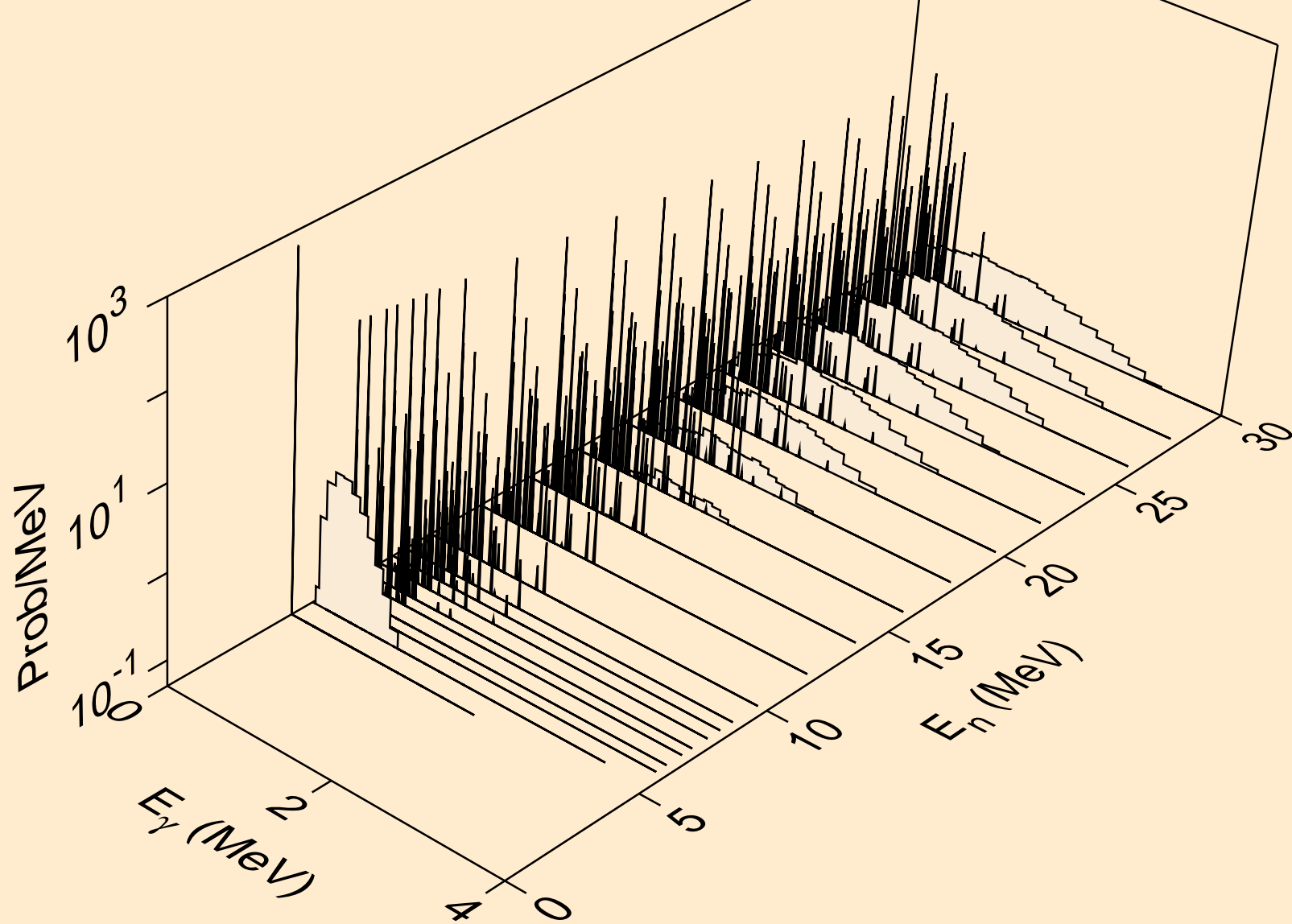

HG191 NEUTRON ACER TENDL-2024 LIBRARY; T=293.6K  
Photon emission for (n,p $\alpha$ )

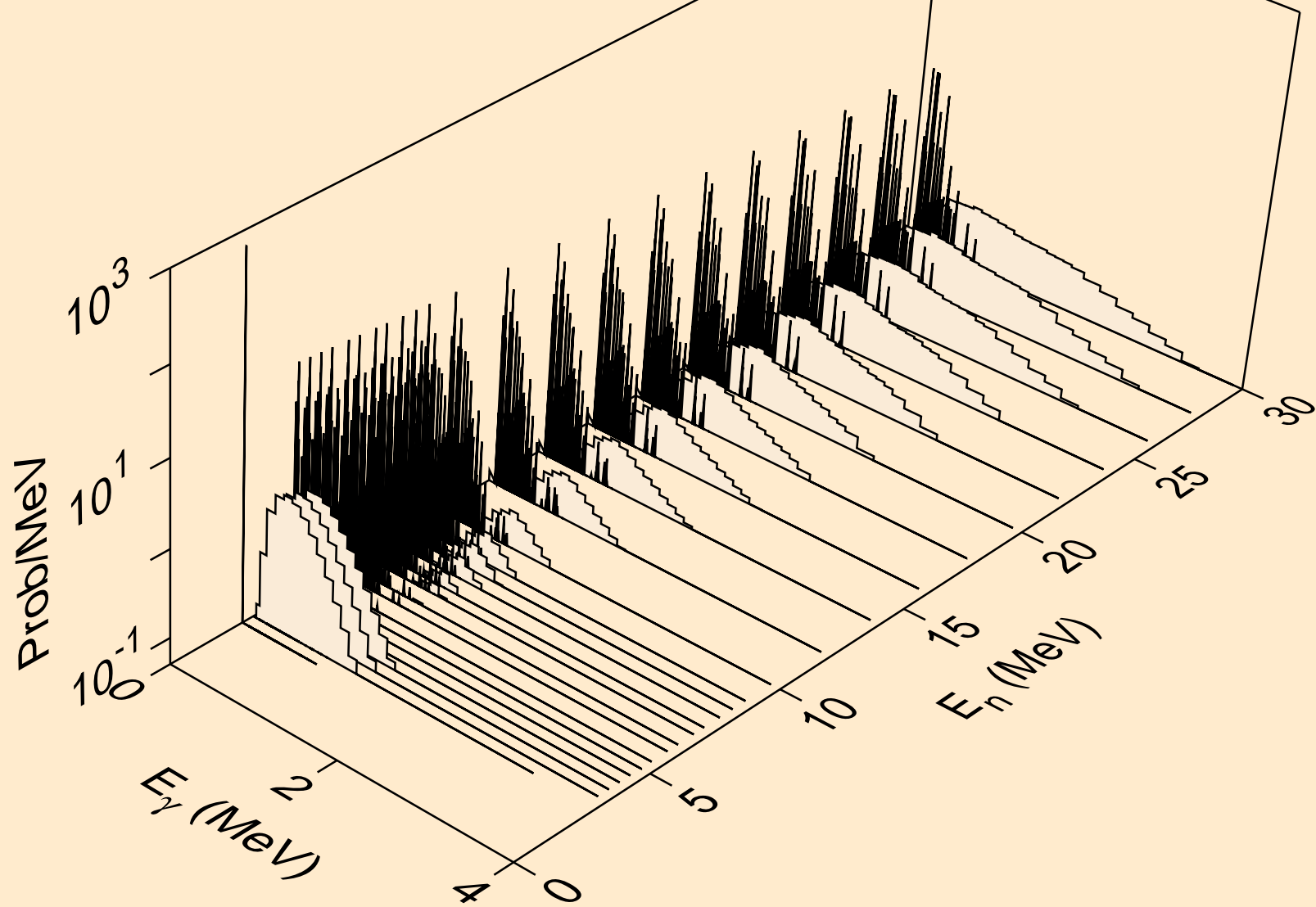

HG191 NEUTRON ACER TENDL-2024 LIBRARY; T=293.6K  
Photon emission for (n,pd)

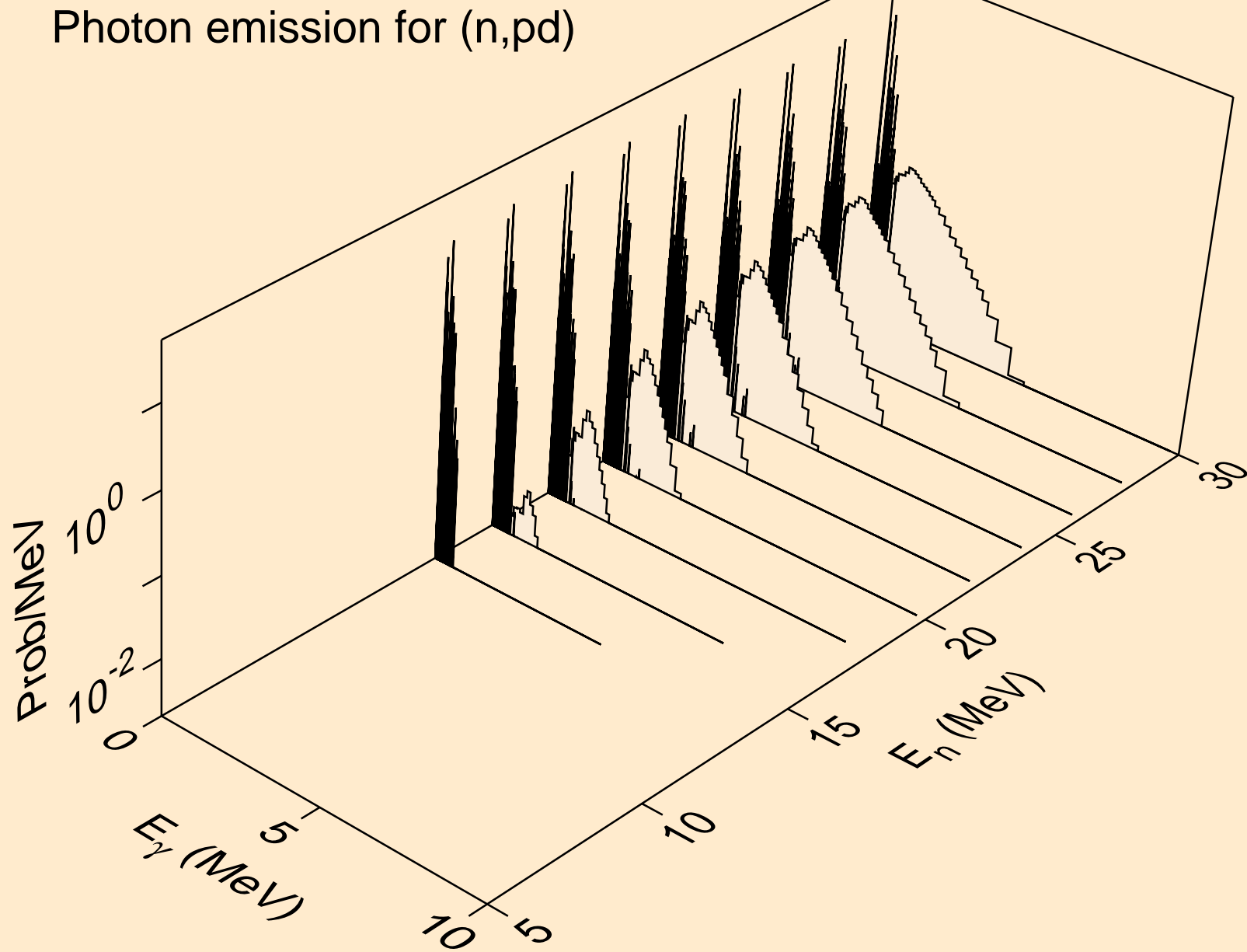

HG191 NEUTRON ACER TENDL-2024 LIBRARY; T=293.6K  
Photon emission for (n,pt)

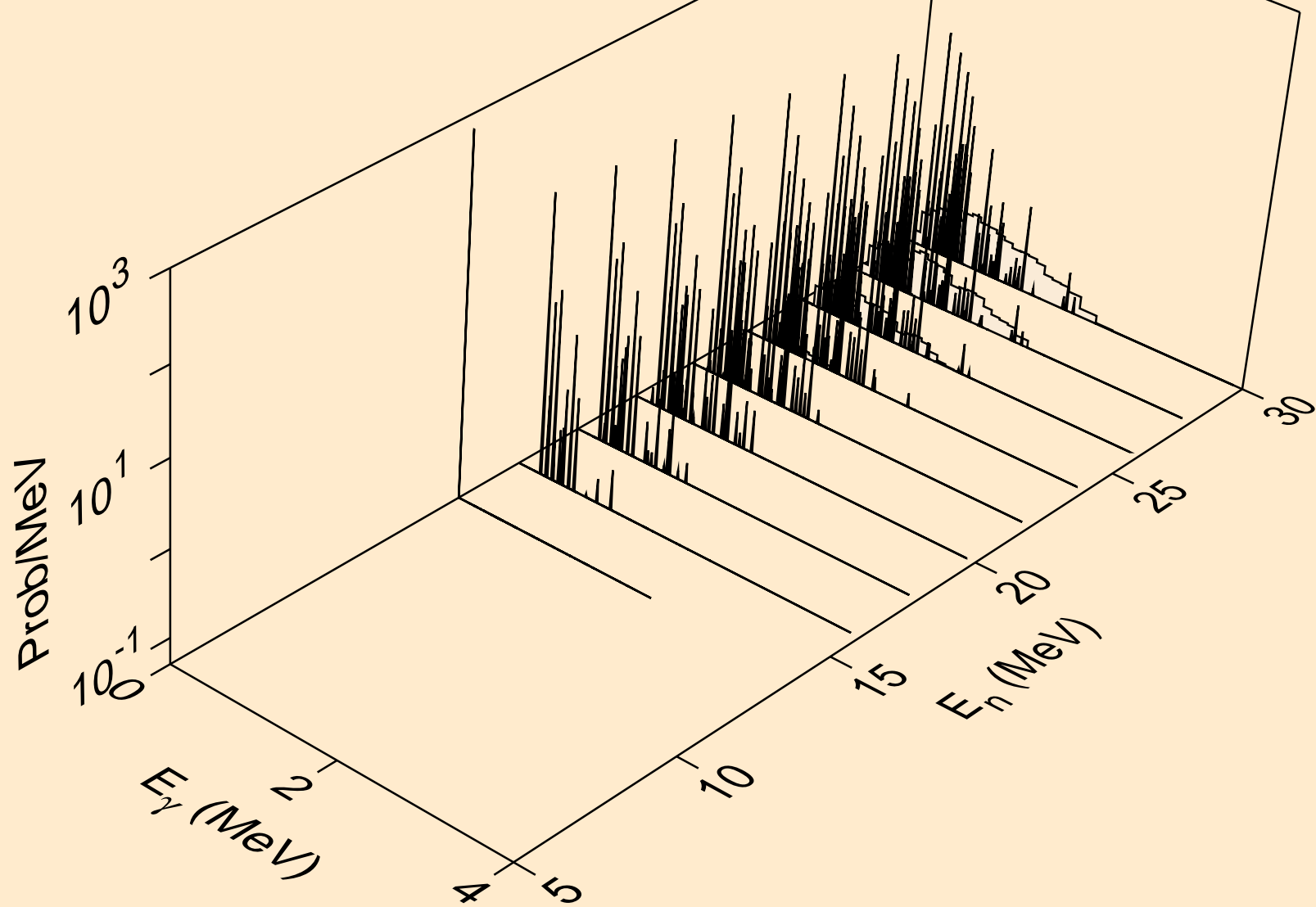

HG191 NEUTRON ACER TENDL-2024 LIBRARY; T=293.6K  
Photon emission for (n,da)

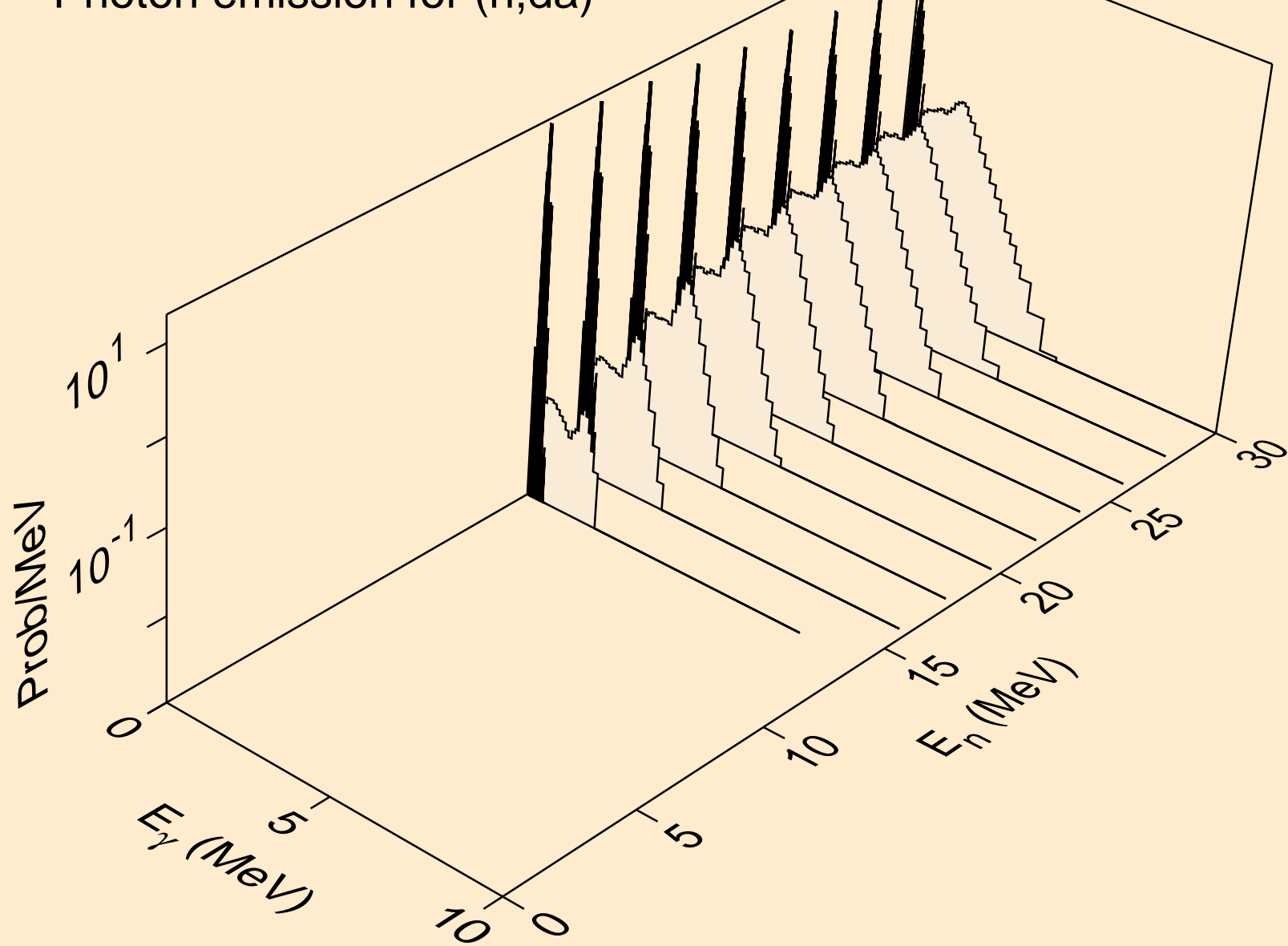

HG191 NEUTRON ACER TENDL-2024 LIBRARY; T=293.6K  
thermal capture photon spectrum

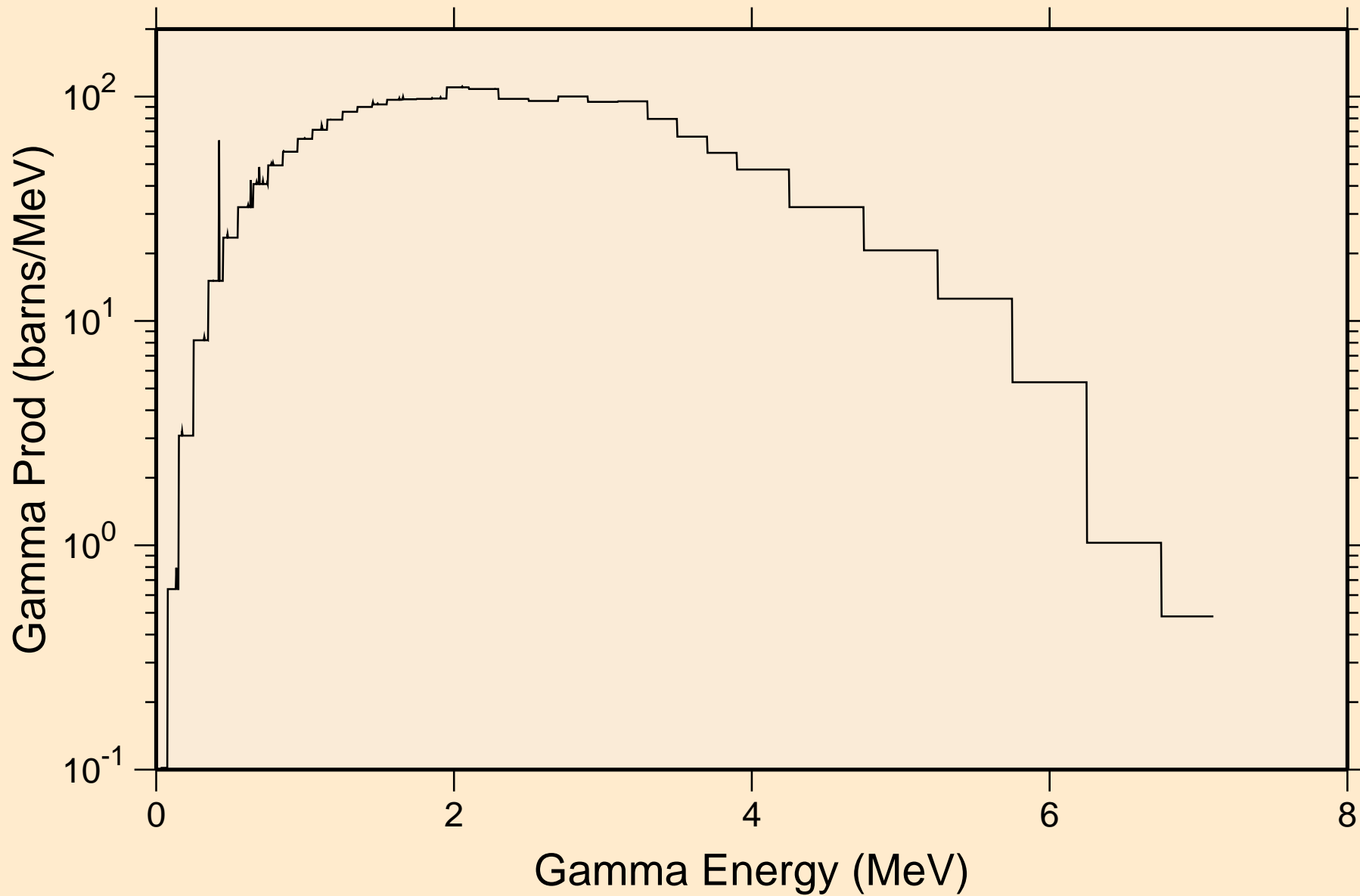

HG191 NEUTRON ACER TENDL-2024 LIBRARY; T=293.6K  
14 MeV photon spectrum

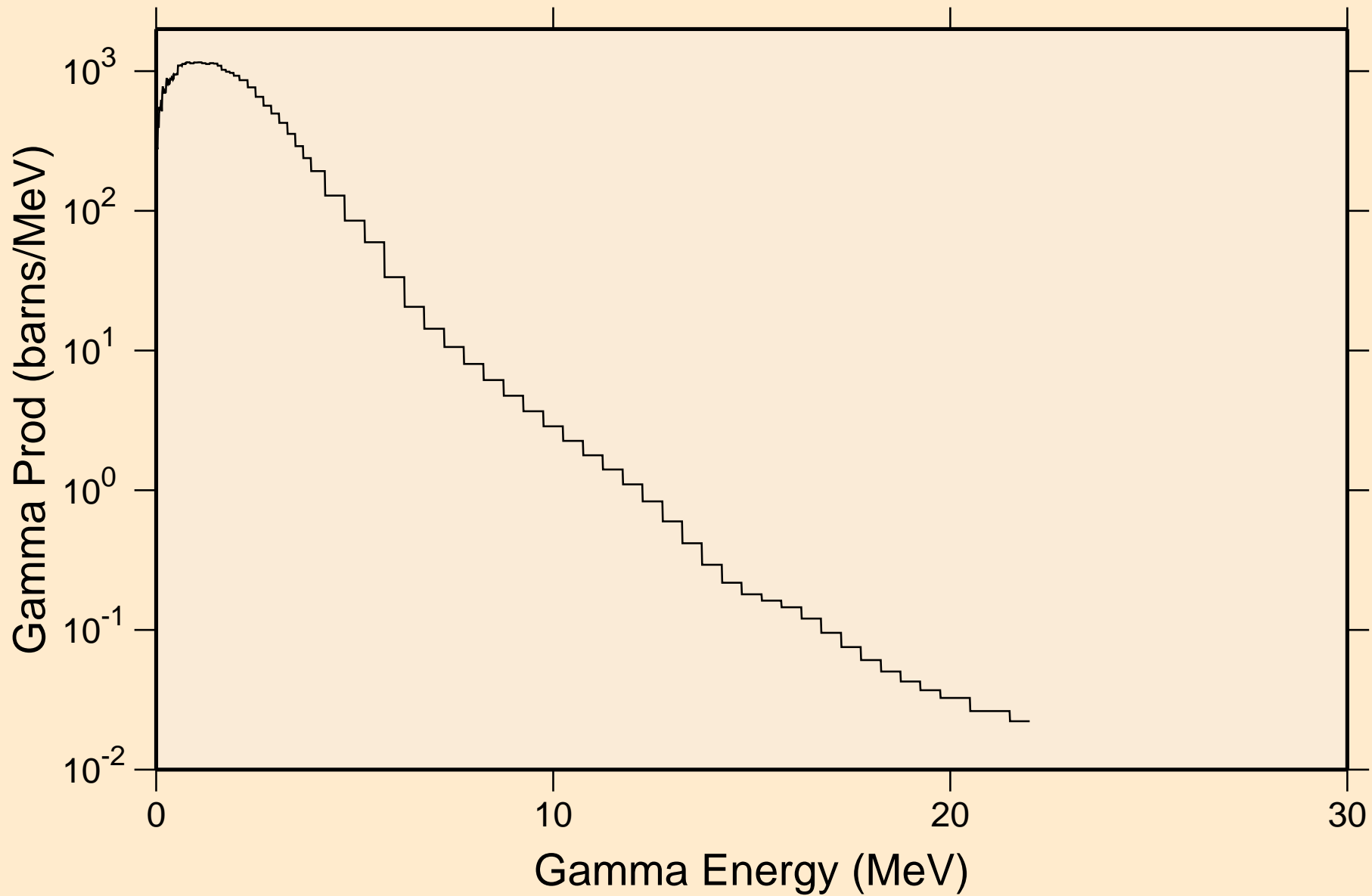

# HG191 NEUTRON ACER TENDL-2024 LIBRARY; T=293.6K

## Particle heating contributions

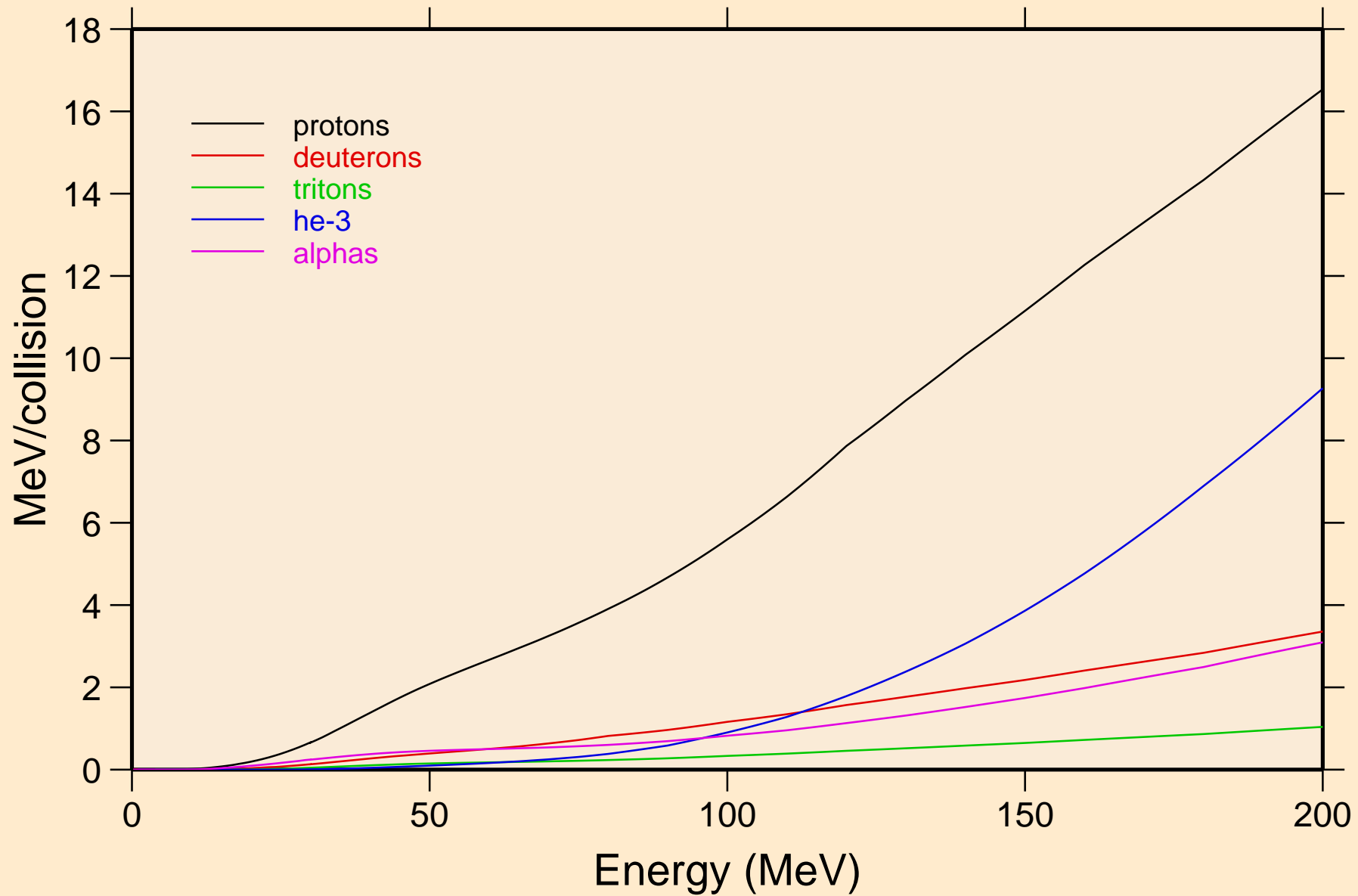

HG191 NEUTRON ACER TENDL-2024 LIBRARY; T=293.6K  
Recoil Heating

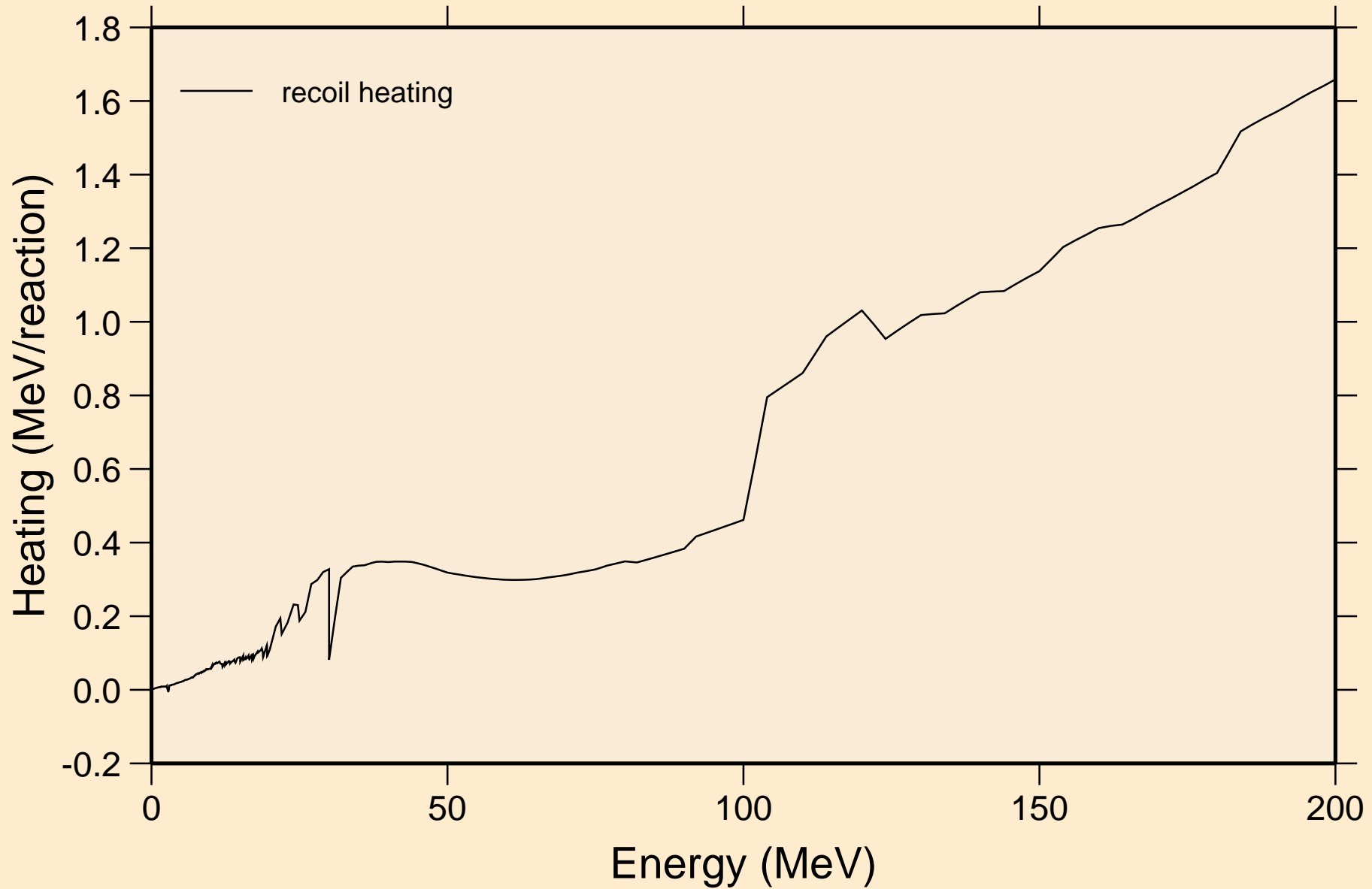

# HG191 NEUTRON ACER TENDL-2024 LIBRARY; T=293.6K

## Particle production cross sections

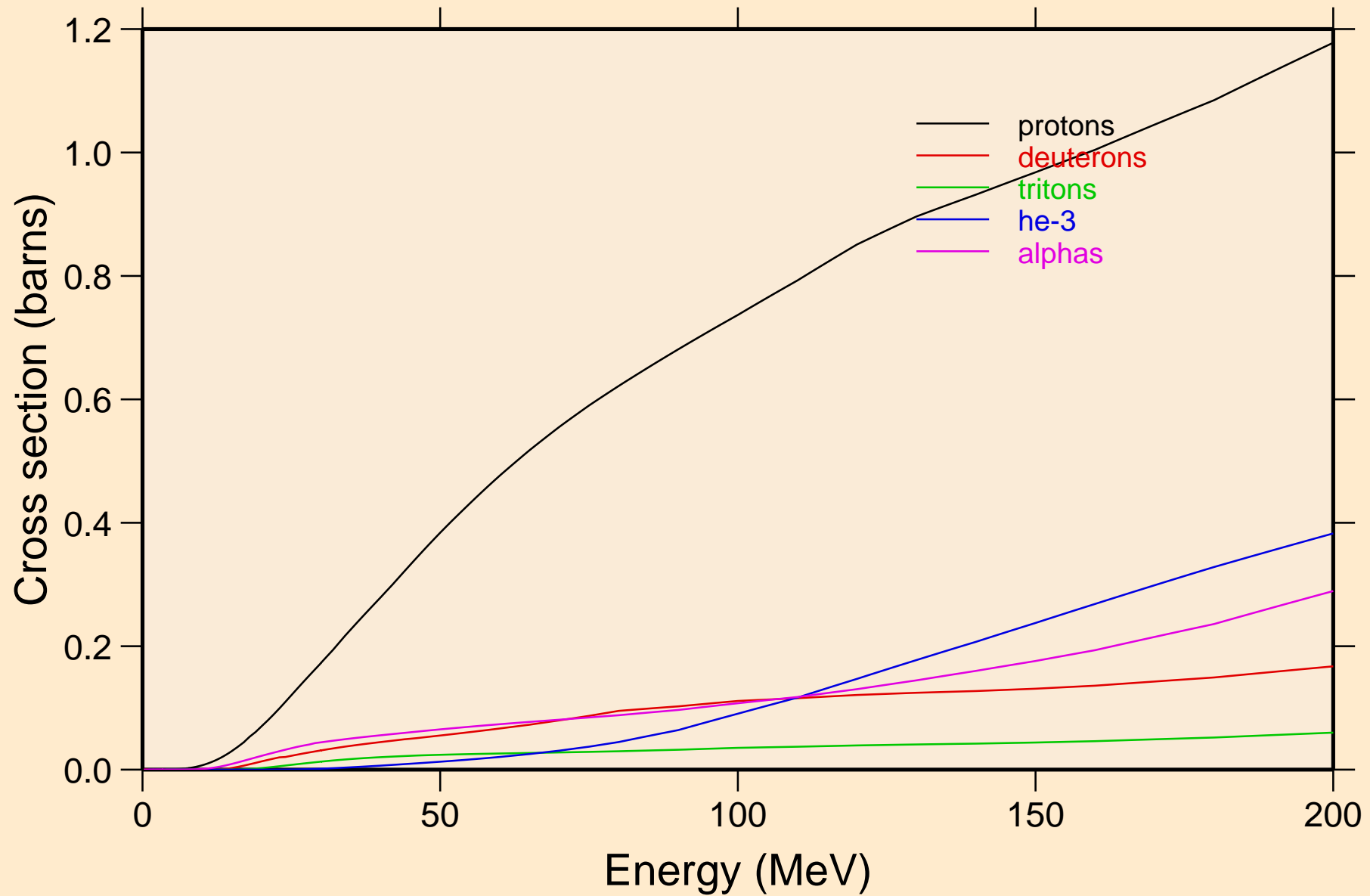

HG191 NEUTRON ACER TENDL-2024 LIBRARY; T=293.6K  
protons from (n,x)

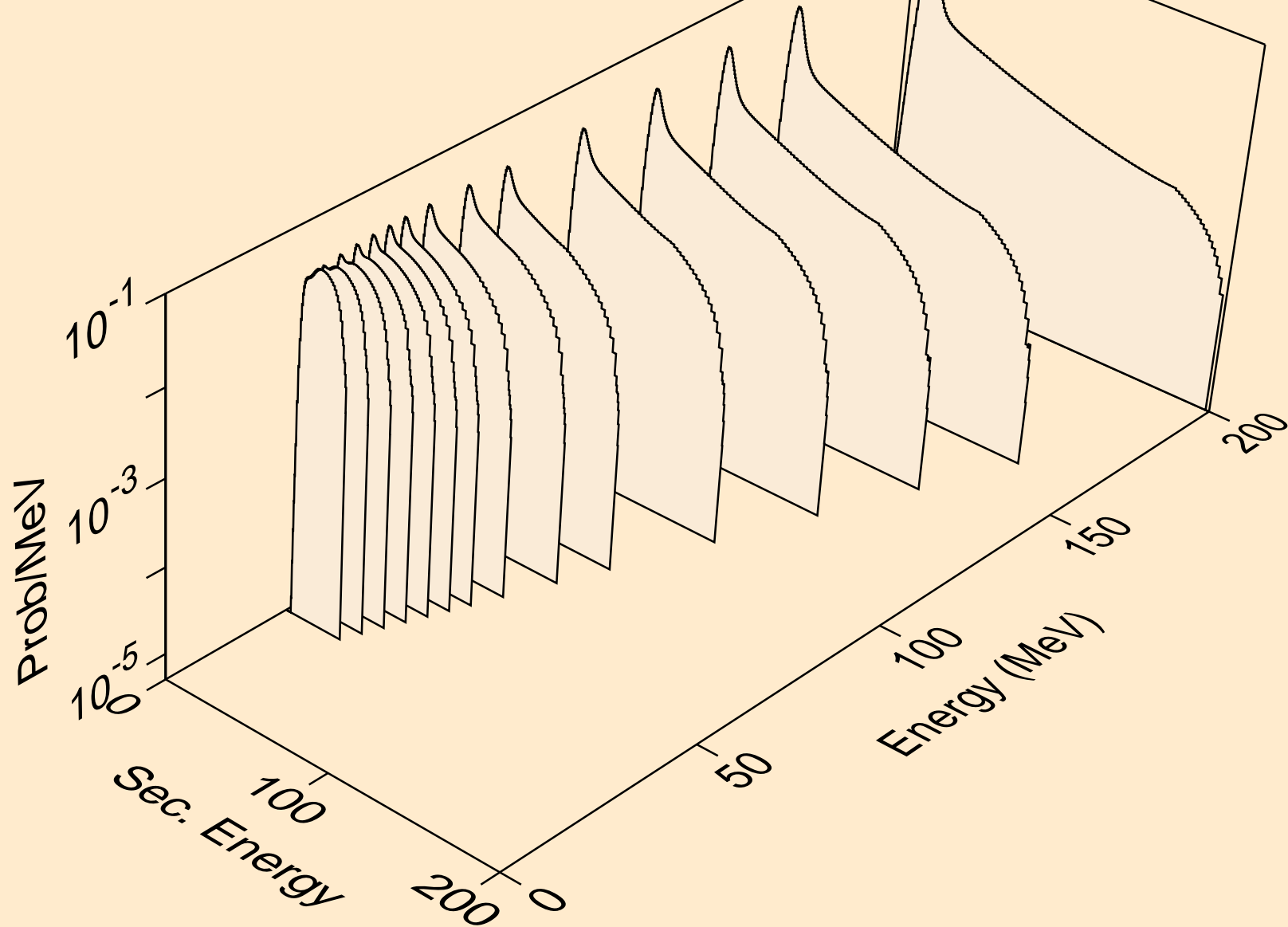

HG191 NEUTRON ACER TENDL-2024 LIBRARY; T=293.6K  
protons from (n,n\*)p

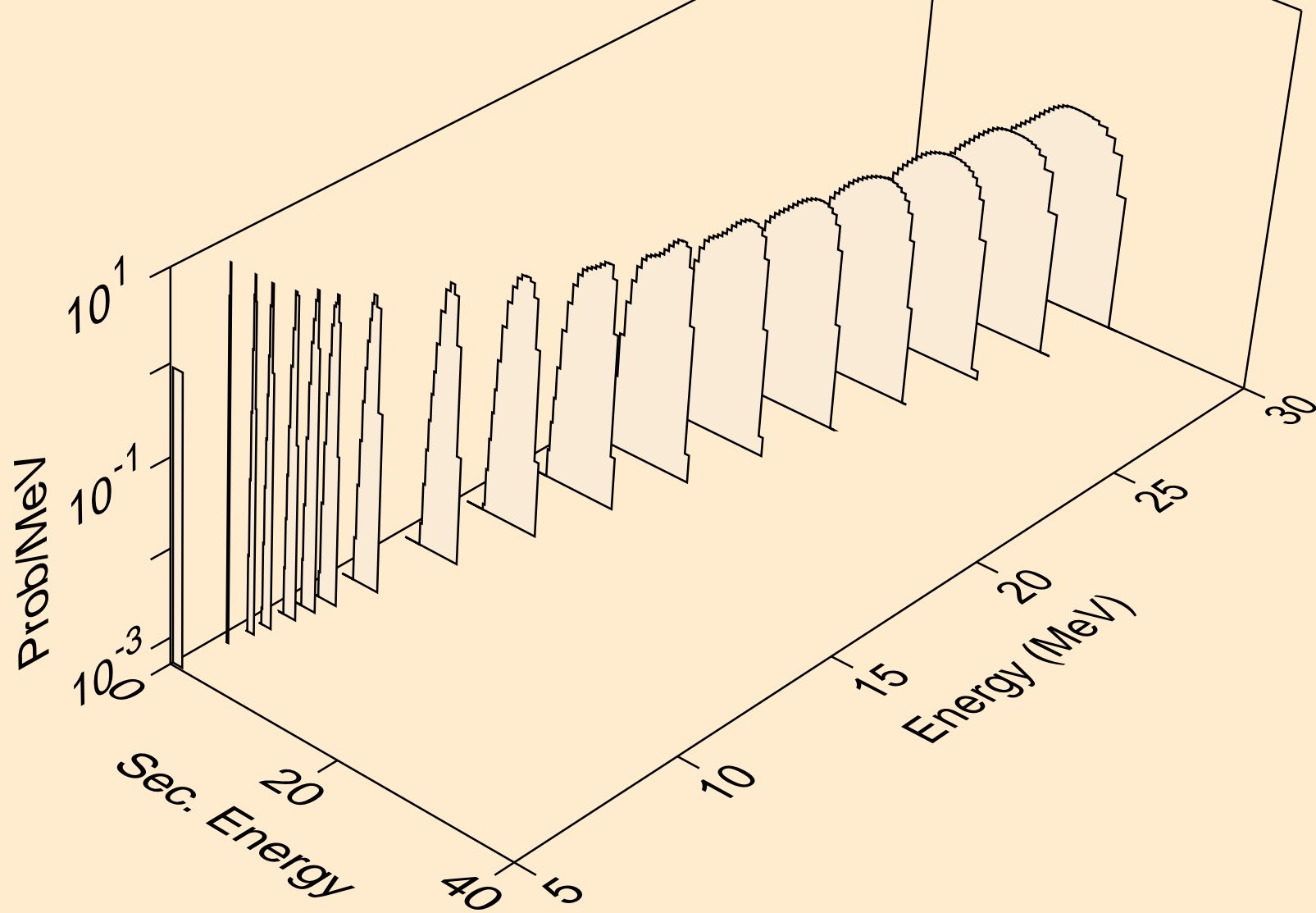

HG191 NEUTRON ACER TENDL-2024 LIBRARY; T=293.6K  
protons from (n,2np)

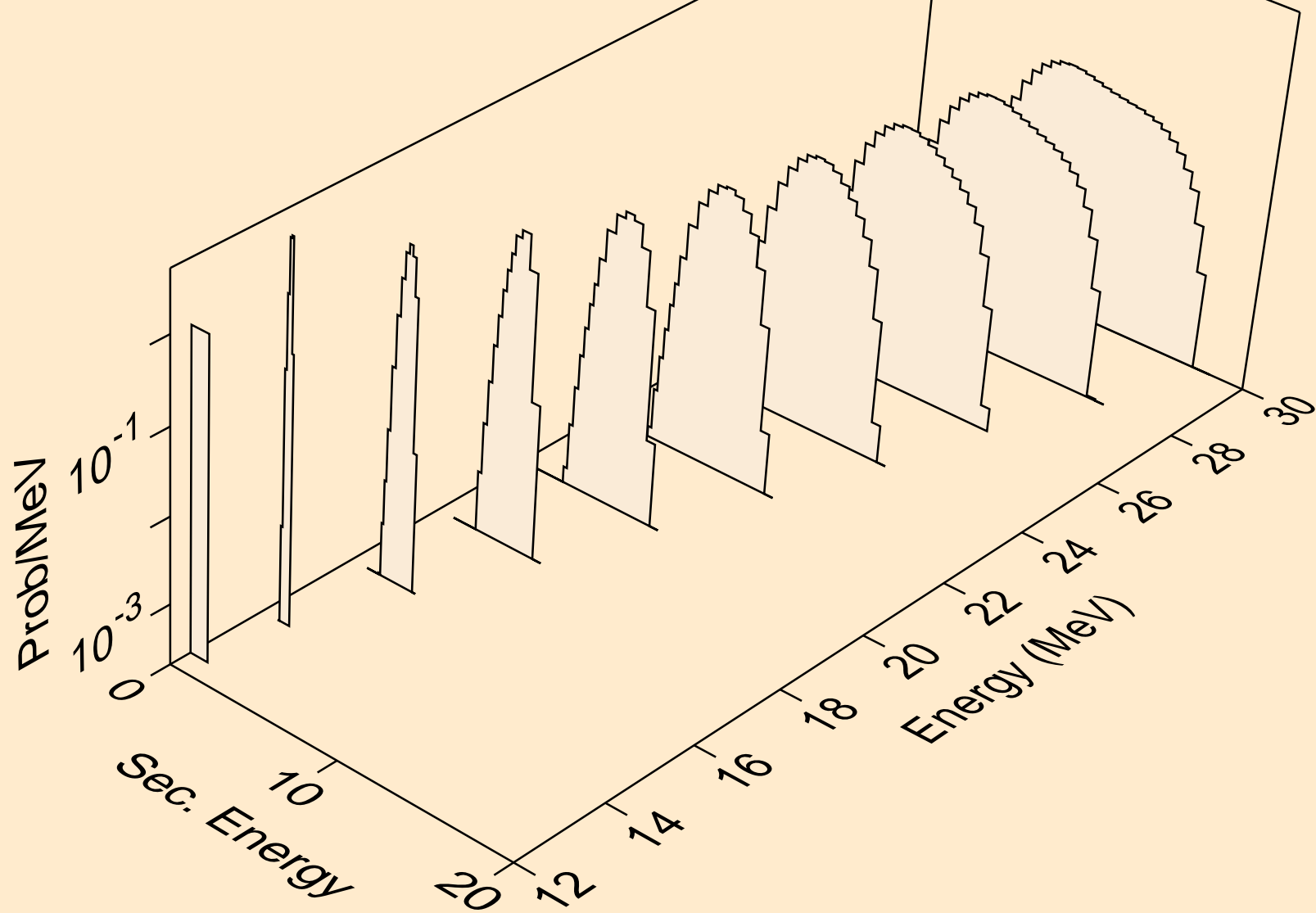

HG191 NEUTRON ACER TENDL-2024 LIBRARY; T=293.6K  
protons from (n,3np)

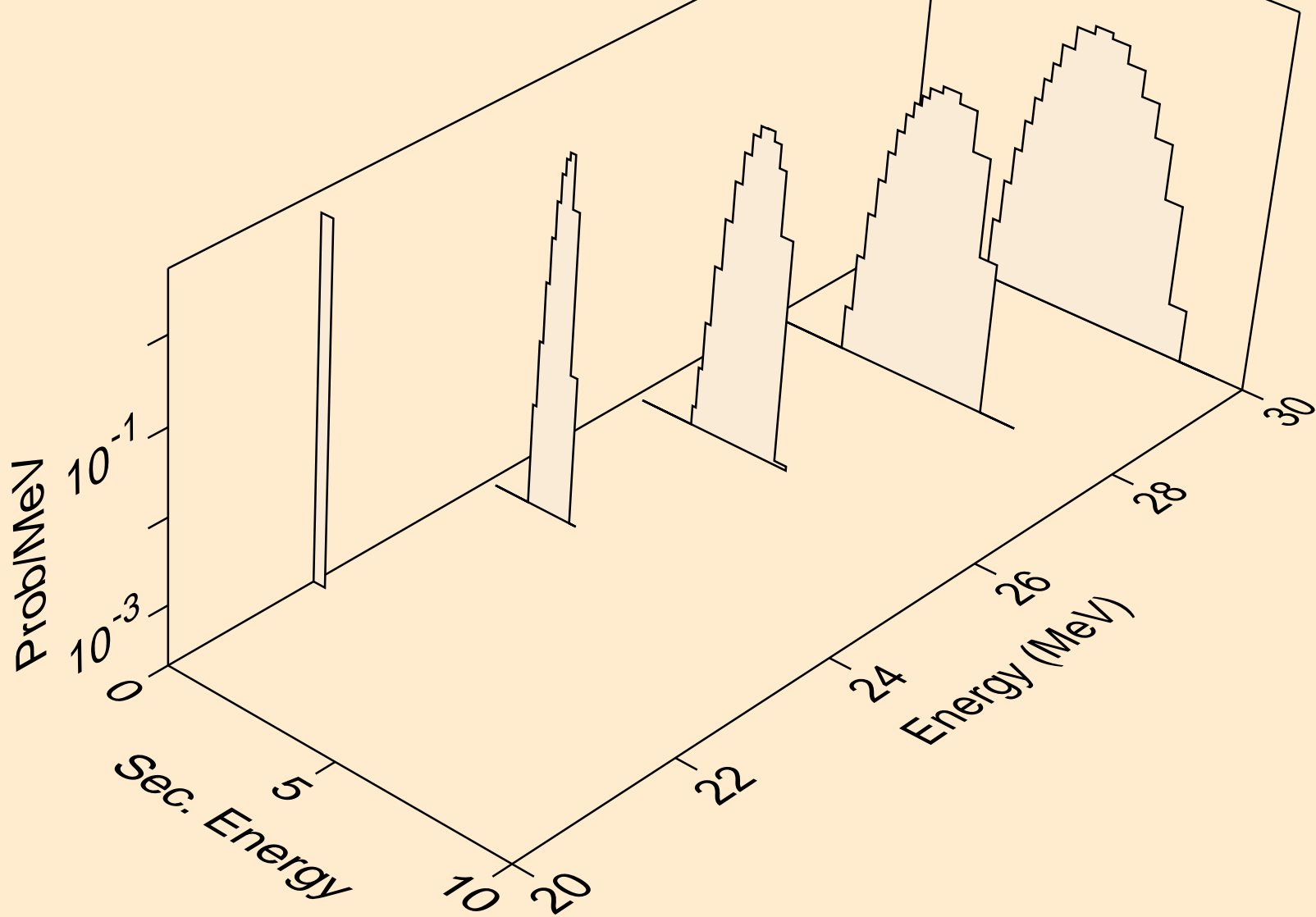

HG191 NEUTRON ACER TENDL-2024 LIBRARY; T=293.6K  
protons from (n,n2p)

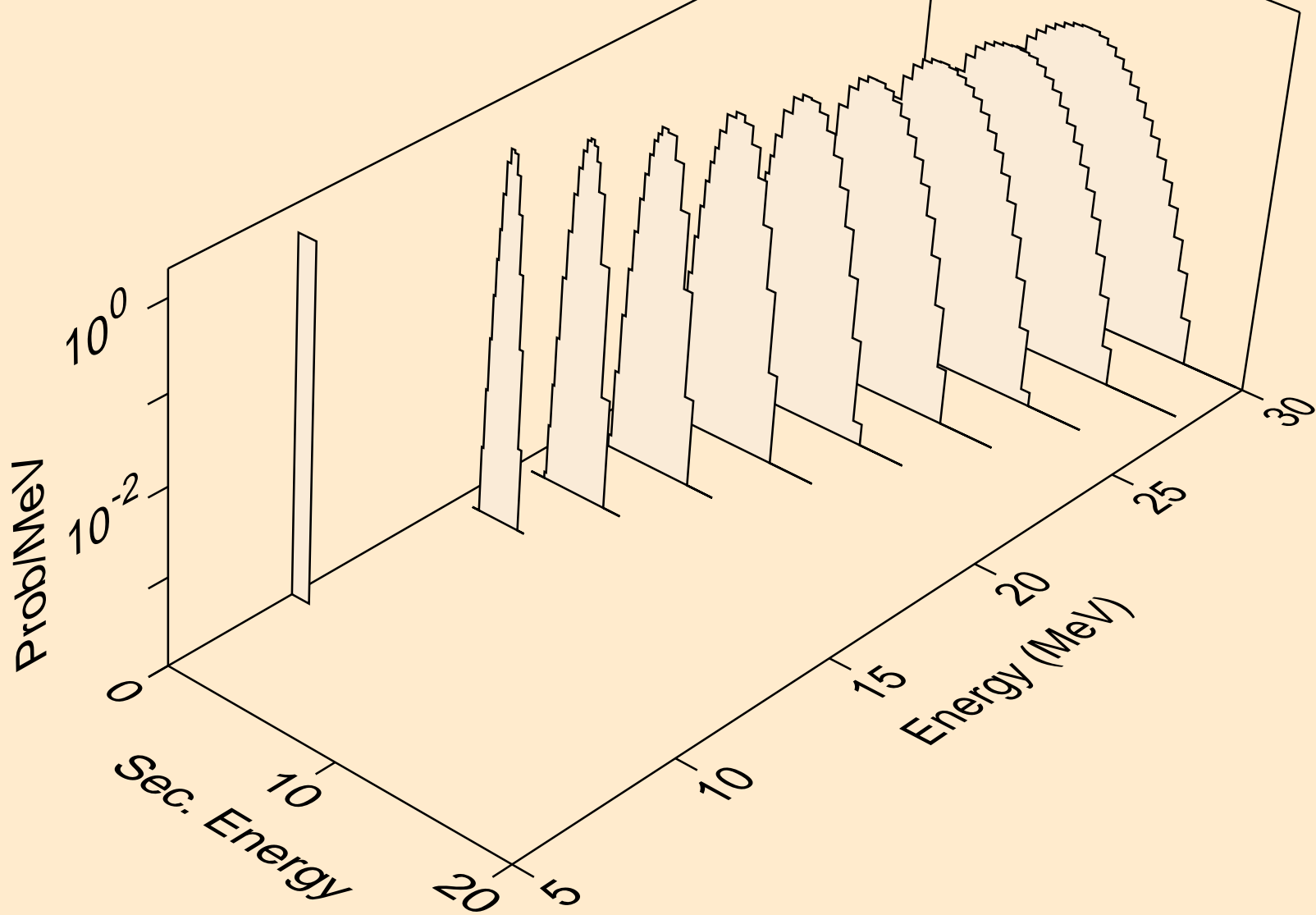

HG191 NEUTRON ACER TENDL-2024 LIBRARY; T=293.6K  
protons from (n,npa)

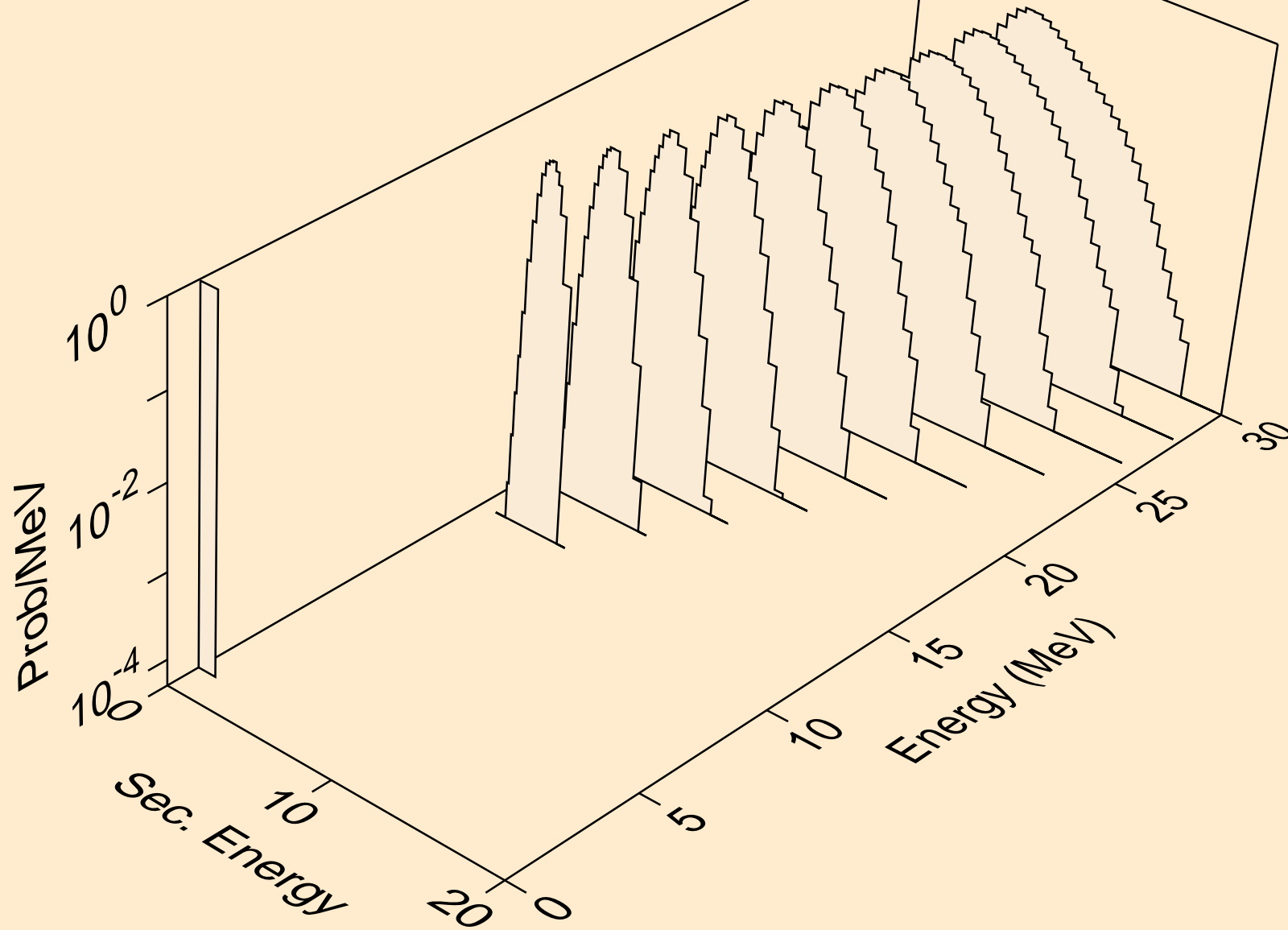

HG191 NEUTRON ACER TENDL-2024 LIBRARY; T=293.6K  
protons from (n,p)

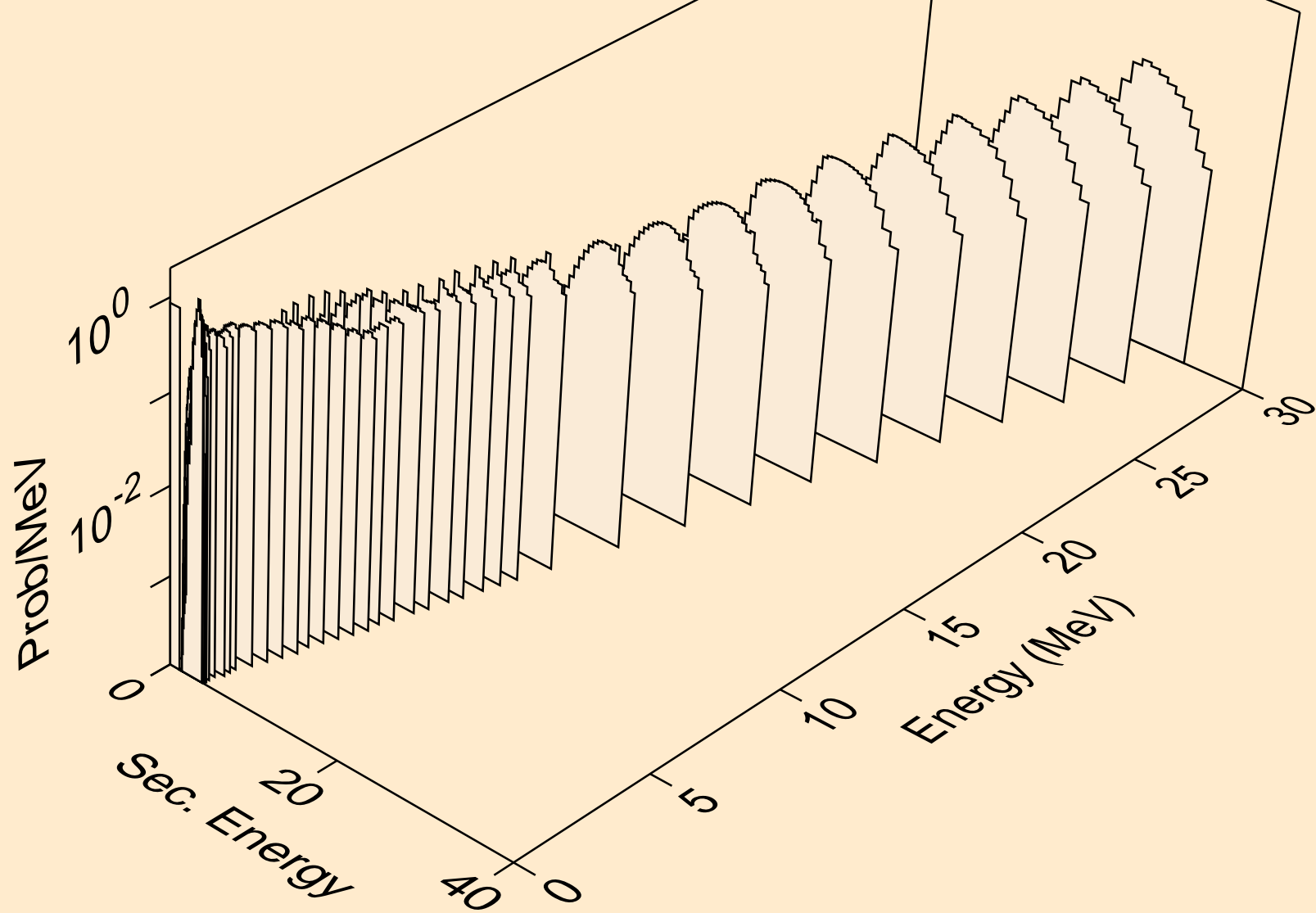

HG191 NEUTRON ACER TENDL-2024 LIBRARY; T=293.6K  
protons from (n,2p)

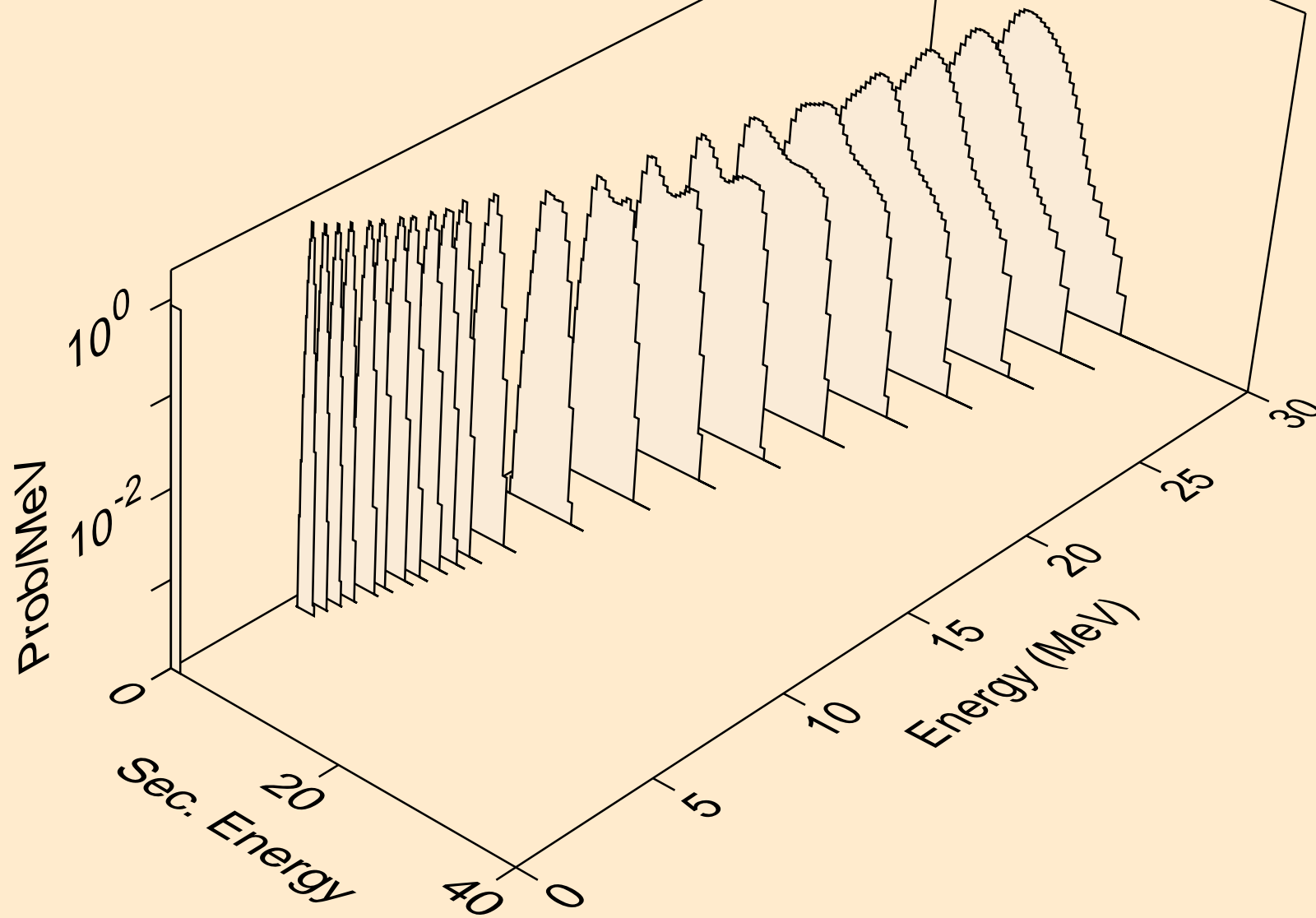

HG191 NEUTRON ACER TENDL-2024 LIBRARY; T=293.6K  
protons from (n,p)

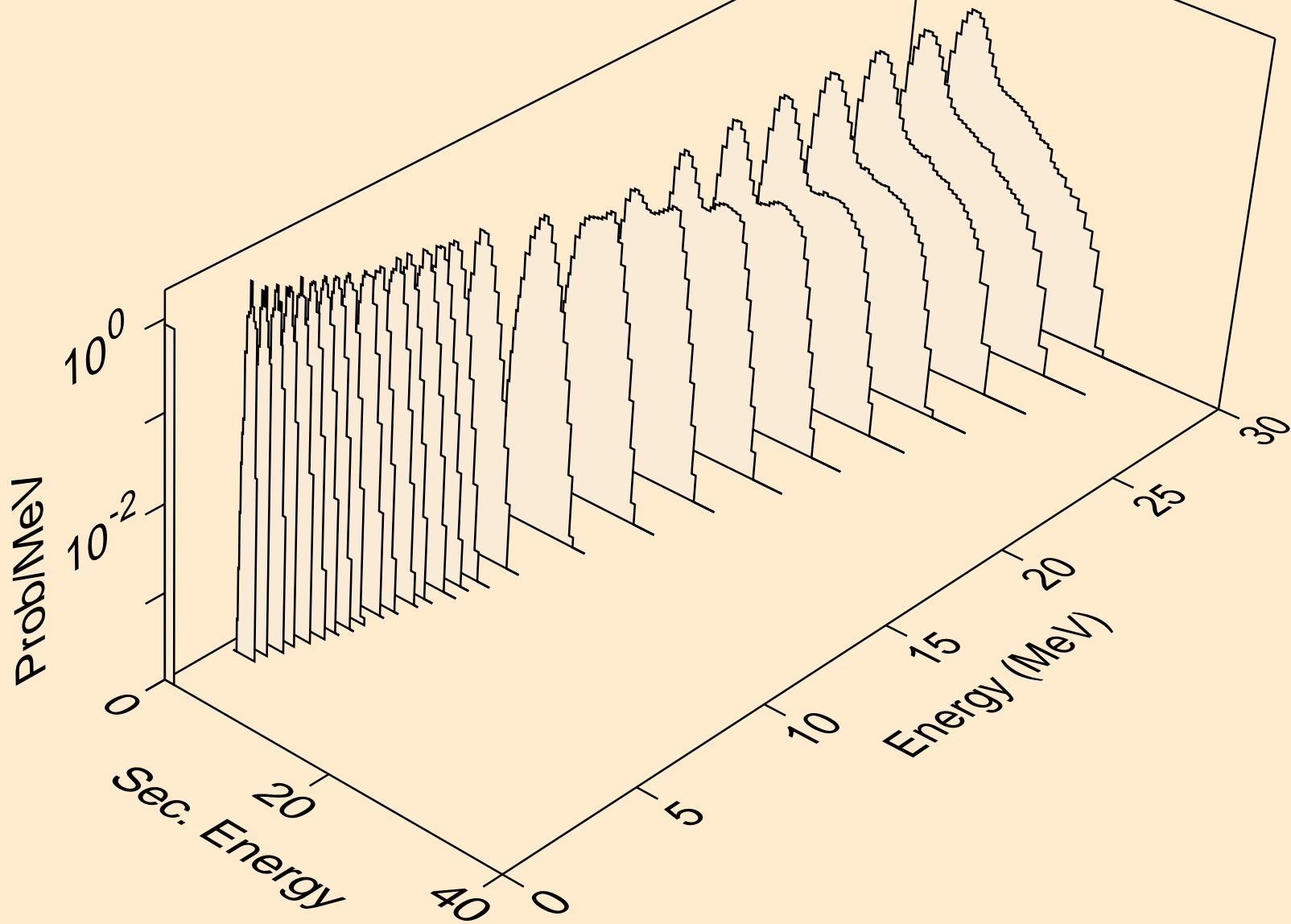

HG191 NEUTRON ACER TENDL-2024 LIBRARY; T=293.6K  
protons from (n,pd)

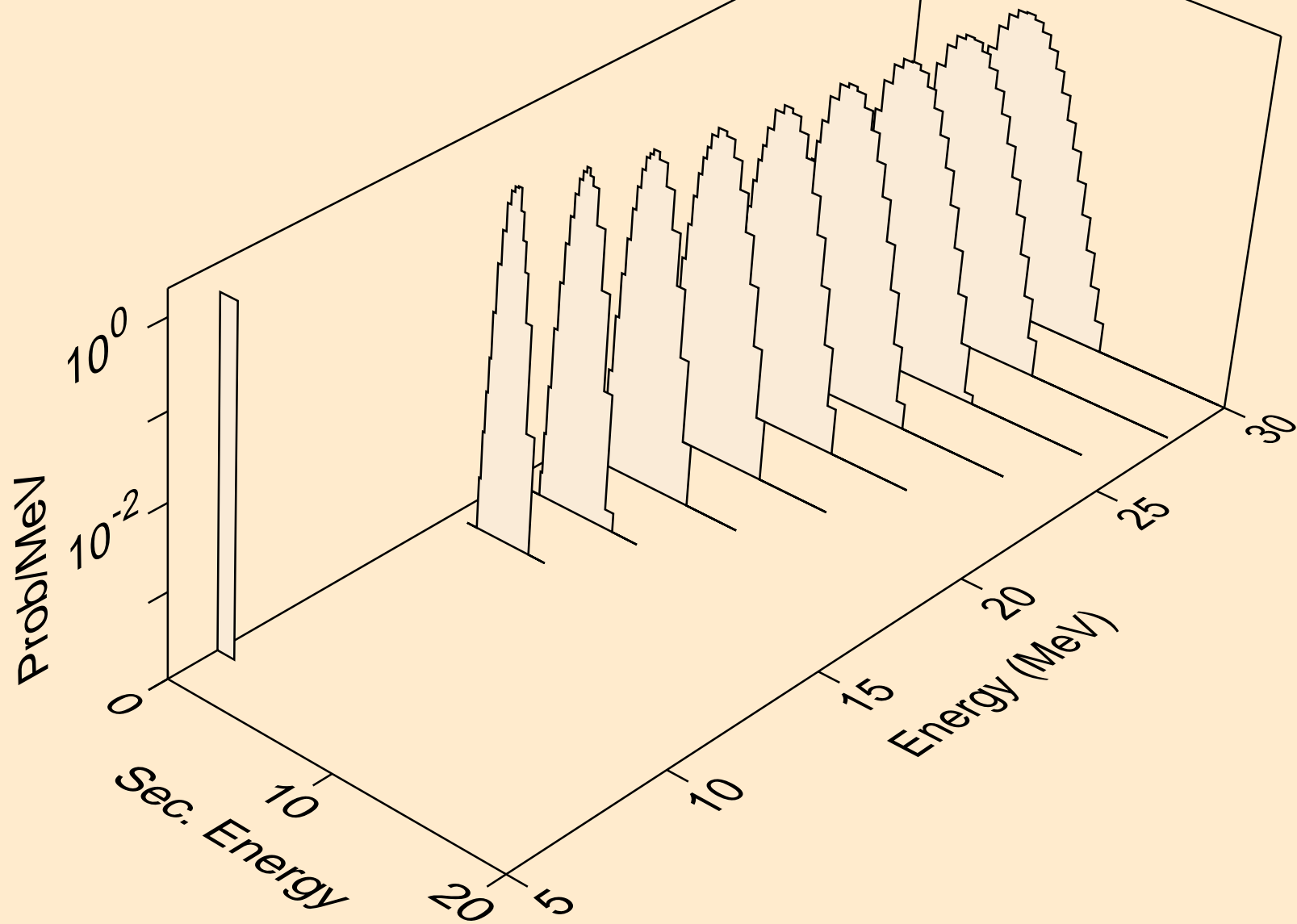

HG191 NEUTRON ACER TENDL-2024 LIBRARY; T=293.6K  
protons from (n,pt)

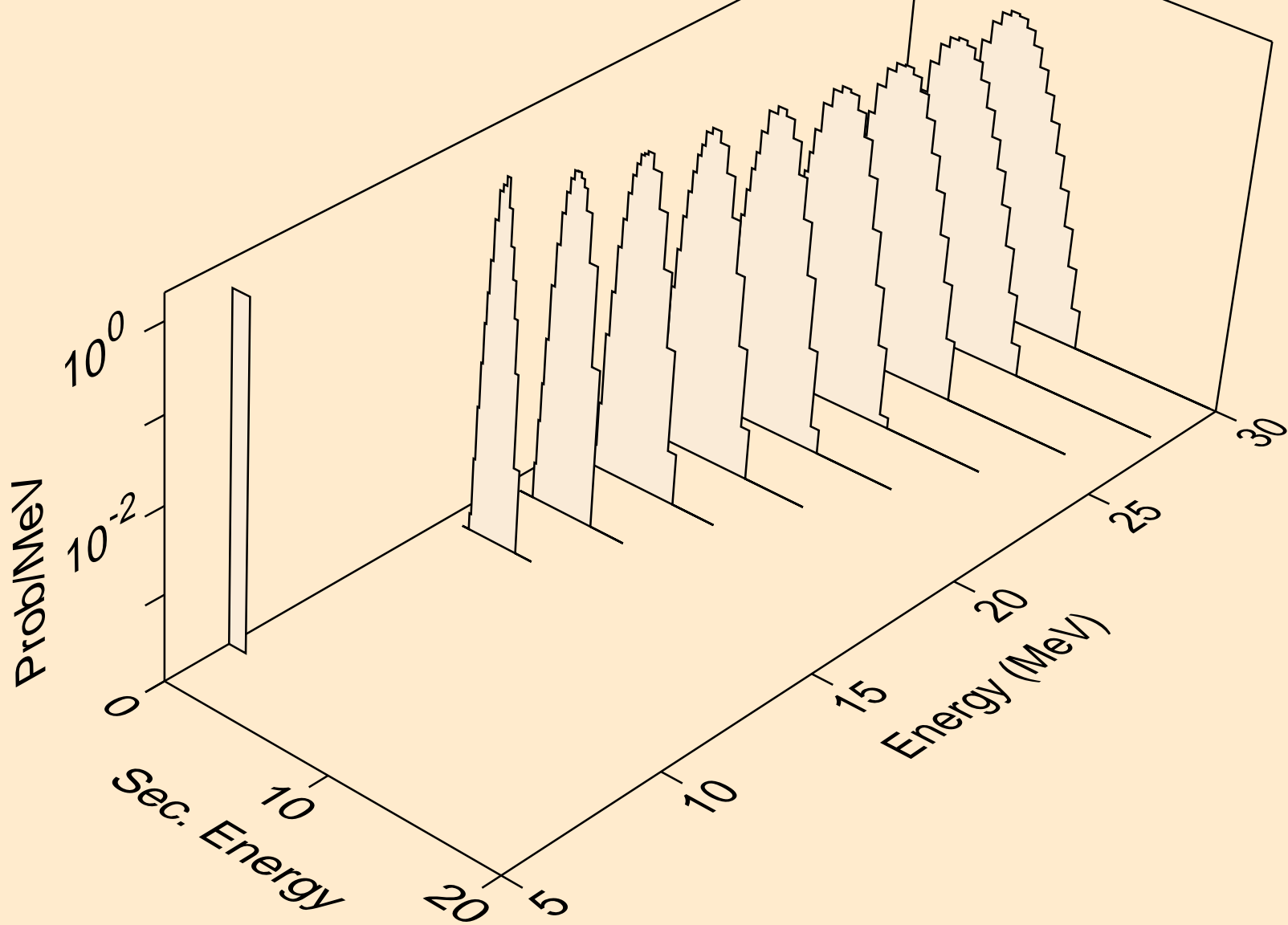

HG191 NEUTRON ACER TENDL-2024 LIBRARY; T=293.6K  
deuterons from (n,x)

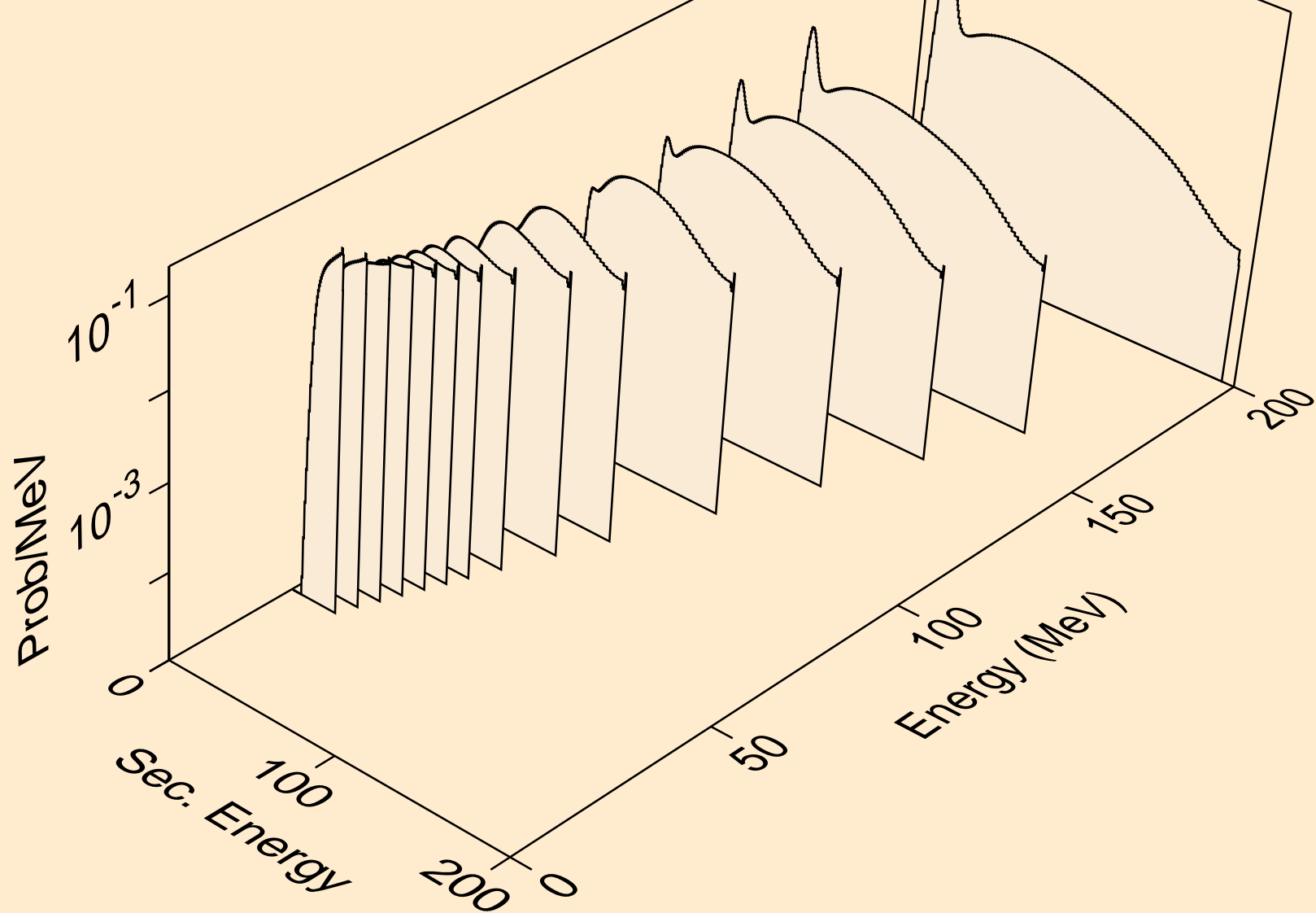

HG191 NEUTRON ACER TENDL-2024 LIBRARY; T=293.6K  
deuterons from (n,2nd)

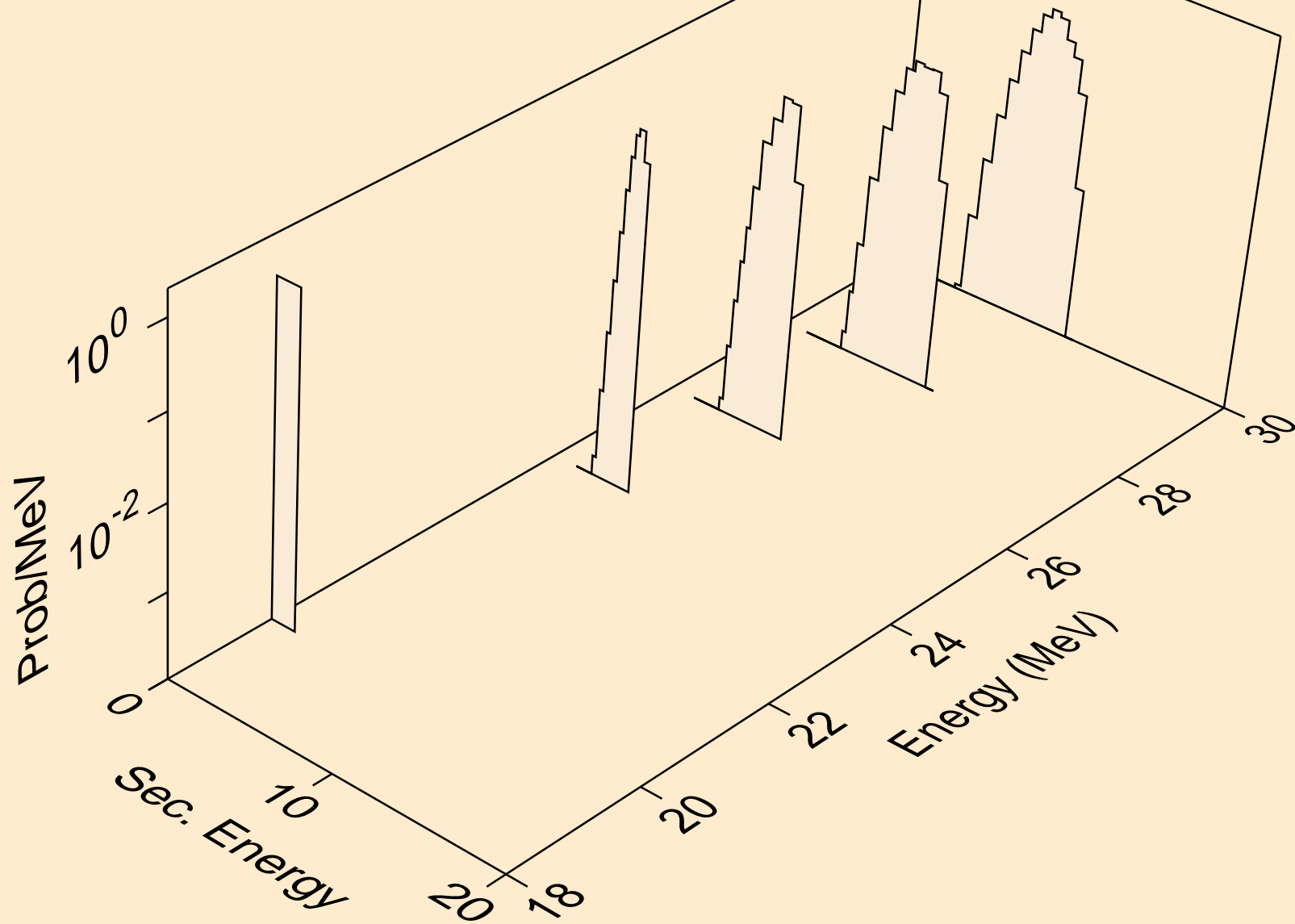

HG191 NEUTRON ACER TENDL-2024 LIBRARY; T=293.6K  
deuterons from (n,n\*)d

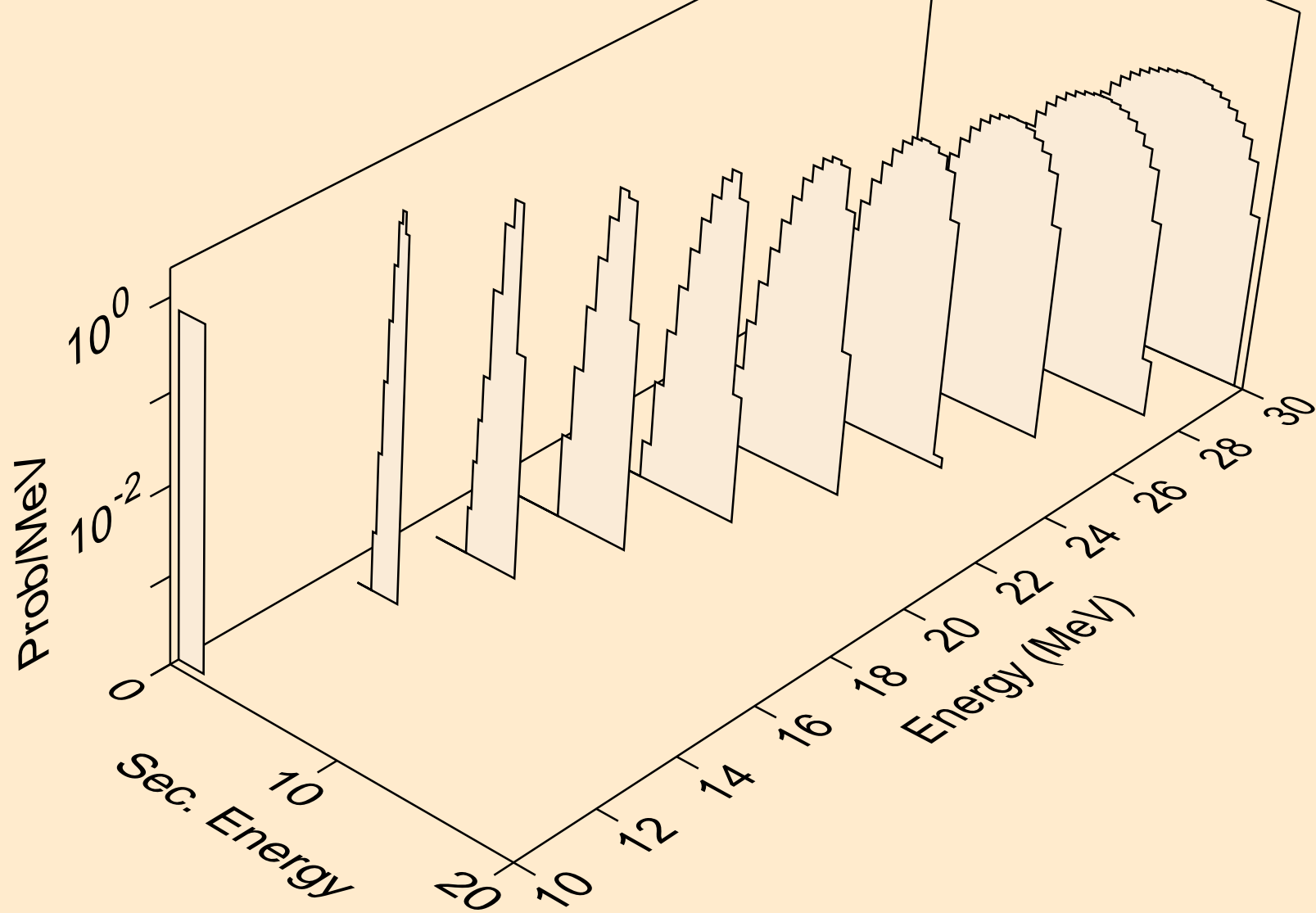

HG191 NEUTRON ACER TENDL-2024 LIBRARY; T=293.6K  
deuterons from (n,d)

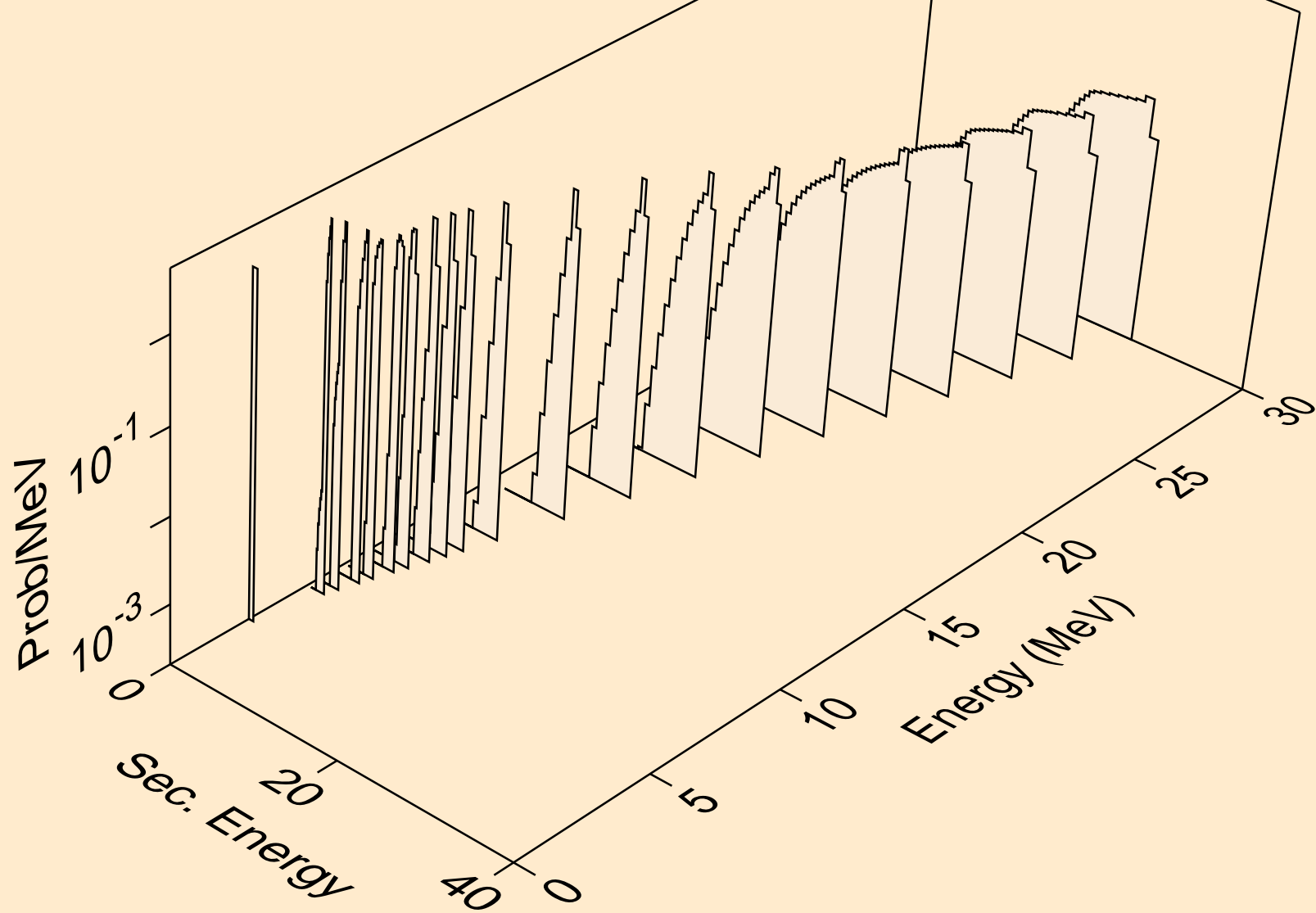

HG191 NEUTRON ACER TENDL-2024 LIBRARY; T=293.6K  
deuterons from (n,pd)

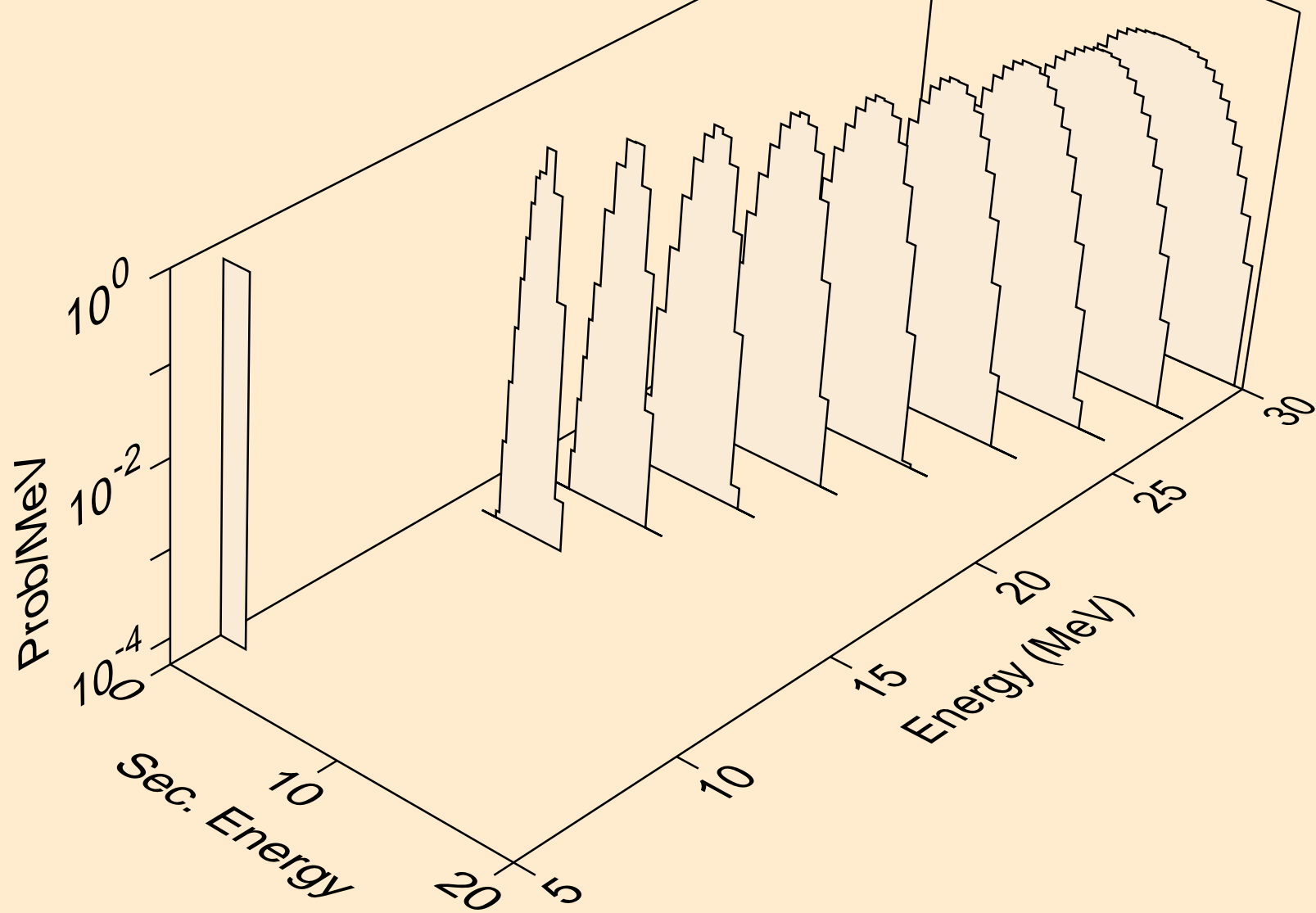

HG191 NEUTRON ACER TENDL-2024 LIBRARY; T=293.6K  
deuterons from (n,da)

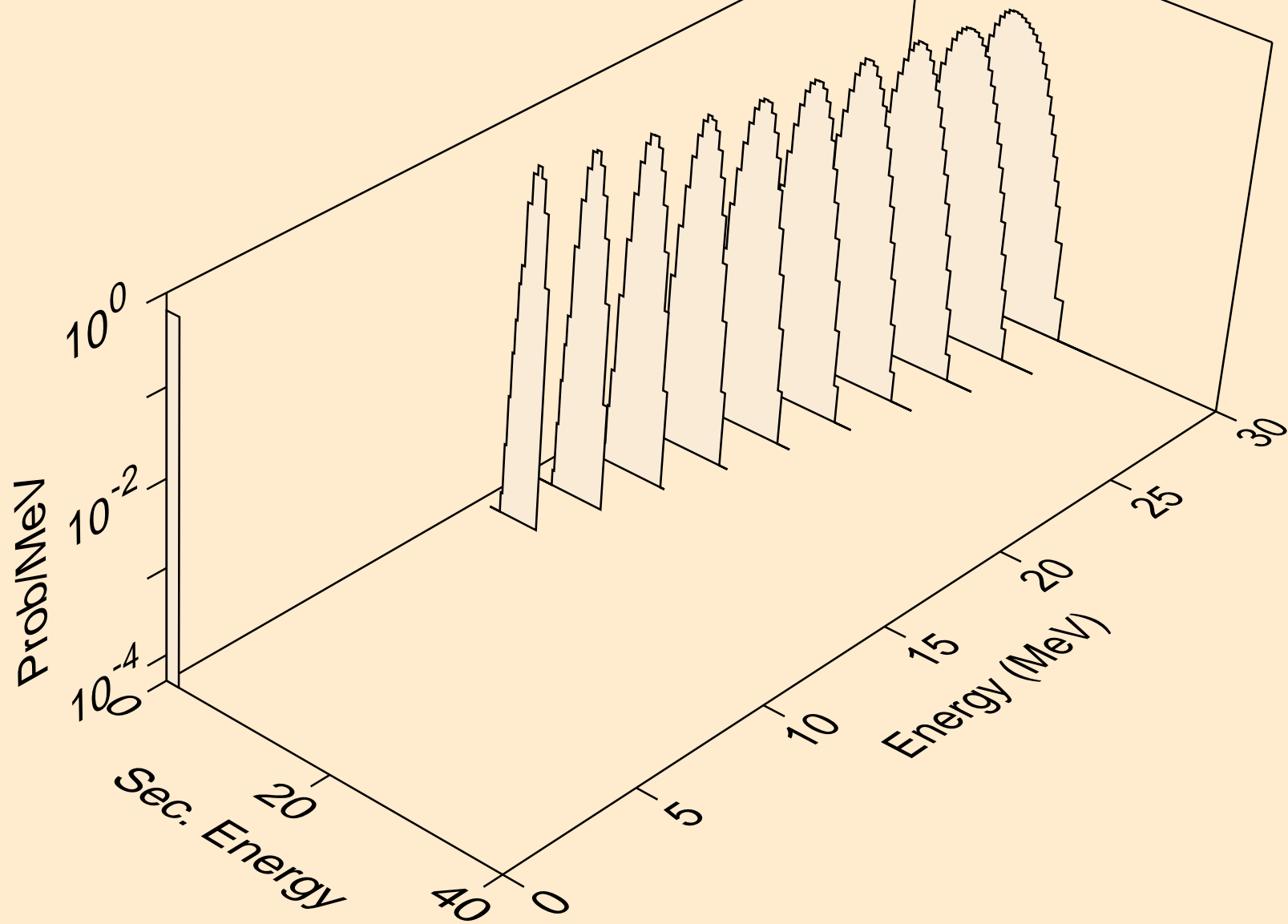

HG191 NEUTRON ACER TENDL-2024 LIBRARY; T=293.6K  
tritons from (n,x)

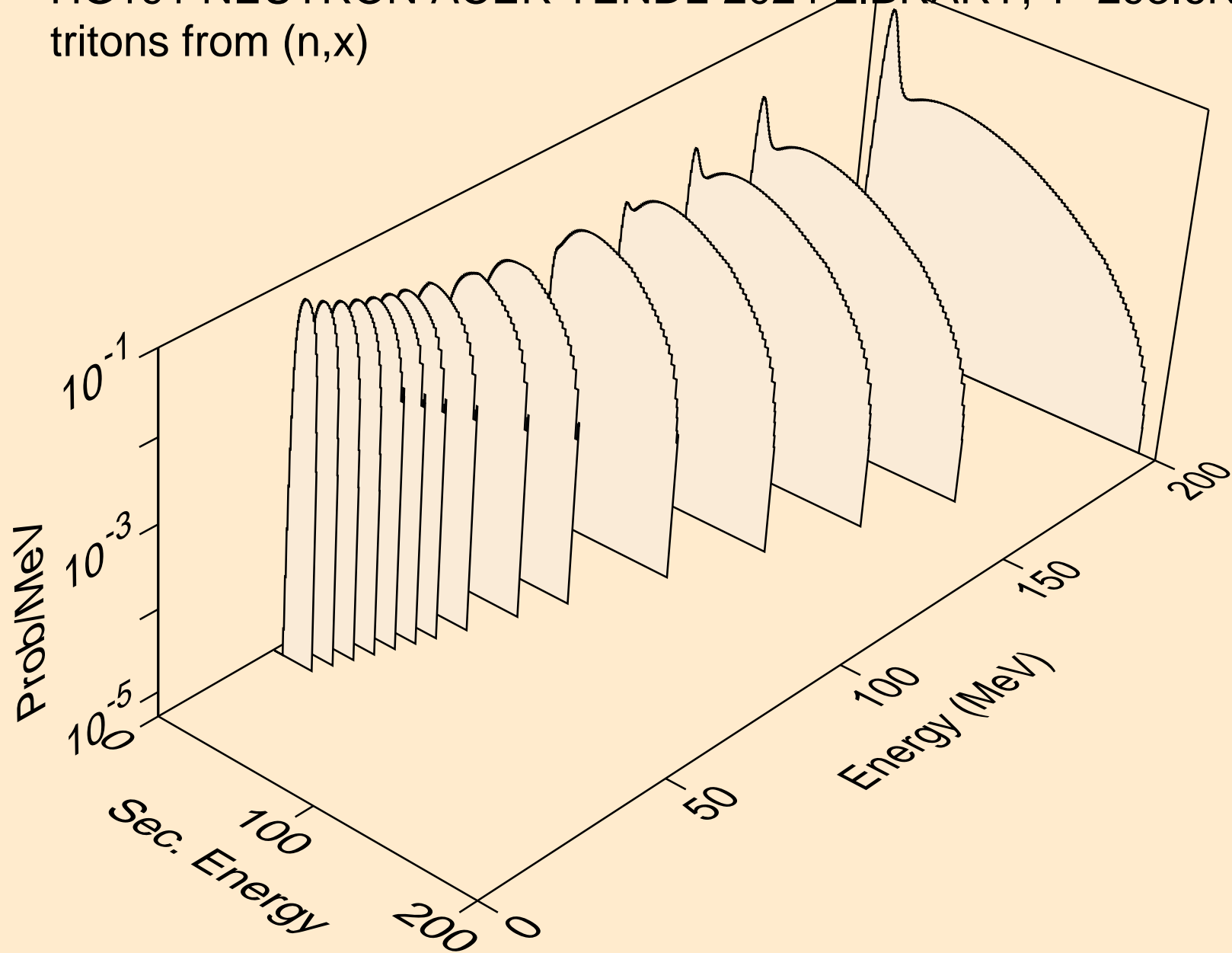

HG191 NEUTRON ACER TENDL-2024 LIBRARY; T=293.6K  
tritons from (n,n\*)t

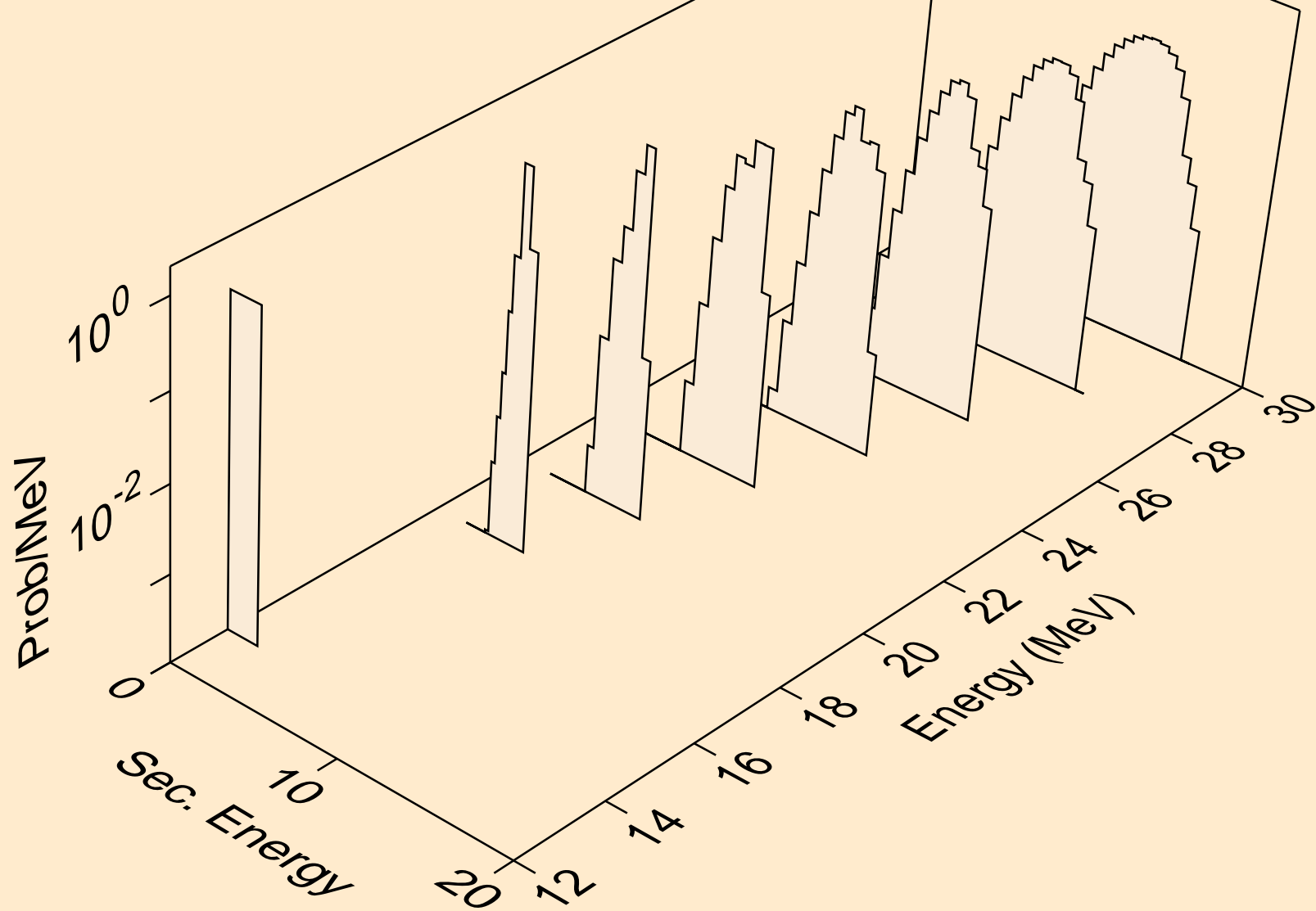

HG191 NEUTRON ACER TENDL-2024 LIBRARY; T=293.6K  
tritons from (n,t)

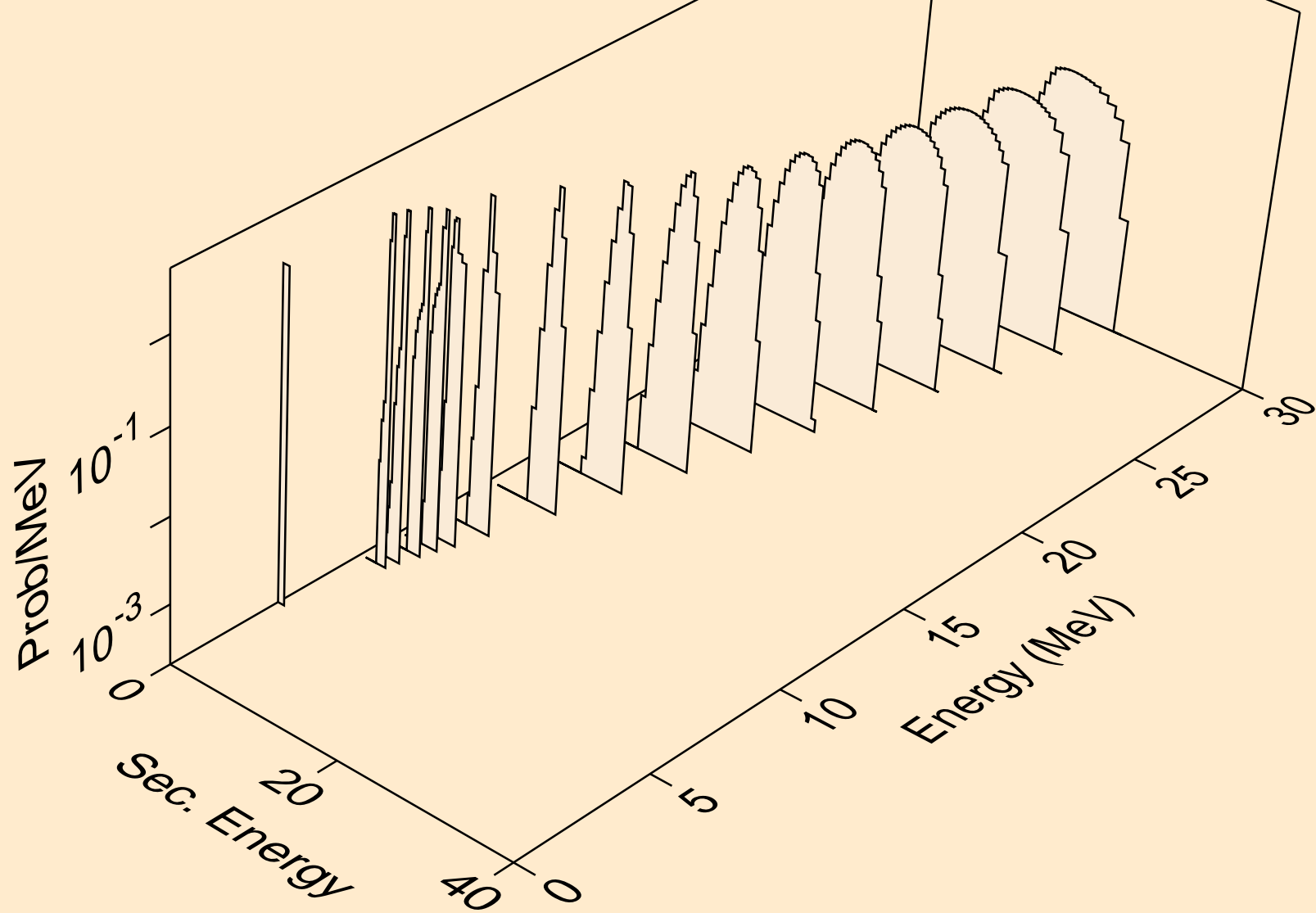

HG191 NEUTRON ACER TENDL-2024 LIBRARY; T=293.6K  
tritons from (n,pt)

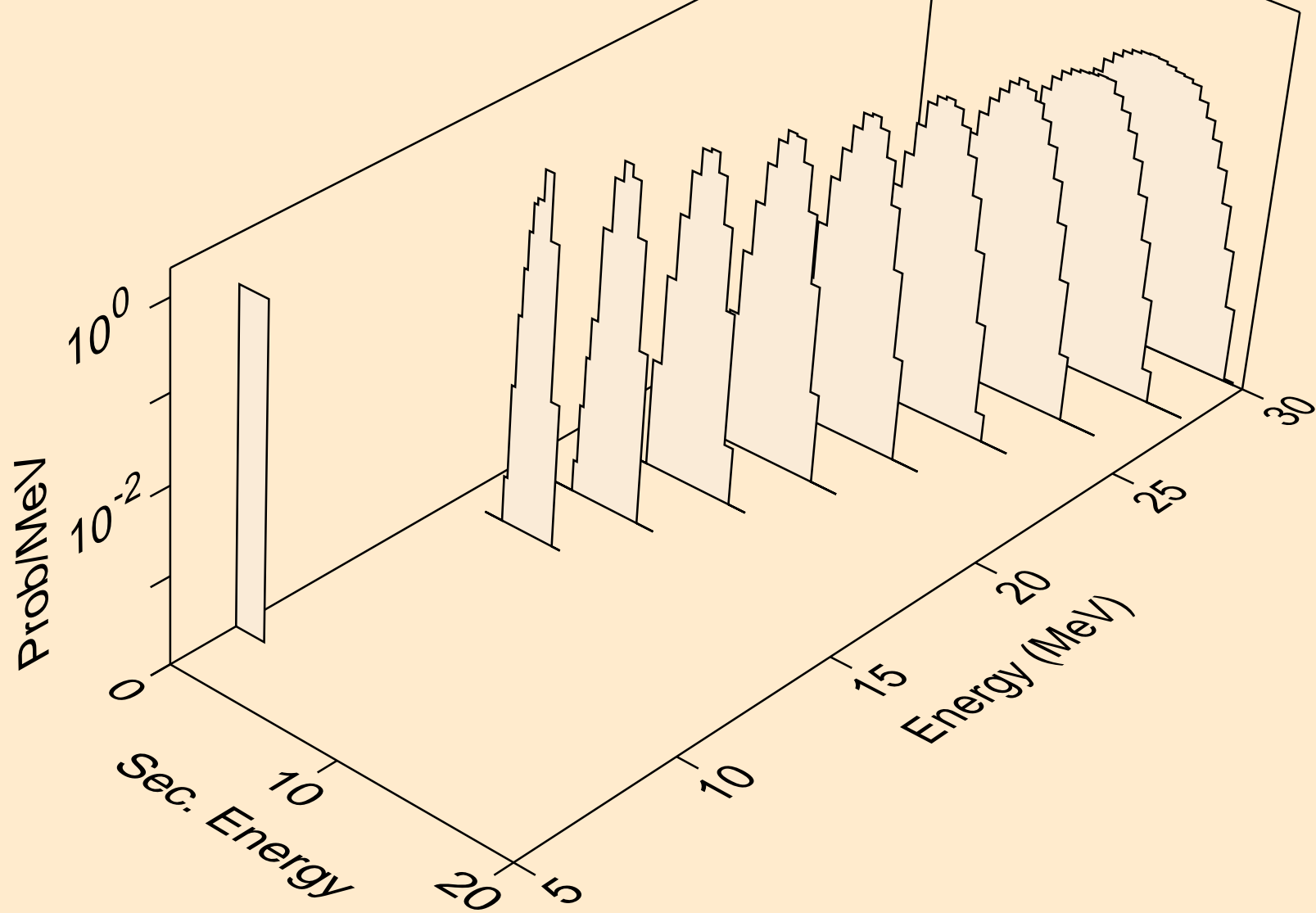

HG191 NEUTRON ACER TENDL-2024 LIBRARY; T=293.6K  
he3s from (n,x)

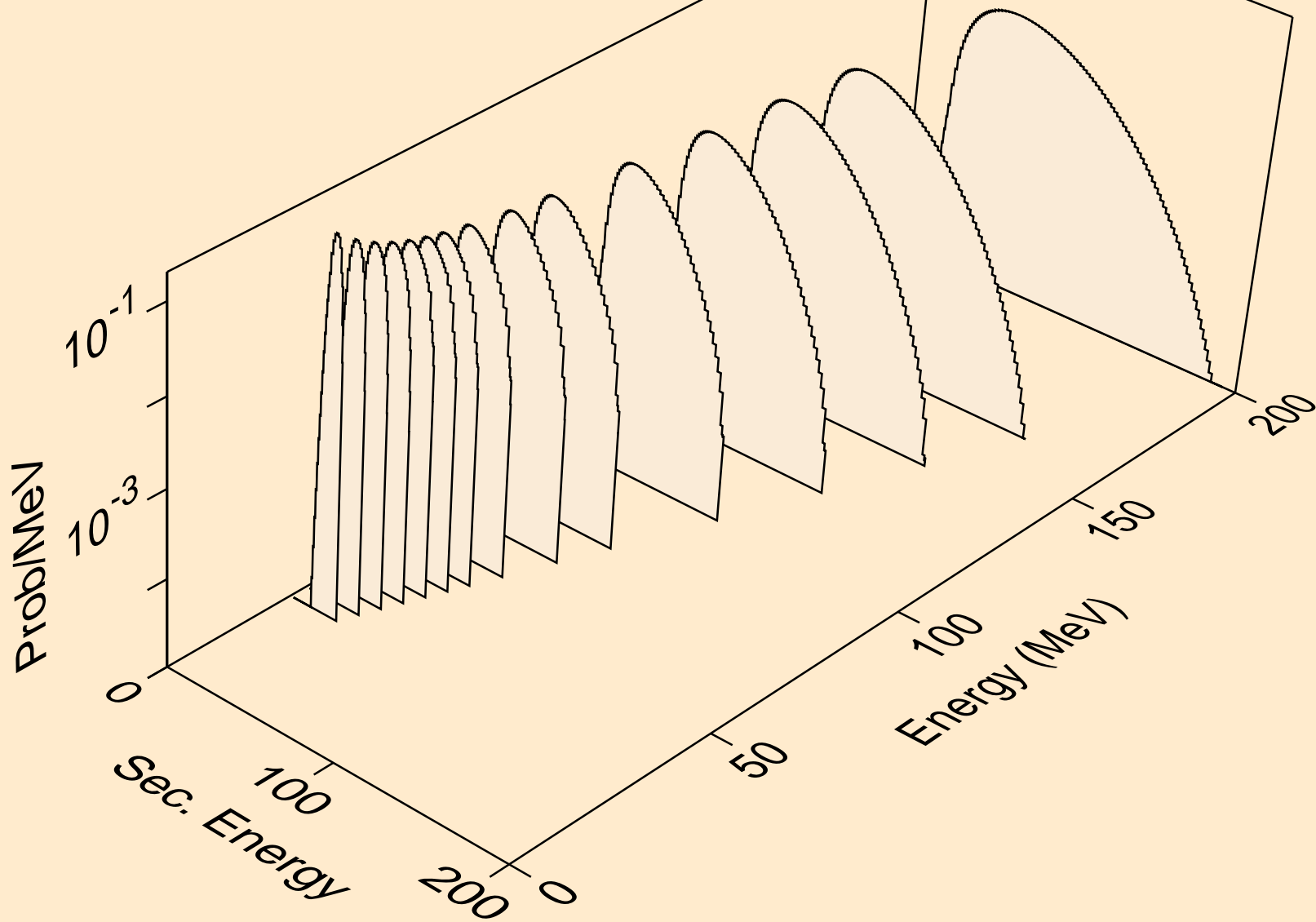

HG191 NEUTRON ACER TENDL-2024 LIBRARY; T=293.6K  
he3s from (n,n\*)he3

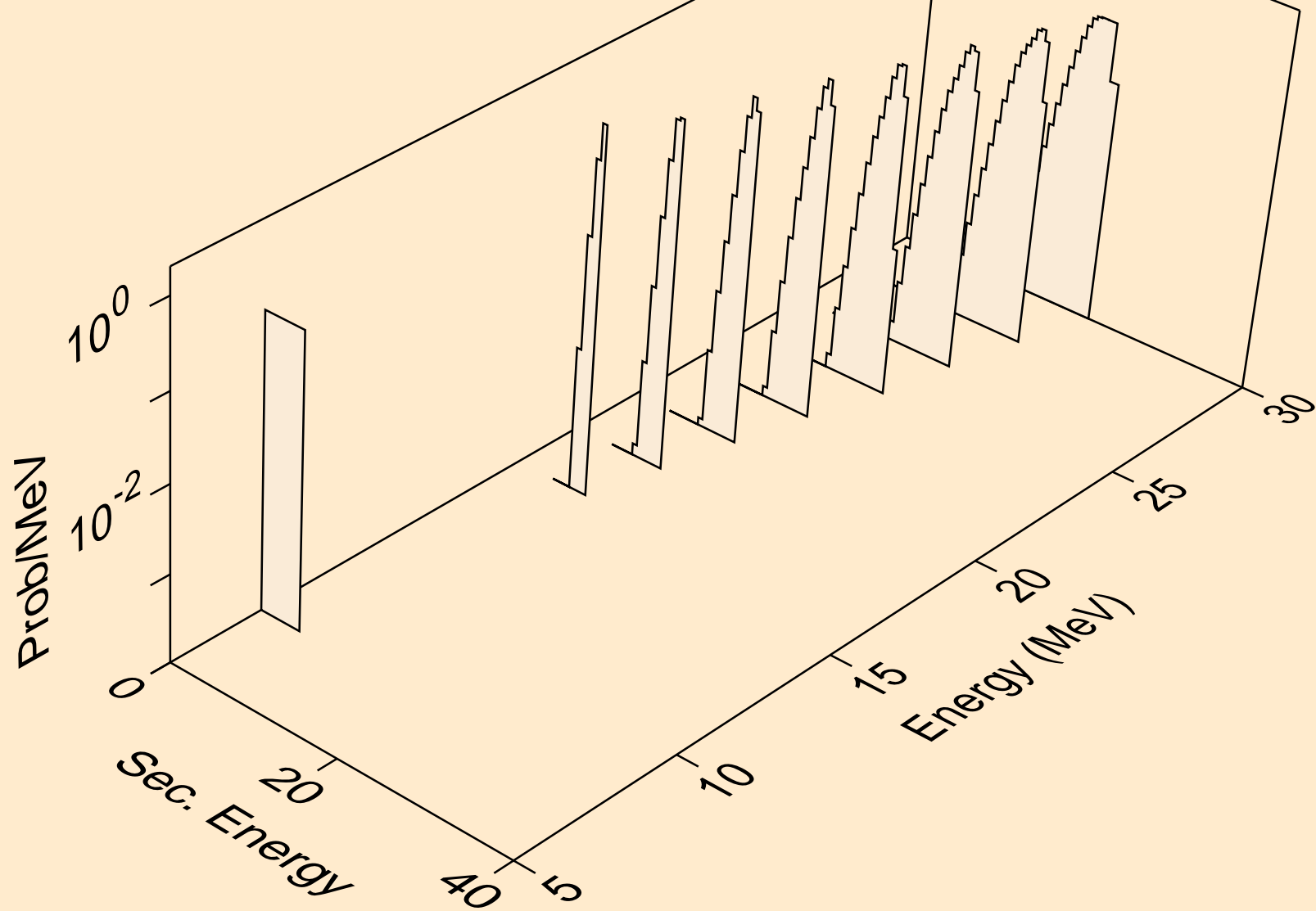

HG191 NEUTRON ACER TENDL-2024 LIBRARY; T=293.6K  
he3s from (n,he3)

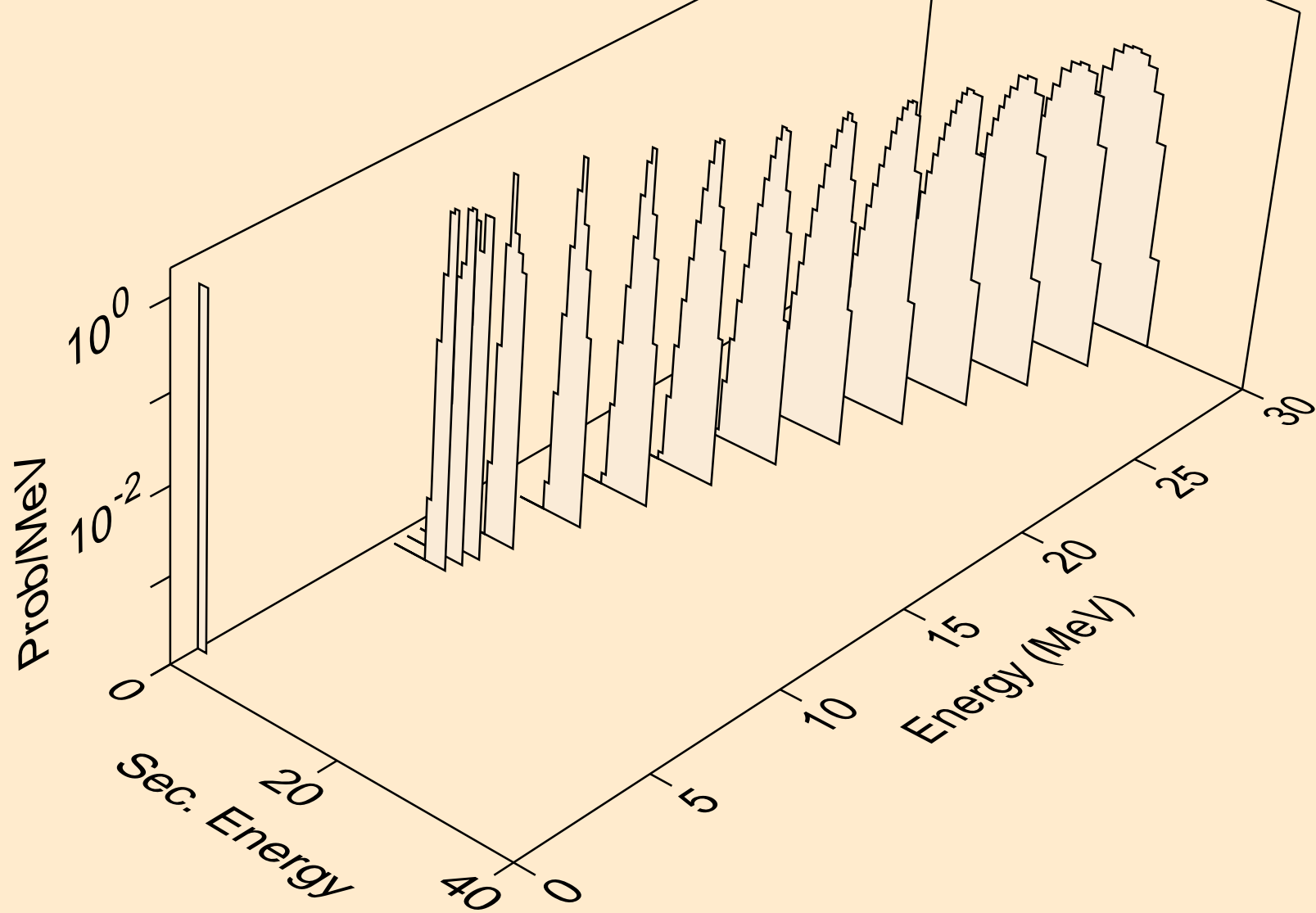

HG191 NEUTRON ACER TENDL-2024 LIBRARY; T=293.6K  
alphas from (n,x)

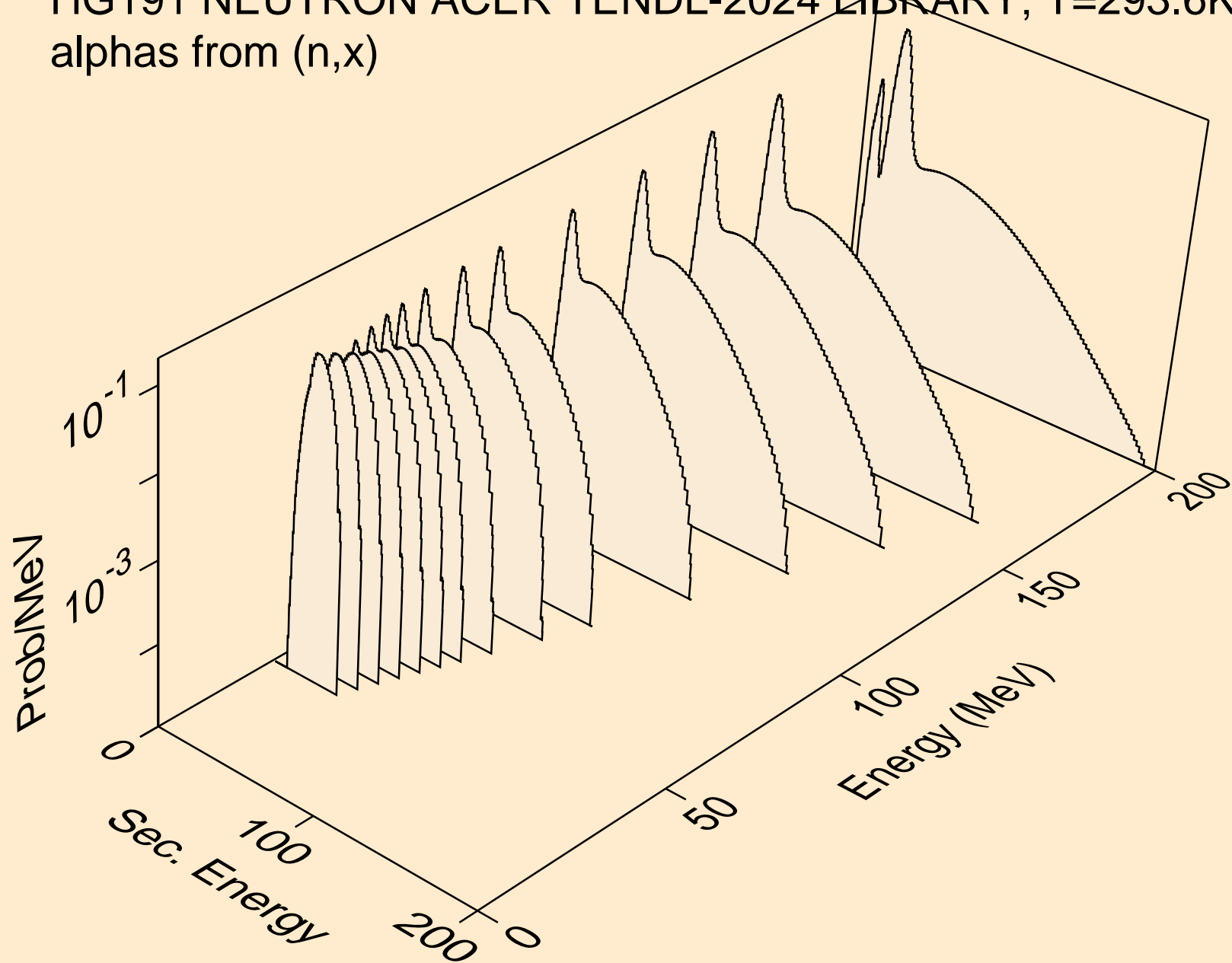

HG191 NEUTRON ACER TENDL-2024 LIBRARY; T=293.6K  
alphas from (n,n\*)a

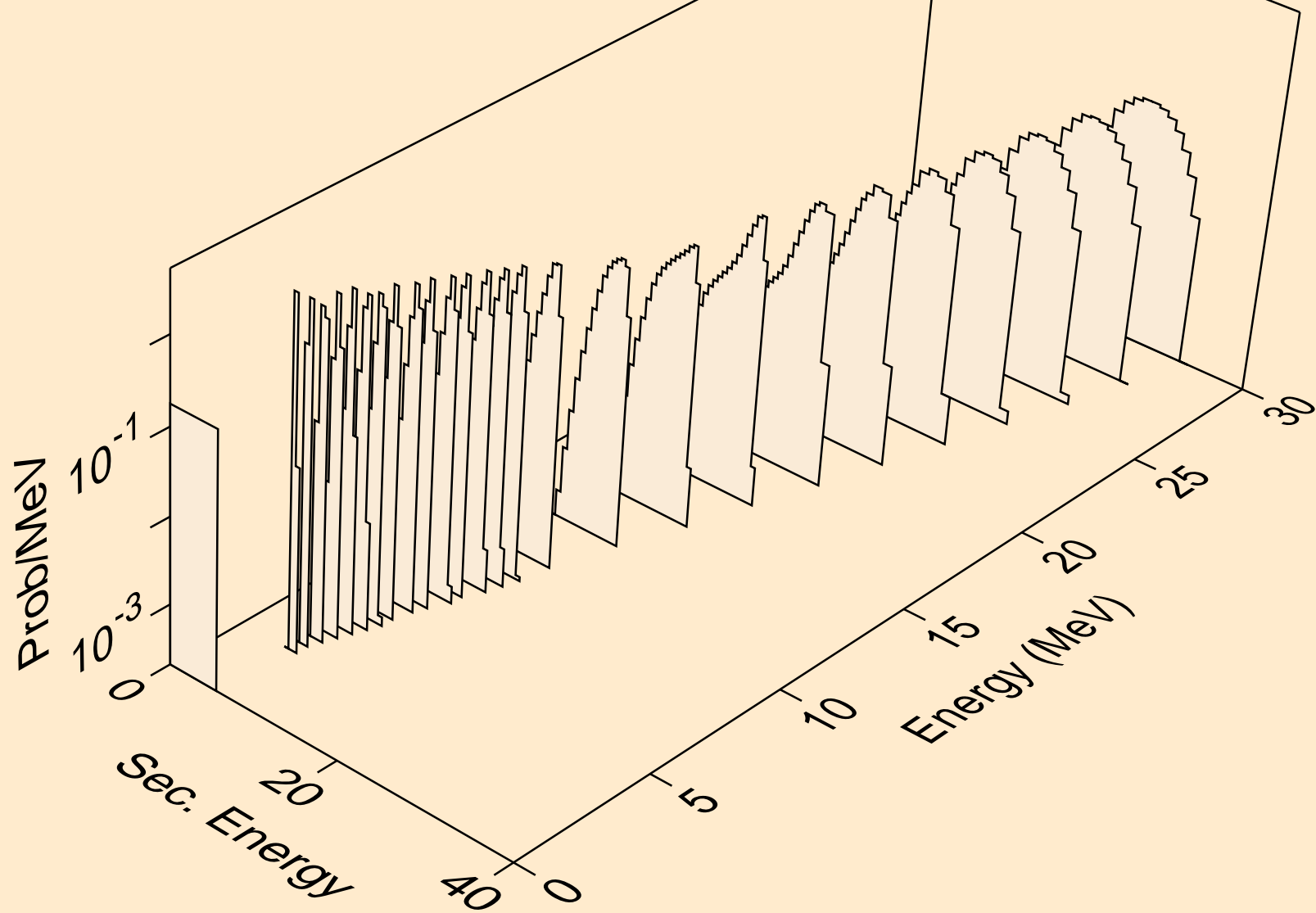

HG191 NEUTRON ACER TENDL-2024 LIBRARY; T=293.6K  
alphas from (n,2n)a

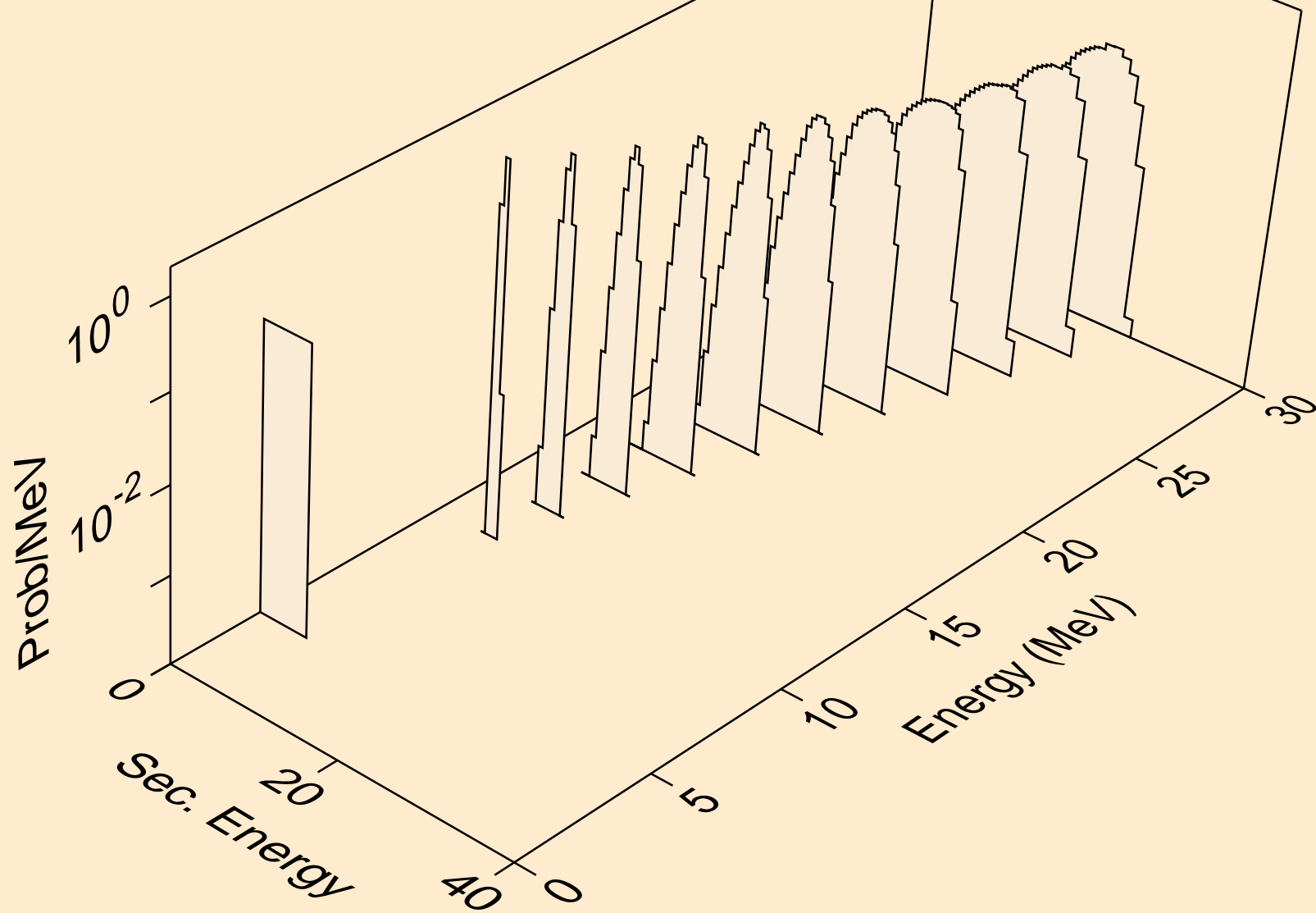

HG191 NEUTRON ACER TENDL-2024 LIBRARY; T=293.6K  
alphas from (n,3n)a

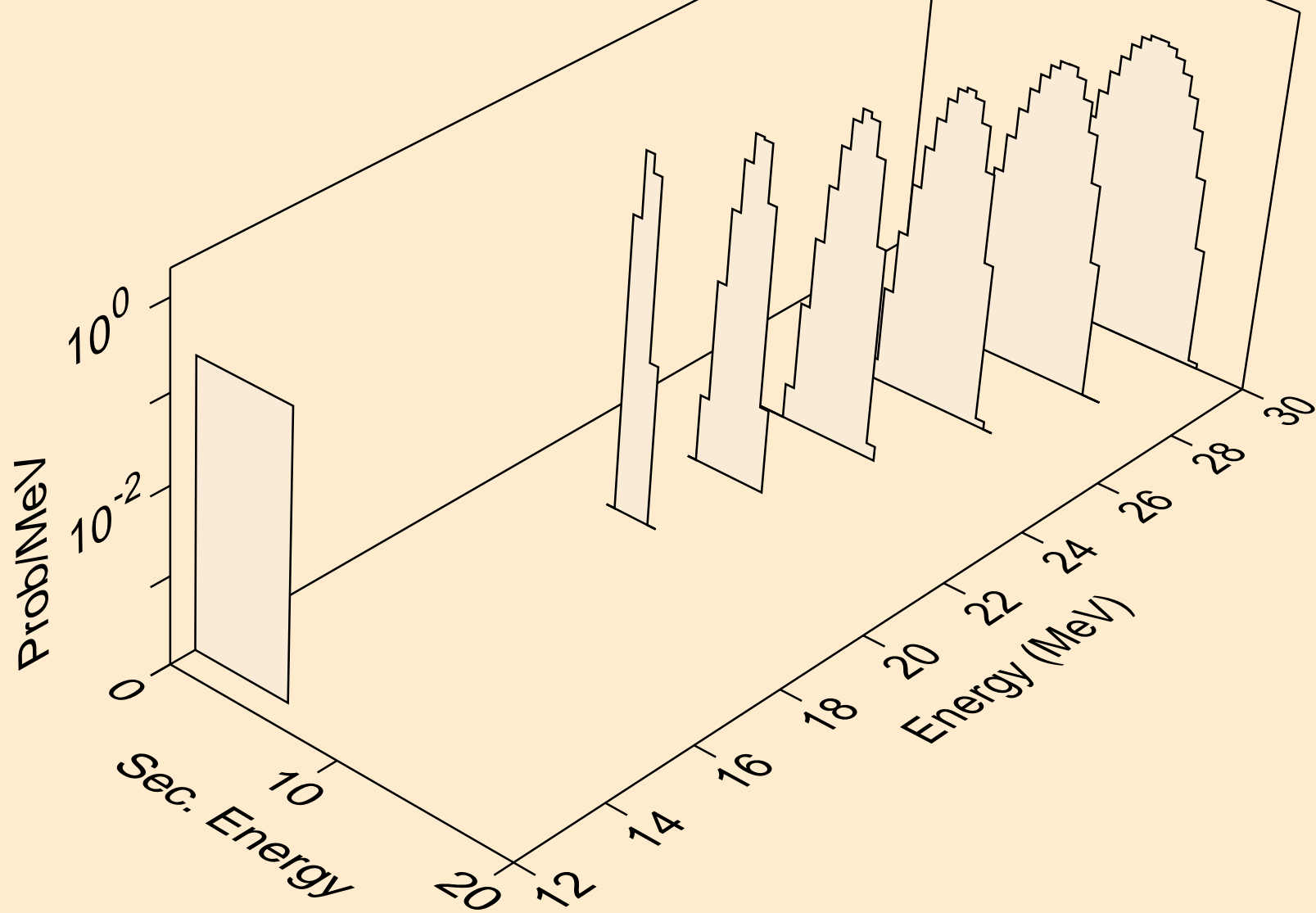

HG191 NEUTRON ACER TENDL-2024 LIBRARY; T=293.6K  
alphas from (n,n\*)2a

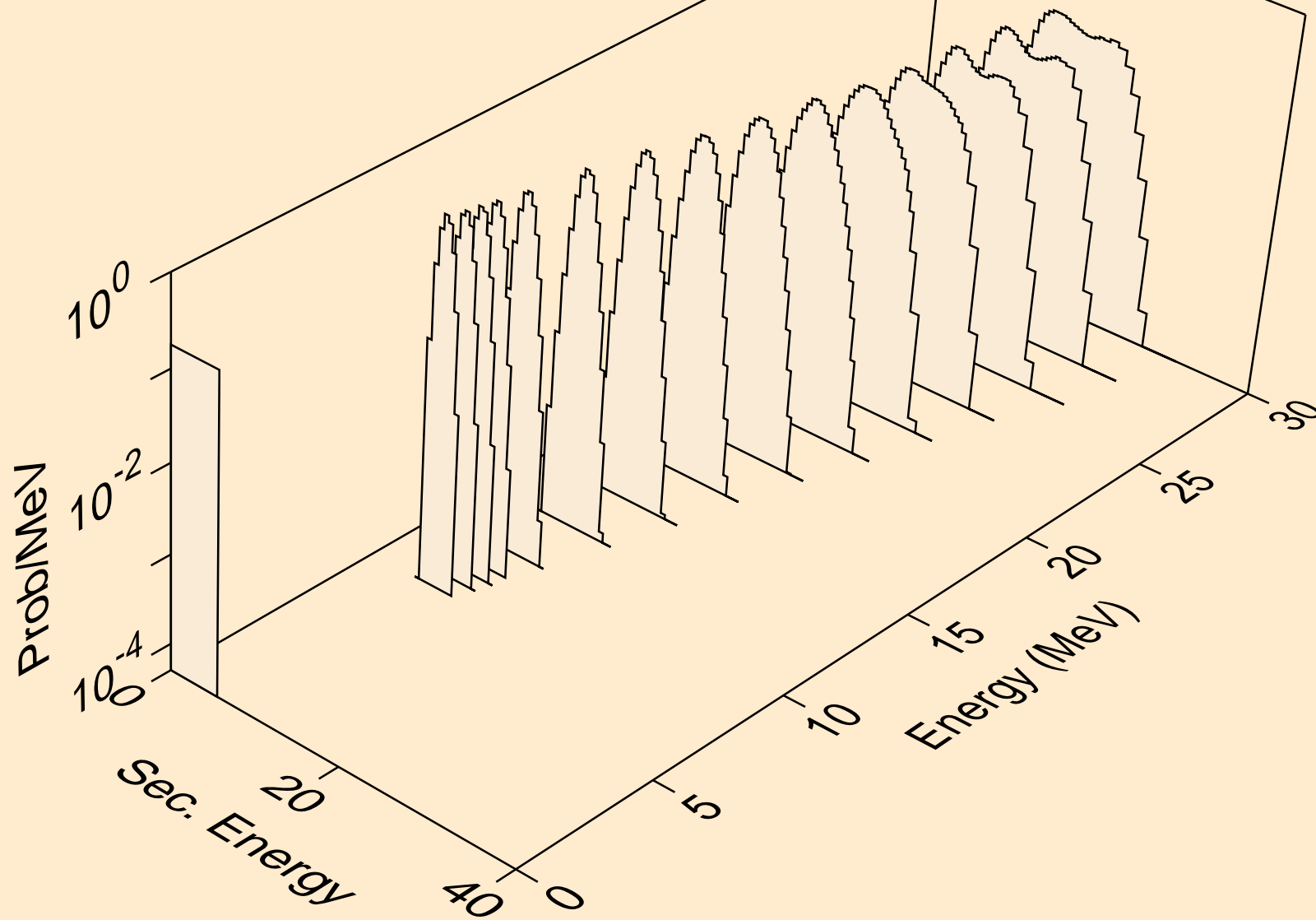

HG191 NEUTRON ACER TENDL-2024 LIBRARY; T=293.6K  
alphas from (n,2n)2a

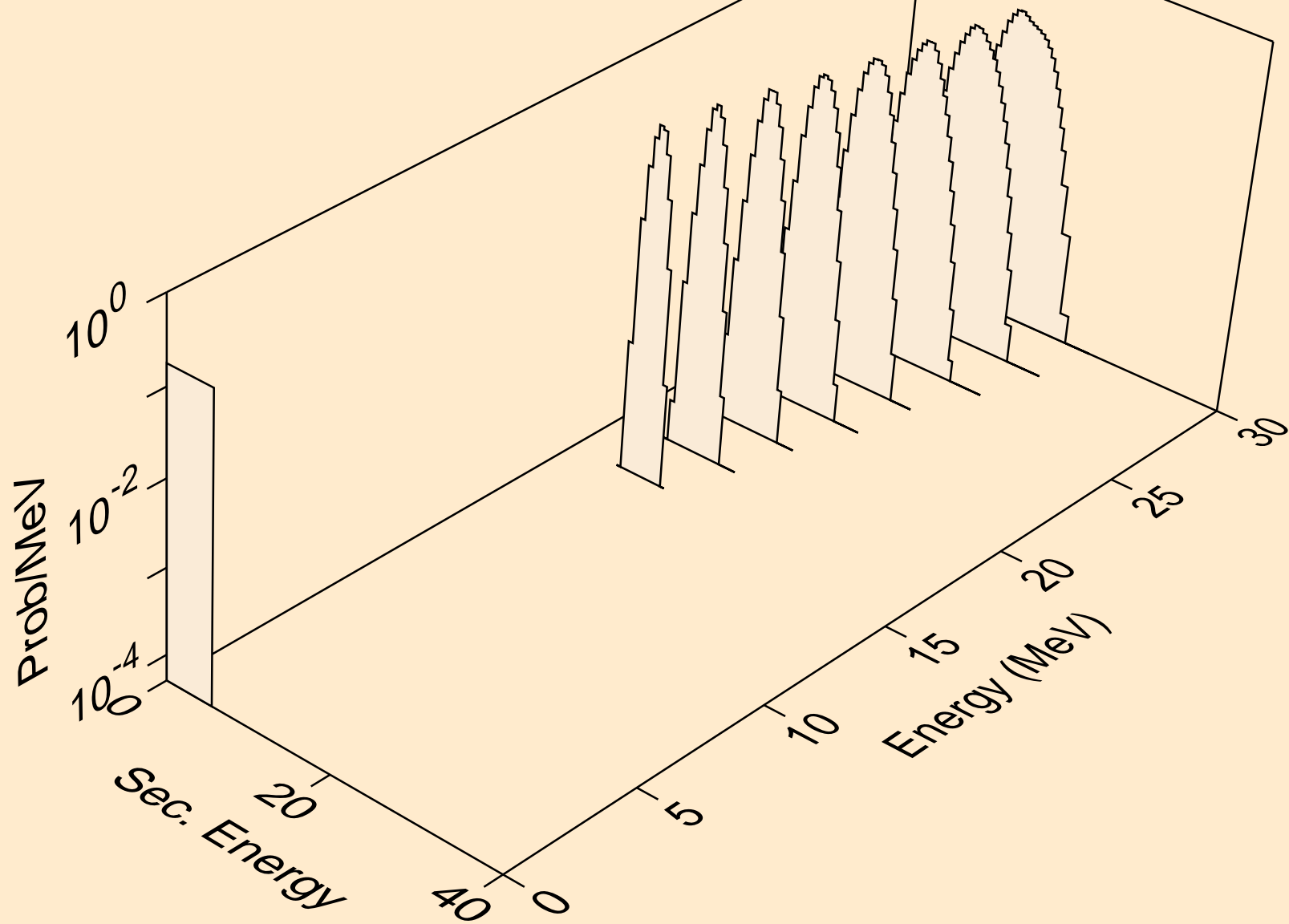

HG191 NEUTRON ACER TENDL-2024 LIBRARY; T=293.6K  
alphas from (n,npa)

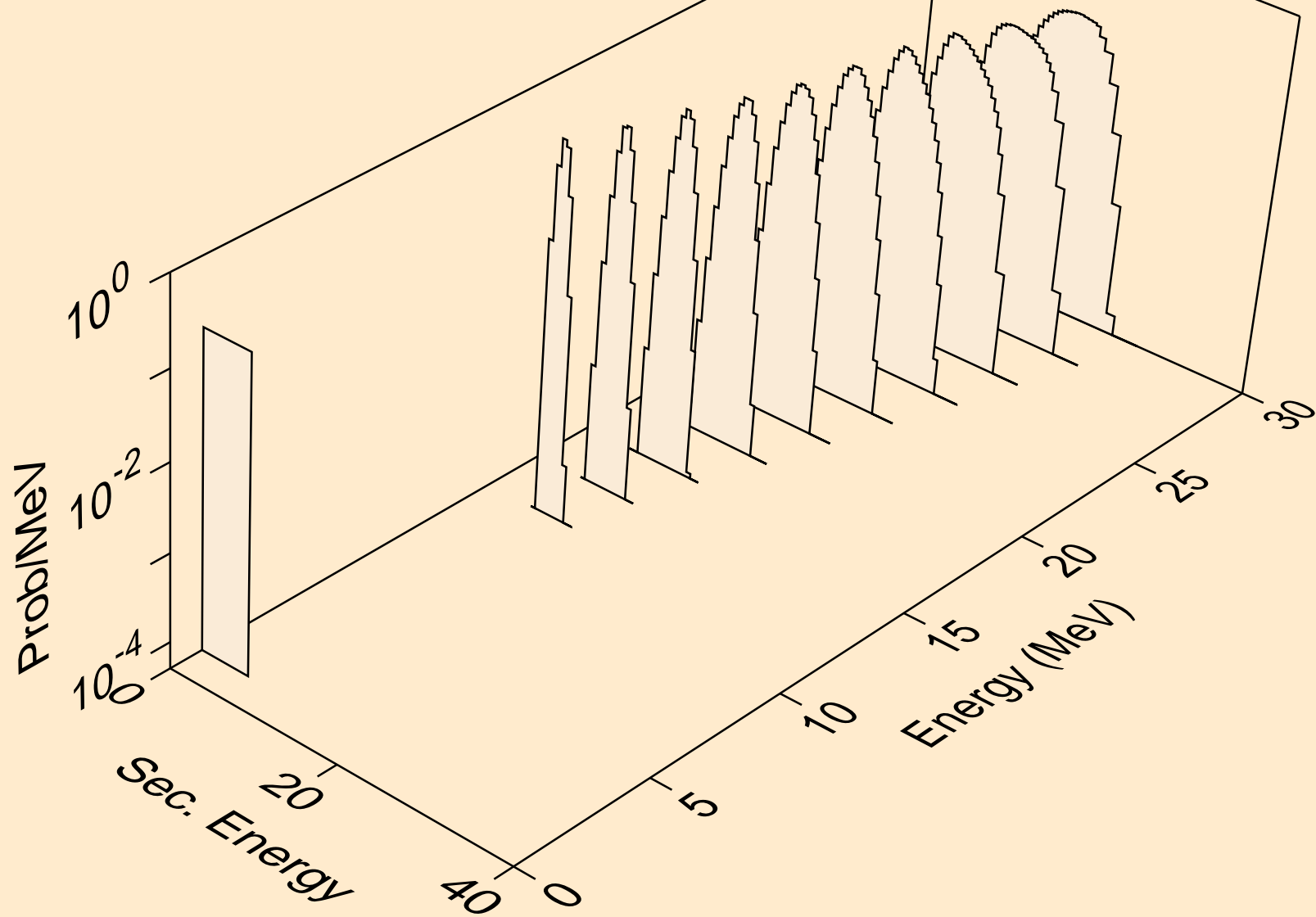

HG191 NEUTRON ACER TENDL-2024 LIBRARY; T=293.6K  
alphas from (n,a)

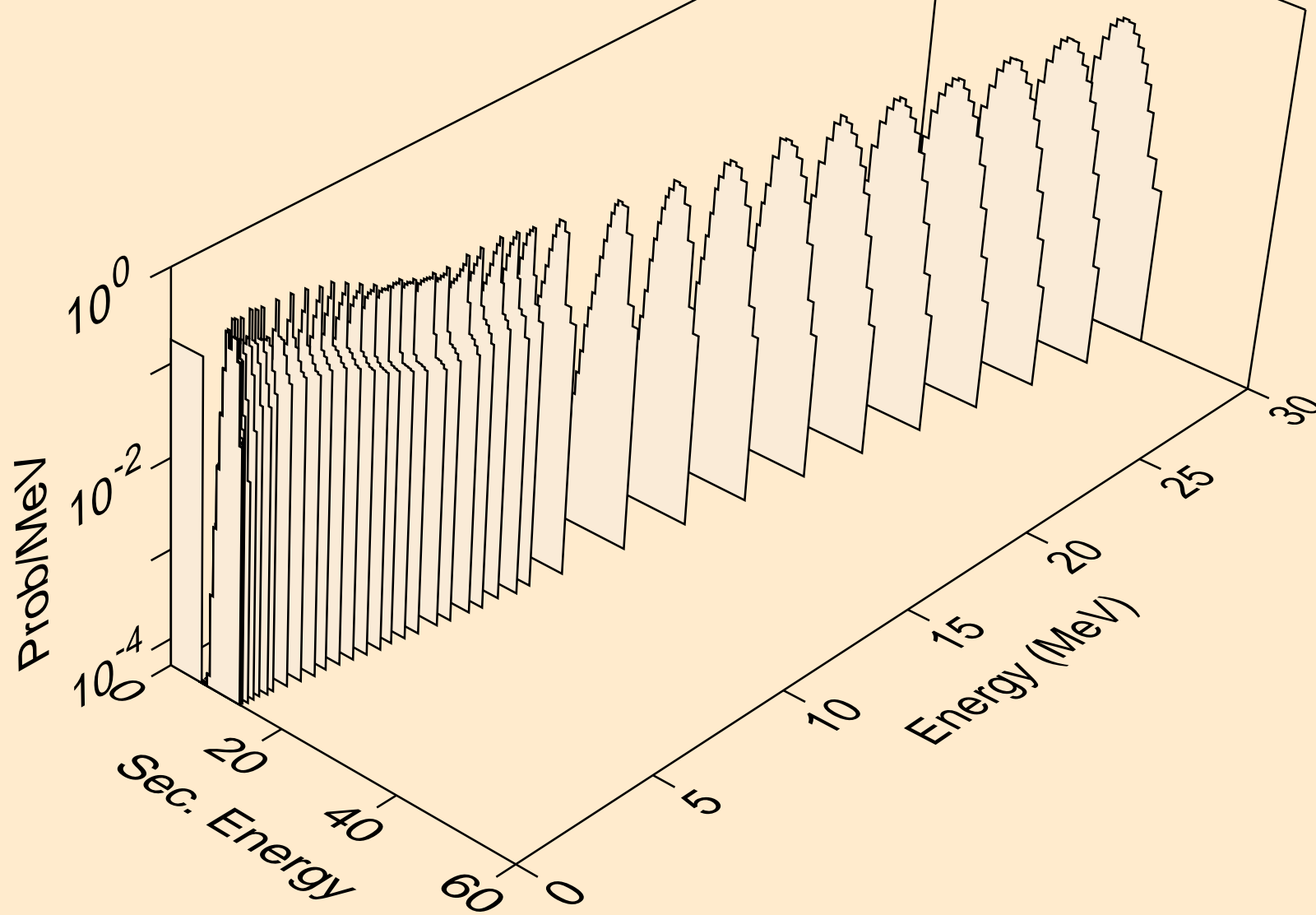

HG191 NEUTRON ACER TENDL-2024 LIBRARY; T=293.6K  
alphas from (n,2a)

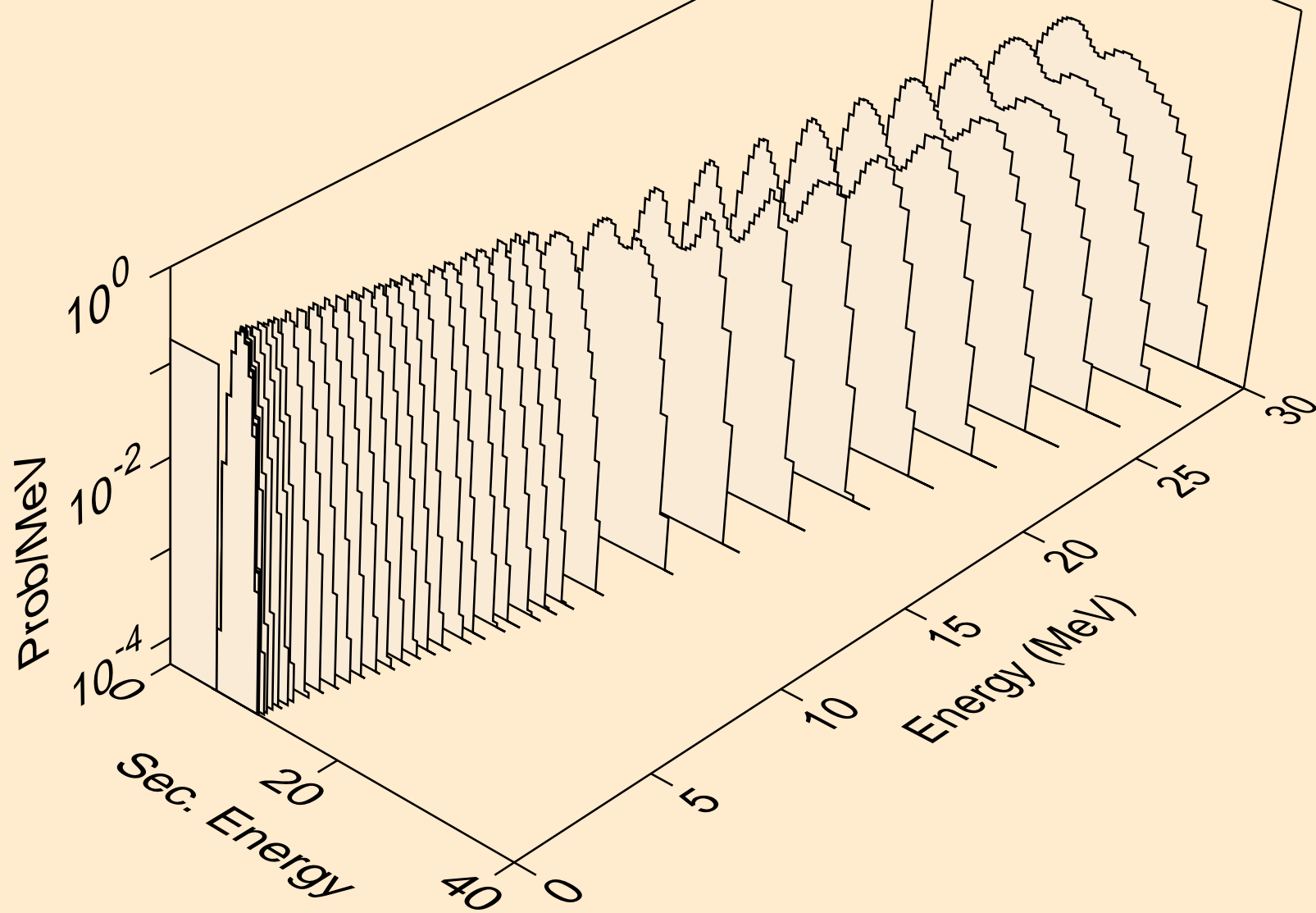

HG191 NEUTRON ACER TENDL-2024 LIBRARY; T=293.6K  
alphas from (n,pa)

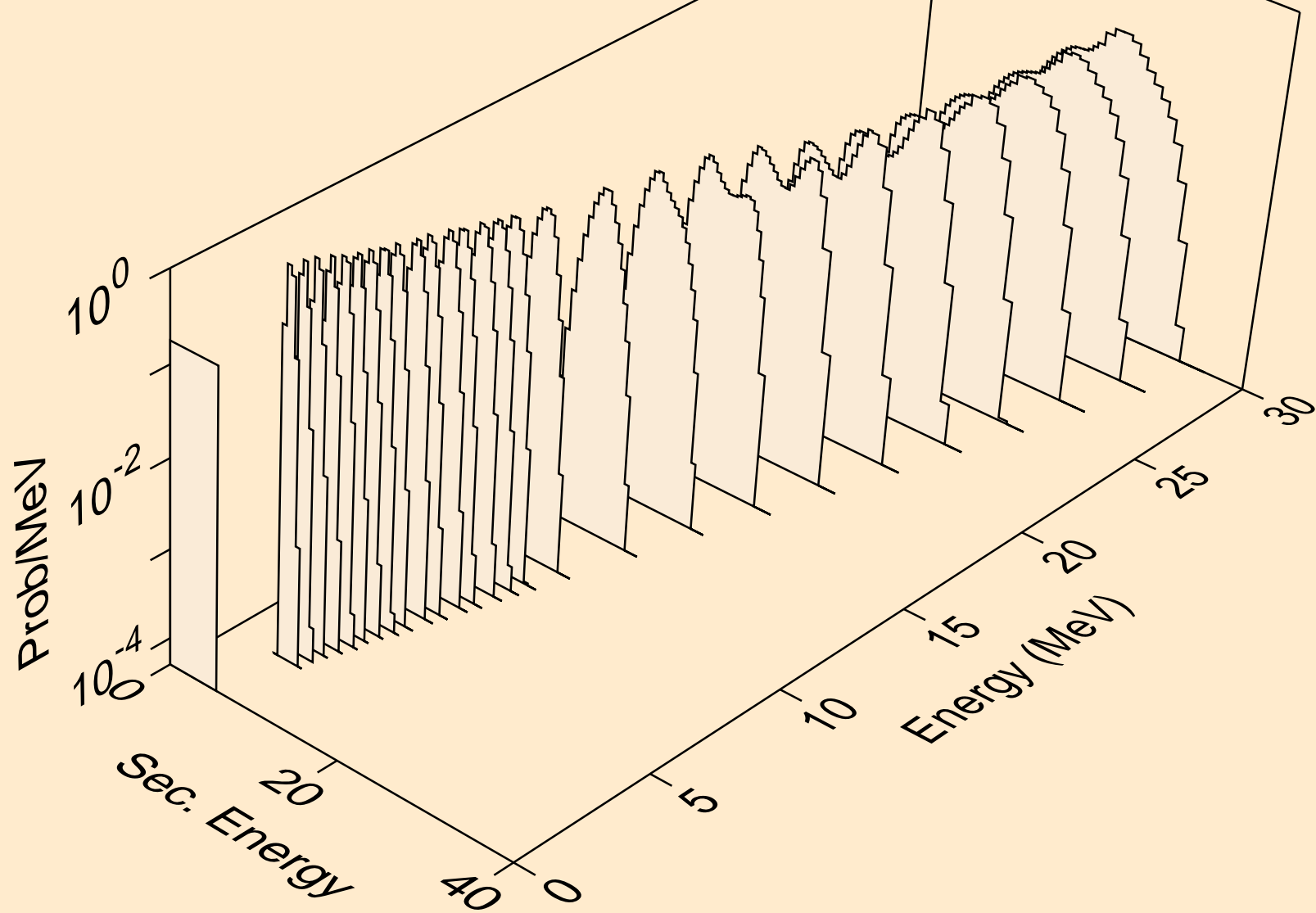

HG191 NEUTRON ACER TENDL-2024 LIBRARY; T=293.6K  
alphas from (n,da)

