

HO166 NEUTRON ACER TENDL-2024 LIBRARY; T=293.6K

Principal cross sections

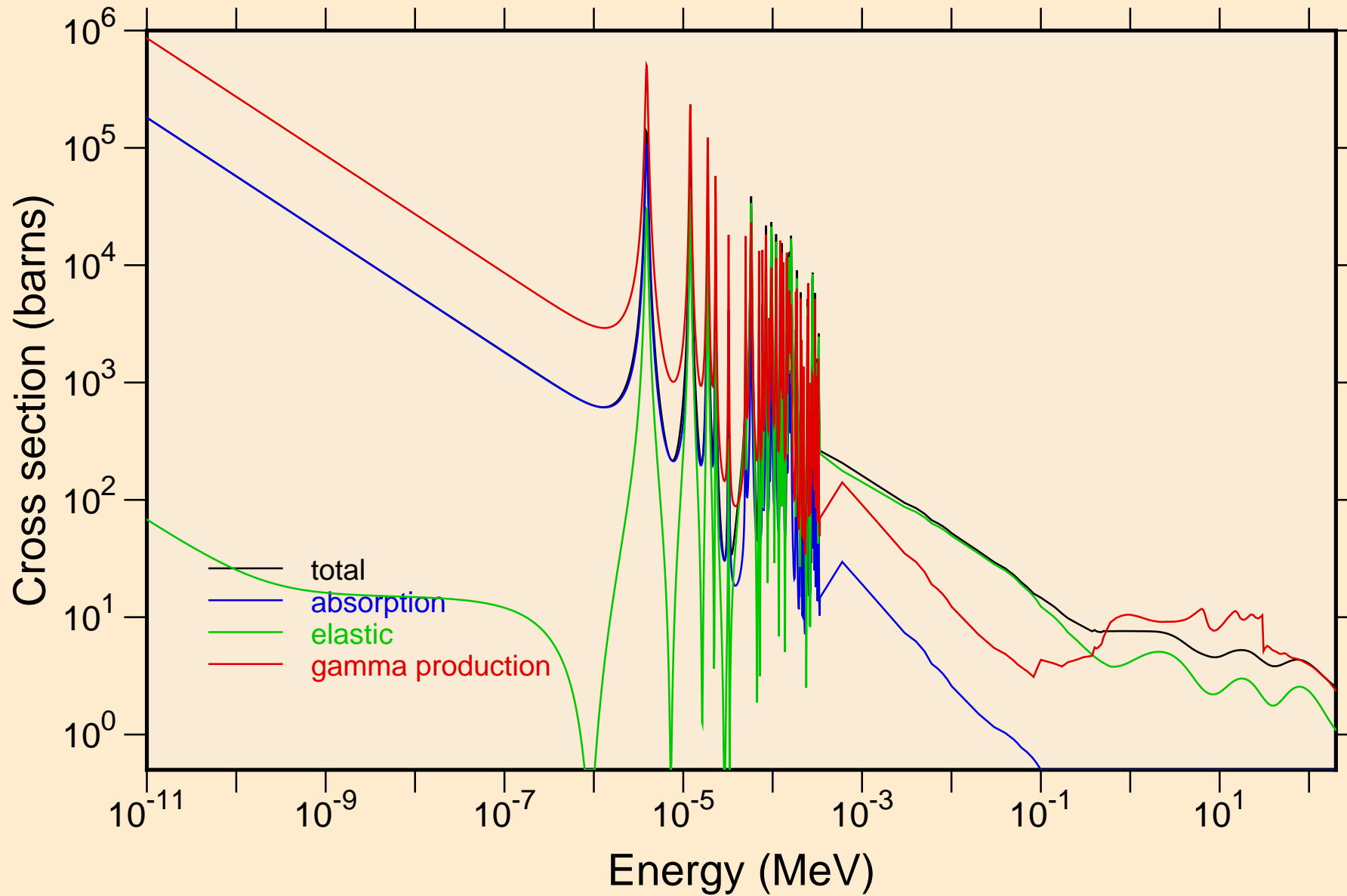

HO166 NEUTRON ACER TENDL-2024 LIBRARY; T=293.6K
resonance total cross section

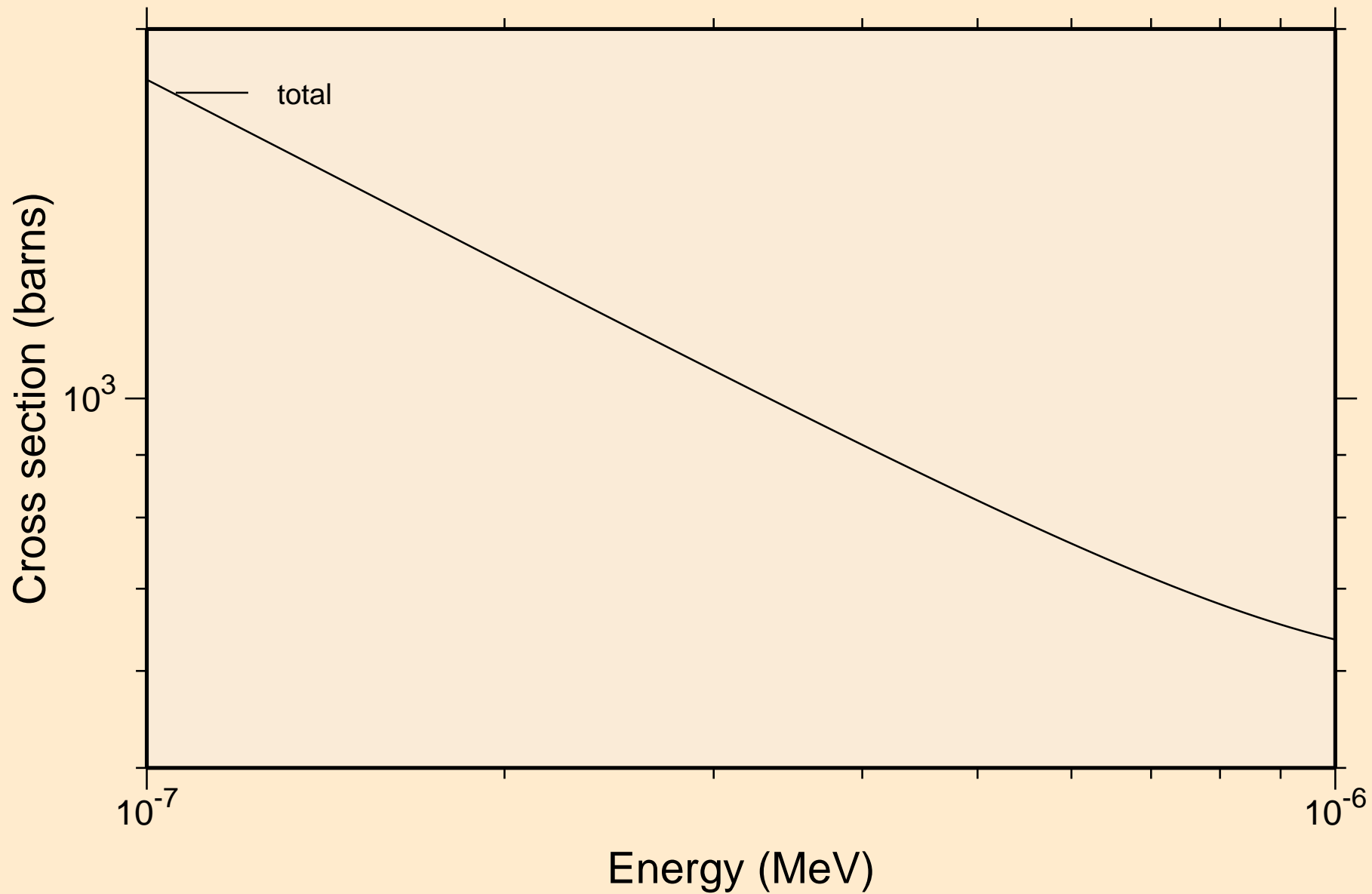

HO166 NEUTRON ACER TENDL-2024 LIBRARY; T=293.6K
resonance total cross section

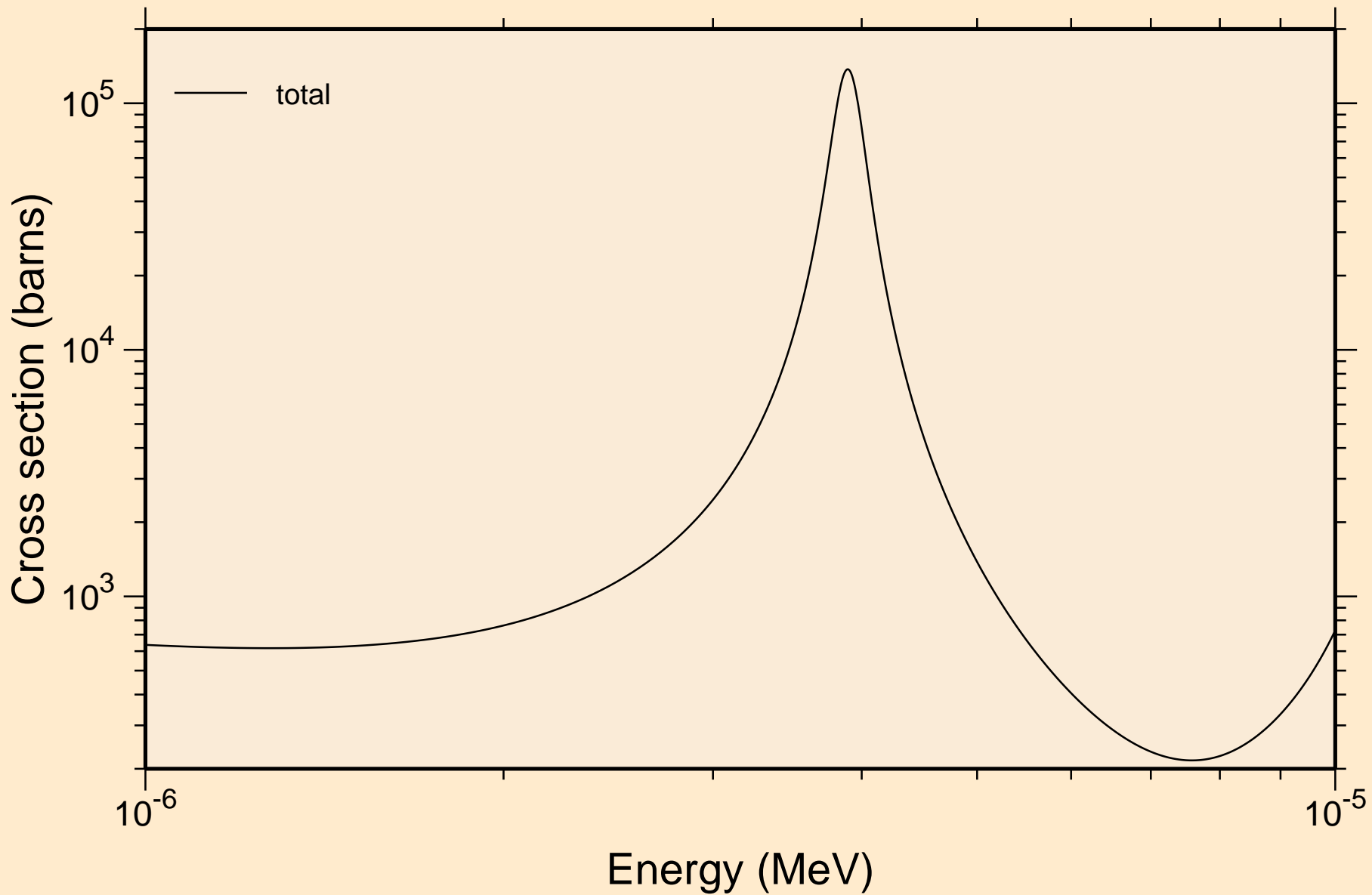

HO166 NEUTRON ACER TENDL-2024 LIBRARY; T=293.6K
resonance total cross section

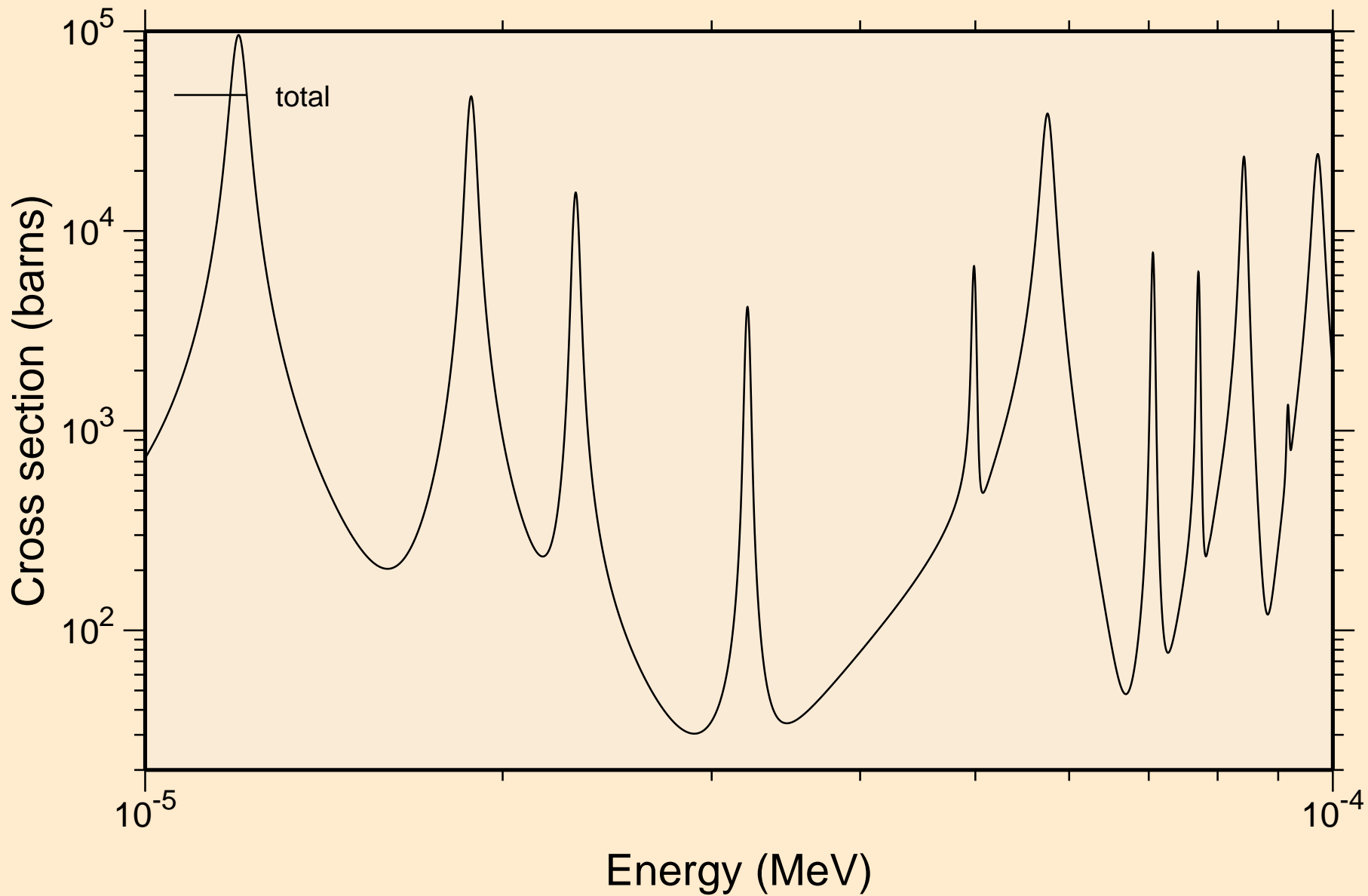

HO166 NEUTRON ACER TENDL-2024 LIBRARY; T=293.6K
resonance total cross section

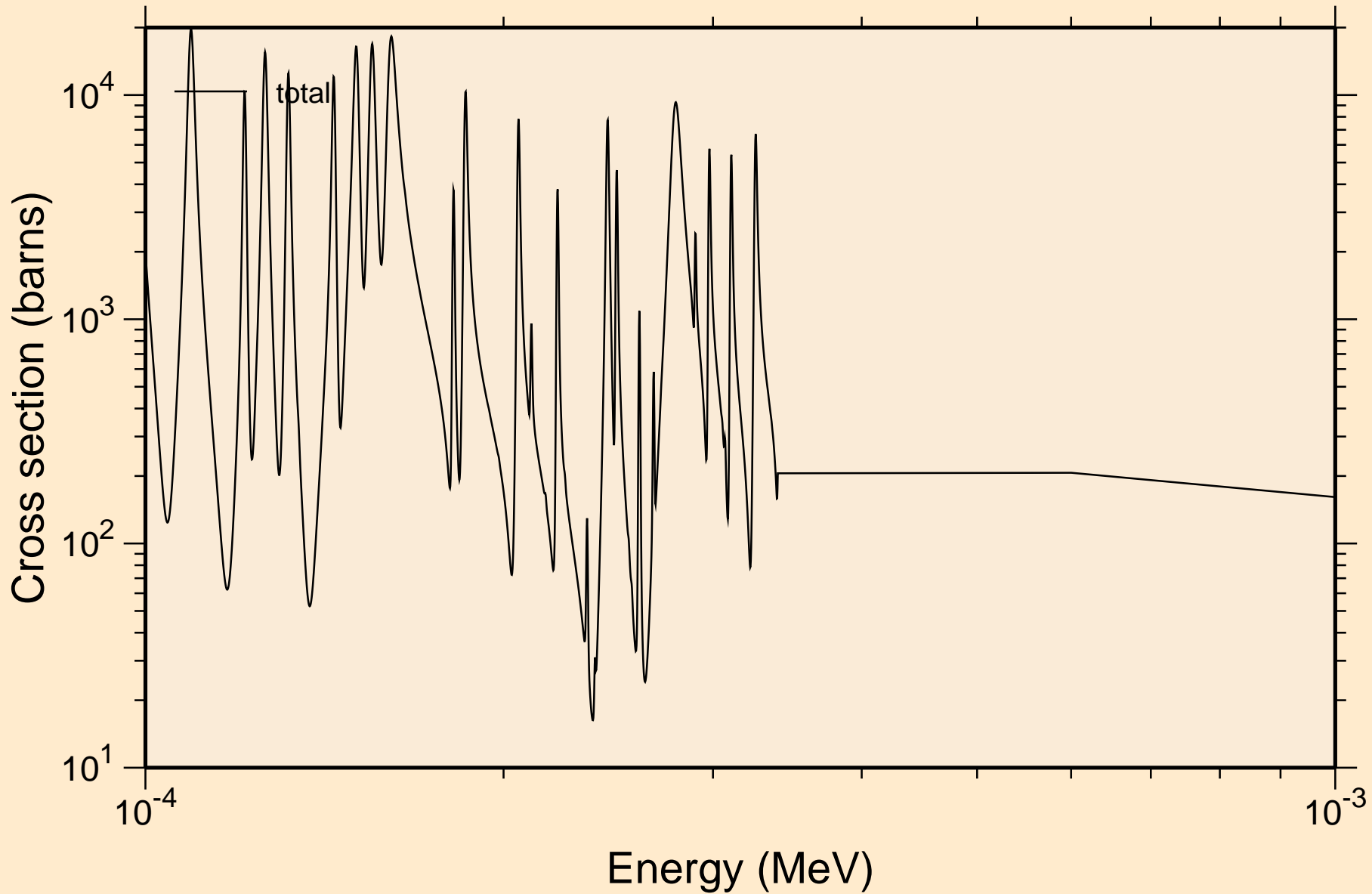

HO166 NEUTRON ACER TENDL-2024 LIBRARY; T=293.6K
resonance total cross section

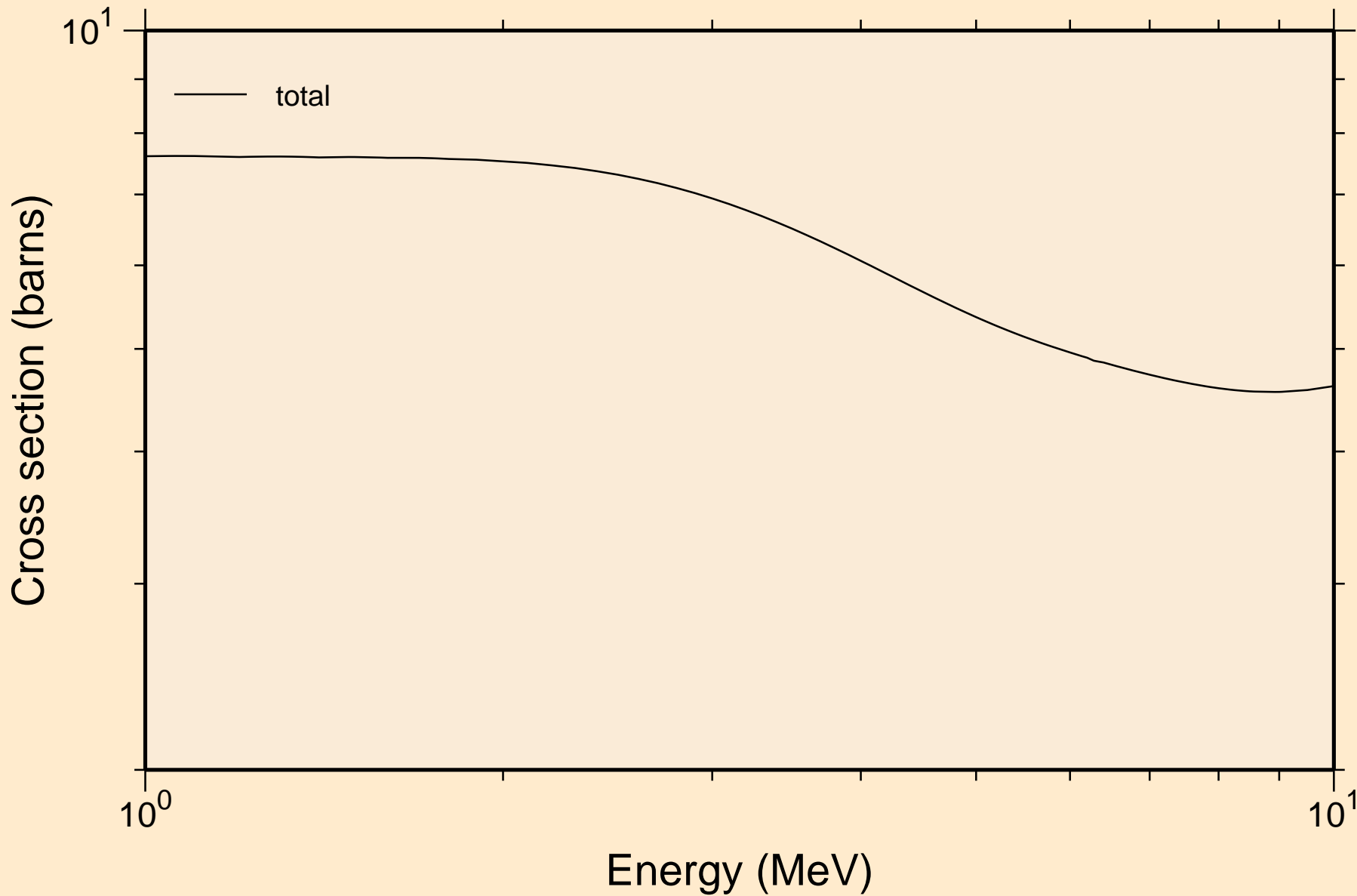

HO166 NEUTRON ACER TENDL-2024 LIBRARY; T=293.6K
resonance absorption cross sections

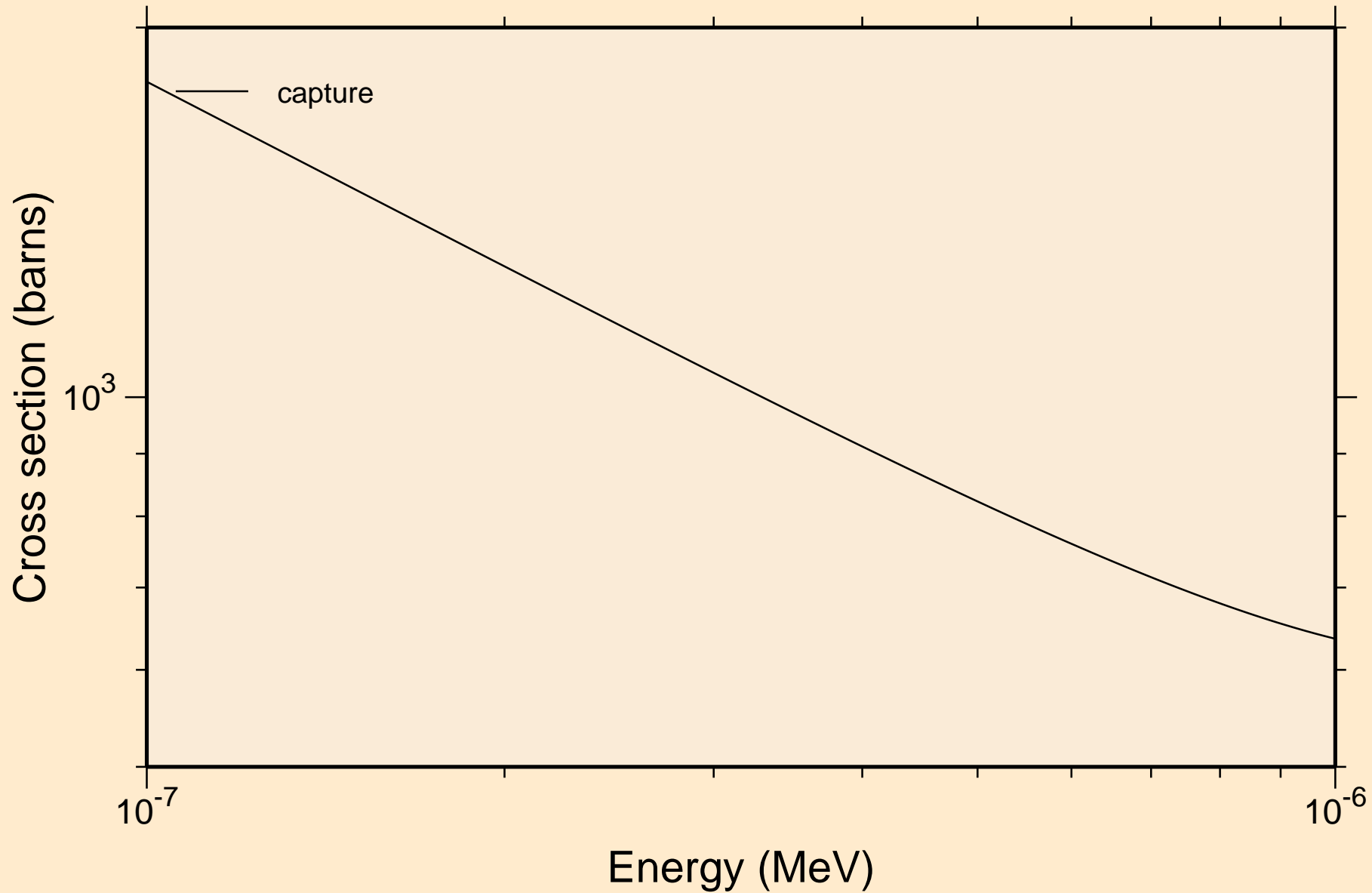

HO166 NEUTRON ACER TENDL-2024 LIBRARY; T=293.6K
resonance absorption cross sections

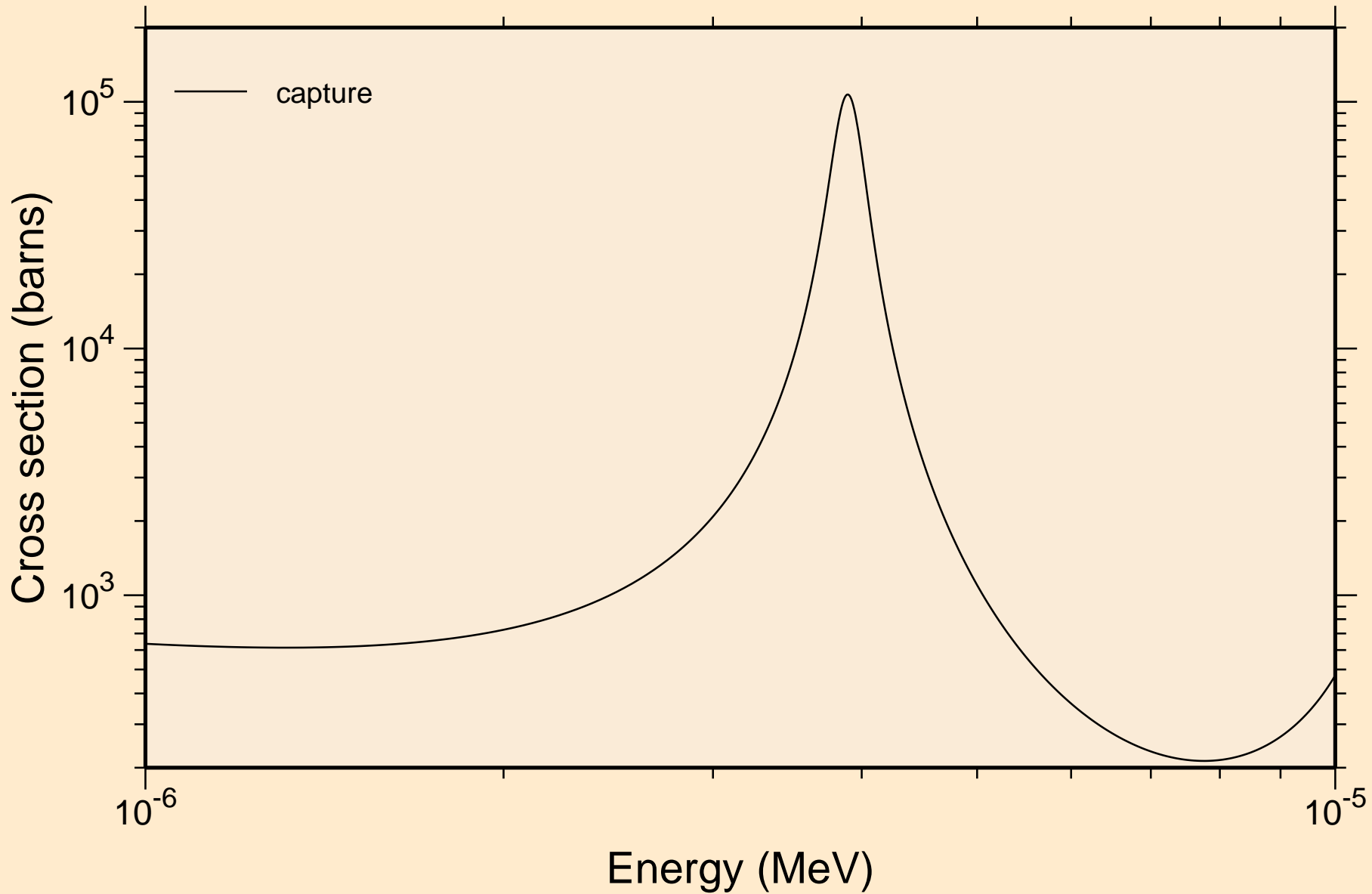

HO166 NEUTRON ACER TENDL-2024 LIBRARY; T=293.6K
resonance absorption cross sections

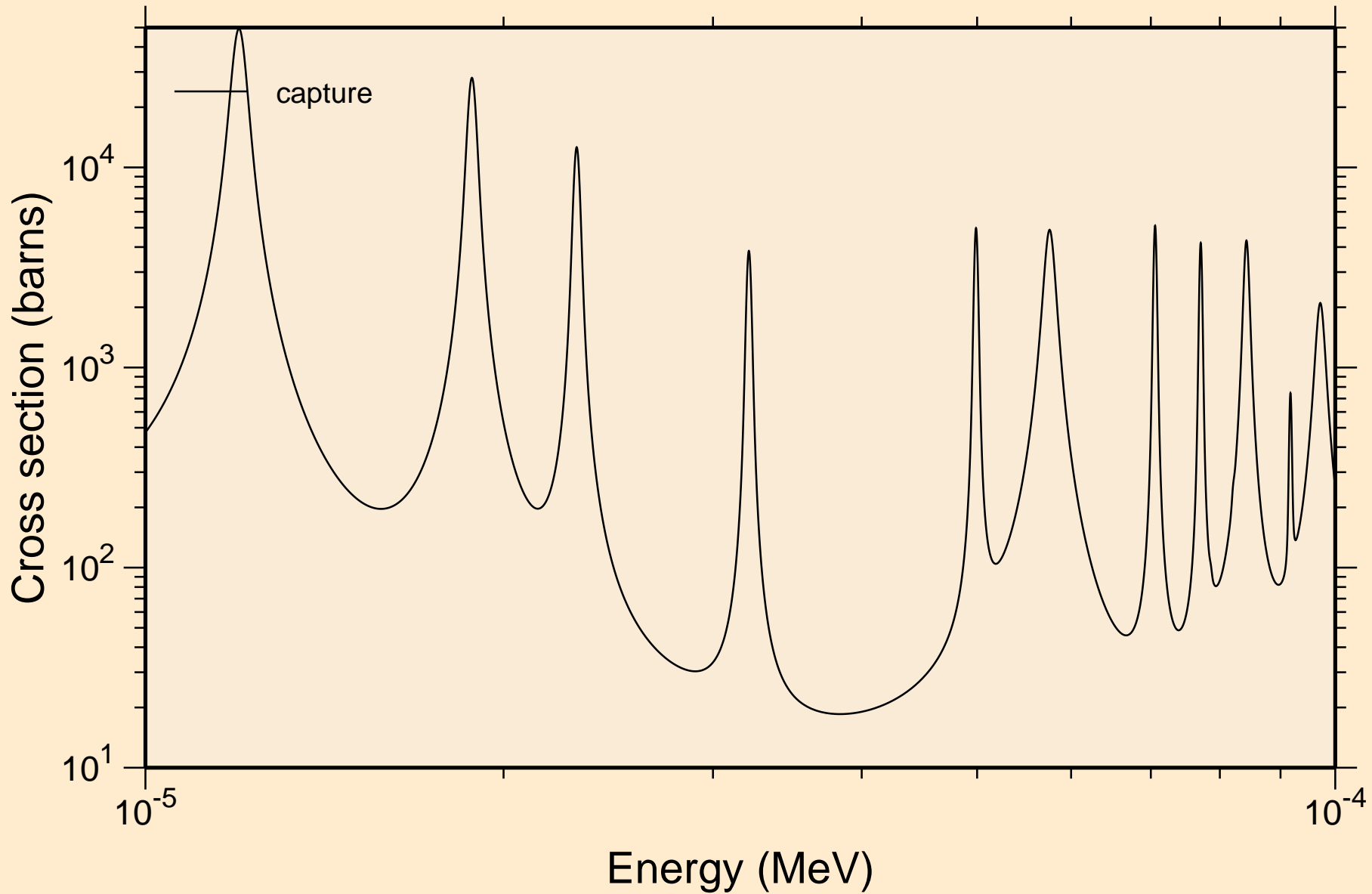

HO166 NEUTRON ACER TENDL-2024 LIBRARY; T=293.6K
resonance absorption cross sections

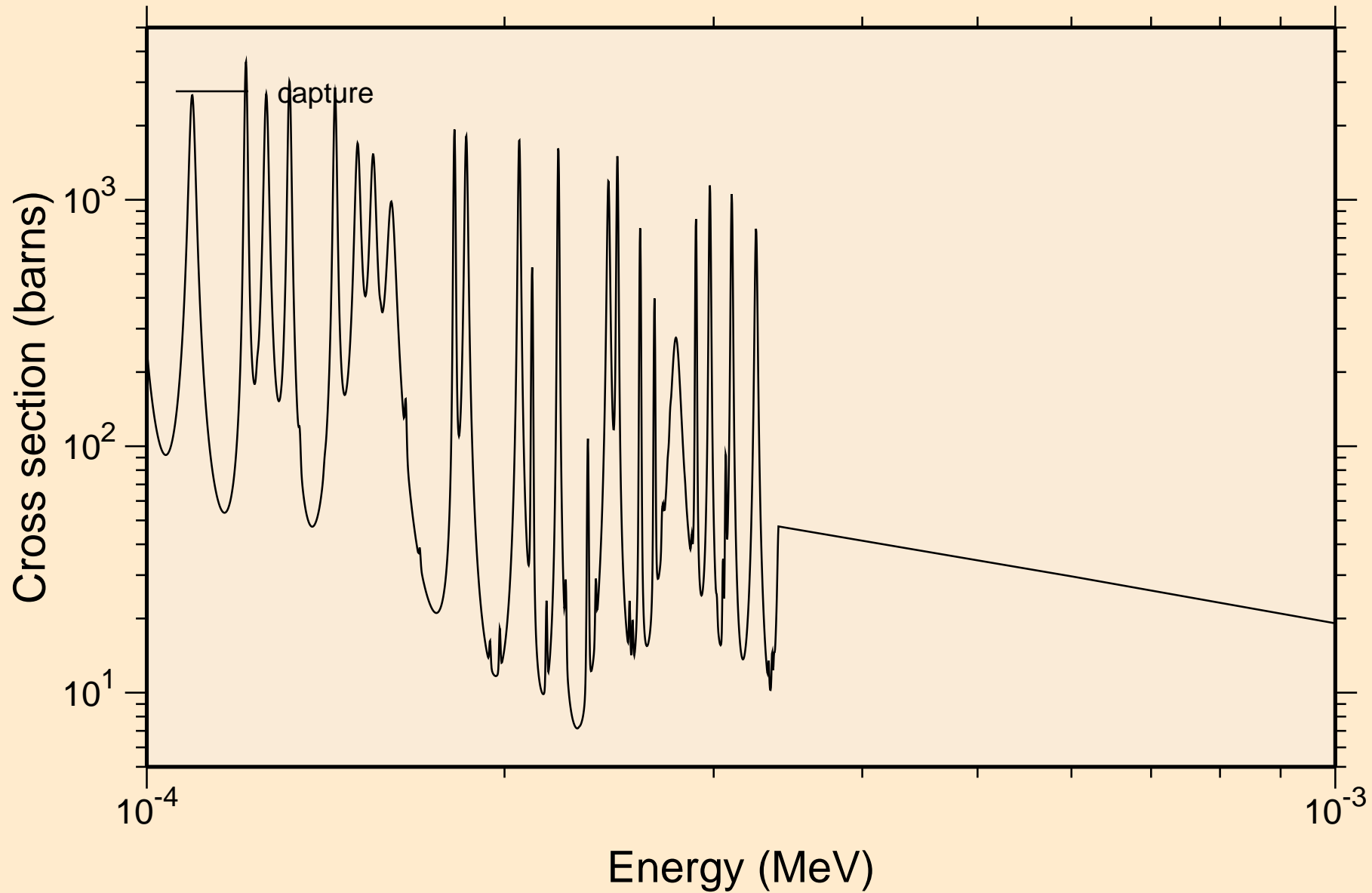

HO166 NEUTRON ACER TENDL-2024 LIBRARY; T=293.6K
resonance absorption cross sections

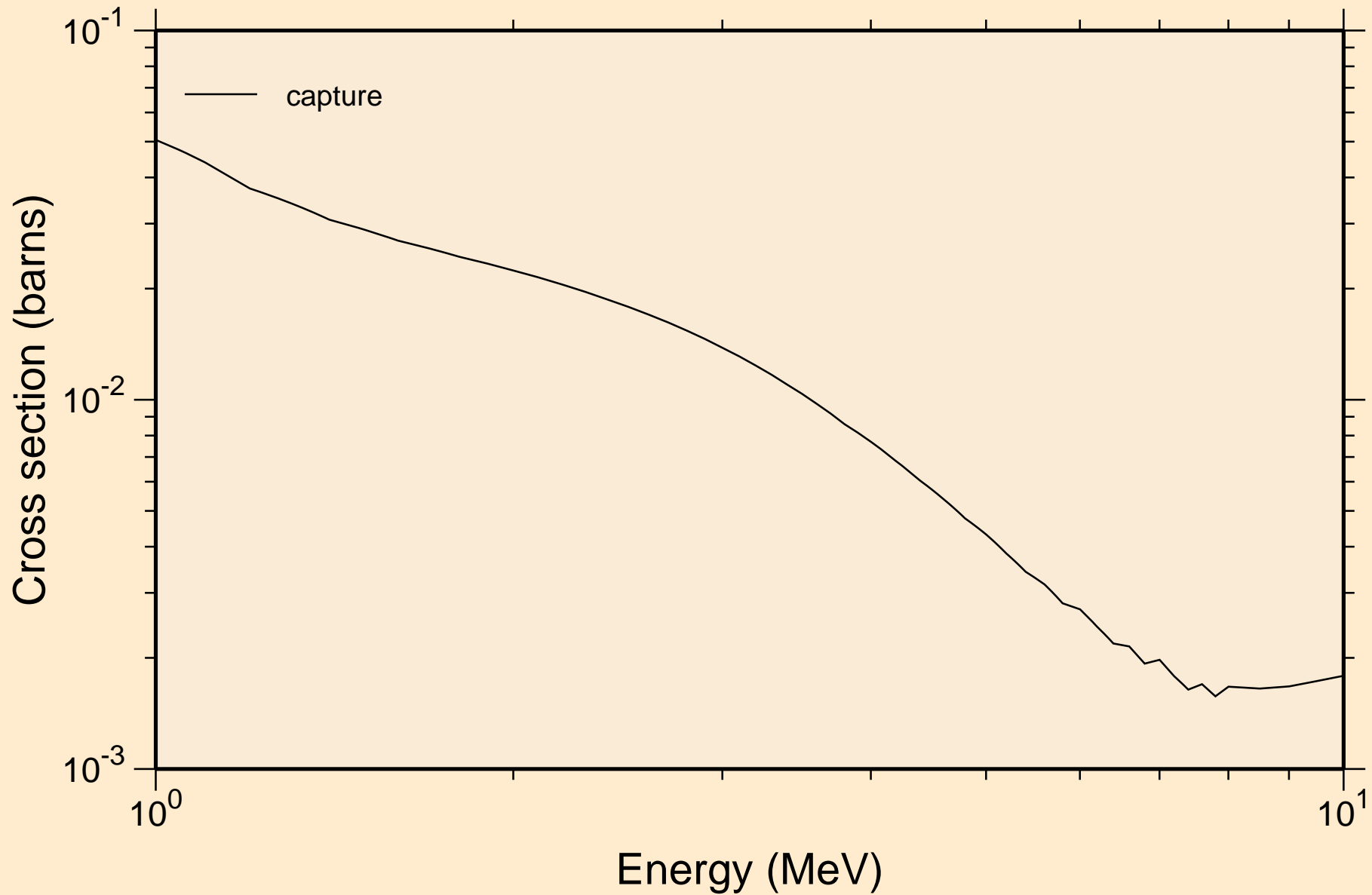

HO166 NEUTRON ACER TENDL-2024 LIBRARY; T=293.6K
Heating

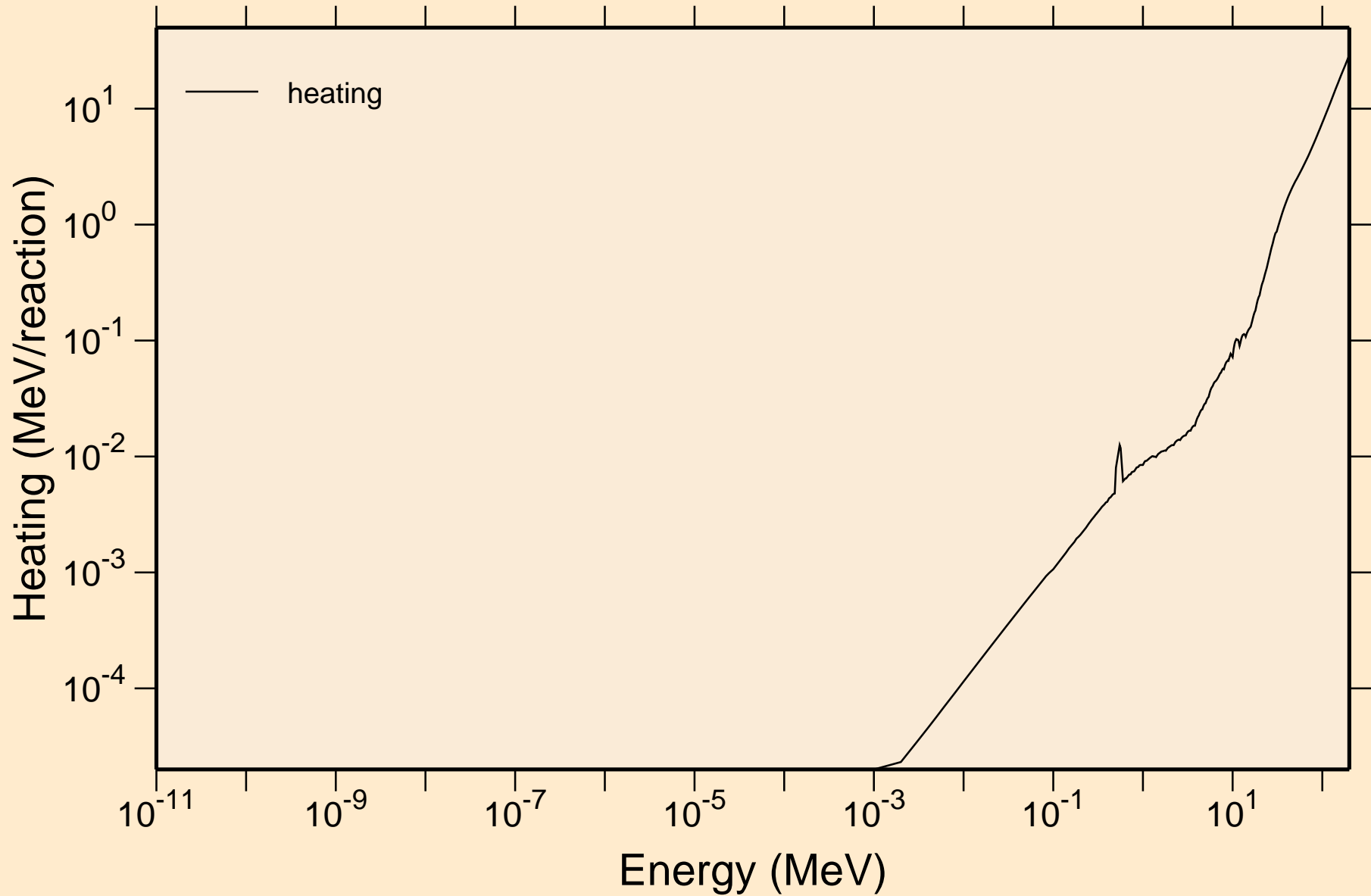

HO166 NEUTRON ACER TENDL-2024 LIBRARY; T=293.6K

Damage

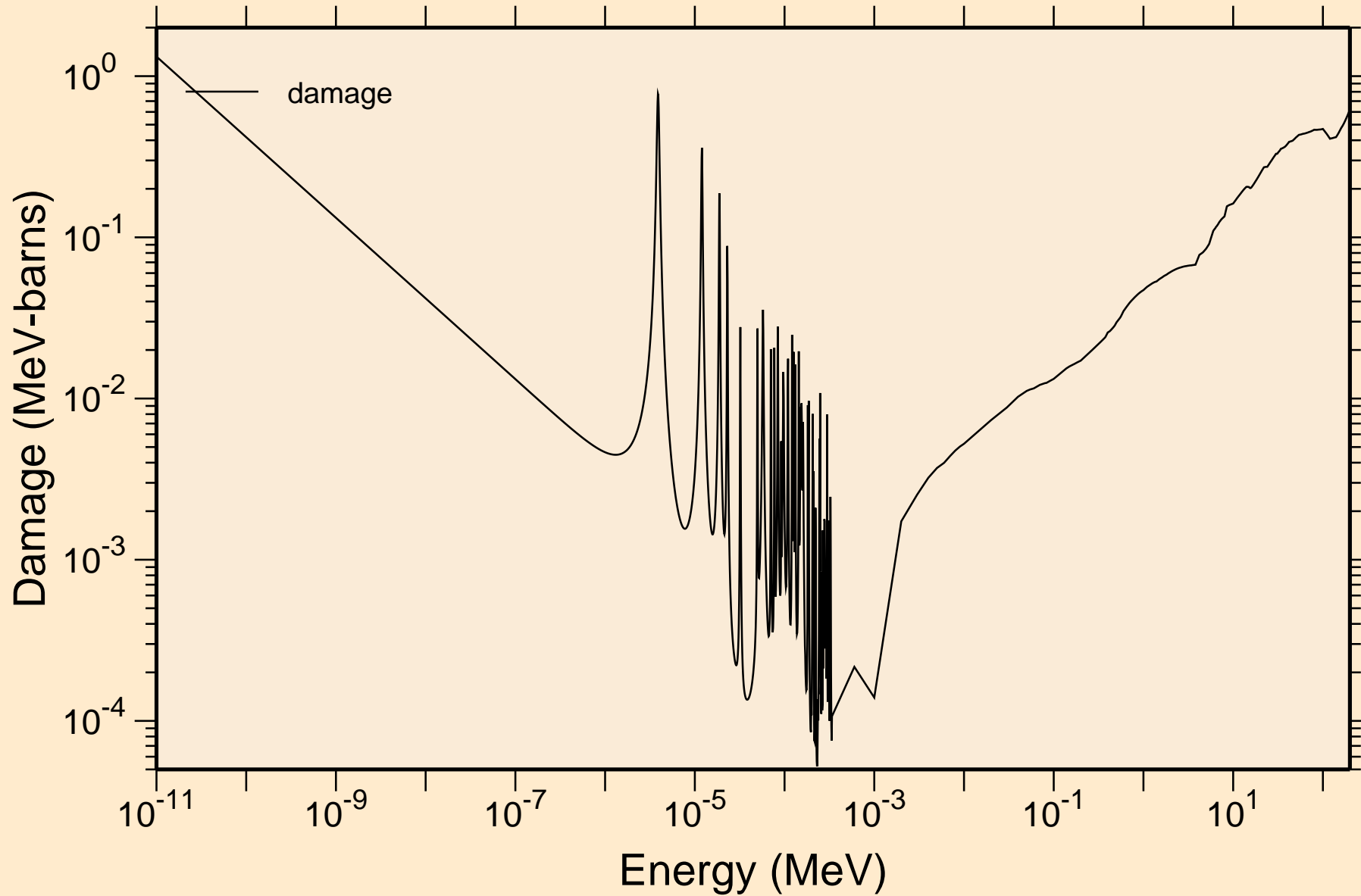

HO166 NEUTRON ACER TENDL-2024 LIBRARY; T=293.6K

Non-threshold reactions

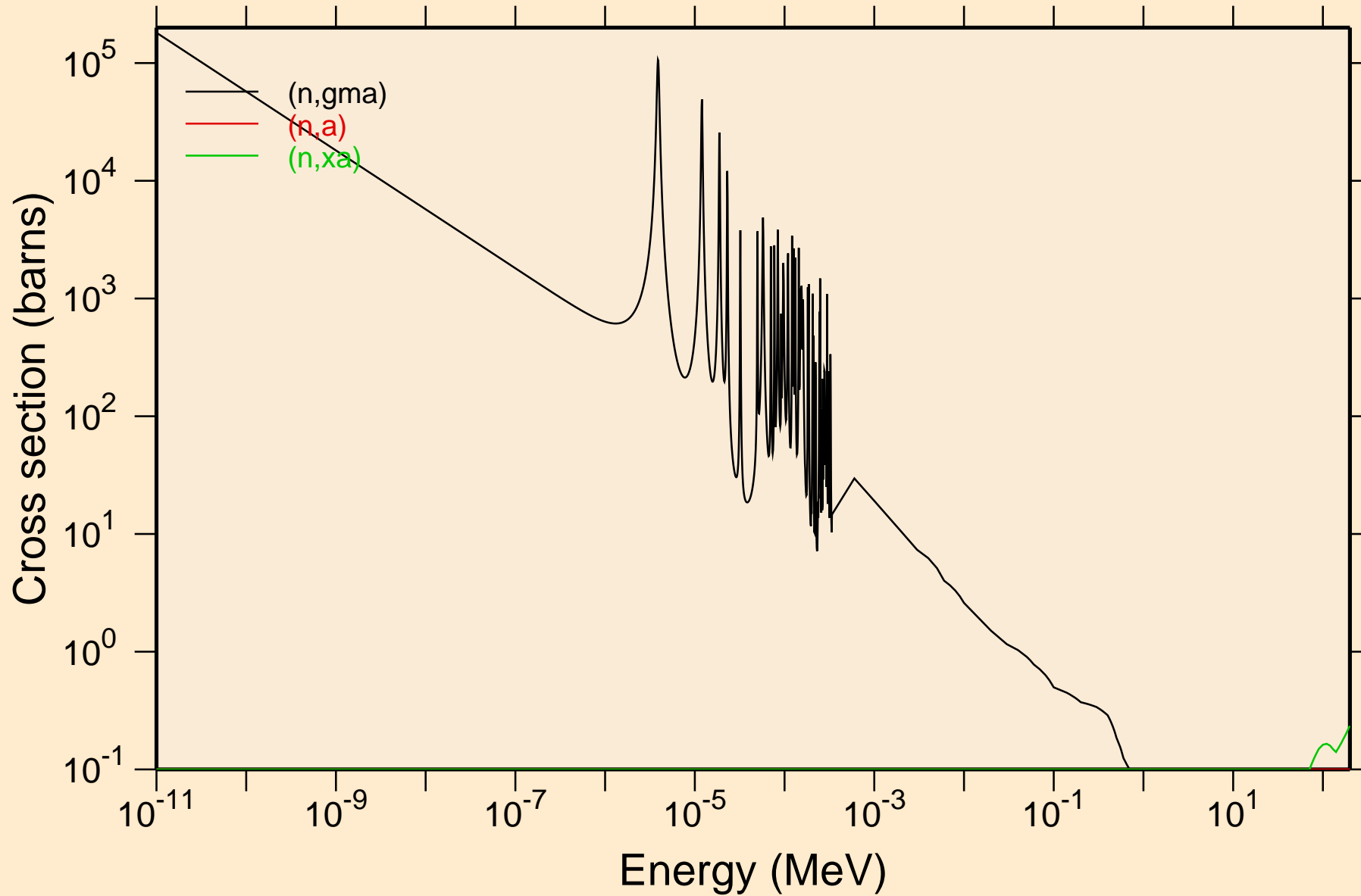

HO166 NEUTRON ACER TENDL-2024 LIBRARY; T=293.6K

Principal cross sections

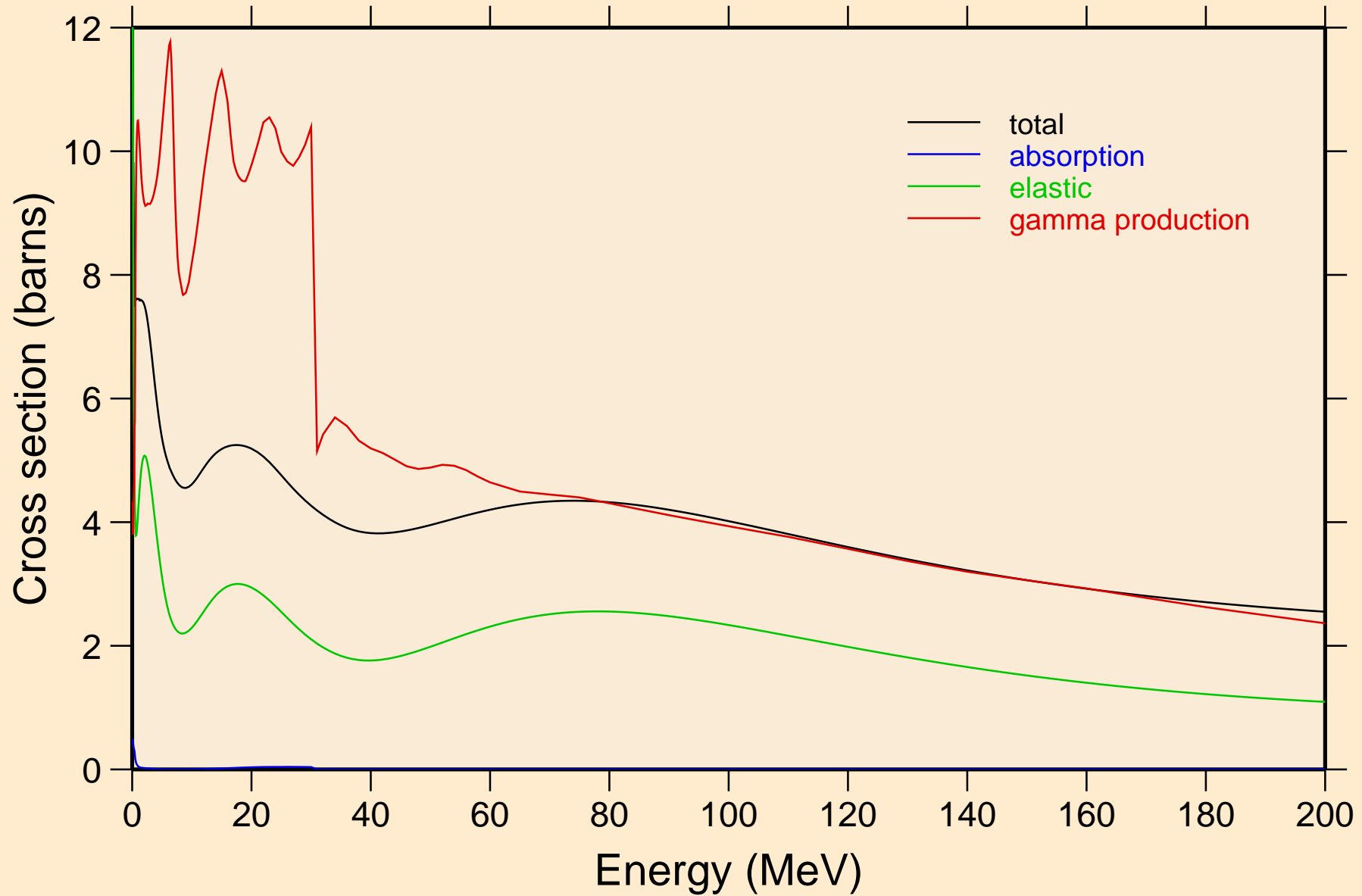

HO166 NEUTRON ACER TENDL-2024 LIBRARY; T=293.6K
Heating

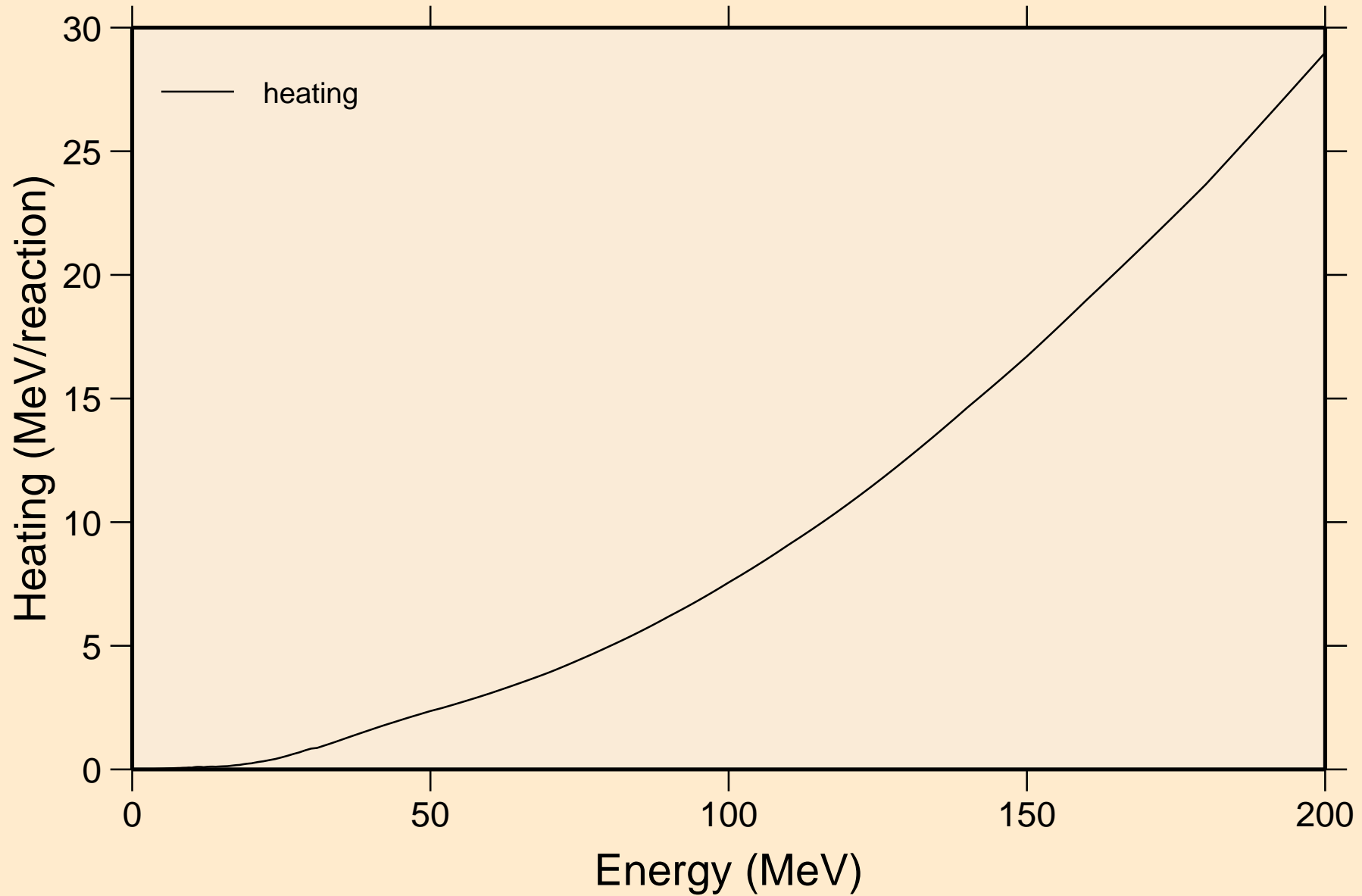

HO166 NEUTRON ACER TENDL-2024 LIBRARY; T=293.6K
Damage

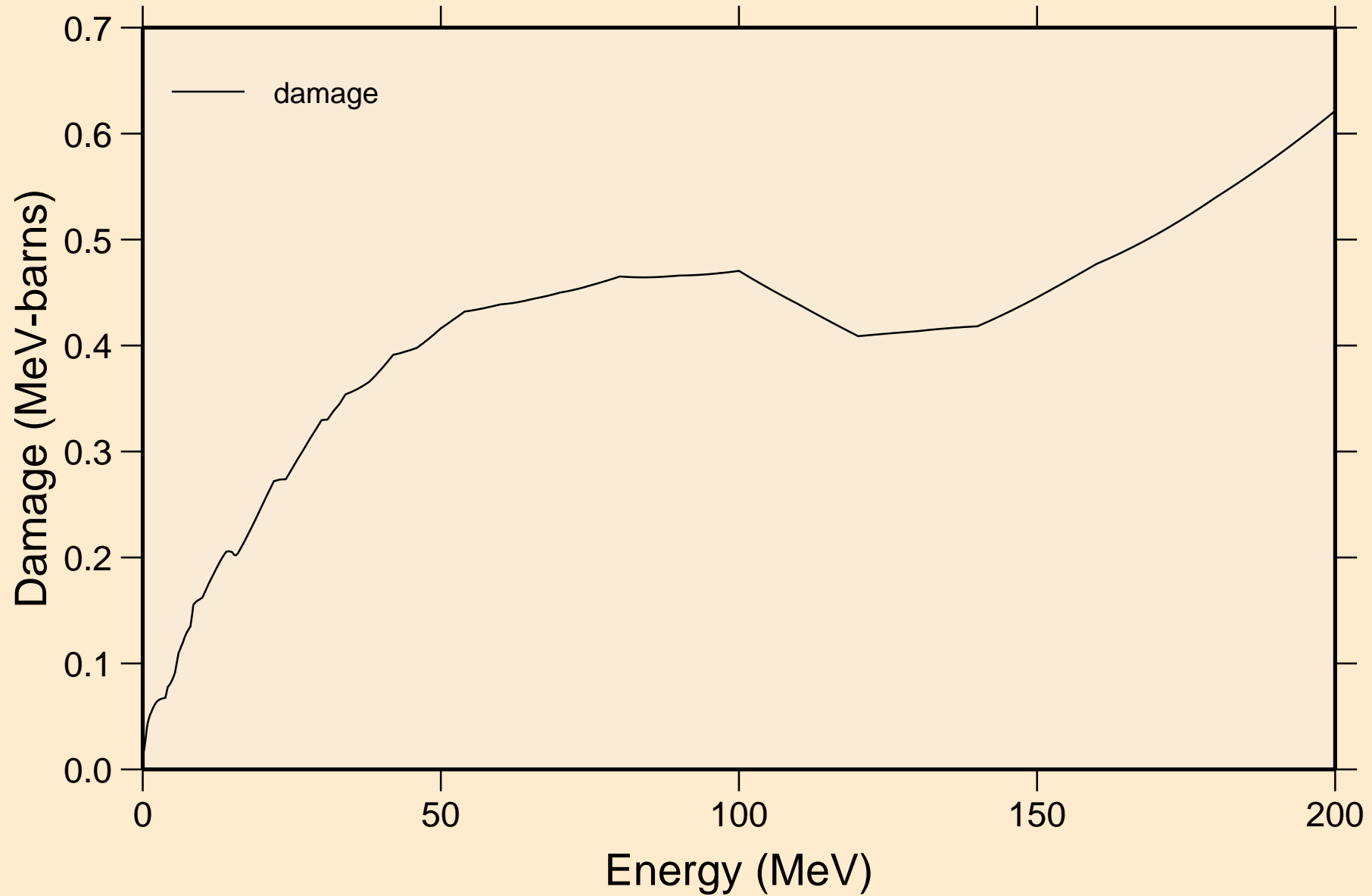

HO166 NEUTRON ACER TENDL-2024 LIBRARY; T=293.6K
Non-threshold reactions

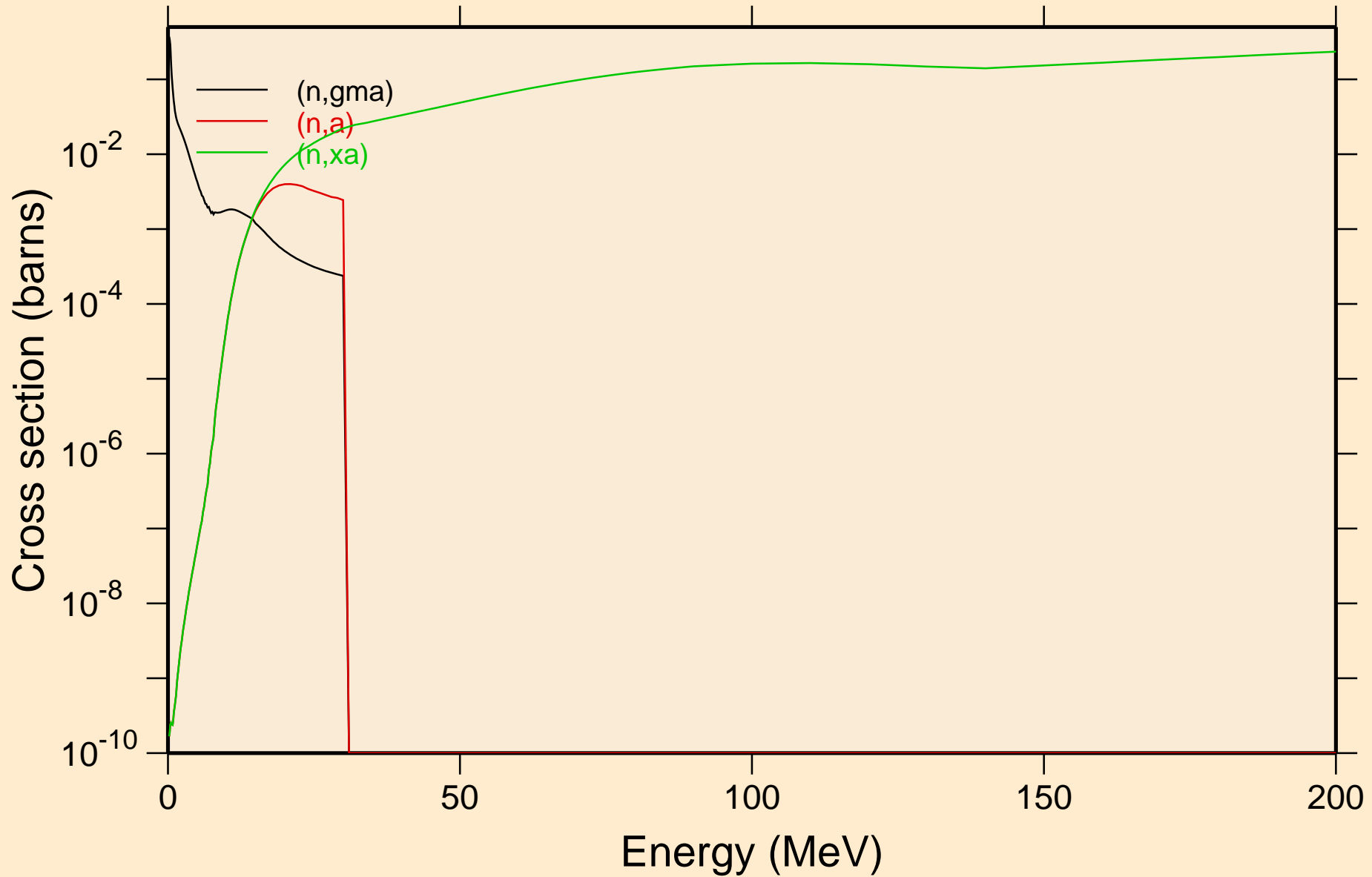

HO166 NEUTRON ACER TENDL-2024 LIBRARY; T=293.6K
Inelastic levels

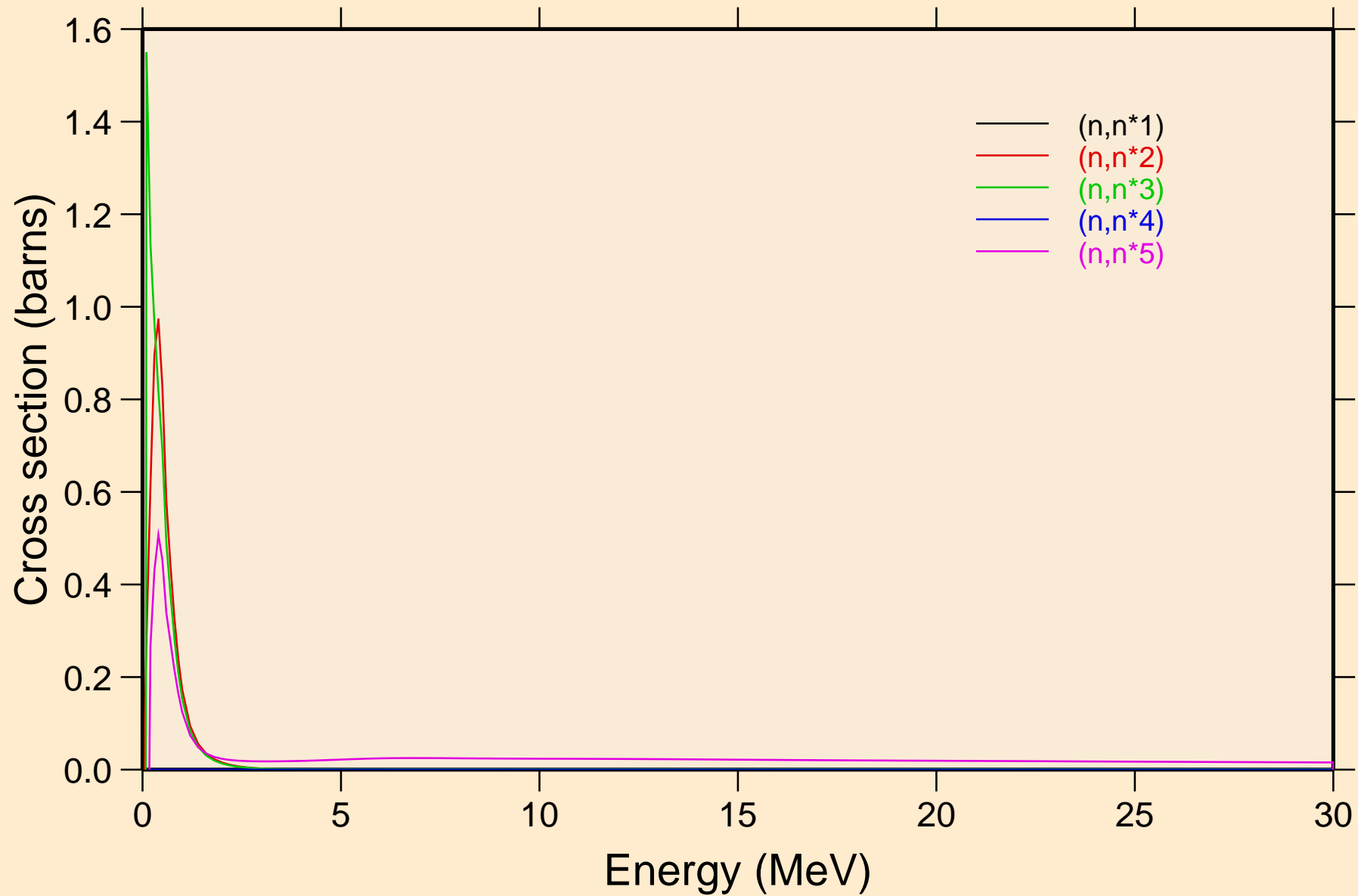

HO166 NEUTRON ACER TENDL-2024 LIBRARY; T=293.6K

Inelastic levels

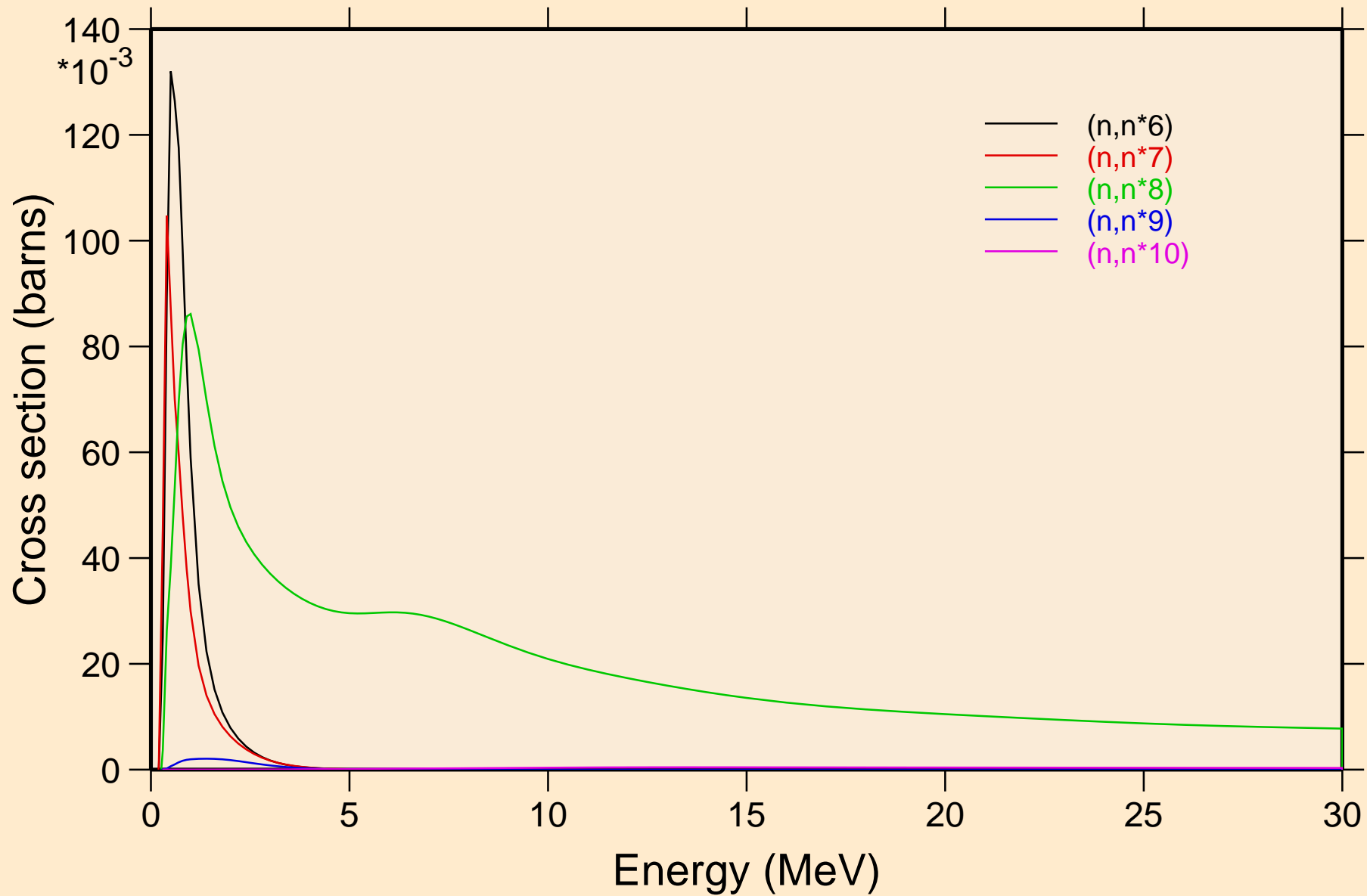

HO166 NEUTRON ACER TENDL-2024 LIBRARY; T=293.6K
Inelastic levels

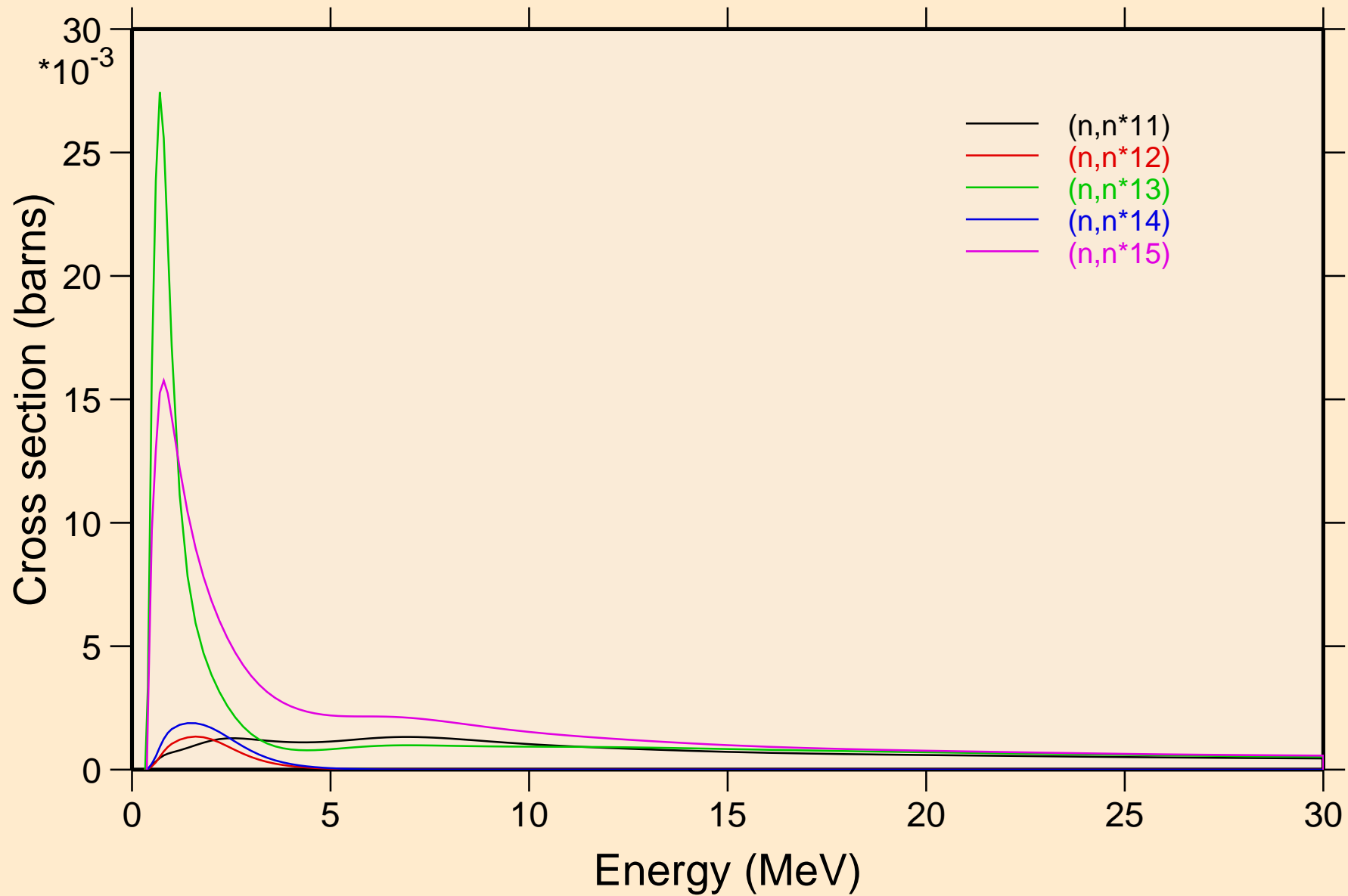

HO166 NEUTRON ACER TENDL-2024 LIBRARY; T=293.6K
Inelastic levels

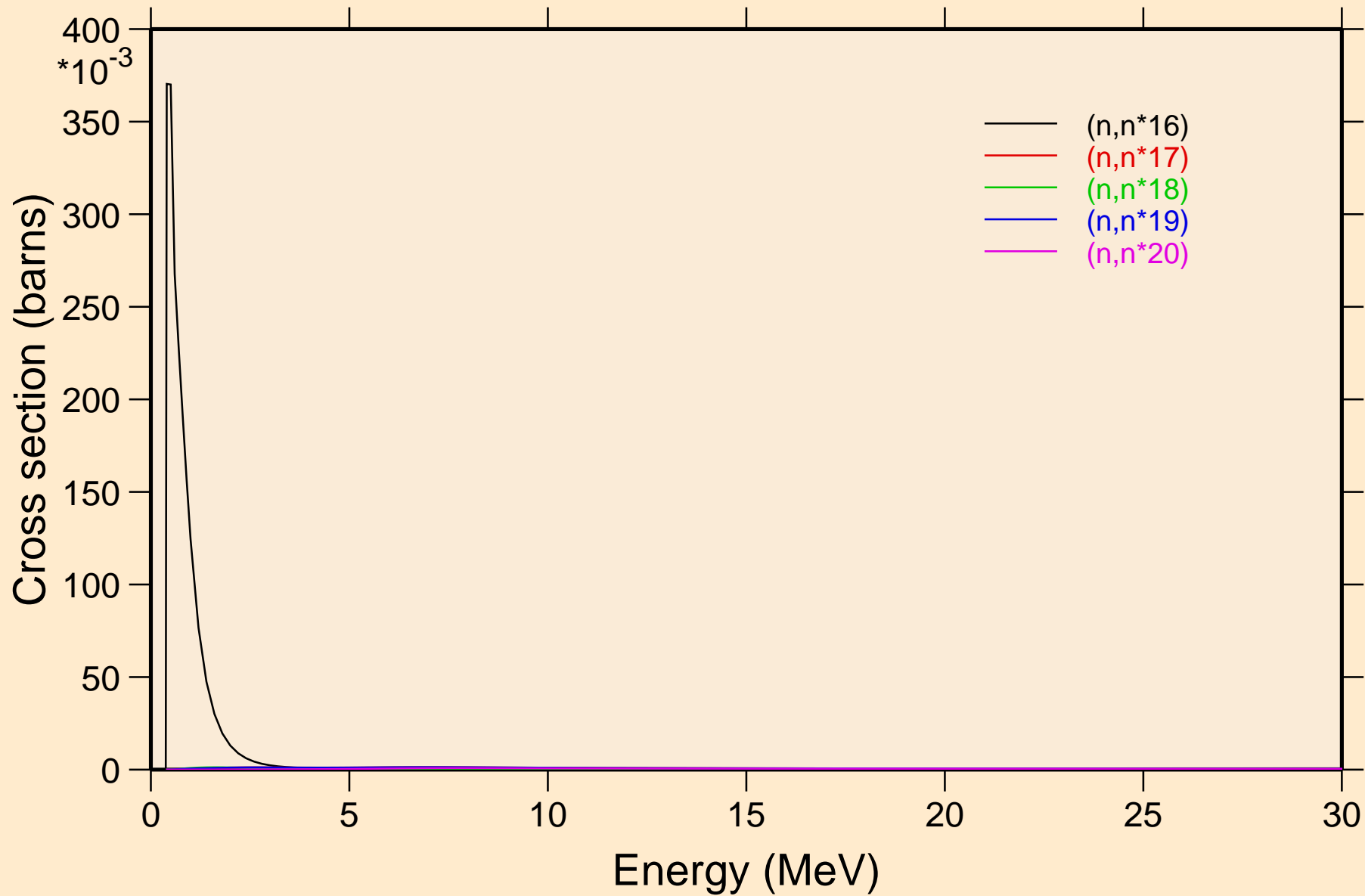

HO166 NEUTRON ACER TENDL-2024 LIBRARY; T=293.6K
Inelastic levels

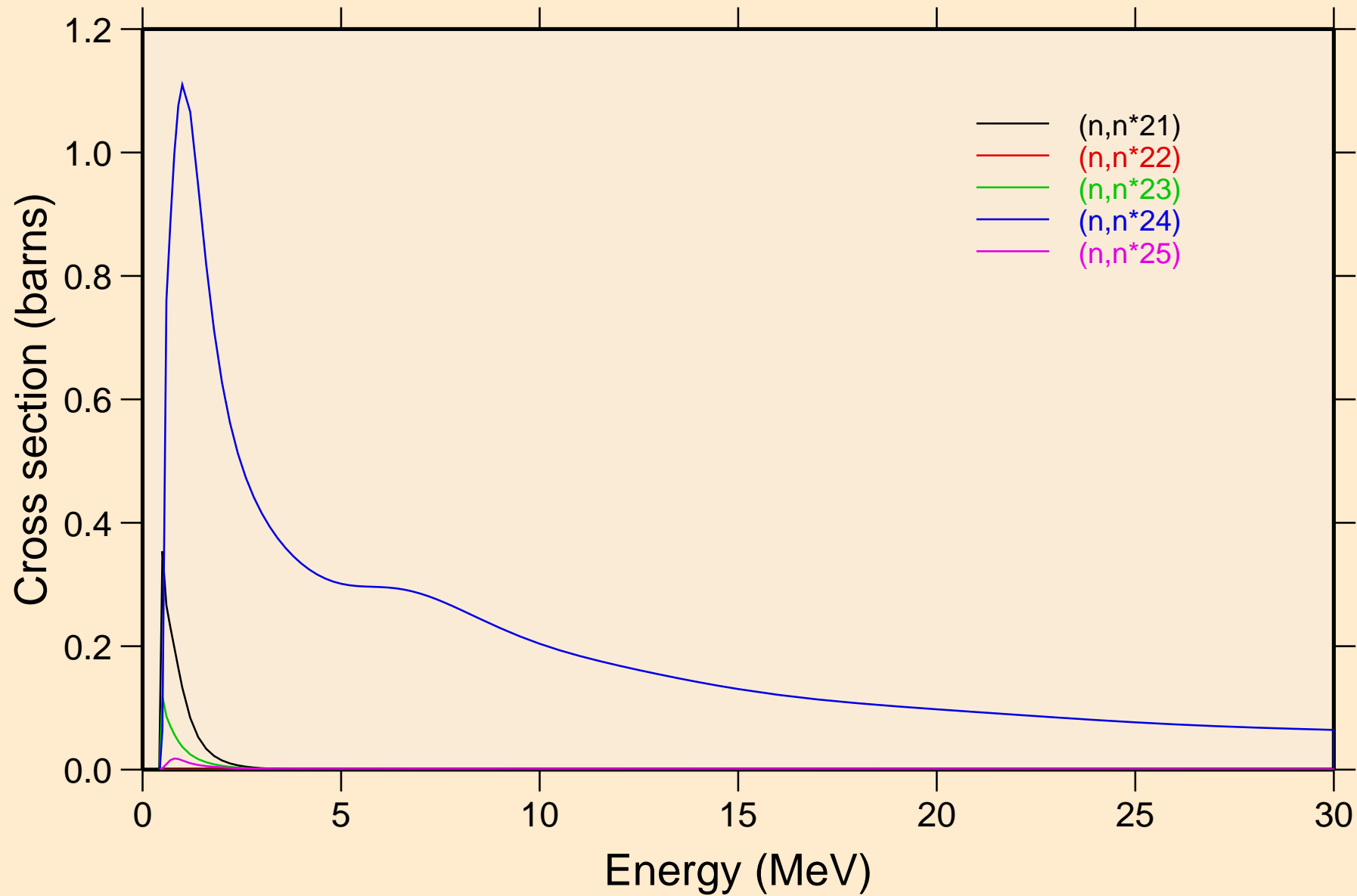

HO166 NEUTRON ACER TENDL-2024 LIBRARY; T=293.6K
Inelastic levels

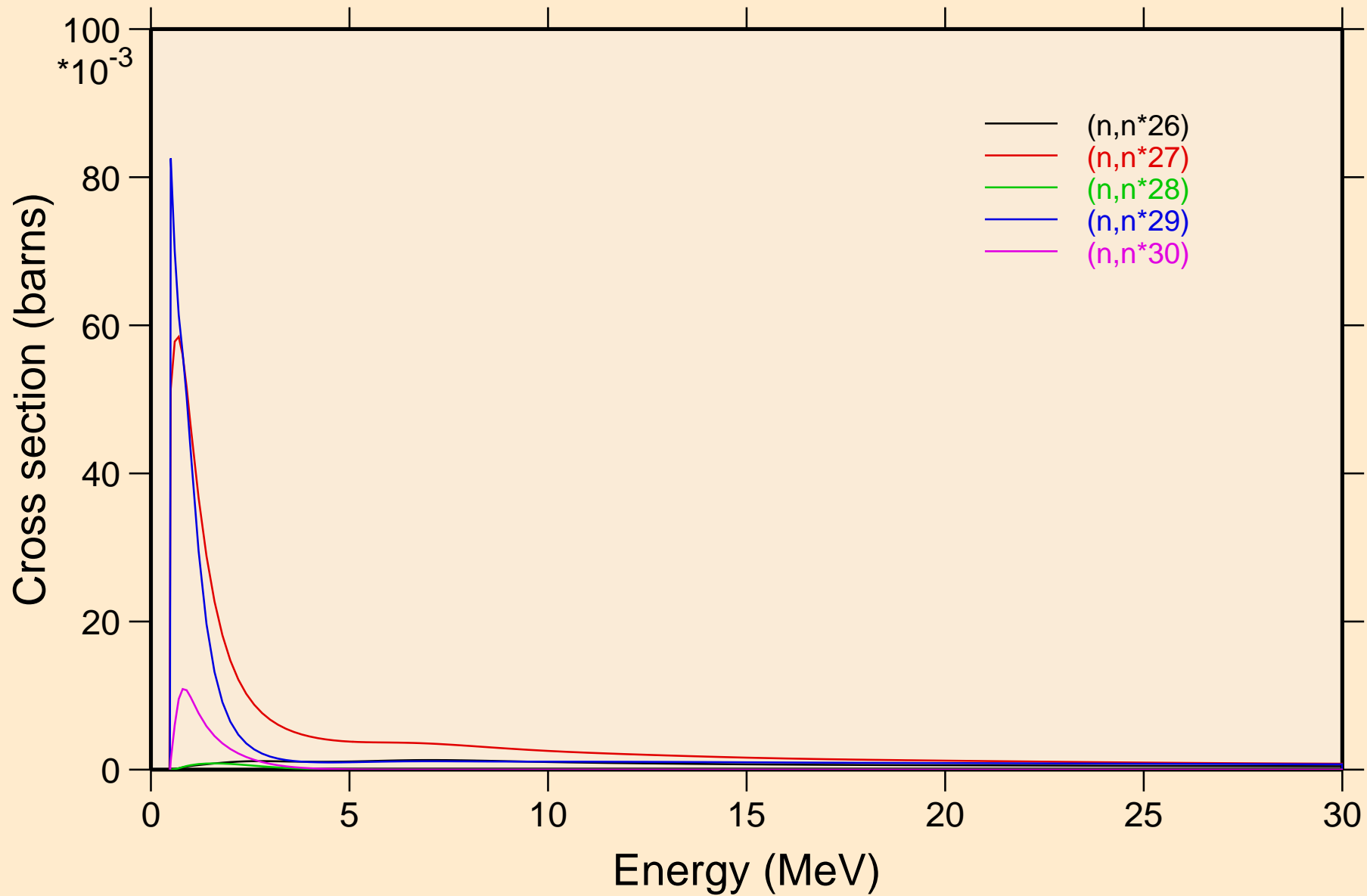

HO166 NEUTRON ACER TENDL-2024 LIBRARY; T=293.6K

Threshold reactions

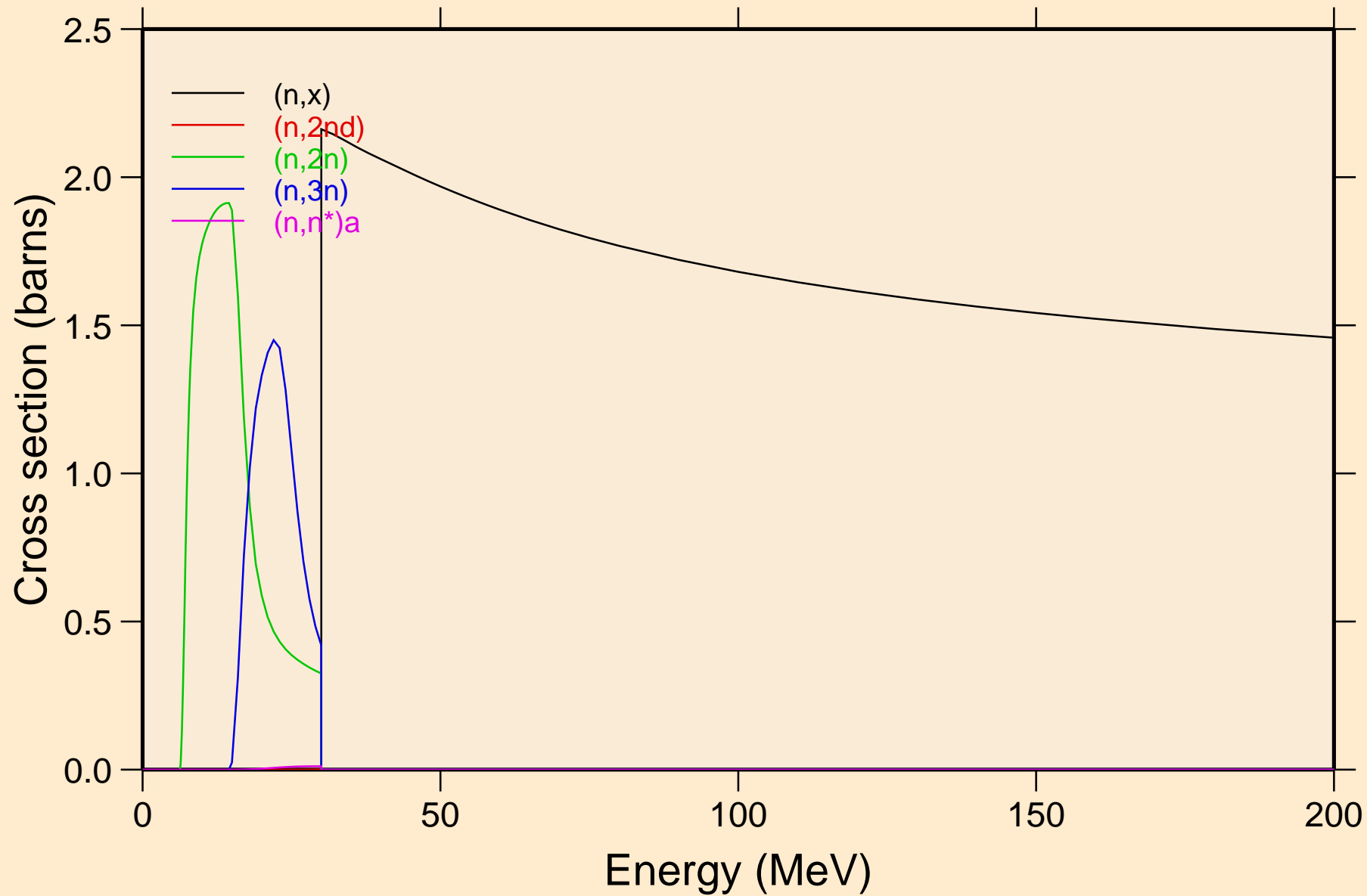

HO166 NEUTRON ACER TENDL-2024 LIBRARY; T=293.6K

Threshold reactions

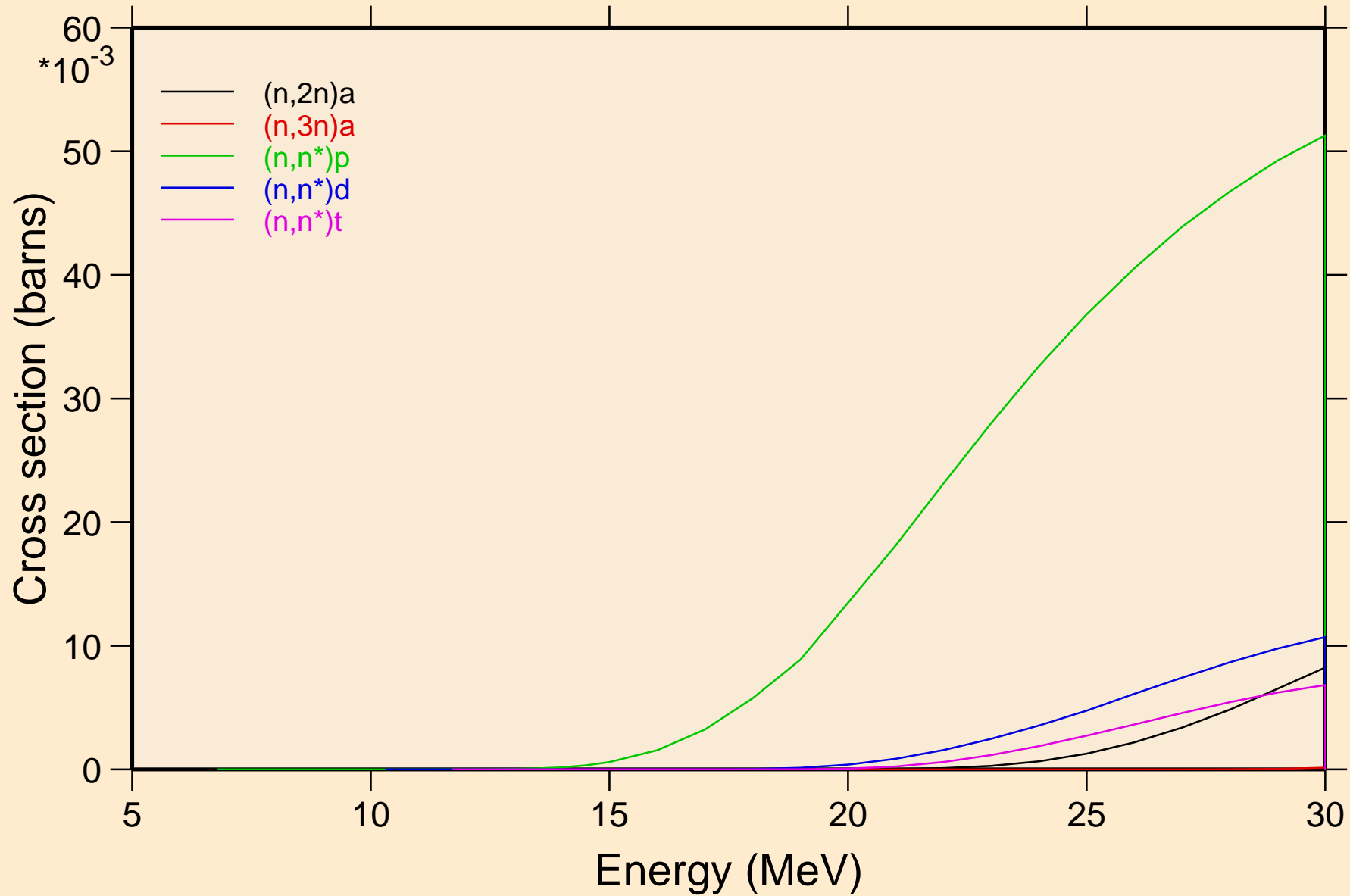

HO166 NEUTRON ACER TENDL-2024 LIBRARY; T=293.6K
Threshold reactions

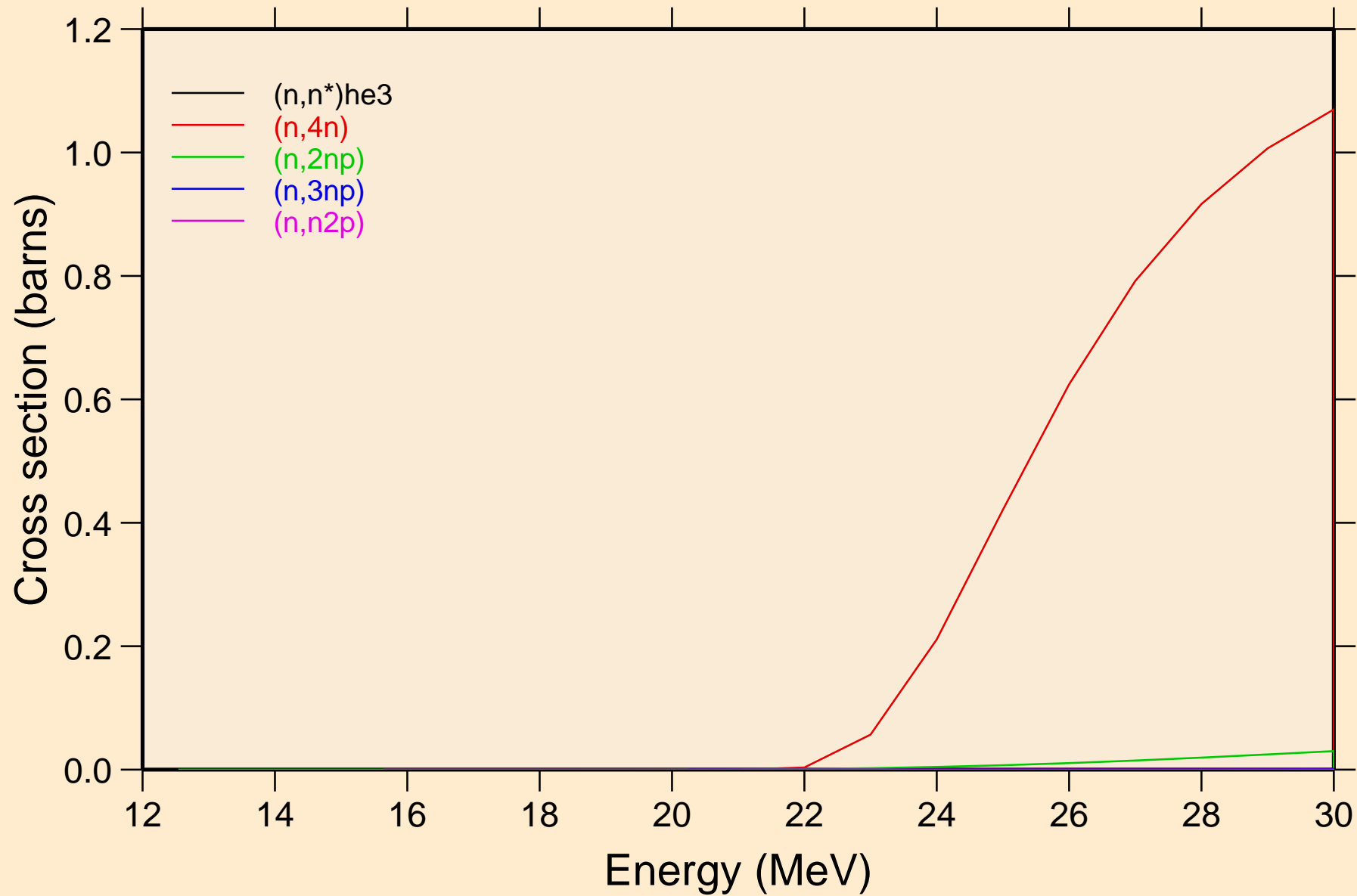

HO166 NEUTRON ACER TENDL-2024 LIBRARY; T=293.6K

Threshold reactions

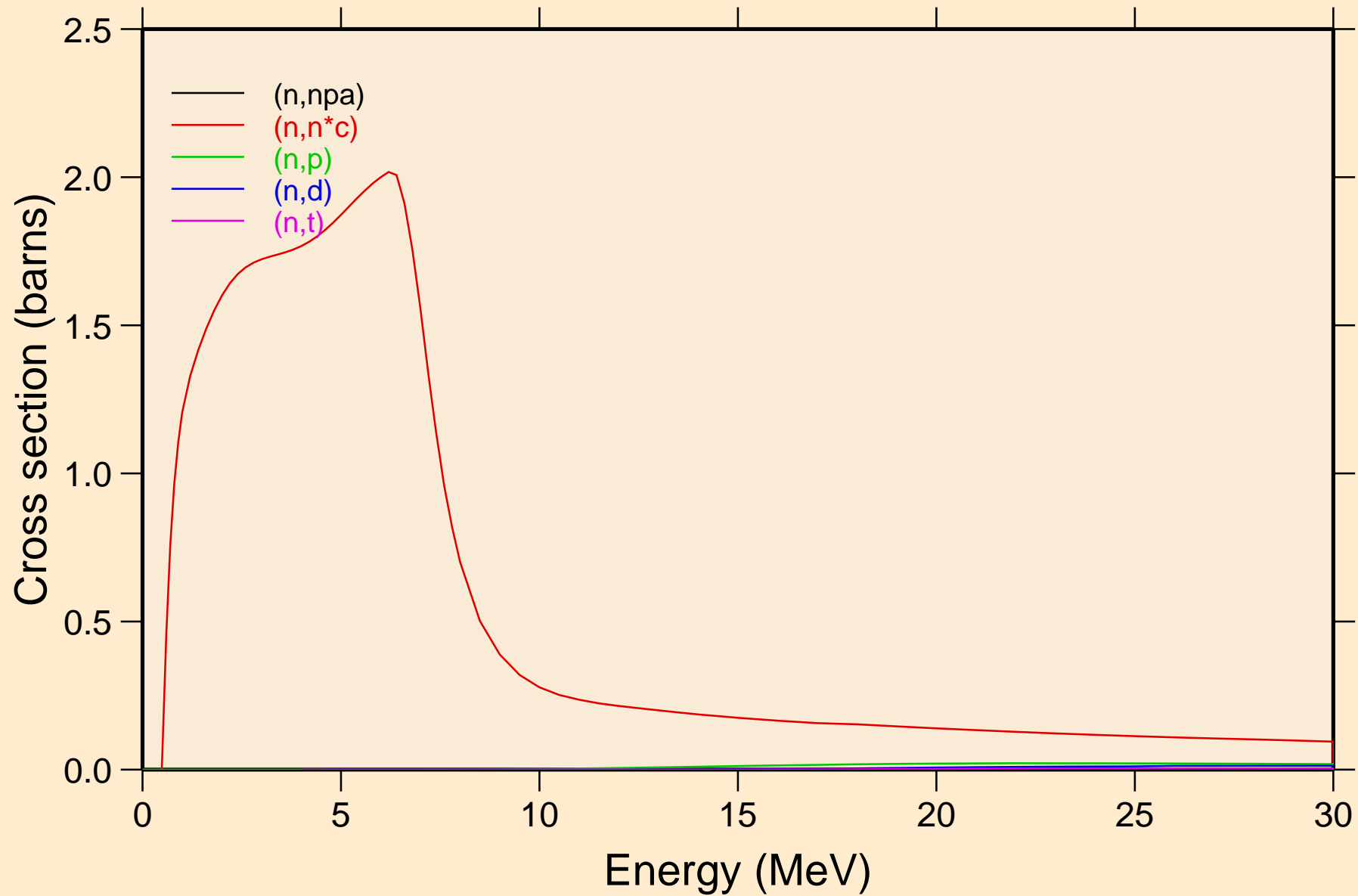

HO166 NEUTRON ACER TENDL-2024 LIBRARY; T=293.6K

Threshold reactions

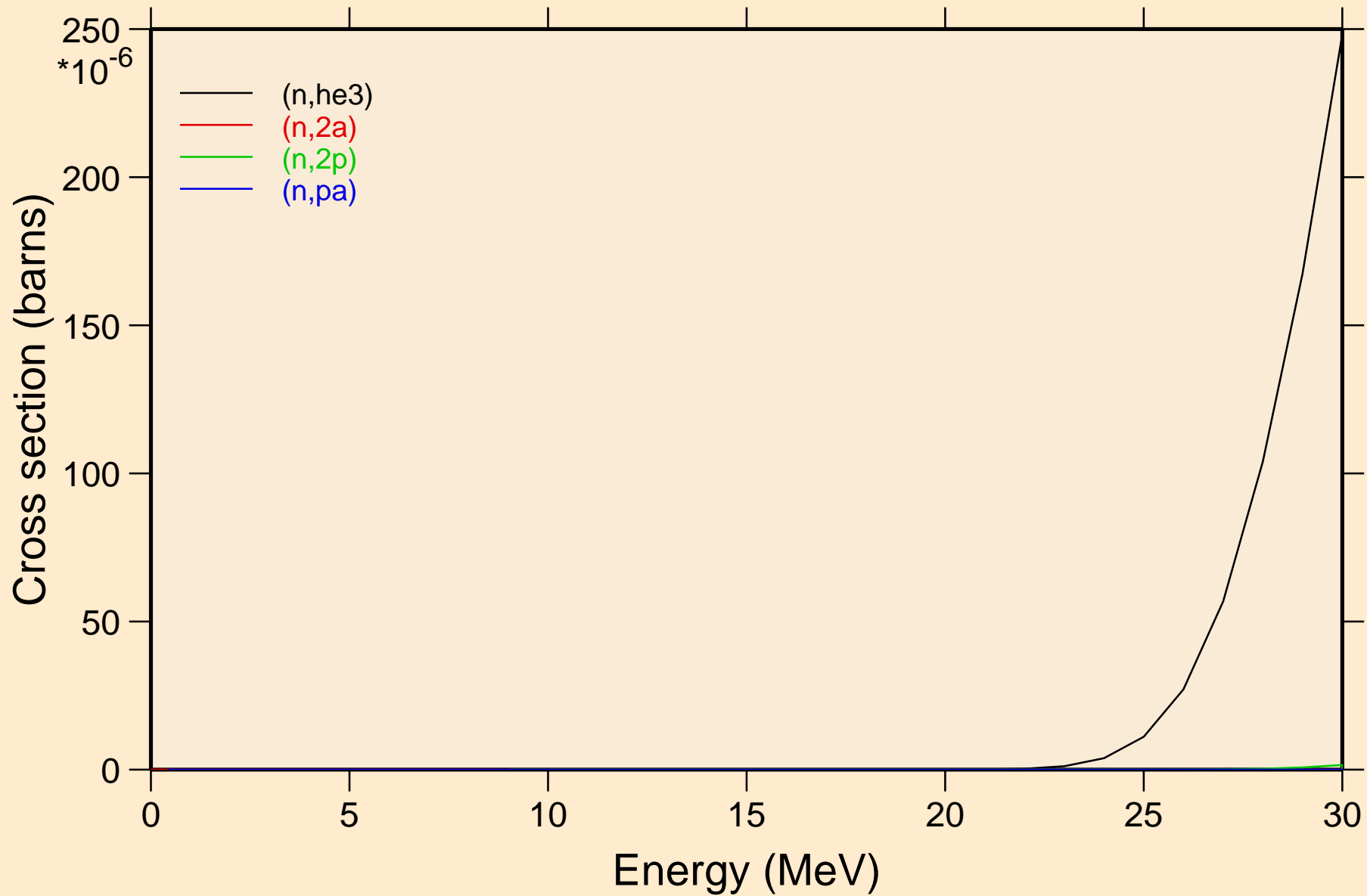

HO166 NEUTRON ACER TENDL-2024 LIBRARY; T=293.6K

Threshold reactions

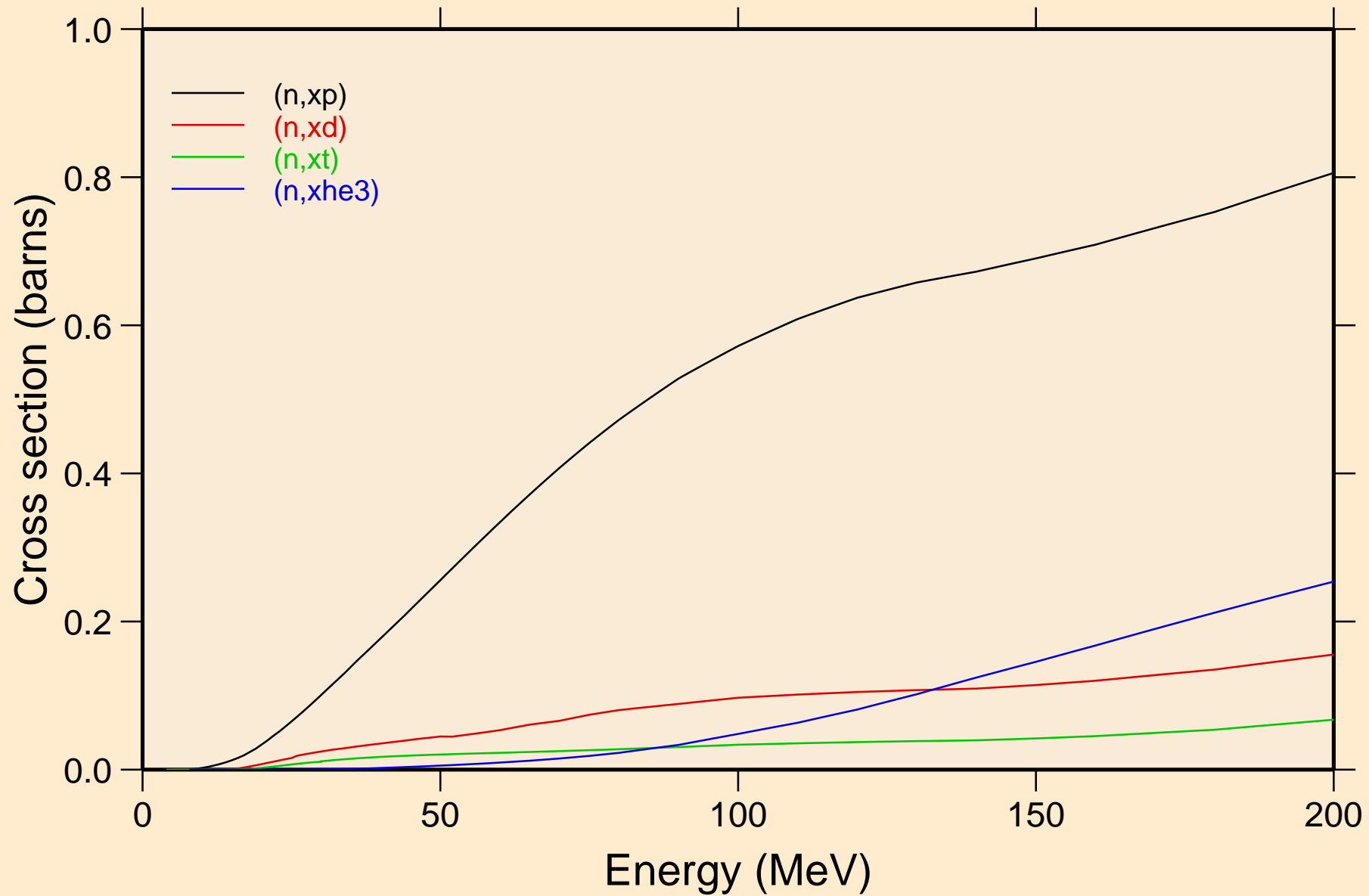

HO166 NEUTRON ACER TENDL-2024 LIBRARY; T=293.6K
angular distribution for elastic

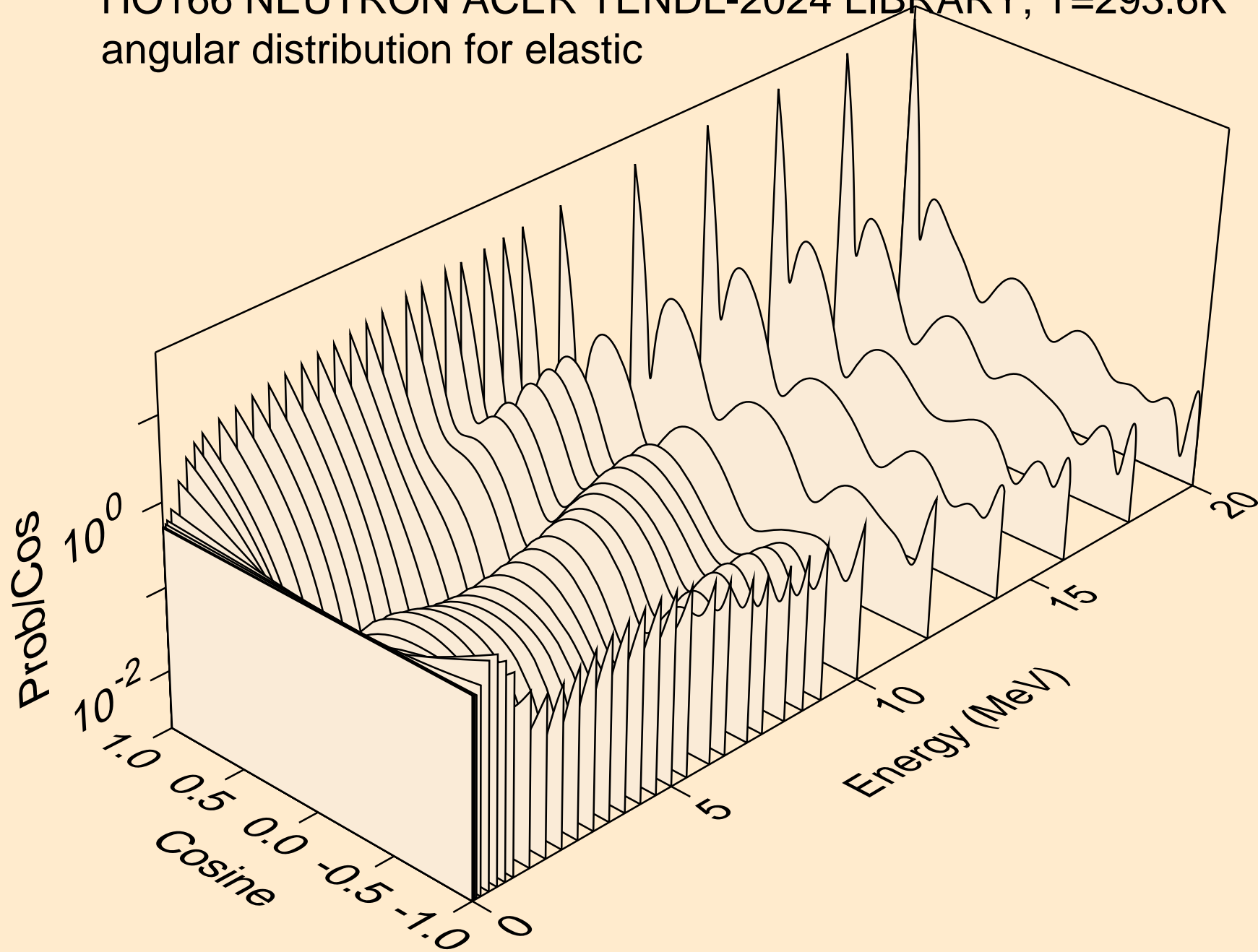

HO166 NEUTRON ACER TENDL-2024 LIBRARY; T=293.6K
angular distribution for elastic

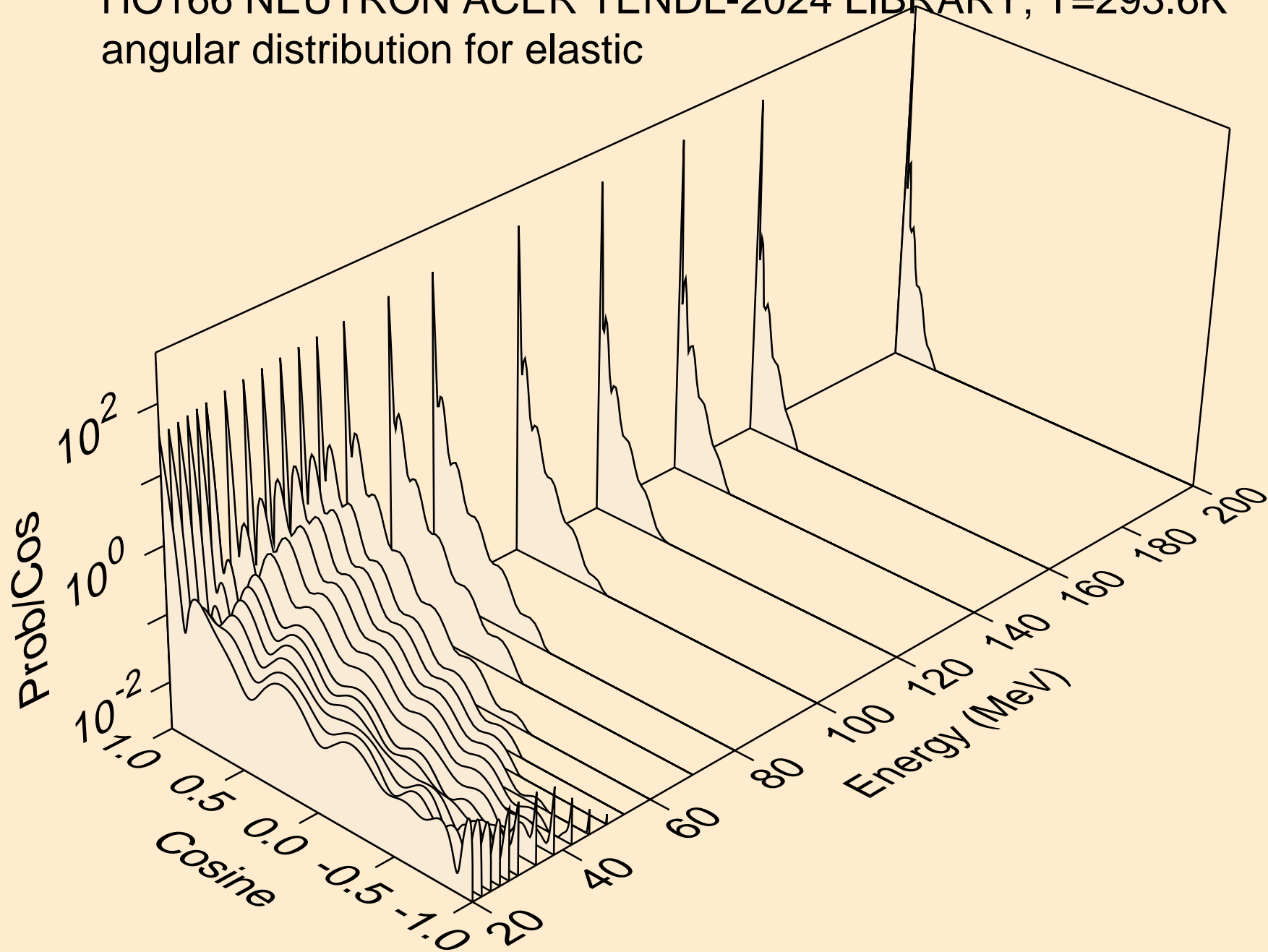

HO166 NEUTRON ACER TENDL-2024 LIBRARY; T=293.6K
angular distribution for (n,n*1)

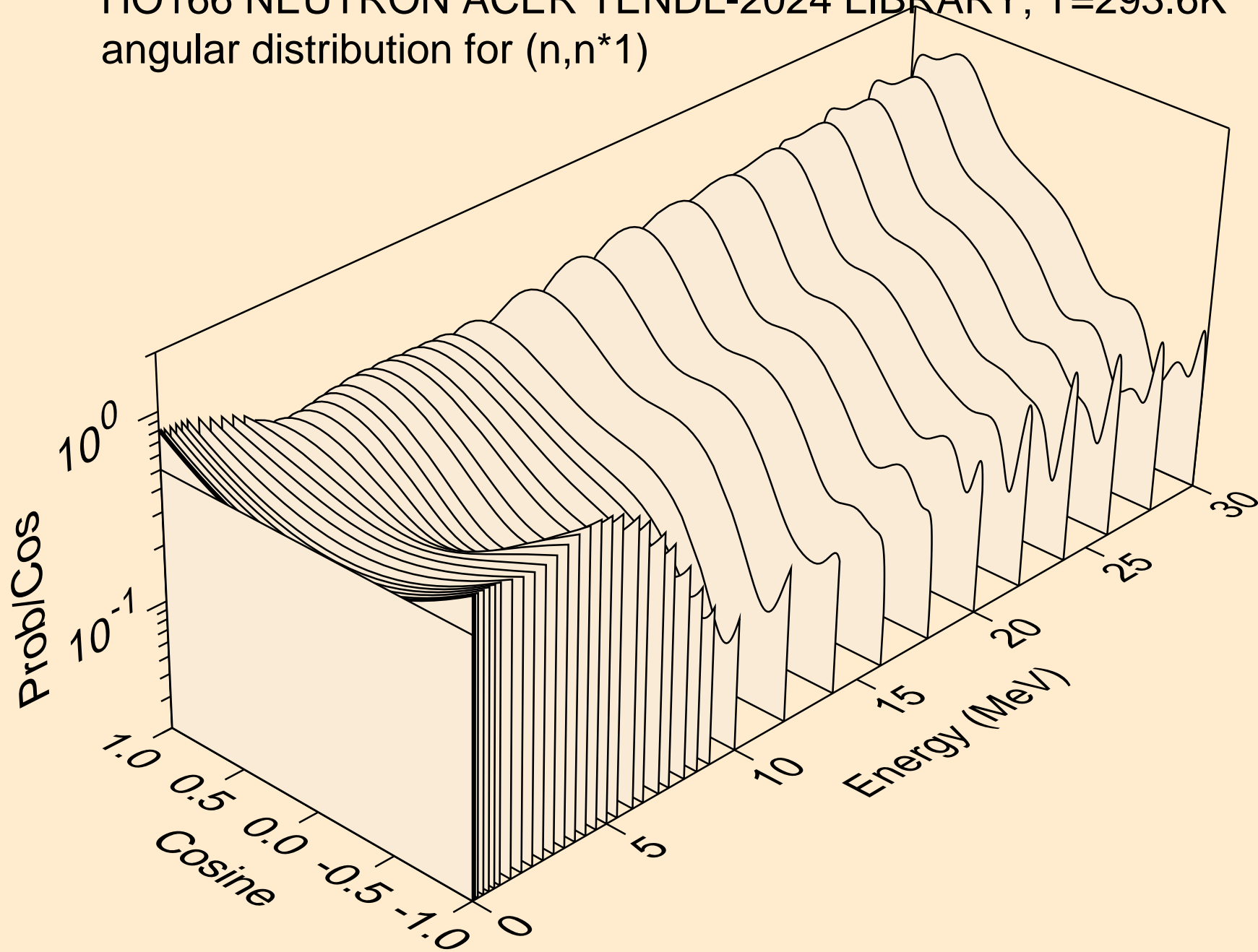

HO166 NEUTRON ACER TENDL-2024 LIBRARY; T=293.6K
angular distribution for (n,n*2)

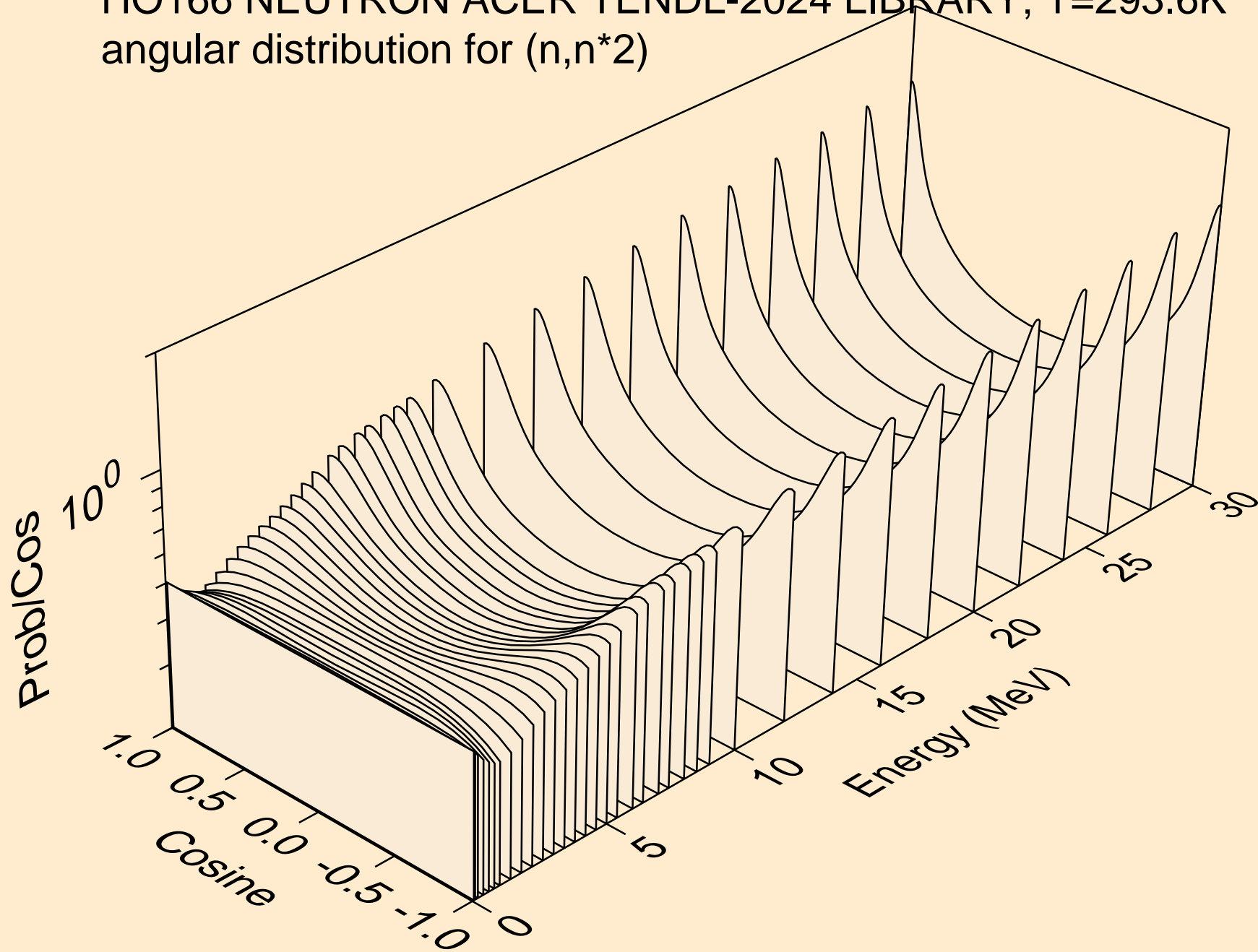

HO166 NEUTRON ACER TENDL-2024 LIBRARY; T=293.6K
angular distribution for (n,n*3)

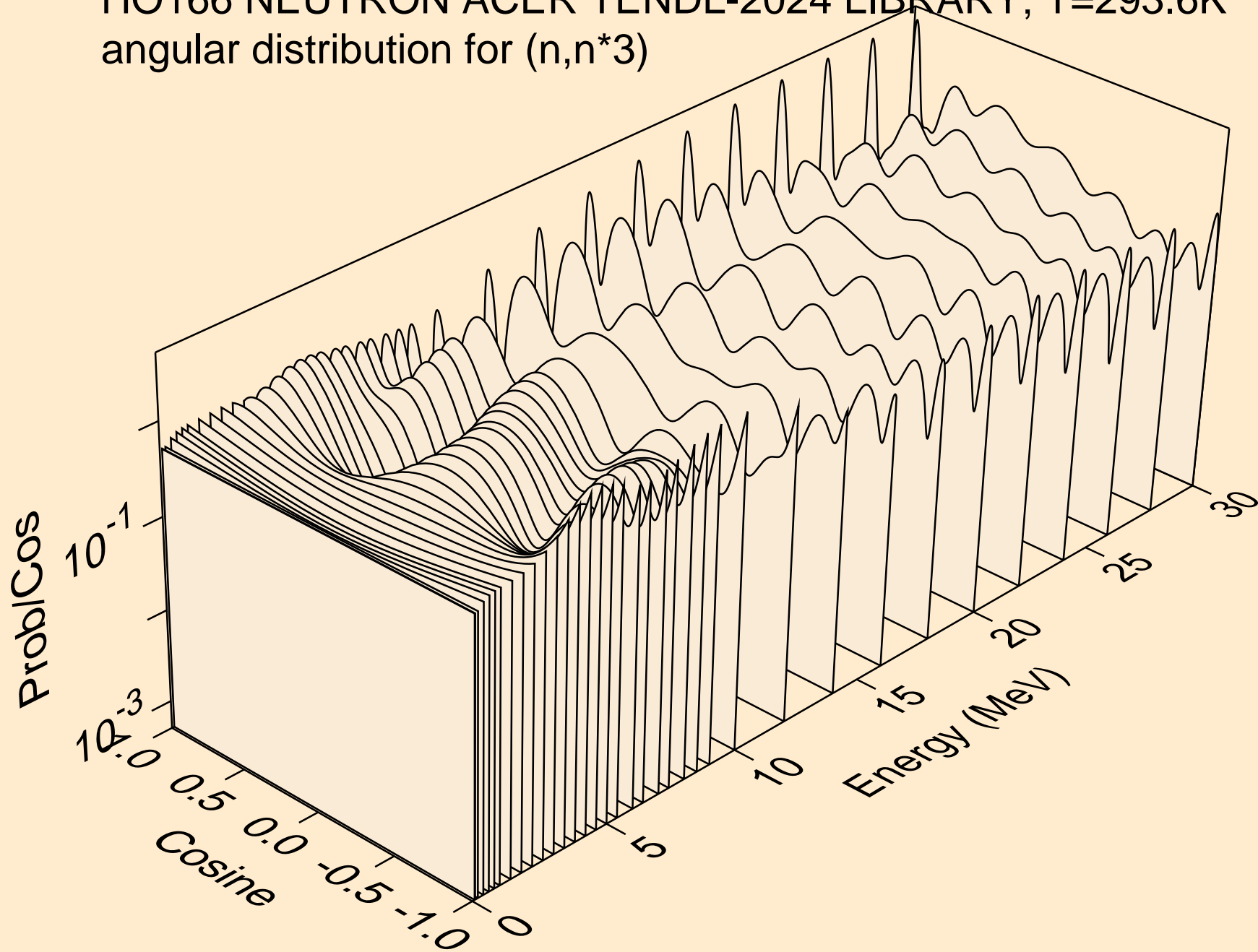

HO166 NEUTRON ACER TENDL-2024 LIBRARY; T=293.6K
angular distribution for (n,n*4)

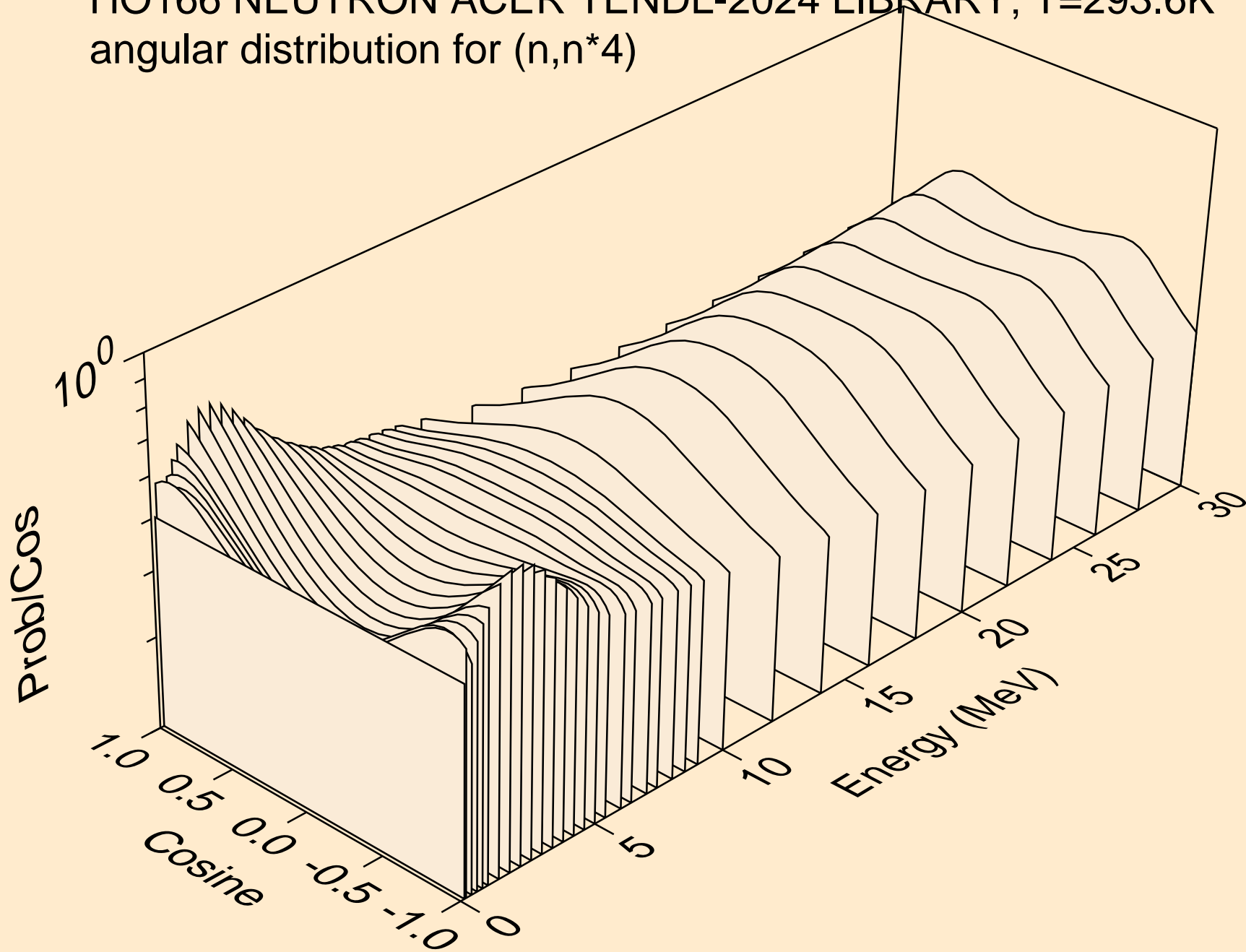

HO166 NEUTRON ACER TENDL-2024 LIBRARY; T=293.6K
angular distribution for (n,n*5)

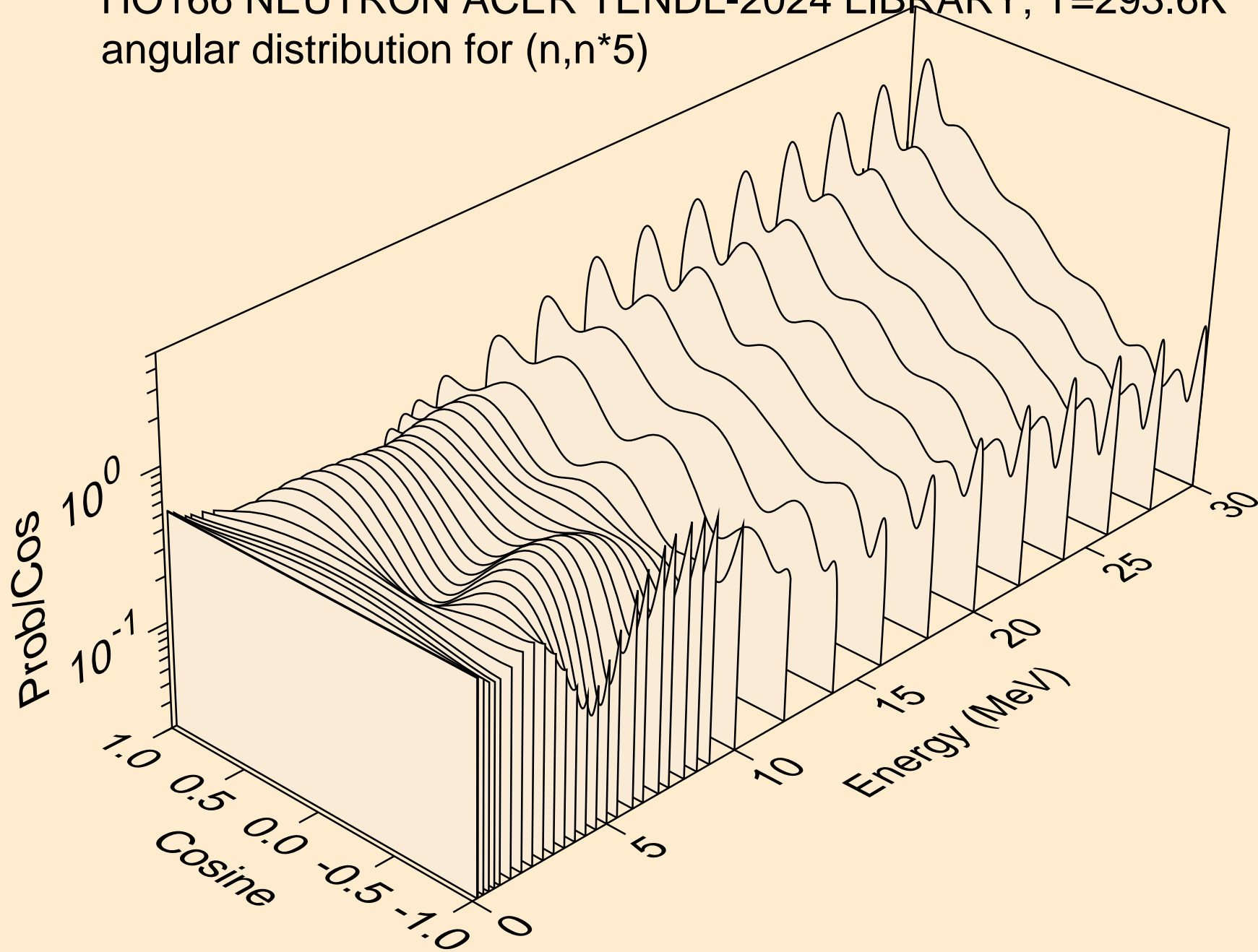

HO166 NEUTRON ACER TENDL-2024 LIBRARY; T=293.6K
angular distribution for (n,n*6)

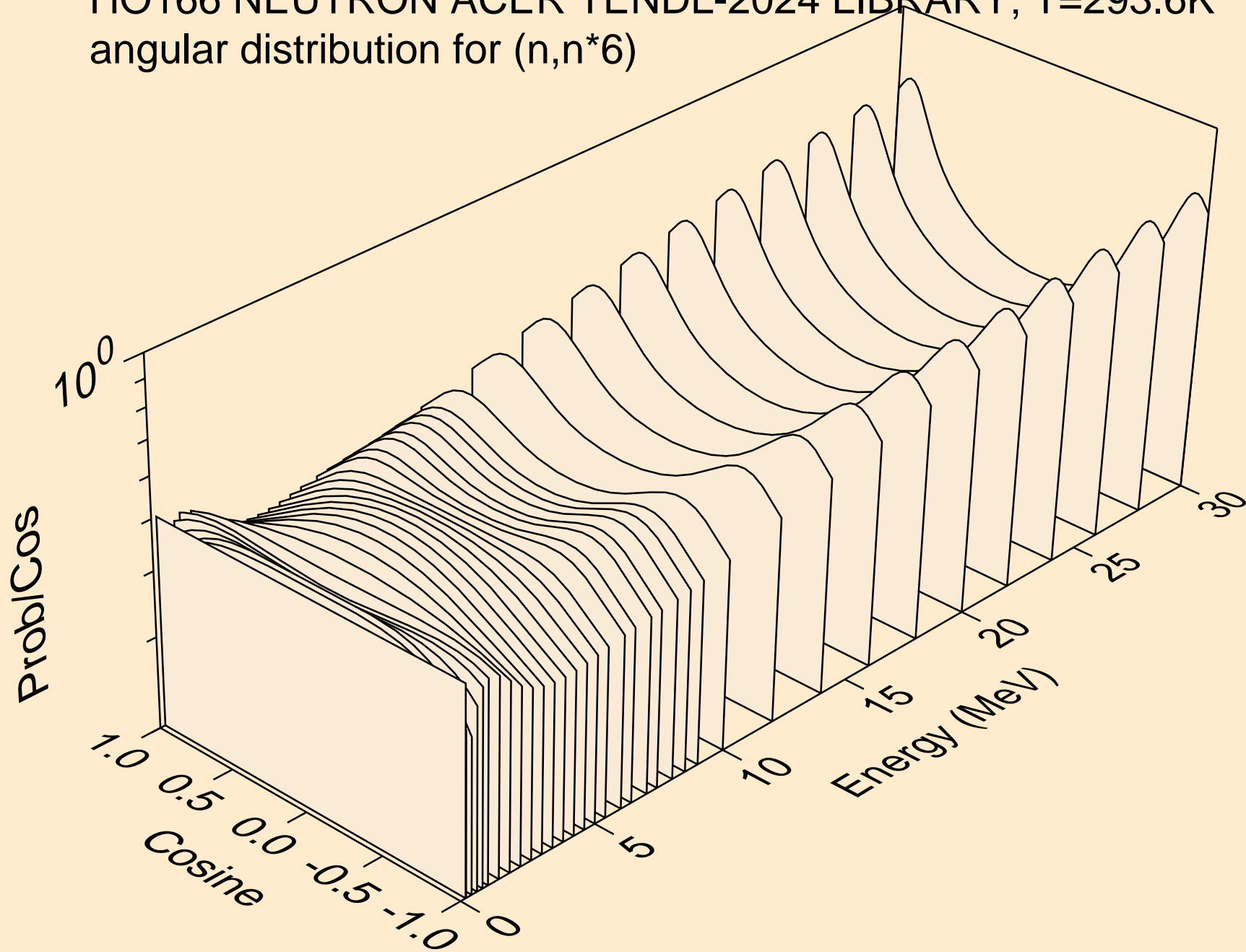

HO166 NEUTRON ACER TENDL-2024 LIBRARY; T=293.6K
angular distribution for (n,n*7)

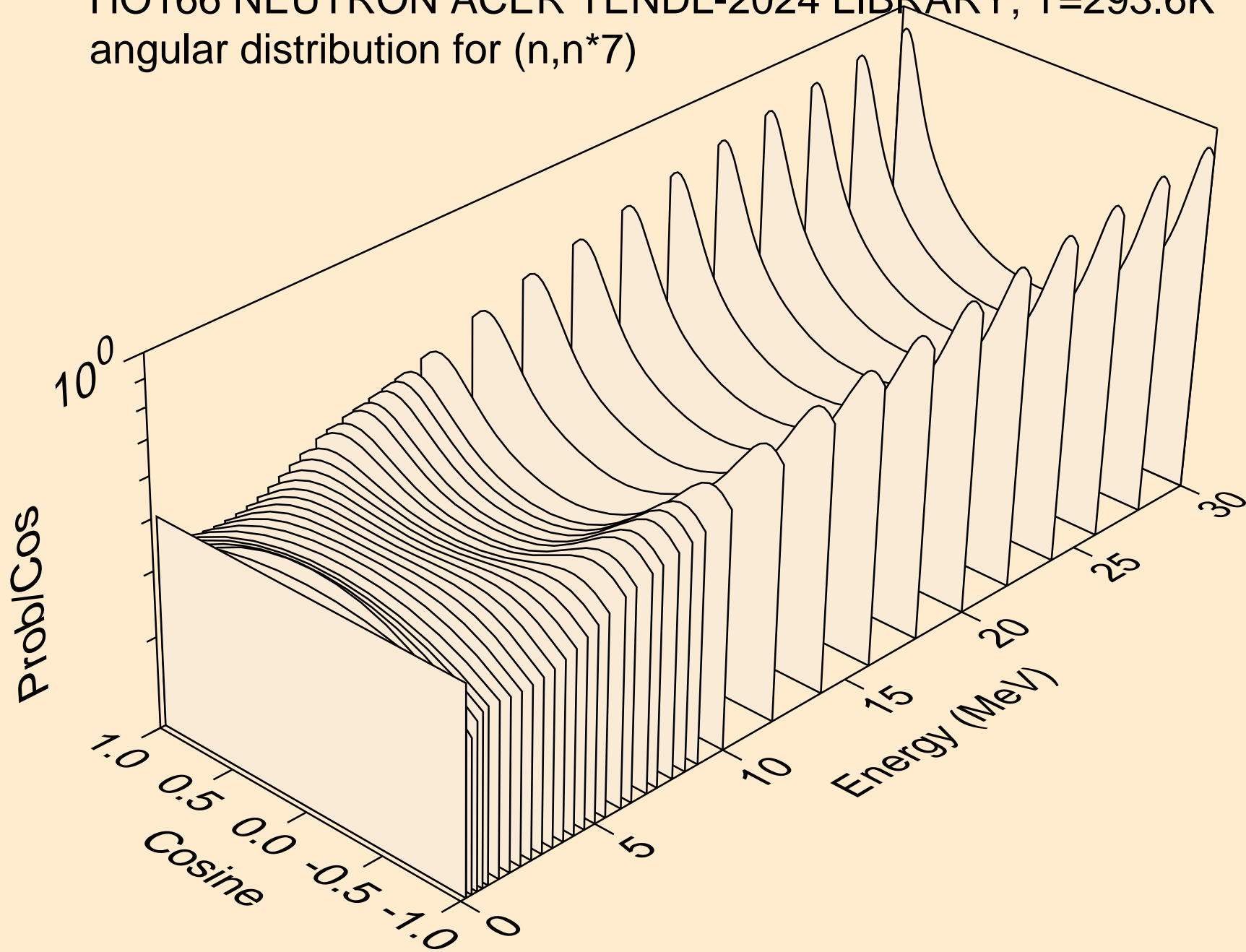

HO166 NEUTRON ACER TENDL-2024 LIBRARY; T=293.6K
angular distribution for (n,n*8)

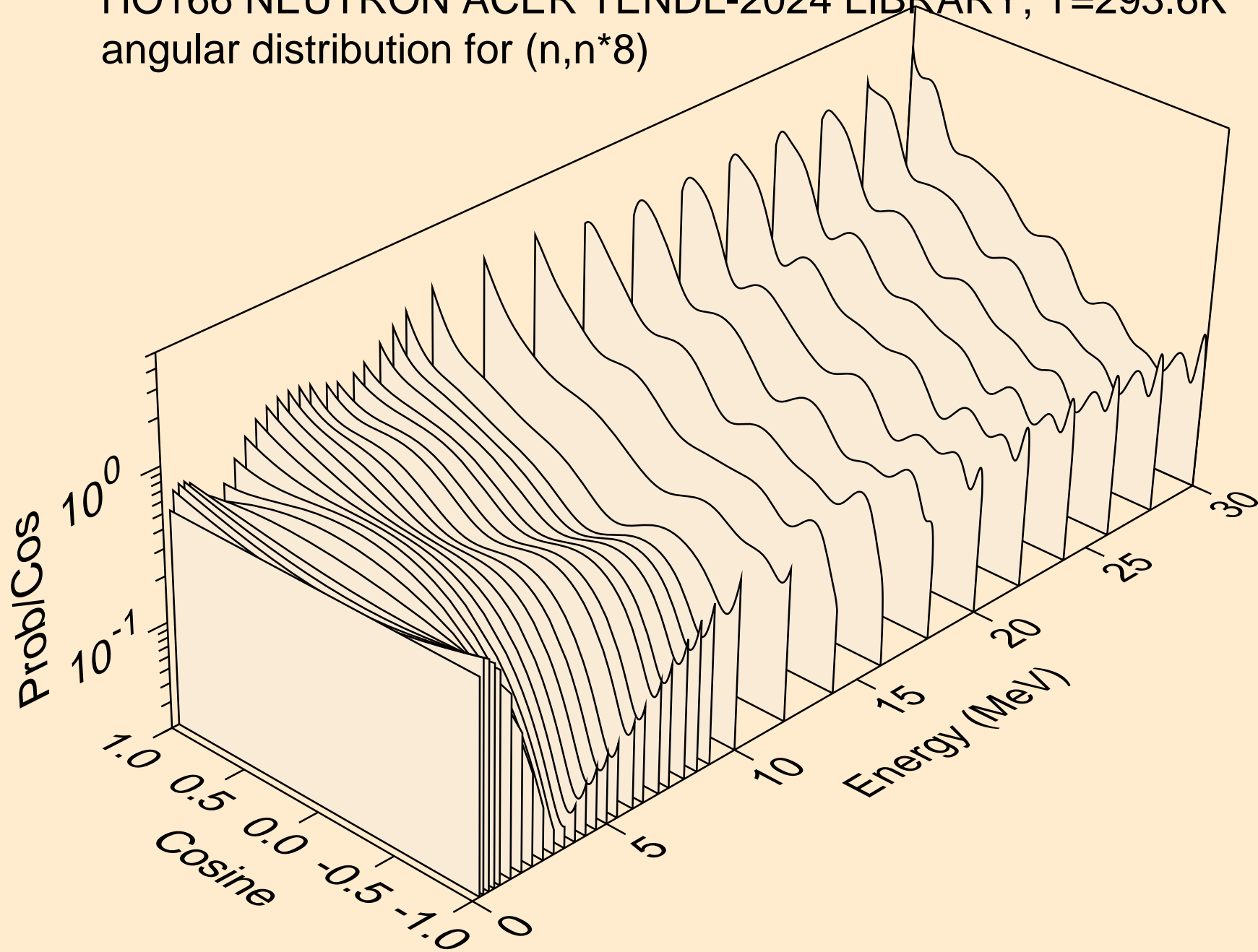

HO166 NEUTRON ACER TENDL-2024 LIBRARY; T=293.6K
angular distribution for (n,n*9)

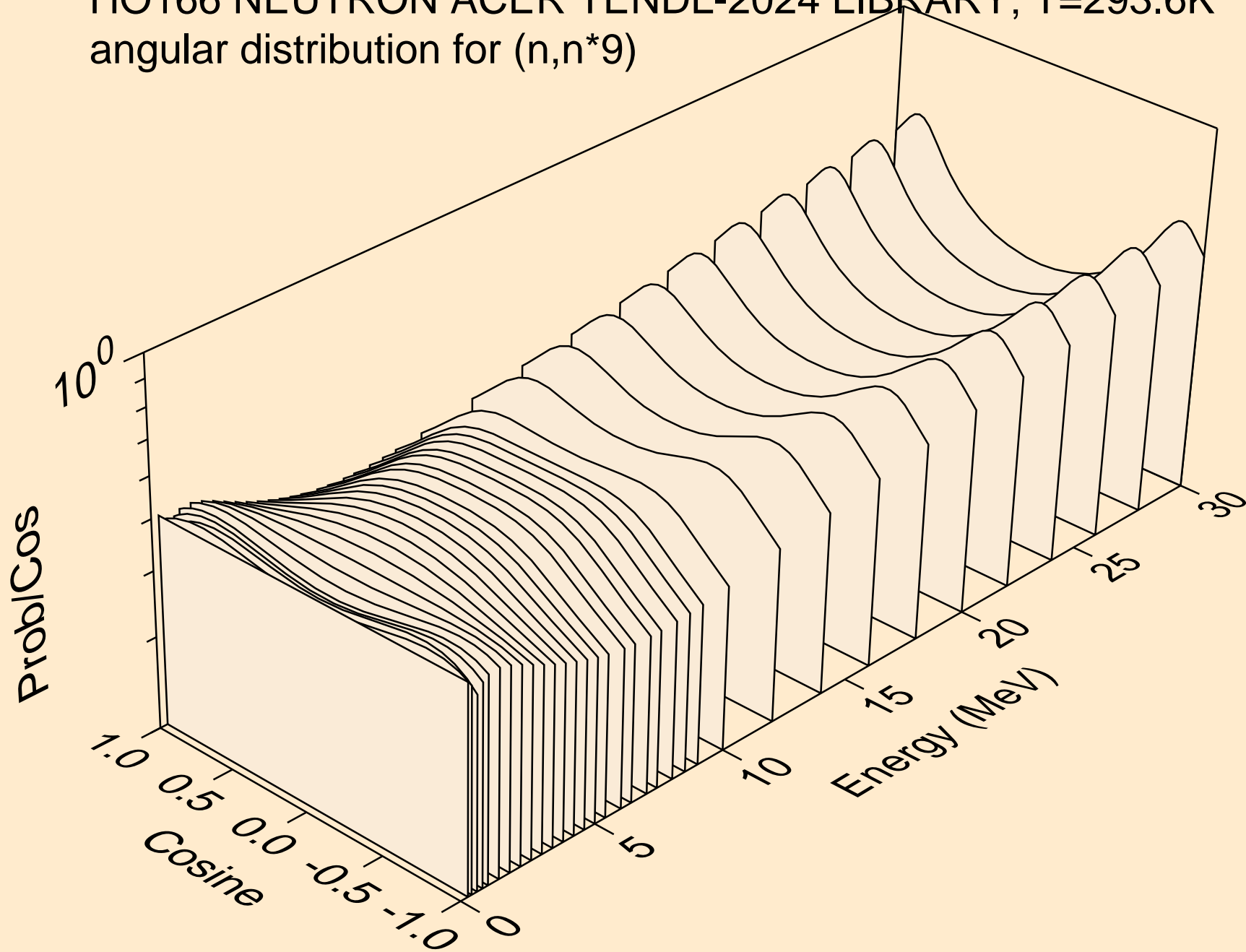

HO166 NEUTRON ACER TENDL-2024 LIBRARY; T=293.6K
angular distribution for (n,n*10)

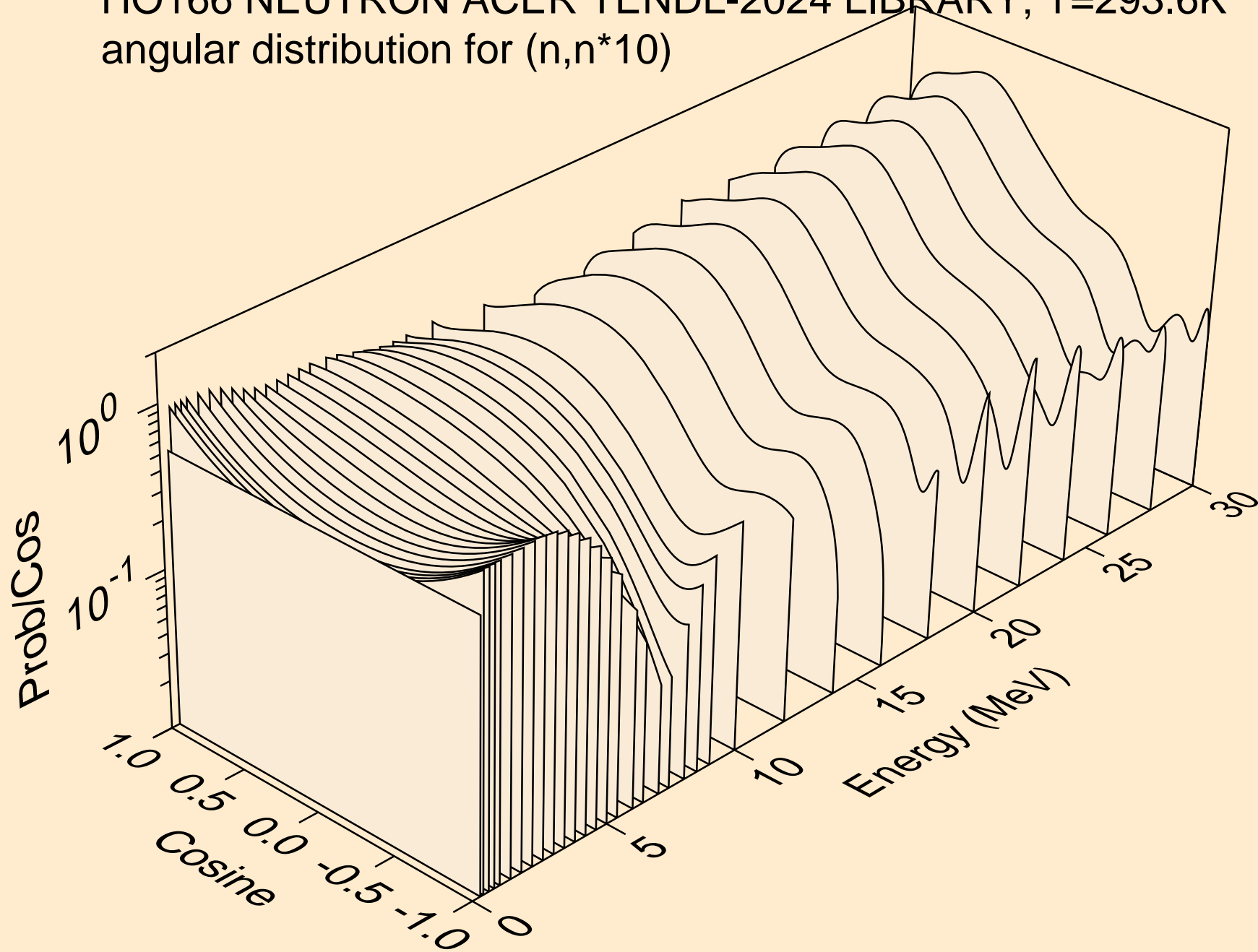

HO166 NEUTRON ACER TENDL-2024 LIBRARY; T=293.6K
angular distribution for (n,n*11)

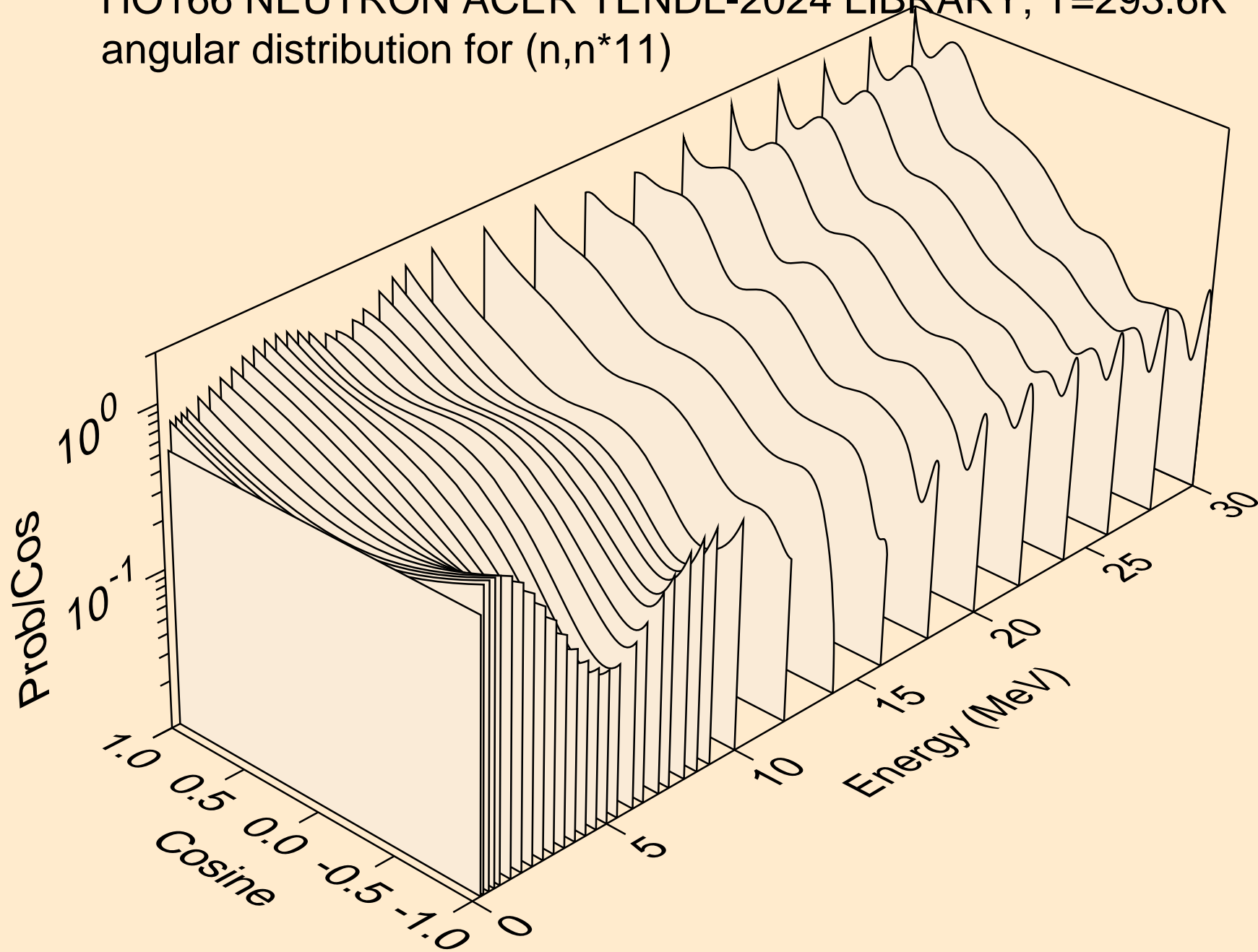

HO166 NEUTRON ACER TENDL-2024 LIBRARY; T=293.6K
angular distribution for (n,n*12)

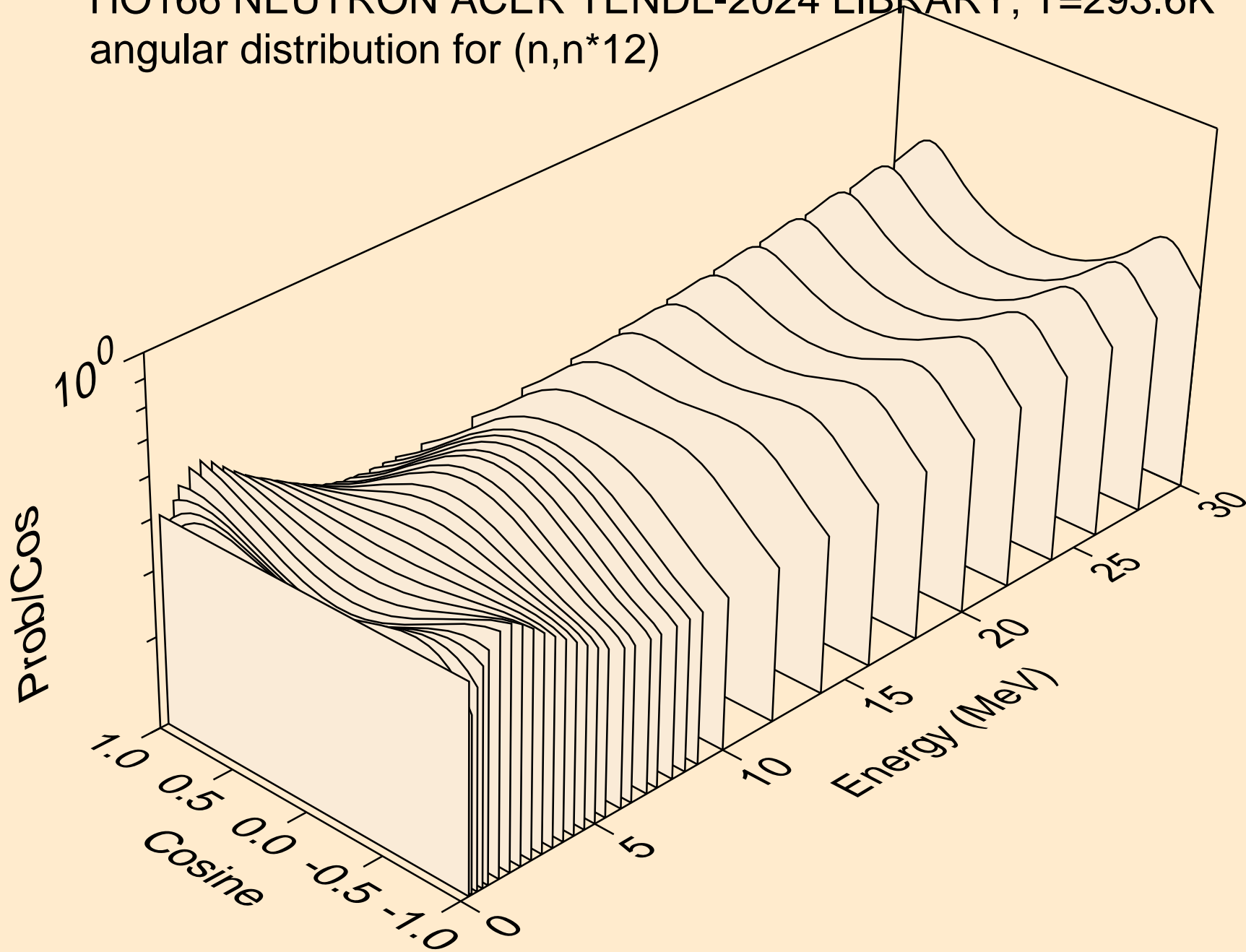

HO166 NEUTRON ACER TENDL-2024 LIBRARY; T=293.6K
angular distribution for (n,n*13)

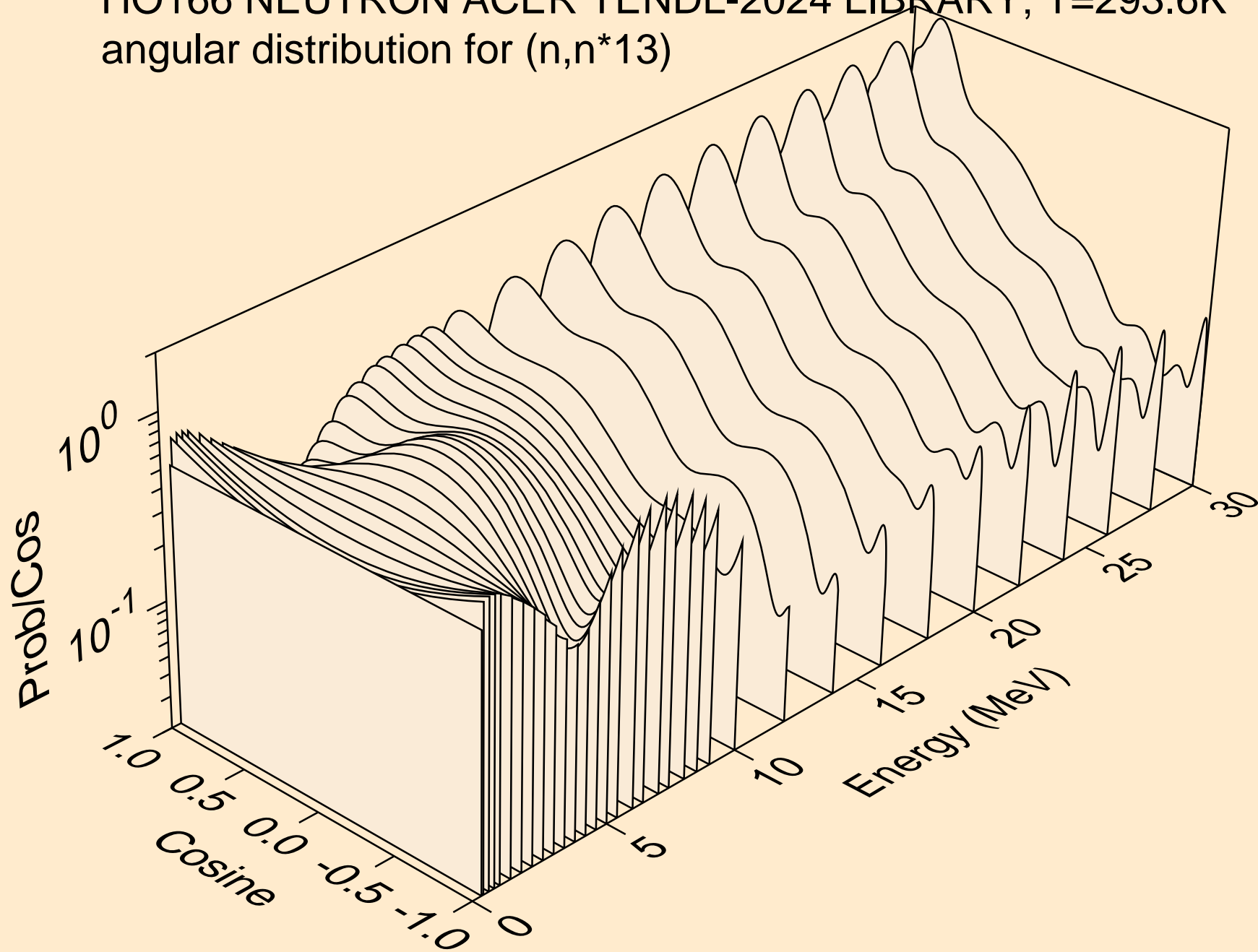

HO166 NEUTRON ACER TENDL-2024 LIBRARY; T=293.6K
angular distribution for (n,n*14)

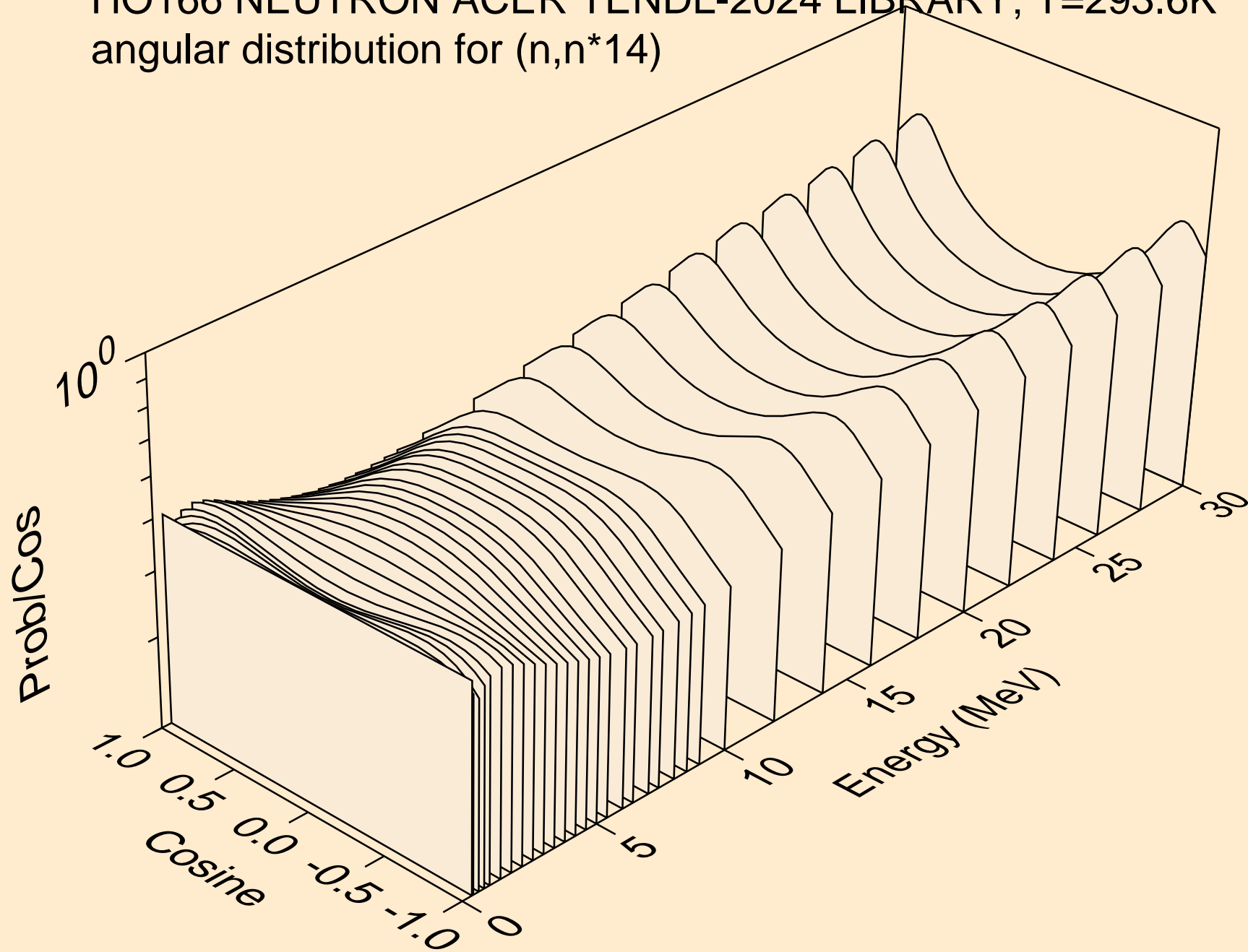

HO166 NEUTRON ACER TENDL-2024 LIBRARY; T=293.6K
angular distribution for (n,n*15)

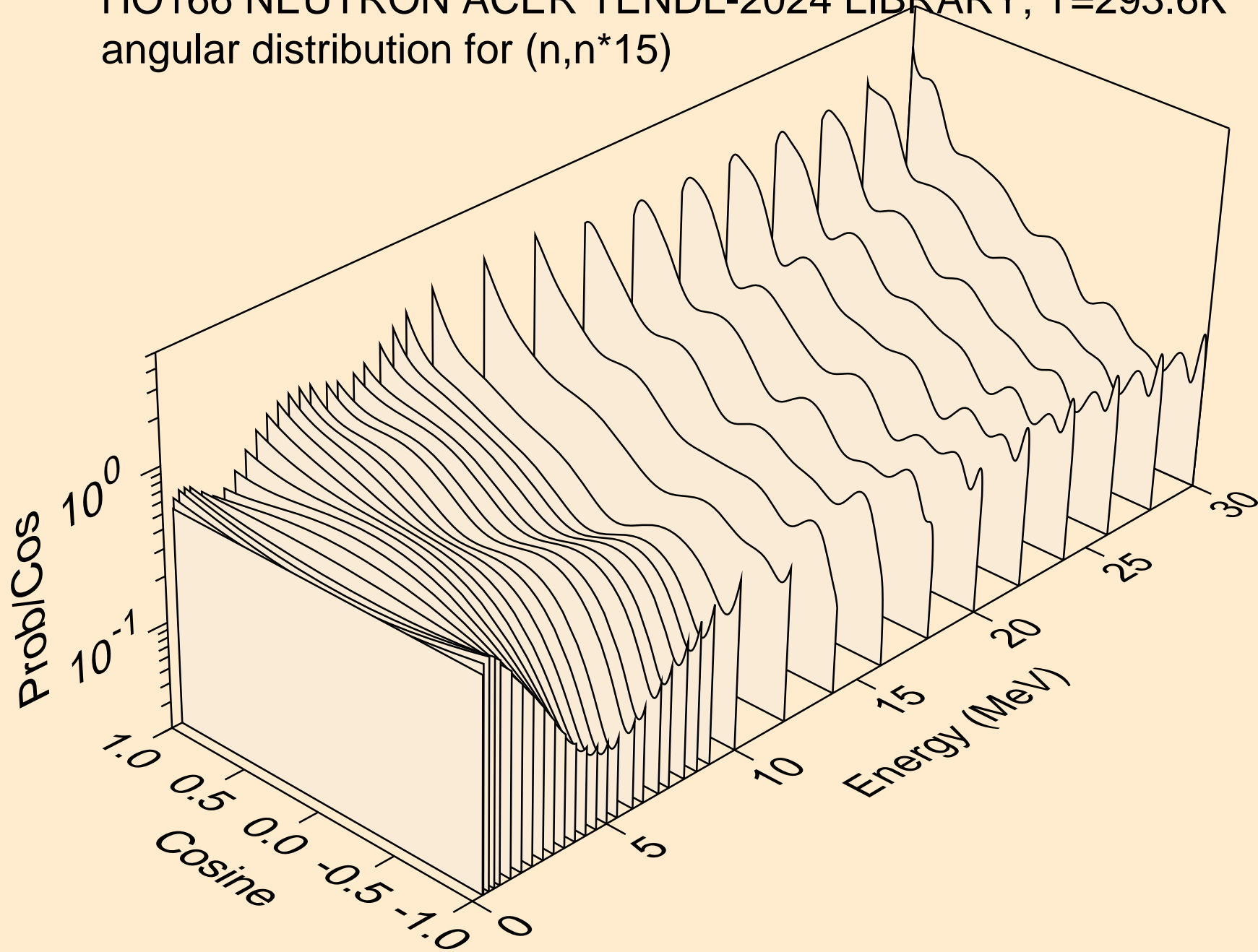

HO166 NEUTRON ACER TENDL-2024 LIBRARY; T=293.6K
angular distribution for (n,n*16)

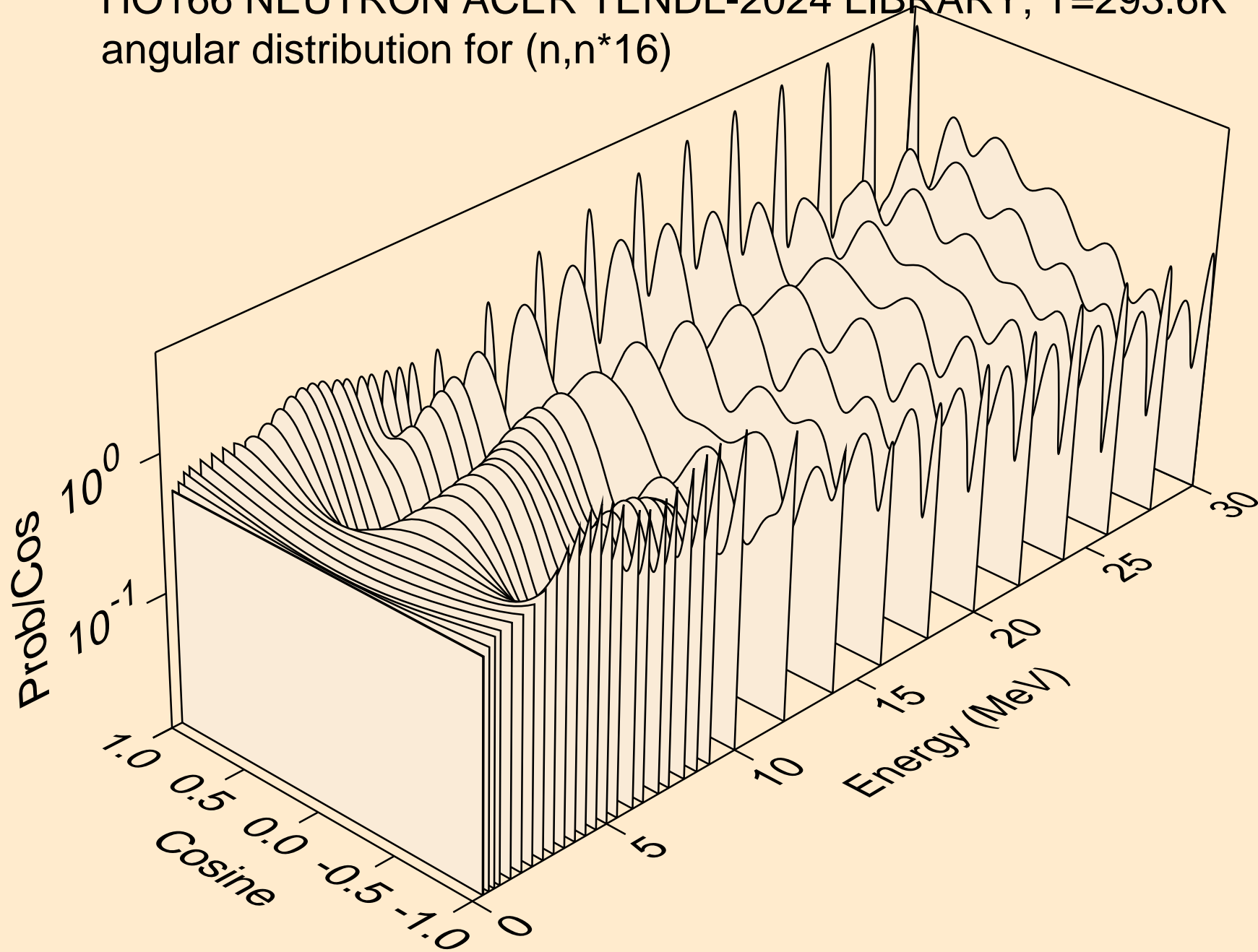

HO166 NEUTRON ACER TENDL-2024 LIBRARY; T=293.6K
angular distribution for (n,n*17)

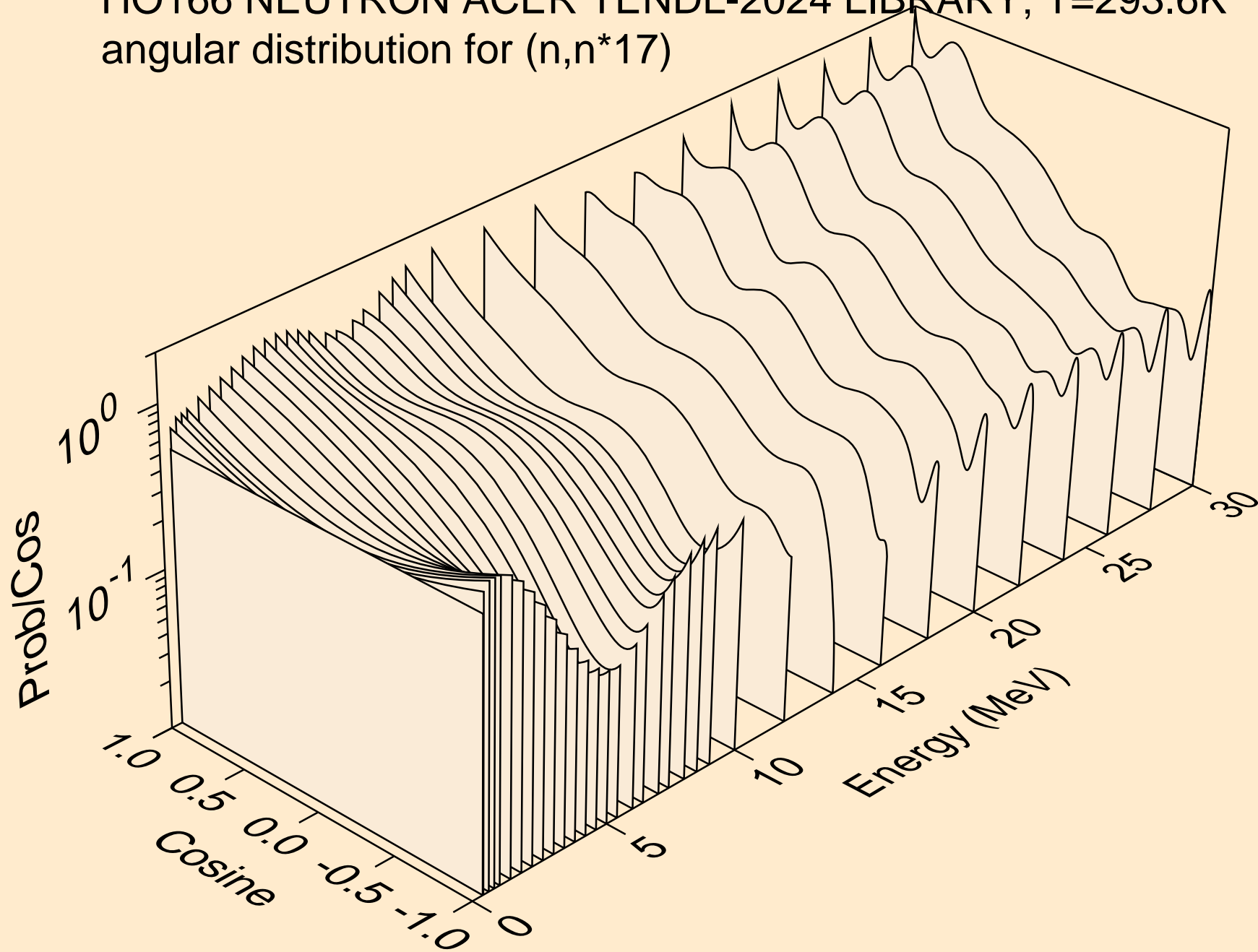

HO166 NEUTRON ACER TENDL-2024 LIBRARY; T=293.6K
angular distribution for (n,n*18)

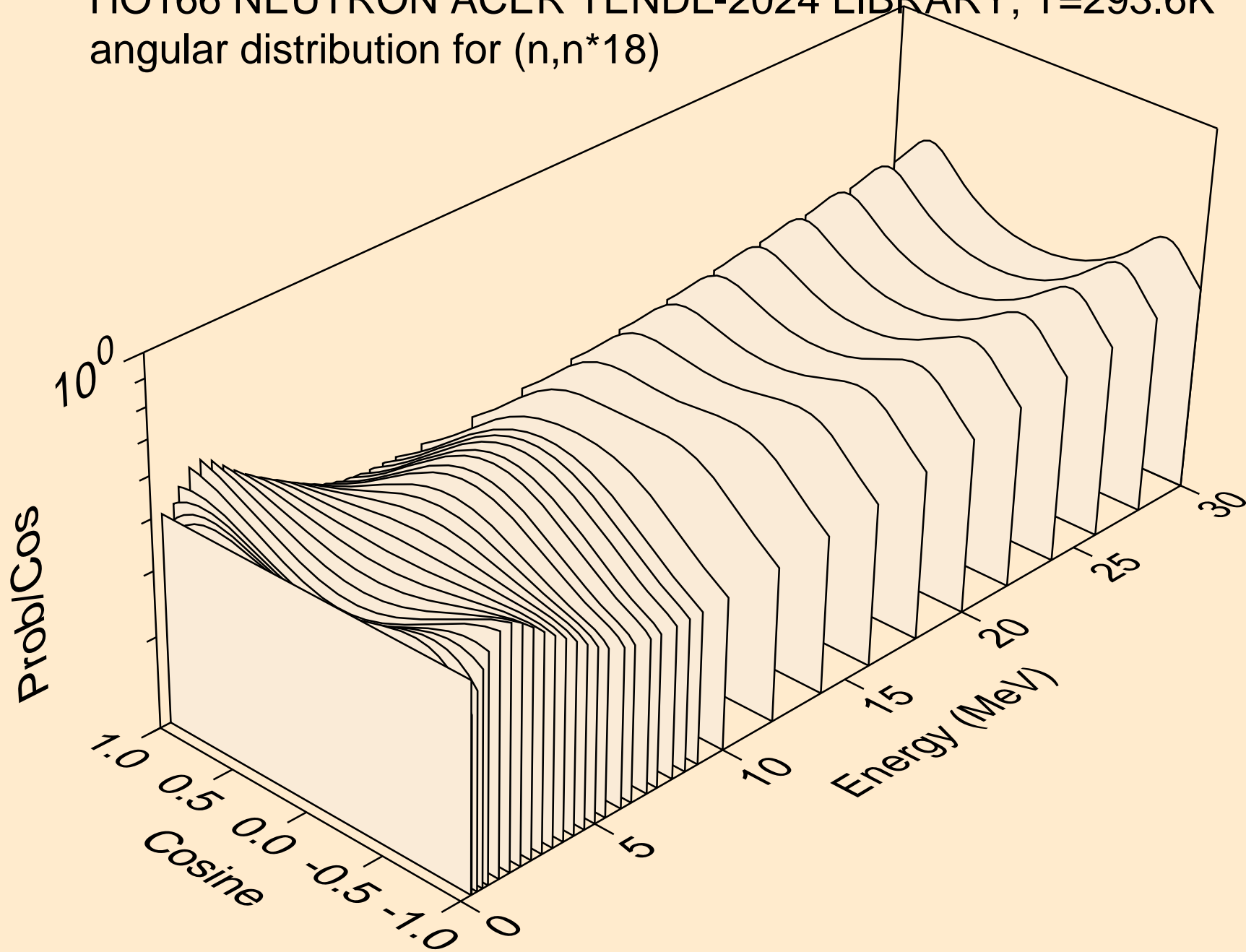

HO166 NEUTRON ACER TENDL-2024 LIBRARY; T=293.6K
angular distribution for (n,n*19)

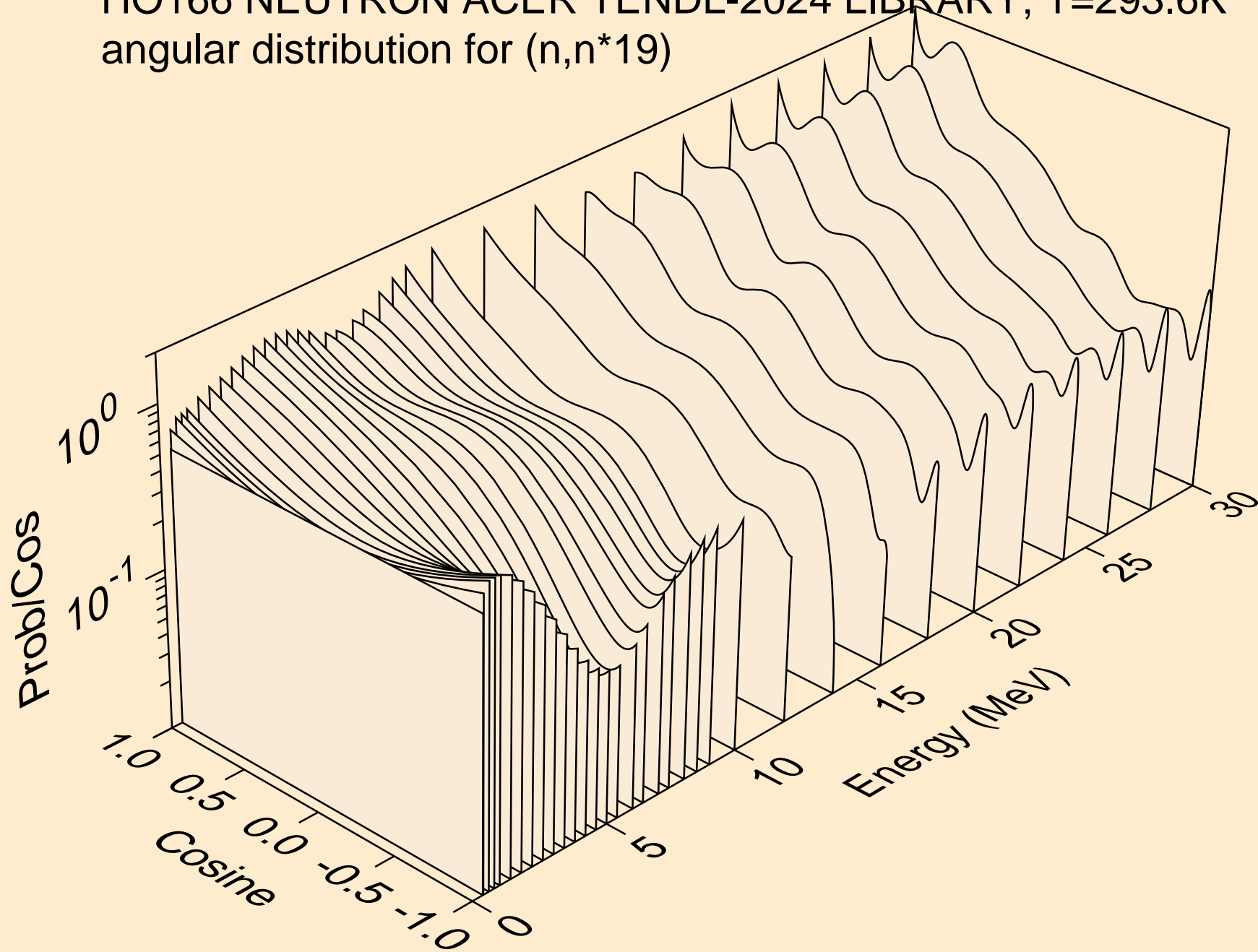

HO166 NEUTRON ACER TENDL-2024 LIBRARY; T=293.6K
angular distribution for (n,n*20)

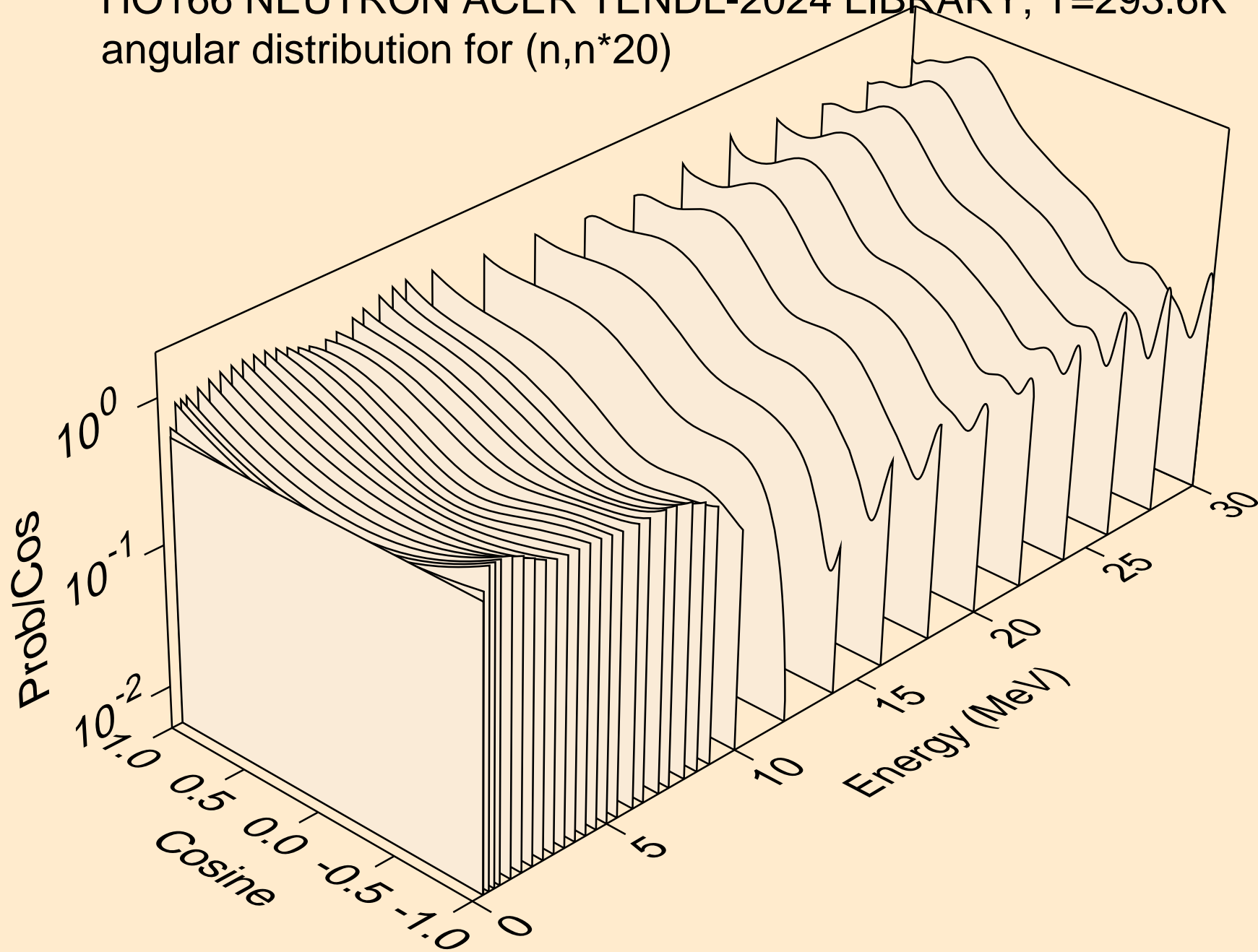

HO166 NEUTRON ACER TENDL-2024 LIBRARY; T=293.6K
angular distribution for (n,n*21)

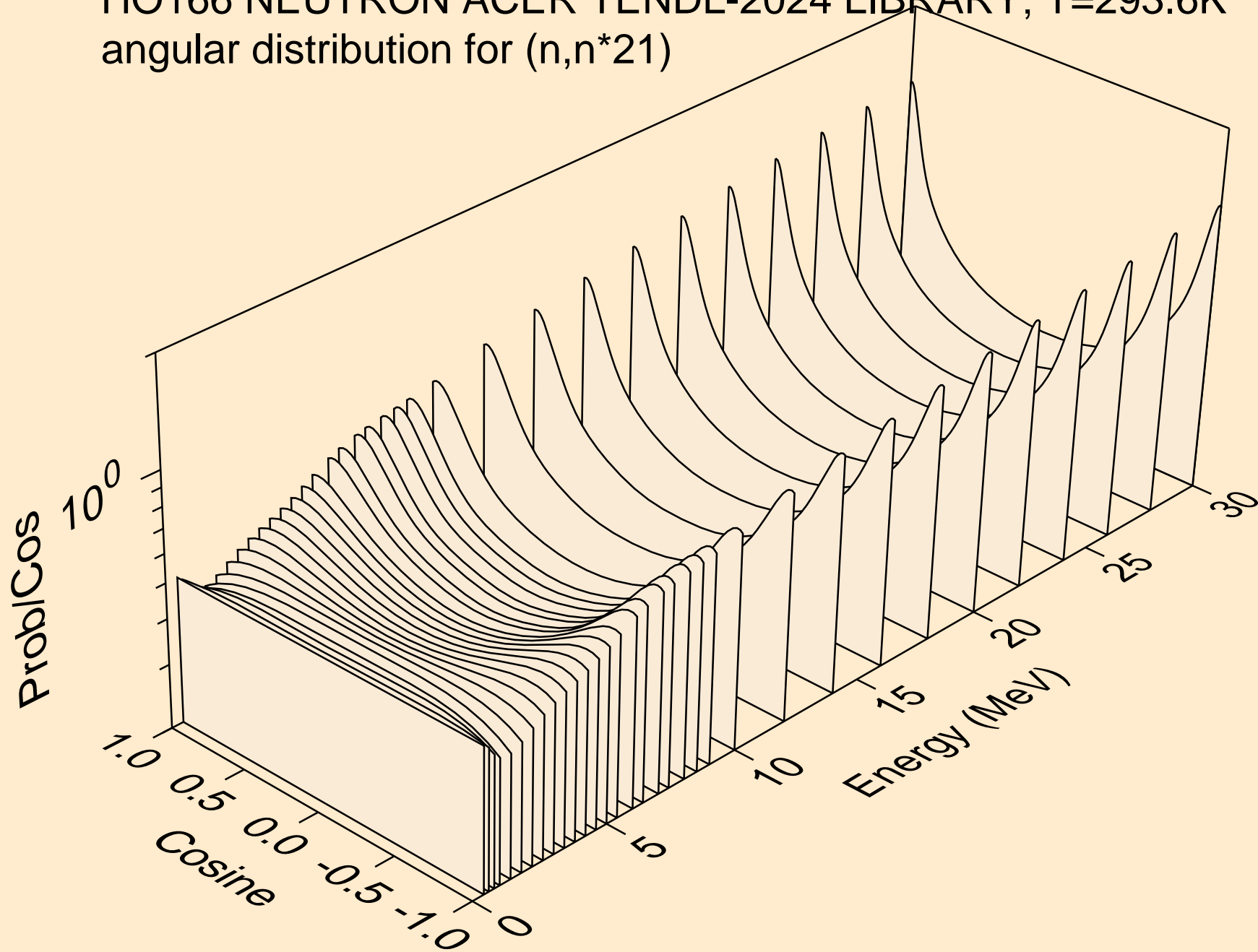

HO166 NEUTRON ACER TENDL-2024 LIBRARY; T=293.6K
angular distribution for (n,n*22)

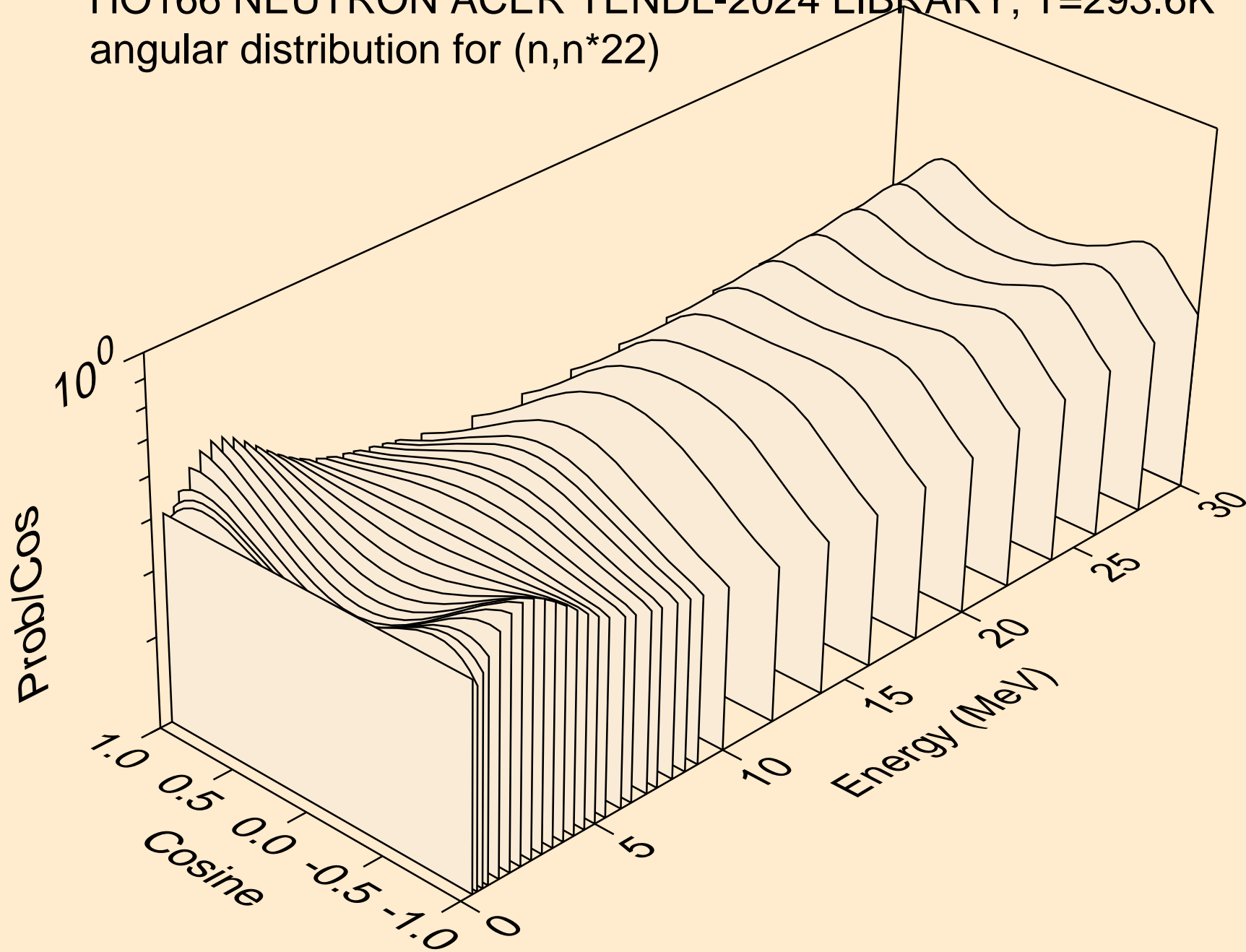

HO166 NEUTRON ACER TENDL-2024 LIBRARY; T=293.6K
angular distribution for (n,n*23)

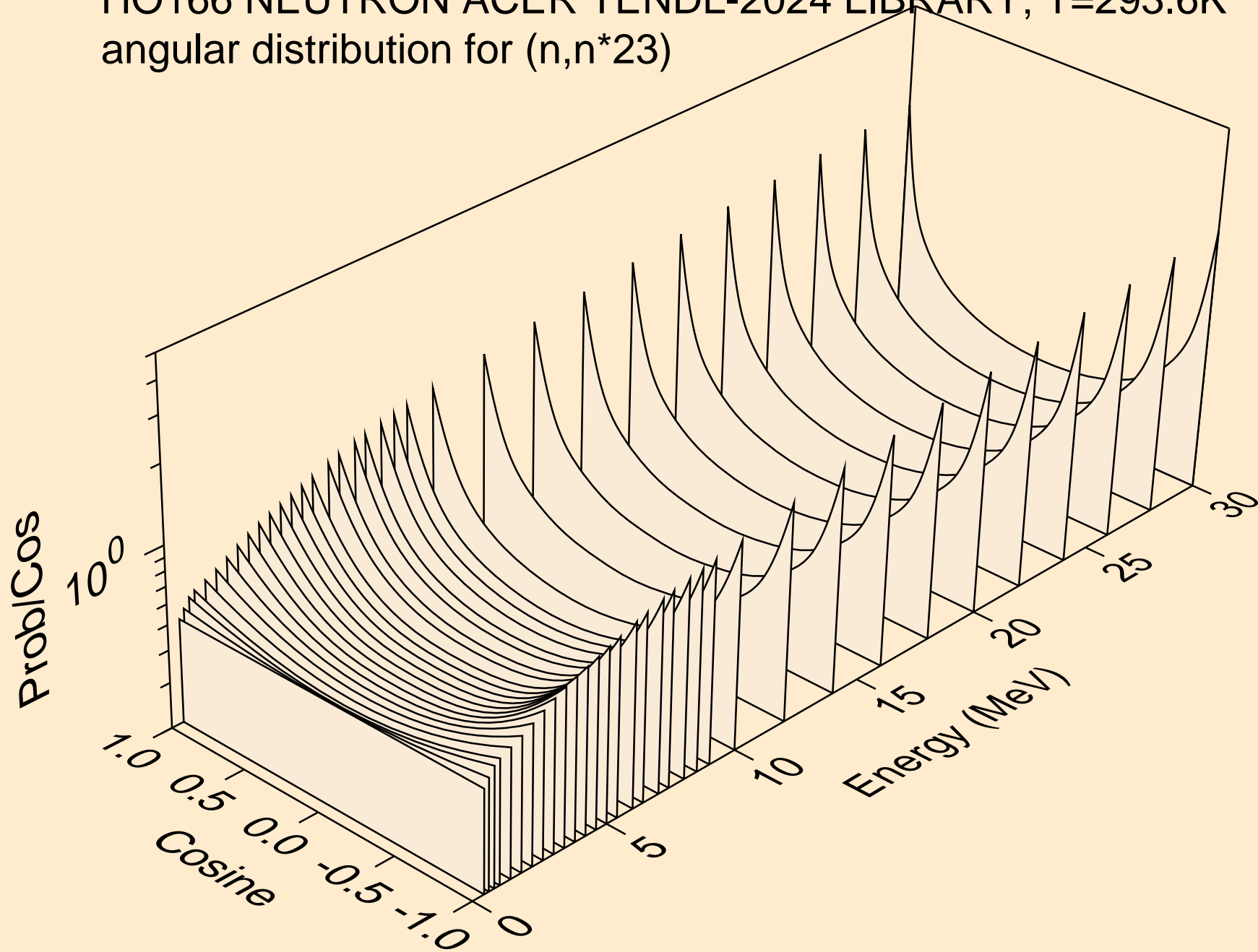

HO166 NEUTRON ACER TENDL-2024 LIBRARY; T=293.6K
angular distribution for (n,n*24)

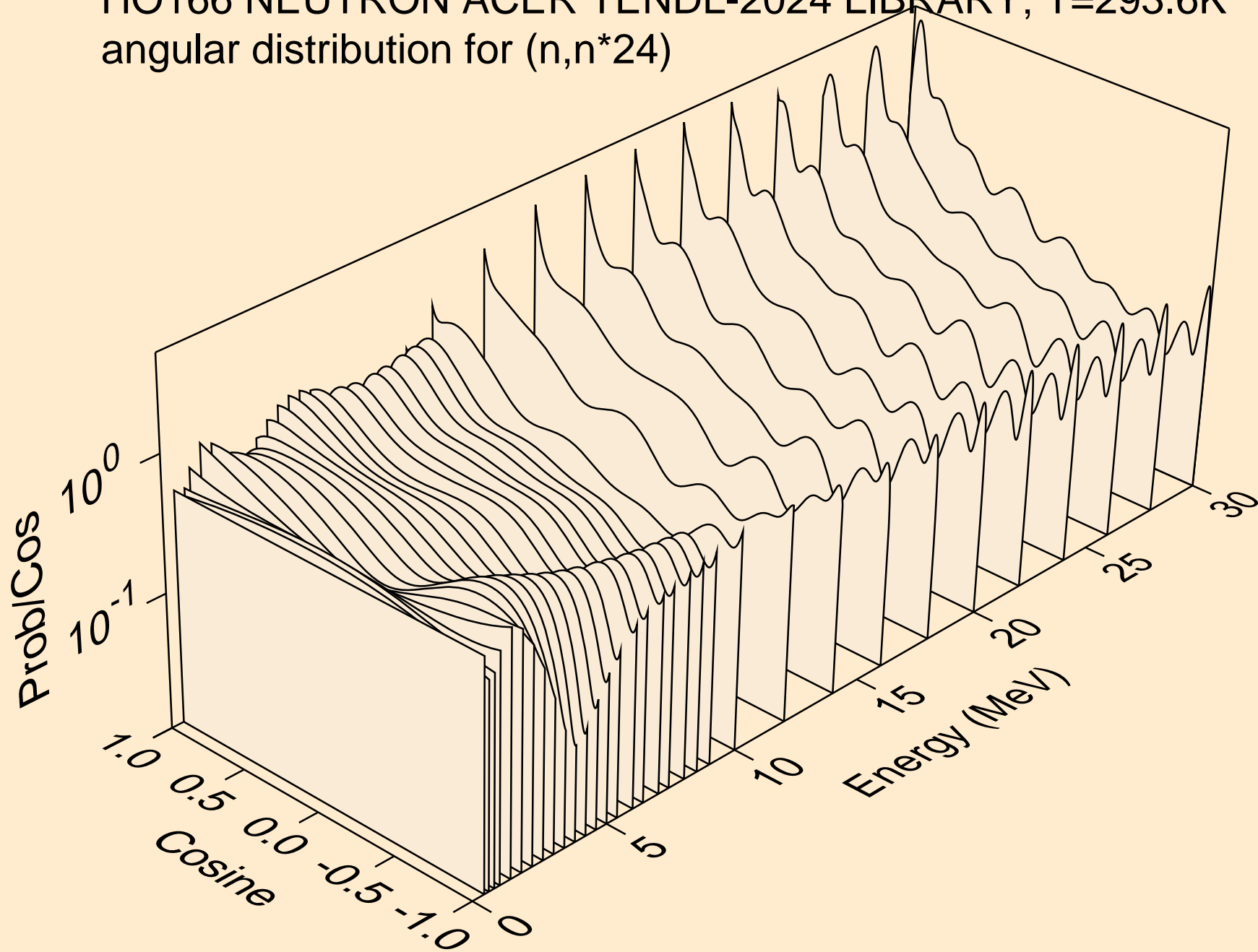

HO166 NEUTRON ACER TENDL-2024 LIBRARY; T=293.6K
angular distribution for (n,n*25)

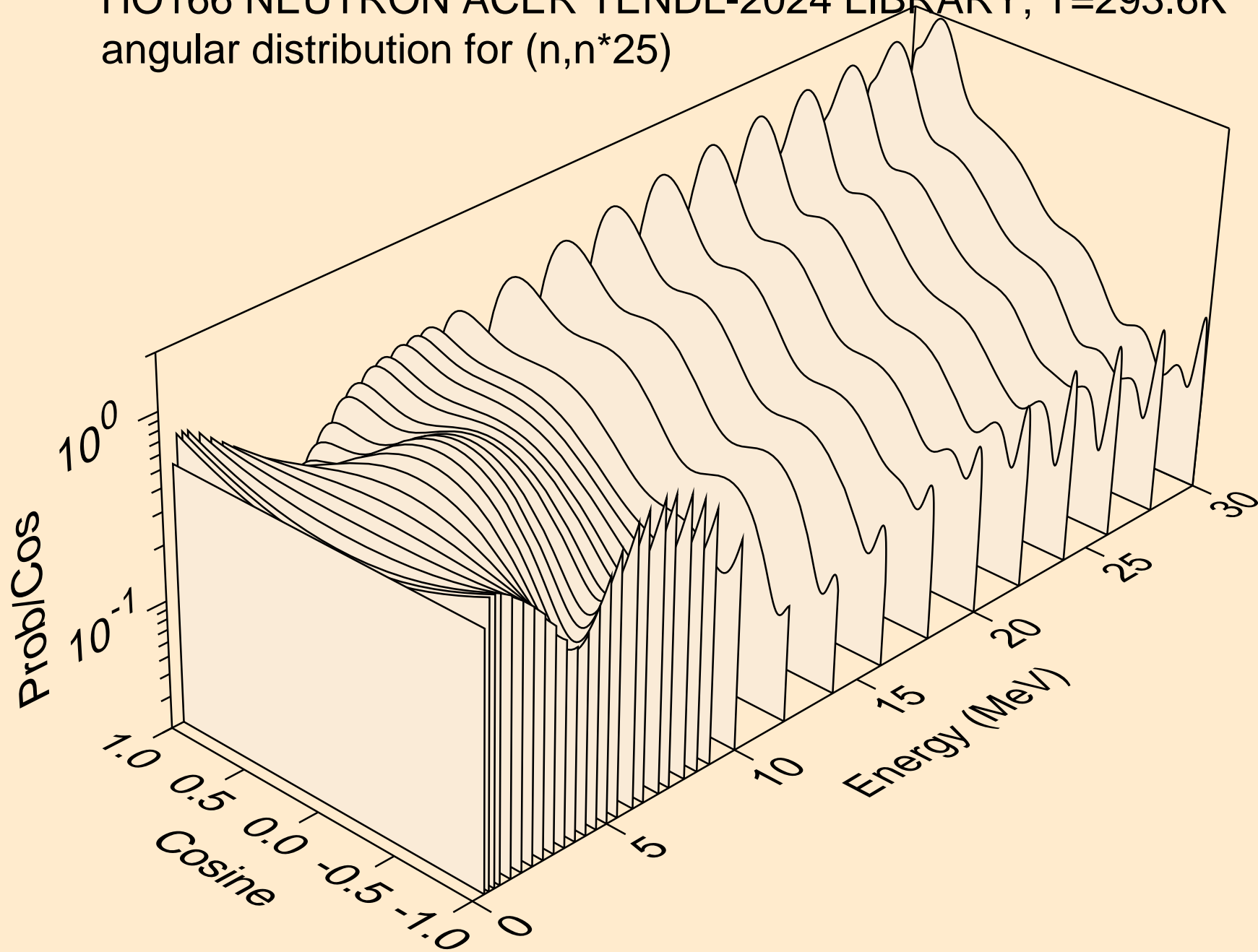

HO166 NEUTRON ACER TENDL-2024 LIBRARY; T=293.6K
angular distribution for (n,n*26)

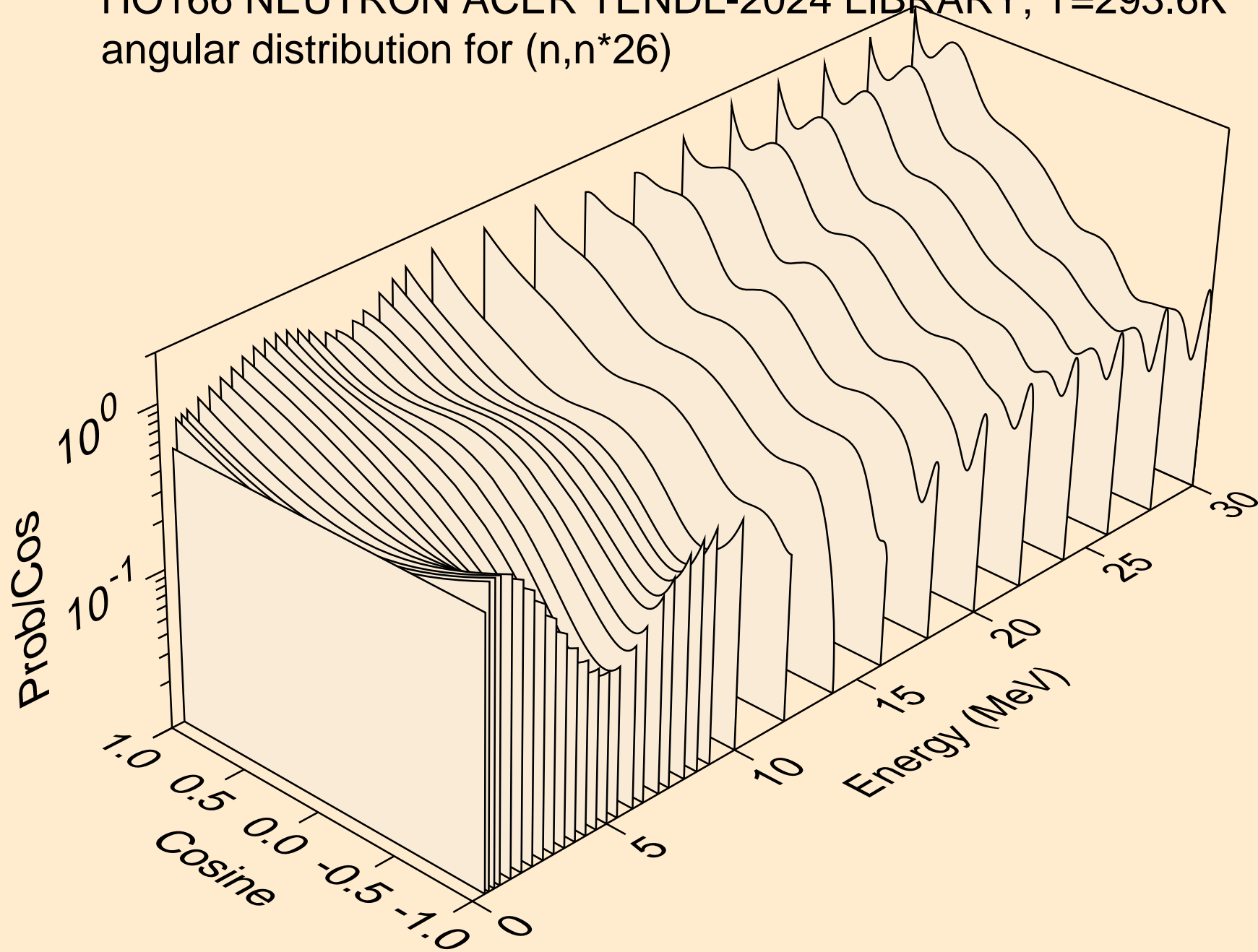

HO166 NEUTRON ACER TENDL-2024 LIBRARY; T=293.6K
angular distribution for (n,n*27)

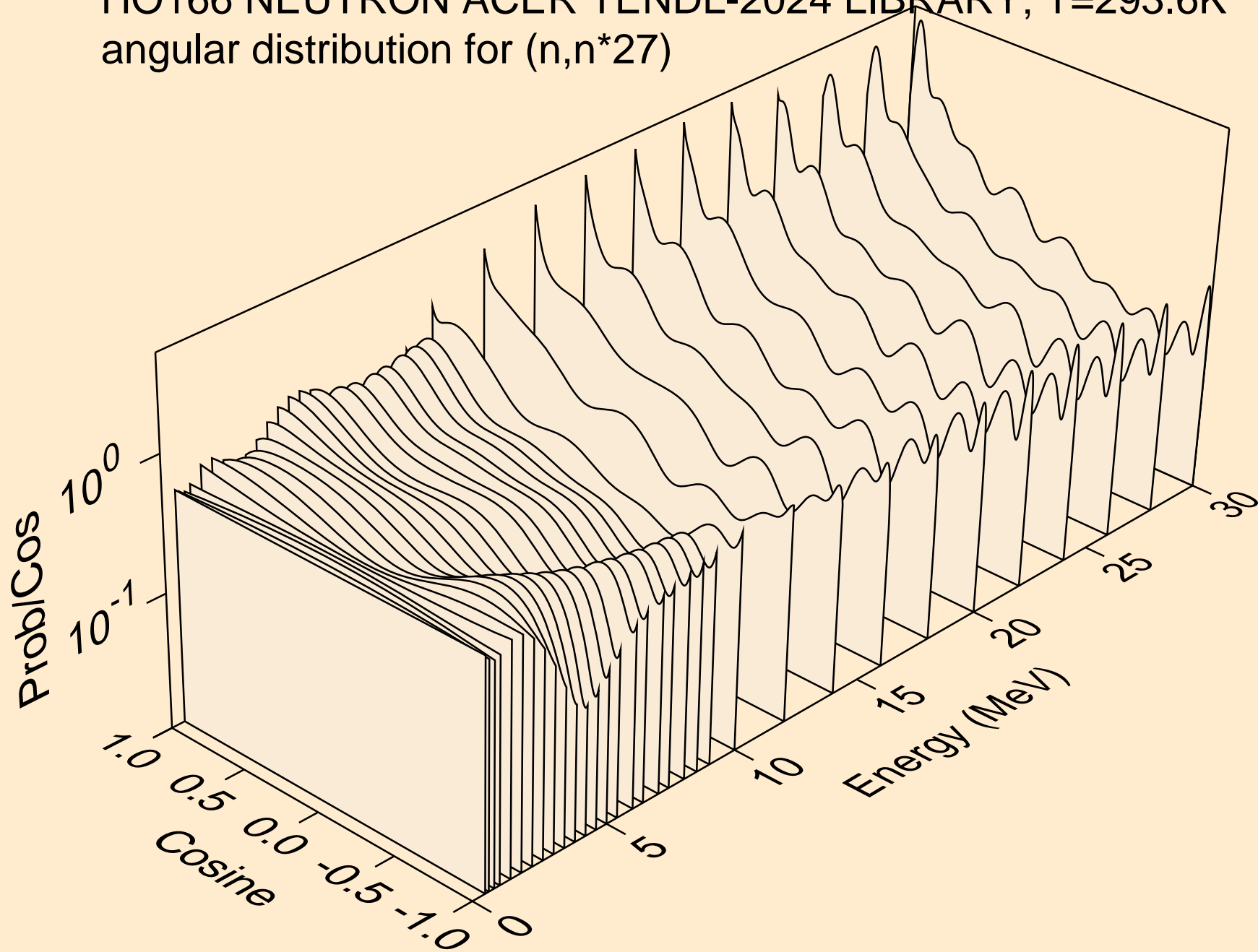

HO166 NEUTRON ACER TENDL-2024 LIBRARY; T=293.6K
angular distribution for (n,n*28)

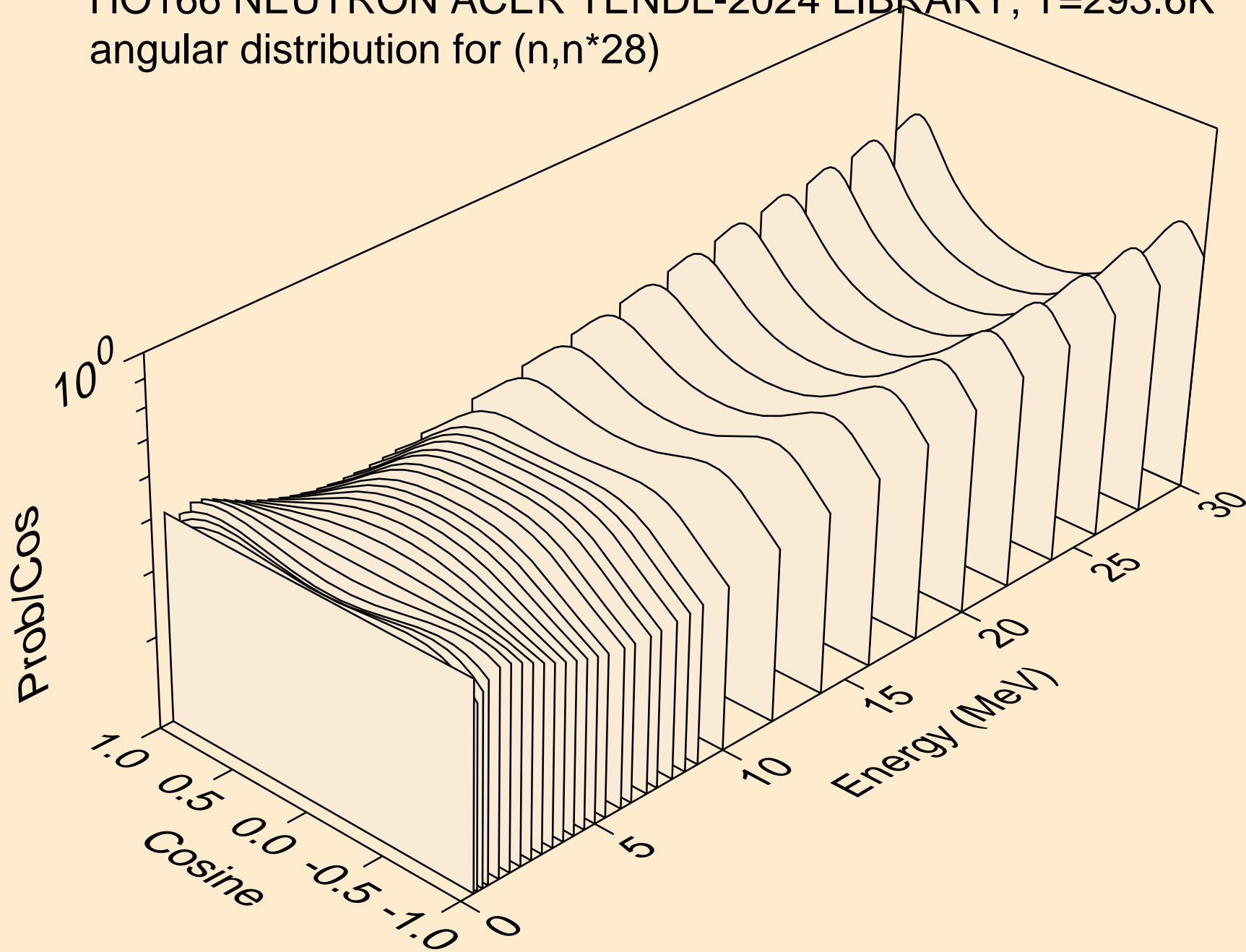

HO166 NEUTRON ACER TENDL-2024 LIBRARY; T=293.6K
angular distribution for (n,n*29)

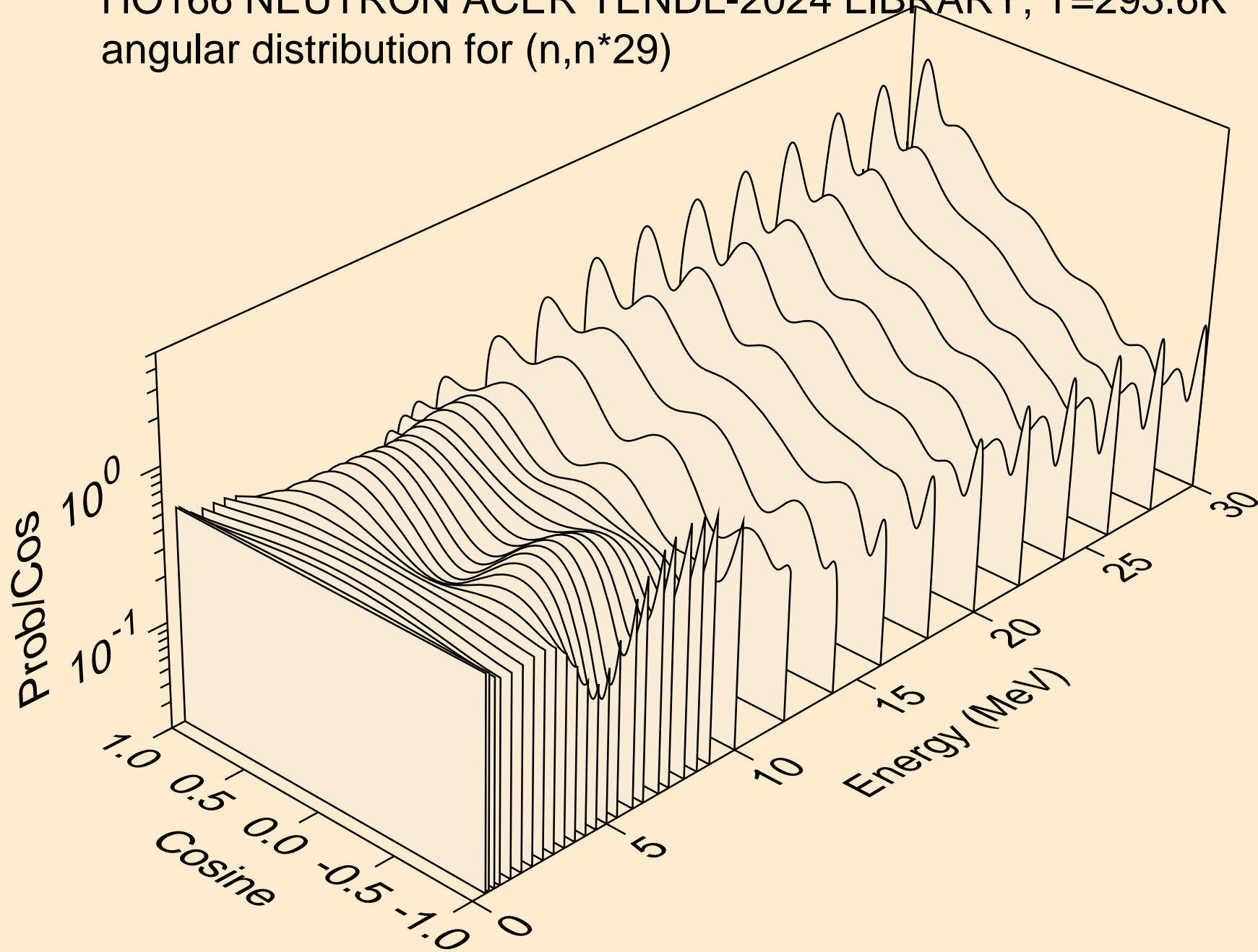

HO166 NEUTRON ACER TENDL-2024 LIBRARY; T=293.6K
angular distribution for (n,n*30)

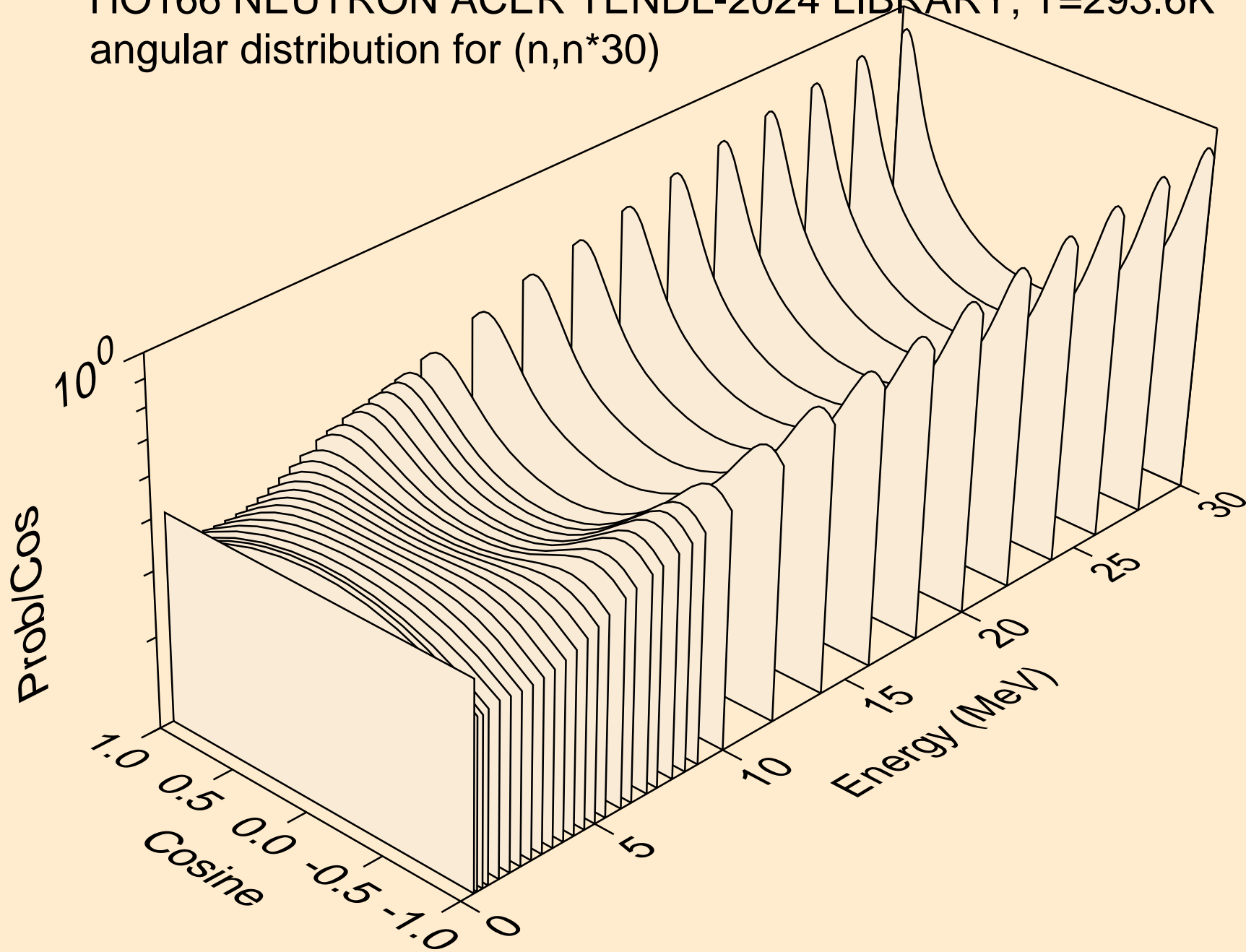

HO166 NEUTRON ACER TENDL-2024 LIBRARY; T=293.6K
Neutron emission for (n,x)

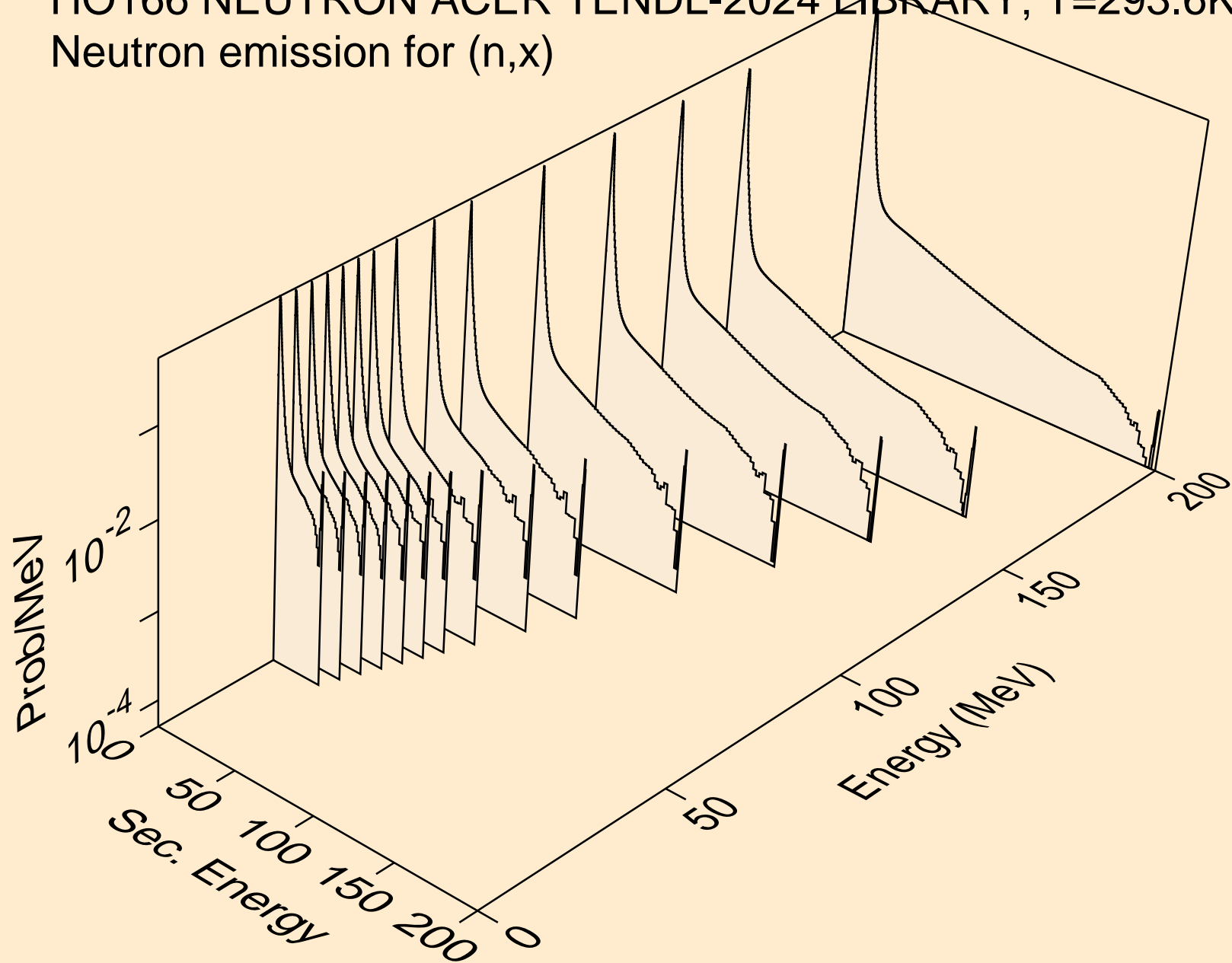

HO166 NEUTRON ACER TENDL-2024 LIBRARY; T=293.6K
Neutron emission for (n,2nd)

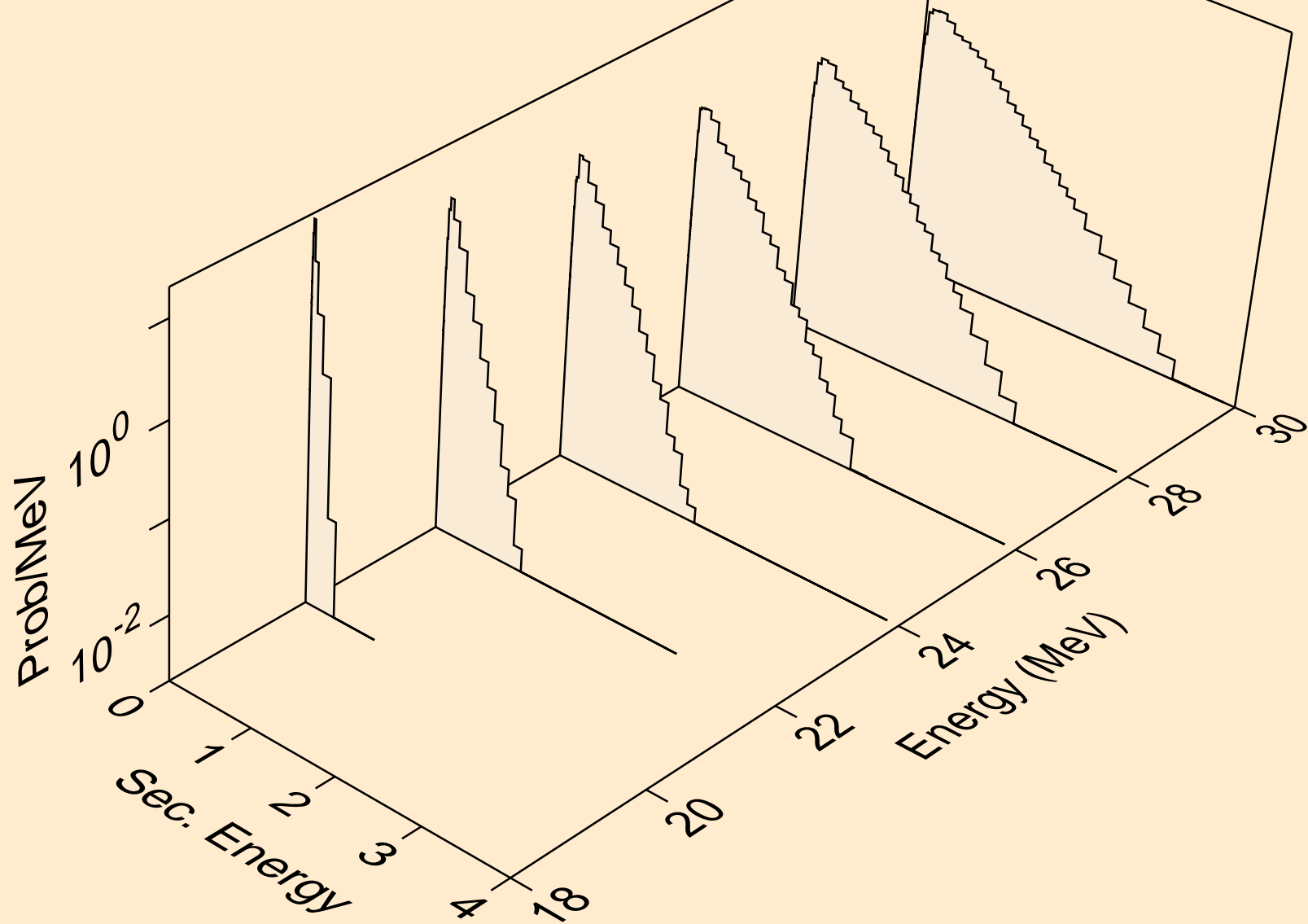

HO166 NEUTRON ACER TENDL-2024 LIBRARY; T=293.6K
Neutron emission for (n,2n)

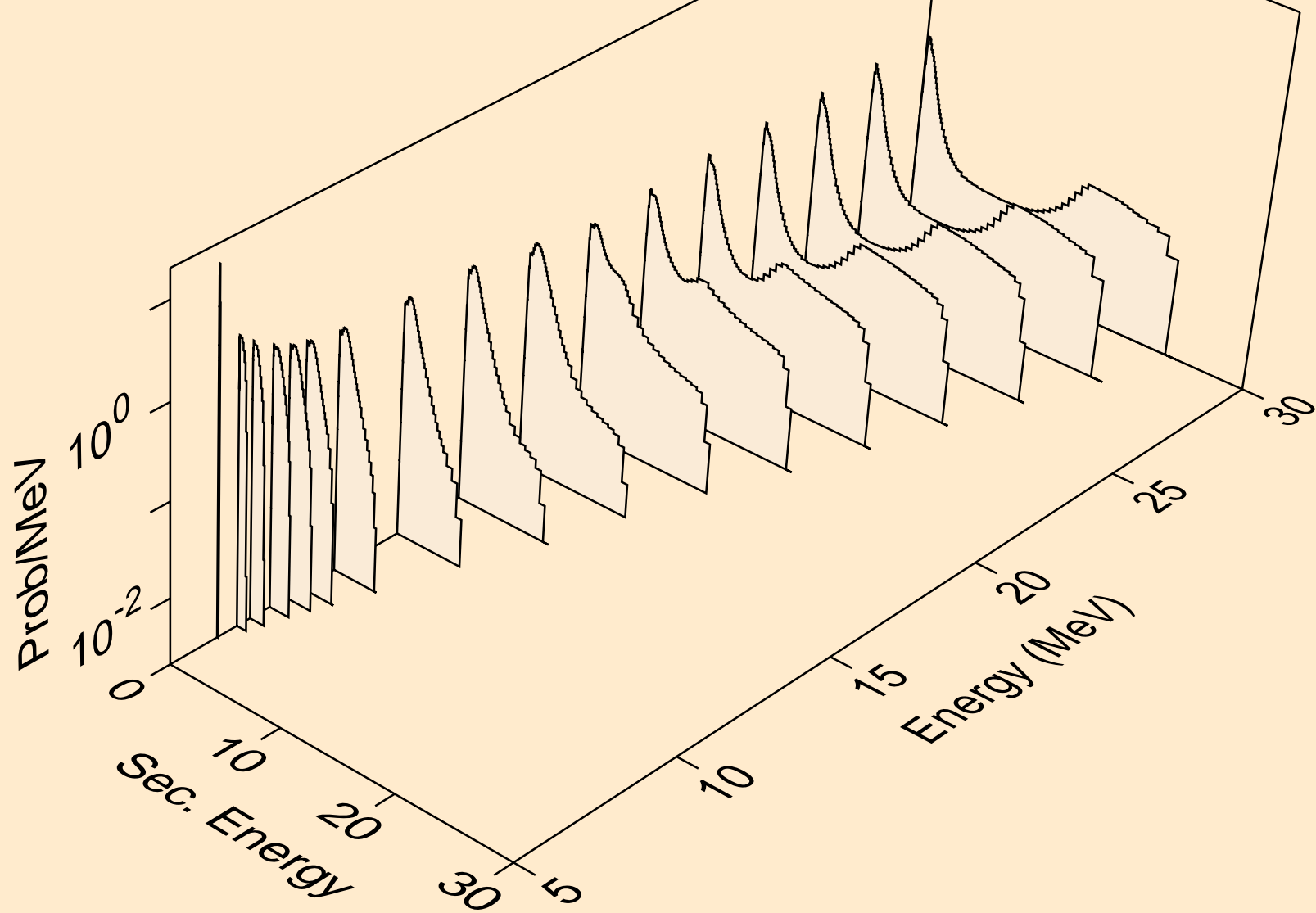

HO166 NEUTRON ACER TENDL-2024 LIBRARY; T=293.6K
Neutron emission for (n,3n)

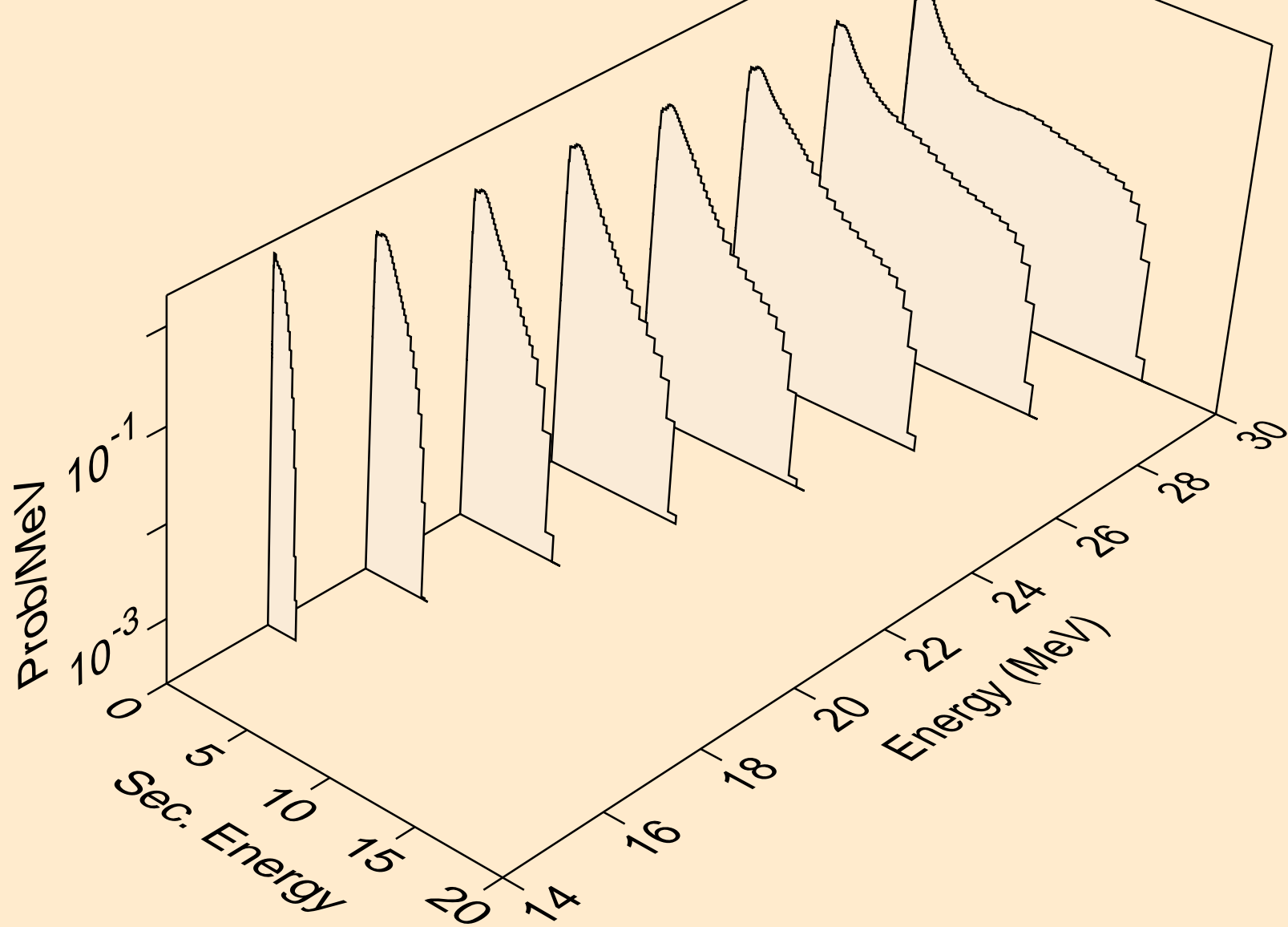

HO166 NEUTRON ACER TENDL-2024 LIBRARY; T=293.6K
Neutron emission for (n,n*)a

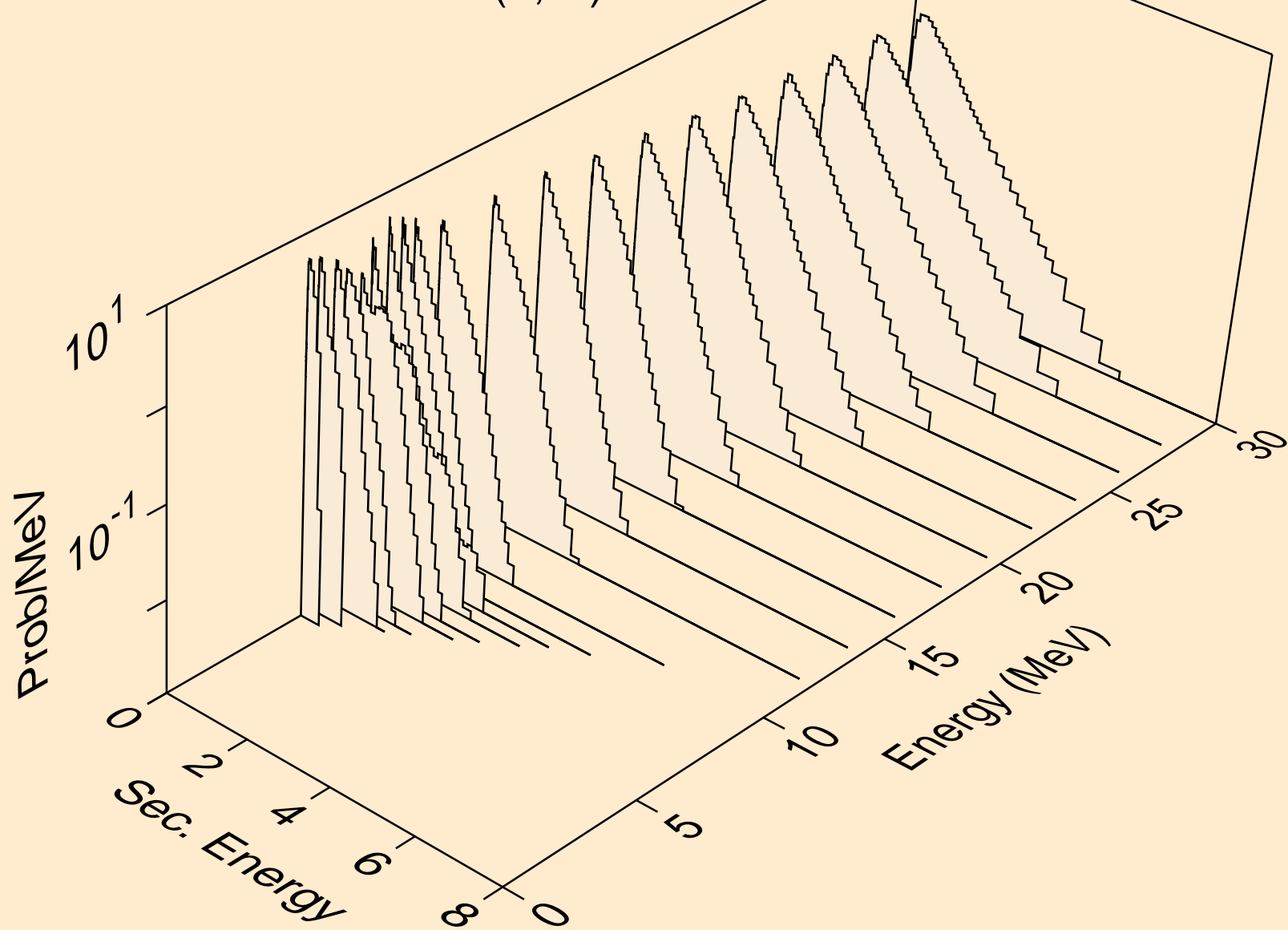

HO166 NEUTRON ACER TENDL-2024 LIBRARY; T=293.6K
Neutron emission for (n,2n)a

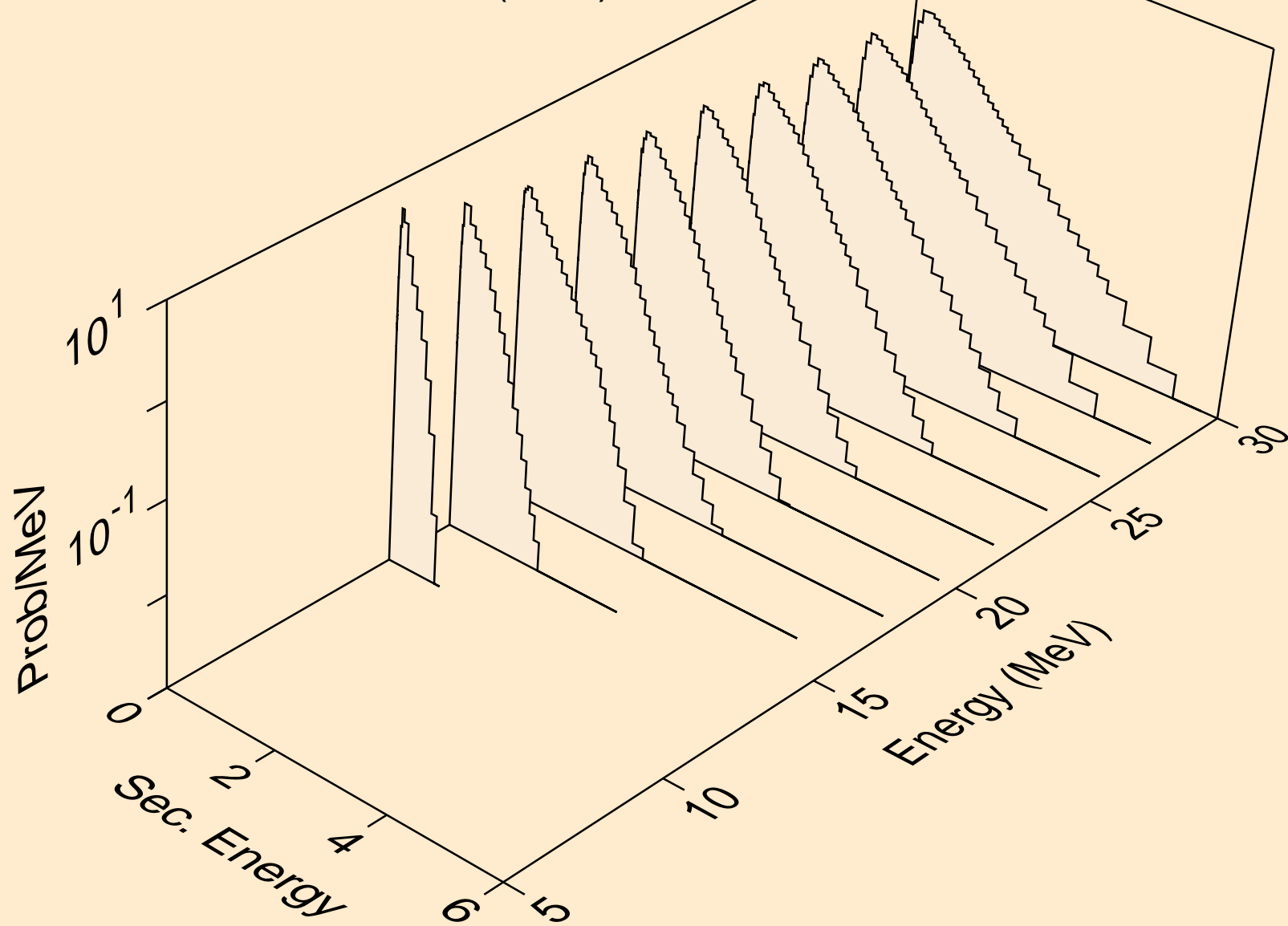

HO166 NEUTRON ACER TENDL-2024 LIBRARY; T=293.6K
Neutron emission for (n,3n)a

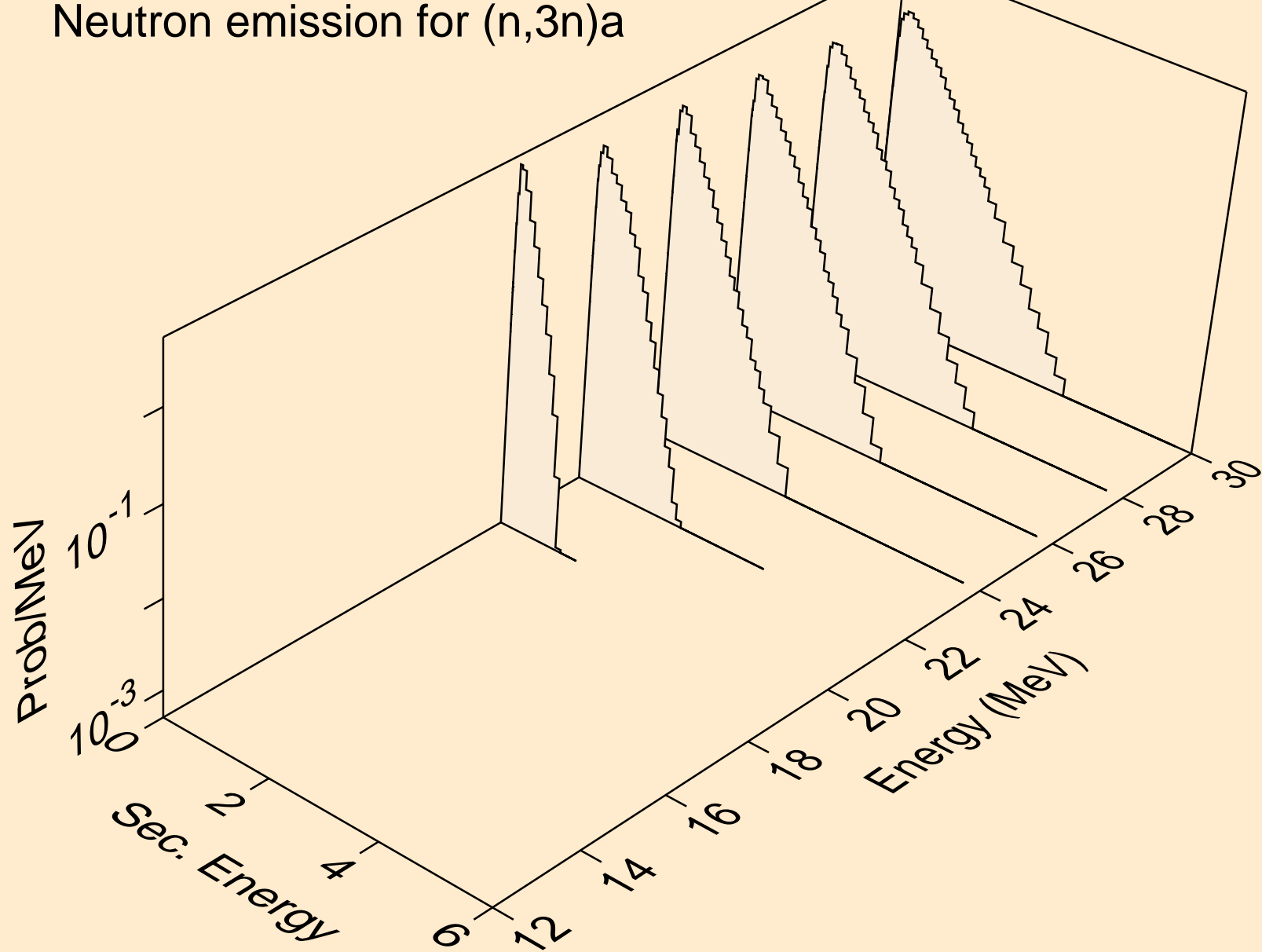

HO166 NEUTRON ACER TENDL-2024 LIBRARY; T=293.6K
Neutron emission for (n,n*)p

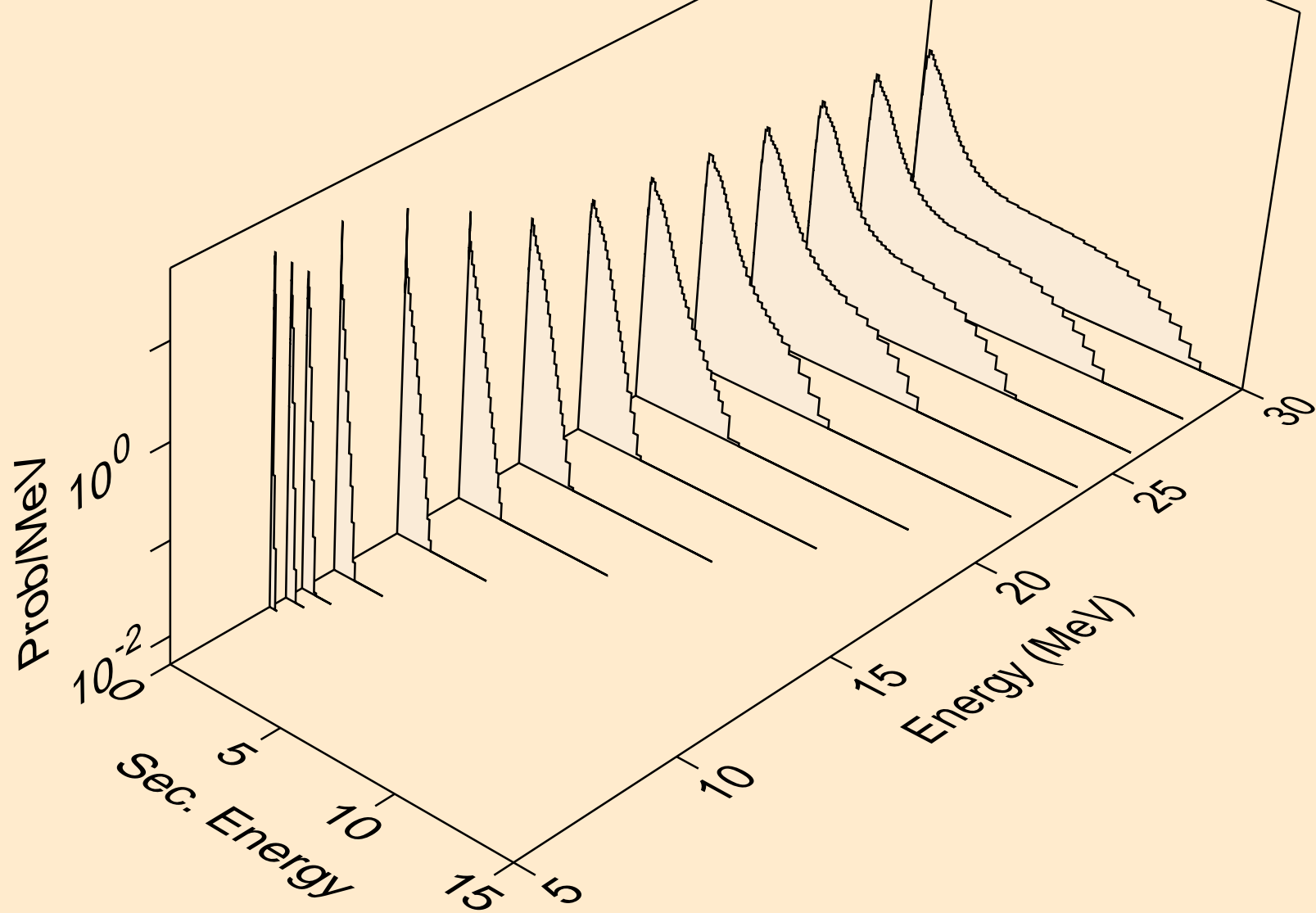

HO166 NEUTRON ACER TENDL-2024 LIBRARY; T=293.6K
Neutron emission for (n,n*)d

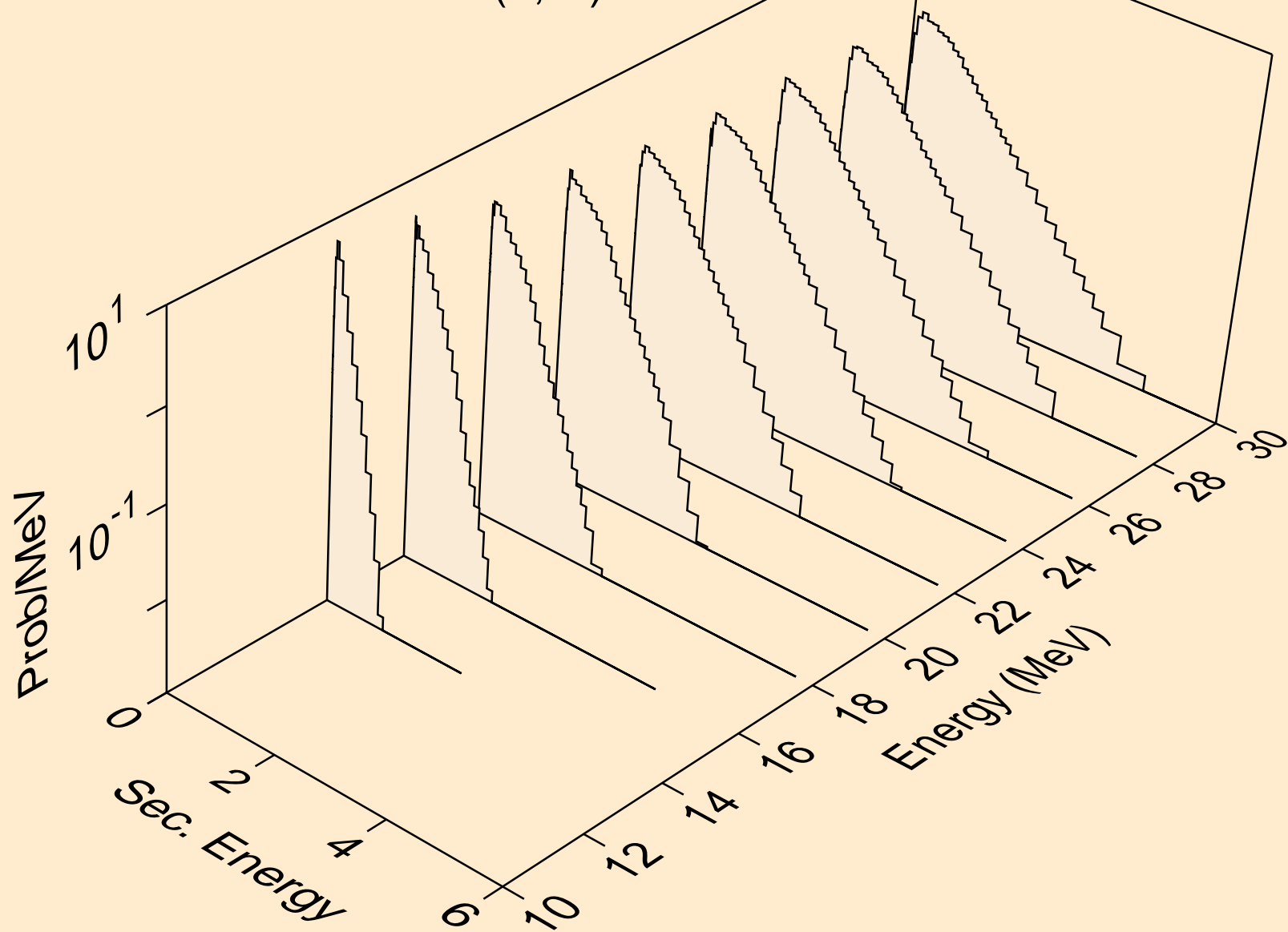

HO166 NEUTRON ACER TENDL-2024 LIBRARY; T=293.6K
Neutron emission for (n,n*)t

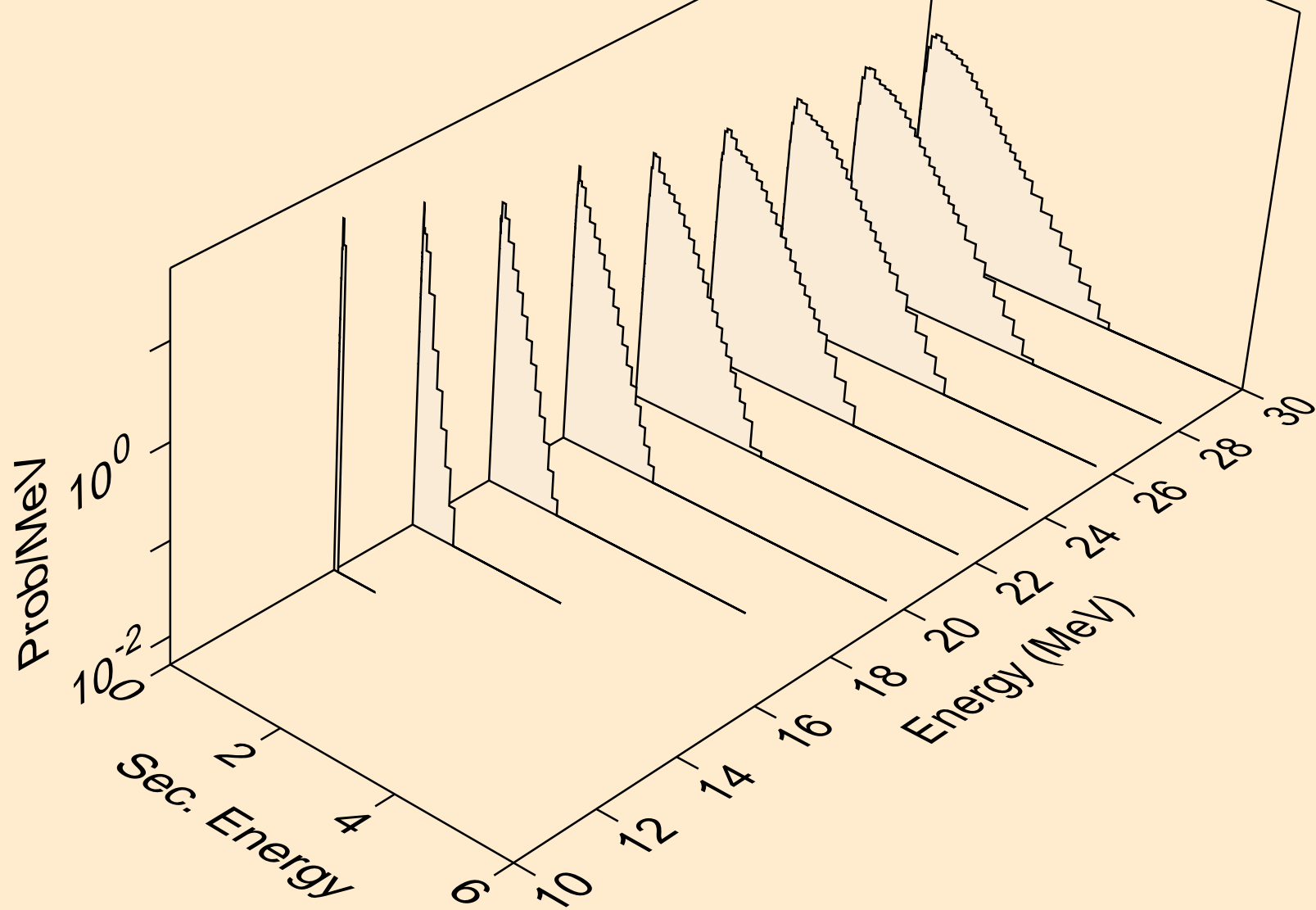

HO166 NEUTRON ACER TENDL-2024 LIBRARY; T=293.6K
Neutron emission for (n,n*)he3

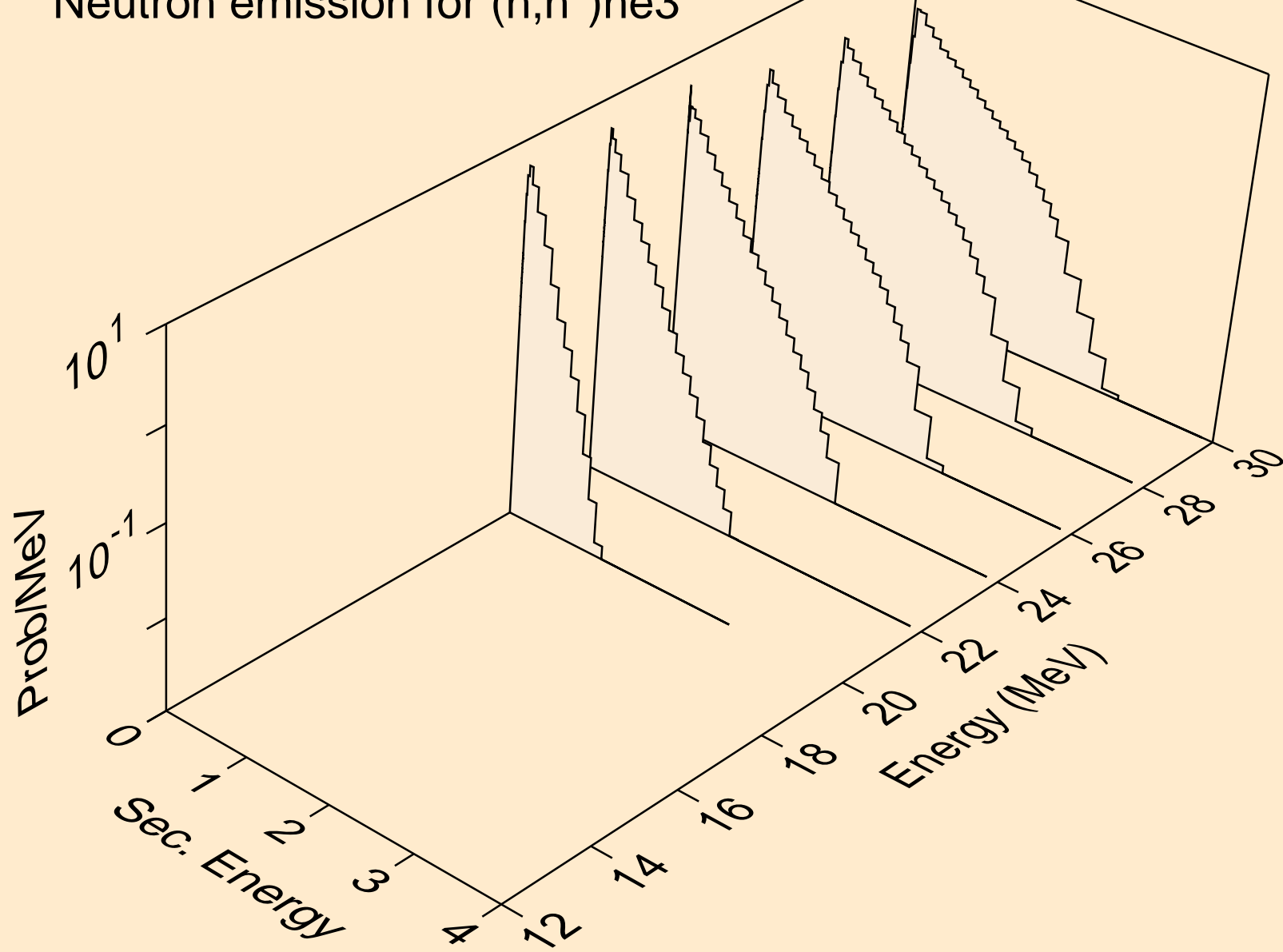

HO166 NEUTRON ACER TENDL-2024 LIBRARY; T=293.6K
Neutron emission for (n,4n)

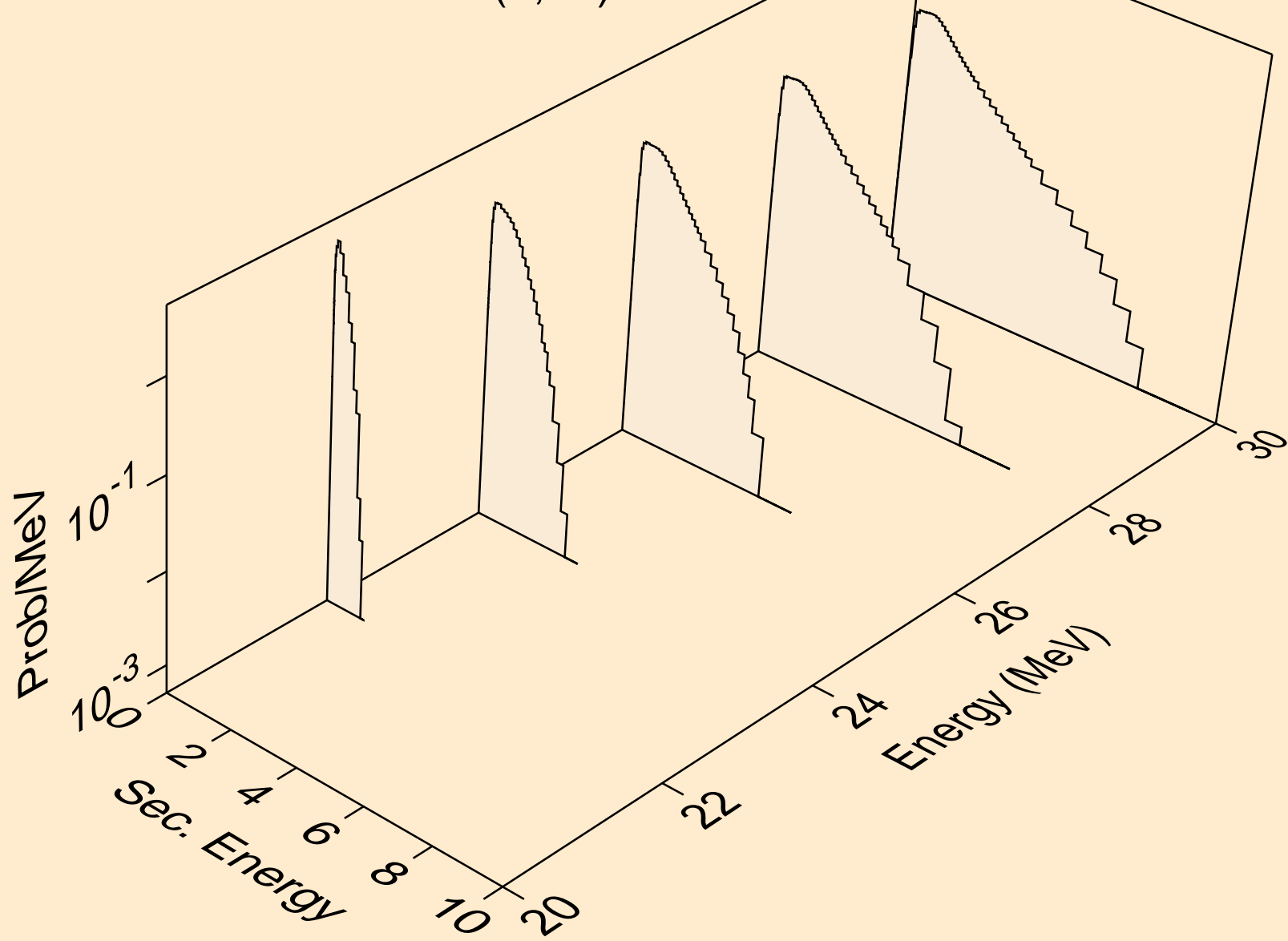

HO166 NEUTRON ACER TENDL-2024 LIBRARY; T=293.6K
Neutron emission for (n,2np)

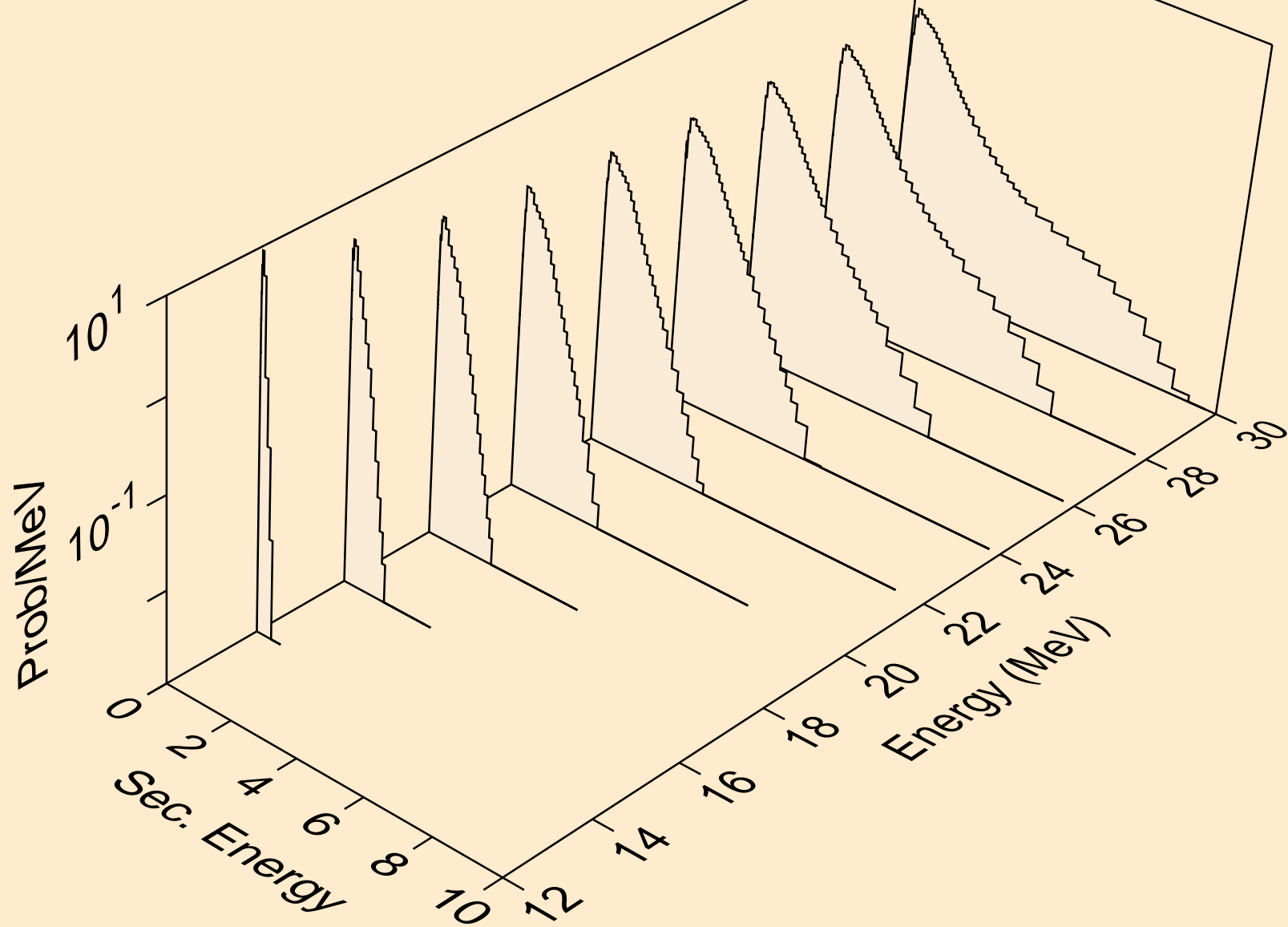

HO166 NEUTRON ACER TENDL-2024 LIBRARY; T=293.6K
Neutron emission for (n,3np)

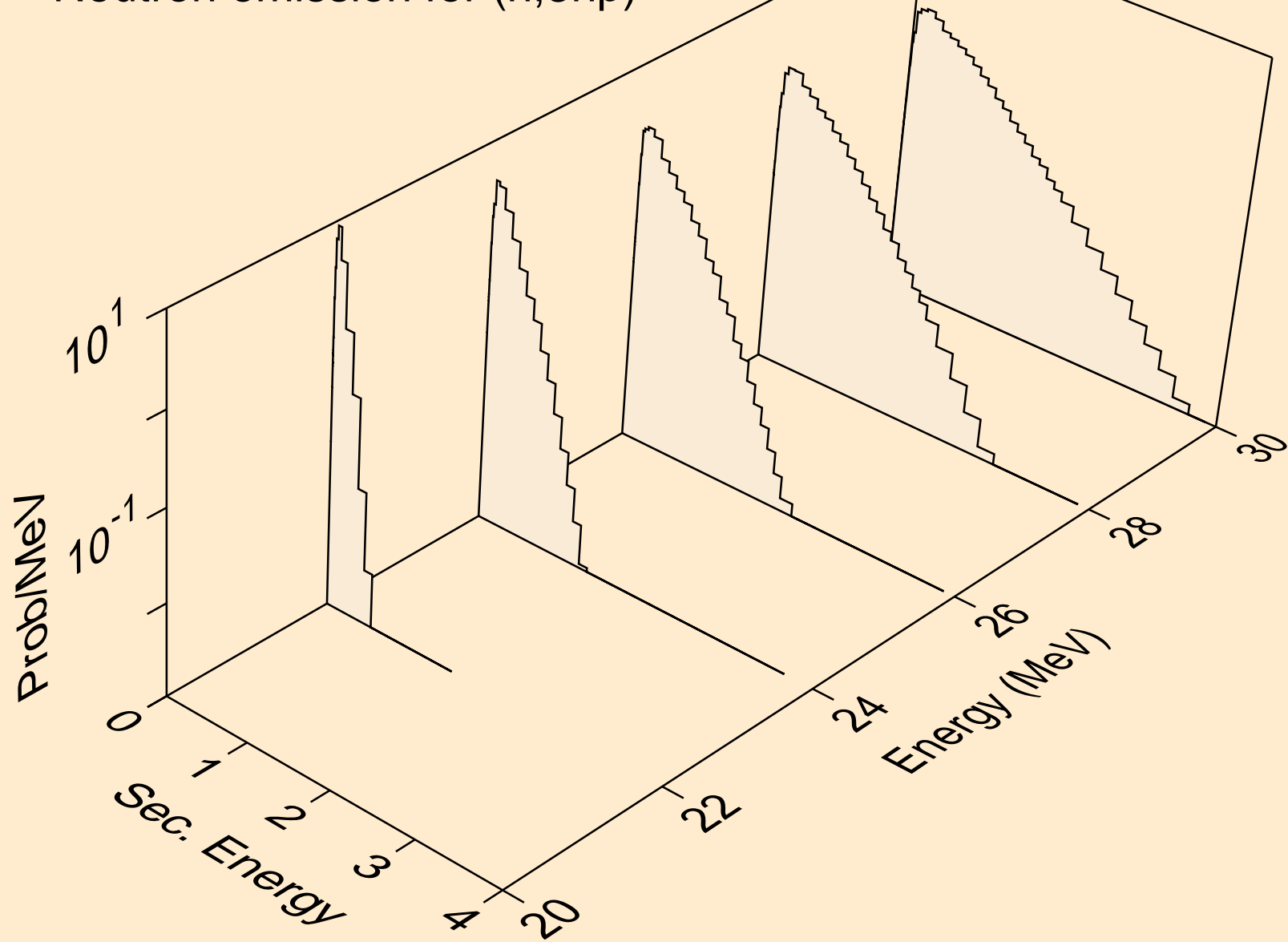

HO166 NEUTRON ACER TENDL-2024 LIBRARY; T=293.6K
Neutron emission for (n,n2p)

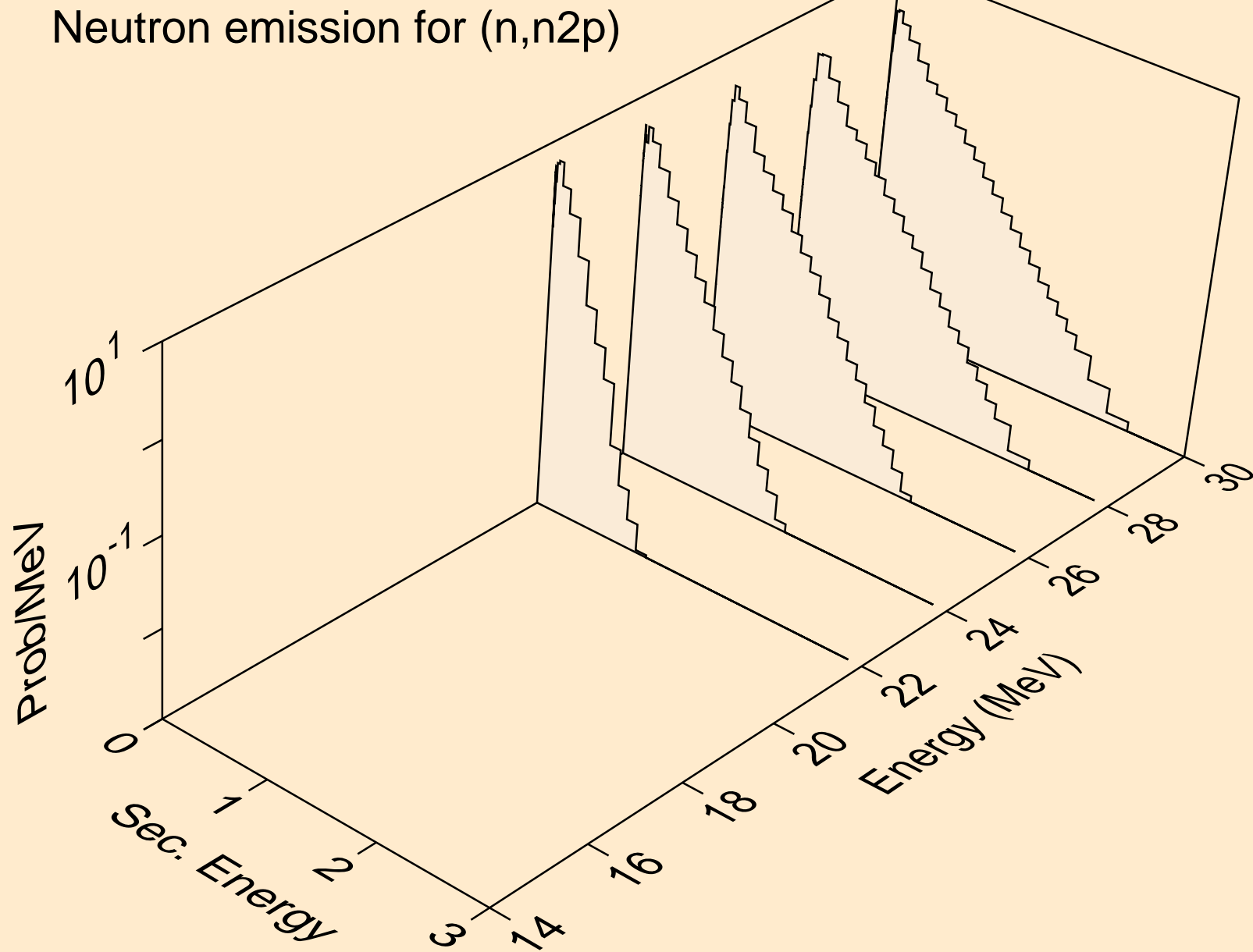

HO166 NEUTRON ACER TENDL-2024 LIBRARY; T=293.6K
Neutron emission for (n,npa)

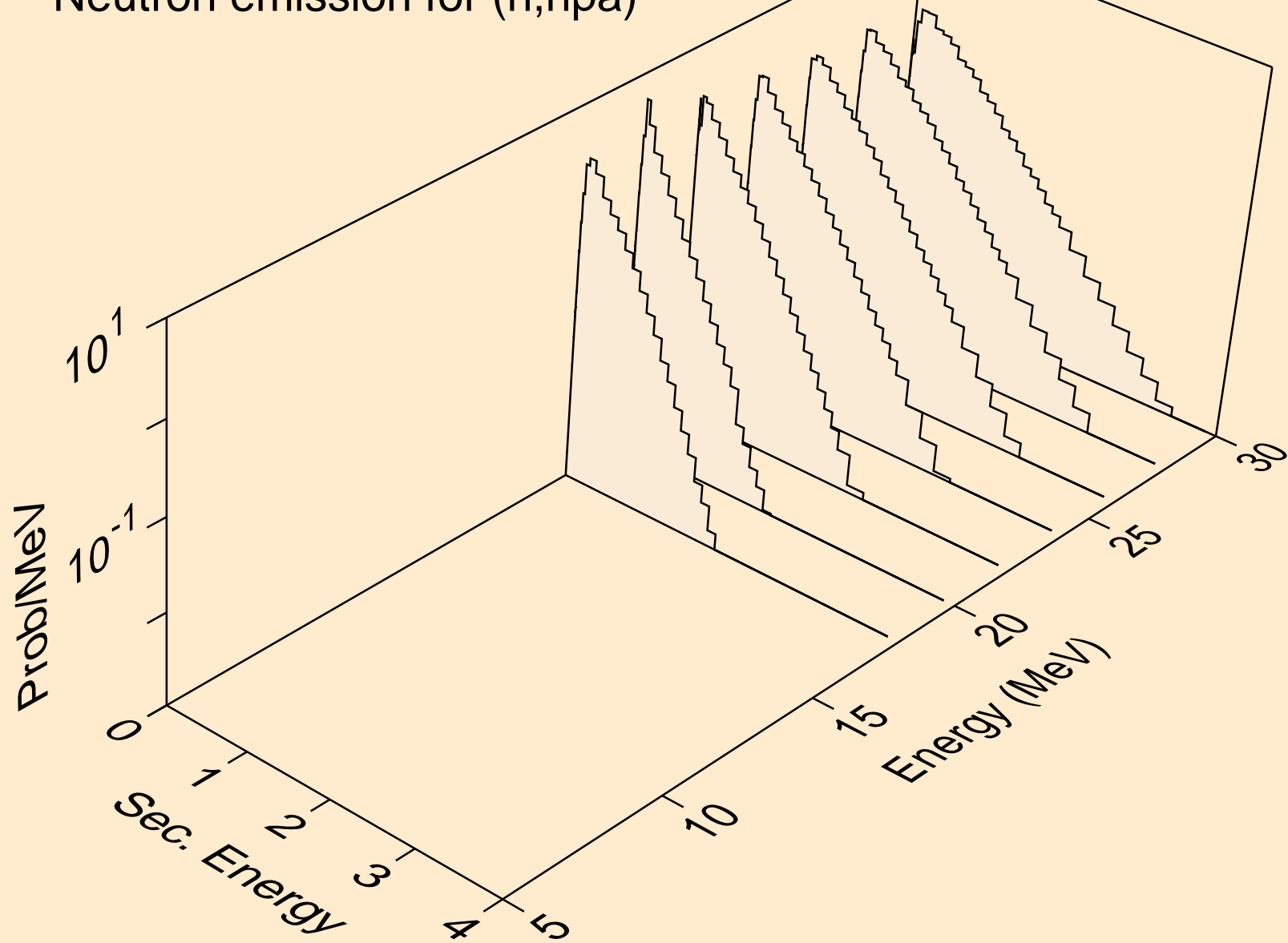

HO166 NEUTRON ACER TENDL-2024 LIBRARY; T=293.6K
Neutron emission for (n,n*c)

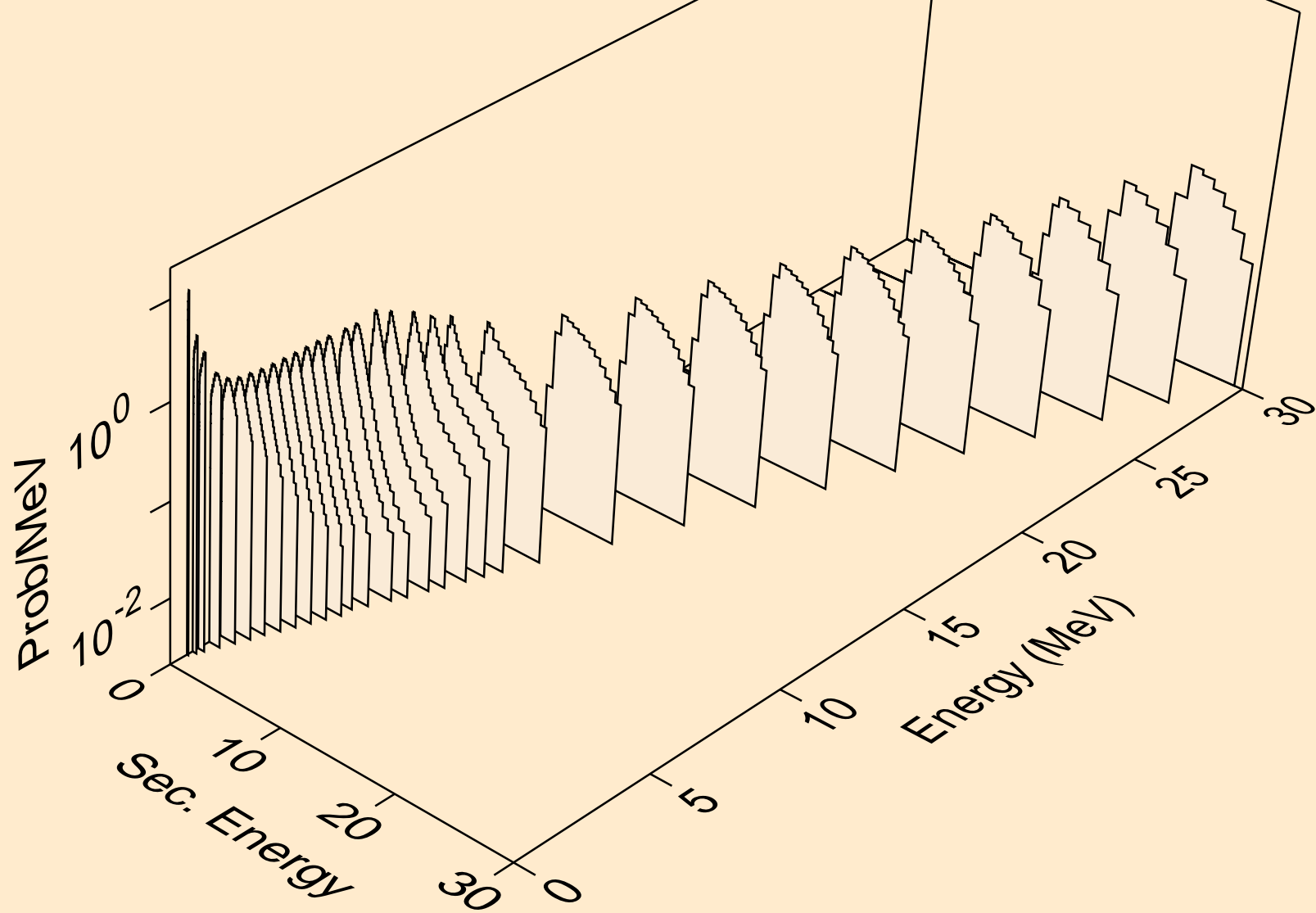

HO166 NEUTRON ACER TENDL-2024 LIBRARY; T=293.6K
Photon emission for (n,x)

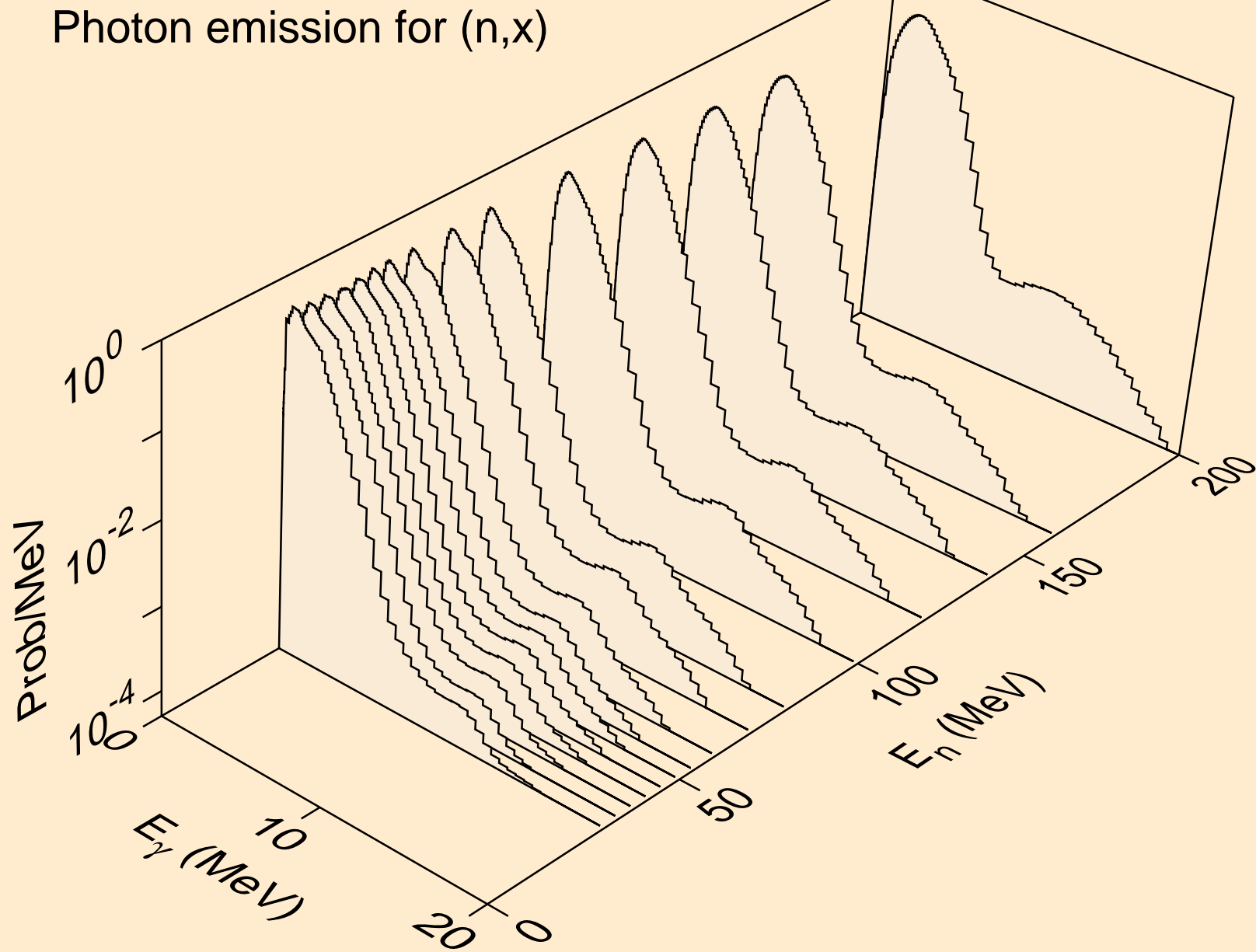

HO166 NEUTRON ACER TENDL-2024 LIBRARY; T=293.6K
Photon emission for (n,2nd)

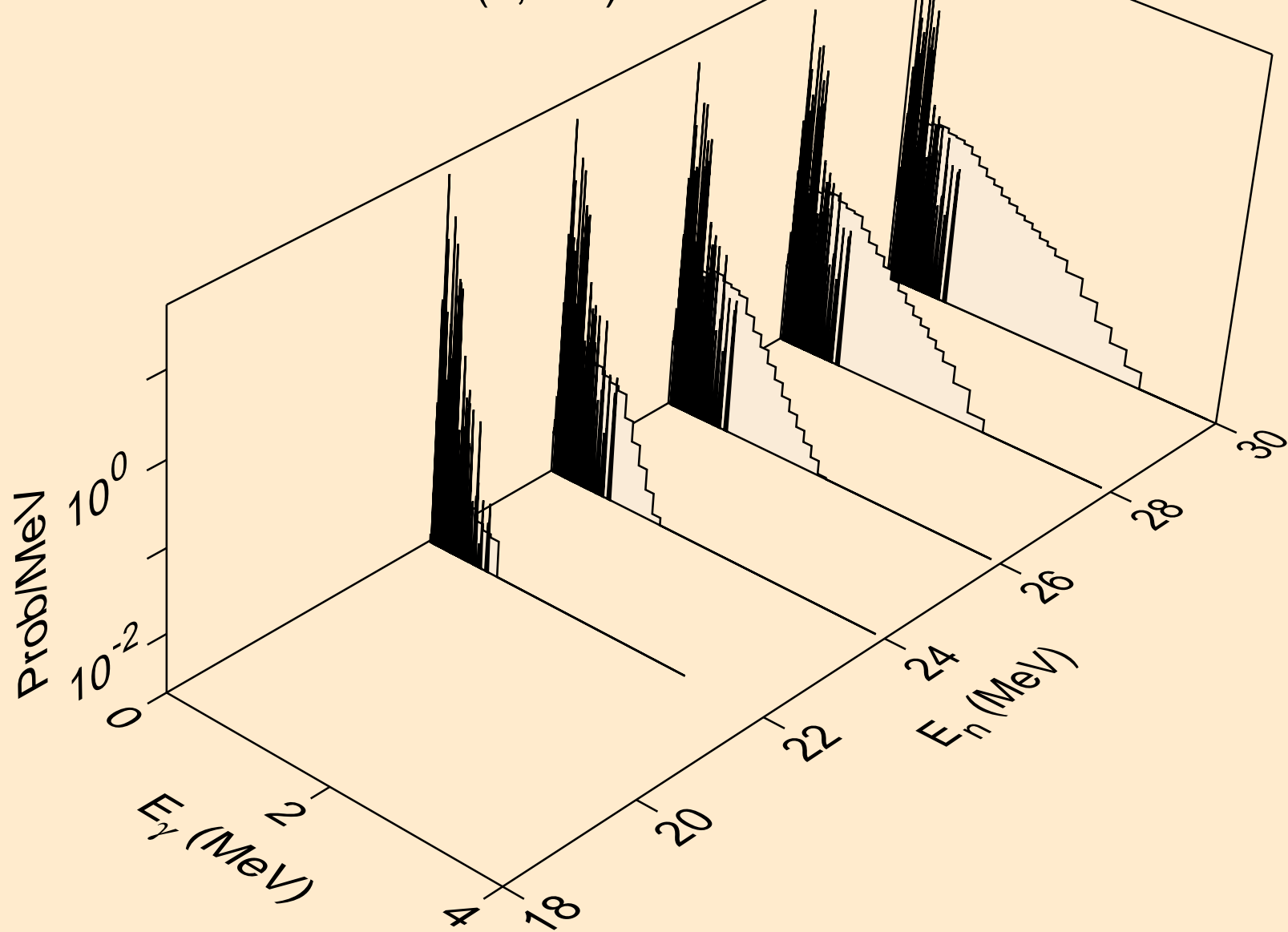

HO166 NEUTRON ACER TENDL-2024 LIBRARY; T=293.6K
Photon emission for (n,2n)

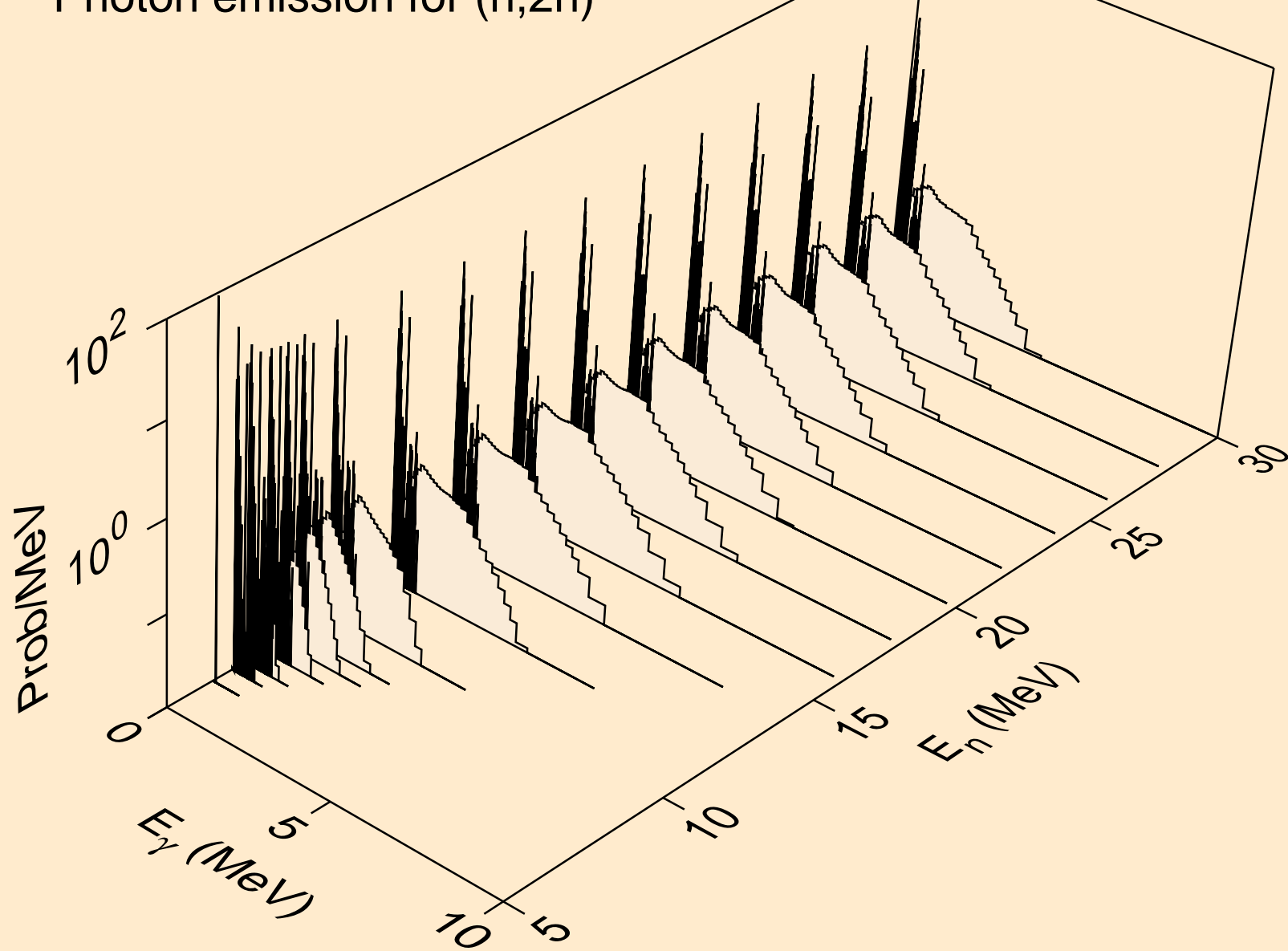

HO166 NEUTRON ACER TENDL-2024 LIBRARY; T=293.6K
Photon emission for (n,3n)

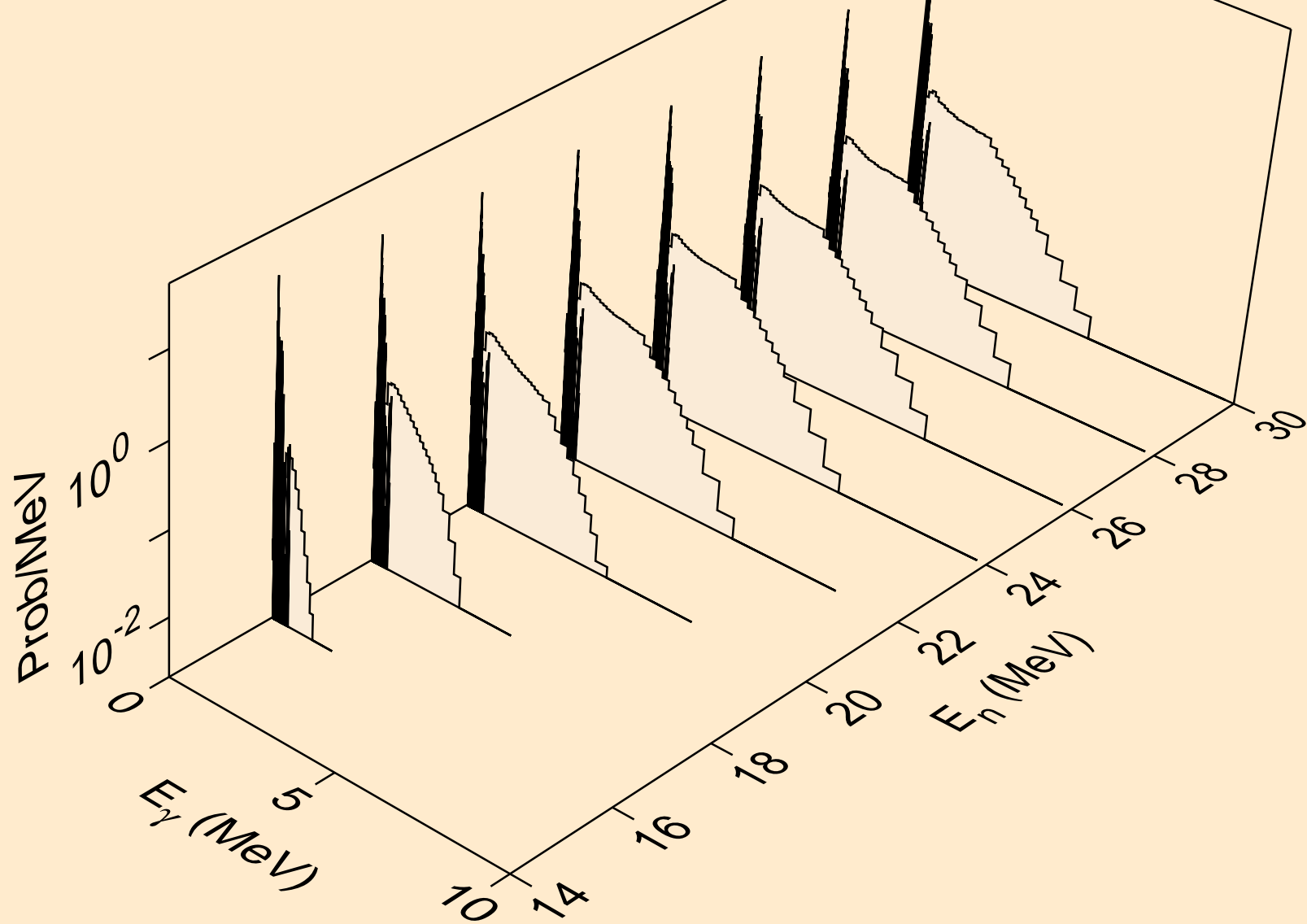

HO166 NEUTRON ACER TENDL-2024 LIBRARY; T=293.6K
Photon emission for (n,n*)a

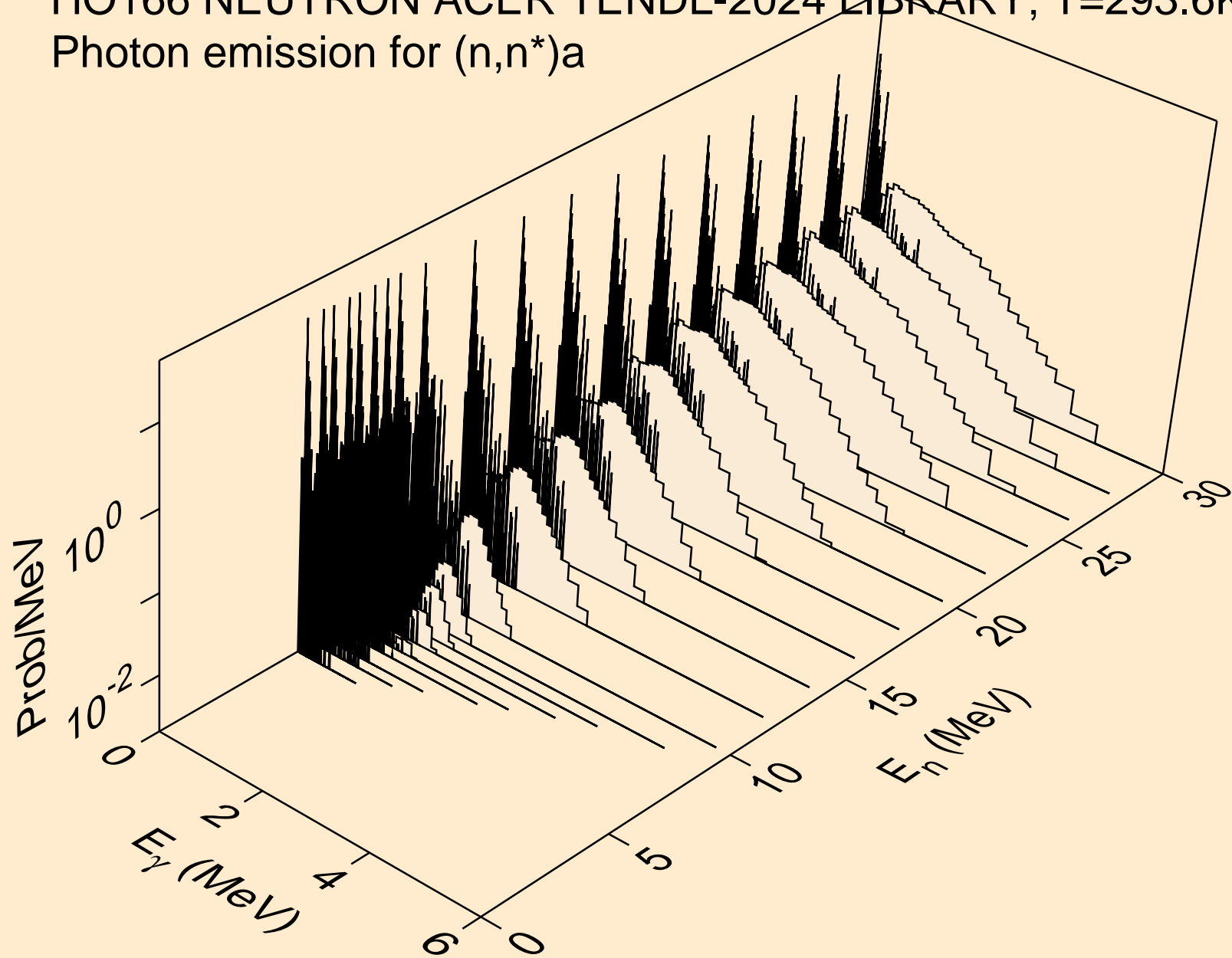

HO166 NEUTRON ACER TENDL-2024 LIBRARY; T=293.6K
Photon emission for (n,2n)a

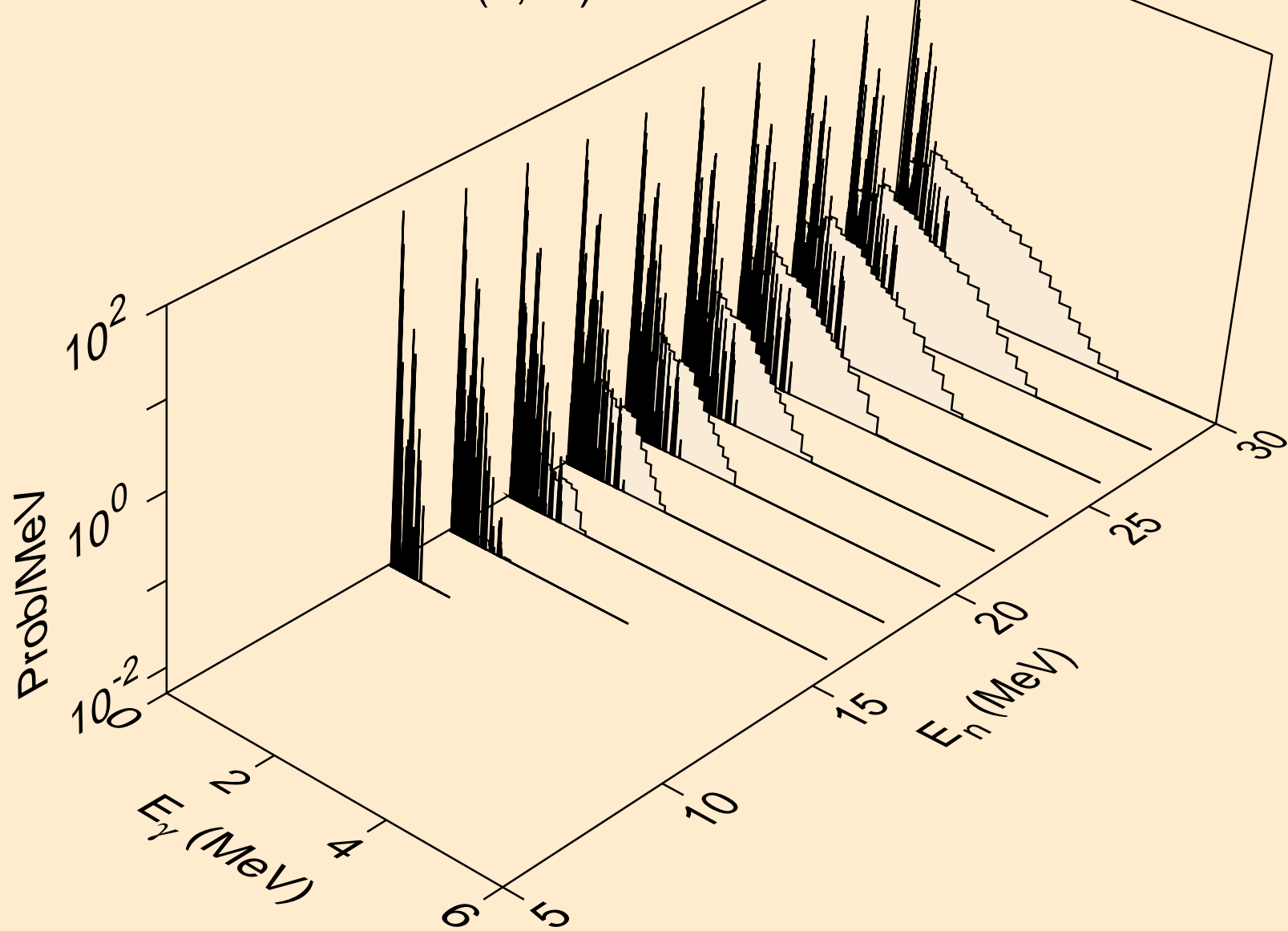

HO166 NEUTRON ACER TENDL-2024 LIBRARY; T=293.6K
Photon emission for (n,3n)a

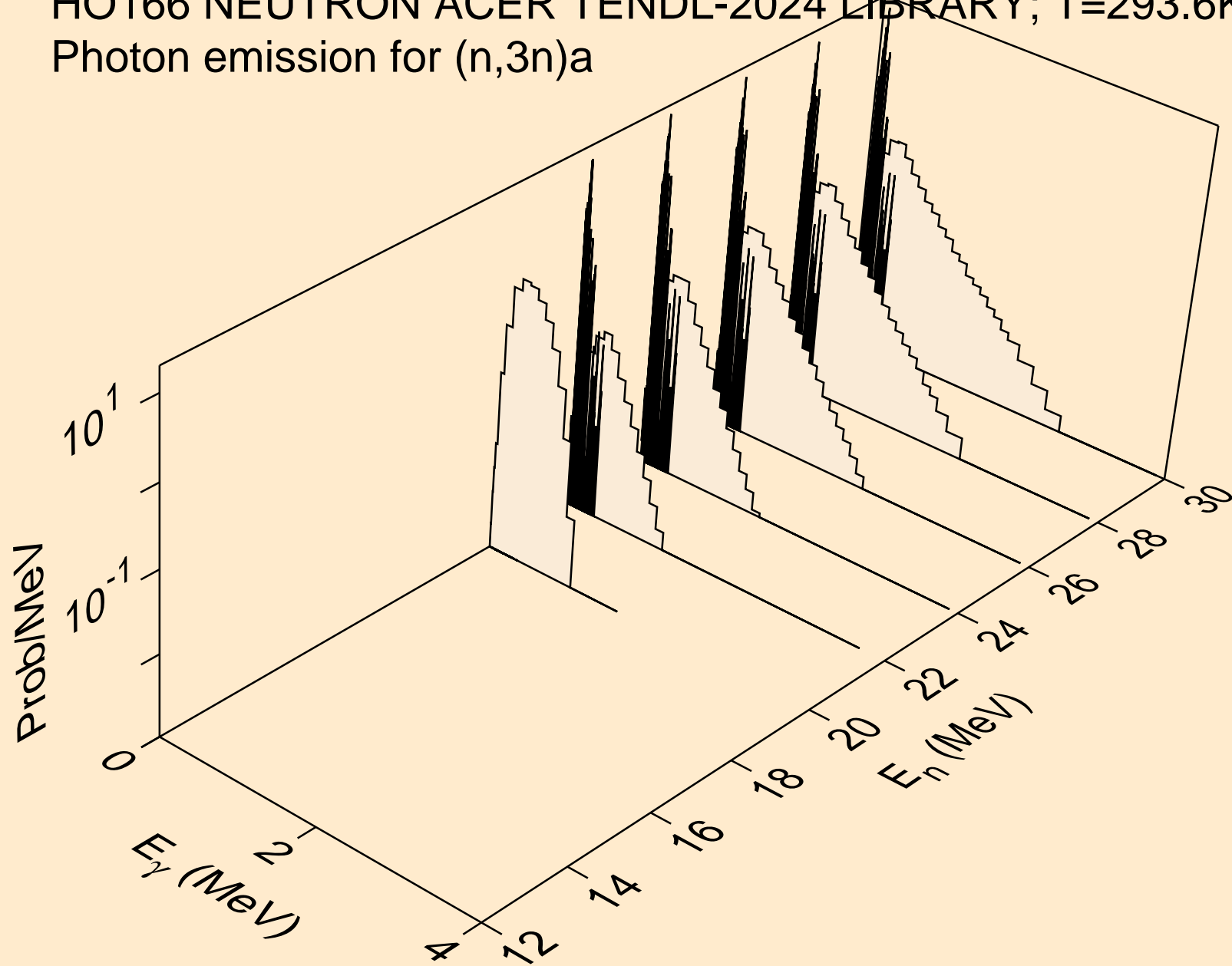

HO166 NEUTRON ACER TENDL-2024 LIBRARY; T=293.6K
Photon emission for (n,n*)p

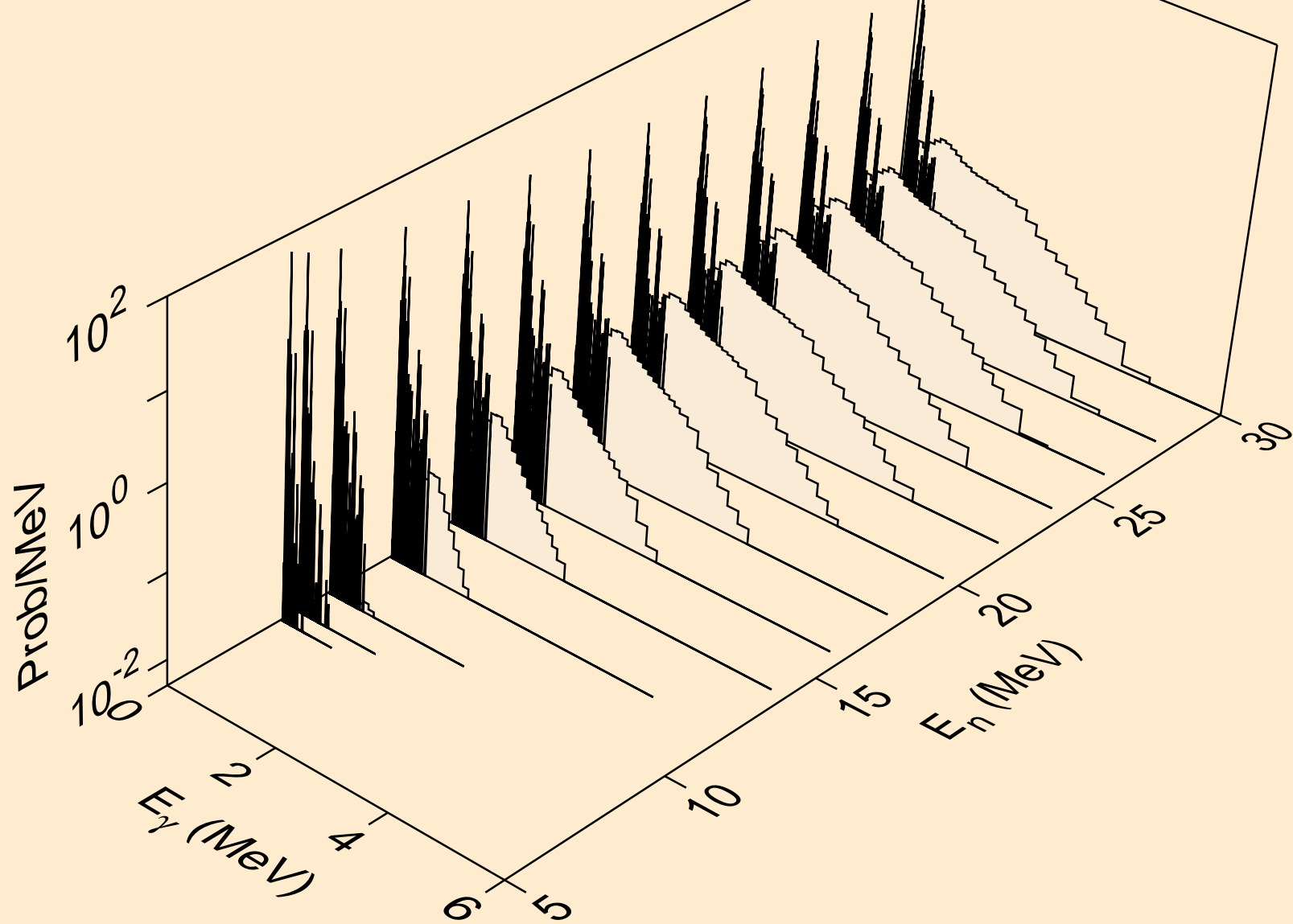

HO166 NEUTRON ACER TENDL-2024 LIBRARY; T=293.6K
Photon emission for (n,n*)d

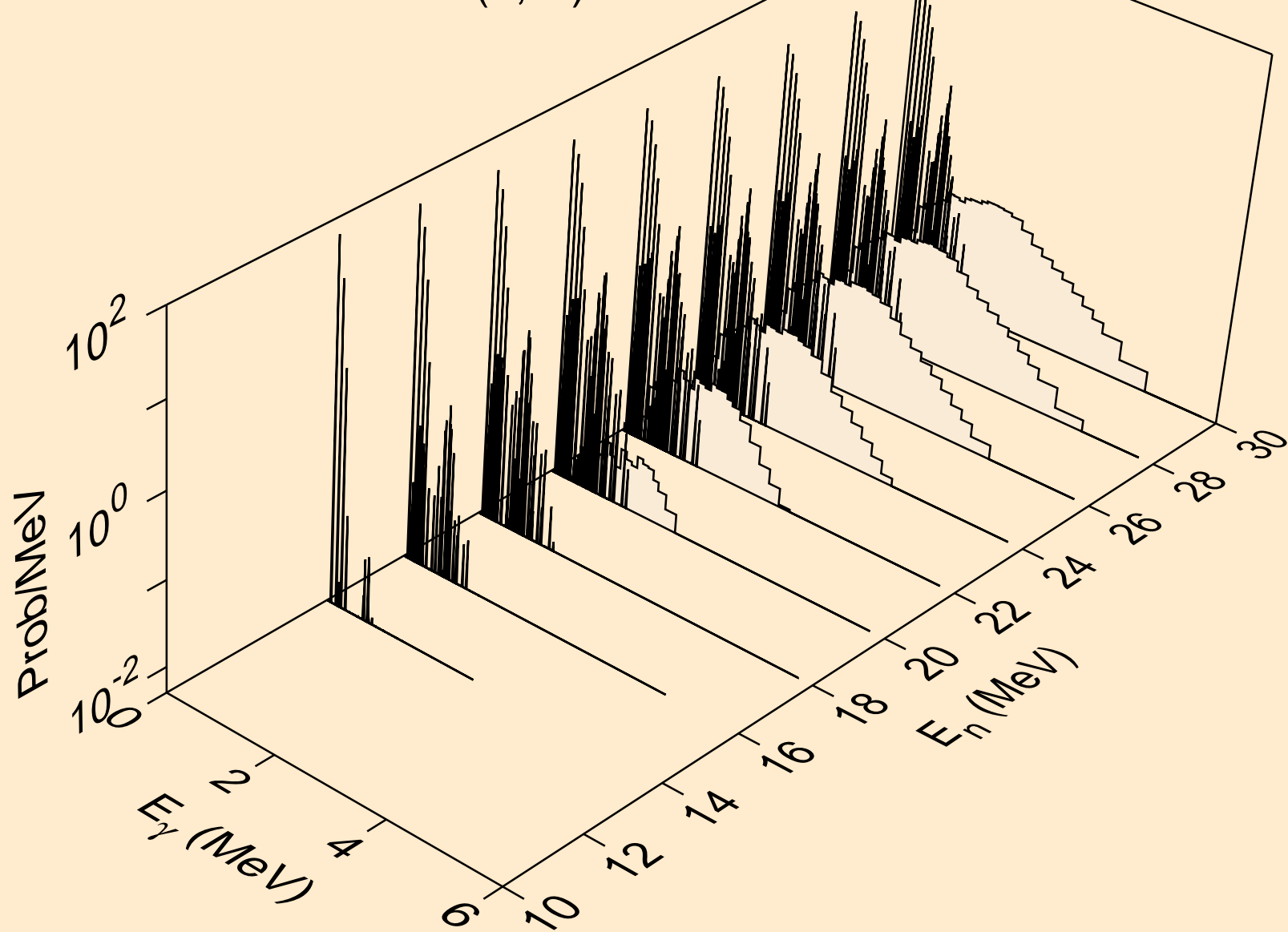

HO166 NEUTRON ACER TENDL-2024 LIBRARY; T=293.6K
Photon emission for (n,n*)t

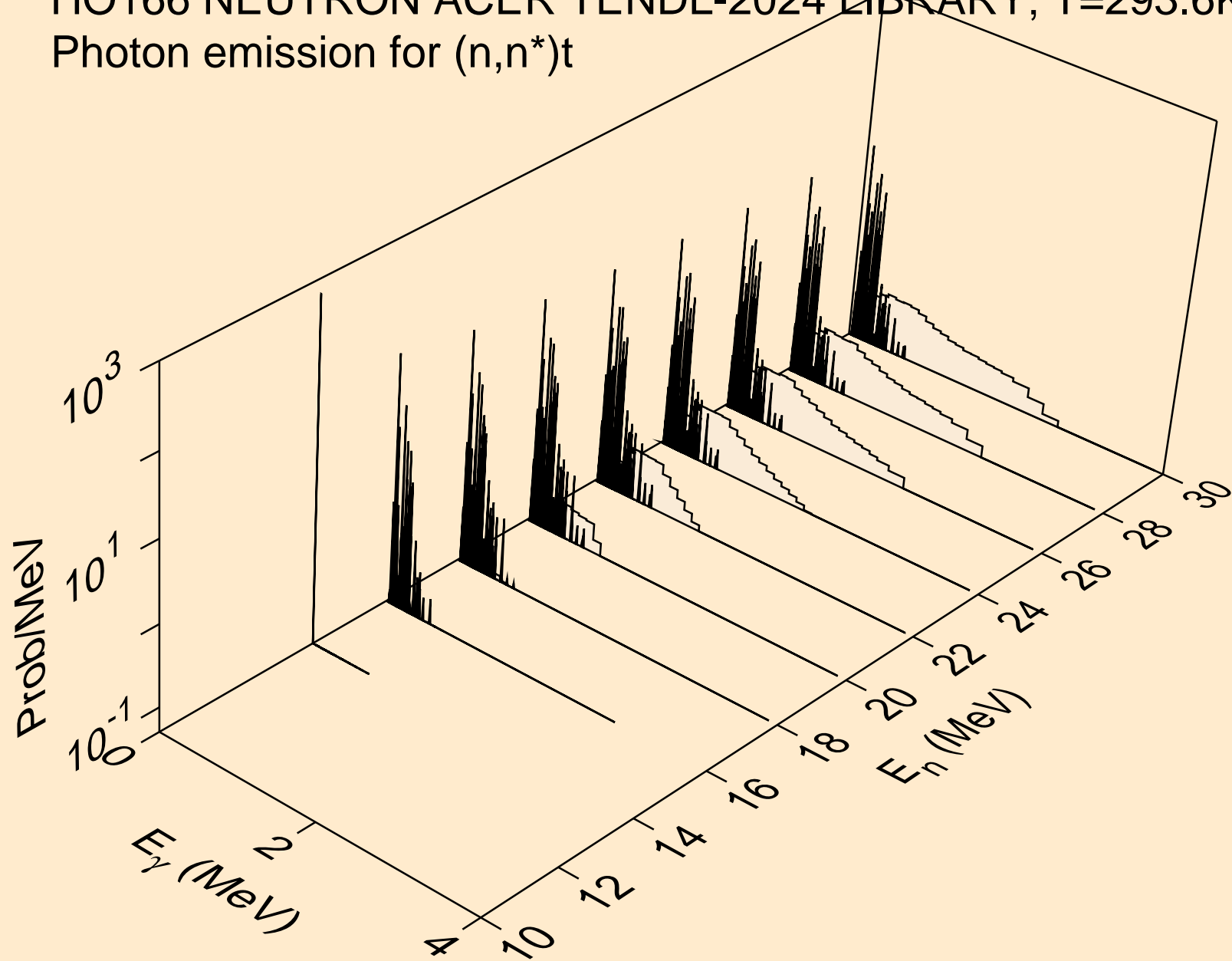

HO166 NEUTRON ACER TENDL-2024 LIBRARY; T=293.6K
Photon emission for (n,n*)he3

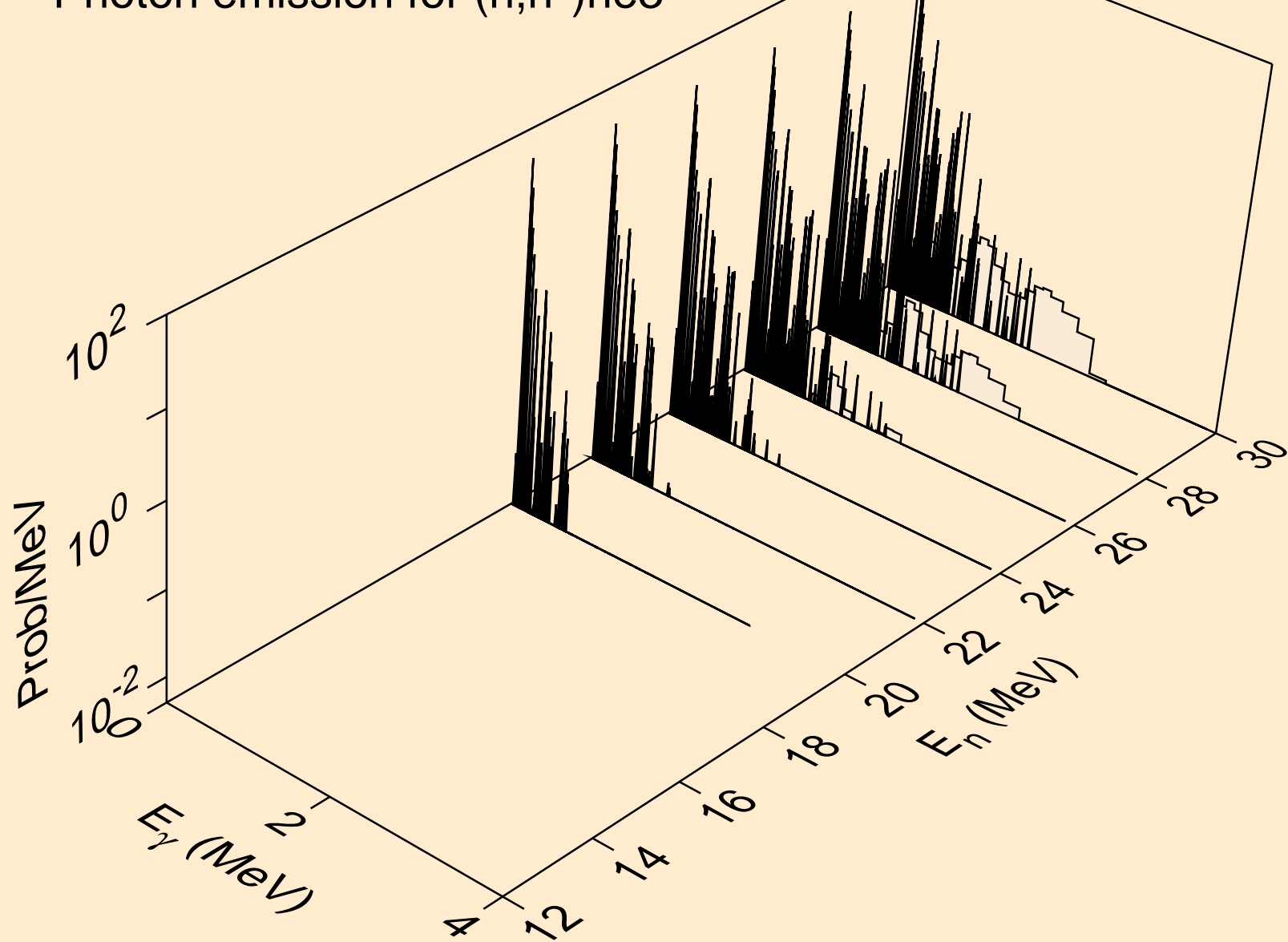

HO166 NEUTRON ACER TENDL-2024 LIBRARY; T=293.6K
Photon emission for (n,4n)

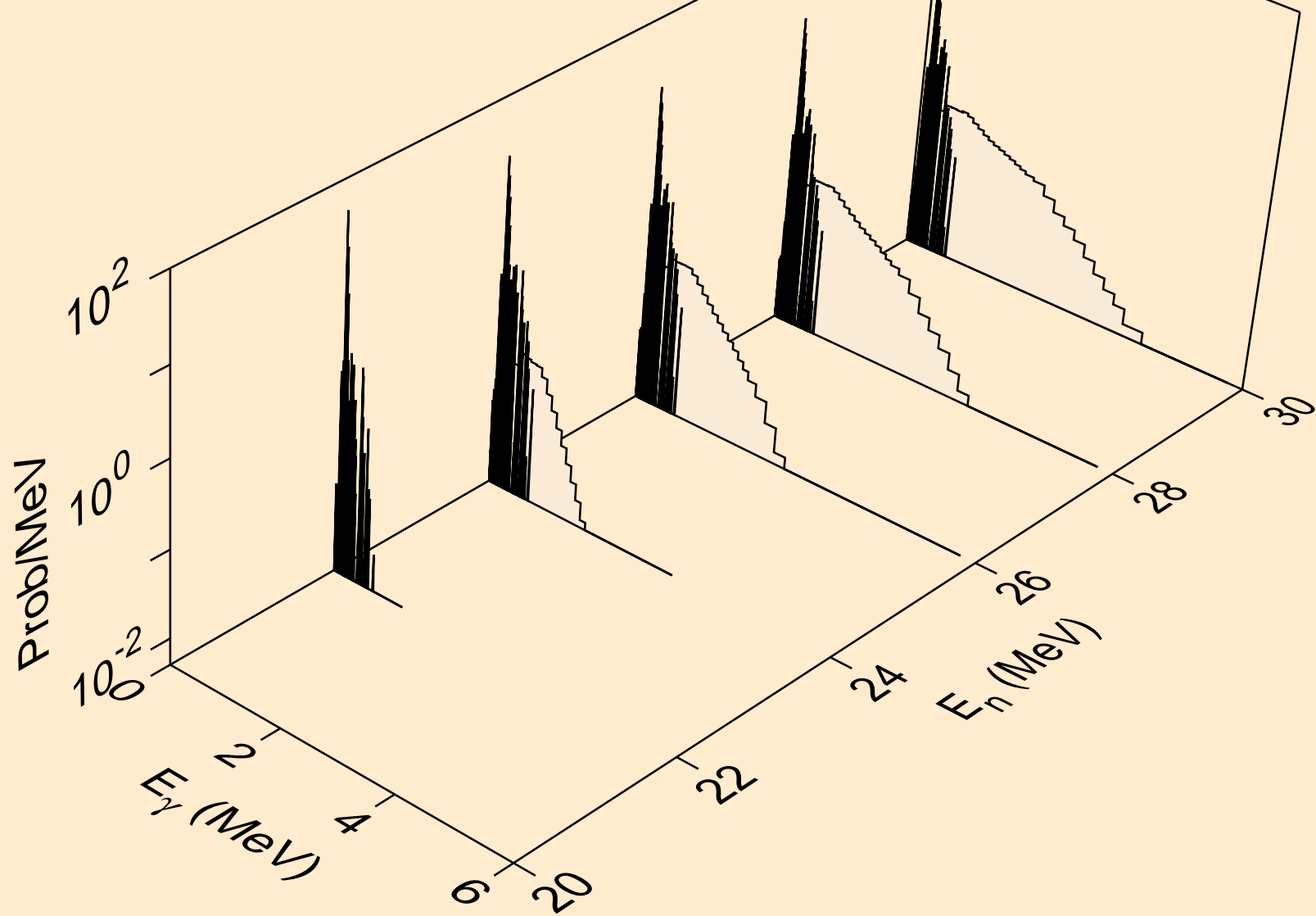

HO166 NEUTRON ACER TENDL-2024 LIBRARY; T=293.6K
Photon emission for (n,2np)

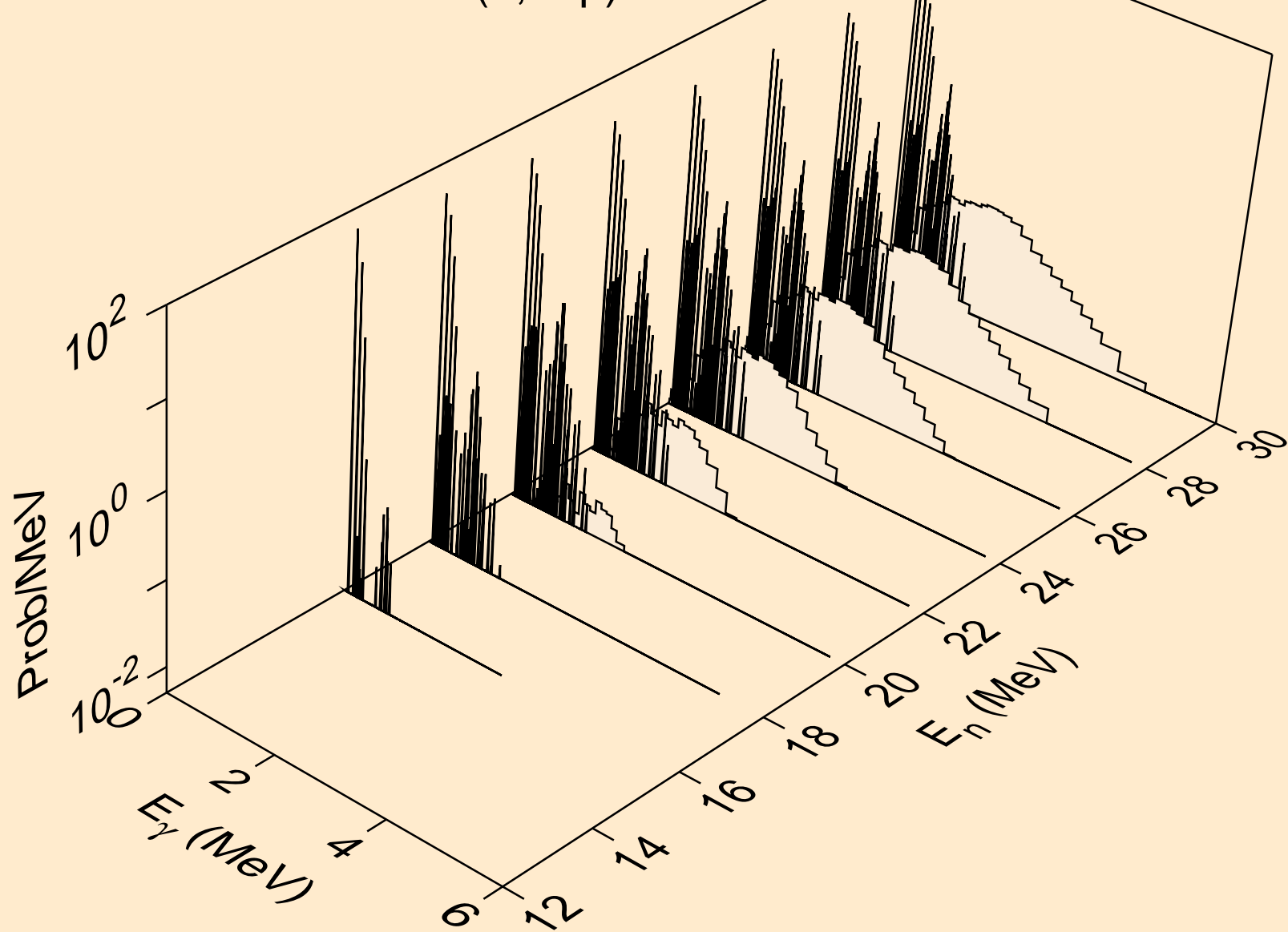

HO166 NEUTRON ACER TENDL-2024 LIBRARY; T=293.6K
Photon emission for (n,3np)

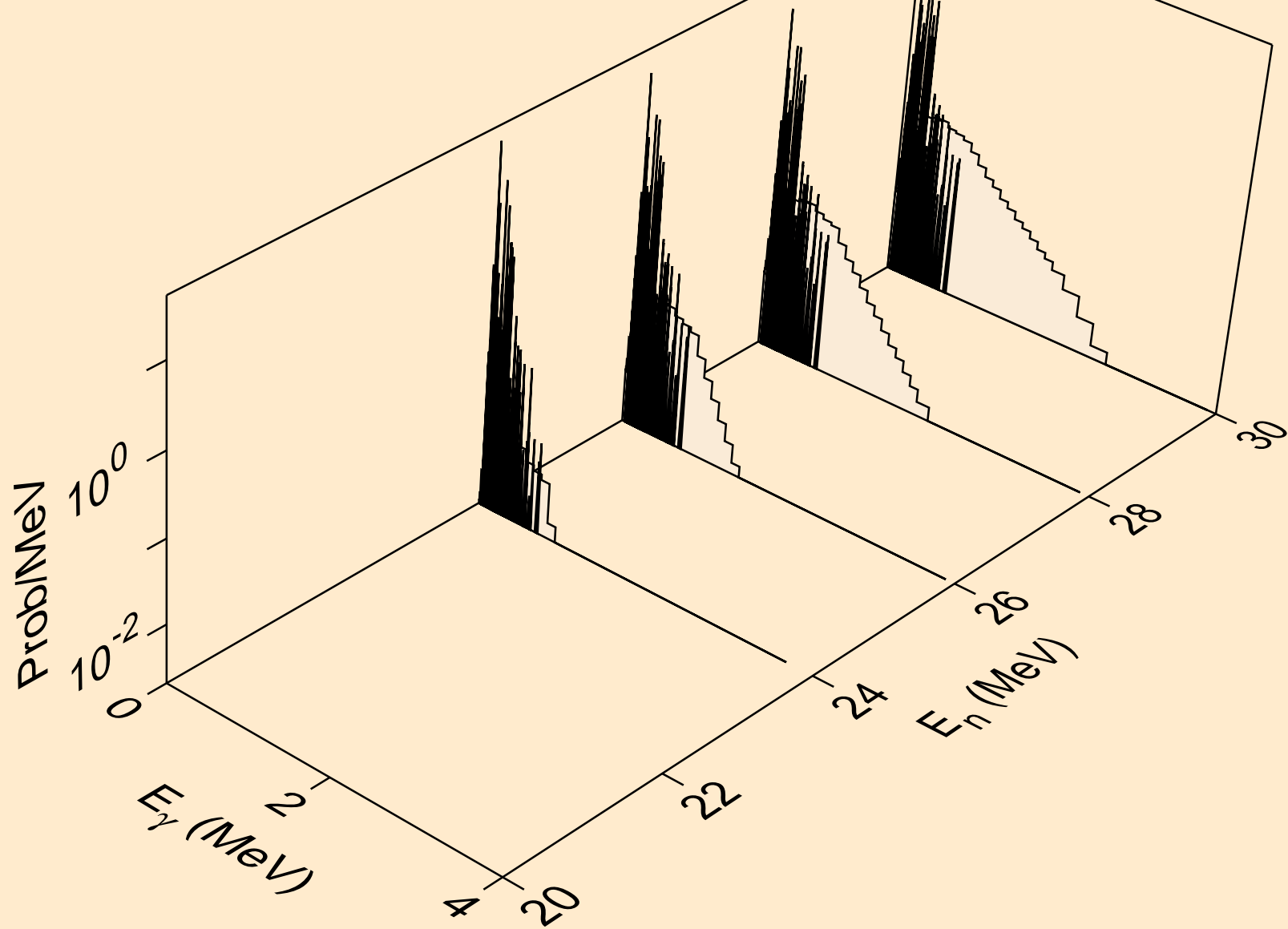

HO166 NEUTRON ACER TENDL-2024 LIBRARY; T=293.6K
Photon emission for (n,n2p)

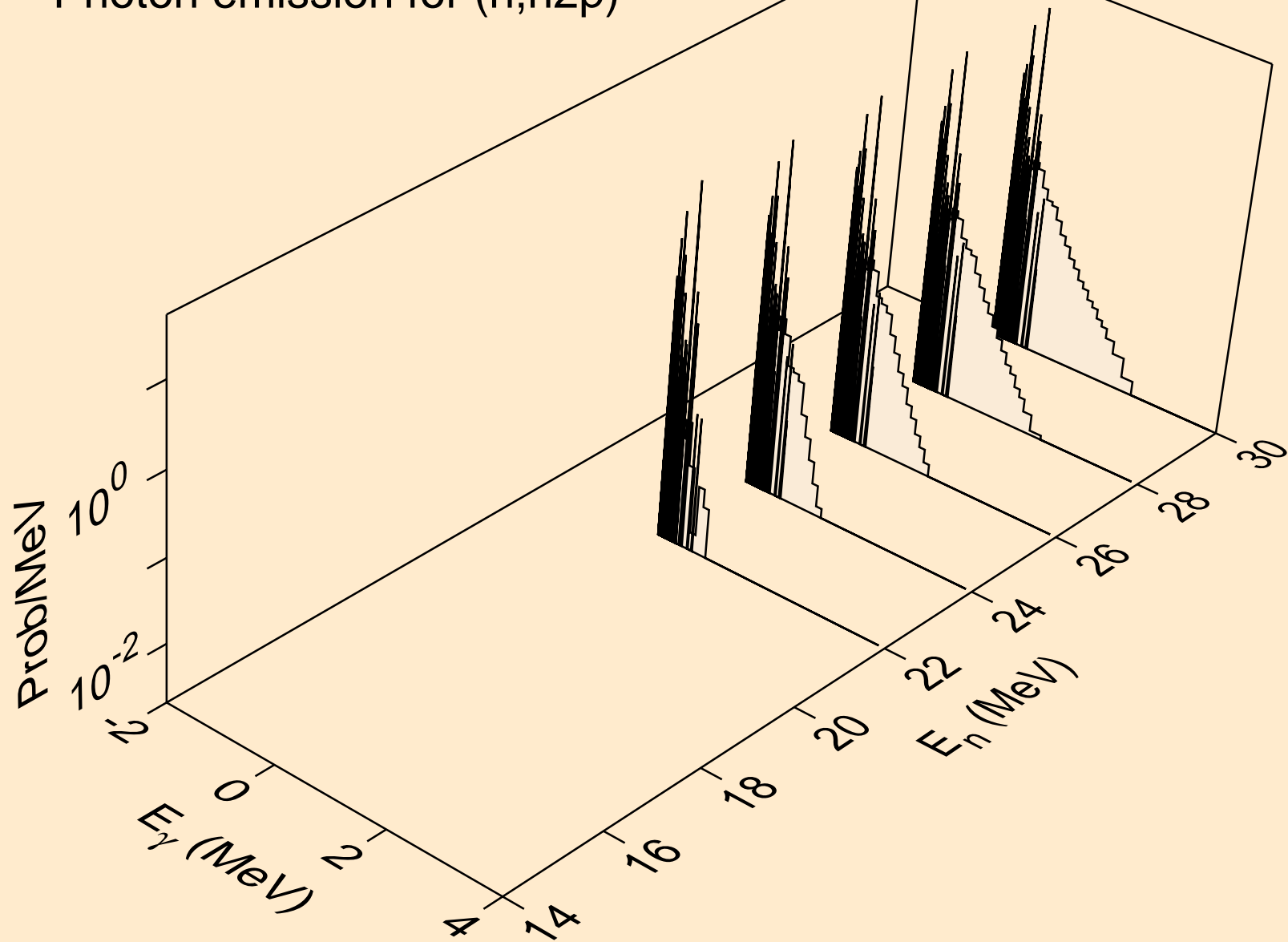

HO166 NEUTRON ACER TENDL-2024 LIBRARY; T=293.6K
Photon emission for (n,npa)

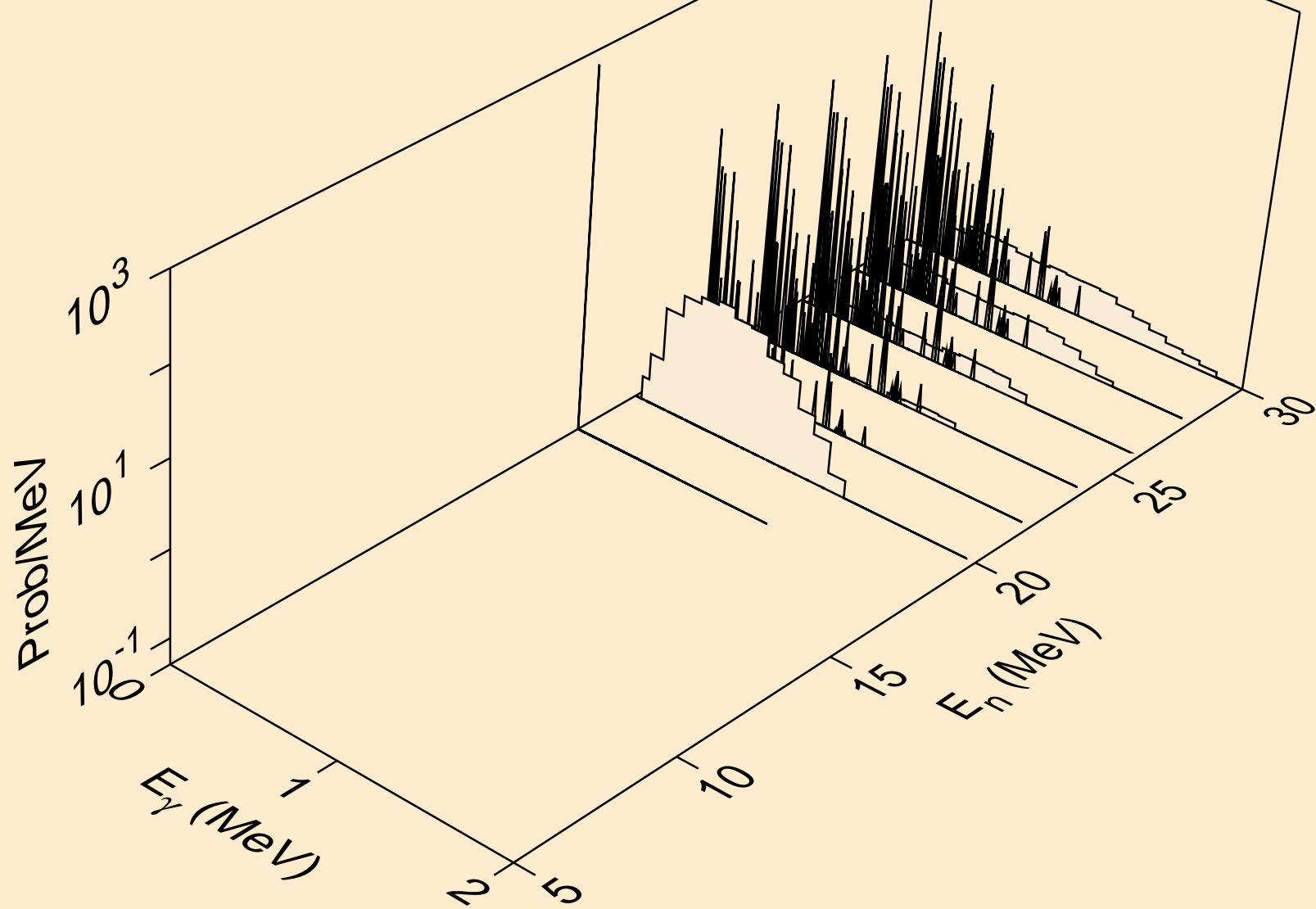

HO166 NEUTRON ACER TENDL-2024 LIBRARY; T=293.6K
Photon emission for (n,n*c)

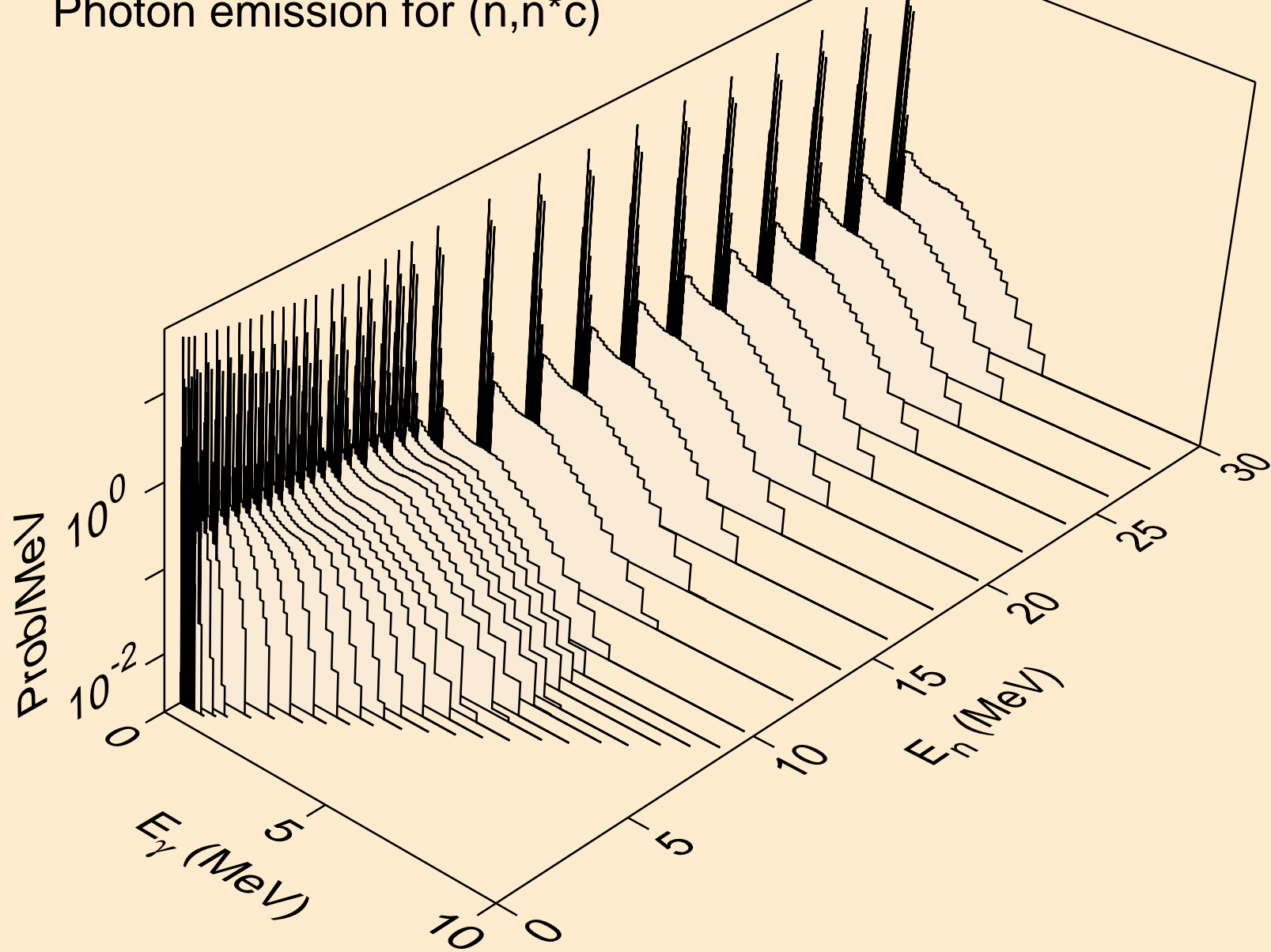

HO166 NEUTRON ACER TENDL-2024 LIBRARY; T=293.6K
Photon emission for (n,gma)

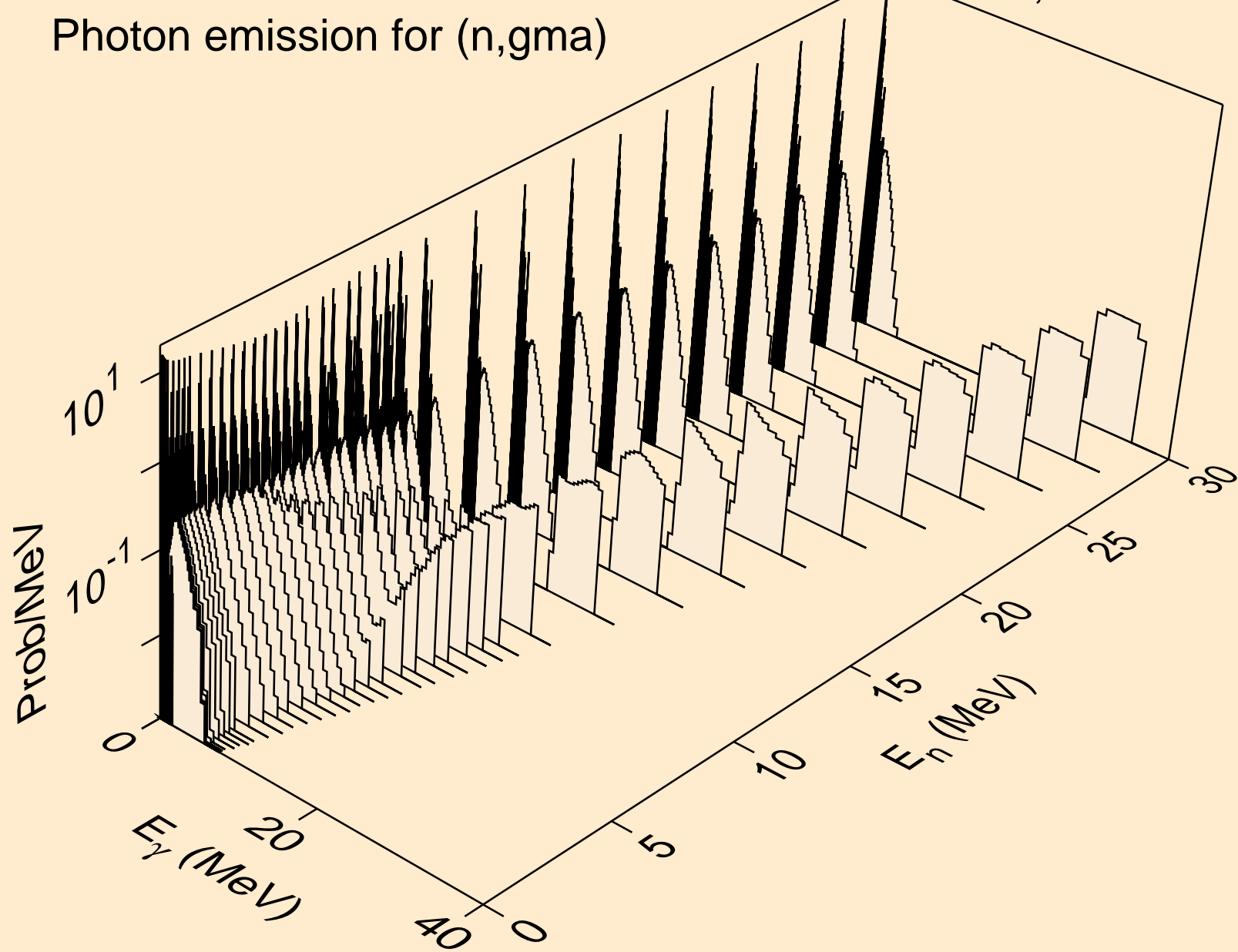

HO166 NEUTRON ACER TENDL-2024 LIBRARY; T=293.6K
Photon emission for (n,p)

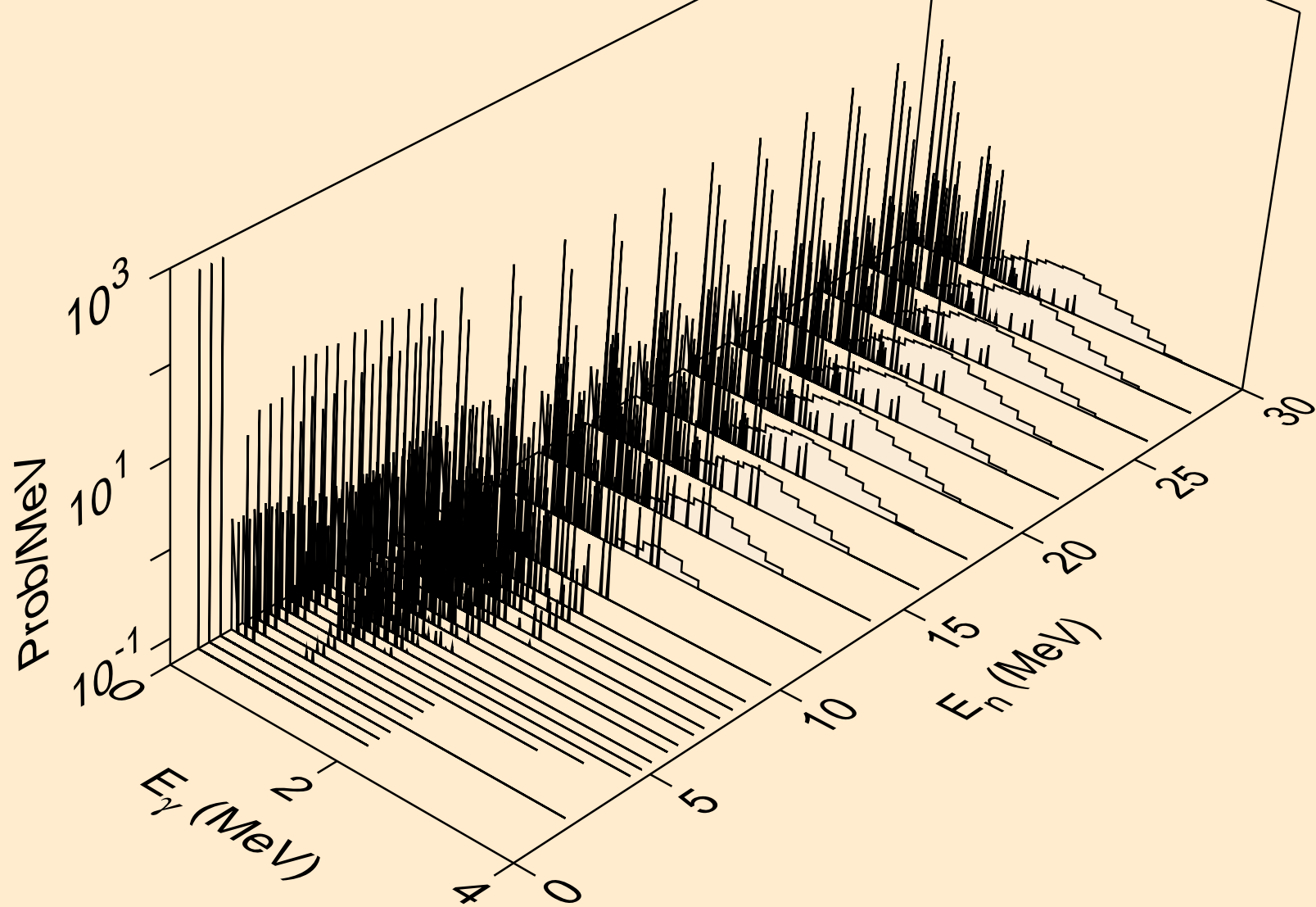

HO166 NEUTRON ACER TENDL-2024 LIBRARY; T=293.6K
Photon emission for (n,d)

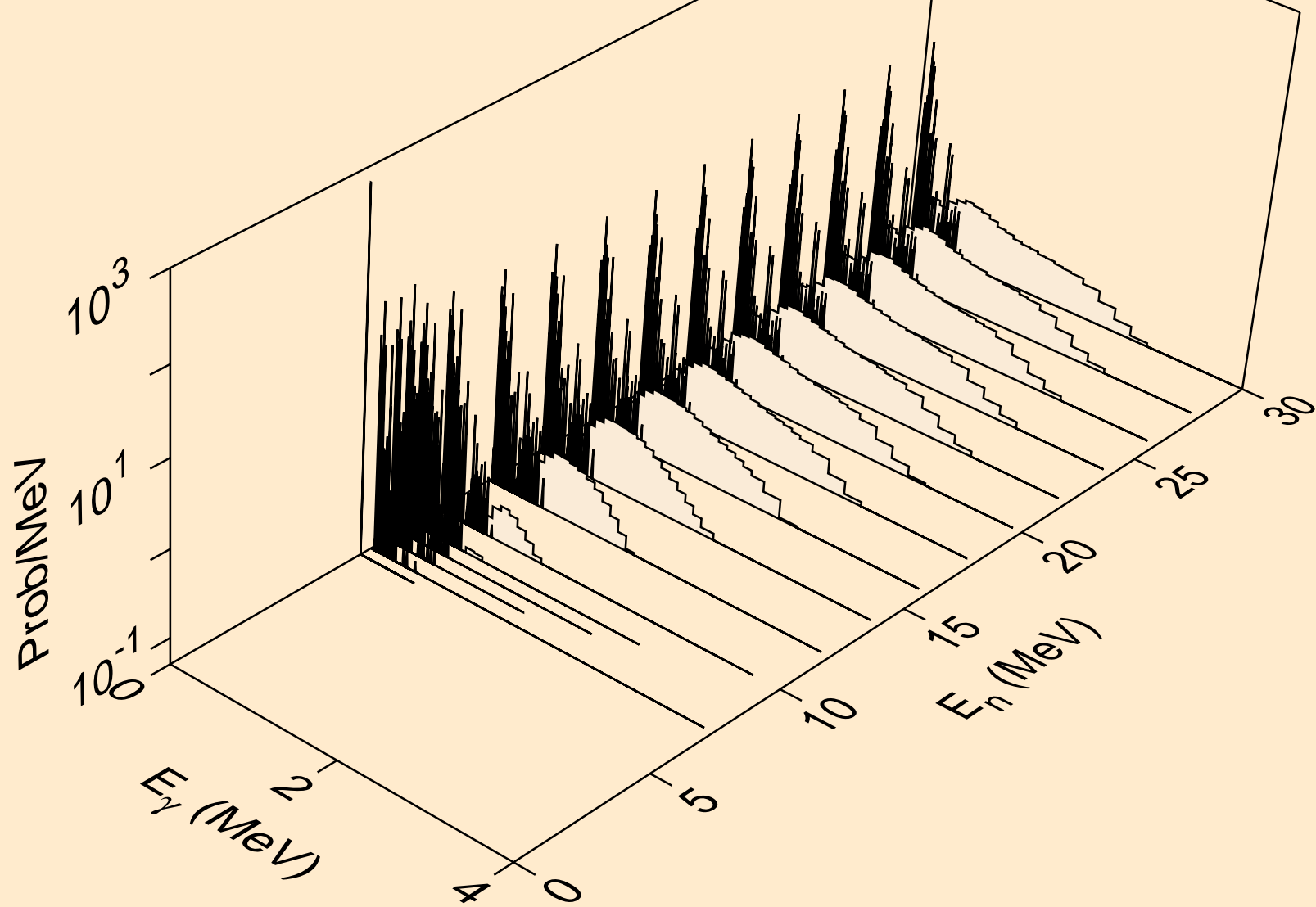

HO166 NEUTRON ACER TENDL-2024 LIBRARY; T=293.6K
Photon emission for (n,t)

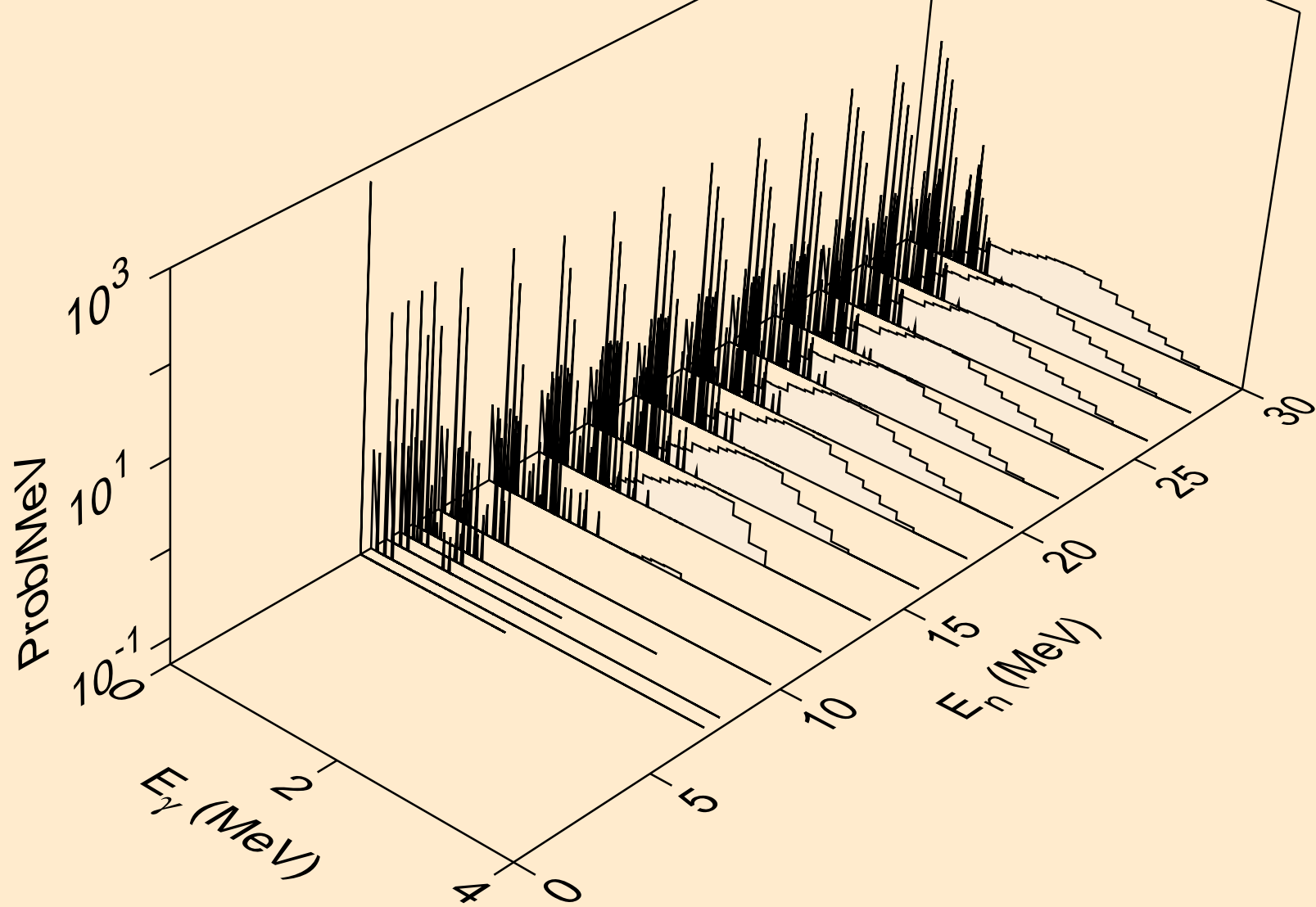

HO166 NEUTRON ACER TENDL-2024 LIBRARY; T=293.6K
Photon emission for (n,he3)

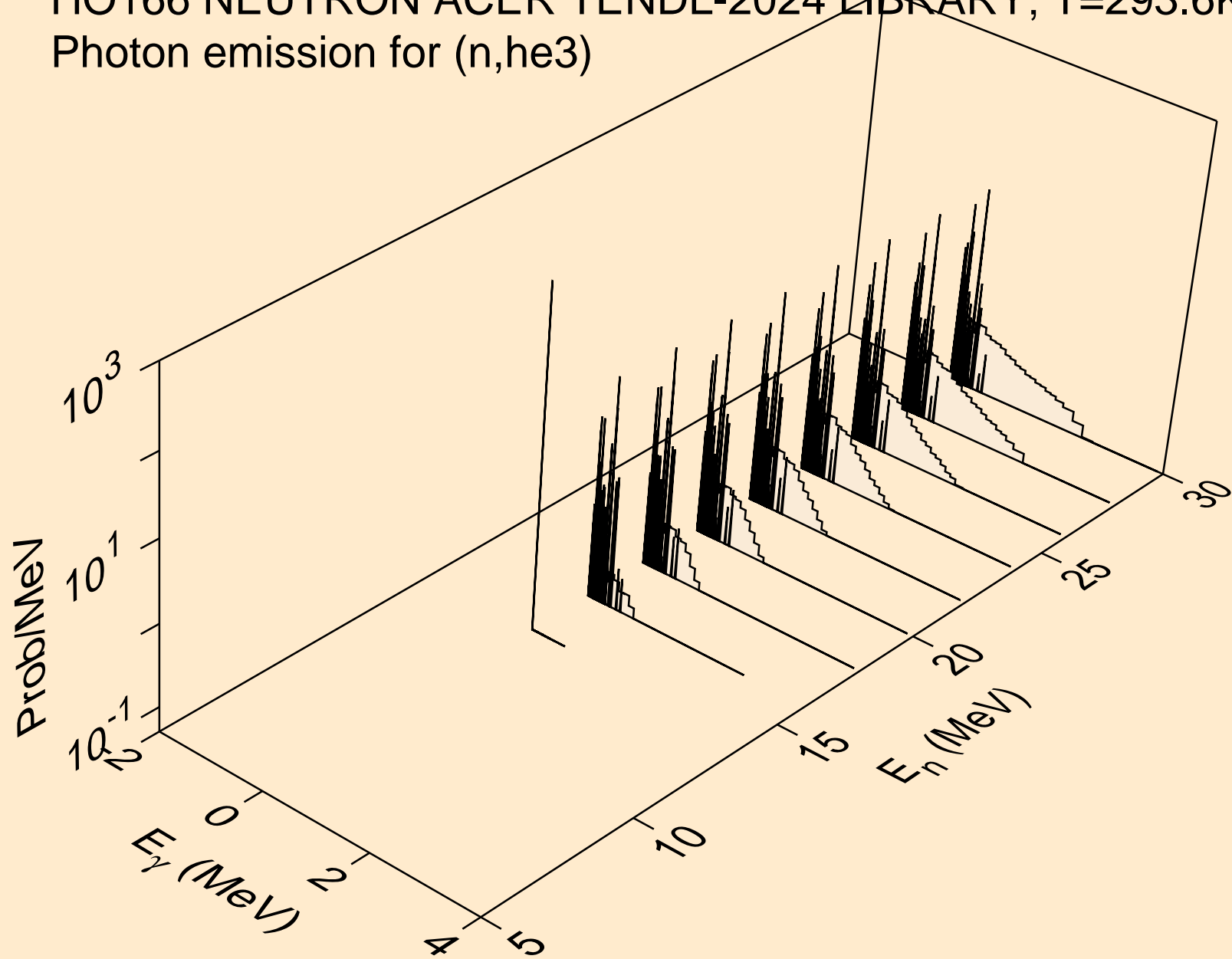

HO166 NEUTRON ACER TENDL-2024 LIBRARY; T=293.6K
Photon emission for (n,a)

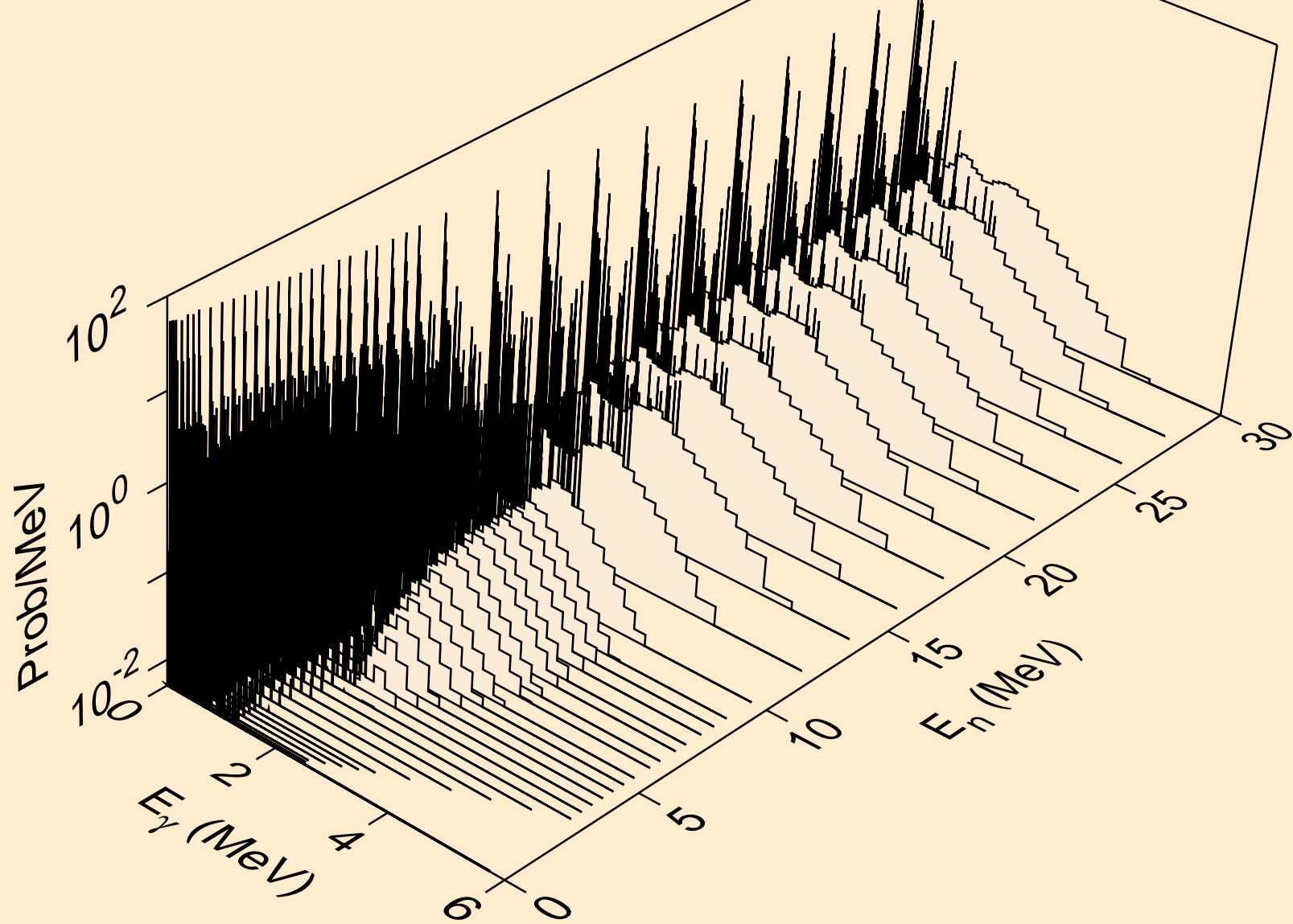

HO166 NEUTRON ACER TENDL-2024 LIBRARY; T=293.6K
Photon emission for (n,2a)

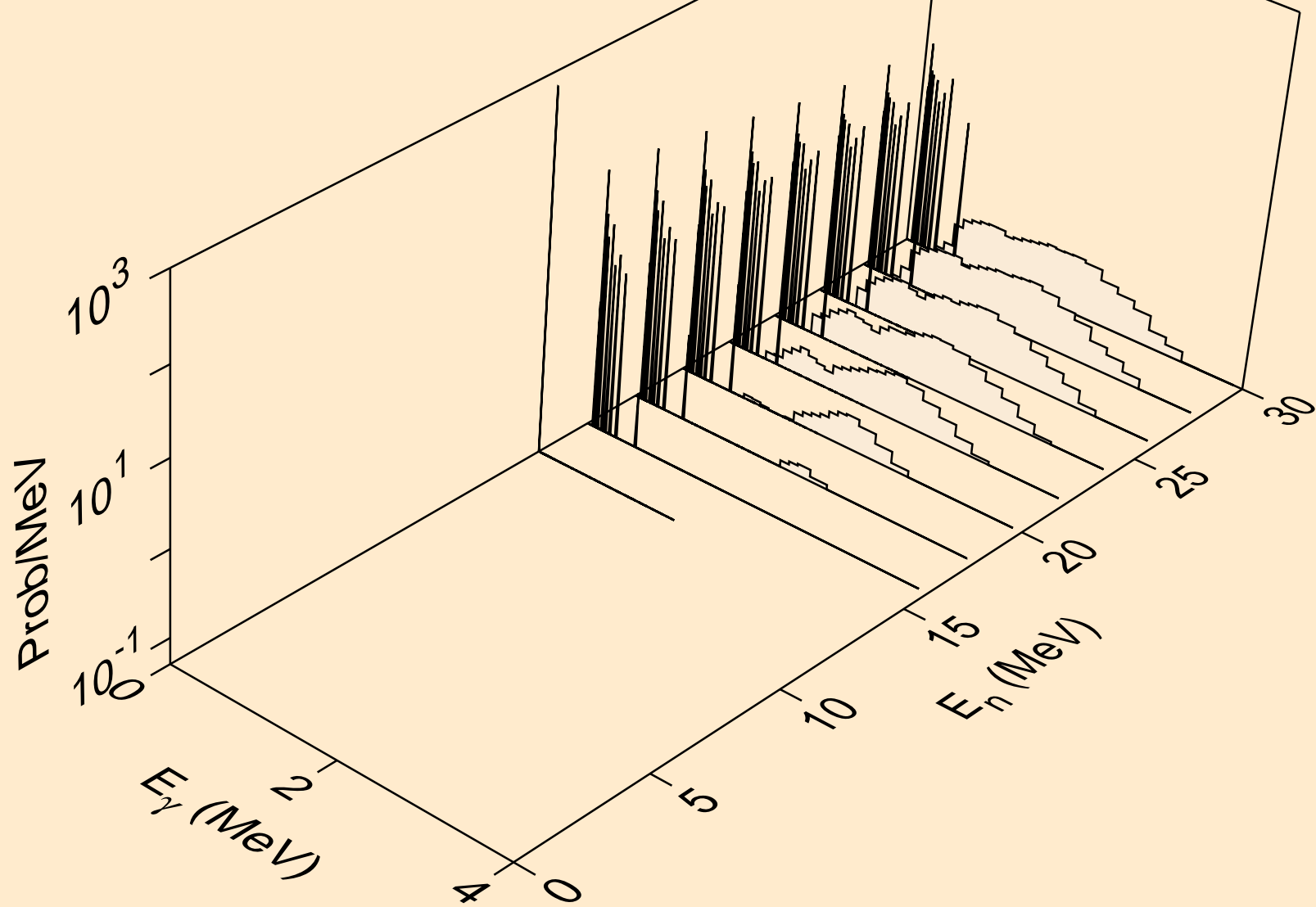

HO166 NEUTRON ACER TENDL-2024 LIBRARY; T=293.6K
Photon emission for (n,2p)

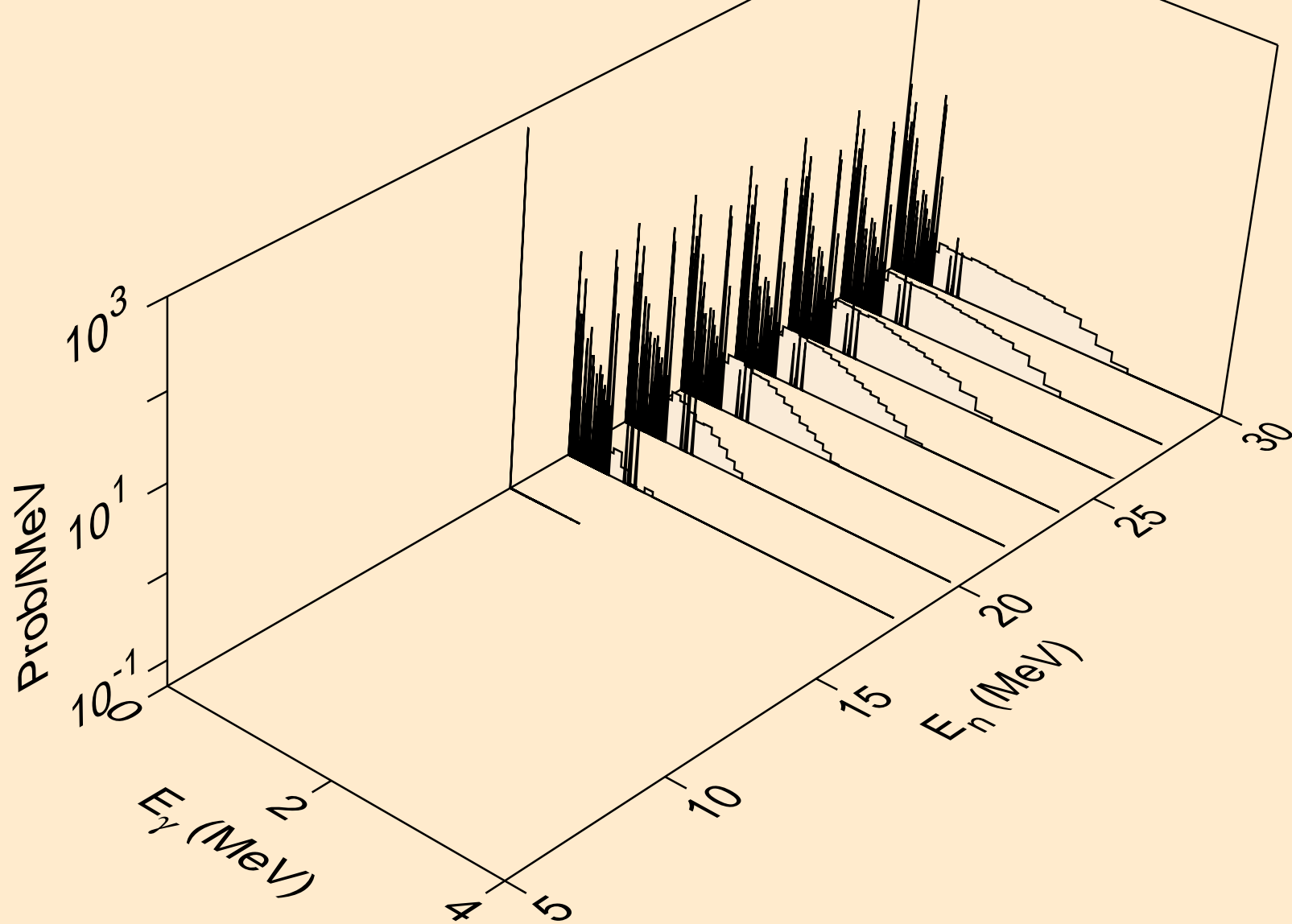

HO166 NEUTRON ACER TENDL-2024 LIBRARY; T=293.6K
Photon emission for (n,p)

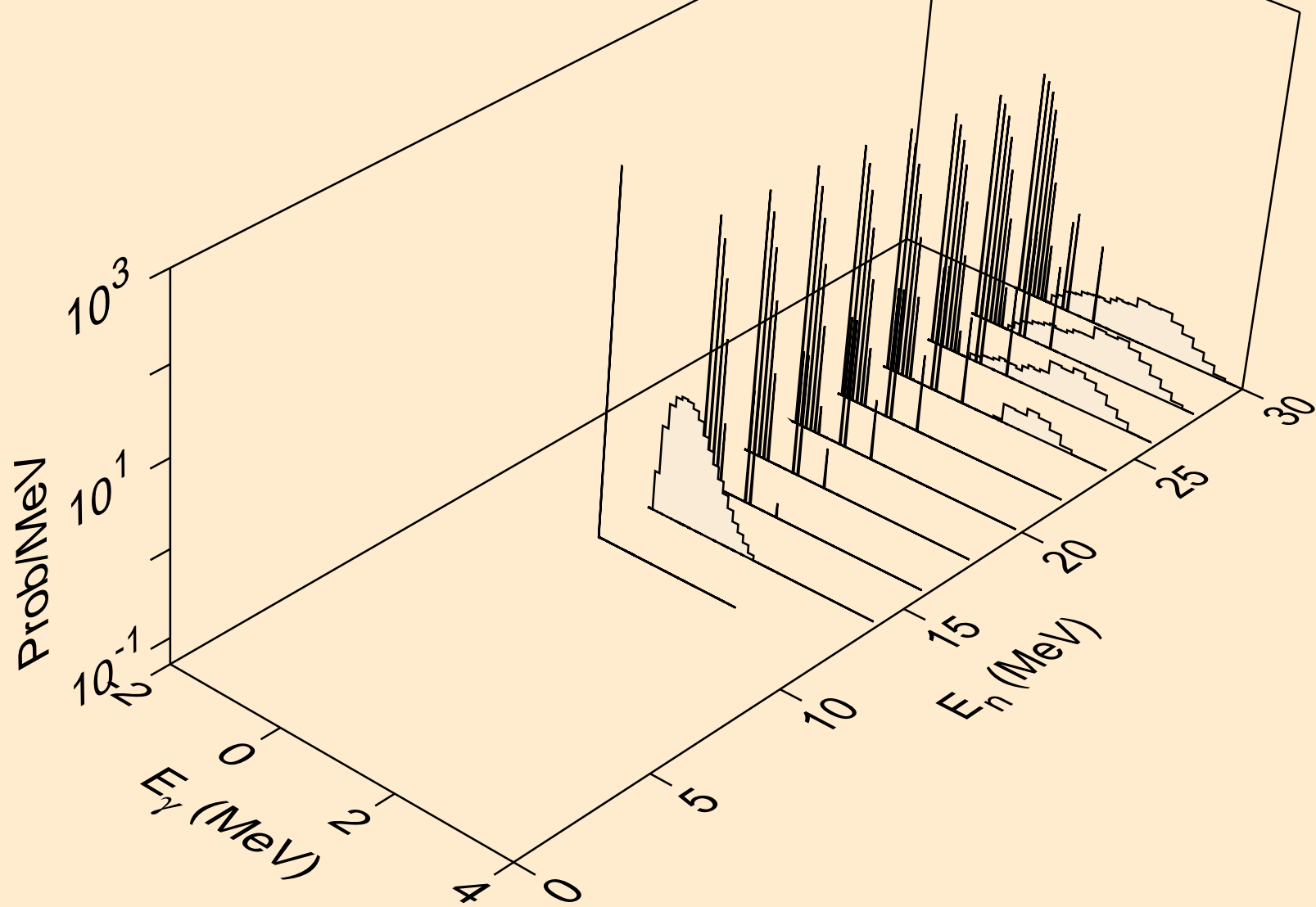

HO166 NEUTRON ACER TENDL-2024 LIBRARY; T=293.6K
thermal capture photon spectrum

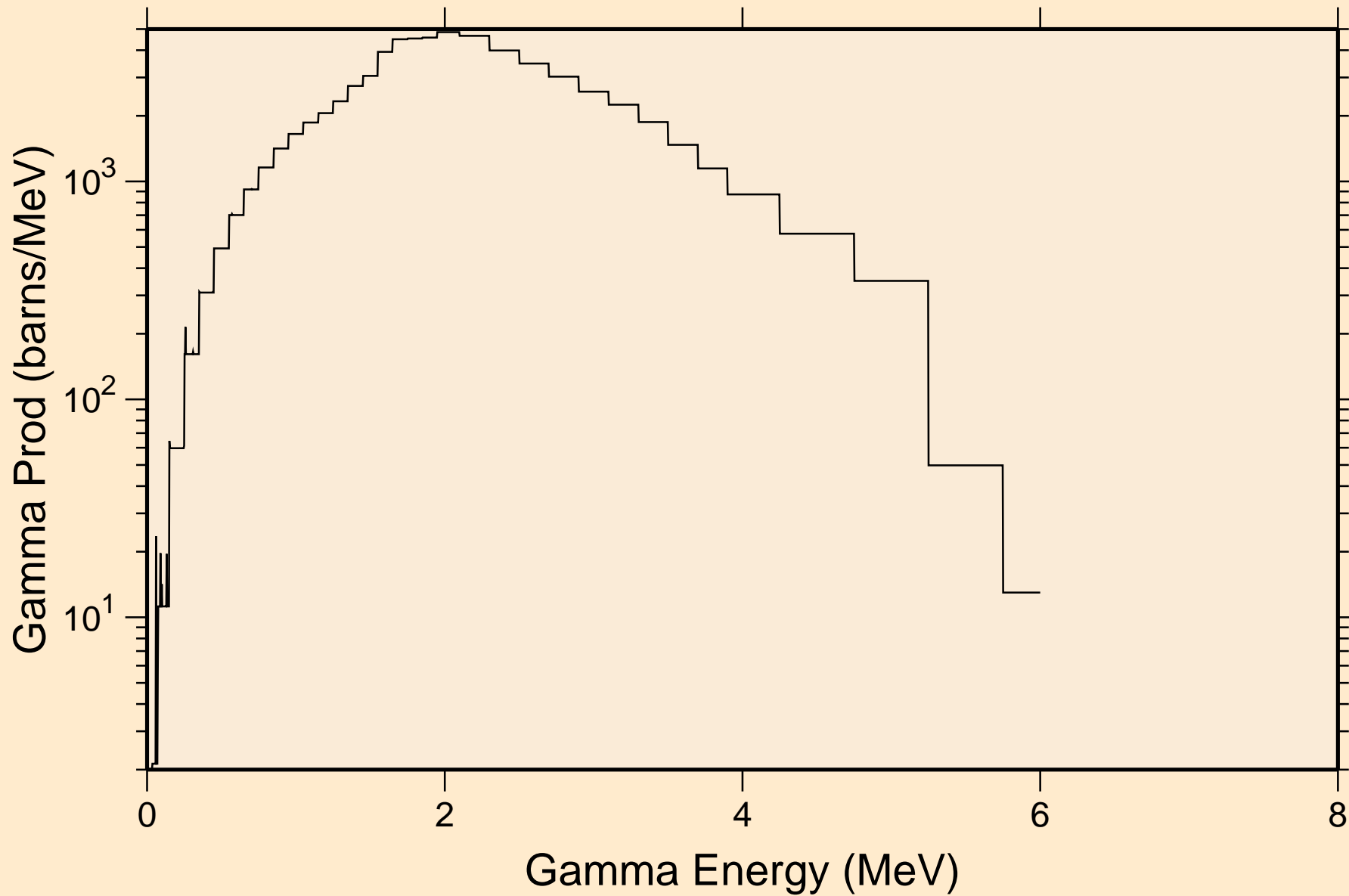

HO166 NEUTRON ACER TENDL-2024 LIBRARY; T=293.6K
14 MeV photon spectrum

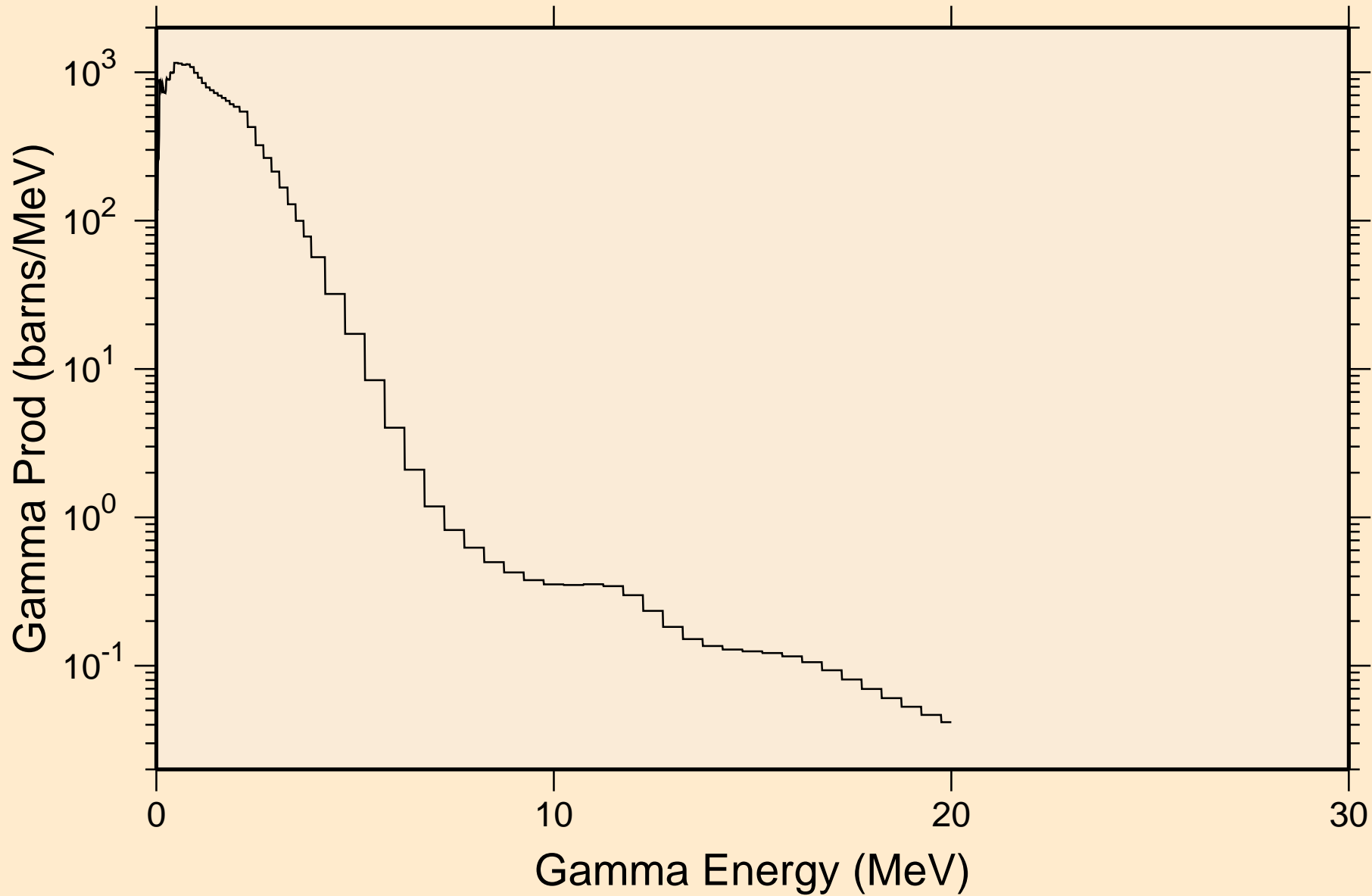

HO166 NEUTRON ACER TENDL-2024 LIBRARY; T=293.6K

Particle heating contributions

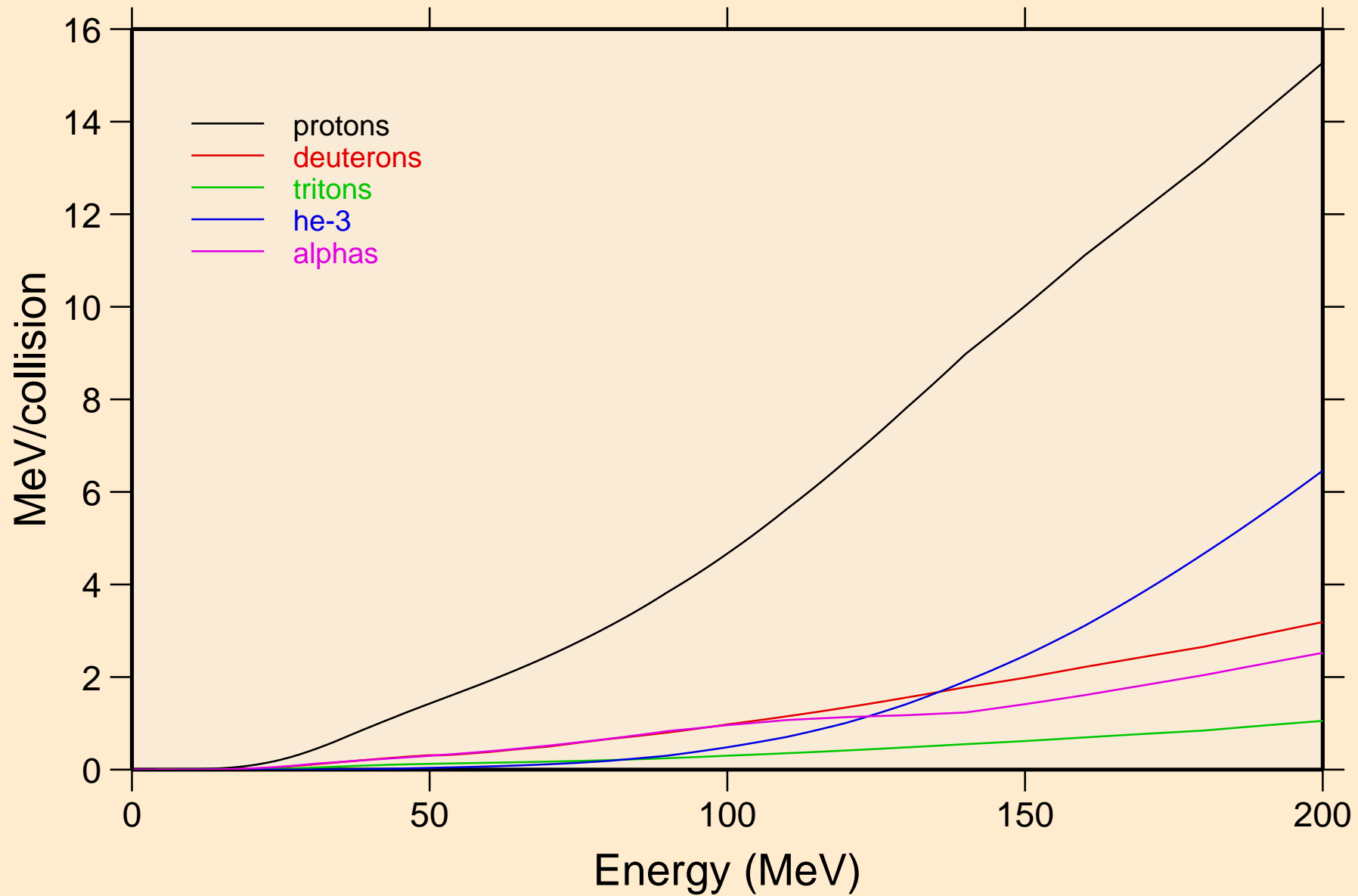

HO166 NEUTRON ACER TENDL-2024 LIBRARY; T=293.6K
Recoil Heating

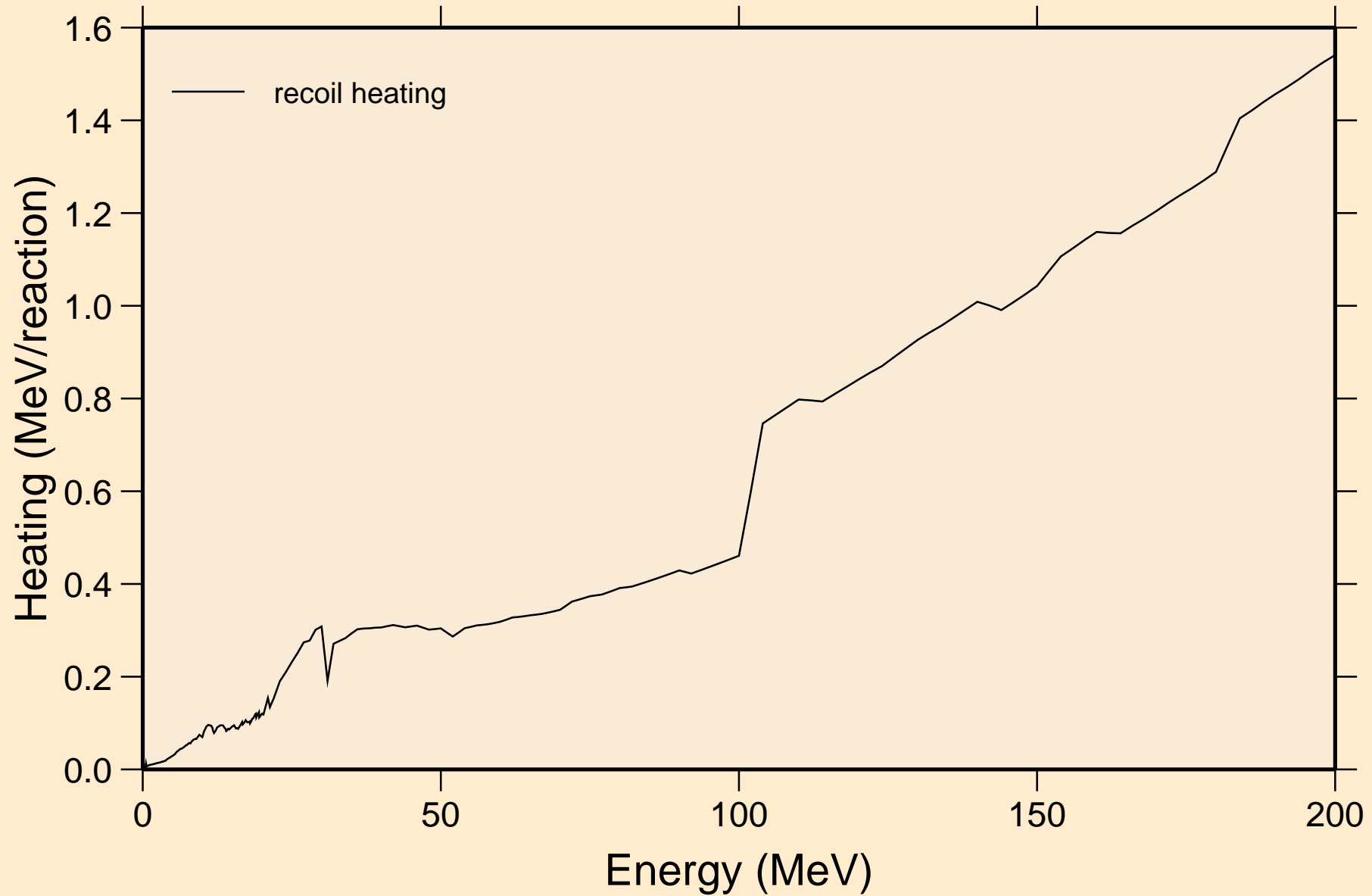

HO166 NEUTRON ACER TENDL-2024 LIBRARY; T=293.6K
Particle production cross sections

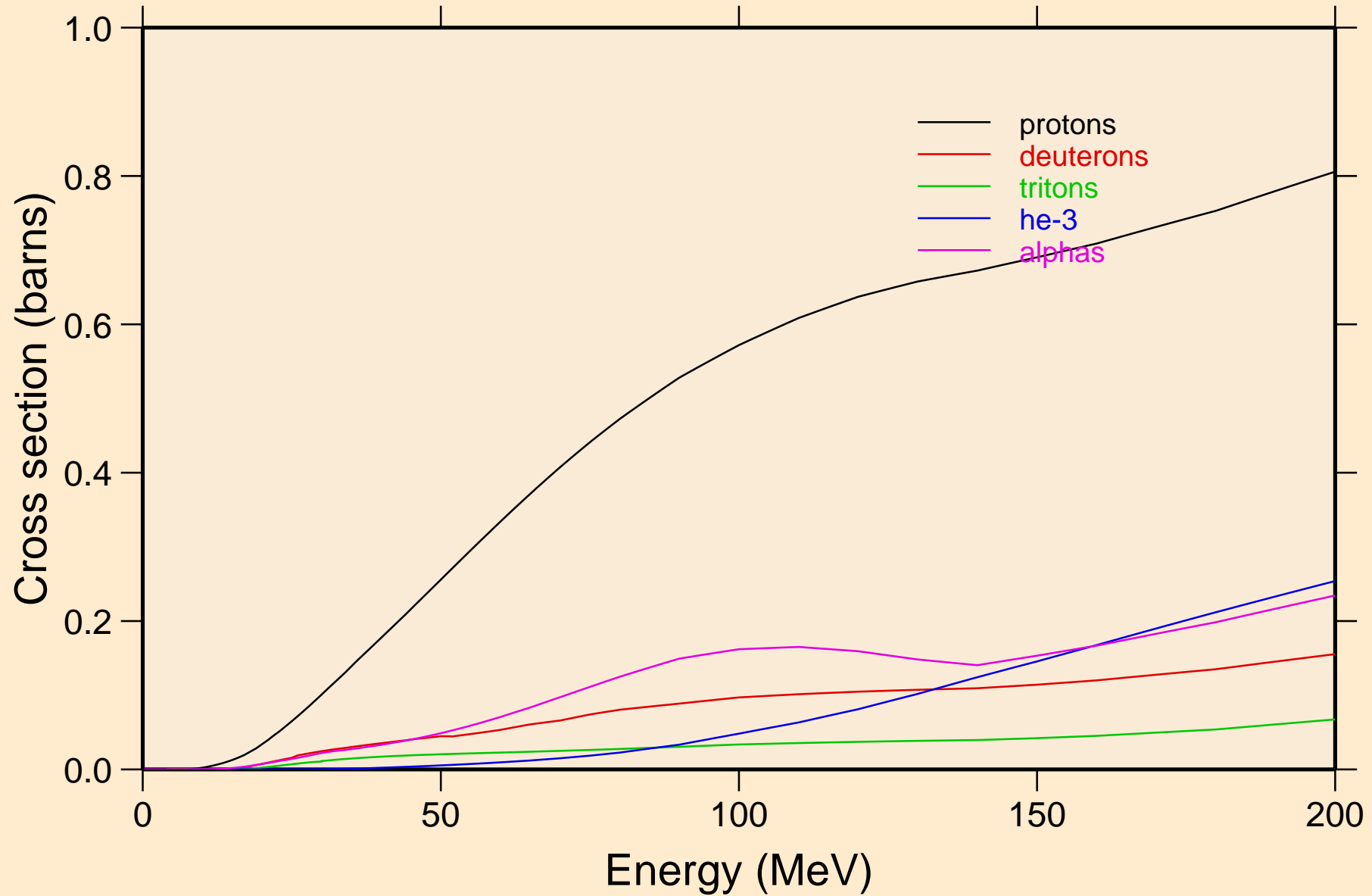

HO166 NEUTRON ACER TENDL-2024 LIBRARY; T=293.6K
protons from (n,x)

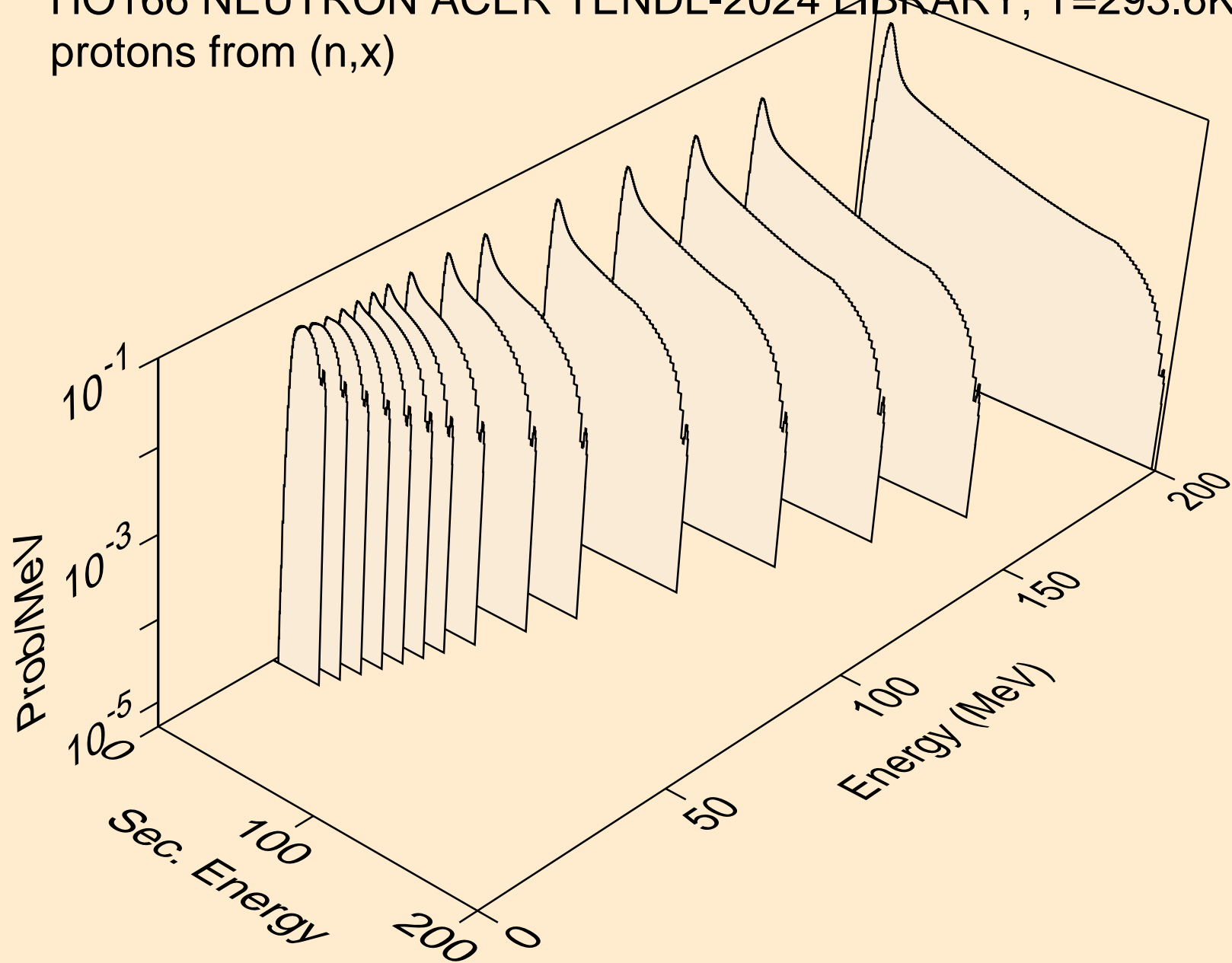

HO166 NEUTRON ACER TENDL-2024 LIBRARY; T=293.6K
protons from (n,n*)p

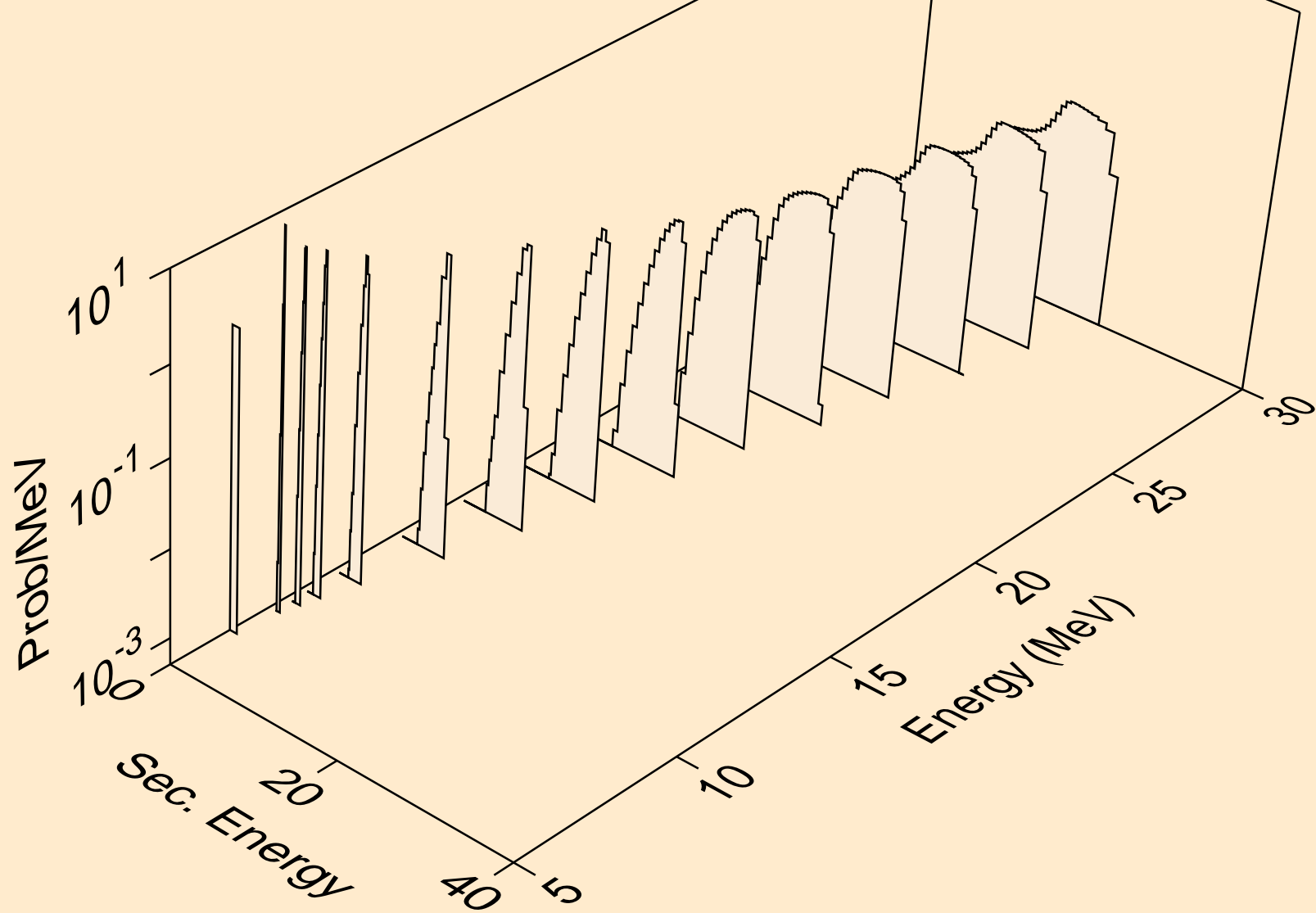

HO166 NEUTRON ACER TENDL-2024 LIBRARY; T=293.6K
protons from (n,2np)

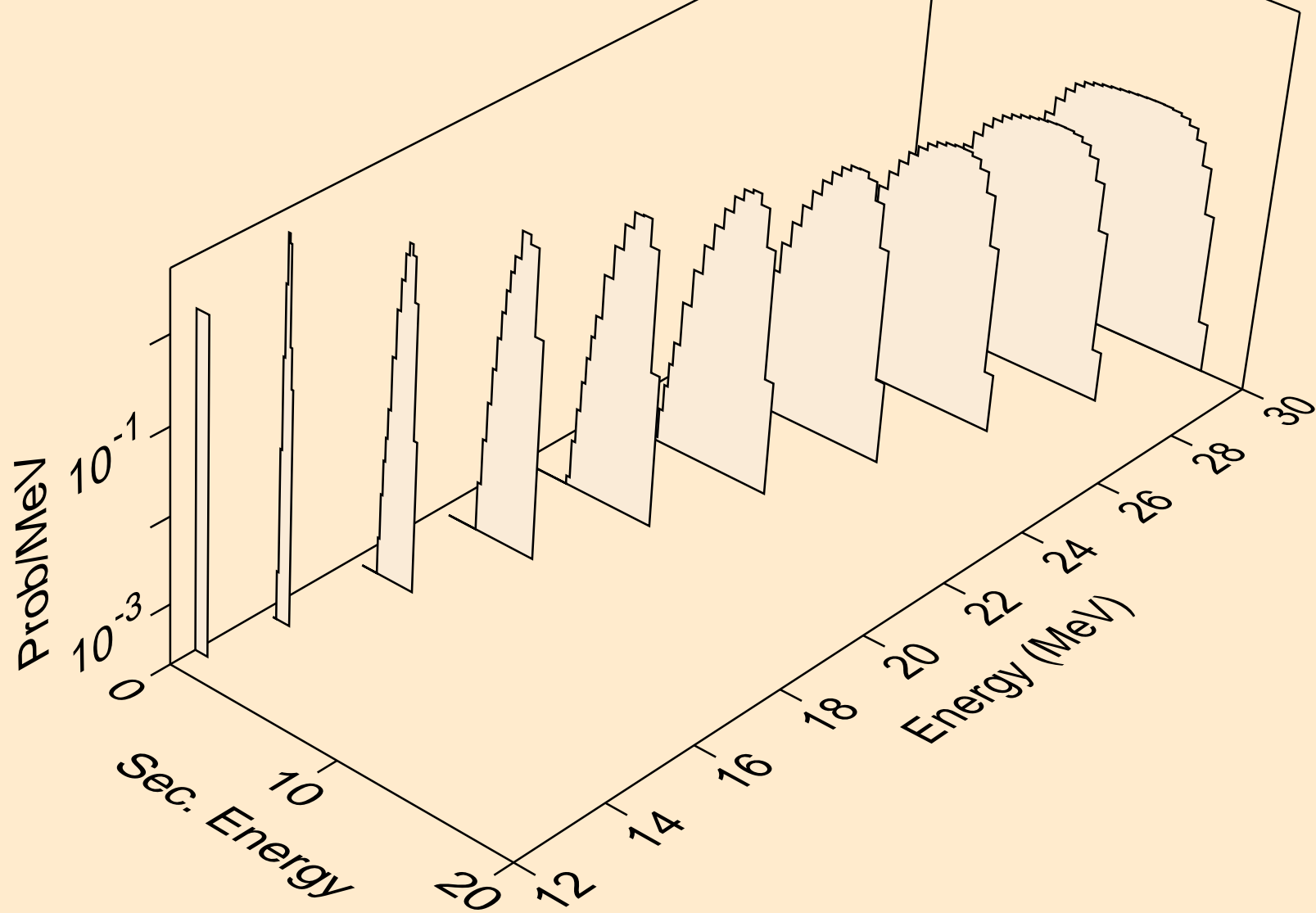

HO166 NEUTRON ACER TENDL-2024 LIBRARY; T=293.6K
protons from (n,3np)

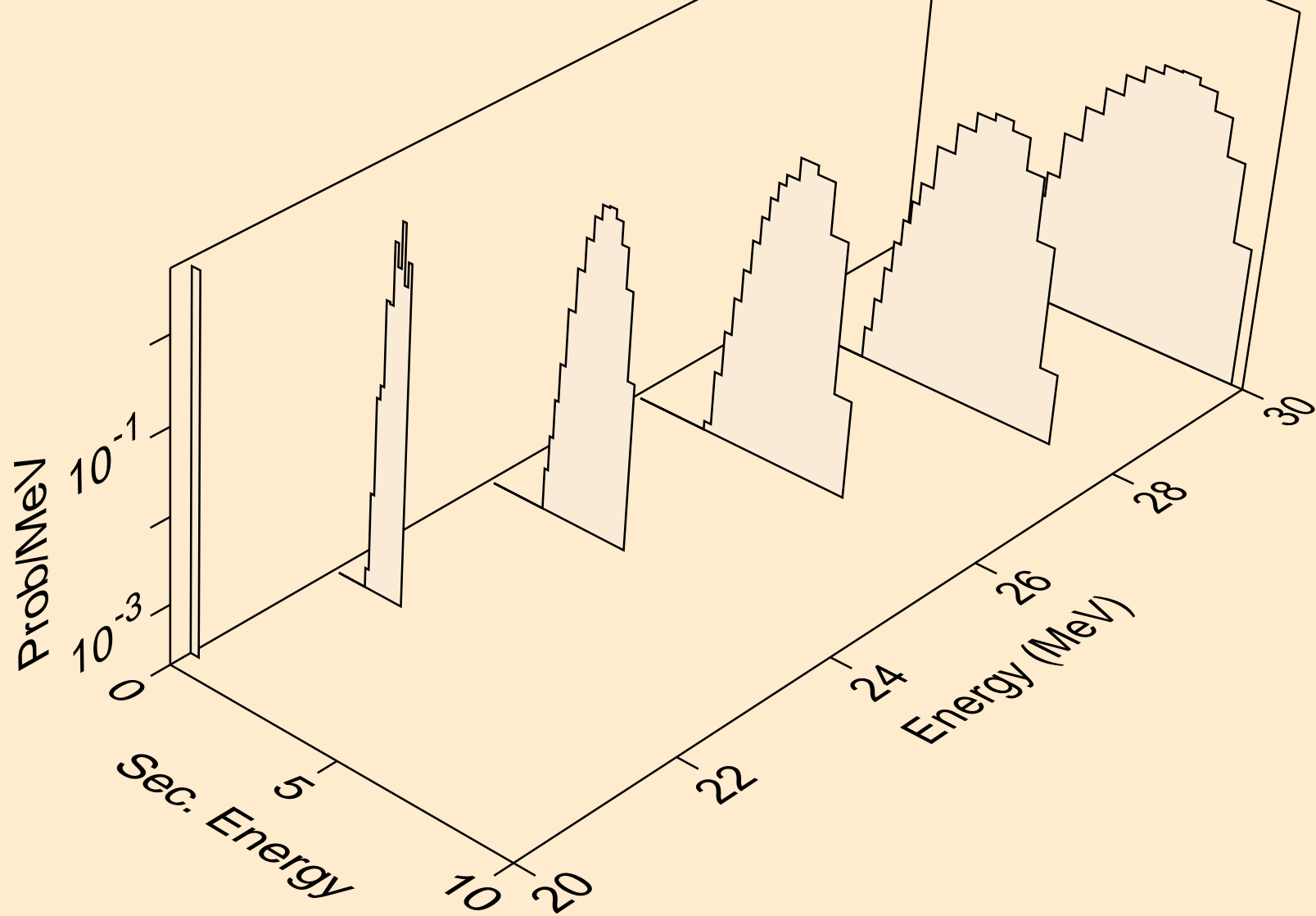

HO166 NEUTRON ACER TENDL-2024 LIBRARY; T=293.6K
protons from (n,n2p)

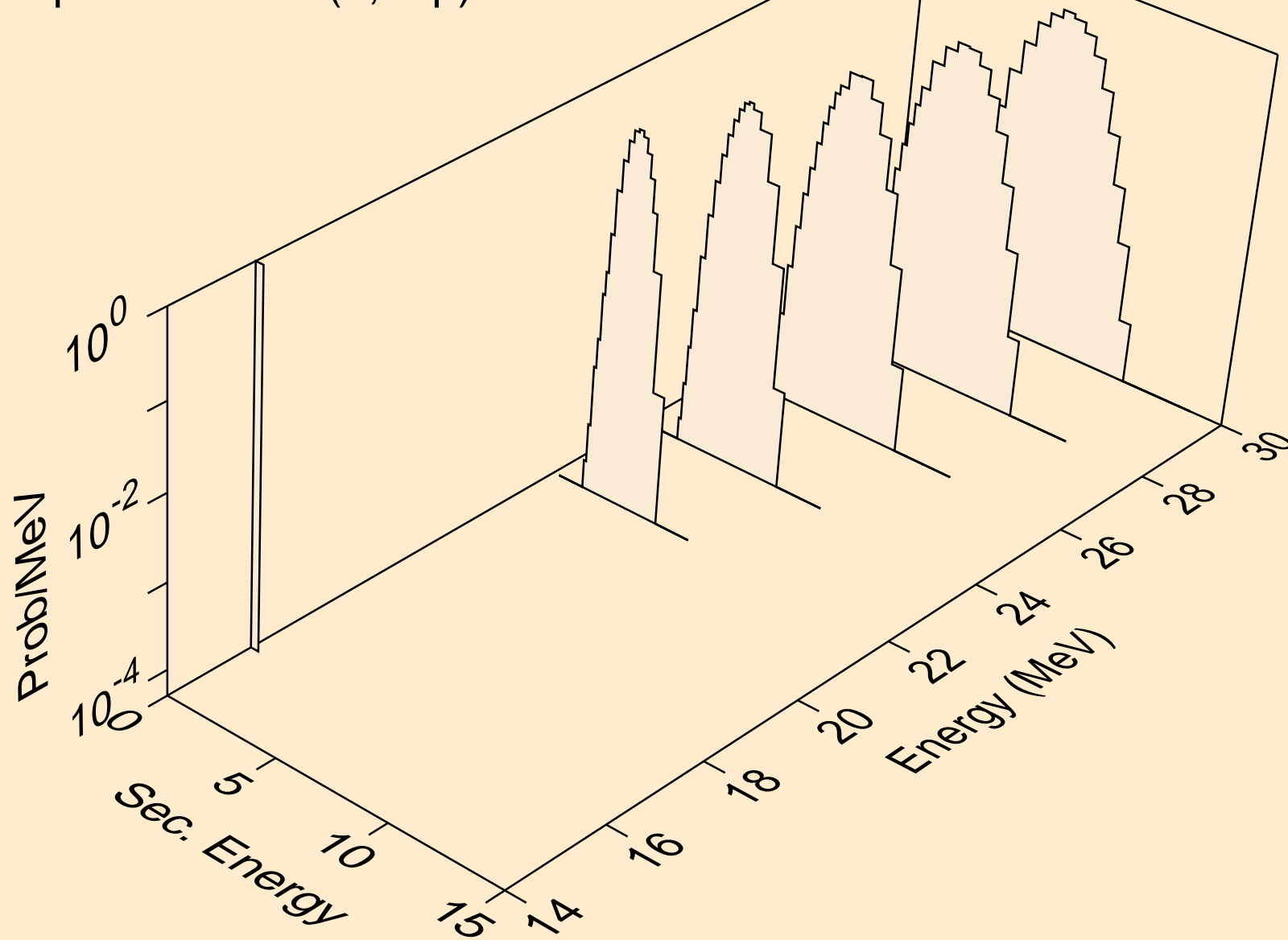

HO166 NEUTRON ACER TENDL-2024 LIBRARY; T=293.6K
protons from (n,npa)

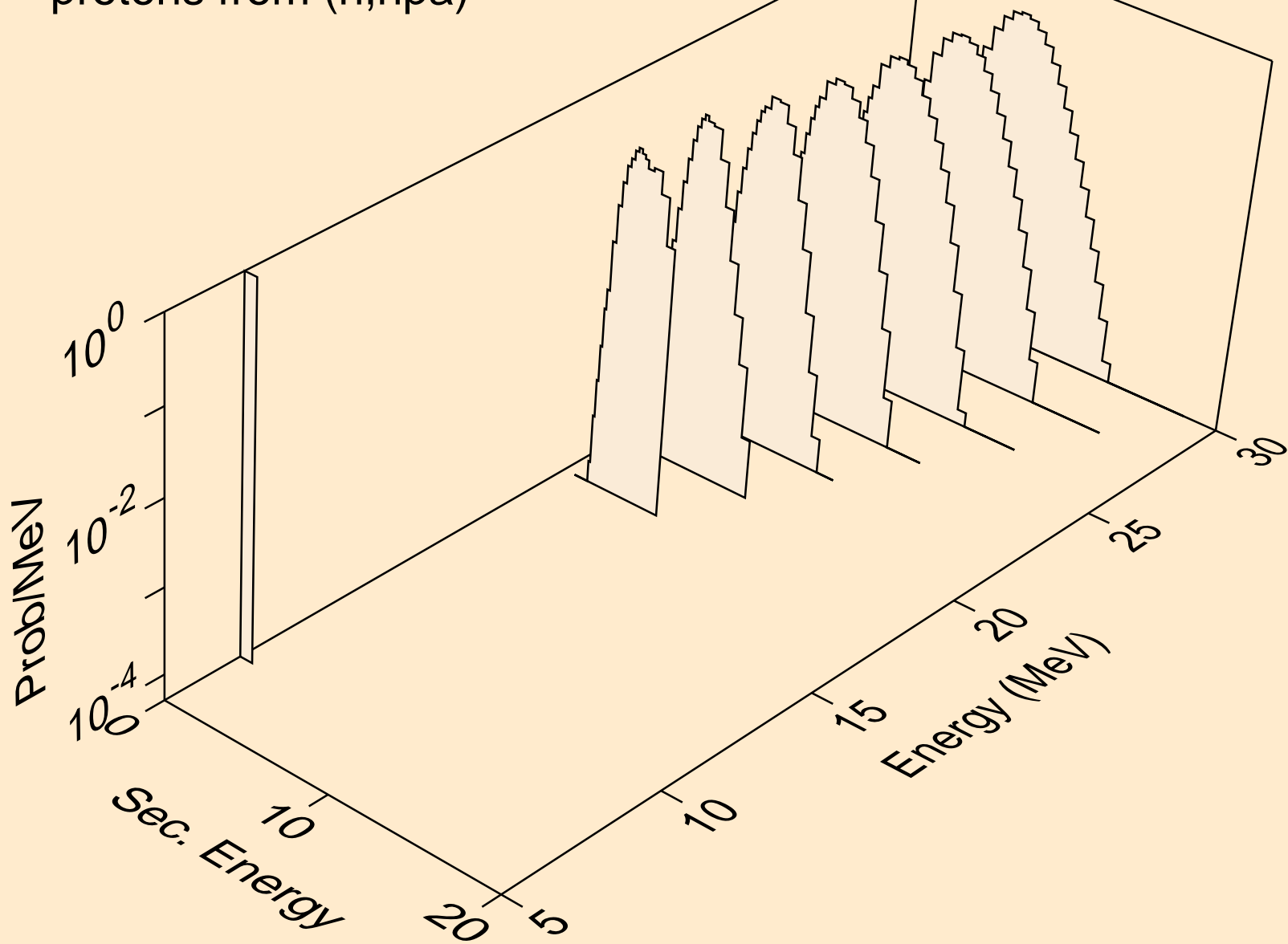

HO166 NEUTRON ACER TENDL-2024 LIBRARY; T=293.6K
protons from (n,p)

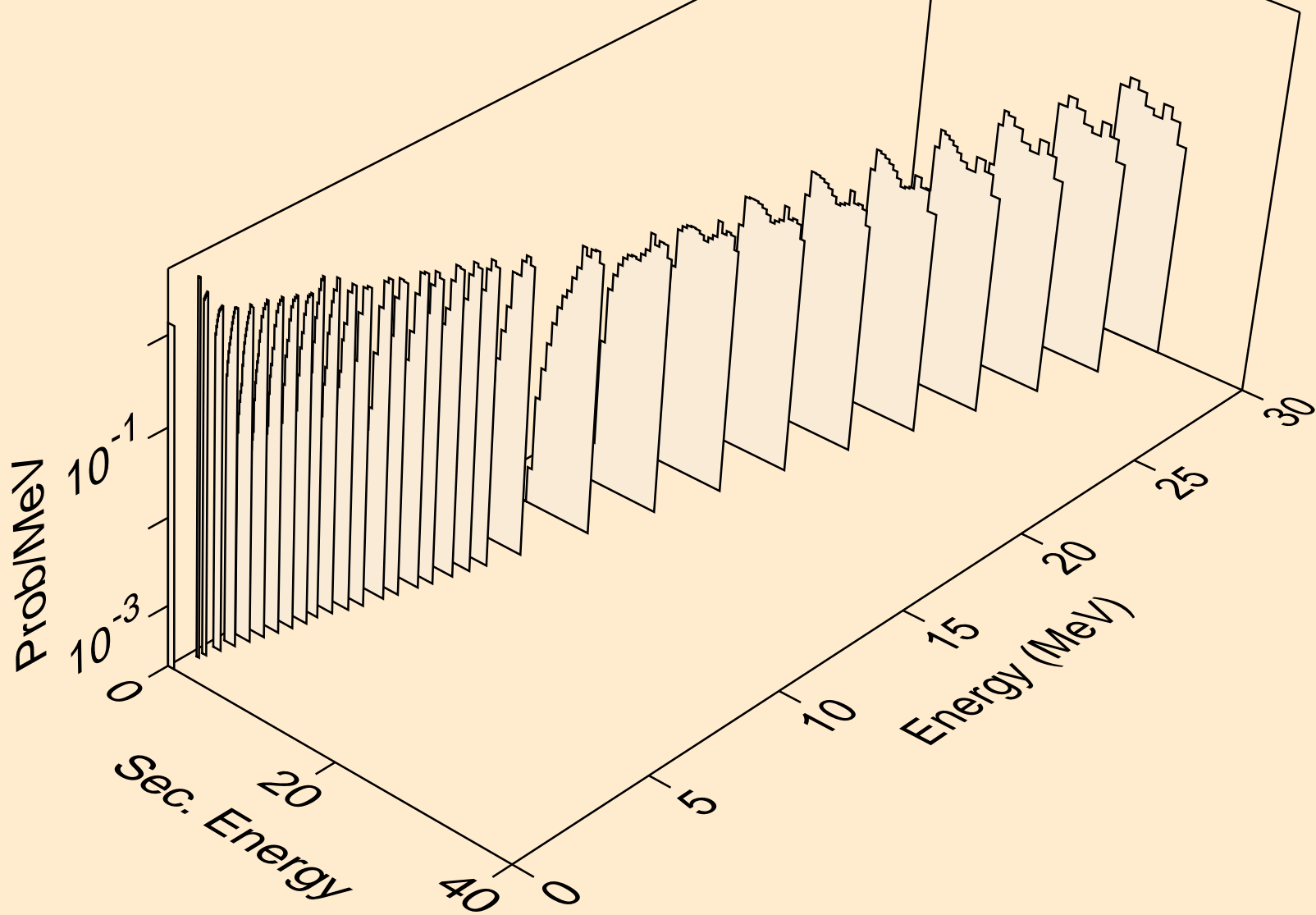

HO166 NEUTRON ACER TENDL-2024 LIBRARY; T=293.6K
protons from (n,2p)

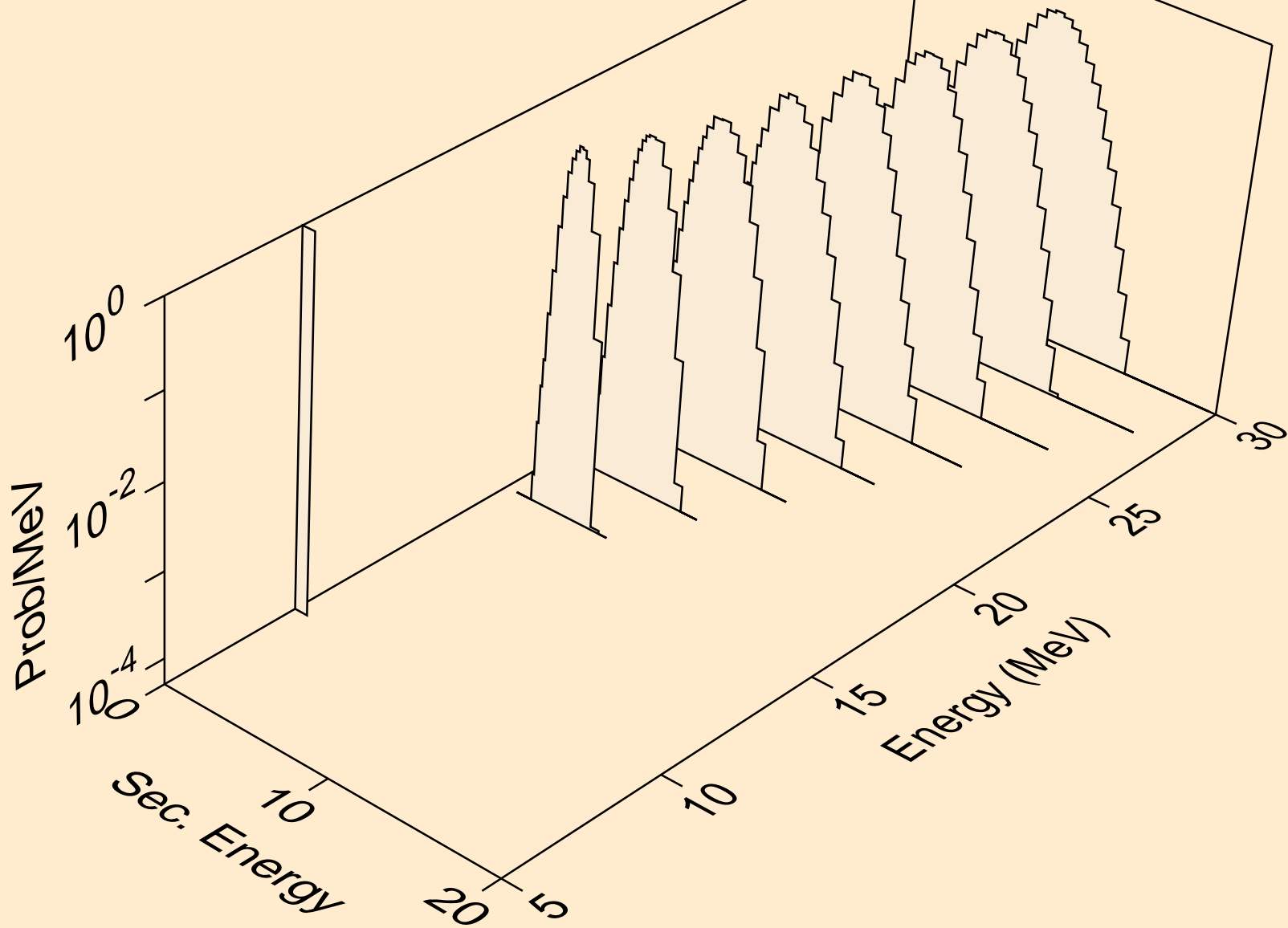

HO166 NEUTRON ACER TENDL-2024 LIBRARY; T=293.6K
protons from (n,p)

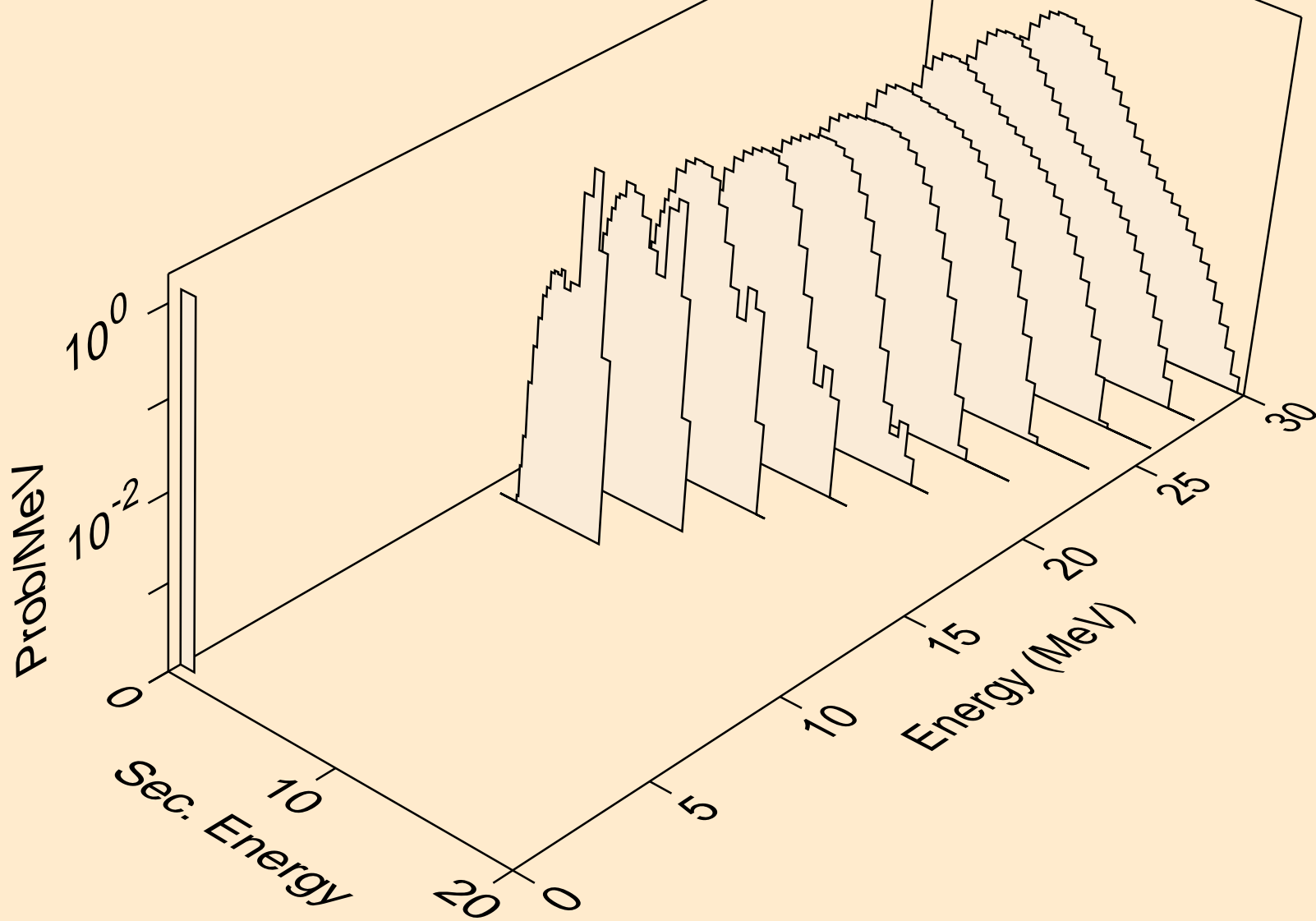

HO166 NEUTRON ACER TENDL-2024 LIBRARY; T=293.6K
deuterons from (n,x)

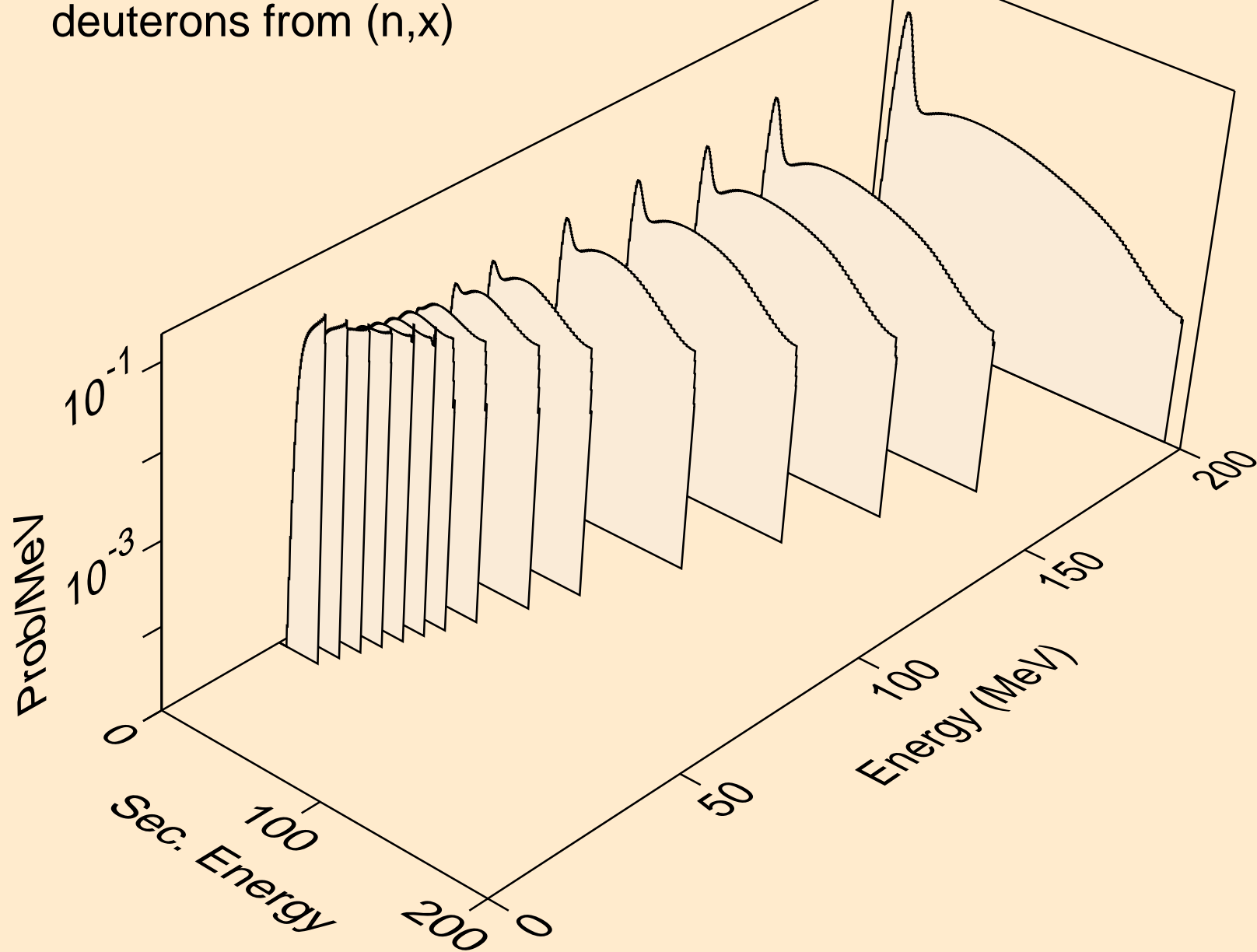

HO166 NEUTRON ACER TENDL-2024 LIBRARY; T=293.6K
deuterons from (n,2nd)

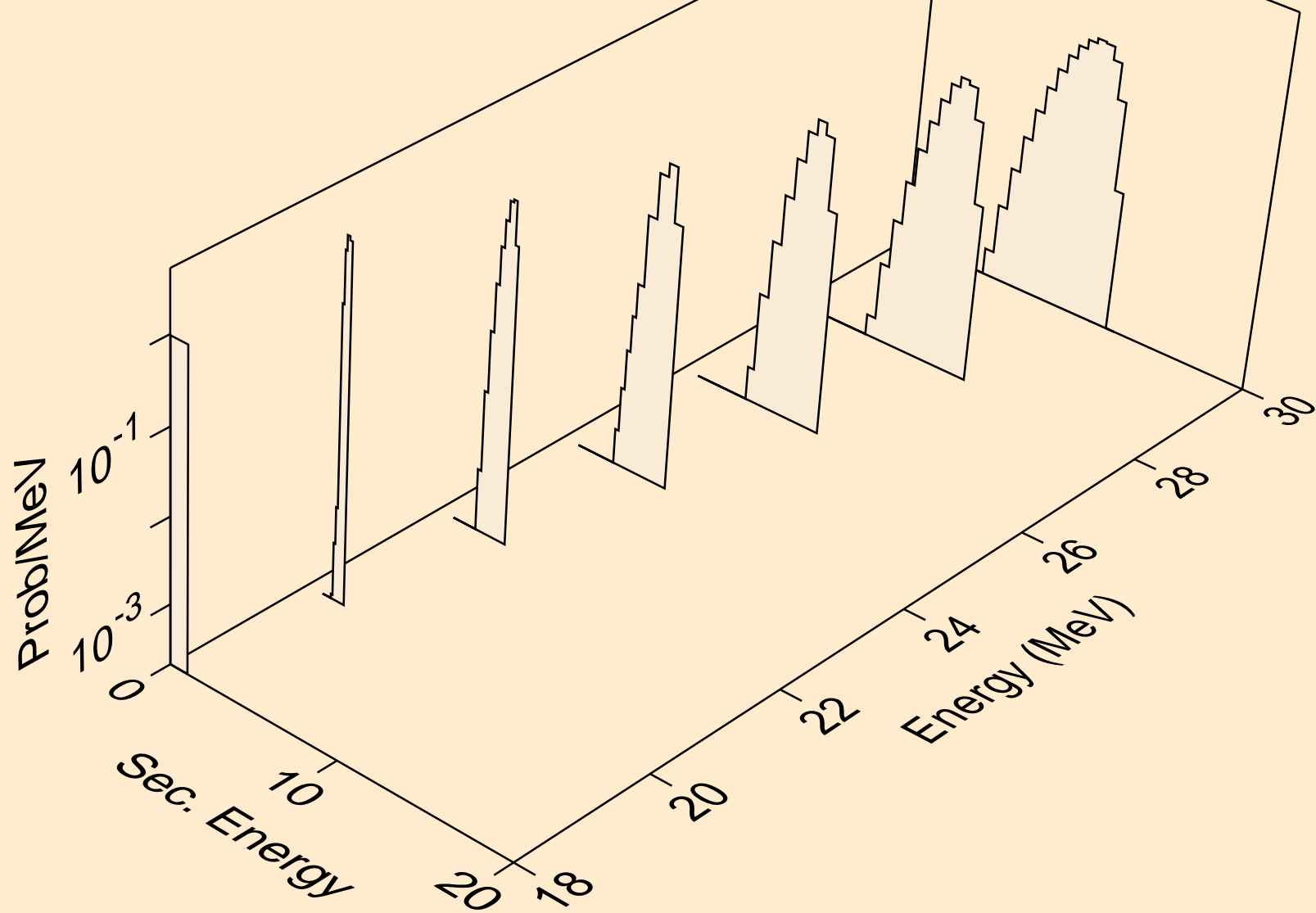

HO166 NEUTRON ACER TENDL-2024 LIBRARY; T=293.6K
deuterons from (n,n*)d

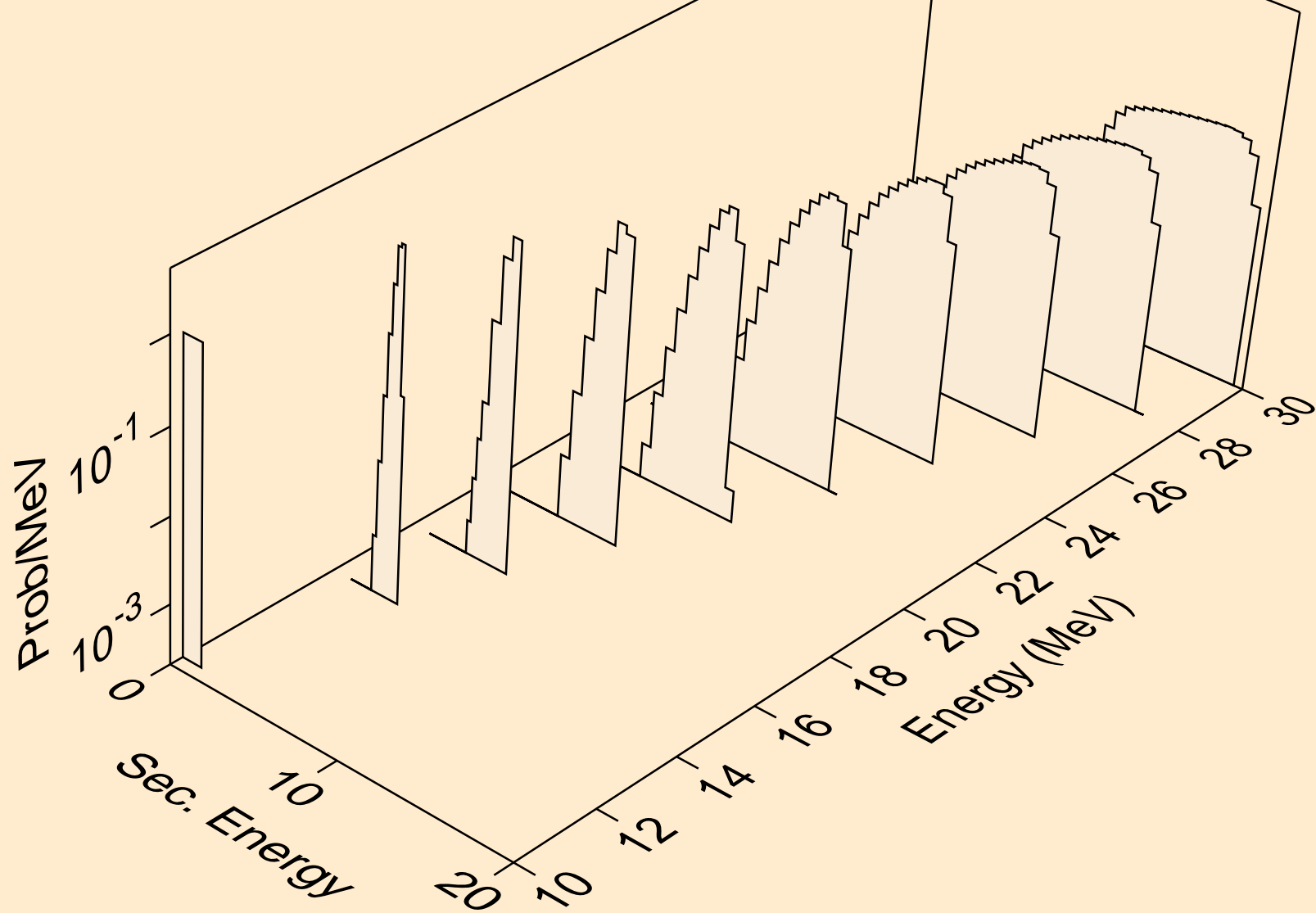

HO166 NEUTRON ACER TENDL-2024 LIBRARY; T=293.6K
deuterons from (n,d)

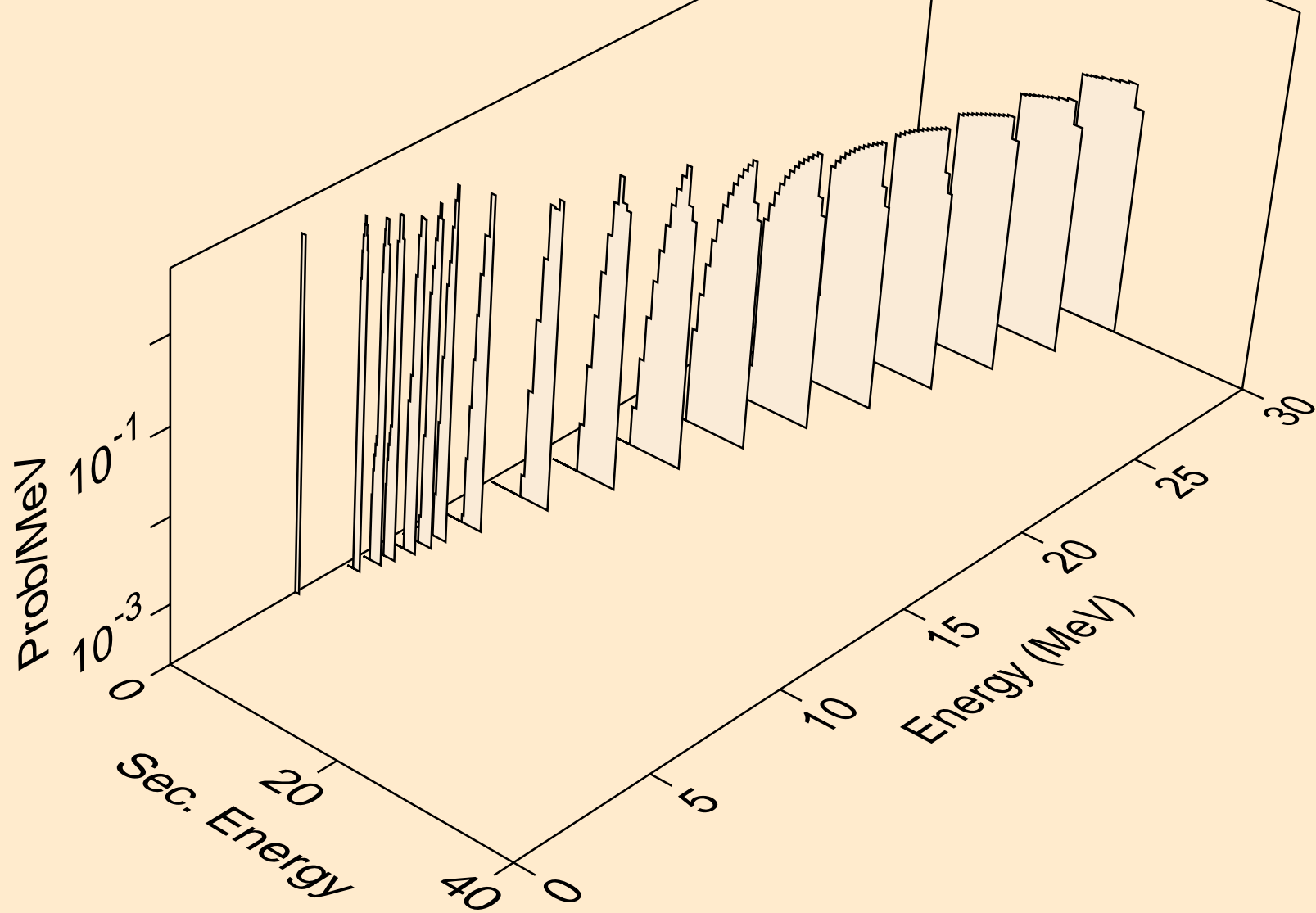

HO166 NEUTRON ACER TENDL-2024 LIBRARY; T=293.6K
tritons from (n,x)

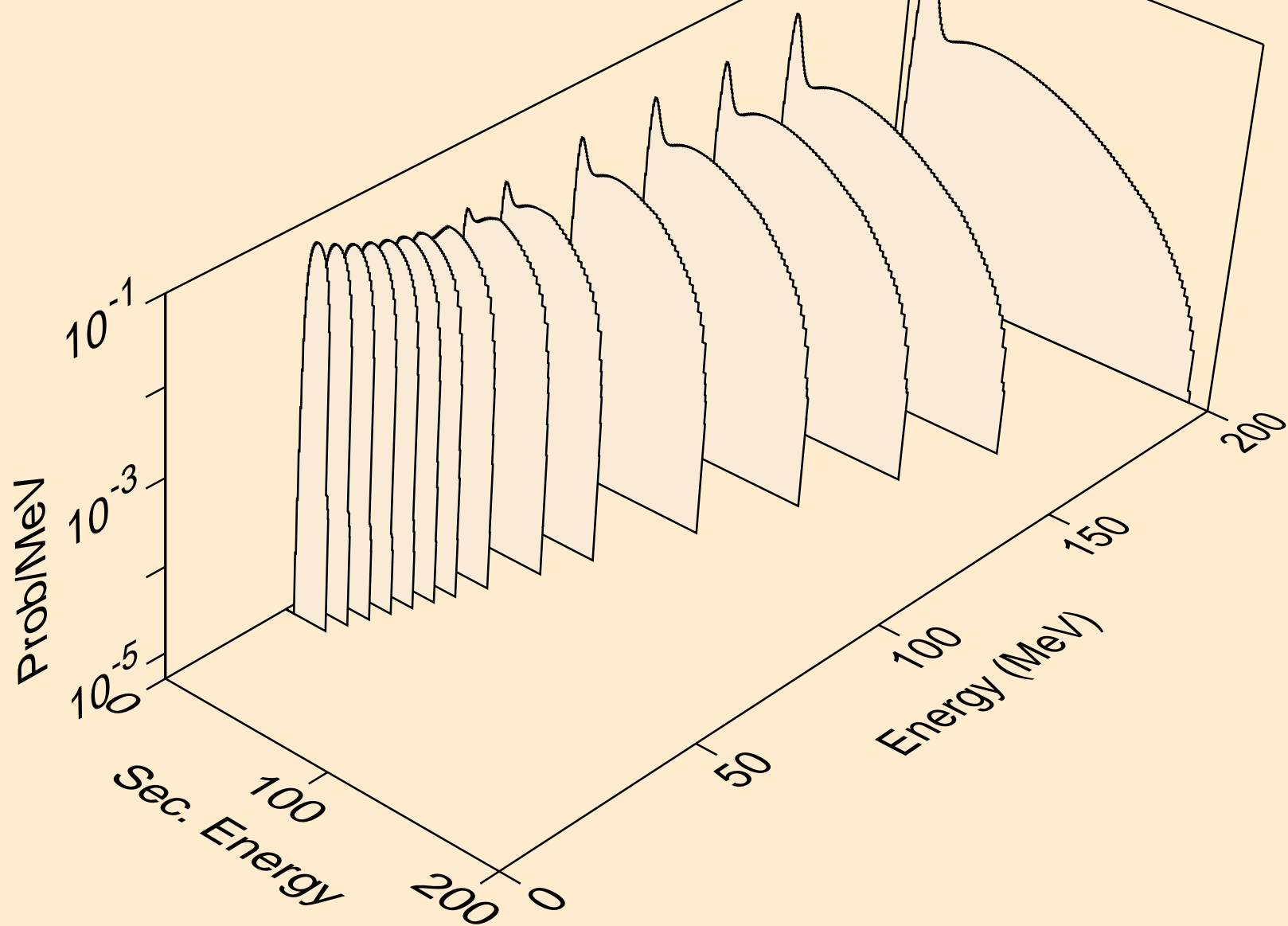

HO166 NEUTRON ACER TENDL-2024 LIBRARY; T=293.6K
tritons from (n,n*)t

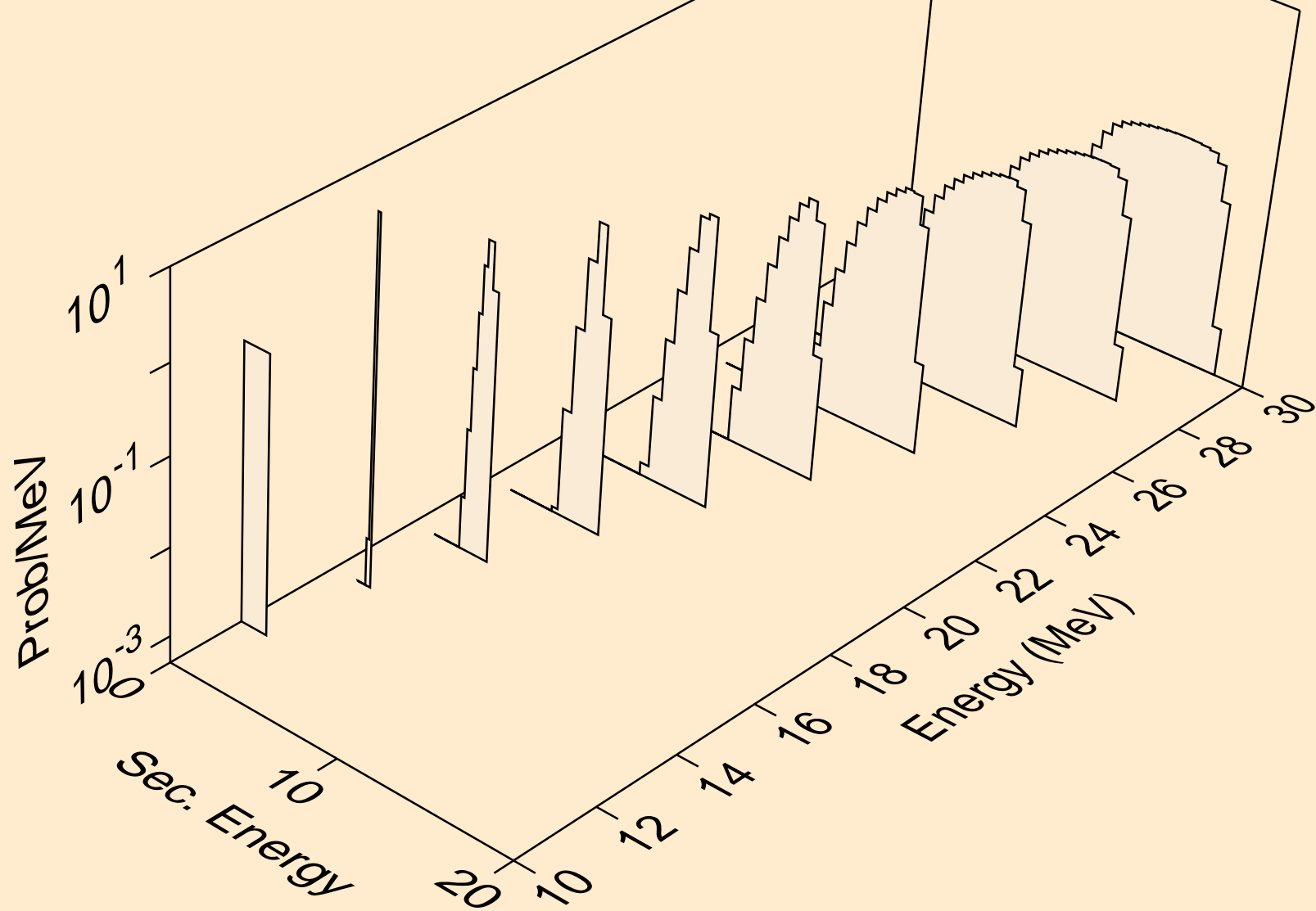

HO166 NEUTRON ACER TENDL-2024 LIBRARY; T=293.6K
tritons from (n,t)

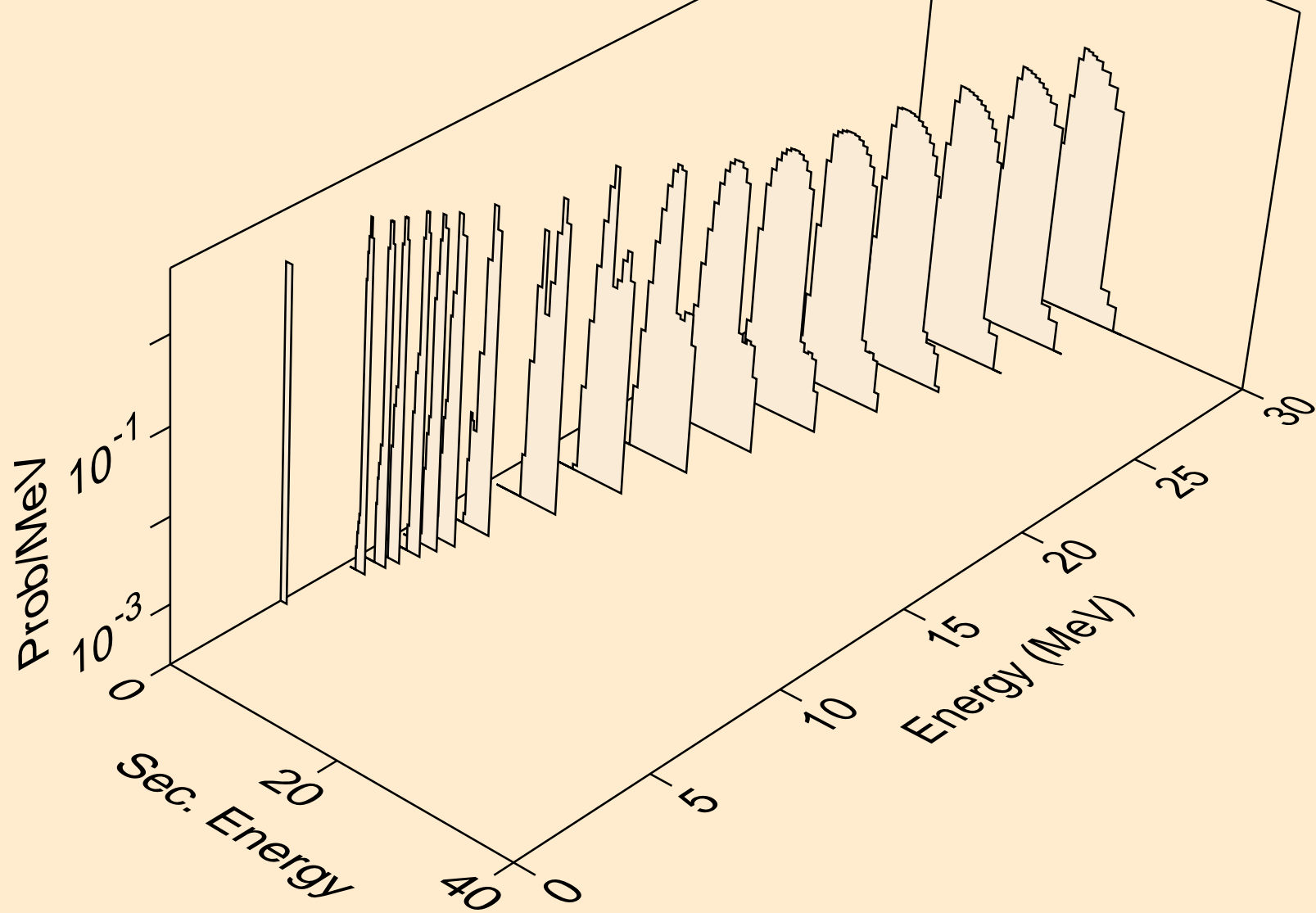

HO166 NEUTRON ACER TENDL-2024 LIBRARY; T=293.6K
he3s from (n,x)

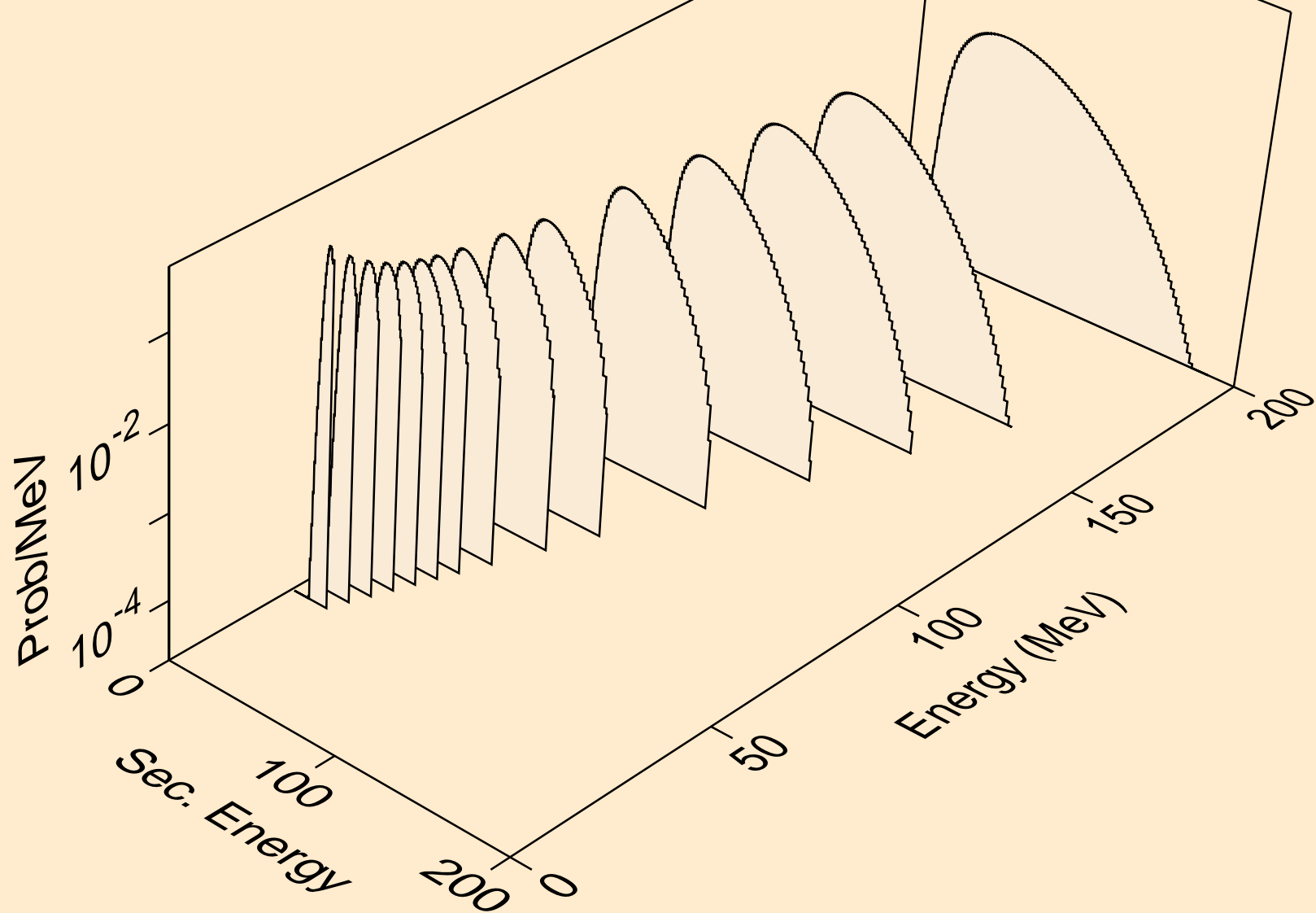

HO166 NEUTRON ACER TENDL-2024 LIBRARY; T=293.6K
he3s from (n,n*)he3

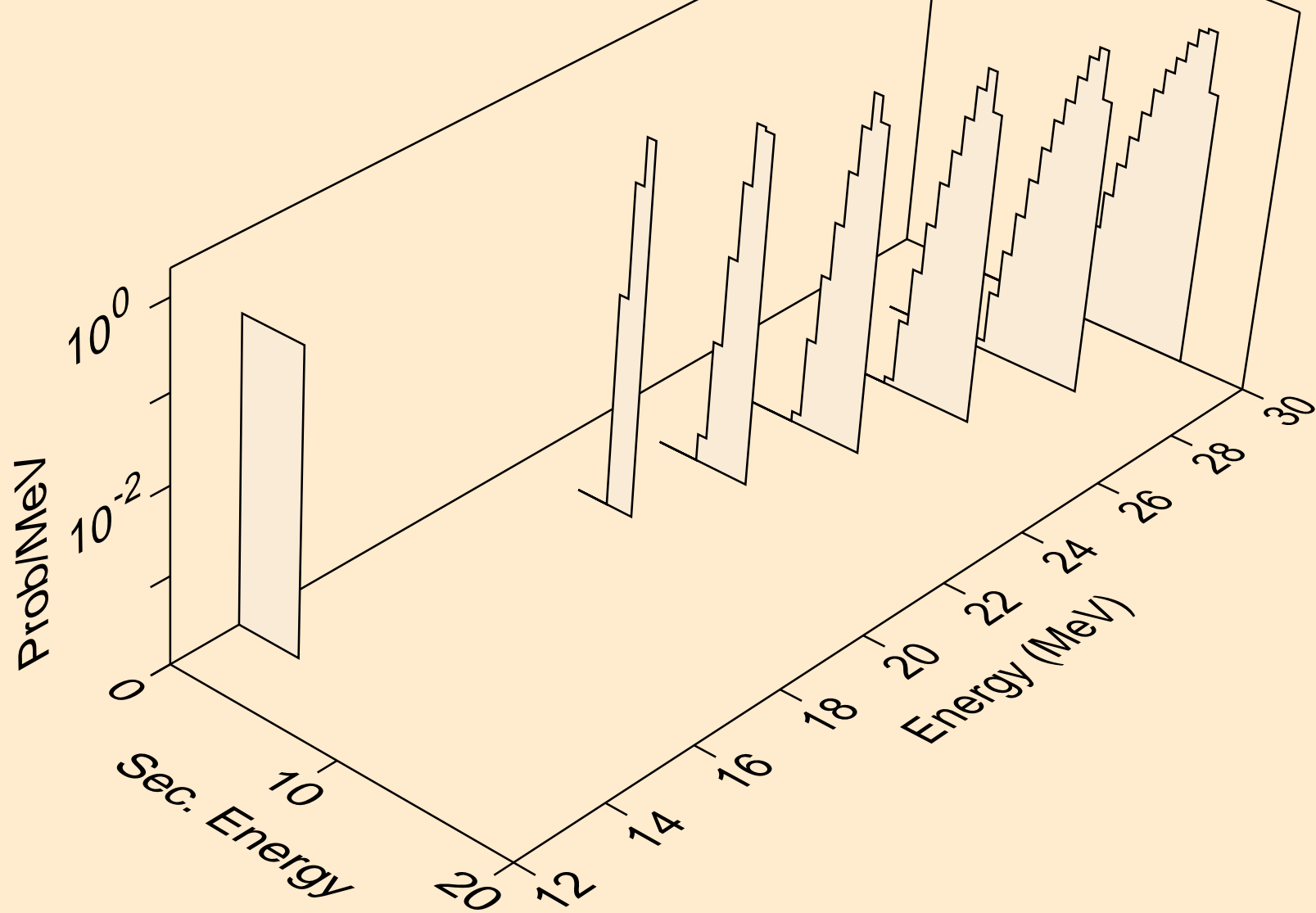

HO166 NEUTRON ACER TENDL-2024 LIBRARY; T=293.6K
he3s from (n,he3)

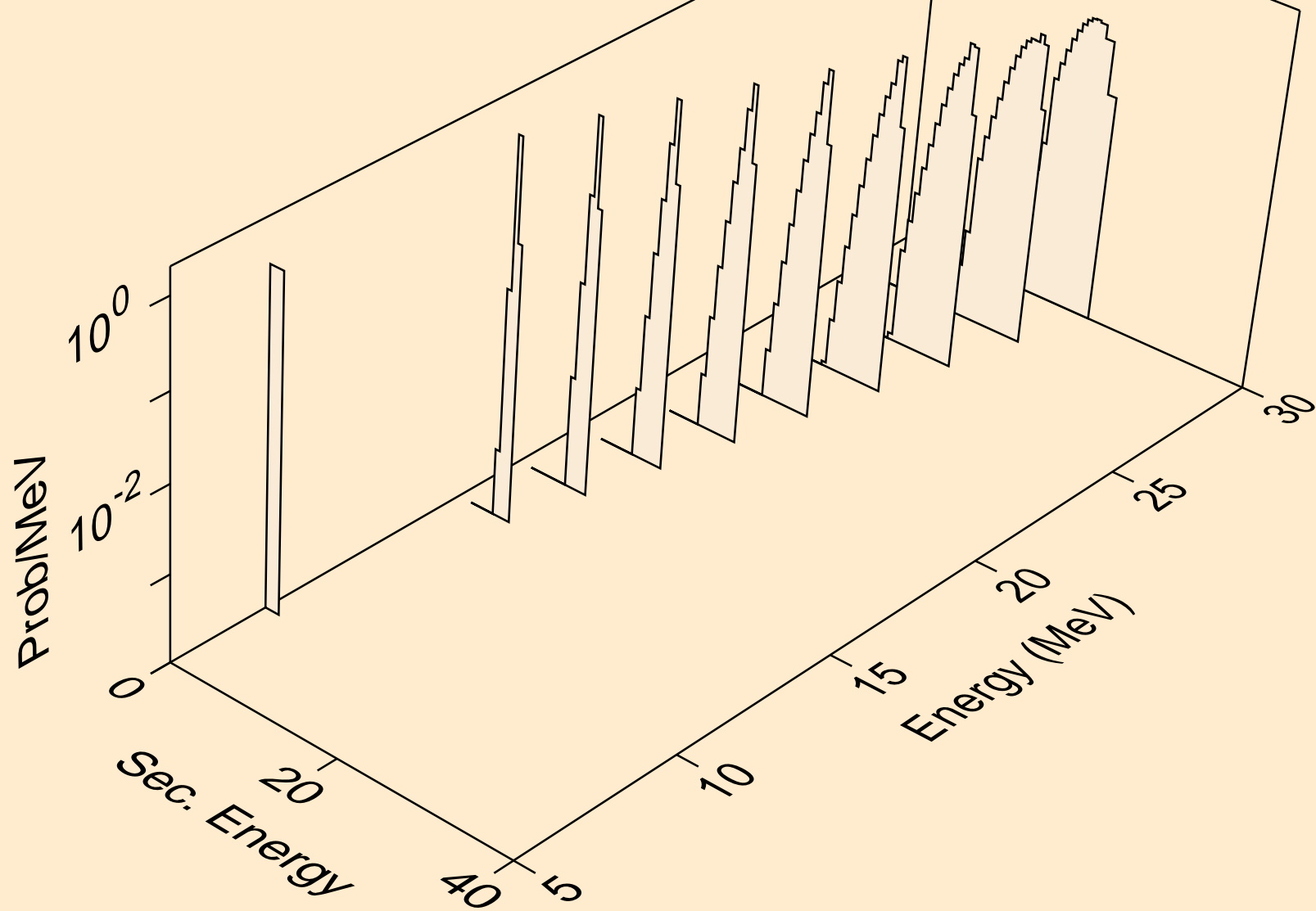

HO166 NEUTRON ACER TENDL-2024 LIBRARY; T=293.6K
alphas from (n,x)

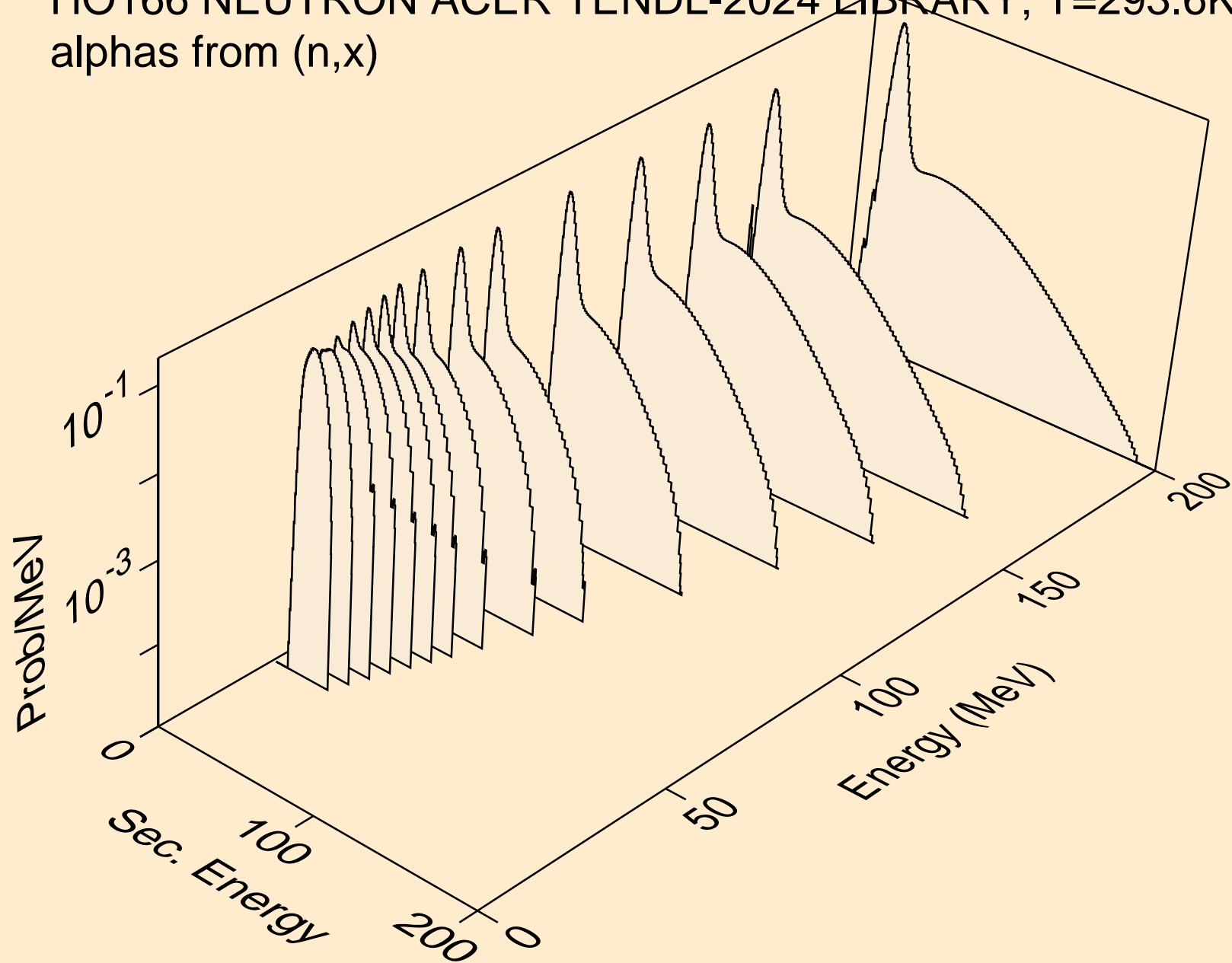

HO166 NEUTRON ACER TENDL-2024 LIBRARY; T=293.6K
alphas from (n,n*)a

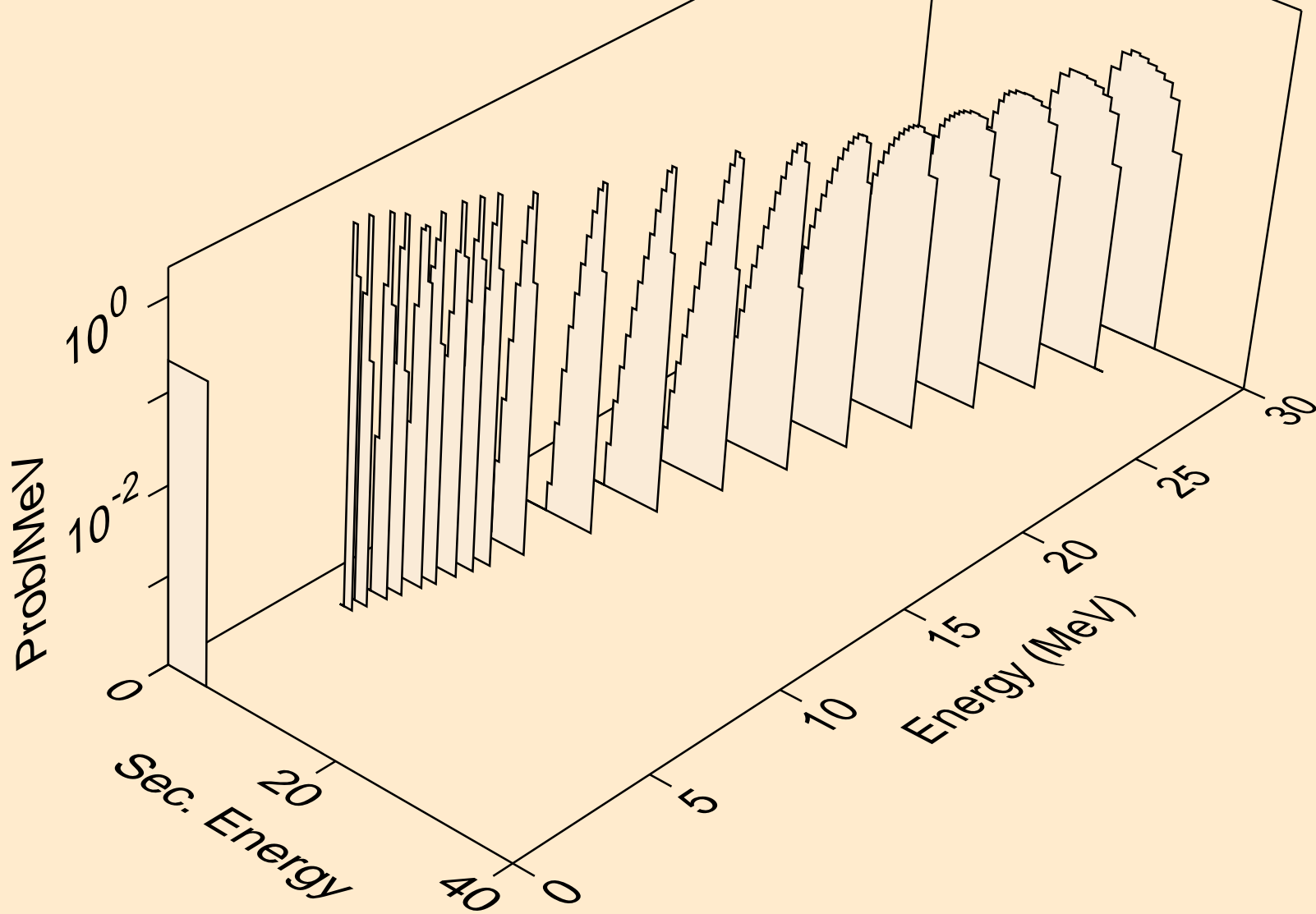

HO166 NEUTRON ACER TENDL-2024 LIBRARY; T=293.6K
alphas from (n,2n)a

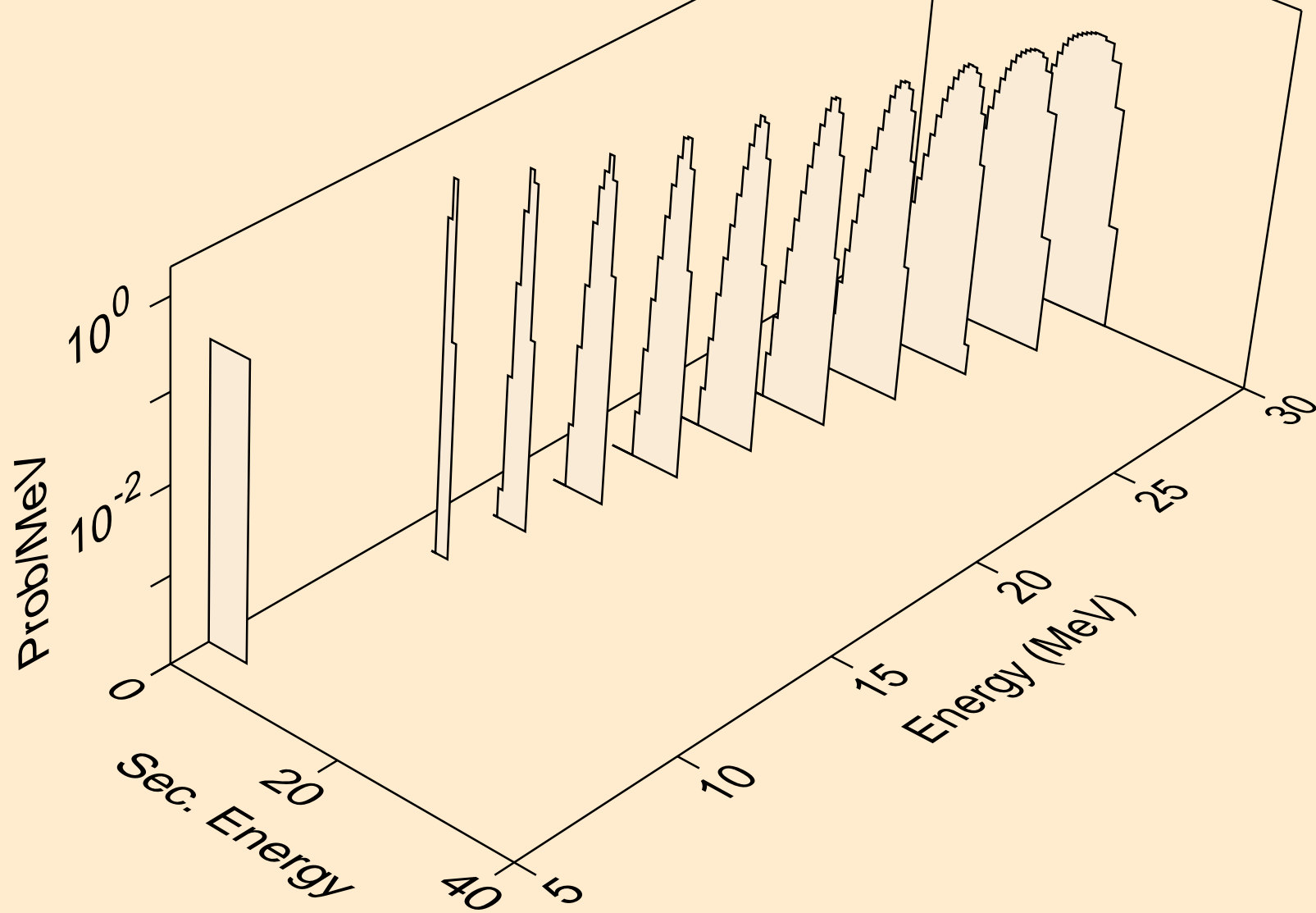

HO166 NEUTRON ACER TENDL-2024 LIBRARY; T=293.6K
alphas from (n,3n)a

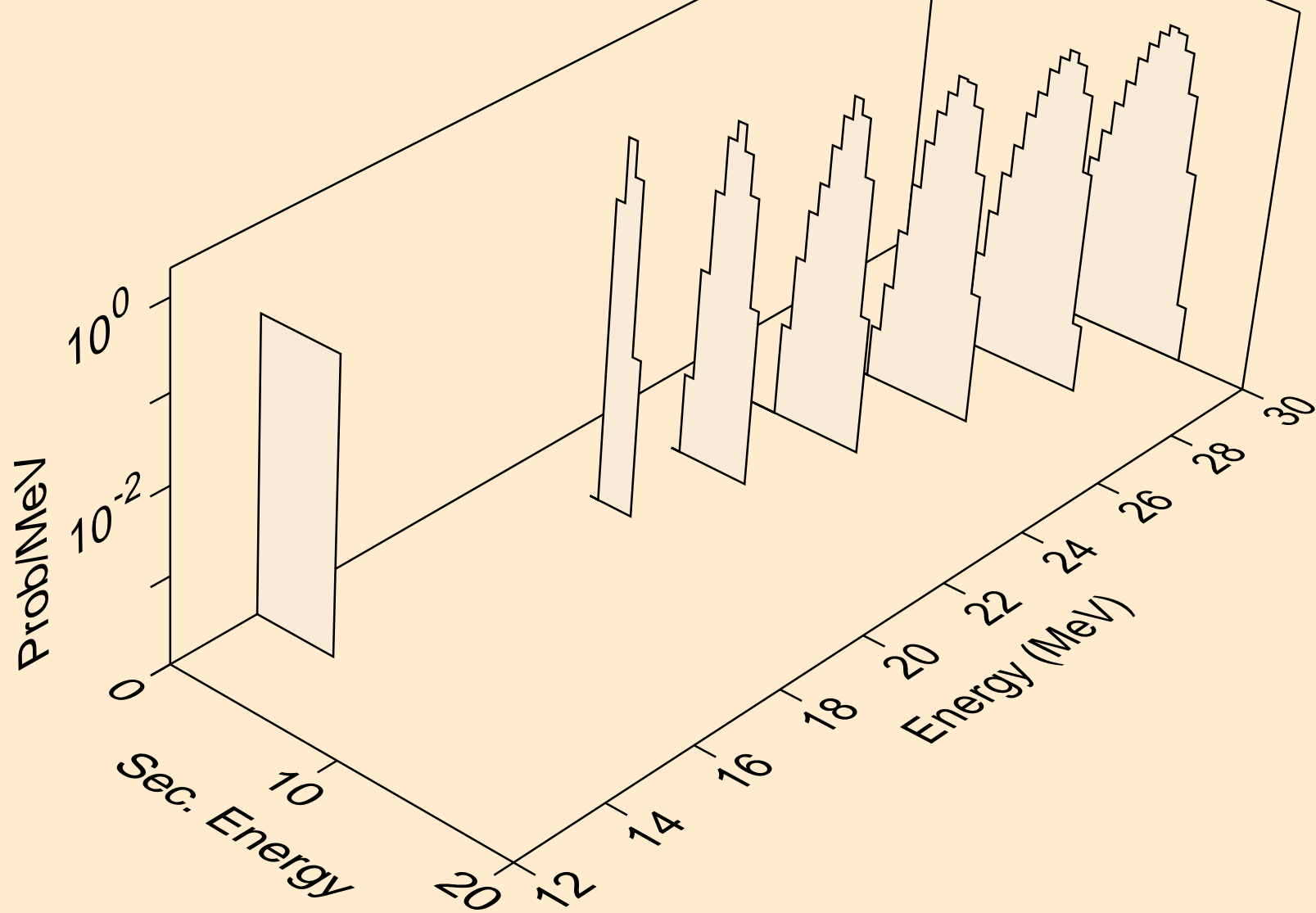

HO166 NEUTRON ACER TENDL-2024 LIBRARY; T=293.6K
alphas from (n,npa)

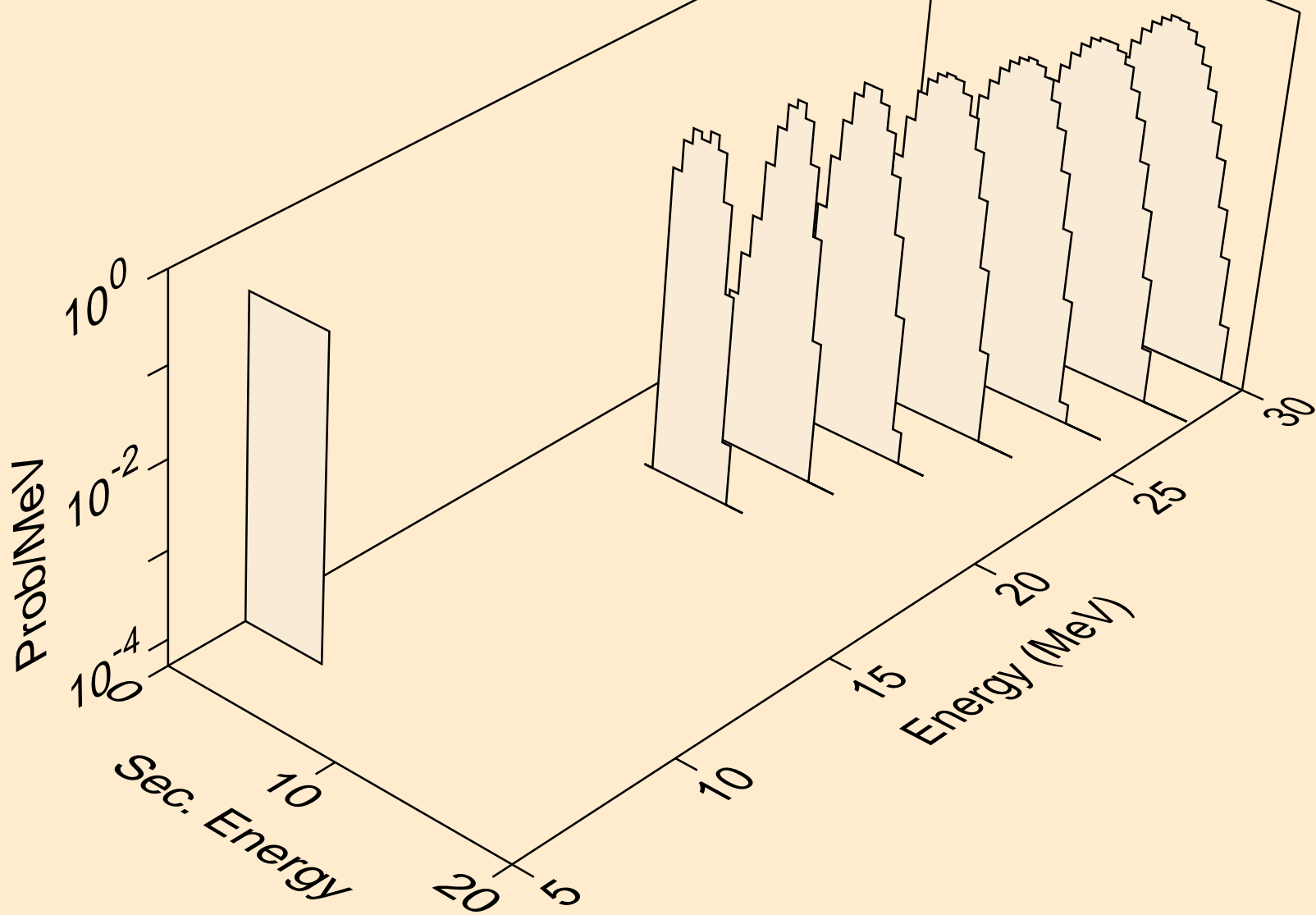

HO166 NEUTRON ACER TENDL-2024 LIBRARY; T=293.6K
alphas from (n,a)

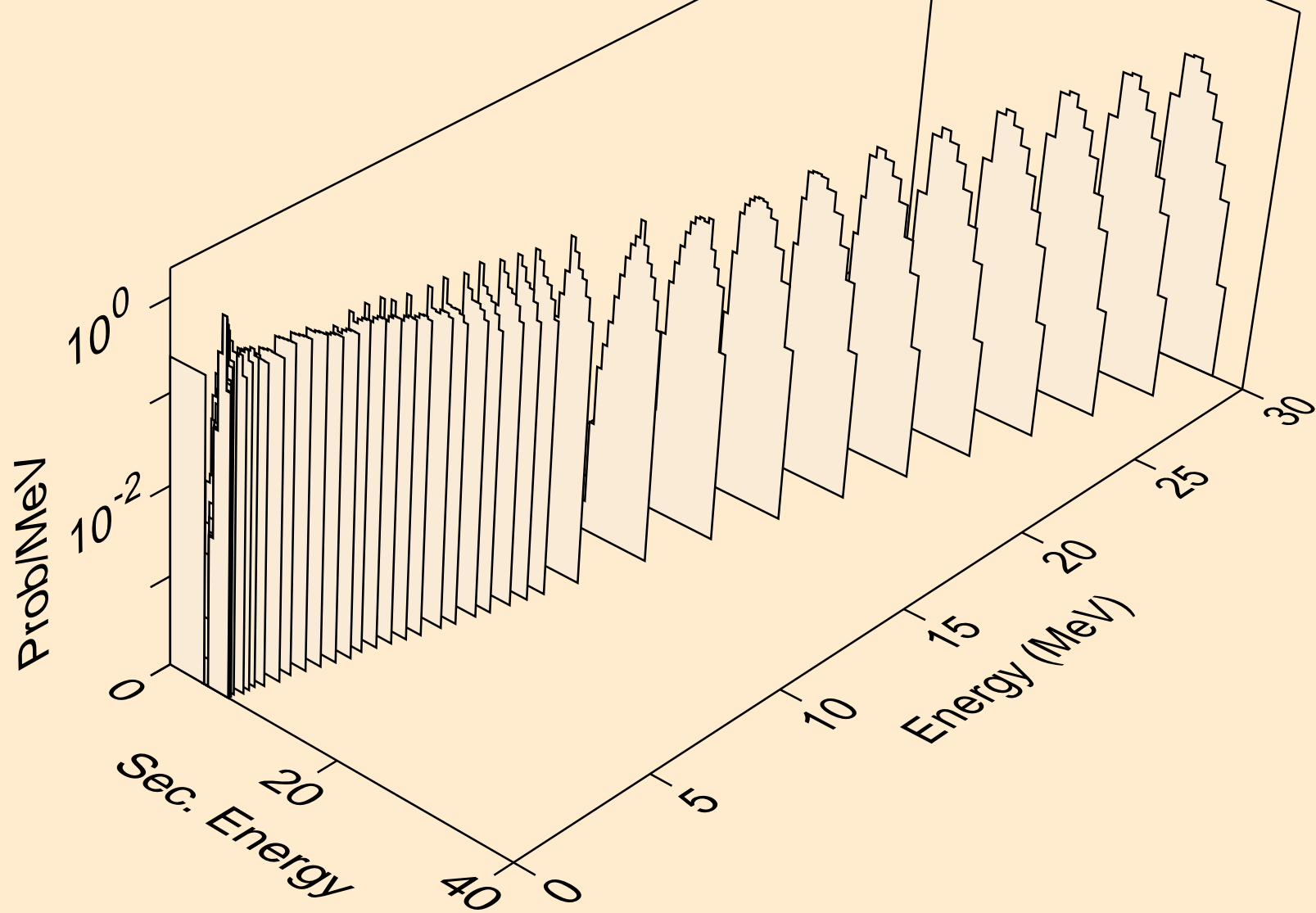

HO166 NEUTRON ACER TENDL-2024 LIBRARY; T=293.6K
alphas from (n,2a)

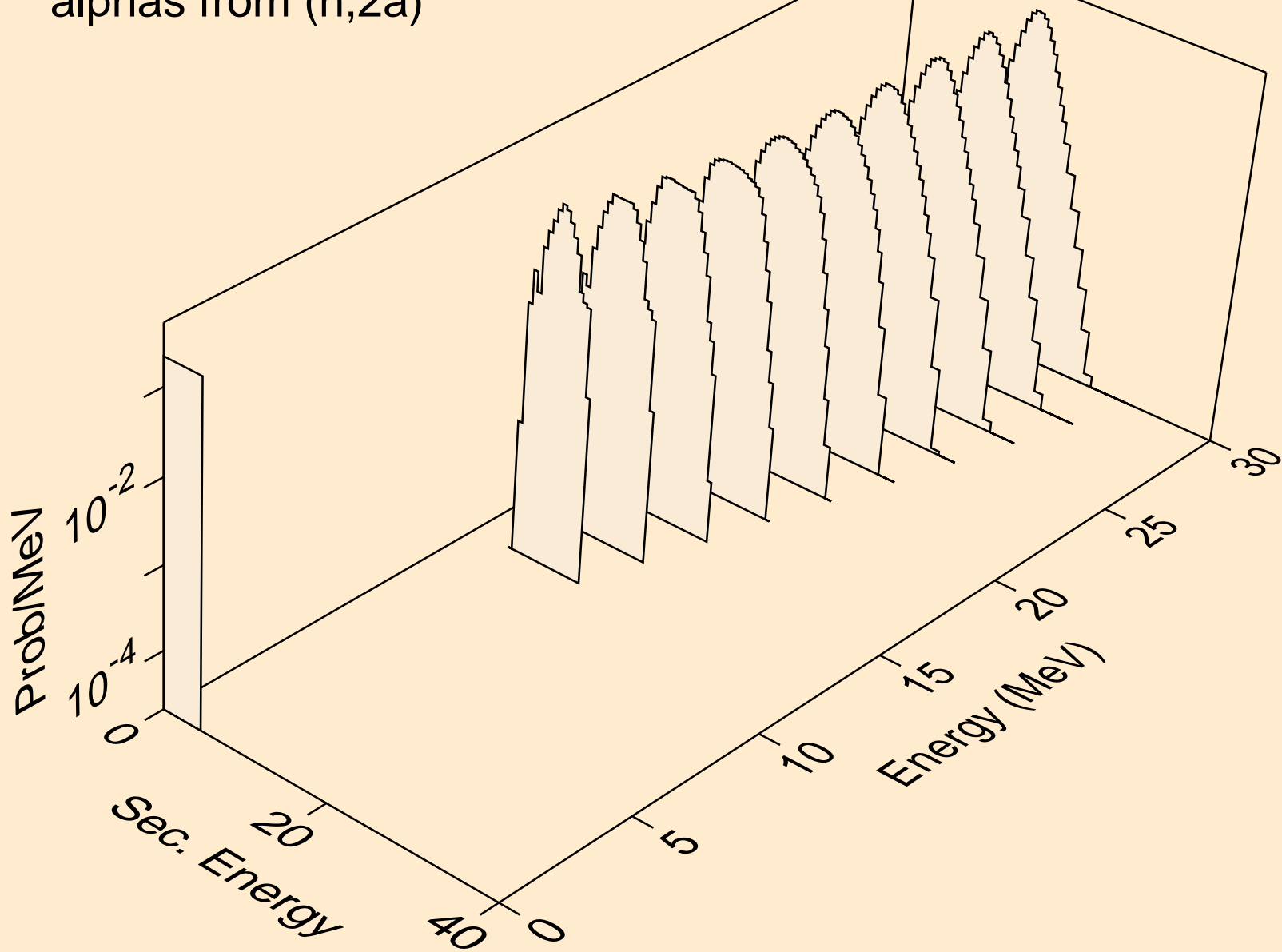

HO166 NEUTRON ACER TENDL-2024 LIBRARY; T=293.6K
alphas from (n,pa)

