

I115 NEUTRON ACER TENDL-2024 LIBRARY; T=293.6K

Principal cross sections

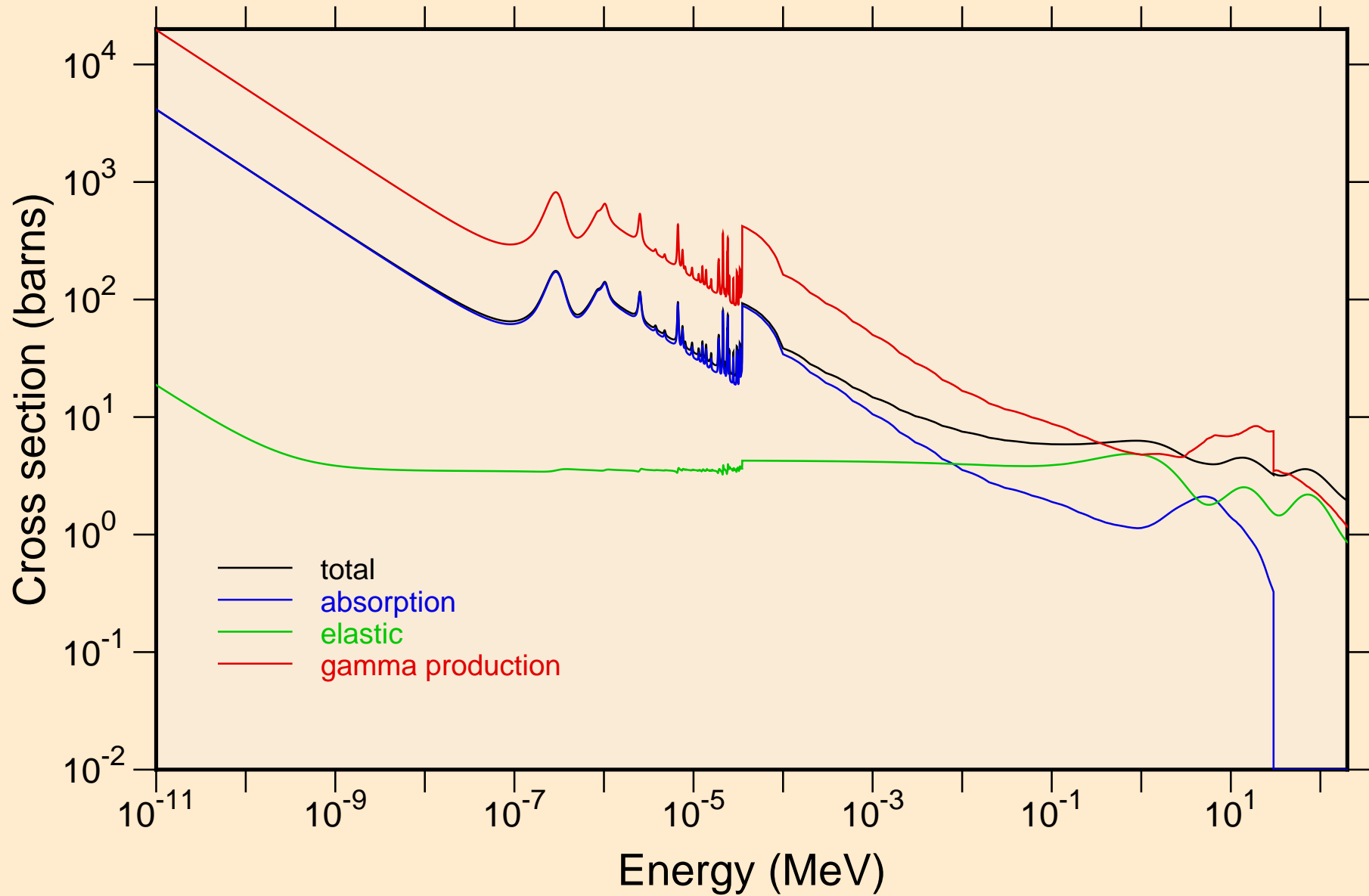

I115 NEUTRON ACER TENDL-2024 LIBRARY; T=293.6K
resonance total cross section

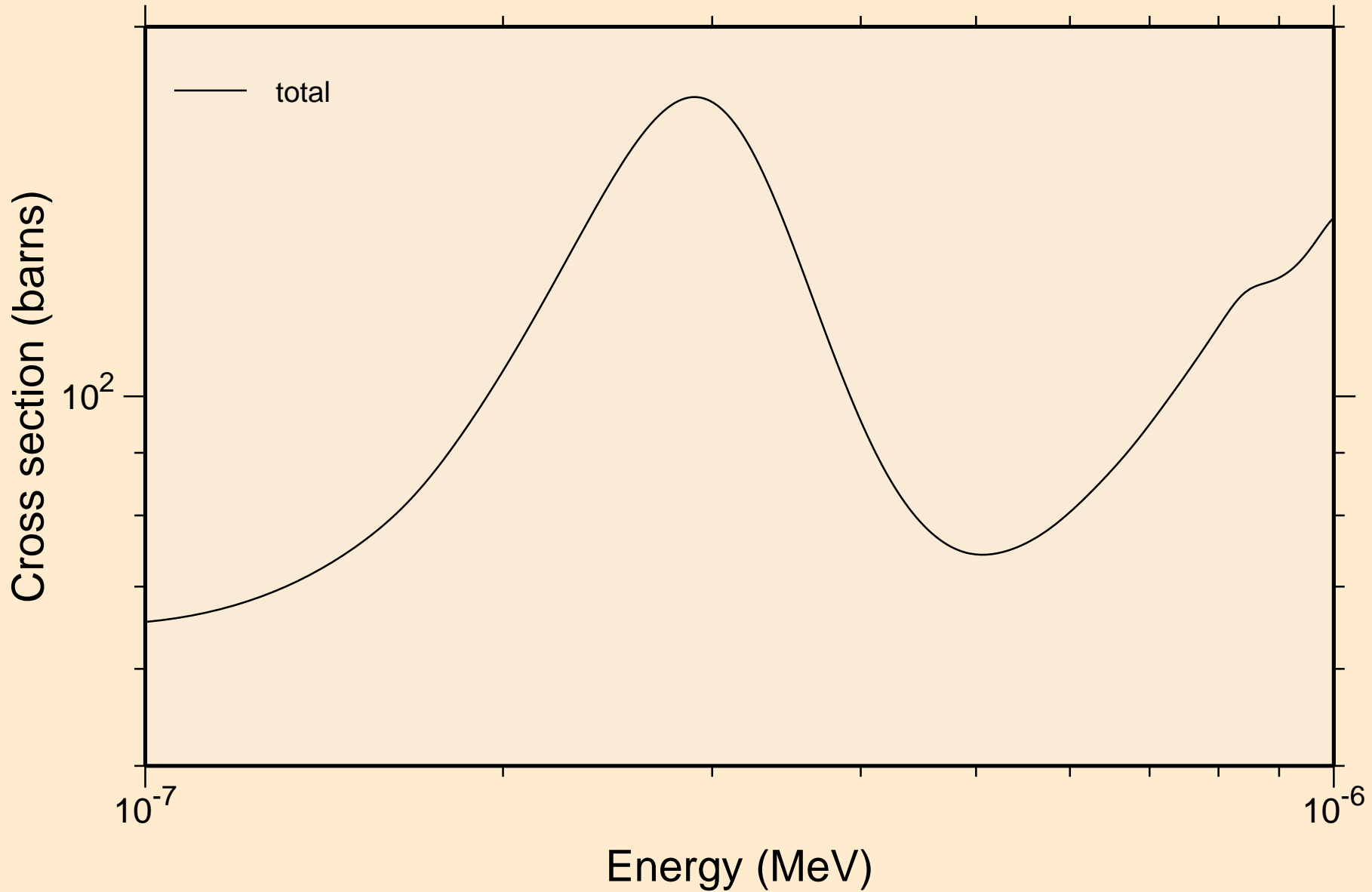

I115 NEUTRON ACER TENDL-2024 LIBRARY; T=293.6K
resonance total cross section

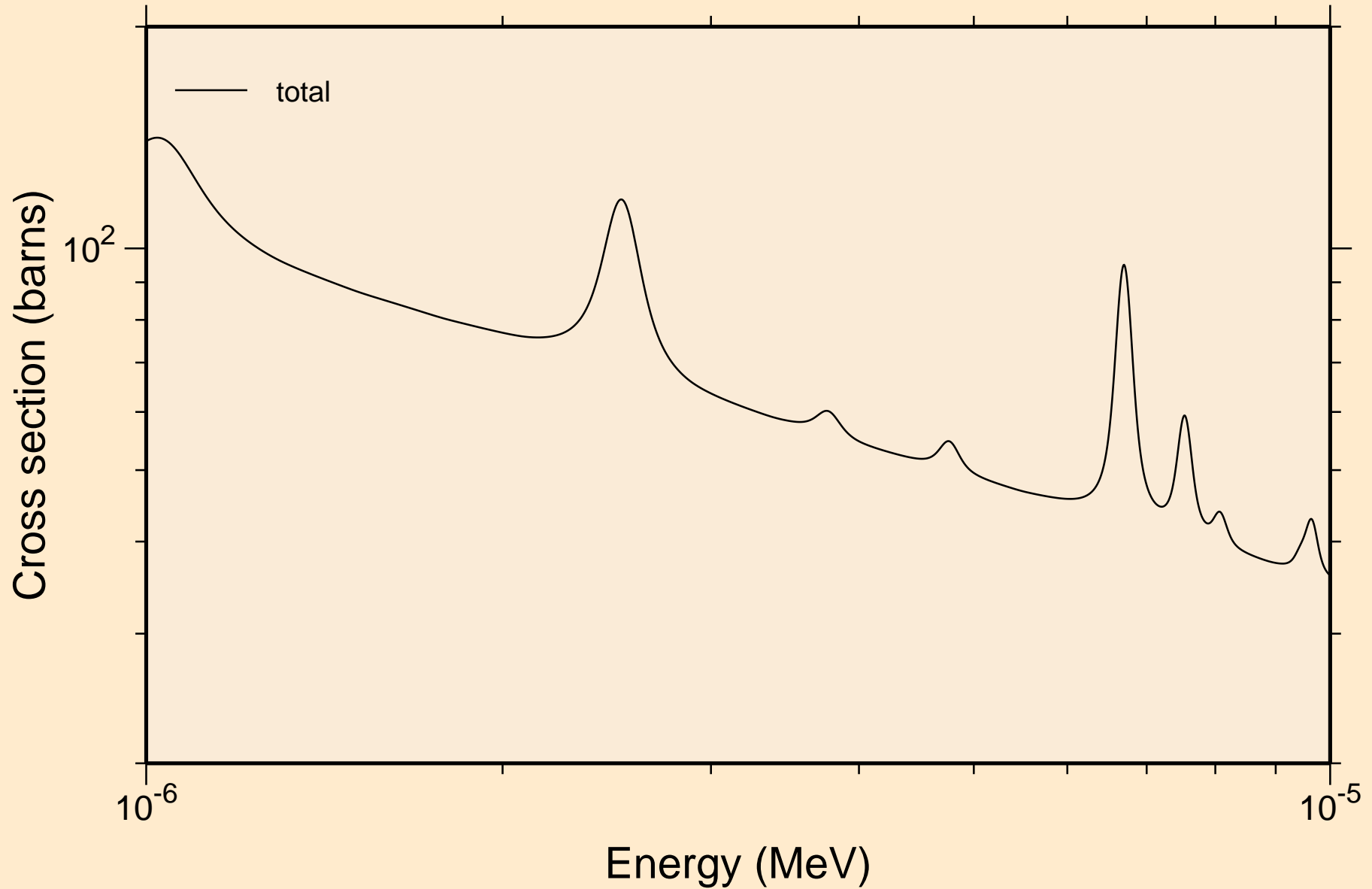

I115 NEUTRON ACER TENDL-2024 LIBRARY; T=293.6K
resonance total cross section

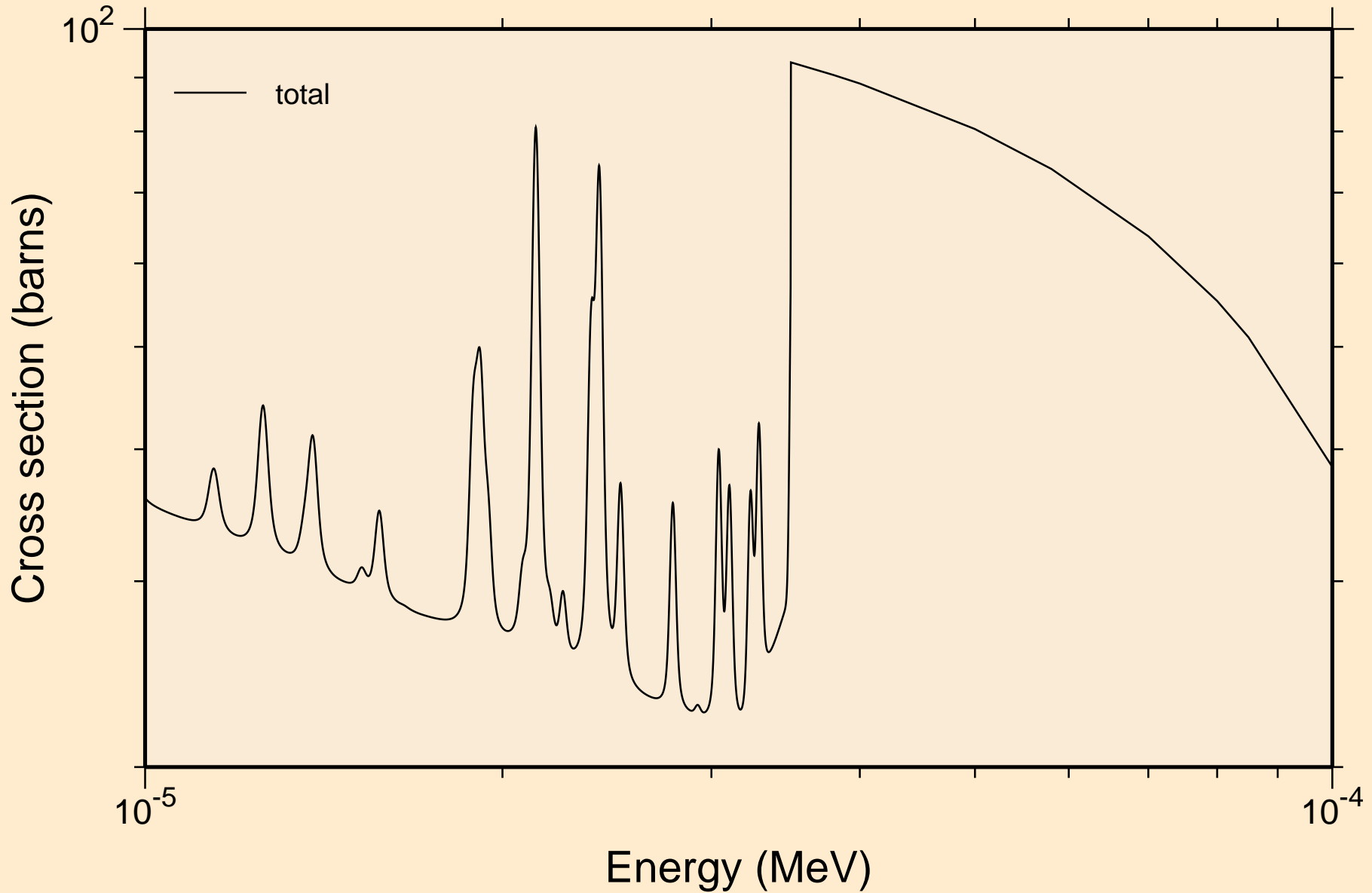

I115 NEUTRON ACER TENDL-2024 LIBRARY; T=293.6K
resonance total cross section

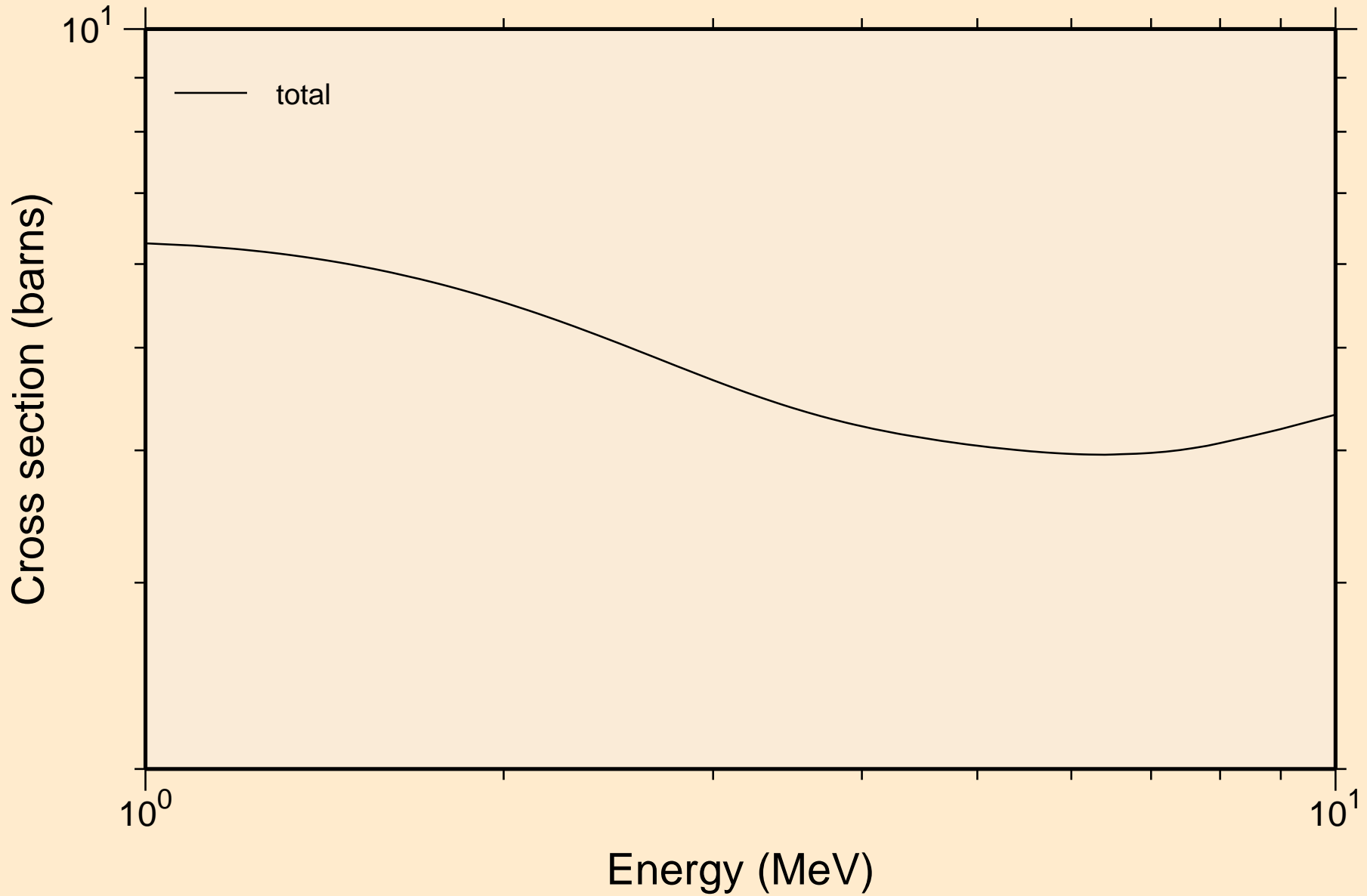

I115 NEUTRON ACER TENDL-2024 LIBRARY; T=293.6K
resonance absorption cross sections

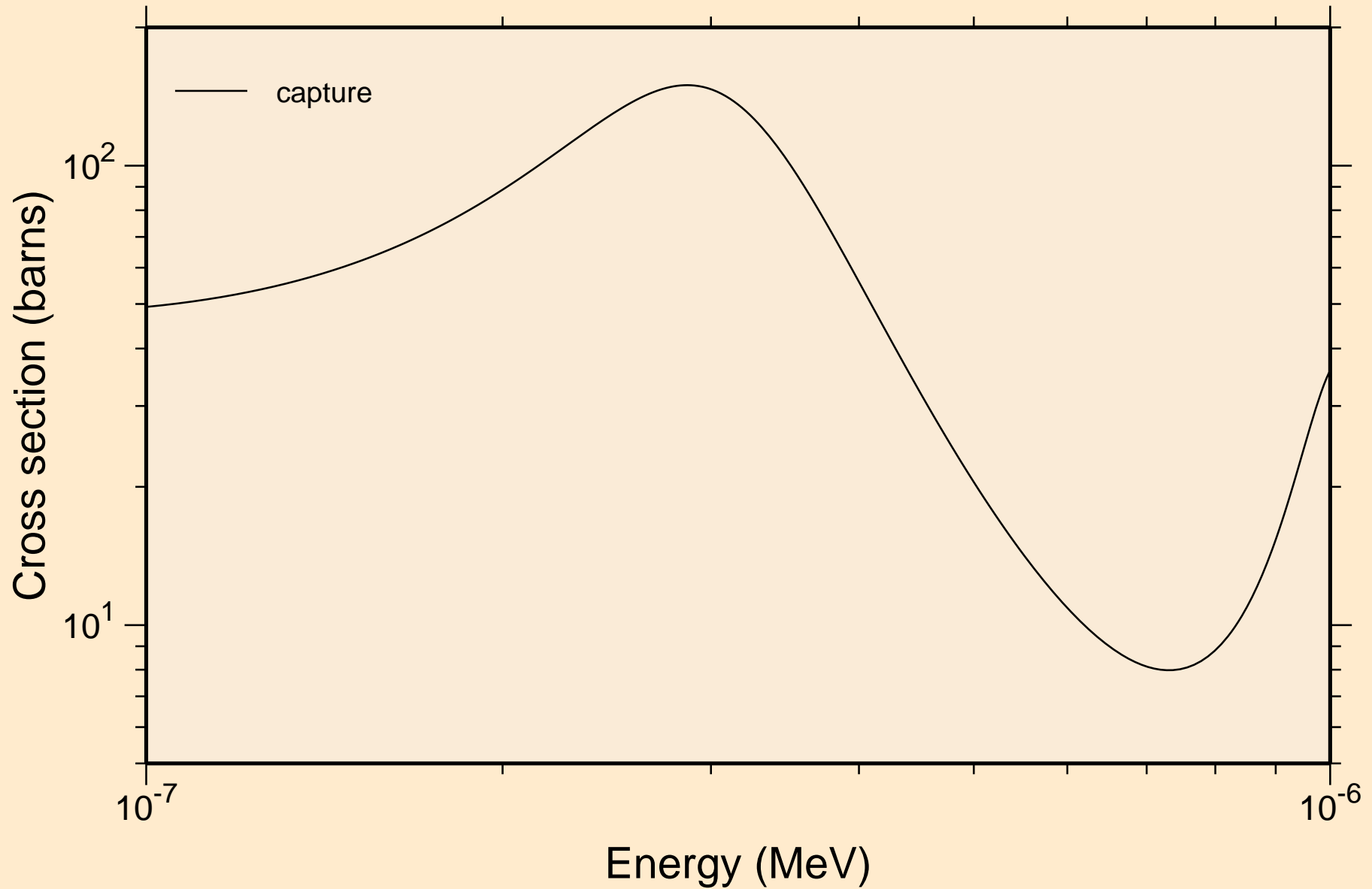

I115 NEUTRON ACER TENDL-2024 LIBRARY; T=293.6K
resonance absorption cross sections

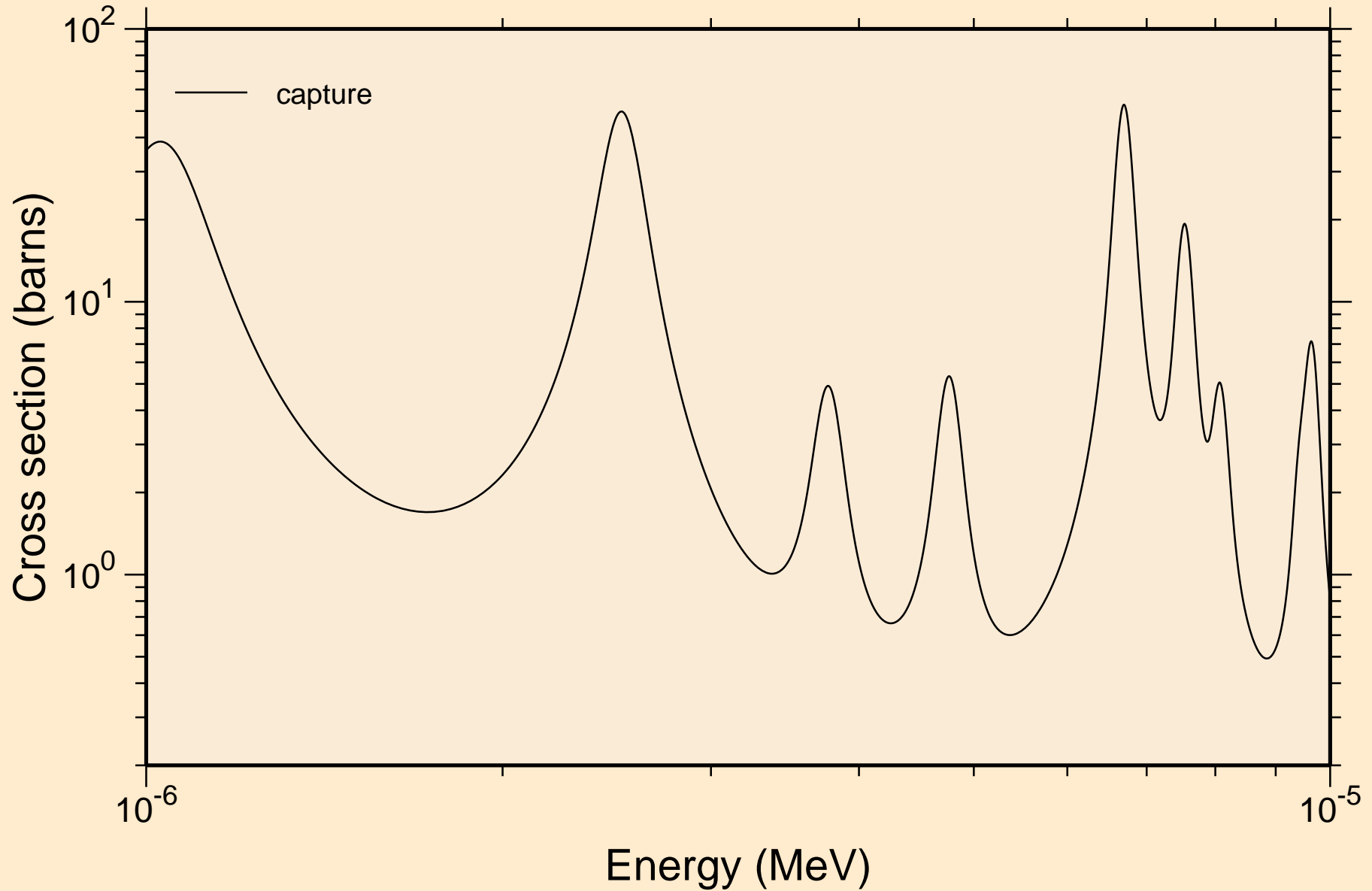

I115 NEUTRON ACER TENDL-2024 LIBRARY; T=293.6K
resonance absorption cross sections

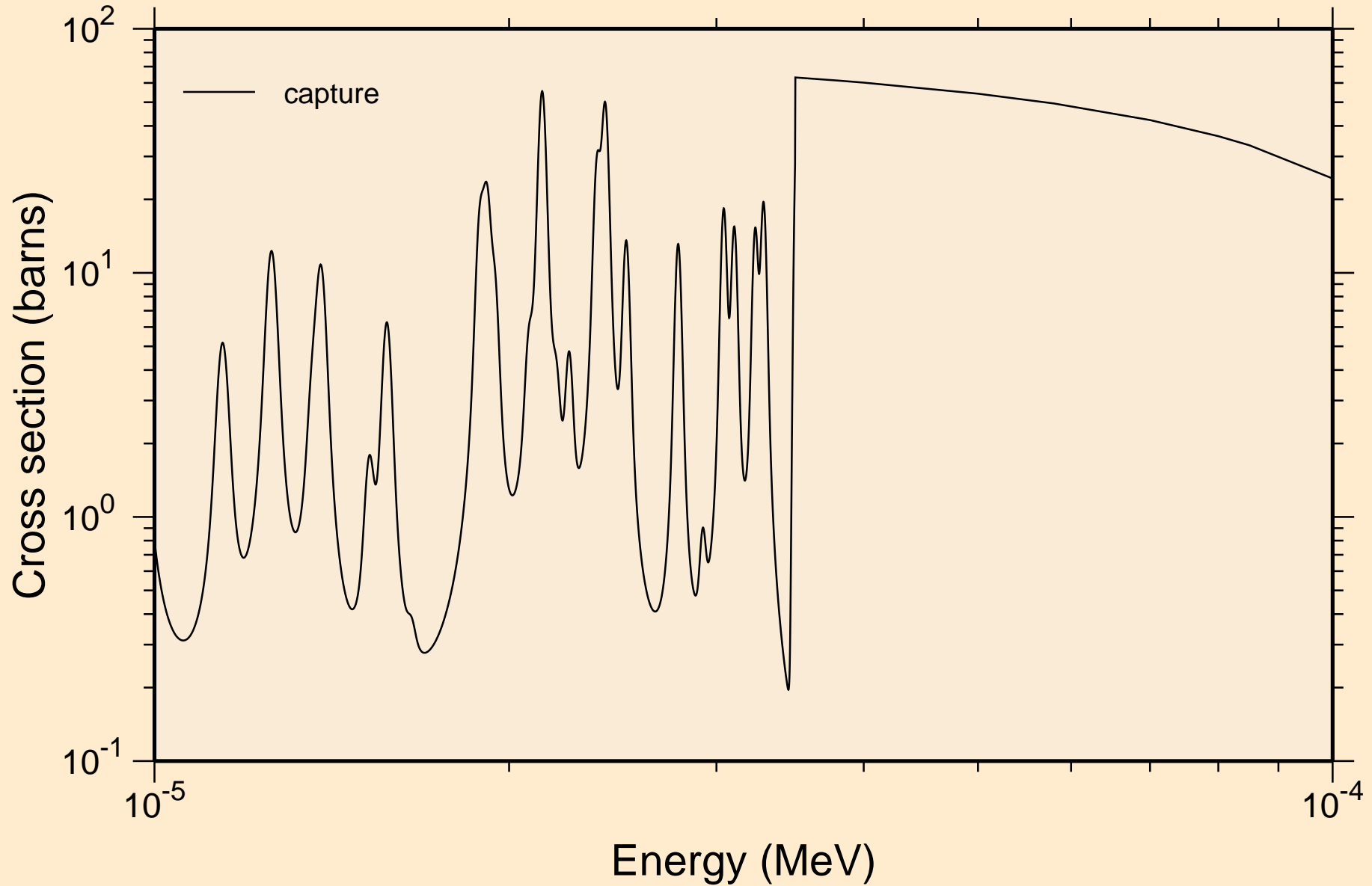

I115 NEUTRON ACER TENDL-2024 LIBRARY; T=293.6K
resonance absorption cross sections

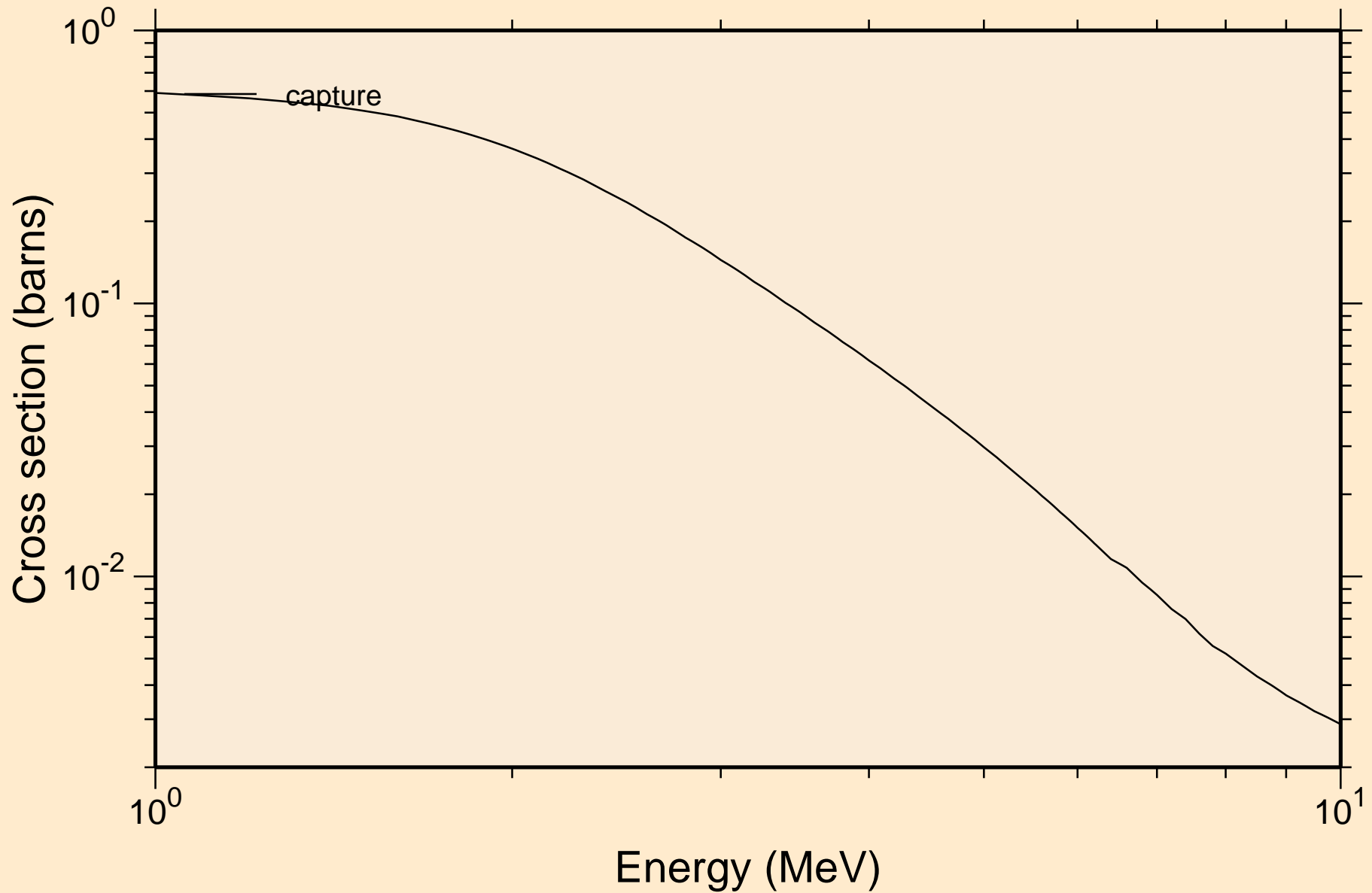

I115 NEUTRON ACER TENDL-2024 LIBRARY; T=293.6K

Heating

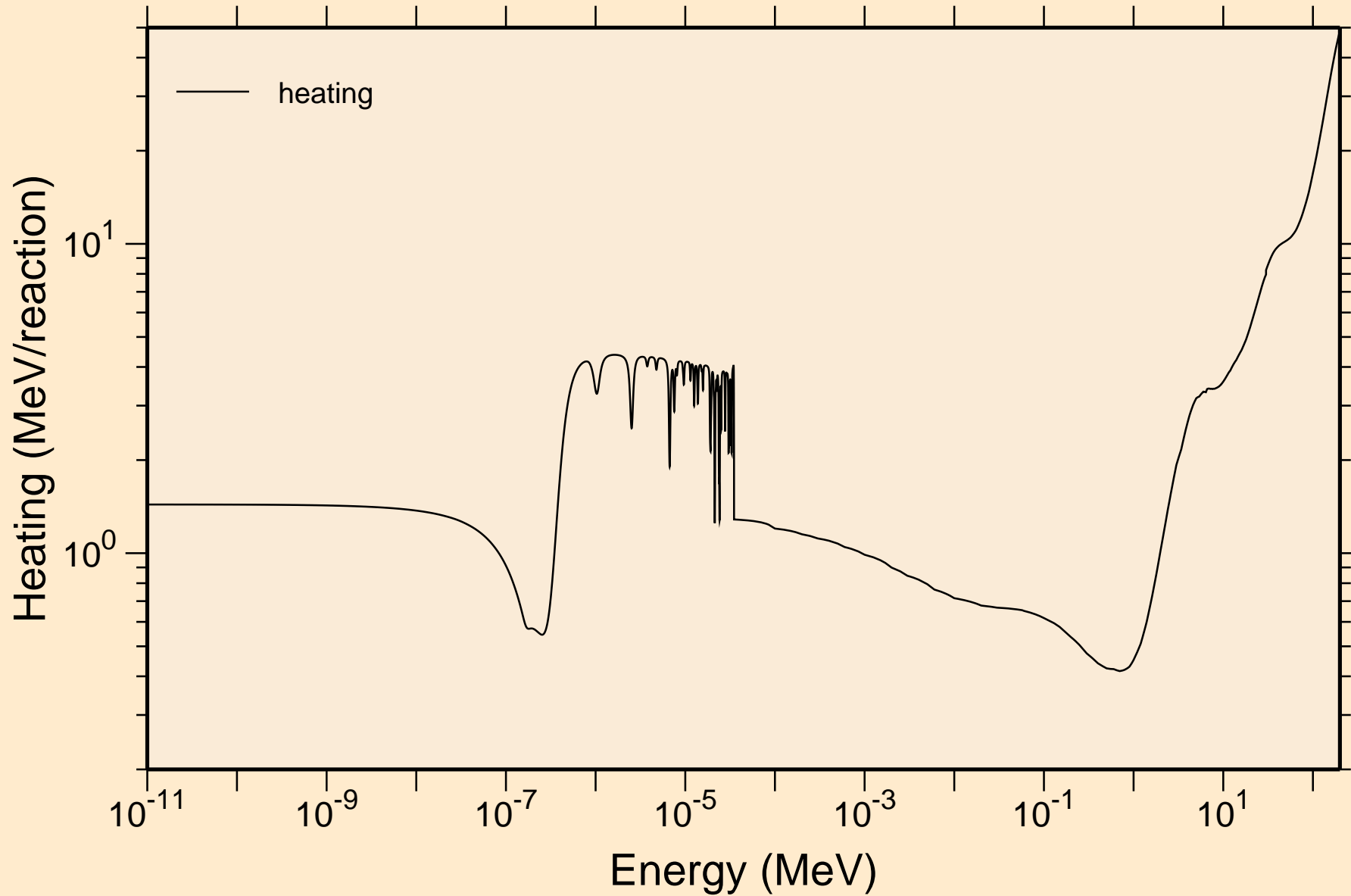

I115 NEUTRON ACER TENDL-2024 LIBRARY; T=293.6K
Damage

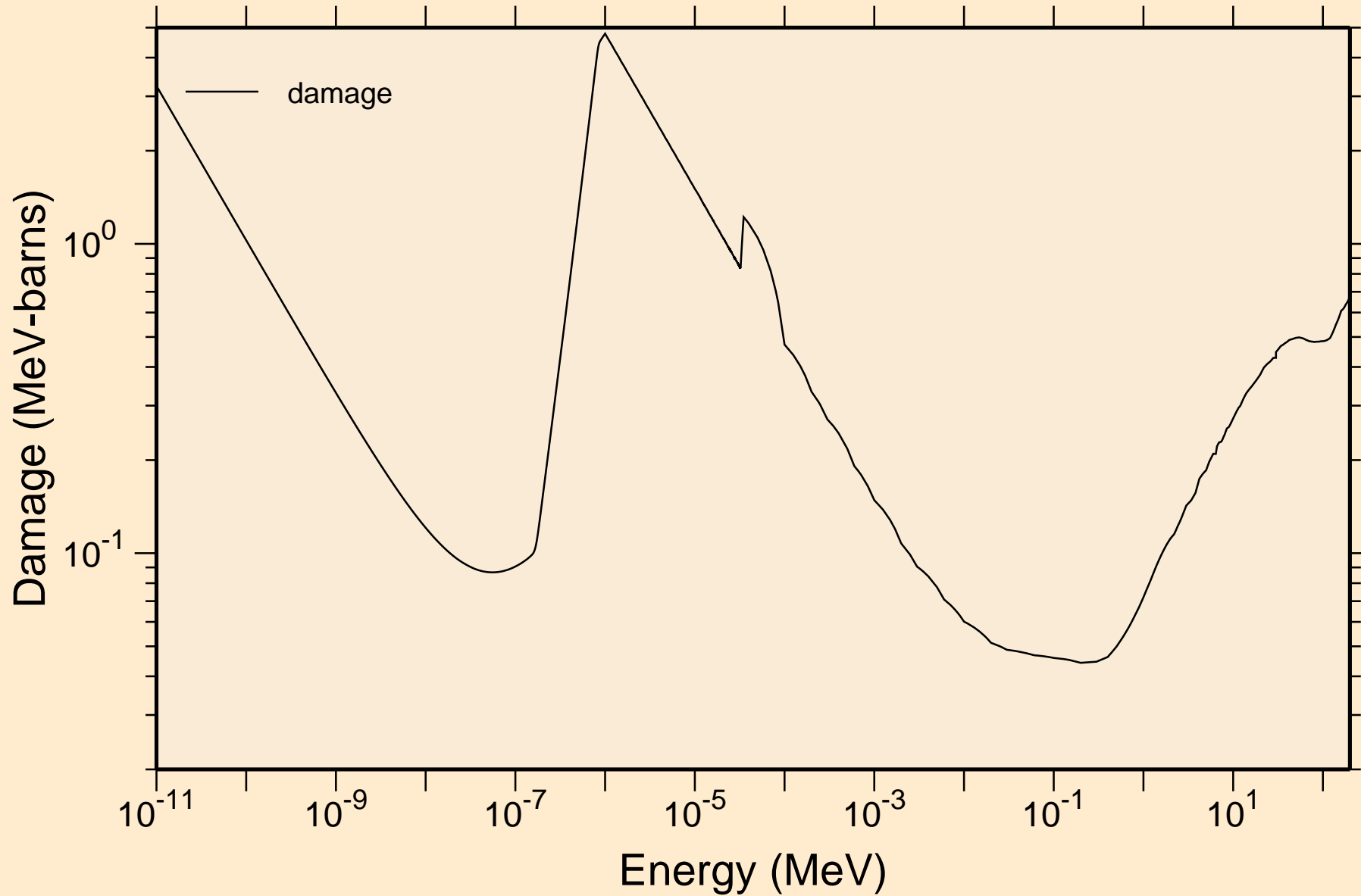

I115 NEUTRON ACER TENDL-2024 LIBRARY; T=293.6K
Non-threshold reactions

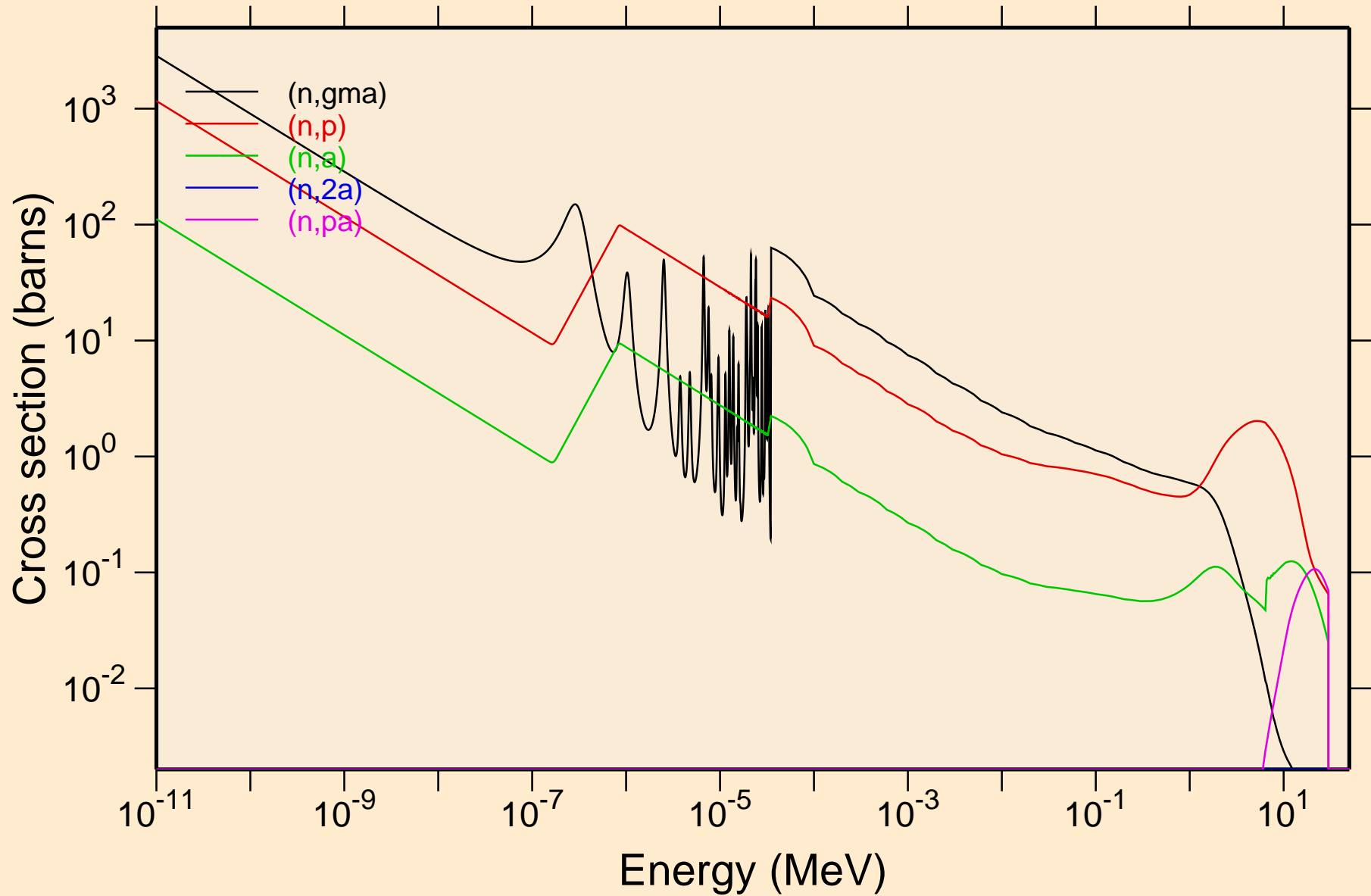

I115 NEUTRON ACER TENDL-2024 LIBRARY; T=293.6K
Non-threshold reactions

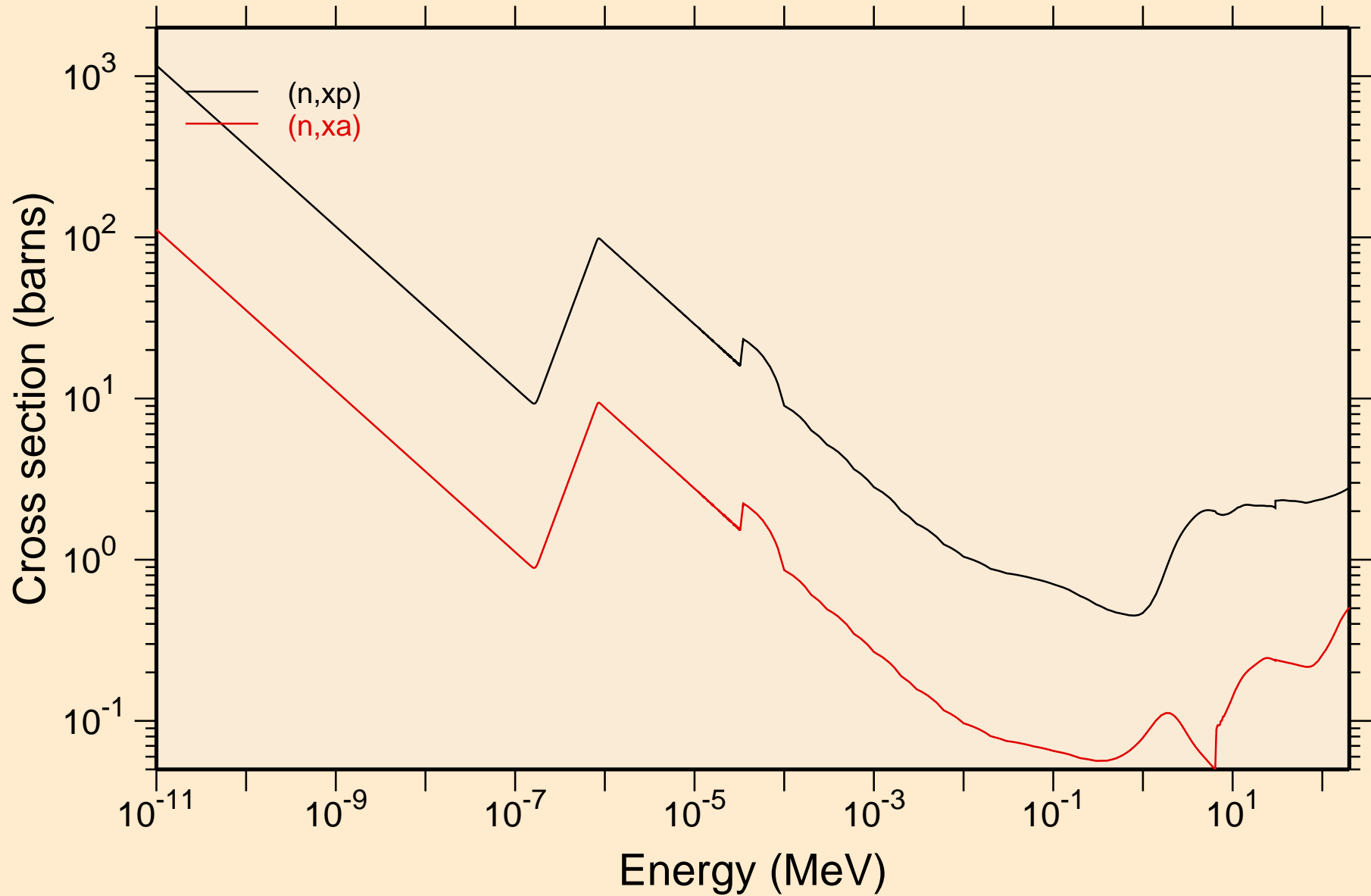

I115 NEUTRON ACER TENDL-2024 LIBRARY; T=293.6K

Principal cross sections

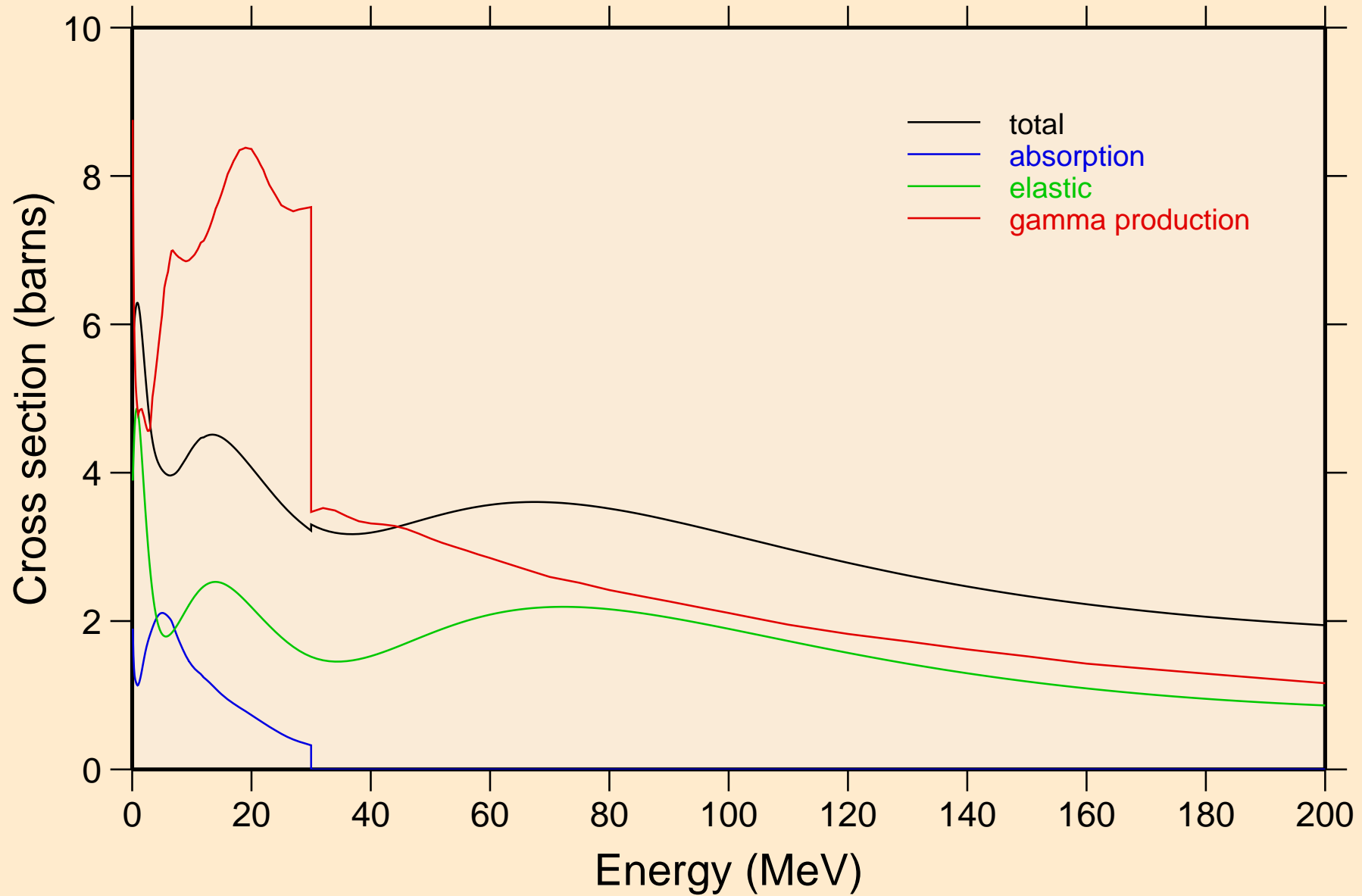

I115 NEUTRON ACER TENDL-2024 LIBRARY; T=293.6K

Heating

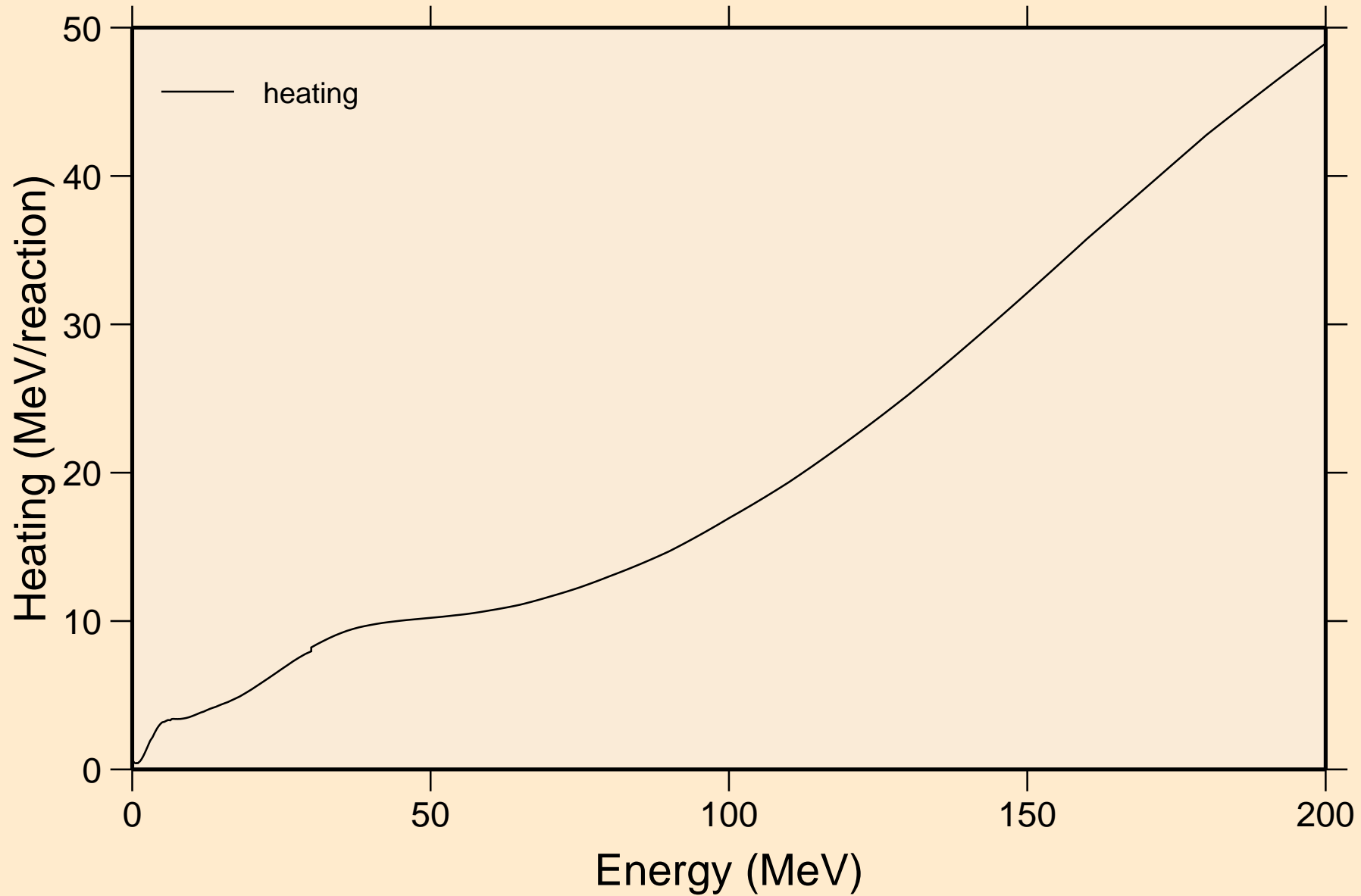

I115 NEUTRON ACER TENDL-2024 LIBRARY; T=293.6K
Damage

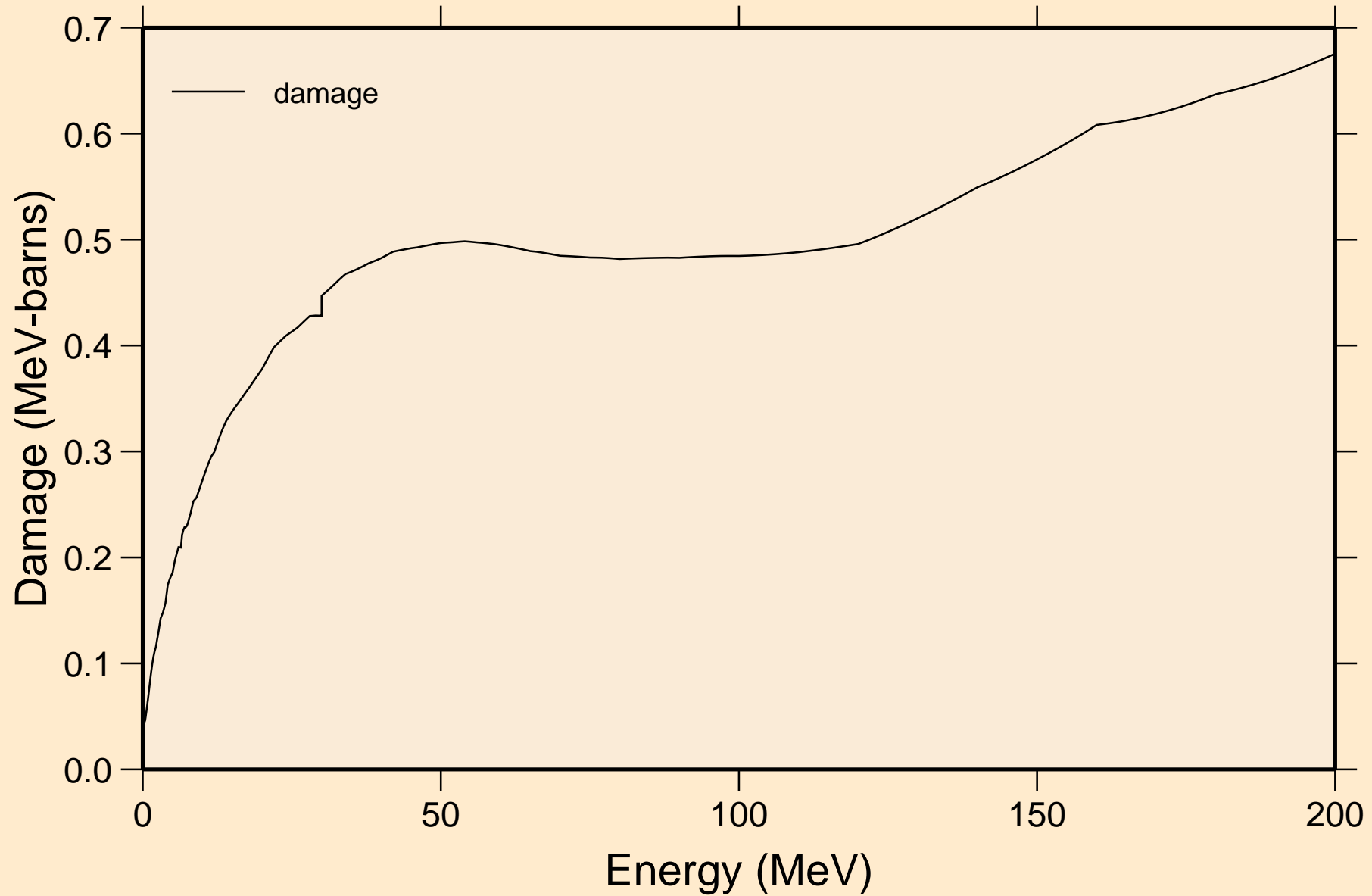

I115 NEUTRON ACER TENDL-2024 LIBRARY; T=293.6K
Non-threshold reactions

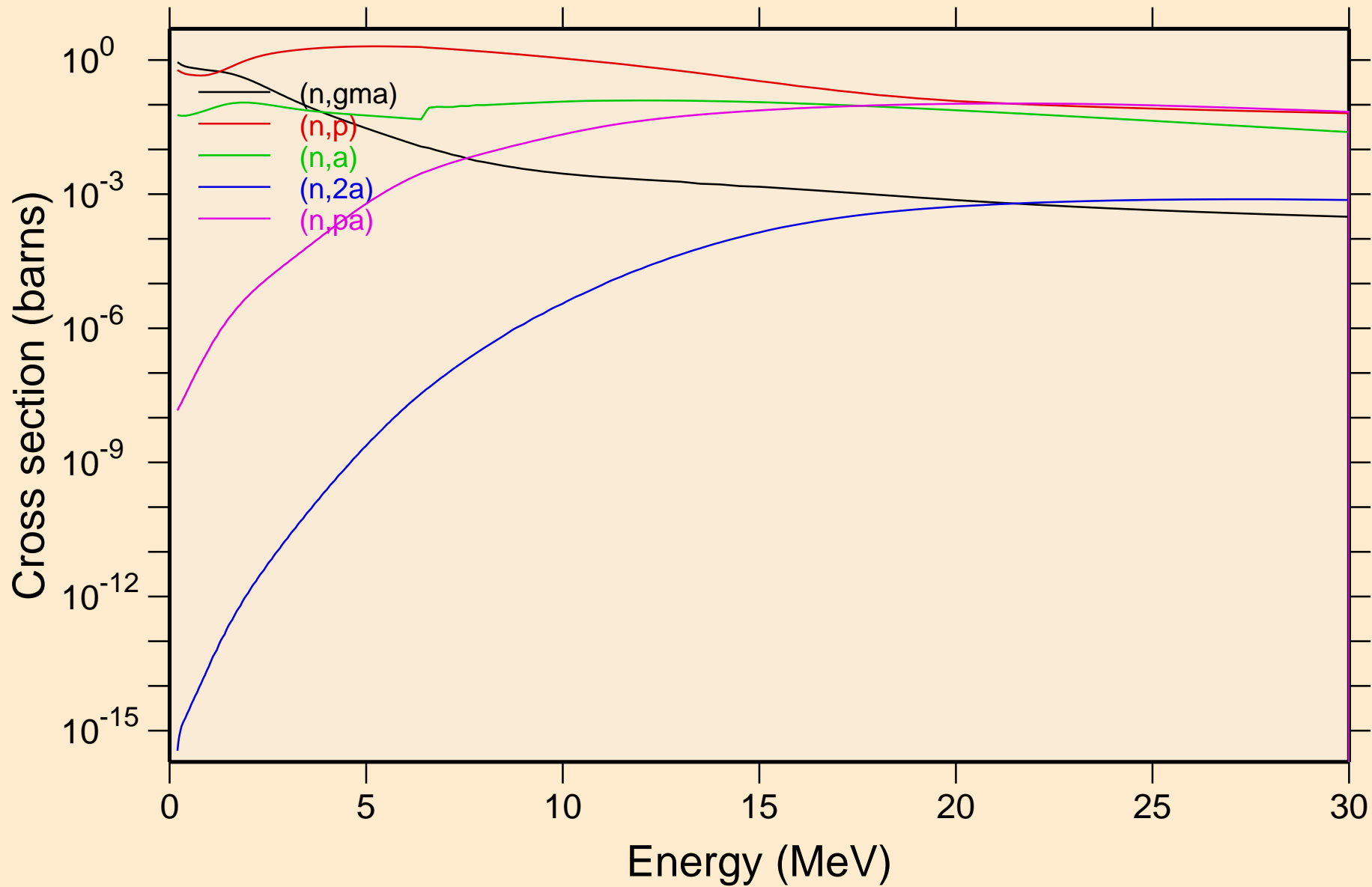

I115 NEUTRON ACER TENDL-2024 LIBRARY; T=293.6K
Non-threshold reactions

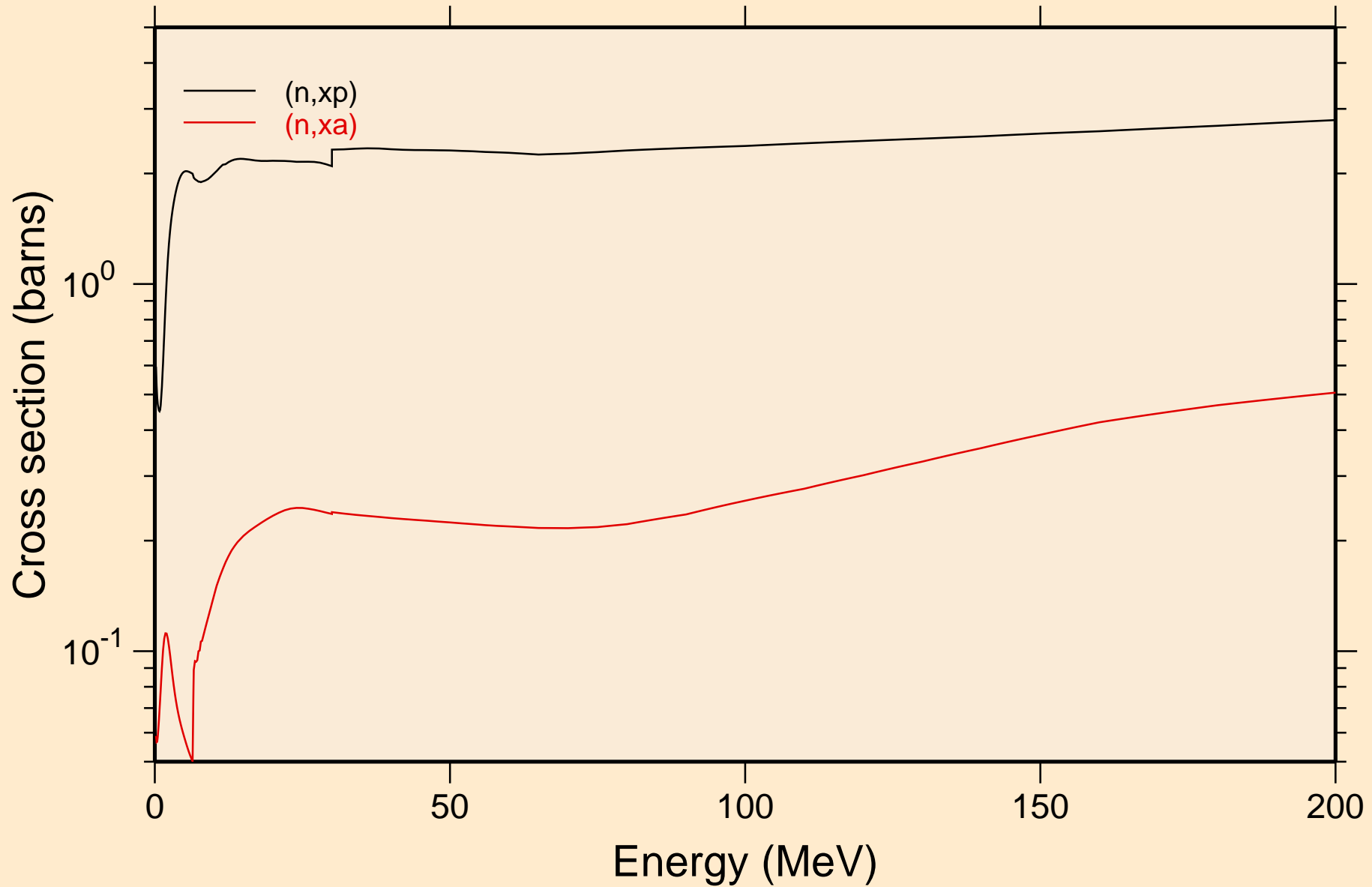

I115 NEUTRON ACER TENDL-2024 LIBRARY; T=293.6K
Inelastic levels

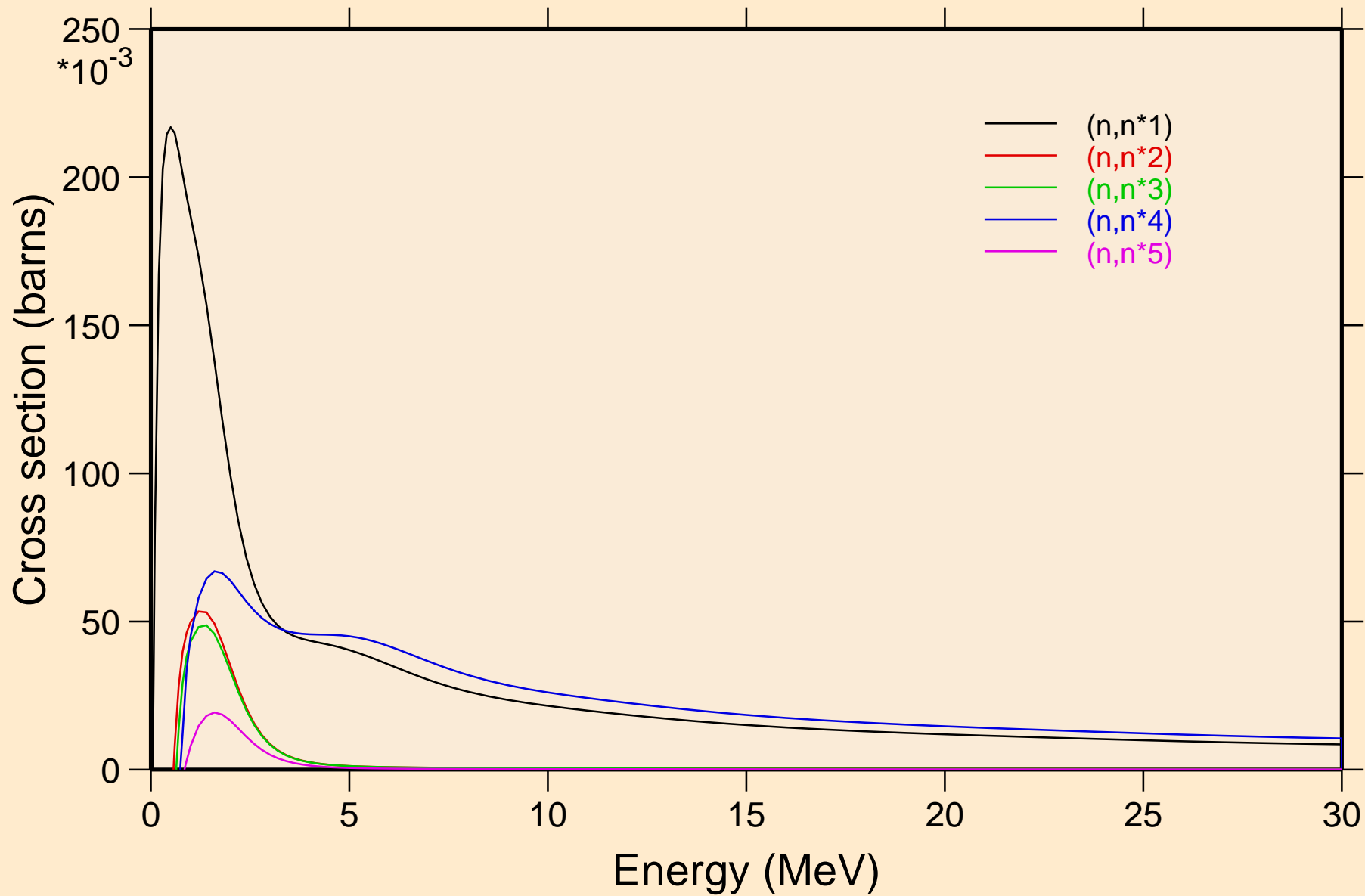

I115 NEUTRON ACER TENDL-2024 LIBRARY; T=293.6K
Inelastic levels

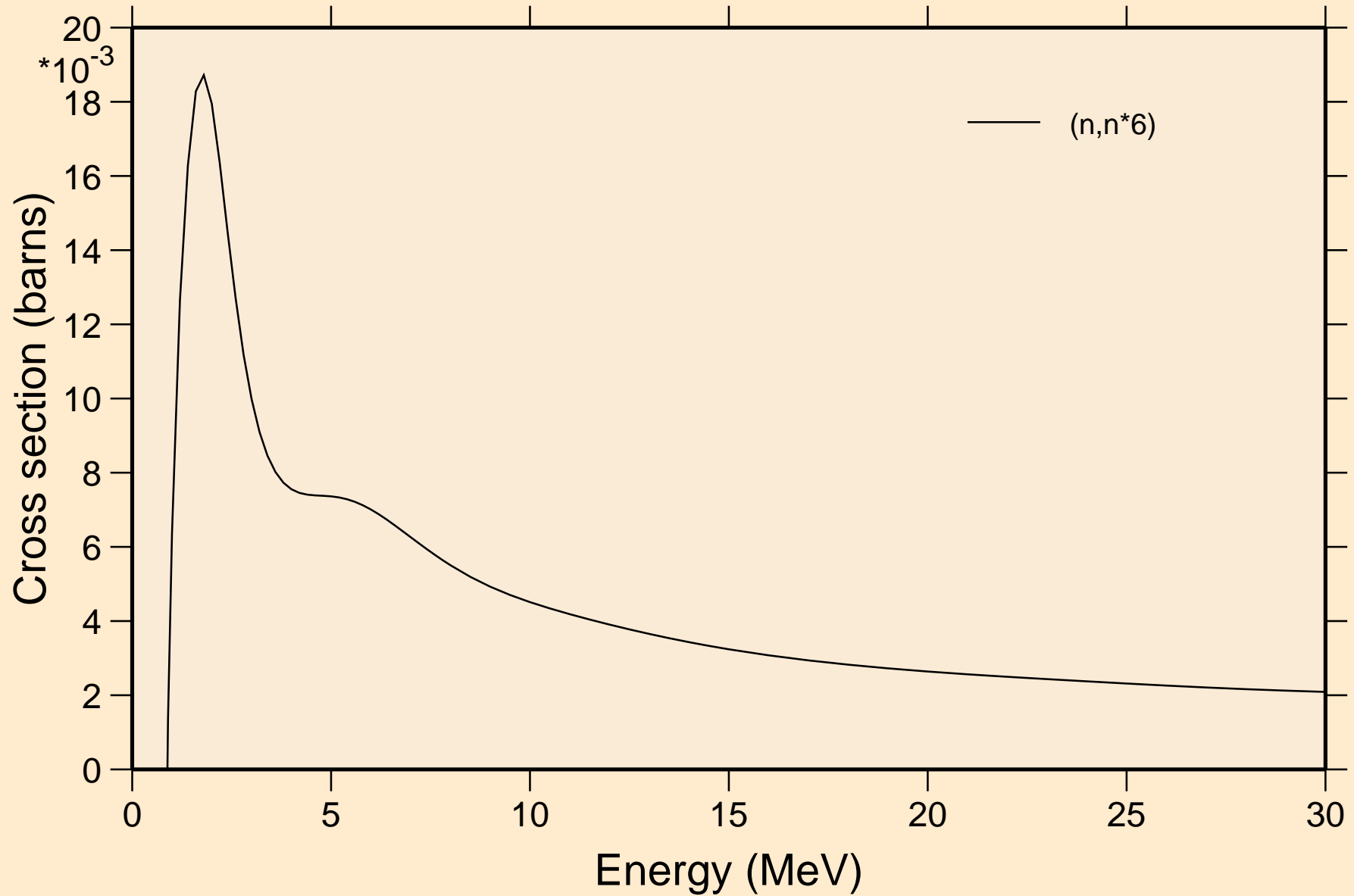

I115 NEUTRON ACER TENDL-2024 LIBRARY; T=293.6K
Threshold reactions

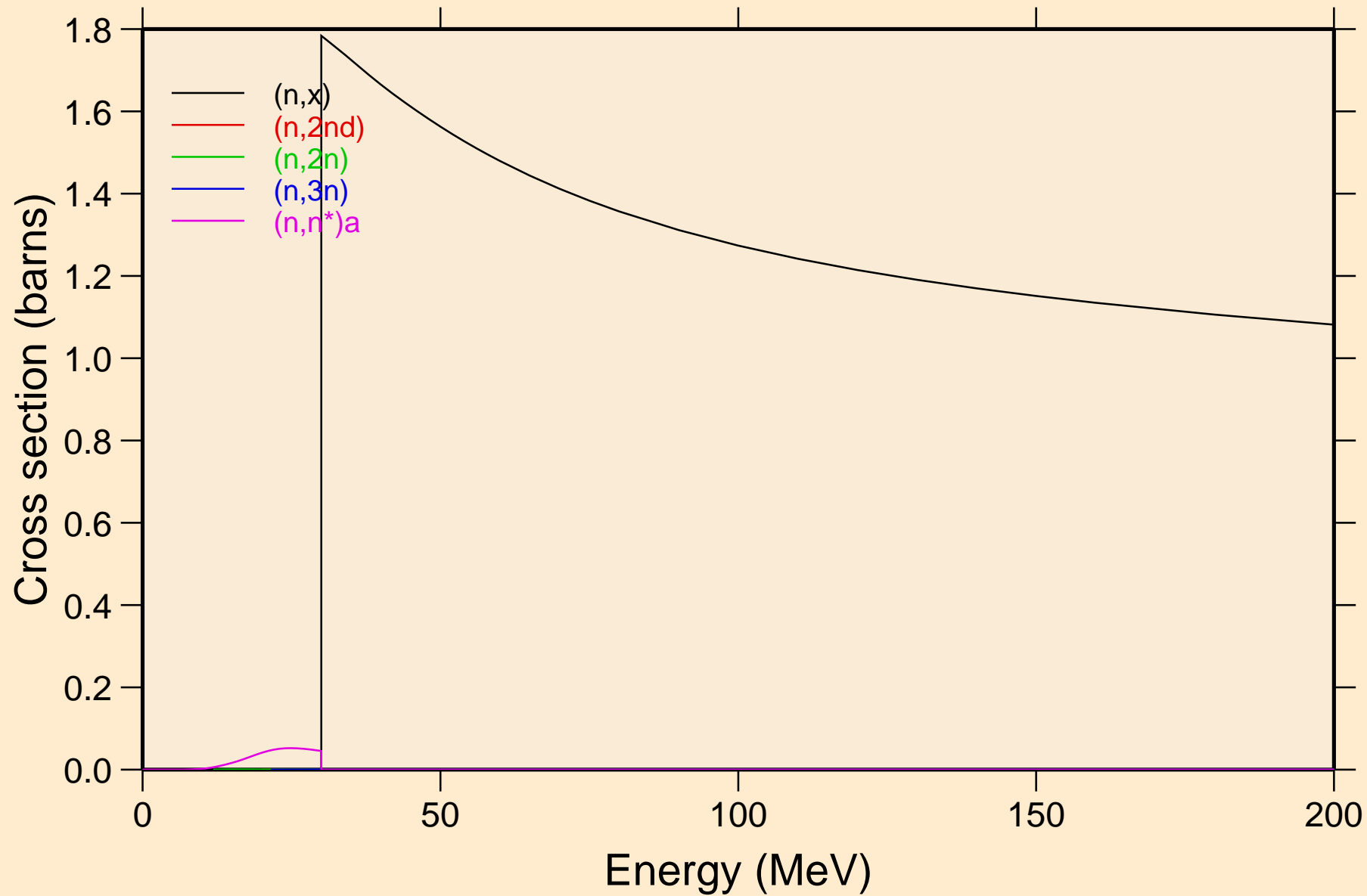

I115 NEUTRON ACER TENDL-2024 LIBRARY; T=293.6K
Threshold reactions

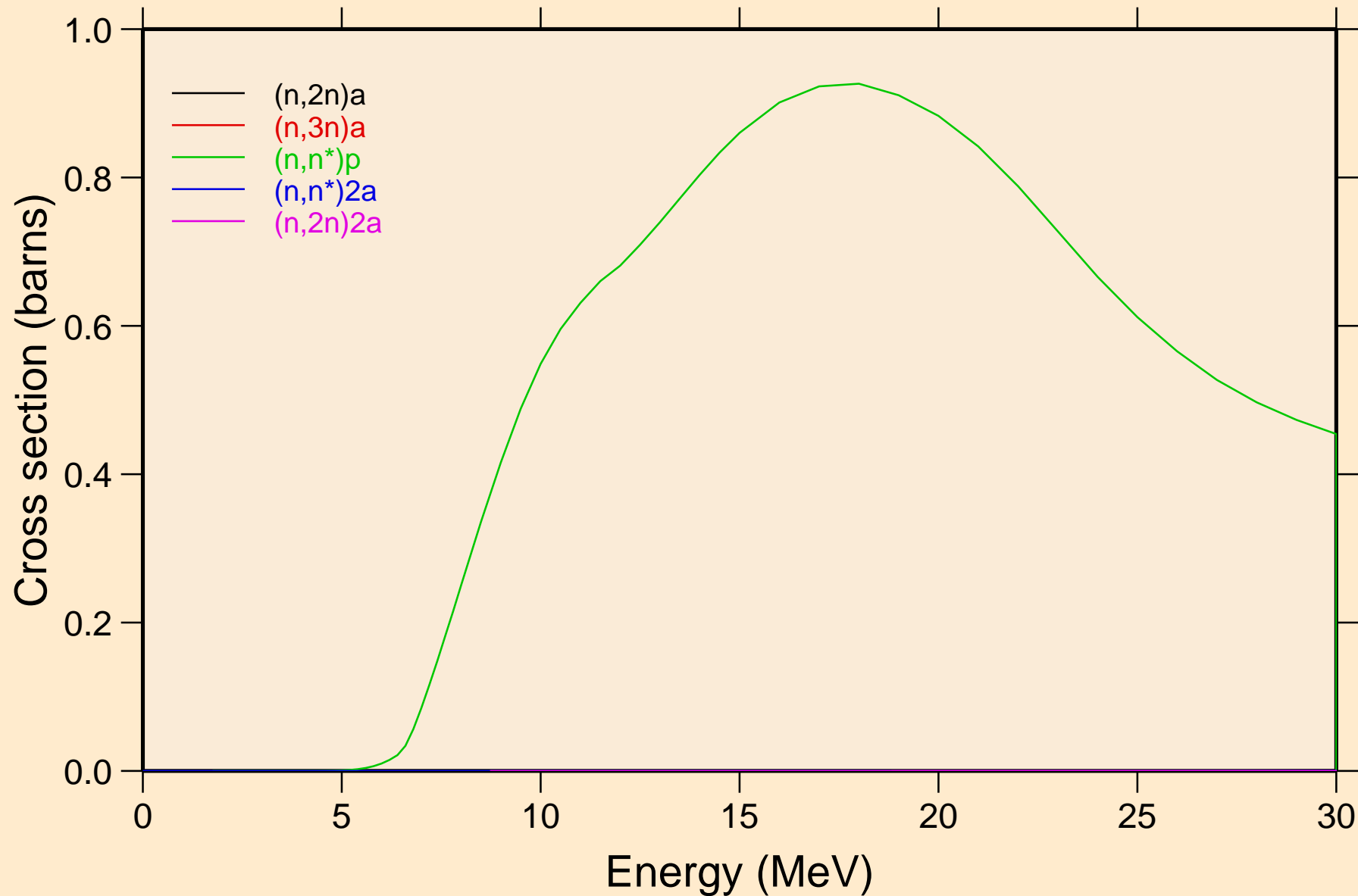

I115 NEUTRON ACER TENDL-2024 LIBRARY; T=293.6K

Threshold reactions

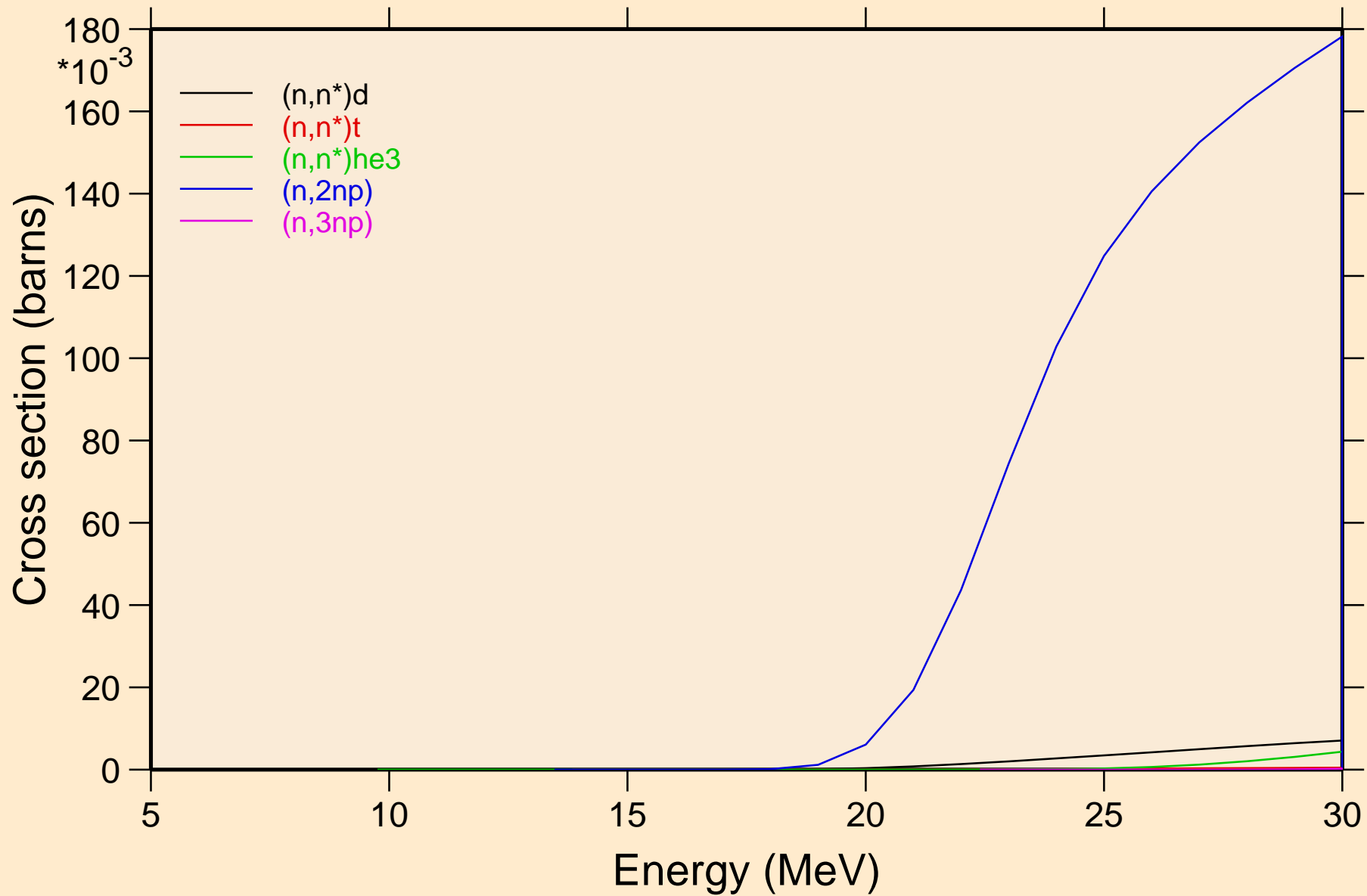

I115 NEUTRON ACER TENDL-2024 LIBRARY; T=293.6K

Threshold reactions

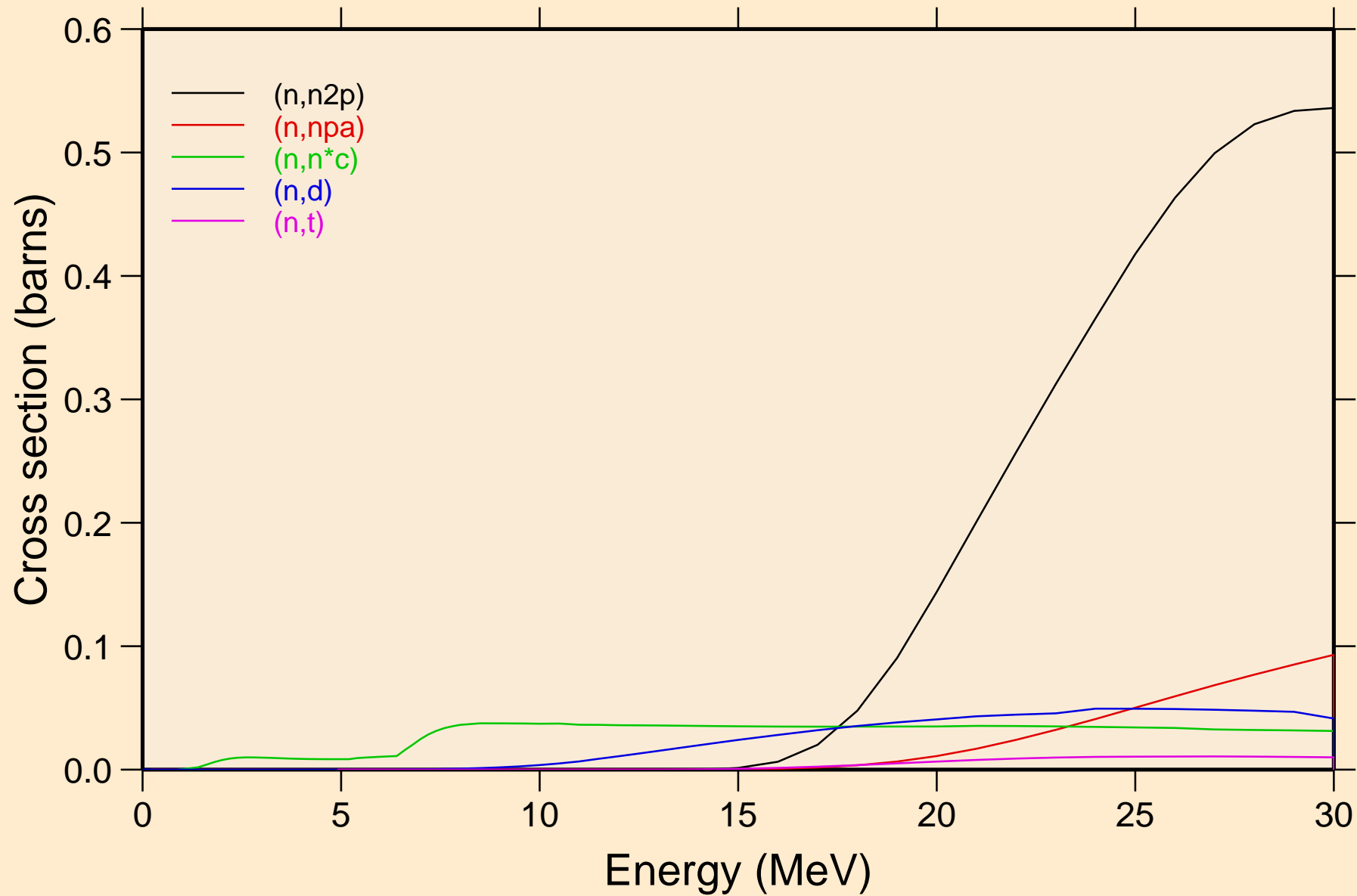

I115 NEUTRON ACER TENDL-2024 LIBRARY; T=293.6K
Threshold reactions

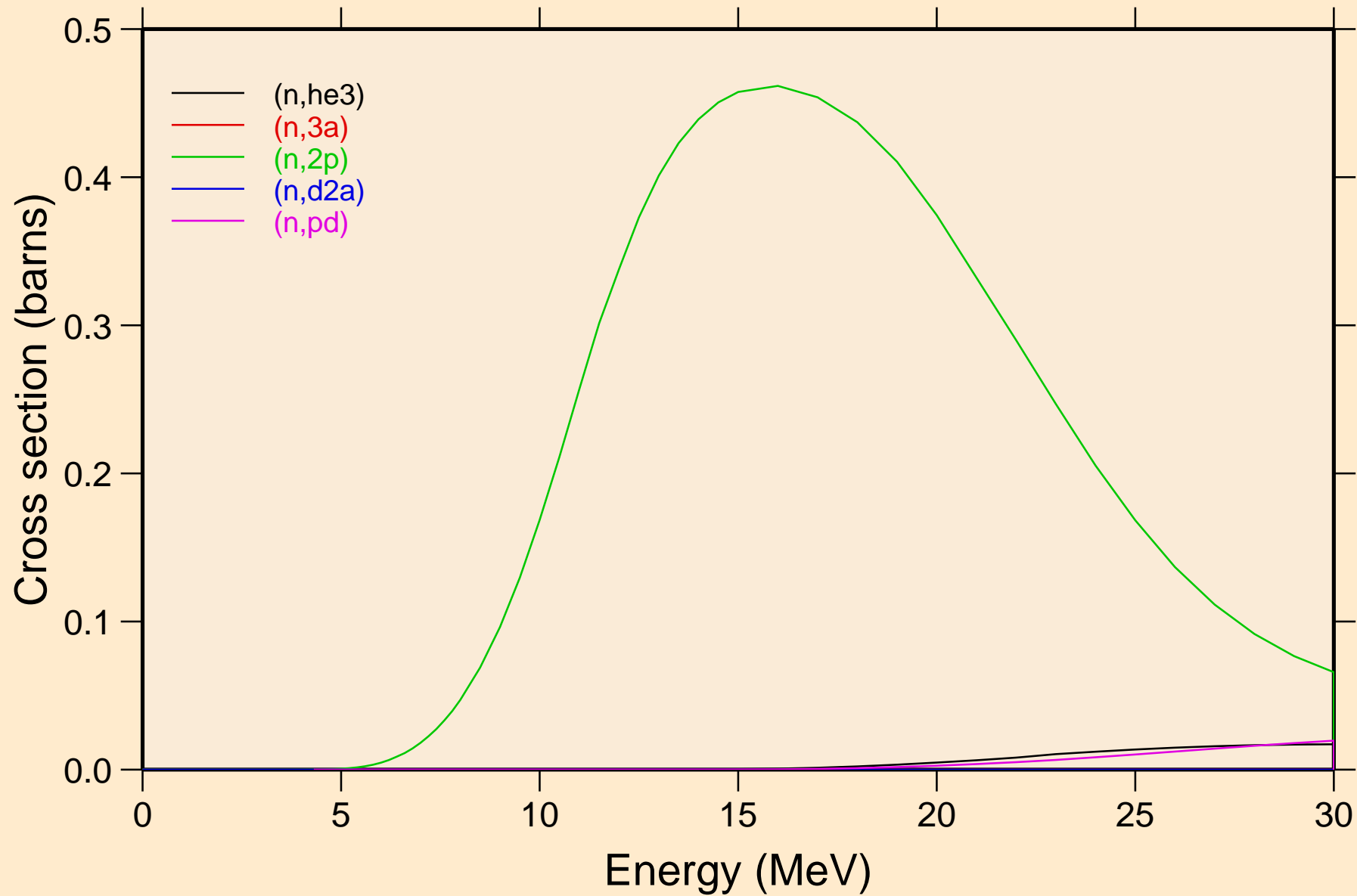

I115 NEUTRON ACER TENDL-2024 LIBRARY; T=293.6K
Threshold reactions

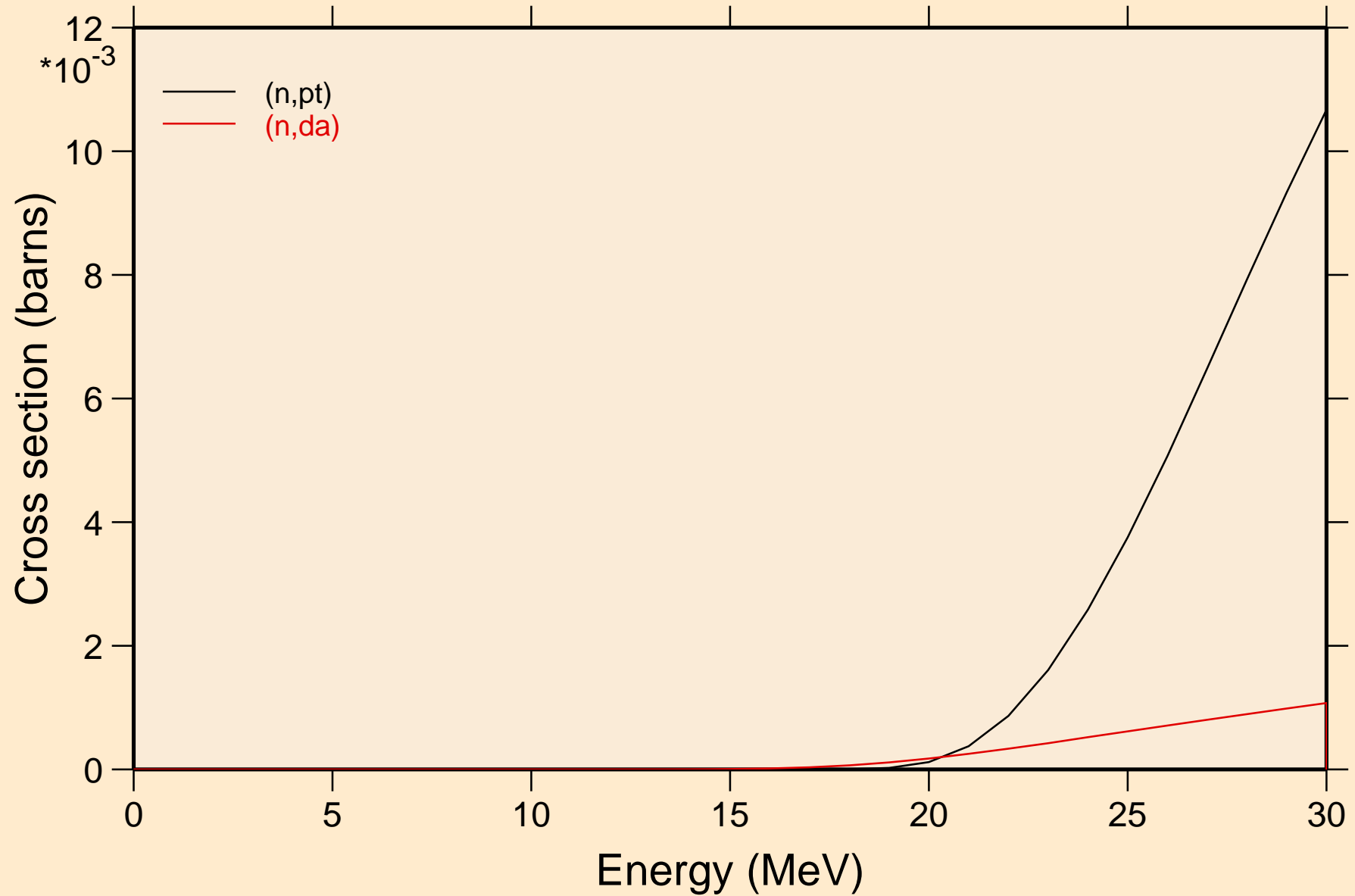

I115 NEUTRON ACER TENDL-2024 LIBRARY; T=293.6K
Threshold reactions

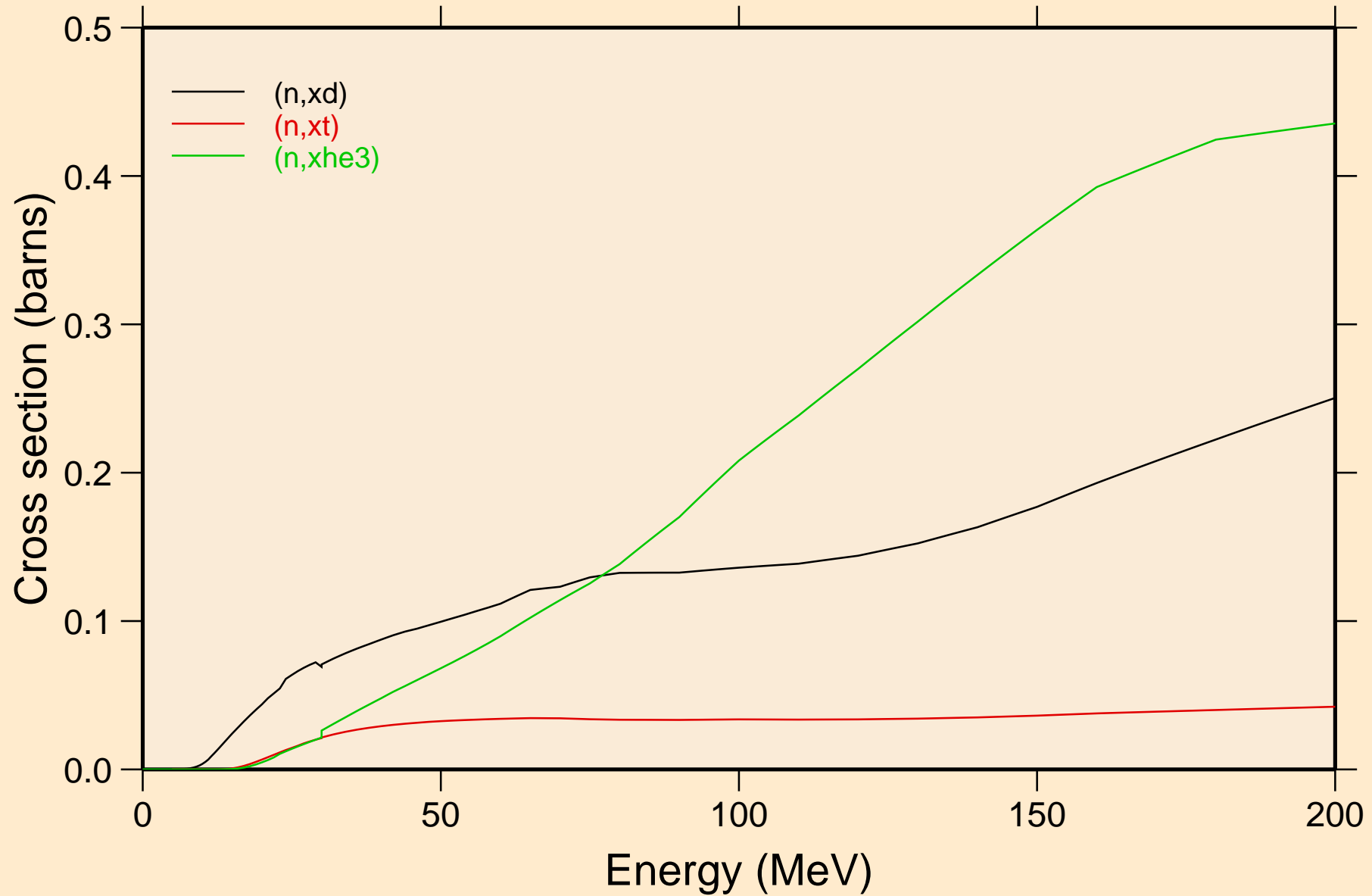

I115 NEUTRON ACER TENDL-2024 LIBRARY; T=293.6K
angular distribution for elastic

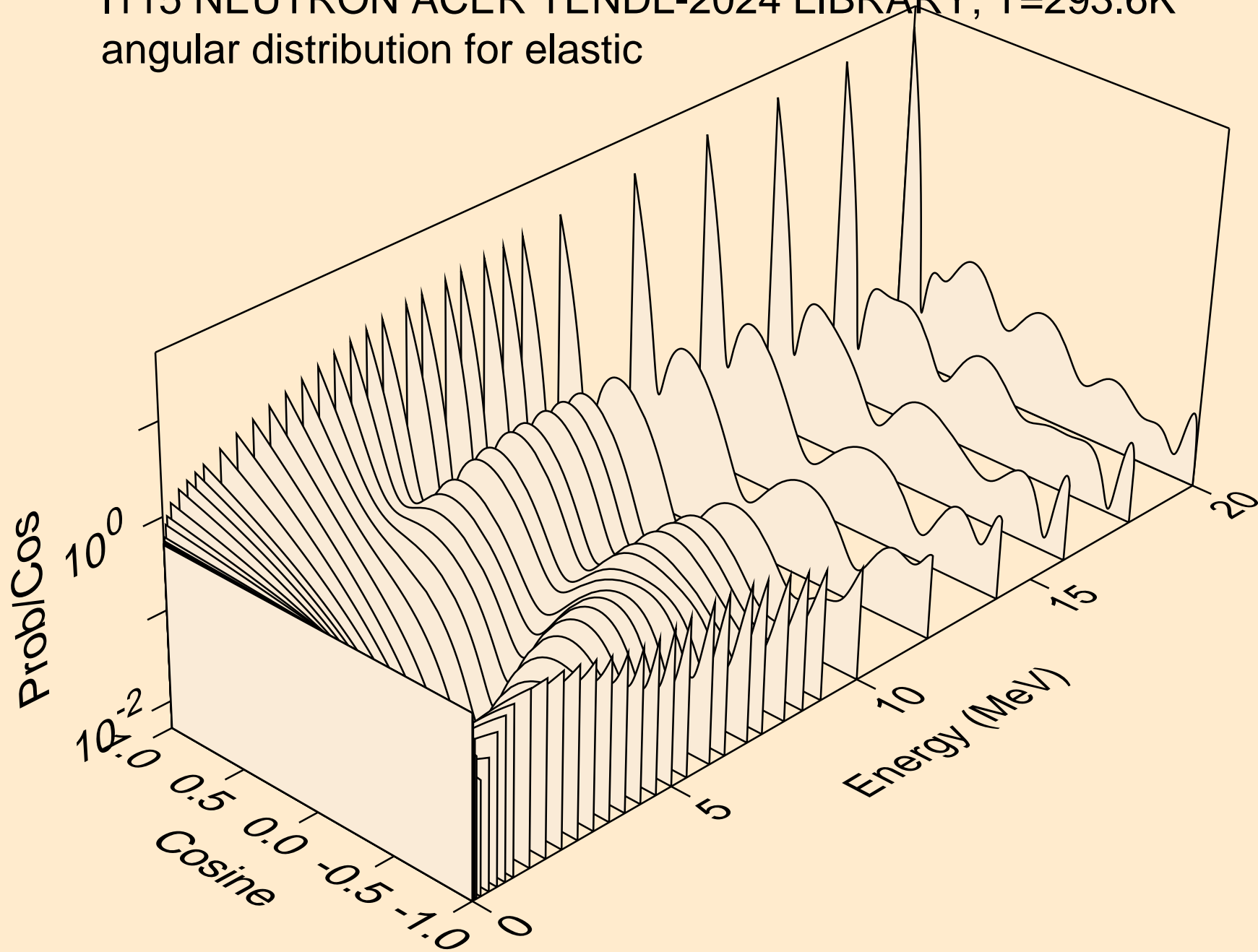

I115 NEUTRON ACER TENDL-2024 LIBRARY; T=293.6K
angular distribution for elastic

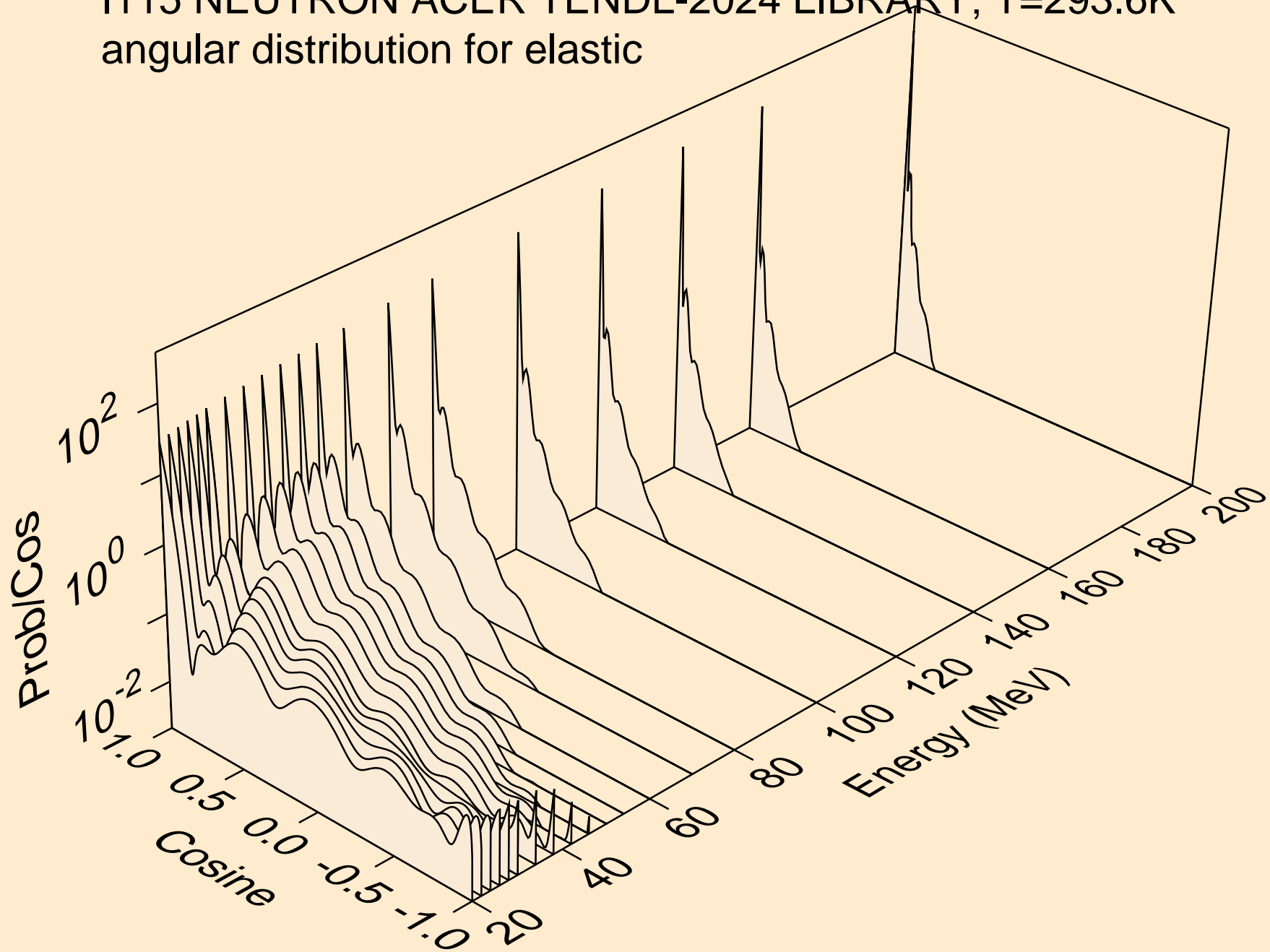

I115 NEUTRON ACER TENDL-2024 LIBRARY; T=293.6K
angular distribution for (n,n*1)

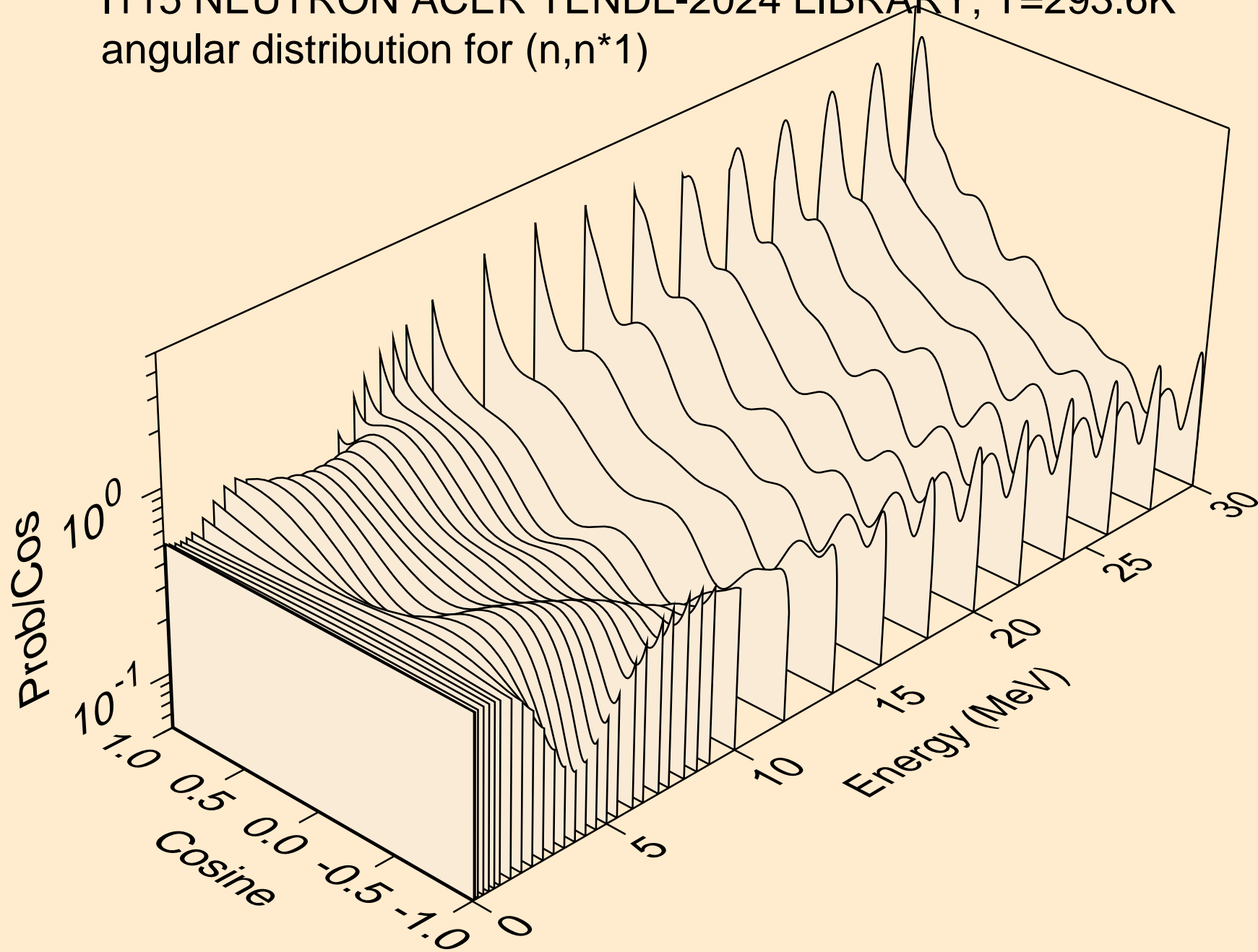

I115 NEUTRON ACER TENDL-2024 LIBRARY; T=293.6K
angular distribution for (n,n*2)

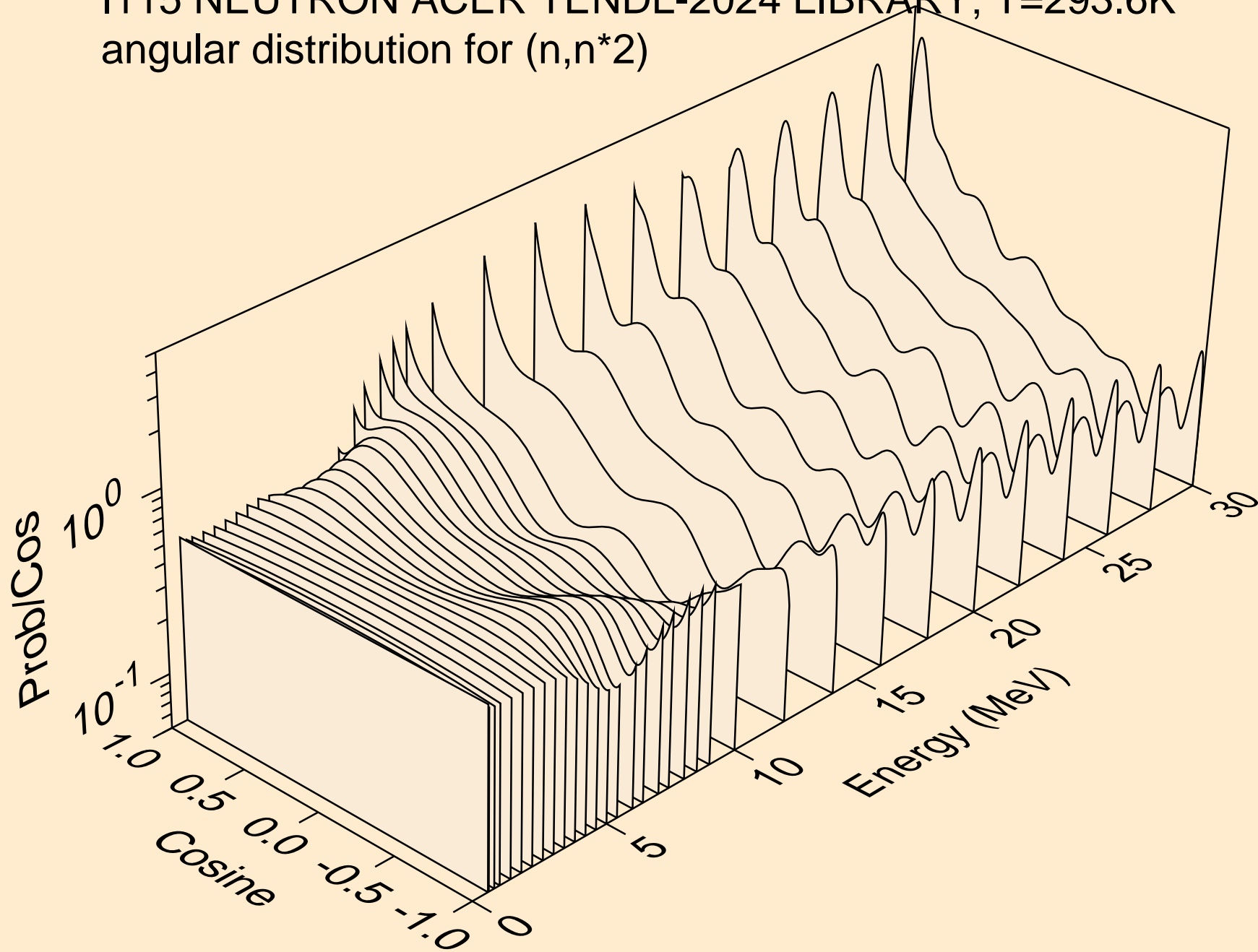

I115 NEUTRON ACER TENDL-2024 LIBRARY; T=293.6K
angular distribution for (n,n*3)

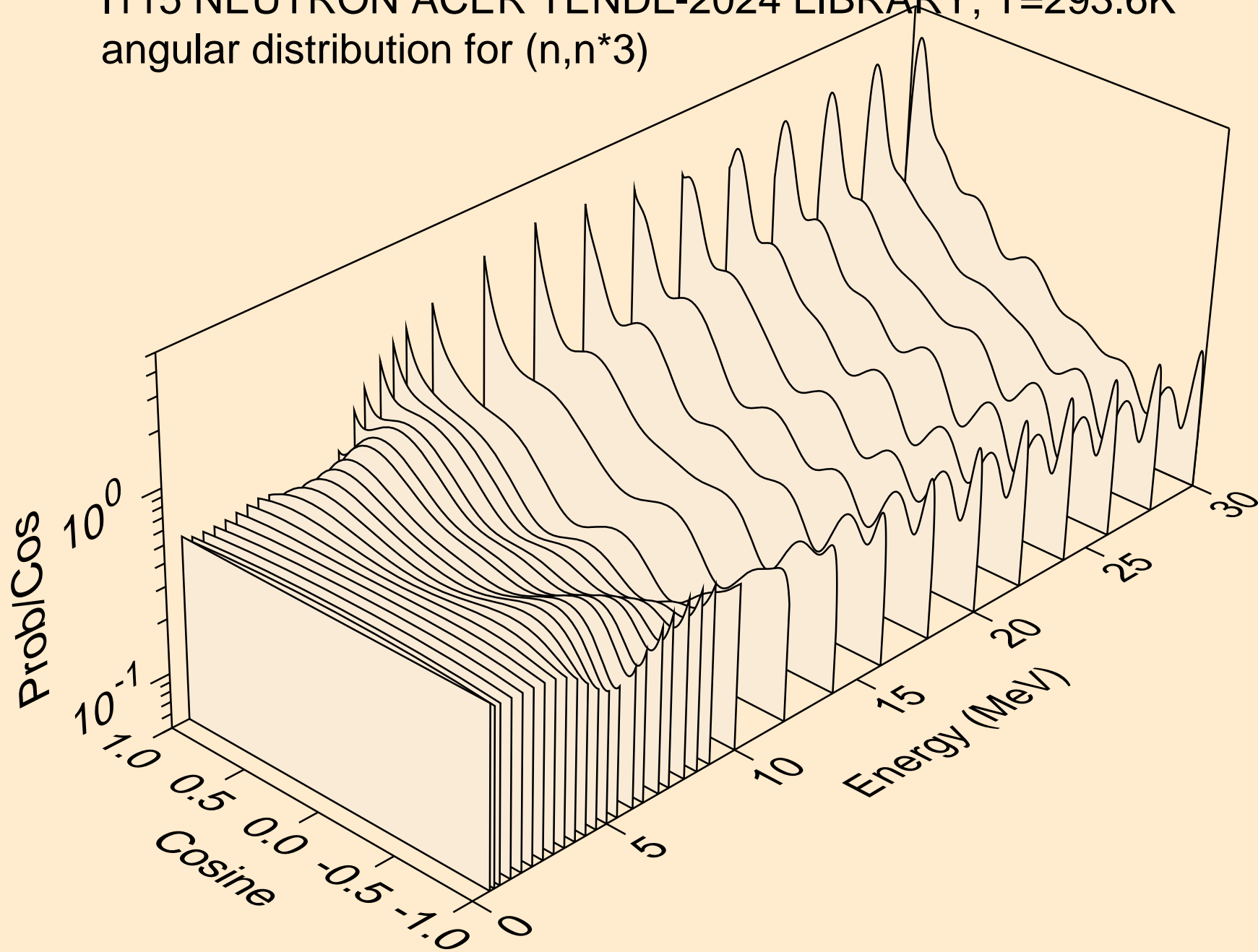

I115 NEUTRON ACER TENDL-2024 LIBRARY; T=293.6K
angular distribution for (n,n*4)

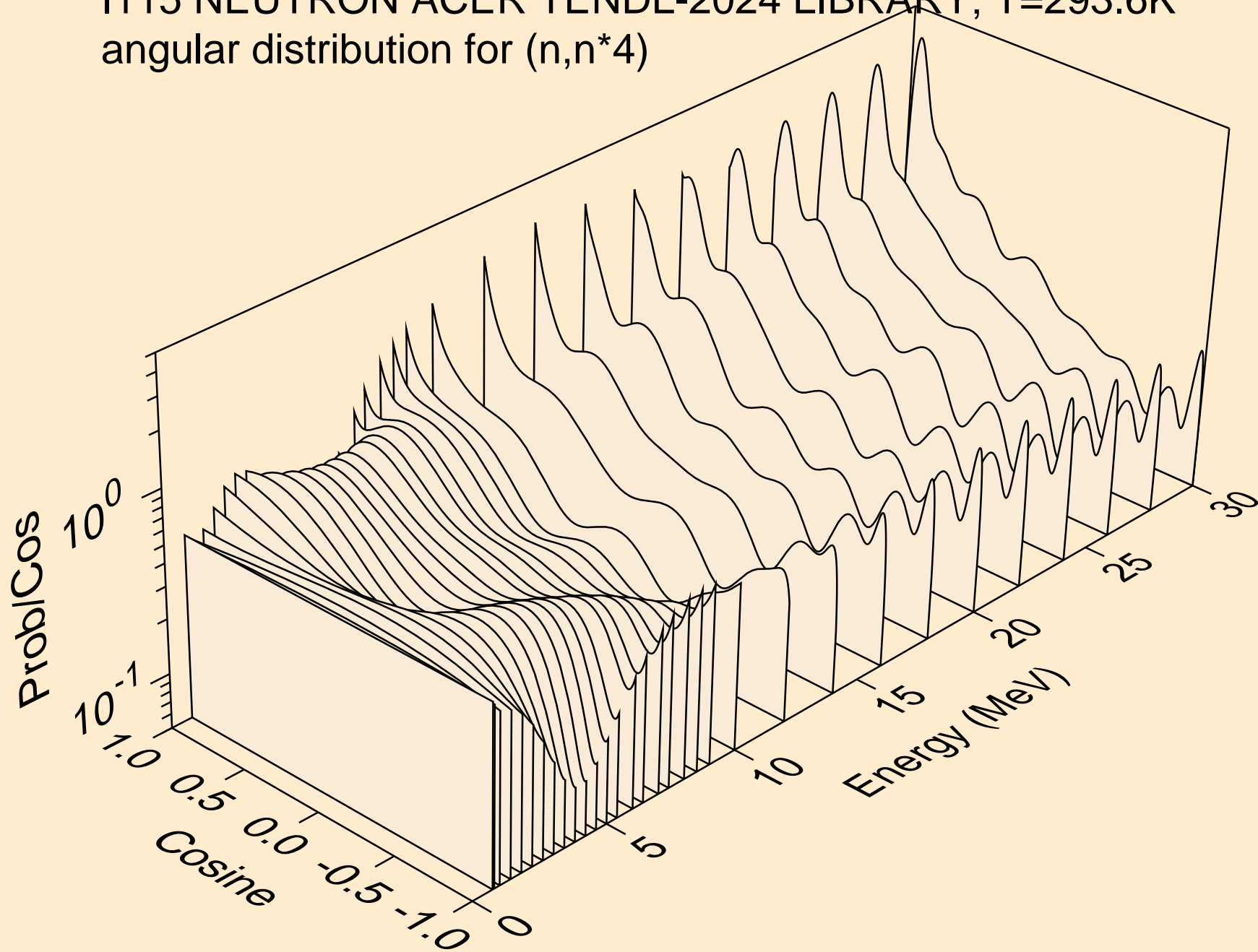

I115 NEUTRON ACER TENDL-2024 LIBRARY; T=293.6K
angular distribution for (n,n*5)

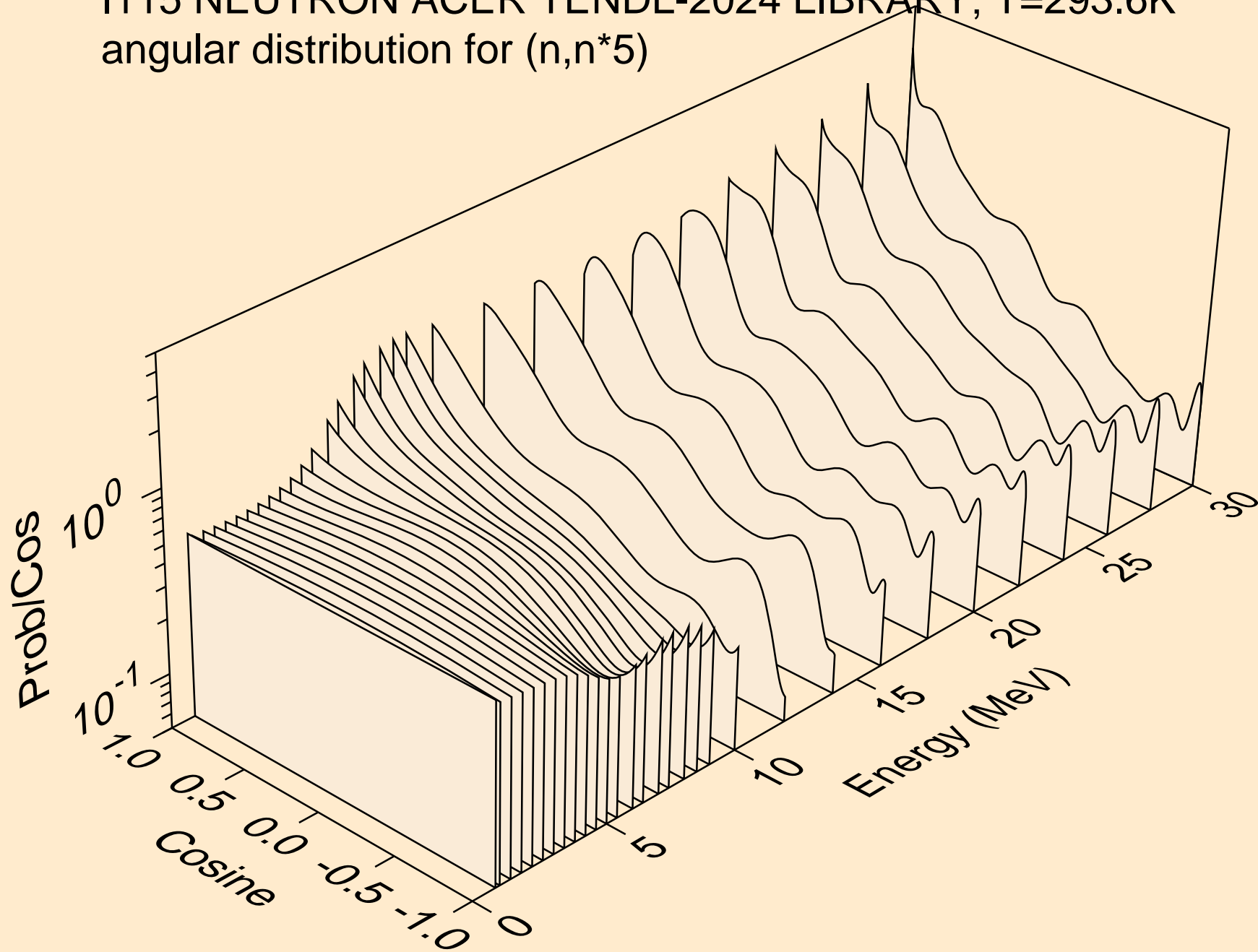

I115 NEUTRON ACER TENDL-2024 LIBRARY; T=293.6K
angular distribution for (n,n*6)

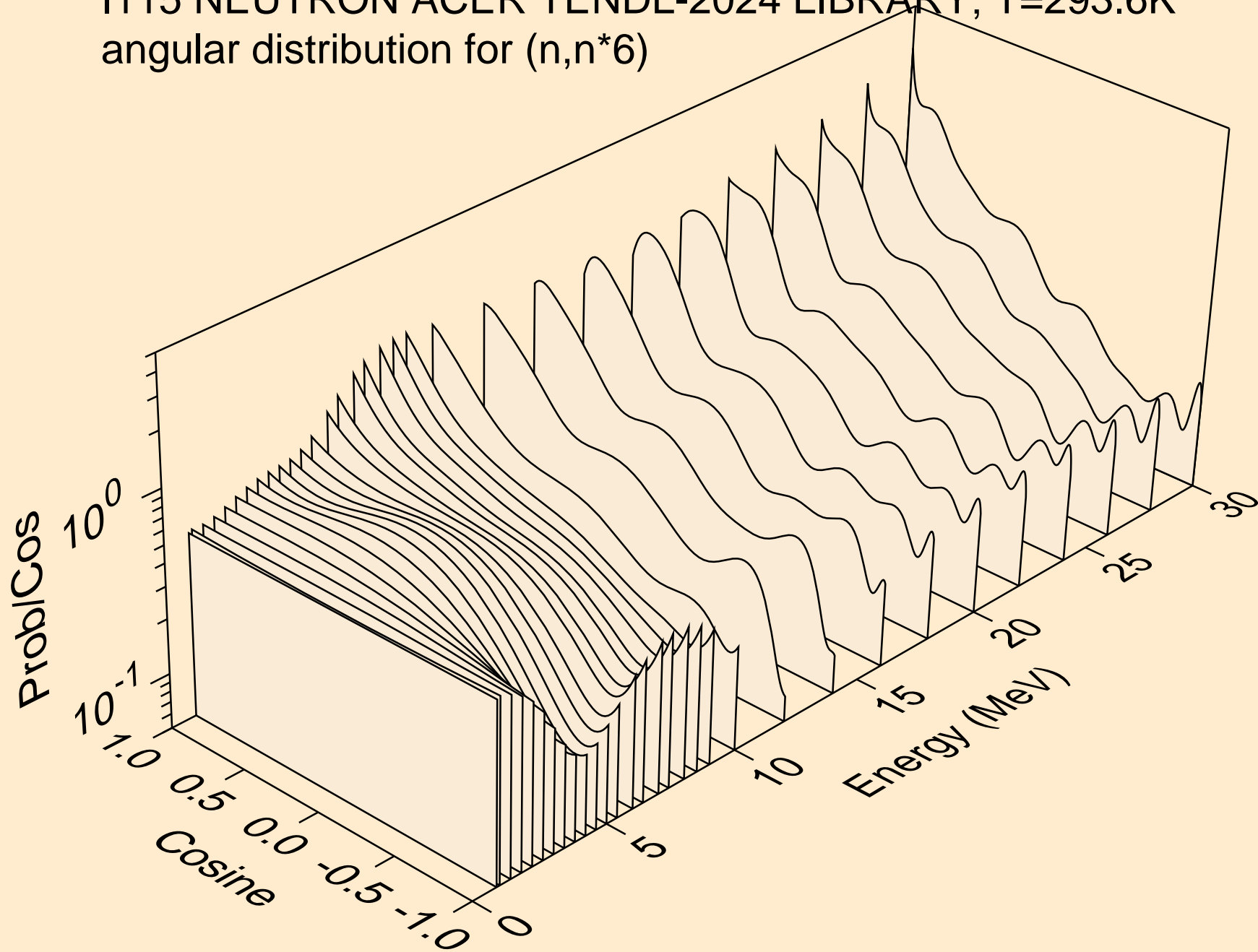

I115 NEUTRON ACER TENDL-2024 LIBRARY; T=293.6K
Neutron emission for (n,x)

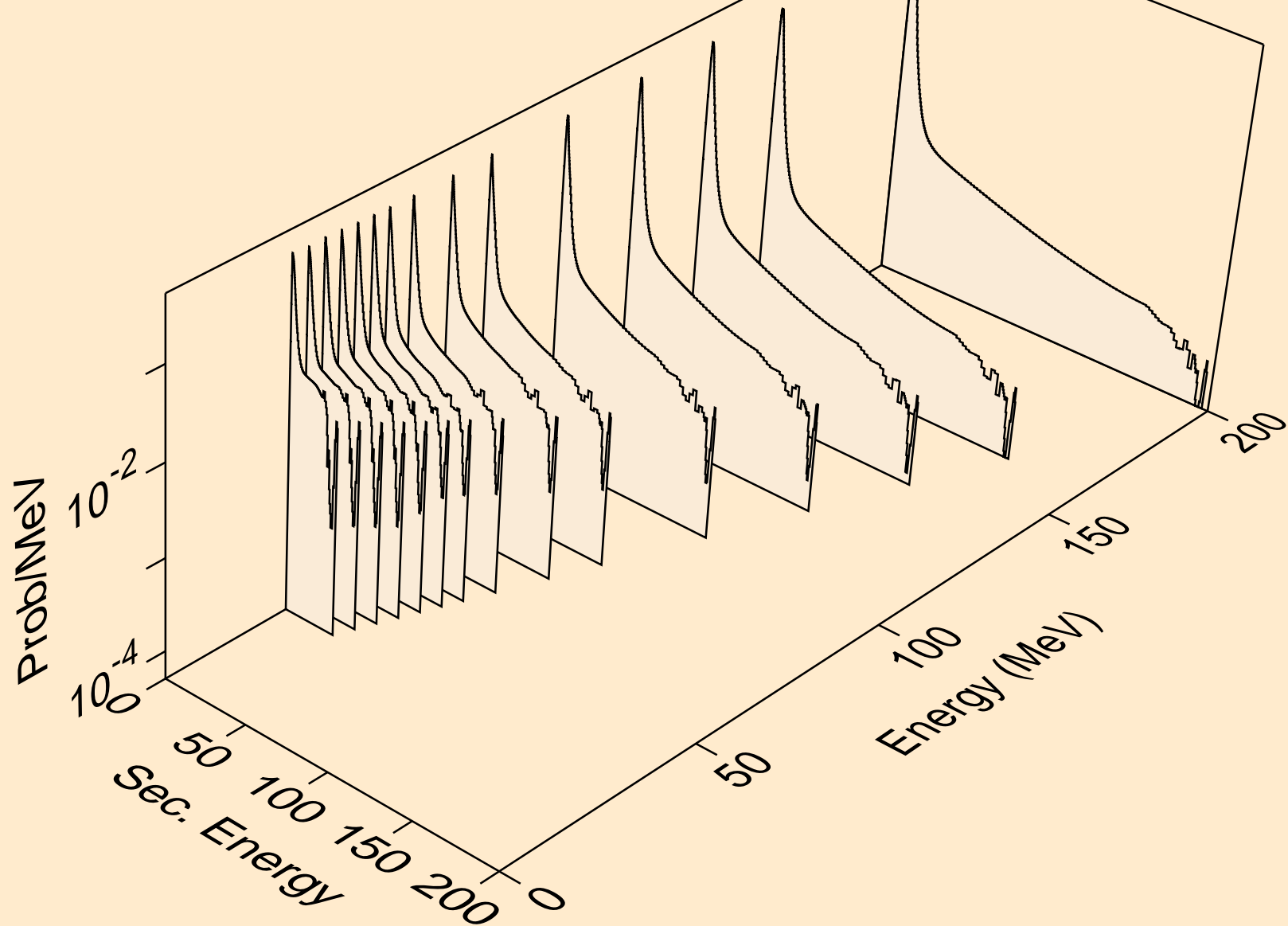

I115 NEUTRON ACER TENDL-2024 LIBRARY; T=293.6K
Neutron emission for (n,2nd)

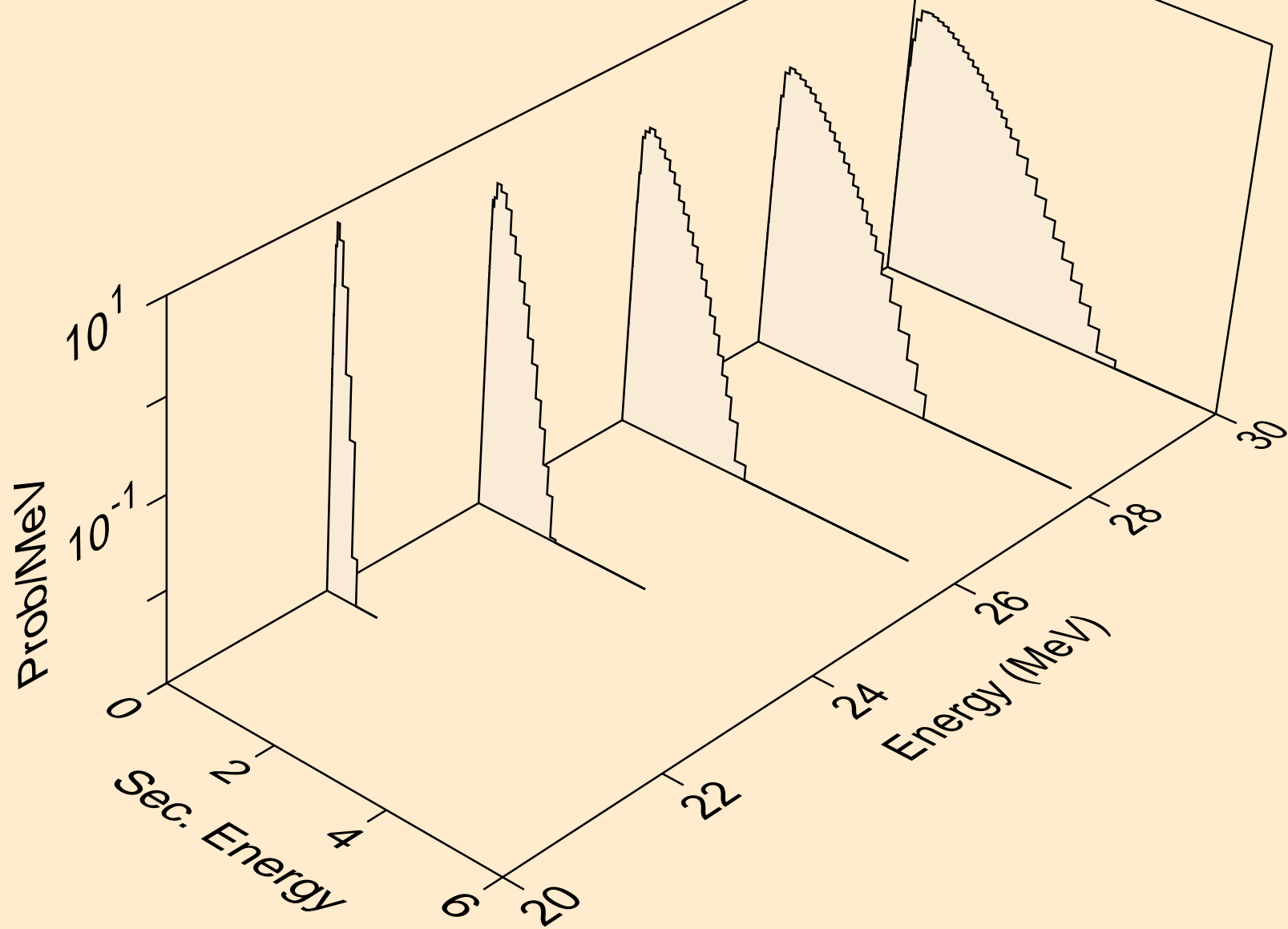

I115 NEUTRON ACER TENDL-2024 LIBRARY; T=293.6K
Neutron emission for (n,2n)

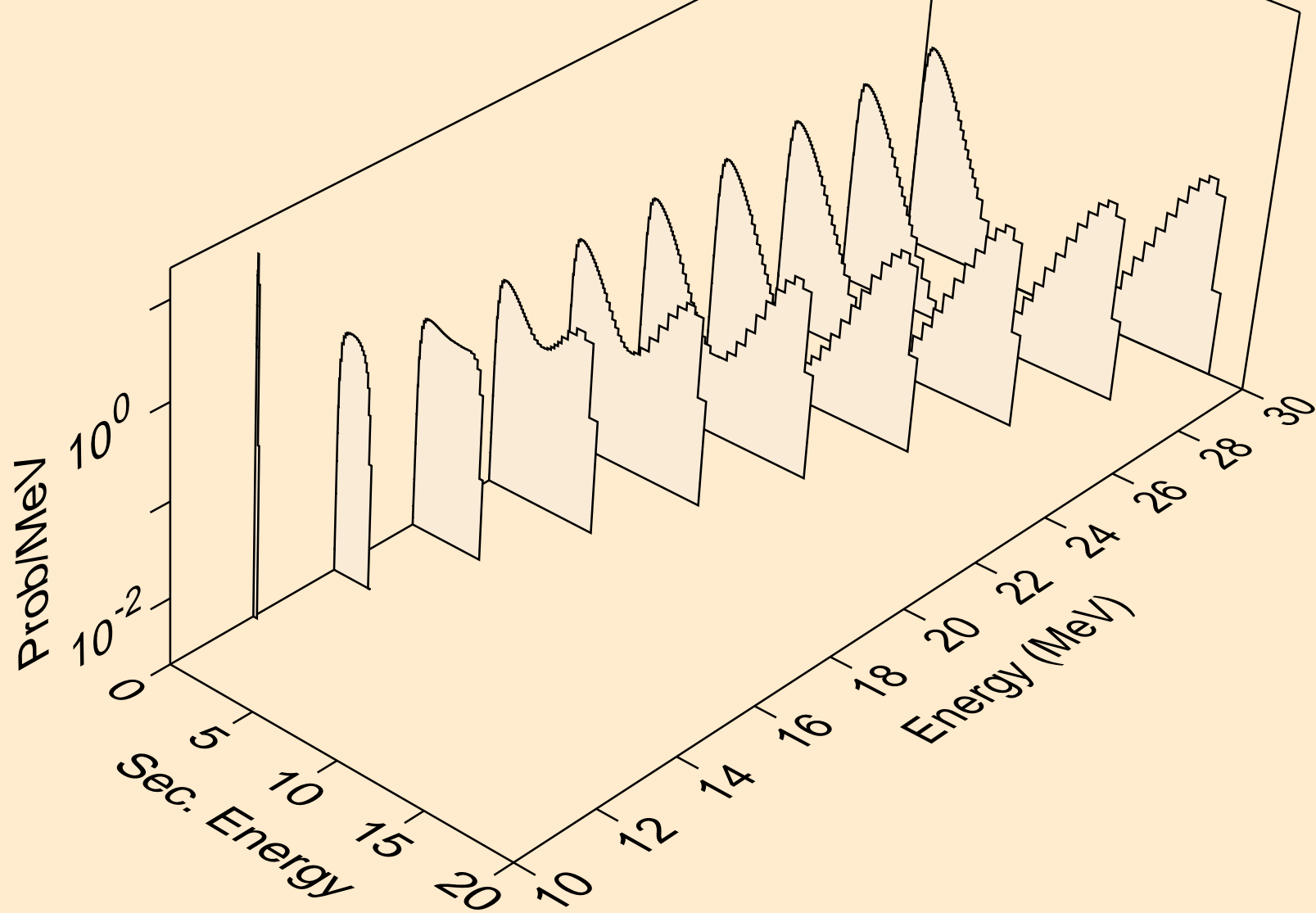

I115 NEUTRON ACER TENDL-2024 LIBRARY; T=293.6K
Neutron emission for (n,3n)

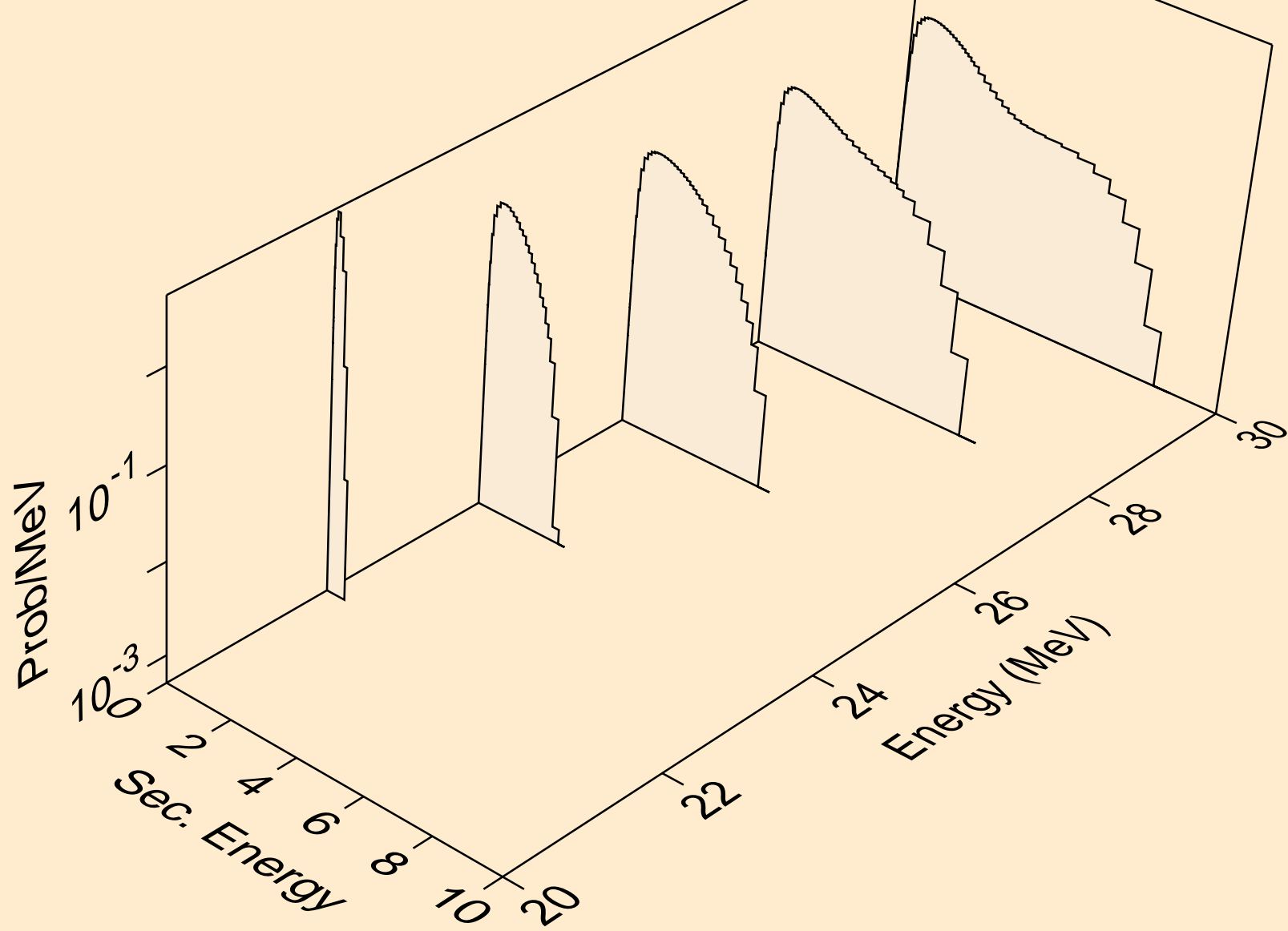

I115 NEUTRON ACER TENDL-2024 LIBRARY; T=293.6K
Neutron emission for (n,n*)a

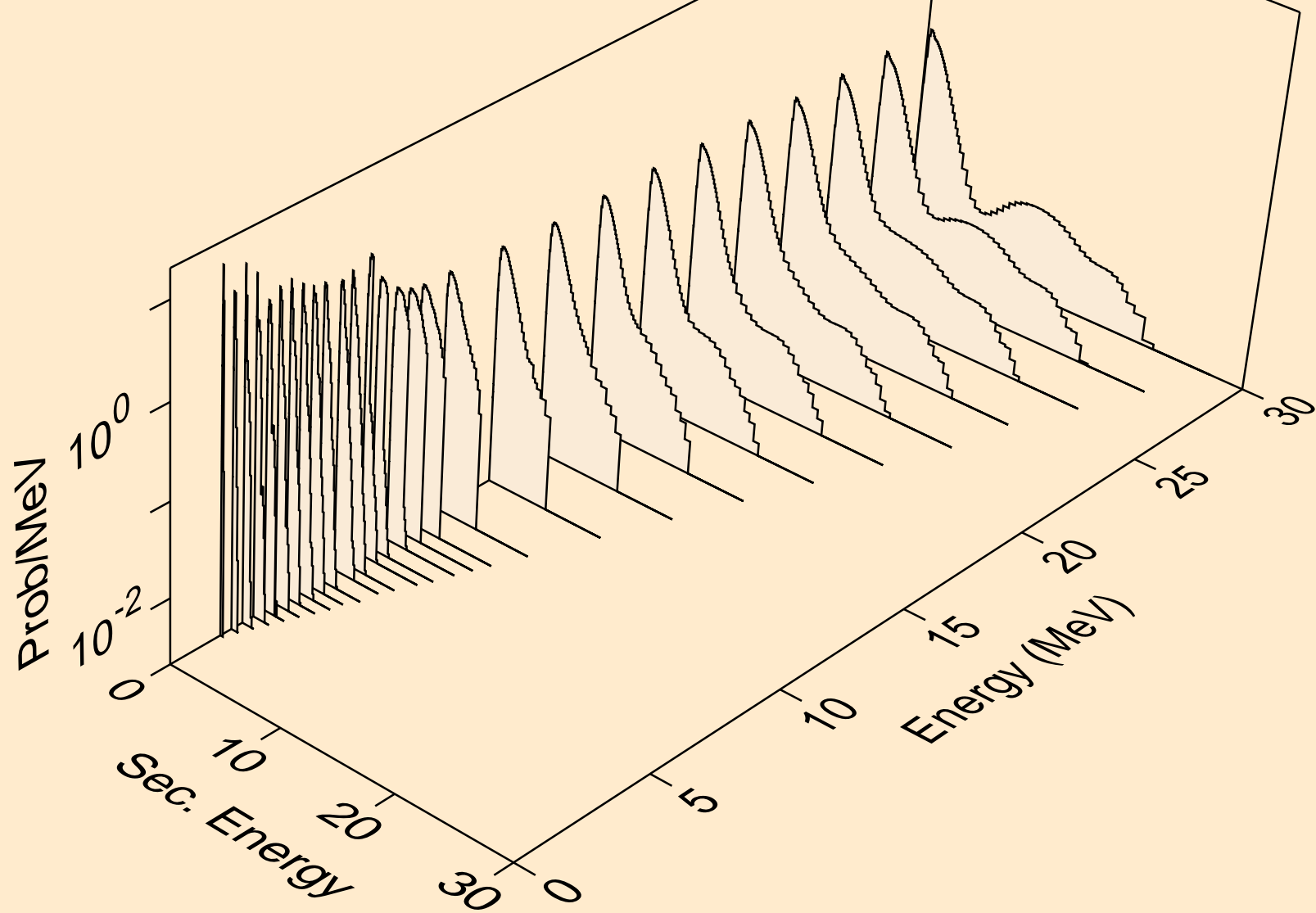

I115 NEUTRON ACER TENDL-2024 LIBRARY; T=293.6K
Neutron emission for (n,2n)a

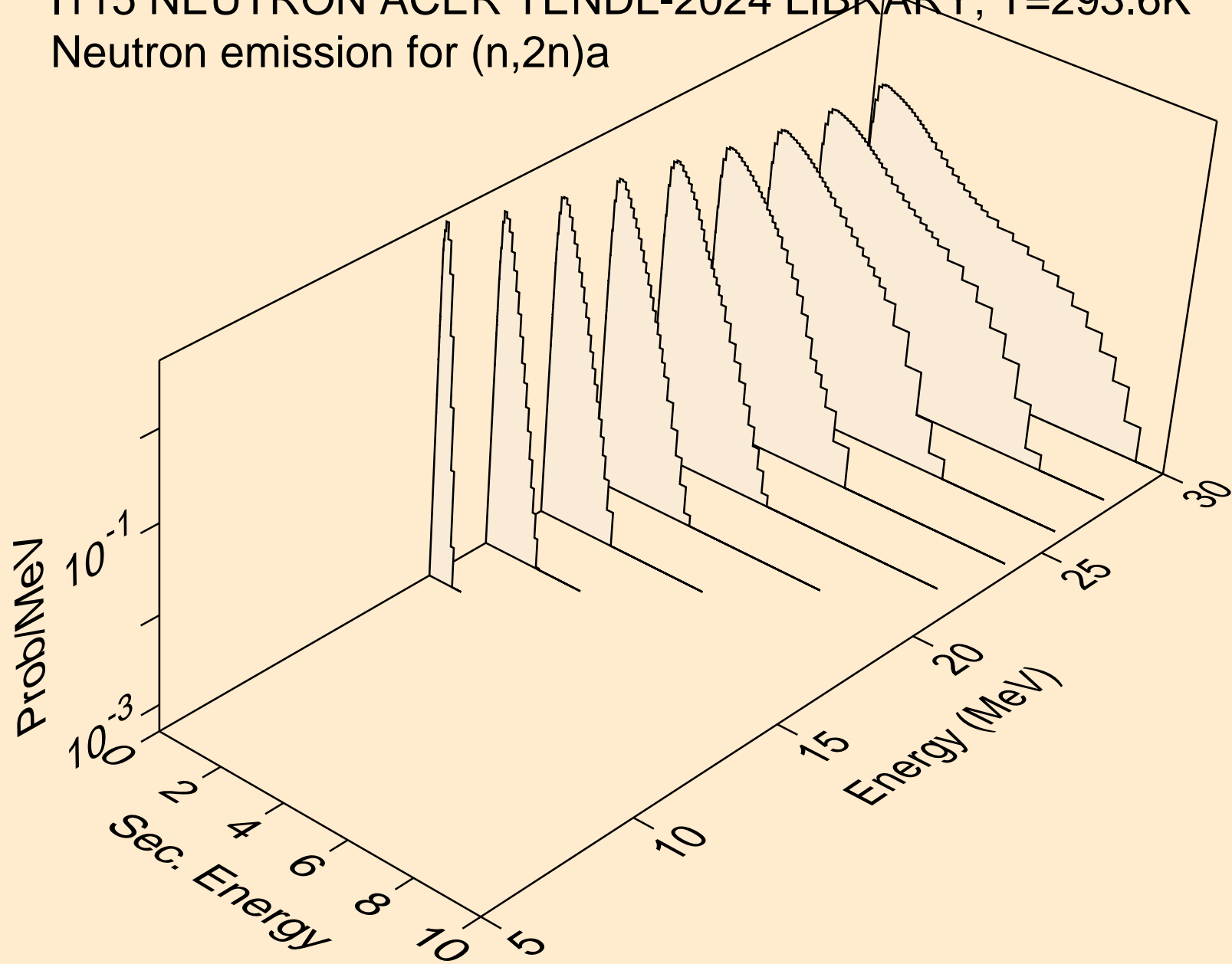

I115 NEUTRON ACER TENDL-2024 LIBRARY; T=293.6K
Neutron emission for (n,3n)a

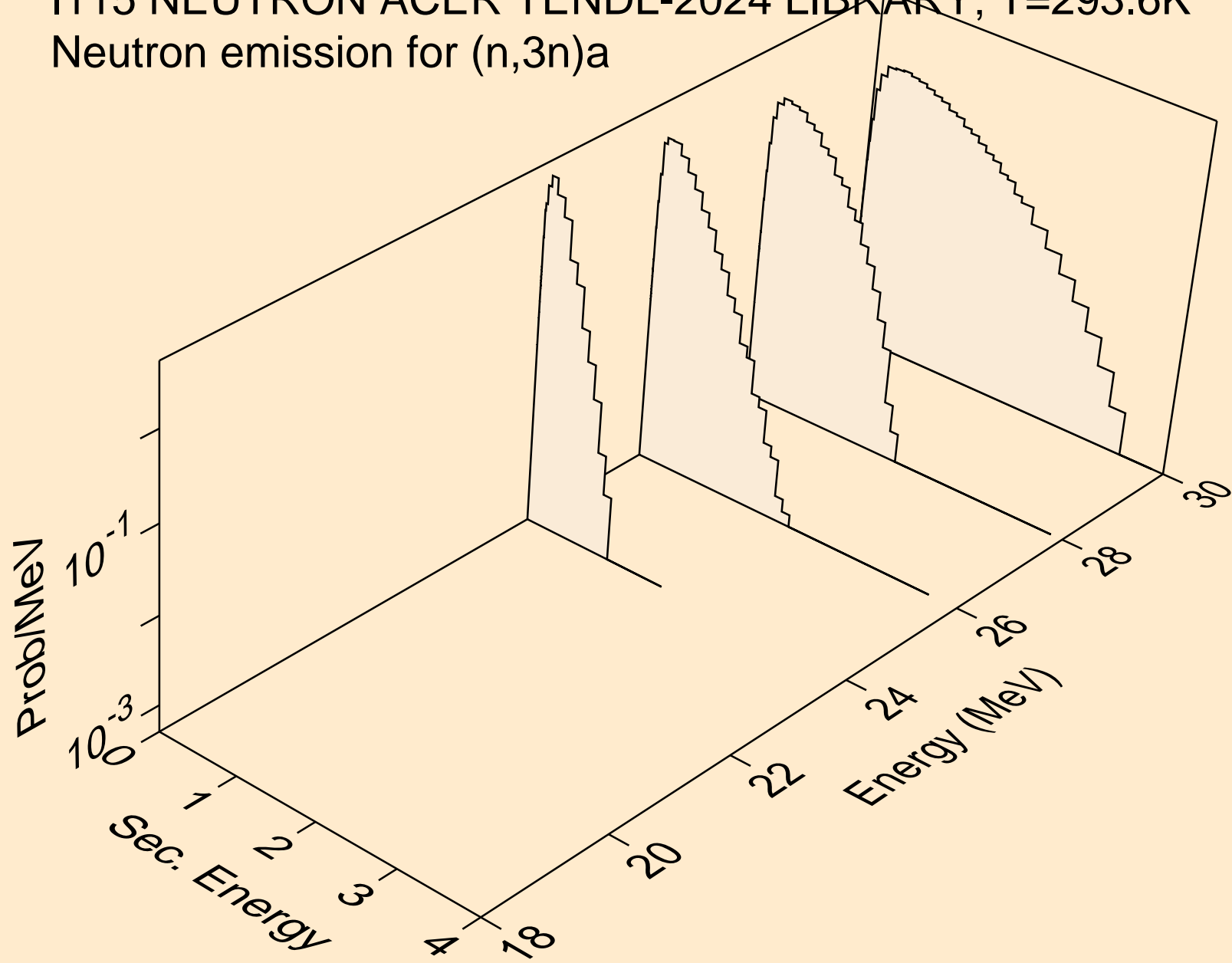

I115 NEUTRON ACER TENDL-2024 LIBRARY; T=293.6K
Neutron emission for (n,n*)p

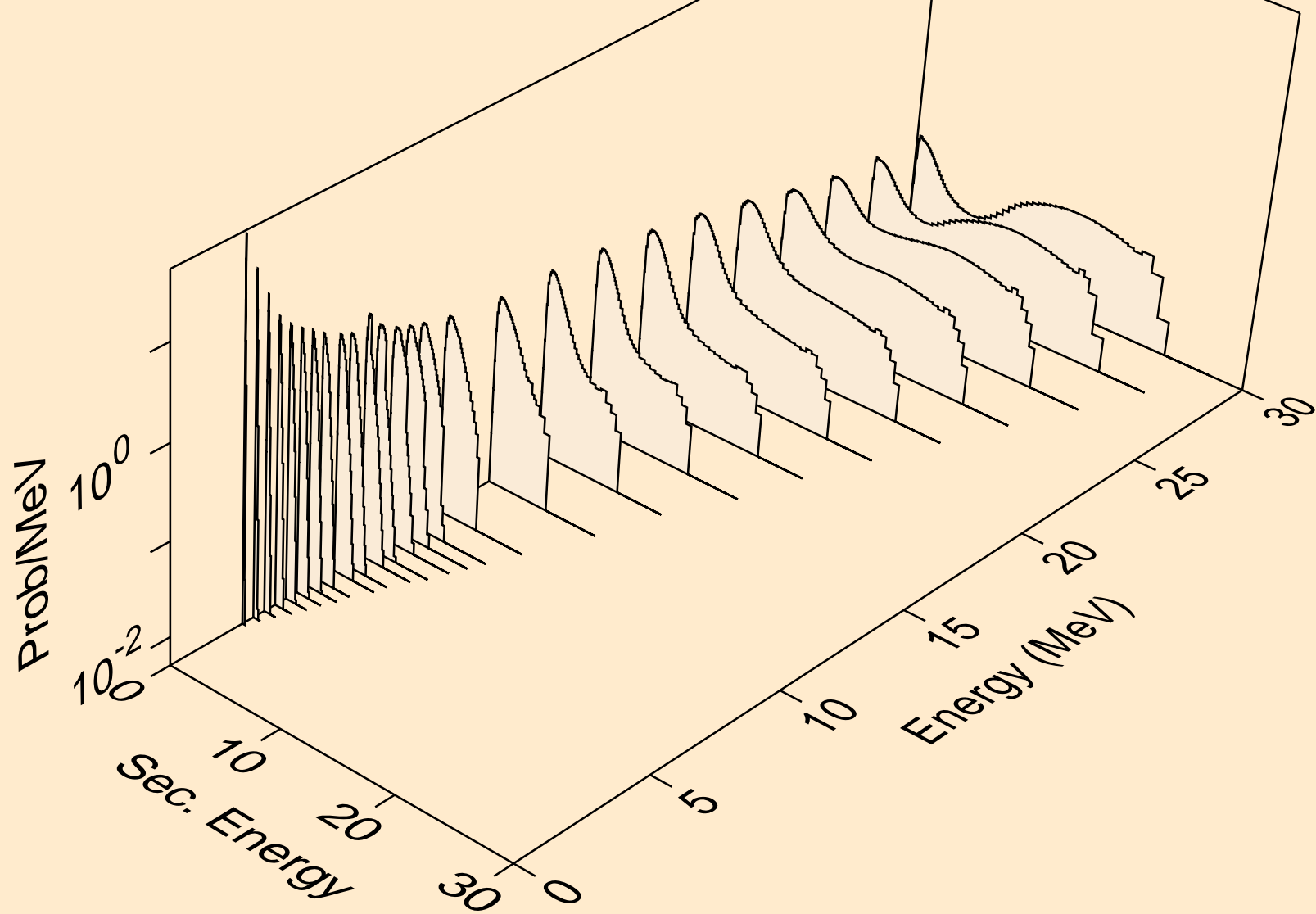

I115 NEUTRON ACER TENDL-2024 LIBRARY; T=293.6K
Neutron emission for (n,n*)2a

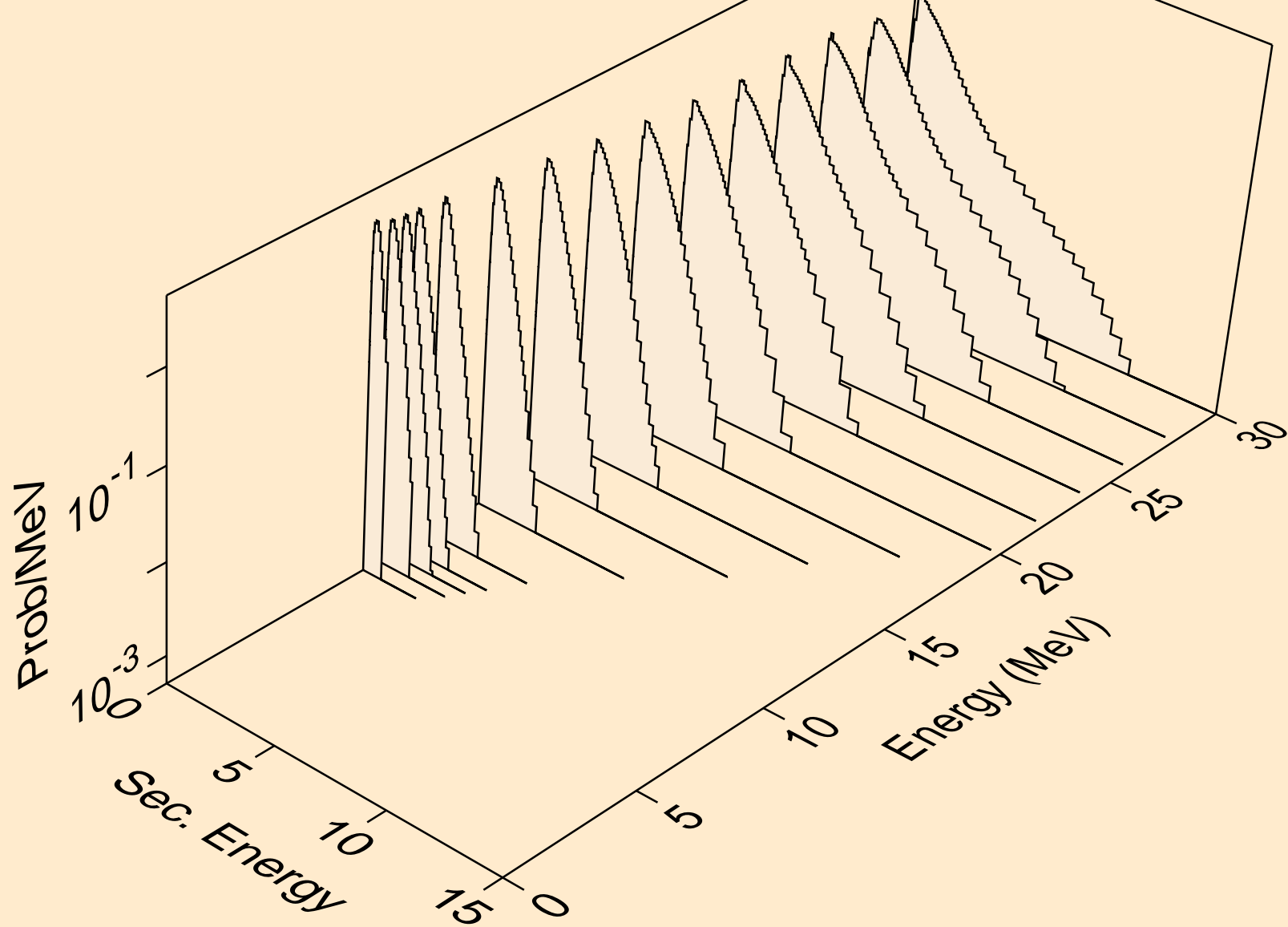

I115 NEUTRON ACER TENDL-2024 LIBRARY; T=293.6K
Neutron emission for (n,2n)2a

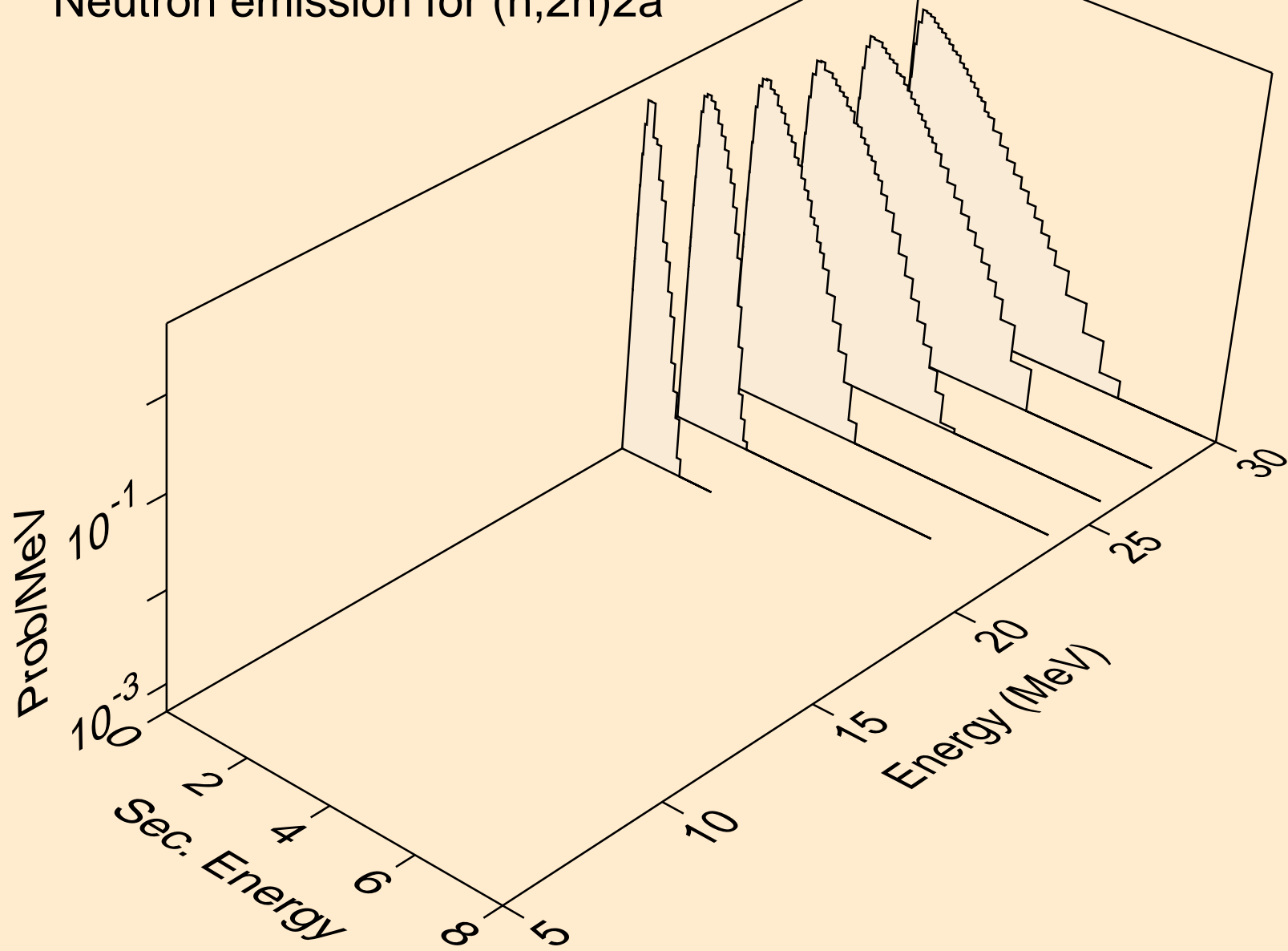

I115 NEUTRON ACER TENDL-2024 LIBRARY; T=293.6K
Neutron emission for (n,n*)d

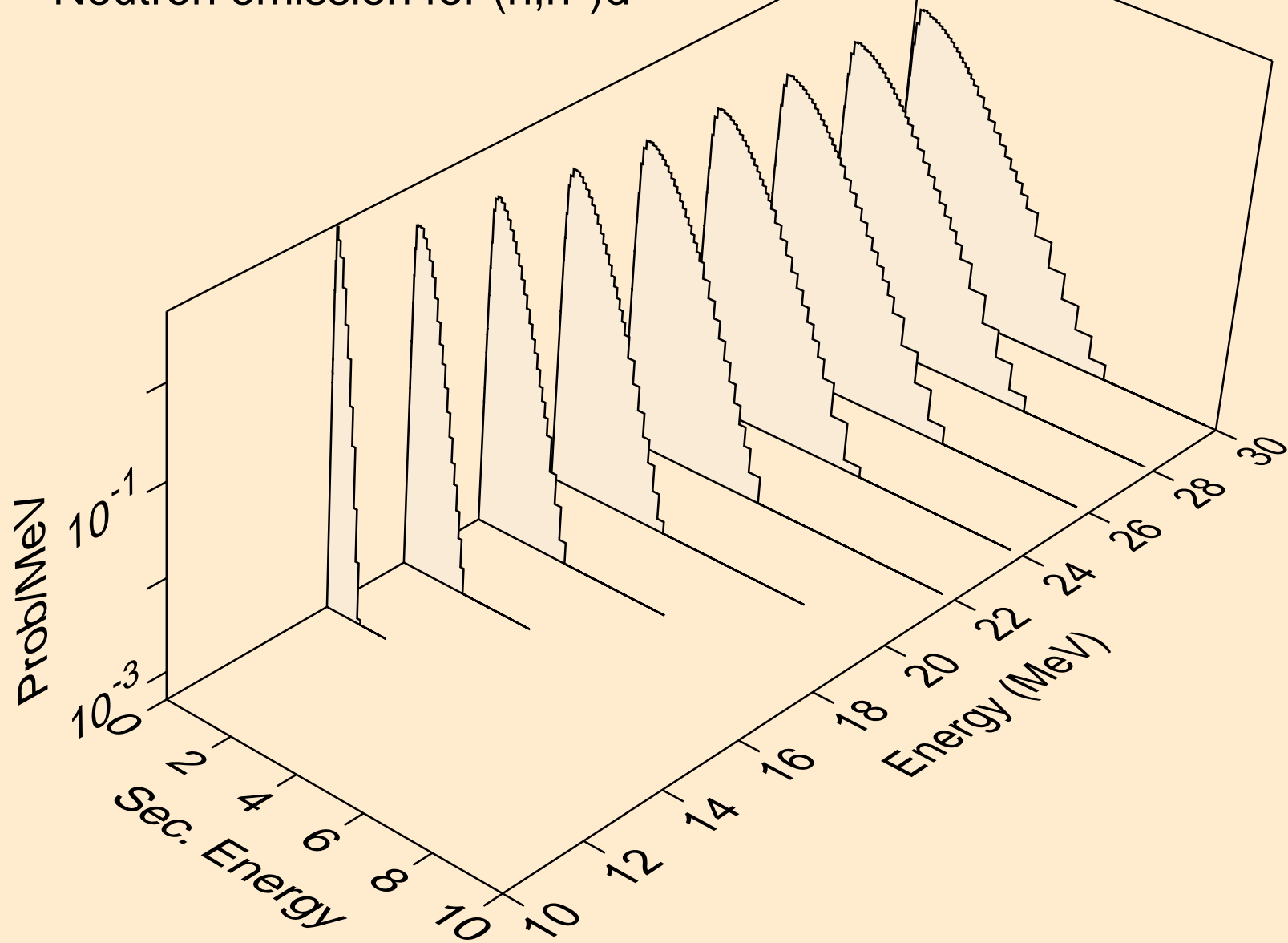

I115 NEUTRON ACER TENDL-2024 LIBRARY; T=293.6K
Neutron emission for (n,n*)t

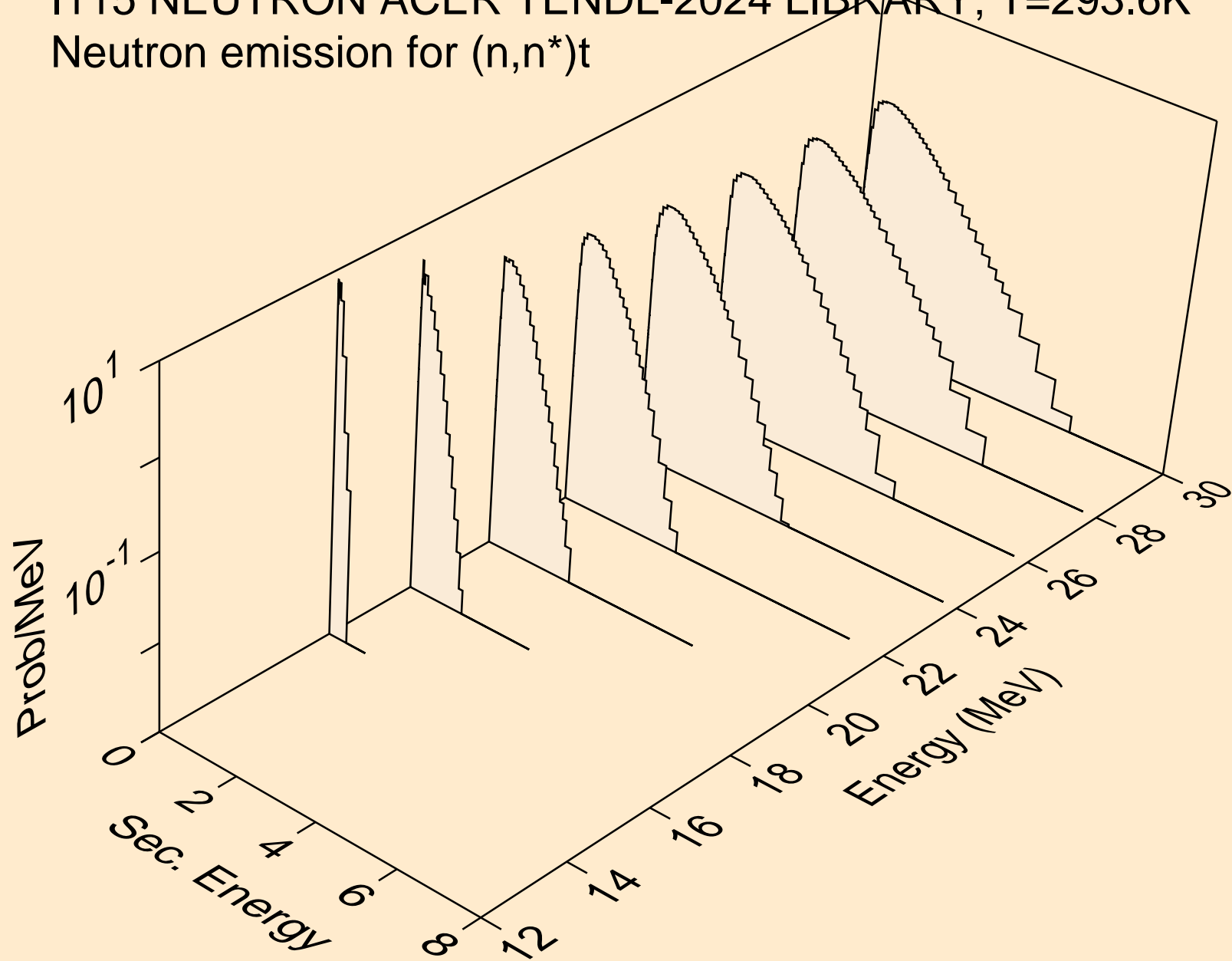

I115 NEUTRON ACER TENDL-2024 LIBRARY; T=293.6K
Neutron emission for (n,n*)he3

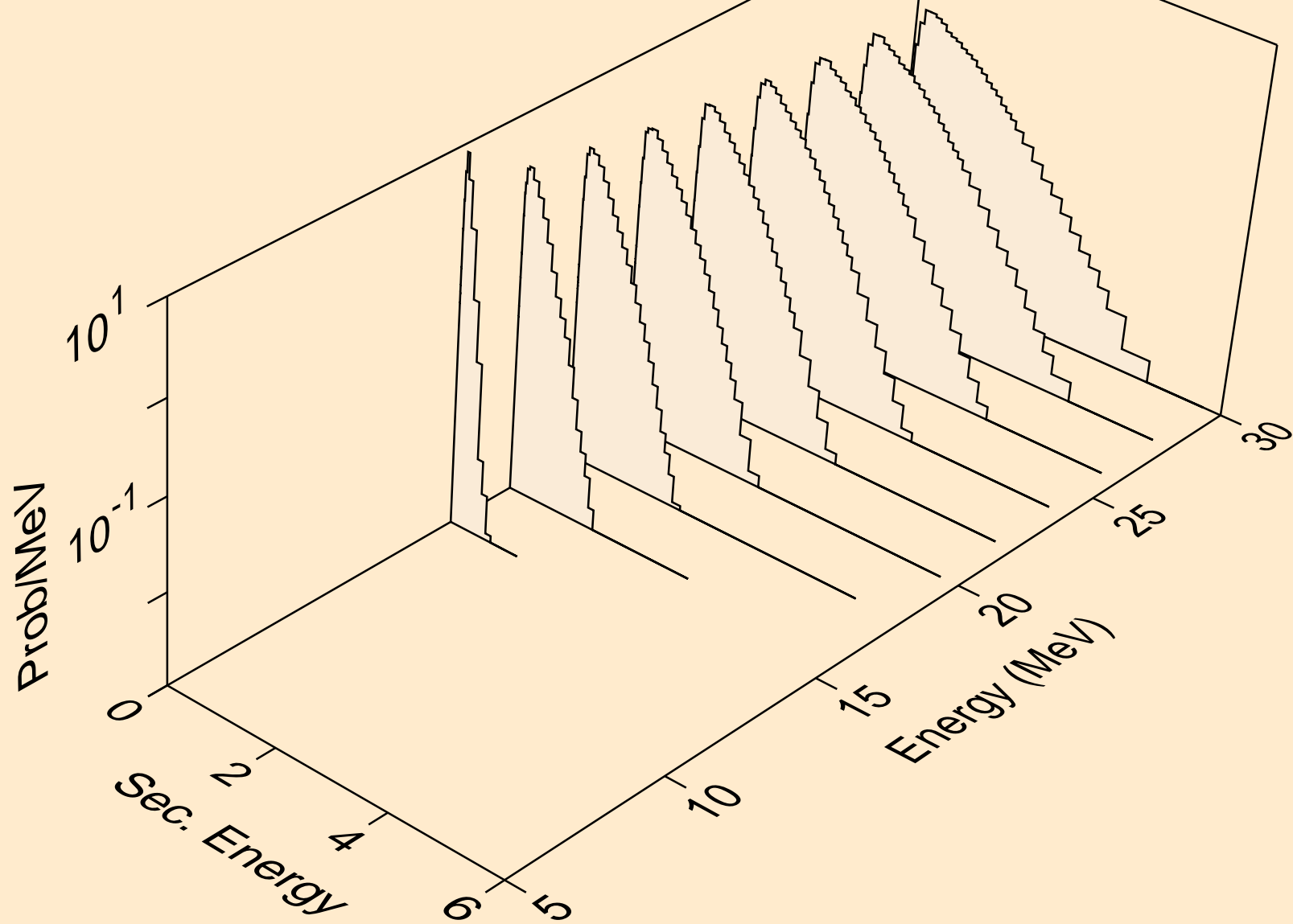

I115 NEUTRON ACER TENDL-2024 LIBRARY; T=293.6K
Neutron emission for (n,2np)

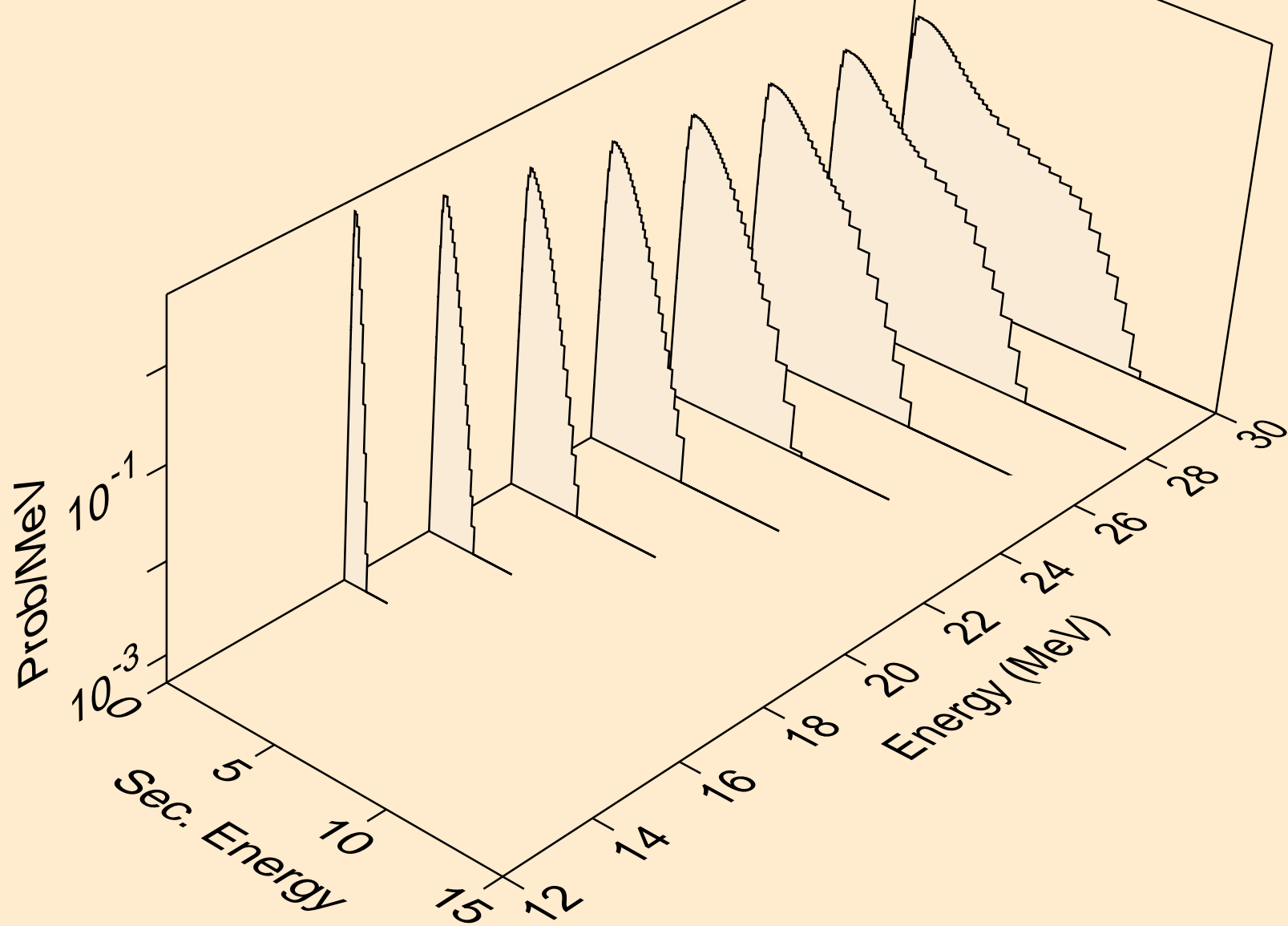

I115 NEUTRON ACER TENDL-2024 LIBRARY; T=293.6K
Neutron emission for (n,3np)

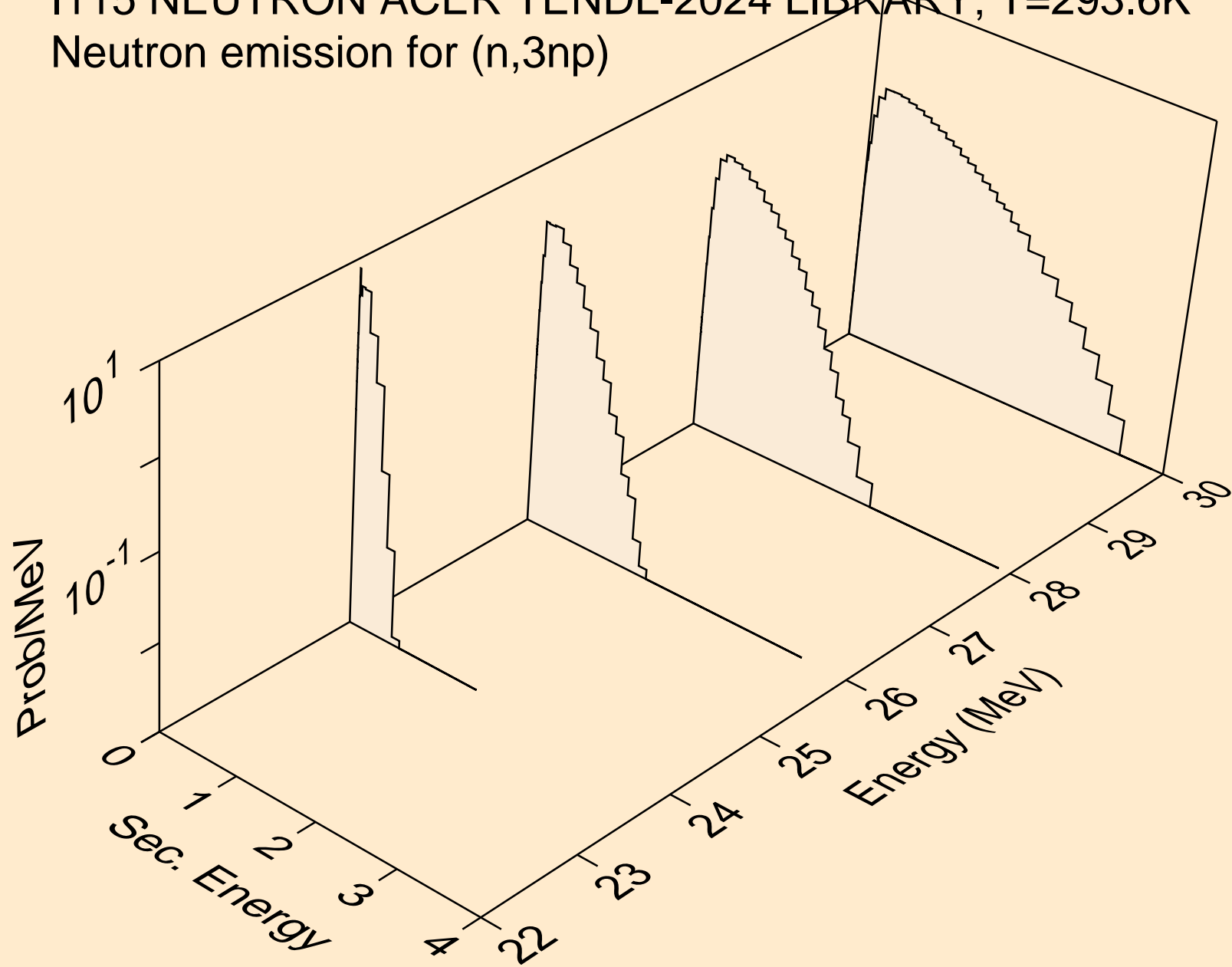

I115 NEUTRON ACER TENDL-2024 LIBRARY; T=293.6K
Neutron emission for (n,n2p)

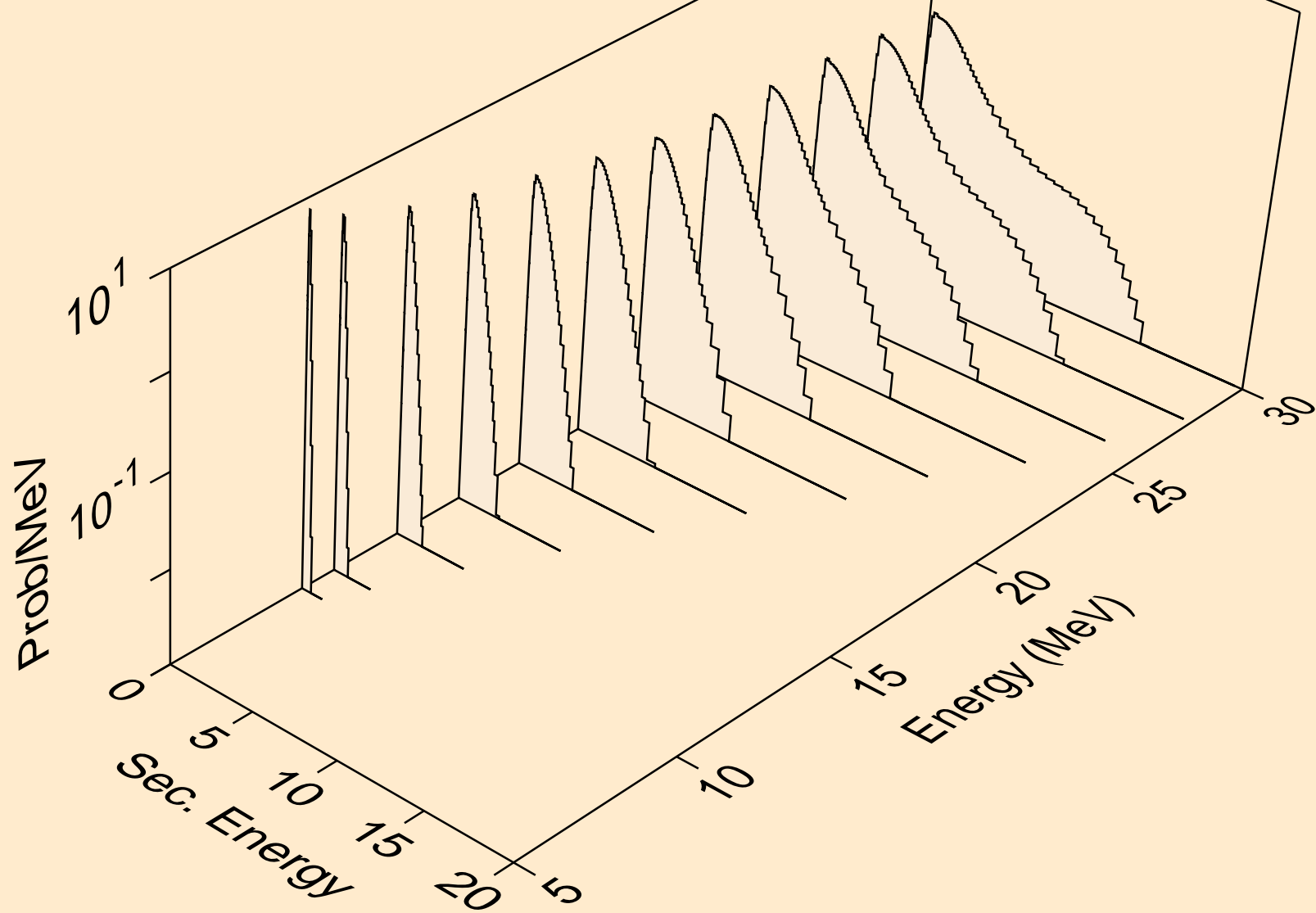

I115 NEUTRON ACER TENDL-2024 LIBRARY; T=293.6K
Neutron emission for (n,npa)

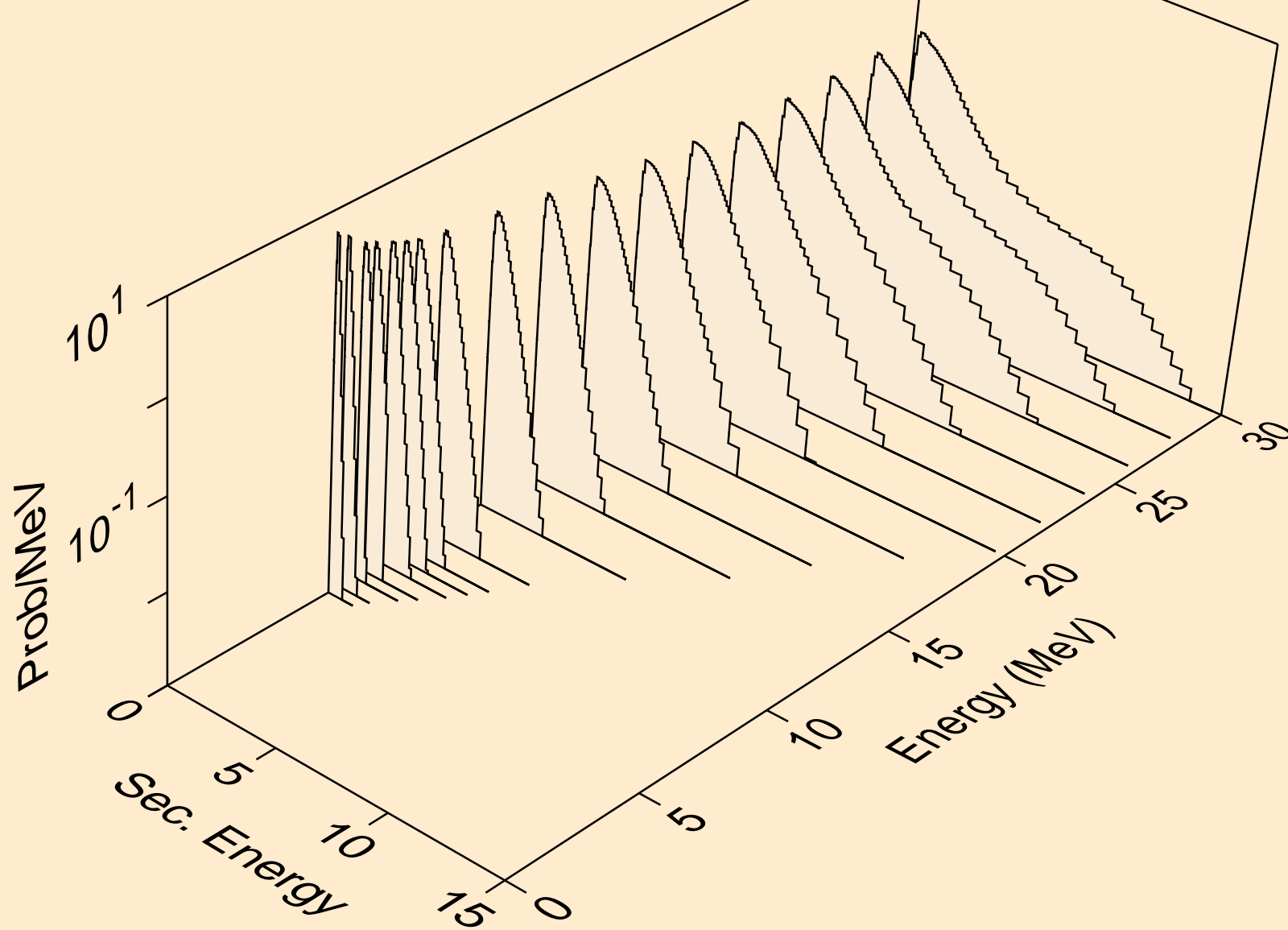

I115 NEUTRON ACER TENDL-2024 LIBRARY; T=293.6K
Neutron emission for (n,n*c)

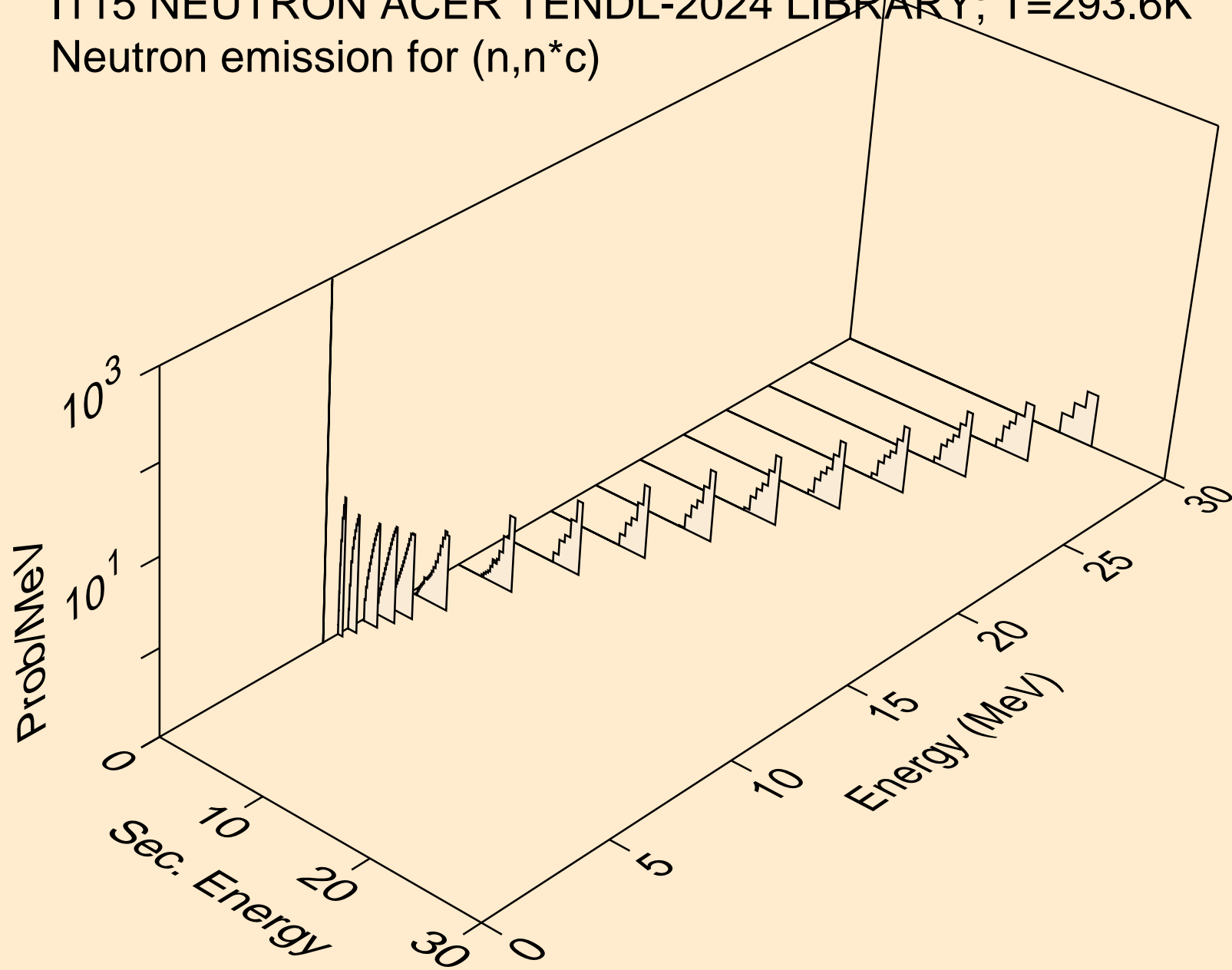

I115 NEUTRON ACER TENDL-2024 LIBRARY; T=293.6K
Photon emission for (n,x)

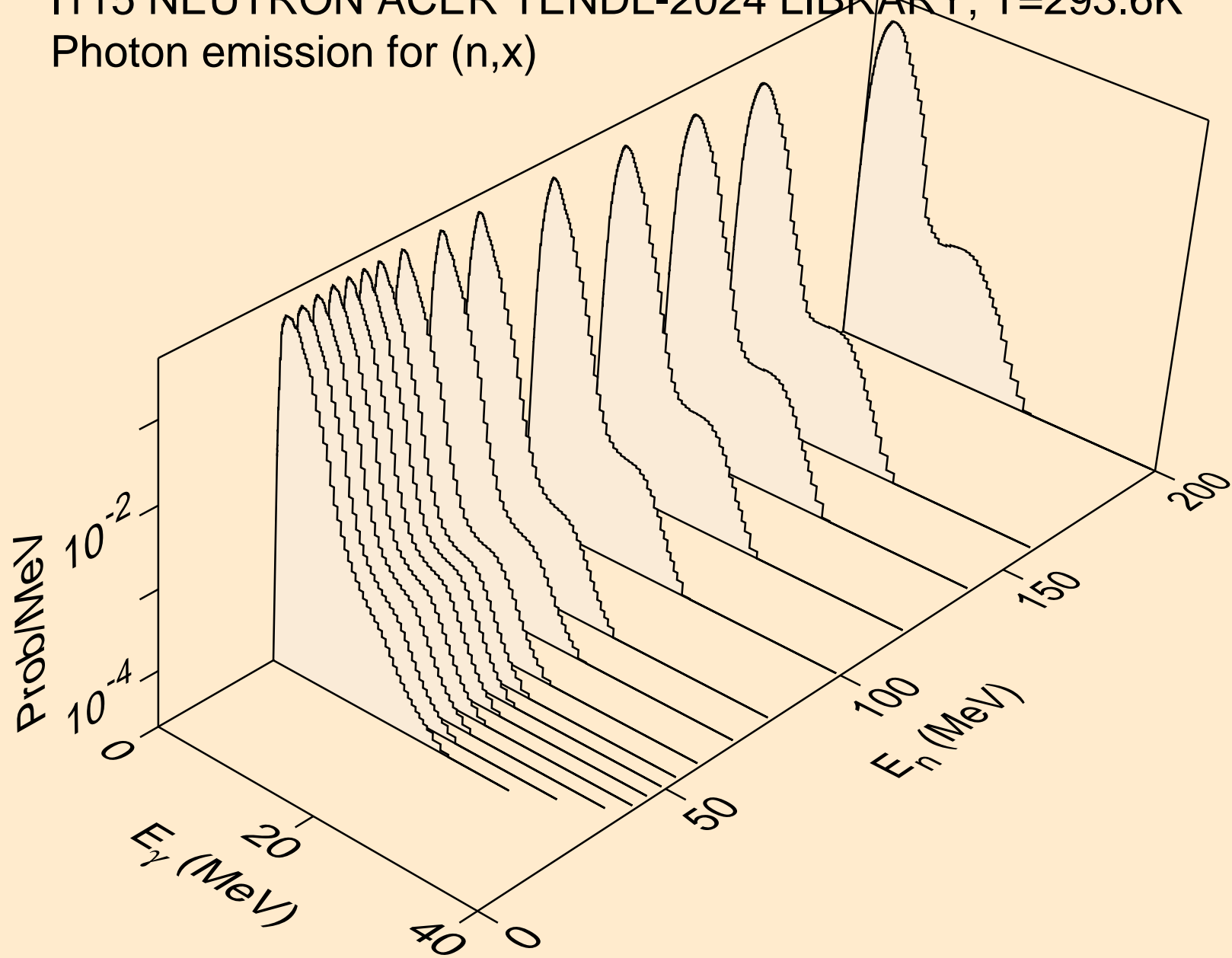

I115 NEUTRON ACER TENDL-2024 LIBRARY; T=293.6K
Photon emission for (n,2nd)

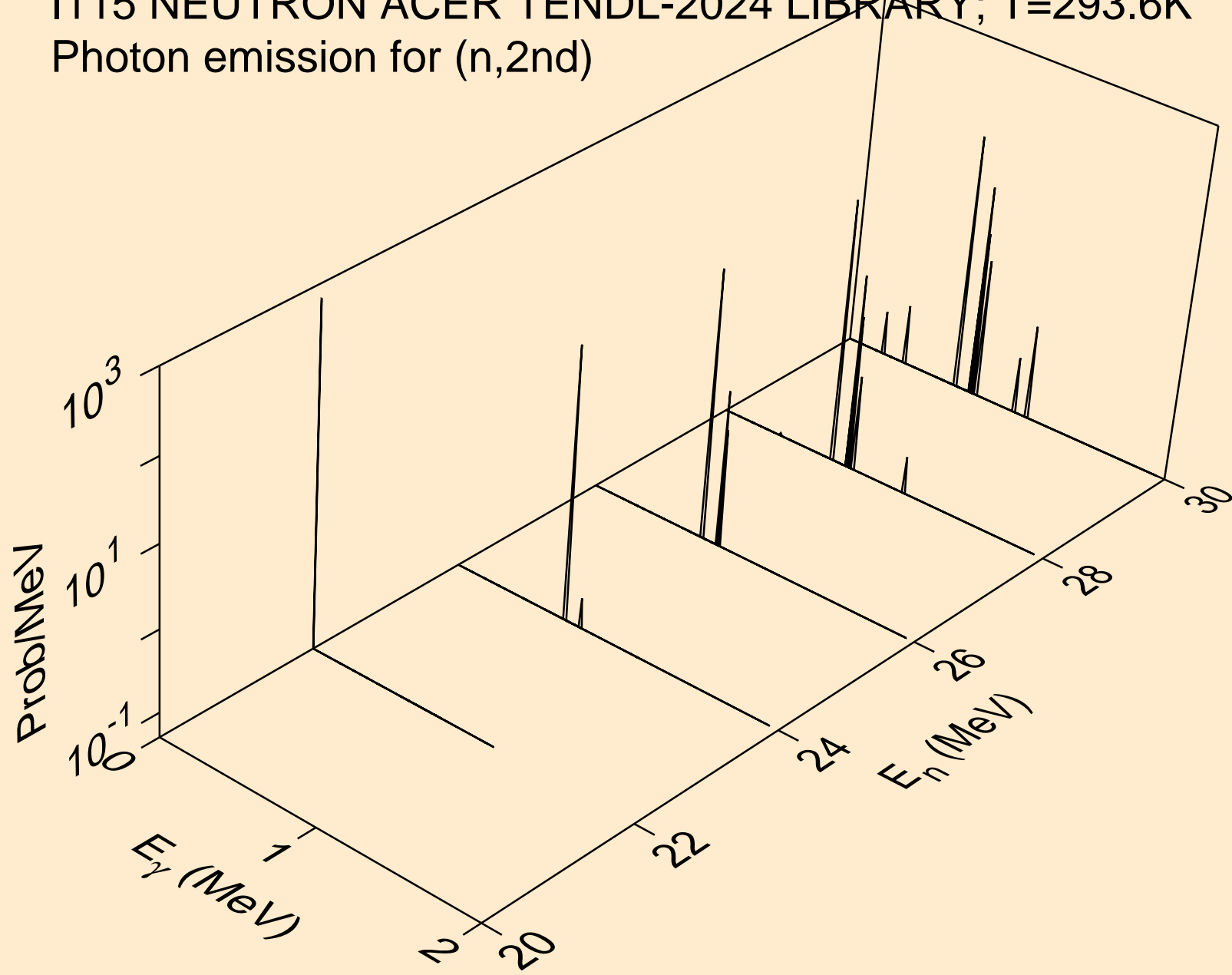

I115 NEUTRON ACER TENDL-2024 LIBRARY; T=293.6K
Photon emission for (n,2n)

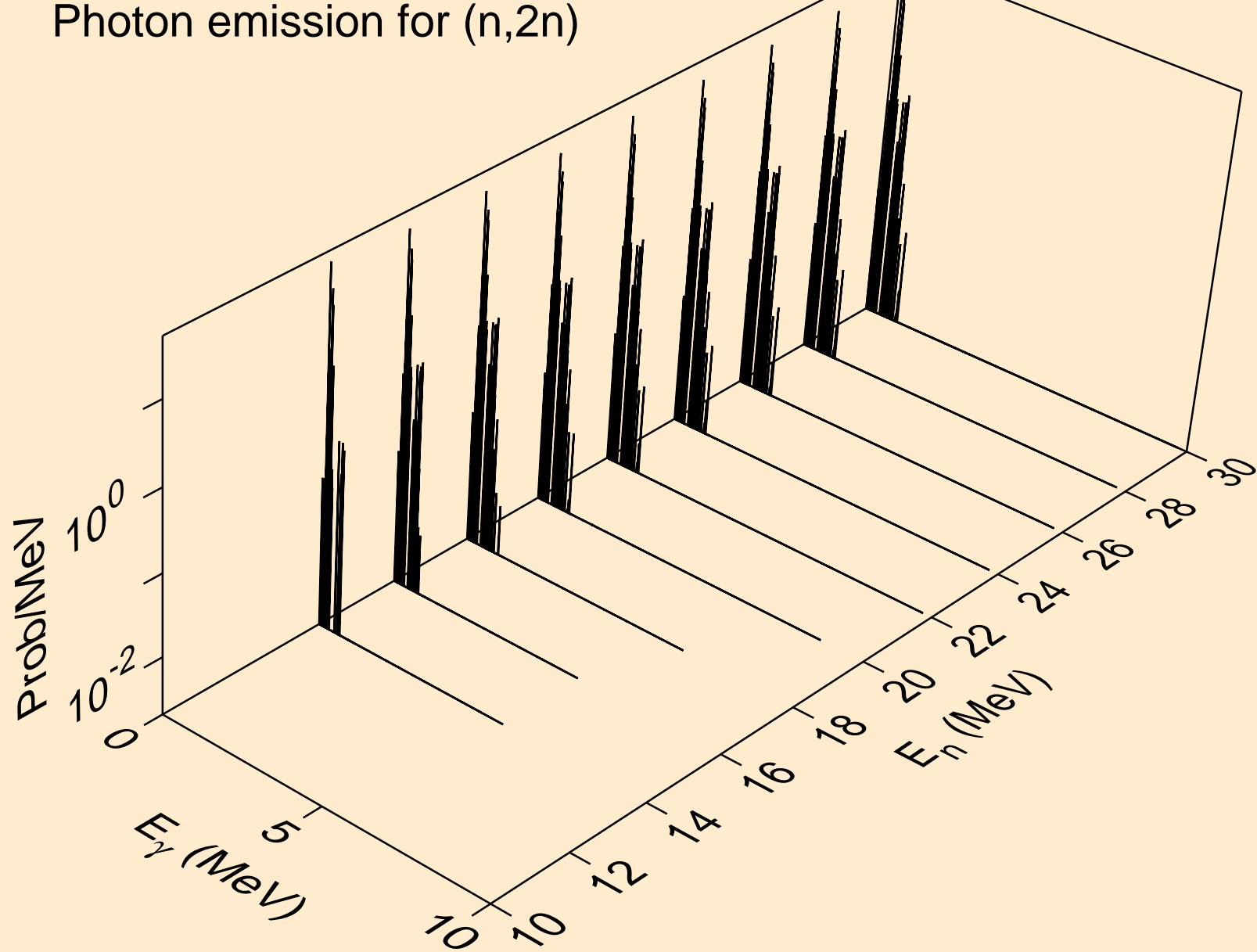

I115 NEUTRON ACER TENDL-2024 LIBRARY; T=293.6K
Photon emission for (n,3n)

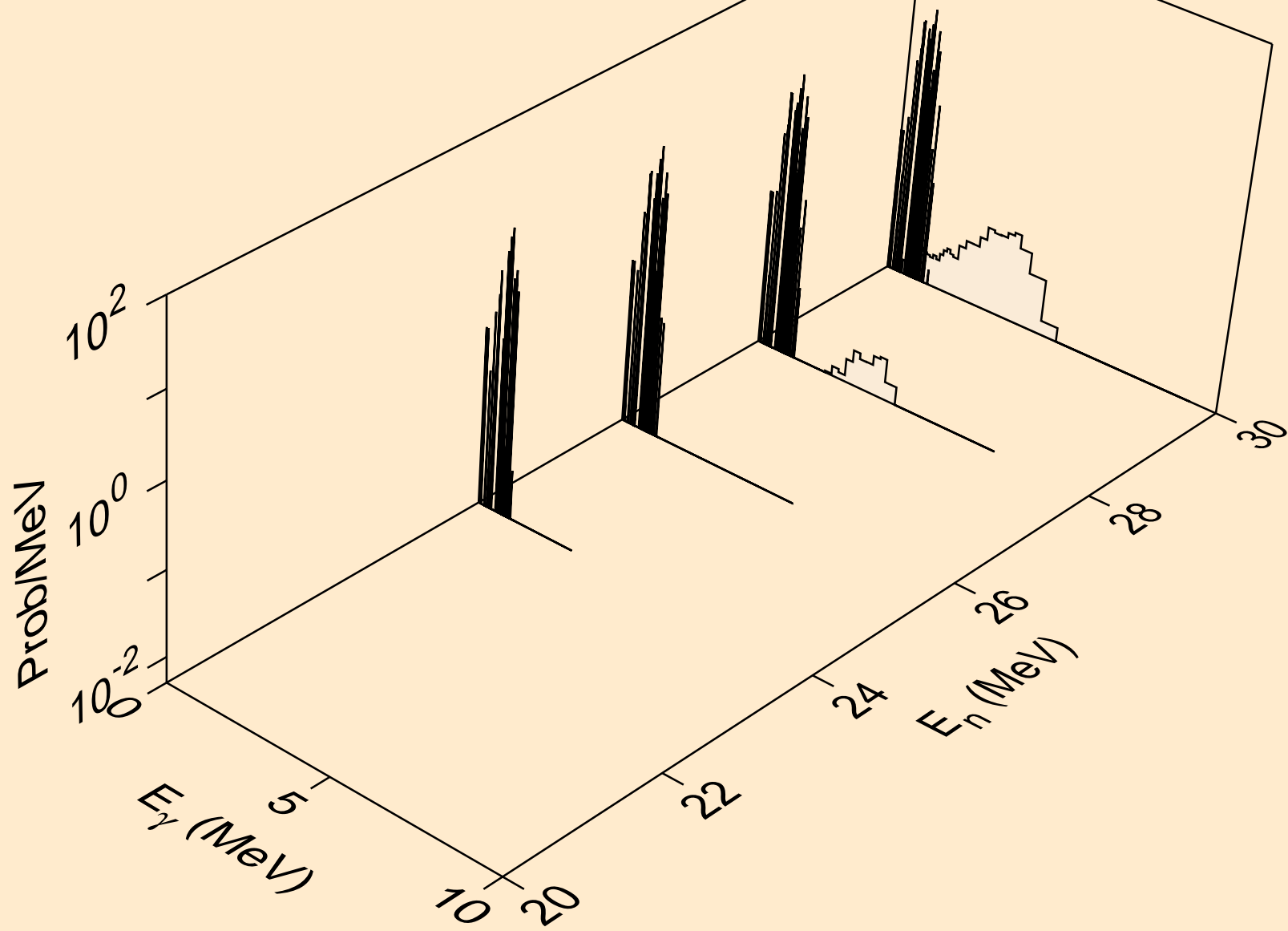

I115 NEUTRON ACER TENDL-2024 LIBRARY; T=293.6K
Photon emission for (n,n*)a

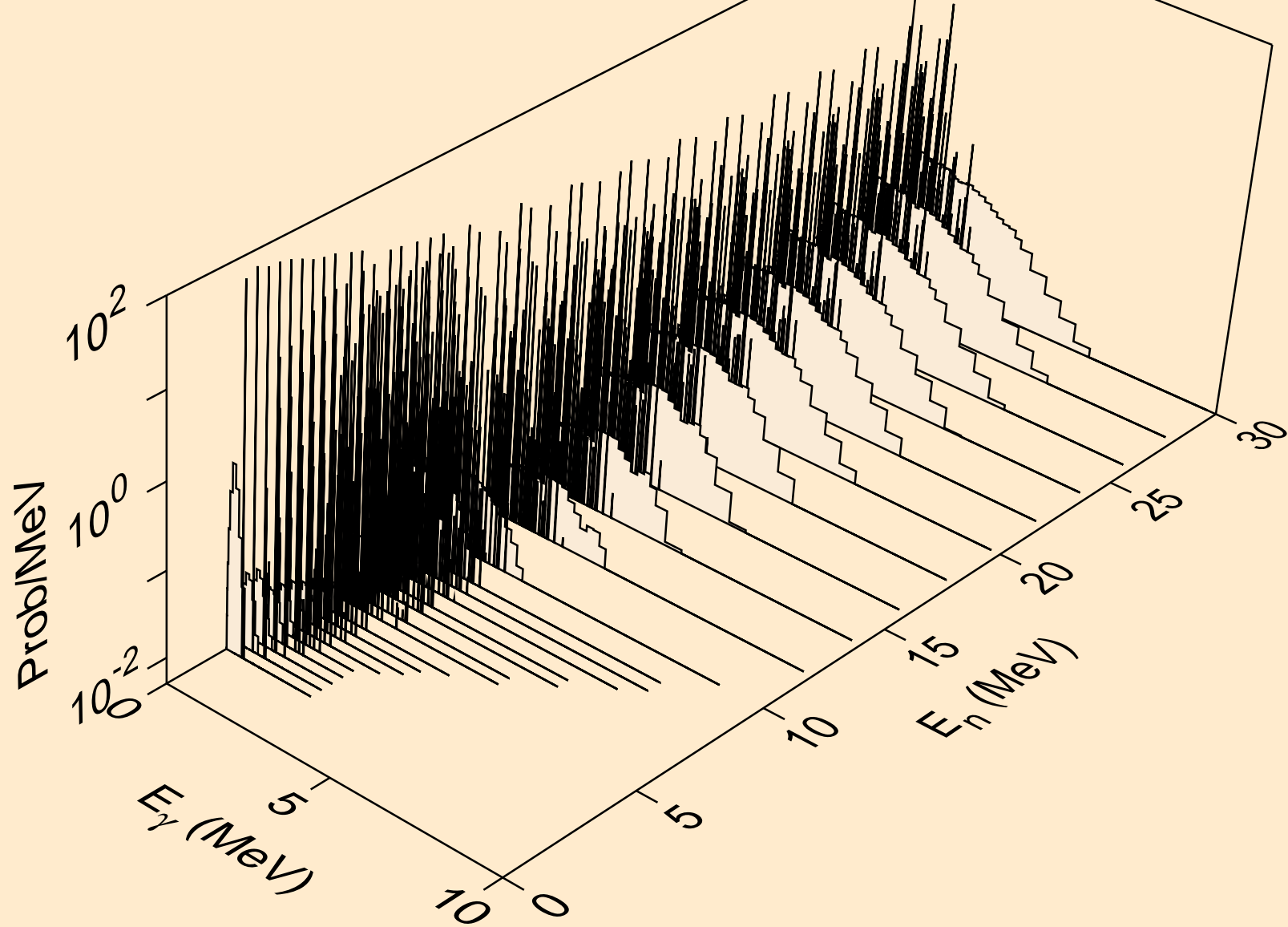

I115 NEUTRON ACER TENDL-2024 LIBRARY; T=293.6K
Photon emission for (n,2n)a

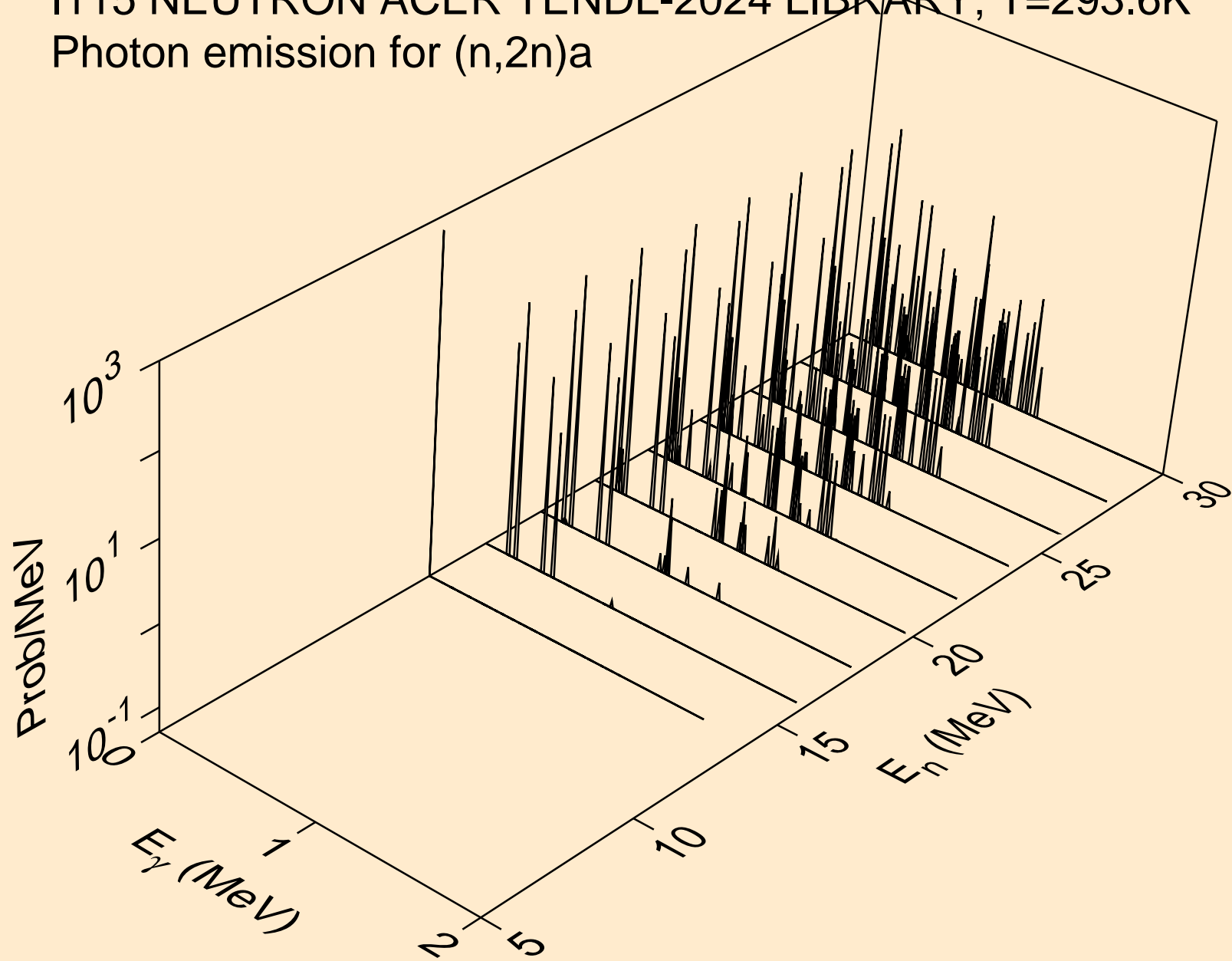

I115 NEUTRON ACER TENDL-2024 LIBRARY; T=293.6K
Photon emission for (n,3n)a

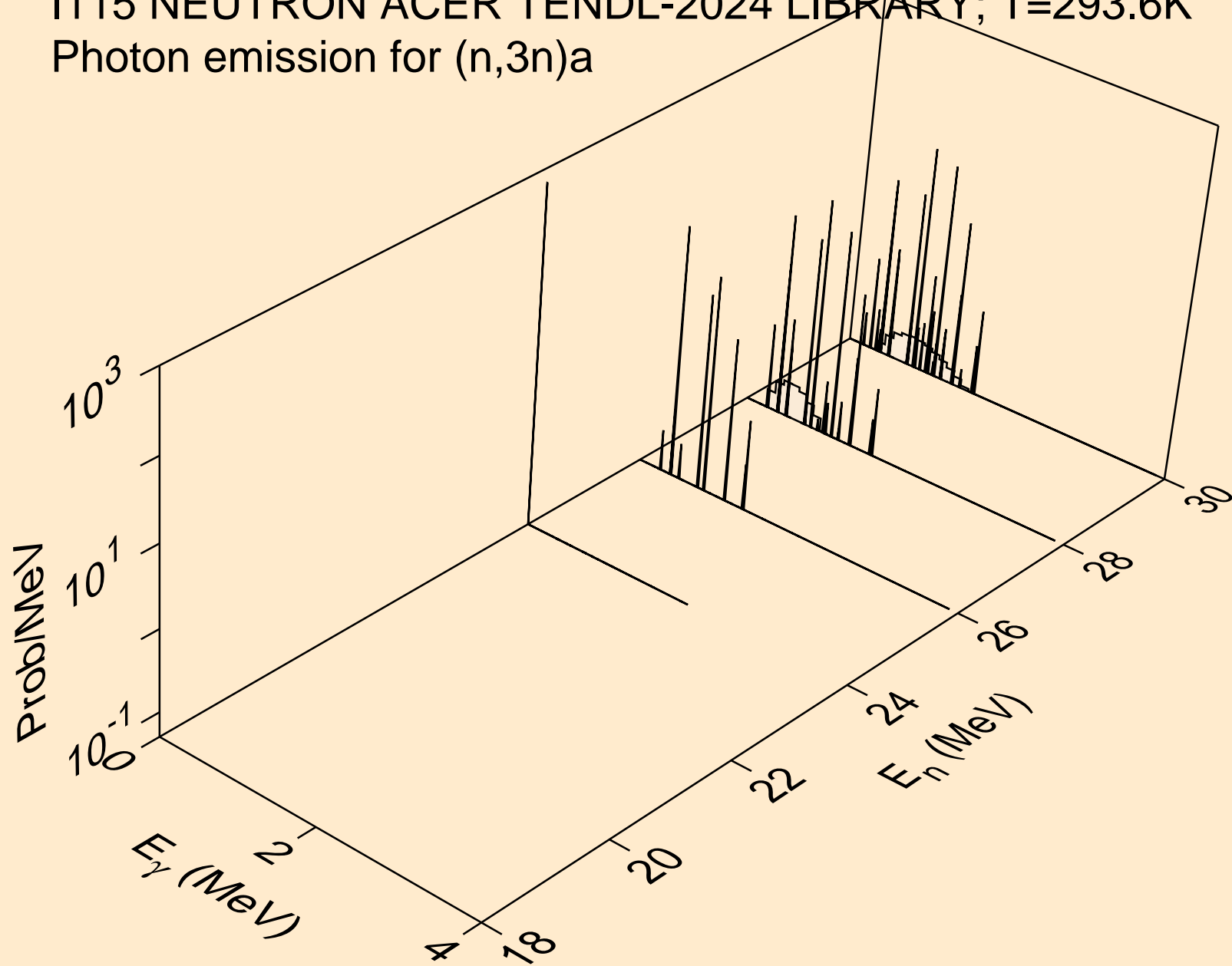

I115 NEUTRON ACER TENDL-2024 LIBRARY; T=293.6K
Photon emission for (n,n*)p

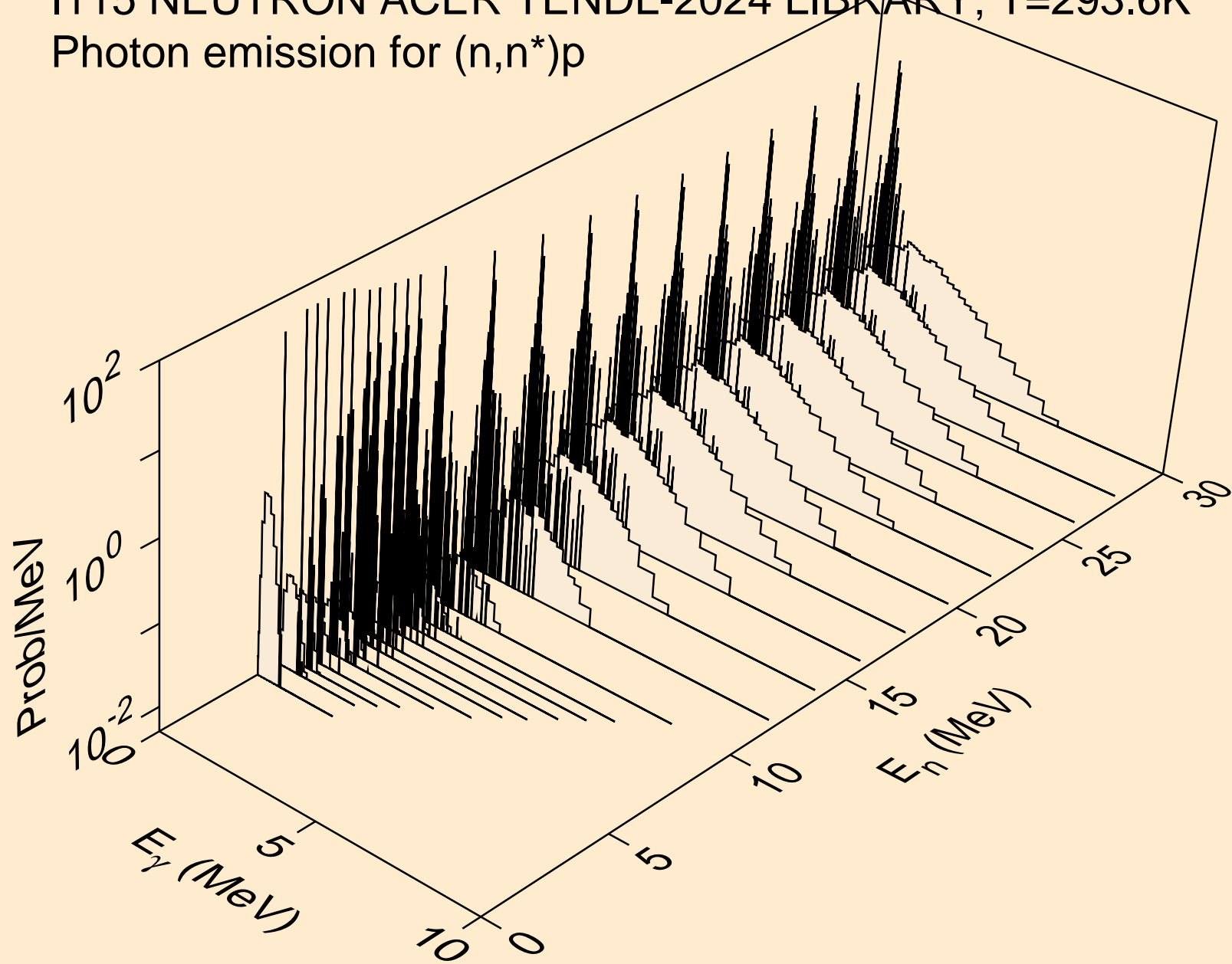

I115 NEUTRON ACER TENDL-2024 LIBRARY; T=293.6K
Photon emission for (n,n*)2a

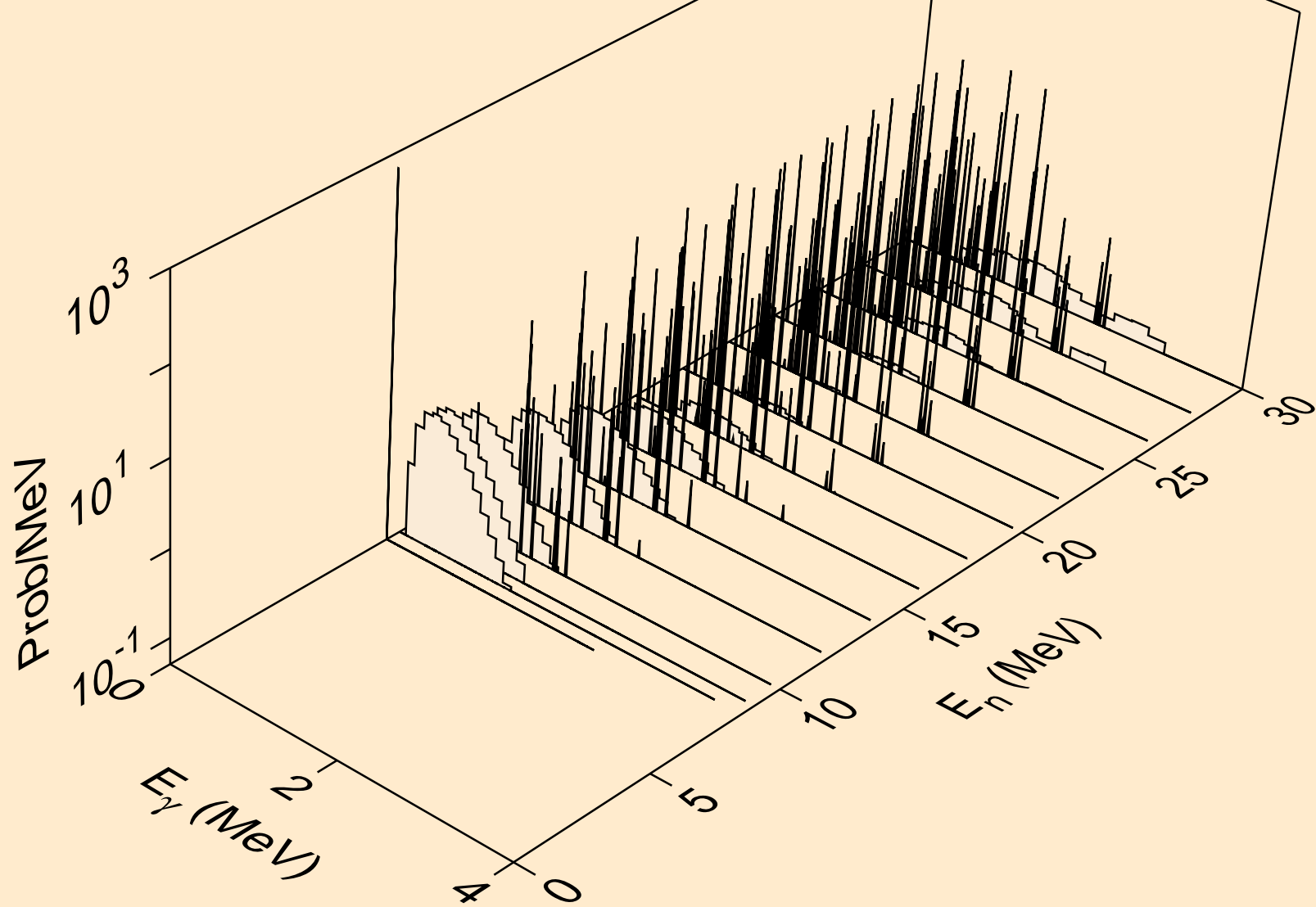

I115 NEUTRON ACER TENDL-2024 LIBRARY; T=293.6K
Photon emission for (n,2n)2a

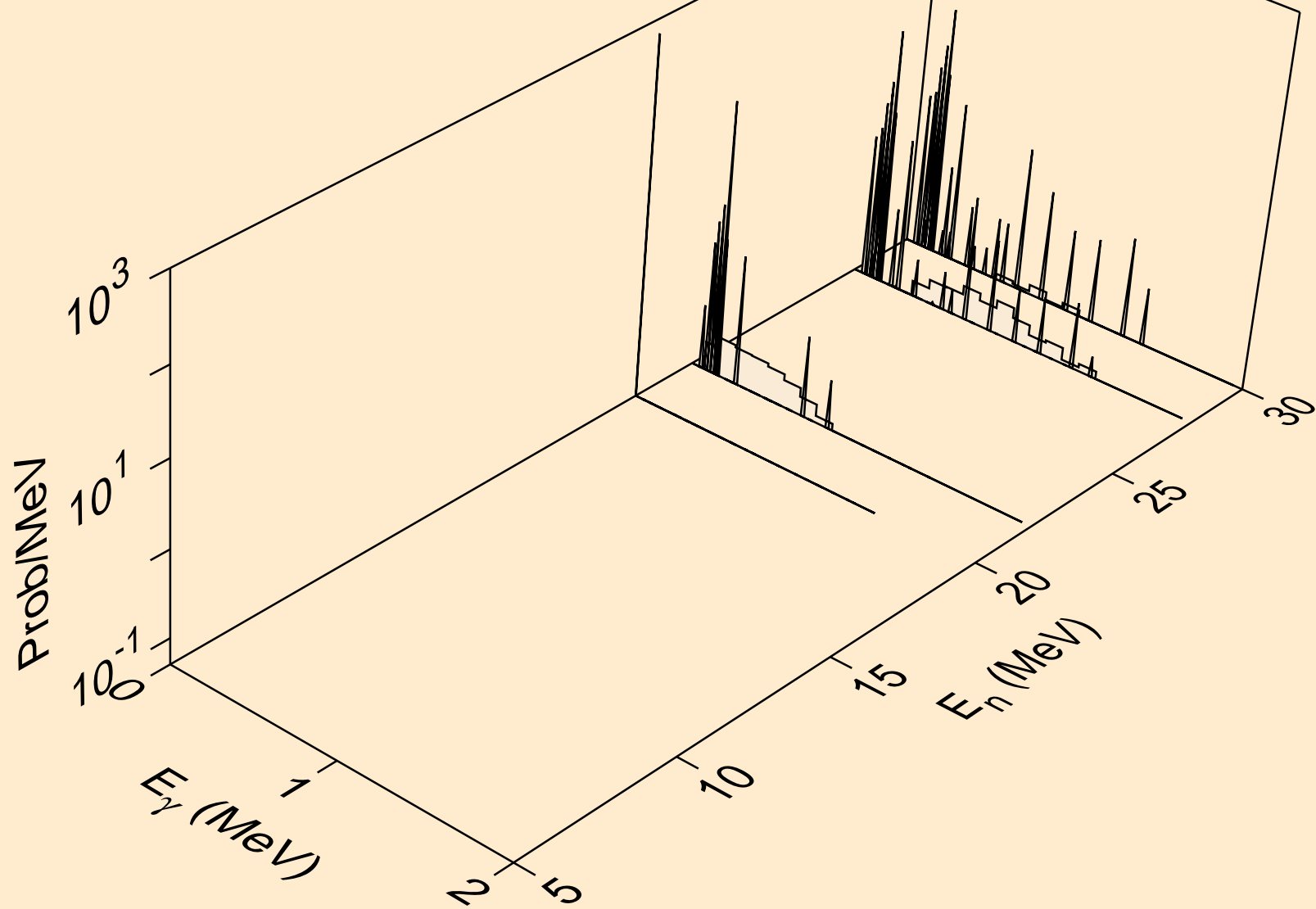

I115 NEUTRON ACER TENDL-2024 LIBRARY; T=293.6K
Photon emission for (n,n*)d

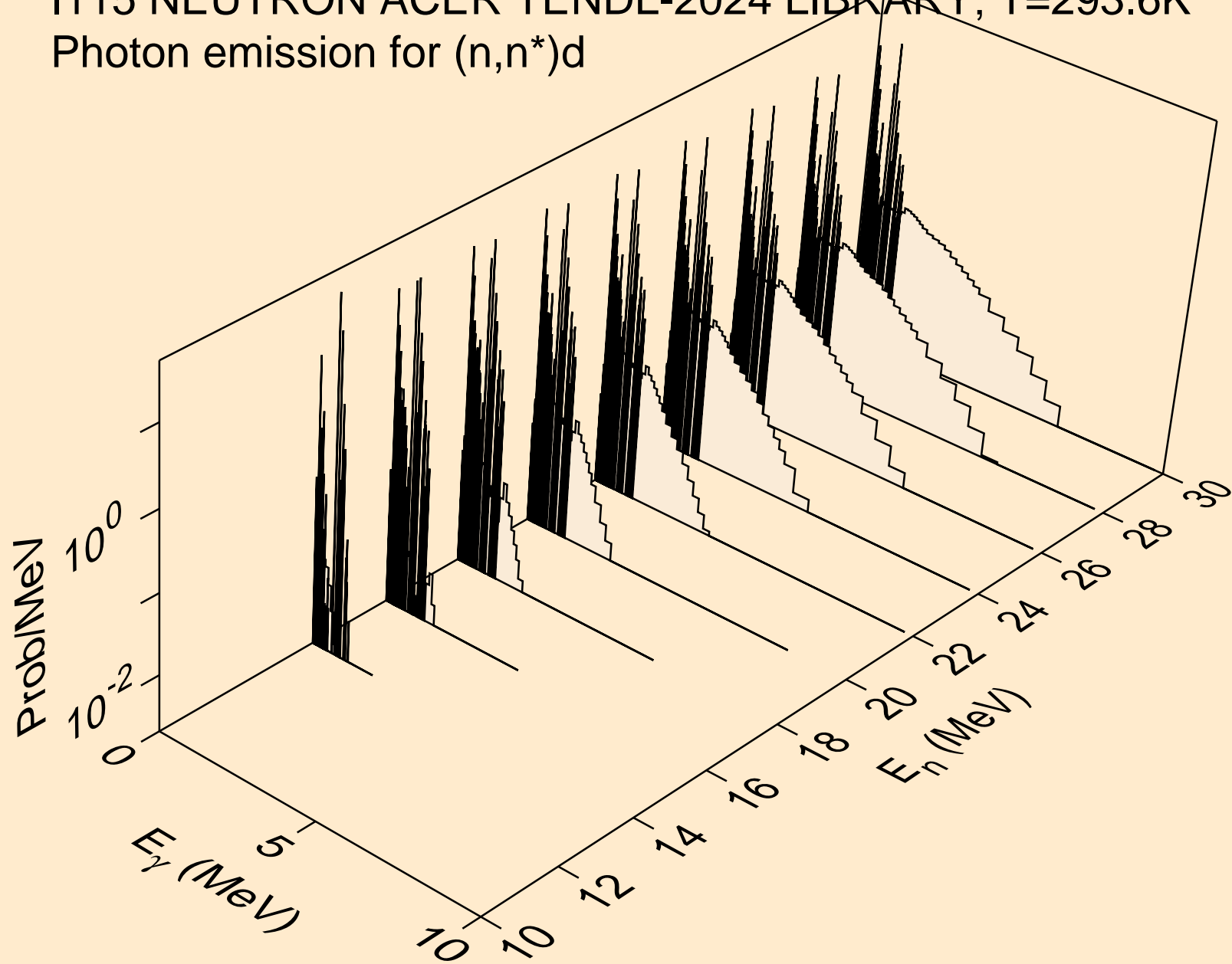

I115 NEUTRON ACER TENDL-2024 LIBRARY; T=293.6K
Photon emission for (n,n*)t

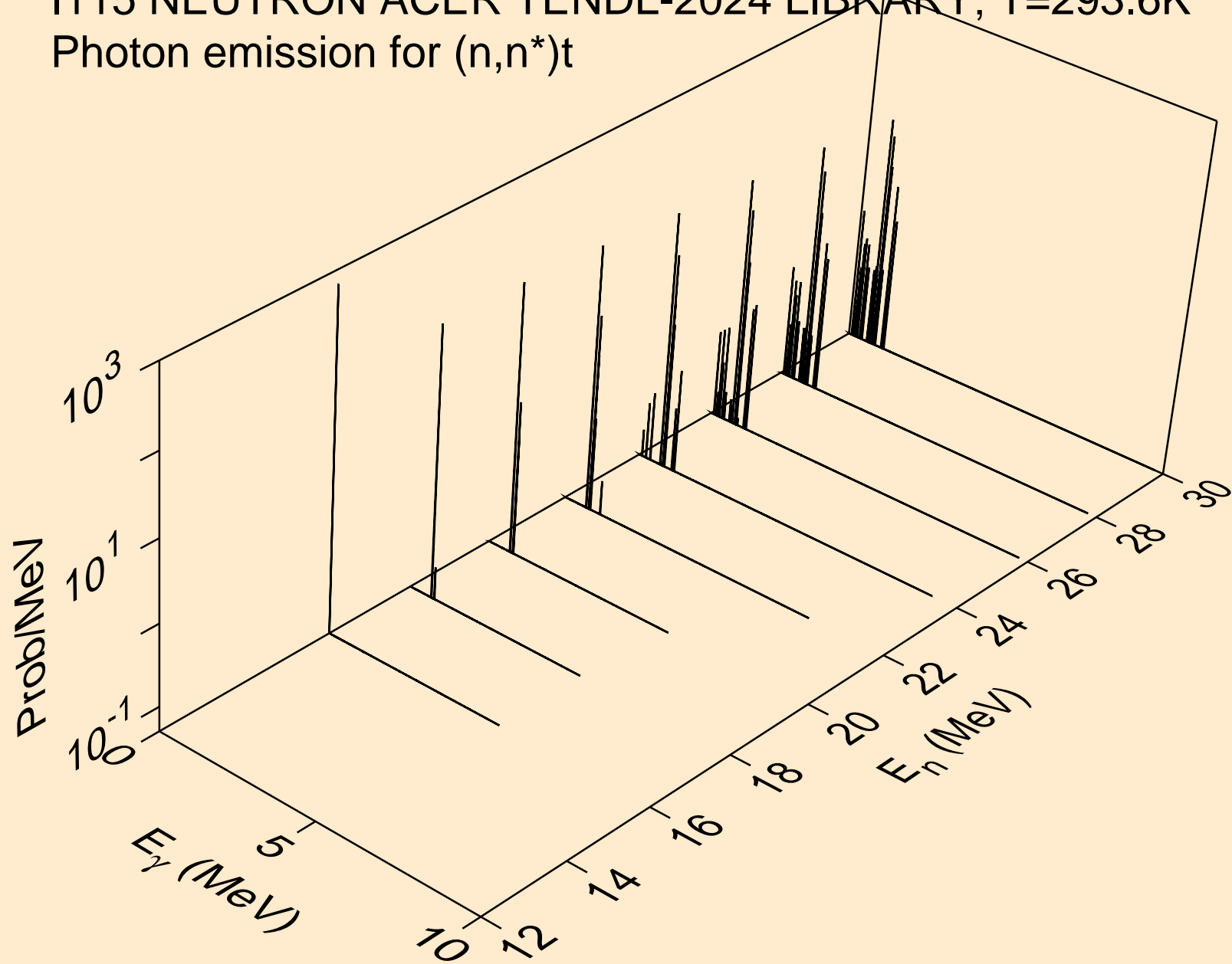

I115 NEUTRON ACER TENDL-2024 LIBRARY; T=293.6K
Photon emission for (n,n*)he3

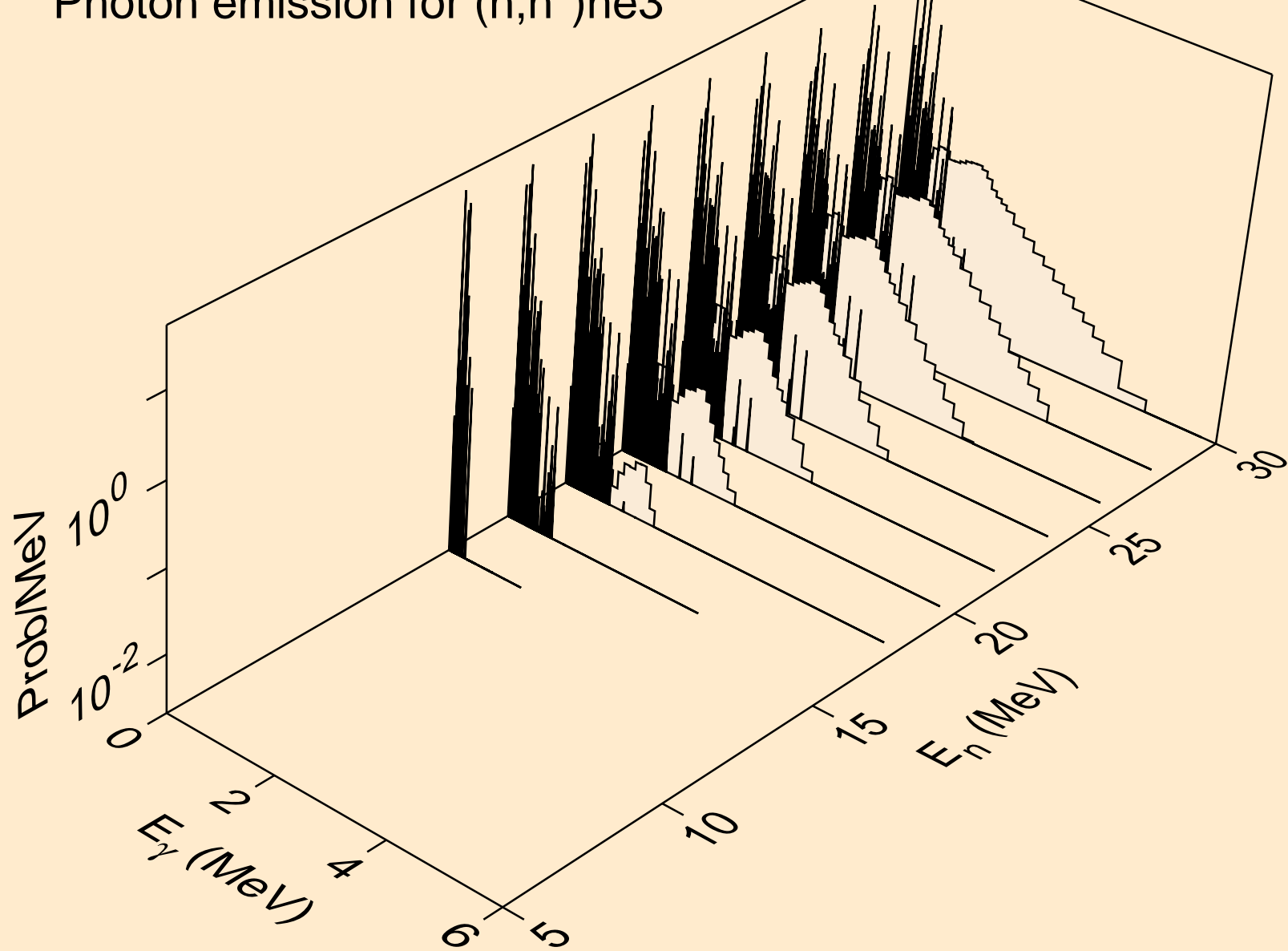

I115 NEUTRON ACER TENDL-2024 LIBRARY; T=293.6K
Photon emission for (n,2np)

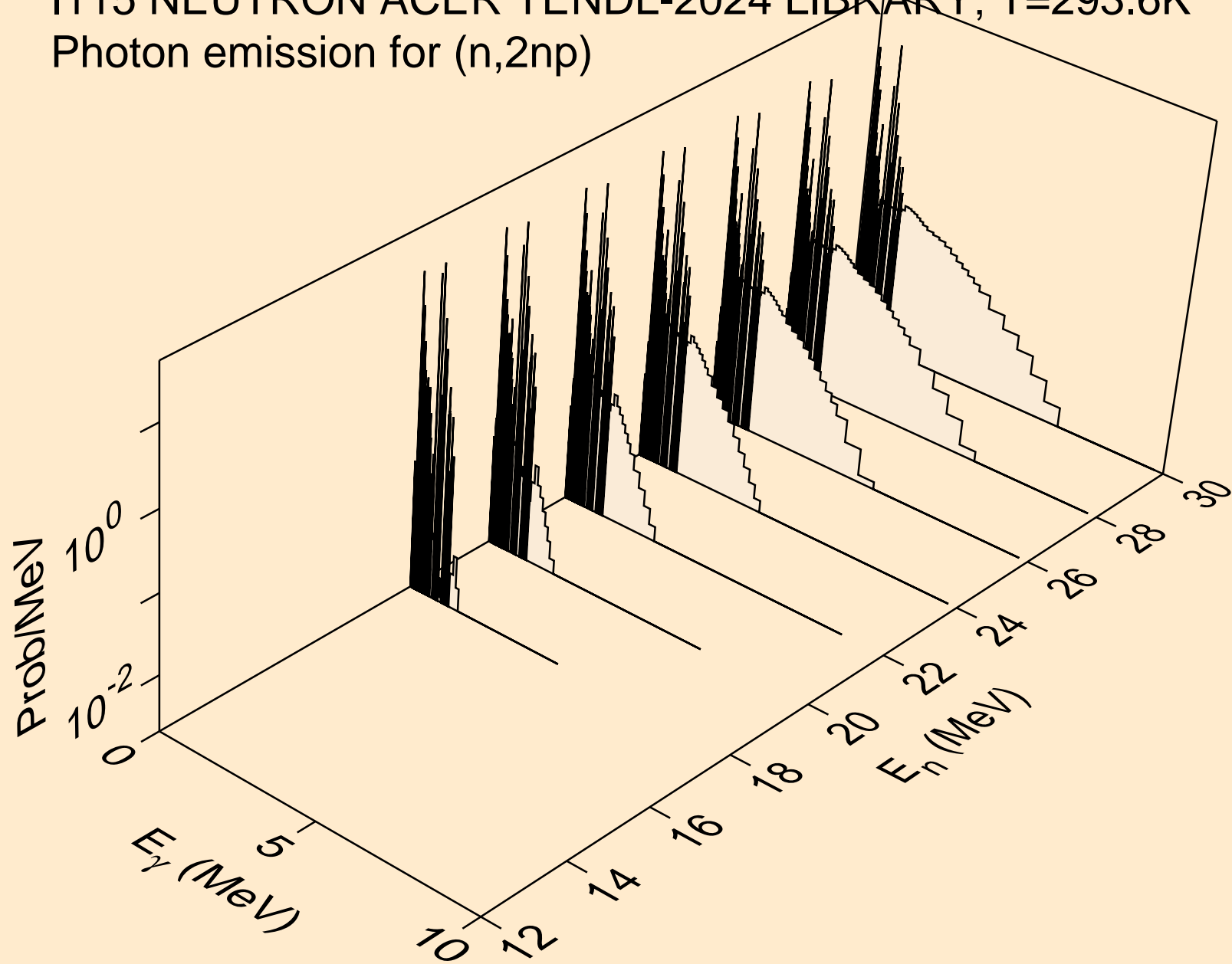

I115 NEUTRON ACER TENDL-2024 LIBRARY; T=293.6K
Photon emission for (n,3np)

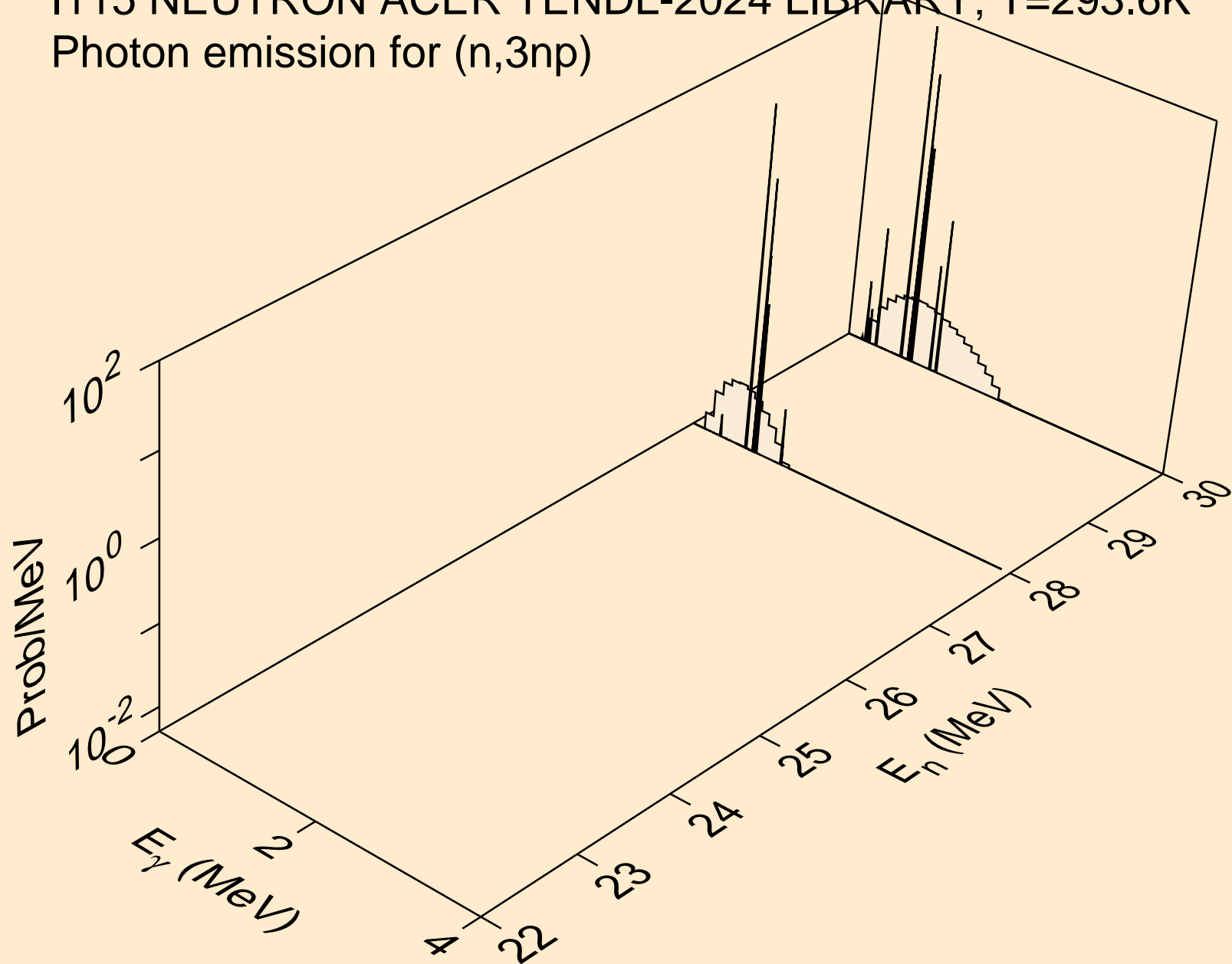

I115 NEUTRON ACER TENDL-2024 LIBRARY; T=293.6K
Photon emission for (n,n2p)

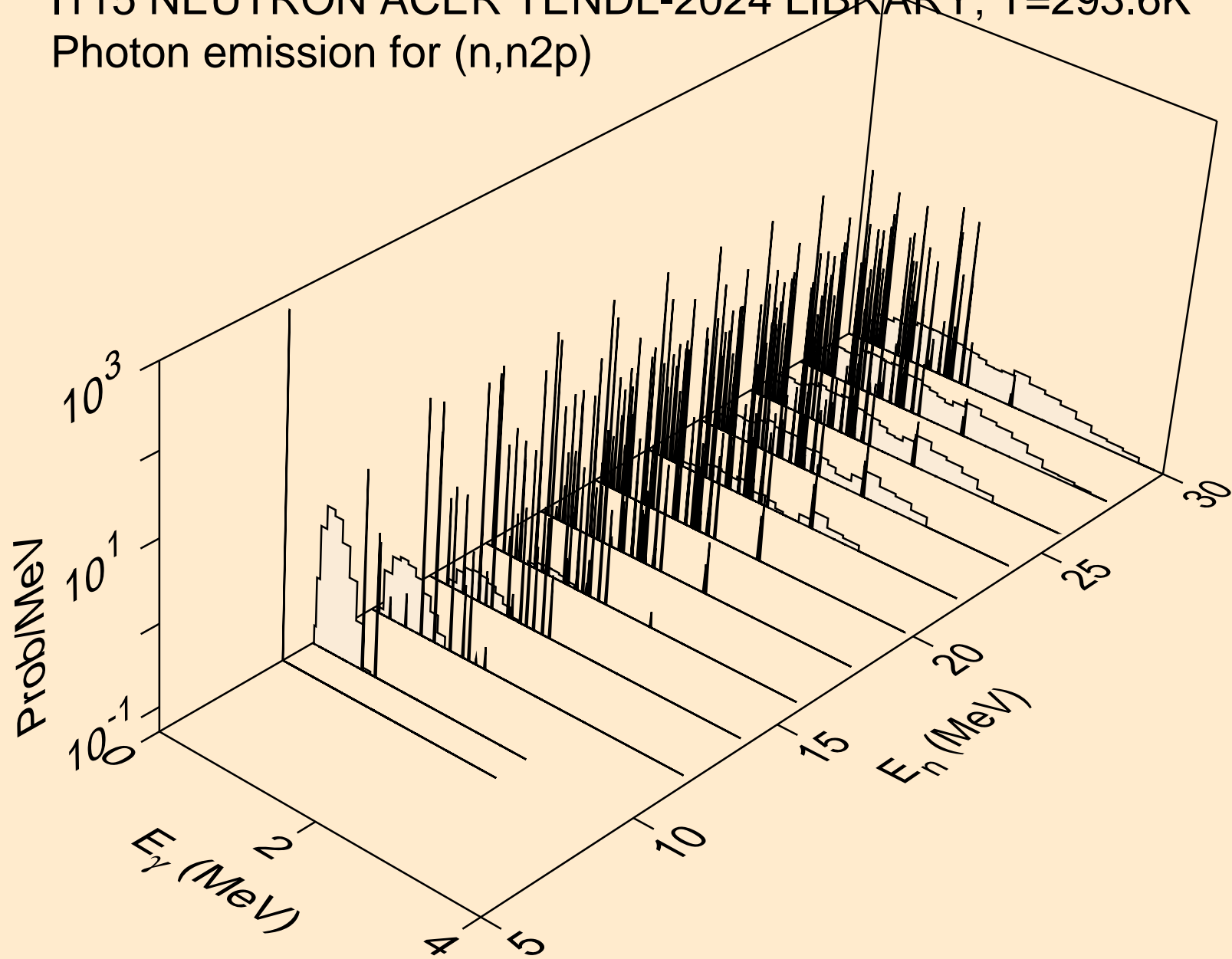

I115 NEUTRON ACER TENDL-2024 LIBRARY; T=293.6K
Photon emission for (n,npa)

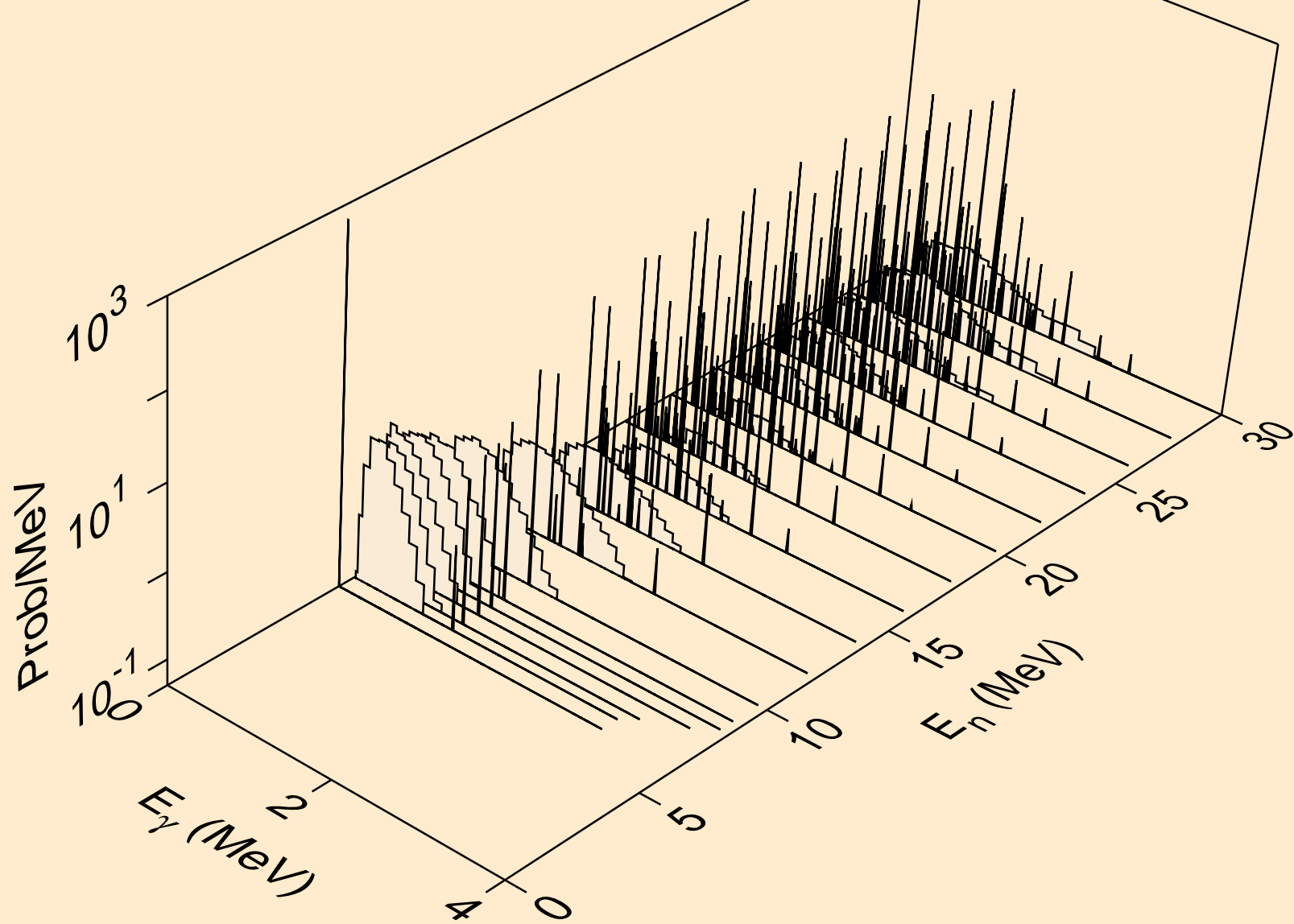

I115 NEUTRON ACER TENDL-2024 LIBRARY; T=293.6K
Photon emission for (n,n*c)

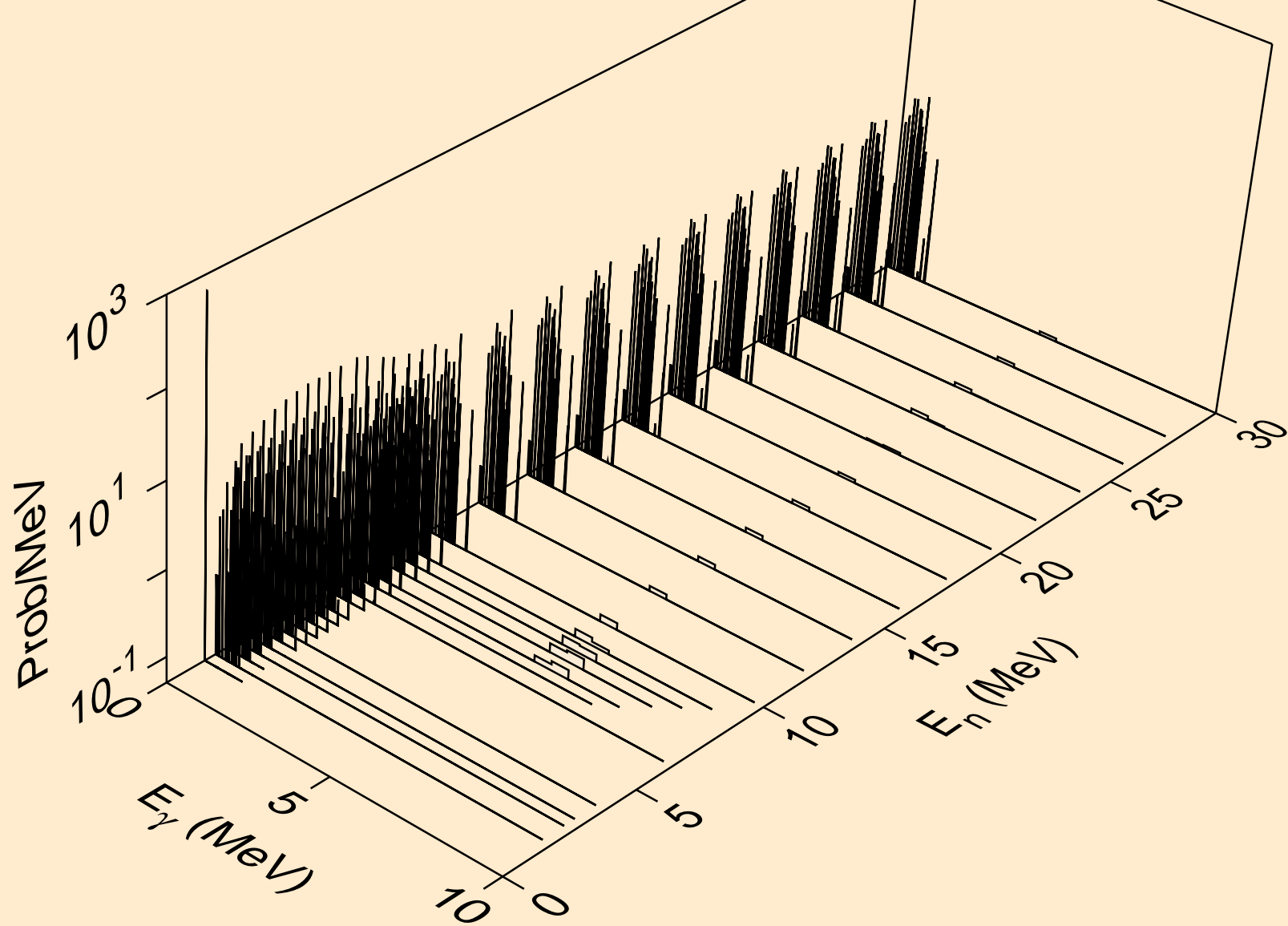

I115 NEUTRON ACER TENDL-2024 LIBRARY; T=293.6K
Photon emission for (n,gma)

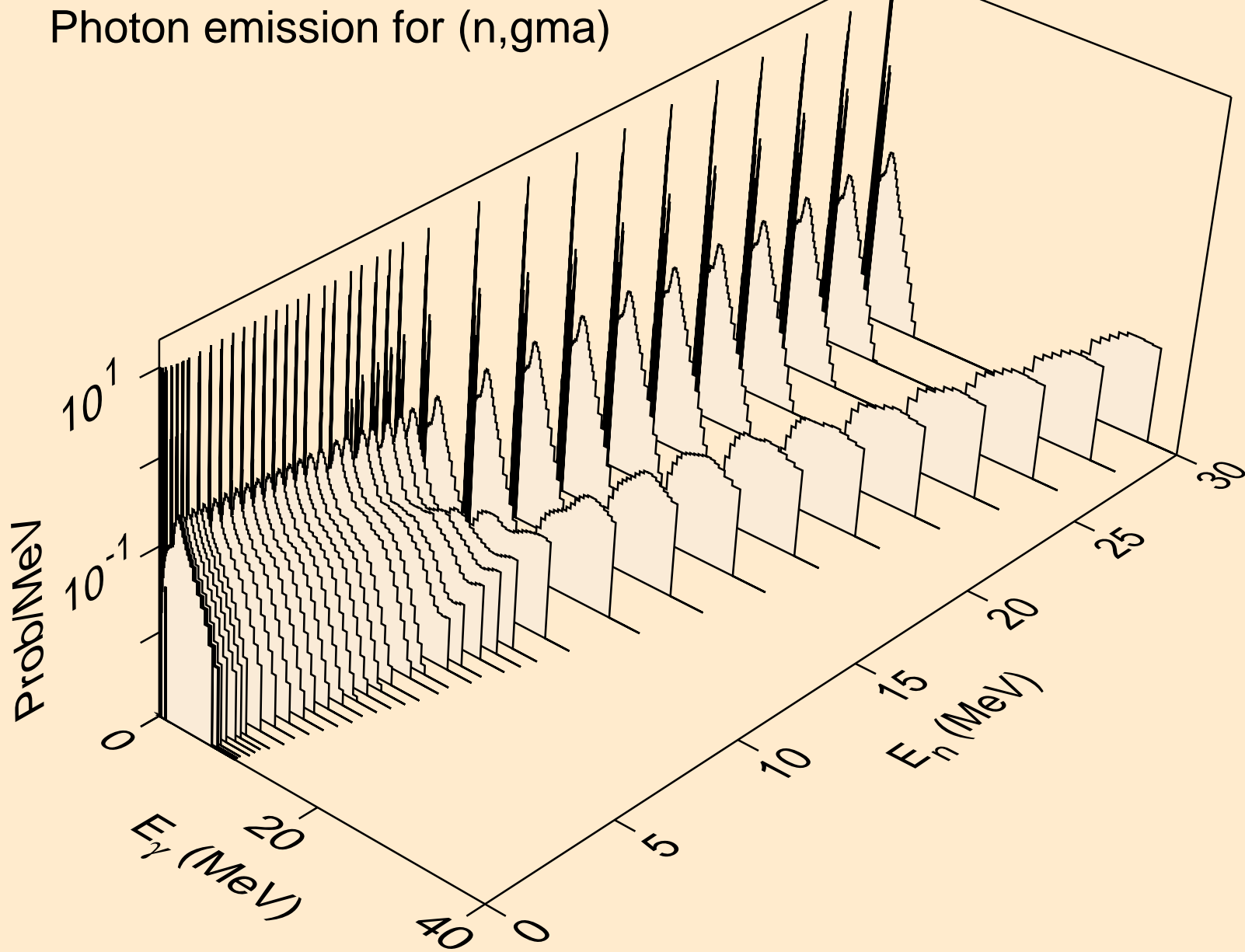

I115 NEUTRON ACER TENDL-2024 LIBRARY; T=293.6K
Photon emission for (n,p)

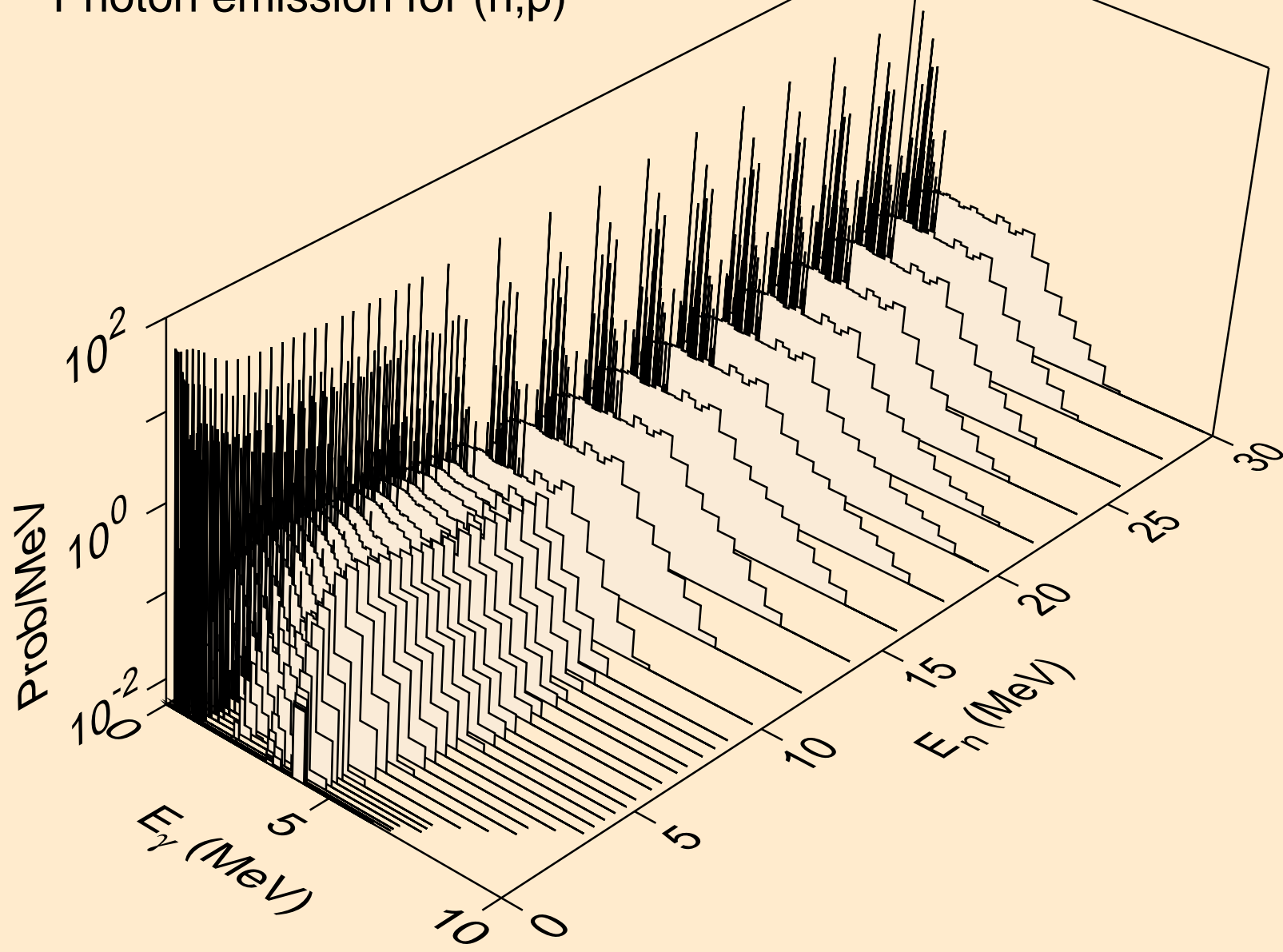

I115 NEUTRON ACER TENDL-2024 LIBRARY; T=293.6K
Photon emission for (n,d)

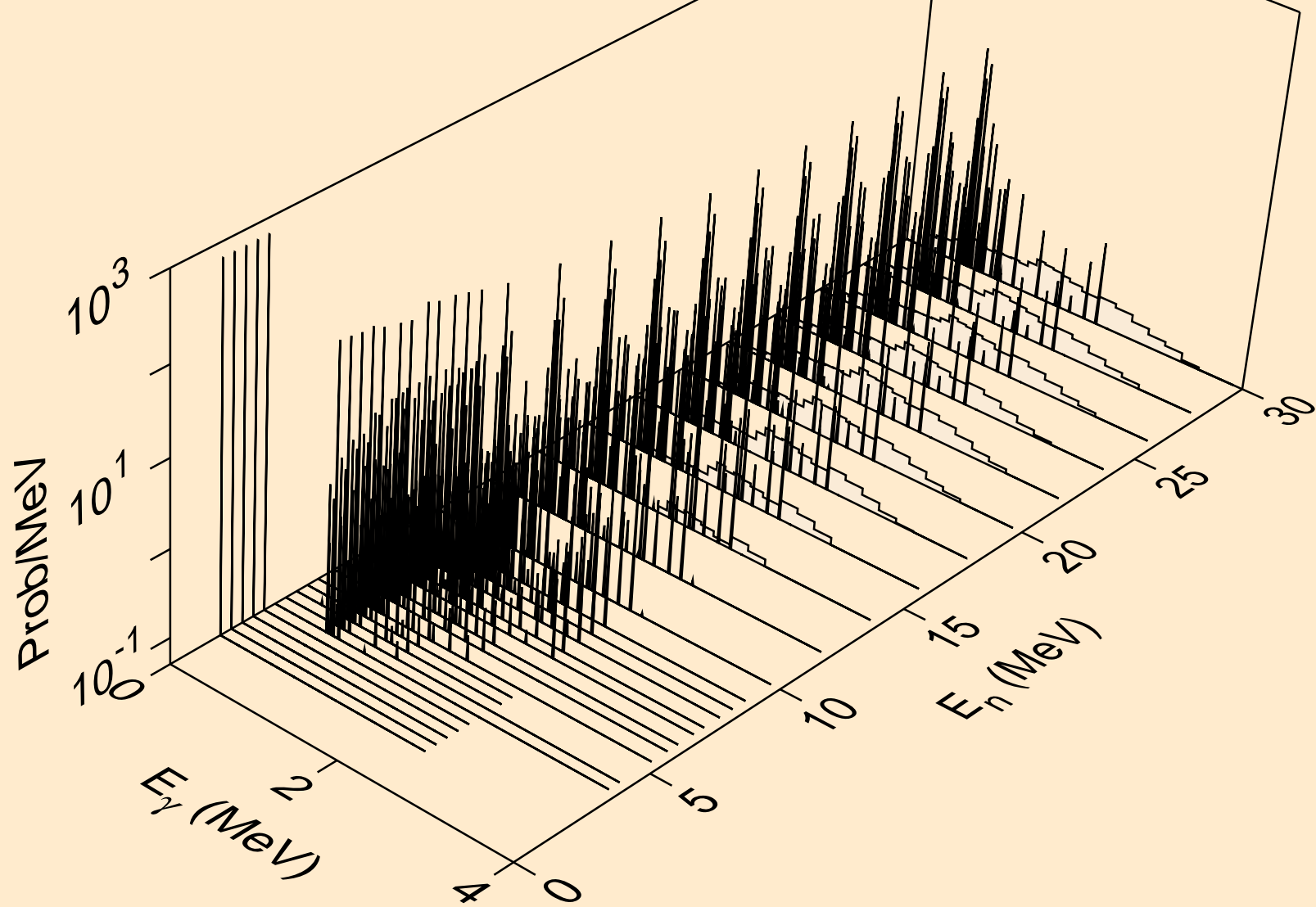

I115 NEUTRON ACER TENDL-2024 LIBRARY; T=293.6K
Photon emission for (n,t)

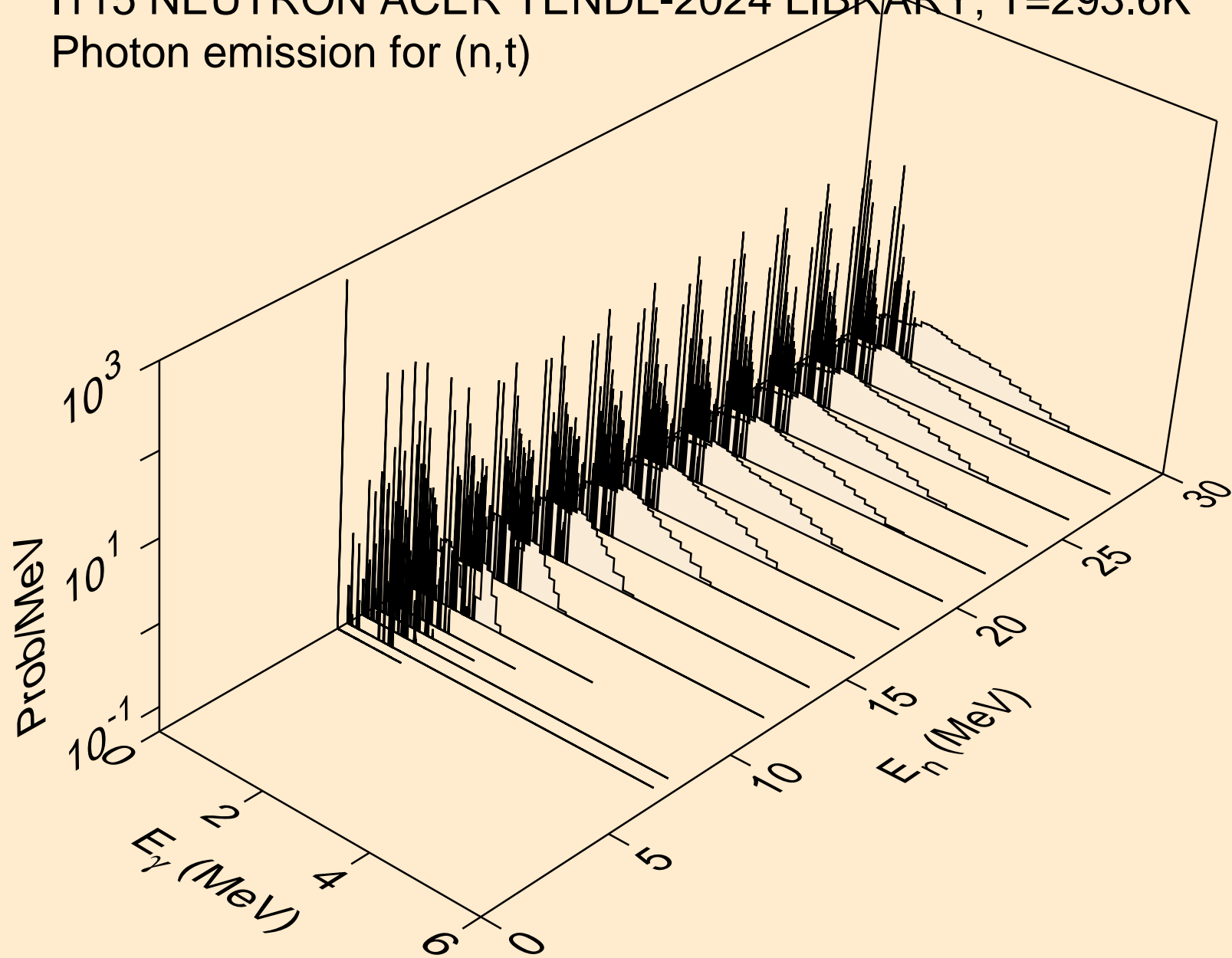

I115 NEUTRON ACER TENDL-2024 LIBRARY; T=293.6K
Photon emission for (n,he3)

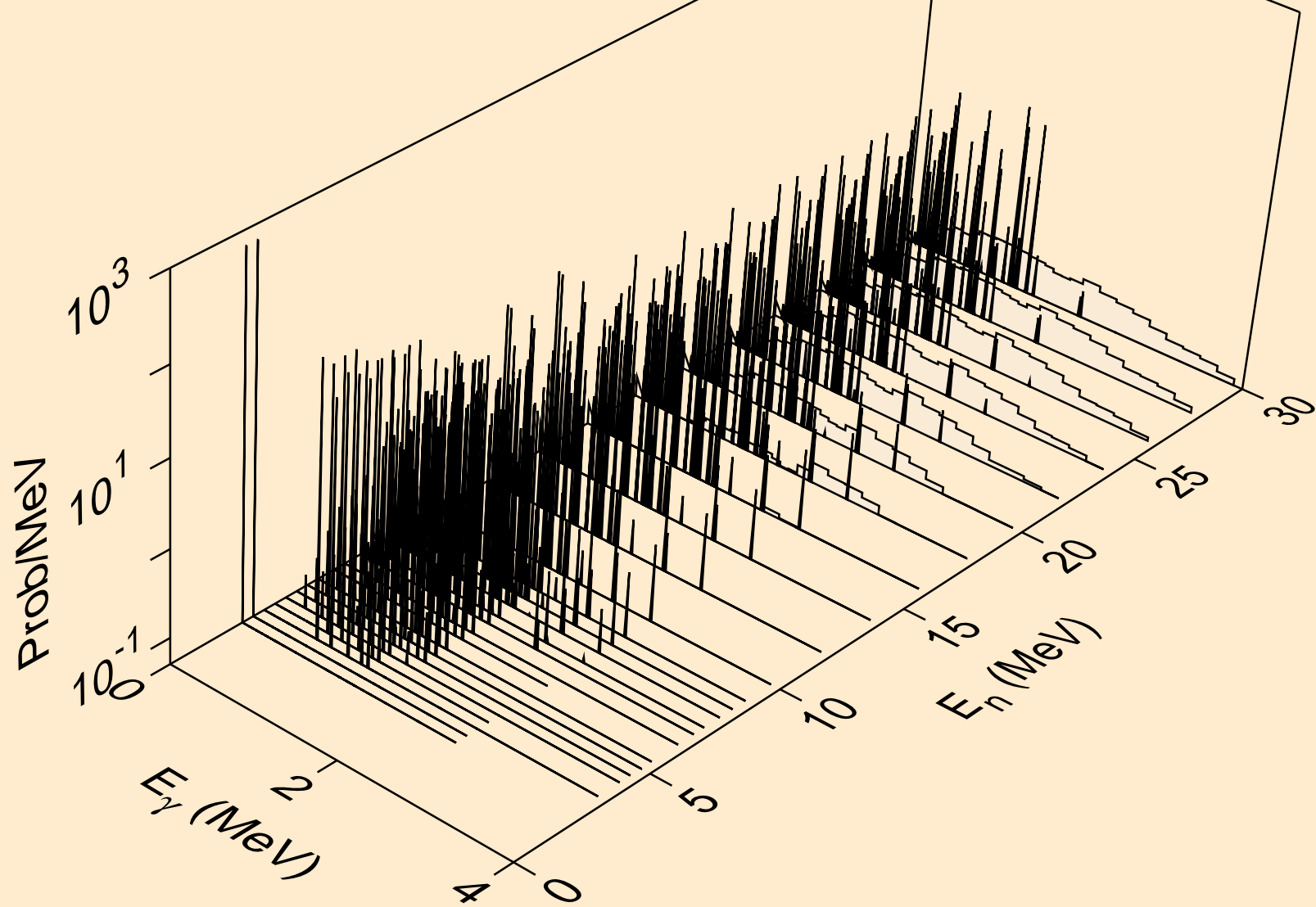

I115 NEUTRON ACER TENDL-2024 LIBRARY; T=293.6K
Photon emission for (n,a)

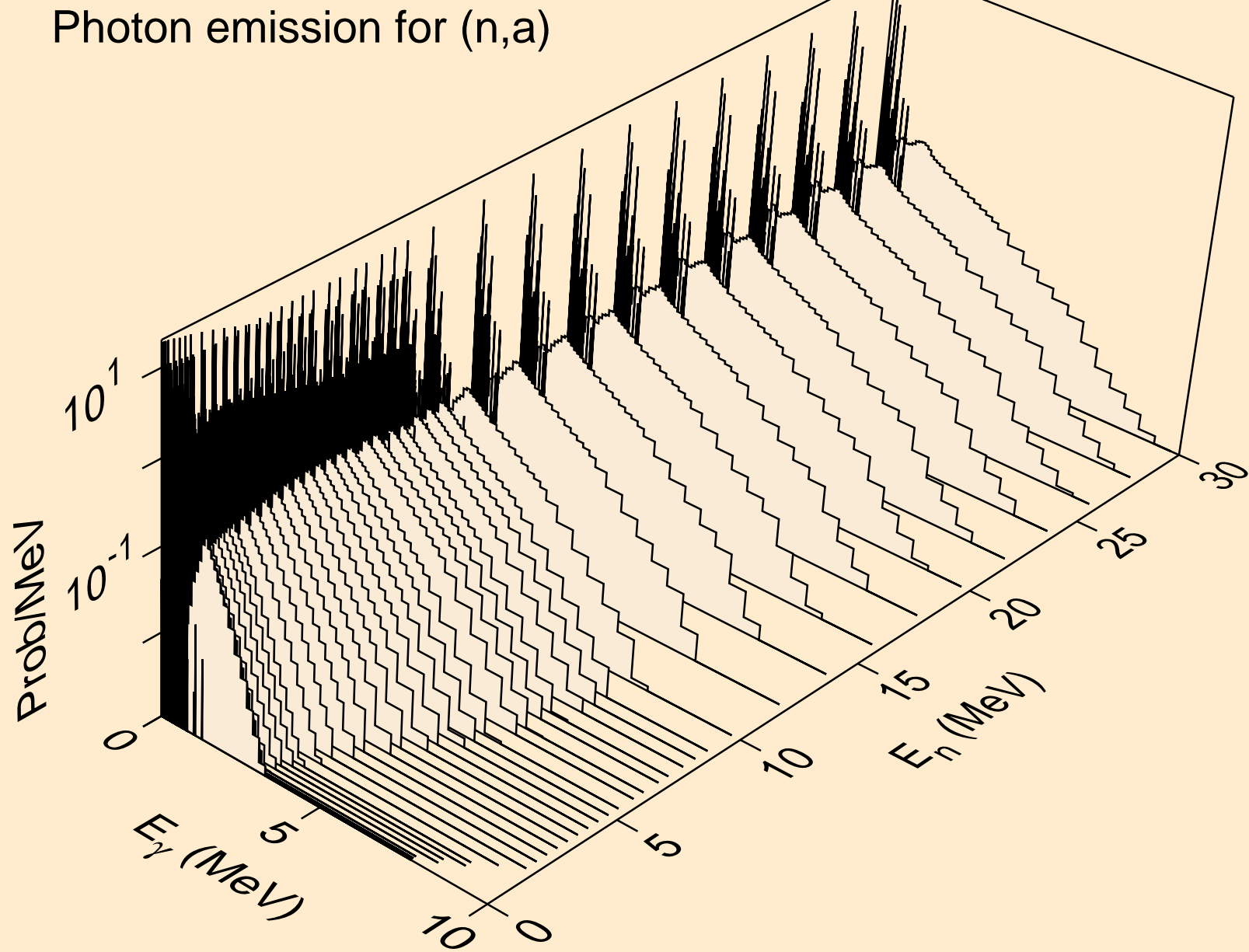

I115 NEUTRON ACER TENDL-2024 LIBRARY; T=293.6K
Photon emission for (n,2a)

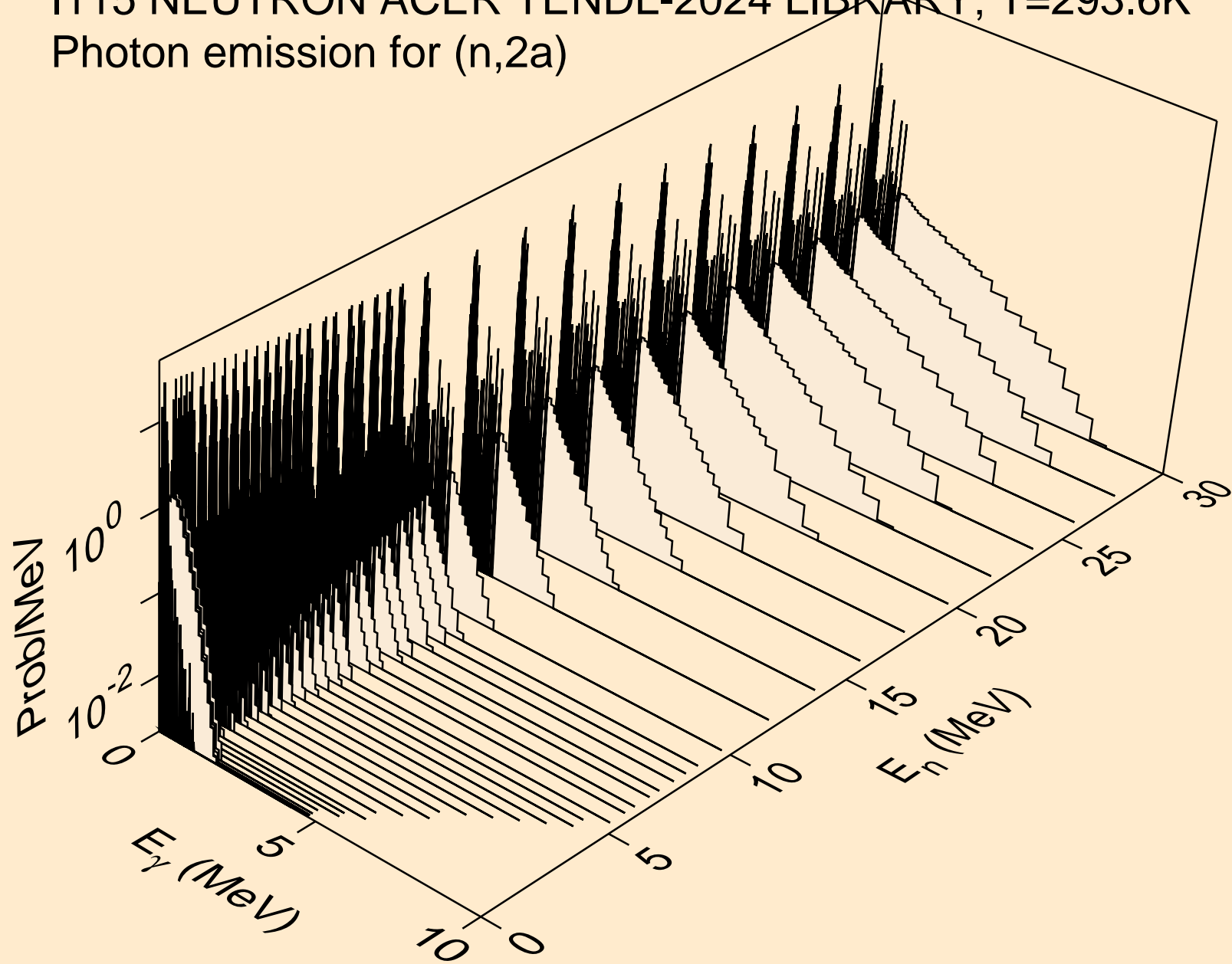

I115 NEUTRON ACER TENDL-2024 LIBRARY; T=293.6K
Photon emission for (n,3a)

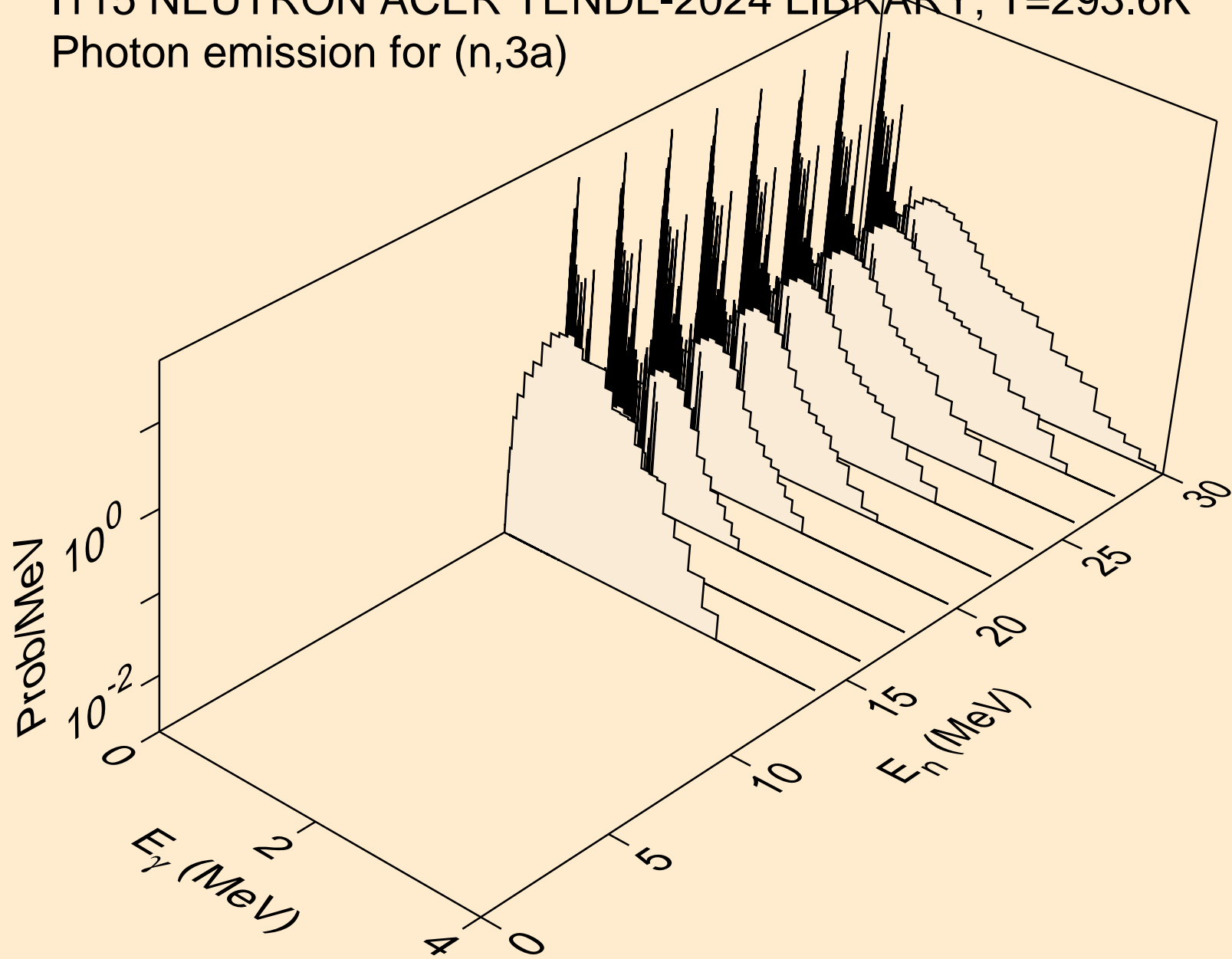

I115 NEUTRON ACER TENDL-2024 LIBRARY; T=293.6K
Photon emission for (n,2p)

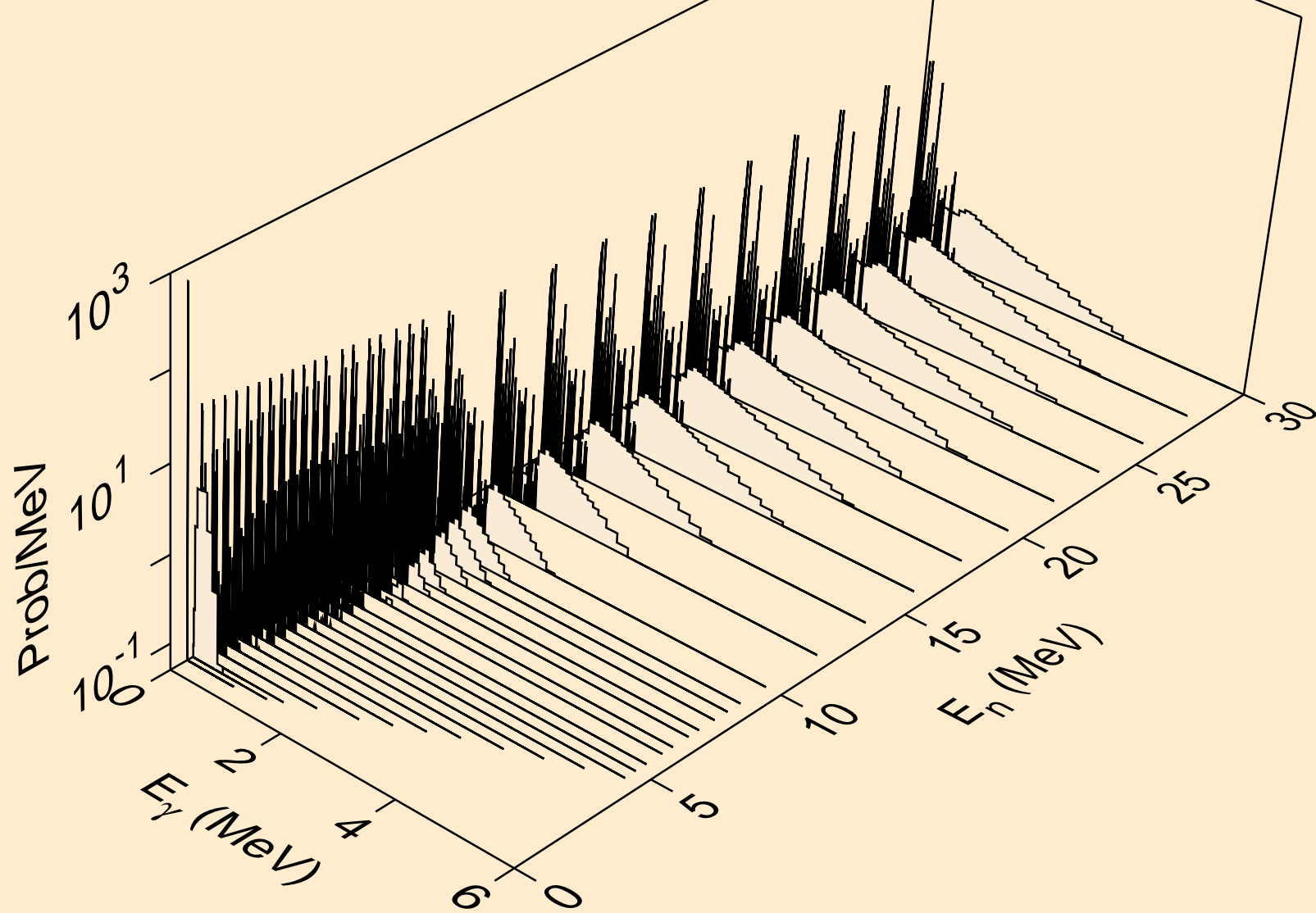

I115 NEUTRON ACER TENDL-2024 LIBRARY; T=293.6K
Photon emission for (n,p α)

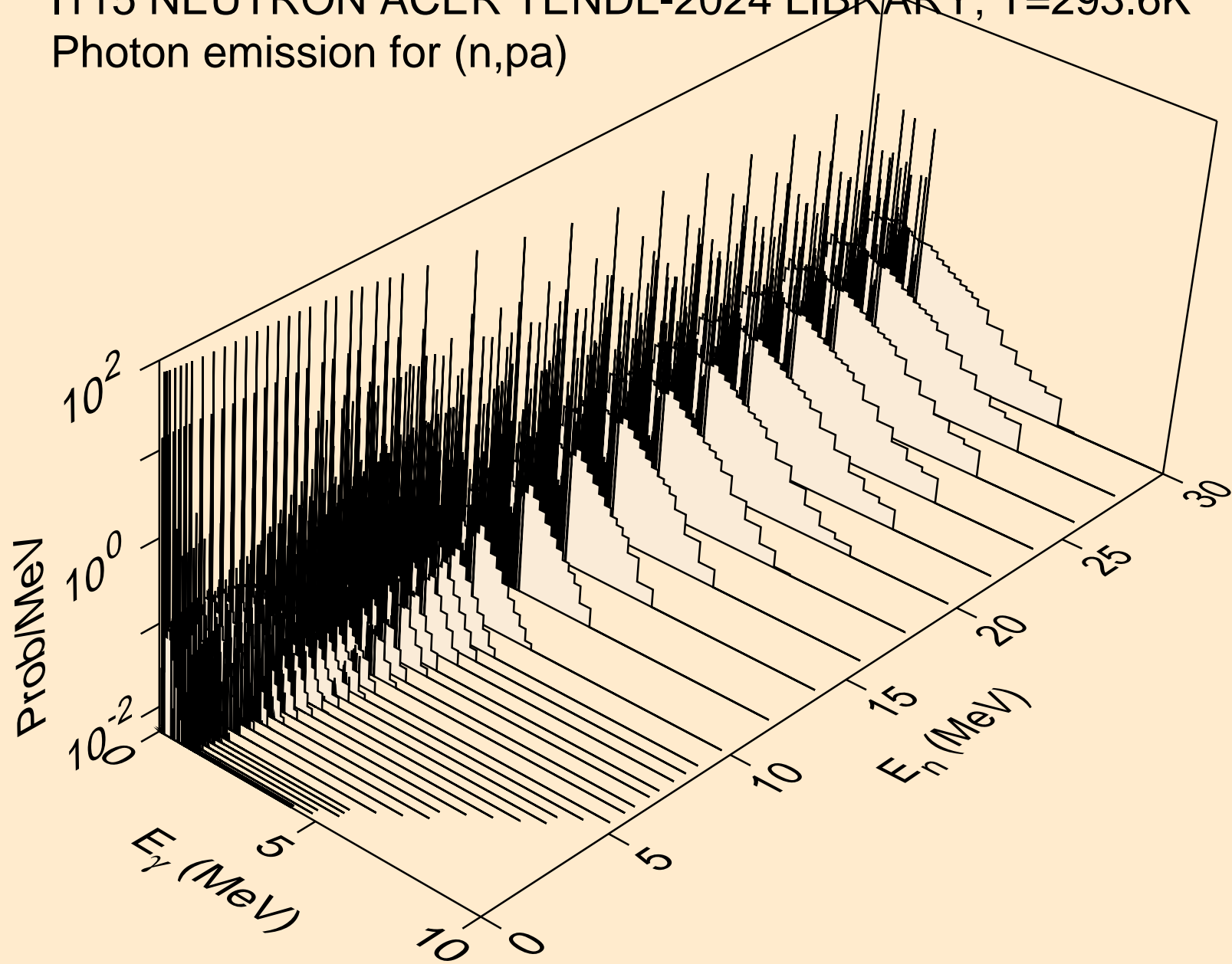

I115 NEUTRON ACER TENDL-2024 LIBRARY; T=293.6K
Photon emission for (n,d2a)

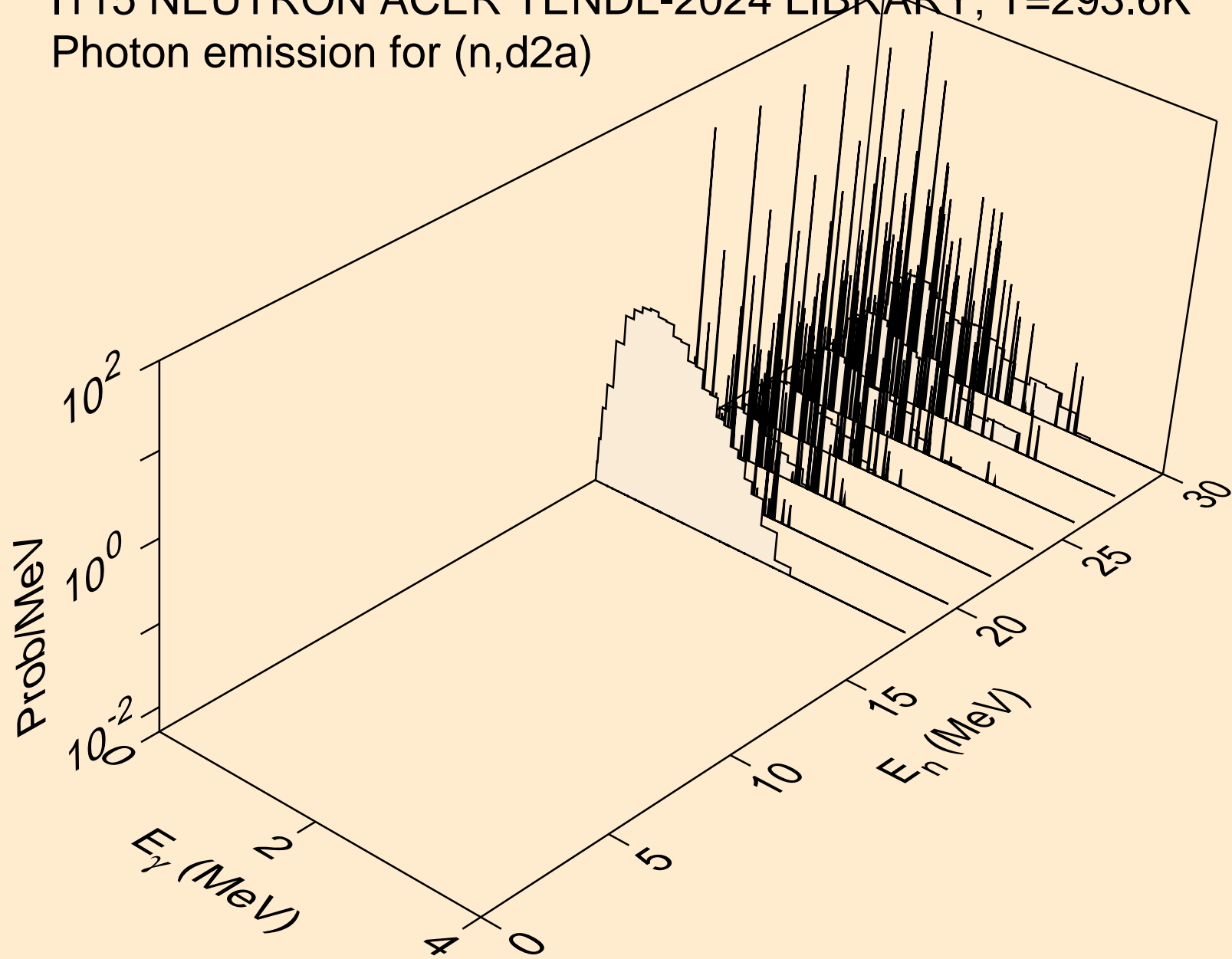

I115 NEUTRON ACER TENDL-2024 LIBRARY; T=293.6K
Photon emission for (n,pd)

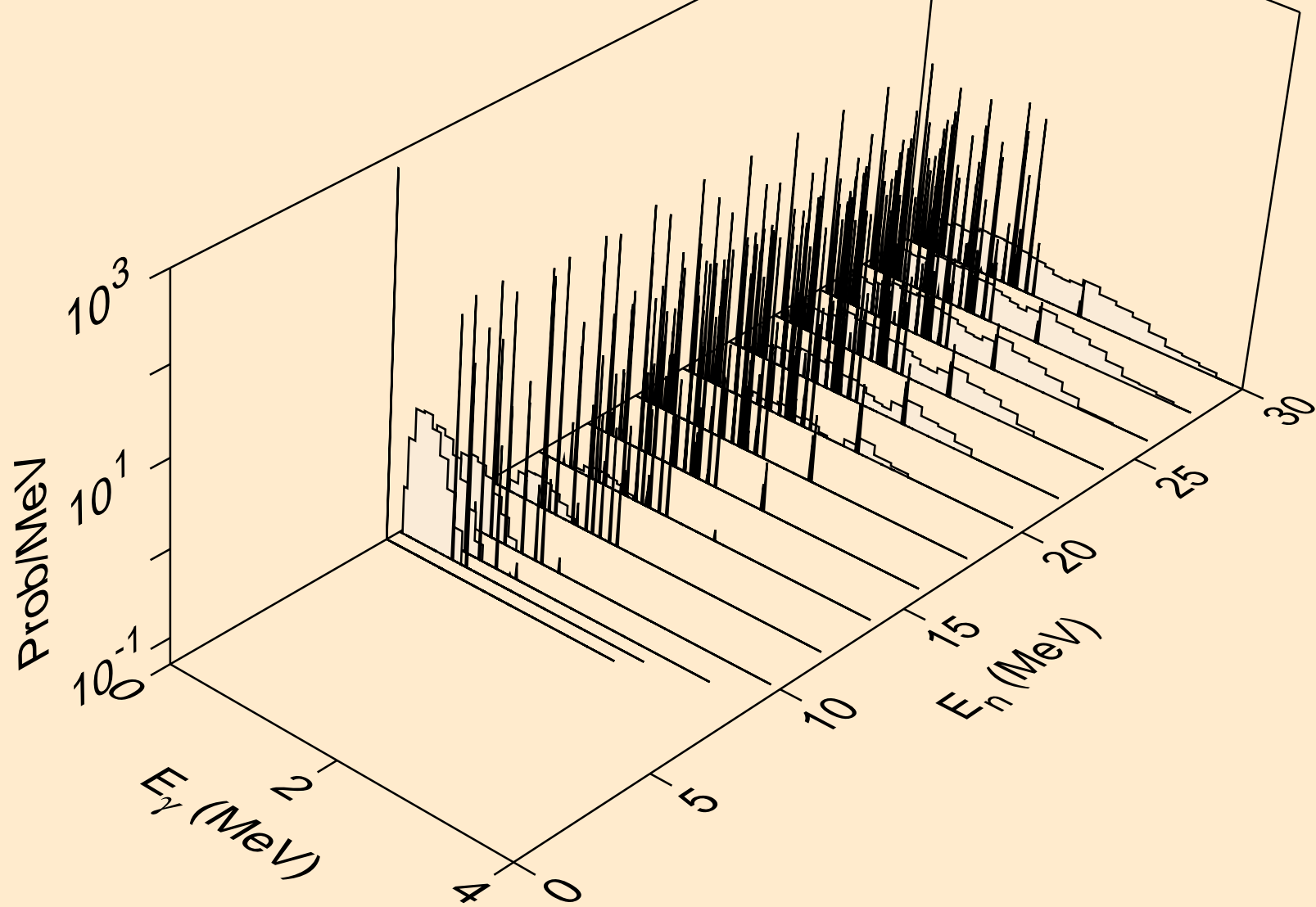

I115 NEUTRON ACER TENDL-2024 LIBRARY; T=293.6K
Photon emission for (n,pt)

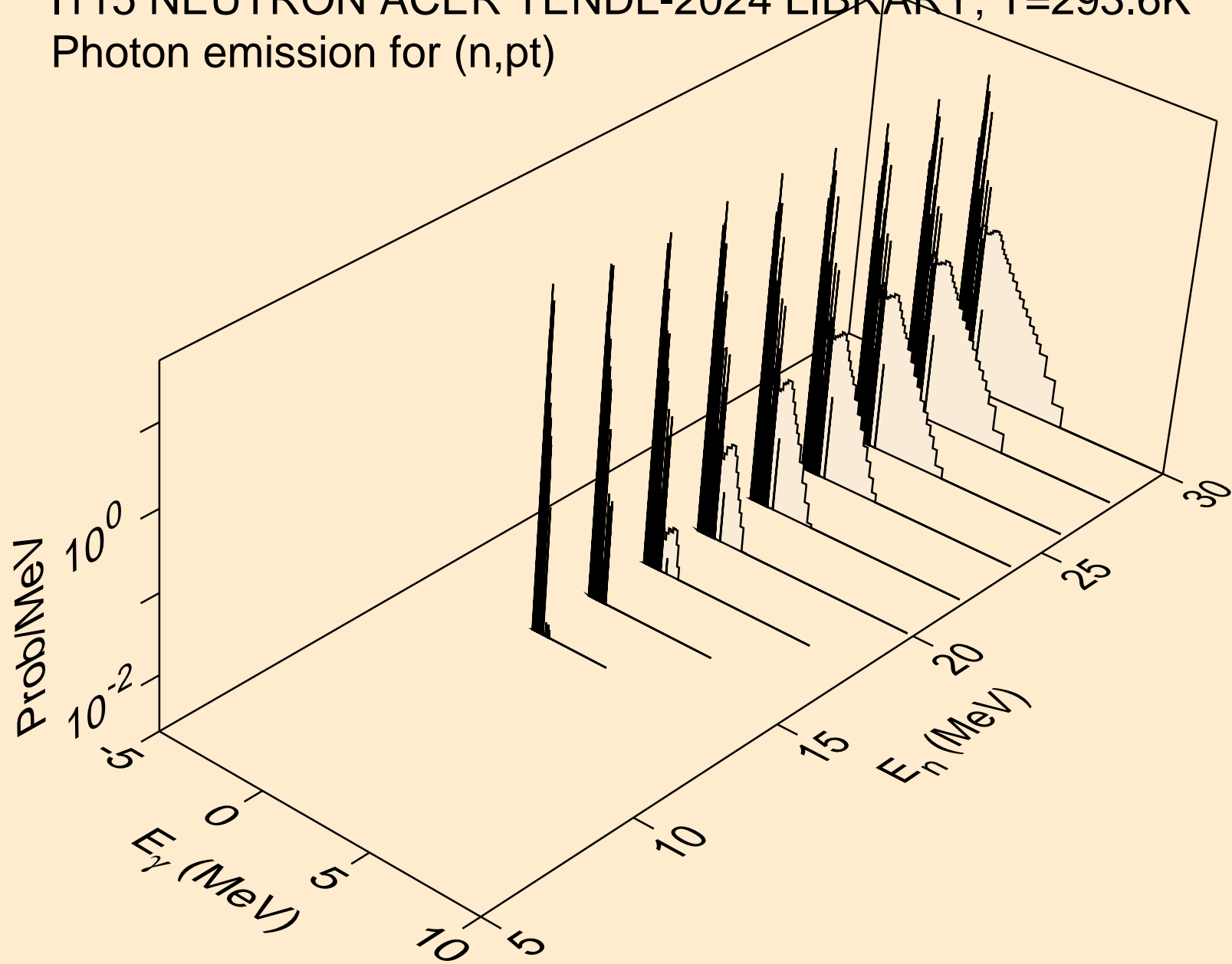

I115 NEUTRON ACER TENDL-2024 LIBRARY; T=293.6K
Photon emission for (n,da)

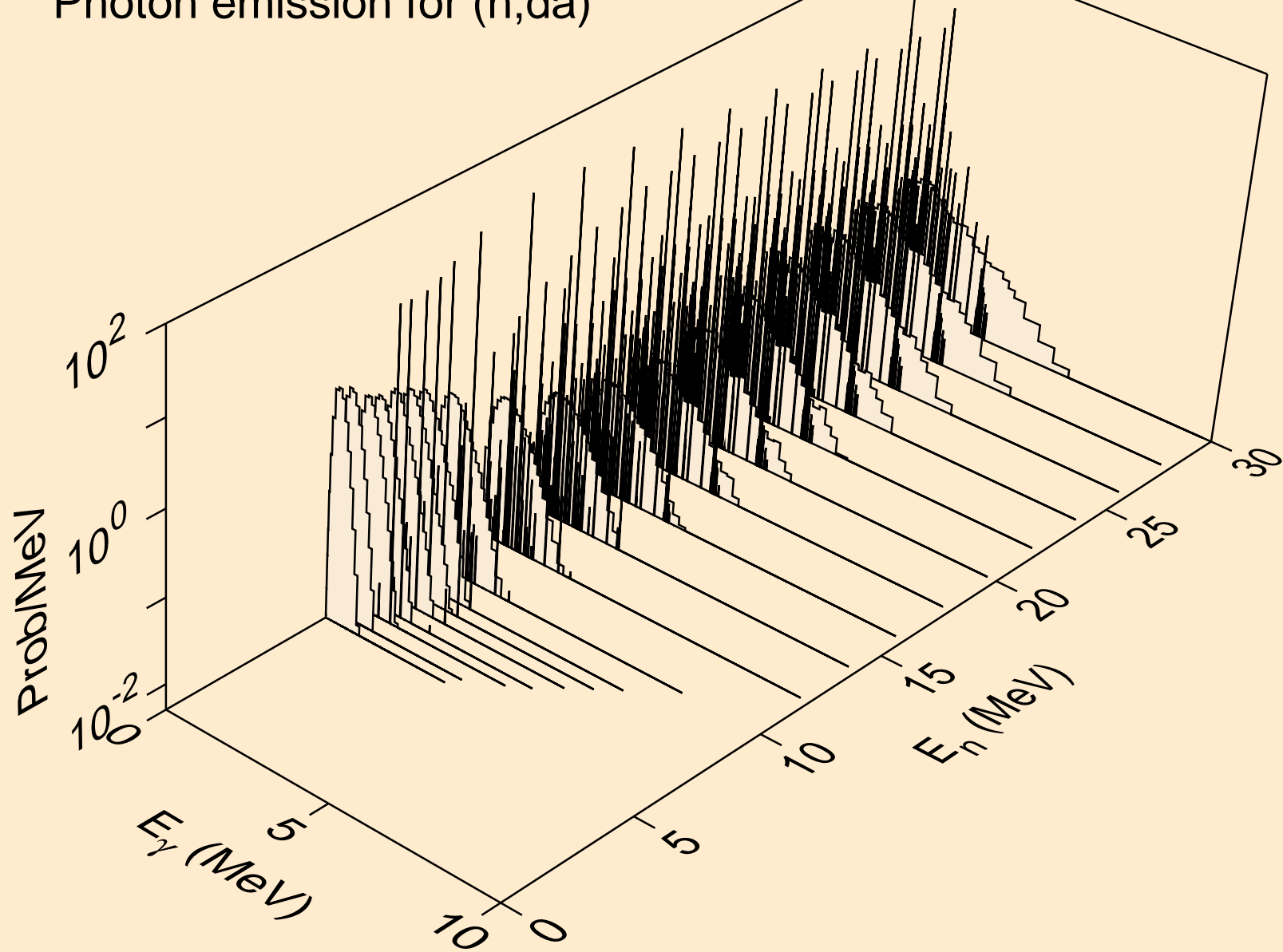

I115 NEUTRON ACER TENDL-2024 LIBRARY; T=293.6K
thermal capture photon spectrum

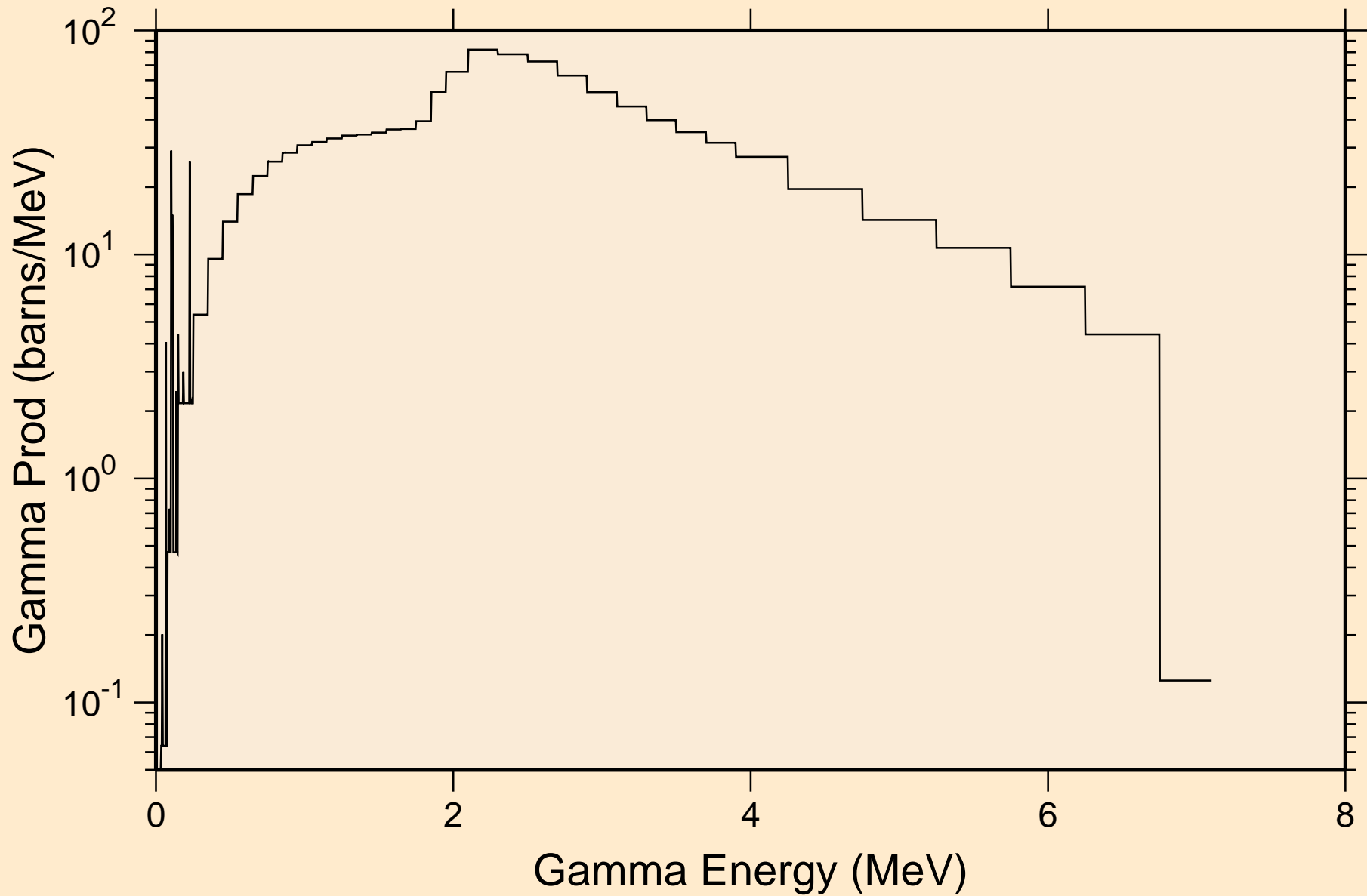

I115 NEUTRON ACER TENDL-2024 LIBRARY; T=293.6K
14 MeV photon spectrum

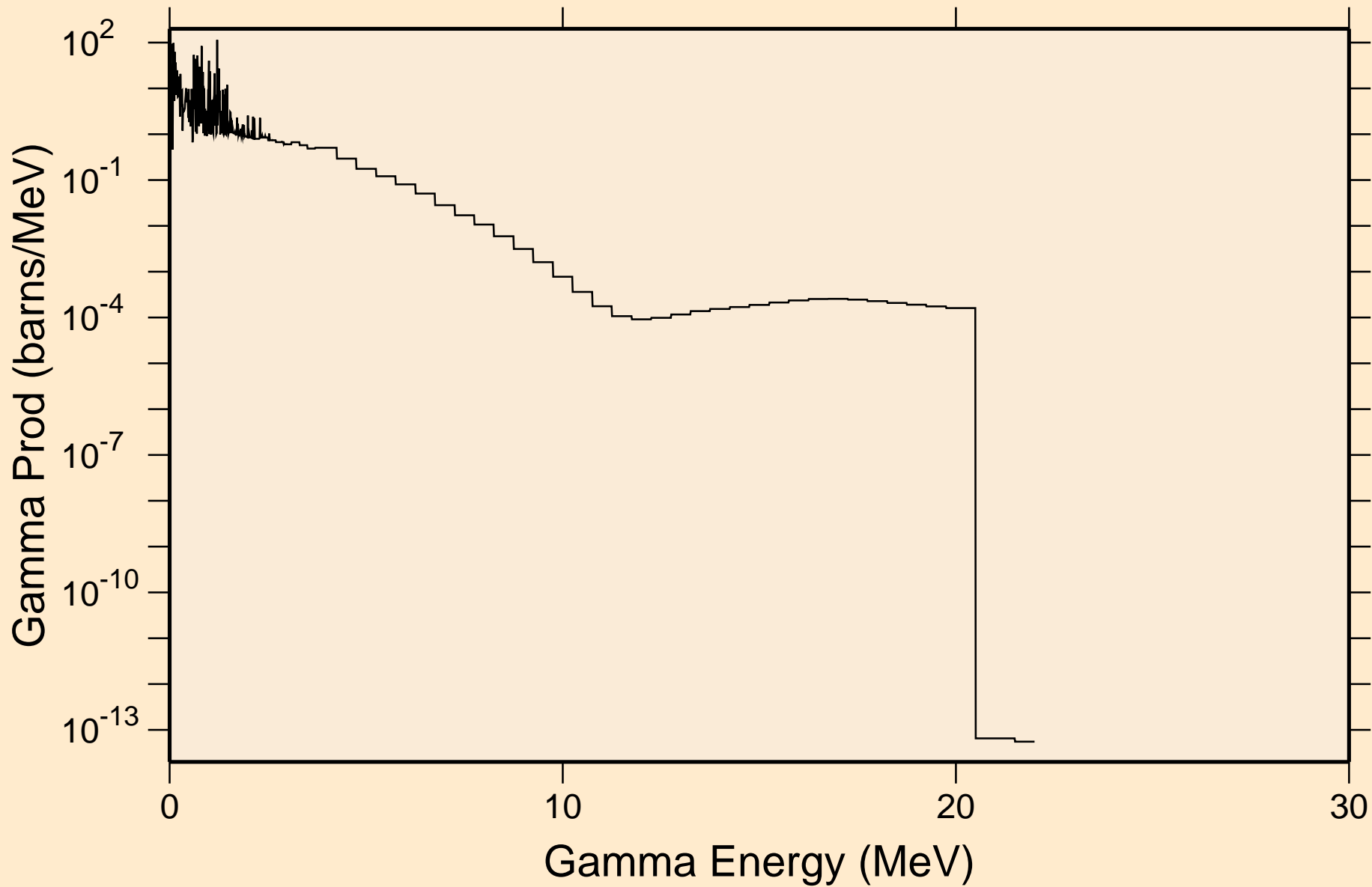

I115 NEUTRON ACER TENDL-2024 LIBRARY; T=293.6K

Particle heating contributions

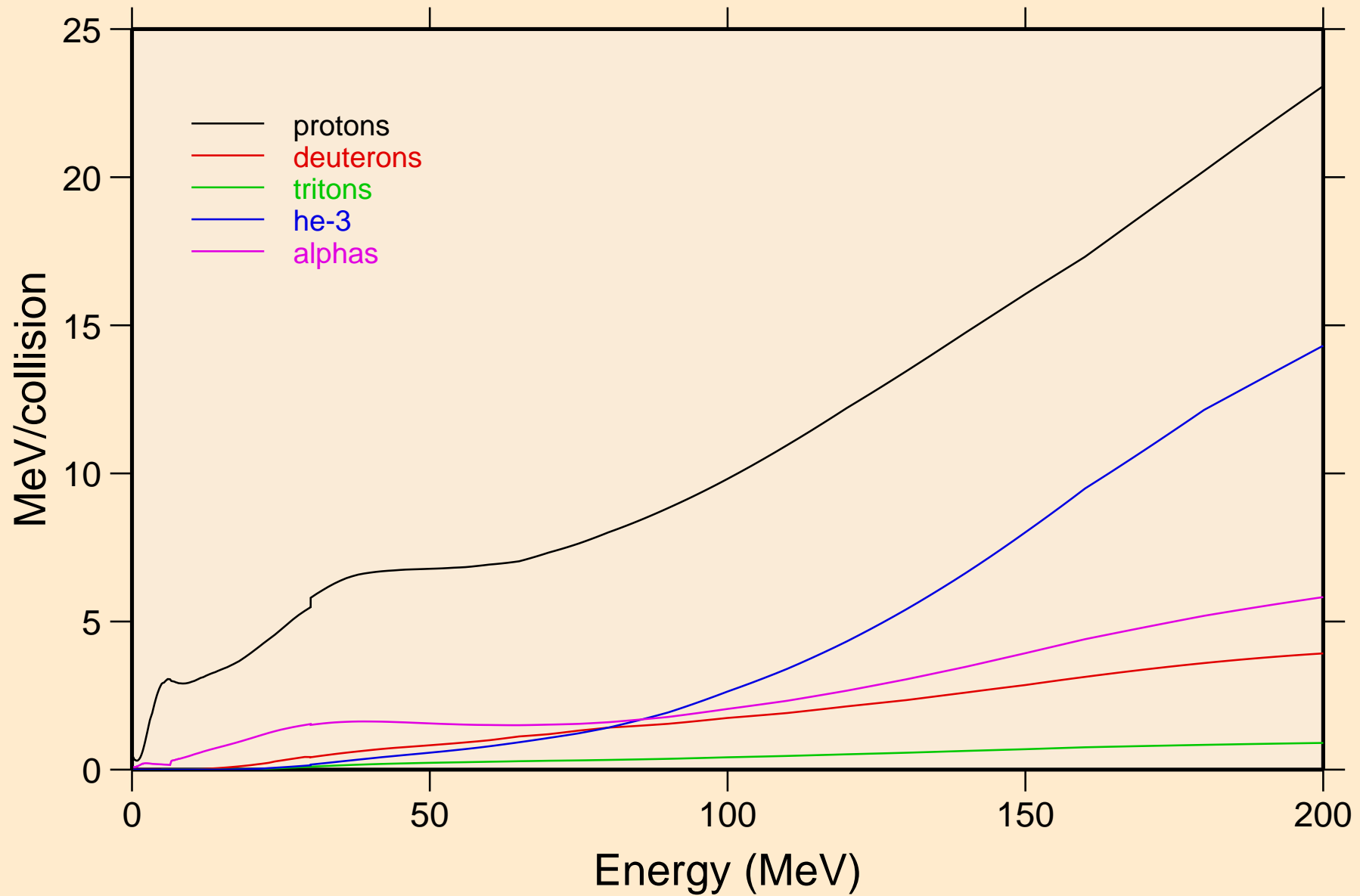

I115 NEUTRON ACER TENDL-2024 LIBRARY; T=293.6K

Recoil Heating

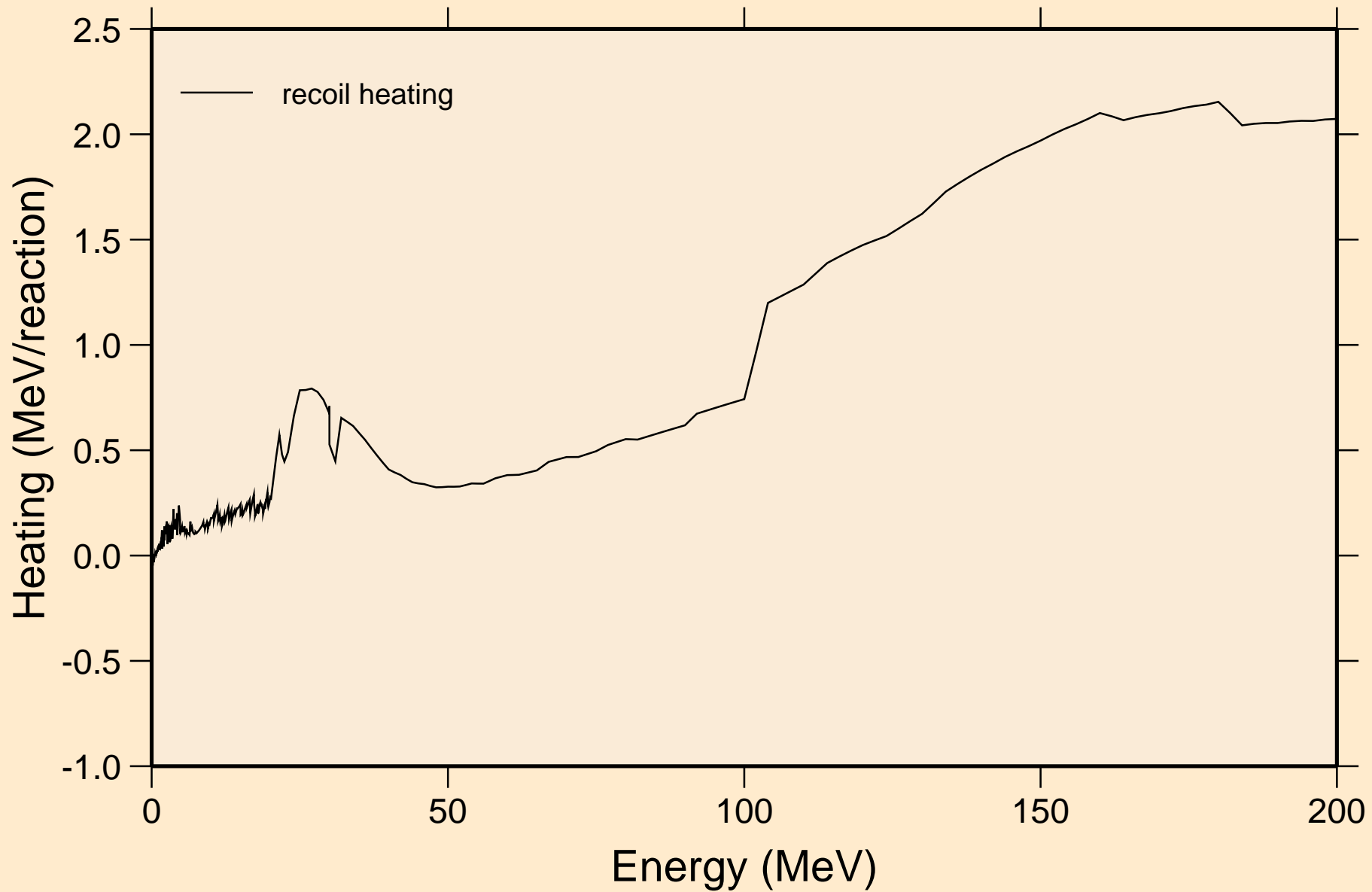

I115 NEUTRON ACER TENDL-2024 LIBRARY; T=293.6K
Particle production cross sections

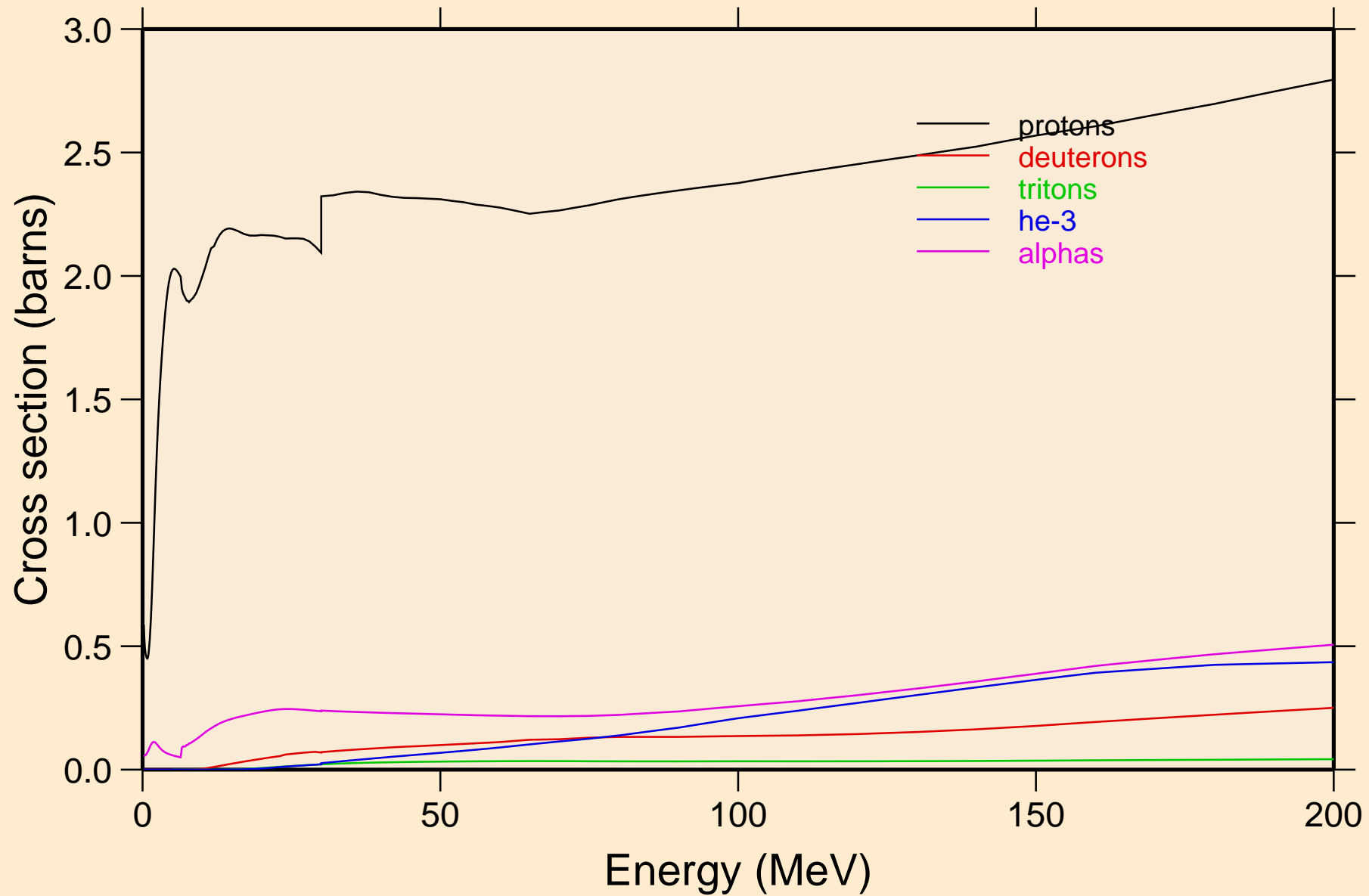

I115 NEUTRON ACER TENDL-2024 LIBRARY; T=293.6K
protons from (n,x)

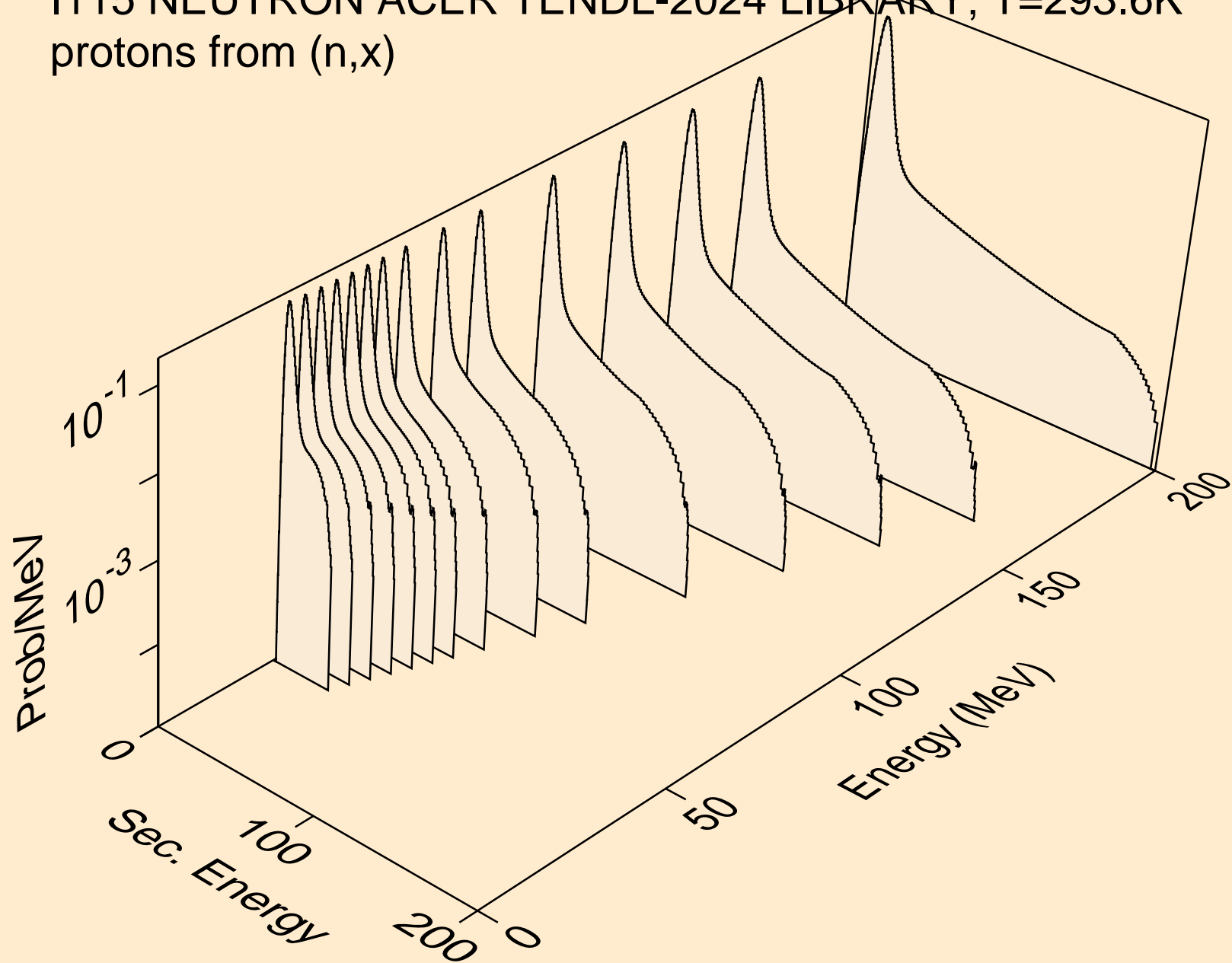

I115 NEUTRON ACER TENDL-2024 LIBRARY; T=293.6K
protons from (n,n*)p

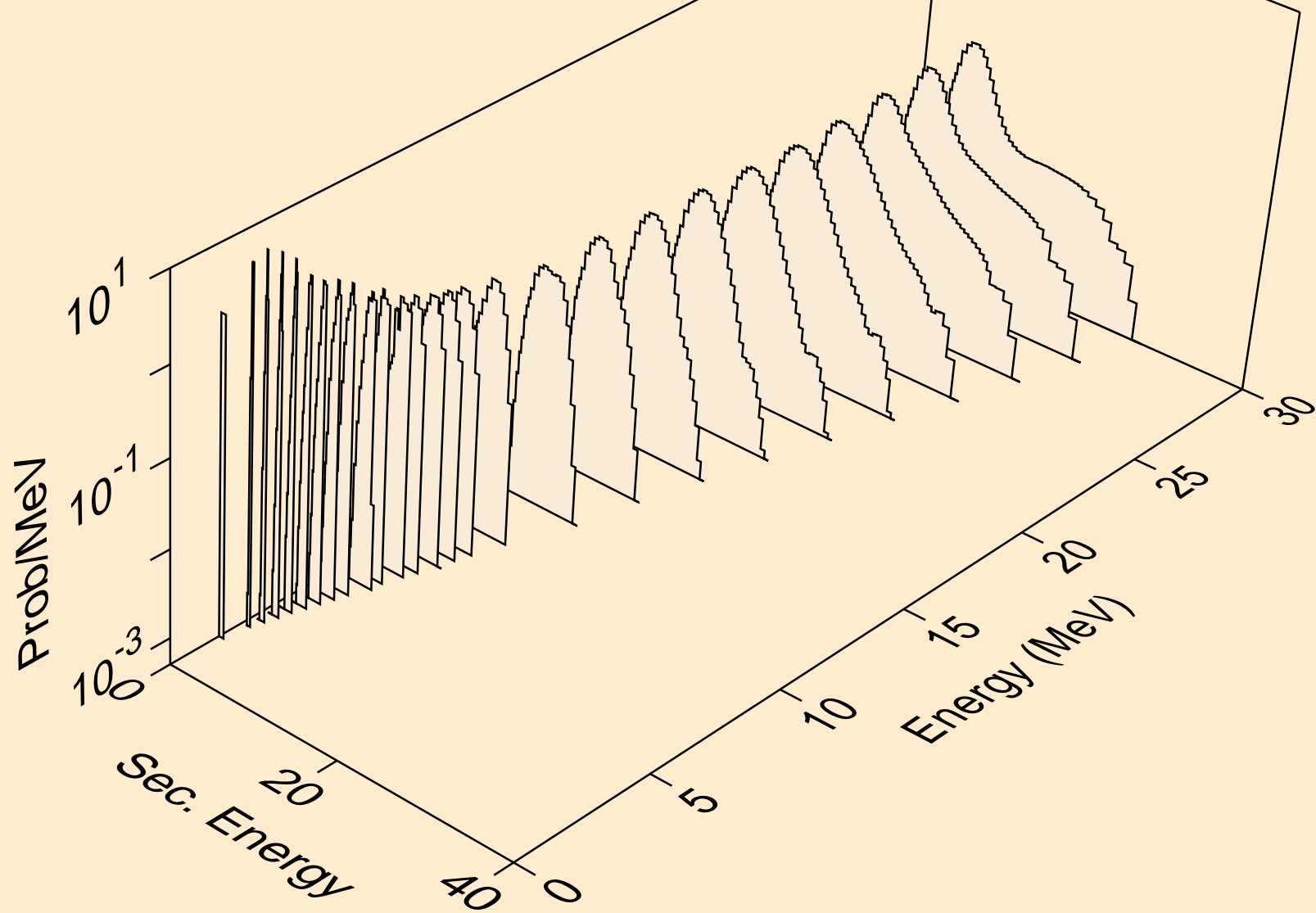

I115 NEUTRON ACER TENDL-2024 LIBRARY; T=293.6K
protons from (n,2np)

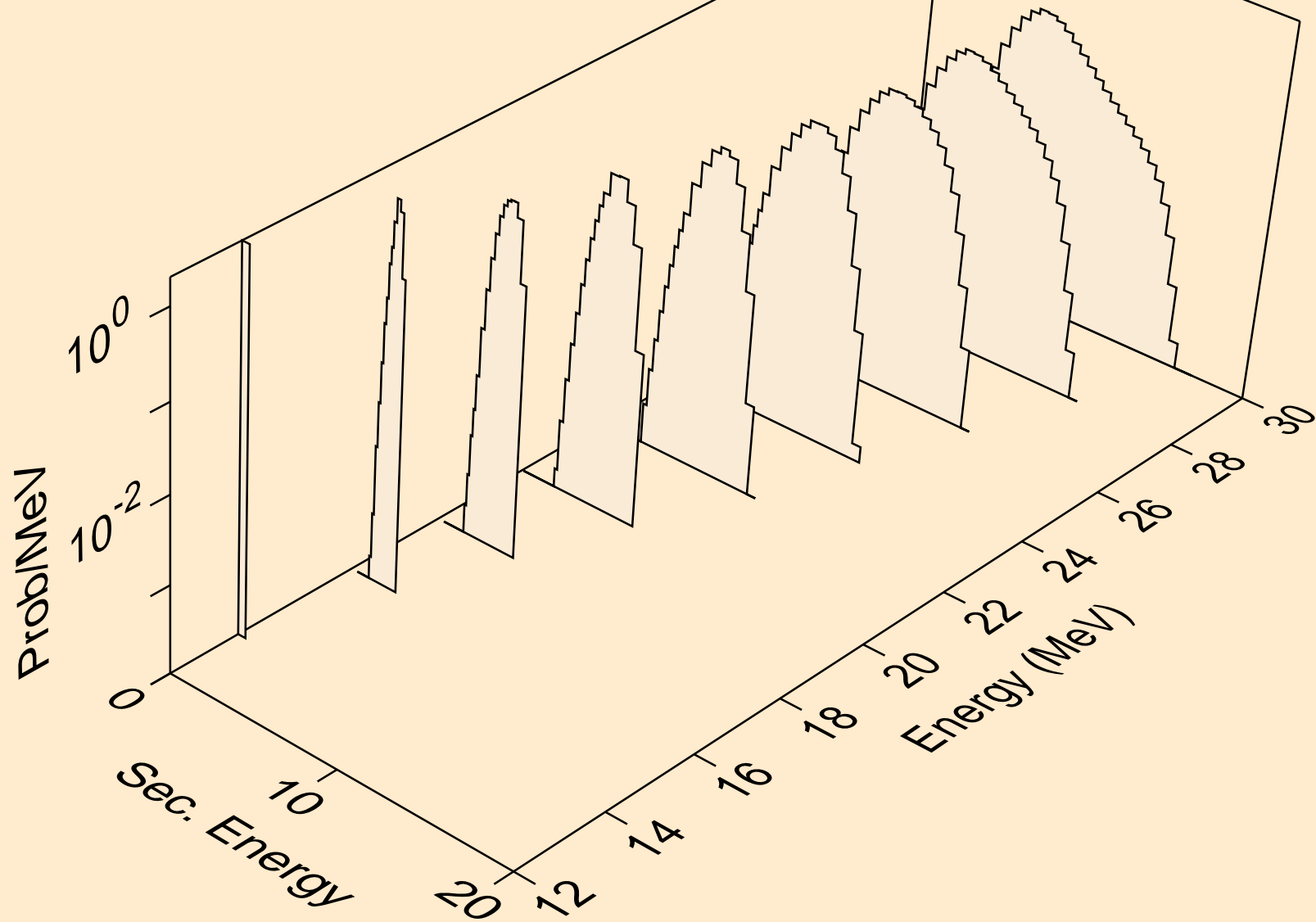

I115 NEUTRON ACER TENDL-2024 LIBRARY; T=293.6K
protons from (n,3np)

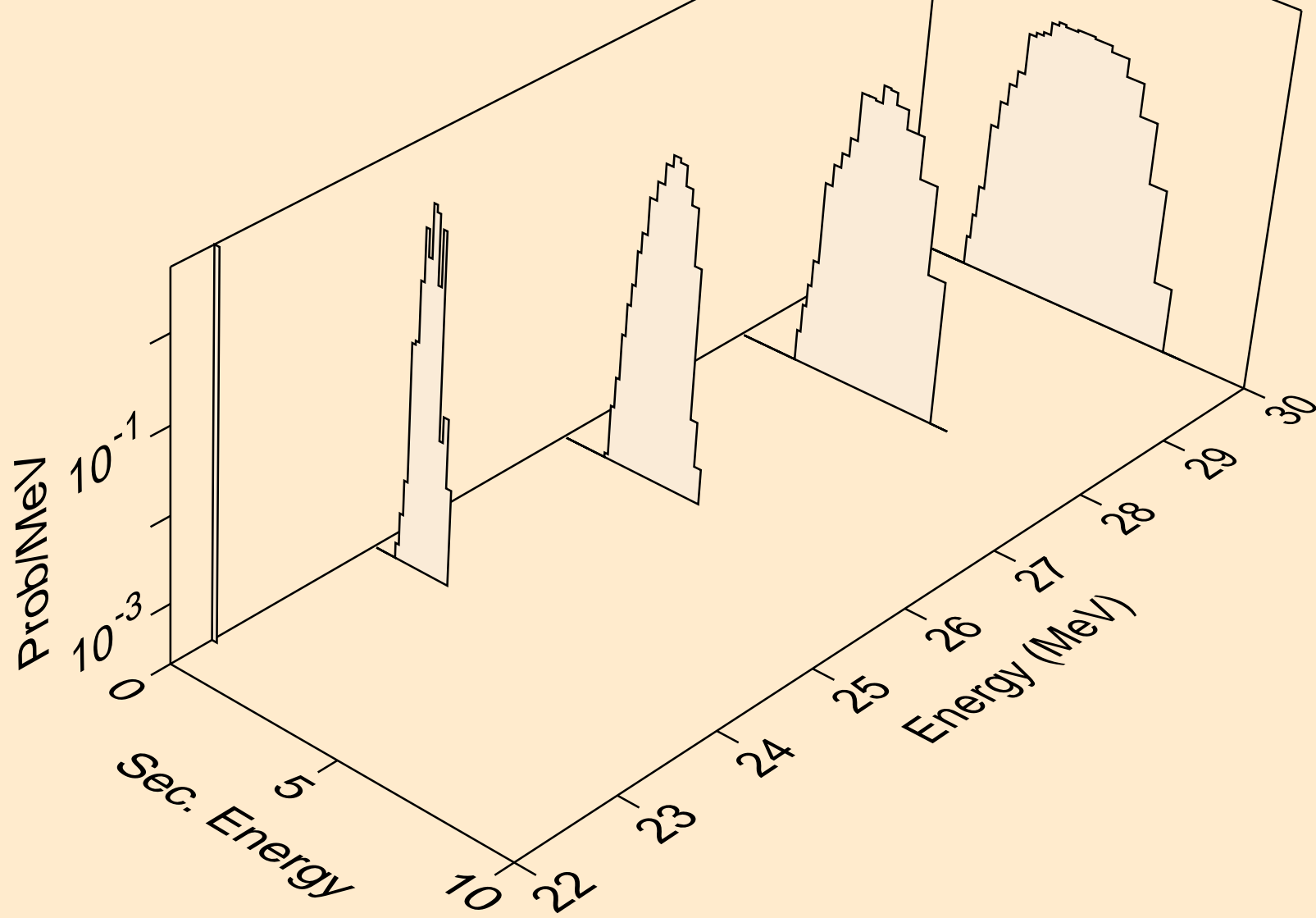

I115 NEUTRON ACER TENDL-2024 LIBRARY; T=293.6K
protons from (n,n2p)

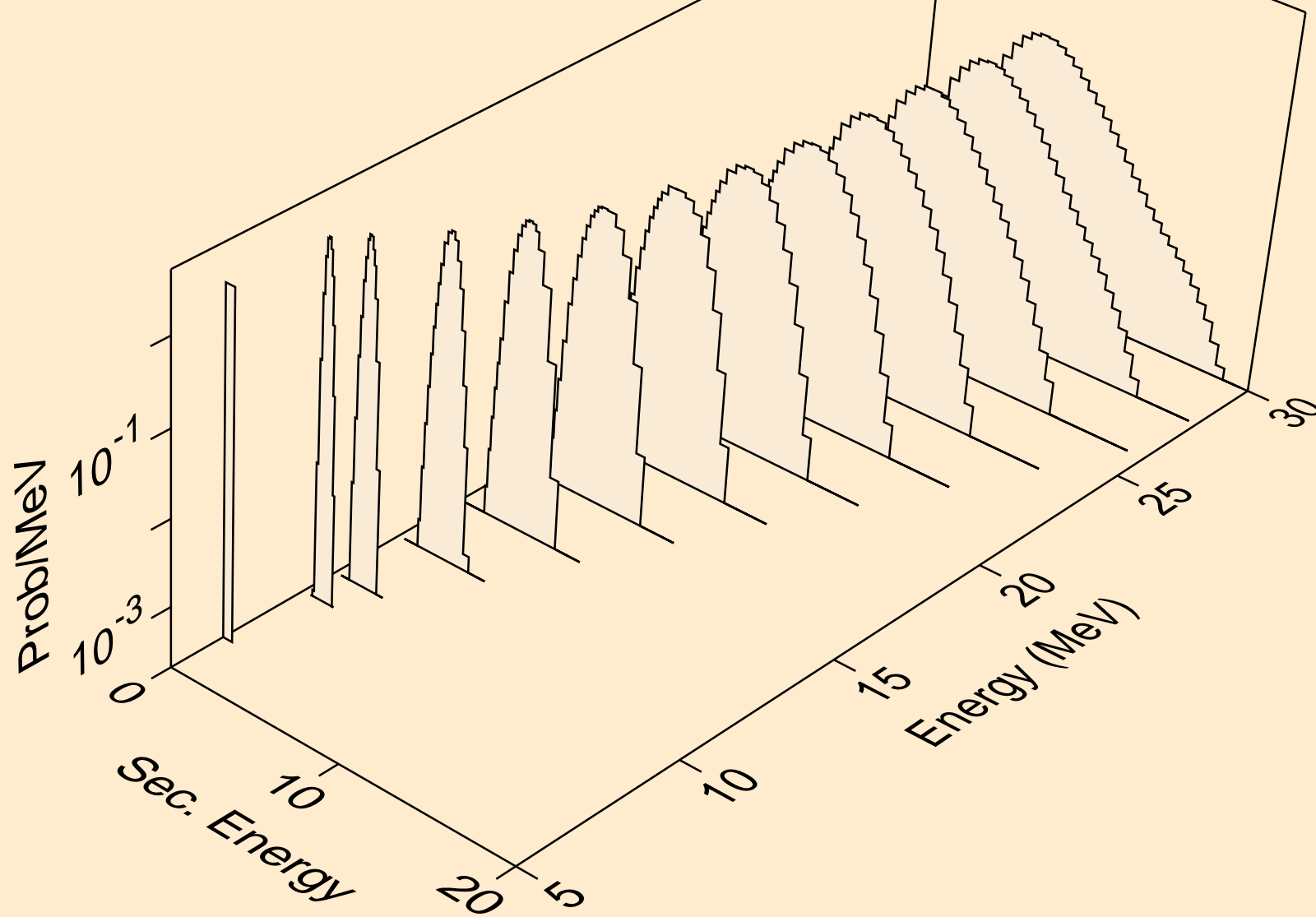

I115 NEUTRON ACER TENDL-2024 LIBRARY; T=293.6K
protons from (n,npa)

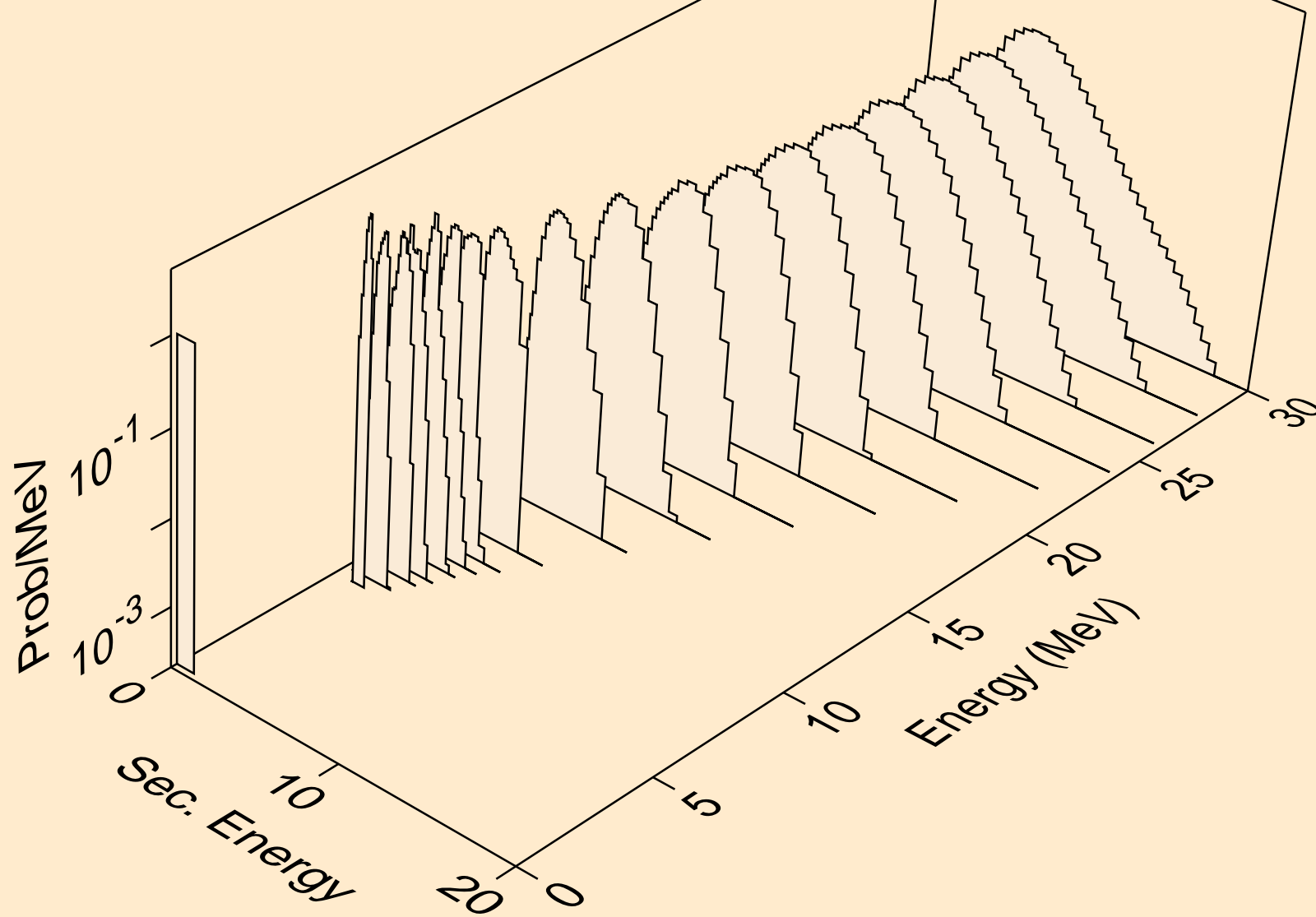

I115 NEUTRON ACER TENDL-2024 LIBRARY; T=293.6K
protons from (n,p)

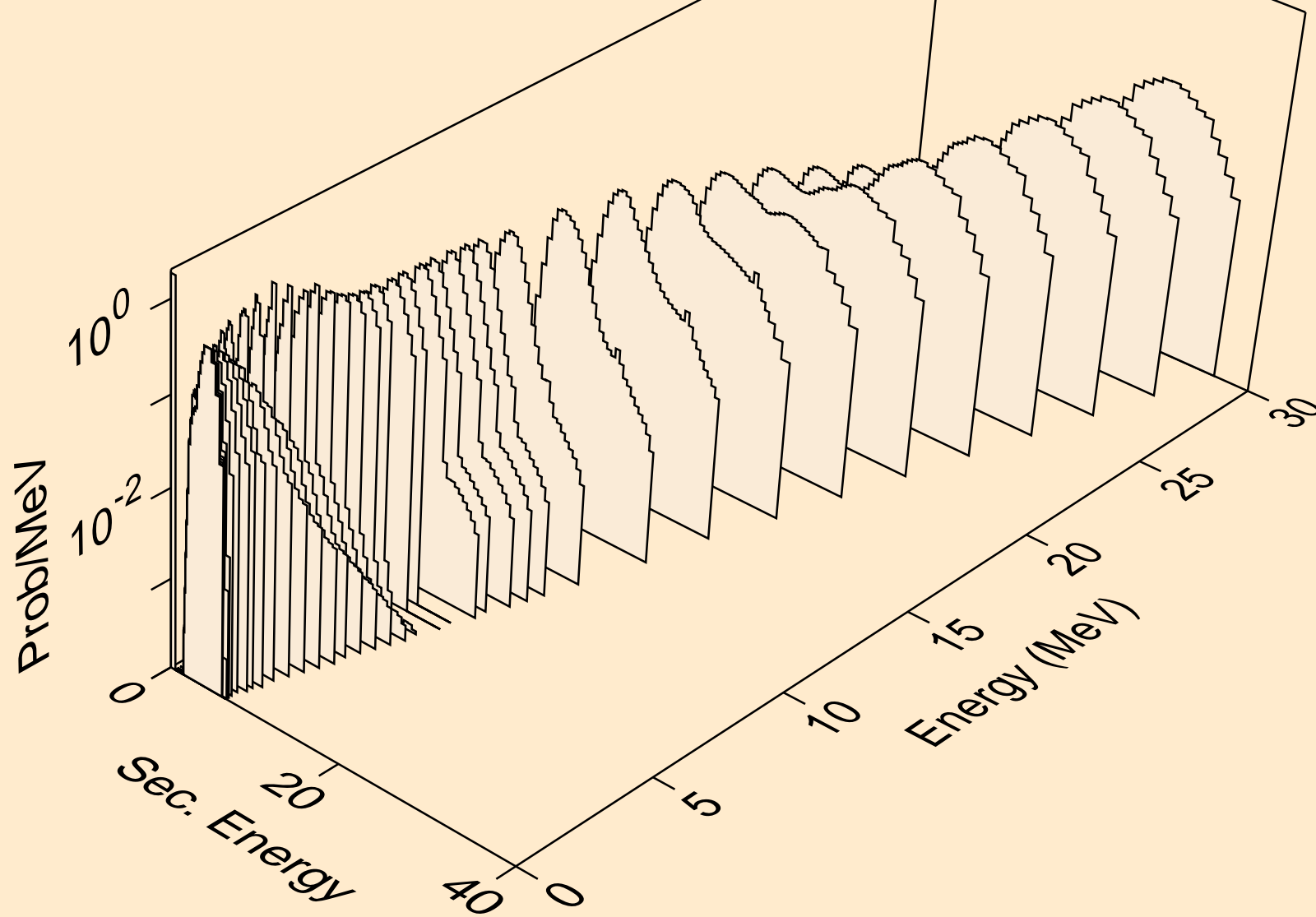

I115 NEUTRON ACER TENDL-2024 LIBRARY; T=293.6K
protons from (n,2p)

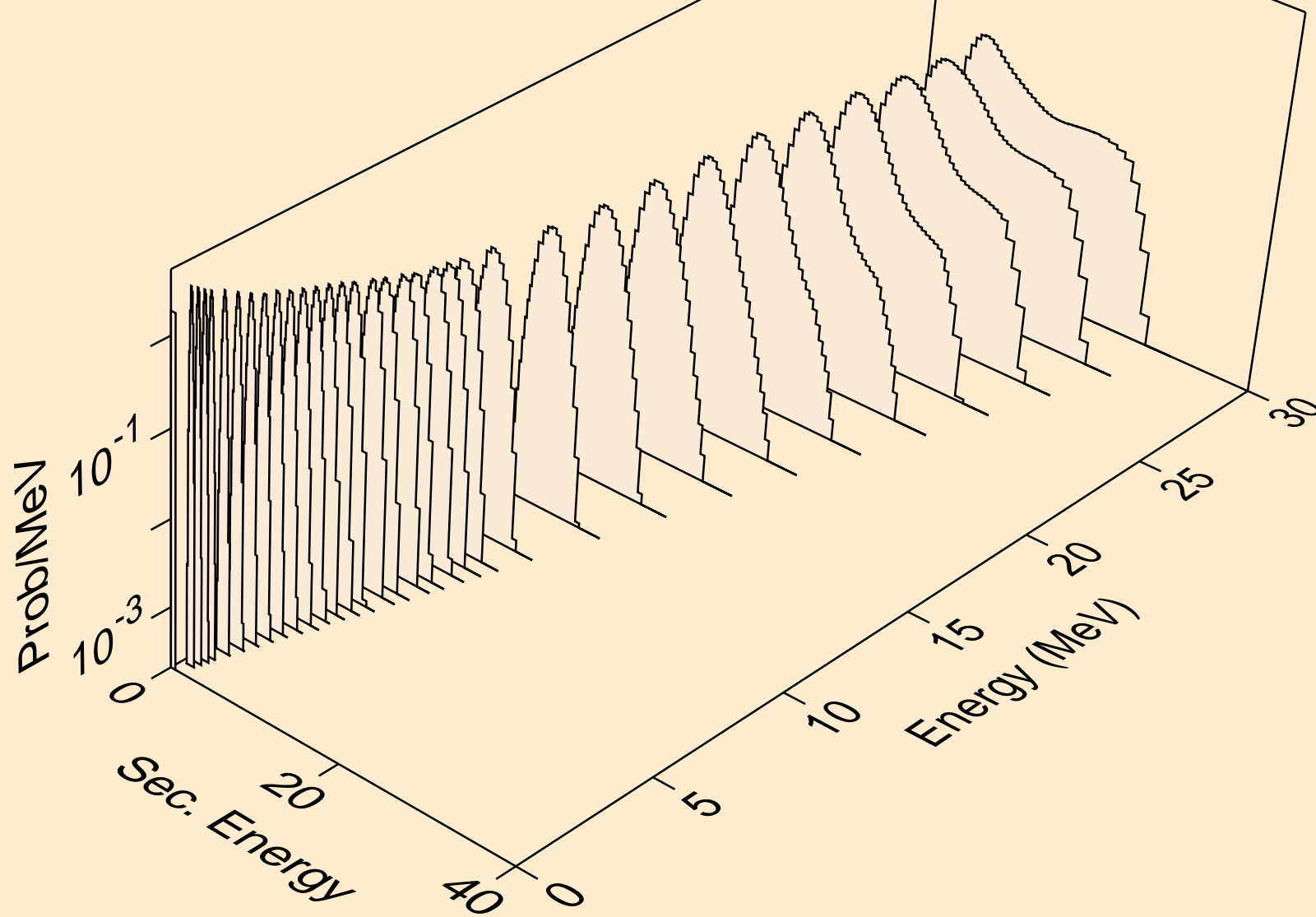

I115 NEUTRON ACER TENDL-2024 LIBRARY; T=293.6K
protons from (n,p)

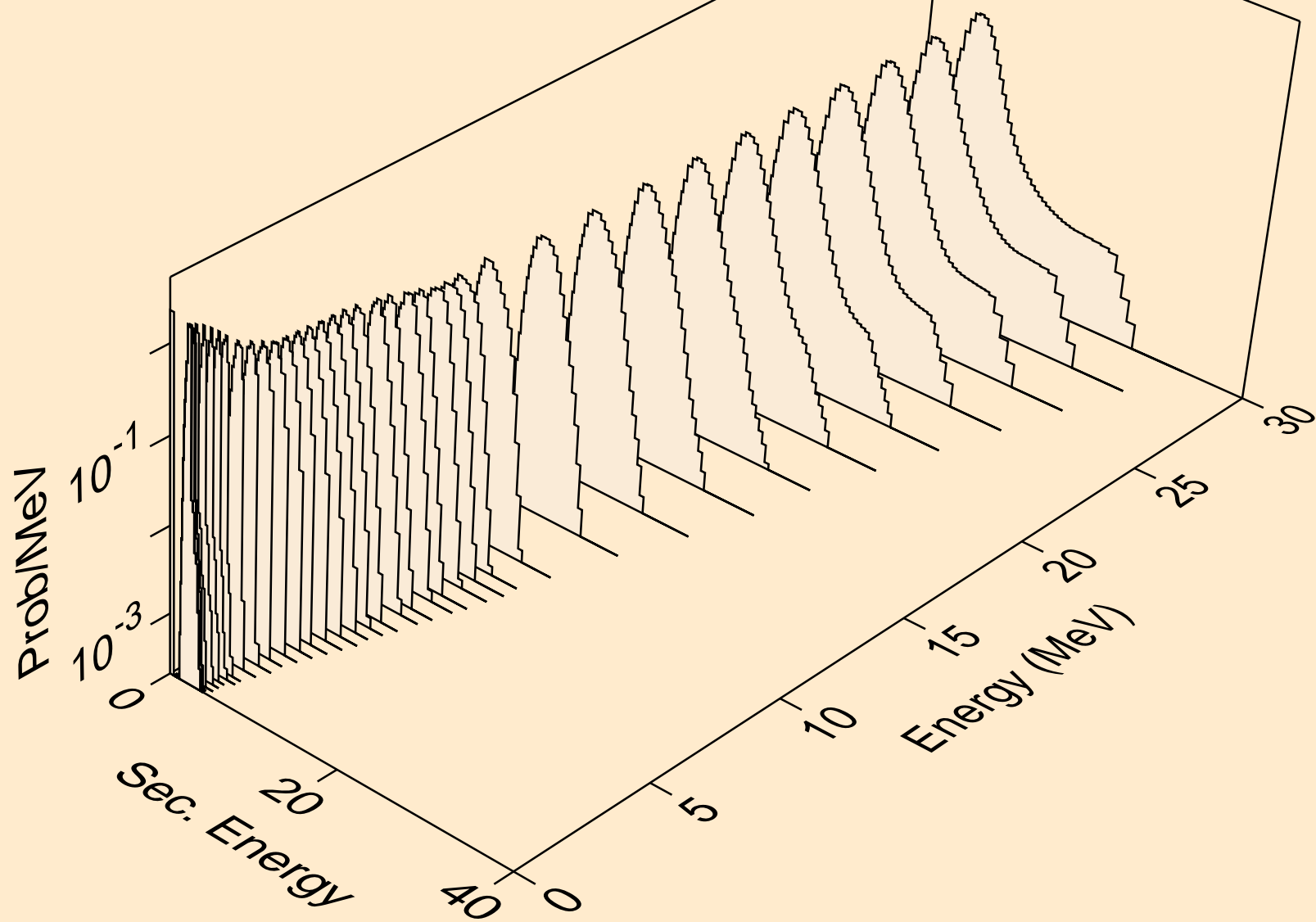

I115 NEUTRON ACER TENDL-2024 LIBRARY; T=293.6K
protons from (n,pd)

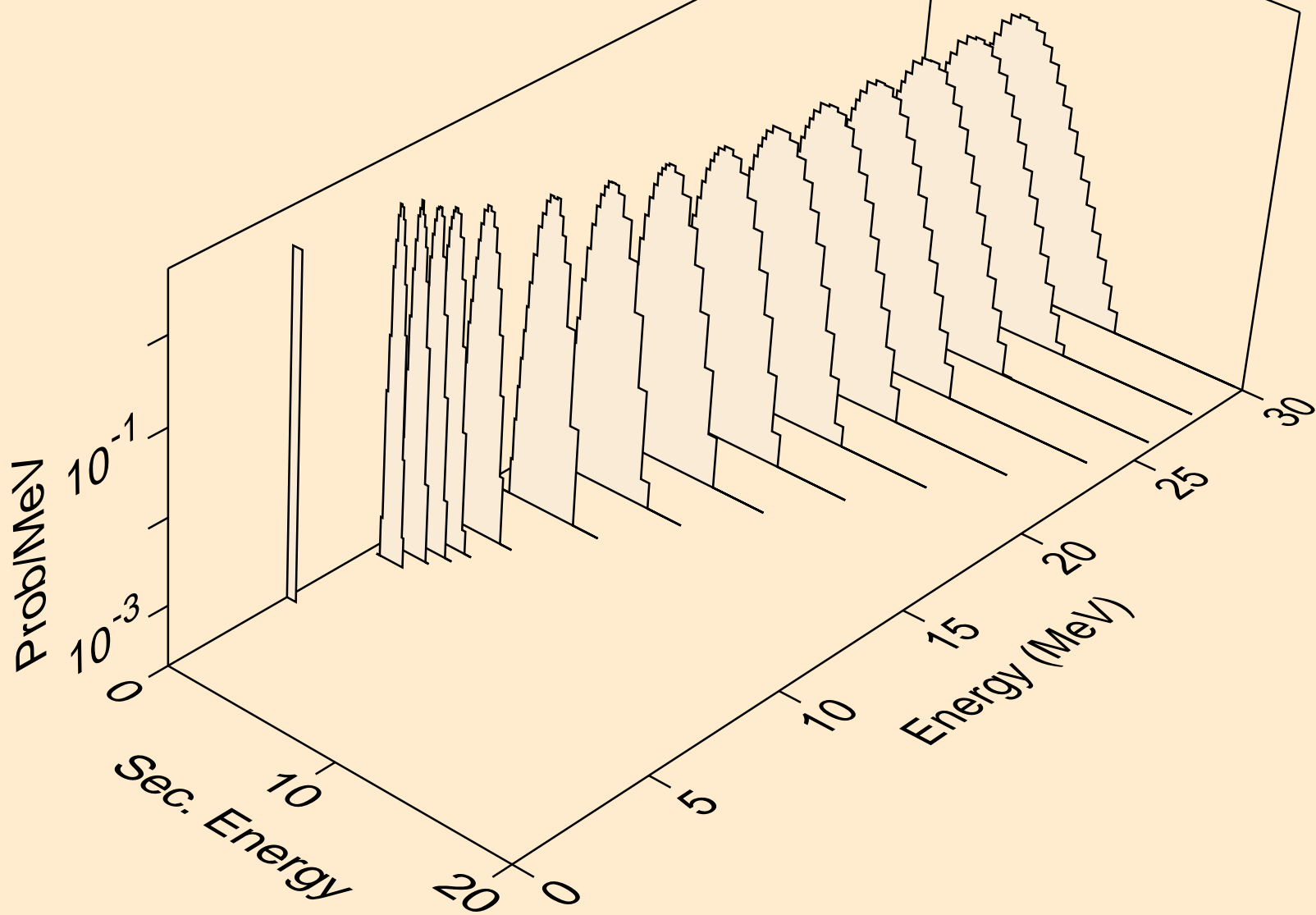

I115 NEUTRON ACER TENDL-2024 LIBRARY; T=293.6K
protons from (n,pt)

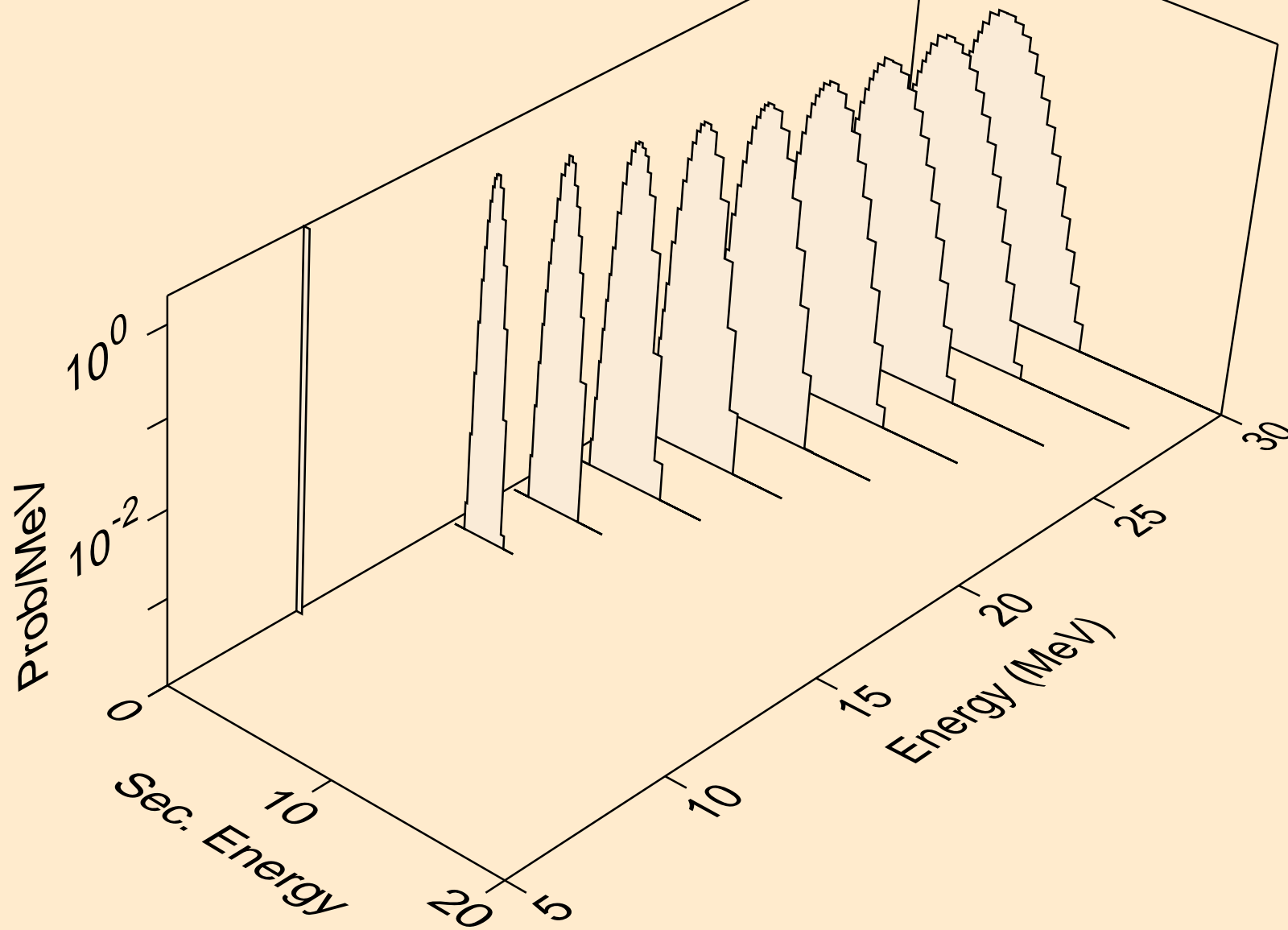

I115 NEUTRON ACER TENDL-2024 LIBRARY; T=293.6K
deuterons from (n,x)

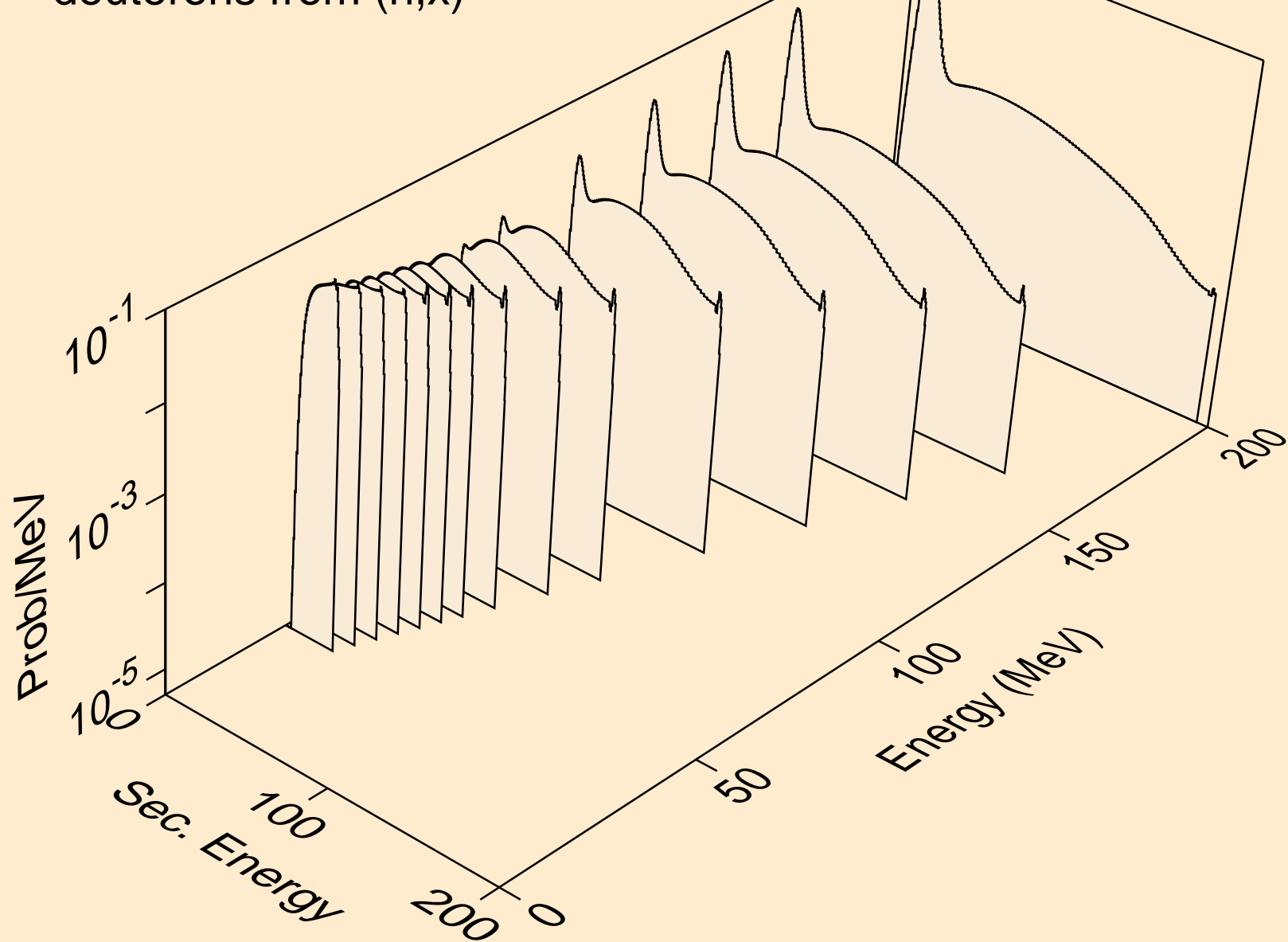

I115 NEUTRON ACER TENDL-2024 LIBRARY; T=293.6K
deuterons from (n,2nd)

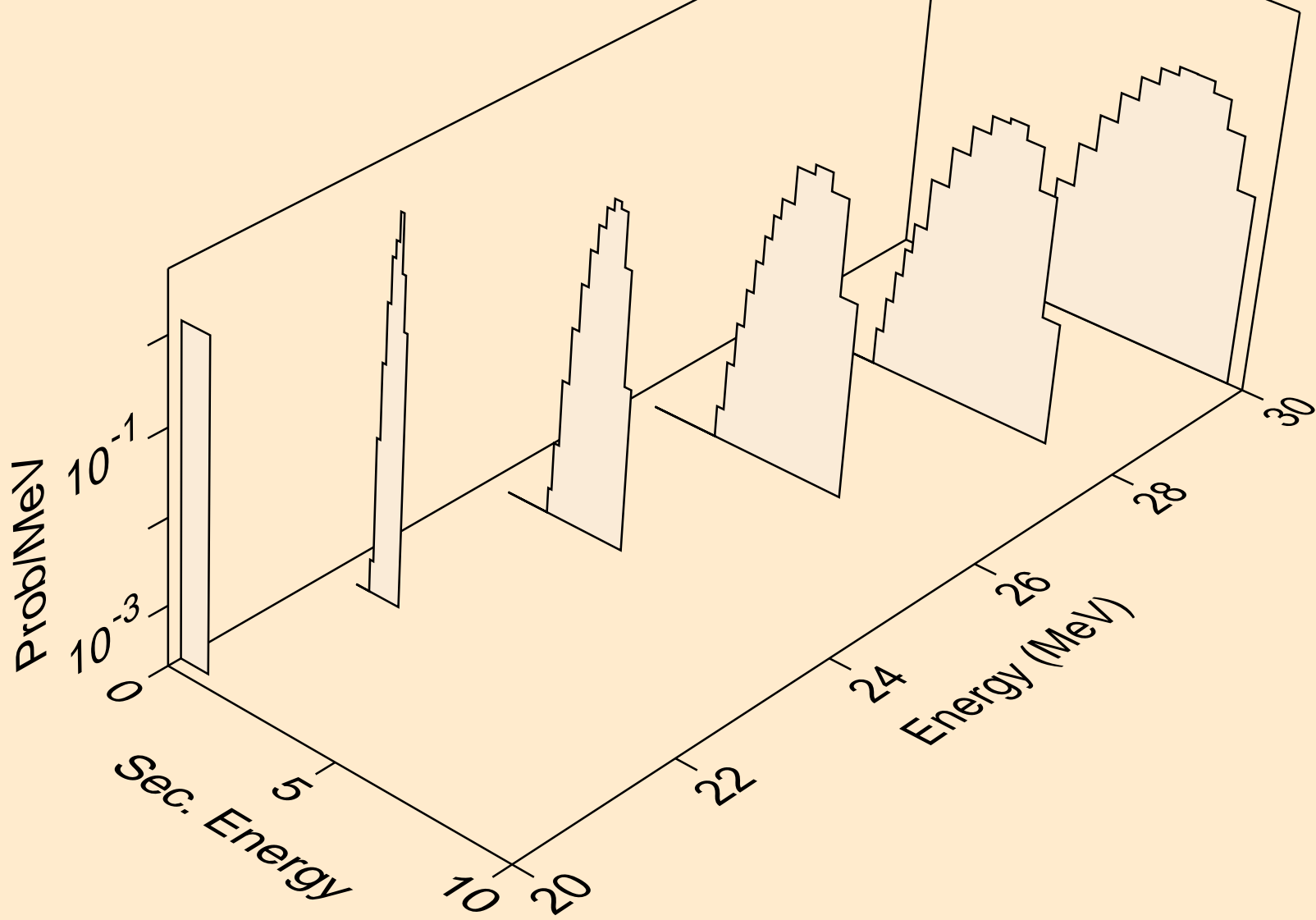

I115 NEUTRON ACER TENDL-2024 LIBRARY; T=293.6K
deuterons from (n,n*)d

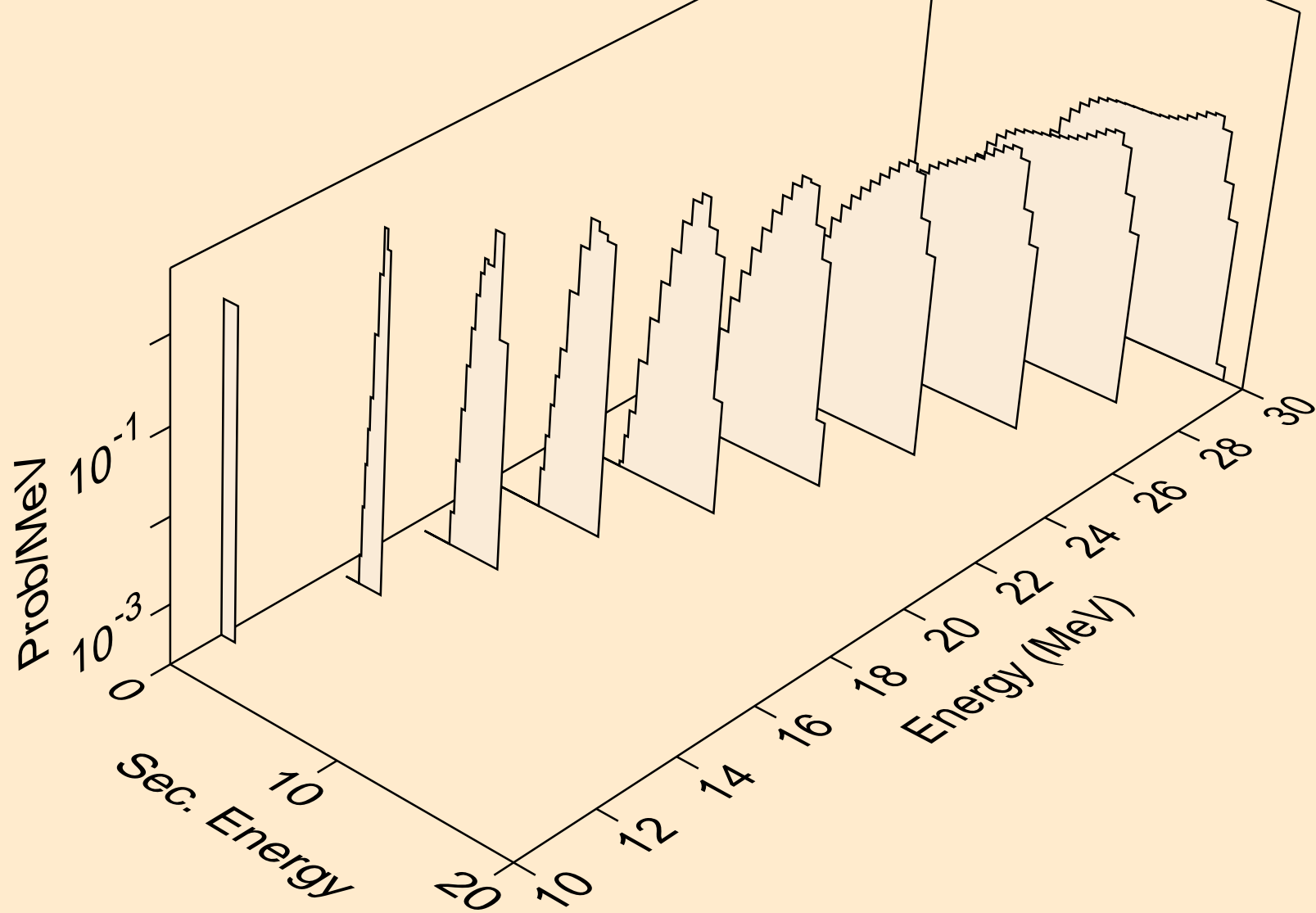

I115 NEUTRON ACER TENDL-2024 LIBRARY; T=293.6K
deuterons from (n,d)

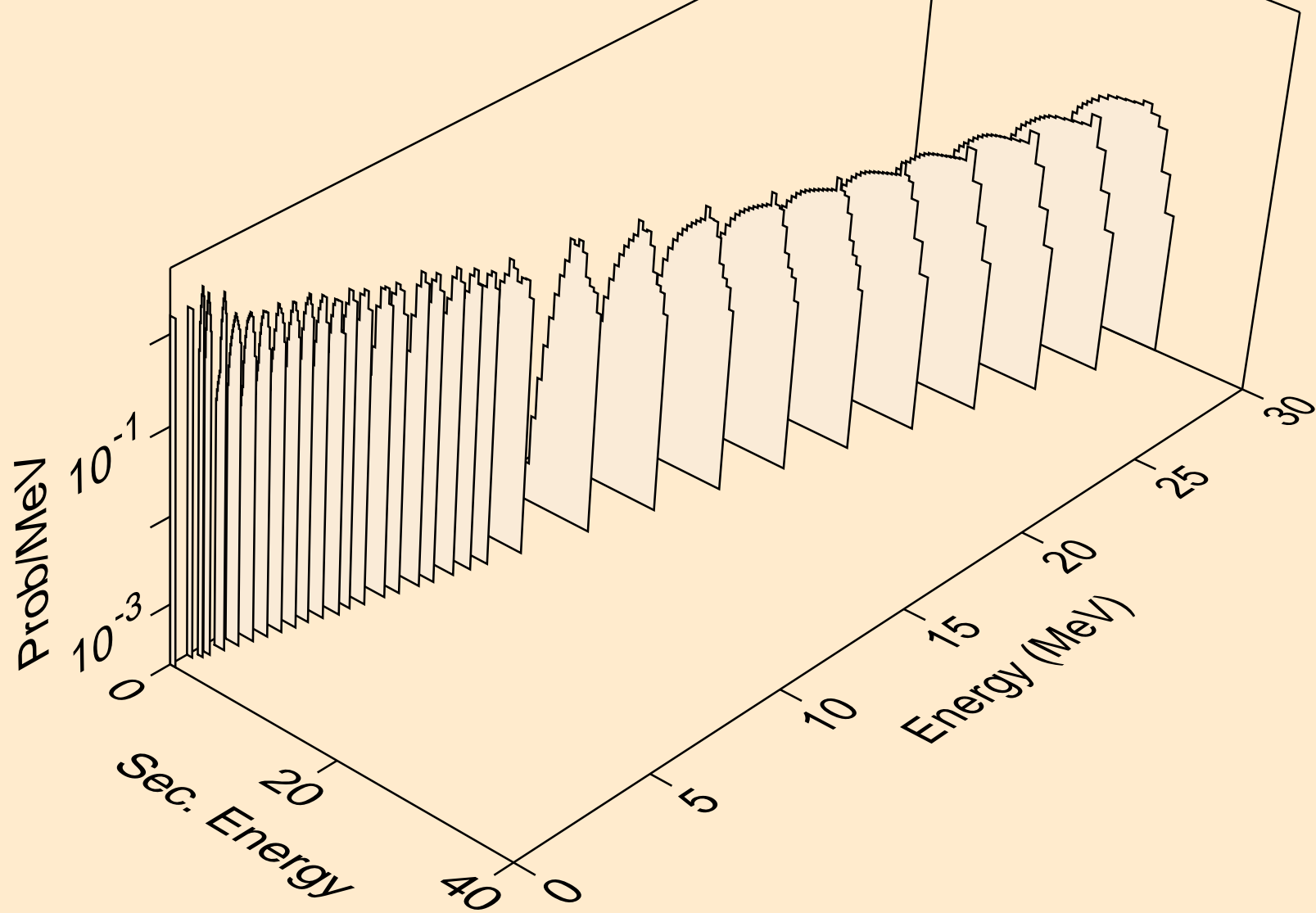

I115 NEUTRON ACER TENDL-2024 LIBRARY; T=293.6K
deuterons from (n,d2a)

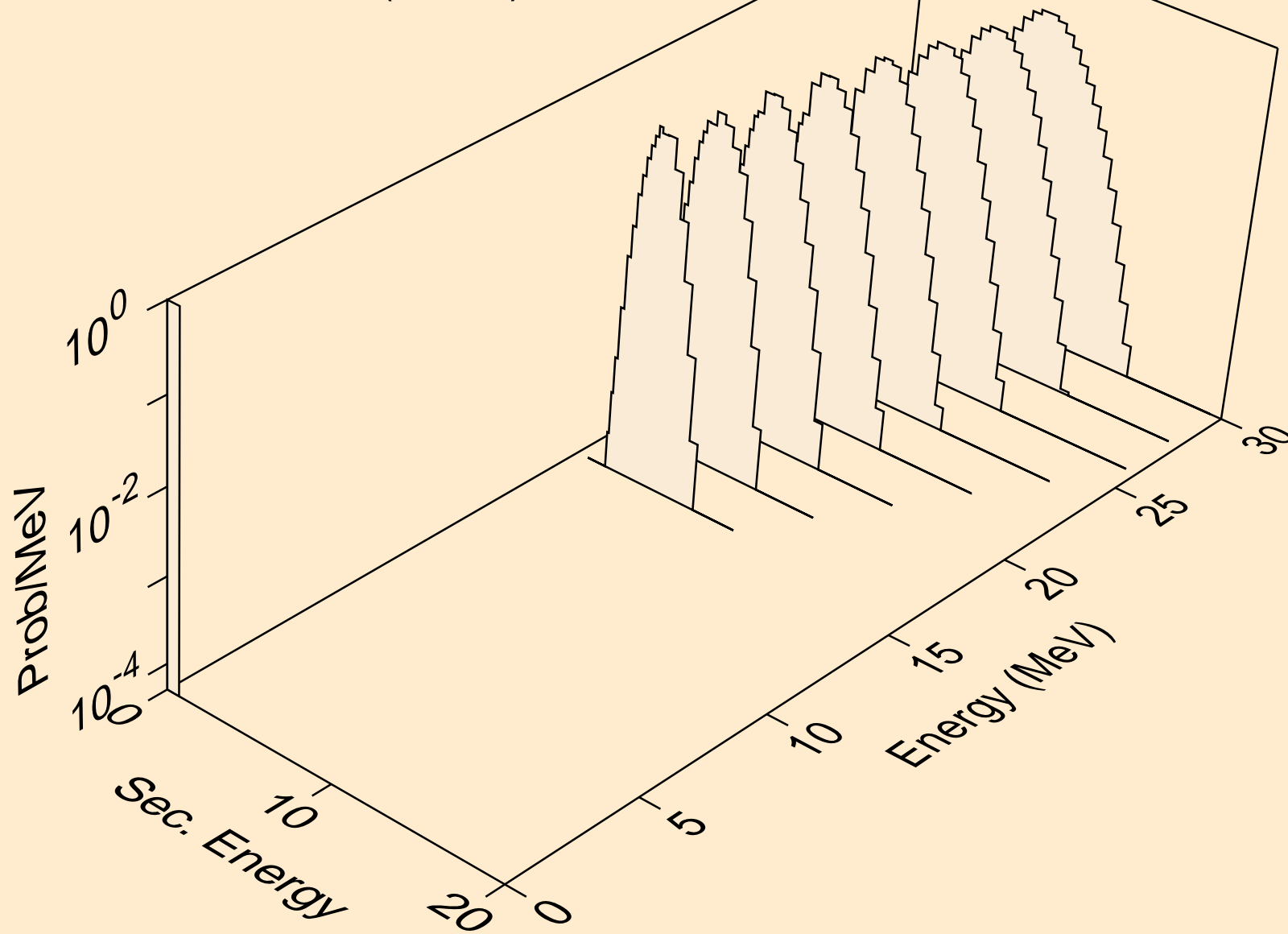

I115 NEUTRON ACER TENDL-2024 LIBRARY; T=293.6K
deuterons from (n,pd)

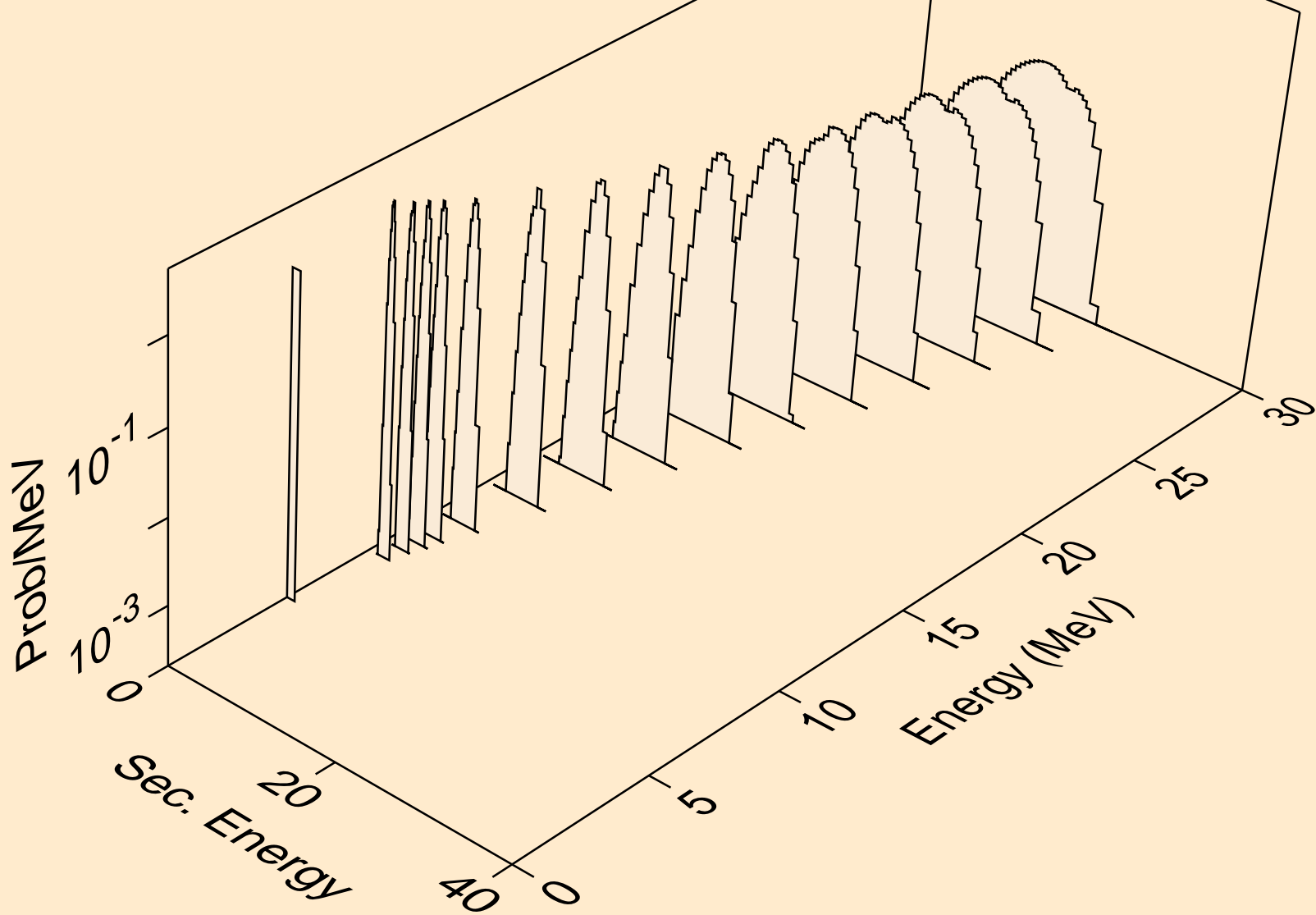

I115 NEUTRON ACER TENDL-2024 LIBRARY; T=293.6K
deuterons from (n,da)

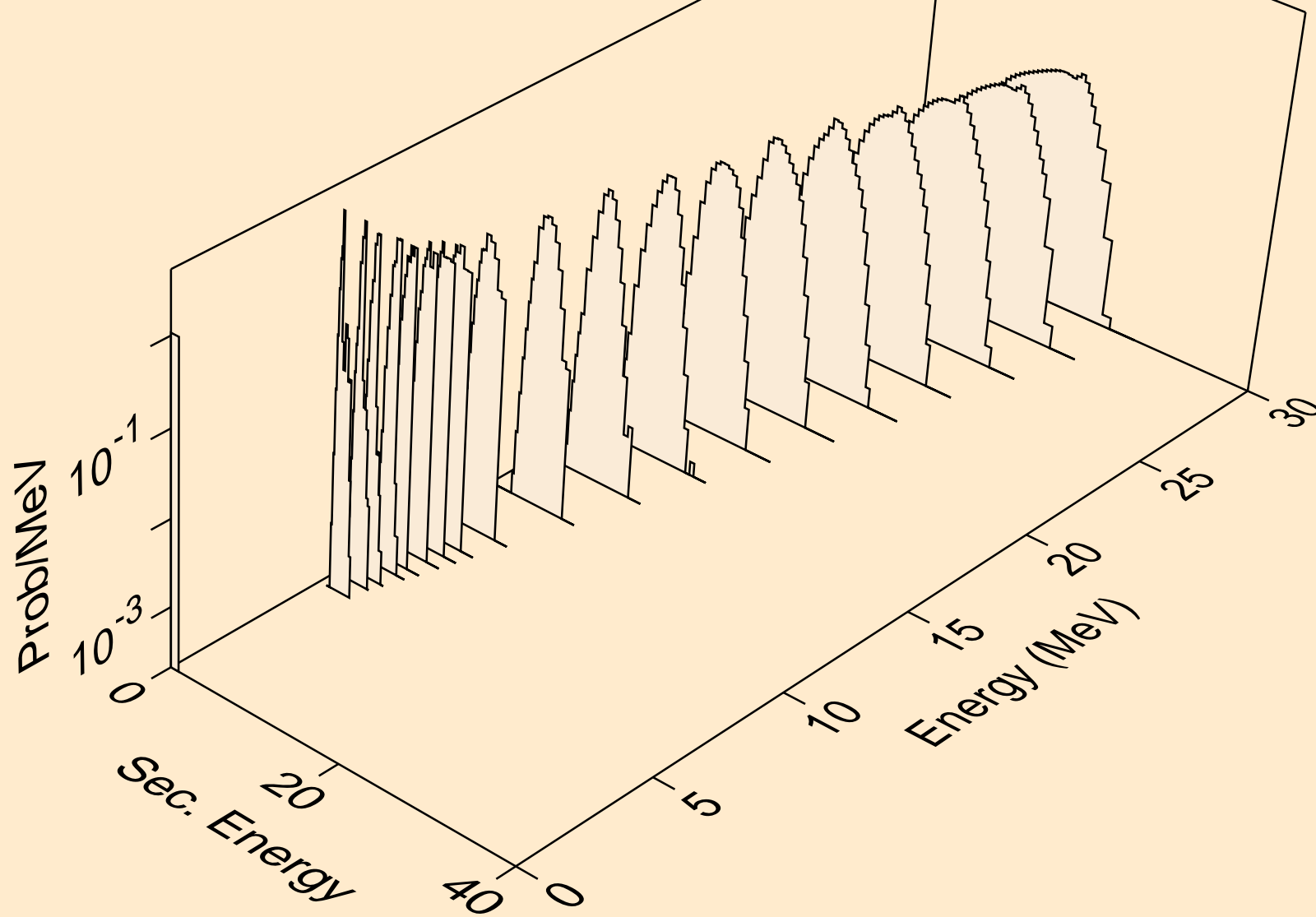

I115 NEUTRON ACER TENDL-2024 LIBRARY; T=293.6K
tritons from (n,x)

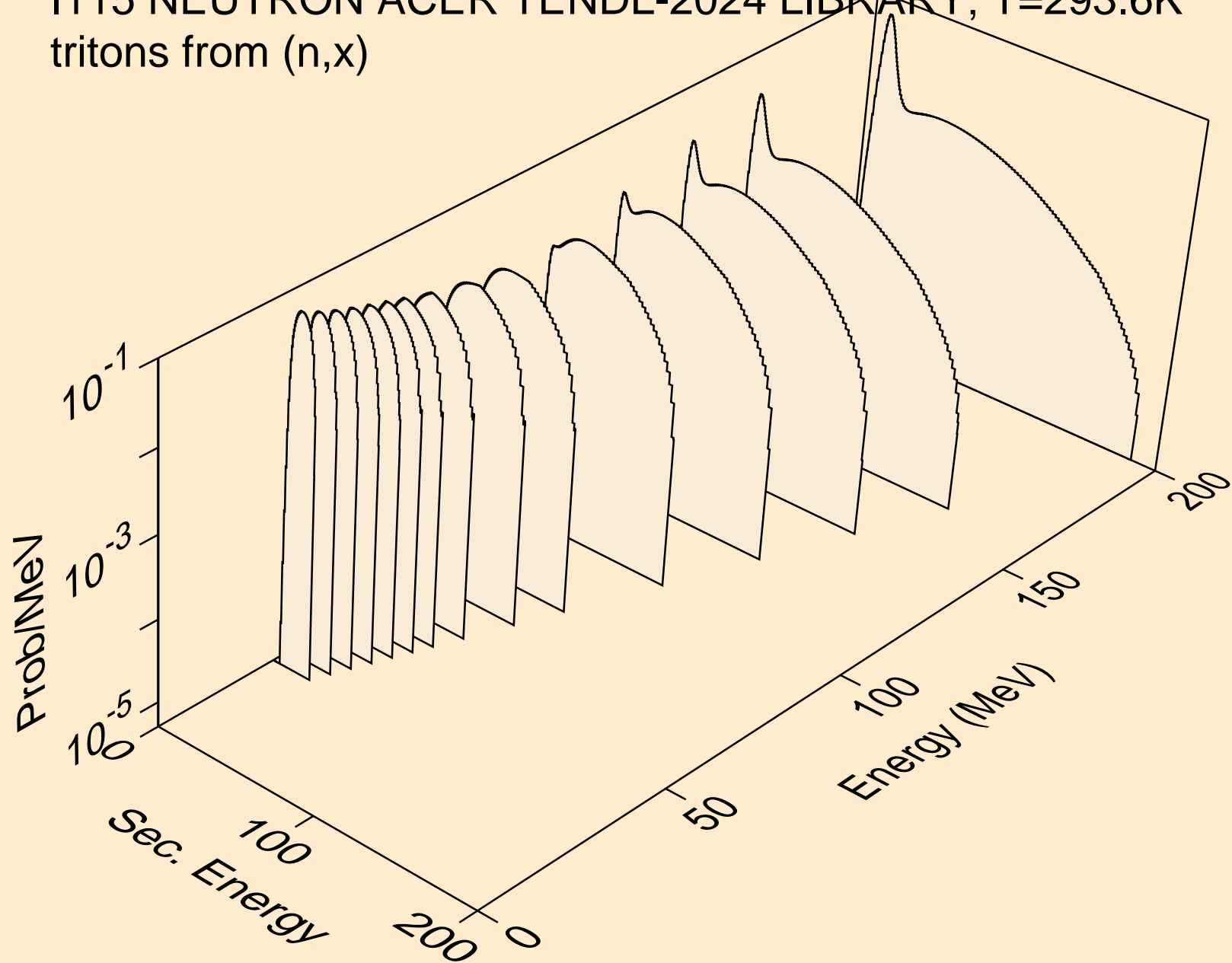

I115 NEUTRON ACER TENDL-2024 LIBRARY; T=293.6K
tritons from (n,n*)t

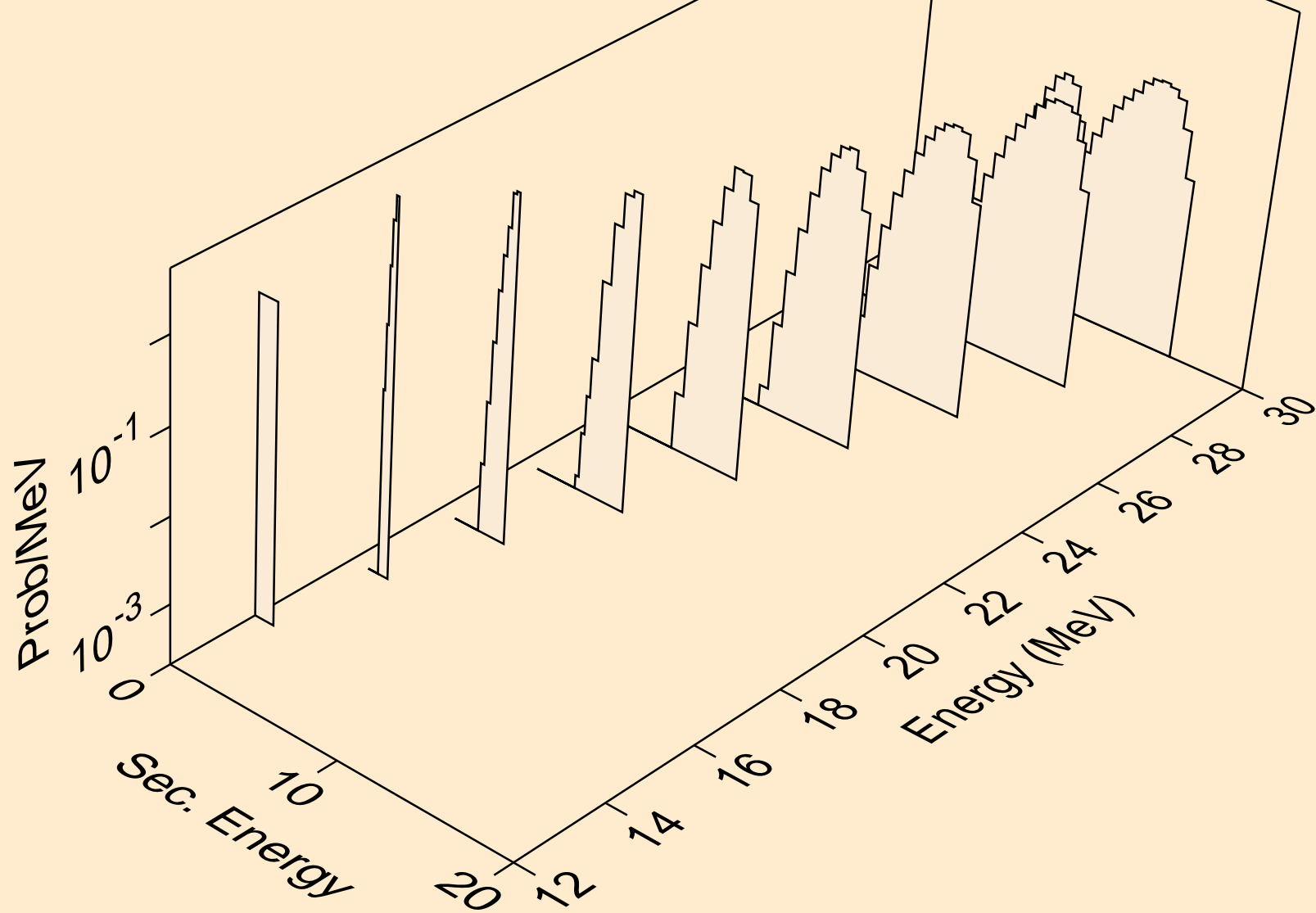

I115 NEUTRON ACER TENDL-2024 LIBRARY; T=293.6K
tritons from (n,t)

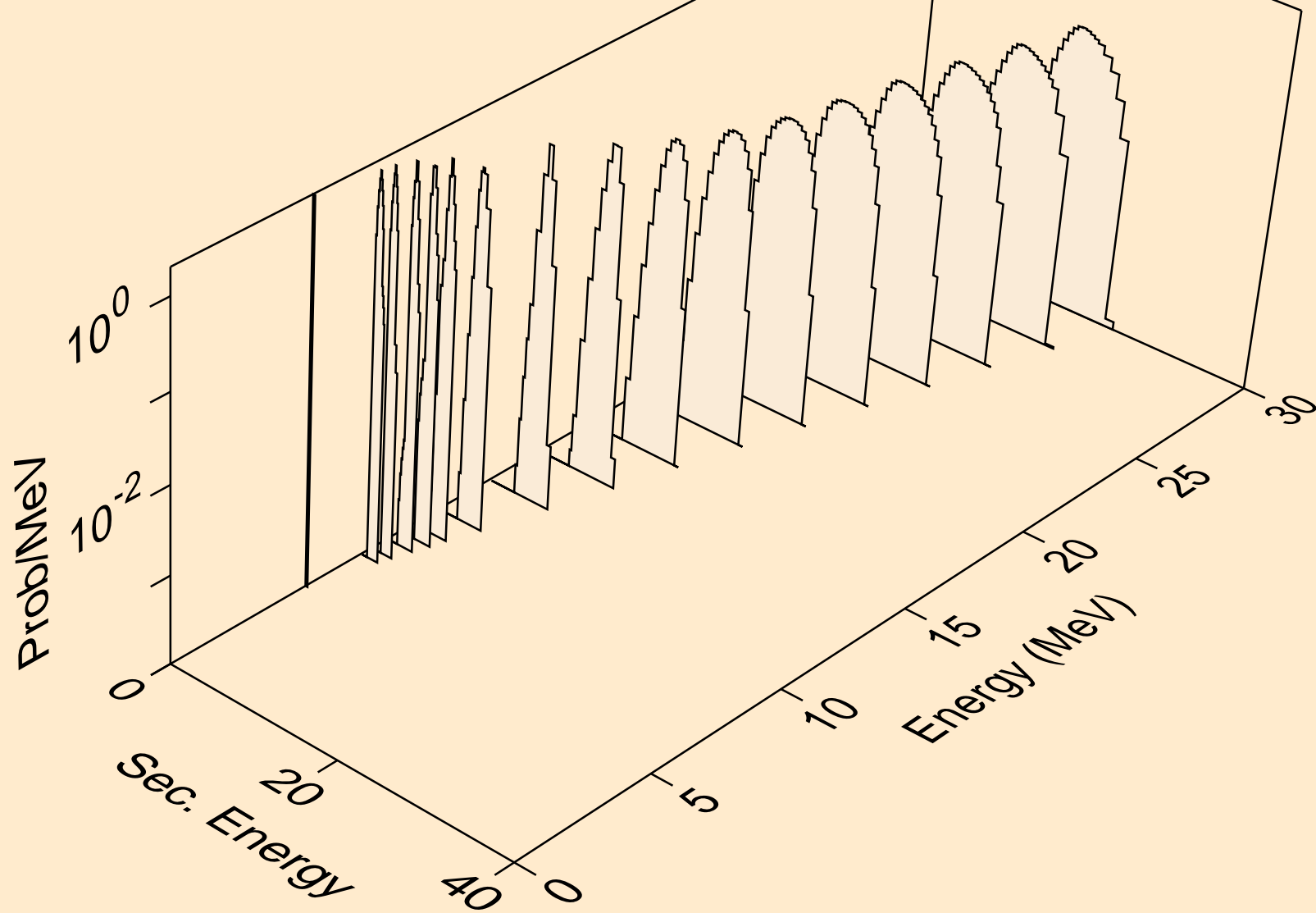

I115 NEUTRON ACER TENDL-2024 LIBRARY; T=293.6K
tritons from (n,pt)

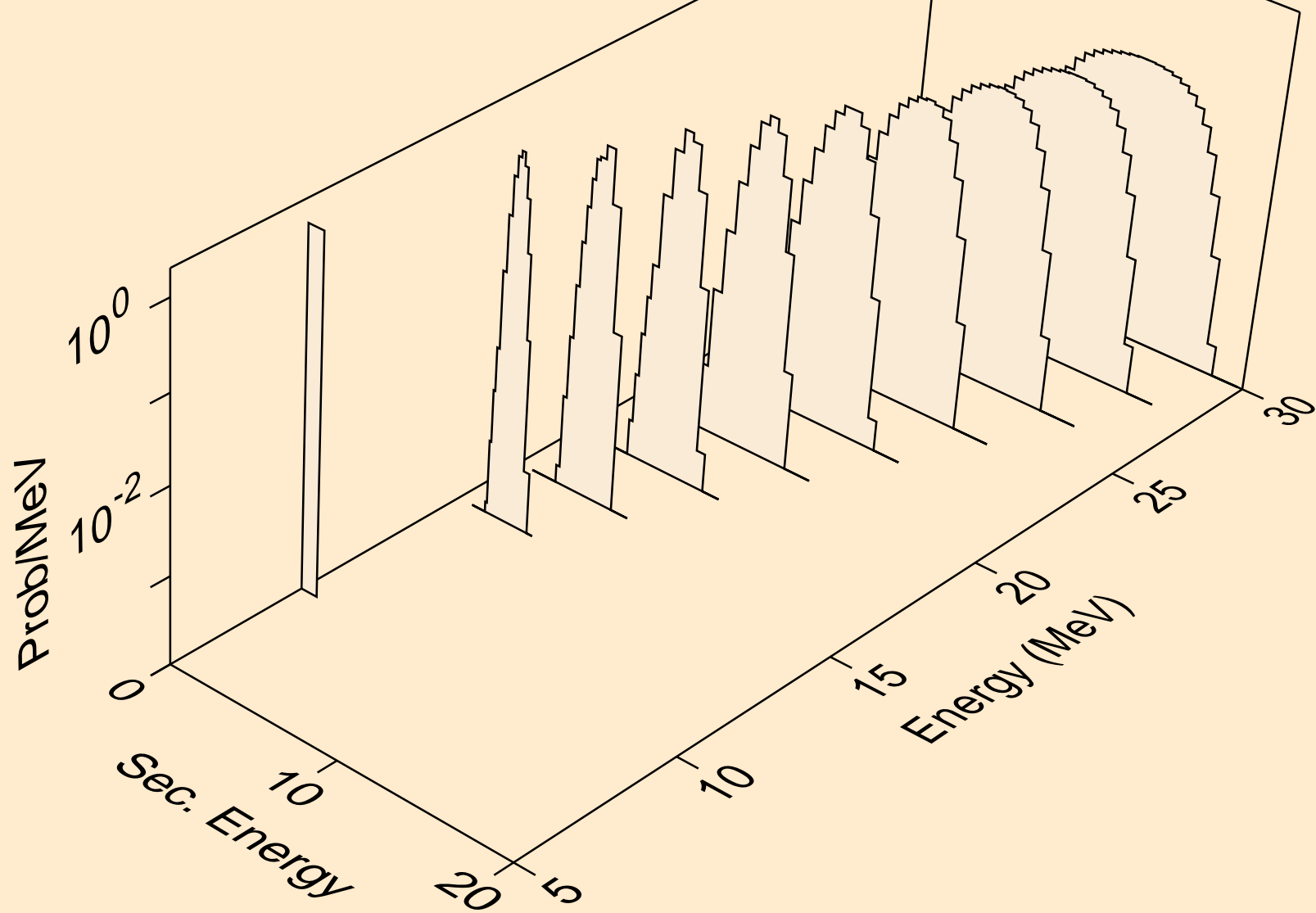

I115 NEUTRON ACER TENDL-2024 LIBRARY; T=293.6K
he3s from (n,x)

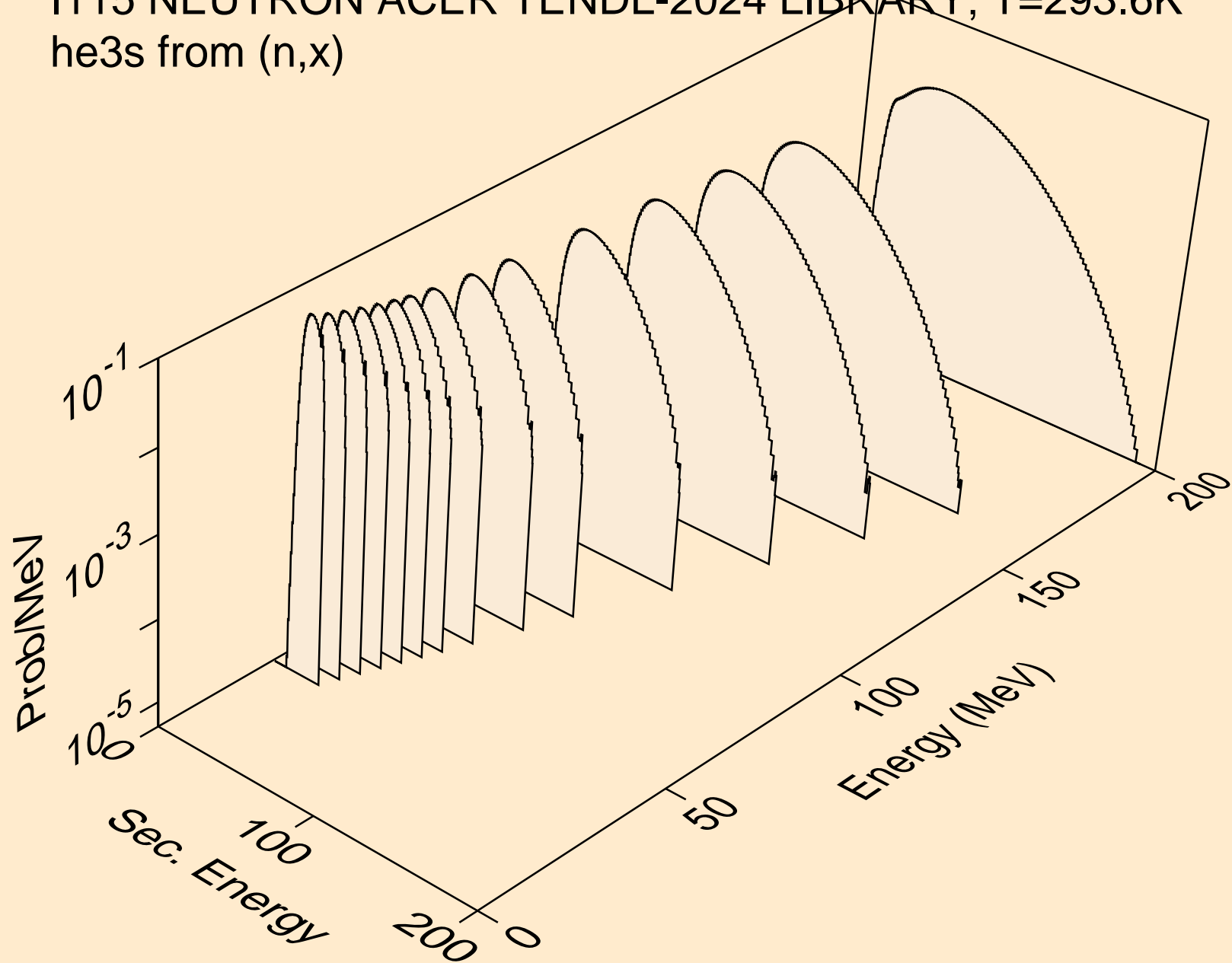

I115 NEUTRON ACER TENDL-2024 LIBRARY; T=293.6K
he3s from (n,n*)he3

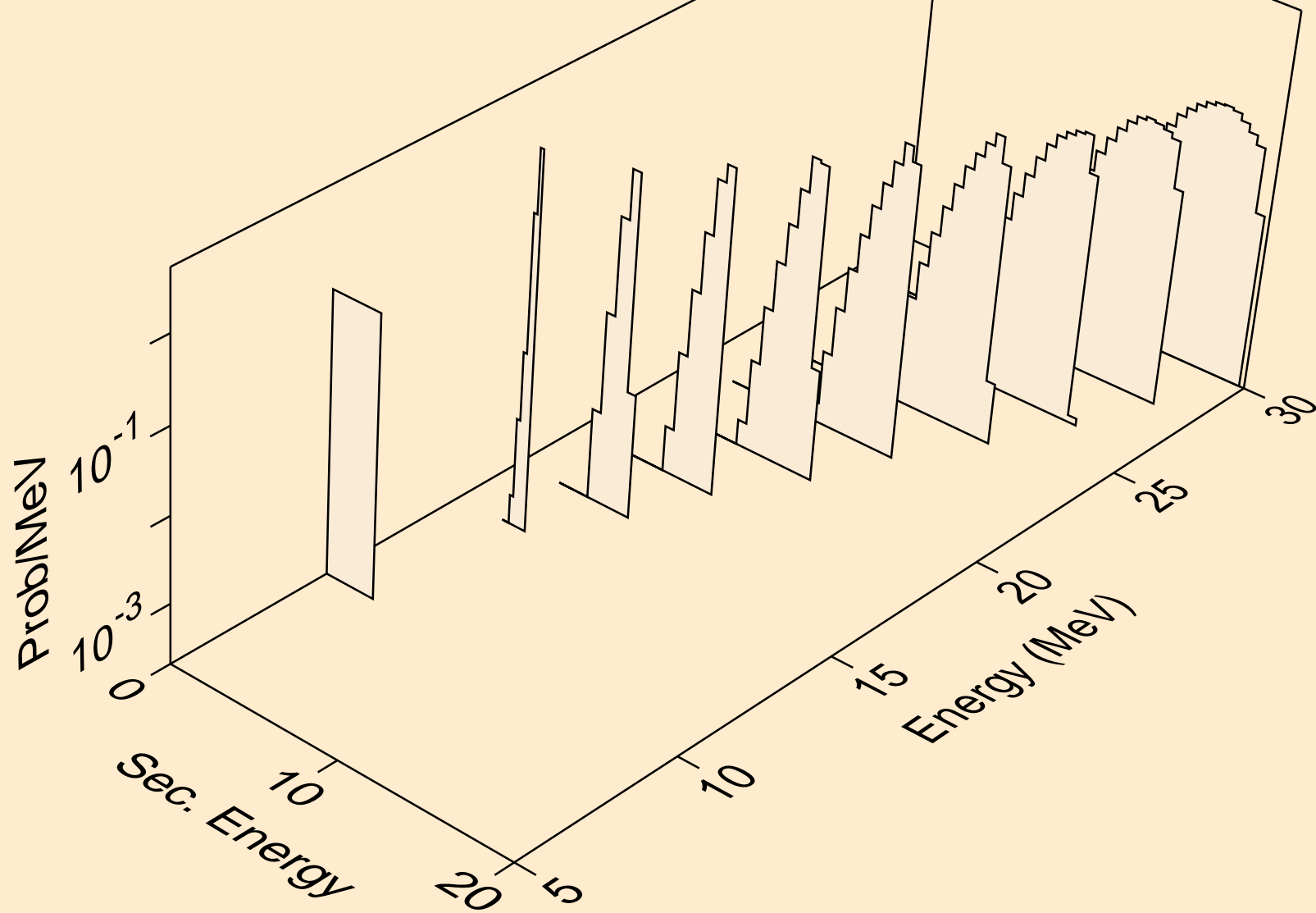

I115 NEUTRON ACER TENDL-2024 LIBRARY; T=293.6K
he3s from (n,he3)

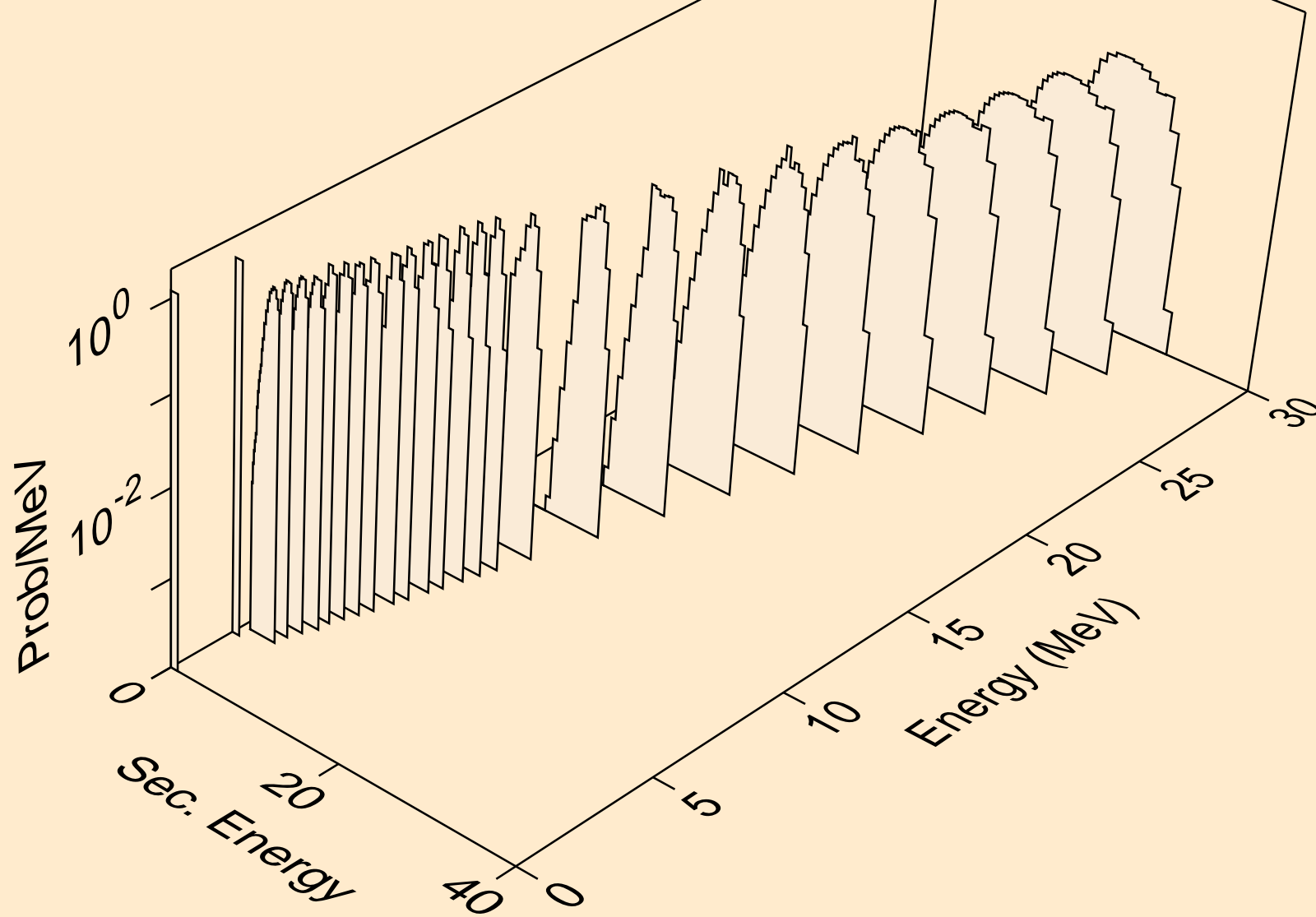

I115 NEUTRON ACER TENDL-2024 LIBRARY; T=293.6K
alphas from (n,x)

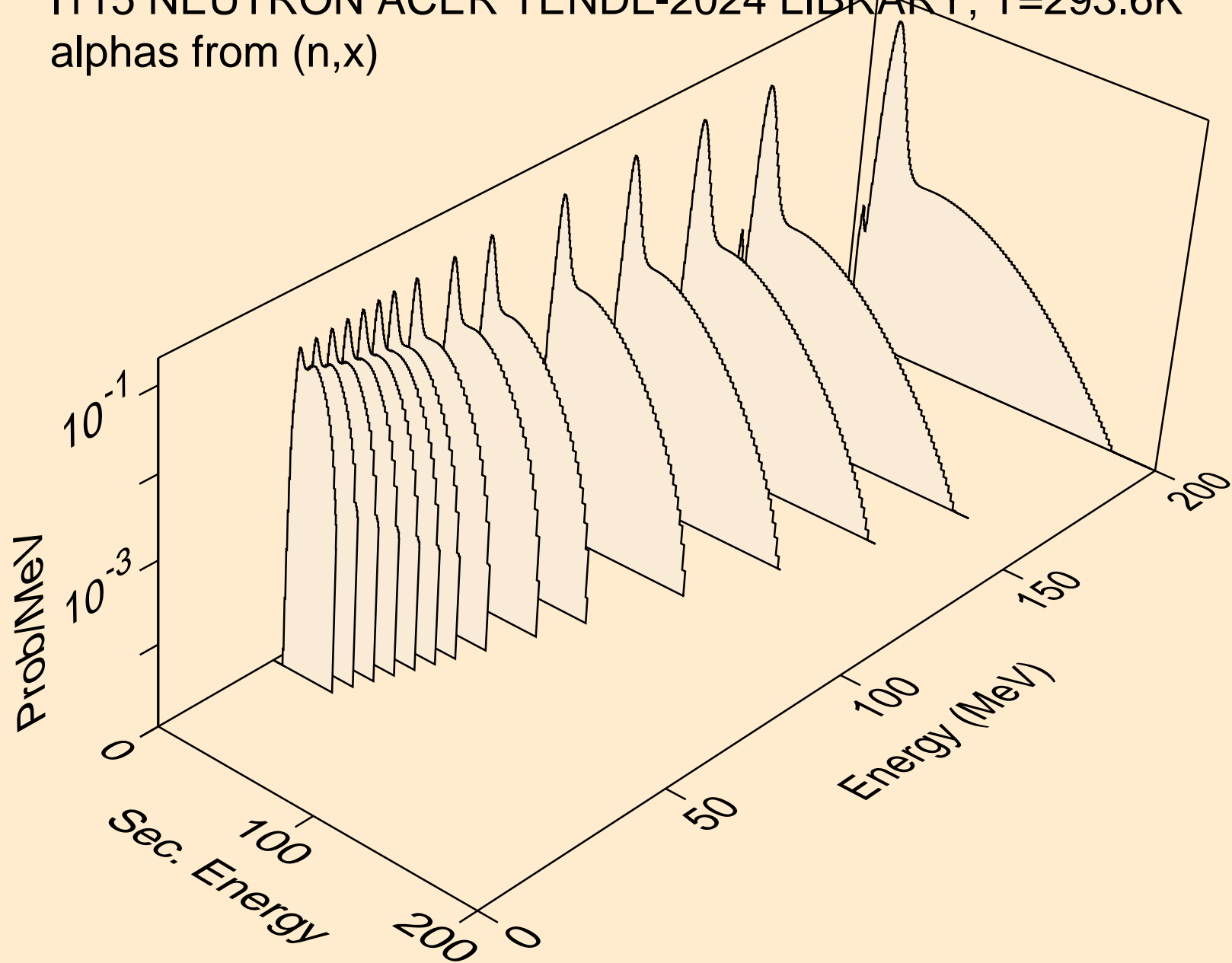

I115 NEUTRON ACER TENDL-2024 LIBRARY; T=293.6K
alphas from (n,n*)a

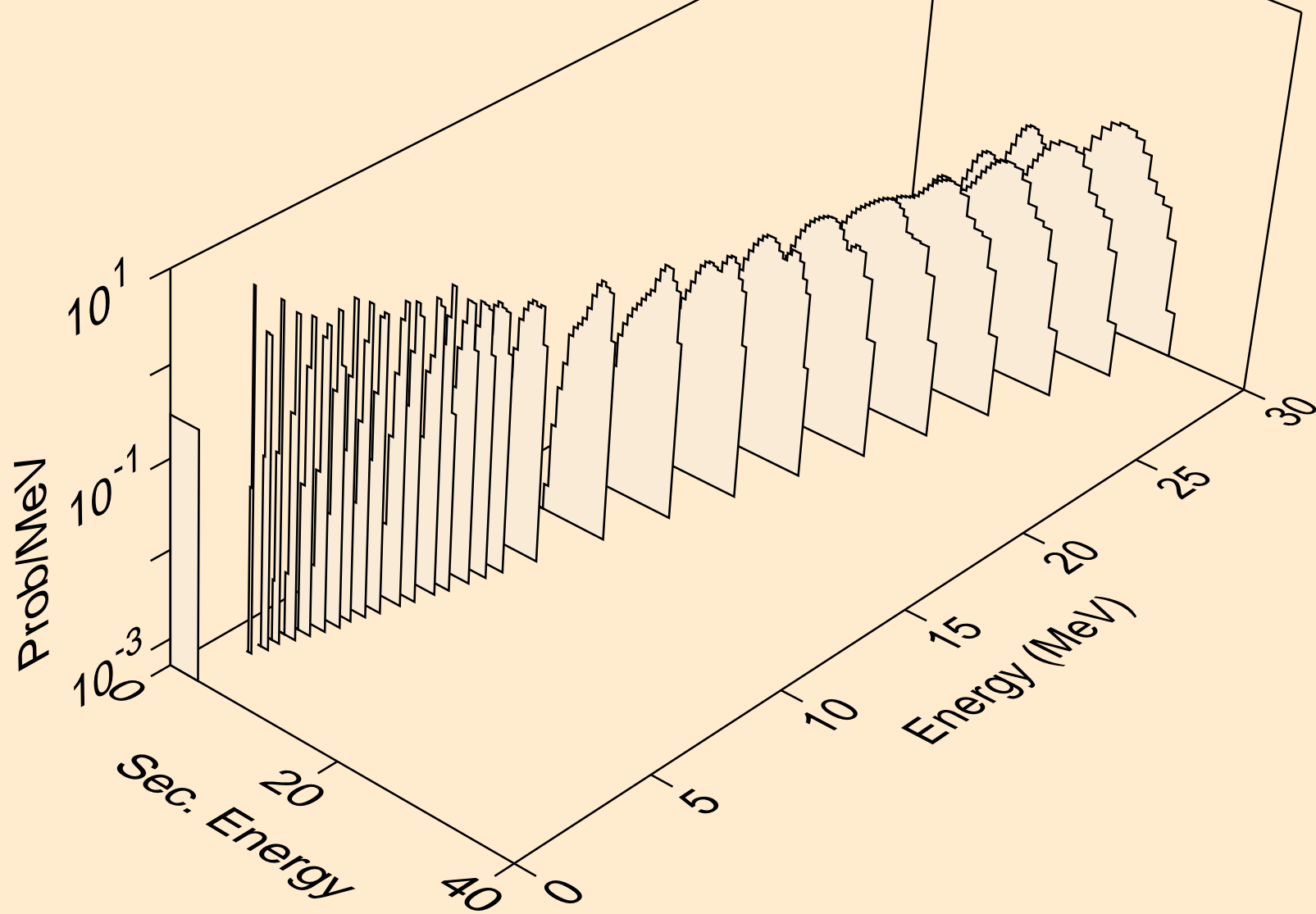

I115 NEUTRON ACER TENDL-2024 LIBRARY; T=293.6K
alphas from (n,2n)a

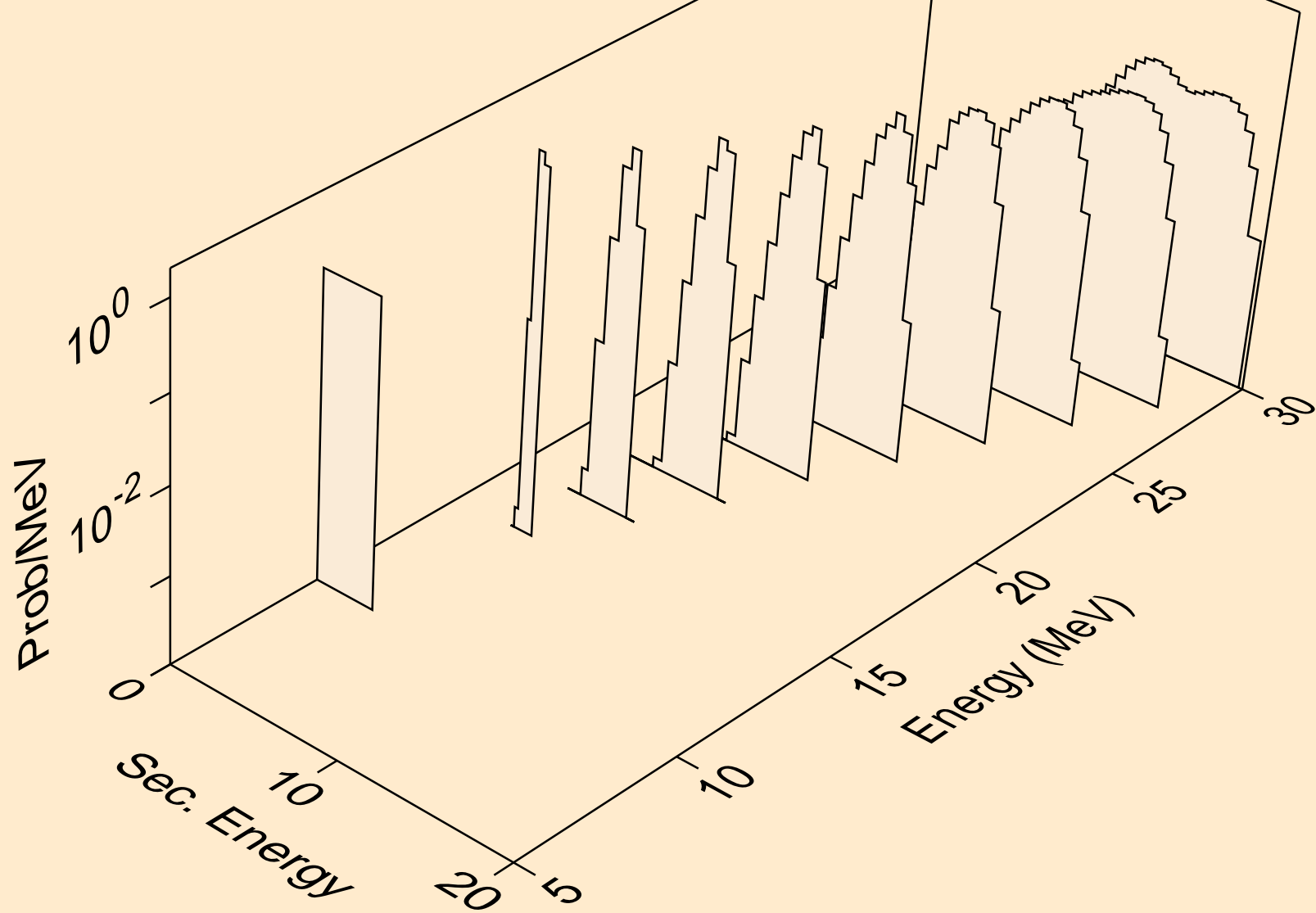

I115 NEUTRON ACER TENDL-2024 LIBRARY; T=293.6K
alphas from (n,3n)a

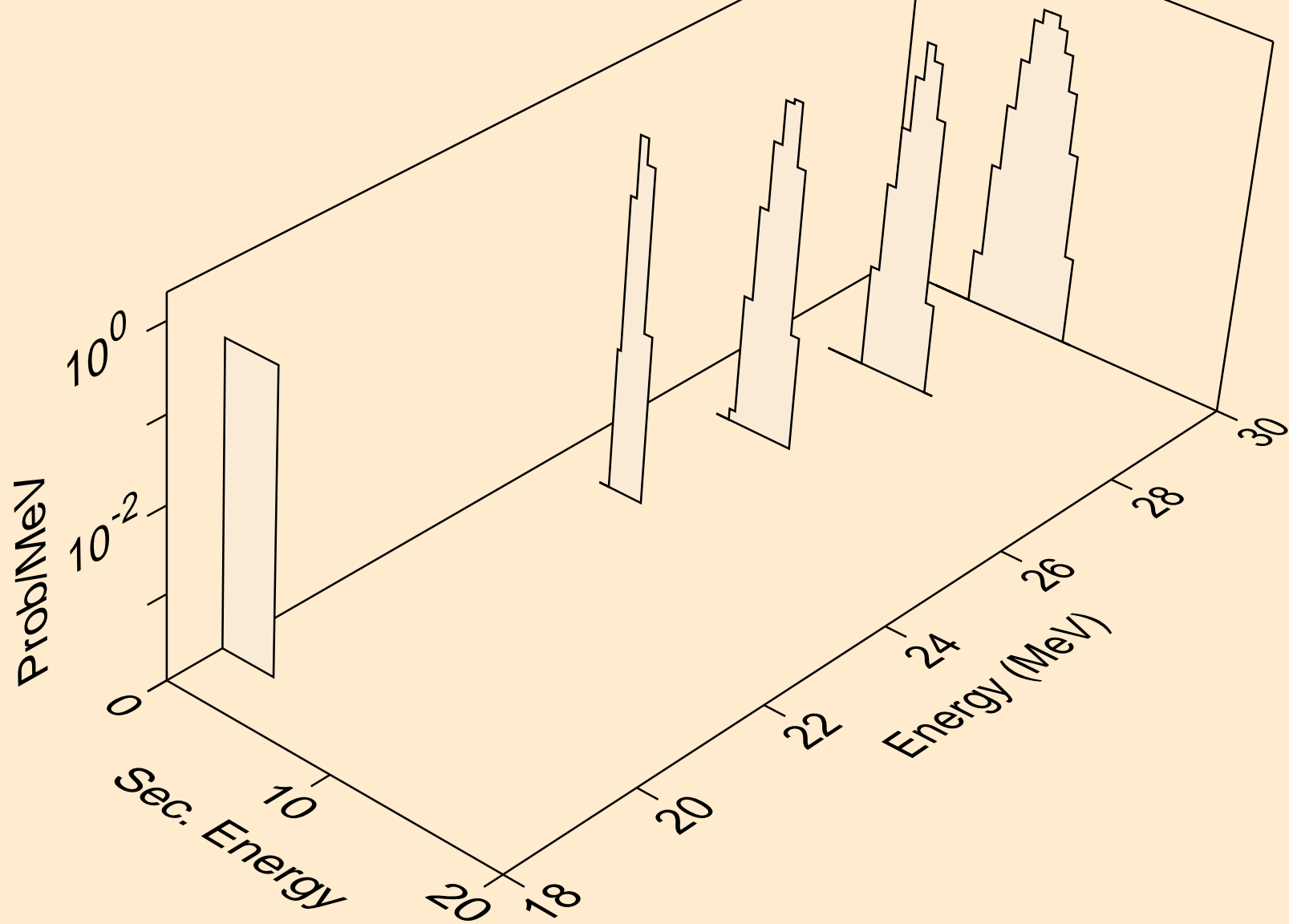

I115 NEUTRON ACER TENDL-2024 LIBRARY; T=293.6K
alphas from (n,n*)2a

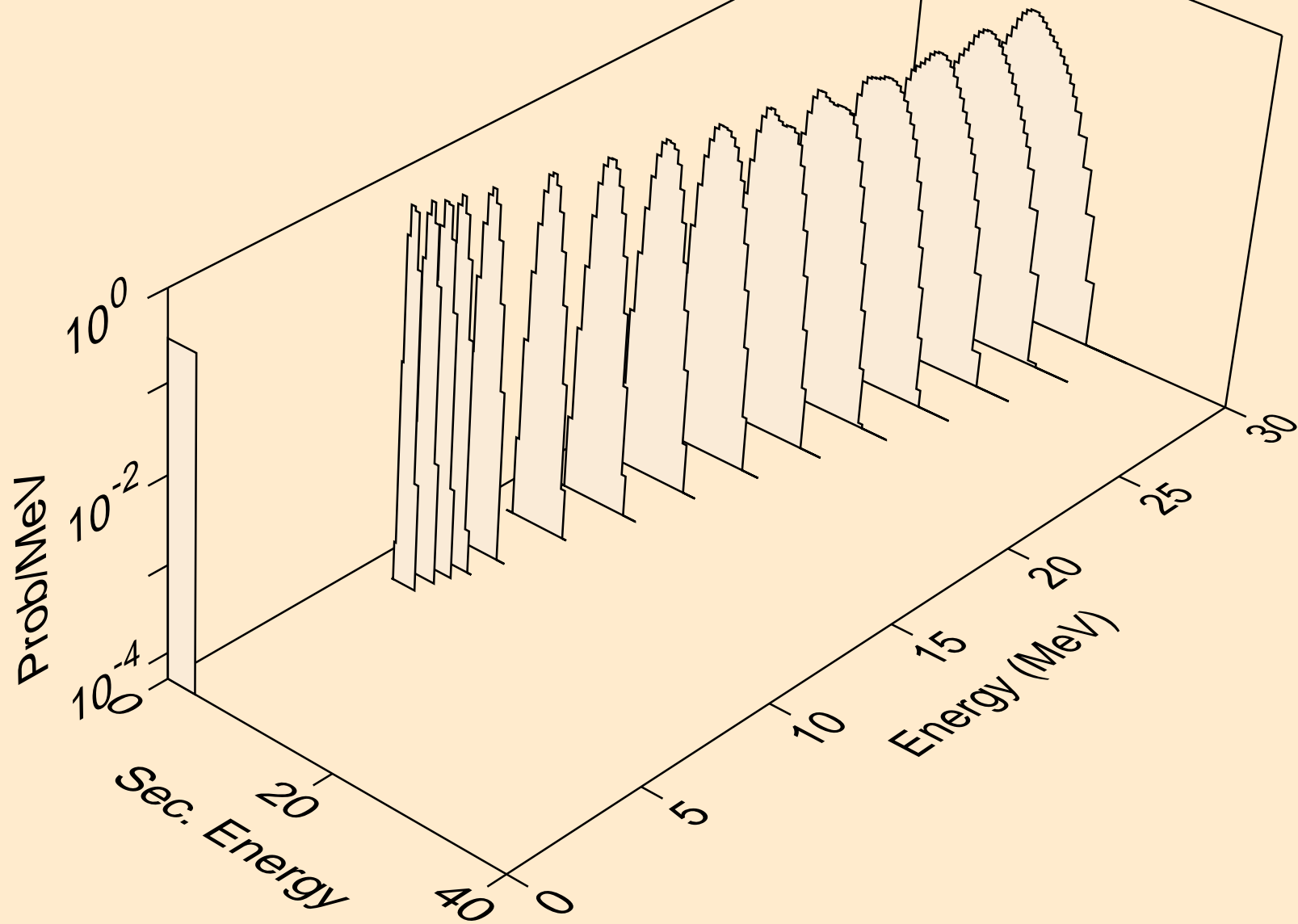

I115 NEUTRON ACER TENDL-2024 LIBRARY; T=293.6K
alphas from (n,2n)2a

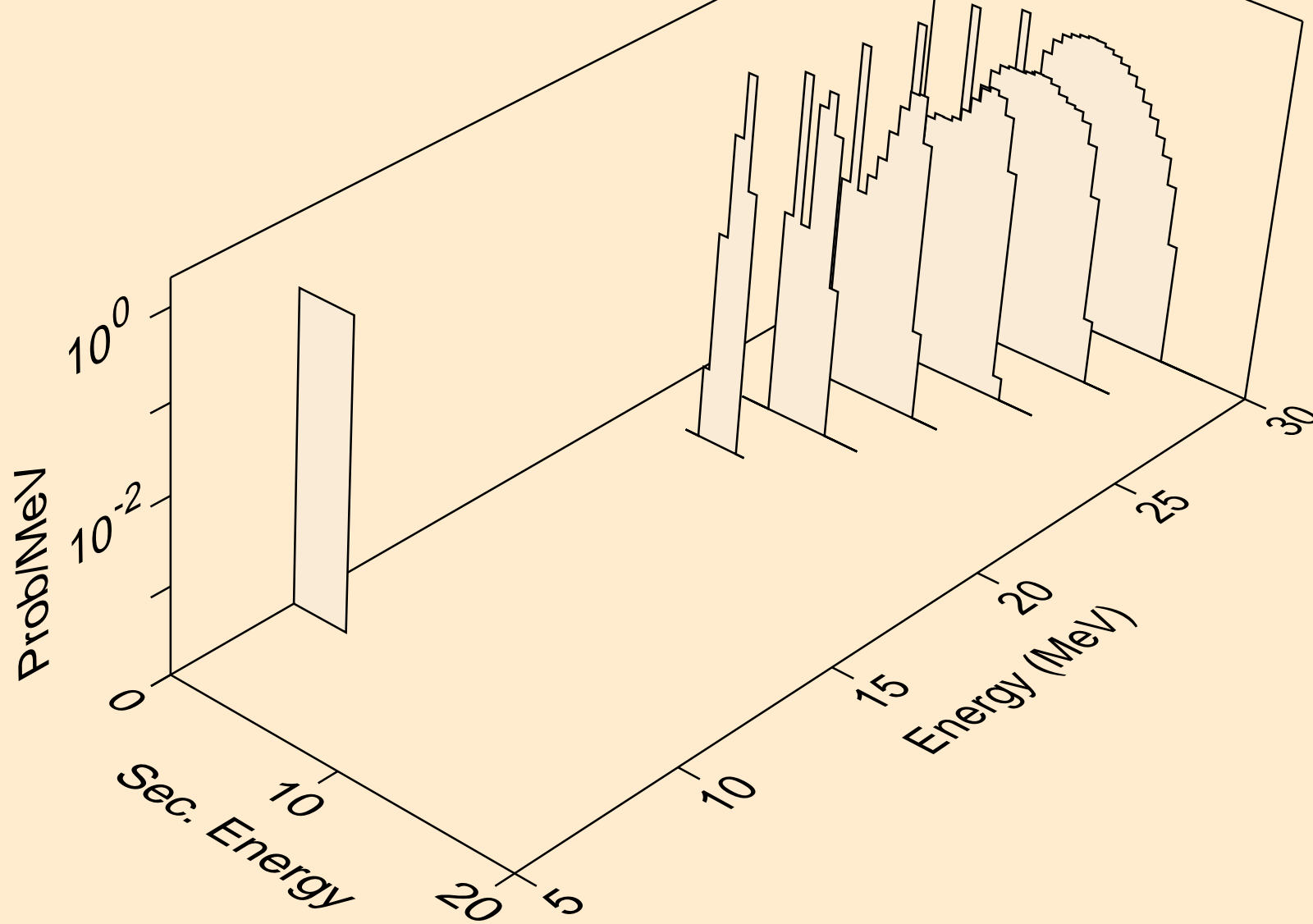

I115 NEUTRON ACER TENDL-2024 LIBRARY; T=293.6K
alphas from (n,npa)

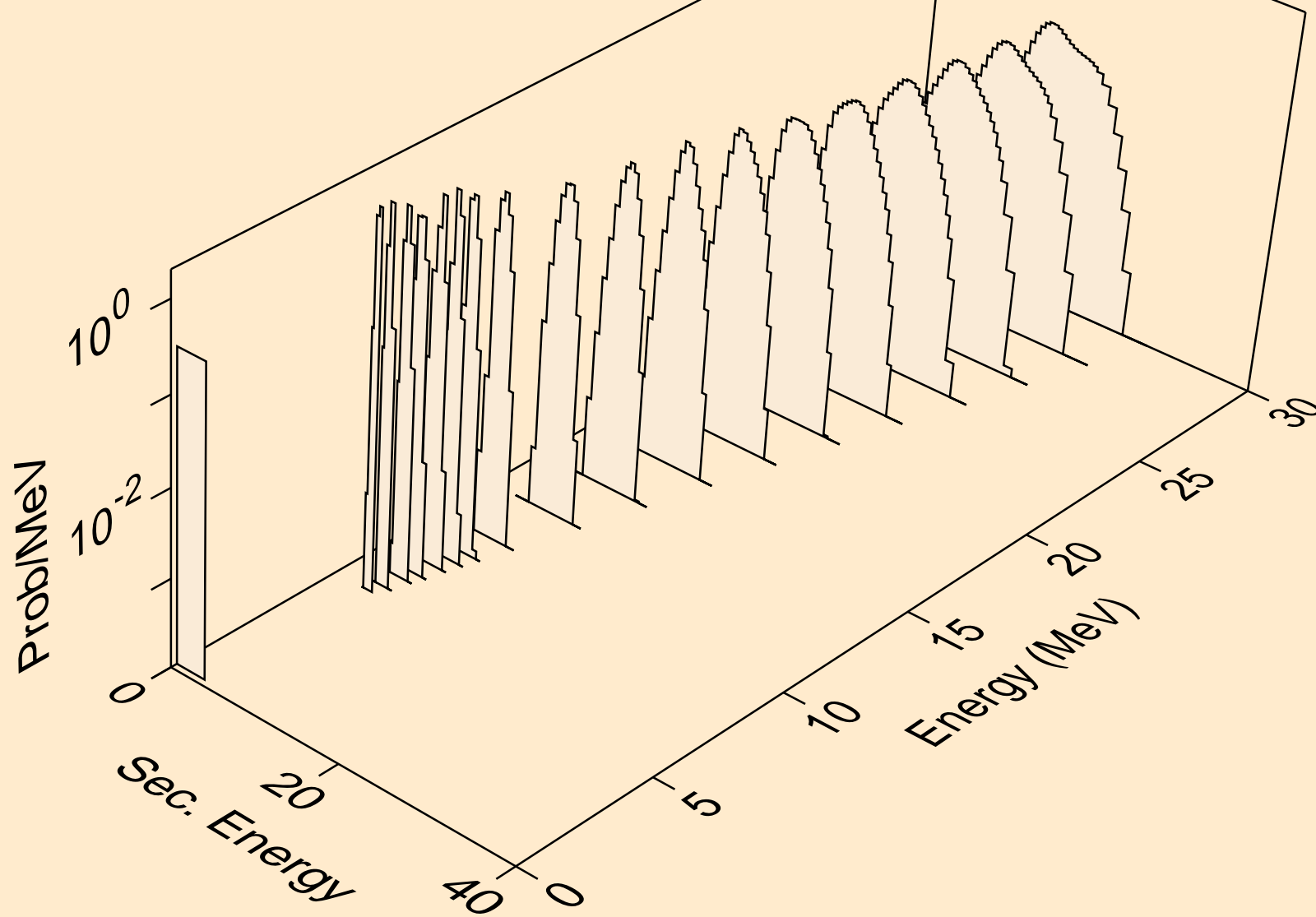

I115 NEUTRON ACER TENDL-2024 LIBRARY; T=293.6K
alphas from (n,a)

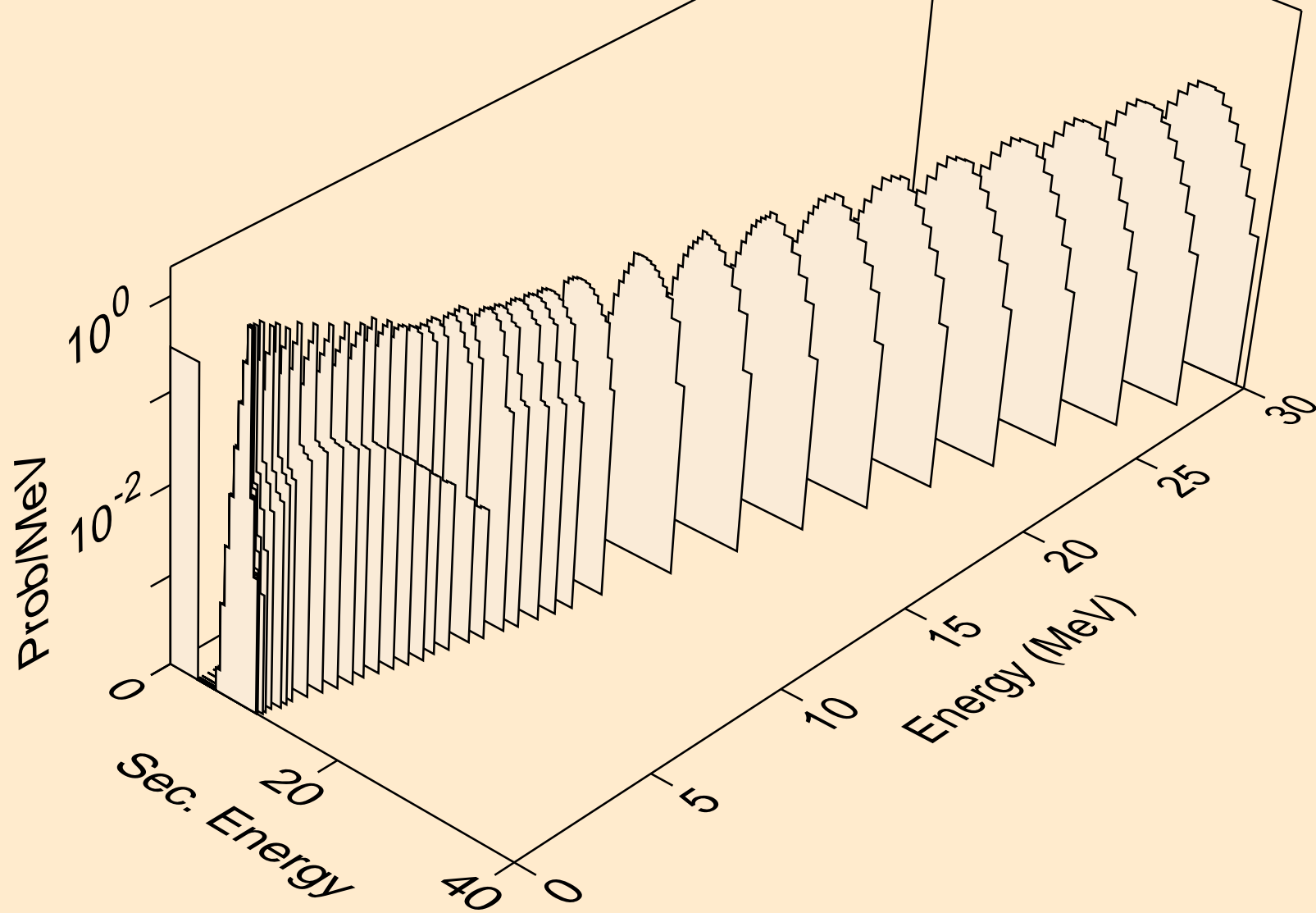

I115 NEUTRON ACER TENDL-2024 LIBRARY; T=293.6K
alphas from (n,2a)

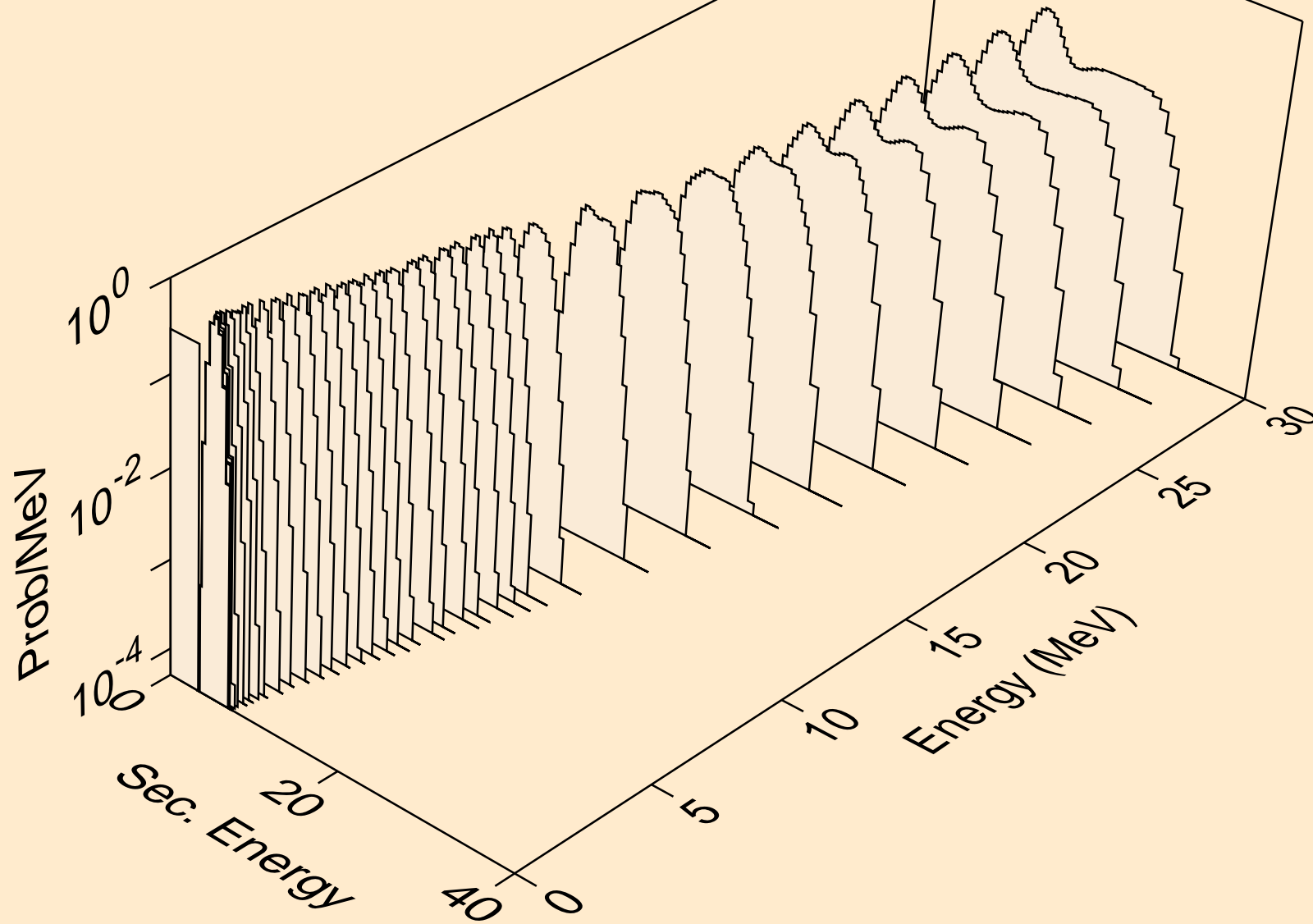

I115 NEUTRON ACER TENDL-2024 LIBRARY; T=293.6K
alphas from (n,3a)

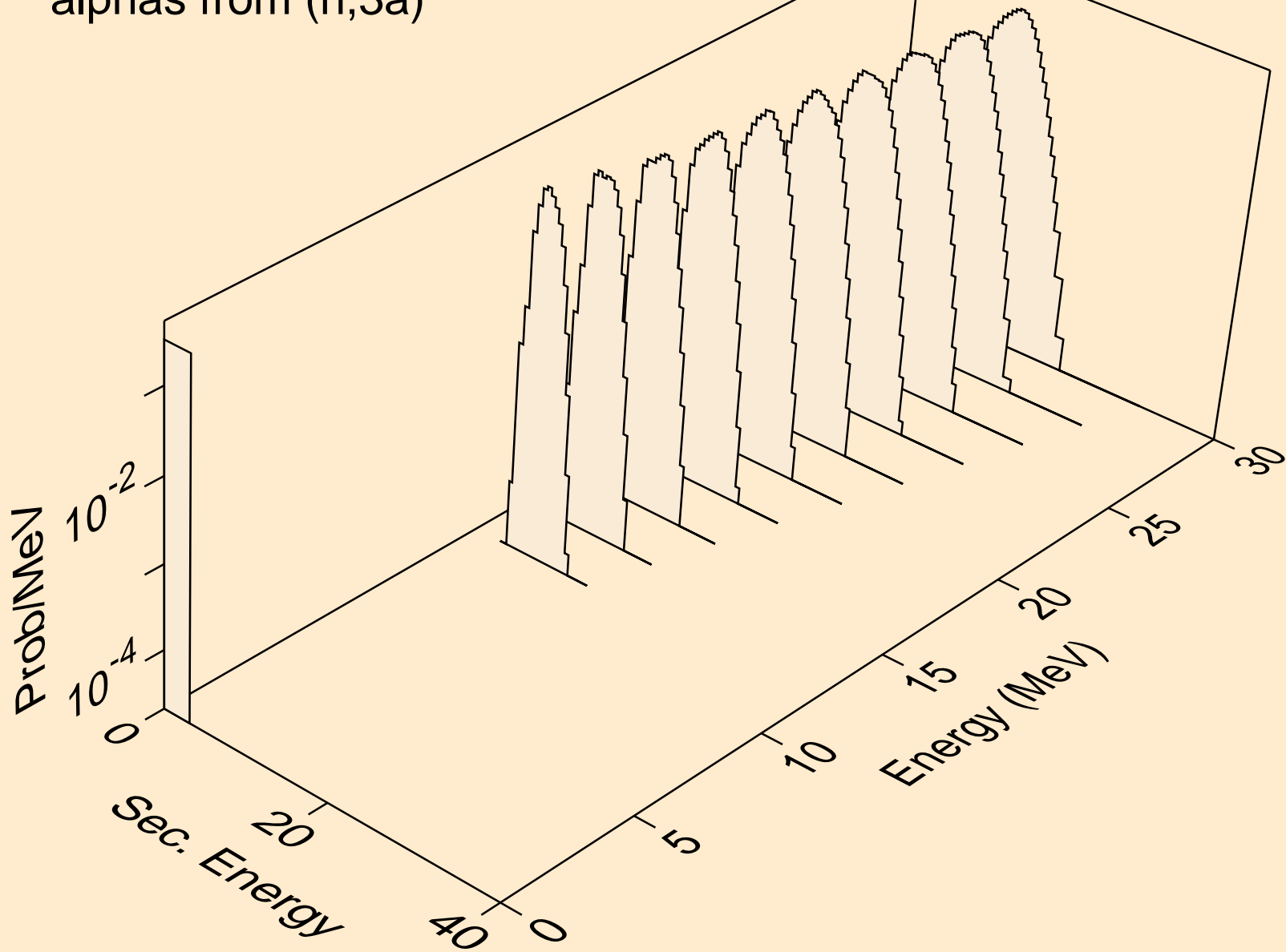

I115 NEUTRON ACER TENDL-2024 LIBRARY; T=293.6K
alphas from (n,pa)

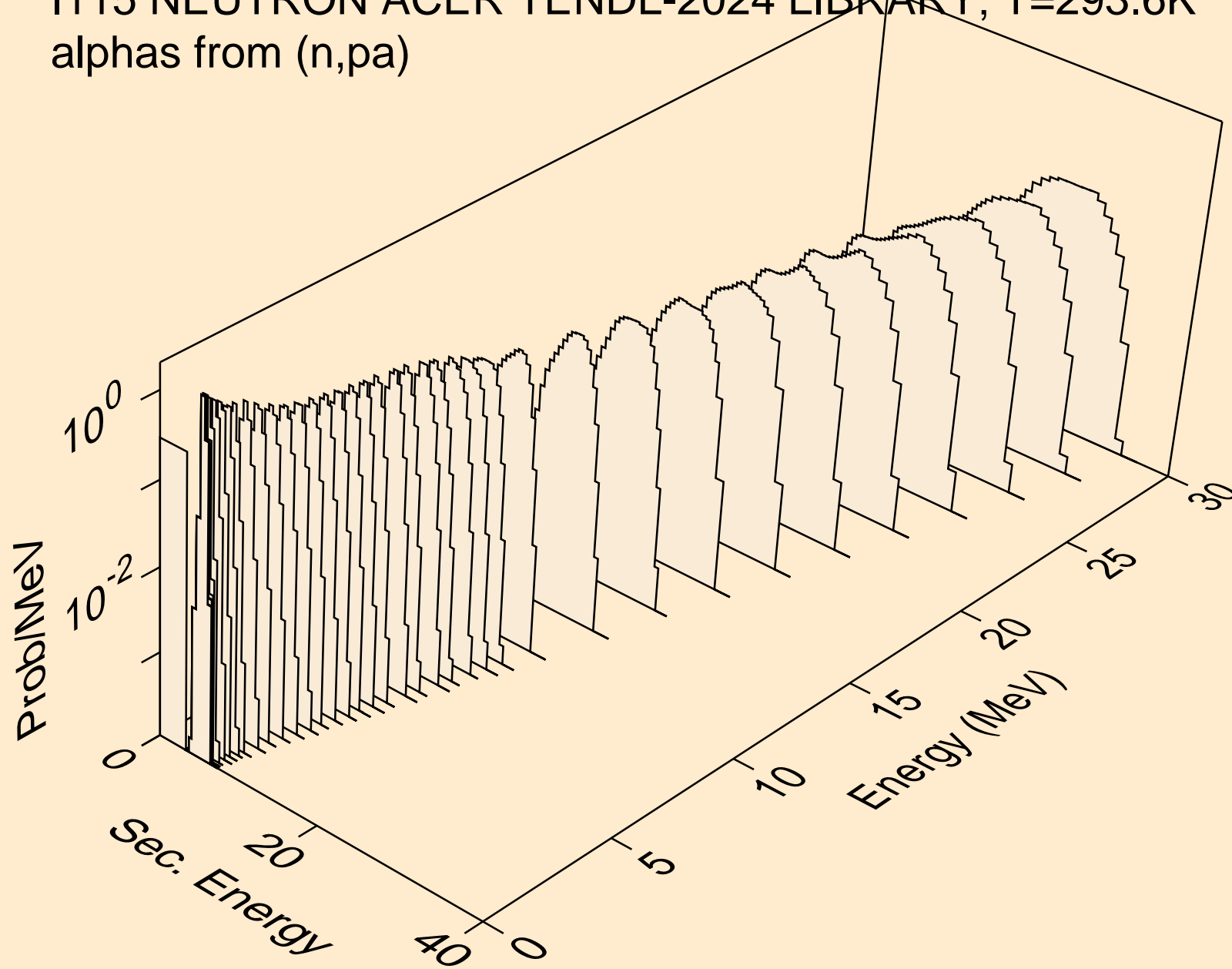

I115 NEUTRON ACER TENDL-2024 LIBRARY; T=293.6K
alphas from (n,d2a)

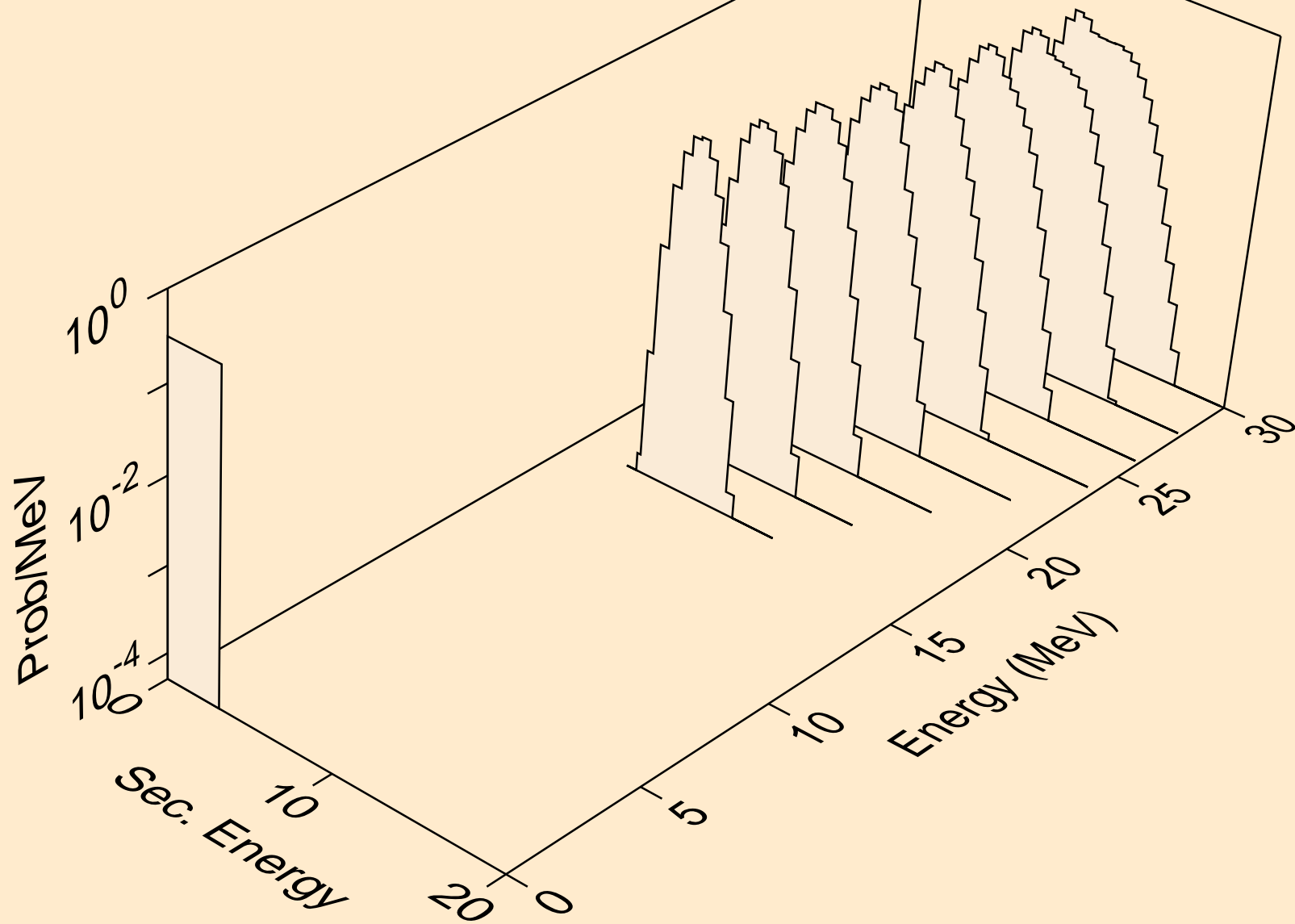

I115 NEUTRON ACER TENDL-2024 LIBRARY; T=293.6K
alphas from (n,da)

