

I118 NEUTRON ACER TENDL-2024 LIBRARY; T=293.6K  
Principal cross sections

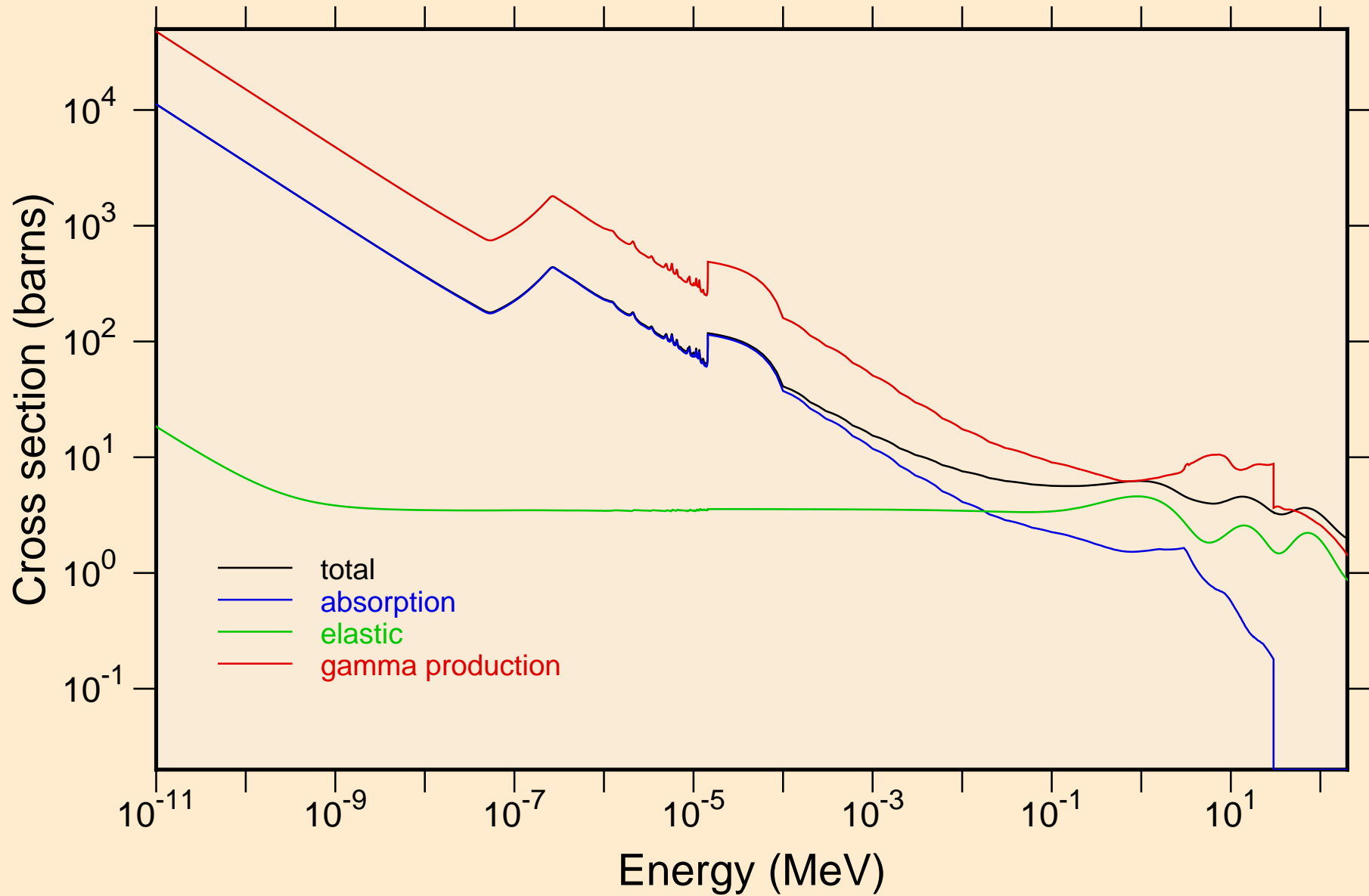

I118 NEUTRON ACER TENDL-2024 LIBRARY; T=293.6K  
resonance total cross section

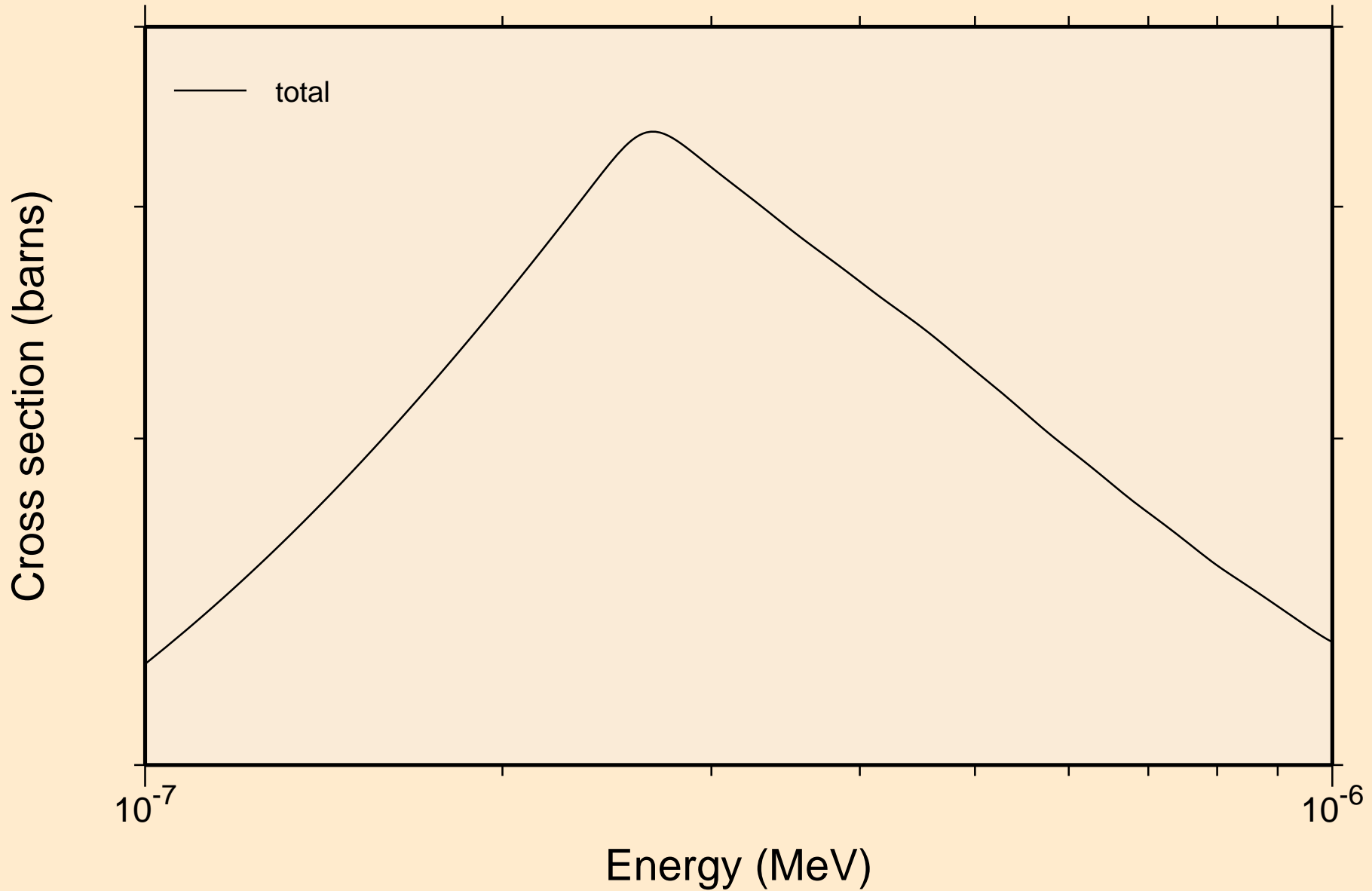

I118 NEUTRON ACER TENDL-2024 LIBRARY; T=293.6K  
resonance total cross section

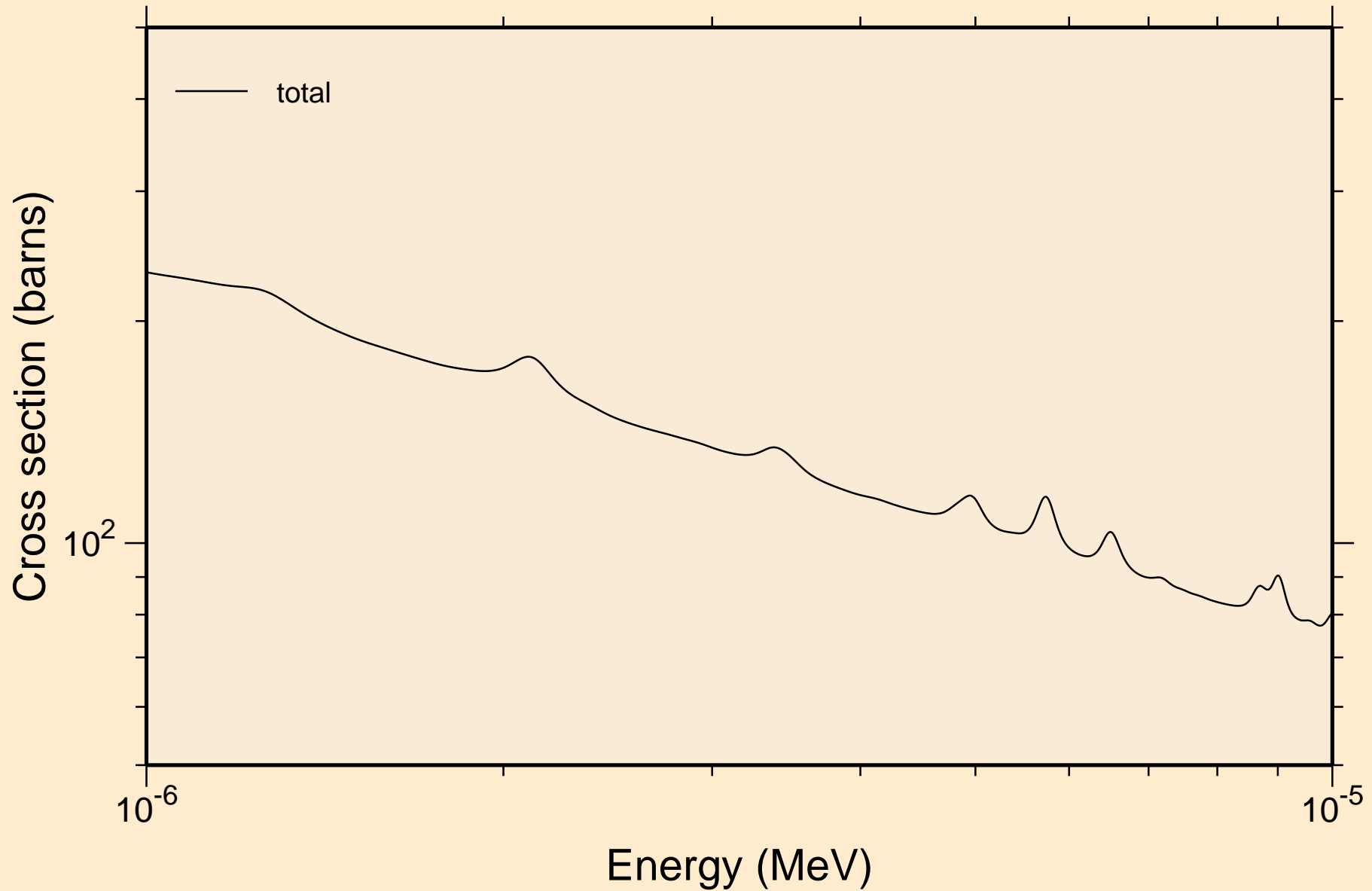

I118 NEUTRON ACER TENDL-2024 LIBRARY; T=293.6K  
resonance total cross section

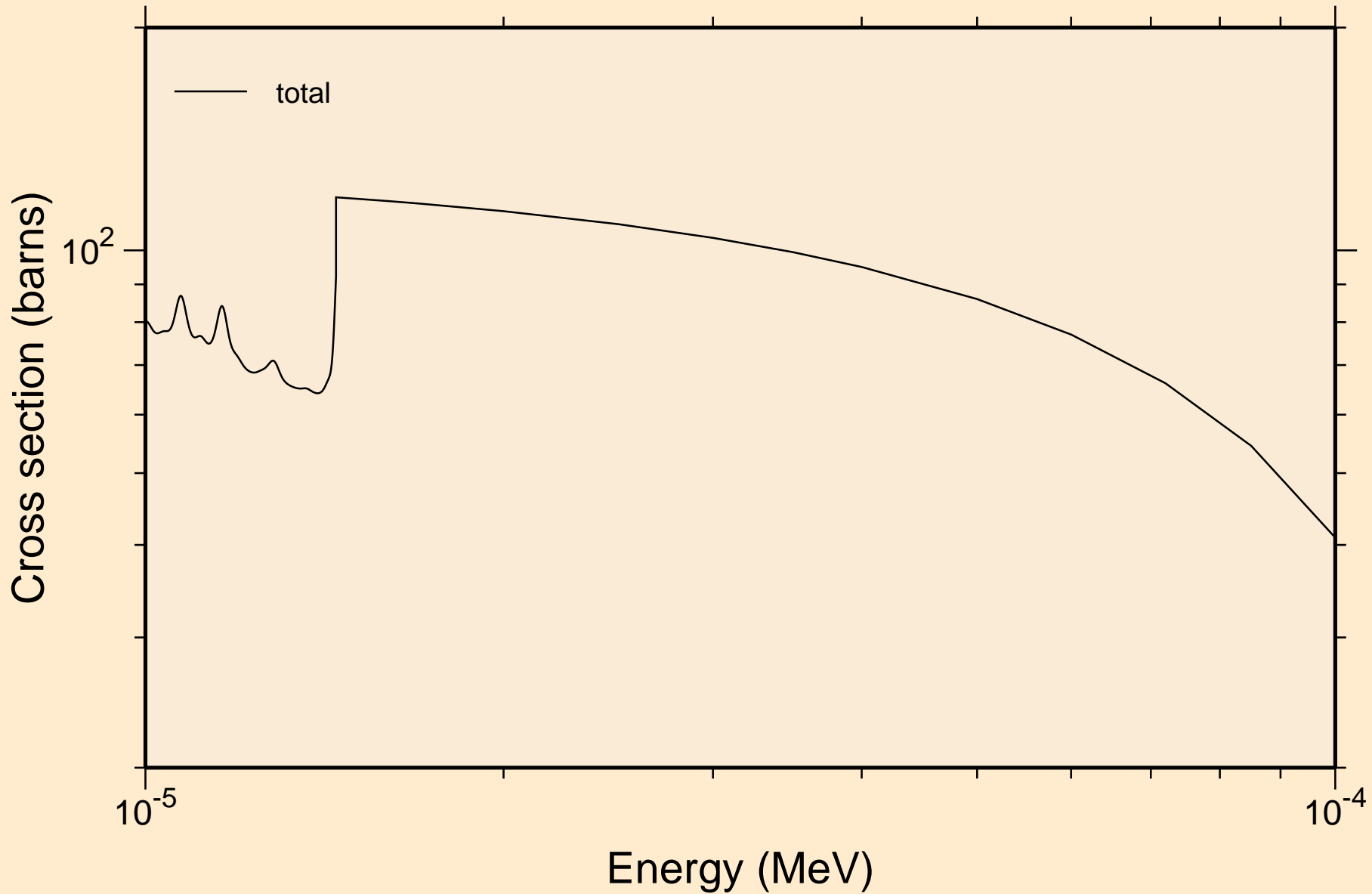

I118 NEUTRON ACER TENDL-2024 LIBRARY; T=293.6K  
resonance total cross section

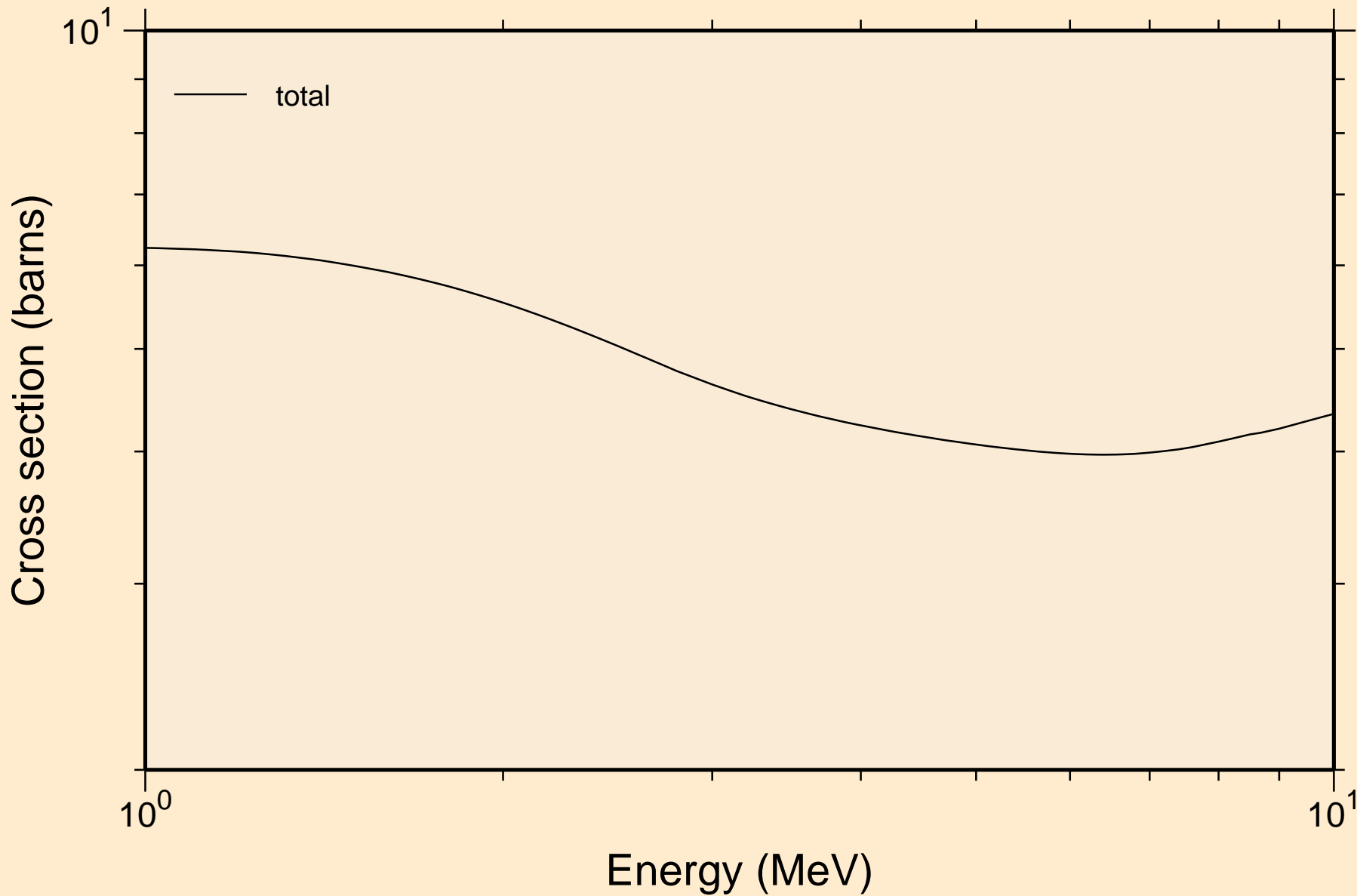

I118 NEUTRON ACER TENDL-2024 LIBRARY; T=293.6K  
resonance absorption cross sections

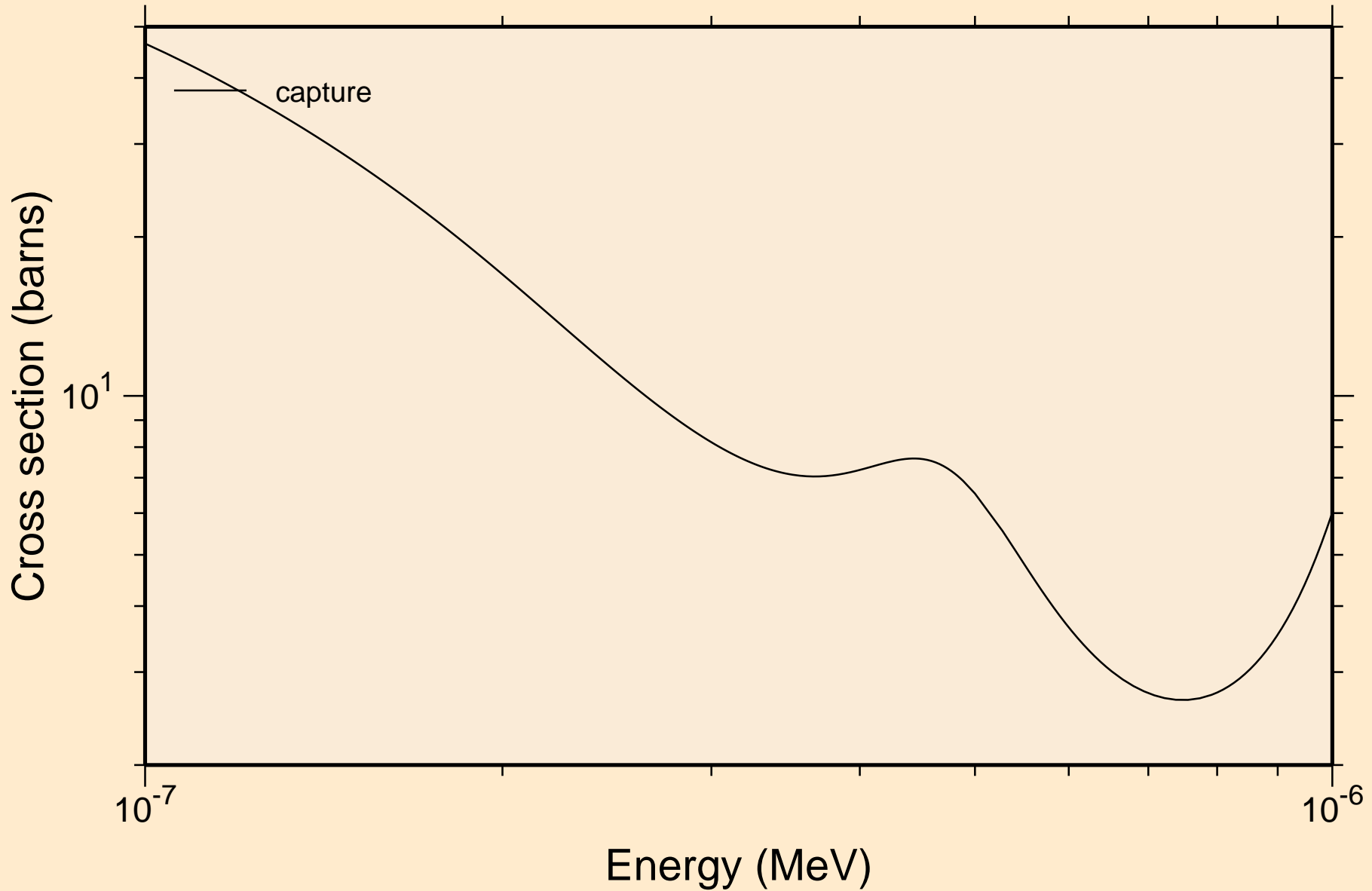

I118 NEUTRON ACER TENDL-2024 LIBRARY; T=293.6K  
resonance absorption cross sections

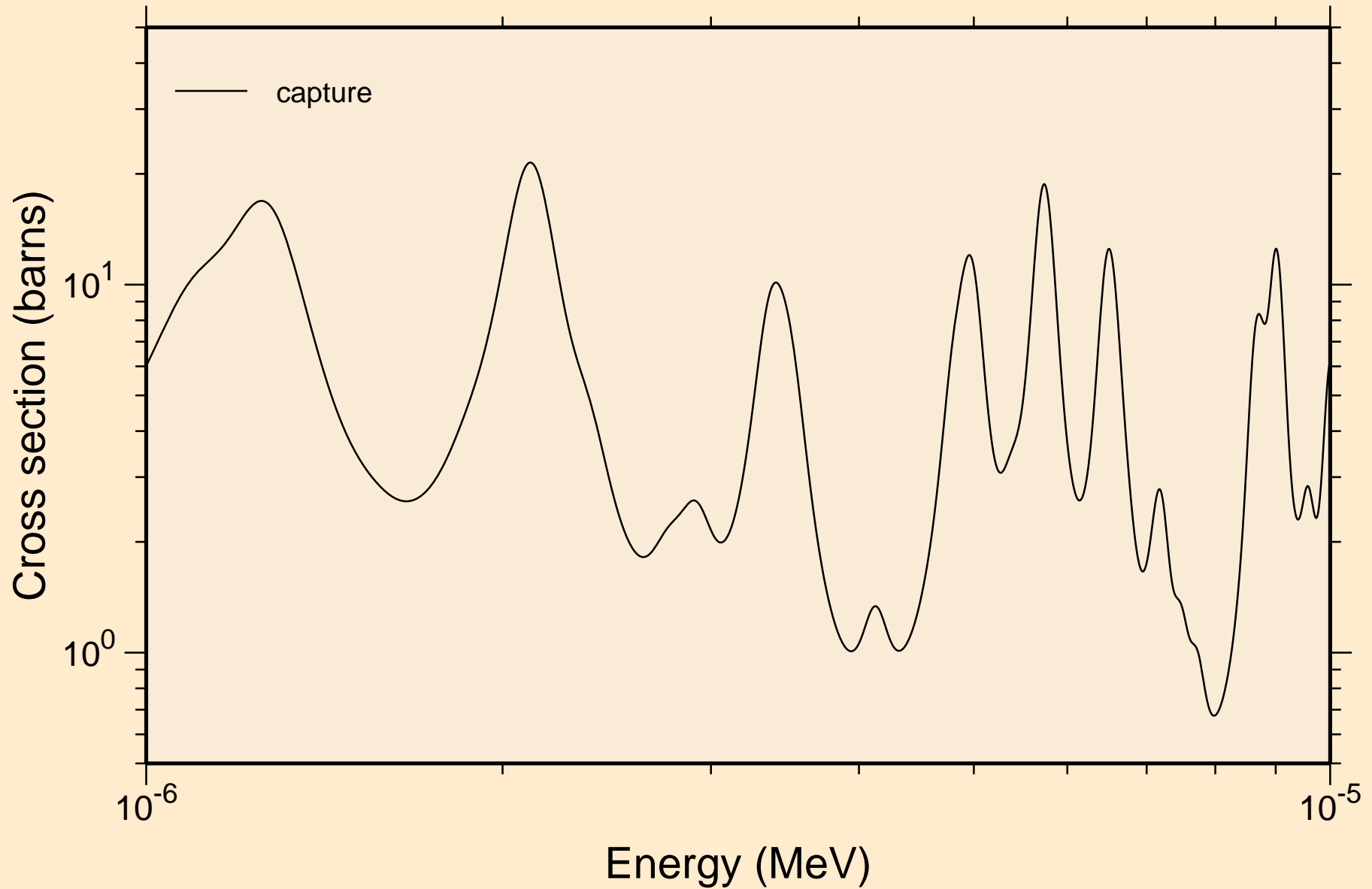

I118 NEUTRON ACER TENDL-2024 LIBRARY; T=293.6K  
resonance absorption cross sections

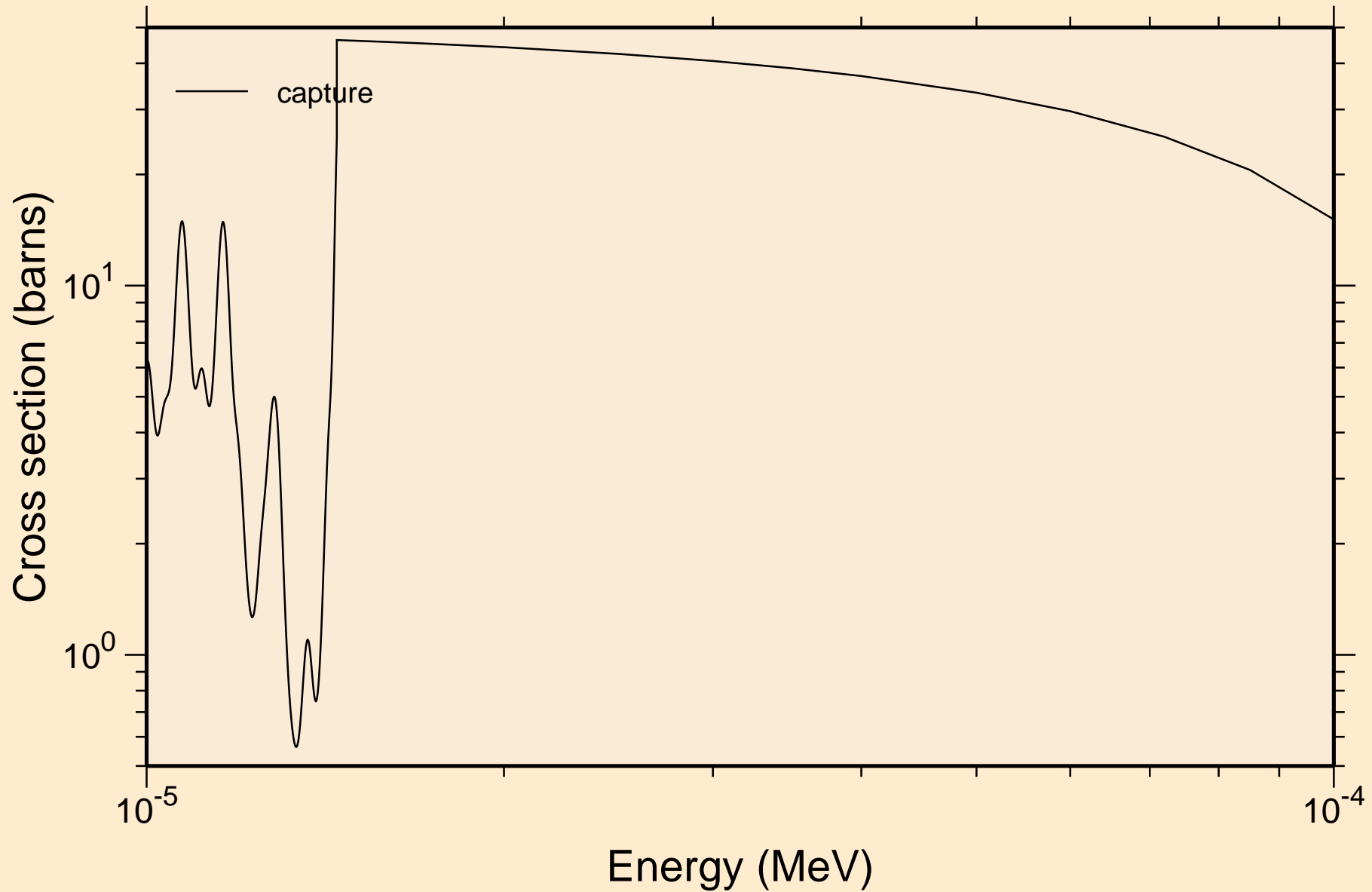

I118 NEUTRON ACER TENDL-2024 LIBRARY; T=293.6K  
resonance absorption cross sections

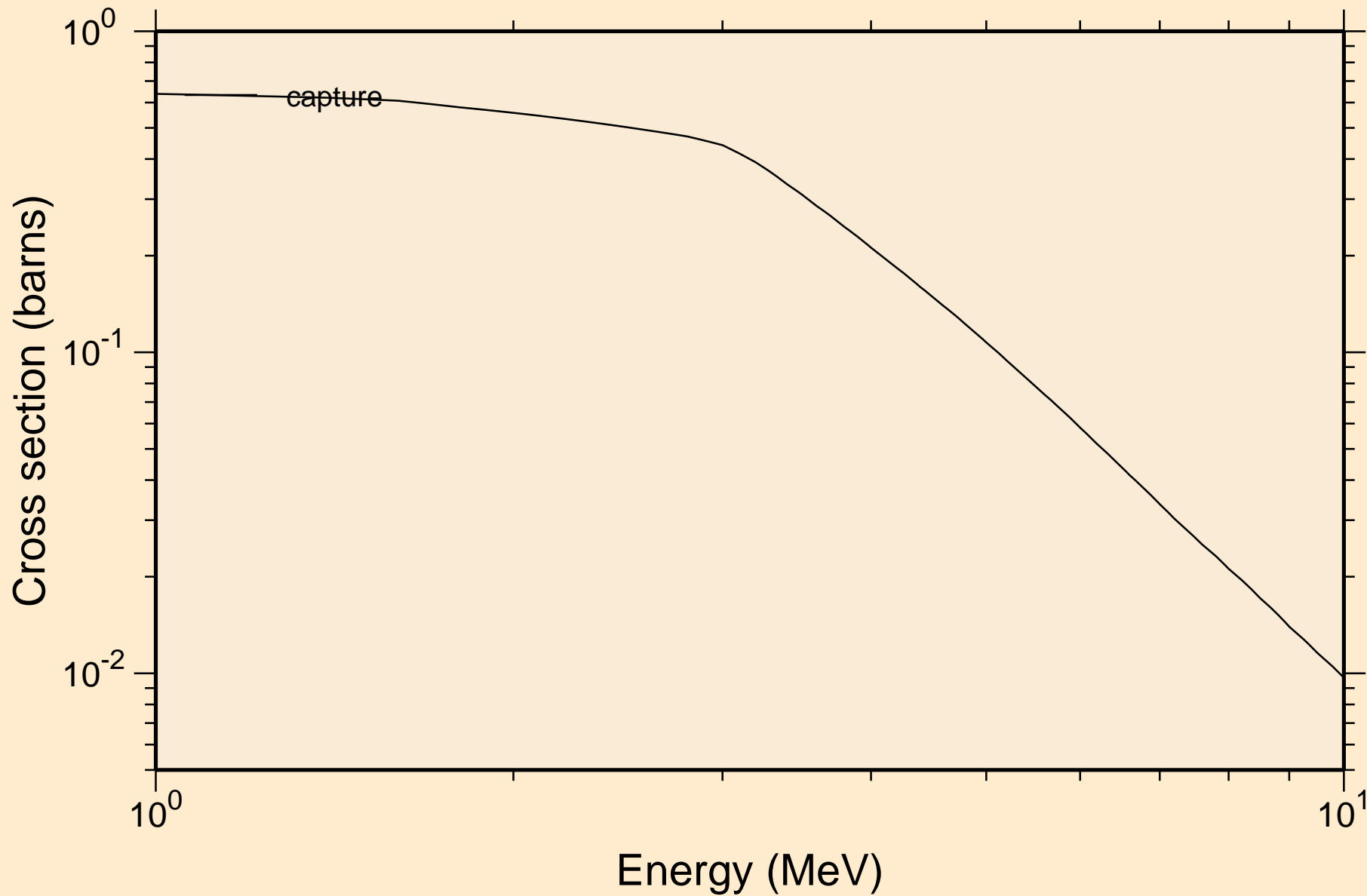

# I118 NEUTRON ACER TENDL-2024 LIBRARY; T=293.6K

## Heating

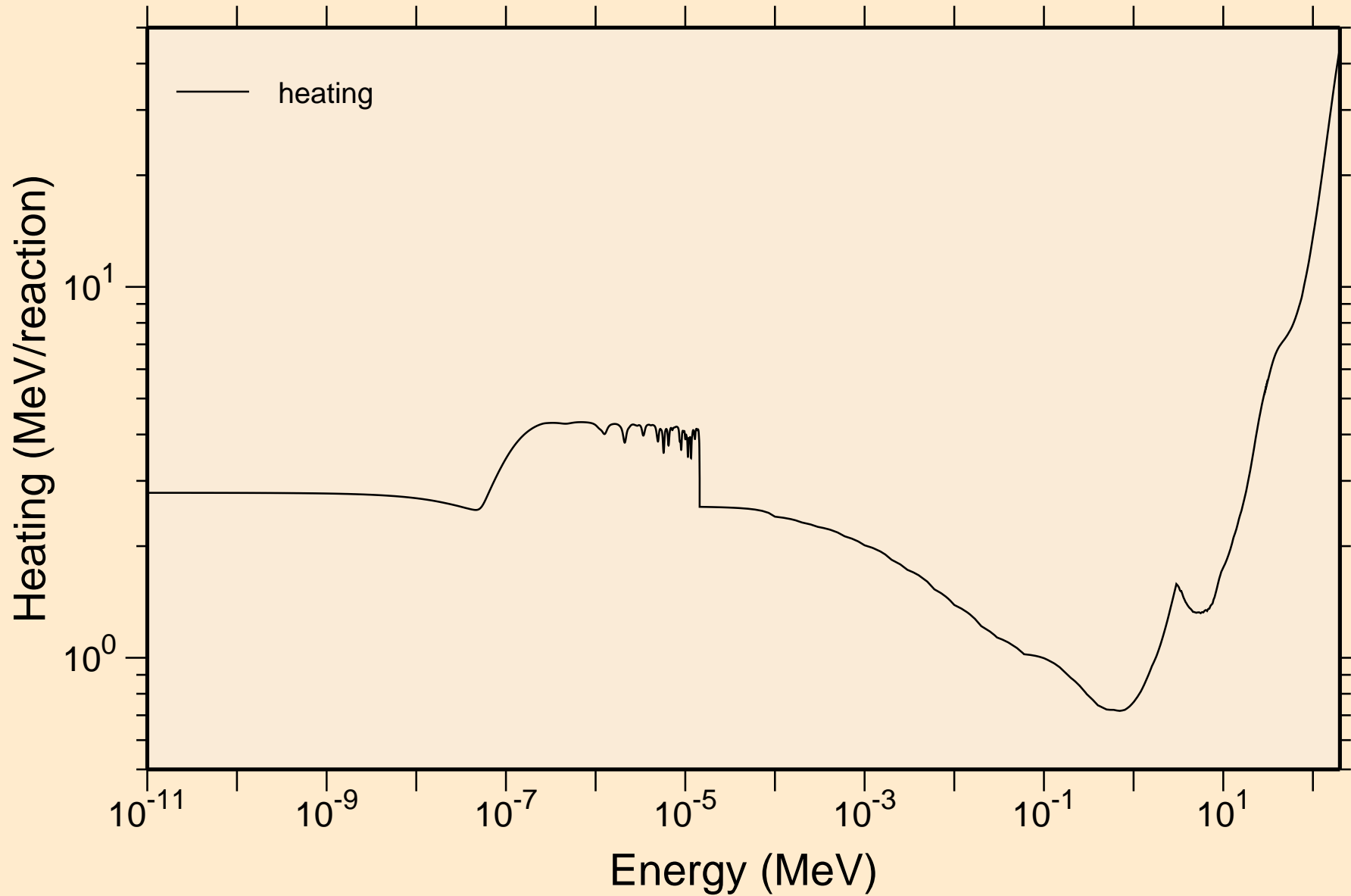

I118 NEUTRON ACER TENDL-2024 LIBRARY; T=293.6K  
Damage

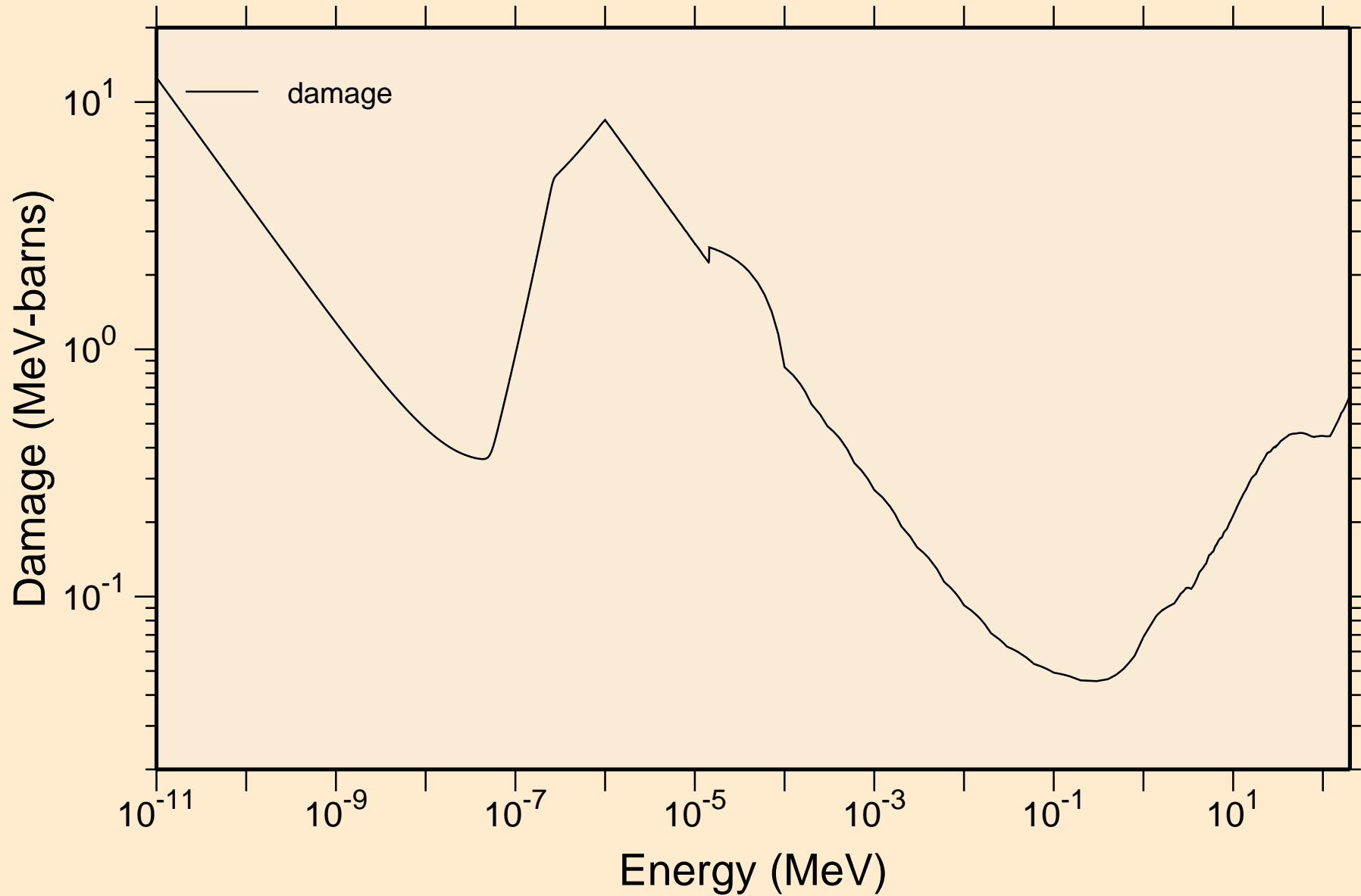

I118 NEUTRON ACER TENDL-2024 LIBRARY; T=293.6K  
Non-threshold reactions

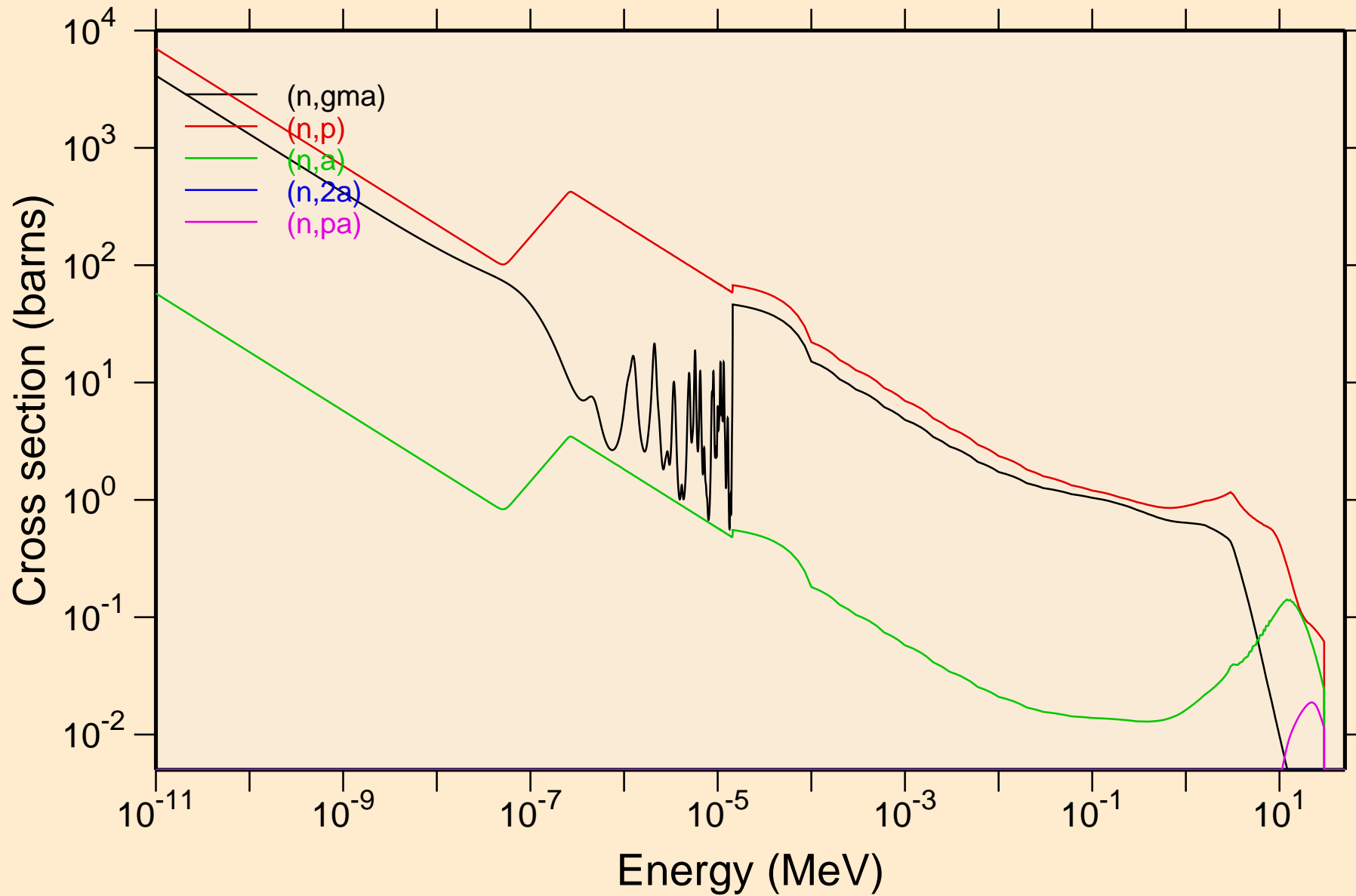

I118 NEUTRON ACER TENDL-2024 LIBRARY; T=293.6K  
Non-threshold reactions

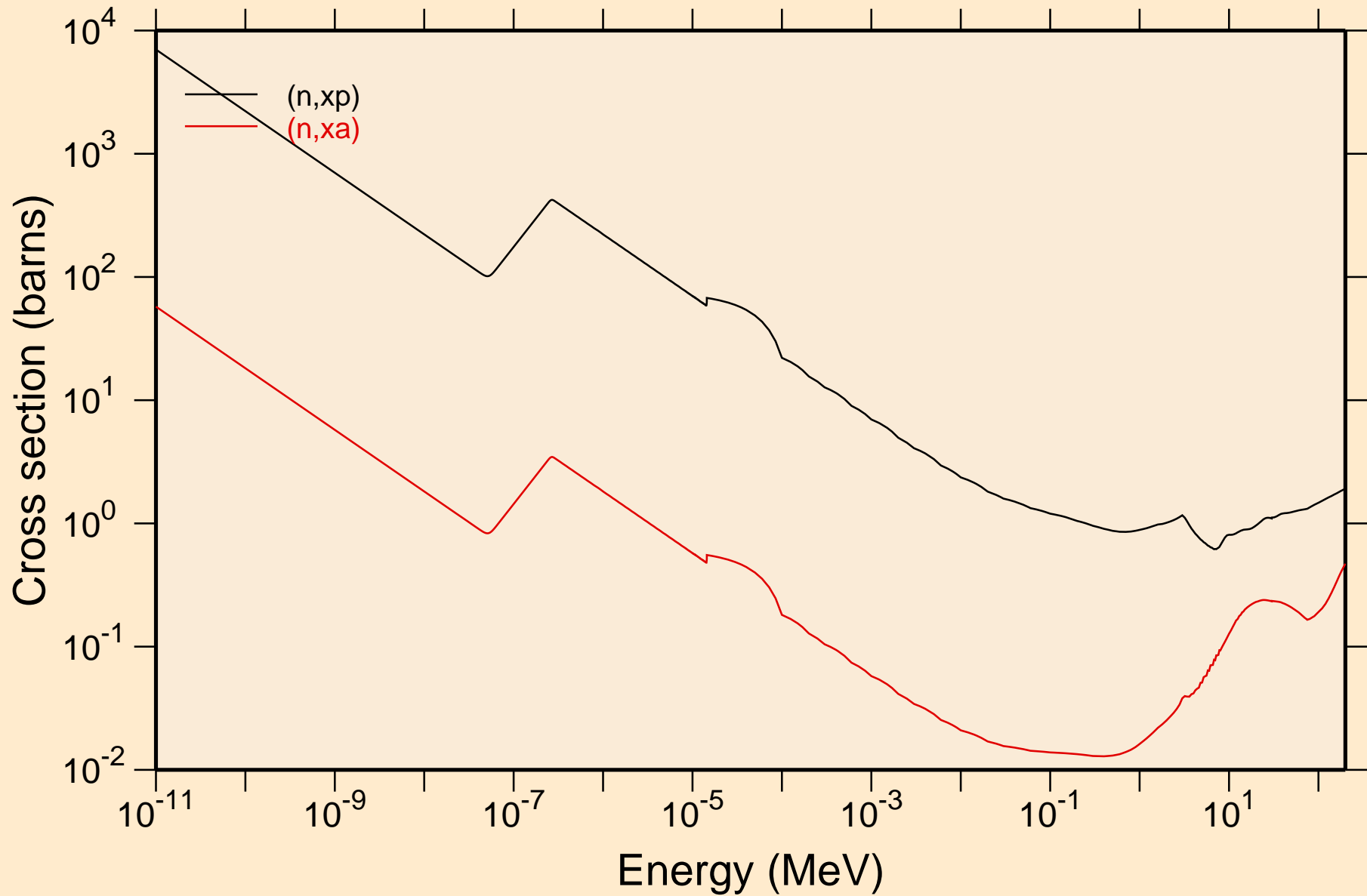

# I118 NEUTRON ACER TENDL-2024 LIBRARY; T=293.6K

## Principal cross sections

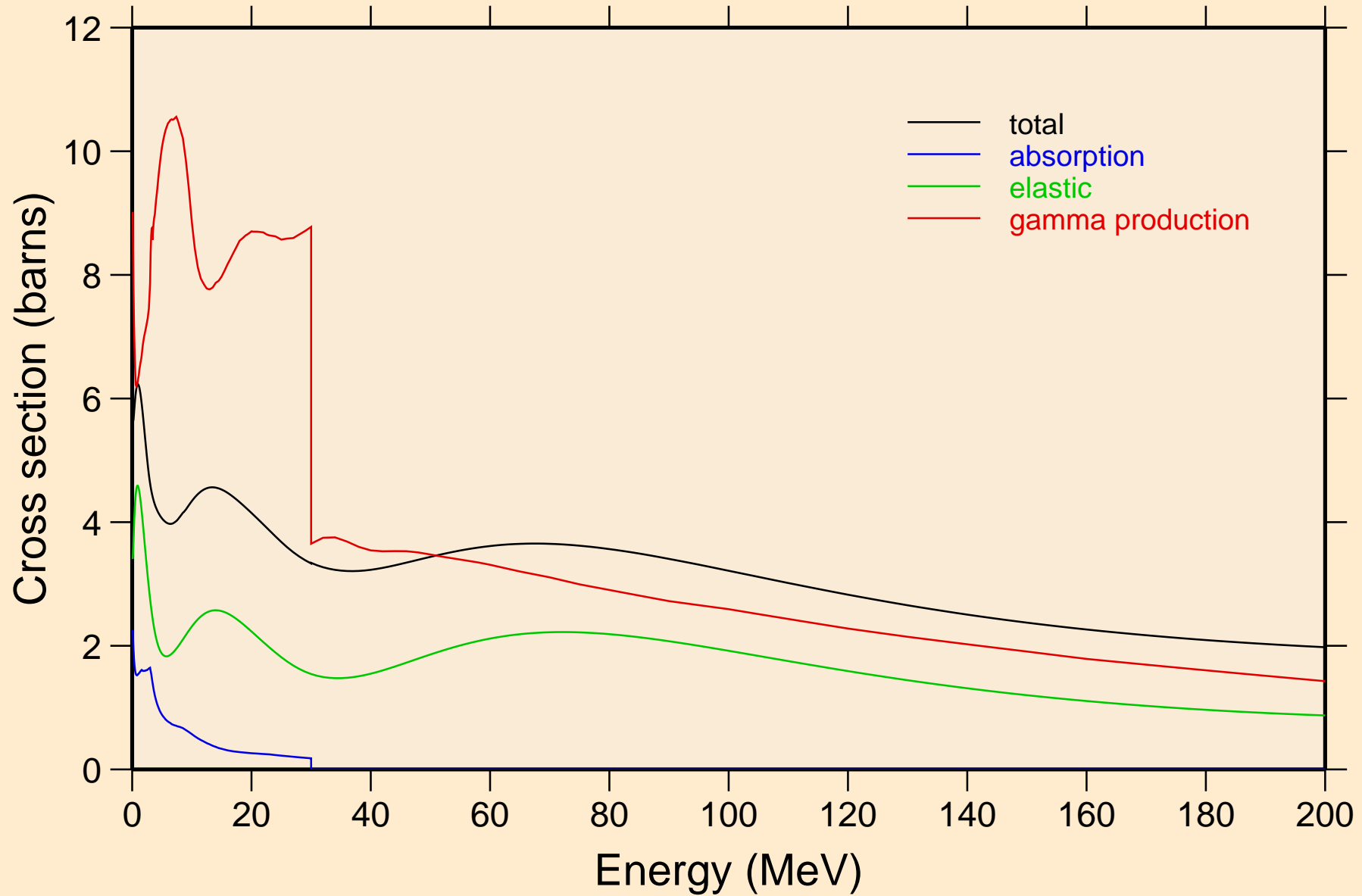

# I118 NEUTRON ACER TENDL-2024 LIBRARY; T=293.6K

## Heating

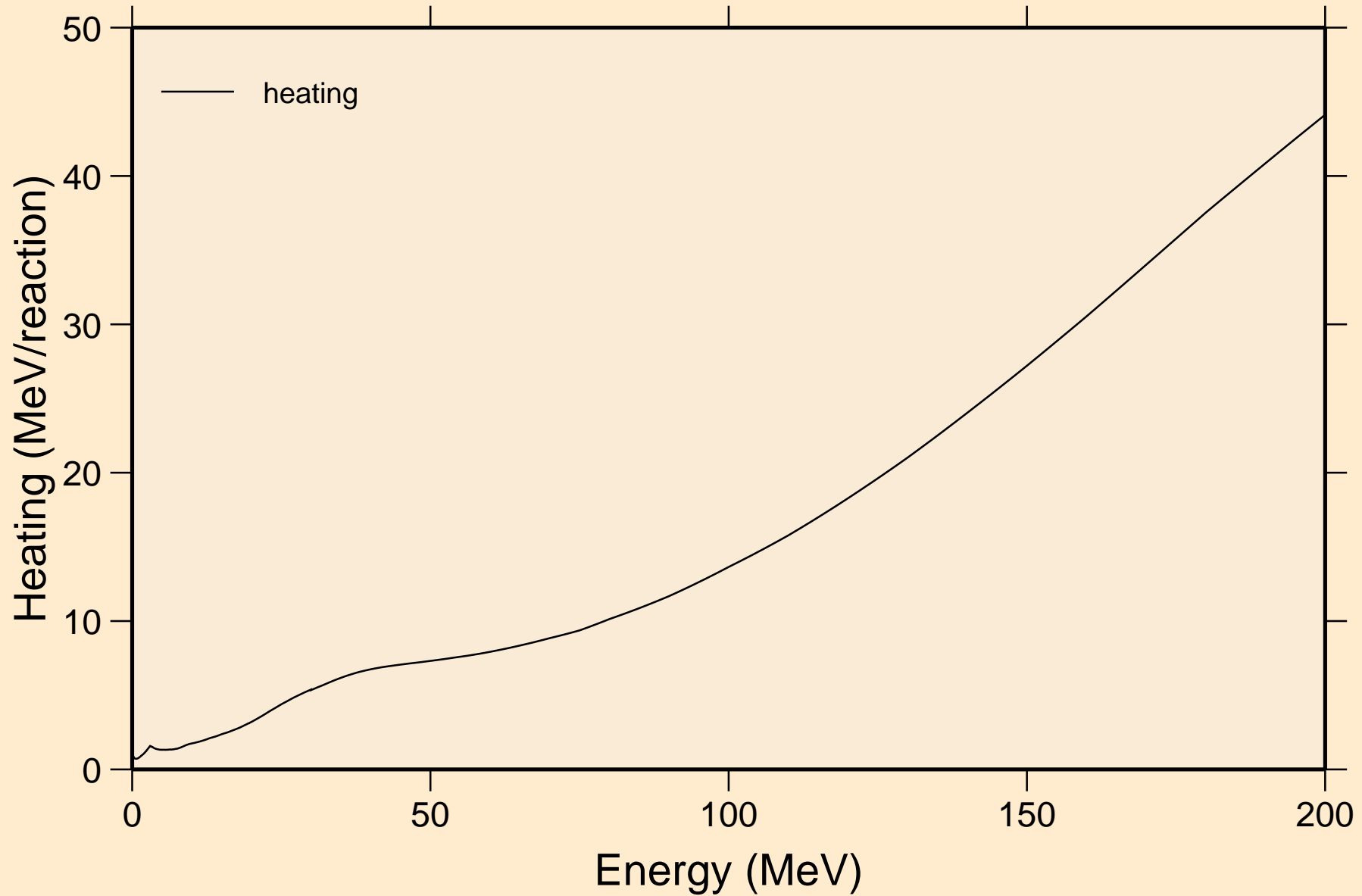

# I118 NEUTRON ACER TENDL-2024 LIBRARY; T=293.6K

## Damage

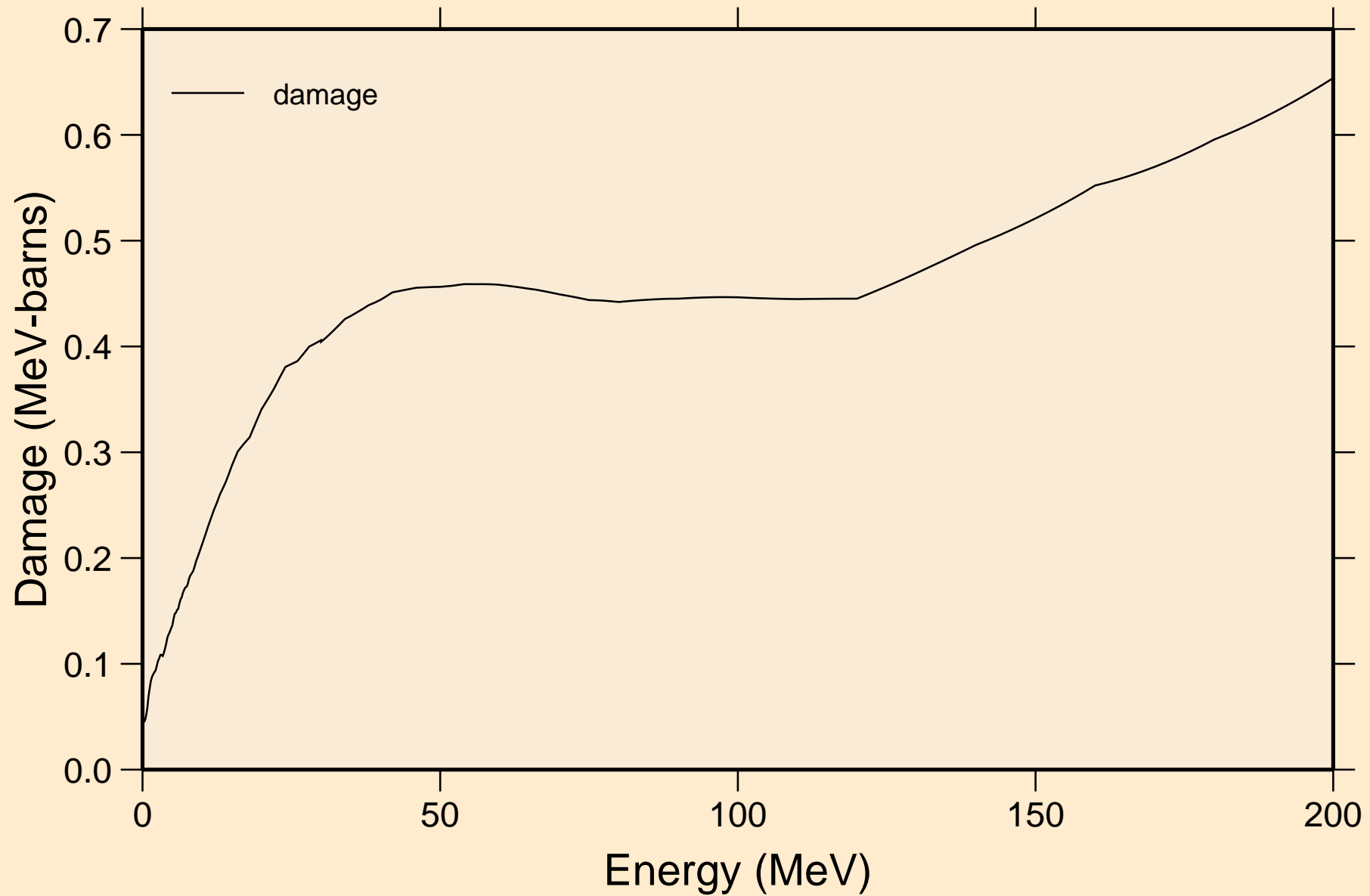

I118 NEUTRON ACER TENDL-2024 LIBRARY; T=293.6K  
Non-threshold reactions

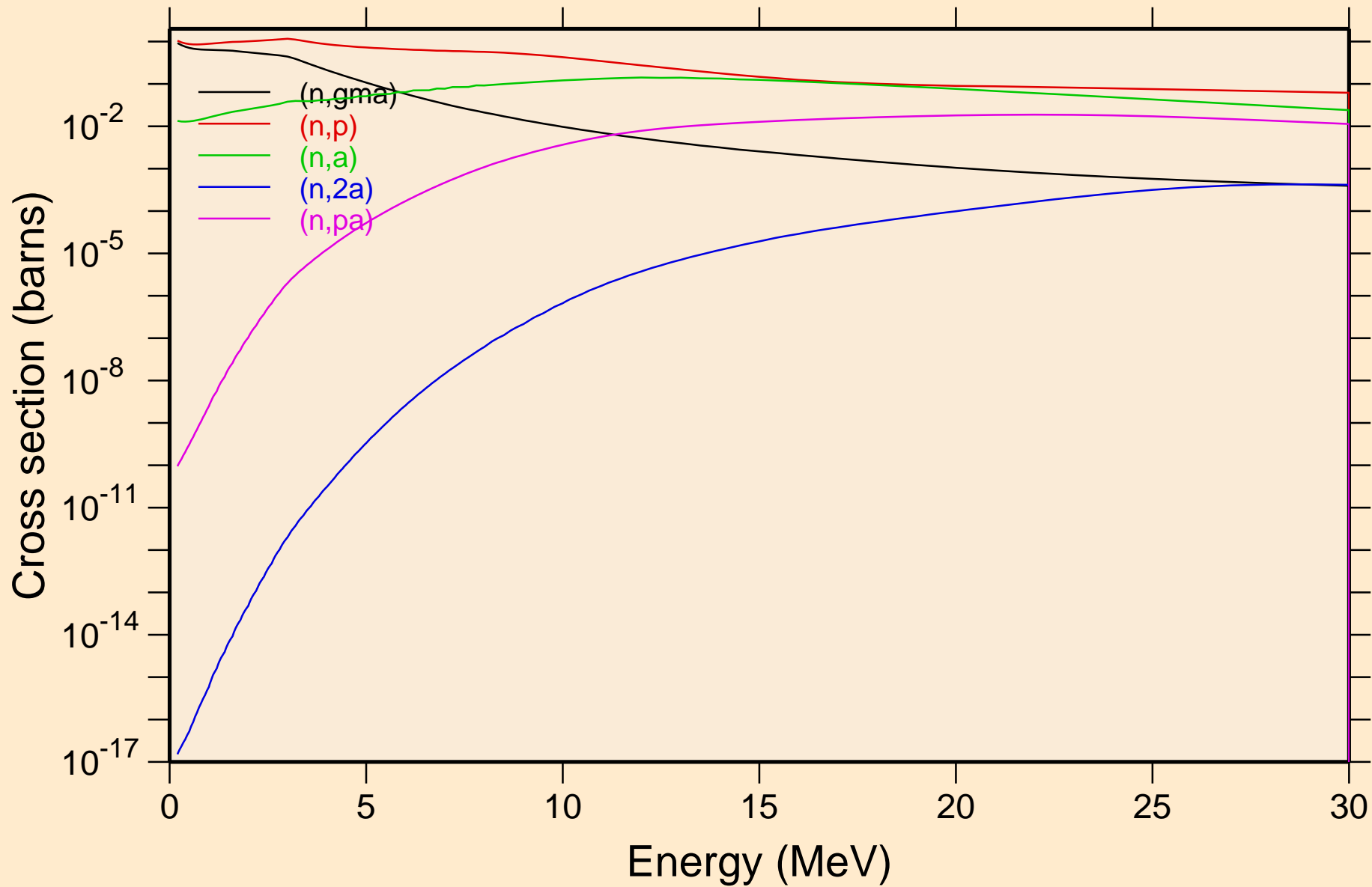

I118 NEUTRON ACER TENDL-2024 LIBRARY; T=293.6K  
Non-threshold reactions

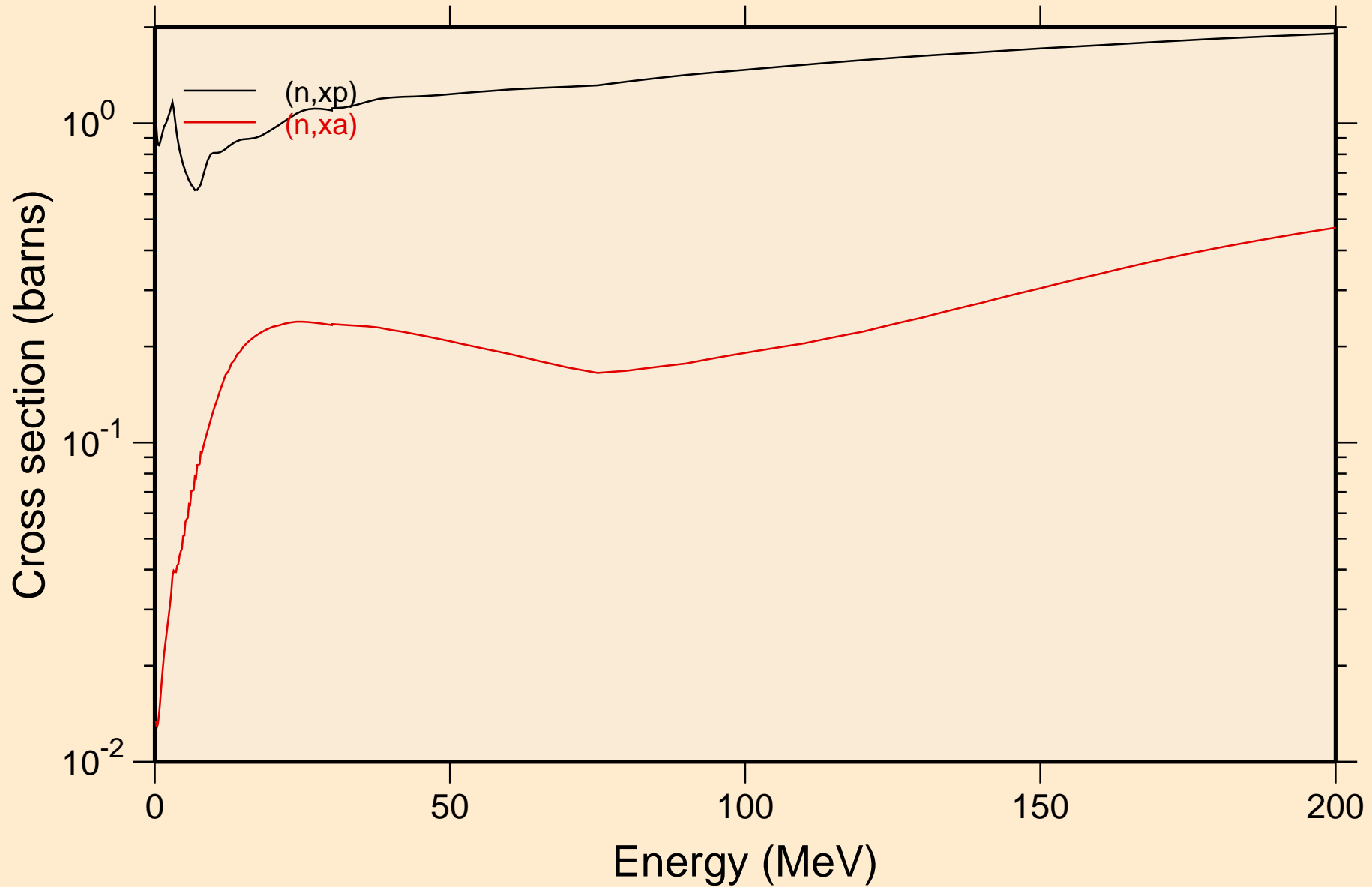

I118 NEUTRON ACER TENDL-2024 LIBRARY; T=293.6K  
Inelastic levels

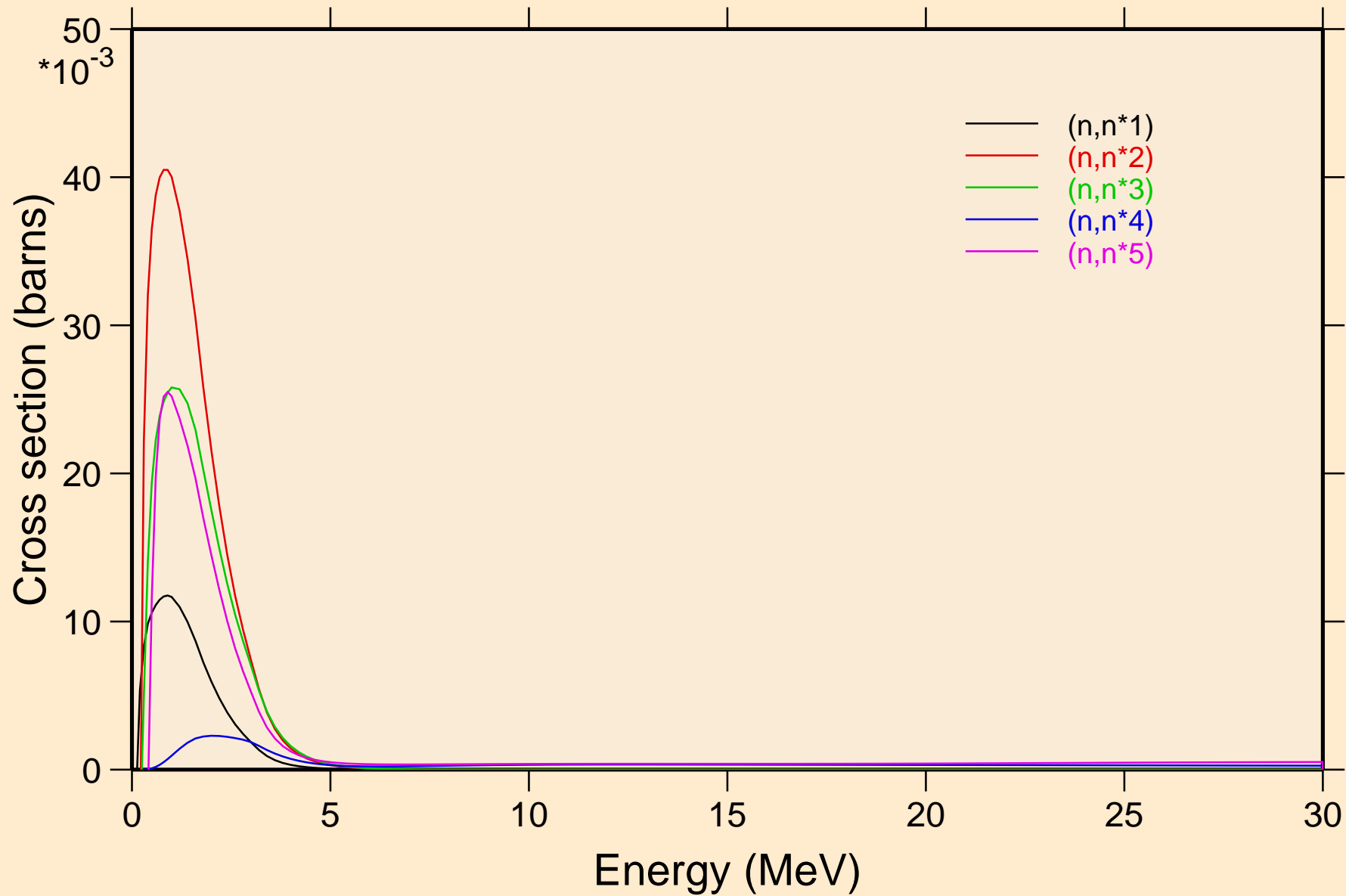

I118 NEUTRON ACER TENDL-2024 LIBRARY; T=293.6K  
Inelastic levels

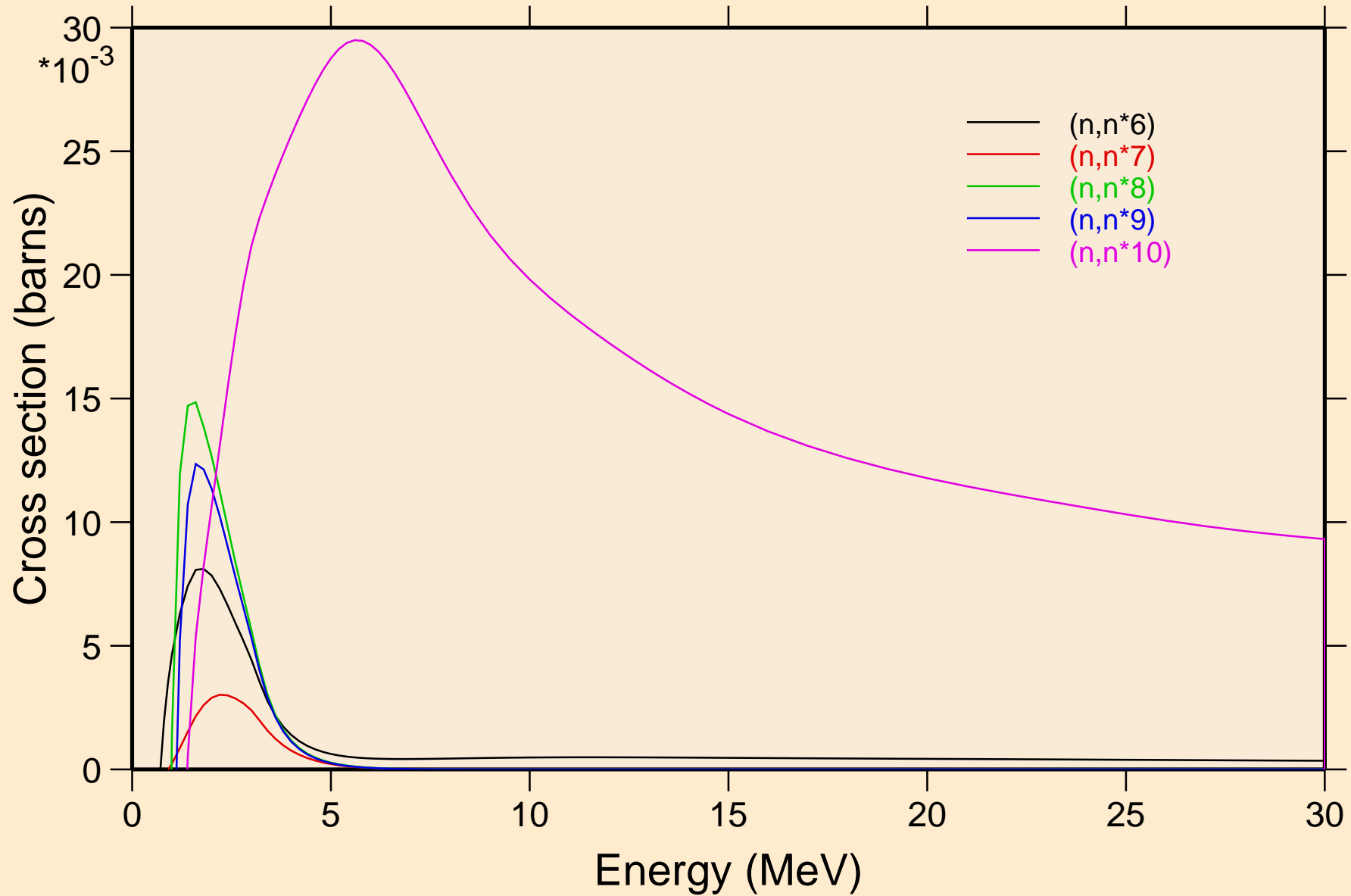

I118 NEUTRON ACER TENDL-2024 LIBRARY; T=293.6K  
Inelastic levels

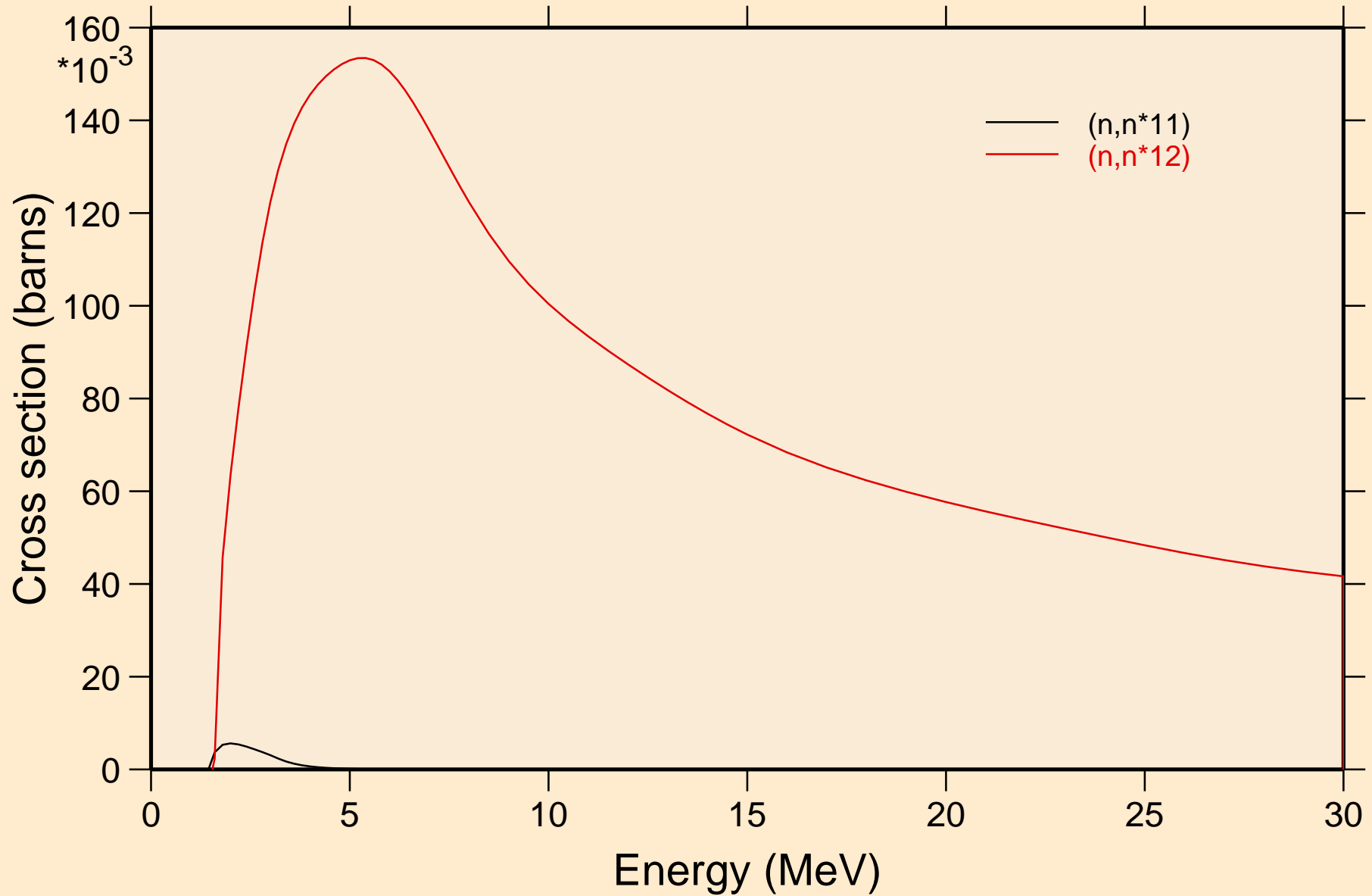

# I118 NEUTRON ACER TENDL-2024 LIBRARY; T=293.6K

## Threshold reactions

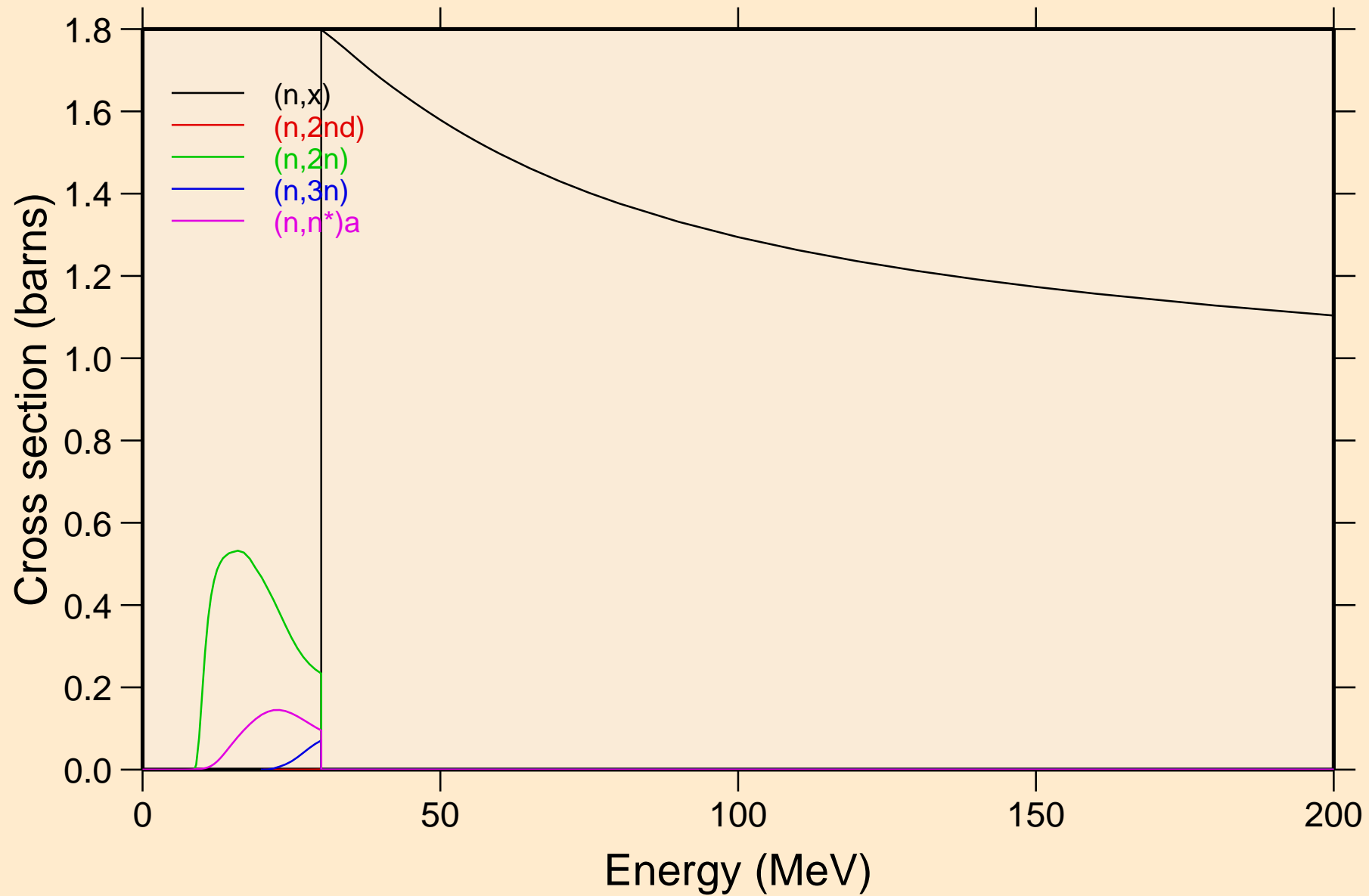

# I118 NEUTRON ACER TENDL-2024 LIBRARY; T=293.6K

## Threshold reactions

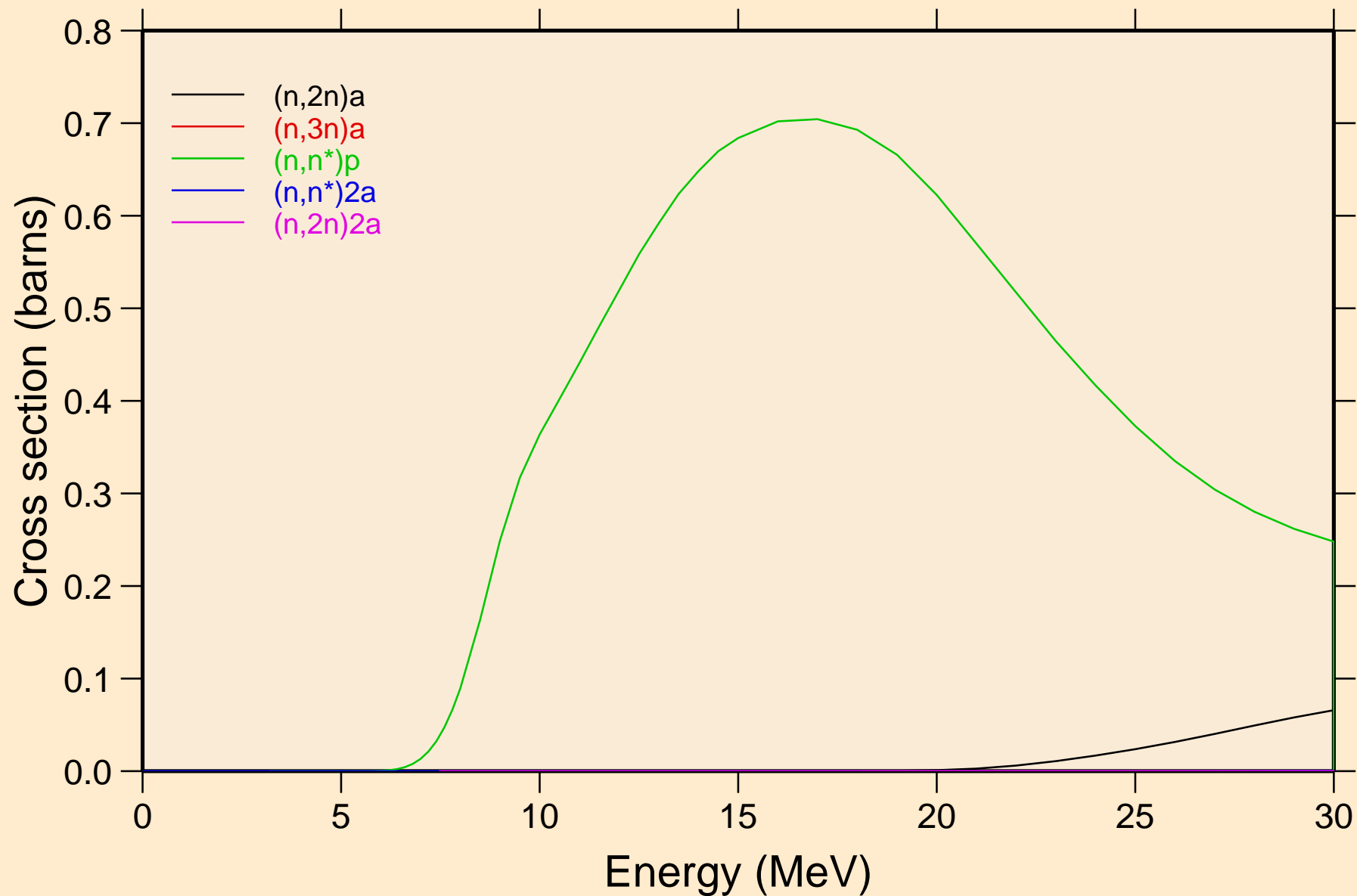

# I118 NEUTRON ACER TENDL-2024 LIBRARY; T=293.6K

## Threshold reactions

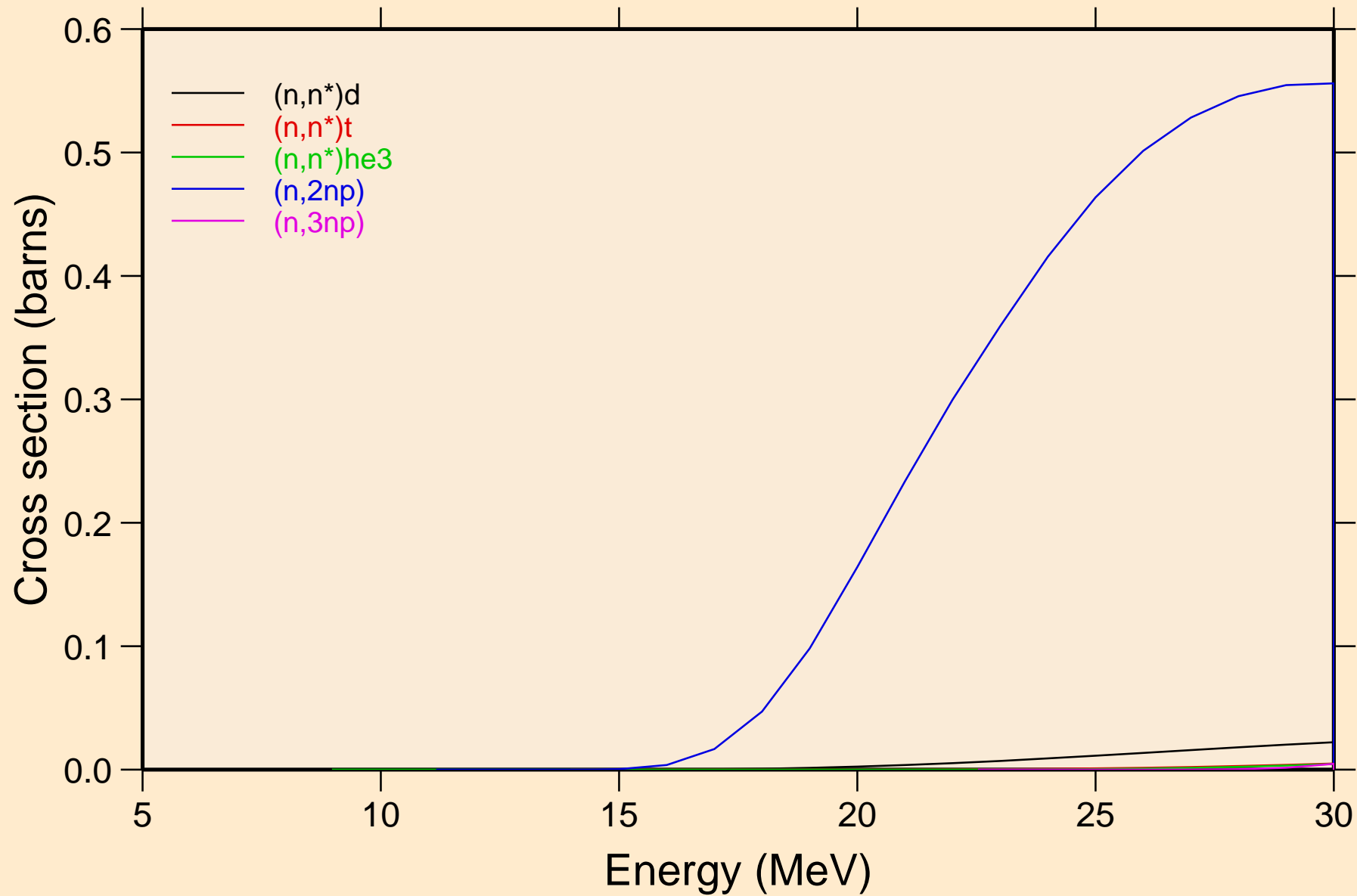

# I118 NEUTRON ACER TENDL-2024 LIBRARY; T=293.6K

## Threshold reactions

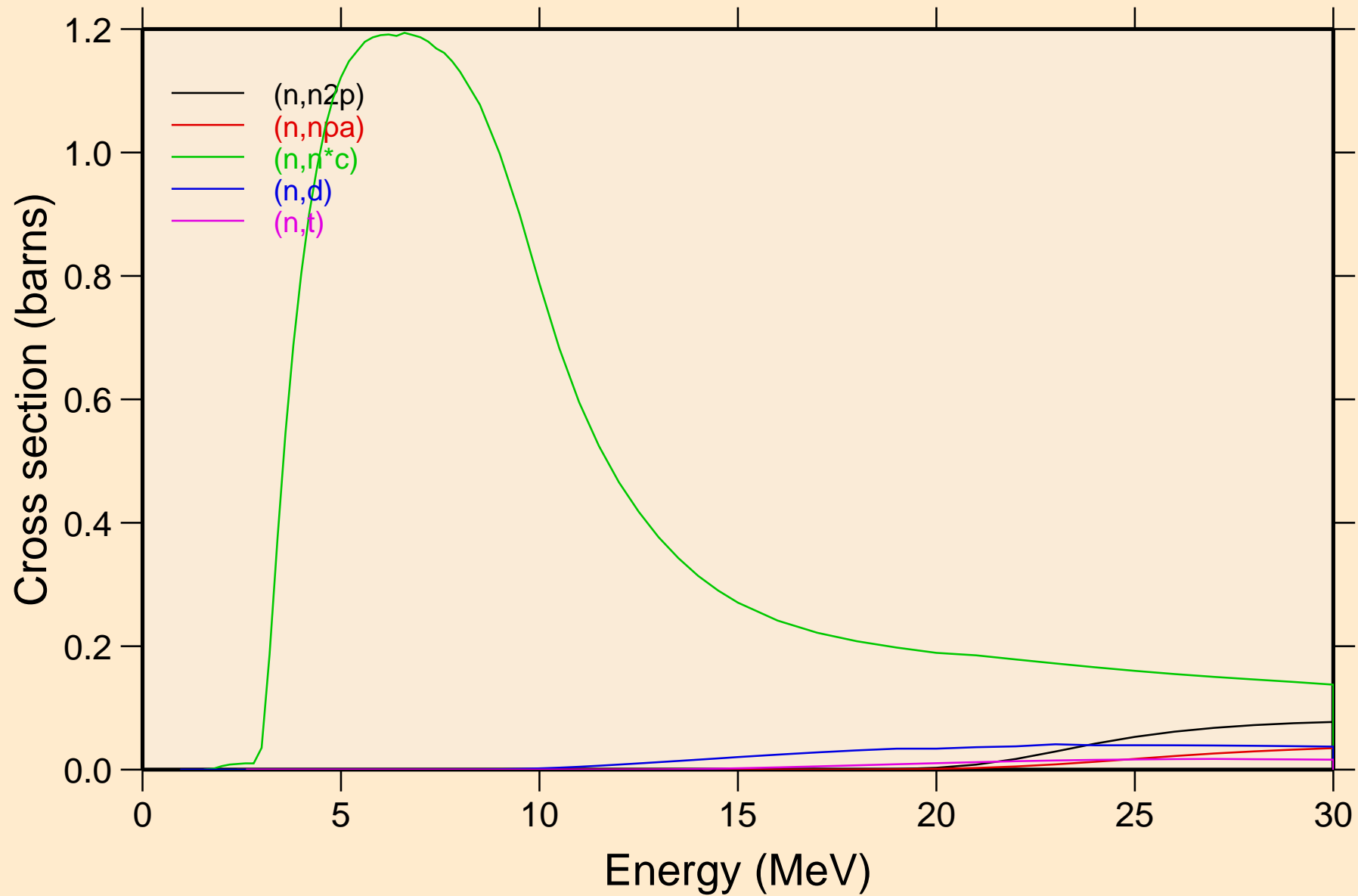

I118 NEUTRON ACER TENDL-2024 LIBRARY; T=293.6K  
Threshold reactions

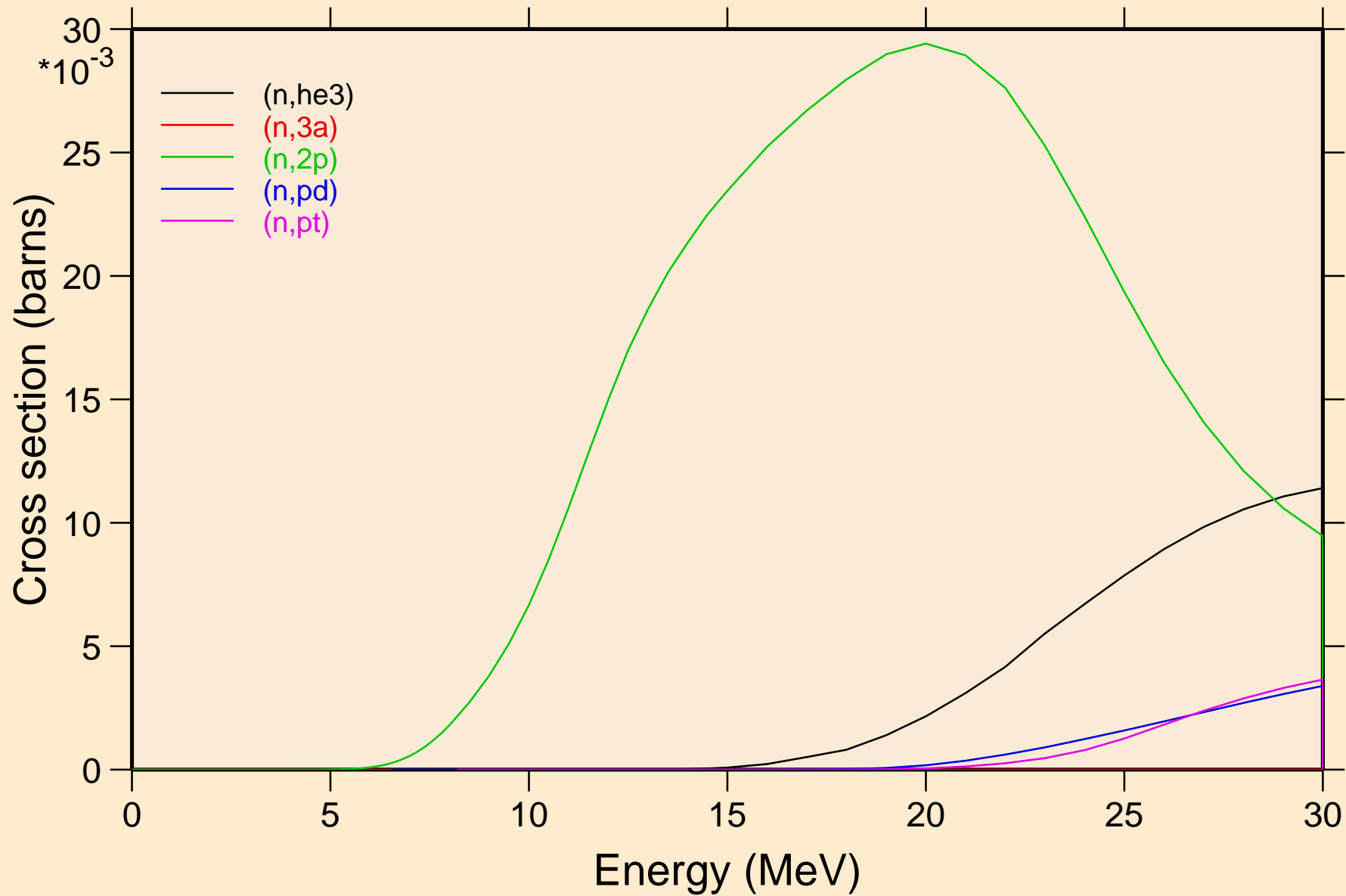

I118 NEUTRON ACER TENDL-2024 LIBRARY; T=293.6K  
Threshold reactions

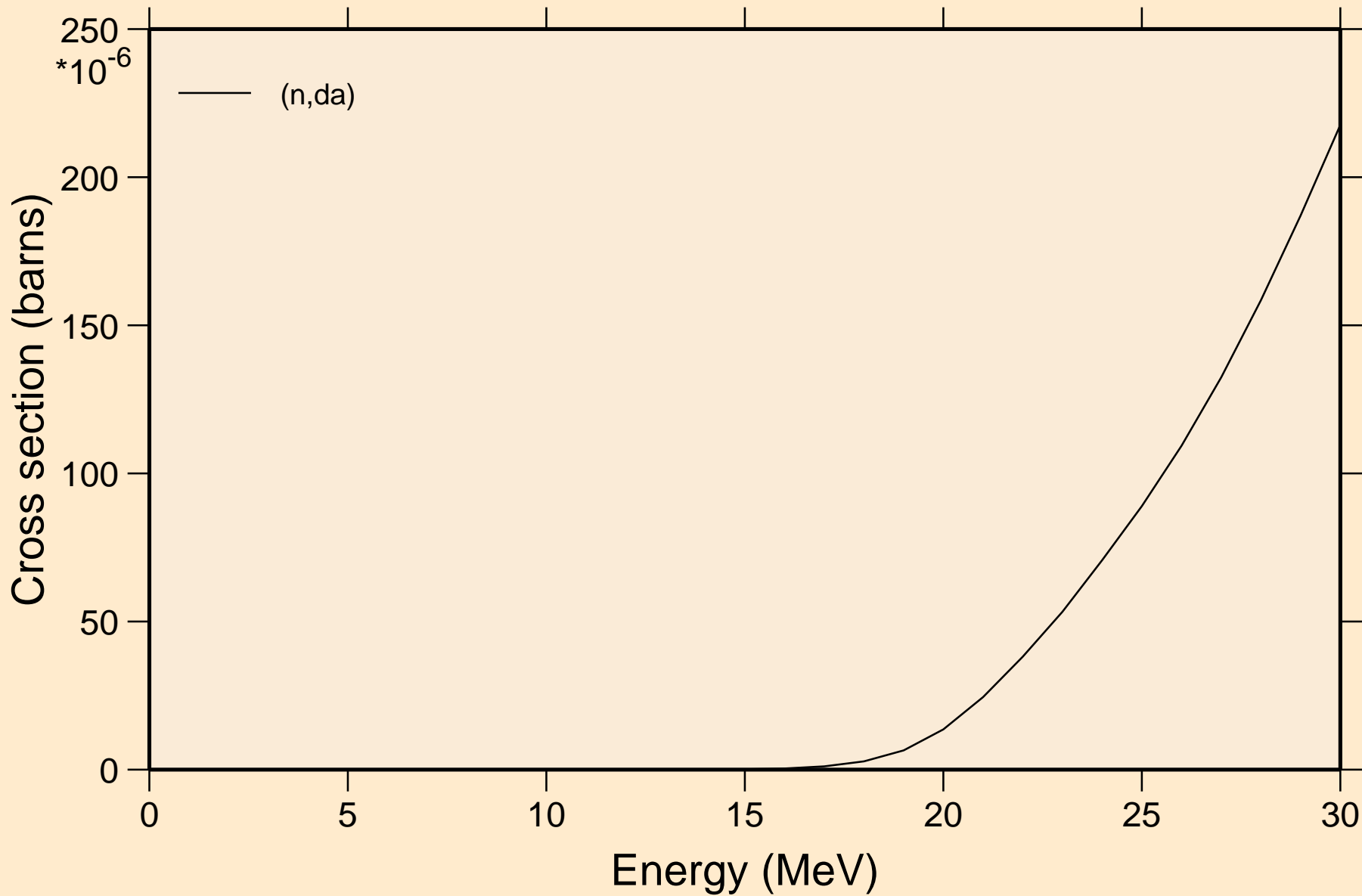

I118 NEUTRON ACER TENDL-2024 LIBRARY; T=293.6K  
Threshold reactions

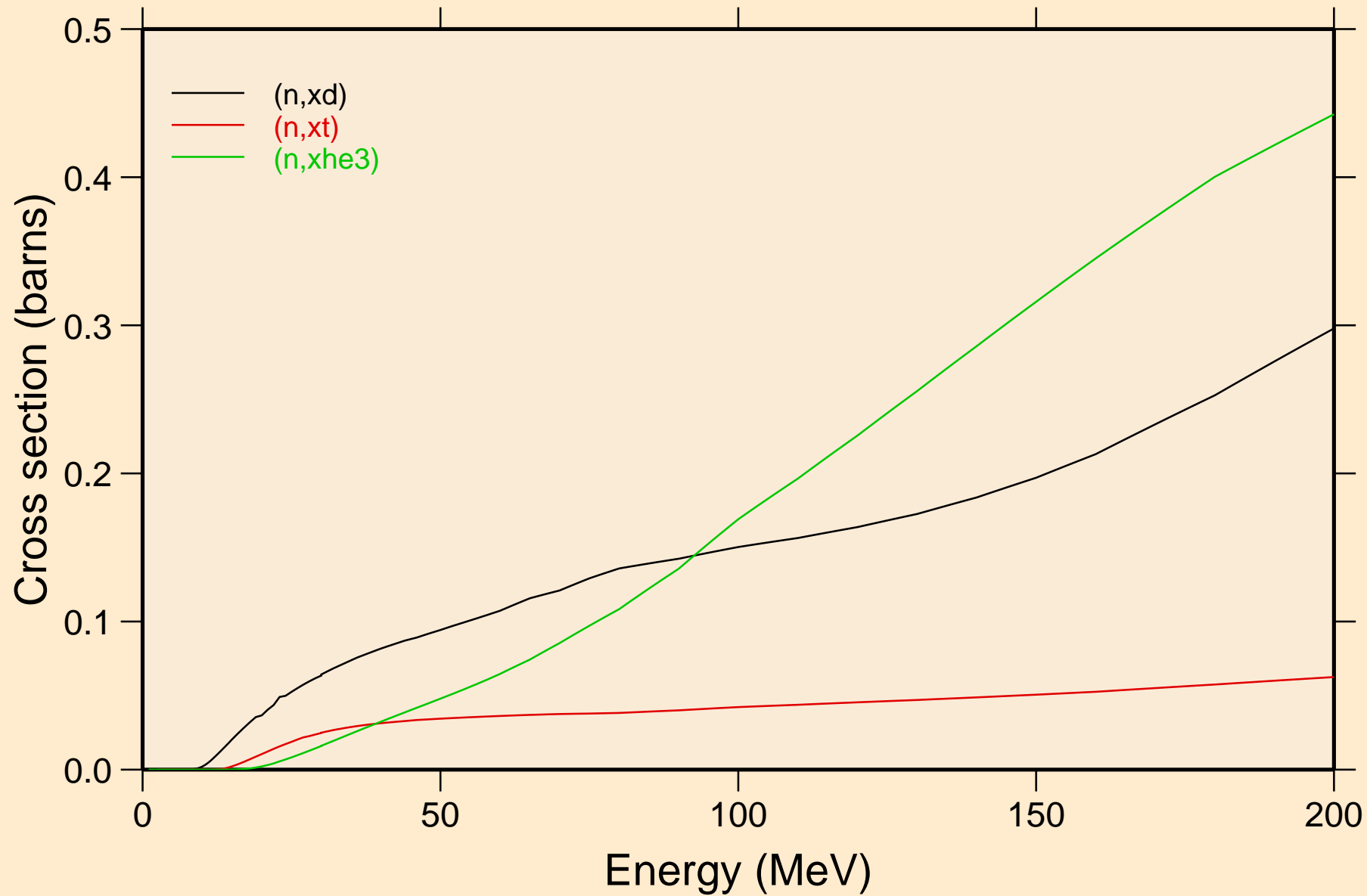

I118 NEUTRON ACER TENDL-2024 LIBRARY; T=293.6K  
angular distribution for elastic

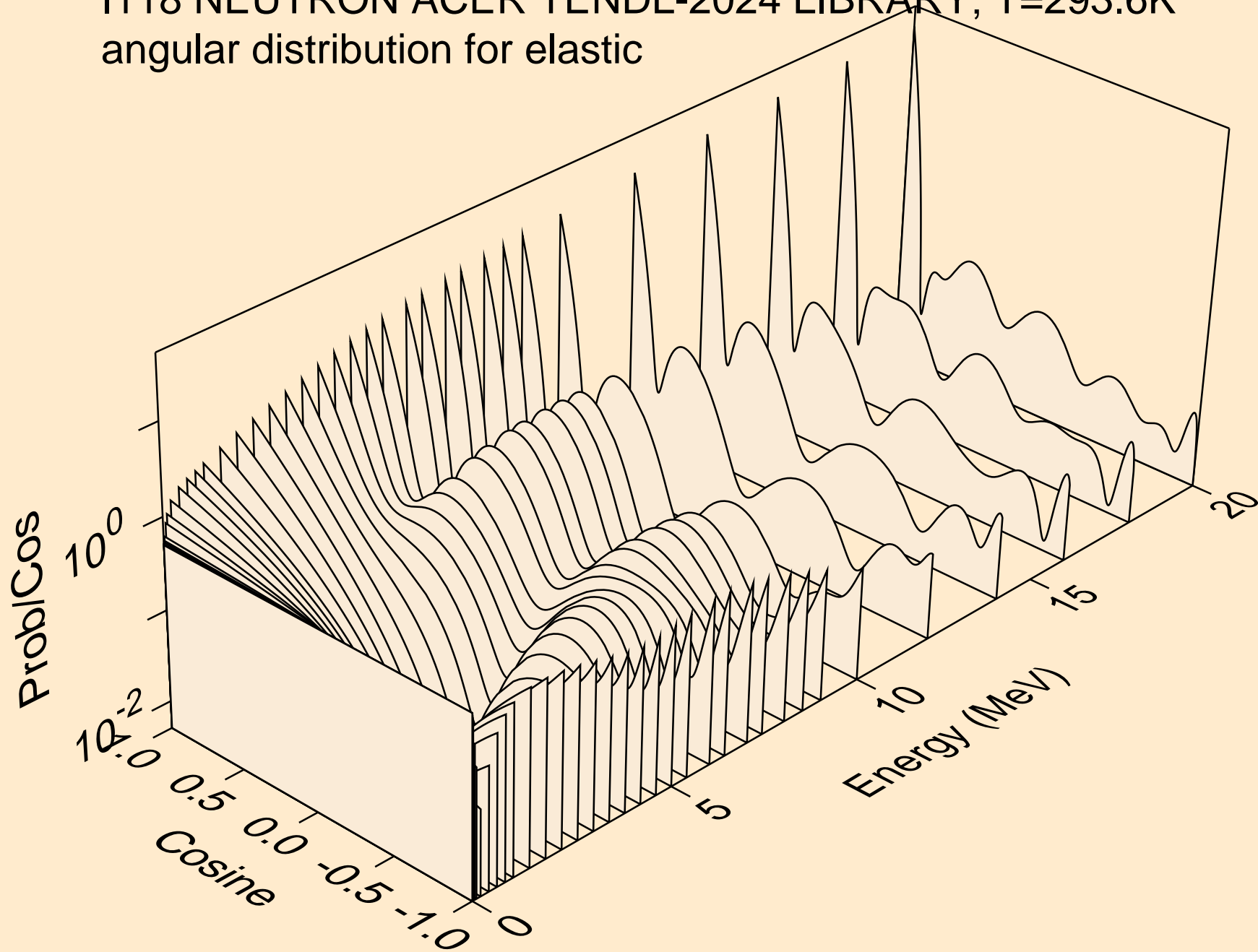

I118 NEUTRON ACER TENDL-2024 LIBRARY; T=293.6K  
angular distribution for elastic

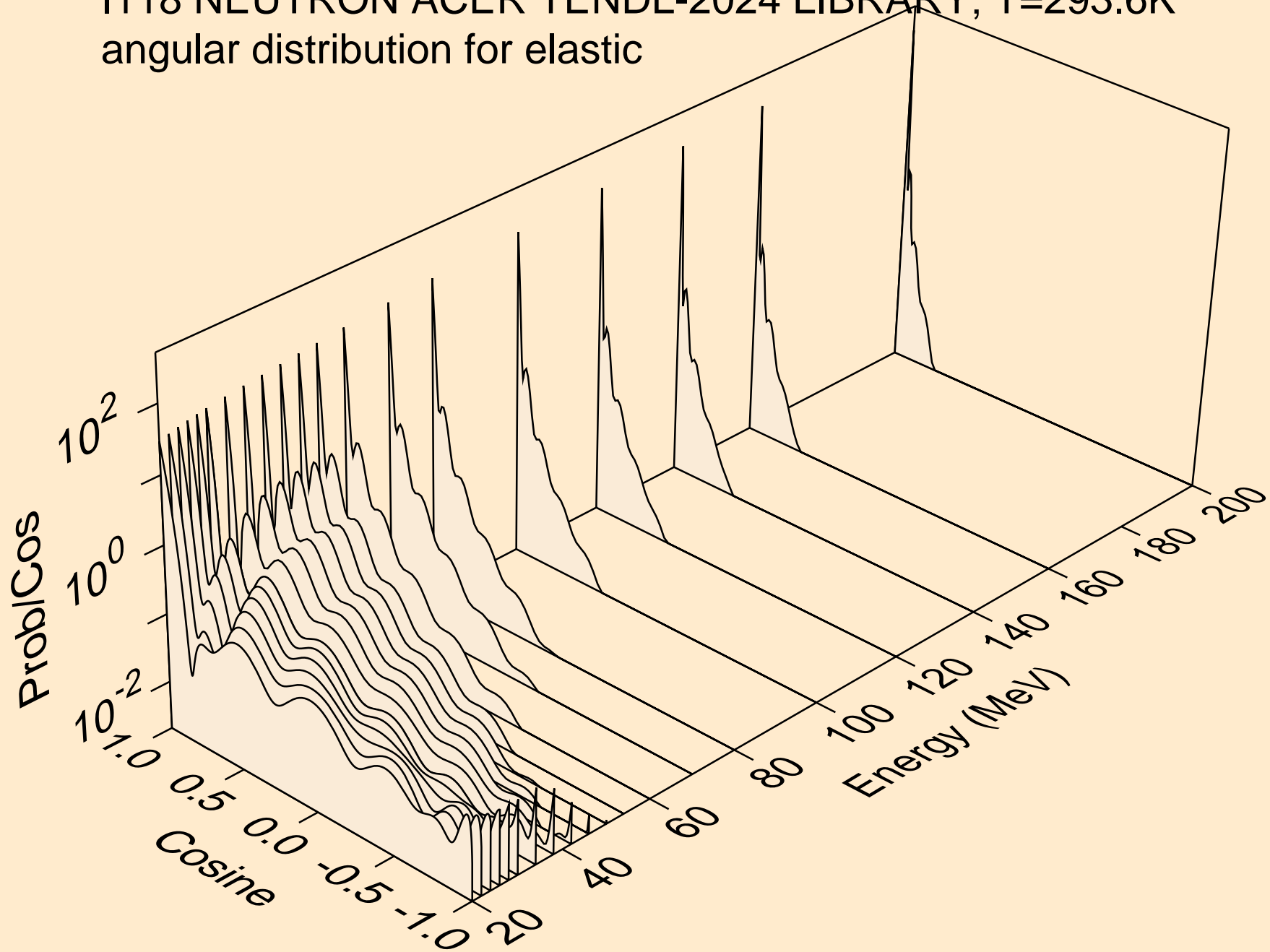

I118 NEUTRON ACER TENDL-2024 LIBRARY; T=293.6K  
angular distribution for (n,n\*1)

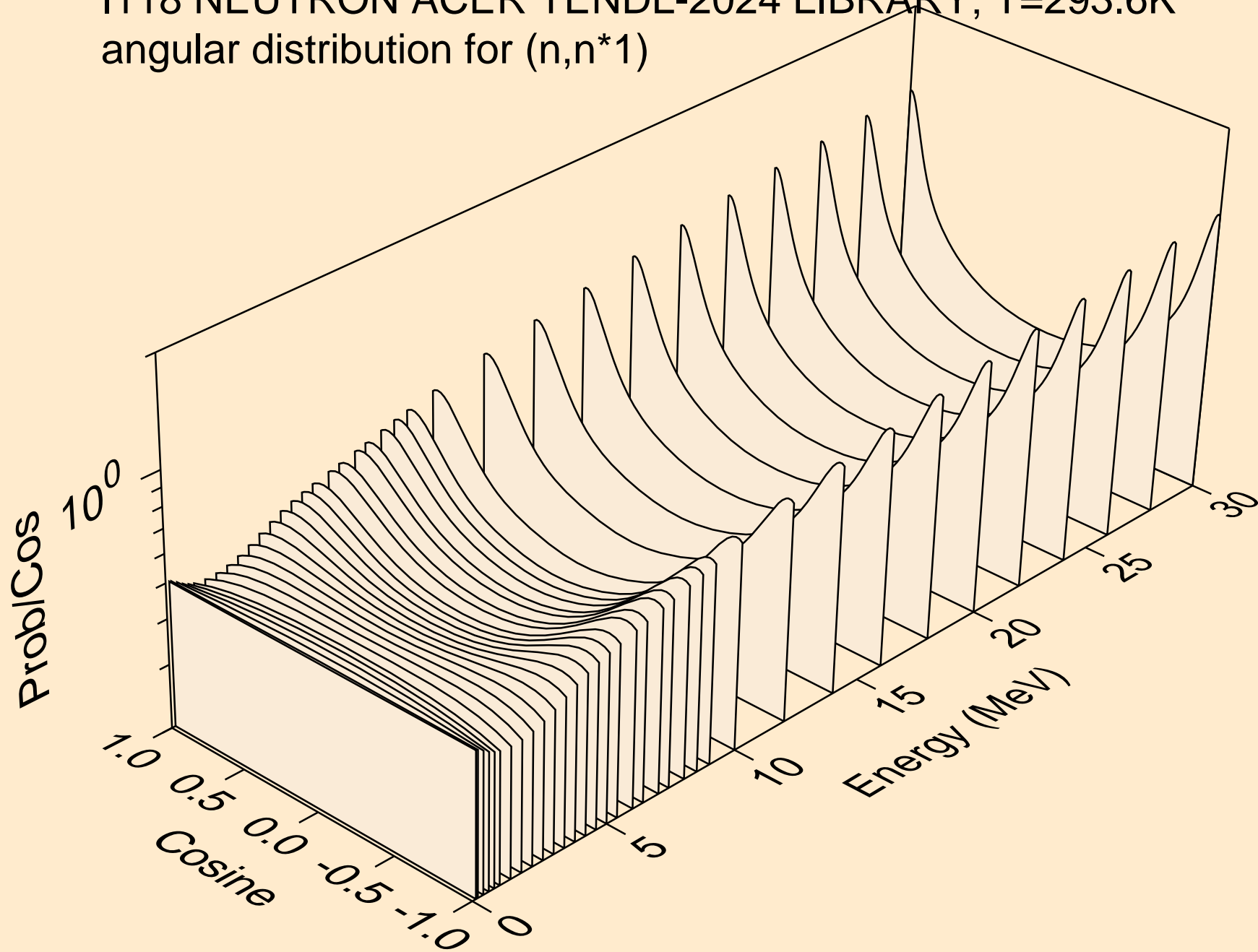

I118 NEUTRON ACER TENDL-2024 LIBRARY; T=293.6K  
angular distribution for (n,n\*2)

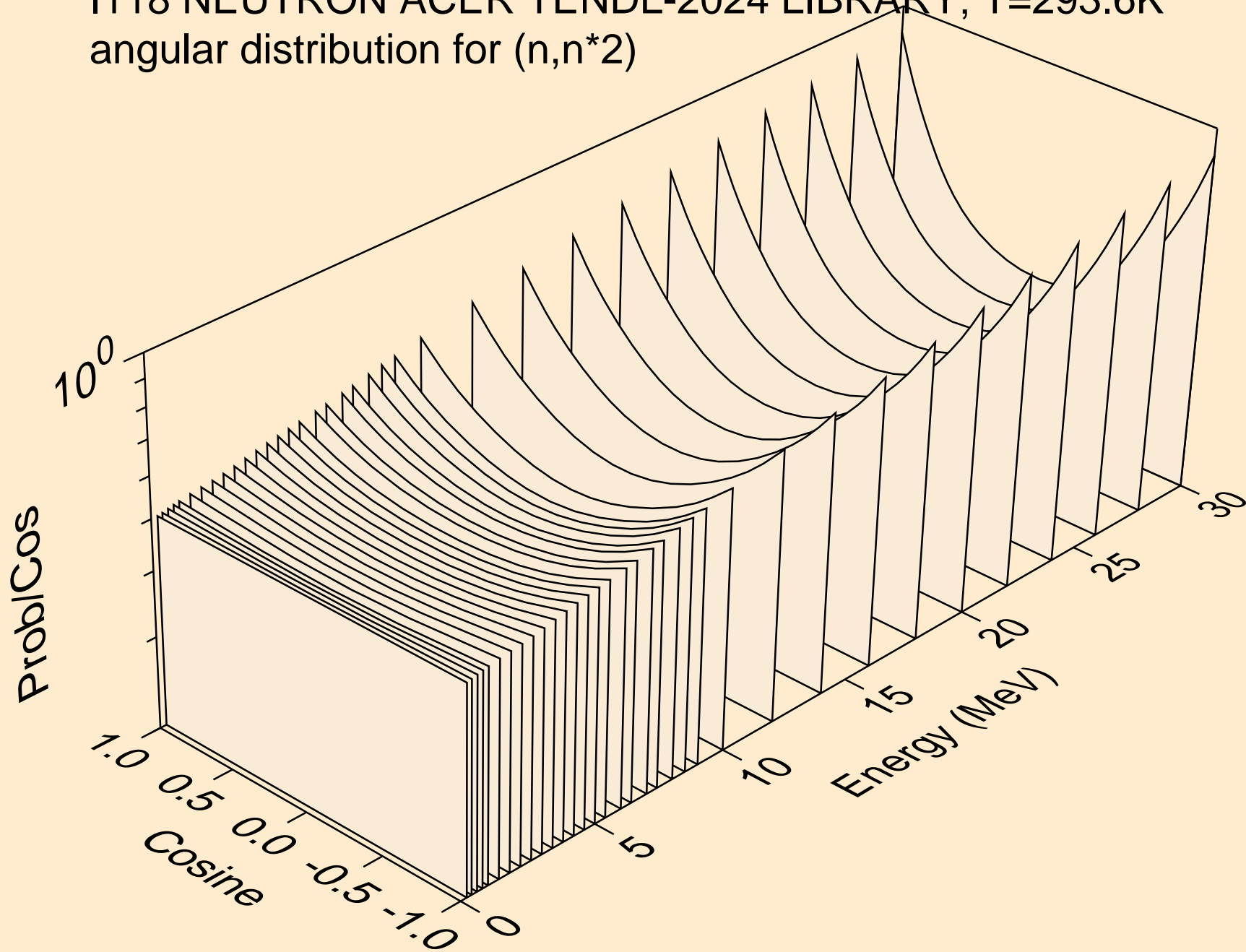

I118 NEUTRON ACER TENDL-2024 LIBRARY; T=293.6K  
angular distribution for (n,n\*3)

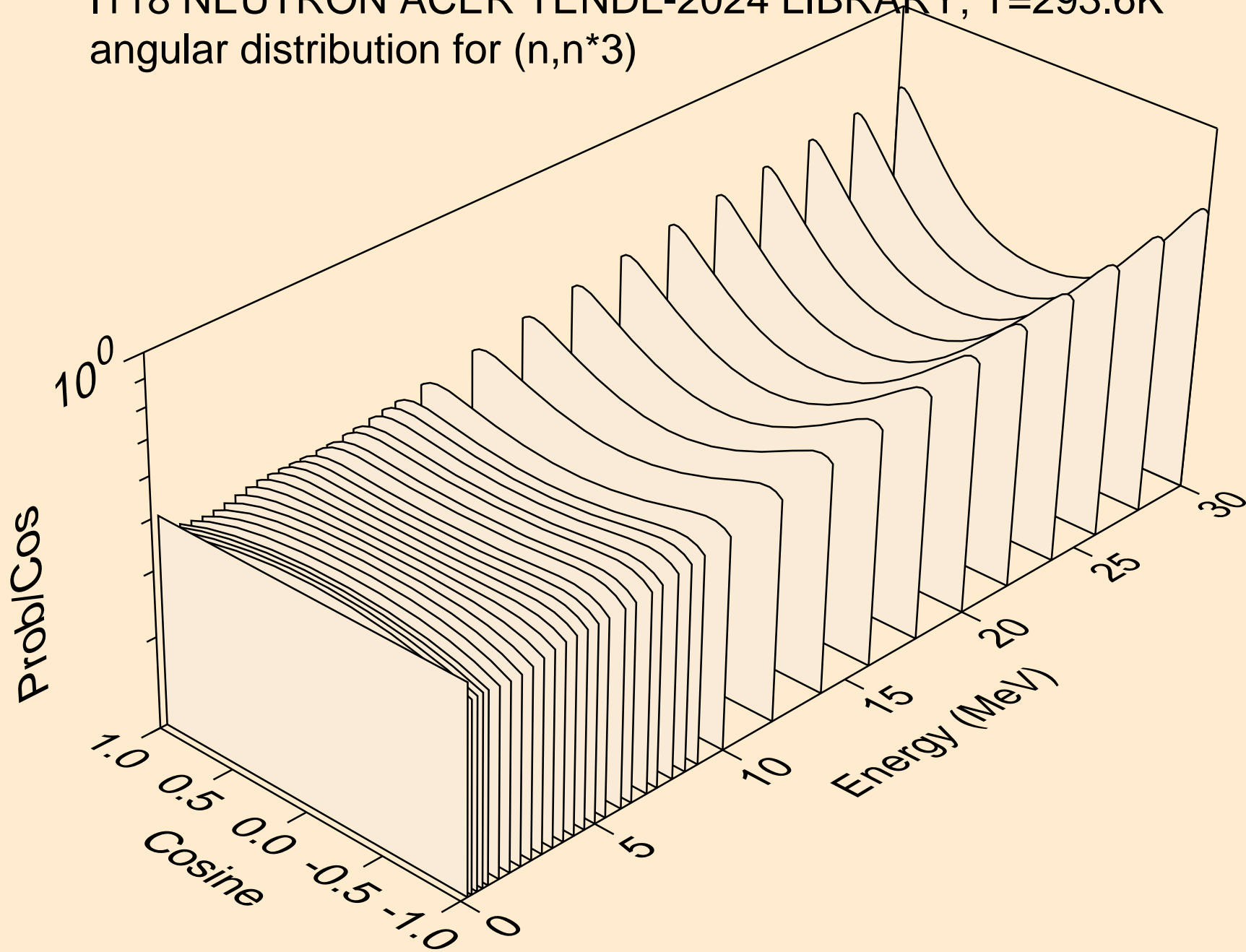

I118 NEUTRON ACER TENDL-2024 LIBRARY; T=293.6K  
angular distribution for (n,n\*4)

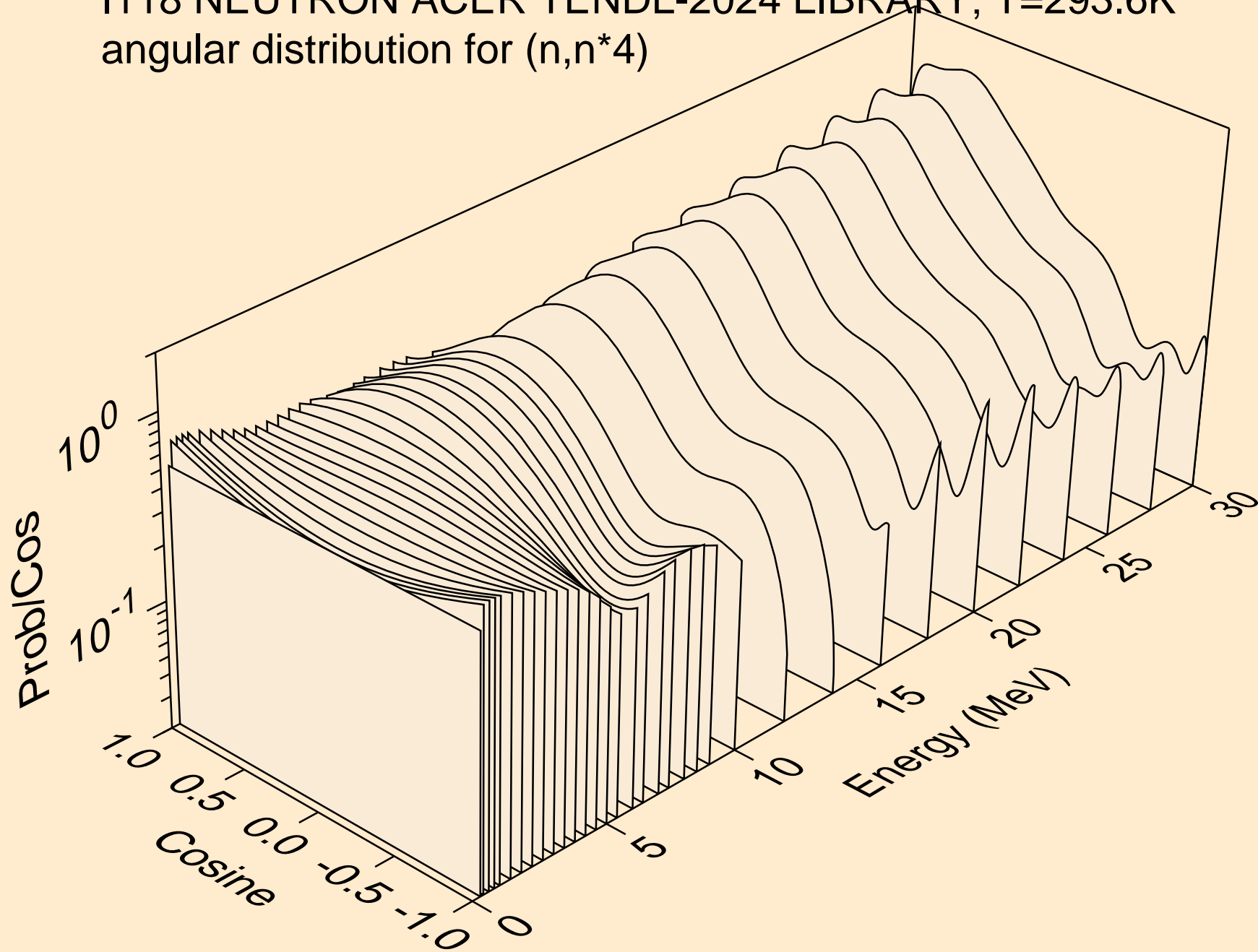

I118 NEUTRON ACER TENDL-2024 LIBRARY; T=293.6K  
angular distribution for (n,n\*5)

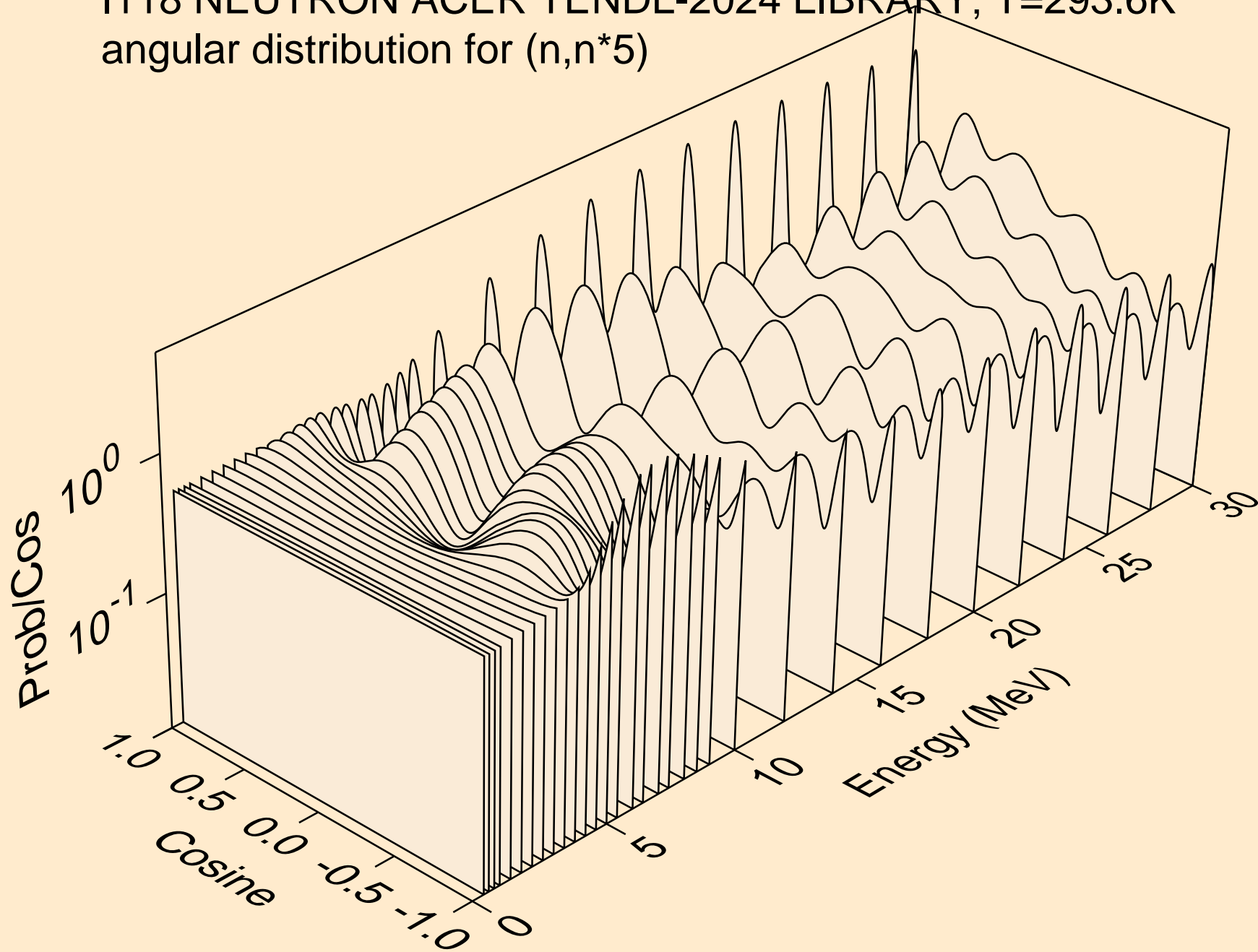

I118 NEUTRON ACER TENDL-2024 LIBRARY; T=293.6K  
angular distribution for (n,n\*6)

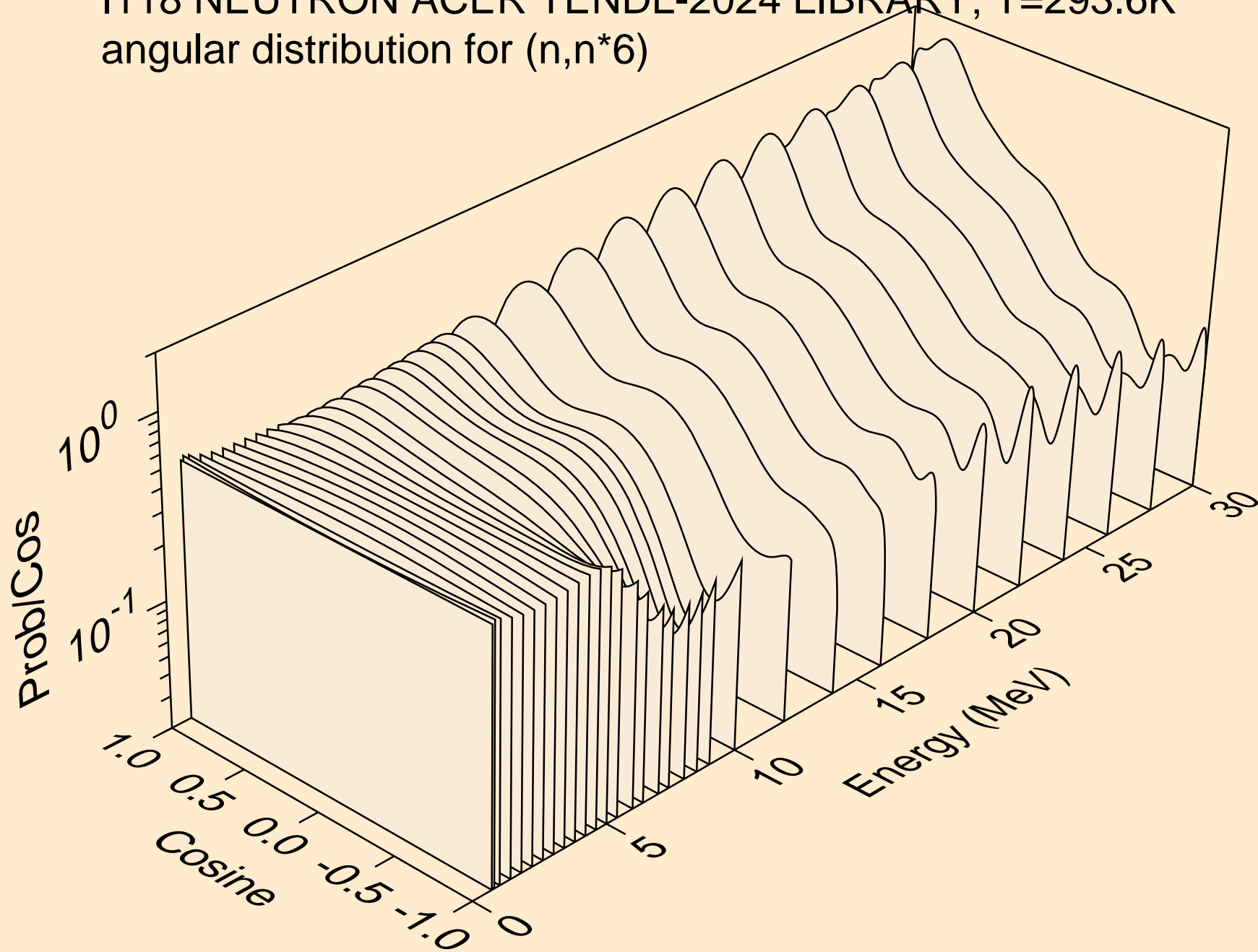

I118 NEUTRON ACER TENDL-2024 LIBRARY; T=293.6K  
angular distribution for (n,n\*7)

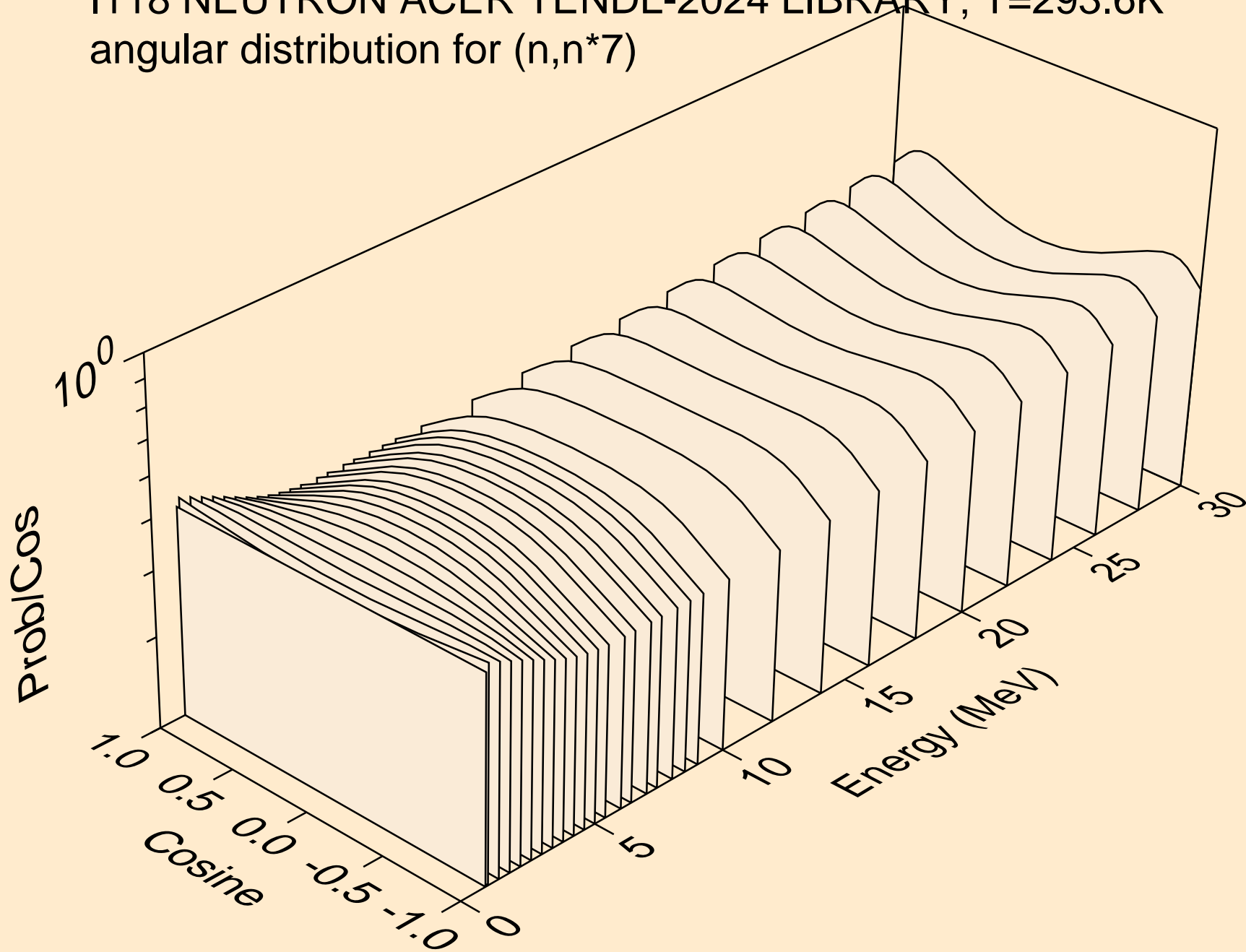

I118 NEUTRON ACER TENDL-2024 LIBRARY; T=293.6K  
angular distribution for (n,n\*8)

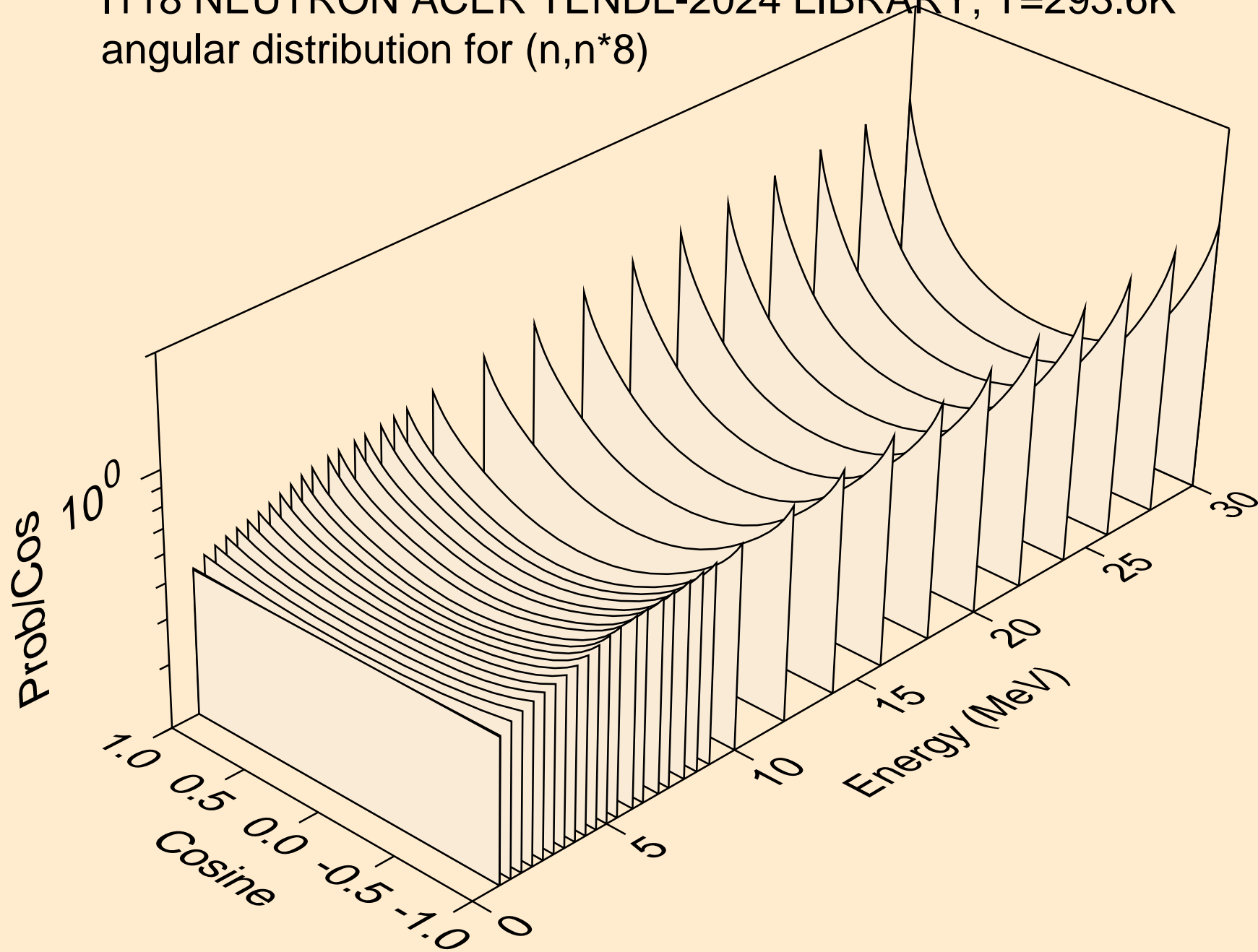

I118 NEUTRON ACER TENDL-2024 LIBRARY; T=293.6K  
angular distribution for (n,n\*9)

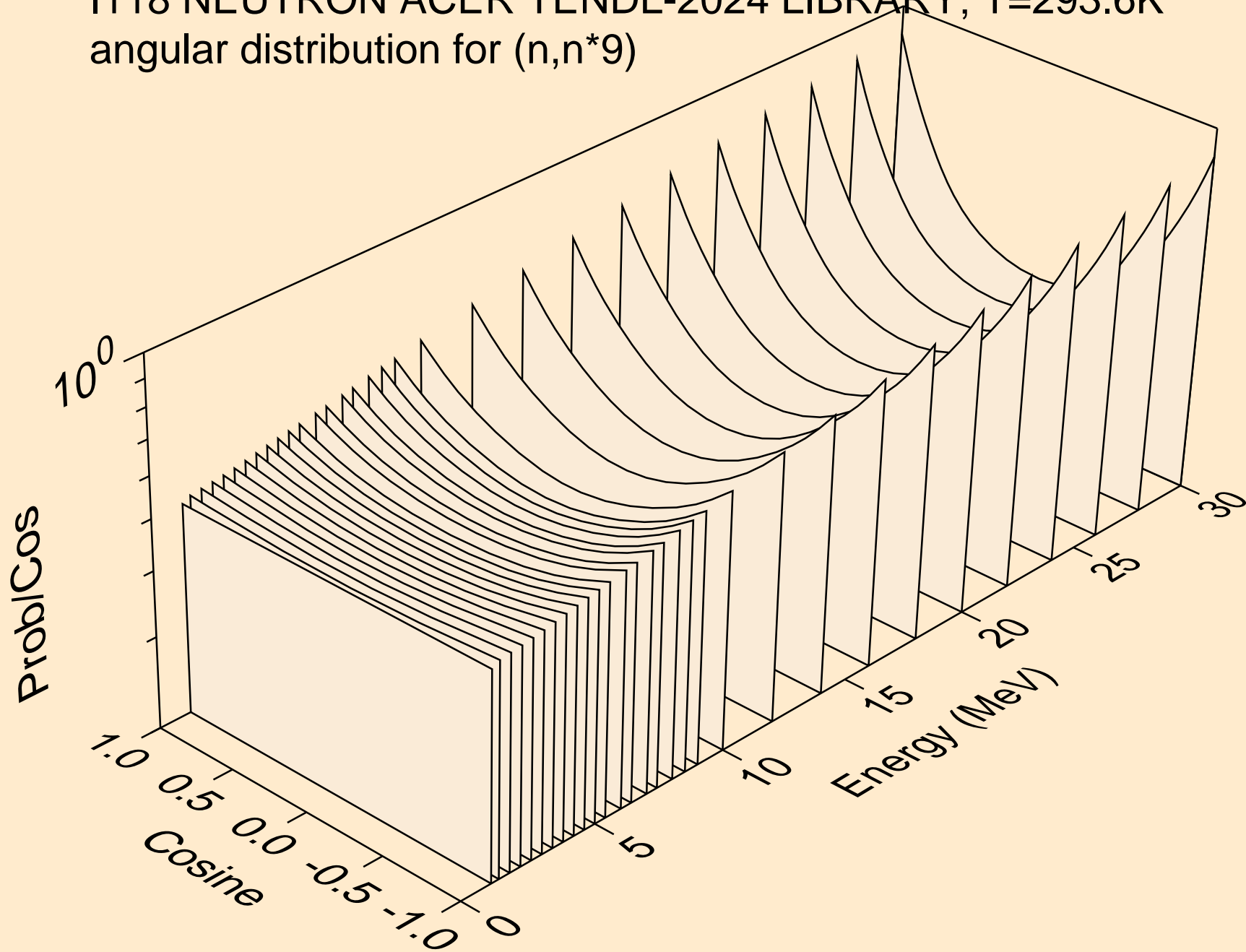

I118 NEUTRON ACER TENDL-2024 LIBRARY; T=293.6K  
angular distribution for (n,n\*10)

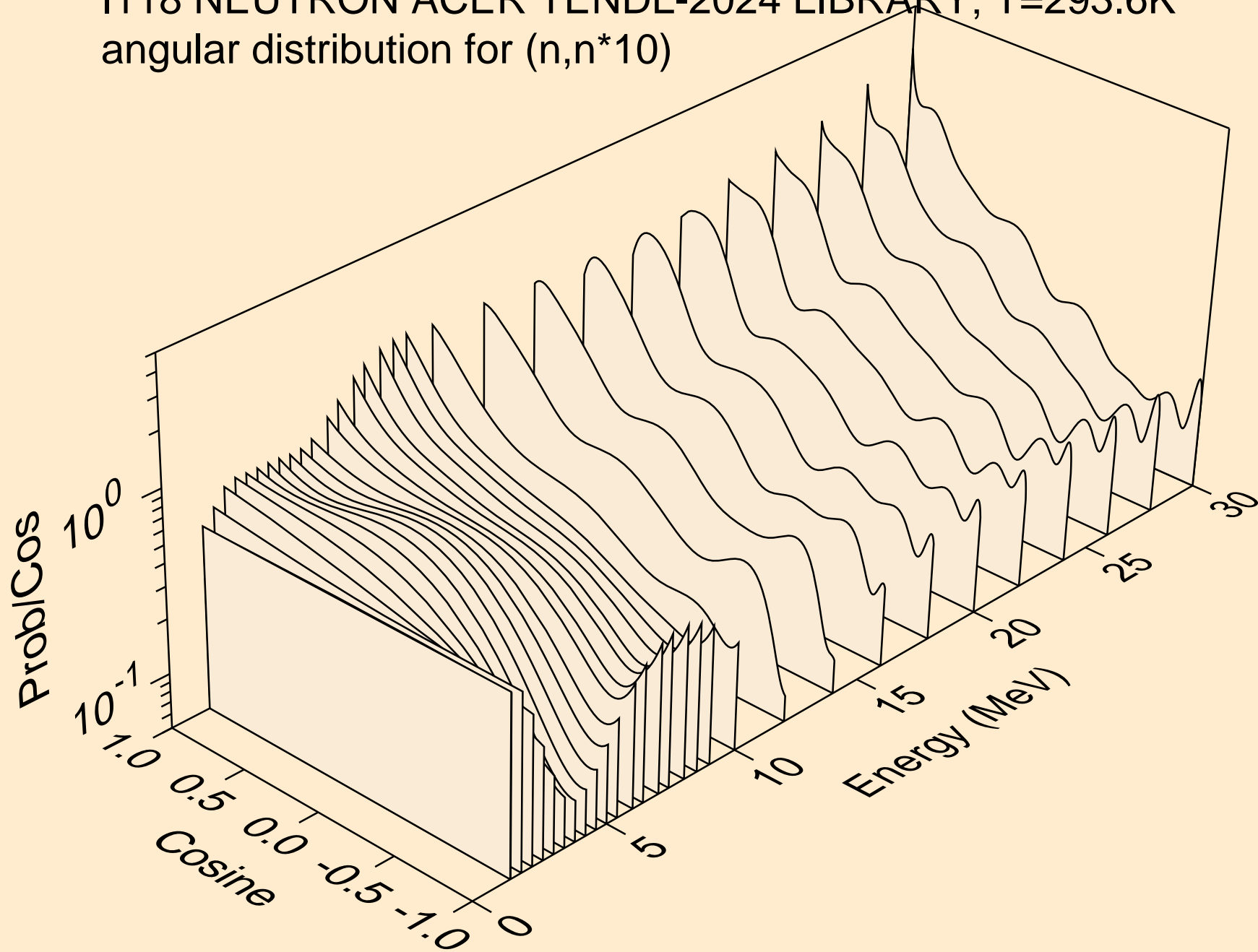

I118 NEUTRON ACER TENDL-2024 LIBRARY; T=293.6K  
angular distribution for (n,n\*11)

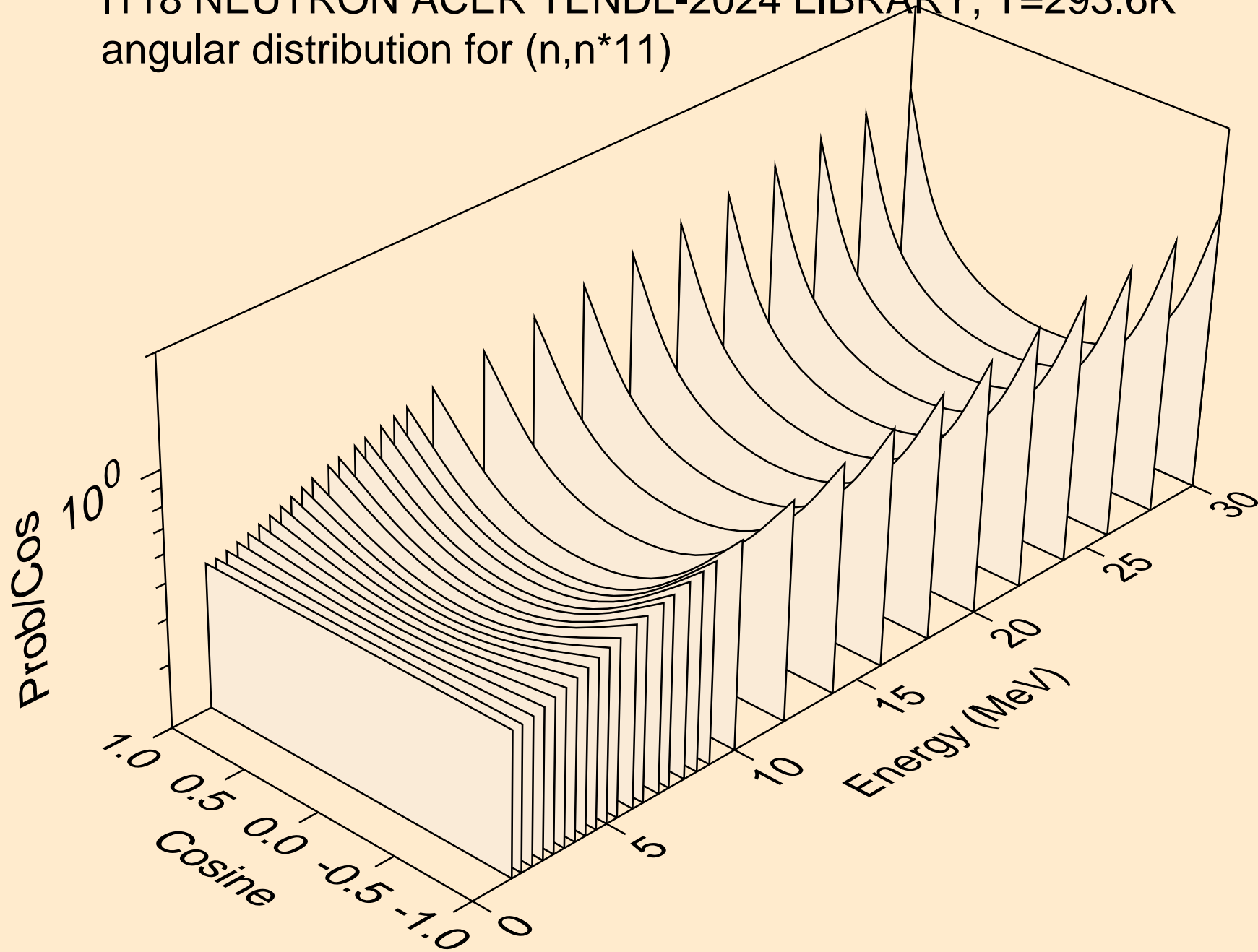

I118 NEUTRON ACER TENDL-2024 LIBRARY; T=293.6K  
angular distribution for (n,n\*12)

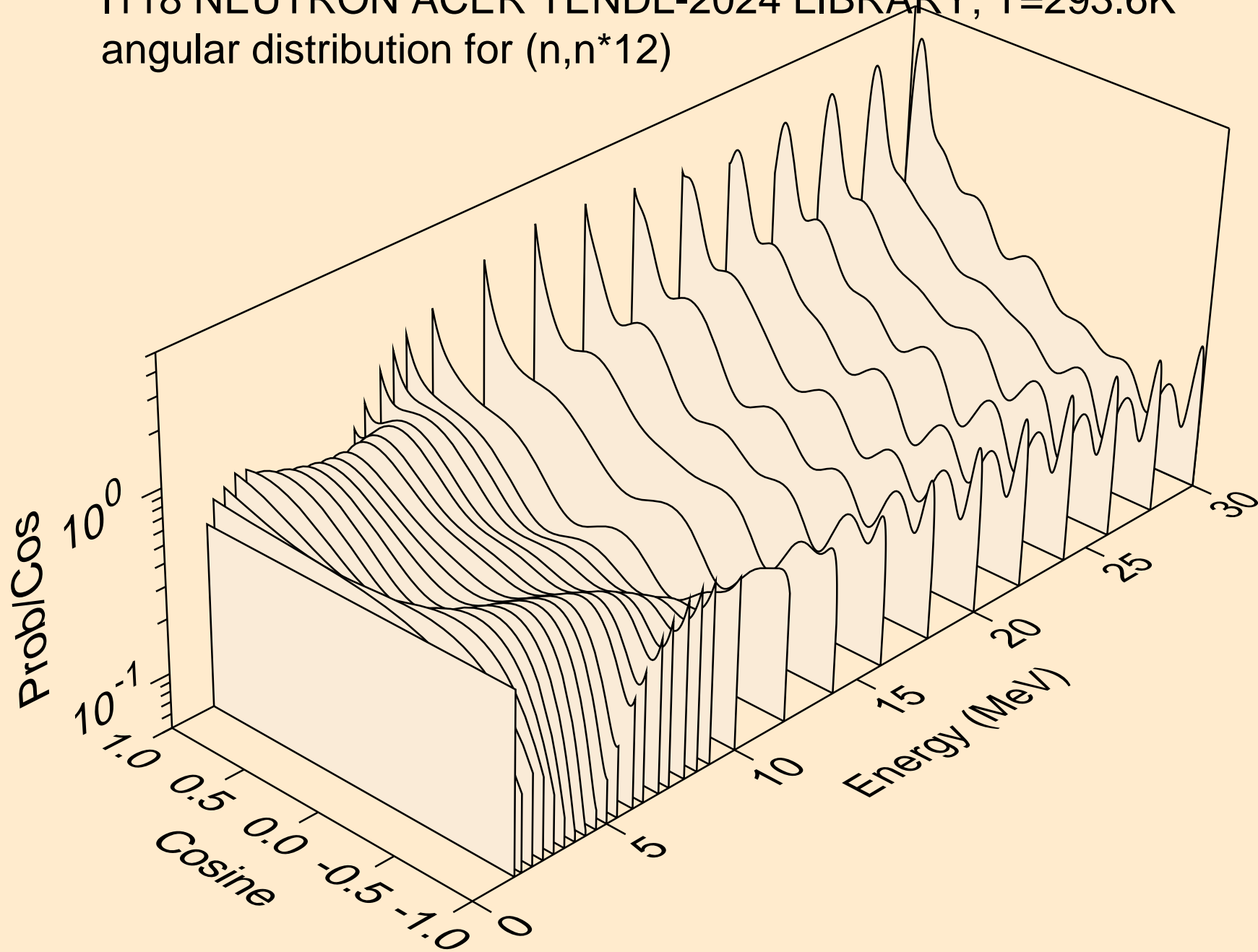

I118 NEUTRON ACER TENDL-2024 LIBRARY; T=293.6K  
Neutron emission for (n,x)

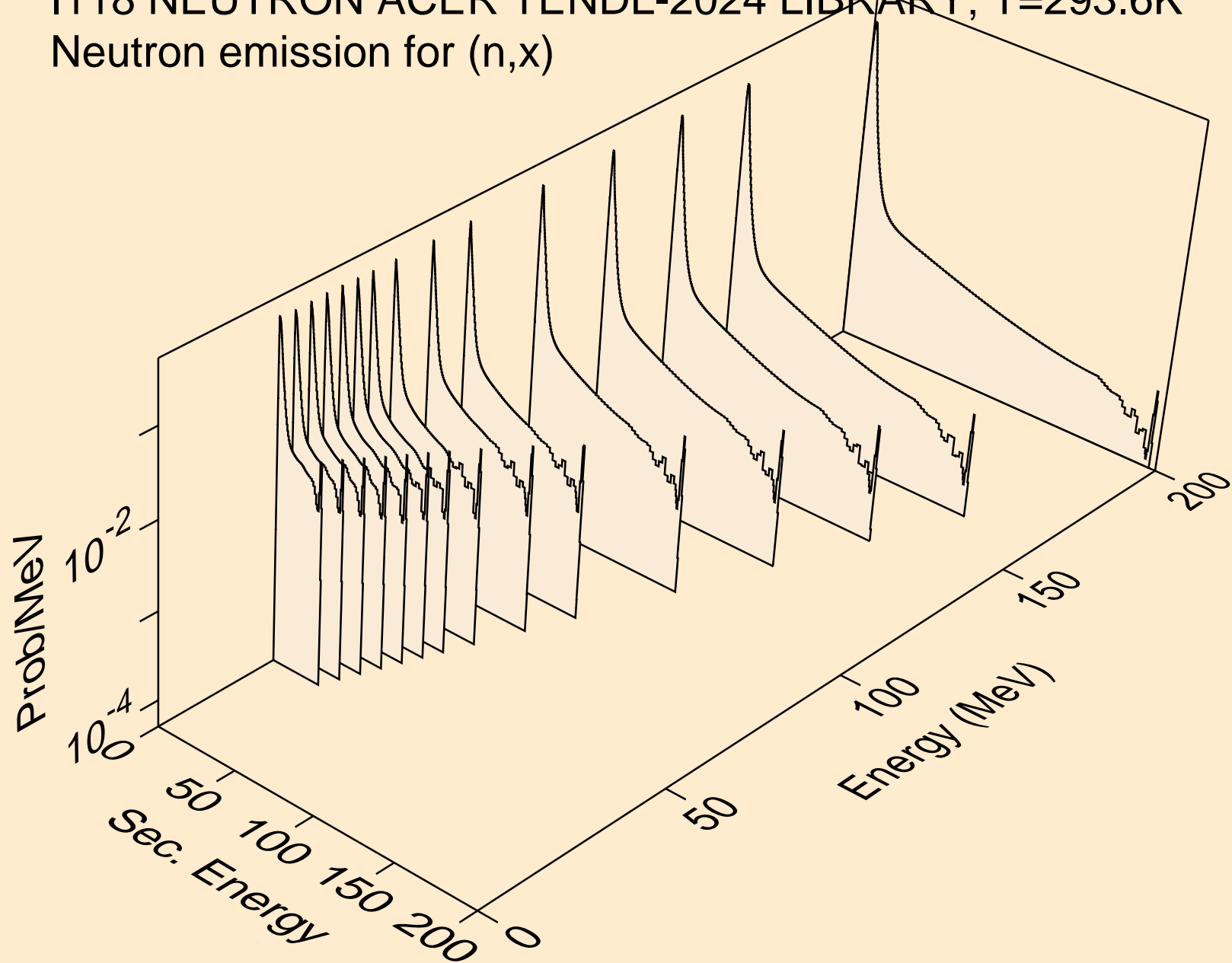

I118 NEUTRON ACER TENDL-2024 LIBRARY; T=293.6K  
Neutron emission for (n,2nd)

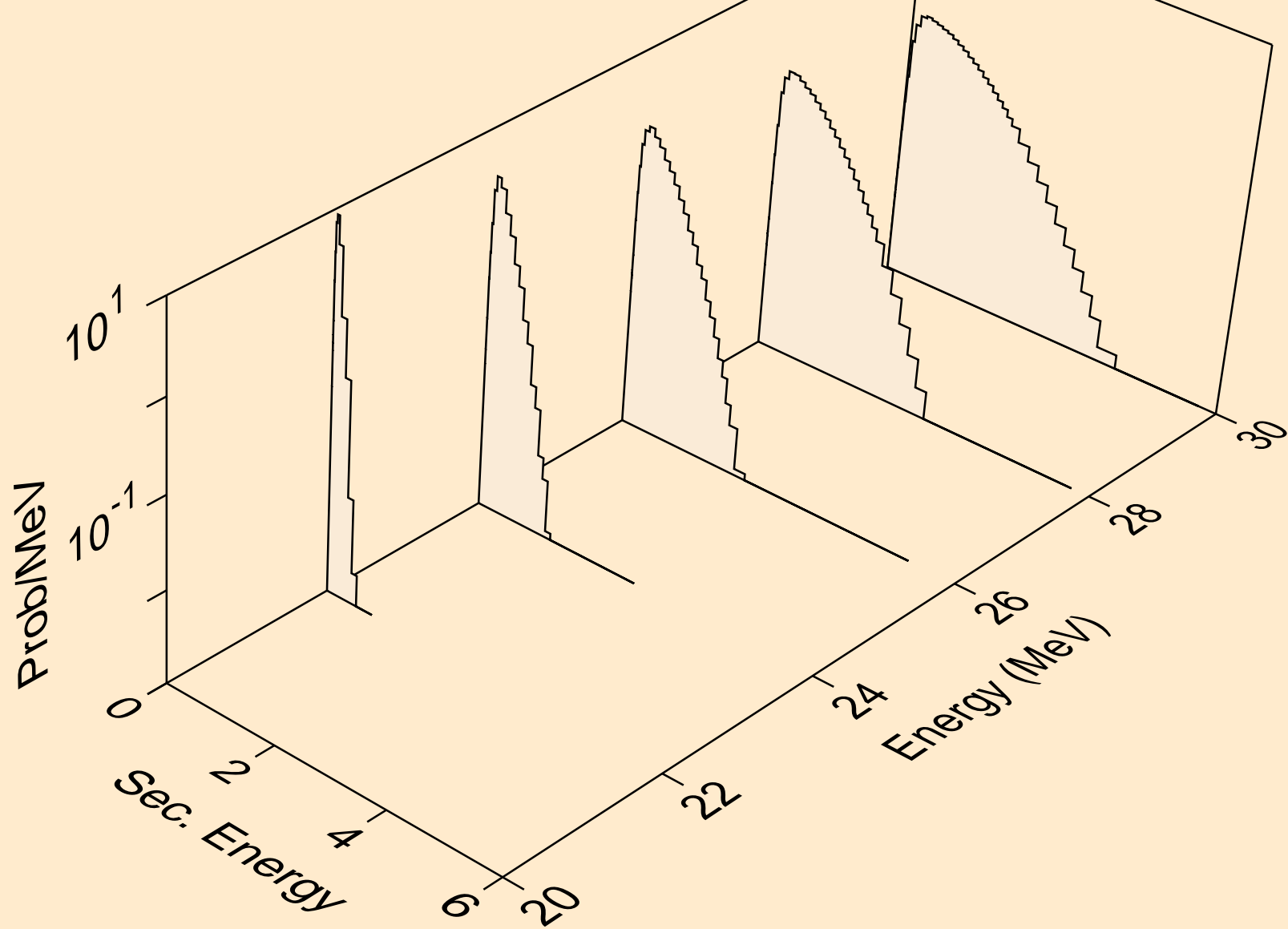

I118 NEUTRON ACER TENDL-2024 LIBRARY; T=293.6K  
Neutron emission for (n,2n)

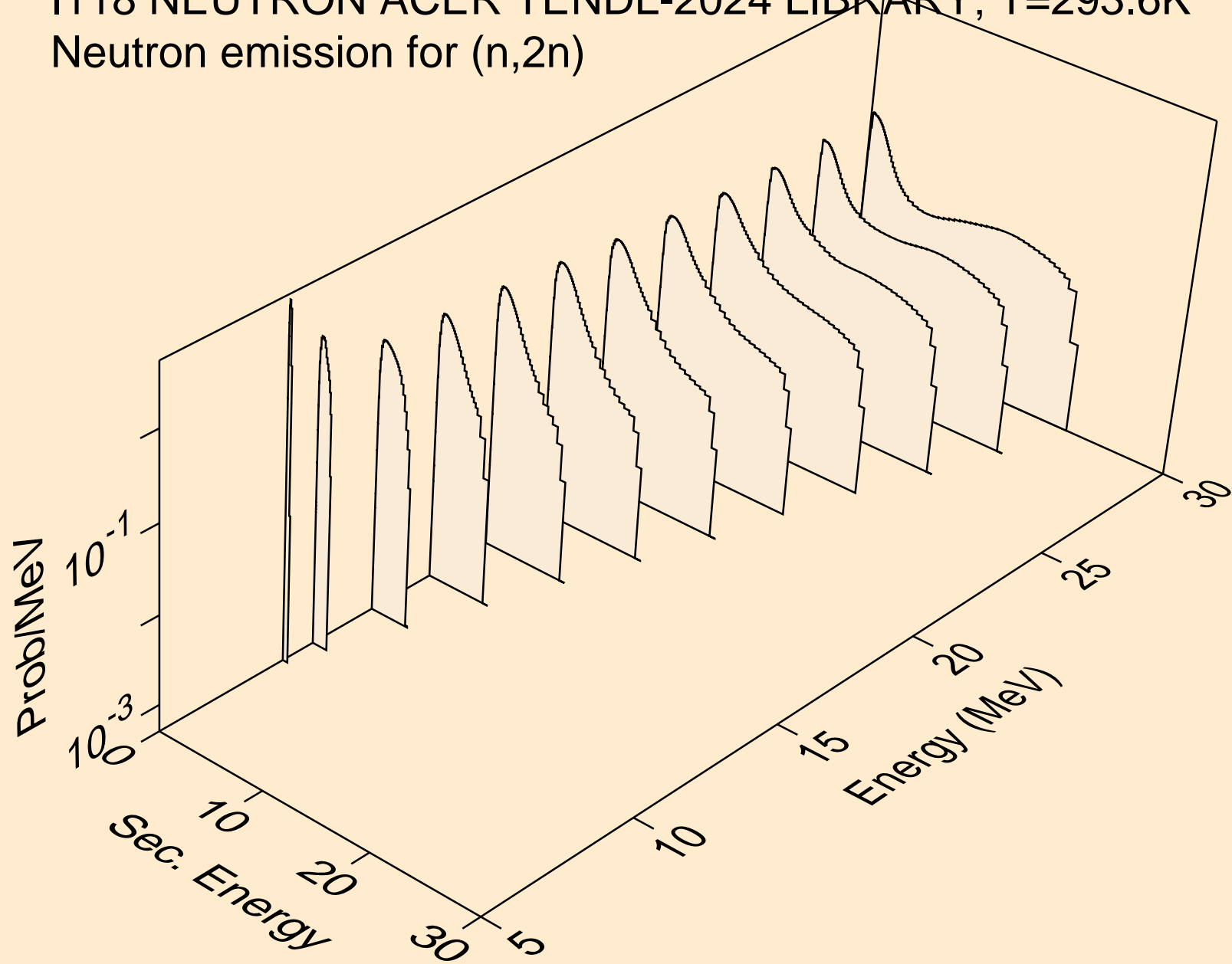

I118 NEUTRON ACER TENDL-2024 LIBRARY; T=293.6K  
Neutron emission for (n,3n)

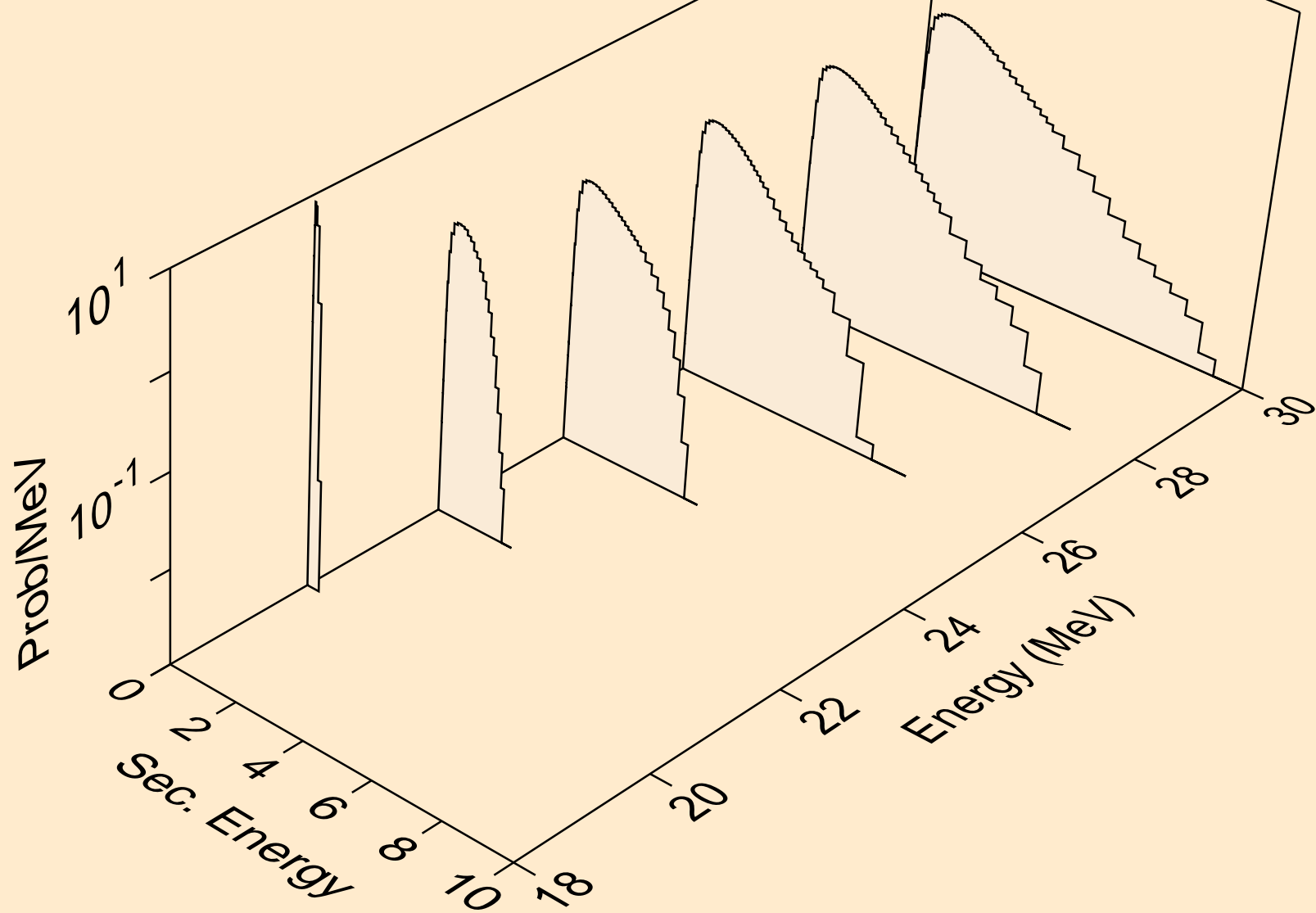

I118 NEUTRON ACER TENDL-2024 LIBRARY; T=293.6K  
Neutron emission for (n,n\*)a

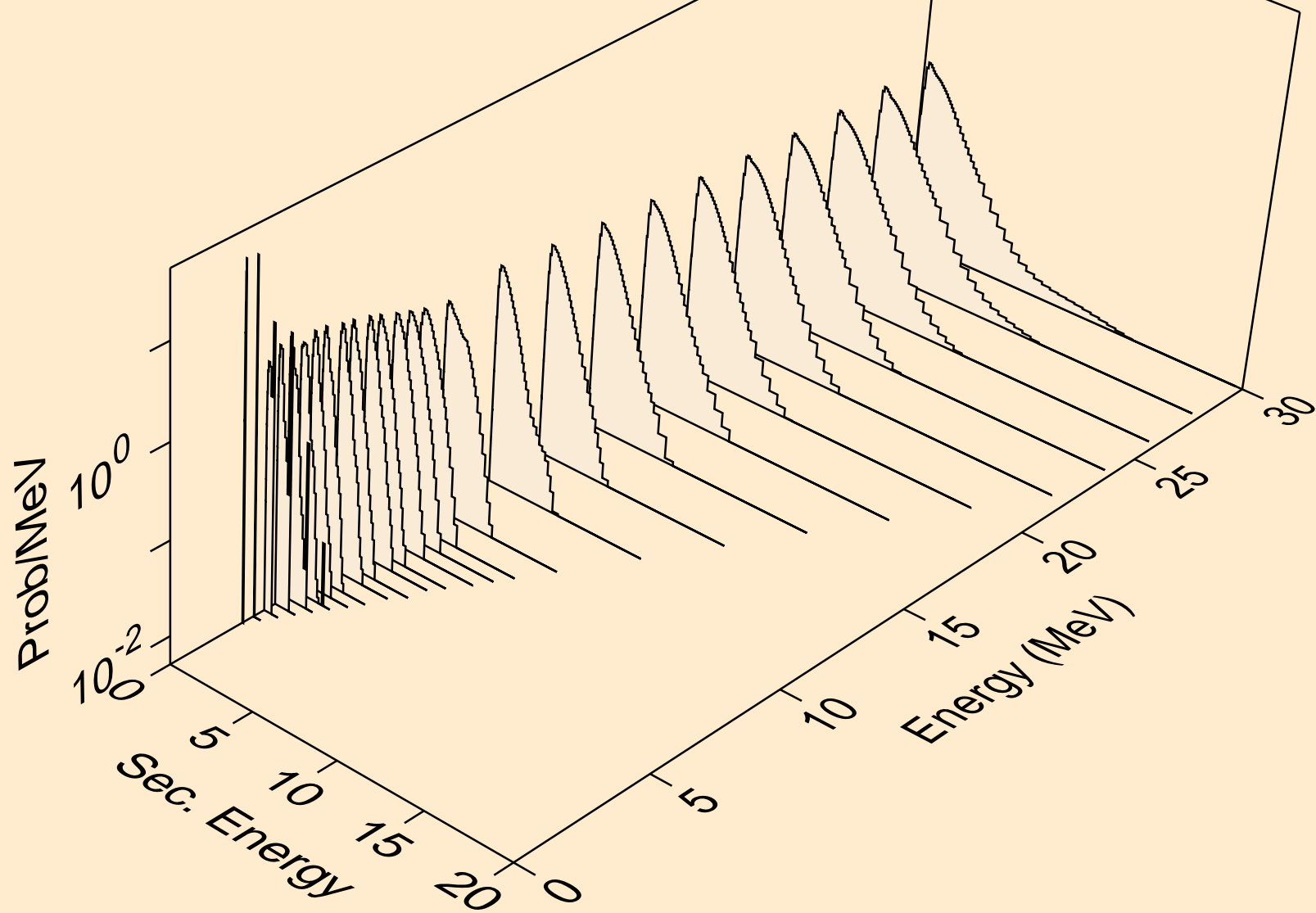

I118 NEUTRON ACER TENDL-2024 LIBRARY; T=293.6K  
Neutron emission for (n,2n)a

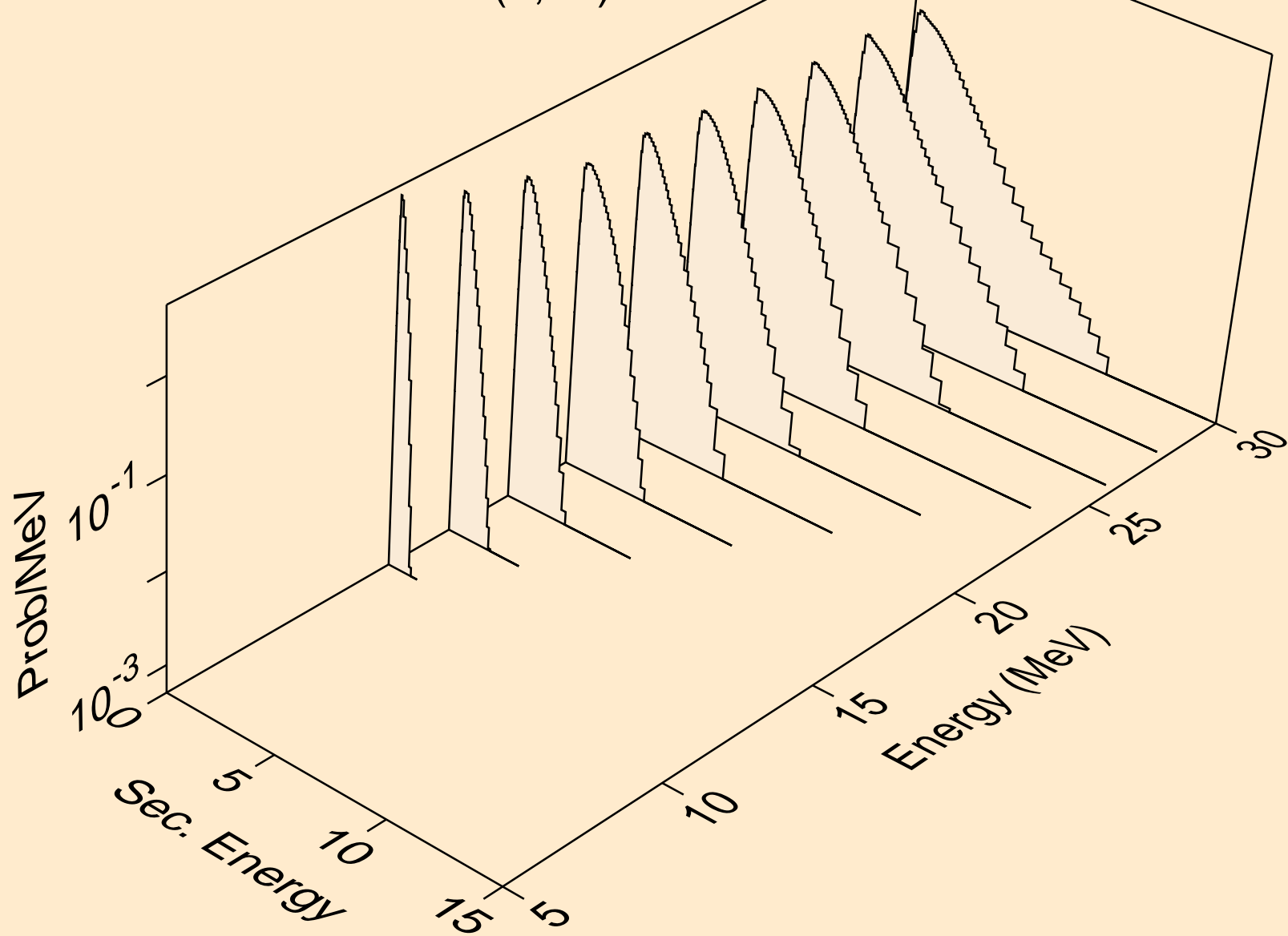

I118 NEUTRON ACER TENDL-2024 LIBRARY; T=293.6K  
Neutron emission for (n,3n)a

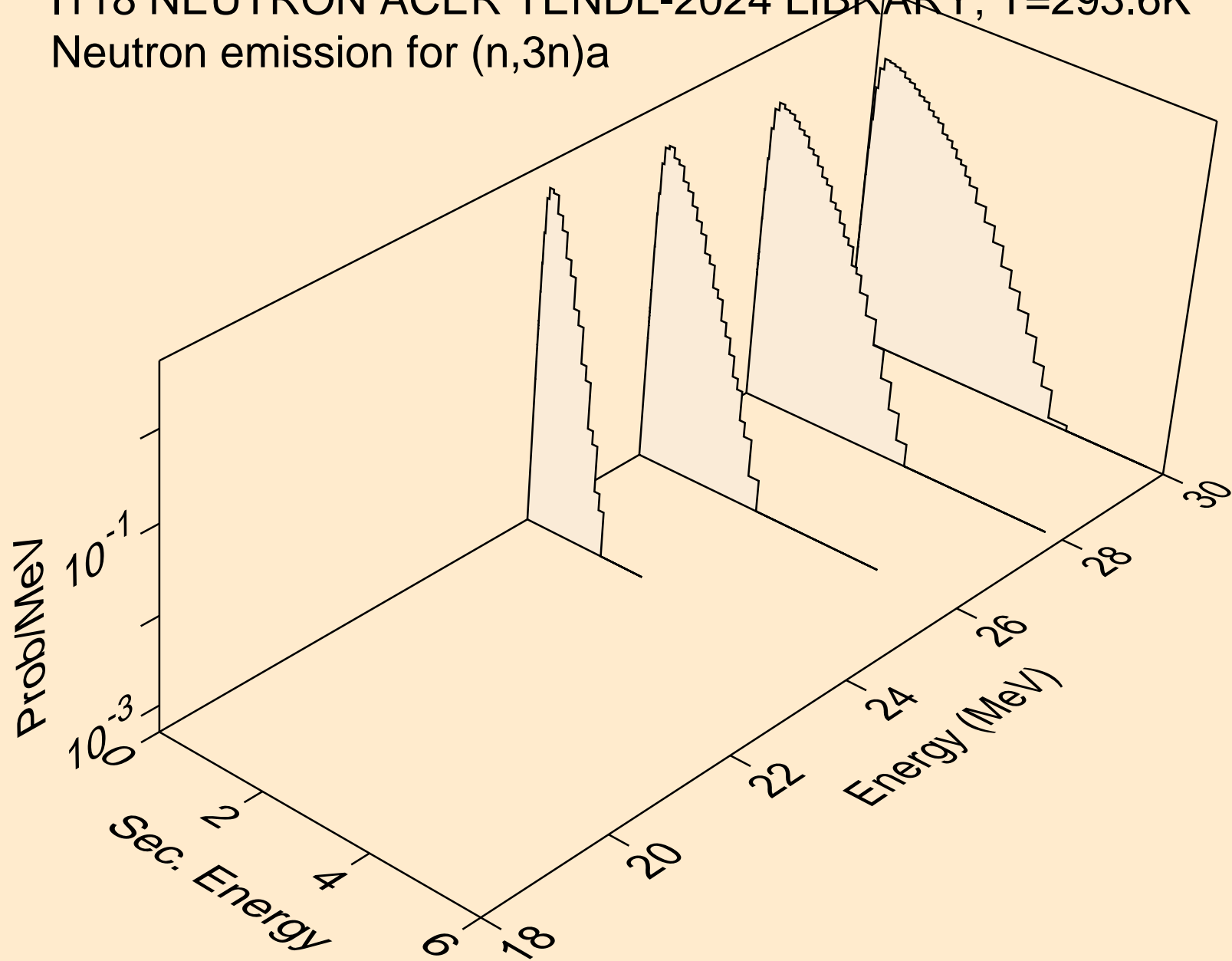

I118 NEUTRON ACER TENDL-2024 LIBRARY; T=293.6K  
Neutron emission for (n,n\*)p

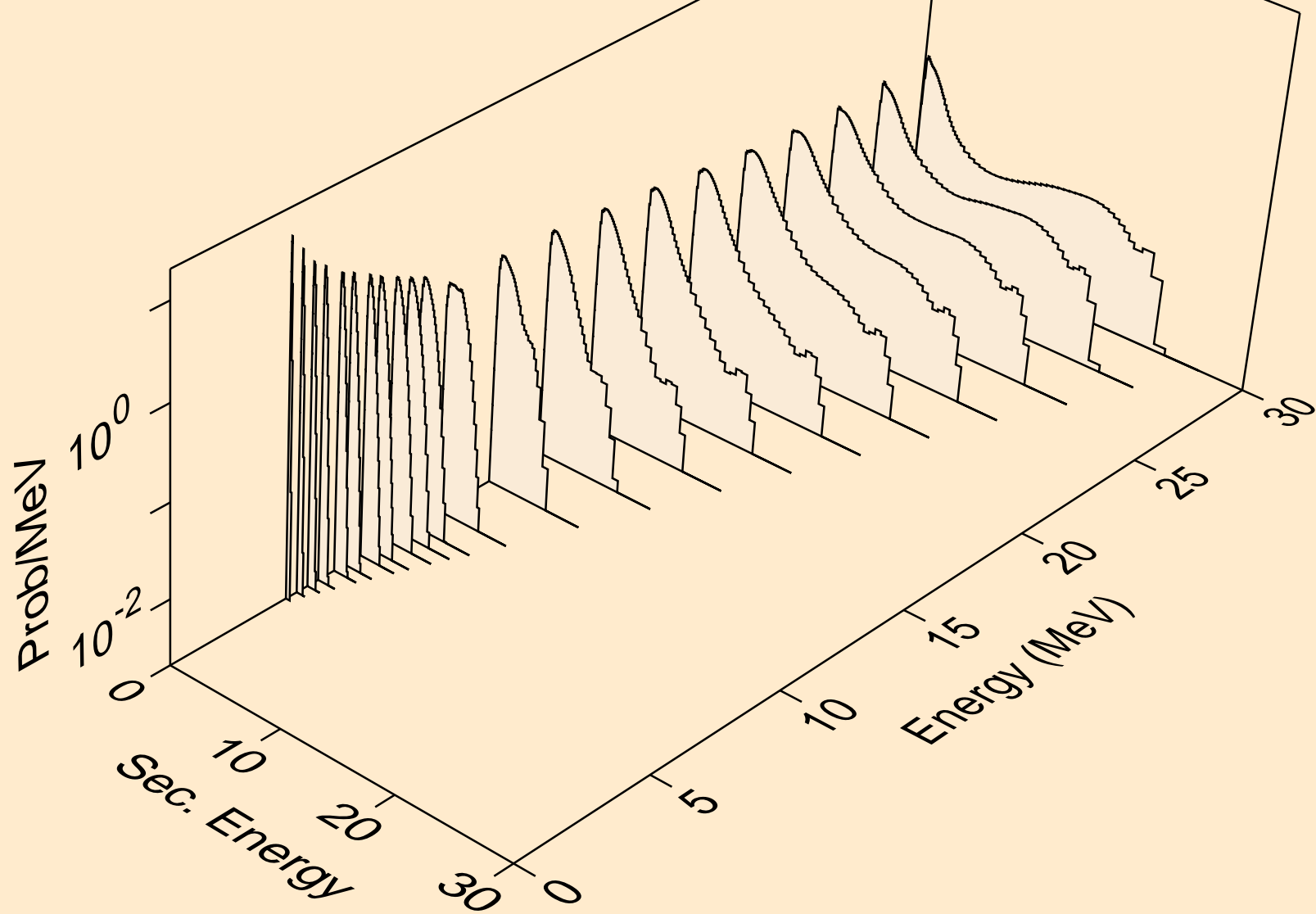

I118 NEUTRON ACER TENDL-2024 LIBRARY; T=293.6K  
Neutron emission for (n,n\*)2a

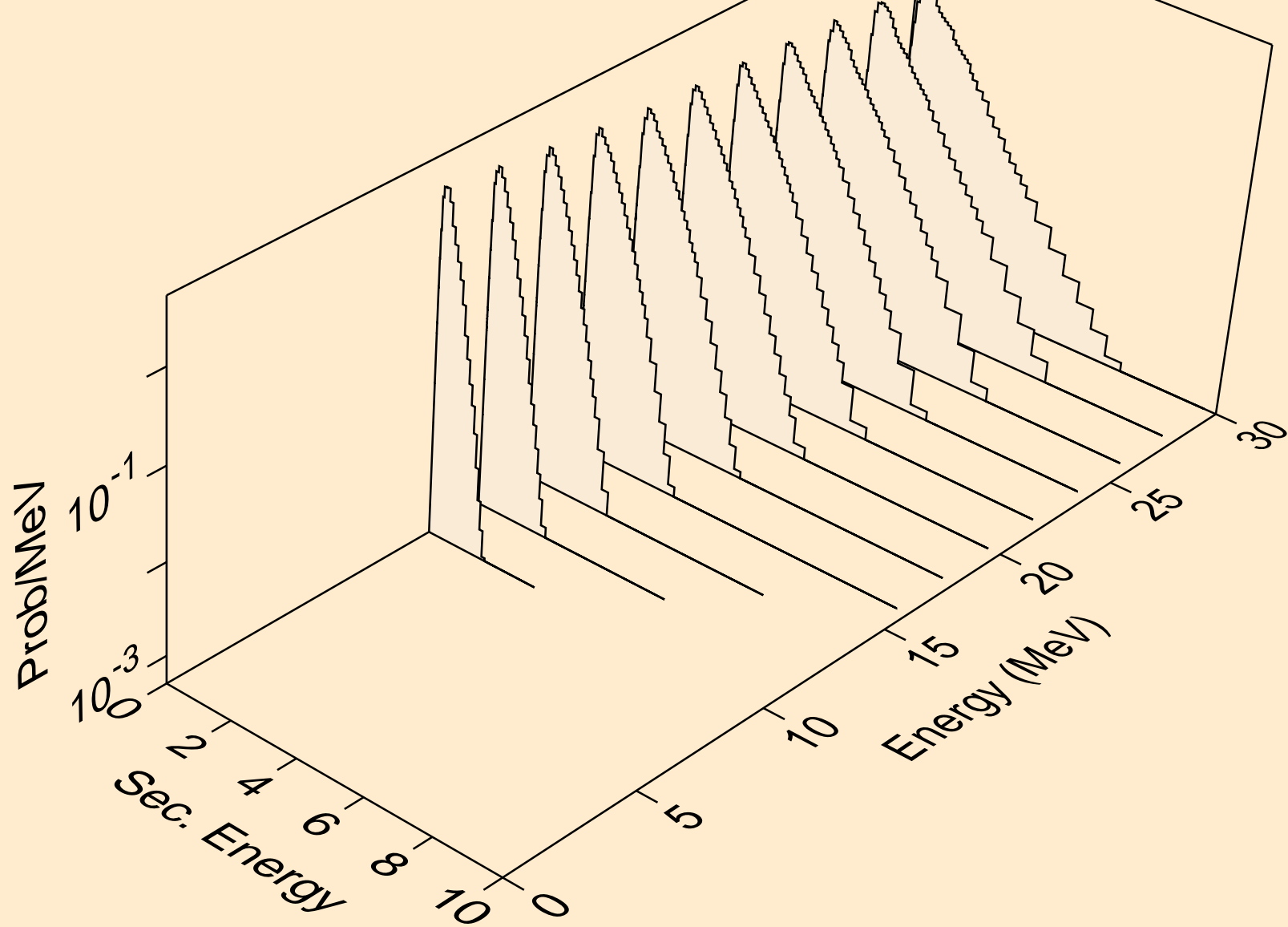

I118 NEUTRON ACER TENDL-2024 LIBRARY; T=293.6K  
Neutron emission for (n,2n)2a

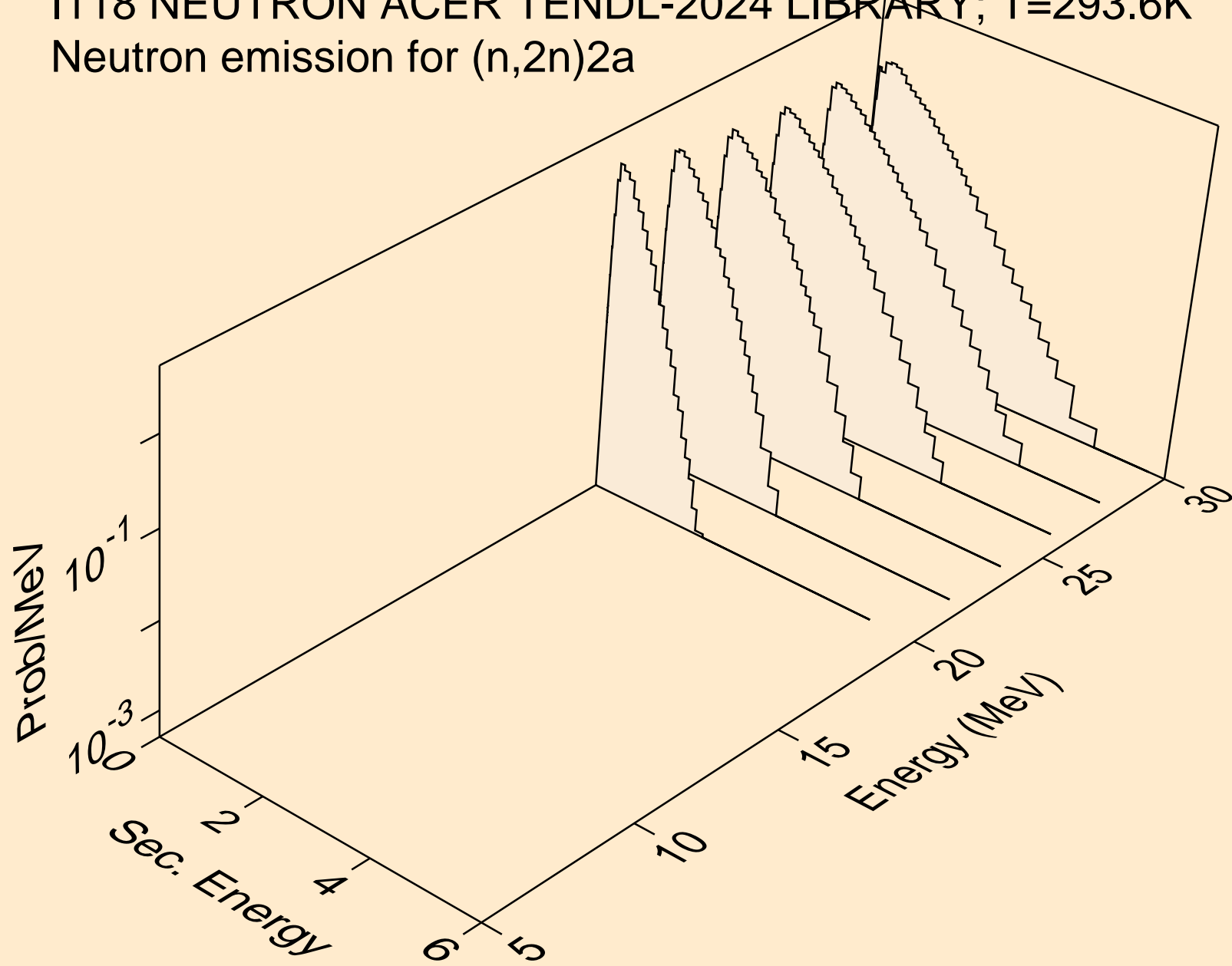

I118 NEUTRON ACER TENDL-2024 LIBRARY; T=293.6K  
Neutron emission for (n,n\*)d

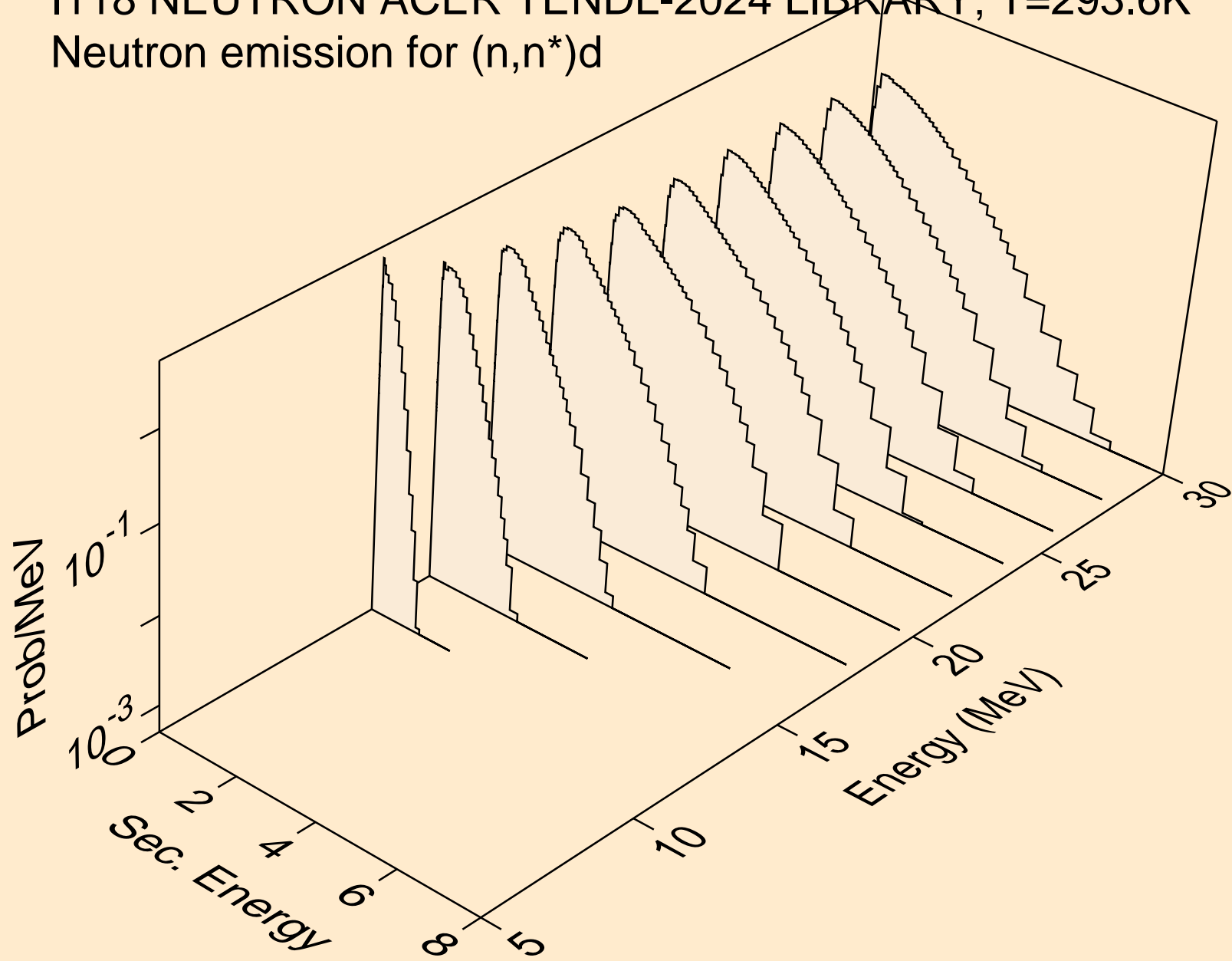

I118 NEUTRON ACER TENDL-2024 LIBRARY; T=293.6K  
Neutron emission for (n,n\*)t

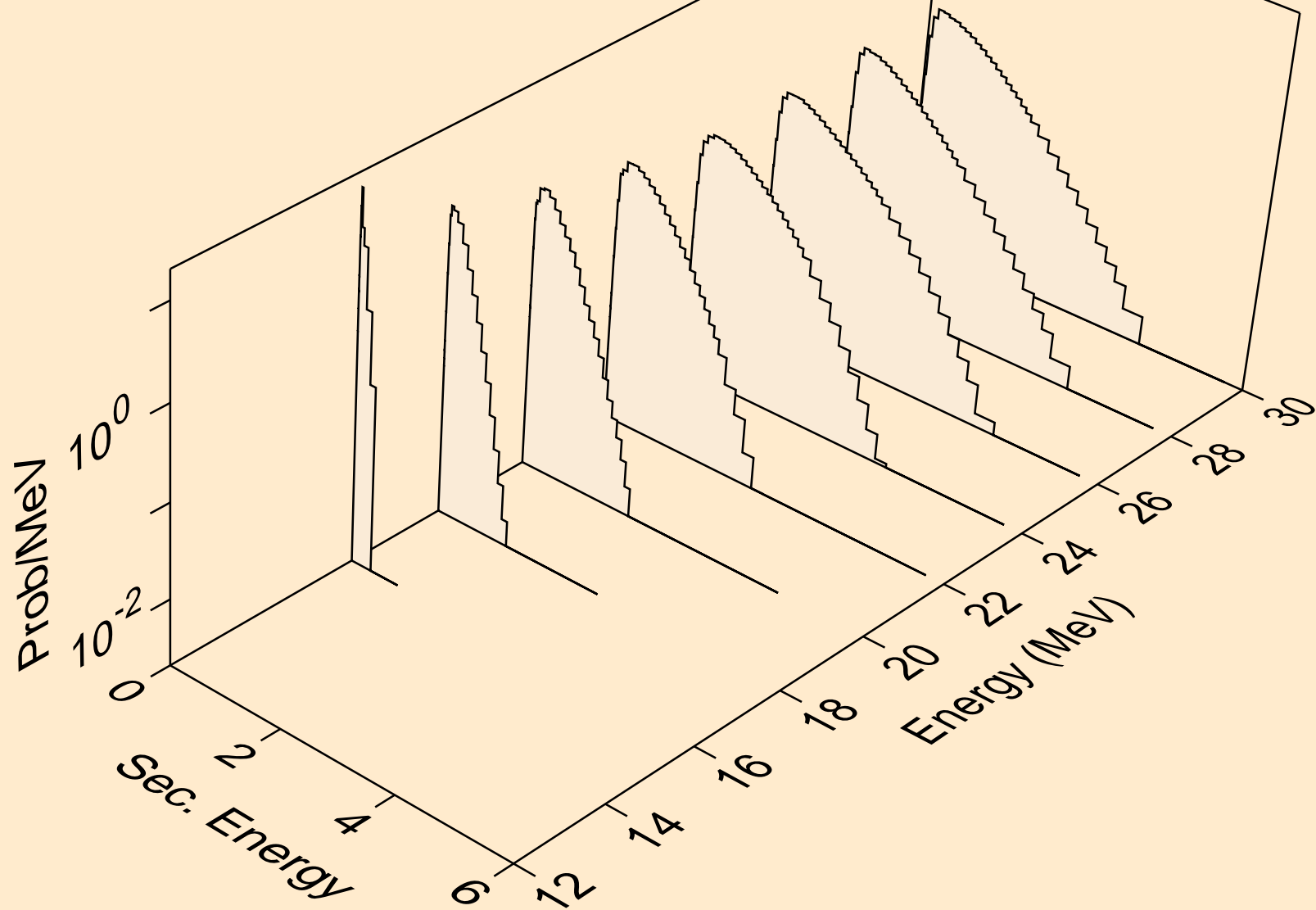

I118 NEUTRON ACER TENDL-2024 LIBRARY; T=293.6K  
Neutron emission for (n,n\*)he3

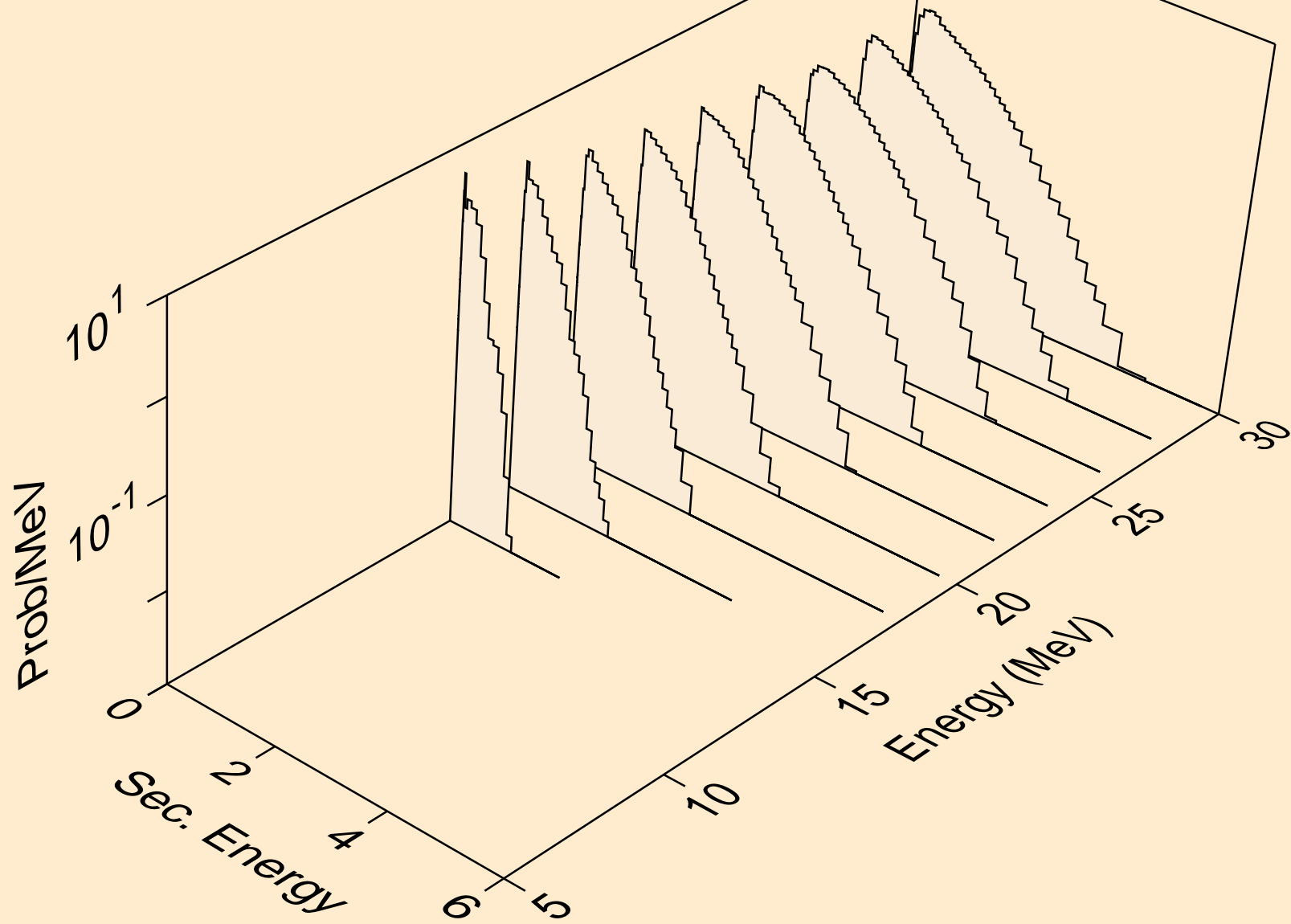

I118 NEUTRON ACER TENDL-2024 LIBRARY; T=293.6K  
Neutron emission for (n,2np)

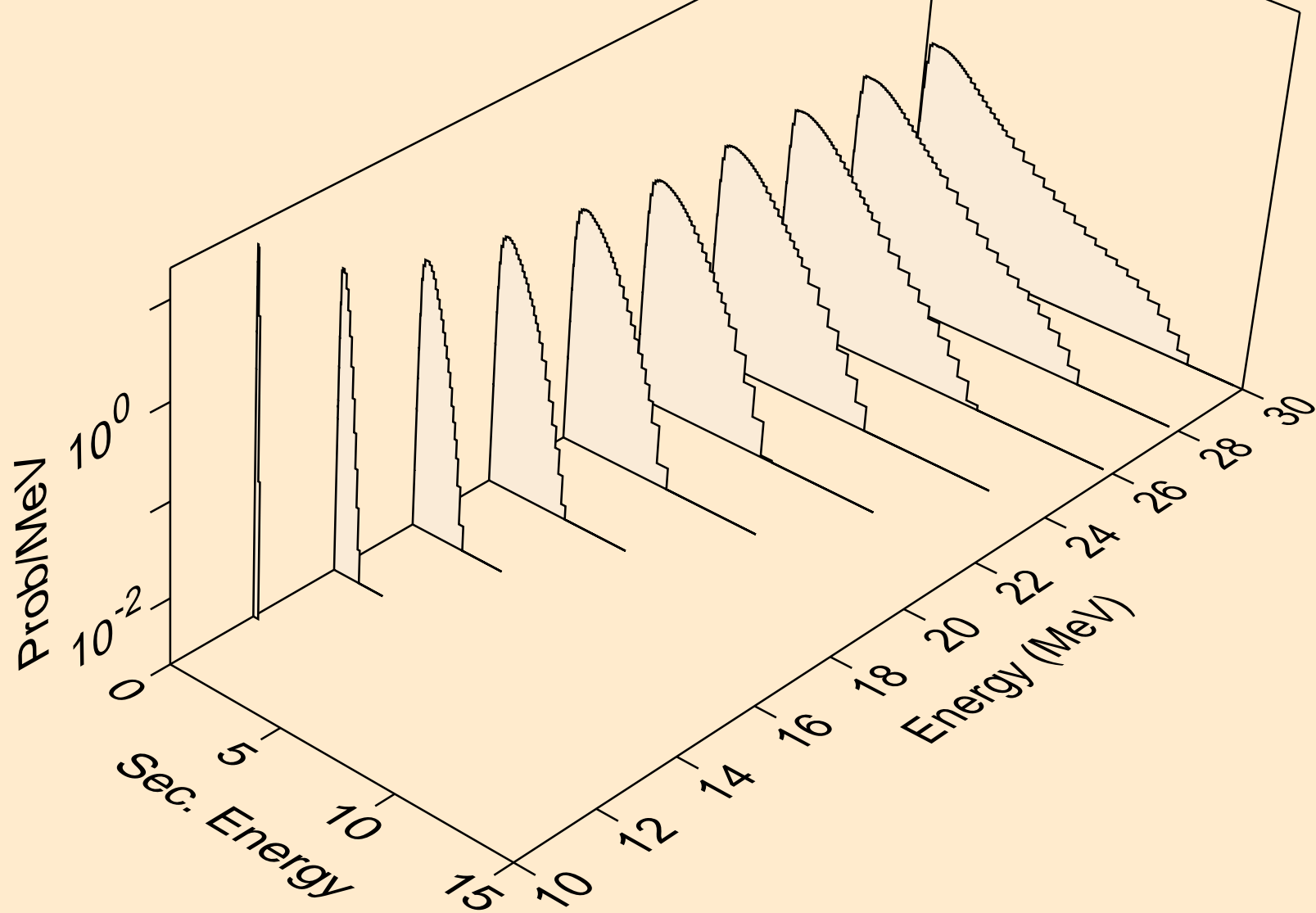

I118 NEUTRON ACER TENDL-2024 LIBRARY; T=293.6K  
Neutron emission for (n,3np)

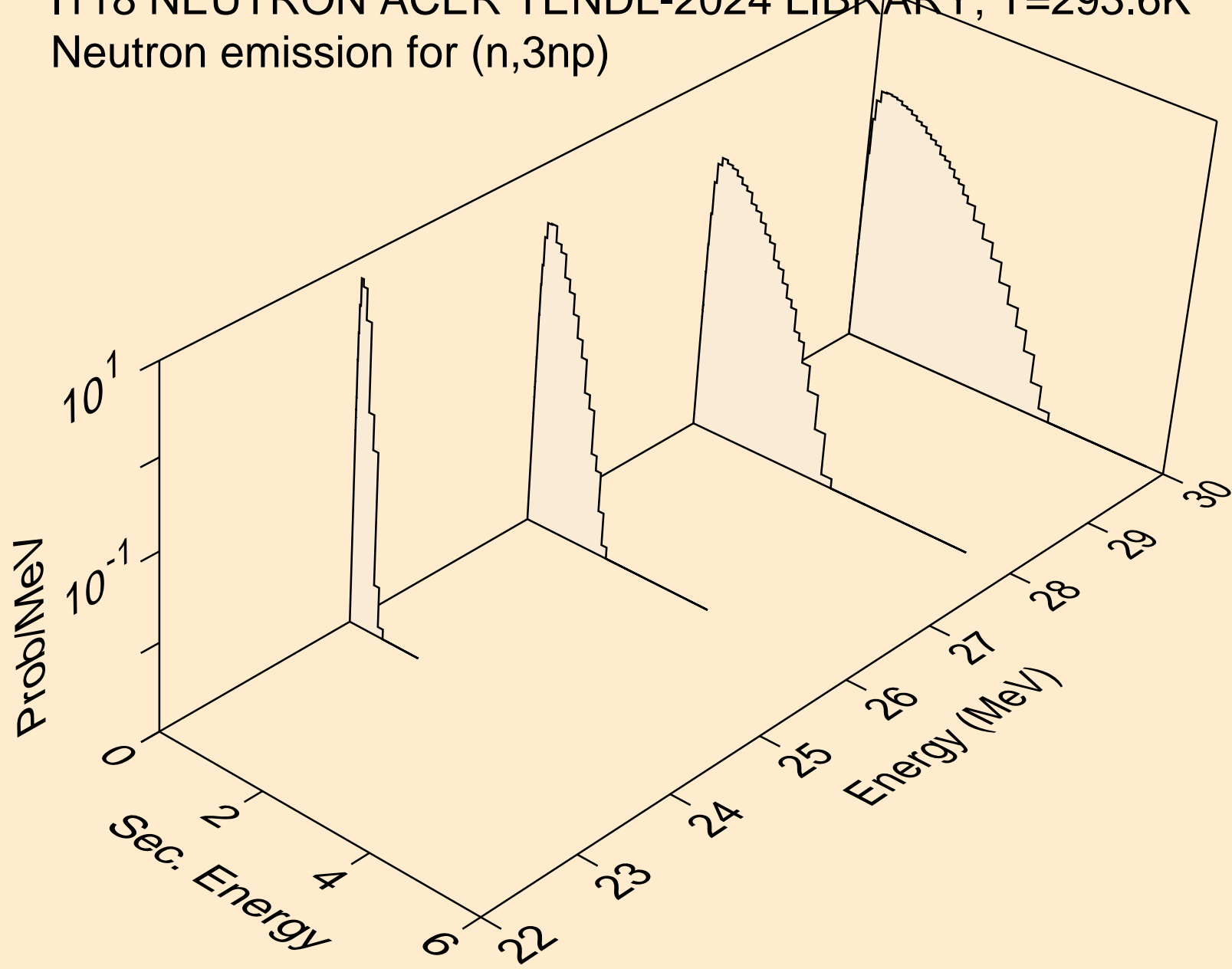

I118 NEUTRON ACER TENDL-2024 LIBRARY; T=293.6K  
Neutron emission for (n,n2p)

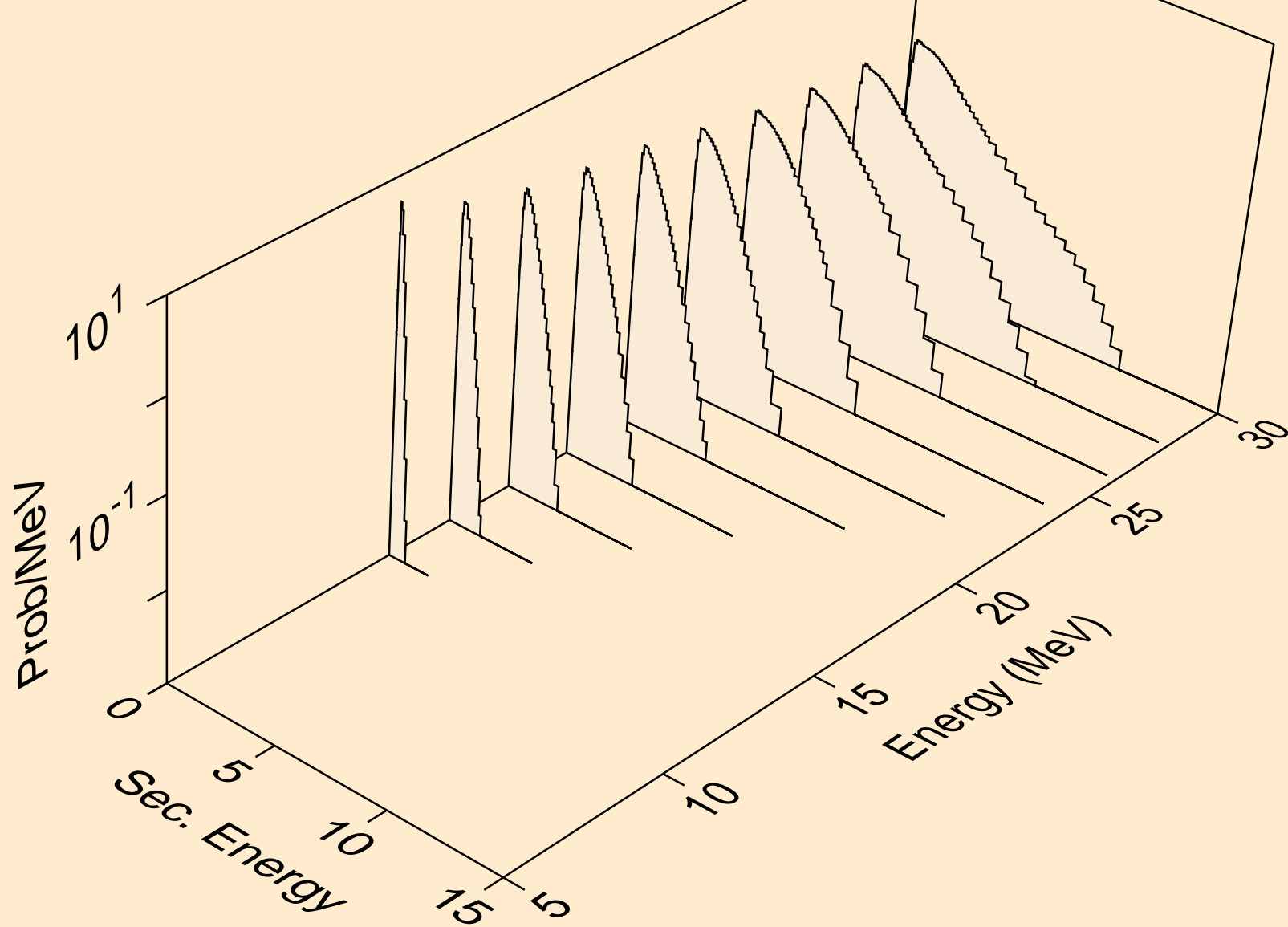

I118 NEUTRON ACER TENDL-2024 LIBRARY; T=293.6K  
Neutron emission for (n,npa)

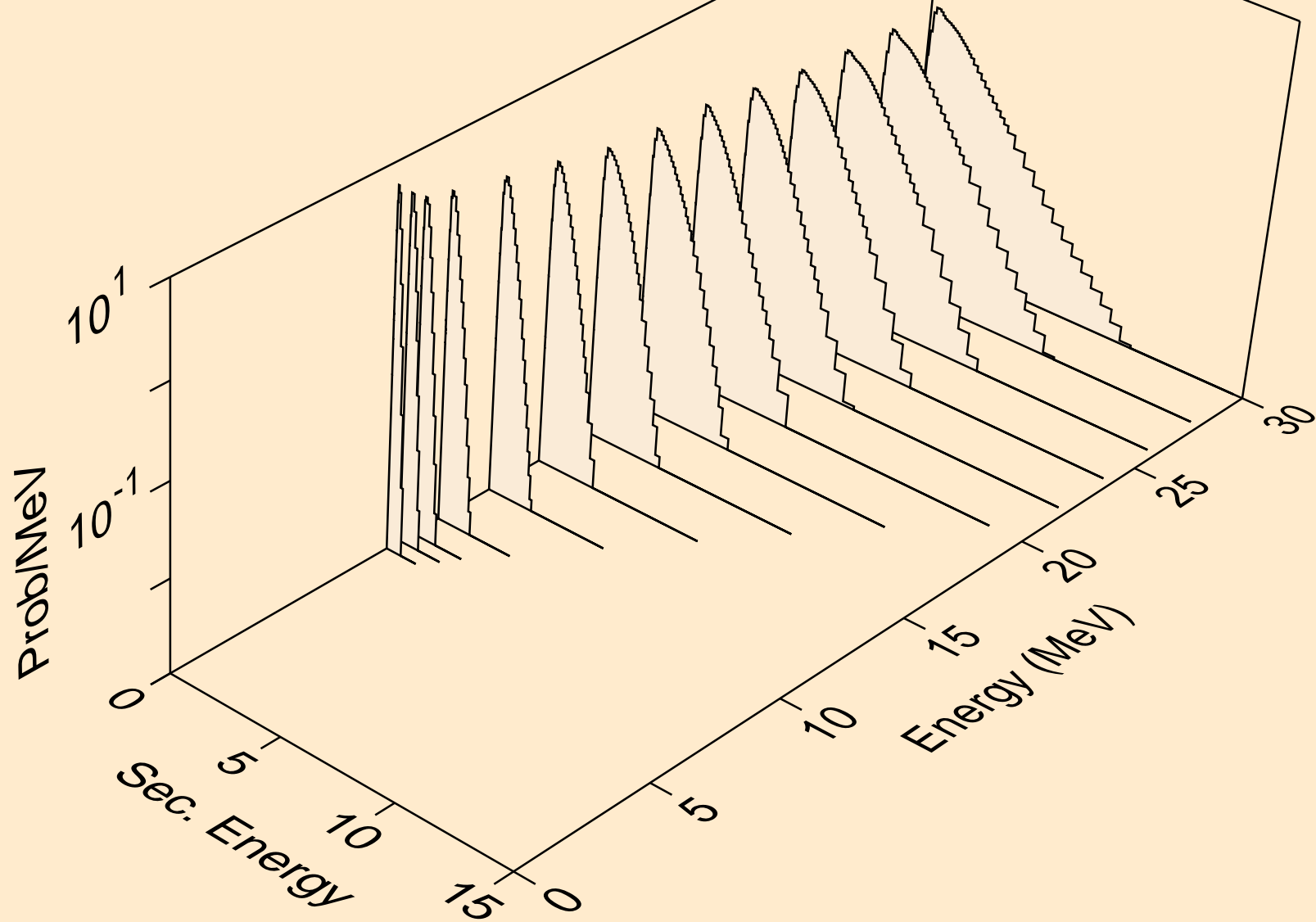

I118 NEUTRON ACER TENDL-2024 LIBRARY; T=293.6K  
Neutron emission for (n,n\*c)

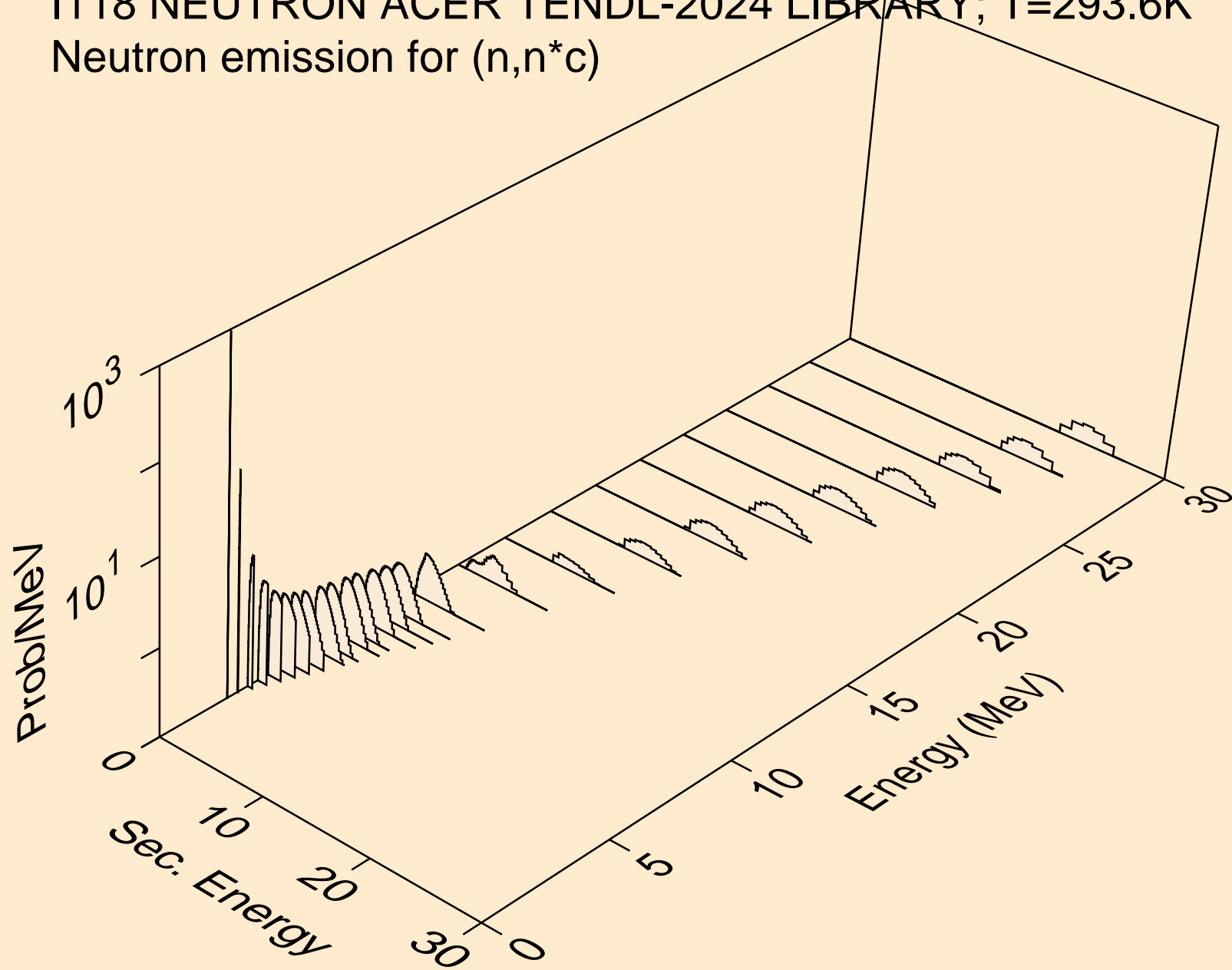

I118 NEUTRON ACER TENDL-2024 LIBRARY; T=293.6K  
Photon emission for (n,x)

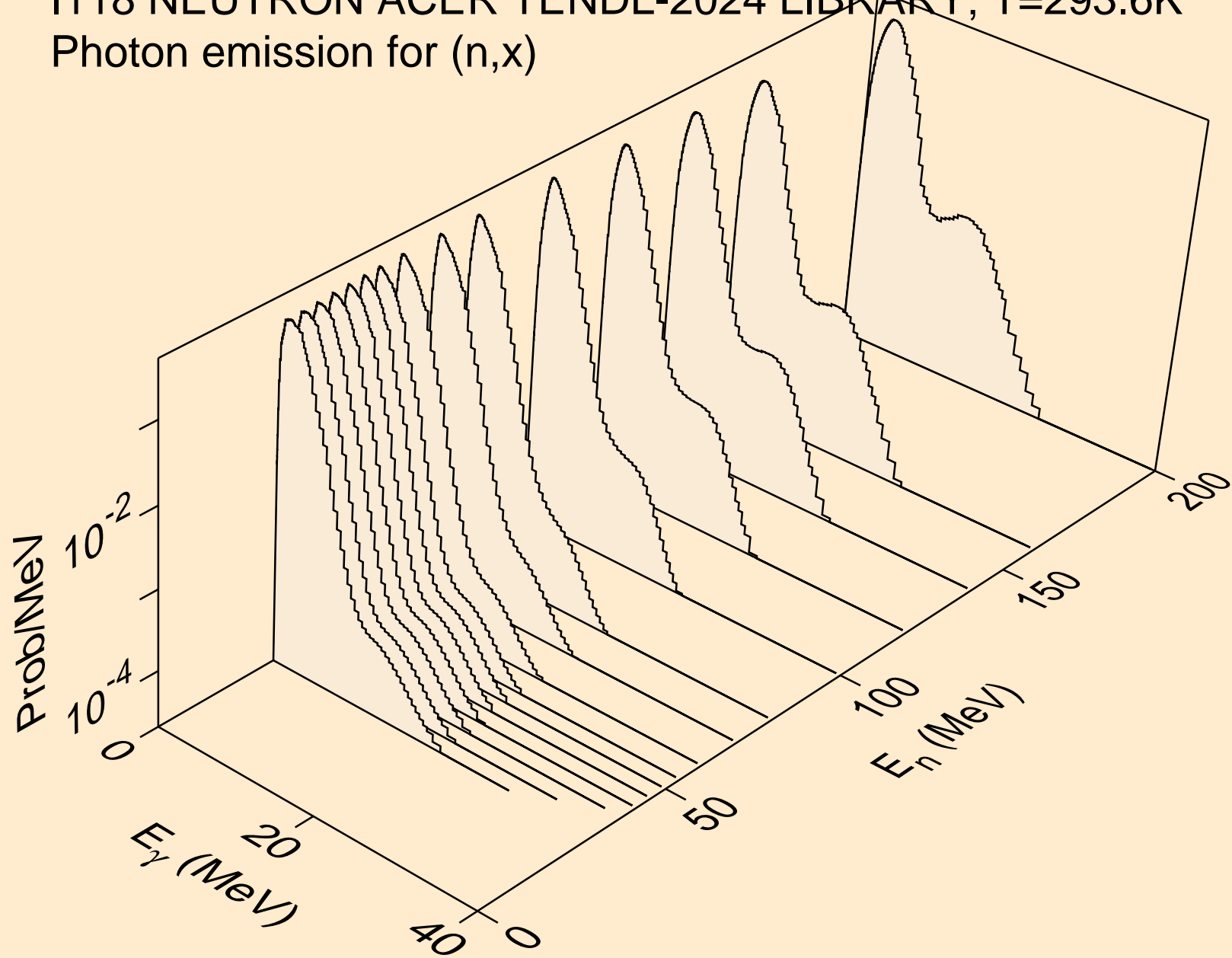

I118 NEUTRON ACER TENDL-2024 LIBRARY; T=293.6K  
Photon emission for (n,2nd)

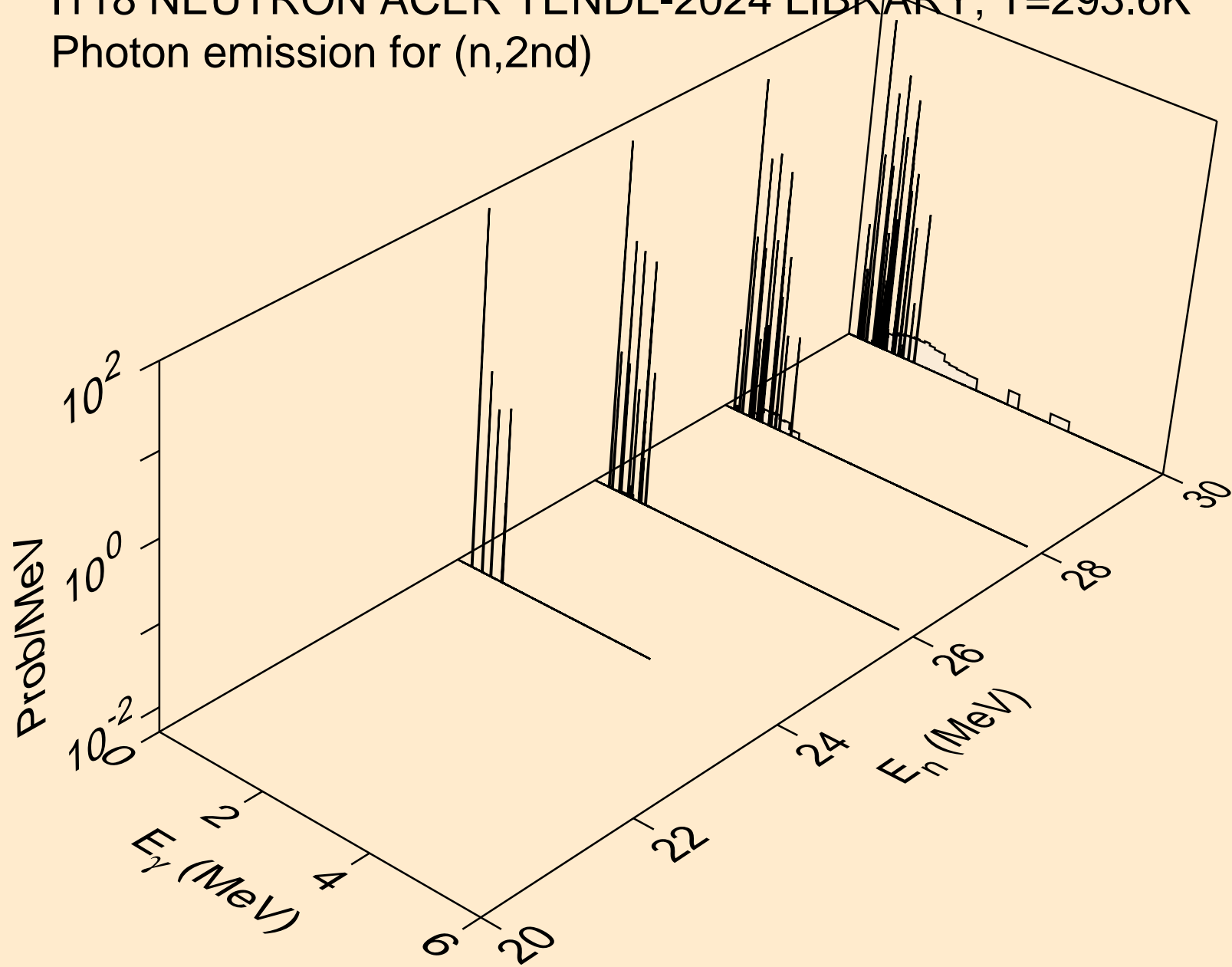

I118 NEUTRON ACER TENDL-2024 LIBRARY; T=293.6K  
Photon emission for (n,2n)

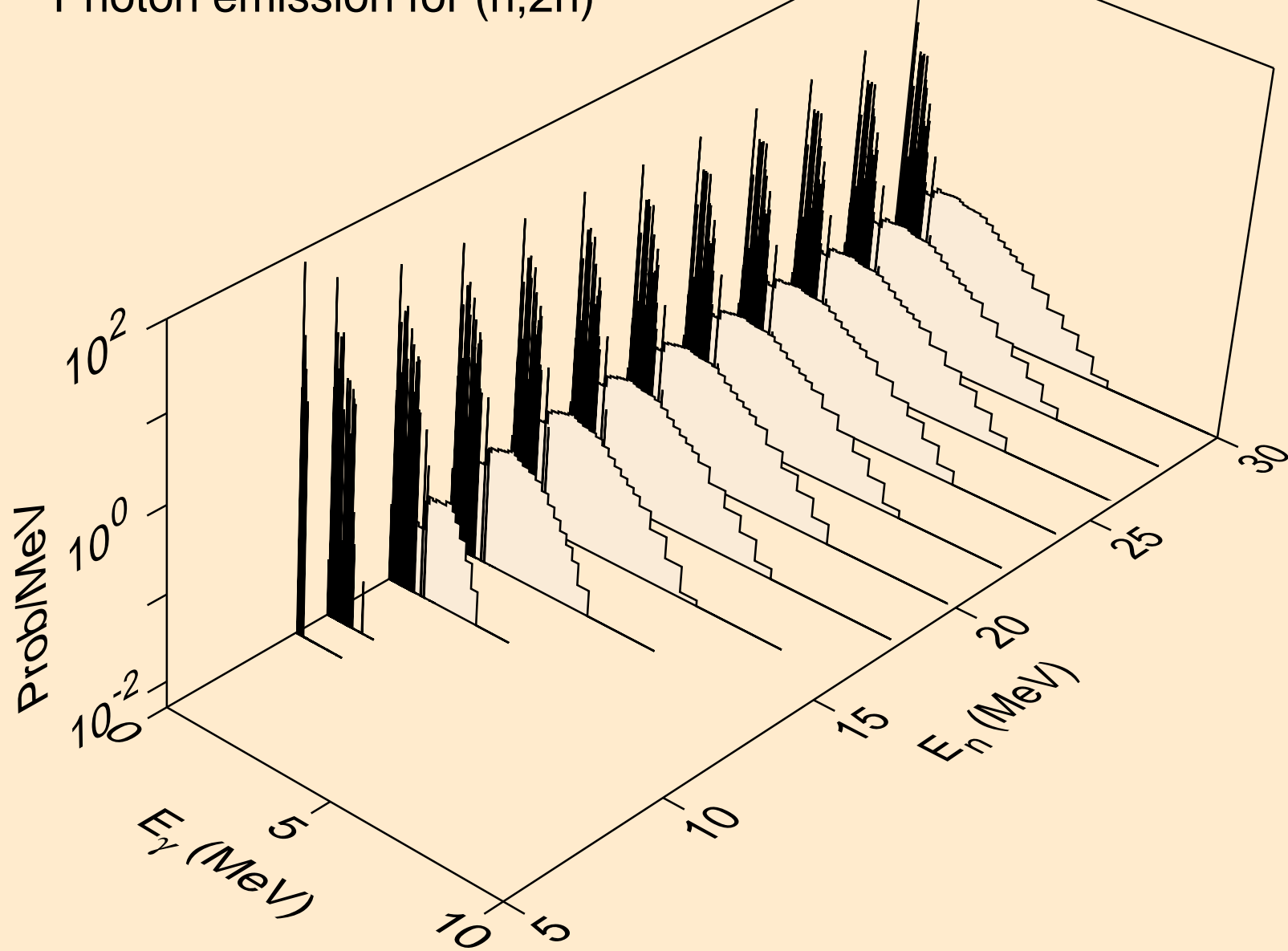

I118 NEUTRON ACER TENDL-2024 LIBRARY; T=293.6K  
Photon emission for (n,3n)

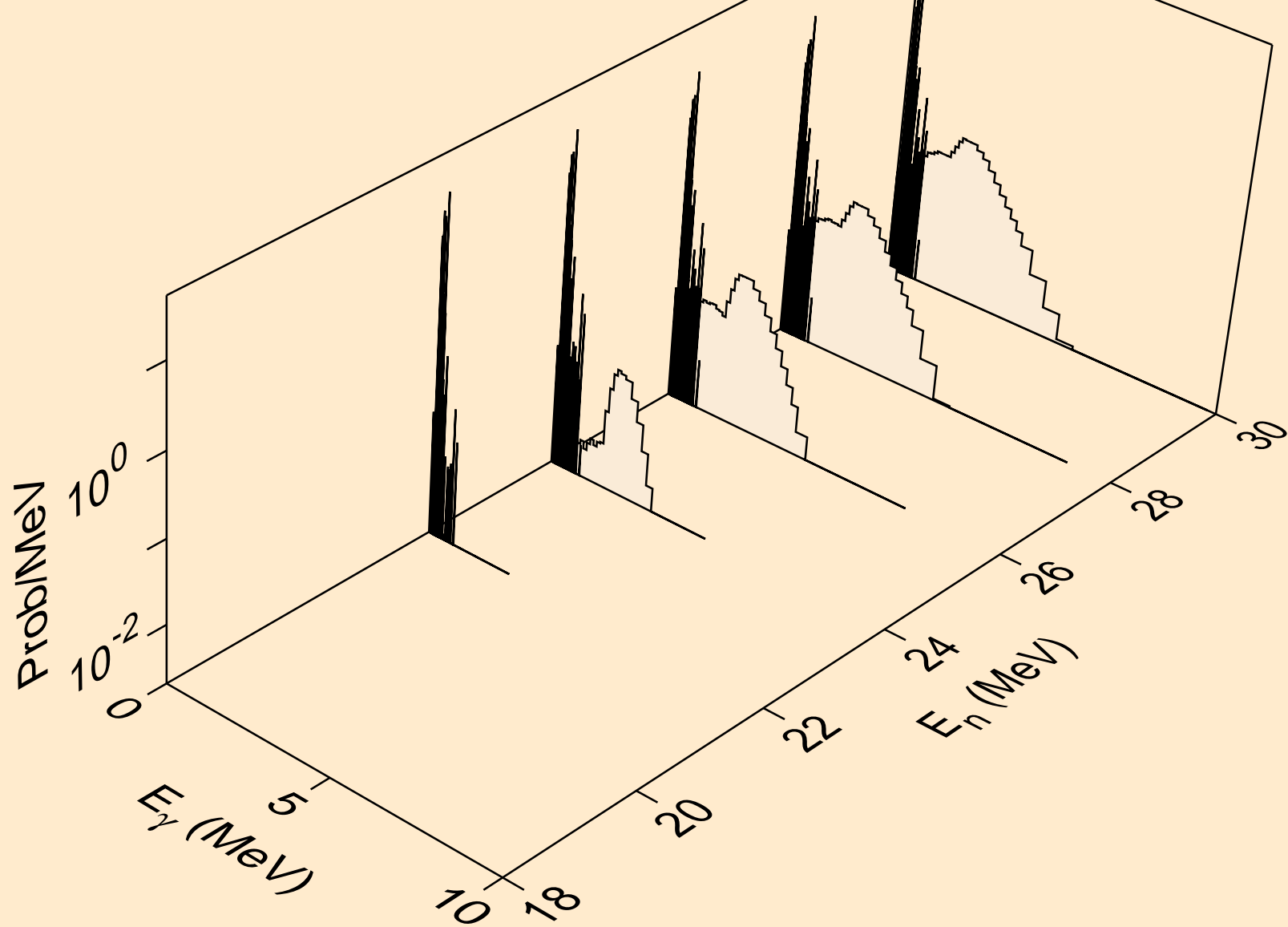

I118 NEUTRON ACER TENDL-2024 LIBRARY; T=293.6K  
Photon emission for (n,n\*)a

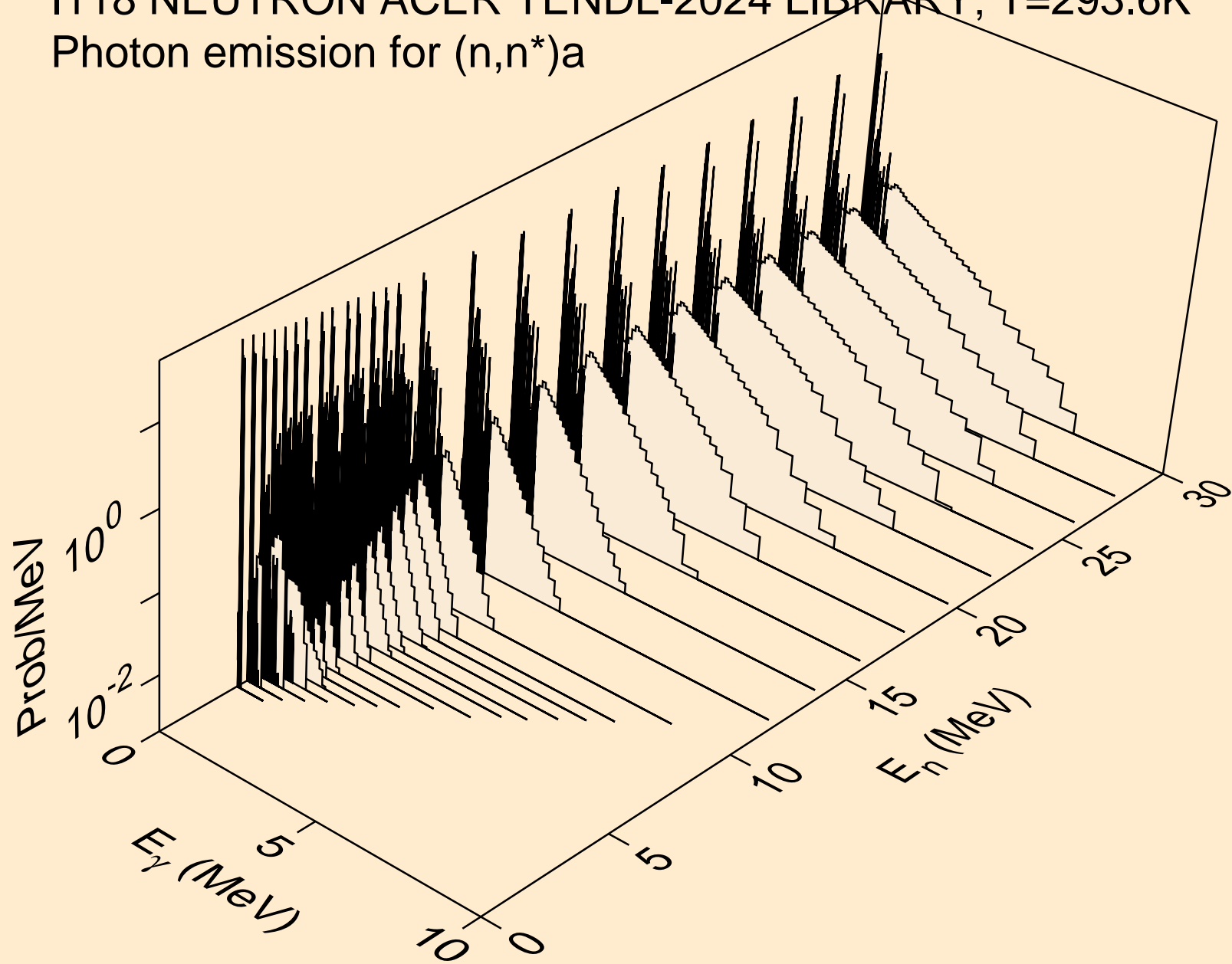

I118 NEUTRON ACER TENDL-2024 LIBRARY; T=293.6K  
Photon emission for (n,2n)a

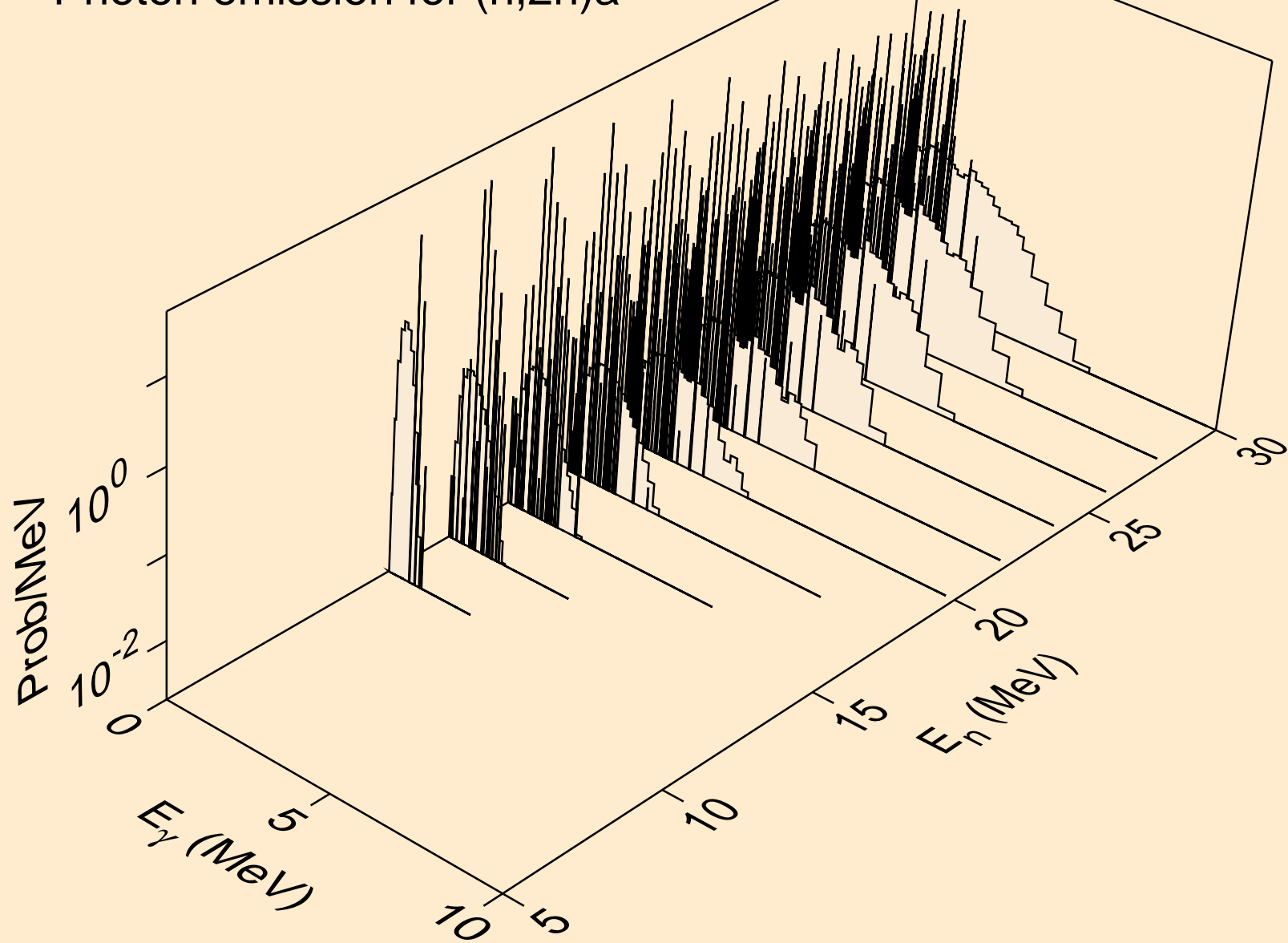

I118 NEUTRON ACER TENDL-2024 LIBRARY; T=293.6K  
Photon emission for (n,3n)a

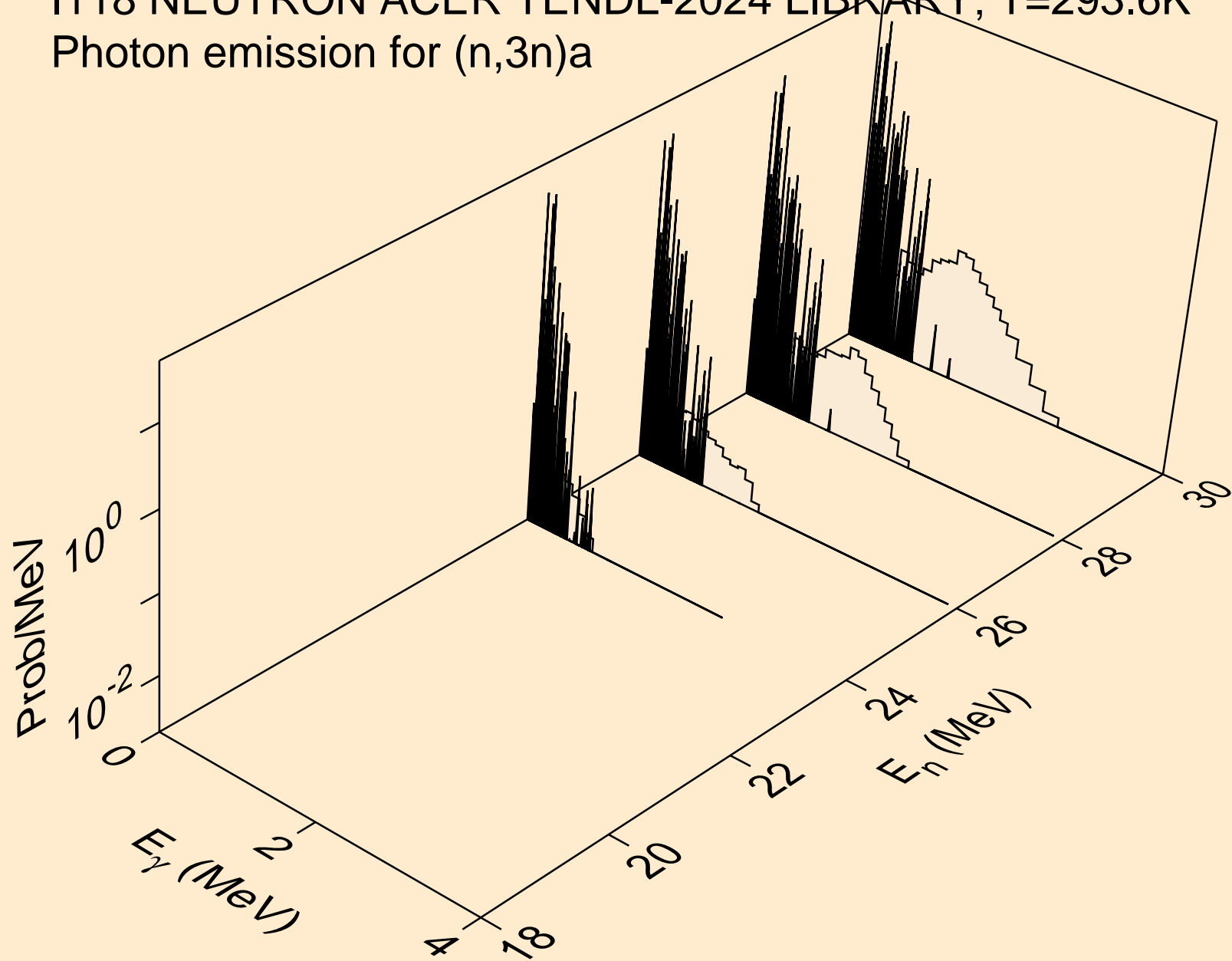

I118 NEUTRON ACER TENDL-2024 LIBRARY; T=293.6K  
Photon emission for (n,n\*)p

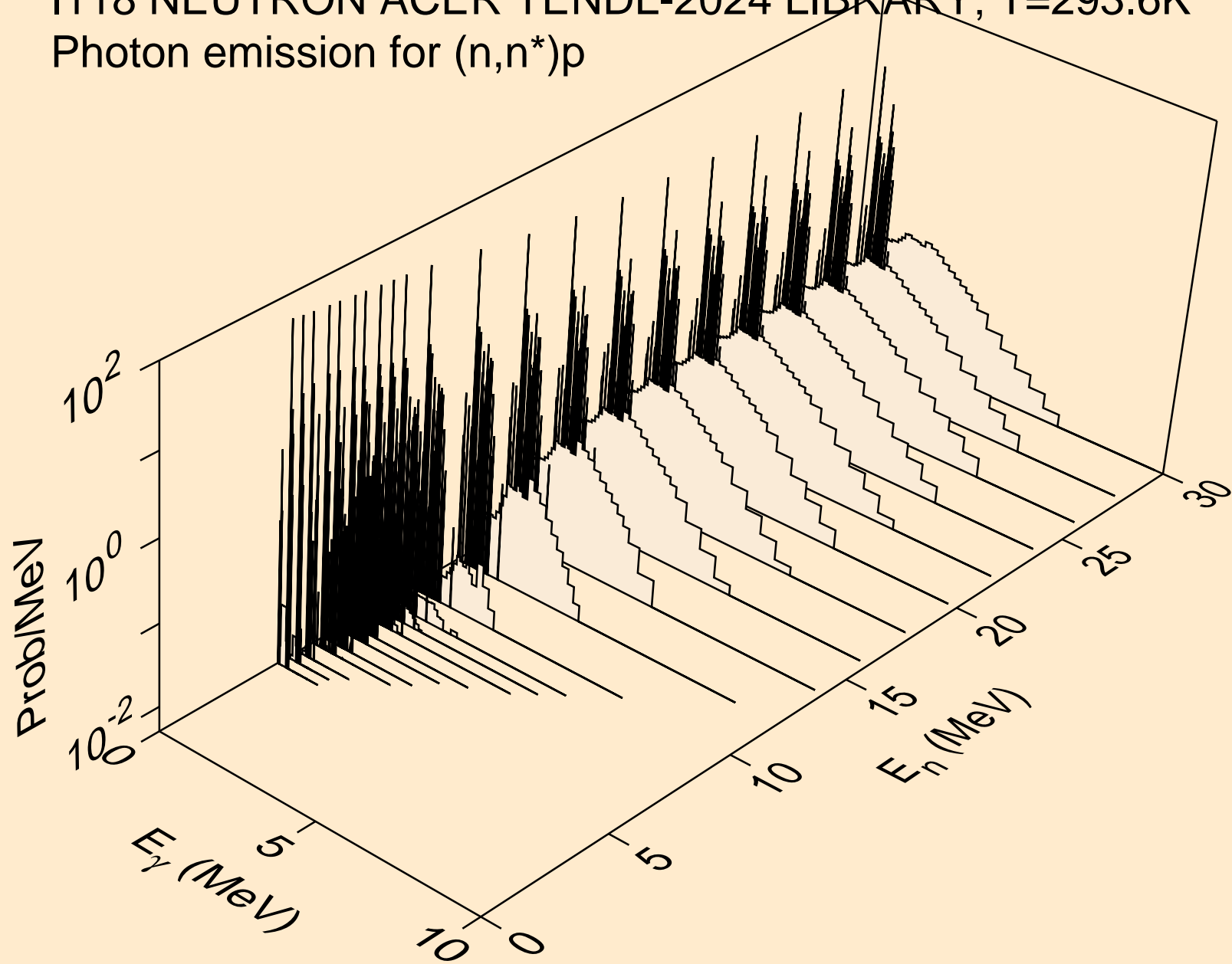

I118 NEUTRON ACER TENDL-2024 LIBRARY; T=293.6K  
Photon emission for (n,n\*)2a

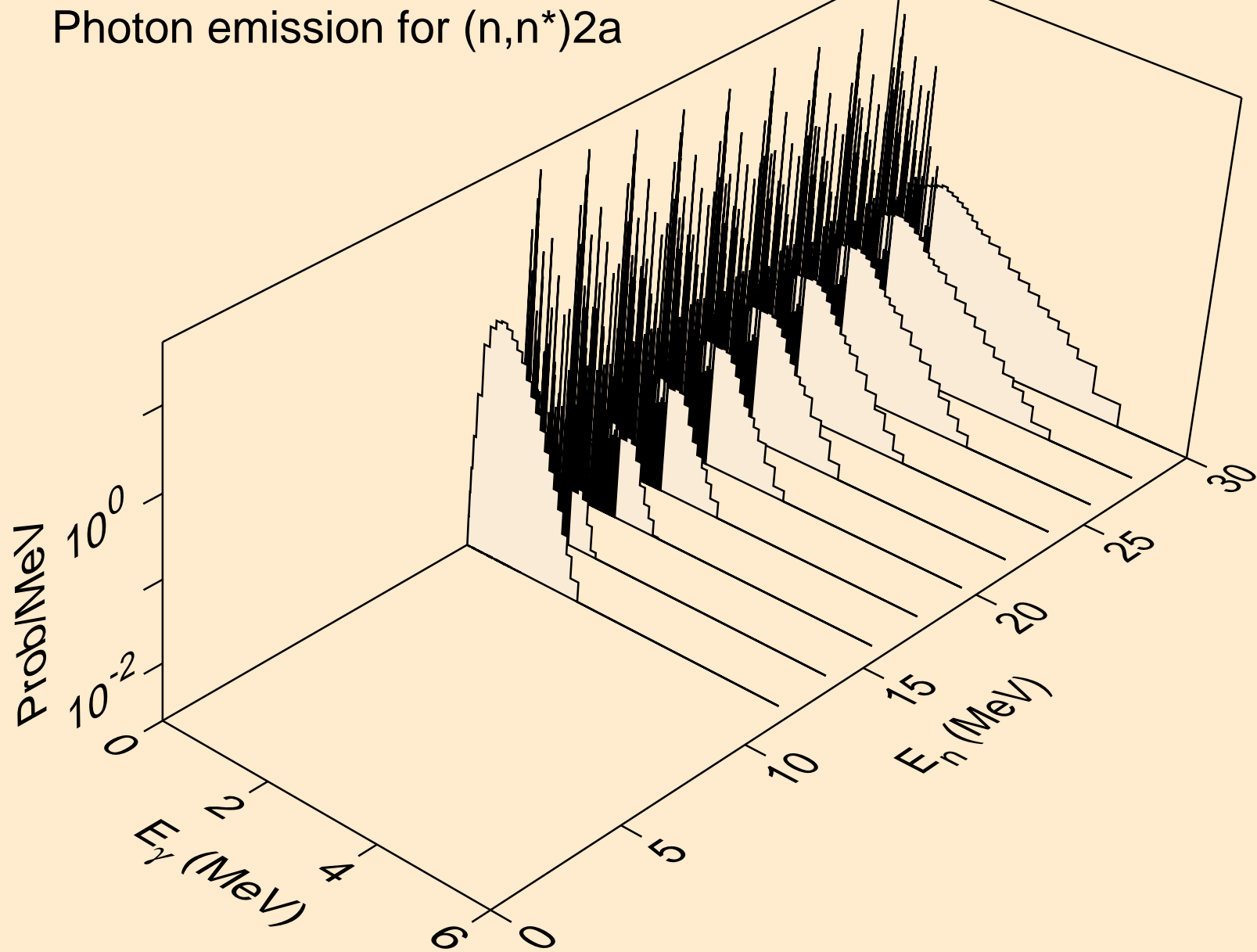

I118 NEUTRON ACER TENDL-2024 LIBRARY; T=293.6K  
Photon emission for (n,2n)2a

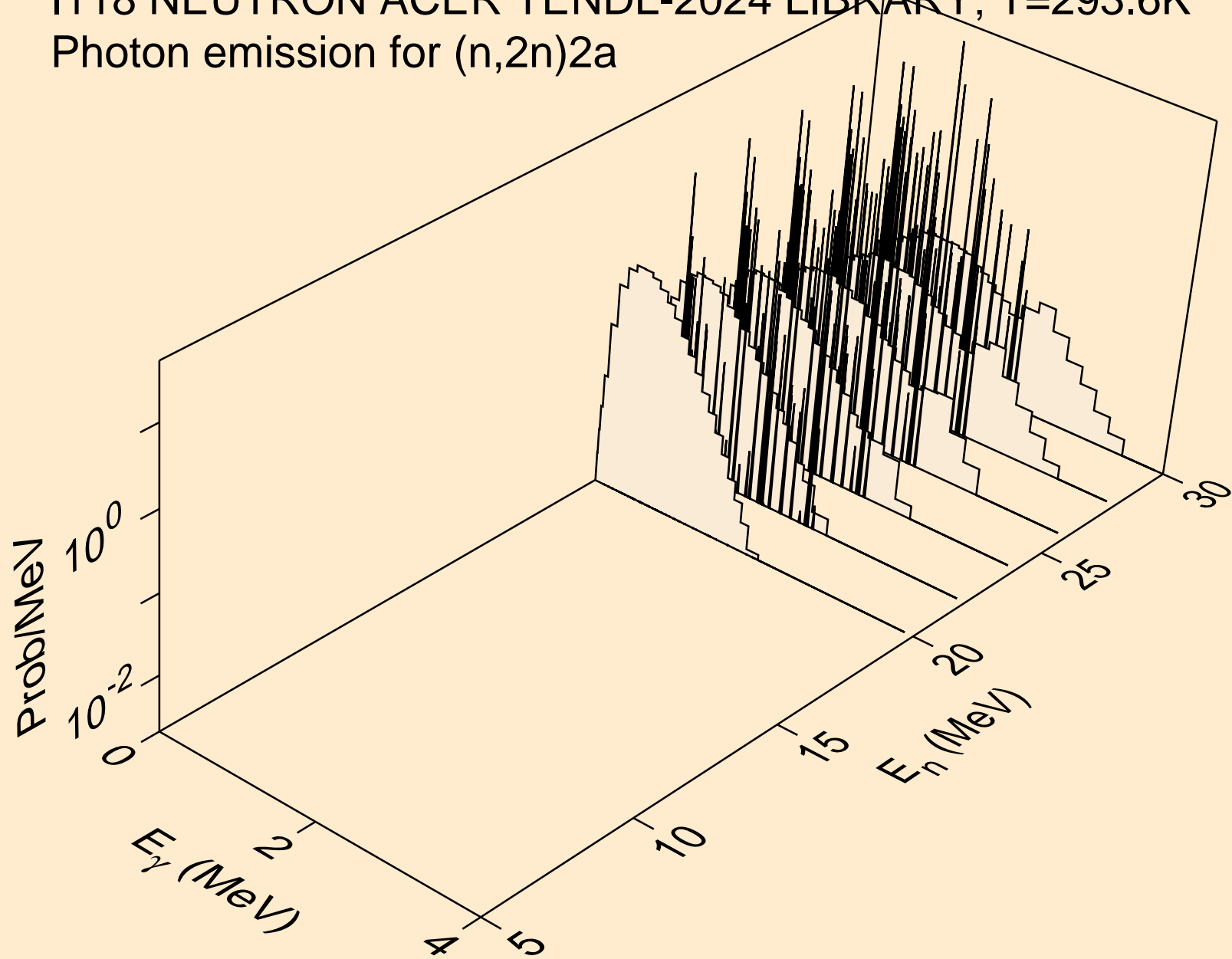

I118 NEUTRON ACER TENDL-2024 LIBRARY; T=293.6K  
Photon emission for (n,n\*)d

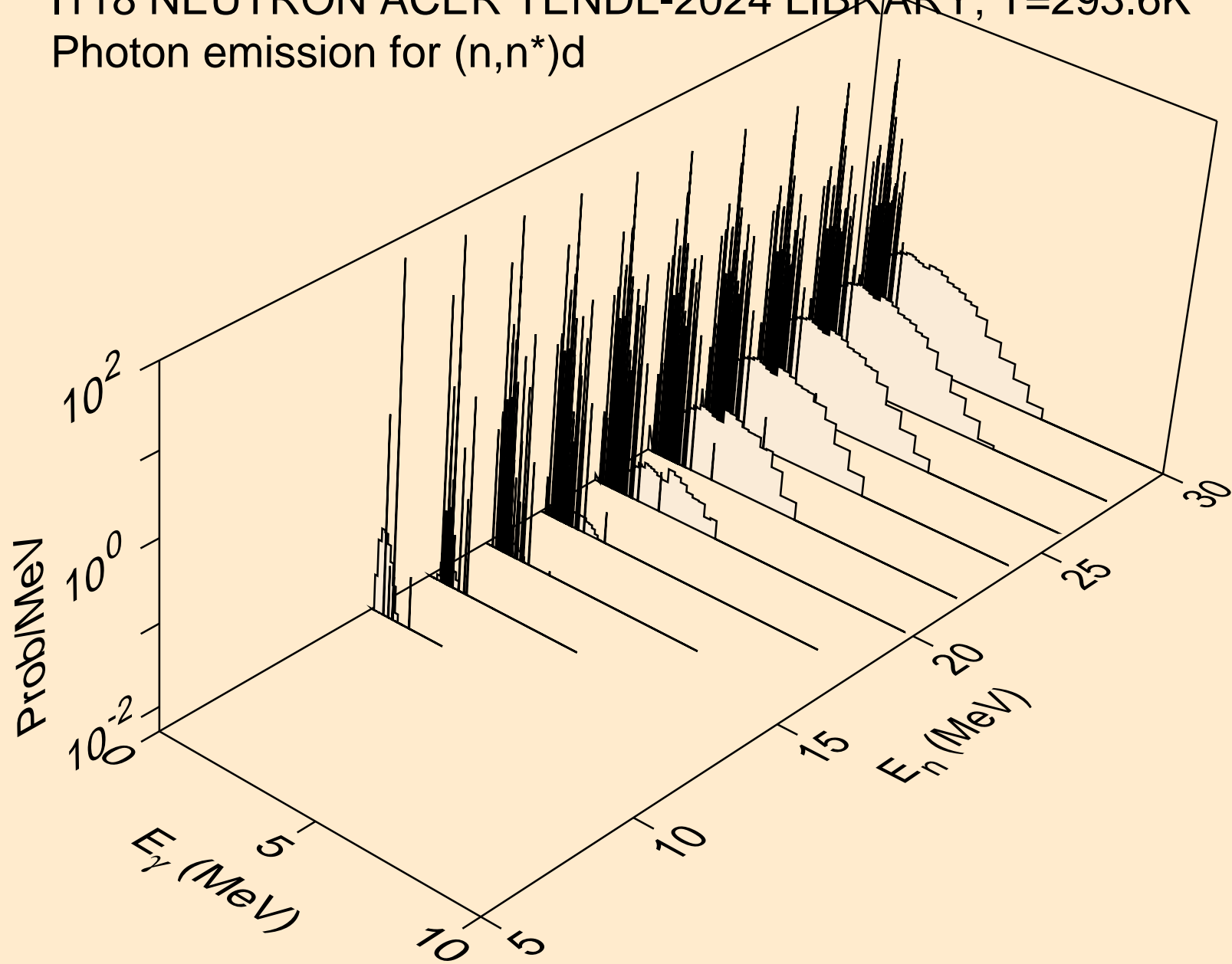

I118 NEUTRON ACER TENDL-2024 LIBRARY; T=293.6K  
Photon emission for (n,n\*)t

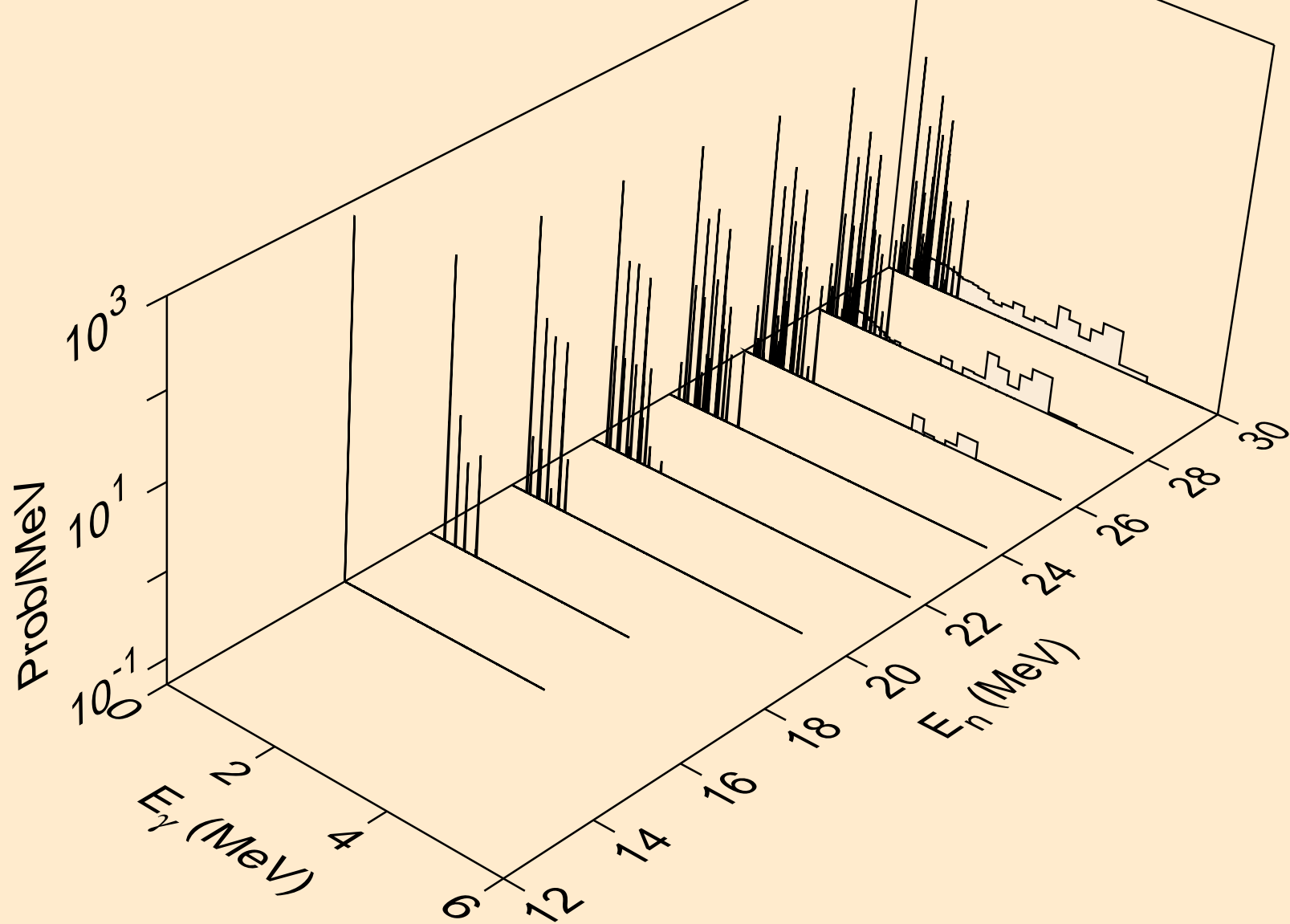

I118 NEUTRON ACER TENDL-2024 LIBRARY; T=293.6K  
Photon emission for (n,n\*)he3

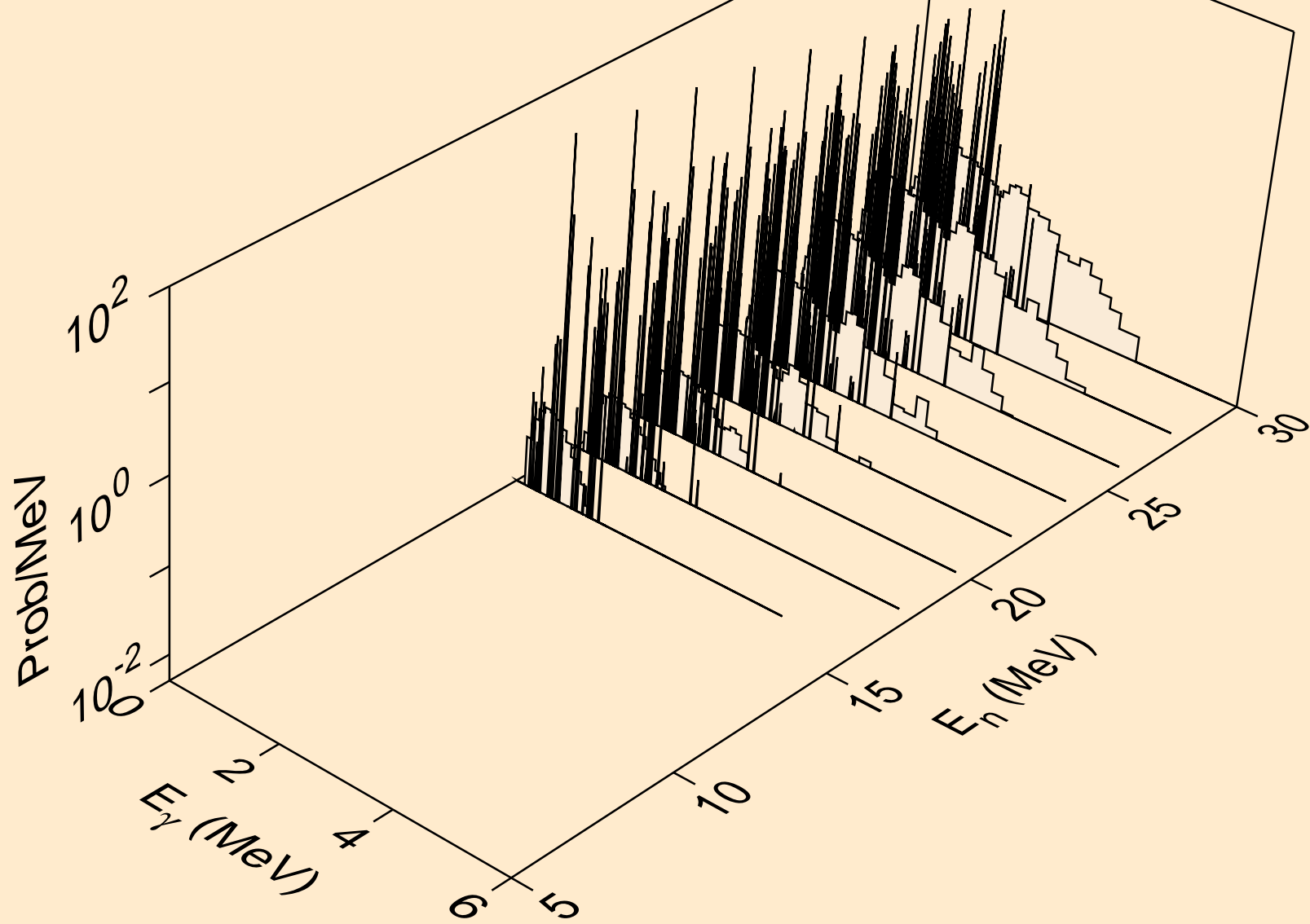

I118 NEUTRON ACER TENDL-2024 LIBRARY; T=293.6K  
Photon emission for (n,2np)

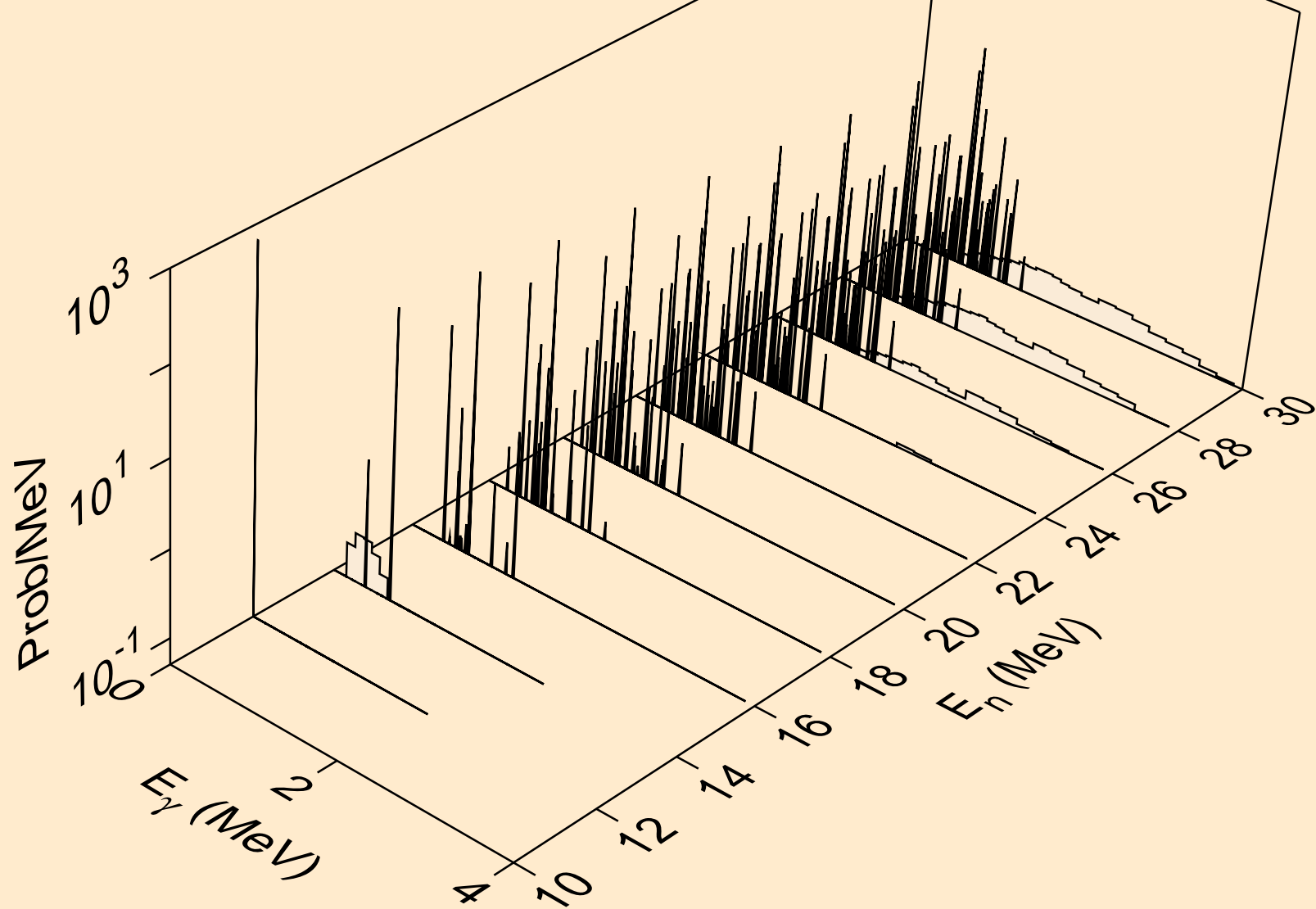

I118 NEUTRON ACER TENDL-2024 LIBRARY; T=293.6K  
Photon emission for (n,3np)

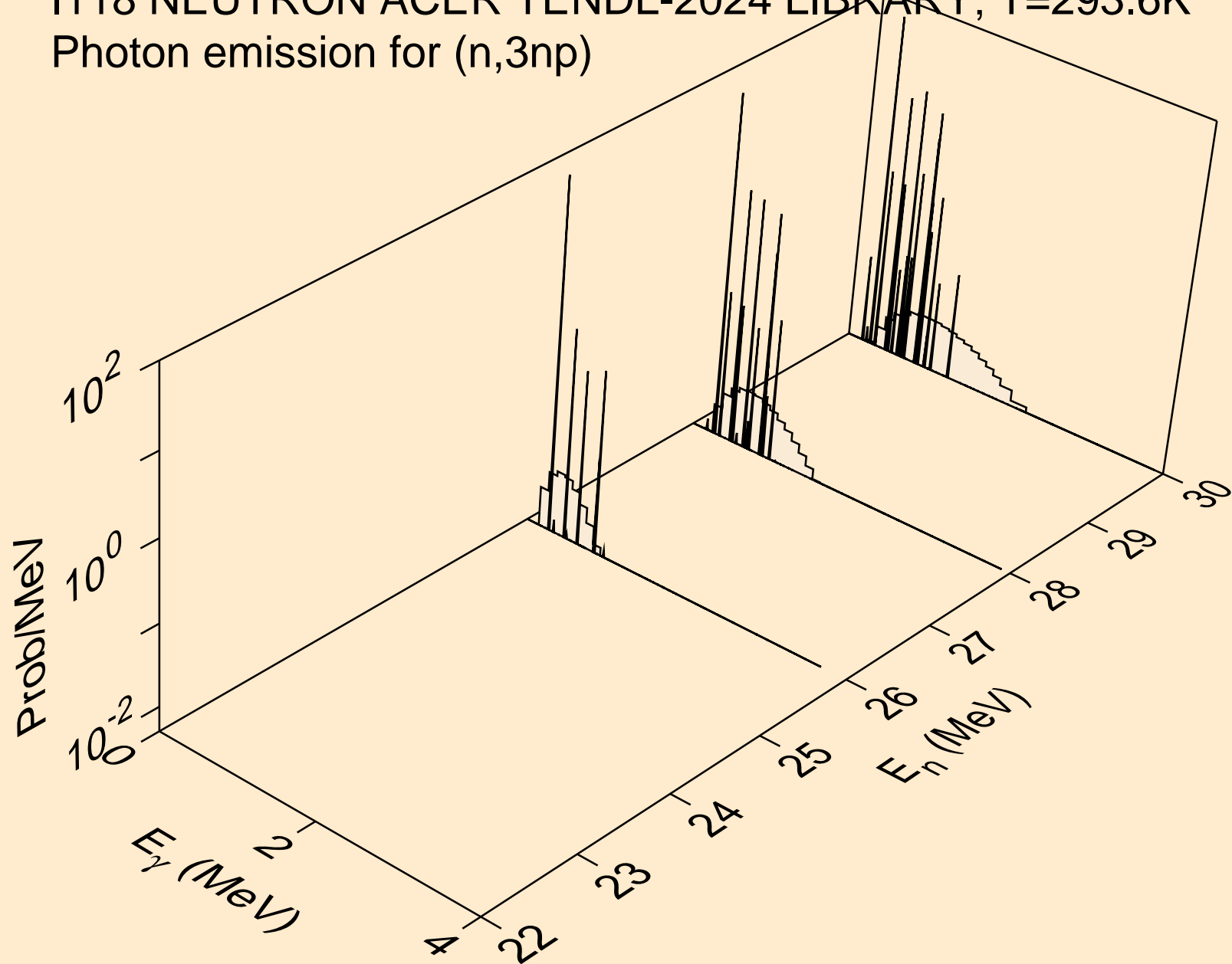

I118 NEUTRON ACER TENDL-2024 LIBRARY; T=293.6K  
Photon emission for (n,n2p)

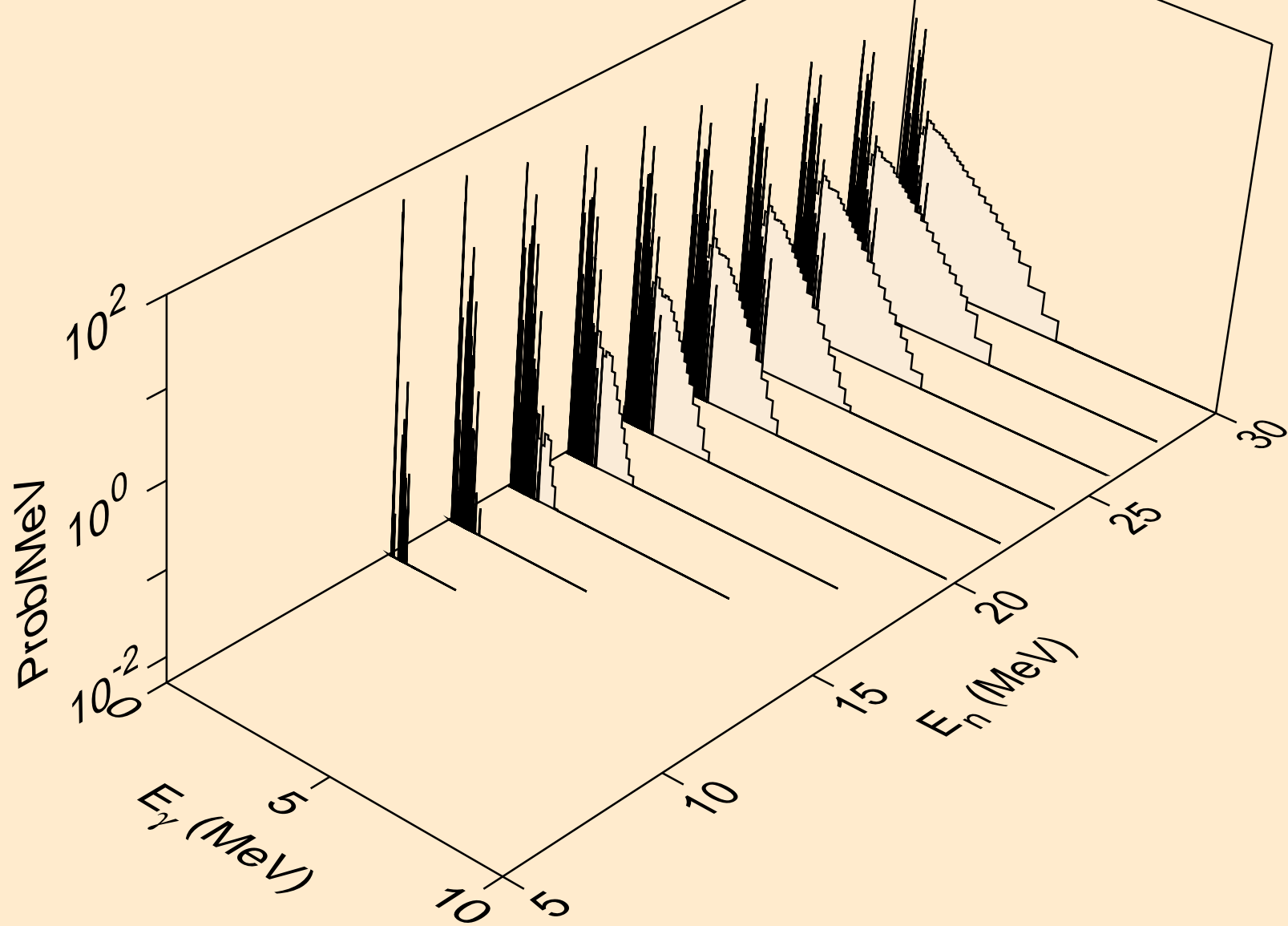

I118 NEUTRON ACER TENDL-2024 LIBRARY; T=293.6K  
Photon emission for (n,npa)

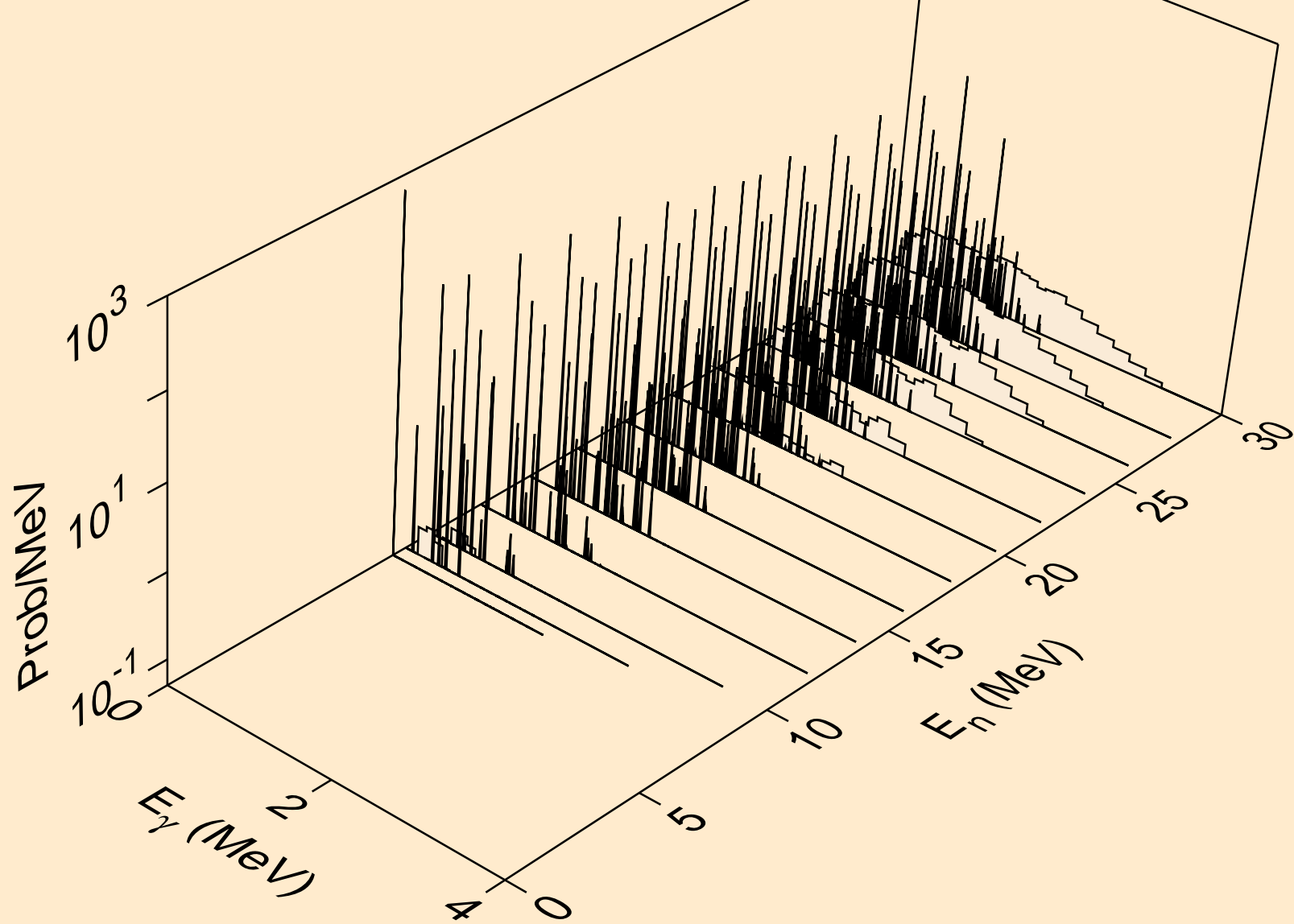

I118 NEUTRON ACER TENDL-2024 LIBRARY; T=293.6K  
Photon emission for (n,n\*c)

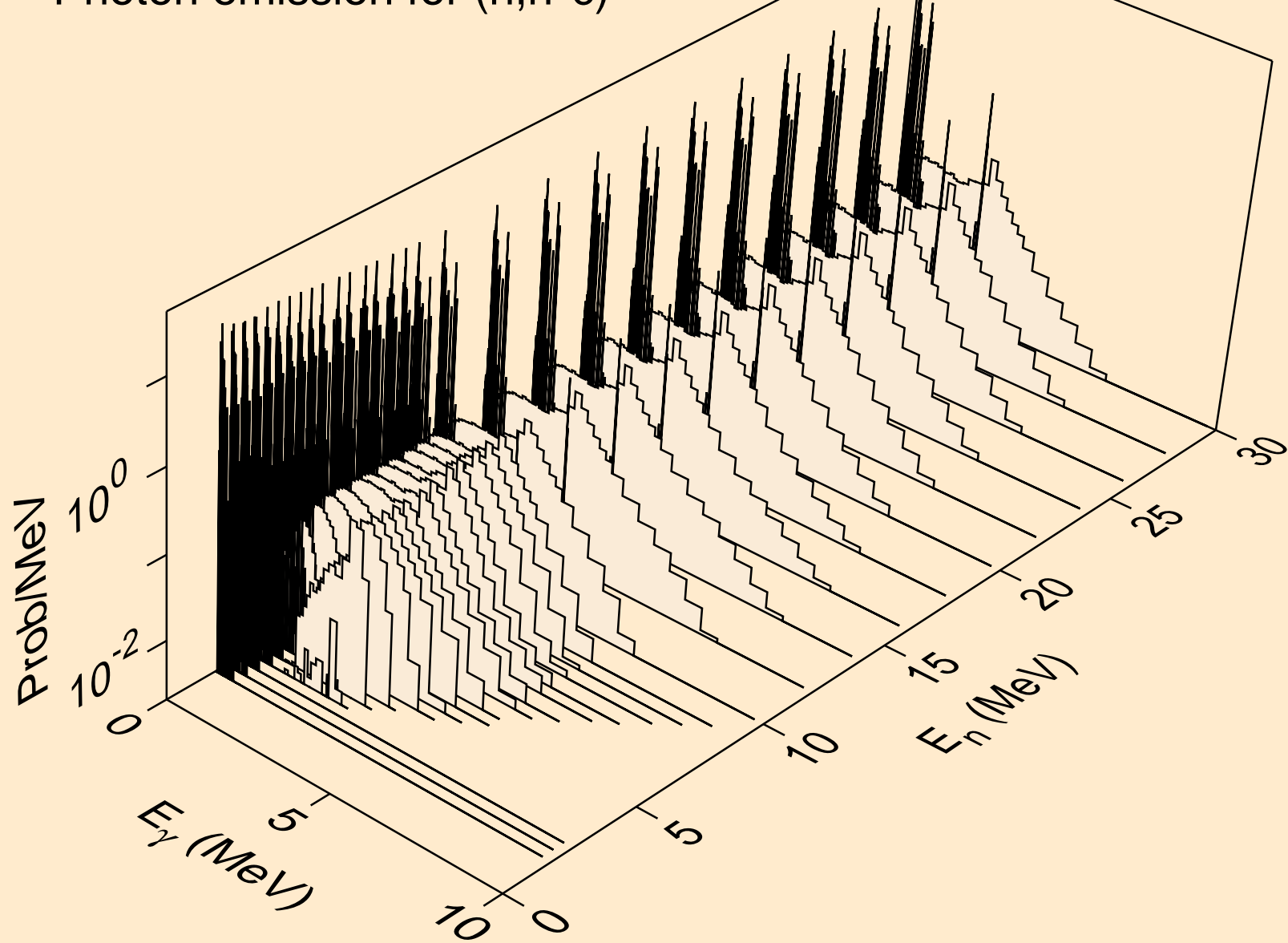

I118 NEUTRON ACER TENDL-2024 LIBRARY; T=293.6K  
Photon emission for (n,gma)

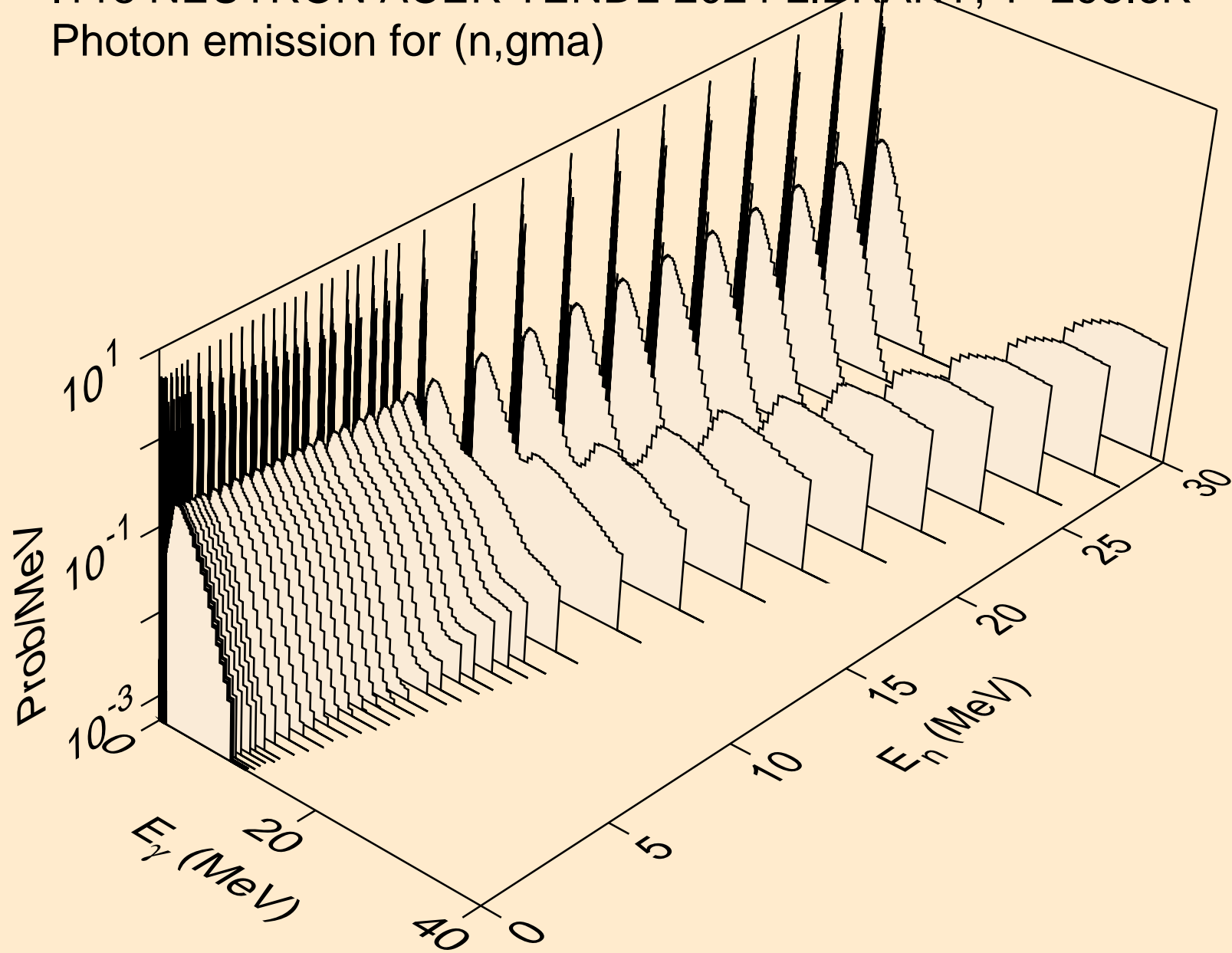

I118 NEUTRON ACER TENDL-2024 LIBRARY; T=293.6K  
Photon emission for (n,p)

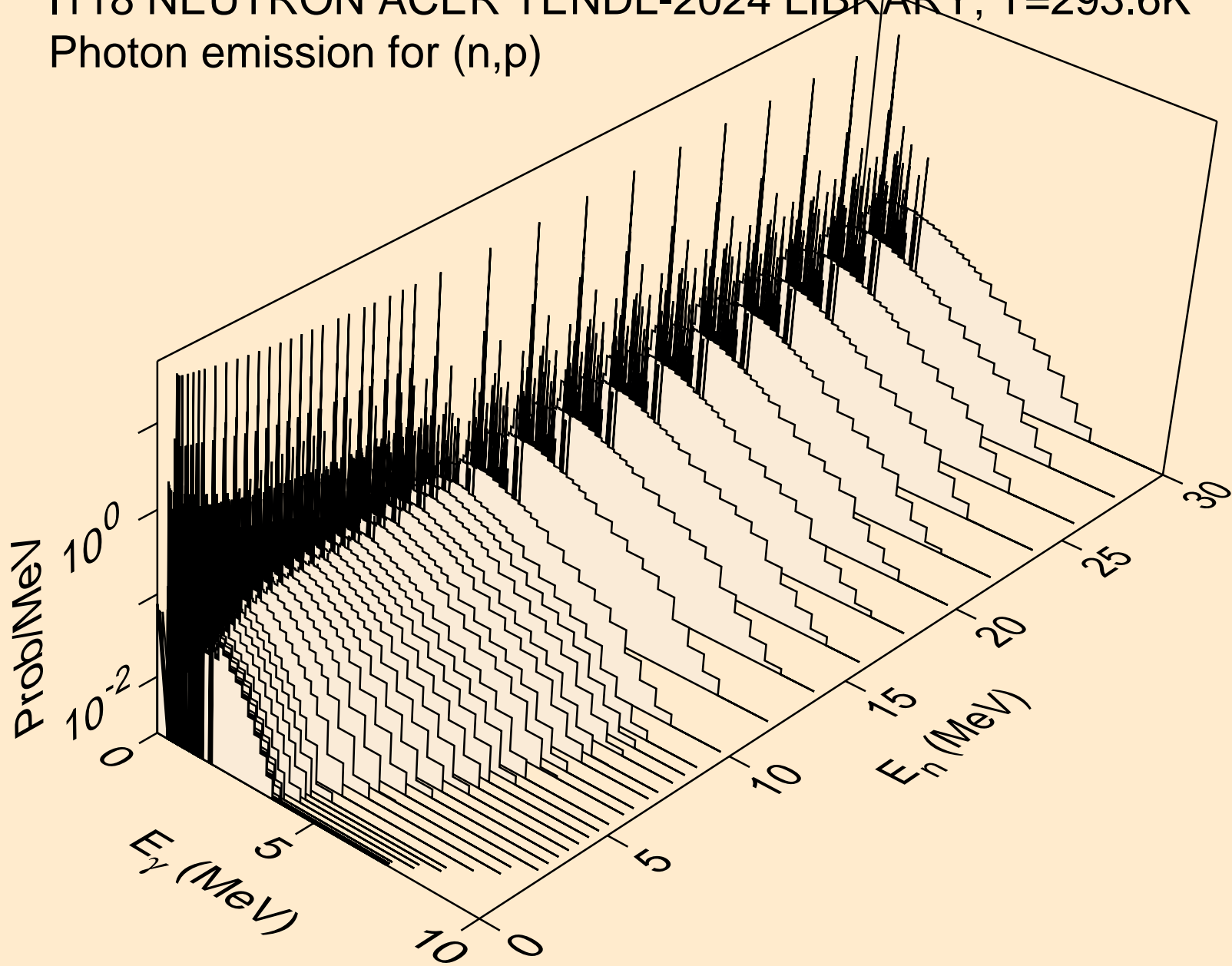

I118 NEUTRON ACER TENDL-2024 LIBRARY; T=293.6K  
Photon emission for (n,d)

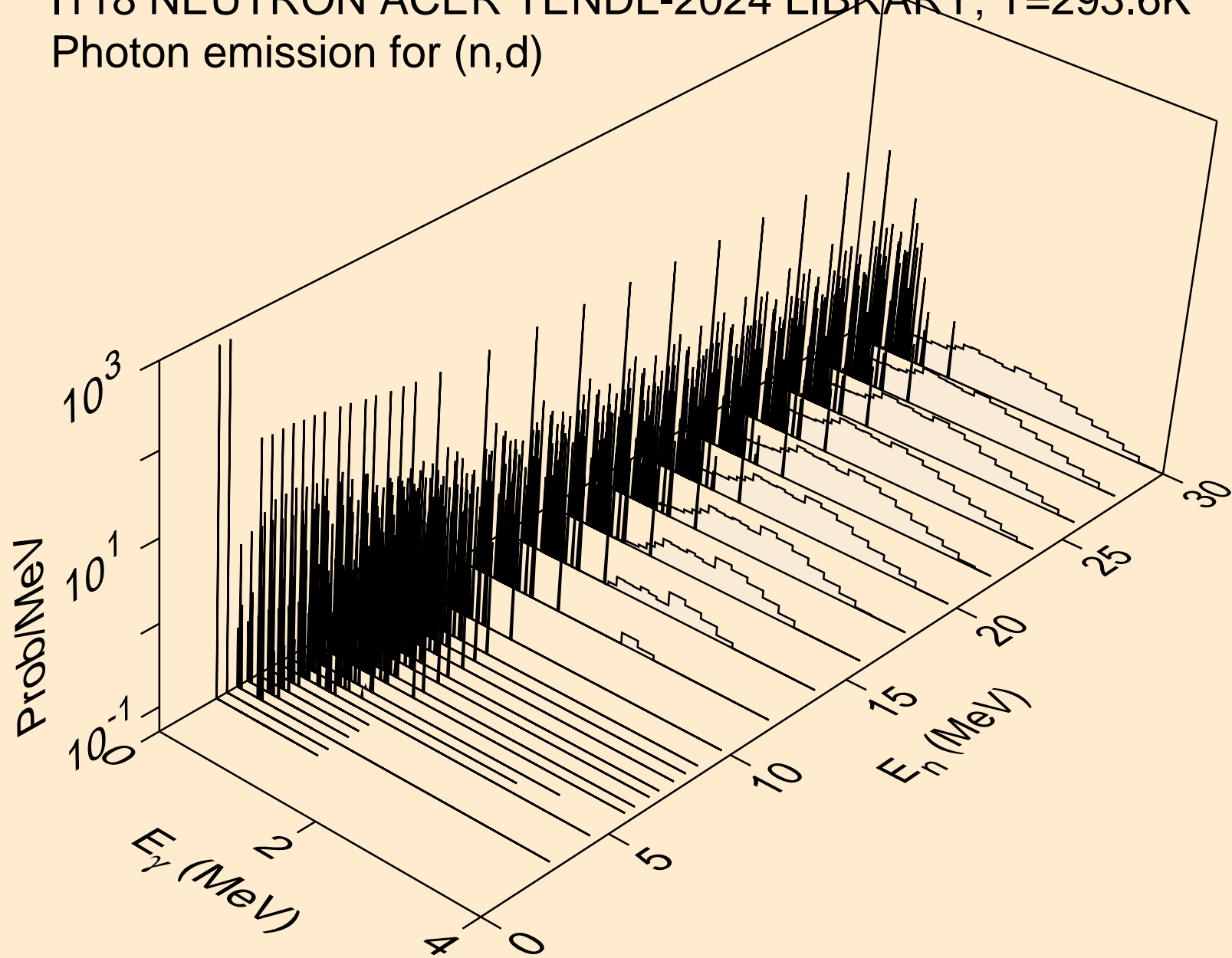

I118 NEUTRON ACER TENDL-2024 LIBRARY; T=293.6K  
Photon emission for (n,t)

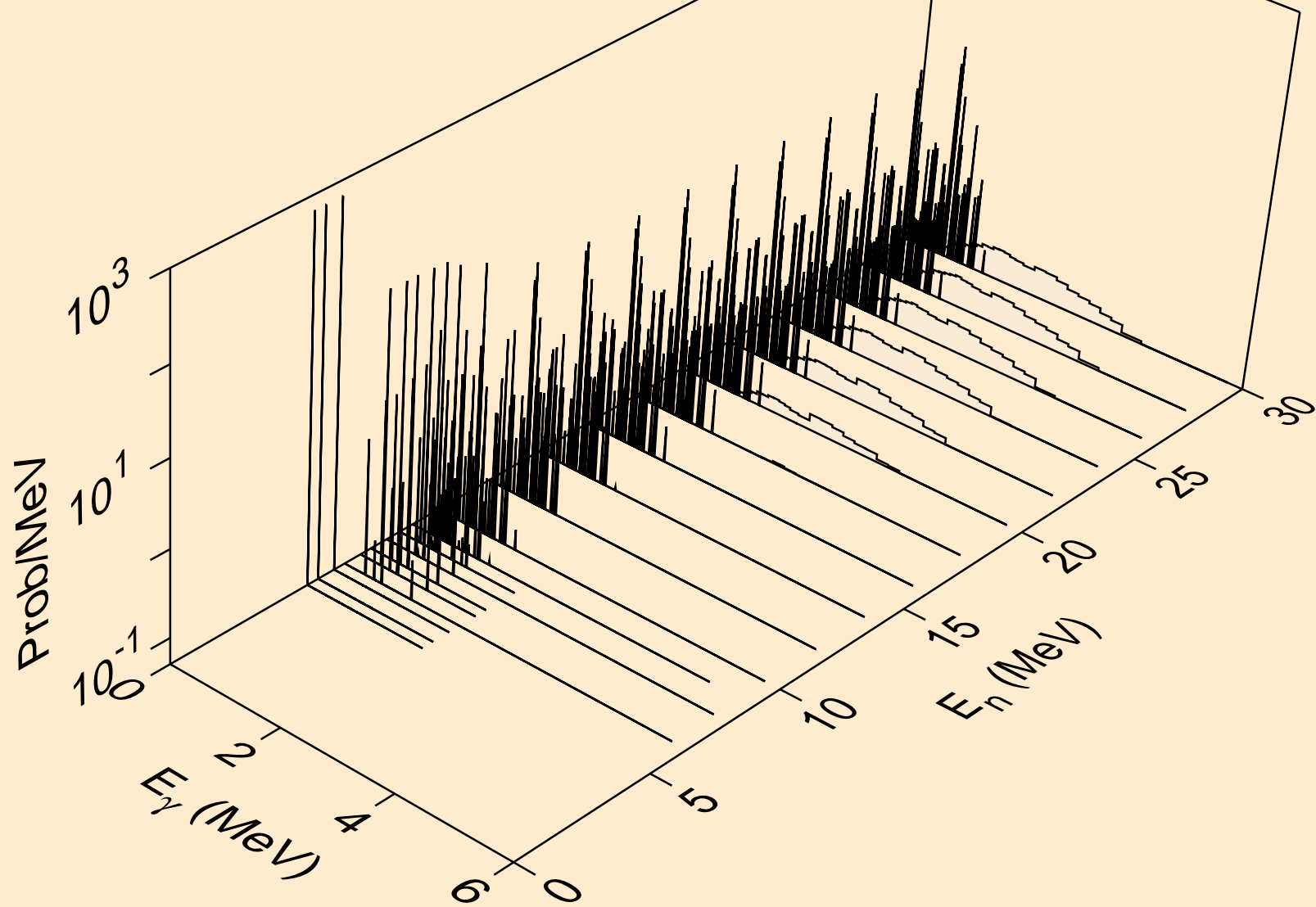

I118 NEUTRON ACER TENDL-2024 LIBRARY; T=293.6K  
Photon emission for (n,he3)

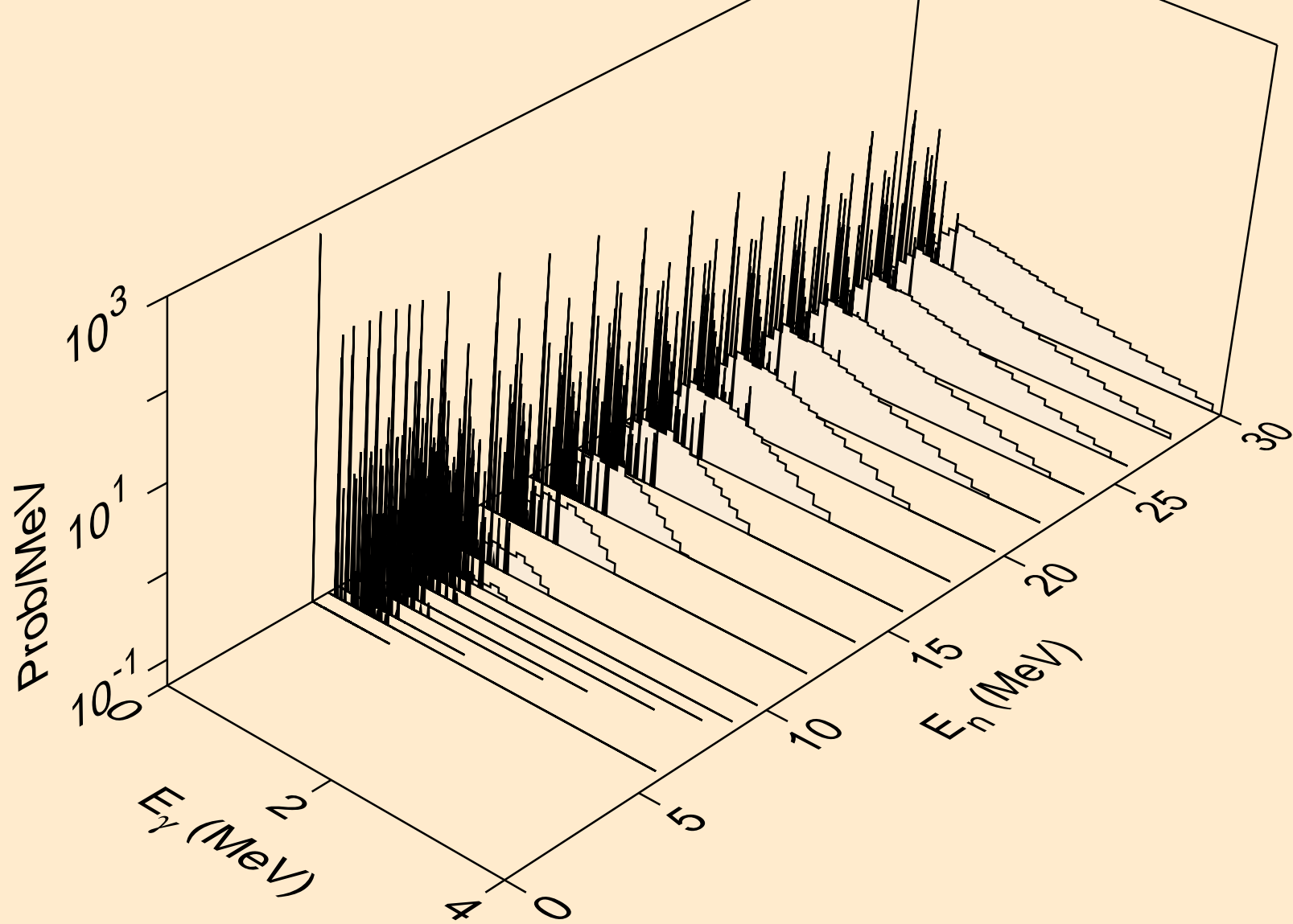

I118 NEUTRON ACER TENDL-2024 LIBRARY; T=293.6K  
Photon emission for (n,a)

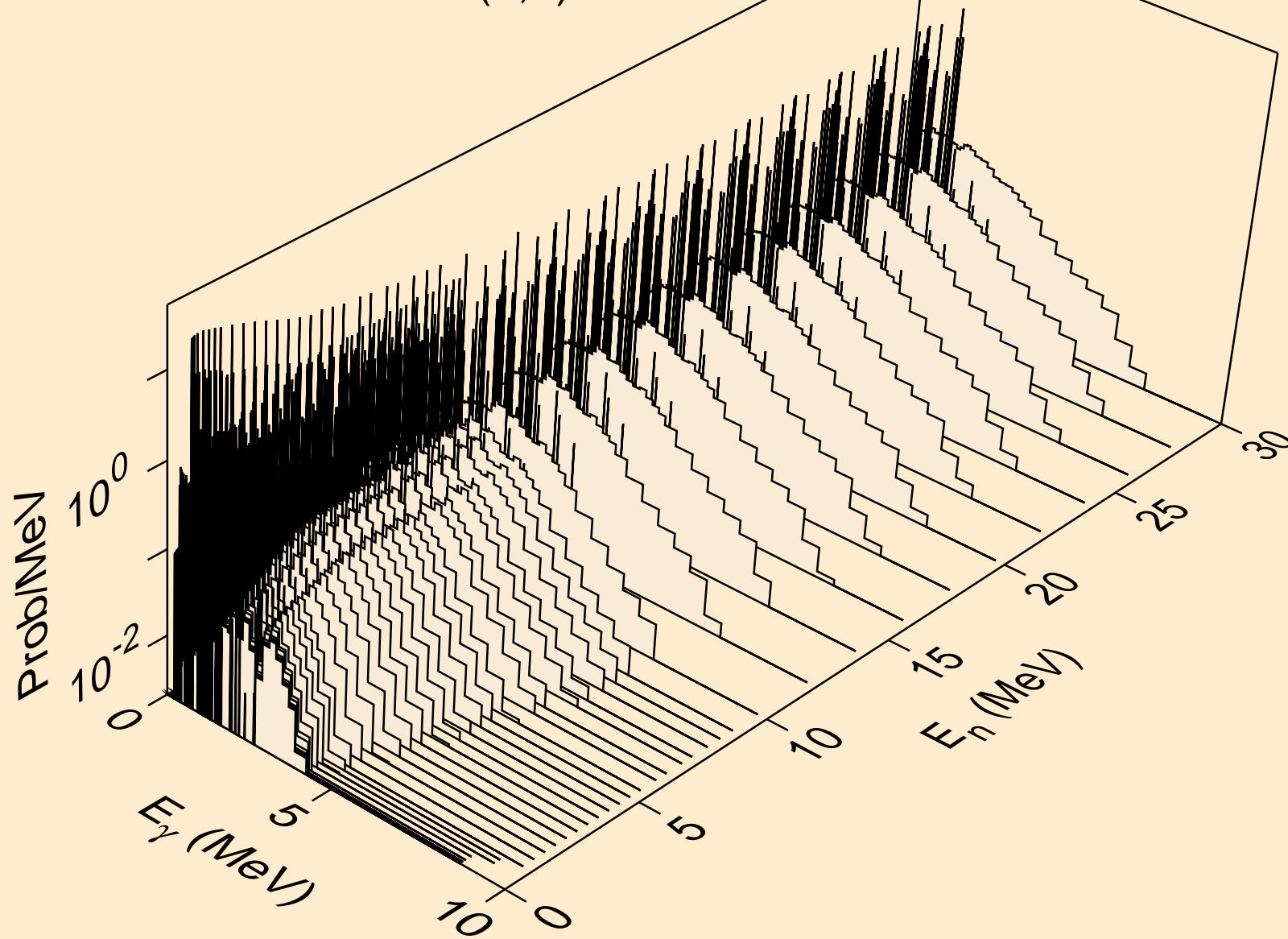

I118 NEUTRON ACER TENDL-2024 LIBRARY; T=293.6K  
Photon emission for (n,2a)

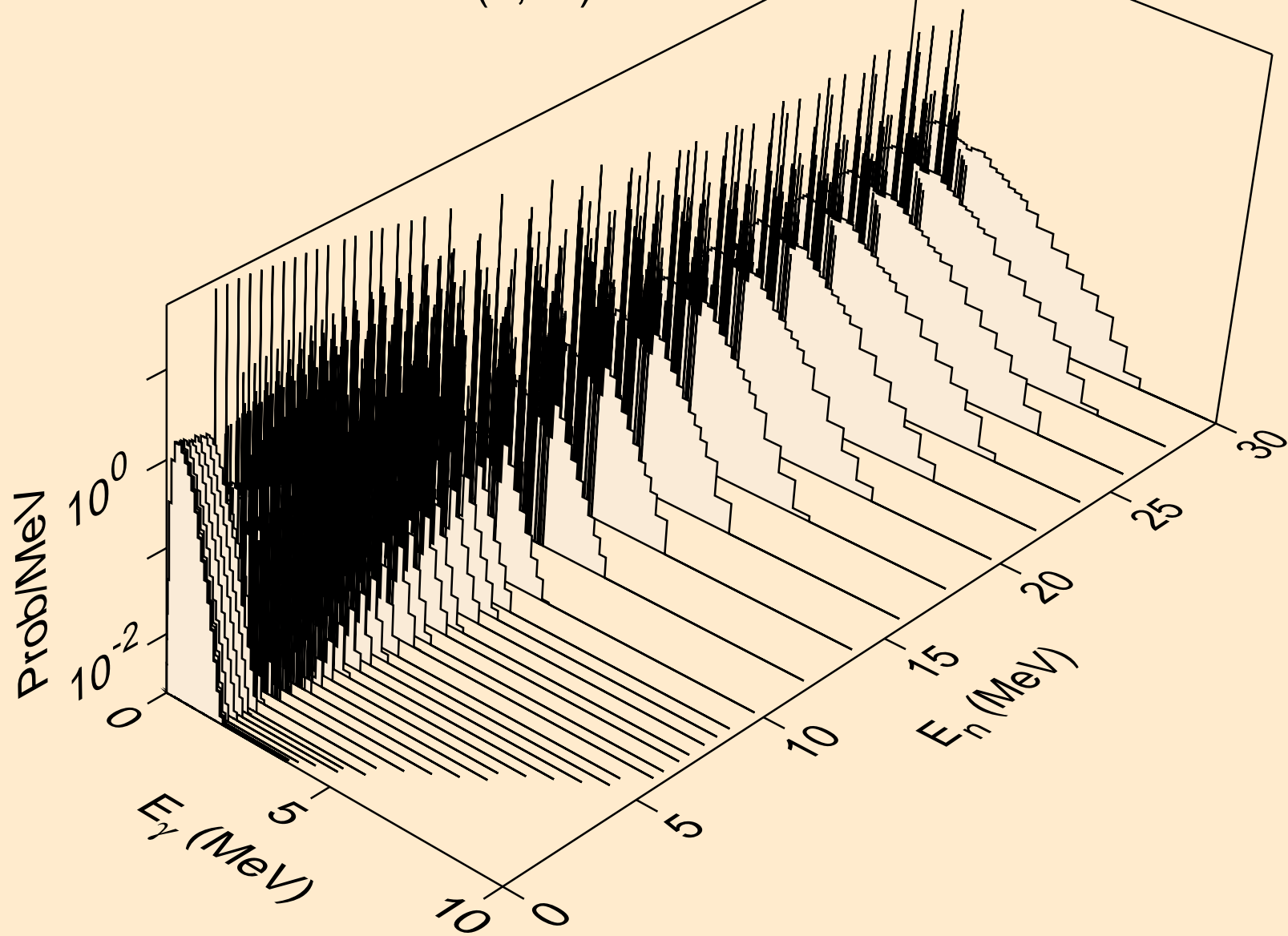

I118 NEUTRON ACER TENDL-2024 LIBRARY; T=293.6K  
Photon emission for (n,3a)

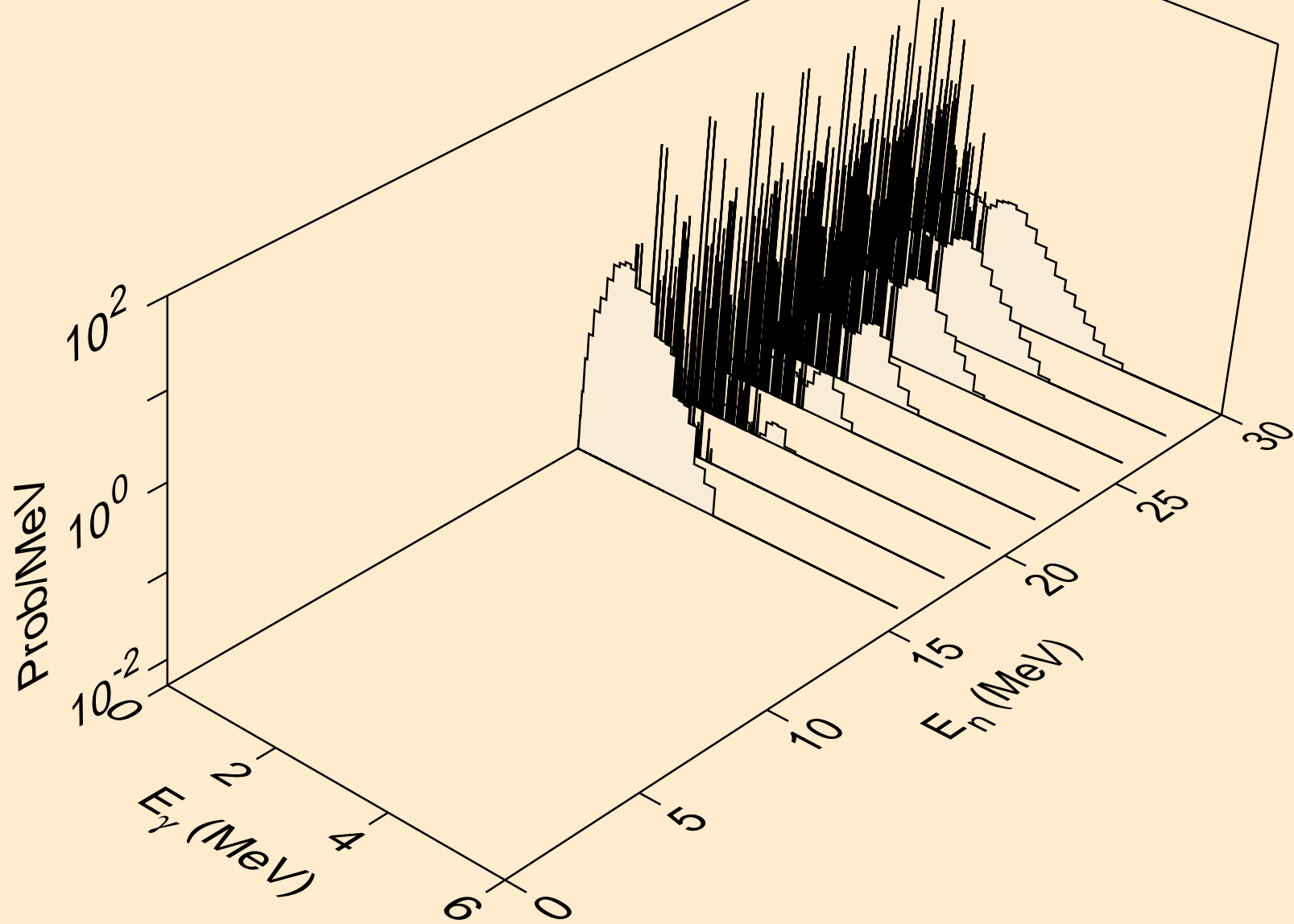

I118 NEUTRON ACER TENDL-2024 LIBRARY; T=293.6K  
Photon emission for (n,2p)

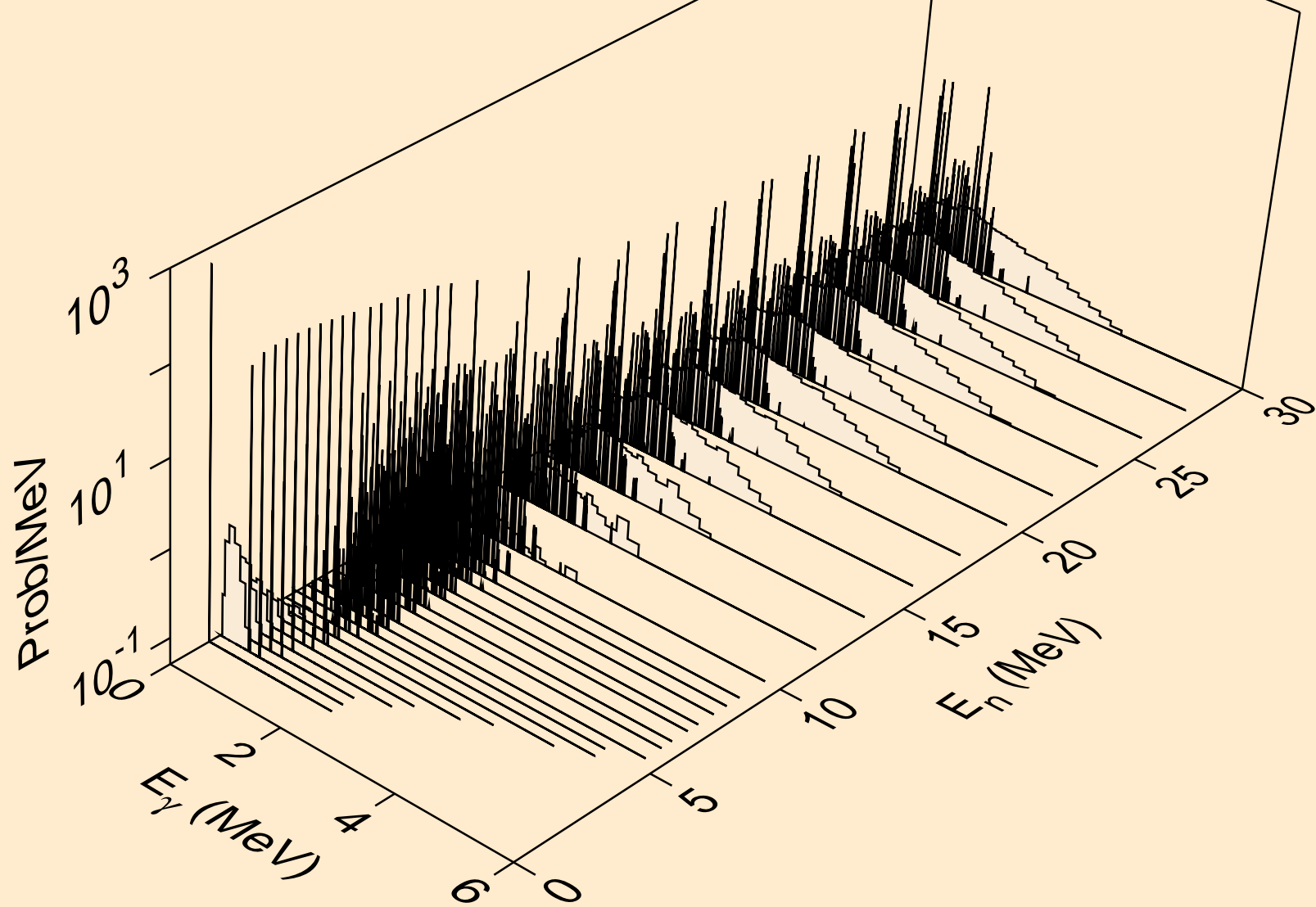

I118 NEUTRON ACER TENDL-2024 LIBRARY; T=293.6K  
Photon emission for (n,p $\alpha$ )

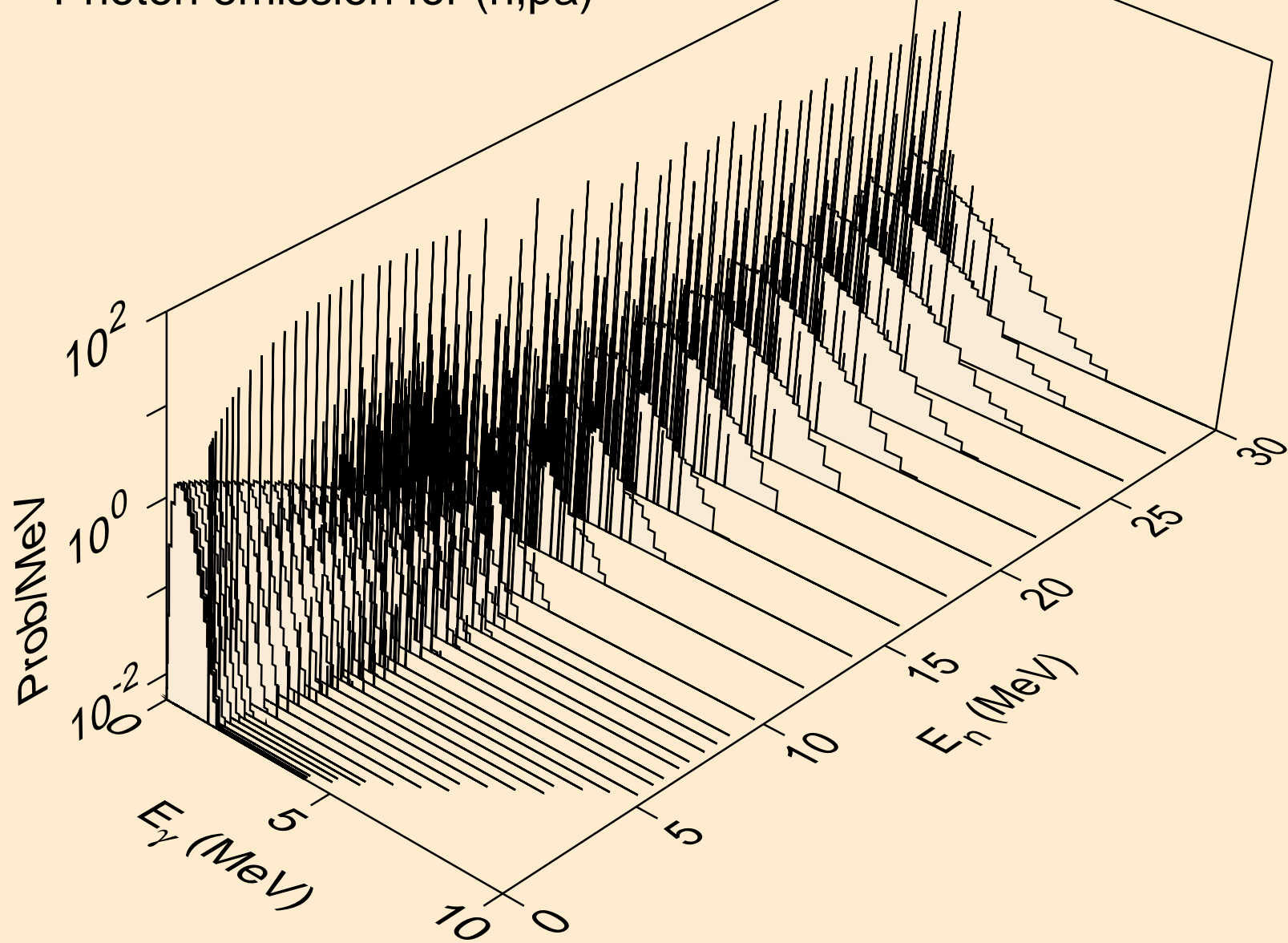

I118 NEUTRON ACER TENDL-2024 LIBRARY; T=293.6K  
Photon emission for (n,pd)

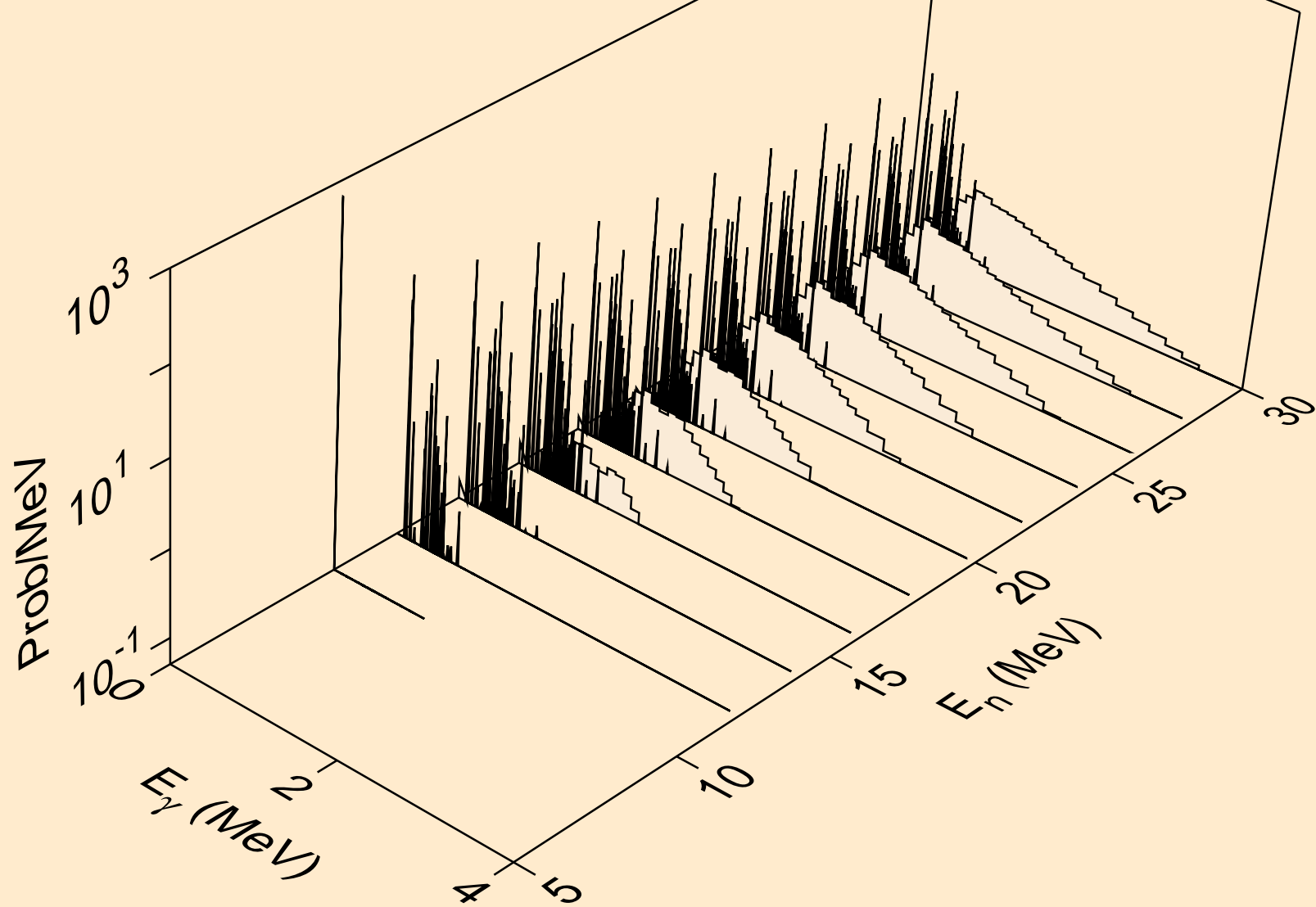

I118 NEUTRON ACER TENDL-2024 LIBRARY; T=293.6K  
Photon emission for (n,pt)

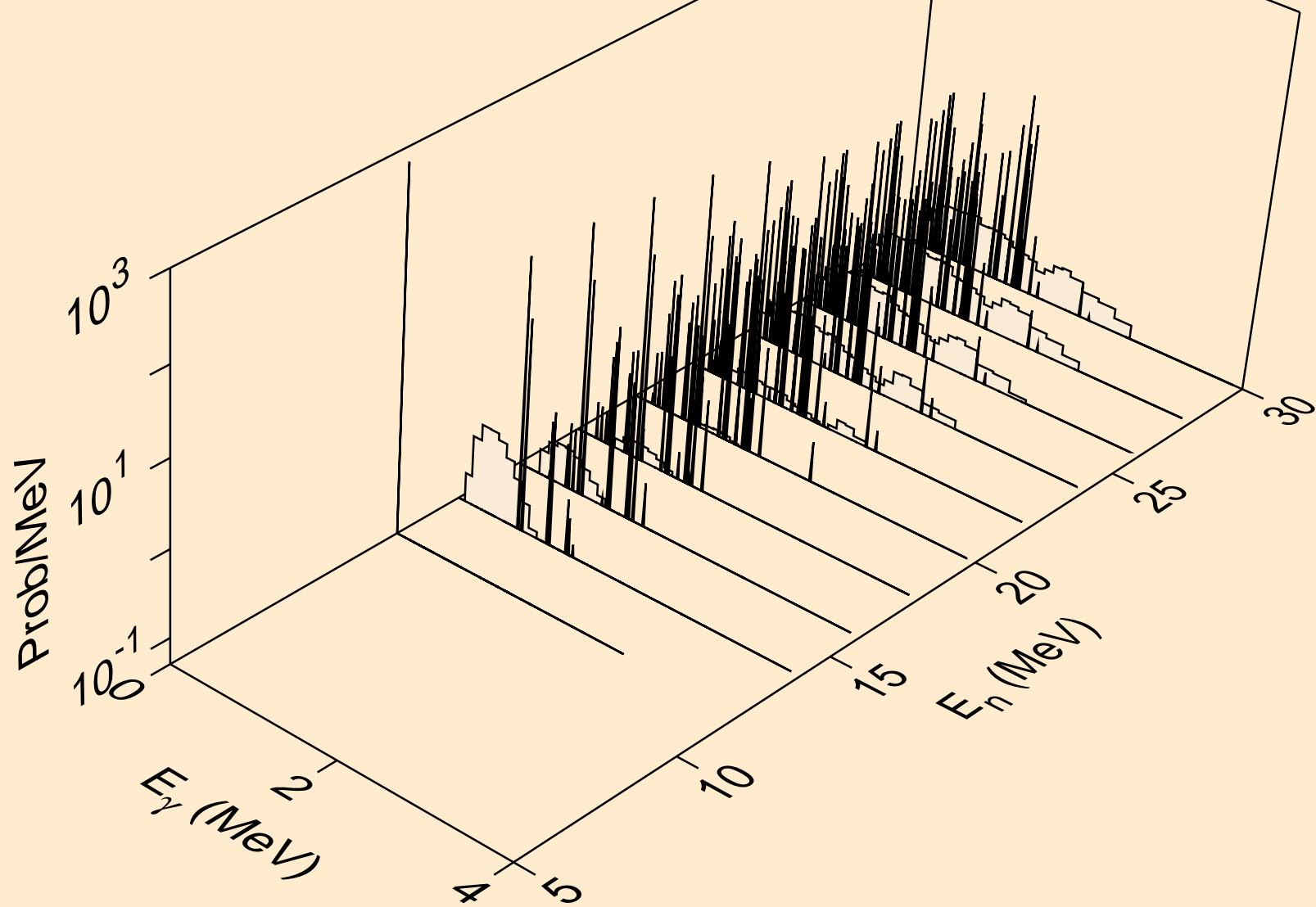

I118 NEUTRON ACER TENDL-2024 LIBRARY; T=293.6K  
Photon emission for (n,da)

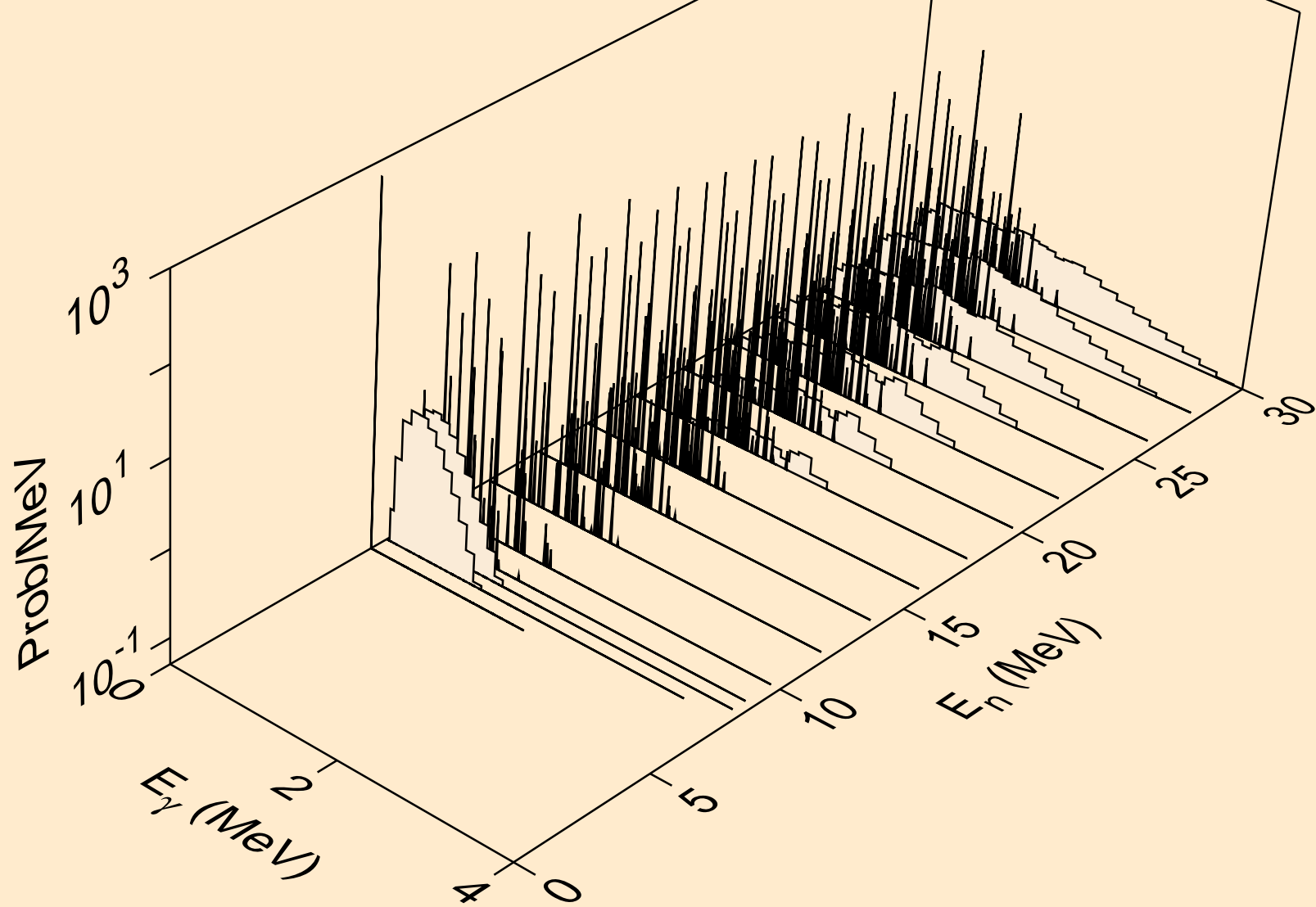

I118 NEUTRON ACER TENDL-2024 LIBRARY; T=293.6K  
thermal capture photon spectrum

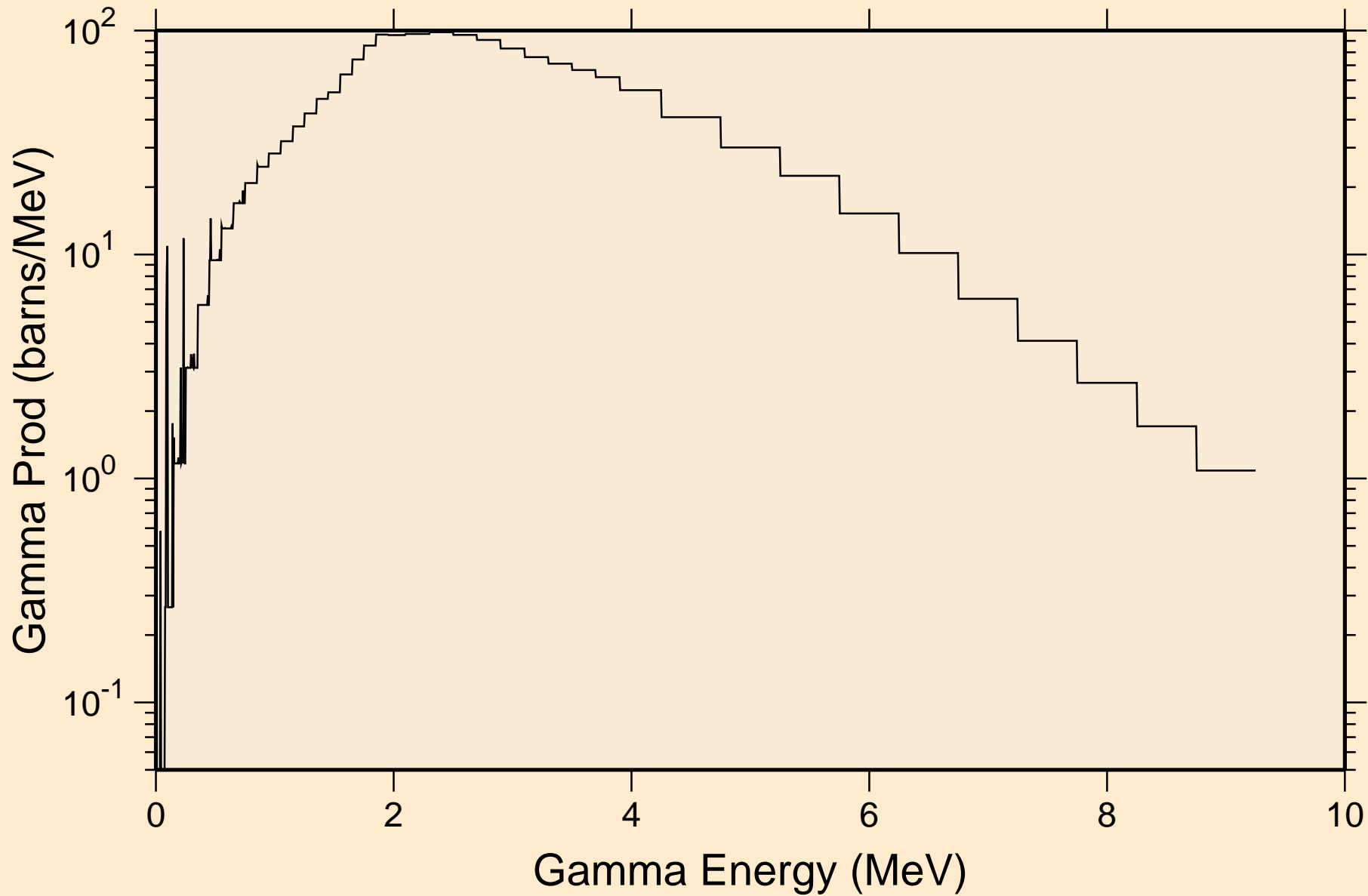

I118 NEUTRON ACER TENDL-2024 LIBRARY; T=293.6K  
14 MeV photon spectrum

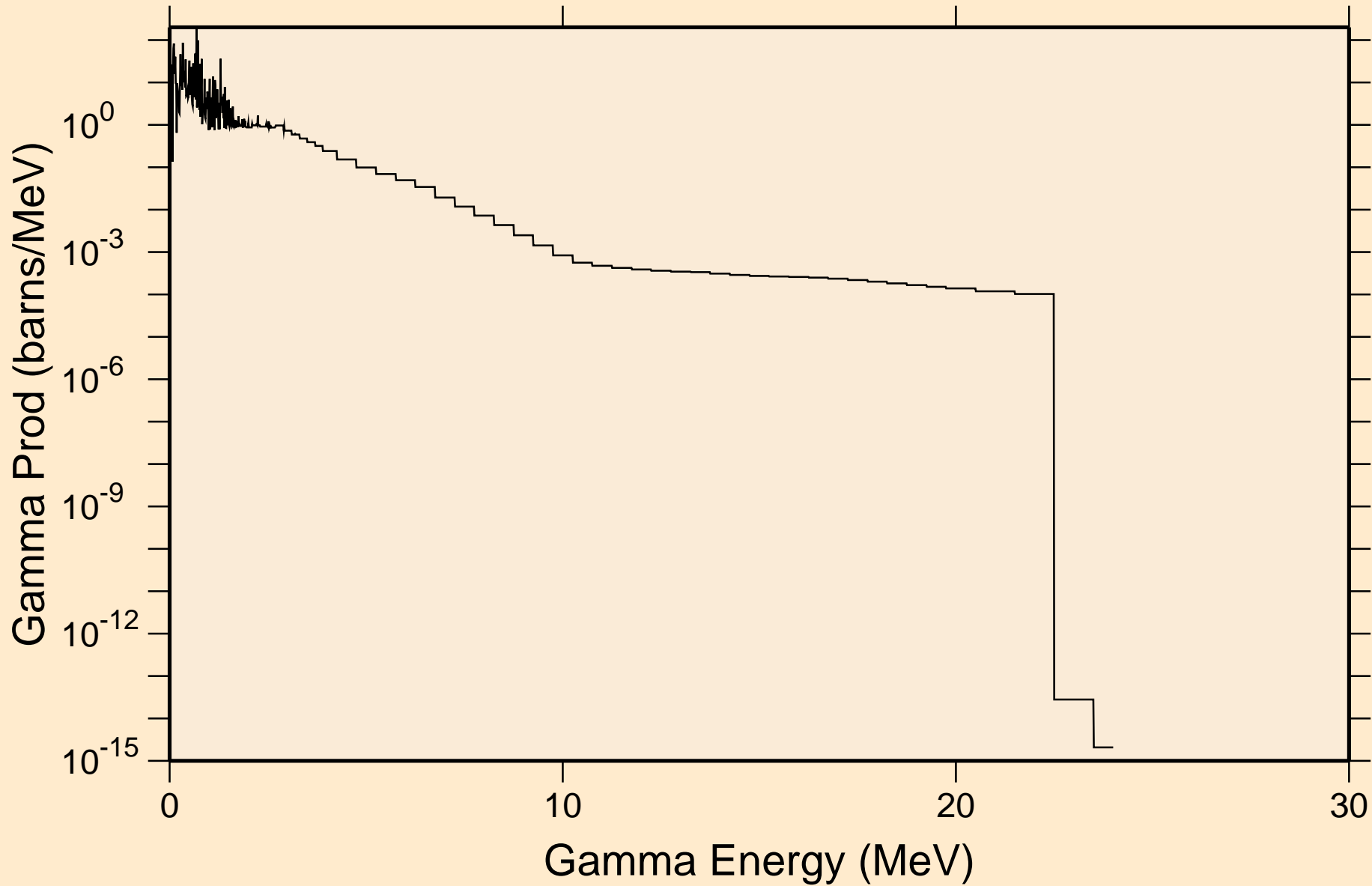

# I118 NEUTRON ACER TENDL-2024 LIBRARY; T=293.6K

## Particle heating contributions

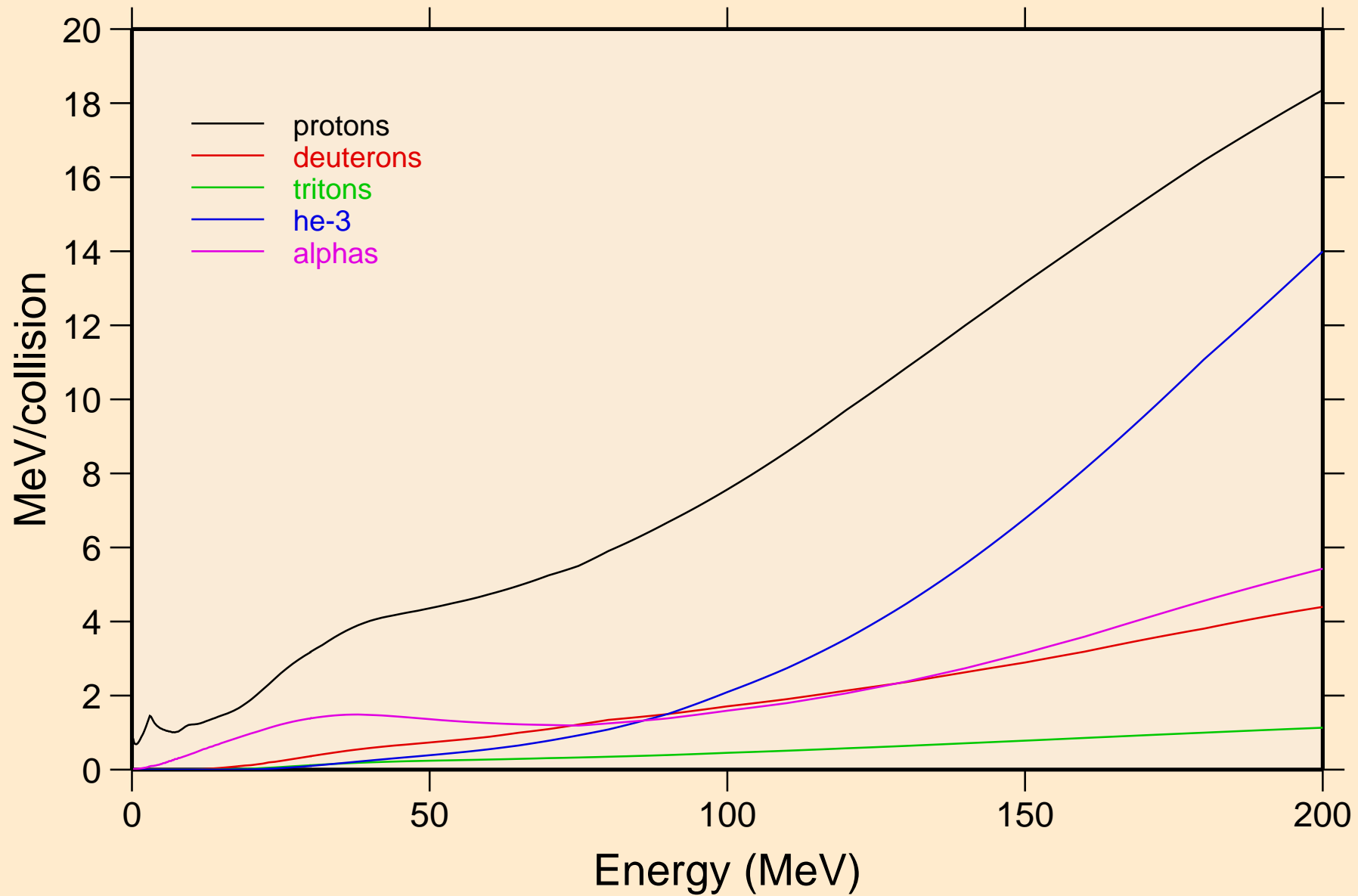

I118 NEUTRON ACER TENDL-2024 LIBRARY; T=293.6K  
Recoil Heating

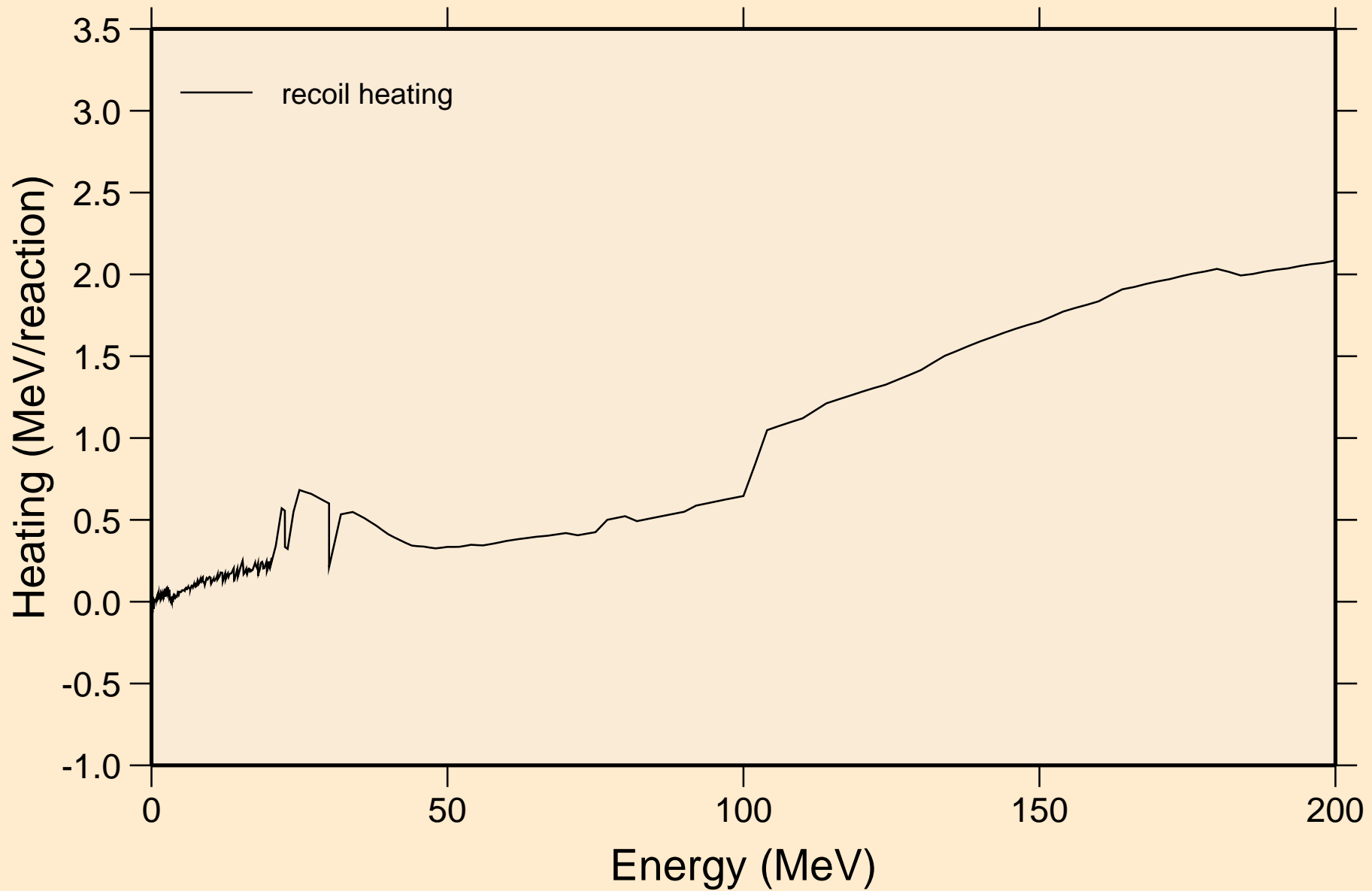

# I118 NEUTRON ACER TENDL-2024 LIBRARY; T=293.6K

## Particle production cross sections

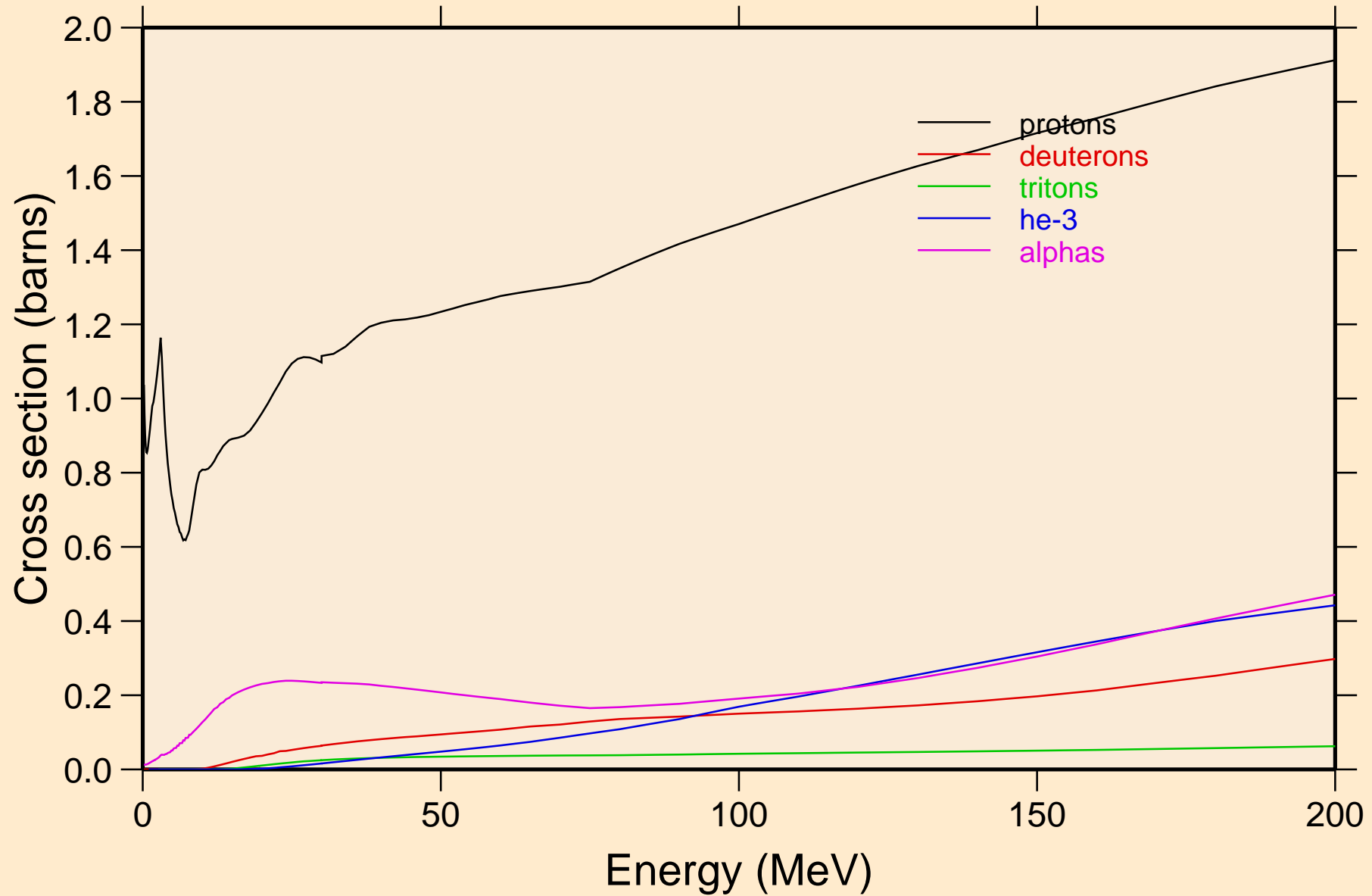

I118 NEUTRON ACER TENDL-2024 LIBRARY; T=293.6K  
protons from (n,x)

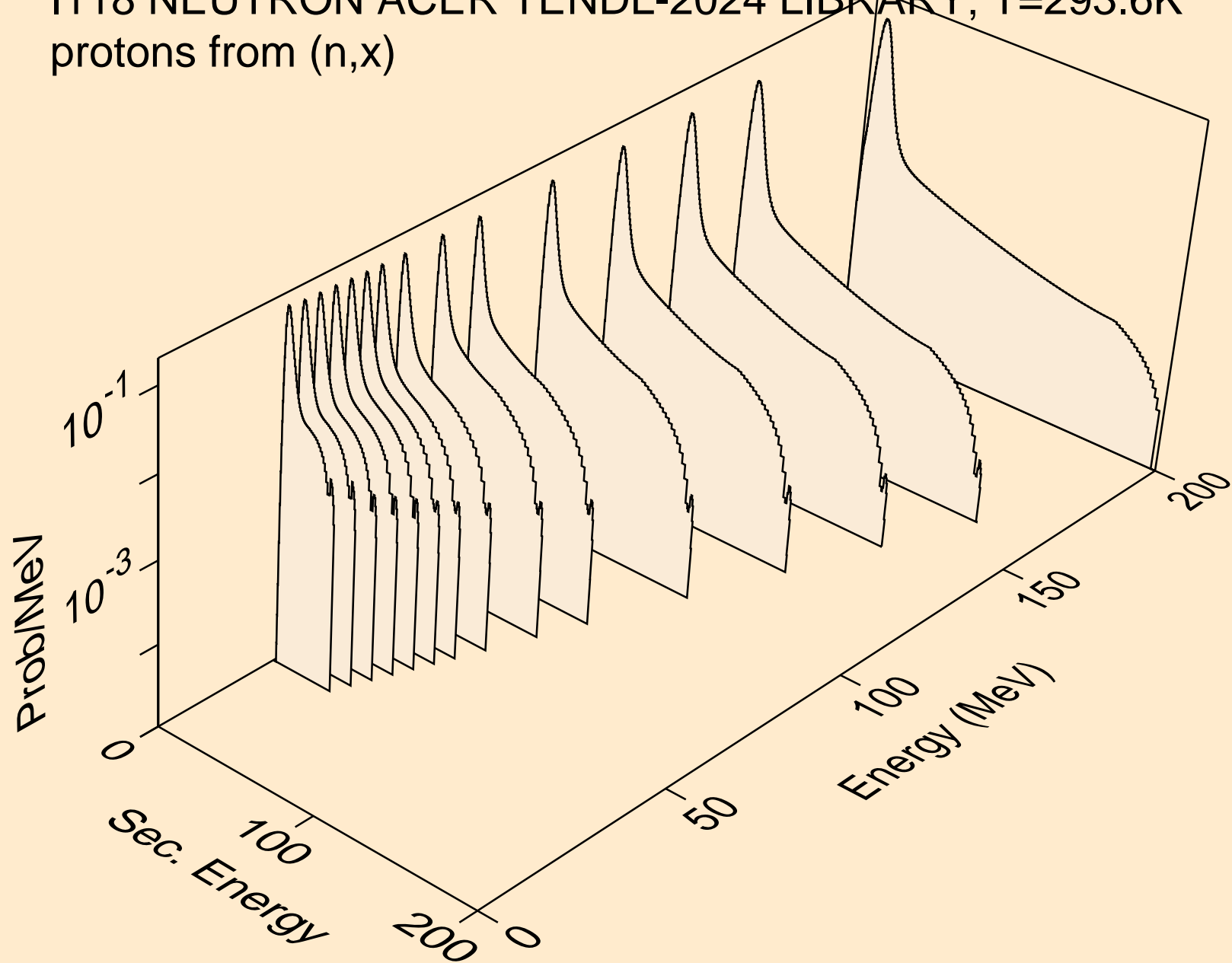

I118 NEUTRON ACER TENDL-2024 LIBRARY; T=293.6K  
protons from (n,n\*)p

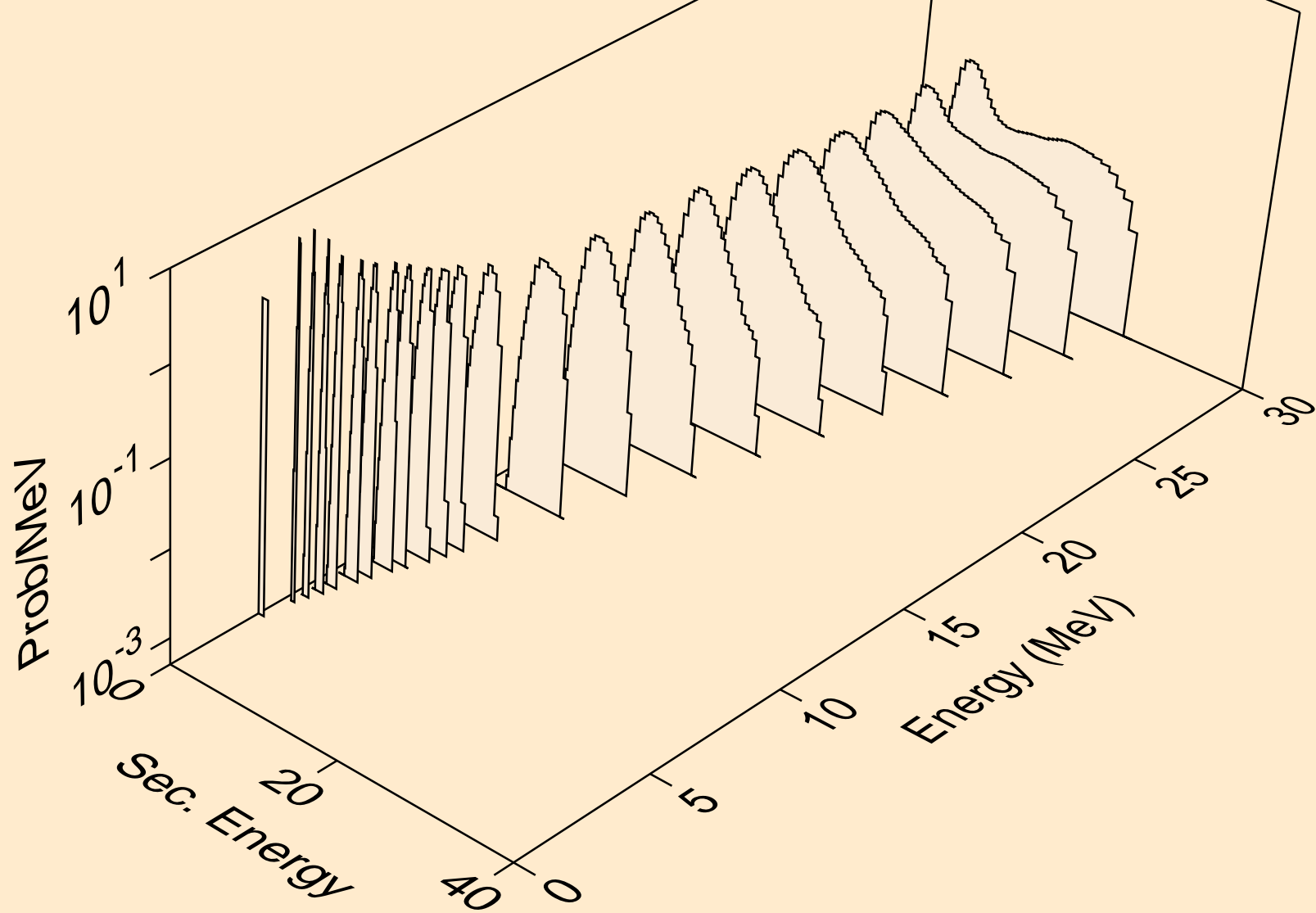

I118 NEUTRON ACER TENDL-2024 LIBRARY; T=293.6K  
protons from (n,2np)

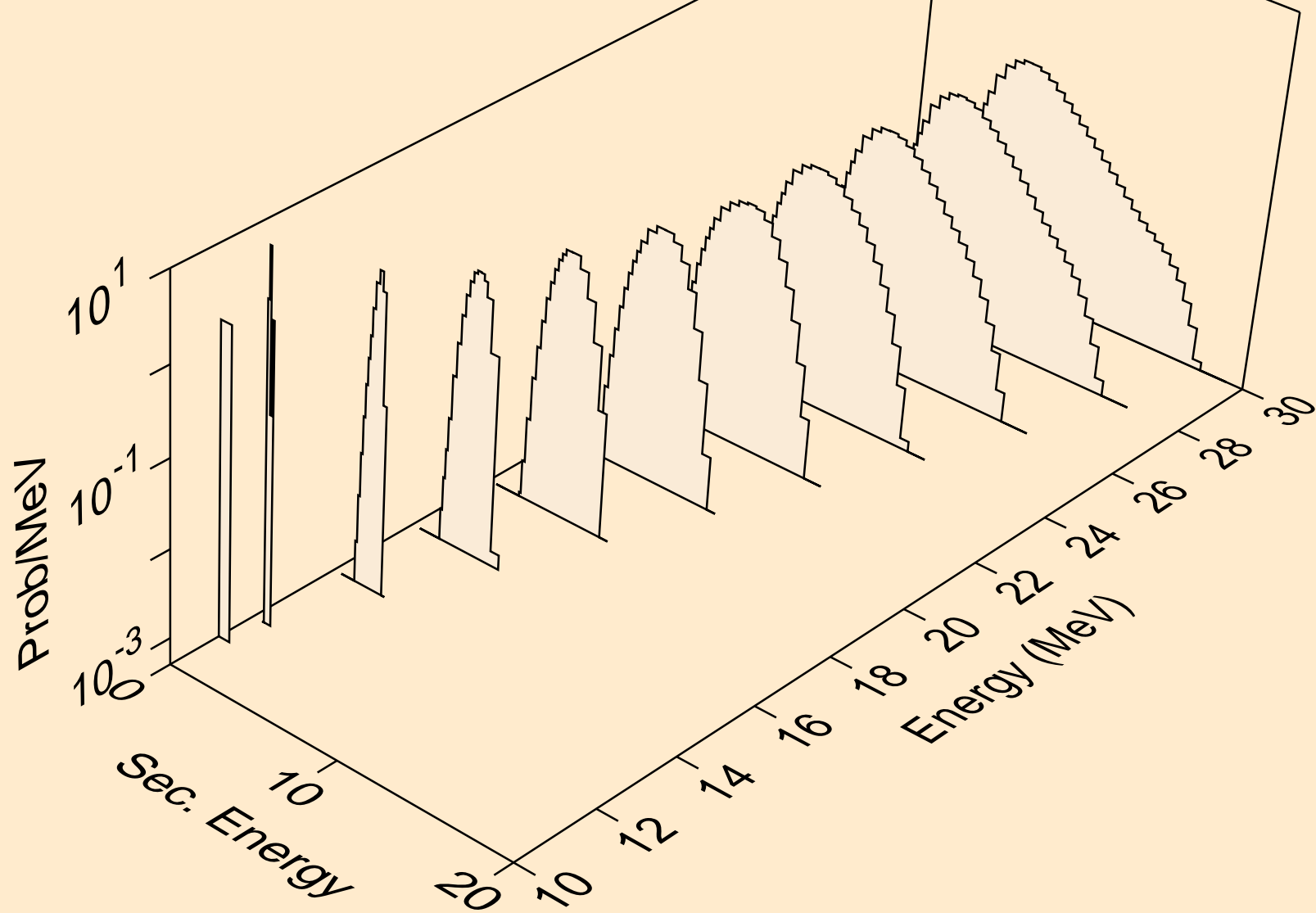

I118 NEUTRON ACER TENDL-2024 LIBRARY; T=293.6K  
protons from (n,3np)

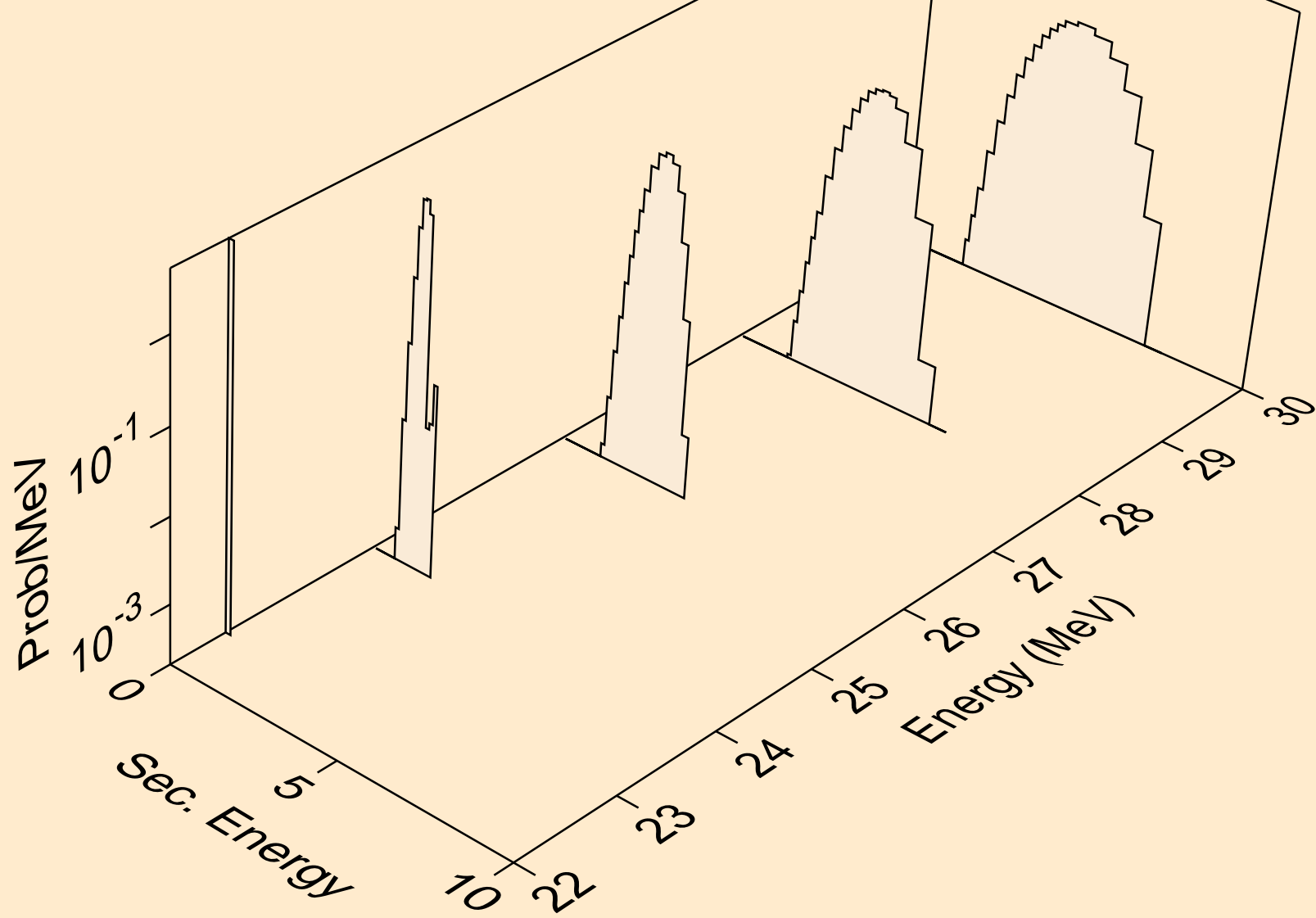

I118 NEUTRON ACER TENDL-2024 LIBRARY; T=293.6K  
protons from (n,n2p)

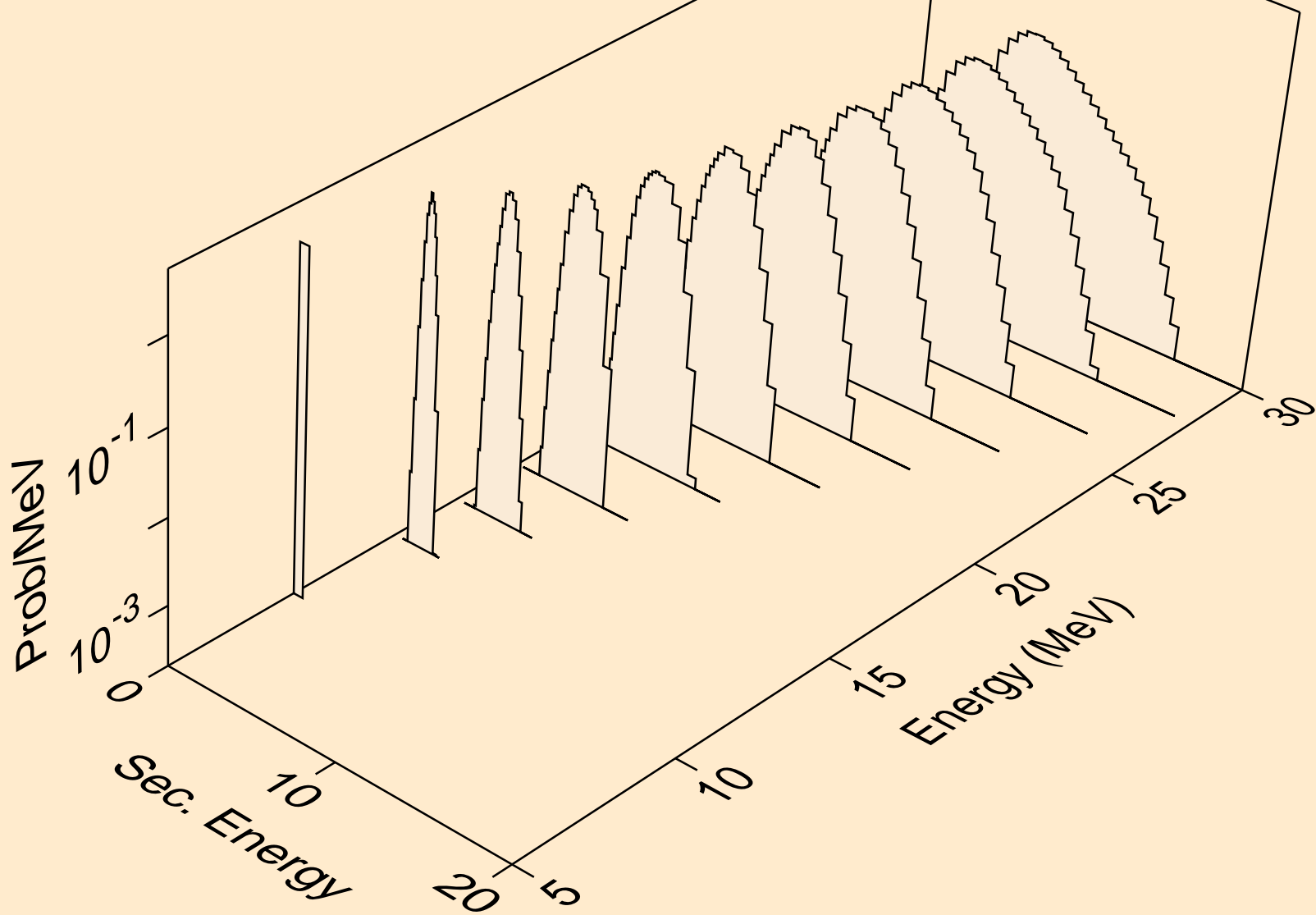

I118 NEUTRON ACER TENDL-2024 LIBRARY; T=293.6K  
protons from (n,npa)

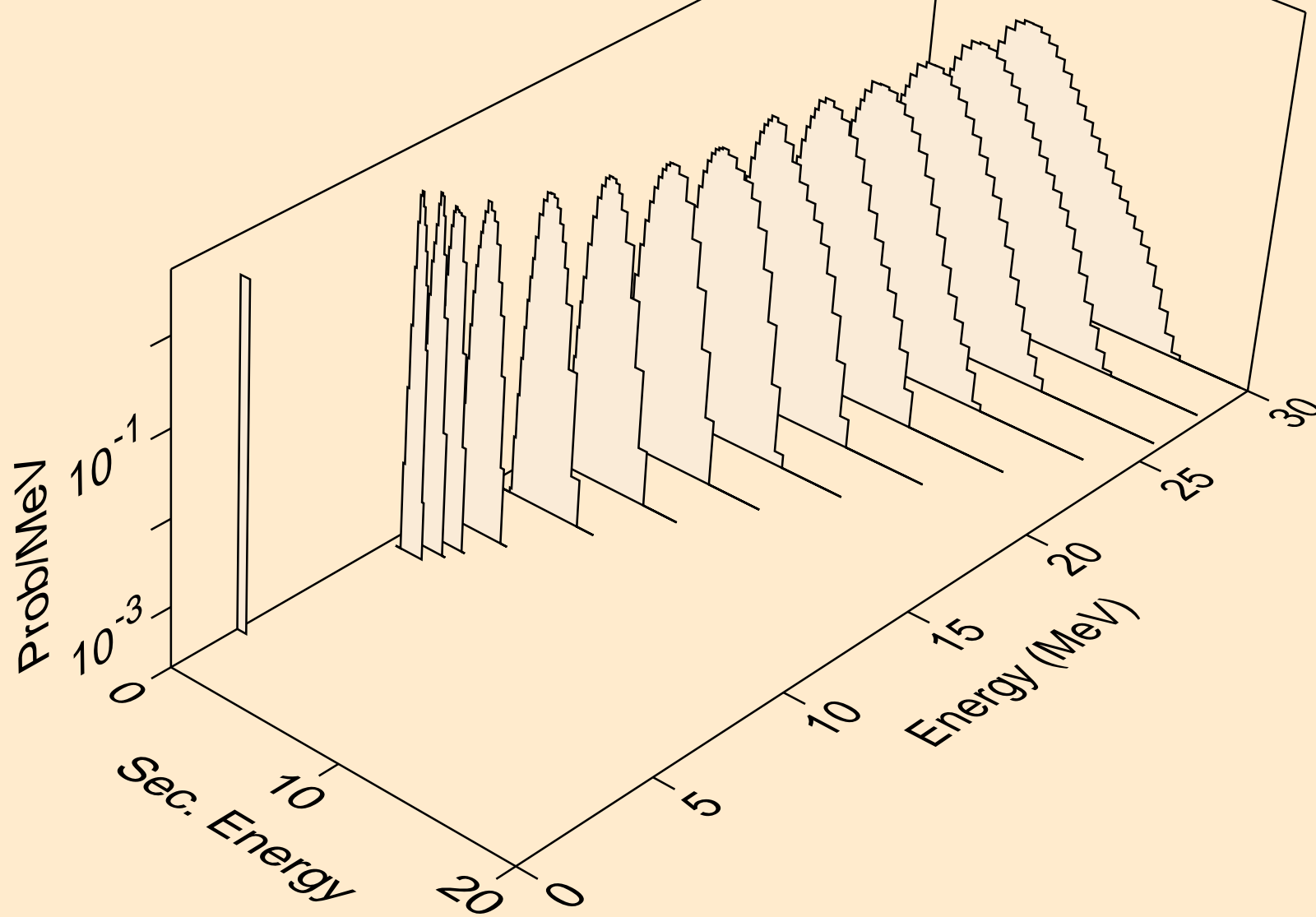

I118 NEUTRON ACER TENDL-2024 LIBRARY; T=293.6K  
protons from (n,p)

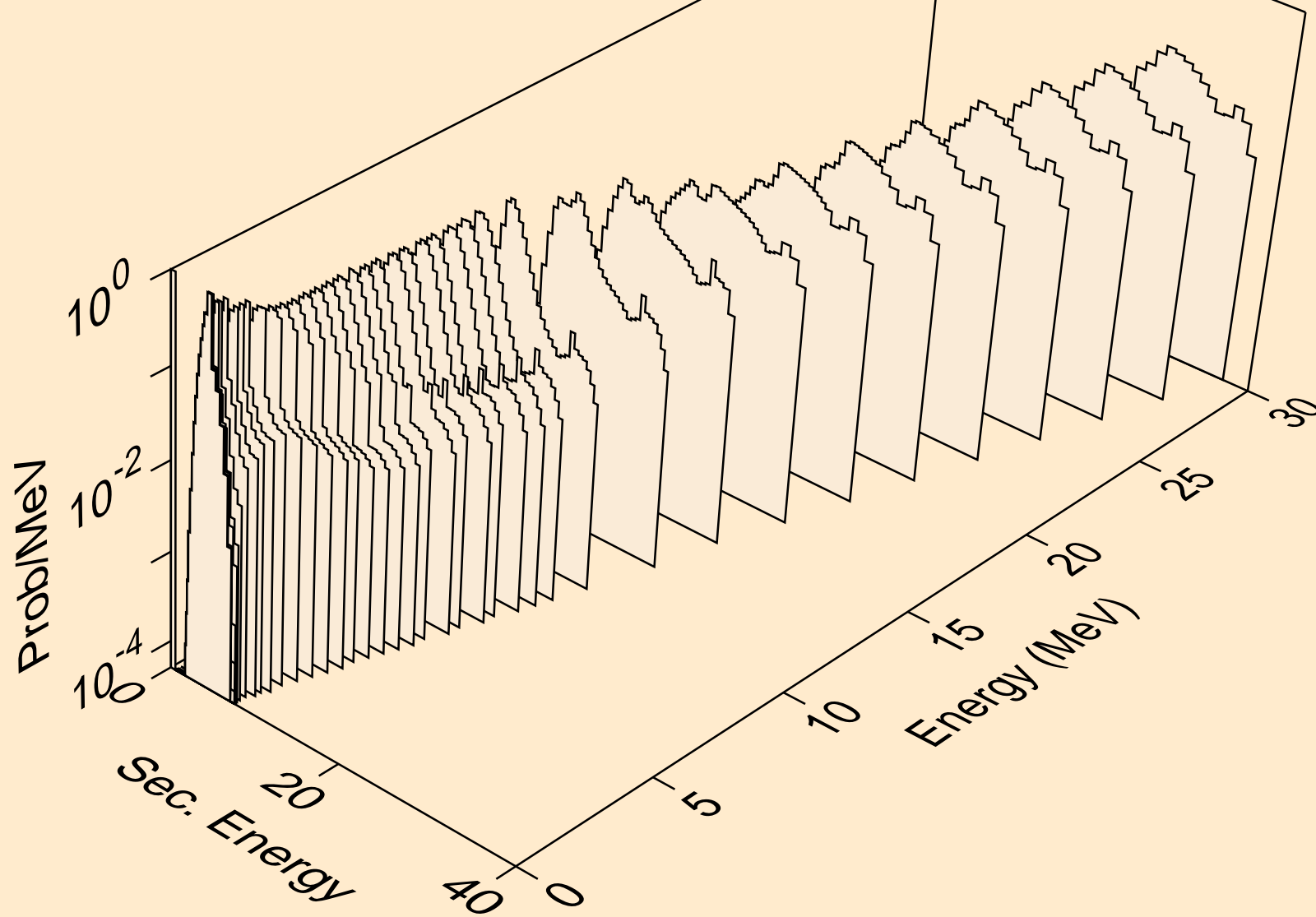

I118 NEUTRON ACER TENDL-2024 LIBRARY; T=293.6K  
protons from (n,2p)

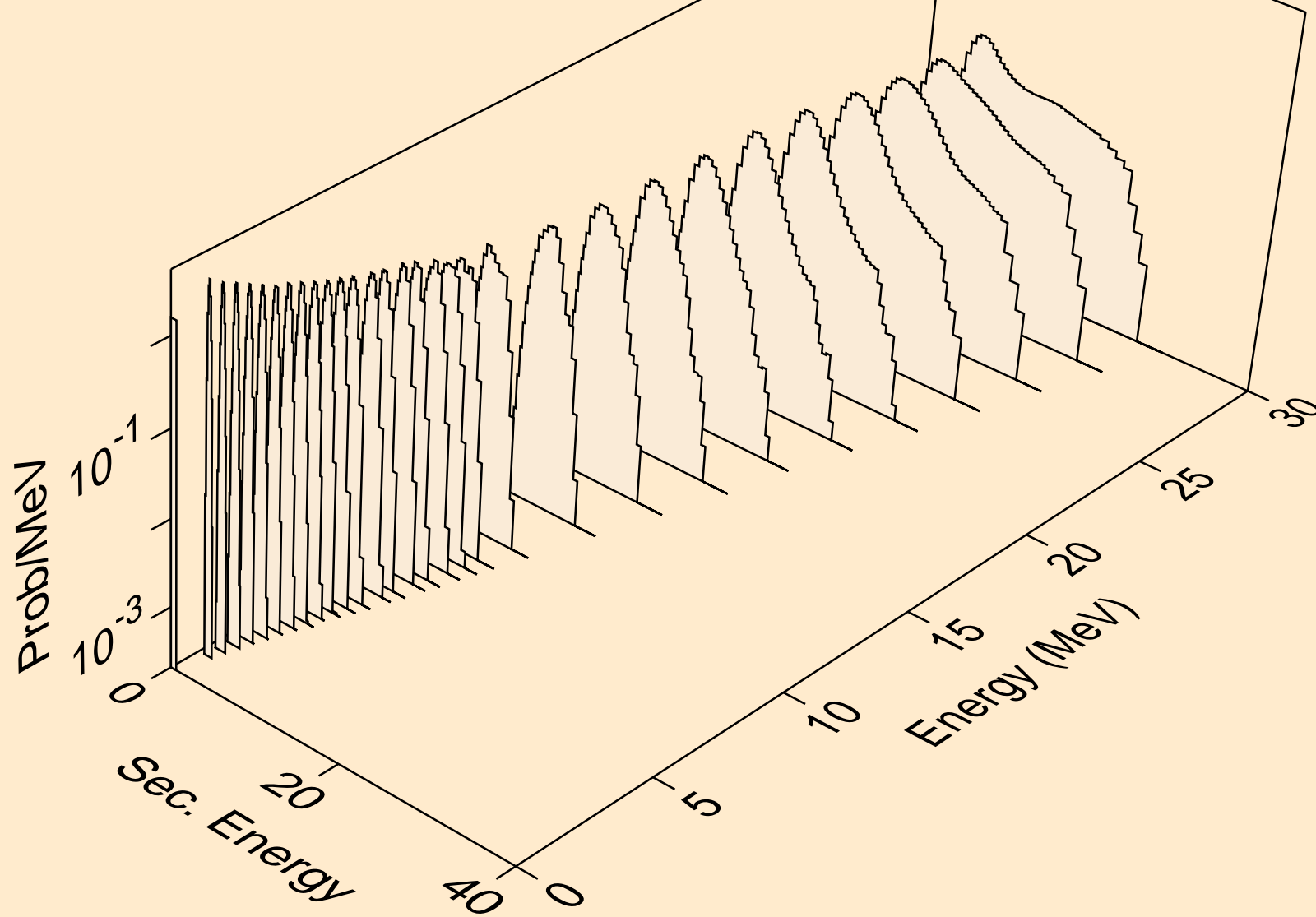

I118 NEUTRON ACER TENDL-2024 LIBRARY; T=293.6K  
protons from (n,p)

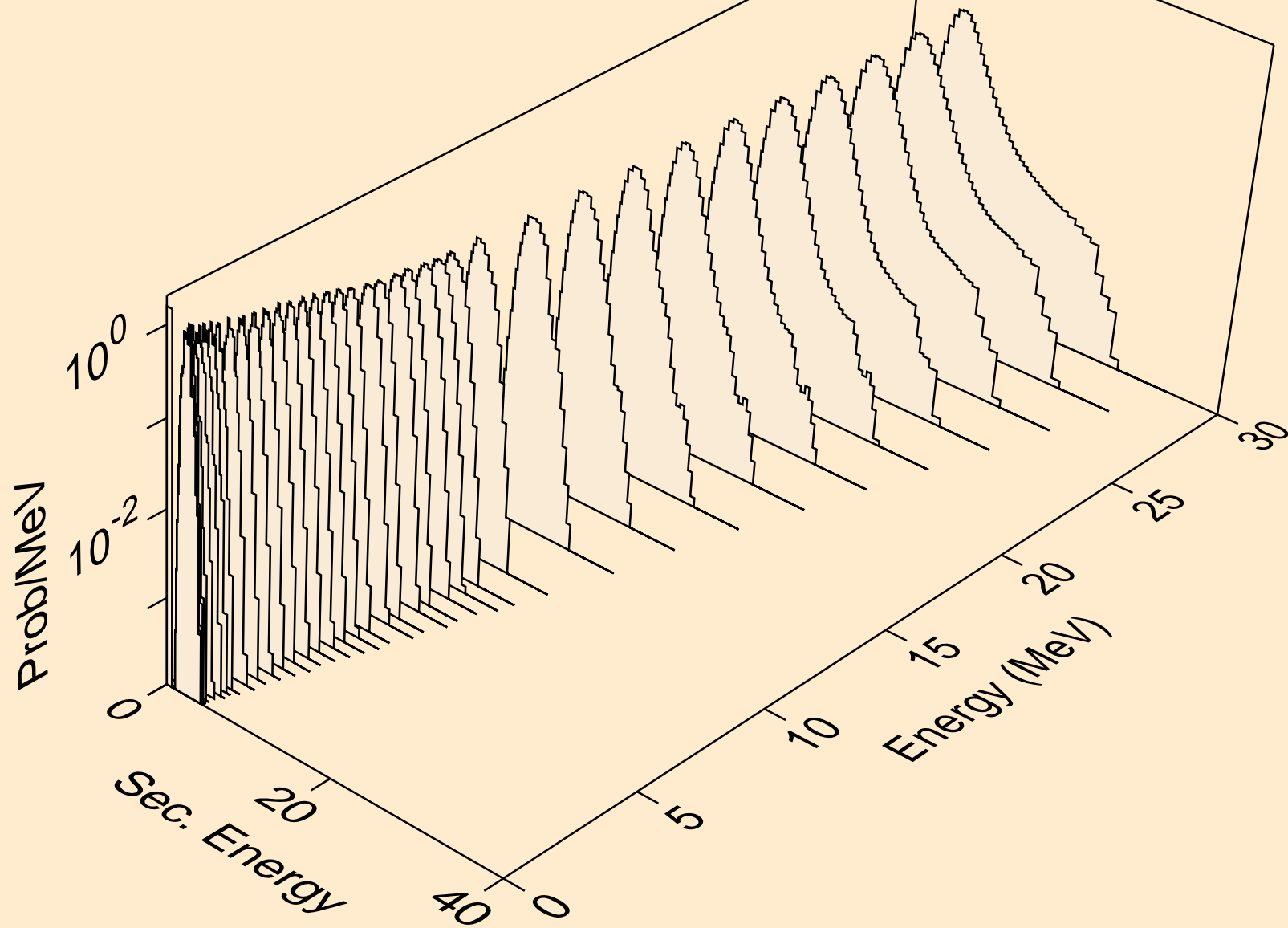

I118 NEUTRON ACER TENDL-2024 LIBRARY; T=293.6K  
protons from (n,pd)

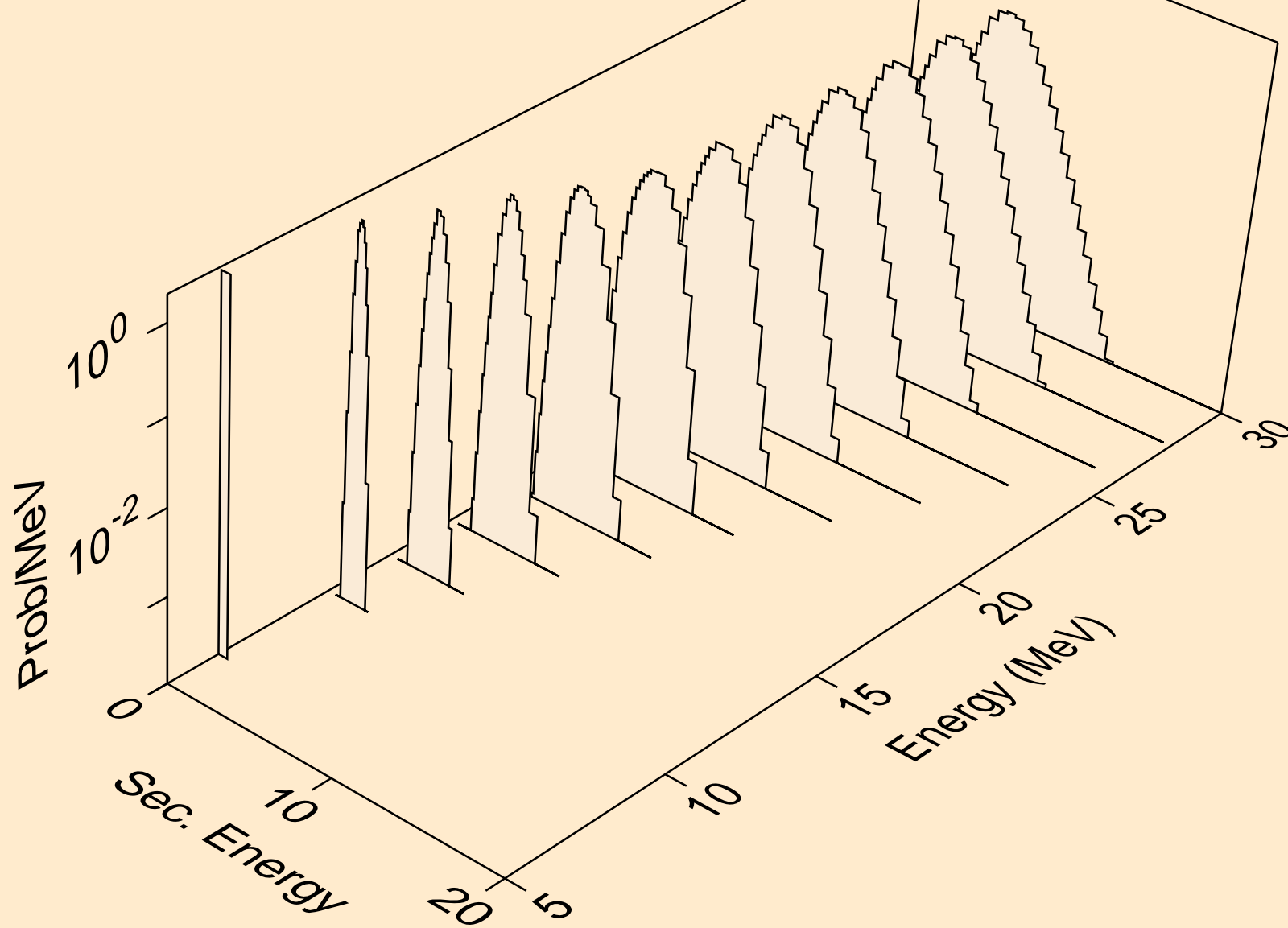

I118 NEUTRON ACER TENDL-2024 LIBRARY; T=293.6K  
protons from (n,pt)

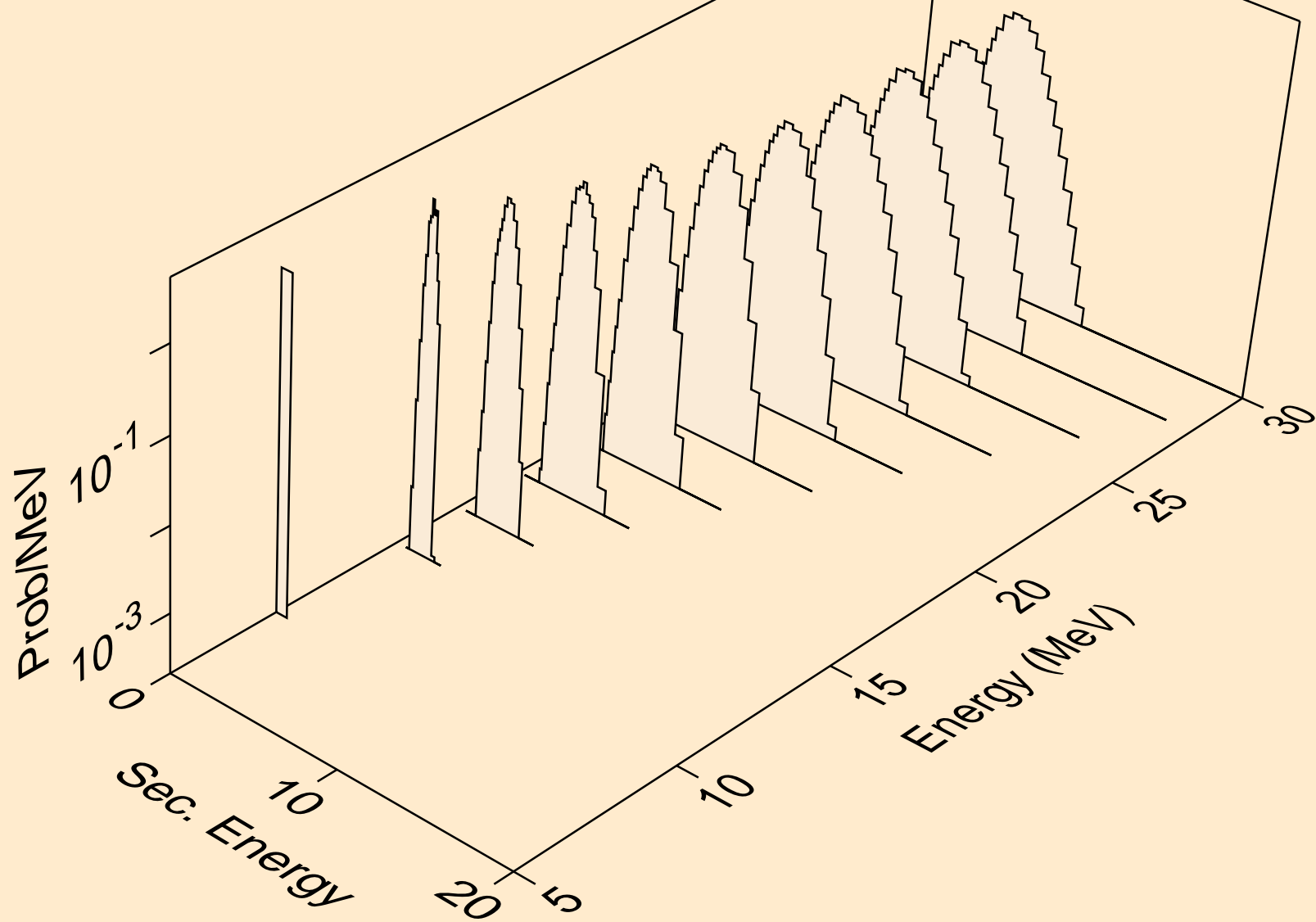

I118 NEUTRON ACER TENDL-2024 LIBRARY; T=293.6K  
deuterons from (n,x)

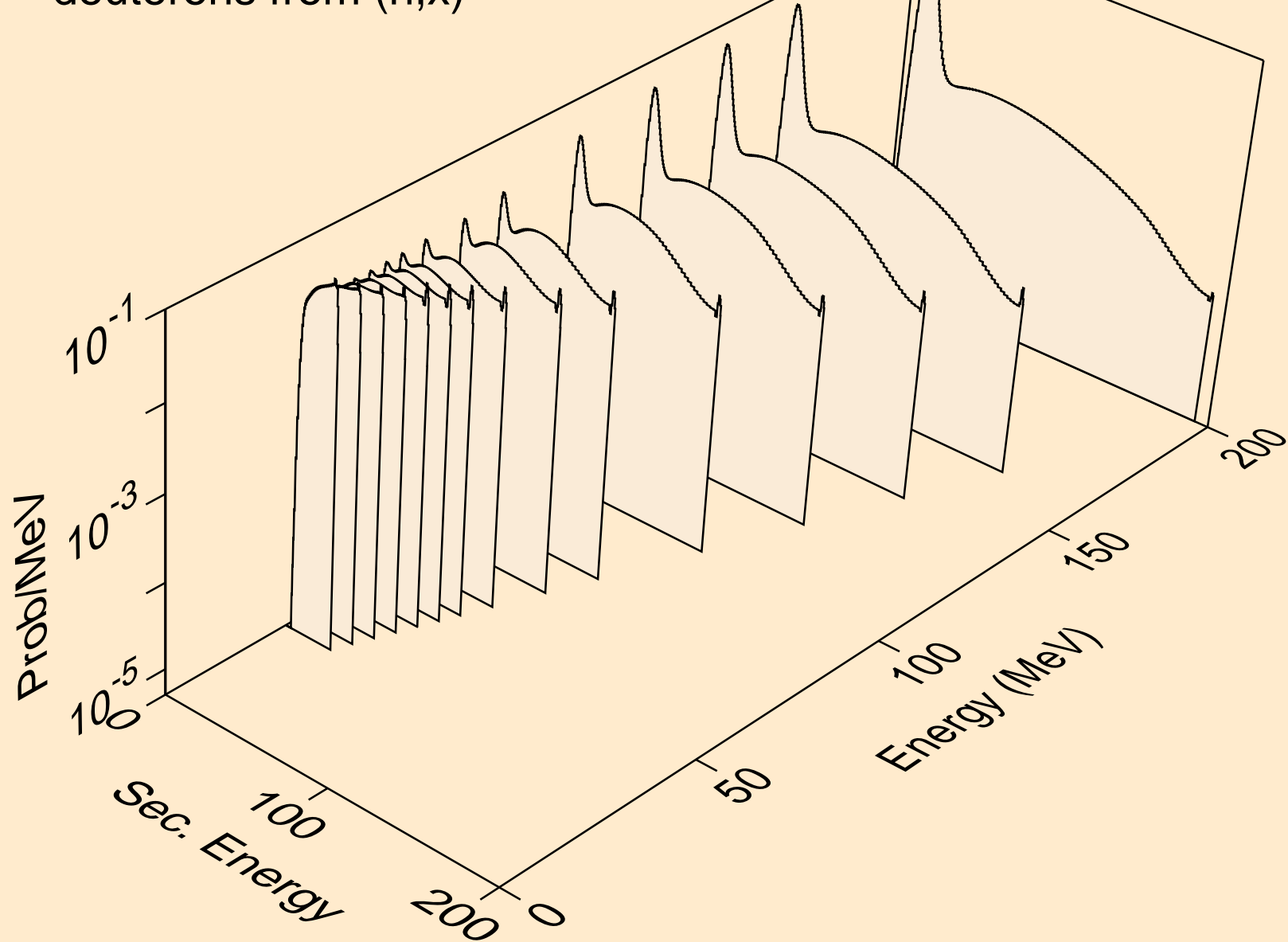

I118 NEUTRON ACER TENDL-2024 LIBRARY; T=293.6K  
deuterons from (n,2nd)

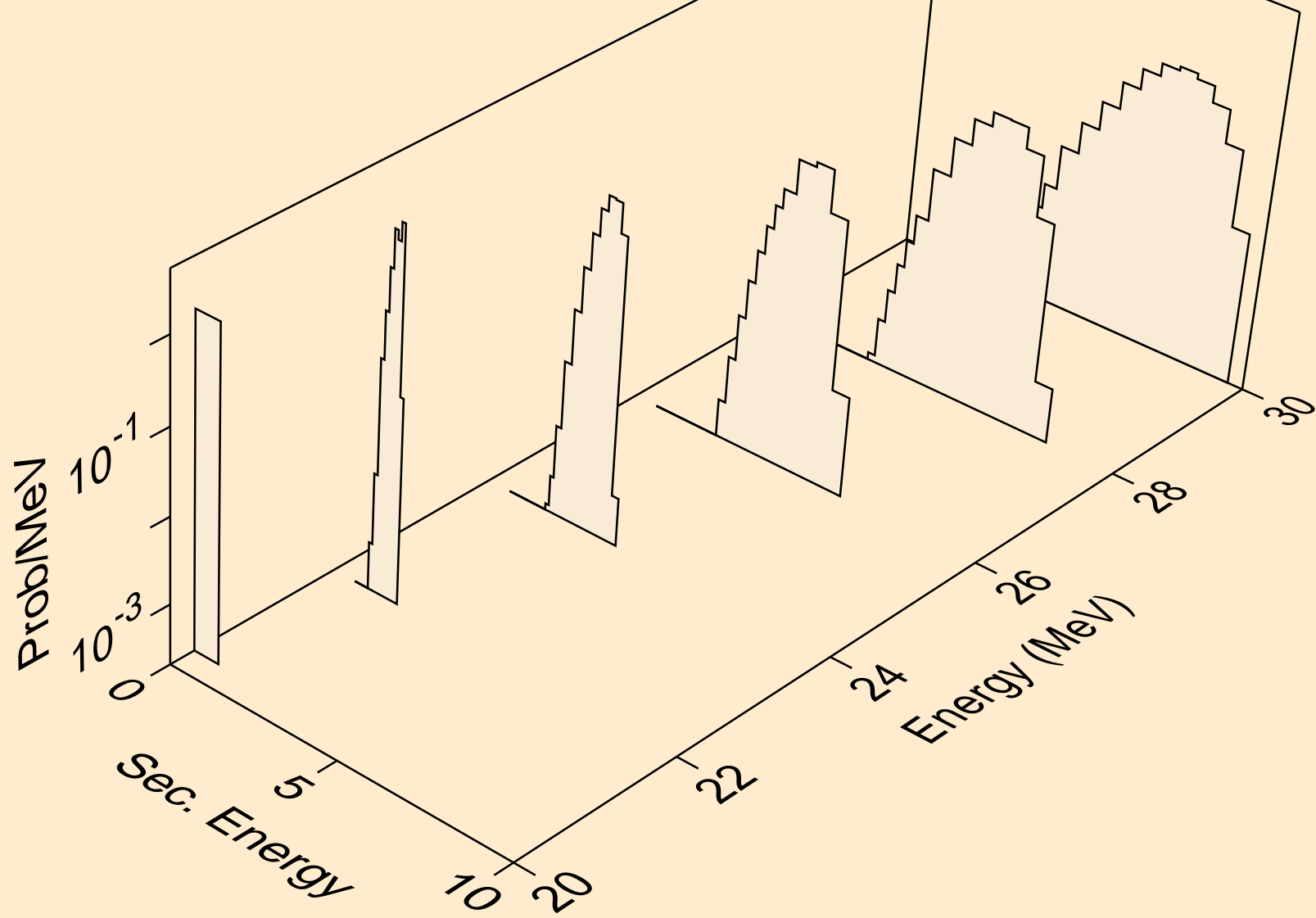

I118 NEUTRON ACER TENDL-2024 LIBRARY; T=293.6K  
deuterons from (n,n\*)d

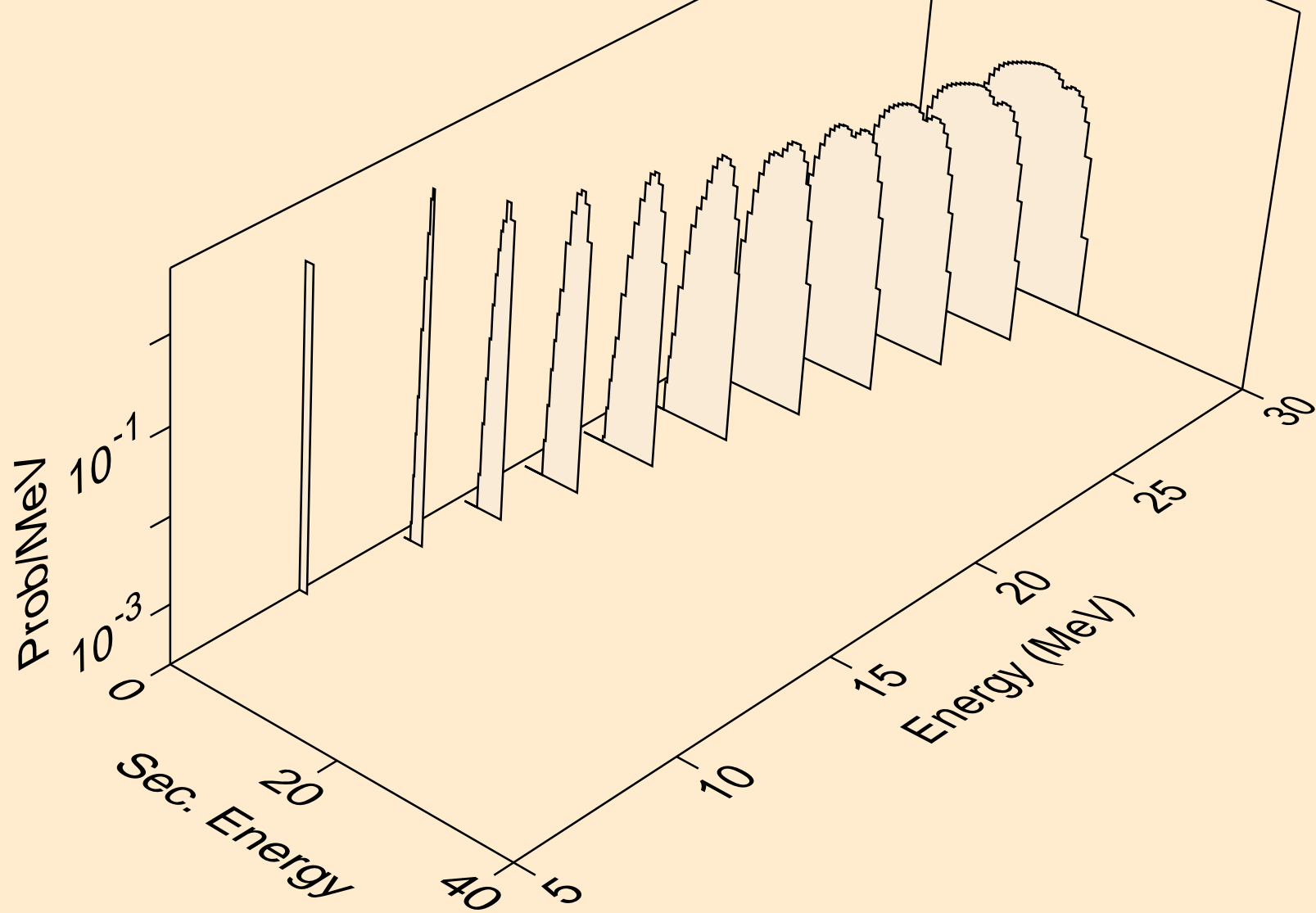

I118 NEUTRON ACER TENDL-2024 LIBRARY; T=293.6K  
deuterons from (n,d)

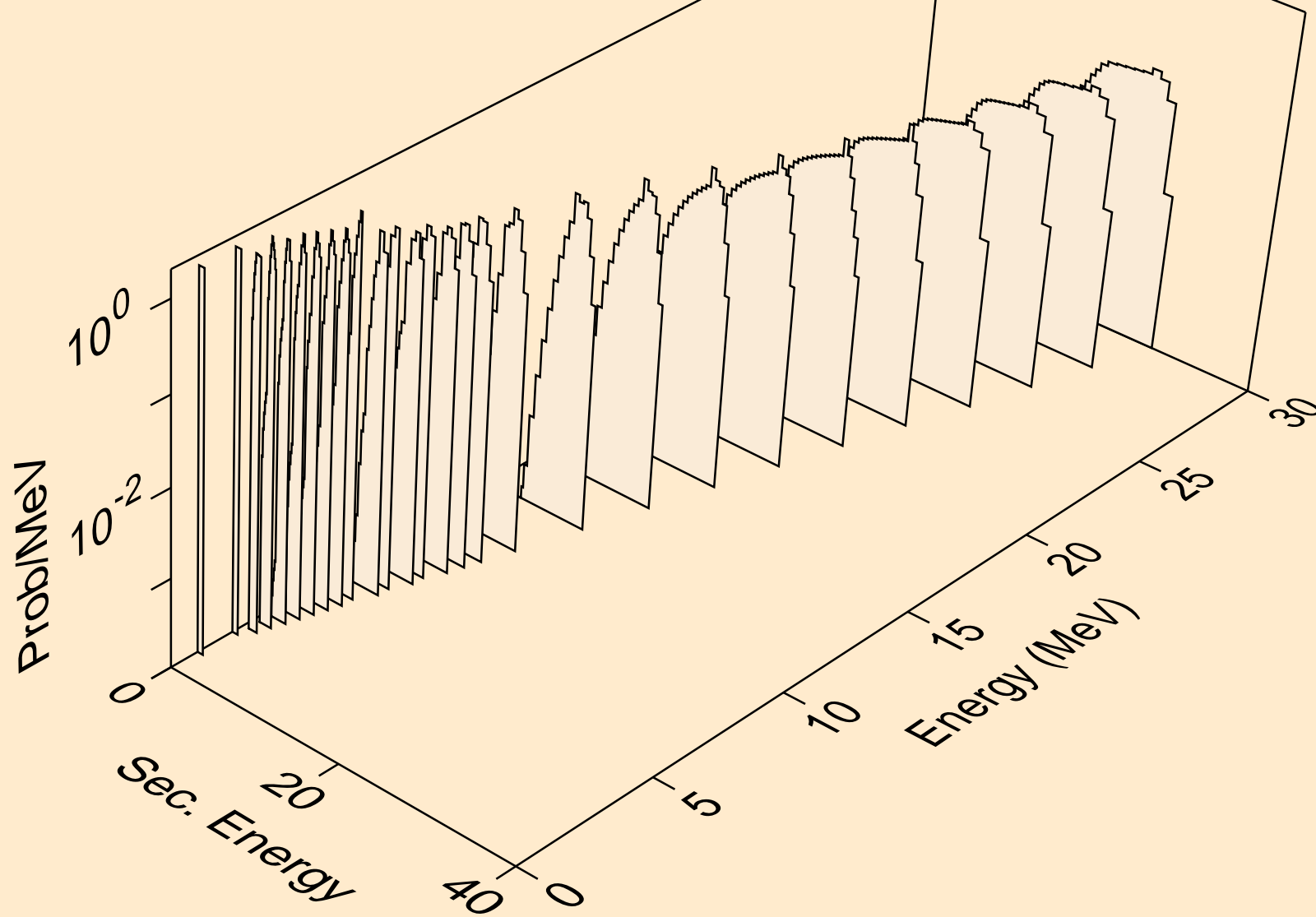

I118 NEUTRON ACER TENDL-2024 LIBRARY; T=293.6K  
deuterons from (n,pd)

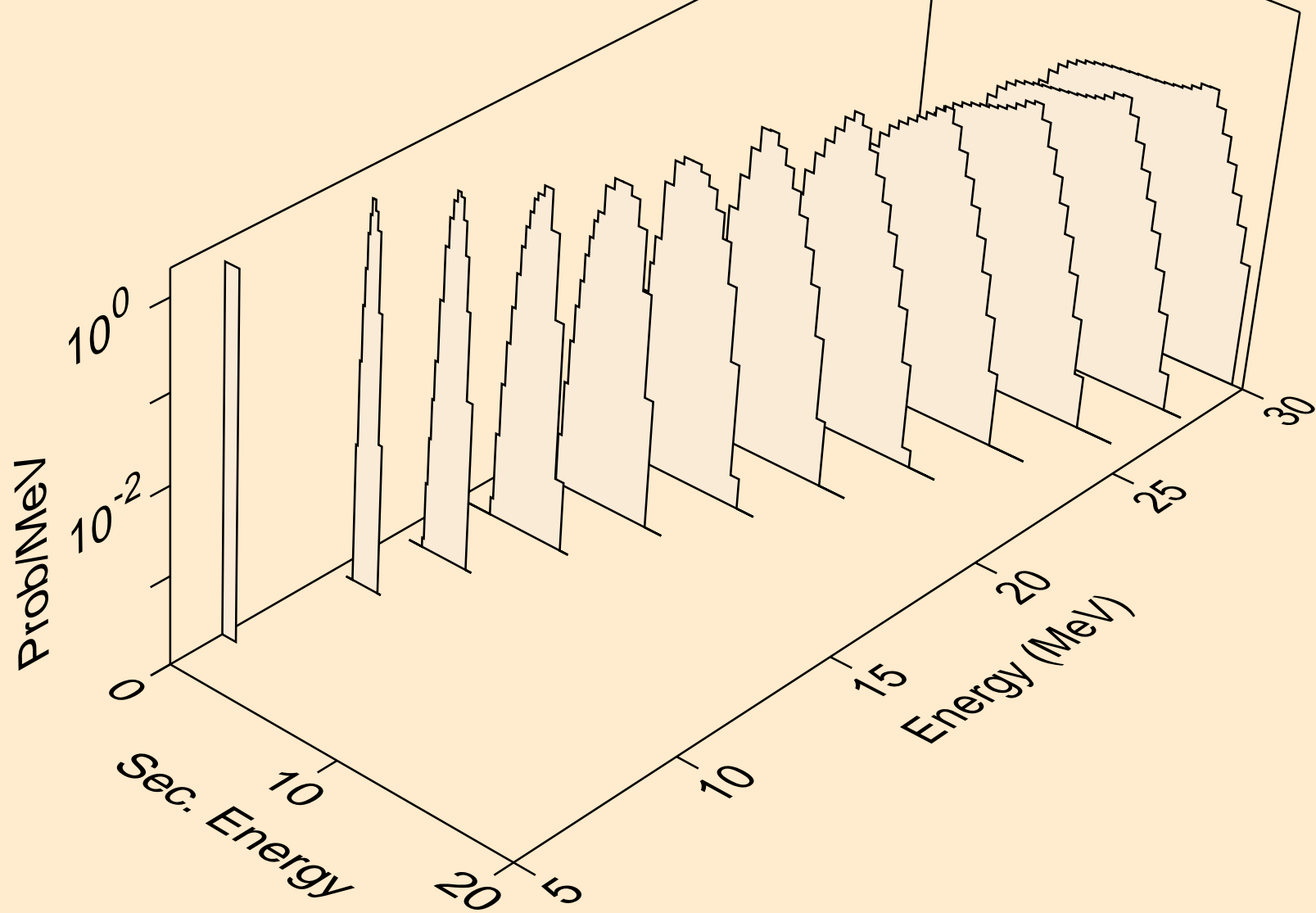

I118 NEUTRON ACER TENDL-2024 LIBRARY; T=293.6K  
deuterons from (n,da)

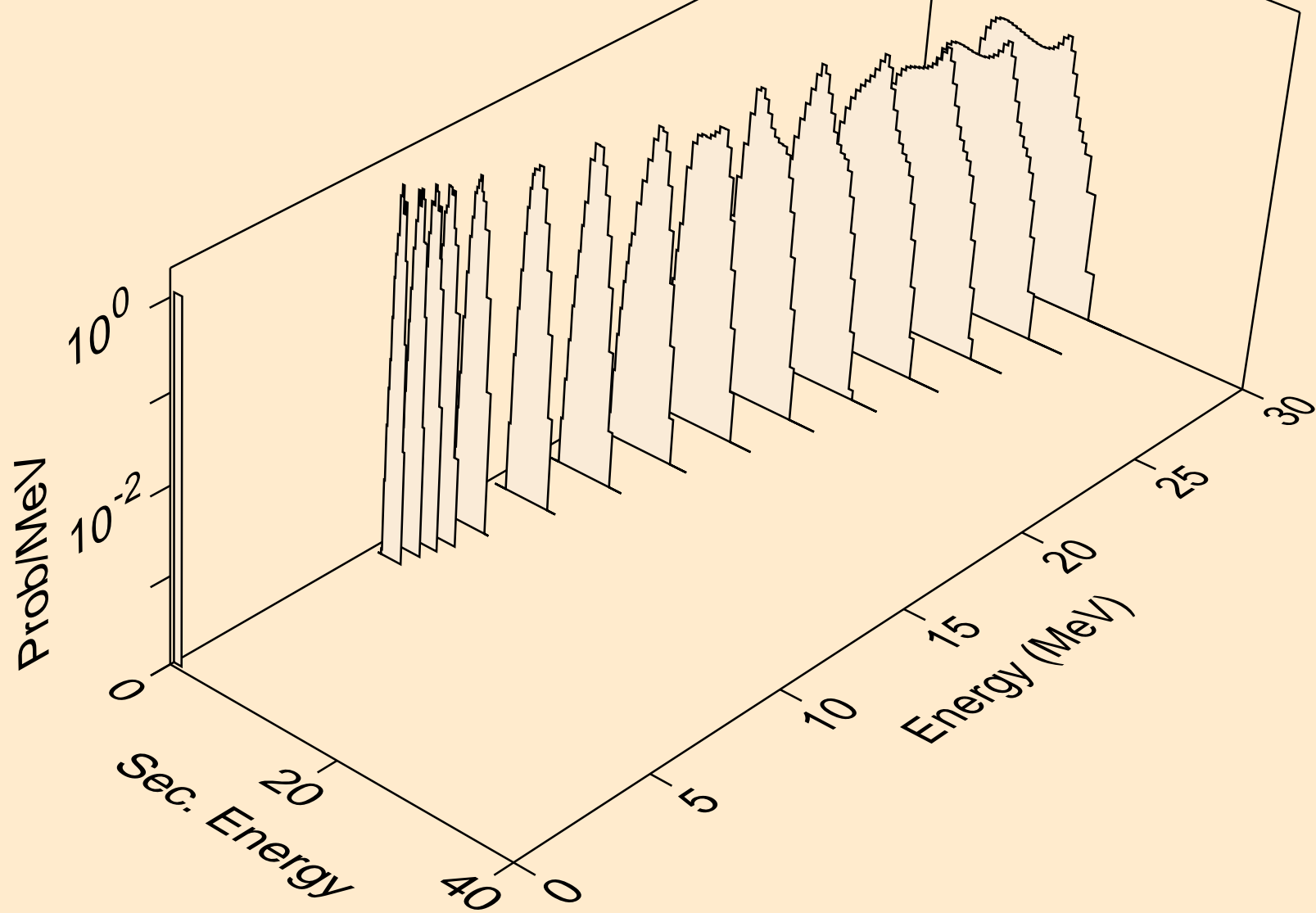

I118 NEUTRON ACER TENDL-2024 LIBRARY; T=293.6K  
tritons from (n,x)

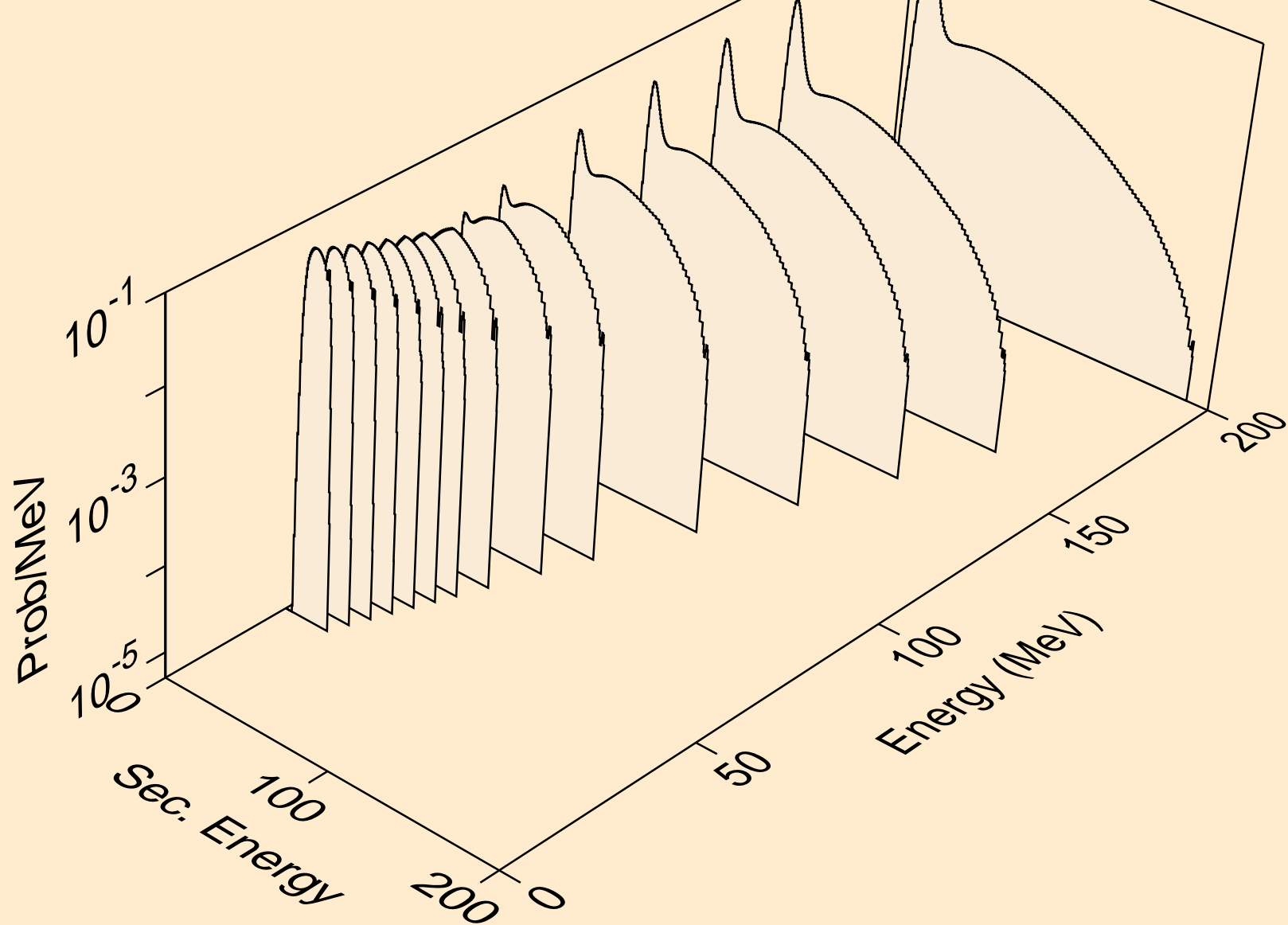

I118 NEUTRON ACER TENDL-2024 LIBRARY; T=293.6K  
tritons from (n,n\*)t

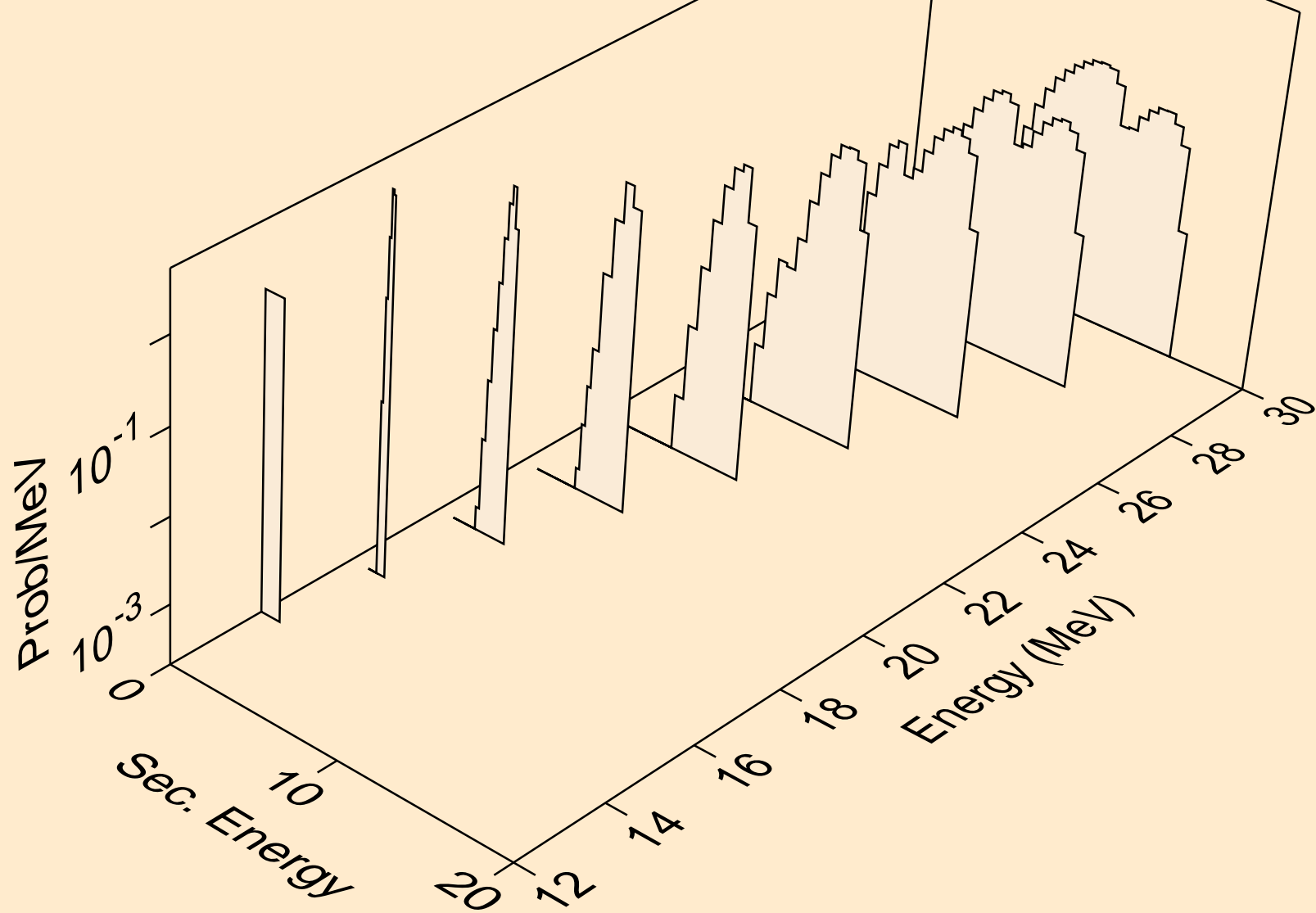

I118 NEUTRON ACER TENDL-2024 LIBRARY; T=293.6K  
tritons from (n,t)

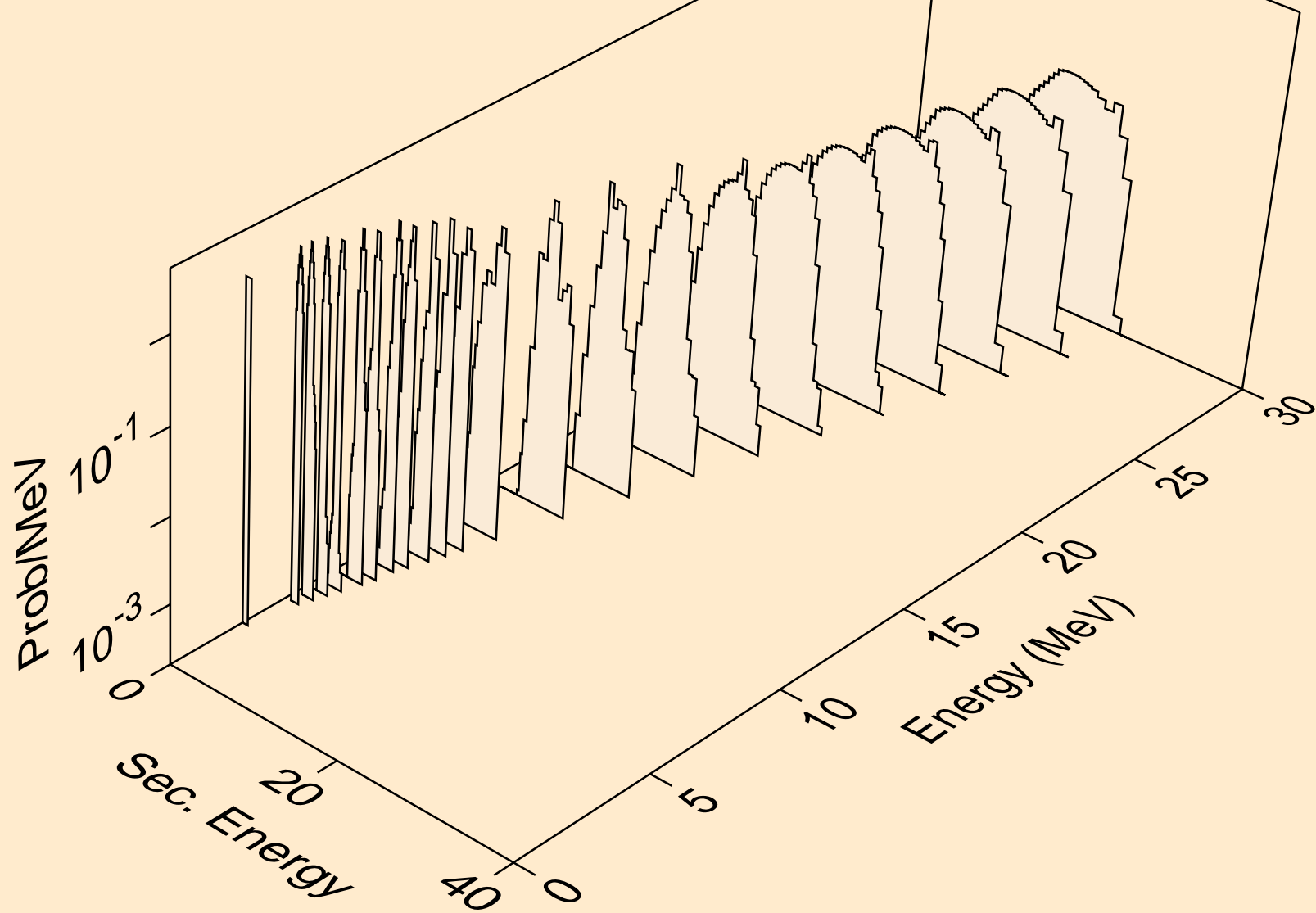

I118 NEUTRON ACER TENDL-2024 LIBRARY; T=293.6K  
tritons from (n,pt)

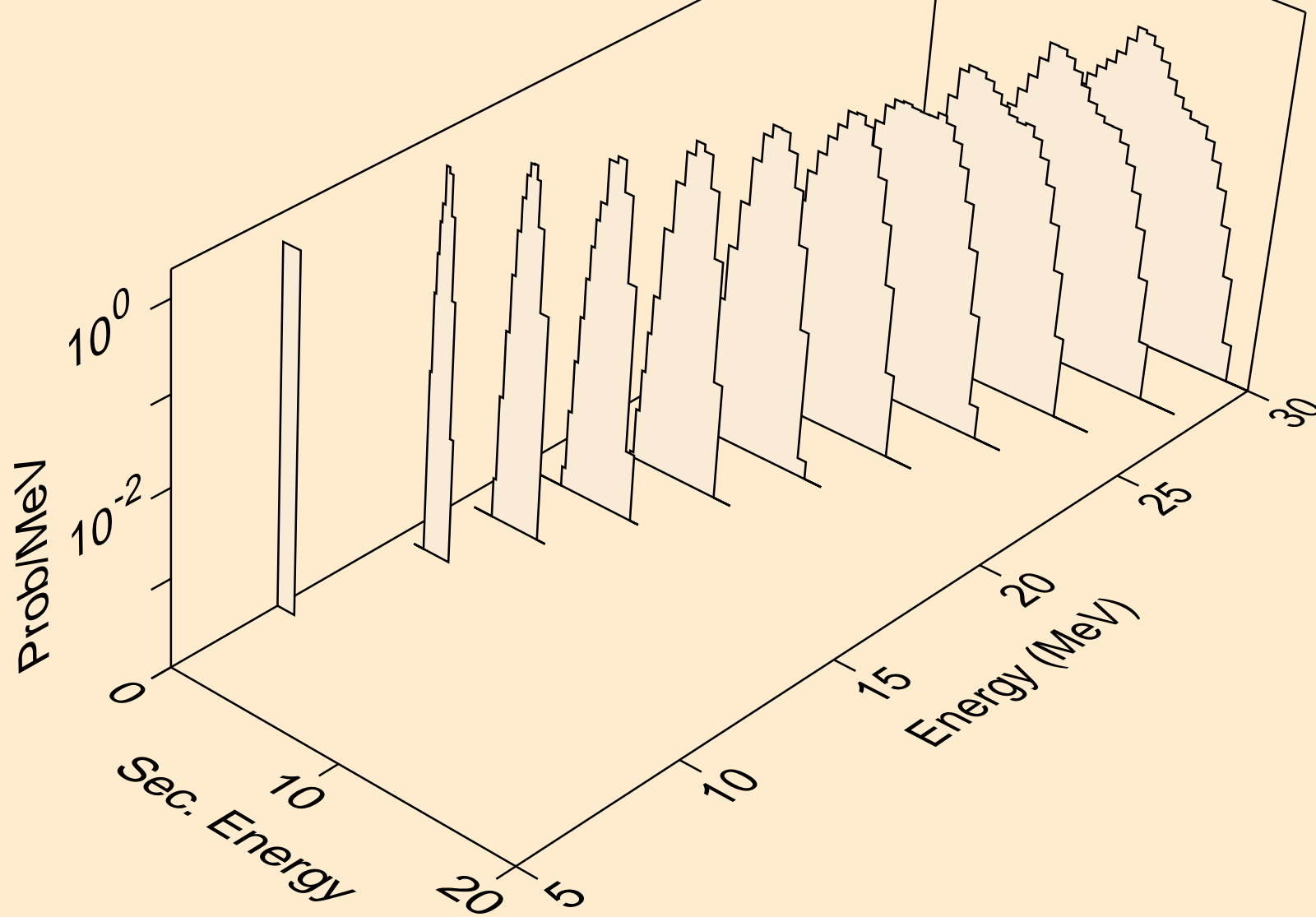

I118 NEUTRON ACER TENDL-2024 LIBRARY; T=293.6K  
he3s from (n,x)

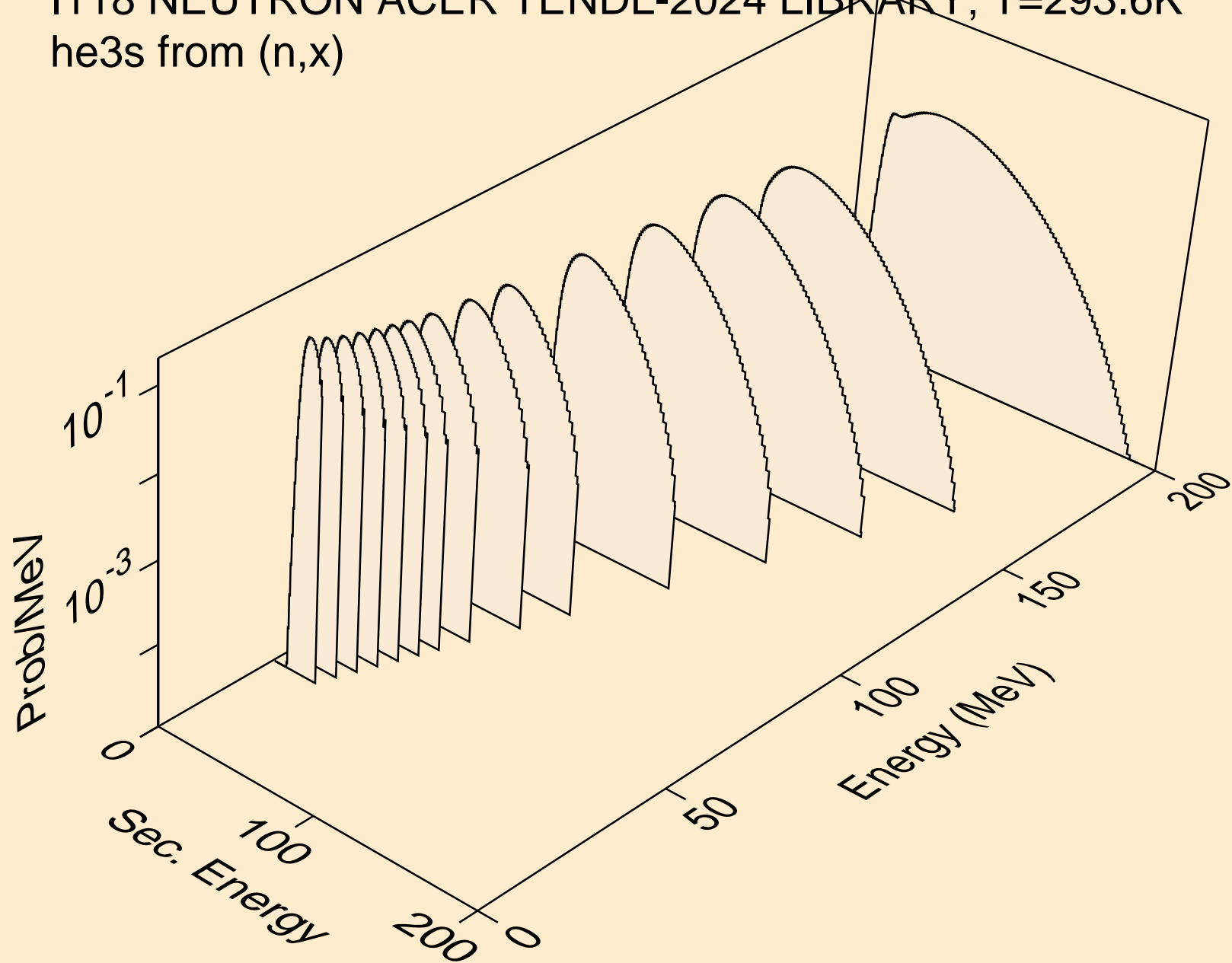

I118 NEUTRON ACER TENDL-2024 LIBRARY; T=293.6K  
he3s from (n,n\*)he3

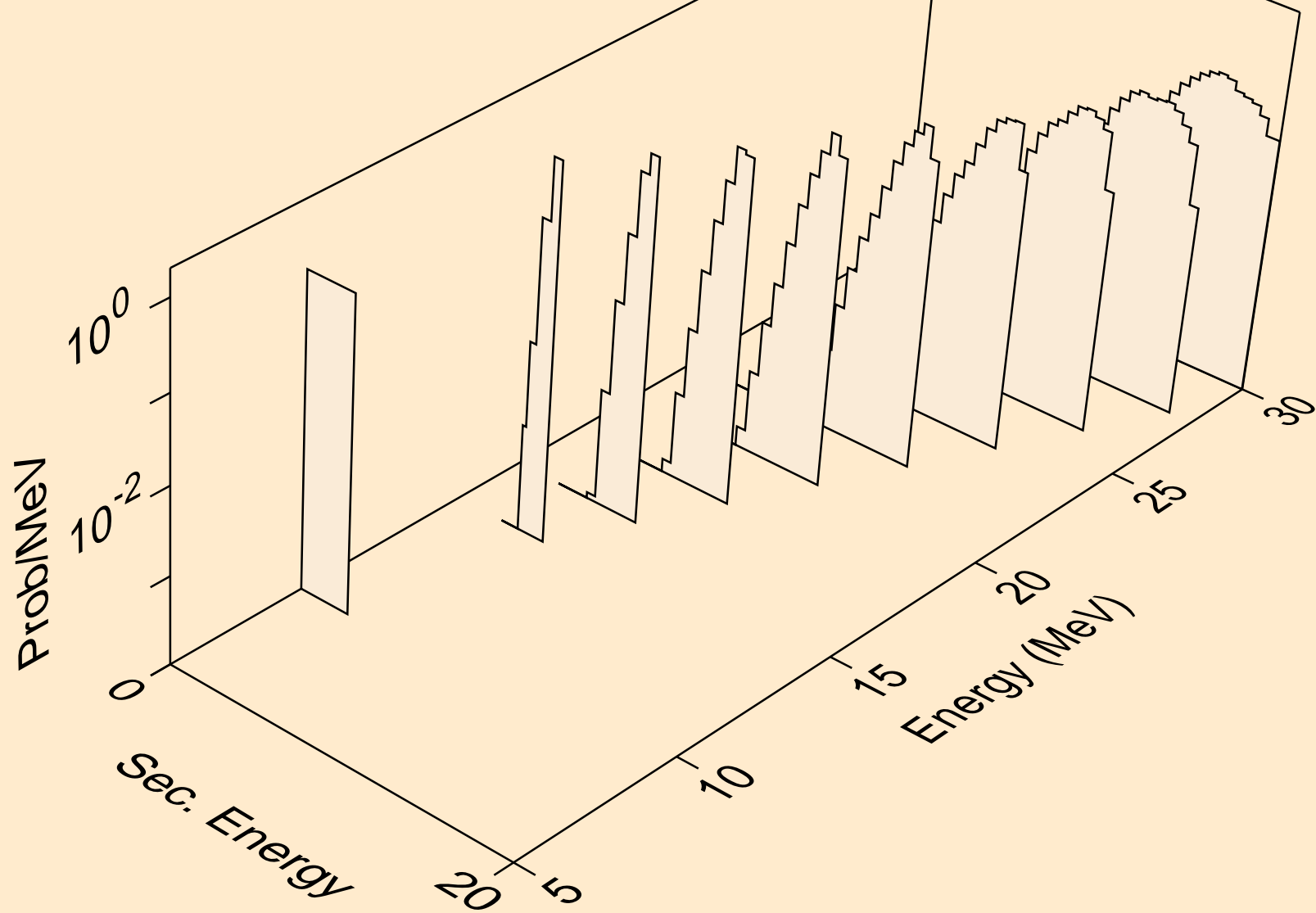

I118 NEUTRON ACER TENDL-2024 LIBRARY; T=293.6K  
he3s from (n,he3)

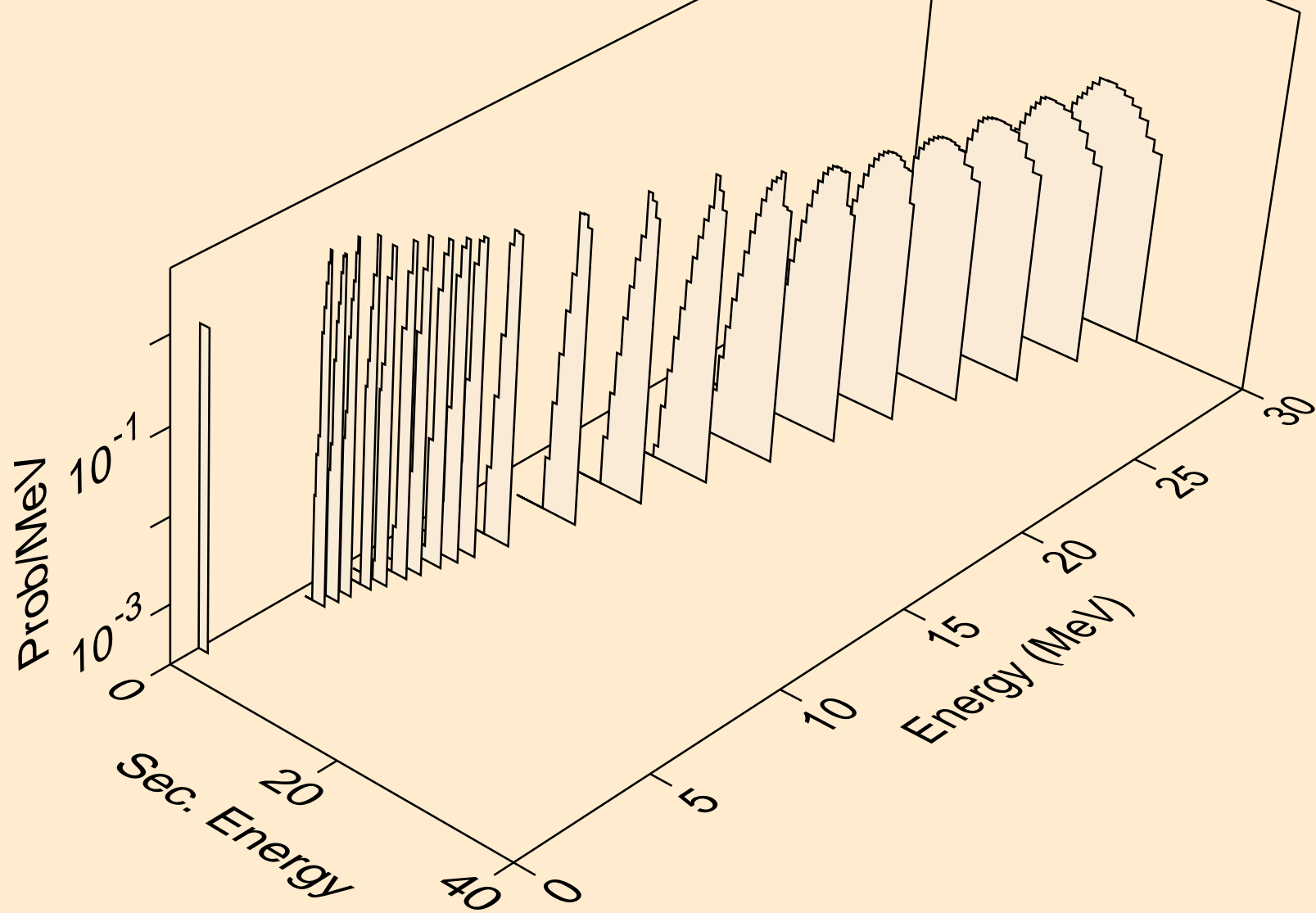

I118 NEUTRON ACER TENDL-2024 LIBRARY; T=293.6K  
alphas from (n,x)

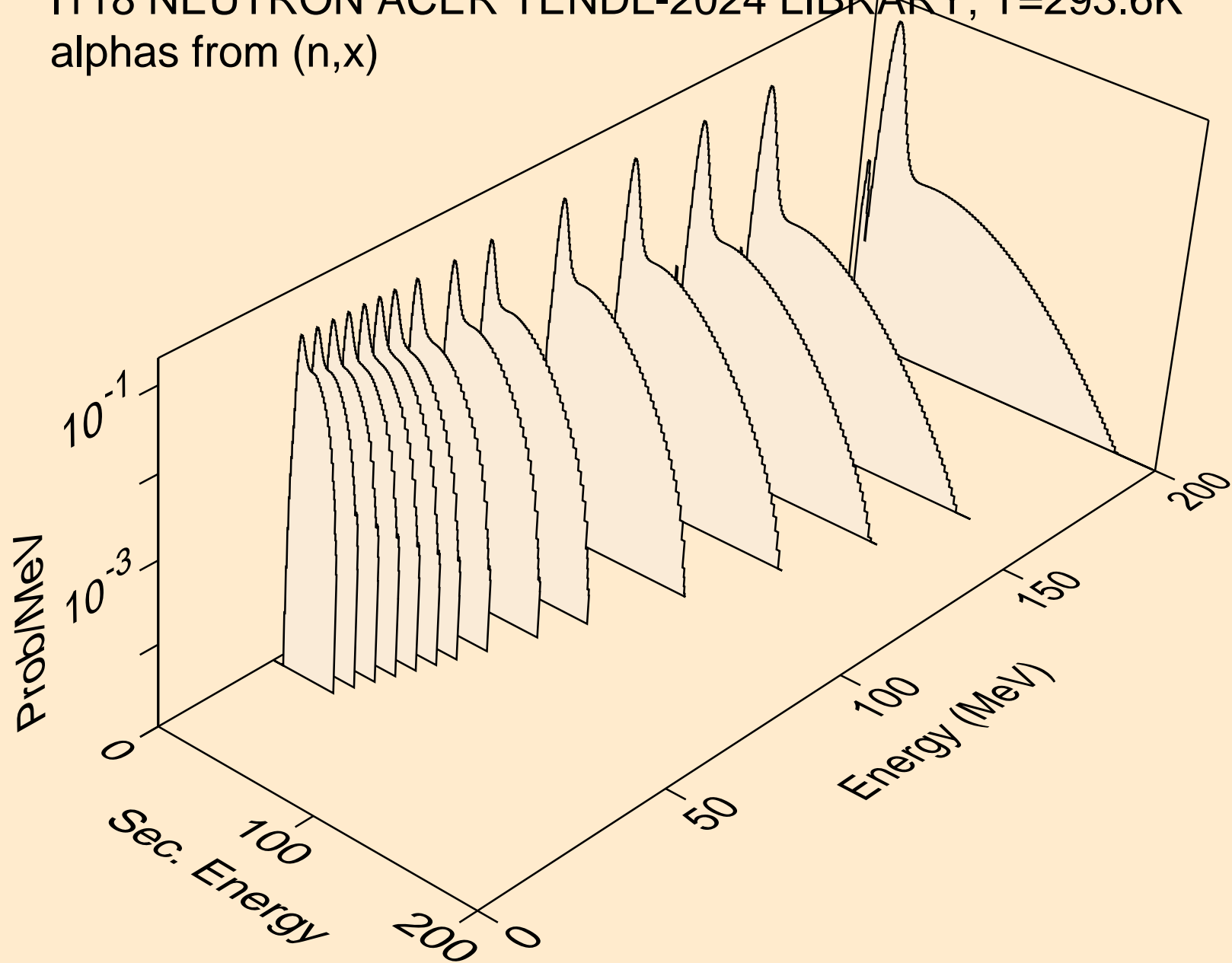

I118 NEUTRON ACER TENDL-2024 LIBRARY; T=293.6K  
alphas from (n,n\*)a

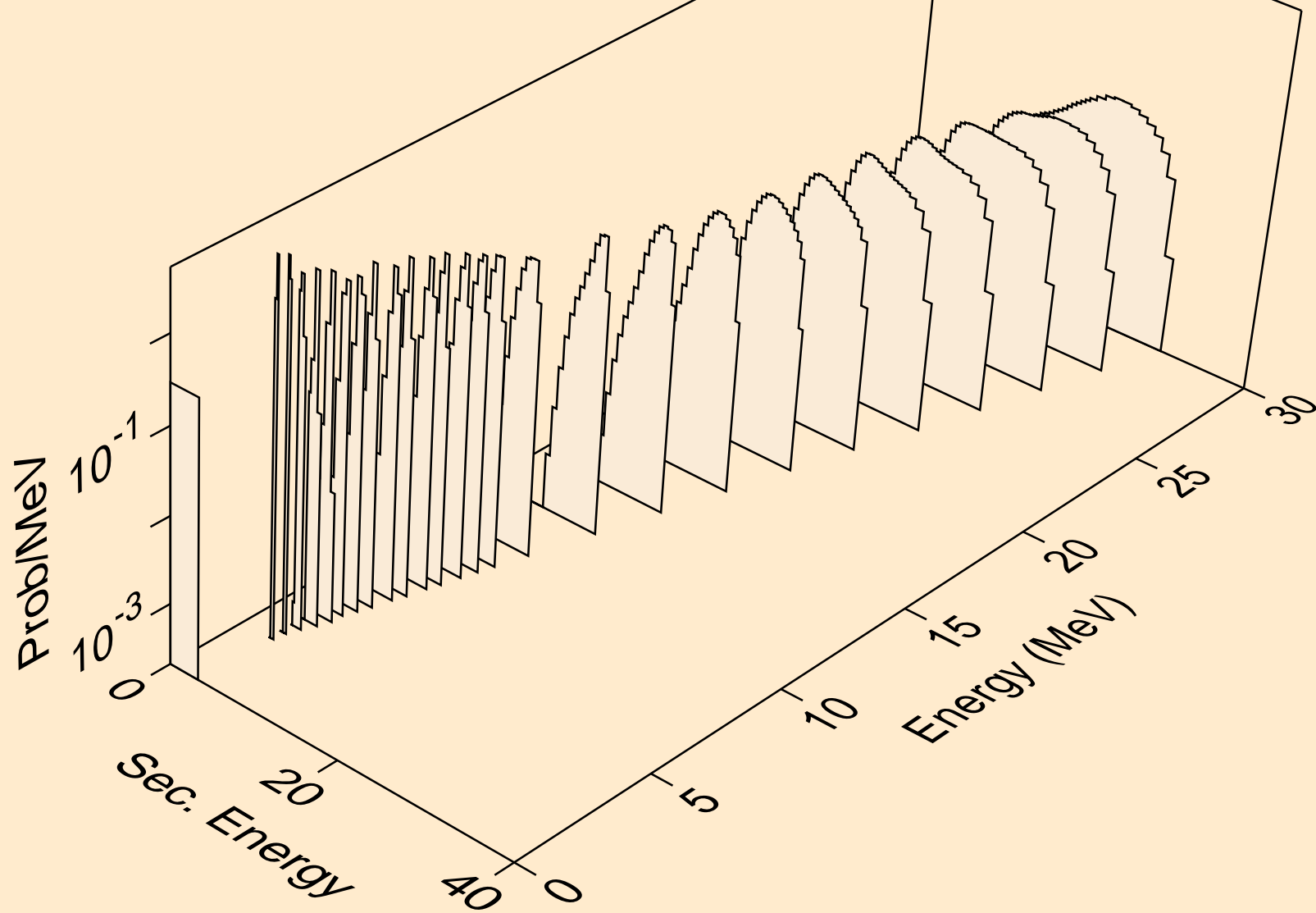

I118 NEUTRON ACER TENDL-2024 LIBRARY; T=293.6K  
alphas from (n,2n)a

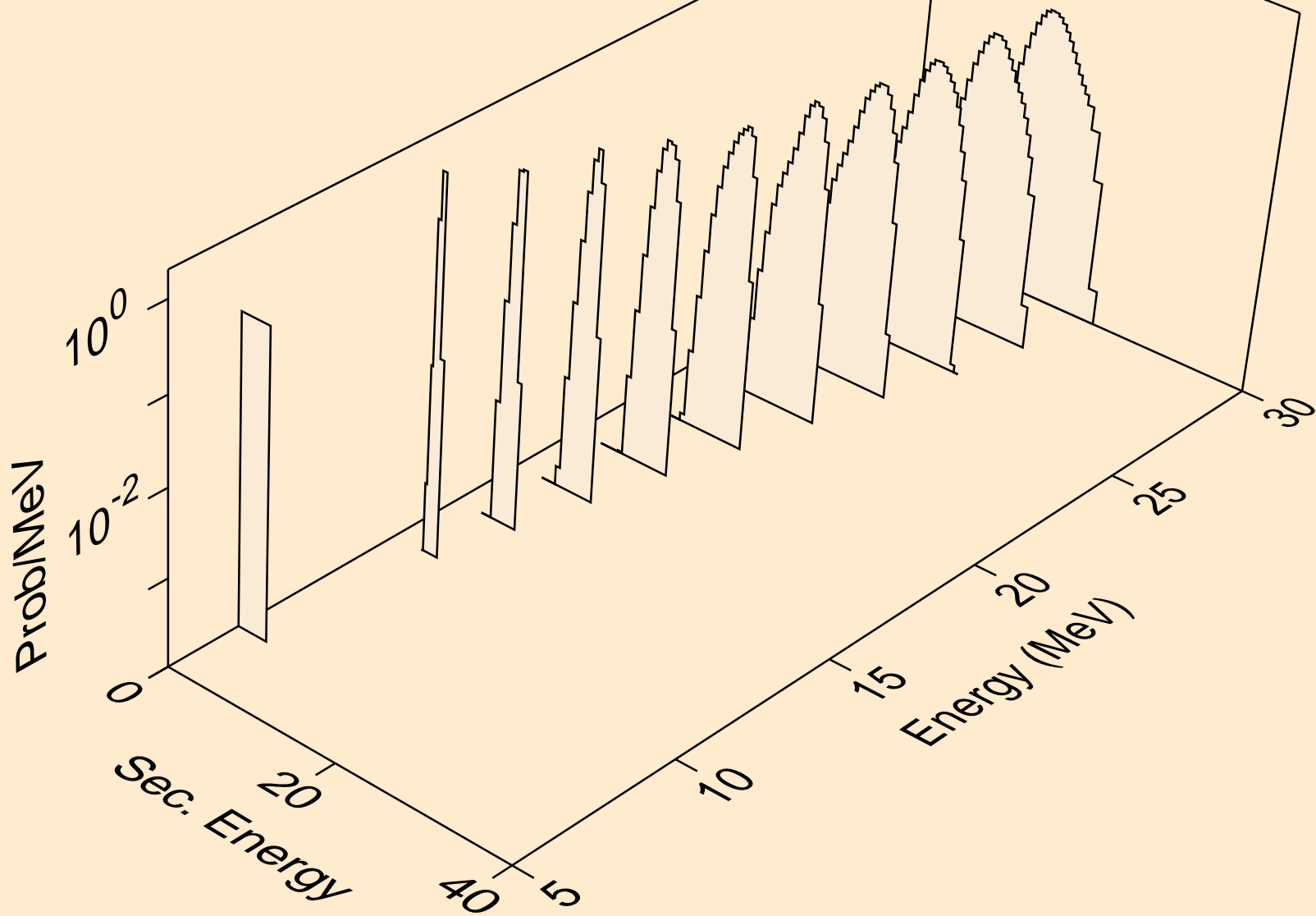

I118 NEUTRON ACER TENDL-2024 LIBRARY; T=293.6K  
alphas from (n,3n)a

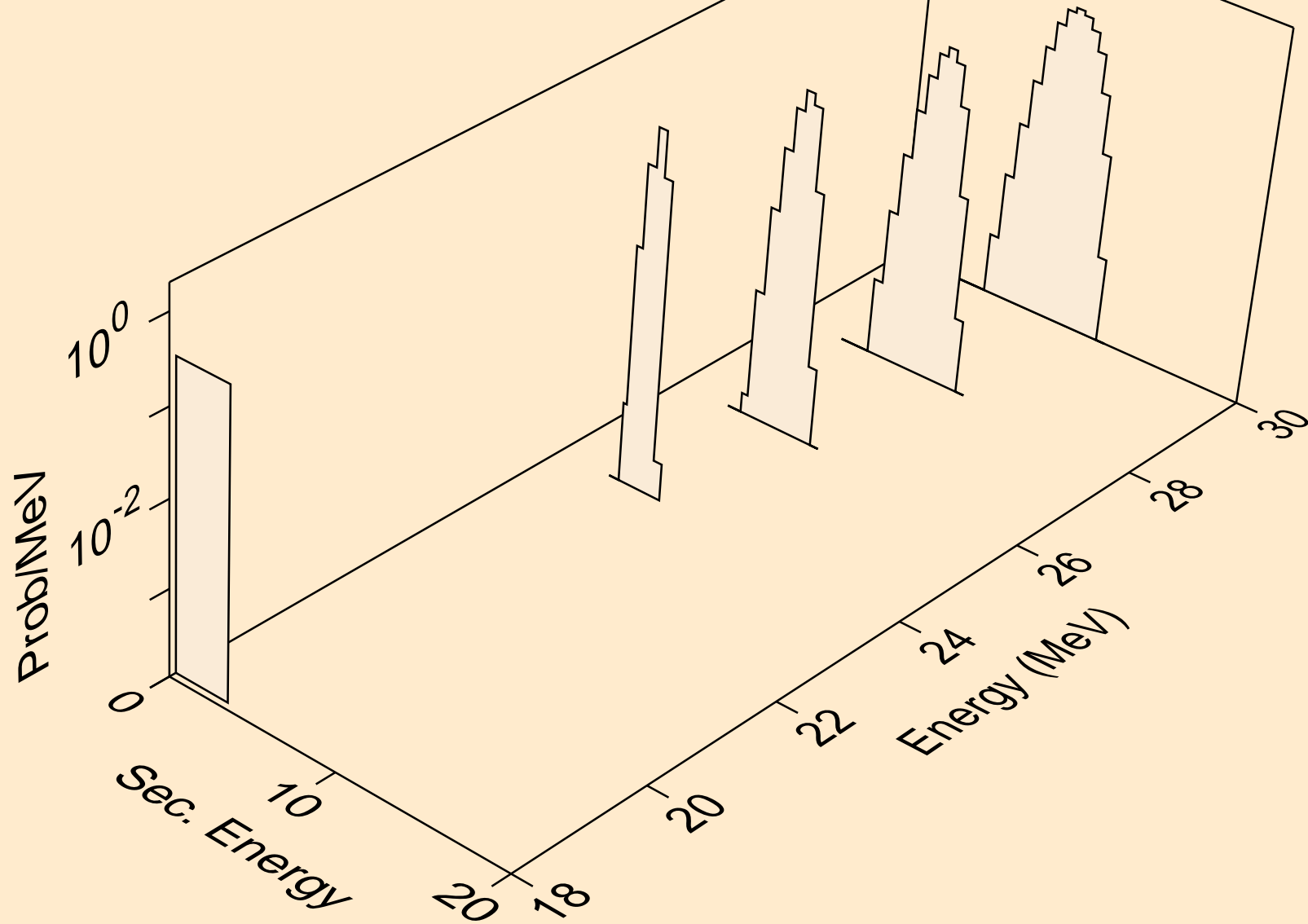

I118 NEUTRON ACER TENDL-2024 LIBRARY; T=293.6K  
alphas from (n,n\*)2a

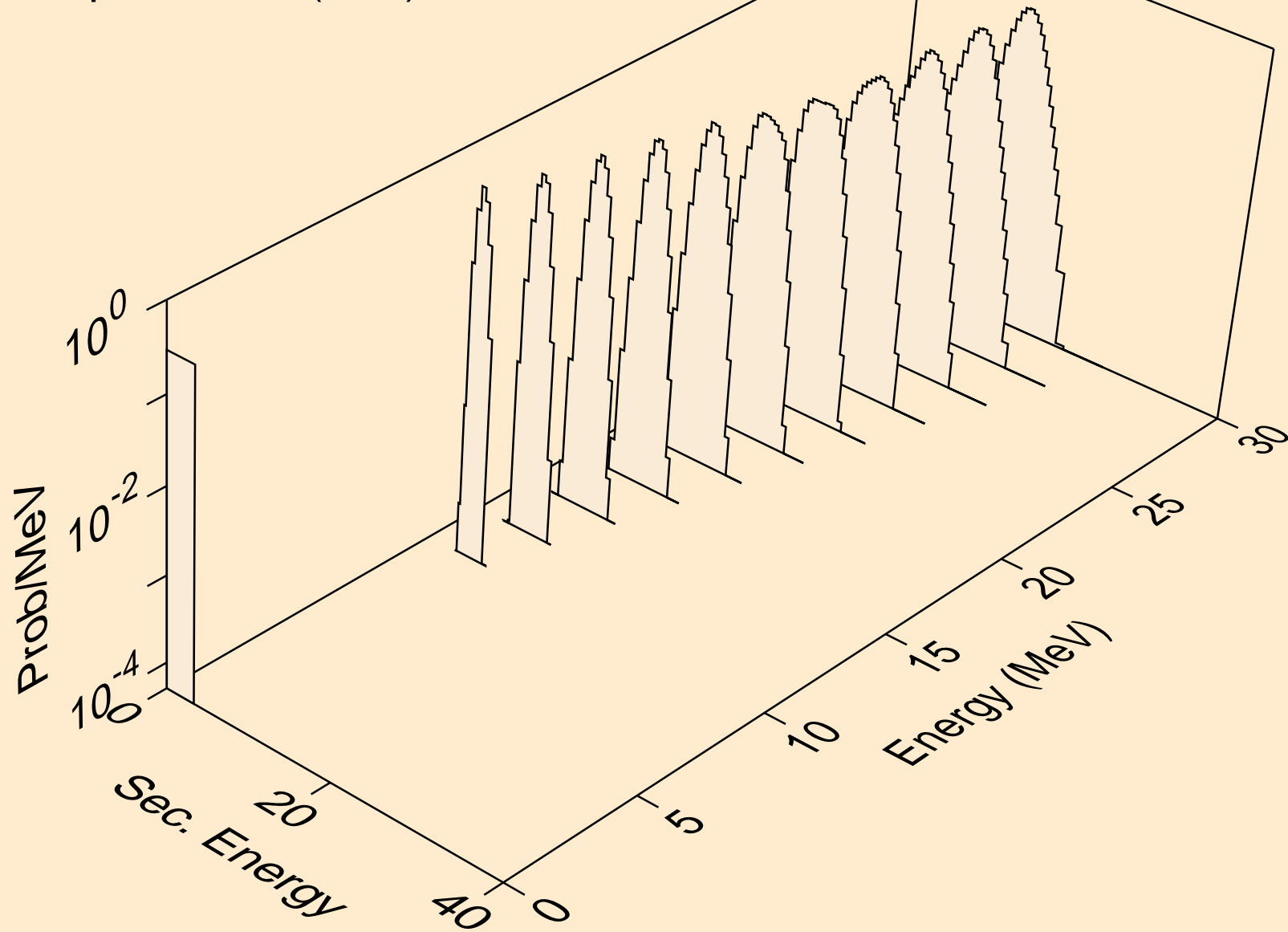

I118 NEUTRON ACER TENDL-2024 LIBRARY; T=293.6K  
alphas from (n,2n)2a

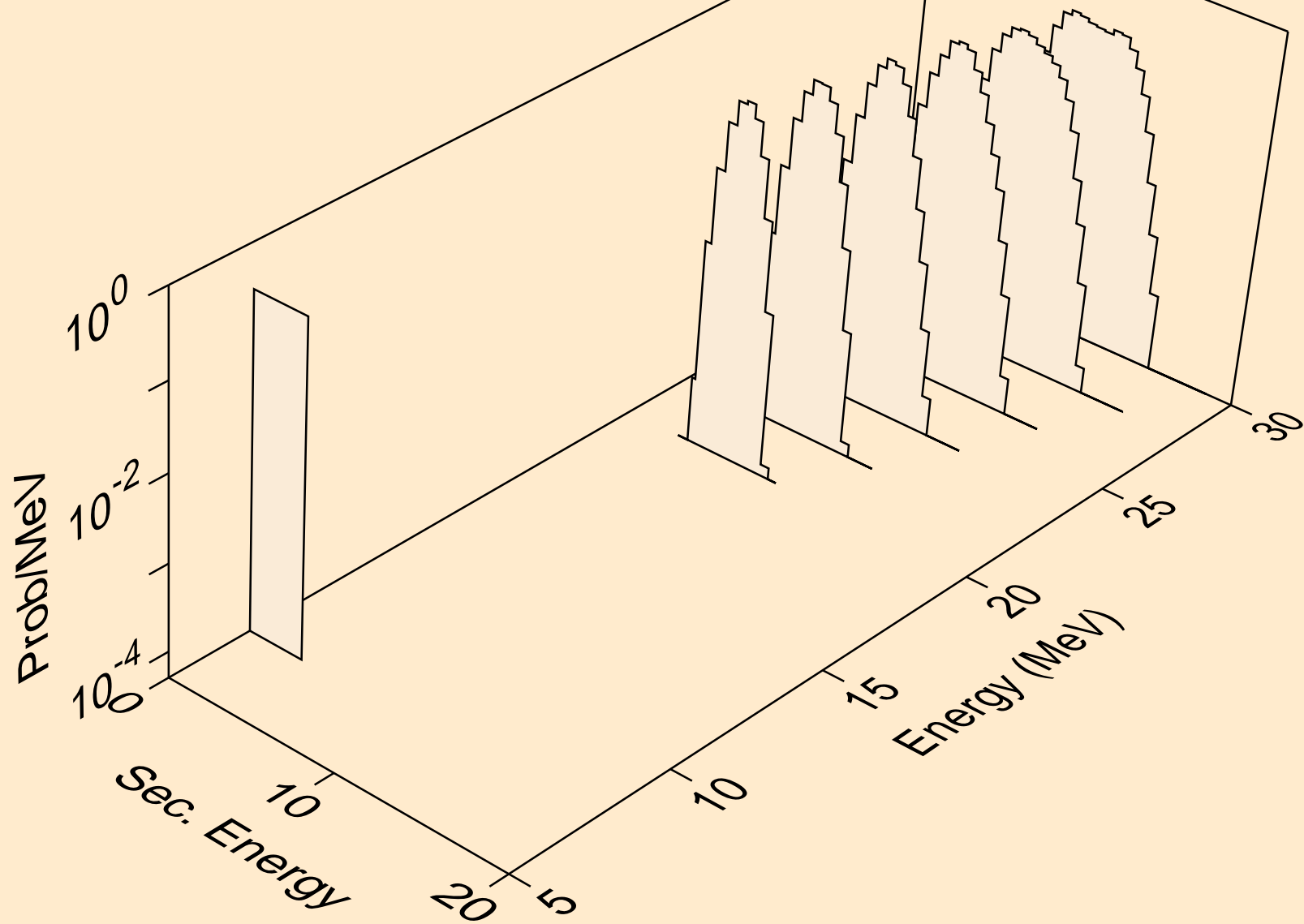

I118 NEUTRON ACER TENDL-2024 LIBRARY; T=293.6K  
alphas from (n,npa)

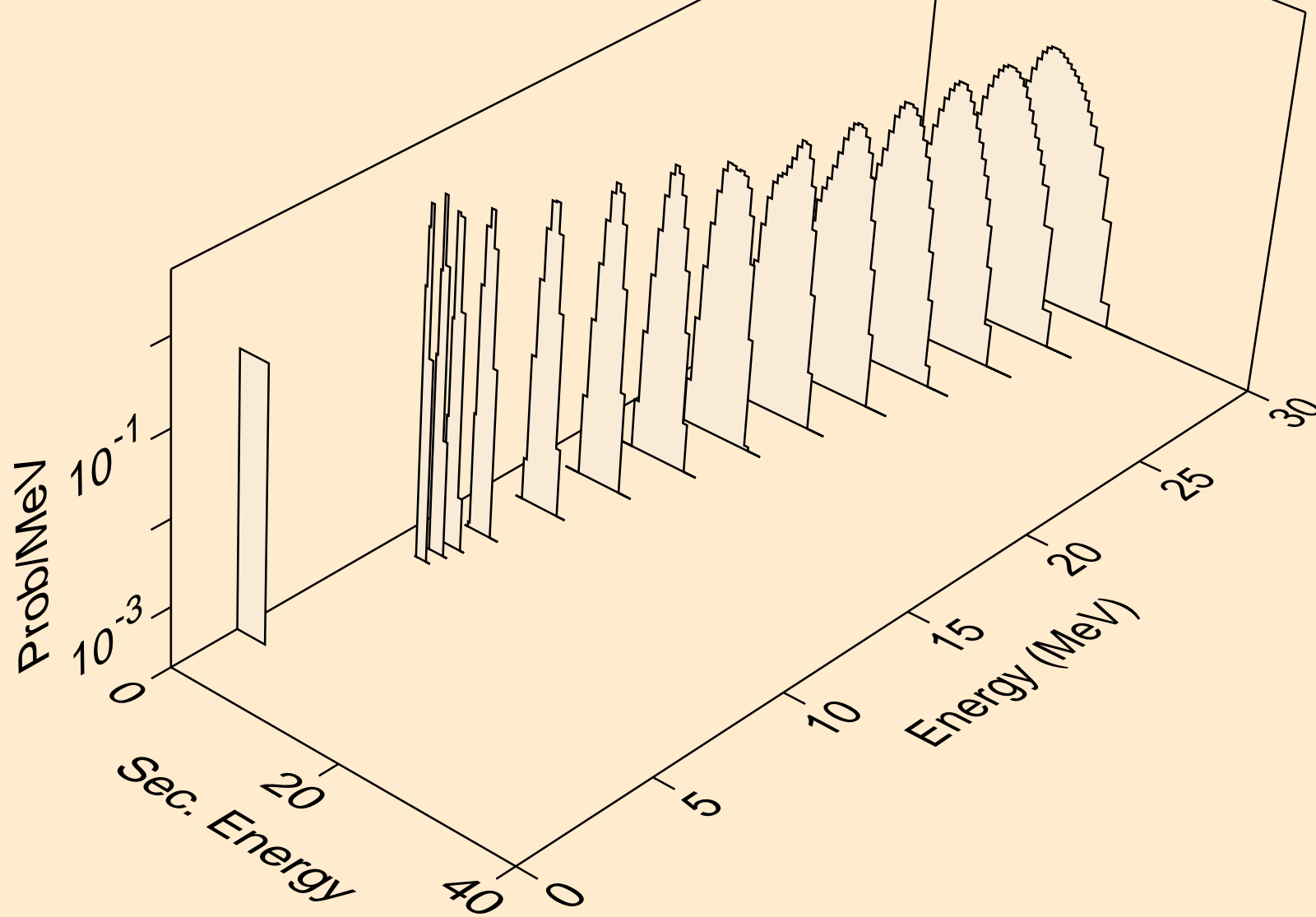

I118 NEUTRON ACER TENDL-2024 LIBRARY; T=293.6K  
alphas from (n,a)

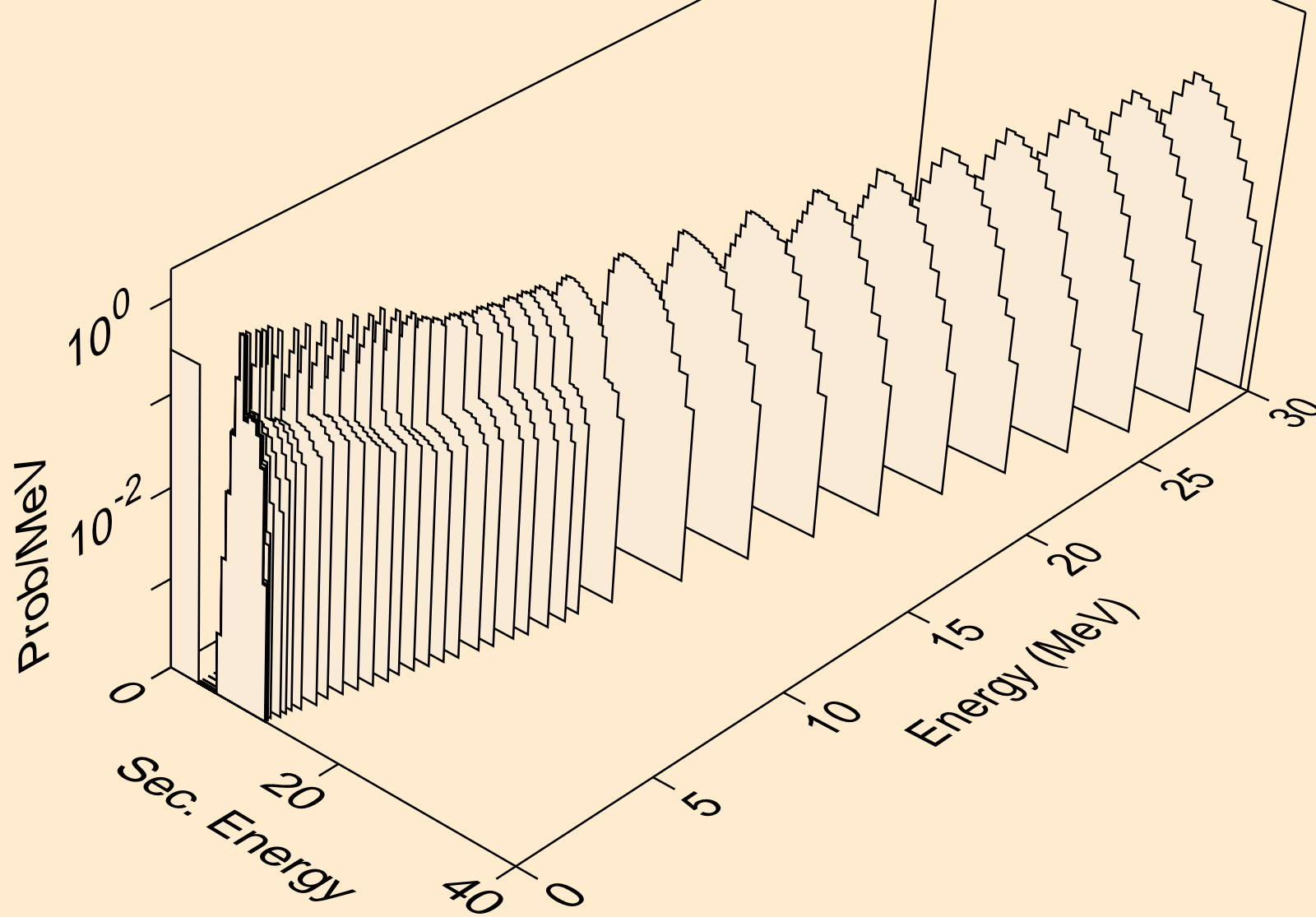

I118 NEUTRON ACER TENDL-2024 LIBRARY; T=293.6K  
alphas from (n,2a)

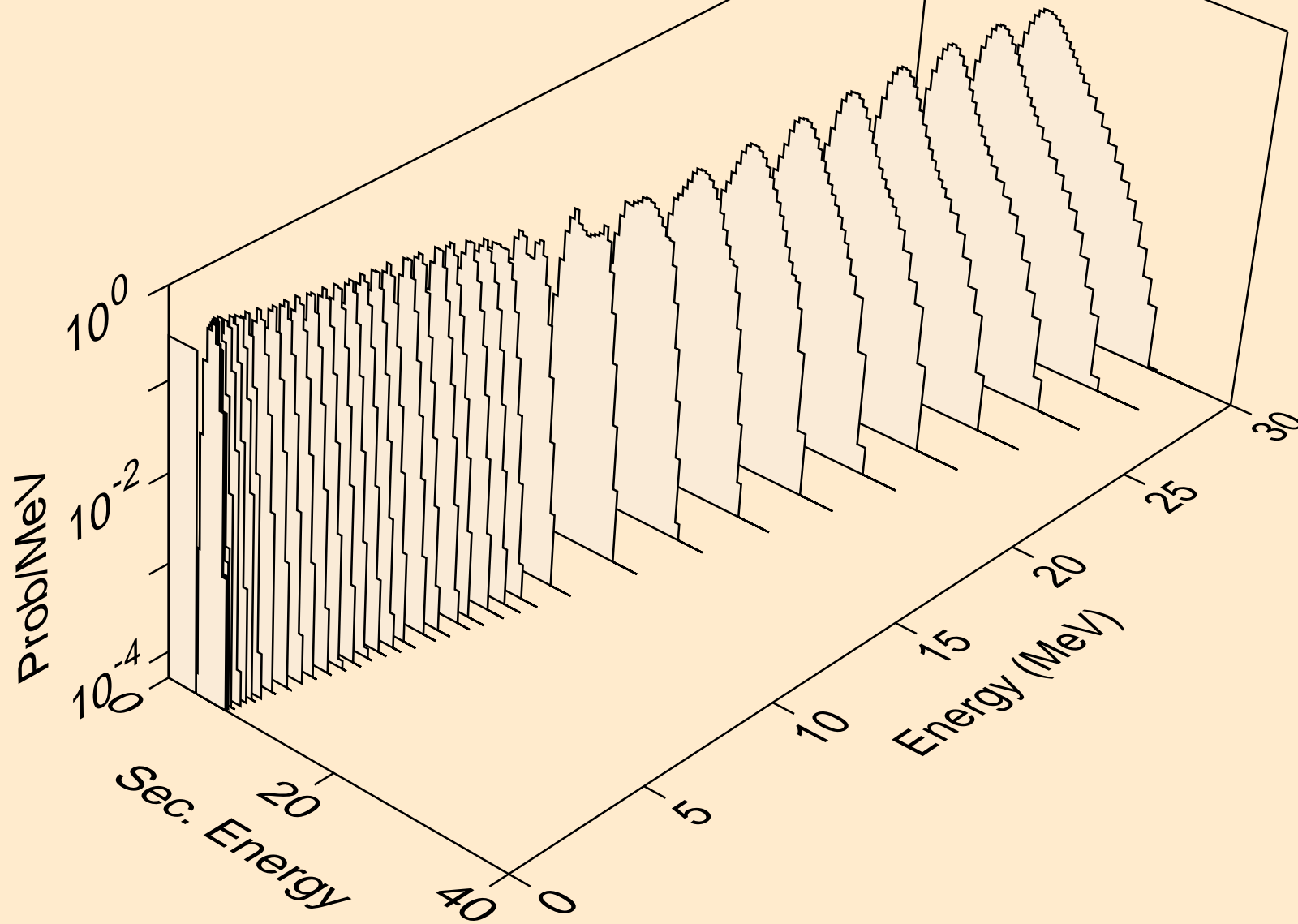

I118 NEUTRON ACER TENDL-2024 LIBRARY; T=293.6K  
alphas from (n,3a)

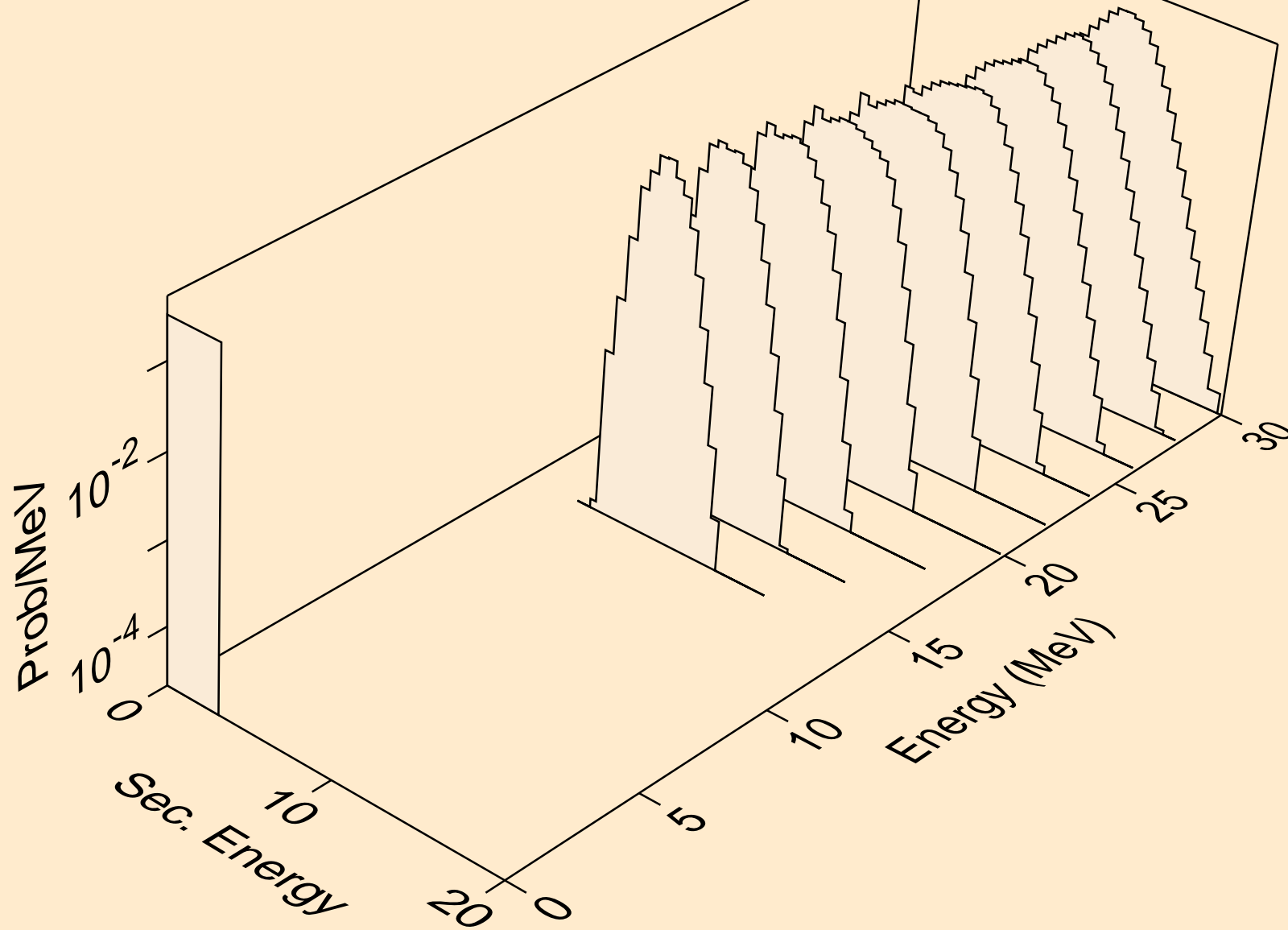

I118 NEUTRON ACER TENDL-2024 LIBRARY; T=293.6K  
alphas from (n,pa)

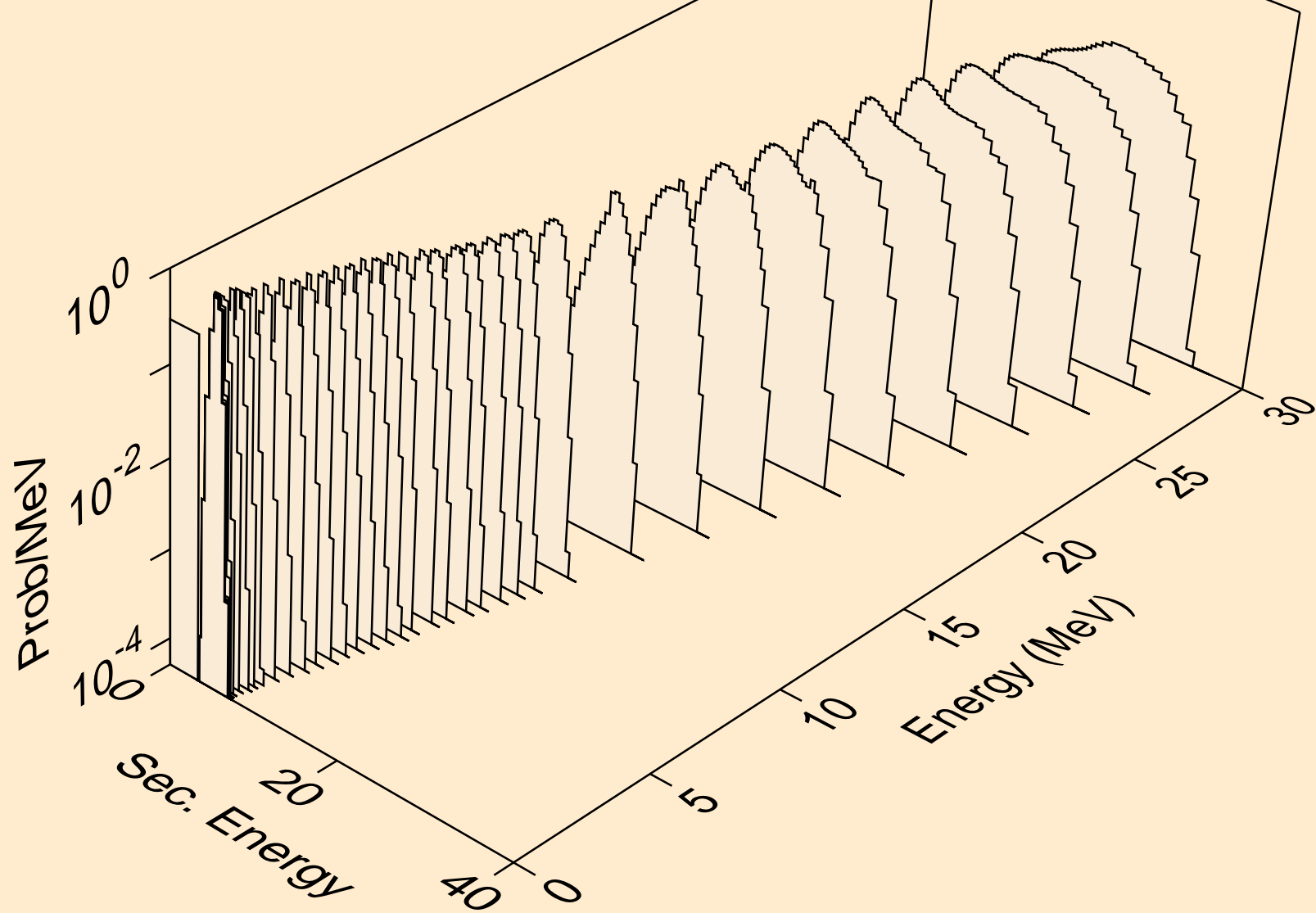

I118 NEUTRON ACER TENDL-2024 LIBRARY; T=293.6K  
alphas from (n,da)

