

I119 NEUTRON ACER TENDL-2024 LIBRARY; T=293.6K

Principal cross sections

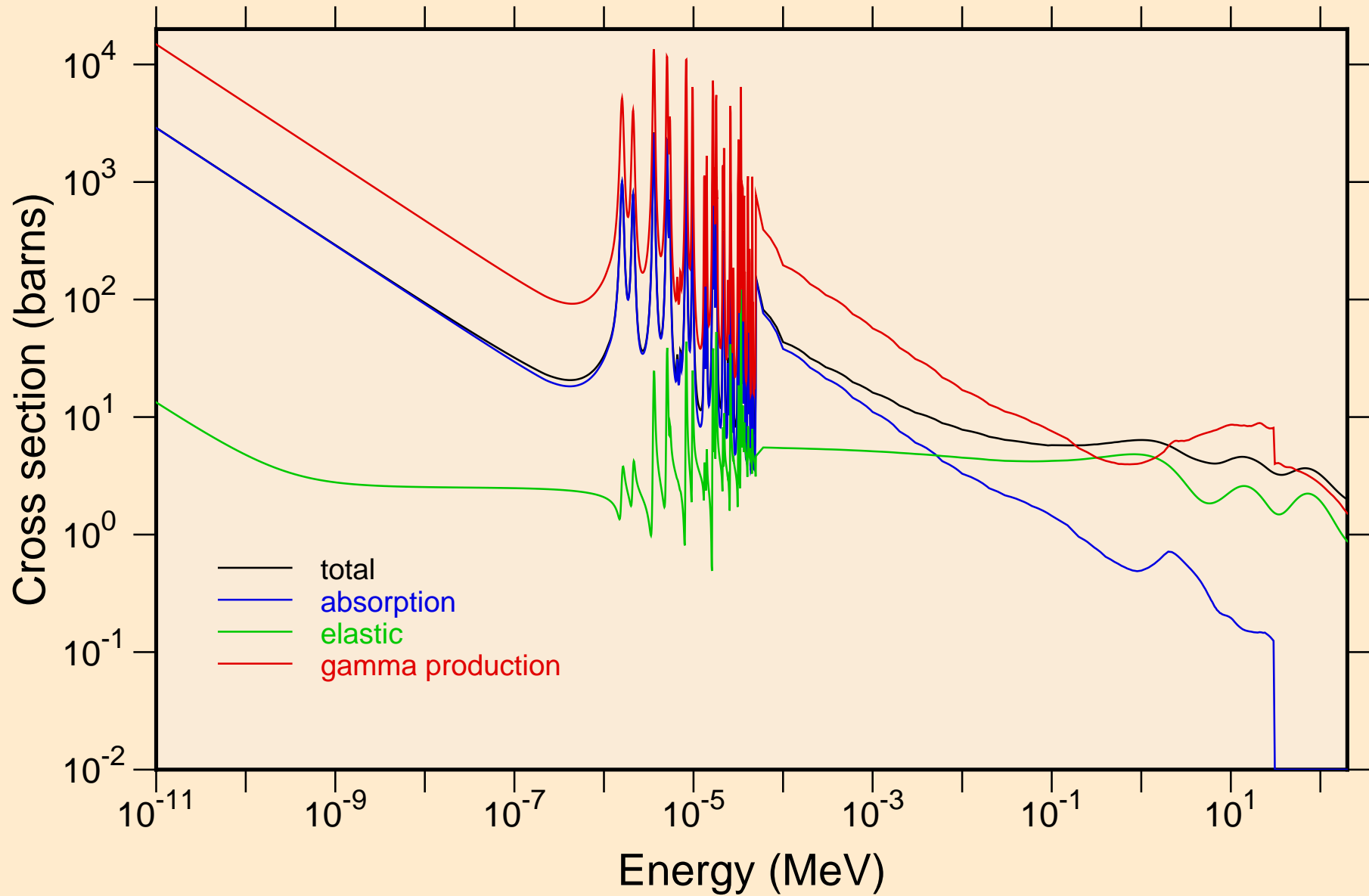

I119 NEUTRON ACER TENDL-2024 LIBRARY; T=293.6K
resonance total cross section

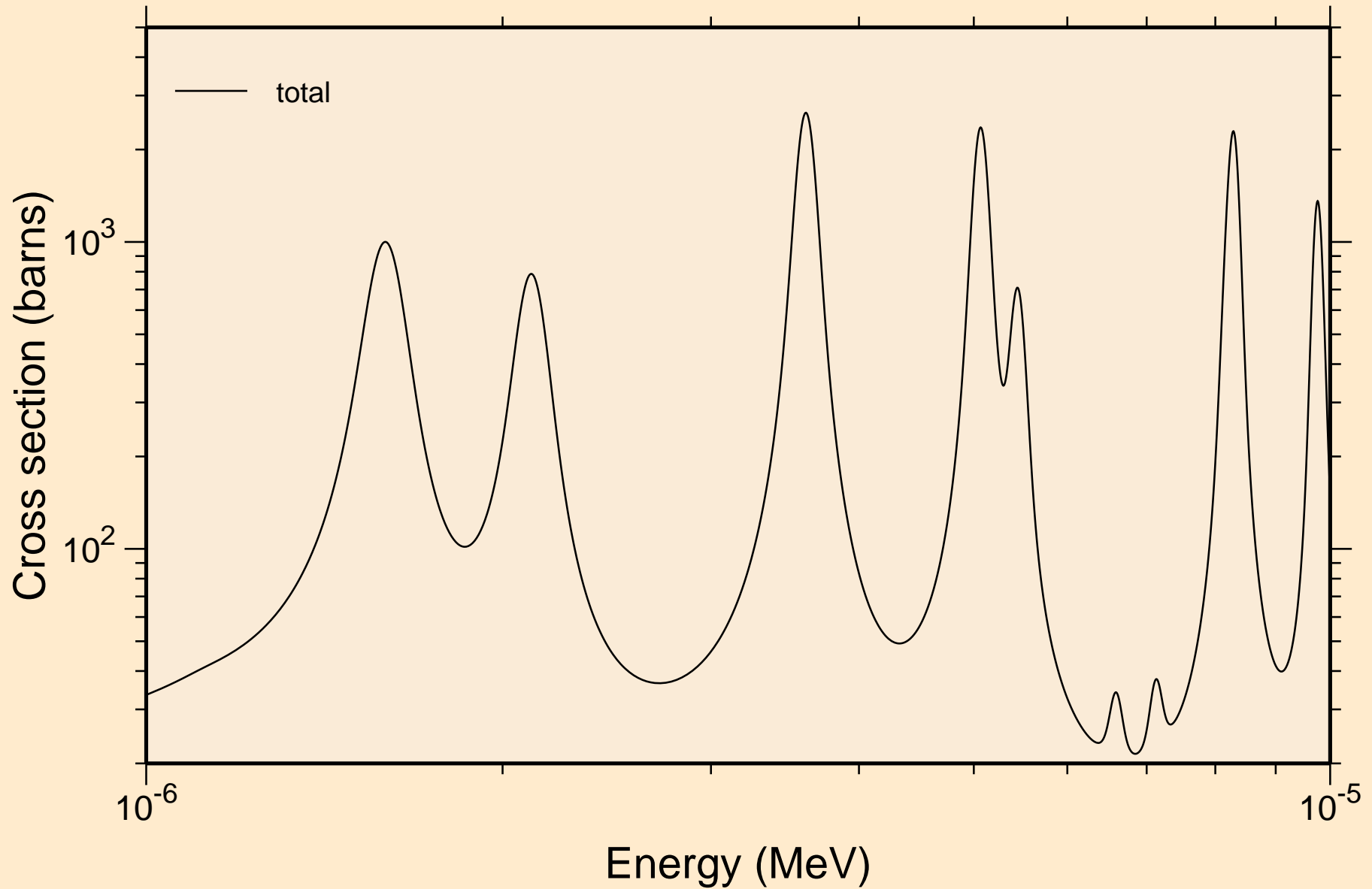

I119 NEUTRON ACER TENDL-2024 LIBRARY; T=293.6K
resonance total cross section

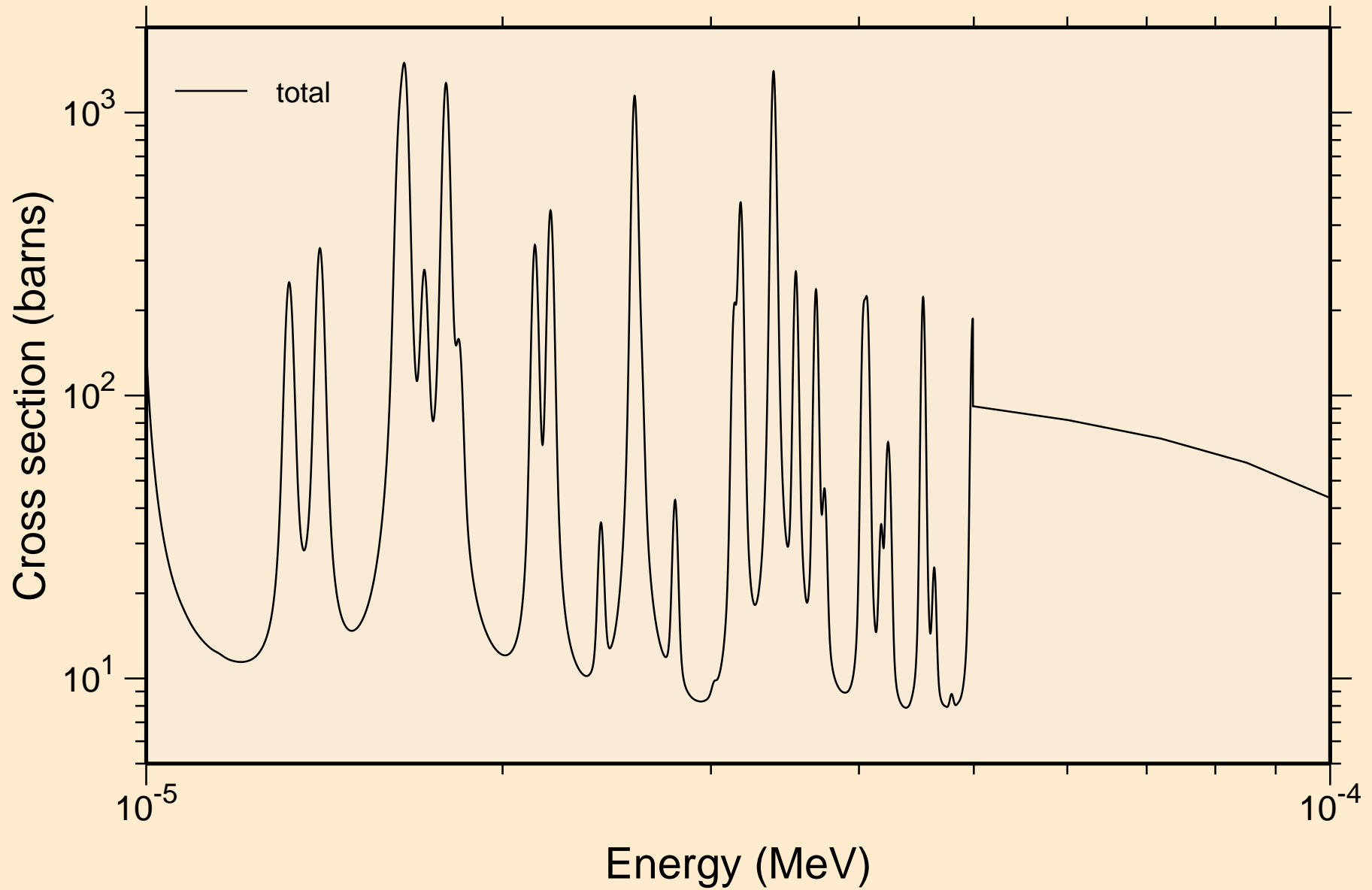

I119 NEUTRON ACER TENDL-2024 LIBRARY; T=293.6K
resonance total cross section

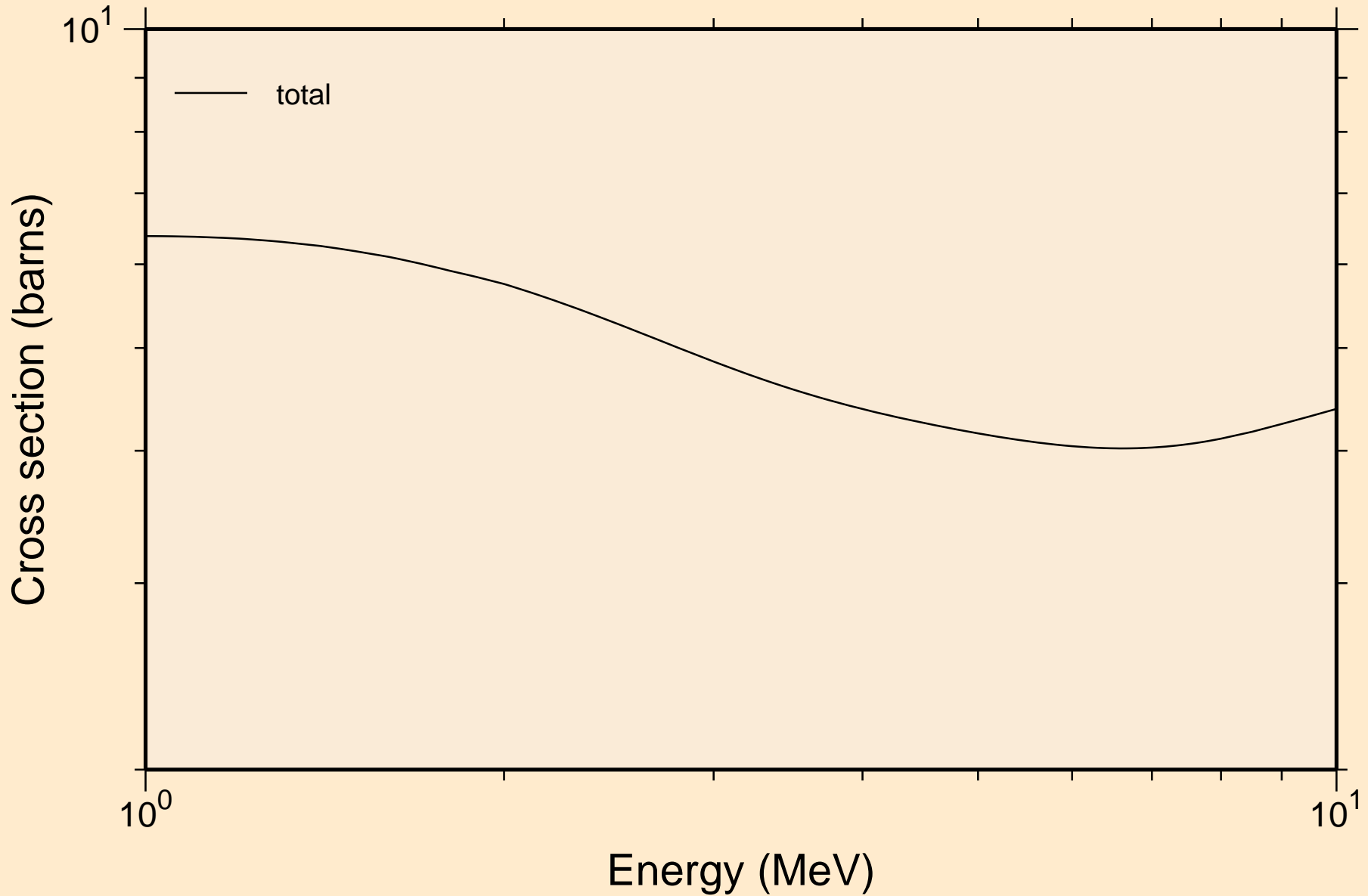

I119 NEUTRON ACER TENDL-2024 LIBRARY; T=293.6K
resonance absorption cross sections

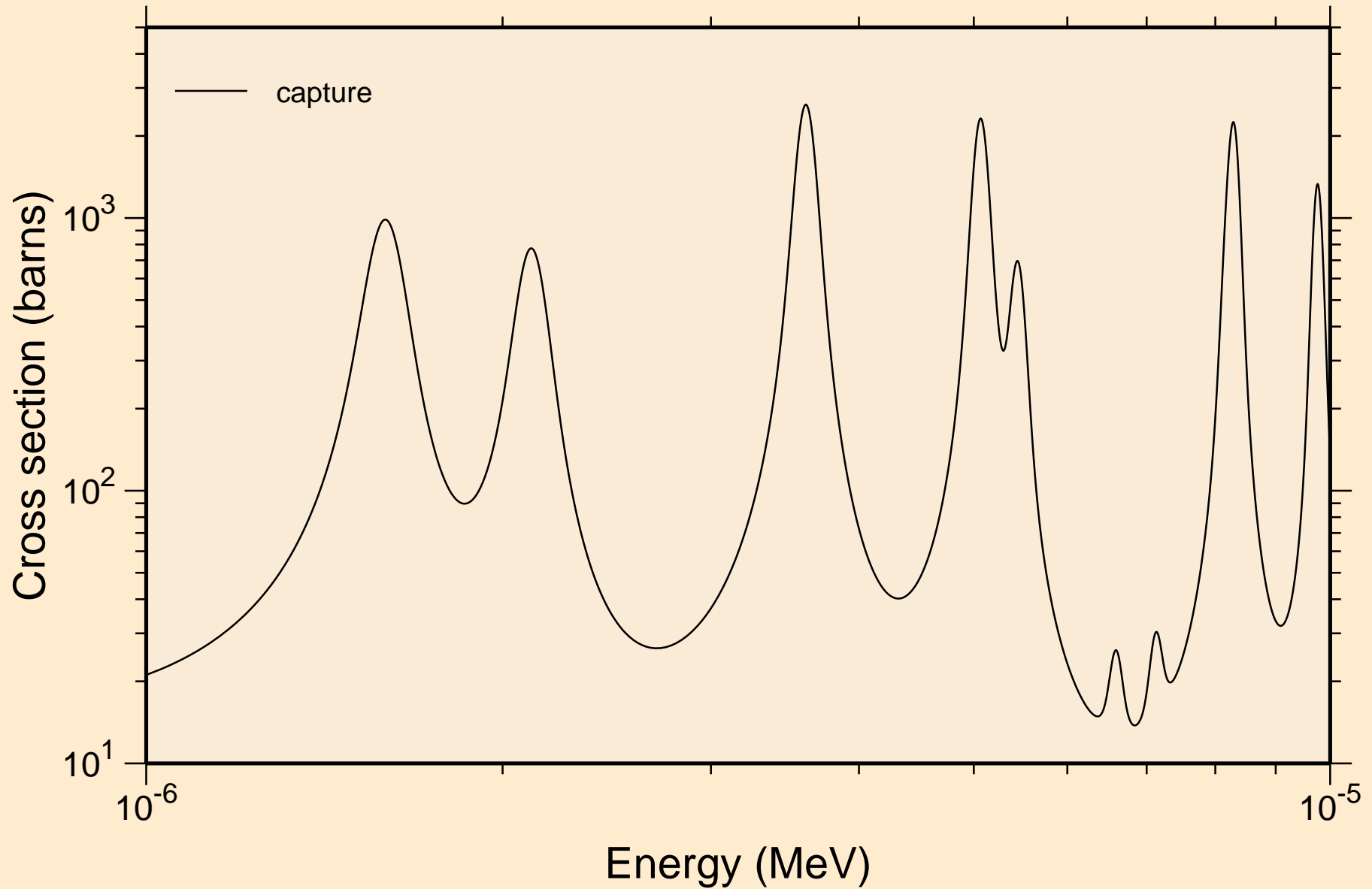

I119 NEUTRON ACER TENDL-2024 LIBRARY; T=293.6K
resonance absorption cross sections

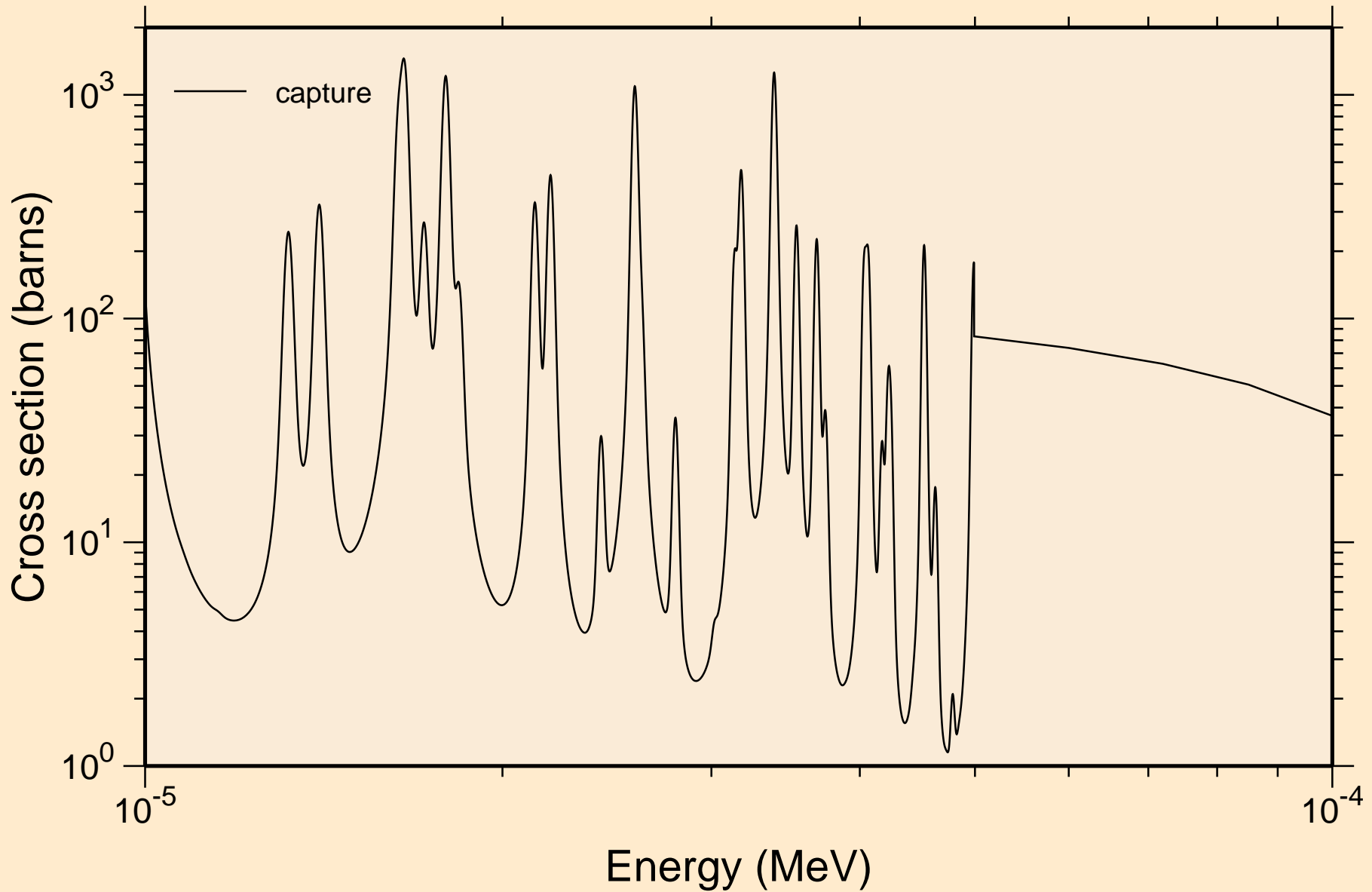

I119 NEUTRON ACER TENDL-2024 LIBRARY; T=293.6K
resonance absorption cross sections

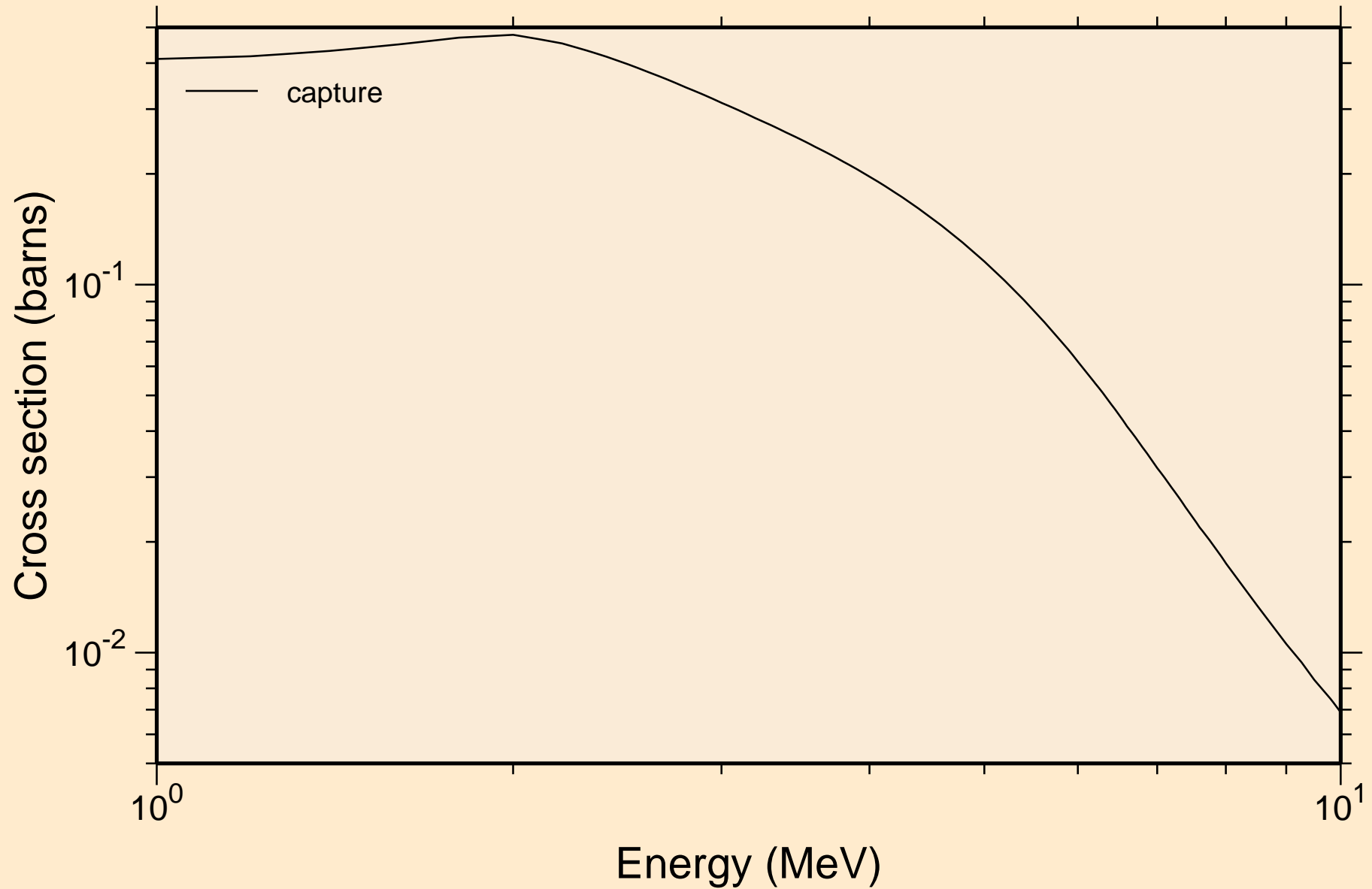

I119 NEUTRON ACER TENDL-2024 LIBRARY; T=293.6K
Heating

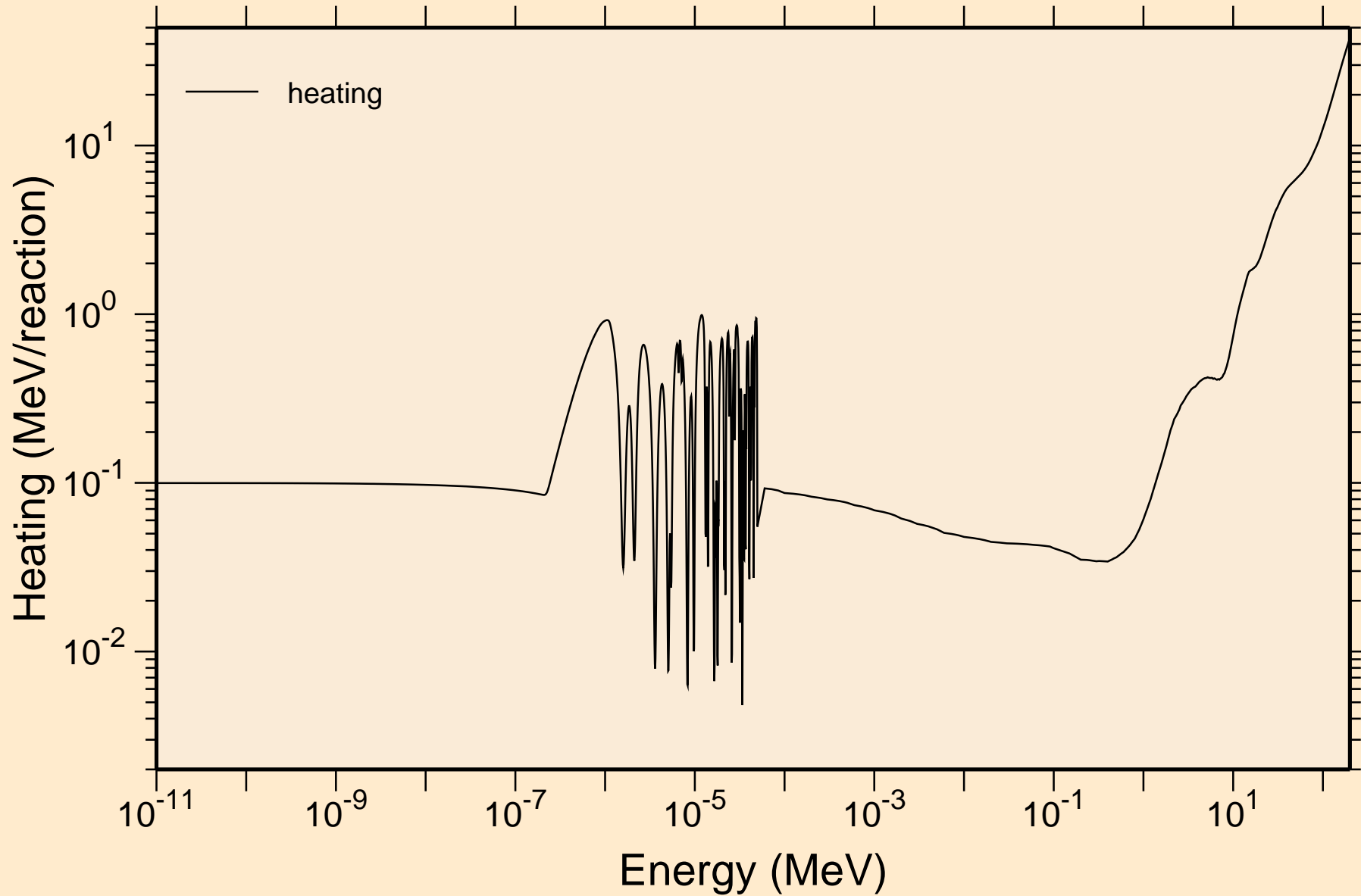

I119 NEUTRON ACER TENDL-2024 LIBRARY; T=293.6K
Damage

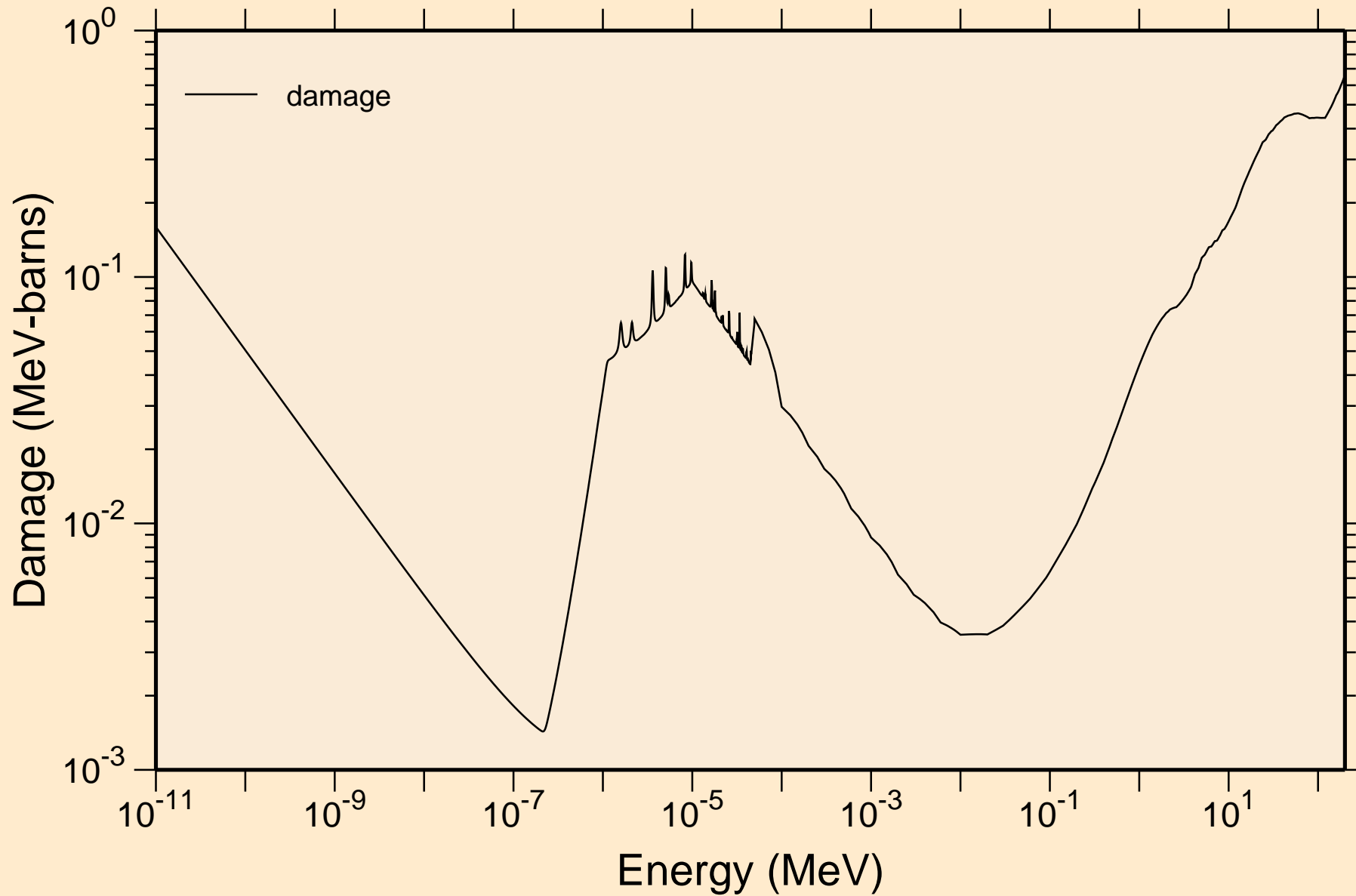

I119 NEUTRON ACER TENDL-2024 LIBRARY; T=293.6K
Non-threshold reactions

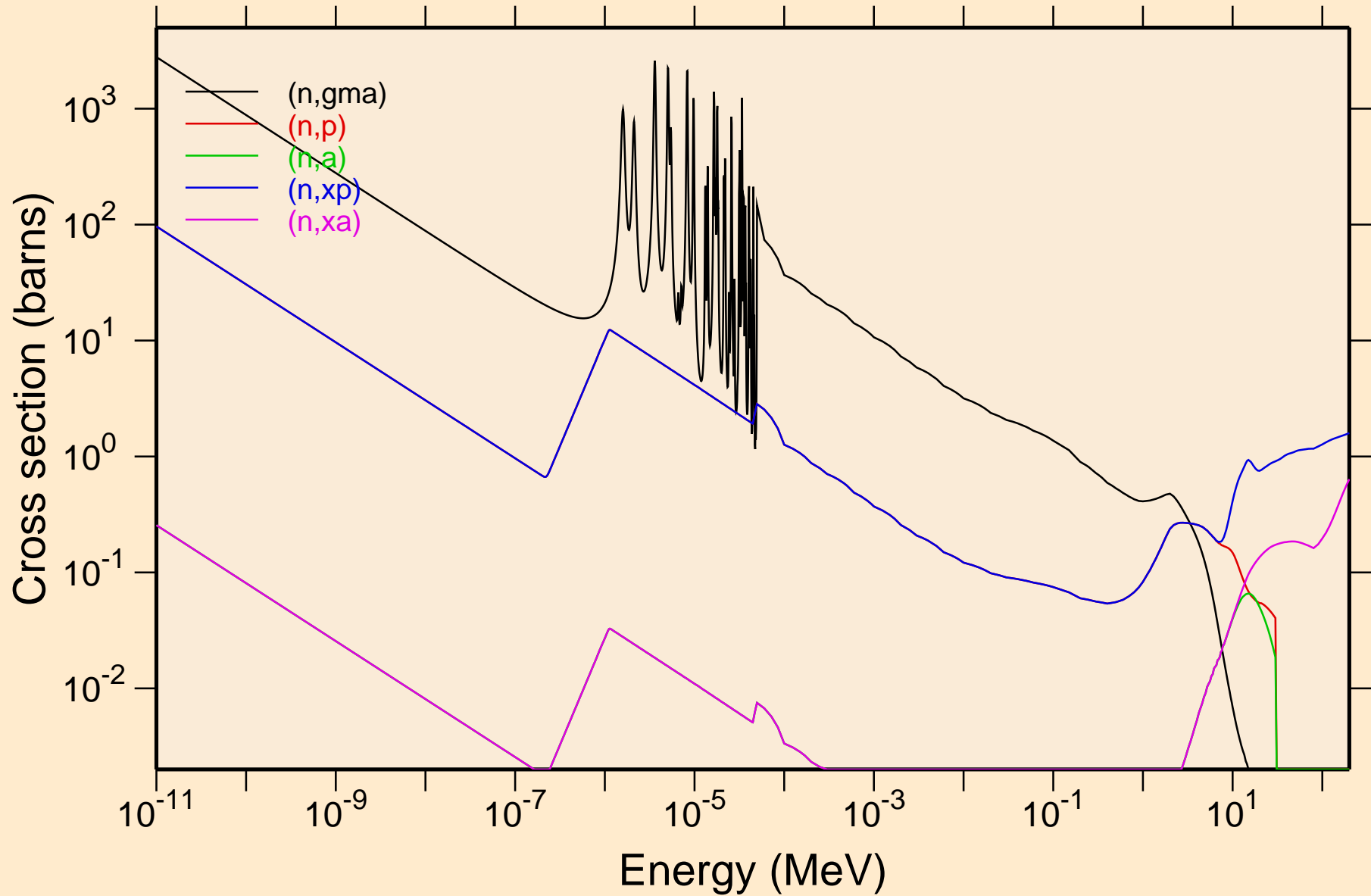

I119 NEUTRON ACER TENDL-2024 LIBRARY; T=293.6K

Principal cross sections

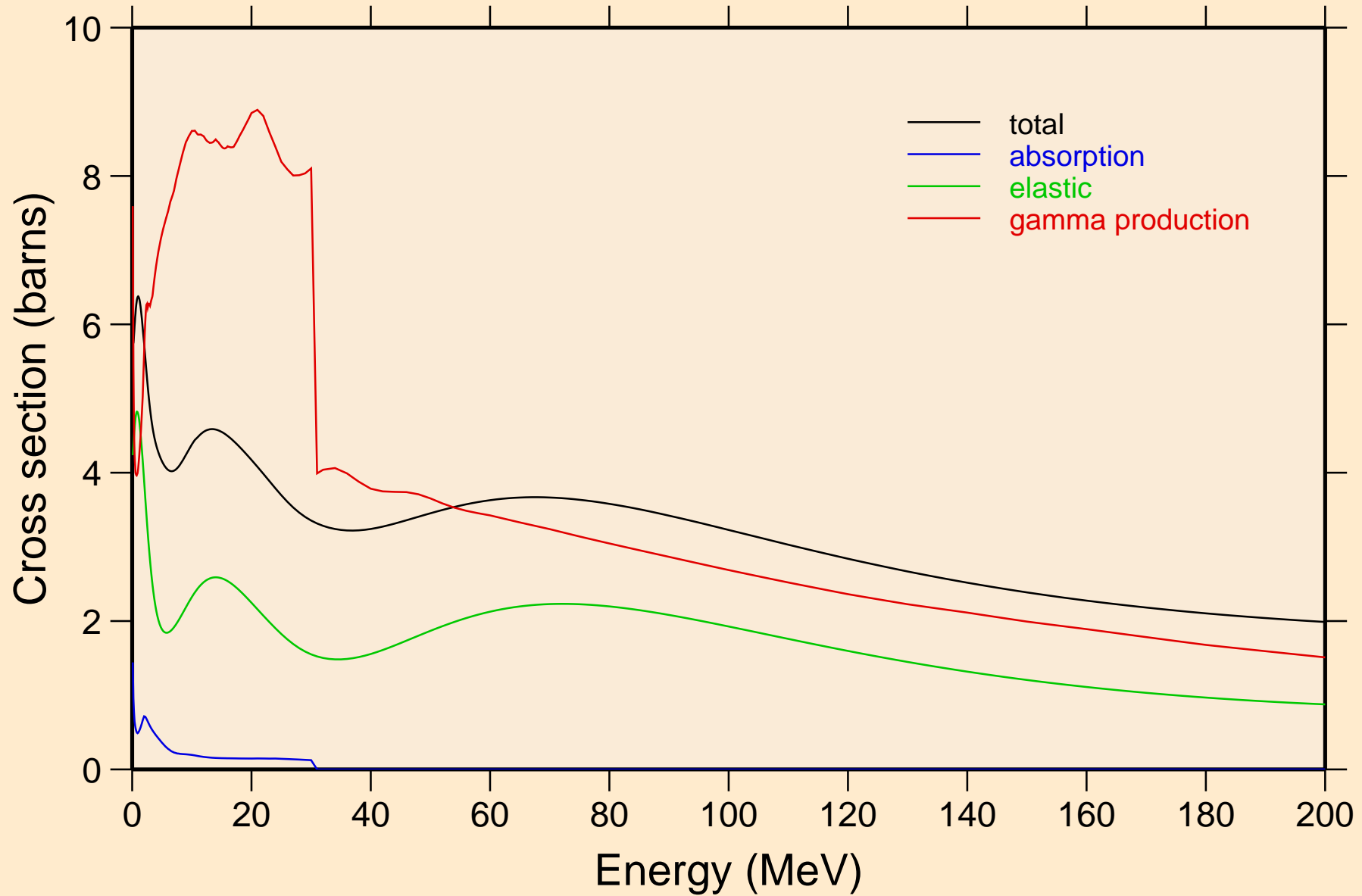

I119 NEUTRON ACER TENDL-2024 LIBRARY; T=293.6K

Heating

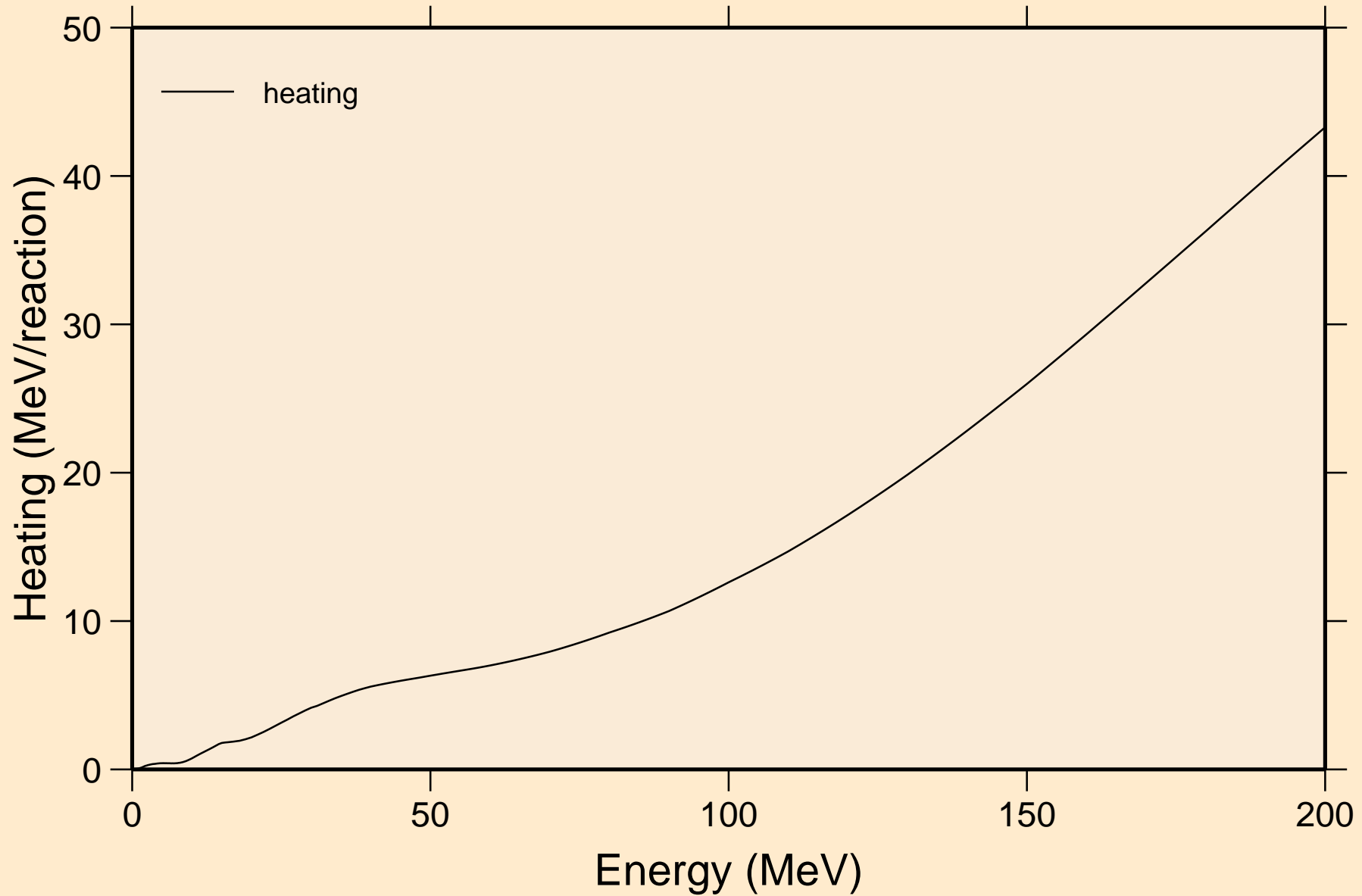

I119 NEUTRON ACER TENDL-2024 LIBRARY; T=293.6K

Damage

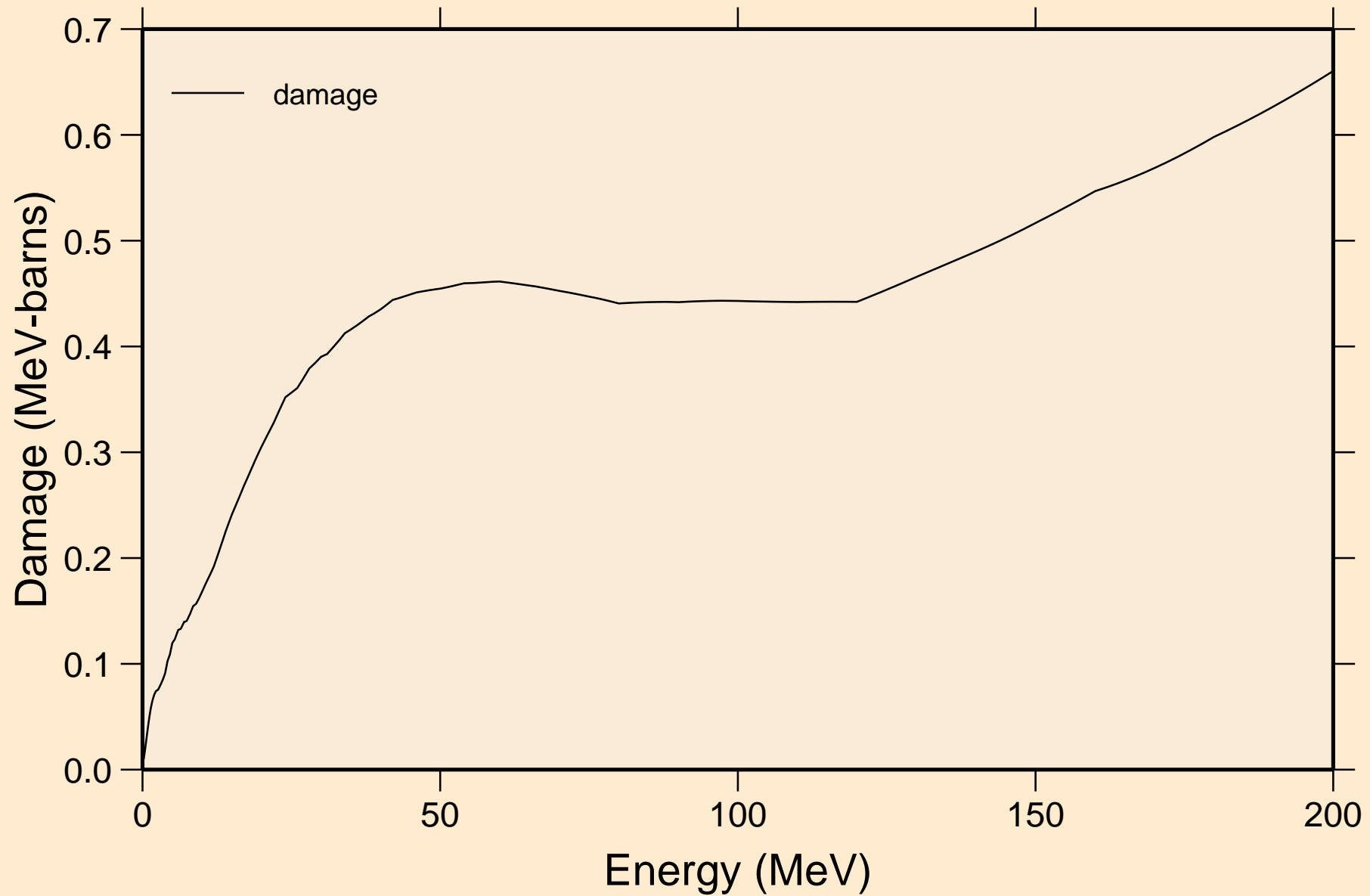

I119 NEUTRON ACER TENDL-2024 LIBRARY; T=293.6K

Non-threshold reactions

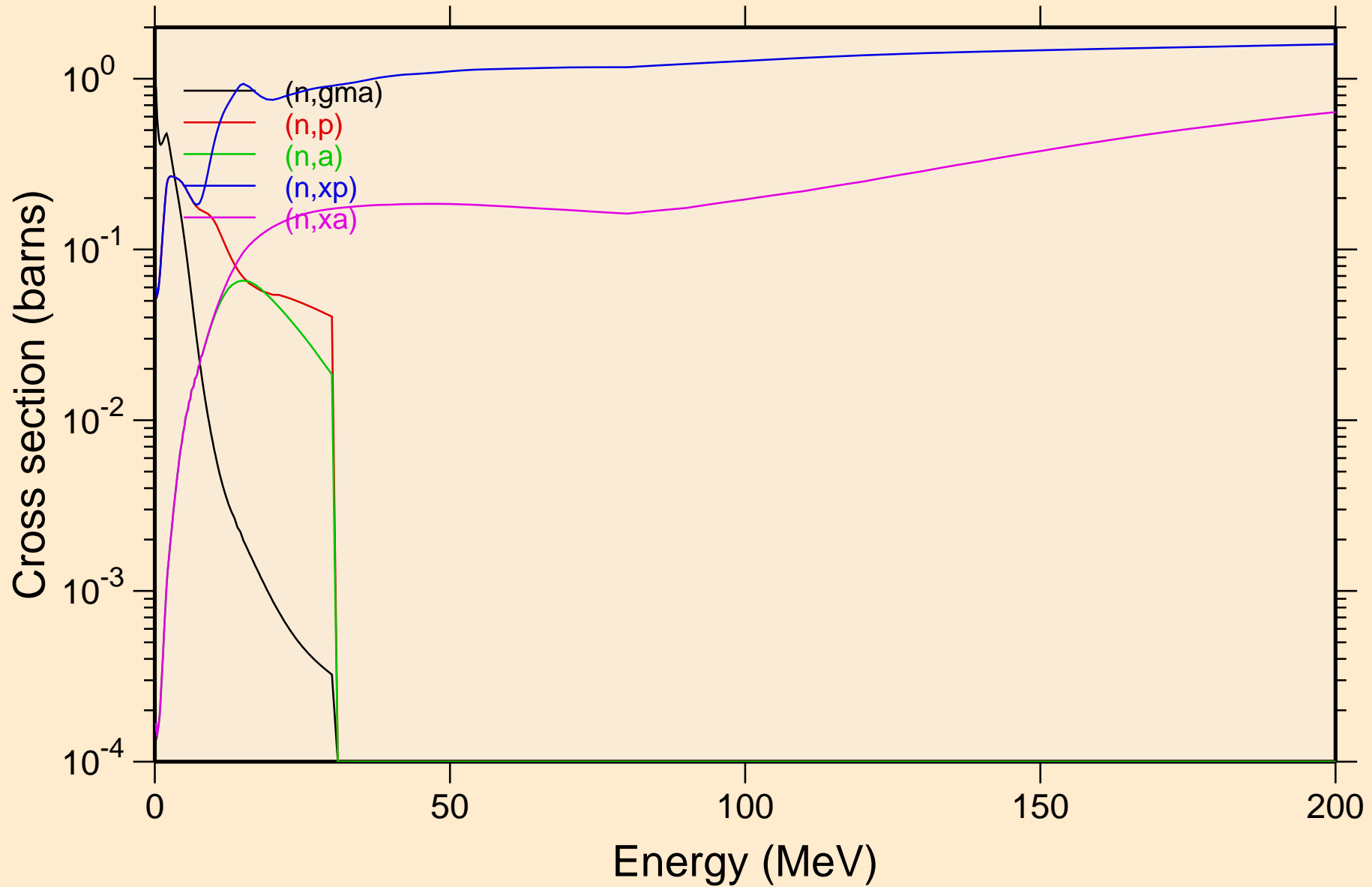

I119 NEUTRON ACER TENDL-2024 LIBRARY; T=293.6K
Inelastic levels

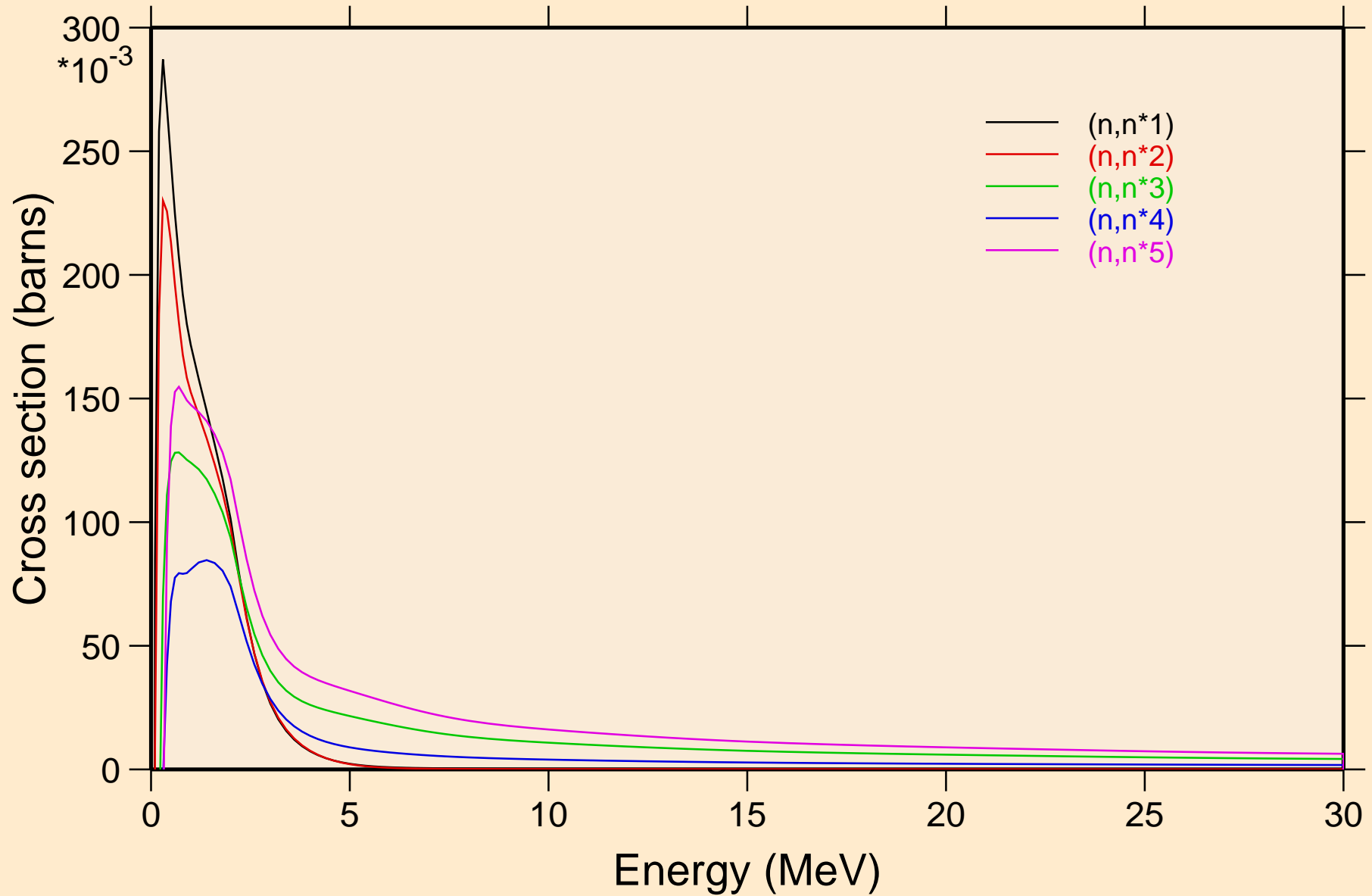

I119 NEUTRON ACER TENDL-2024 LIBRARY; T=293.6K
Inelastic levels

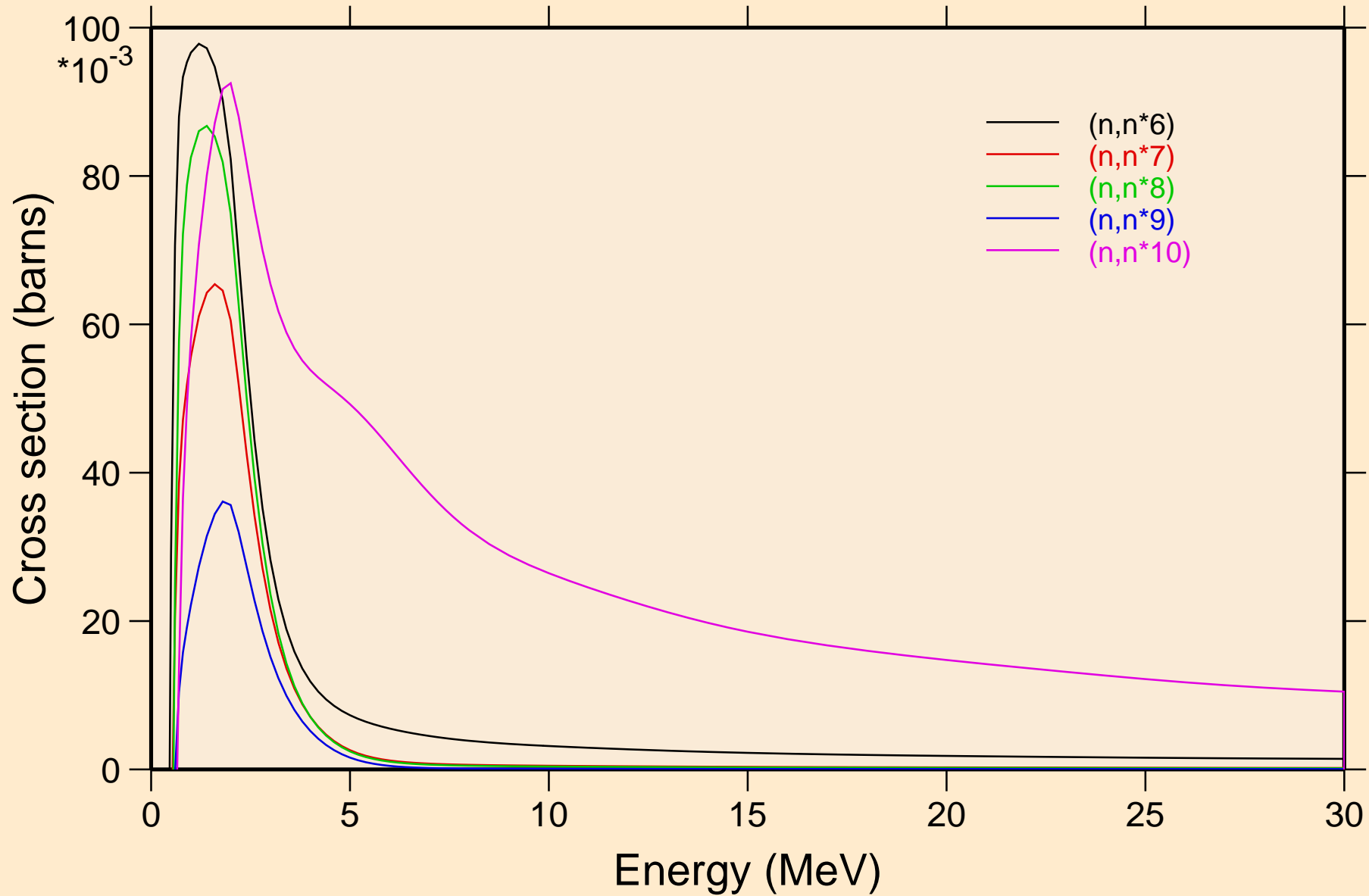

I119 NEUTRON ACER TENDL-2024 LIBRARY; T=293.6K
Inelastic levels

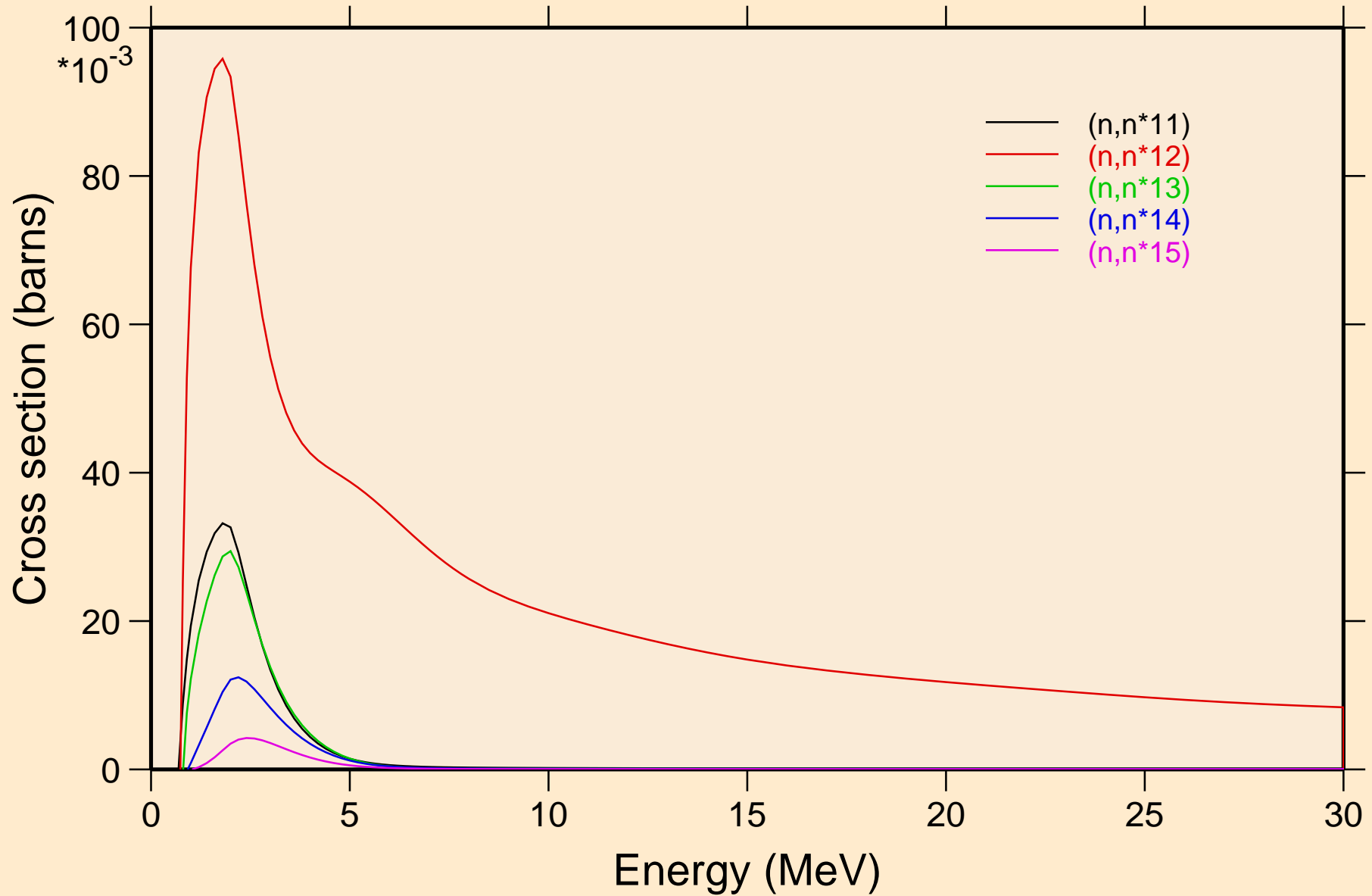

I119 NEUTRON ACER TENDL-2024 LIBRARY; T=293.6K
Inelastic levels

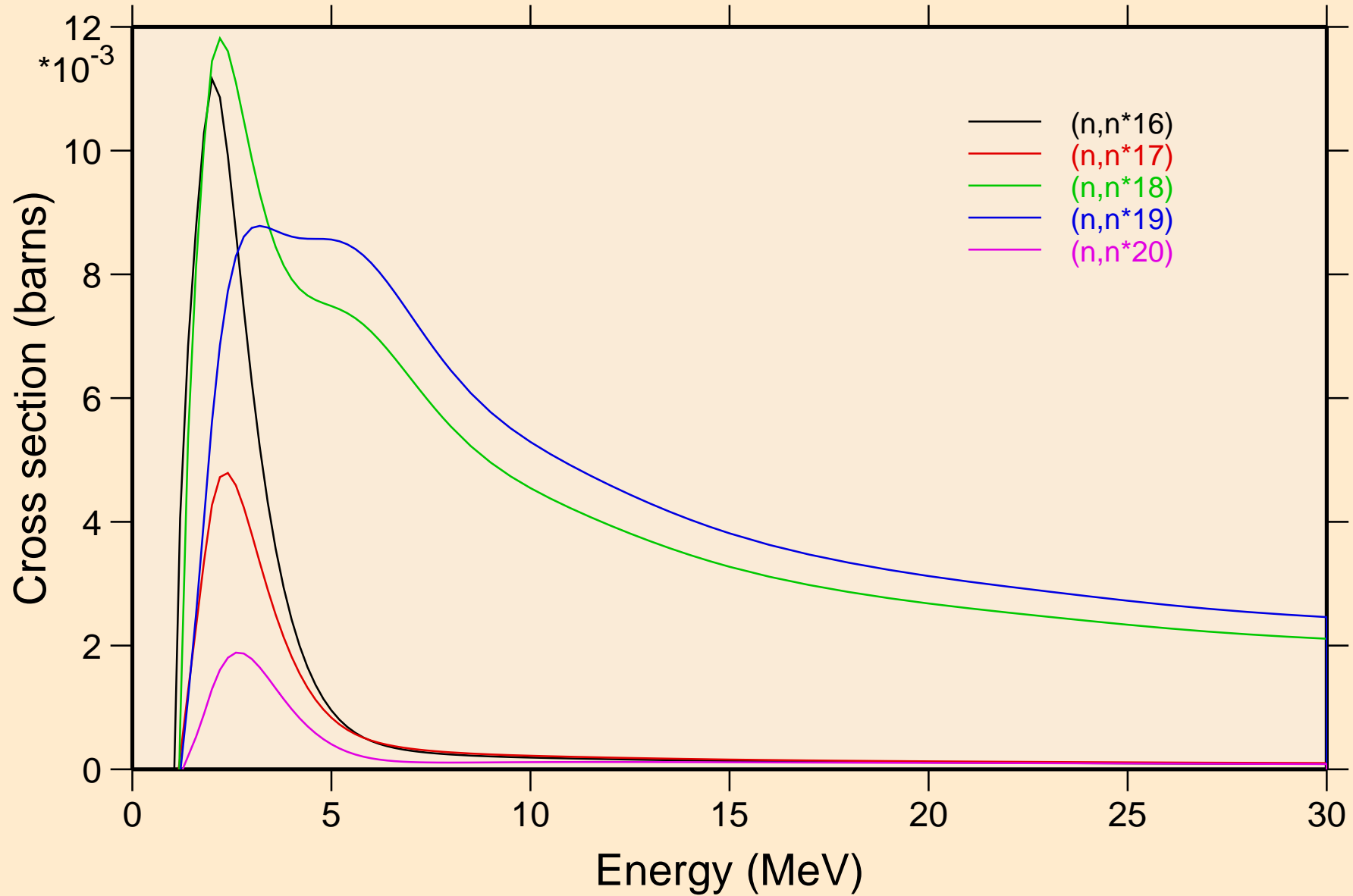

I119 NEUTRON ACER TENDL-2024 LIBRARY; T=293.6K
Inelastic levels

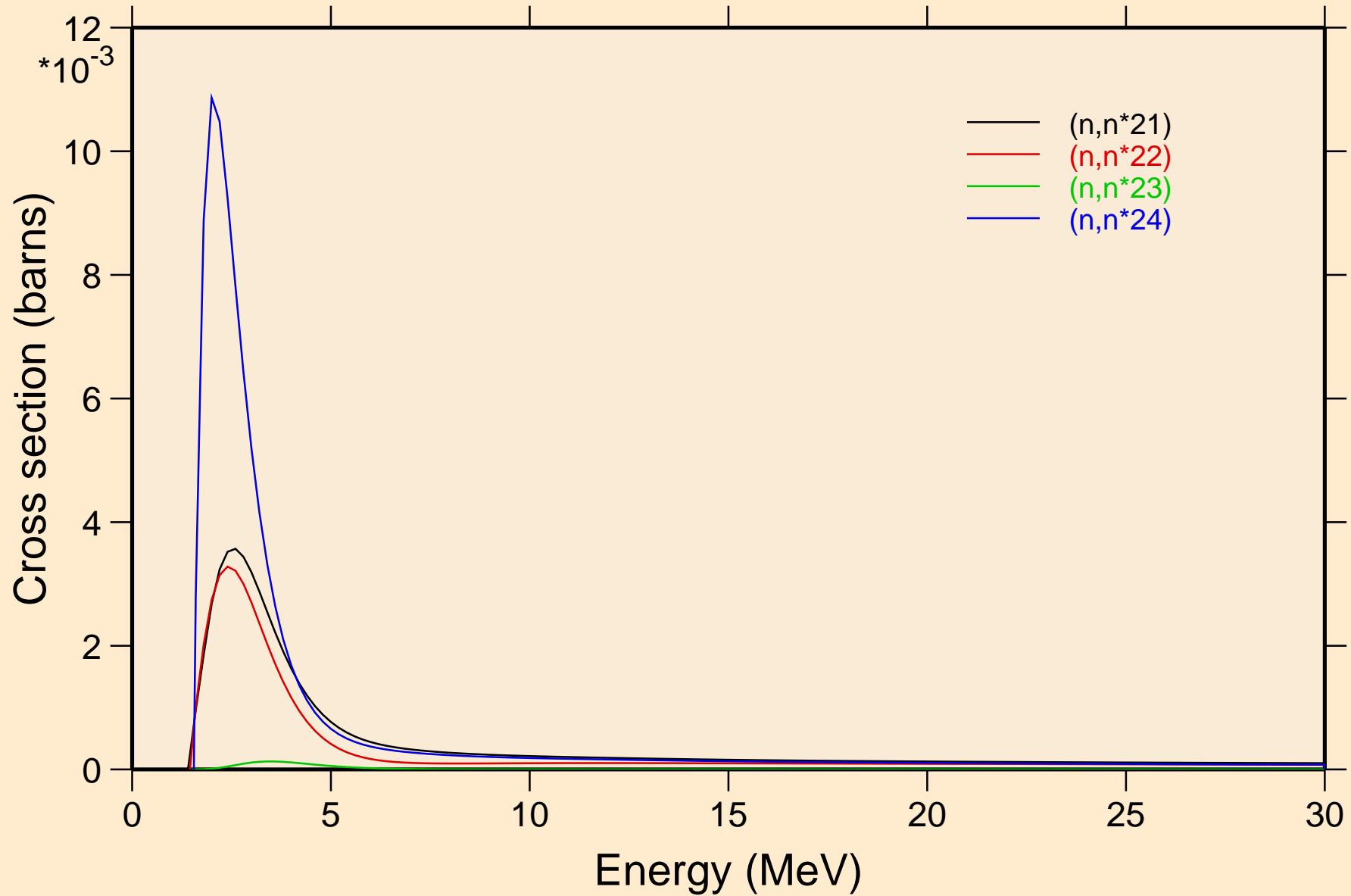

I119 NEUTRON ACER TENDL-2024 LIBRARY; T=293.6K

Threshold reactions

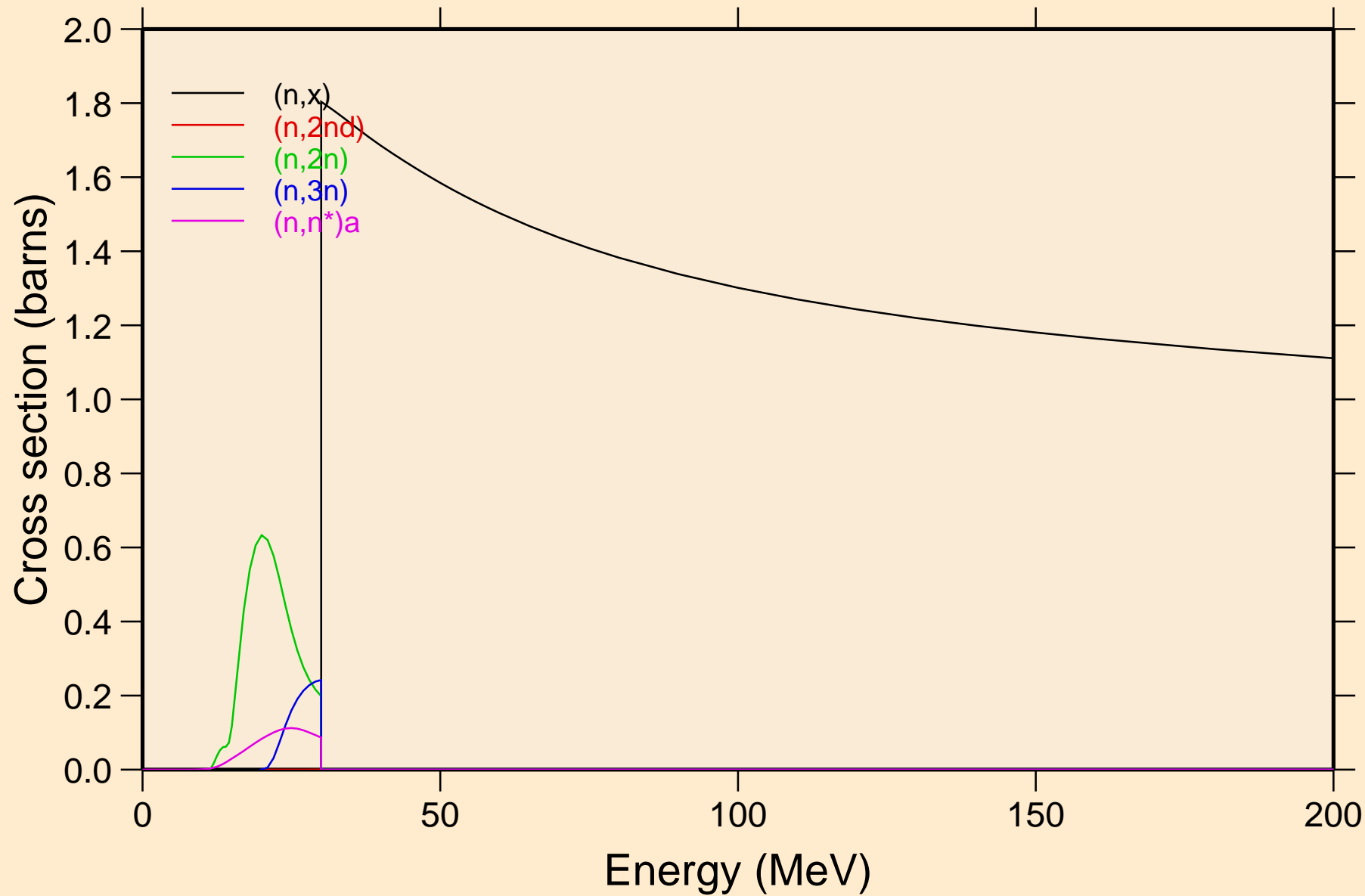

I119 NEUTRON ACER TENDL-2024 LIBRARY; T=293.6K
Threshold reactions

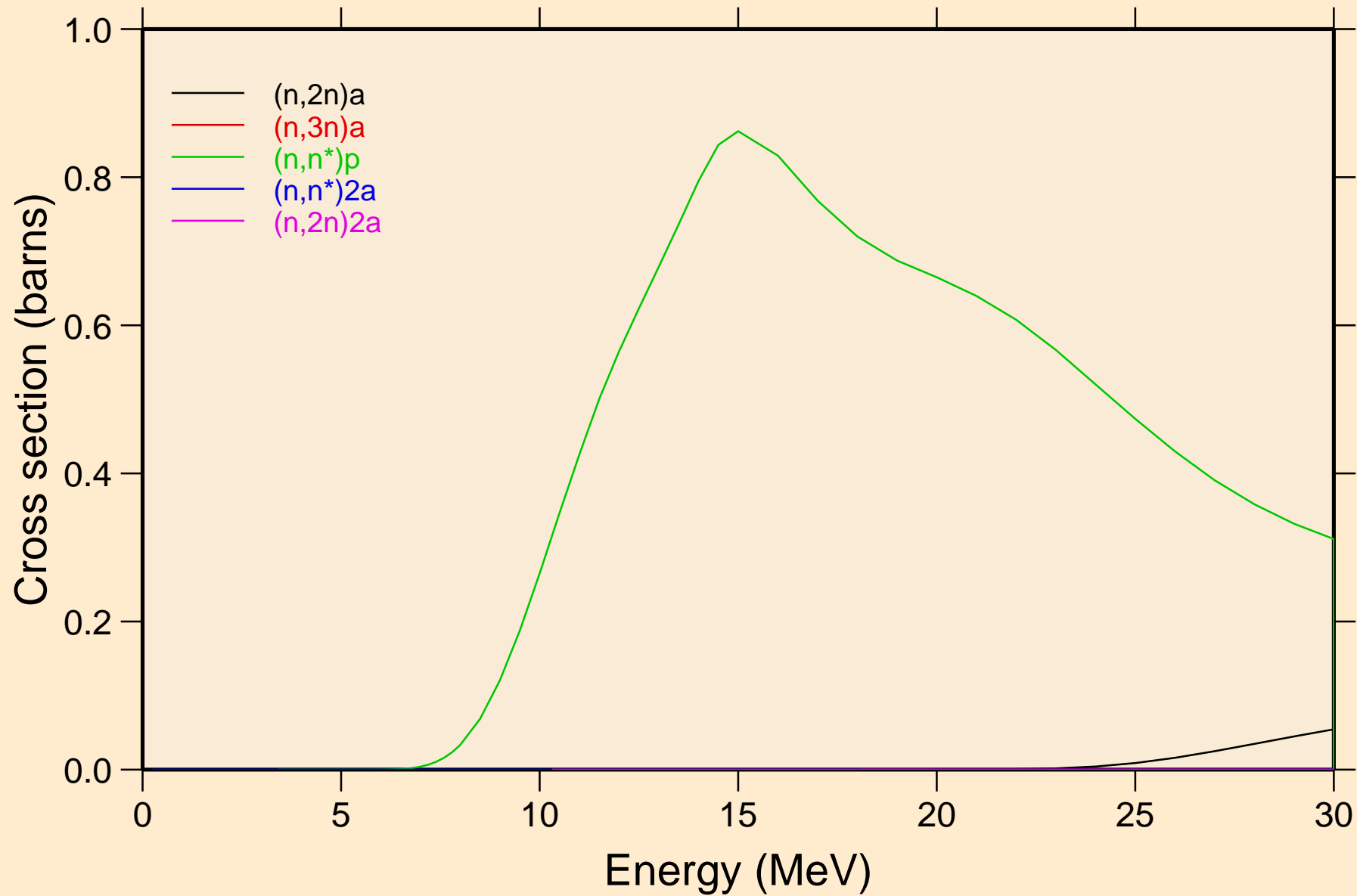

I119 NEUTRON ACER TENDL-2024 LIBRARY; T=293.6K

Threshold reactions

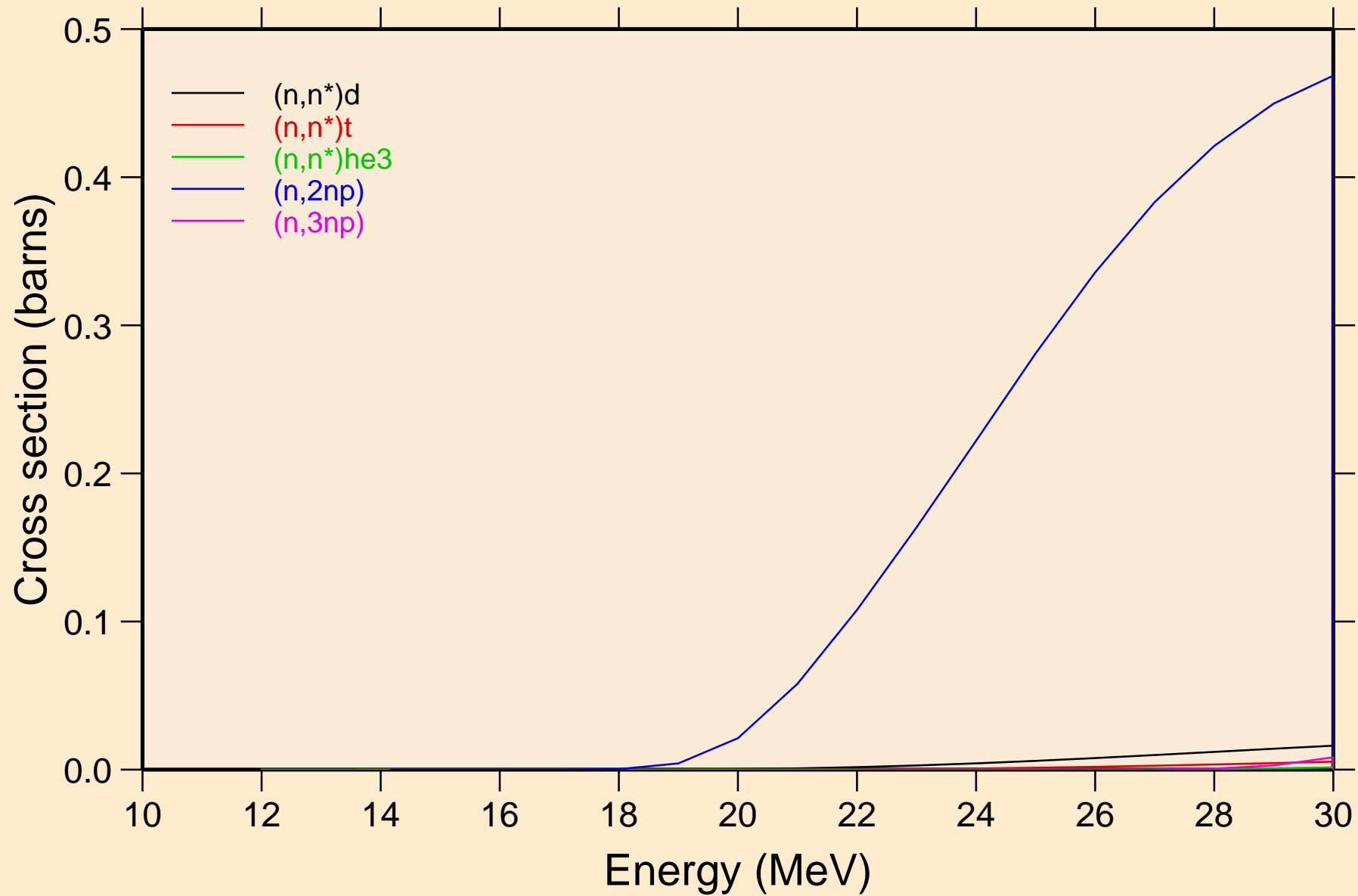

I119 NEUTRON ACER TENDL-2024 LIBRARY; T=293.6K
Threshold reactions

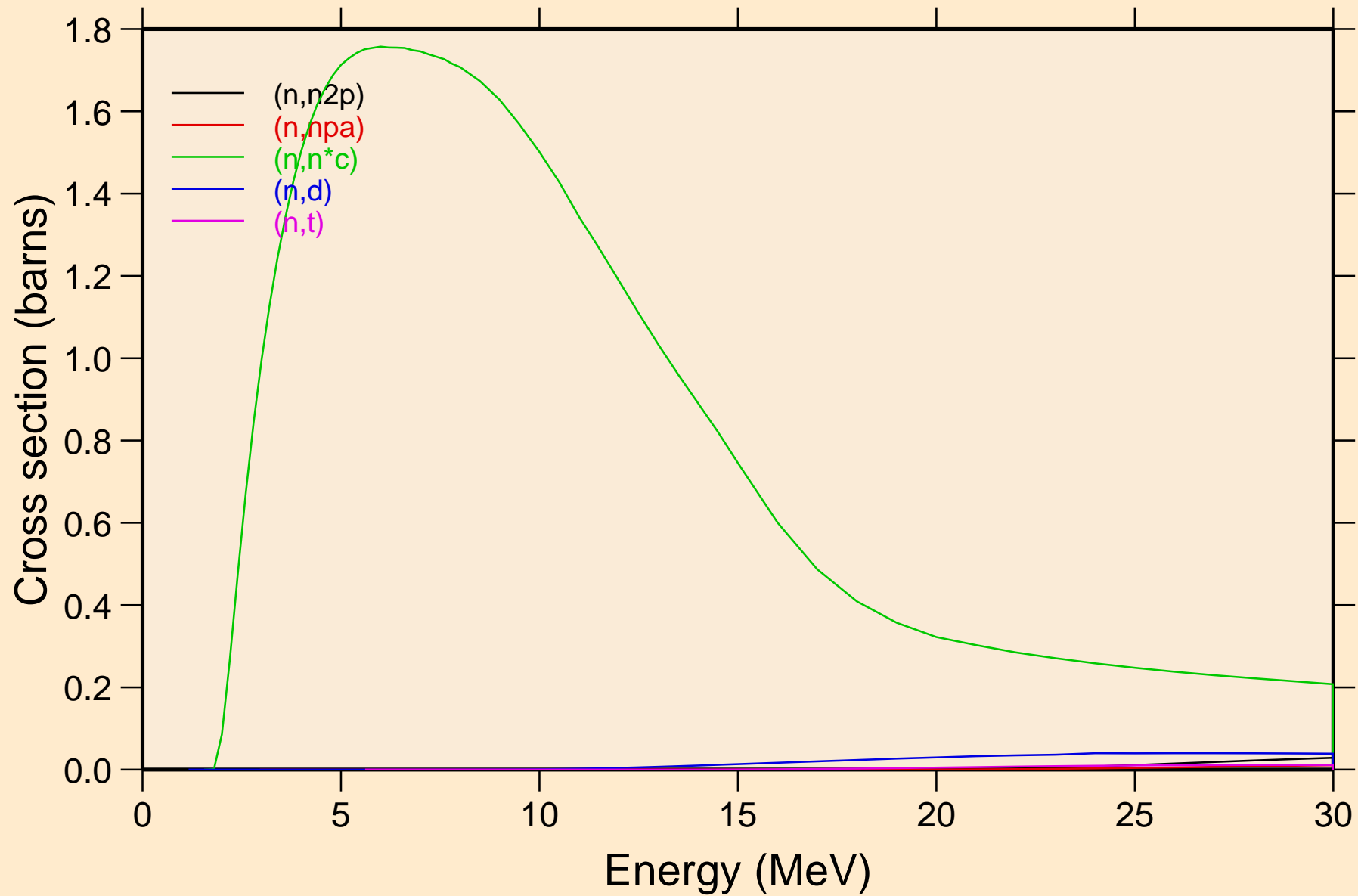

I119 NEUTRON ACER TENDL-2024 LIBRARY; T=293.6K

Threshold reactions

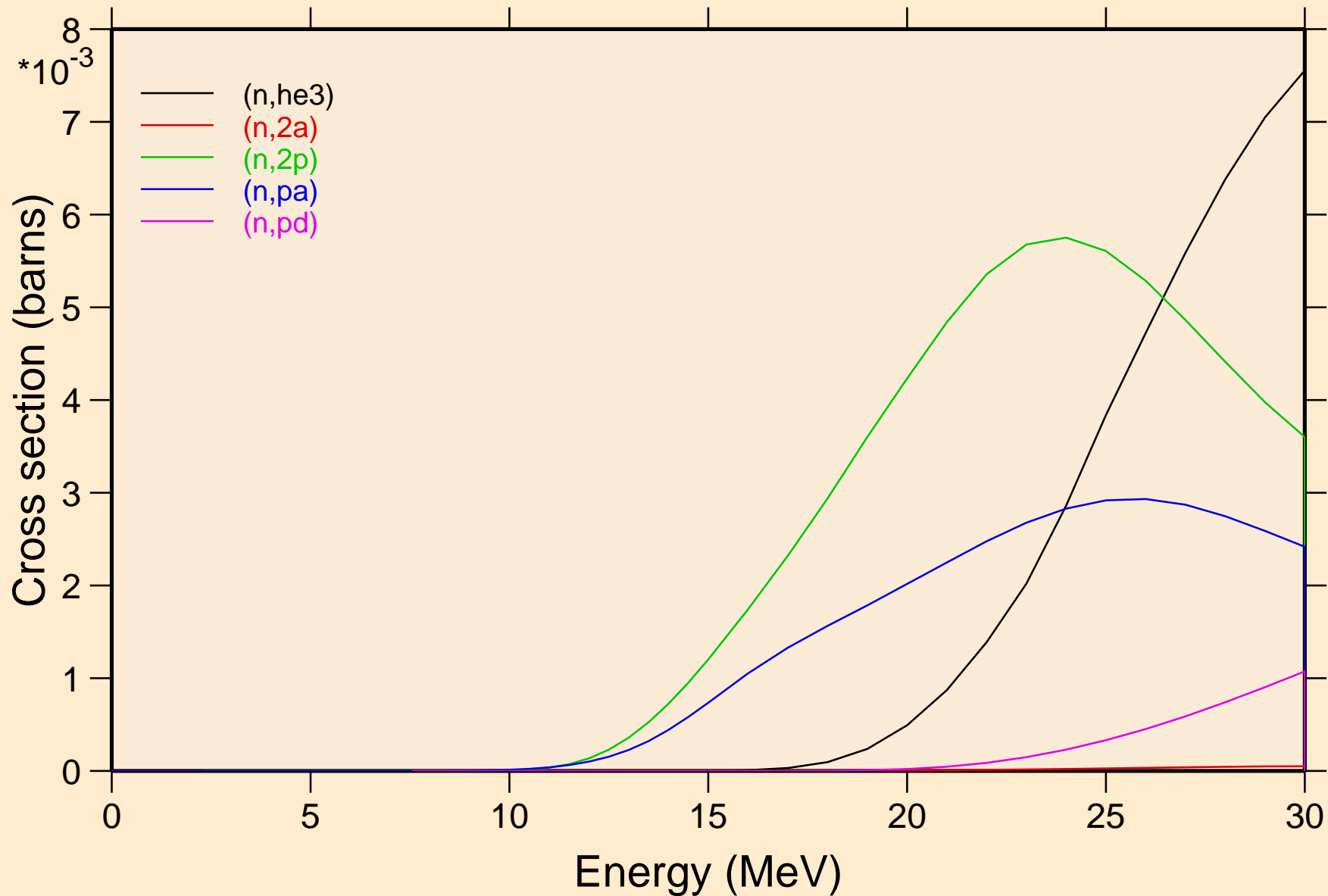

I119 NEUTRON ACER TENDL-2024 LIBRARY; T=293.6K
Threshold reactions

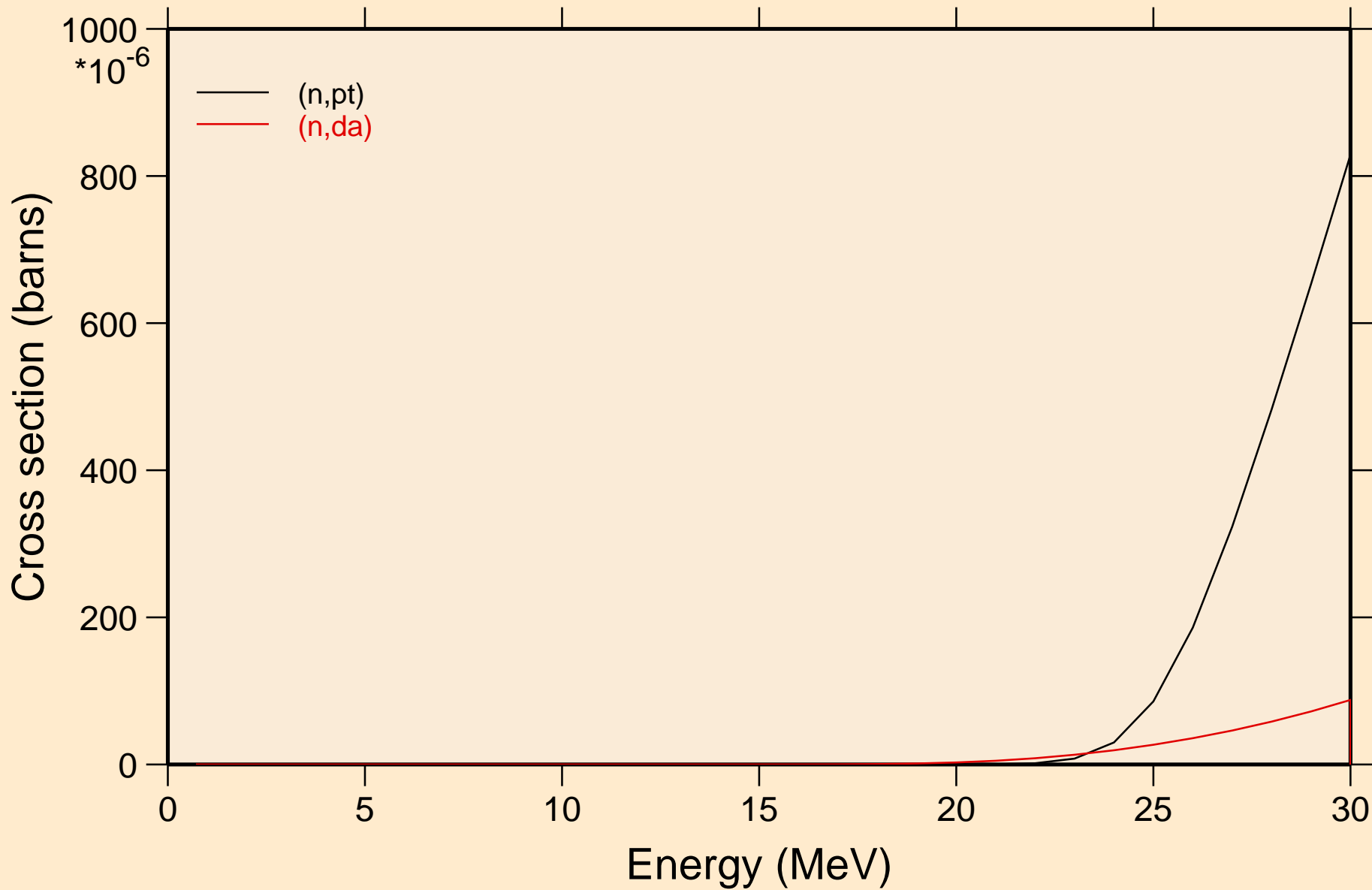

I119 NEUTRON ACER TENDL-2024 LIBRARY; T=293.6K
Threshold reactions

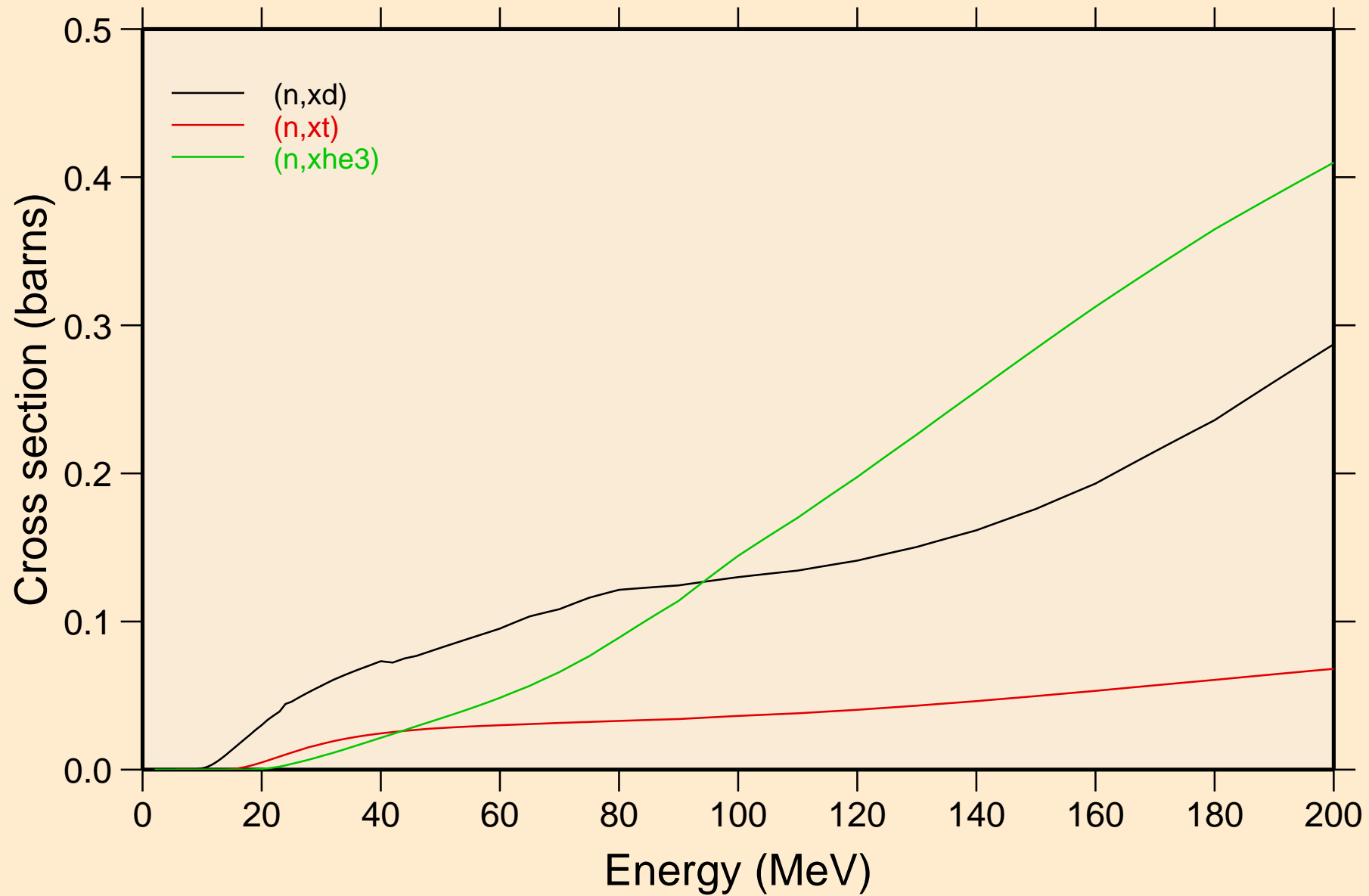

I119 NEUTRON ACER TENDL-2024 LIBRARY; T=293.6K
angular distribution for elastic

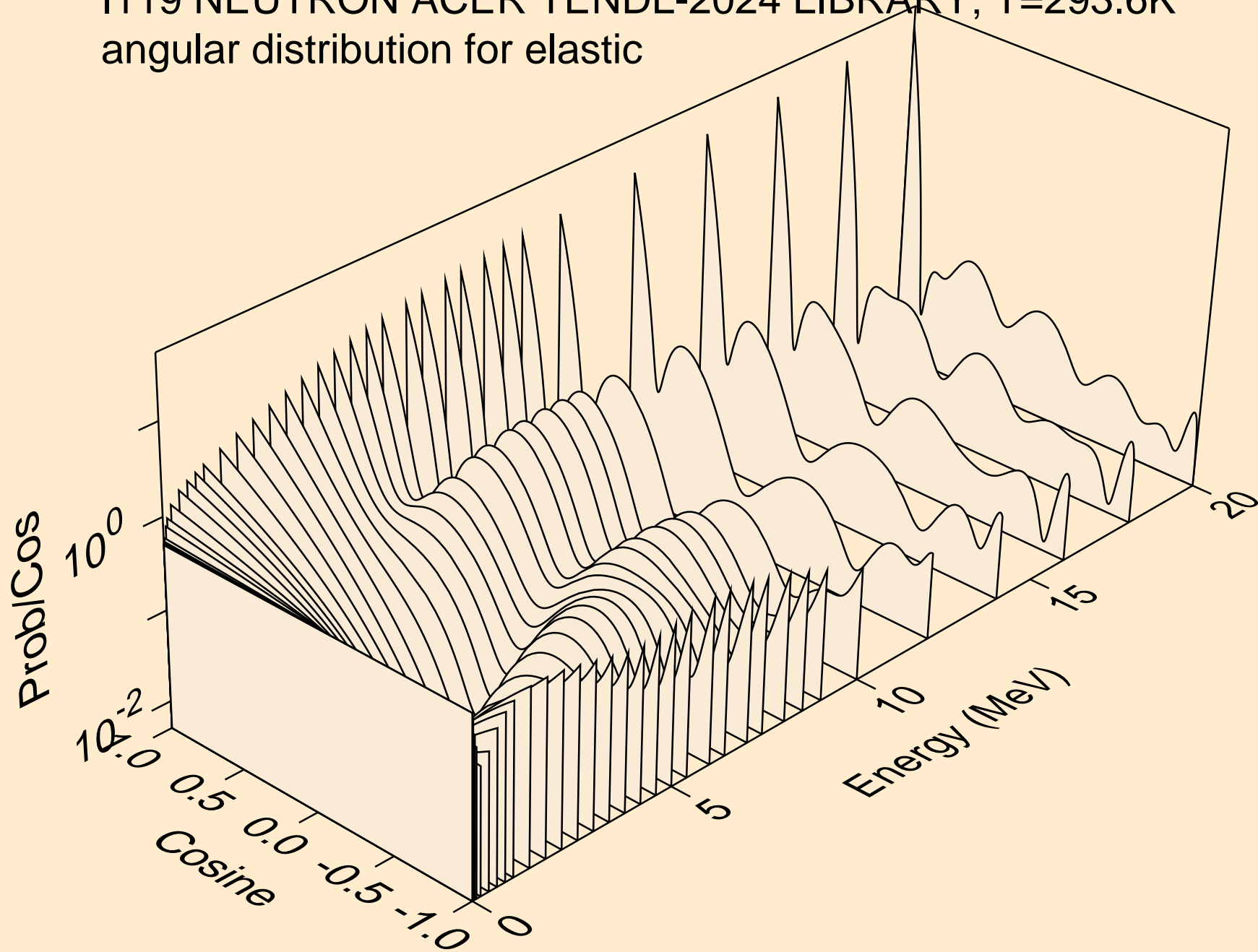

I119 NEUTRON ACER TENDL-2024 LIBRARY; T=293.6K
angular distribution for elastic

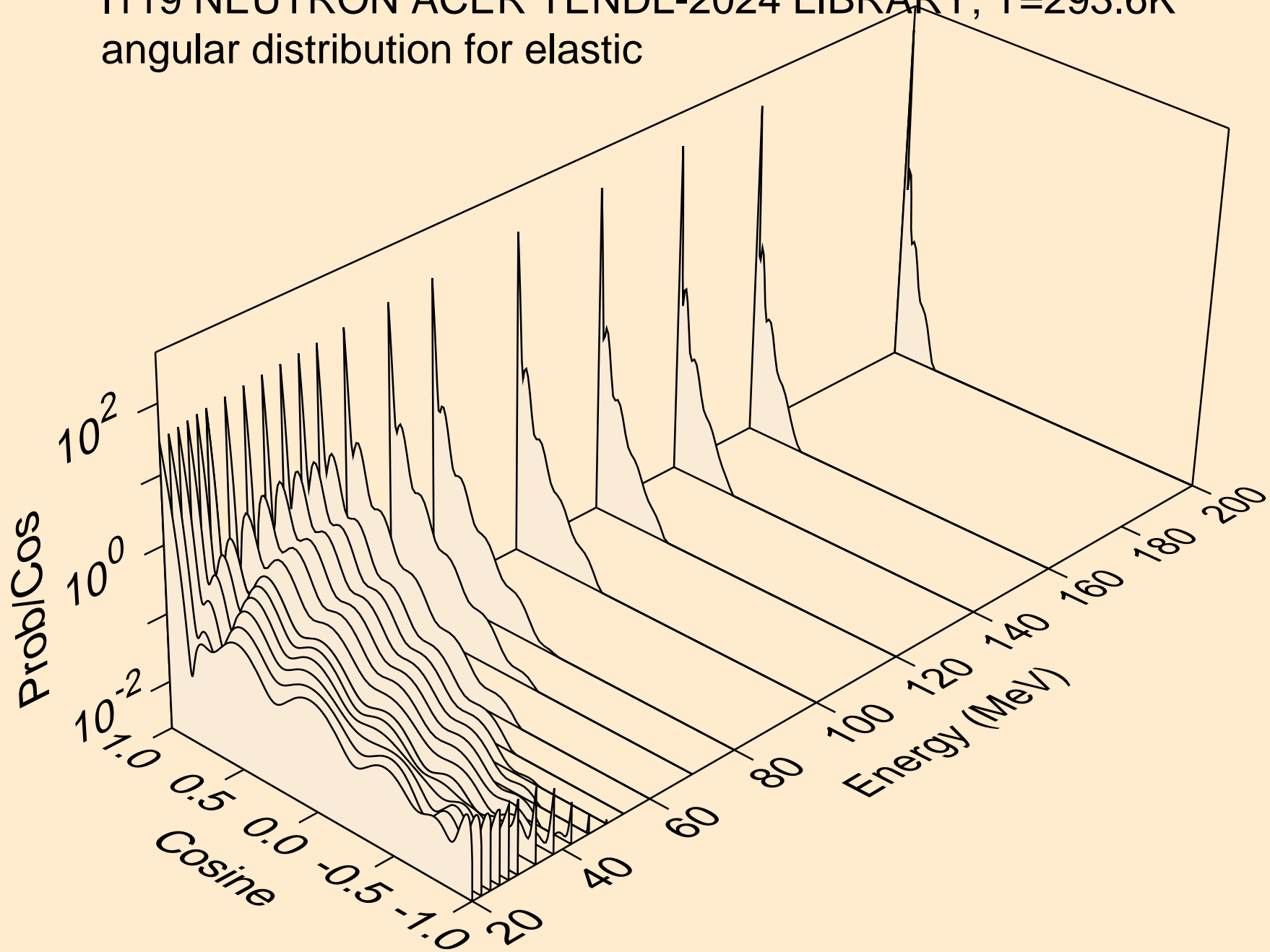

I119 NEUTRON ACER TENDL-2024 LIBRARY; T=293.6K
angular distribution for (n,n*1)

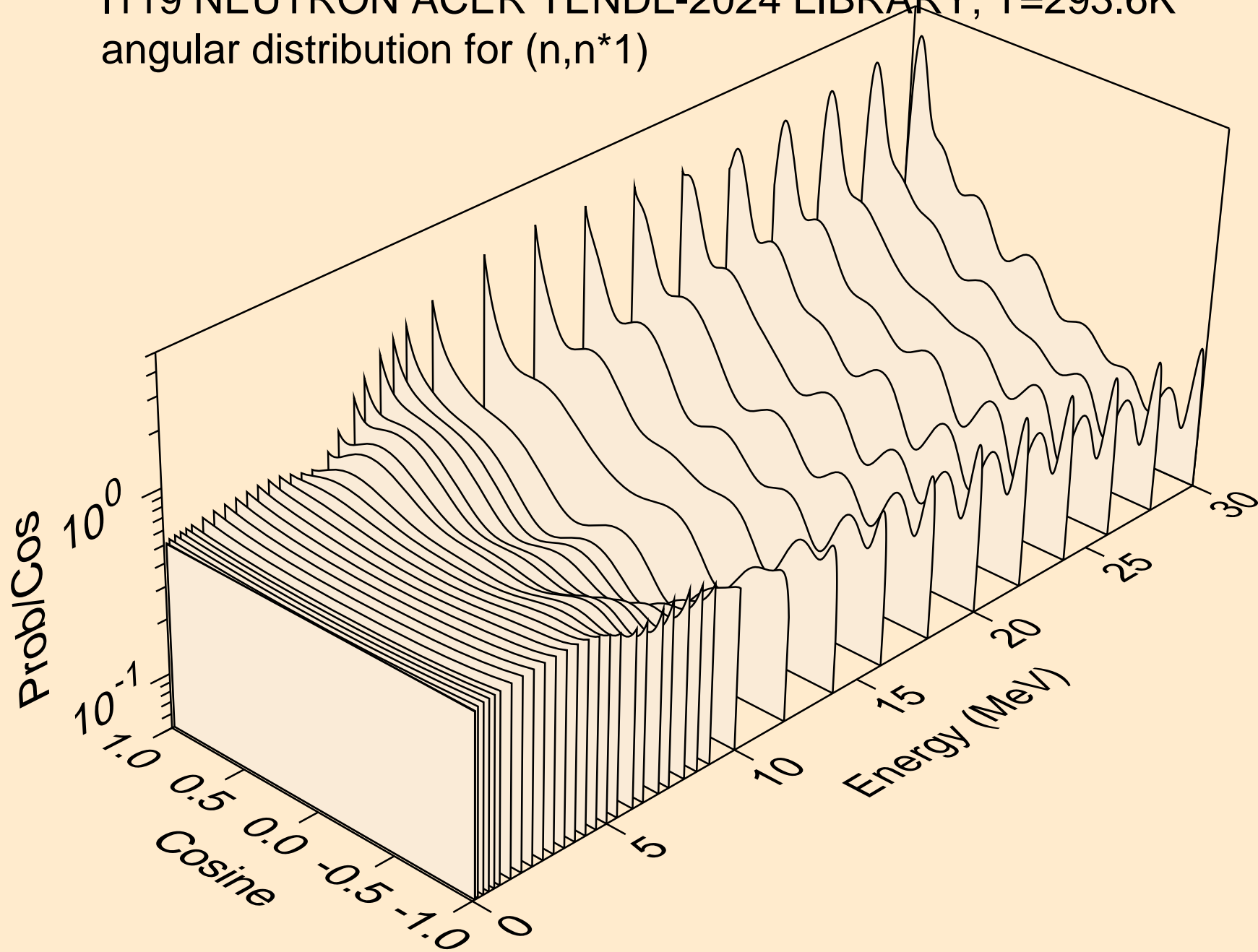

I119 NEUTRON ACER TENDL-2024 LIBRARY; T=293.6K
angular distribution for (n,n*2)

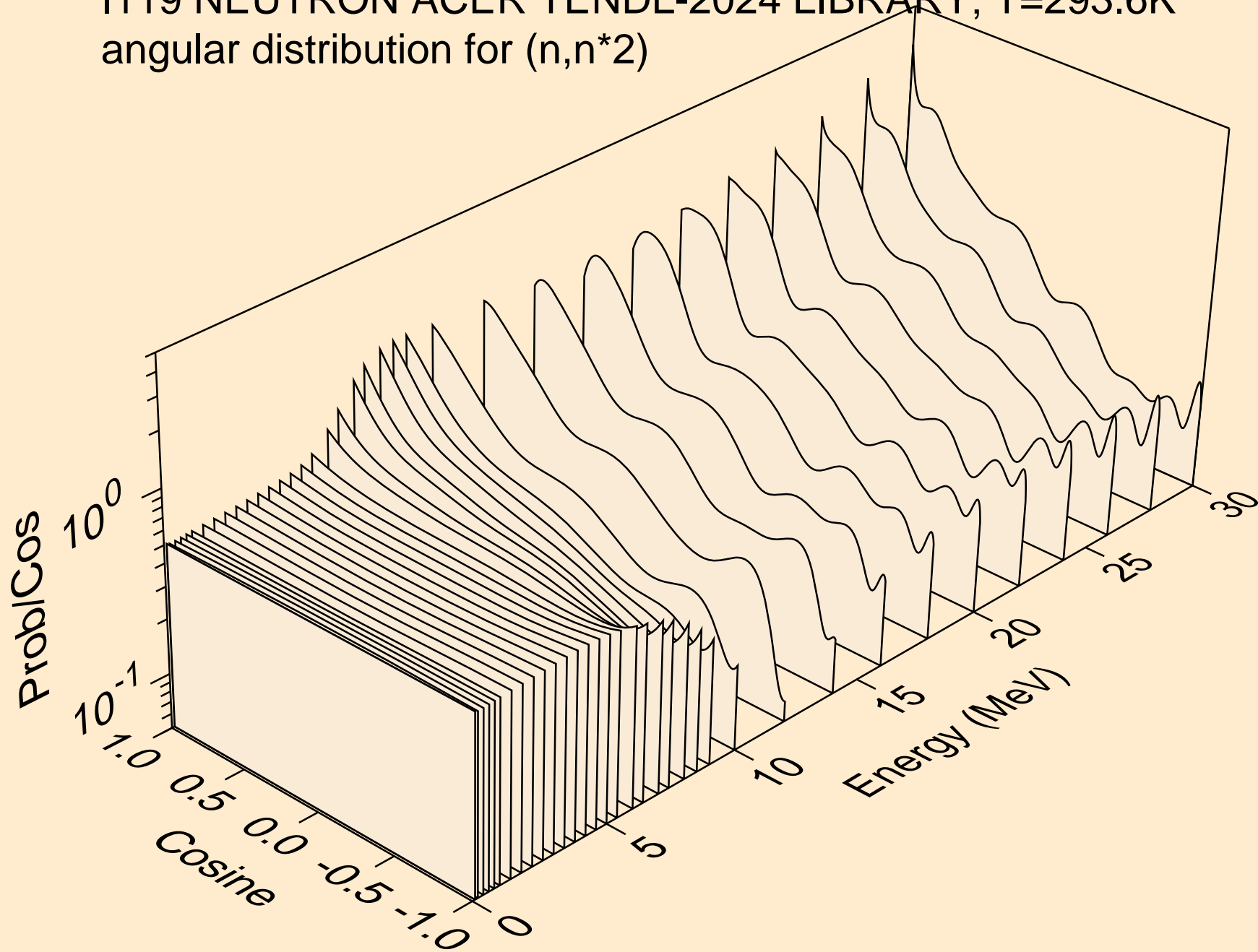

I119 NEUTRON ACER TENDL-2024 LIBRARY; T=293.6K
angular distribution for (n,n*3)

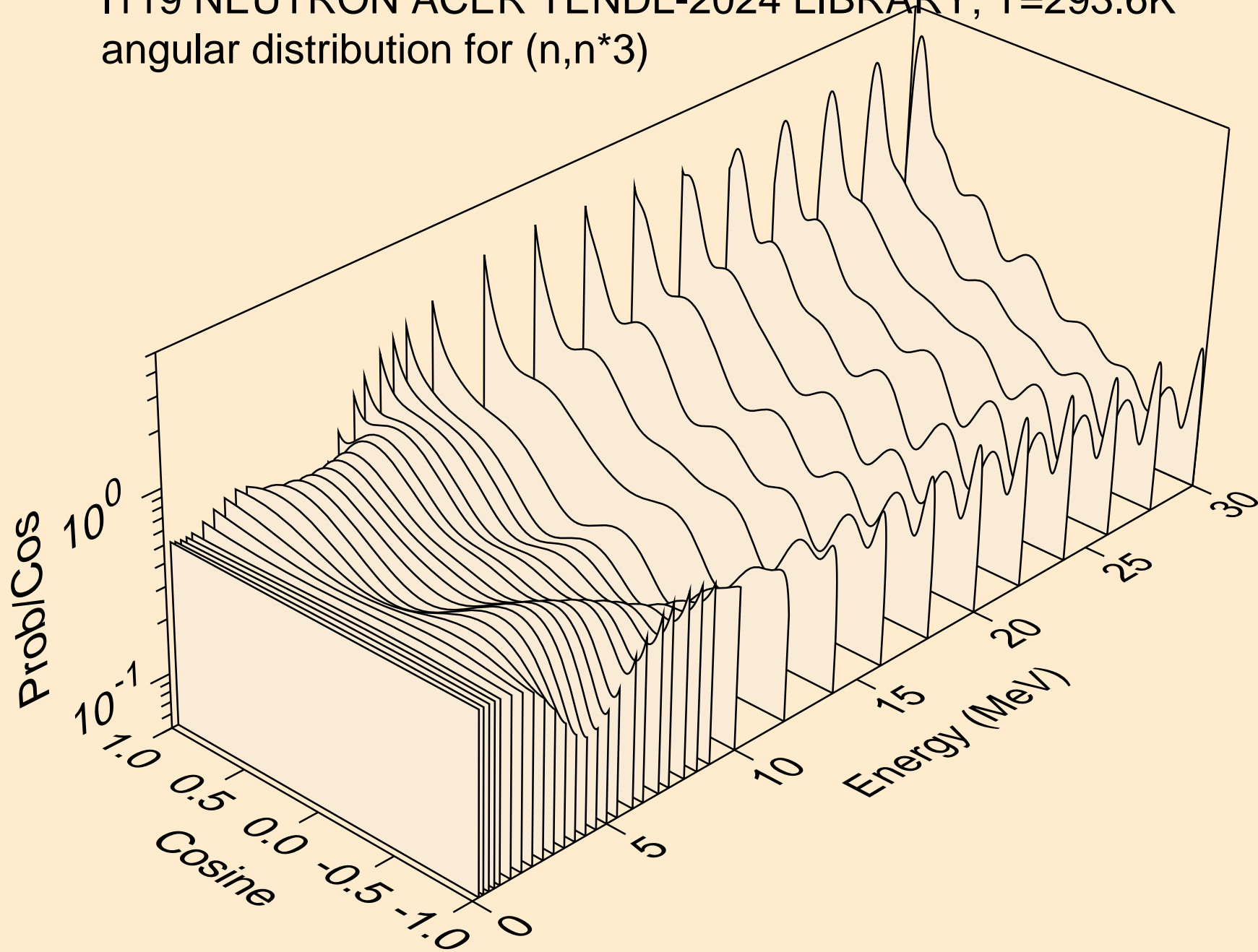

I119 NEUTRON ACER TENDL-2024 LIBRARY; T=293.6K
angular distribution for (n,n*4)

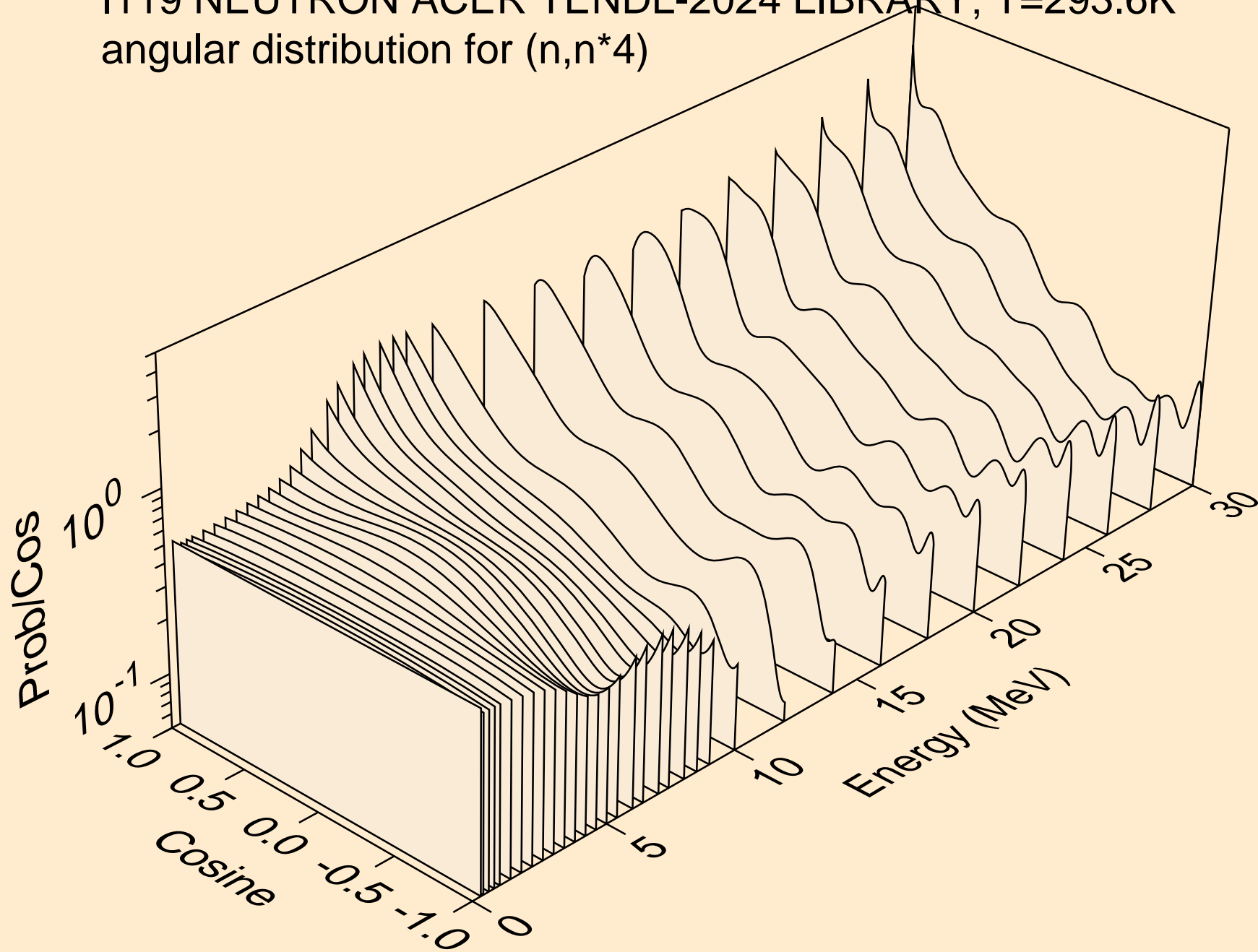

I119 NEUTRON ACER TENDL-2024 LIBRARY; T=293.6K
angular distribution for (n,n*5)

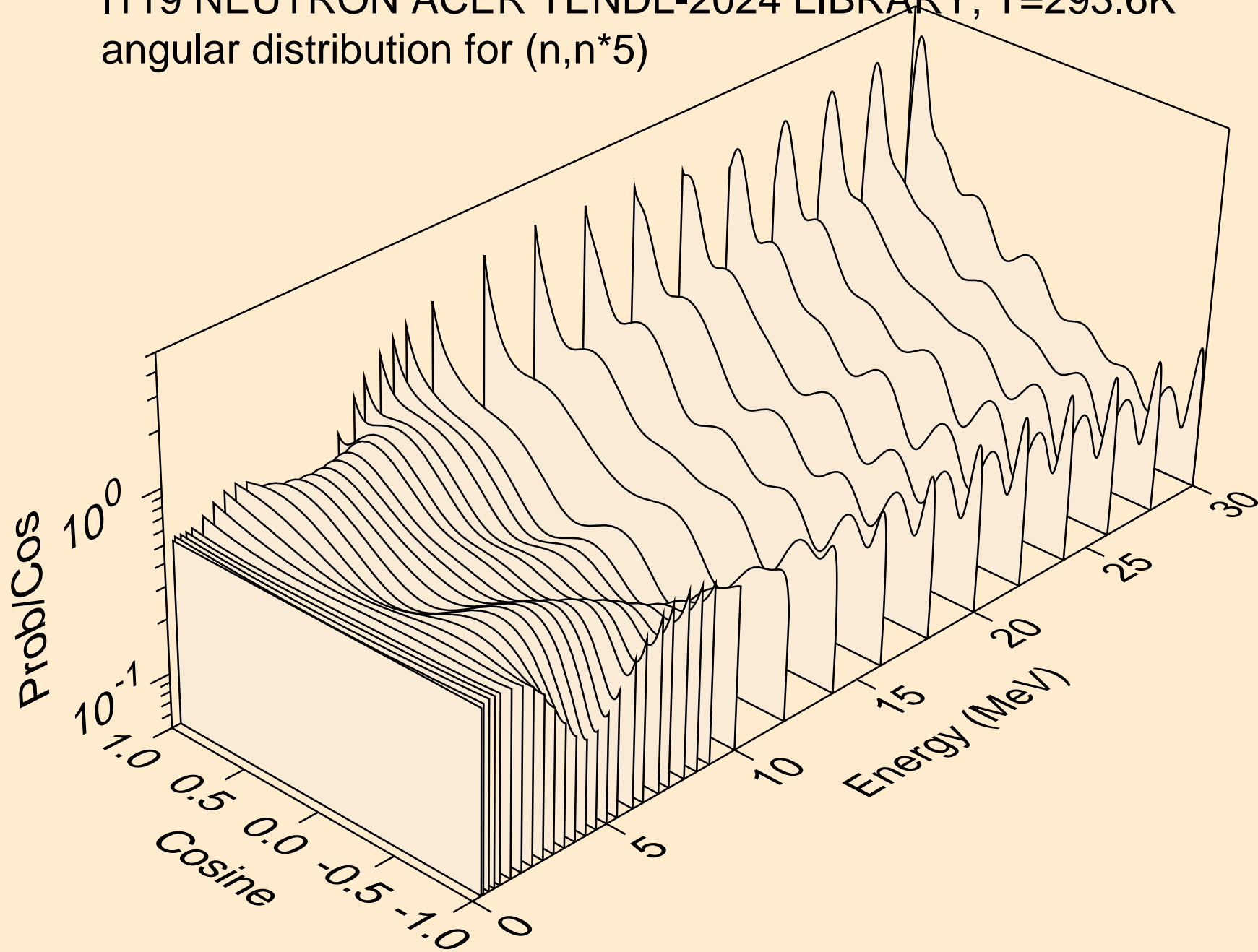

I119 NEUTRON ACER TENDL-2024 LIBRARY; T=293.6K
angular distribution for (n,n*6)

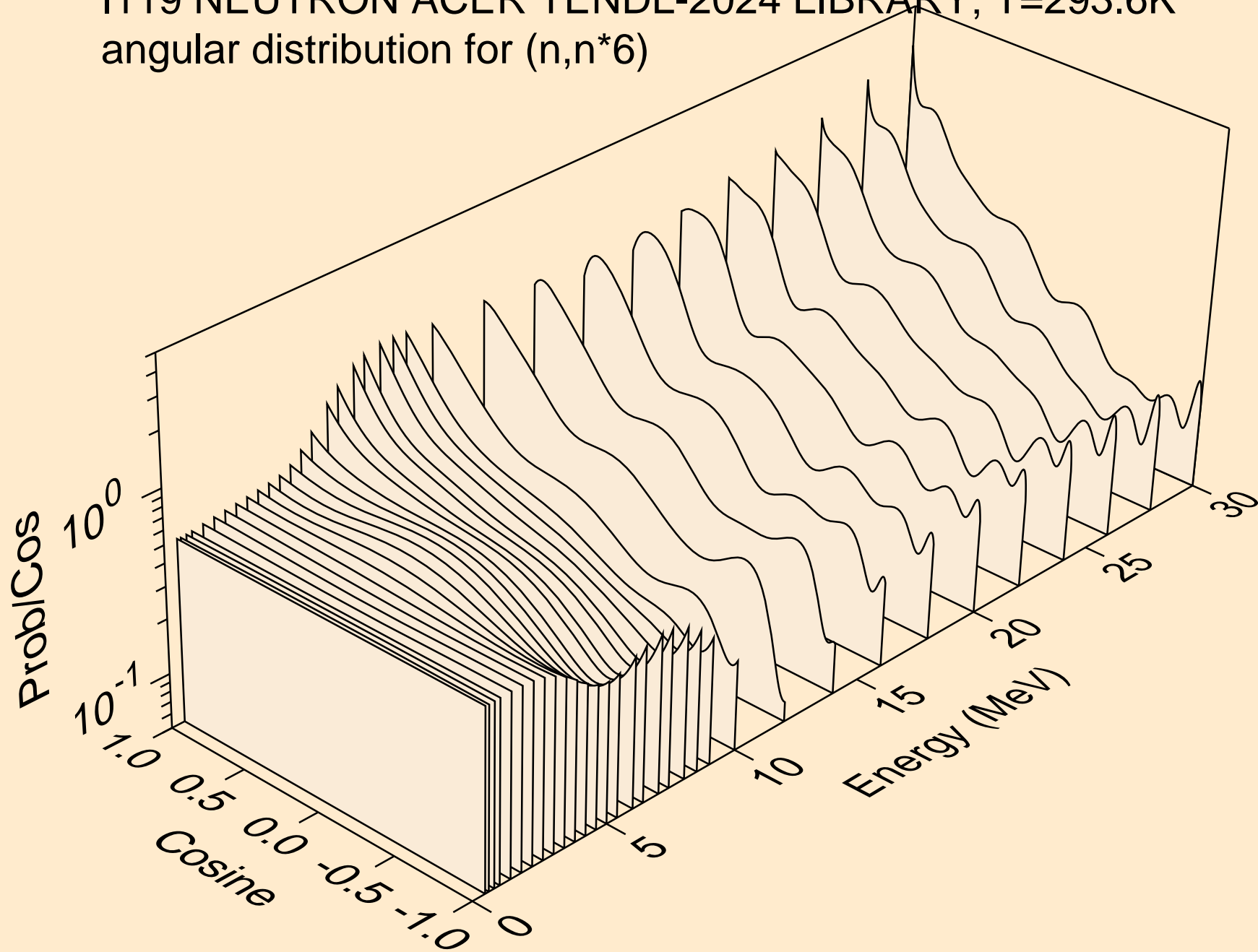

I119 NEUTRON ACER TENDL-2024 LIBRARY; T=293.6K
angular distribution for (n,n*7)

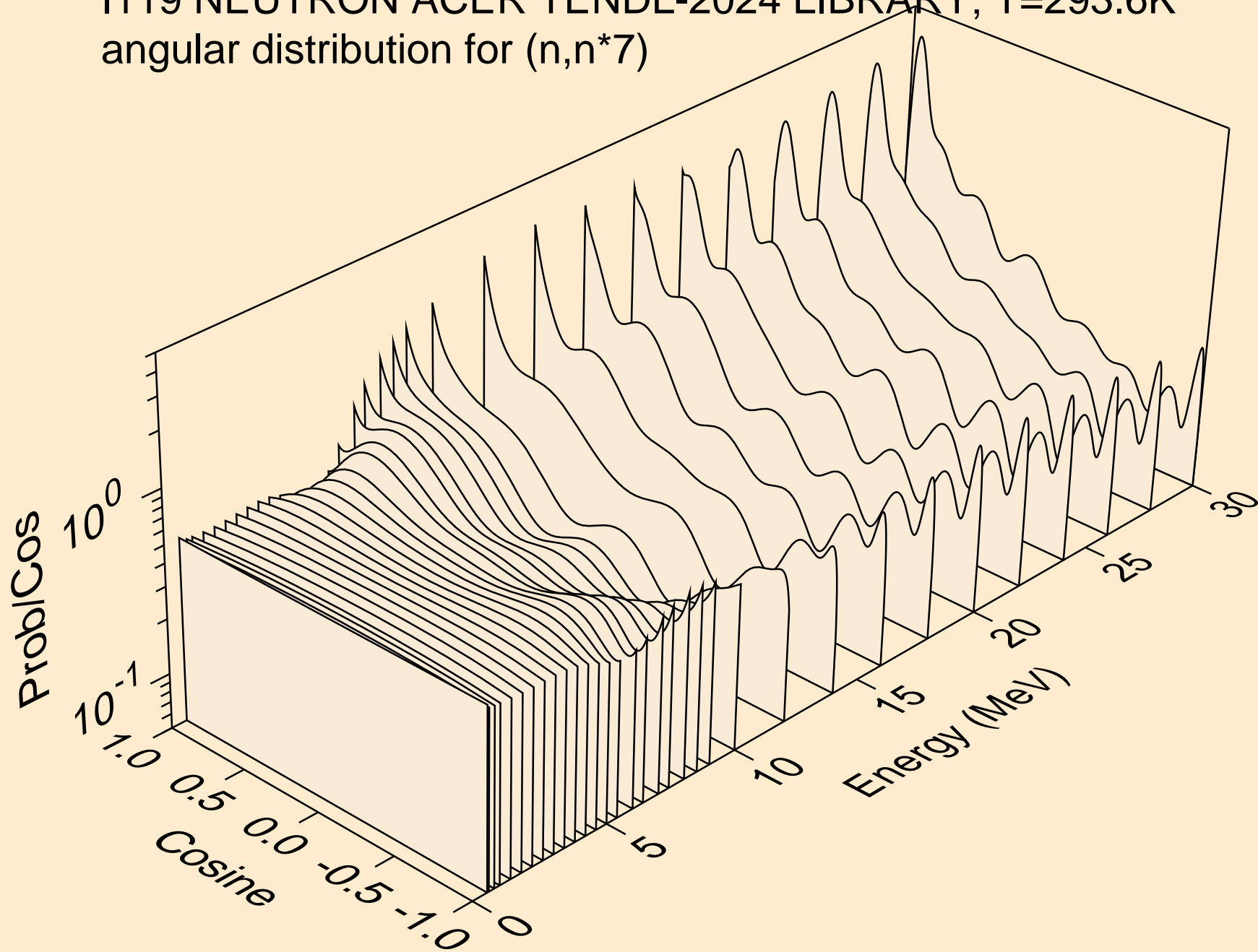

I119 NEUTRON ACER TENDL-2024 LIBRARY; T=293.6K
angular distribution for (n,n*8)

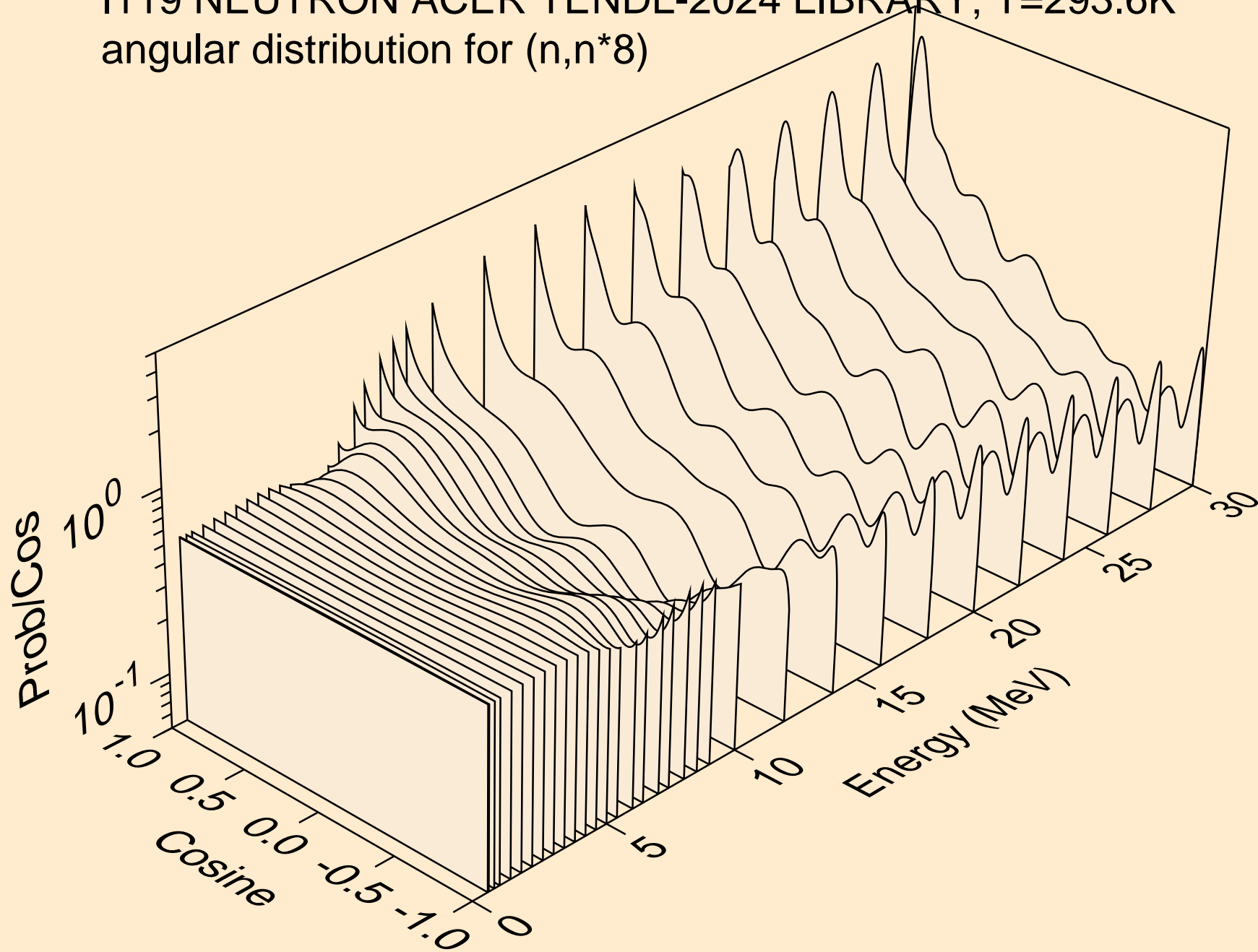

I119 NEUTRON ACER TENDL-2024 LIBRARY; T=293.6K
angular distribution for (n,n*9)

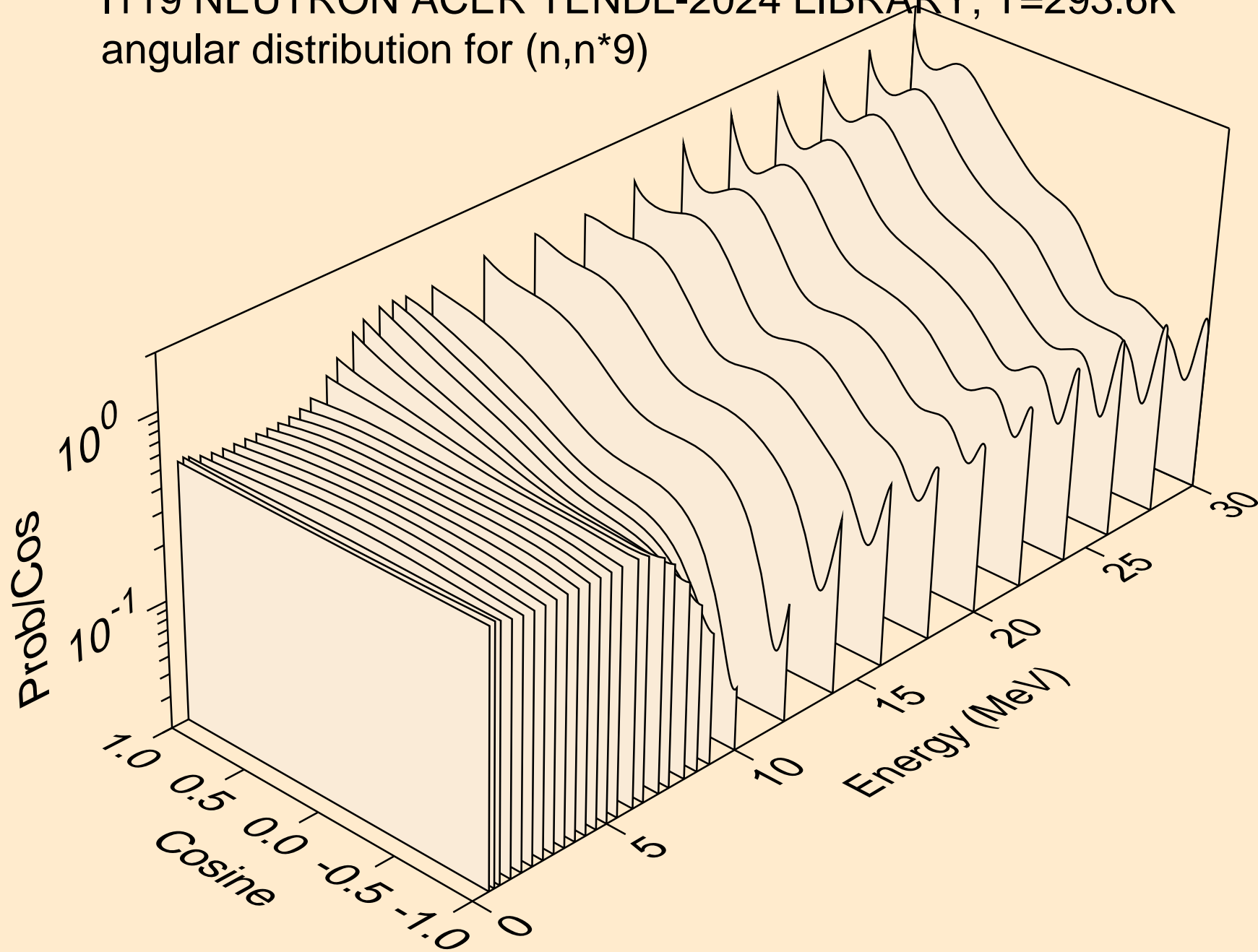

I119 NEUTRON ACER TENDL-2024 LIBRARY; T=293.6K
angular distribution for (n,n*10)

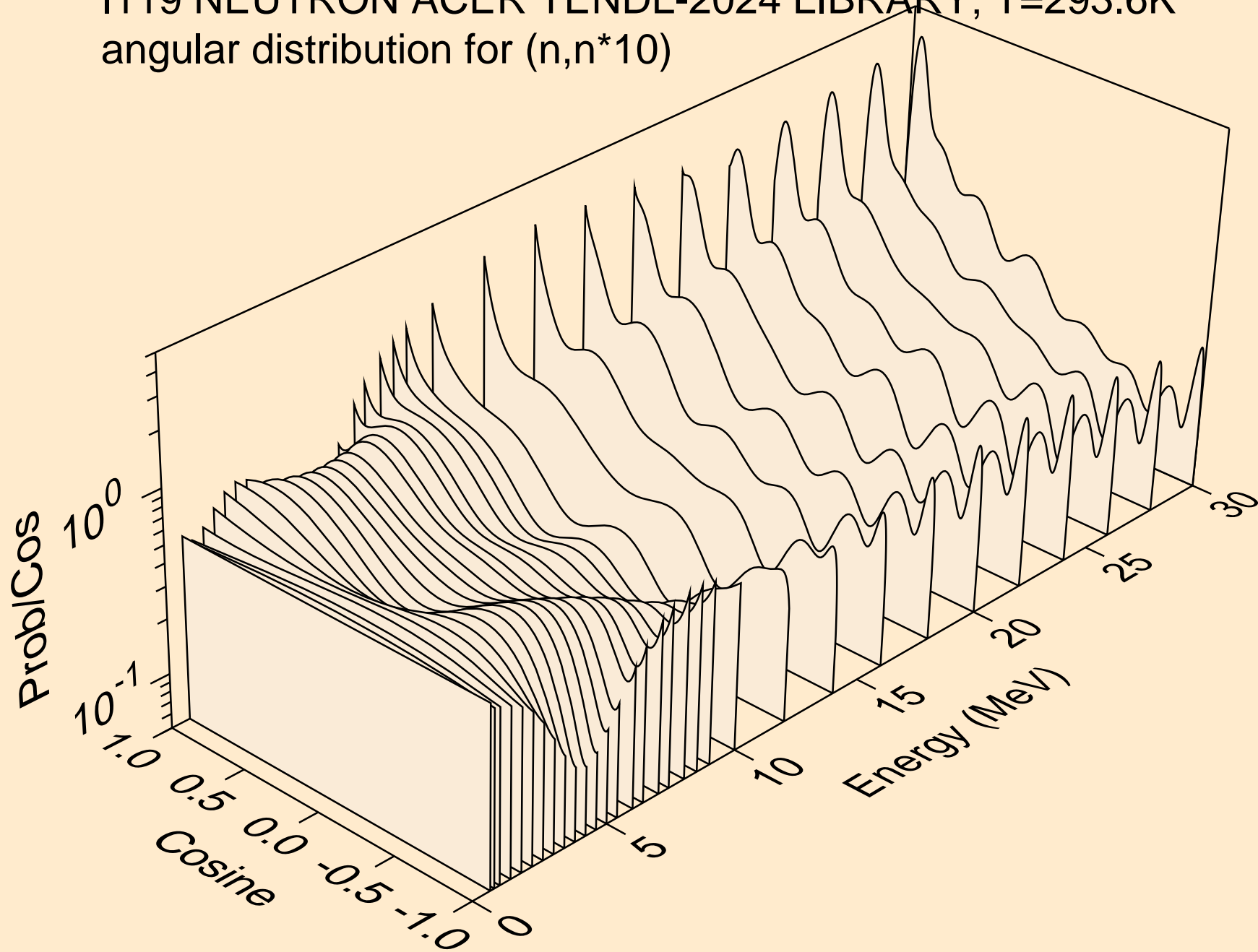

I119 NEUTRON ACER TENDL-2024 LIBRARY; T=293.6K
angular distribution for (n,n*11)

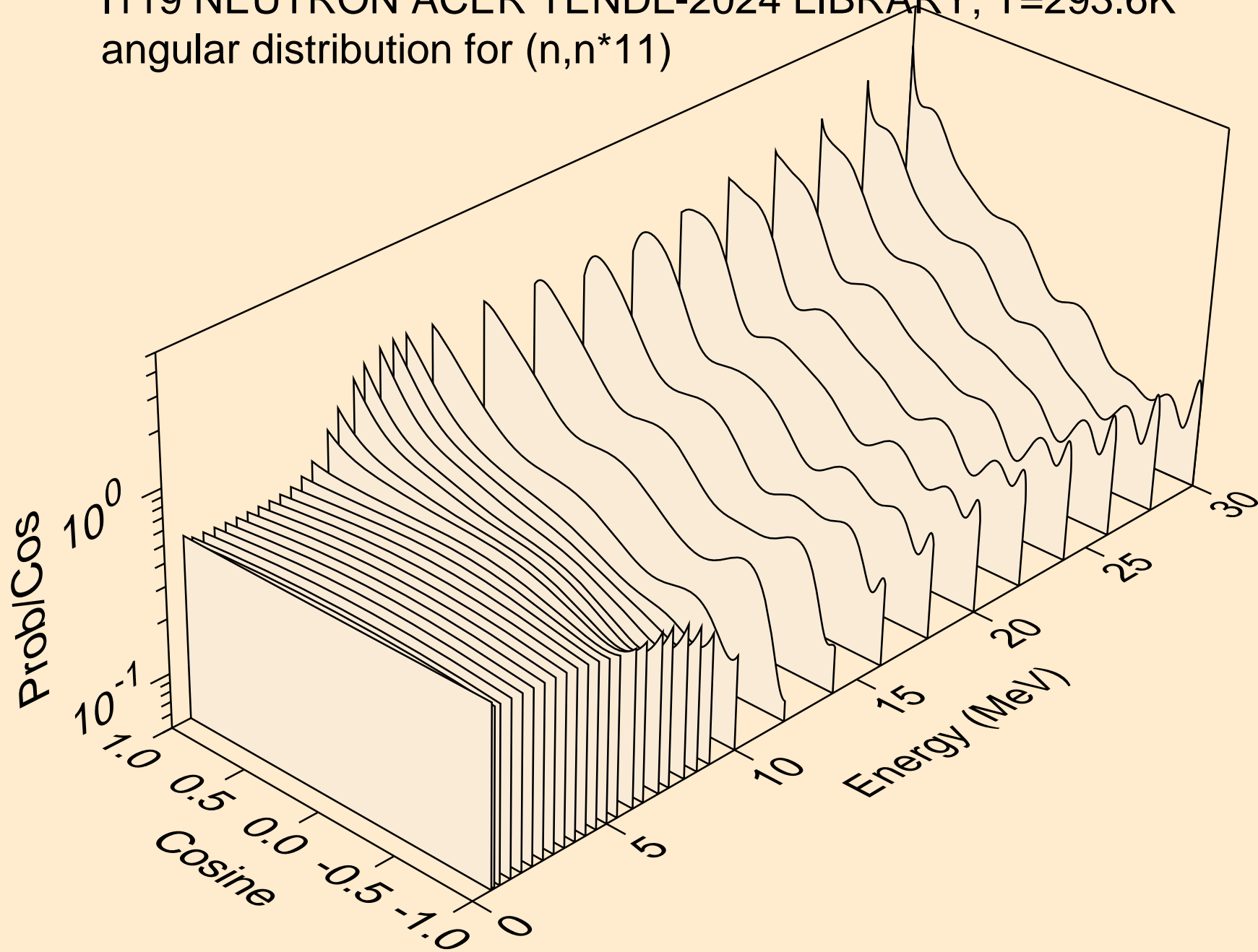

I119 NEUTRON ACER TENDL-2024 LIBRARY; T=293.6K
angular distribution for (n,n*12)

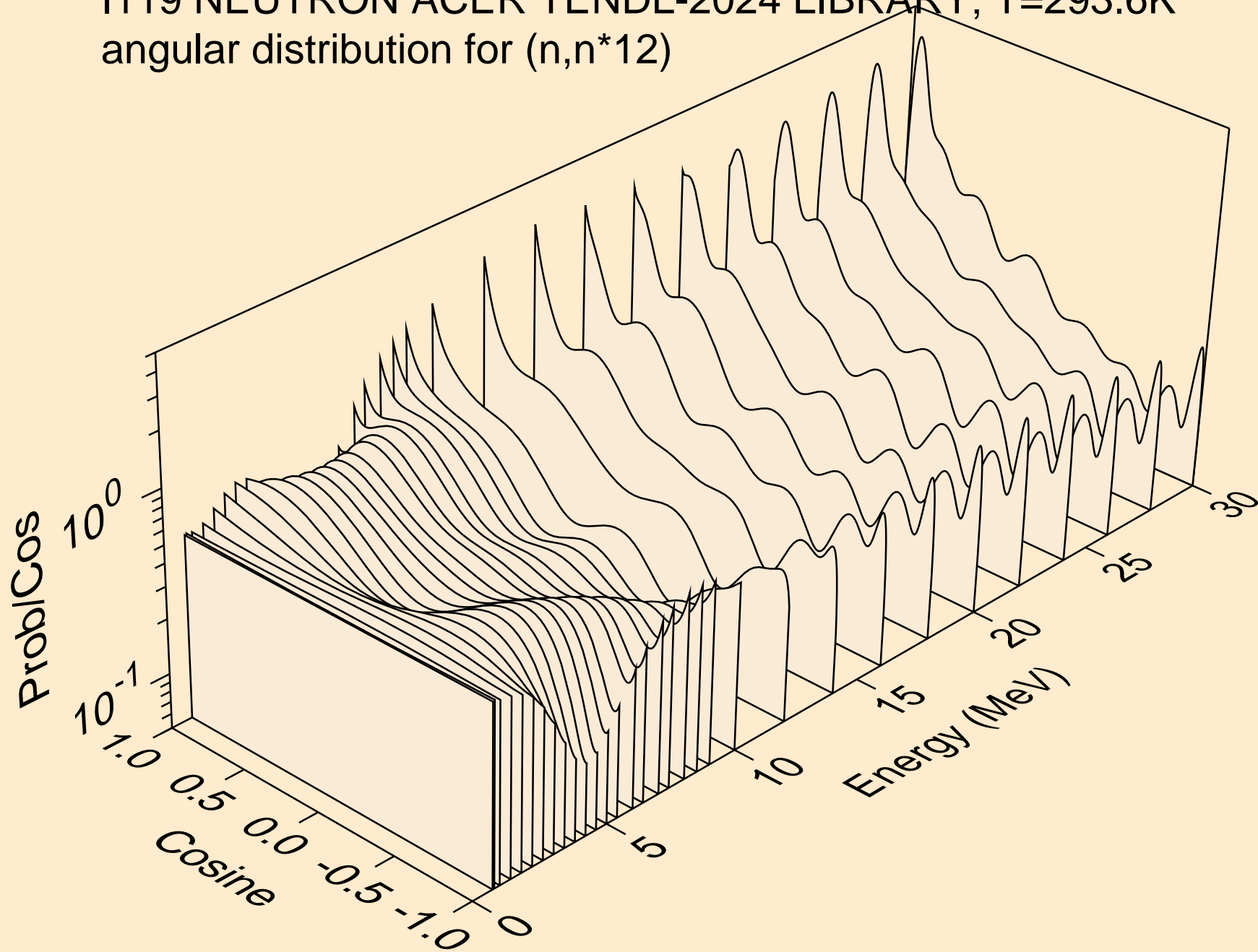

I119 NEUTRON ACER TENDL-2024 LIBRARY; T=293.6K
angular distribution for (n,n*13)

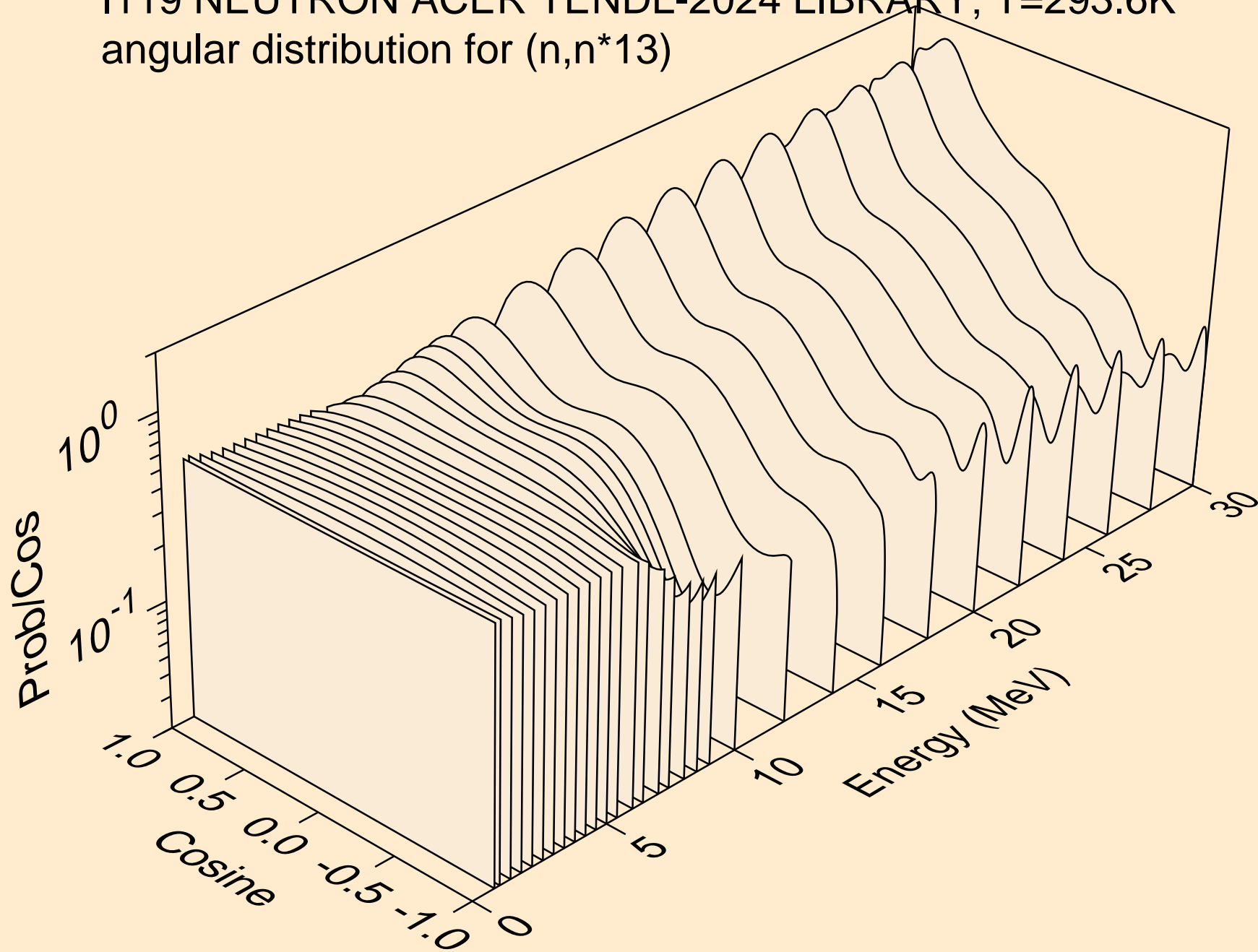

I119 NEUTRON ACER TENDL-2024 LIBRARY; T=293.6K
angular distribution for (n,n*14)

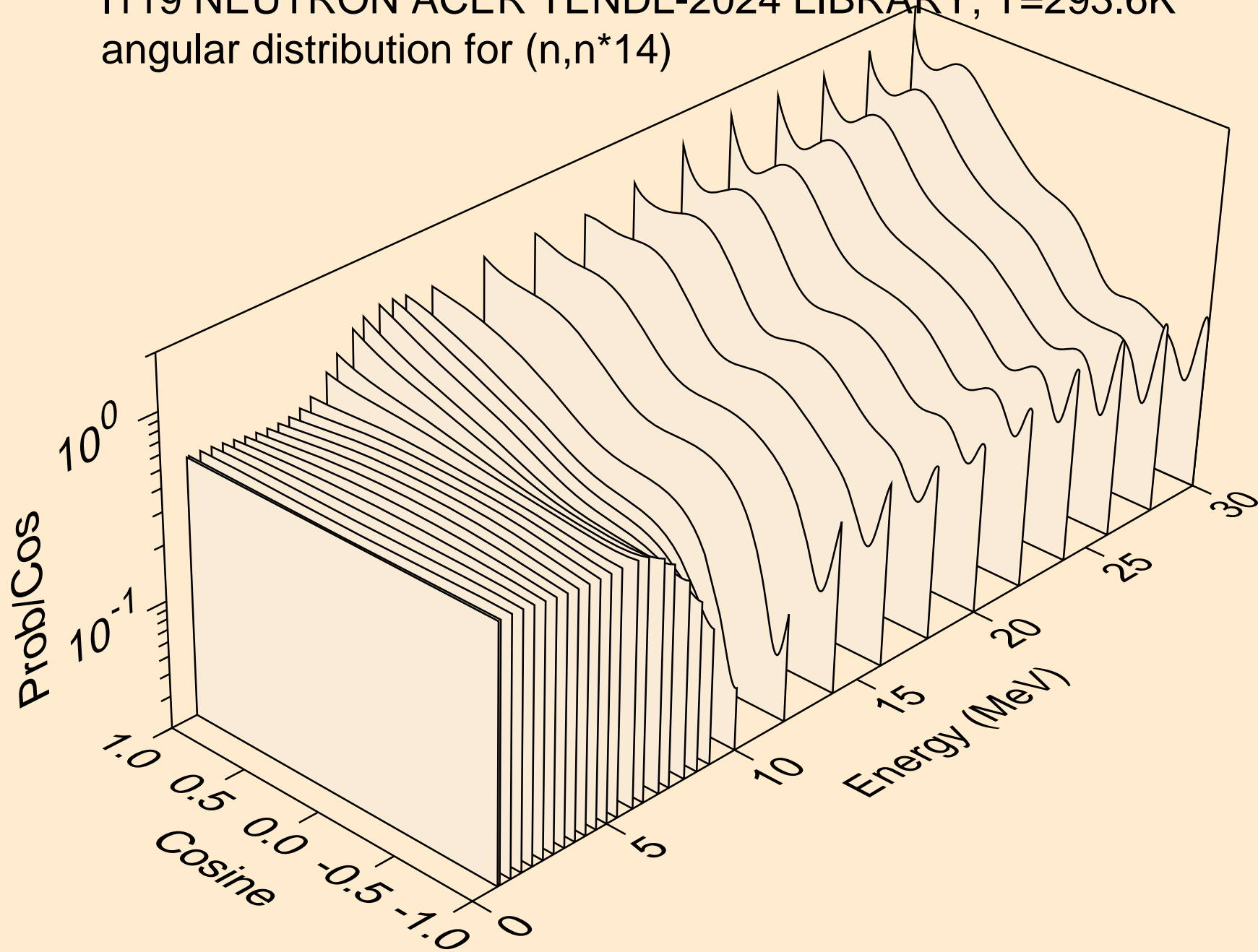

I119 NEUTRON ACER TENDL-2024 LIBRARY; T=293.6K
angular distribution for (n,n*15)

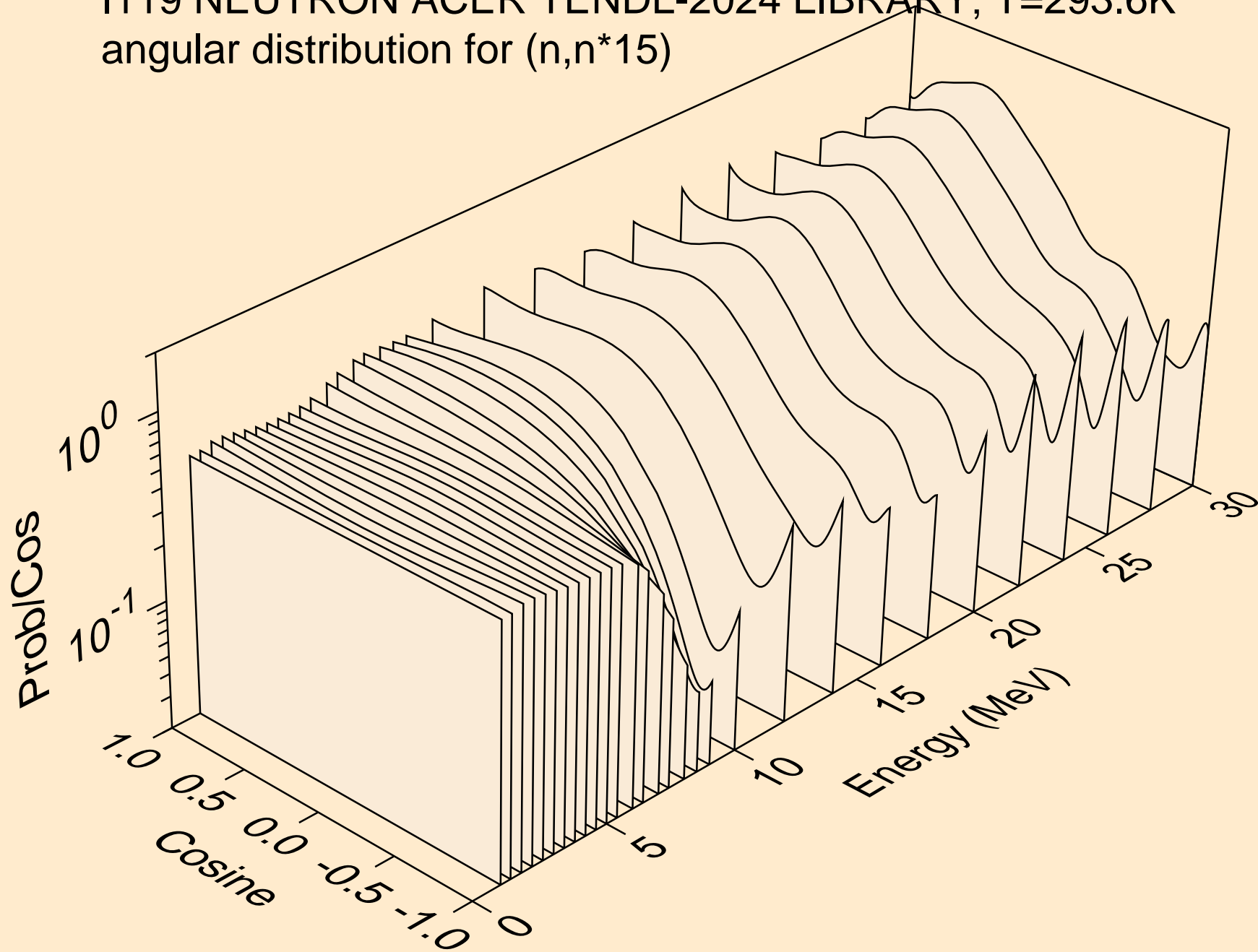

I119 NEUTRON ACER TENDL-2024 LIBRARY; T=293.6K
angular distribution for (n,n*16)

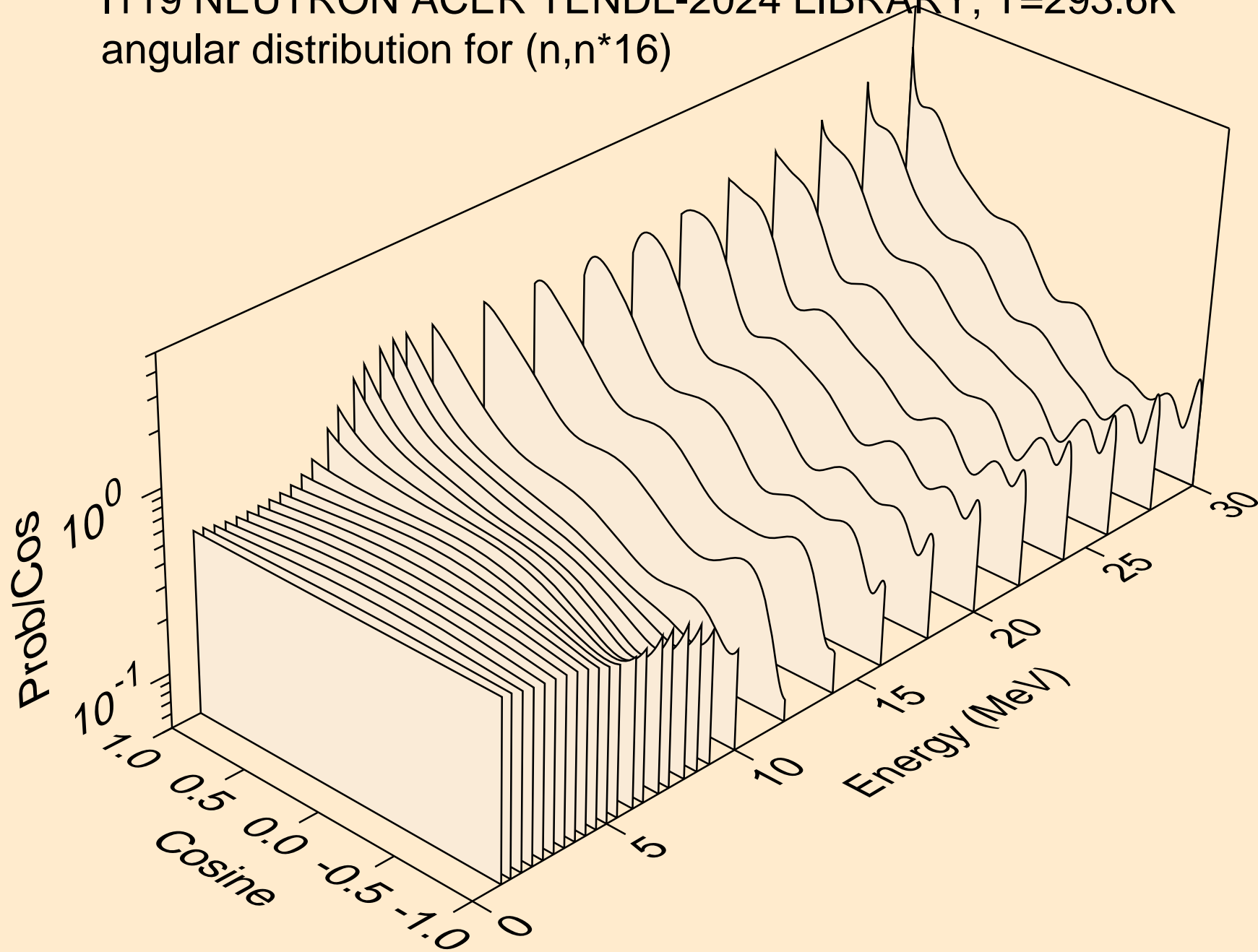

I119 NEUTRON ACER TENDL-2024 LIBRARY; T=293.6K
angular distribution for (n,n*17)

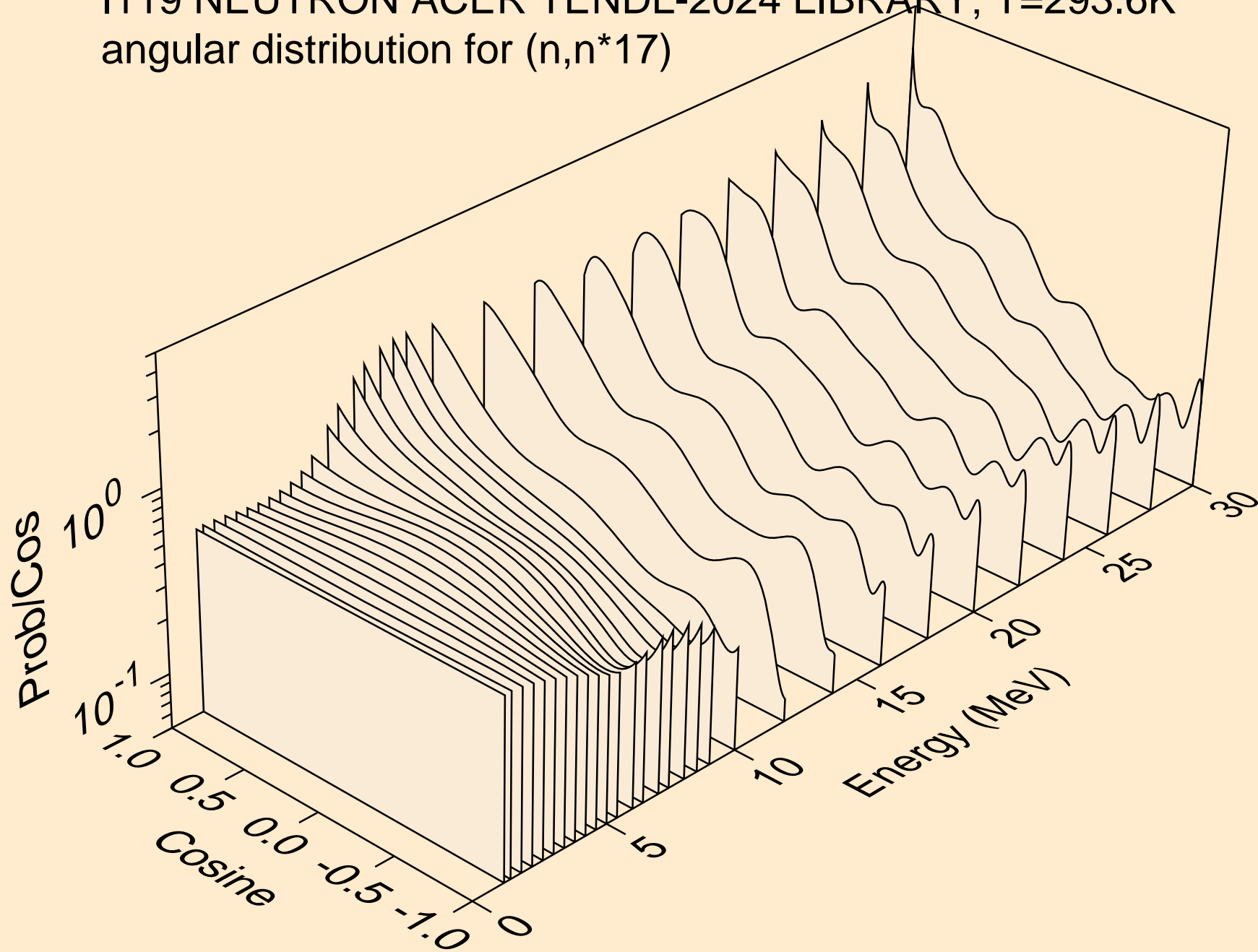

I119 NEUTRON ACER TENDL-2024 LIBRARY; T=293.6K
angular distribution for (n,n*18)

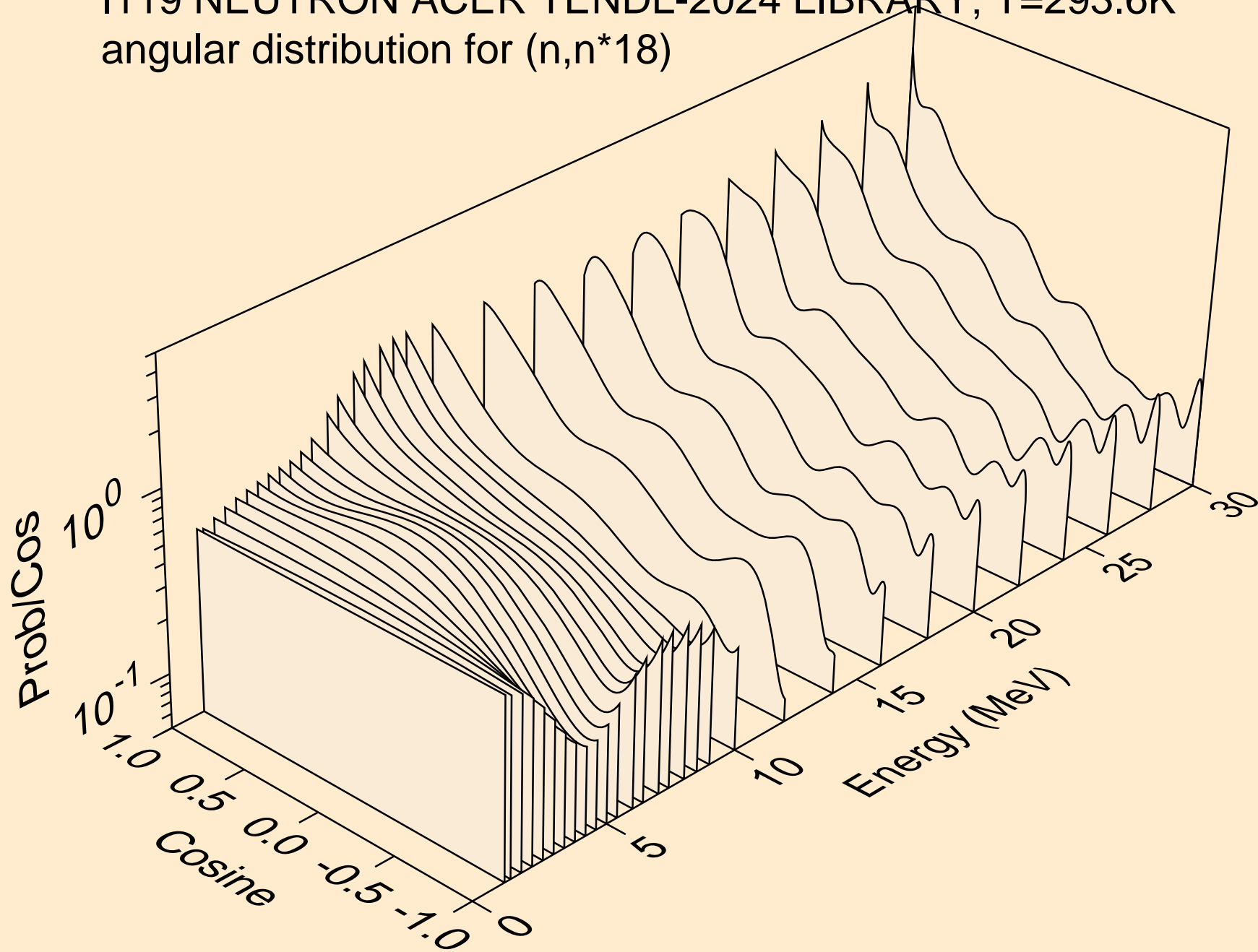

I119 NEUTRON ACER TENDL-2024 LIBRARY; T=293.6K
angular distribution for (n,n*19)

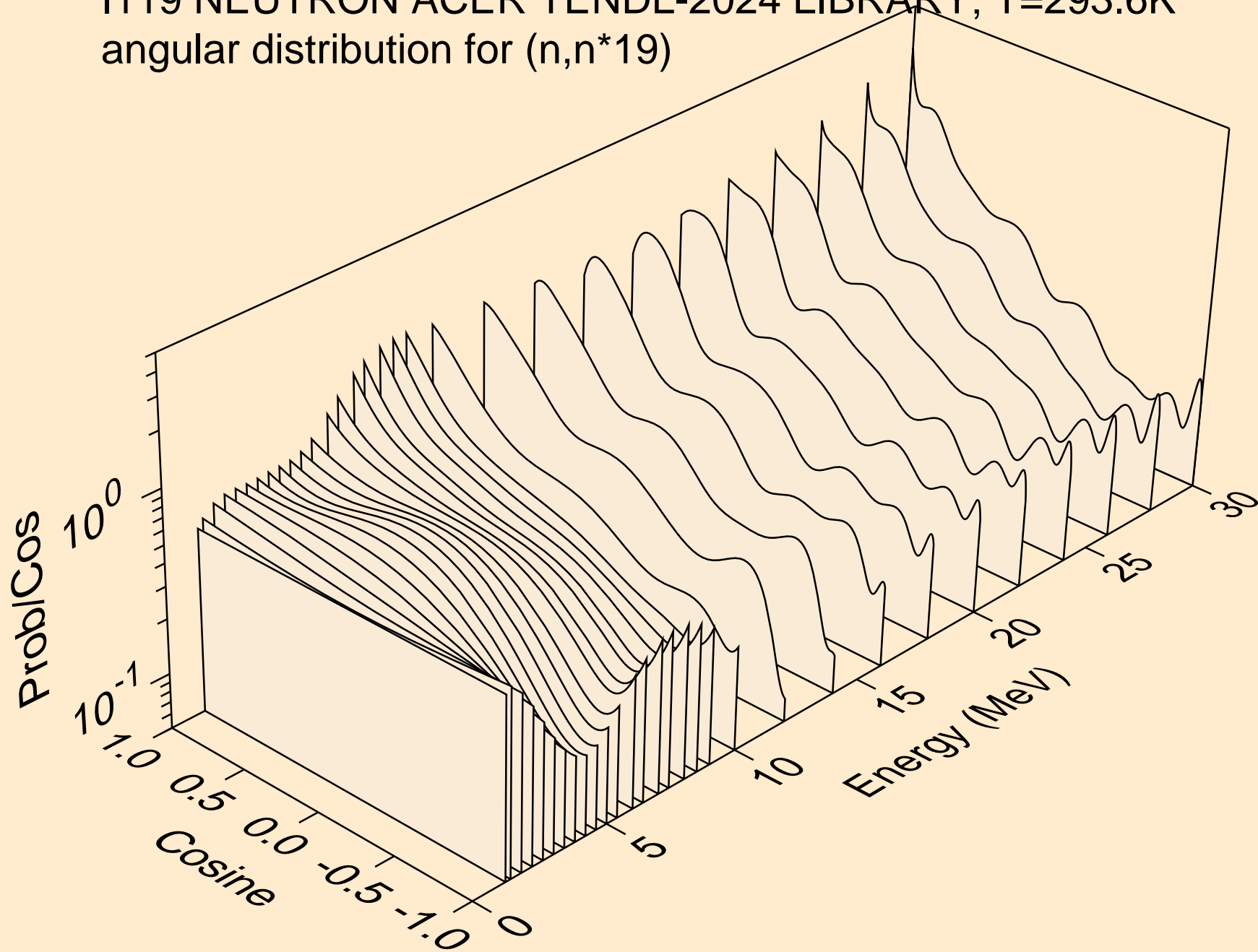

I119 NEUTRON ACER TENDL-2024 LIBRARY; T=293.6K
angular distribution for (n,n*20)

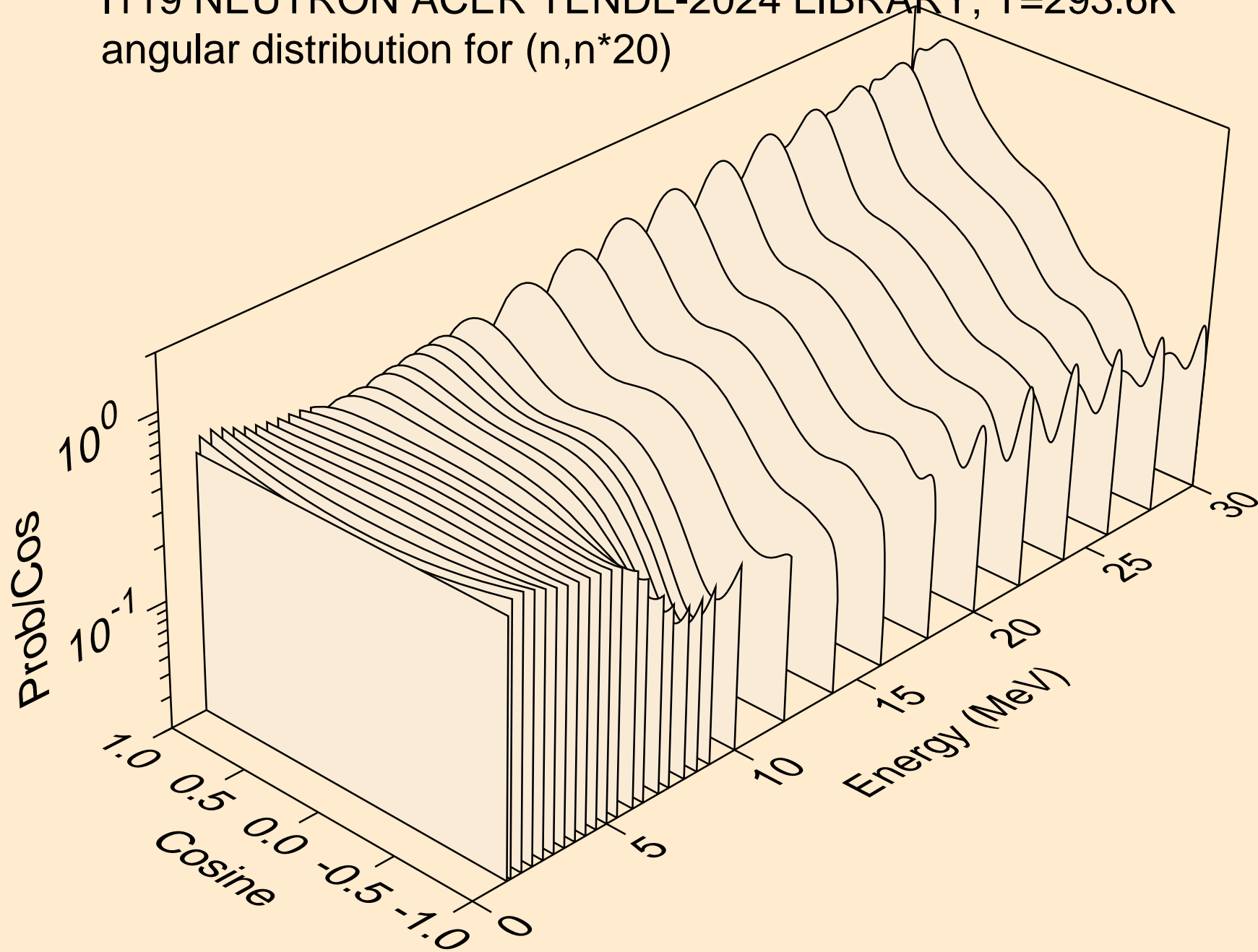

I119 NEUTRON ACER TENDL-2024 LIBRARY; T=293.6K
angular distribution for (n,n*21)

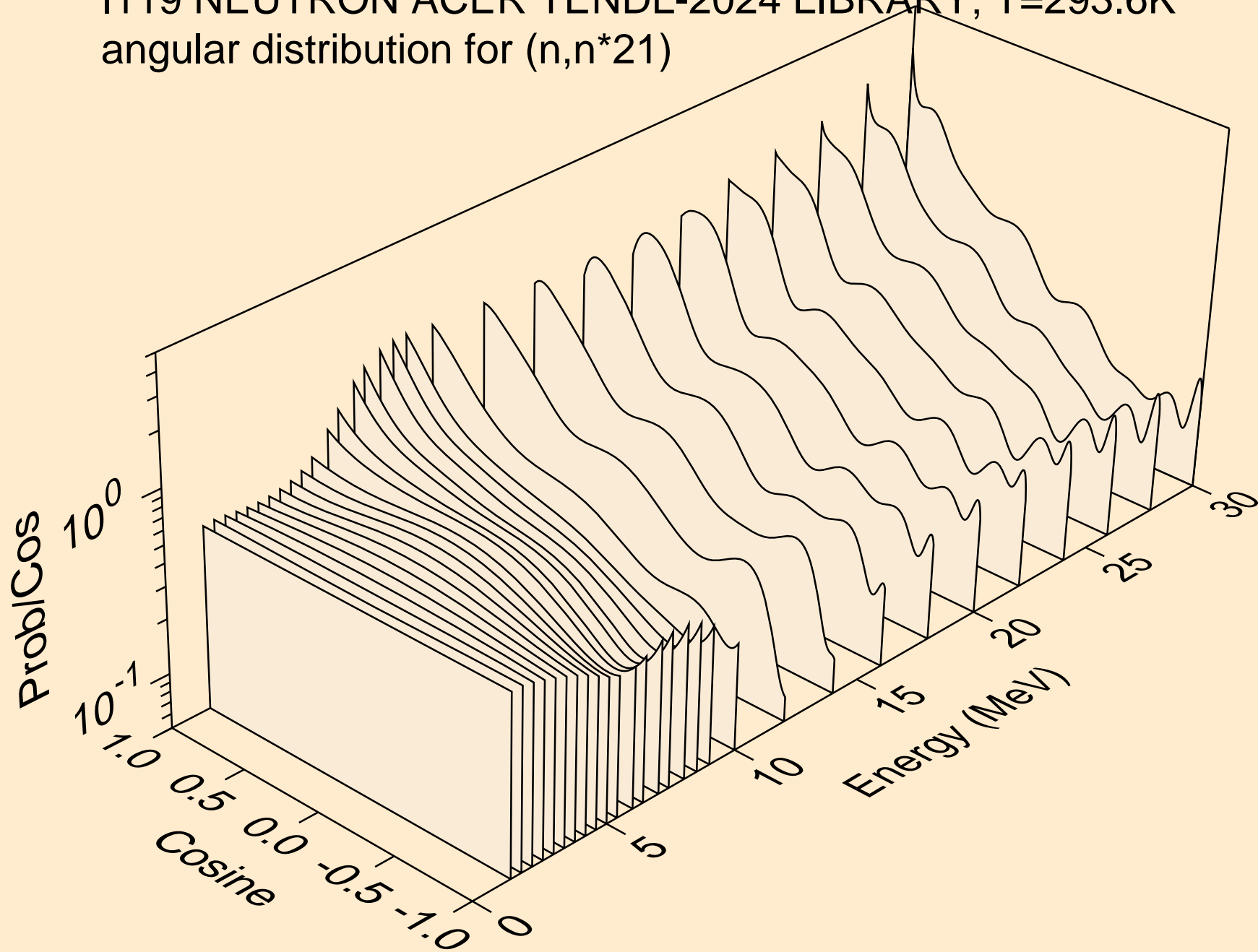

I119 NEUTRON ACER TENDL-2024 LIBRARY; T=293.6K
angular distribution for (n,n*22)

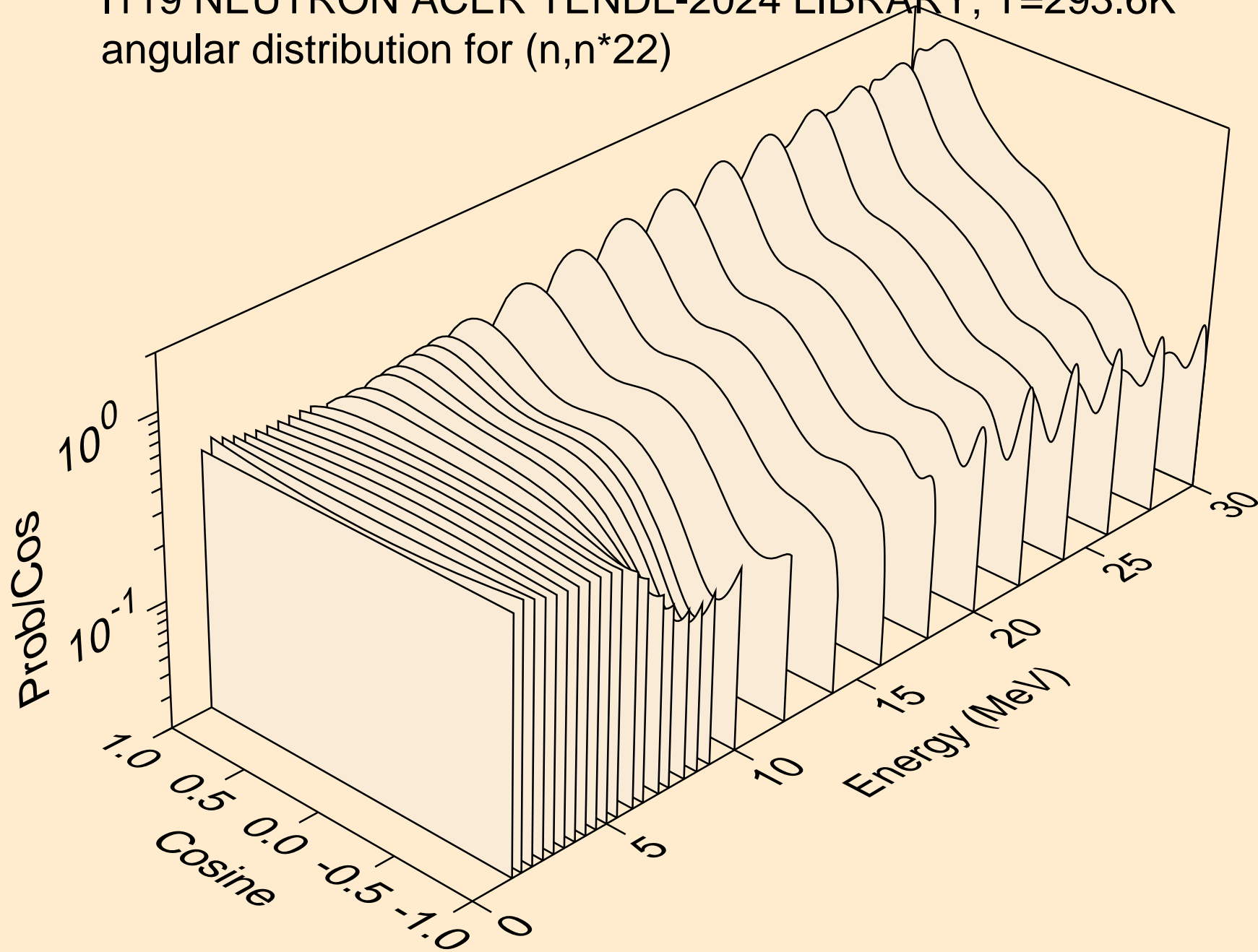

I119 NEUTRON ACER TENDL-2024 LIBRARY; T=293.6K
angular distribution for (n,n*23)

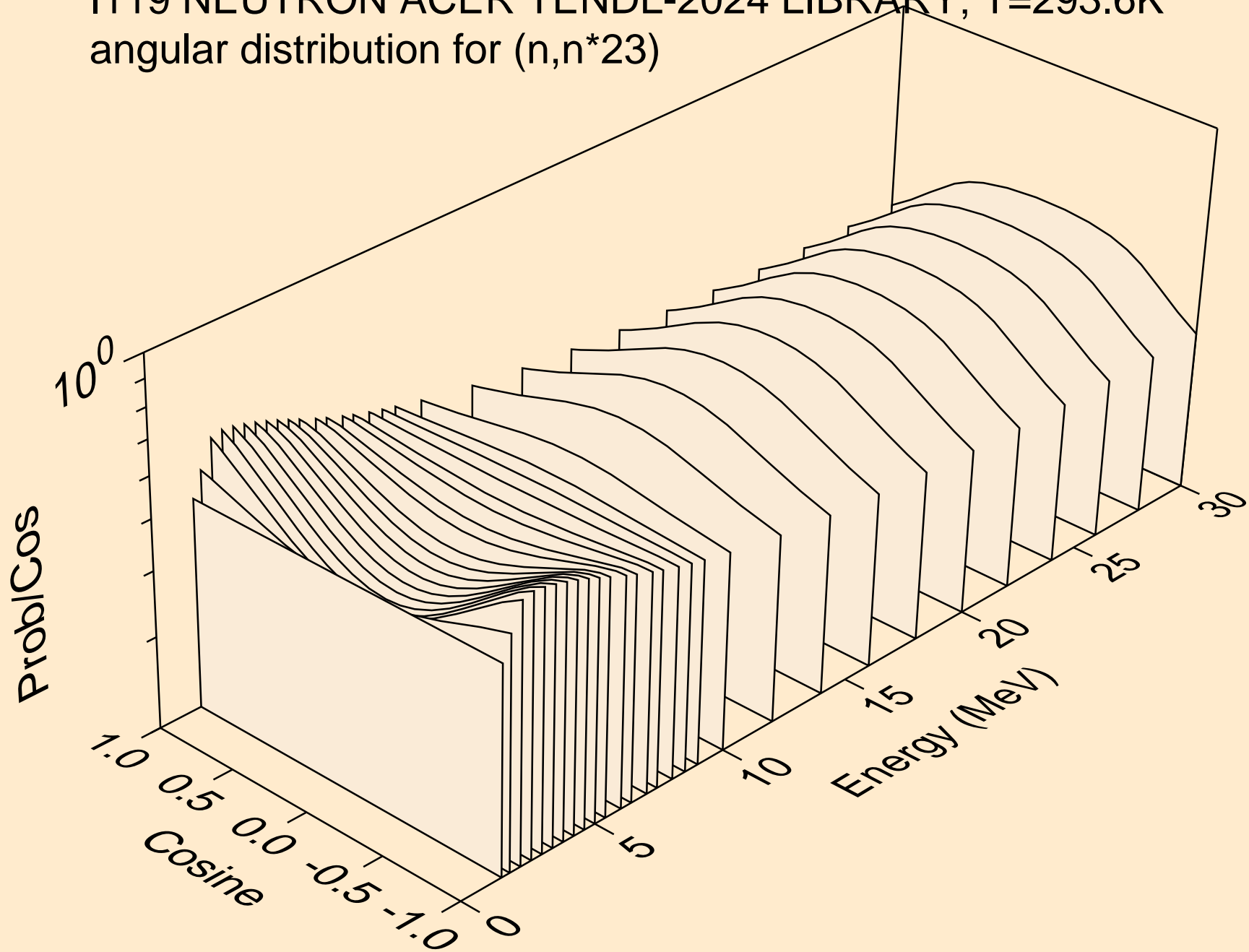

I119 NEUTRON ACER TENDL-2024 LIBRARY; T=293.6K
angular distribution for (n,n*24)

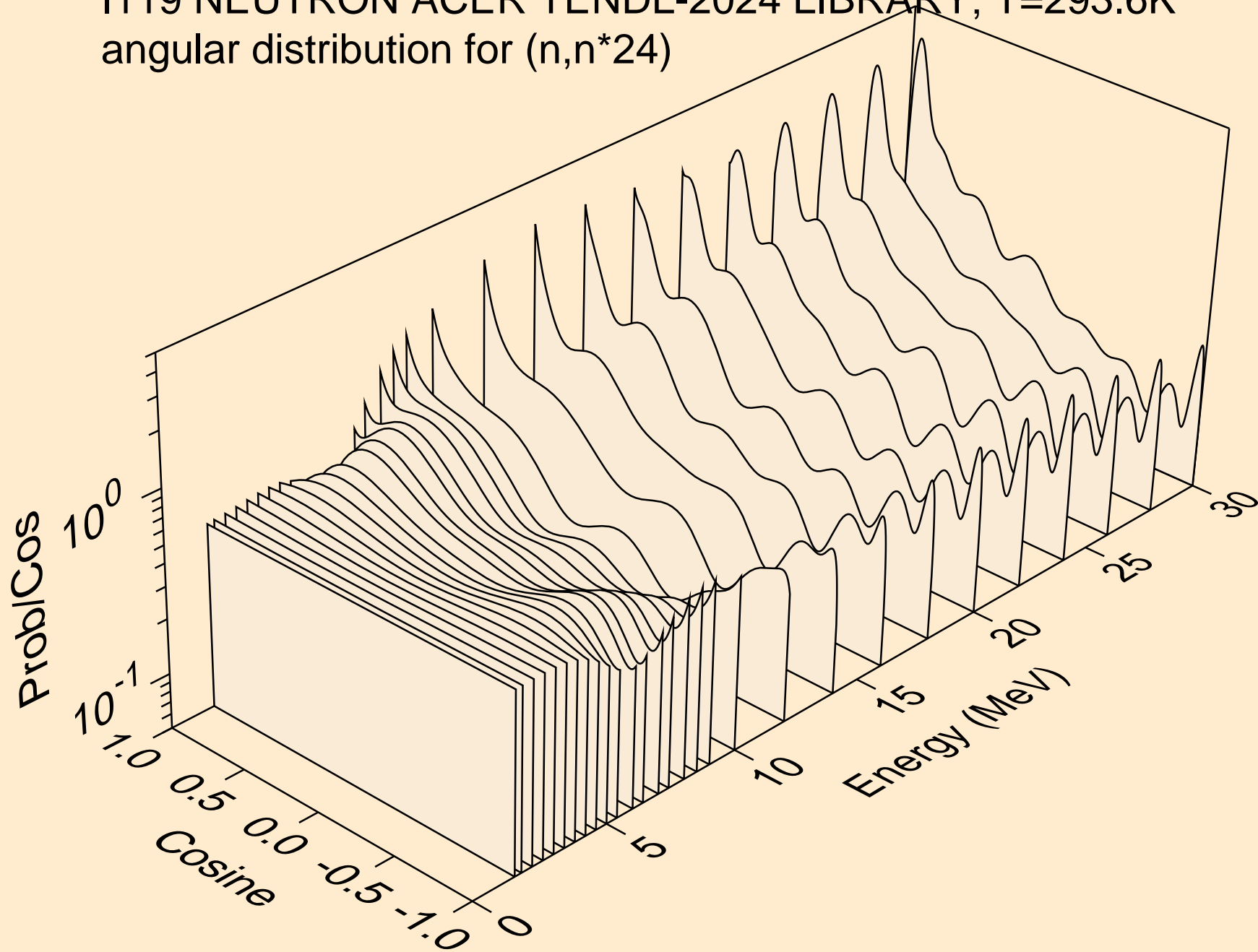

I119 NEUTRON ACER TENDL-2024 LIBRARY; T=293.6K
Neutron emission for (n,x)

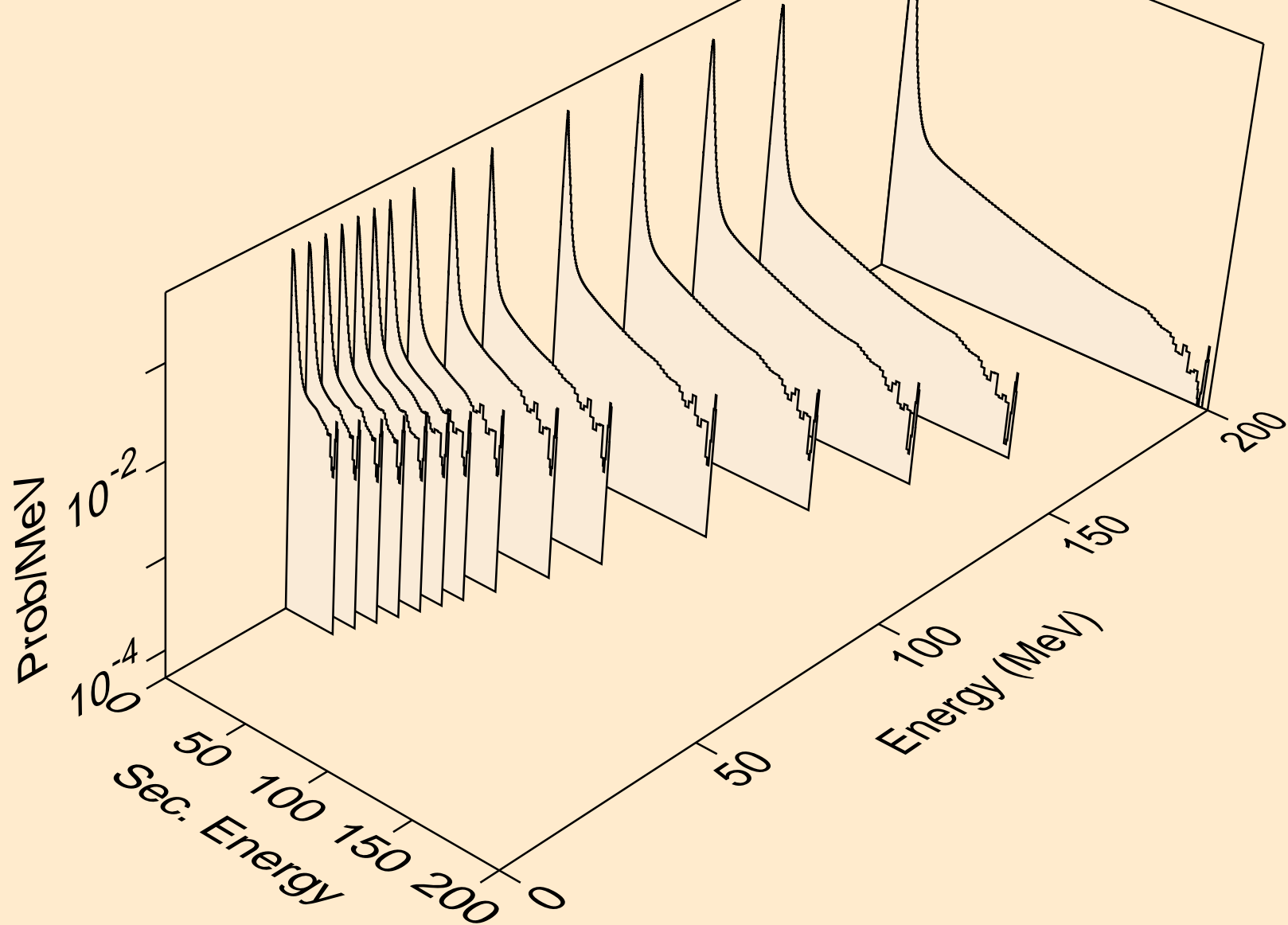

I119 NEUTRON ACER TENDL-2024 LIBRARY; T=293.6K
Neutron emission for (n,2nd)

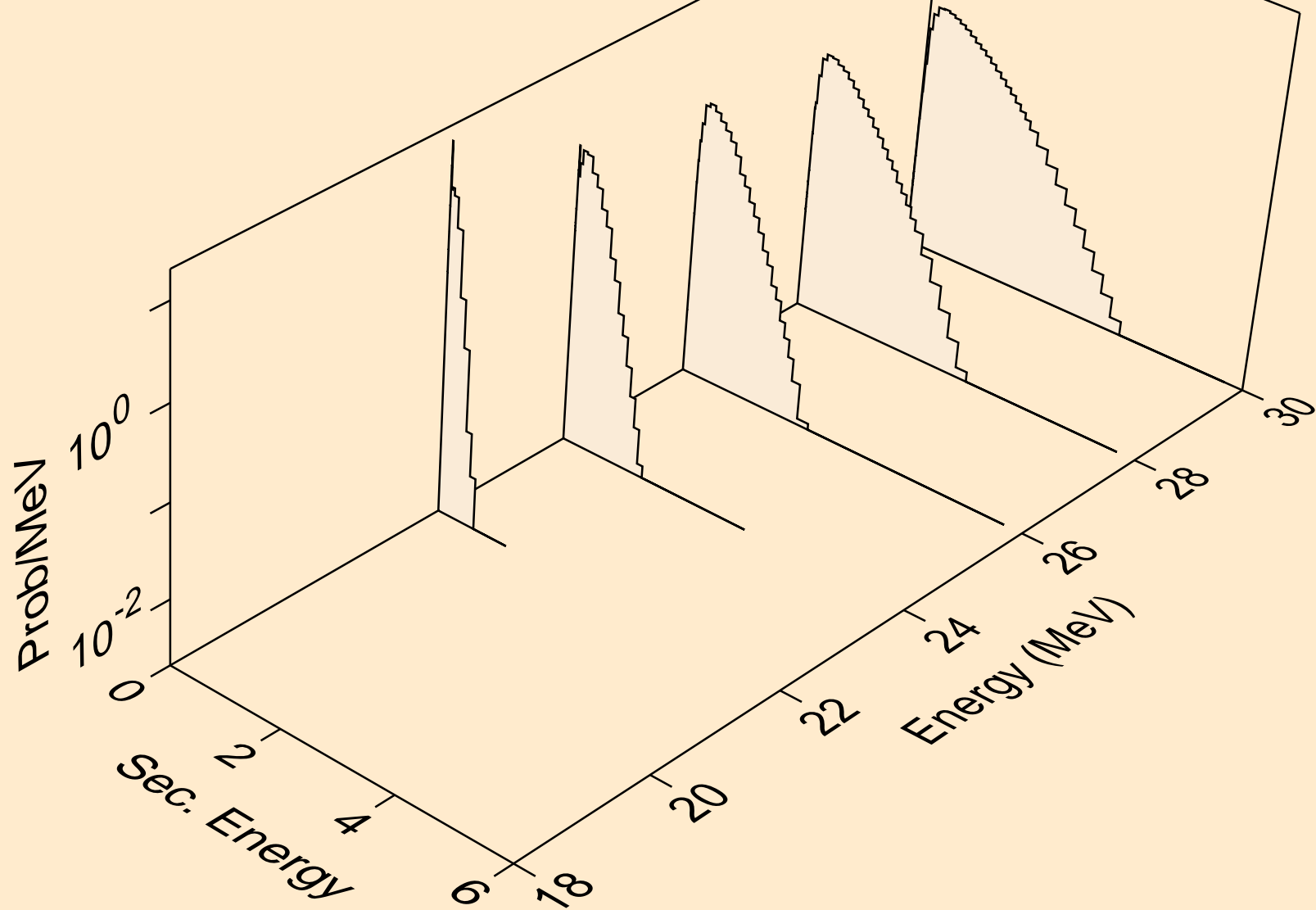

I119 NEUTRON ACER TENDL-2024 LIBRARY; T=293.6K
Neutron emission for (n,2n)

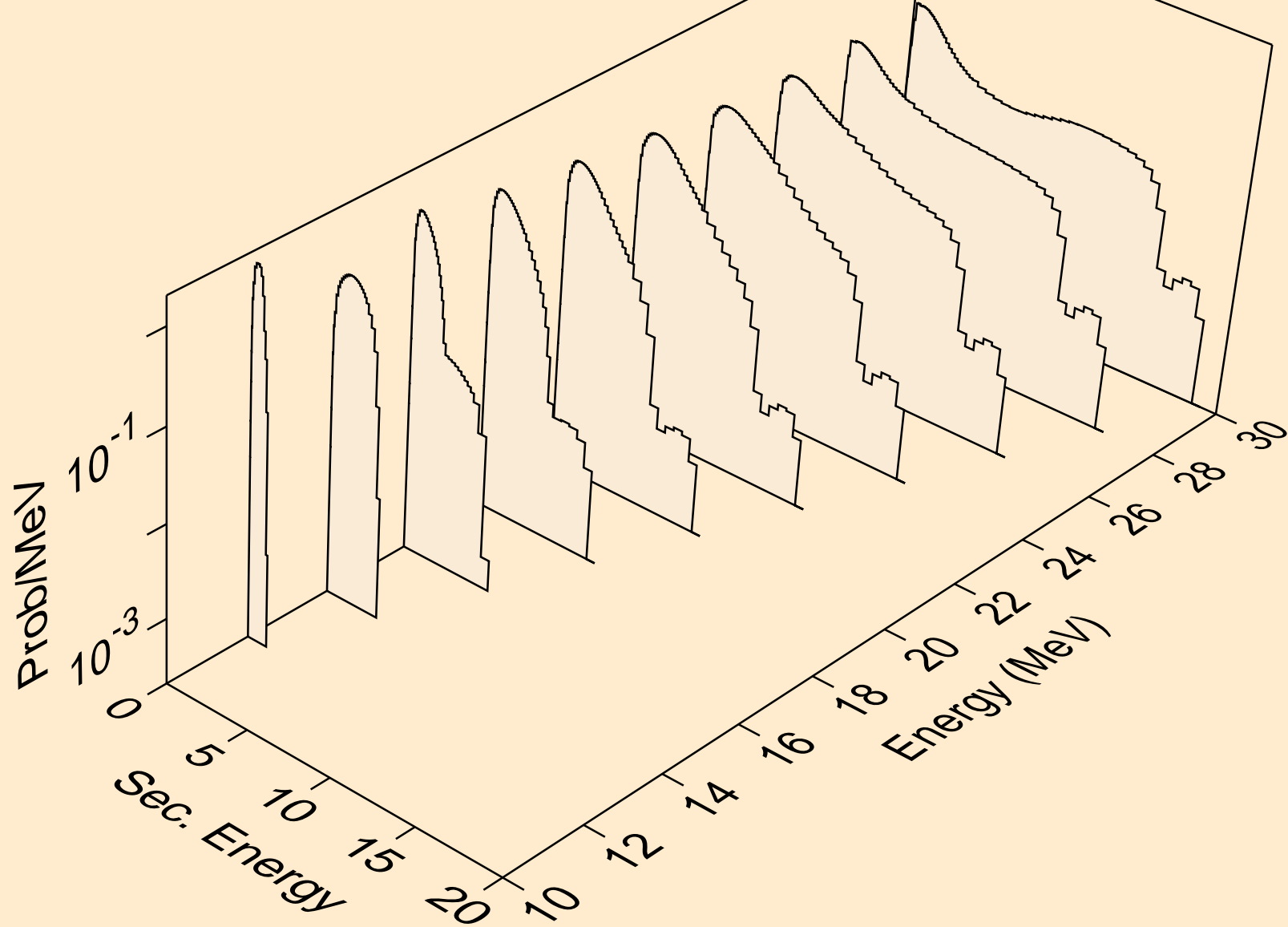

I119 NEUTRON ACER TENDL-2024 LIBRARY; T=293.6K
Neutron emission for (n,3n)

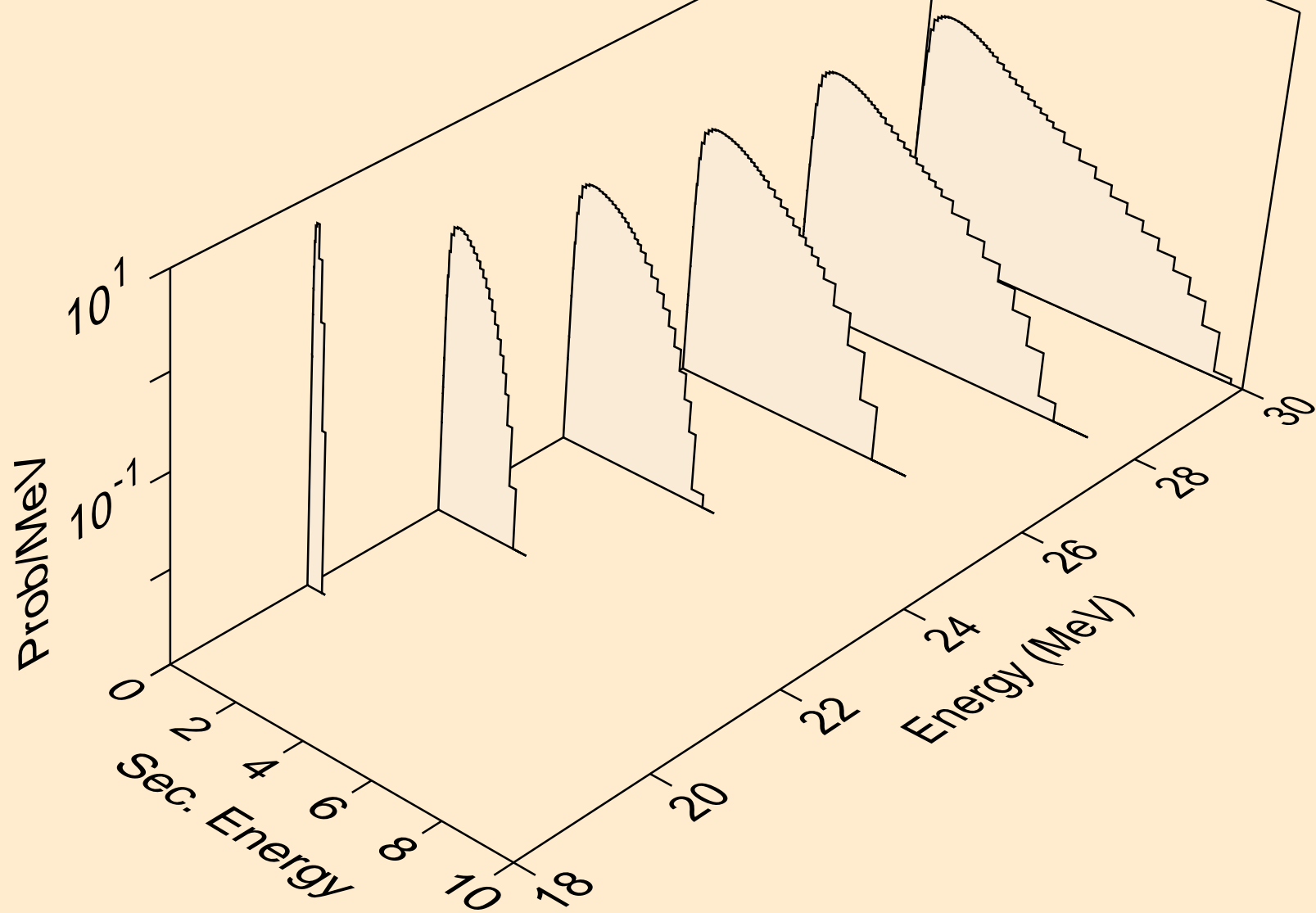

I119 NEUTRON ACER TENDL-2024 LIBRARY; T=293.6K
Neutron emission for (n,n*)a

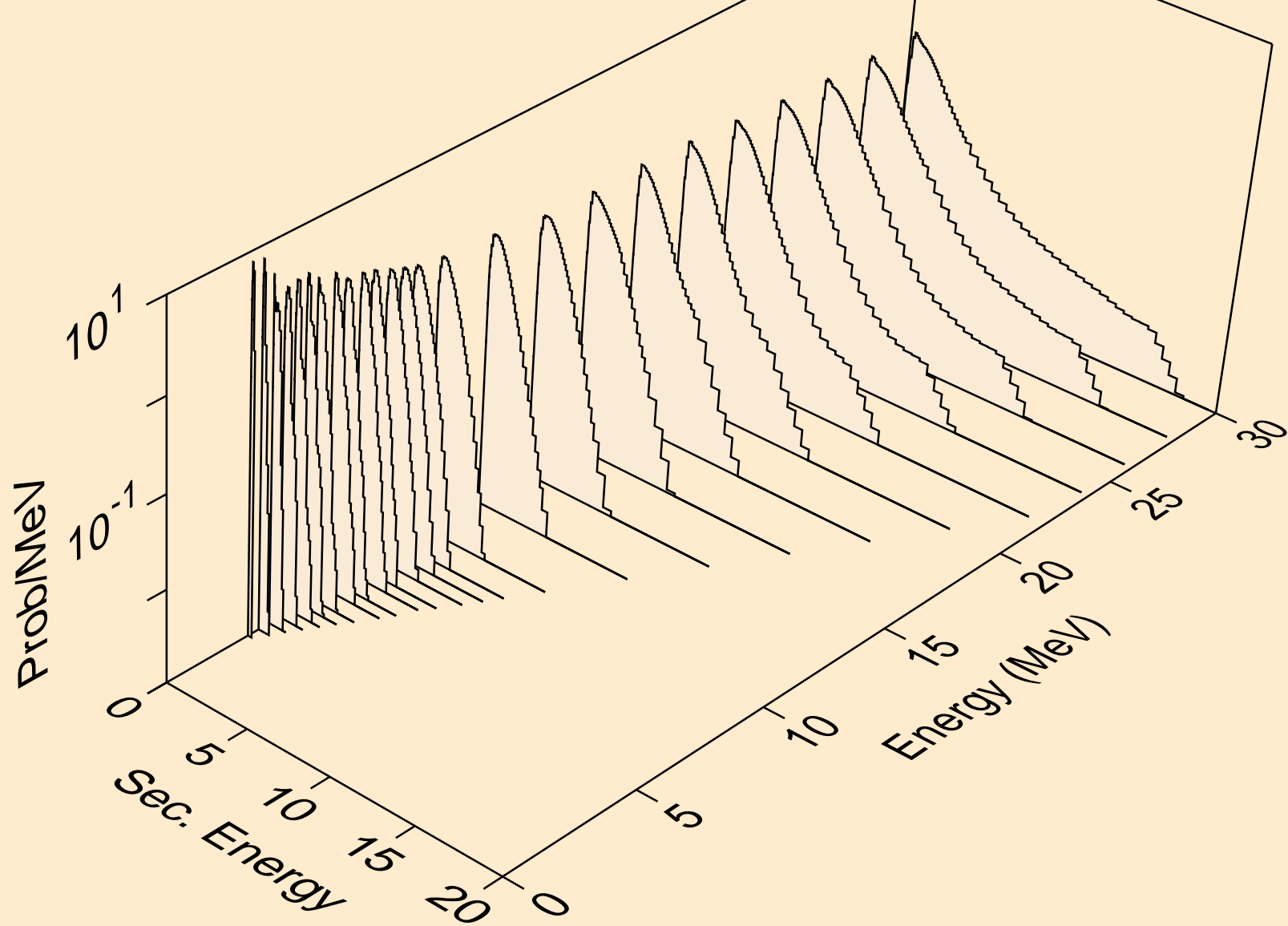

I119 NEUTRON ACER TENDL-2024 LIBRARY; T=293.6K
Neutron emission for (n,2n)a

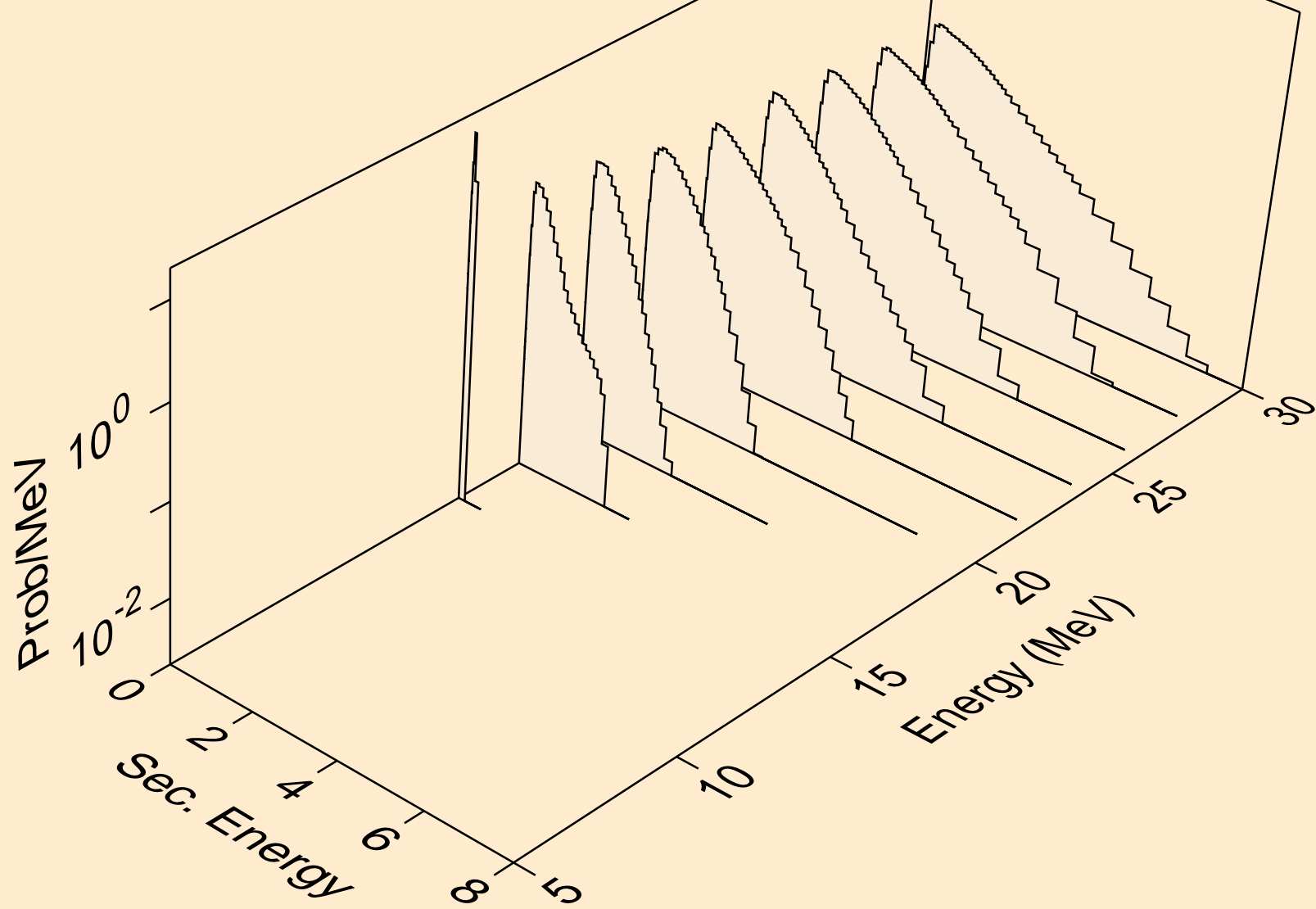

I119 NEUTRON ACER TENDL-2024 LIBRARY; T=293.6K
Neutron emission for (n,3n)a

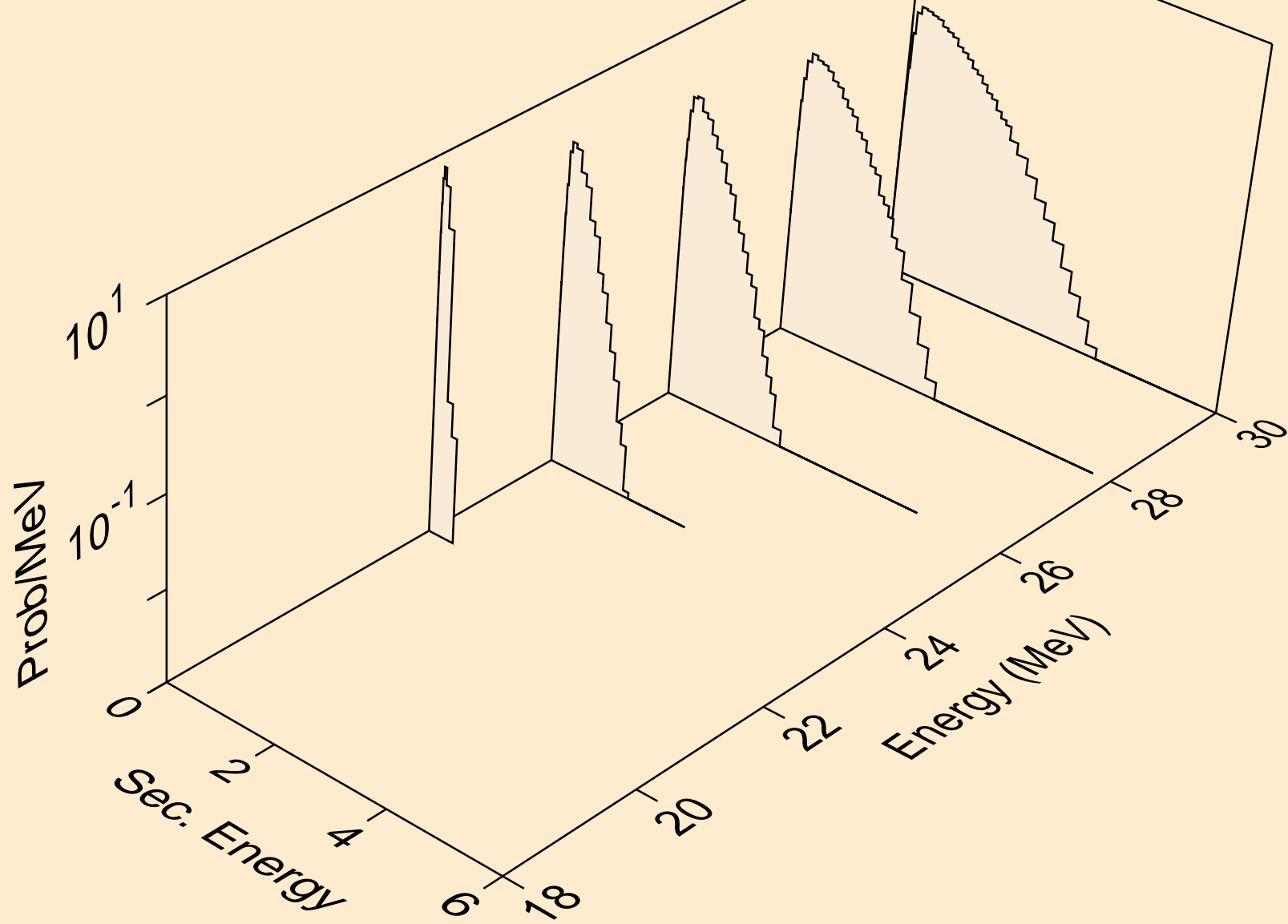

I119 NEUTRON ACER TENDL-2024 LIBRARY; T=293.6K
Neutron emission for (n,n*)p

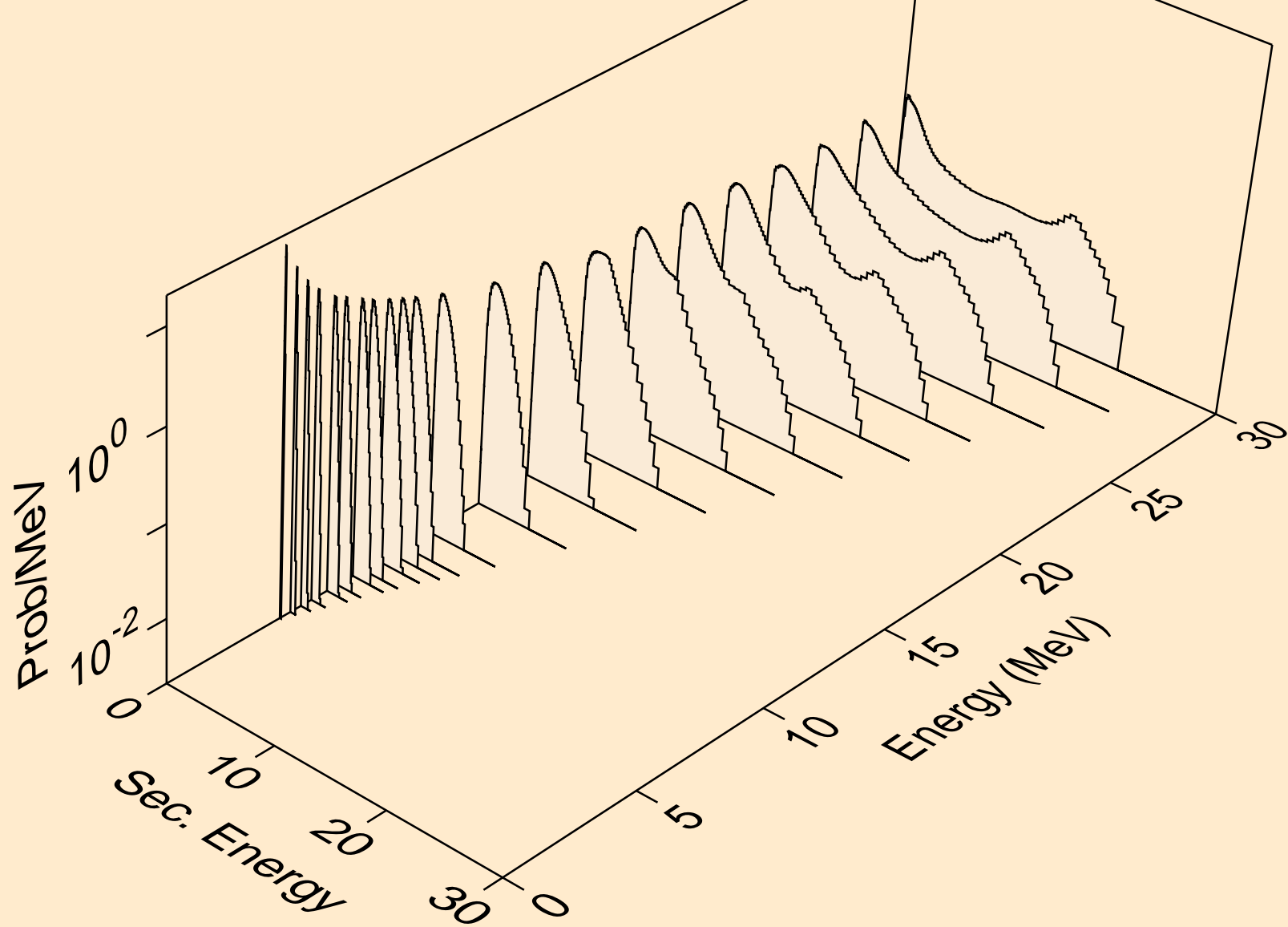

I119 NEUTRON ACER TENDL-2024 LIBRARY; T=293.6K
Neutron emission for (n,n*)2a

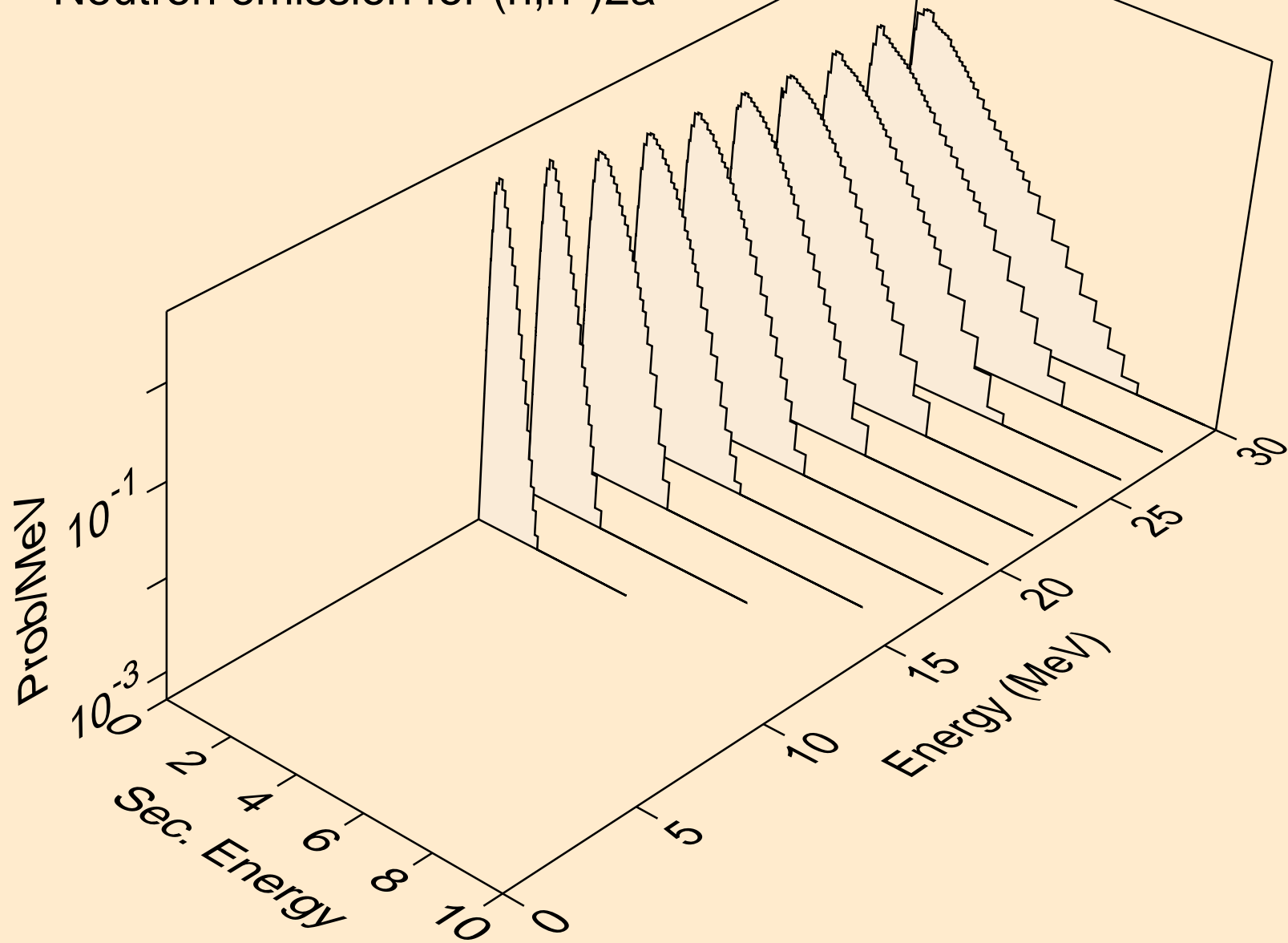

I119 NEUTRON ACER TENDL-2024 LIBRARY; T=293.6K
Neutron emission for (n,2n)2a

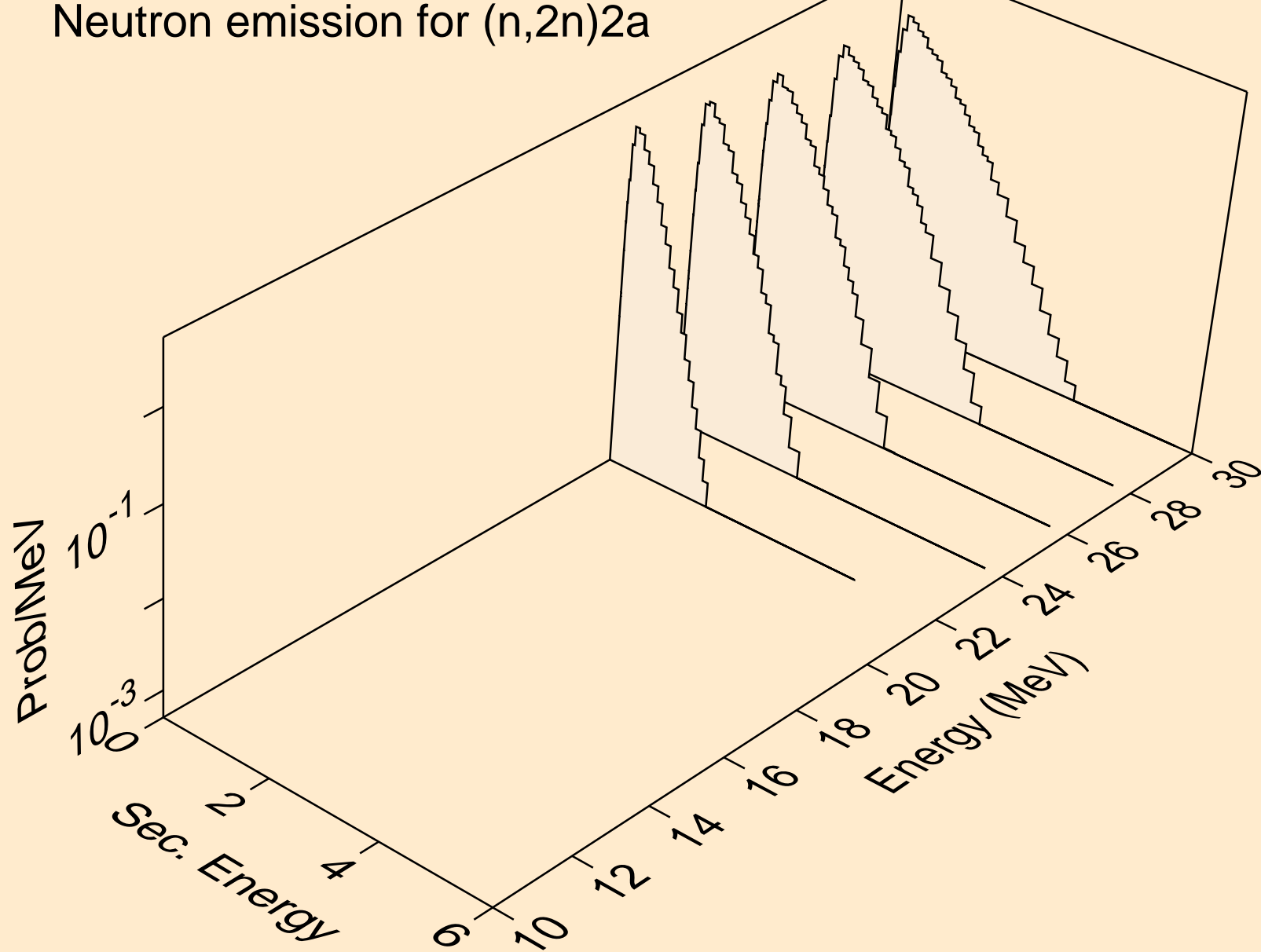

I119 NEUTRON ACER TENDL-2024 LIBRARY; T=293.6K
Neutron emission for (n,n*)d

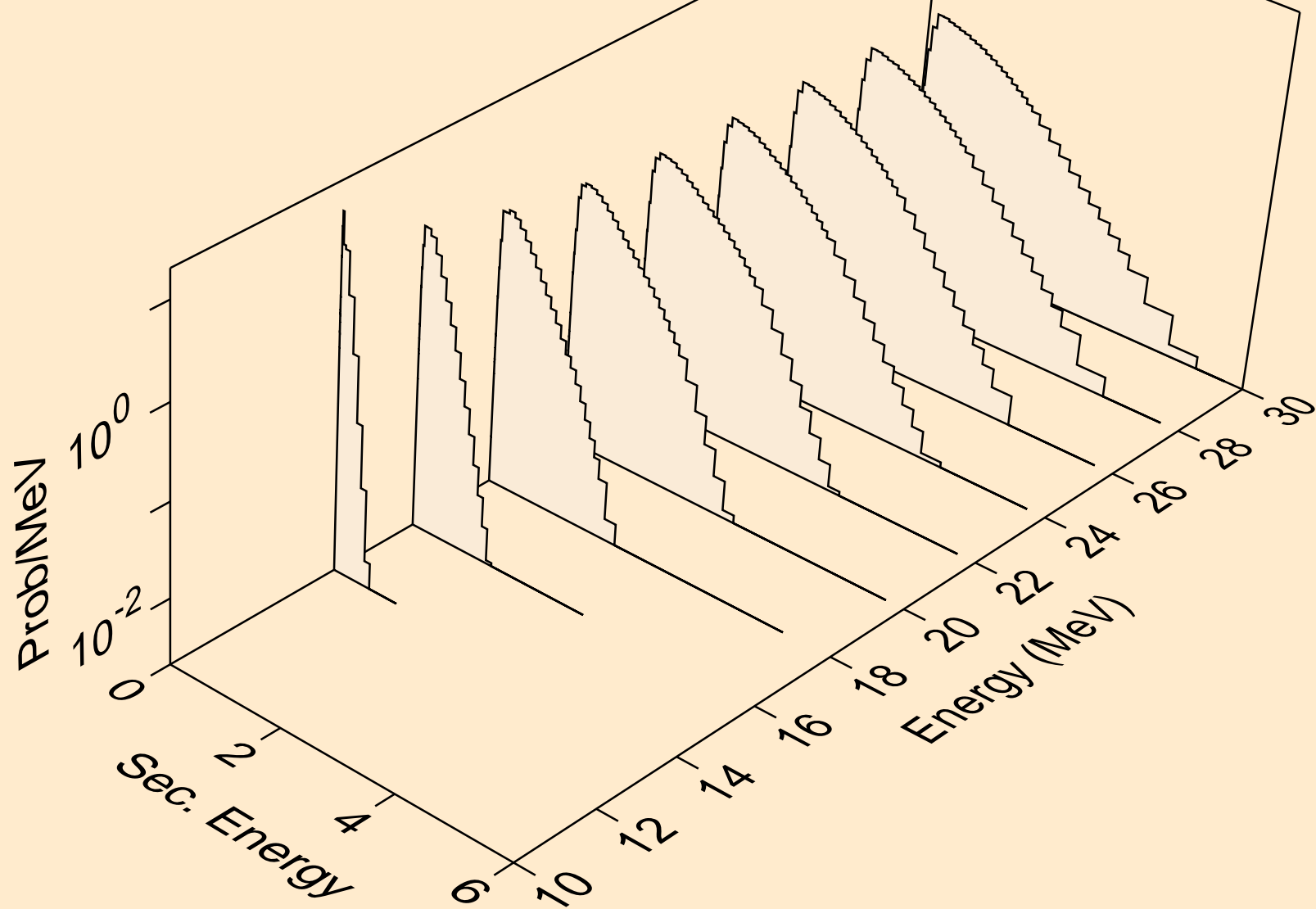

I119 NEUTRON ACER TENDL-2024 LIBRARY; T=293.6K
Neutron emission for (n,n*)t

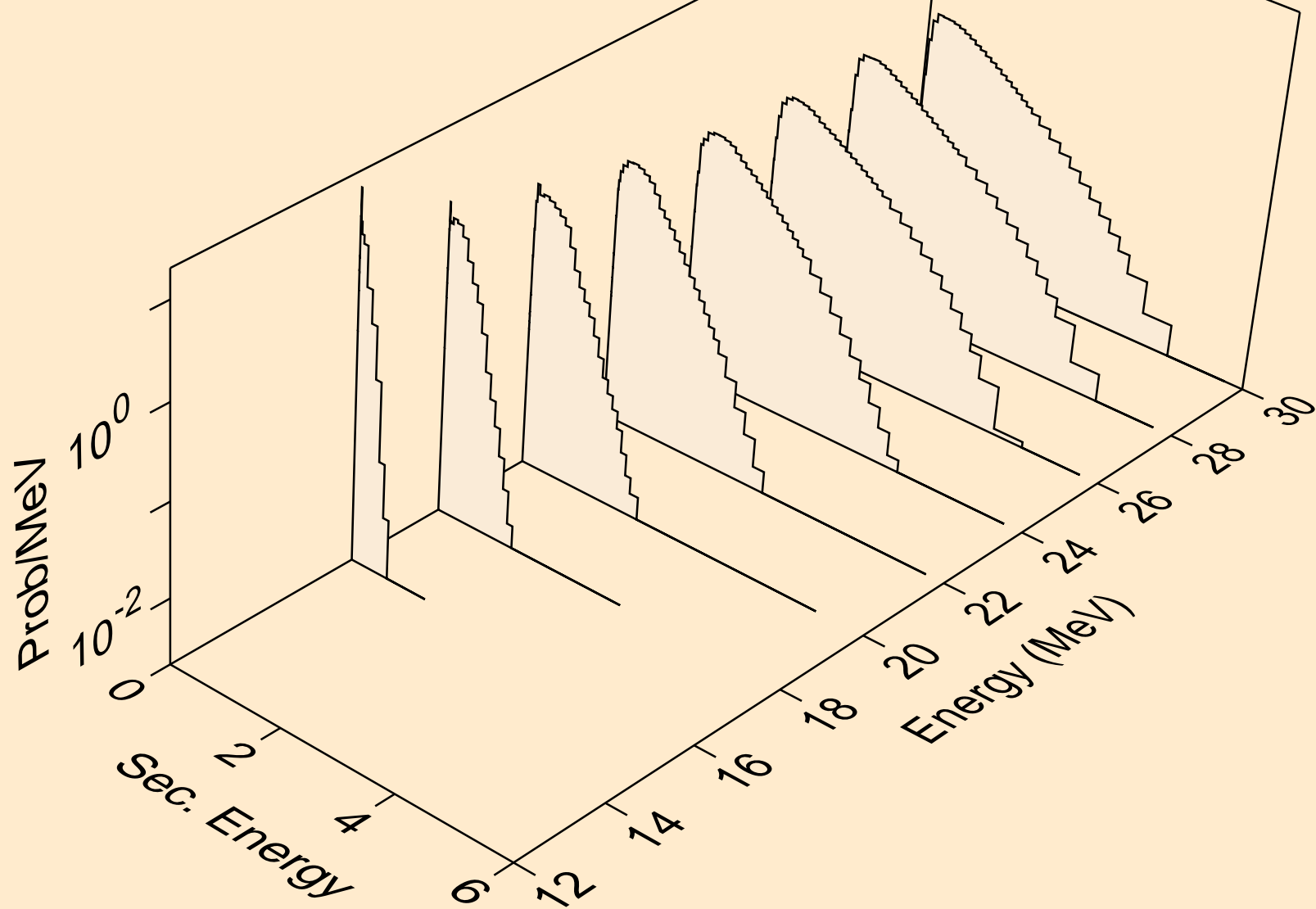

I119 NEUTRON ACER TENDL-2024 LIBRARY; T=293.6K
Neutron emission for (n,n*)he3

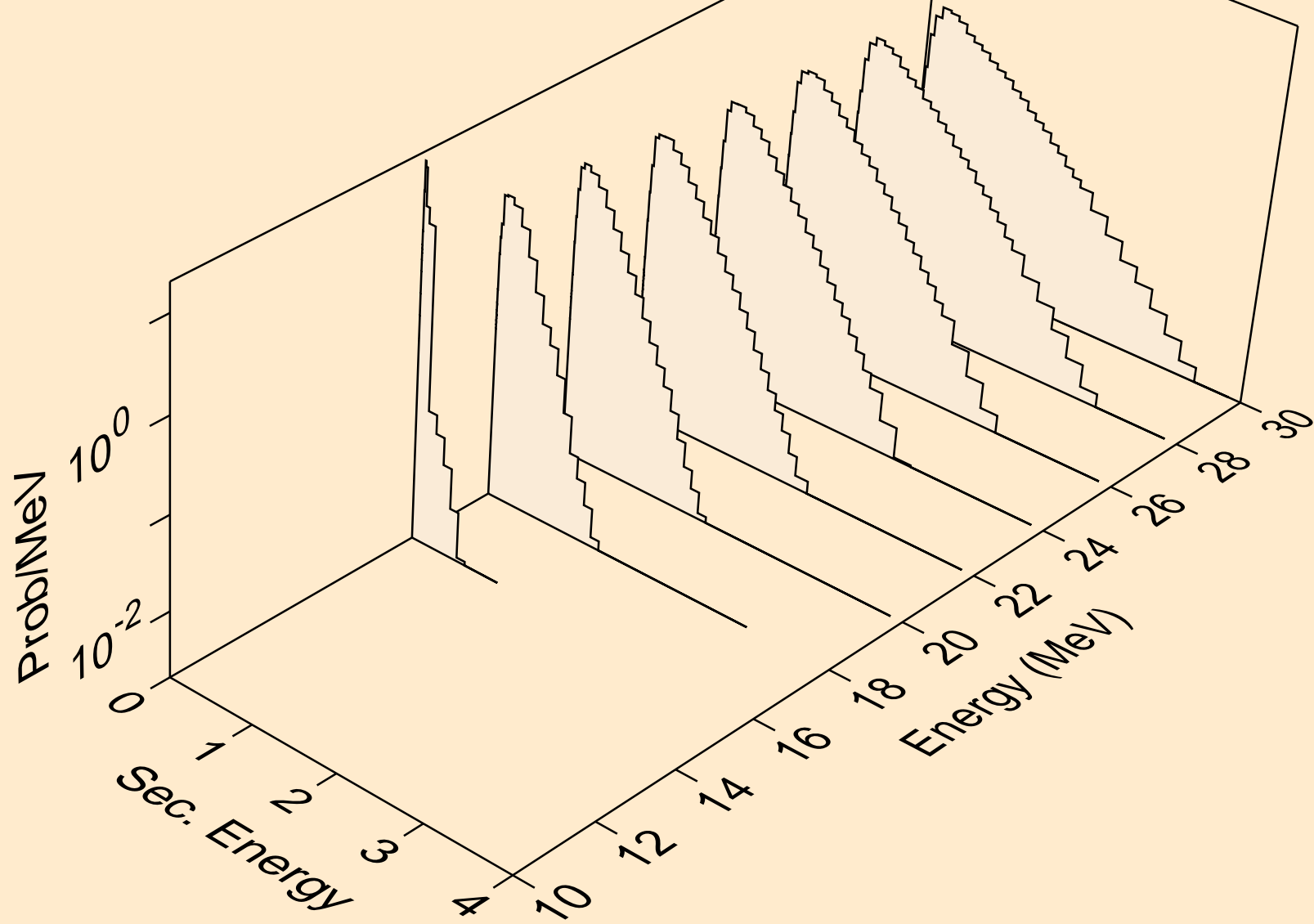

I119 NEUTRON ACER TENDL-2024 LIBRARY; T=293.6K
Neutron emission for (n,2np)

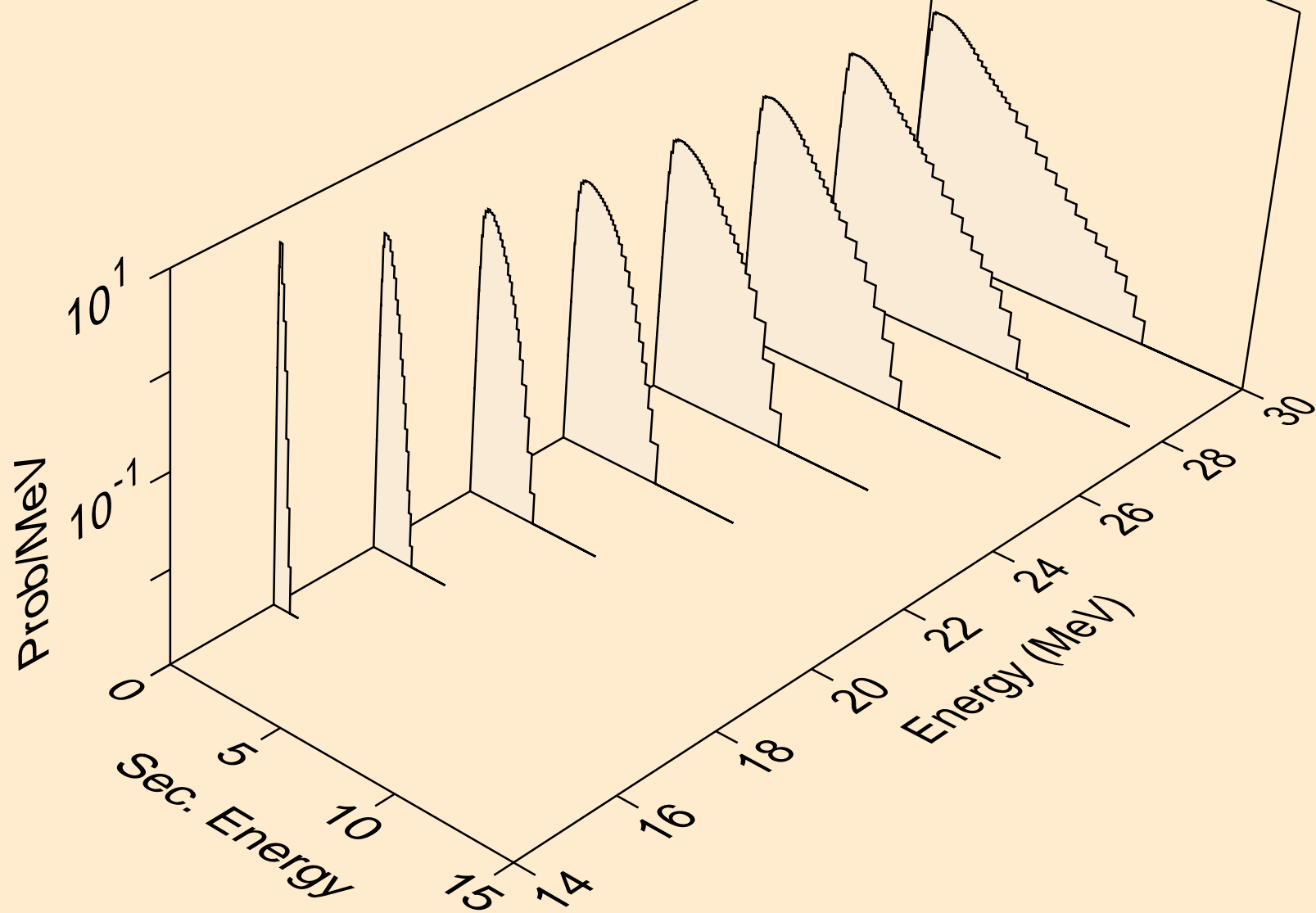

I119 NEUTRON ACER TENDL-2024 LIBRARY; T=293.6K
Neutron emission for (n,3np)

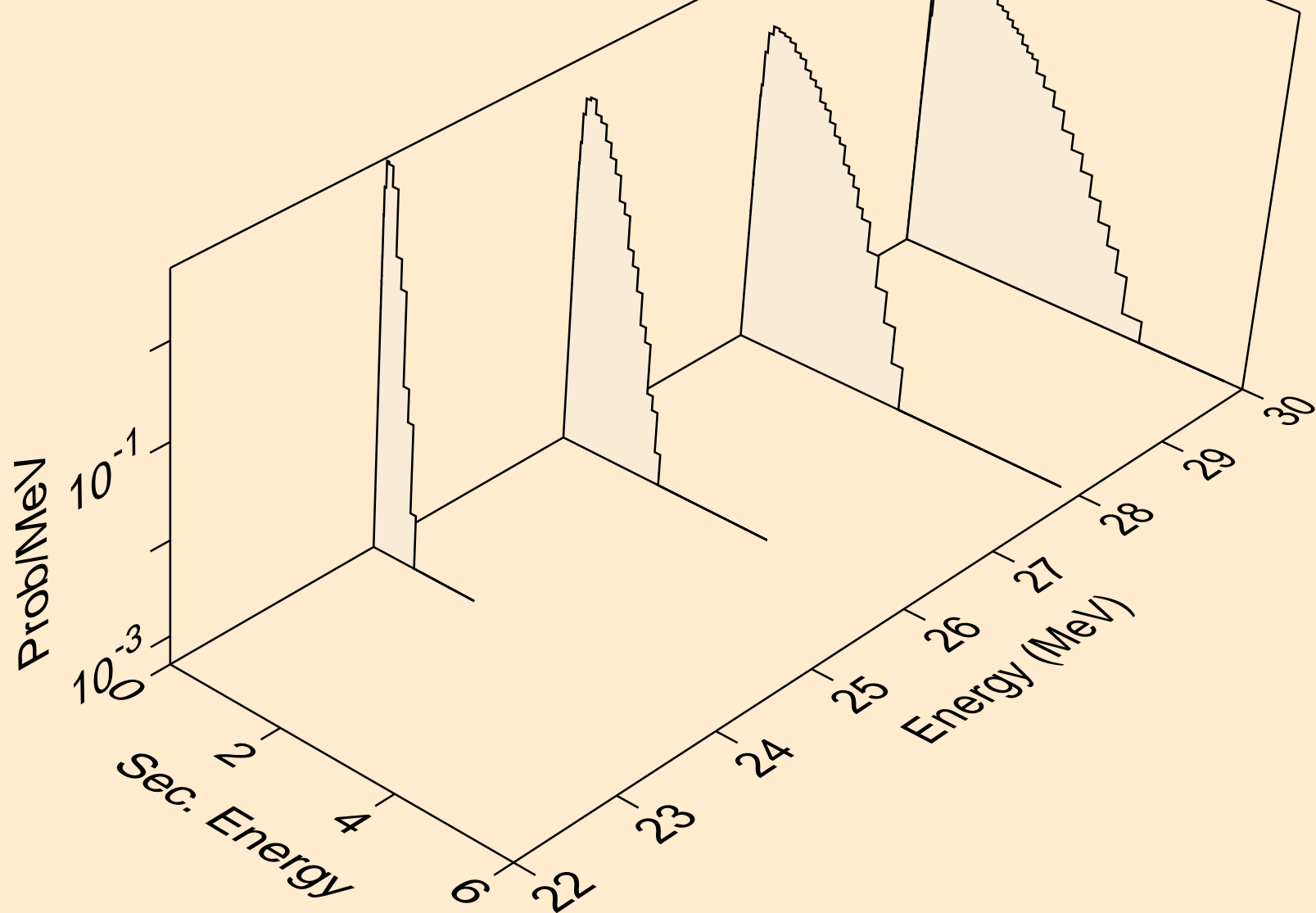

I119 NEUTRON ACER TENDL-2024 LIBRARY; T=293.6K
Neutron emission for (n,n2p)

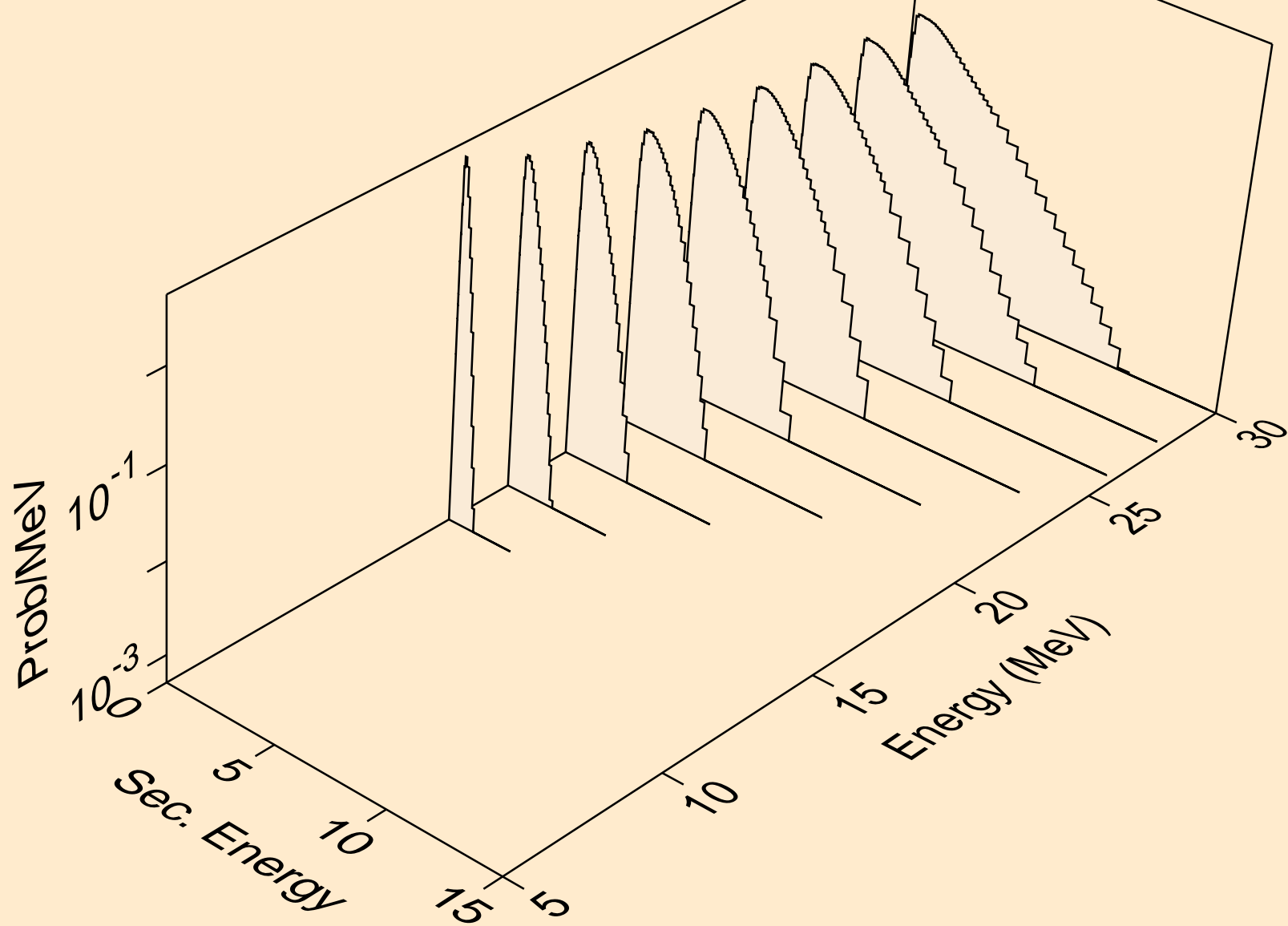

I119 NEUTRON ACER TENDL-2024 LIBRARY; T=293.6K
Neutron emission for (n,npa)

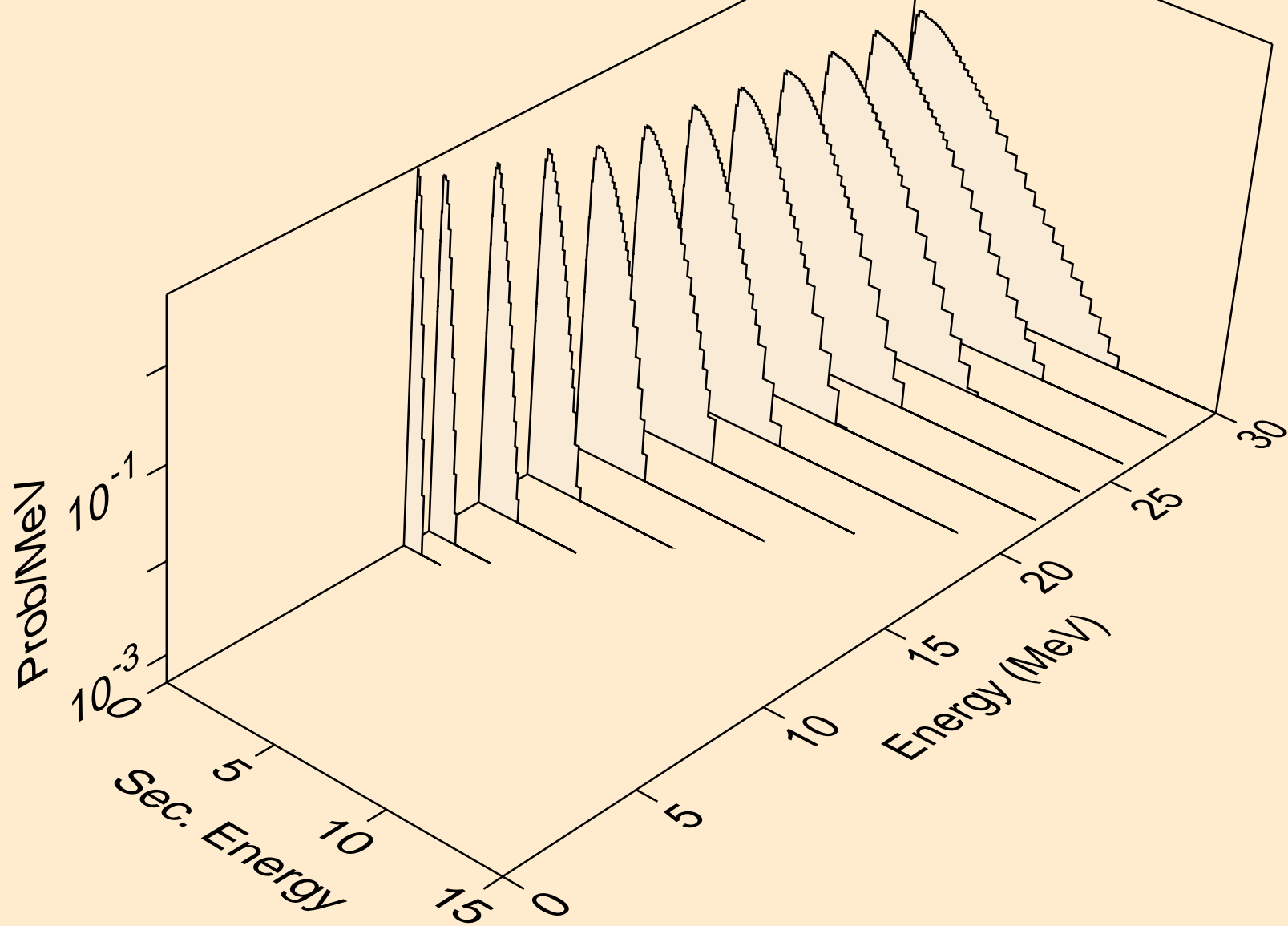

I119 NEUTRON ACER TENDL-2024 LIBRARY; T=293.6K
Neutron emission for (n,n*c)

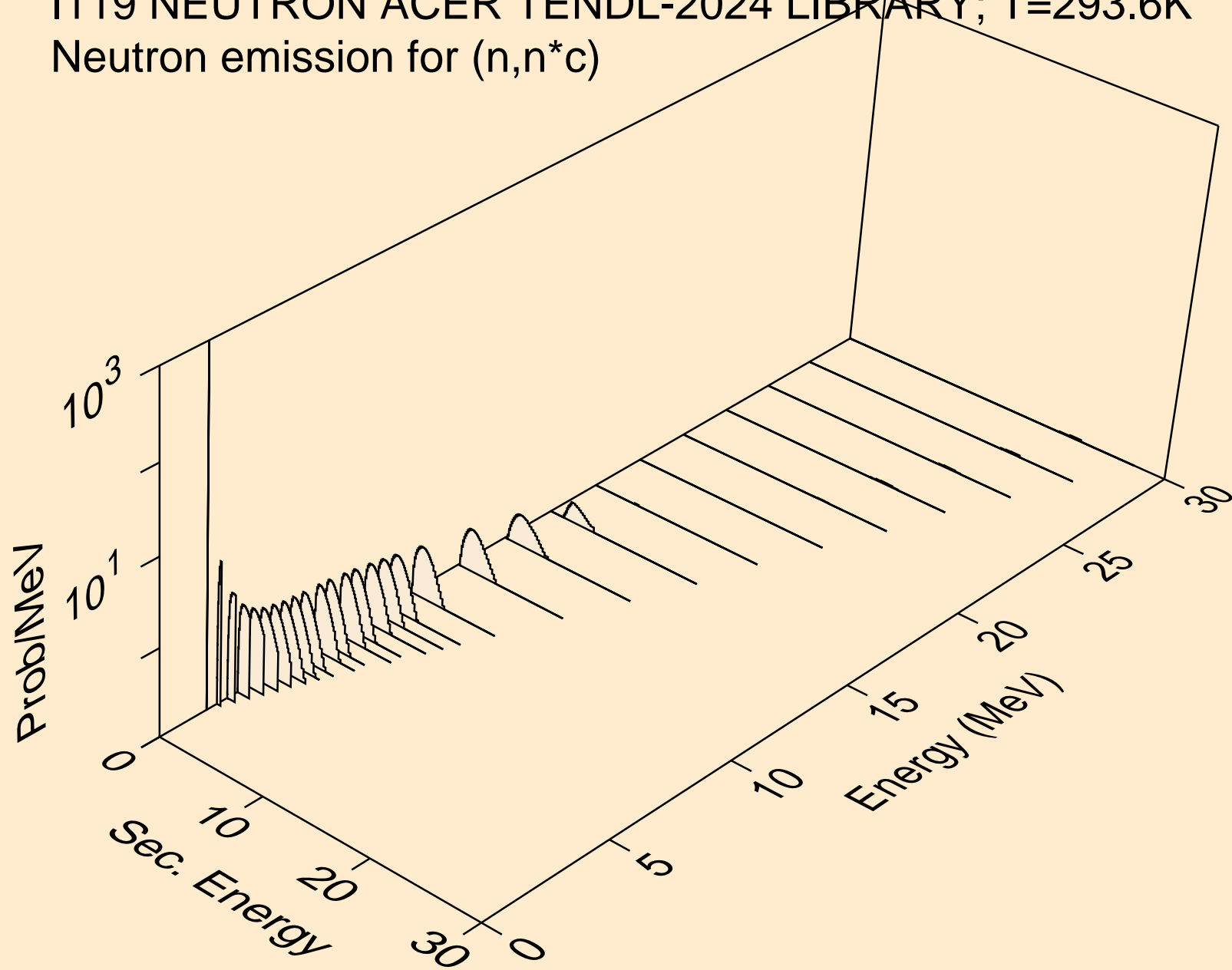

I119 NEUTRON ACER TENDL-2024 LIBRARY; T=293.6K
Photon emission for (n,x)

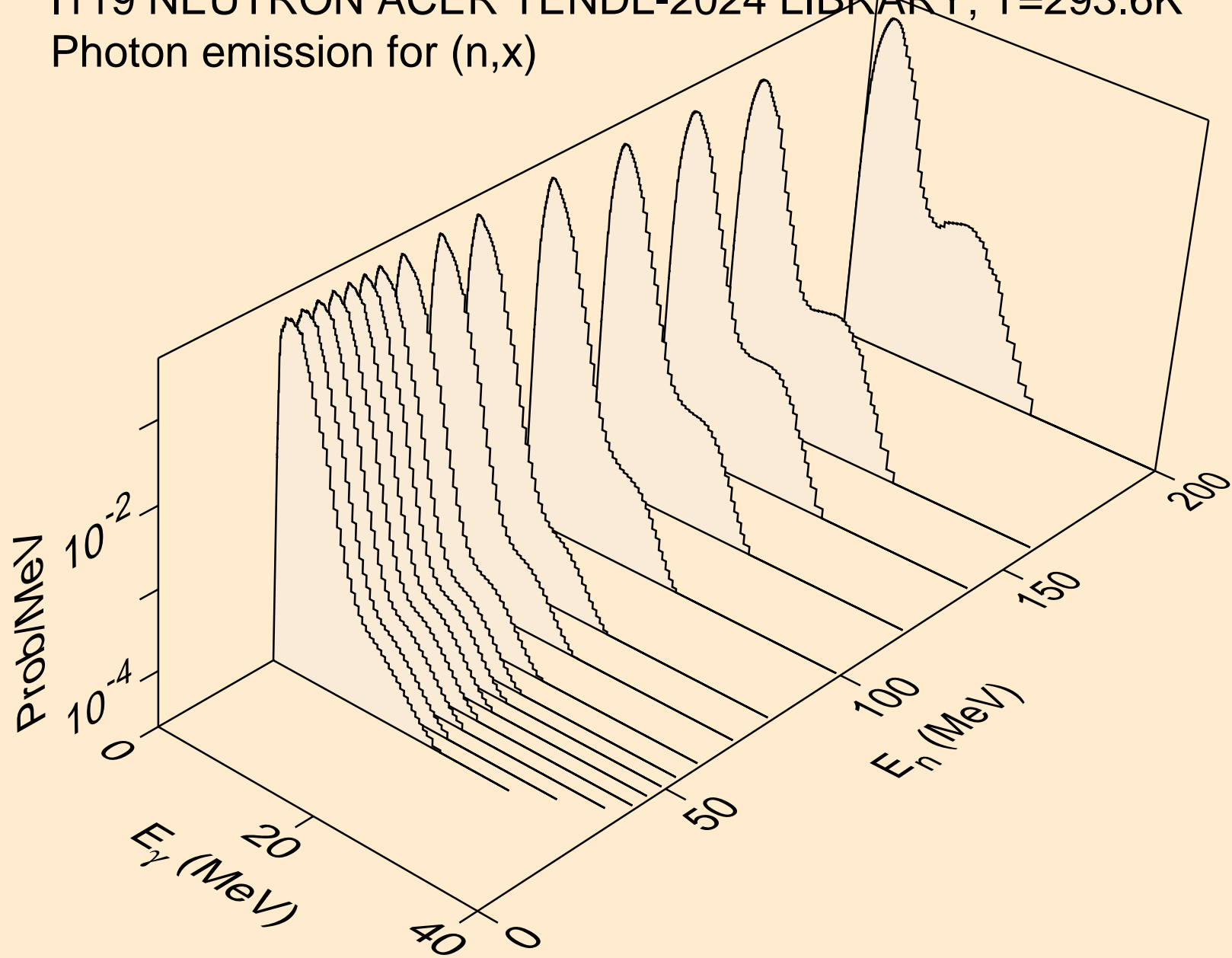

I119 NEUTRON ACER TENDL-2024 LIBRARY; T=293.6K
Photon emission for (n,2nd)

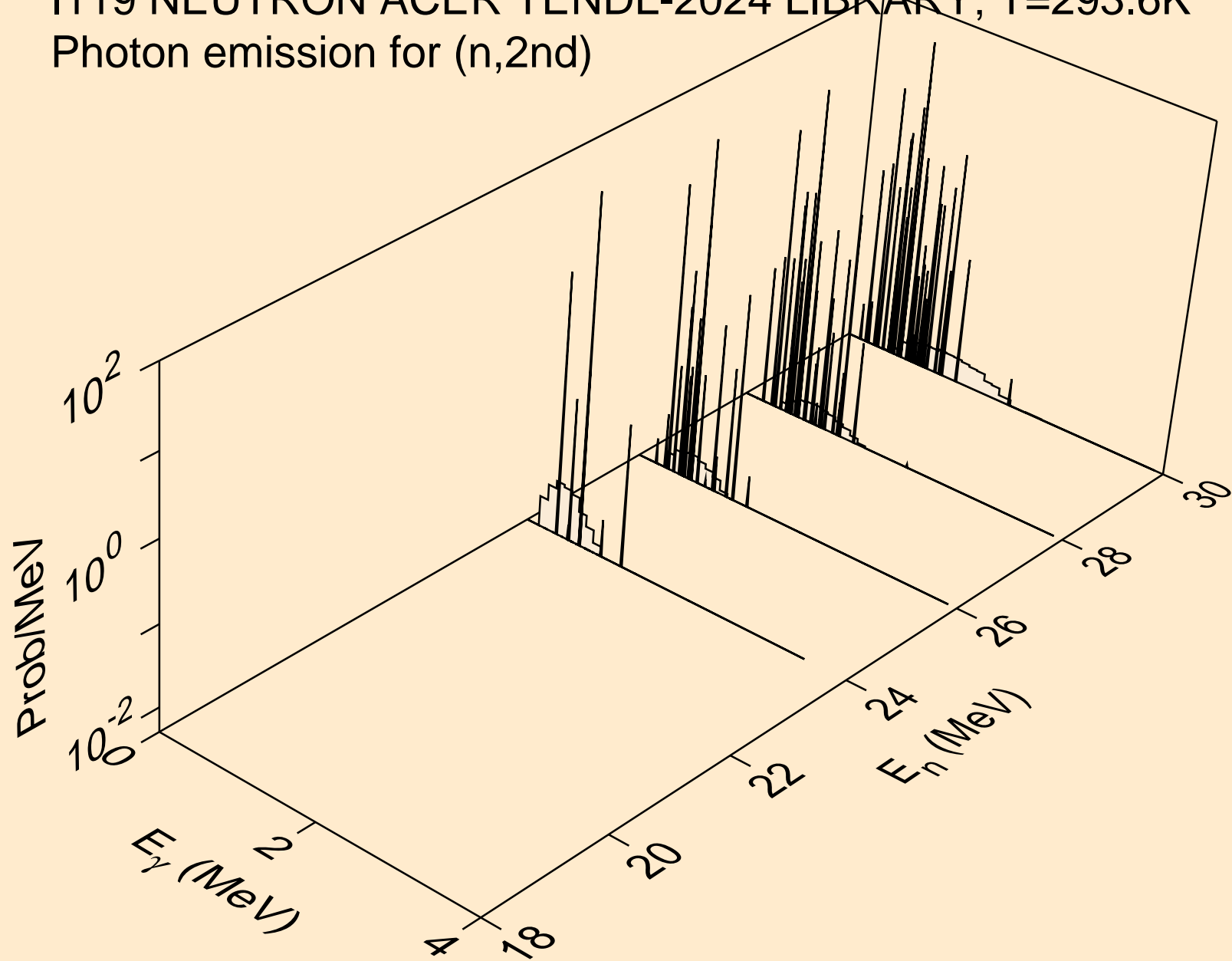

I119 NEUTRON ACER TENDL-2024 LIBRARY; T=293.6K
Photon emission for (n,2n)

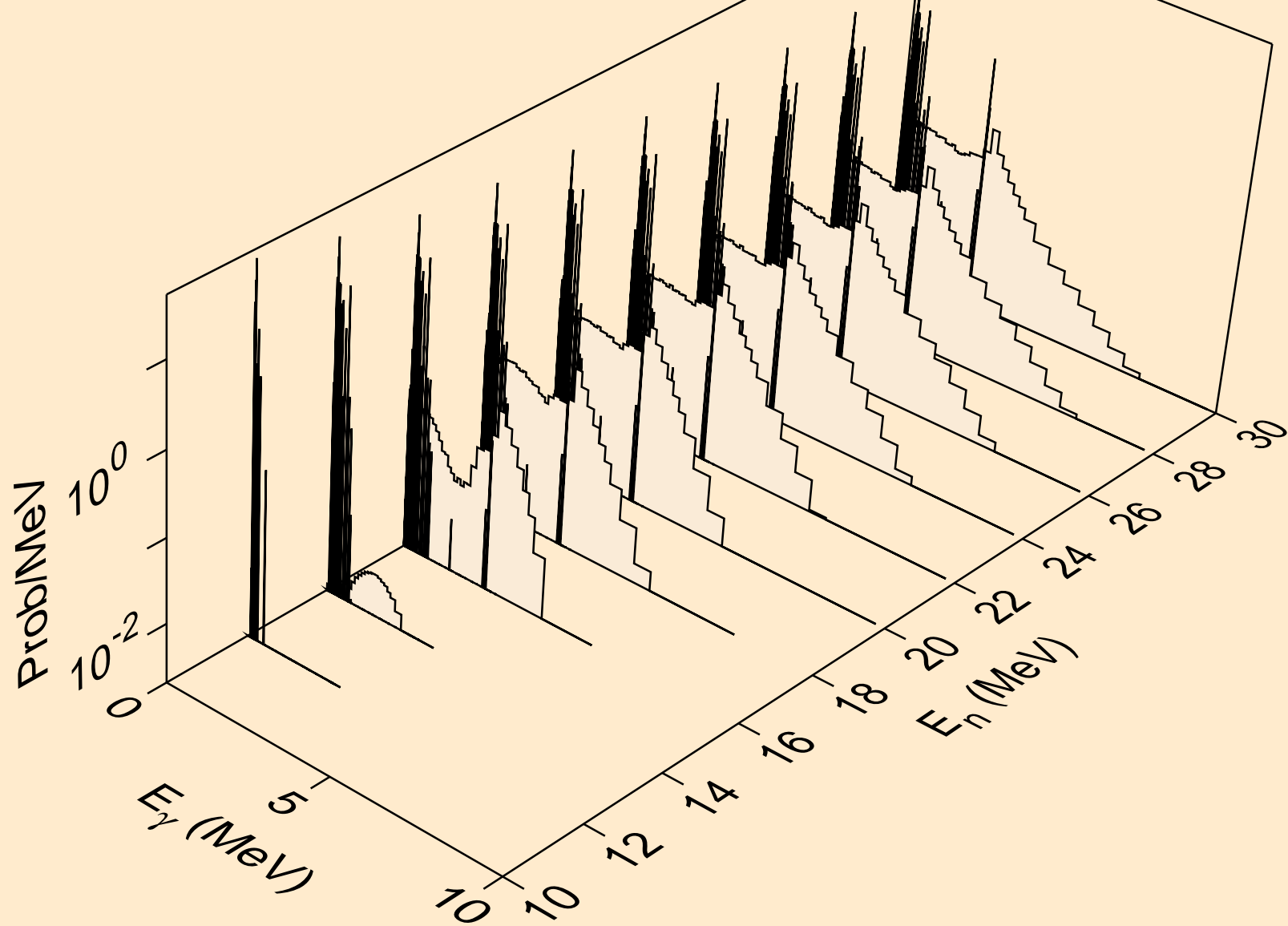

I119 NEUTRON ACER TENDL-2024 LIBRARY; T=293.6K
Photon emission for (n,3n)

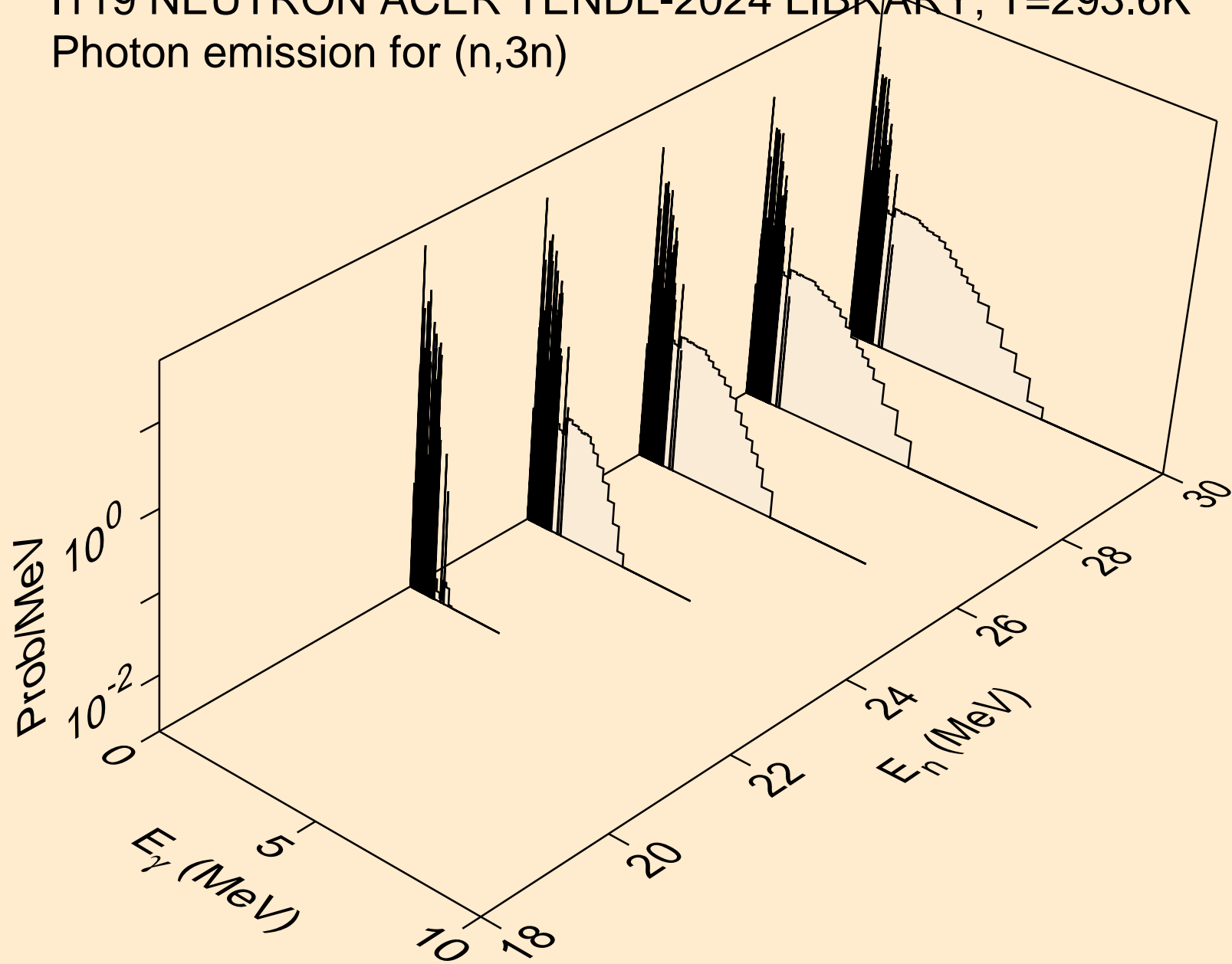

I119 NEUTRON ACER TENDL-2024 LIBRARY; T=293.6K
Photon emission for (n,n*)a

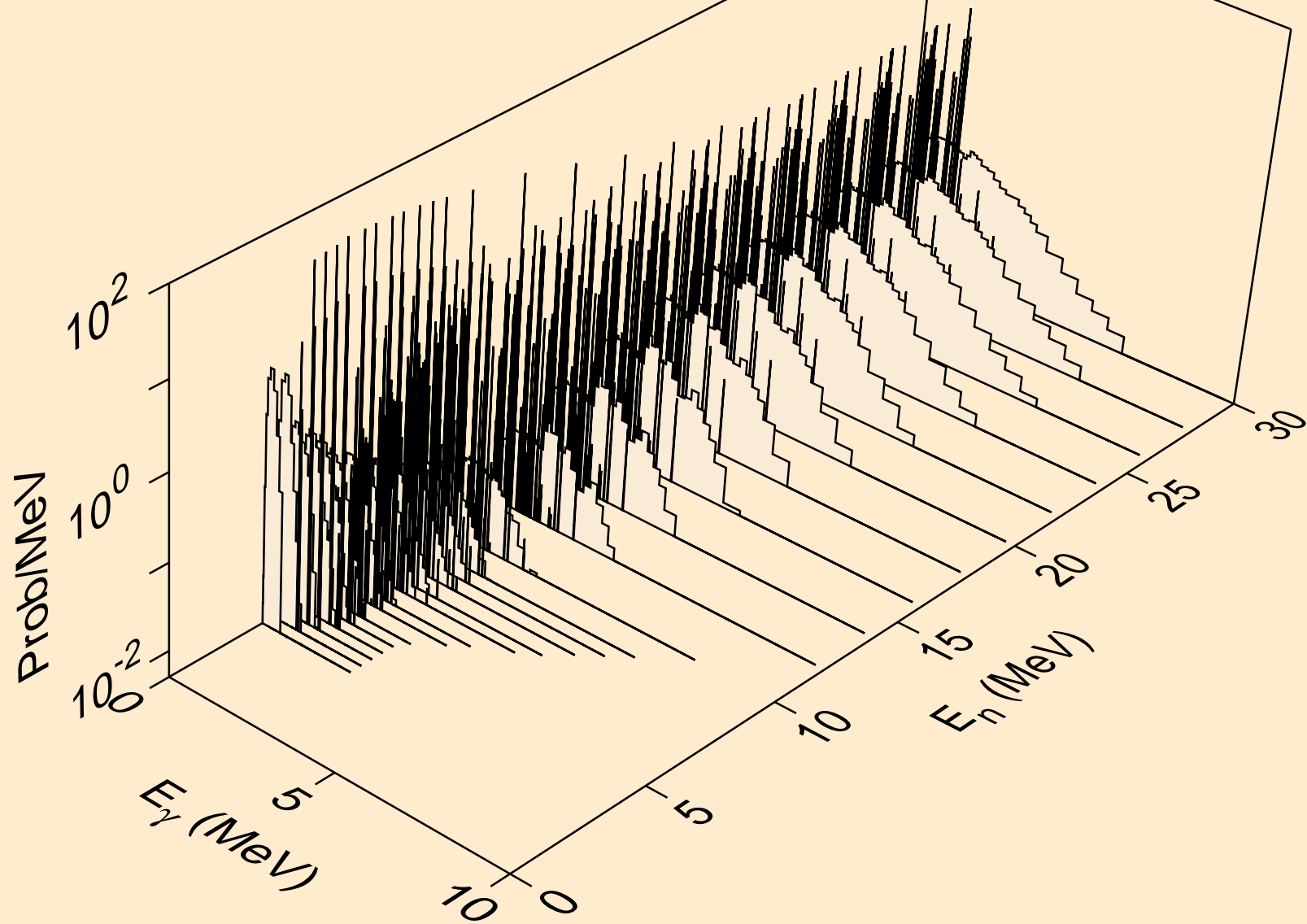

I119 NEUTRON ACER TENDL-2024 LIBRARY; T=293.6K
Photon emission for (n,2n)a

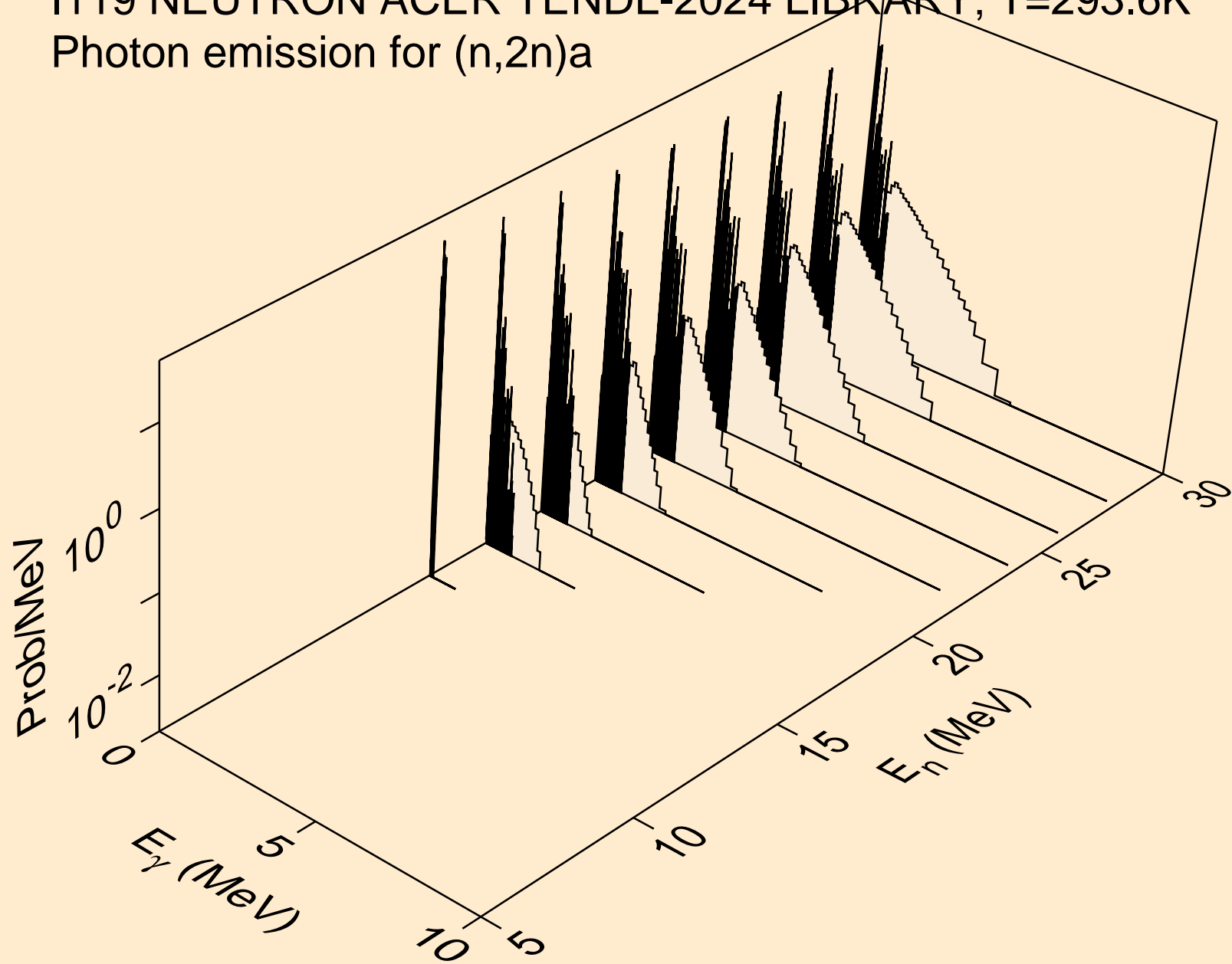

I119 NEUTRON ACER TENDL-2024 LIBRARY; T=293.6K
Photon emission for (n,3n)a

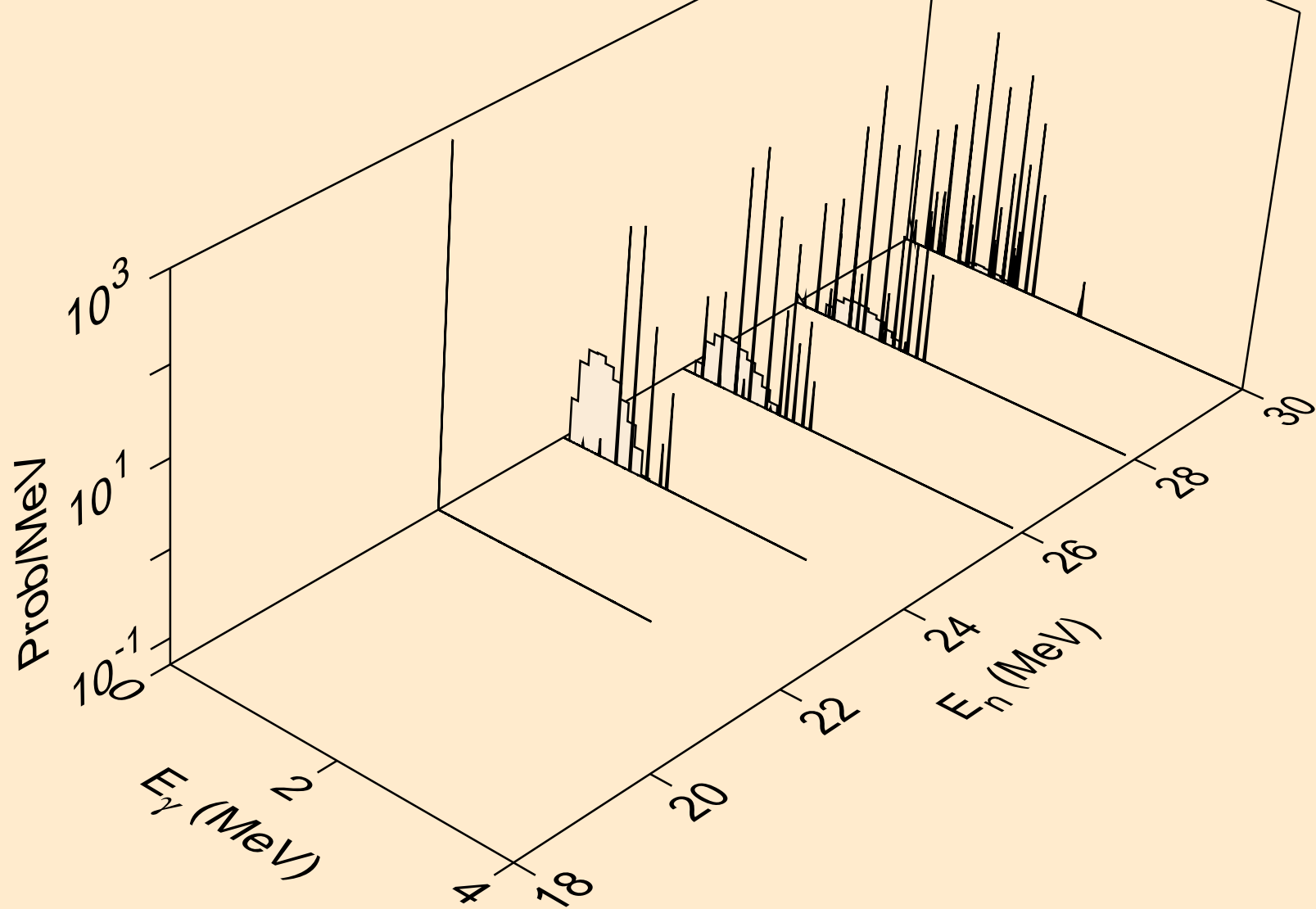

I119 NEUTRON ACER TENDL-2024 LIBRARY; T=293.6K
Photon emission for (n,n*)p

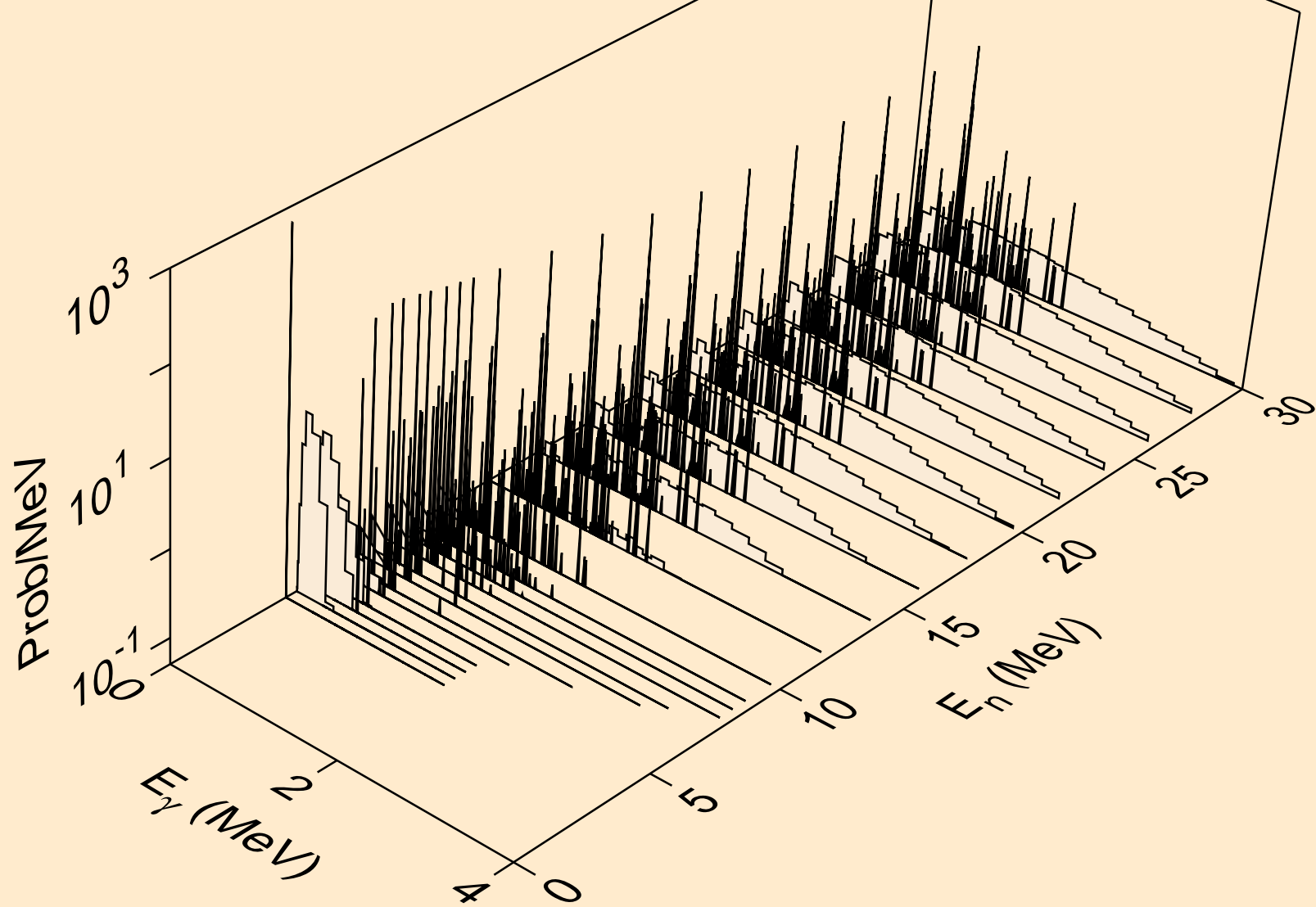

I119 NEUTRON ACER TENDL-2024 LIBRARY; T=293.6K
Photon emission for (n,n*)2a

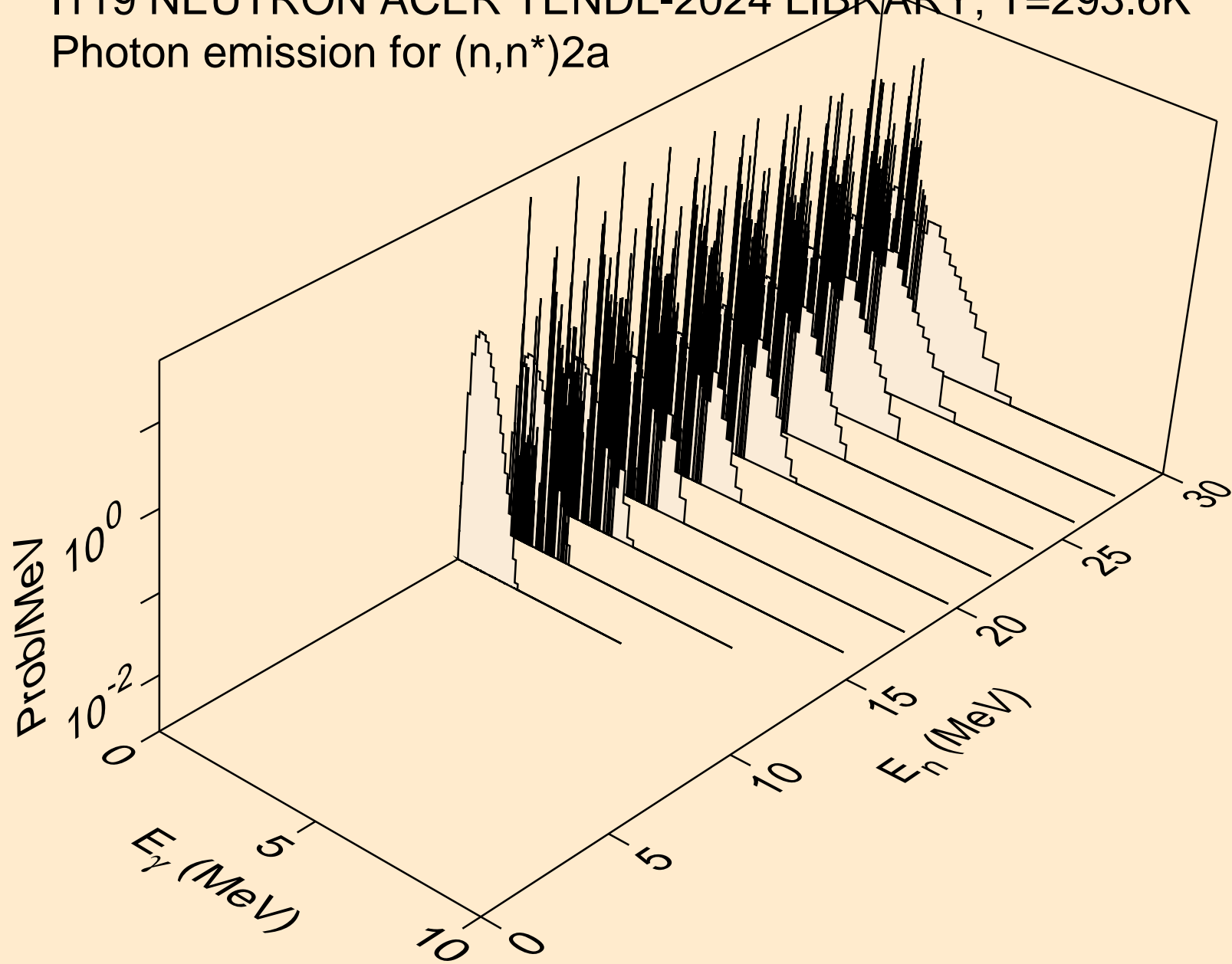

I119 NEUTRON ACER TENDL-2024 LIBRARY; T=293.6K
Photon emission for (n,2n)2a

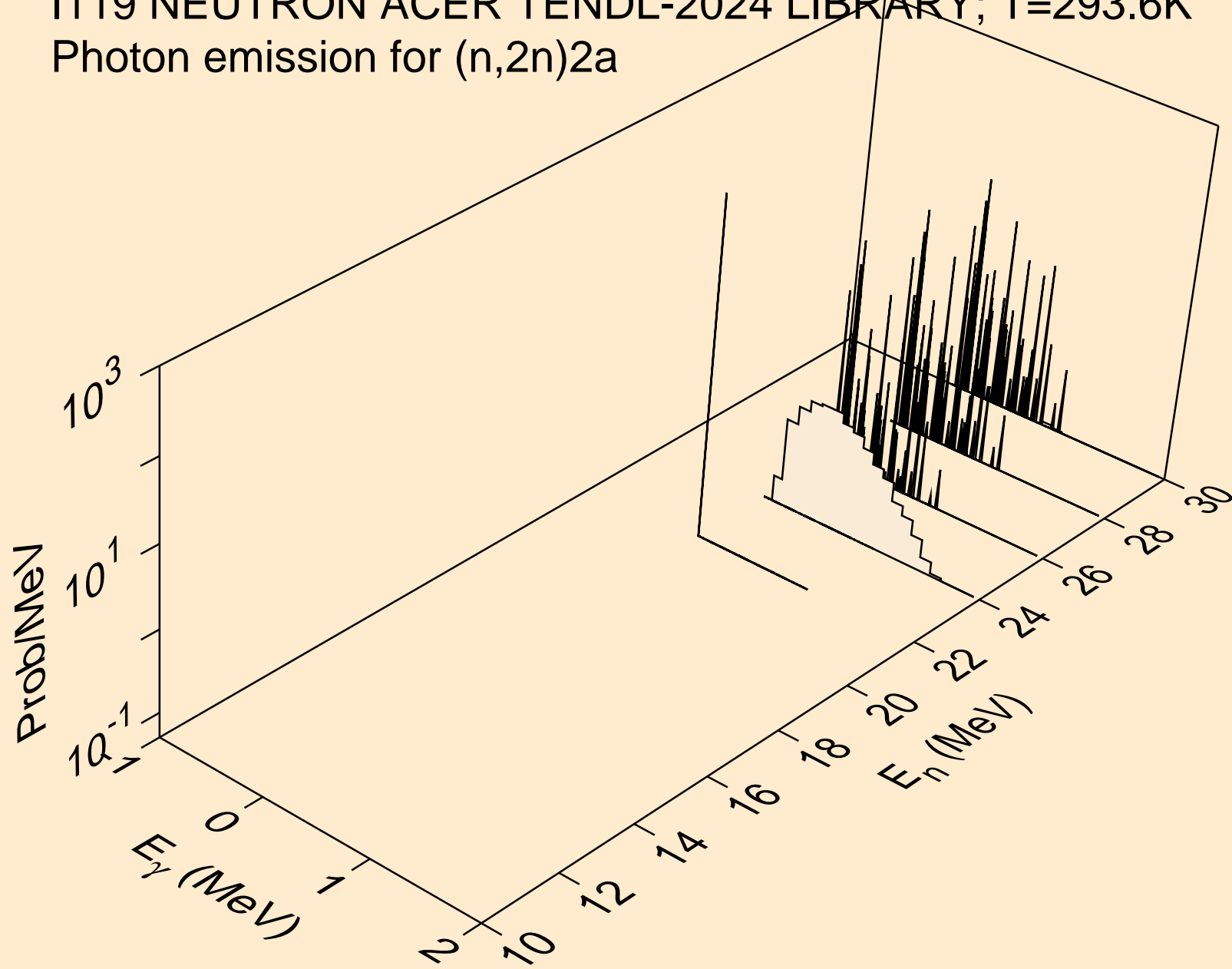

I119 NEUTRON ACER TENDL-2024 LIBRARY; T=293.6K
Photon emission for (n,n*)d

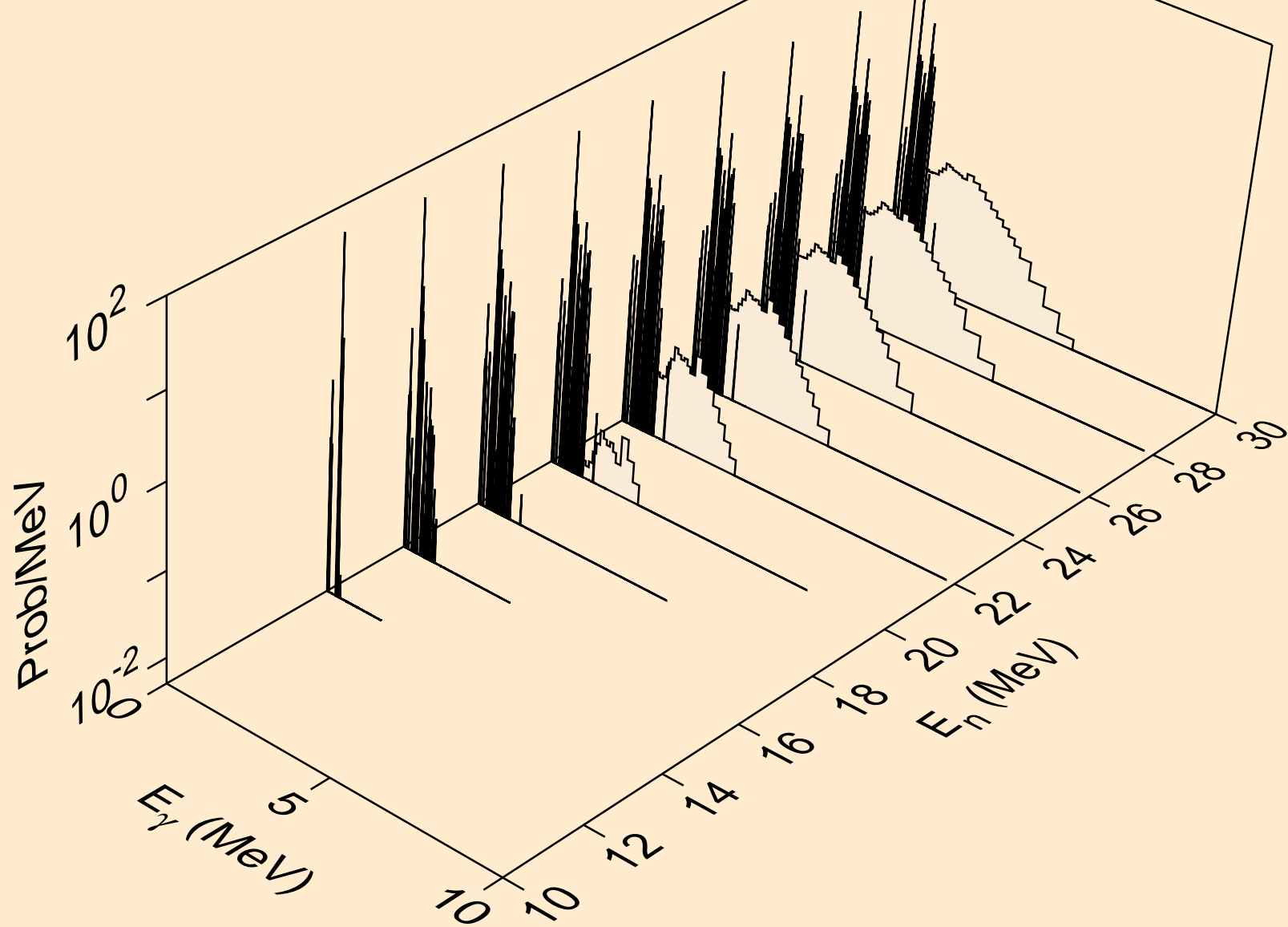

I119 NEUTRON ACER TENDL-2024 LIBRARY; T=293.6K
Photon emission for (n,n*)t

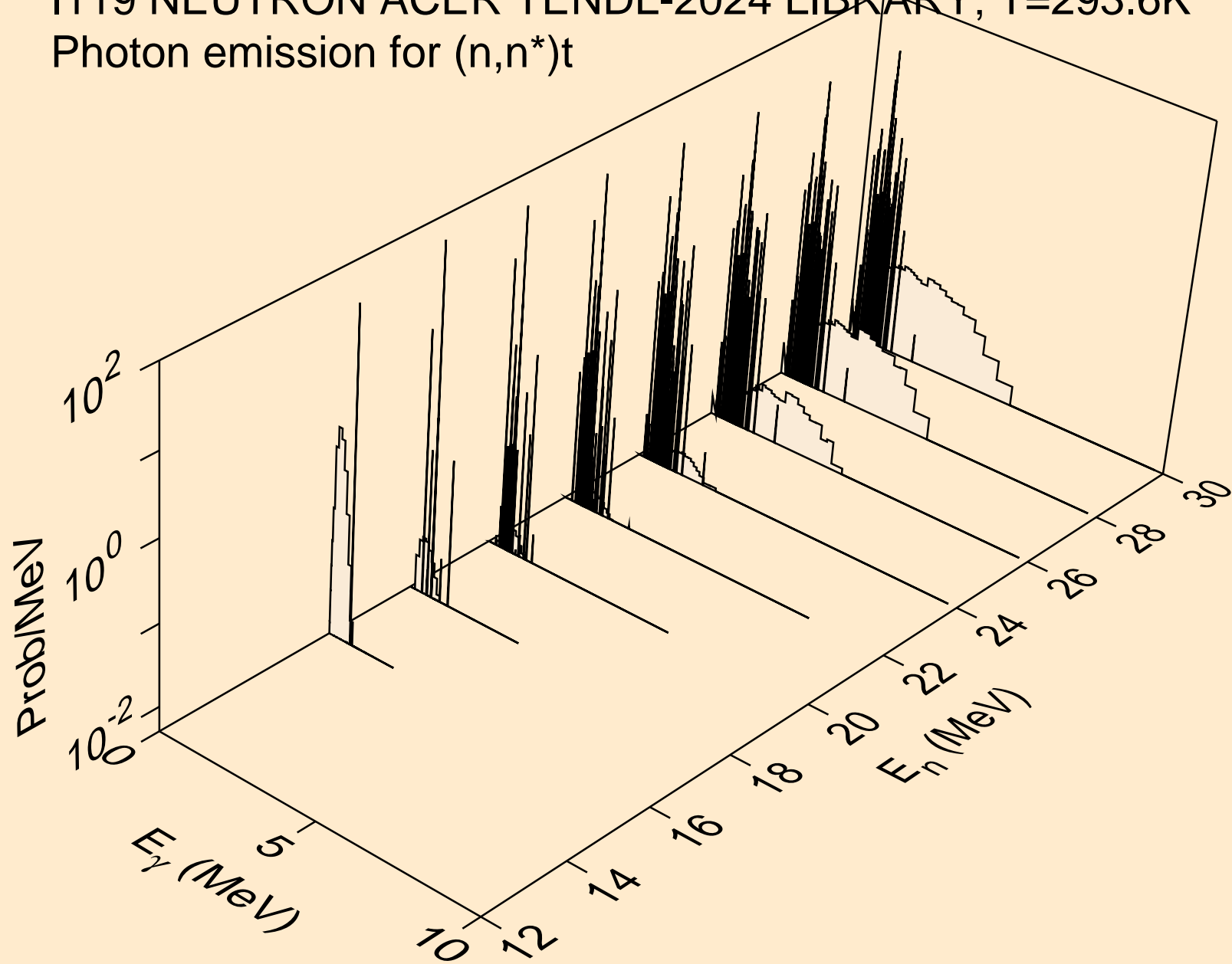

I119 NEUTRON ACER TENDL-2024 LIBRARY; T=293.6K
Photon emission for (n,n*)he3

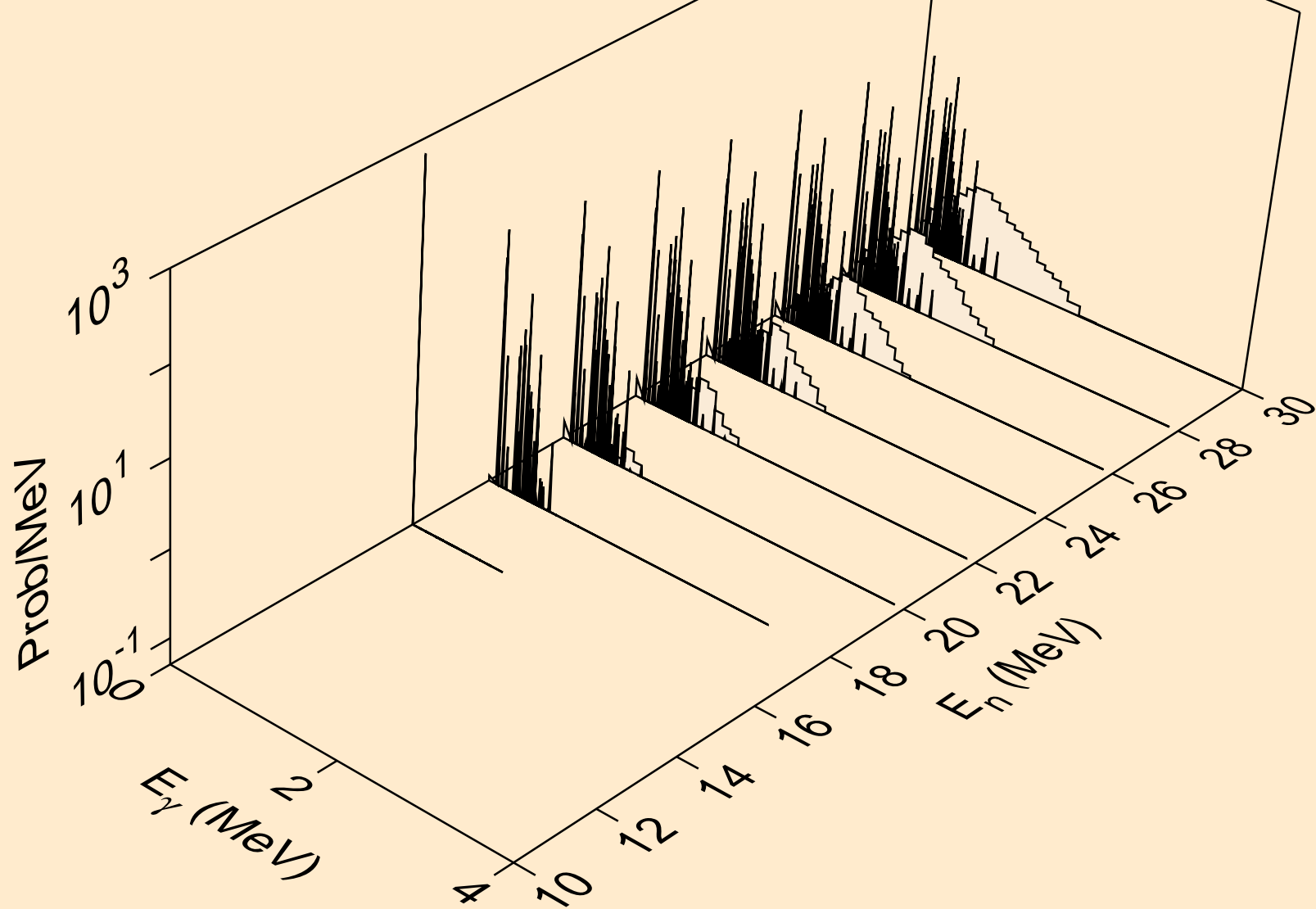

I119 NEUTRON ACER TENDL-2024 LIBRARY; T=293.6K
Photon emission for (n,2np)

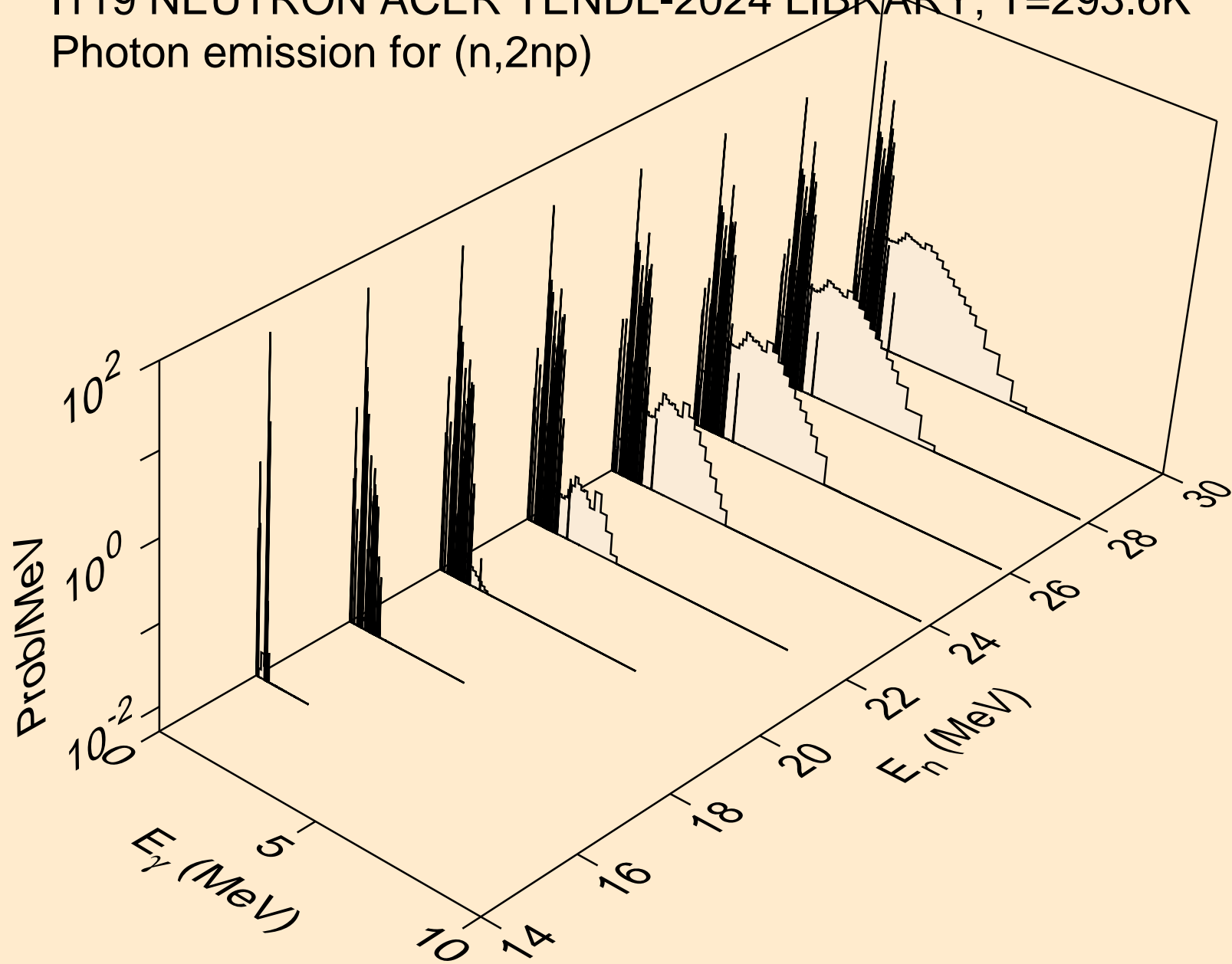

I119 NEUTRON ACER TENDL-2024 LIBRARY; T=293.6K
Photon emission for (n,3np)

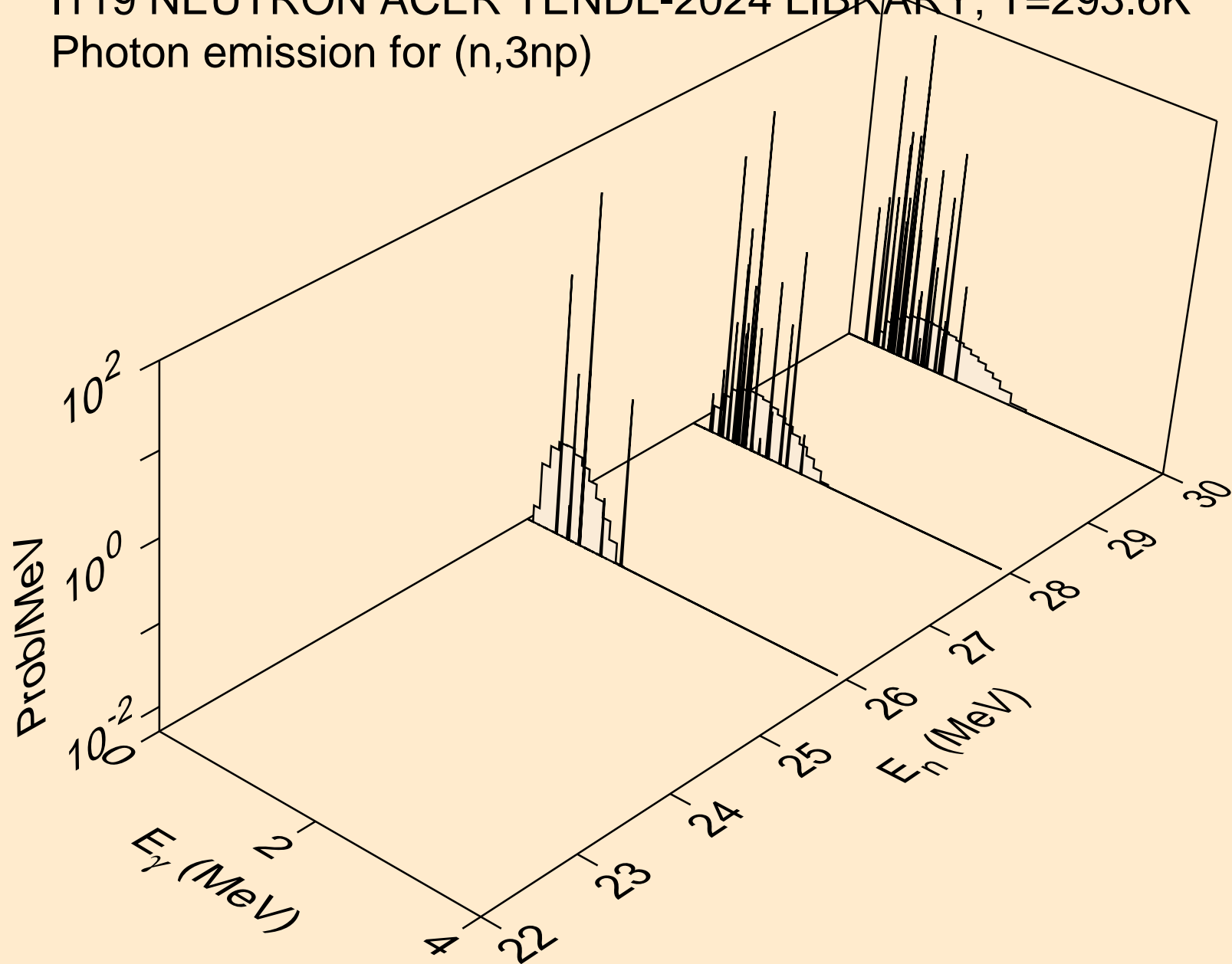

I119 NEUTRON ACER TENDL-2024 LIBRARY; T=293.6K
Photon emission for (n,n2p)

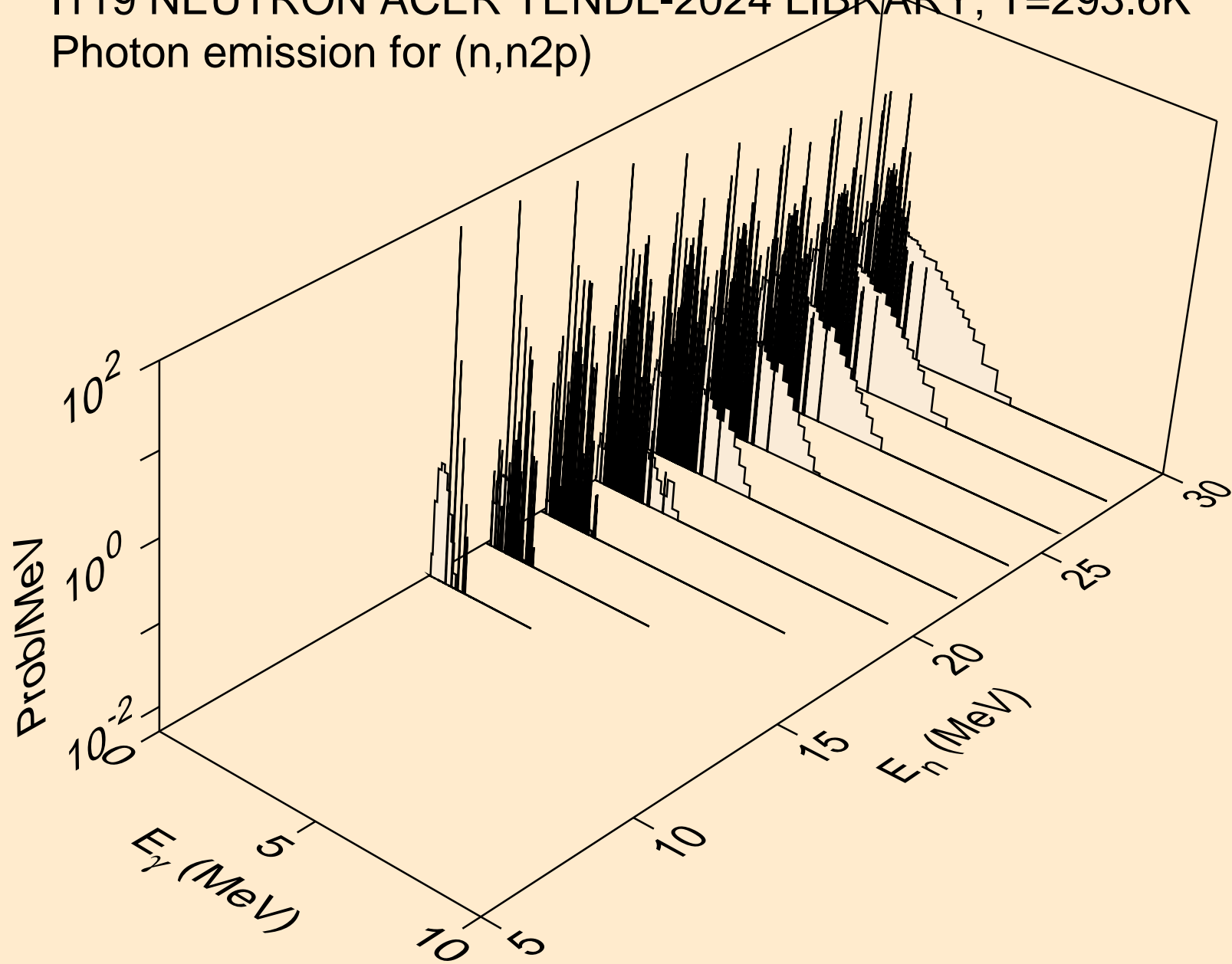

I119 NEUTRON ACER TENDL-2024 LIBRARY; T=293.6K
Photon emission for (n,npa)

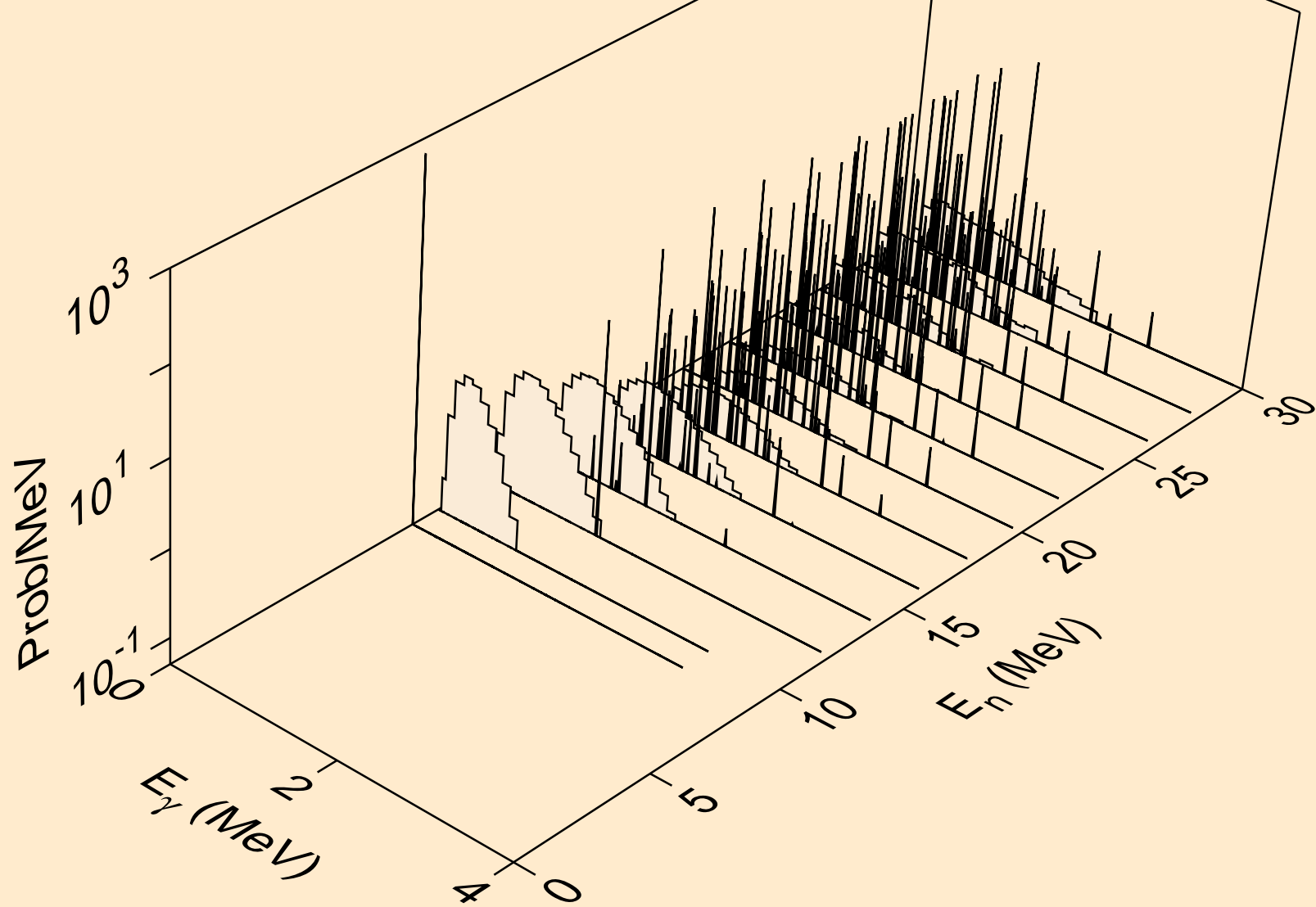

I119 NEUTRON ACER TENDL-2024 LIBRARY; T=293.6K
Photon emission for (n,n*c)

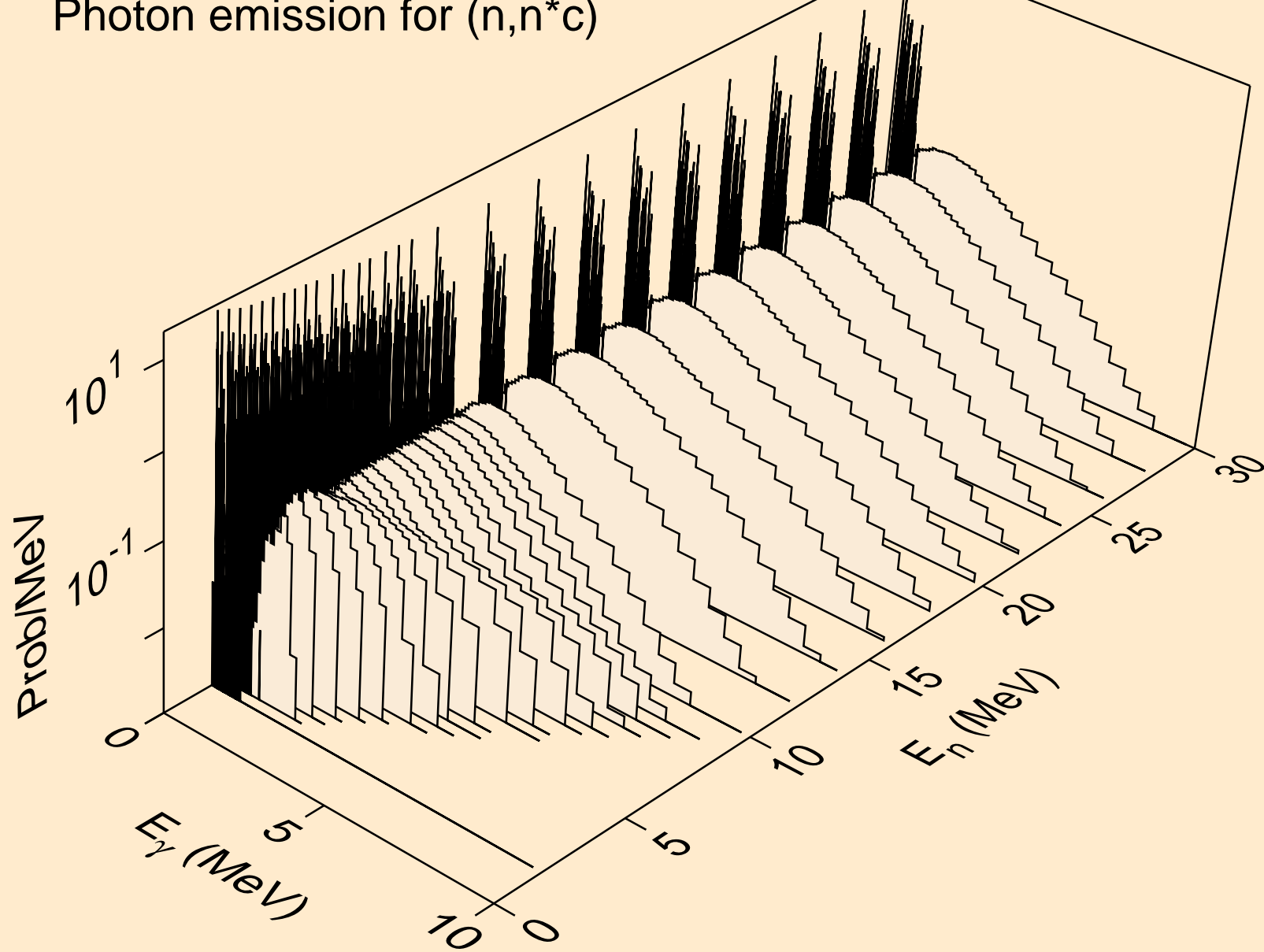

I119 NEUTRON ACER TENDL-2024 LIBRARY; T=293.6K
Photon emission for (n,gma)

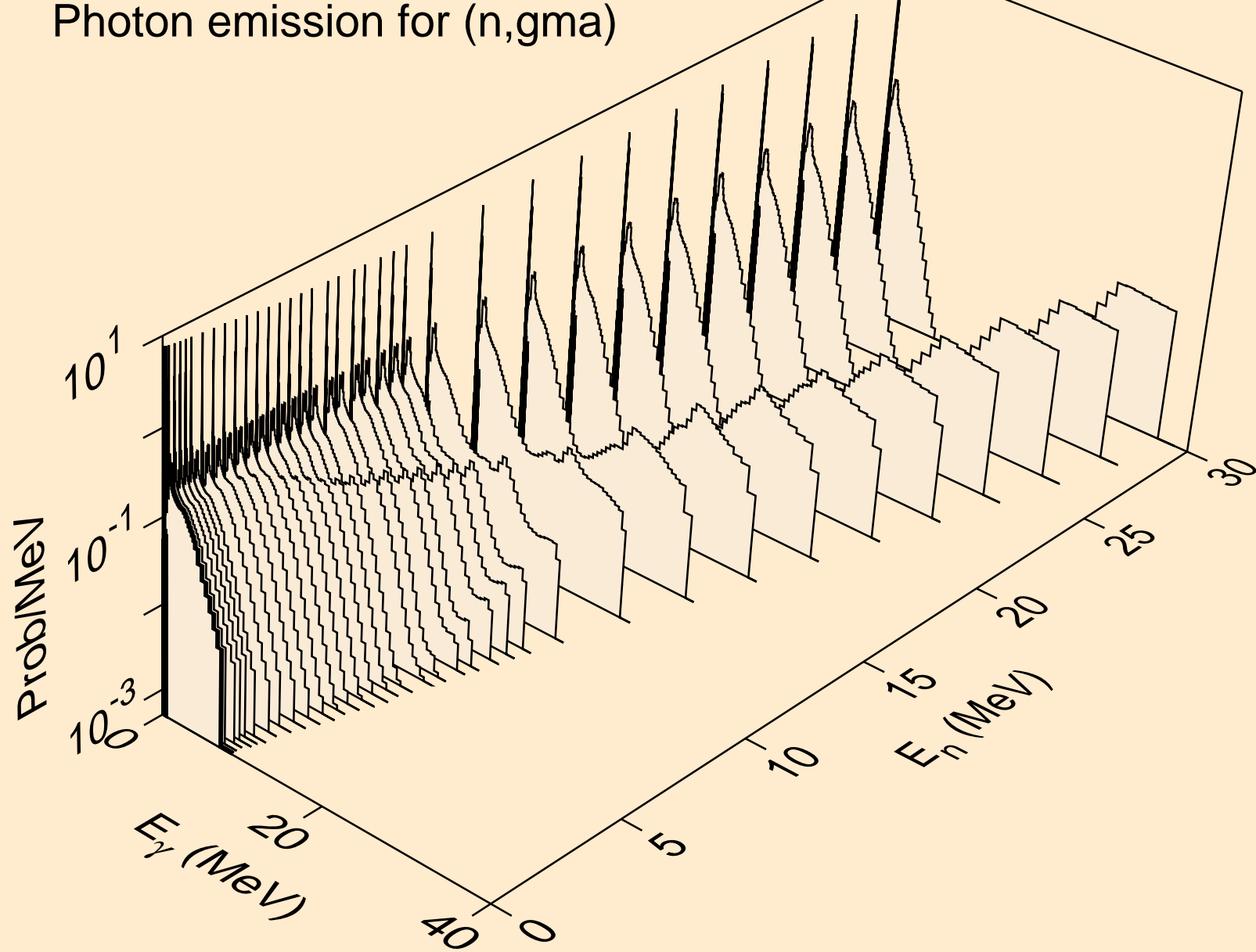

I119 NEUTRON ACER TENDL-2024 LIBRARY; T=293.6K
Photon emission for (n,p)

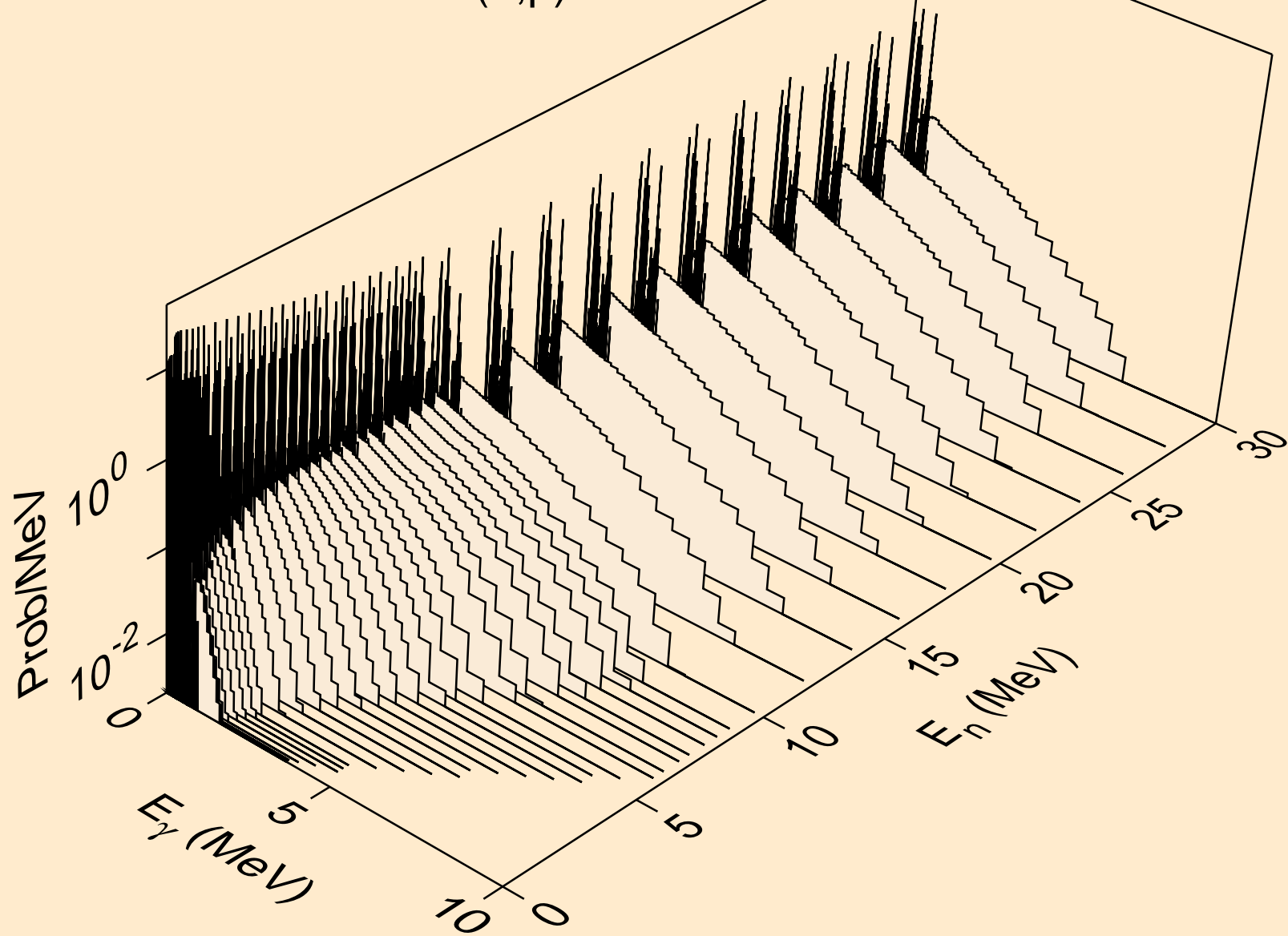

I119 NEUTRON ACER TENDL-2024 LIBRARY; T=293.6K
Photon emission for (n,d)

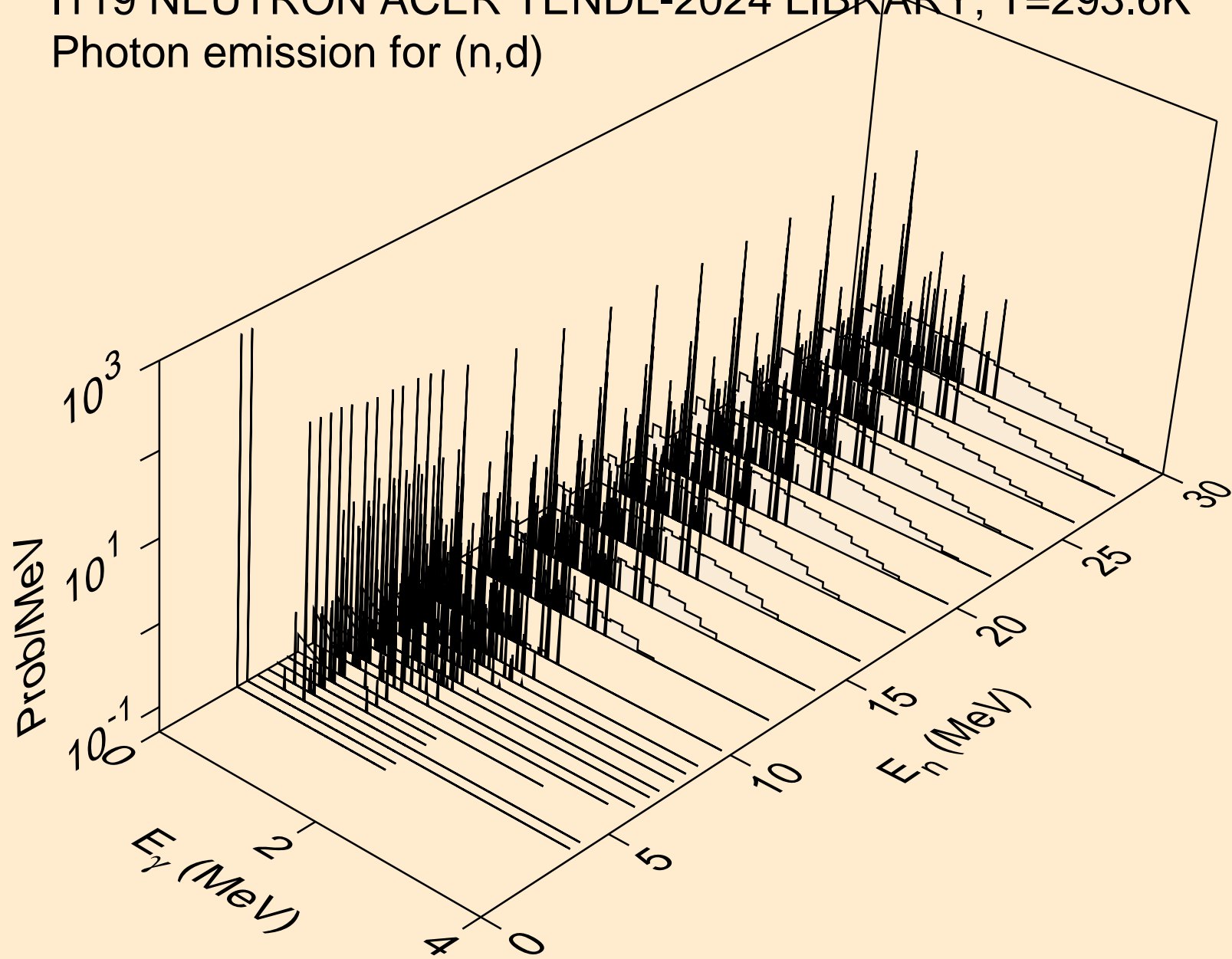

I119 NEUTRON ACER TENDL-2024 LIBRARY; T=293.6K
Photon emission for (n,t)

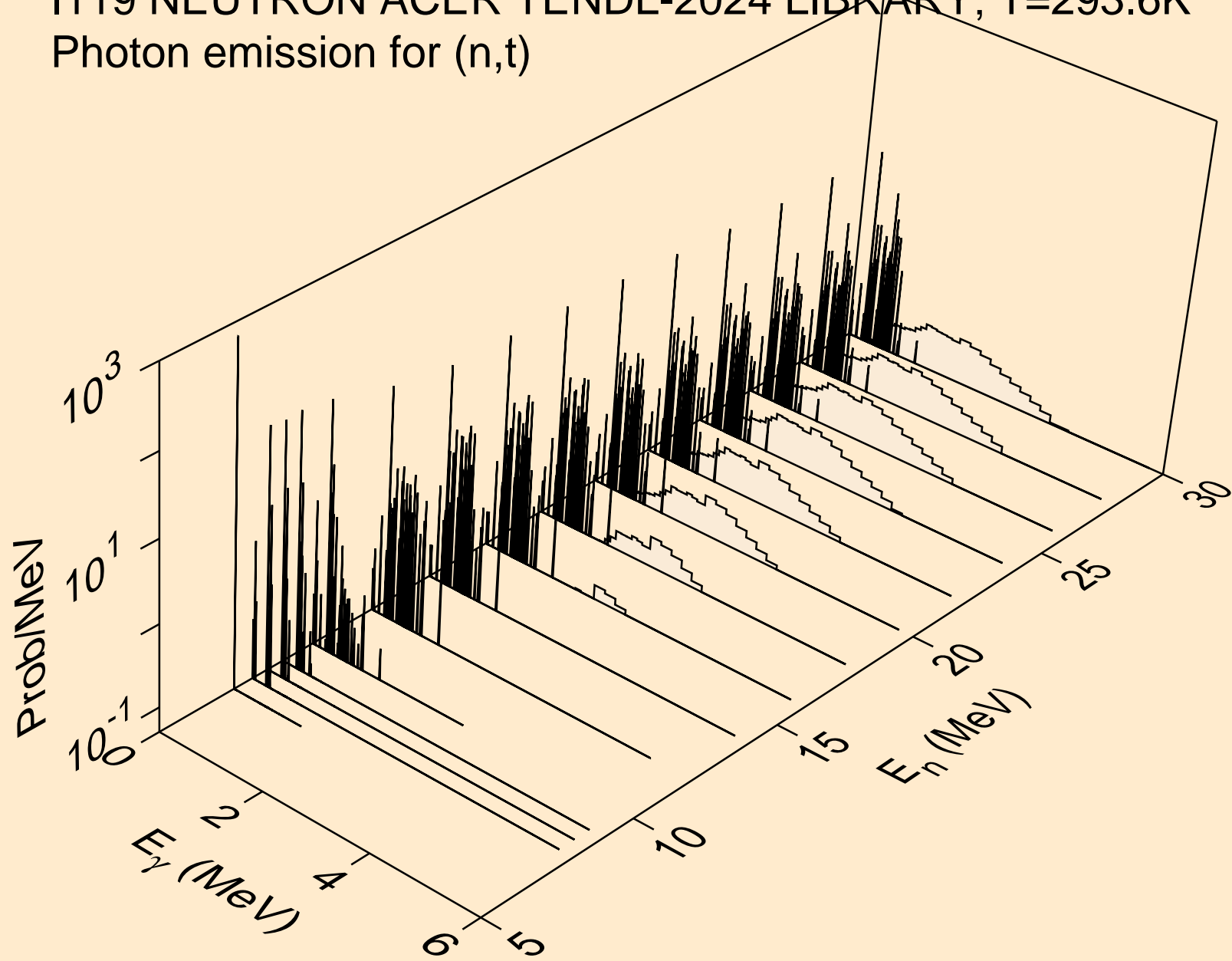

I119 NEUTRON ACER TENDL-2024 LIBRARY; T=293.6K
Photon emission for (n,he3)

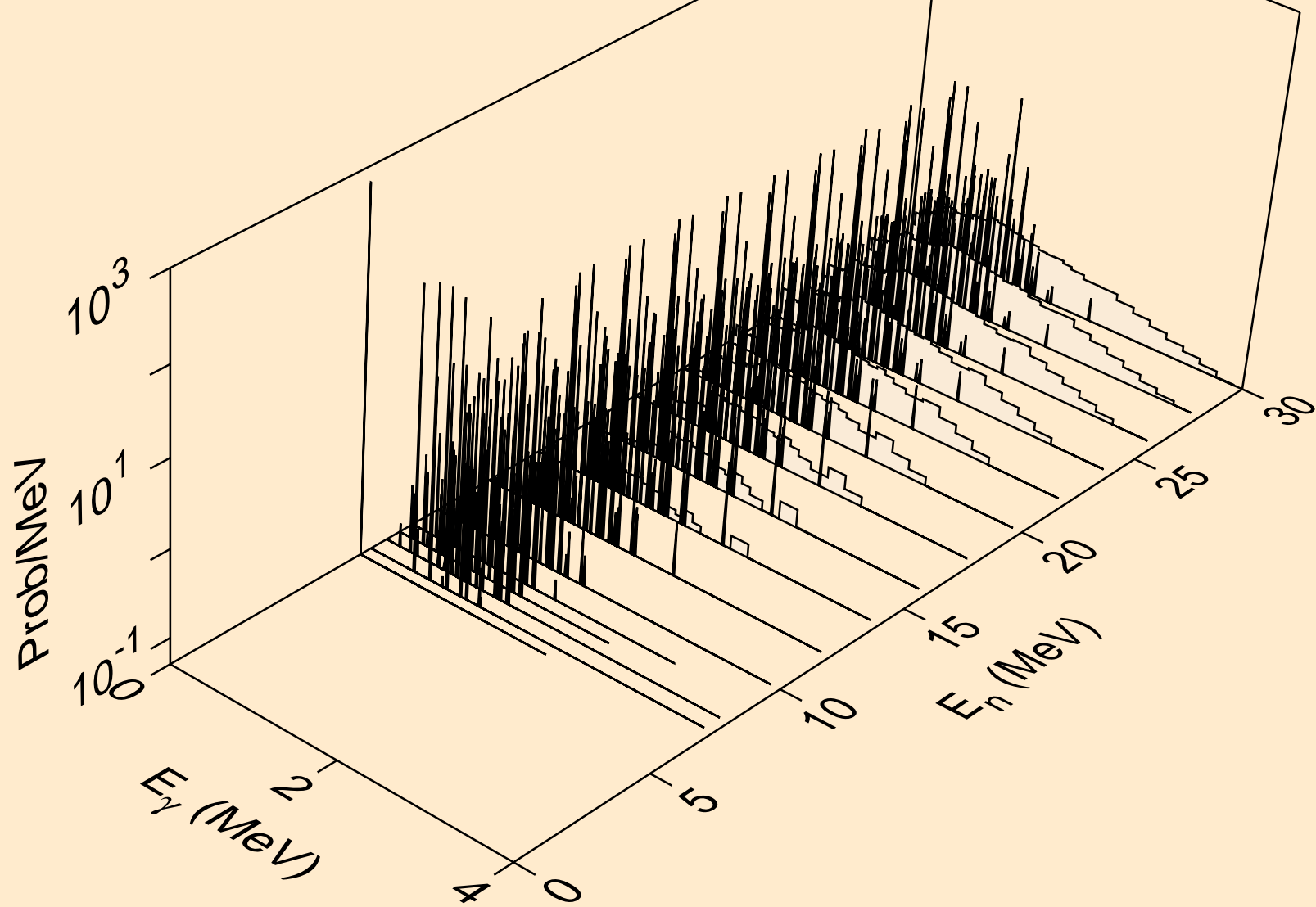

I119 NEUTRON ACER TENDL-2024 LIBRARY; T=293.6K
Photon emission for (n,a)

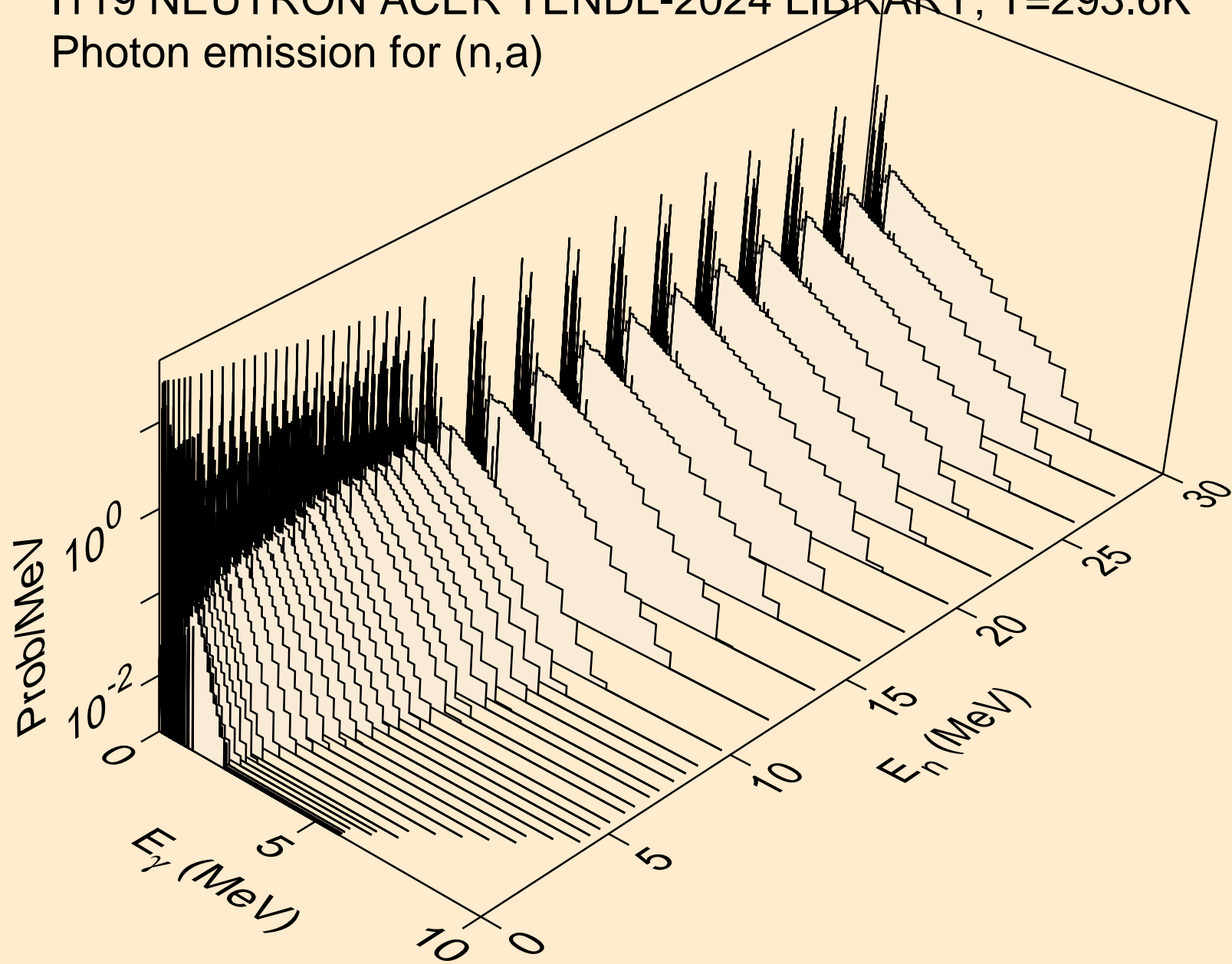

I119 NEUTRON ACER TENDL-2024 LIBRARY; T=293.6K
Photon emission for (n,2a)

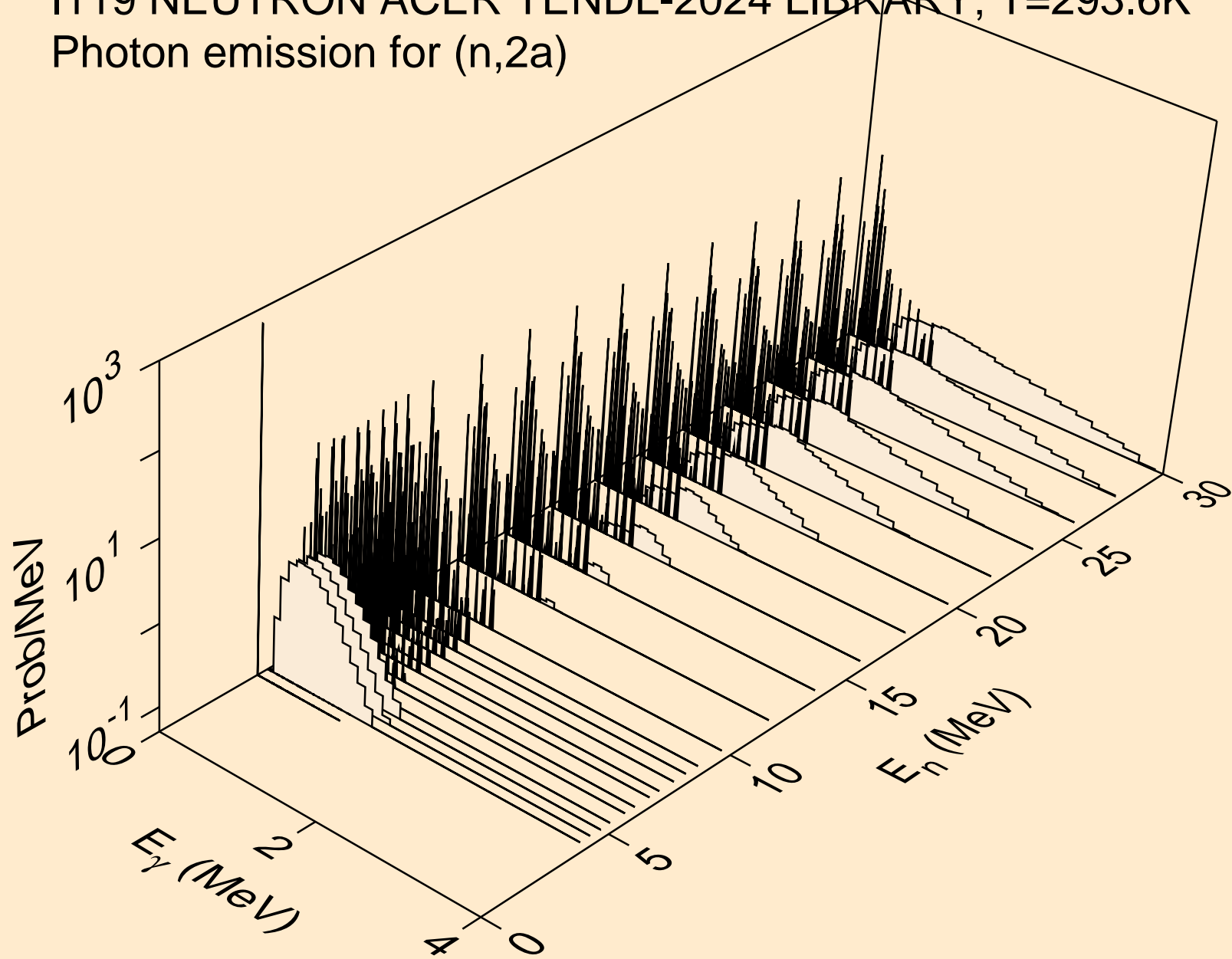

I119 NEUTRON ACER TENDL-2024 LIBRARY; T=293.6K
Photon emission for (n,2p)

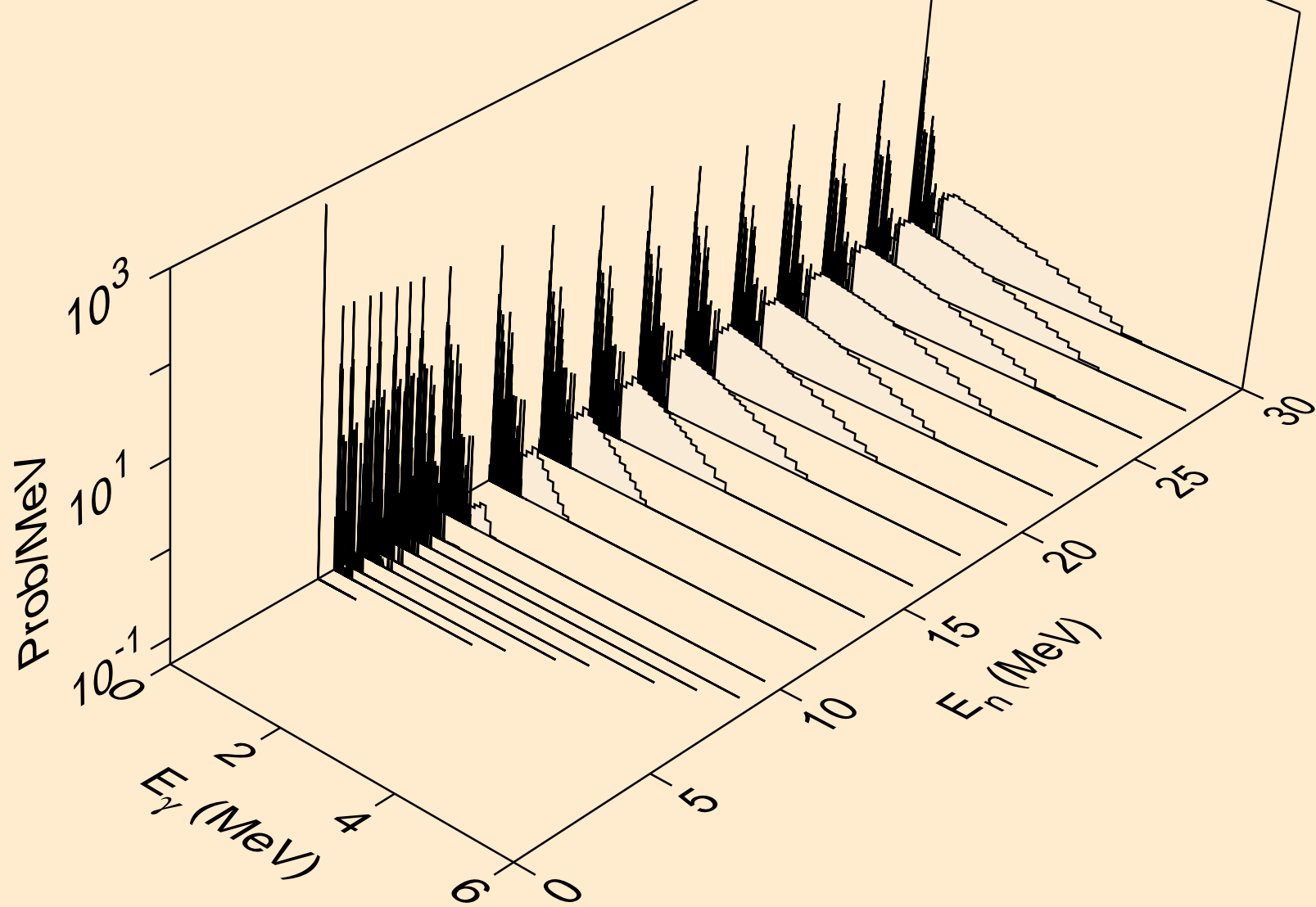

I119 NEUTRON ACER TENDL-2024 LIBRARY; T=293.6K
Photon emission for (n,p α)

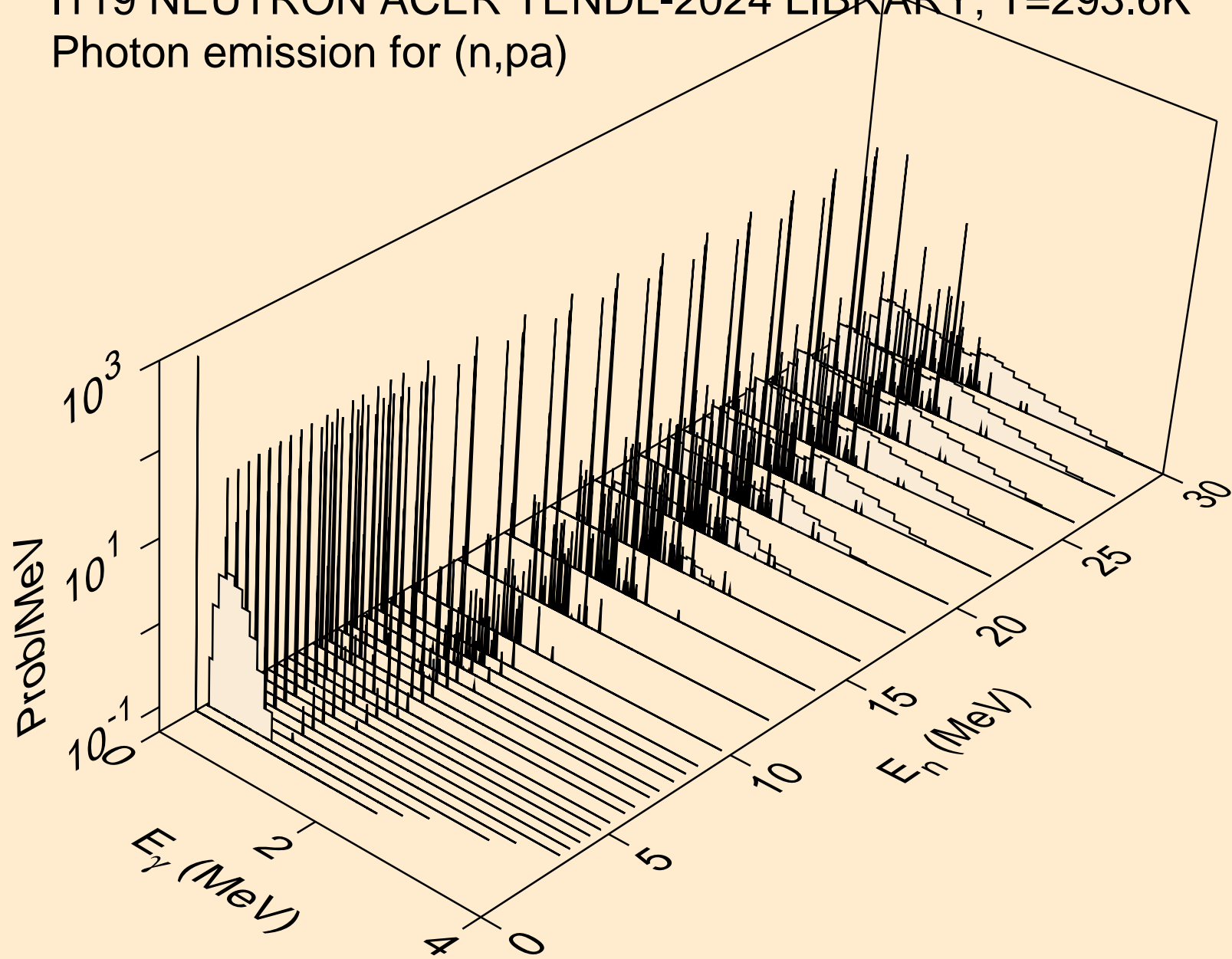

I119 NEUTRON ACER TENDL-2024 LIBRARY; T=293.6K
Photon emission for (n,pd)

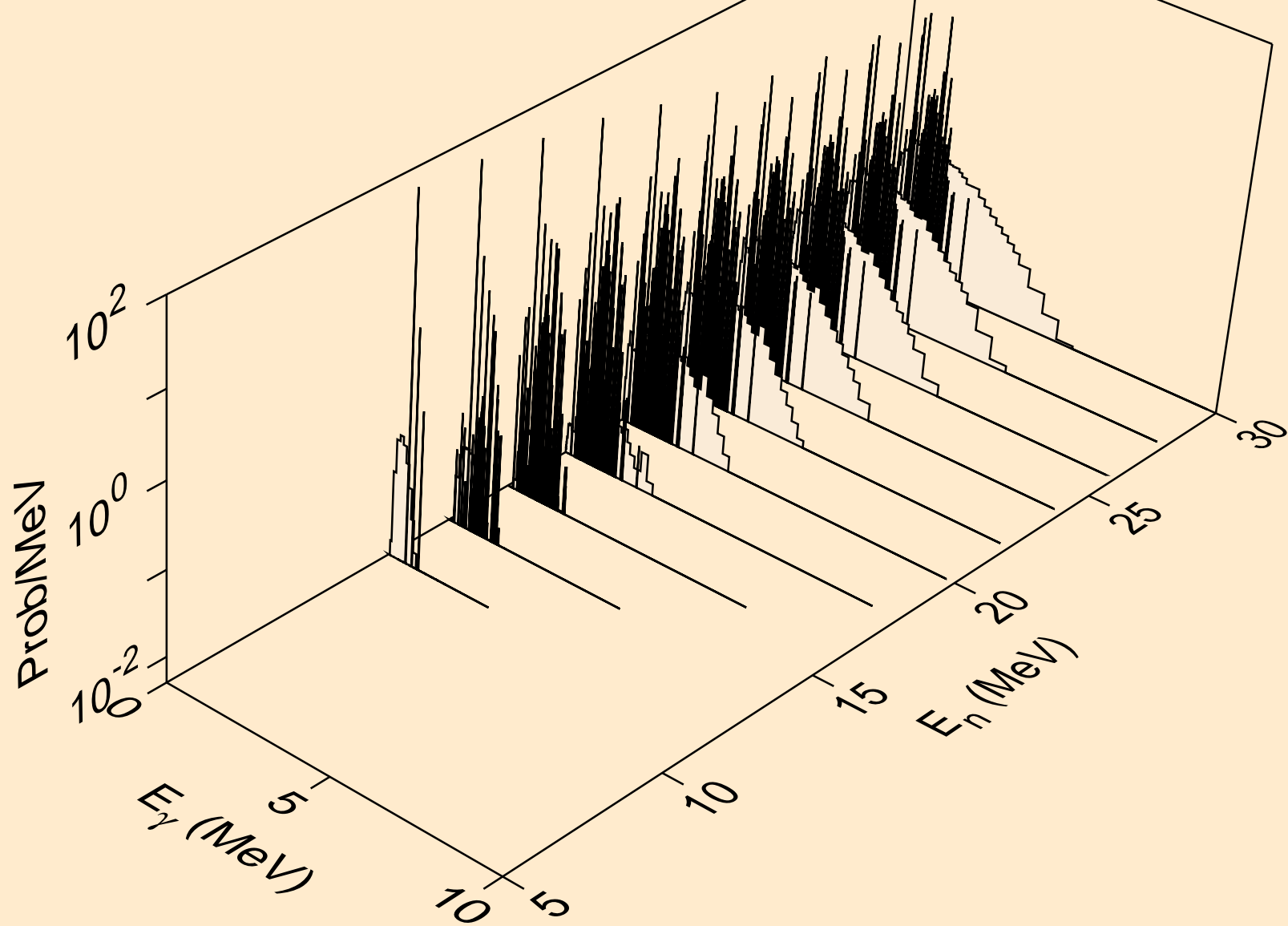

I119 NEUTRON ACER TENDL-2024 LIBRARY; T=293.6K
Photon emission for (n,pt)

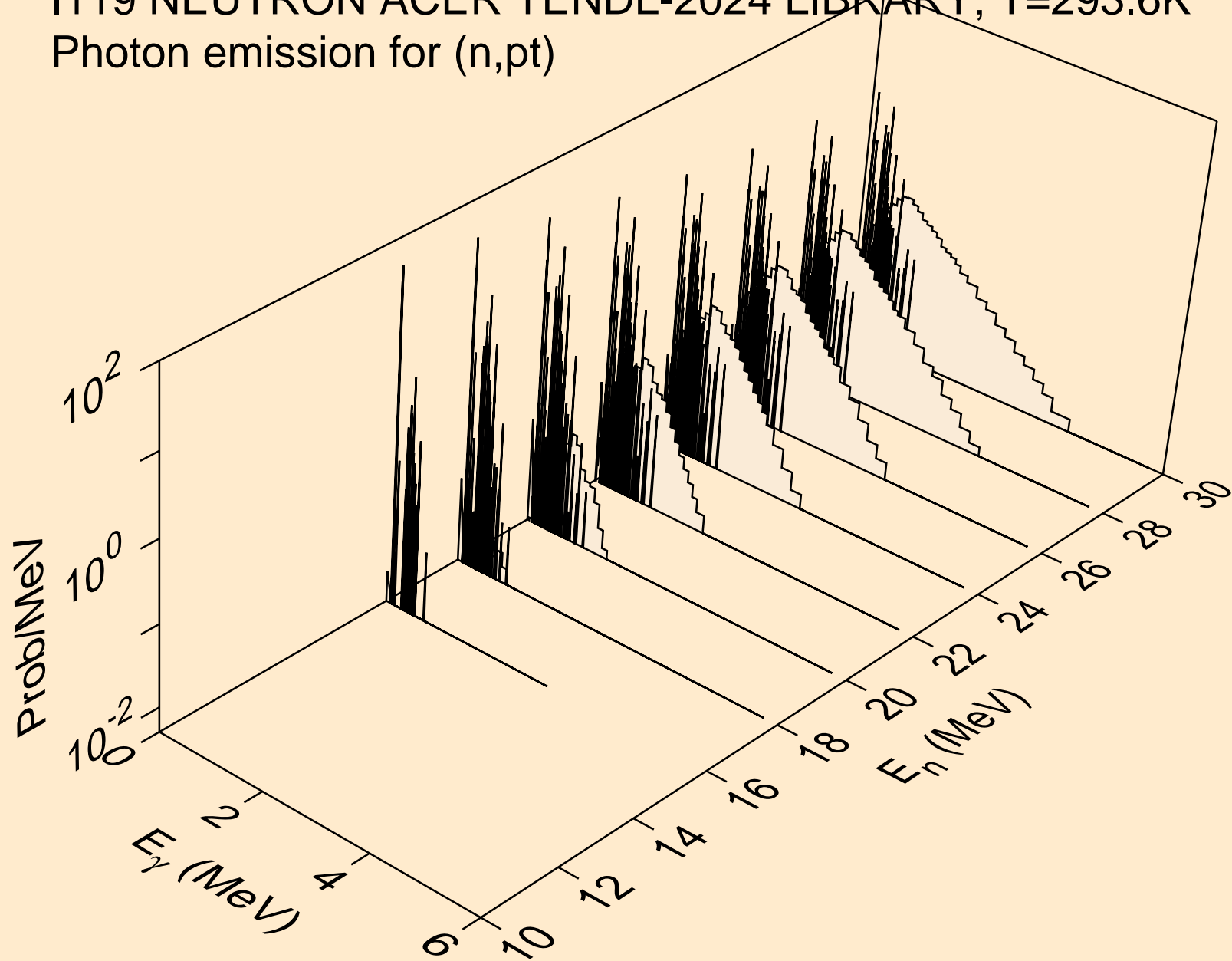

I119 NEUTRON ACER TENDL-2024 LIBRARY; T=293.6K
Photon emission for (n,da)

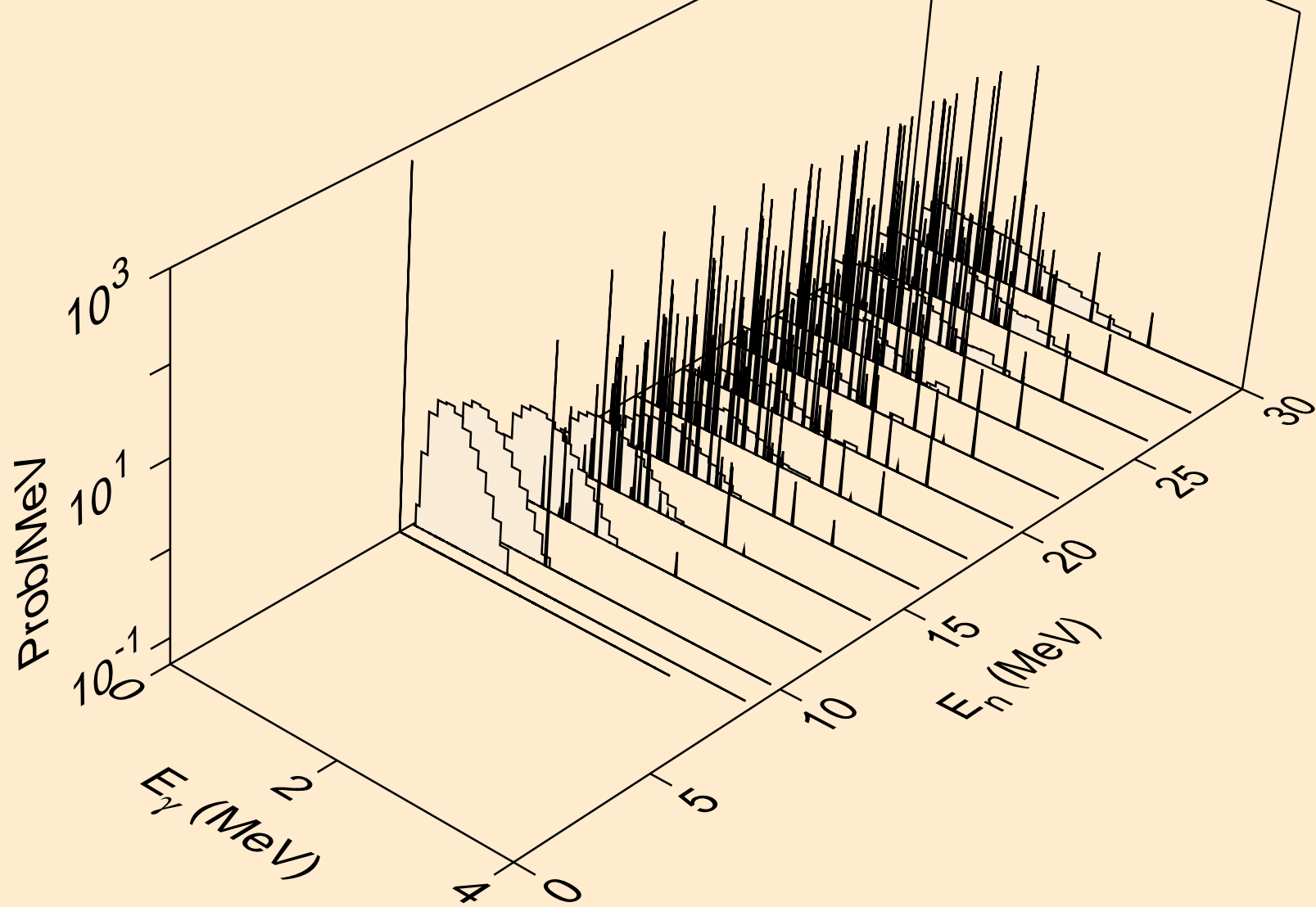

I119 NEUTRON ACER TENDL-2024 LIBRARY; T=293.6K
thermal capture photon spectrum

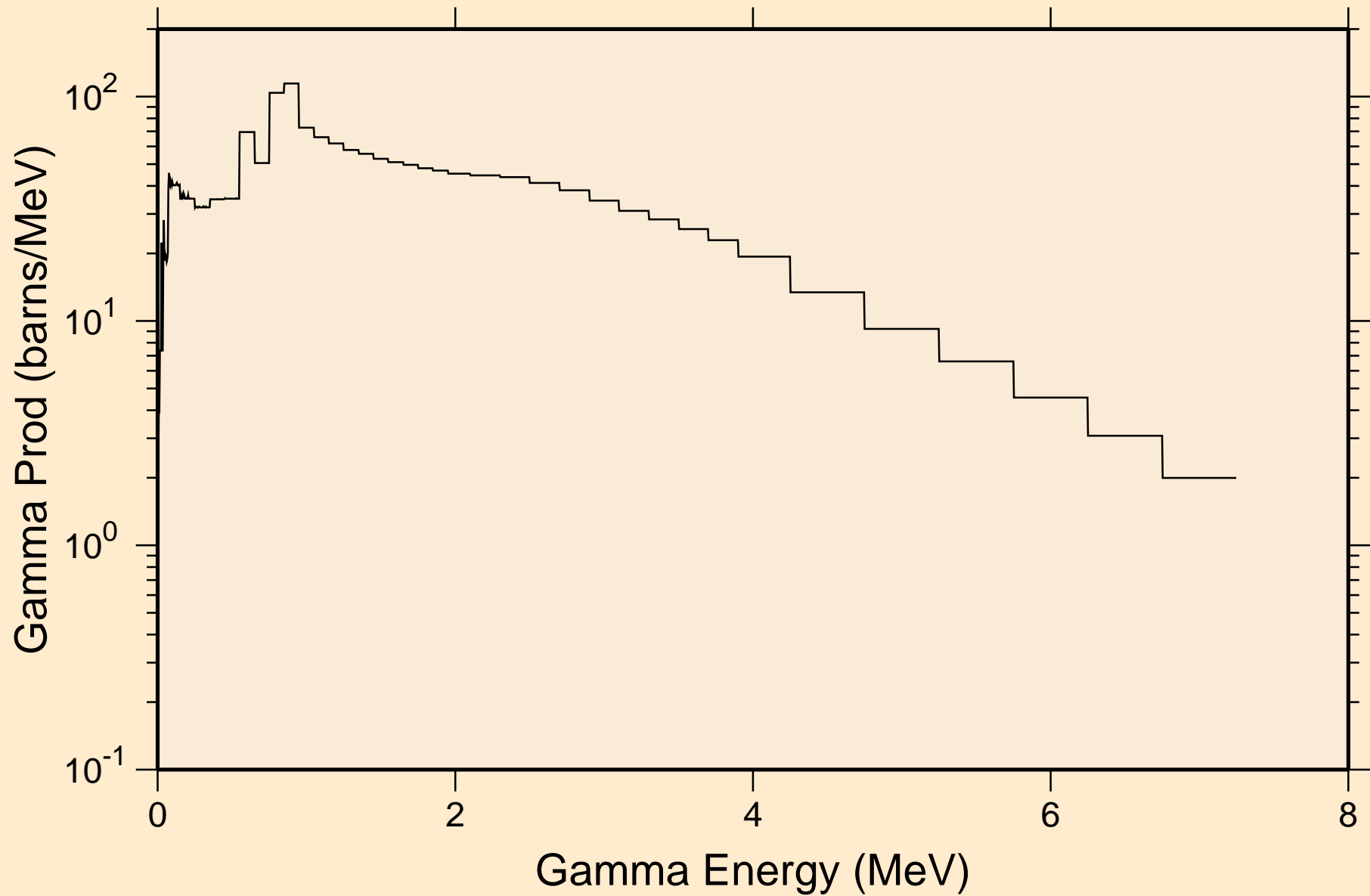

I119 NEUTRON ACER TENDL-2024 LIBRARY; T=293.6K
14 MeV photon spectrum

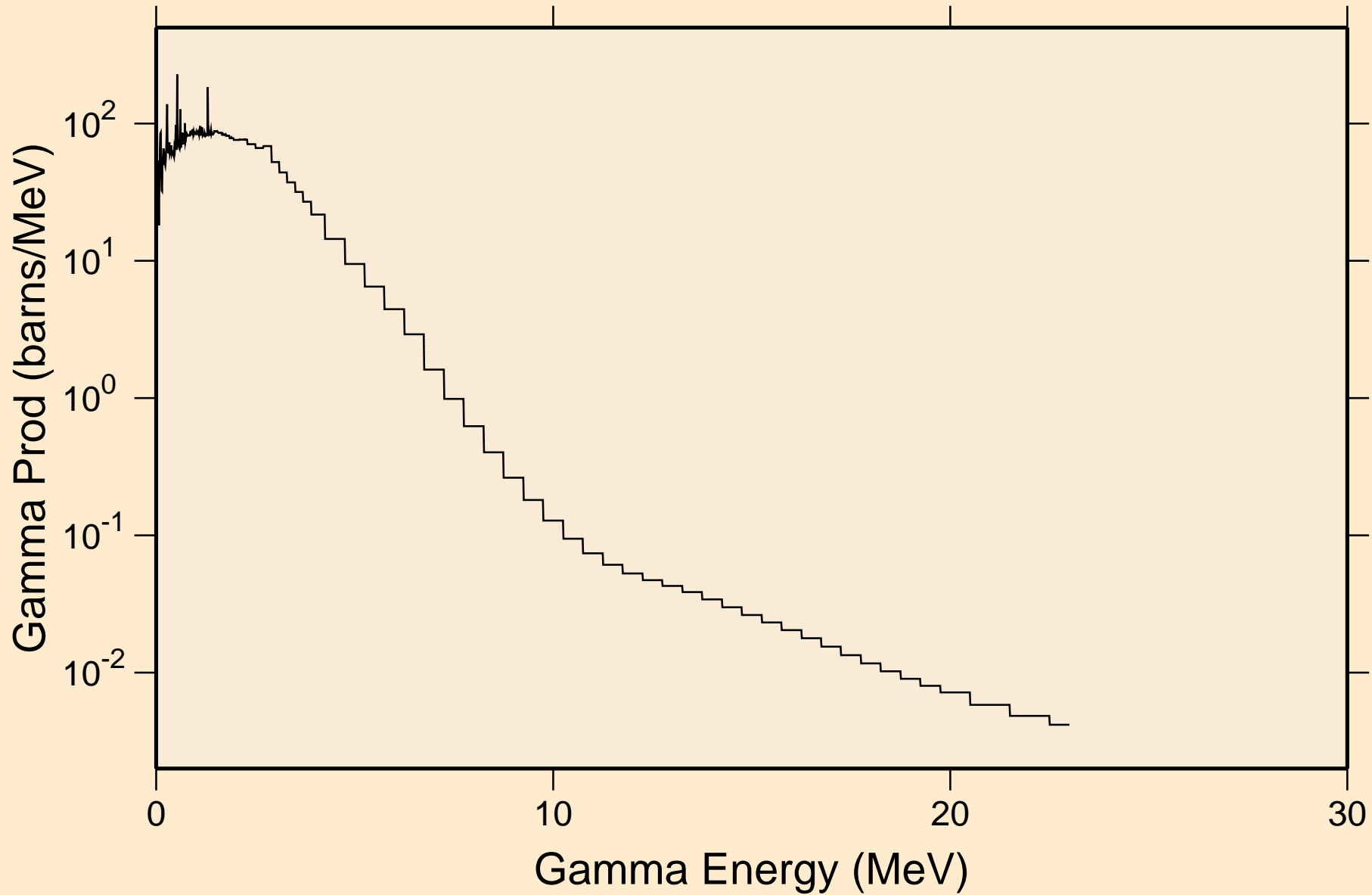

I119 NEUTRON ACER TENDL-2024 LIBRARY; T=293.6K

Particle heating contributions

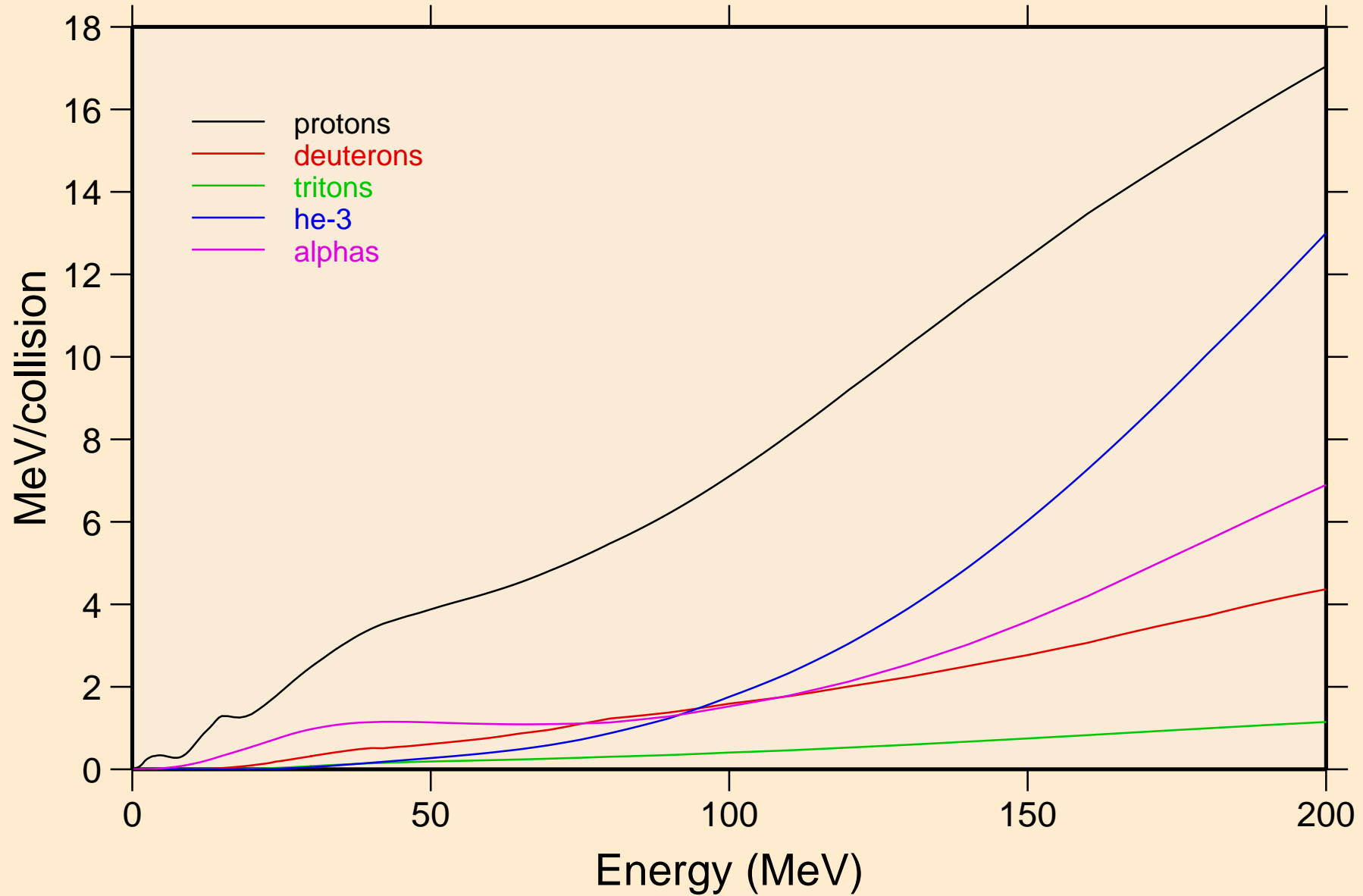

I119 NEUTRON ACER TENDL-2024 LIBRARY; T=293.6K

Recoil Heating

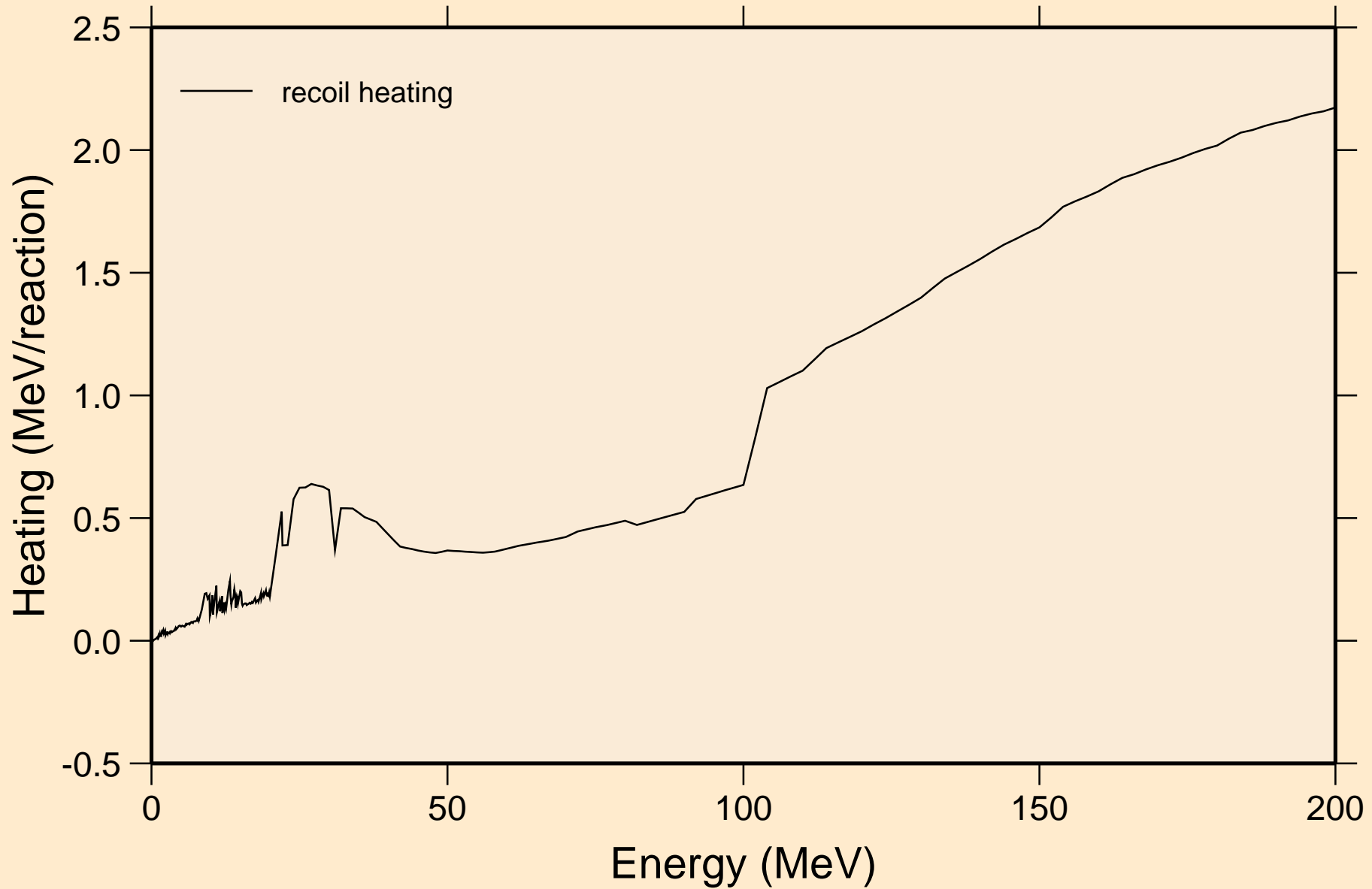

I119 NEUTRON ACER TENDL-2024 LIBRARY; T=293.6K
Particle production cross sections

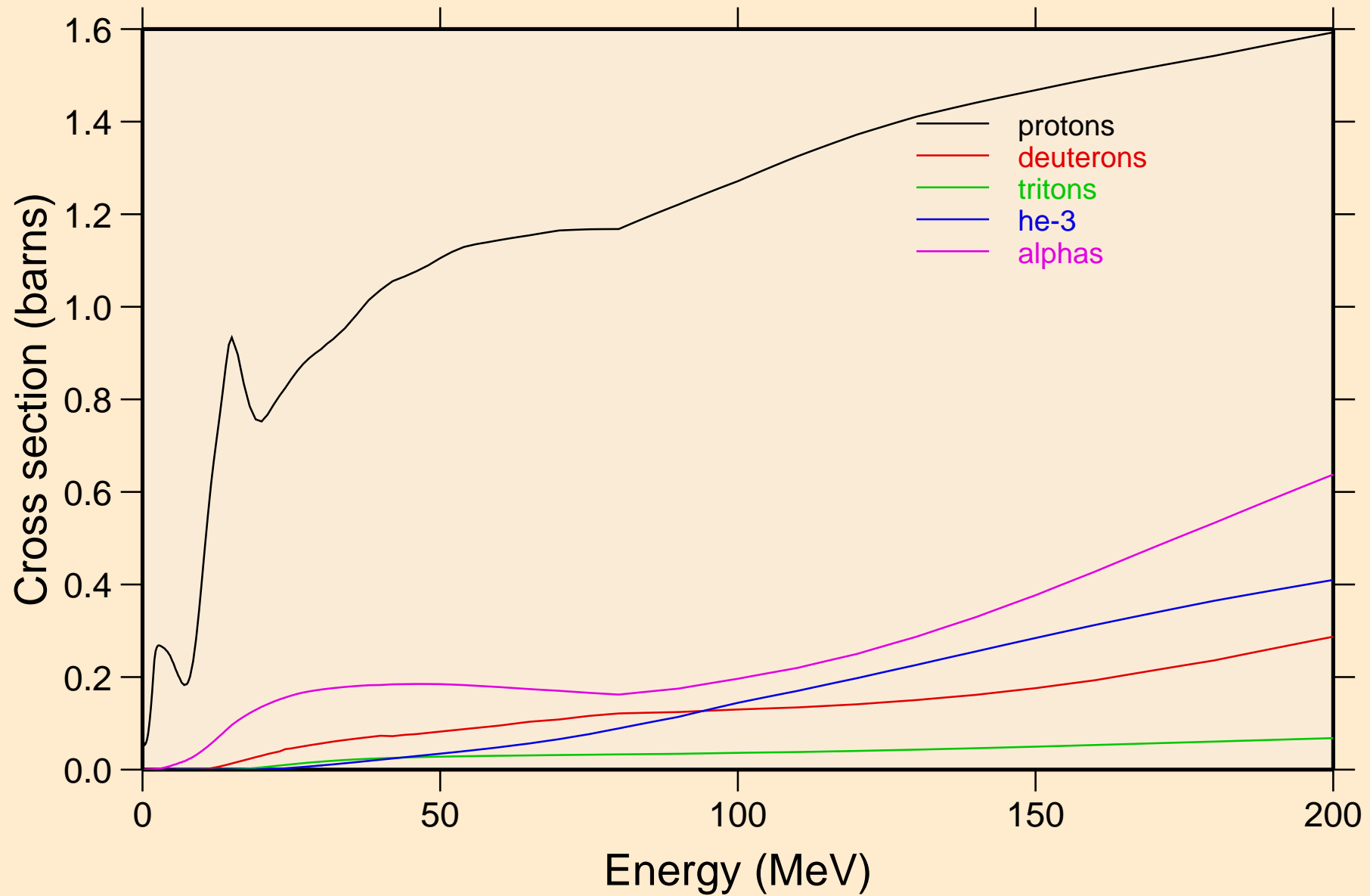

I119 NEUTRON ACER TENDL-2024 LIBRARY; T=293.6K
protons from (n,x)

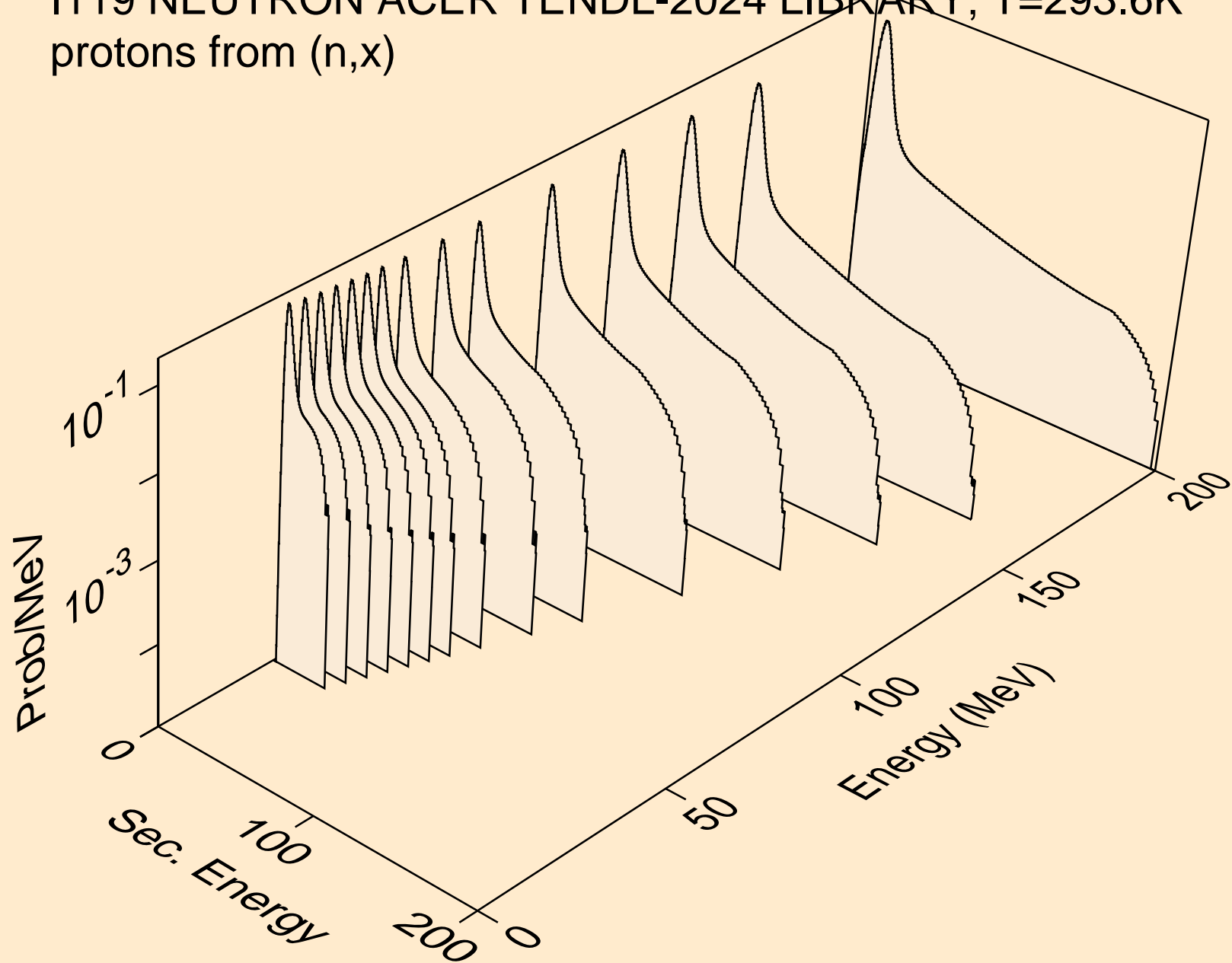

I119 NEUTRON ACER TENDL-2024 LIBRARY; T=293.6K
protons from (n,n*)p

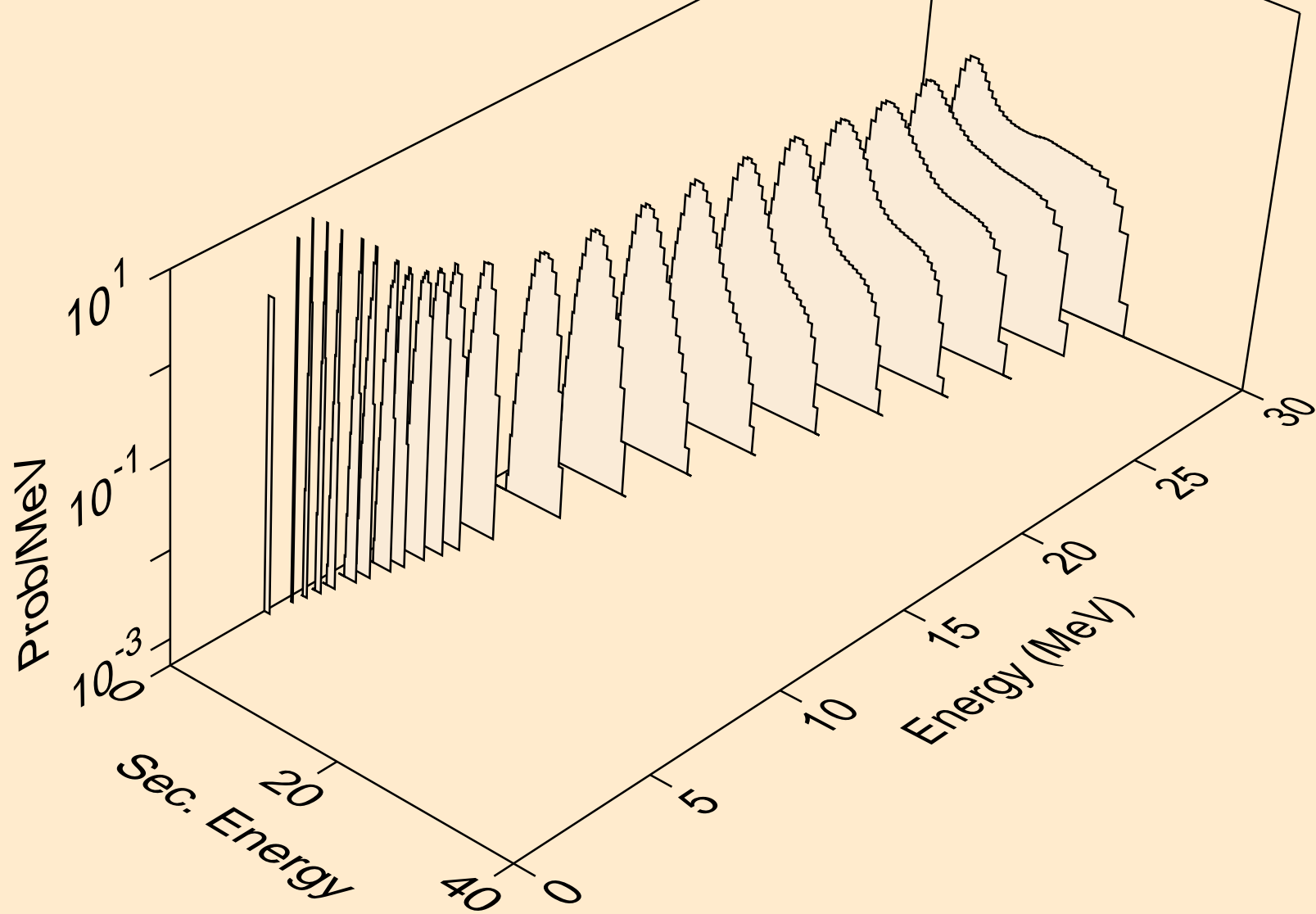

I119 NEUTRON ACER TENDL-2024 LIBRARY; T=293.6K
protons from (n,2np)

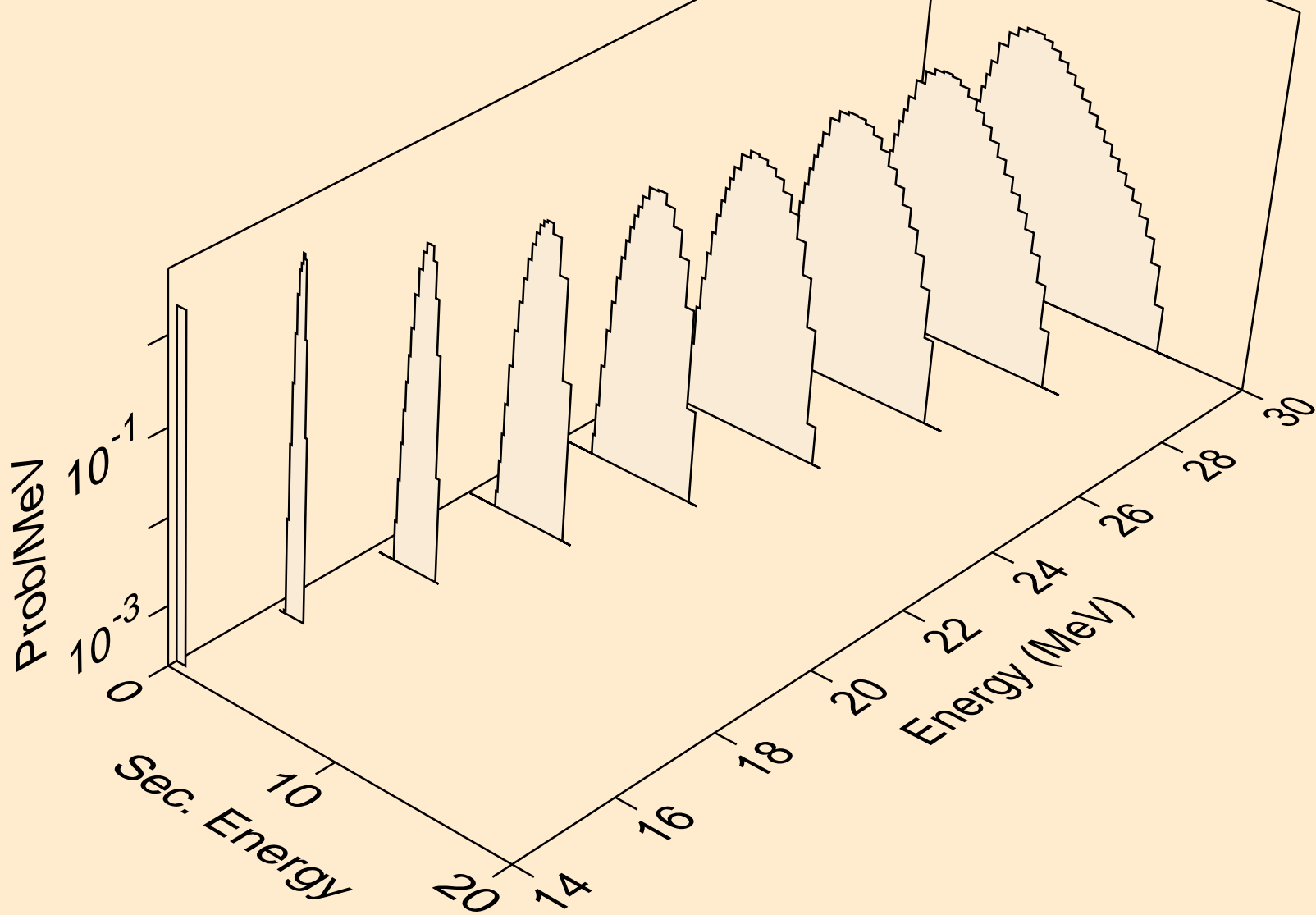

I119 NEUTRON ACER TENDL-2024 LIBRARY; T=293.6K
protons from (n,3np)

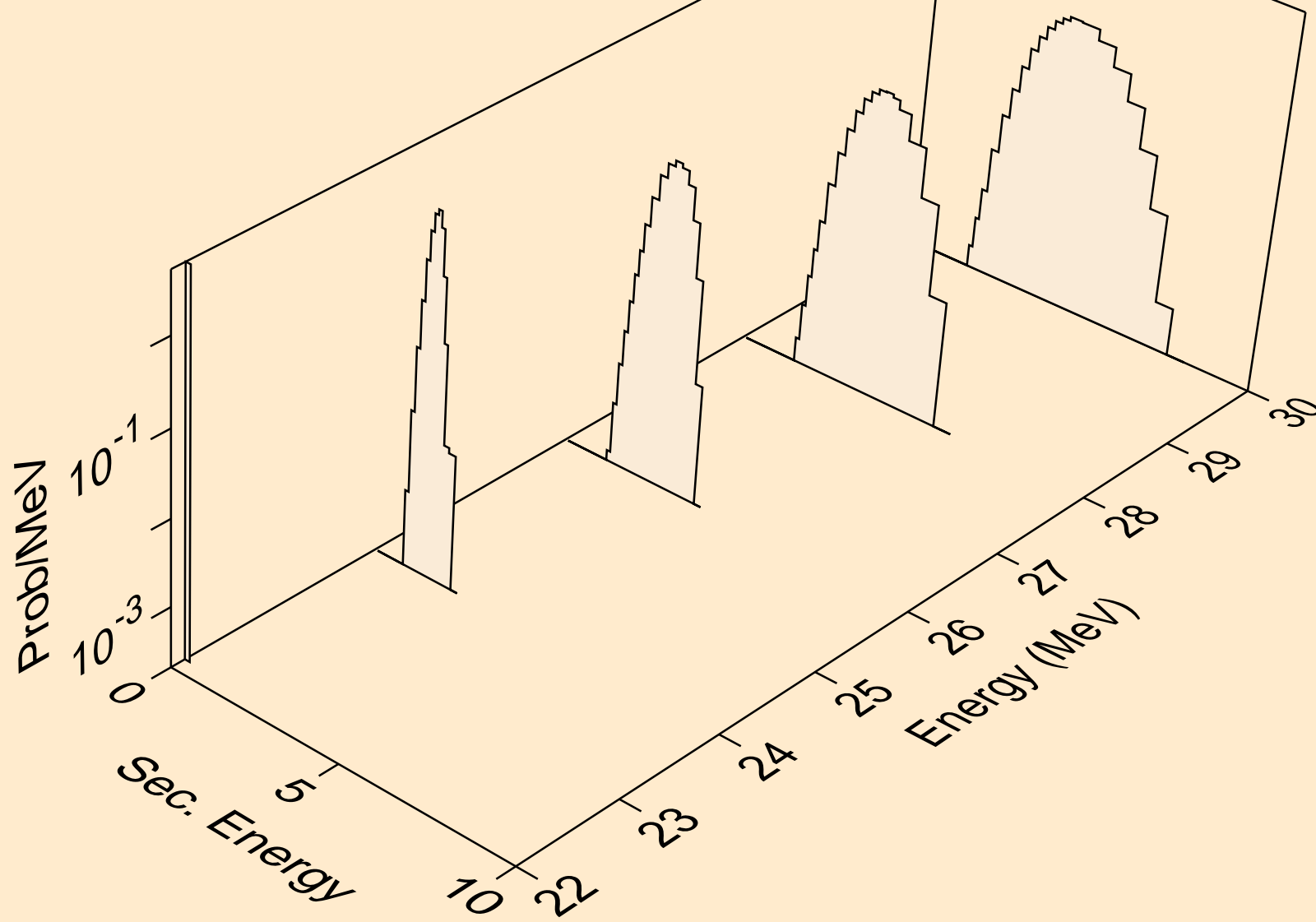

I119 NEUTRON ACER TENDL-2024 LIBRARY; T=293.6K
protons from (n,n2p)

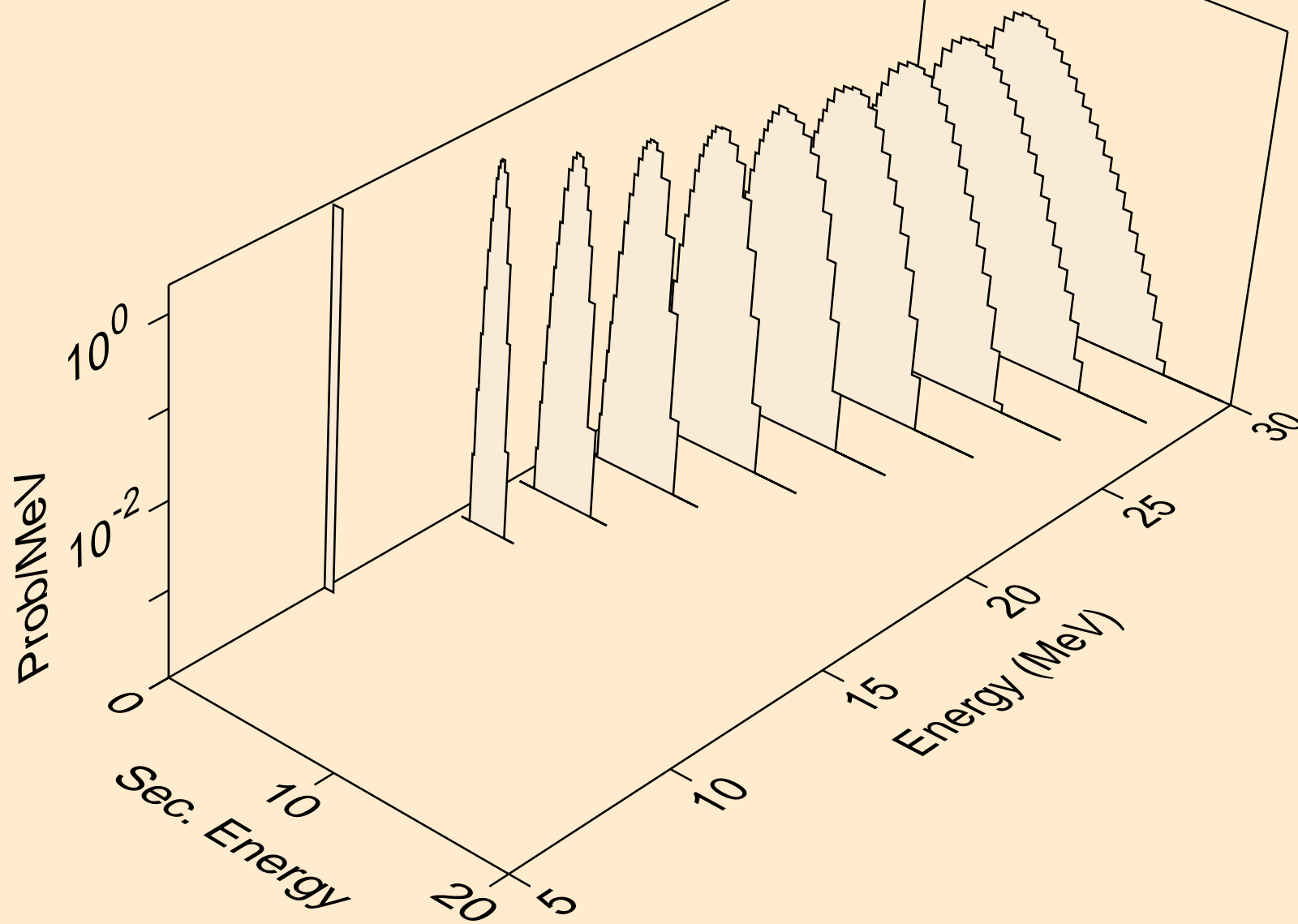

I119 NEUTRON ACER TENDL-2024 LIBRARY; T=293.6K
protons from (n,npa)

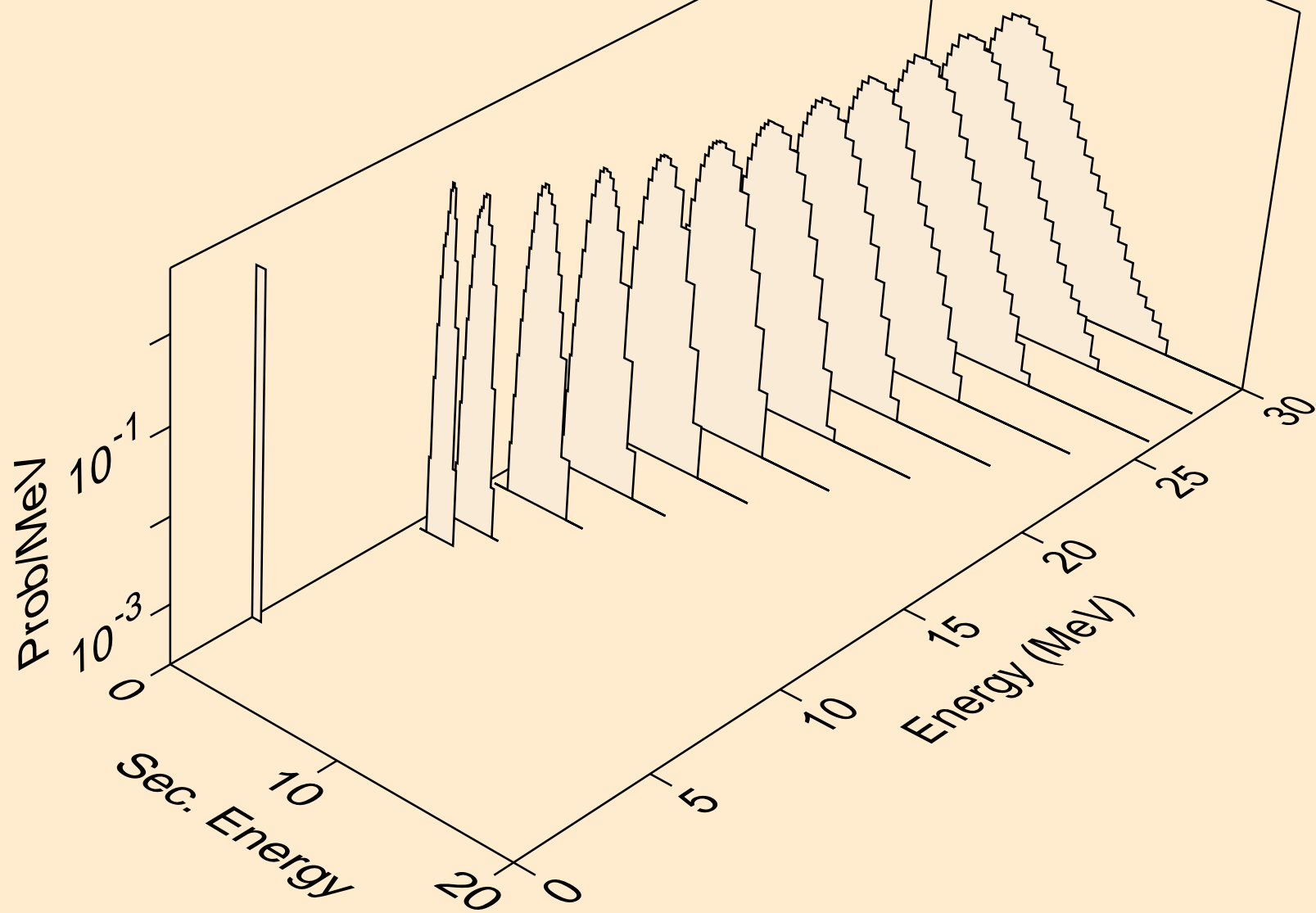

I119 NEUTRON ACER TENDL-2024 LIBRARY; T=293.6K
protons from (n,p)

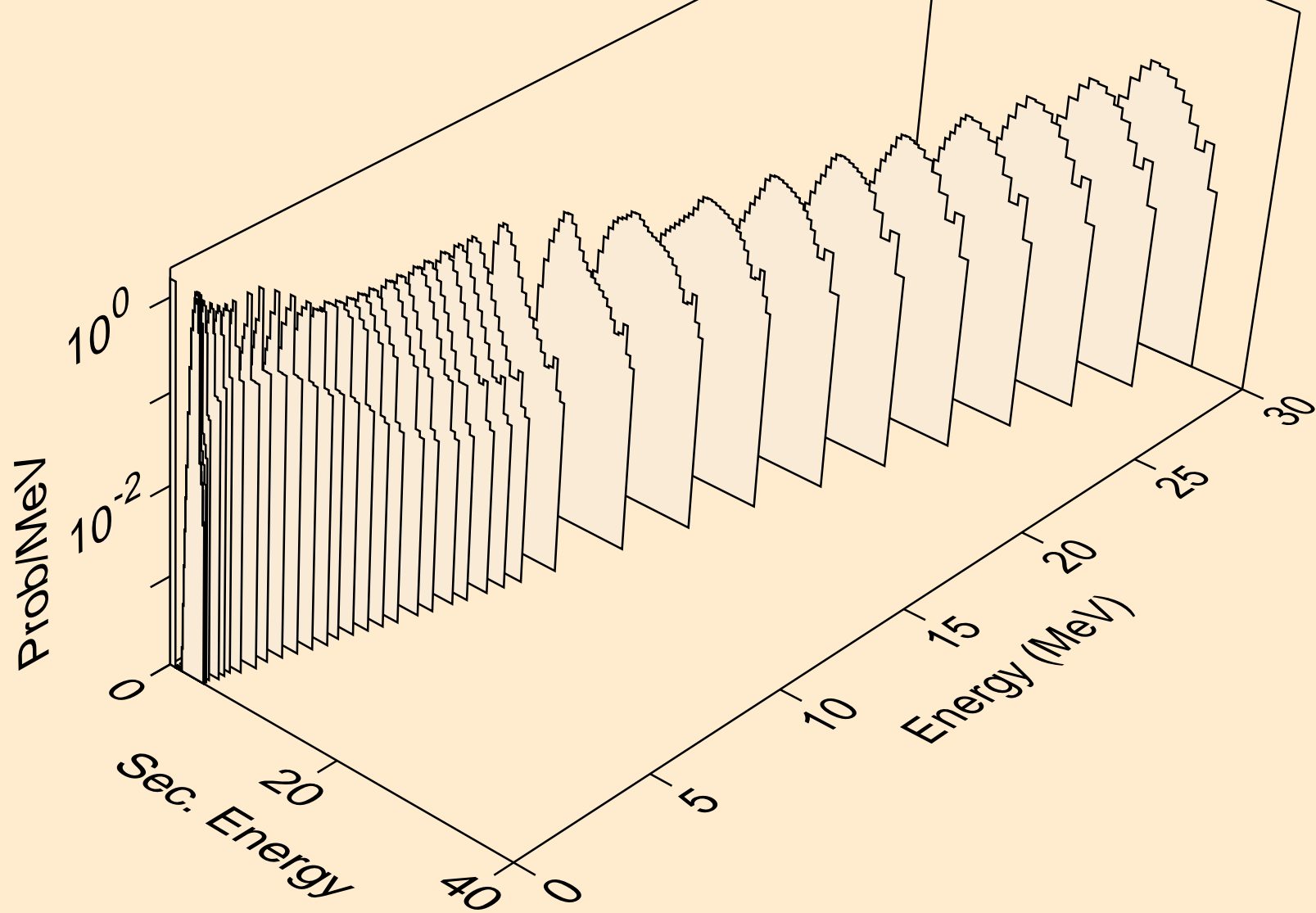

I119 NEUTRON ACER TENDL-2024 LIBRARY; T=293.6K
protons from (n,2p)

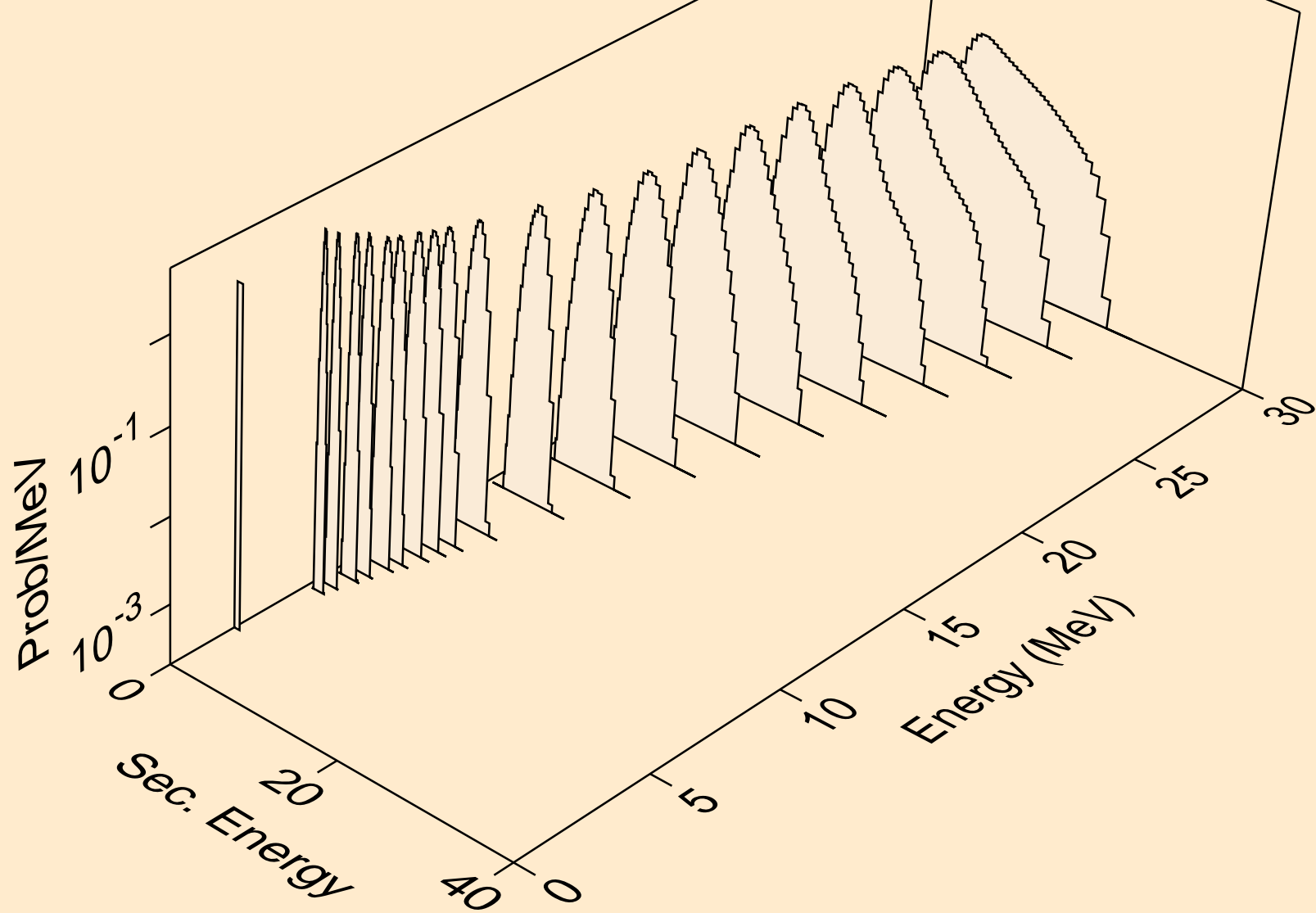

I119 NEUTRON ACER TENDL-2024 LIBRARY; T=293.6K
protons from (n,p)

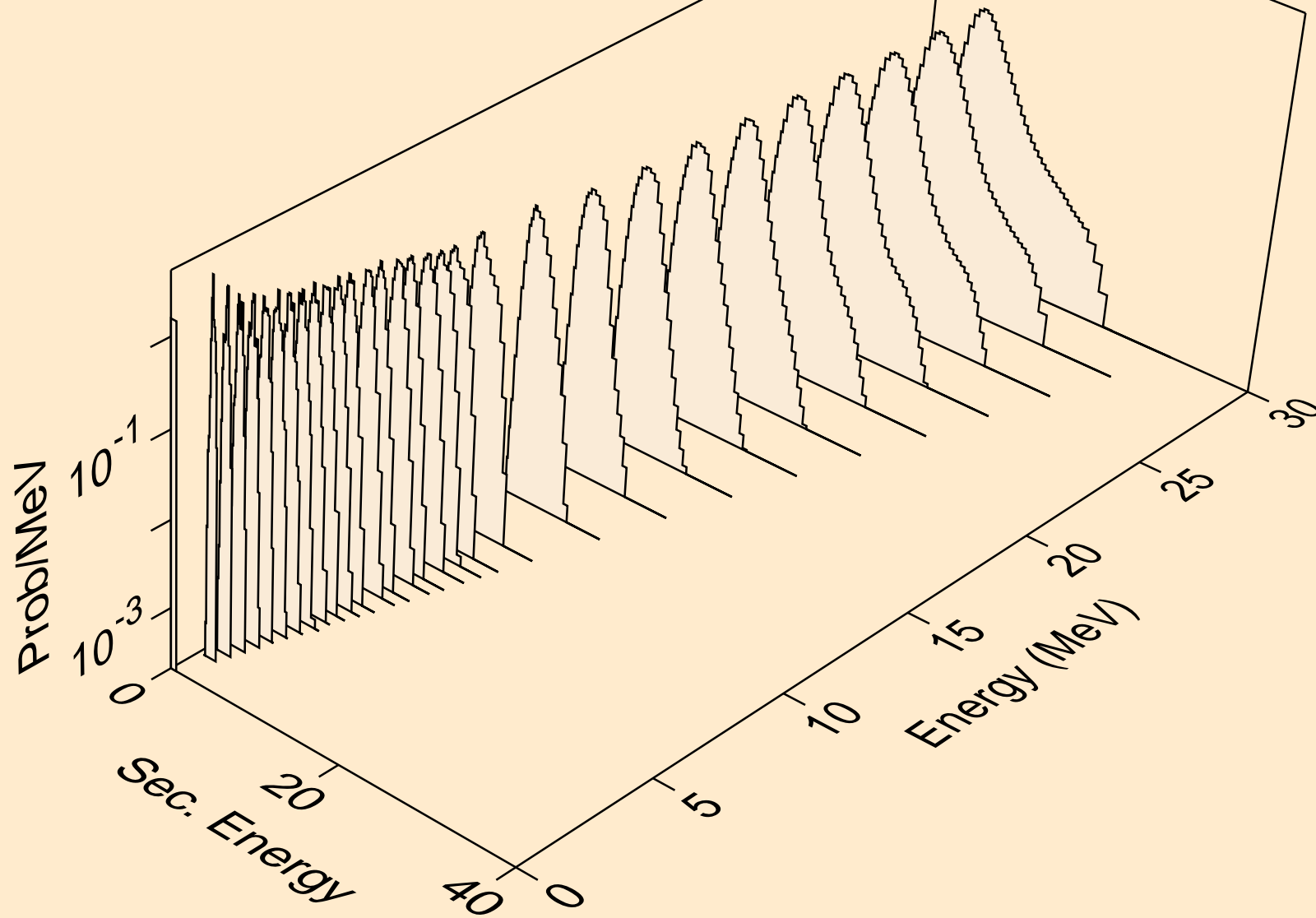

I119 NEUTRON ACER TENDL-2024 LIBRARY; T=293.6K
protons from (n,pd)

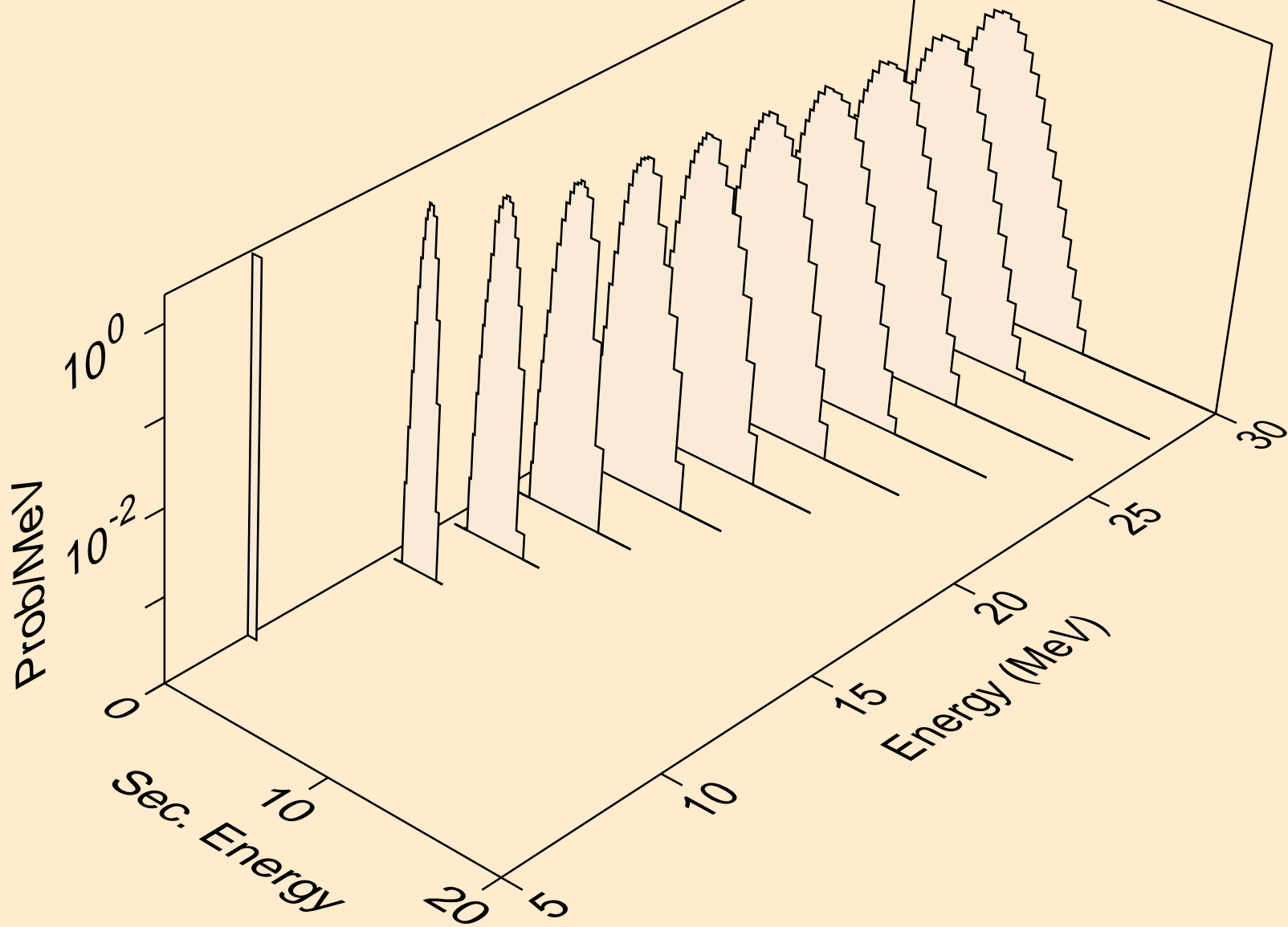

I119 NEUTRON ACER TENDL-2024 LIBRARY; T=293.6K
protons from (n,pt)

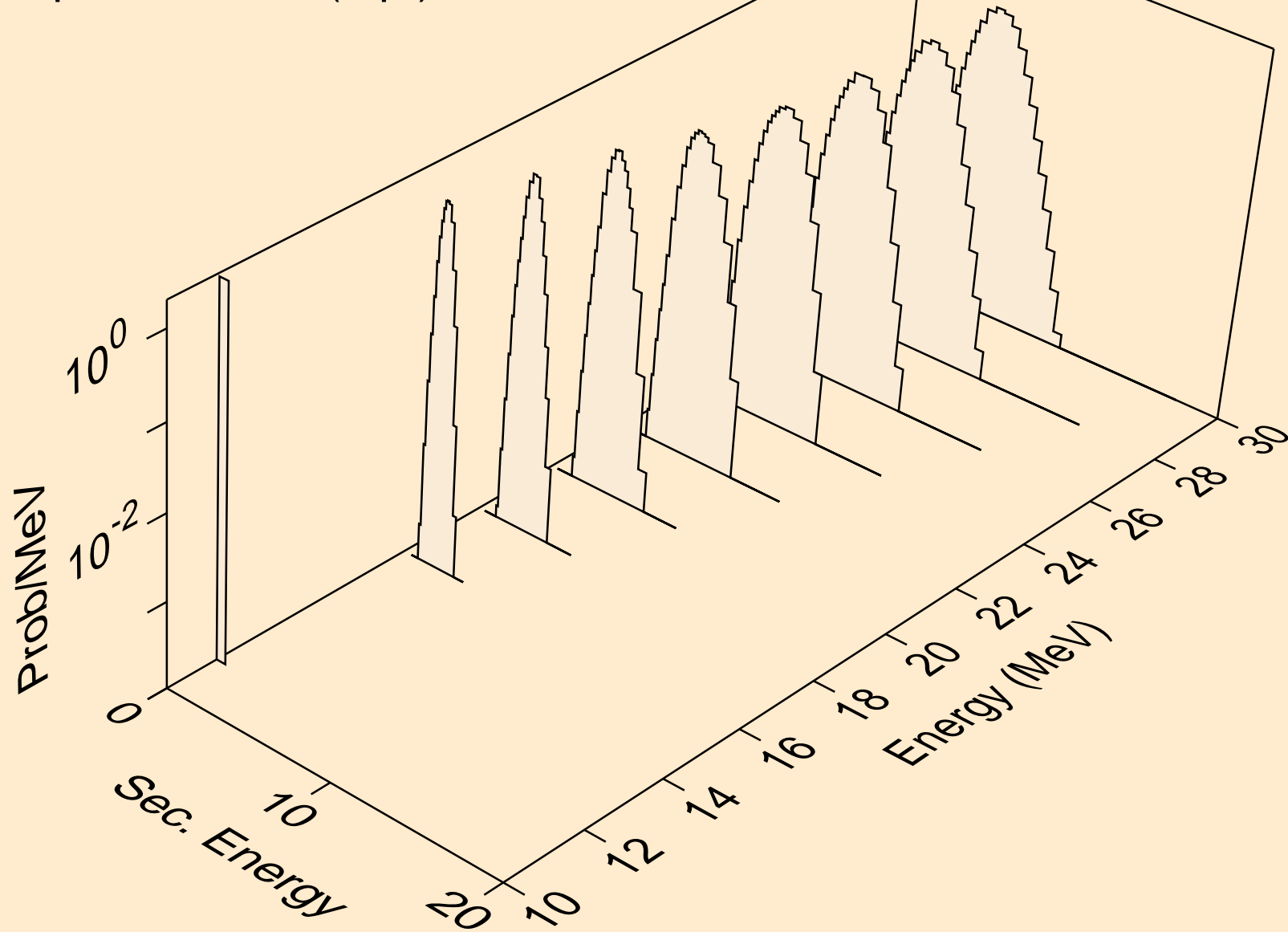

I119 NEUTRON ACER TENDL-2024 LIBRARY; T=293.6K
deuterons from (n,x)

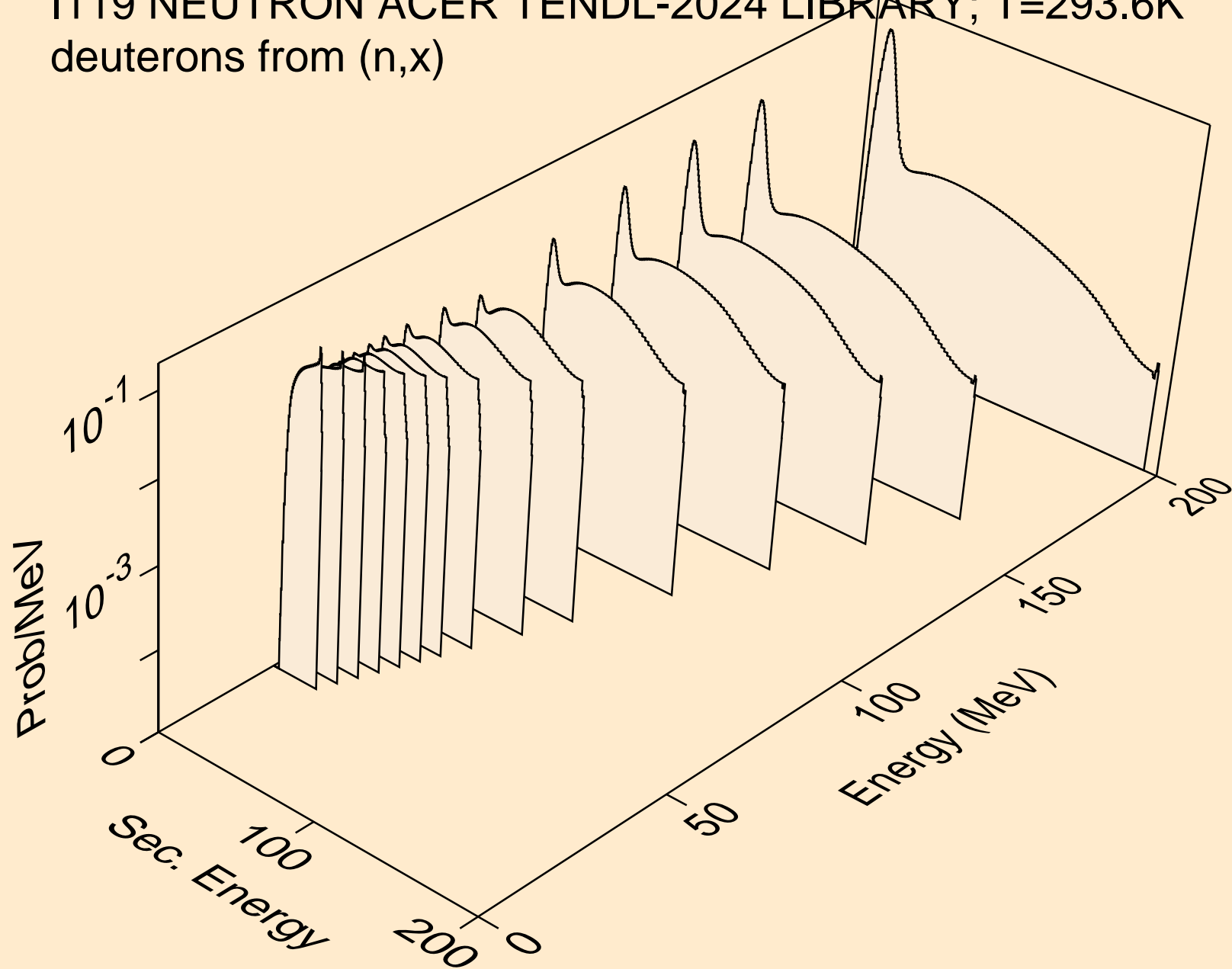

I119 NEUTRON ACER TENDL-2024 LIBRARY; T=293.6K
deuterons from (n,2nd)

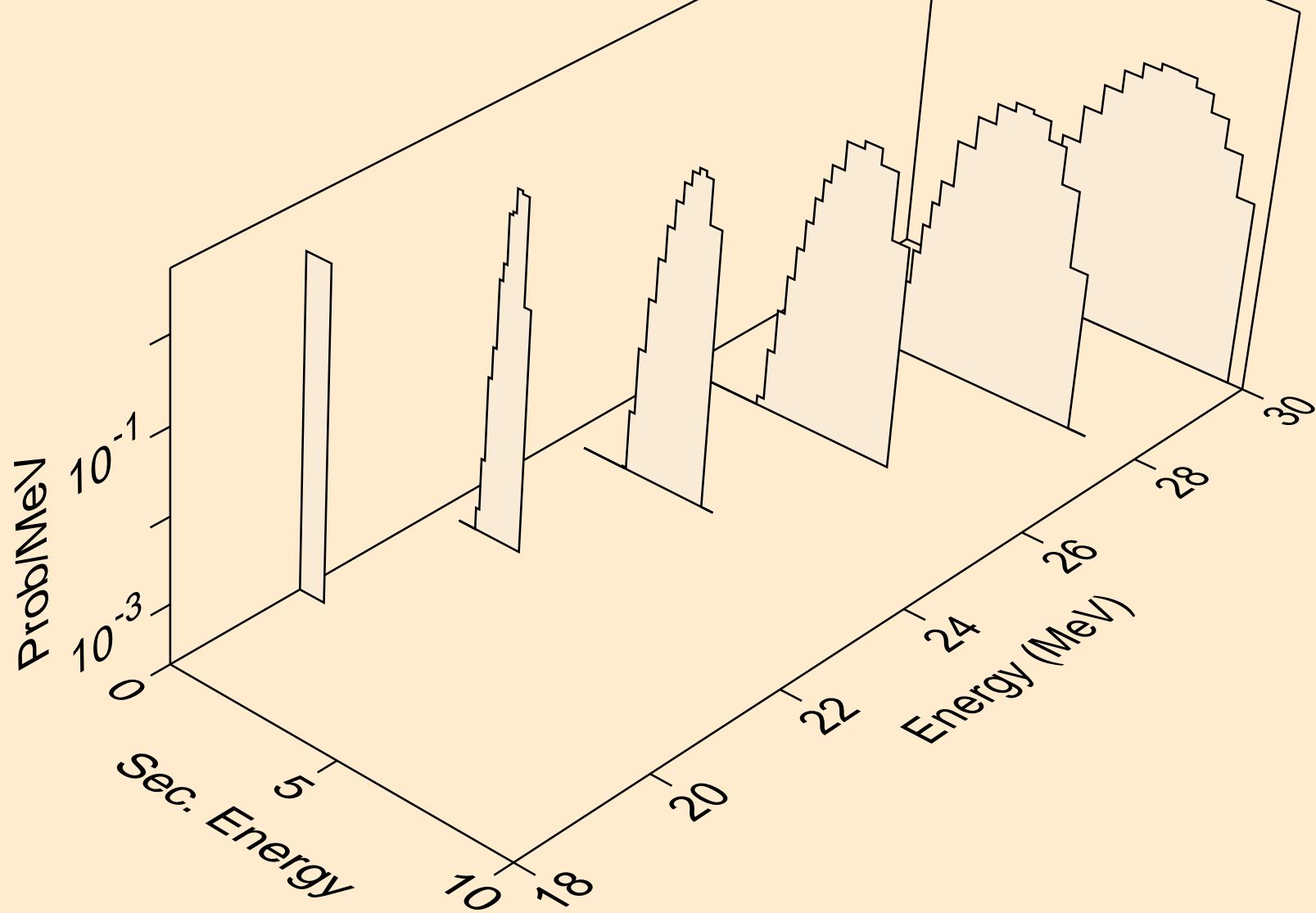

I119 NEUTRON ACER TENDL-2024 LIBRARY; T=293.6K
deuterons from (n,n*)d

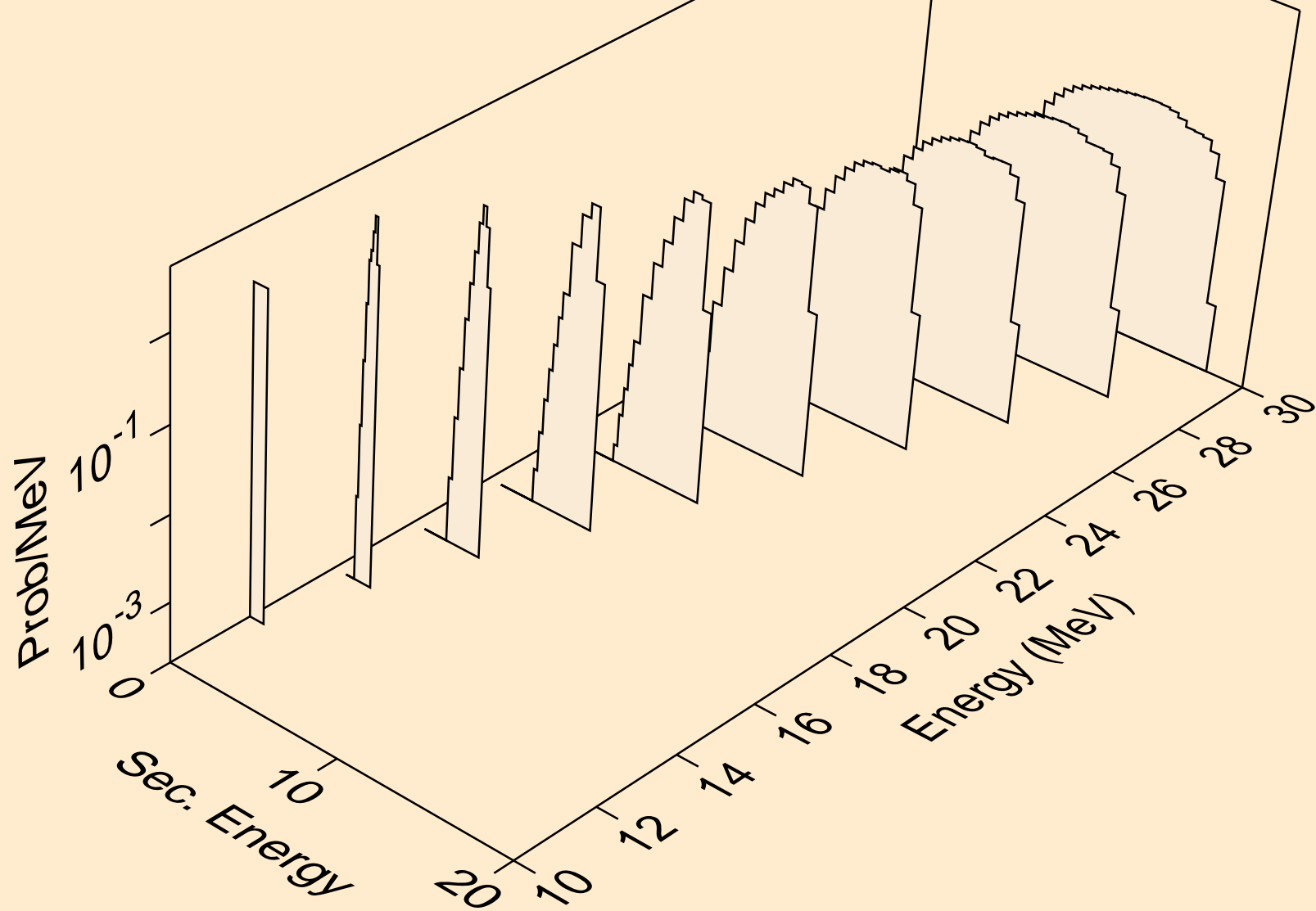

I119 NEUTRON ACER TENDL-2024 LIBRARY; T=293.6K
deuterons from (n,d)

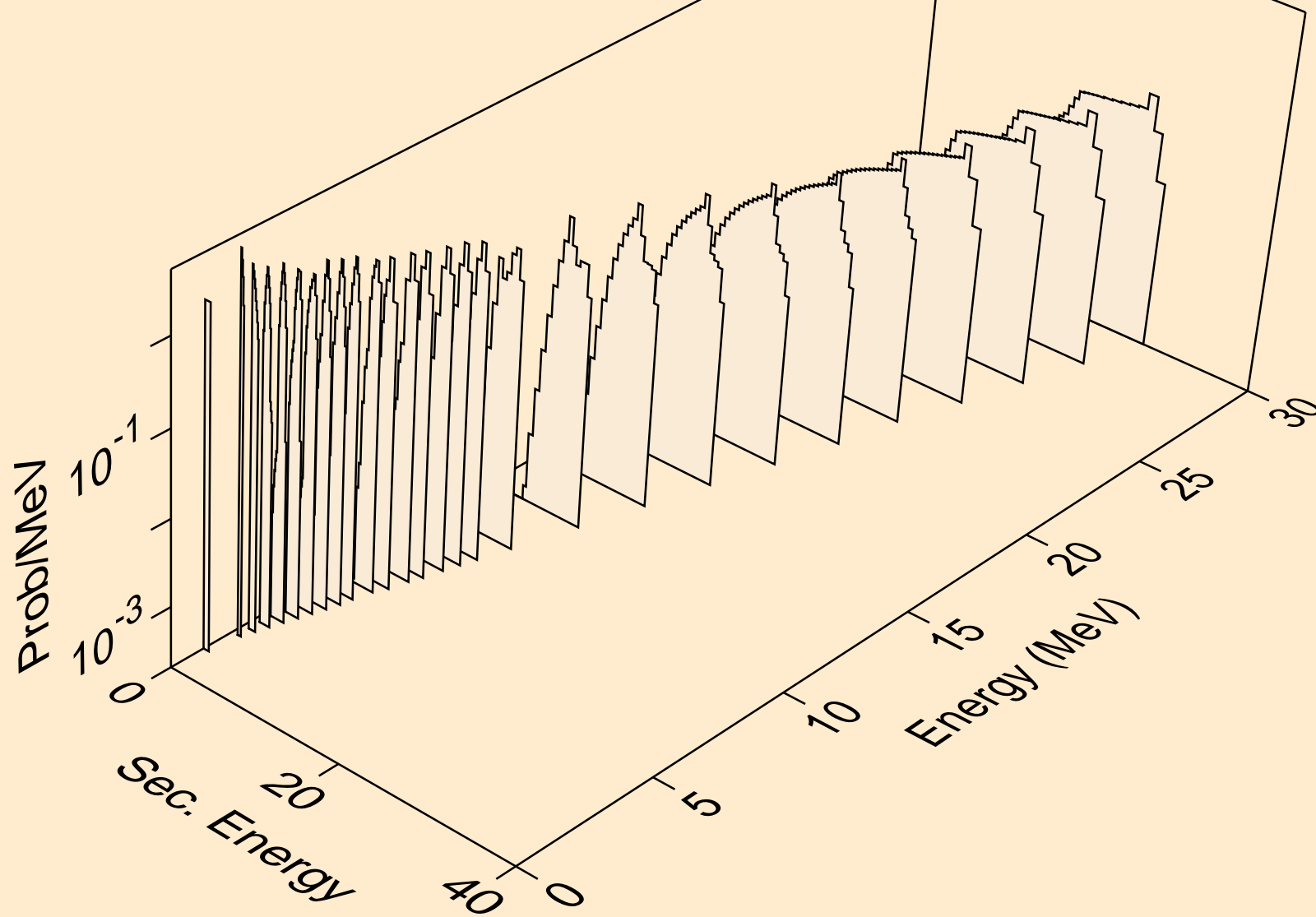

I119 NEUTRON ACER TENDL-2024 LIBRARY; T=293.6K
deuterons from (n,pd)

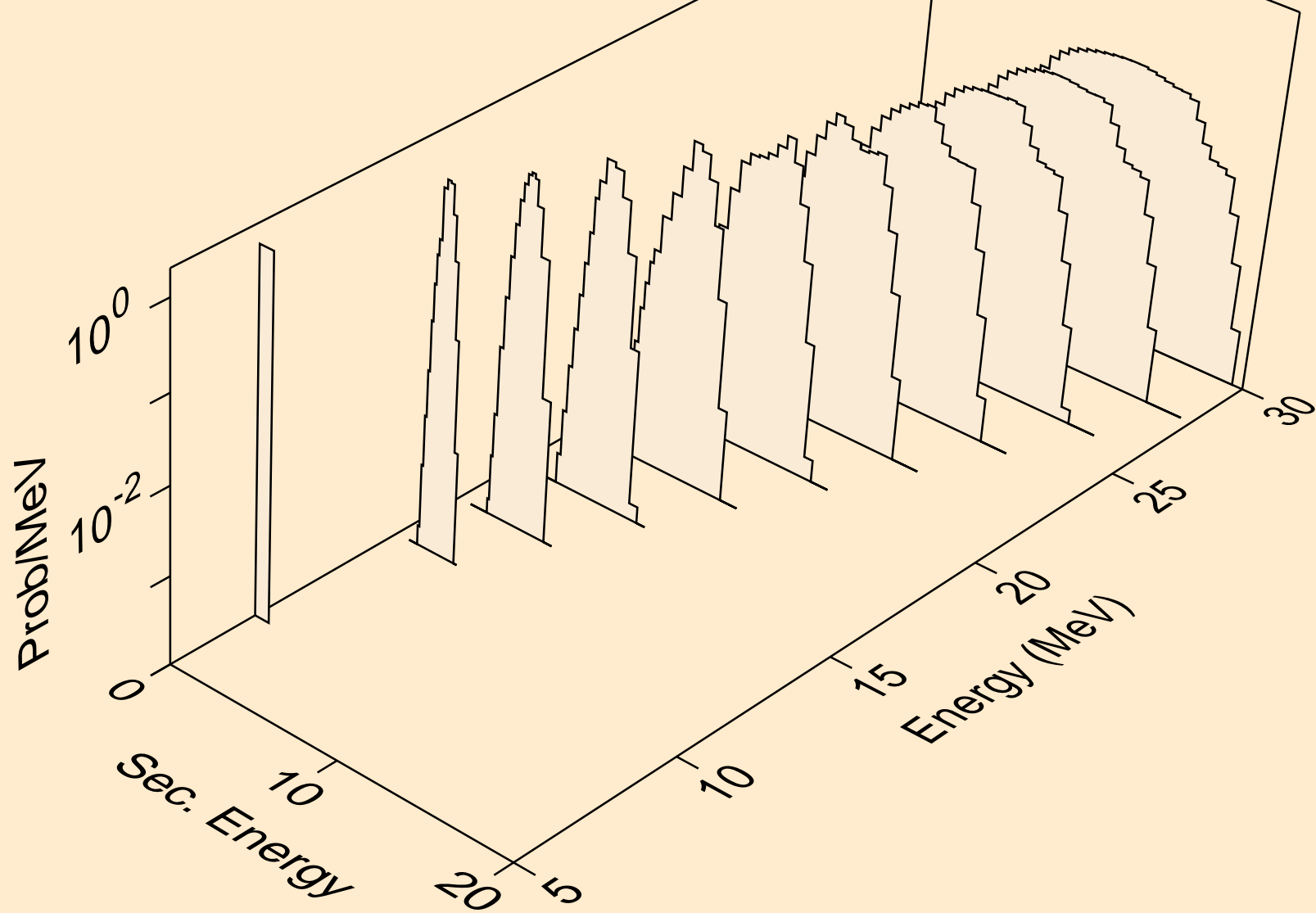

I119 NEUTRON ACER TENDL-2024 LIBRARY; T=293.6K
deuterons from (n,da)

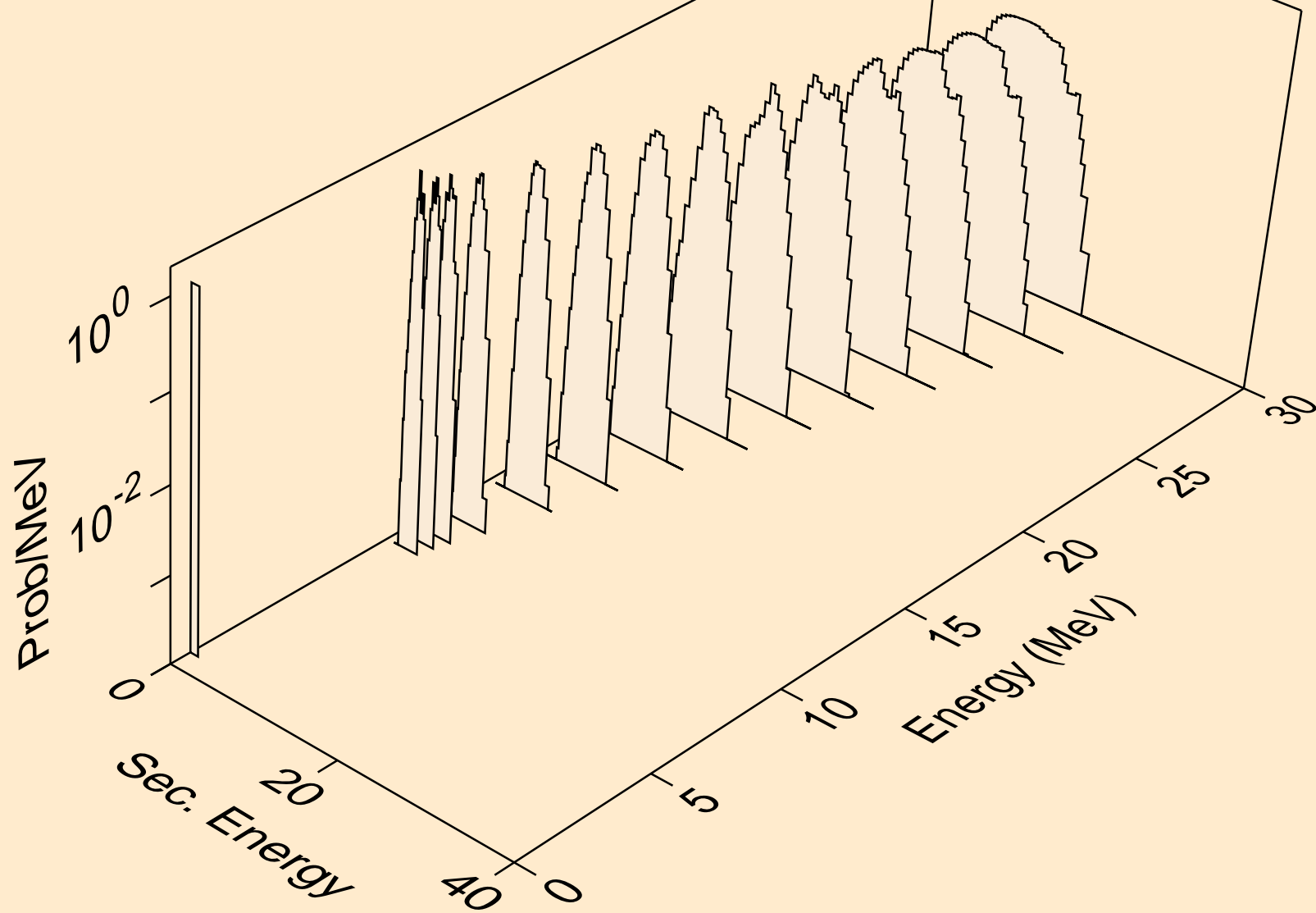

I119 NEUTRON ACER TENDL-2024 LIBRARY; T=293.6K
tritons from (n,x)

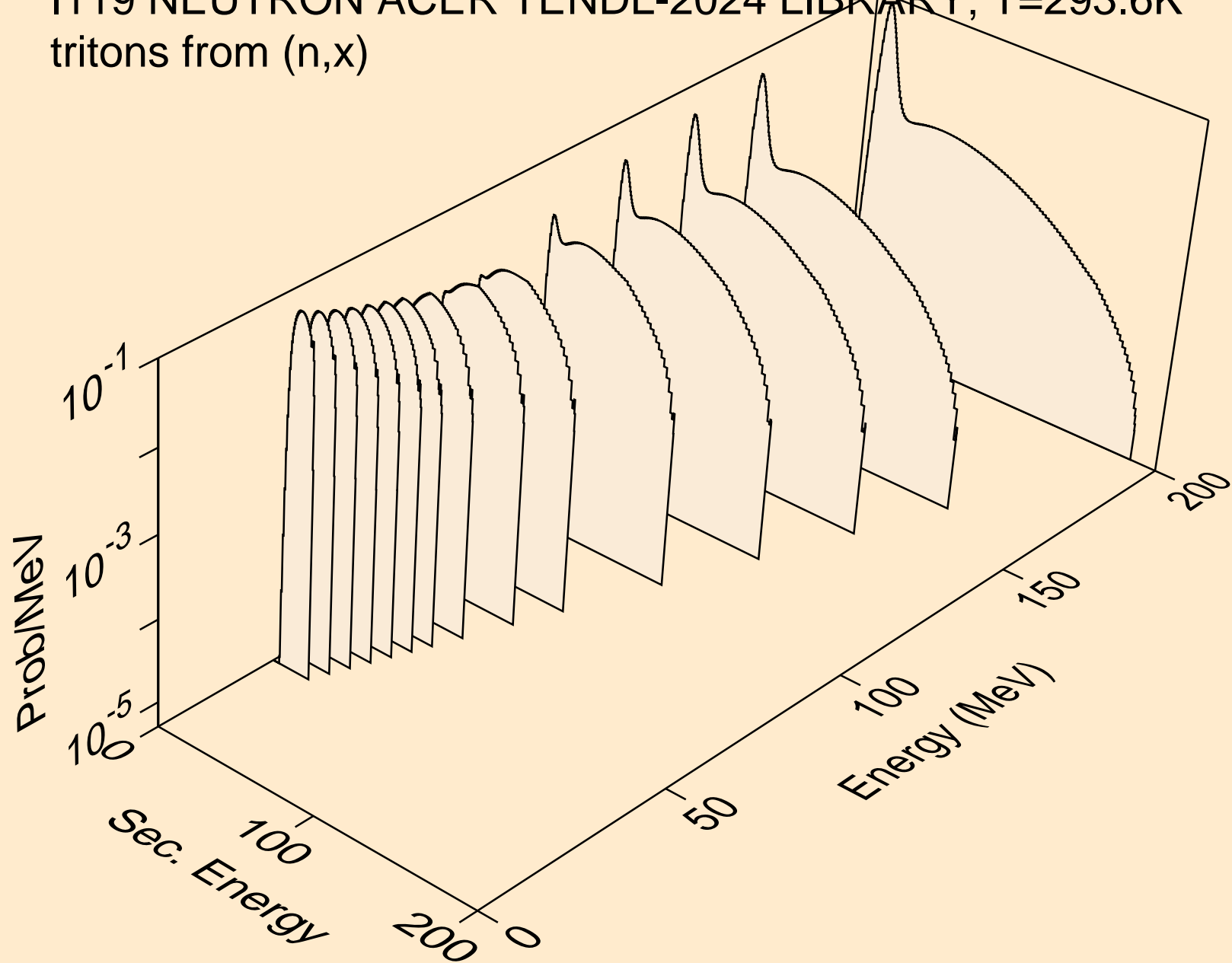

I119 NEUTRON ACER TENDL-2024 LIBRARY; T=293.6K
tritons from (n,n*)t

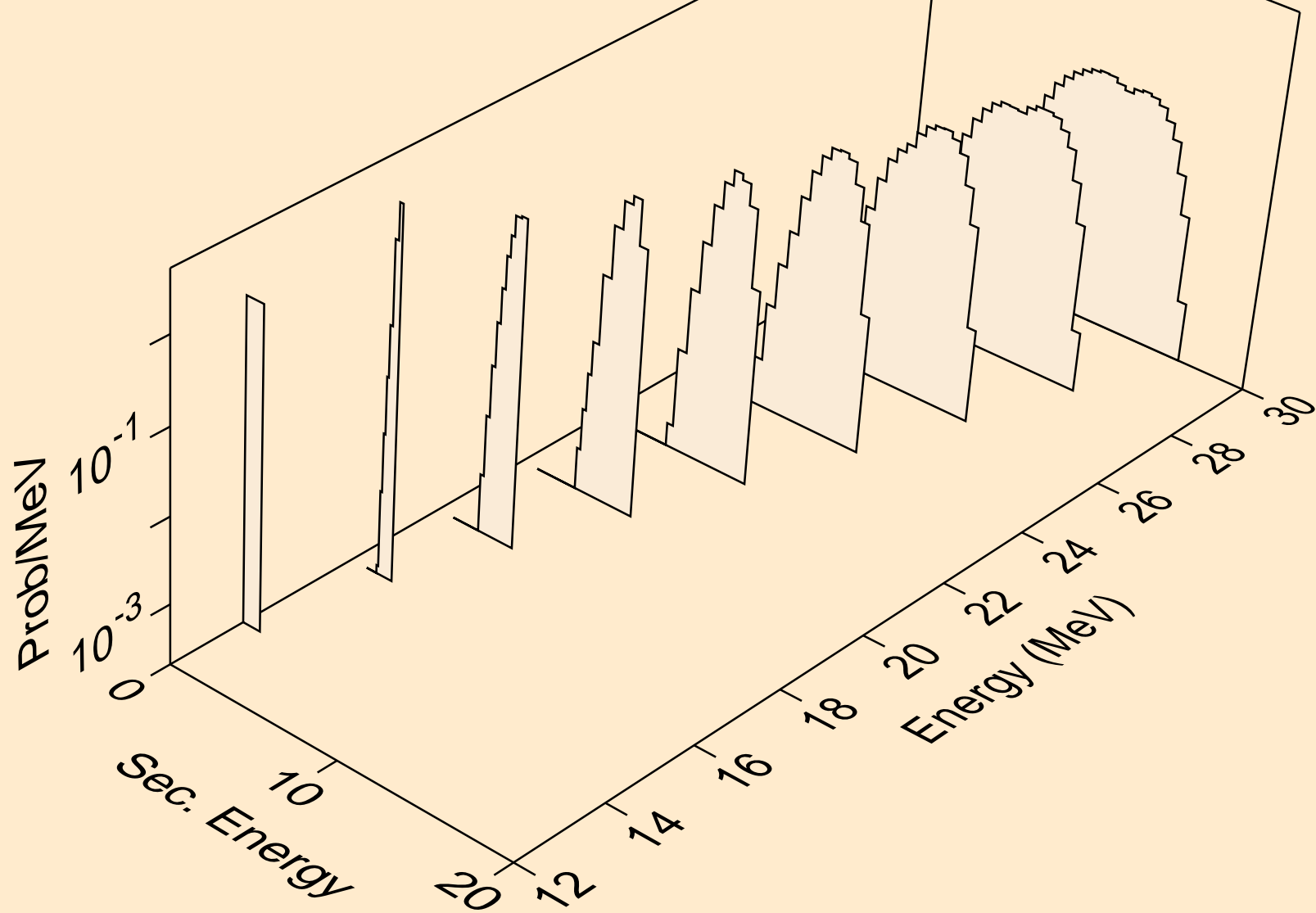

I119 NEUTRON ACER TENDL-2024 LIBRARY; T=293.6K
tritons from (n,t)

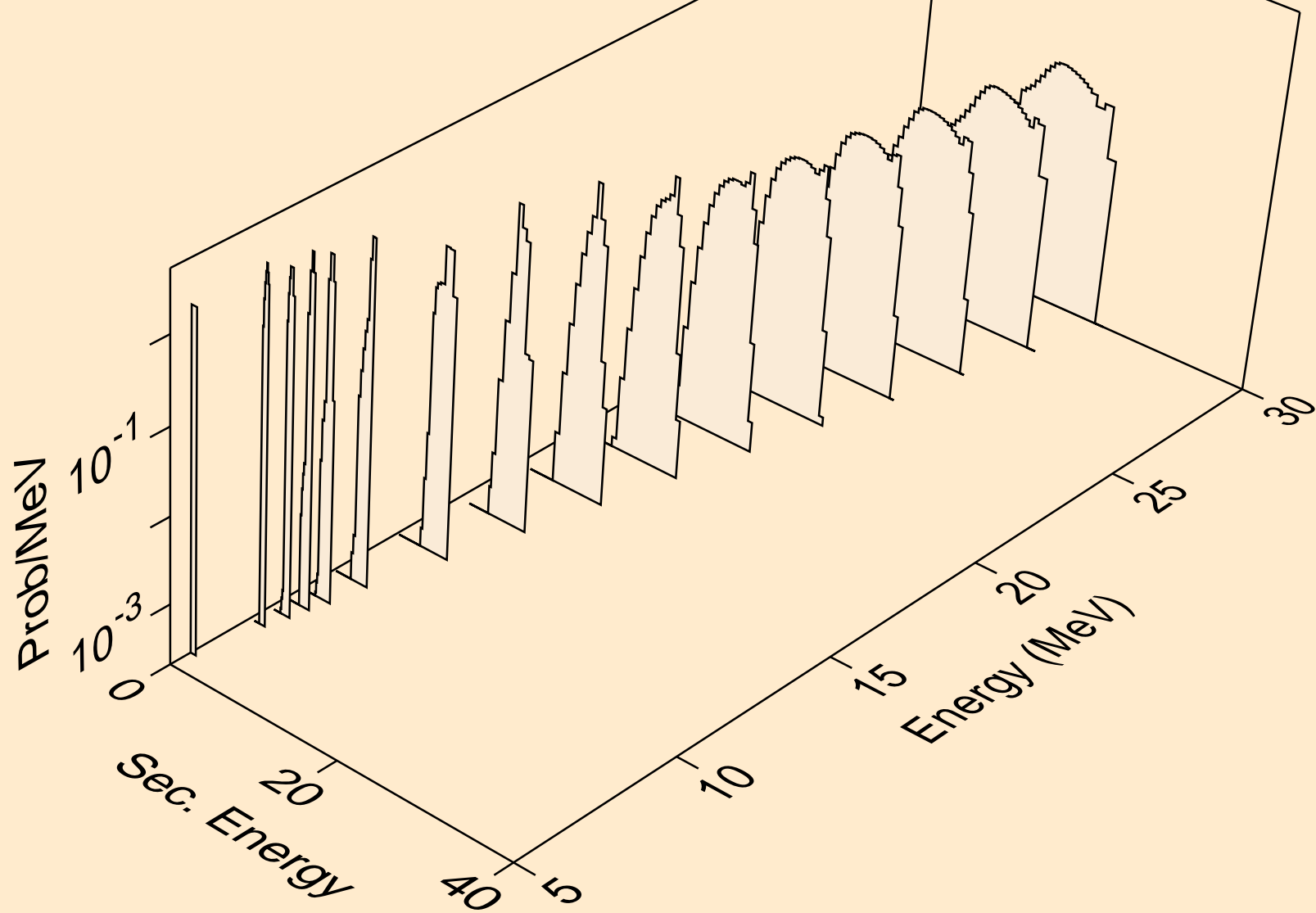

I119 NEUTRON ACER TENDL-2024 LIBRARY; T=293.6K
tritons from (n,pt)

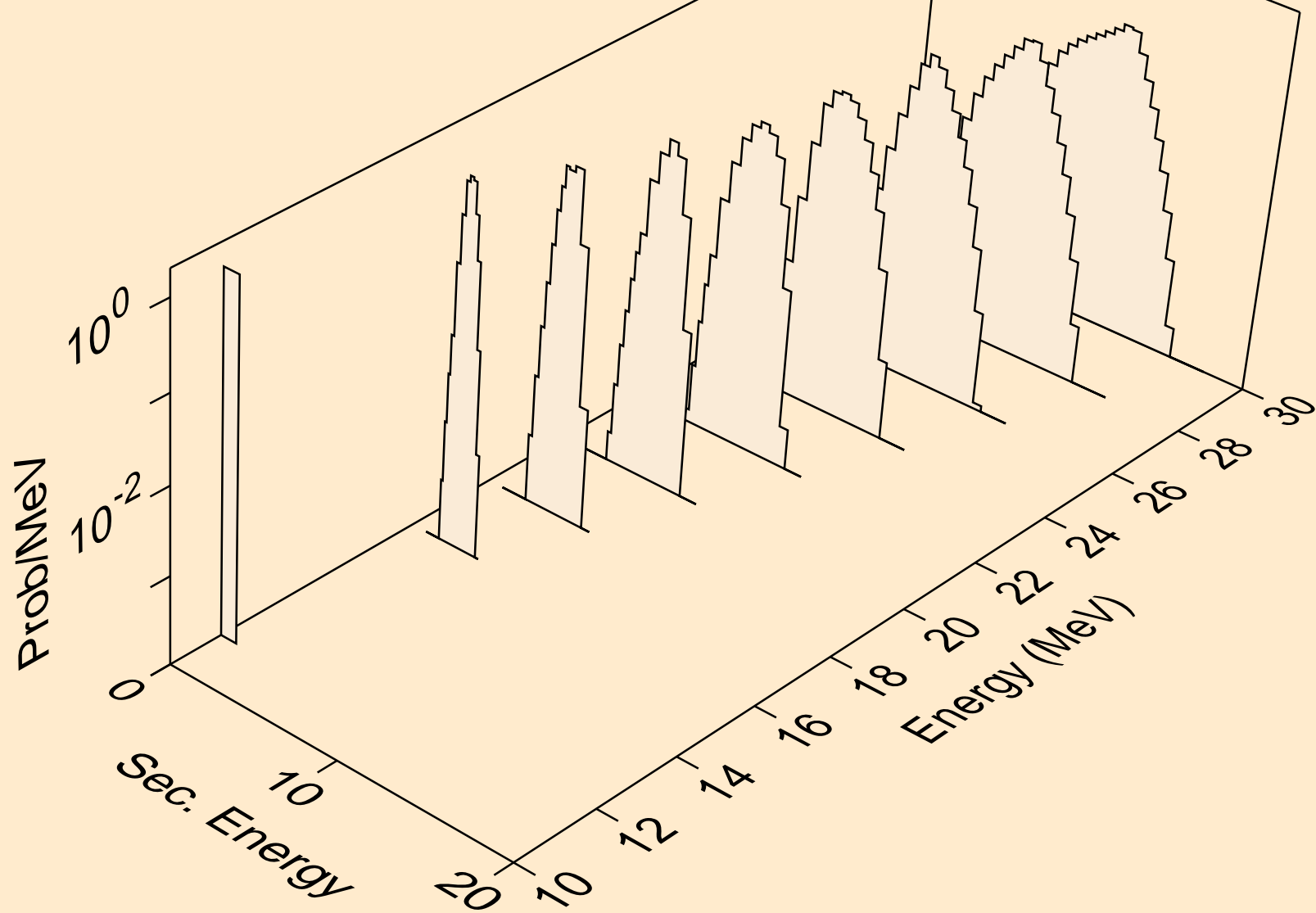

I119 NEUTRON ACER TENDL-2024 LIBRARY; T=293.6K
he3s from (n,x)

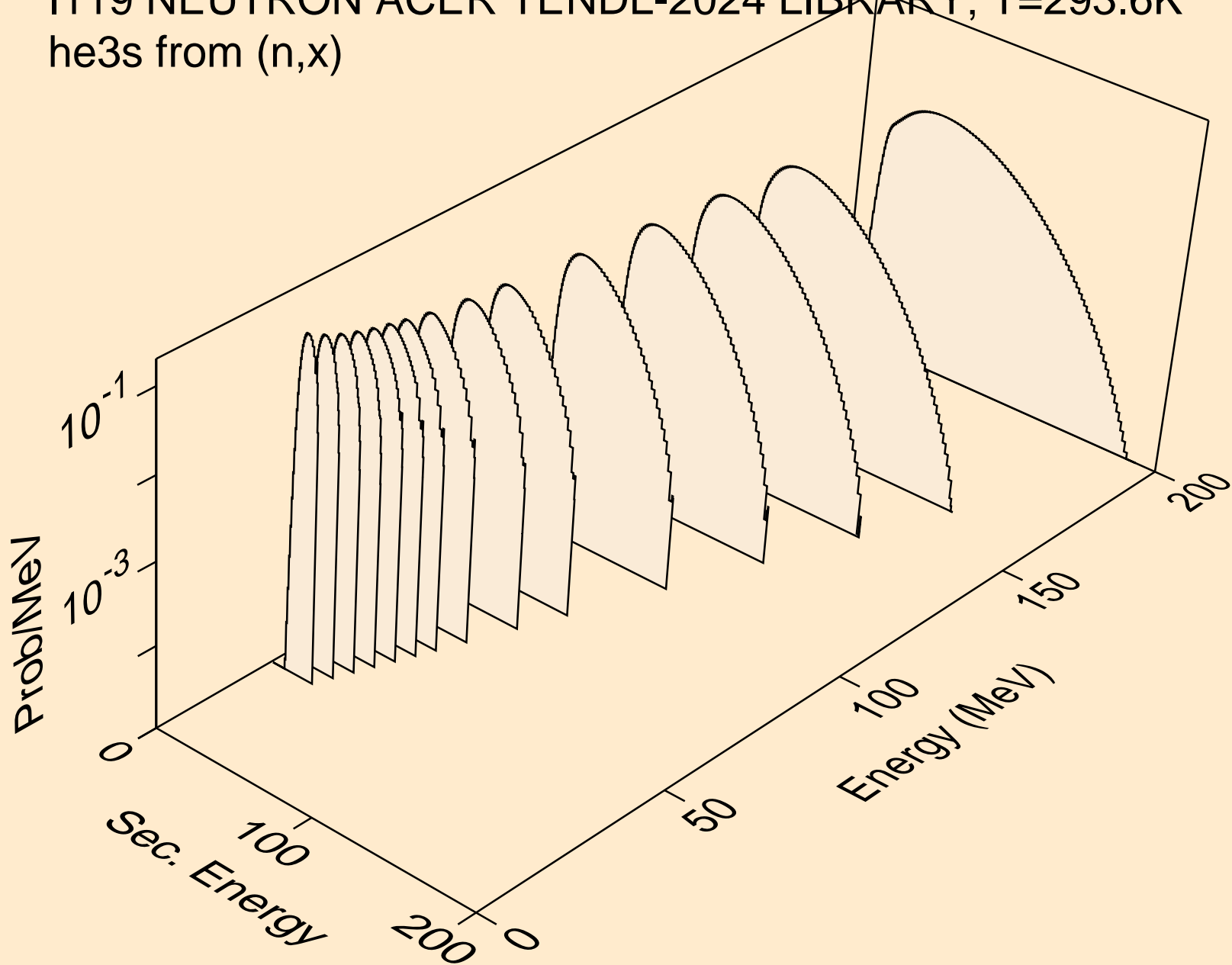

I119 NEUTRON ACER TENDL-2024 LIBRARY; T=293.6K
he3s from (n,n*)he3

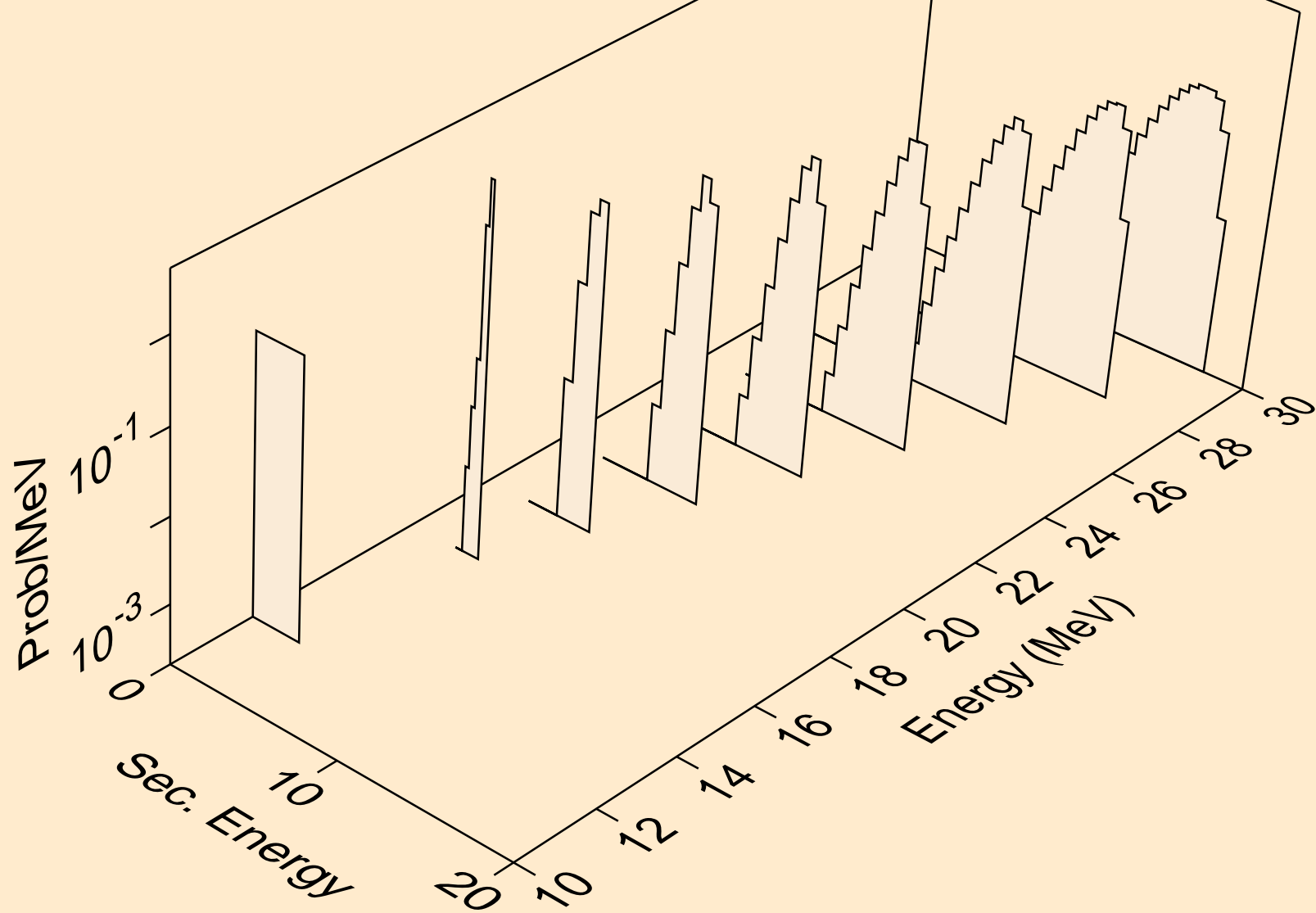

I119 NEUTRON ACER TENDL-2024 LIBRARY; T=293.6K
he3s from (n,he3)

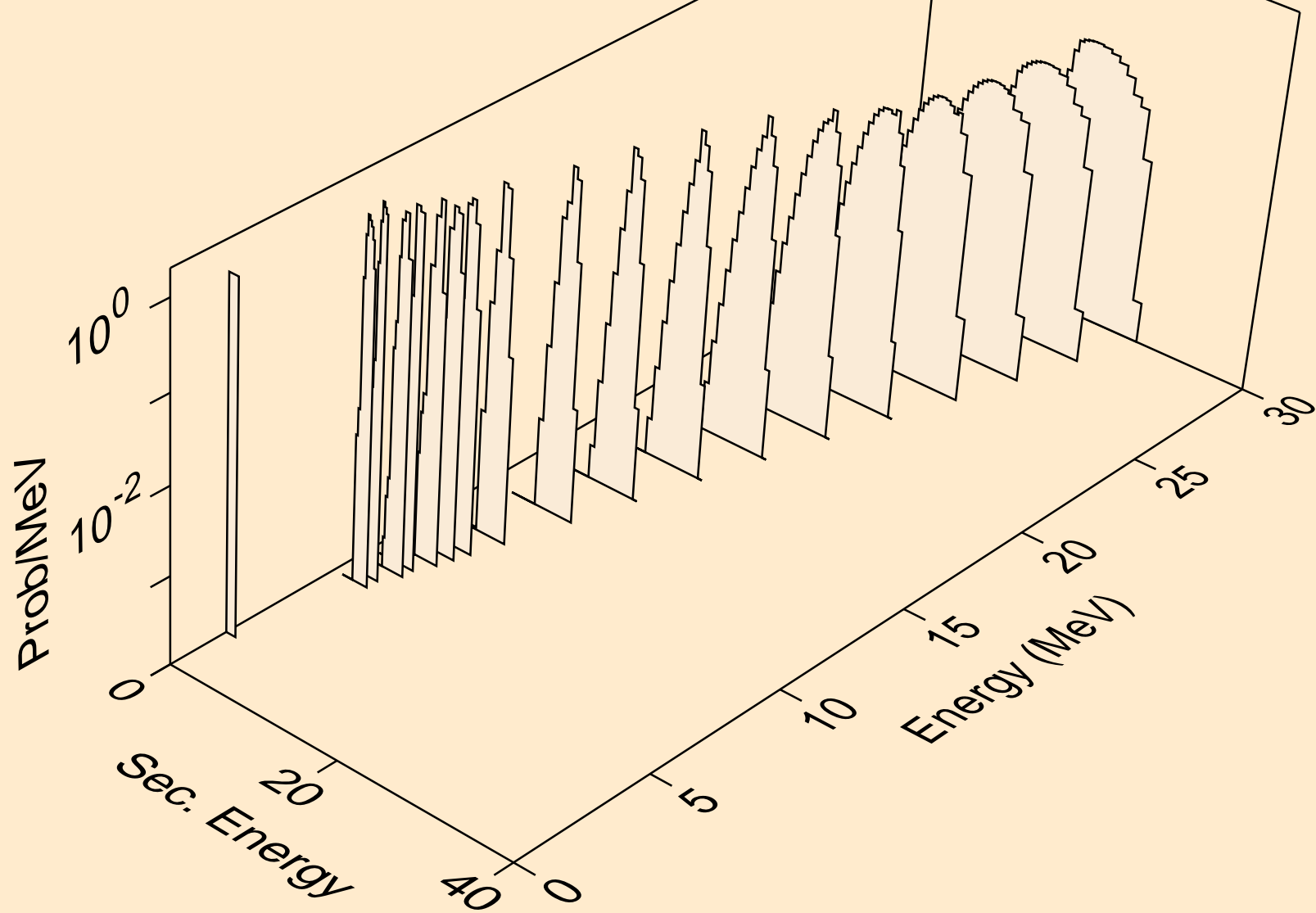

I119 NEUTRON ACER TENDL-2024 LIBRARY; T=293.6K
alphas from (n,x)

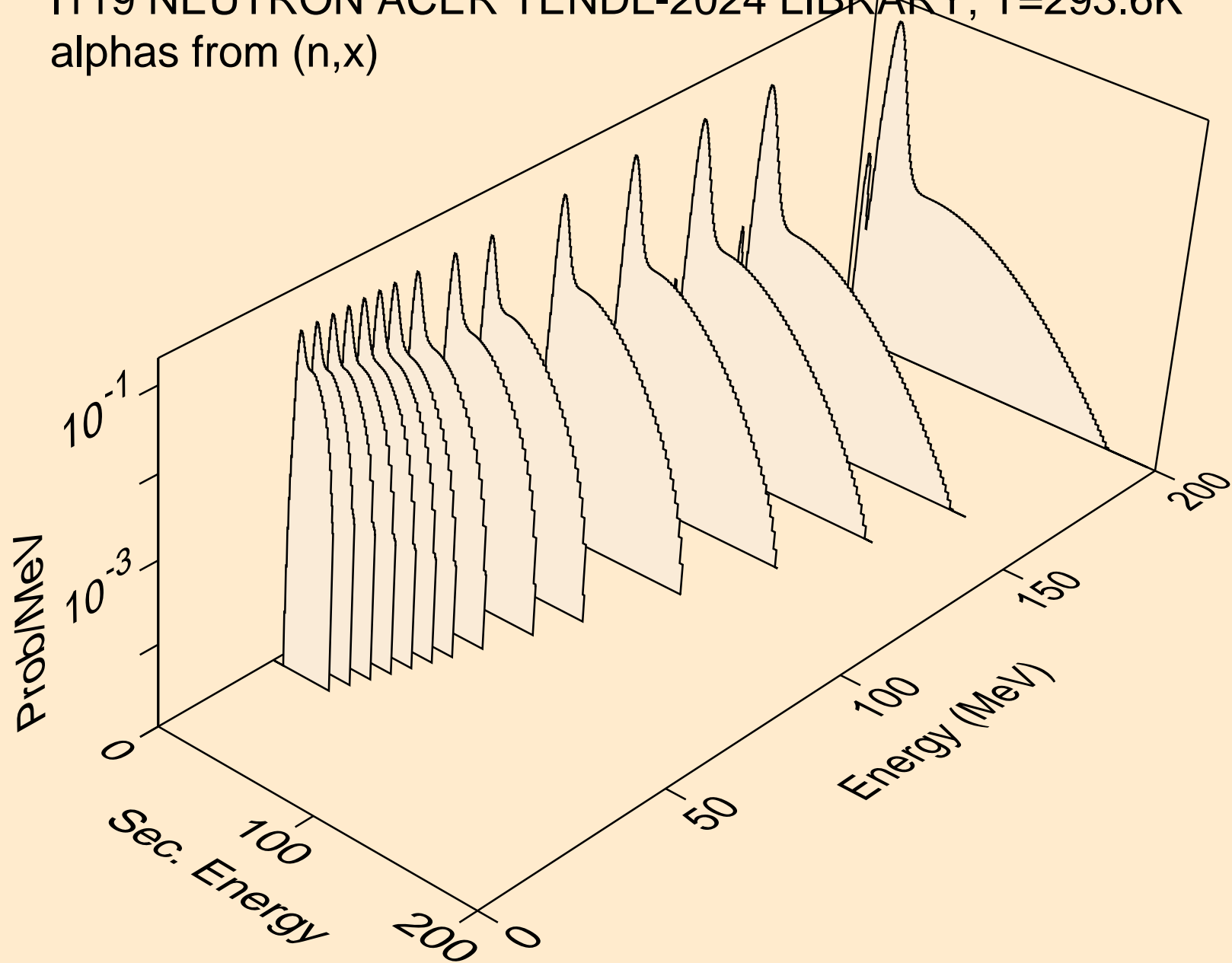

I119 NEUTRON ACER TENDL-2024 LIBRARY; T=293.6K
alphas from (n,n*)a

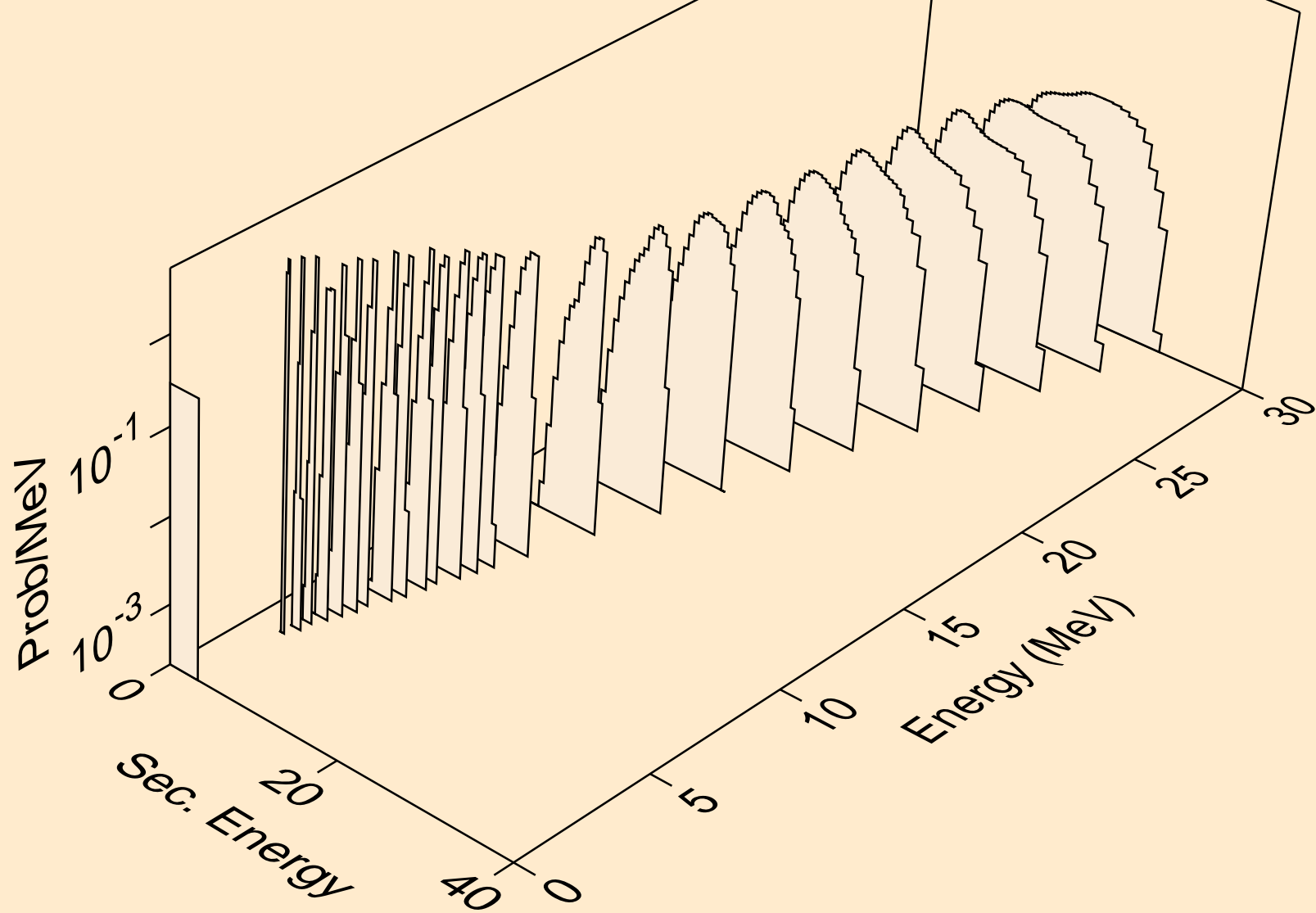

I119 NEUTRON ACER TENDL-2024 LIBRARY; T=293.6K
alphas from (n,2n)a

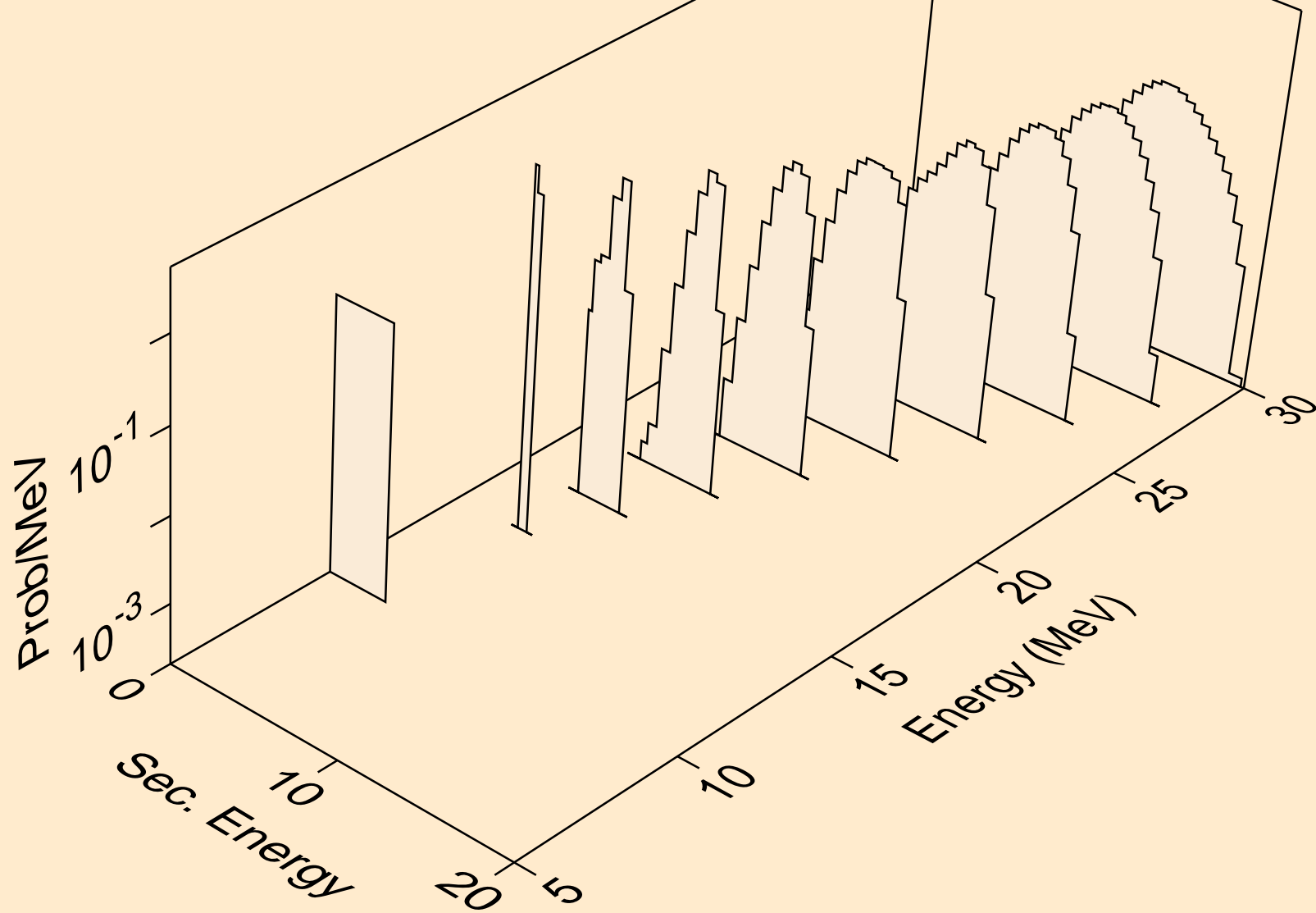

I119 NEUTRON ACER TENDL-2024 LIBRARY; T=293.6K
alphas from (n,3n)a

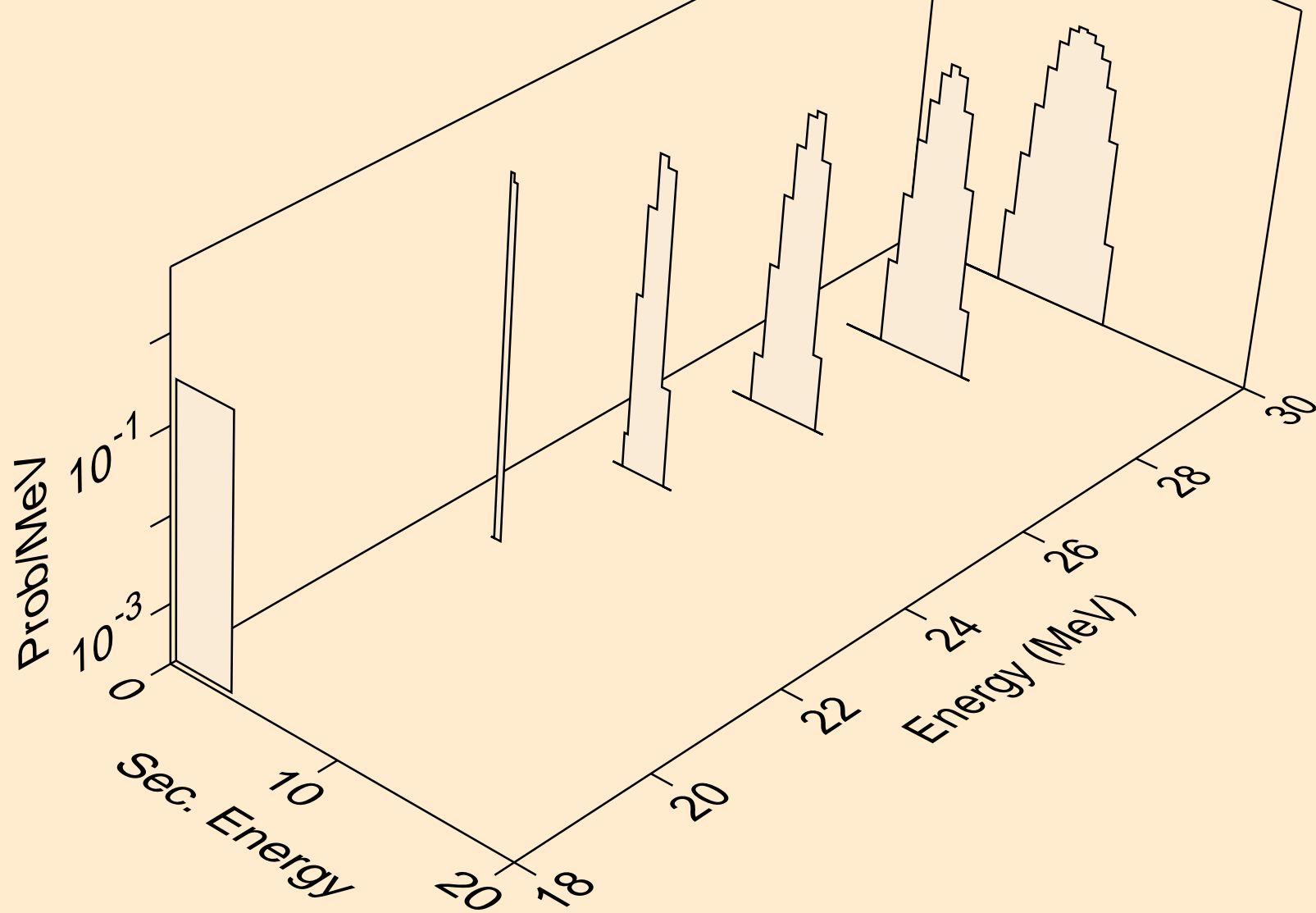

I119 NEUTRON ACER TENDL-2024 LIBRARY; T=293.6K
alphas from (n,n*)2a

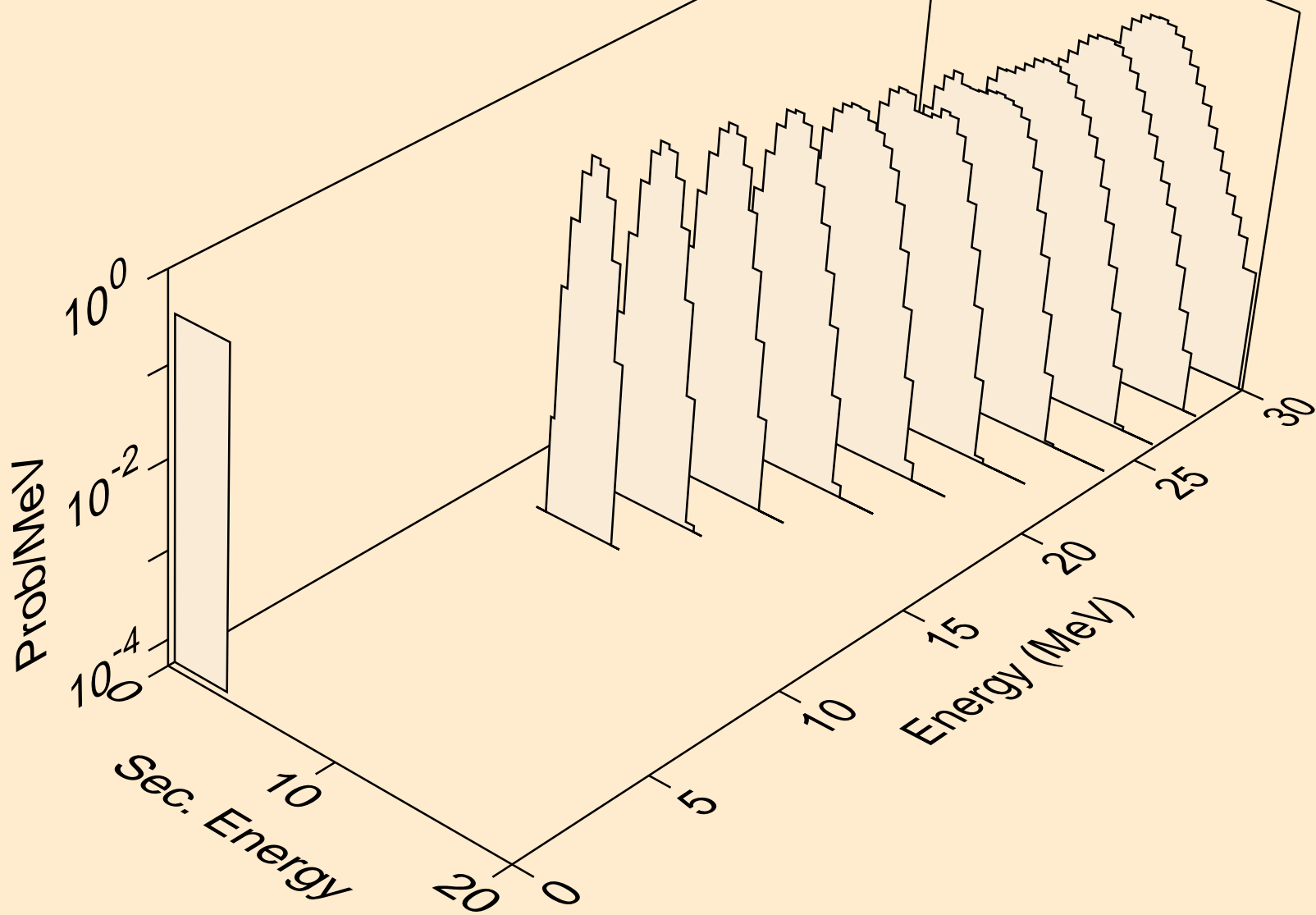

I119 NEUTRON ACER TENDL-2024 LIBRARY; T=293.6K
alphas from (n,2n)2a

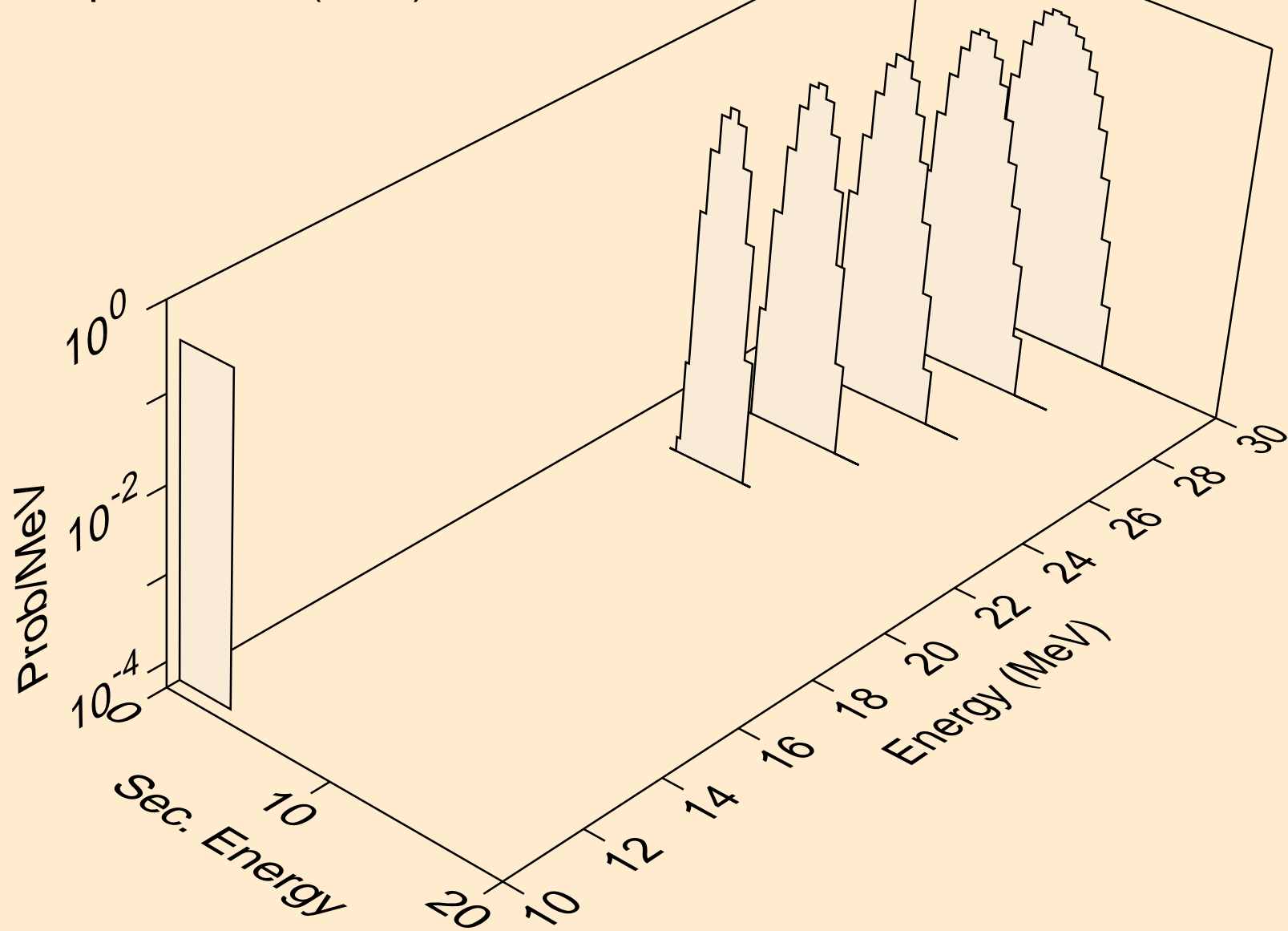

I119 NEUTRON ACER TENDL-2024 LIBRARY; T=293.6K
alphas from (n,npa)

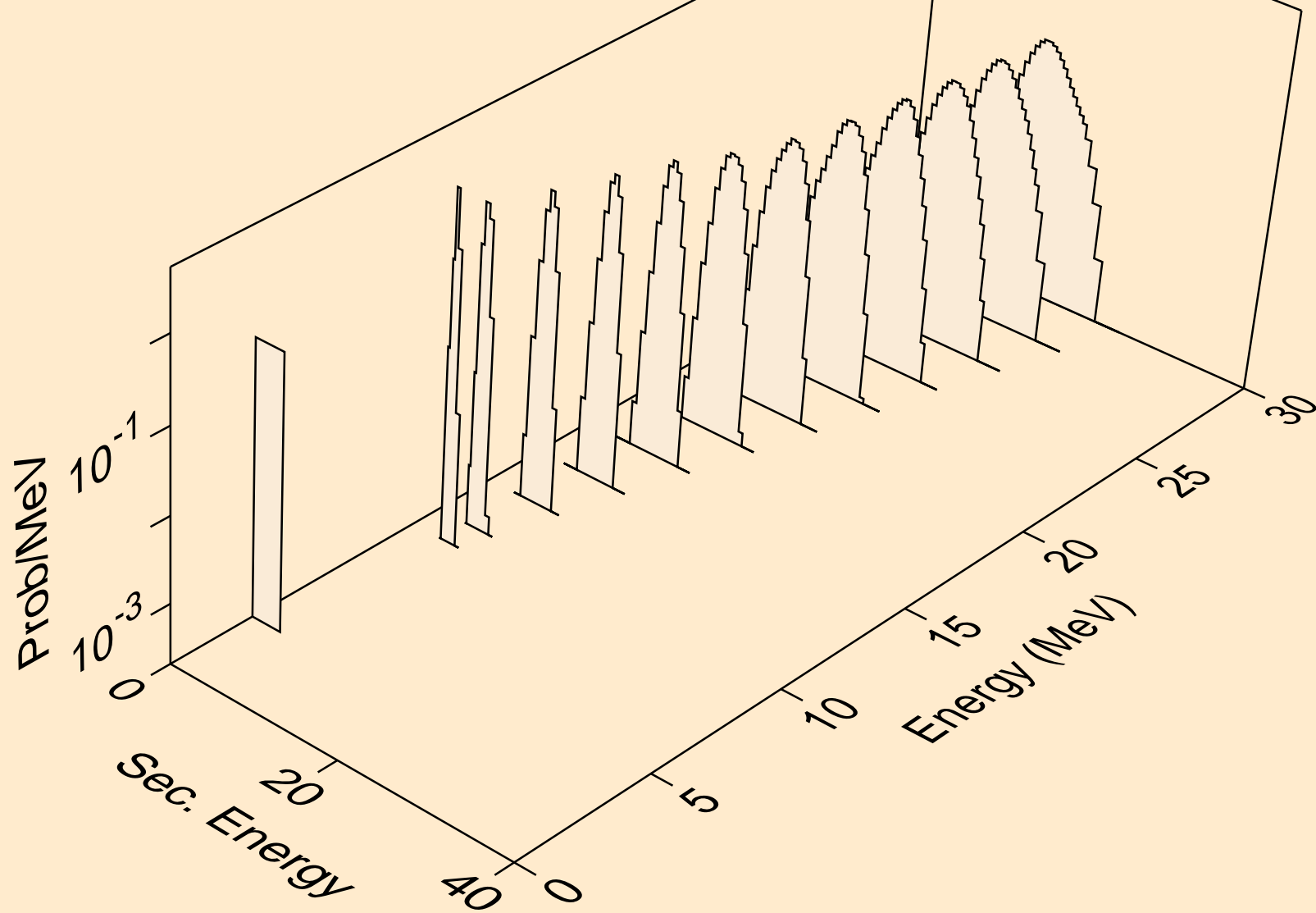

I119 NEUTRON ACER TENDL-2024 LIBRARY; T=293.6K
alphas from (n,a)

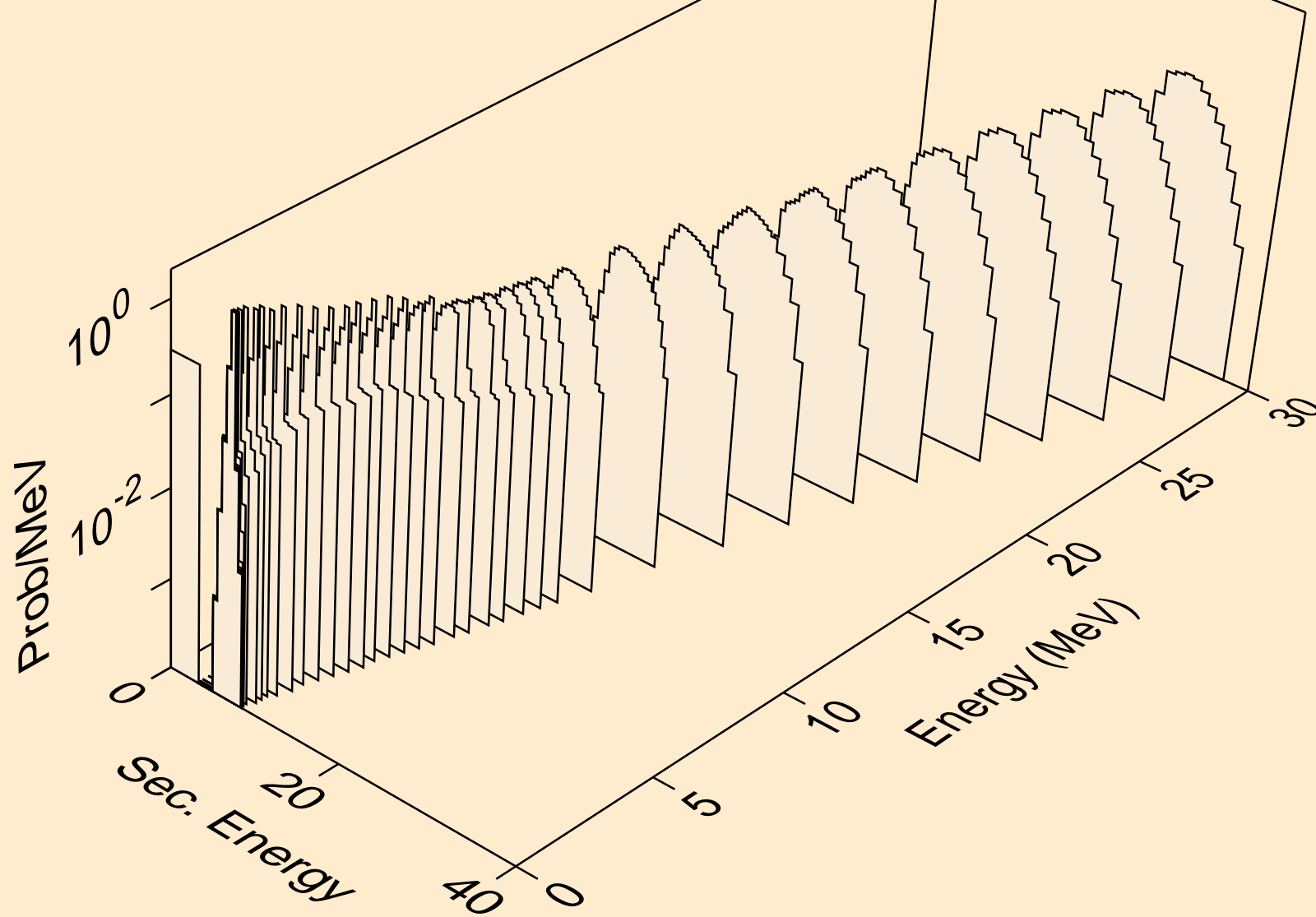

I119 NEUTRON ACER TENDL-2024 LIBRARY; T=293.6K
alphas from (n,2a)

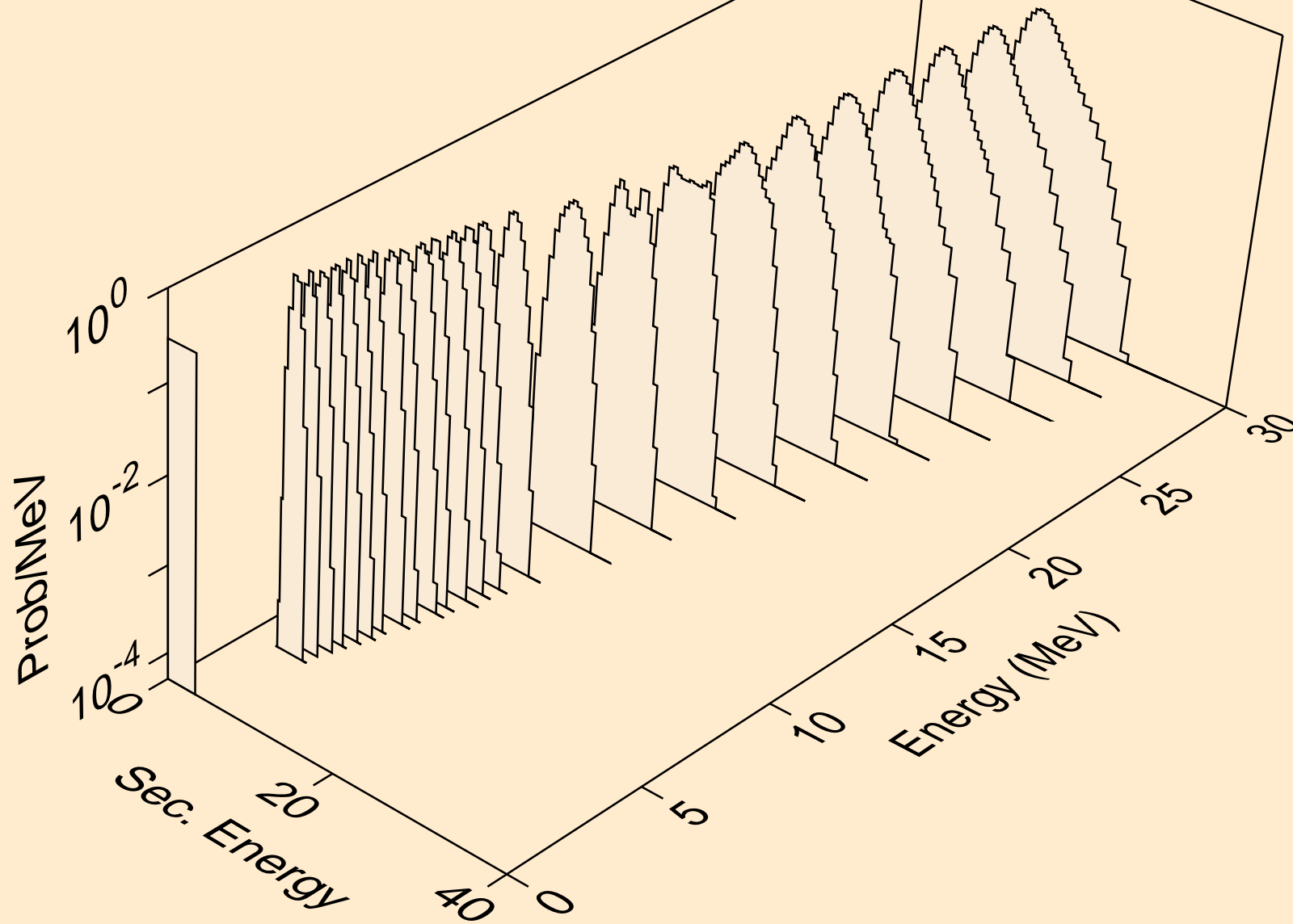

I119 NEUTRON ACER TENDL-2024 LIBRARY; T=293.6K
alphas from (n,pa)

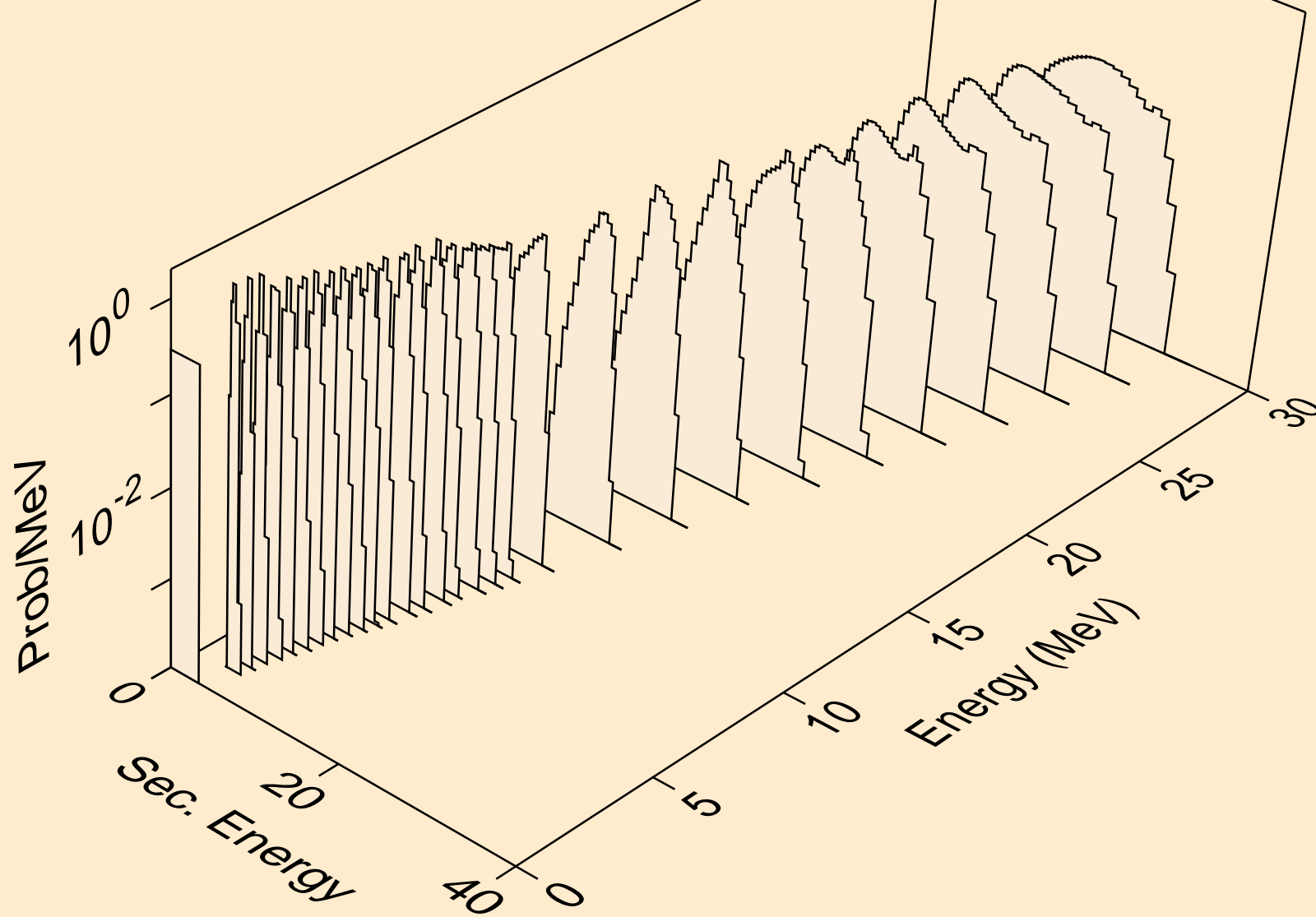

I119 NEUTRON ACER TENDL-2024 LIBRARY; T=293.6K
alphas from (n,da)

