

# I129 NEUTRON ACER TENDL-2024 LIBRARY; T=293.6K

## Principal cross sections

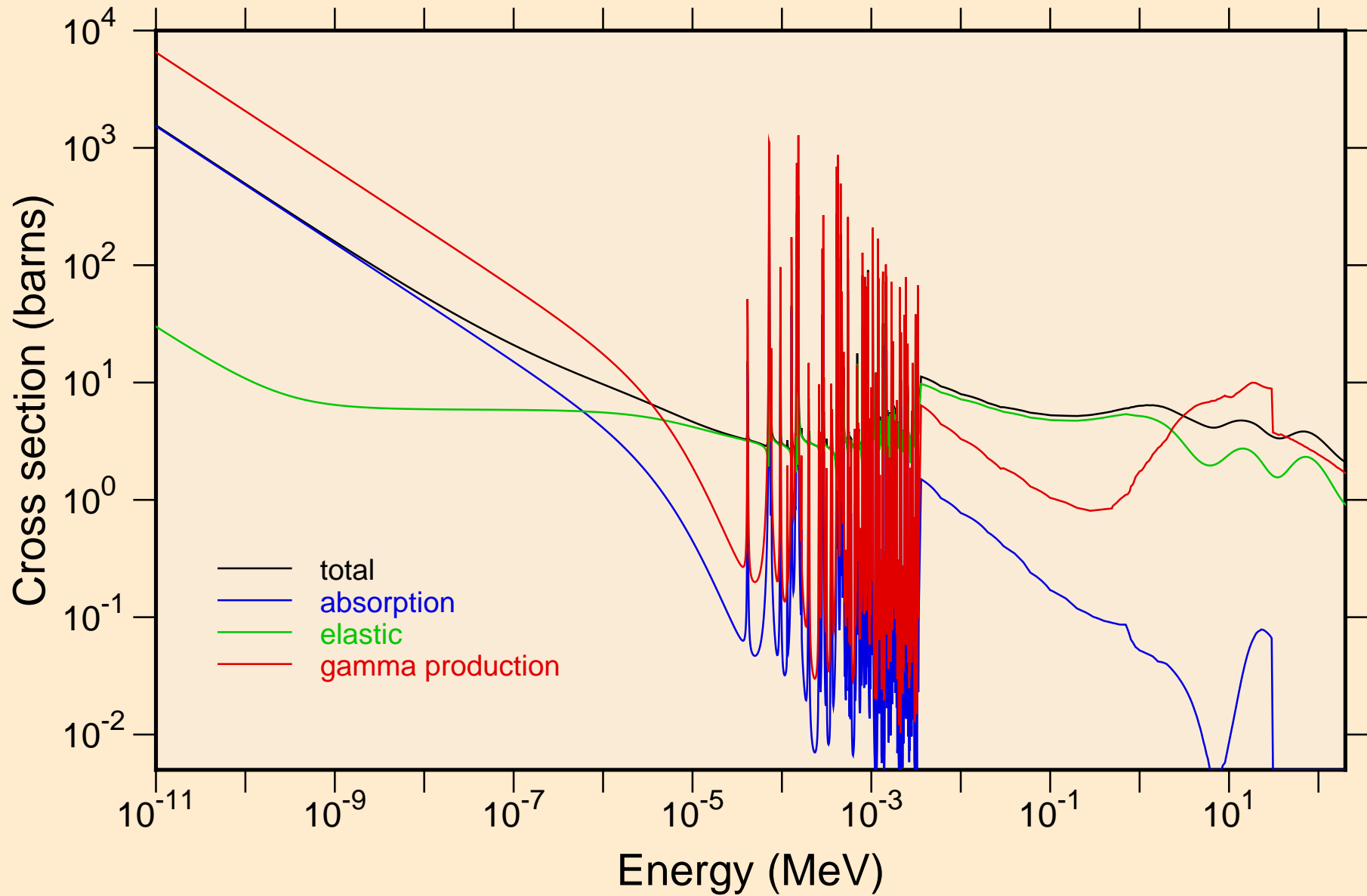

I129 NEUTRON ACER TENDL-2024 LIBRARY; T=293.6K  
resonance total cross section

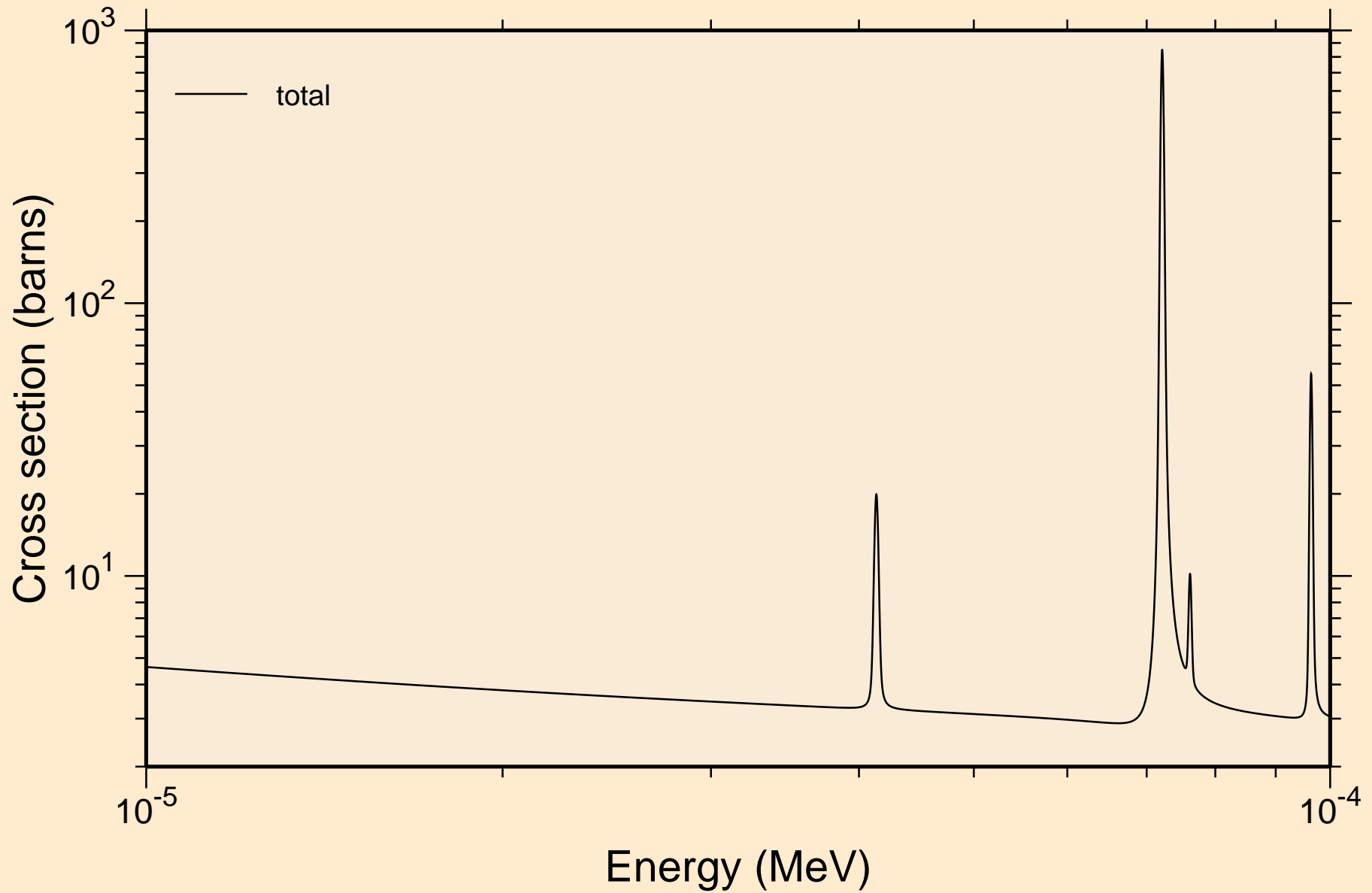

I129 NEUTRON ACER TENDL-2024 LIBRARY; T=293.6K  
resonance total cross section

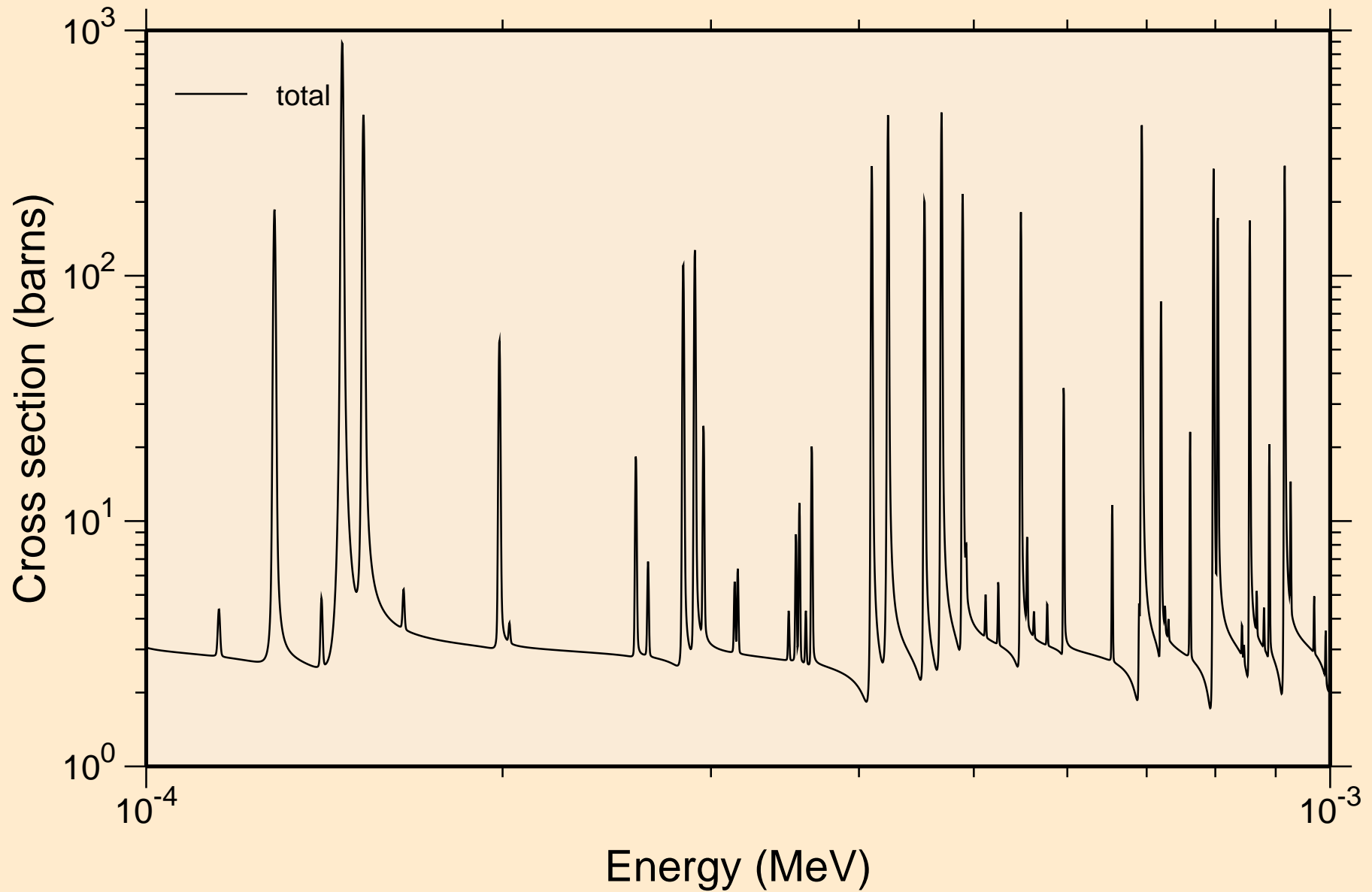

I129 NEUTRON ACER TENDL-2024 LIBRARY; T=293.6K  
resonance total cross section

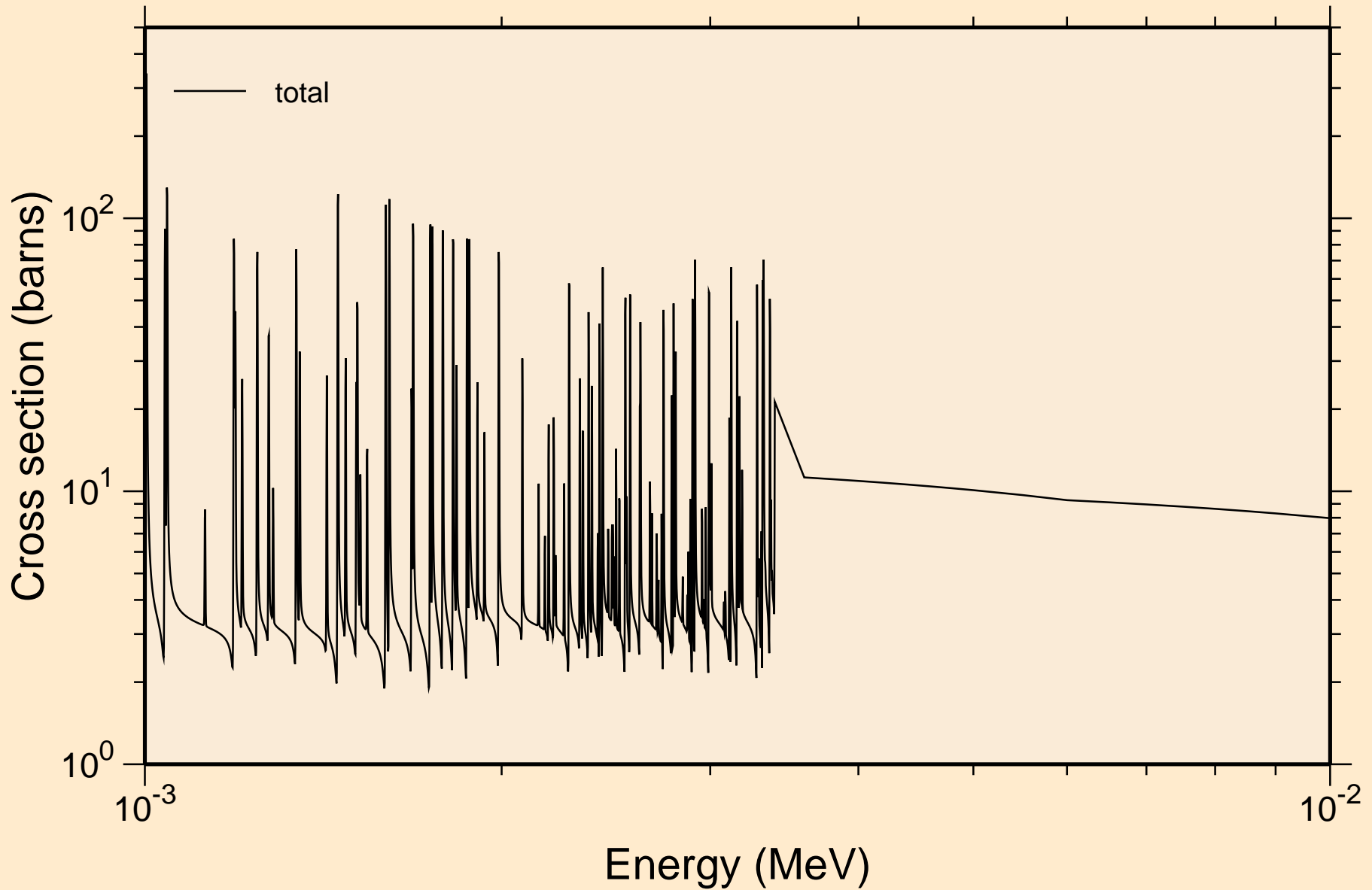

I129 NEUTRON ACER TENDL-2024 LIBRARY; T=293.6K  
resonance total cross section

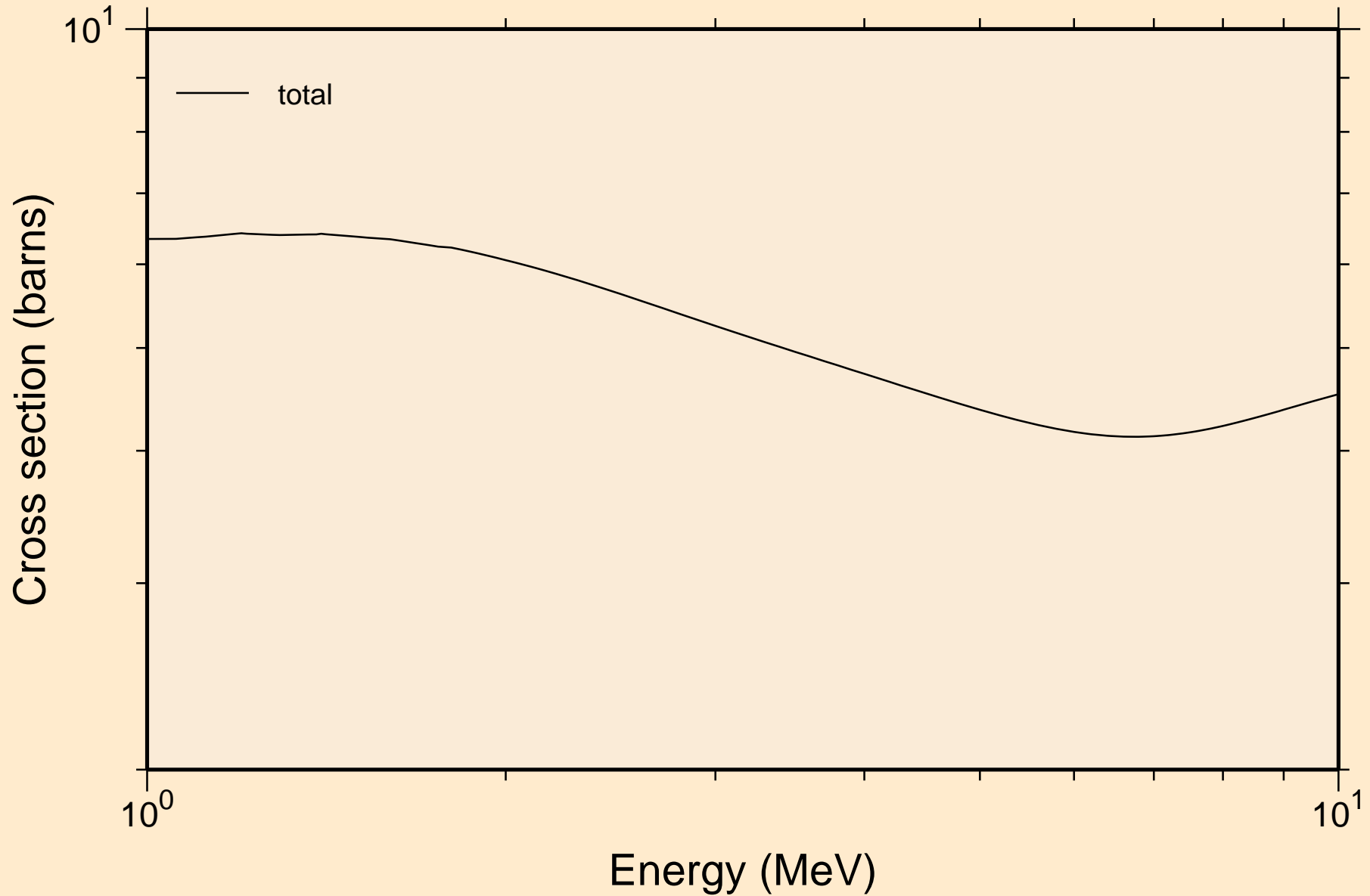

I129 NEUTRON ACER TENDL-2024 LIBRARY; T=293.6K  
resonance absorption cross sections

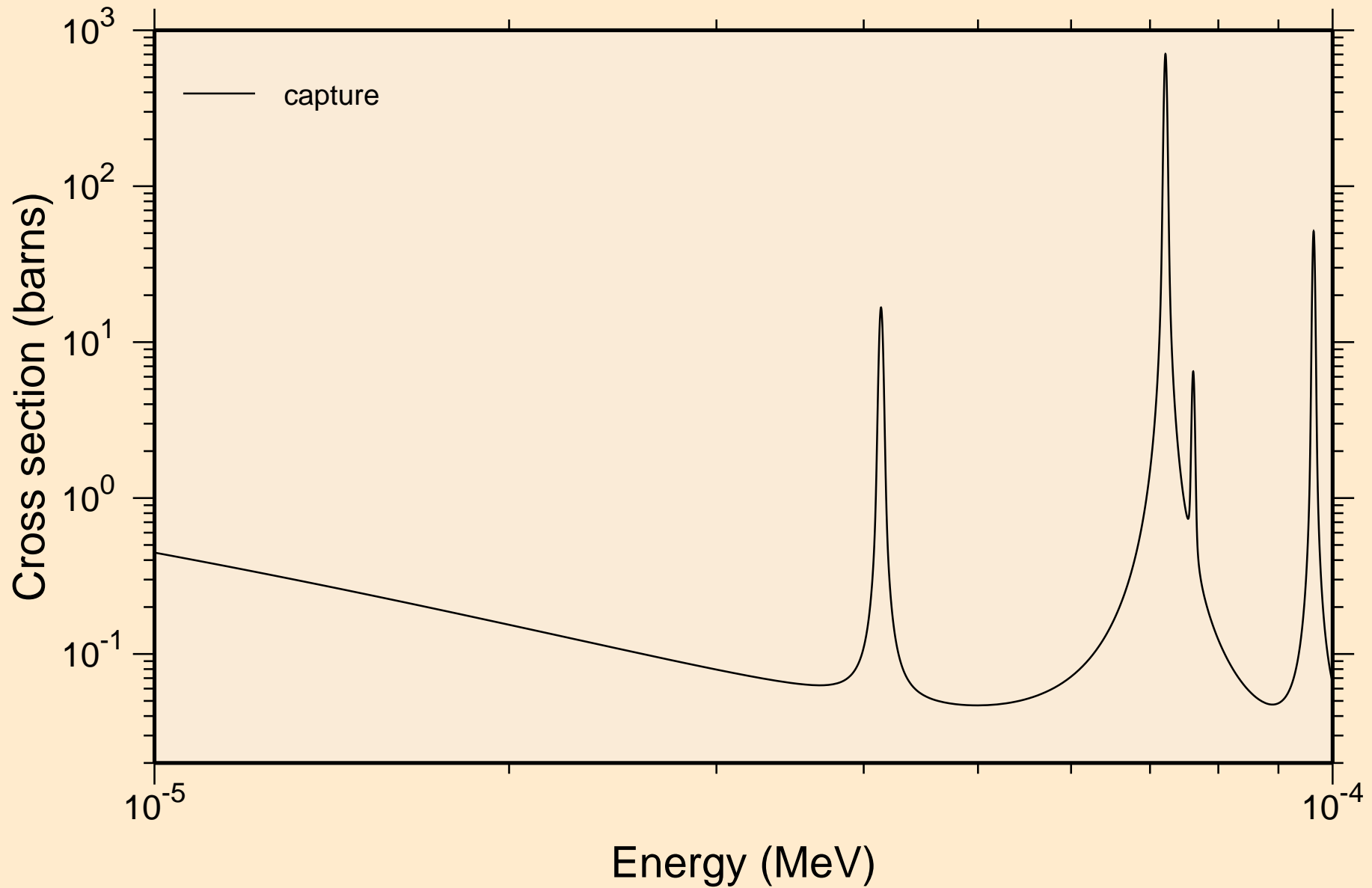

I129 NEUTRON ACER TENDL-2024 LIBRARY; T=293.6K  
resonance absorption cross sections

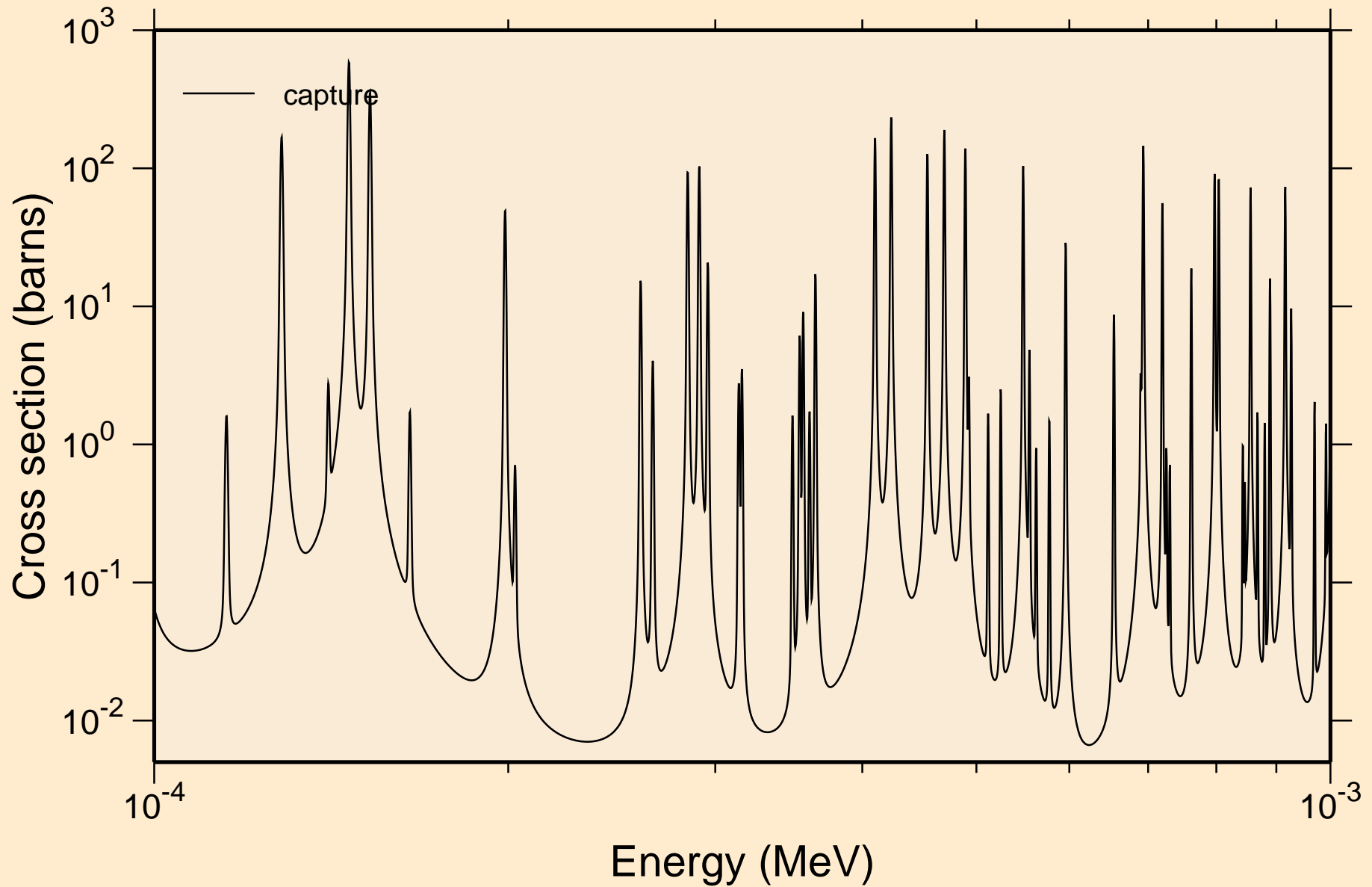

I129 NEUTRON ACER TENDL-2024 LIBRARY; T=293.6K  
resonance absorption cross sections

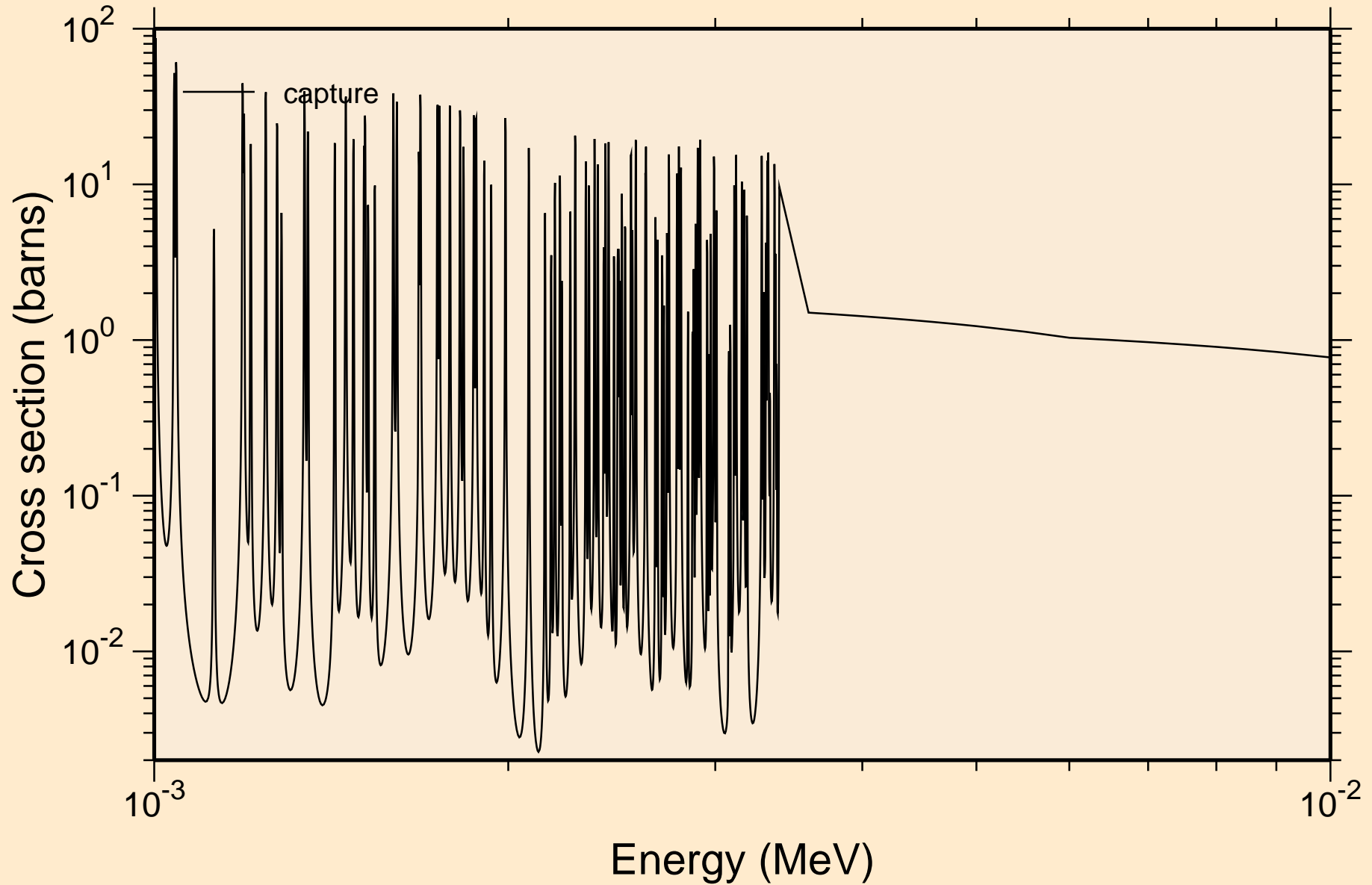

I129 NEUTRON ACER TENDL-2024 LIBRARY; T=293.6K  
resonance absorption cross sections

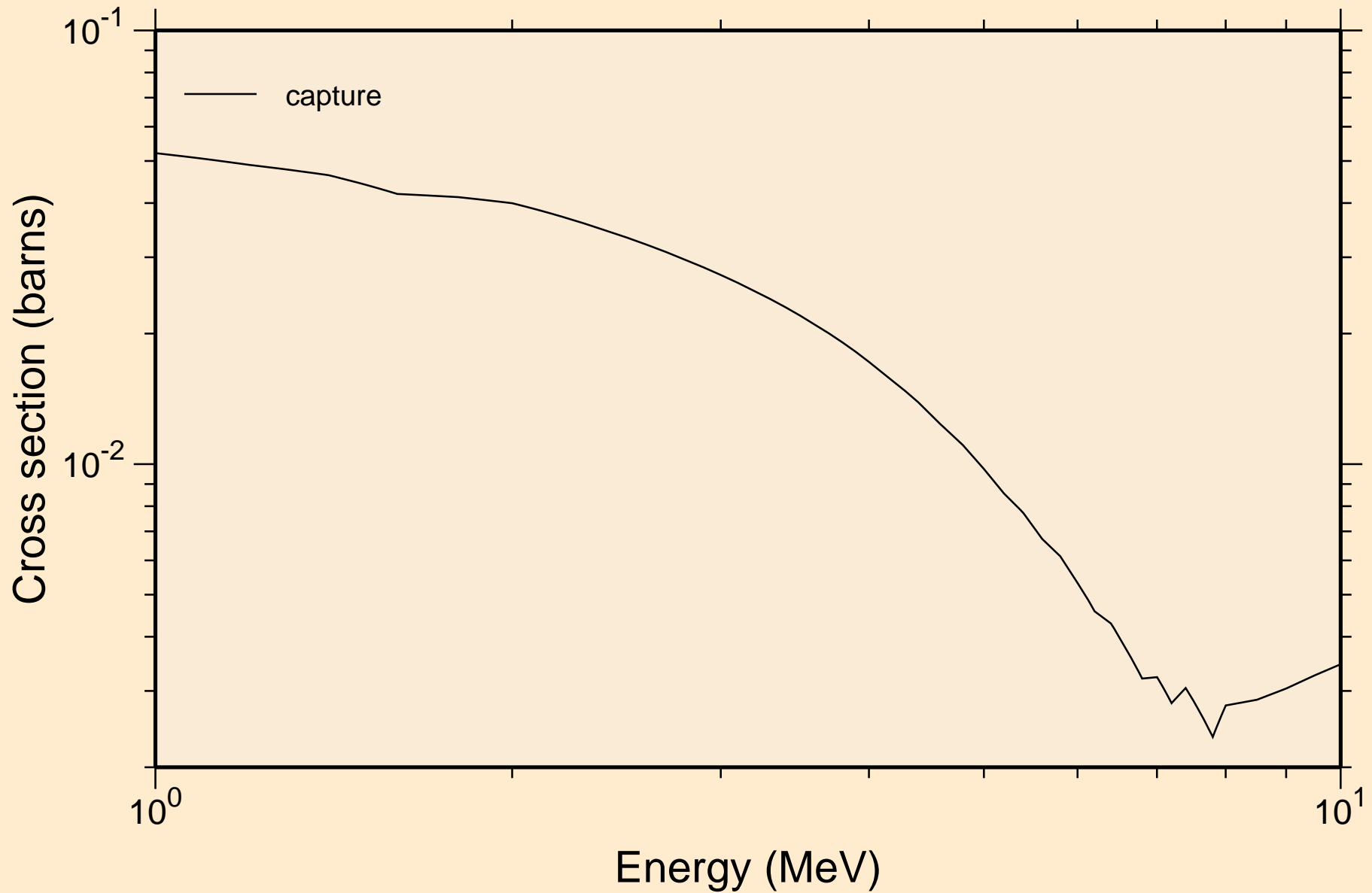

I129 NEUTRON ACER TENDL-2024 LIBRARY; T=293.6K  
Heating

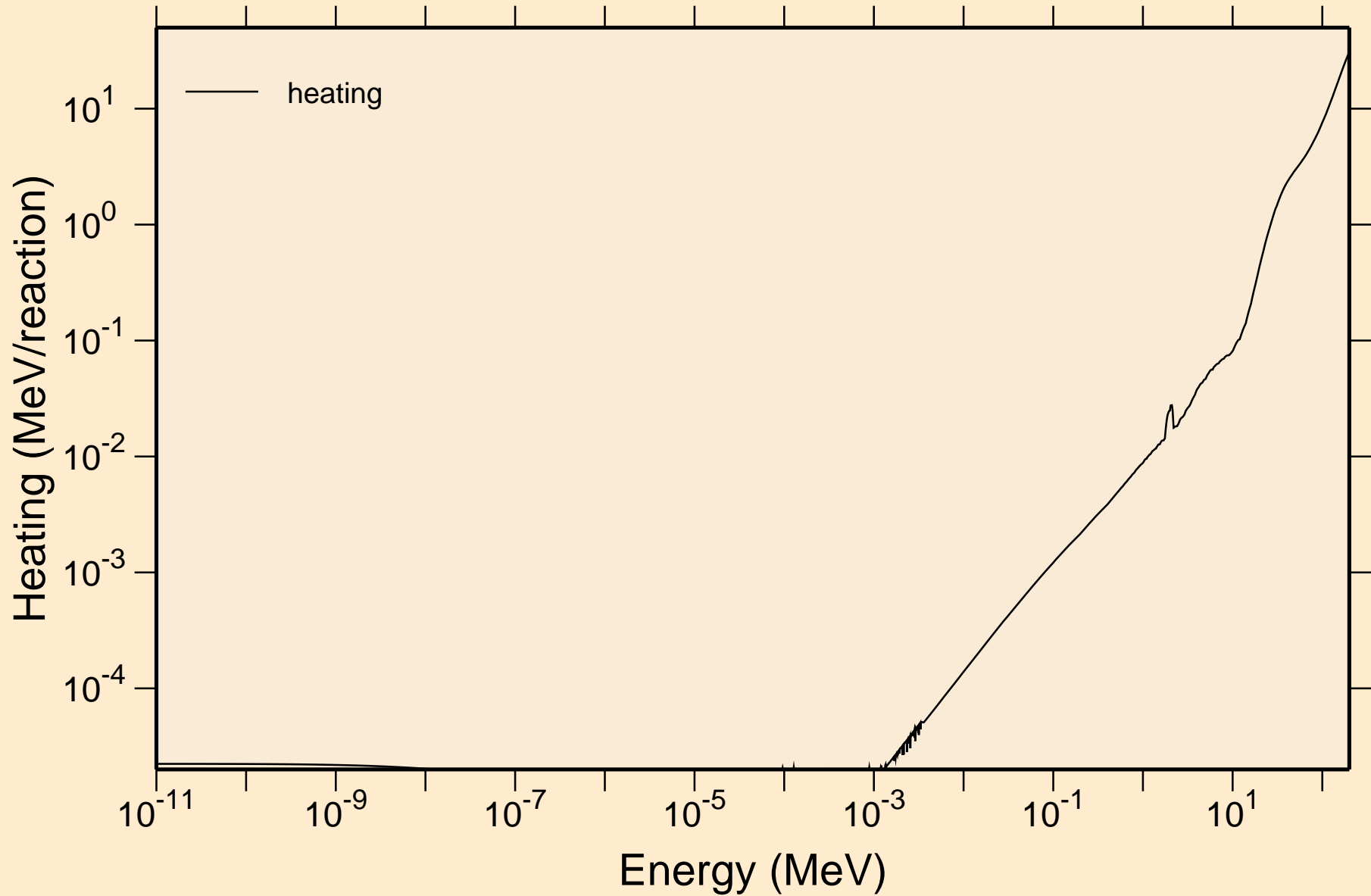

# I129 NEUTRON ACER TENDL-2024 LIBRARY; T=293.6K

## Damage

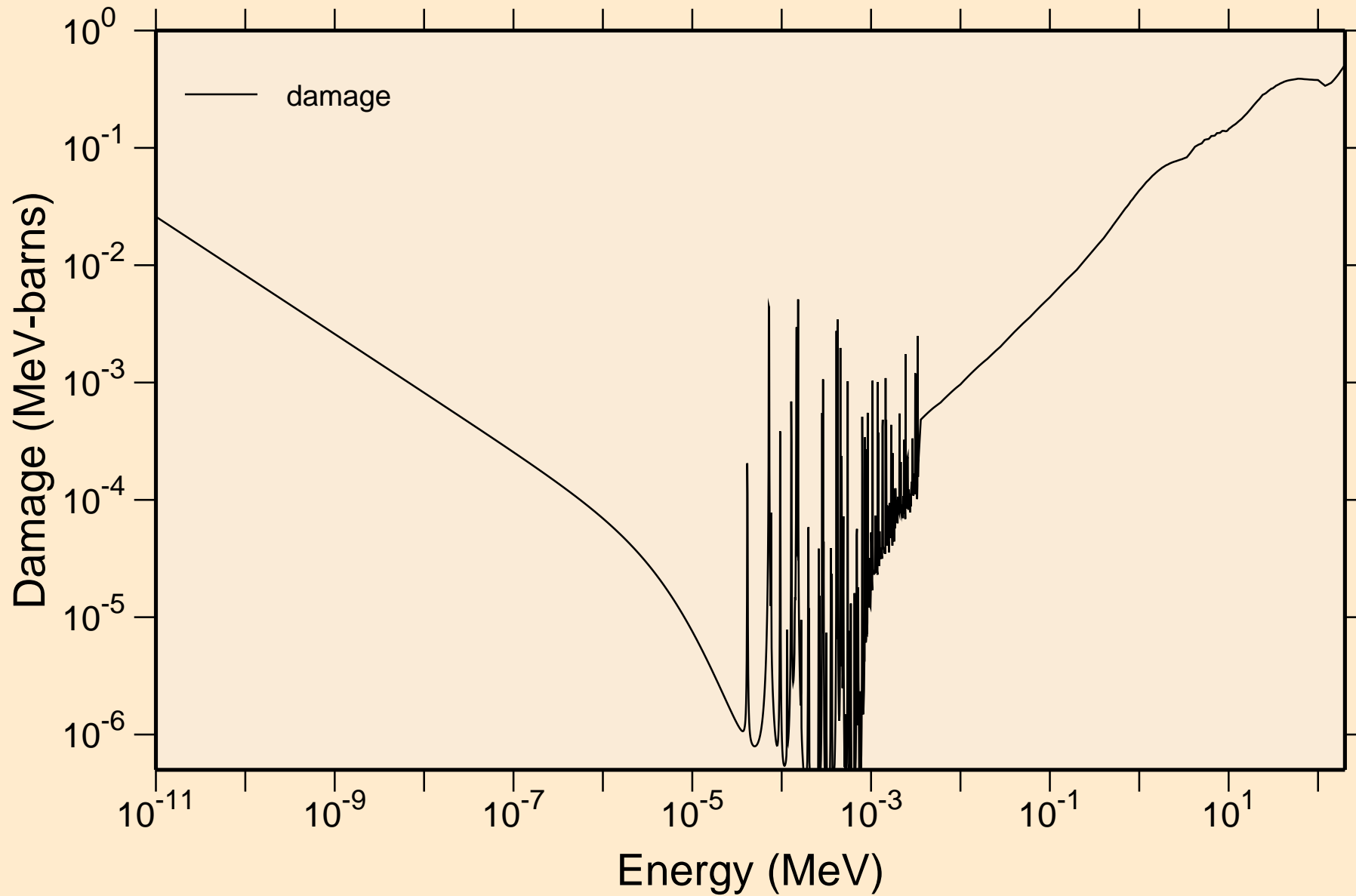

I129 NEUTRON ACER TENDL-2024 LIBRARY; T=293.6K  
Non-threshold reactions

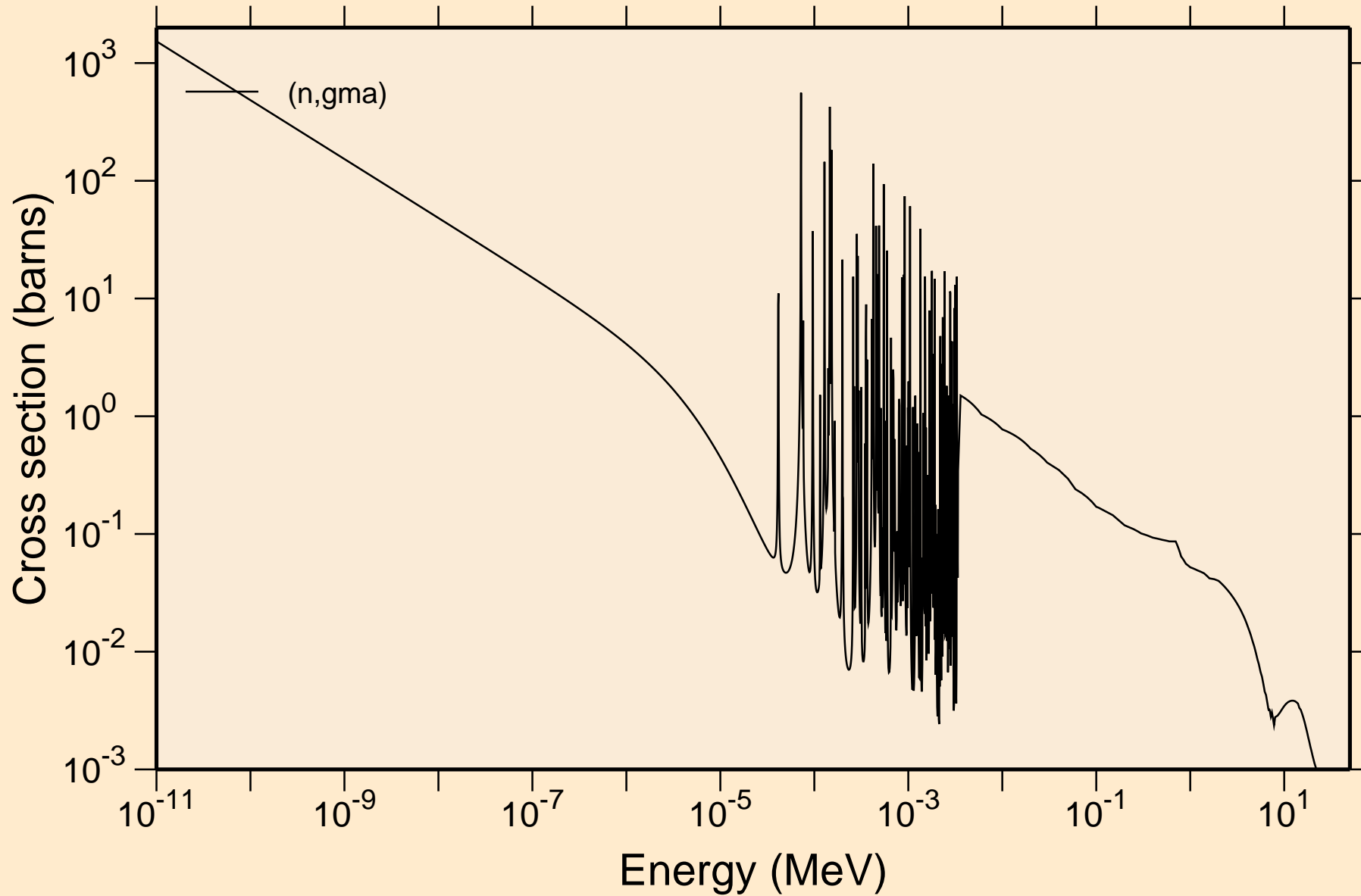

# I129 NEUTRON ACER TENDL-2024 LIBRARY; T=293.6K

## Principal cross sections

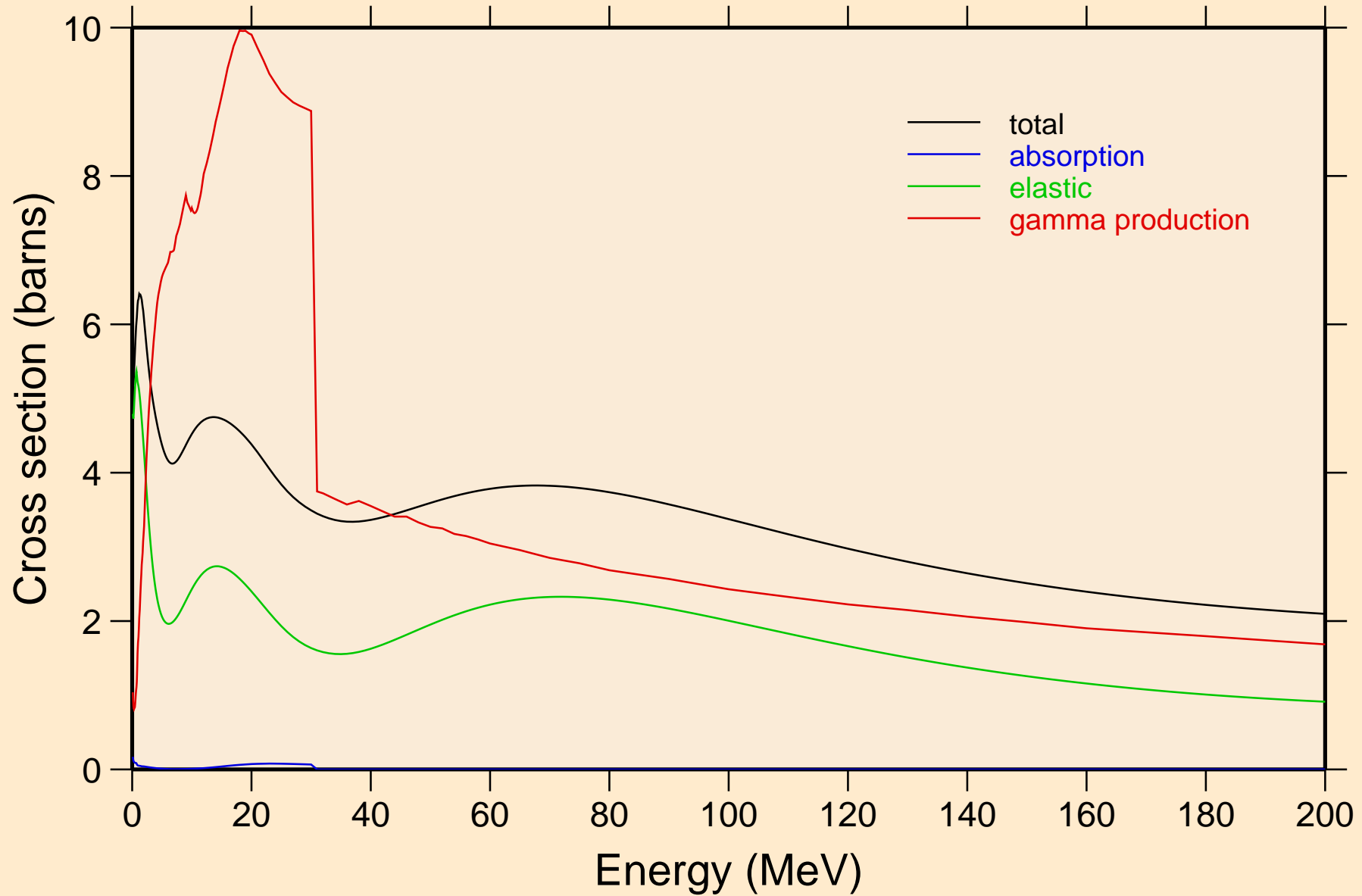

# I129 NEUTRON ACER TENDL-2024 LIBRARY; T=293.6K

## Heating

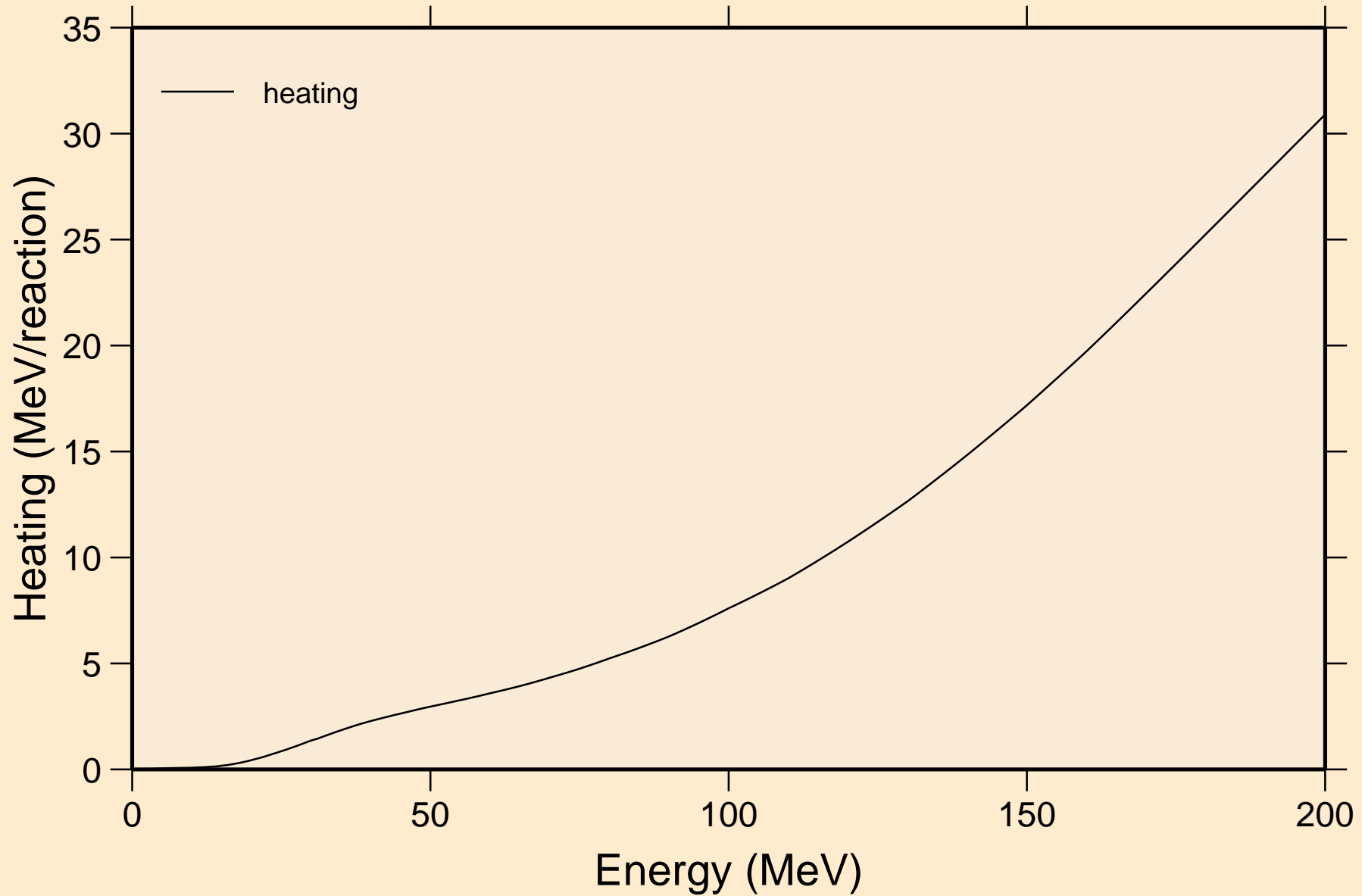

I129 NEUTRON ACER TENDL-2024 LIBRARY; T=293.6K  
Damage

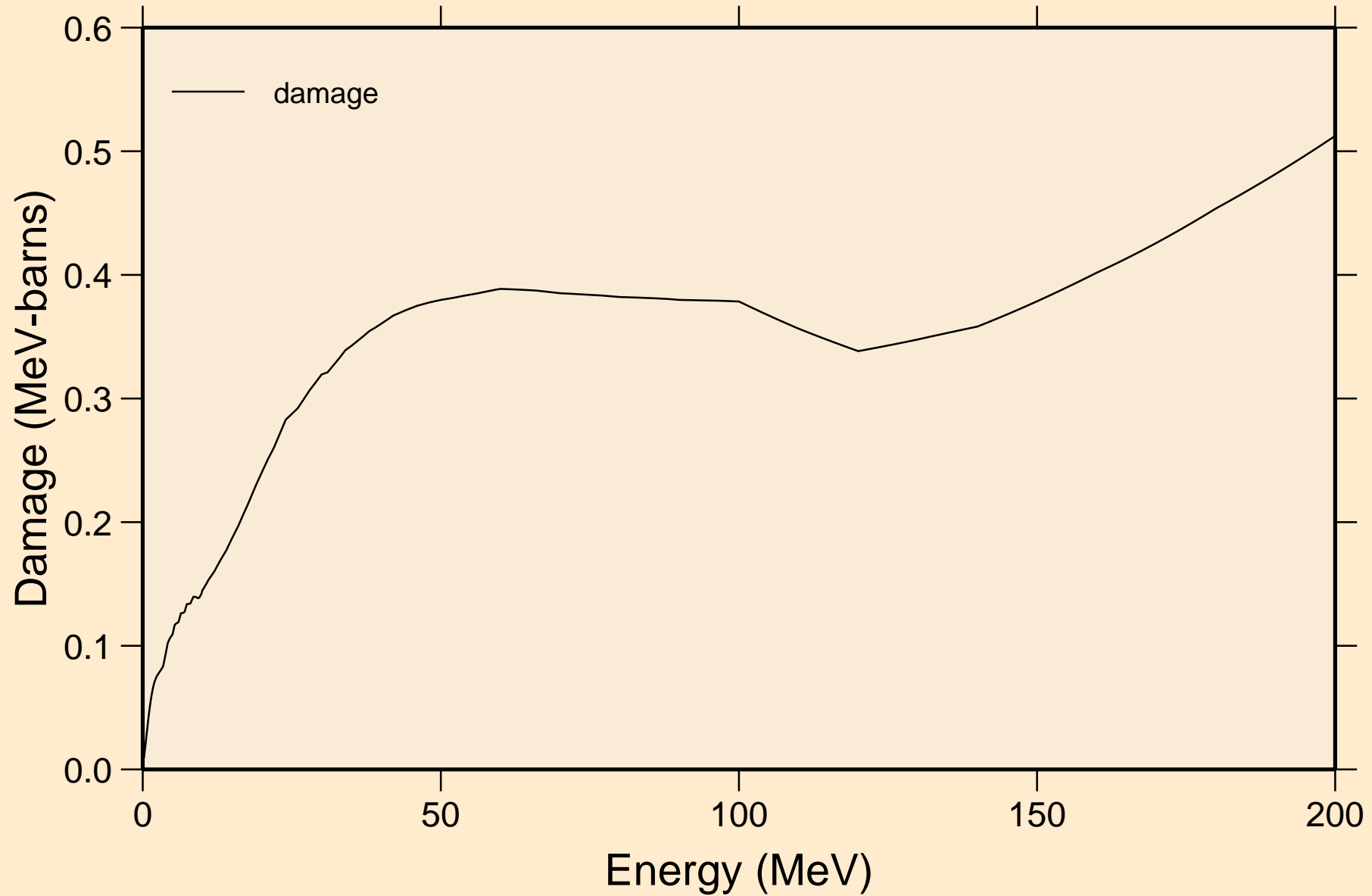

I129 NEUTRON ACER TENDL-2024 LIBRARY; T=293.6K  
Non-threshold reactions

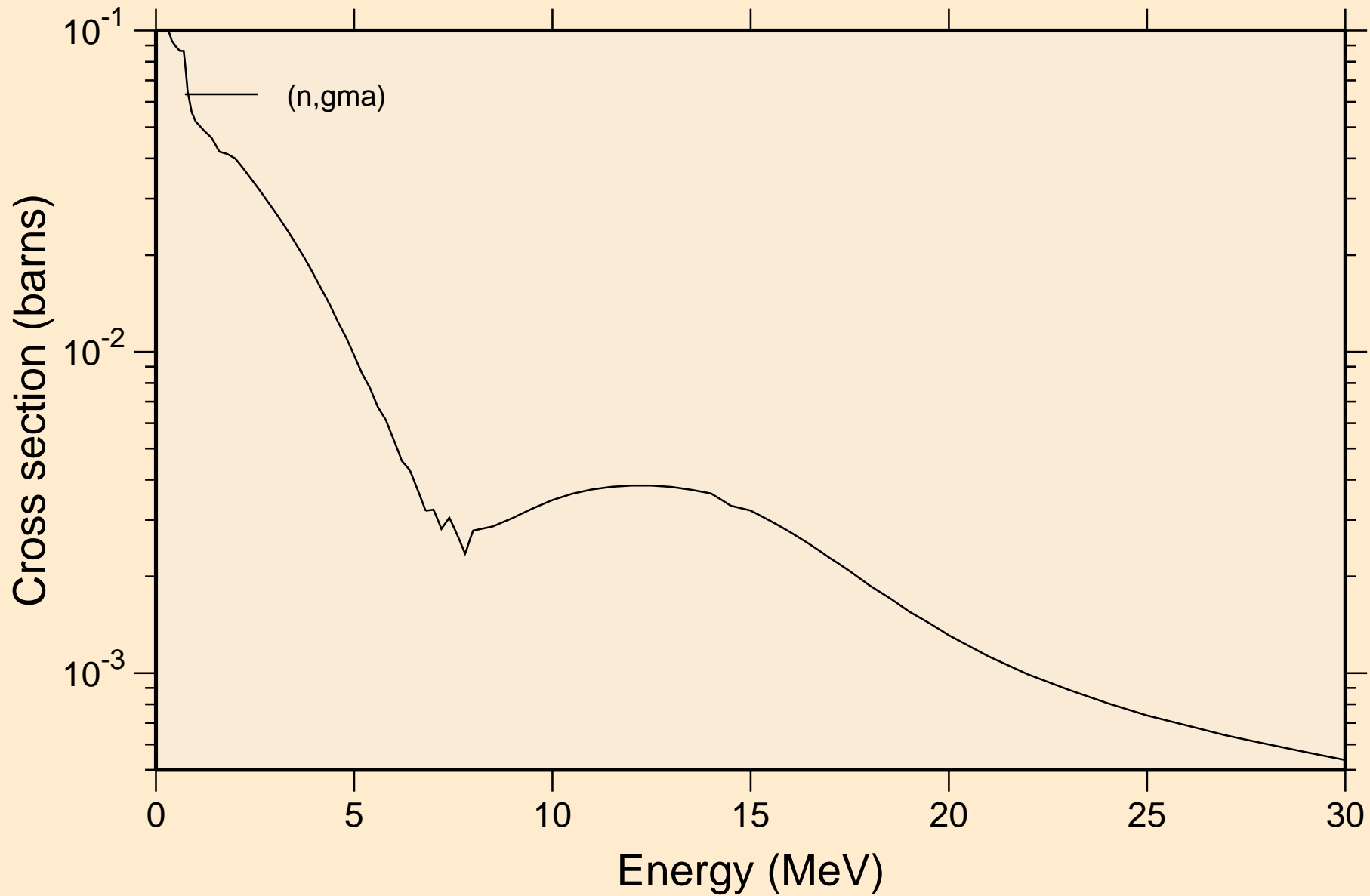

# I129 NEUTRON ACER TENDL-2024 LIBRARY; T=293.6K

## Inelastic levels

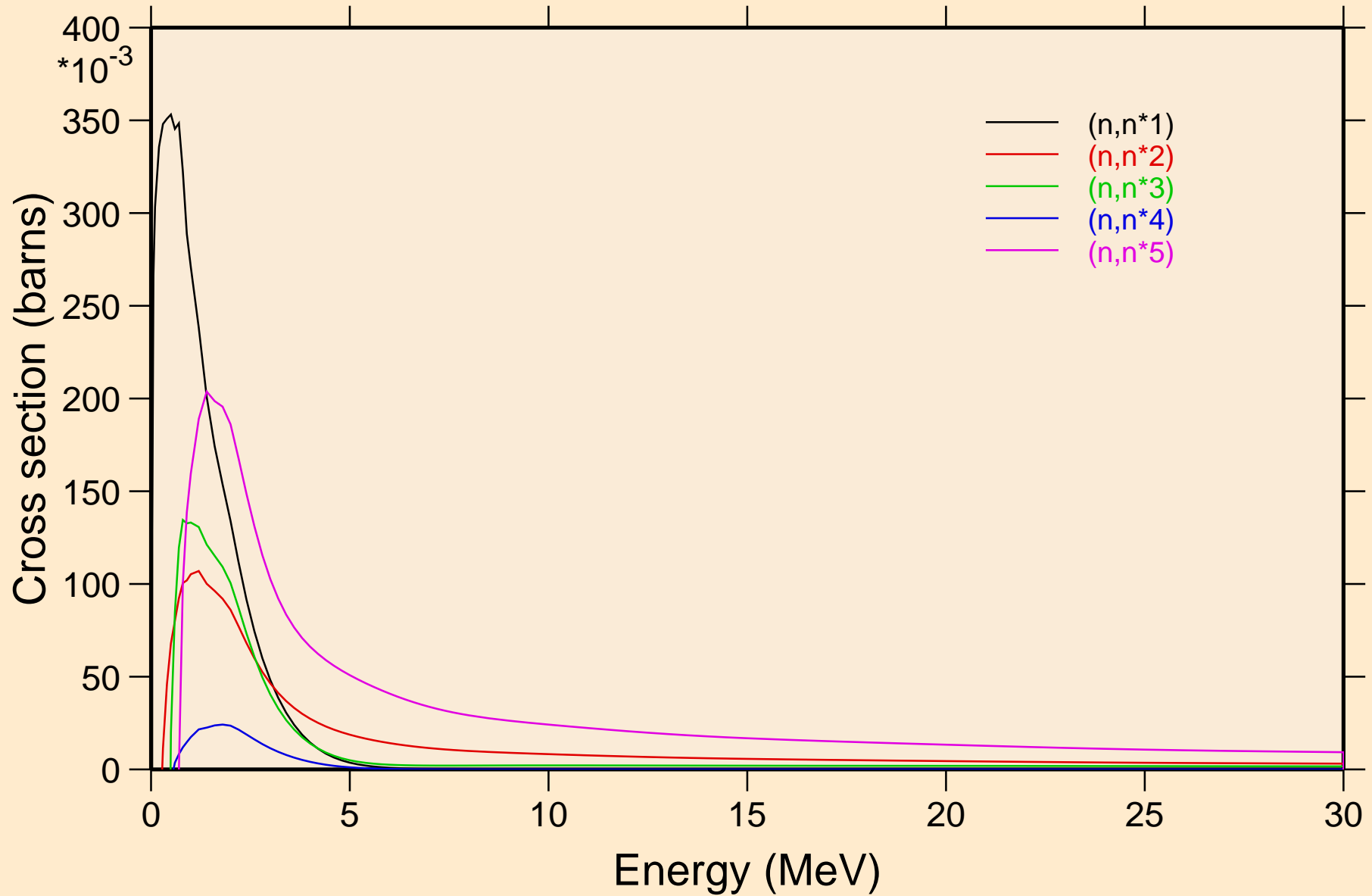

I129 NEUTRON ACER TENDL-2024 LIBRARY; T=293.6K  
Inelastic levels

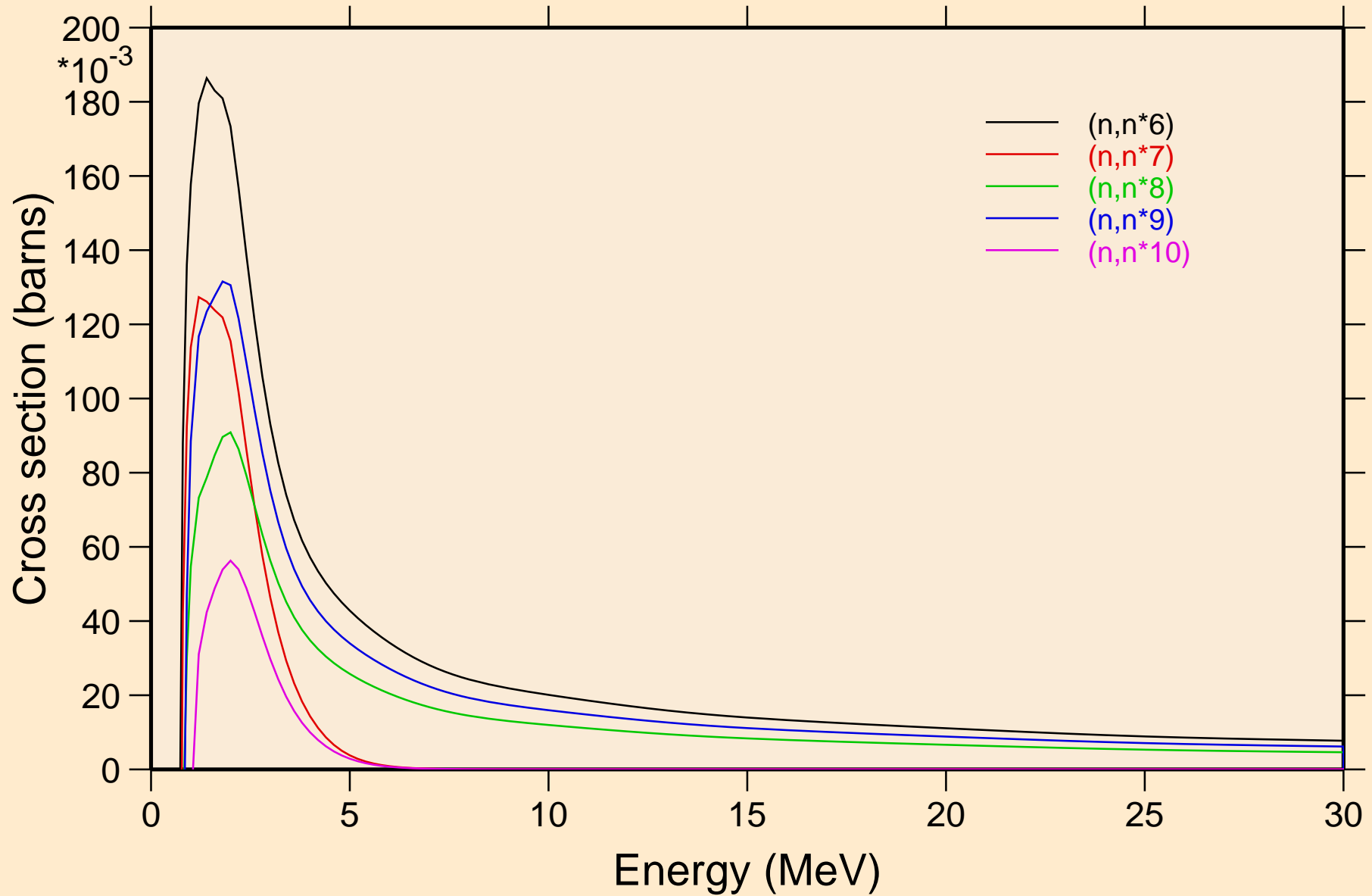

# I129 NEUTRON ACER TENDL-2024 LIBRARY; T=293.6K

## Inelastic levels

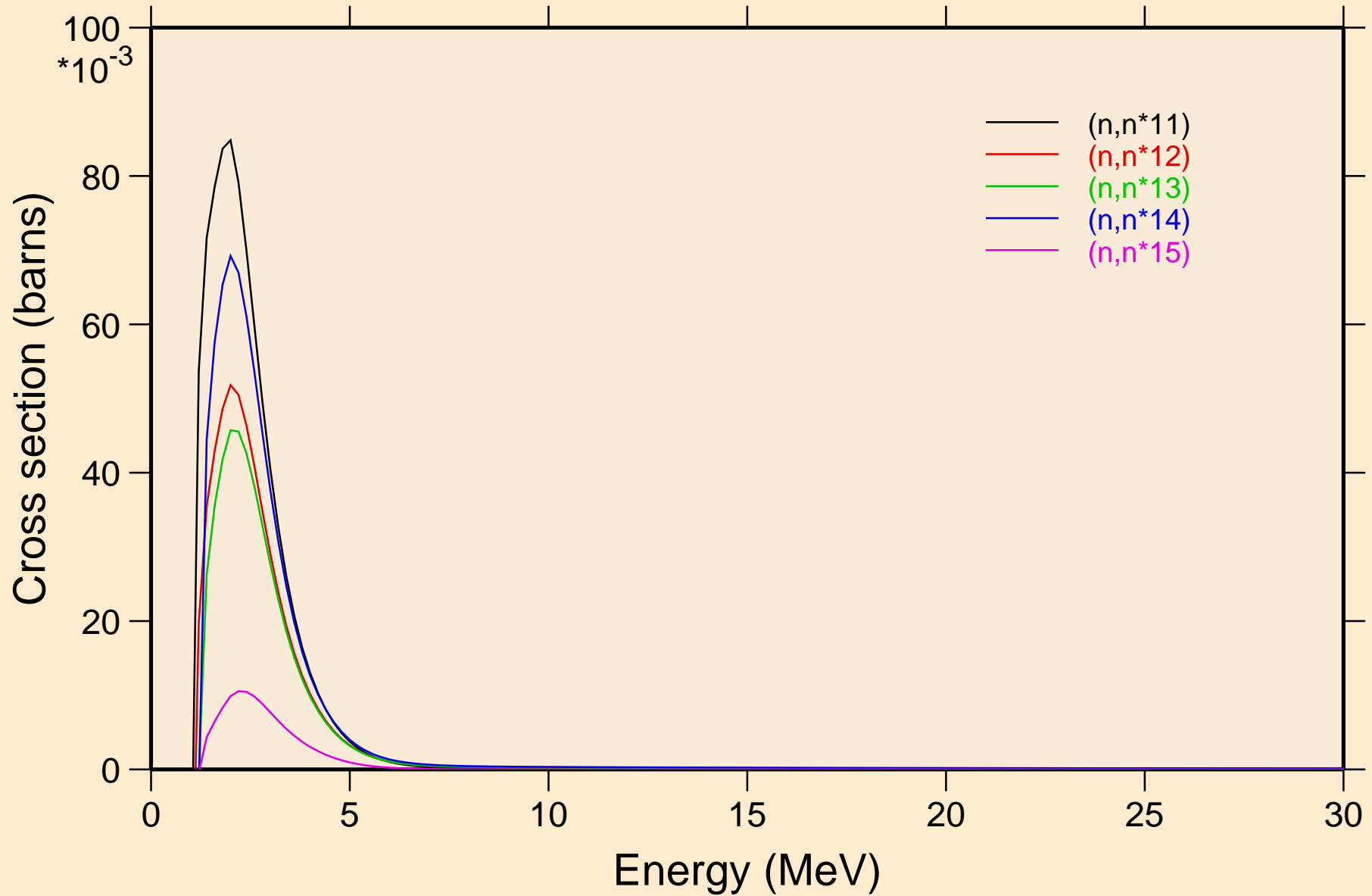

I129 NEUTRON ACER TENDL-2024 LIBRARY; T=293.6K  
Inelastic levels

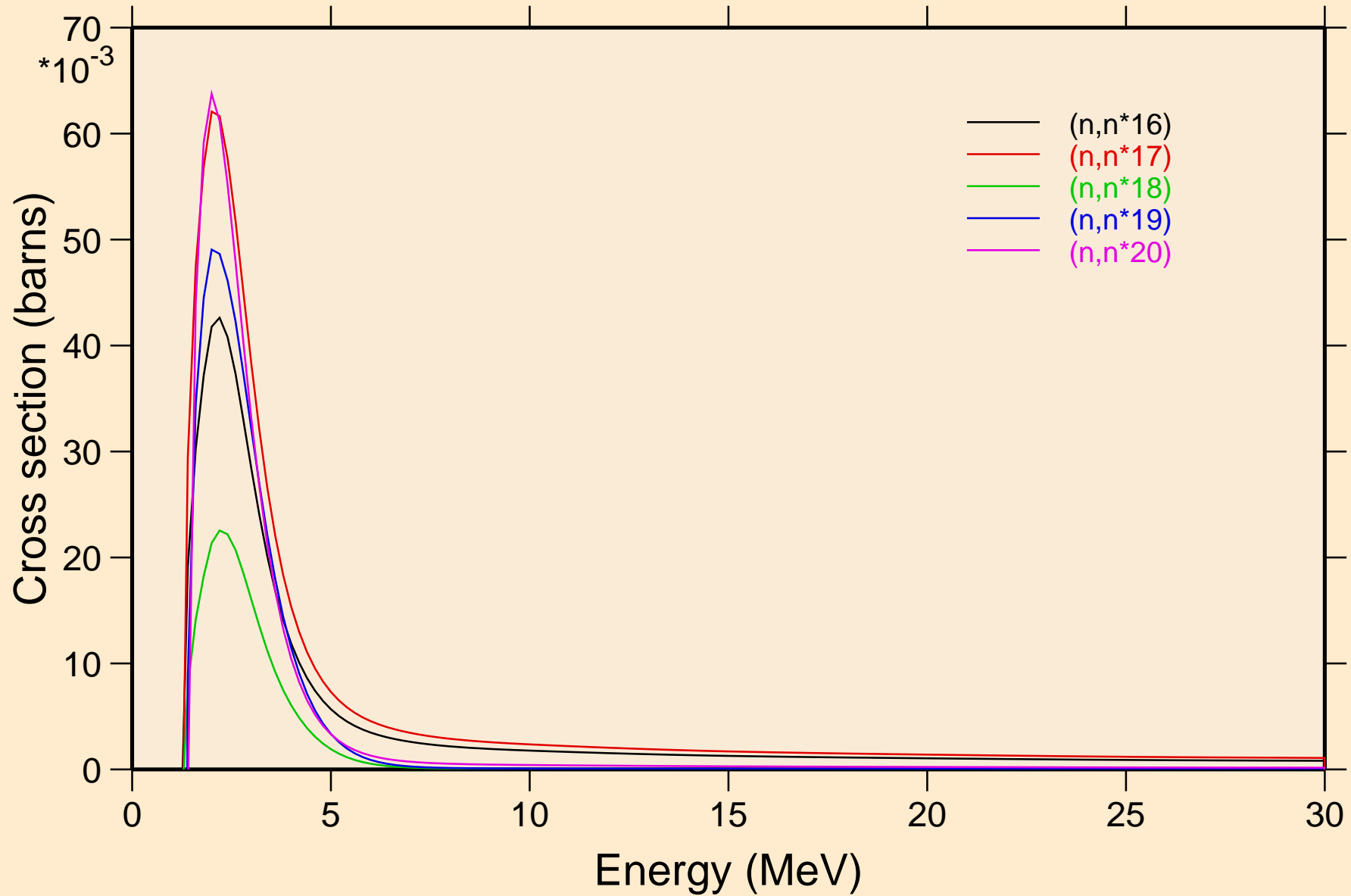

I129 NEUTRON ACER TENDL-2024 LIBRARY; T=293.6K  
Inelastic levels

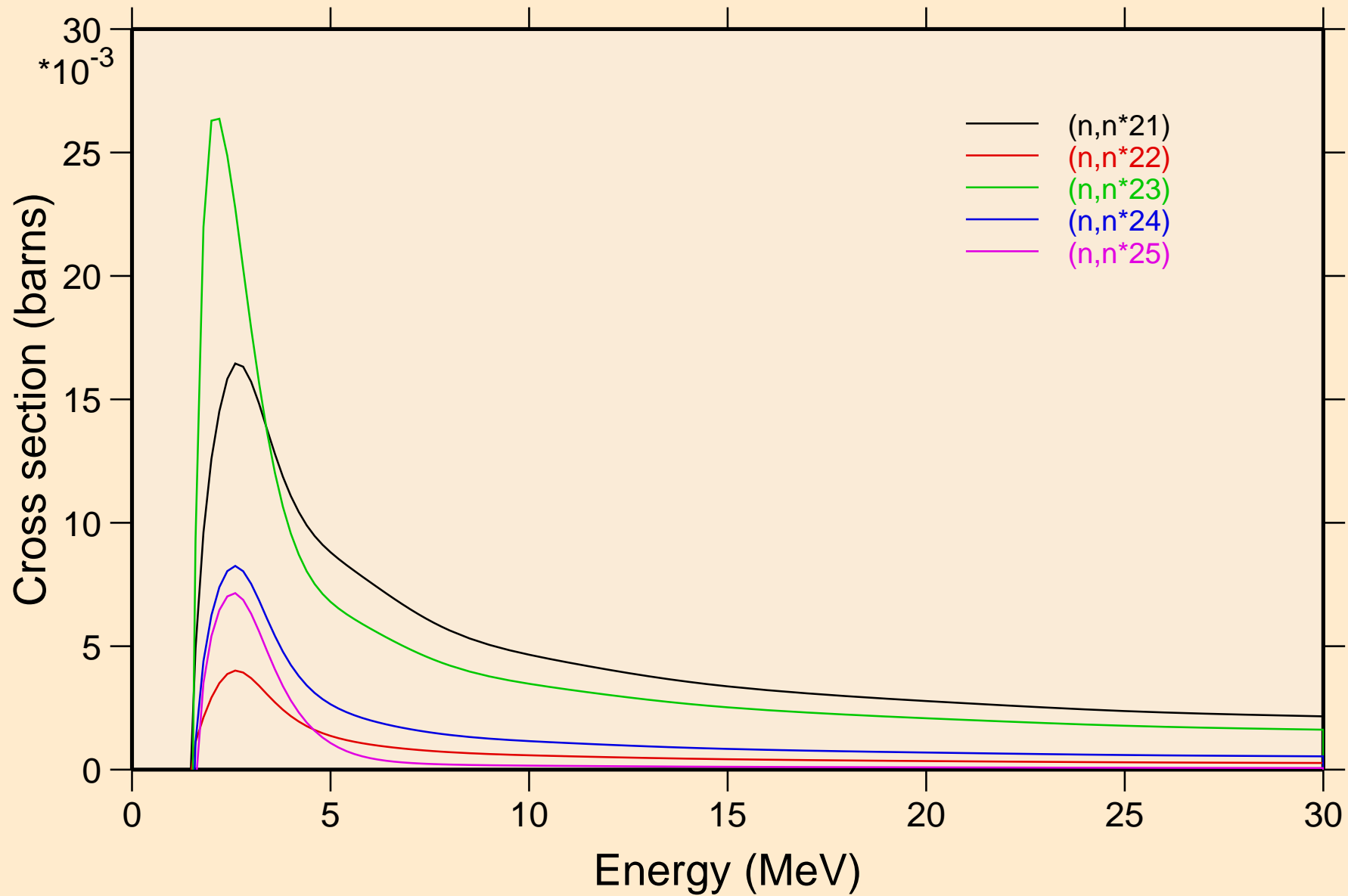

I129 NEUTRON ACER TENDL-2024 LIBRARY; T=293.6K  
Inelastic levels

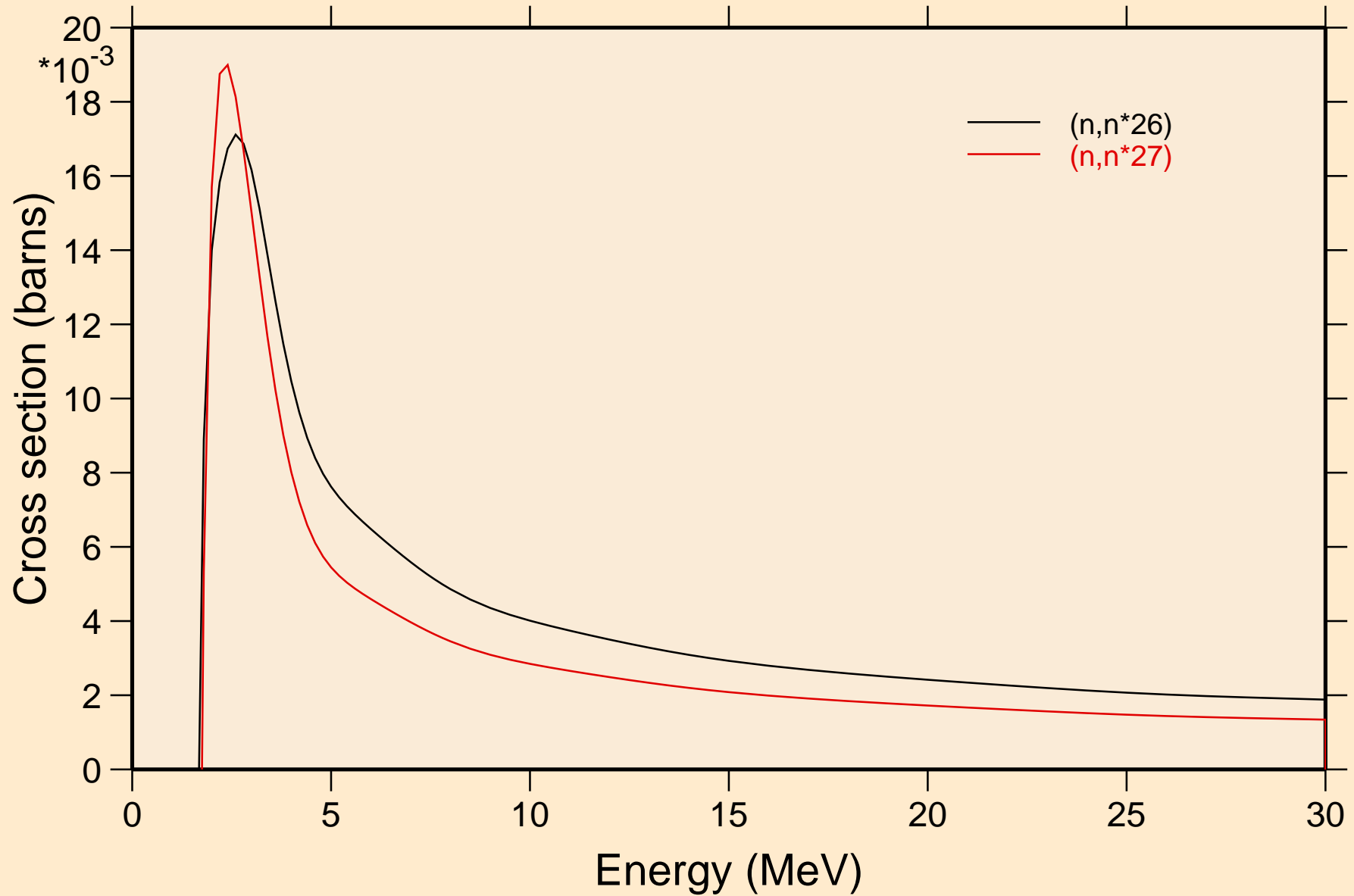

I129 NEUTRON ACER TENDL-2024 LIBRARY; T=293.6K  
Threshold reactions

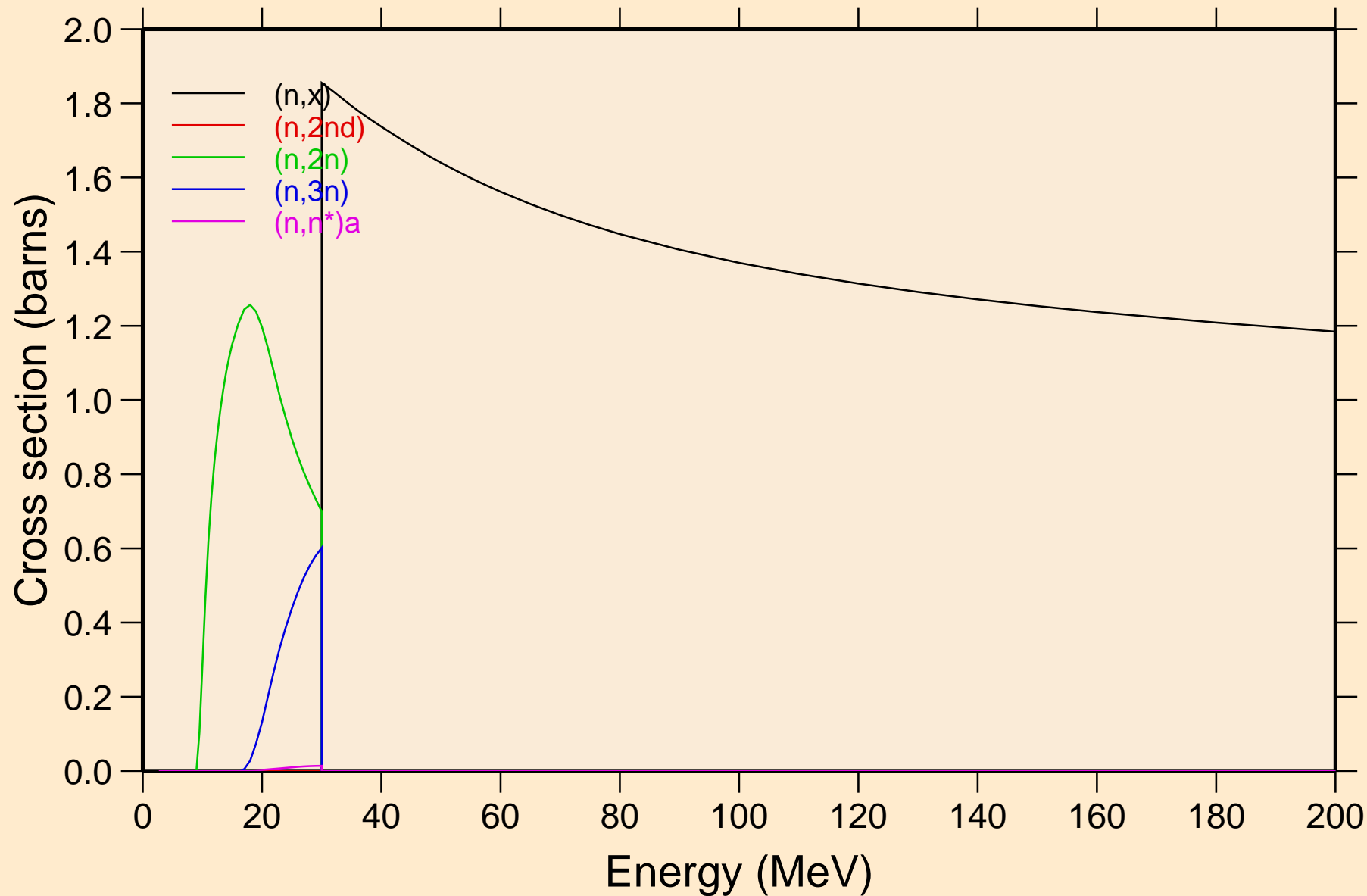

# I129 NEUTRON ACER TENDL-2024 LIBRARY; T=293.6K

## Threshold reactions

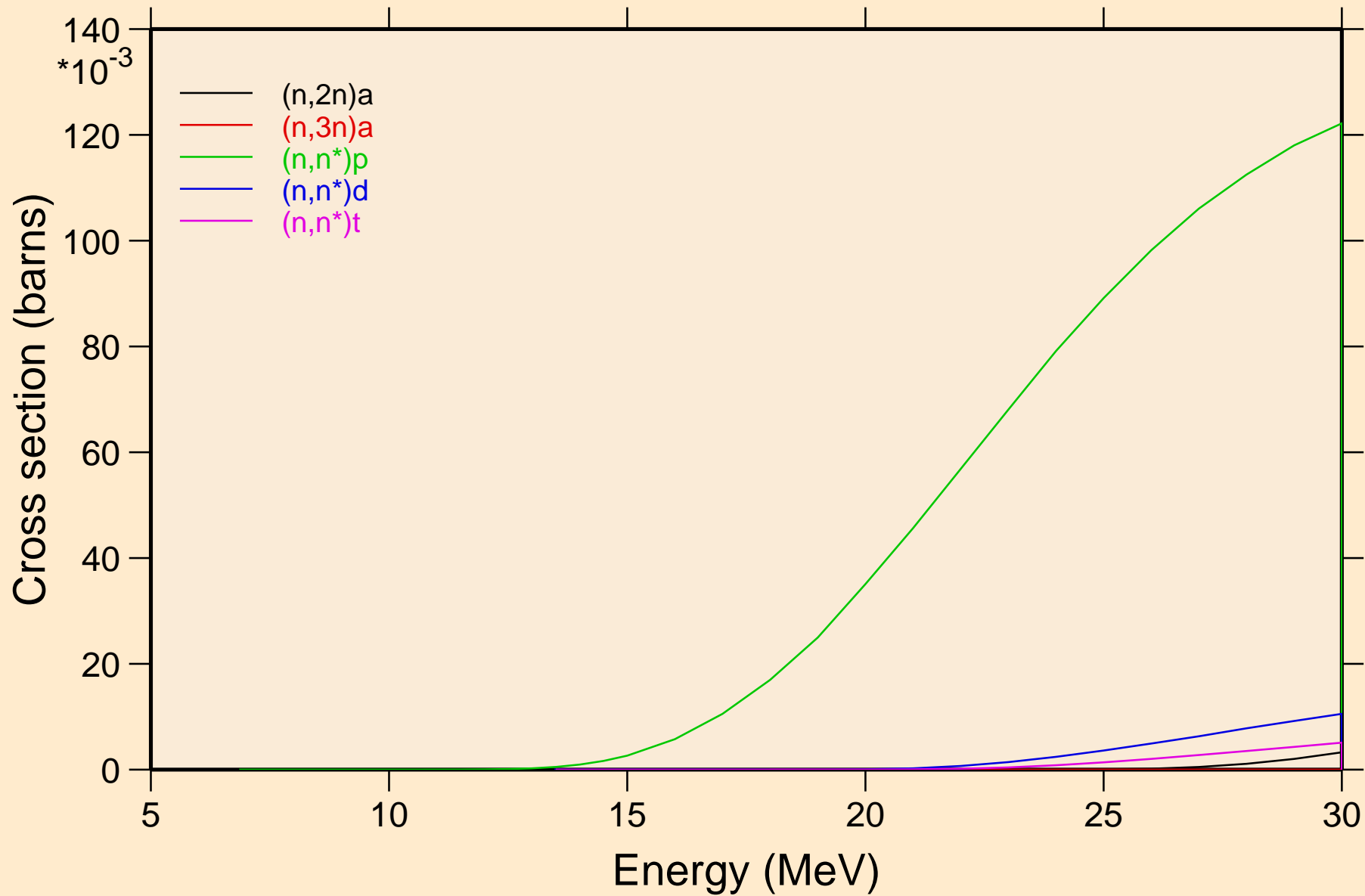

I129 NEUTRON ACER TENDL-2024 LIBRARY; T=293.6K  
Threshold reactions

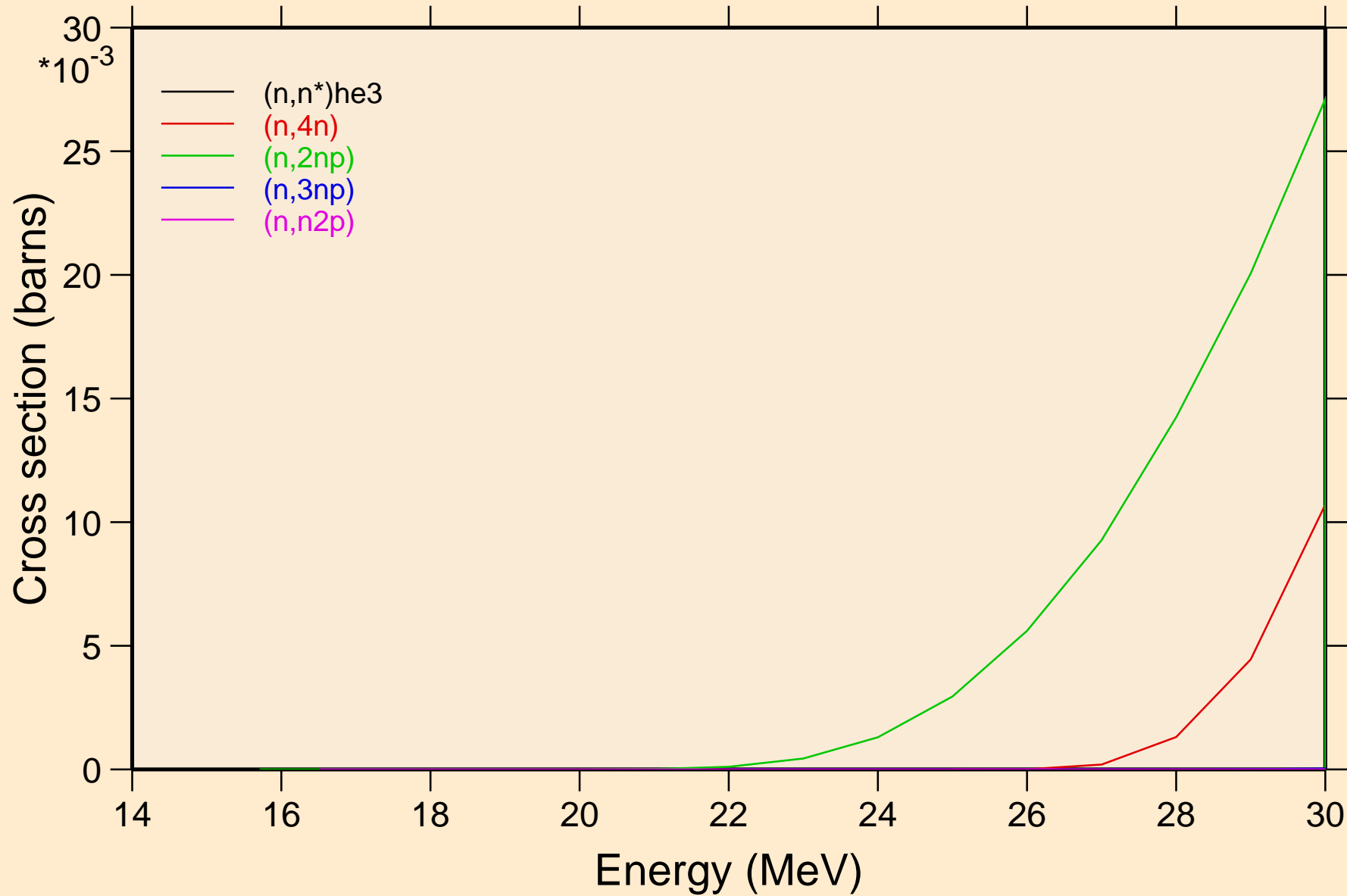

# I129 NEUTRON ACER TENDL-2024 LIBRARY; T=293.6K

## Threshold reactions

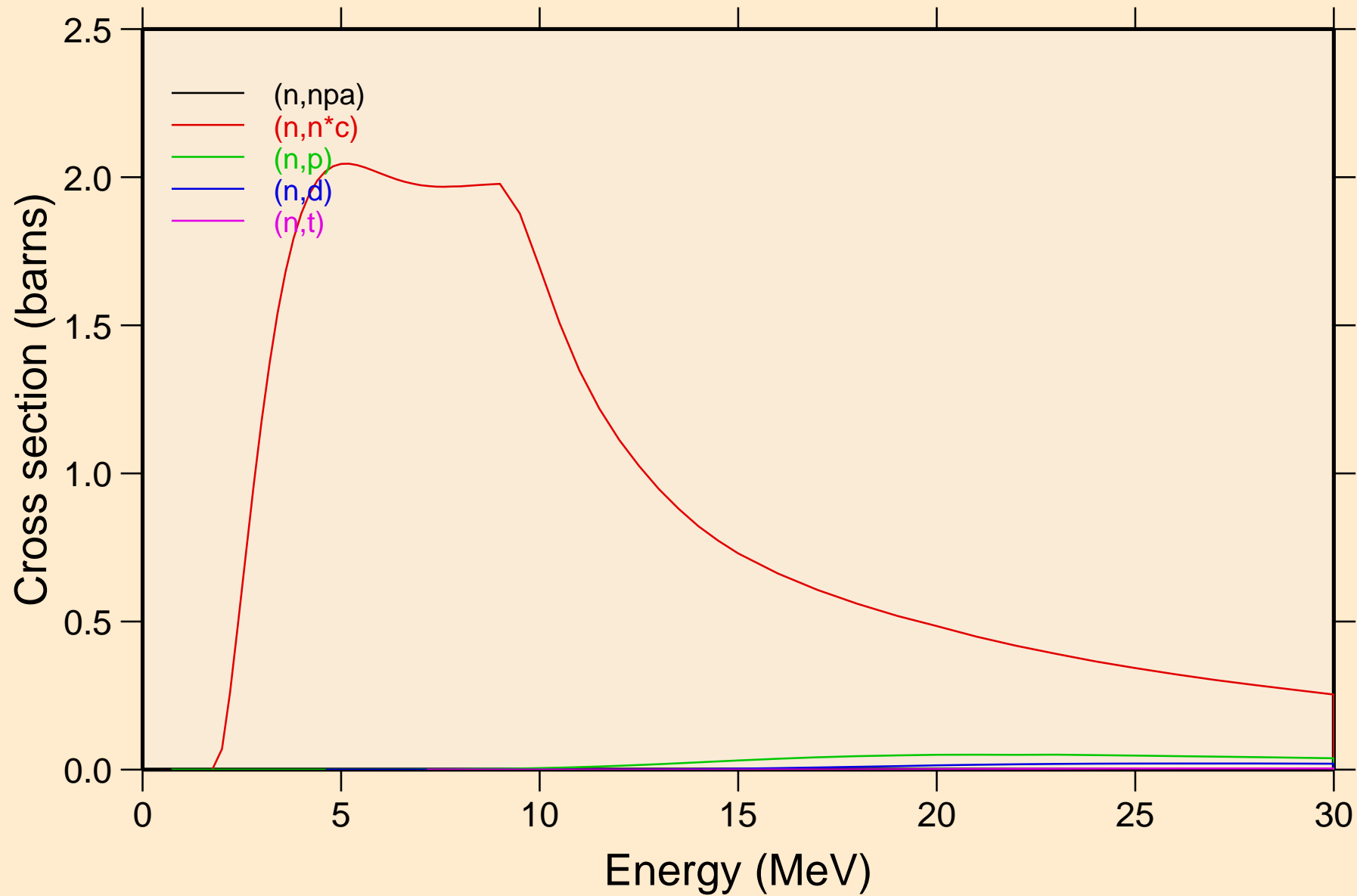

I129 NEUTRON ACER TENDL-2024 LIBRARY; T=293.6K  
Threshold reactions

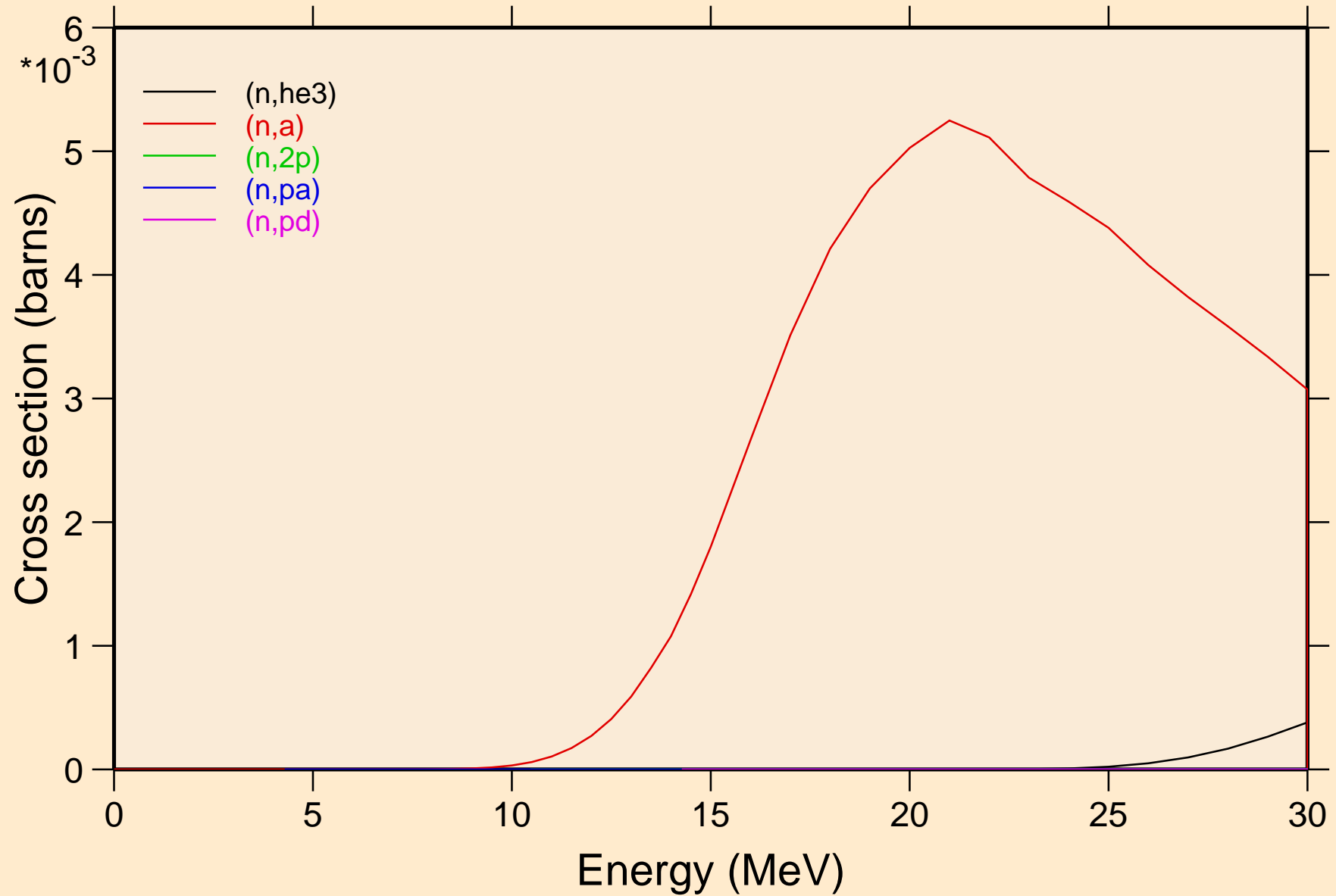

# I129 NEUTRON ACER TENDL-2024 LIBRARY; T=293.6K

## Threshold reactions

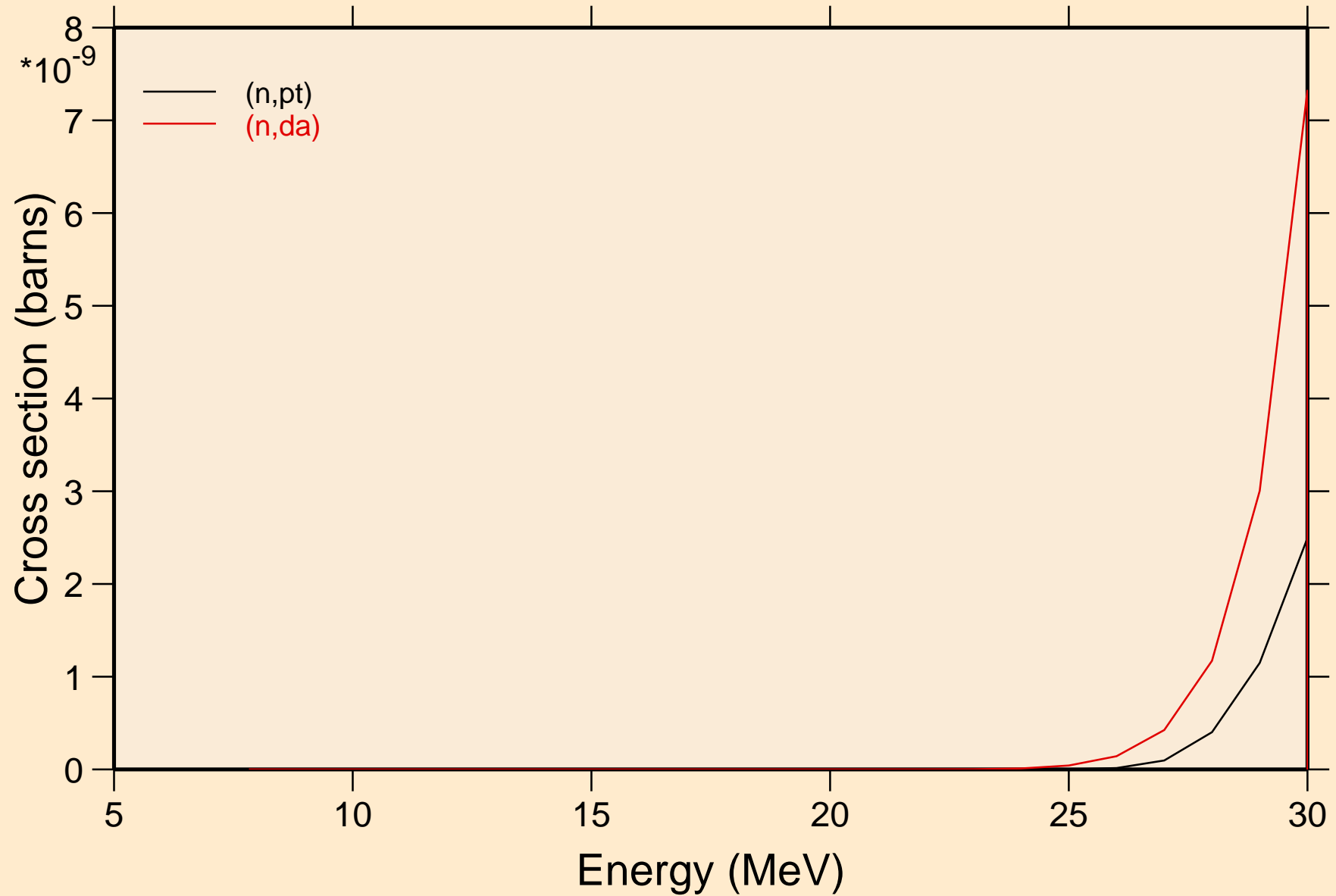

# I129 NEUTRON ACER TENDL-2024 LIBRARY; T=293.6K

## Threshold reactions

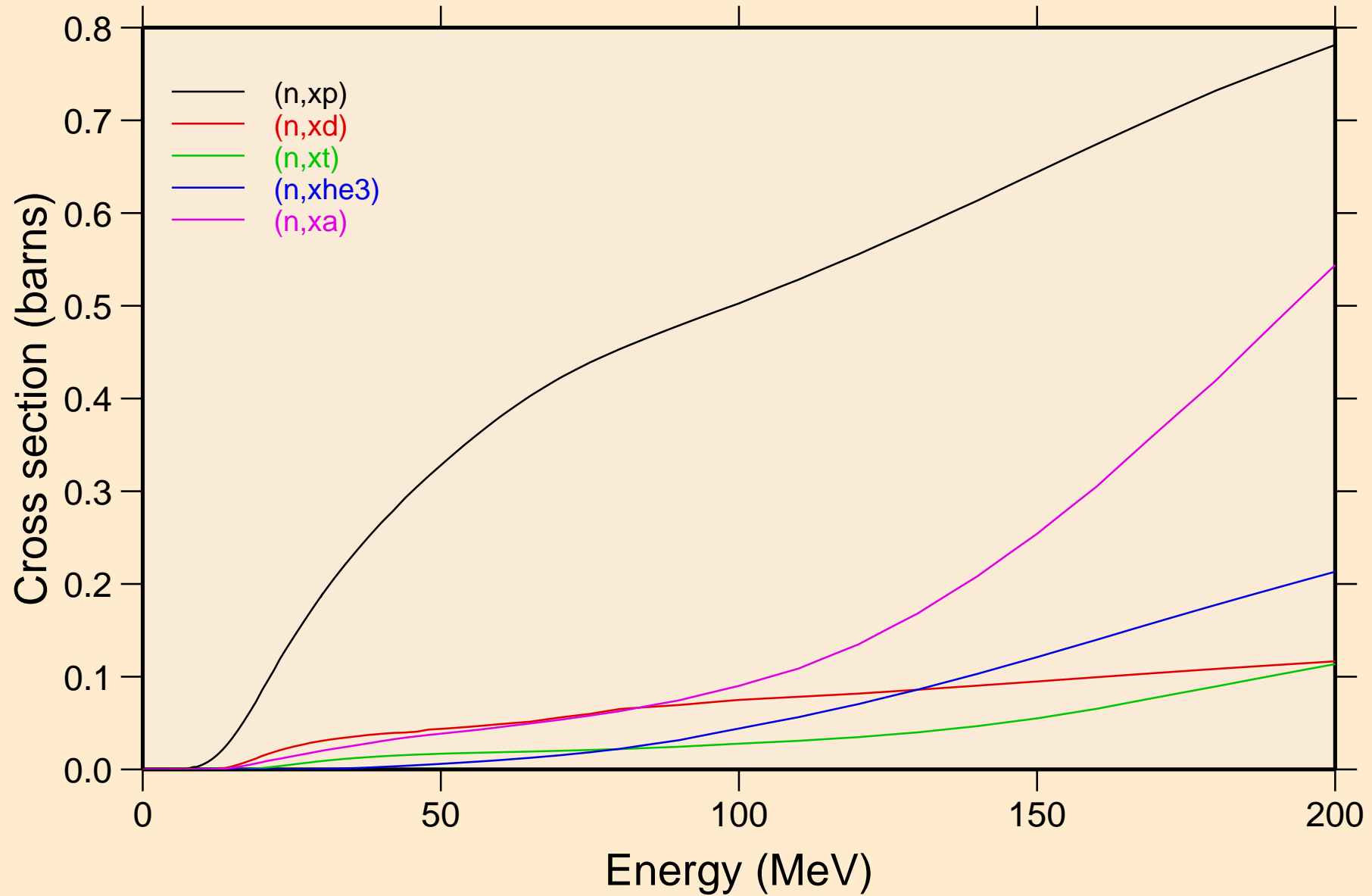

I129 NEUTRON ACER TENDL-2024 LIBRARY; T=293.6K  
angular distribution for elastic

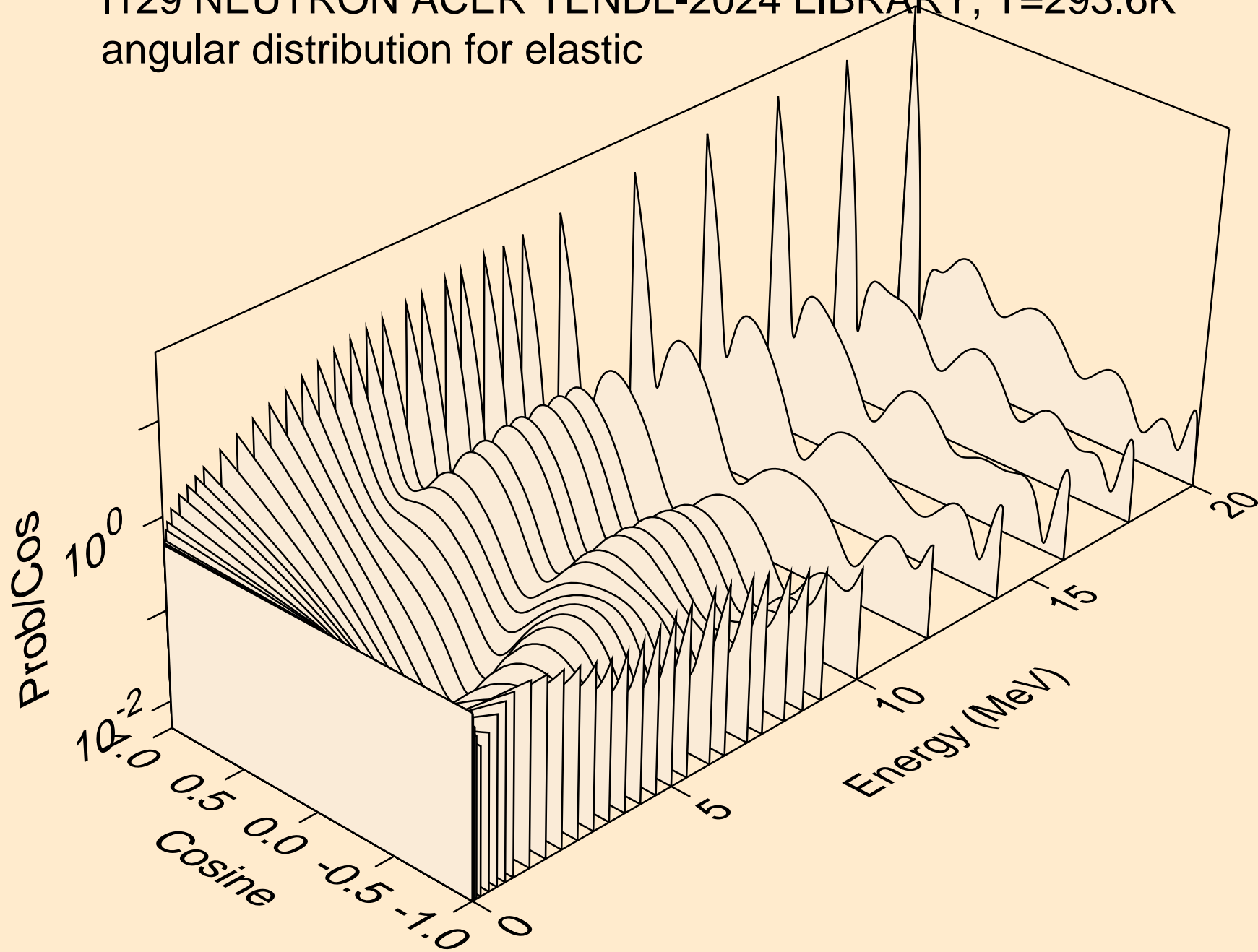

I129 NEUTRON ACER TENDL-2024 LIBRARY; T=293.6K  
angular distribution for elastic

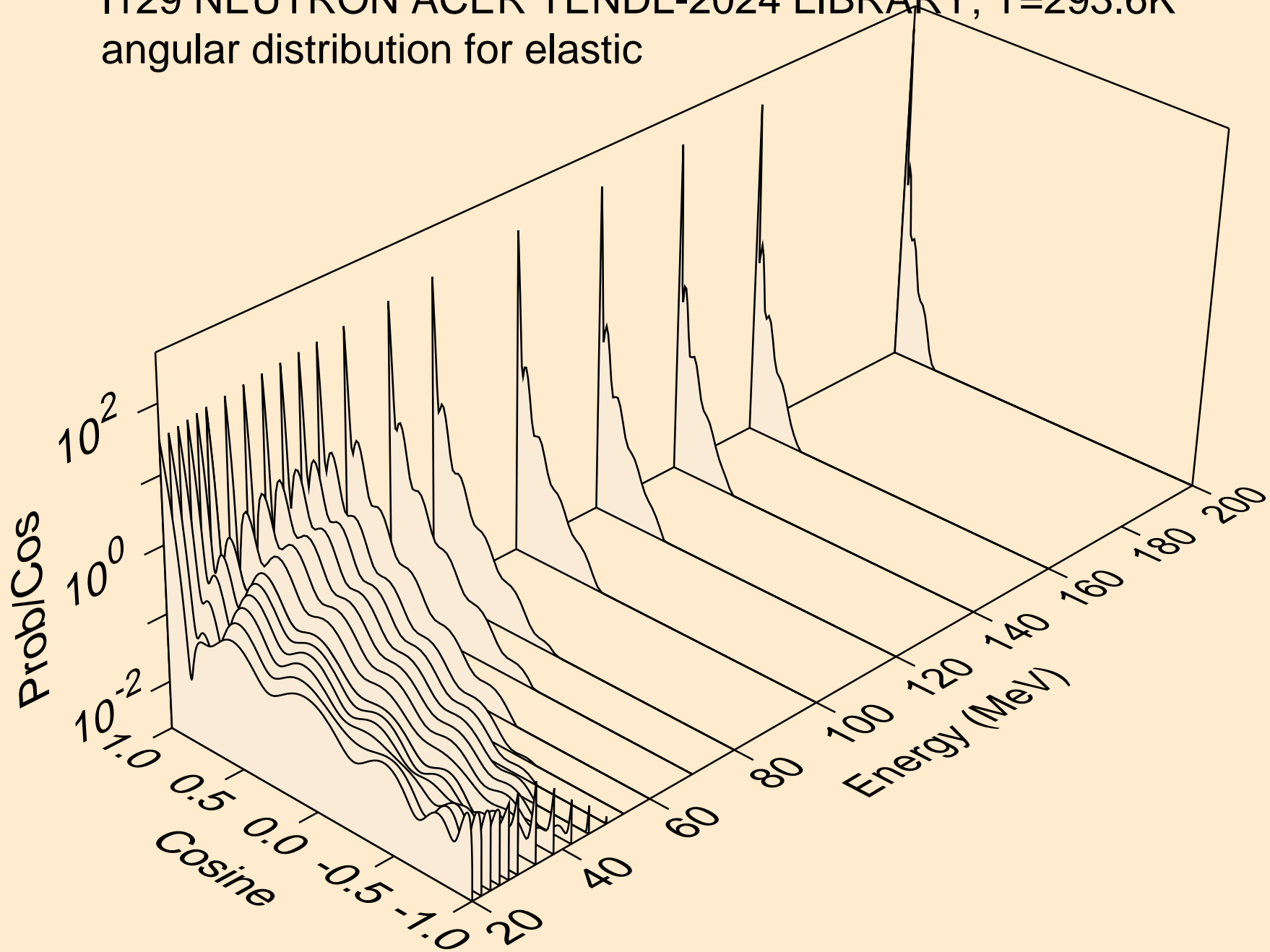

I129 NEUTRON ACER TENDL-2024 LIBRARY; T=293.6K  
angular distribution for (n,n\*1)

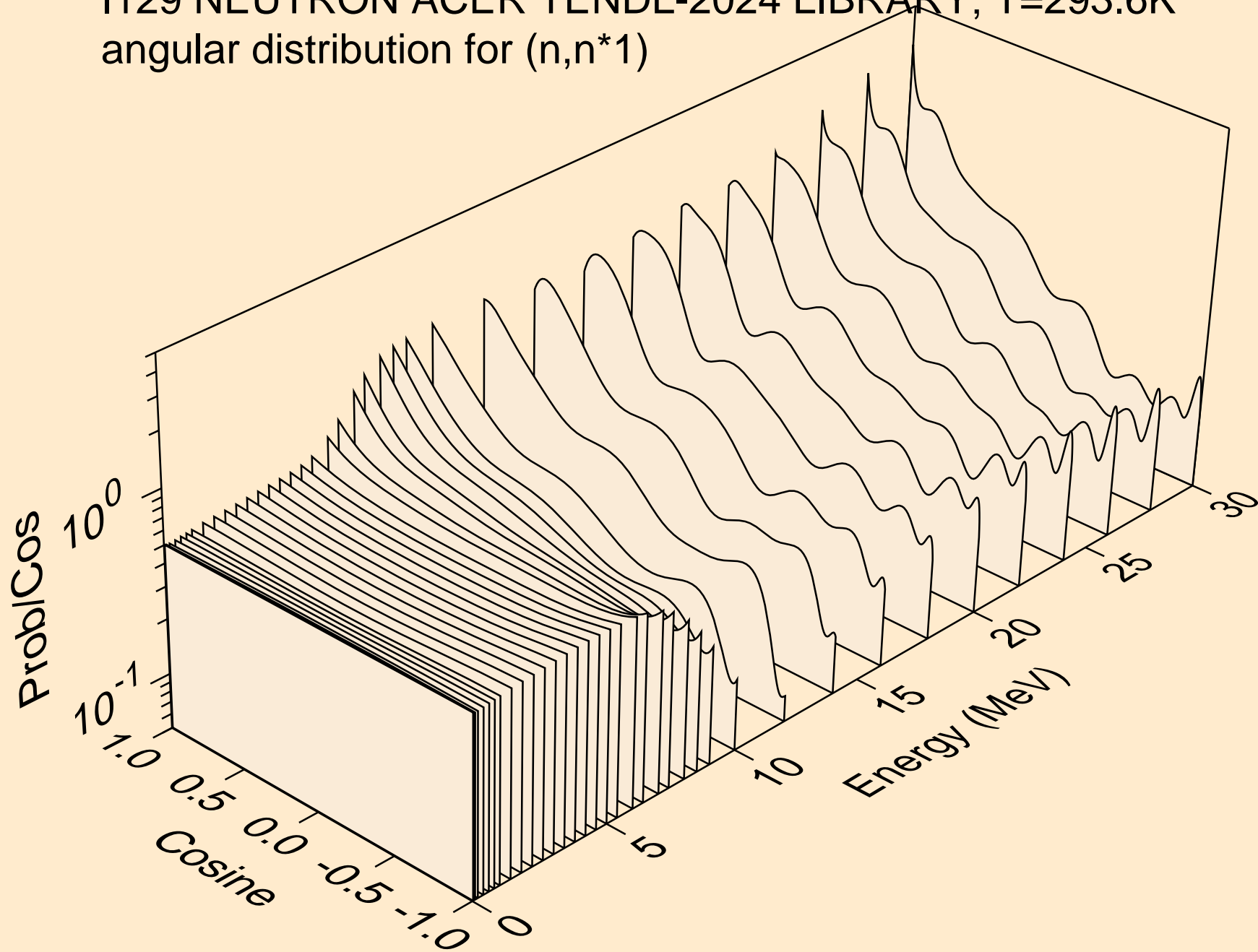

I129 NEUTRON ACER TENDL-2024 LIBRARY; T=293.6K  
angular distribution for (n,n\*2)

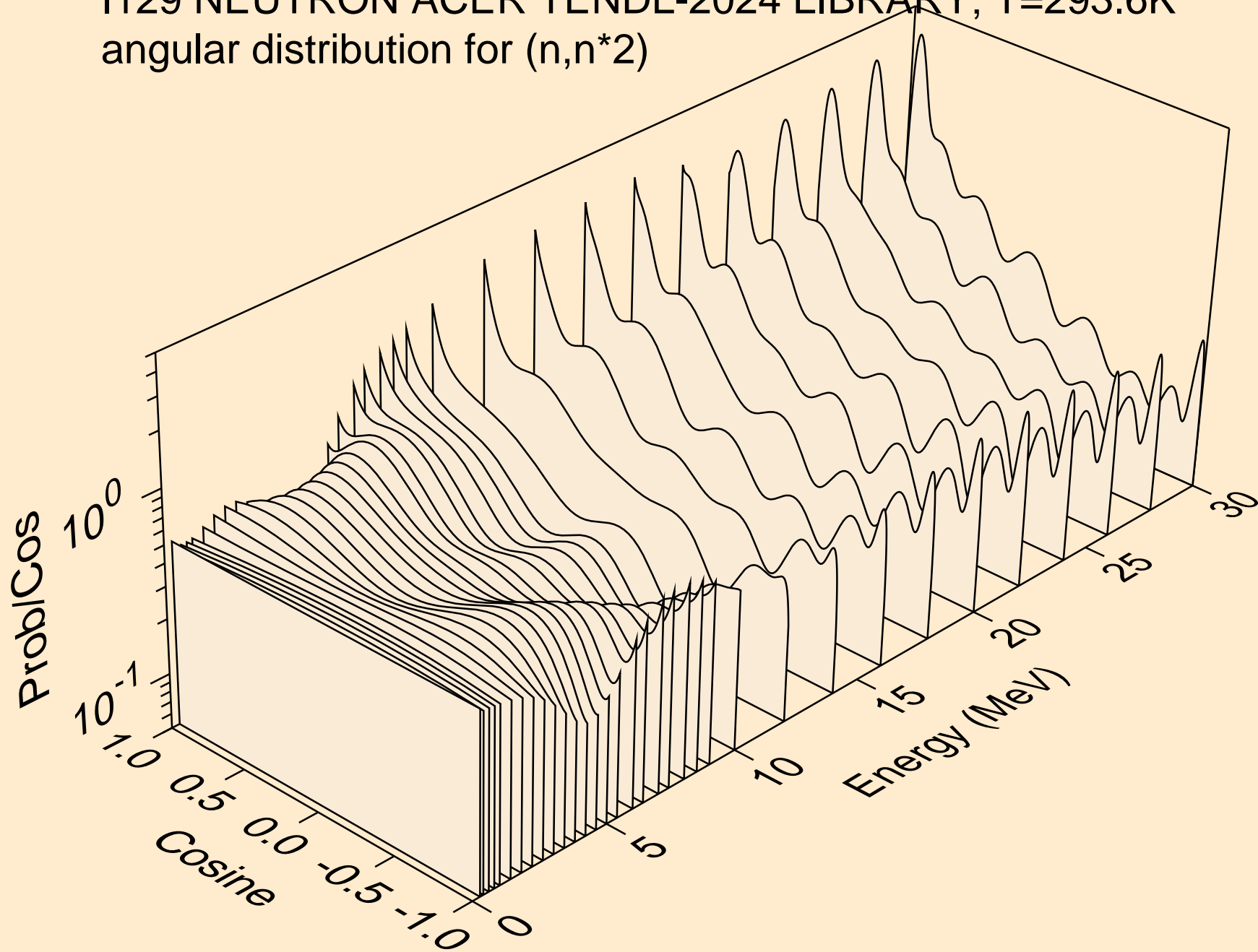

I129 NEUTRON ACER TENDL-2024 LIBRARY; T=293.6K  
angular distribution for (n,n\*3)

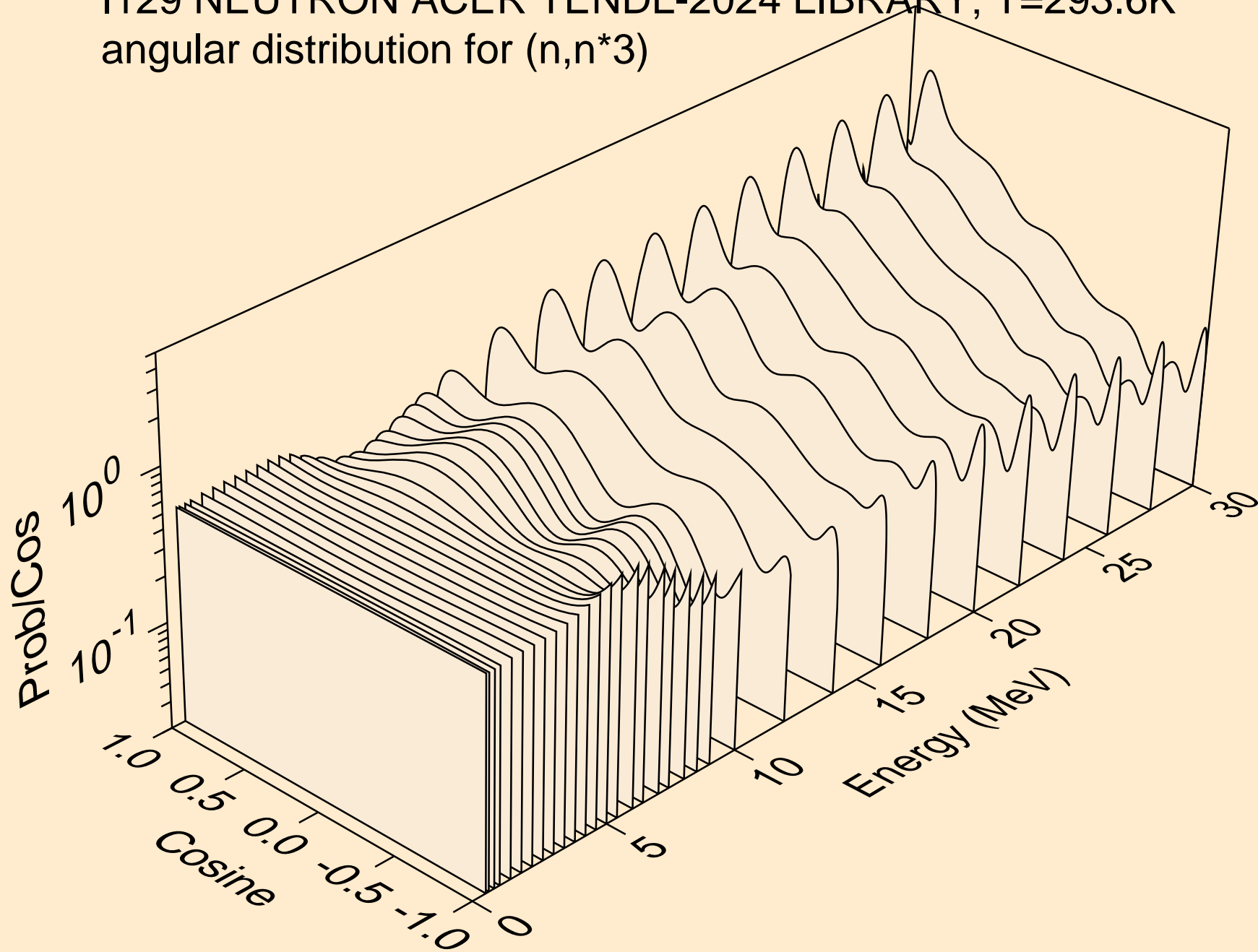

I129 NEUTRON ACER TENDL-2024 LIBRARY; T=293.6K  
angular distribution for (n,n\*4)

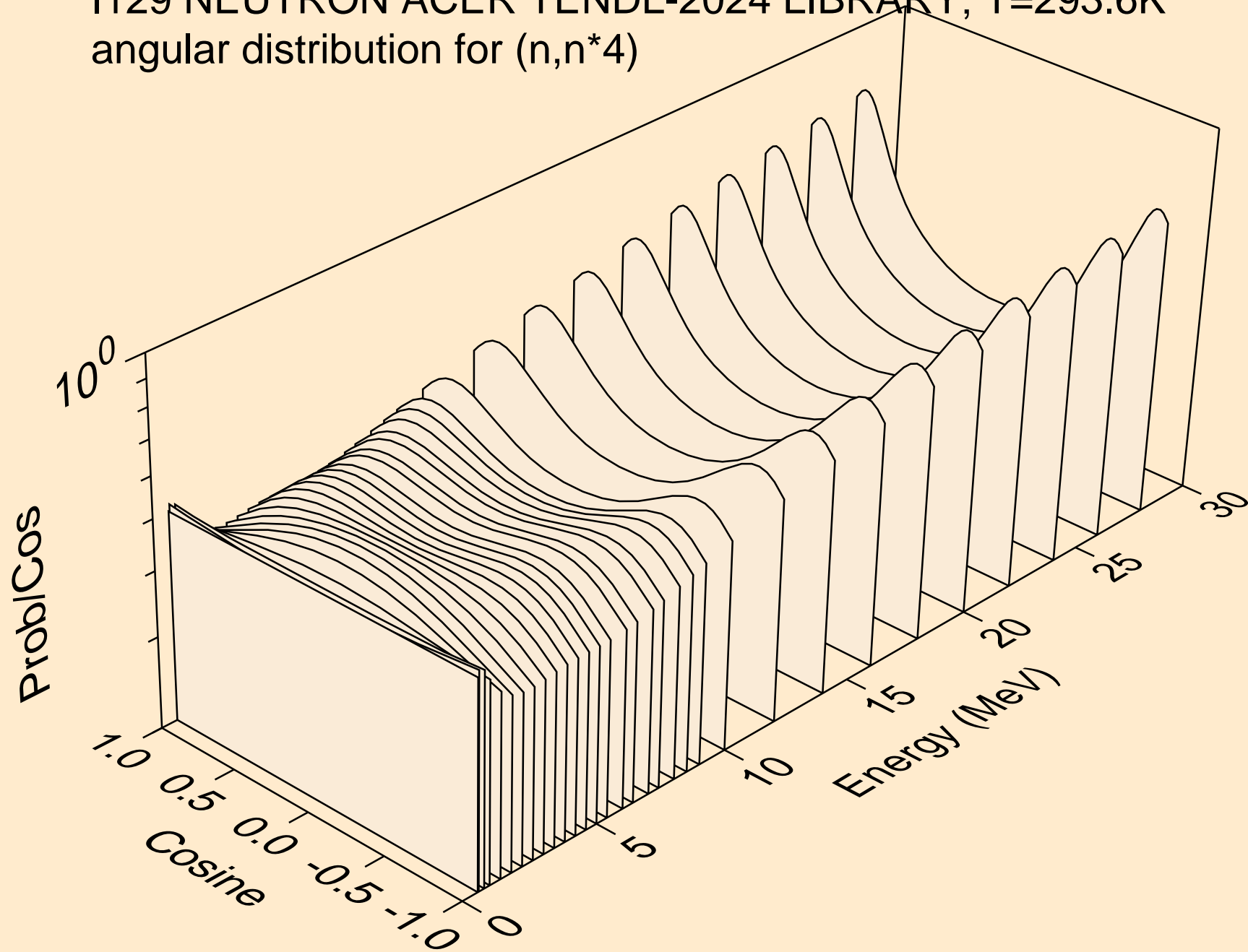

I129 NEUTRON ACER TENDL-2024 LIBRARY; T=293.6K  
angular distribution for (n,n\*5)

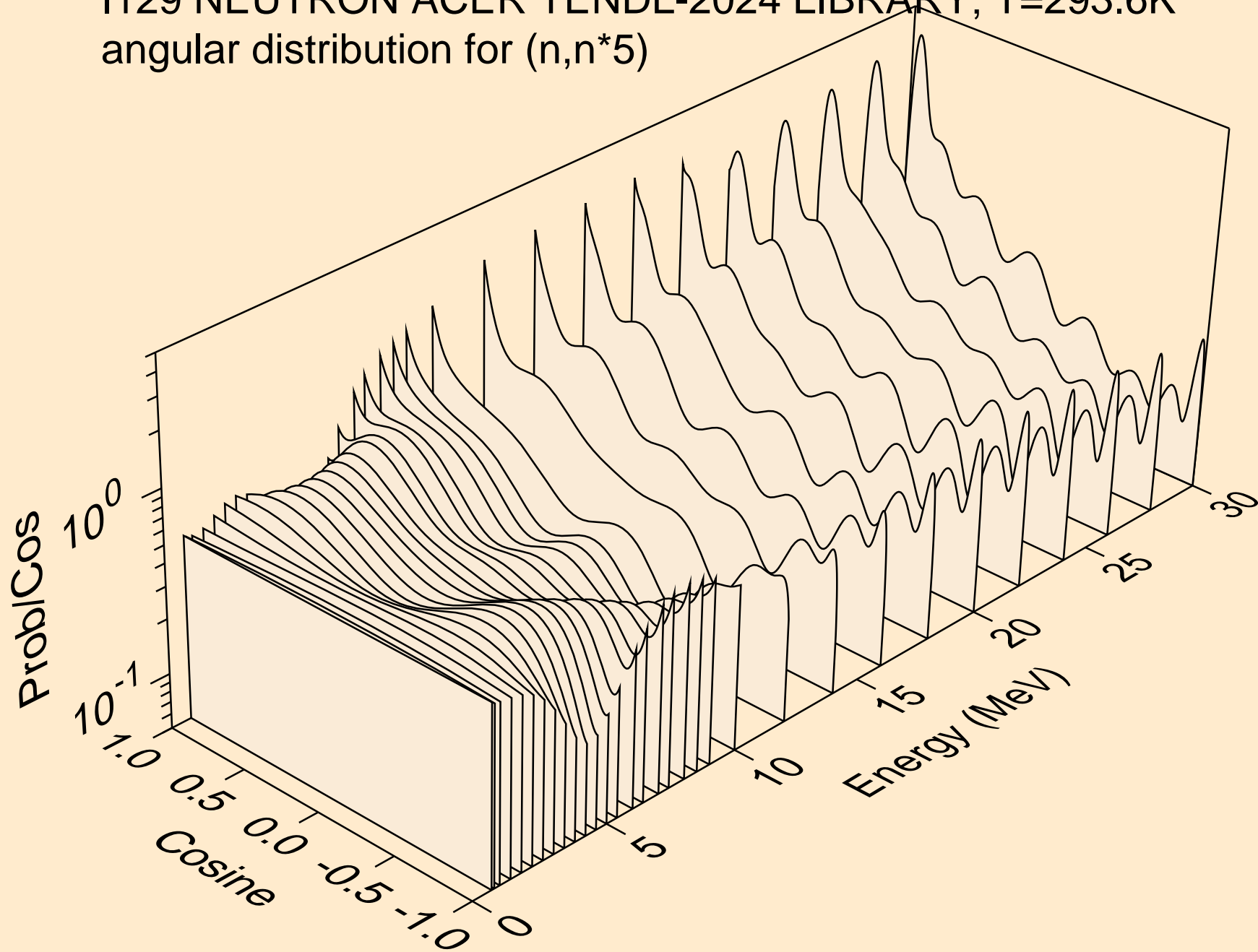

I129 NEUTRON ACER TENDL-2024 LIBRARY; T=293.6K  
angular distribution for (n,n\*6)

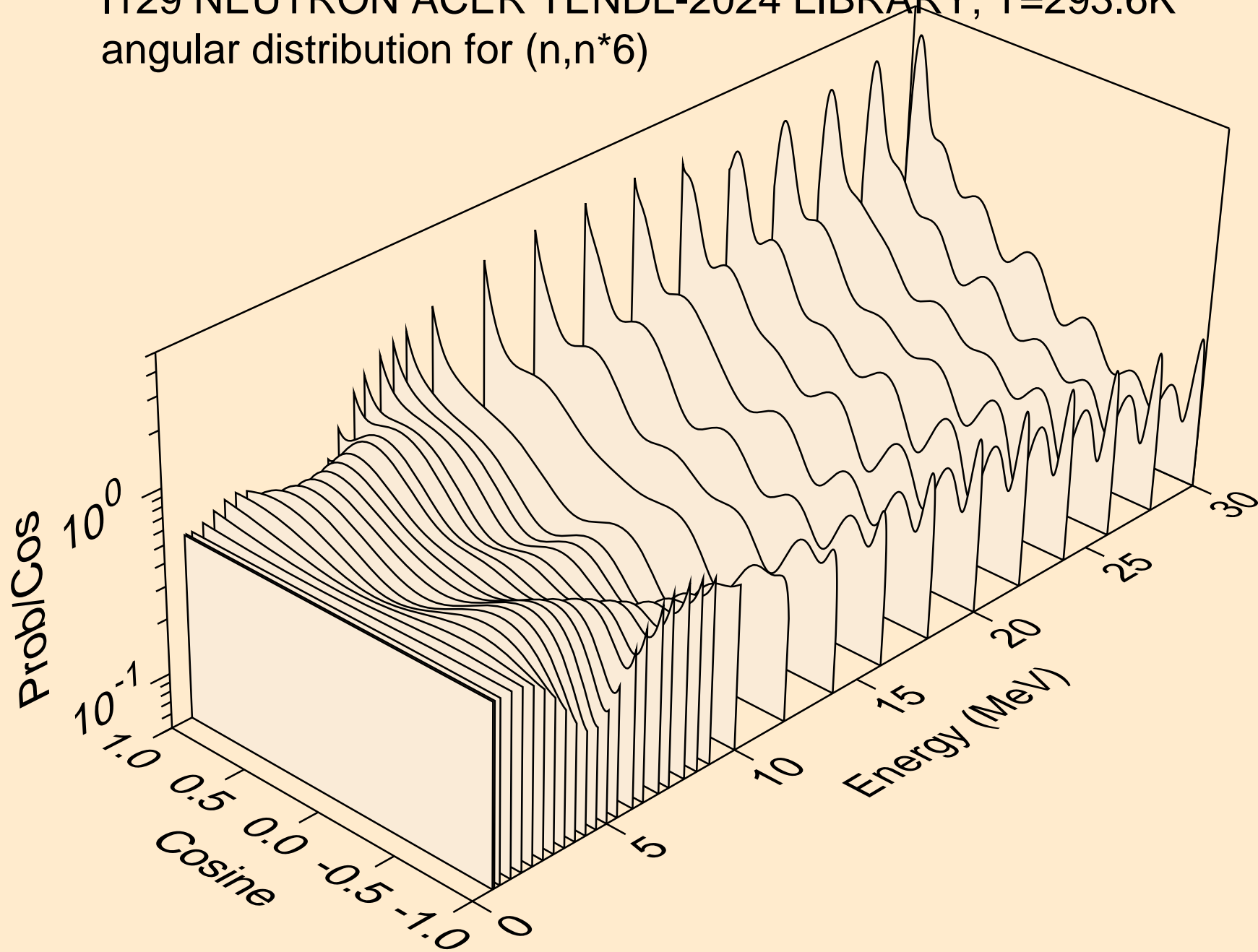

I129 NEUTRON ACER TENDL-2024 LIBRARY; T=293.6K  
angular distribution for (n,n\*7)

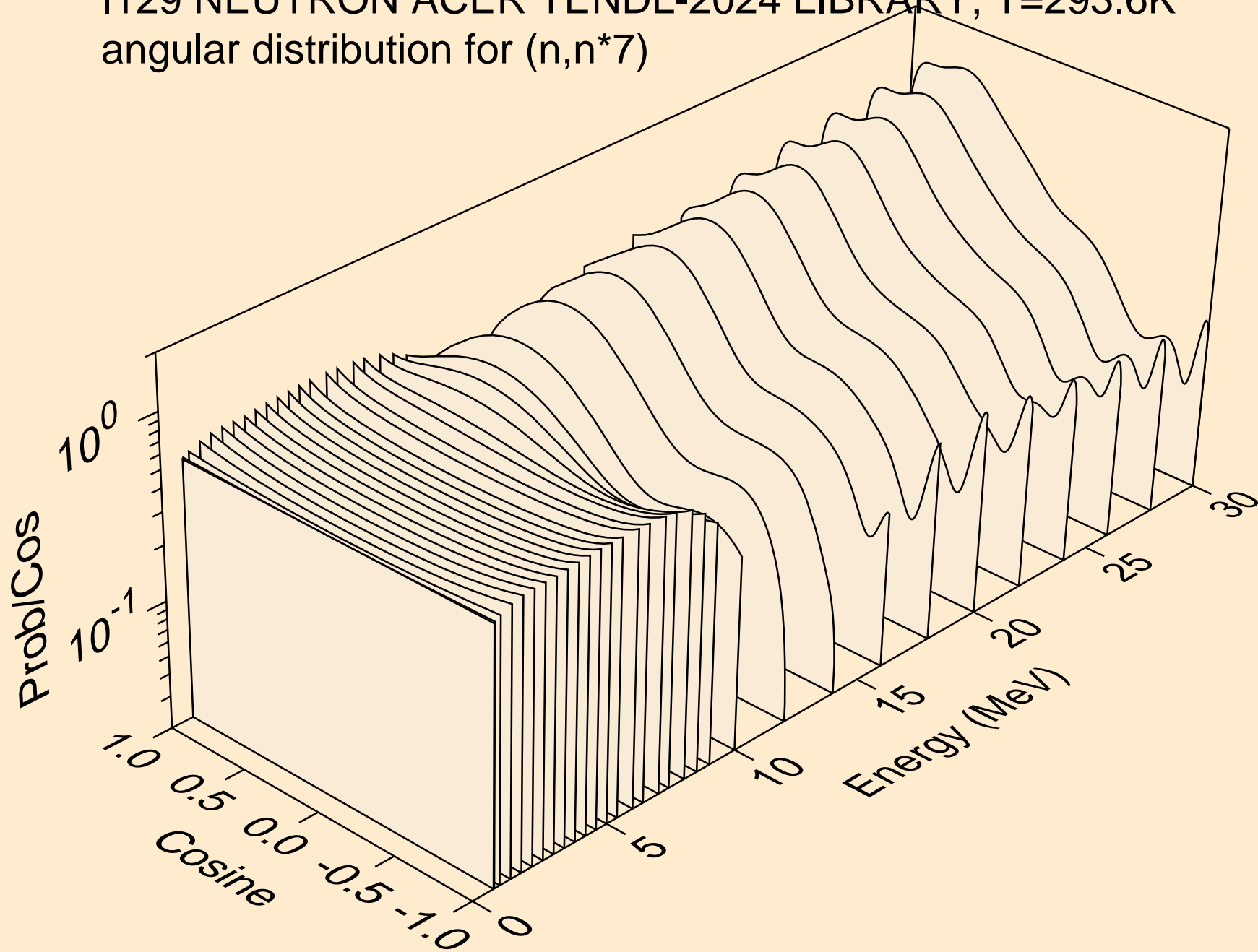

I129 NEUTRON ACER TENDL-2024 LIBRARY; T=293.6K  
angular distribution for (n,n\*8)

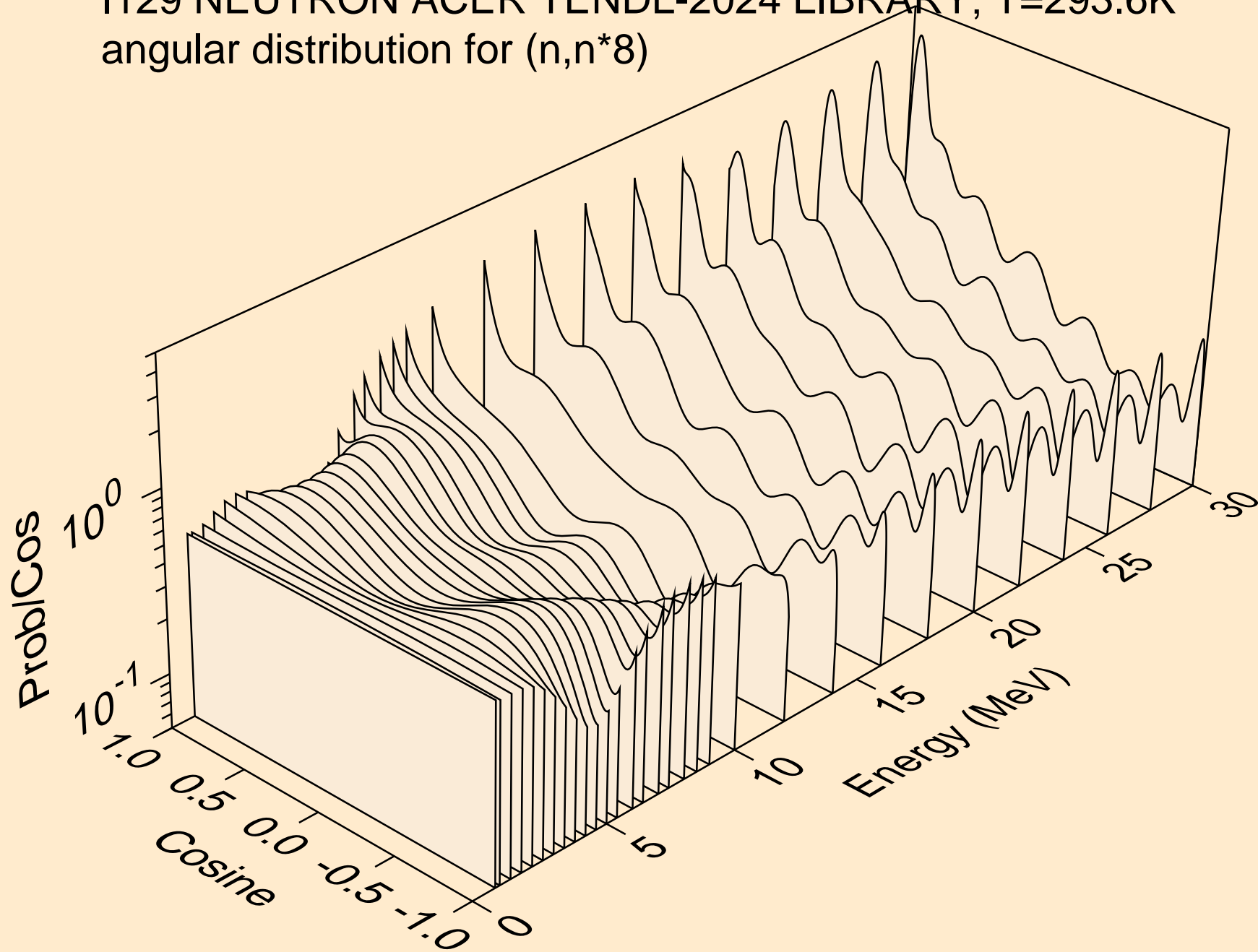

I129 NEUTRON ACER TENDL-2024 LIBRARY; T=293.6K  
angular distribution for (n,n\*9)

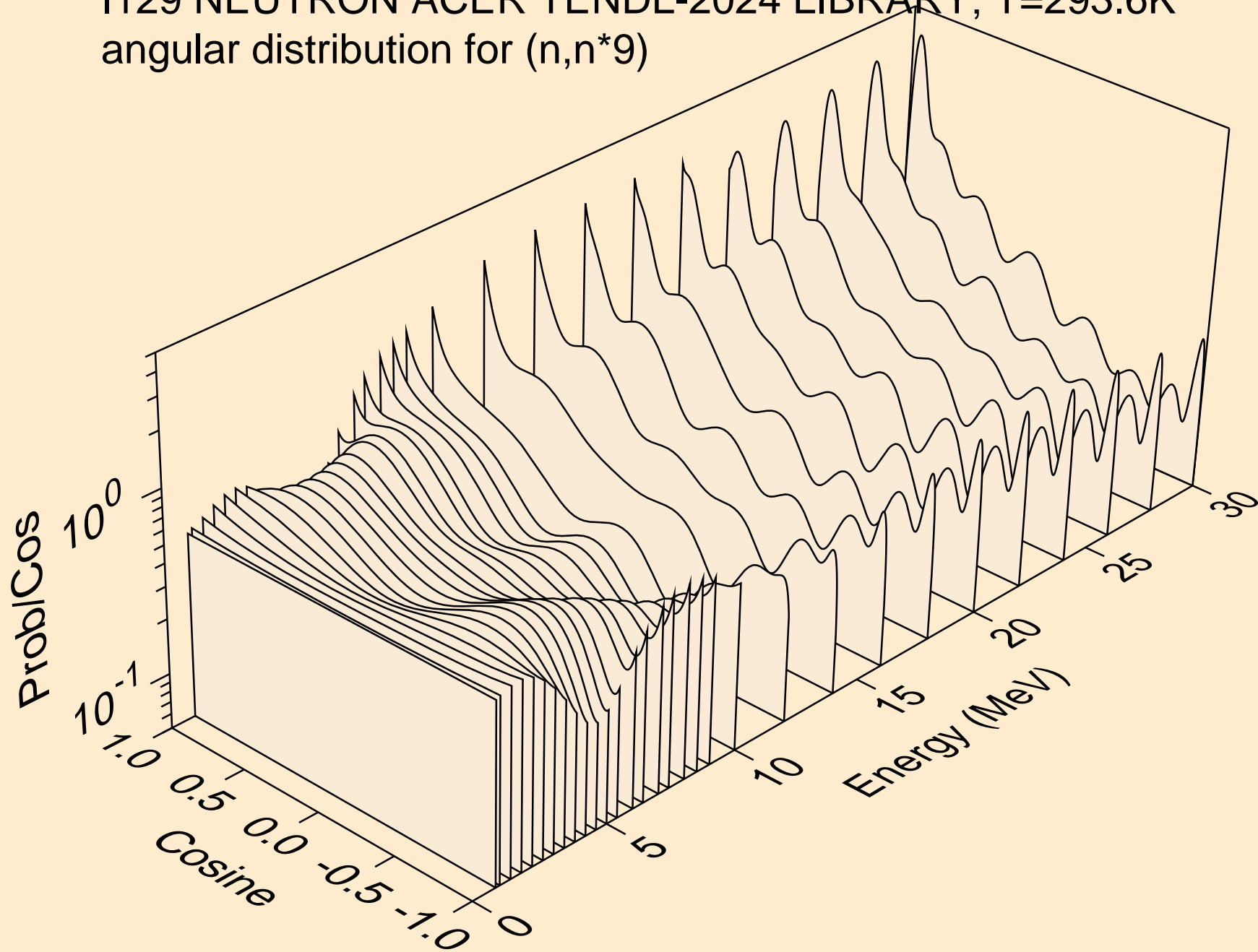

I129 NEUTRON ACER TENDL-2024 LIBRARY; T=293.6K  
angular distribution for (n,n\*10)

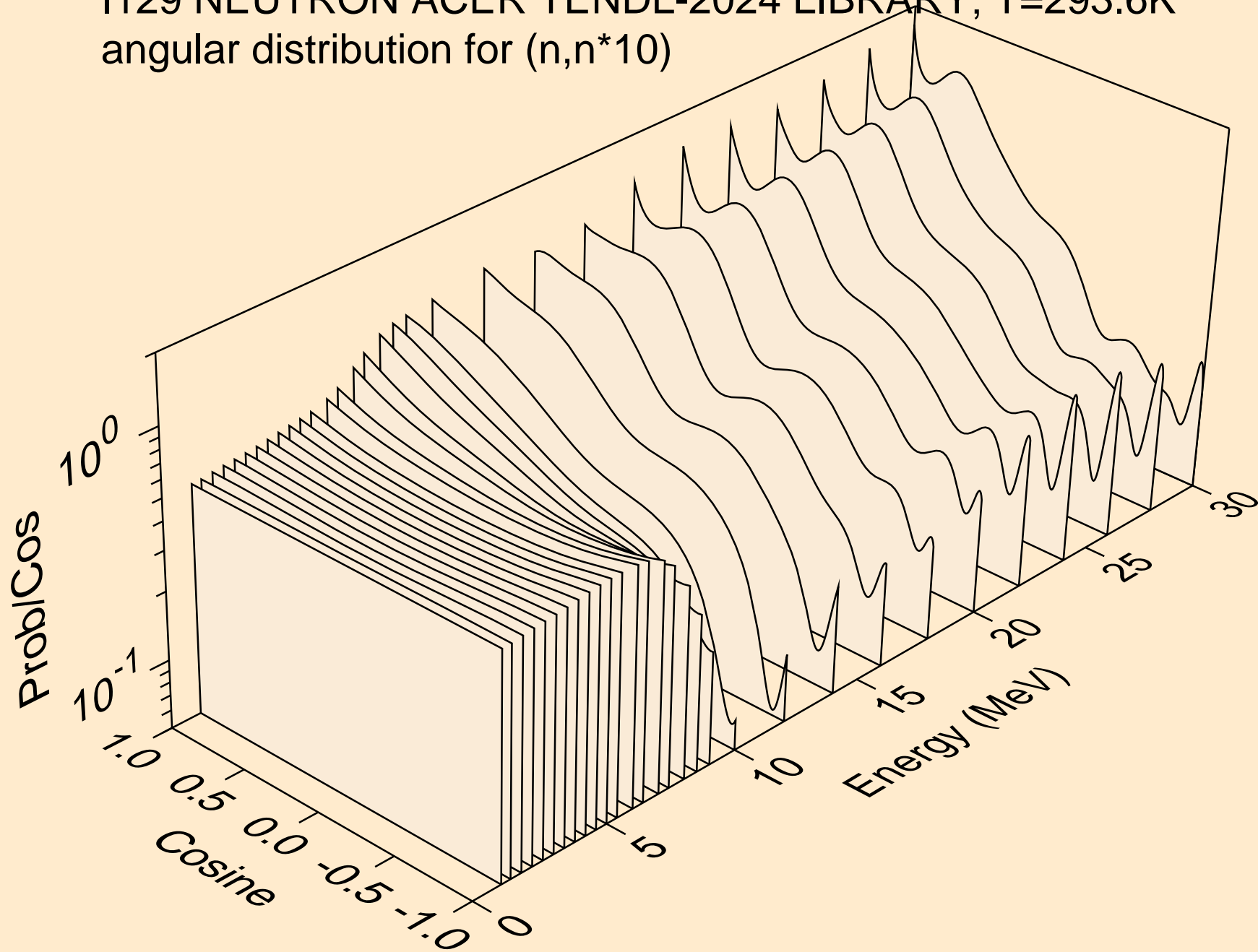

I129 NEUTRON ACER TENDL-2024 LIBRARY; T=293.6K  
angular distribution for (n,n\*11)

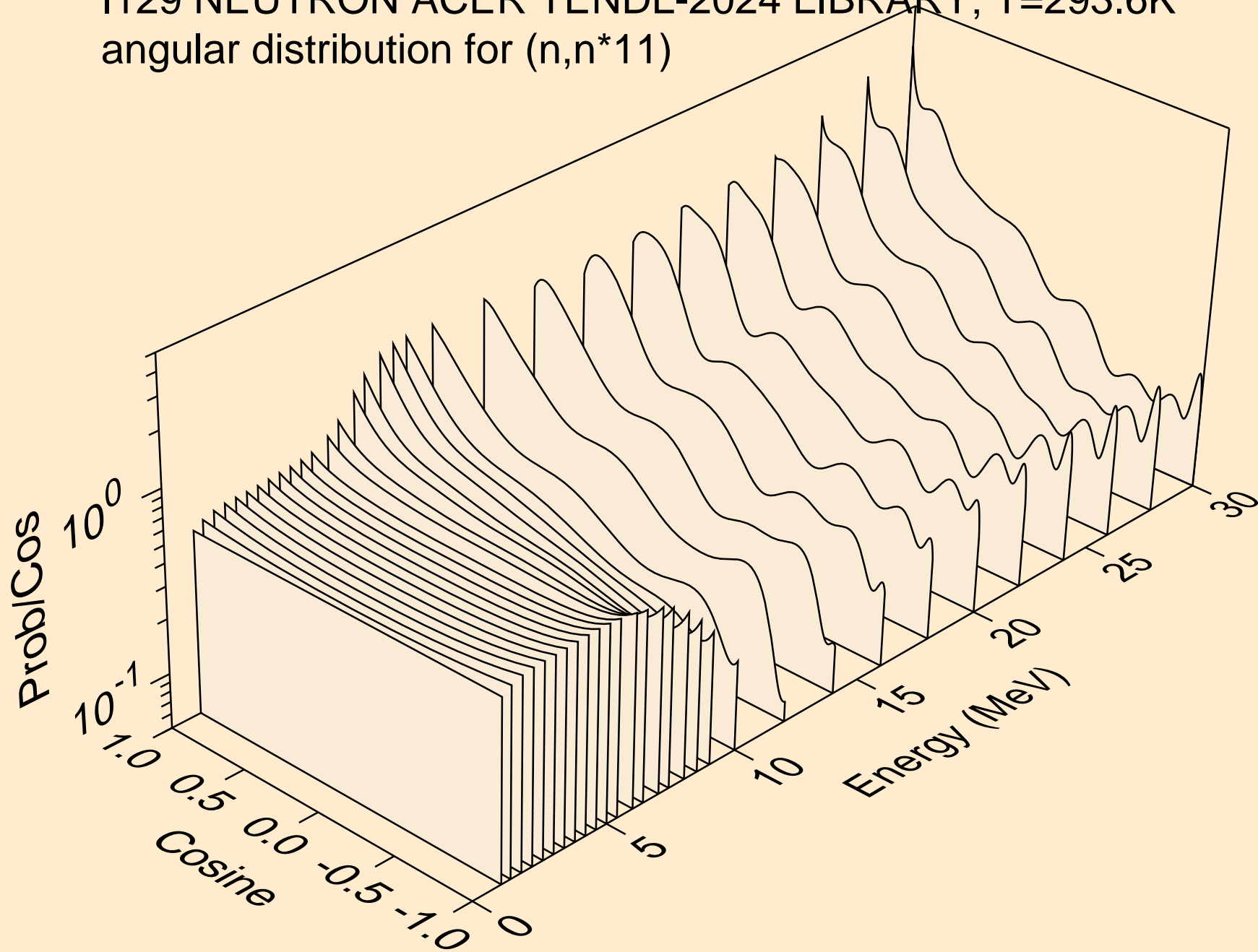

I129 NEUTRON ACER TENDL-2024 LIBRARY; T=293.6K  
angular distribution for (n,n\*12)

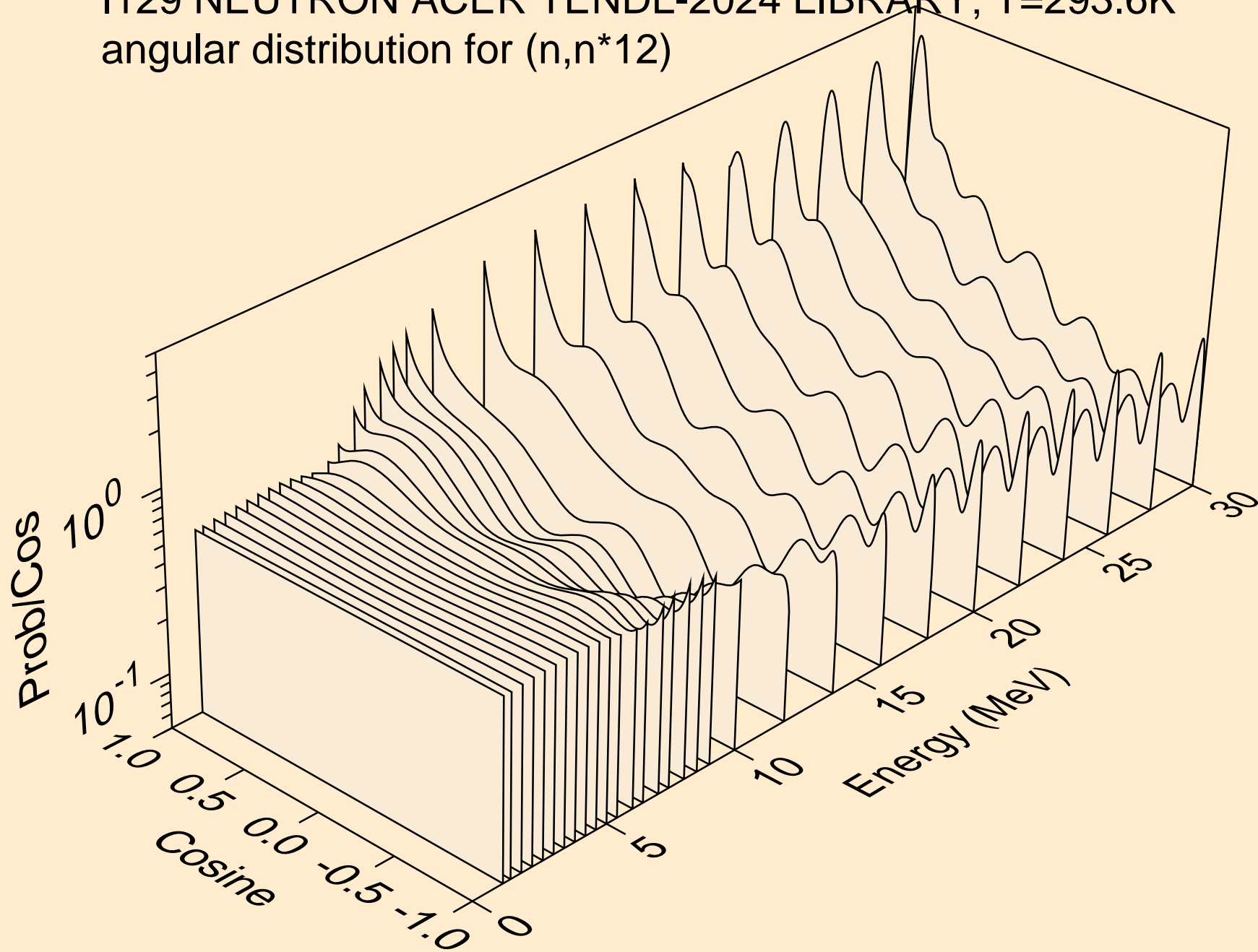

I129 NEUTRON ACER TENDL-2024 LIBRARY; T=293.6K  
angular distribution for (n,n\*13)

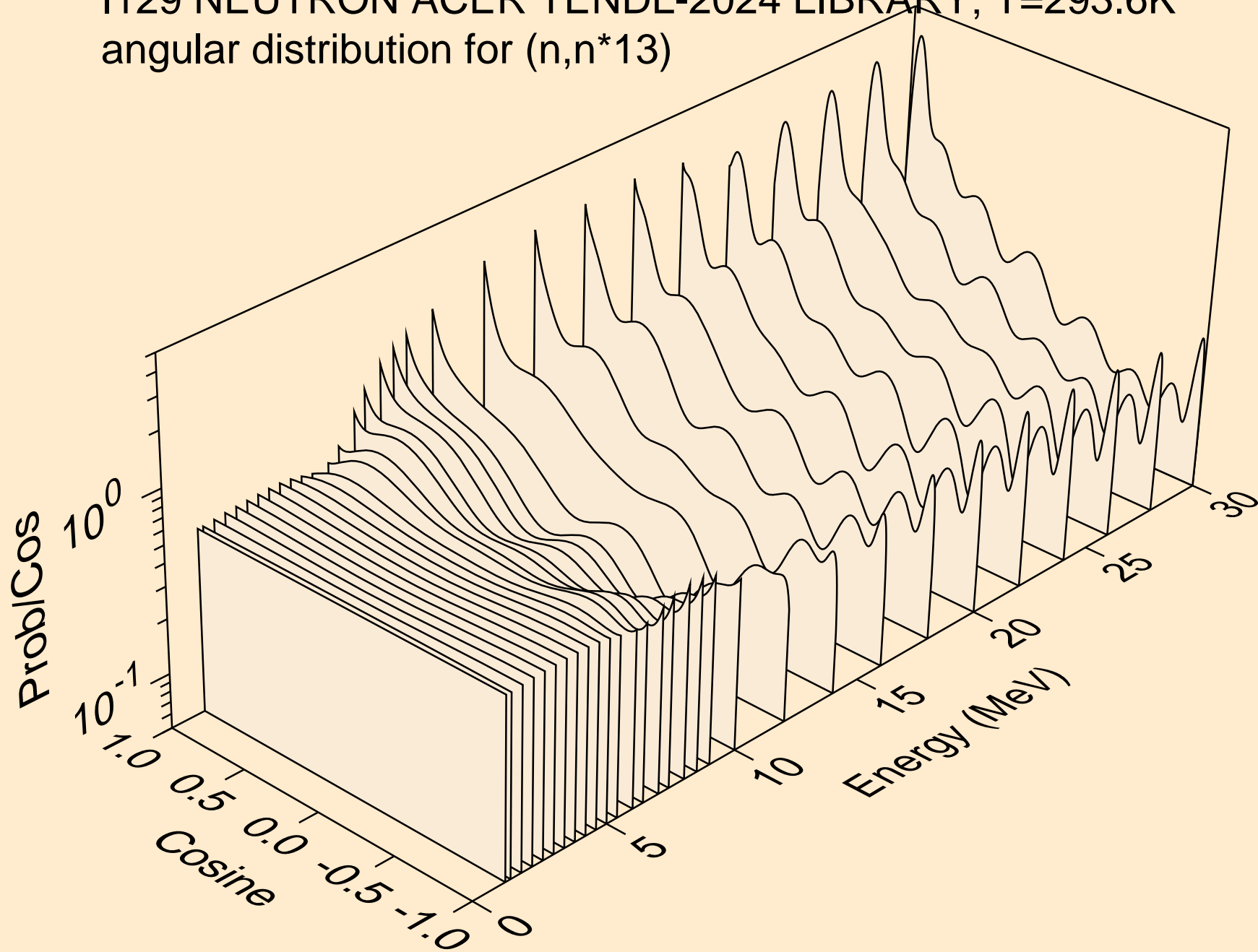

I129 NEUTRON ACER TENDL-2024 LIBRARY; T=293.6K  
angular distribution for (n,n\*14)

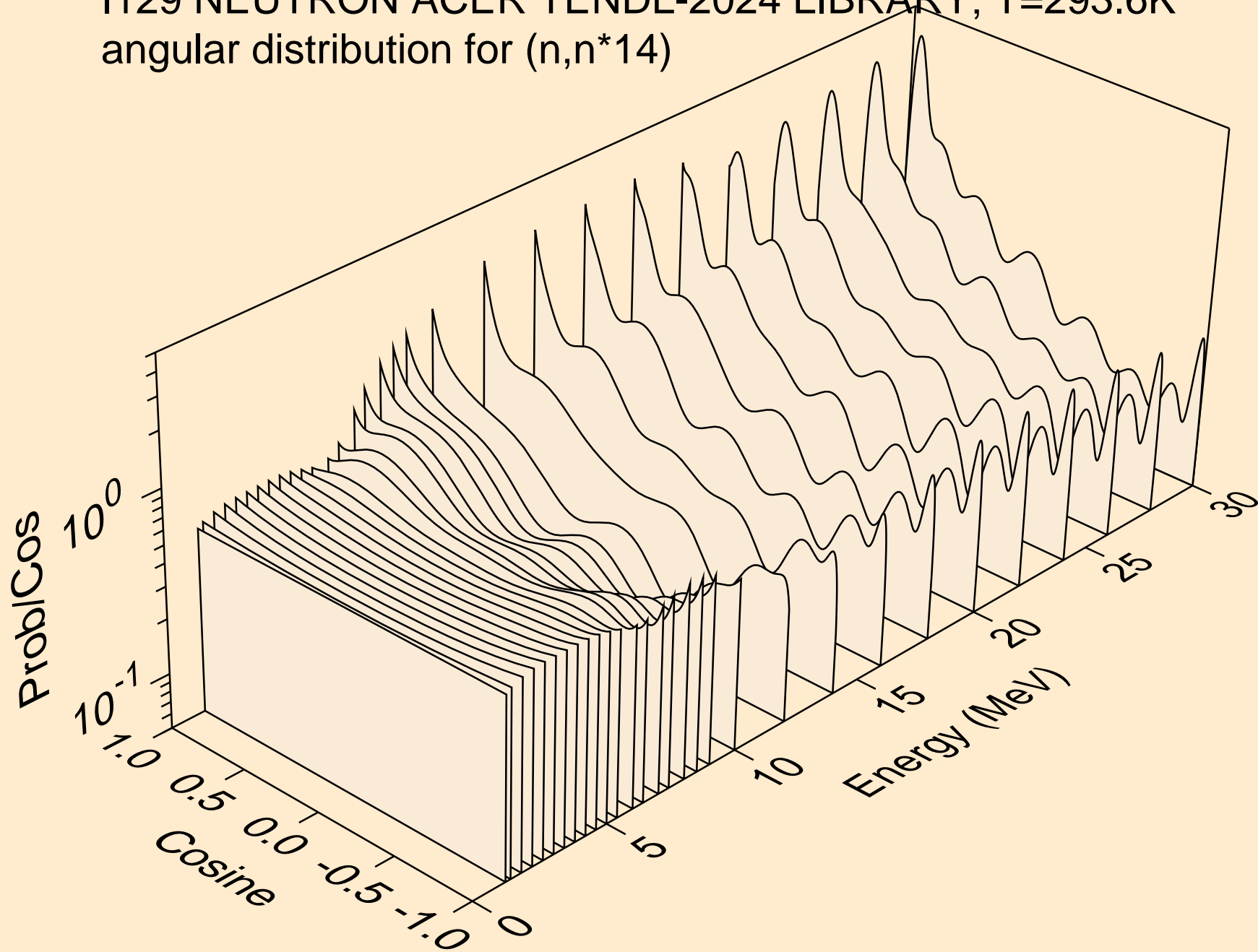

I129 NEUTRON ACER TENDL-2024 LIBRARY; T=293.6K  
angular distribution for (n,n\*15)

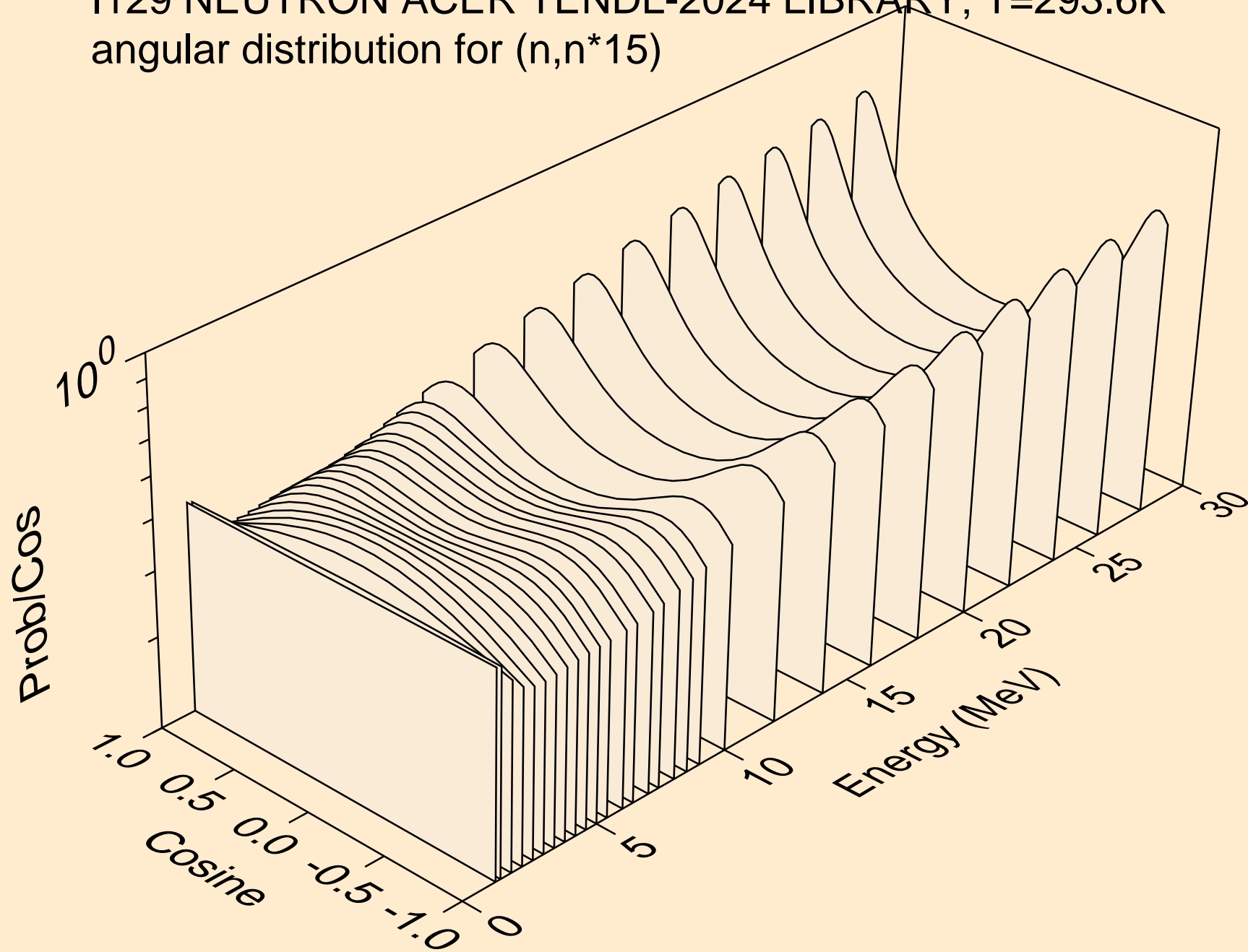

I129 NEUTRON ACER TENDL-2024 LIBRARY; T=293.6K  
angular distribution for (n,n\*16)

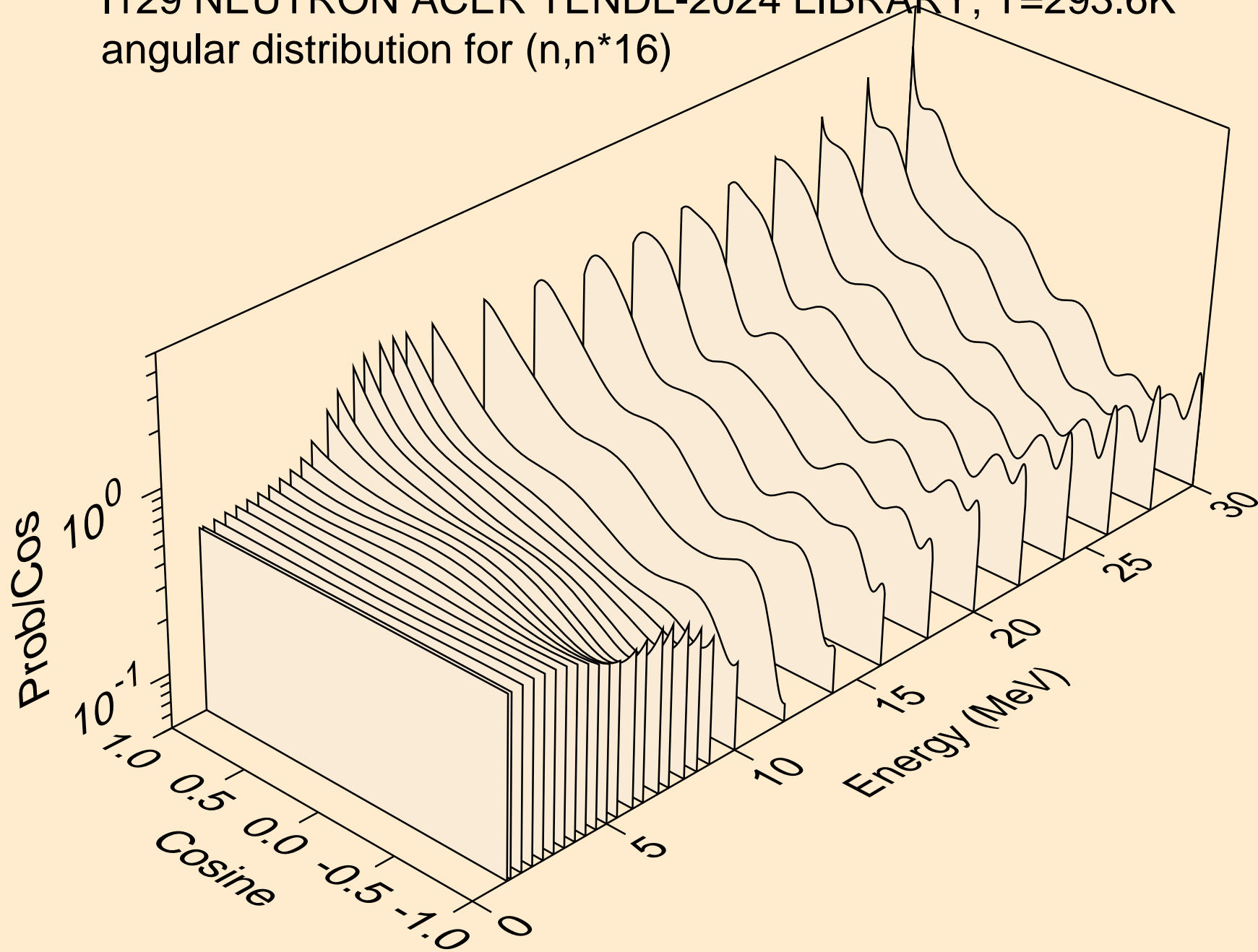

I129 NEUTRON ACER TENDL-2024 LIBRARY; T=293.6K  
angular distribution for (n,n\*17)

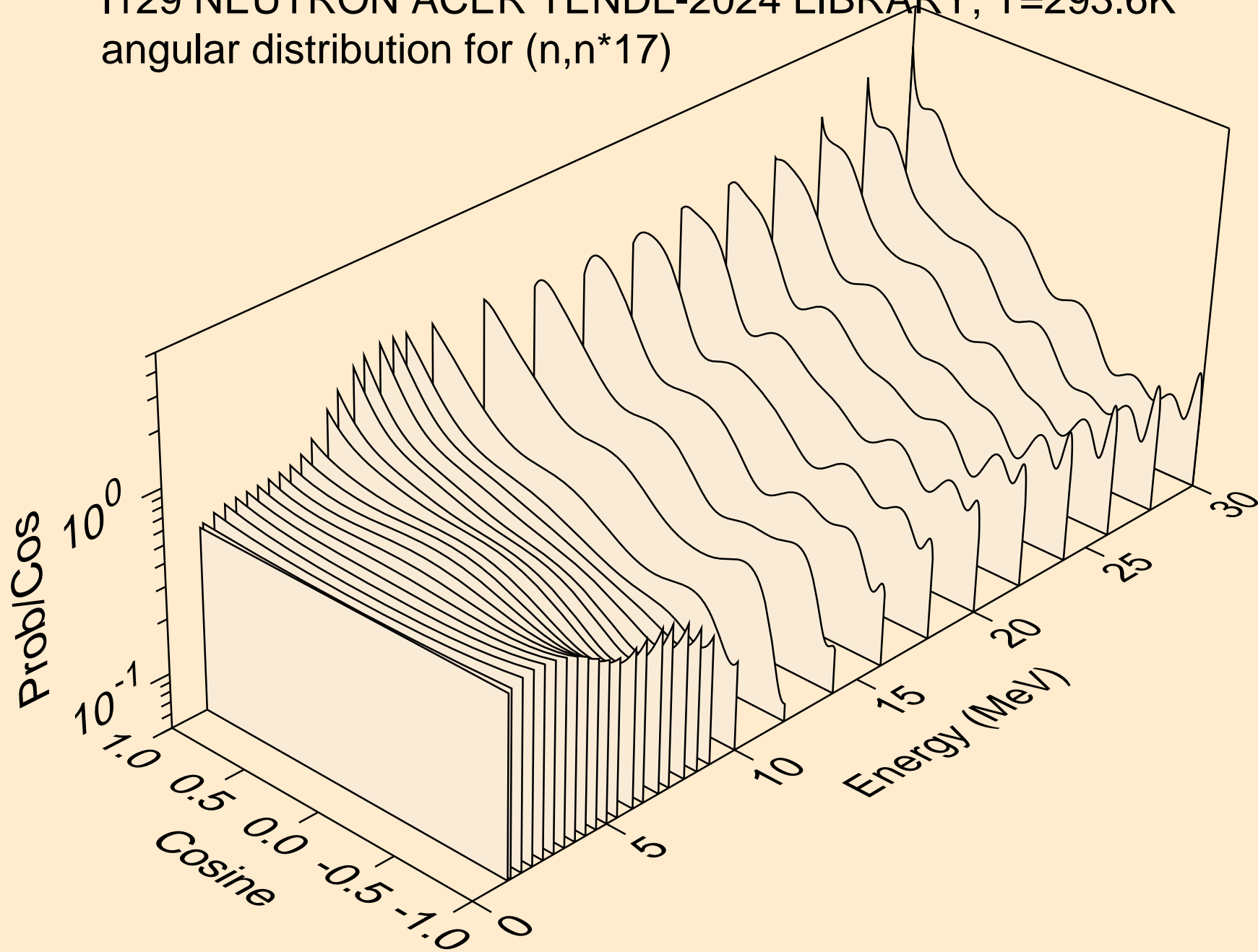

I129 NEUTRON ACER TENDL-2024 LIBRARY; T=293.6K  
angular distribution for (n,n\*18)

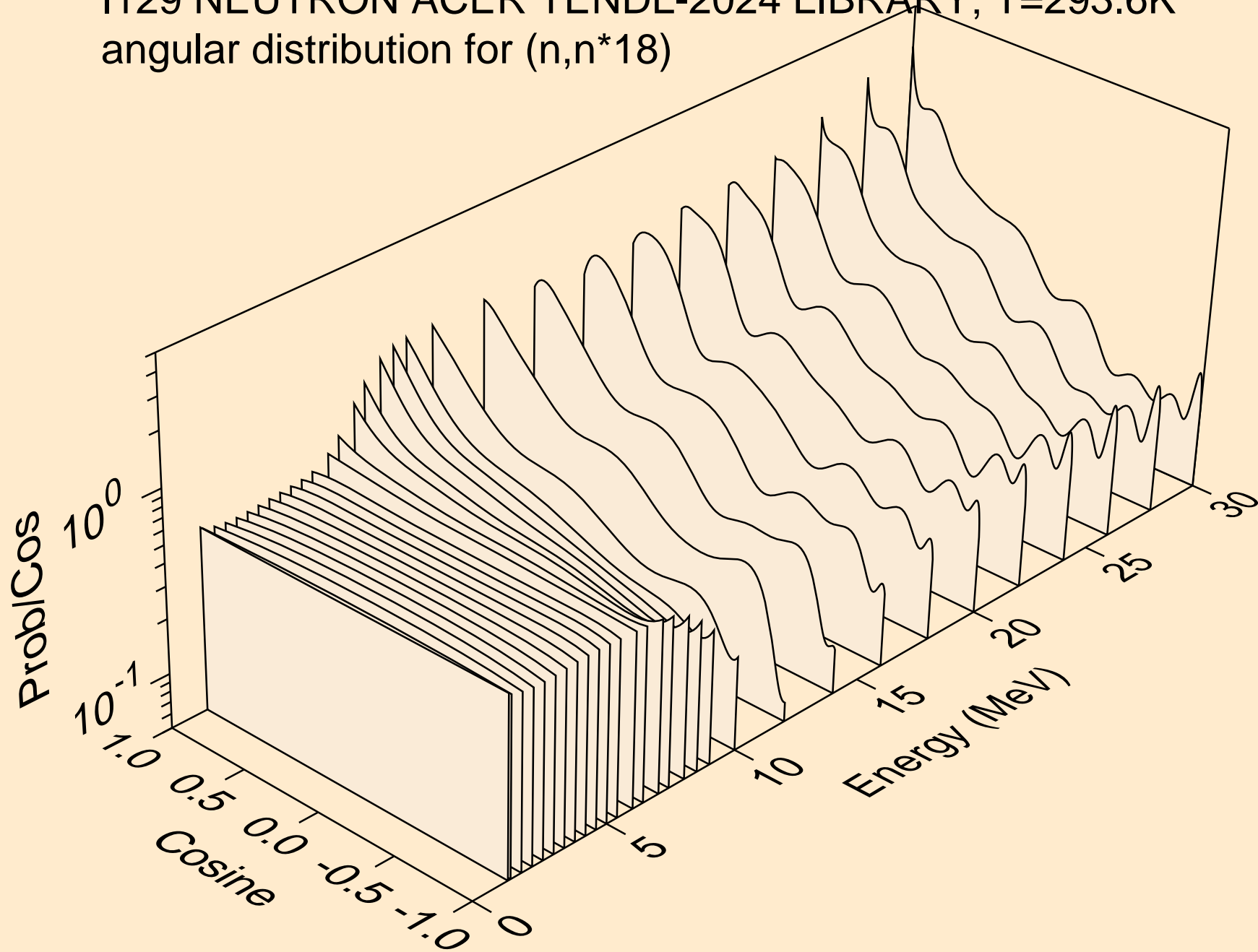

I129 NEUTRON ACER TENDL-2024 LIBRARY; T=293.6K  
angular distribution for (n,n\*19)

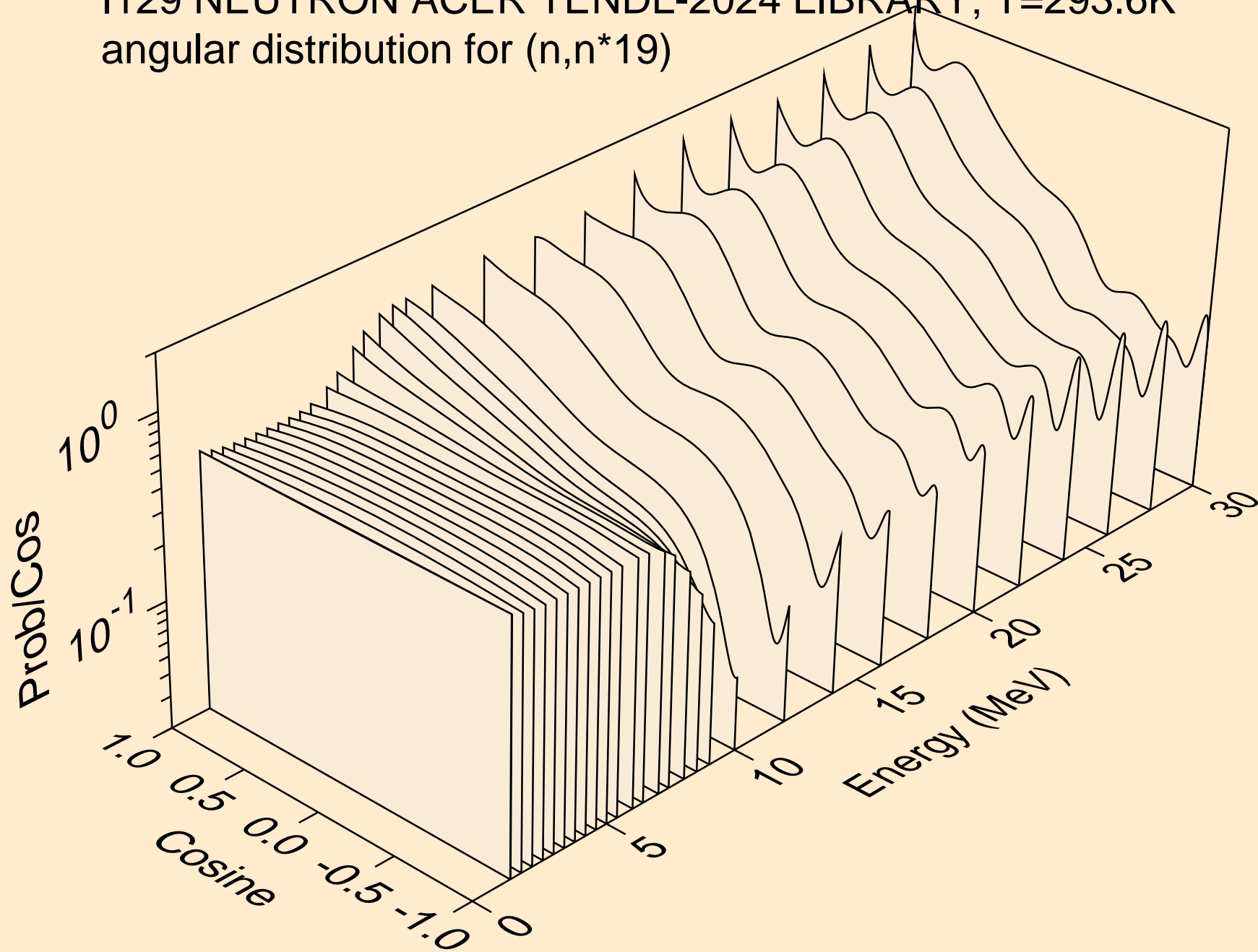

I129 NEUTRON ACER TENDL-2024 LIBRARY; T=293.6K  
angular distribution for (n,n\*20)

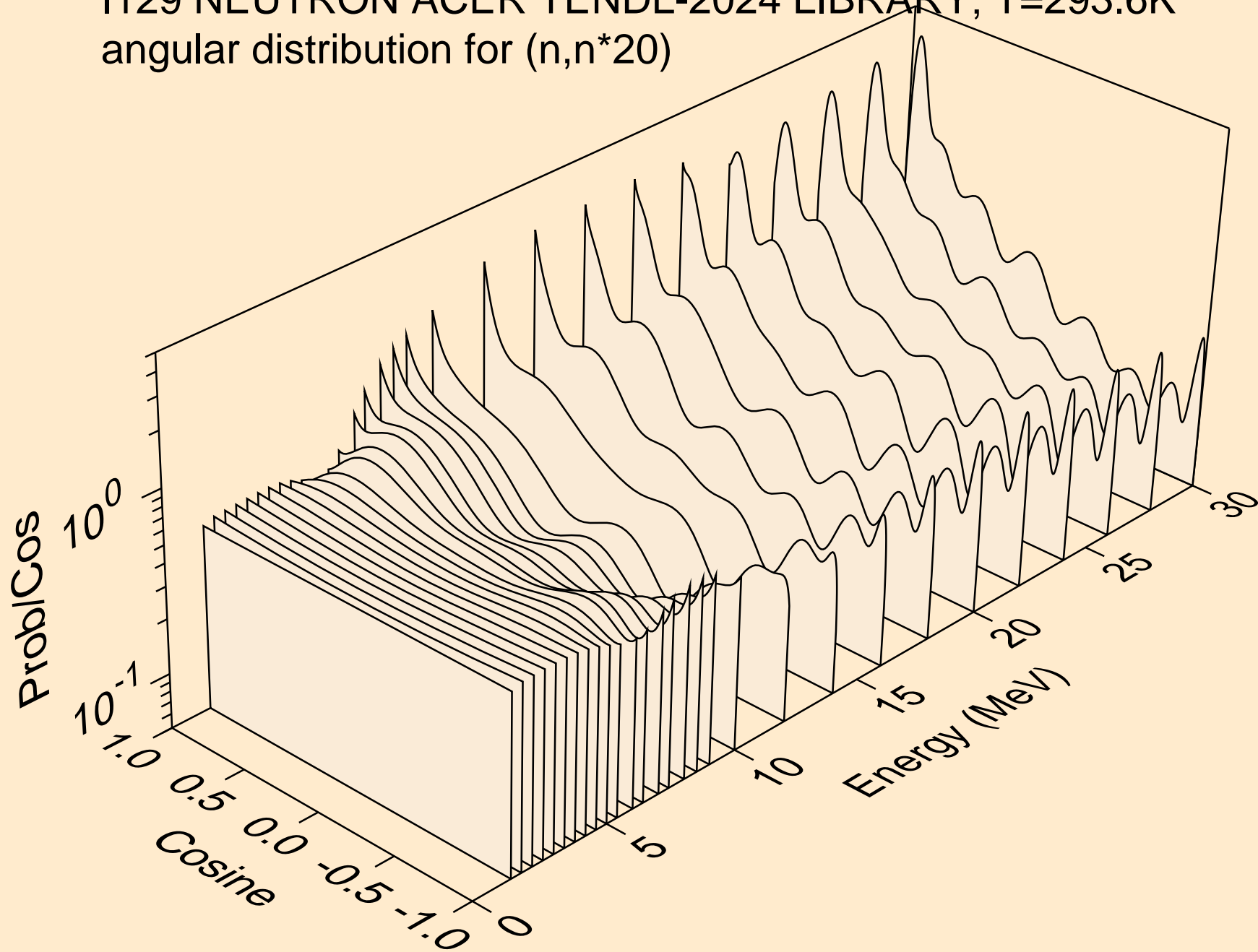

I129 NEUTRON ACER TENDL-2024 LIBRARY; T=293.6K  
angular distribution for (n,n\*21)

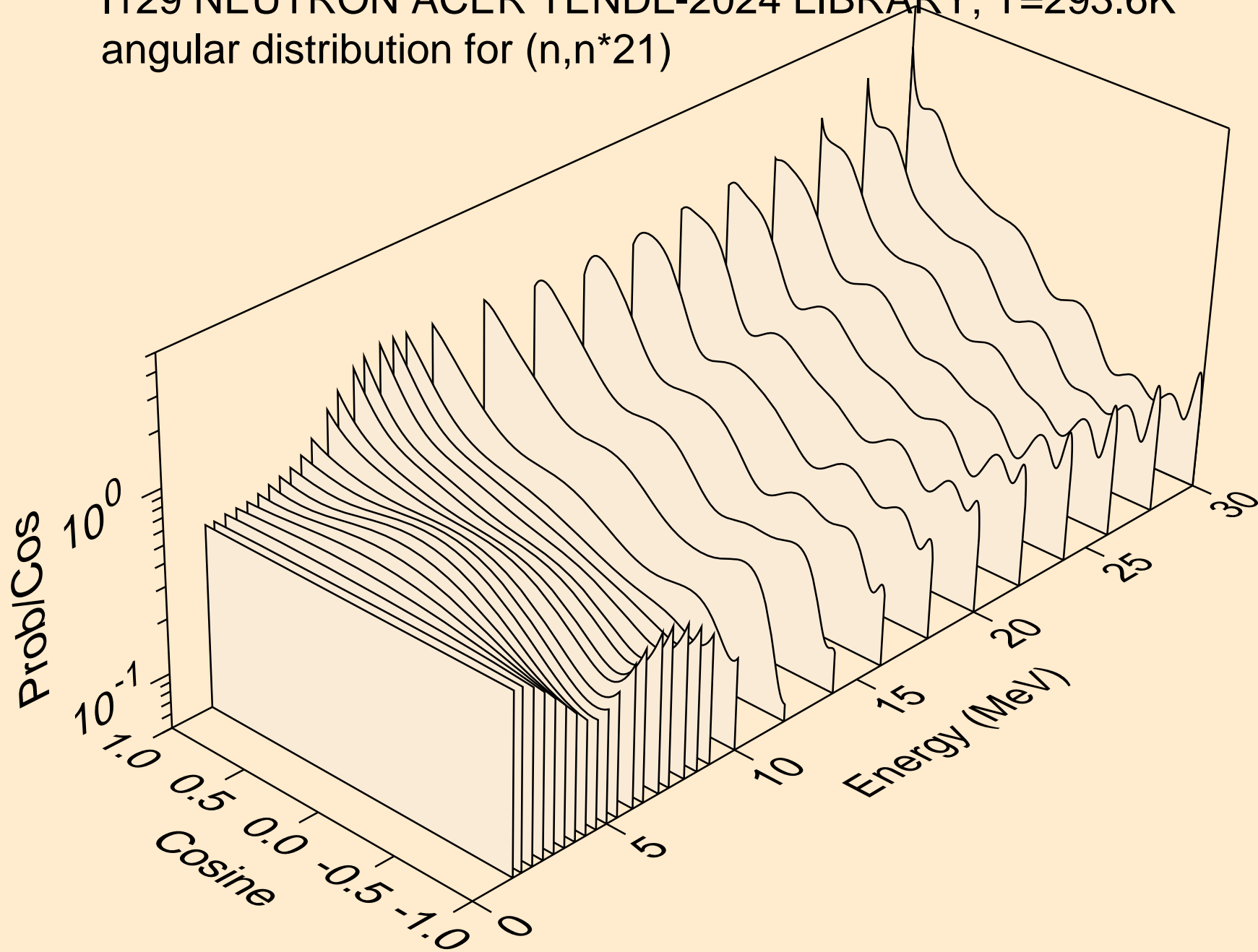

I129 NEUTRON ACER TENDL-2024 LIBRARY; T=293.6K  
angular distribution for (n,n\*22)

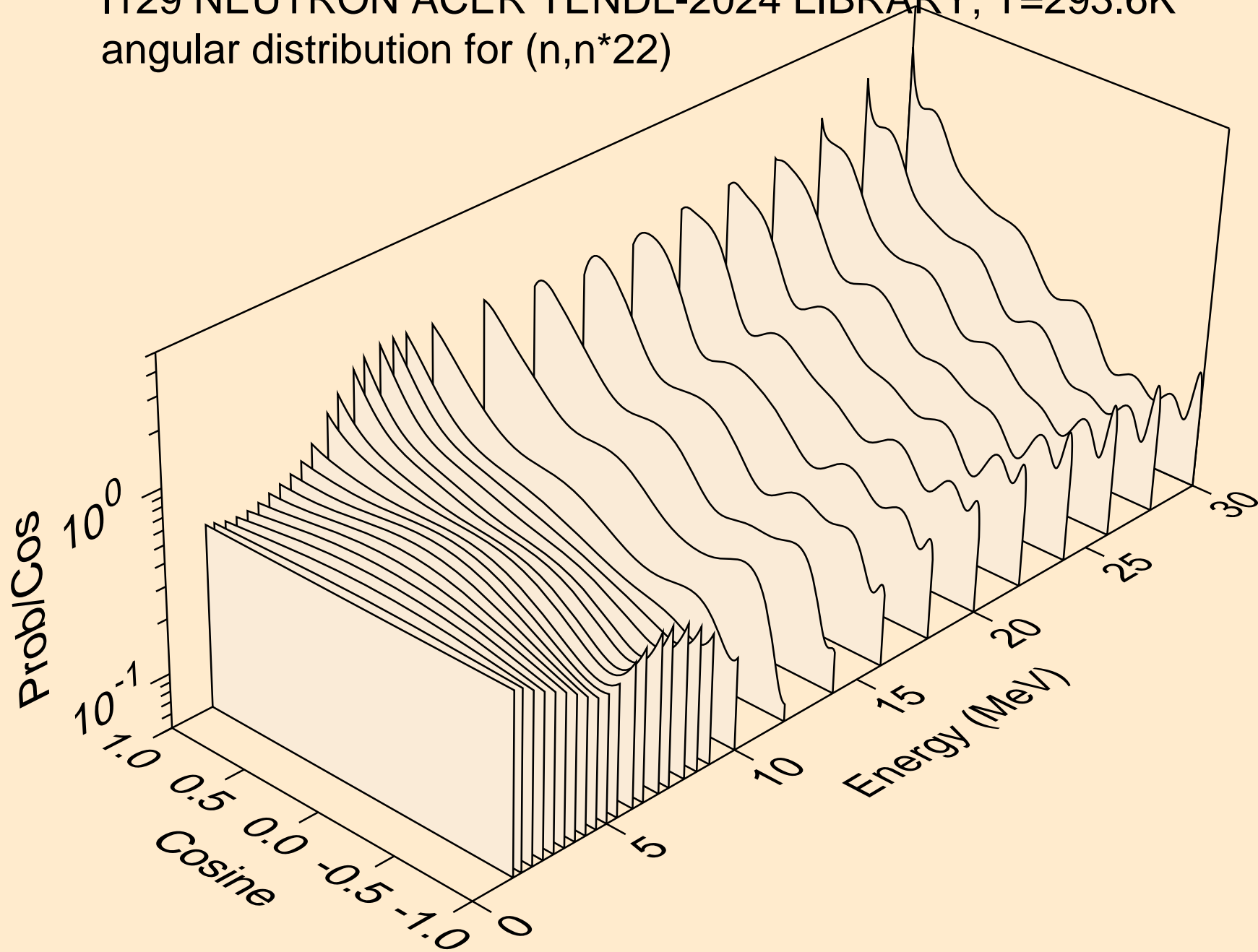

I129 NEUTRON ACER TENDL-2024 LIBRARY; T=293.6K  
angular distribution for (n,n\*23)

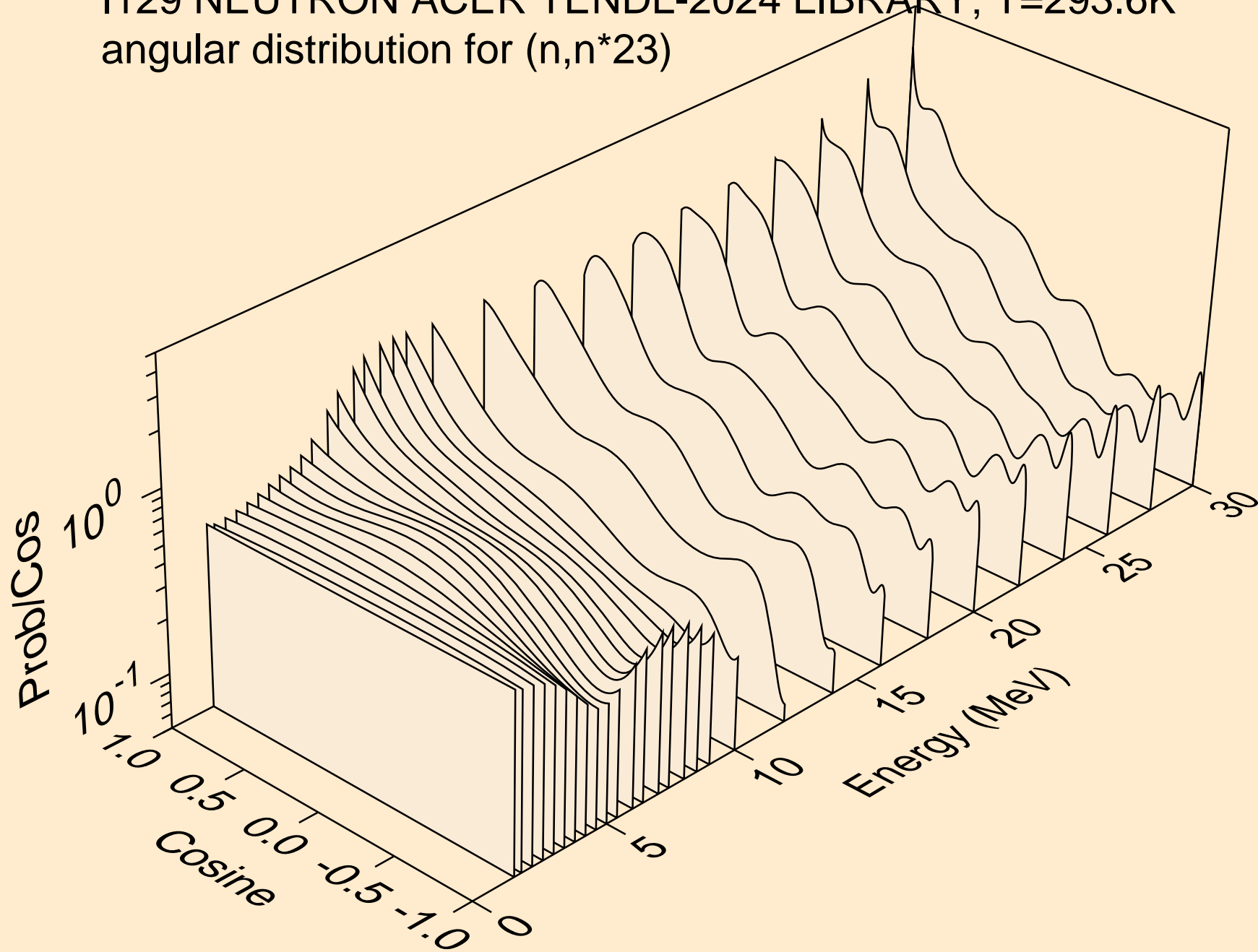

I129 NEUTRON ACER TENDL-2024 LIBRARY; T=293.6K  
angular distribution for (n,n\*24)

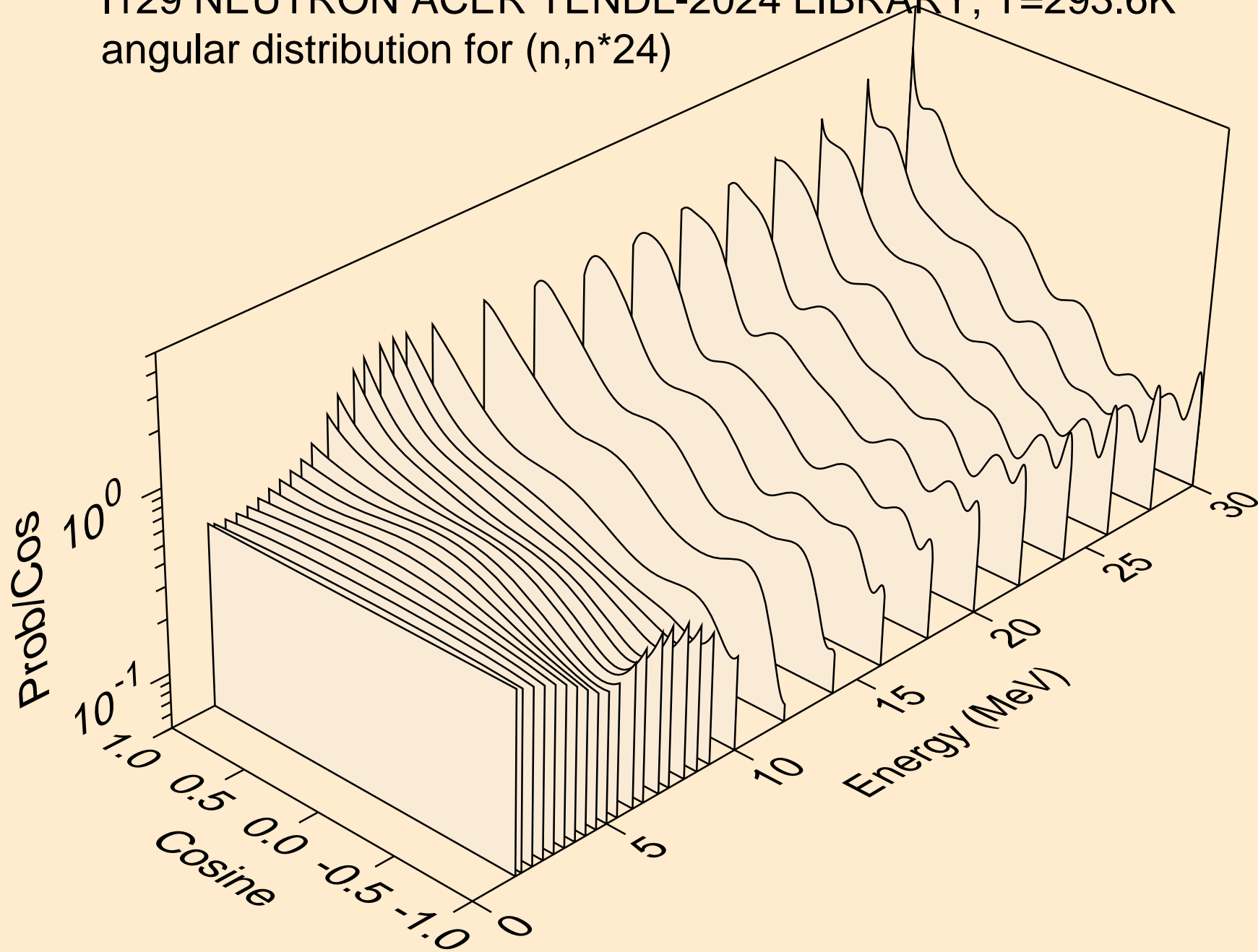

I129 NEUTRON ACER TENDL-2024 LIBRARY; T=293.6K  
angular distribution for (n,n\*25)

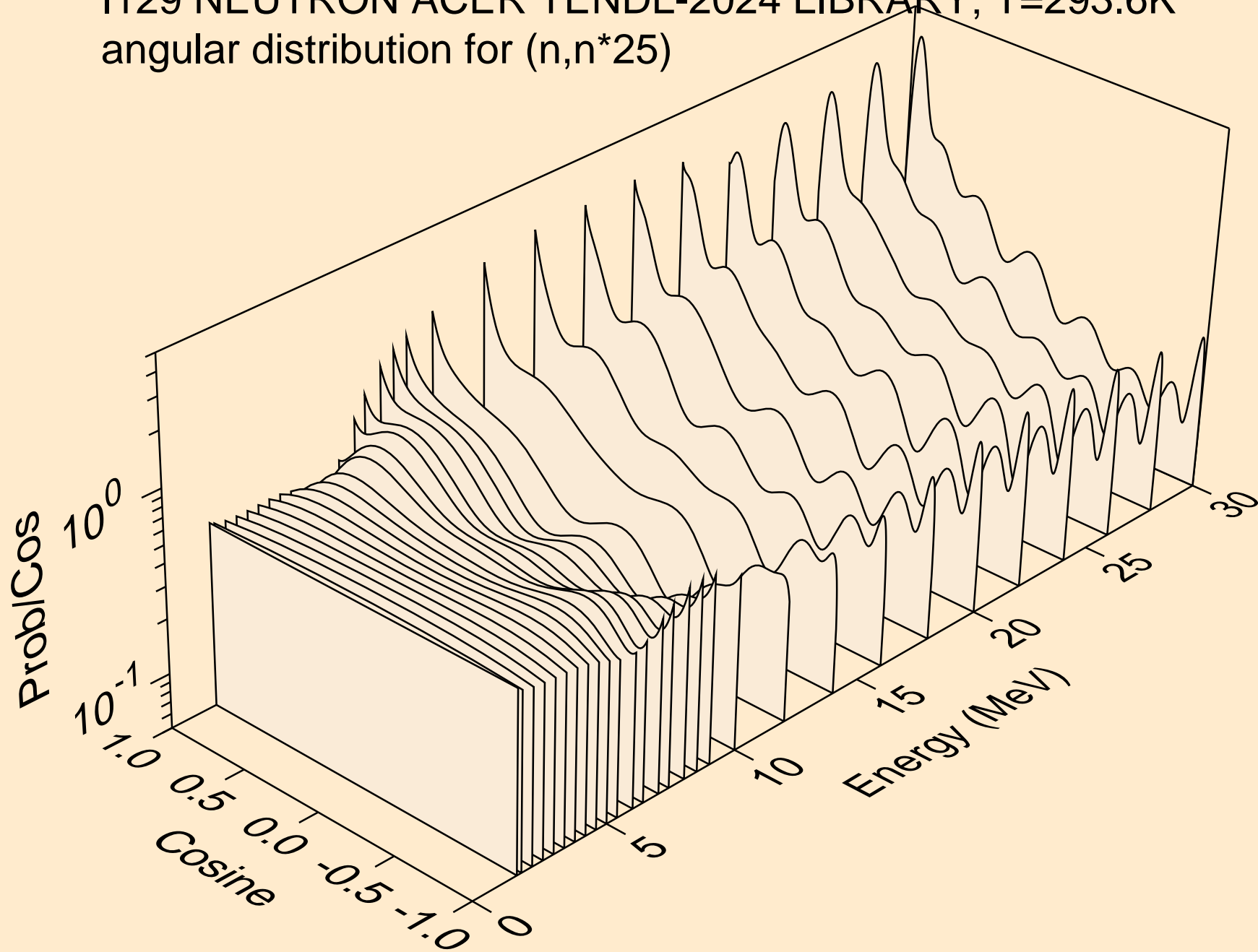

I129 NEUTRON ACER TENDL-2024 LIBRARY; T=293.6K  
angular distribution for (n,n\*26)

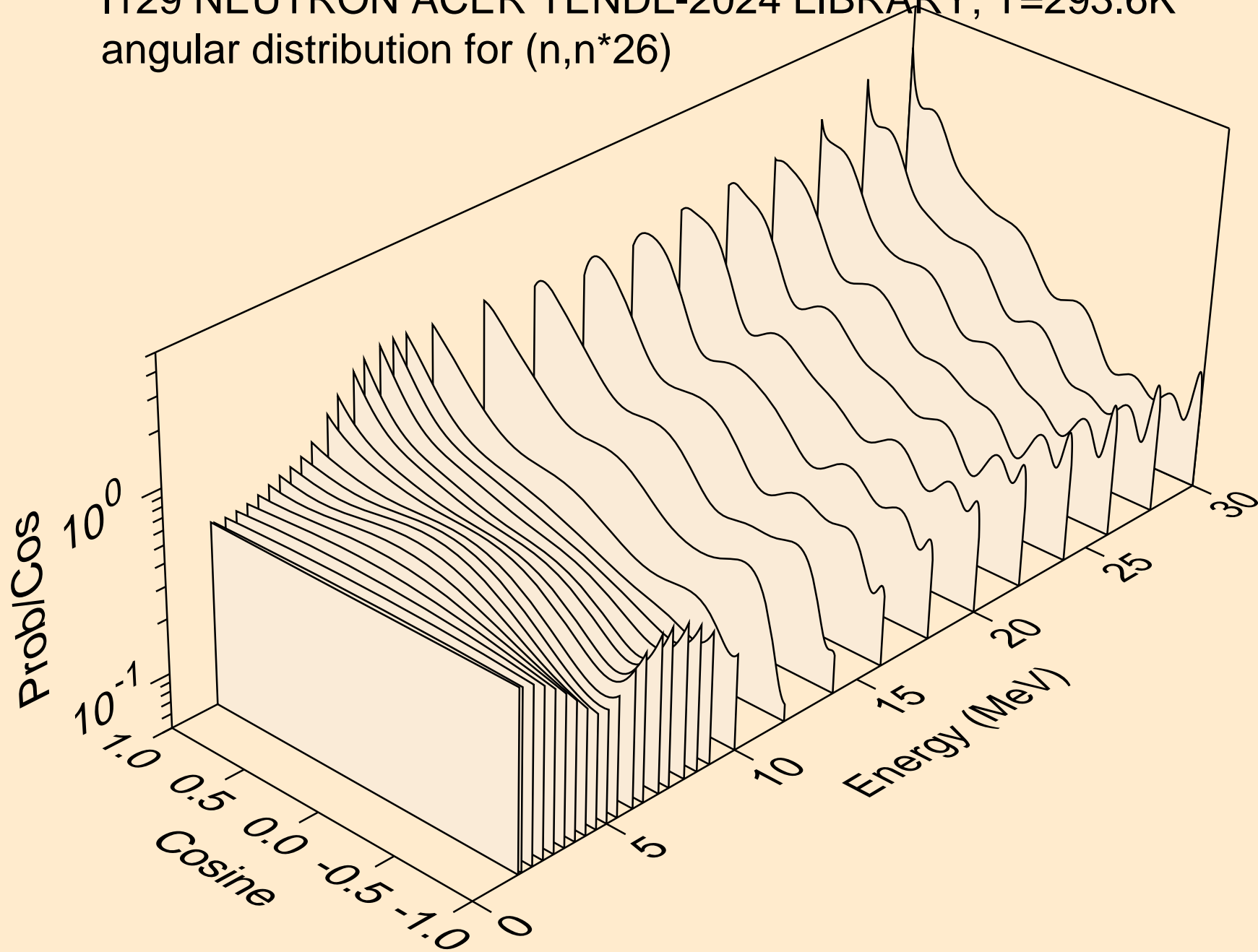

I129 NEUTRON ACER TENDL-2024 LIBRARY; T=293.6K  
angular distribution for (n,n\*27)

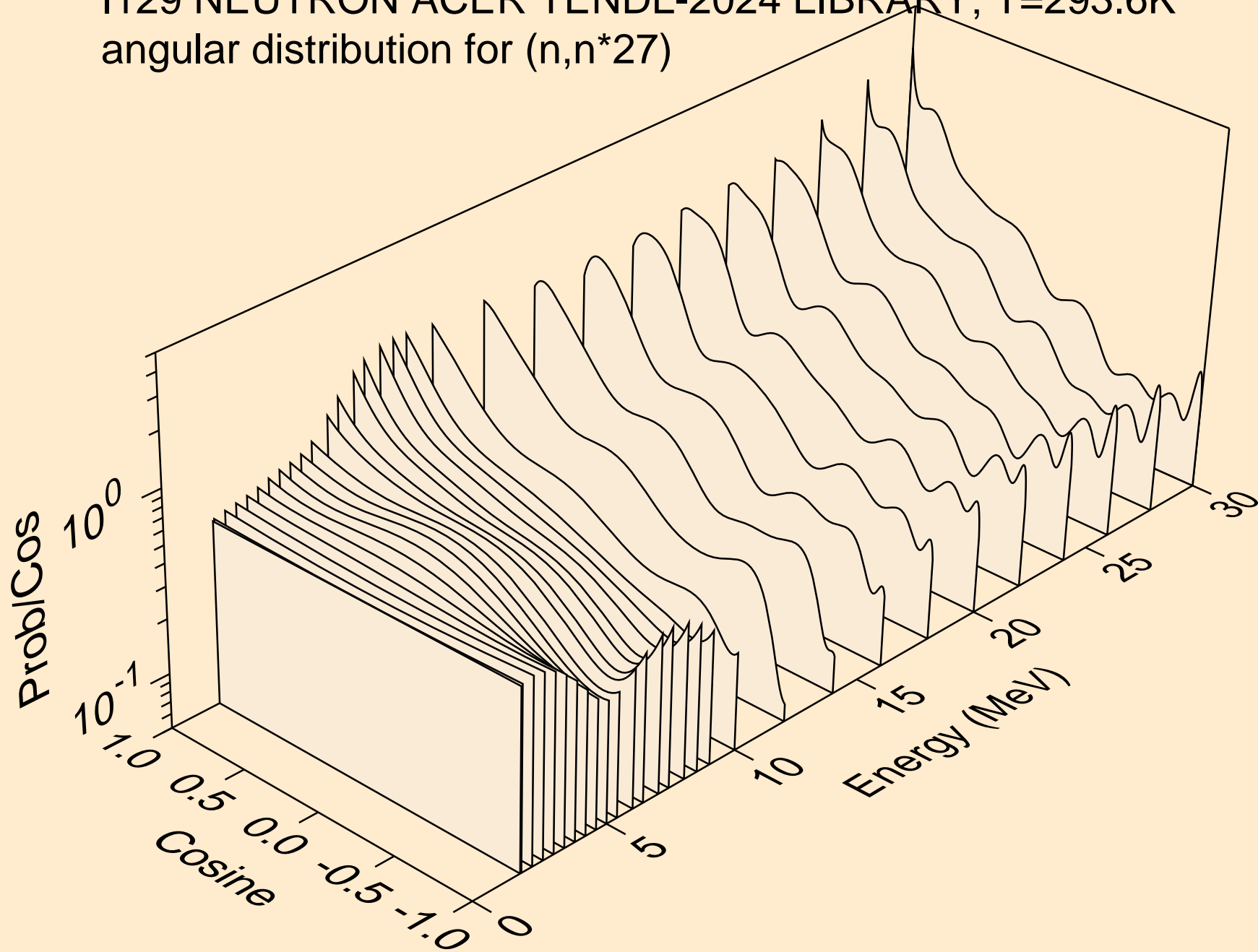

I129 NEUTRON ACER TENDL-2024 LIBRARY; T=293.6K  
Neutron emission for (n,x)

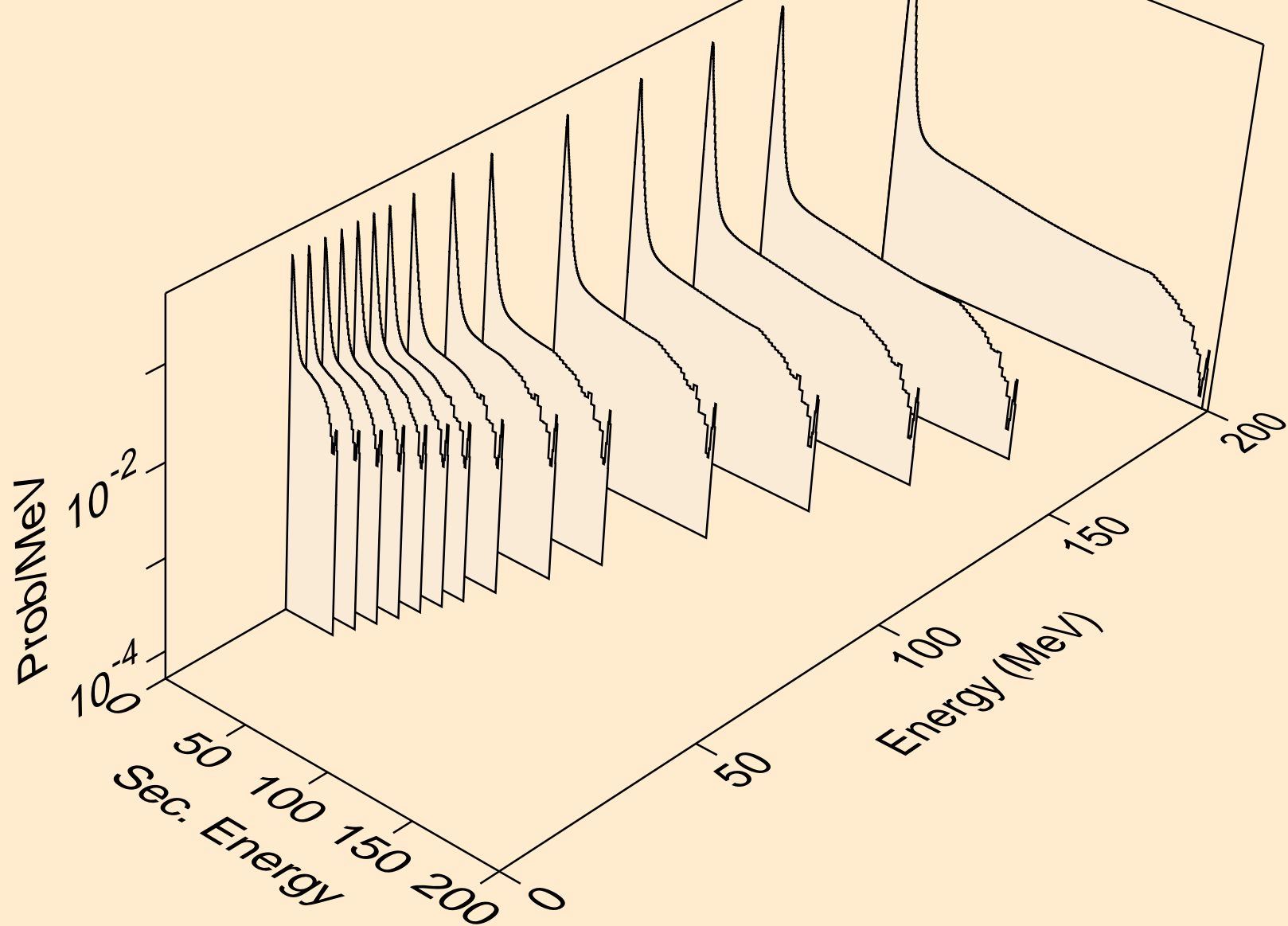

I129 NEUTRON ACER TENDL-2024 LIBRARY; T=293.6K  
Neutron emission for (n,2nd)

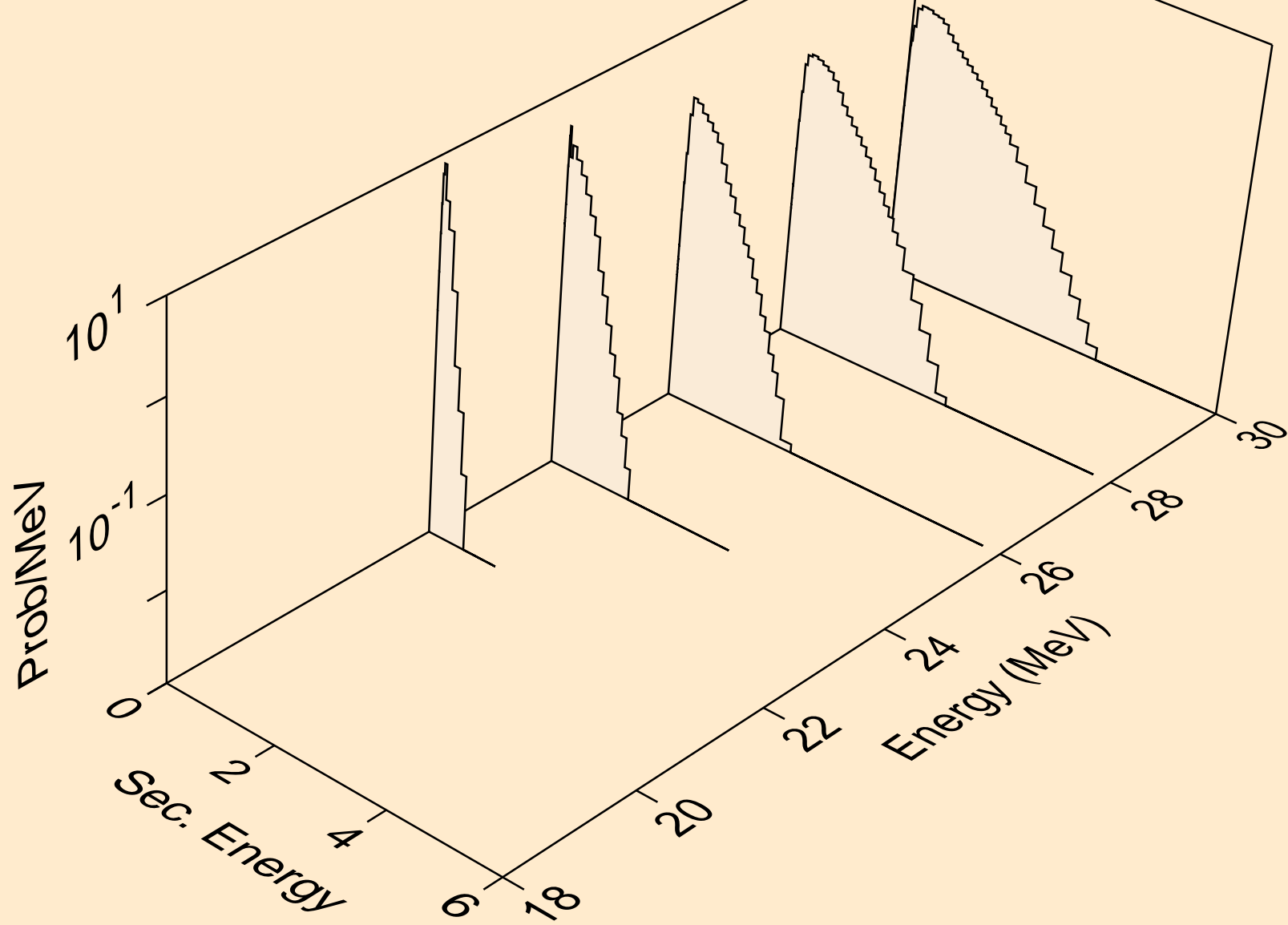

I129 NEUTRON ACER TENDL-2024 LIBRARY; T=293.6K  
Neutron emission for (n,2n)

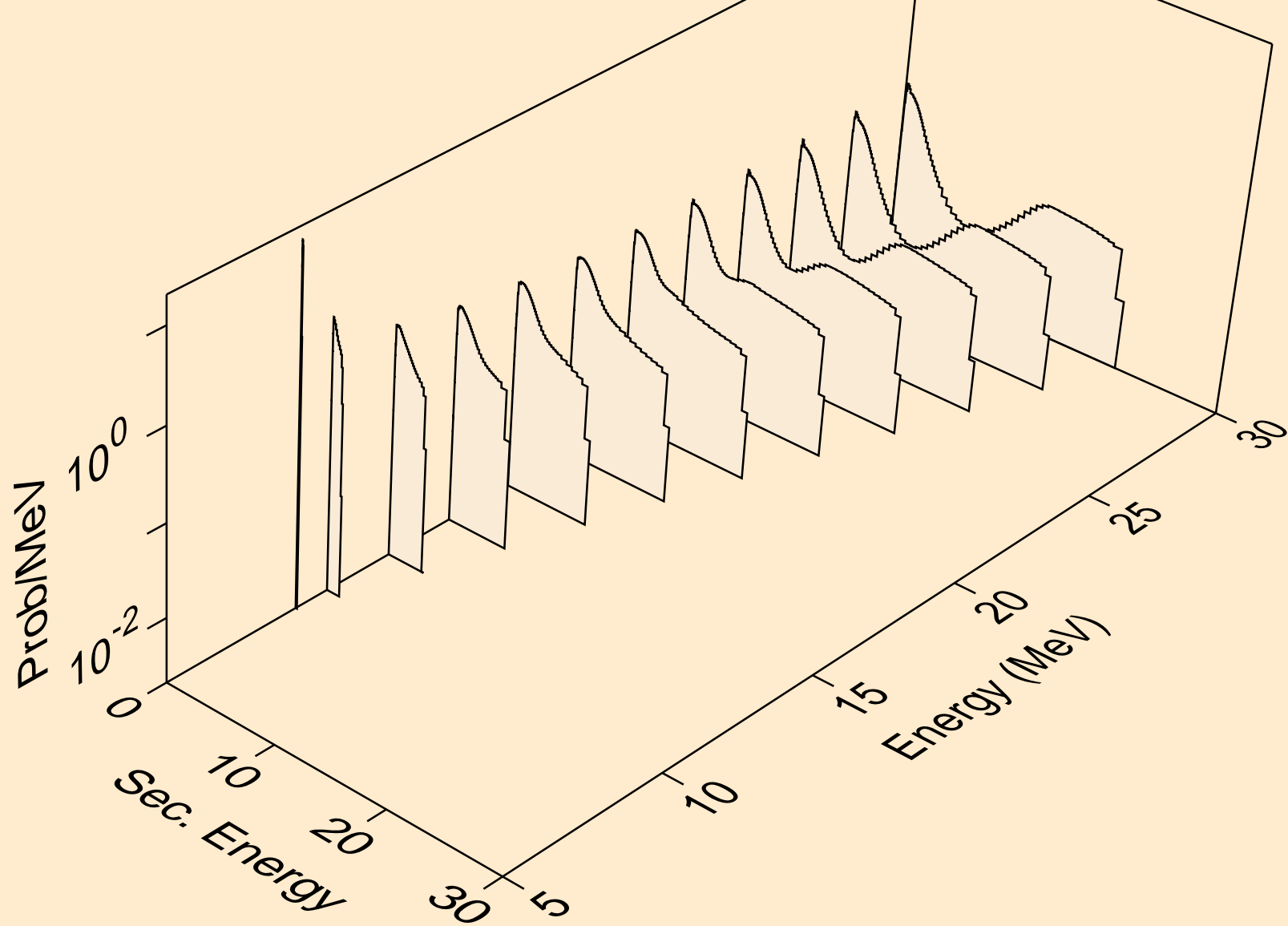

I129 NEUTRON ACER TENDL-2024 LIBRARY; T=293.6K  
Neutron emission for (n,3n)

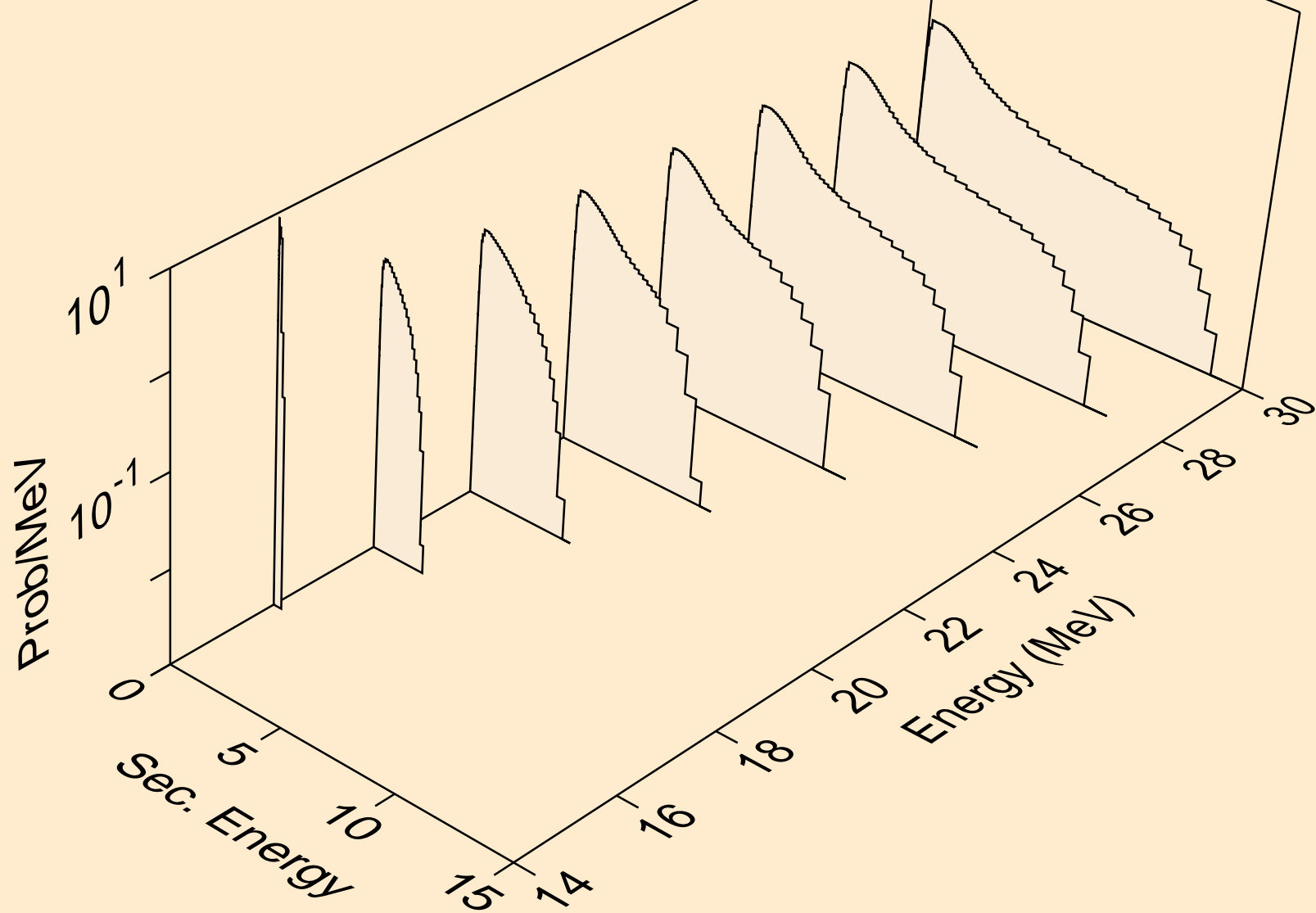

I129 NEUTRON ACER TENDL-2024 LIBRARY; T=293.6K  
Neutron emission for (n,n\*)a

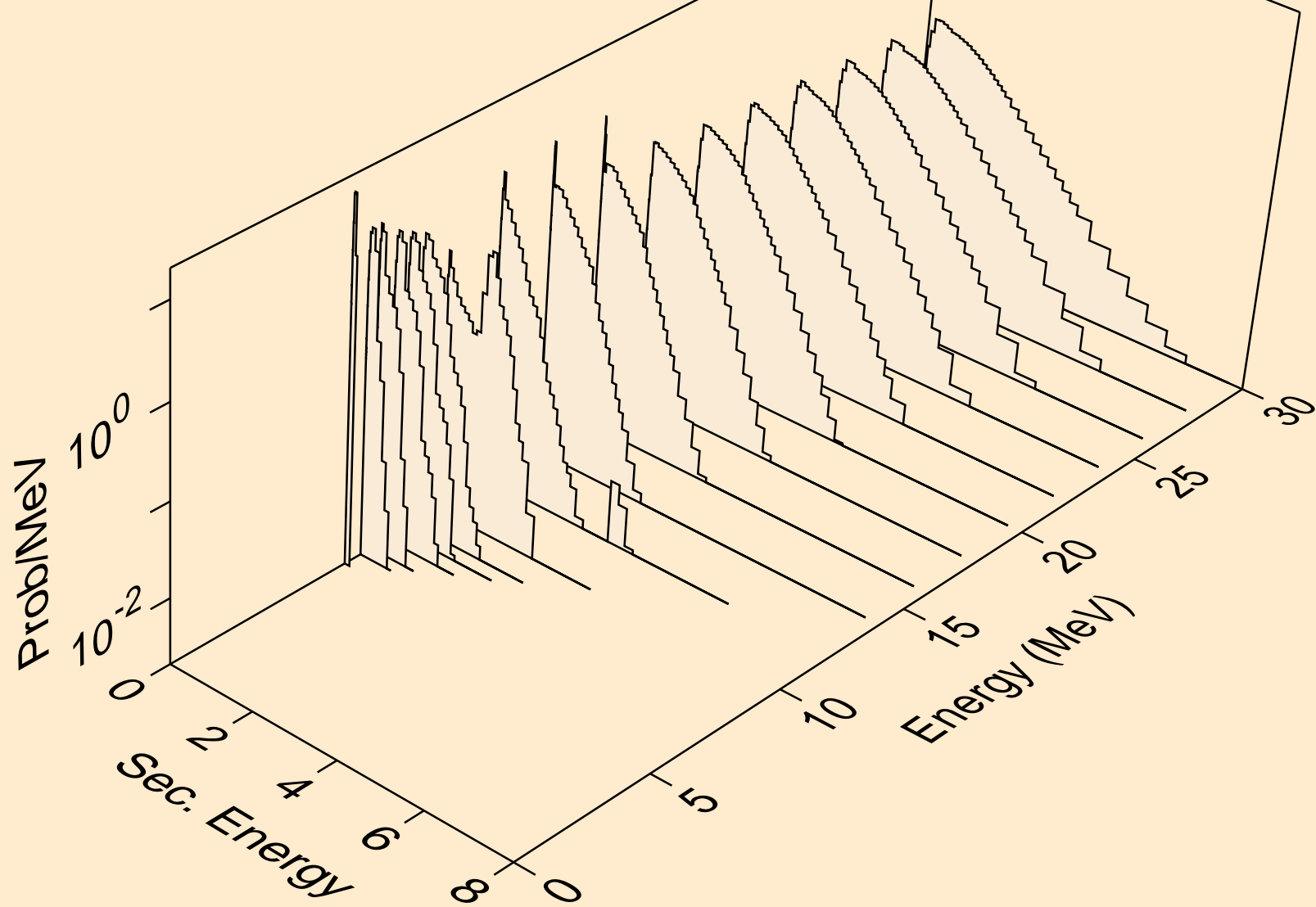

I129 NEUTRON ACER TENDL-2024 LIBRARY; T=293.6K  
Neutron emission for (n,2n)a

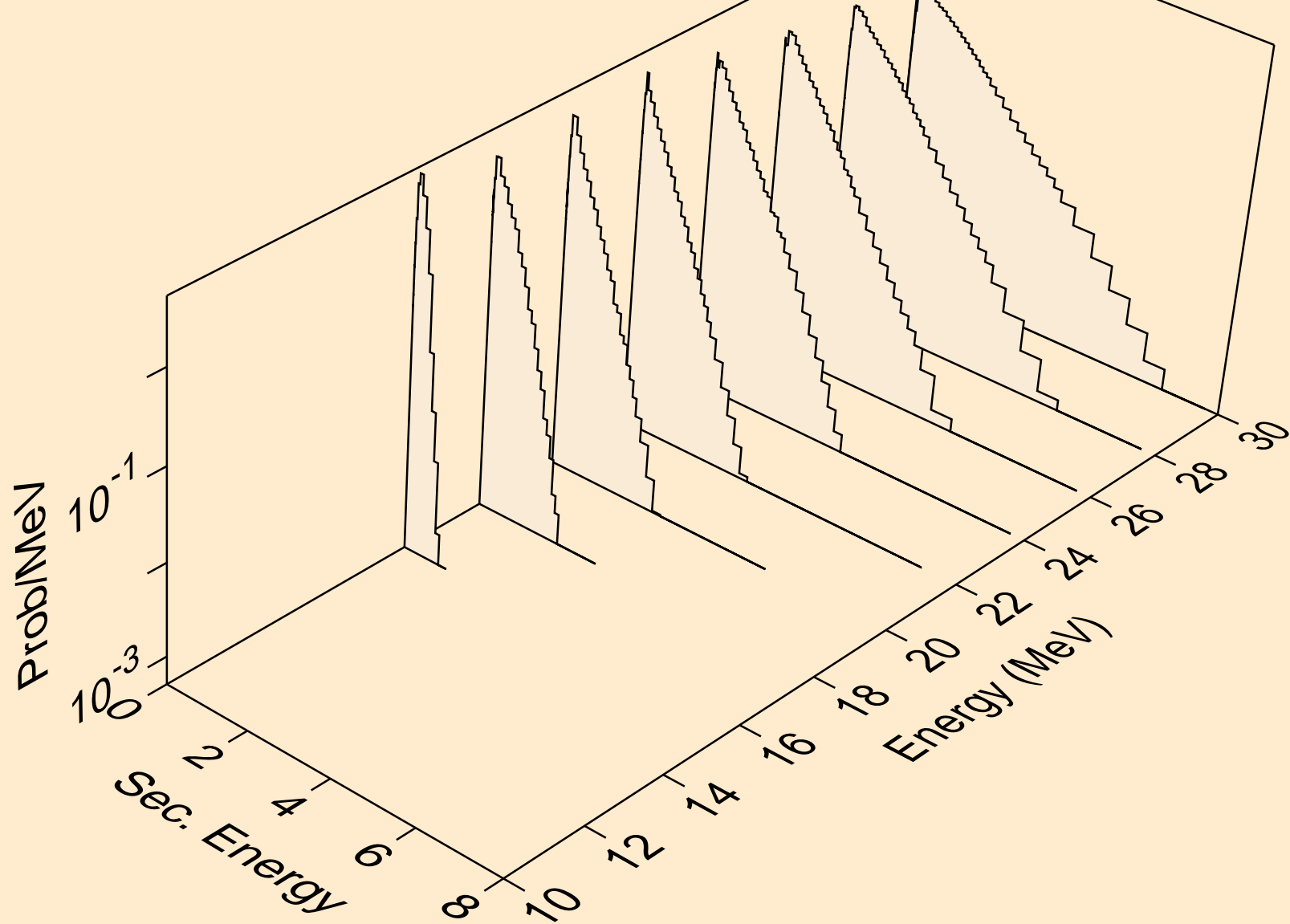

I129 NEUTRON ACER TENDL-2024 LIBRARY; T=293.6K  
Neutron emission for (n,3n)a

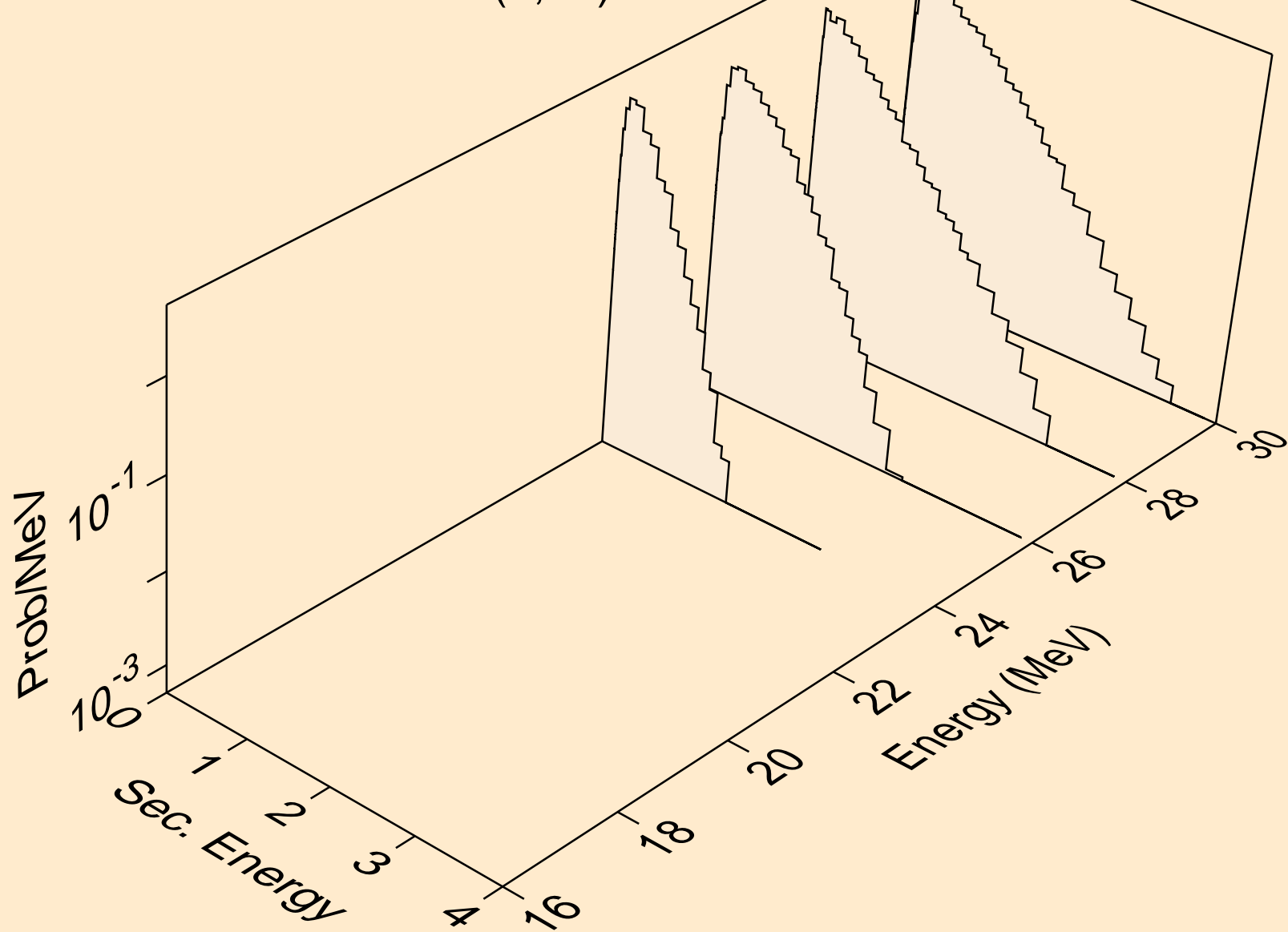

I129 NEUTRON ACER TENDL-2024 LIBRARY; T=293.6K  
Neutron emission for (n,n\*)p

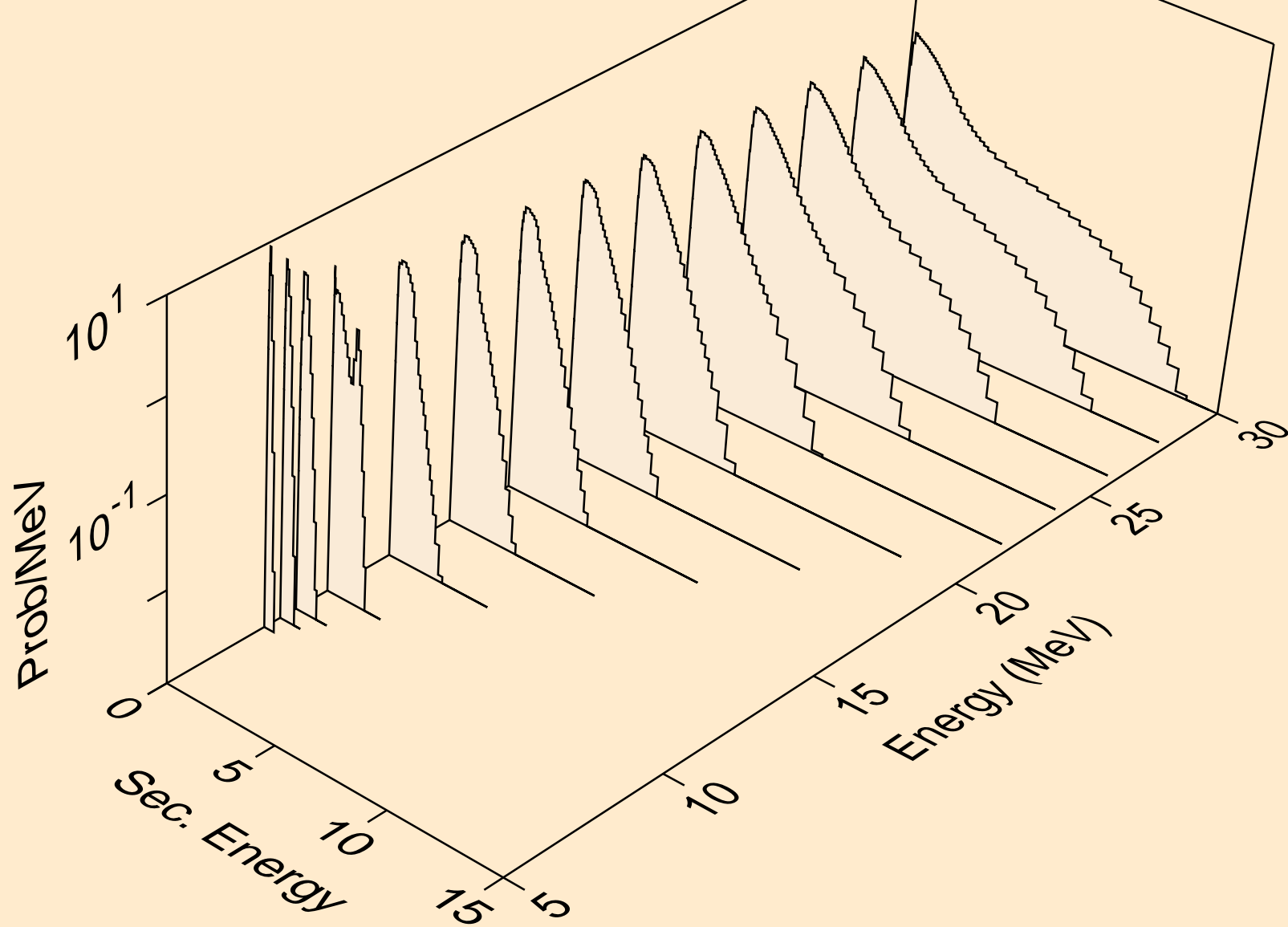

I129 NEUTRON ACER TENDL-2024 LIBRARY; T=293.6K  
Neutron emission for (n,n\*)d

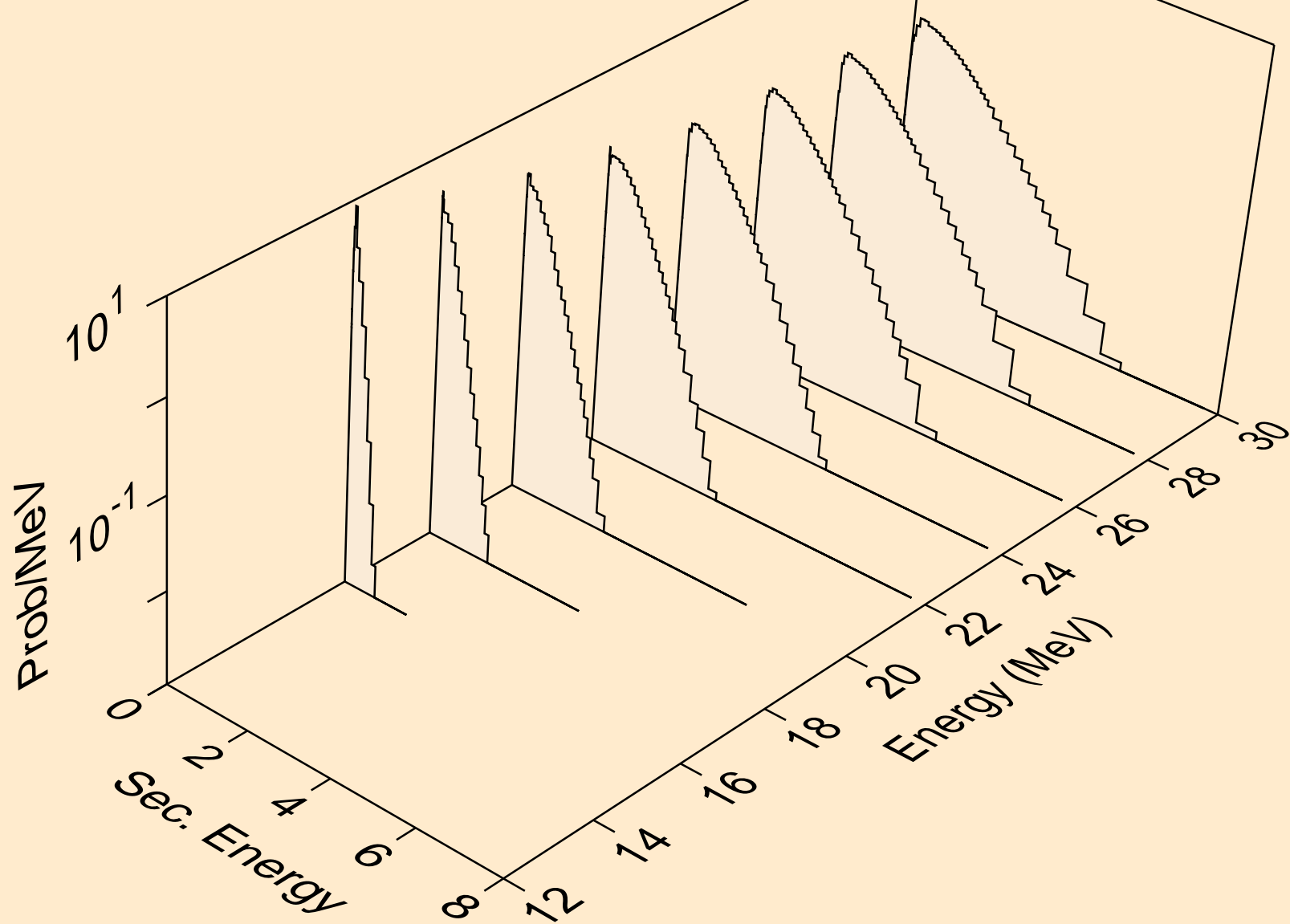

I129 NEUTRON ACER TENDL-2024 LIBRARY; T=293.6K  
Neutron emission for (n,n\*)t

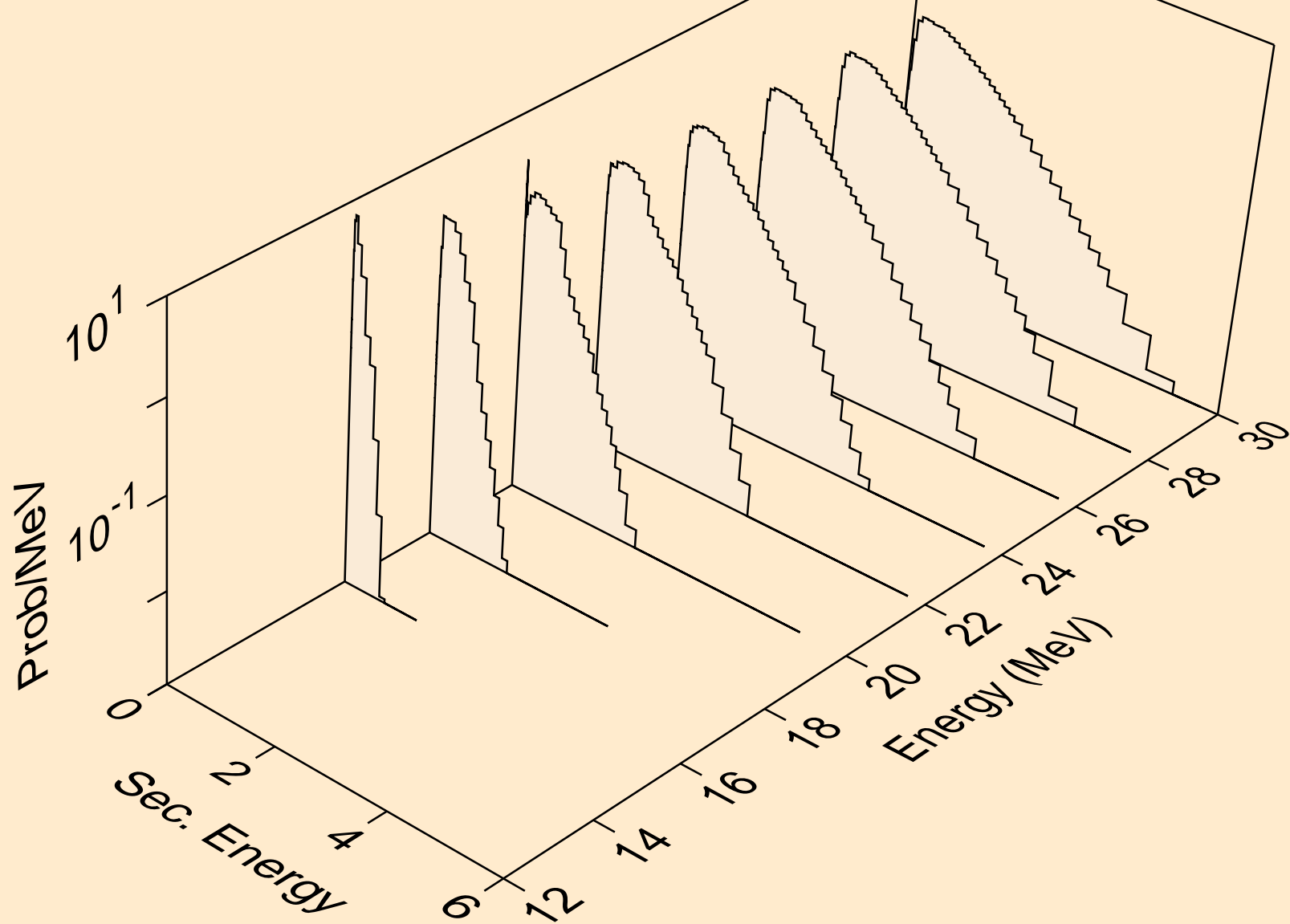

I129 NEUTRON ACER TENDL-2024 LIBRARY; T=293.6K  
Neutron emission for (n,n\*)he3

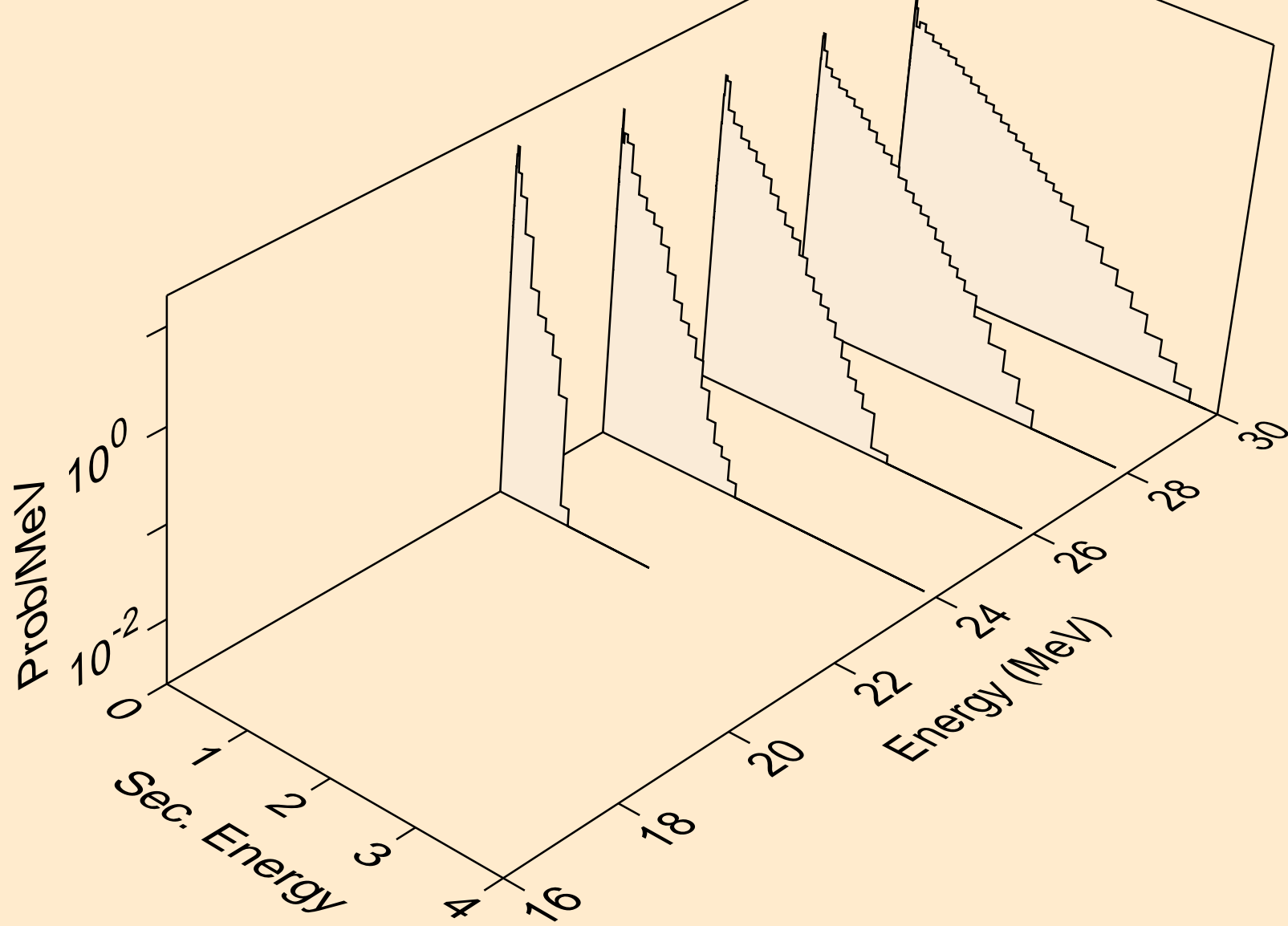

I129 NEUTRON ACER TENDL-2024 LIBRARY; T=293.6K  
Neutron emission for (n,4n)

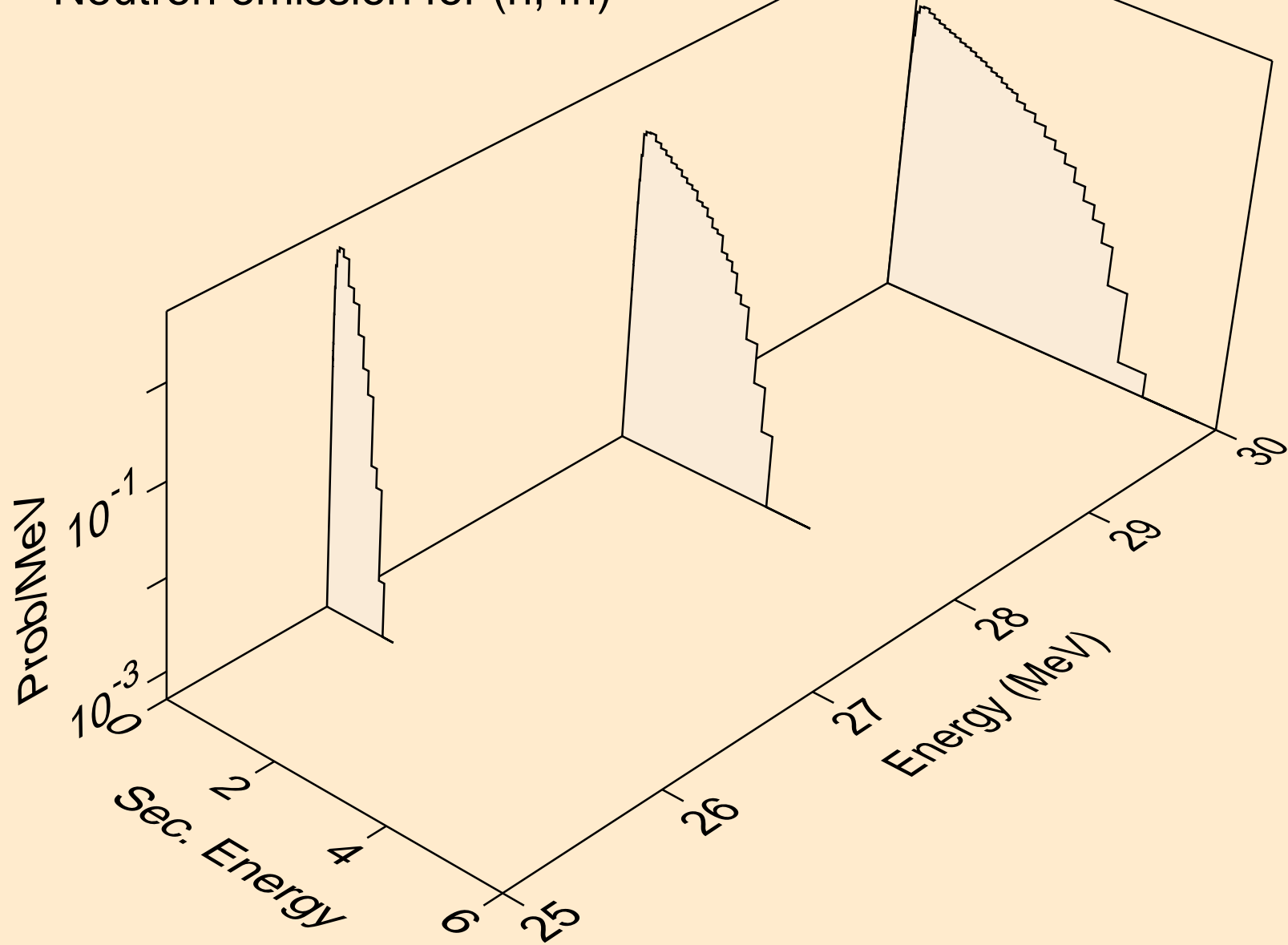

I129 NEUTRON ACER TENDL-2024 LIBRARY; T=293.6K  
Neutron emission for (n,2np)

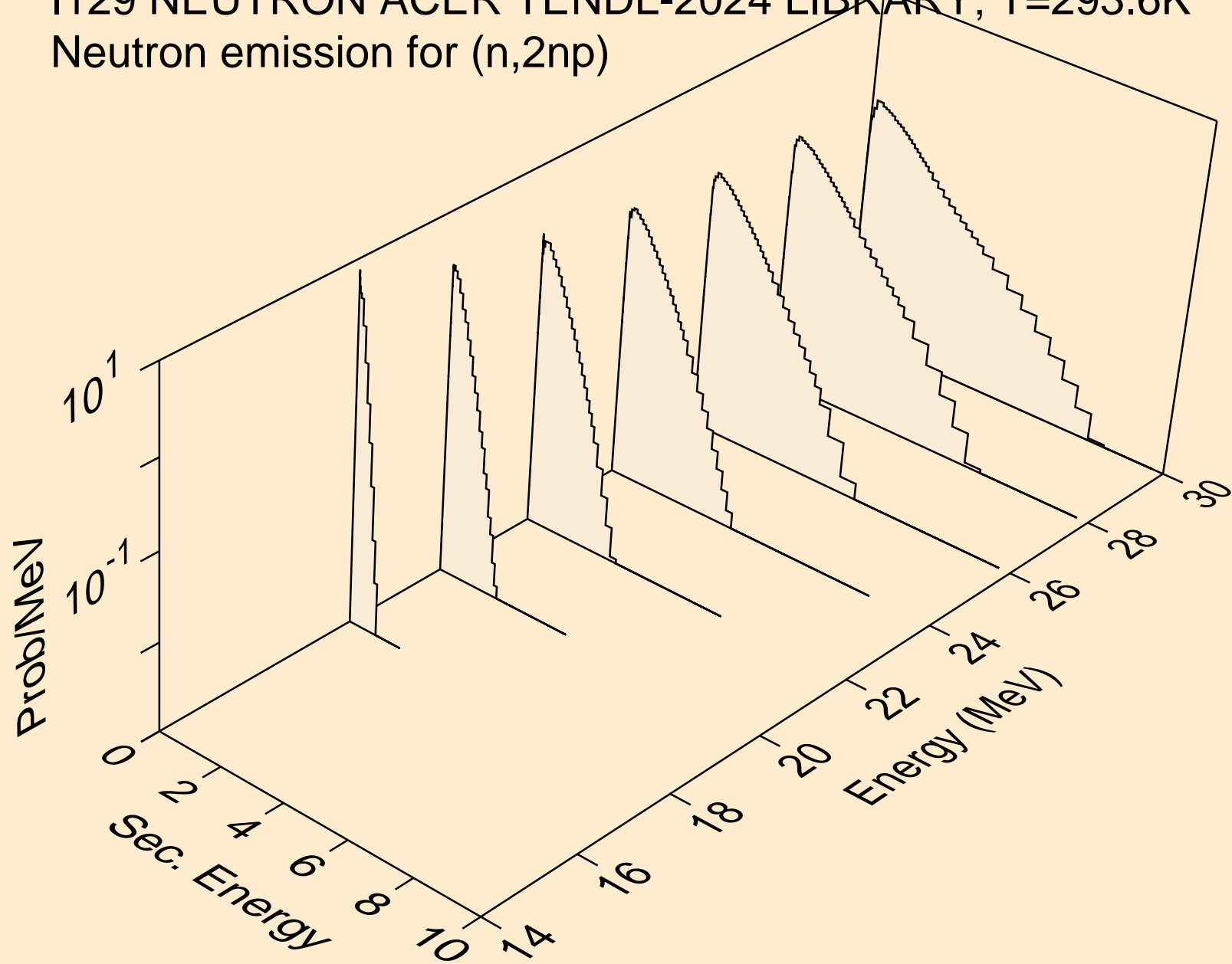

I129 NEUTRON ACER TENDL-2024 LIBRARY; T=293.6K  
Neutron emission for (n,3np)

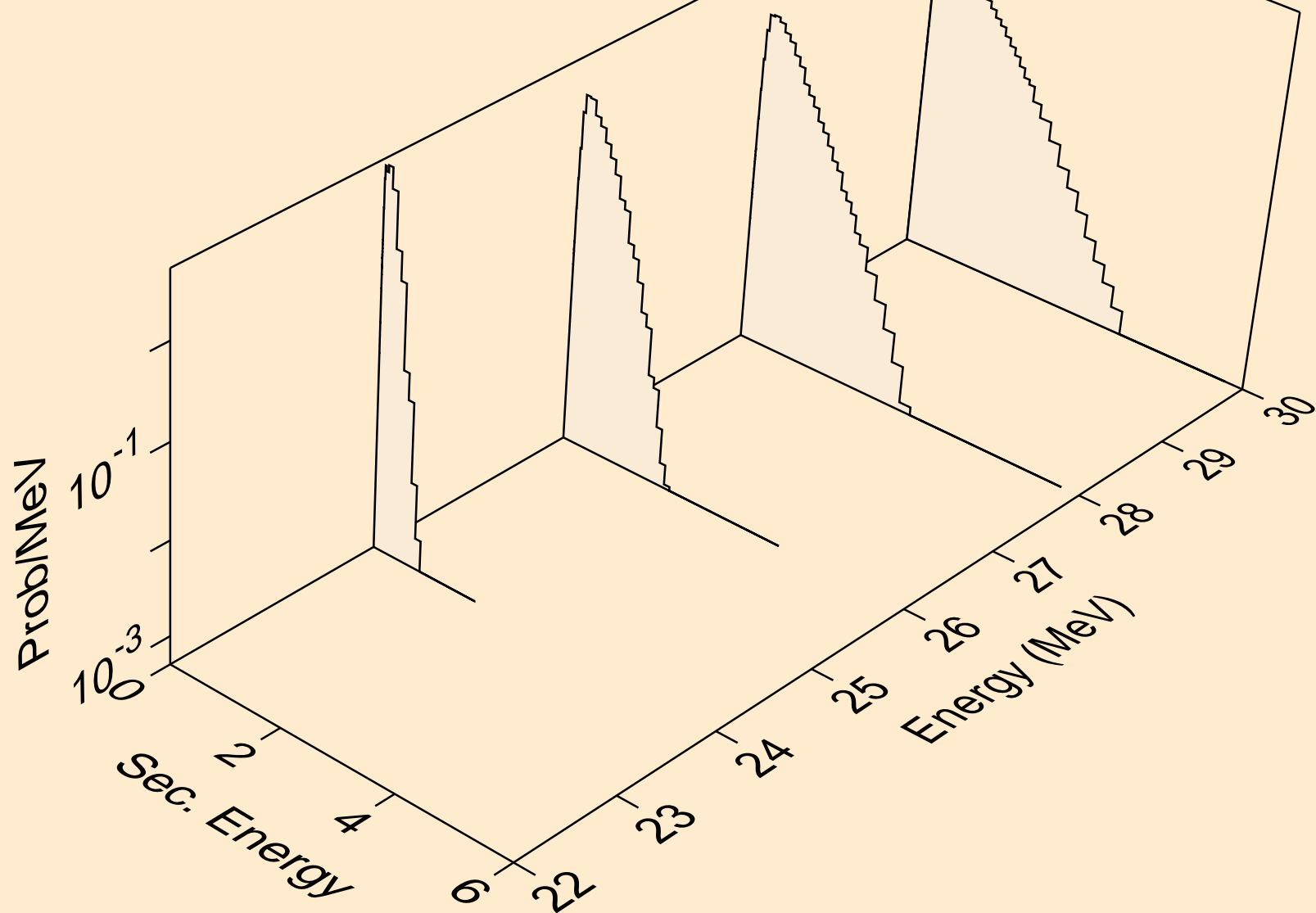

I129 NEUTRON ACER TENDL-2024 LIBRARY; T=293.6K  
Neutron emission for (n,n2p)

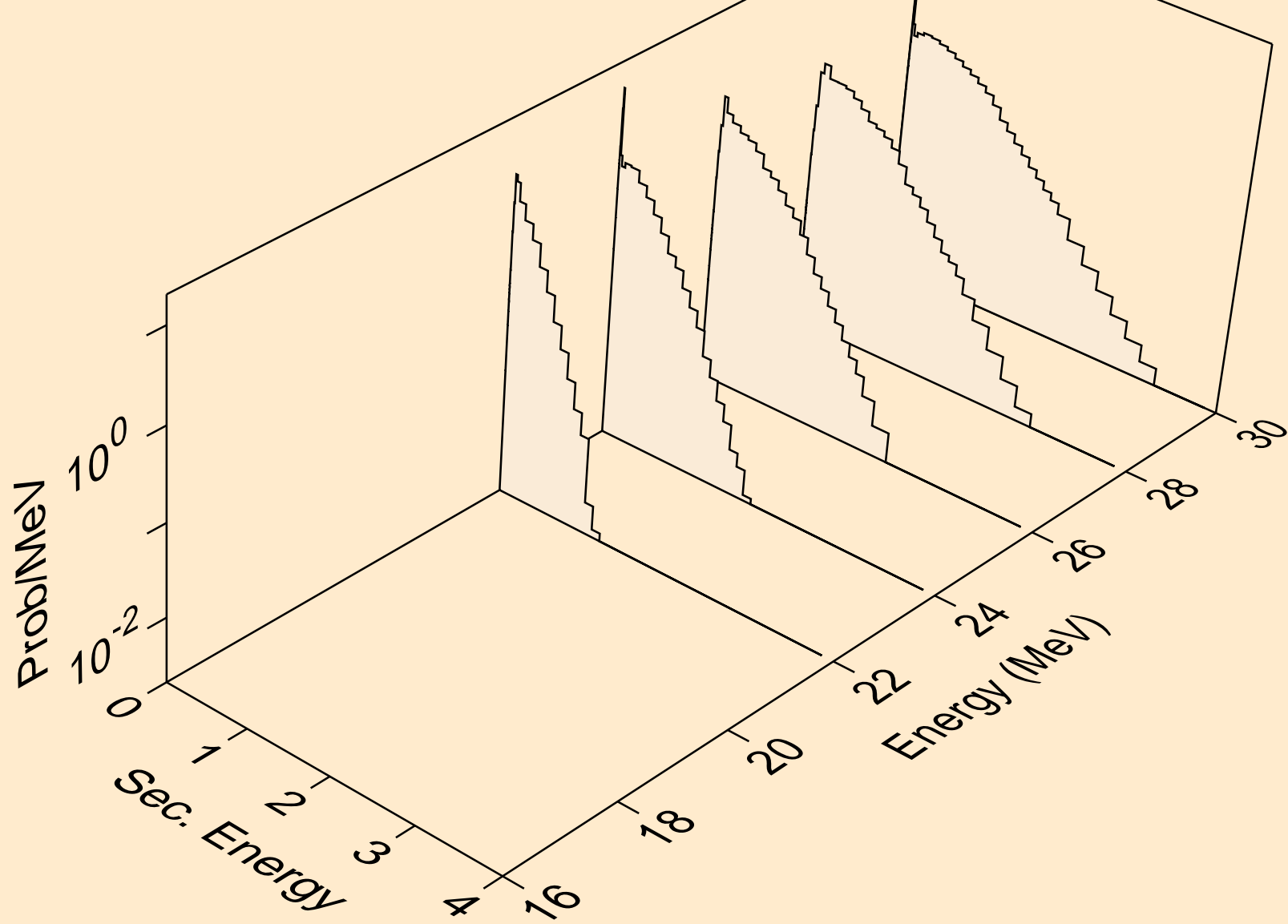

I129 NEUTRON ACER TENDL-2024 LIBRARY; T=293.6K  
Neutron emission for (n,npa)

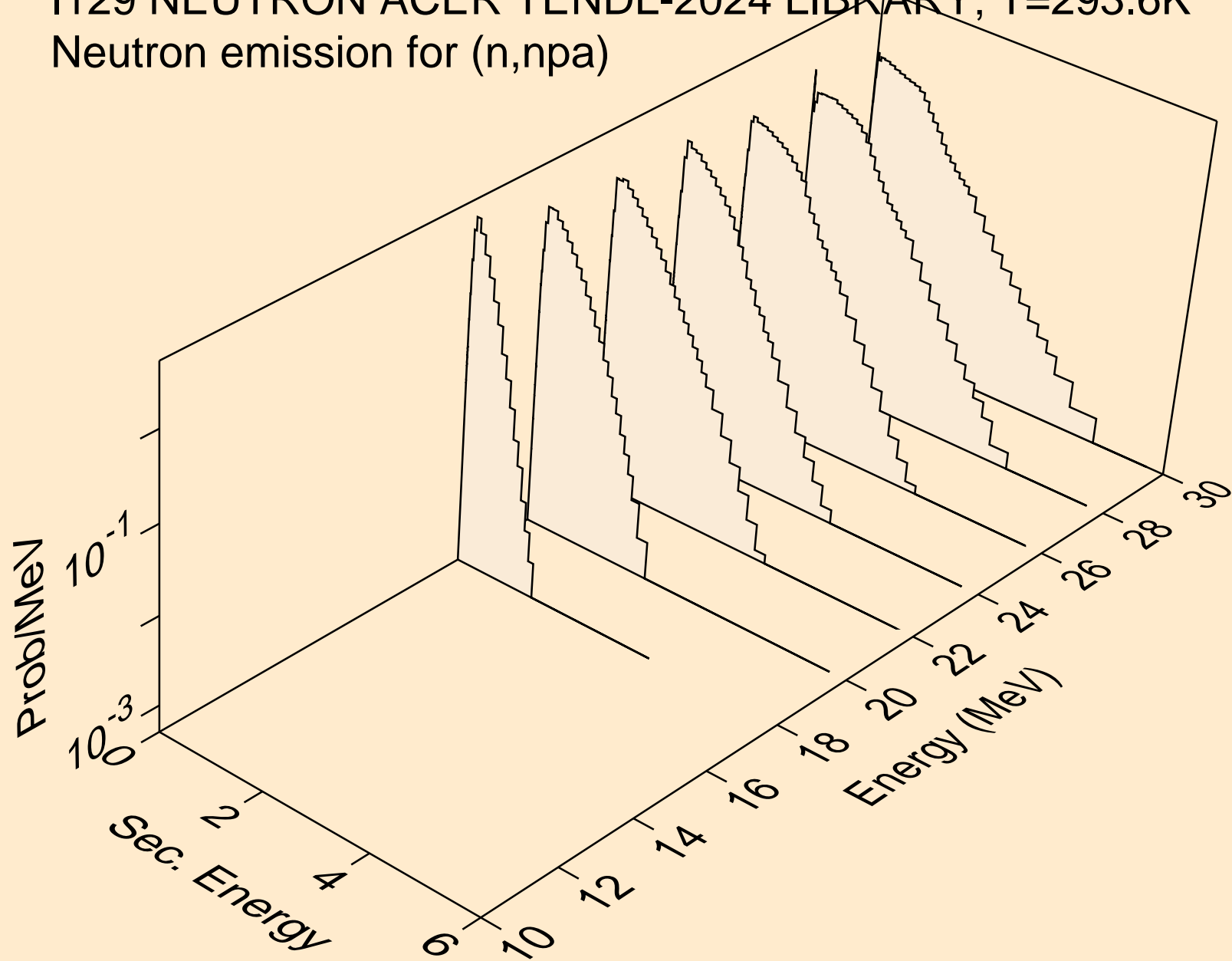

I129 NEUTRON ACER TENDL-2024 LIBRARY; T=293.6K  
Neutron emission for (n,n\*c)

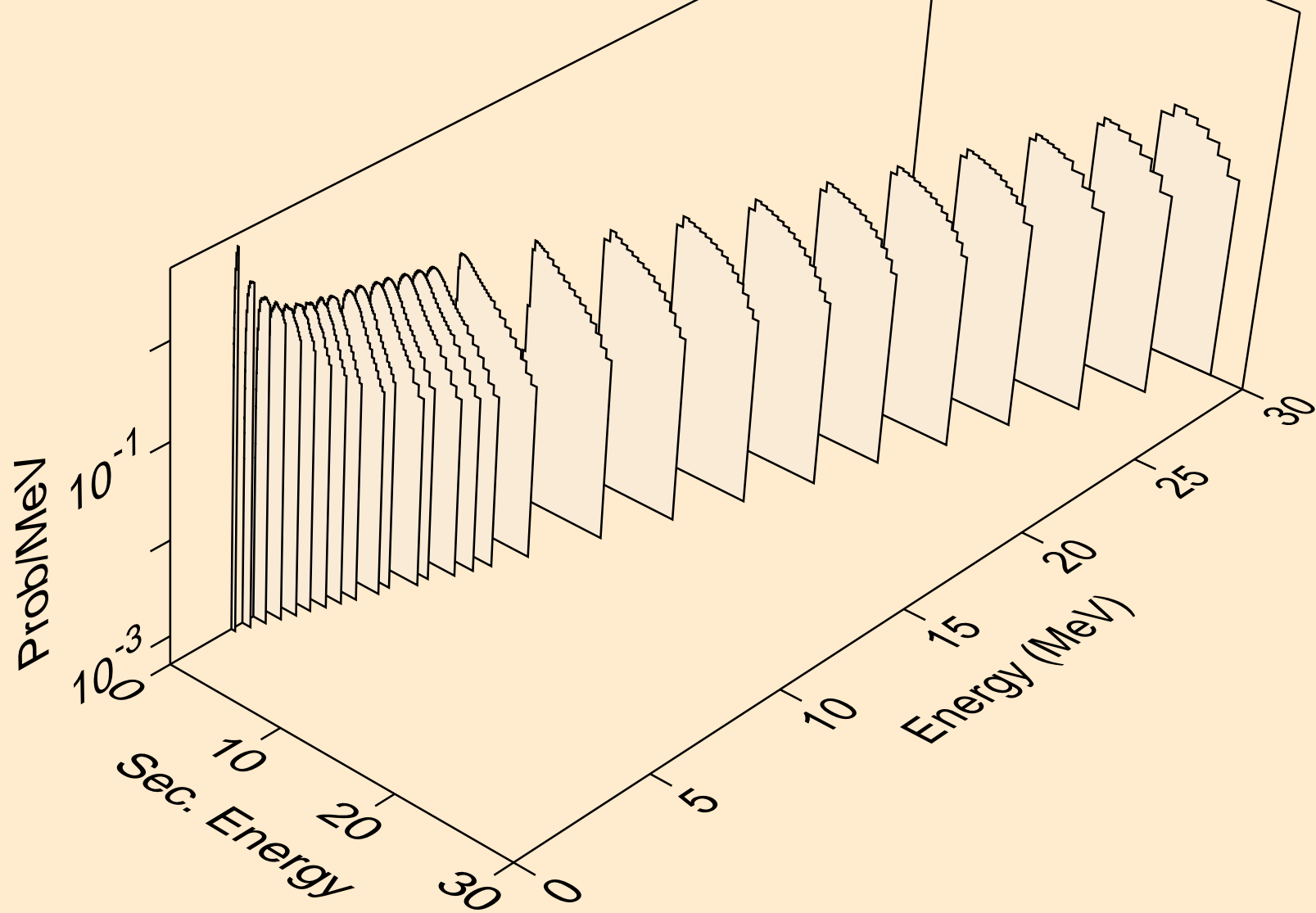

I129 NEUTRON ACER TENDL-2024 LIBRARY; T=293.6K  
Photon emission for (n,x)

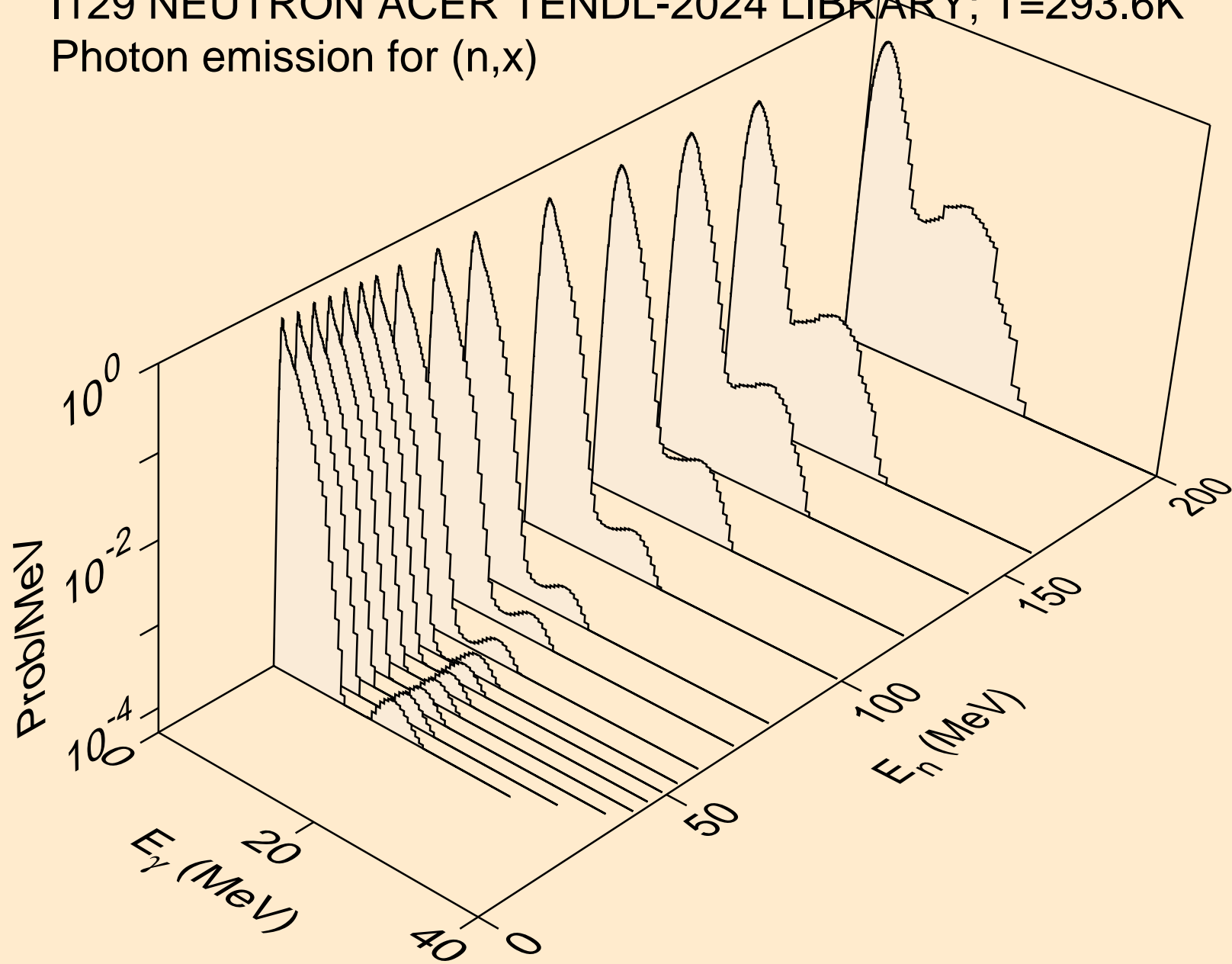

I129 NEUTRON ACER TENDL-2024 LIBRARY; T=293.6K  
Photon emission for (n,2nd)

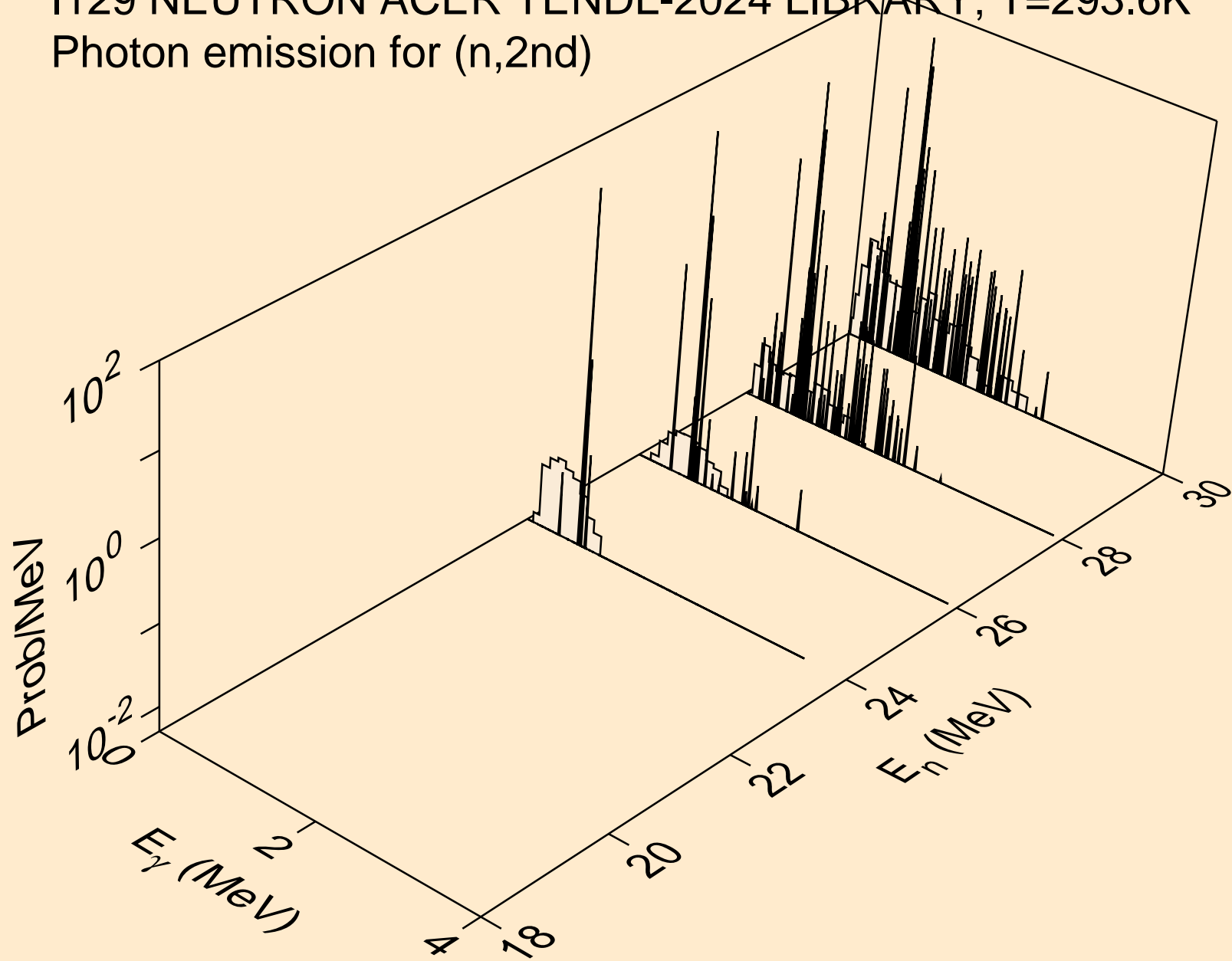

I129 NEUTRON ACER TENDL-2024 LIBRARY; T=293.6K  
Photon emission for (n,2n)

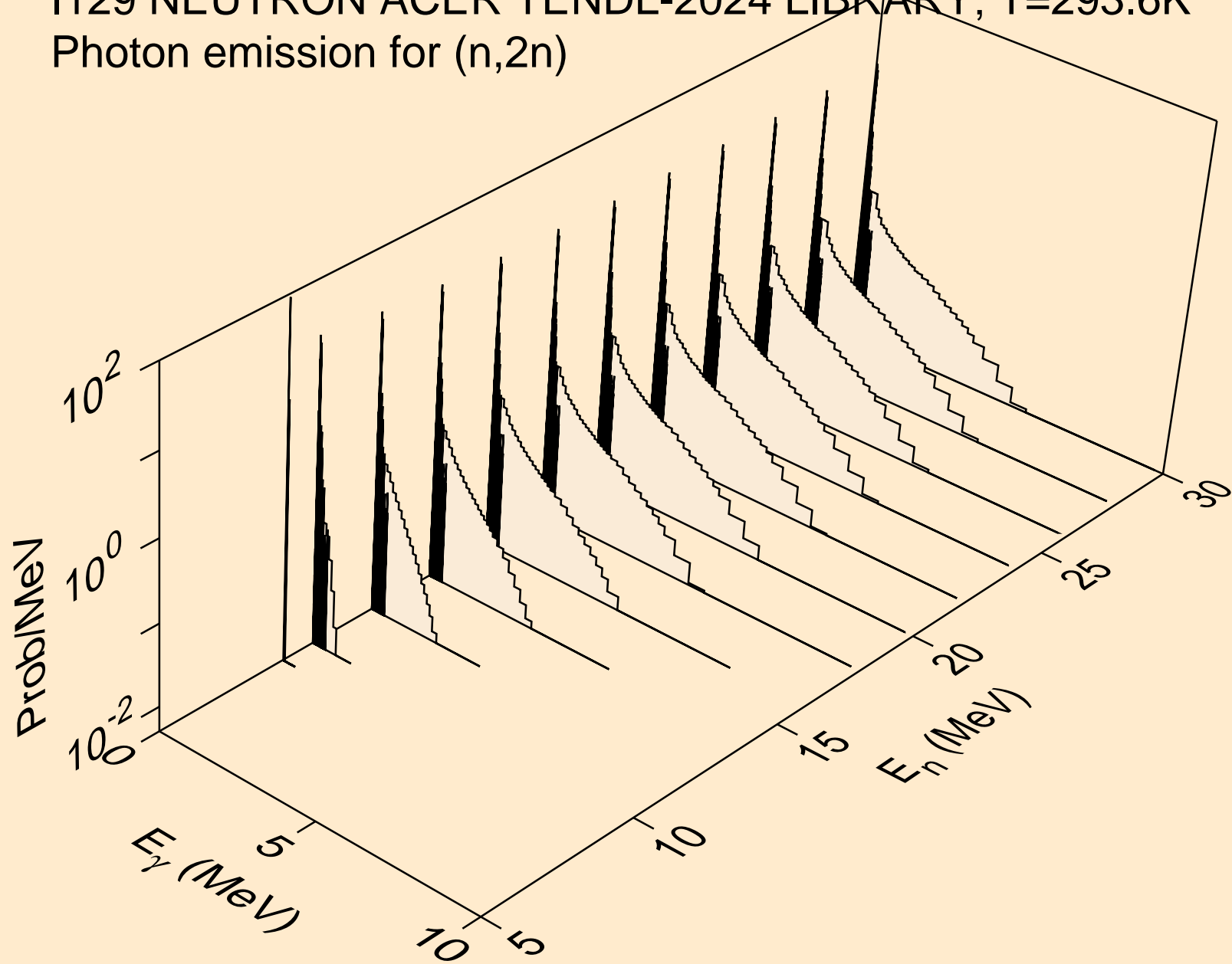

I129 NEUTRON ACER TENDL-2024 LIBRARY; T=293.6K  
Photon emission for (n,3n)

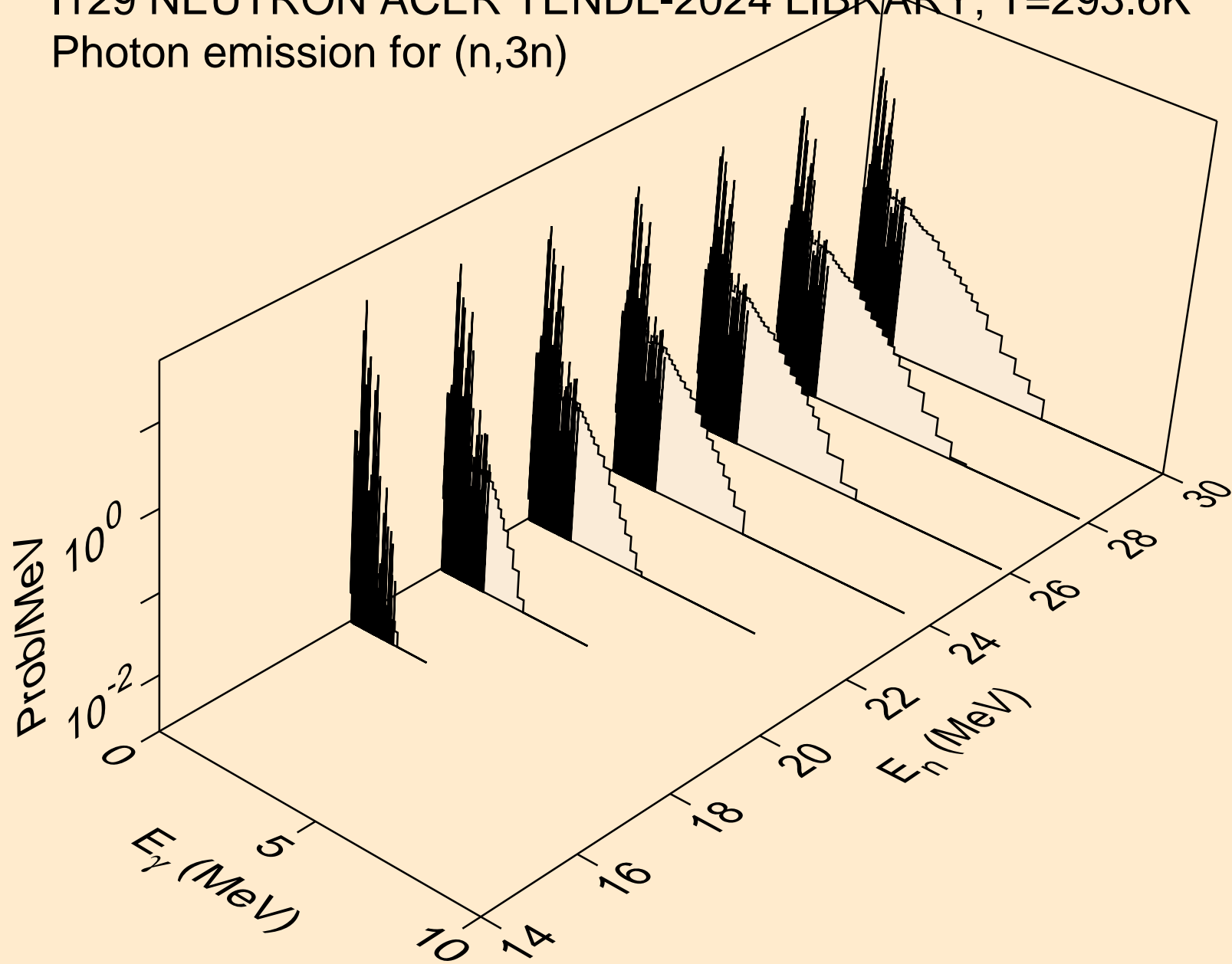

I129 NEUTRON ACER TENDL-2024 LIBRARY; T=293.6K  
Photon emission for (n,n\*)a

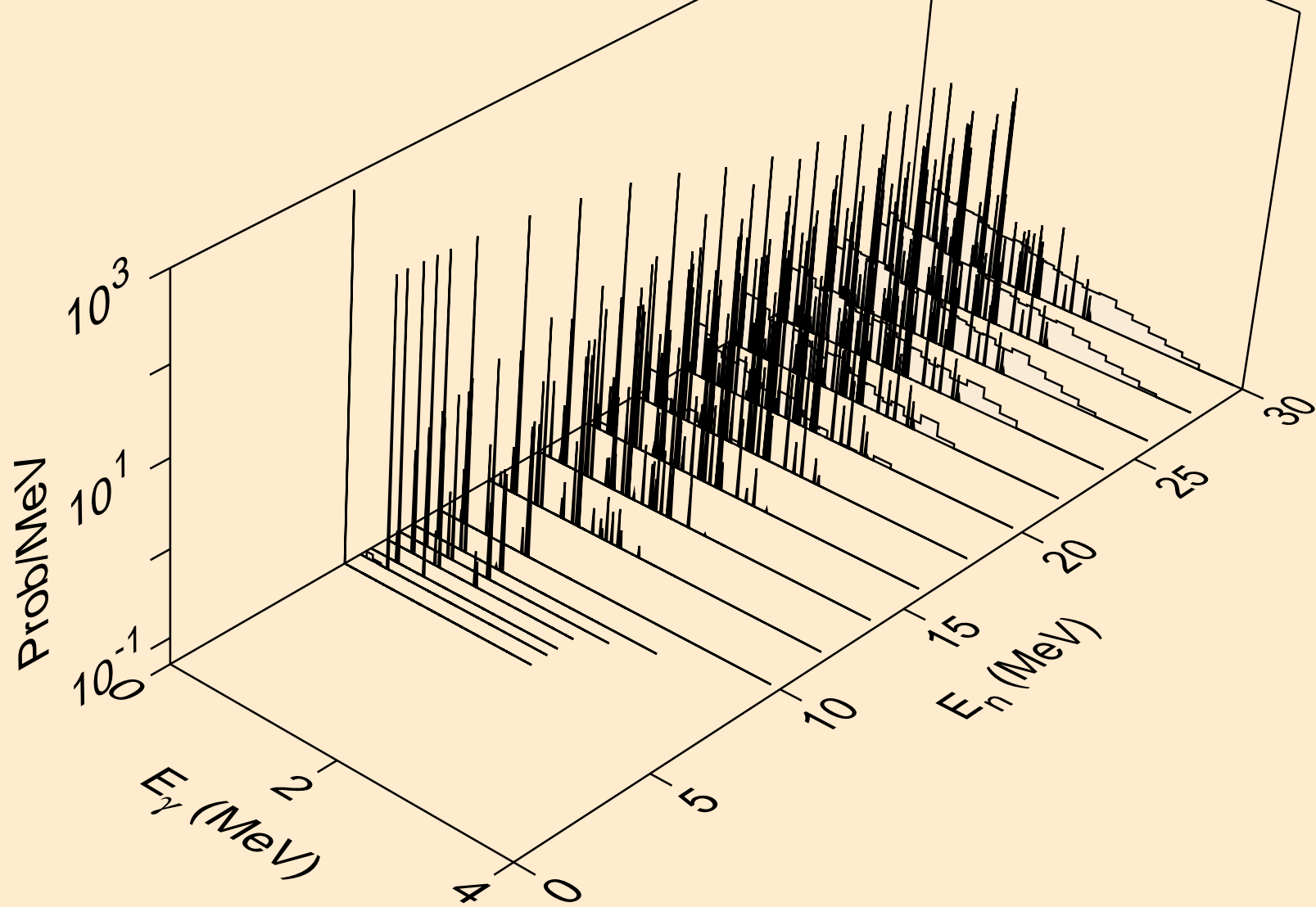

I129 NEUTRON ACER TENDL-2024 LIBRARY; T=293.6K  
Photon emission for (n,2n)a

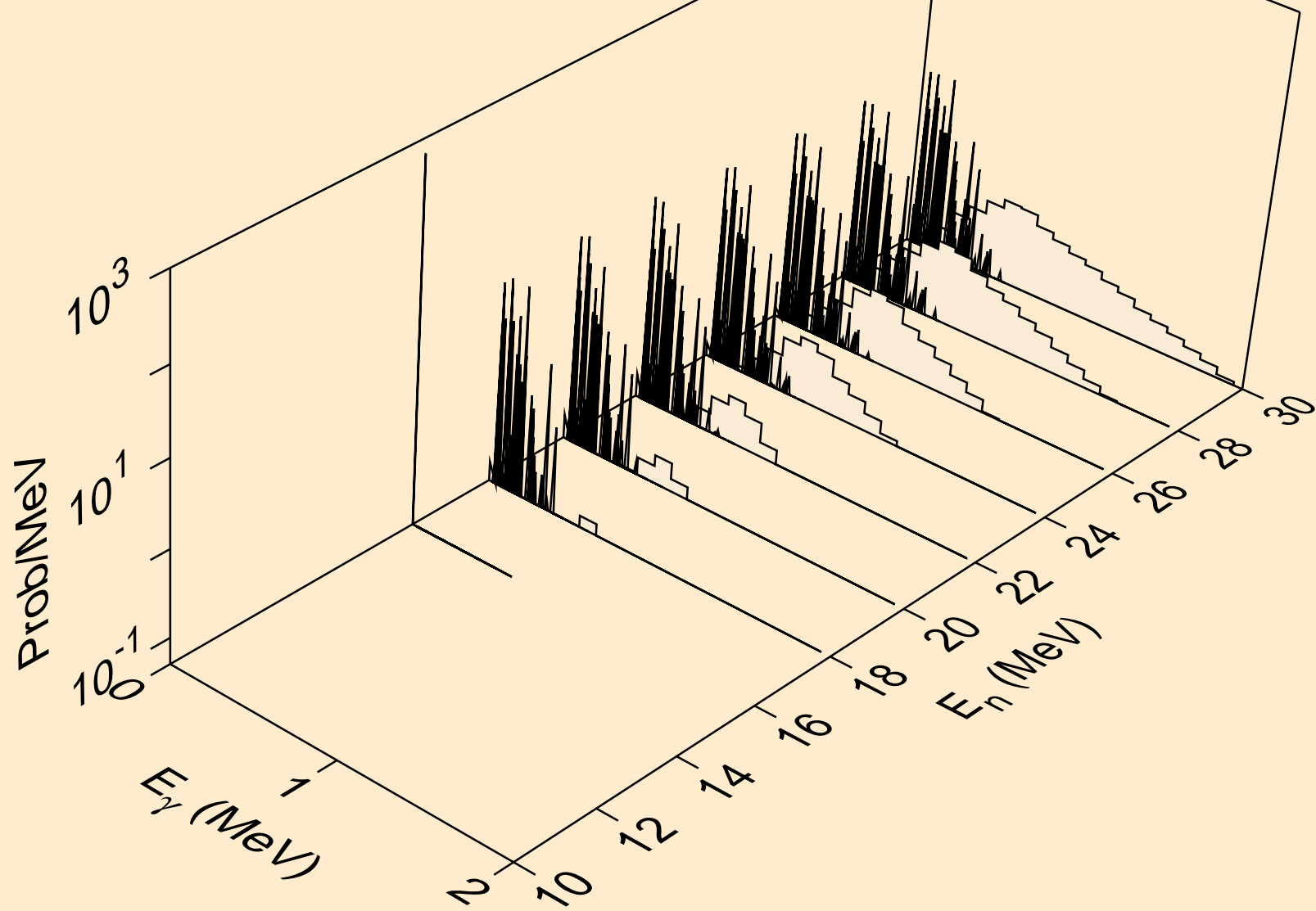

I129 NEUTRON ACER TENDL-2024 LIBRARY; T=293.6K  
Photon emission for (n,3n)a

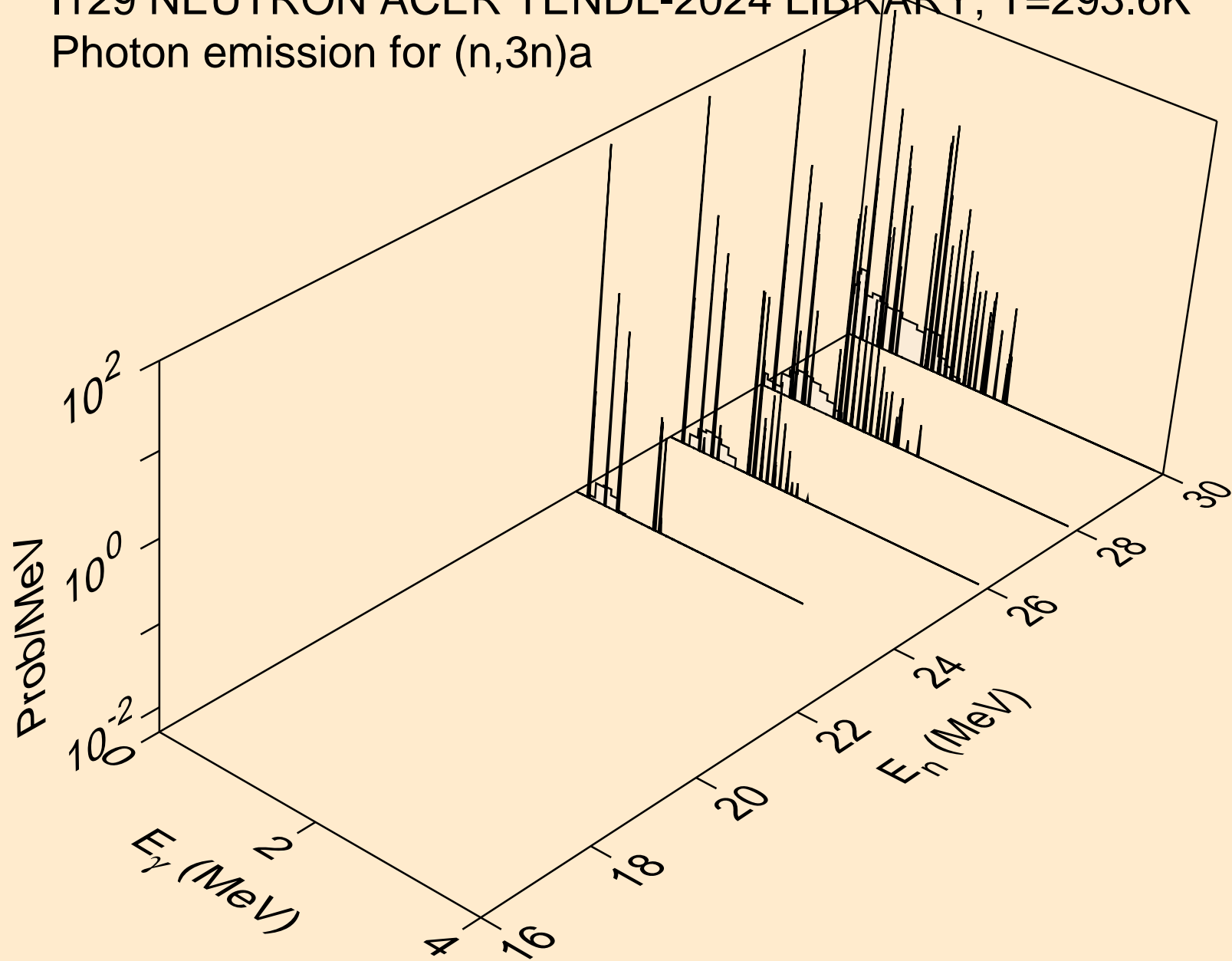

I129 NEUTRON ACER TENDL-2024 LIBRARY; T=293.6K  
Photon emission for (n,n\*)p

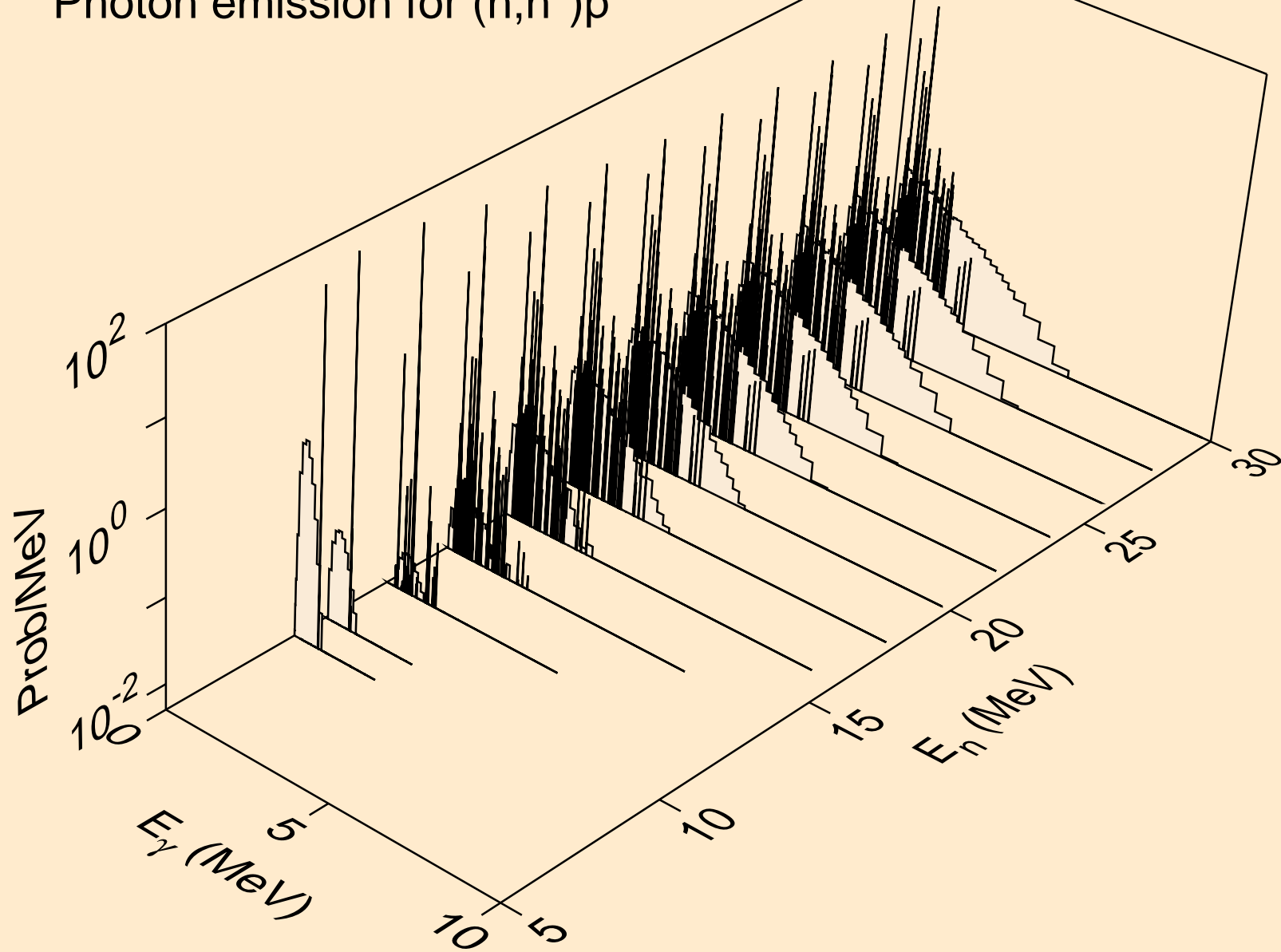

I129 NEUTRON ACER TENDL-2024 LIBRARY; T=293.6K  
Photon emission for (n,n\*)d

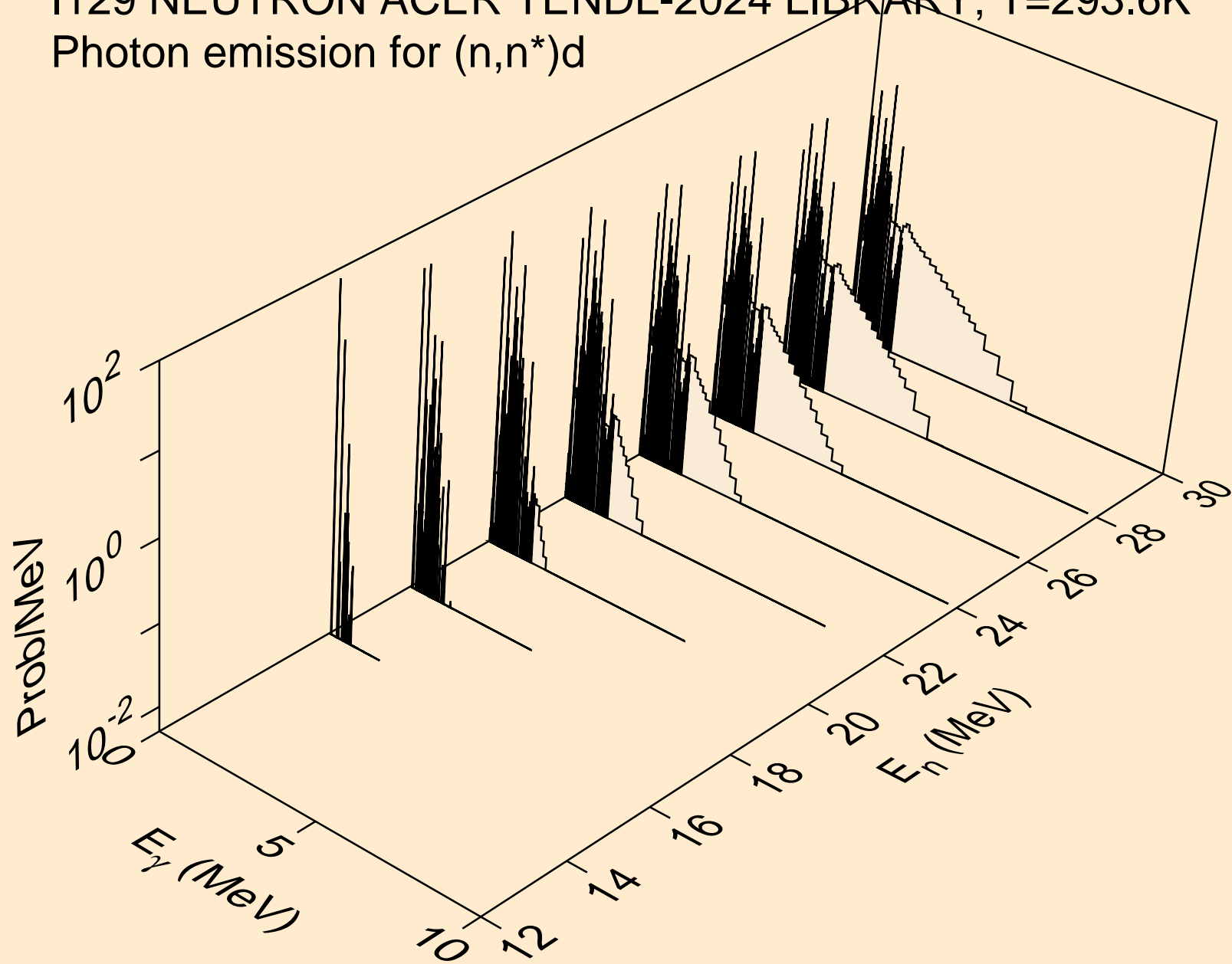

I129 NEUTRON ACER TENDL-2024 LIBRARY; T=293.6K  
Photon emission for (n,n\*)t

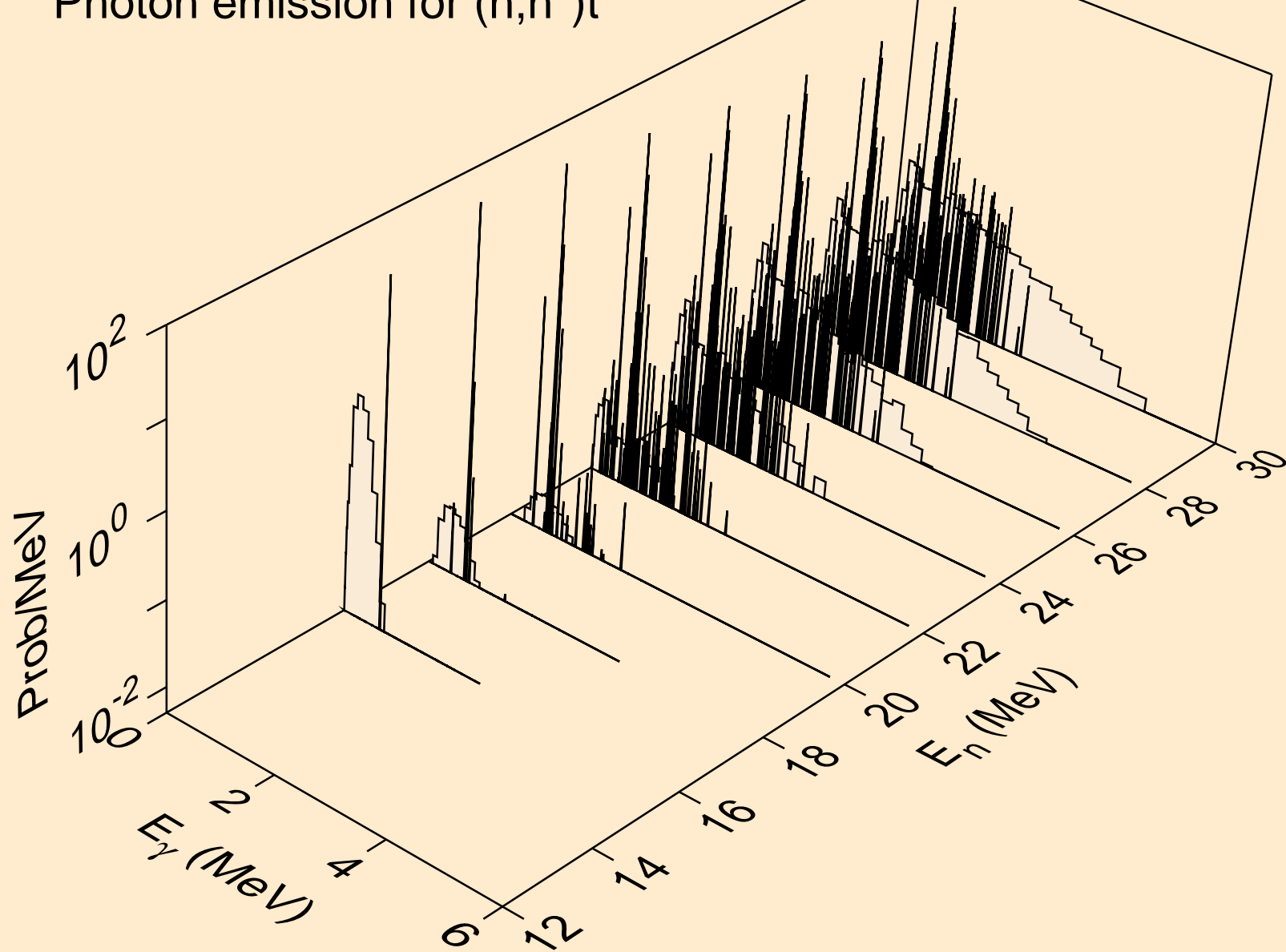

I129 NEUTRON ACER TENDL-2024 LIBRARY; T=293.6K  
Photon emission for (n,n\*)he3

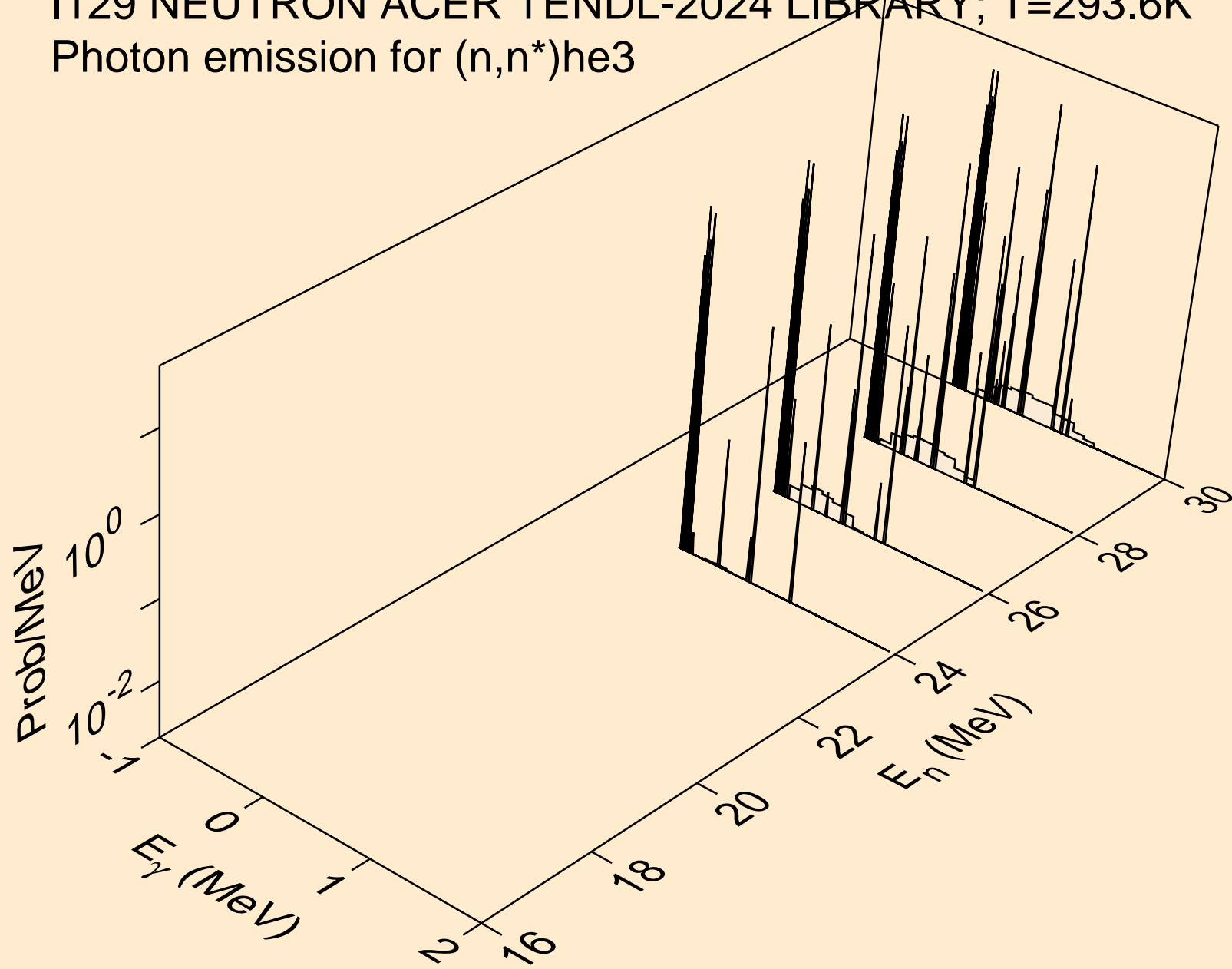

I129 NEUTRON ACER TENDL-2024 LIBRARY; T=293.6K  
Photon emission for (n,4n)

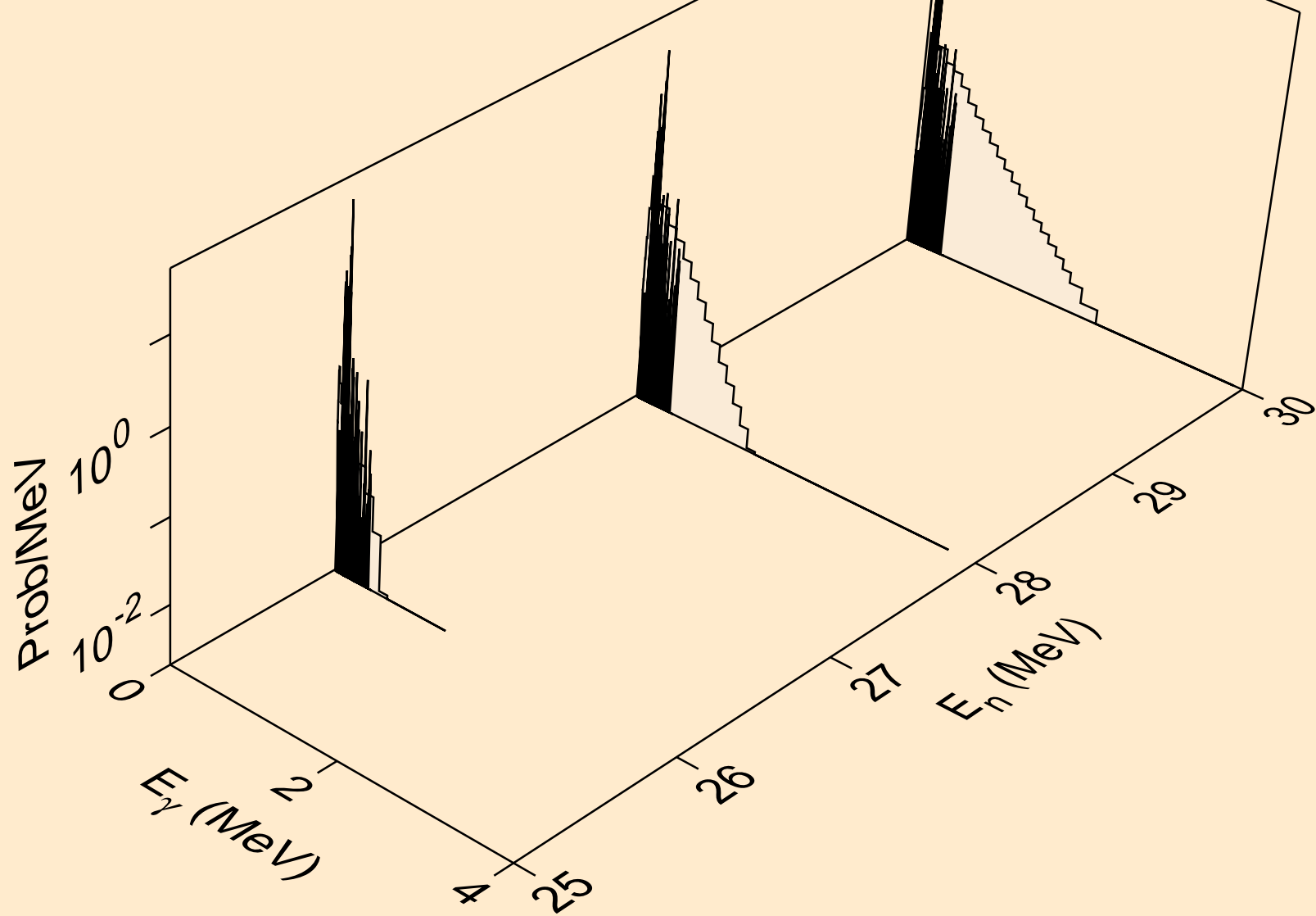

I129 NEUTRON ACER TENDL-2024 LIBRARY; T=293.6K  
Photon emission for (n,2np)

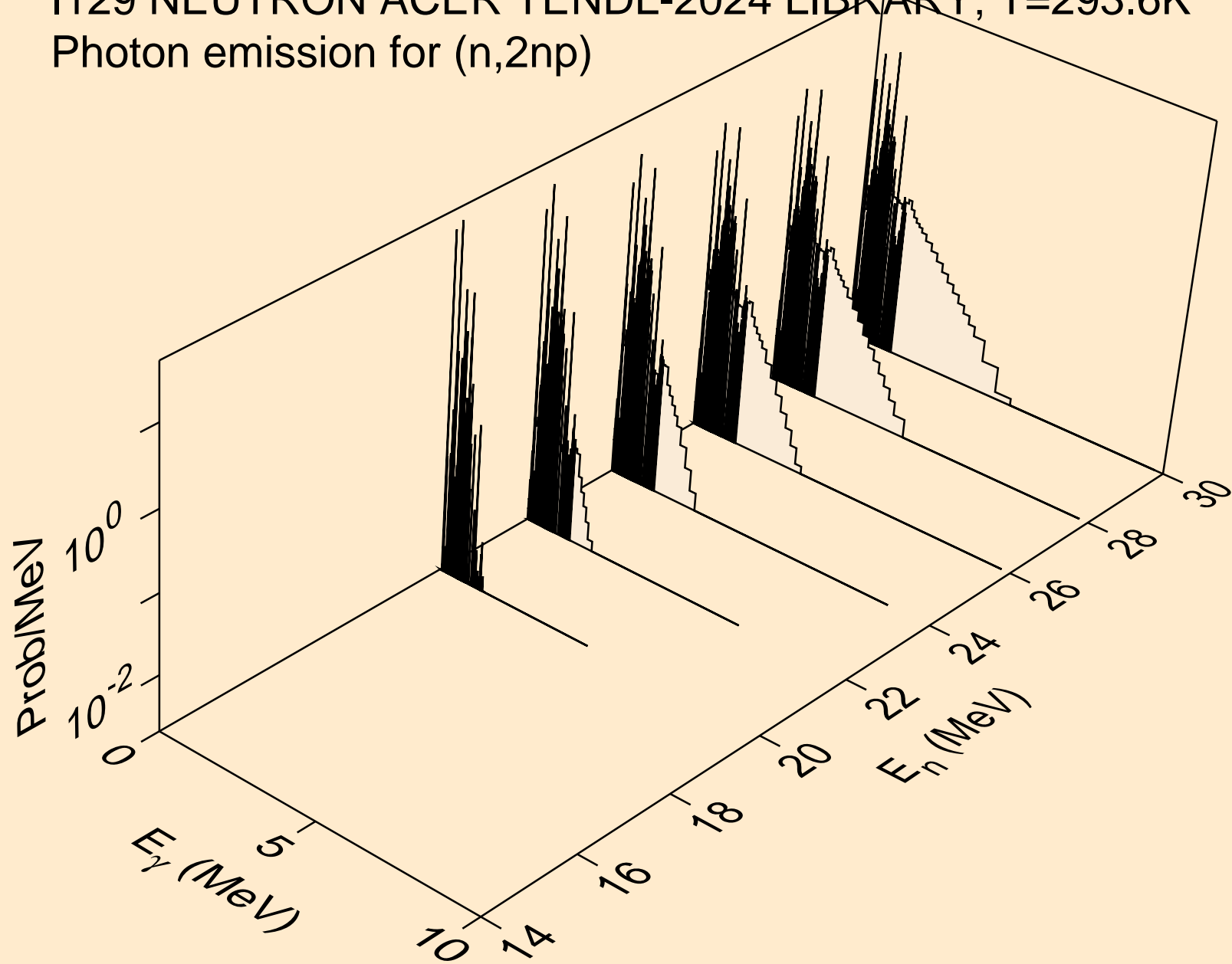

I129 NEUTRON ACER TENDL-2024 LIBRARY; T=293.6K  
Photon emission for (n,3np)

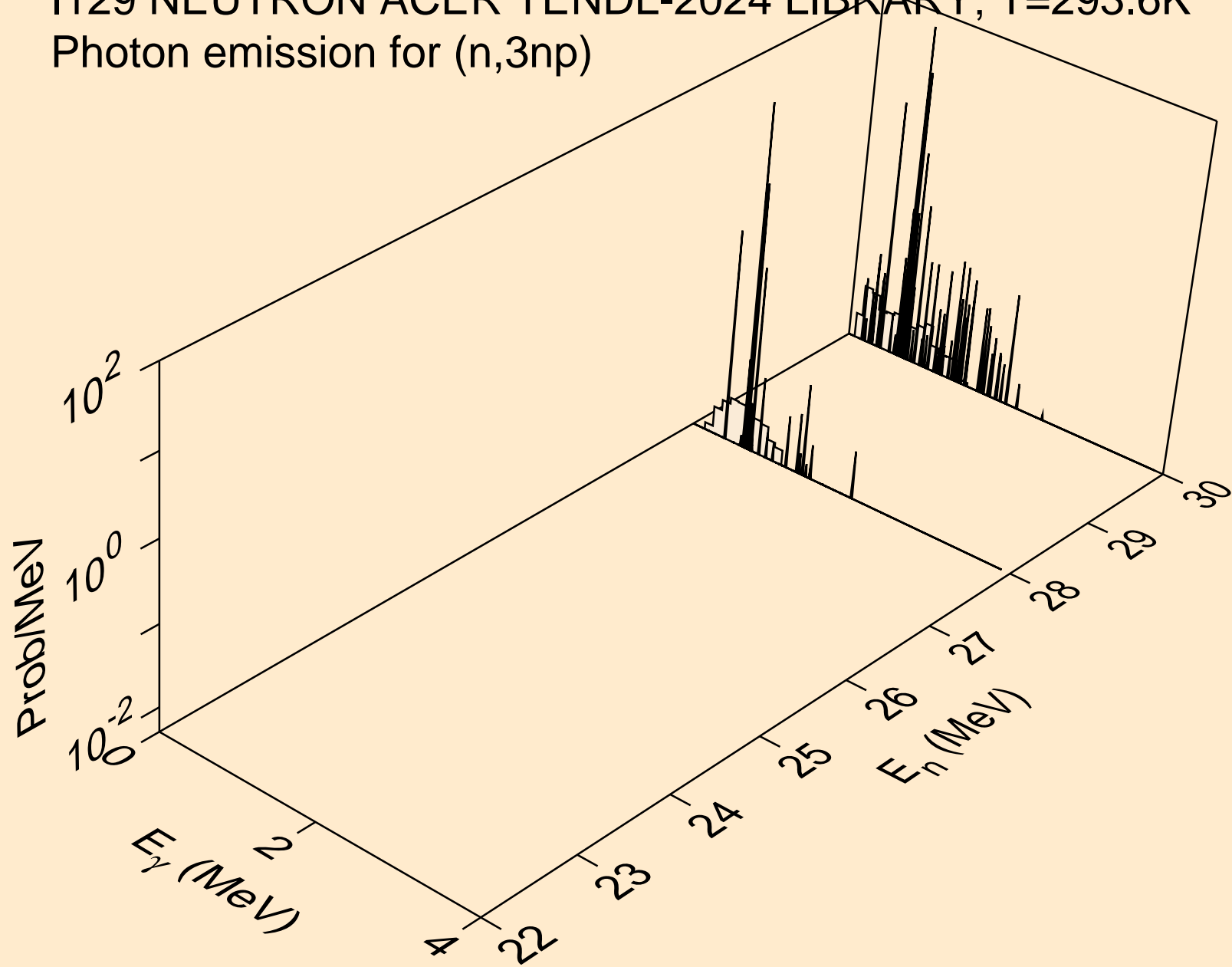

I129 NEUTRON ACER TENDL-2024 LIBRARY; T=293.6K  
Photon emission for (n,n2p)

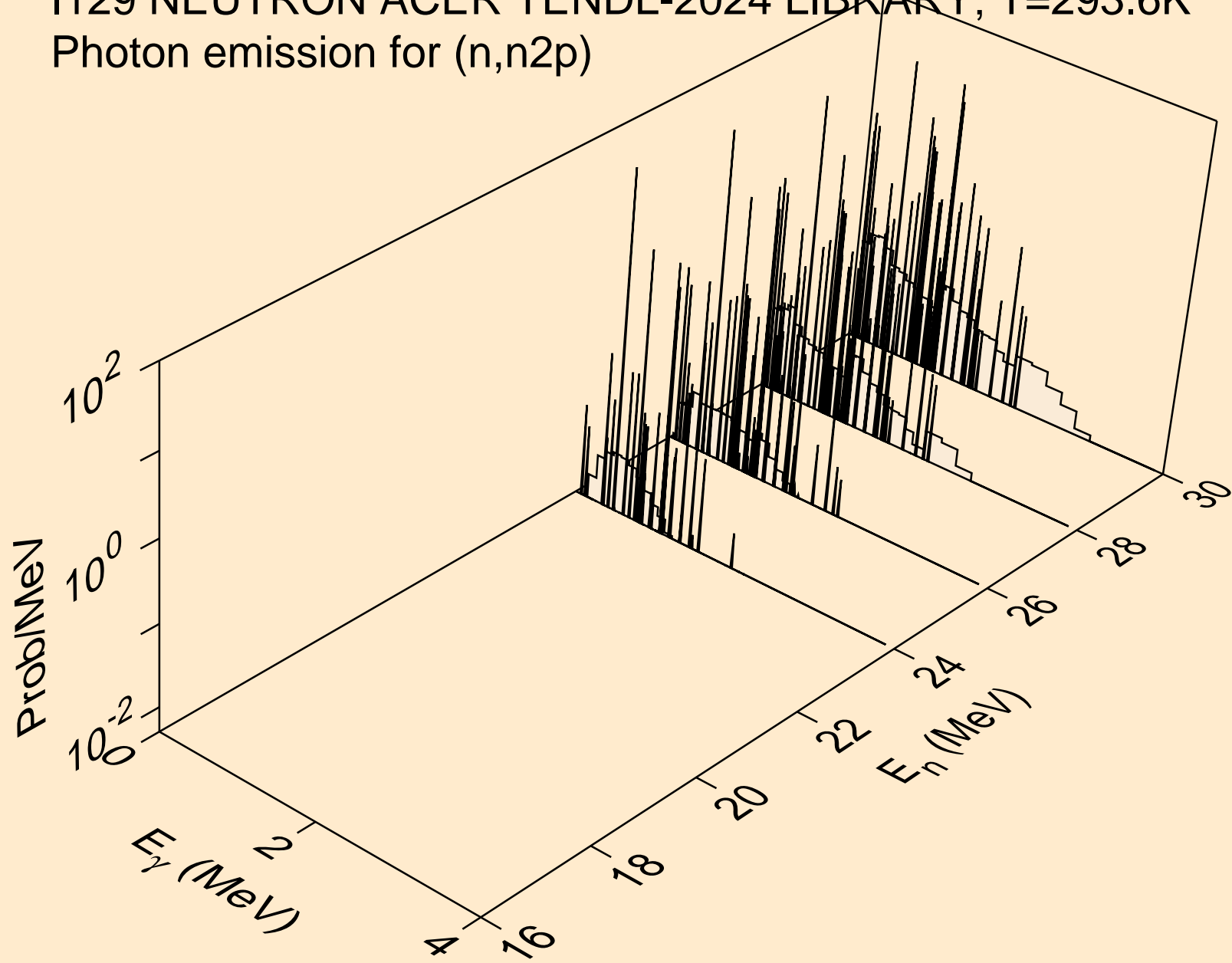

I129 NEUTRON ACER TENDL-2024 LIBRARY; T=293.6K  
Photon emission for (n,npa)

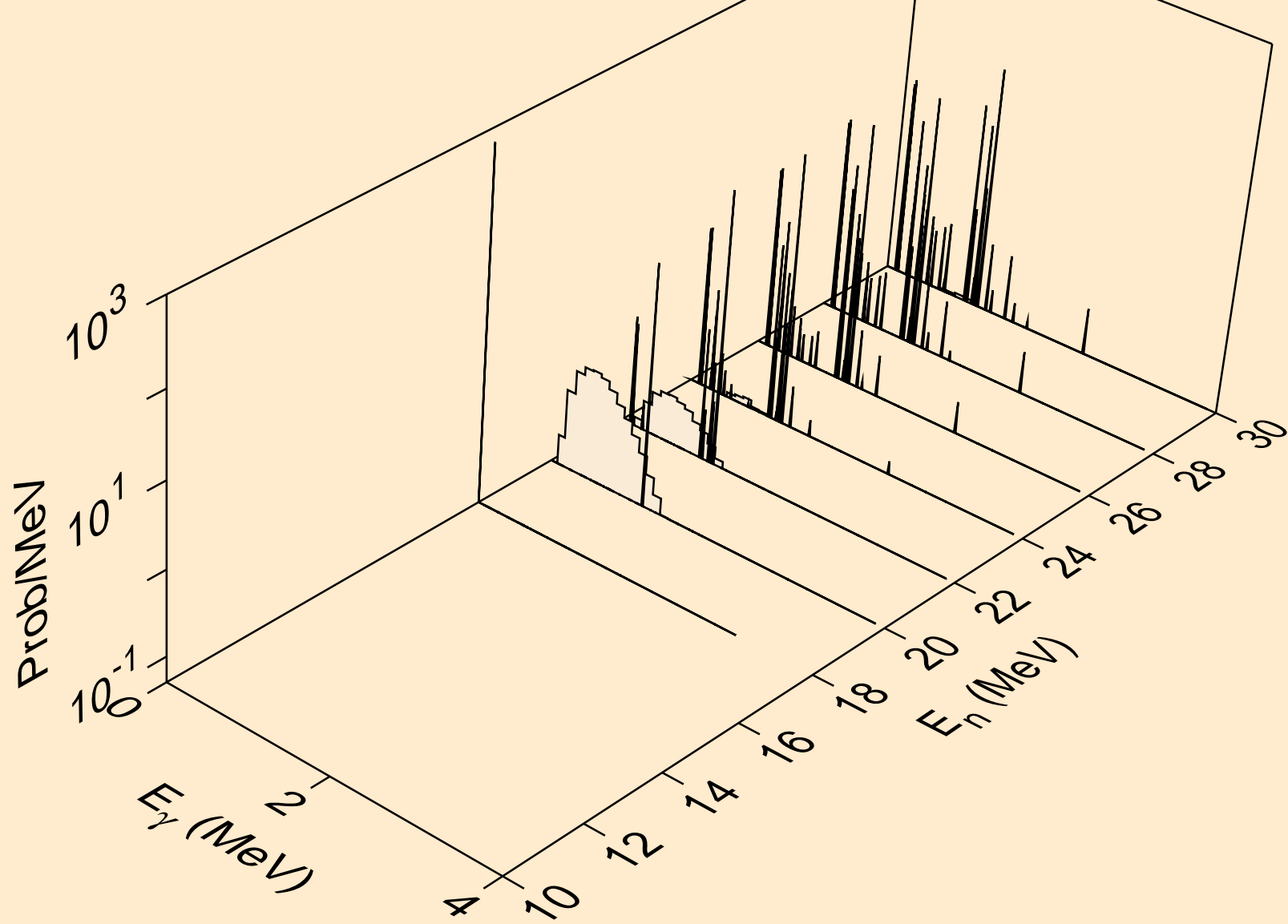

I129 NEUTRON ACER TENDL-2024 LIBRARY; T=293.6K  
Photon emission for (n,n\*c)

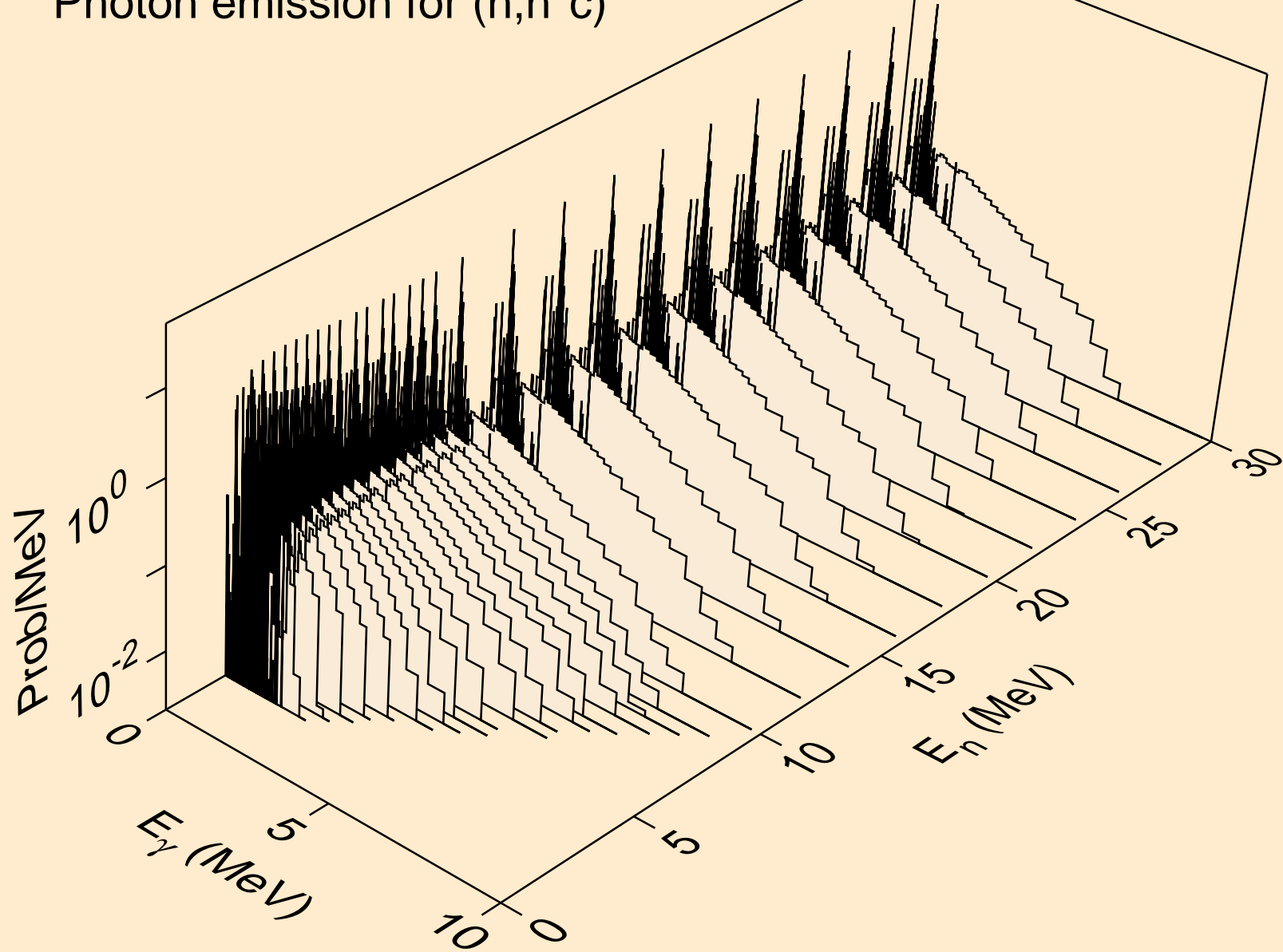

I129 NEUTRON ACER TENDL-2024 LIBRARY; T=293.6K  
Photon emission for (n,gma)

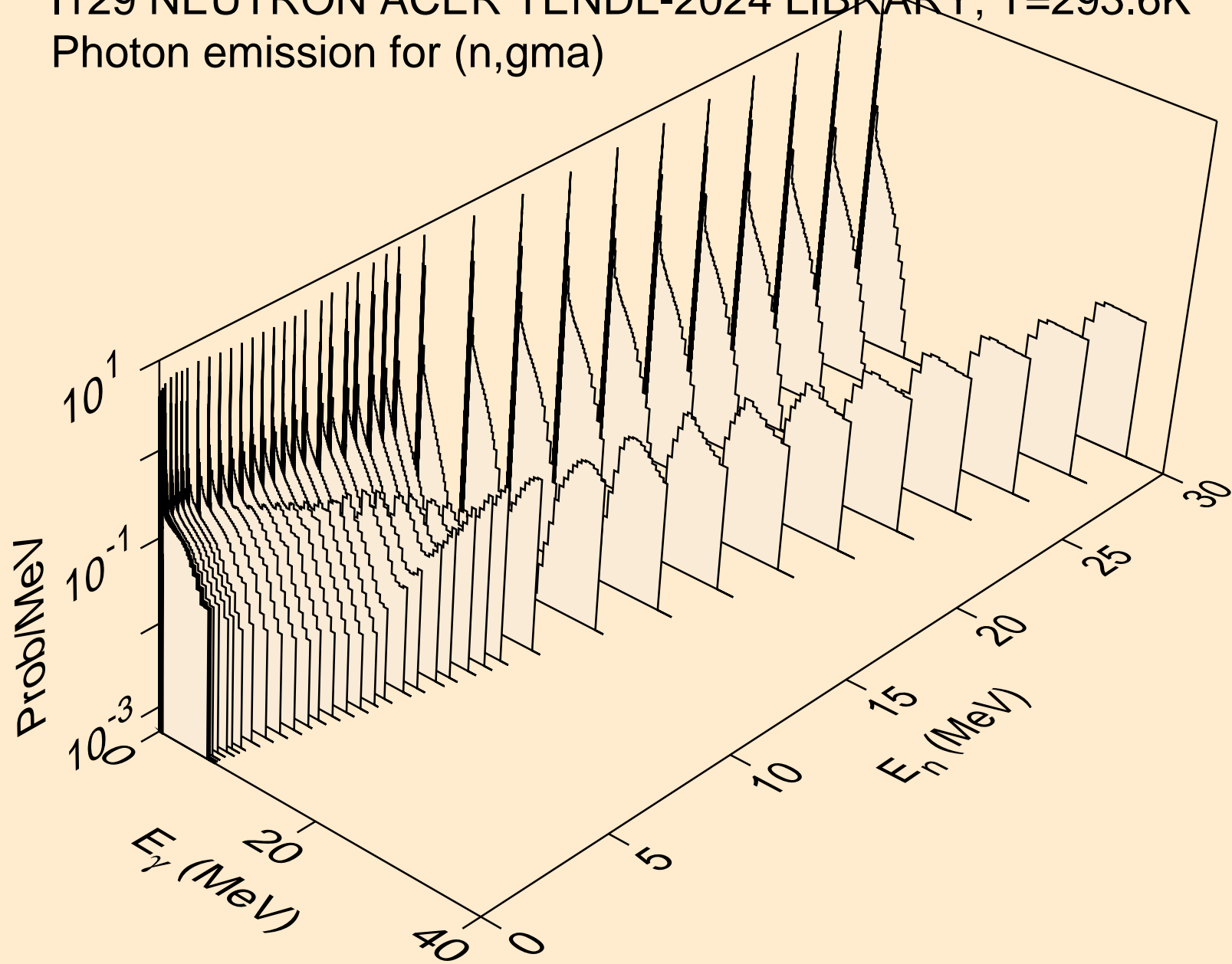

I129 NEUTRON ACER TENDL-2024 LIBRARY; T=293.6K  
Photon emission for (n,p)

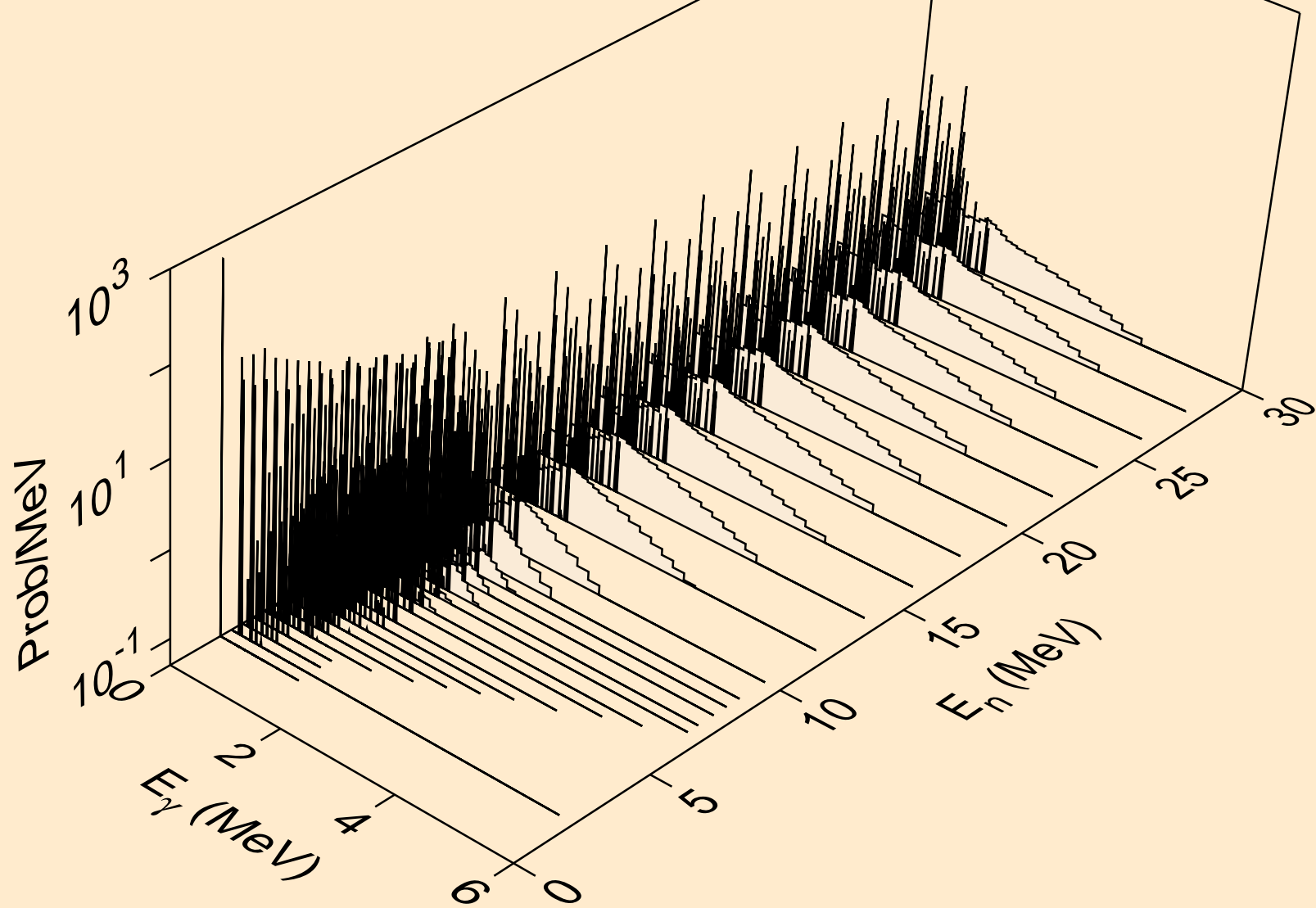

I129 NEUTRON ACER TENDL-2024 LIBRARY; T=293.6K  
Photon emission for (n,d)

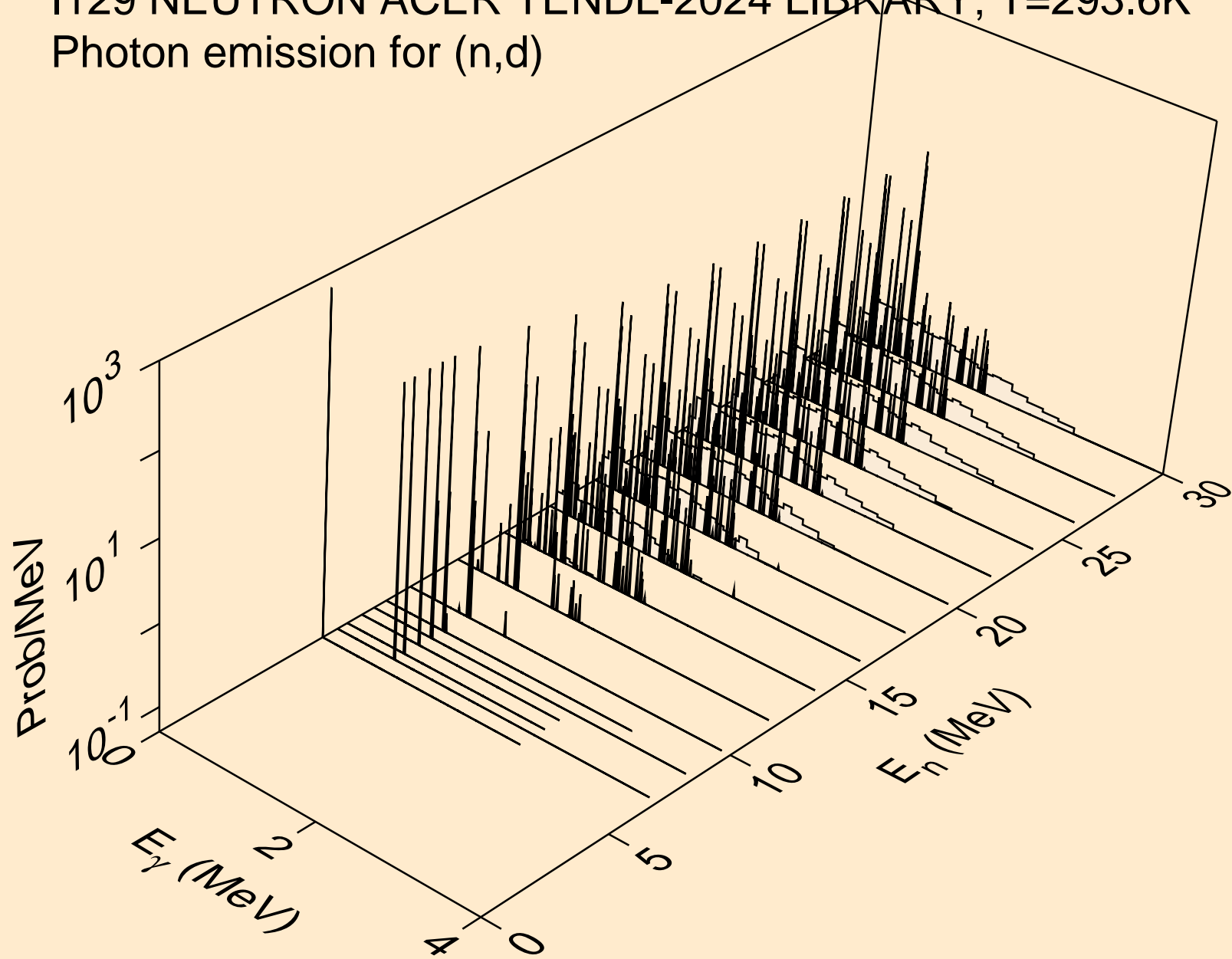

I129 NEUTRON ACER TENDL-2024 LIBRARY; T=293.6K  
Photon emission for (n,t)

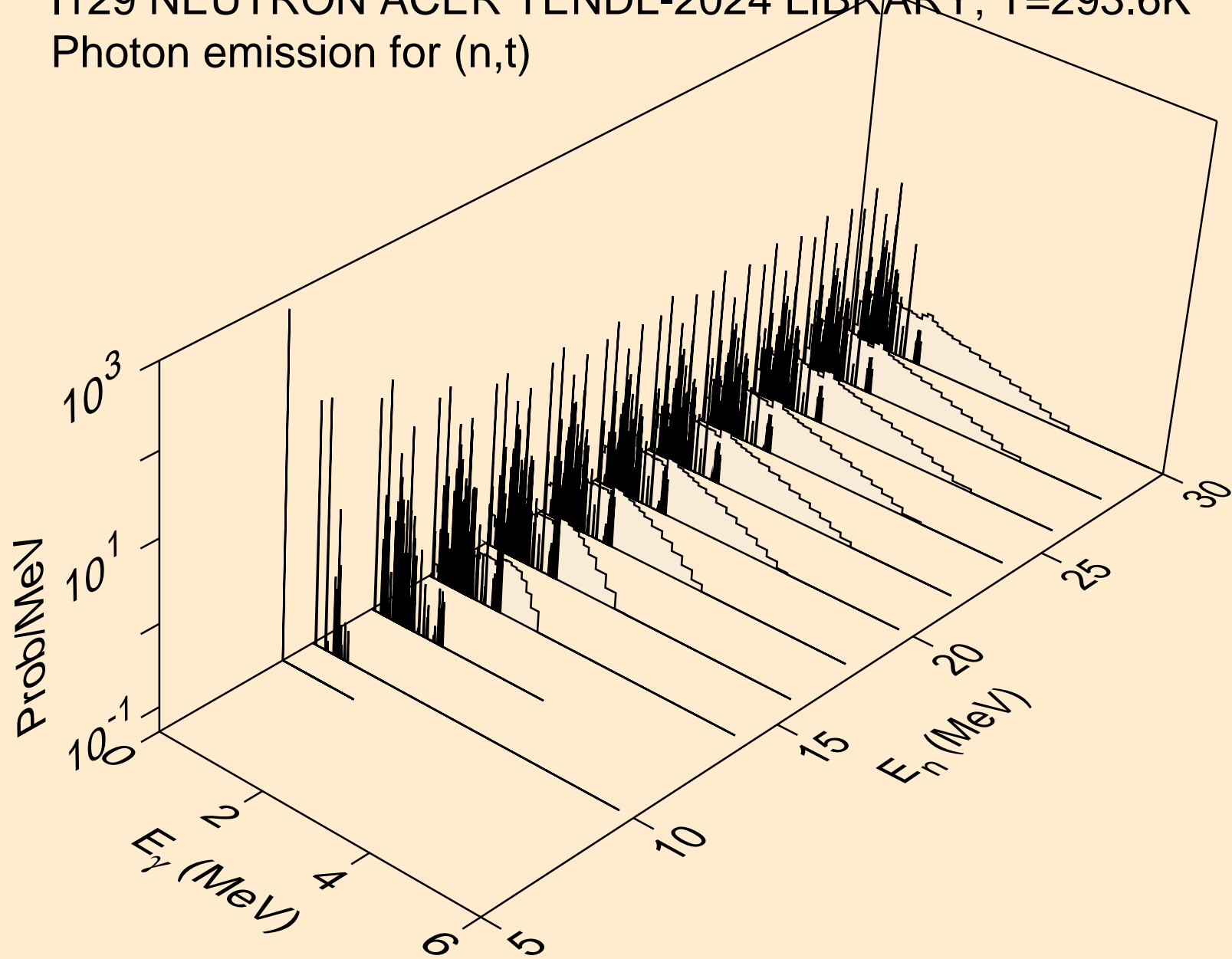

I129 NEUTRON ACER TENDL-2024 LIBRARY; T=293.6K  
Photon emission for (n,he3)

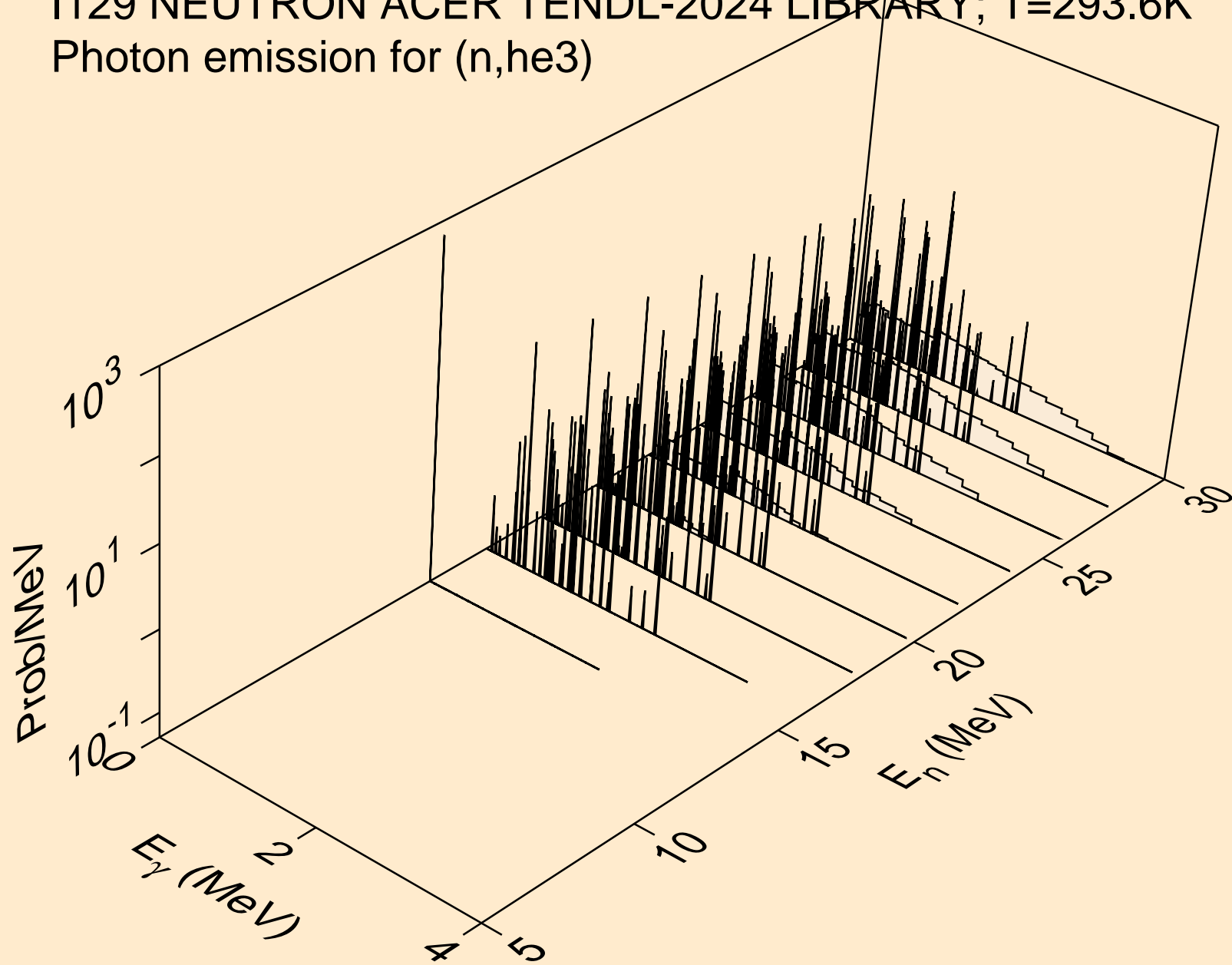

I129 NEUTRON ACER TENDL-2024 LIBRARY; T=293.6K  
Photon emission for (n,a)

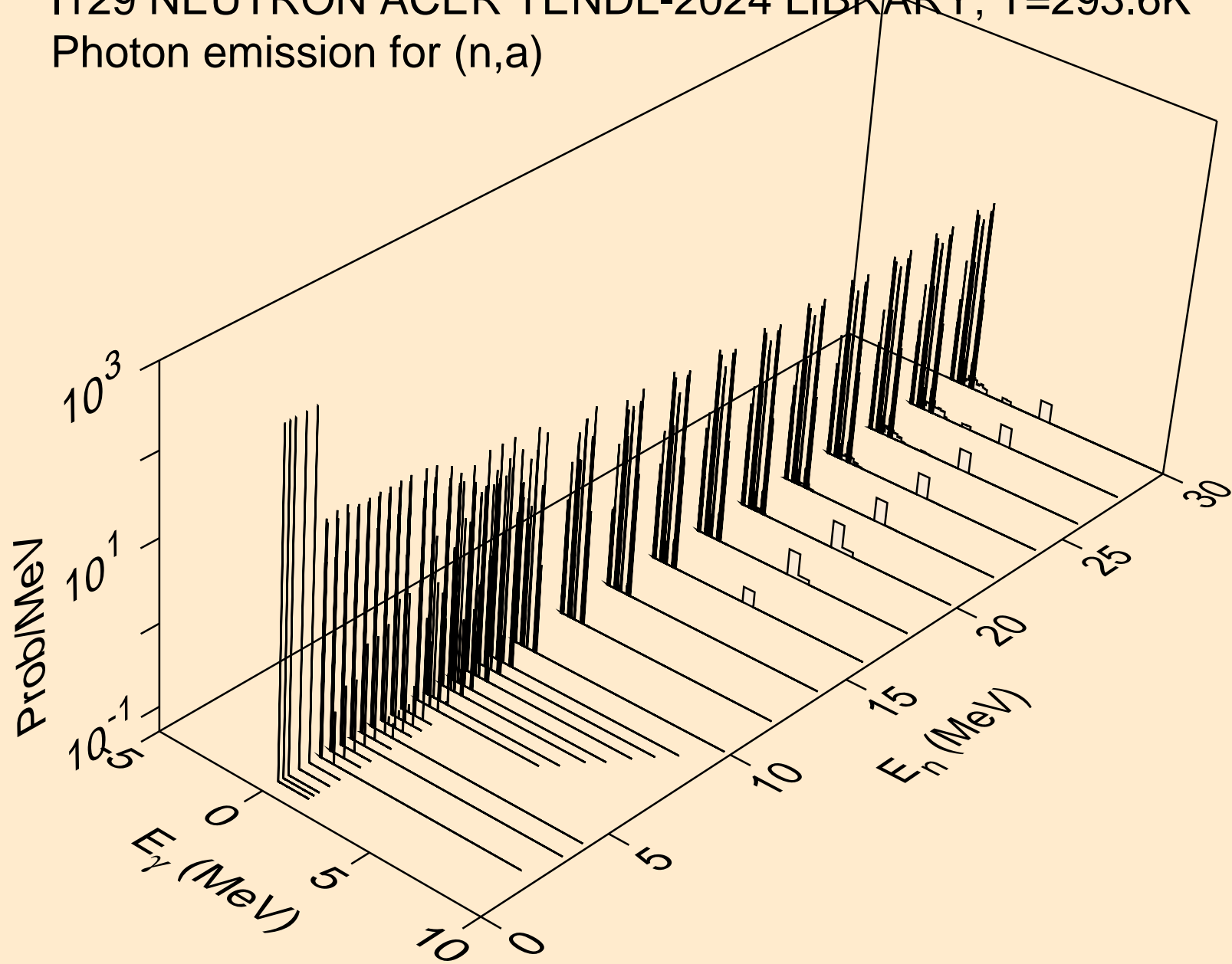

I129 NEUTRON ACER TENDL-2024 LIBRARY; T=293.6K  
Photon emission for (n,2p)

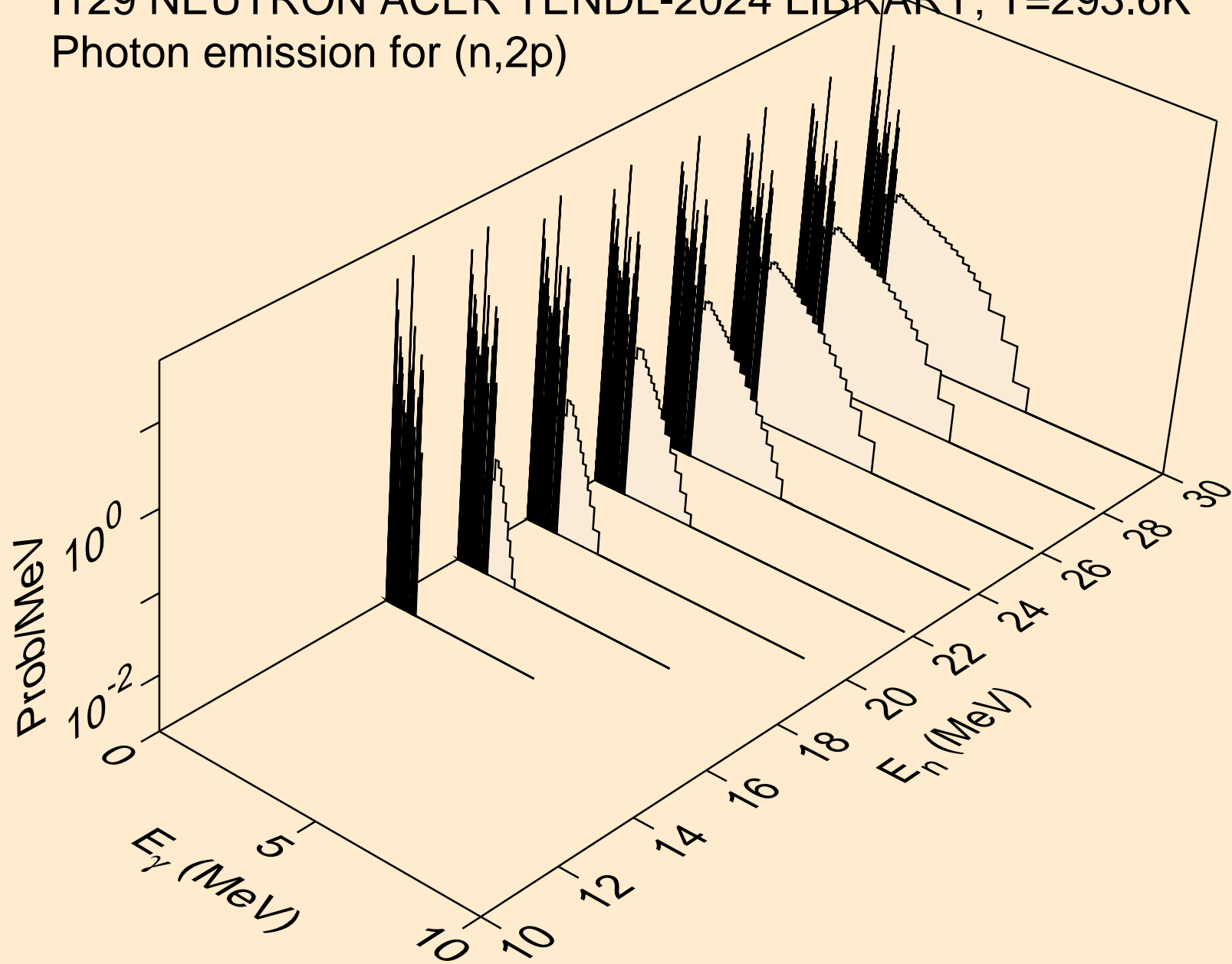

I129 NEUTRON ACER TENDL-2024 LIBRARY; T=293.6K  
Photon emission for (n,p $\alpha$ )

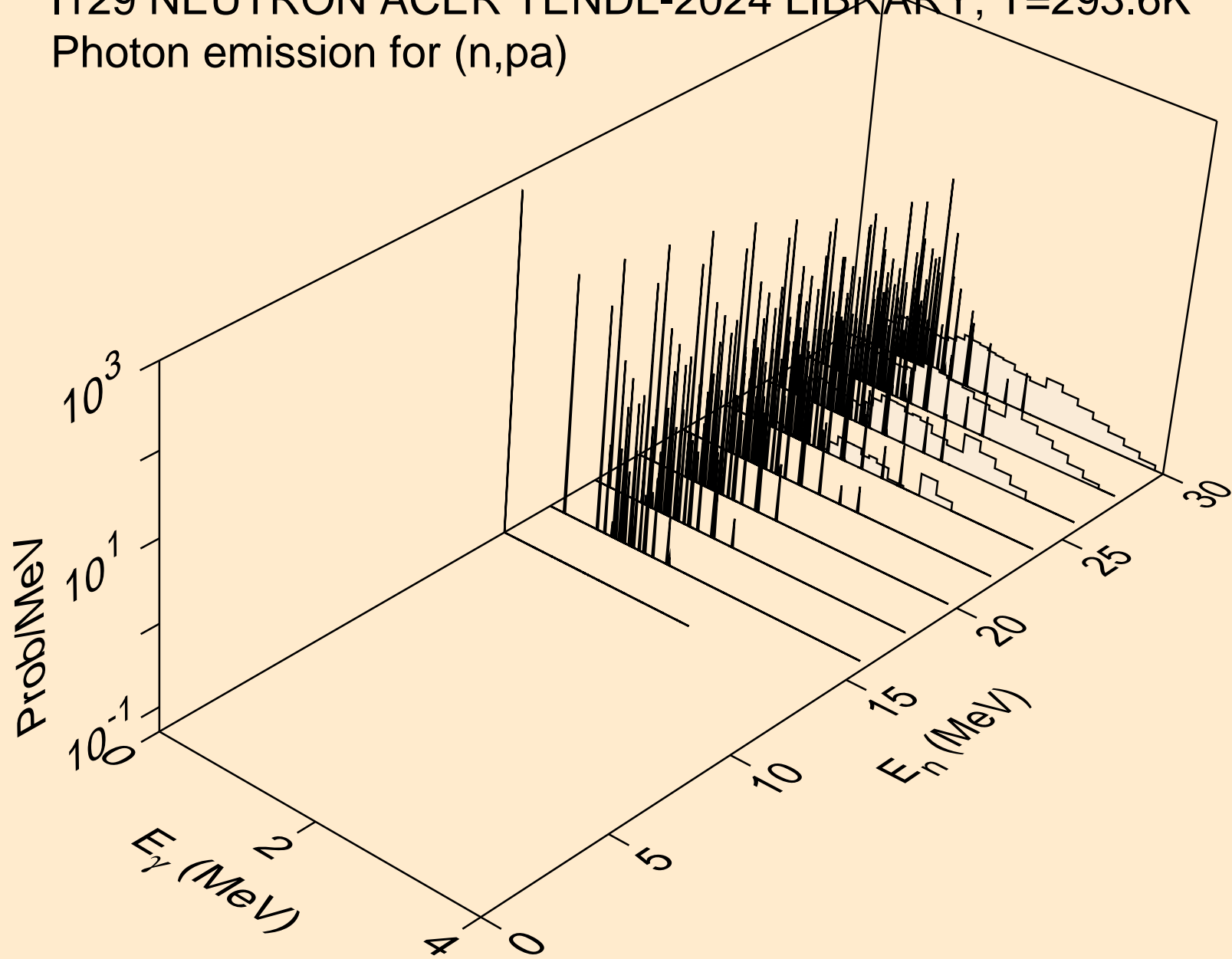

I129 NEUTRON ACER TENDL-2024 LIBRARY; T=293.6K  
Photon emission for (n,pd)

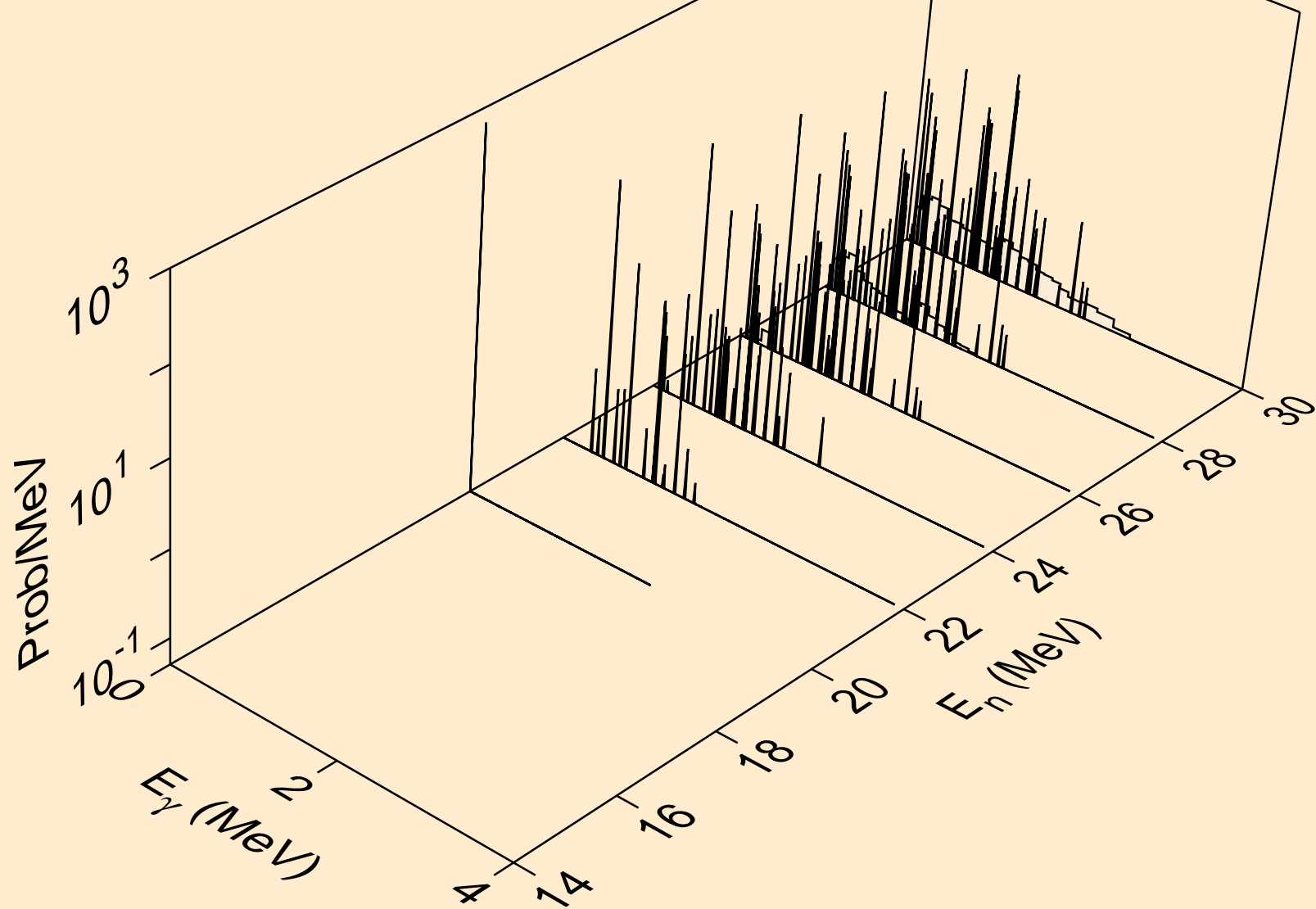

I129 NEUTRON ACER TENDL-2024 LIBRARY; T=293.6K  
Photon emission for (n,pt)

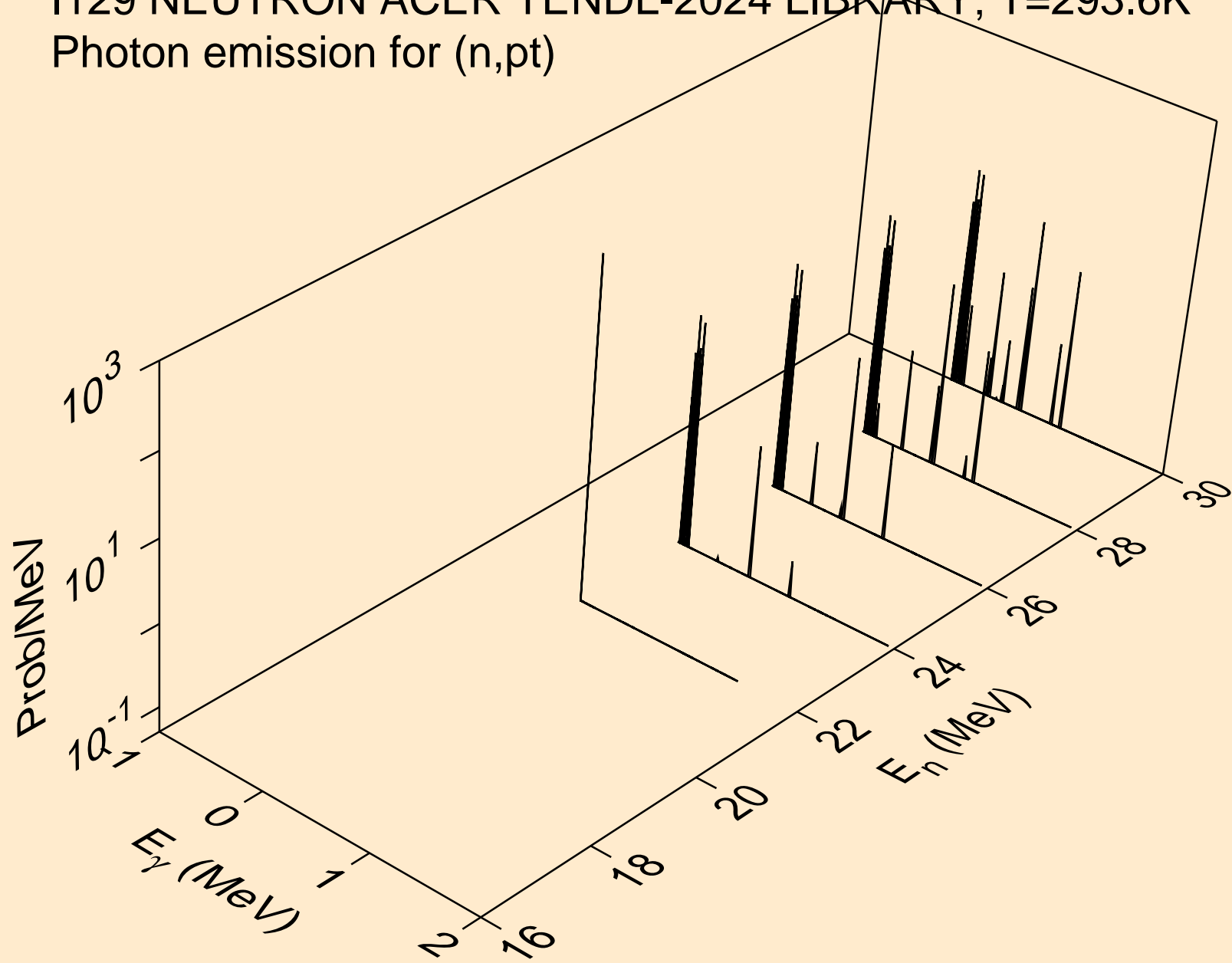

I129 NEUTRON ACER TENDL-2024 LIBRARY; T=293.6K  
Photon emission for (n,da)

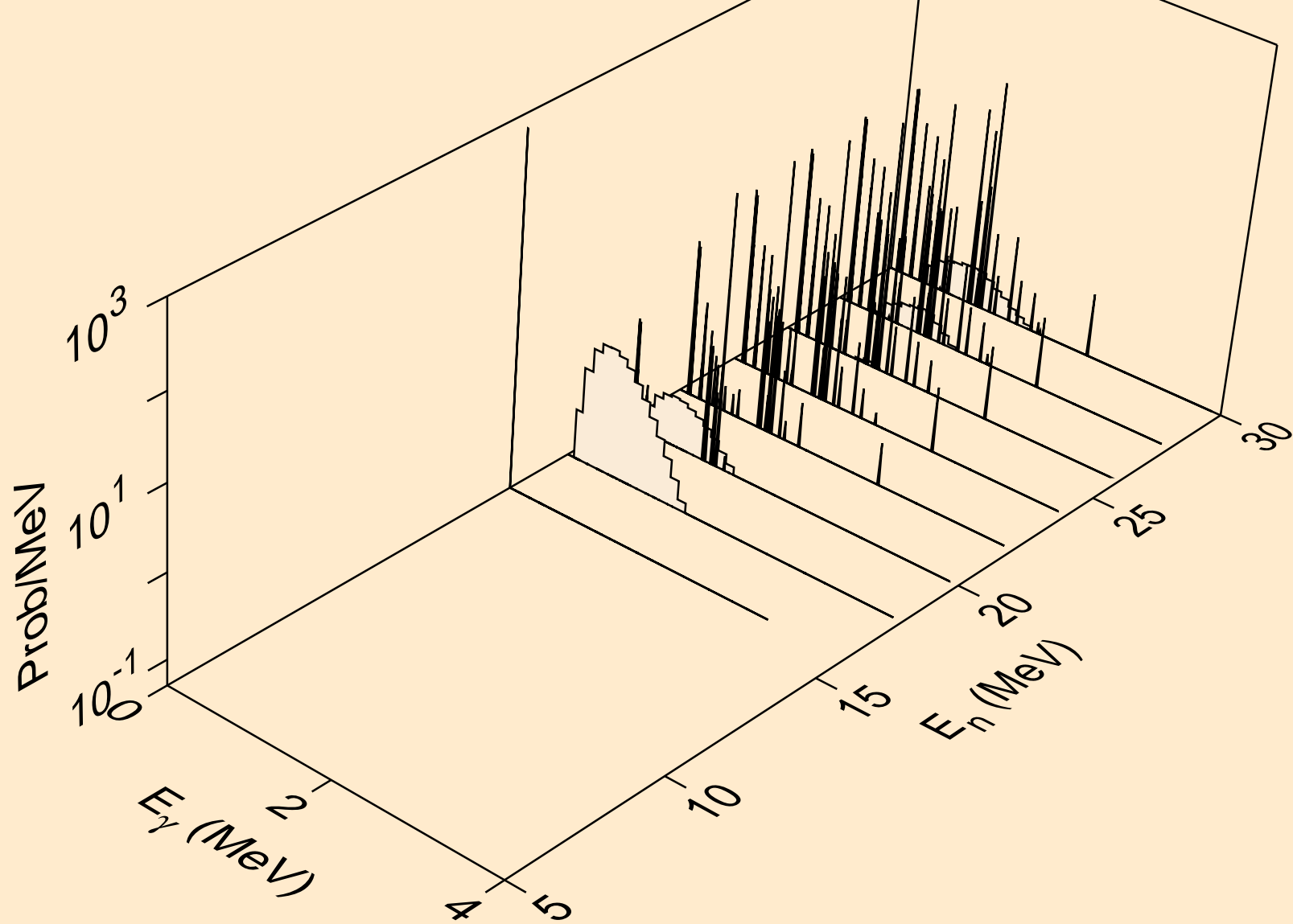

I129 NEUTRON ACER TENDL-2024 LIBRARY; T=293.6K  
thermal capture photon spectrum

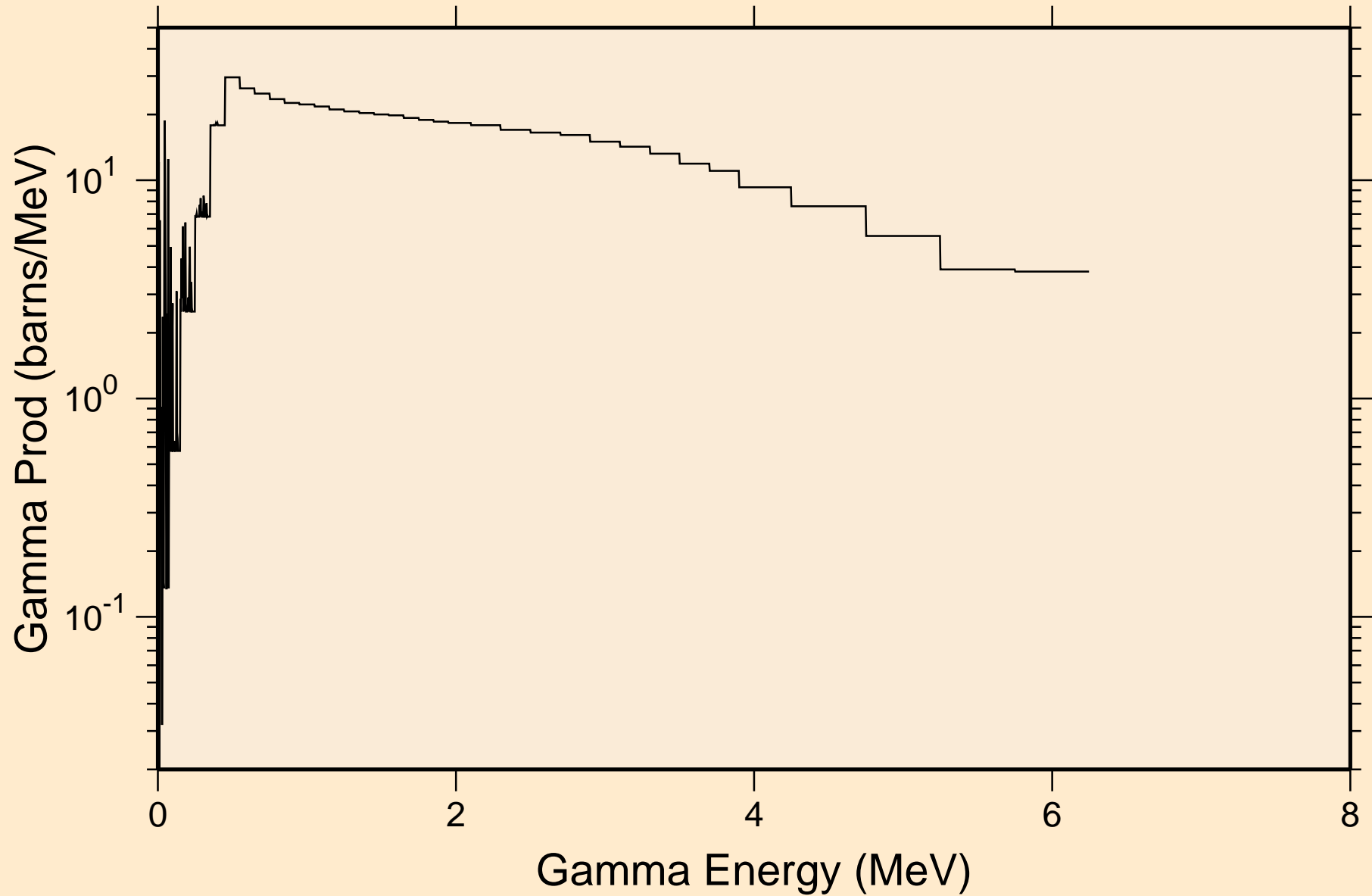

I129 NEUTRON ACER TENDL-2024 LIBRARY; T=293.6K  
14 MeV photon spectrum

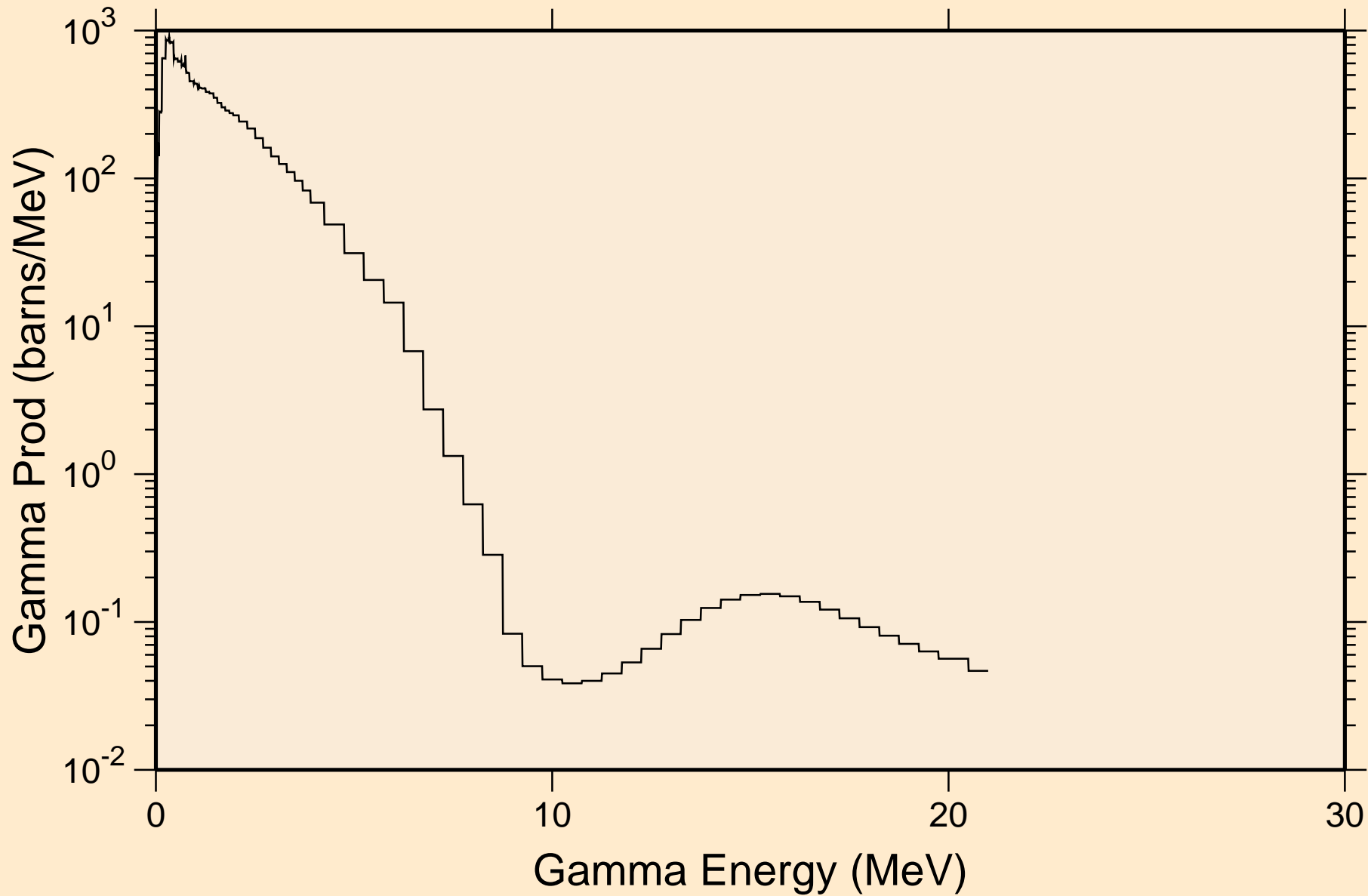

# I129 NEUTRON ACER TENDL-2024 LIBRARY; T=293.6K

## Particle heating contributions

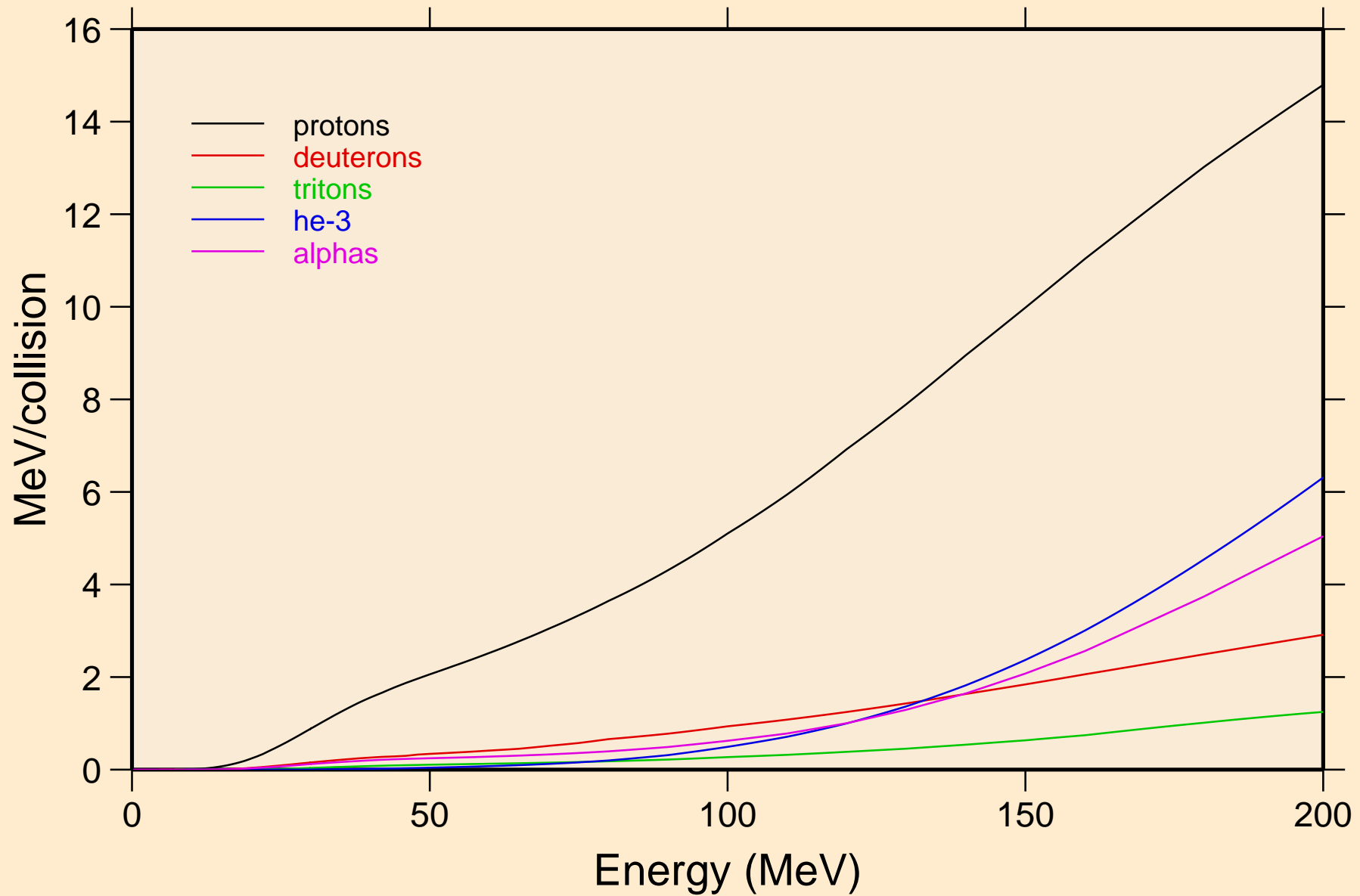

# I129 NEUTRON ACER TENDL-2024 LIBRARY; T=293.6K

## Recoil Heating

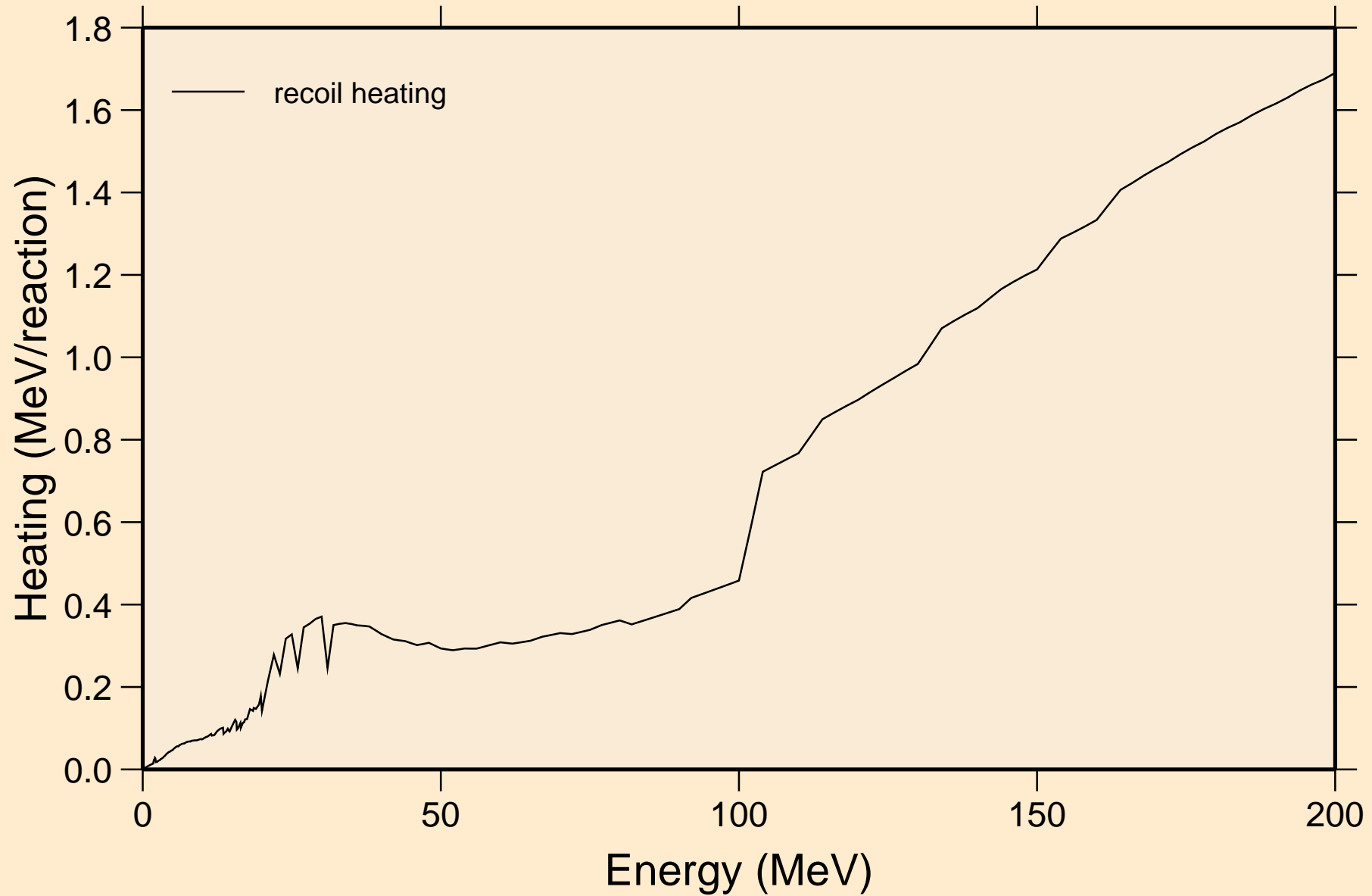

I129 NEUTRON ACER TENDL-2024 LIBRARY; T=293.6K  
Particle production cross sections

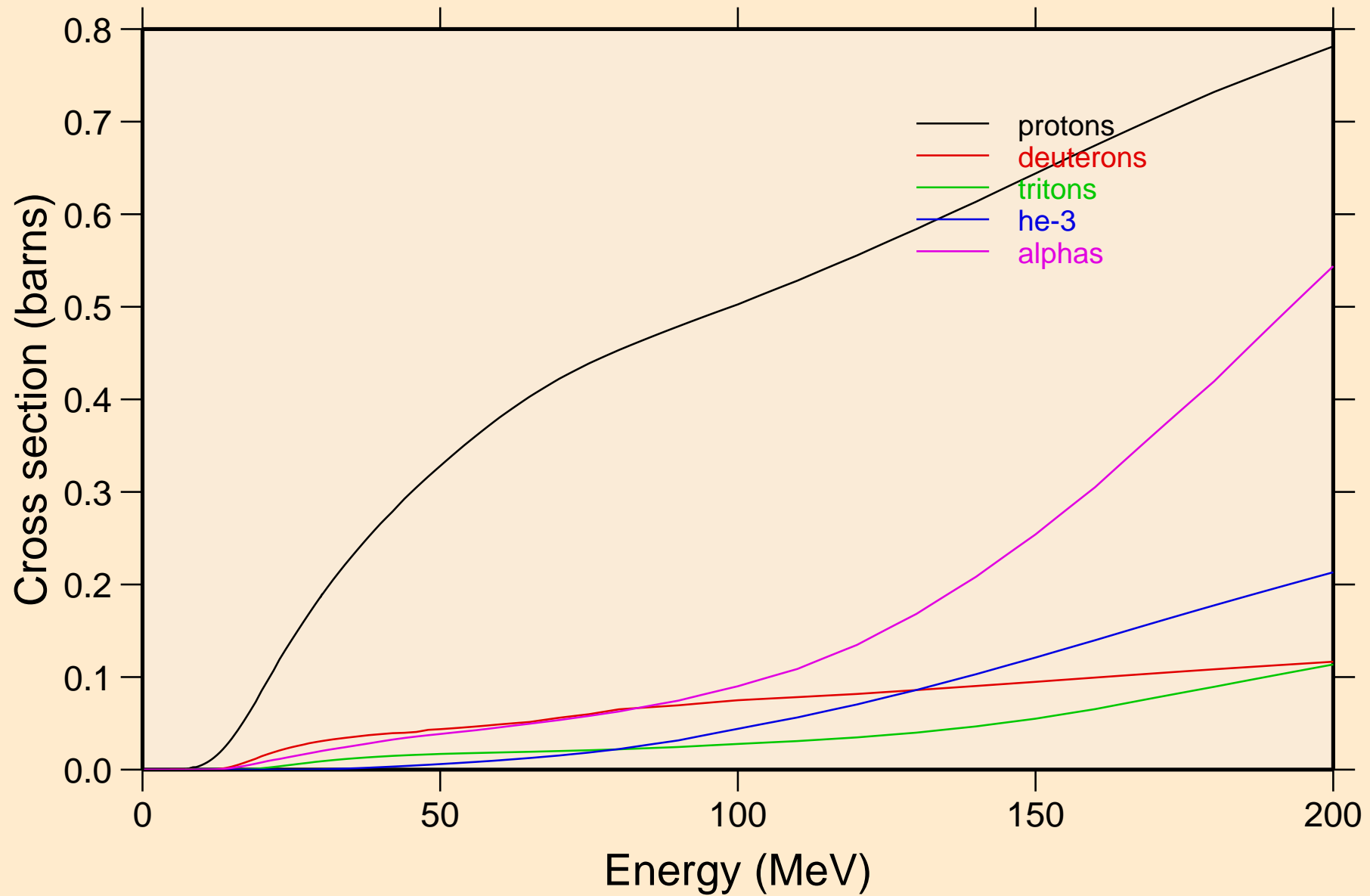

I129 NEUTRON ACER TENDL-2024 LIBRARY; T=293.6K  
protons from (n,x)

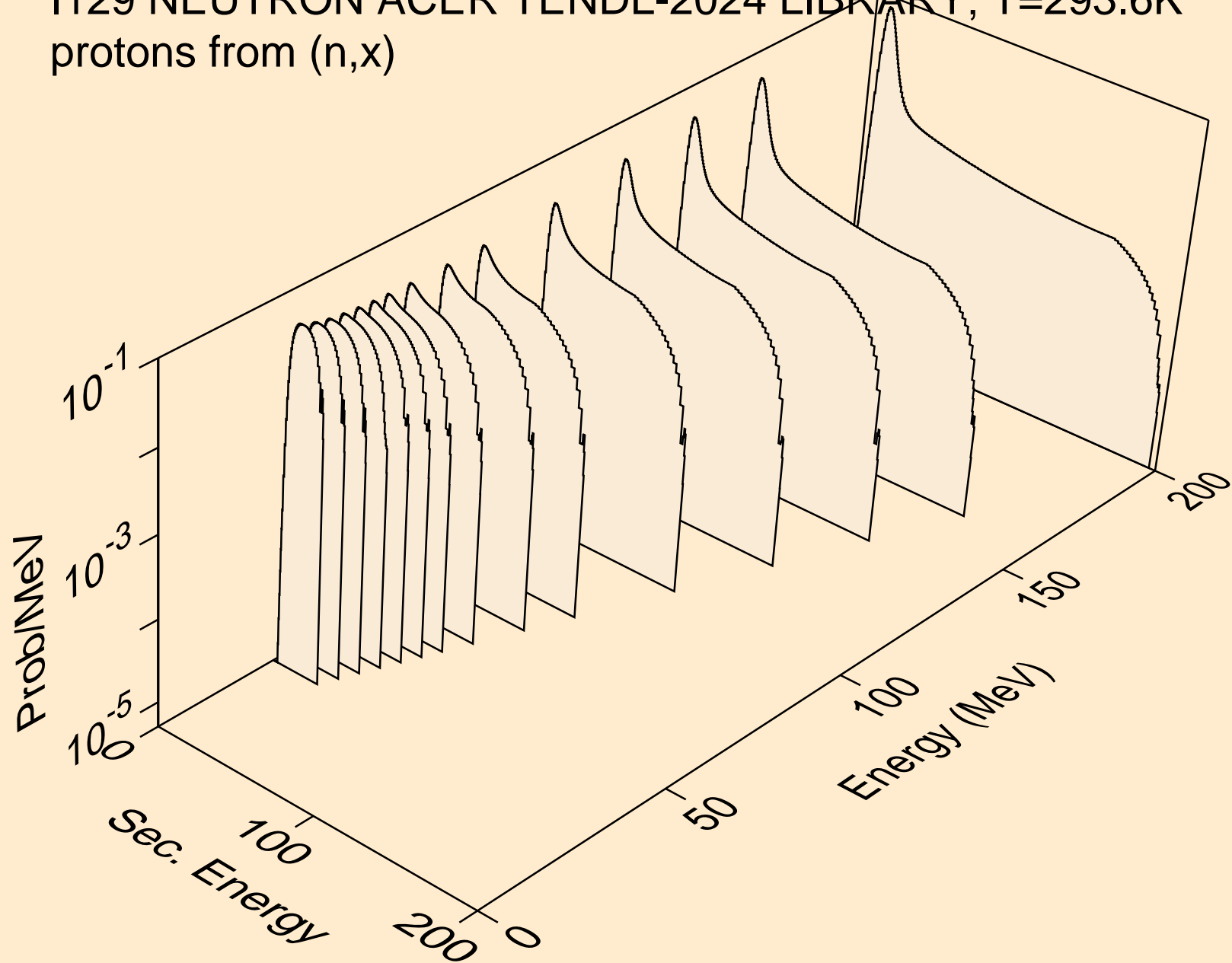

I129 NEUTRON ACER TENDL-2024 LIBRARY; T=293.6K  
protons from (n,n\*)p

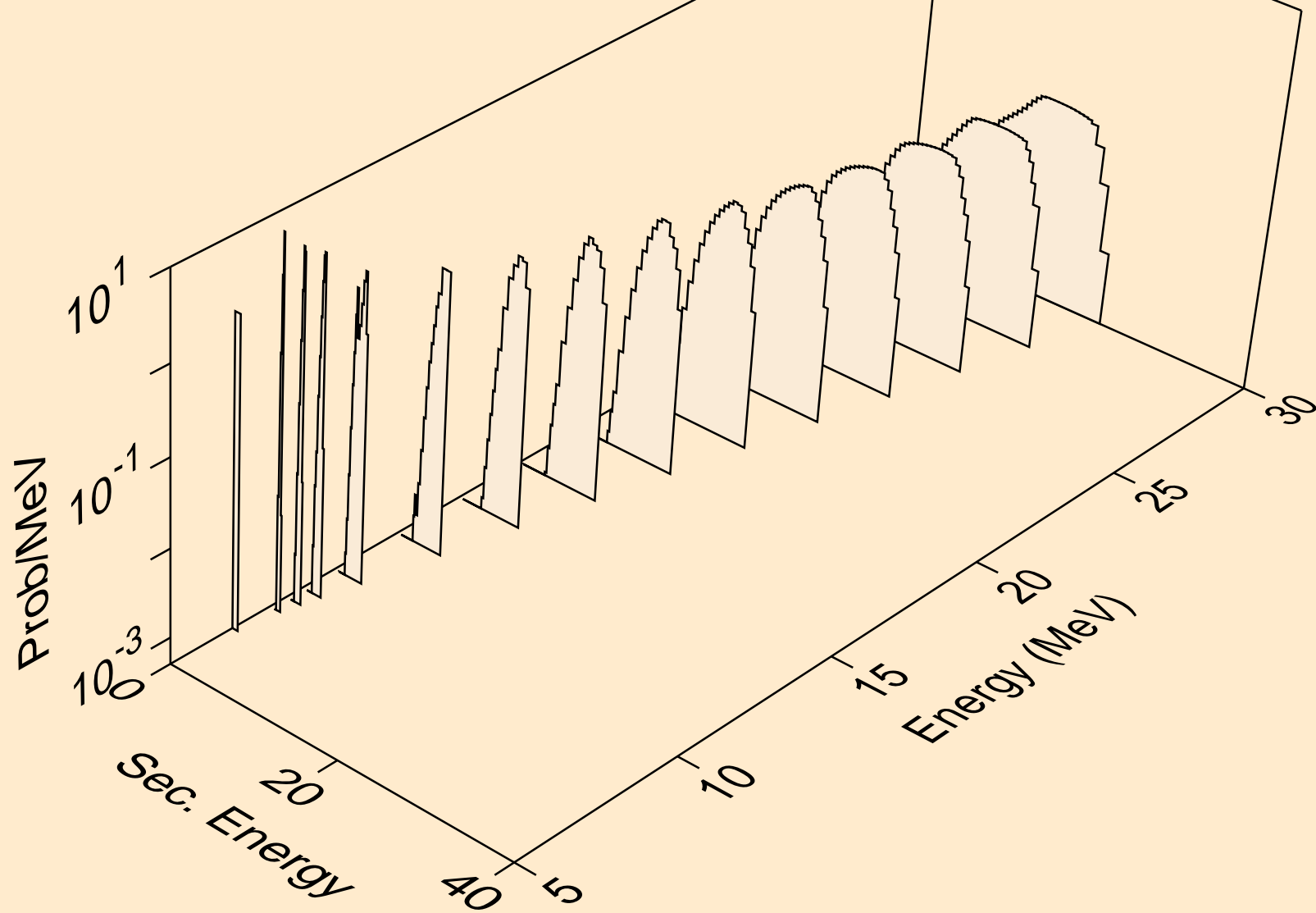

I129 NEUTRON ACER TENDL-2024 LIBRARY; T=293.6K  
protons from (n,2np)

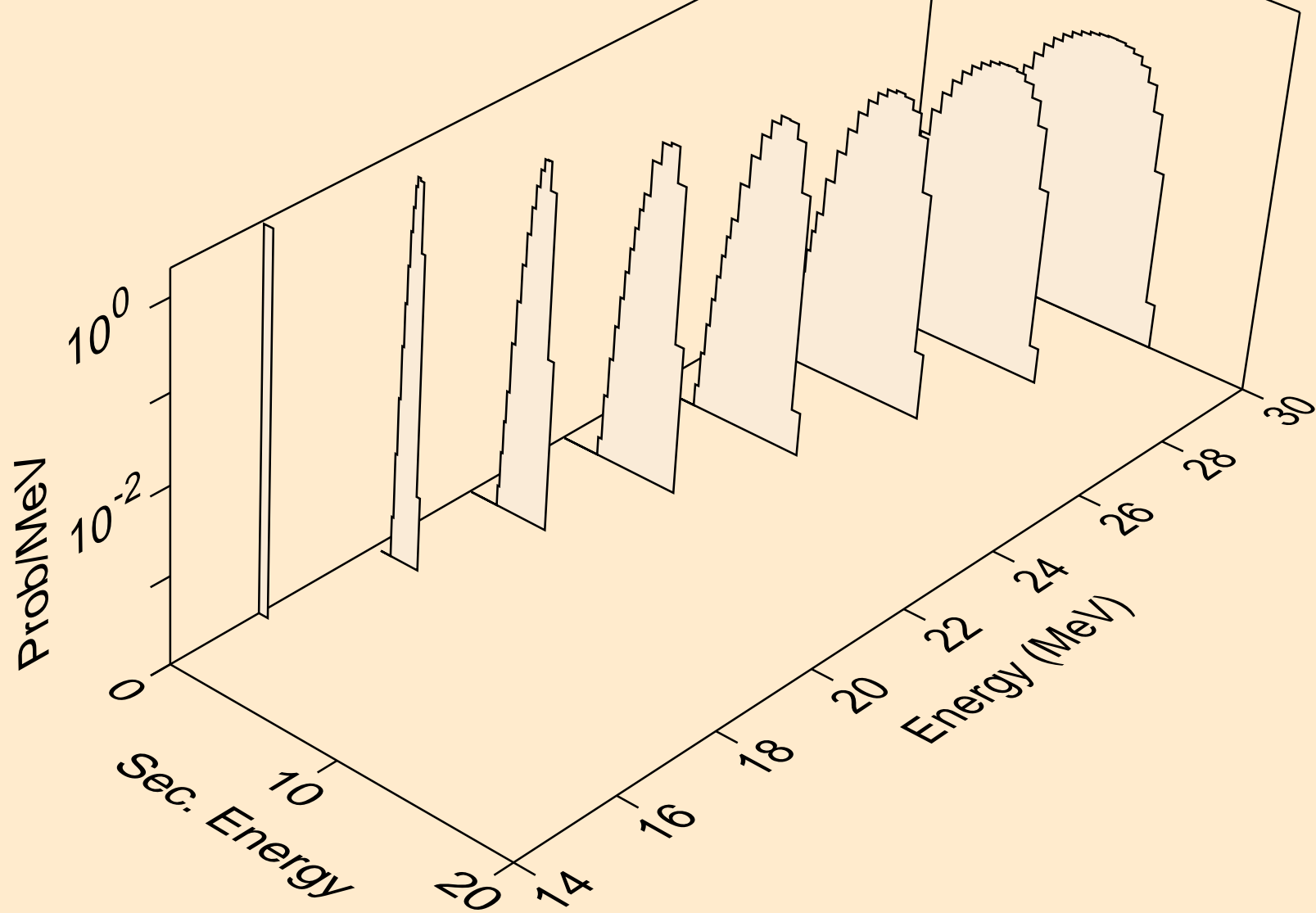

I129 NEUTRON ACER TENDL-2024 LIBRARY; T=293.6K  
protons from (n,3np)

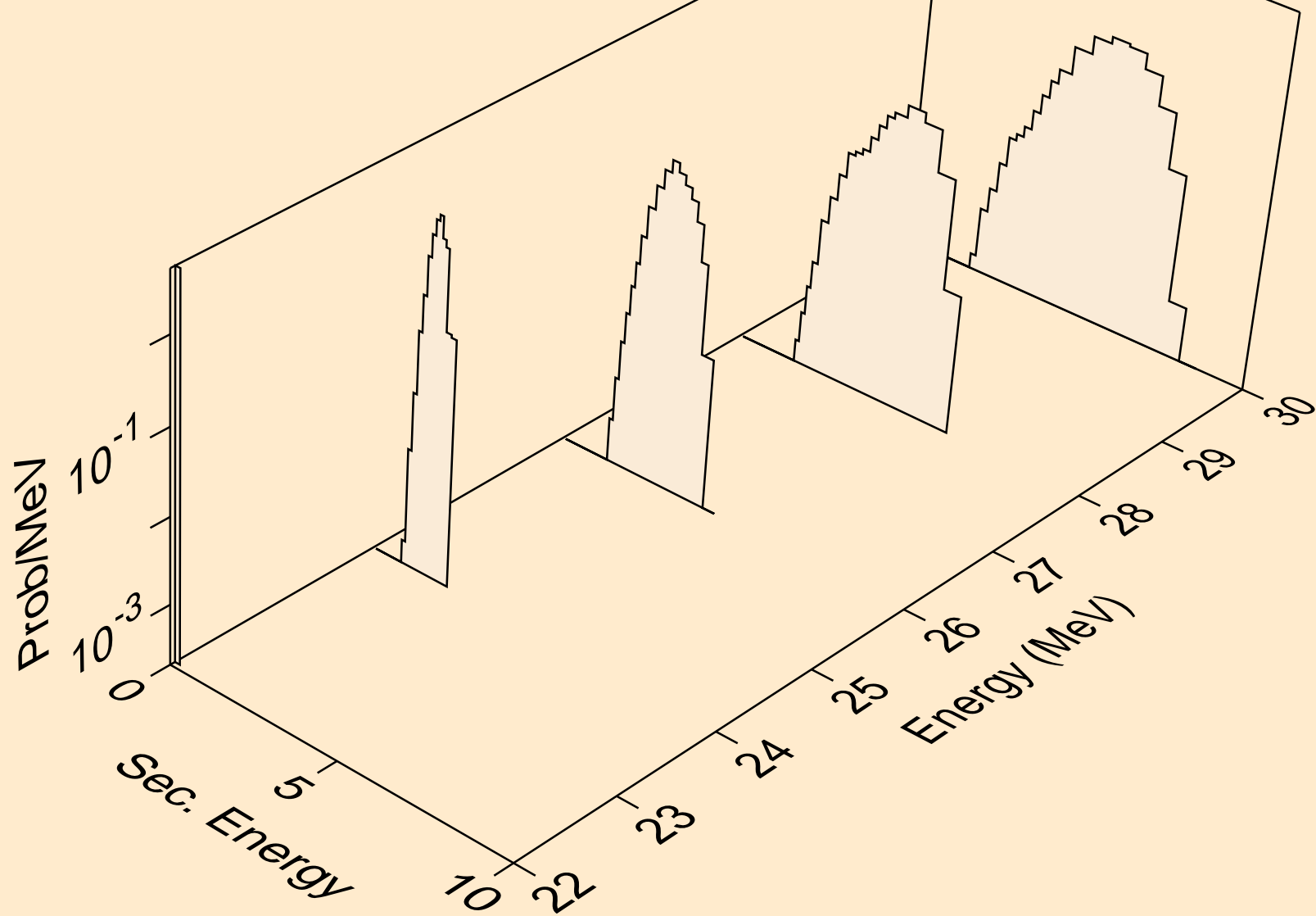

I129 NEUTRON ACER TENDL-2024 LIBRARY; T=293.6K  
protons from (n,n2p)

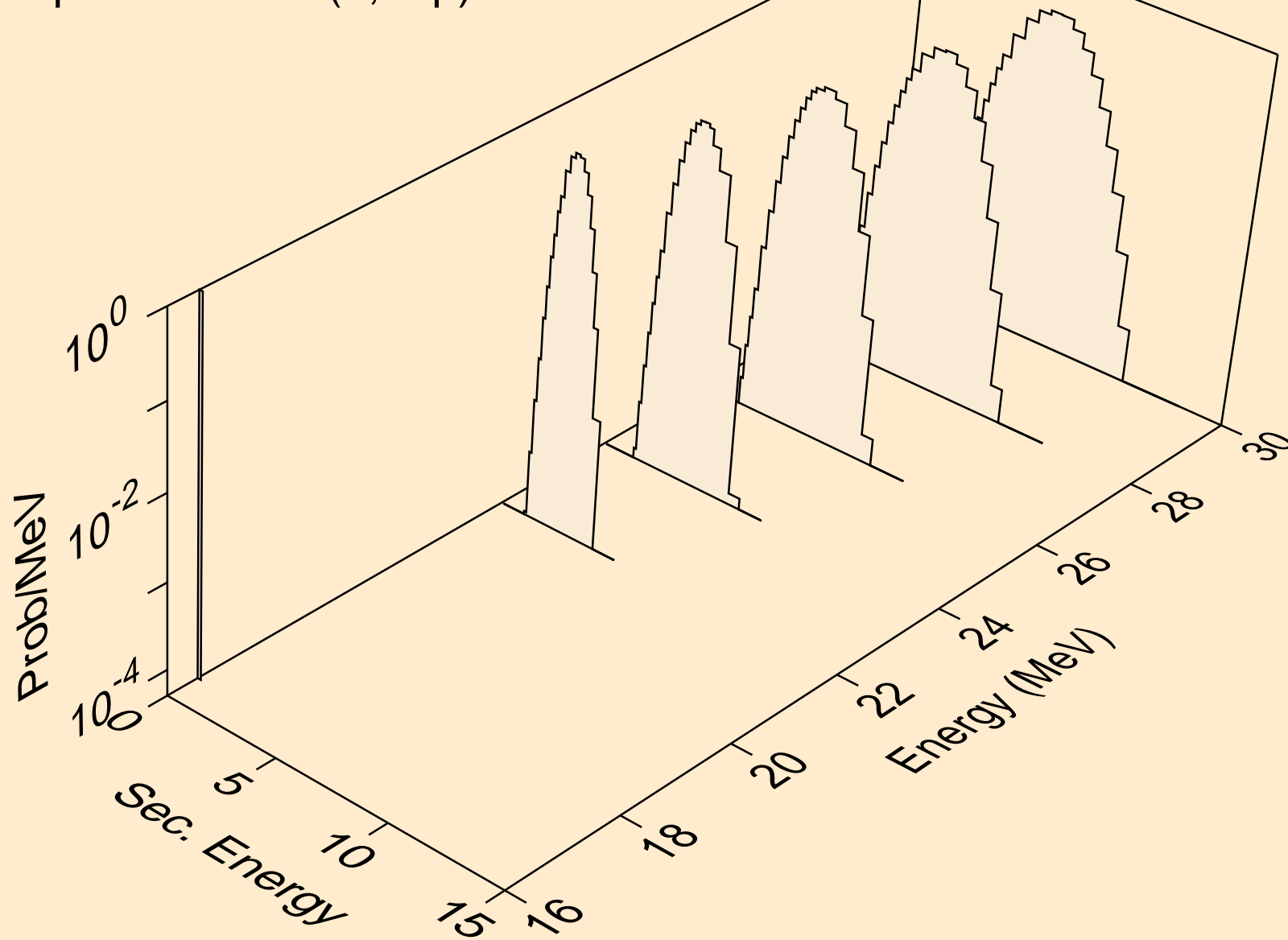

I129 NEUTRON ACER TENDL-2024 LIBRARY; T=293.6K  
protons from (n,npa)

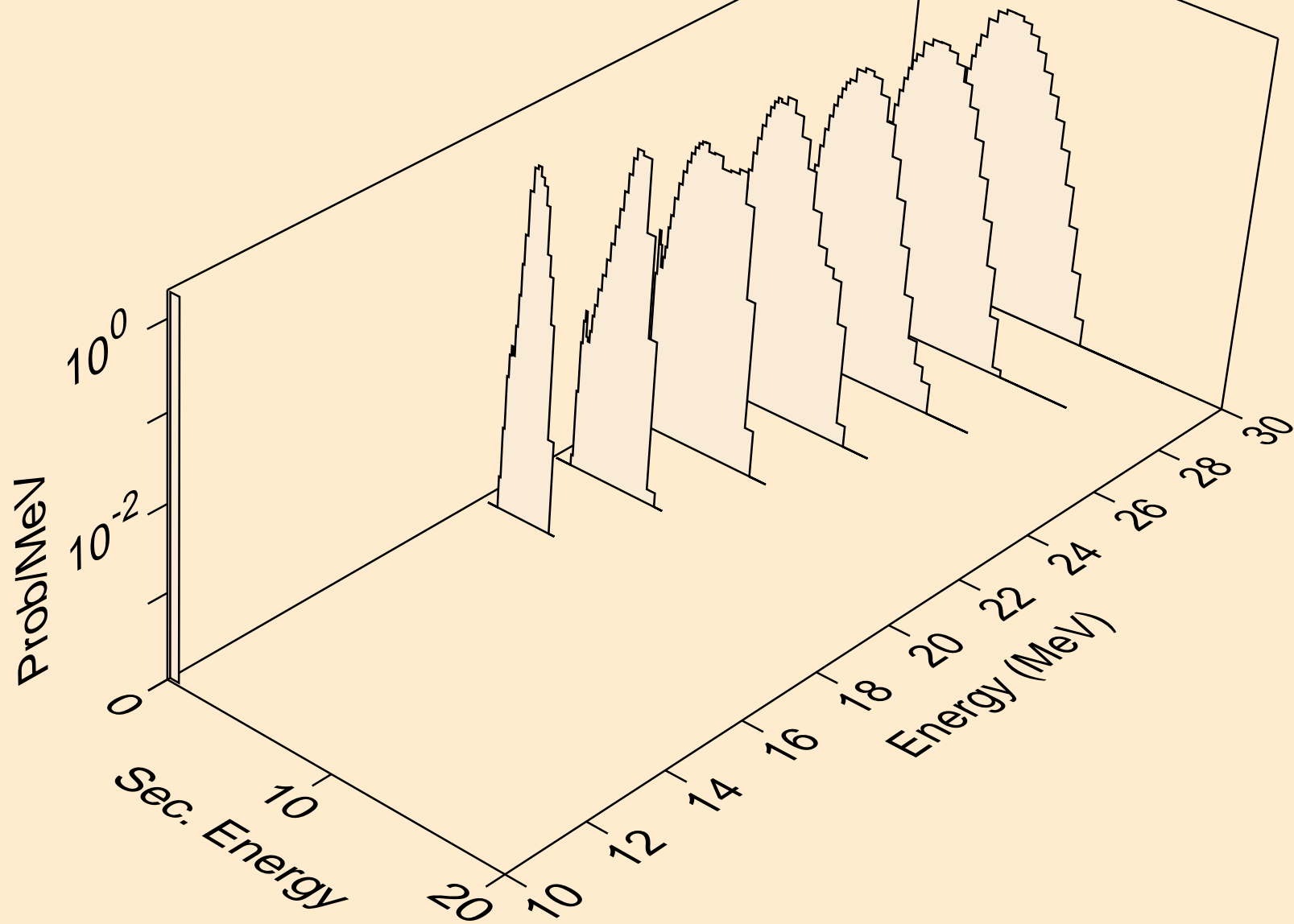

I129 NEUTRON ACER TENDL-2024 LIBRARY; T=293.6K  
protons from (n,p)

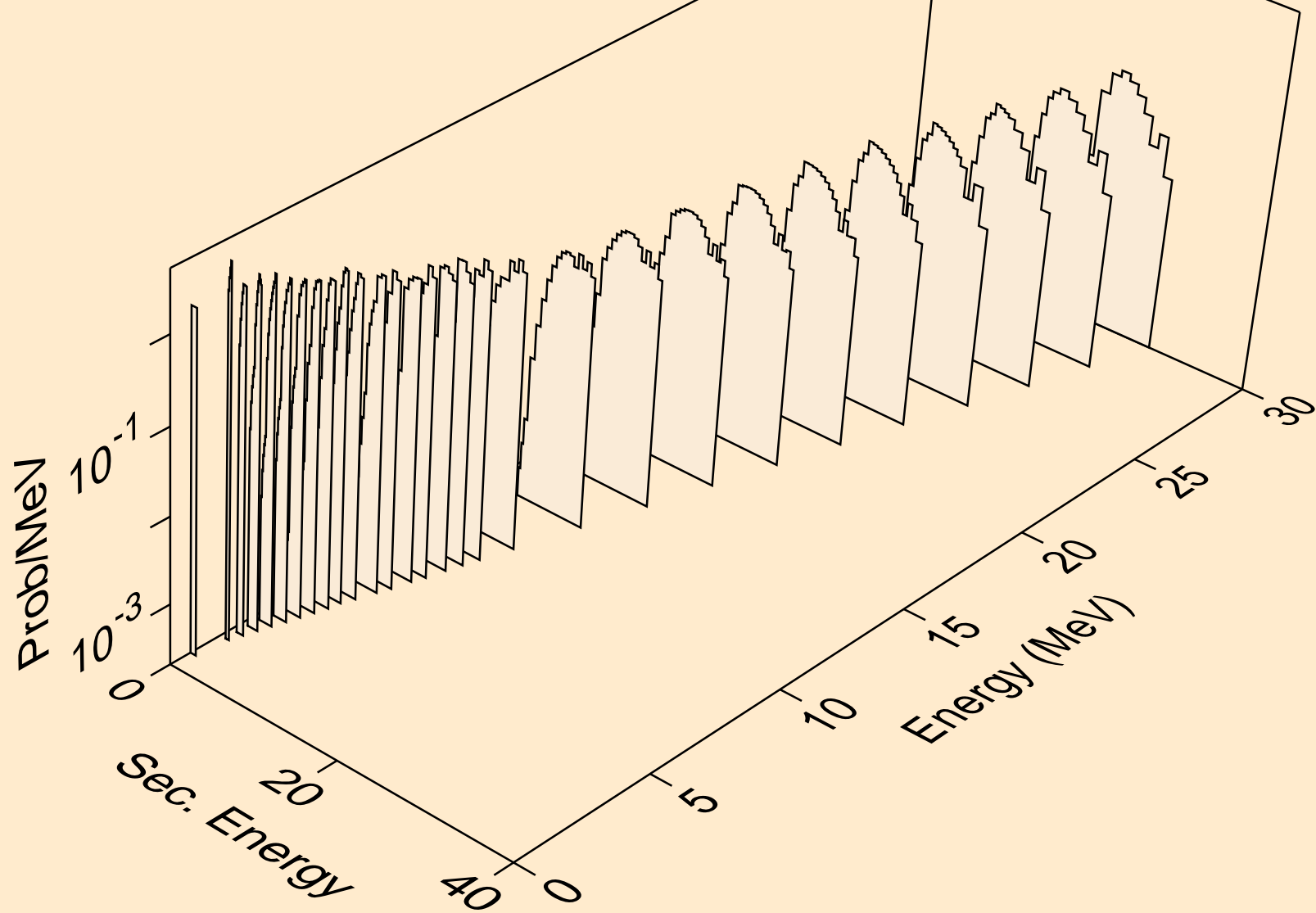

I129 NEUTRON ACER TENDL-2024 LIBRARY; T=293.6K  
protons from (n,2p)

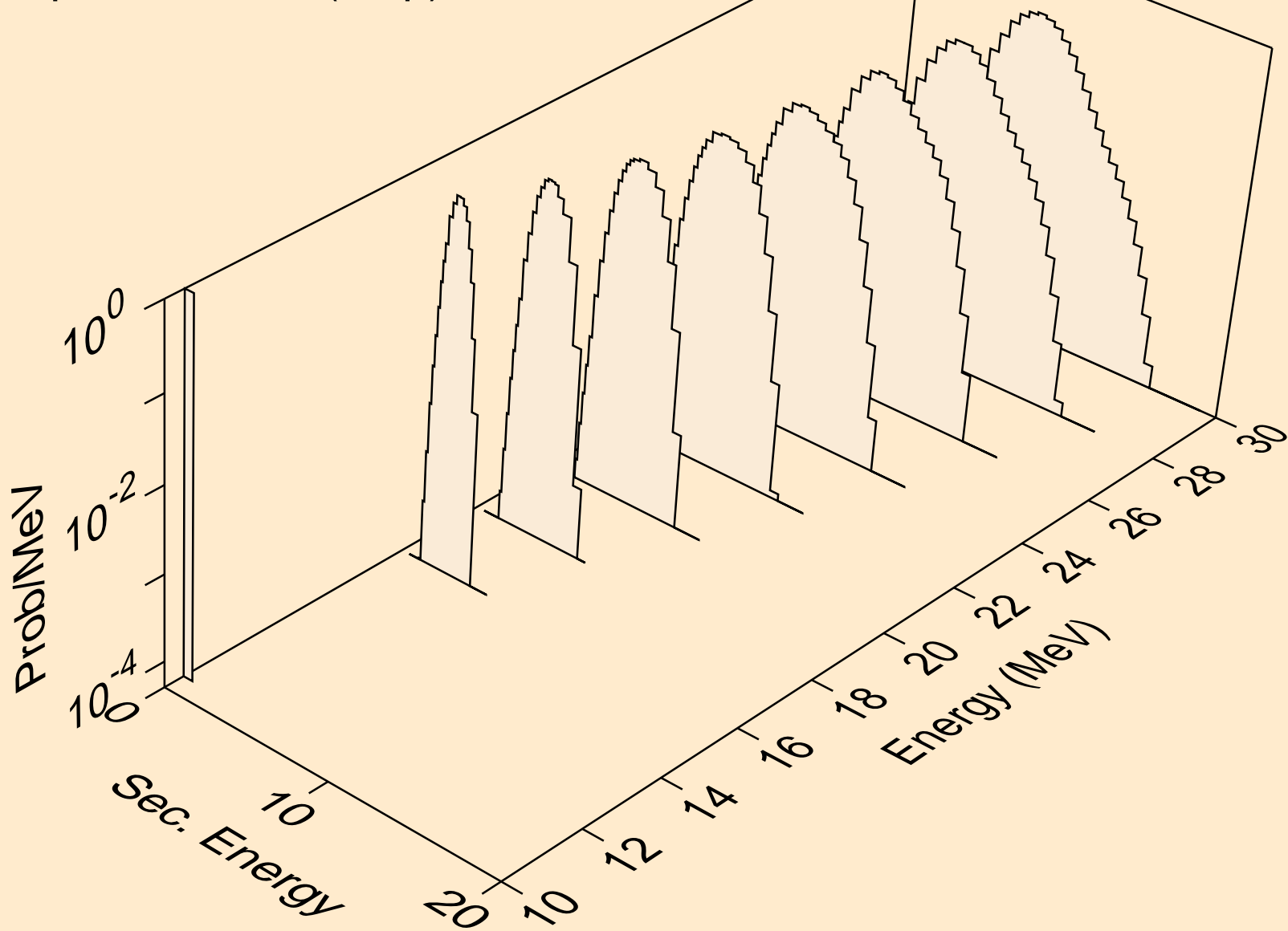

I129 NEUTRON ACER TENDL-2024 LIBRARY; T=293.6K  
protons from (n,p)

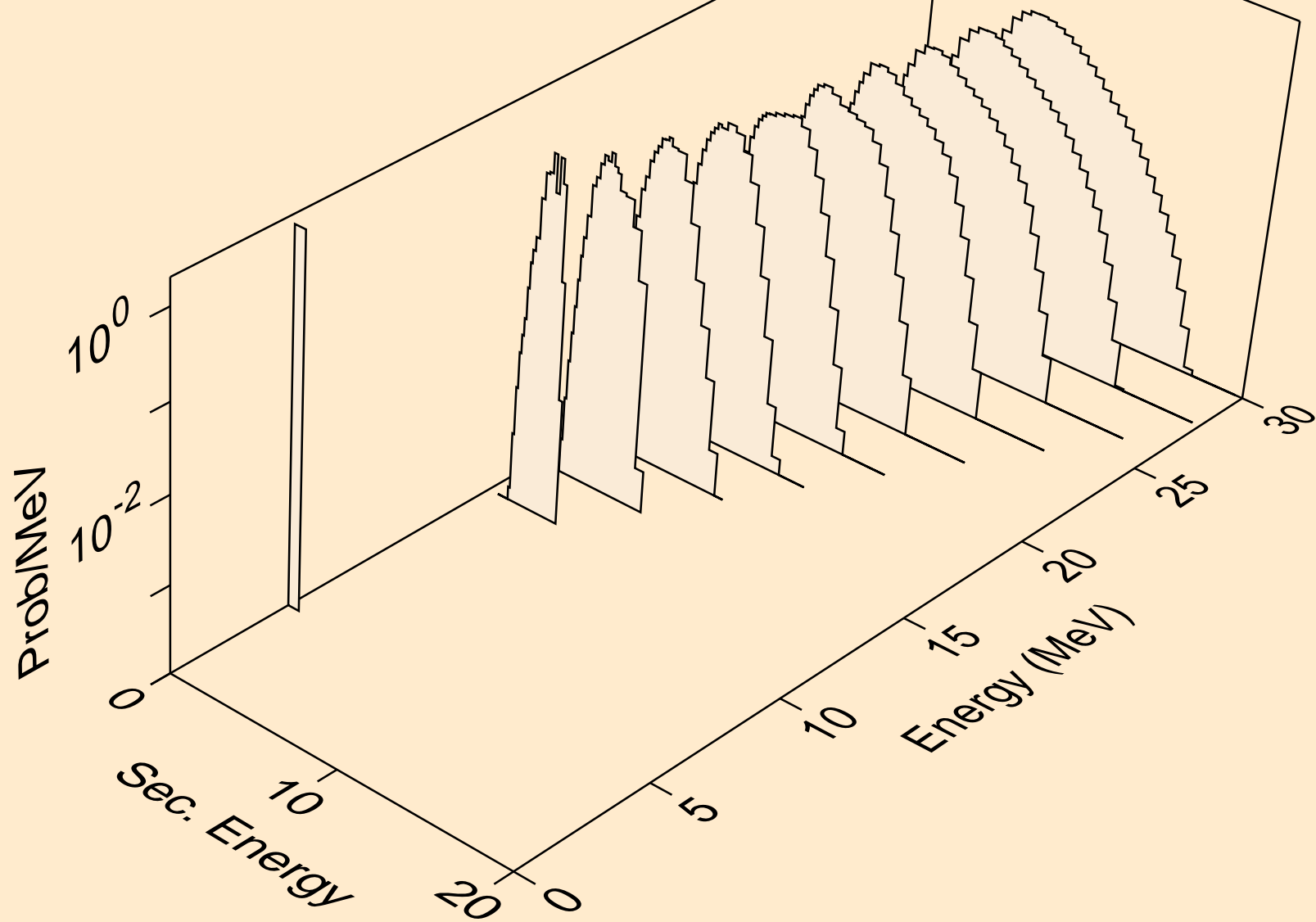

I129 NEUTRON ACER TENDL-2024 LIBRARY; T=293.6K  
protons from (n,pd)

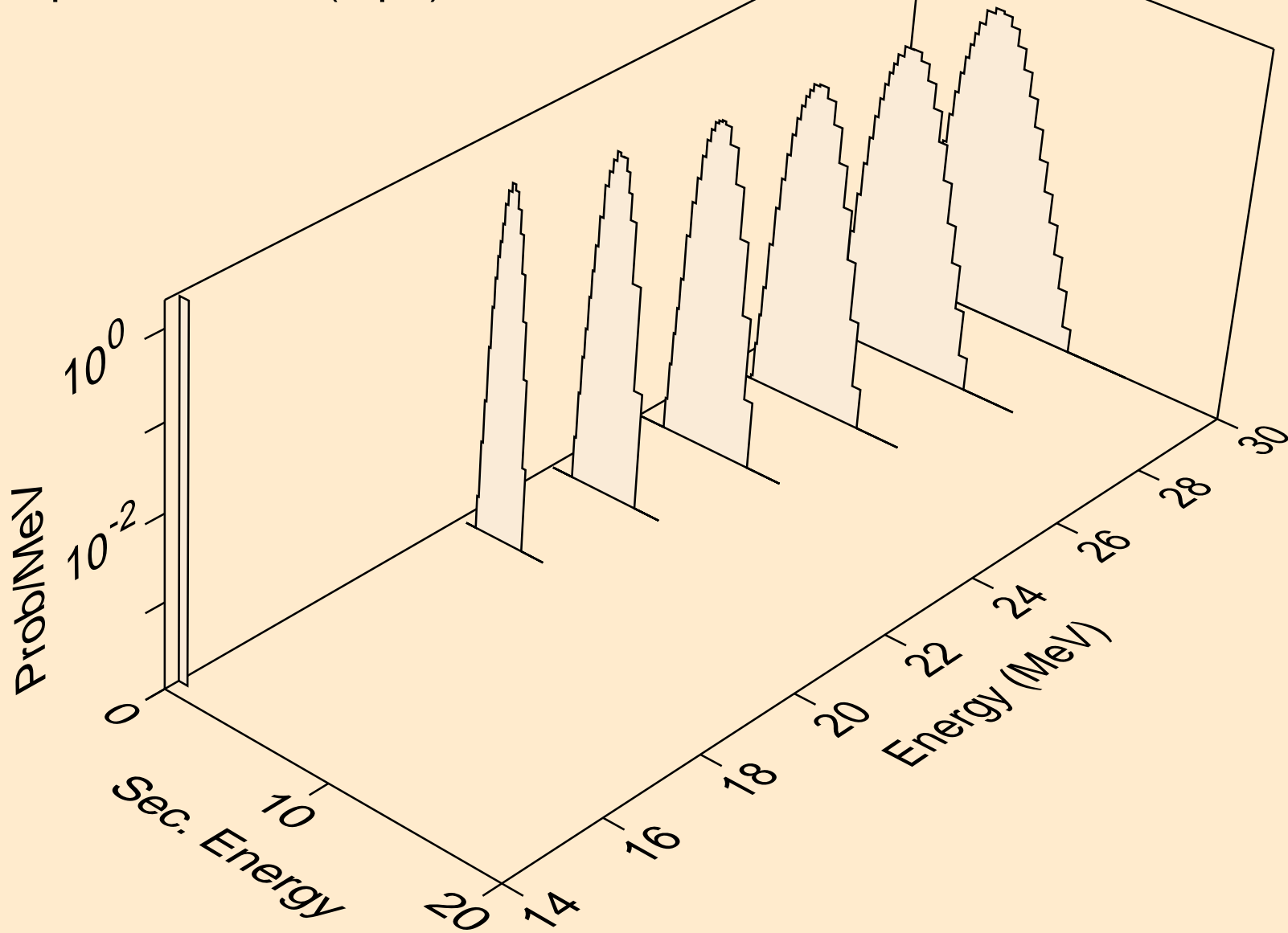

I129 NEUTRON ACER TENDL-2024 LIBRARY; T=293.6K  
protons from (n,pt)

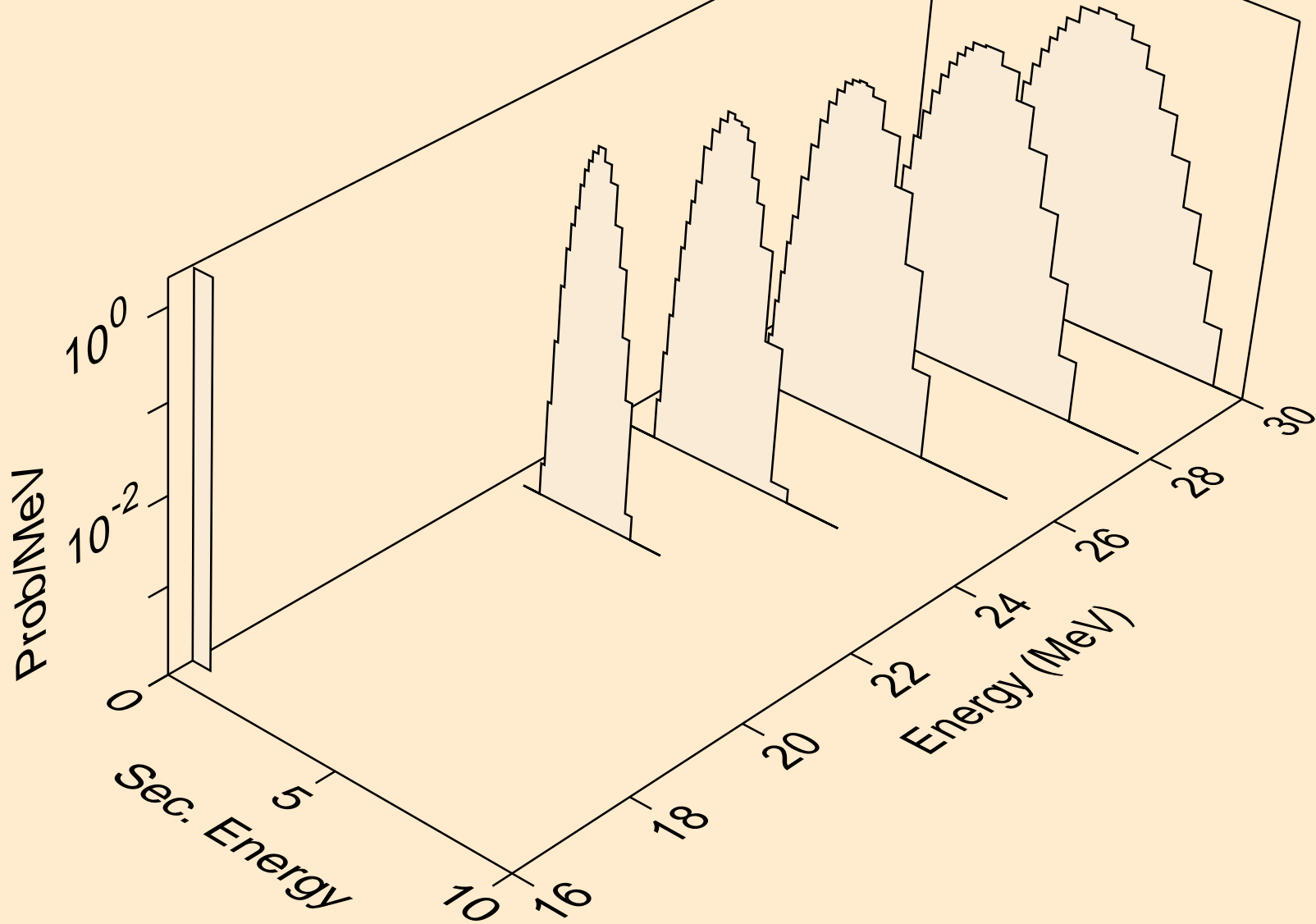

I129 NEUTRON ACER TENDL-2024 LIBRARY; T=293.6K  
deuterons from (n,x)

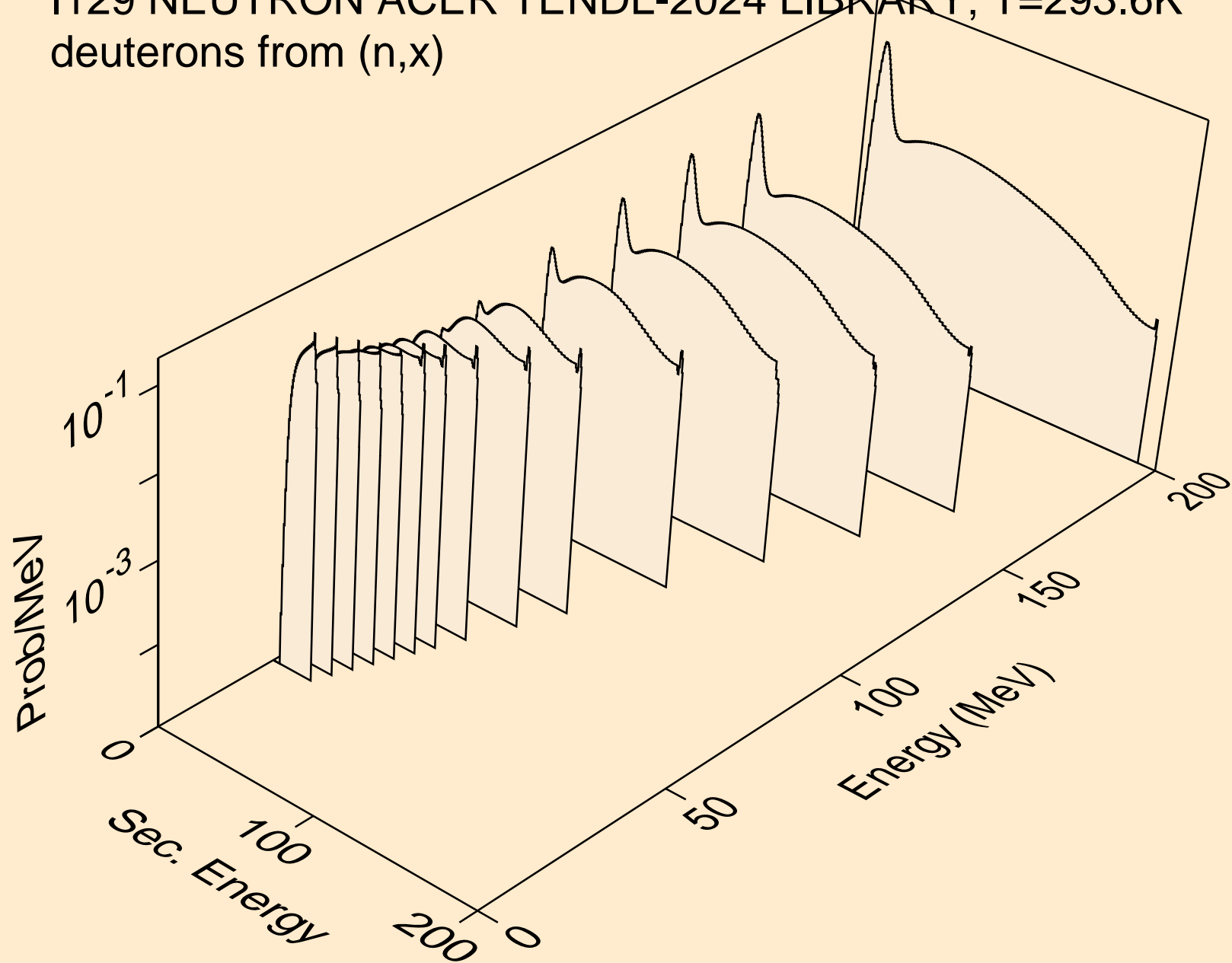

I129 NEUTRON ACER TENDL-2024 LIBRARY; T=293.6K  
deuterons from (n,2nd)

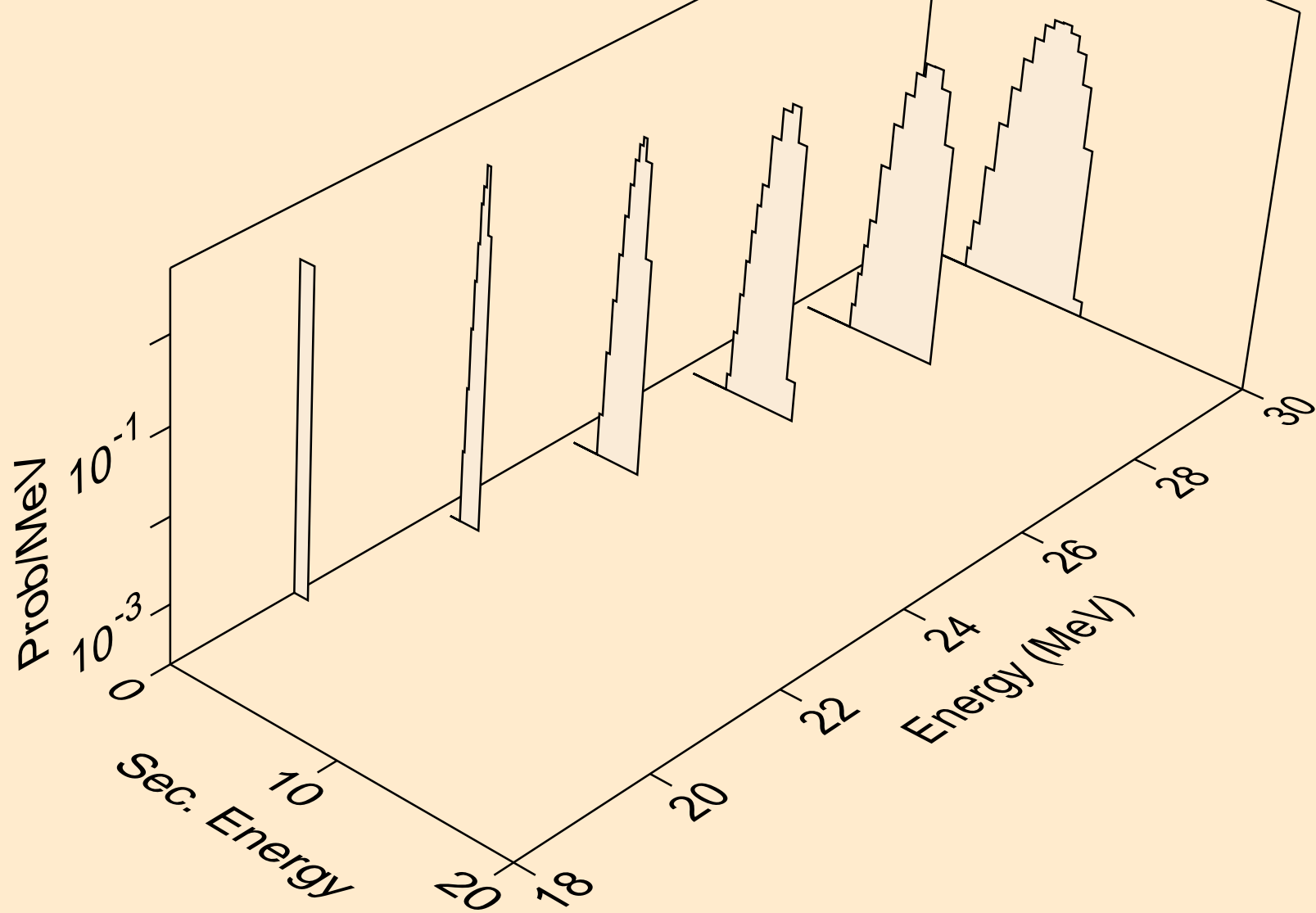

I129 NEUTRON ACER TENDL-2024 LIBRARY; T=293.6K  
deuterons from (n,n\*)d

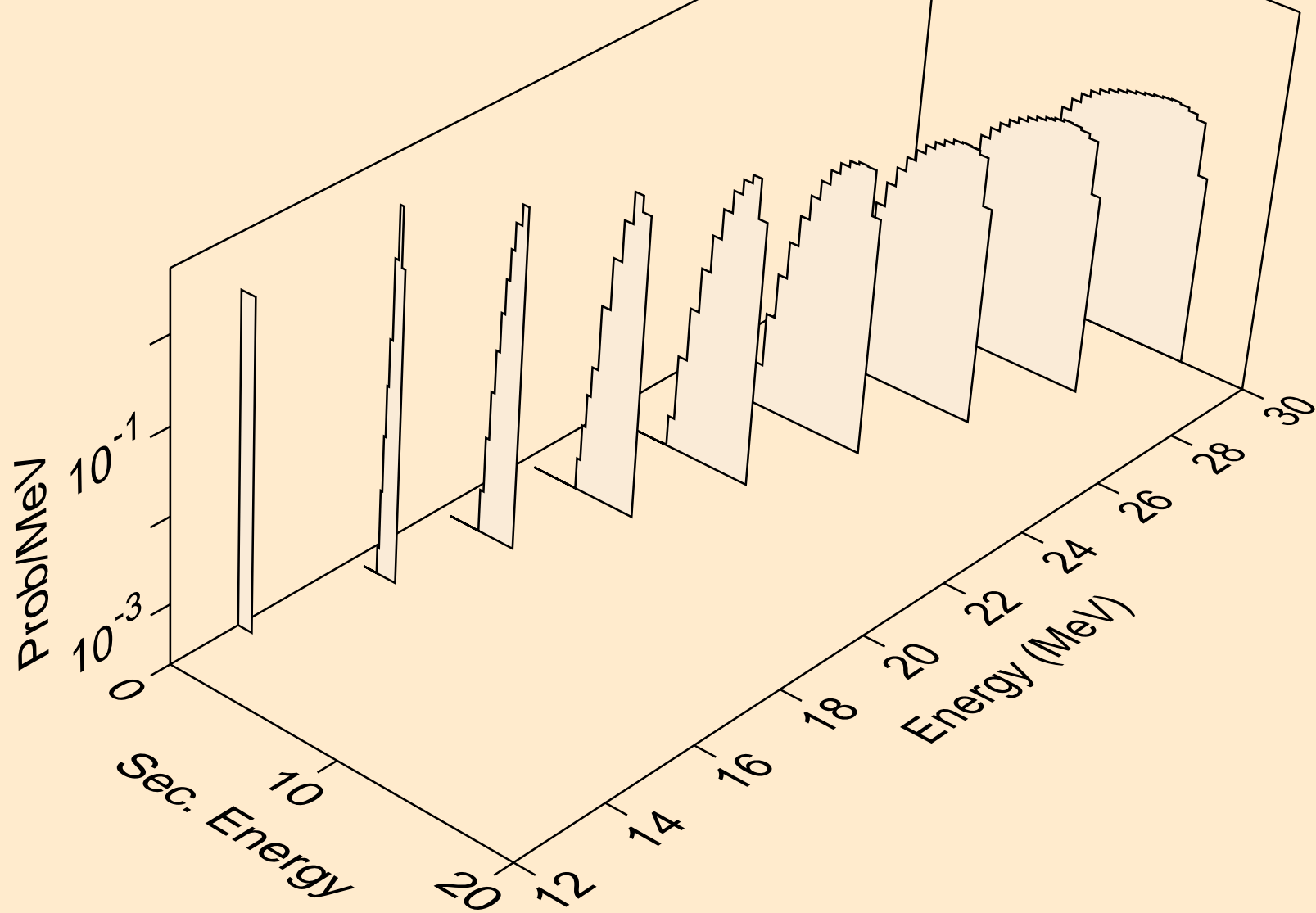

I129 NEUTRON ACER TENDL-2024 LIBRARY; T=293.6K  
deuterons from (n,d)

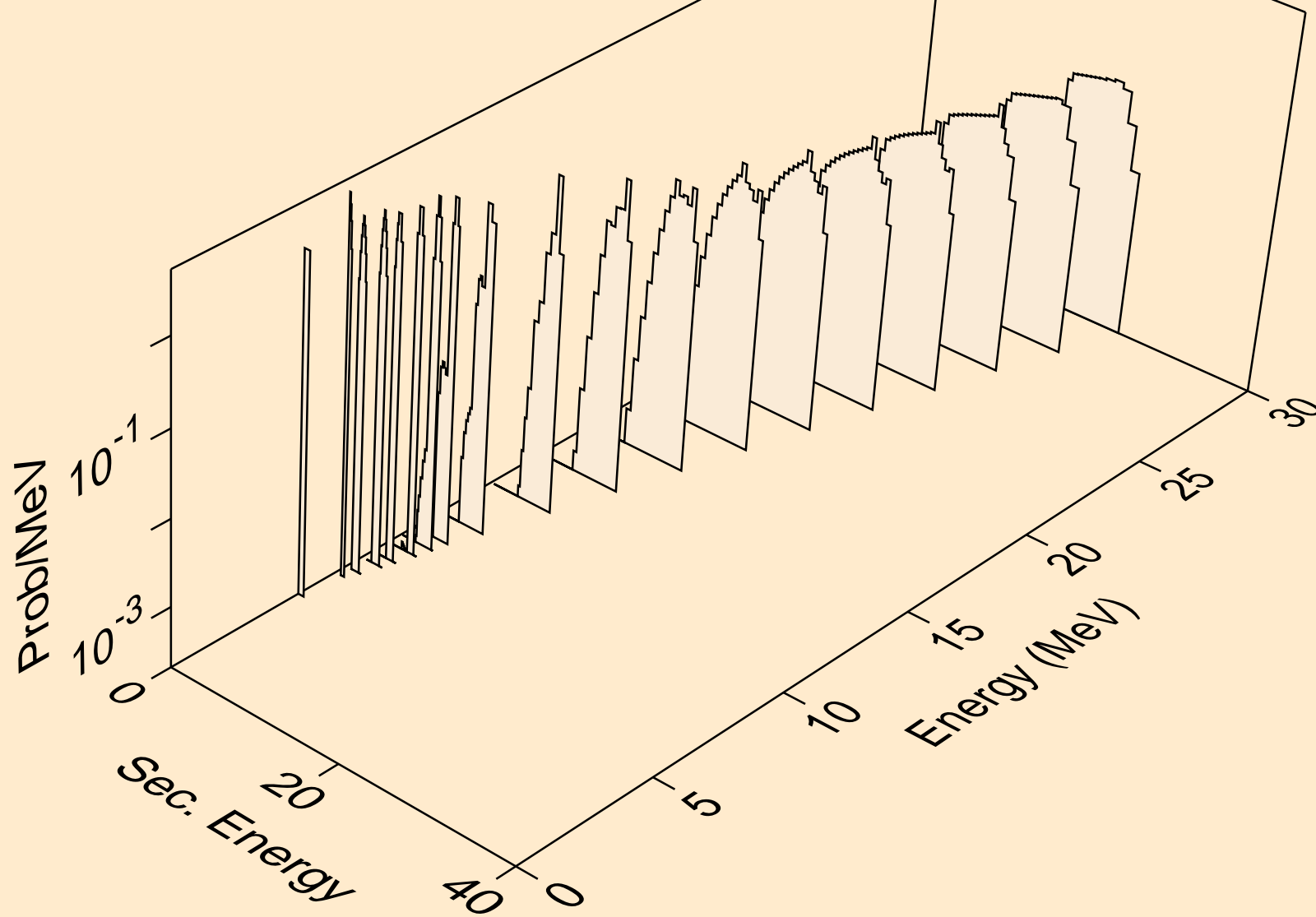

I129 NEUTRON ACER TENDL-2024 LIBRARY; T=293.6K  
deuterons from (n,pd)

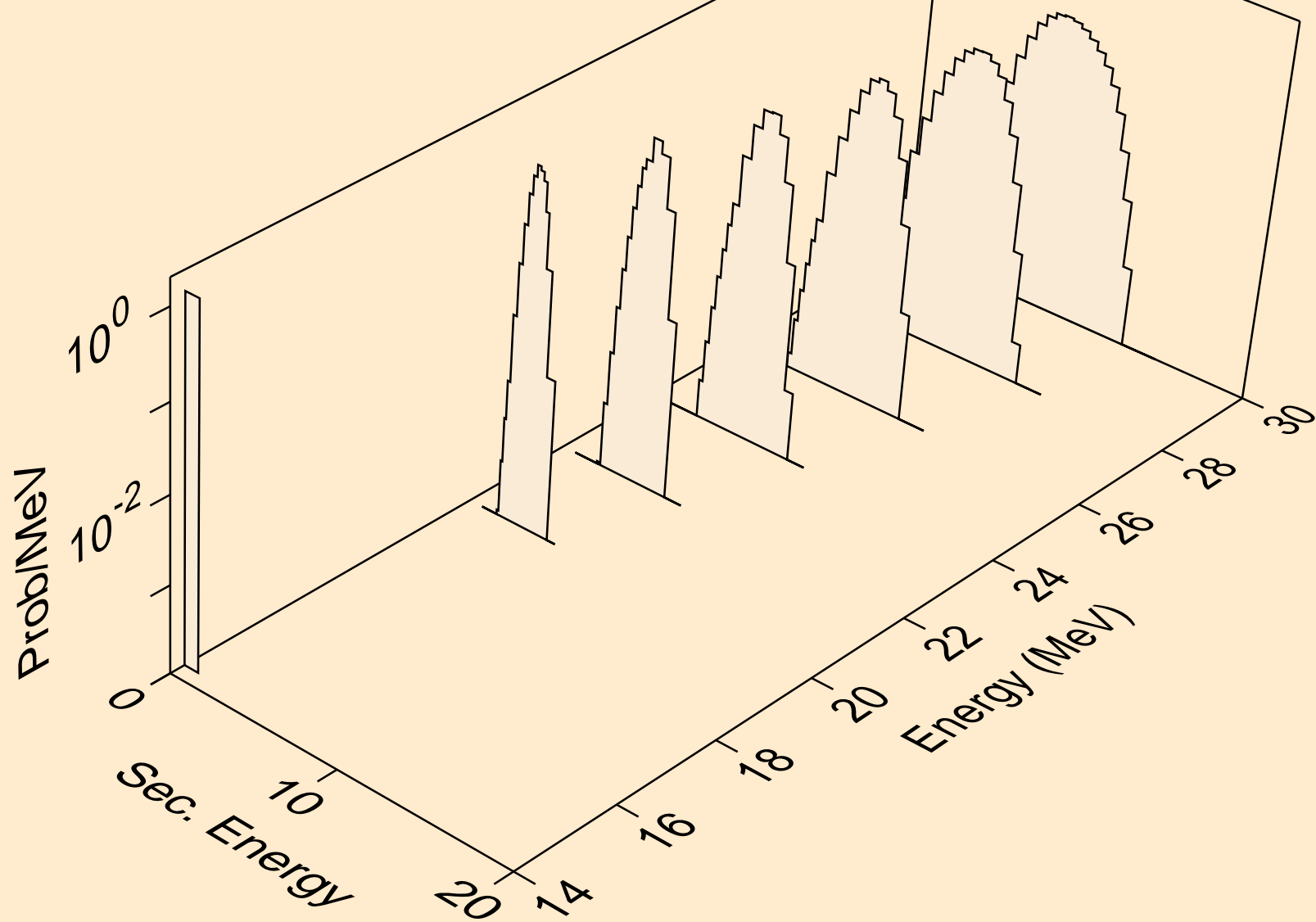

I129 NEUTRON ACER TENDL-2024 LIBRARY; T=293.6K  
deuterons from (n,da)

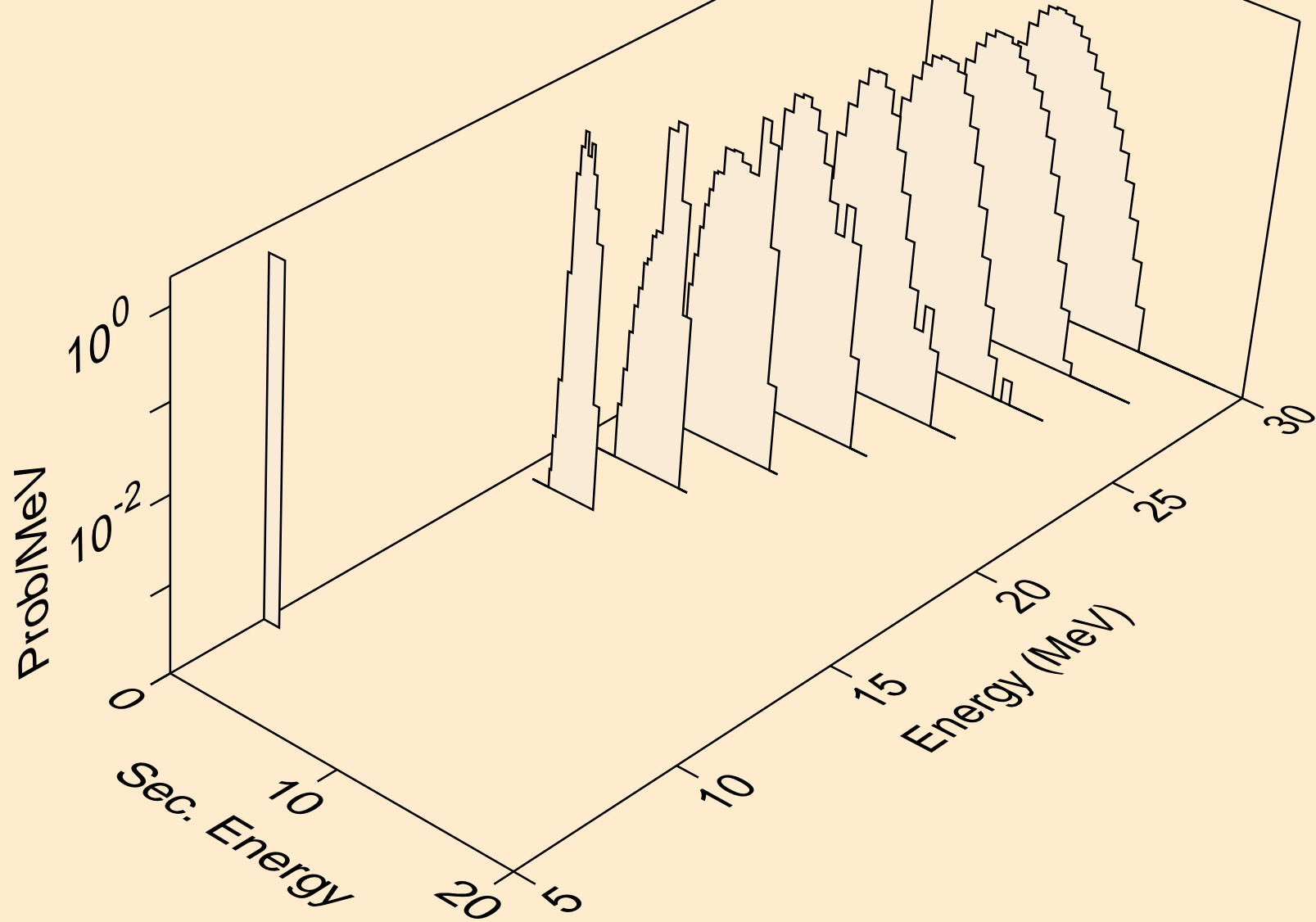

I129 NEUTRON ACER TENDL-2024 LIBRARY; T=293.6K  
tritons from (n,x)

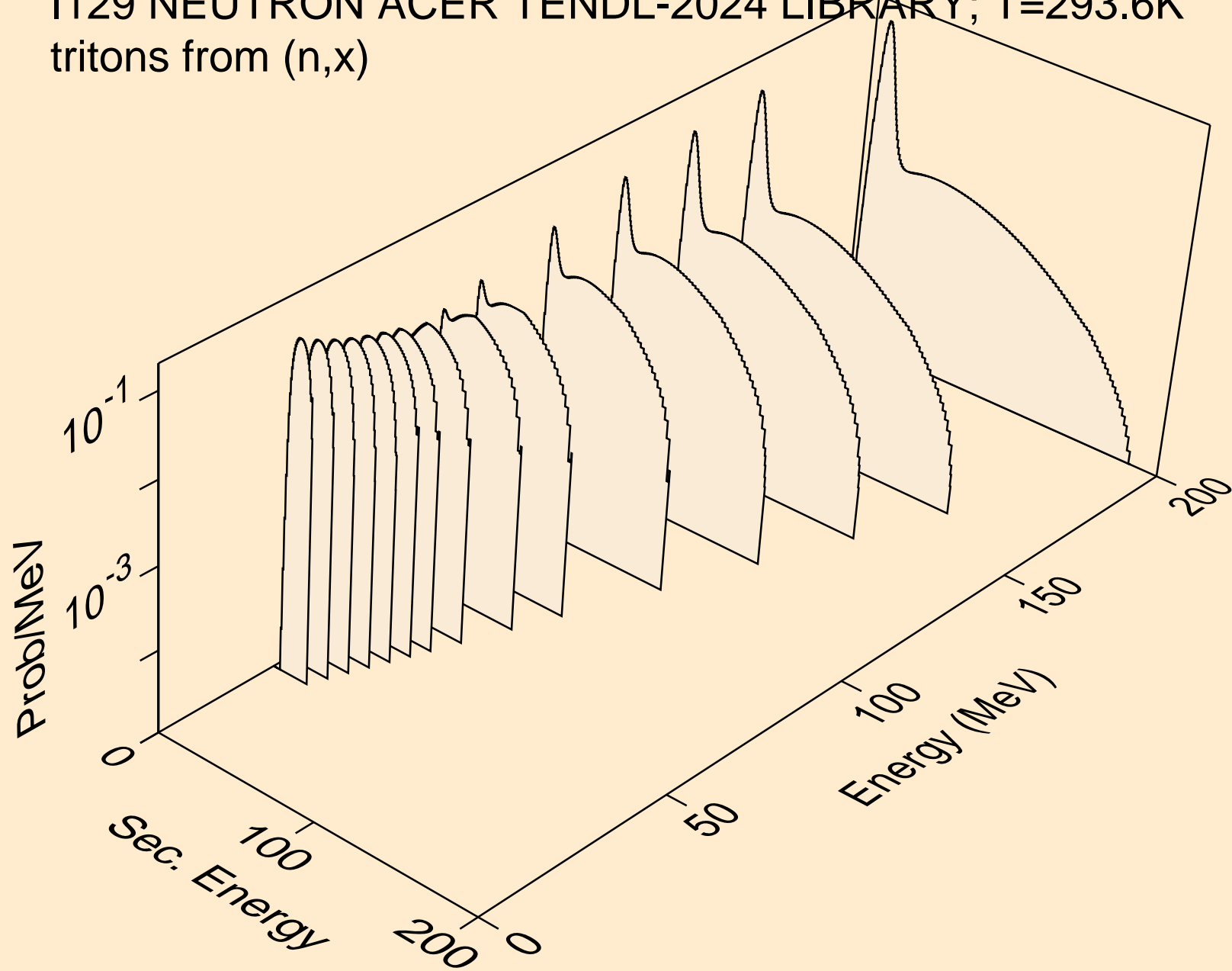

I129 NEUTRON ACER TENDL-2024 LIBRARY; T=293.6K  
tritons from (n,n\*)t

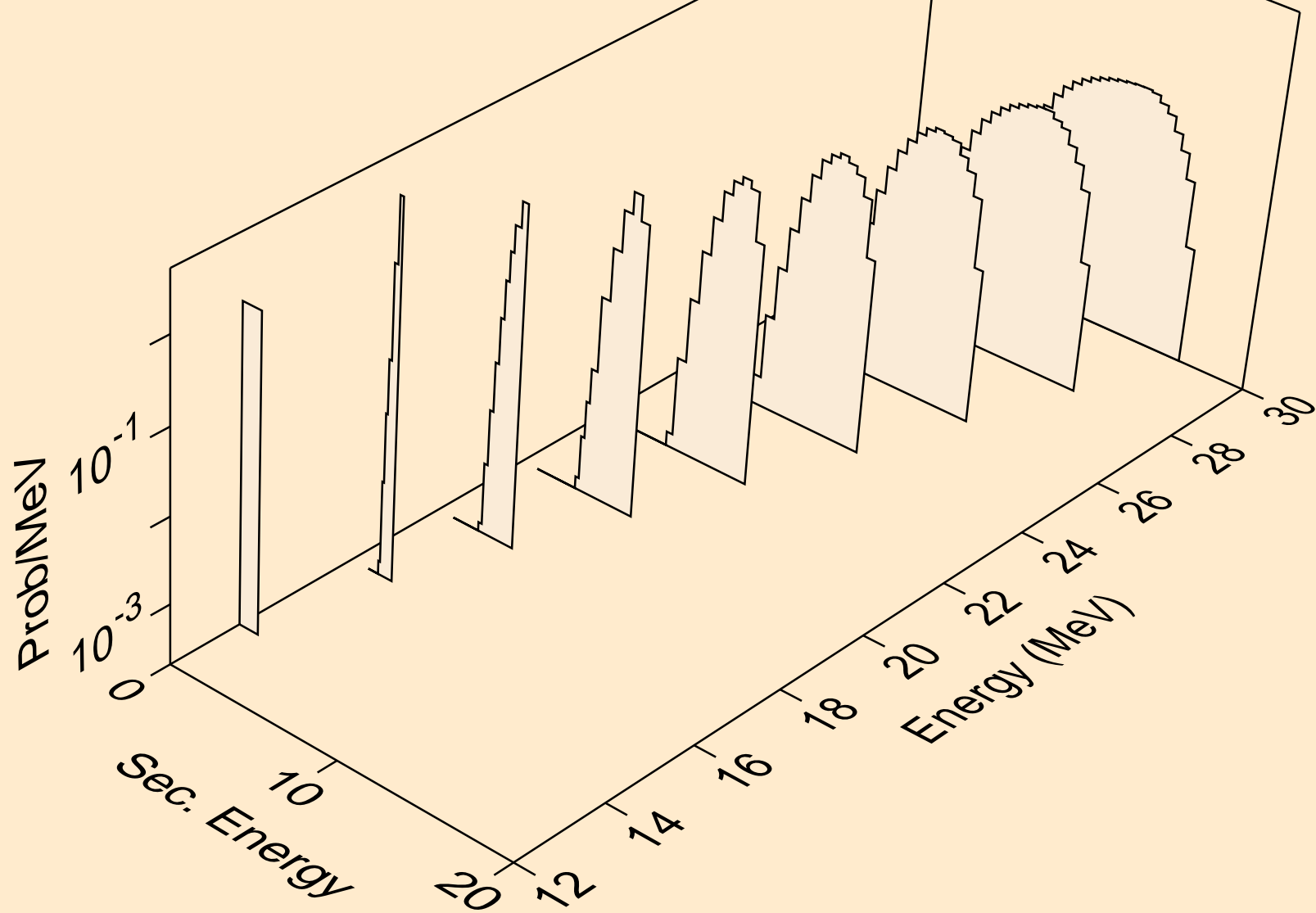

I129 NEUTRON ACER TENDL-2024 LIBRARY; T=293.6K  
tritons from (n,t)

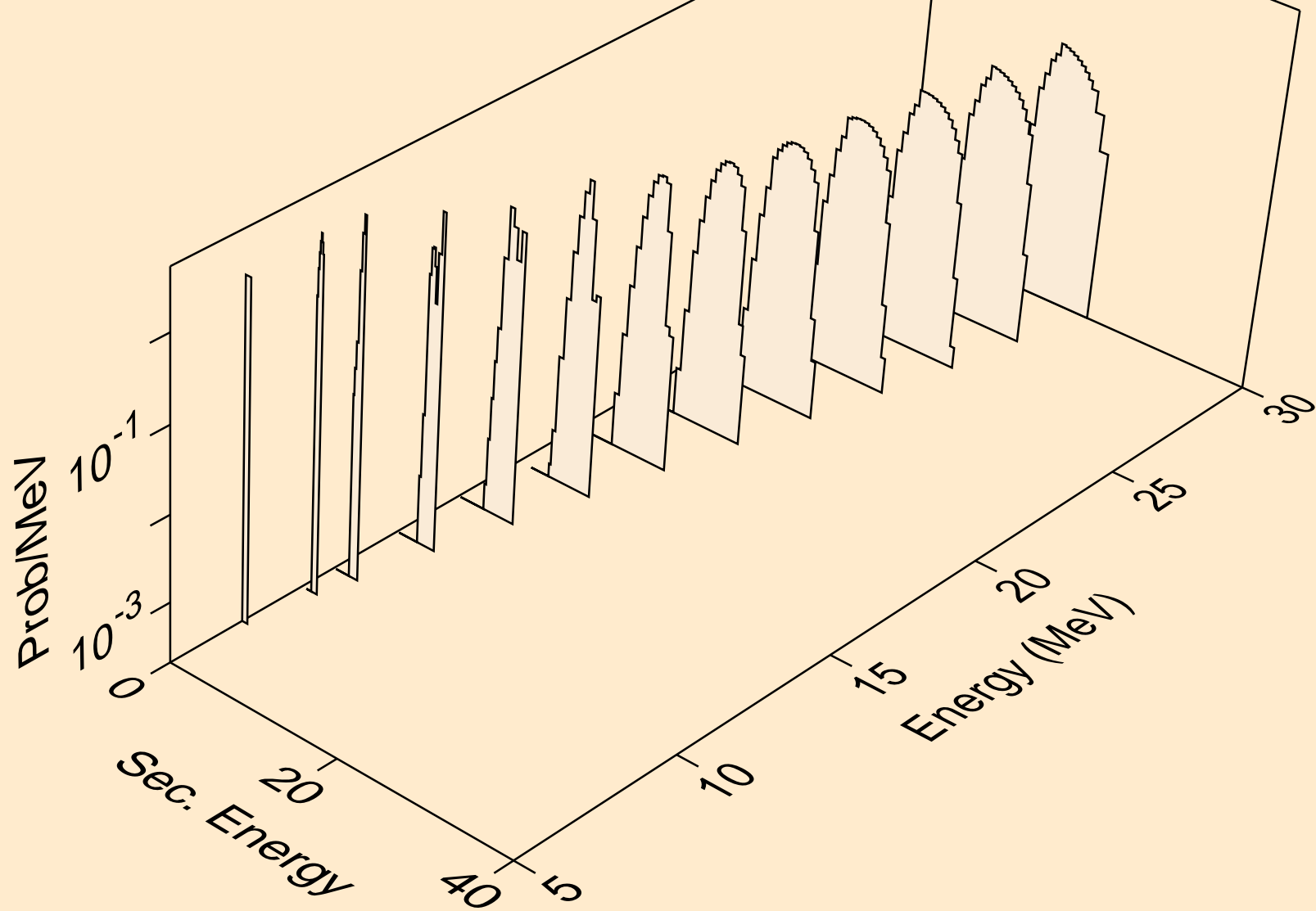

I129 NEUTRON ACER TENDL-2024 LIBRARY; T=293.6K  
tritons from (n,pt)

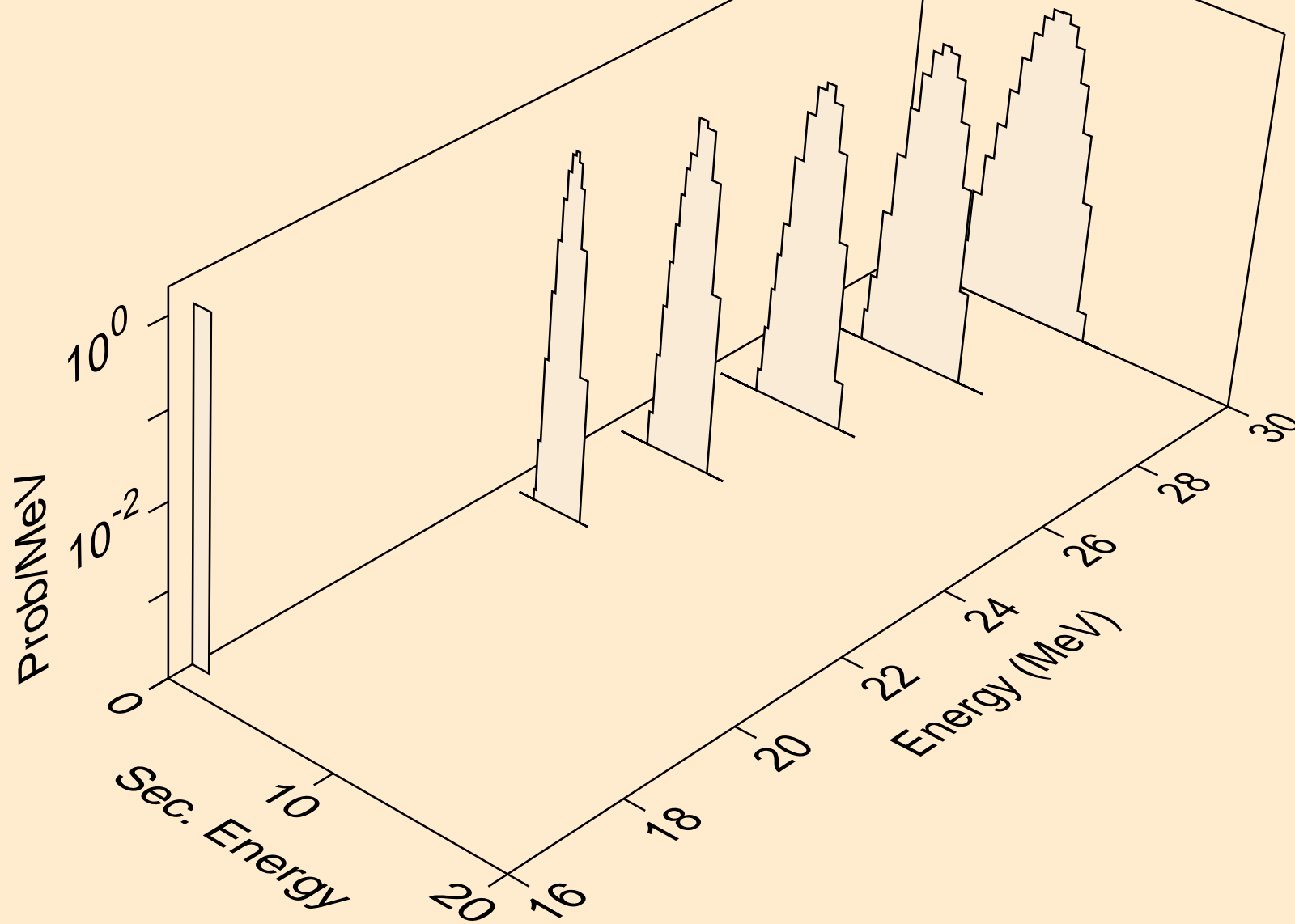

I129 NEUTRON ACER TENDL-2024 LIBRARY; T=293.6K  
he3s from (n,x)

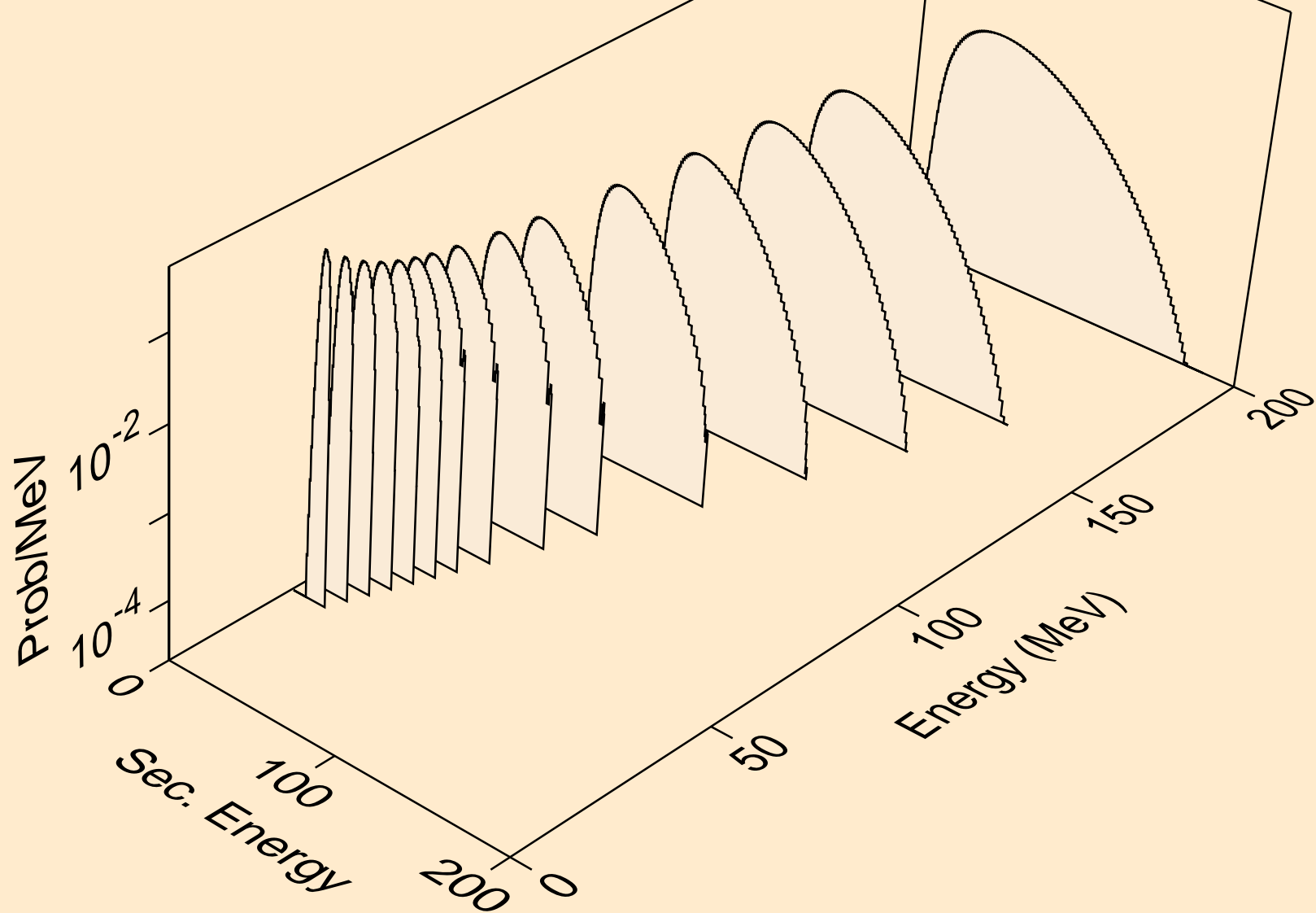

I129 NEUTRON ACER TENDL-2024 LIBRARY; T=293.6K  
he3s from (n,n\*)he3

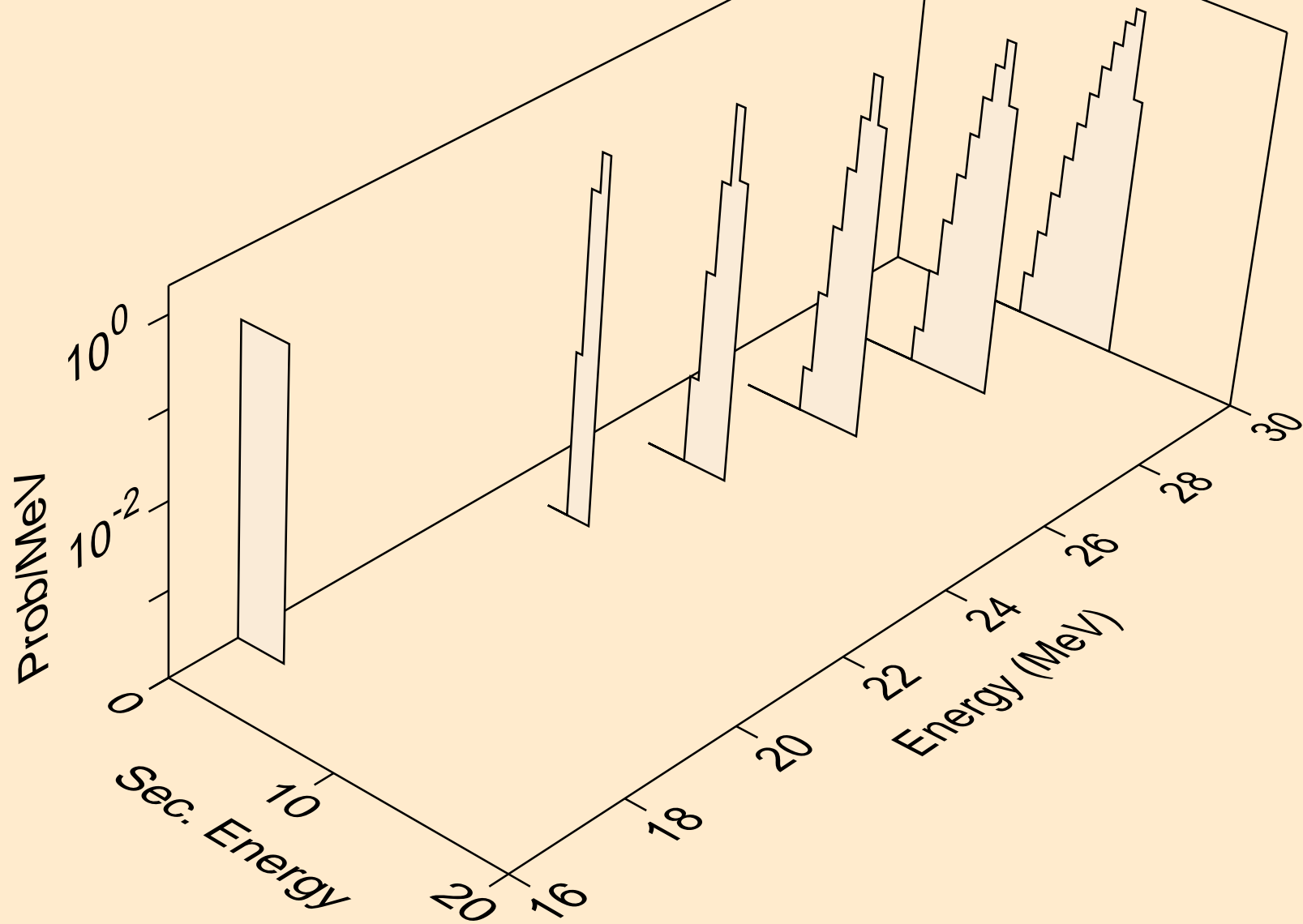

I129 NEUTRON ACER TENDL-2024 LIBRARY; T=293.6K  
he3s from (n,he3)

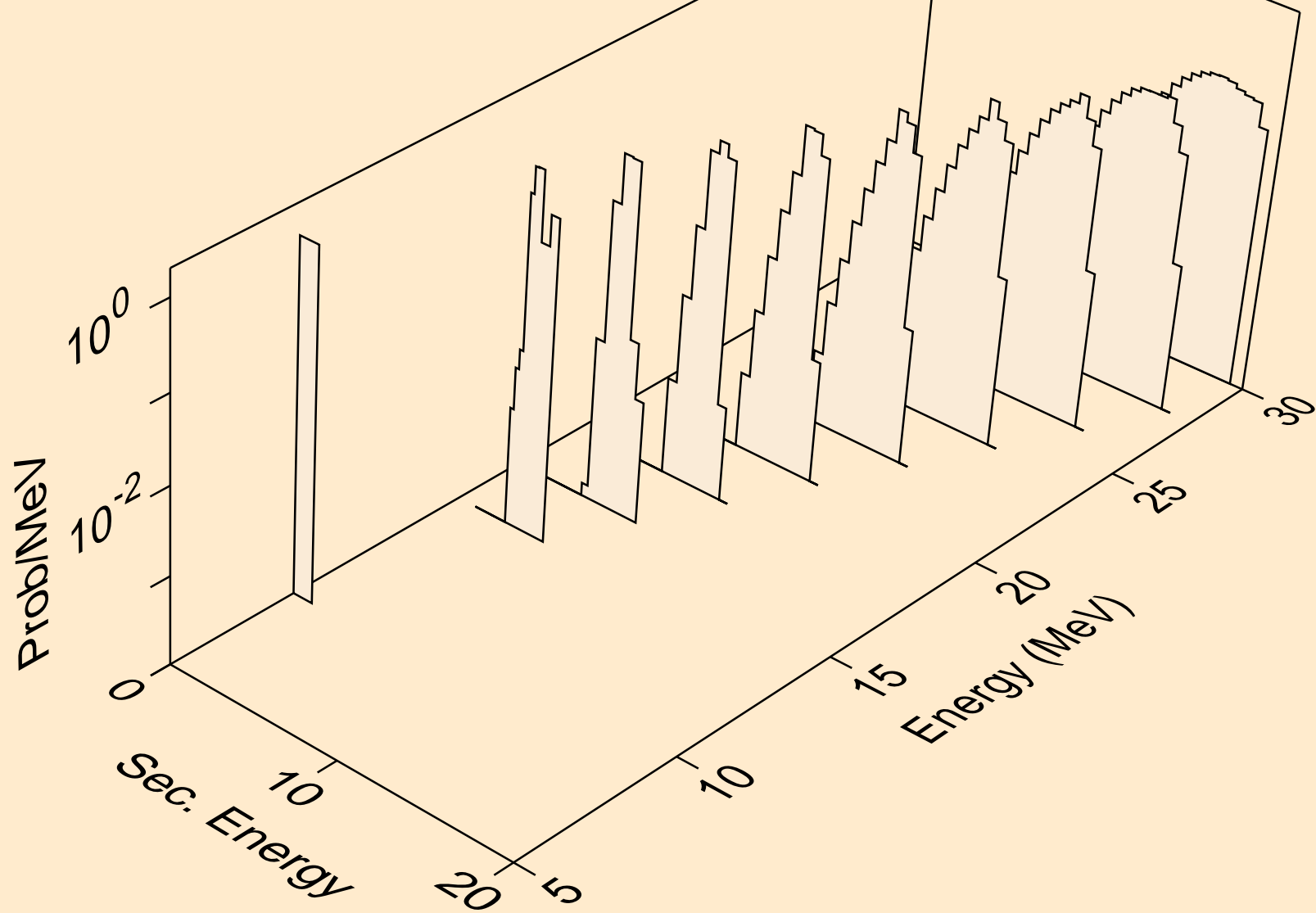

I129 NEUTRON ACER TENDL-2024 LIBRARY; T=293.6K  
alphas from (n,x)

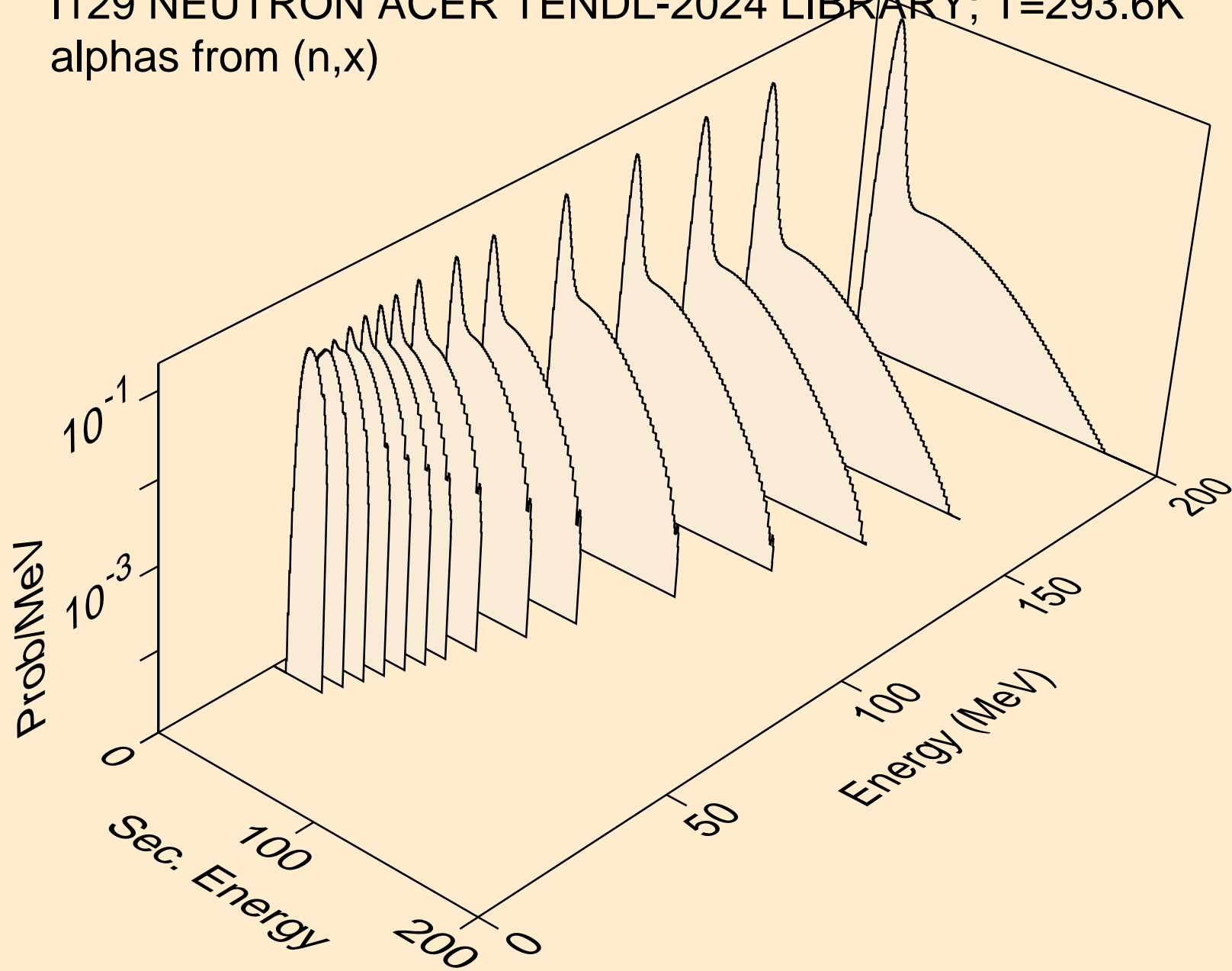

I129 NEUTRON ACER TENDL-2024 LIBRARY; T=293.6K  
alphas from (n,n\*)a

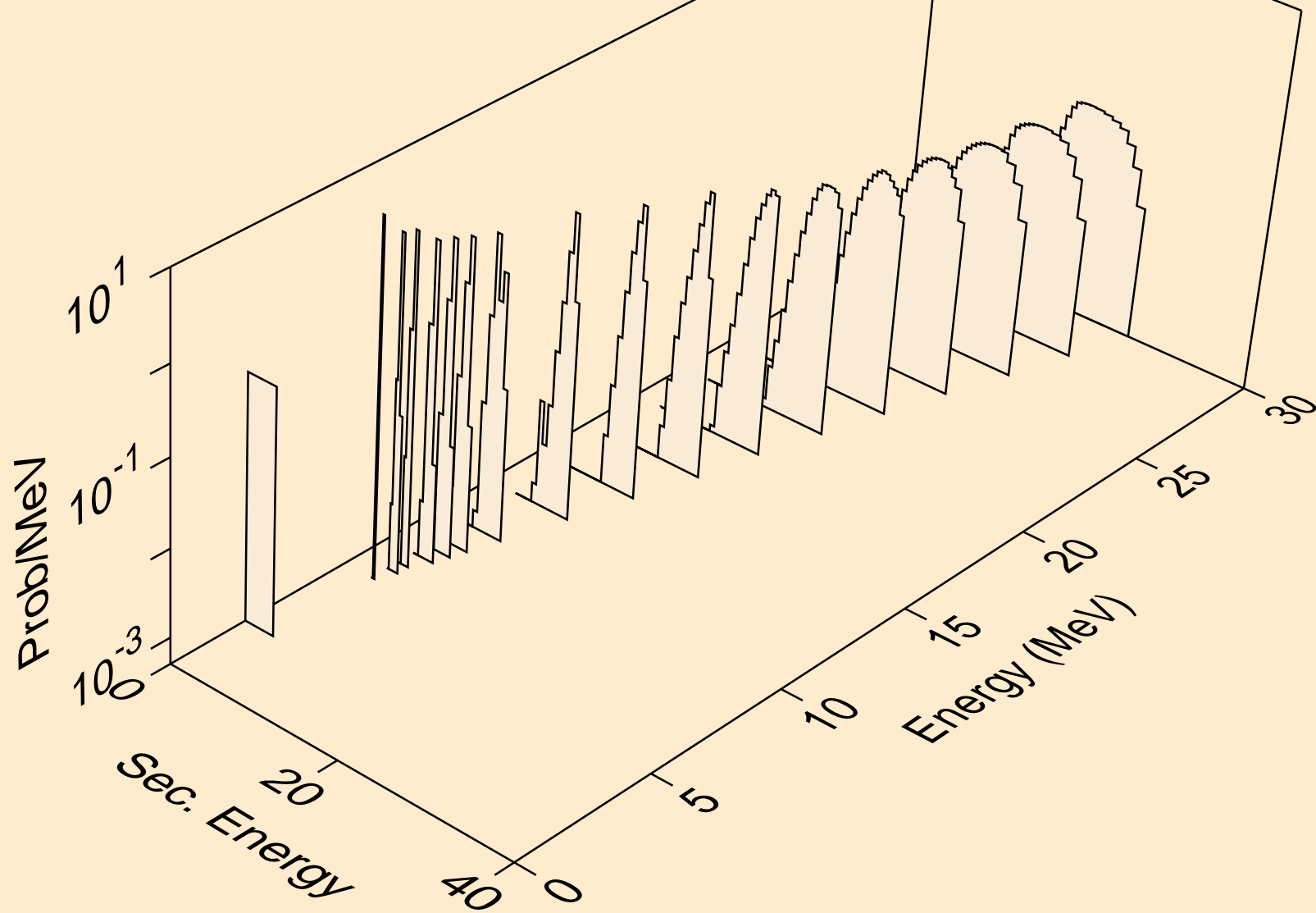

I129 NEUTRON ACER TENDL-2024 LIBRARY; T=293.6K  
alphas from (n,2n)a

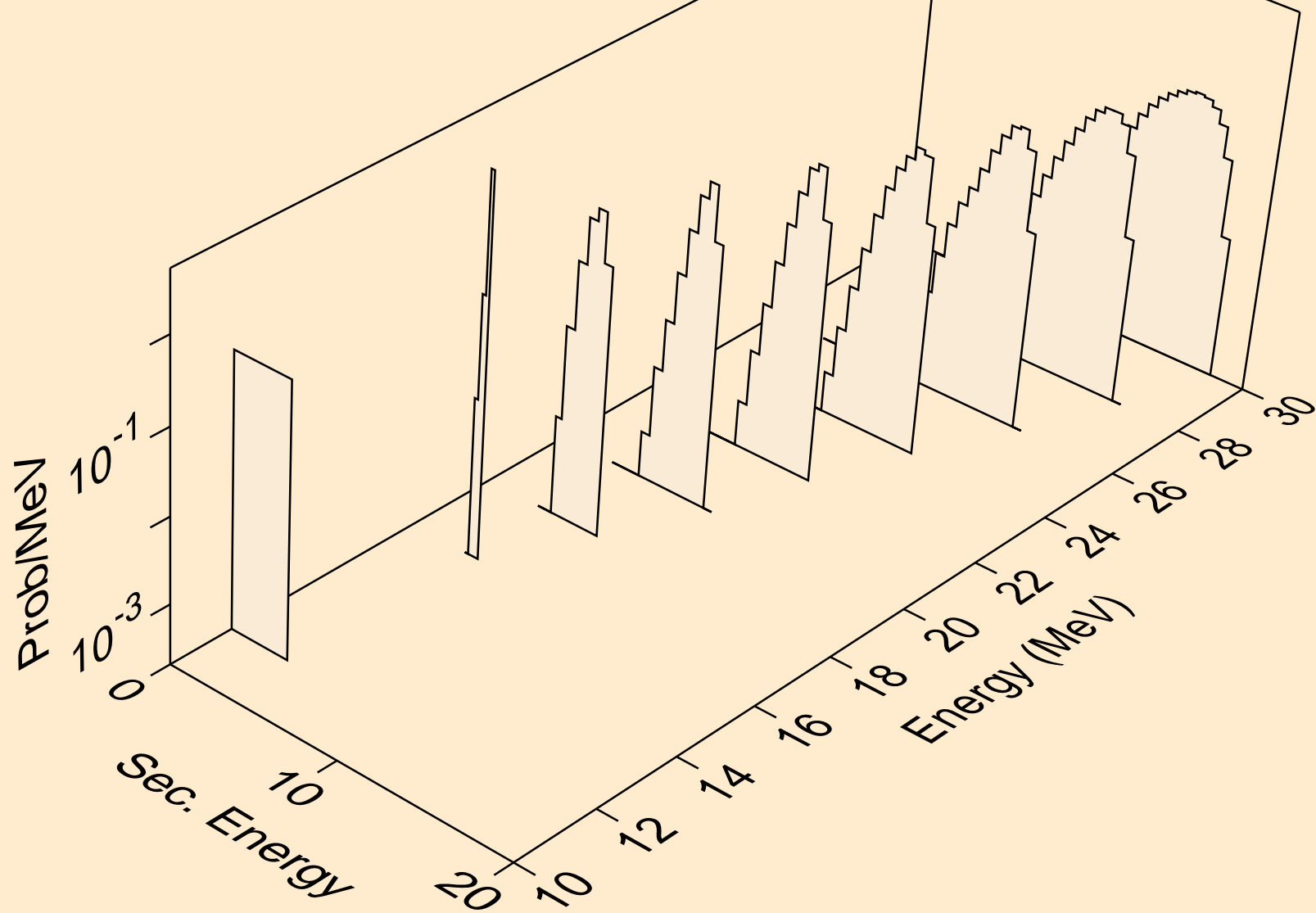

I129 NEUTRON ACER TENDL-2024 LIBRARY; T=293.6K  
alphas from (n,3n)a

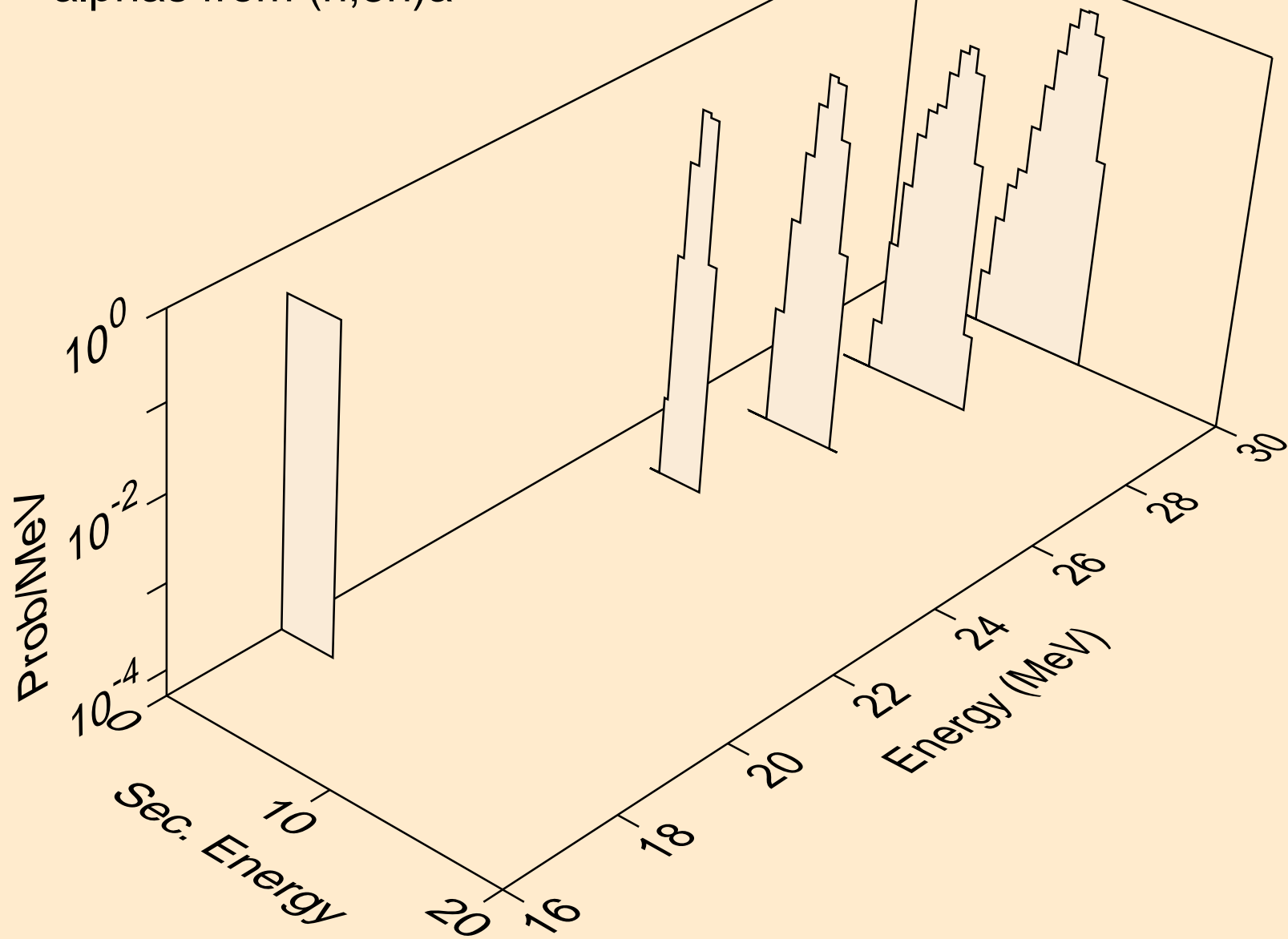

I129 NEUTRON ACER TENDL-2024 LIBRARY; T=293.6K  
alphas from (n,npa)

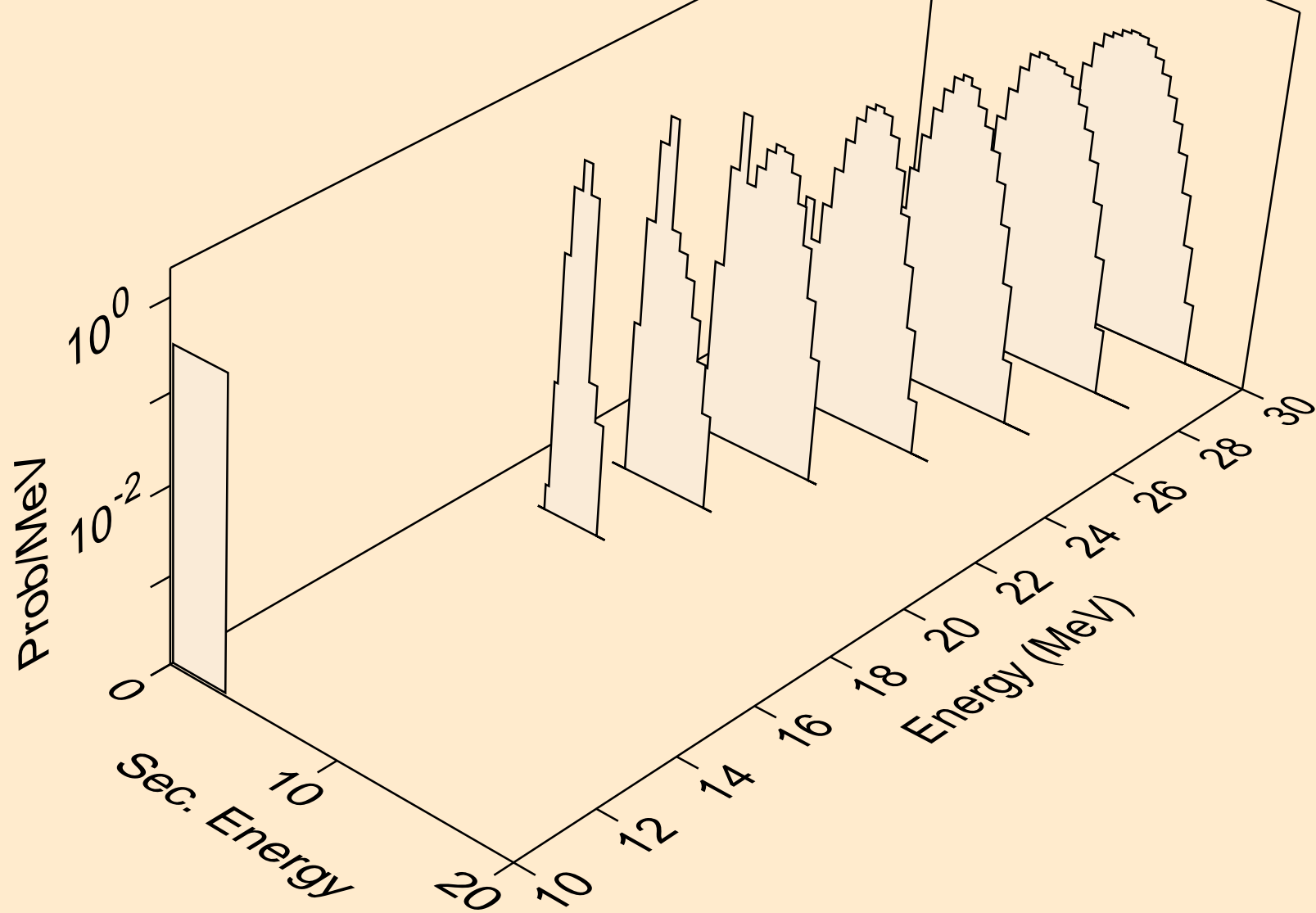

I129 NEUTRON ACER TENDL-2024 LIBRARY; T=293.6K  
alphas from (n,a)

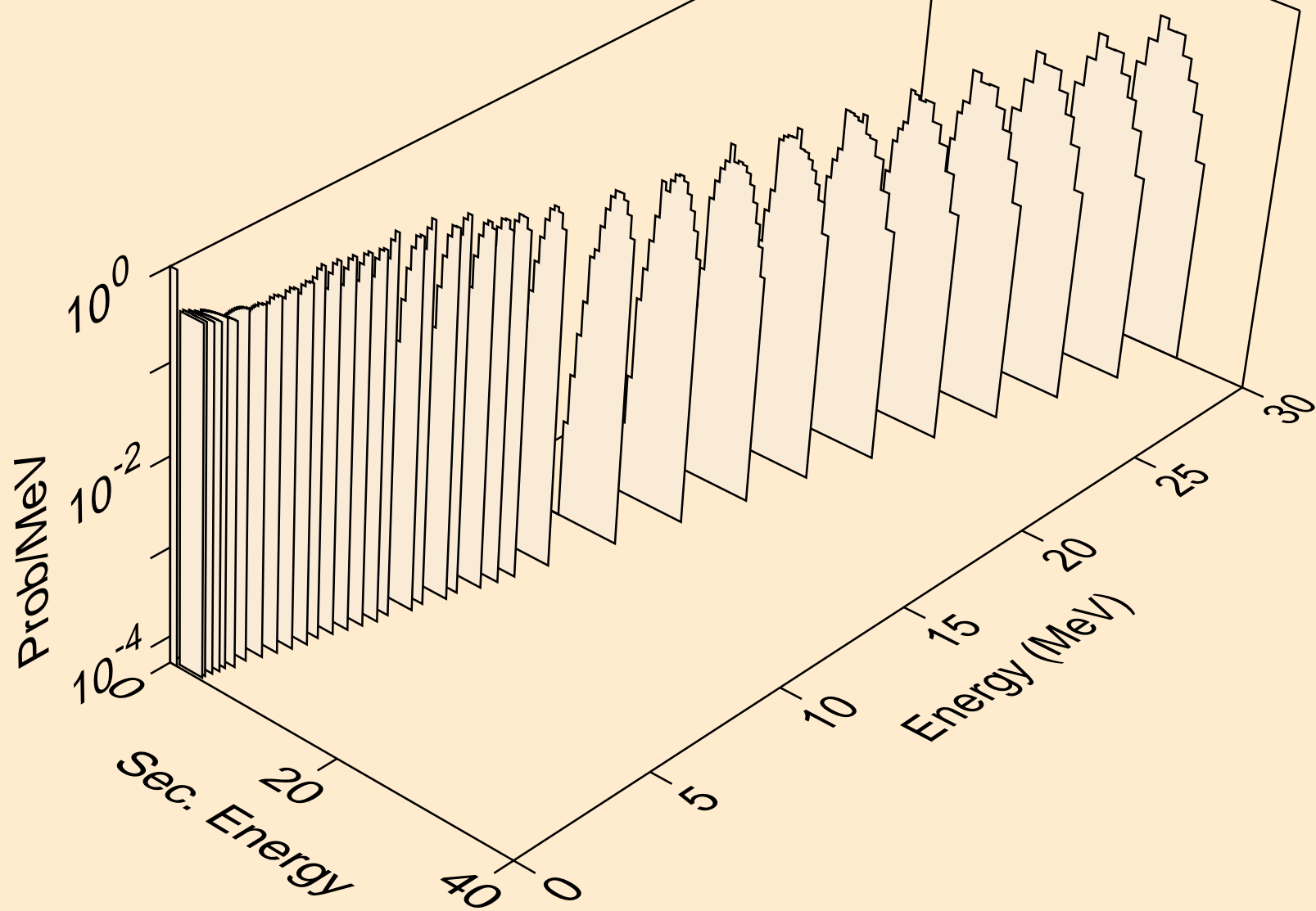

I129 NEUTRON ACER TENDL-2024 LIBRARY; T=293.6K  
alphas from (n,pa)

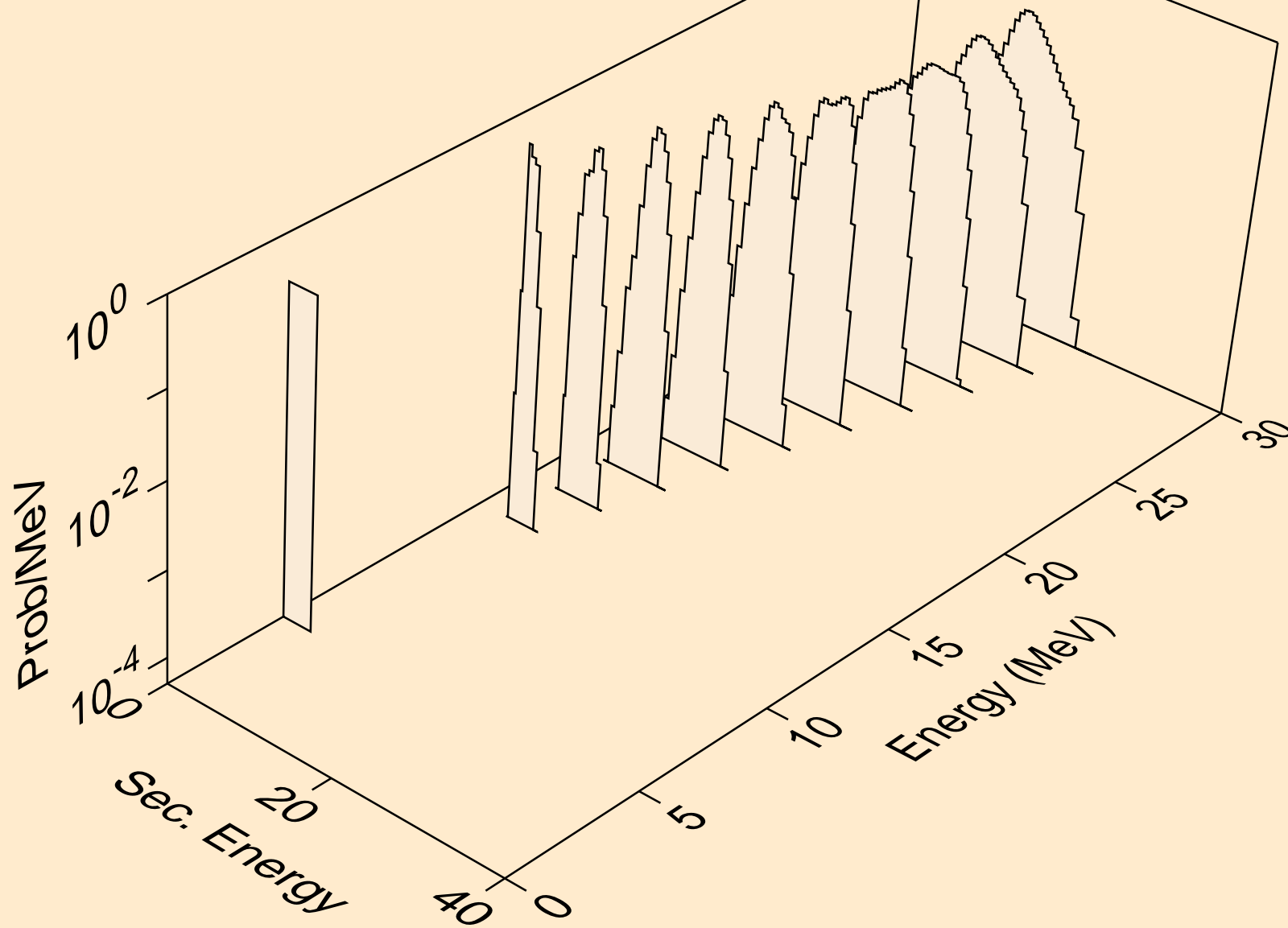

I129 NEUTRON ACER TENDL-2024 LIBRARY; T=293.6K  
alphas from (n,da)

