

Program EVALPLOT
(Version 2021-1)

by

Dermott E. Cullen
(Present Contact Information)

Dermott E. Cullen
1466 Hudson Way
Livermore, CA 94550
U.S.A.

Tele: 925-443-1911

E.Mail:redcullen1@comcast.net

Web:redcullen1.net/HOMEPAGE.NEW

Press Mouse Button to Start

MAT 7707

Neutron Major
293 Kelvin Cross Sections

77-Ir-185

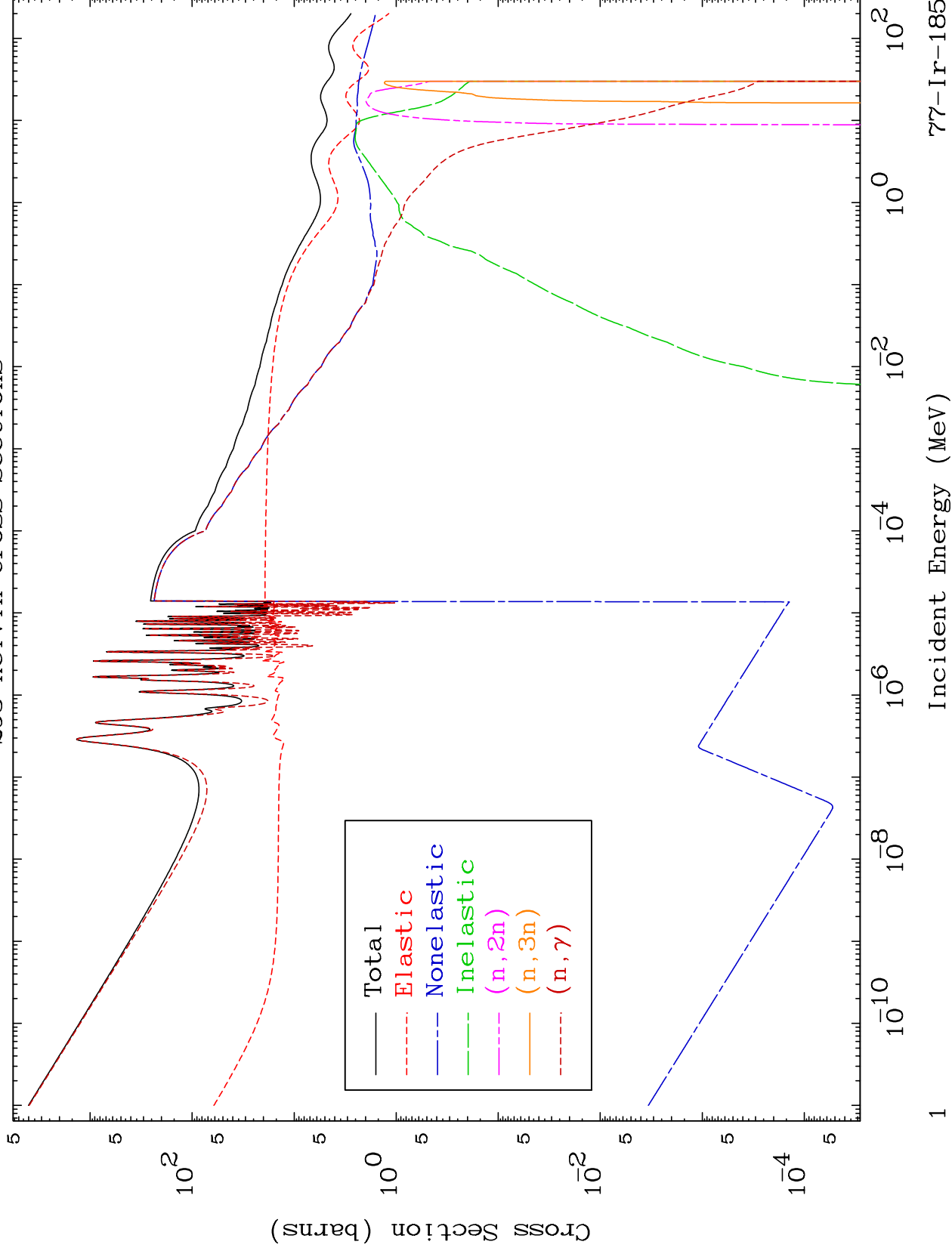

MAT 7707

Neutron Absorption
293 Kelvin Cross Sections

77-Ir-185

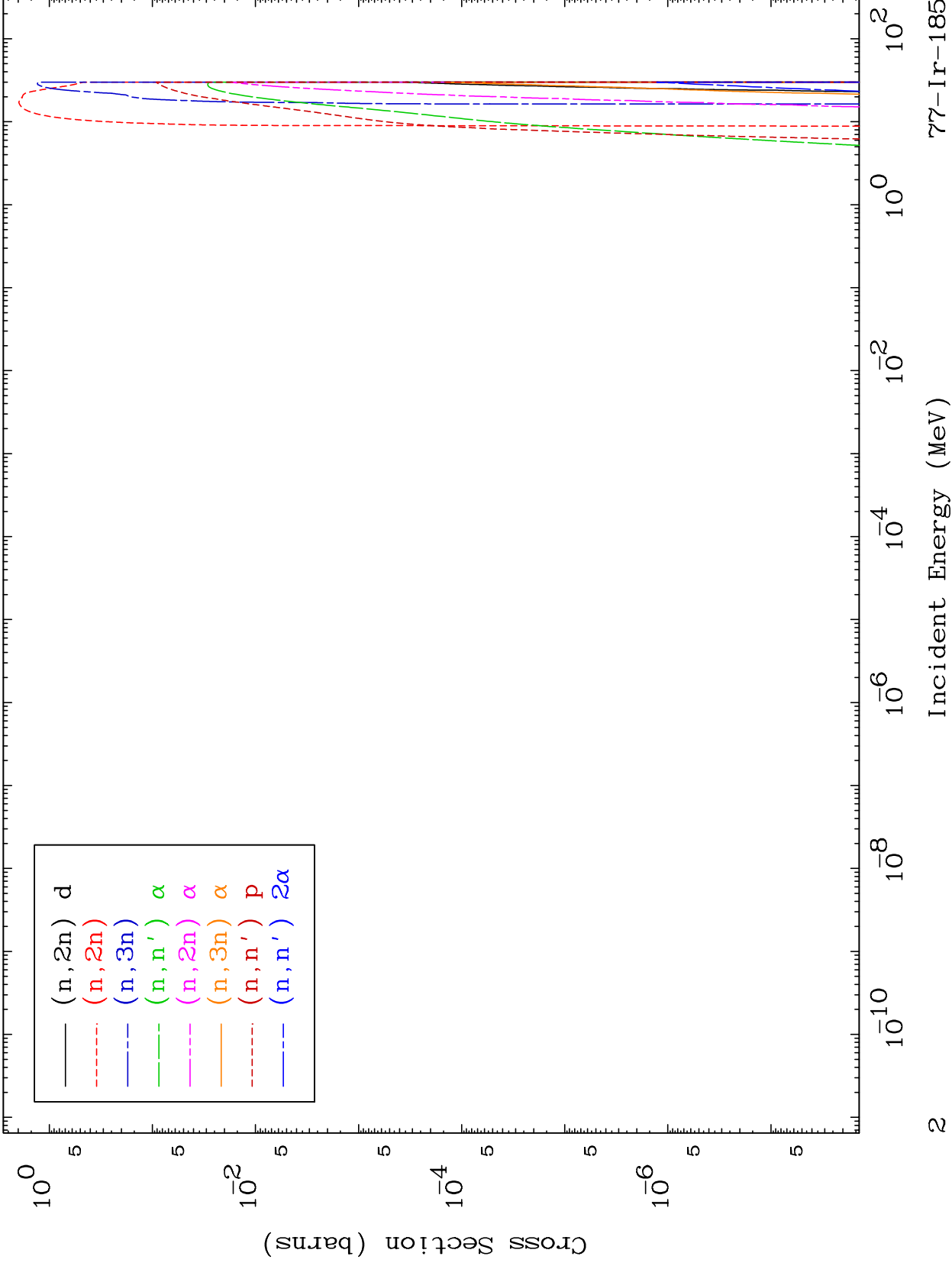

MAT 7707

Neutron Absorption
293 Kelvin Cross Sections

77-Ir-185

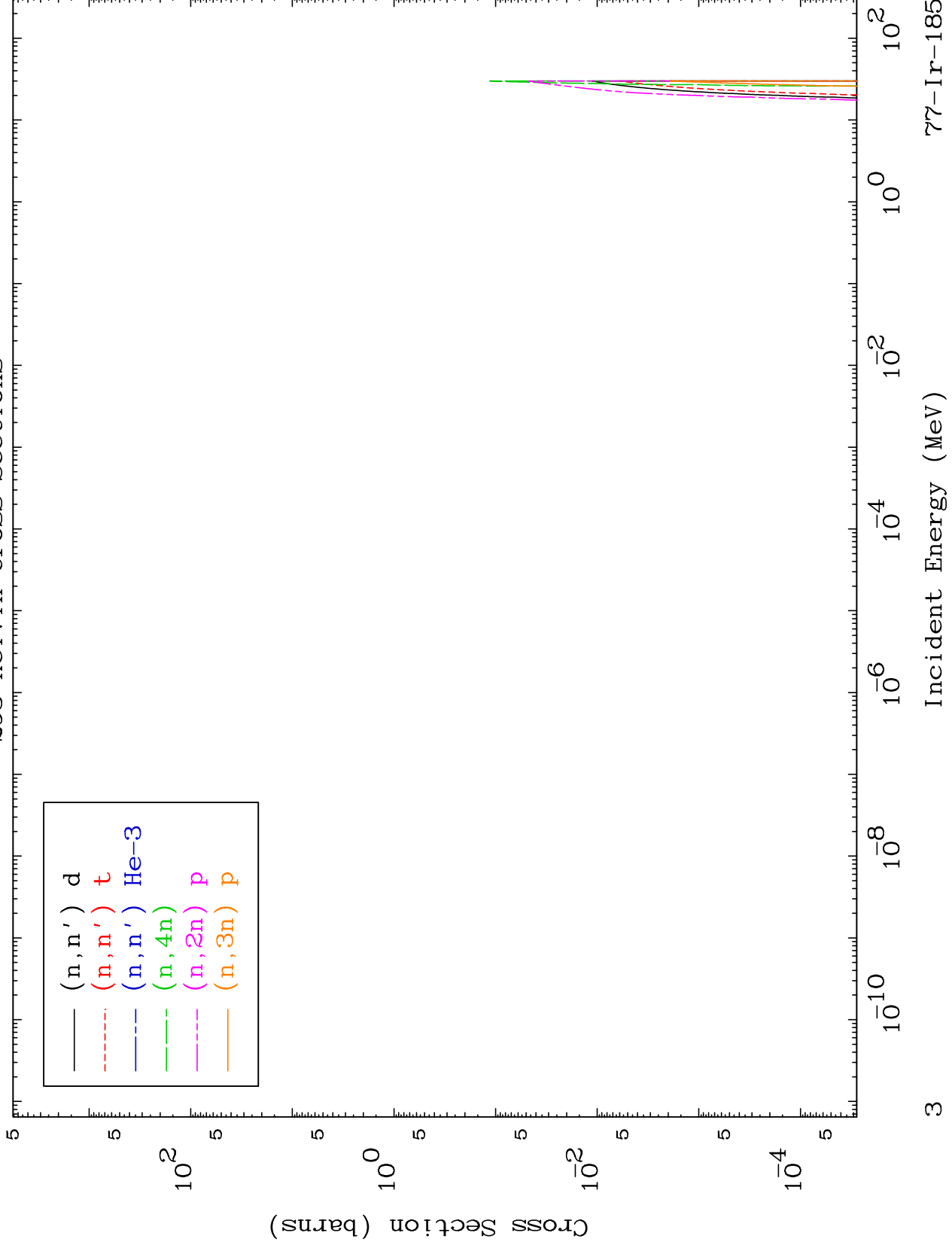

MAT 7707

Neutron Absorption
293 Kelvin Cross Sections

77-Ir-185

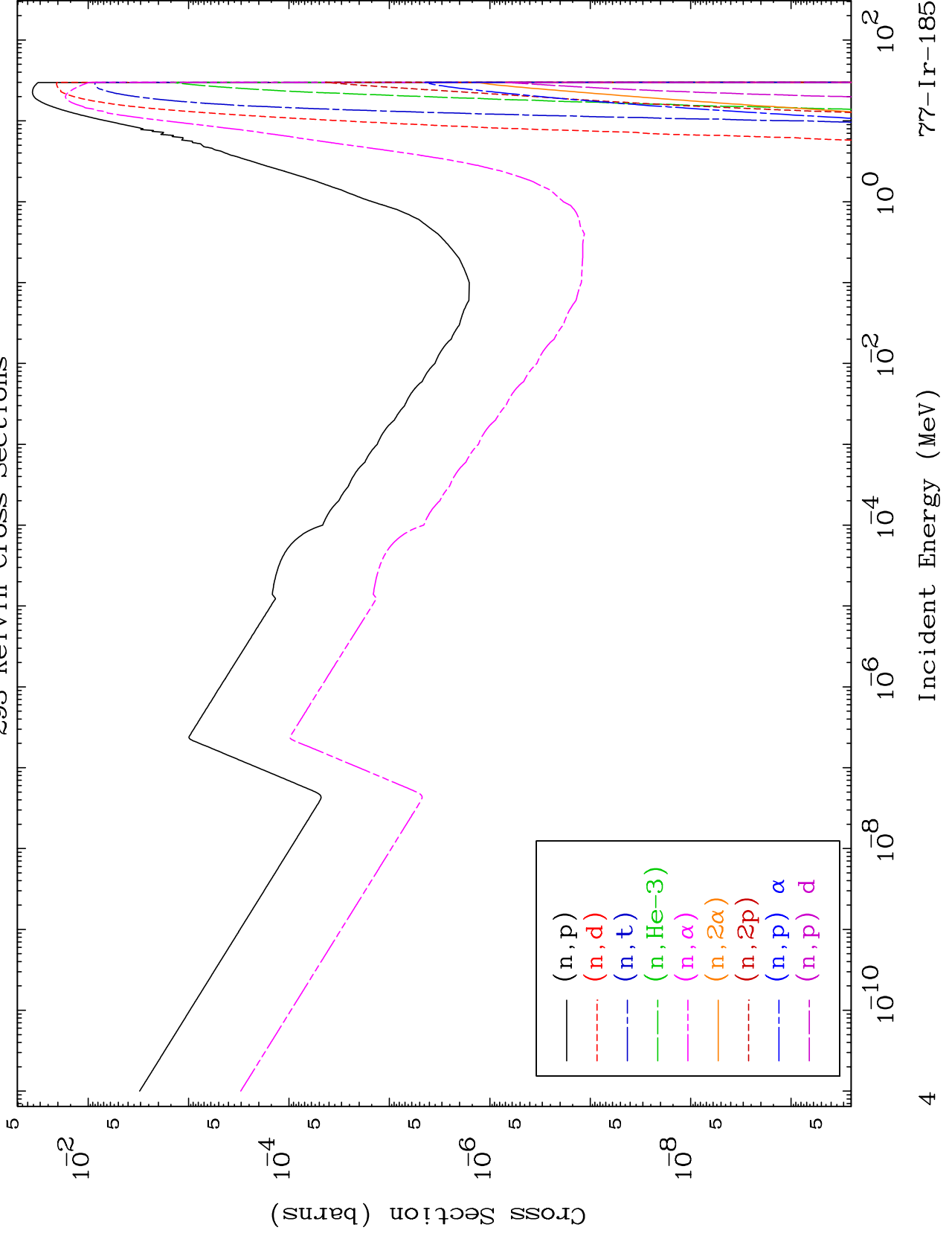

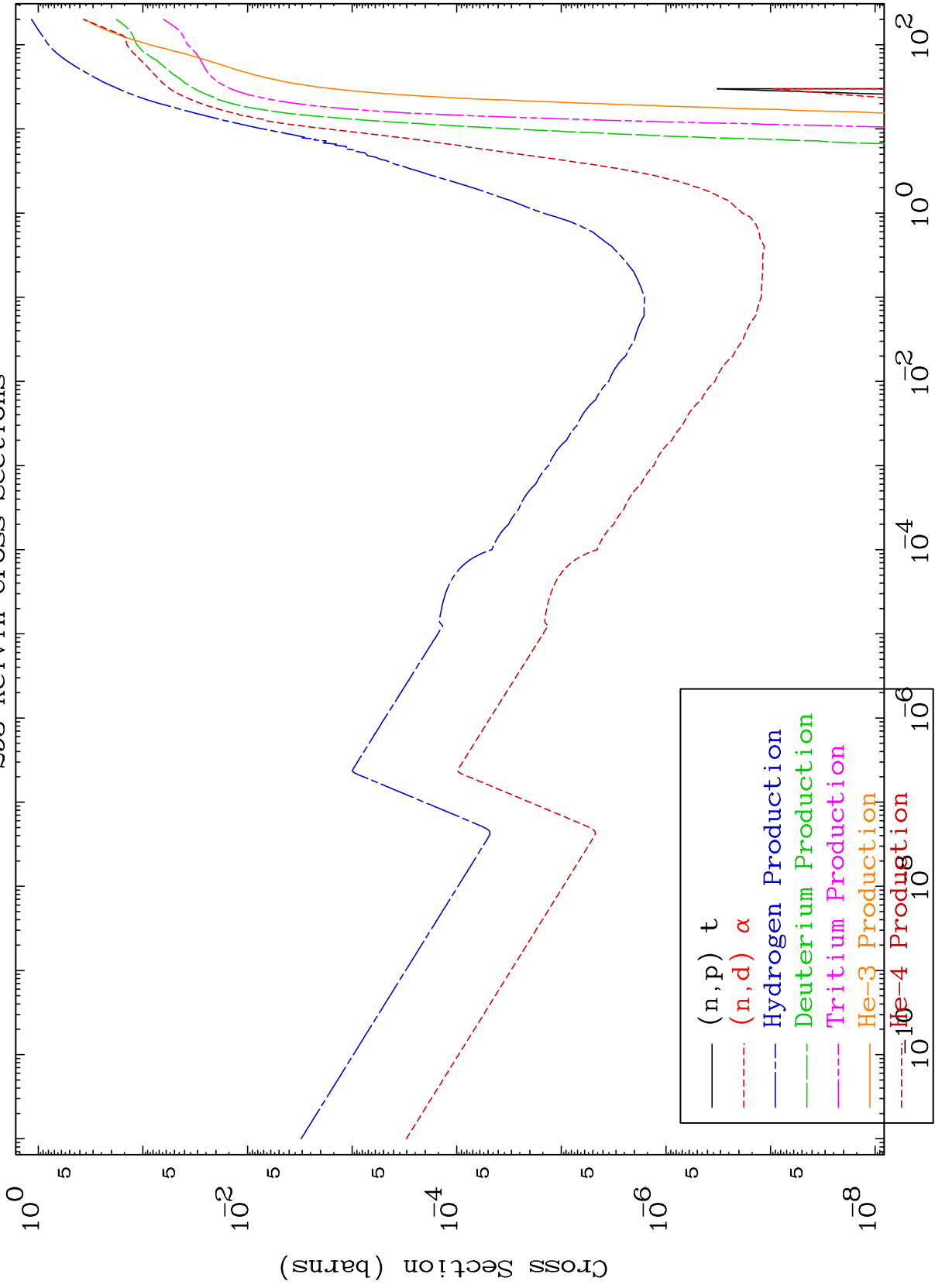

MAT 7707

Charged Particle
293 Kelvin Cross Sections

77-Ir-185

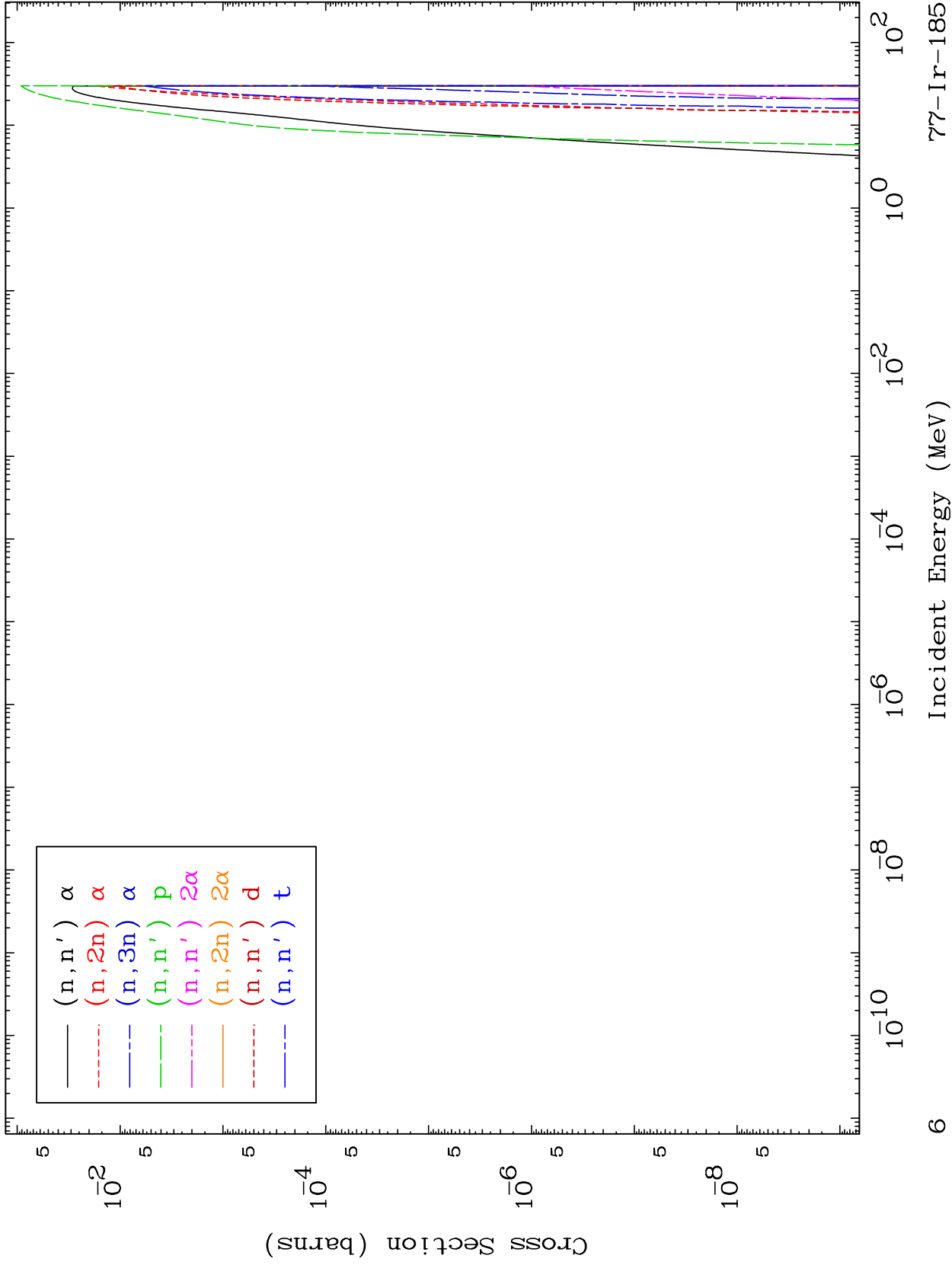

MAT 7707

Charged Particle
293 Kelvin Cross Sections

77-Ir-185

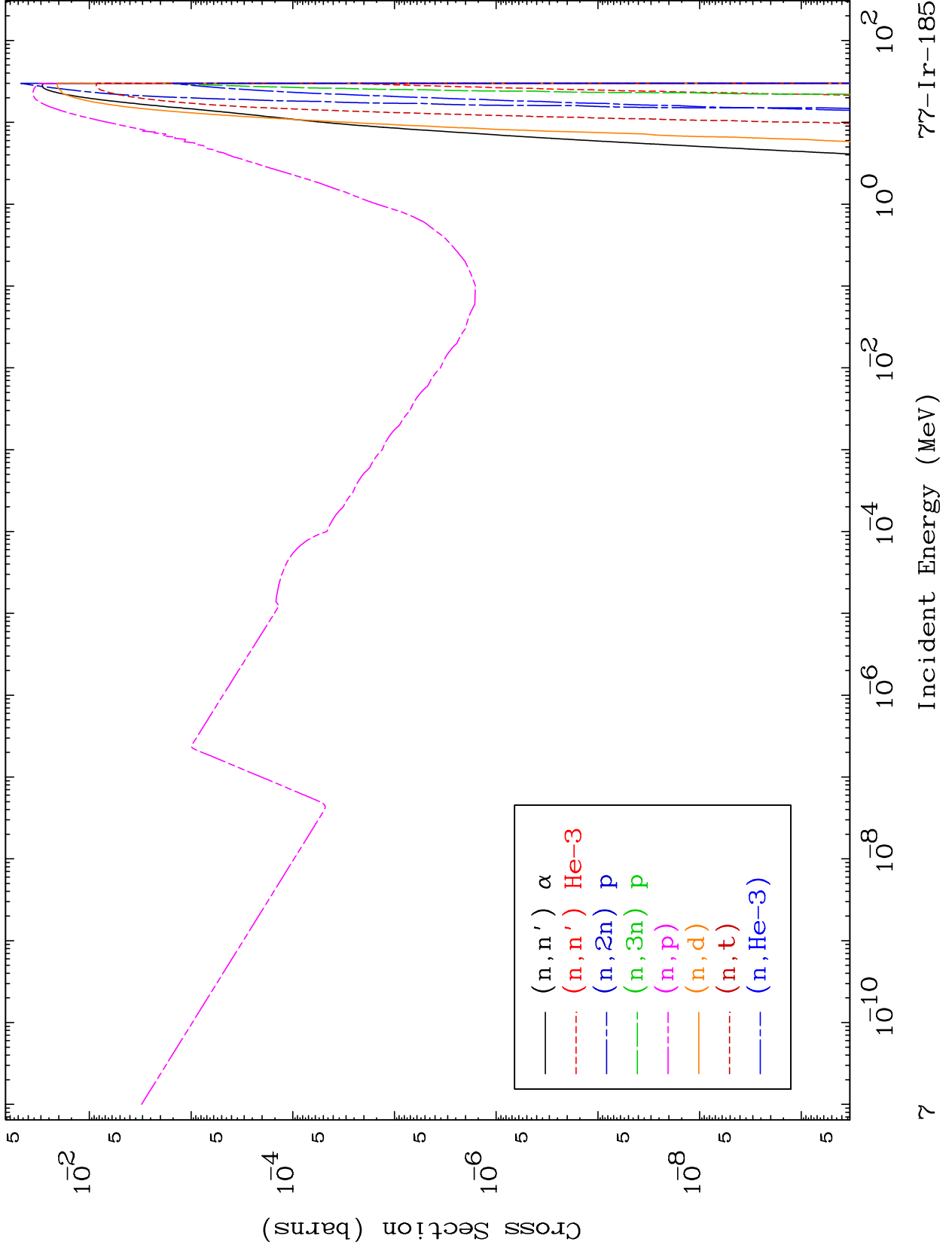

MAT 7707

Charged Particle
293 Kelvin Cross Sections

77-Ir-185

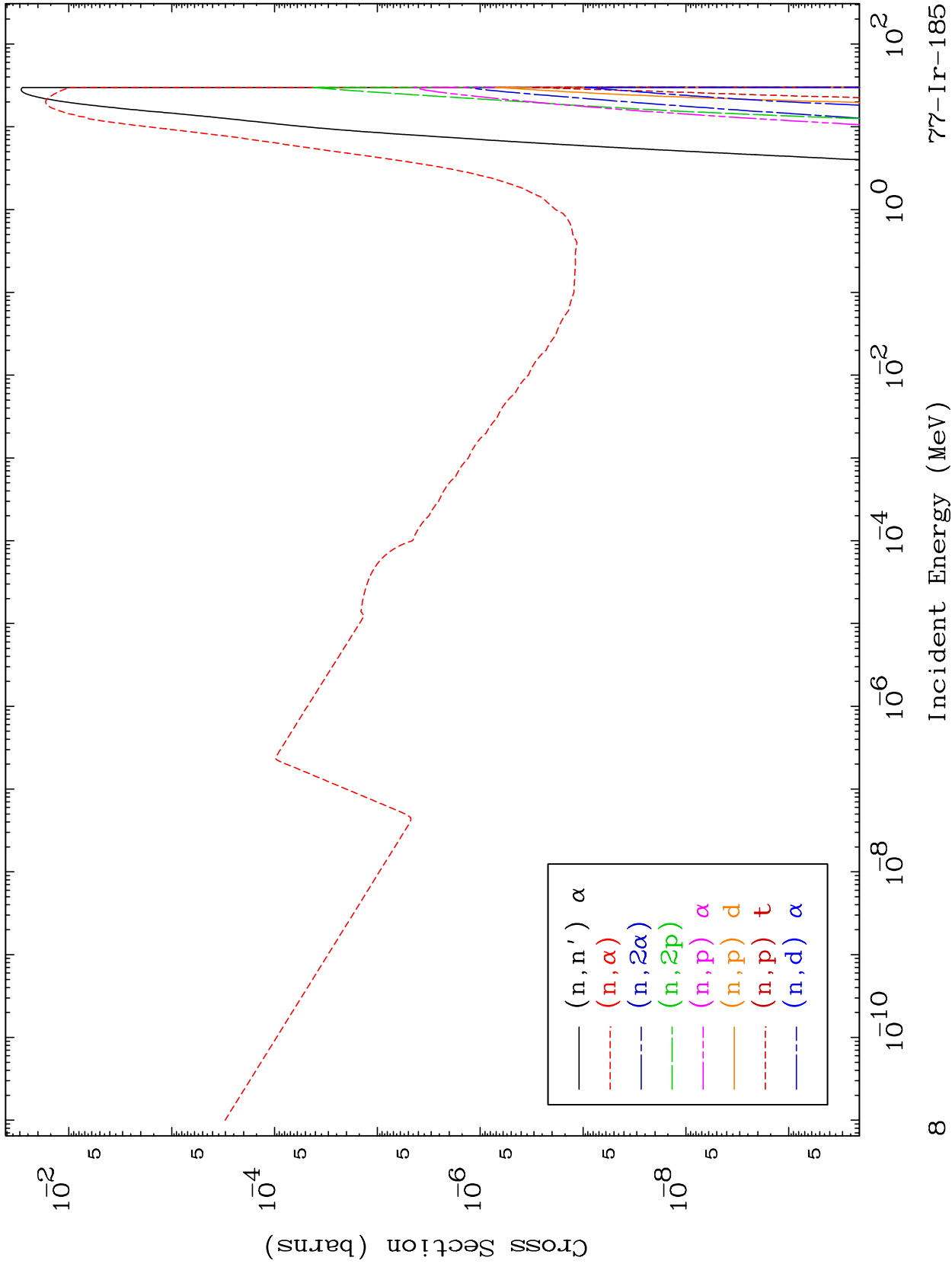

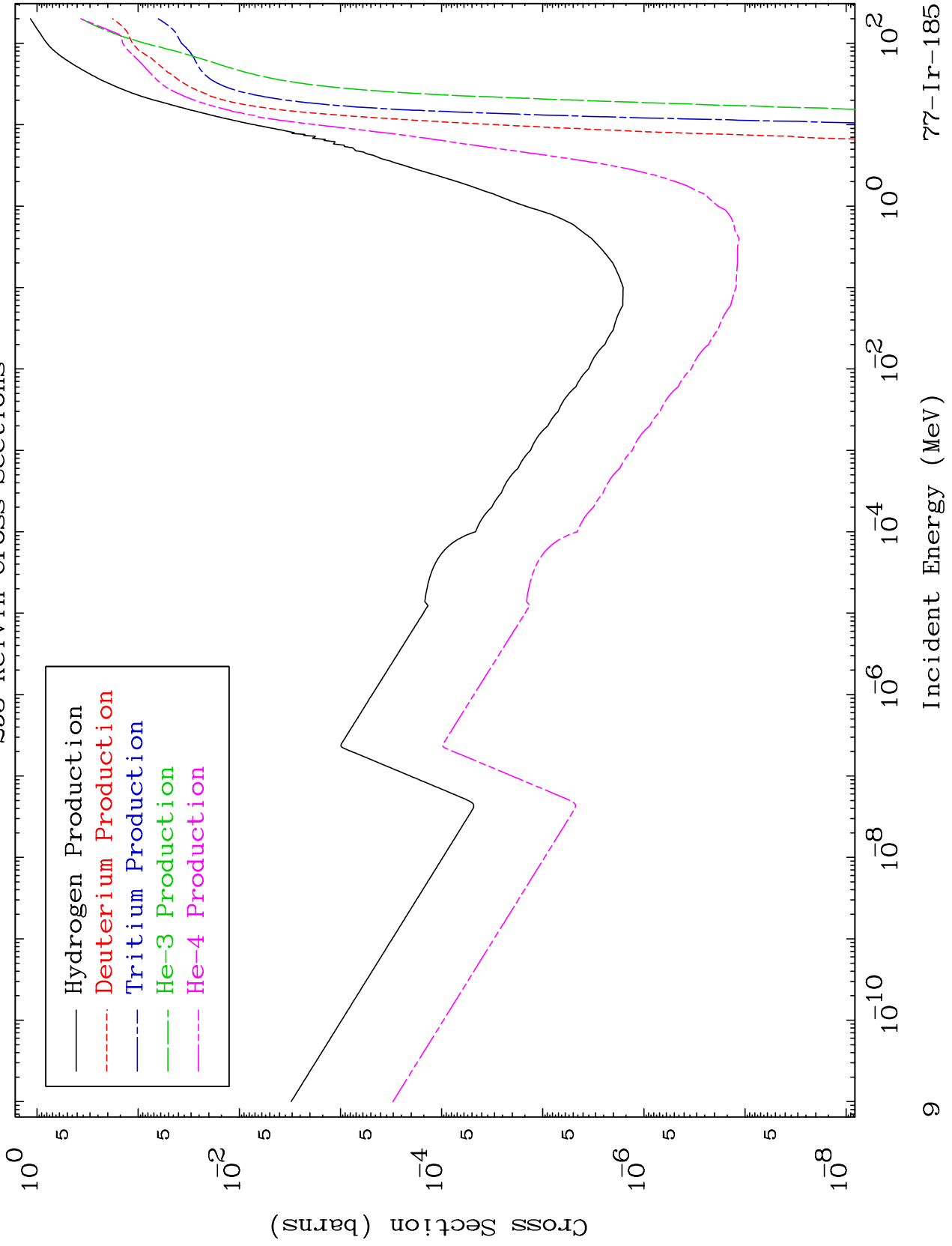

MAT 7707

(n,n') Levels
293 Kelvin Cross Sections

77-Ir-185

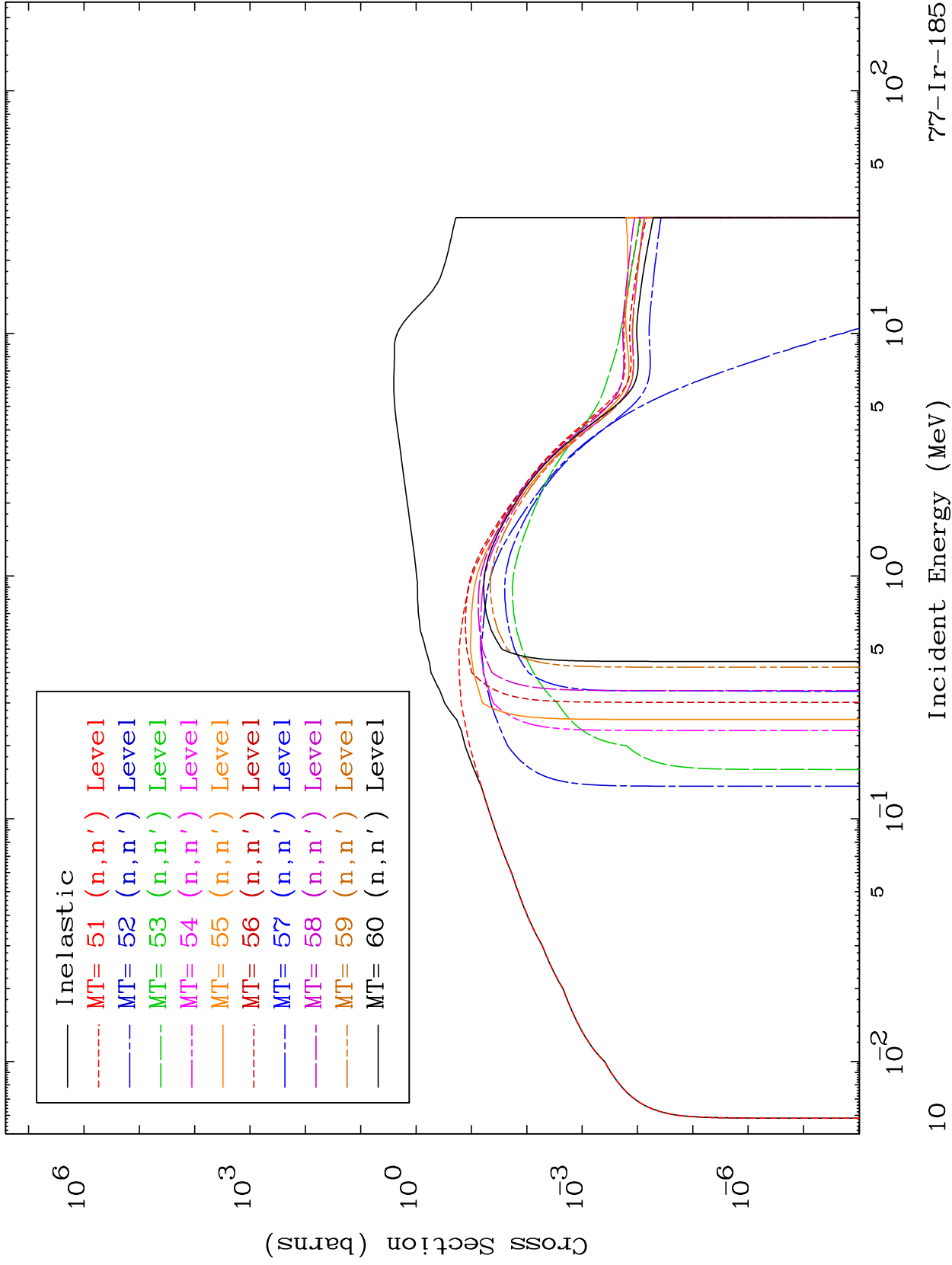

77-Ir-185

MAT 7707

(n,n') Levels
293 Kelvin Cross Sections

77-Ir-185

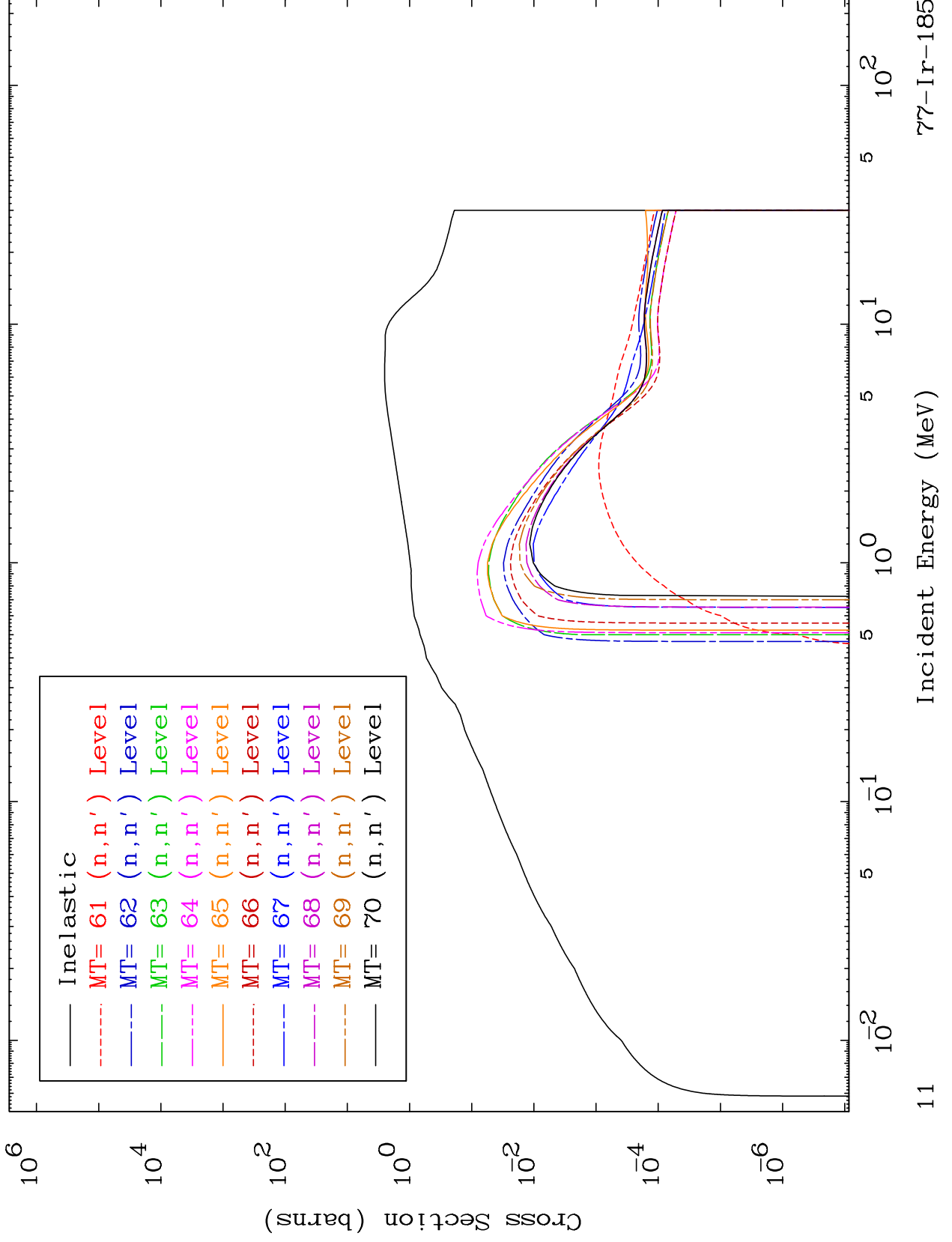

MAT 7707

(n,n') Levels
293 Kelvin Cross Sections

77-Ir-185

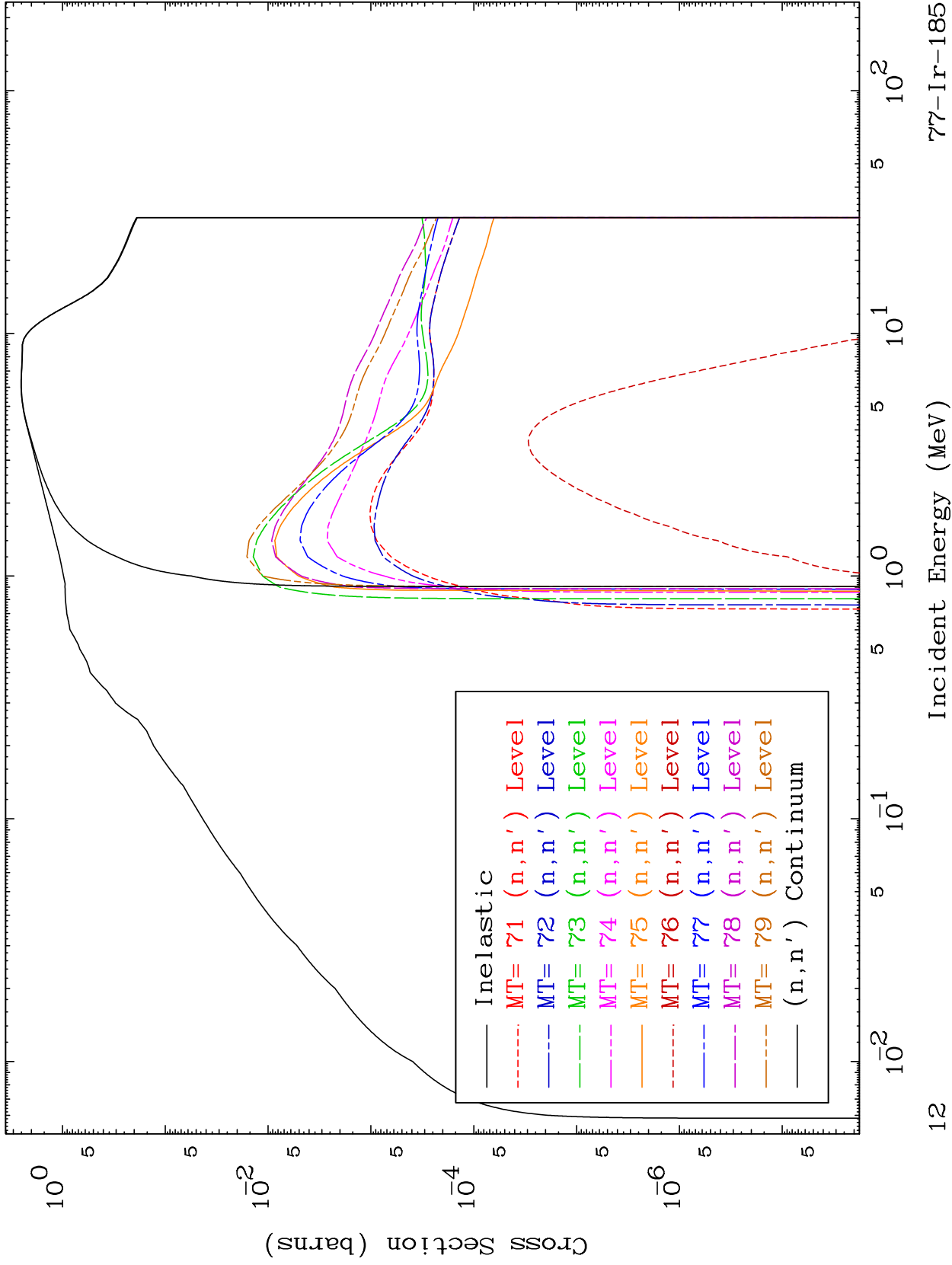

MAT 7707

(n,p) Levels
293 Kelvin Cross Sections

77-Ir-185

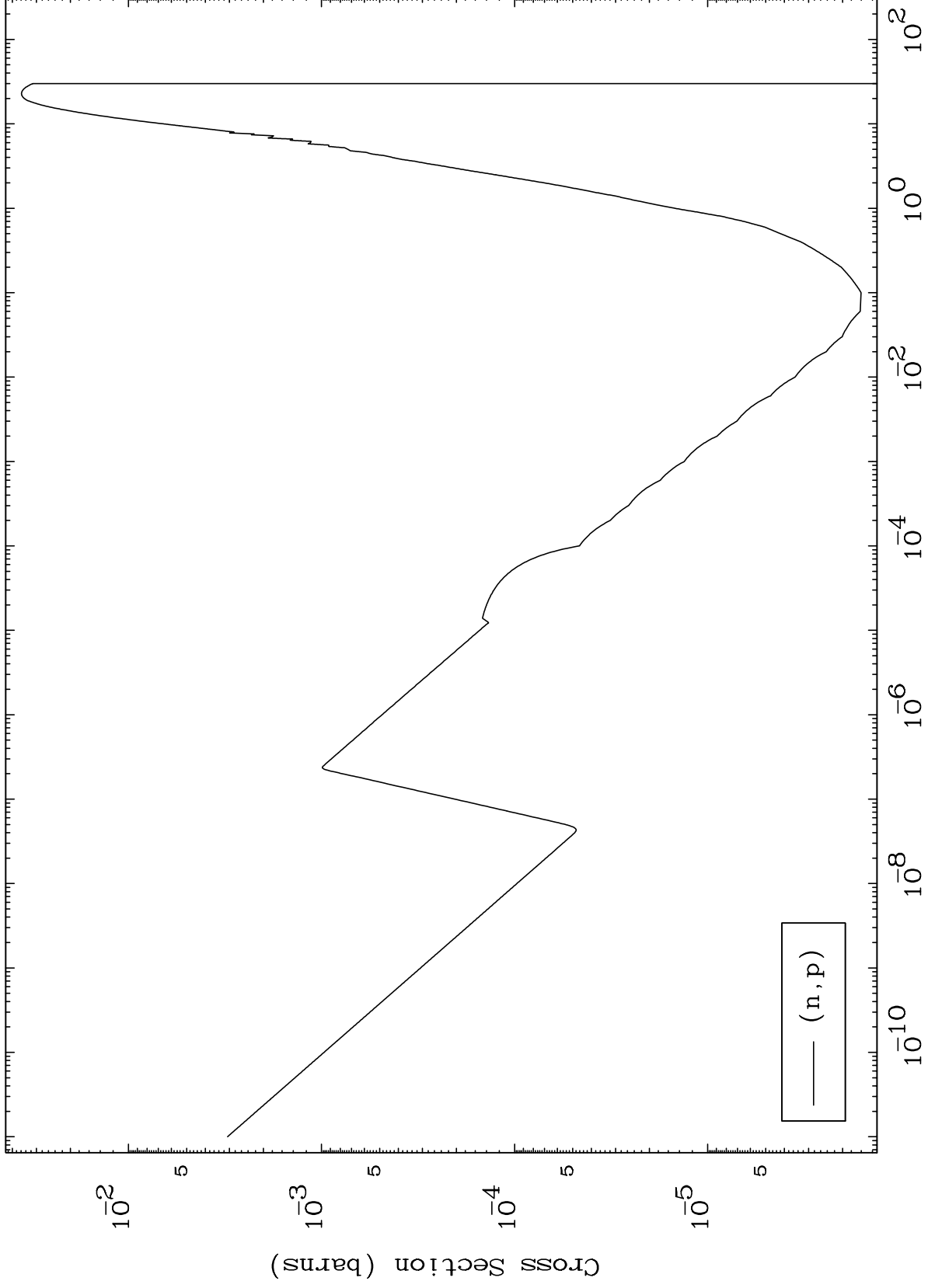

MAT 7707

(n,d) Levels
293 Kelvin Cross Sections

77-Ir-185

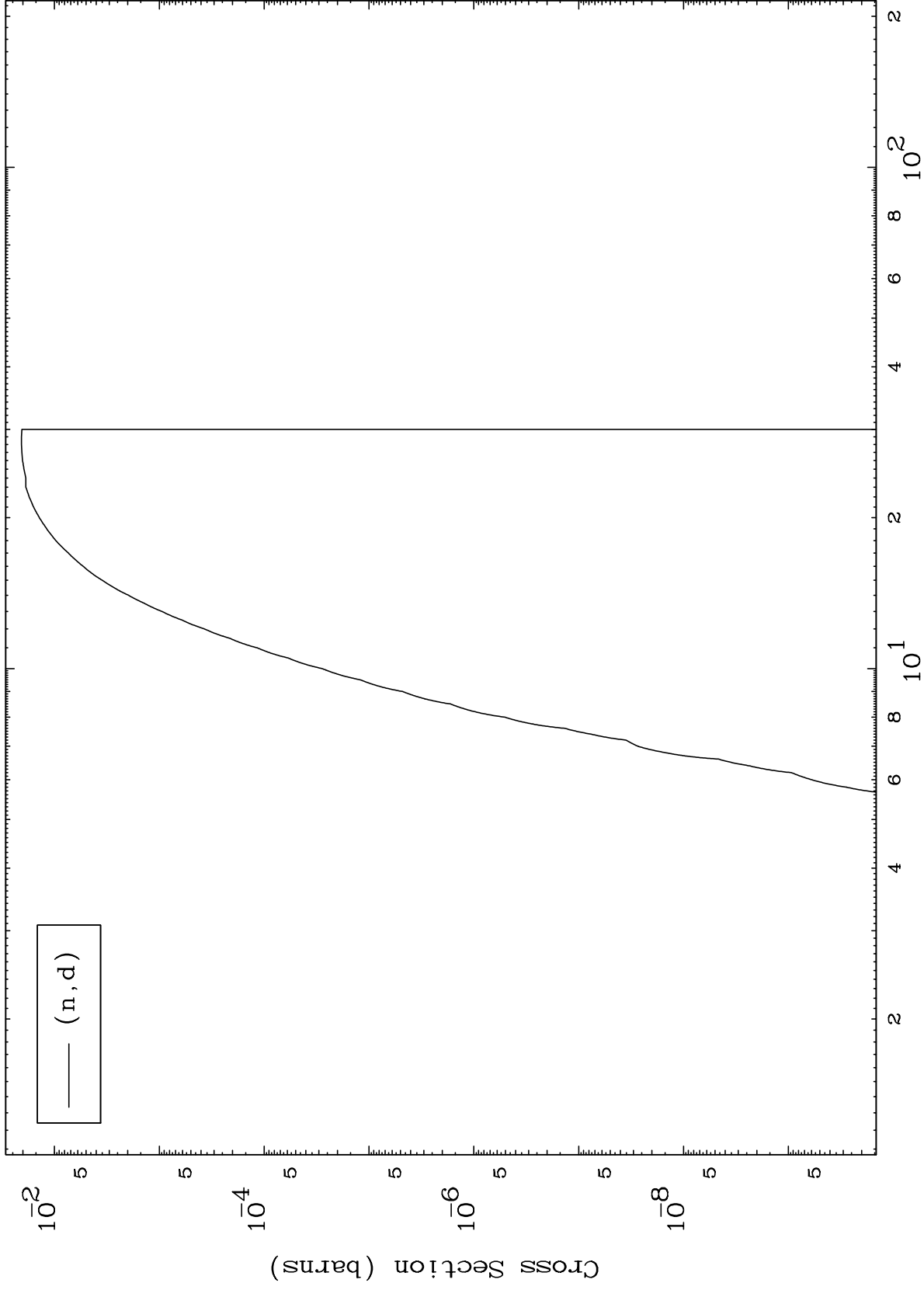

14

Incident Energy (MeV)

77-Ir-185

MAT 7707

(n,t) Levels
293 Kelvin Cross Sections

77-Ir-185

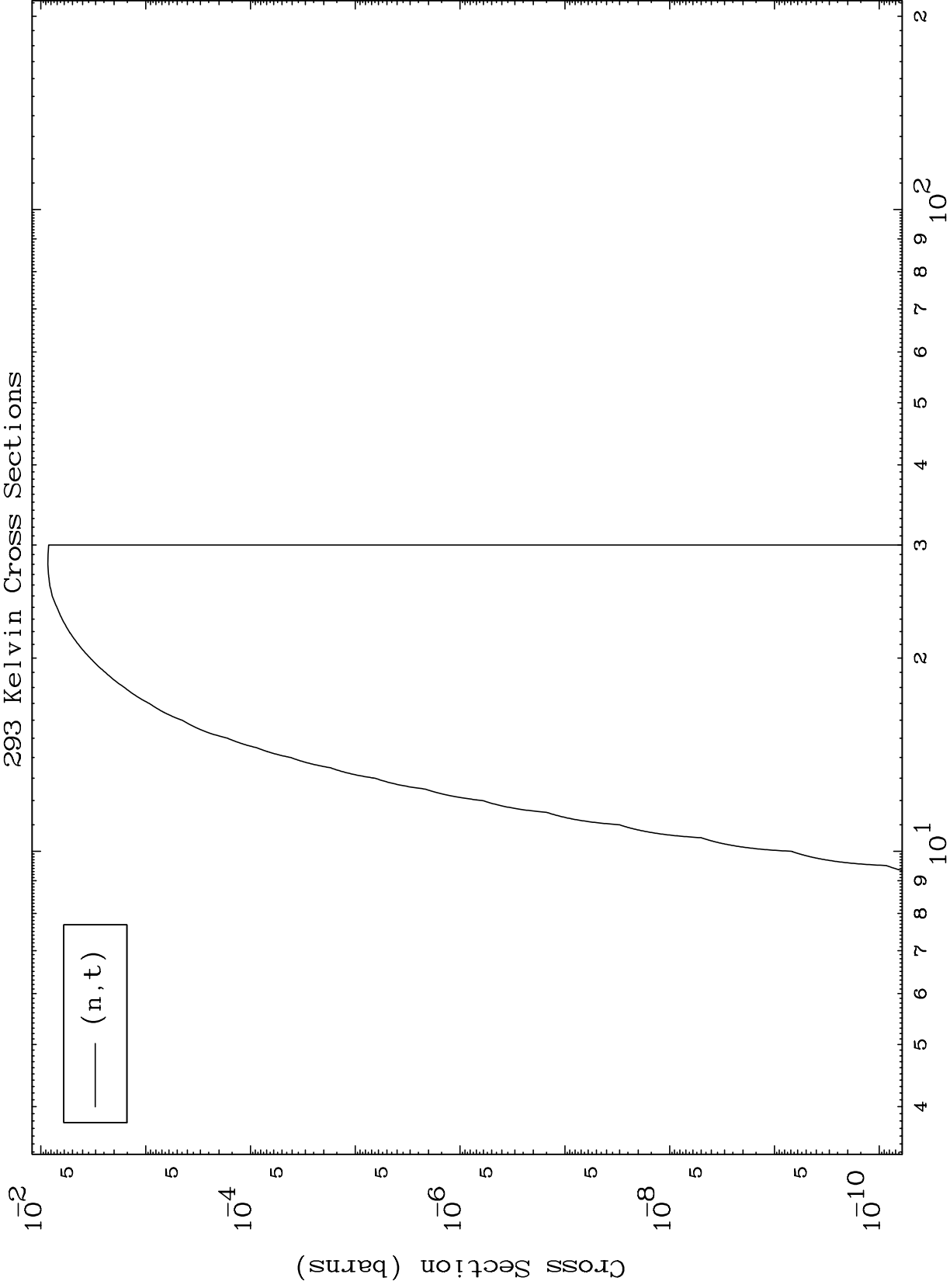

15

Incident Energy (MeV)

77-Ir-185

MAT 7707

(n,He3) Levels
293 Kelvin Cross Sections

77-Ir-185

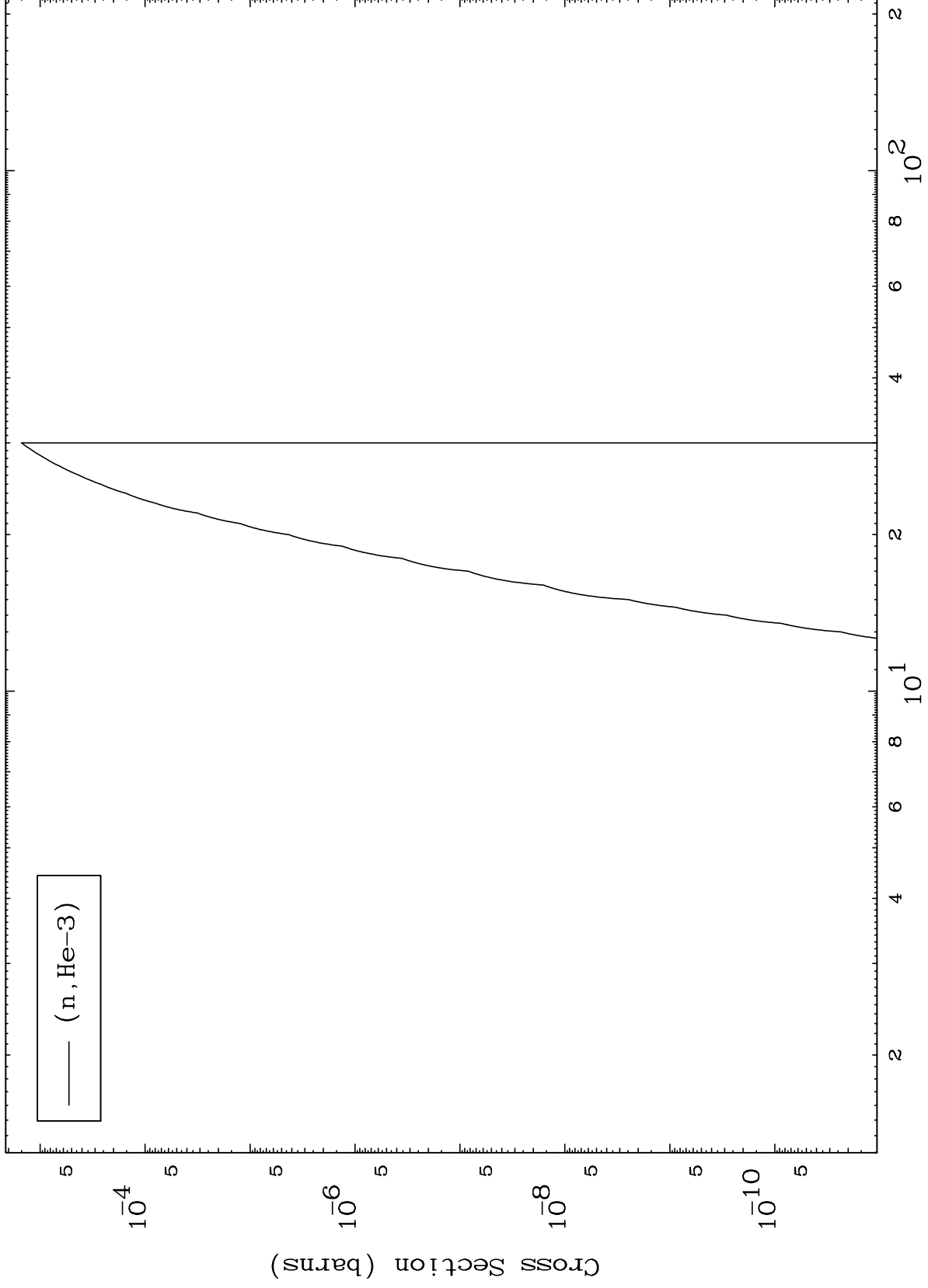

16

Incident Energy (MeV)

77-Ir-185

MAT 7707

(n, α) Levels
293 Kelvin Cross Sections

77-Ir-185

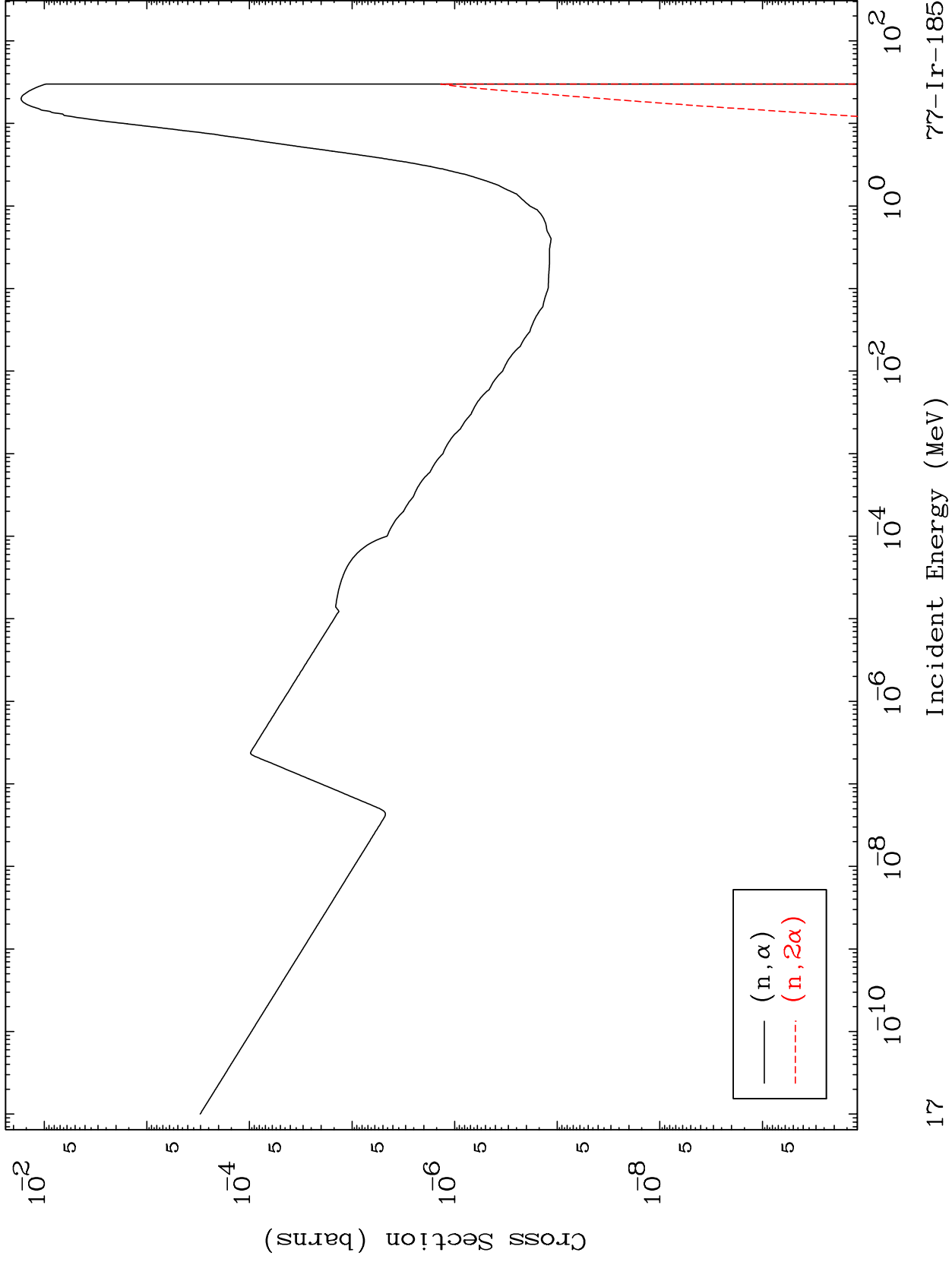

17

77-Ir-185

MAT 7707

Elastic Legendre Coefficients

77-Ir-185

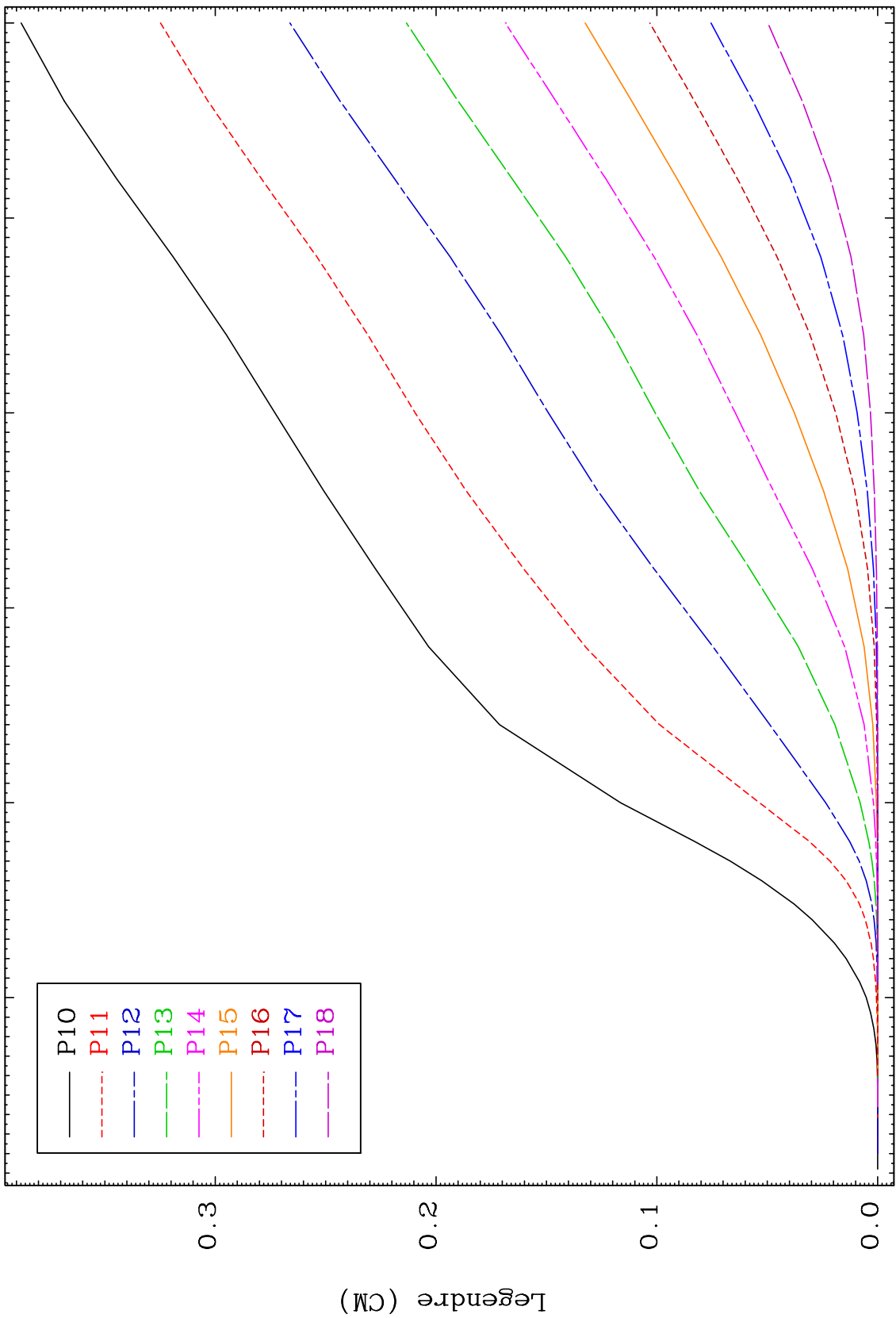

19

Incident Energy (MeV)

77-Ir-185

MAT 7707

Elastic Legendre Coefficients

77-Ir-185

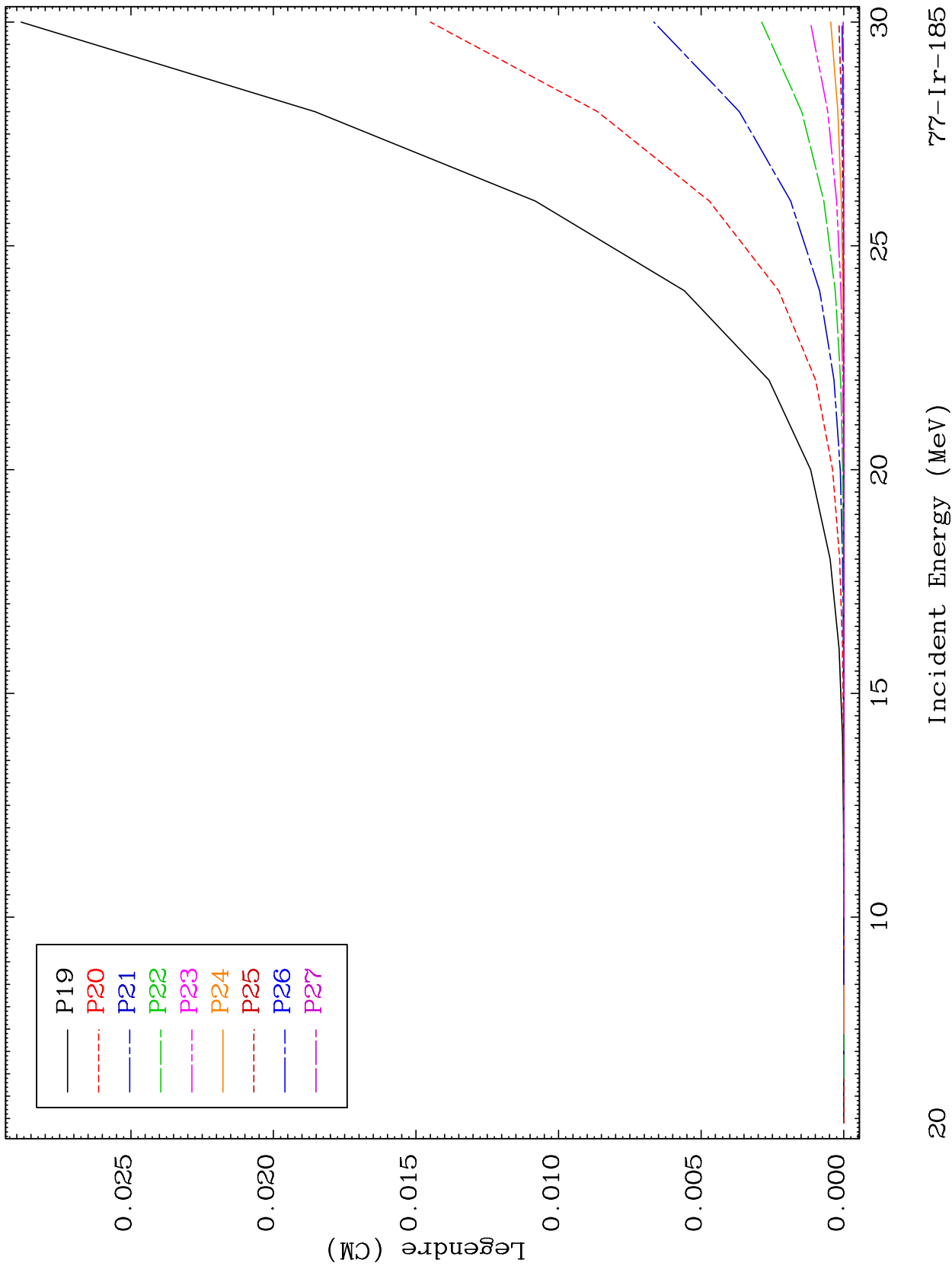

20

Incident Energy (MeV)

77-Ir-185

MAT 7707

Elastic
Legendre Coefficients

77-Ir-185

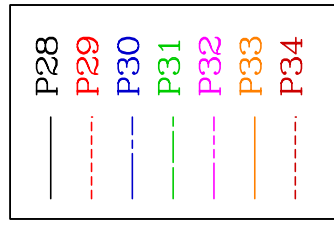

$\times 10^{-6}$

Legendre (CM)

6

4

2

0

15

20

25

30

21

Incident Energy (MeV)

77-Ir-185

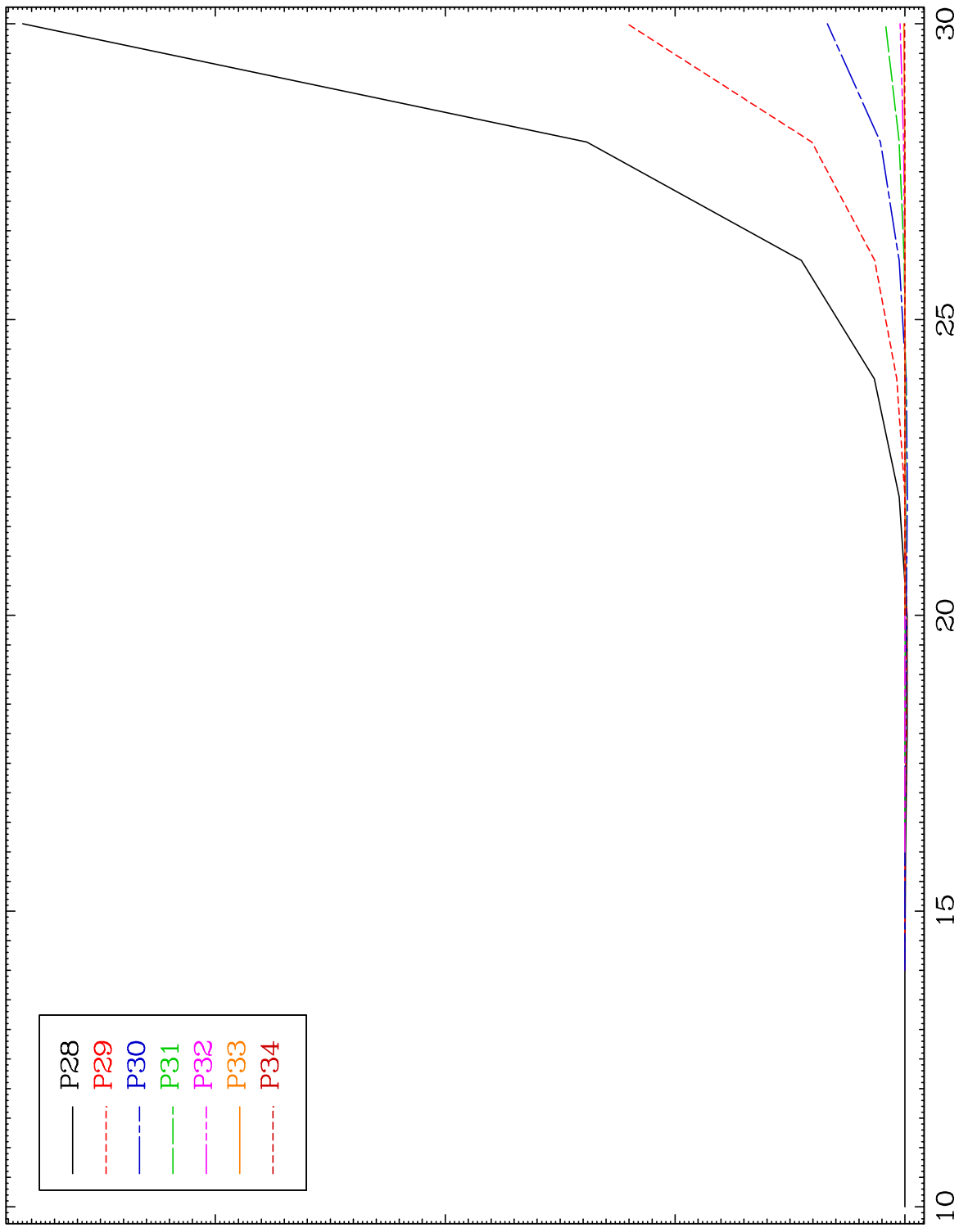

MAT 7707

MT= 51 (n,n') Level
Legendre Coefficients

77-Ir-185

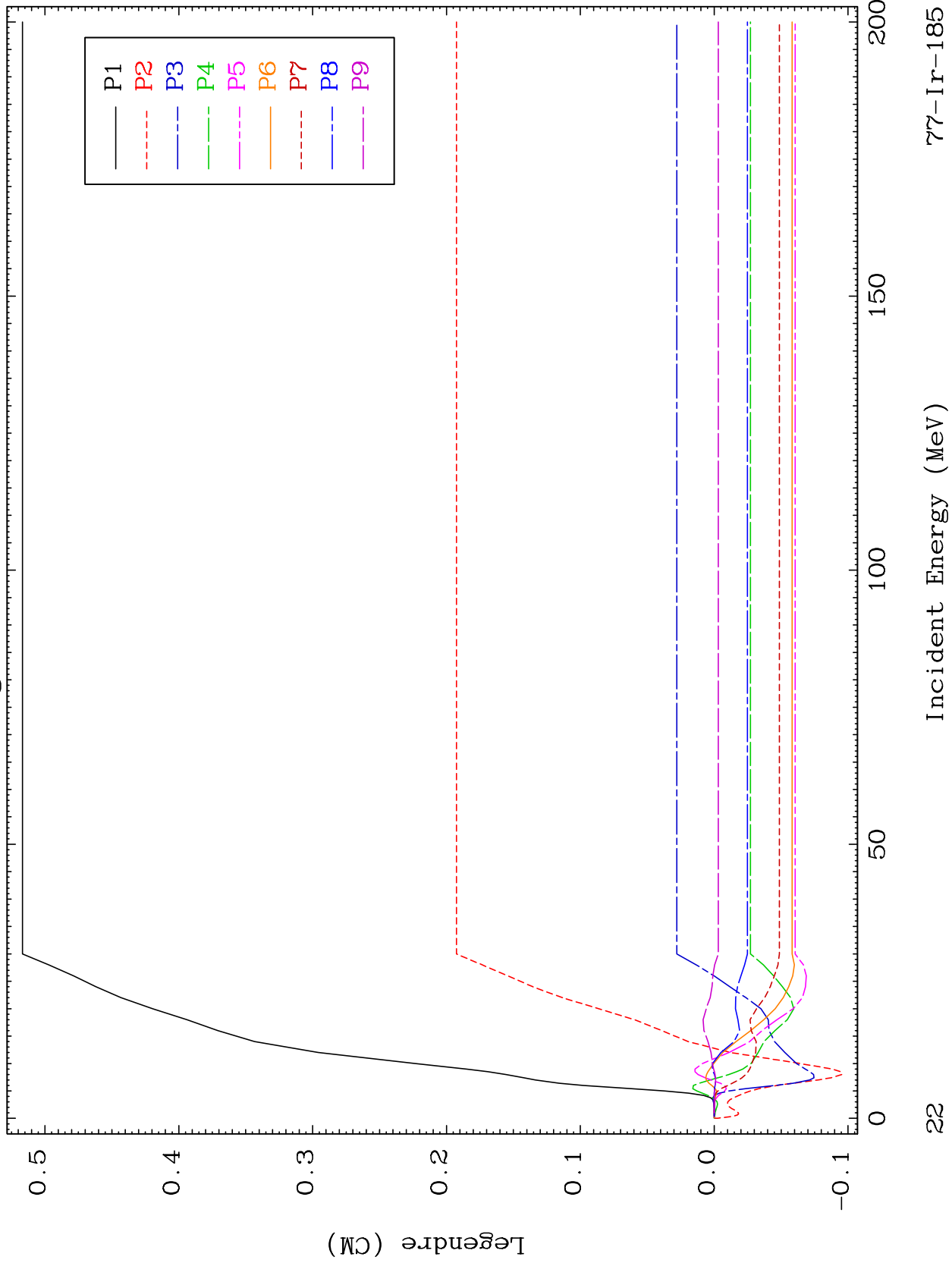

22

Incident Energy (MeV)

77-Ir-185

MAT 7707

MT= 51 (n,n') Level
Legendre Coefficients

77-Ir-185

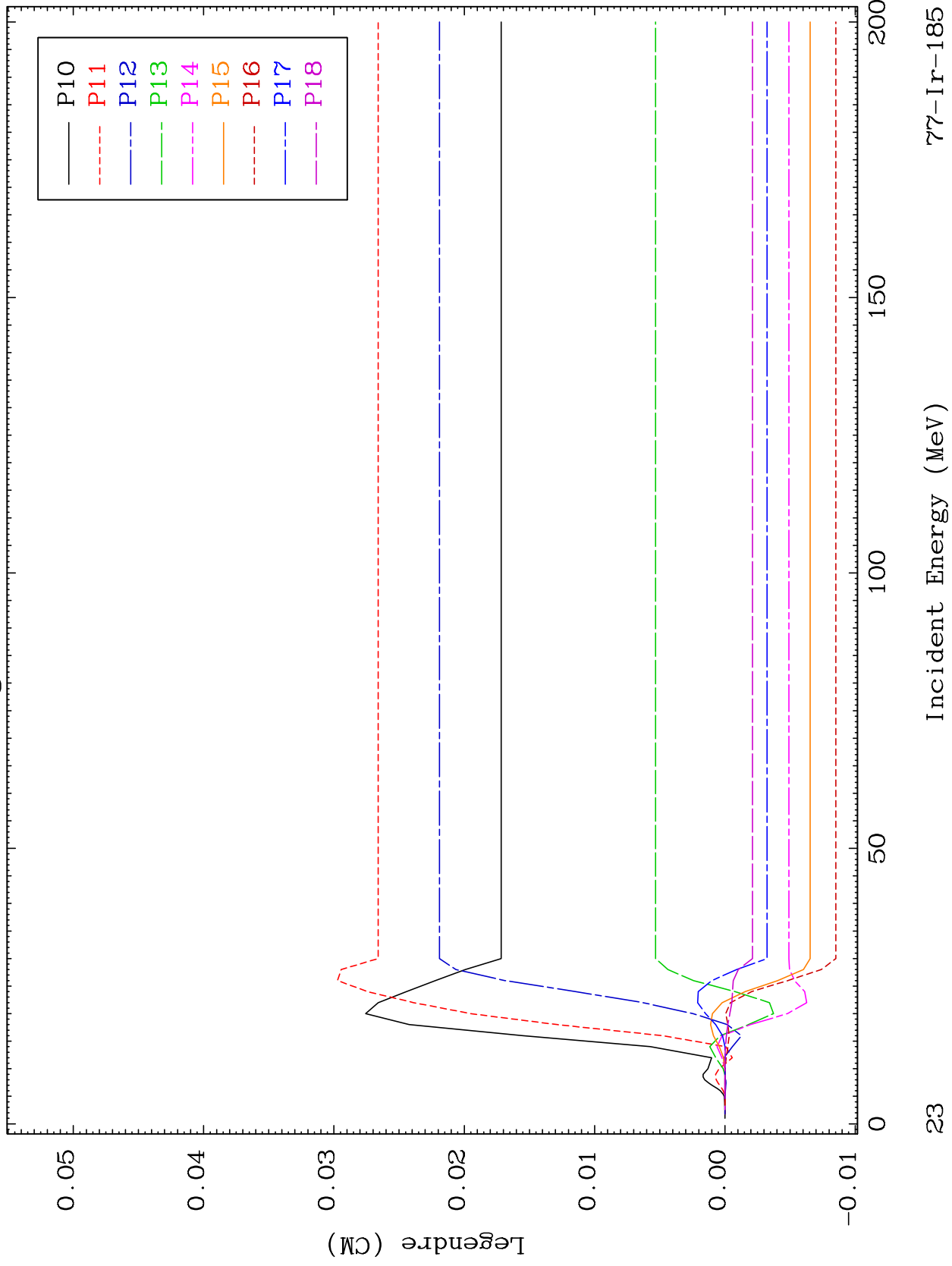

77-Ir-185

Incident Energy (MeV)

23

MAT 7707

MT= 51 (n,n') Level
Legendre Coefficients

77-Ir-185

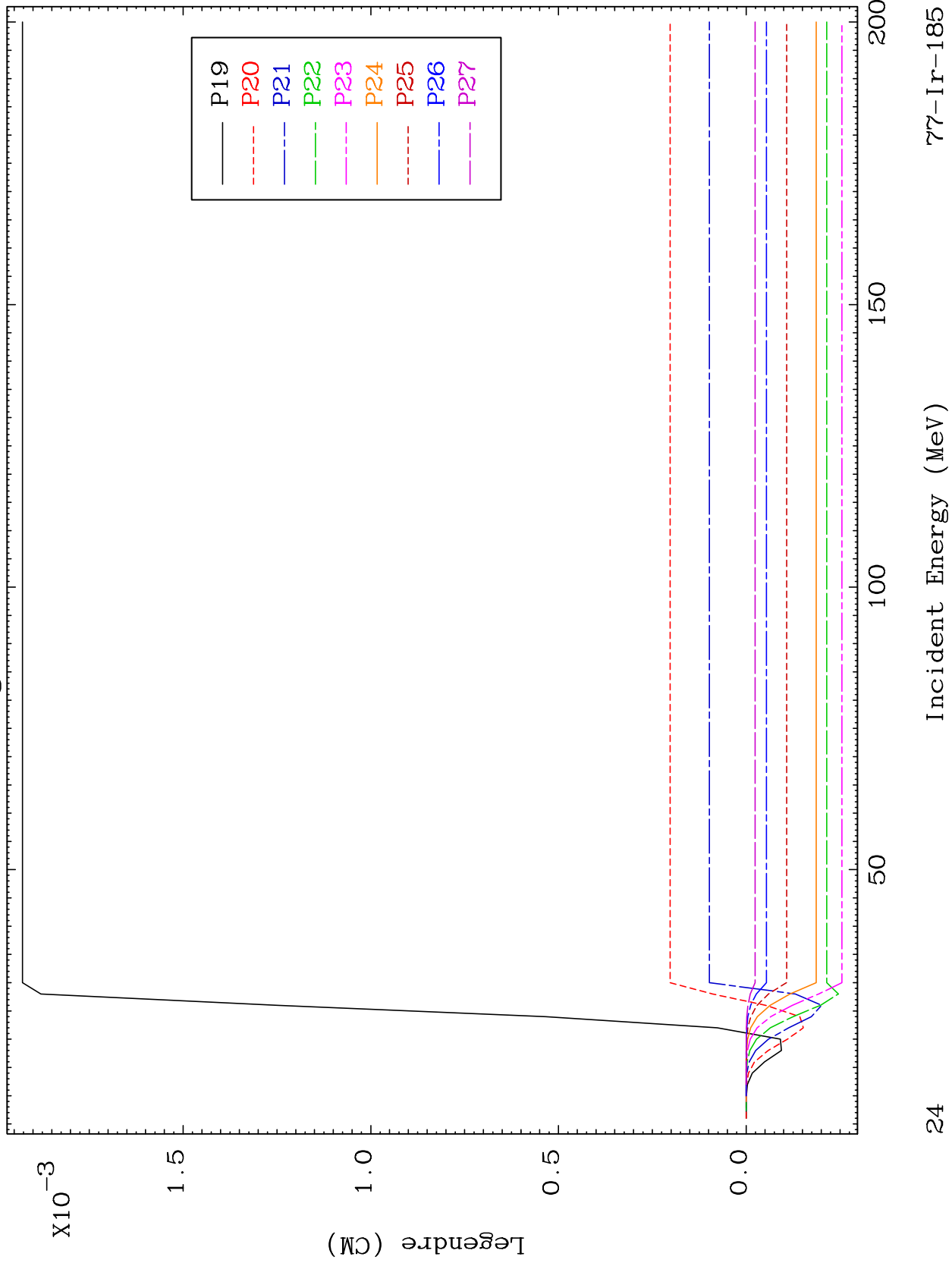

24

77-Ir-185

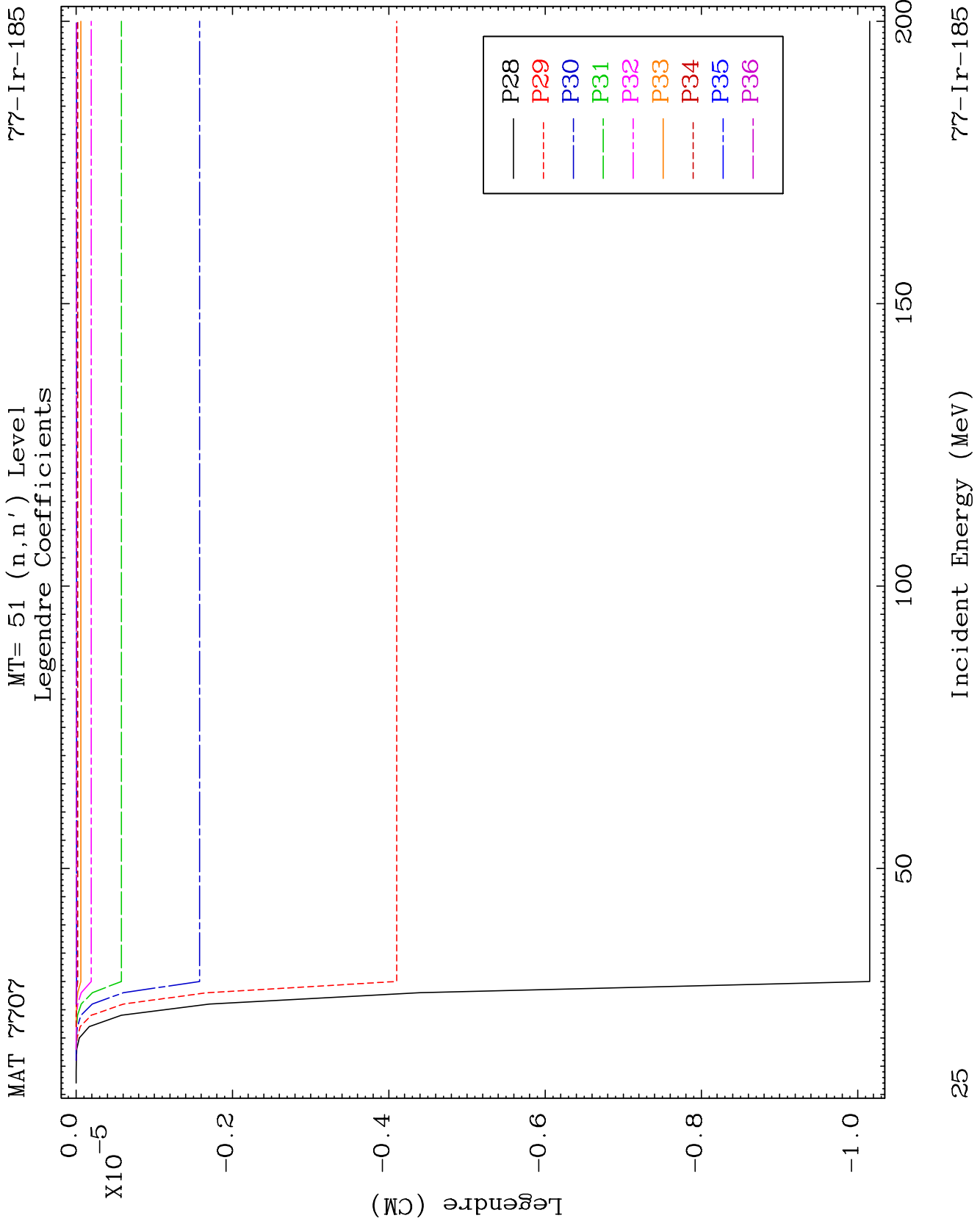

MAT 7707

MT= 52 (n,n') Level
Legendre Coefficients

77-Ir-185

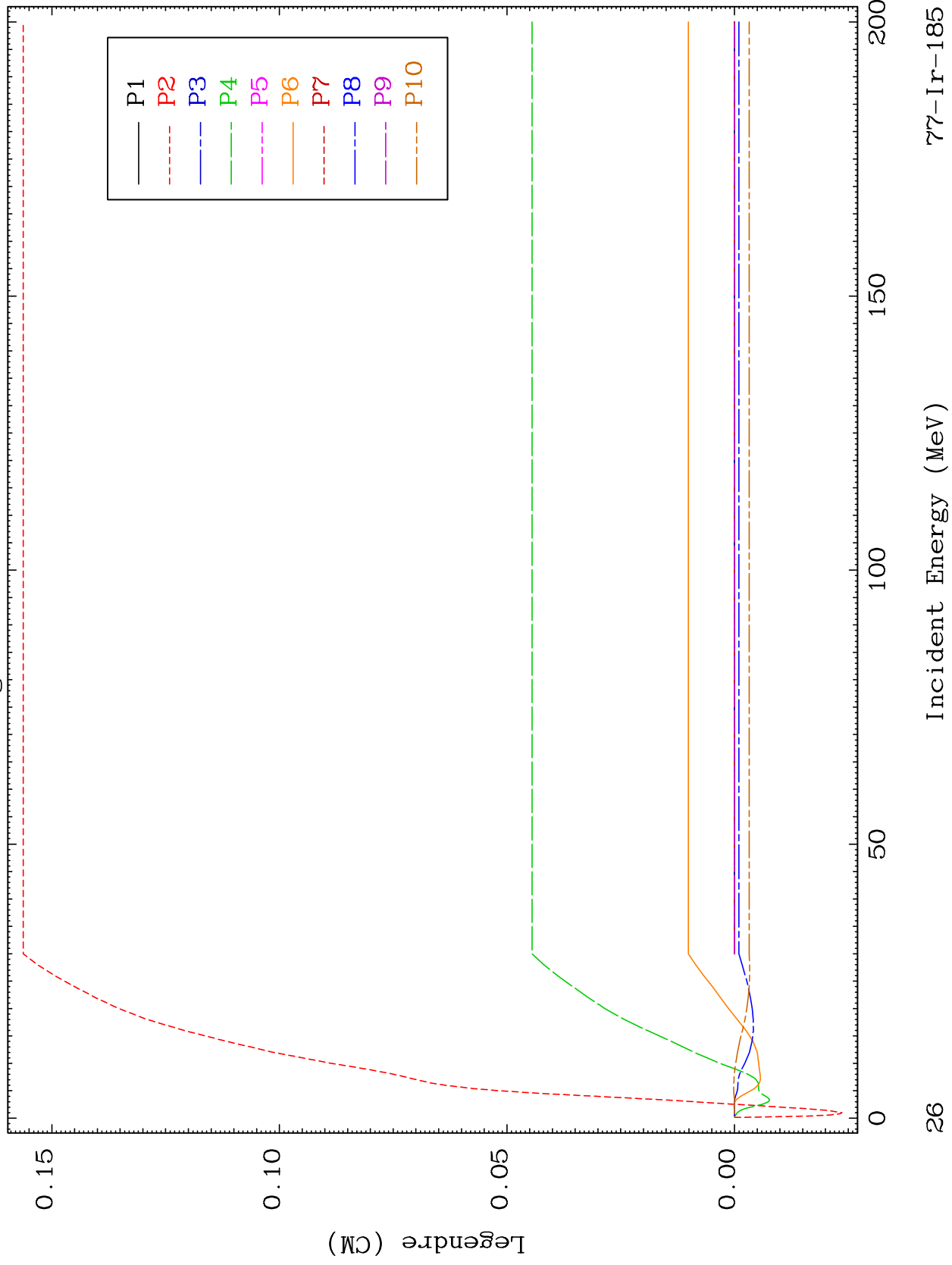

26

77-Ir-185

MAT 7707

MT= 52 (n,n') Level
Legendre Coefficients

77-Ir-185

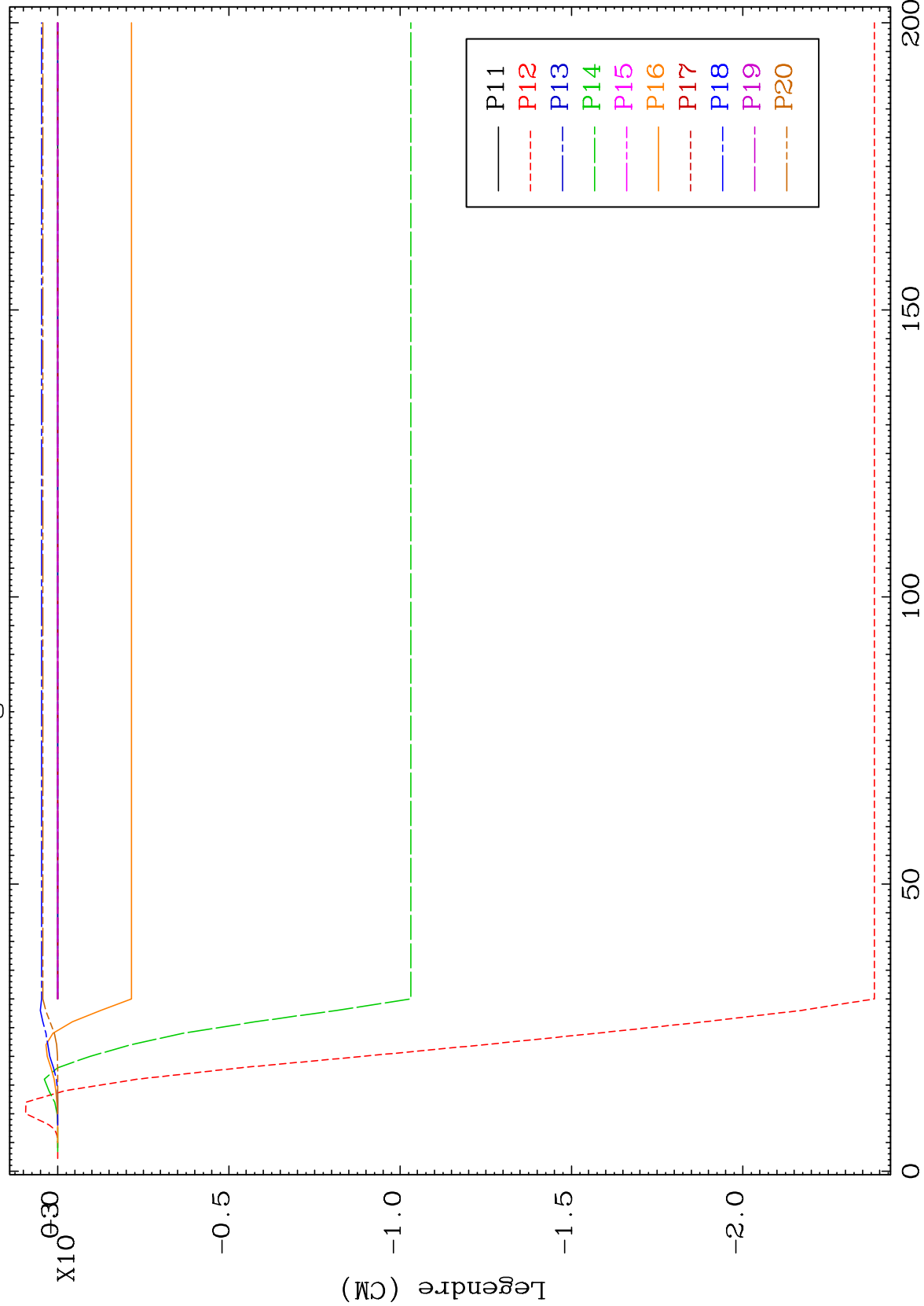

27

Incident Energy (MeV)

77-Ir-185

MAT 7707

MT= 52 (n,n') Level
Legendre Coefficients

77-Ir-185

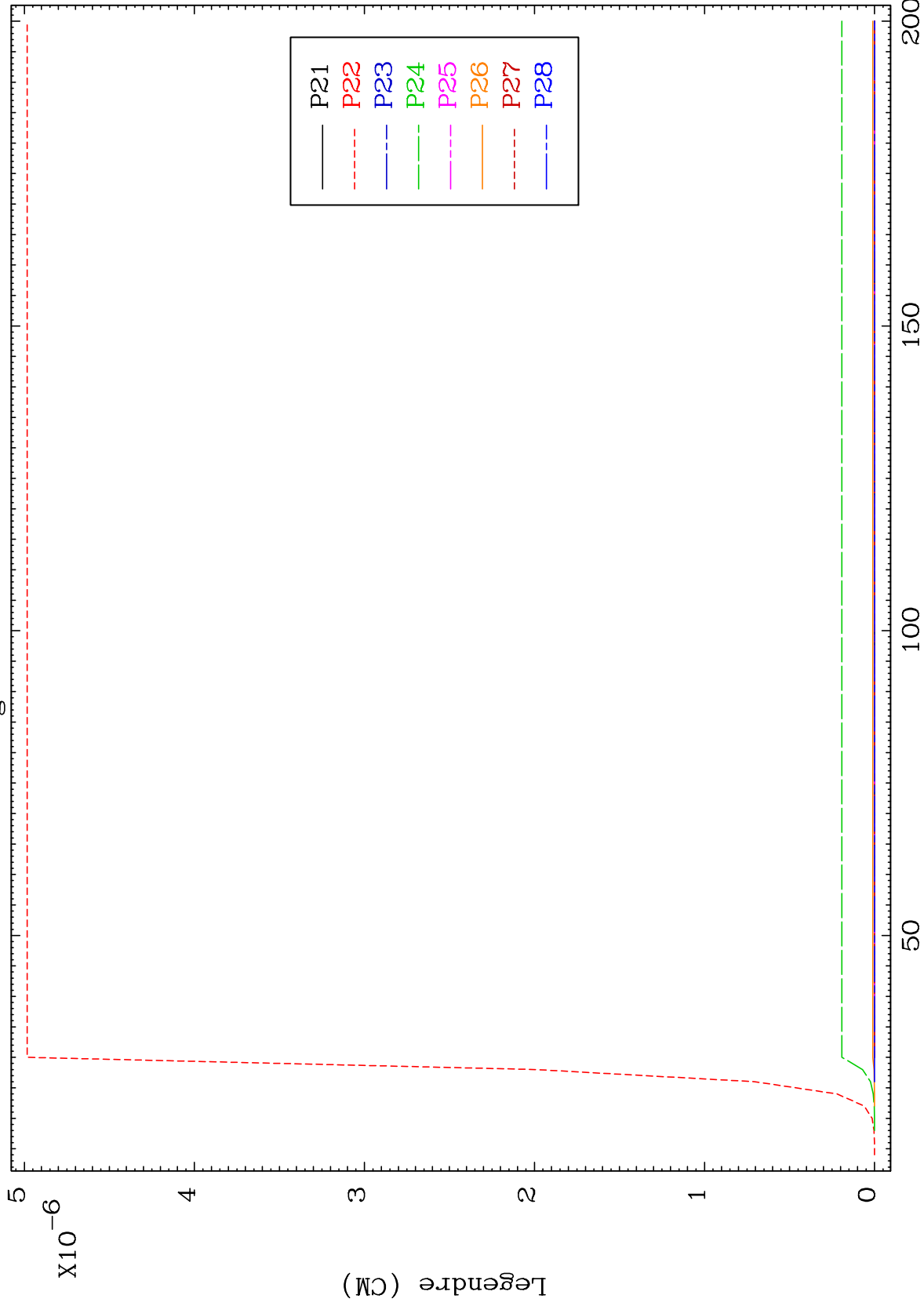

28

Incident Energy (MeV)

77-Ir-185

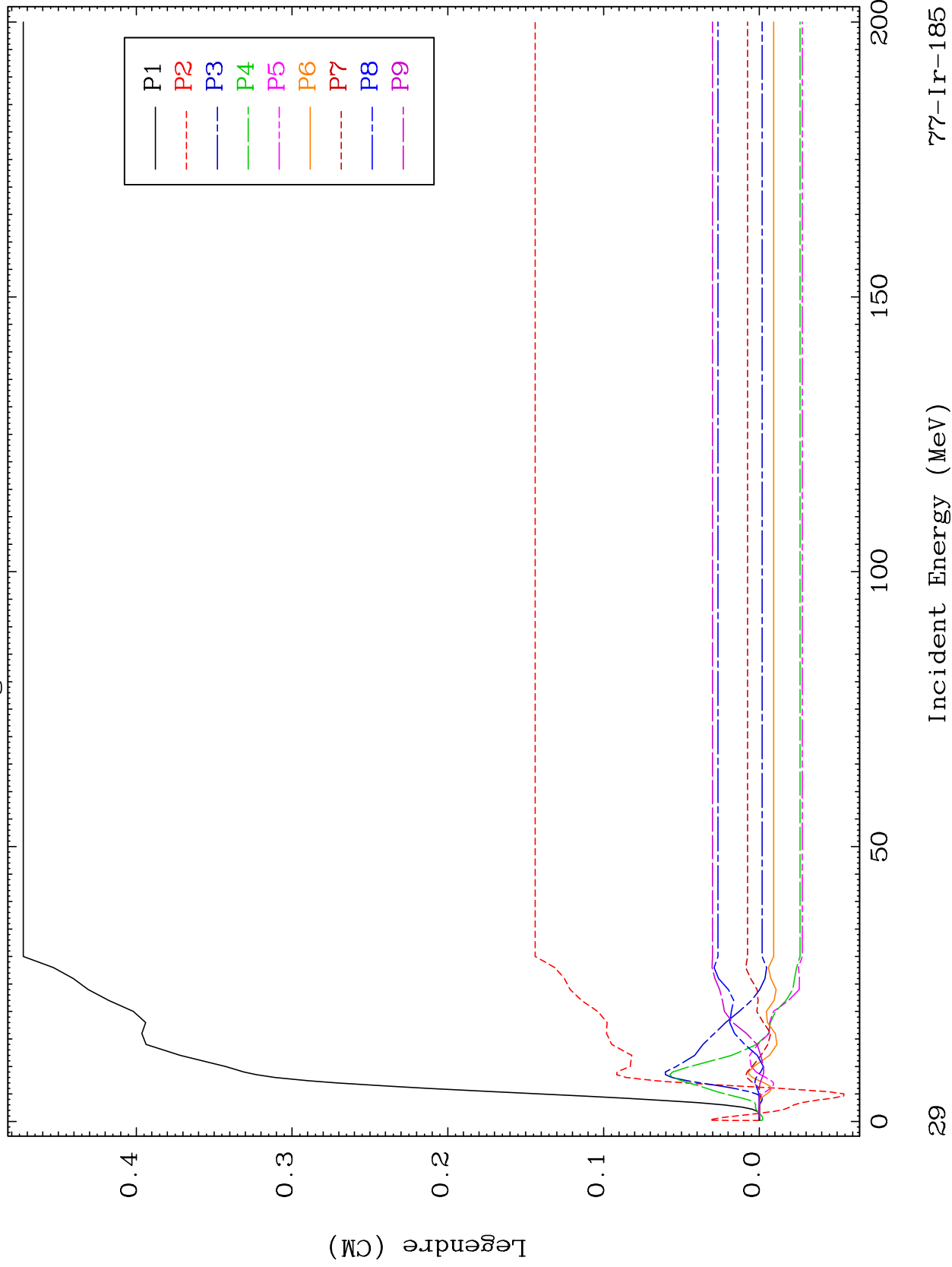

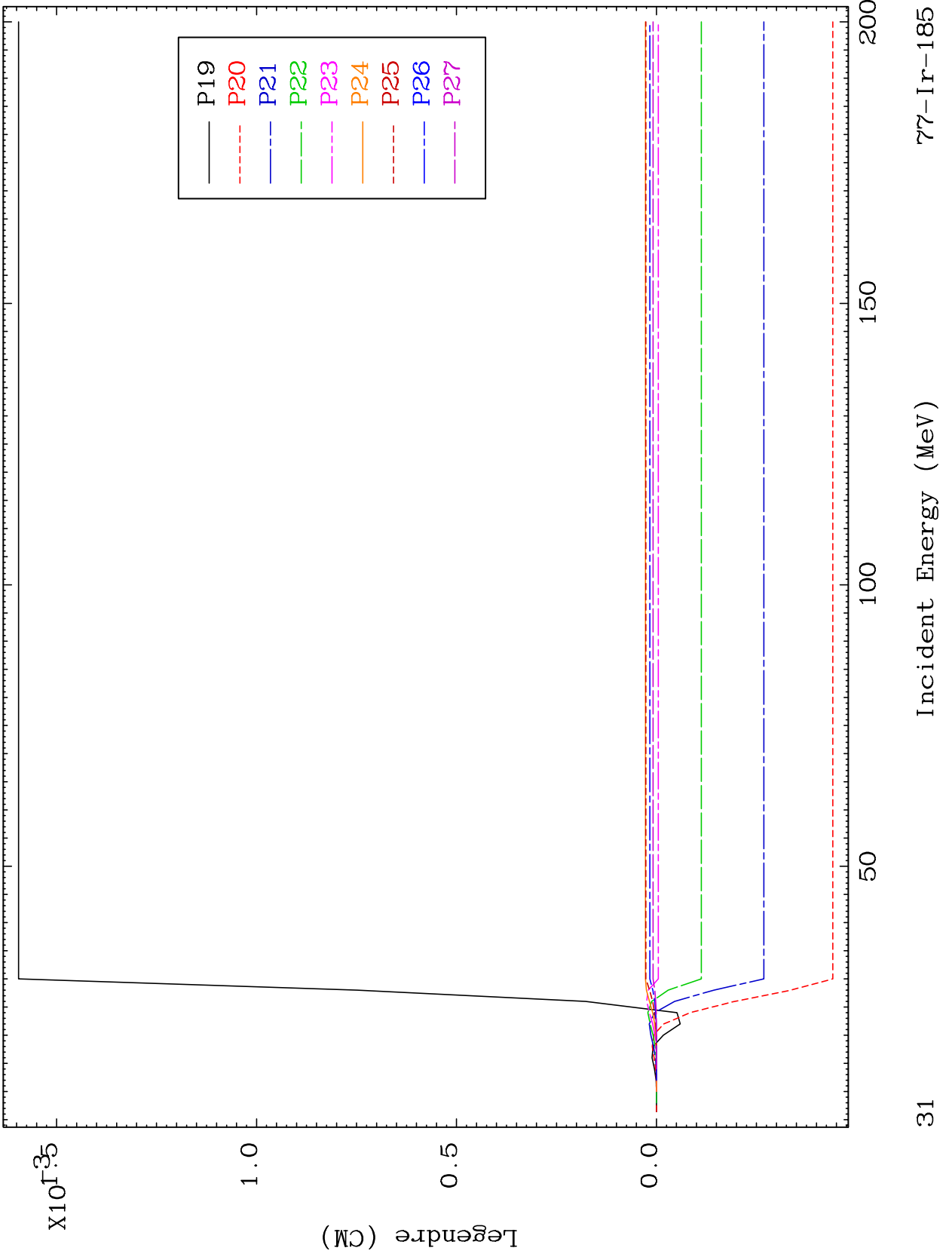

MAT 7707

MT= 53 (n,n') Level
Legendre Coefficients

77-Ir-185

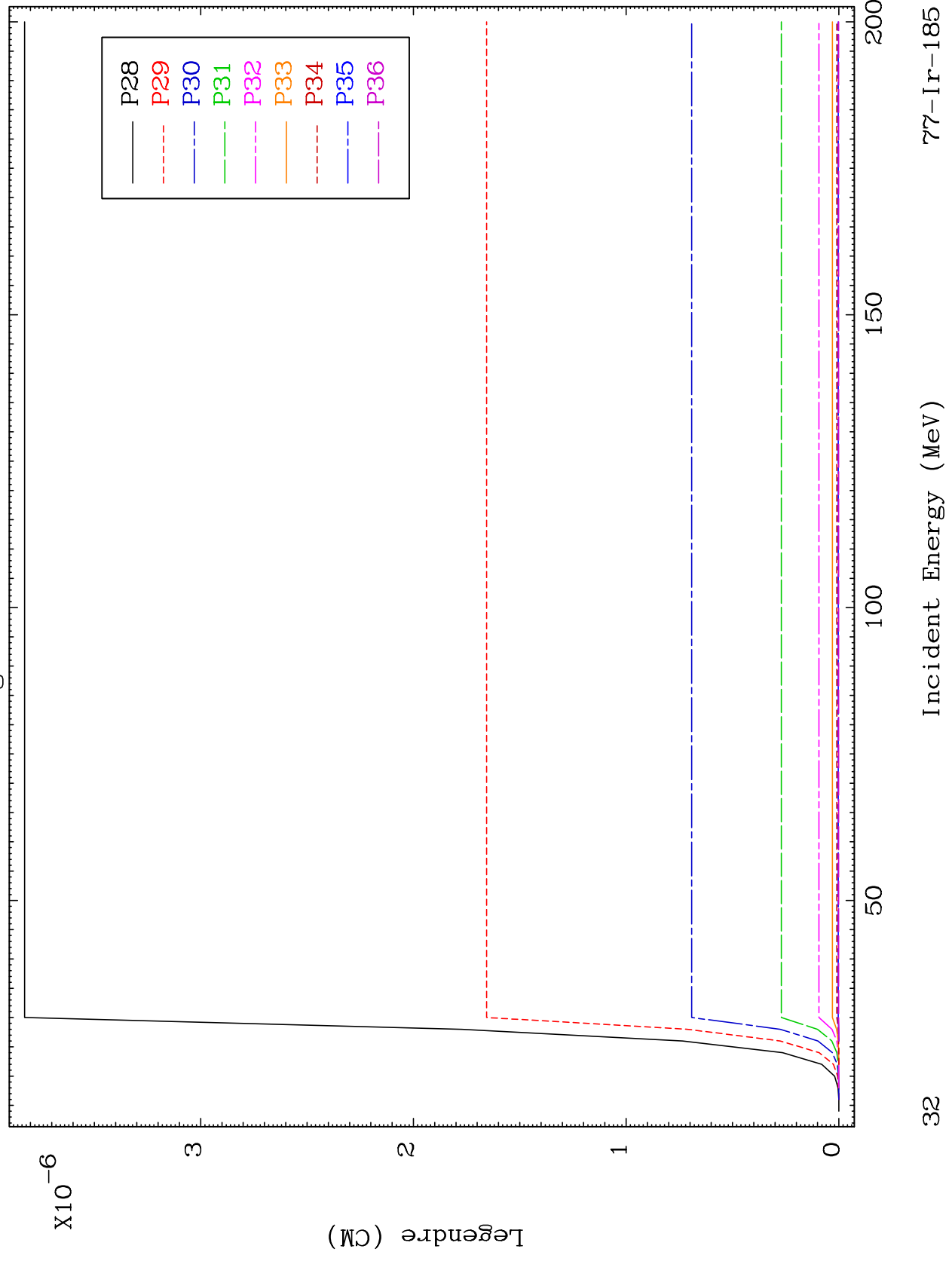

32

77-Ir-185

MAT 7707

MT= 54 (n,n') Level
Legendre Coefficients

77-Ir-185

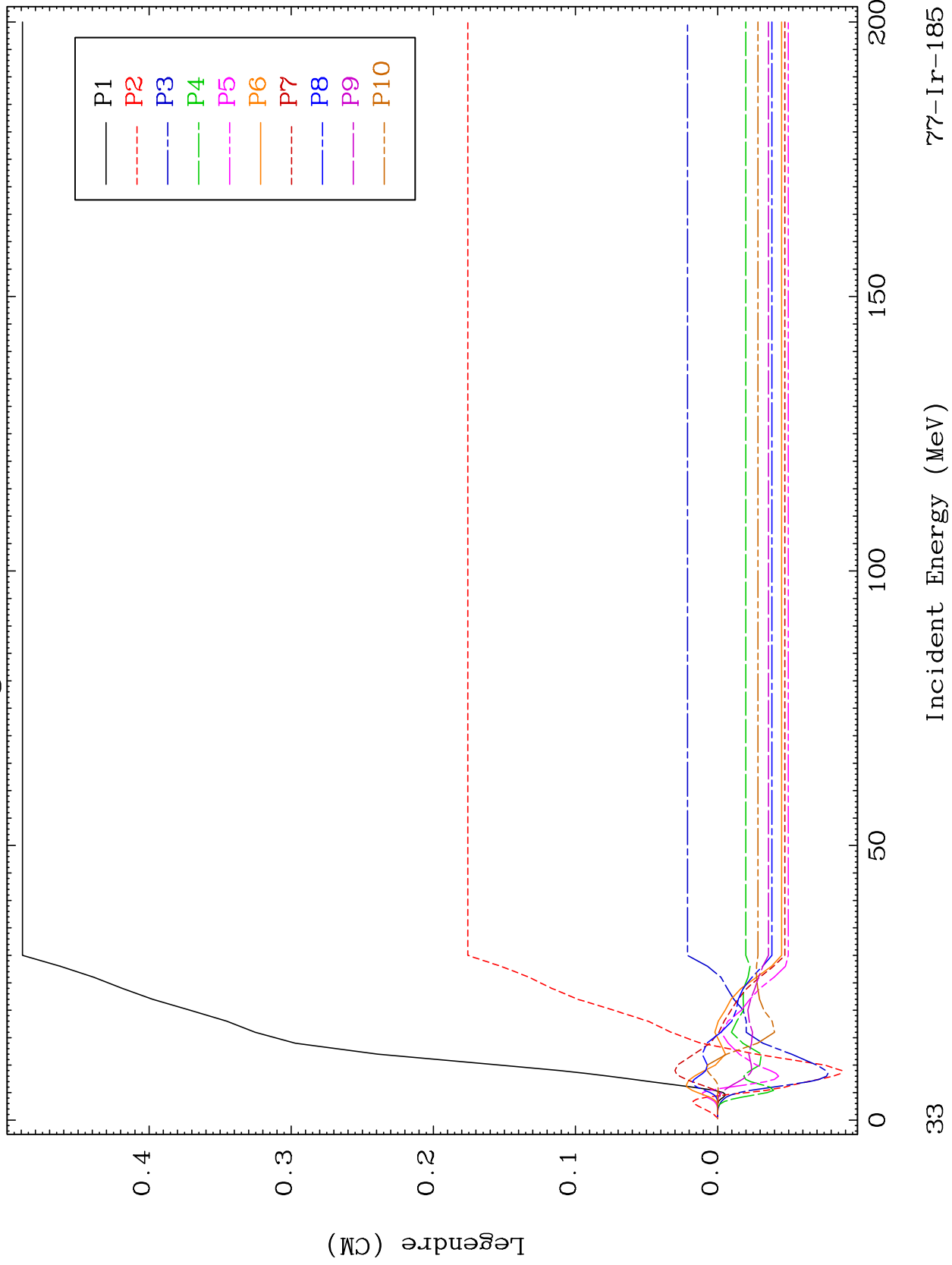

33

77-Ir-185

MAT 7707

MT= 54 (n,n') Level
Legendre Coefficients

77-Ir-185

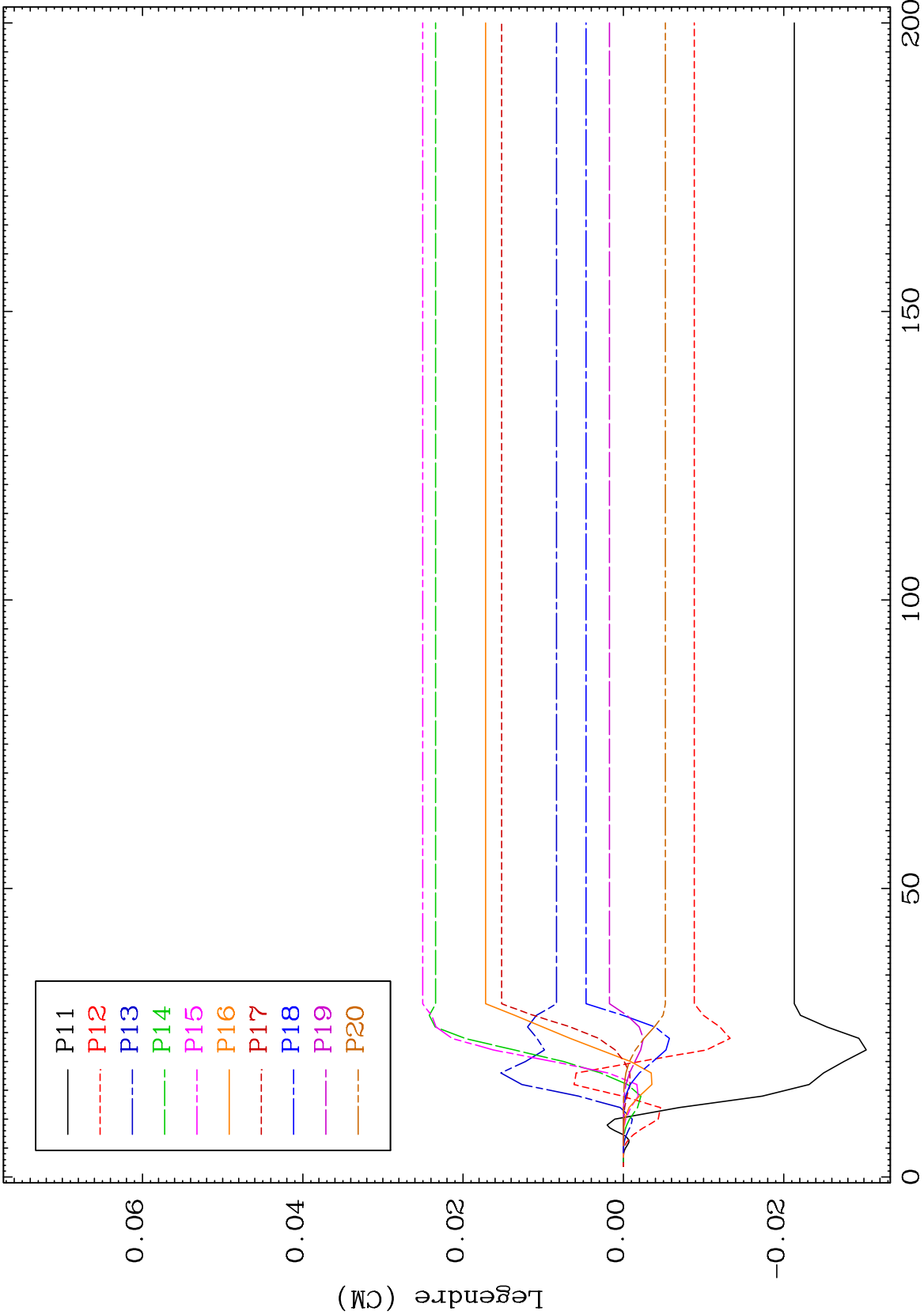

34

Incident Energy (MeV)

77-Ir-185

MAT 7707

MT= 54 (n,n') Level
Legendre Coefficients

77-Ir-185

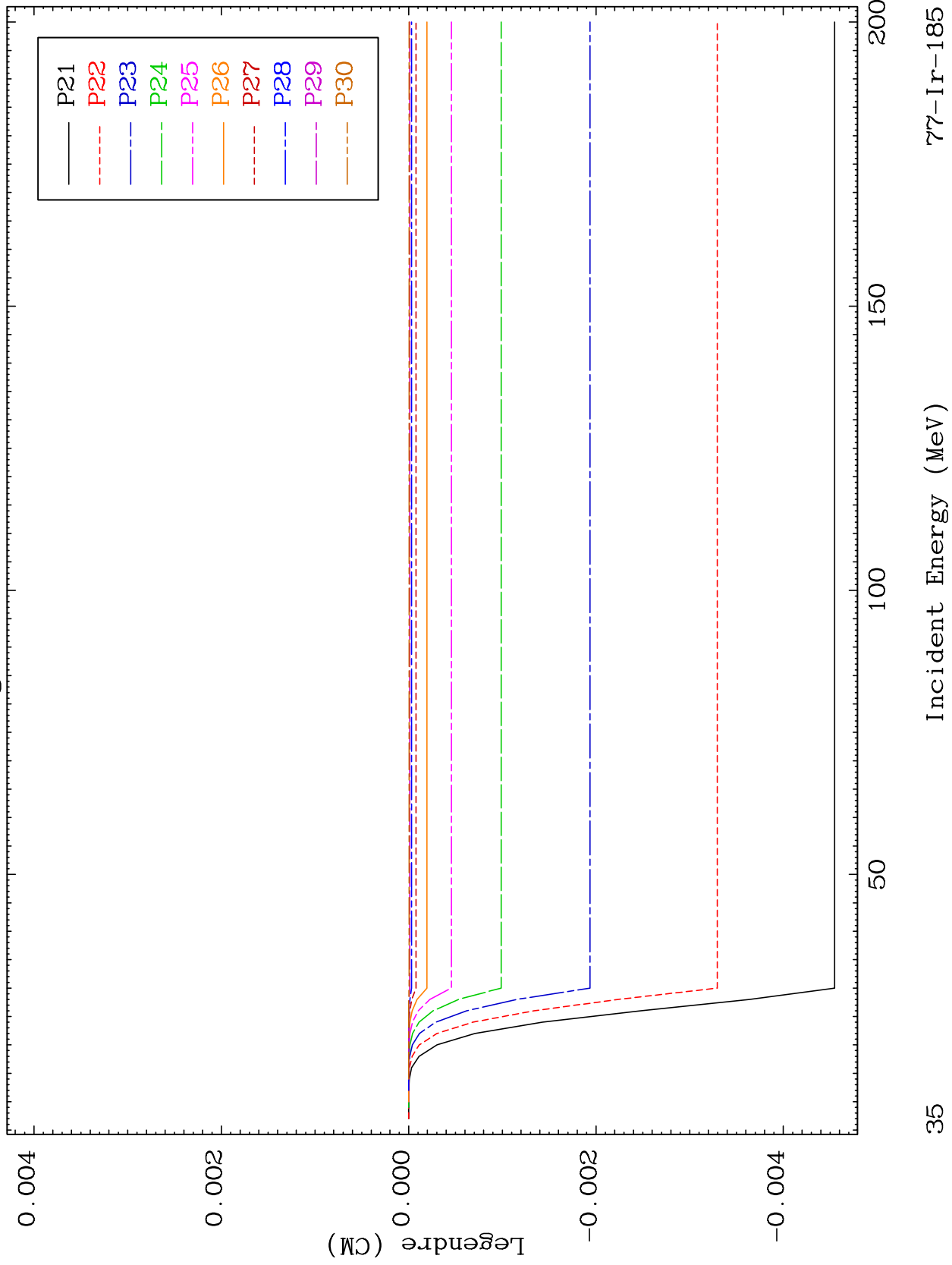

35

Incident Energy (MeV)

77-Ir-185

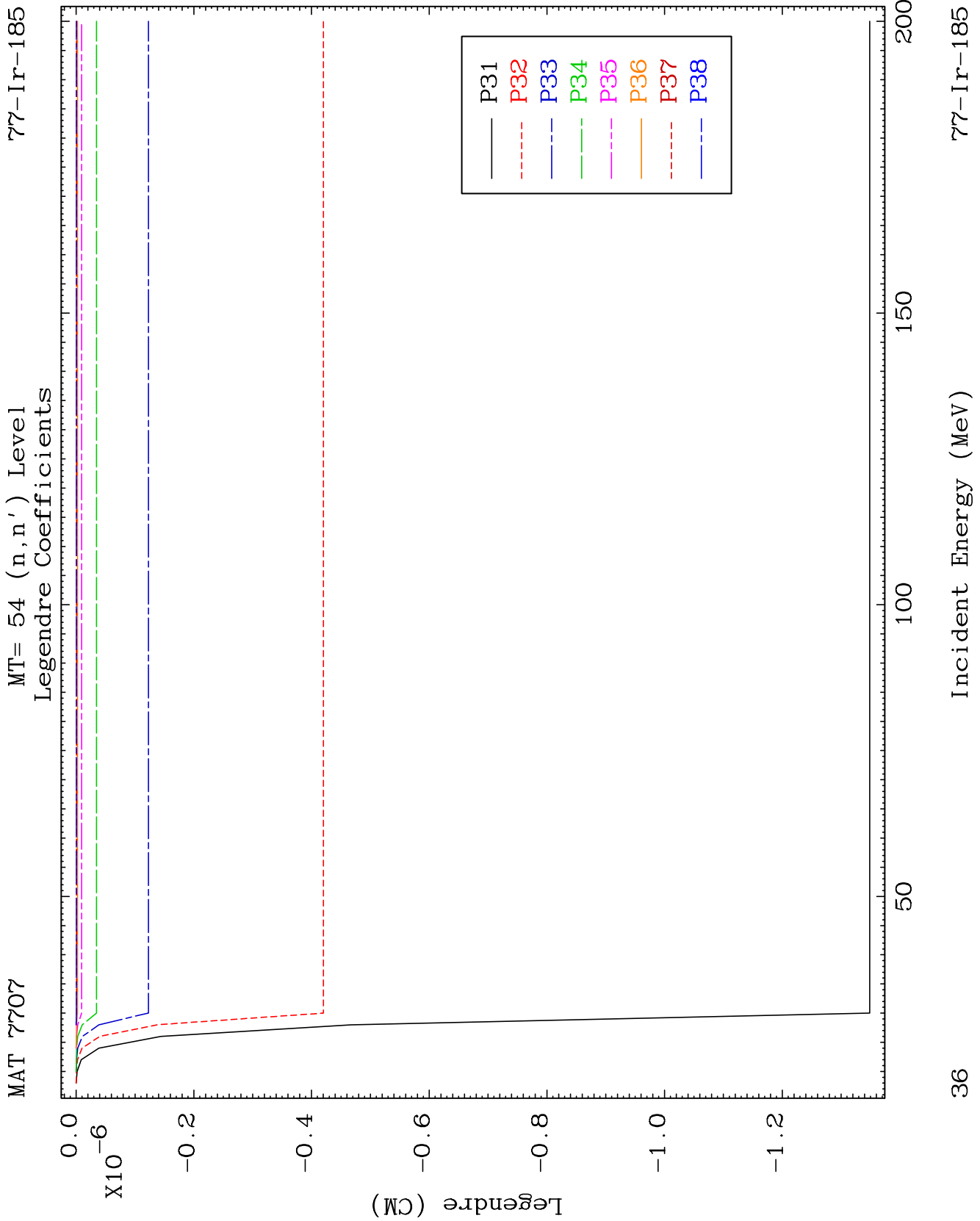

MAT 7707

MT= 55 (n,n') Level

77-Ir-185

Legendre Coefficients

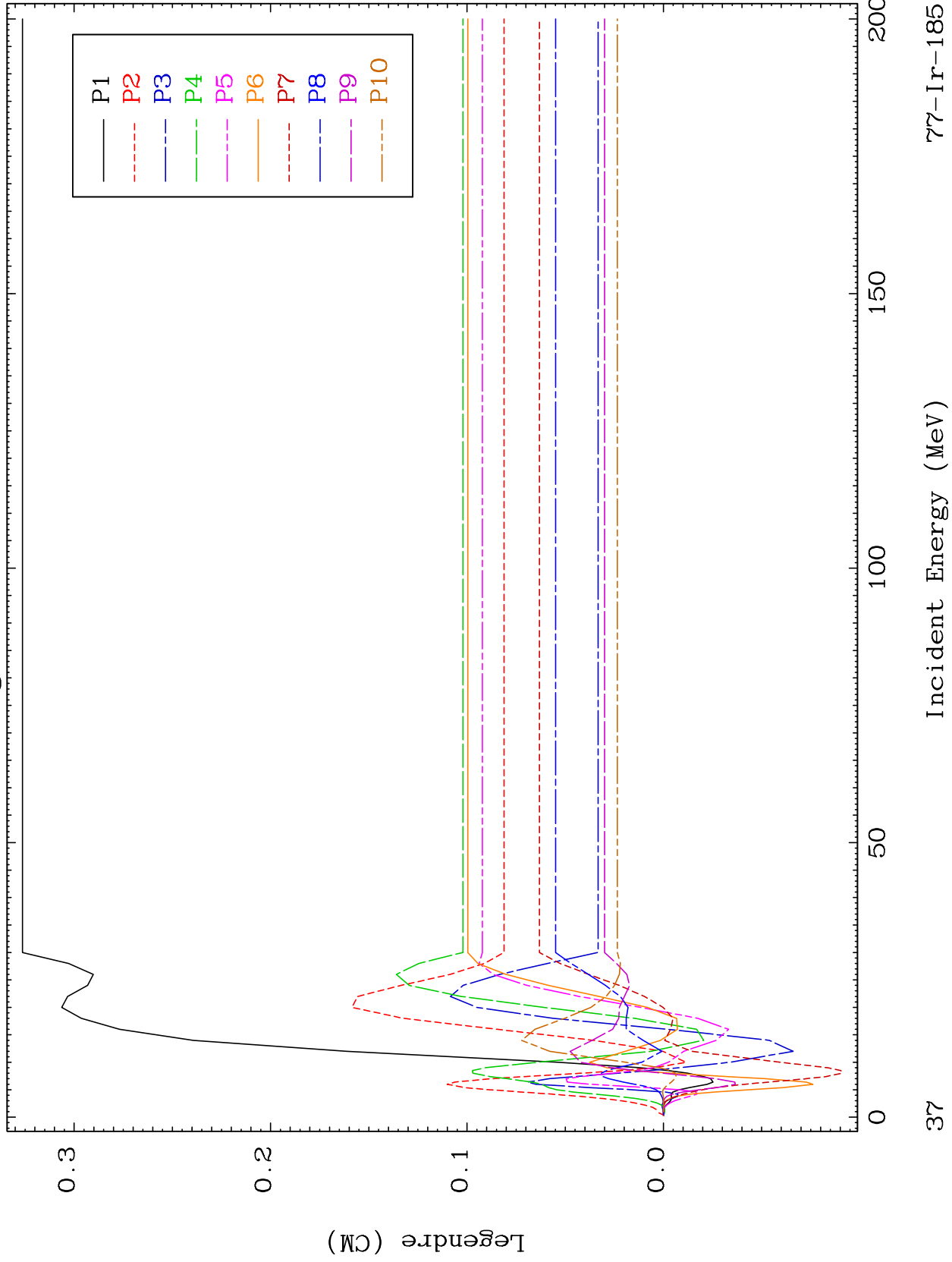

37

Incident Energy (MeV)

77-Ir-185

MAT 7707

MT= 55 (n,n') Level
Legendre Coefficients

77-Ir-185

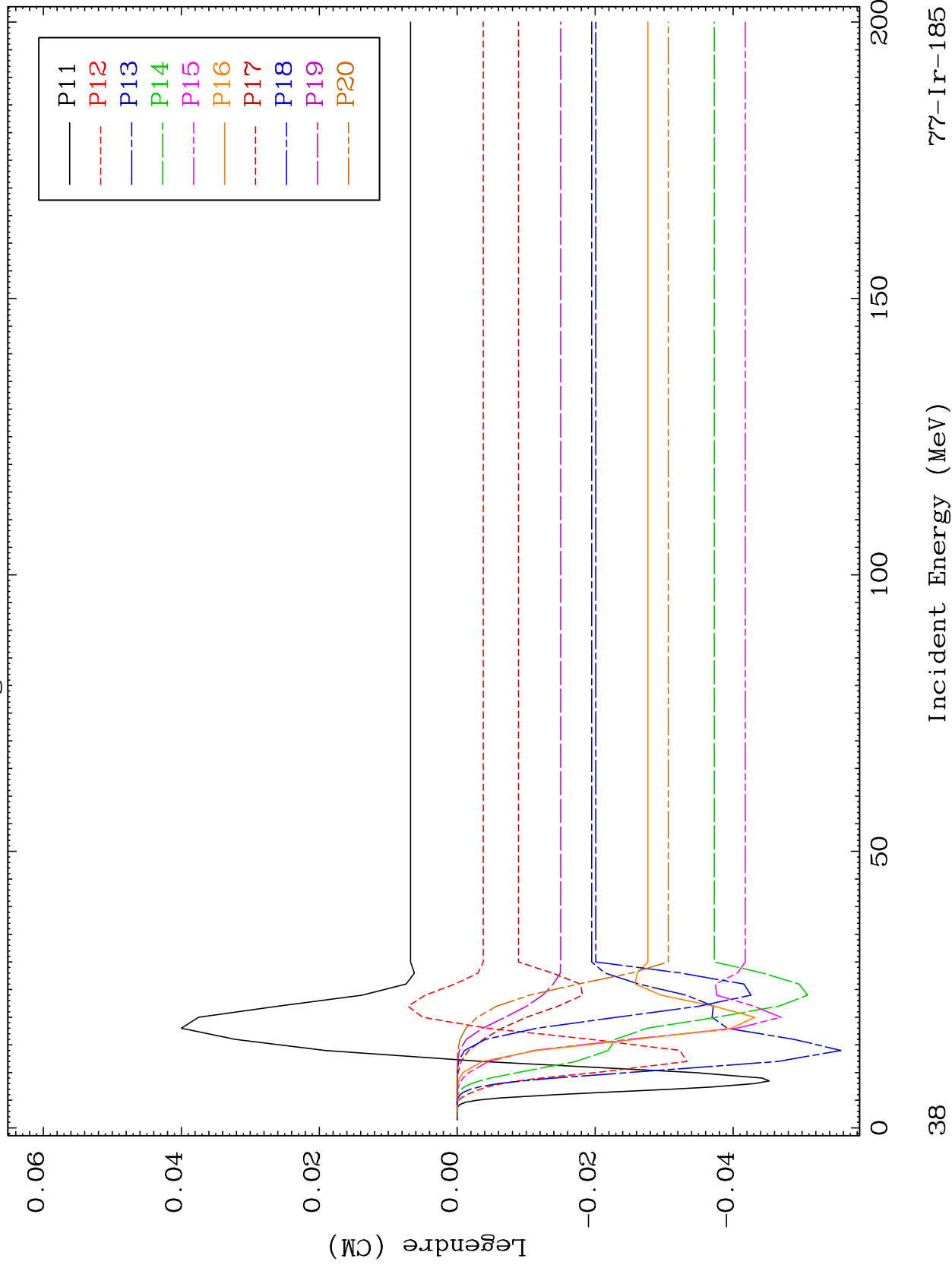

77-Ir-185

Incident Energy (MeV)

38

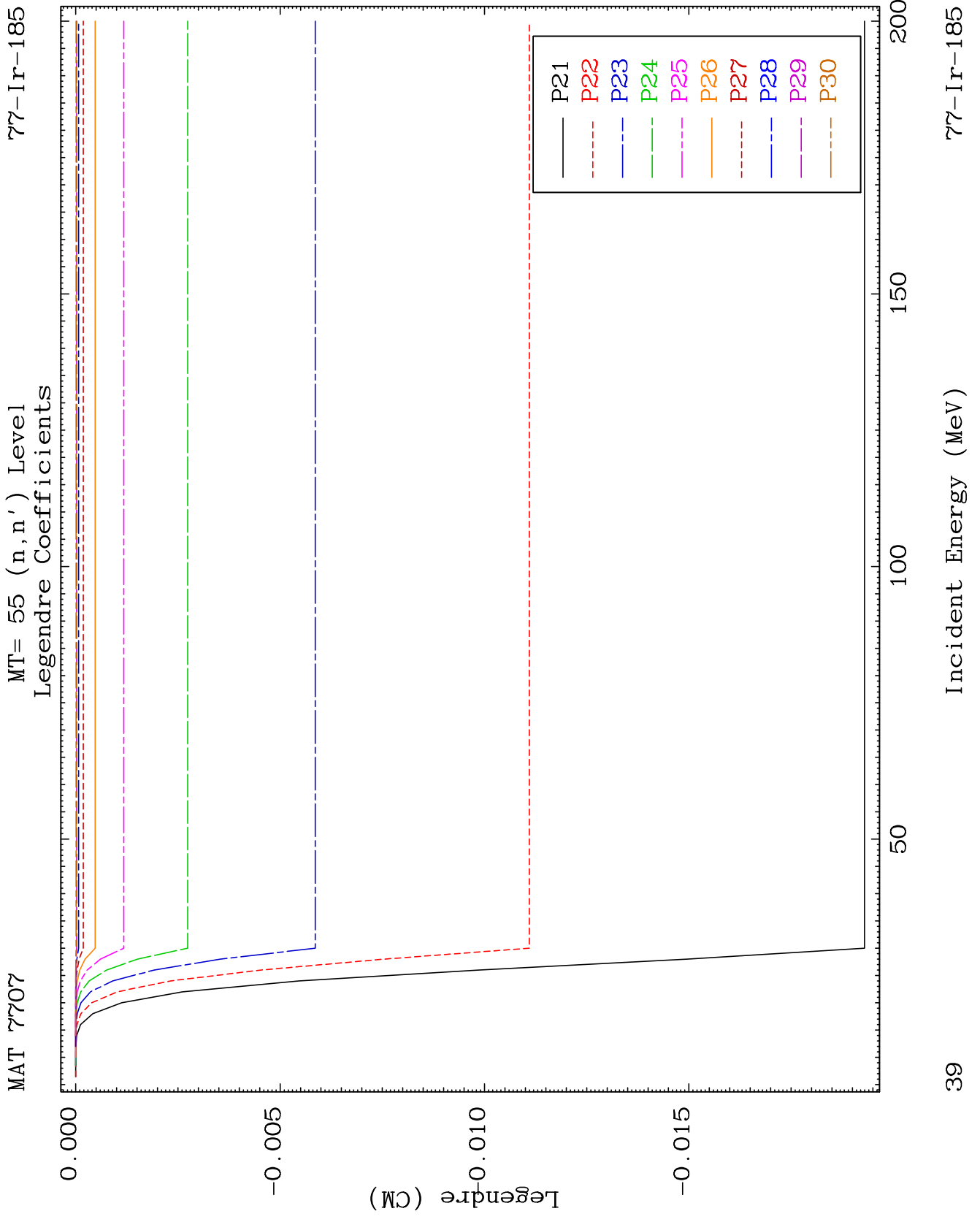

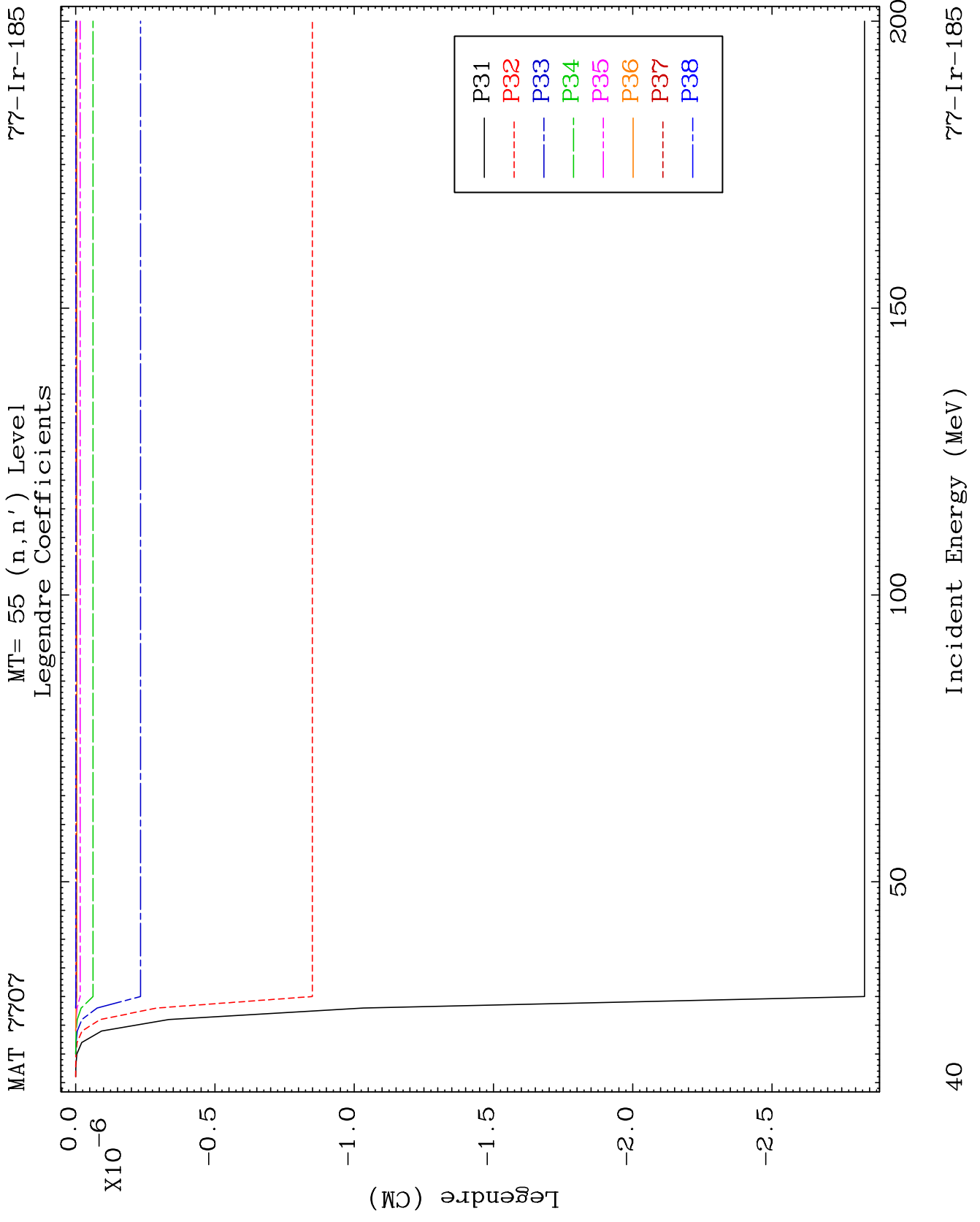

MAT 7707

MT= 56 (n,n') Level
Legendre Coefficients

77-Ir-185

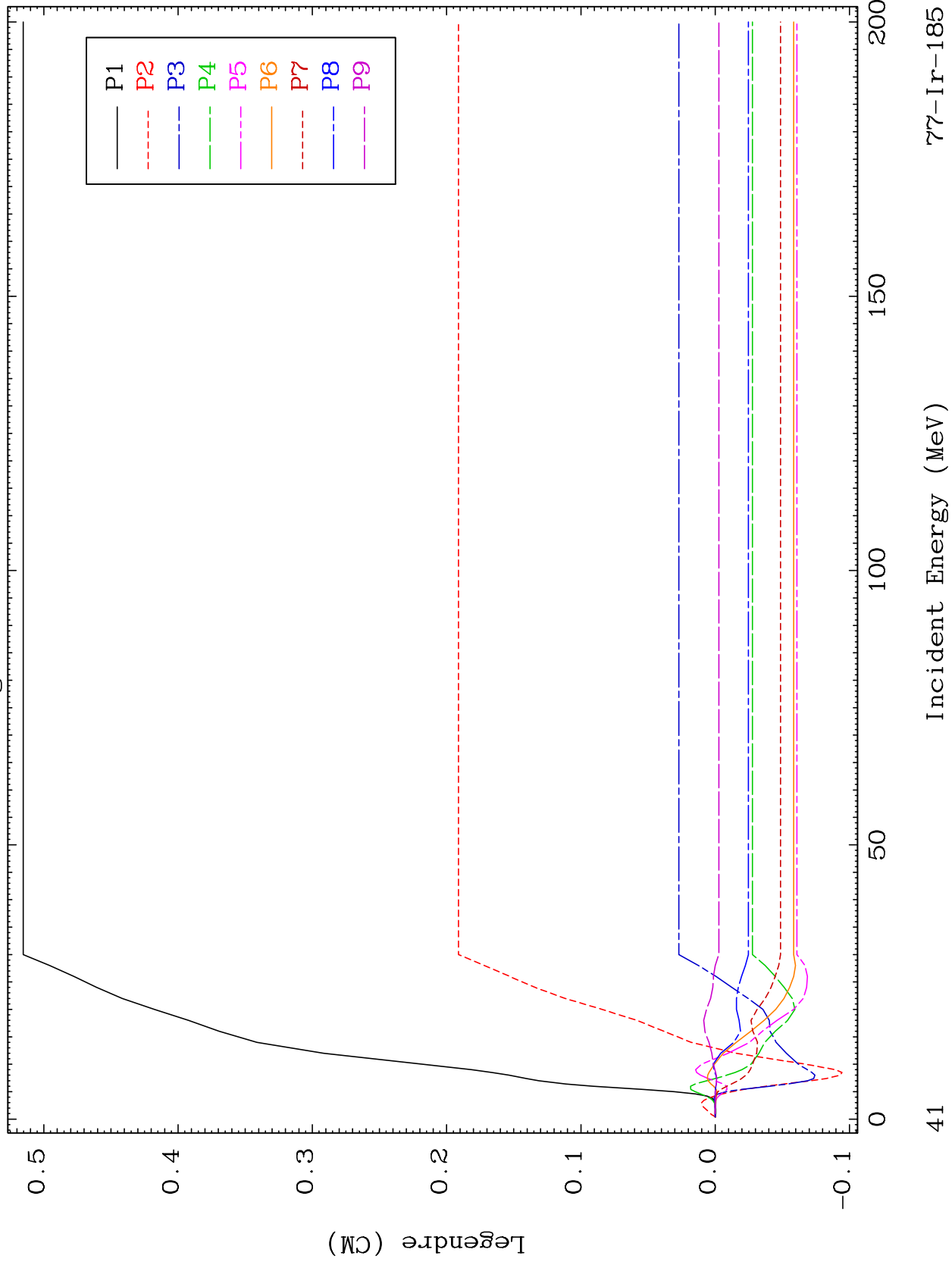

77-Ir-185

Incident Energy (MeV)

41

MAT 7707

MT= 56 (n,n') Level
Legendre Coefficients

77-Ir-185

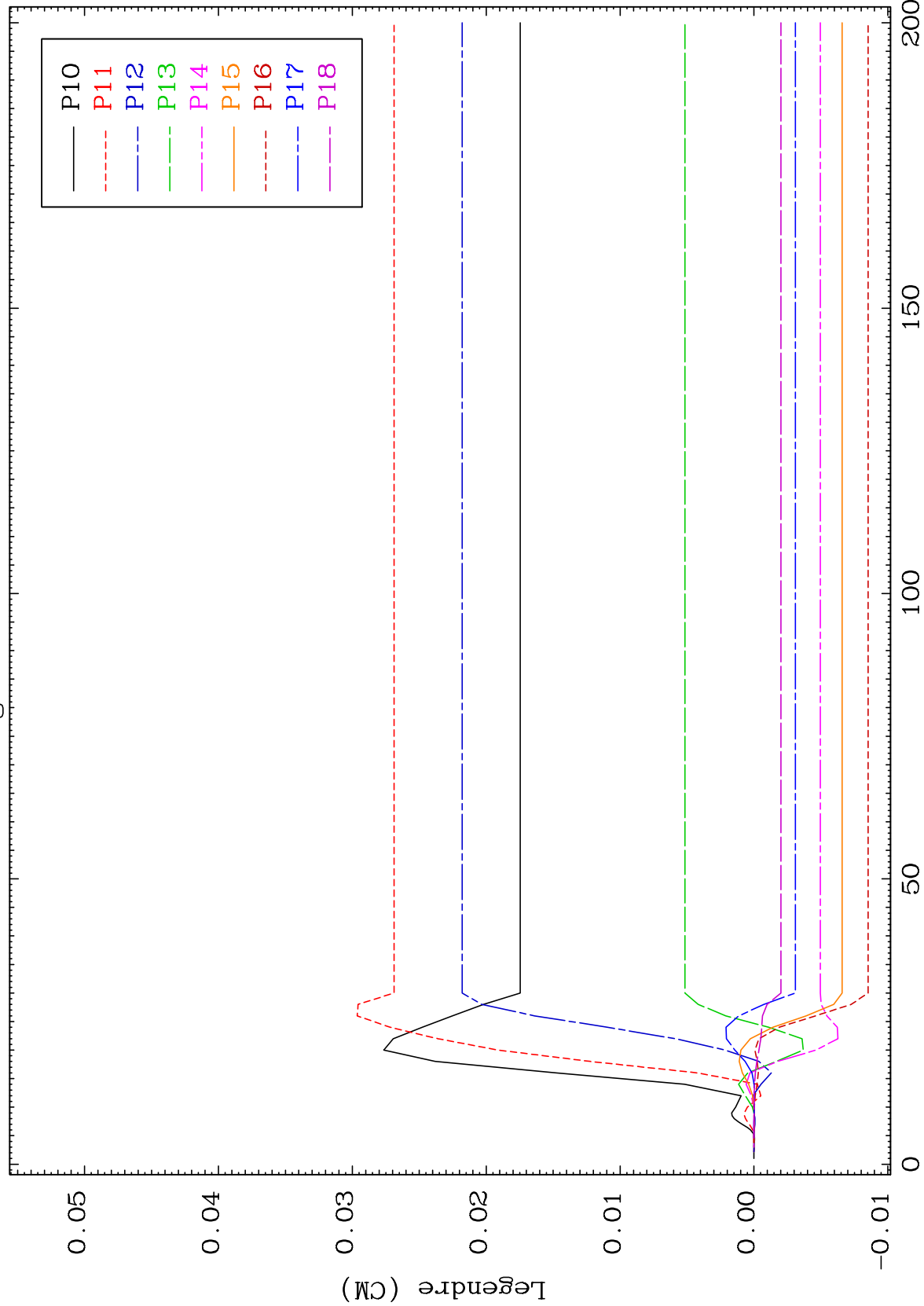

42

Incident Energy (MeV)

77-Ir-185

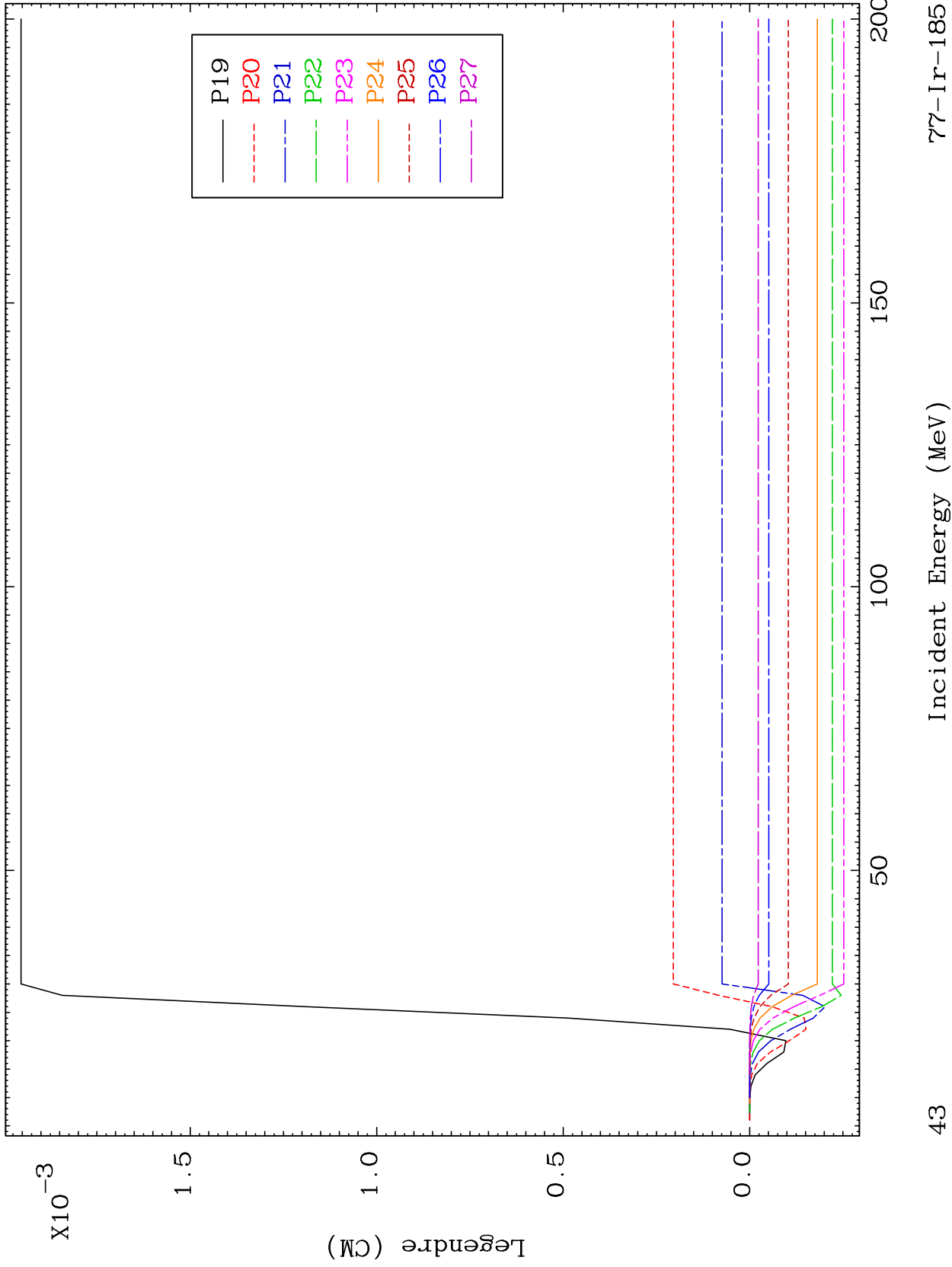

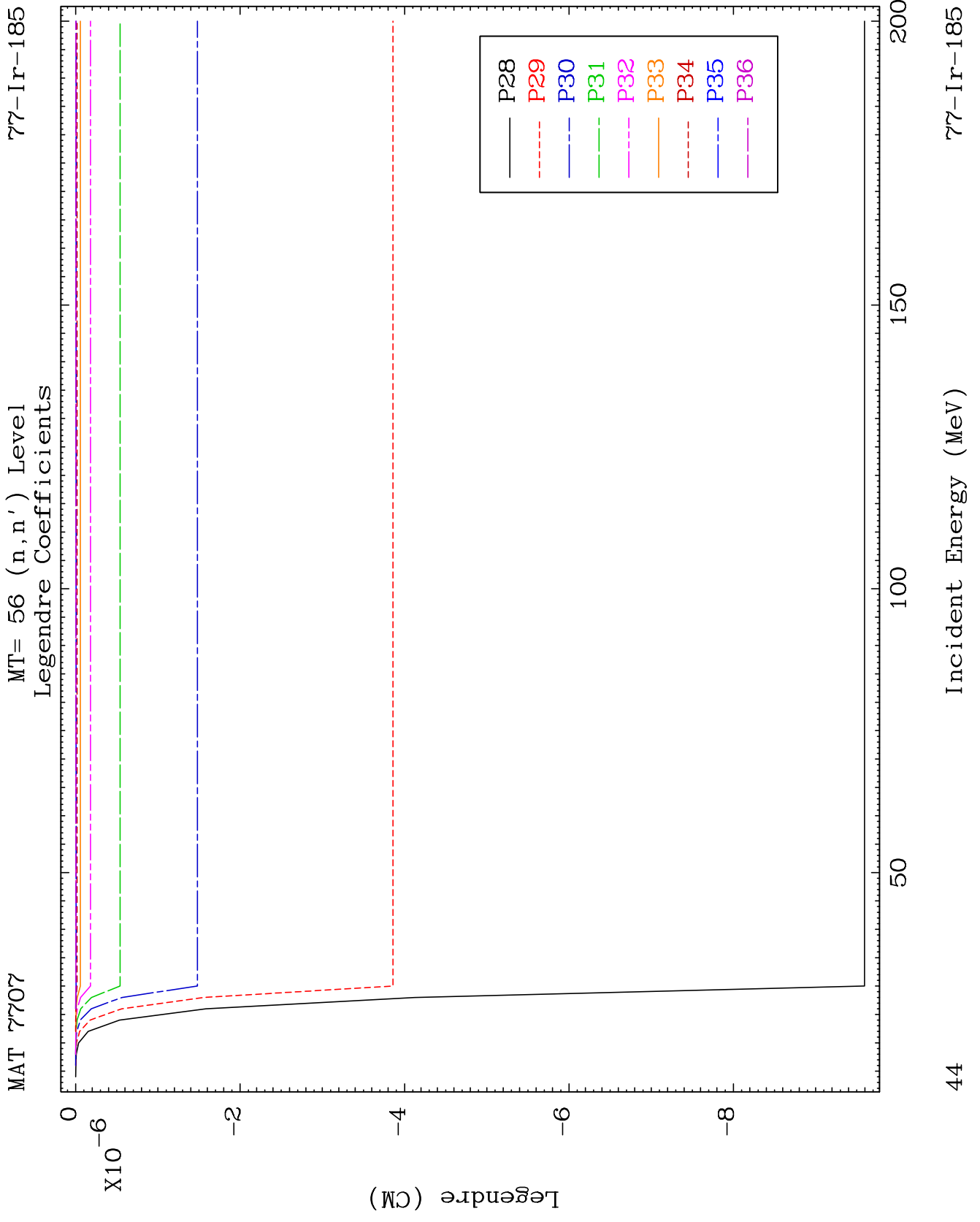

MAT 7707

MT= 57 (n,n') Level
Legendre Coefficients

77-Ir-185

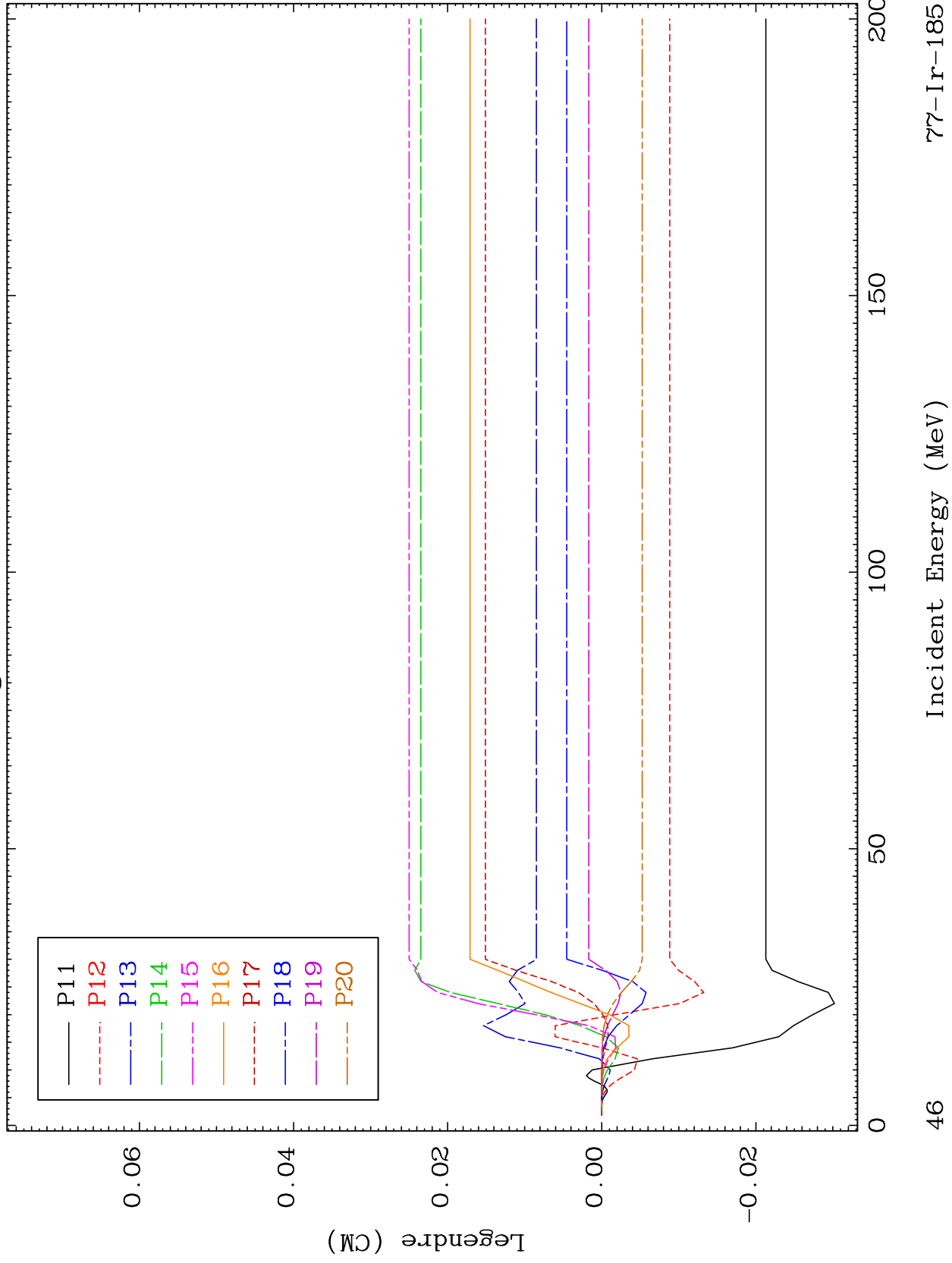

77-Ir-185

Incident Energy (MeV)

46

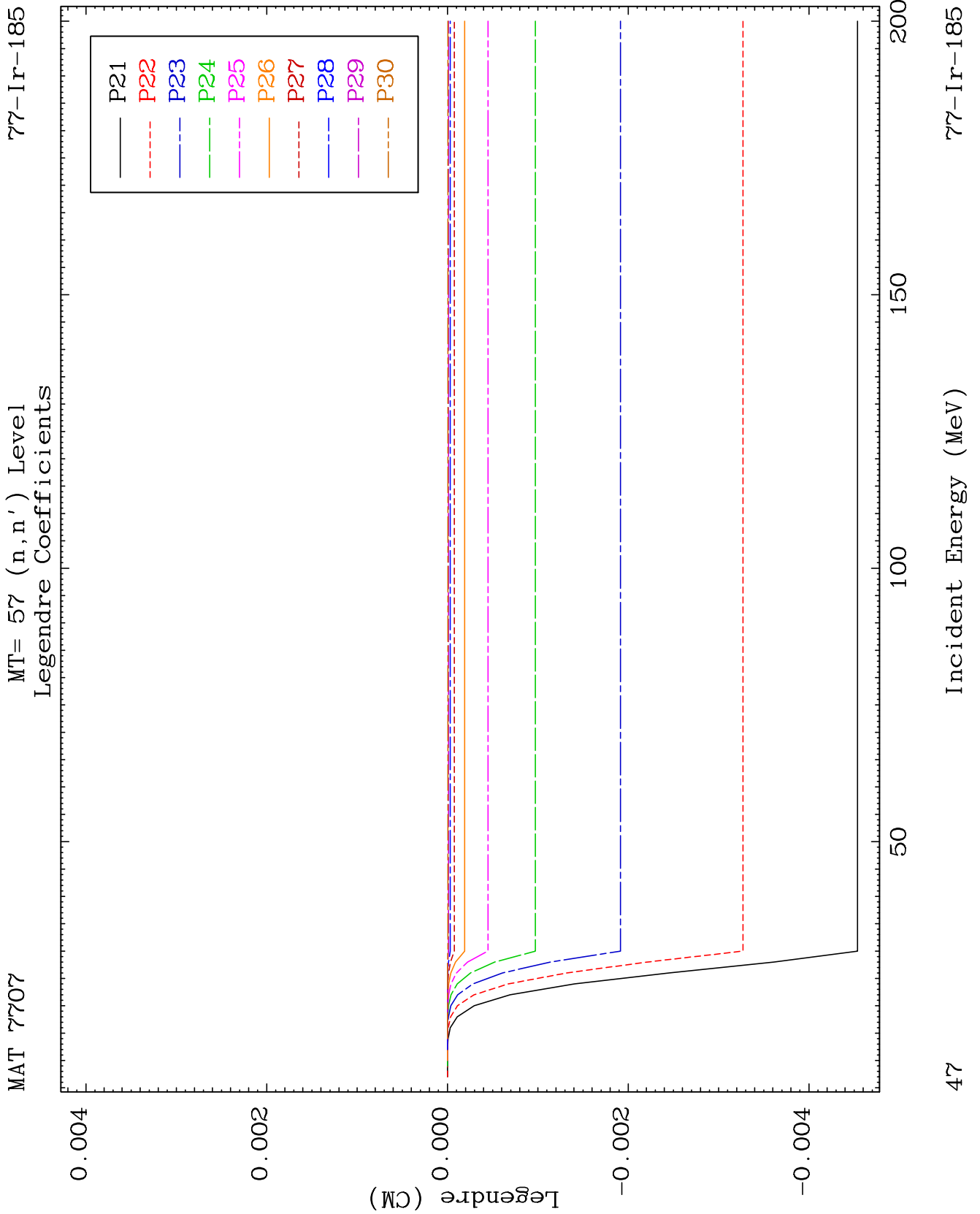

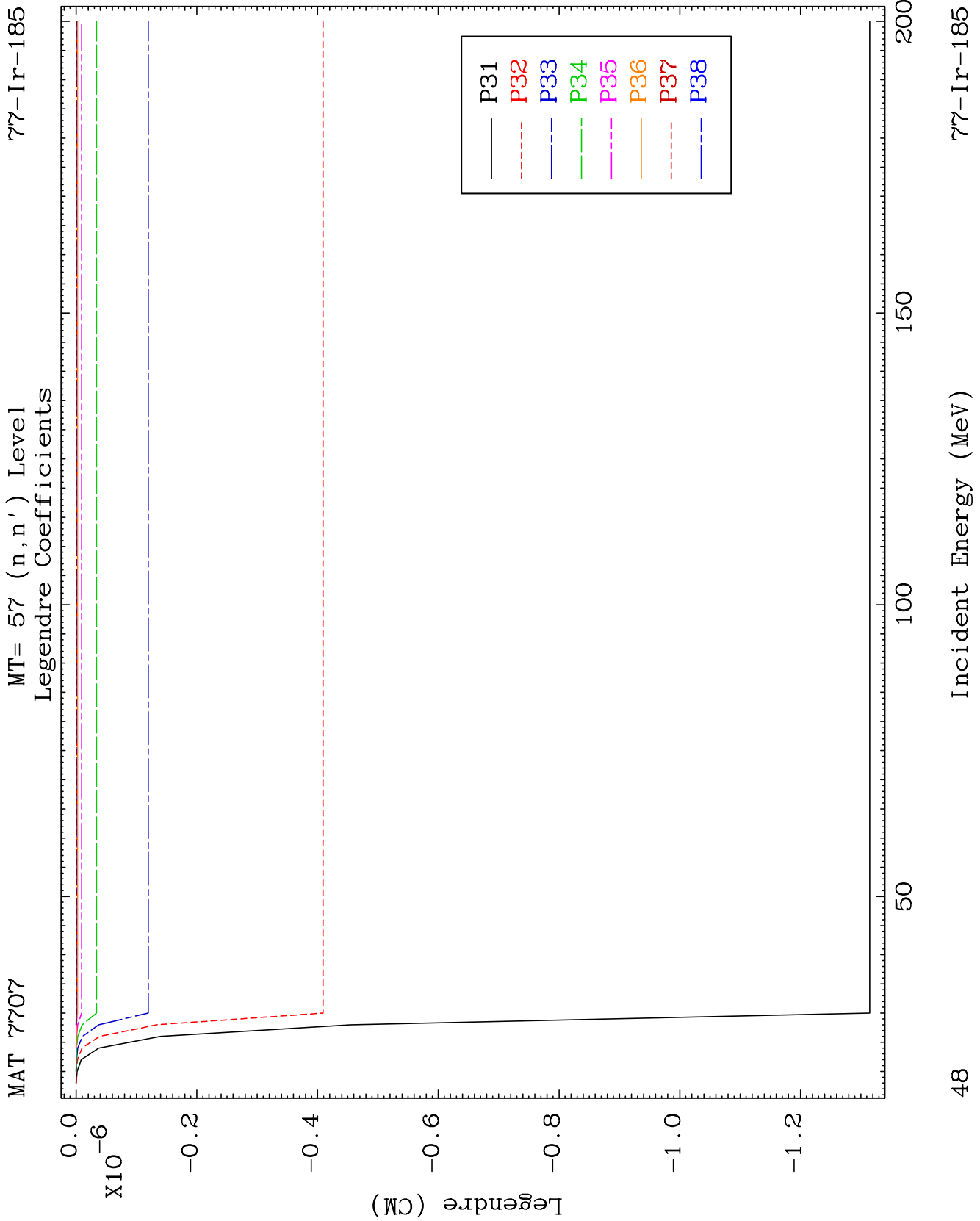

MAT 7707

MT= 58 (n,n') Level
Legendre Coefficients

77-Ir-185

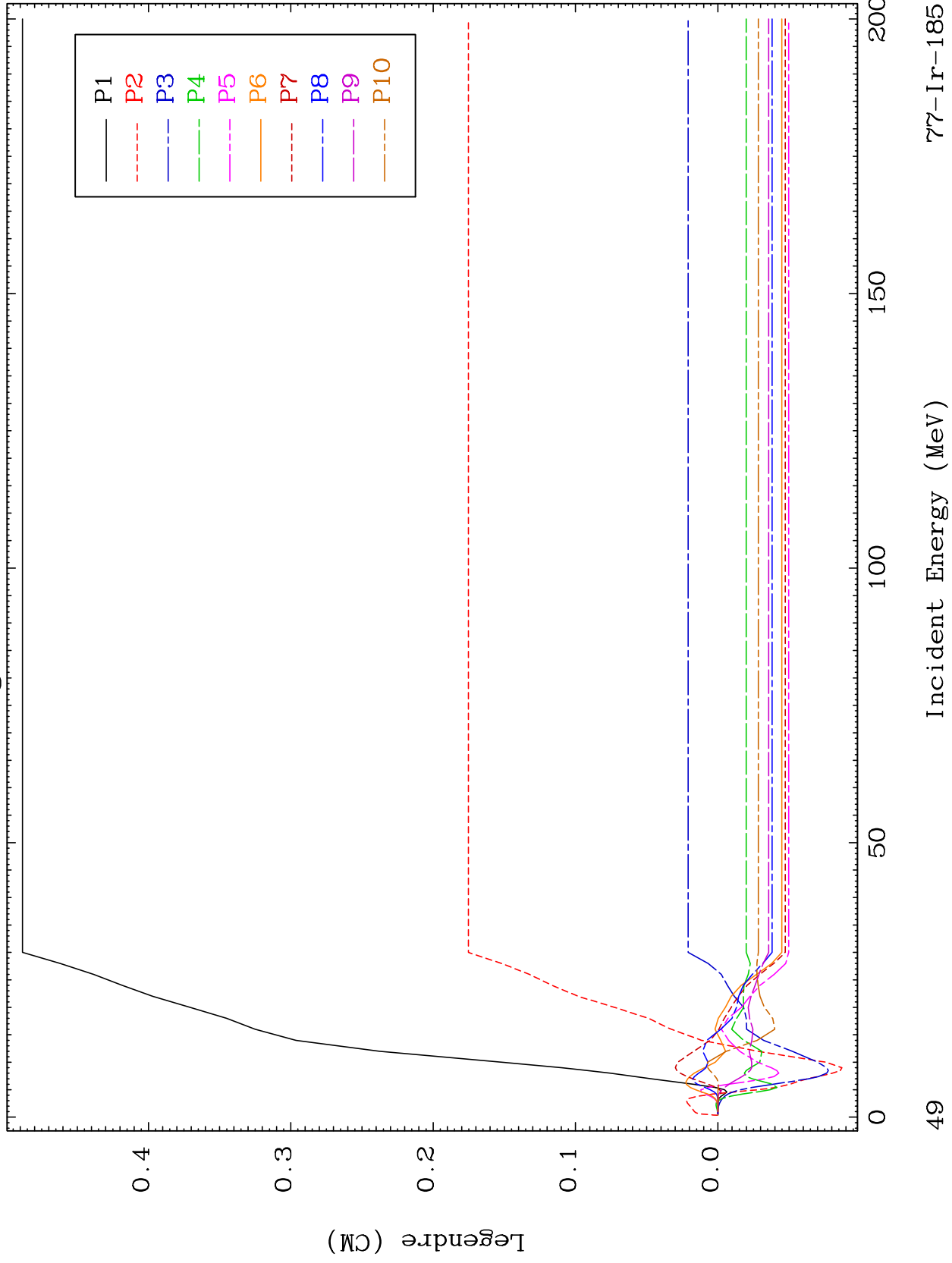

77-Ir-185

Incident Energy (MeV)

49

MAT 7707

MT= 58 (n,n') Level
Legendre Coefficients

77-Ir-185

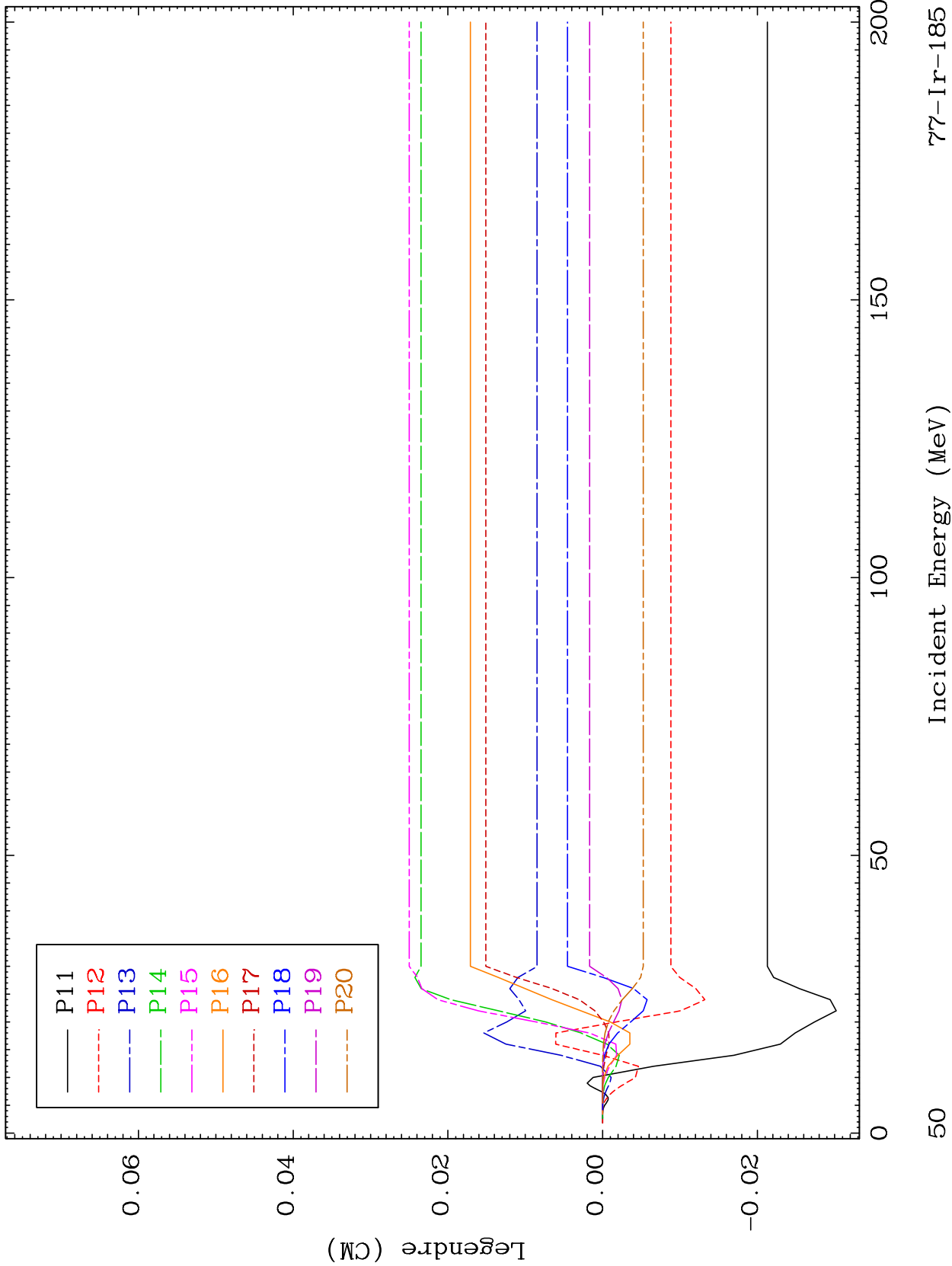

77-Ir-185

MAT 7707

MT= 58 (n,n') Level
Legendre Coefficients

77-Ir-185

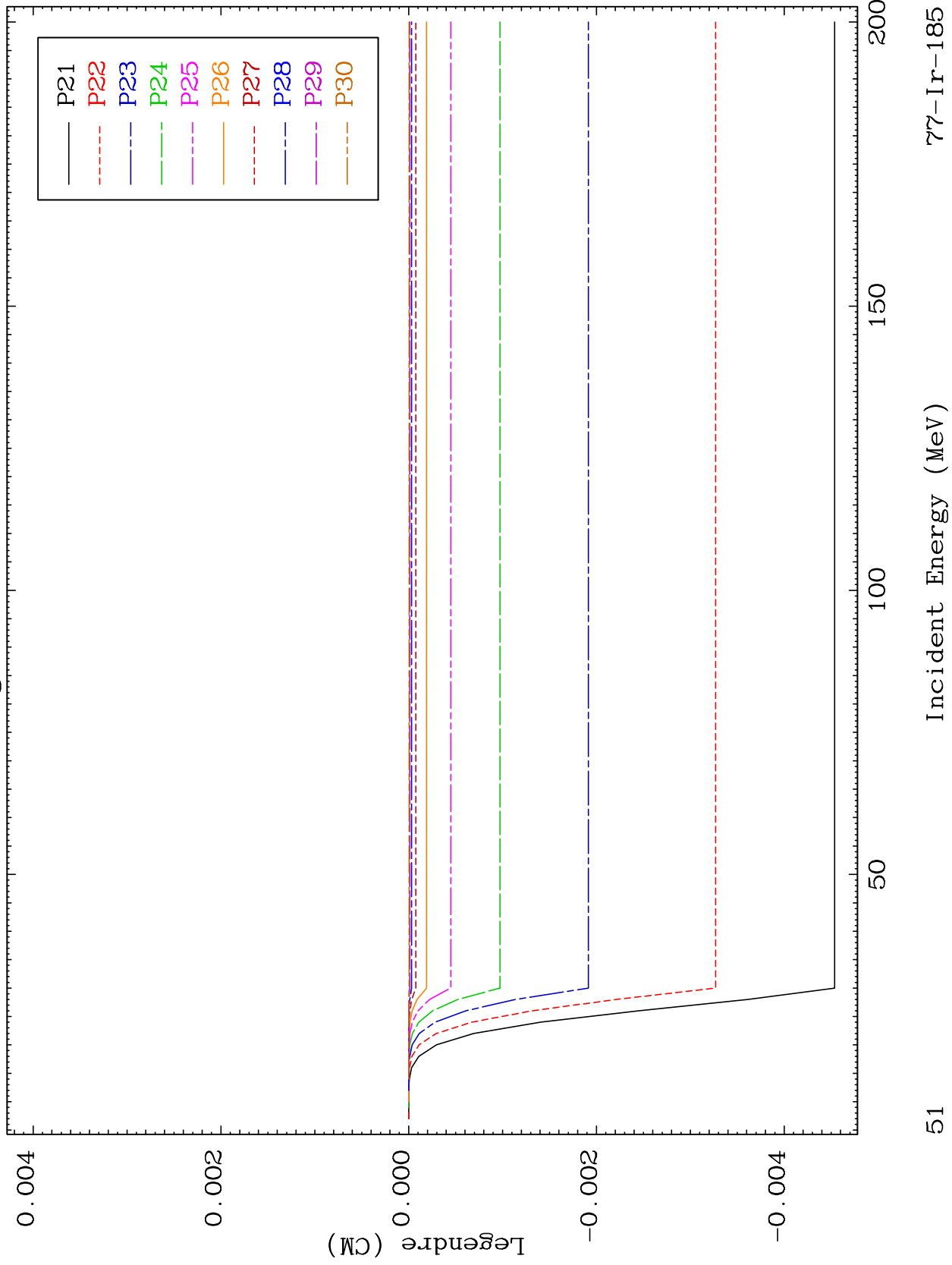

51

Incident Energy (MeV)

77-Ir-185

MAT 7707

MT= 58 (n,n') Level
Legendre Coefficients

77-Ir-185

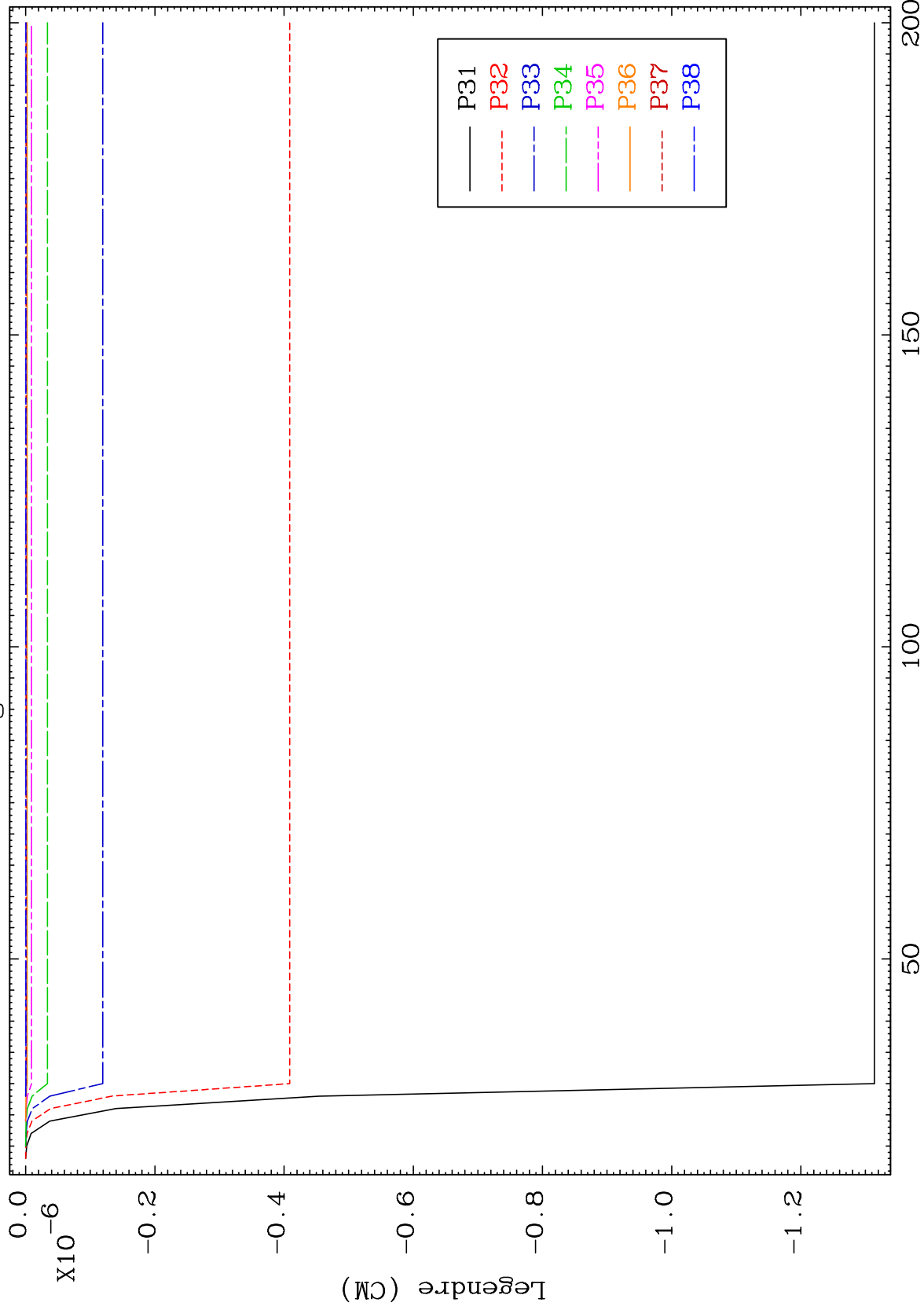

52

Incident Energy (MeV)

77-Ir-185

MAT 7707

MT= 59 (n,n') Level
Legendre Coefficients

77-Ir-185

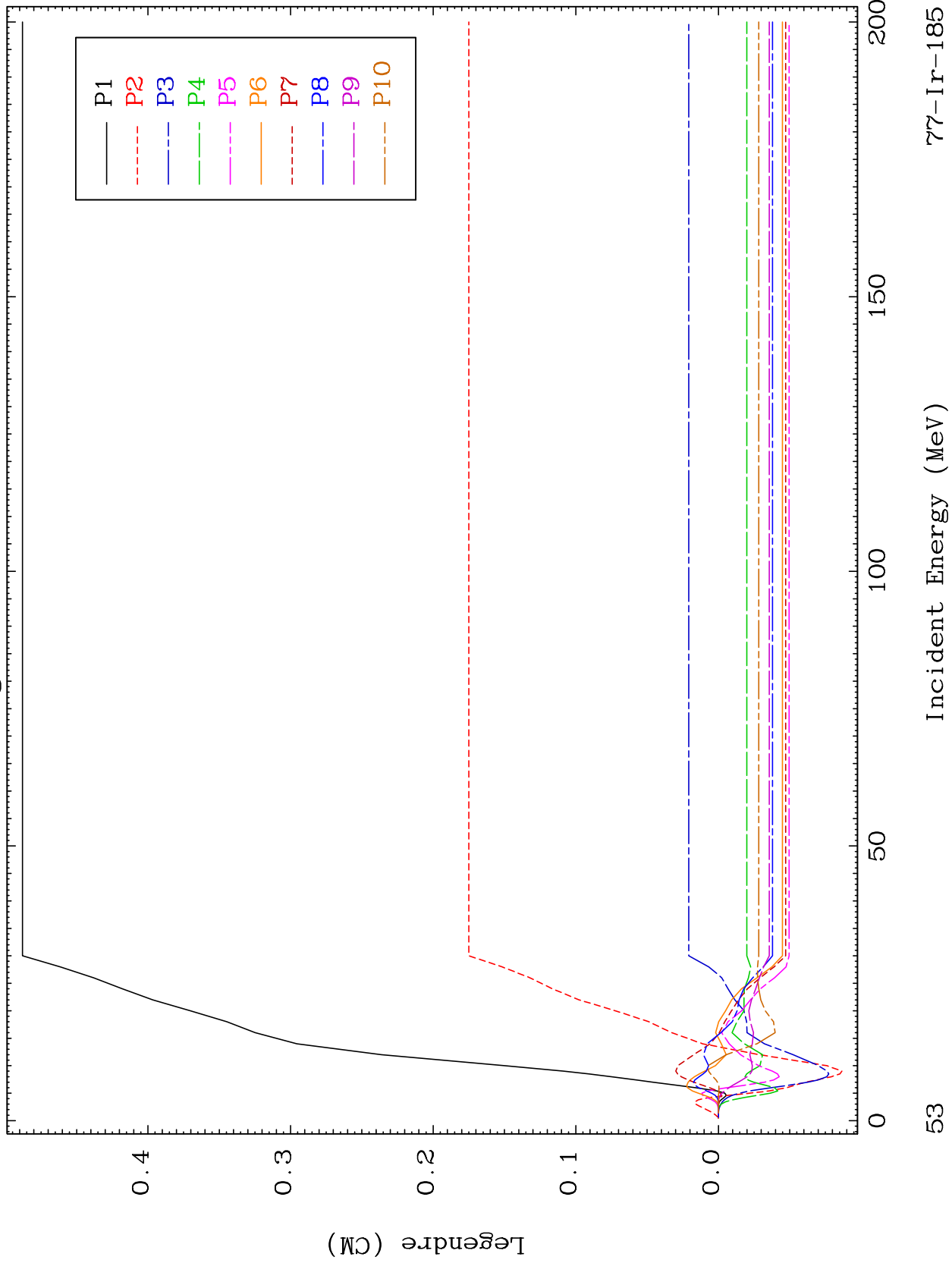

53

77-Ir-185

MAT 7707

MT= 59 (n,n') Level
Legendre Coefficients

77-Ir-185

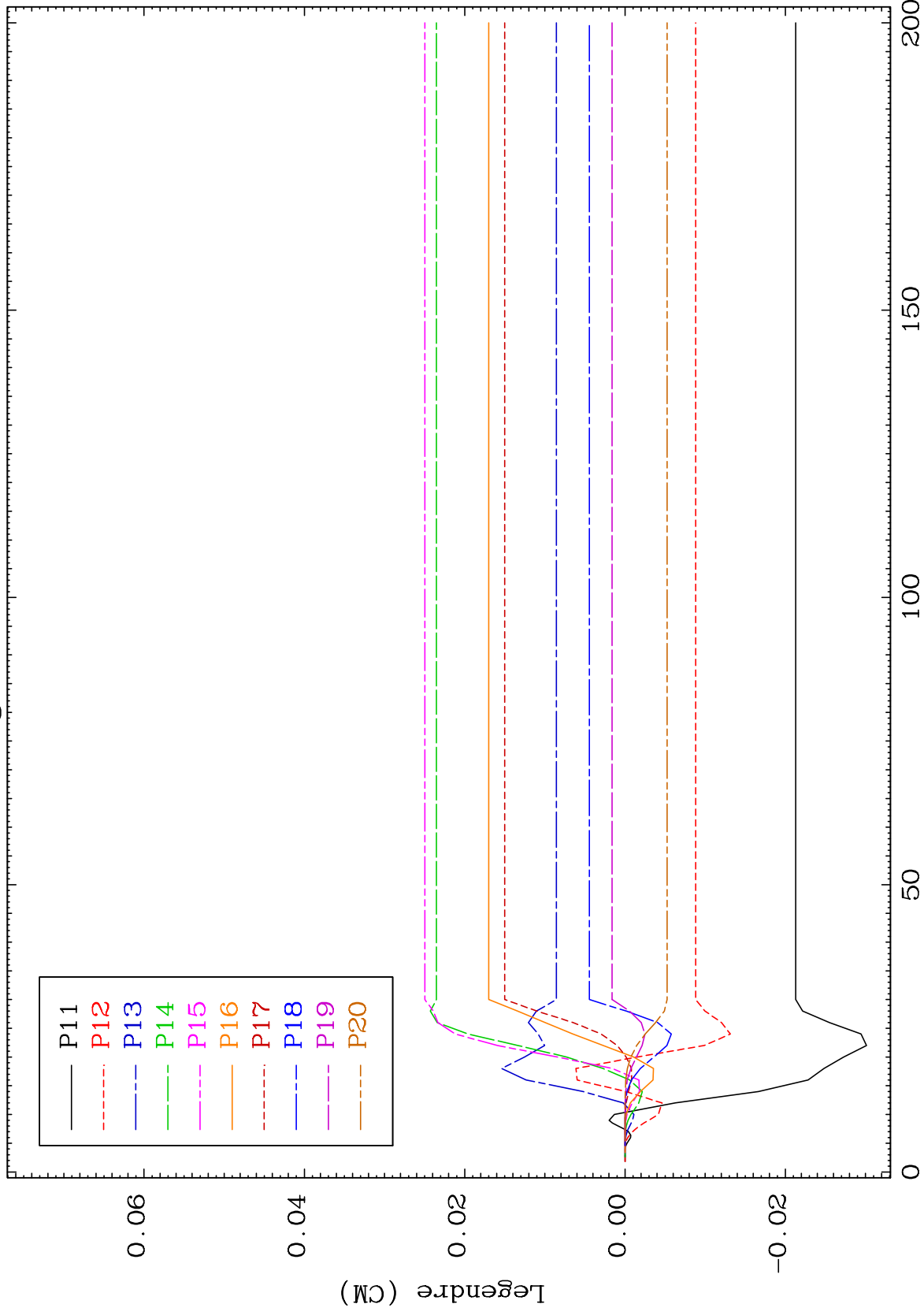

54

Incident Energy (MeV)

77-Ir-185

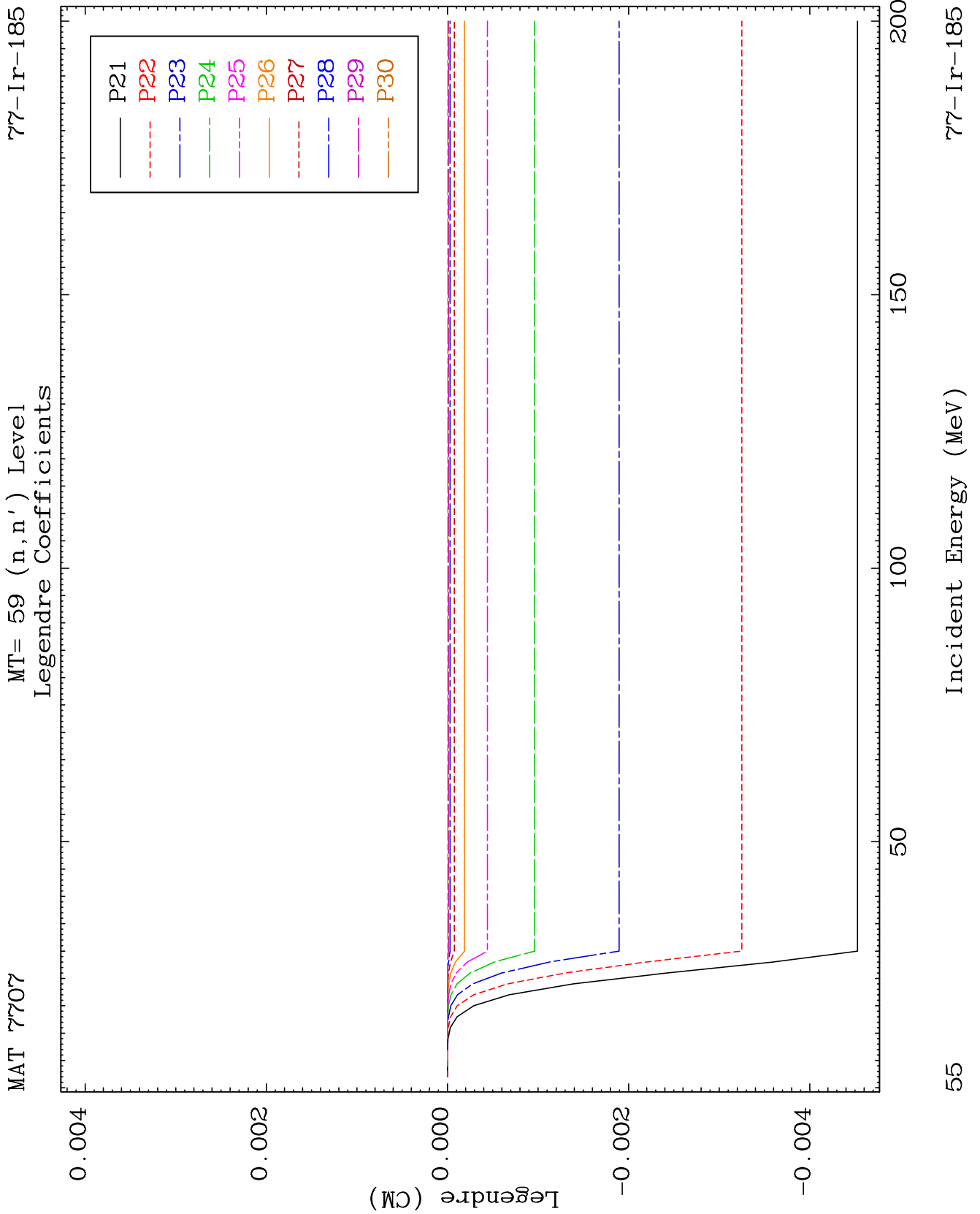

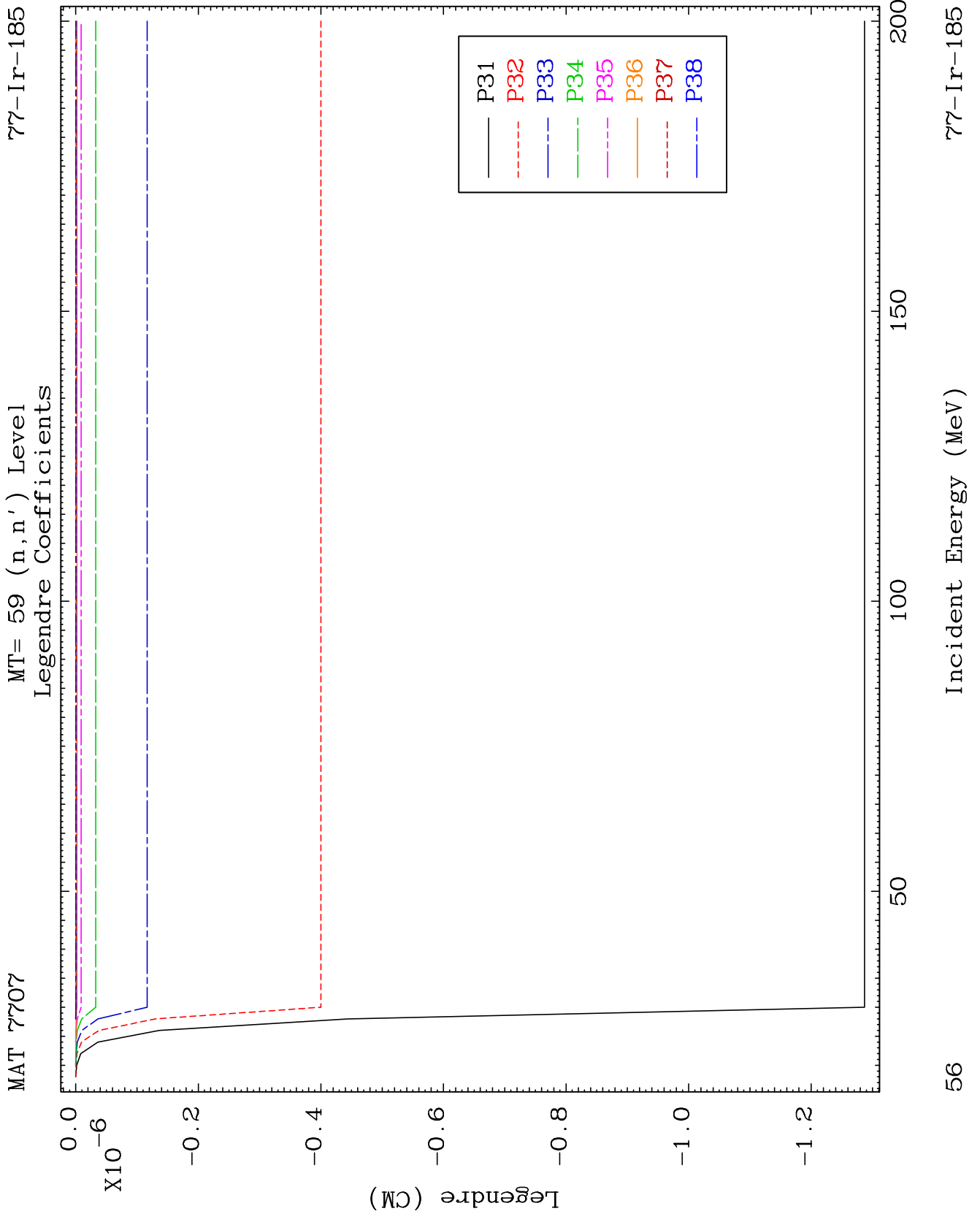

MAT 7707

MT= 60 (n,n') Level
Legendre Coefficients

77-Ir-185

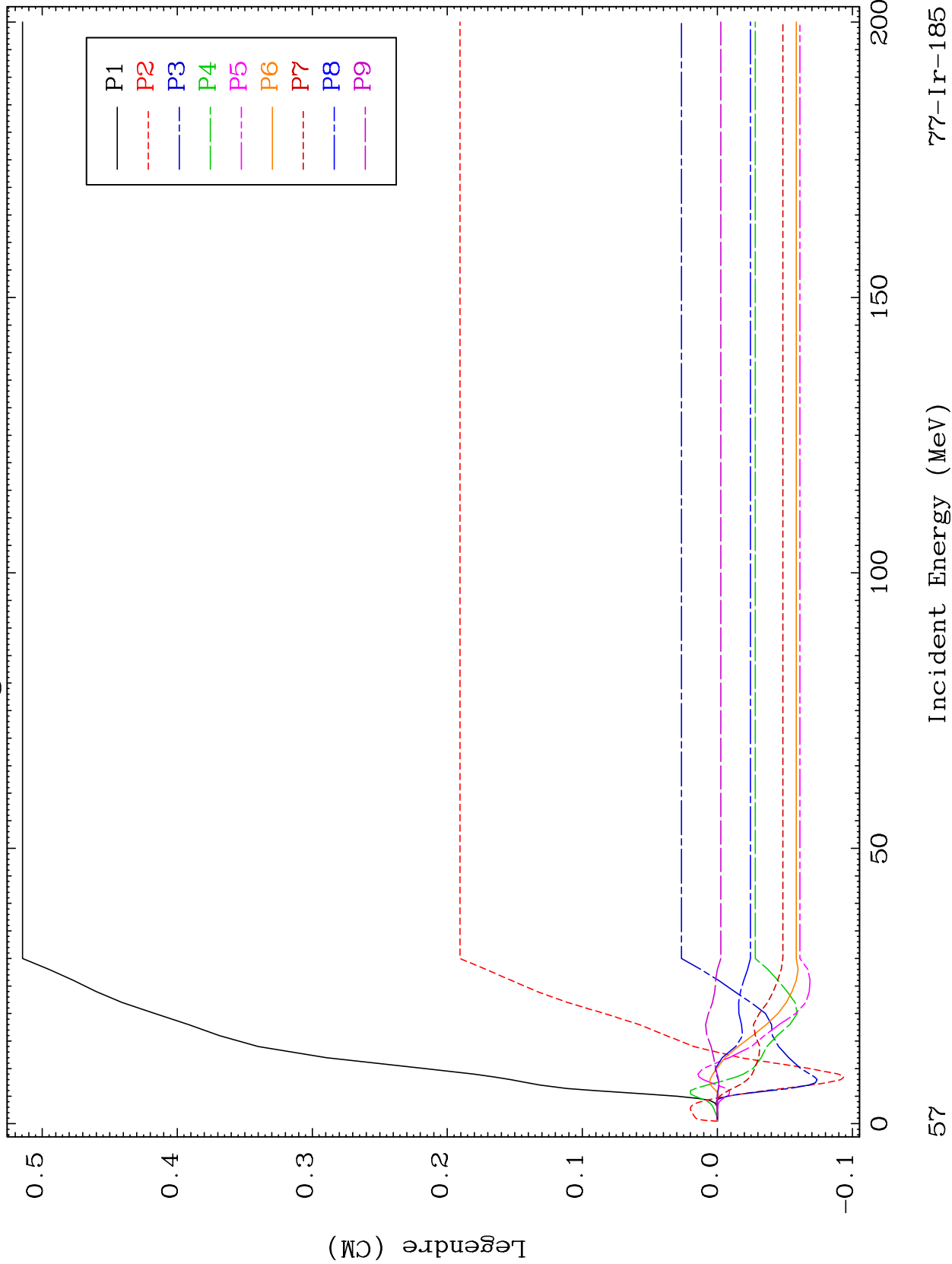

57

Incident Energy (MeV)

77-Ir-185

MAT 7707

MT= 60 (n,n') Level
Legendre Coefficients

77-Ir-185

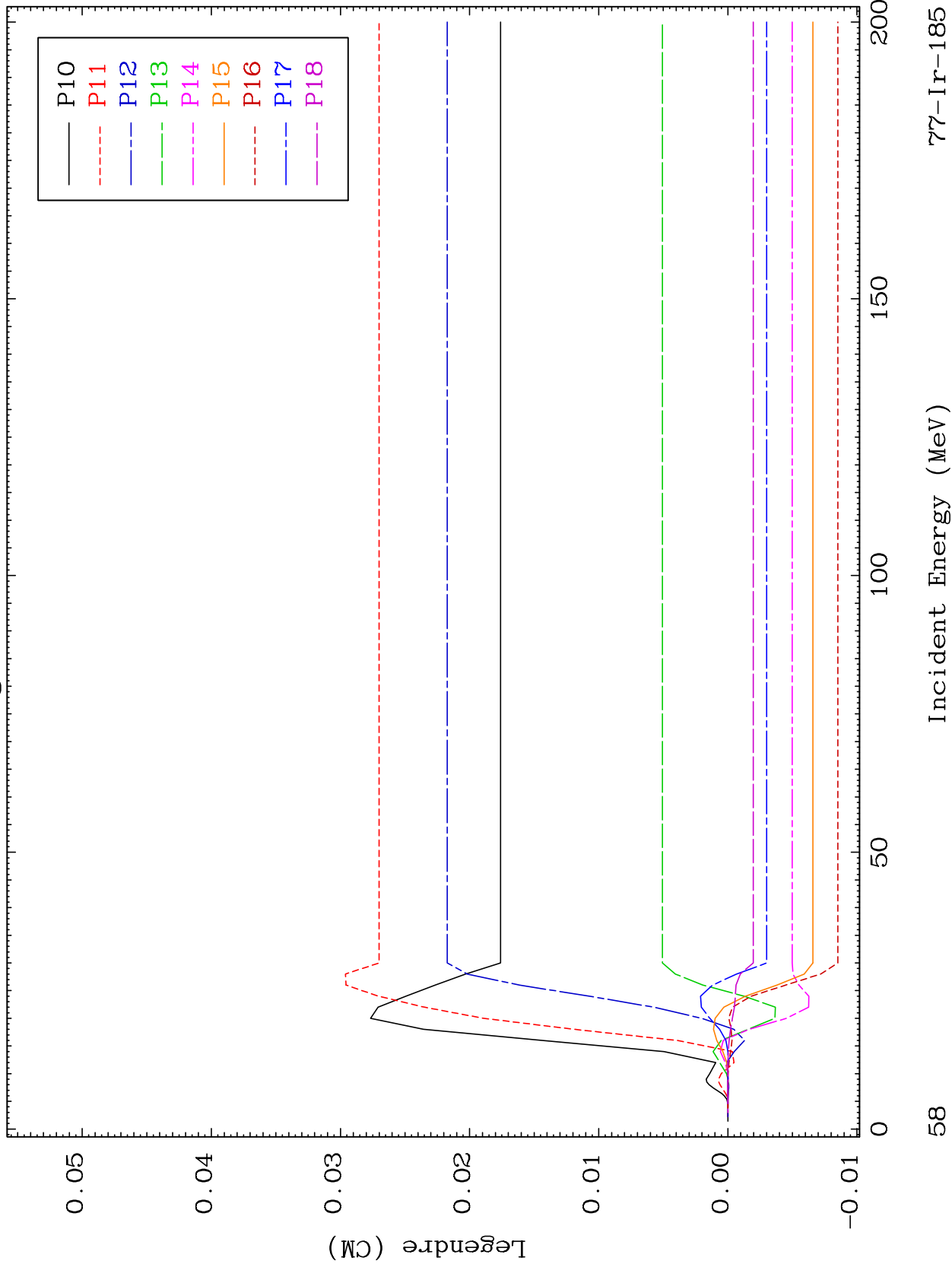

58

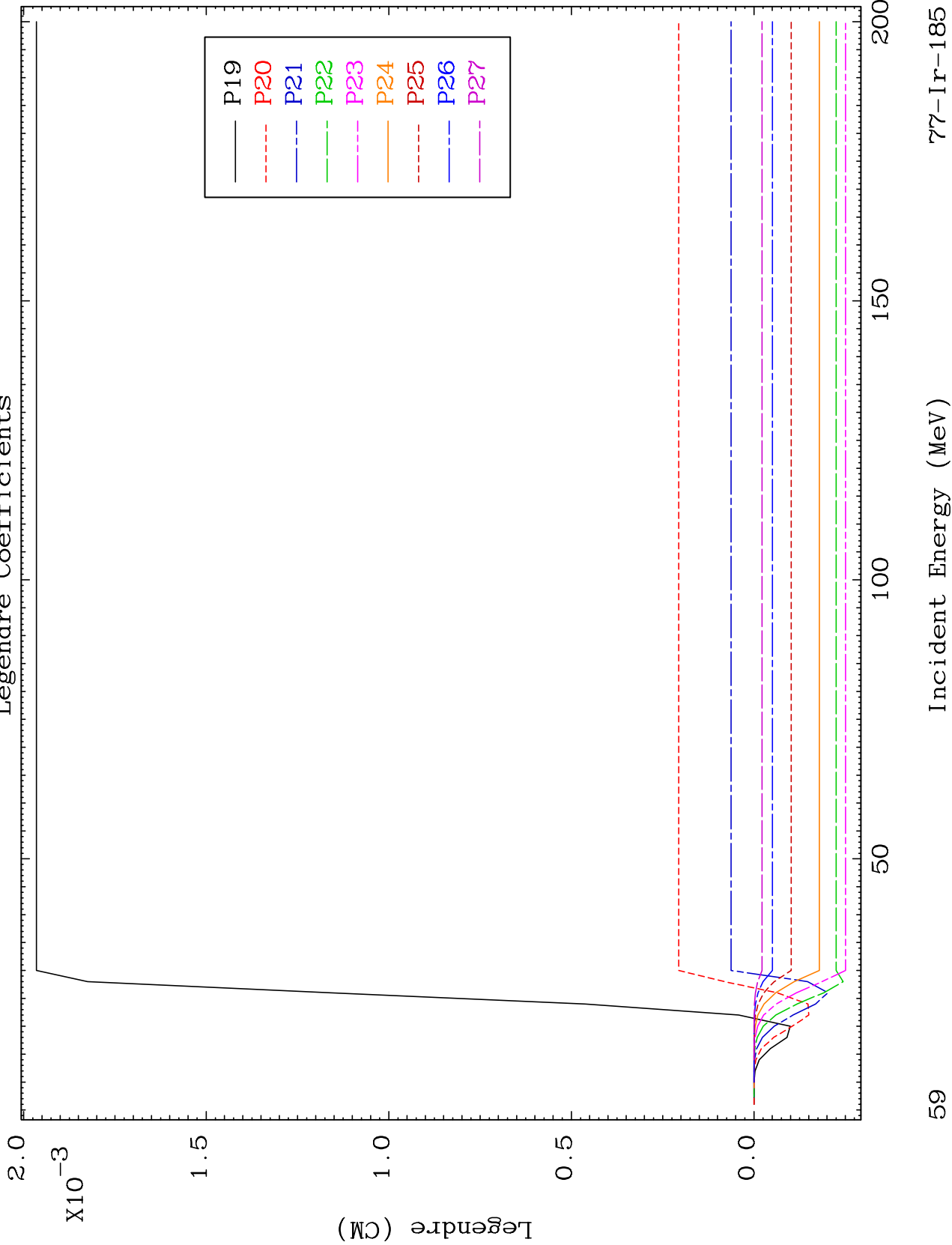

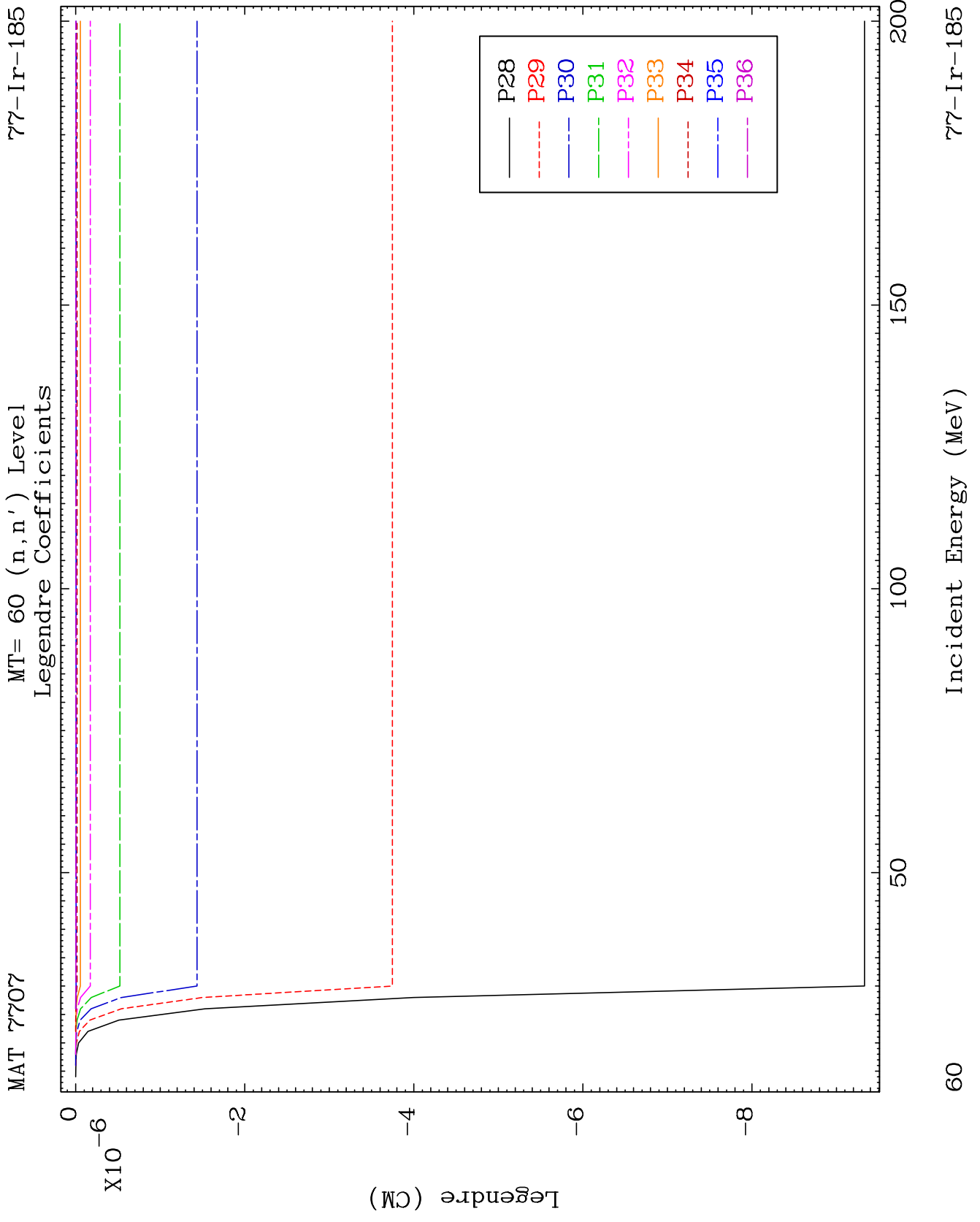

MAT 7707

MT= 61 (n,n') Level
Legendre Coefficients

77-Ir-185

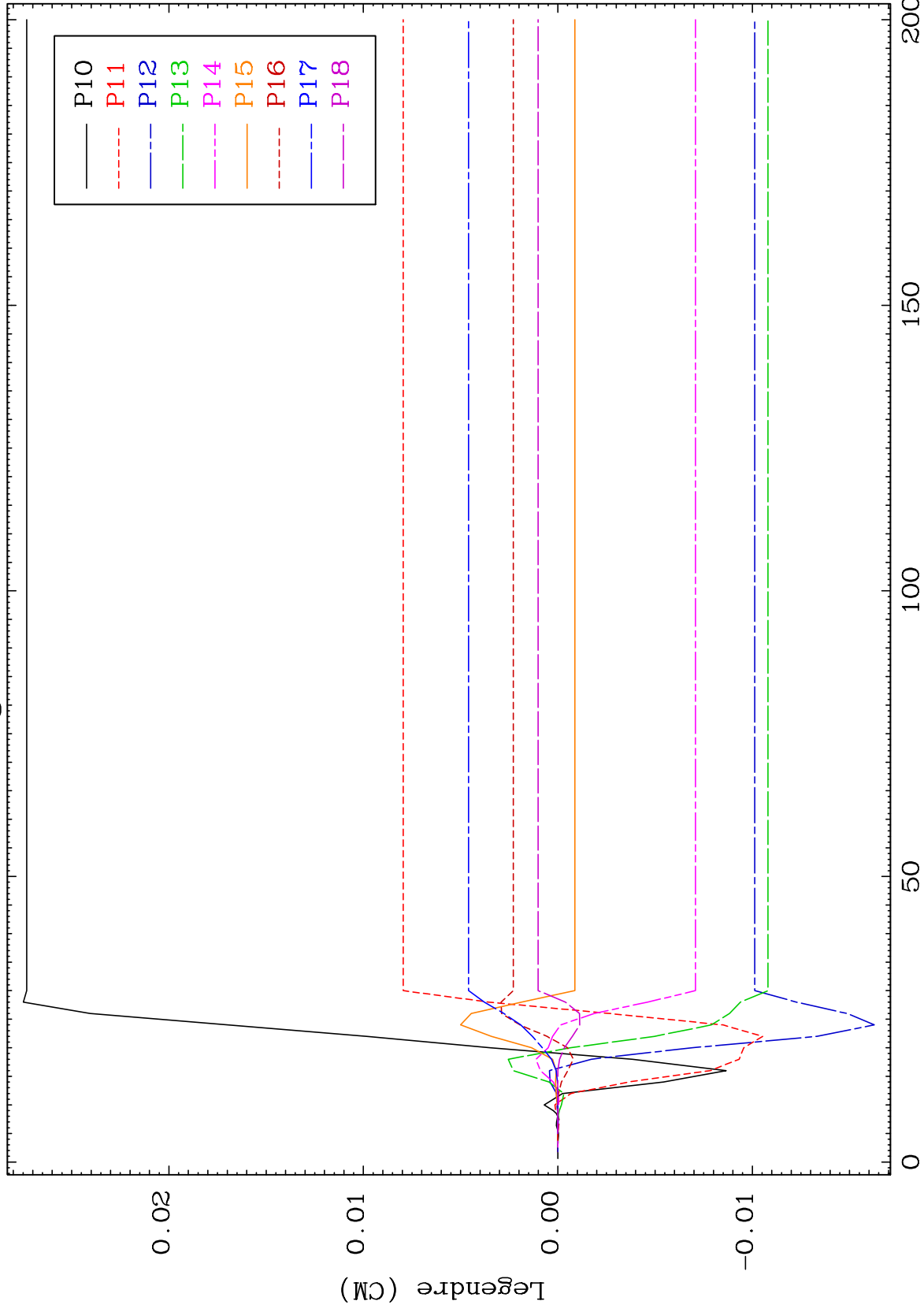

62

Incident Energy (MeV)

77-Ir-185

MAT 7707

MT= 61 (n,n') Level
Legendre Coefficients

77-Ir-185

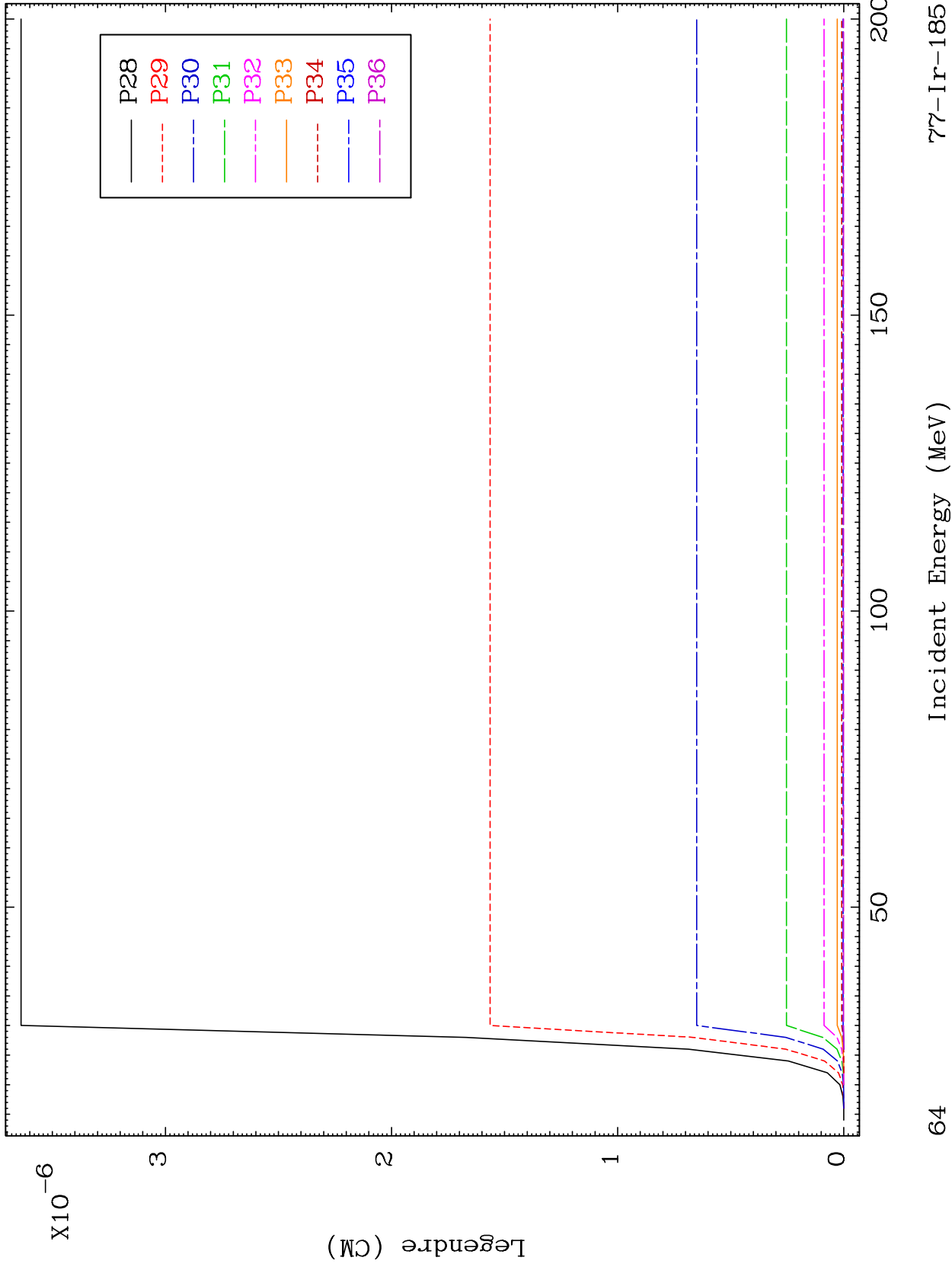

64

Incident Energy (MeV)

77-Ir-185

MAT 7707

MT= 62 (n,n') Level
Legendre Coefficients

77-Ir-185

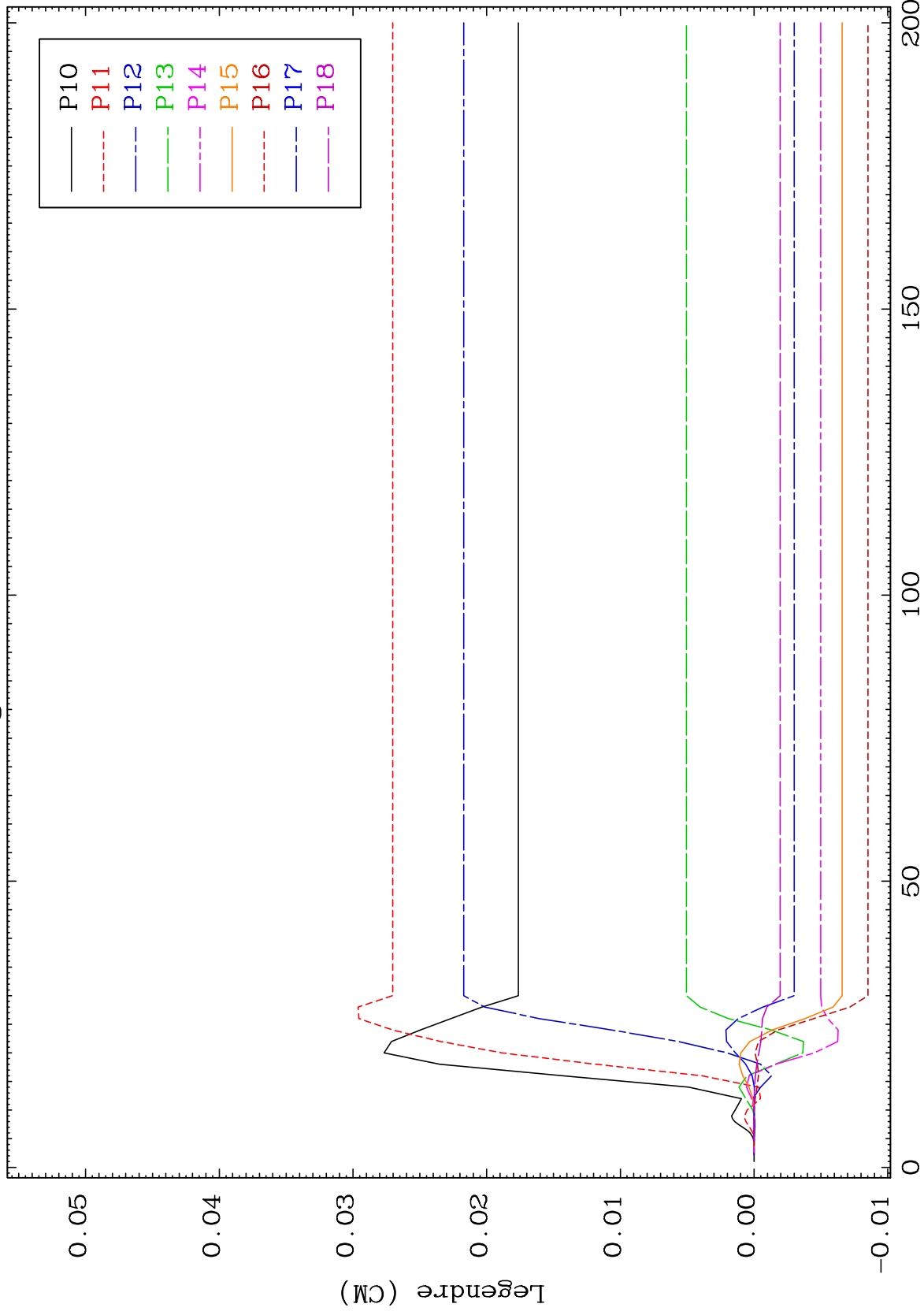

66

Incident Energy (MeV)

77-Ir-185

MAT 7707

MT= 62 (n,n') Level
Legendre Coefficients

77-Ir-185

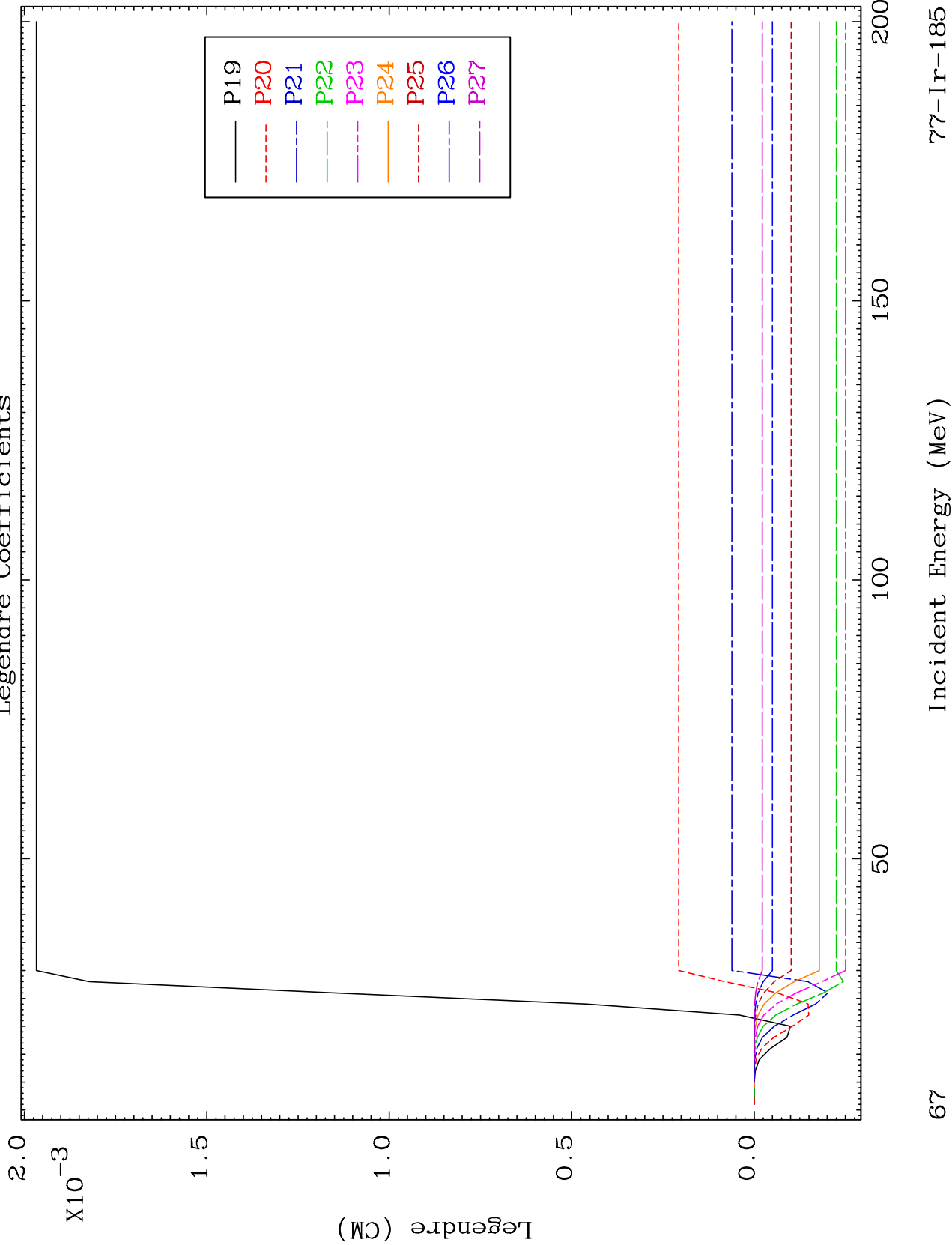

67

77-Ir-185

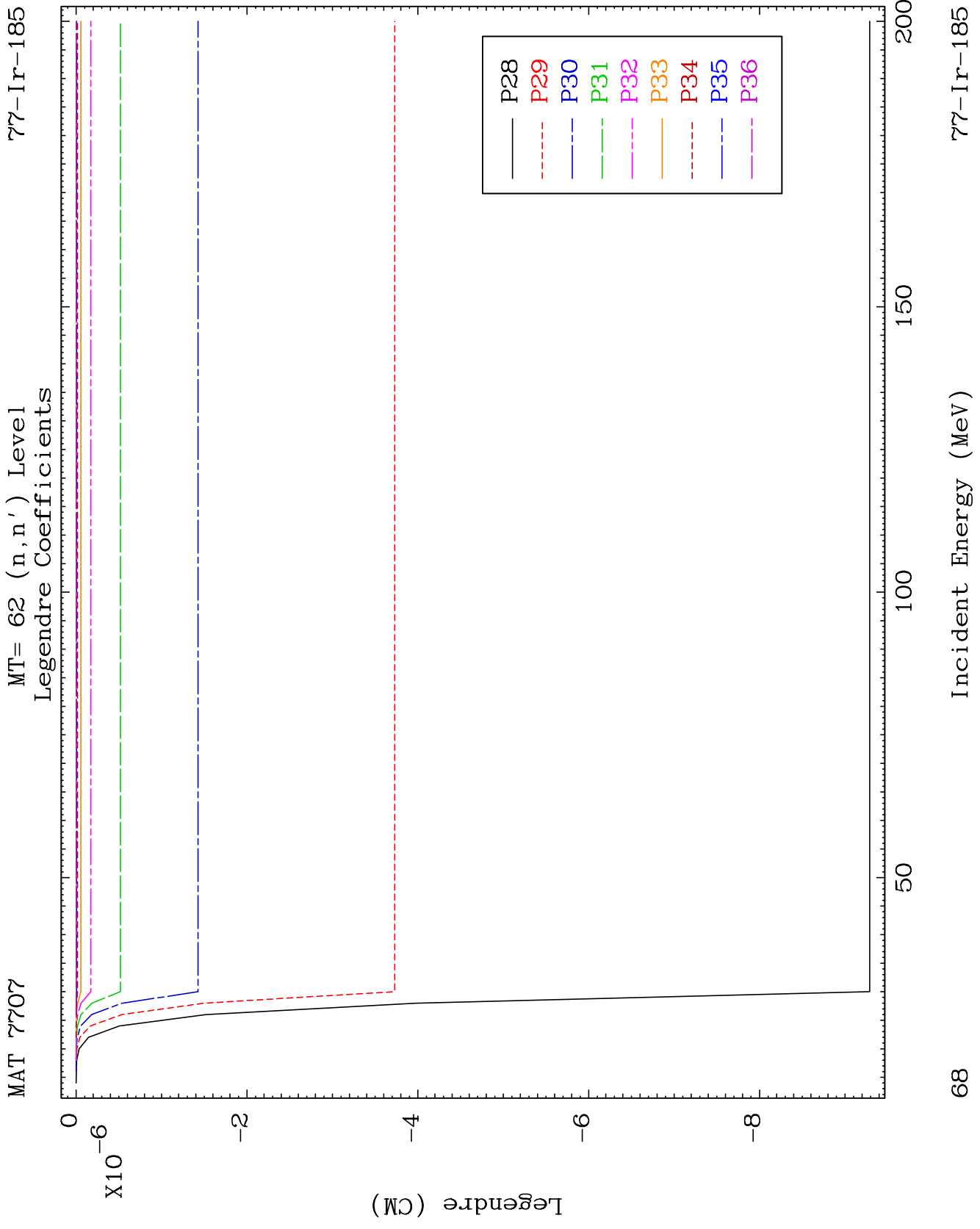

MAT 7707

MT= 63 (n,n') Level
Legendre Coefficients

77-Ir-185

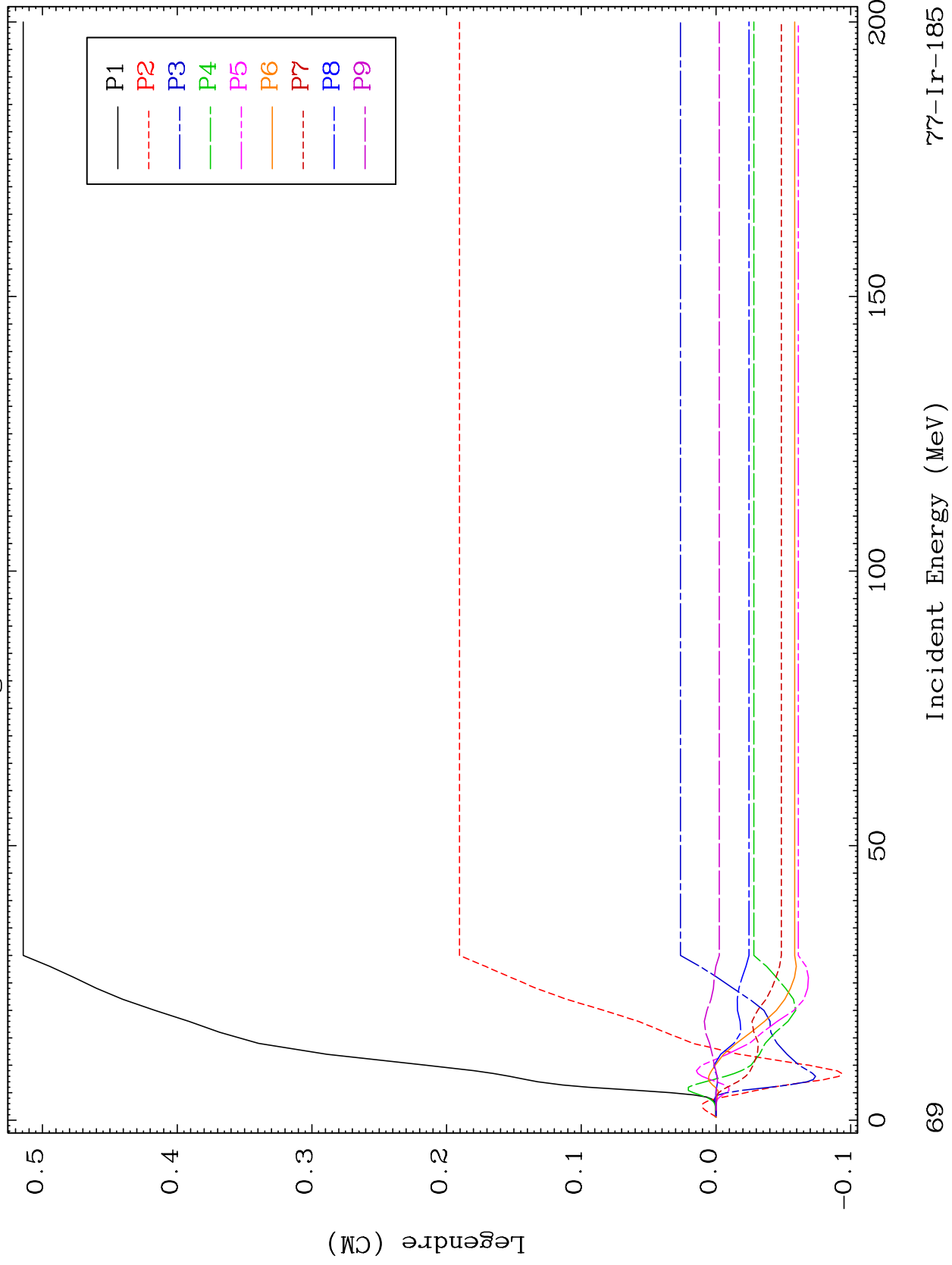

MAT 7707

MT= 63 (n,n') Level
Legendre Coefficients

77-Ir-185

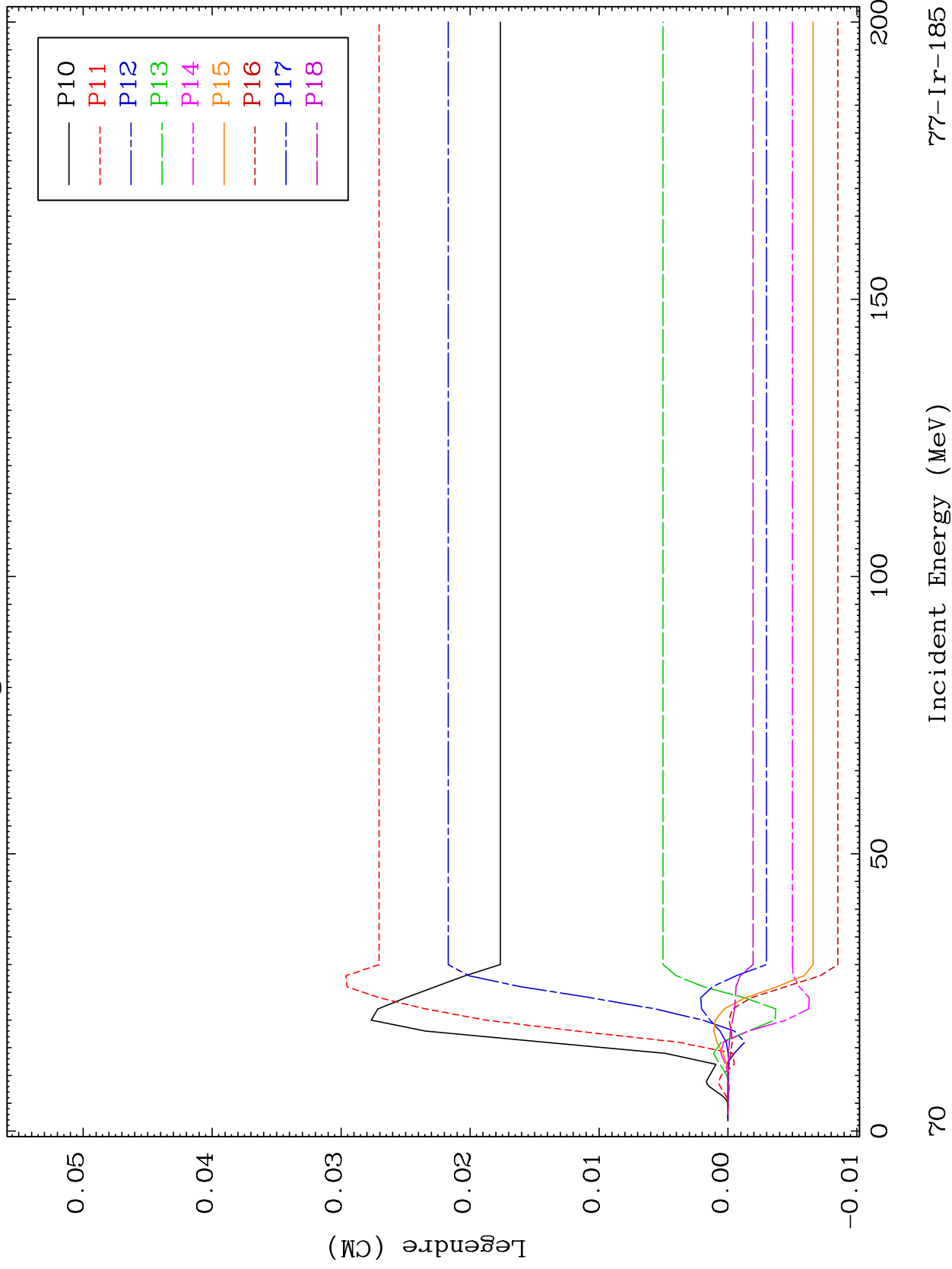

77-Ir-185

Incident Energy (MeV)

70

MAT 7707

MT= 63 (n,n') Level
Legendre Coefficients

77-Ir-185

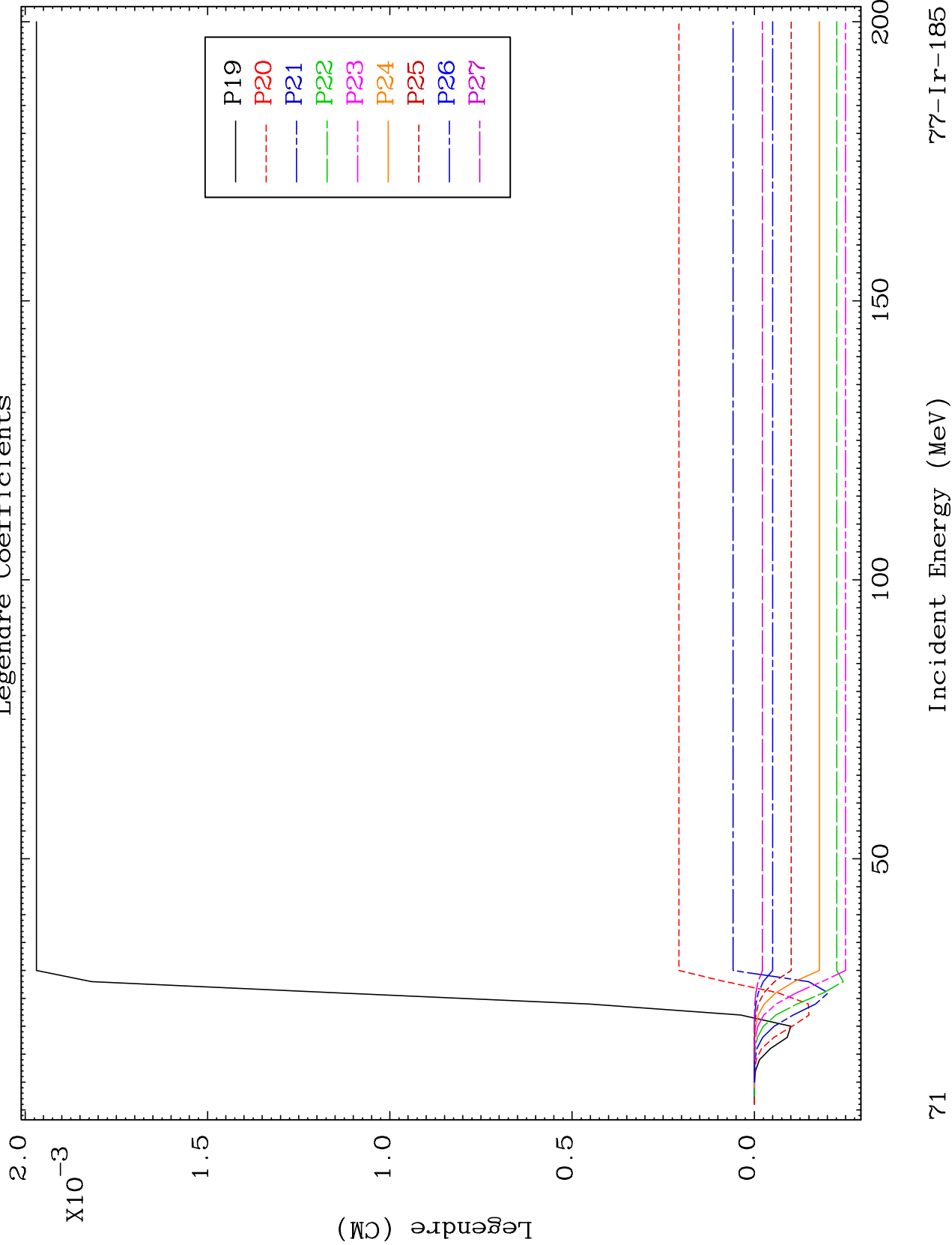

71

Incident Energy (MeV)

77-Ir-185

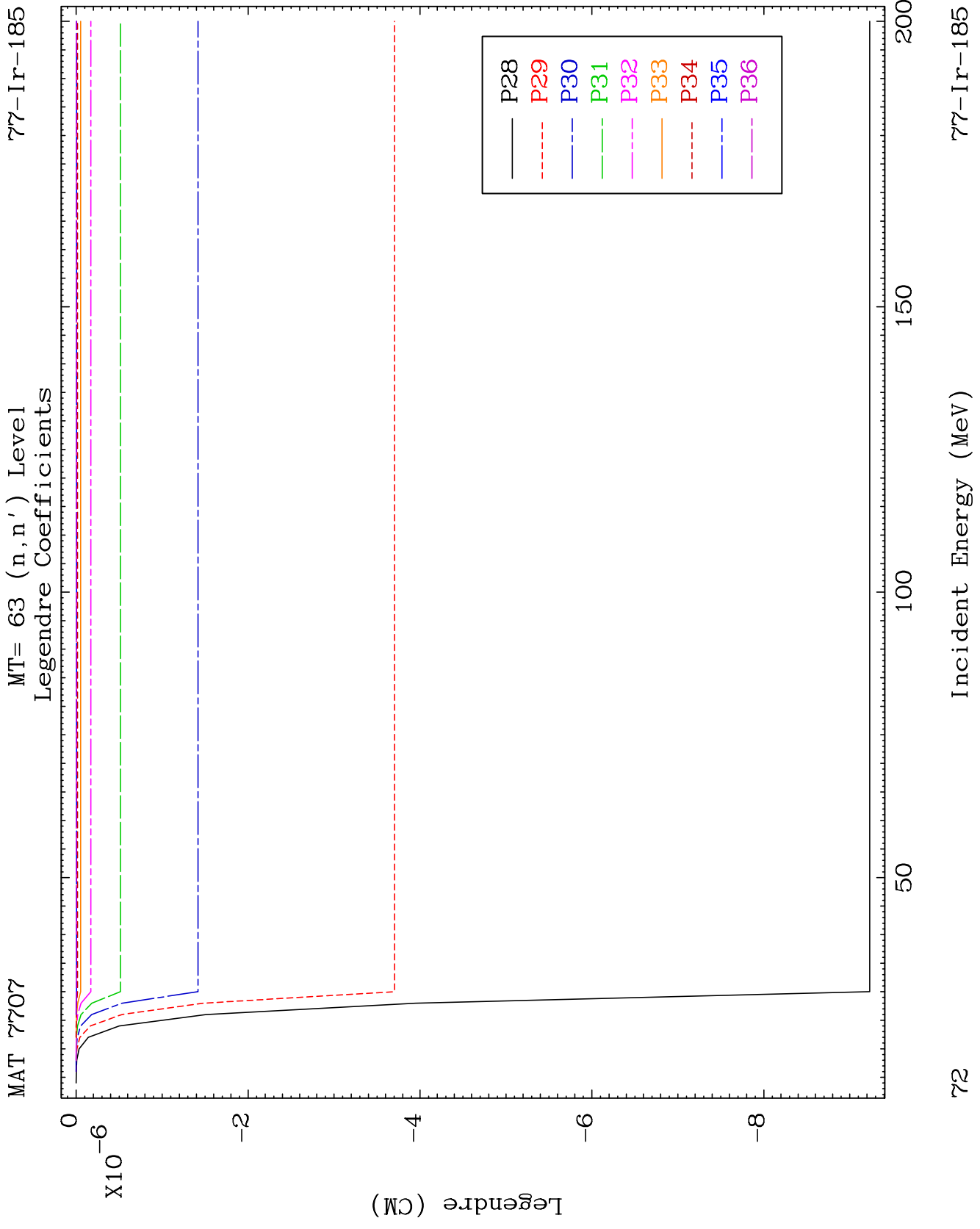

MAT 7707

MT= 64 (n,n') Level
Legendre Coefficients

77-Ir-185

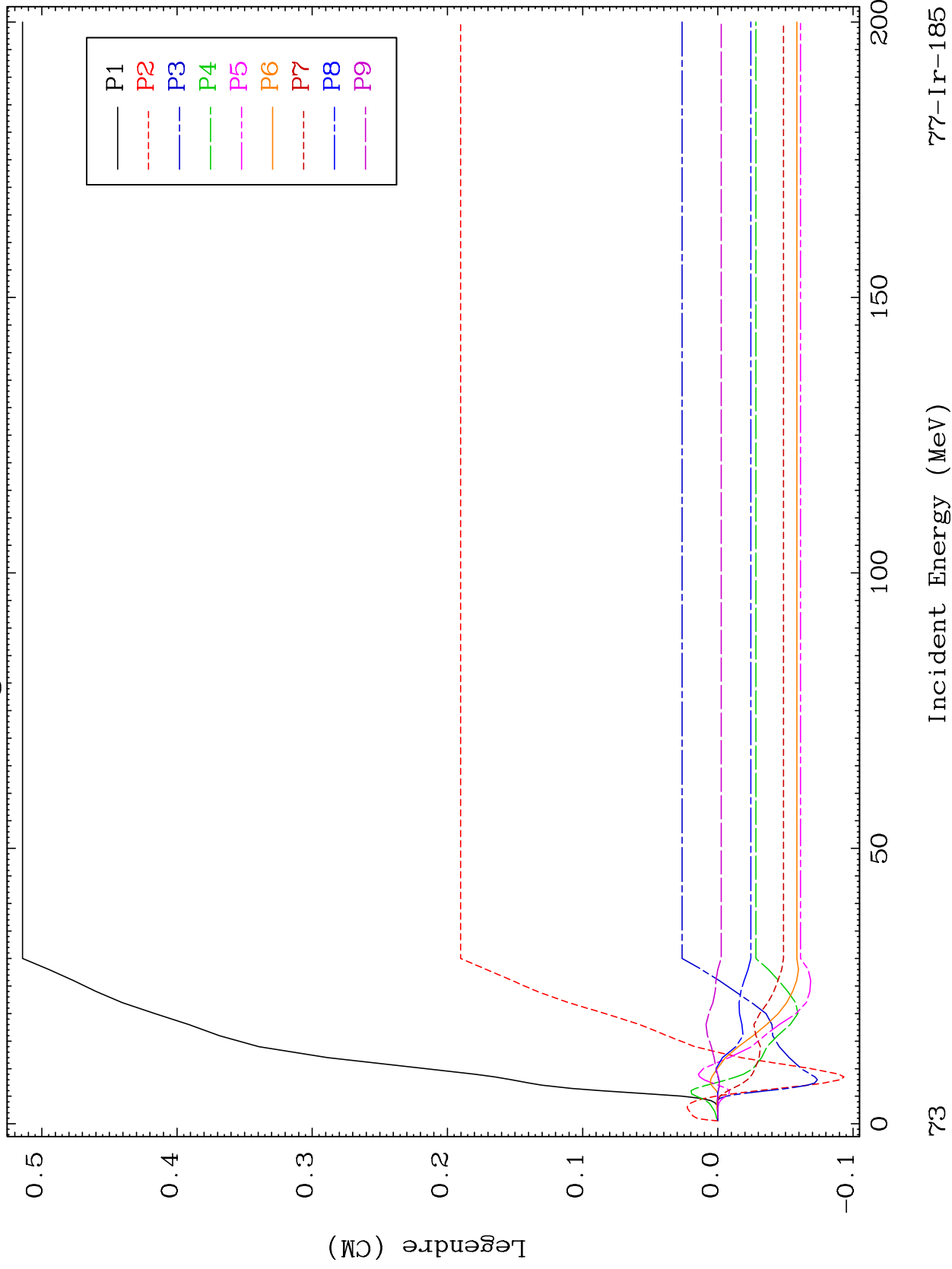

73

Incident Energy (MeV)

77-Ir-185

MAT 7707

MT= 64 (n,n') Level
Legendre Coefficients

77-Ir-185

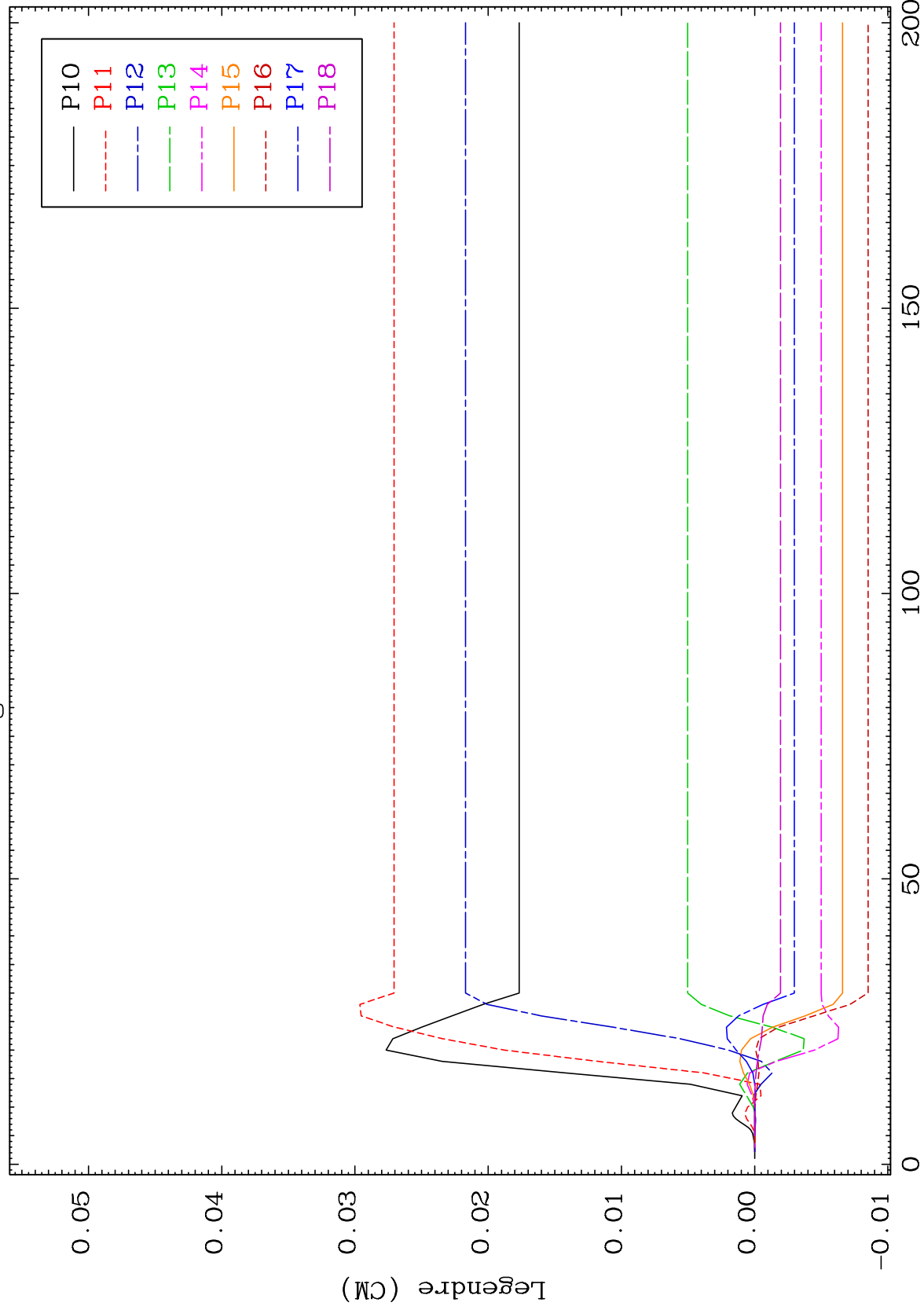

74

Incident Energy (MeV)

77-Ir-185

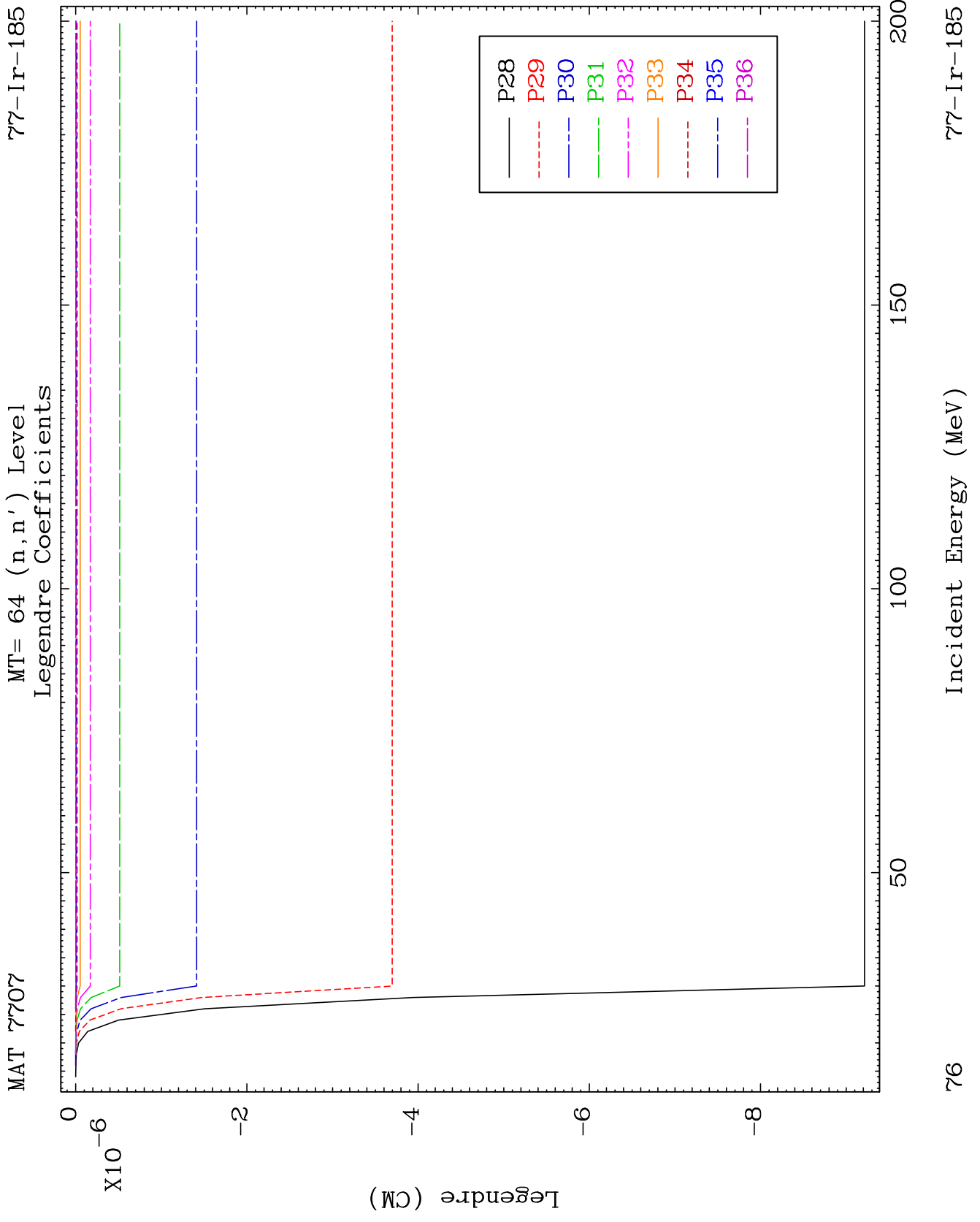

MAT 7707

MT= 65 (n,n') Level
Legendre Coefficients

77-Ir-185

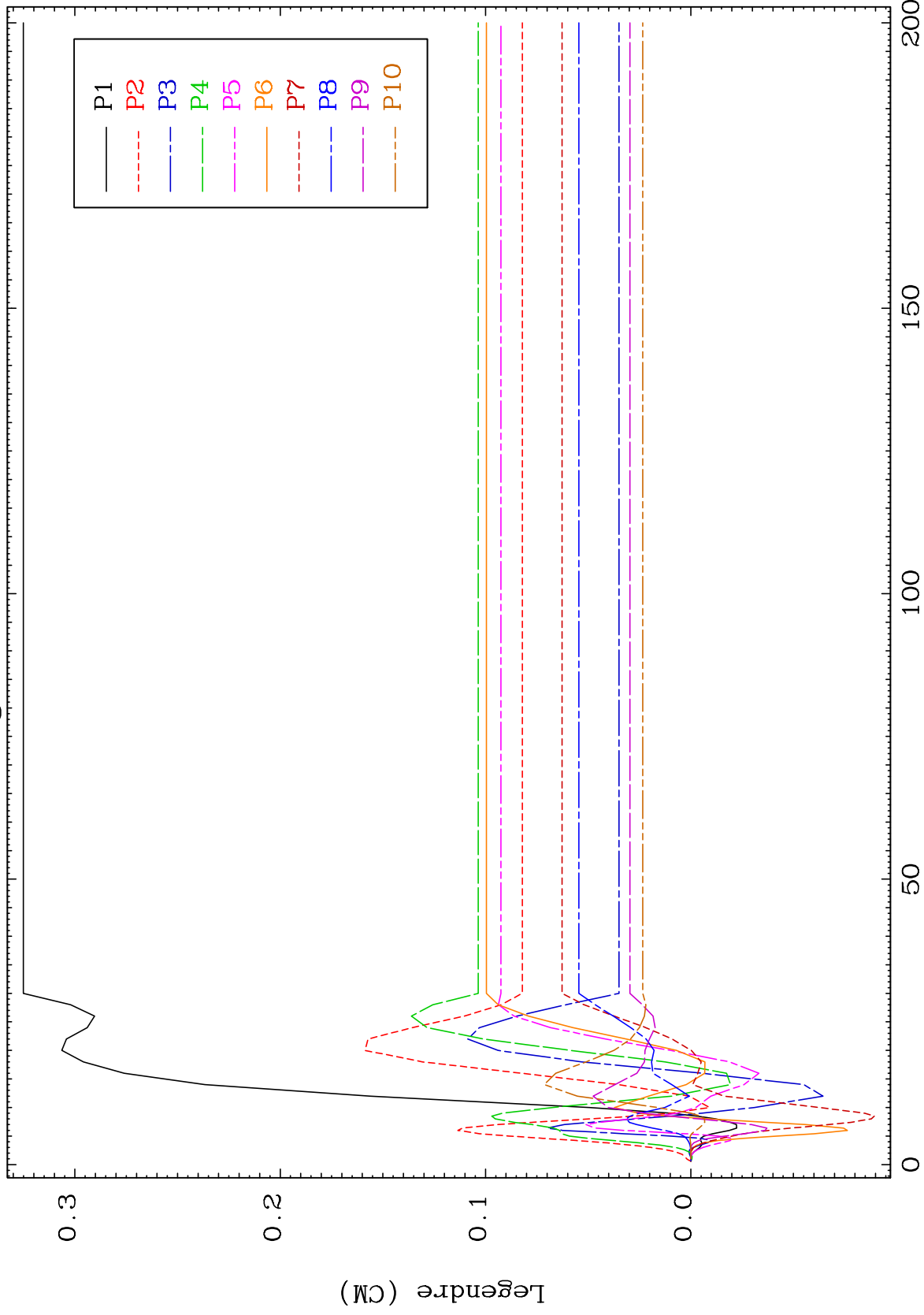

77

Incident Energy (MeV)

77-Ir-185

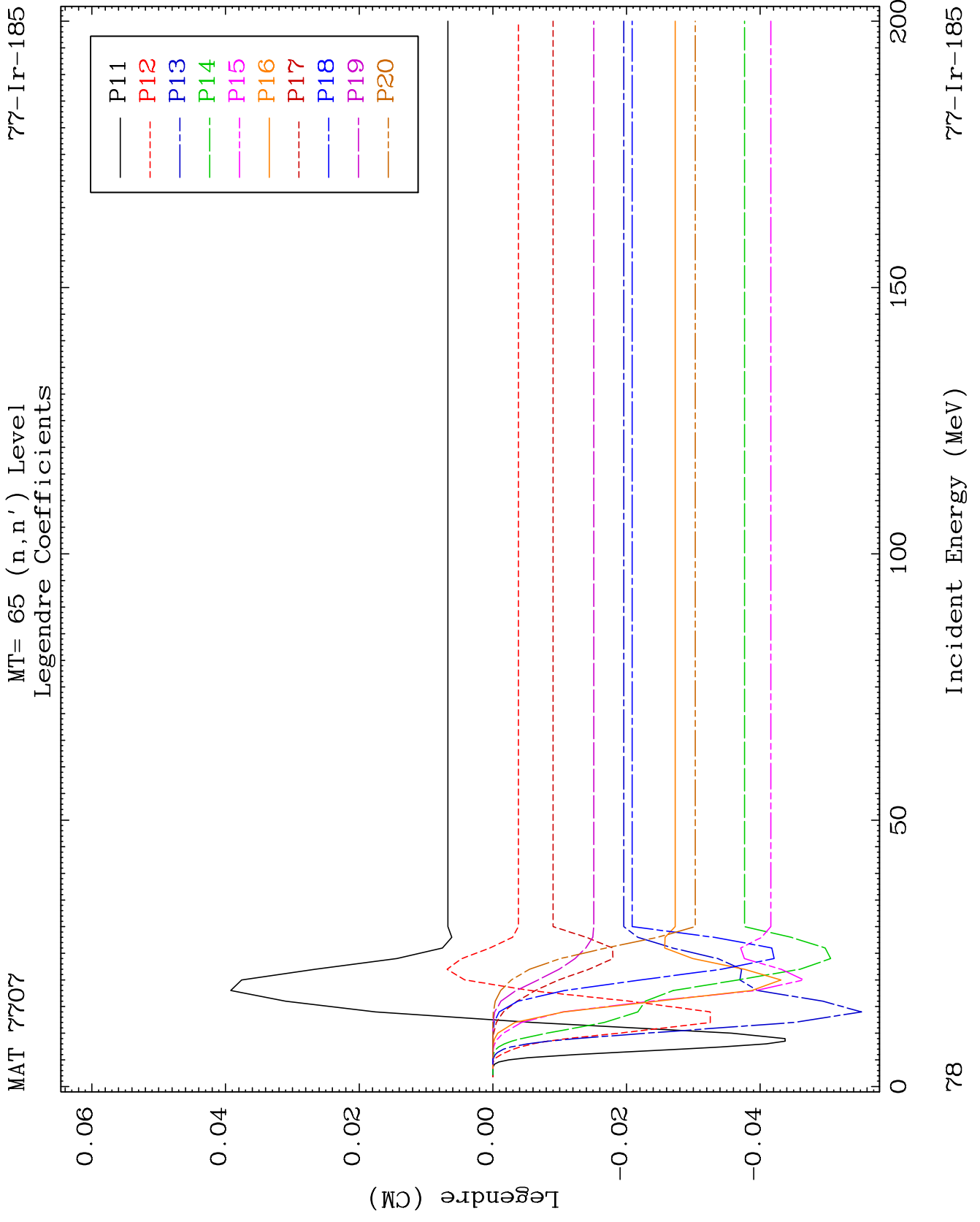

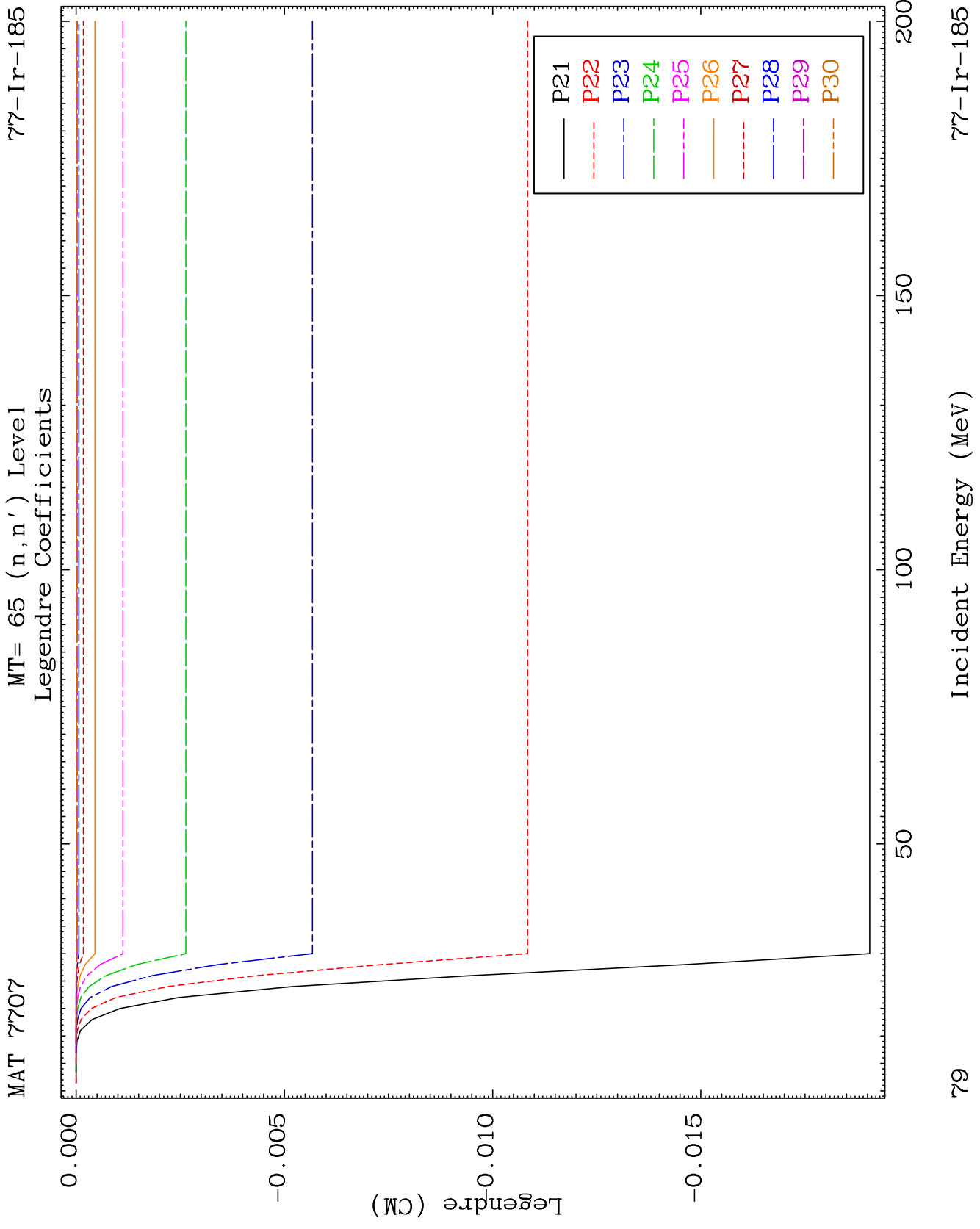

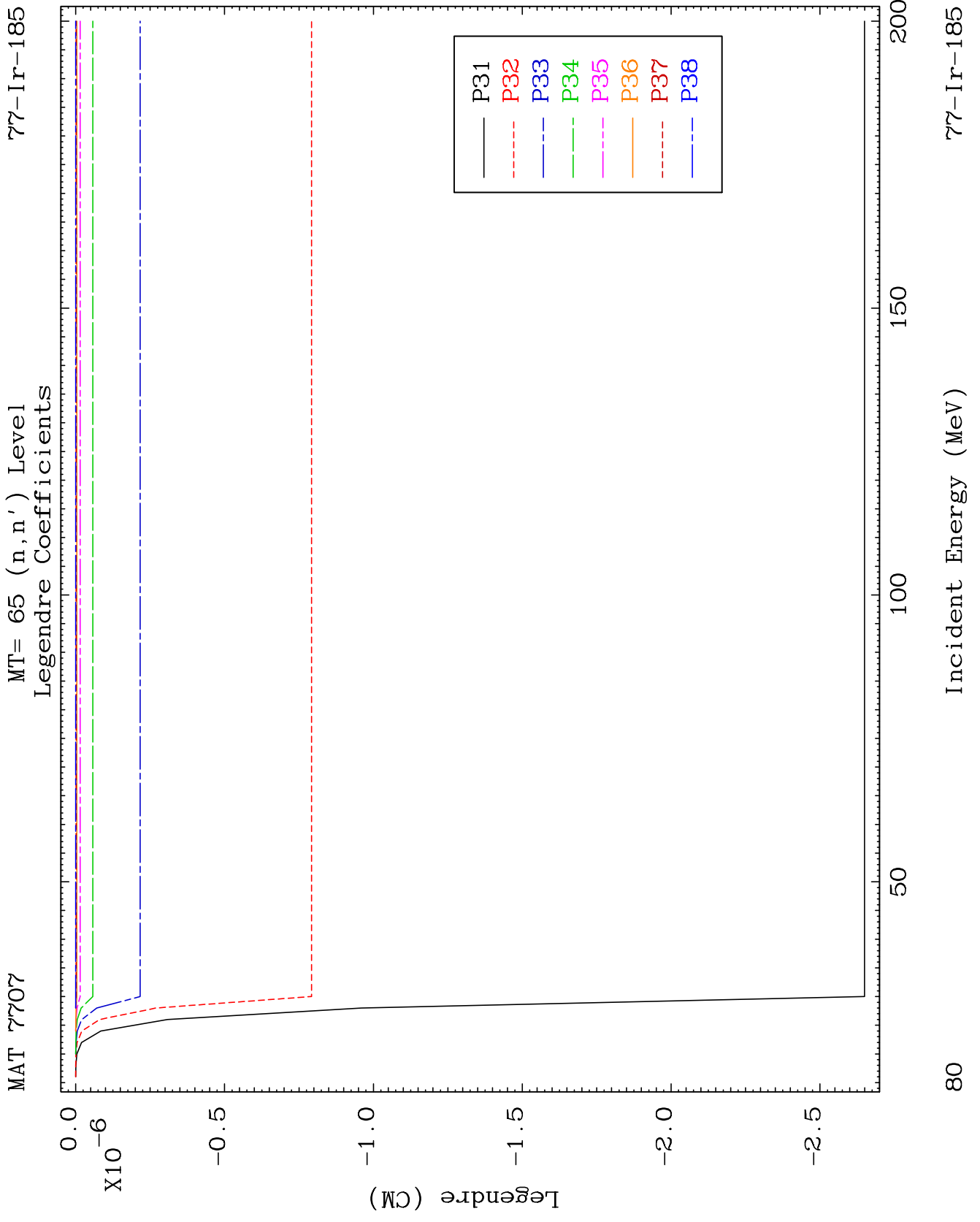

MAT 7707

MT= 66 (n,n') Level
Legendre Coefficients

77-Ir-185

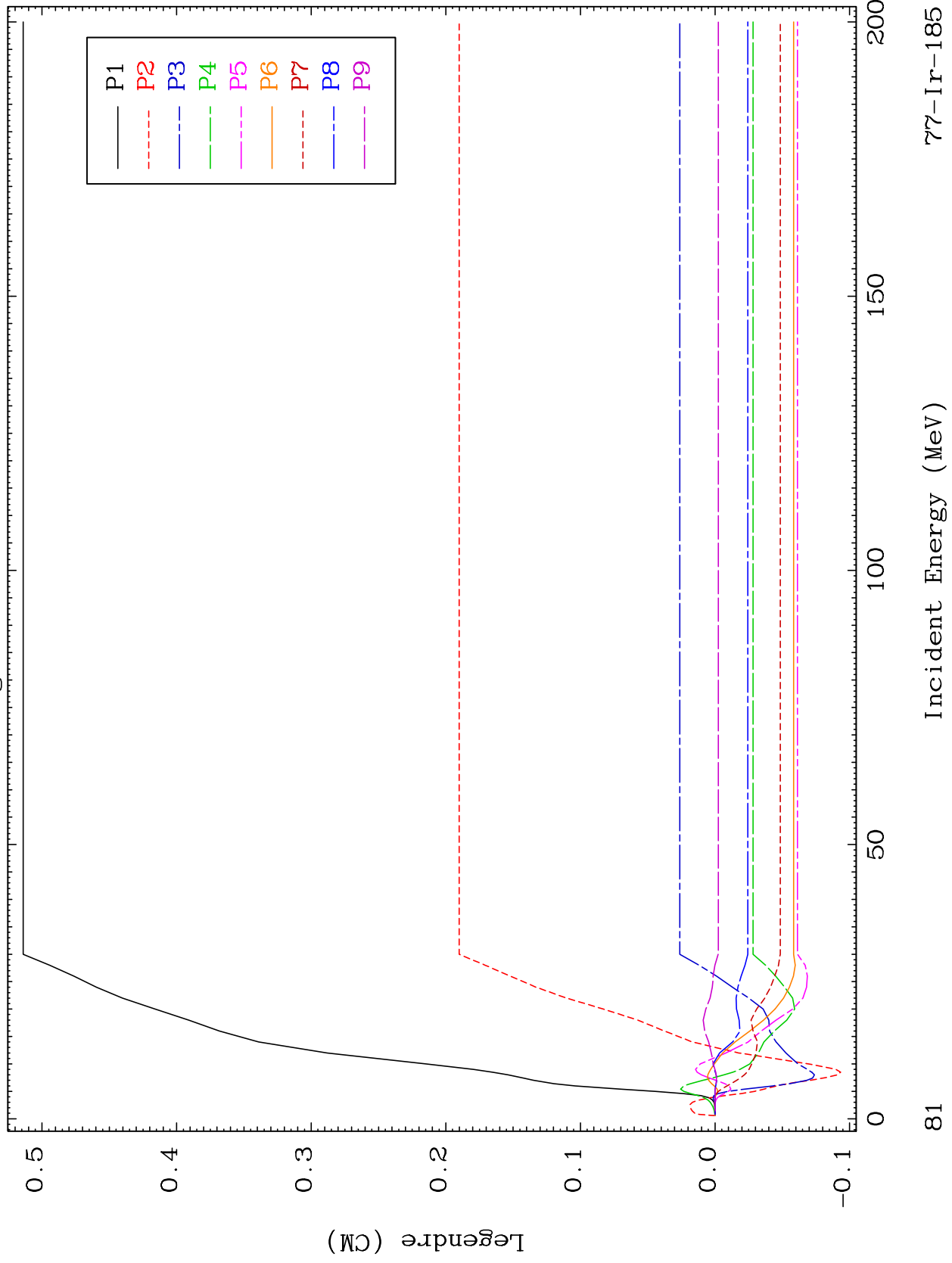

81

Incident Energy (MeV)

77-Ir-185

MAT 7707

MT= 66 (n,n') Level
Legendre Coefficients

77-Ir-185

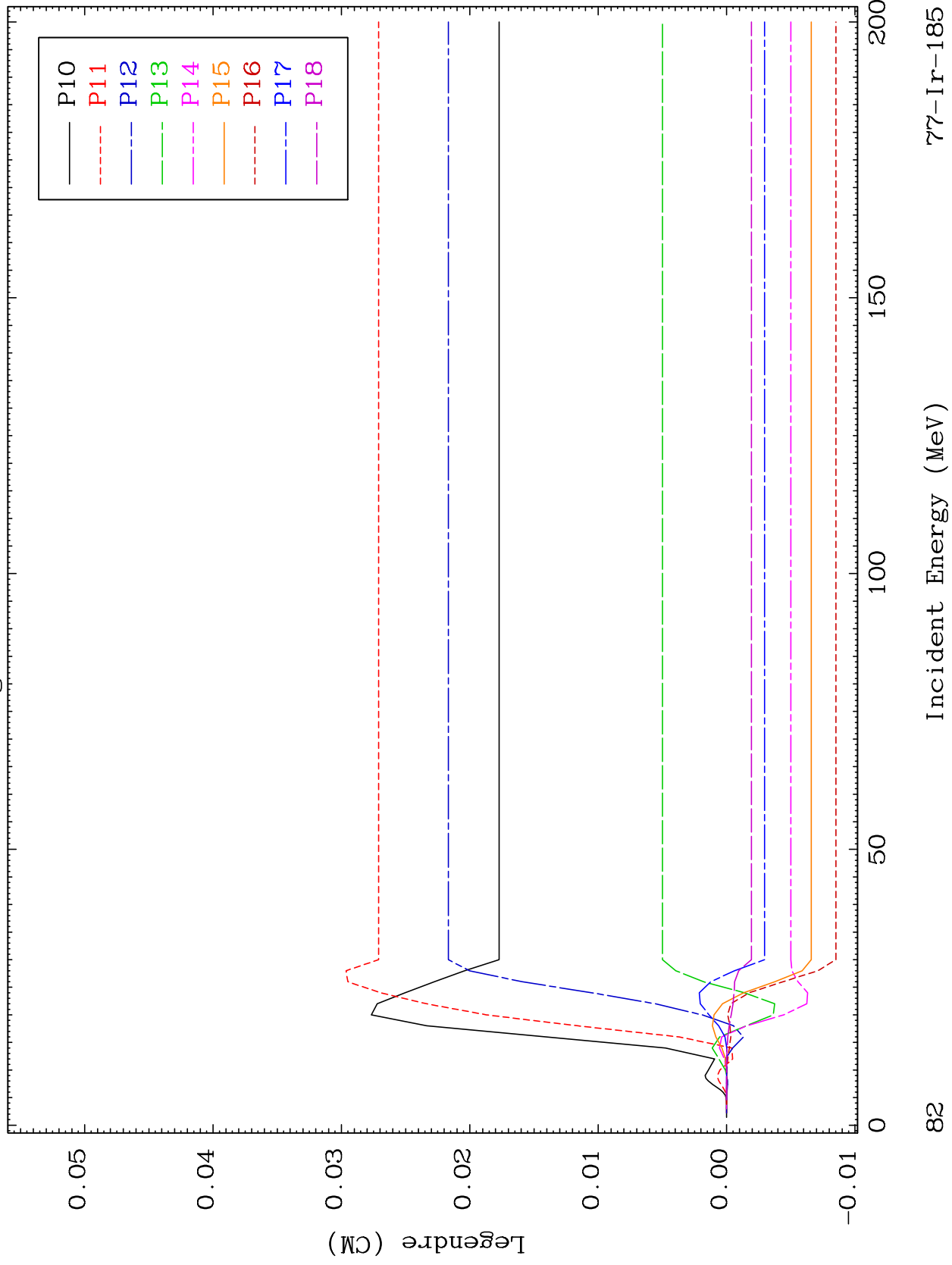

77-Ir-185

Incident Energy (MeV)

82

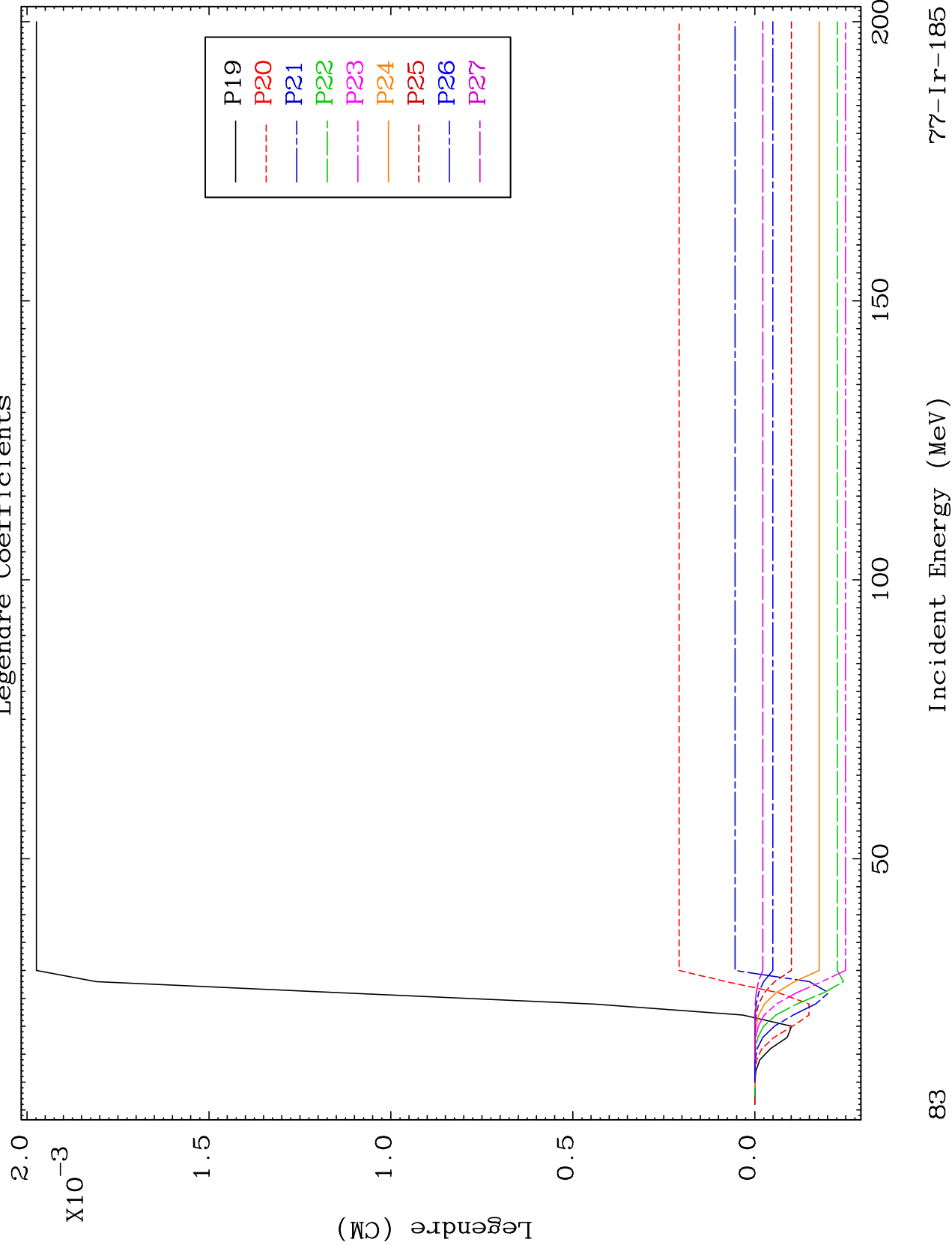

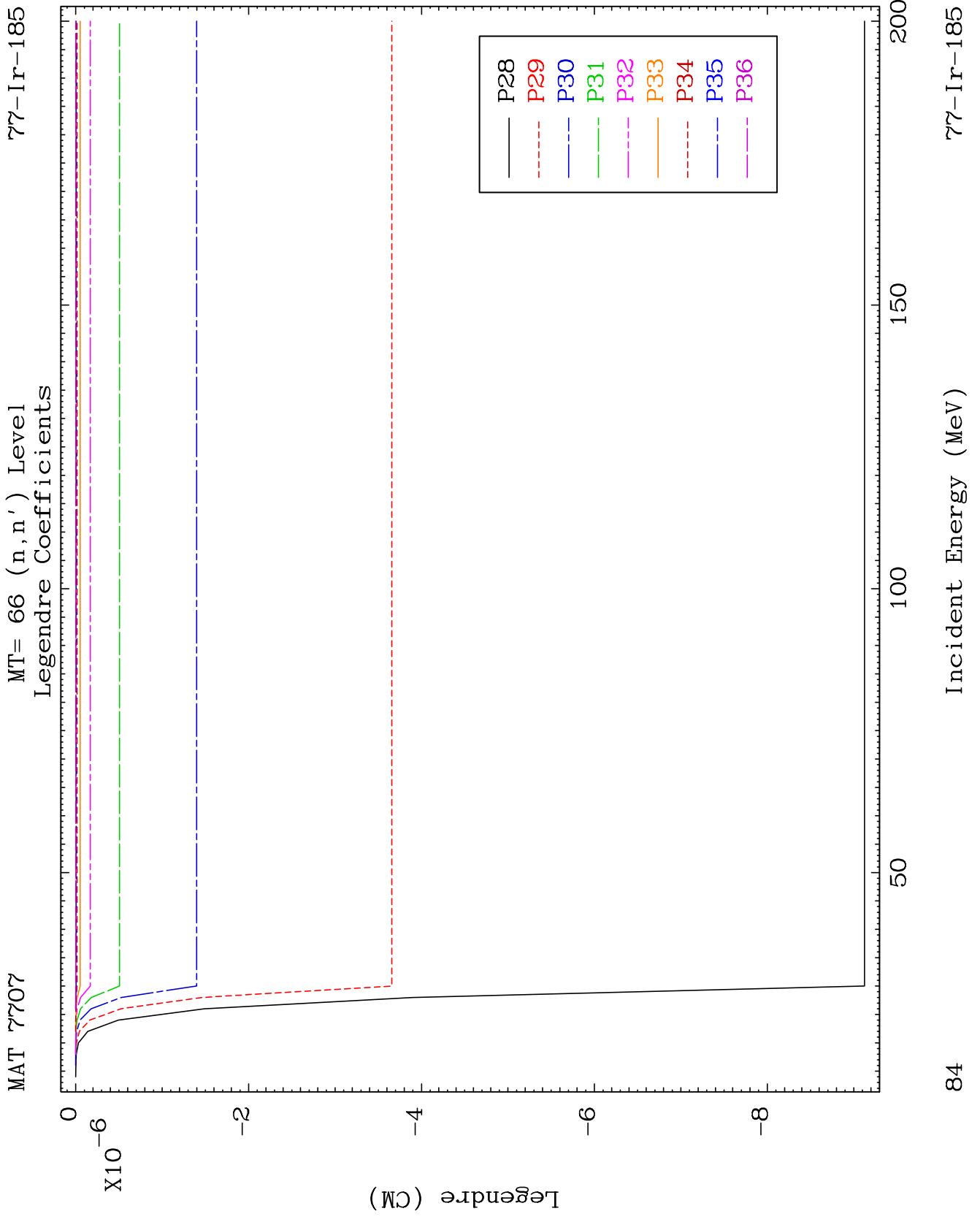

MAT 7707

MT= 67 (n,n') Level
Legendre Coefficients

77-Ir-185

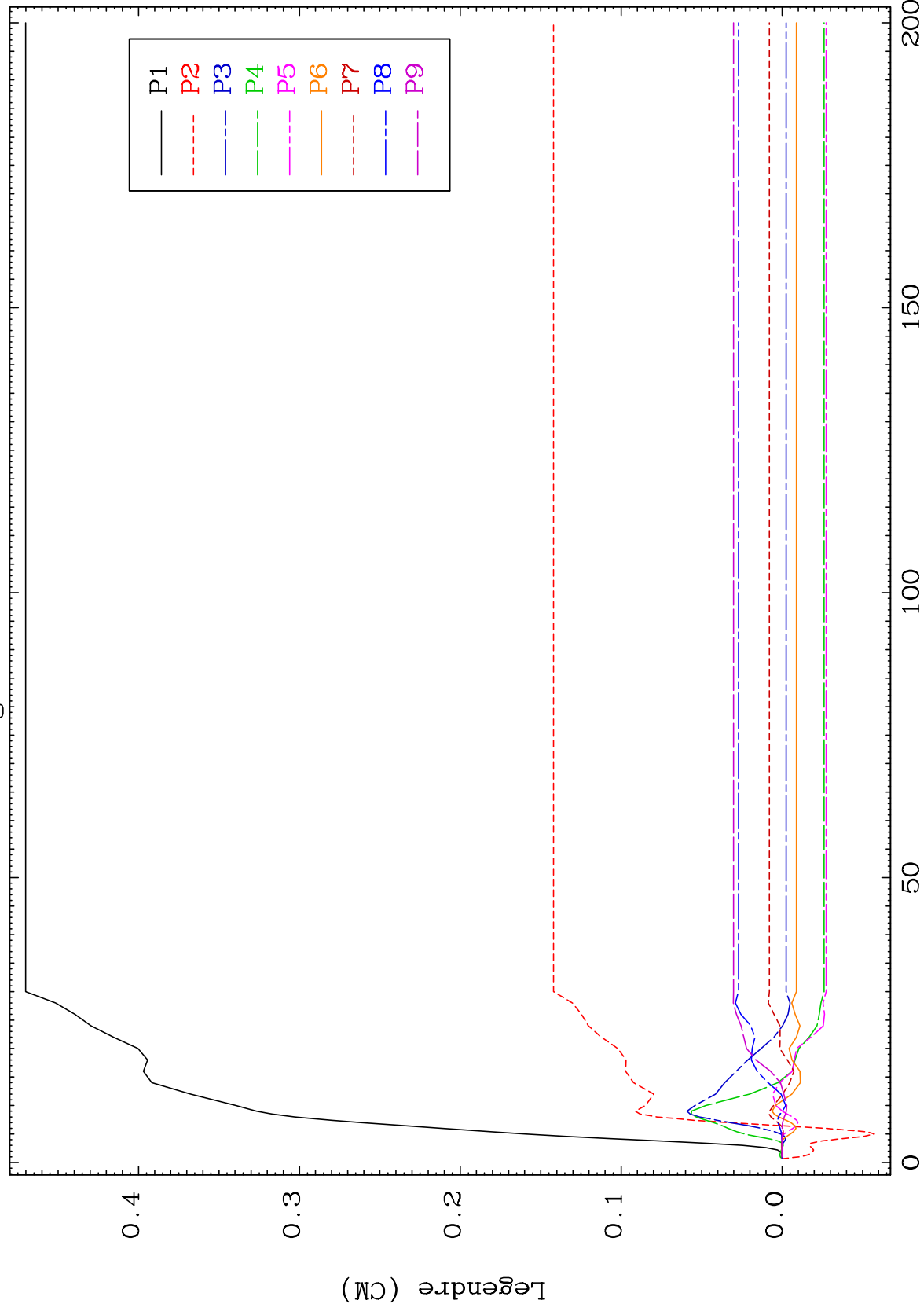

77-Ir-185

Incident Energy (MeV)

85

MAT 7707

MT= 67 (n,n') Level
Legendre Coefficients

77-Ir-185

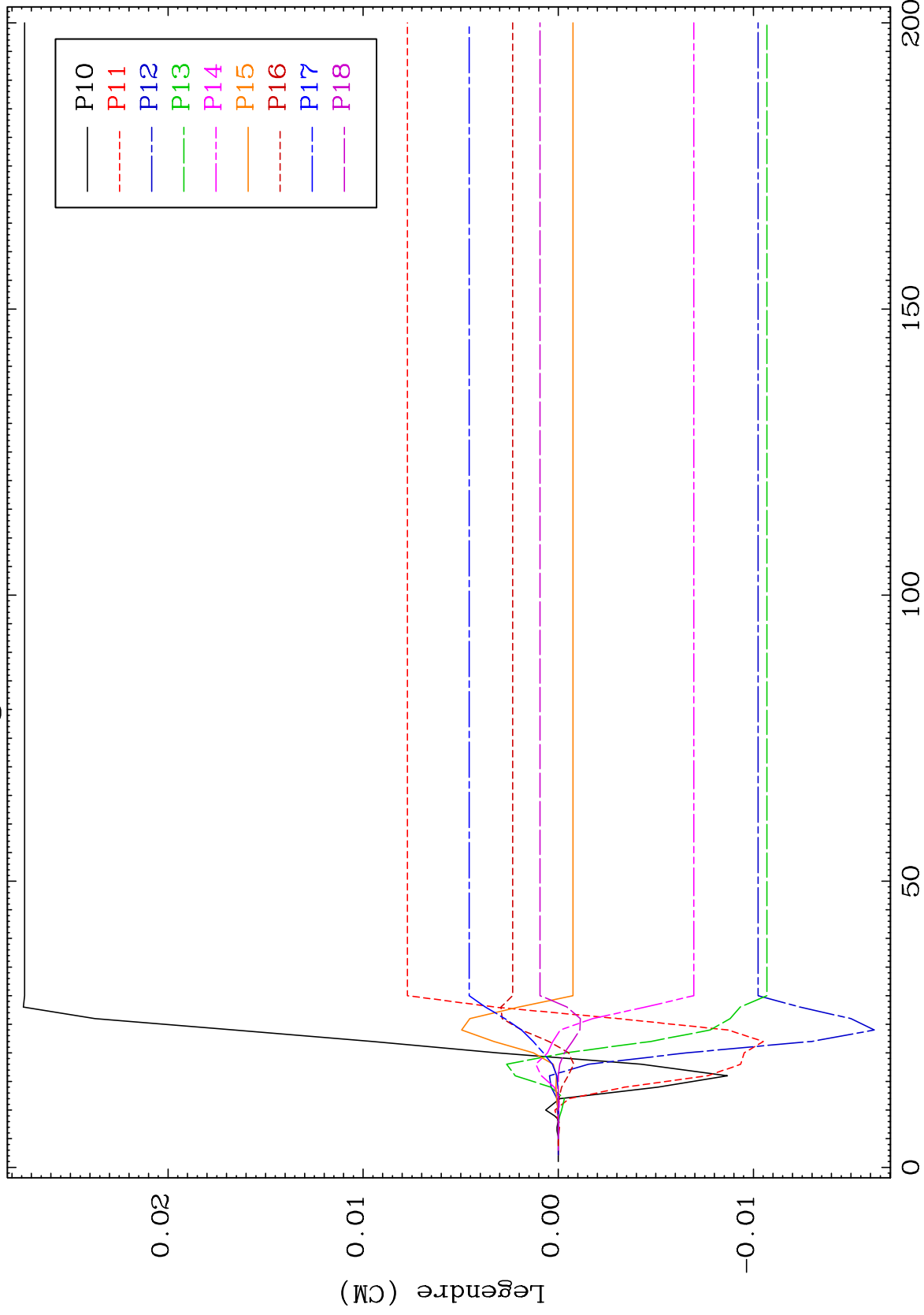

86

Incident Energy (MeV)

77-Ir-185

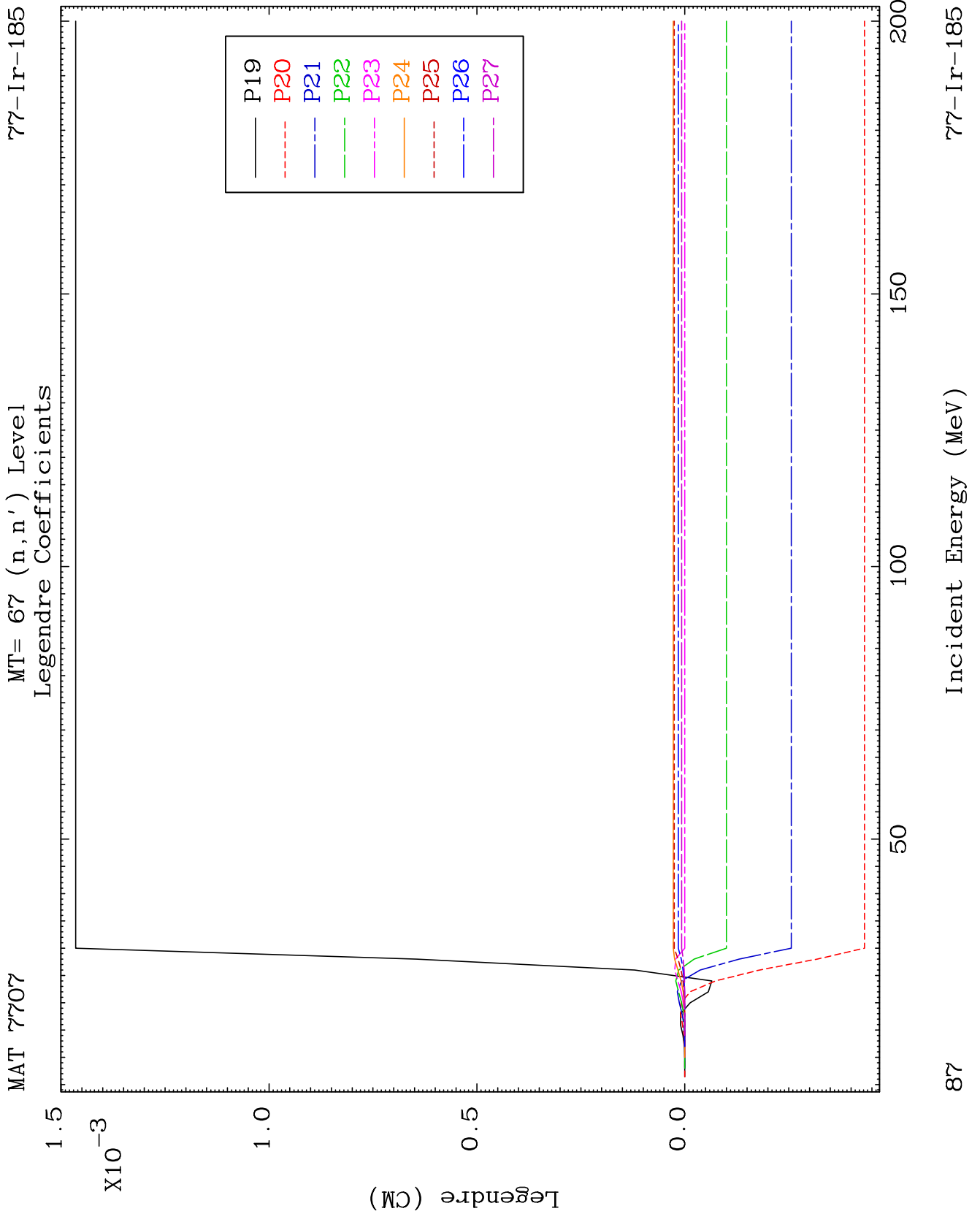

MAT 7707

MT= 67 (n,n') Level
Legendre Coefficients

77-Ir-185

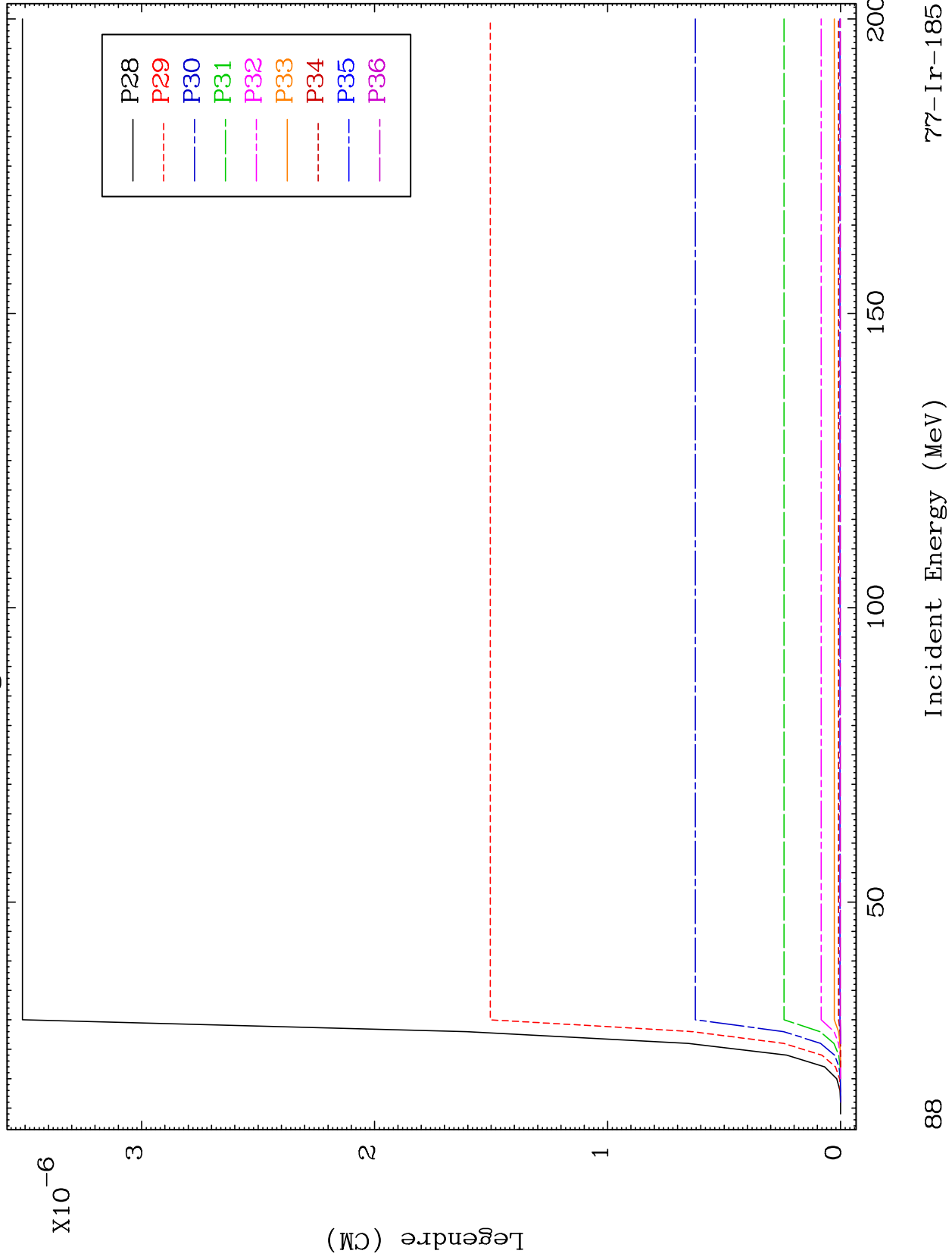

MAT 7707

MT= 68 (n,n') Level
Legendre Coefficients

77-Ir-185

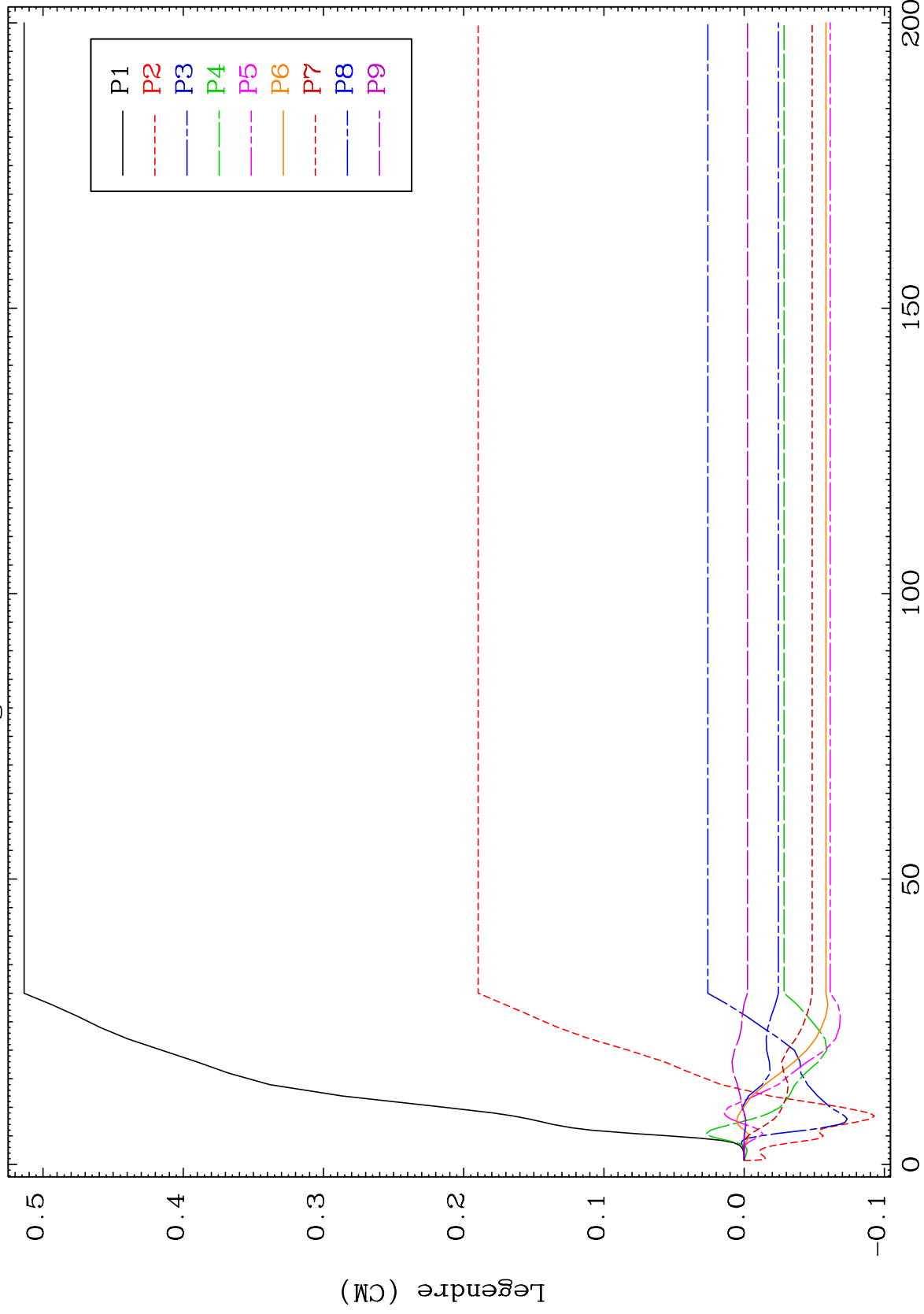

89

Incident Energy (MeV)

77-Ir-185

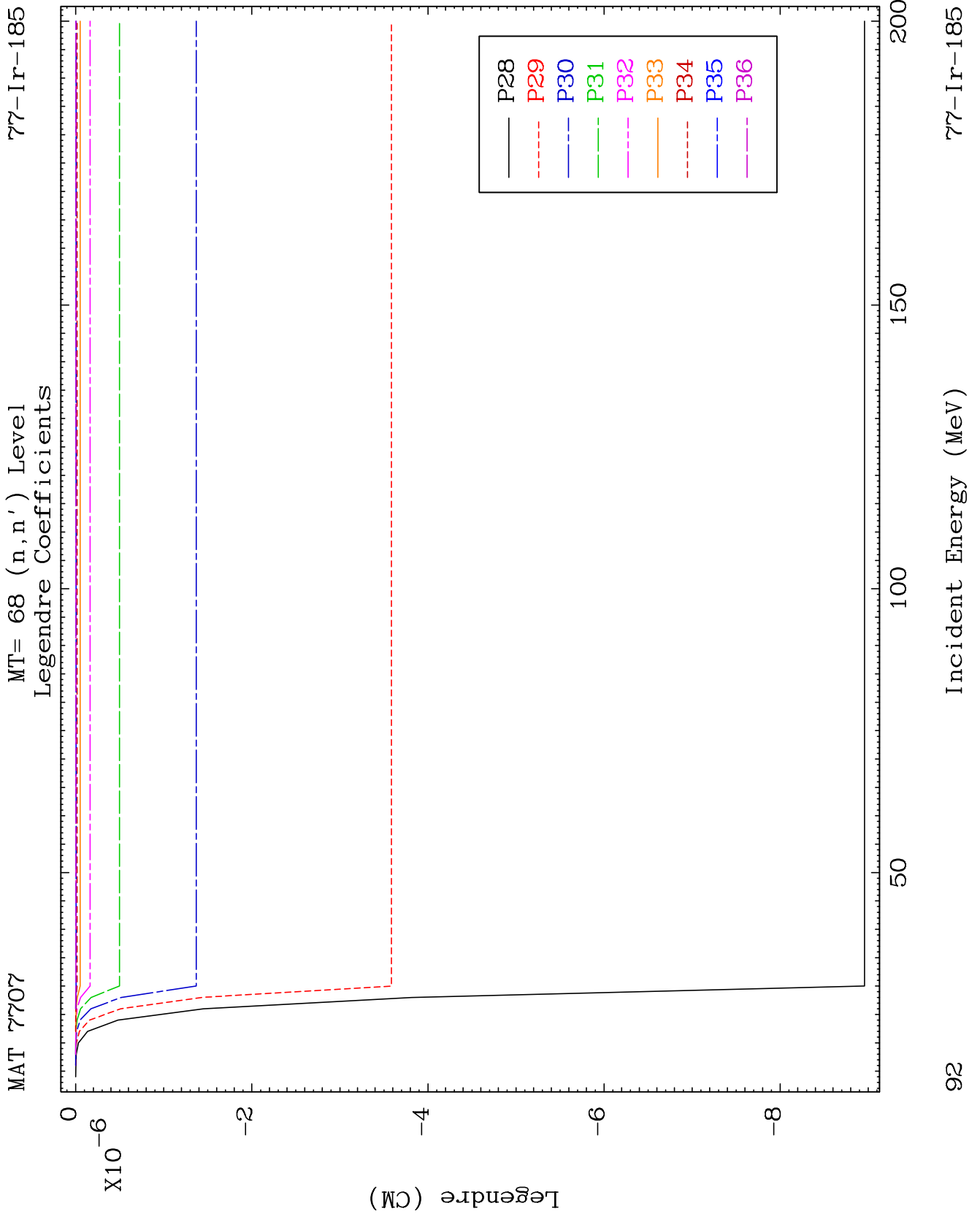

MAT 7707

MT= 69 (n,n') Level
Legendre Coefficients

77-Ir-185

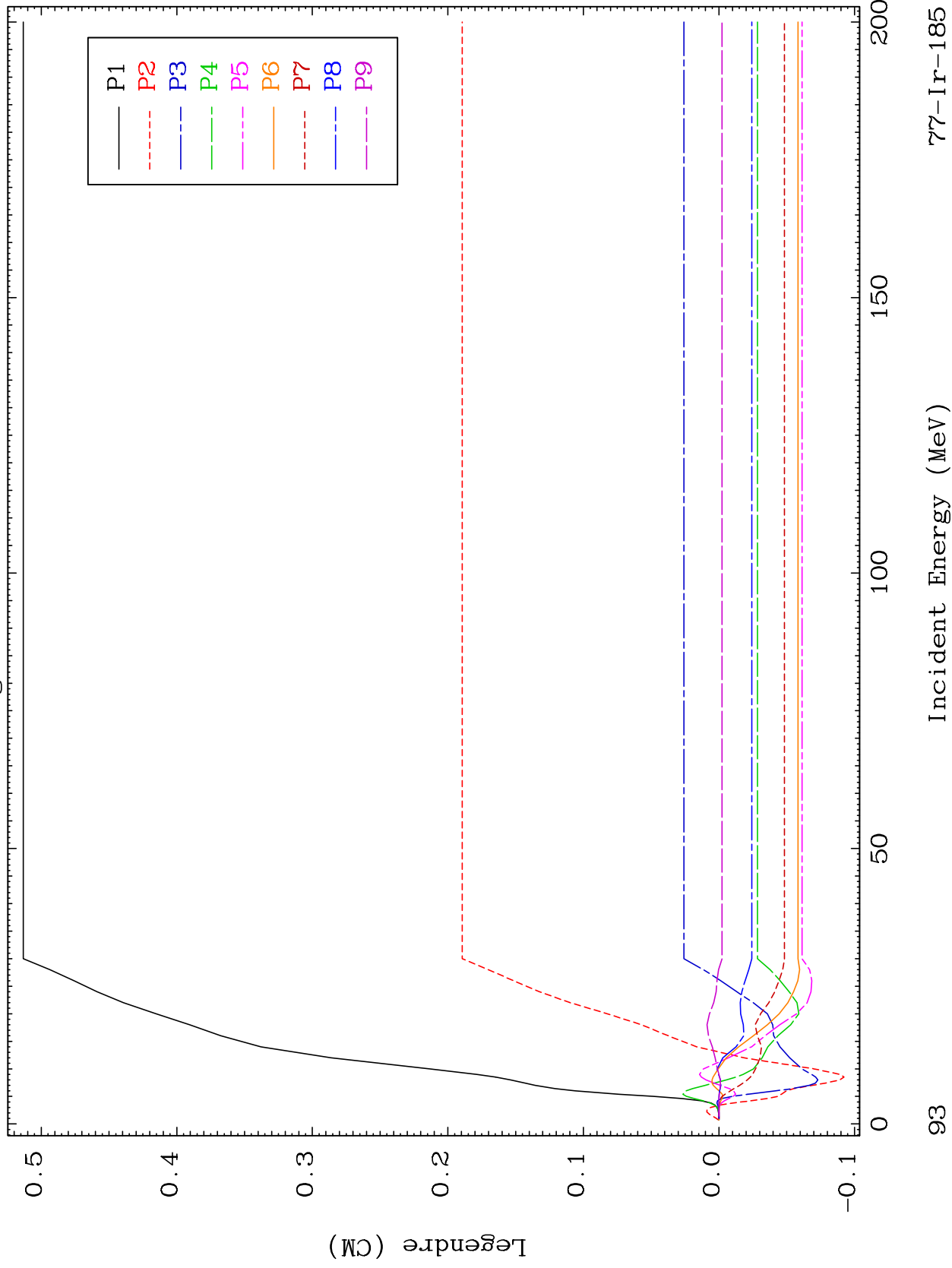

MAT 7707

MT= 69 (n,n') Level
Legendre Coefficients

77-Ir-185

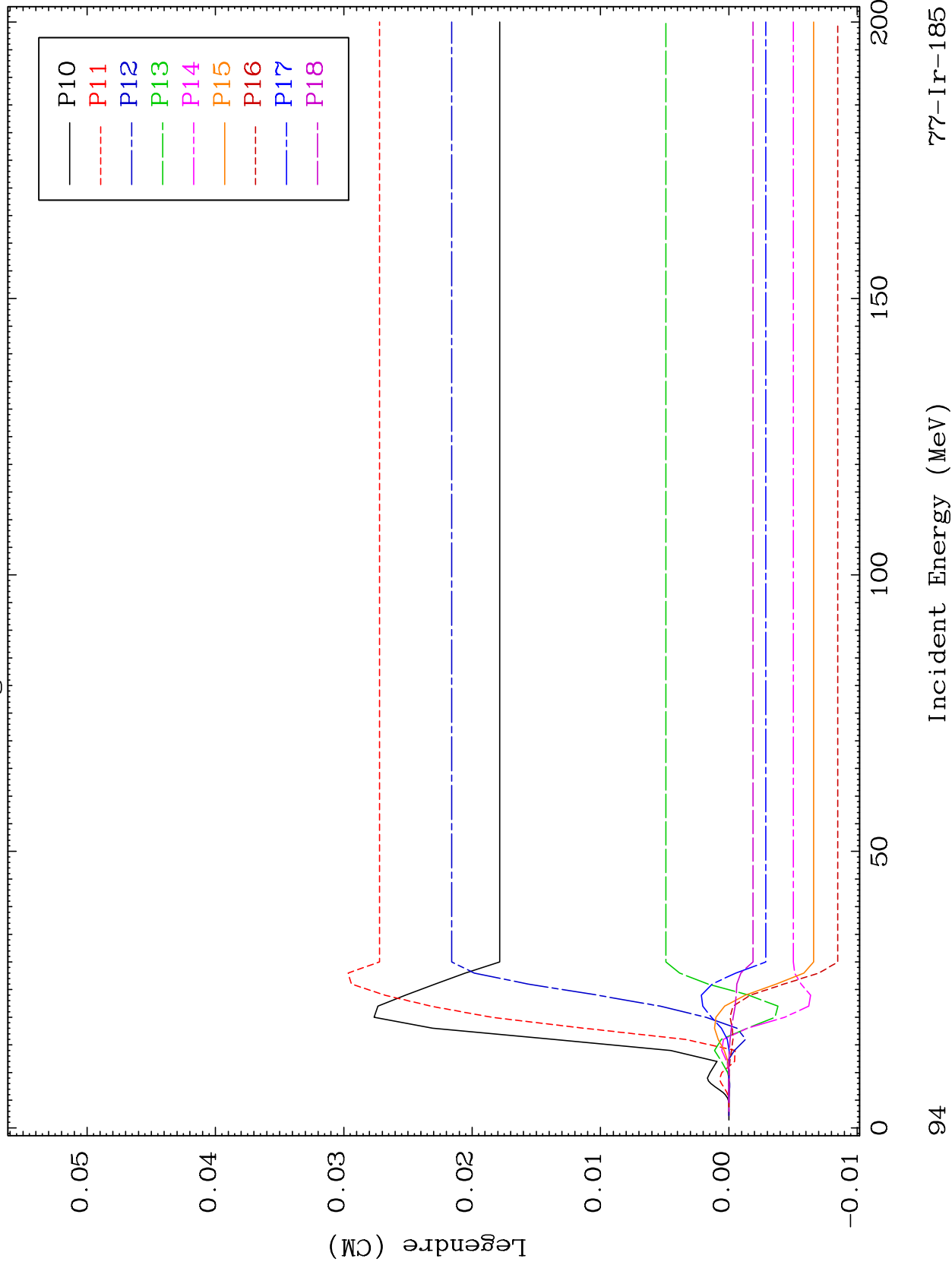

77-Ir-185

Incident Energy (MeV)

94

MAT 7707

MT= 69 (n,n') Level
Legendre Coefficients

77-Ir-185

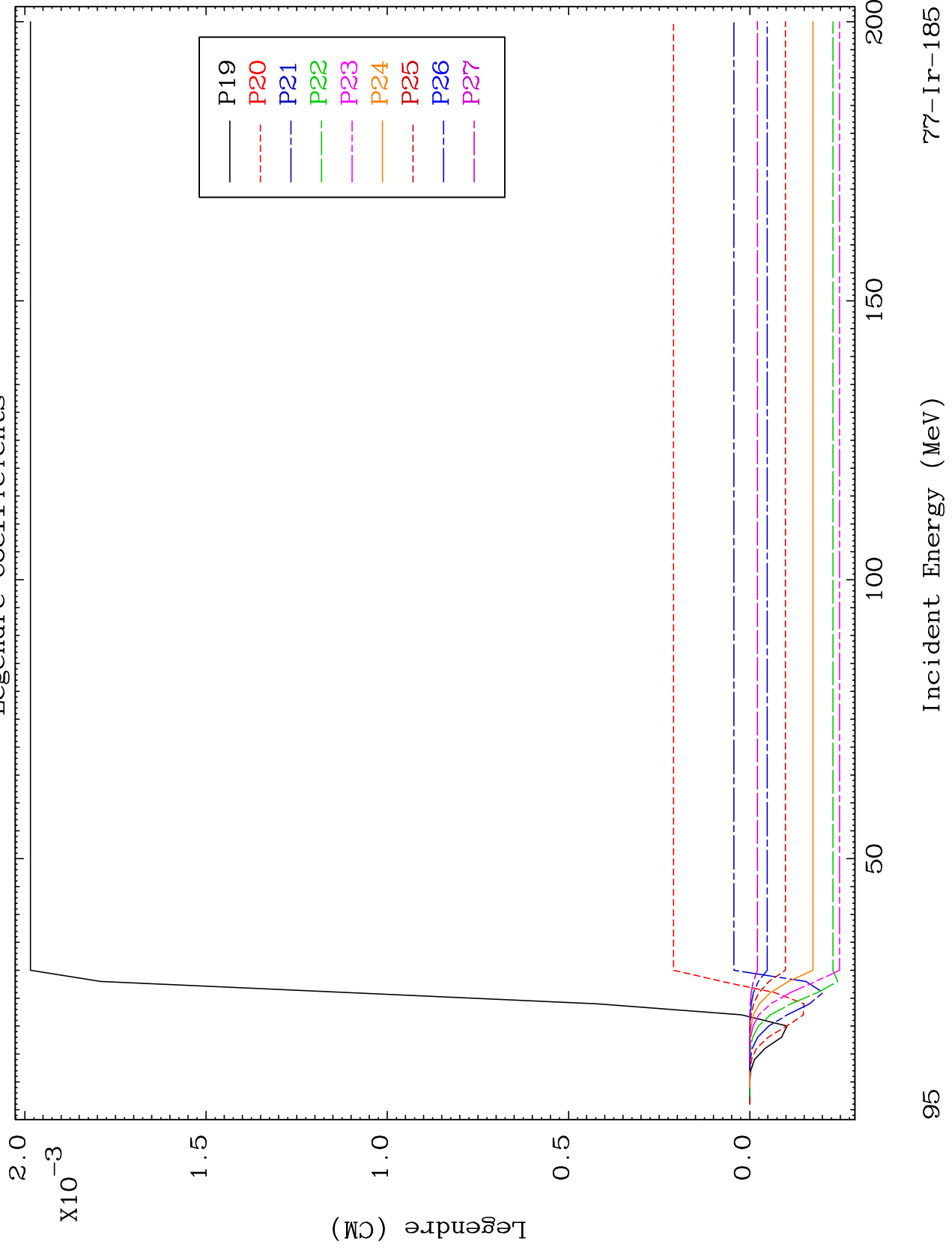

95

Incident Energy (MeV)

77-Ir-185

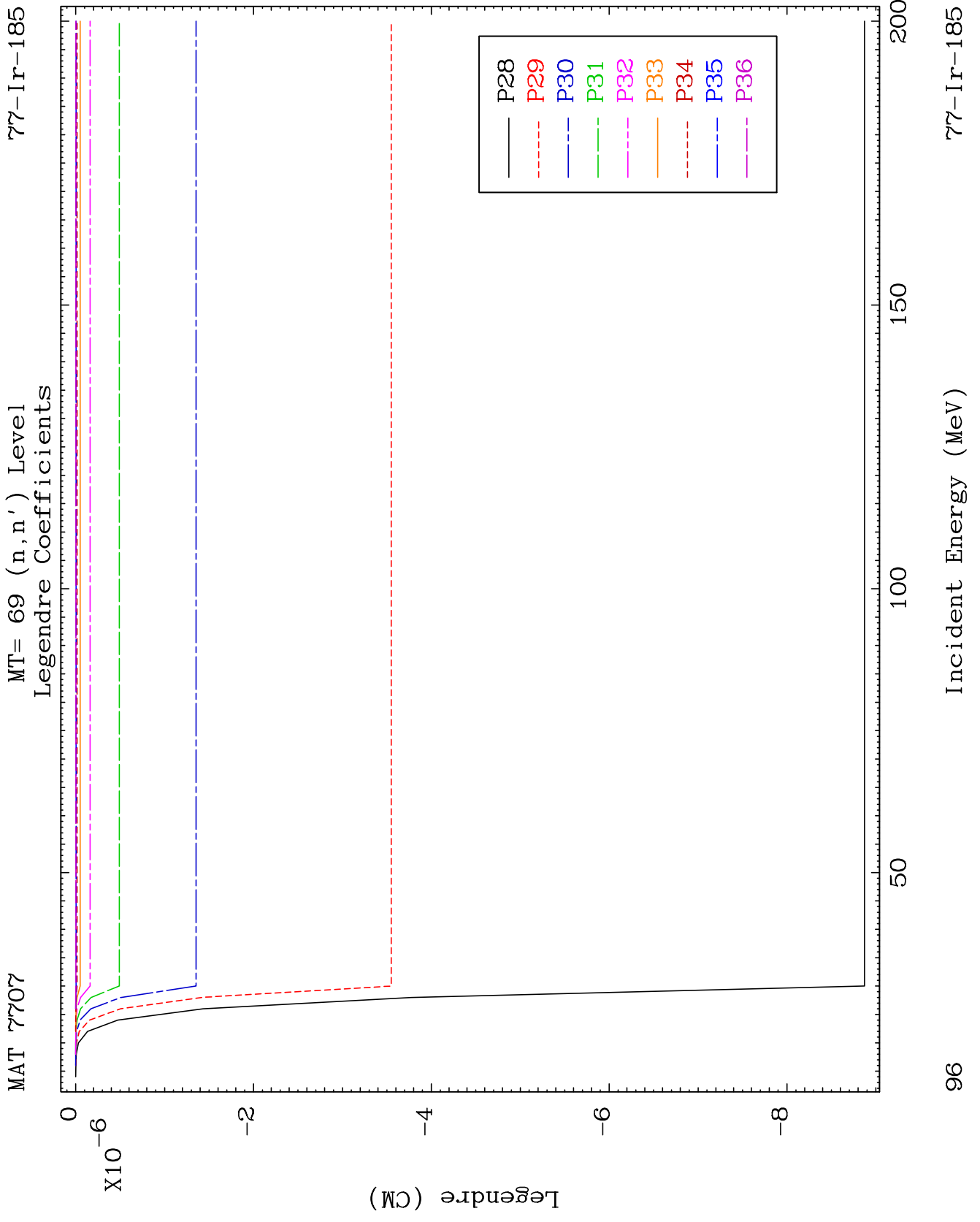

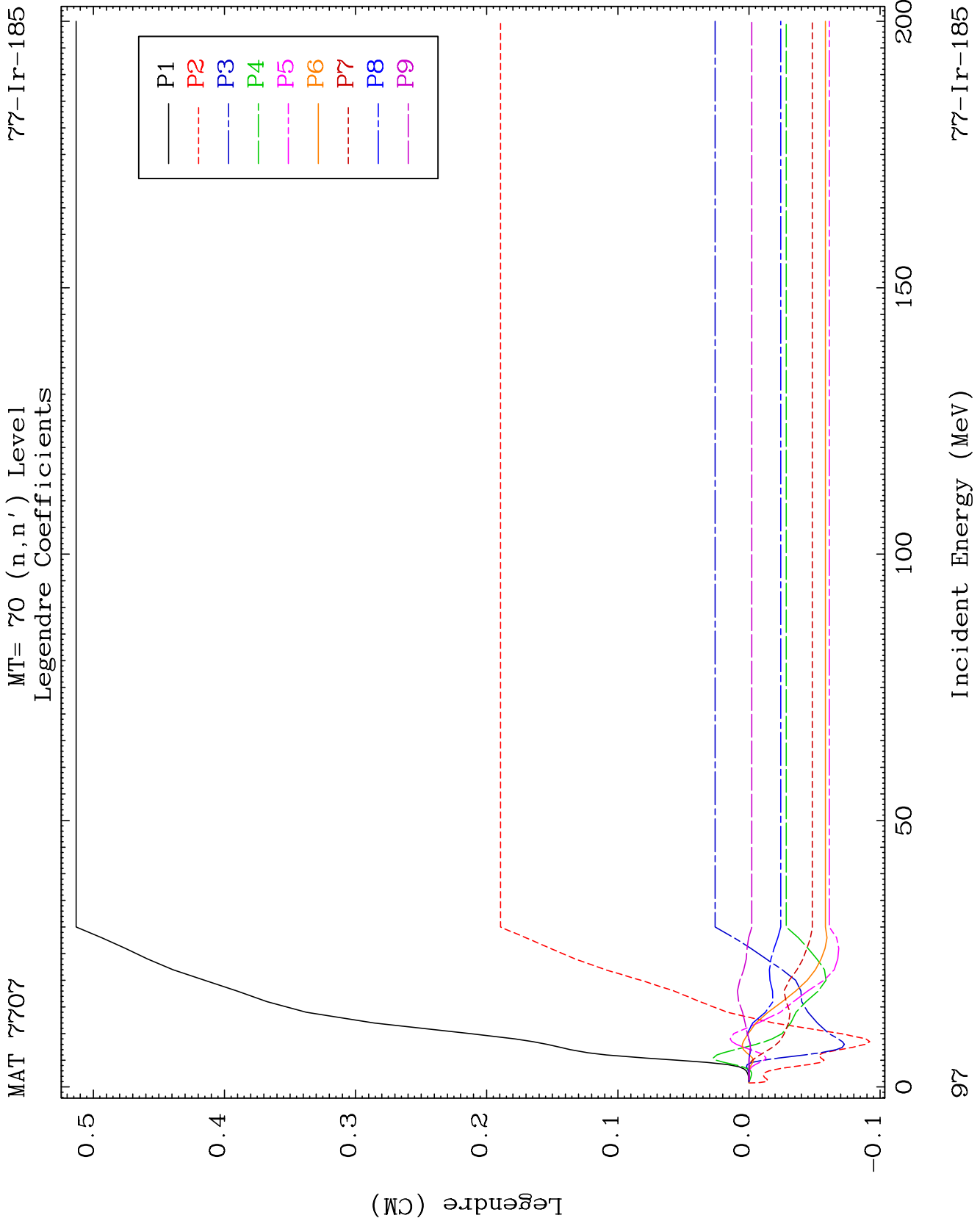

MAT 7707

MT= 70 (n,n') Level
Legendre Coefficients

77-Ir-185

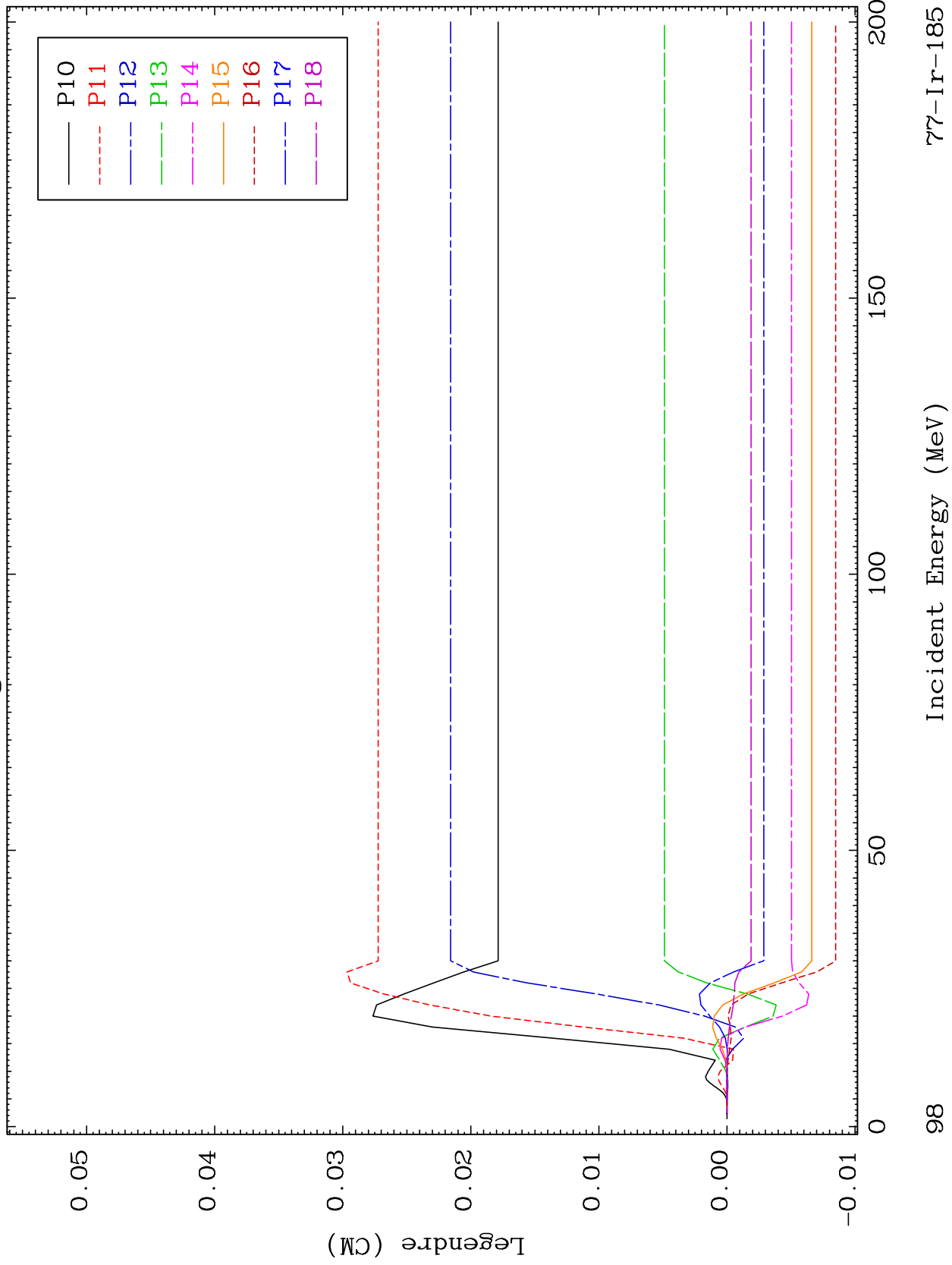

98

Incident Energy (MeV)

77-Ir-185

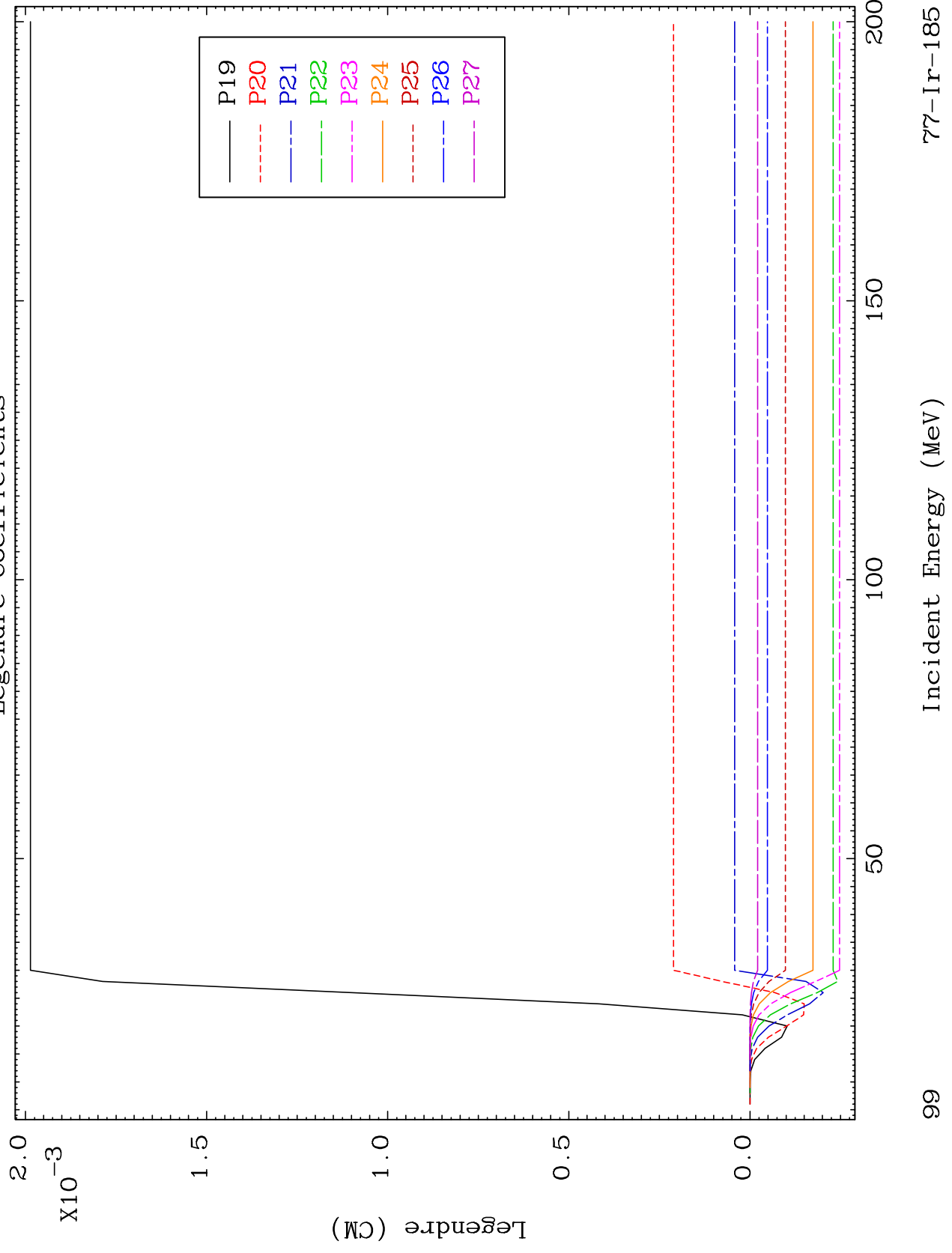

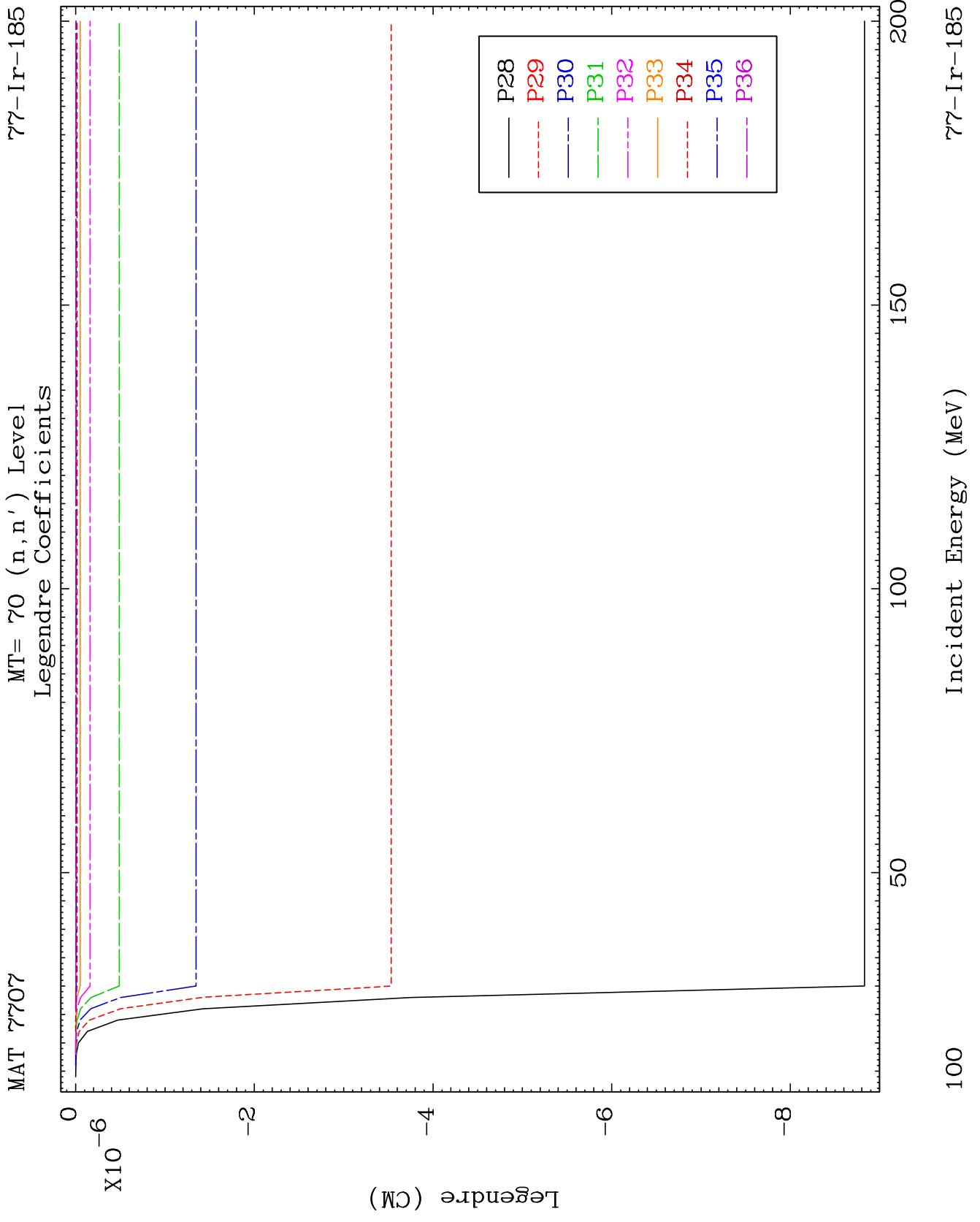

MAT 7707

MT= 71 (n,n') Level
Legendre Coefficients

77-Ir-185

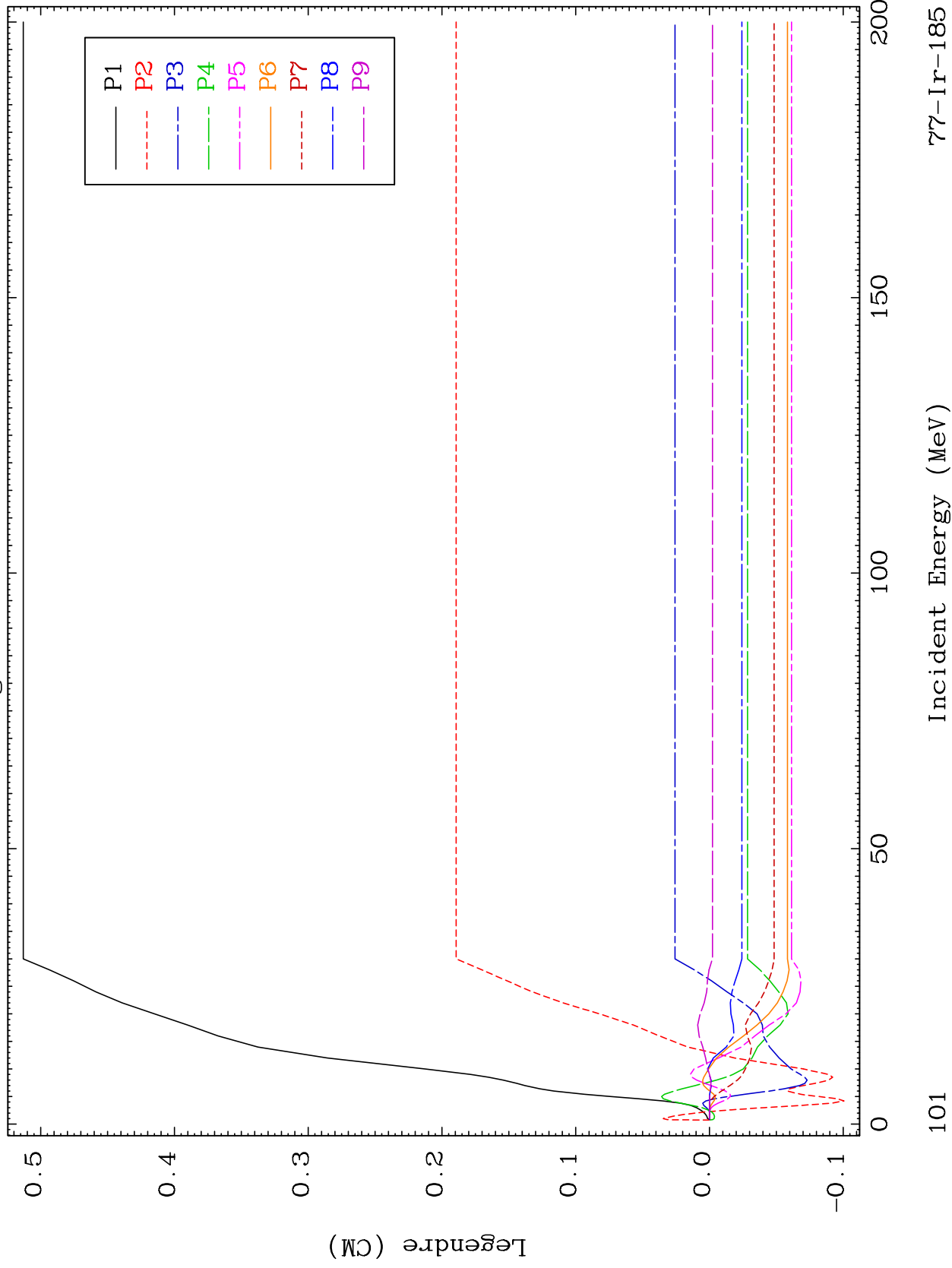

77-Ir-185

Incident Energy (MeV)

101

MAT 7707

MT= 71 (n,n') Level
Legendre Coefficients

77-Ir-185

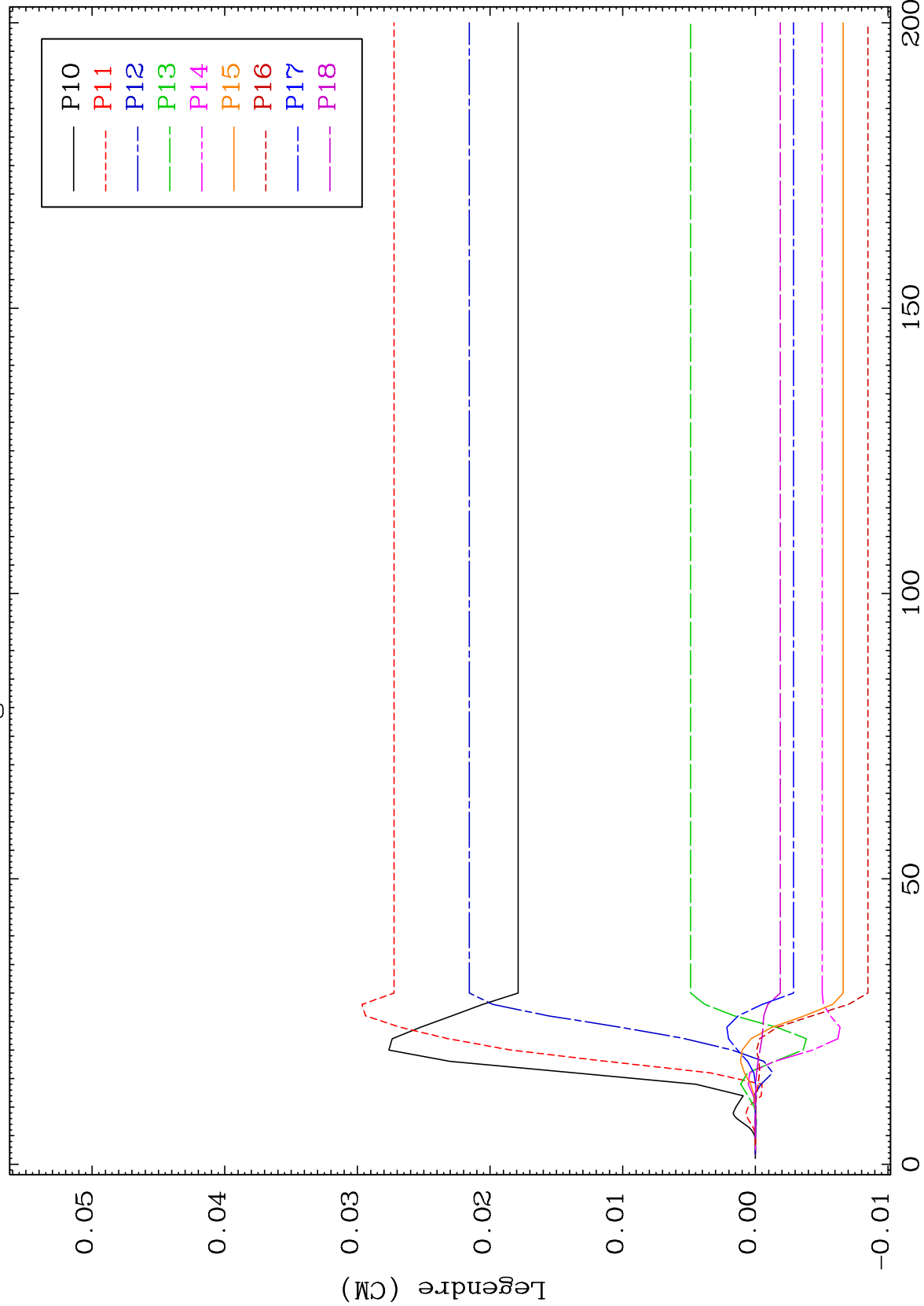

77-Ir-185

Incident Energy (MeV)

102

MAT 7707

MT= 71 (n,n') Level
Legendre Coefficients

77-Ir-185

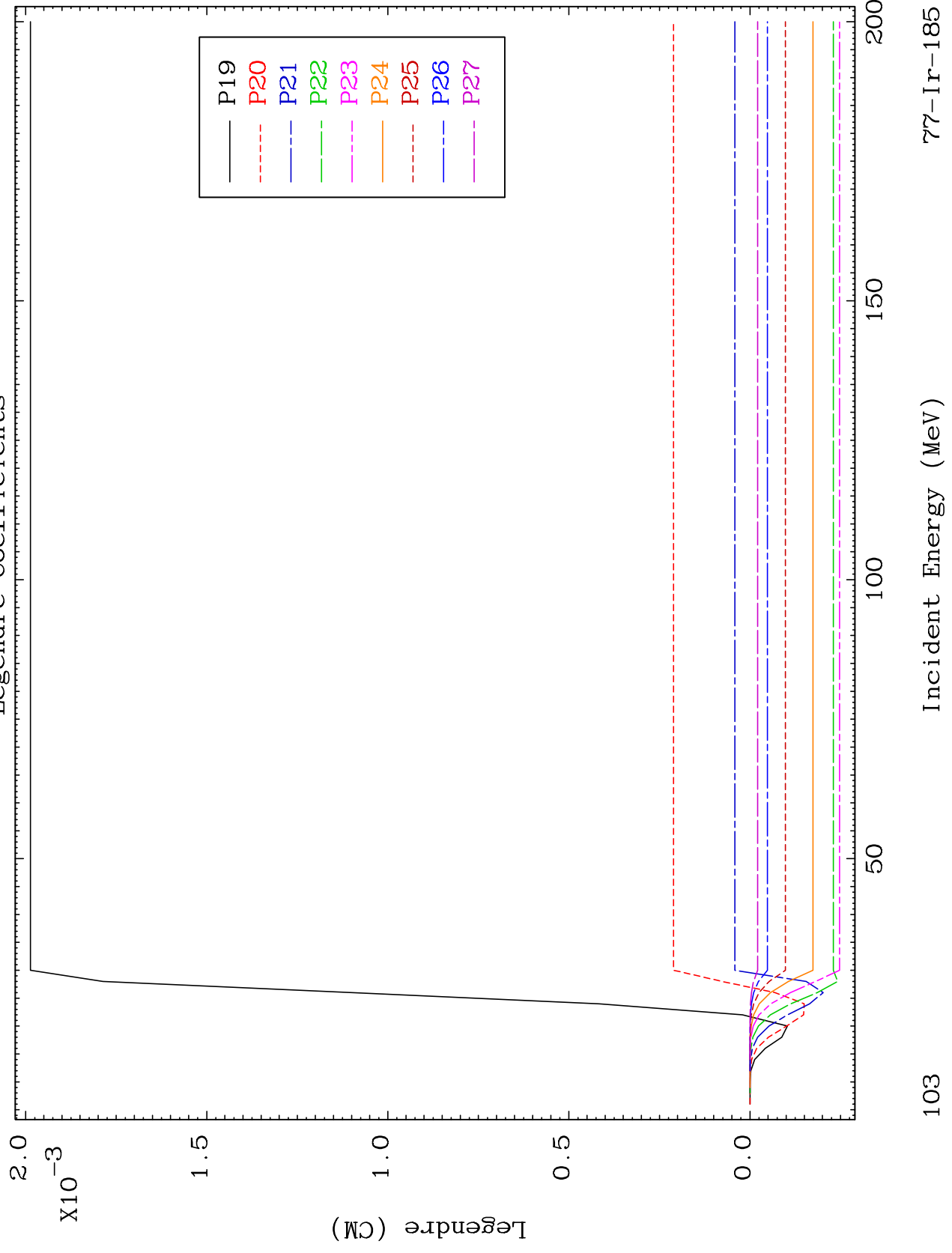

103

Incident Energy (MeV)

77-Ir-185

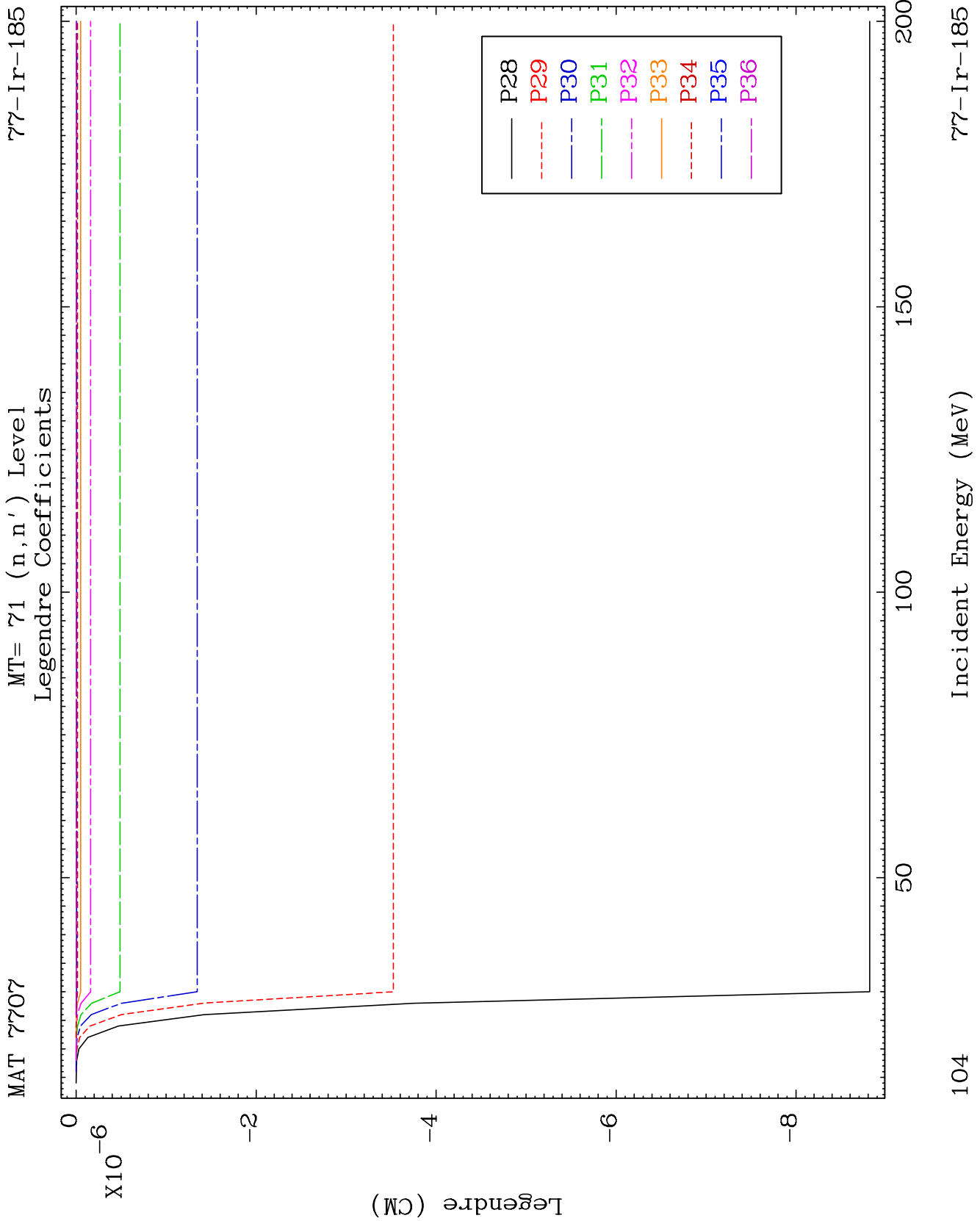

MAT 7707

MT= 72 (n,n') Level
Legendre Coefficients

77-Ir-185

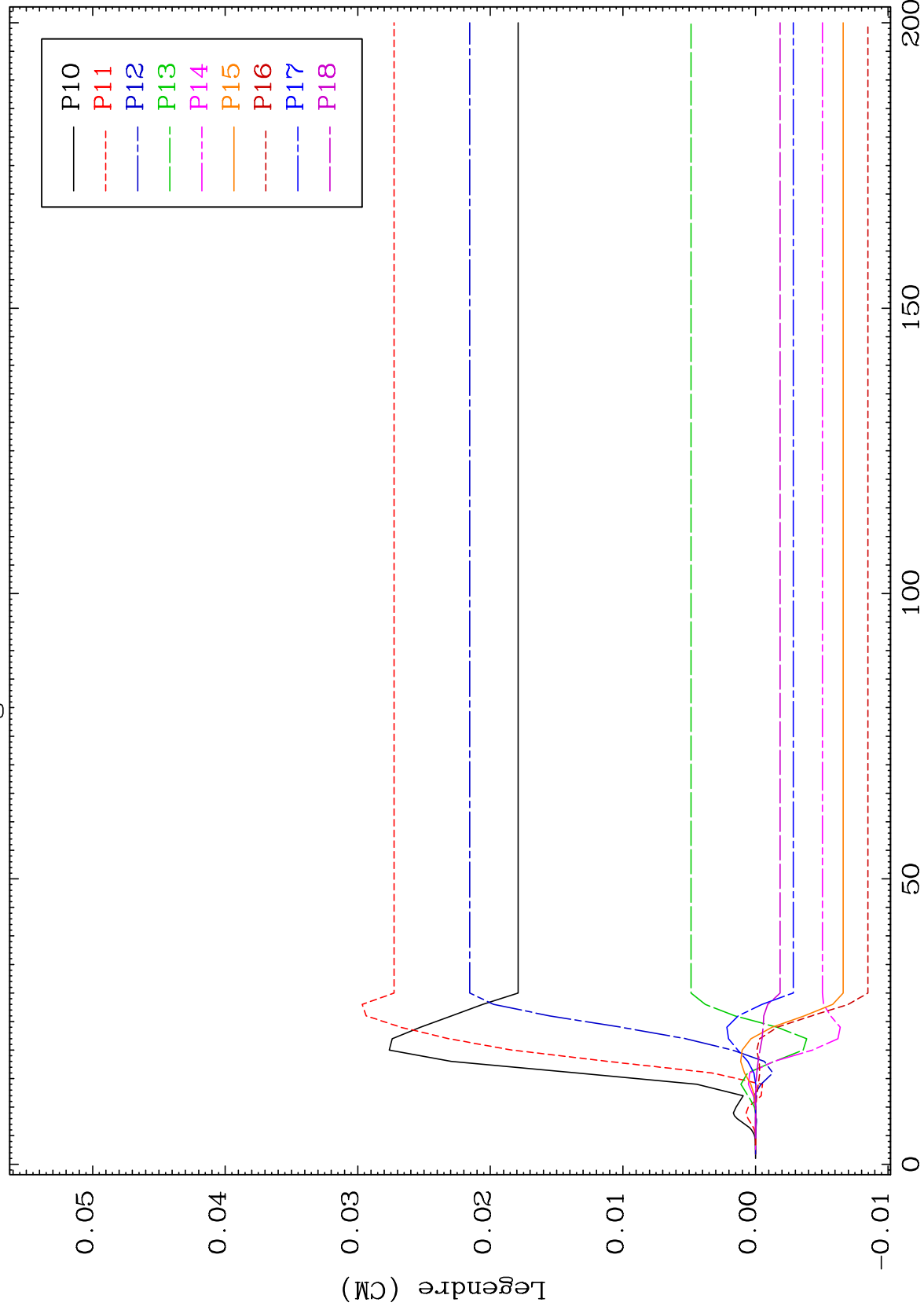

106

Incident Energy (MeV)

77-Ir-185

MAT 7707

MT= 72 (n,n') Level
Legendre Coefficients

77-Ir-185

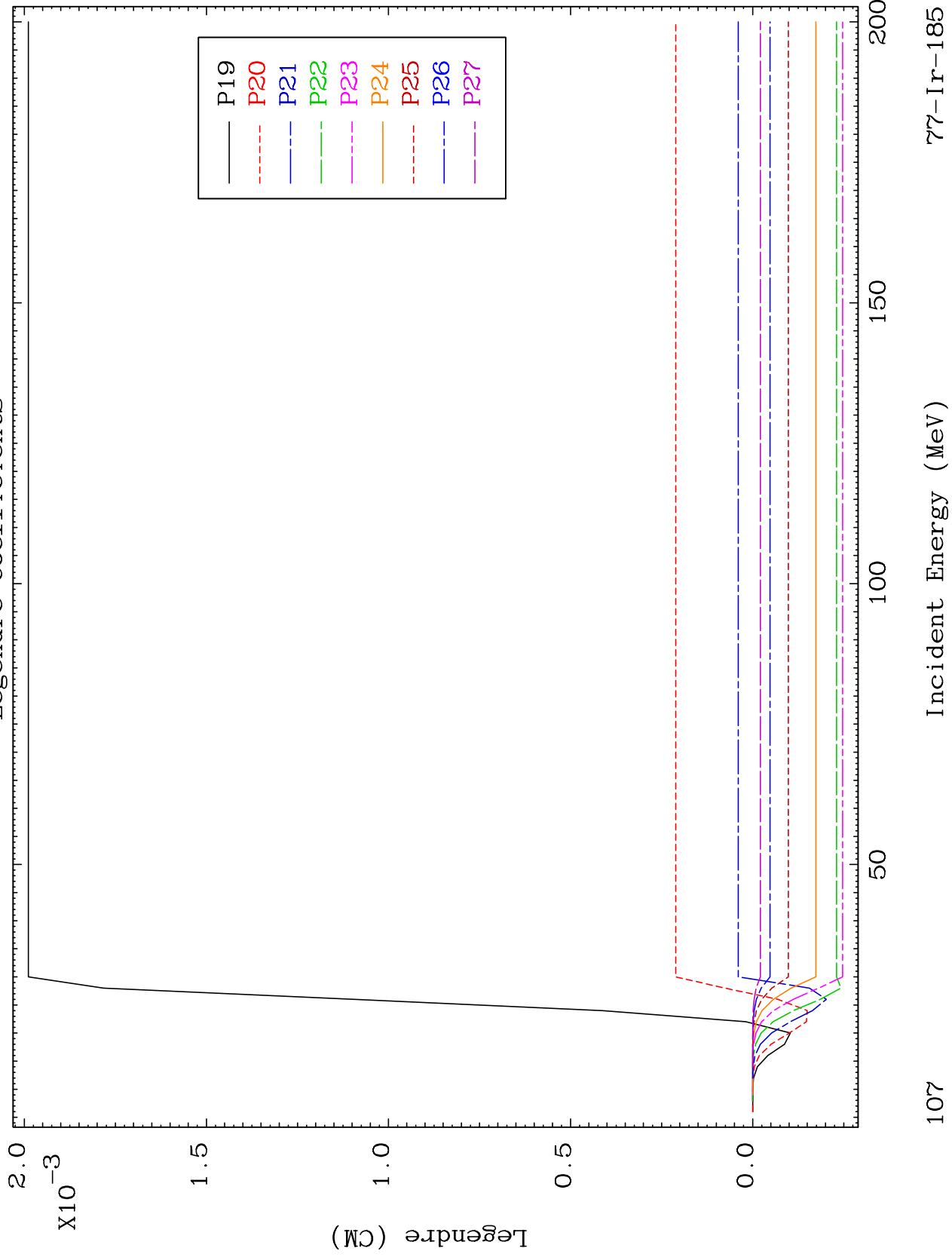

107

Incident Energy (MeV)

77-Ir-185

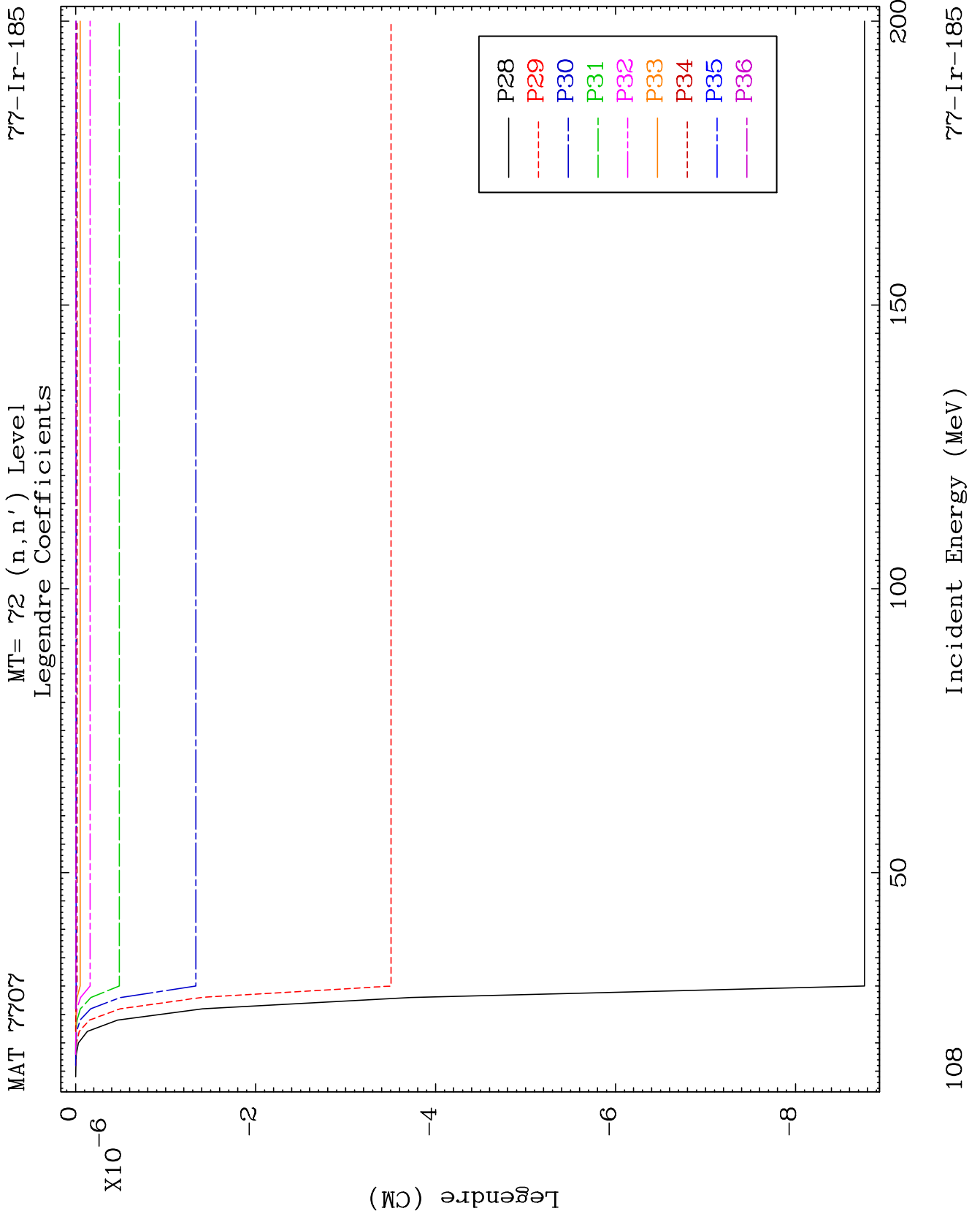

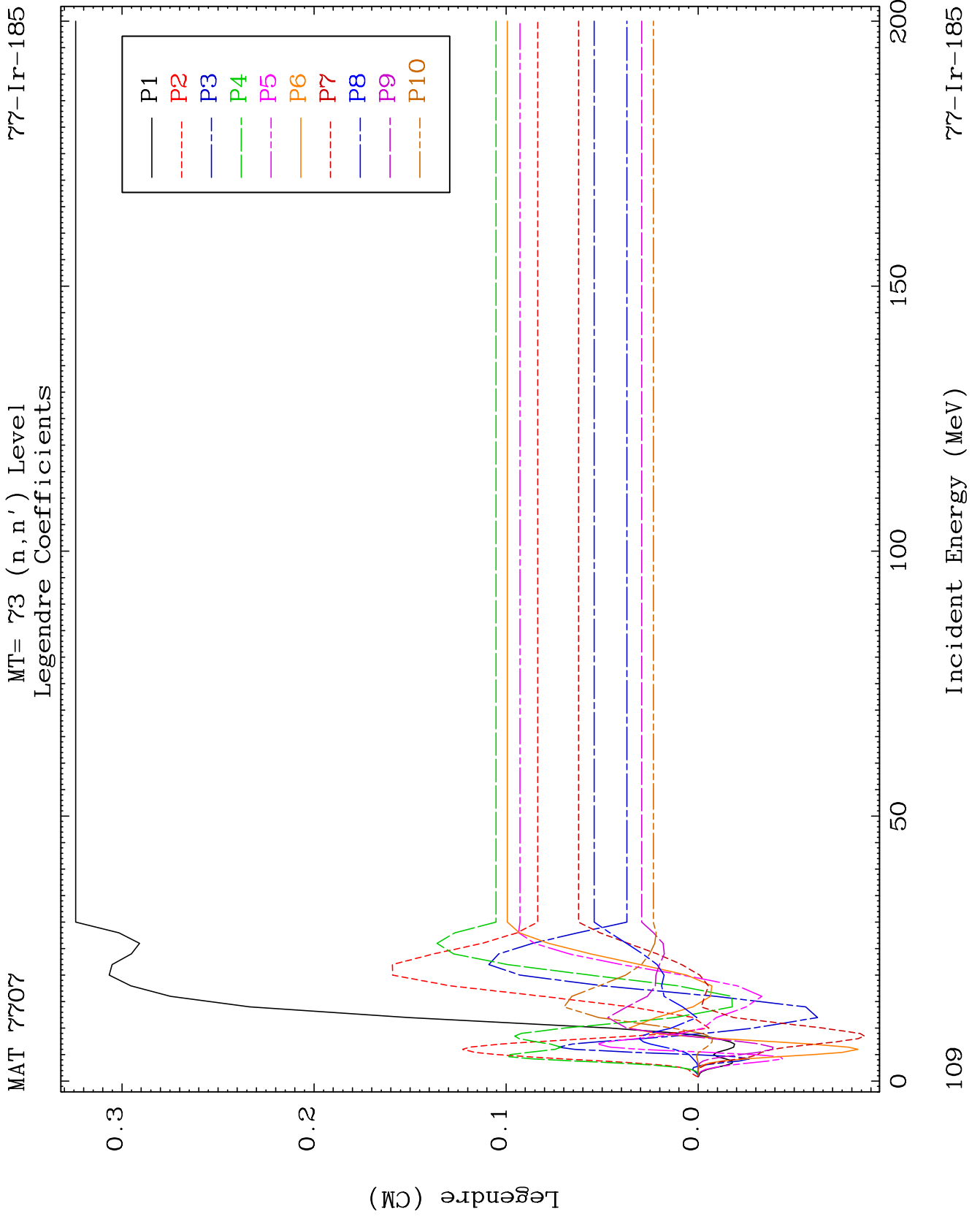

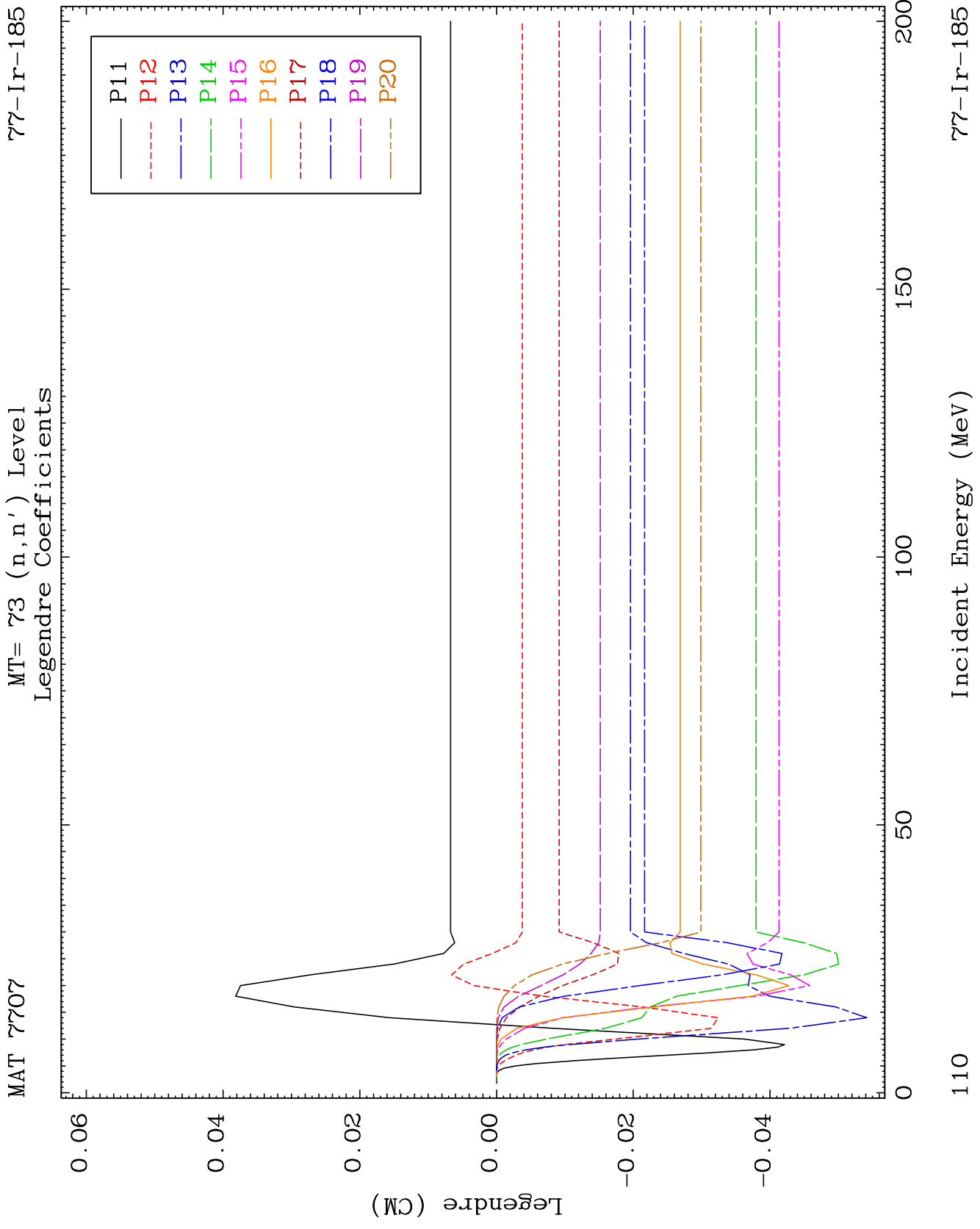

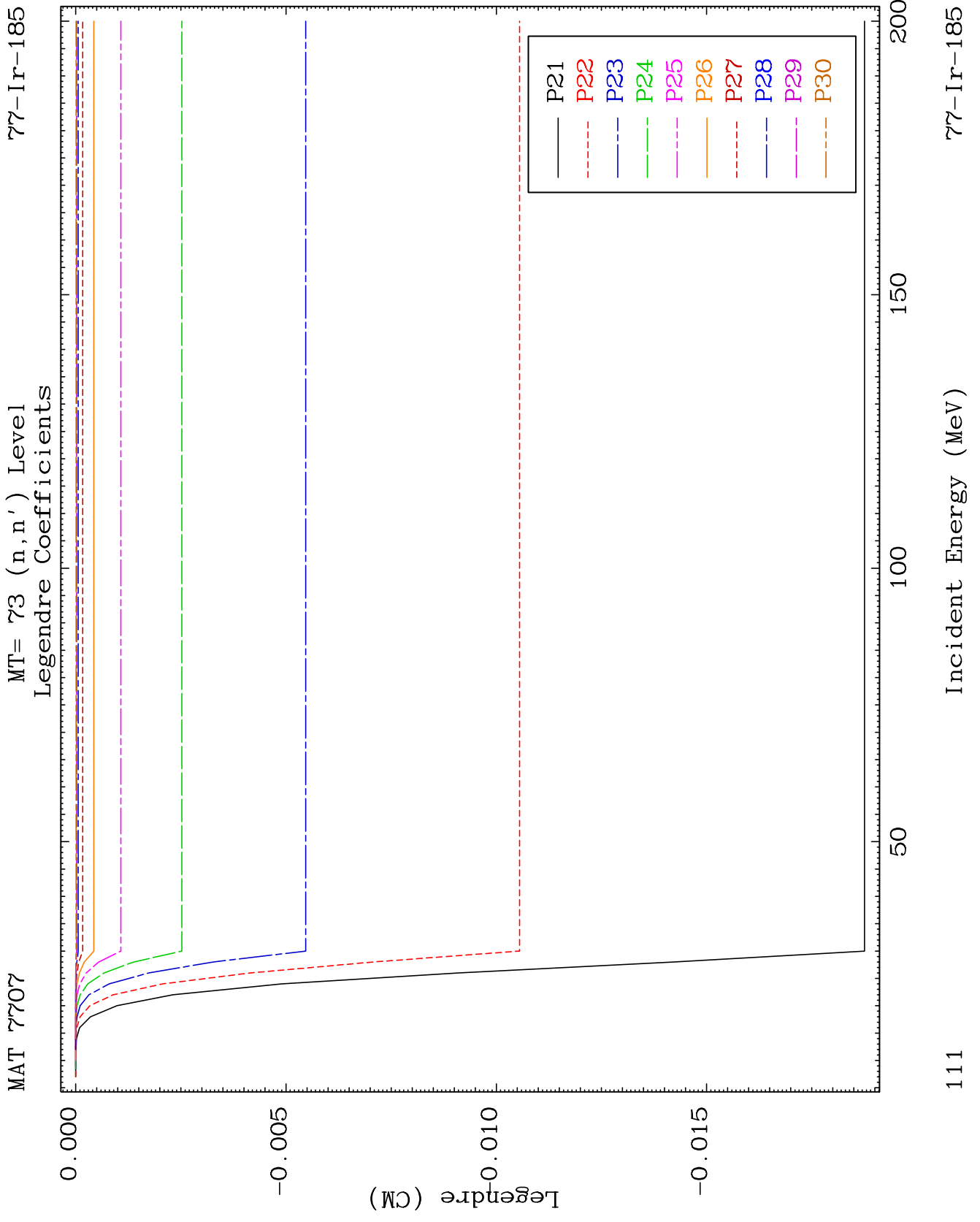

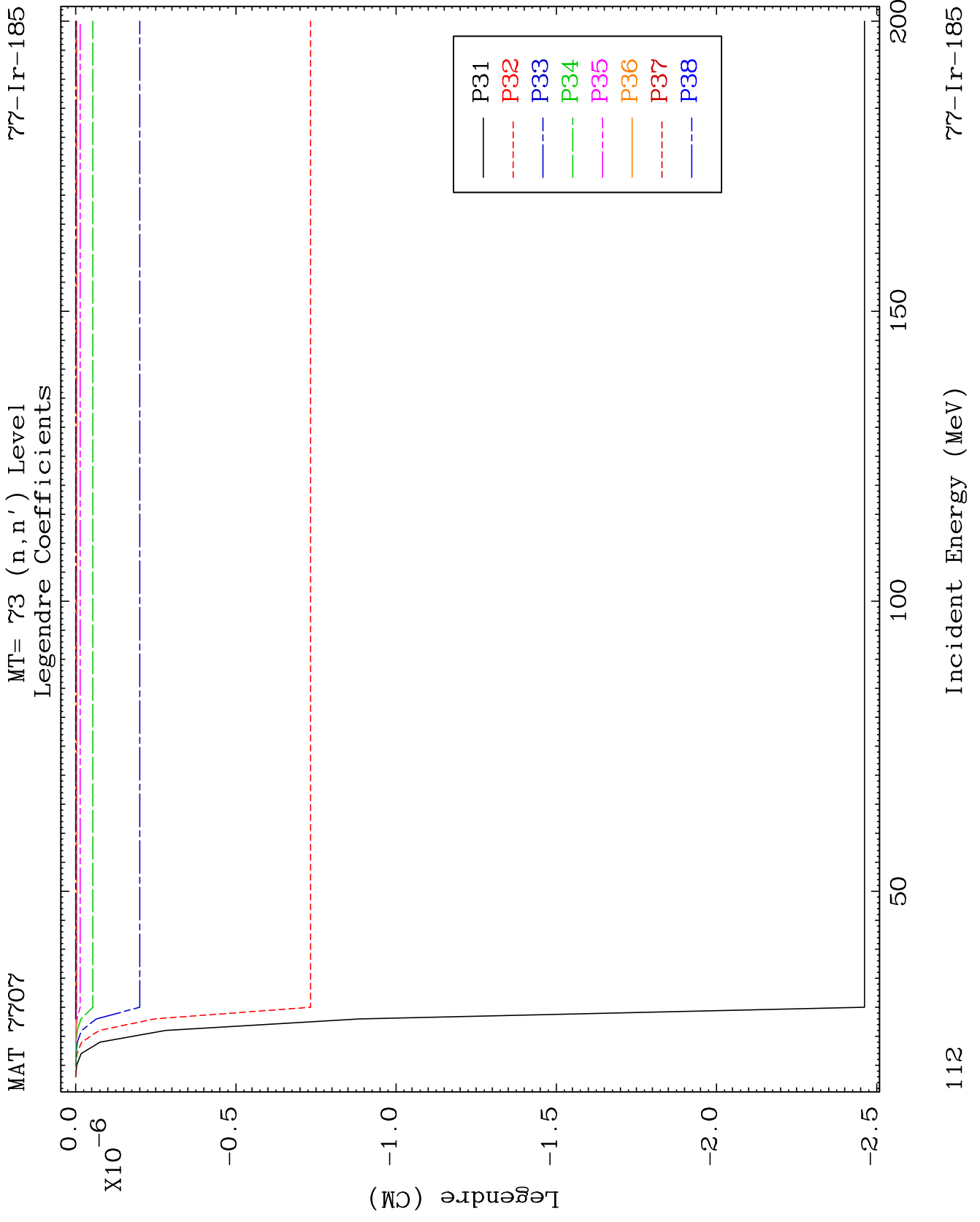

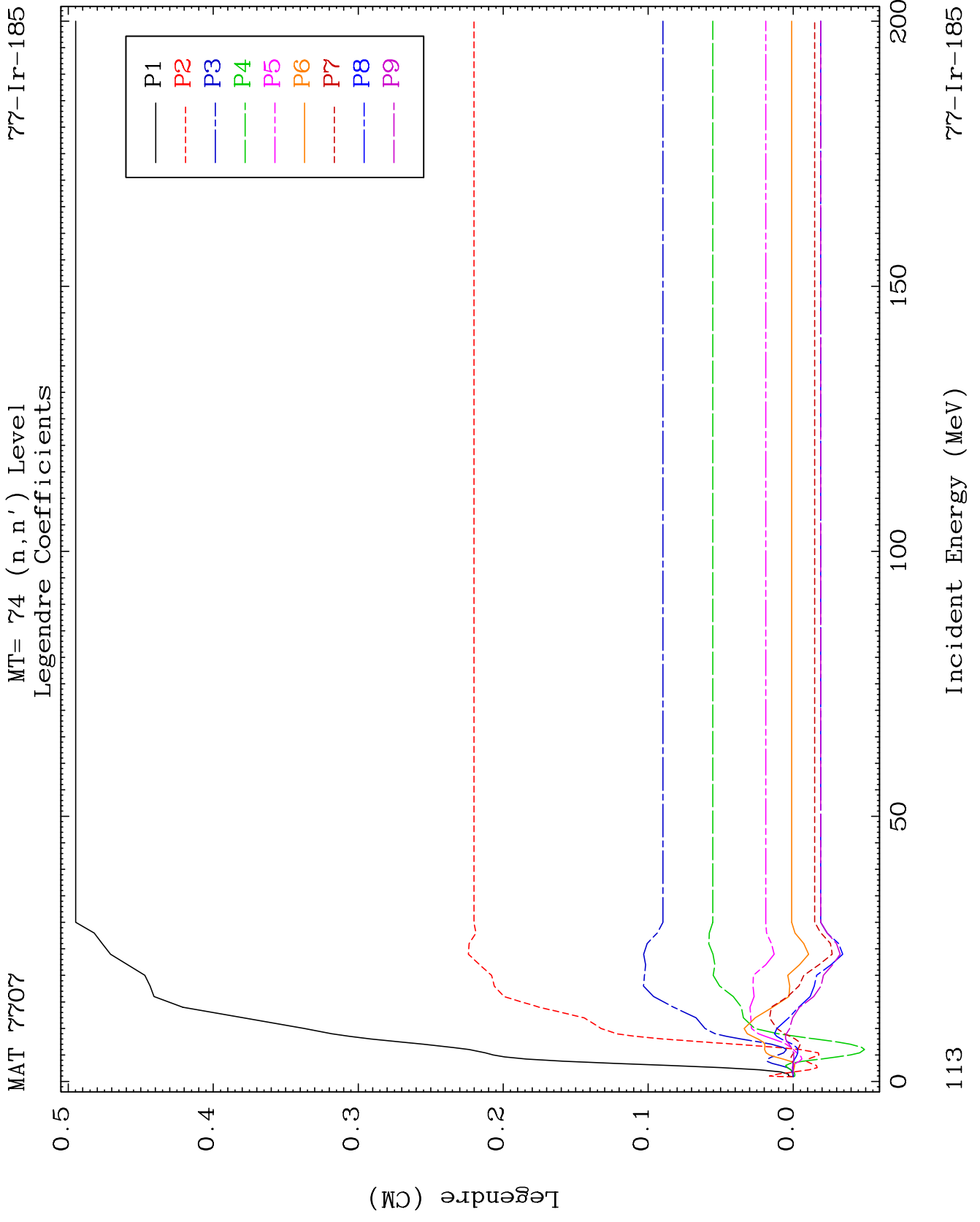

MAT 7707

MT= 74 (n,n') Level
Legendre Coefficients

77-Ir-185

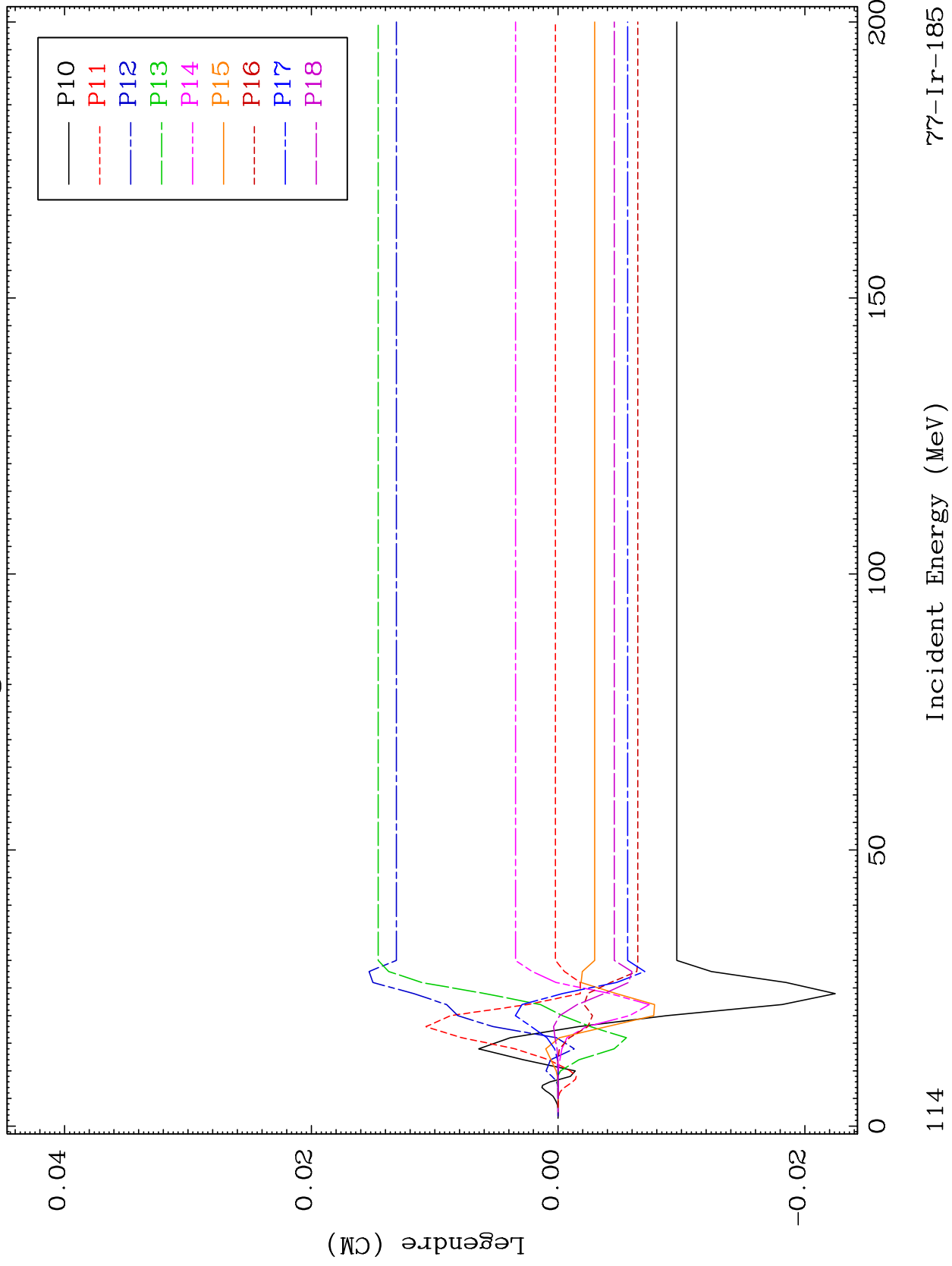

77-Ir-185

Incident Energy (MeV)

114

MAT 7707

MT= 74 (n,n') Level
Legendre Coefficients

77-Ir-185

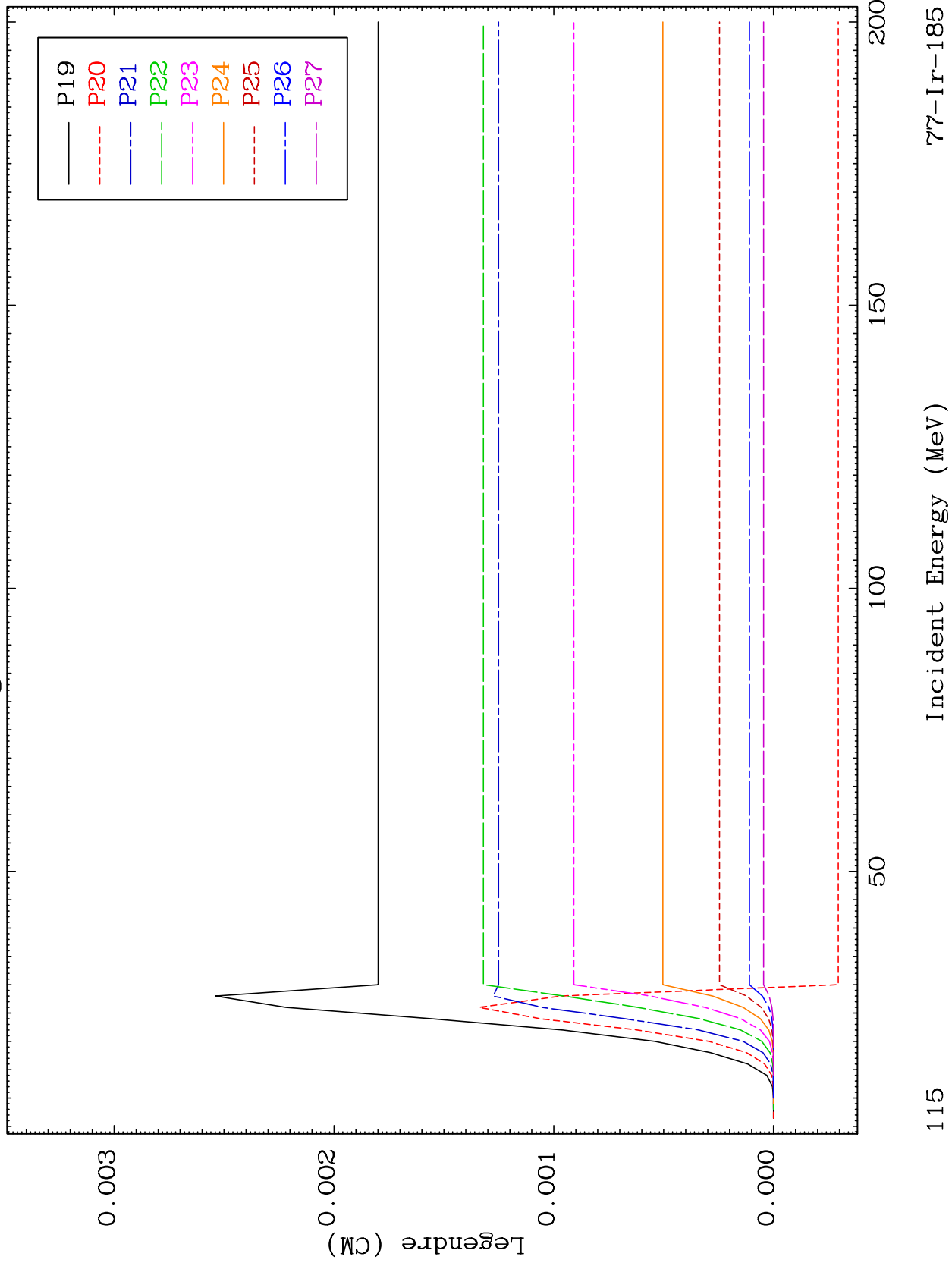

115

Incident Energy (MeV)

77-Ir-185

MAT 7707

MT= 74 (n,n') Level
Legendre Coefficients

77-Ir-185

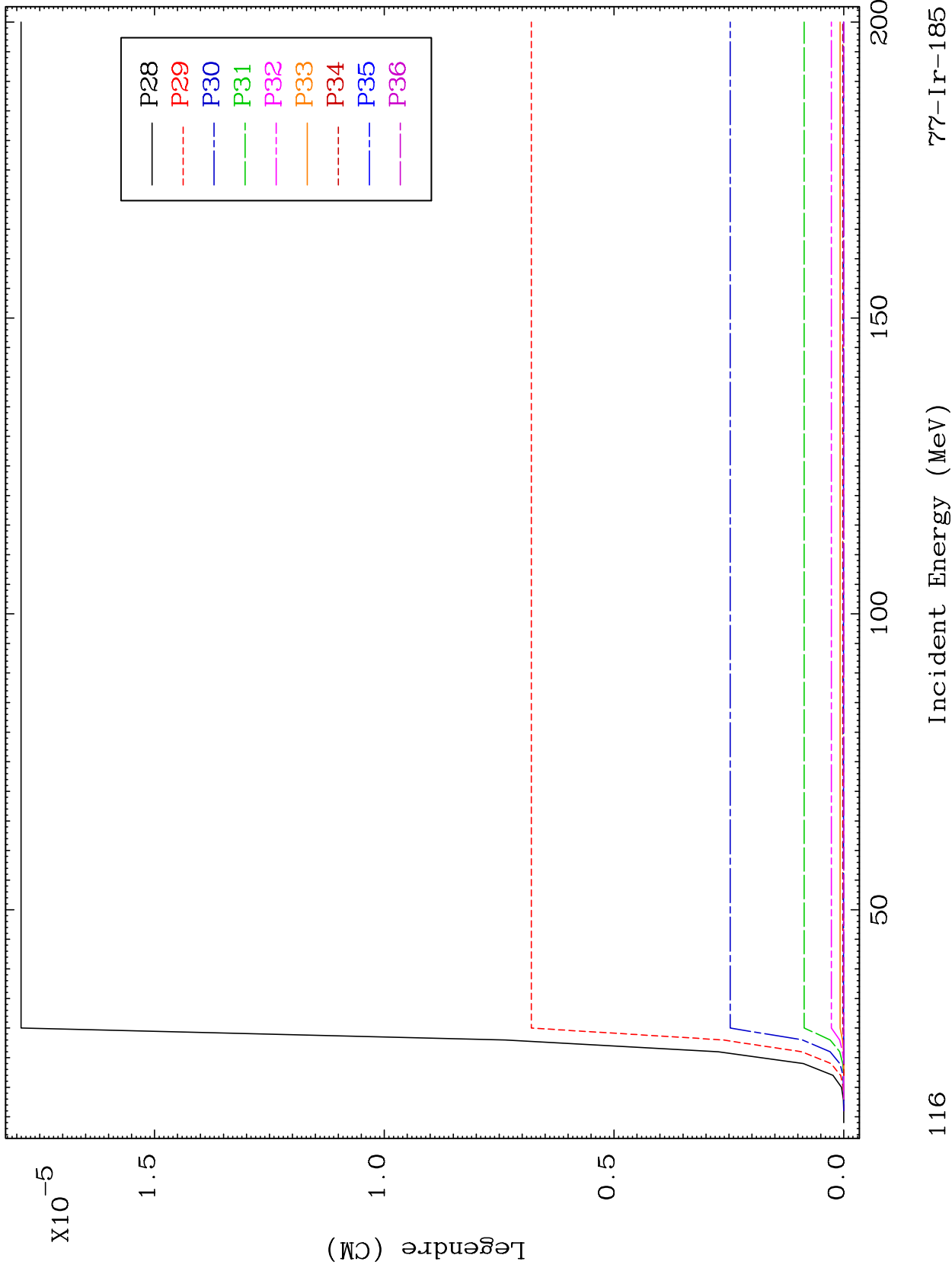

116

MAT 7707

MT= 75 (n,n') Level
Legendre Coefficients

77-Ir-185

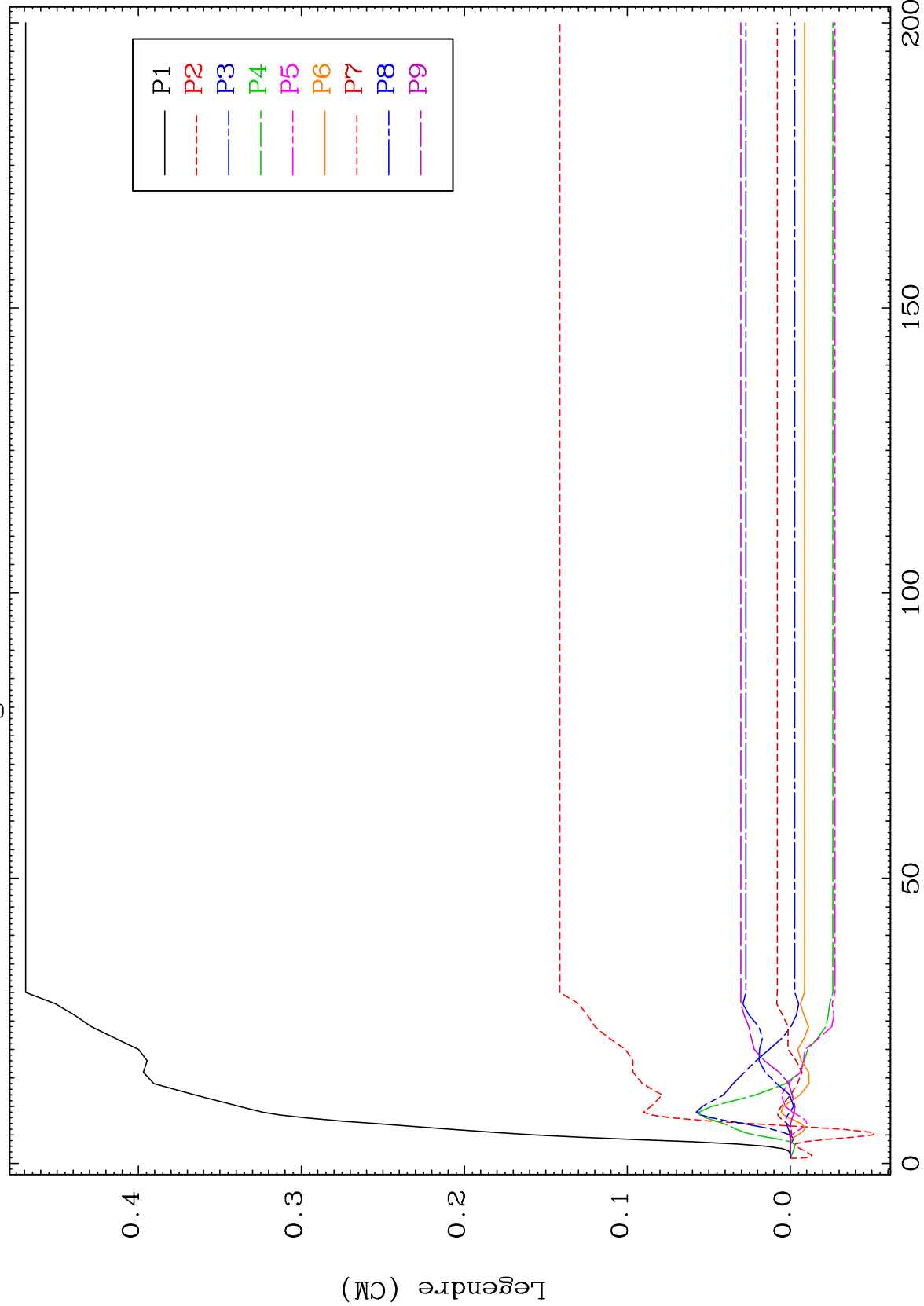

117

Incident Energy (MeV)

77-Ir-185

MAT 7707

MT= 75 (n,n') Level
Legendre Coefficients

77-Ir-185

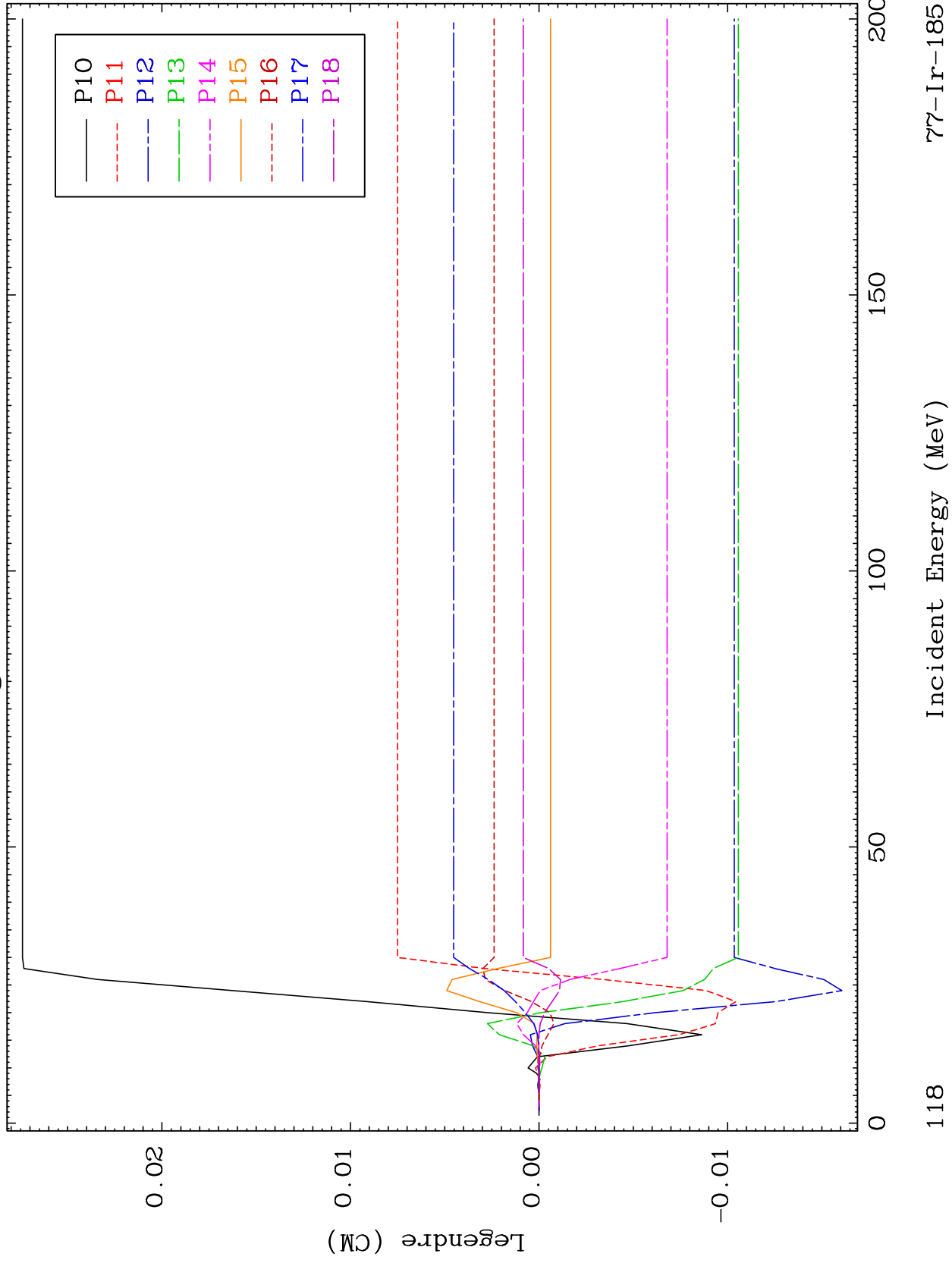

77-Ir-185

Incident Energy (MeV)

118

MAT 7707

MT= 75 (n,n') Level
Legendre Coefficients

77-Ir-185

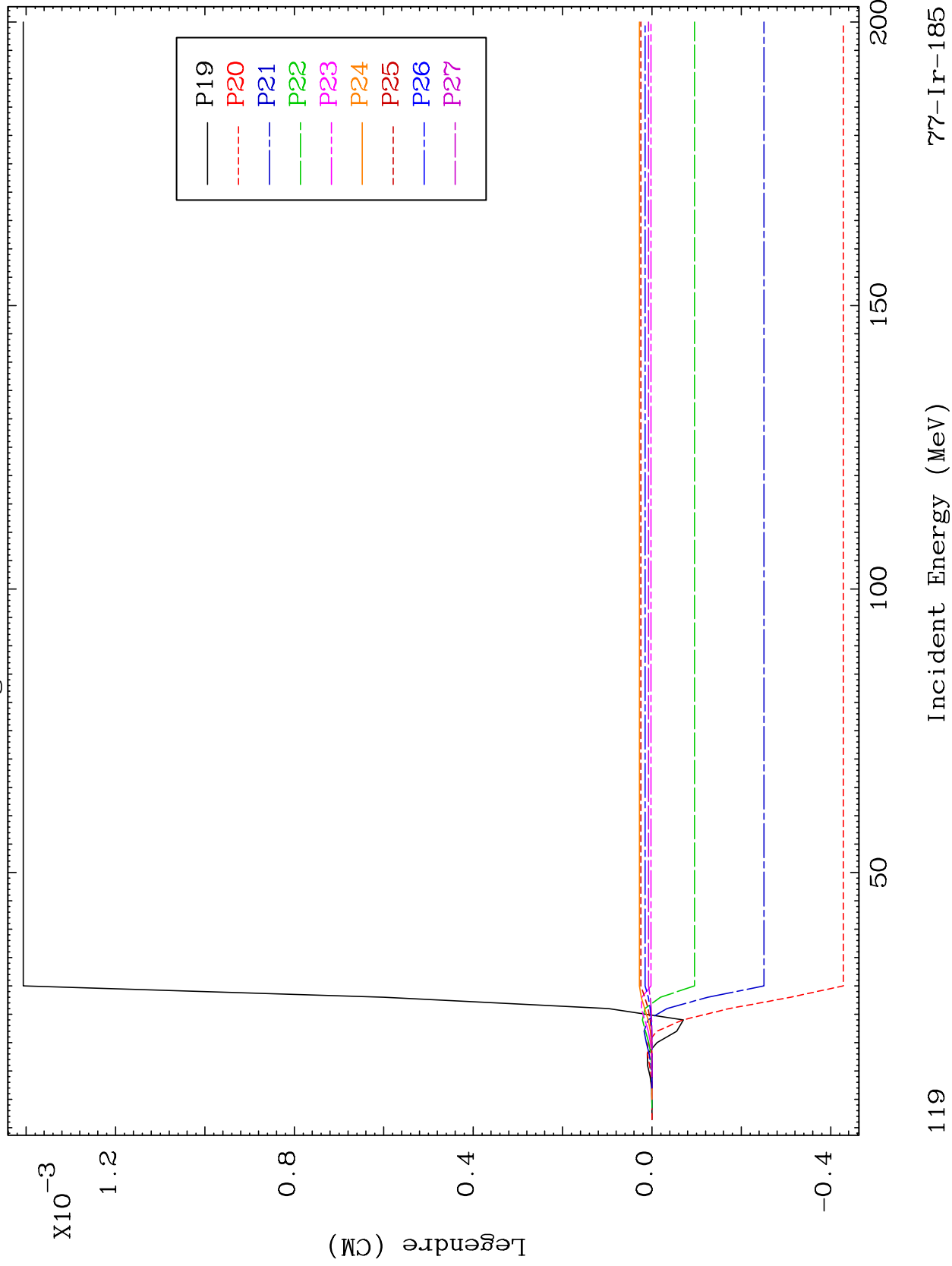

119

77-Ir-185

MAT 7707

MT= 75 (n,n') Level
Legendre Coefficients

77-Ir-185

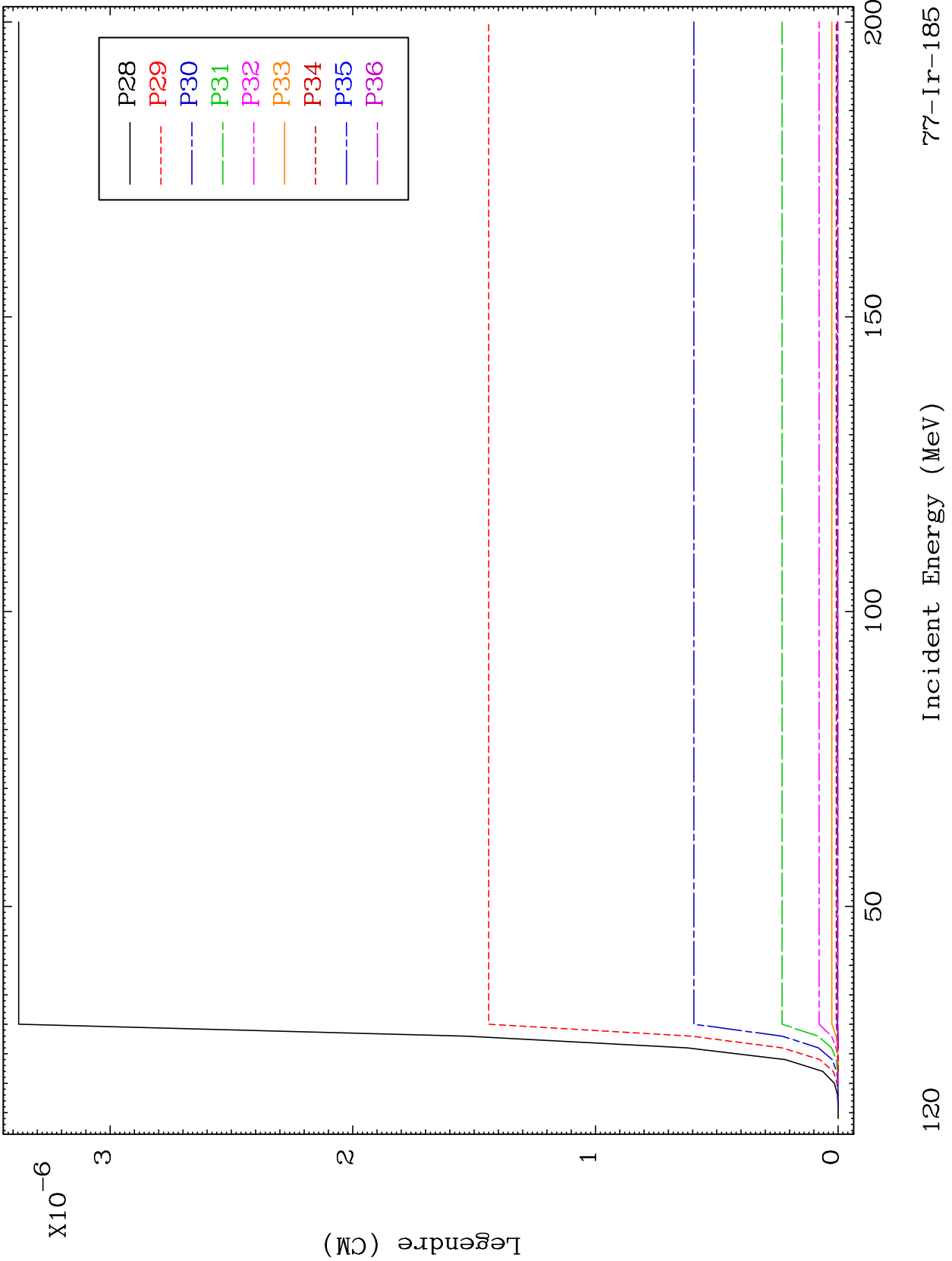

MAT 7707

MT= 76 (n,n') Level
Legendre Coefficients

77-Ir-185

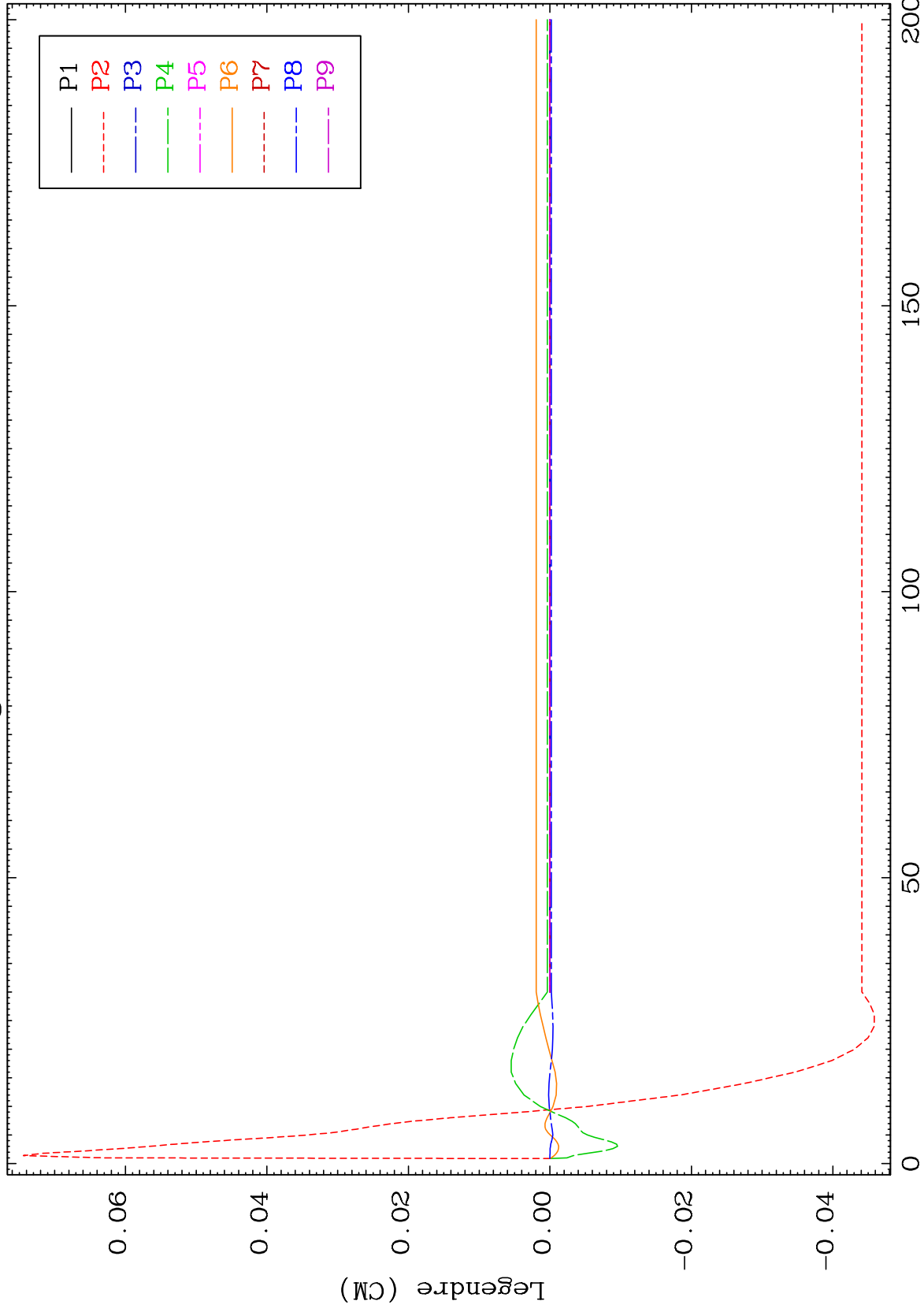

121

Incident Energy (MeV)

77-Ir-185

MAT 7707

MT= 76 (n,n') Level
Legendre Coefficients

77-Ir-185

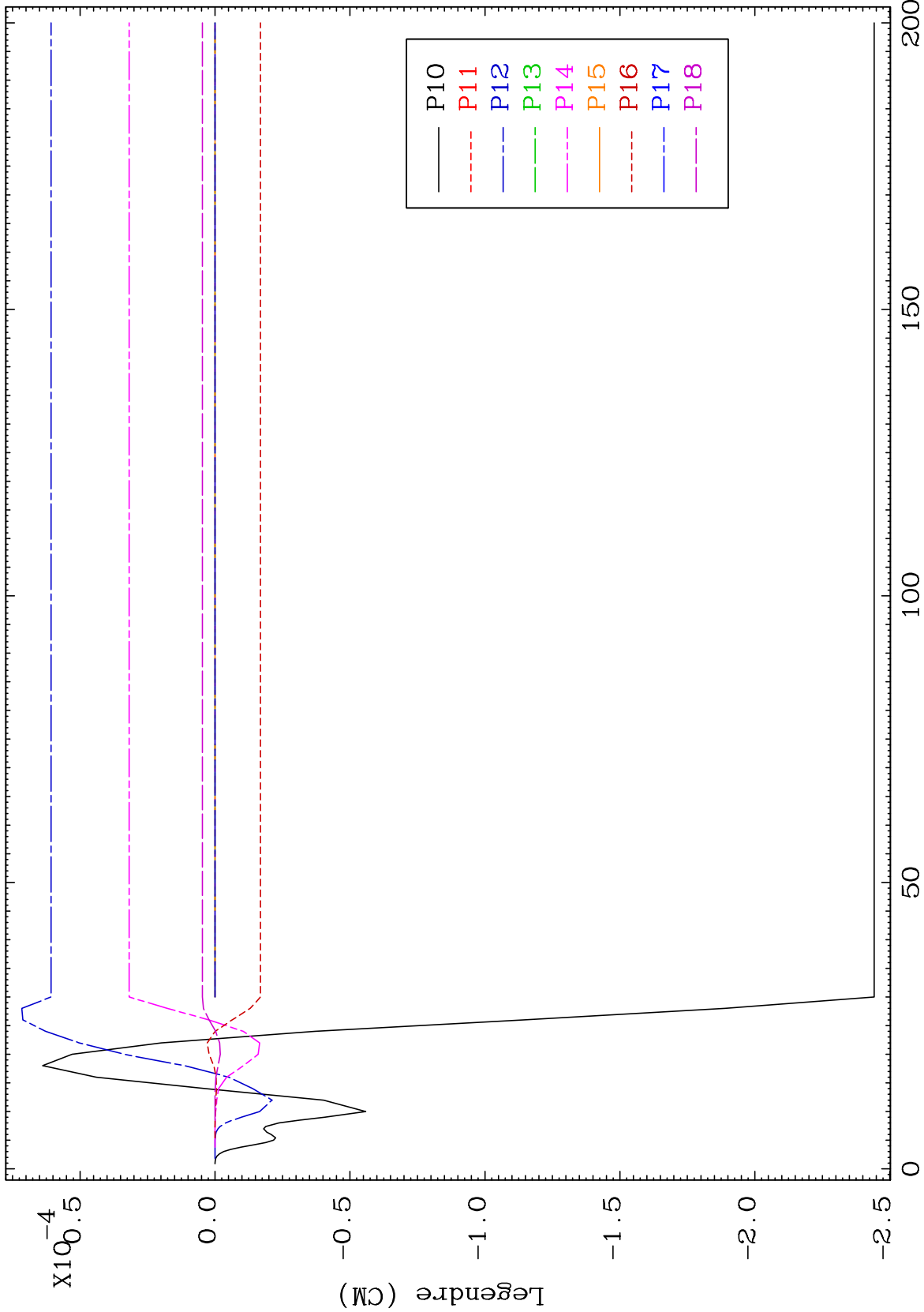

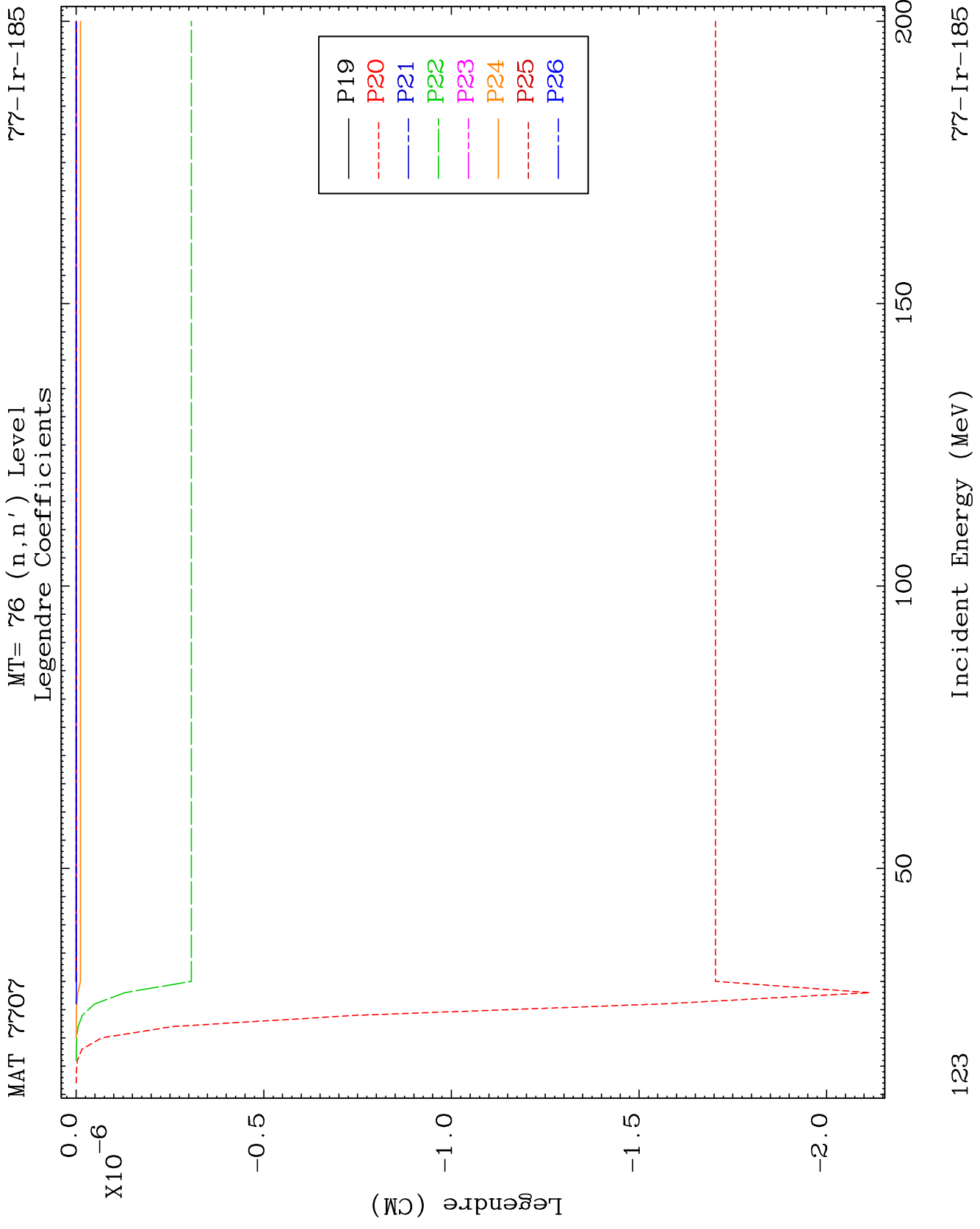

MAT 7707

MT= 77 (n,n') Level
Legendre Coefficients

77-Ir-185

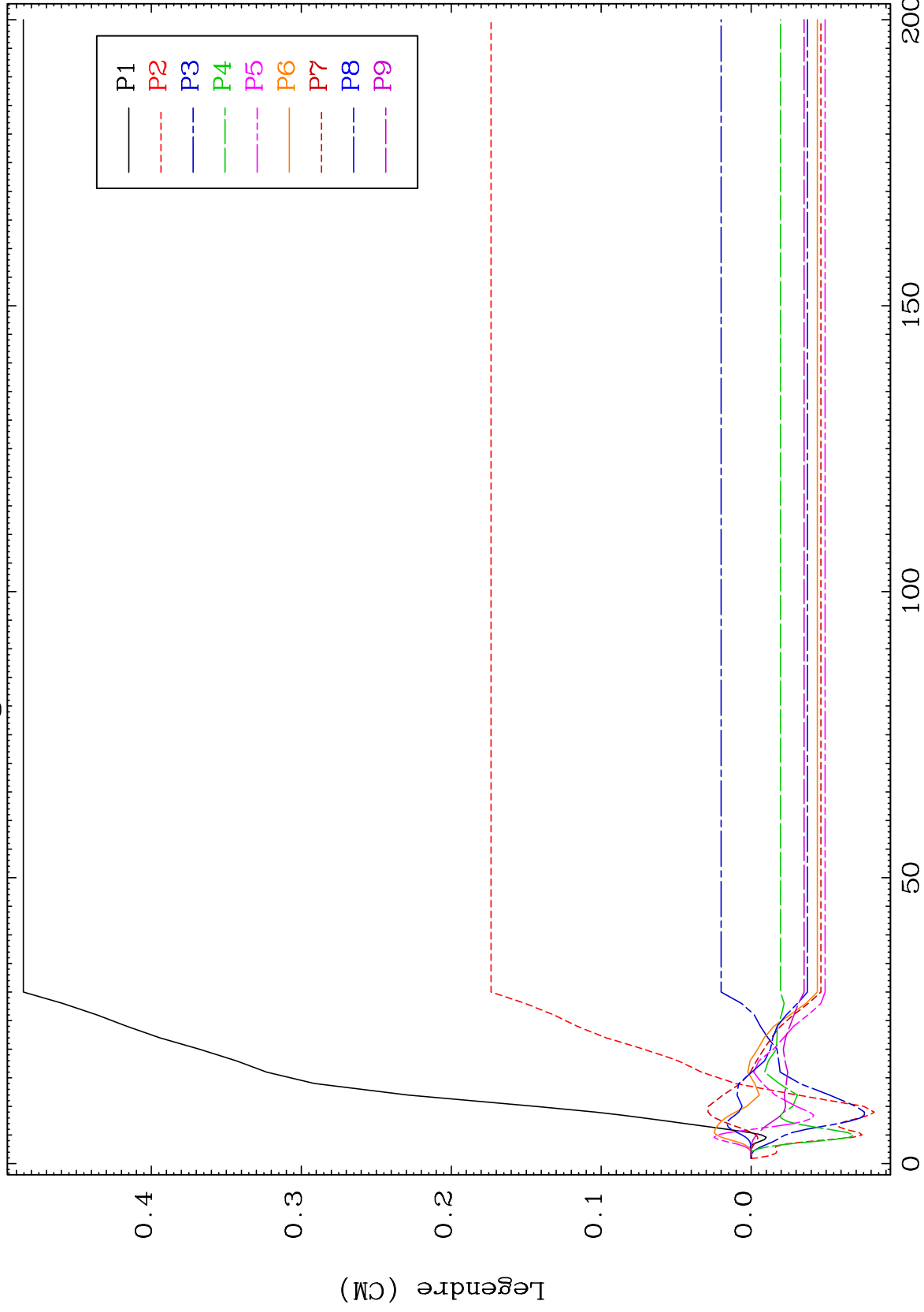

124

Incident Energy (MeV)

77-Ir-185

MAT 7707

MT= 77 (n,n') Level
Legendre Coefficients

77-Ir-185

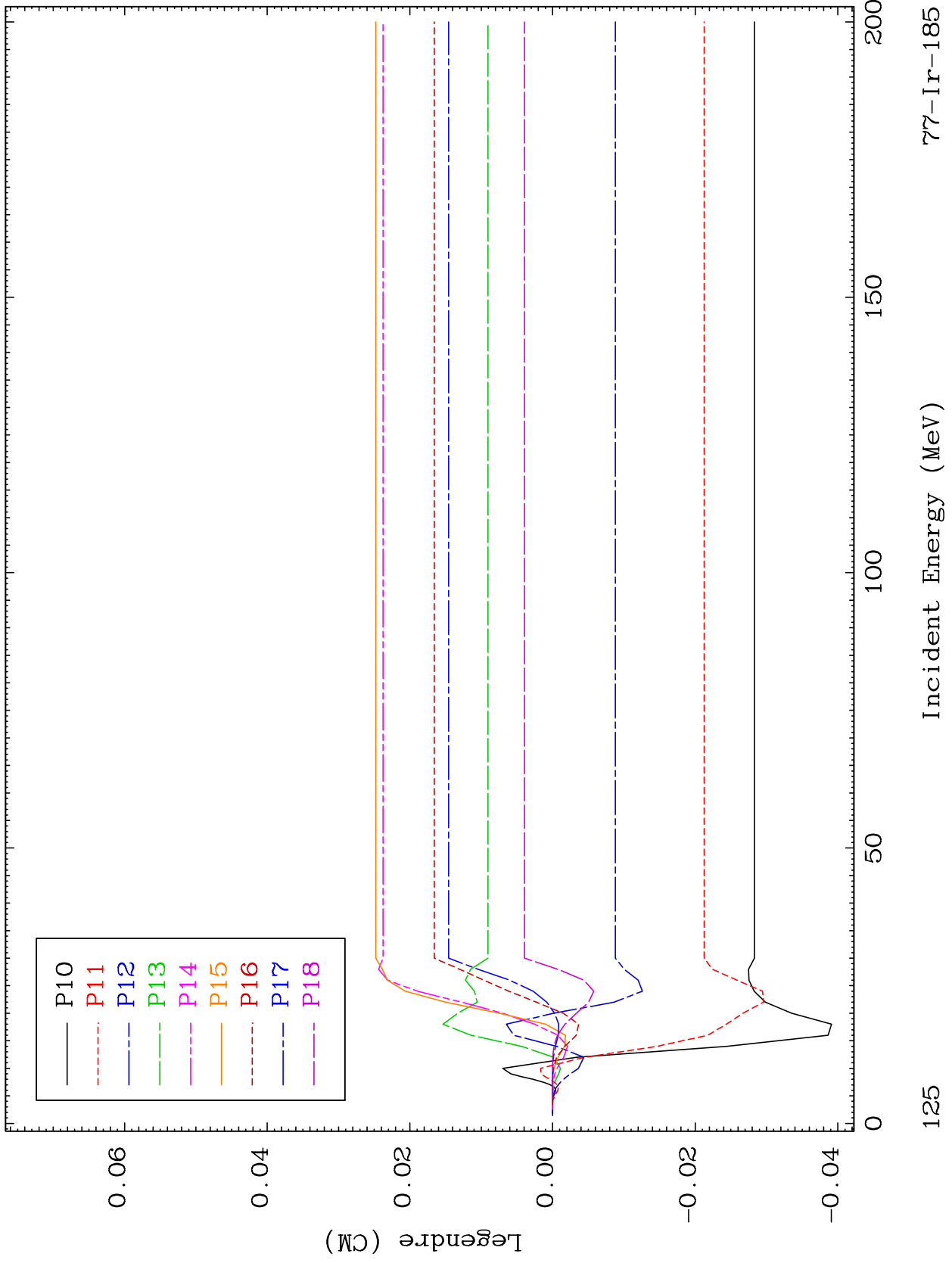

77-Ir-185

Incident Energy (MeV)

125

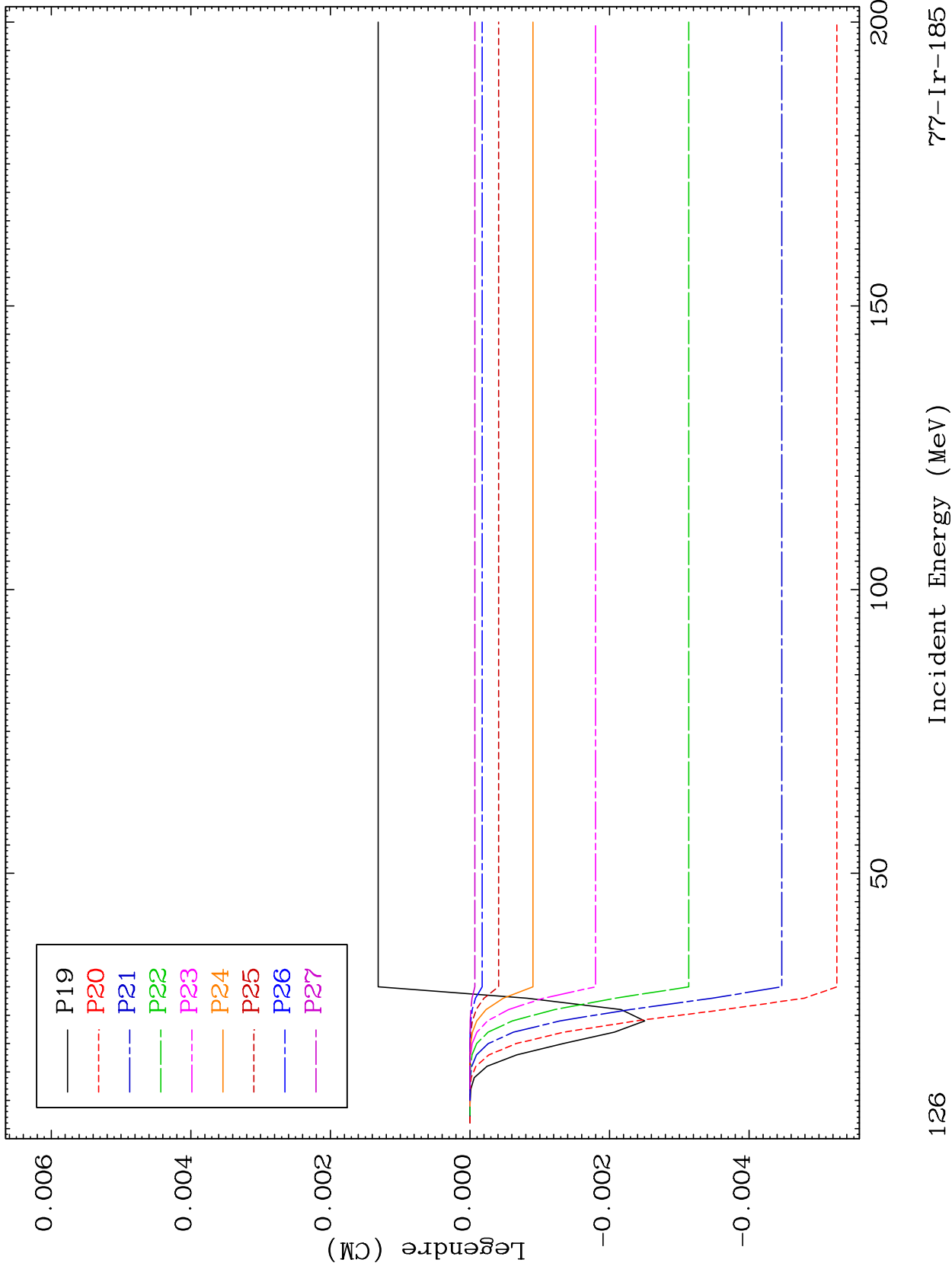

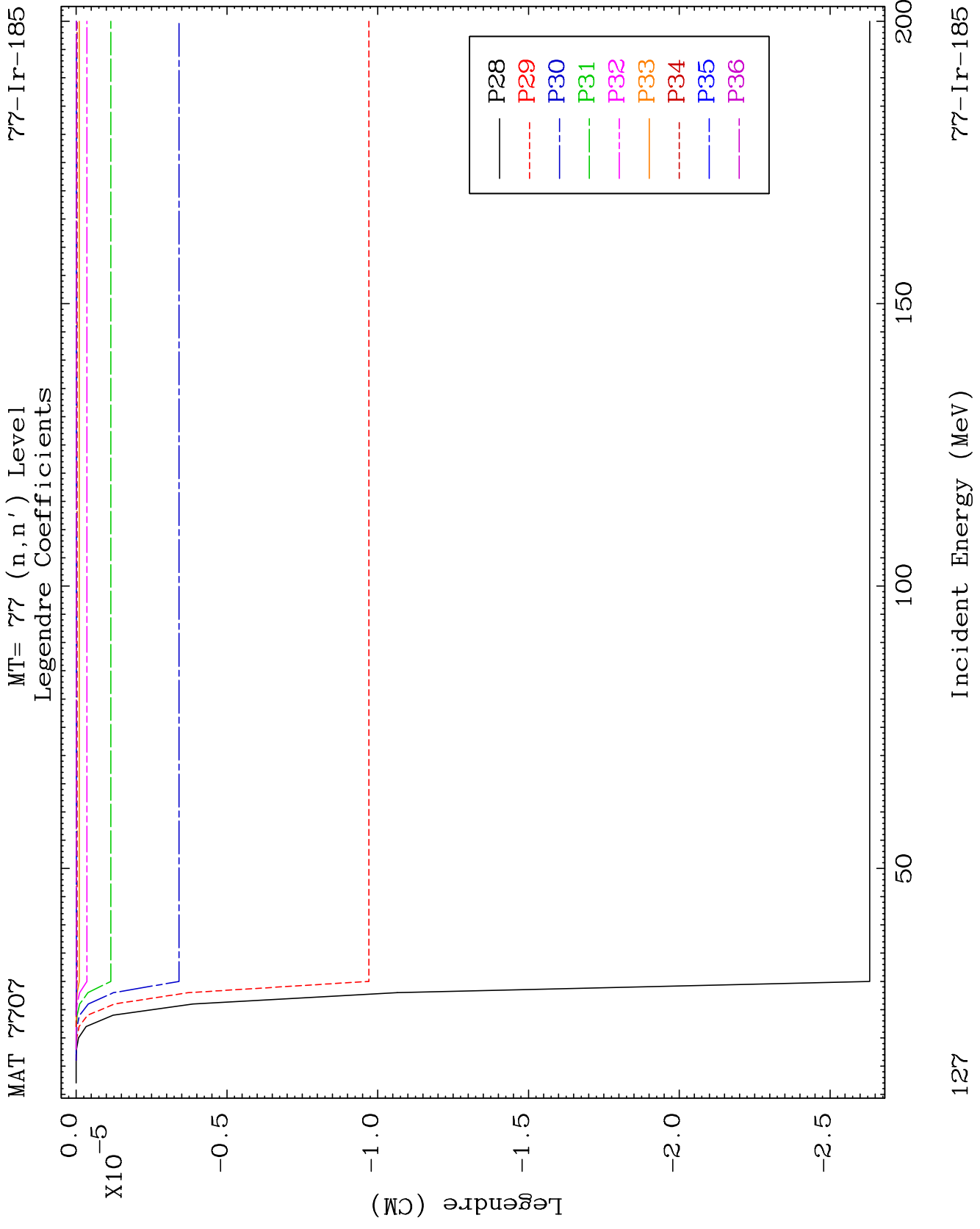

MAT 7707

MT= 78 (n,n') Level
Legendre Coefficients

77-Ir-185

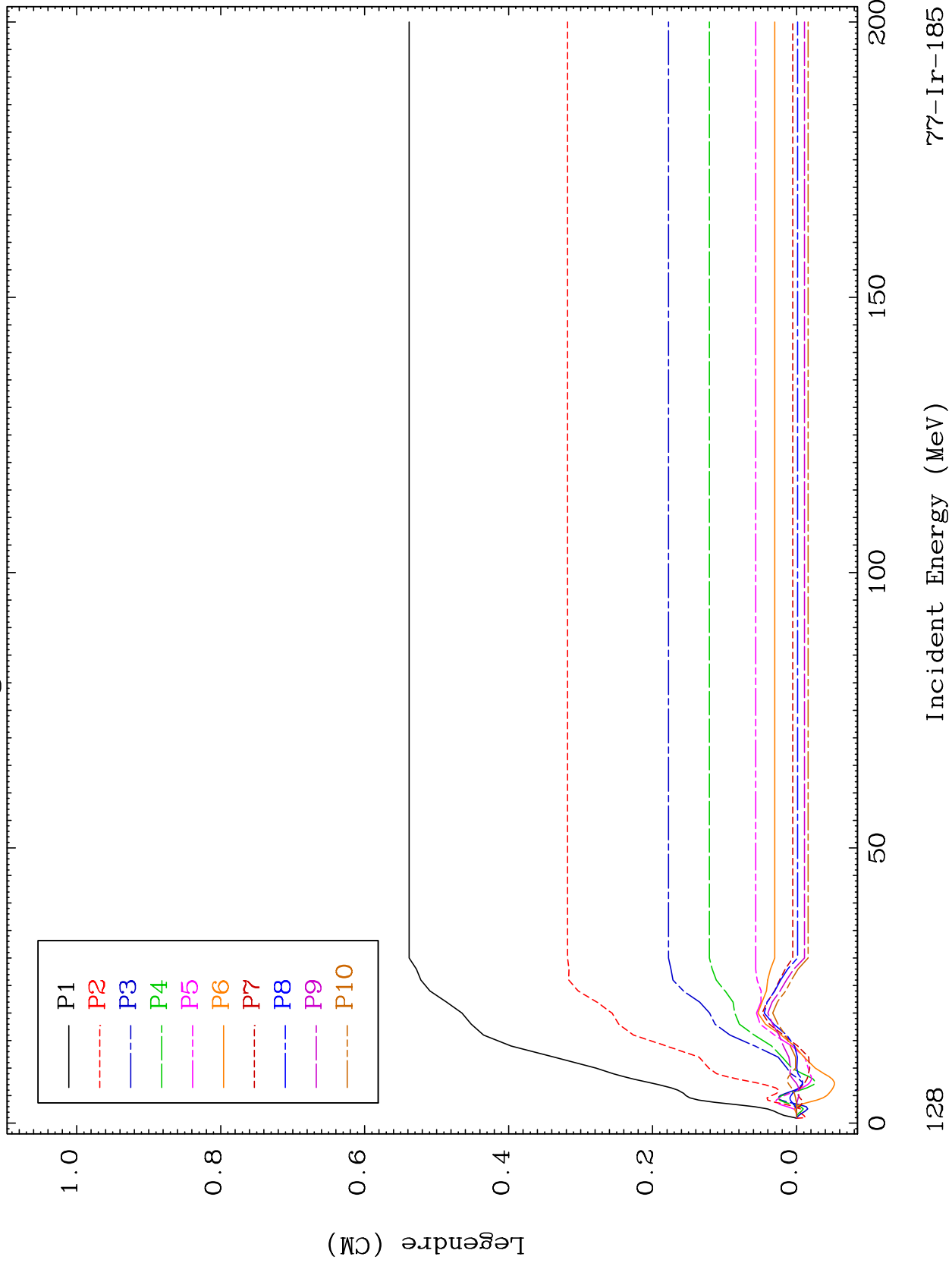

77-Ir-185

Incident Energy (MeV)

128

MAT 7707

MT= 78 (n,n') Level
Legendre Coefficients

77-Ir-185

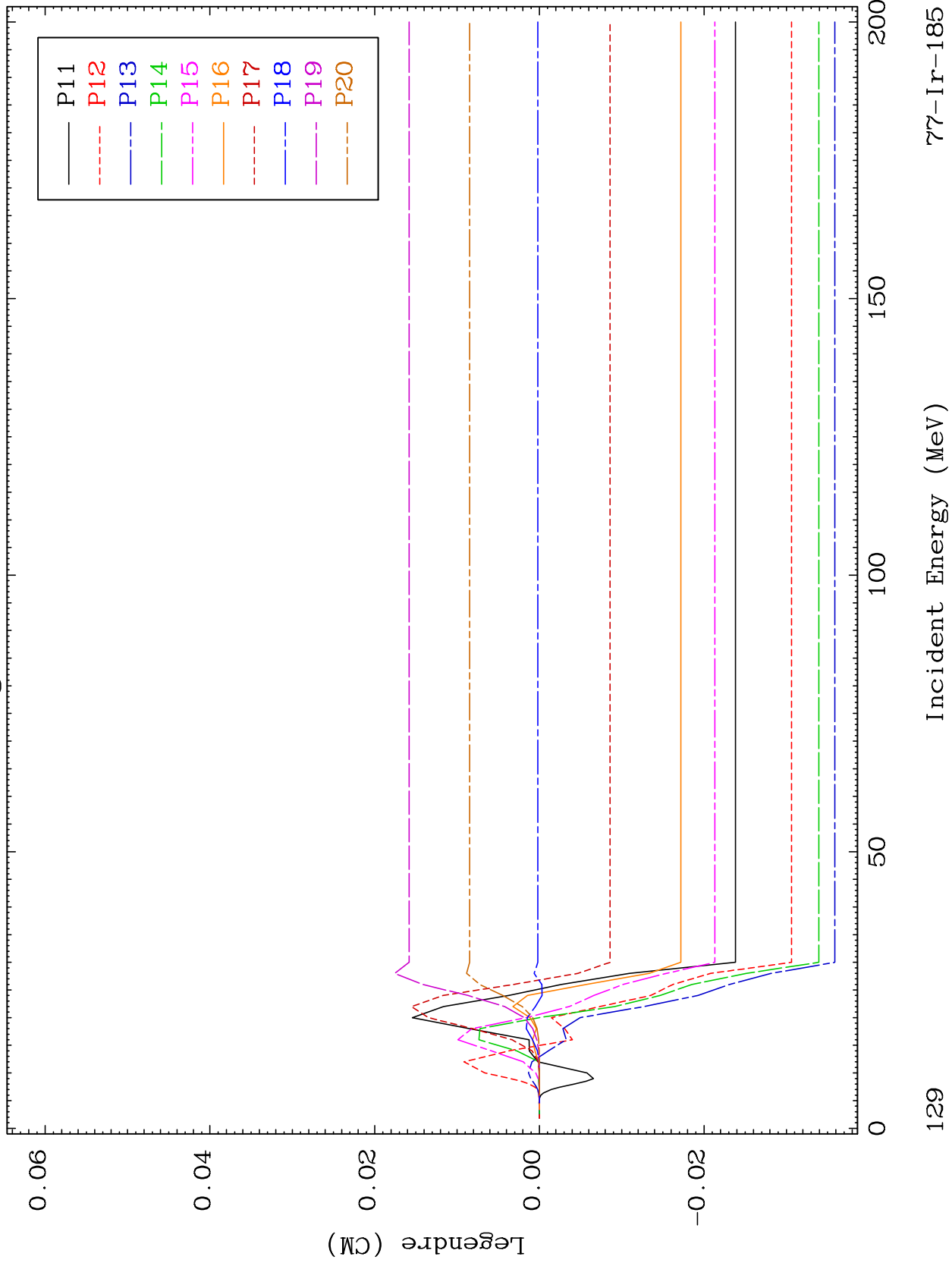

129

Incident Energy (MeV)

77-Ir-185

MAT 7707

MT= 78 (n,n') Level
Legendre Coefficients

77-Ir-185

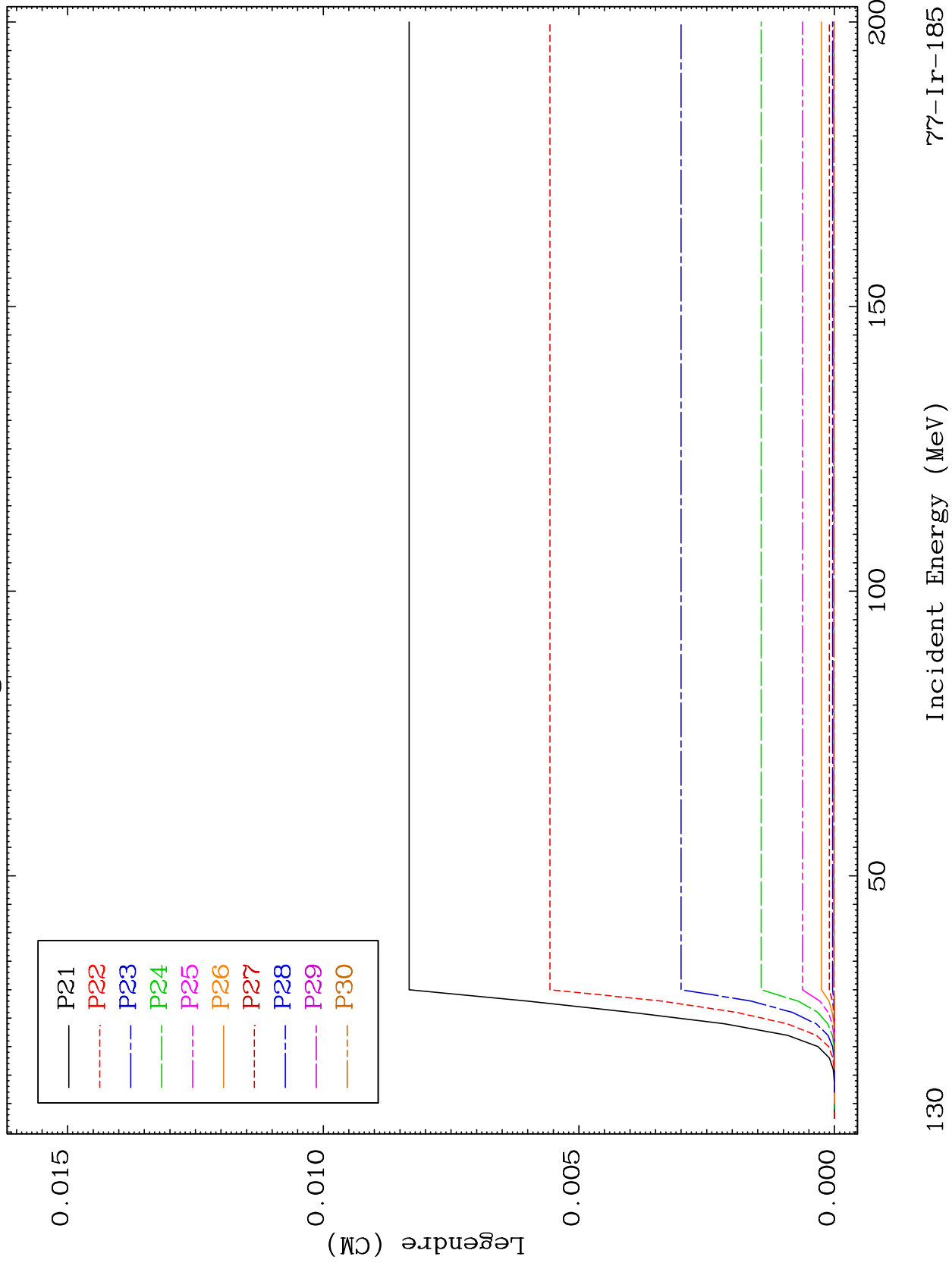

130

Incident Energy (MeV)

77-Ir-185

MAT 7707

MT= 78 (n,n') Level
Legendre Coefficients

77-Ir-185

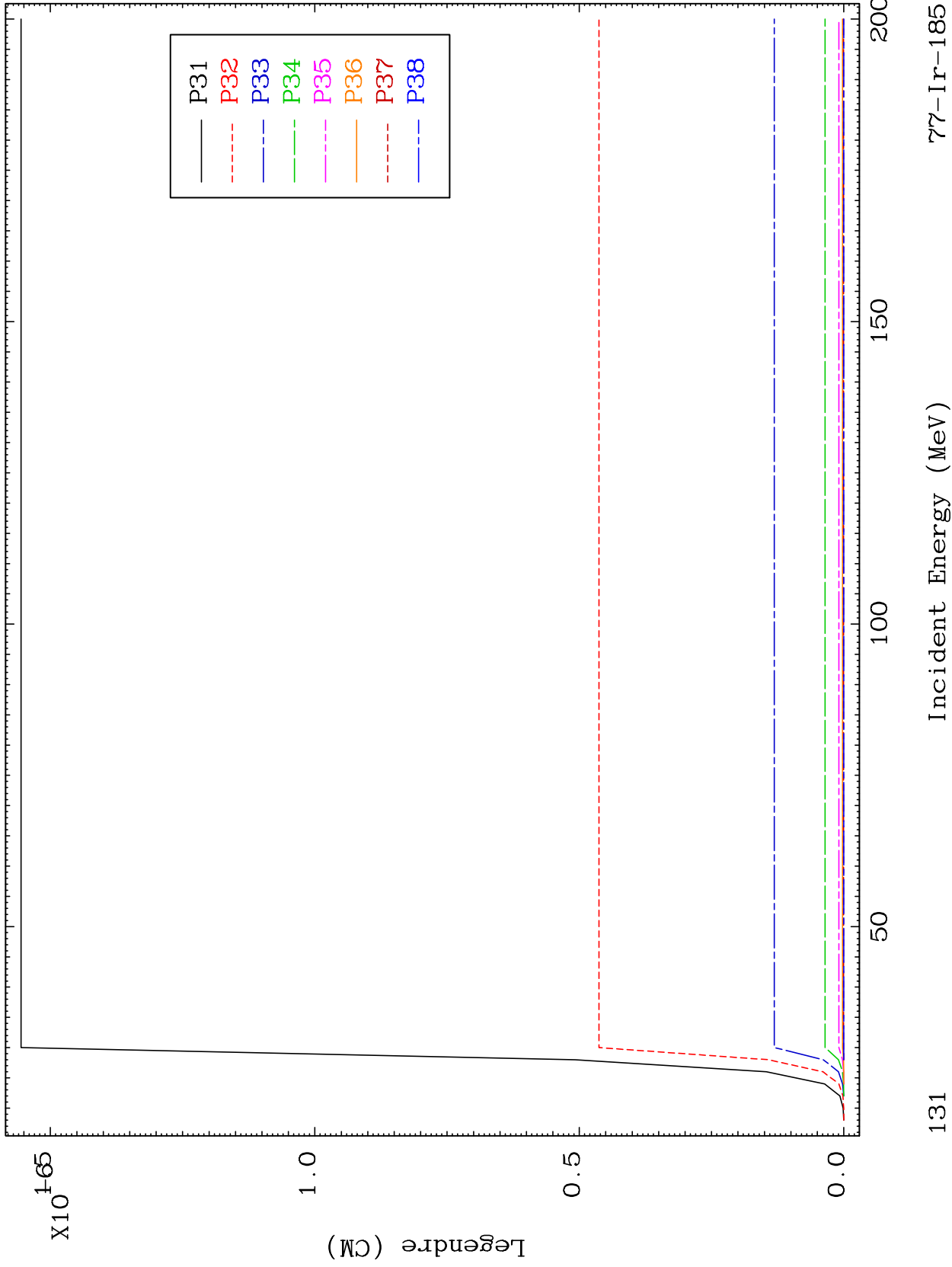

131

MAT 7707

MT= 79 (n,n') Level
Legendre Coefficients

77-Ir-185

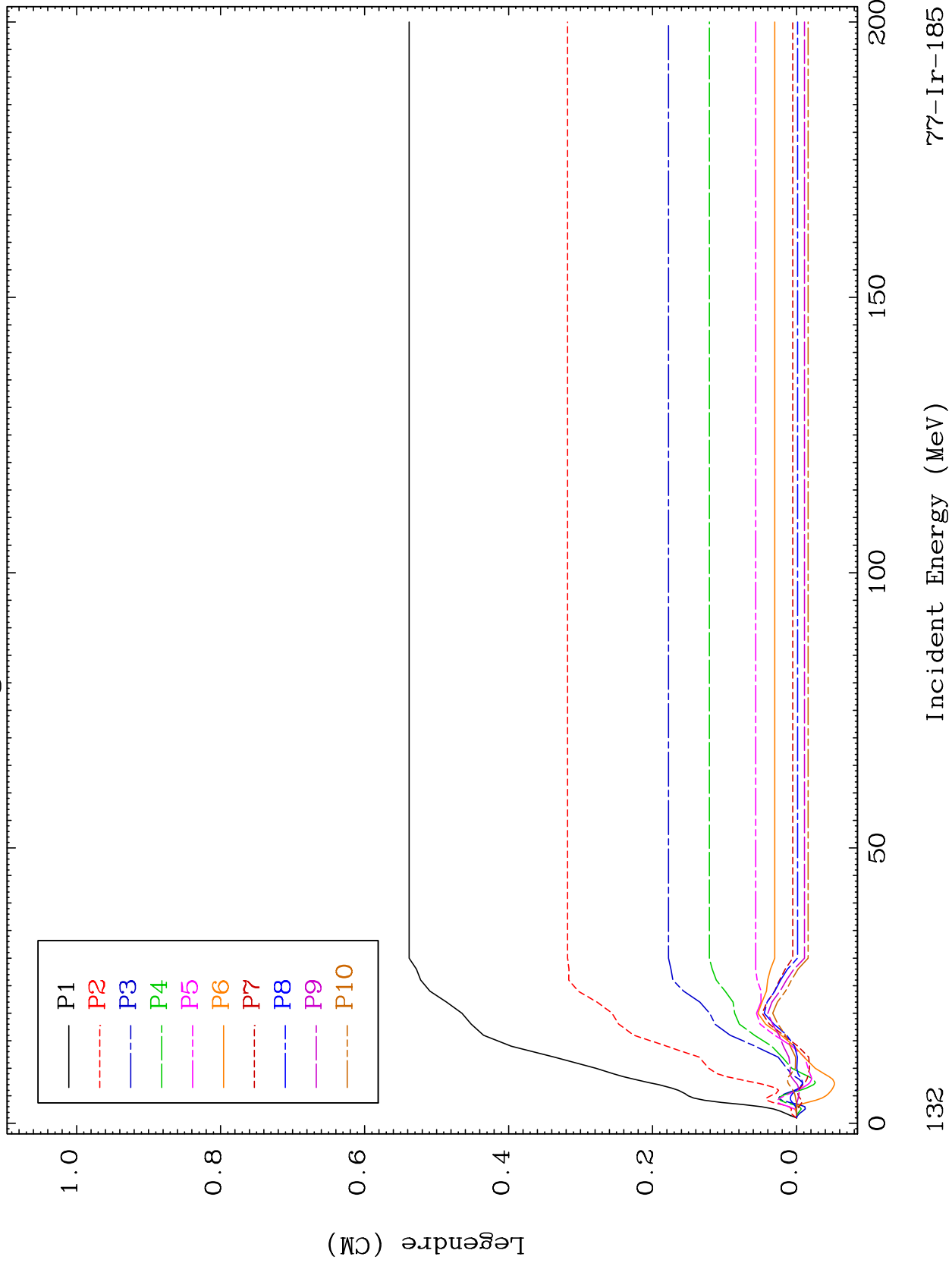

132

MAT 7707

MT= 79 (n,n') Level
Legendre Coefficients

77-Ir-185

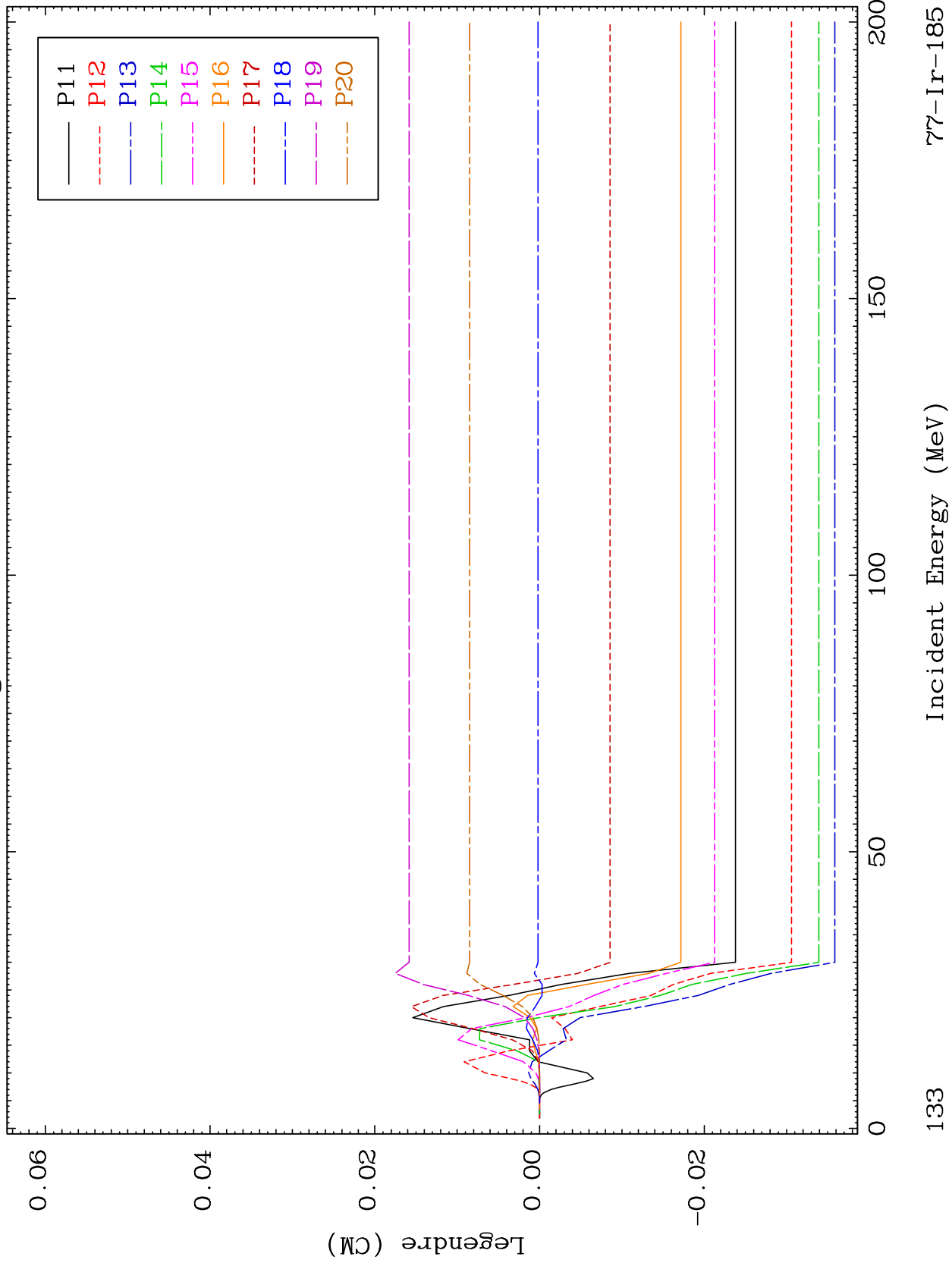

77-Ir-185

Incident Energy (MeV)

133

MAT 7707

MT= 79 (n,n') Level
Legendre Coefficients

77-Ir-185

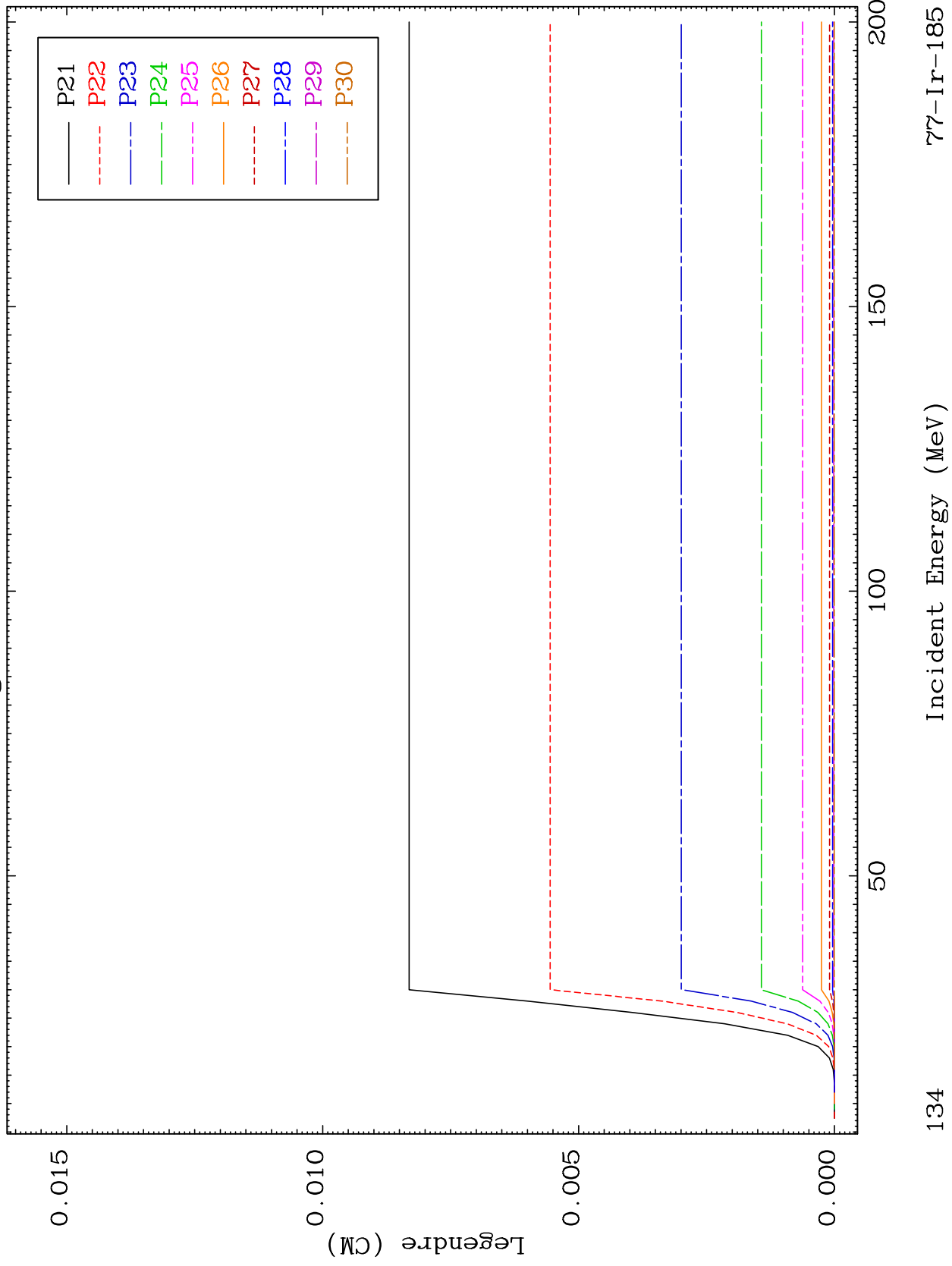

134

Incident Energy (MeV)

77-Ir-185

MAT 7707

MT= 79 (n,n') Level
Legendre Coefficients

77-Ir-185

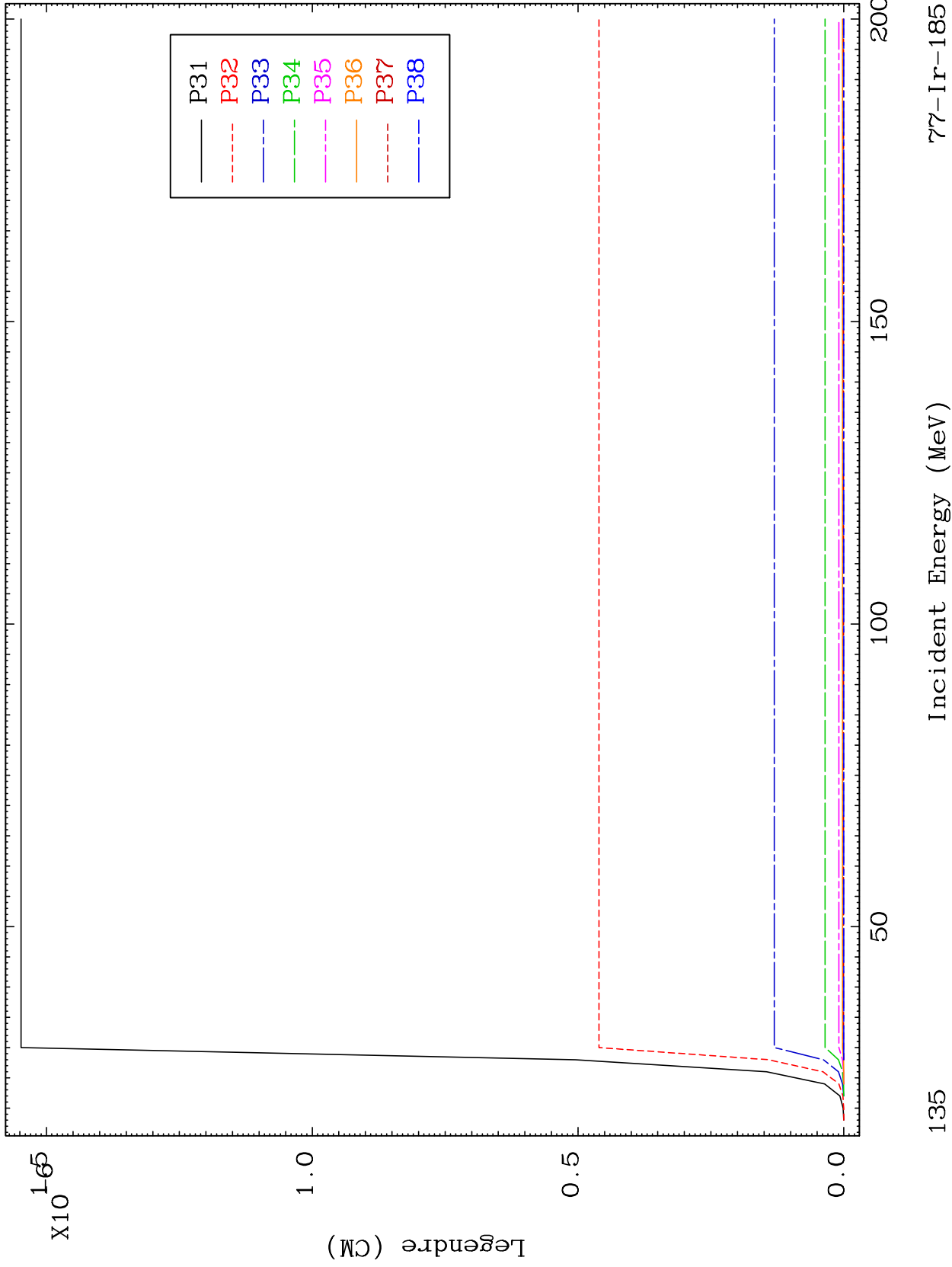

MAT 7707

Fission

⁷⁷Ir-185

Radionuclide Production Cross Section

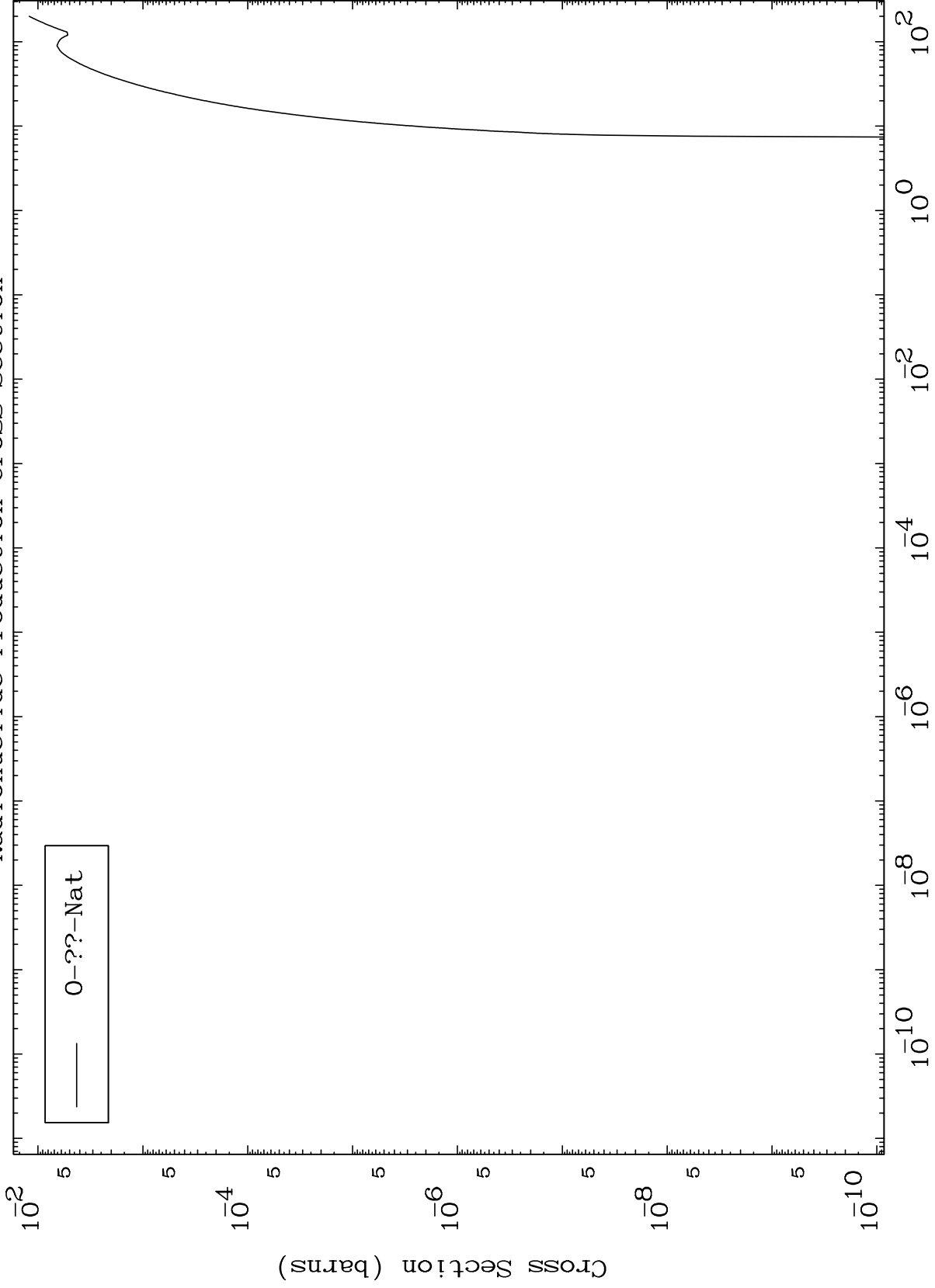

MAT 7707

(n,n') d

77-Ir-185

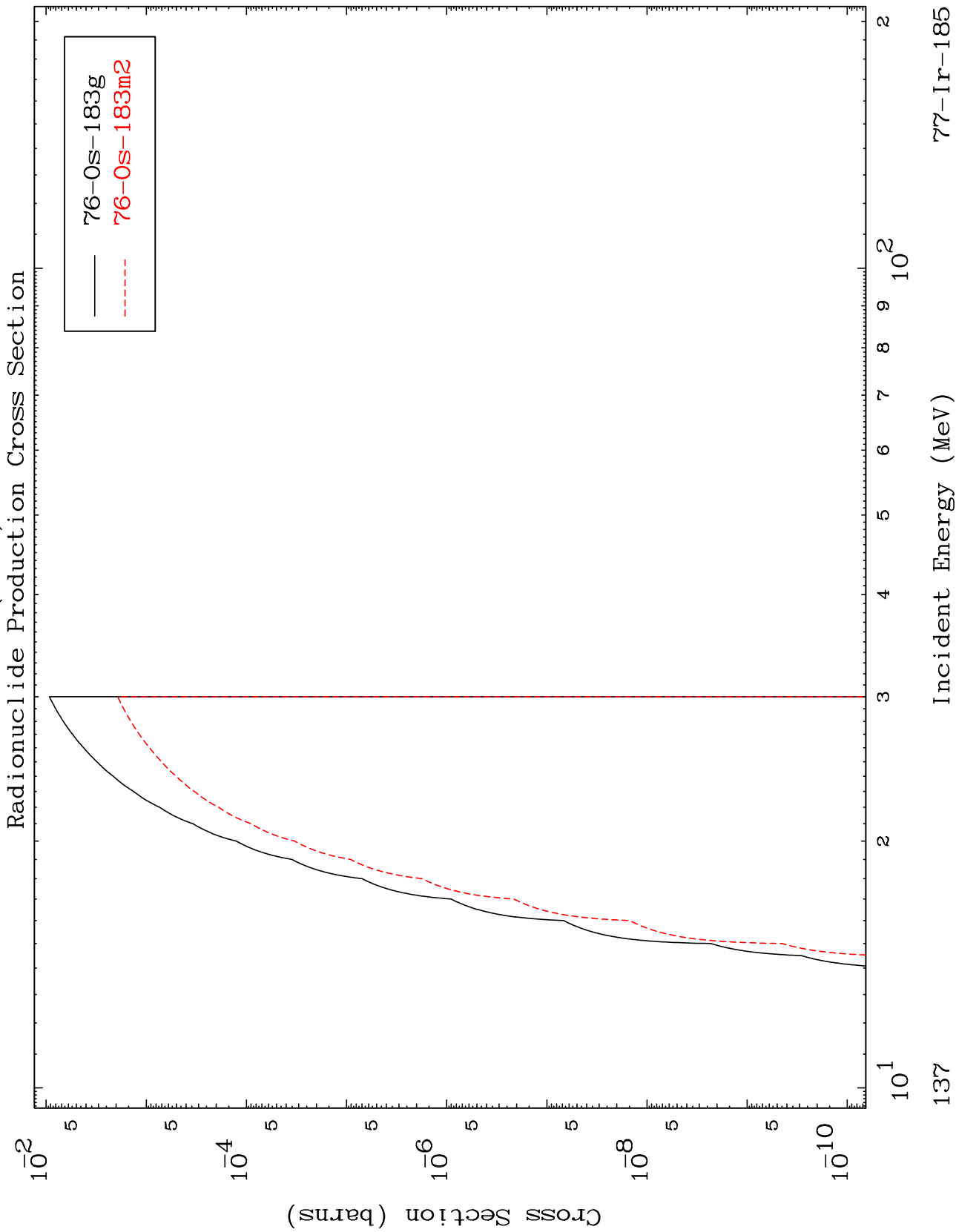

137

Incident Energy (MeV)

77-Ir-185

MAT 7707

(n,n') He-3

77-Ir-185

Radionuclide Production Cross Section

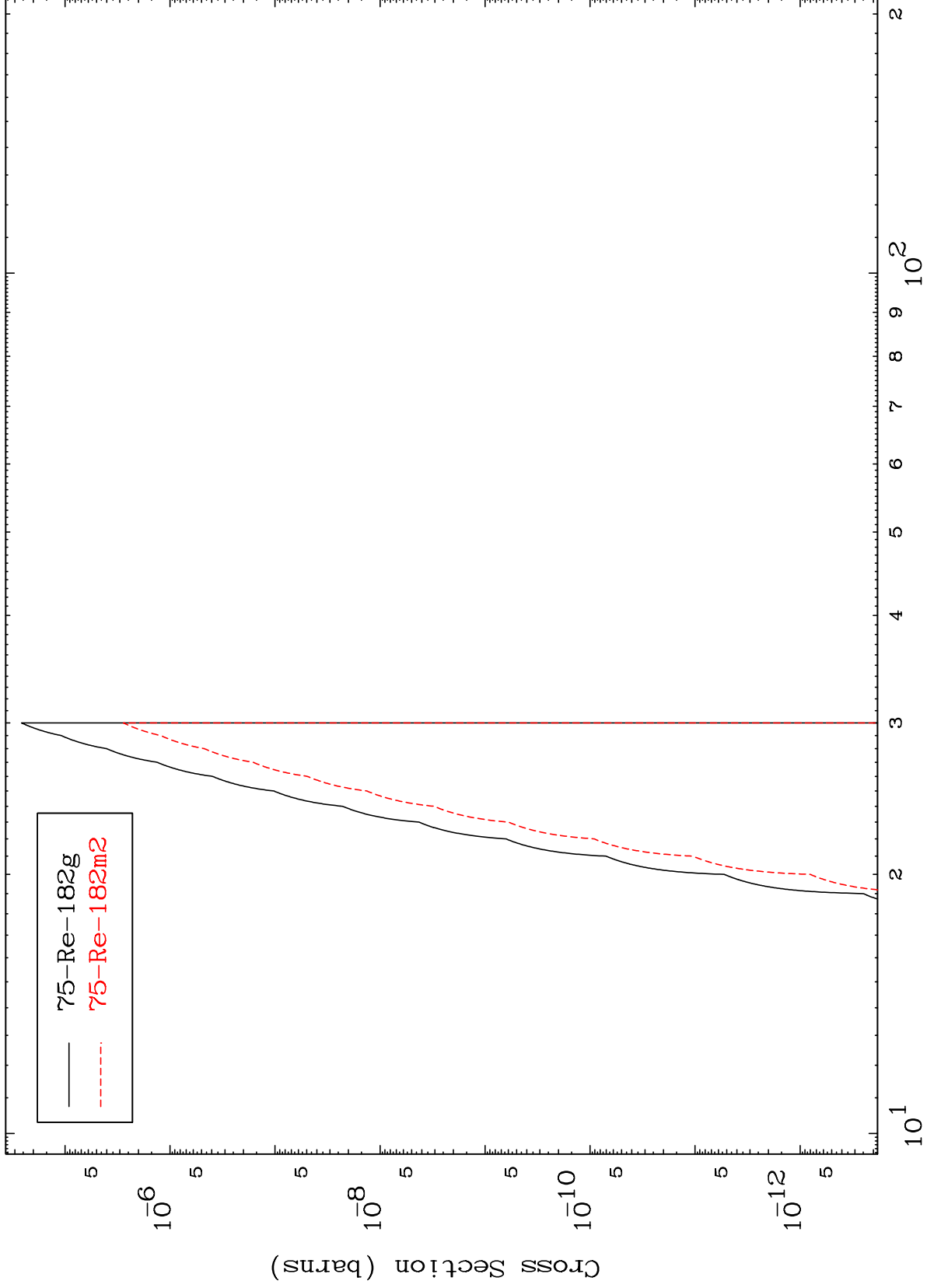

Incident Energy (MeV)

77-Ir-185

138

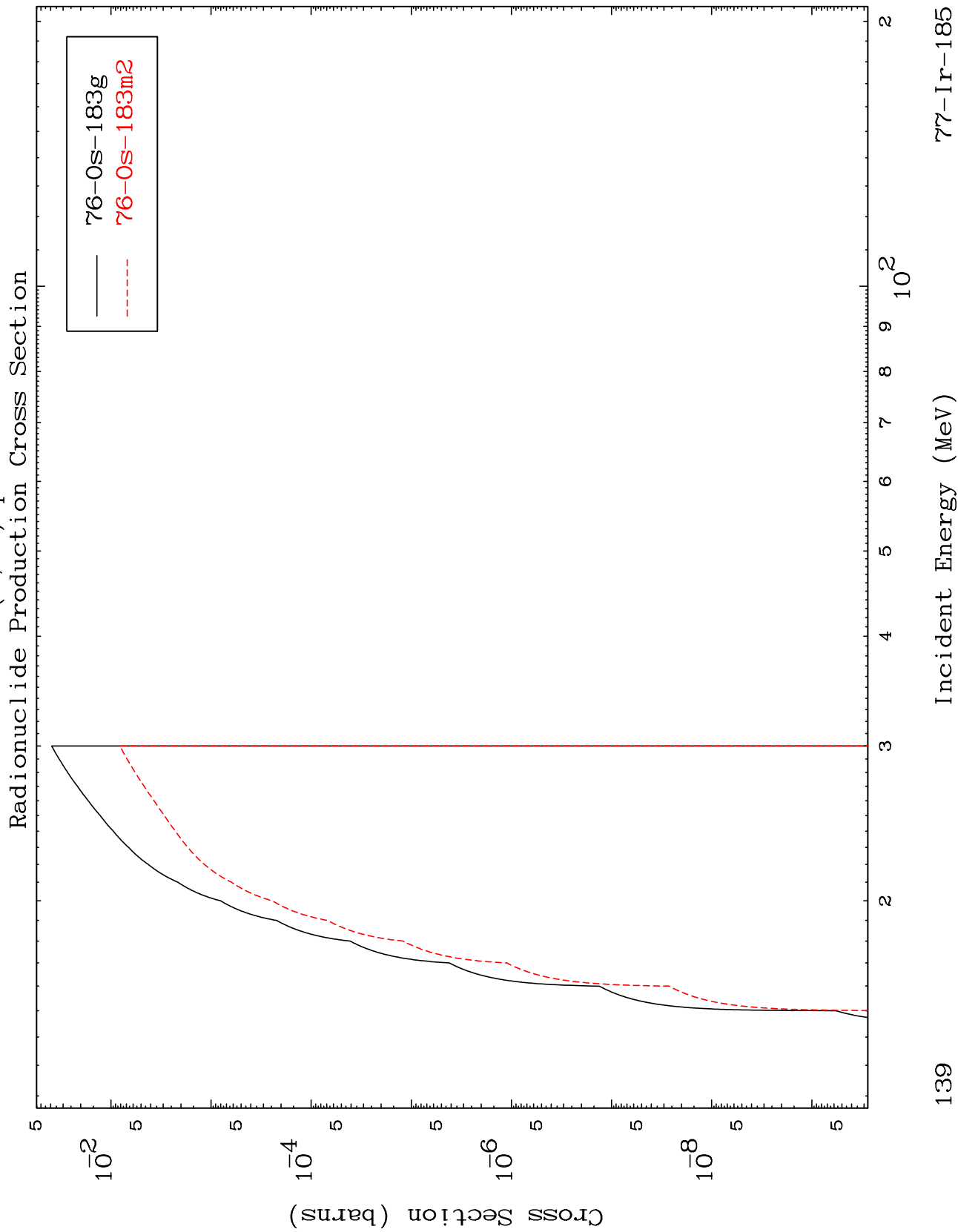

MAT 7707

⁷⁷Ir-185

Radionuclide Production Cross Section

(n,γ)

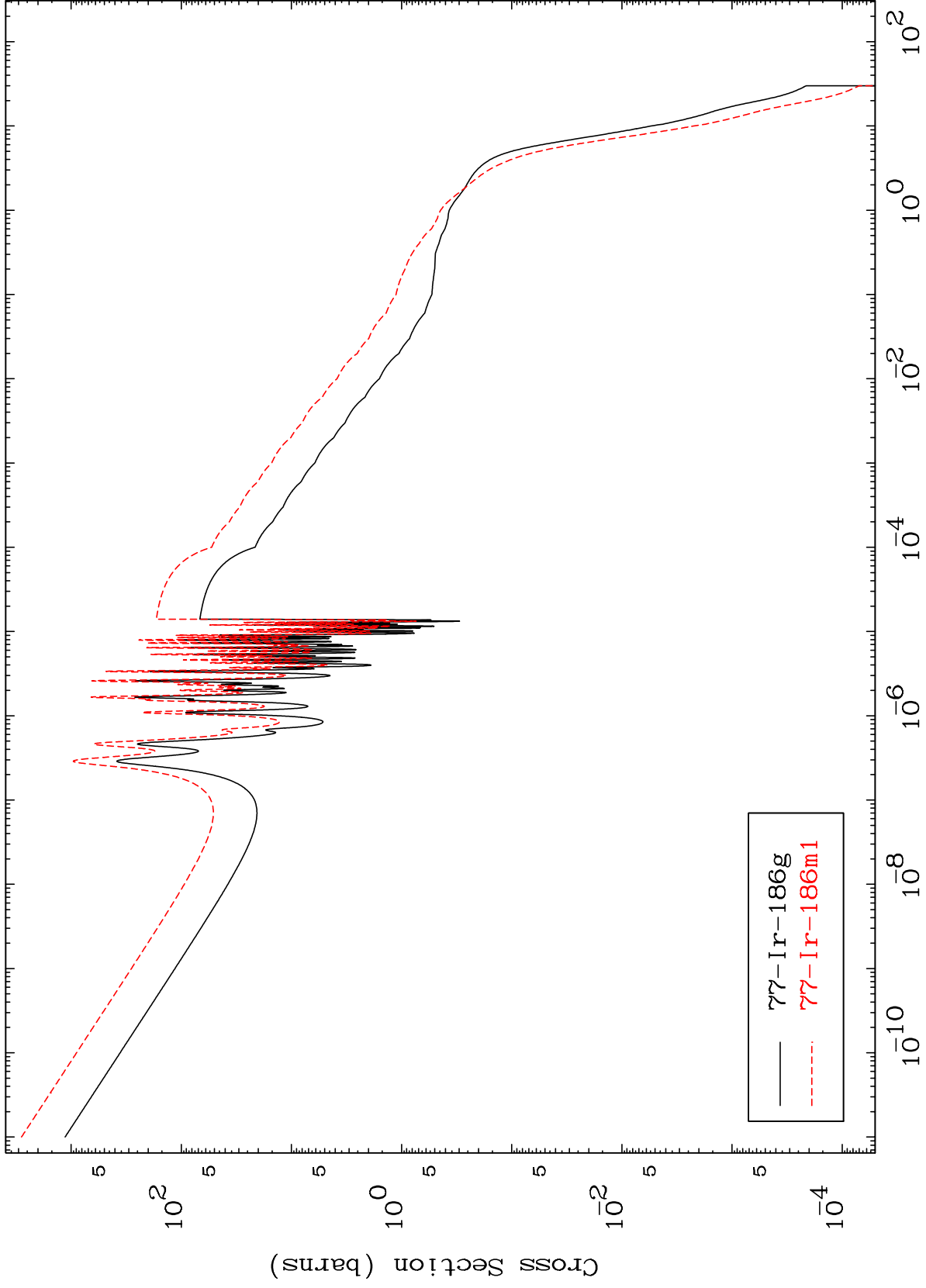

⁷⁷Ir-185

Incident Energy (MeV)

140

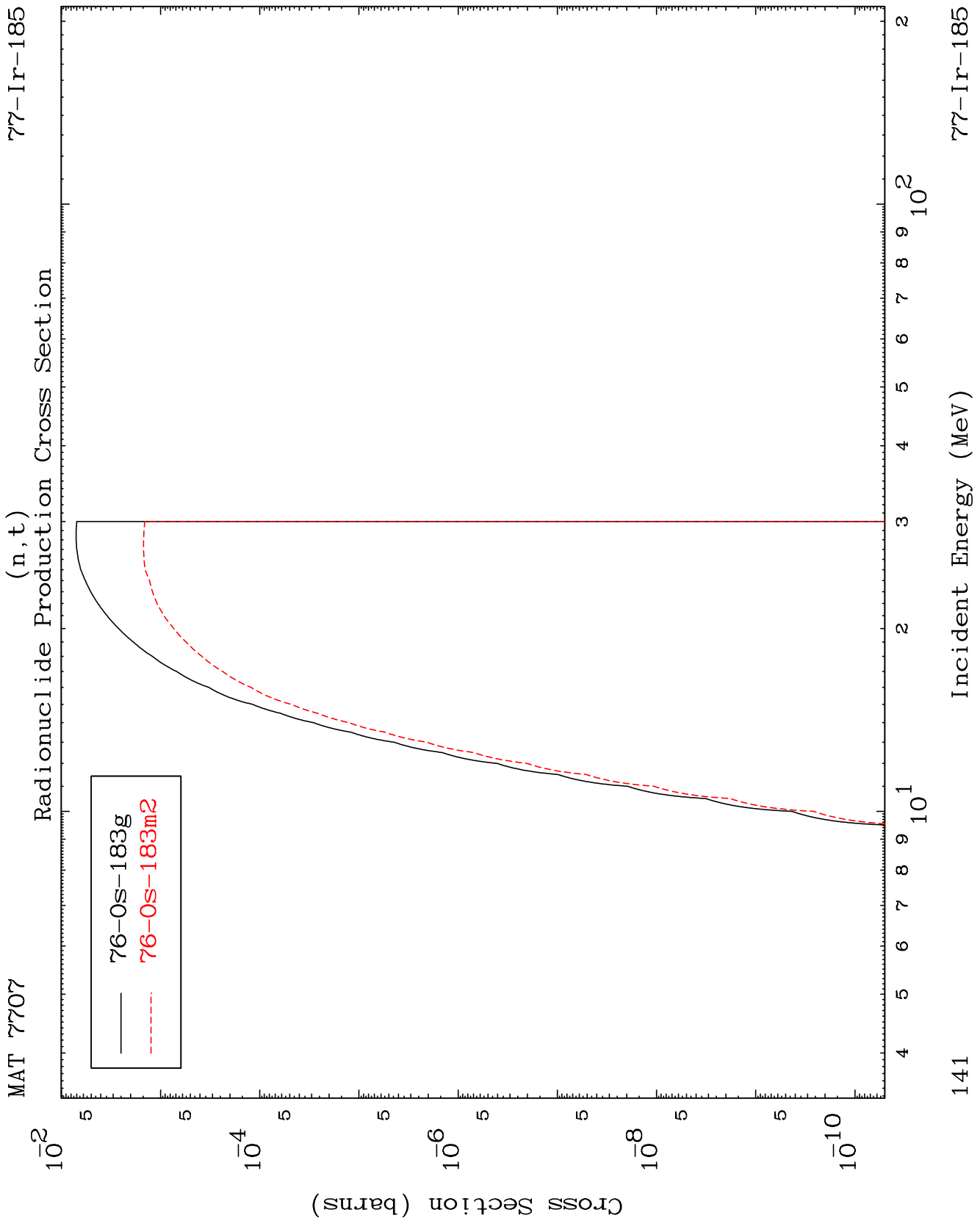

MAT 7707

(n, α)

77-Ir-185

Radionuclide Production Cross Section

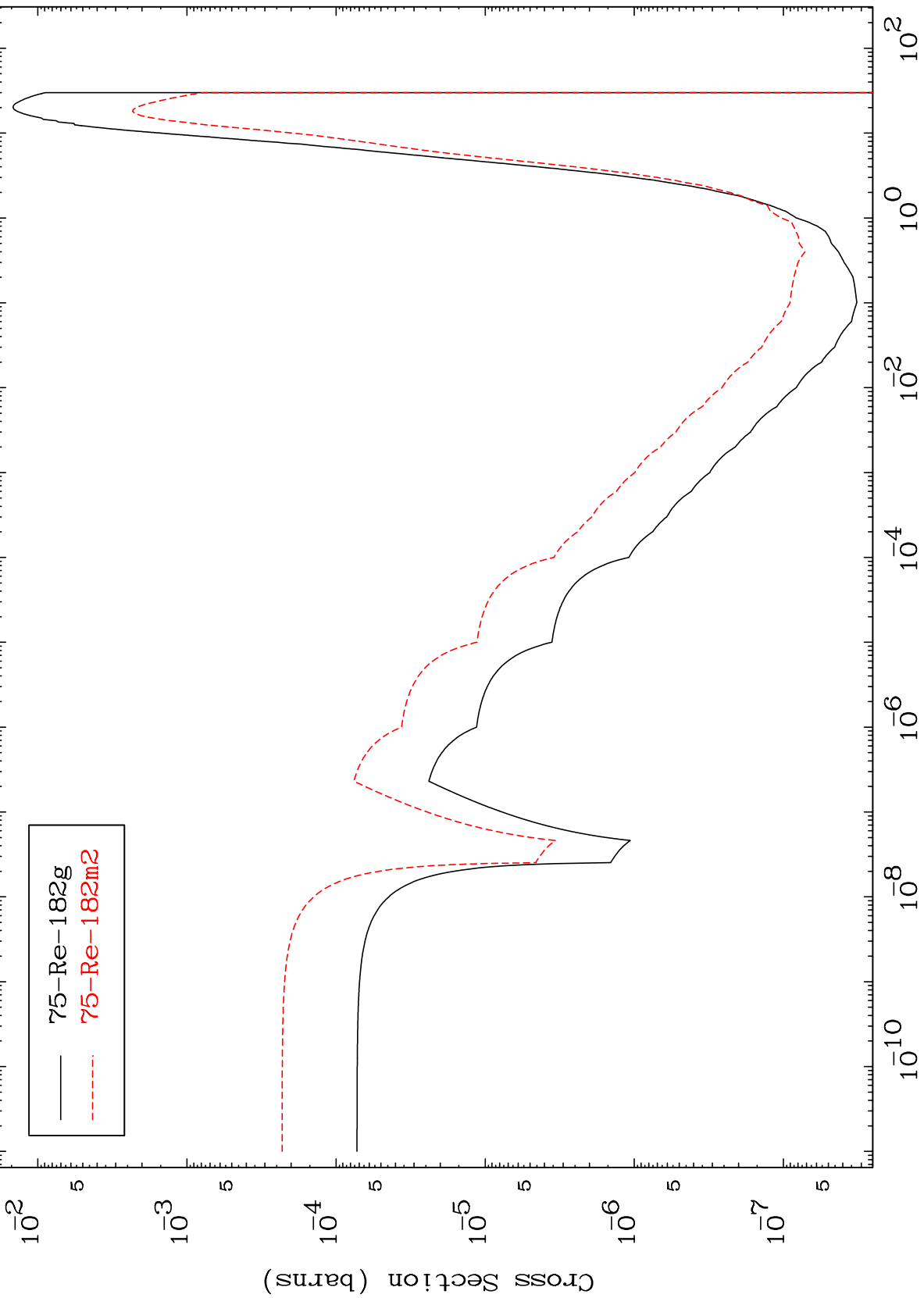

142

Incident Energy (MeV)

77-Ir-185

MAT 7707

77-Ir-185

(n,2p)
Radionuclide Production Cross Section

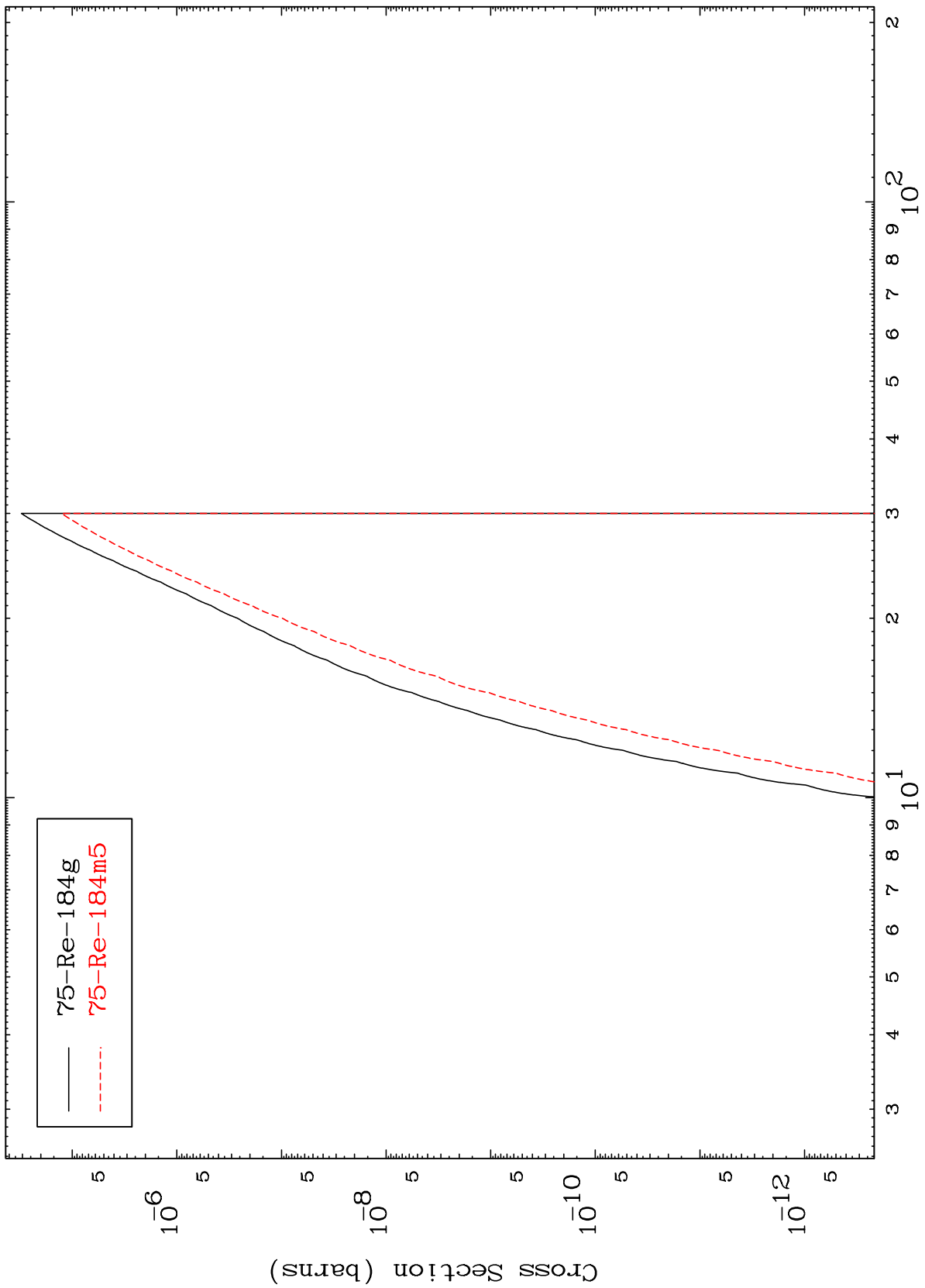

143

Incident Energy (MeV)

77-Ir-185

MAT 7707

(n,p) t

⁷⁷Ir-185

Radionuclide Production Cross Section

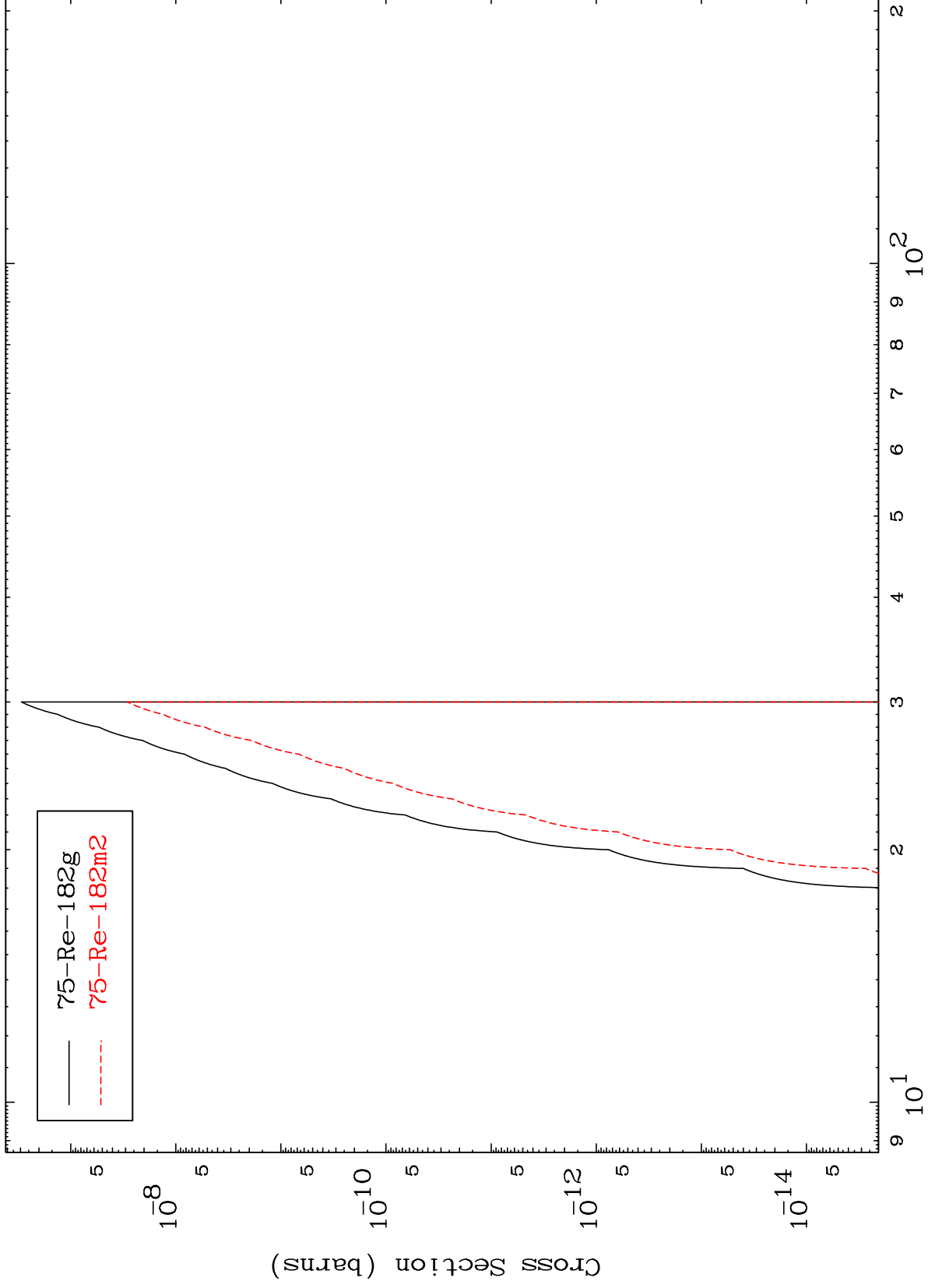

144

Incident Energy (MeV)

⁷⁷Ir-185