

# IR193 NEUTRON ACER TENDL-2024 LIBRARY; T=293.6K

## Principal cross sections

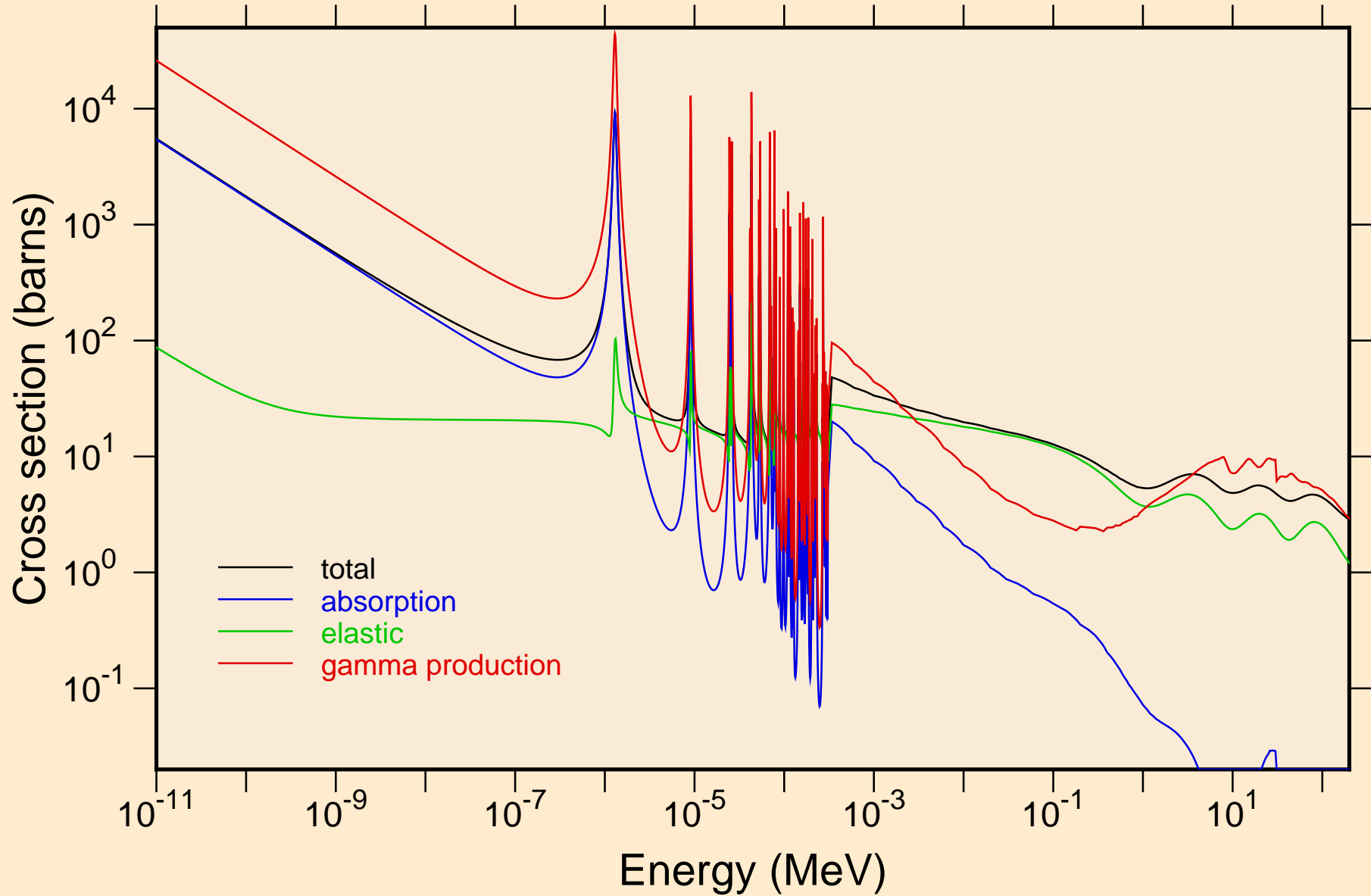

IR193 NEUTRON ACER TENDL-2024 LIBRARY; T=293.6K  
resonance total cross section

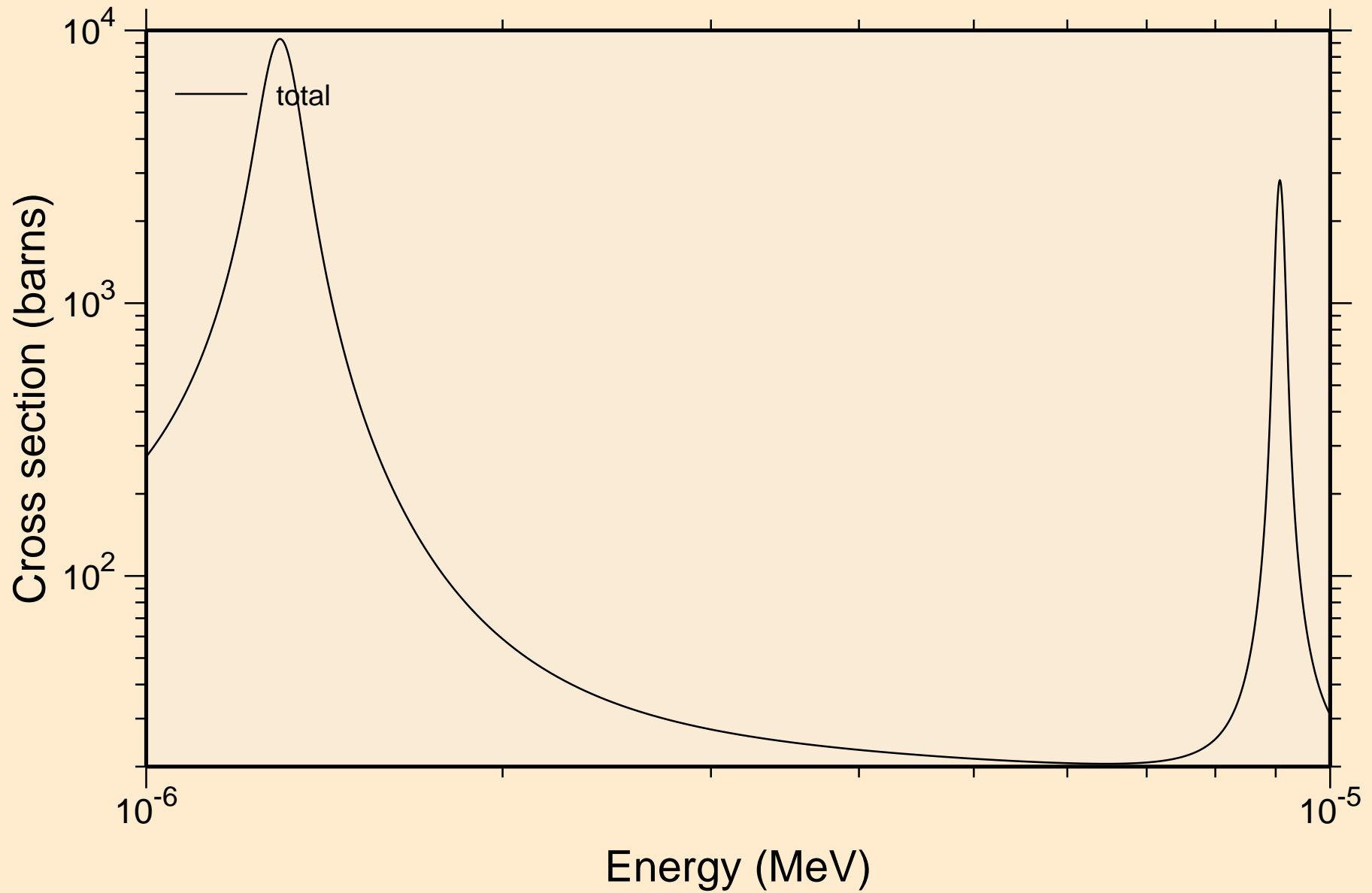

IR193 NEUTRON ACER TENDL-2024 LIBRARY; T=293.6K  
resonance total cross section

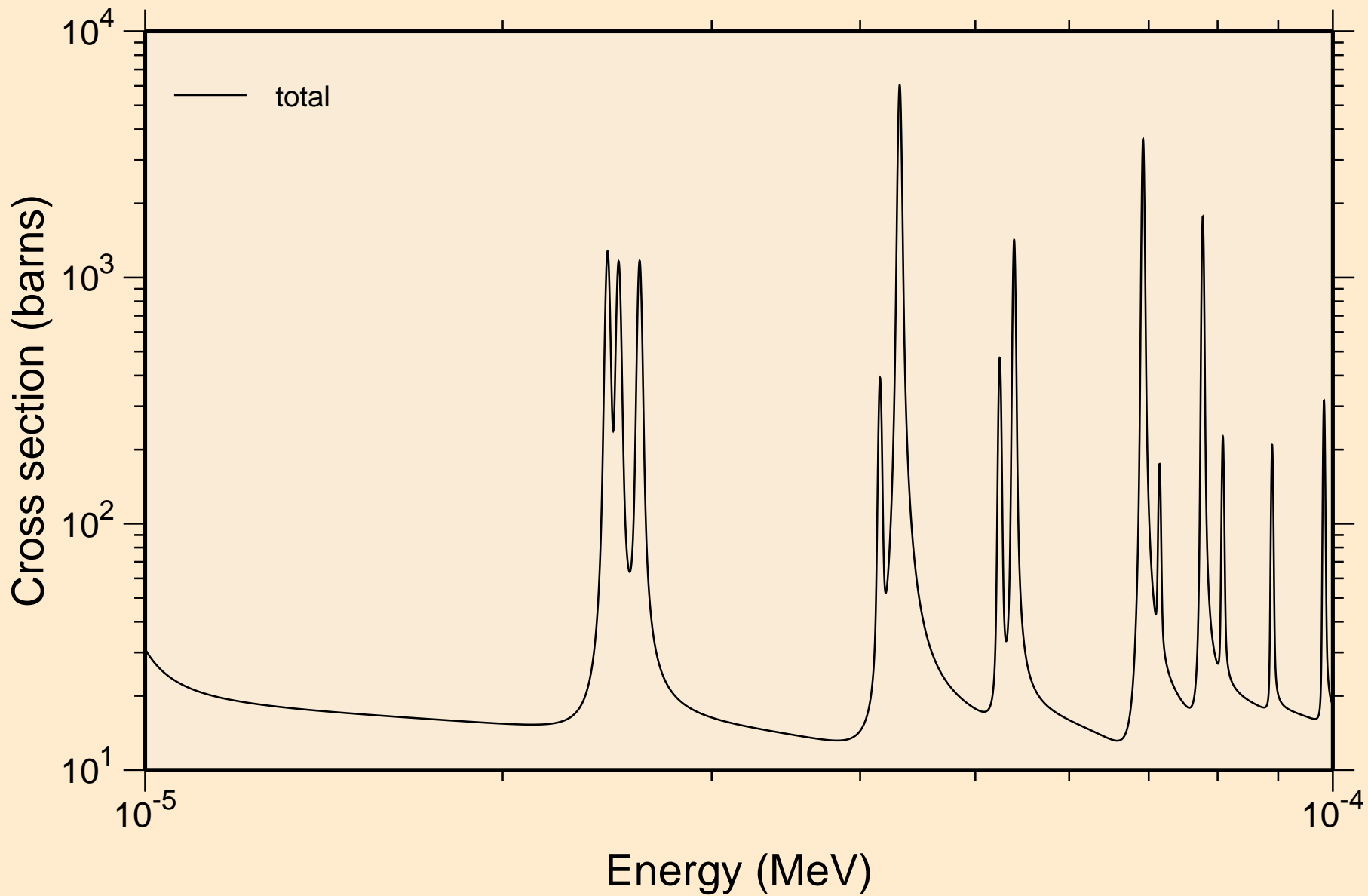

IR193 NEUTRON ACER TENDL-2024 LIBRARY; T=293.6K  
resonance total cross section

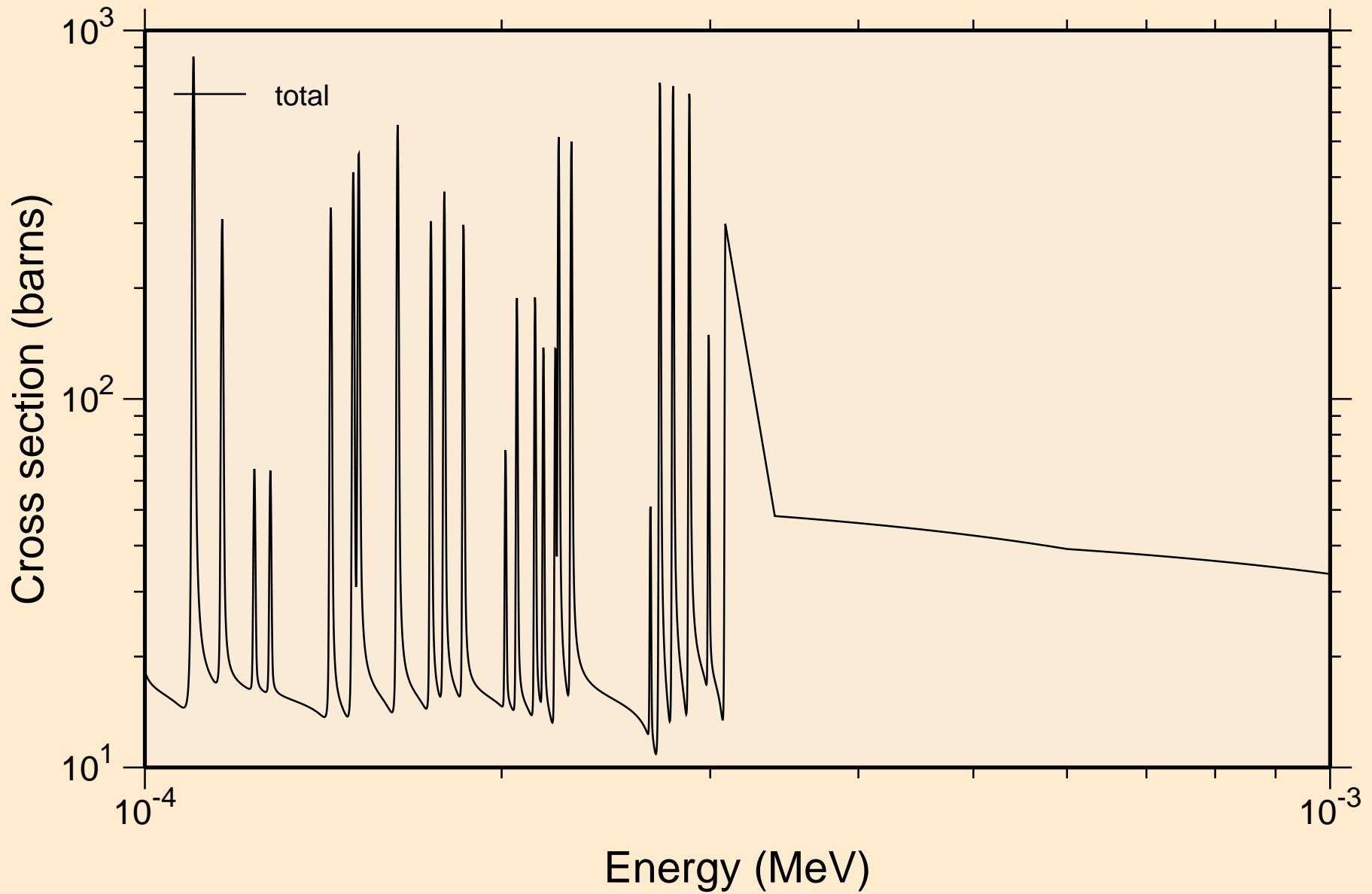

IR193 NEUTRON ACER TENDL-2024 LIBRARY; T=293.6K  
resonance total cross section

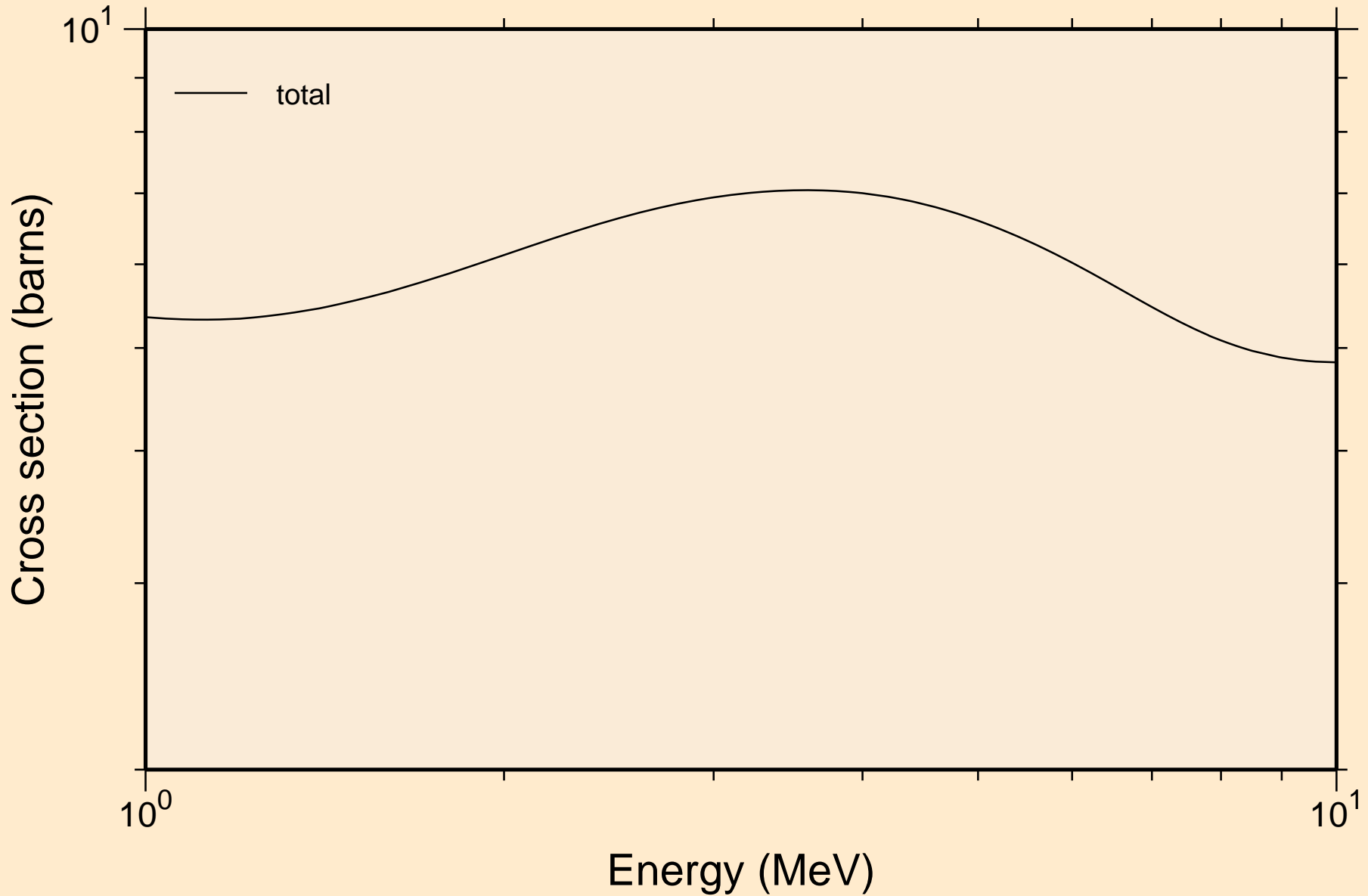

IR193 NEUTRON ACER TENDL-2024 LIBRARY; T=293.6K  
resonance absorption cross sections

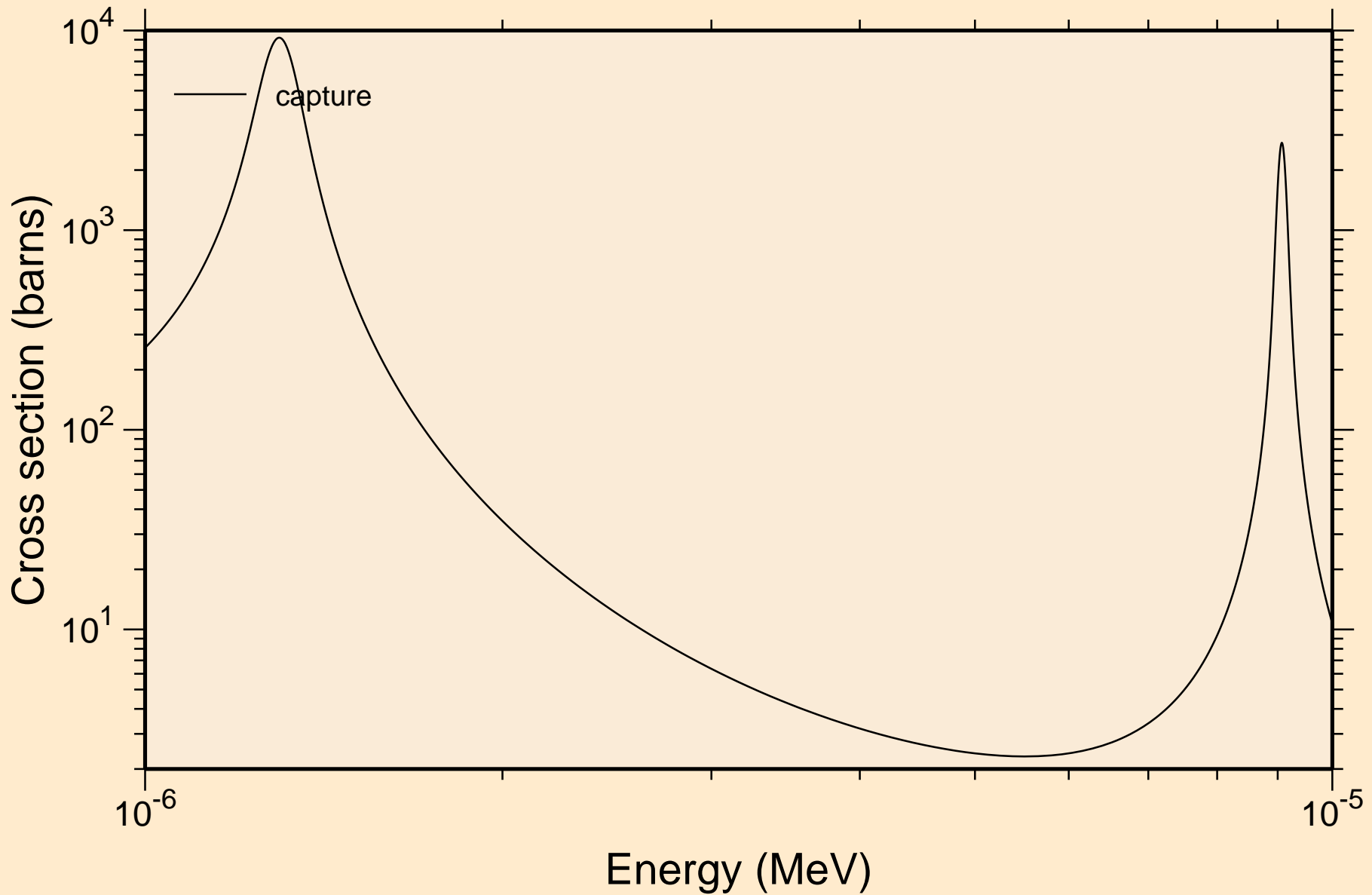

IR193 NEUTRON ACER TENDL-2024 LIBRARY; T=293.6K  
resonance absorption cross sections

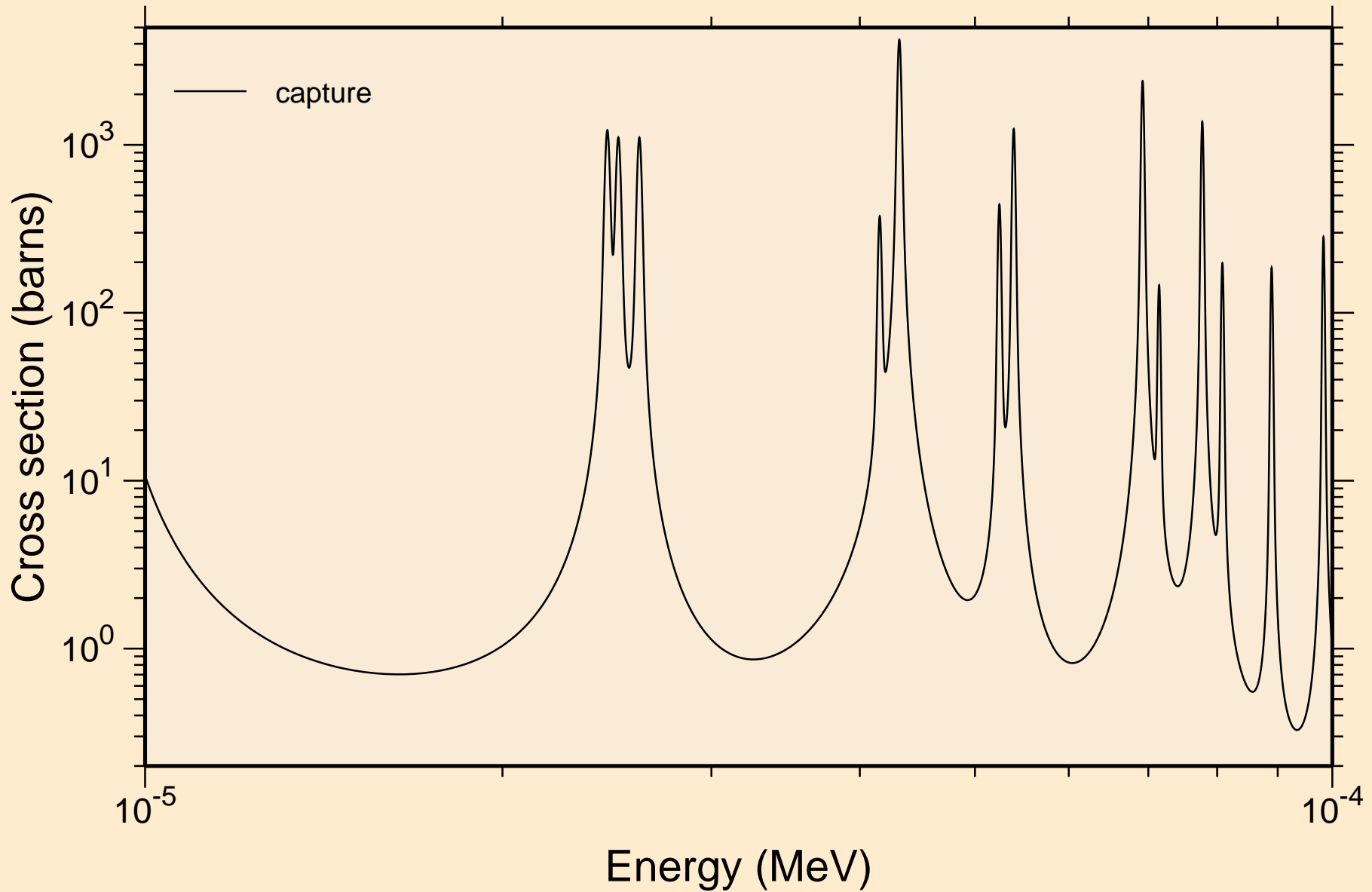

IR193 NEUTRON ACER TENDL-2024 LIBRARY; T=293.6K  
resonance absorption cross sections

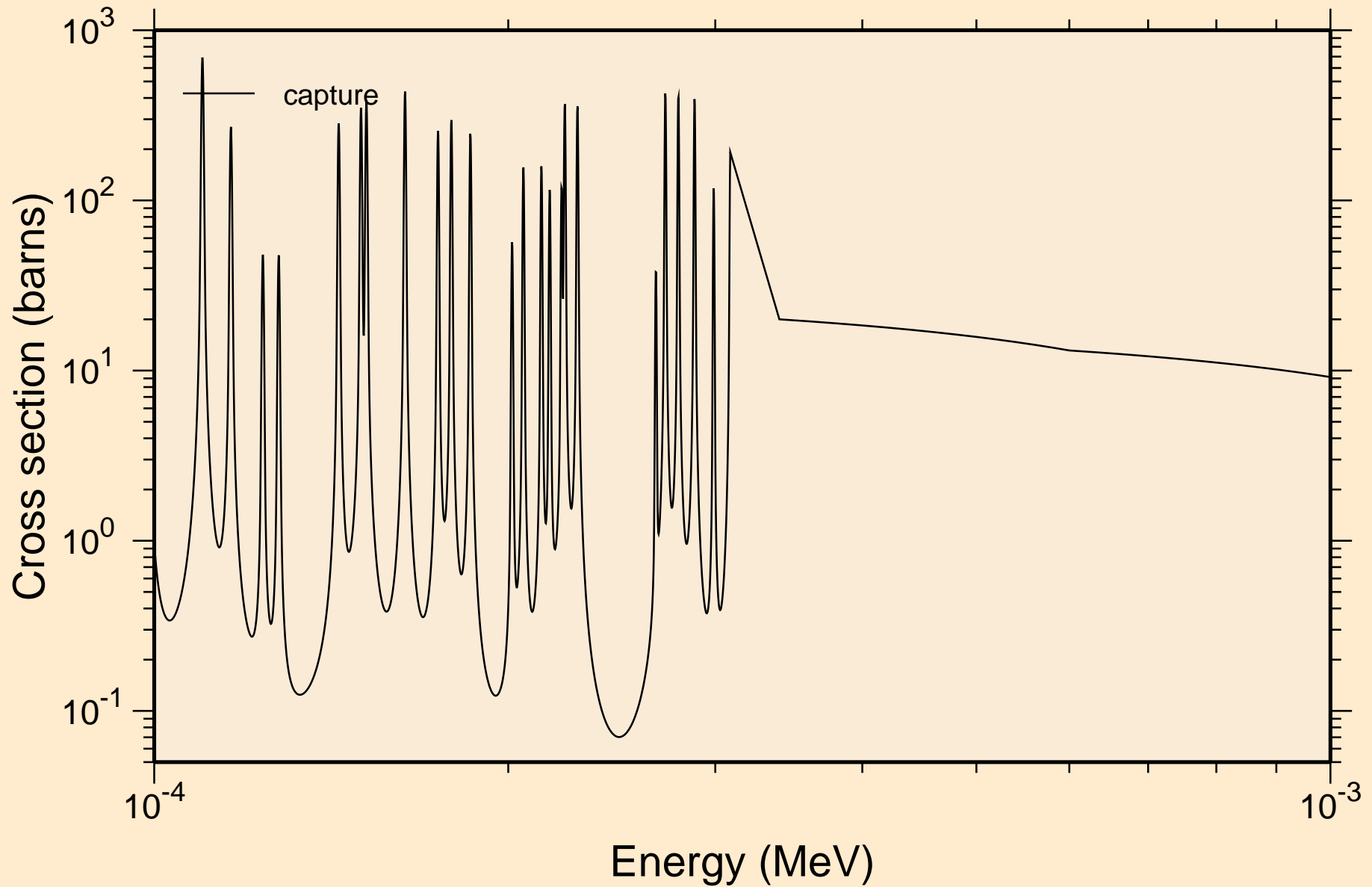

IR193 NEUTRON ACER TENDL-2024 LIBRARY; T=293.6K  
resonance absorption cross sections

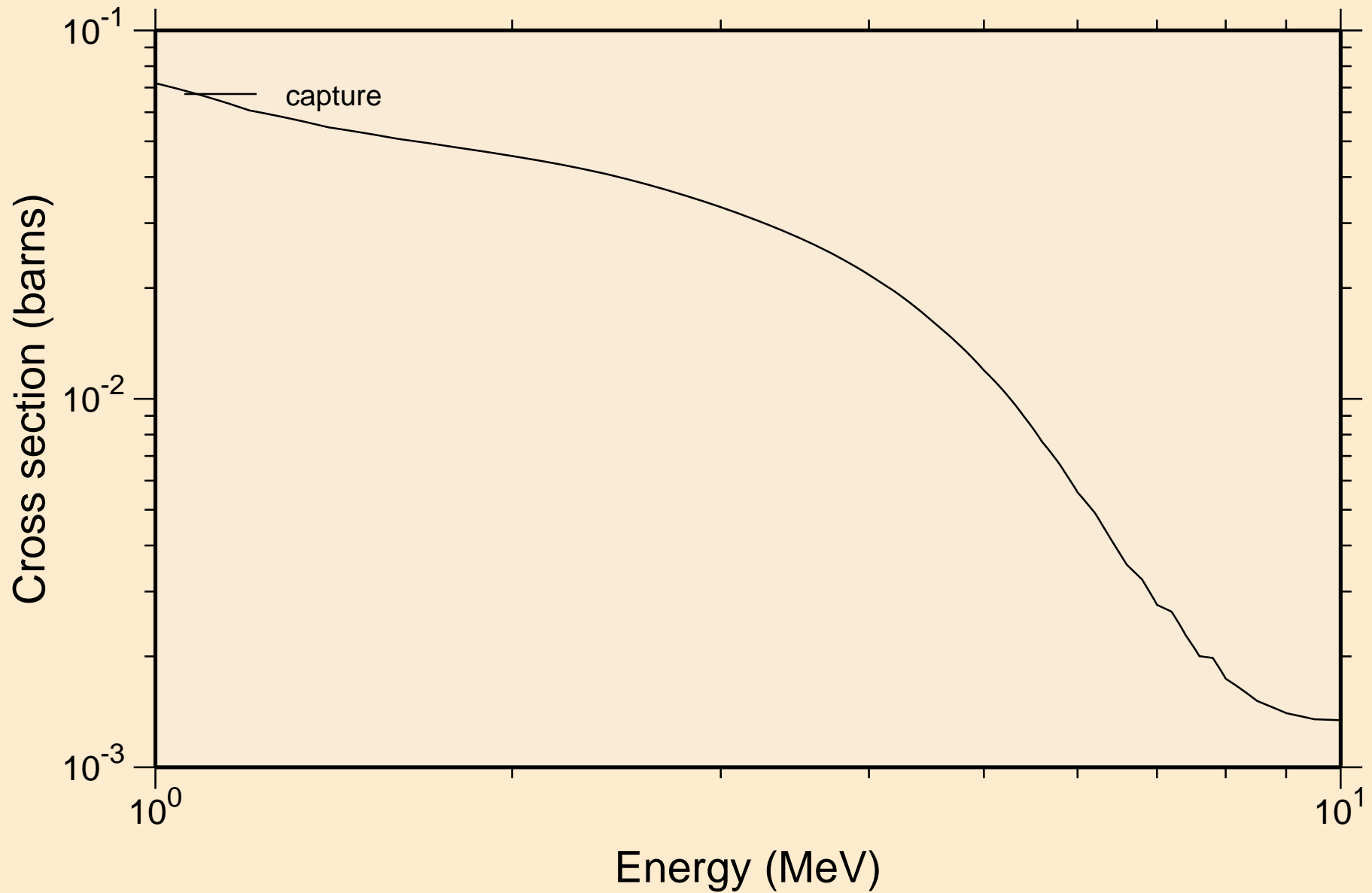

IR193 NEUTRON ACER TENDL-2024 LIBRARY; T=293.6K  
Heating

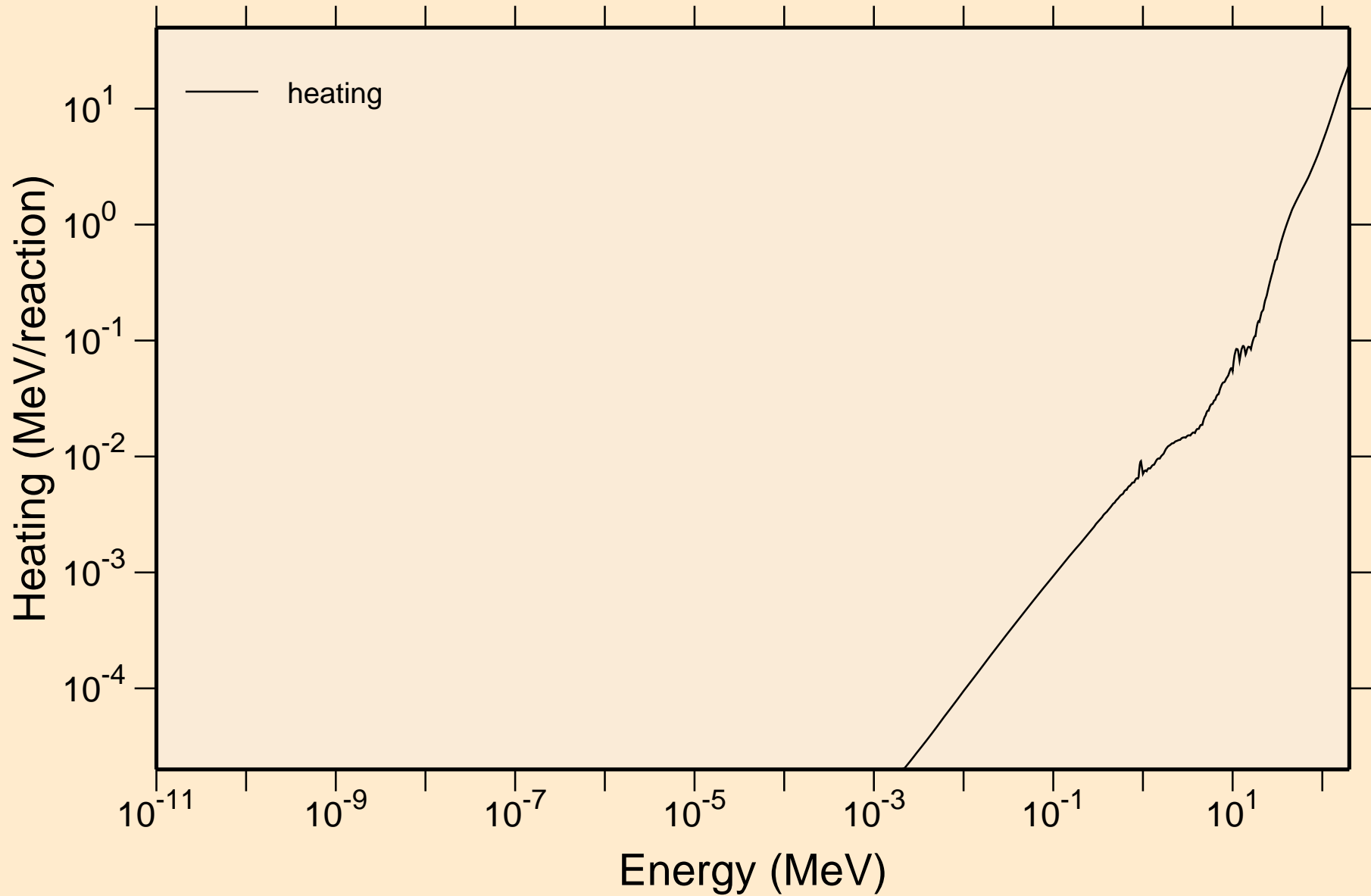

IR193 NEUTRON ACER TENDL-2024 LIBRARY; T=293.6K  
Damage

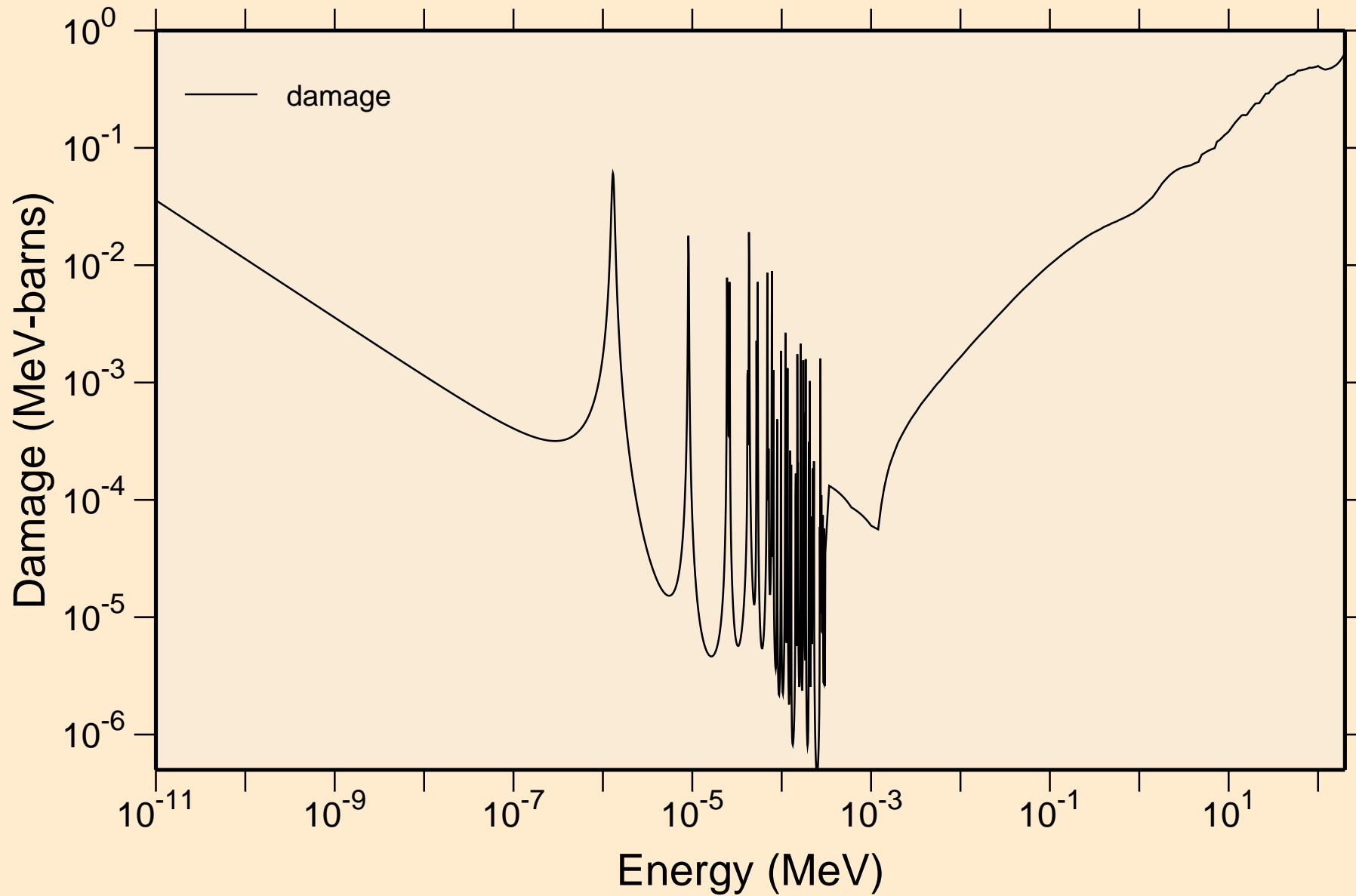

# IR193 NEUTRON ACER TENDL-2024 LIBRARY; T=293.6K

## Non-threshold reactions

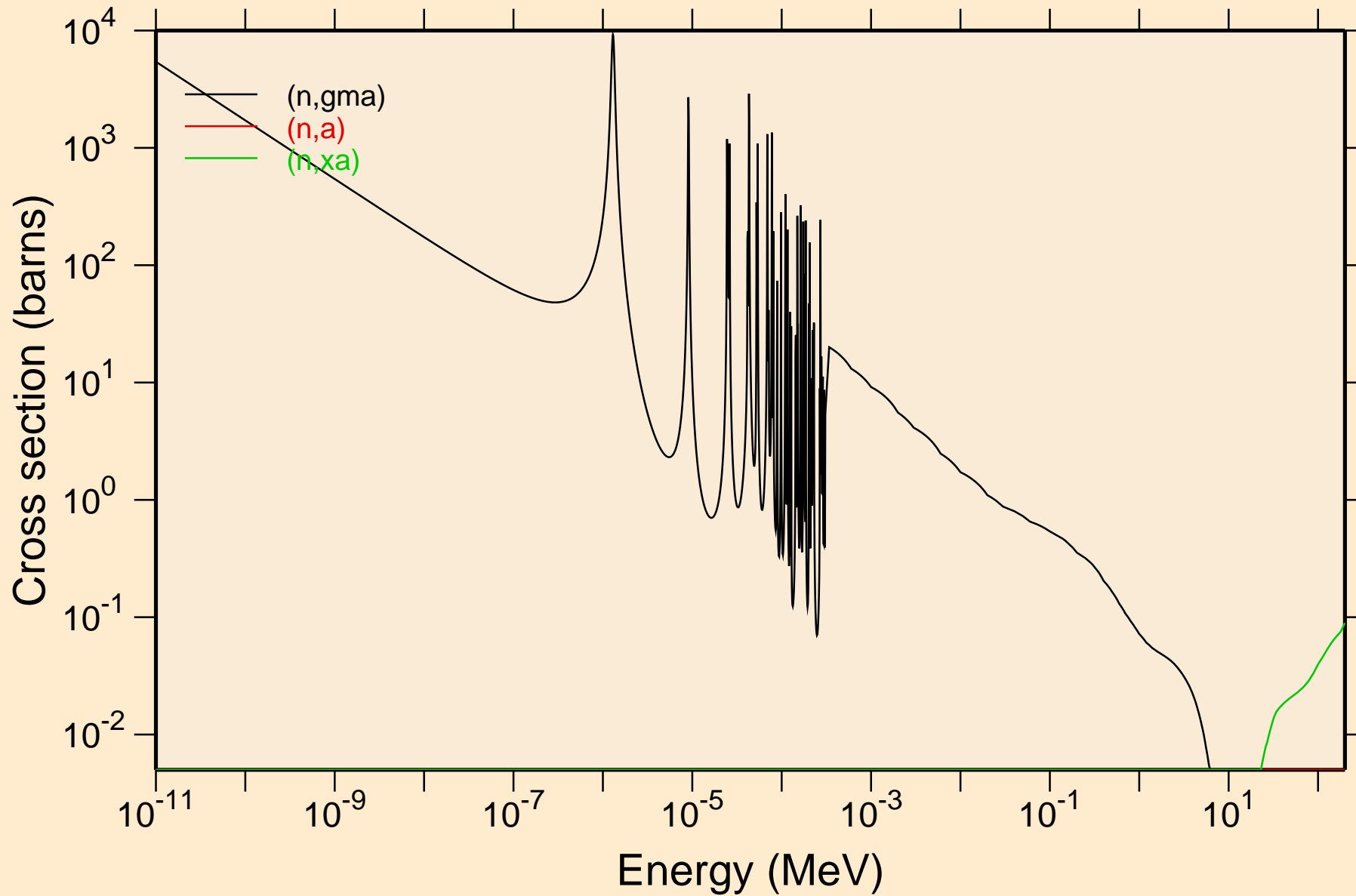

IR193 NEUTRON ACER TENDL-2024 LIBRARY; T=293.6K  
Principal cross sections

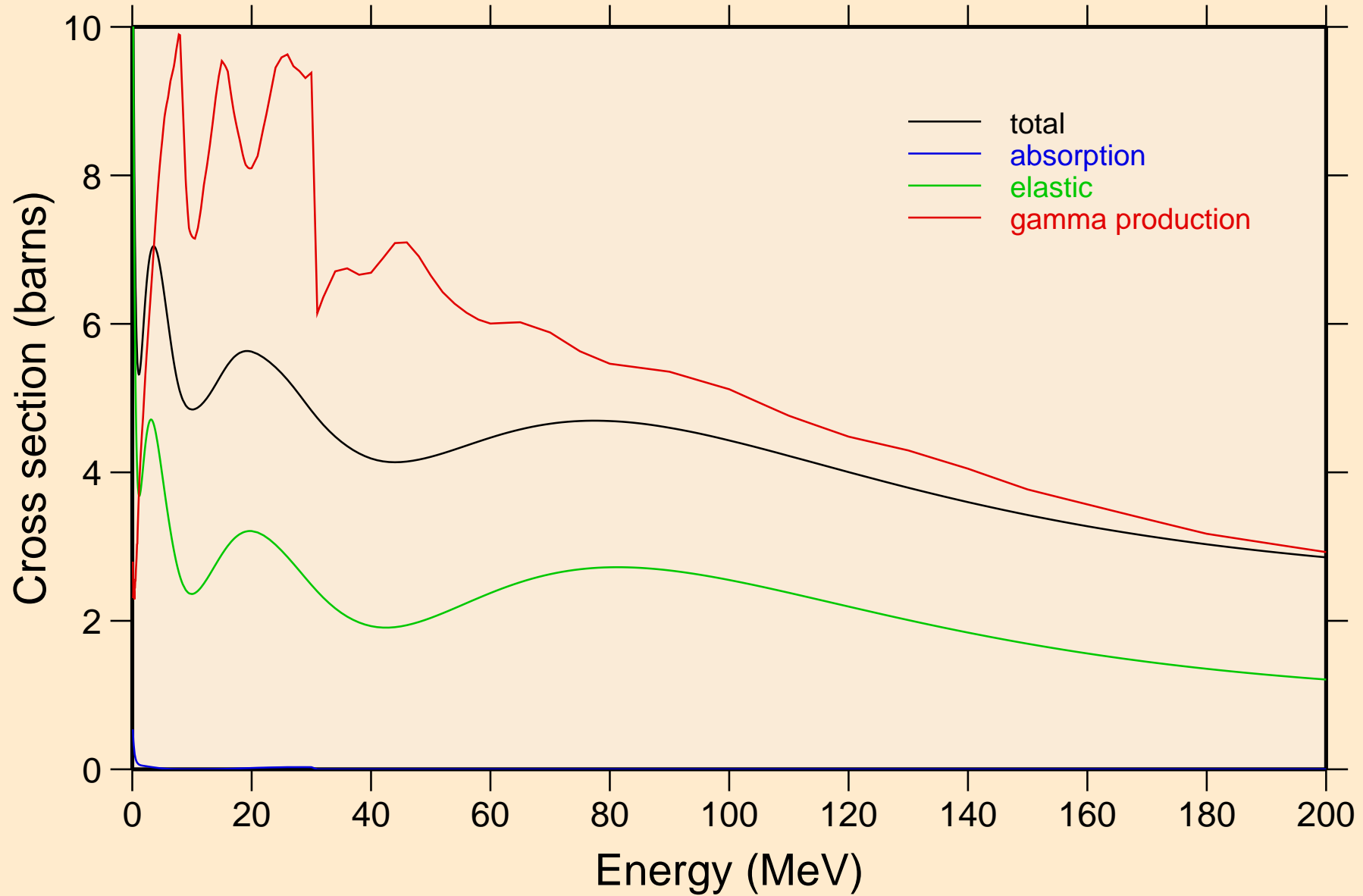

IR193 NEUTRON ACER TENDL-2024 LIBRARY; T=293.6K

Heating

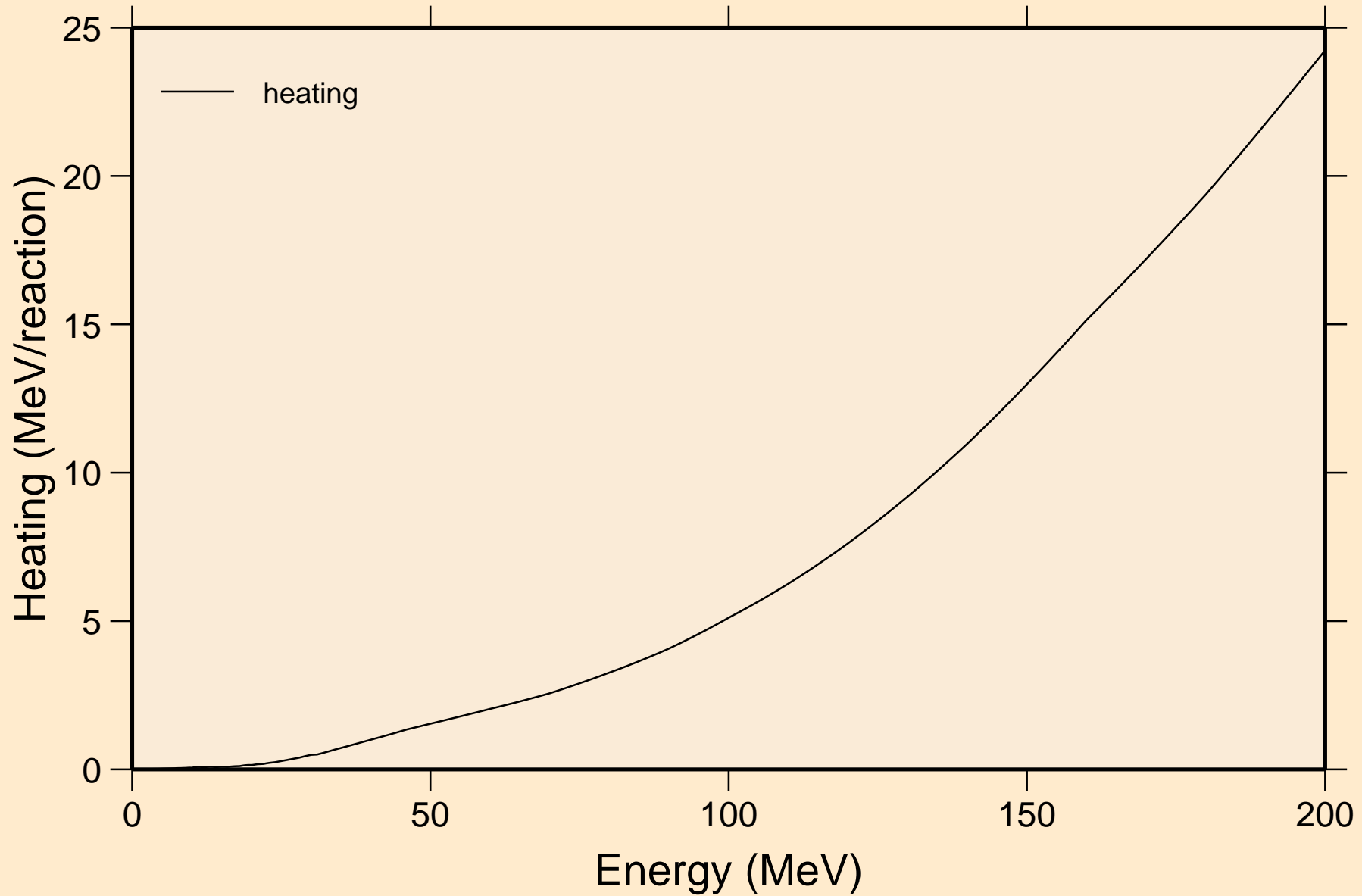

IR193 NEUTRON ACER TENDL-2024 LIBRARY; T=293.6K  
Damage

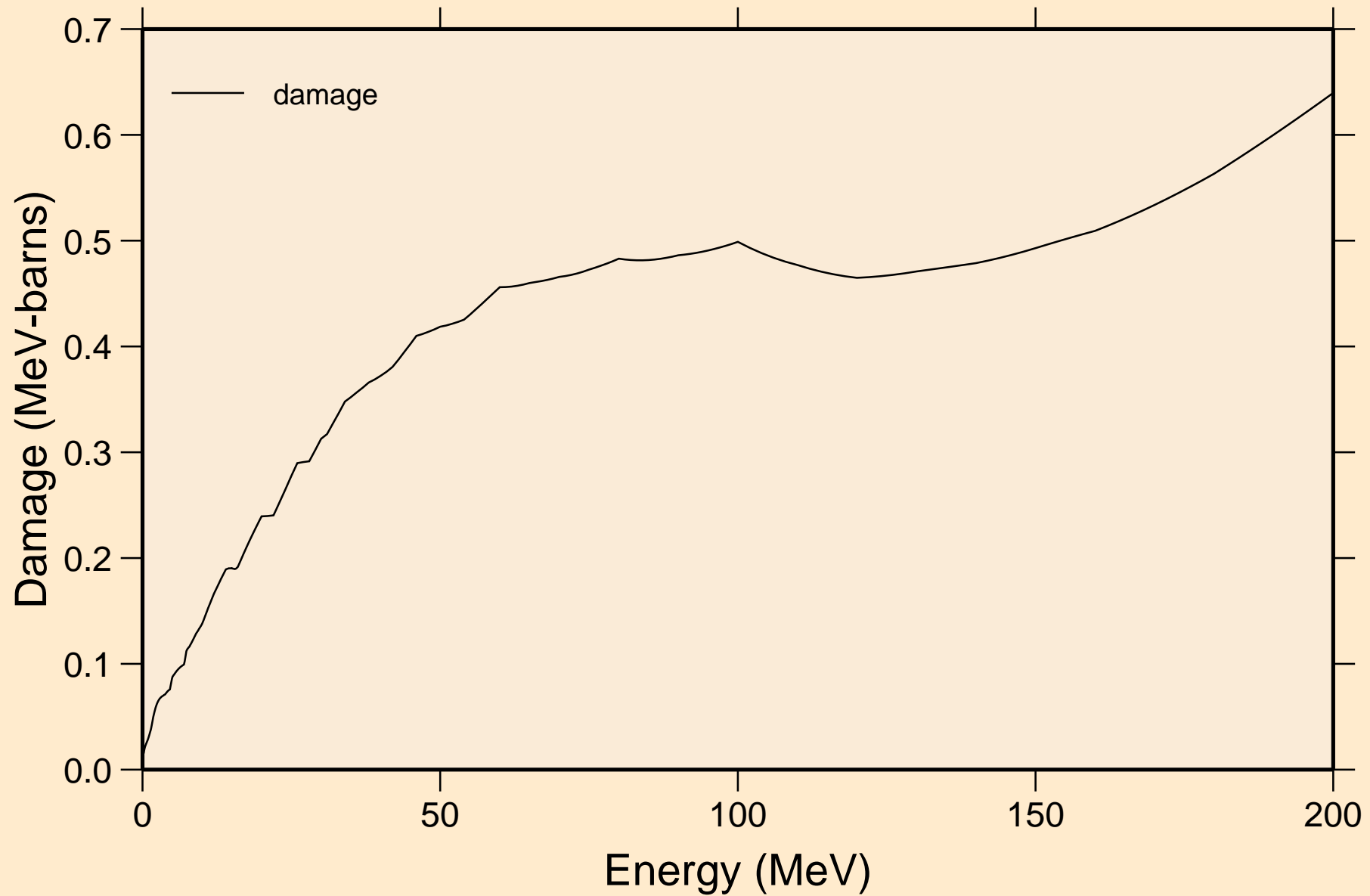

IR193 NEUTRON ACER TENDL-2024 LIBRARY; T=293.6K  
Non-threshold reactions

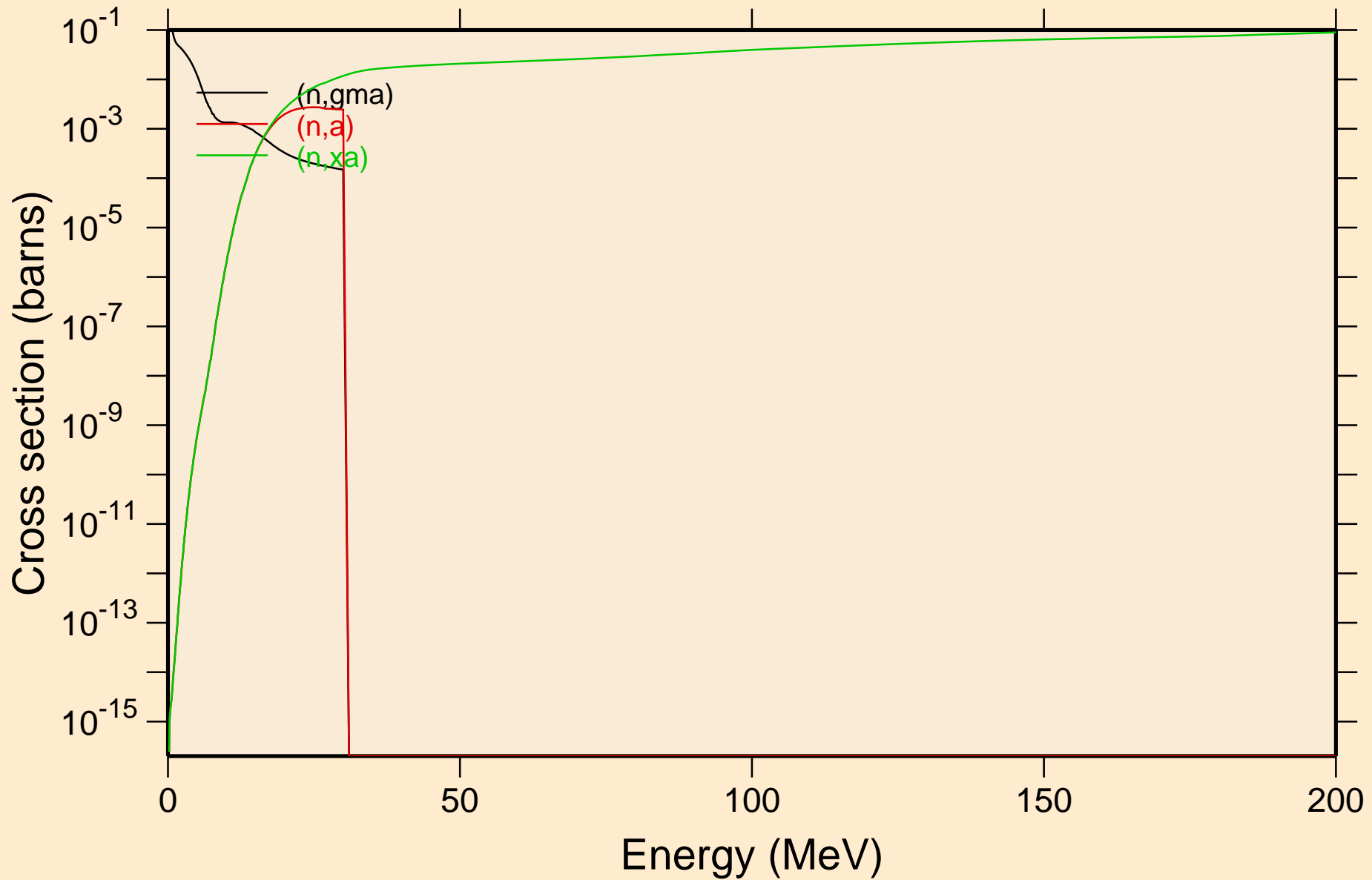

IR193 NEUTRON ACER TENDL-2024 LIBRARY; T=293.6K  
Inelastic levels

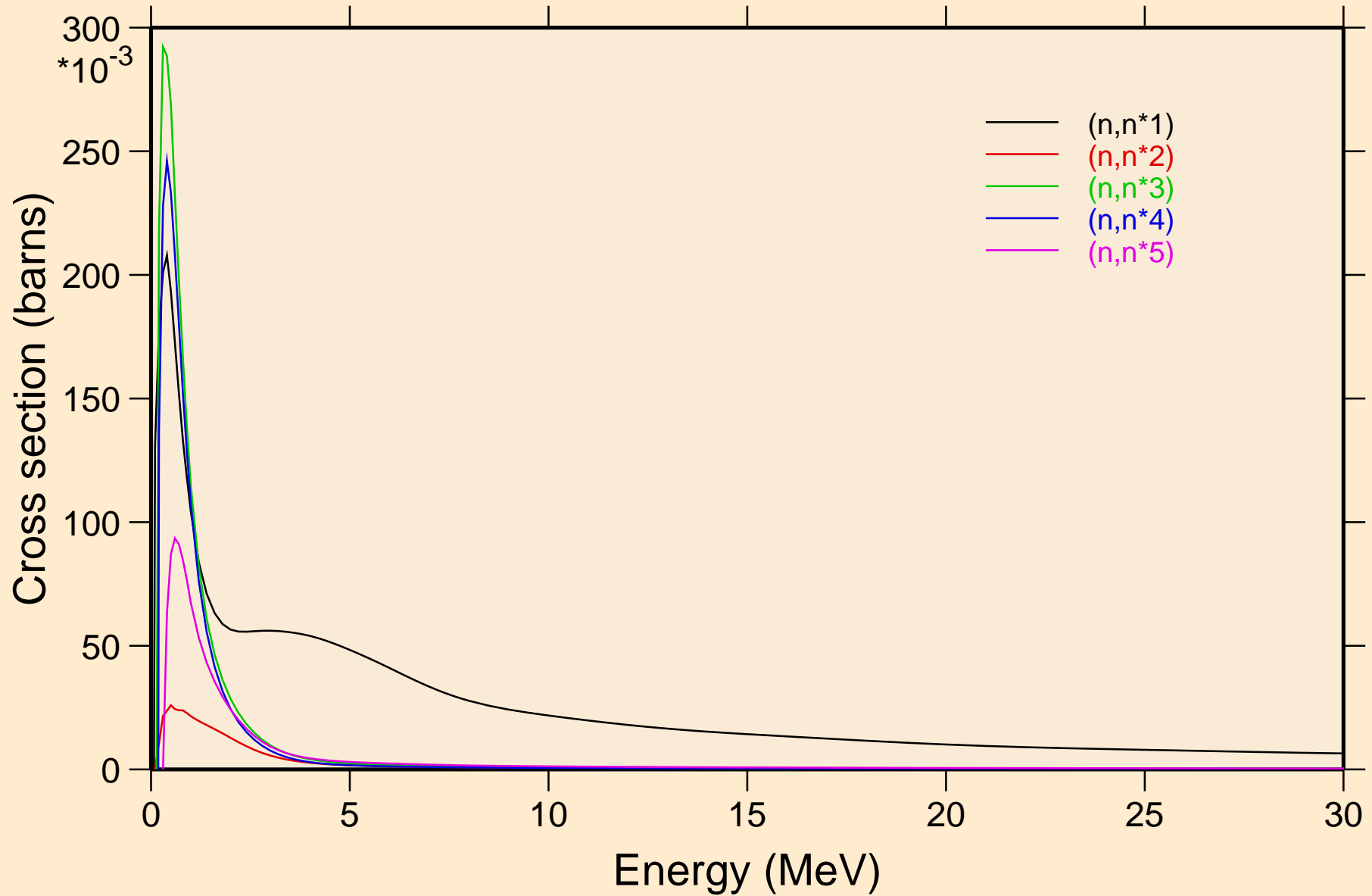

IR193 NEUTRON ACER TENDL-2024 LIBRARY; T=293.6K  
Inelastic levels

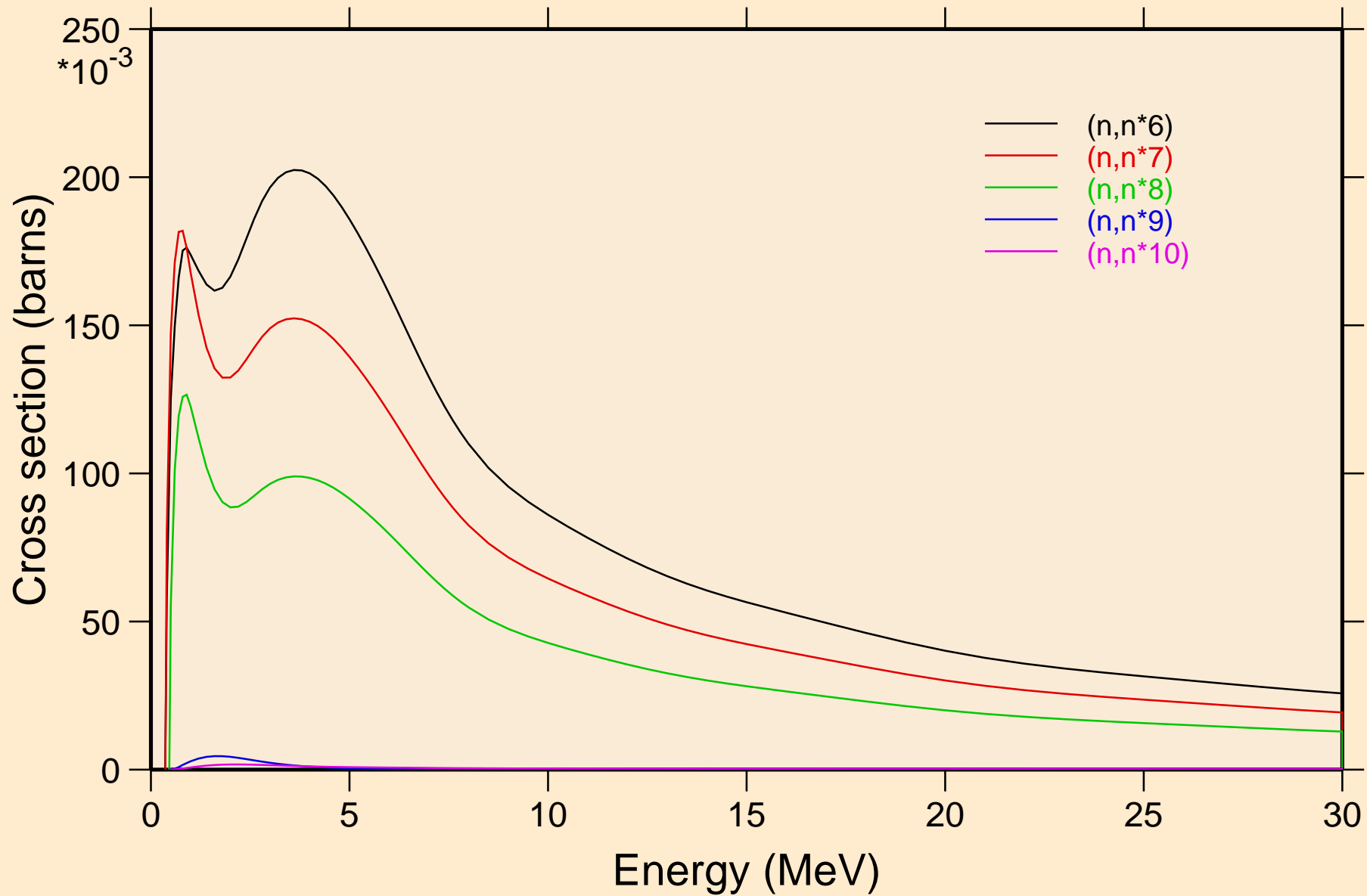

IR193 NEUTRON ACER TENDL-2024 LIBRARY; T=293.6K  
Inelastic levels

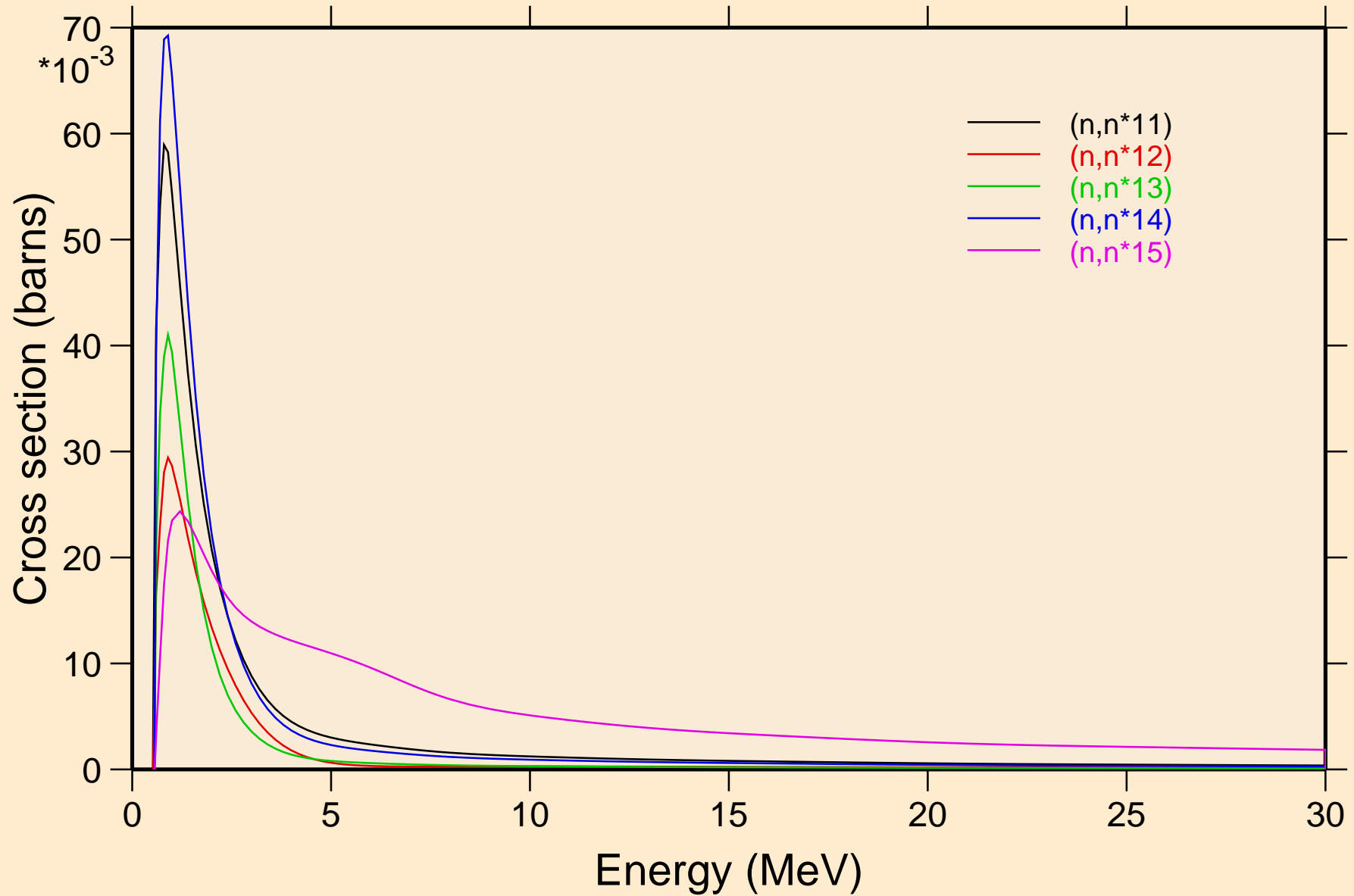

IR193 NEUTRON ACER TENDL-2024 LIBRARY; T=293.6K  
Inelastic levels

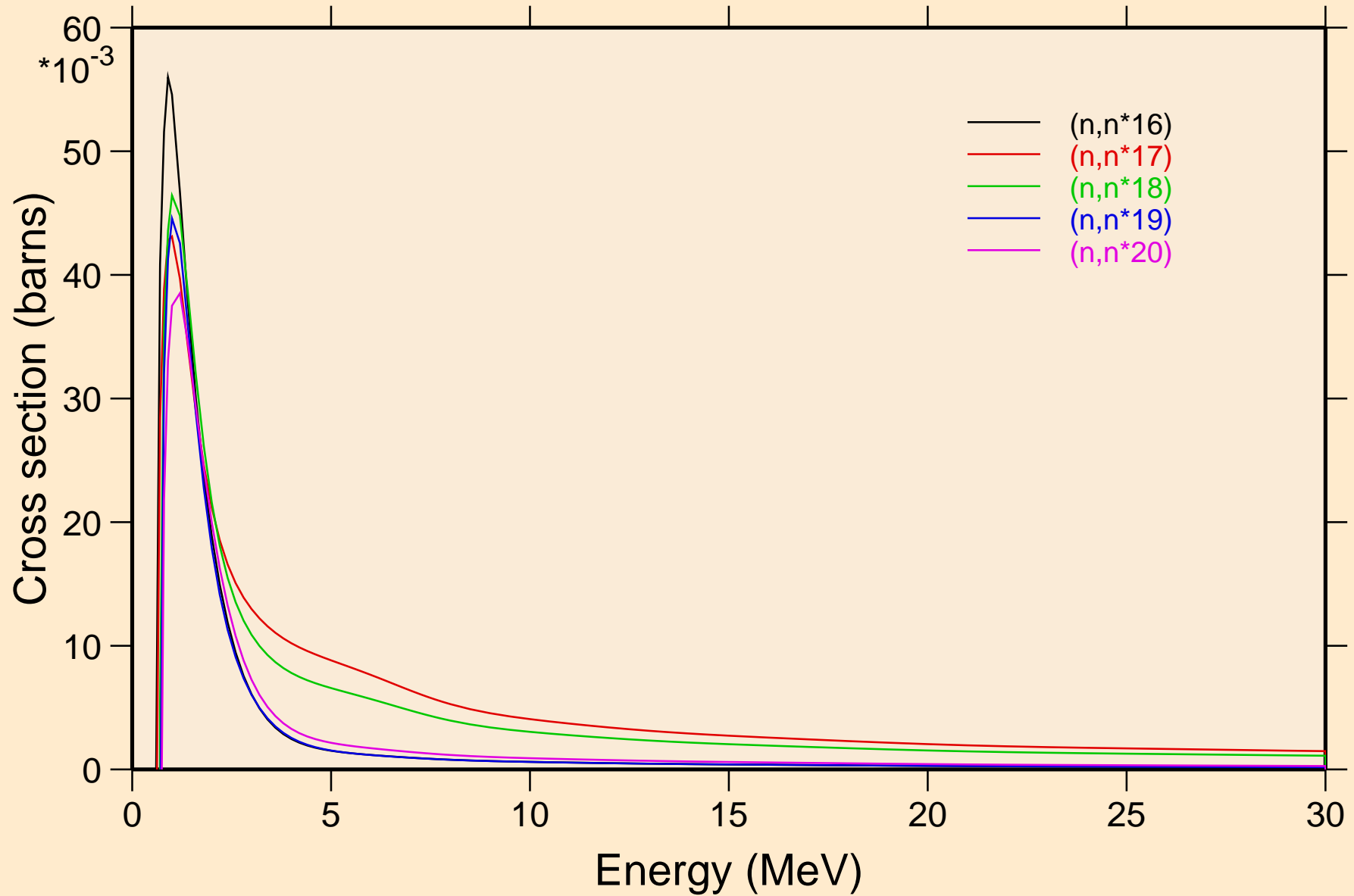

# IR193 NEUTRON ACER TENDL-2024 LIBRARY; T=293.6K

## Inelastic levels

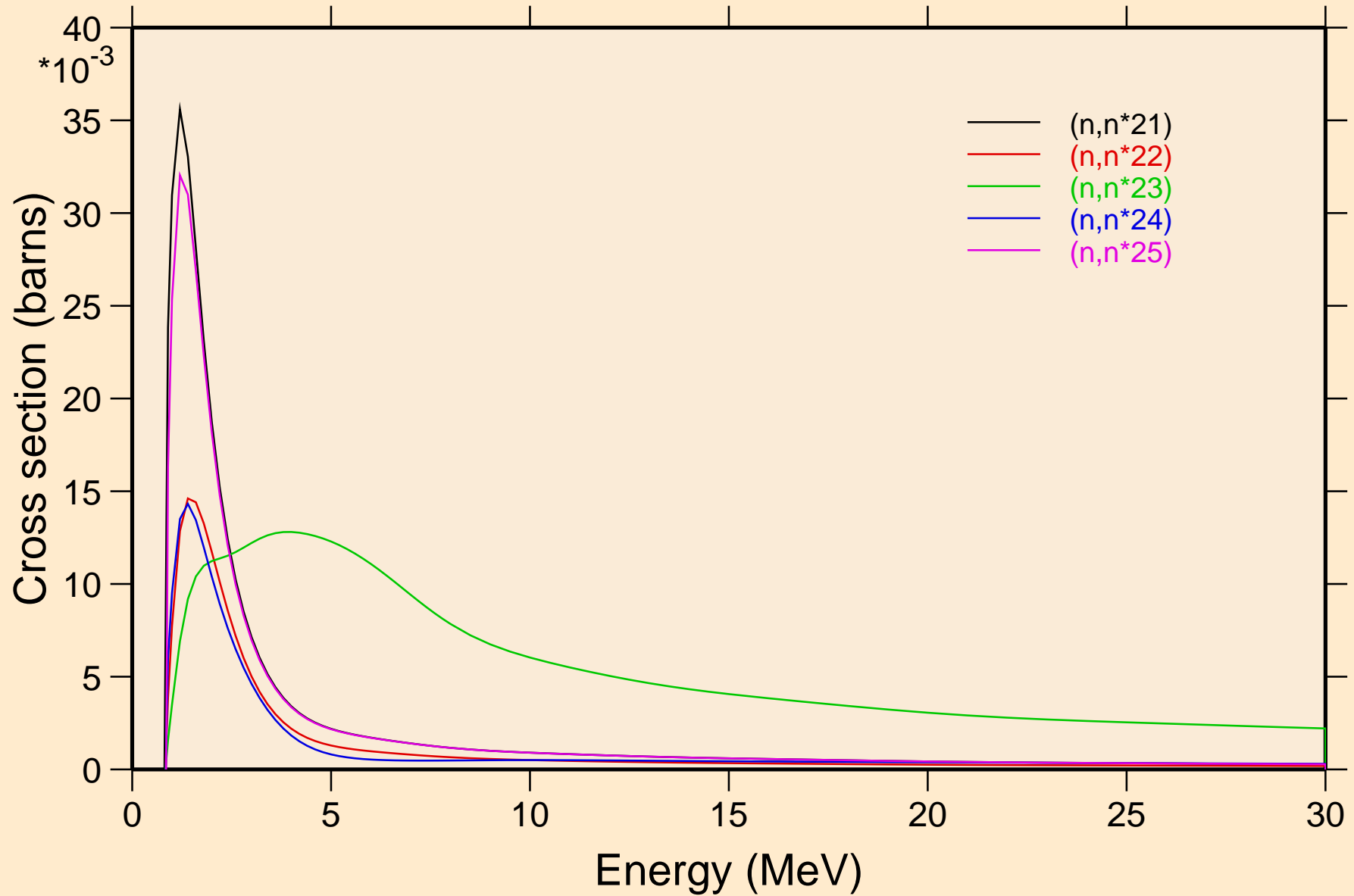

IR193 NEUTRON ACER TENDL-2024 LIBRARY; T=293.6K  
Inelastic levels

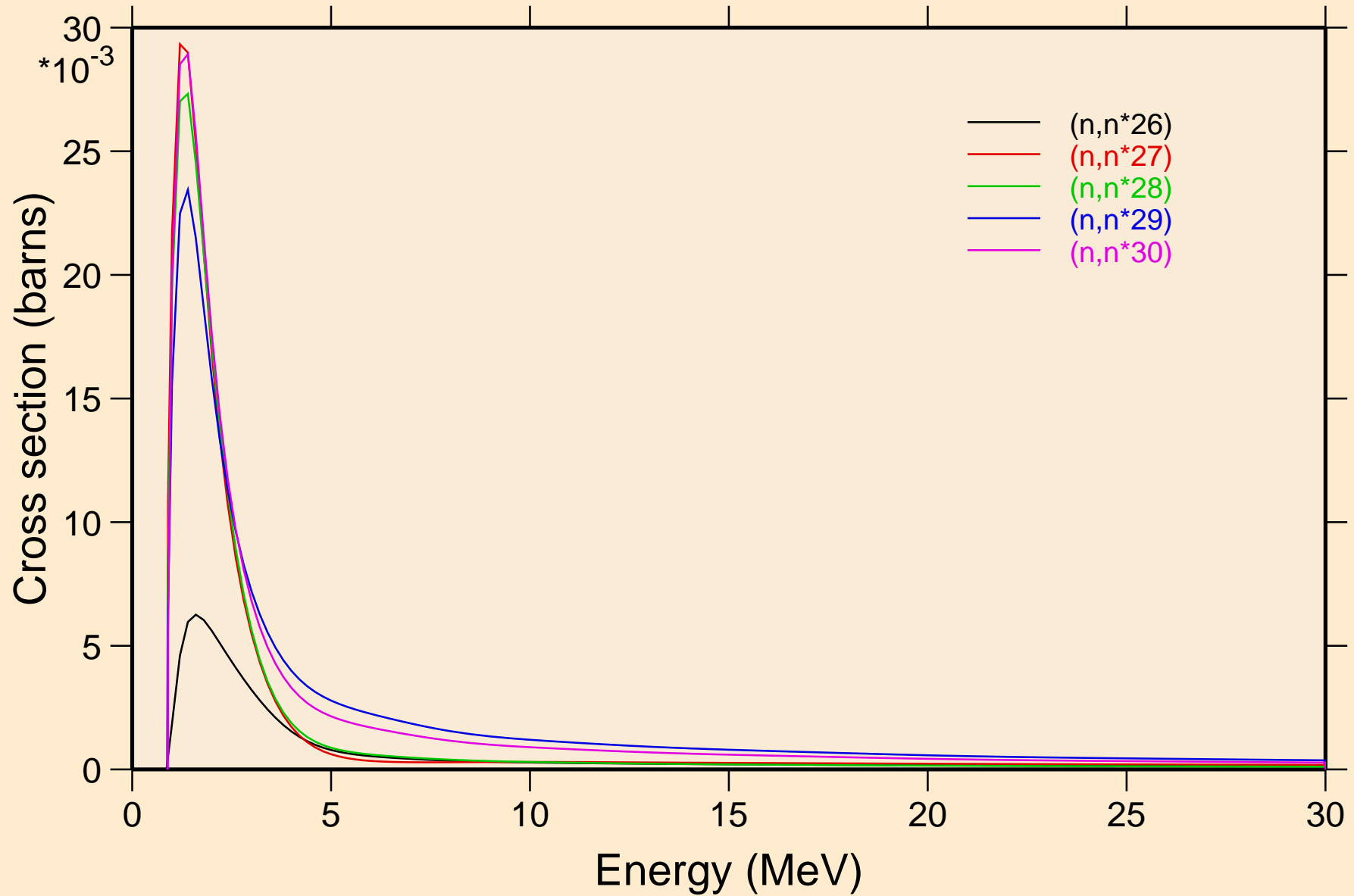

IR193 NEUTRON ACER TENDL-2024 LIBRARY; T=293.6K  
Threshold reactions

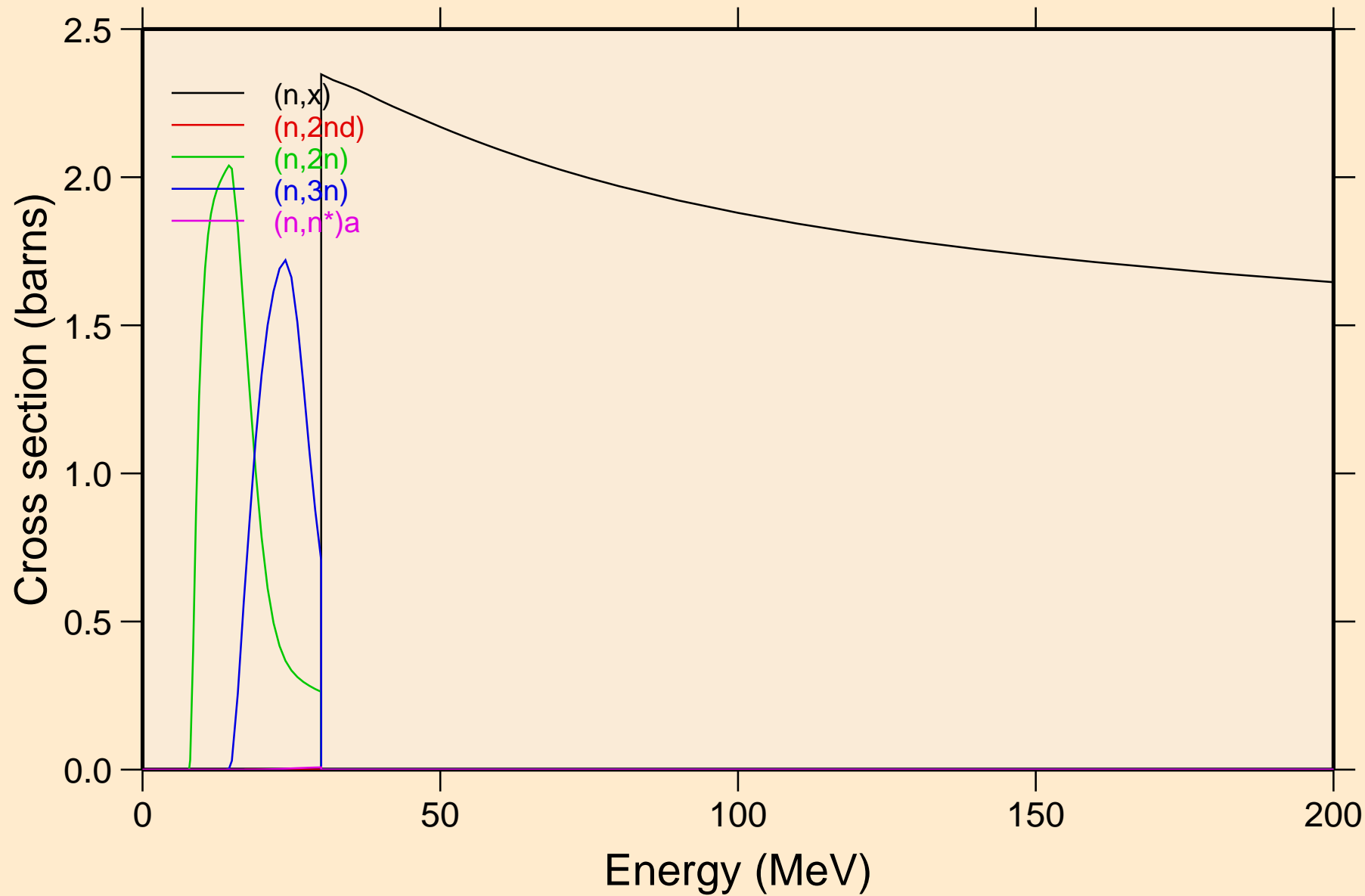

IR193 NEUTRON ACER TENDL-2024 LIBRARY; T=293.6K  
Threshold reactions

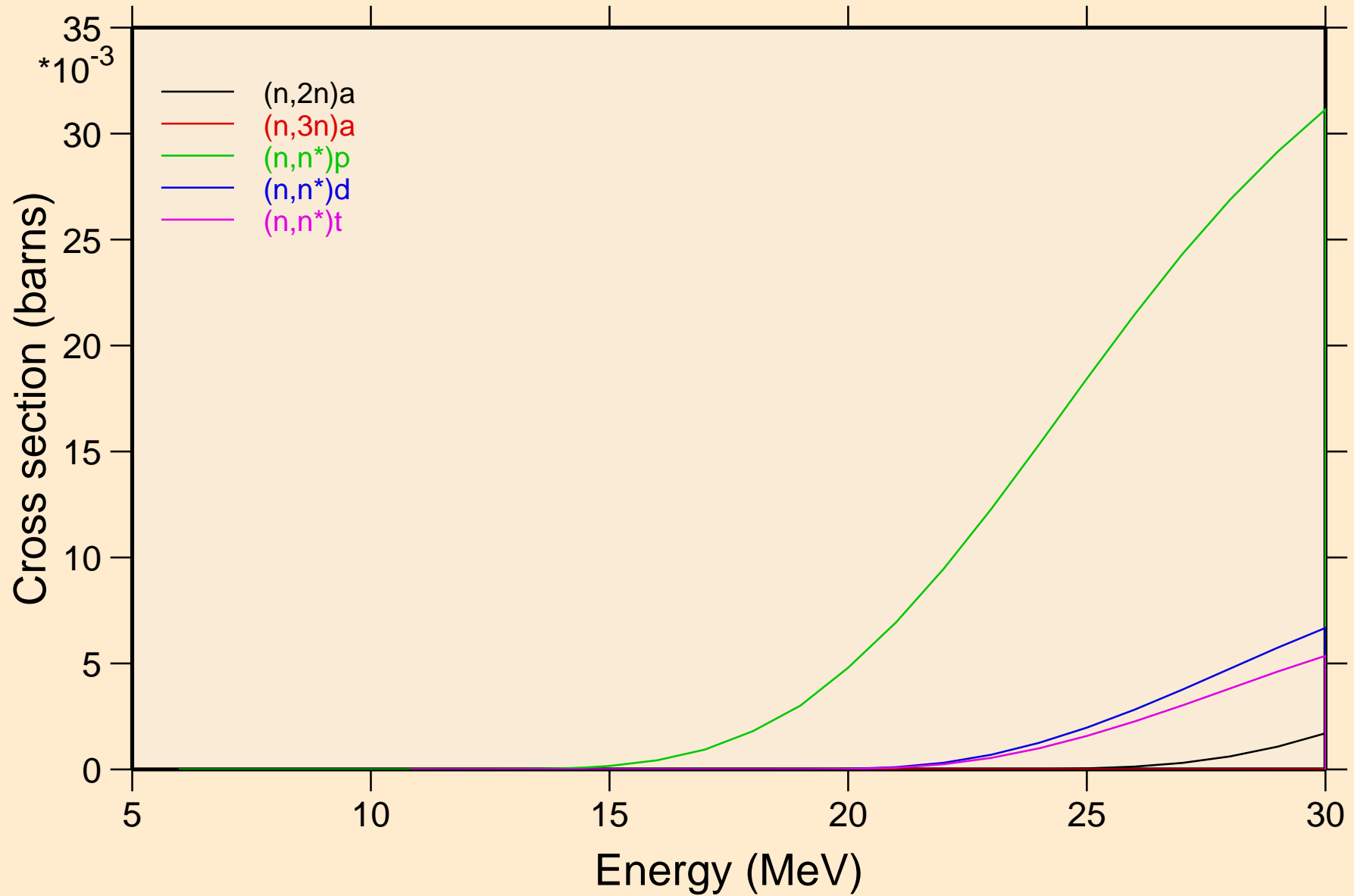

IR193 NEUTRON ACER TENDL-2024 LIBRARY; T=293.6K  
Threshold reactions

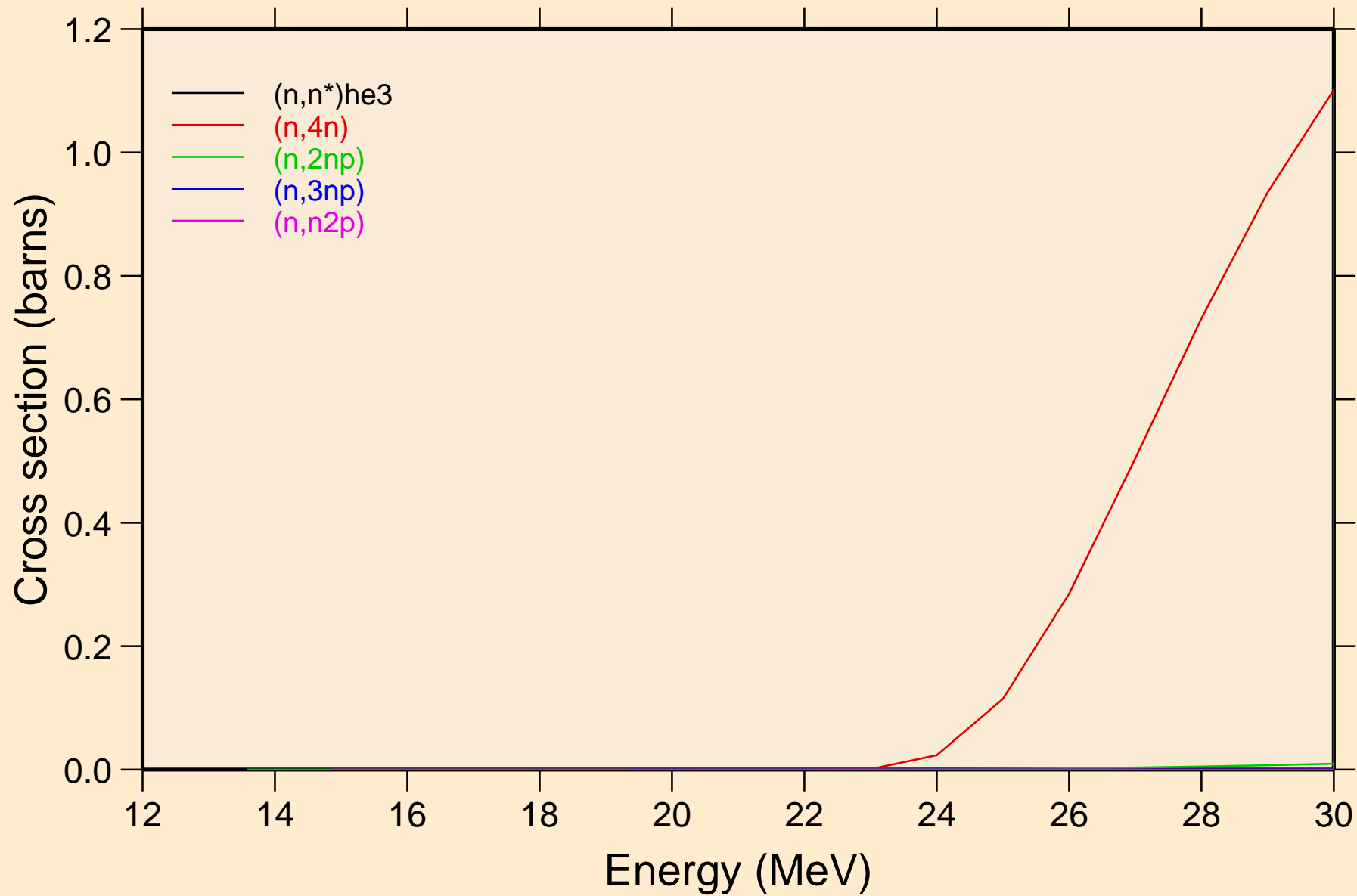

IR193 NEUTRON ACER TENDL-2024 LIBRARY; T=293.6K  
Threshold reactions

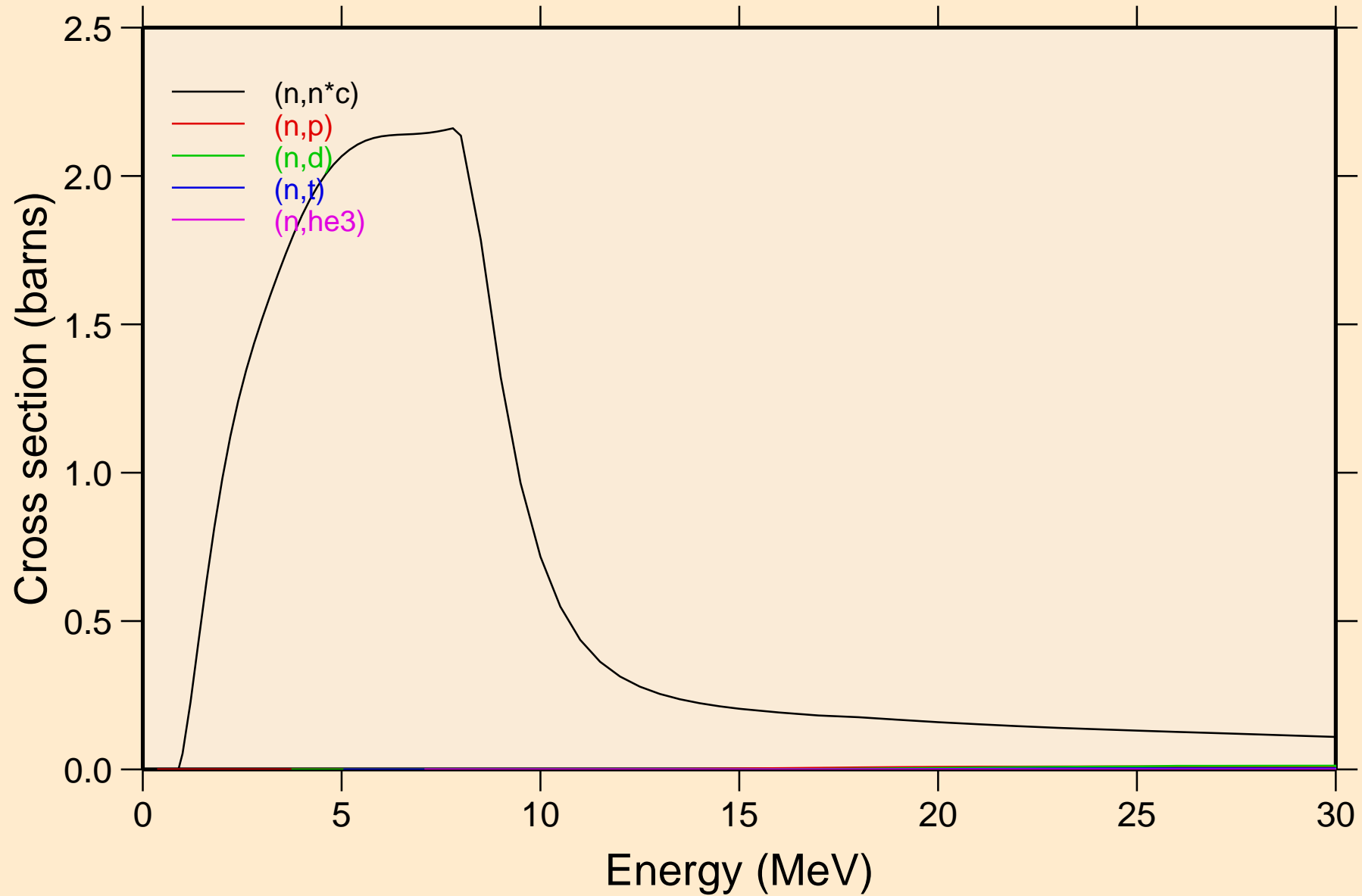

IR193 NEUTRON ACER TENDL-2024 LIBRARY; T=293.6K  
Threshold reactions

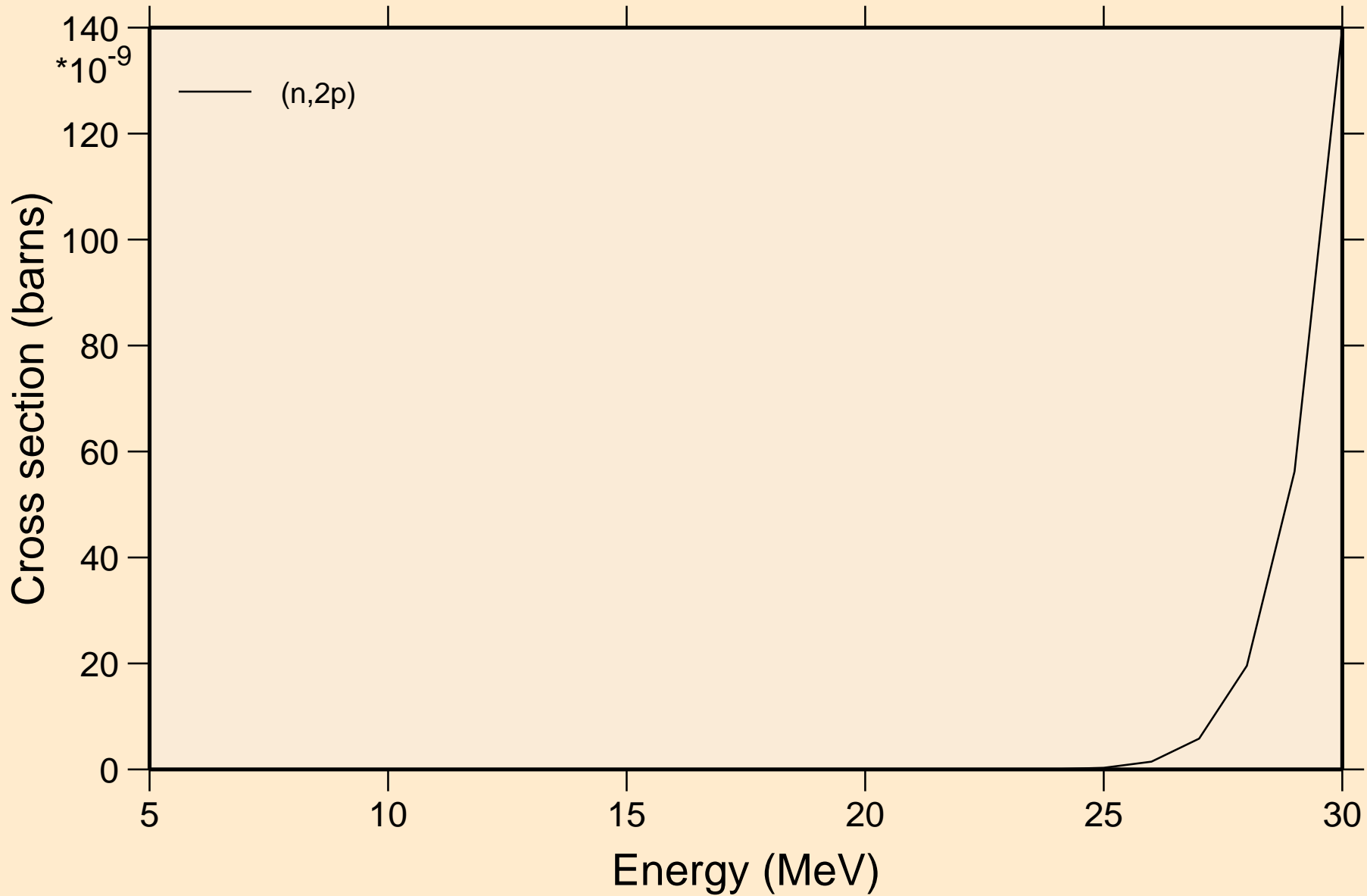

IR193 NEUTRON ACER TENDL-2024 LIBRARY; T=293.6K  
Threshold reactions

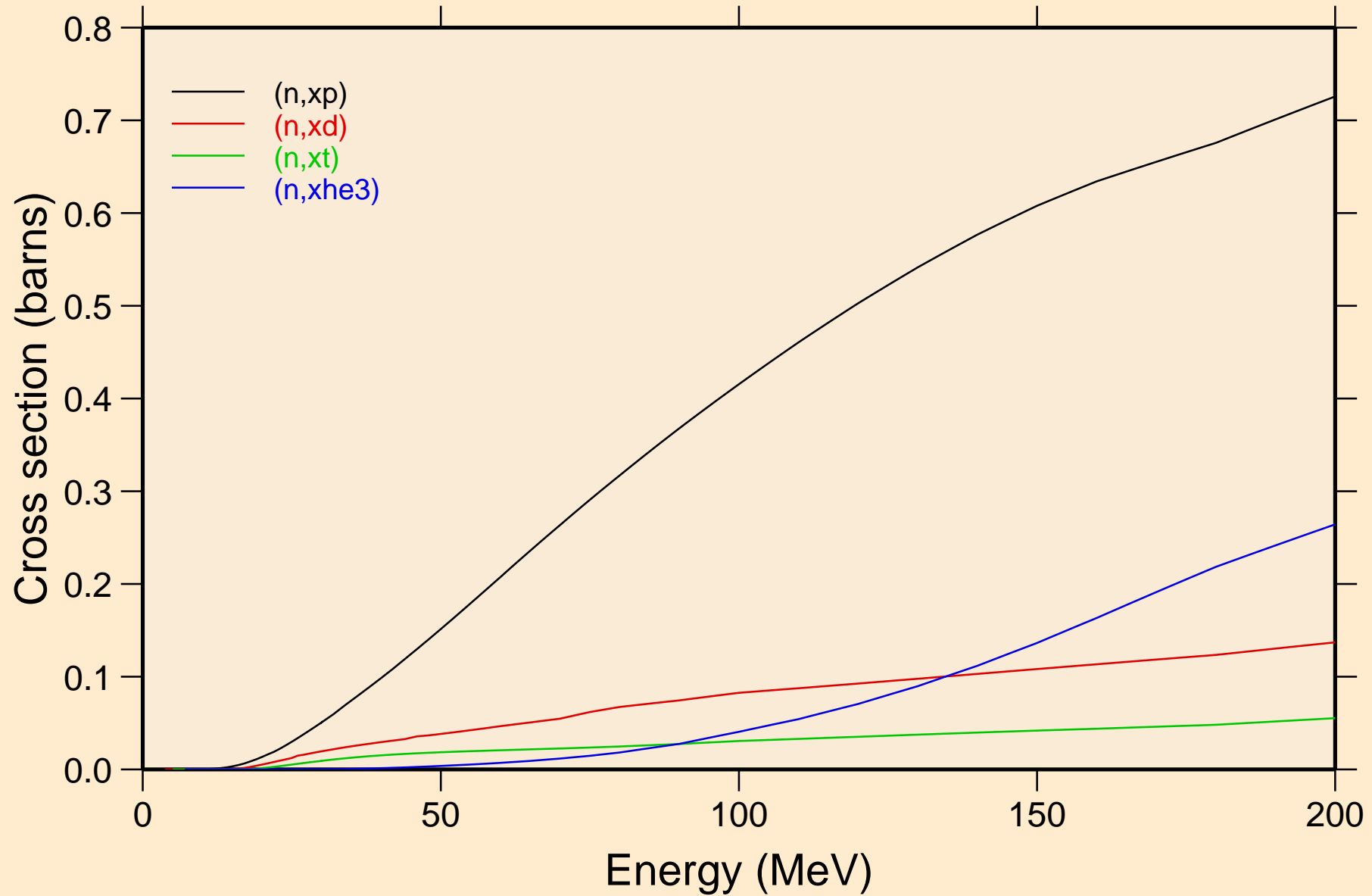

IR193 NEUTRON ACER TENDL-2024 LIBRARY; T=293.6K  
angular distribution for elastic

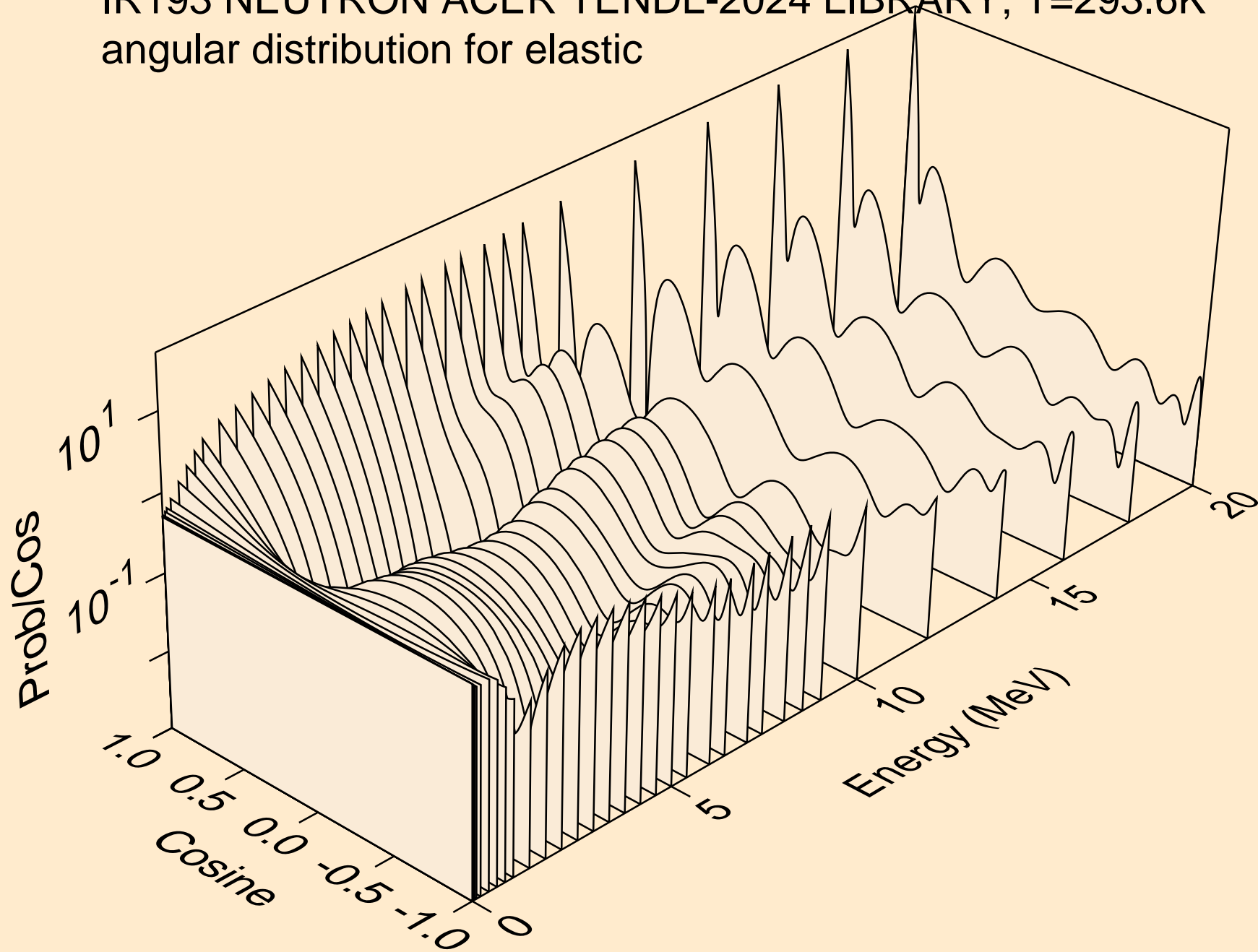

IR193 NEUTRON ACER TENDL-2024 LIBRARY; T=293.6K  
angular distribution for elastic

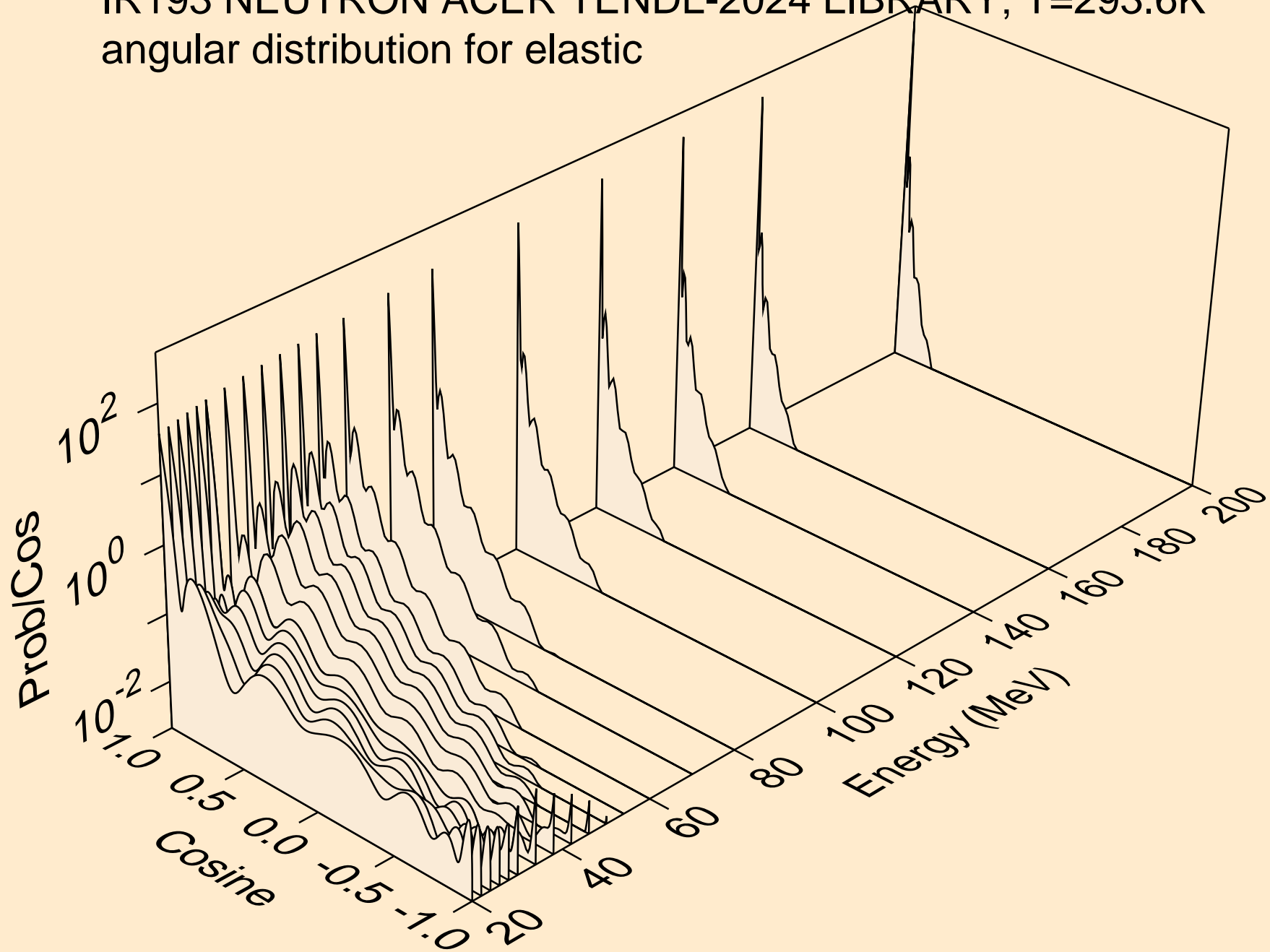

IR193 NEUTRON ACER TENDL-2024 LIBRARY; T=293.6K  
angular distribution for (n,n\*1)

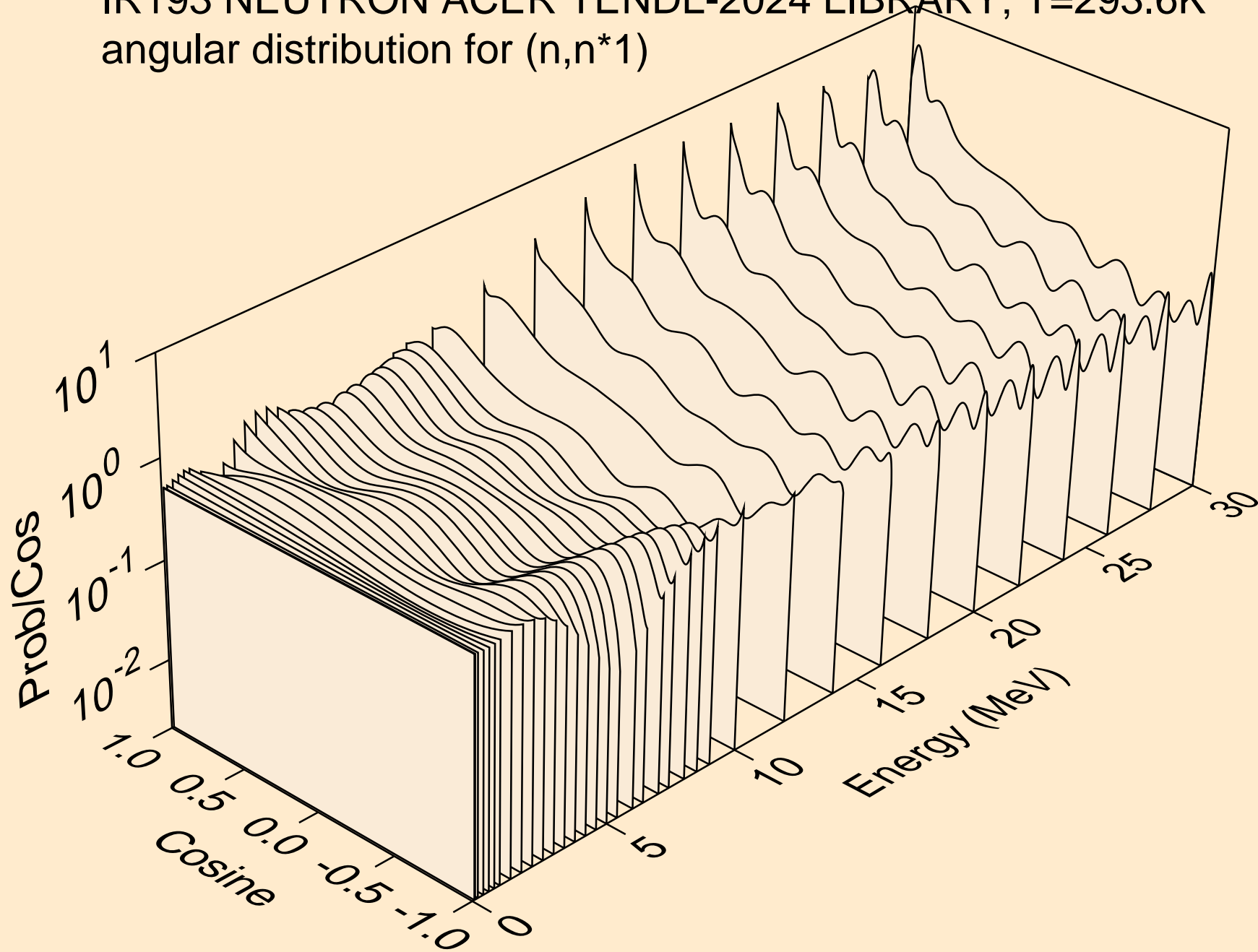

IR193 NEUTRON ACER TENDL-2024 LIBRARY; T=293.6K  
angular distribution for (n,n\*2)

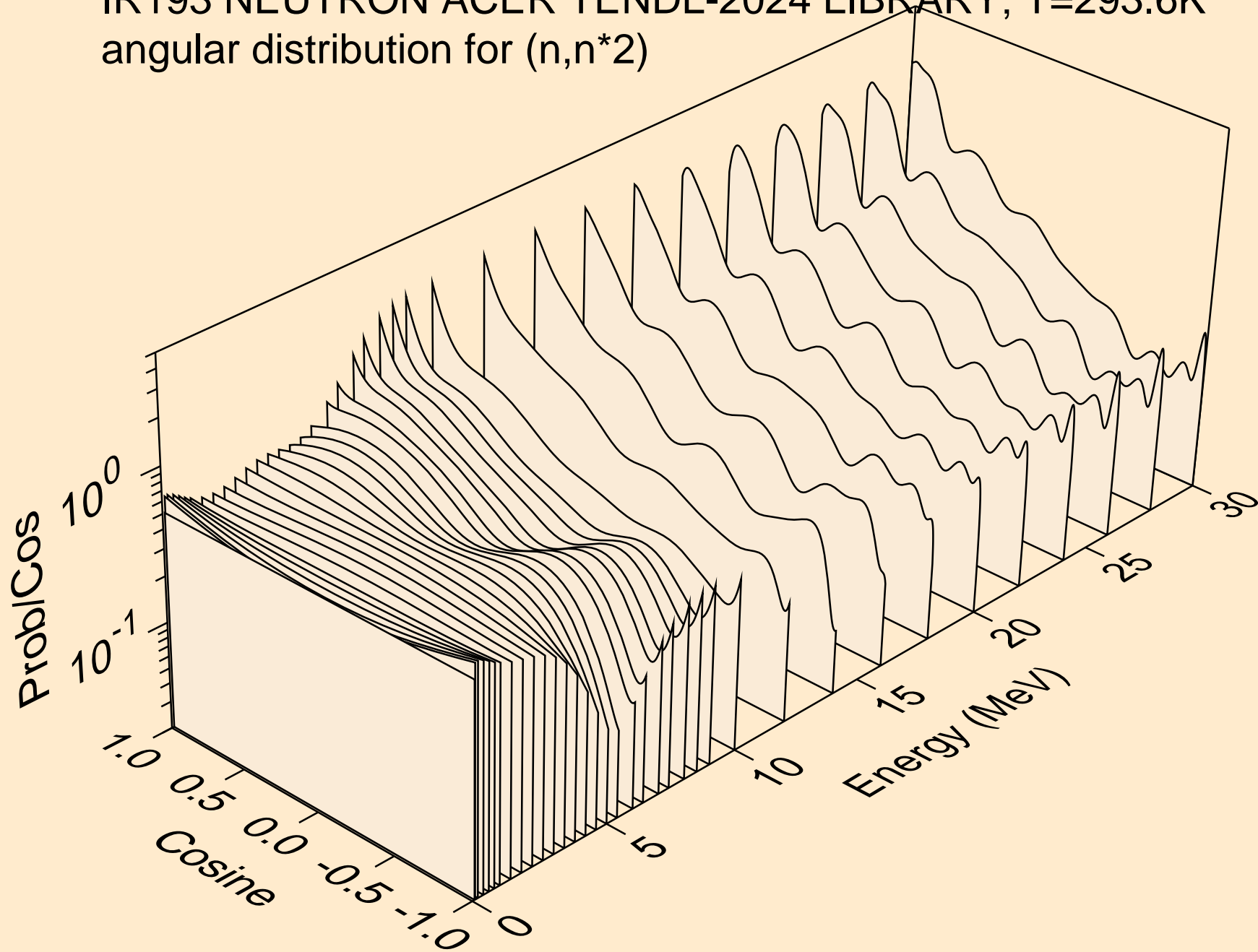

IR193 NEUTRON ACER TENDL-2024 LIBRARY; T=293.6K  
angular distribution for (n,n\*3)

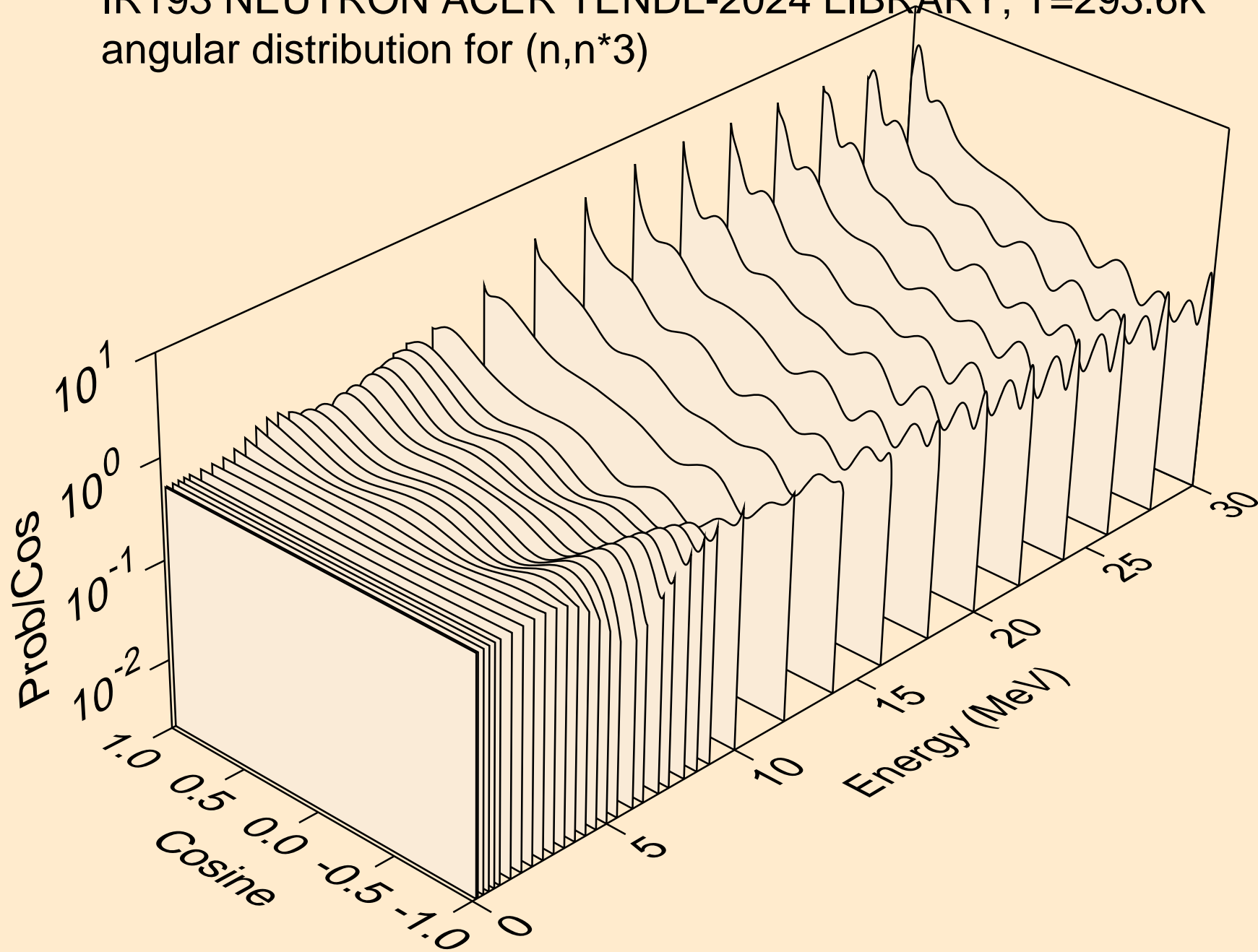

IR193 NEUTRON ACER TENDL-2024 LIBRARY; T=293.6K  
angular distribution for (n,n\*4)

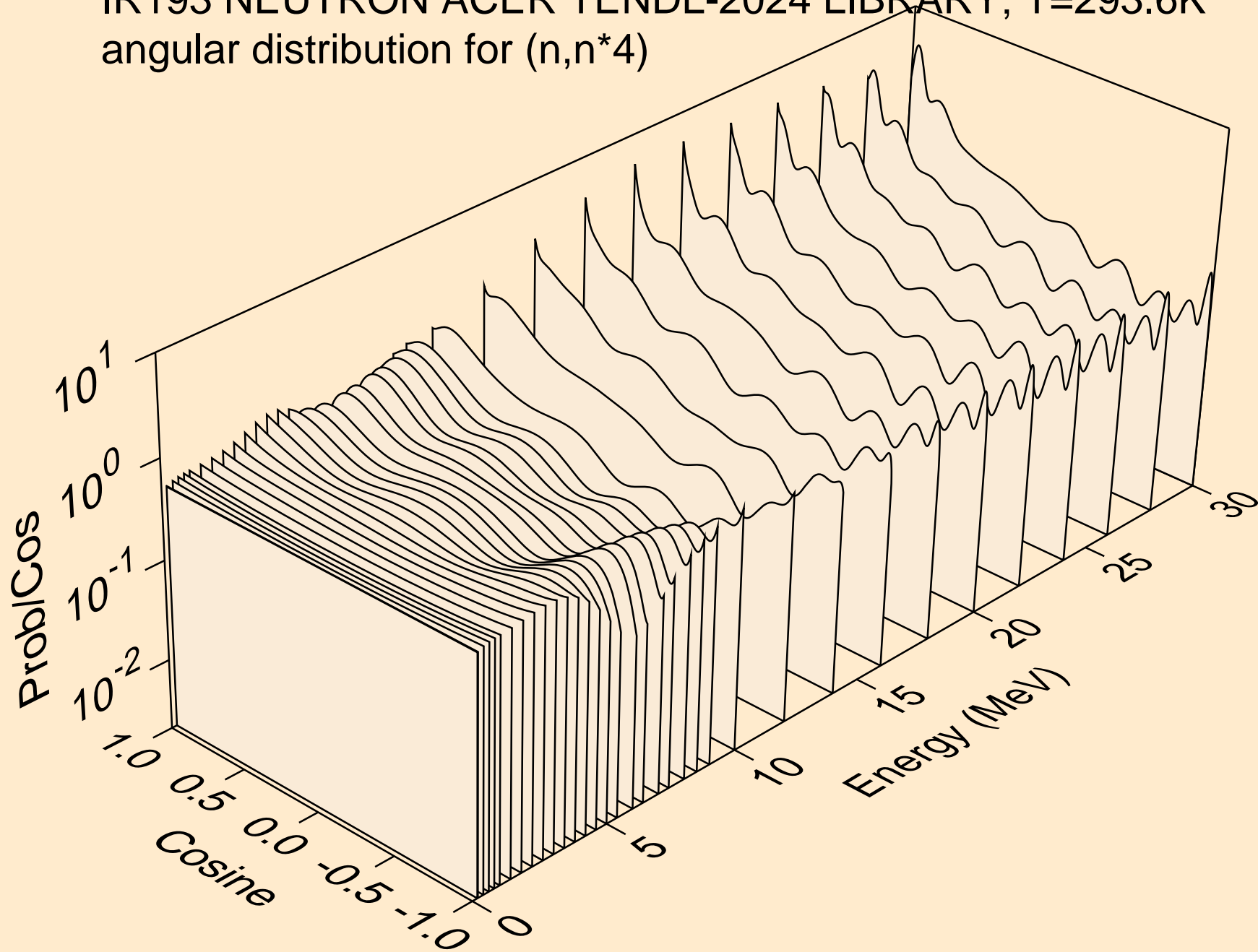

IR193 NEUTRON ACER TENDL-2024 LIBRARY; T=293.6K  
angular distribution for (n,n\*5)

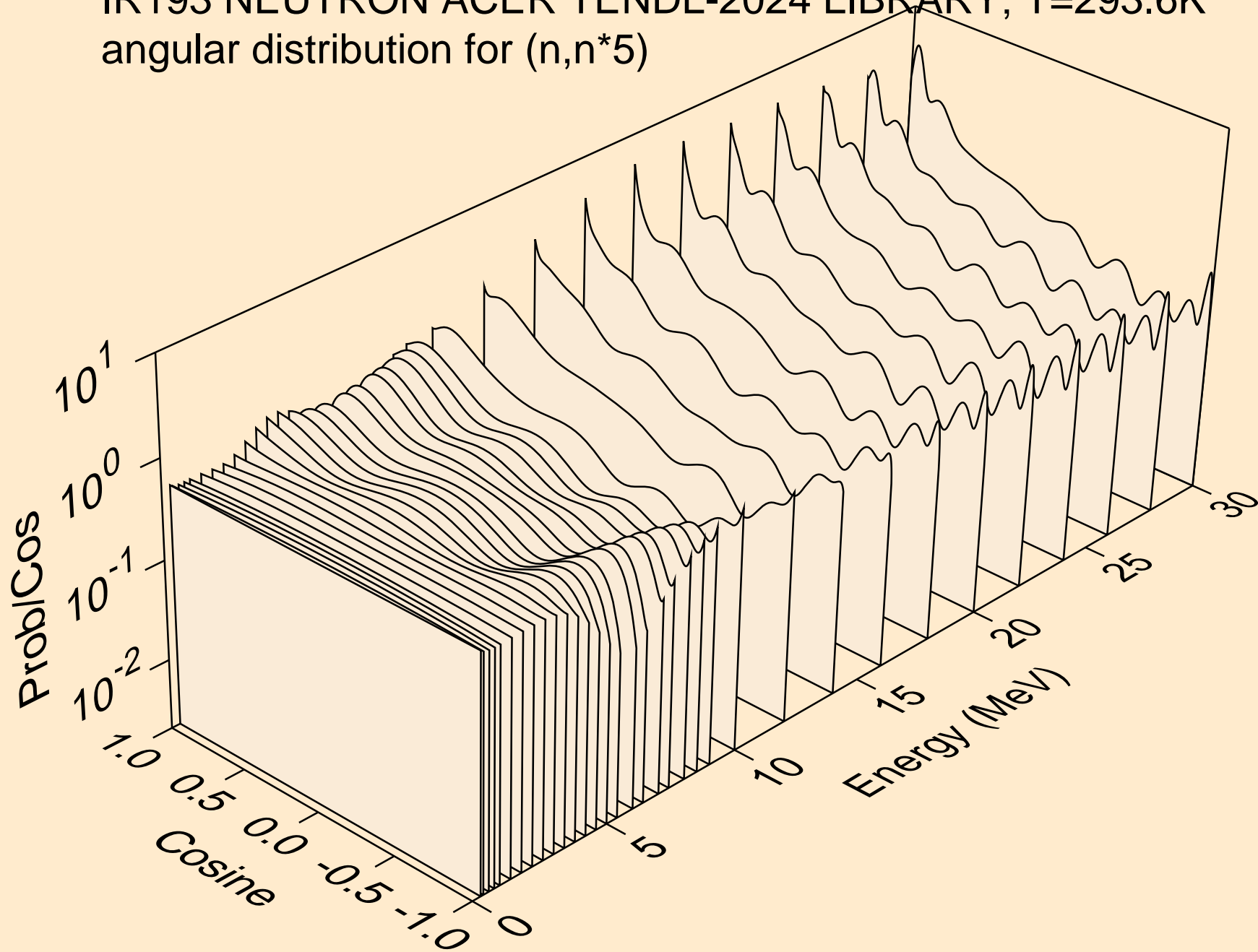

IR193 NEUTRON ACER TENDL-2024 LIBRARY; T=293.6K  
angular distribution for (n,n\*6)

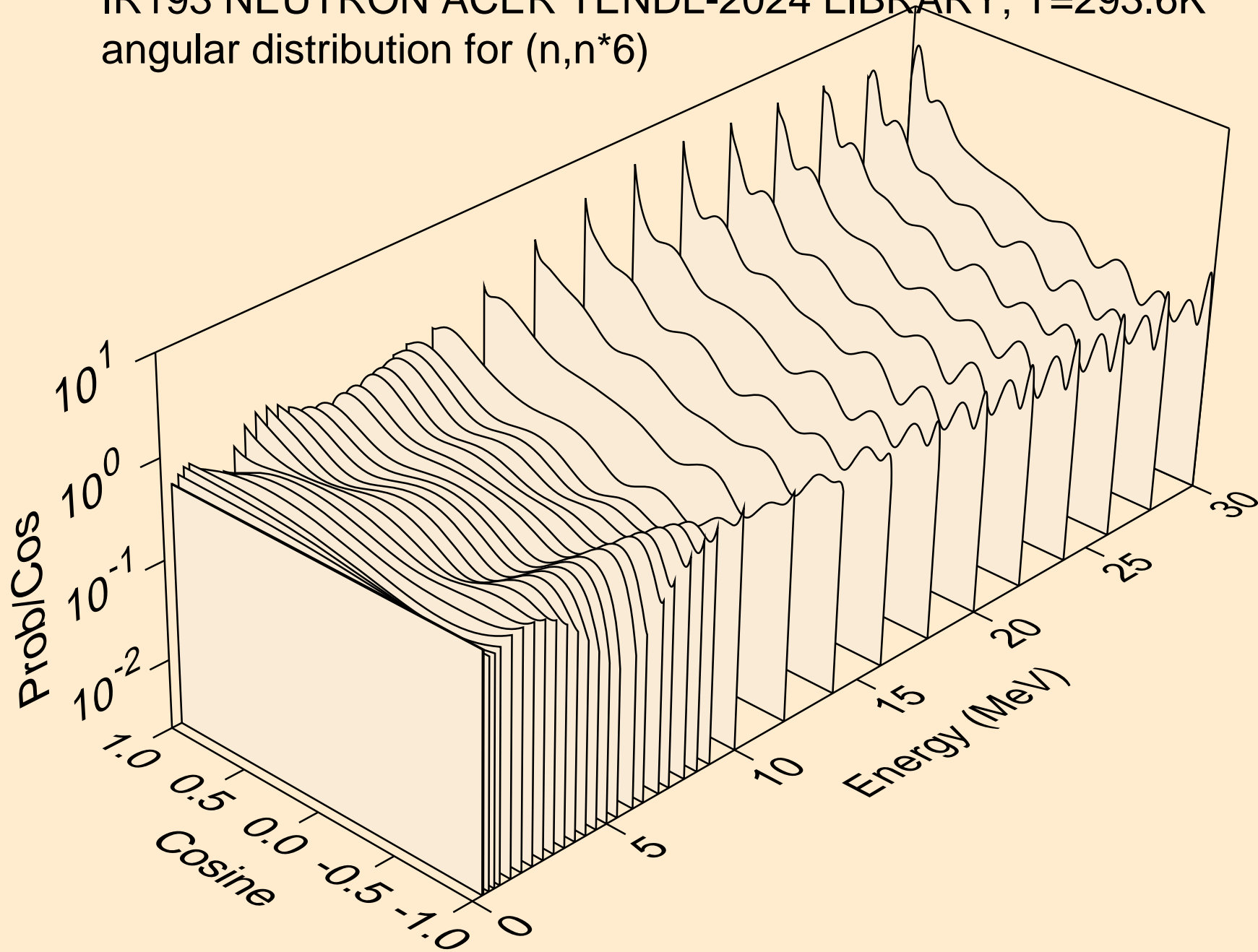

IR193 NEUTRON ACER TENDL-2024 LIBRARY; T=293.6K  
angular distribution for (n,n\*7)

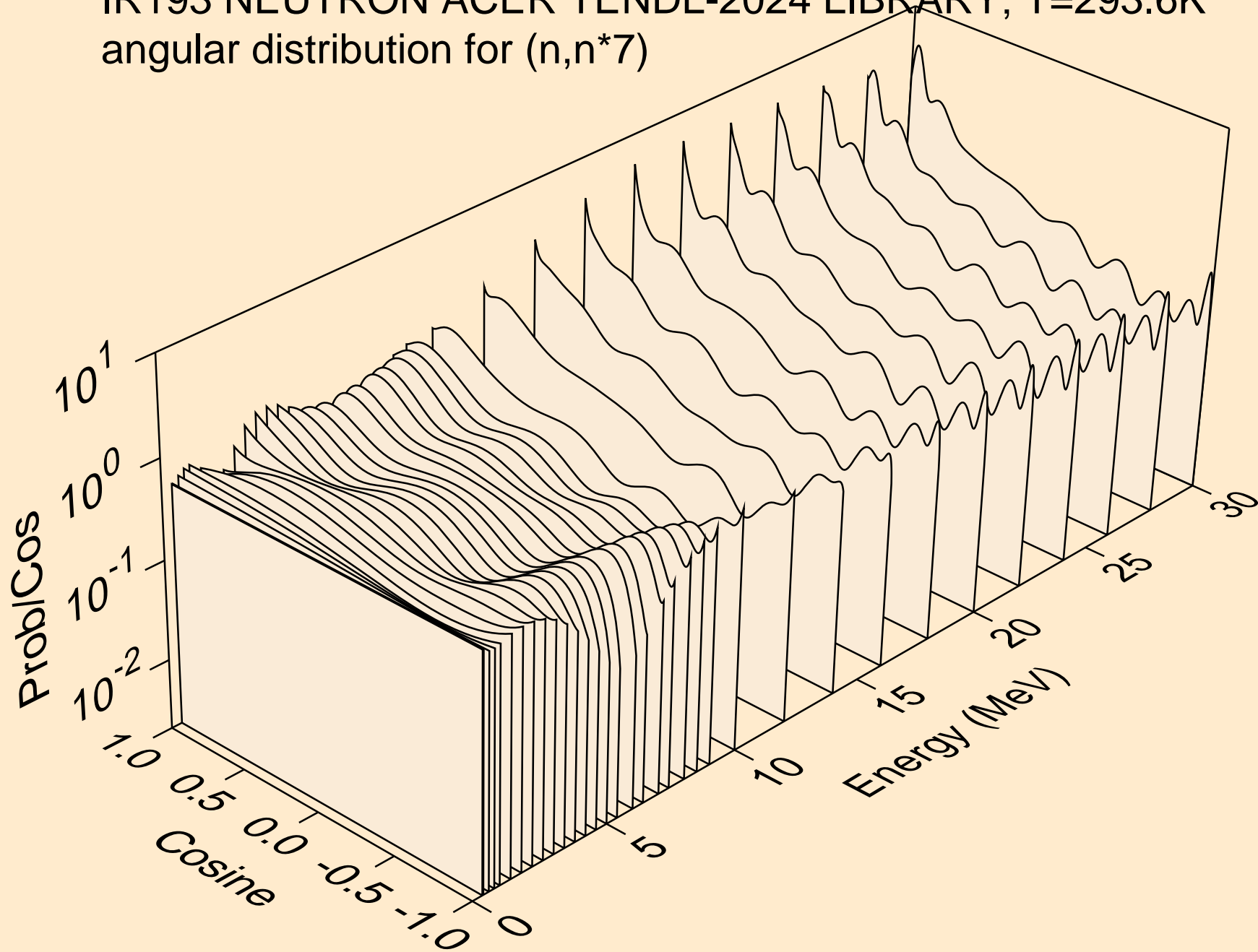

IR193 NEUTRON ACER TENDL-2024 LIBRARY; T=293.6K  
angular distribution for (n,n\*8)

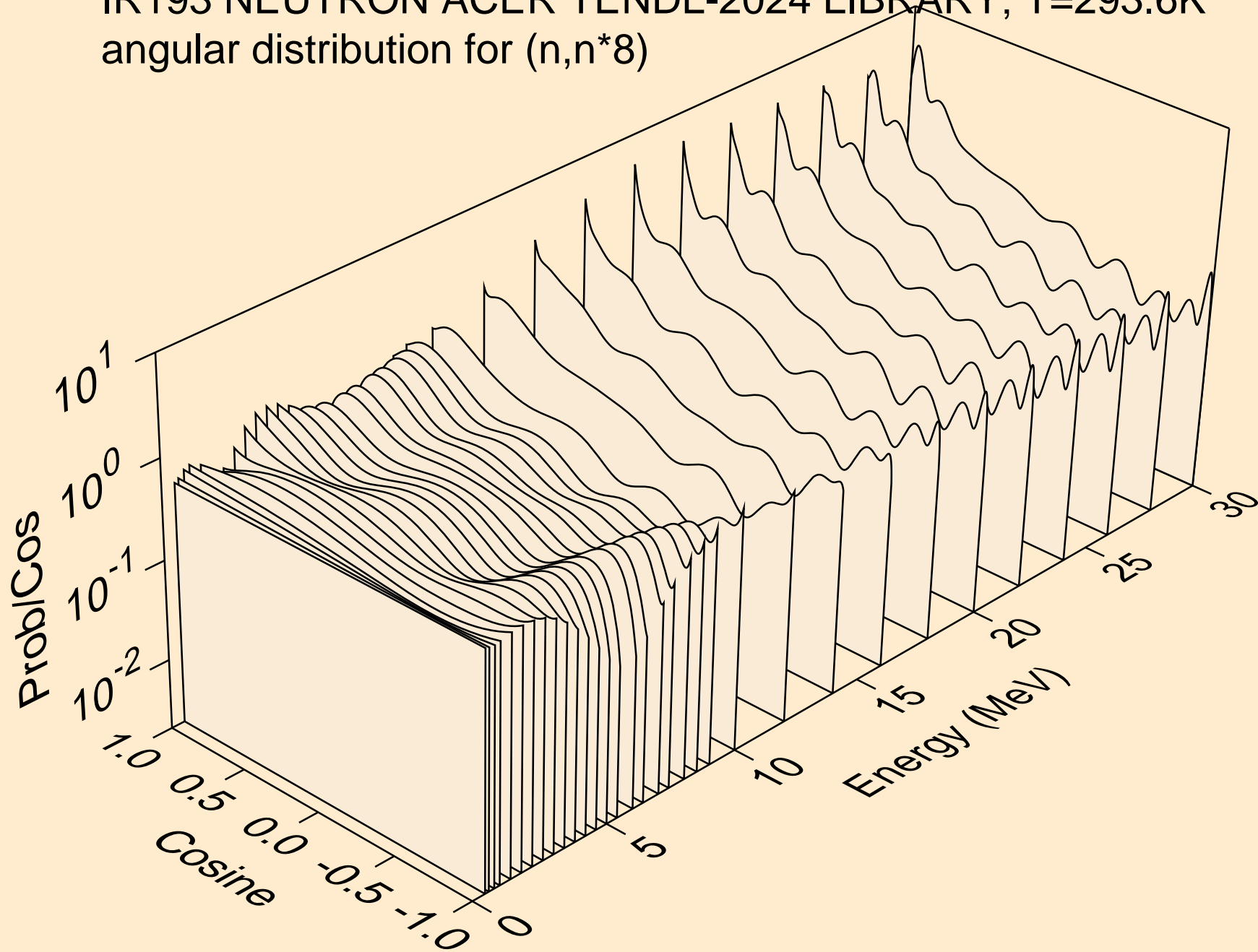

IR193 NEUTRON ACER TENDL-2024 LIBRARY; T=293.6K  
angular distribution for (n,n\*9)

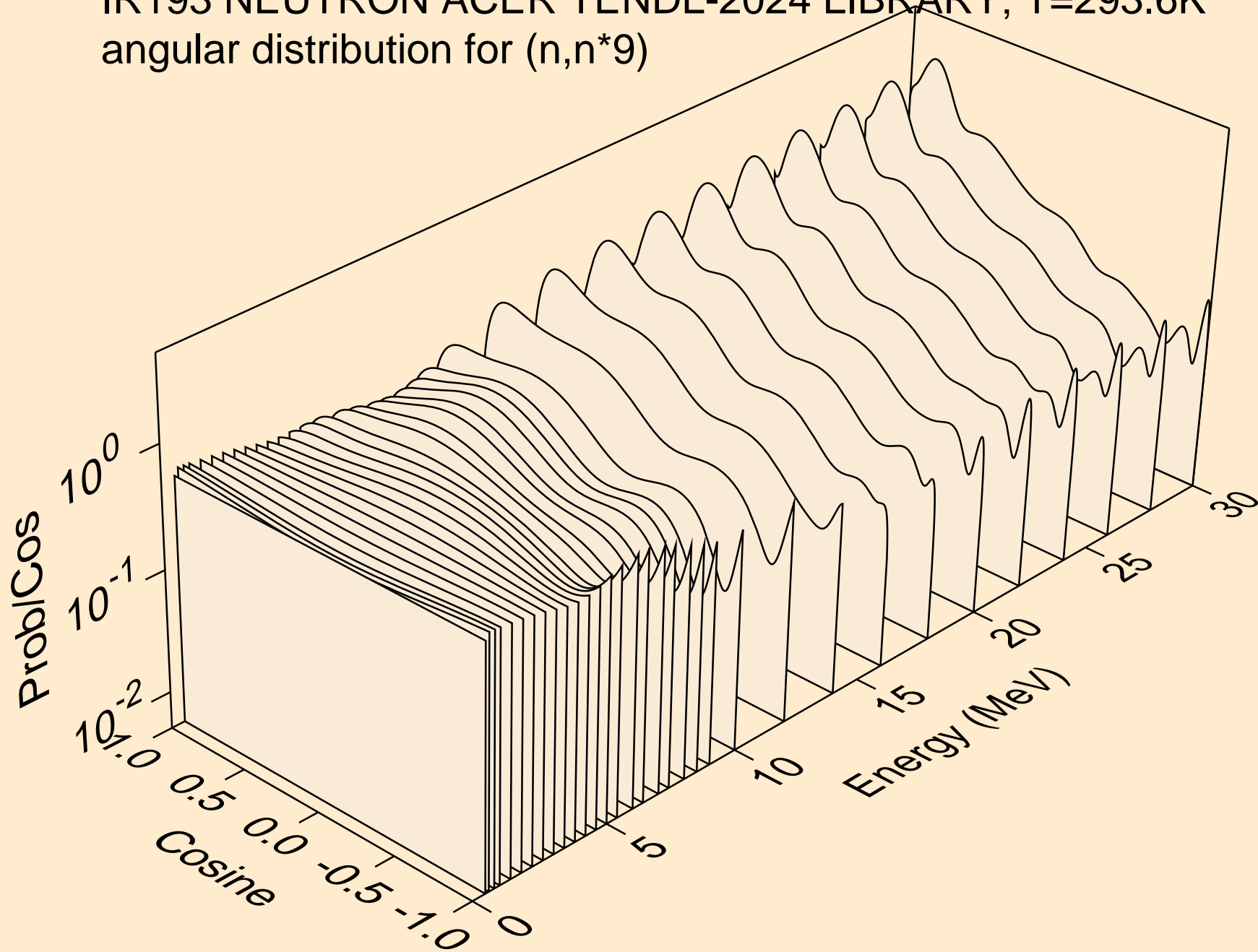

IR193 NEUTRON ACER TENDL-2024 LIBRARY; T=293.6K  
angular distribution for (n,n\*10)

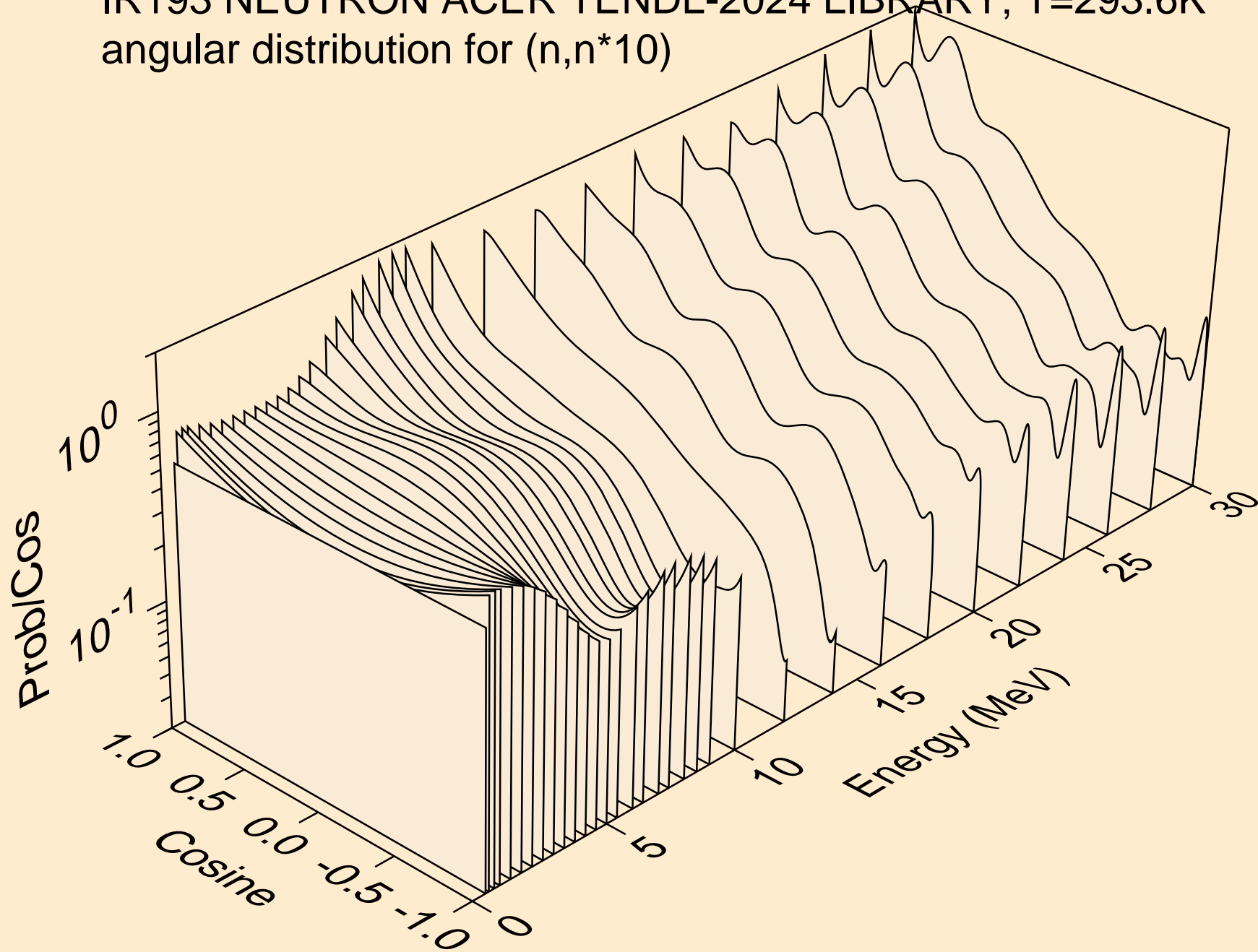

IR193 NEUTRON ACER TENDL-2024 LIBRARY; T=293.6K  
angular distribution for (n,n\*11)

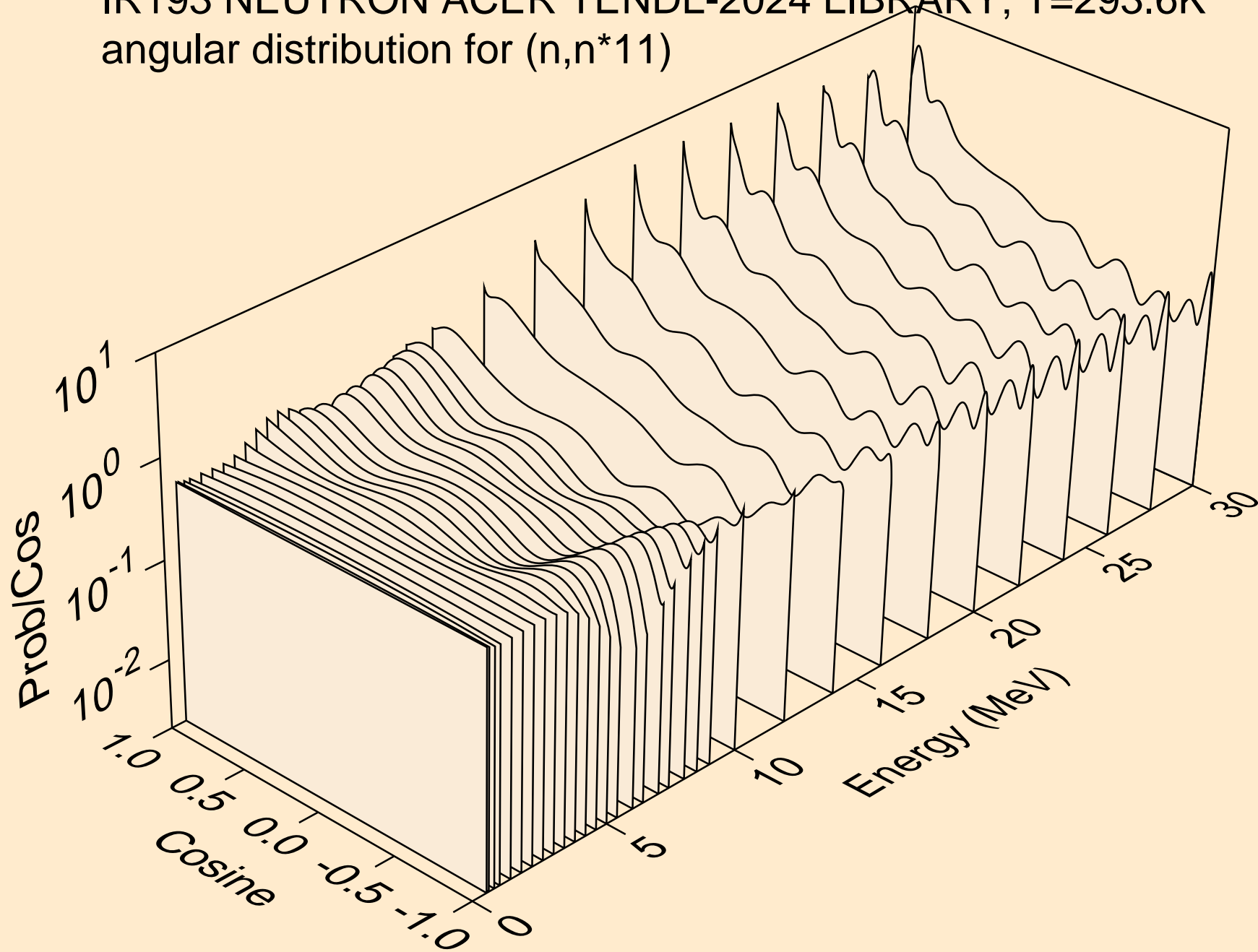

IR193 NEUTRON ACER TENDL-2024 LIBRARY; T=293.6K  
angular distribution for (n,n\*12)

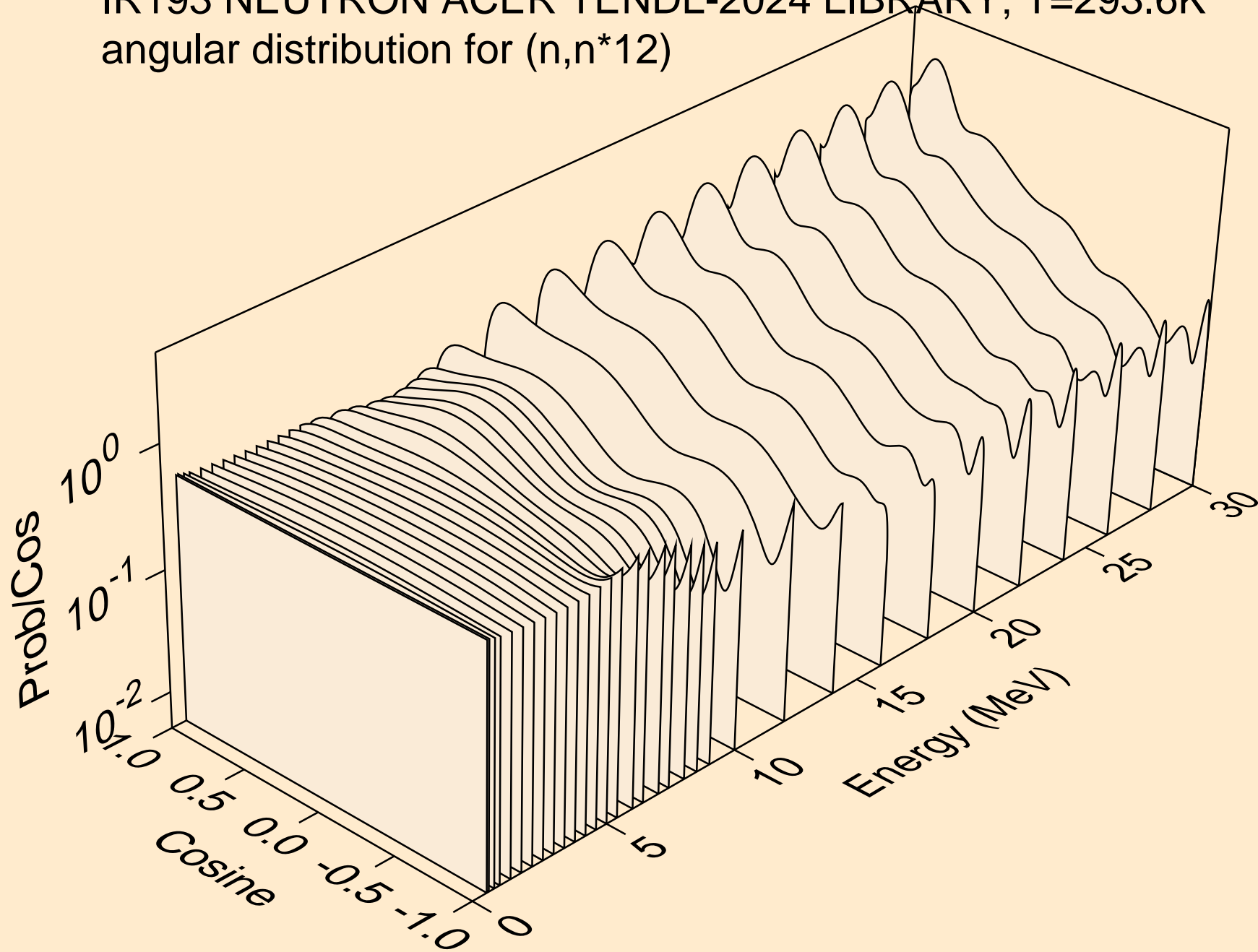

IR193 NEUTRON ACER TENDL-2024 LIBRARY; T=293.6K  
angular distribution for (n,n\*13)

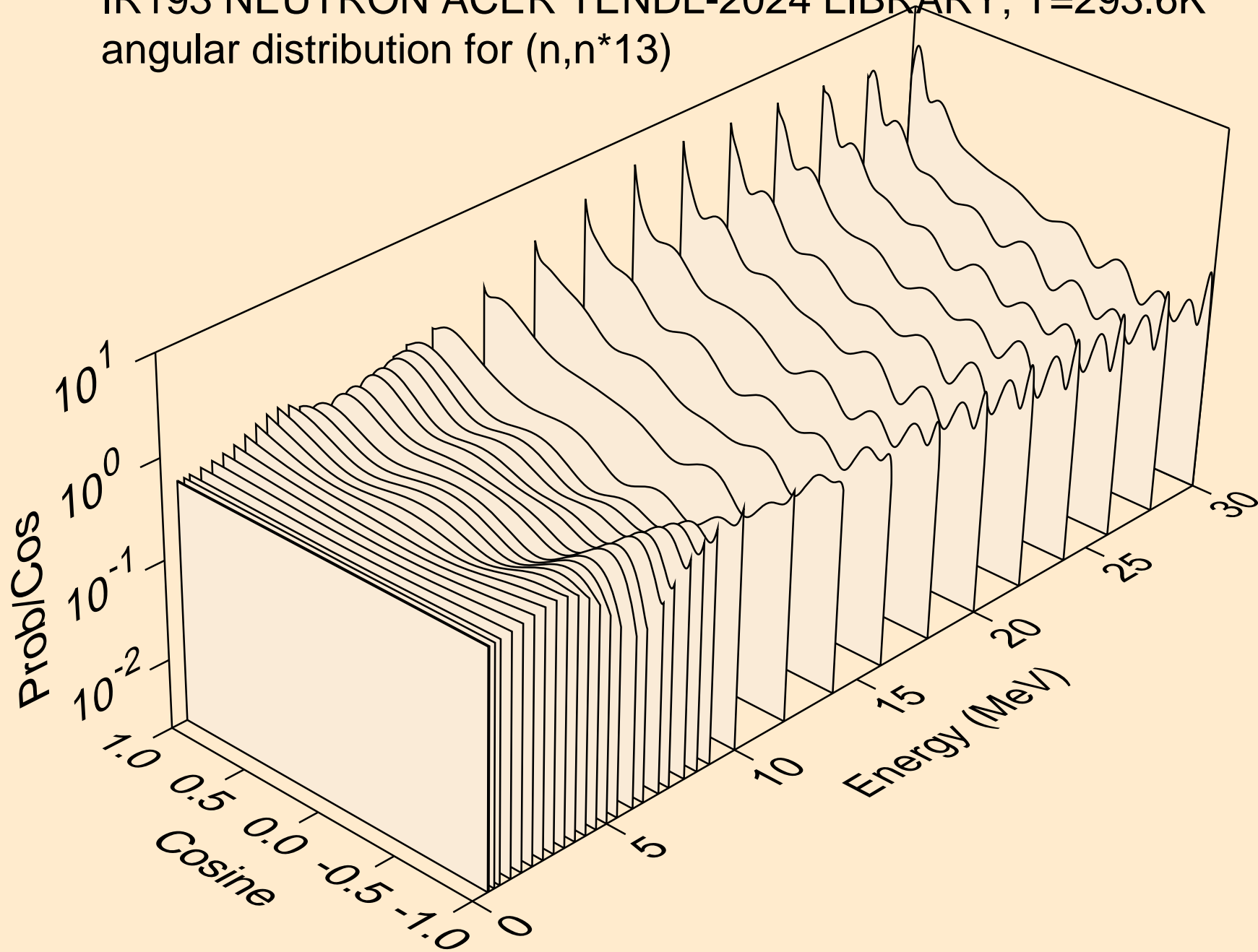

IR193 NEUTRON ACER TENDL-2024 LIBRARY; T=293.6K  
angular distribution for (n,n\*14)

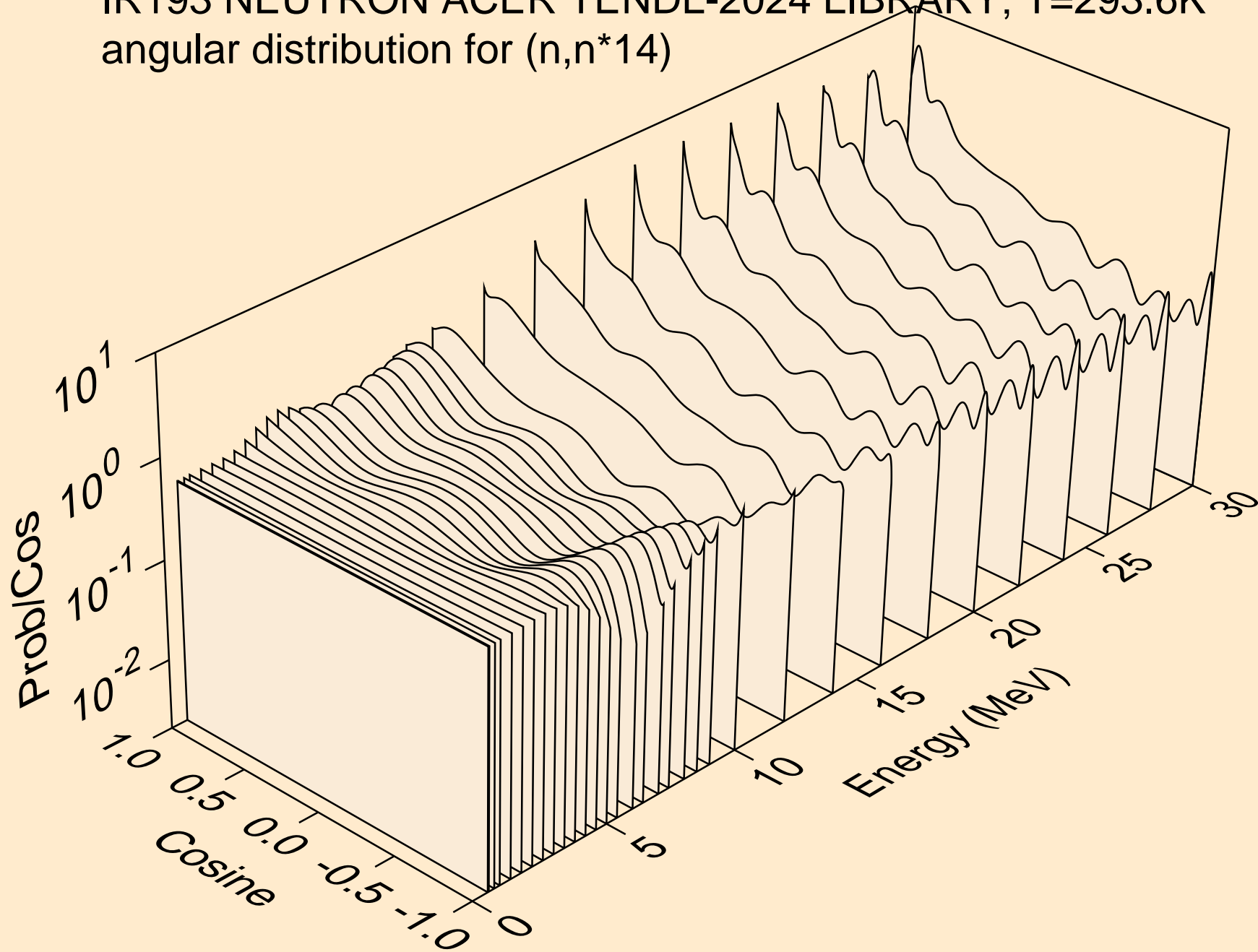

IR193 NEUTRON ACER TENDL-2024 LIBRARY; T=293.6K  
angular distribution for (n,n\*15)

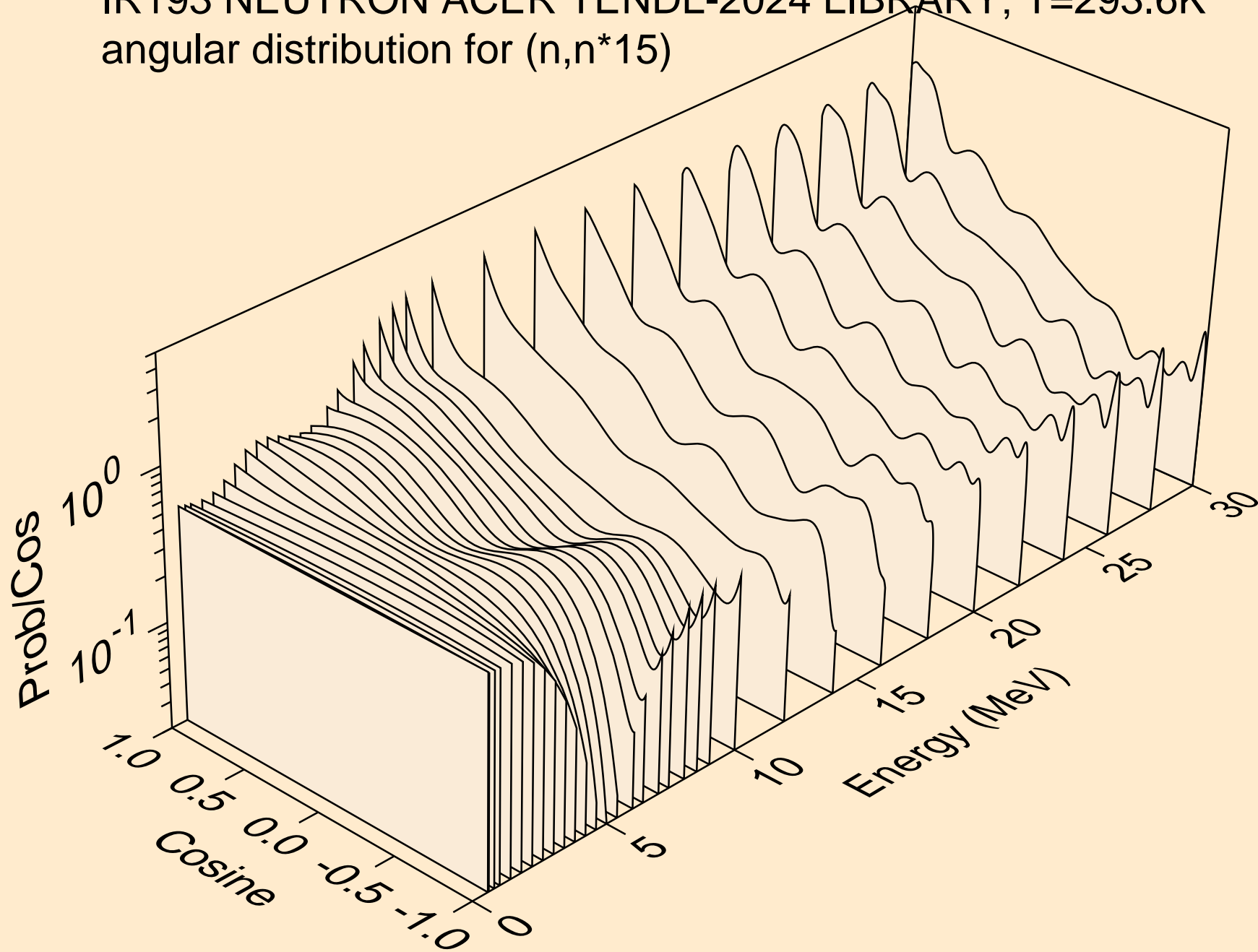

IR193 NEUTRON ACER TENDL-2024 LIBRARY; T=293.6K  
angular distribution for (n,n\*16)

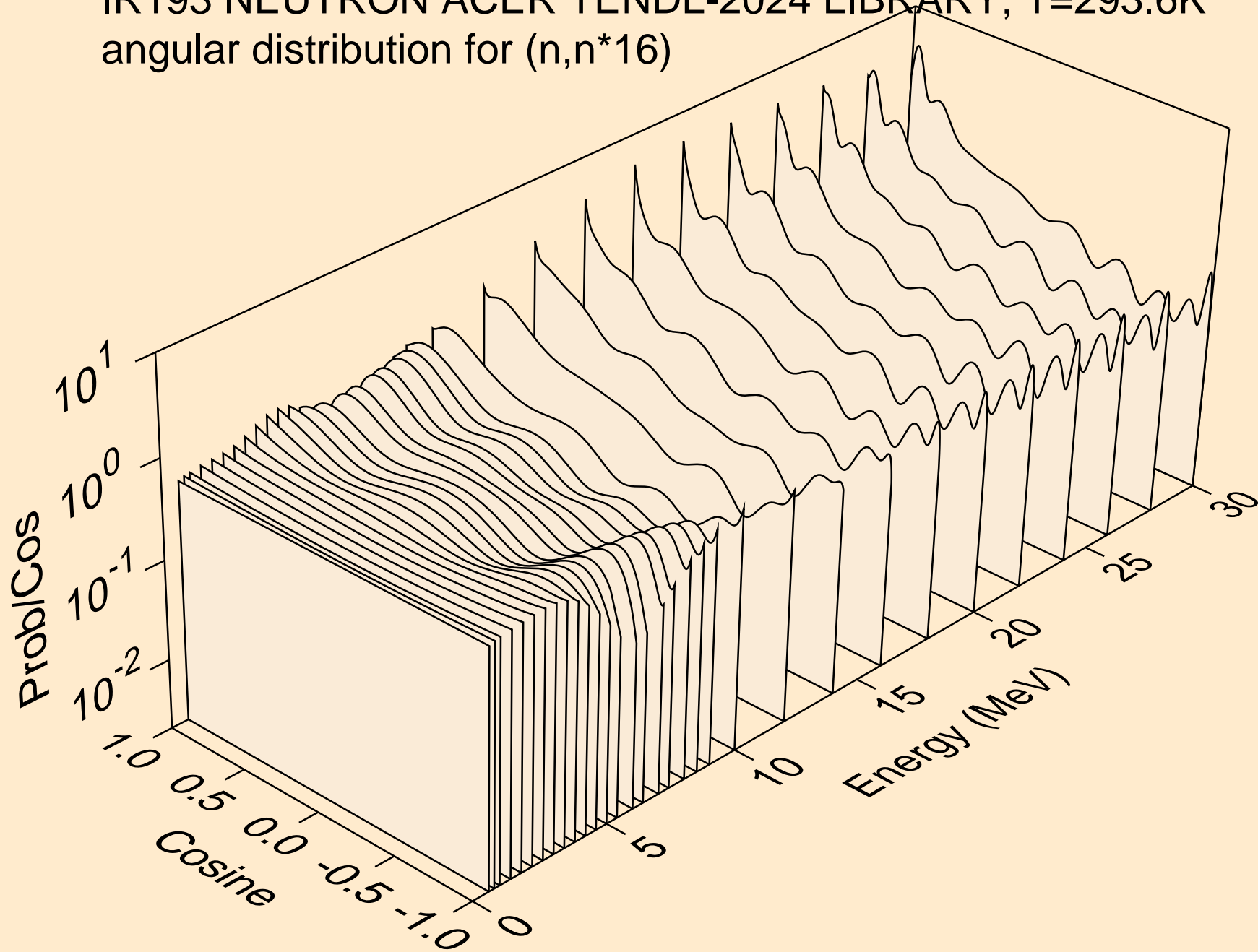

IR193 NEUTRON ACER TENDL-2024 LIBRARY; T=293.6K  
angular distribution for (n,n\*17)

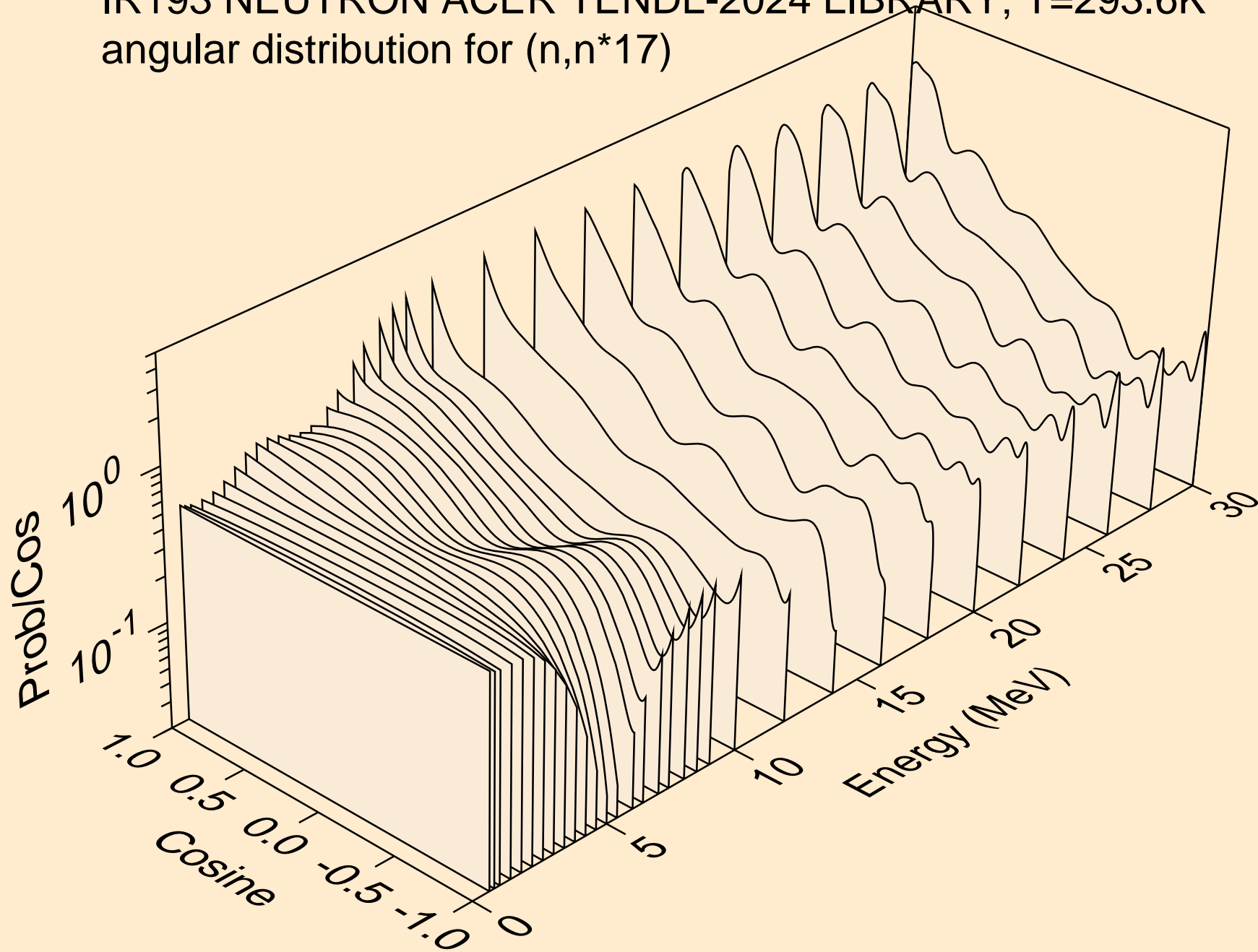

IR193 NEUTRON ACER TENDL-2024 LIBRARY; T=293.6K  
angular distribution for (n,n\*18)

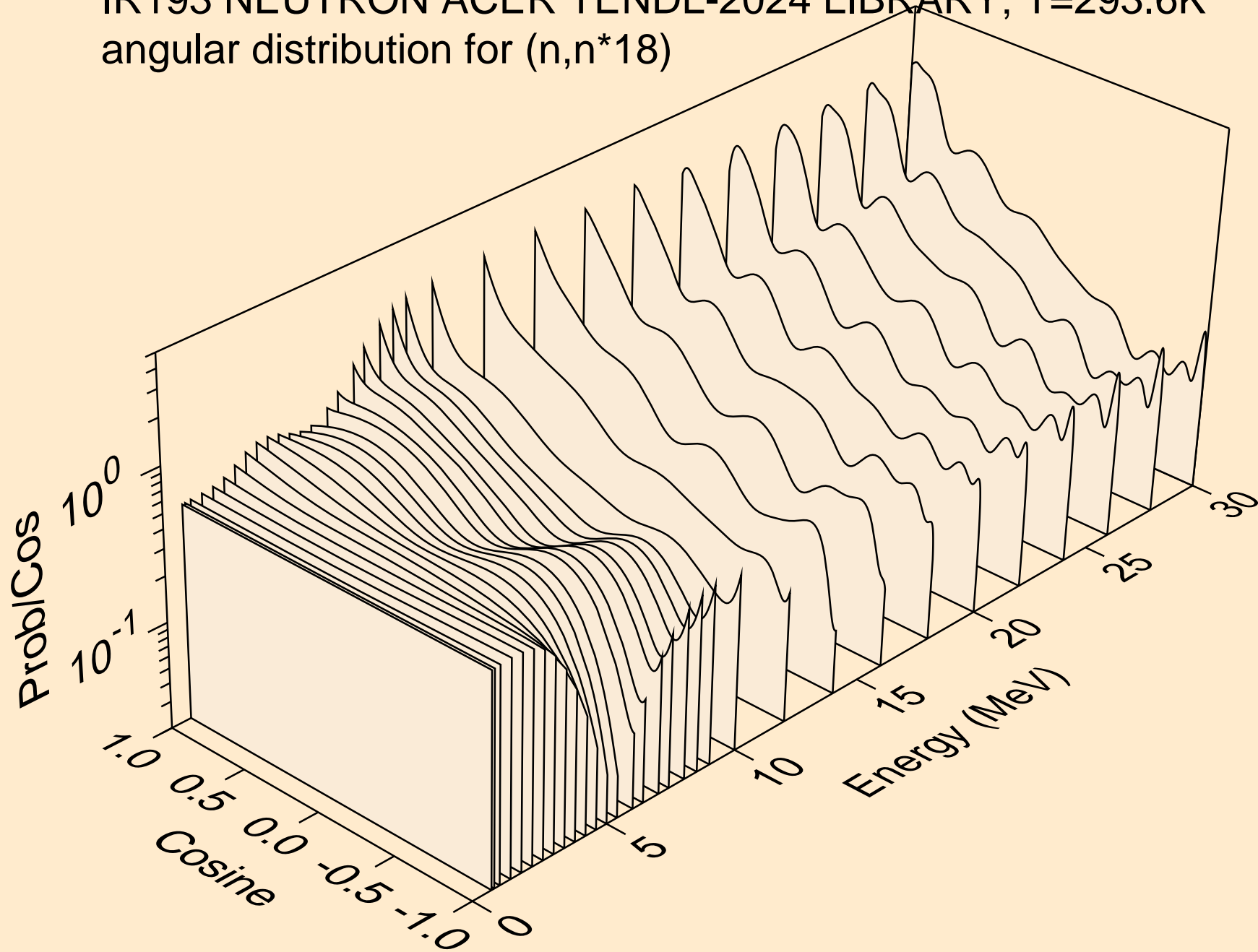

IR193 NEUTRON ACER TENDL-2024 LIBRARY; T=293.6K  
angular distribution for (n,n\*19)

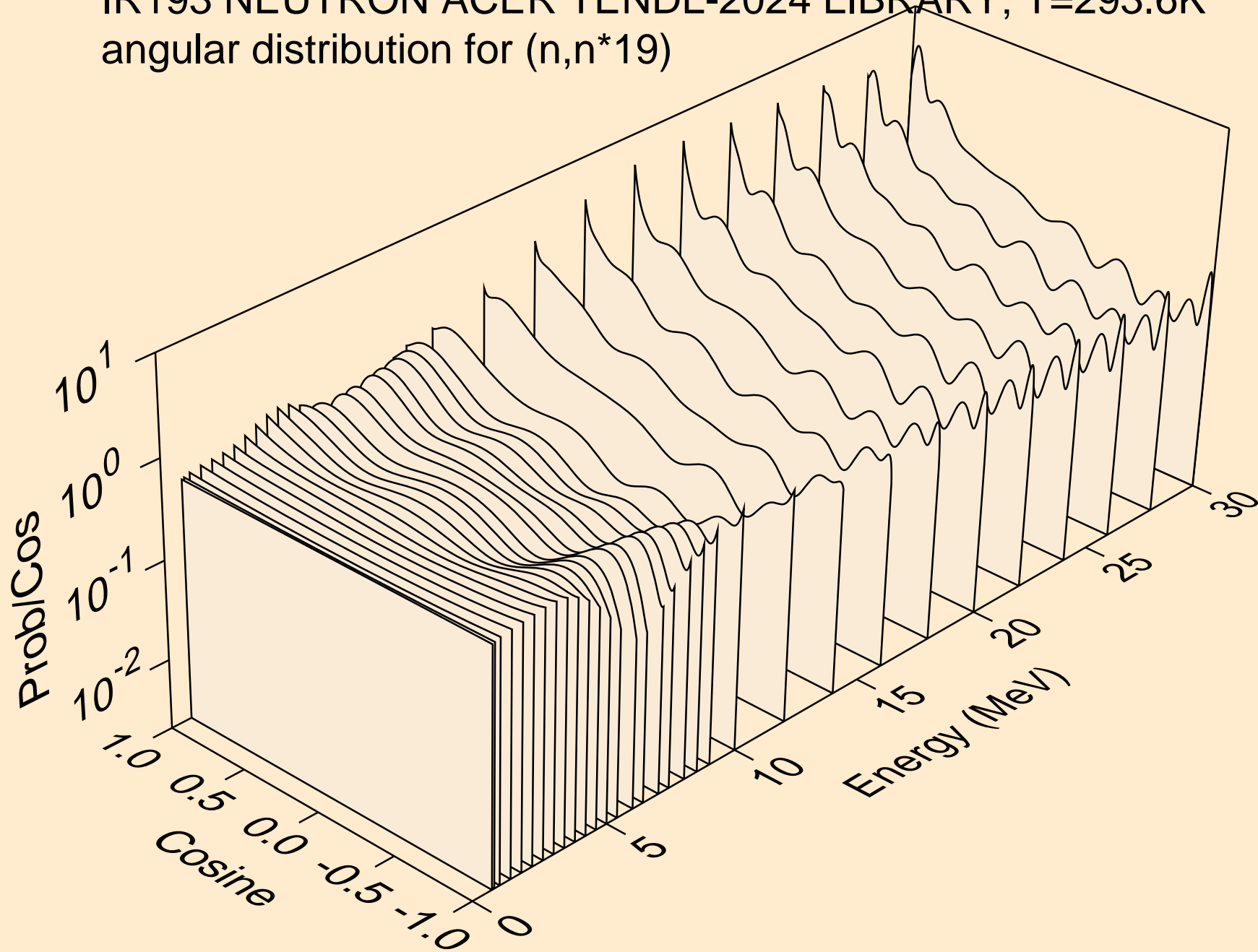

IR193 NEUTRON ACER TENDL-2024 LIBRARY; T=293.6K  
angular distribution for (n,n\*20)

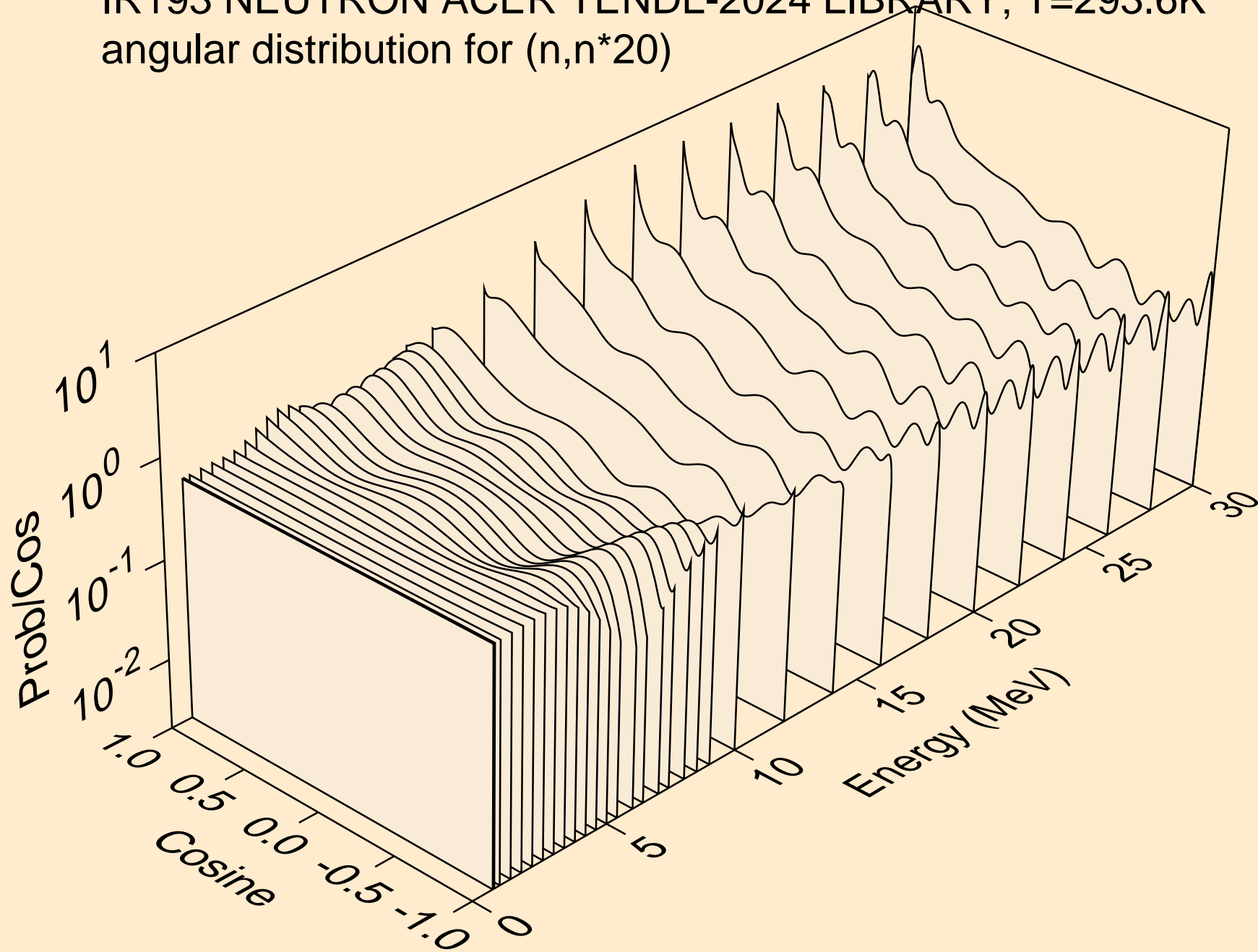

IR193 NEUTRON ACER TENDL-2024 LIBRARY; T=293.6K  
angular distribution for (n,n\*21)

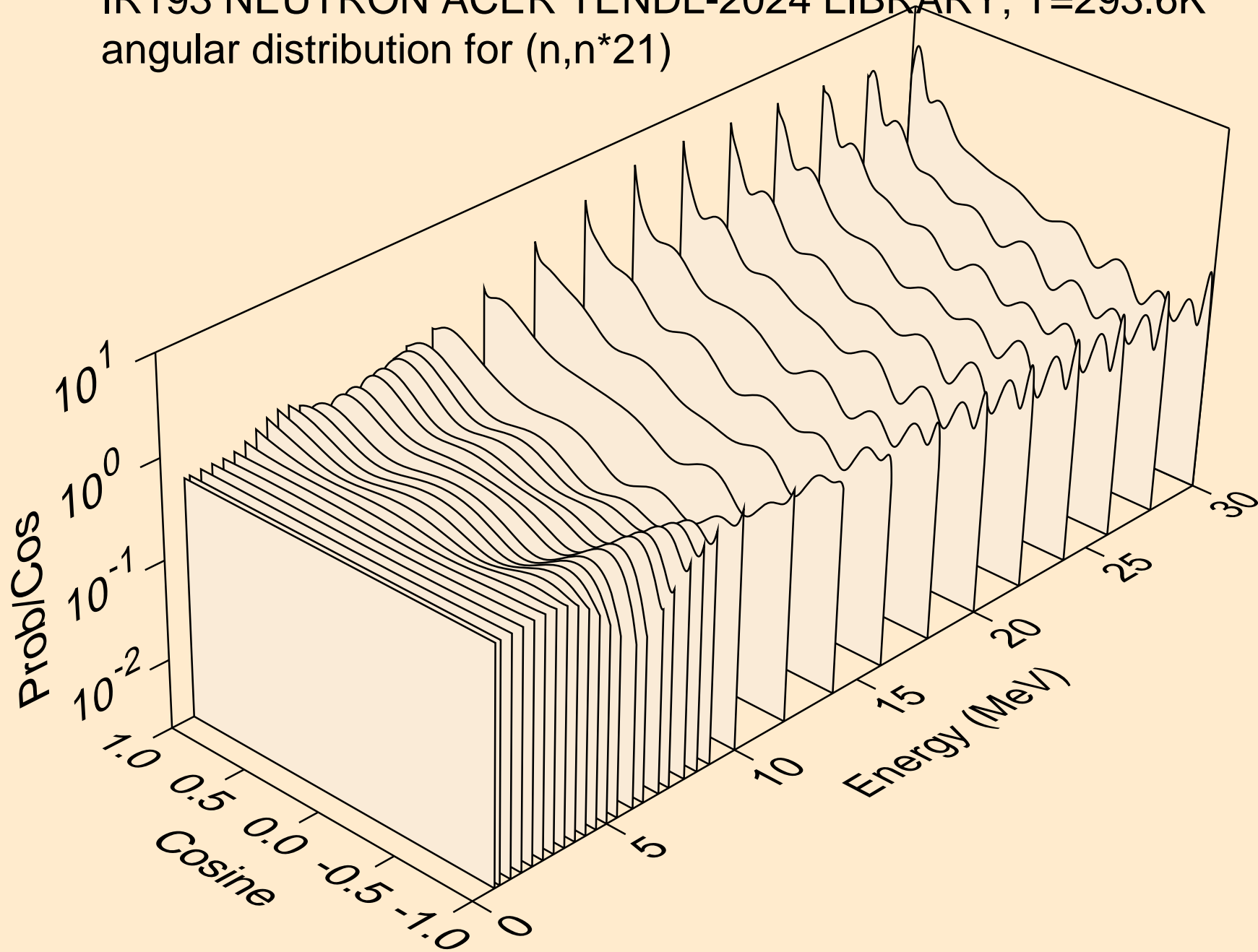

IR193 NEUTRON ACER TENDL-2024 LIBRARY; T=293.6K  
angular distribution for (n,n\*22)

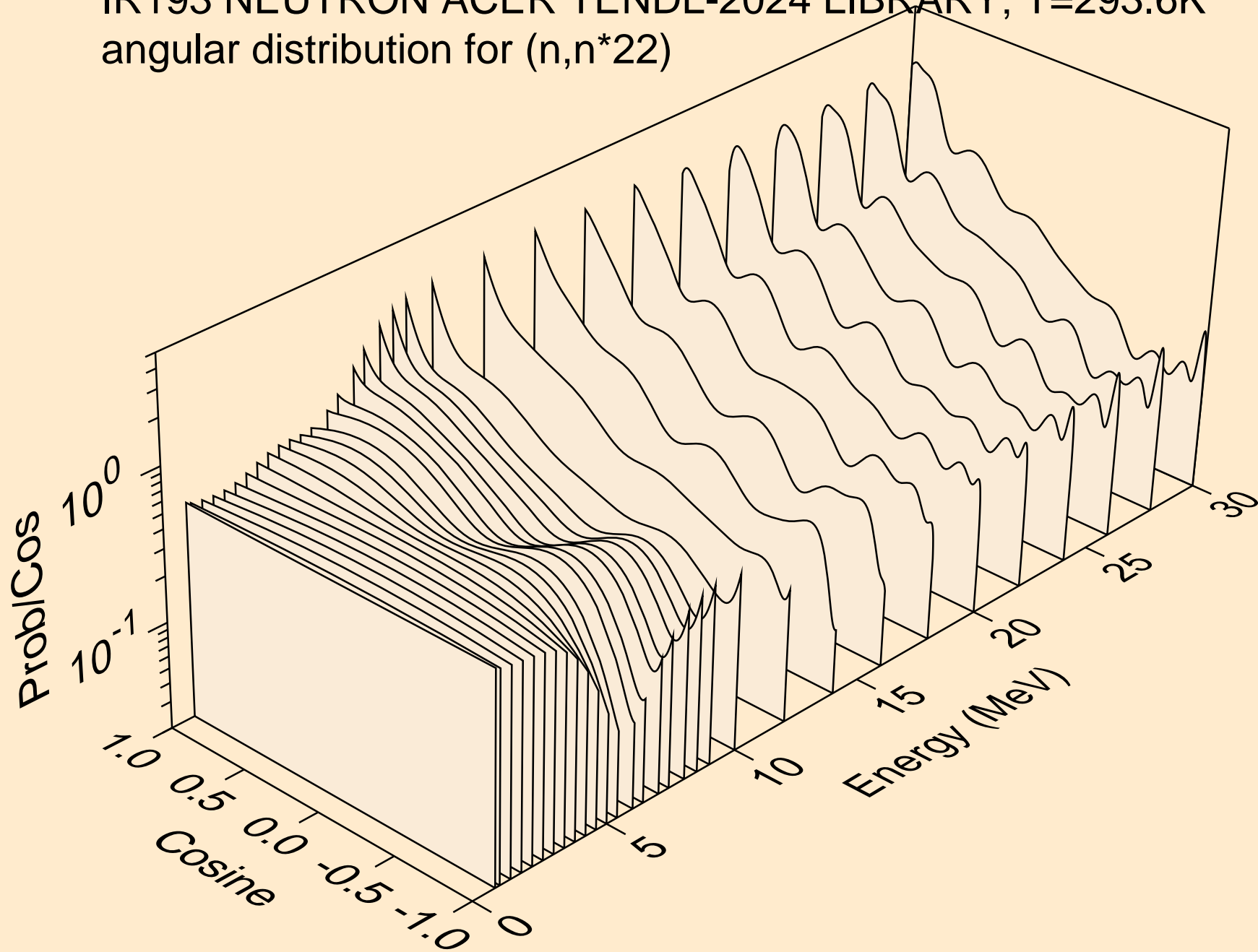

IR193 NEUTRON ACER TENDL-2024 LIBRARY; T=293.6K  
angular distribution for (n,n\*23)

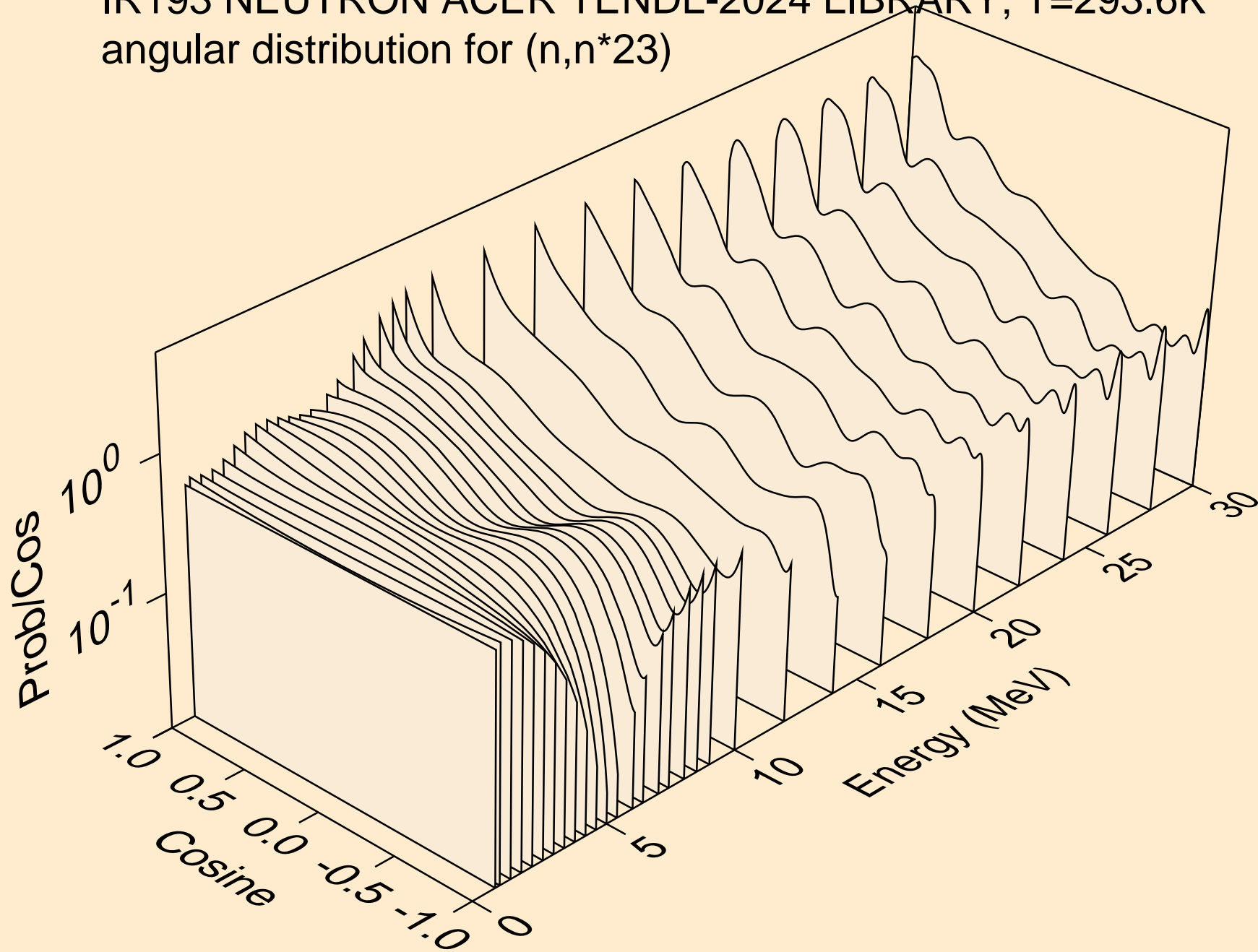

IR193 NEUTRON ACER TENDL-2024 LIBRARY; T=293.6K  
angular distribution for (n,n\*24)

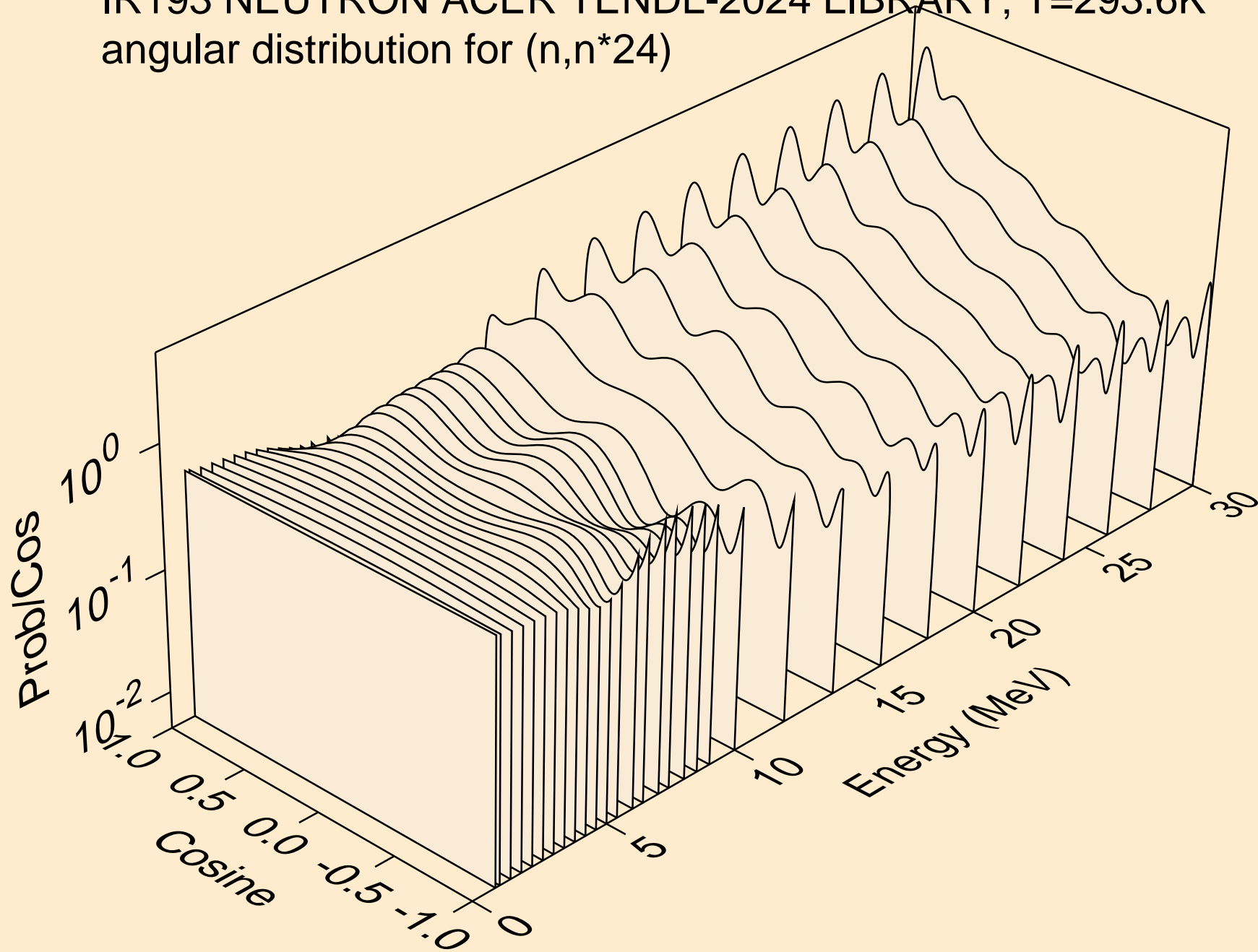

IR193 NEUTRON ACER TENDL-2024 LIBRARY; T=293.6K  
angular distribution for (n,n\*25)

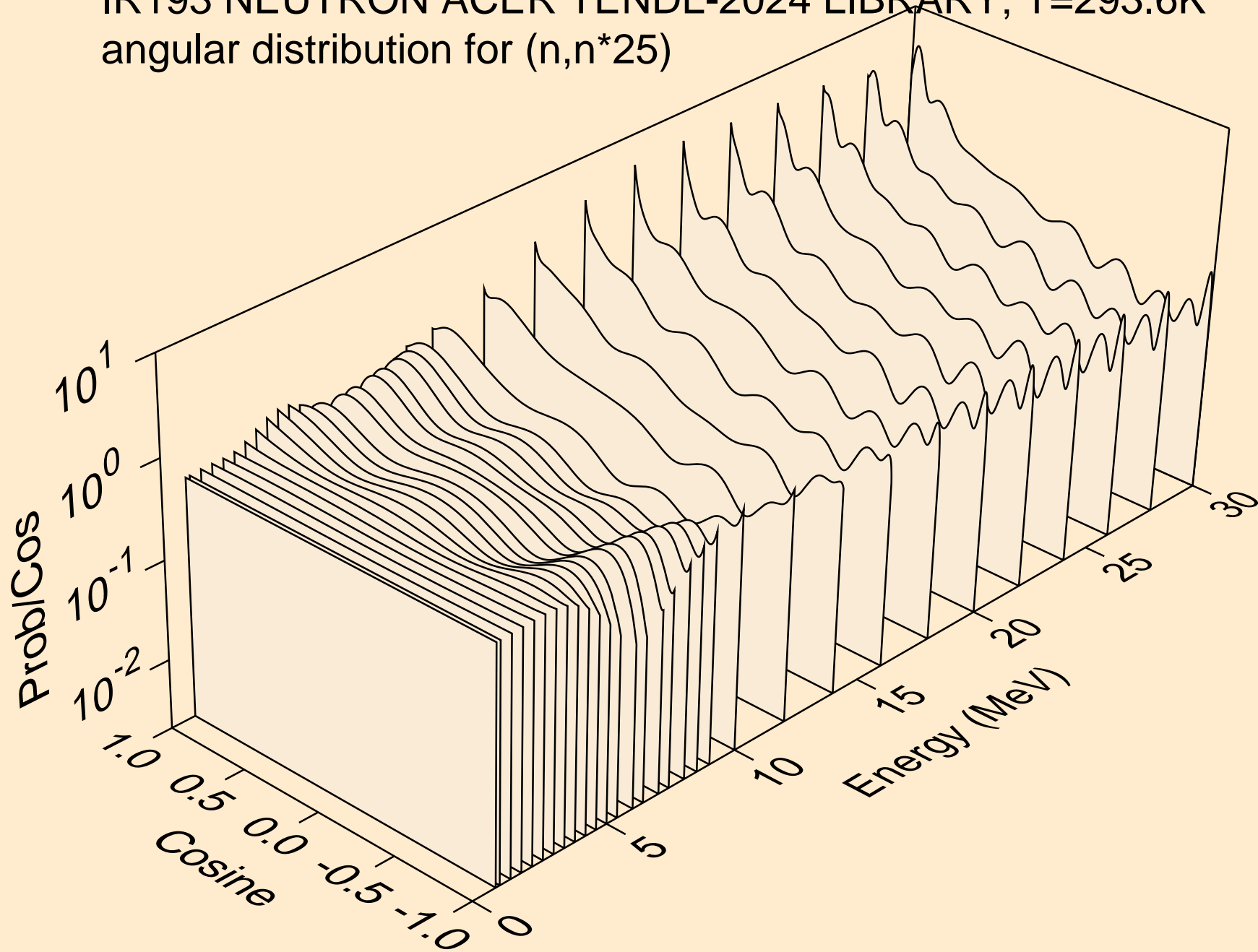

IR193 NEUTRON ACER TENDL-2024 LIBRARY; T=293.6K  
angular distribution for (n,n\*26)

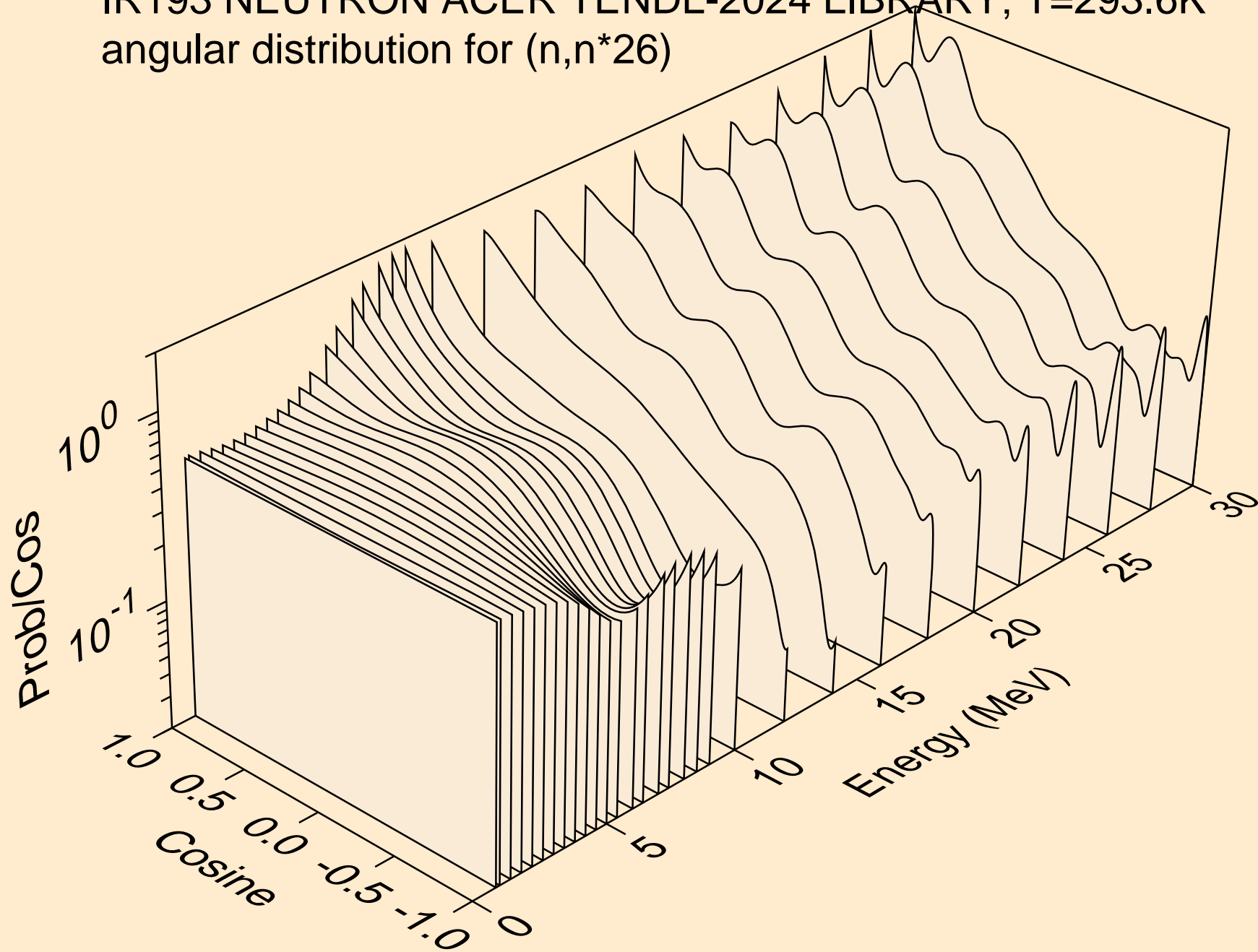

IR193 NEUTRON ACER TENDL-2024 LIBRARY; T=293.6K  
angular distribution for (n,n\*27)

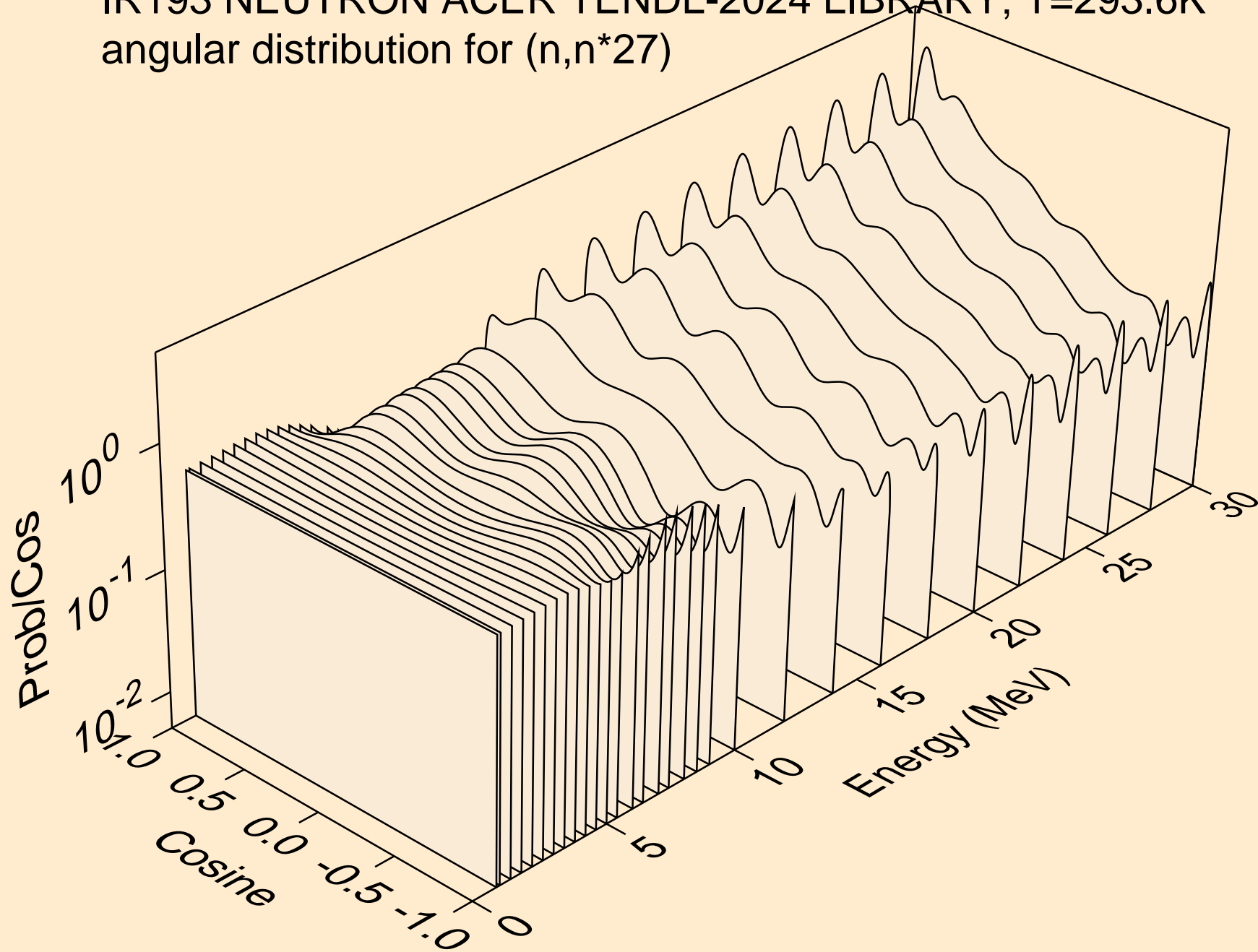

IR193 NEUTRON ACER TENDL-2024 LIBRARY; T=293.6K  
angular distribution for (n,n\*28)

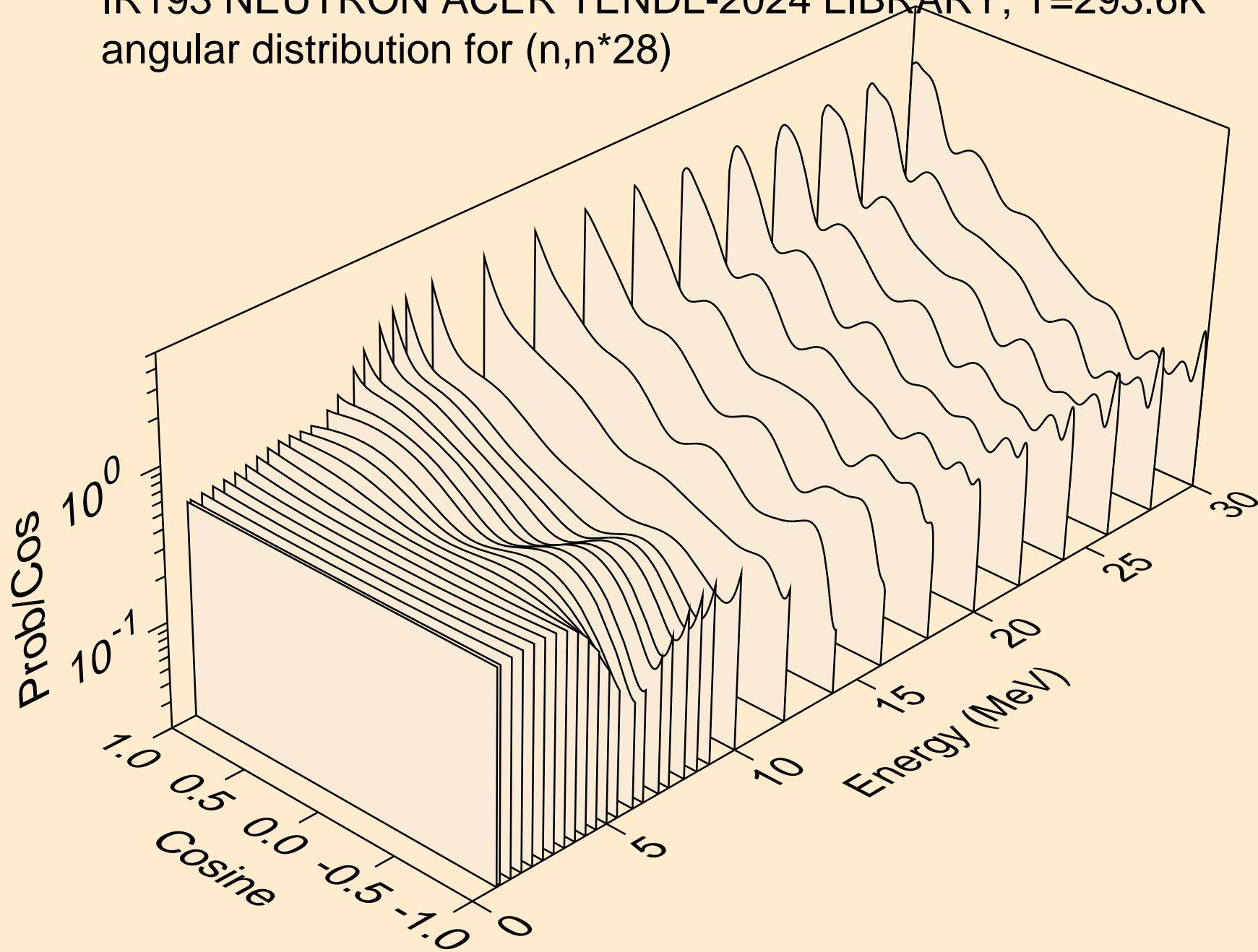

IR193 NEUTRON ACER TENDL-2024 LIBRARY; T=293.6K  
angular distribution for (n,n\*29)

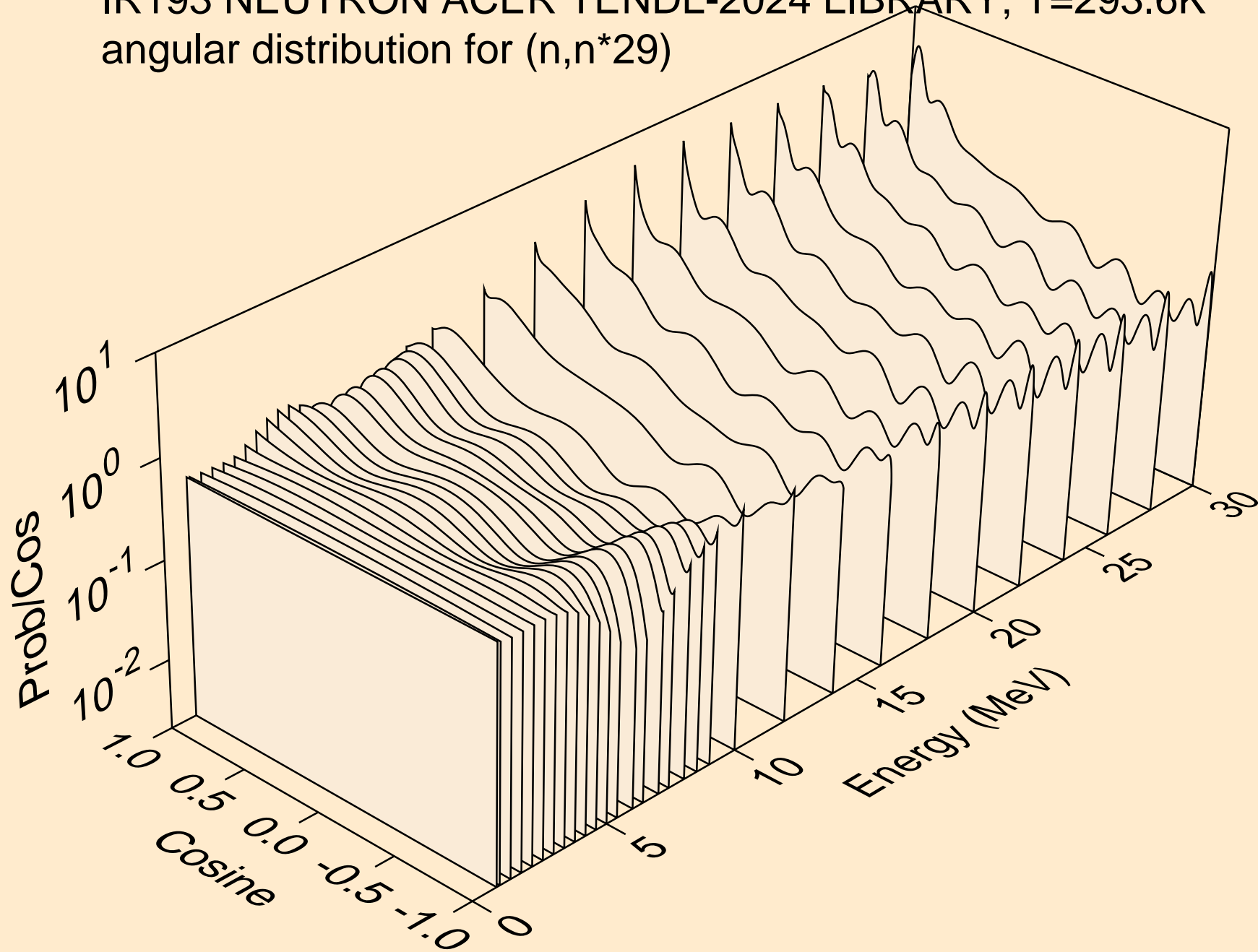

IR193 NEUTRON ACER TENDL-2024 LIBRARY; T=293.6K  
angular distribution for (n,n\*30)

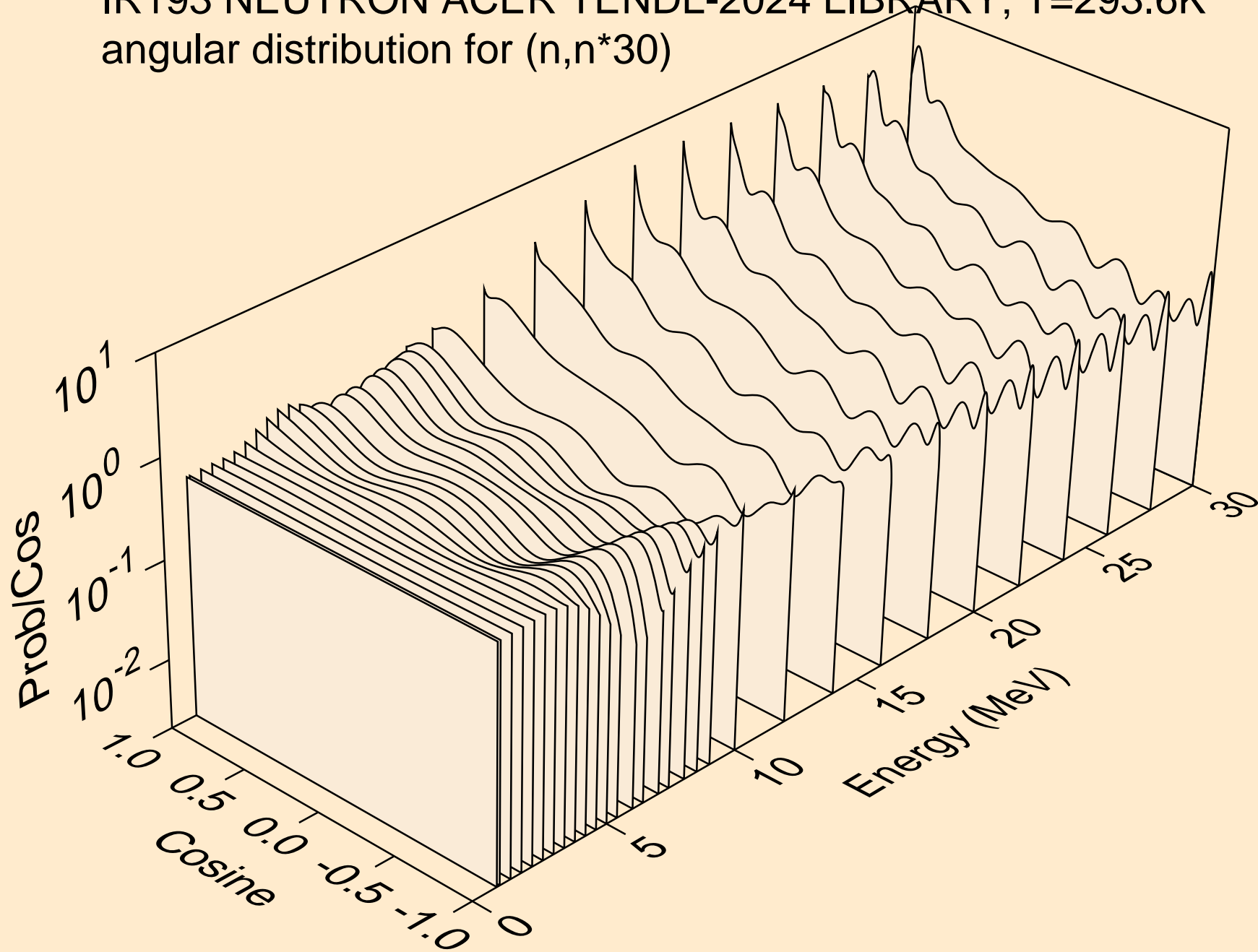

IR193 NEUTRON ACER TENDL-2024 LIBRARY; T=293.6K  
Neutron emission for (n,x)

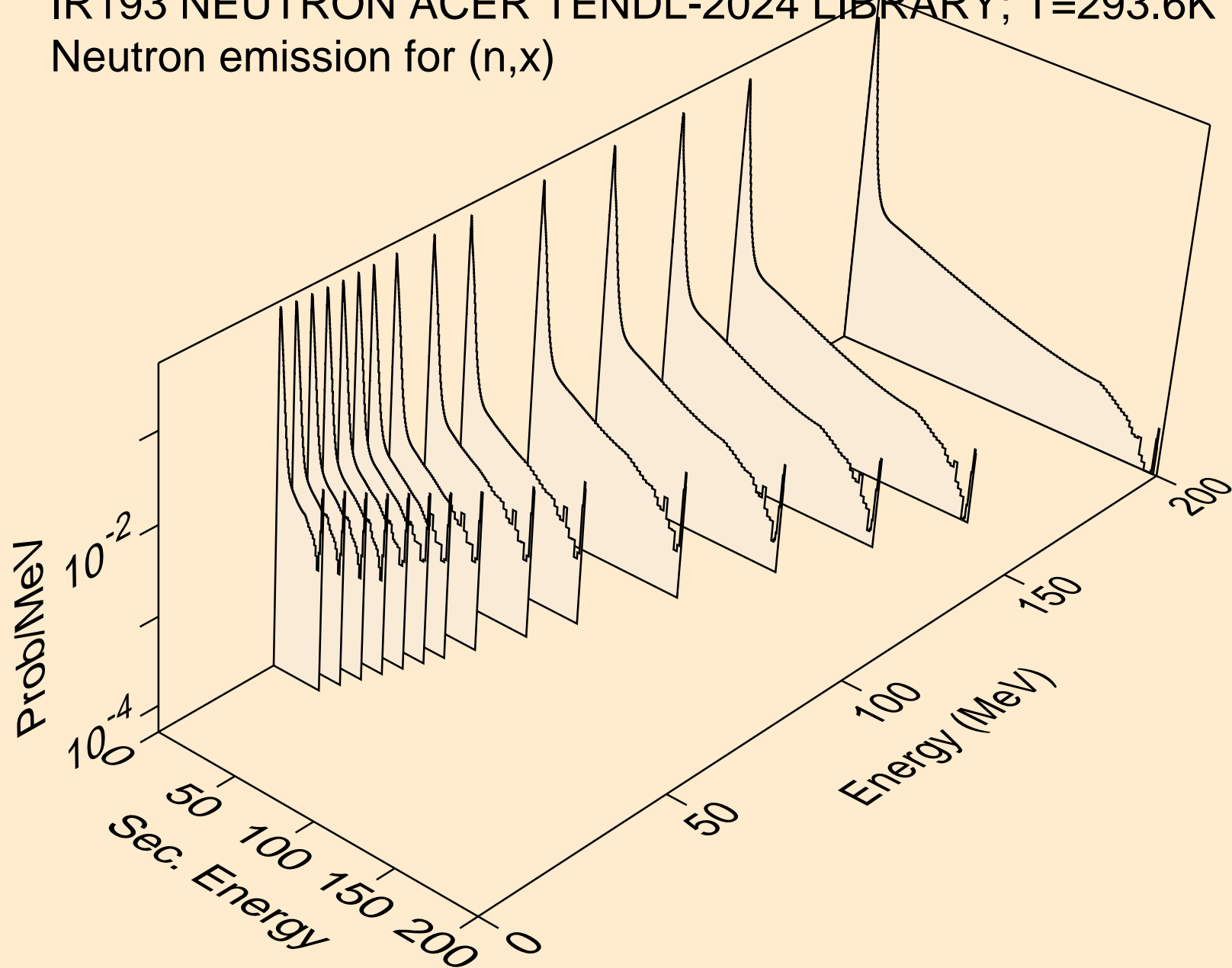

IR193 NEUTRON ACER TENDL-2024 LIBRARY; T=293.6K  
Neutron emission for (n,2nd)

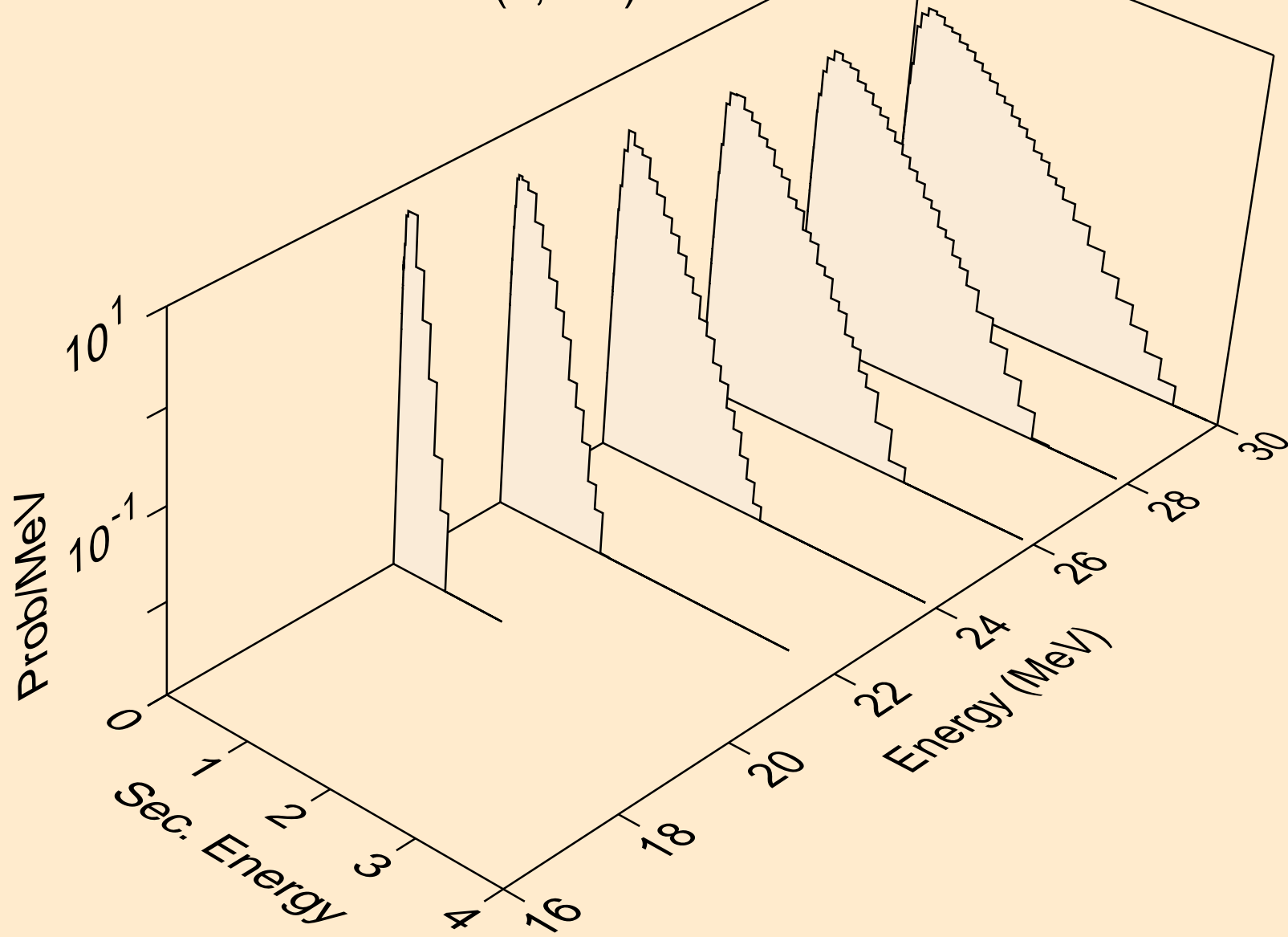

IR193 NEUTRON ACER TENDL-2024 LIBRARY; T=293.6K  
Neutron emission for (n,2n)

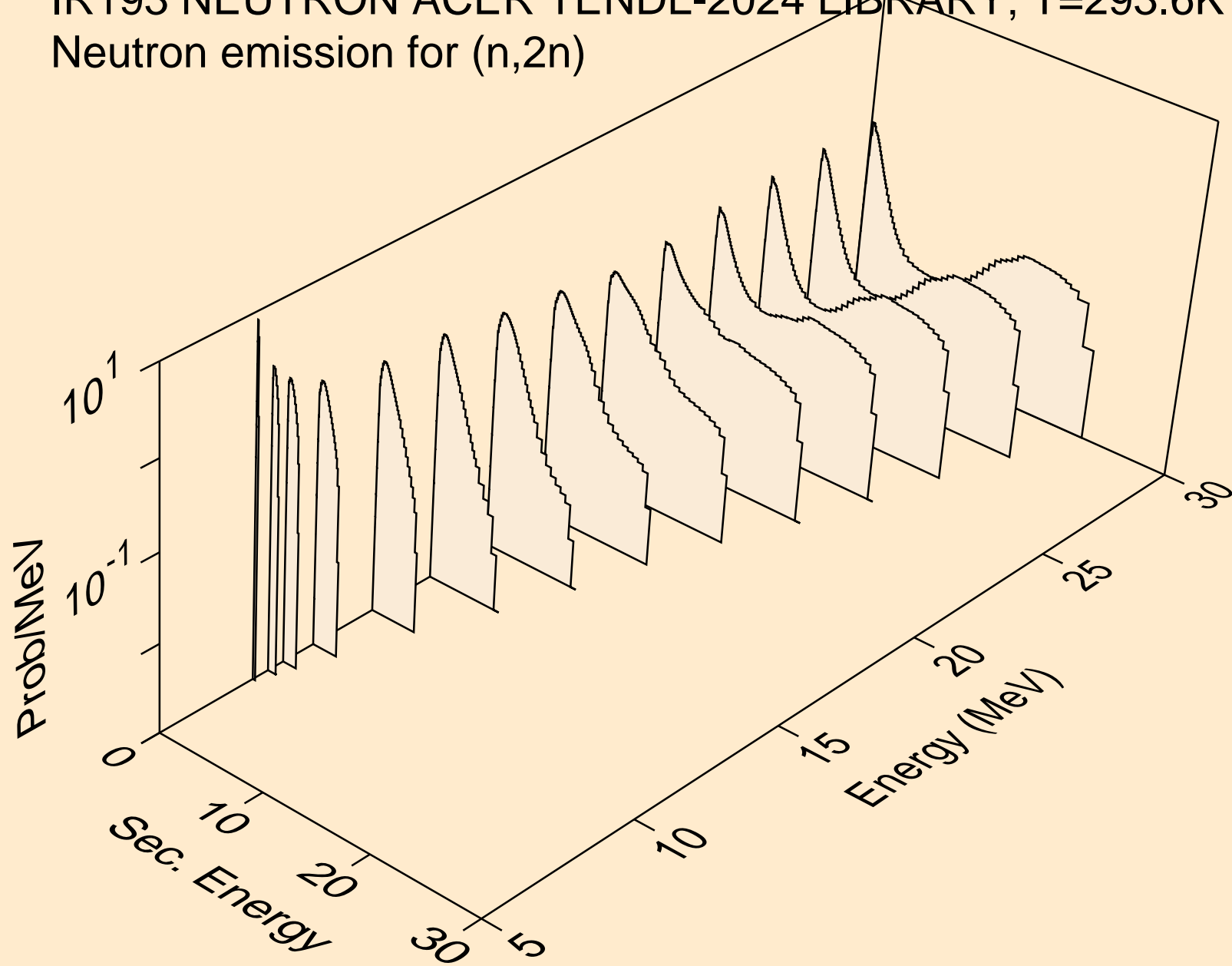

IR193 NEUTRON ACER TENDL-2024 LIBRARY; T=293.6K  
Neutron emission for (n,3n)

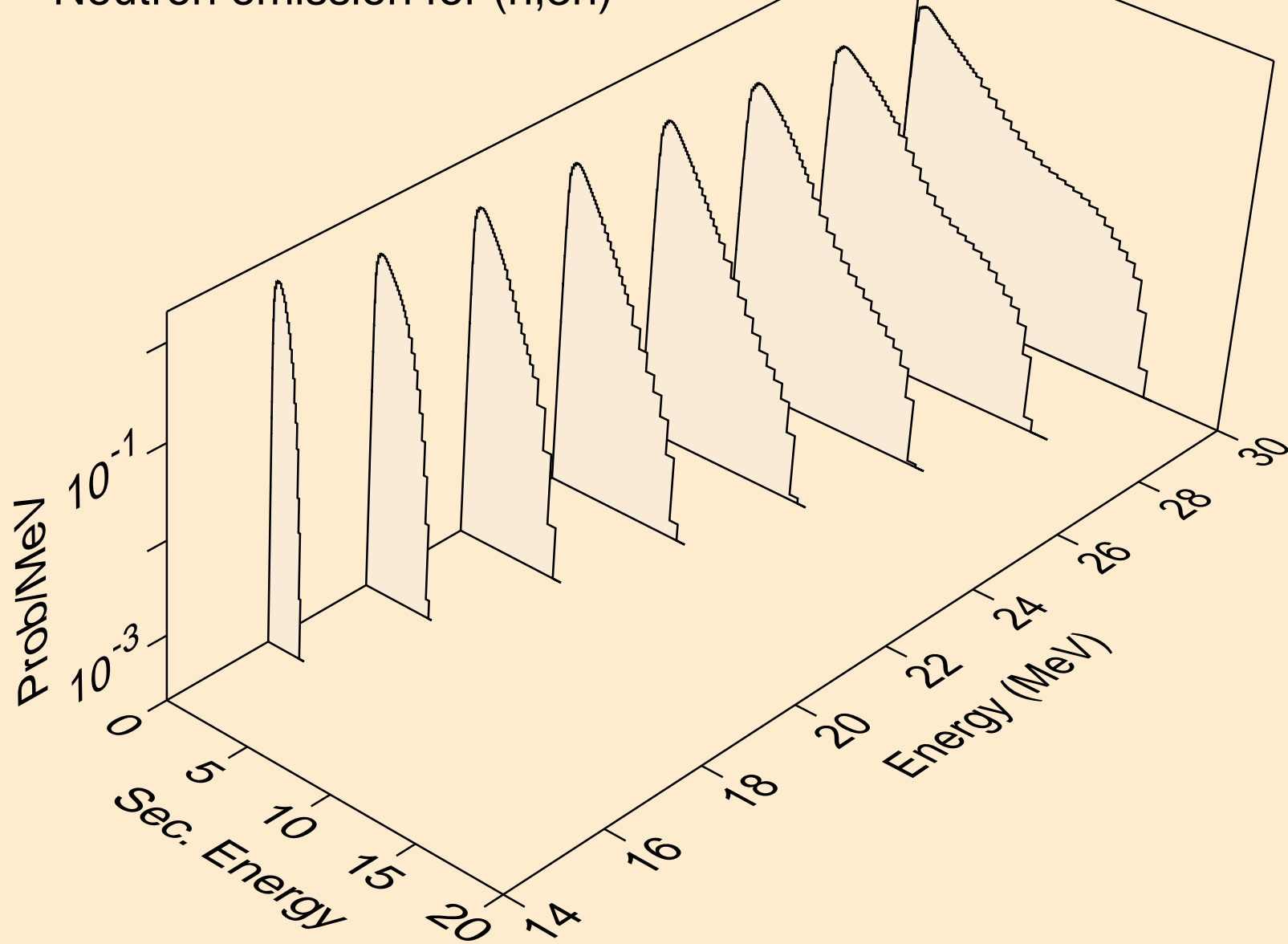

IR193 NEUTRON ACER TENDL-2024 LIBRARY; T=293.6K  
Neutron emission for (n,n\*)a

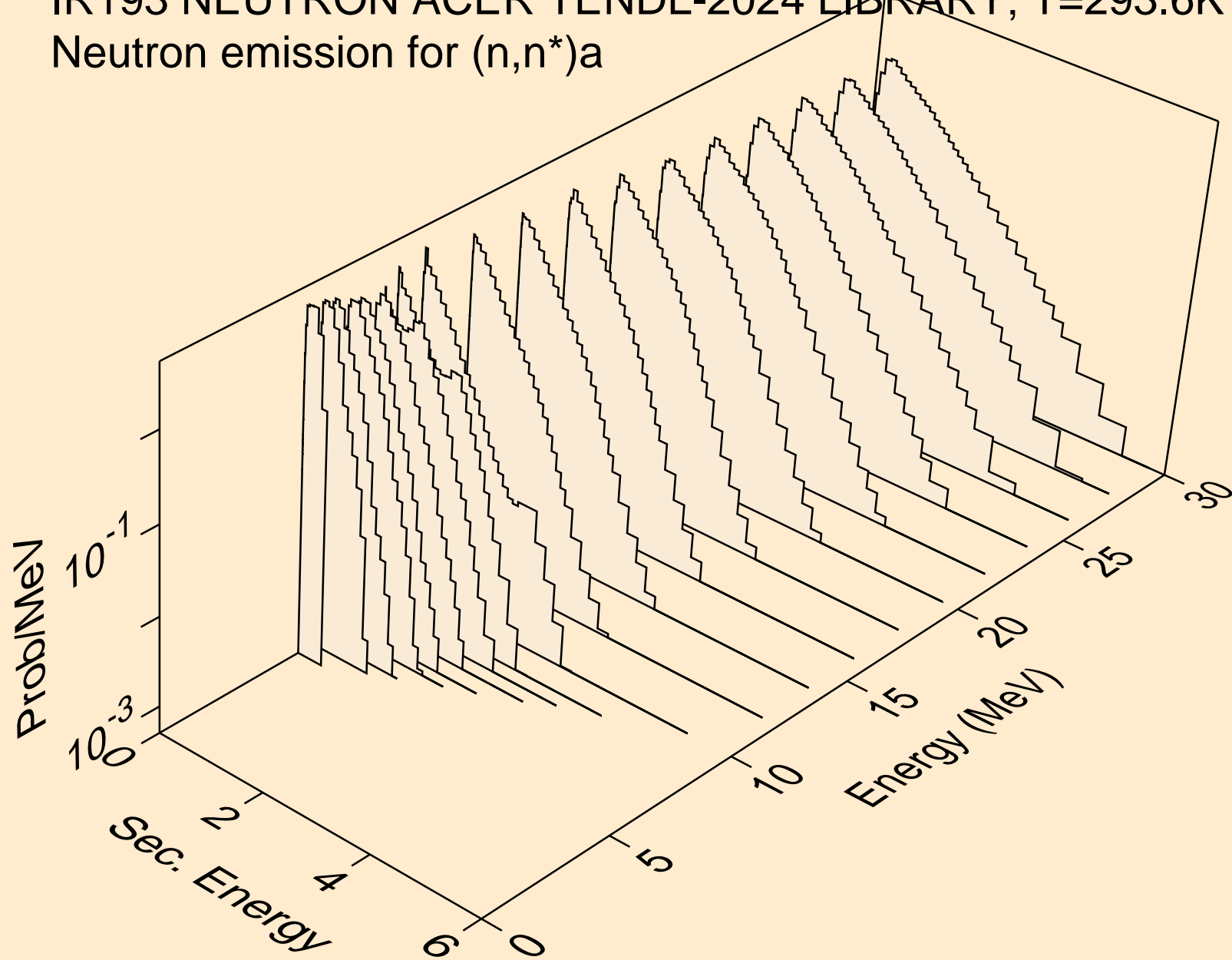

IR193 NEUTRON ACER TENDL-2024 LIBRARY; T=293.6K  
Neutron emission for (n,2n)a

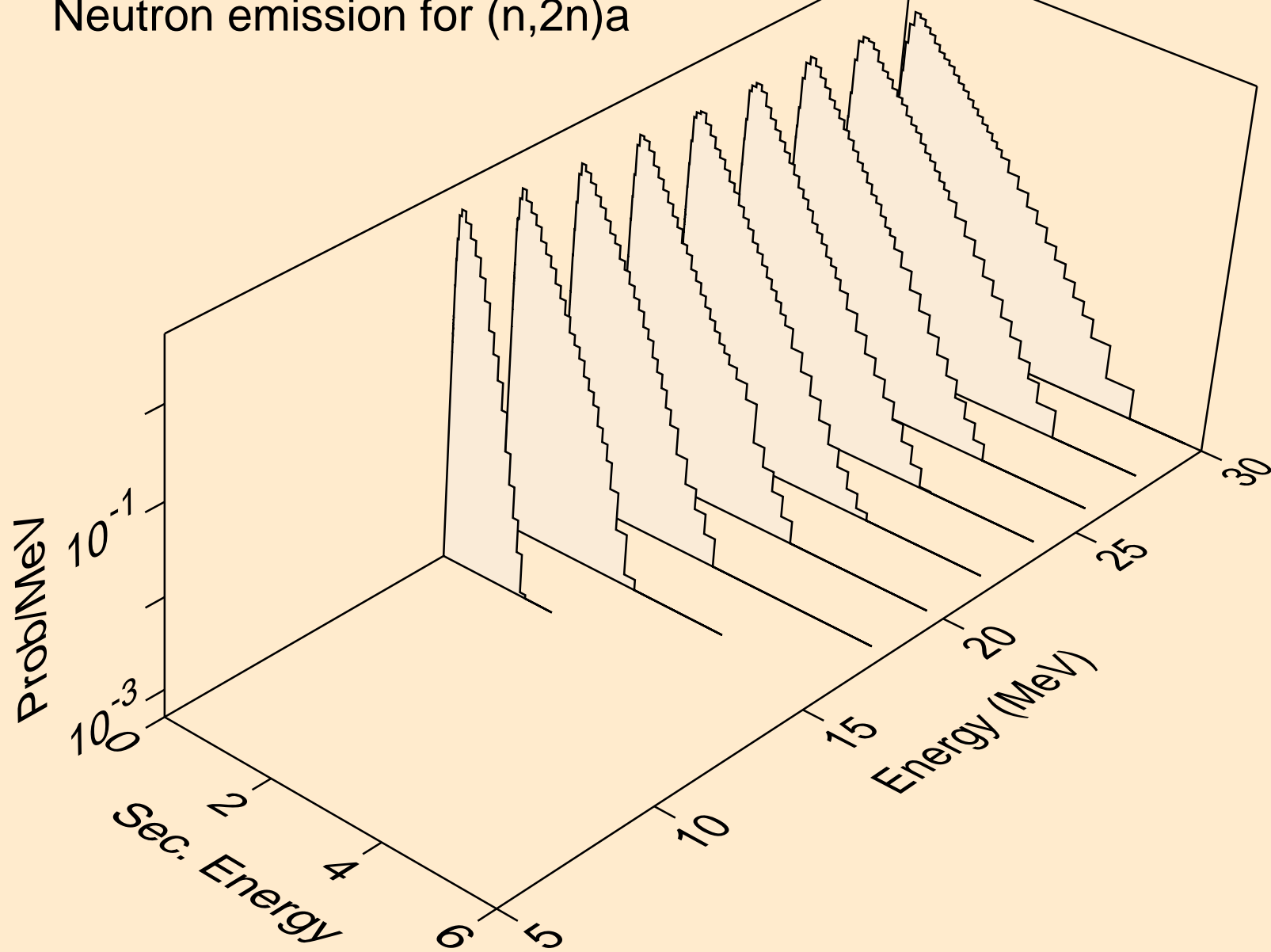

IR193 NEUTRON ACER TENDL-2024 LIBRARY; T=293.6K  
Neutron emission for (n,3n)<sub>a</sub>

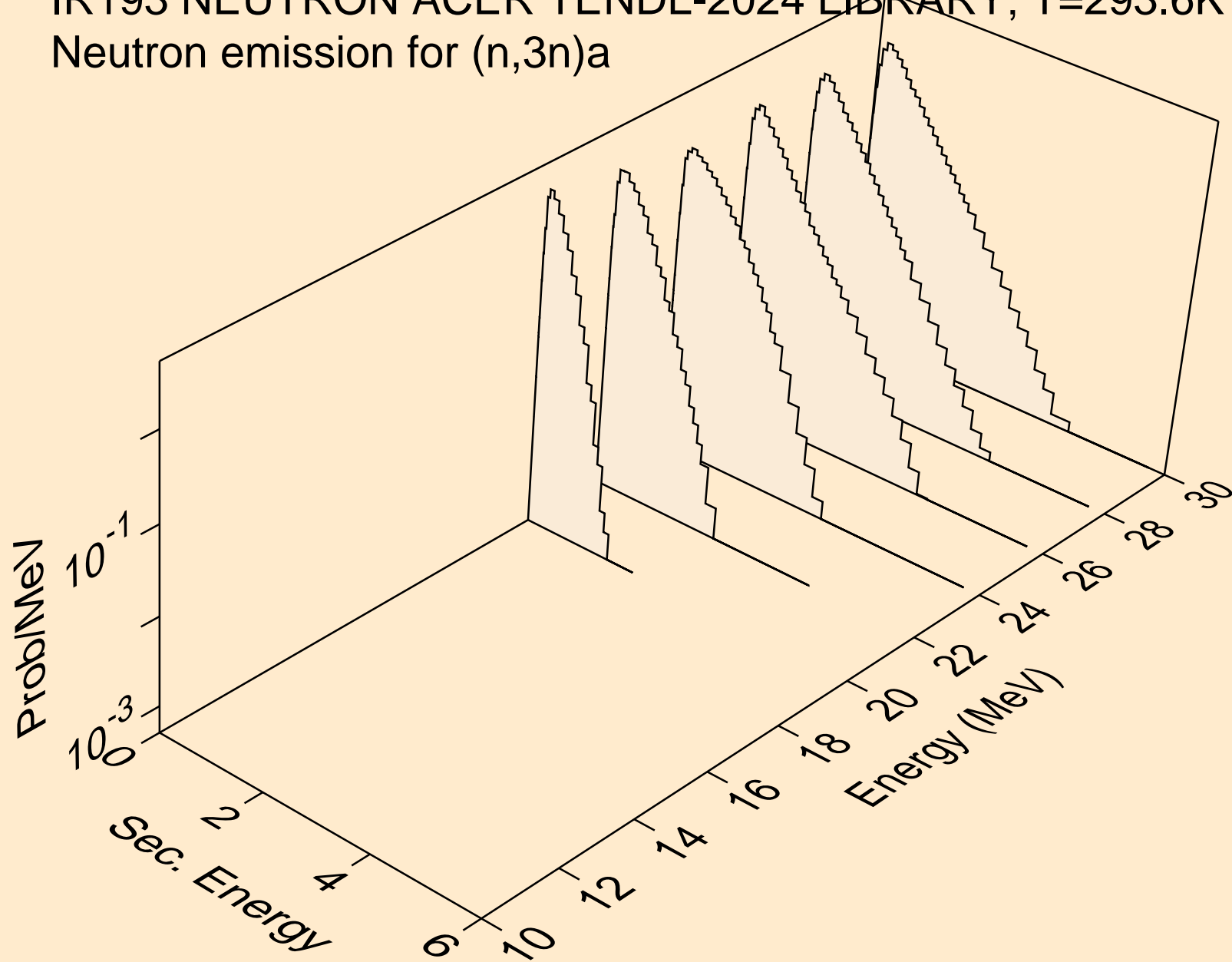

IR193 NEUTRON ACER TENDL-2024 LIBRARY; T=293.6K  
Neutron emission for (n,n\*)p

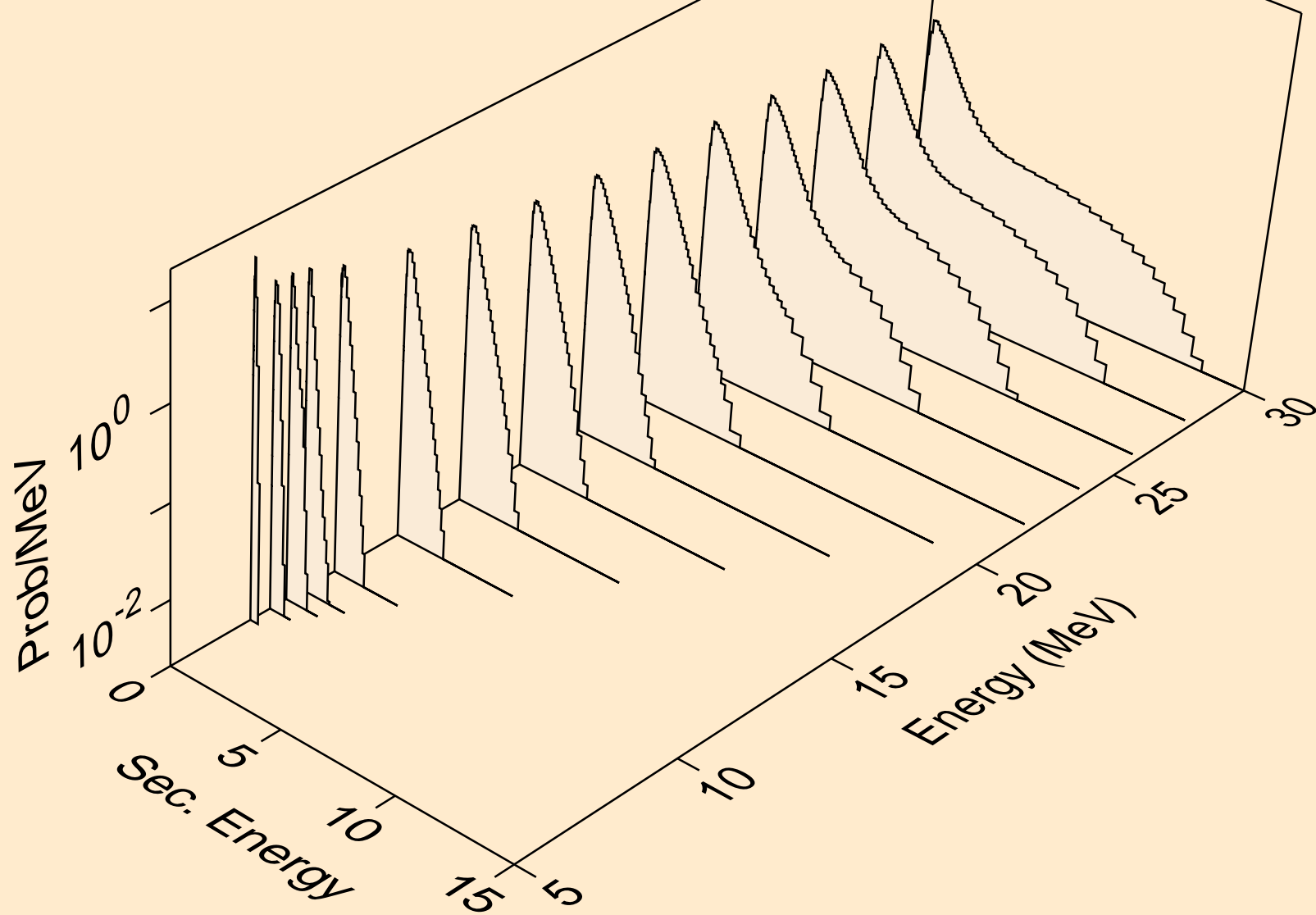

IR193 NEUTRON ACER TENDL-2024 LIBRARY; T=293.6K  
Neutron emission for (n,n\*)d

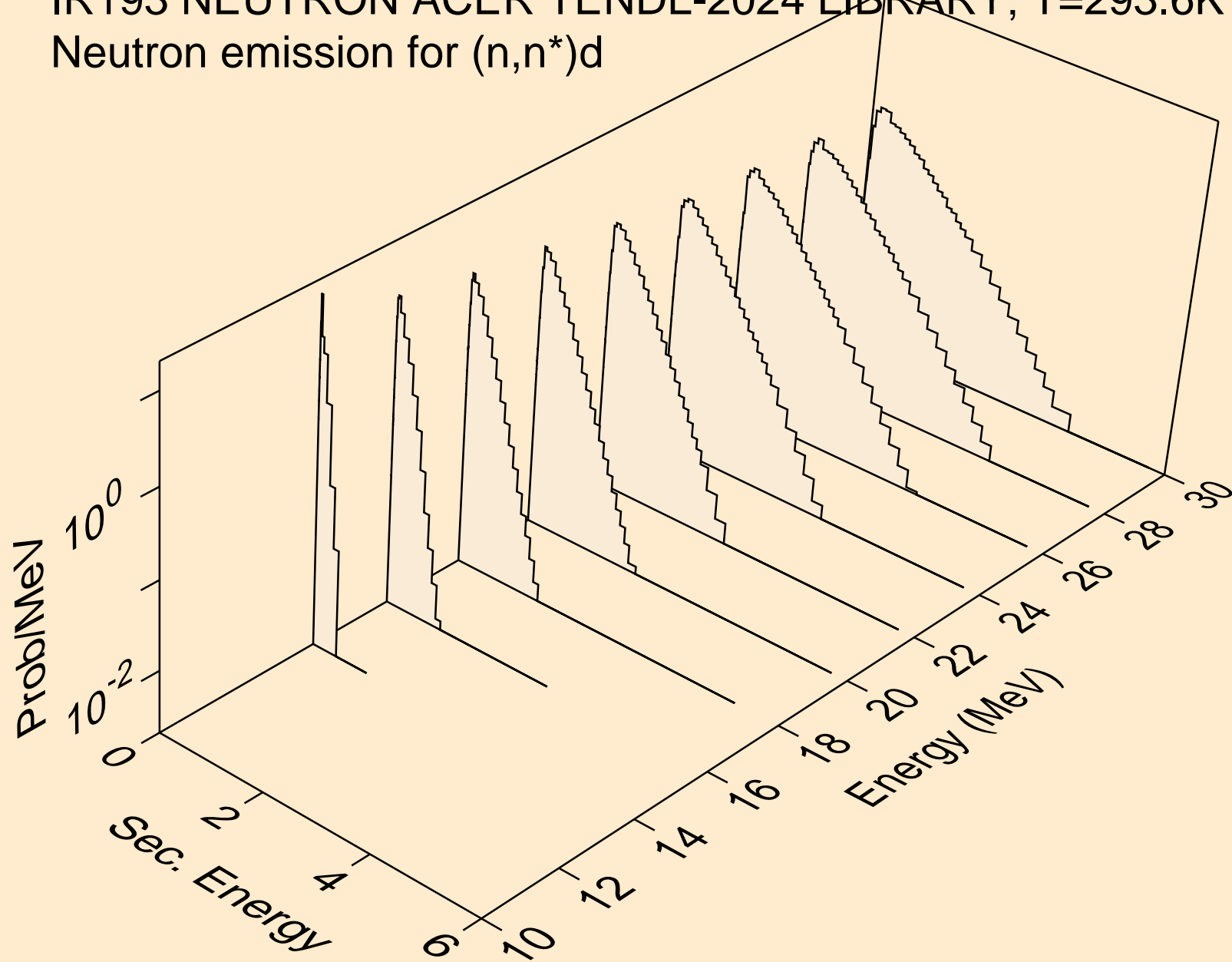

IR193 NEUTRON ACER TENDL-2024 LIBRARY; T=293.6K  
Neutron emission for (n,n\*)t

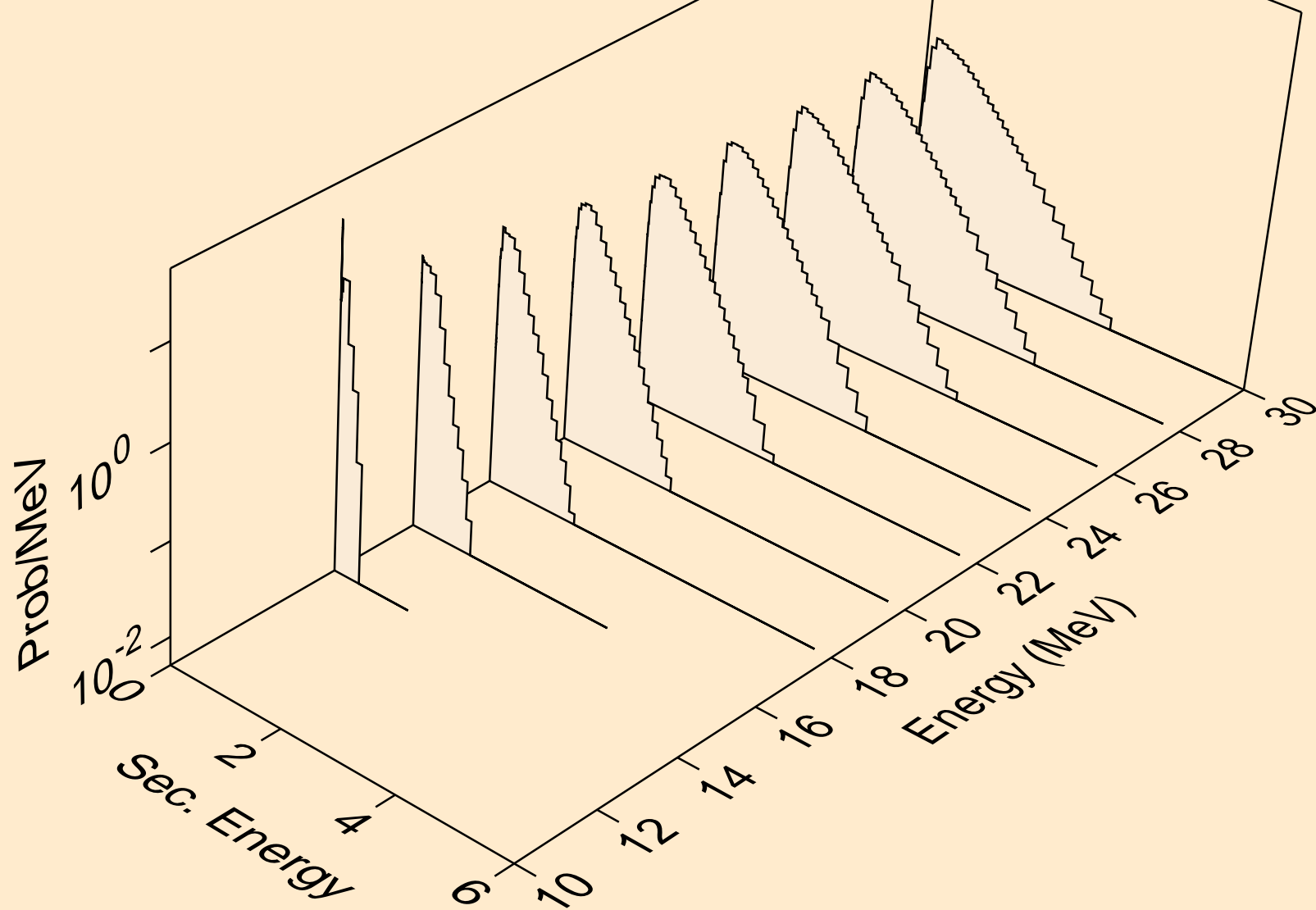

IR193 NEUTRON ACER TENDL-2024 LIBRARY; T=293.6K  
Neutron emission for (n,n\*)he3

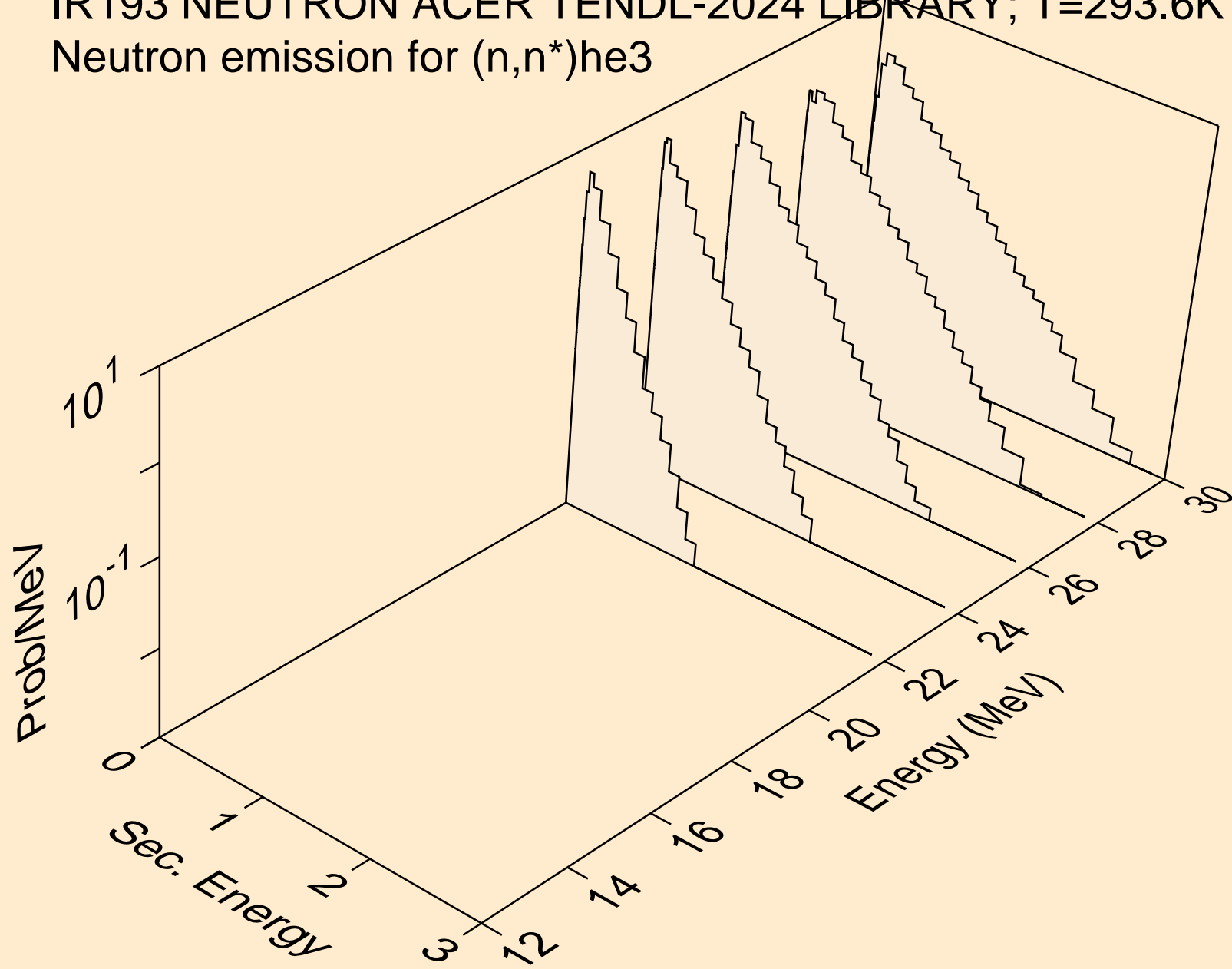

IR193 NEUTRON ACER TENDL-2024 LIBRARY; T=293.6K  
Neutron emission for (n,4n)

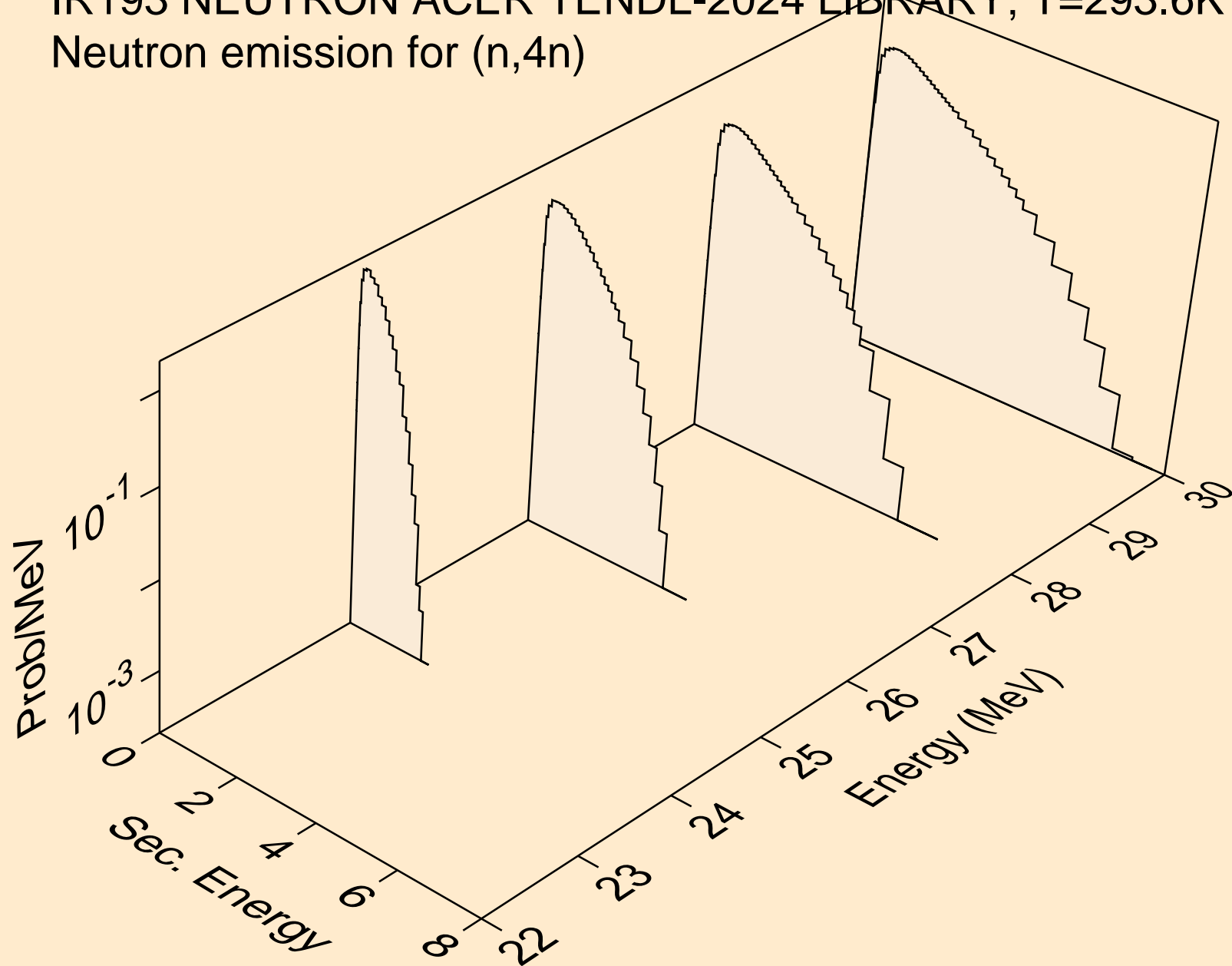

IR193 NEUTRON ACER TENDL-2024 LIBRARY; T=293.6K  
Neutron emission for (n,2np)

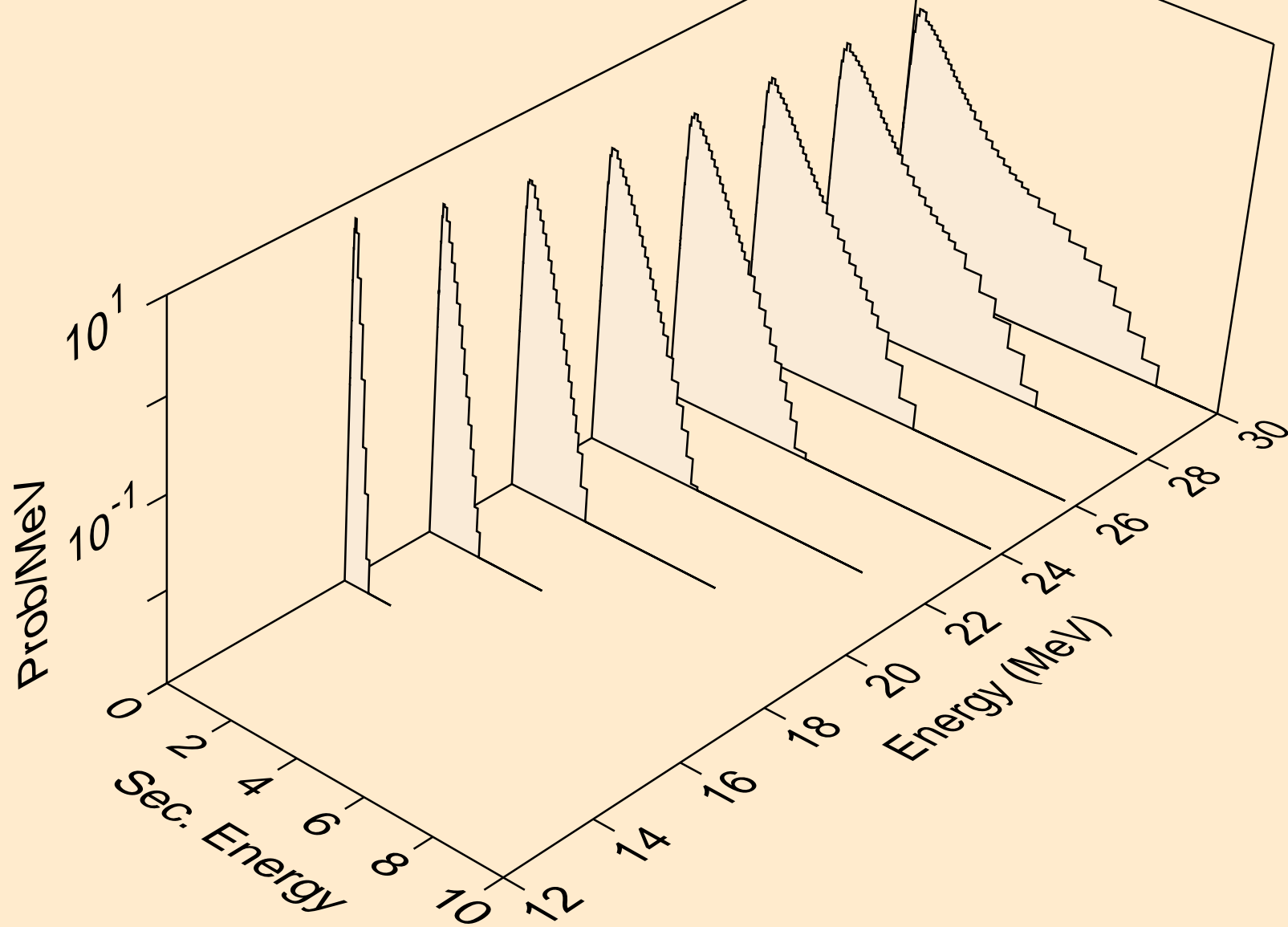

IR193 NEUTRON ACER TENDL-2024 LIBRARY; T=293.6K  
Neutron emission for (n,3np)

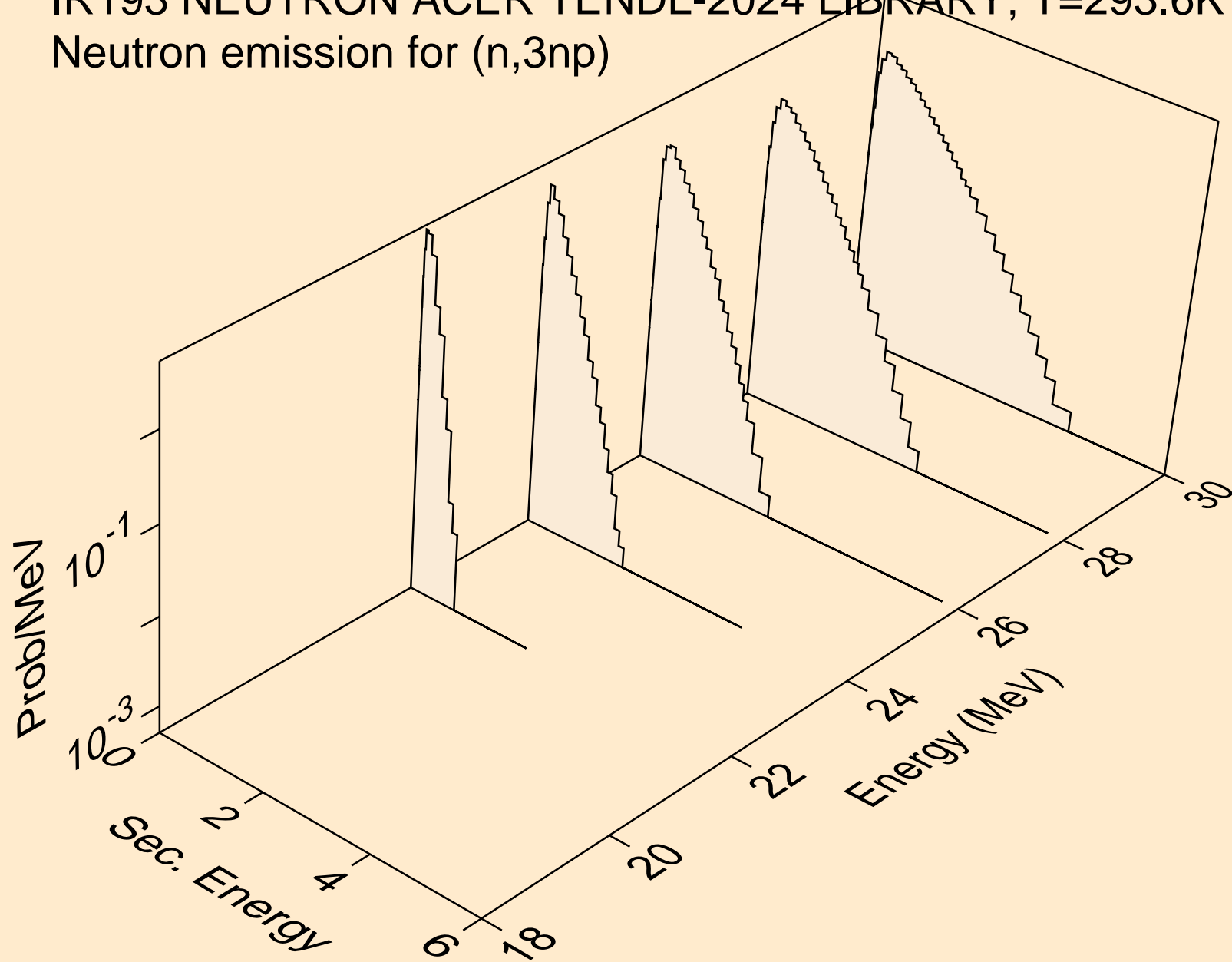

IR193 NEUTRON ACER TENDL-2024 LIBRARY; T=293.6K  
Neutron emission for (n,n2p)

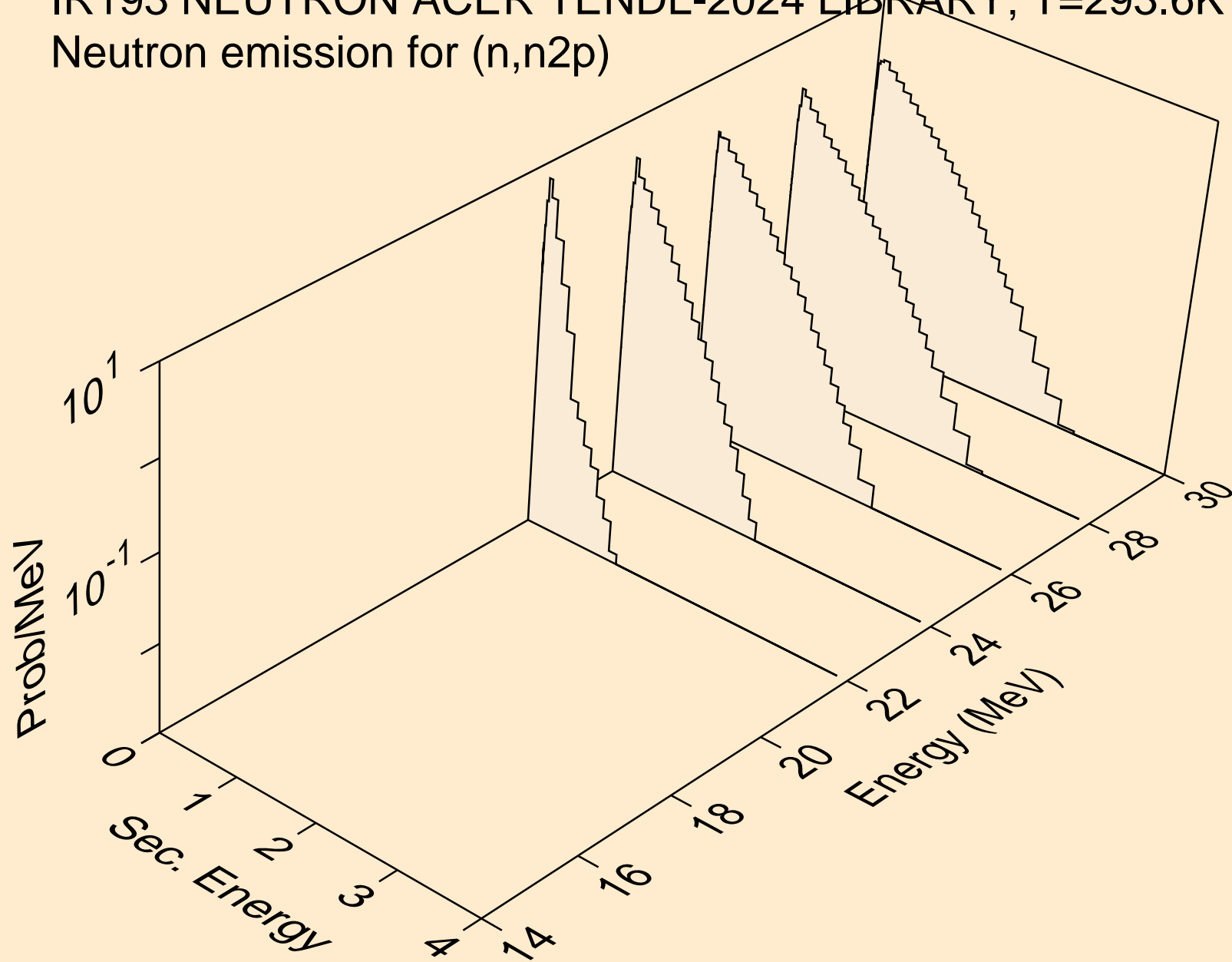

IR193 NEUTRON ACER TENDL-2024 LIBRARY; T=293.6K  
Neutron emission for (n,n\*c)

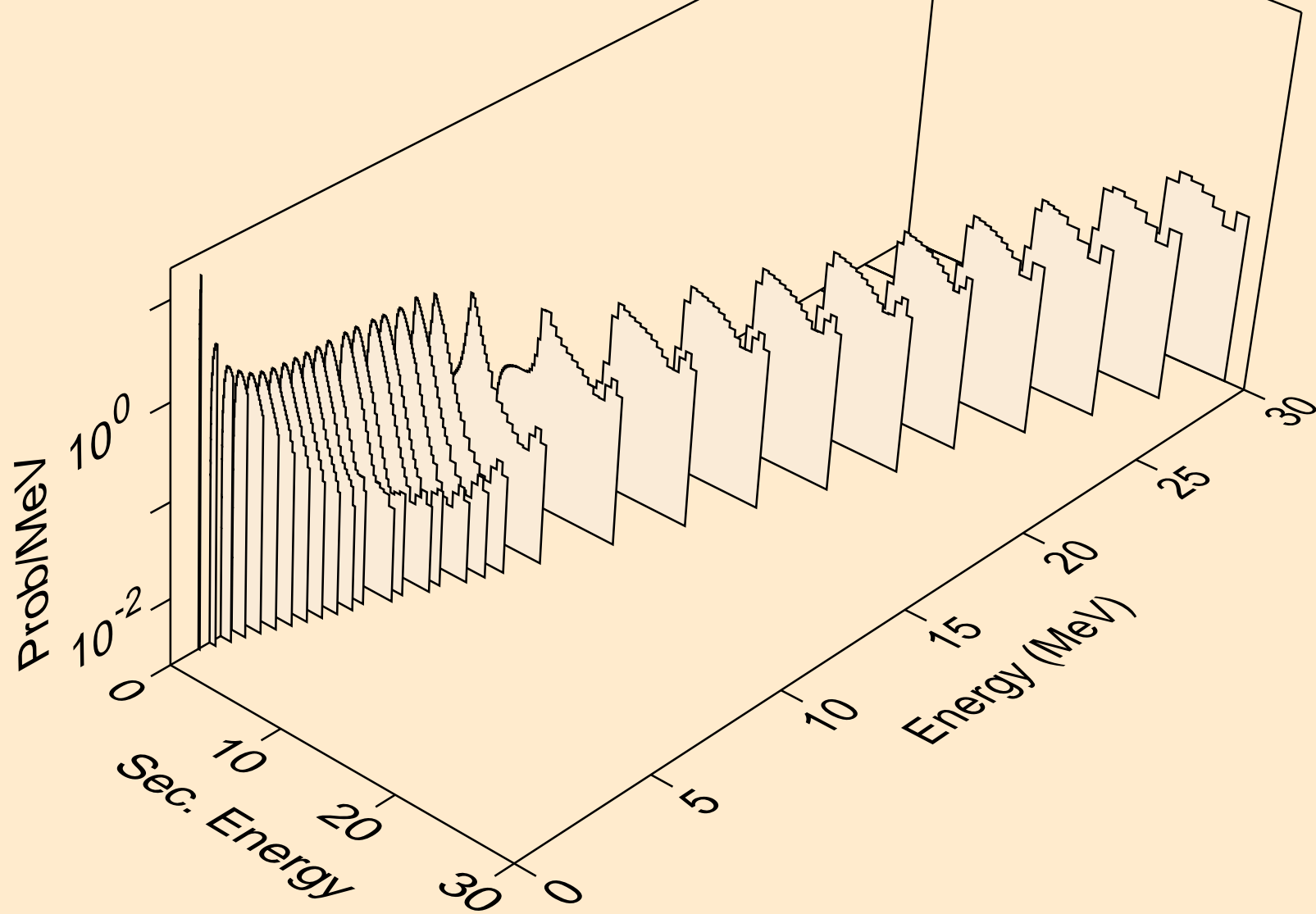

IR193 NEUTRON ACER TENDL-2024 LIBRARY; T=293.6K  
Photon emission for (n,x)

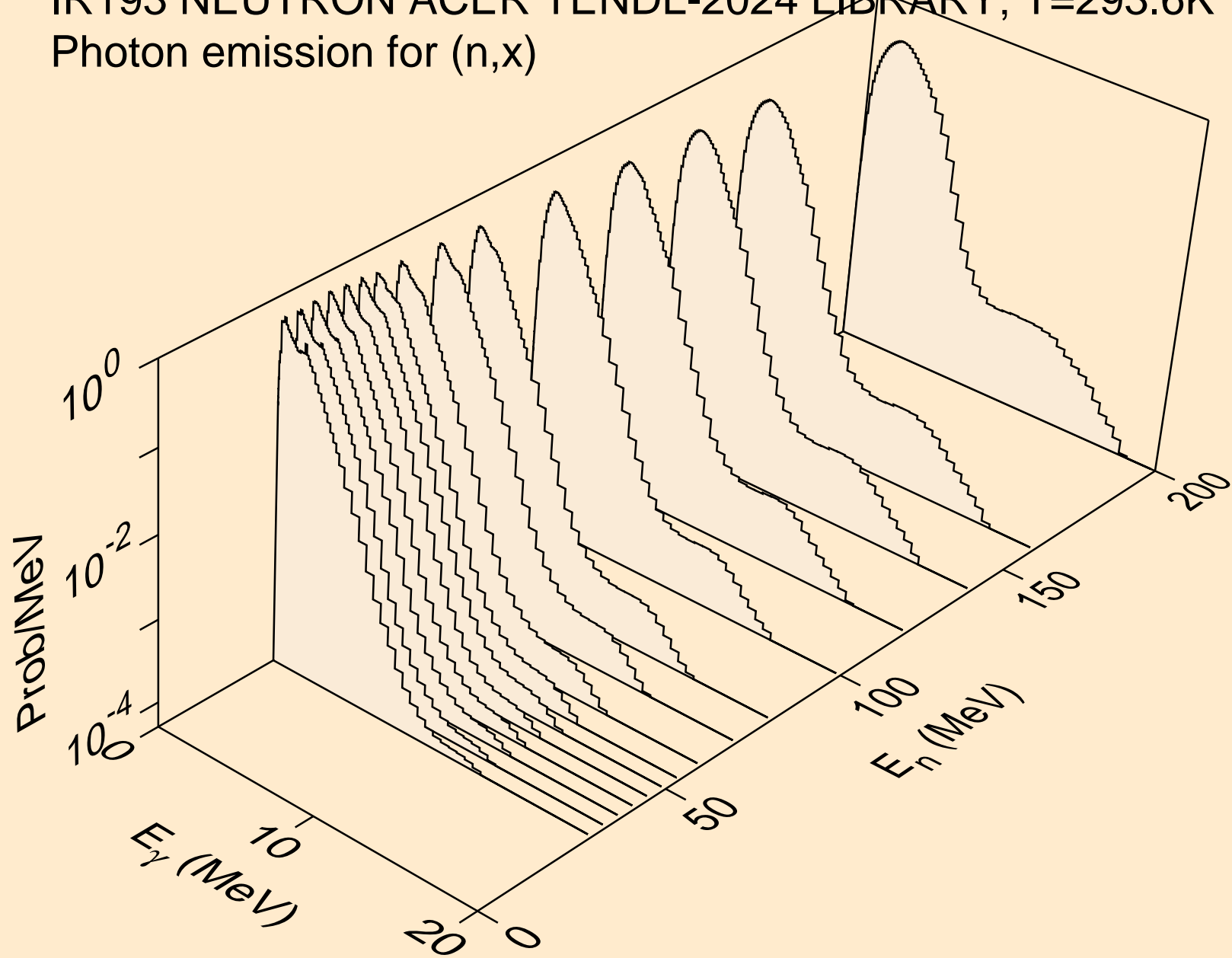

IR193 NEUTRON ACER TENDL-2024 LIBRARY; T=293.6K  
Photon emission for (n,2nd)

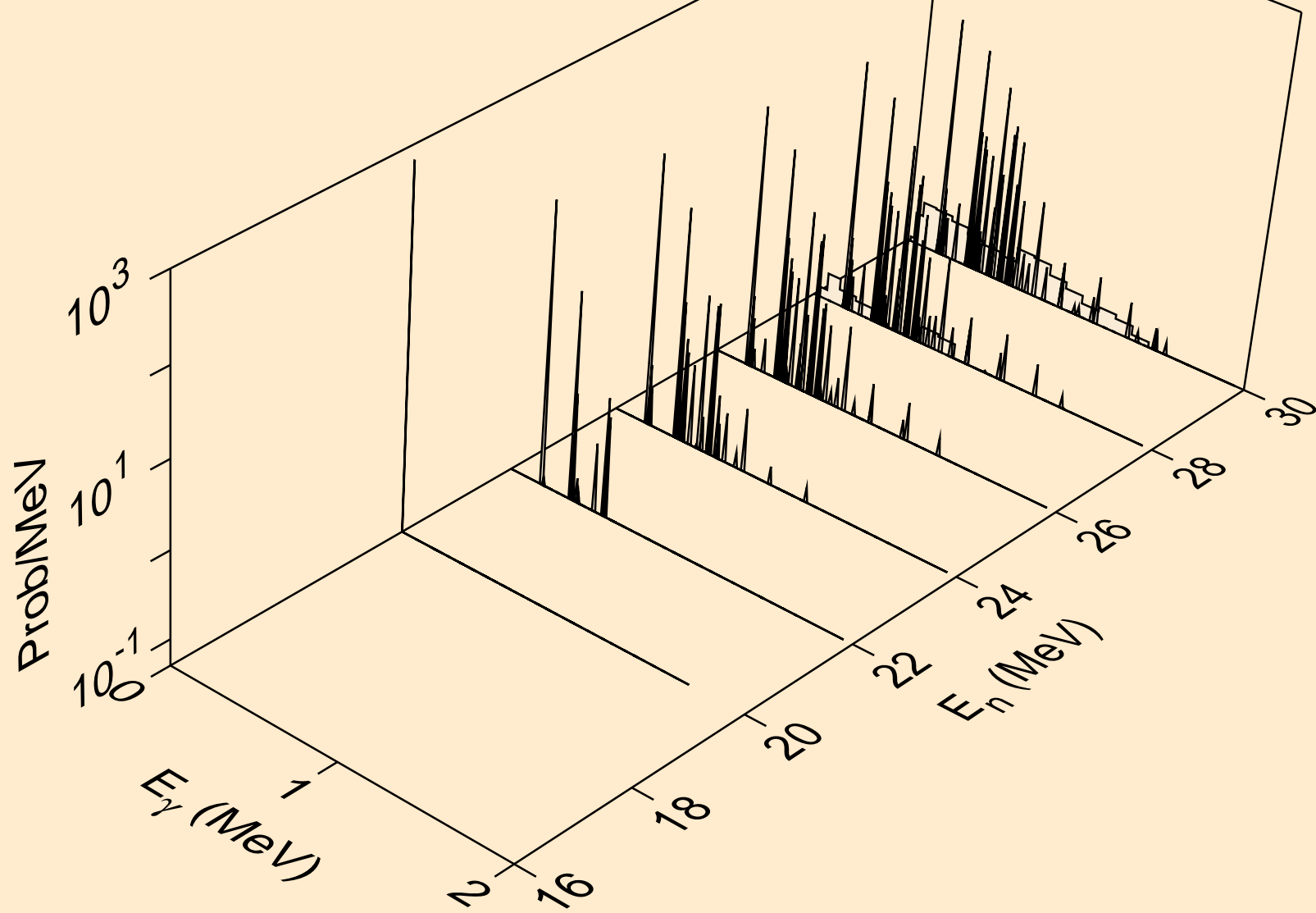

IR193 NEUTRON ACER TENDL-2024 LIBRARY; T=293.6K  
Photon emission for (n,2n)

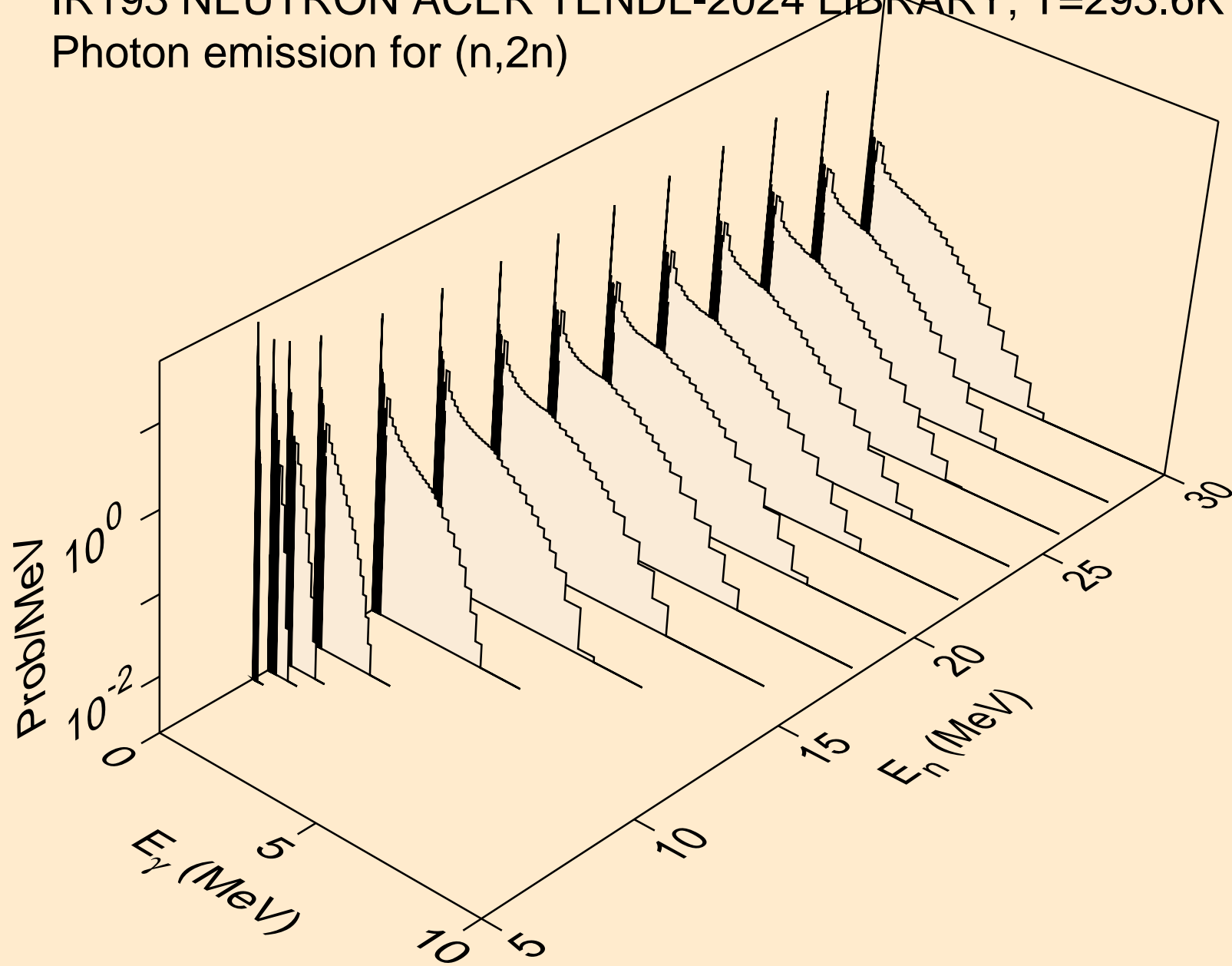

IR193 NEUTRON ACER TENDL-2024 LIBRARY; T=293.6K  
Photon emission for (n,3n)

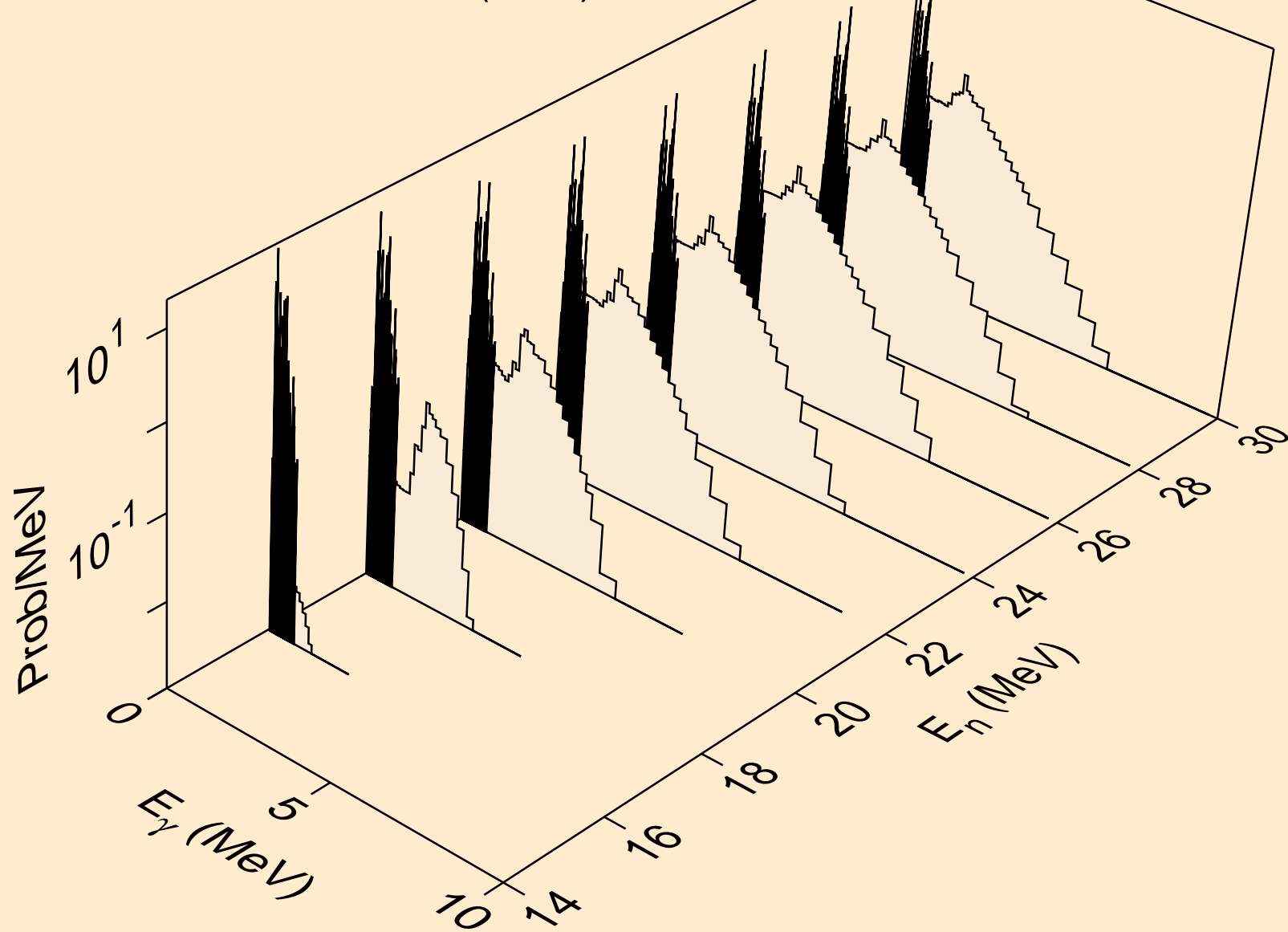

IR193 NEUTRON ACER TENDL-2024 LIBRARY; T=293.6K  
Photon emission for (n,n\*)a

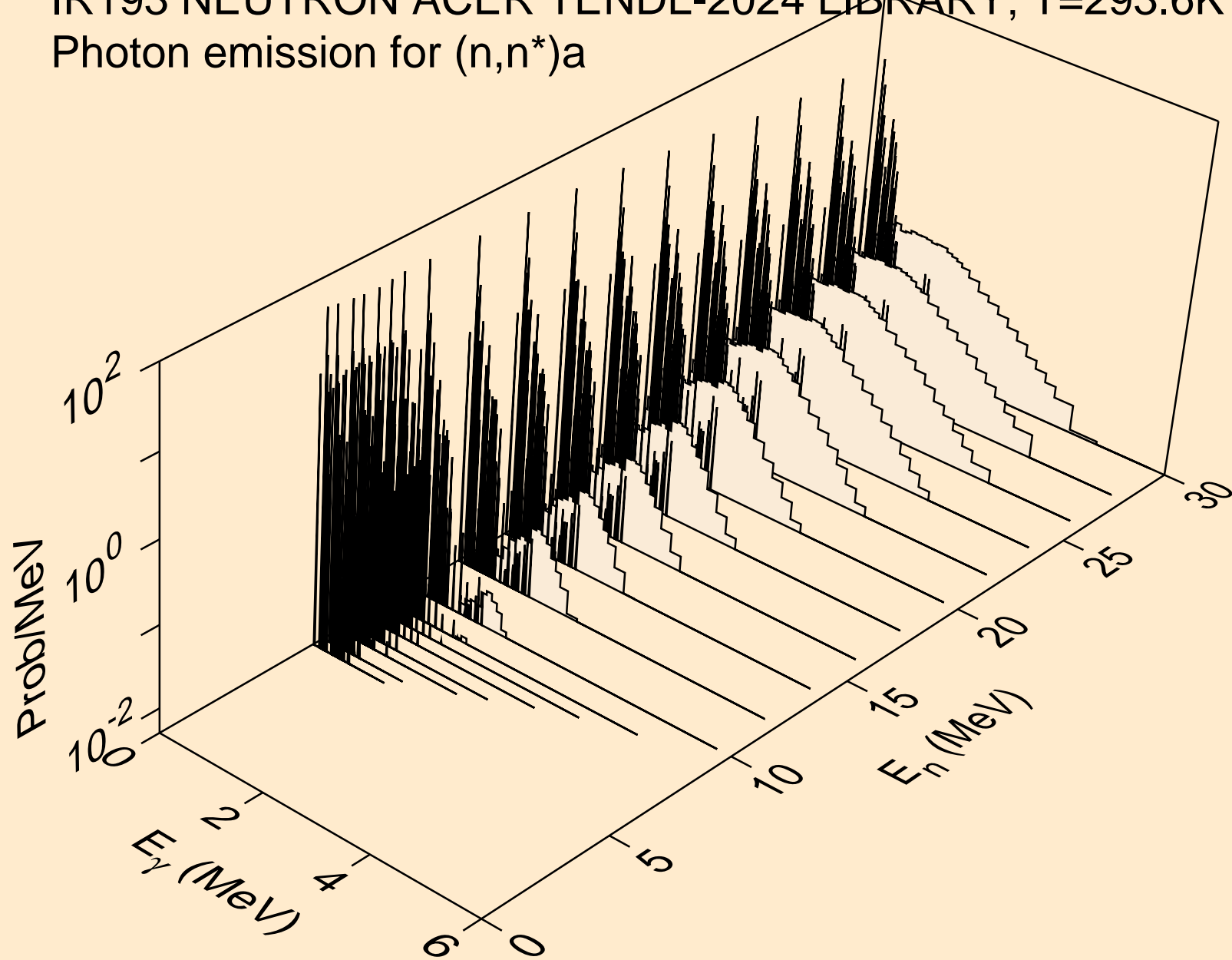

IR193 NEUTRON ACER TENDL-2024 LIBRARY; T=293.6K  
Photon emission for (n,2n)a

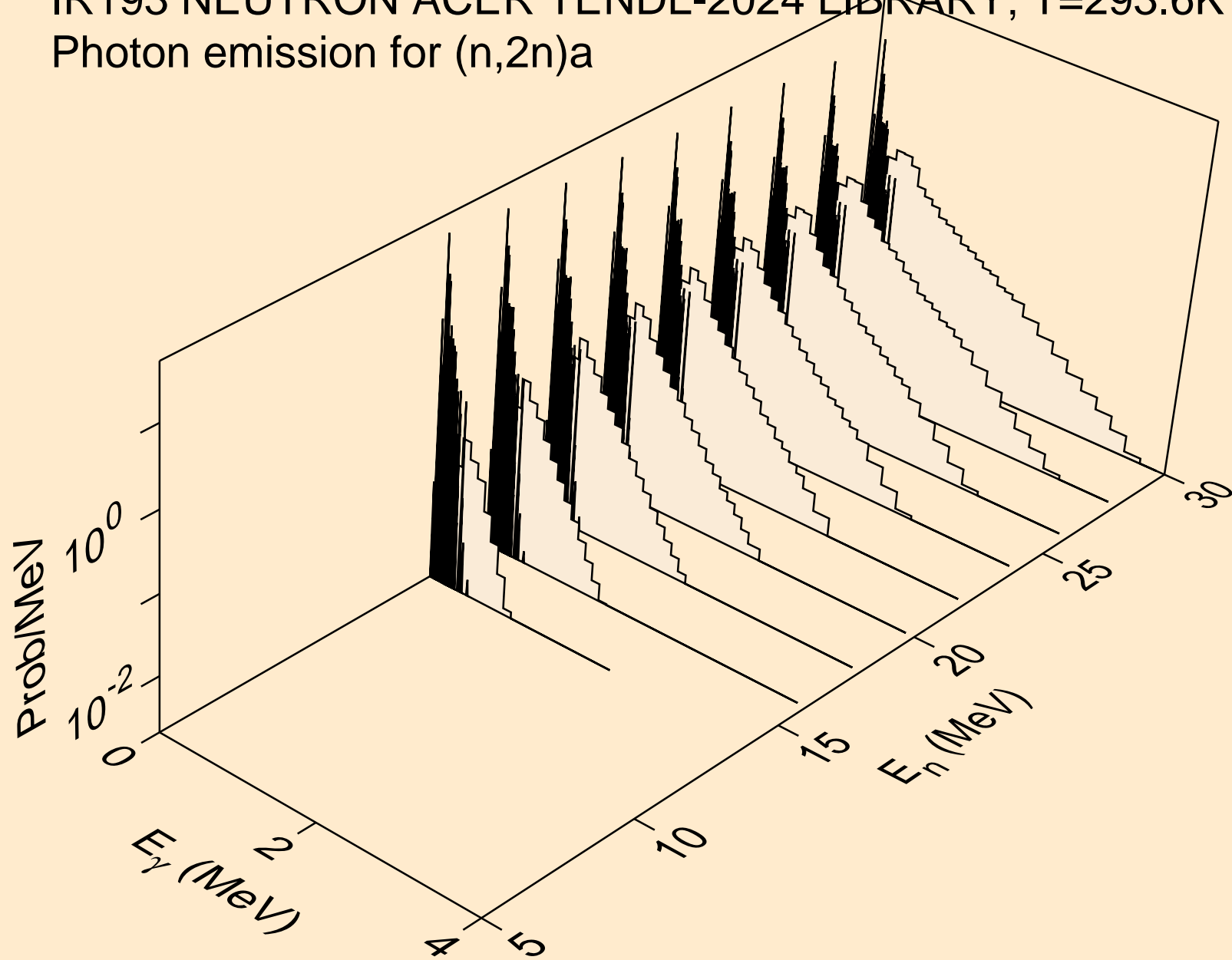

IR193 NEUTRON ACER TENDL-2024 LIBRARY; T=293.6K  
Photon emission for (n,3n)a

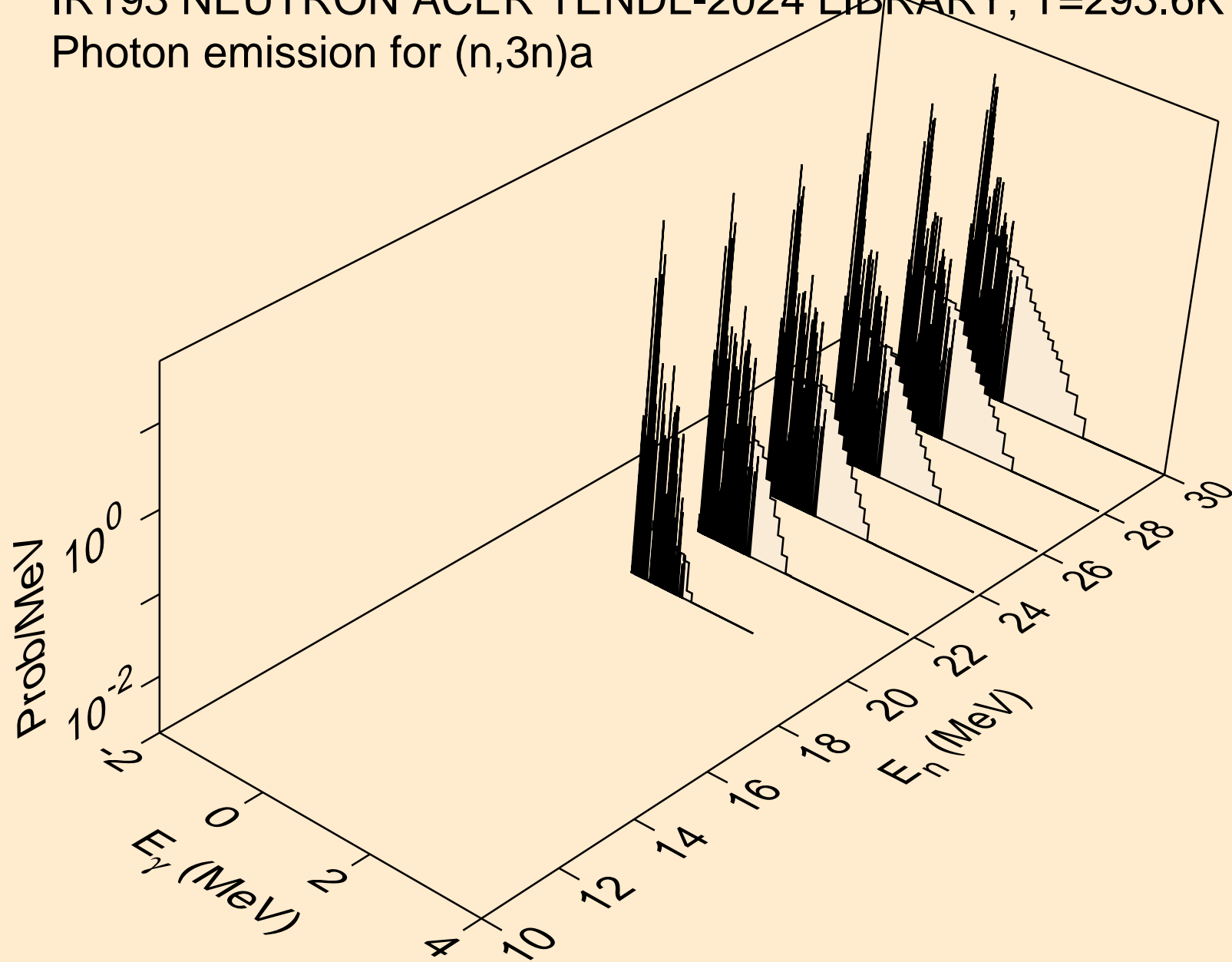

IR193 NEUTRON ACER TENDL-2024 LIBRARY; T=293.6K  
Photon emission for (n,n\*)p

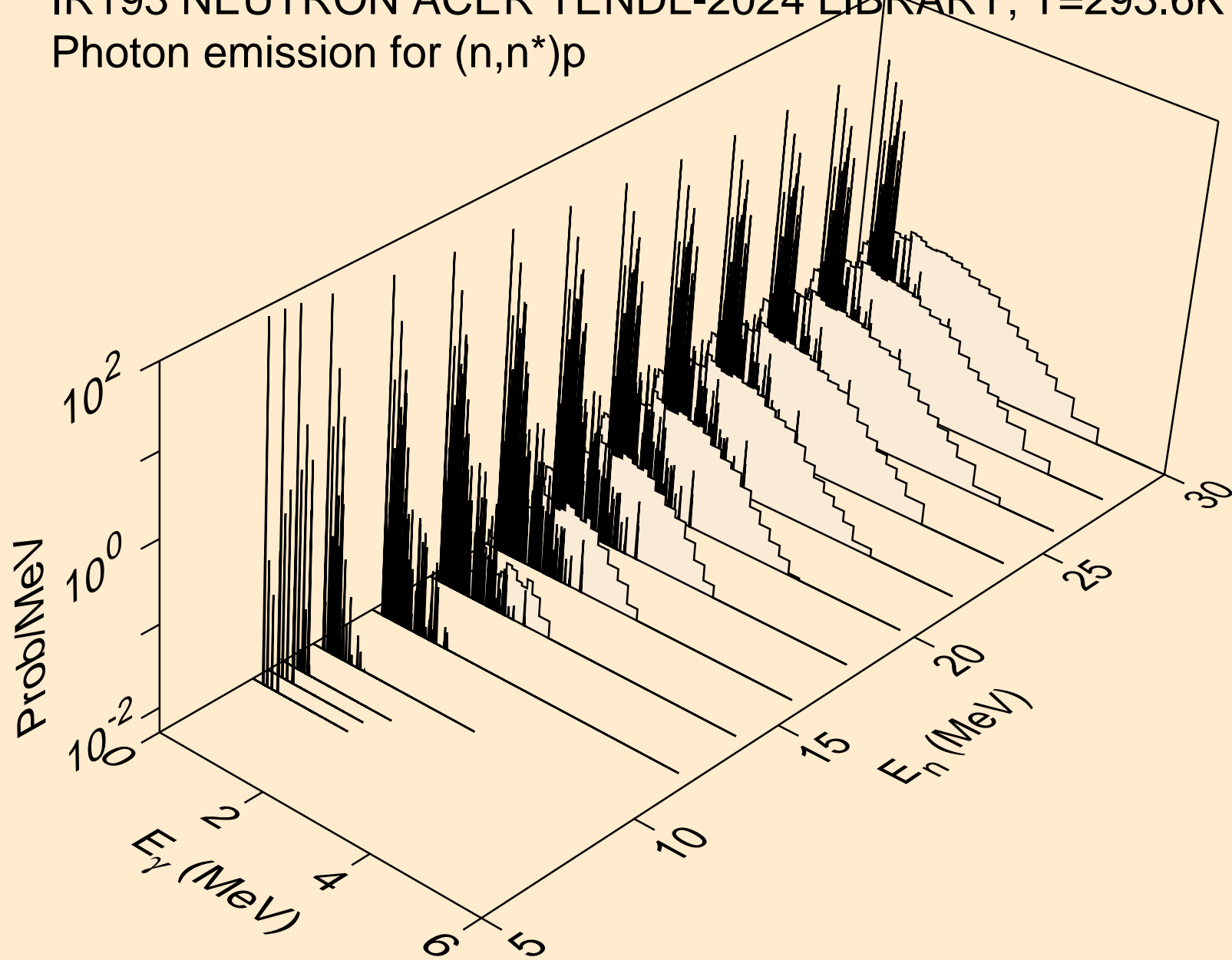

IR193 NEUTRON ACER TENDL-2024 LIBRARY; T=293.6K  
Photon emission for (n,n\*)d

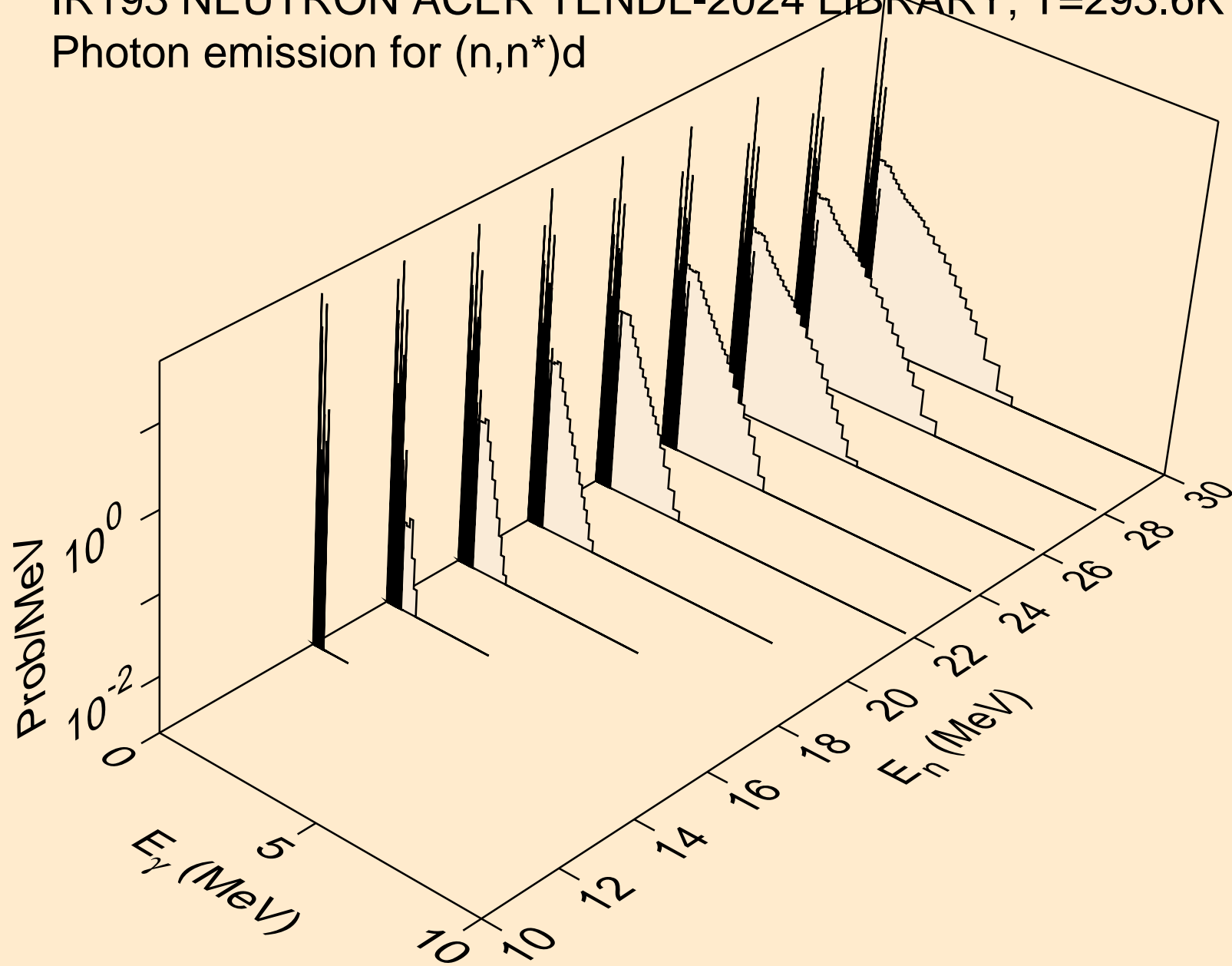

IR193 NEUTRON ACER TENDL-2024 LIBRARY; T=293.6K  
Photon emission for (n,n\*)t

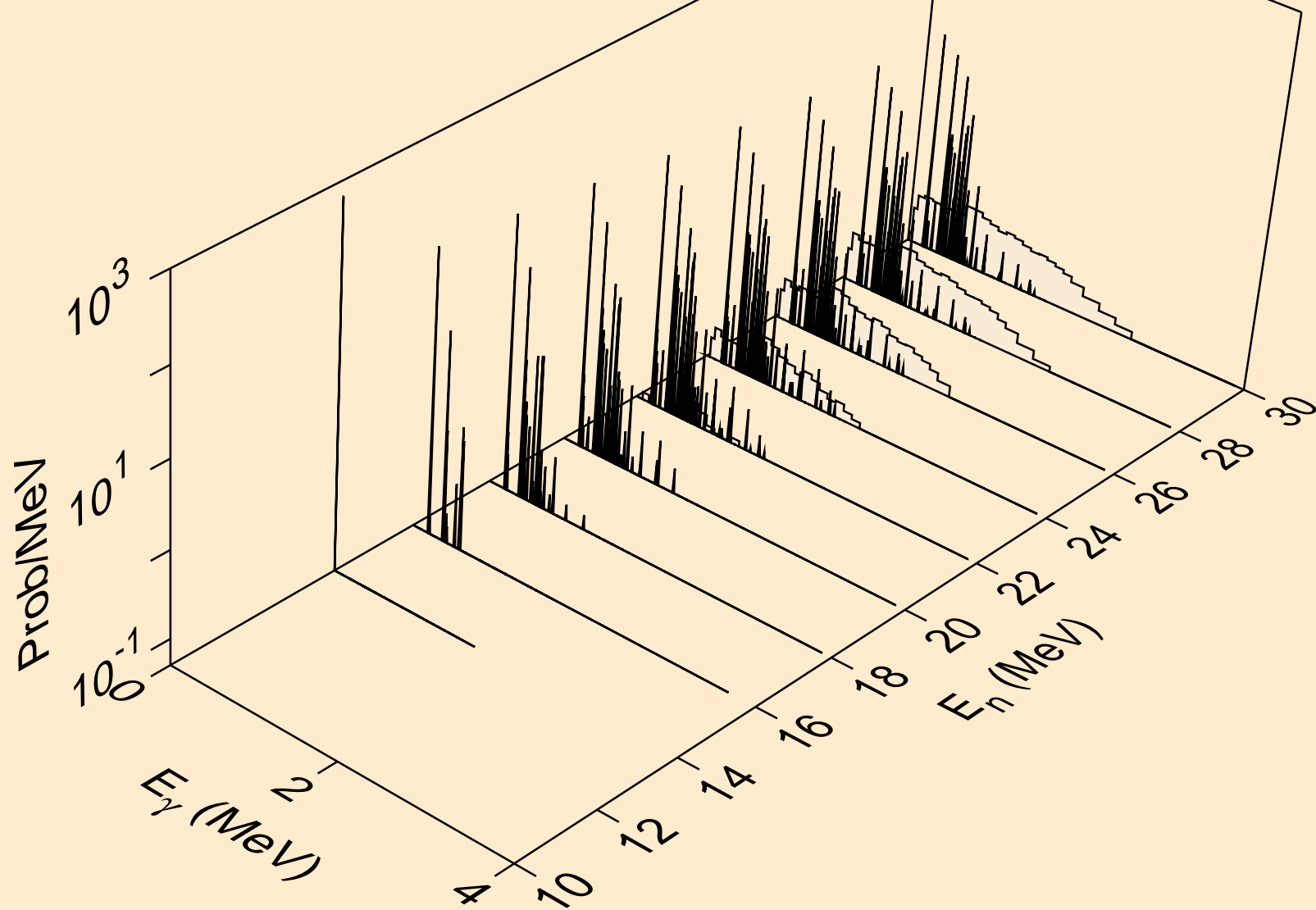

IR193 NEUTRON ACER TENDL-2024 LIBRARY; T=293.6K  
Photon emission for (n,n\*)he3

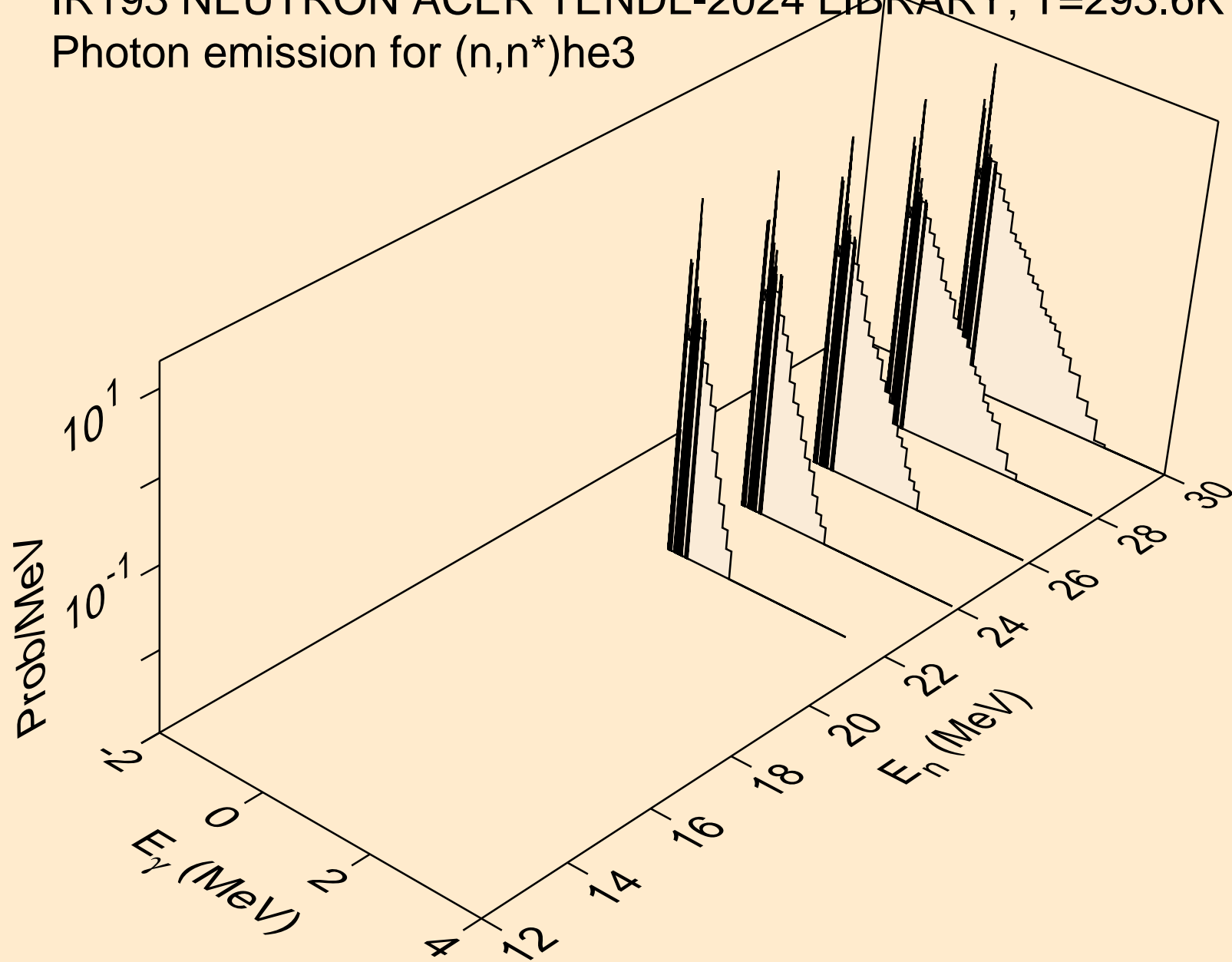

IR193 NEUTRON ACER TENDL-2024 LIBRARY; T=293.6K  
Photon emission for (n,4n)

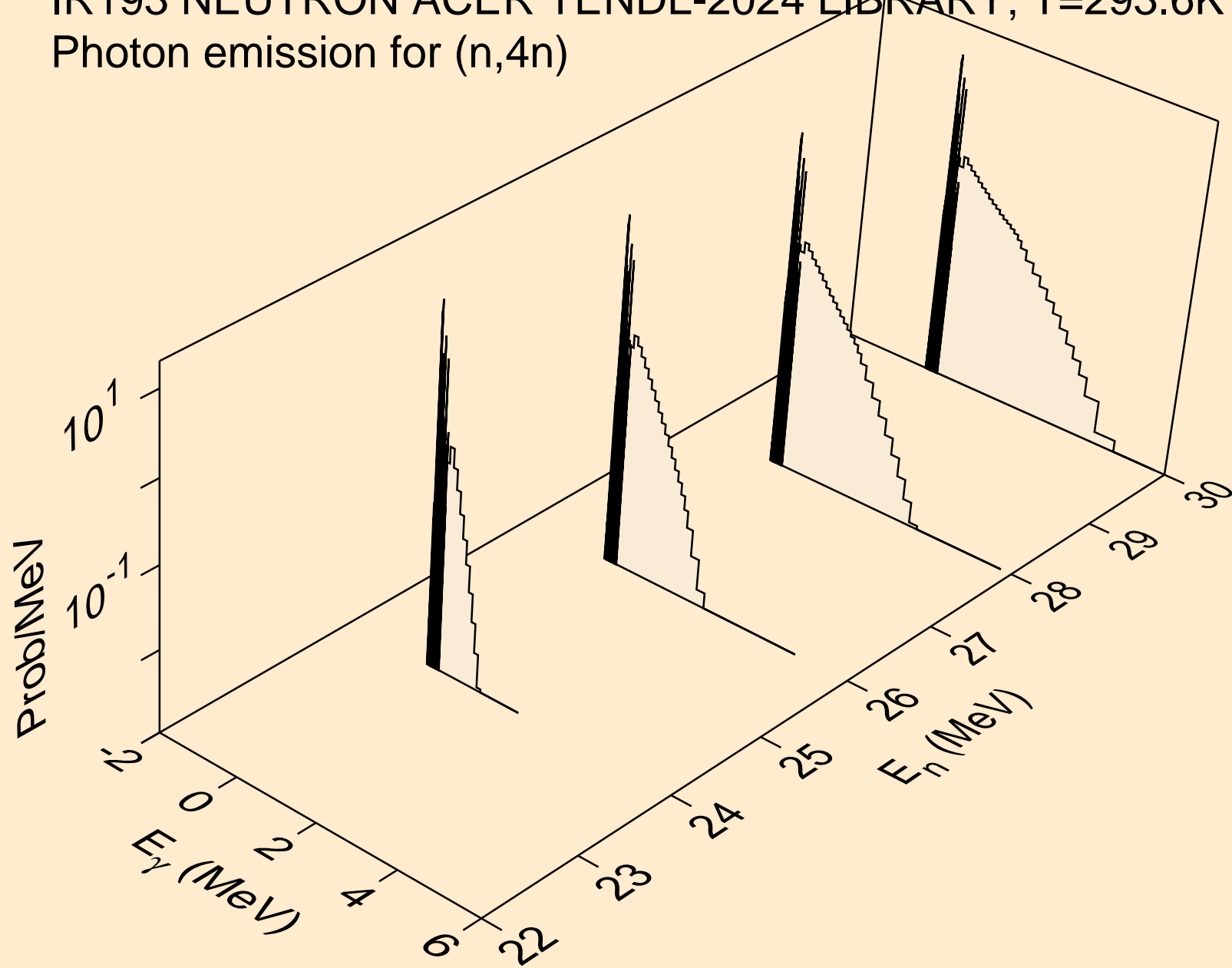

IR193 NEUTRON ACER TENDL-2024 LIBRARY; T=293.6K  
Photon emission for (n,2np)

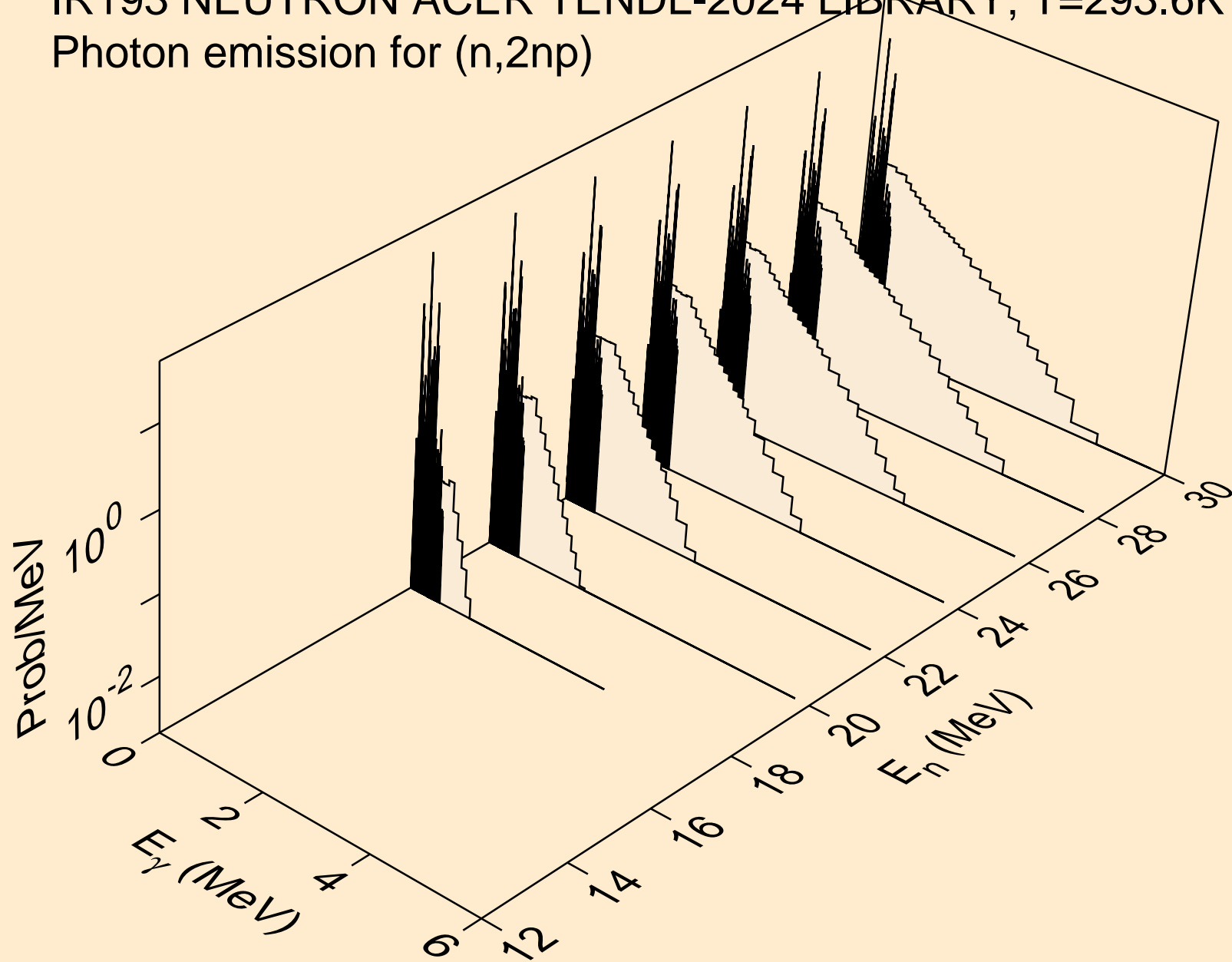

IR193 NEUTRON ACER TENDL-2024 LIBRARY; T=293.6K  
Photon emission for (n,3np)

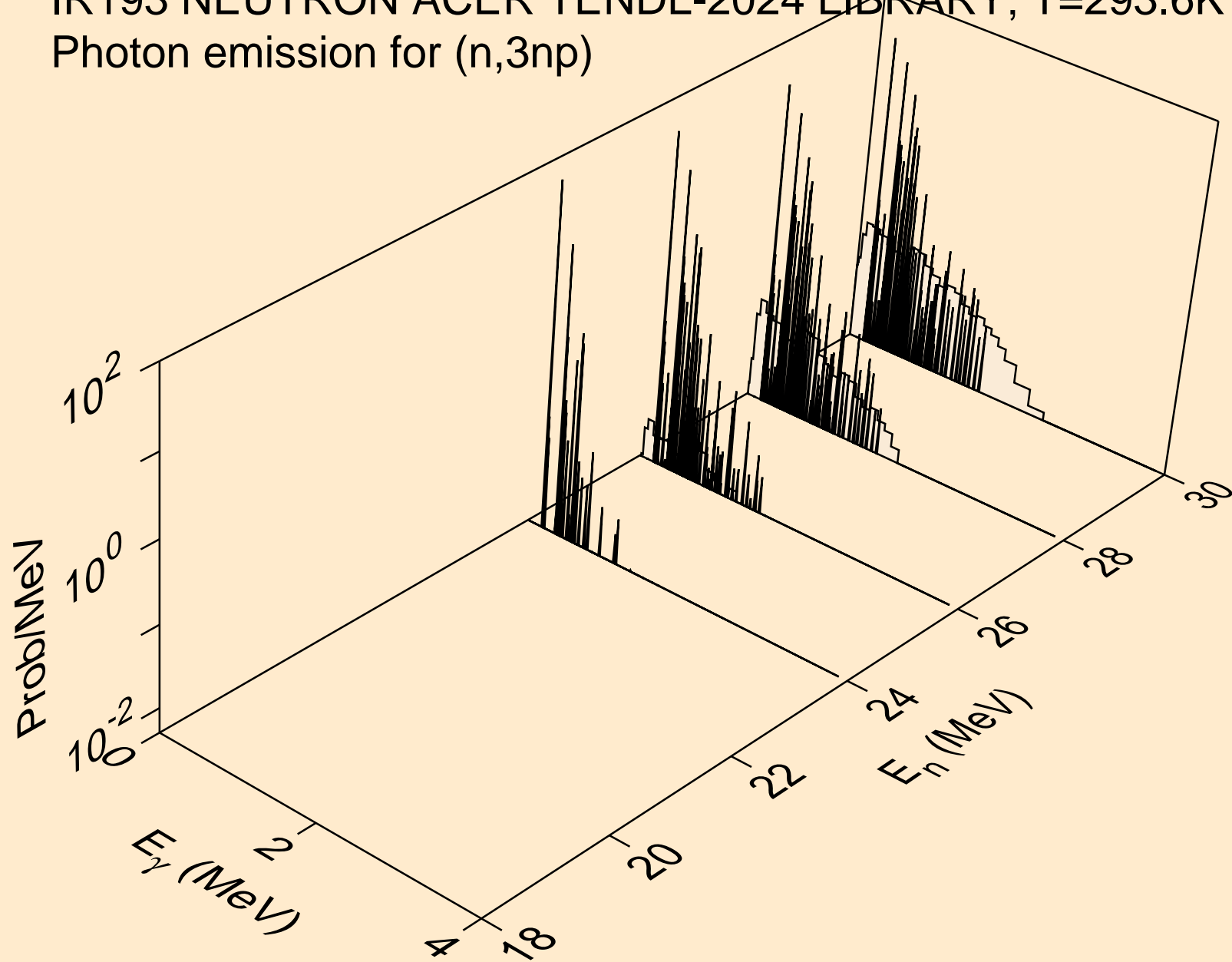

IR193 NEUTRON ACER TENDL-2024 LIBRARY; T=293.6K  
Photon emission for (n,n2p)

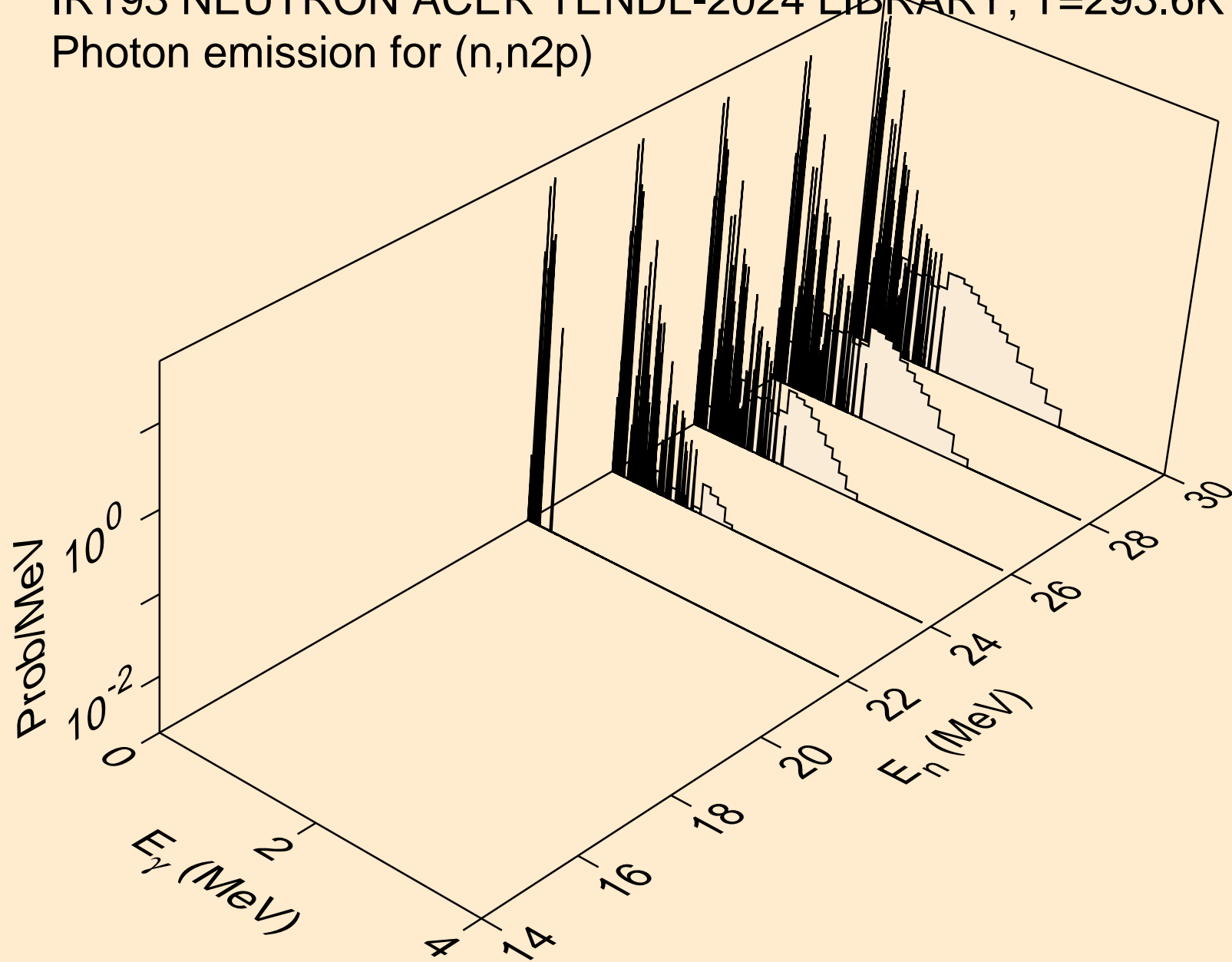

IR193 NEUTRON ACER TENDL-2024 LIBRARY; T=293.6K  
Photon emission for (n,n\*c)

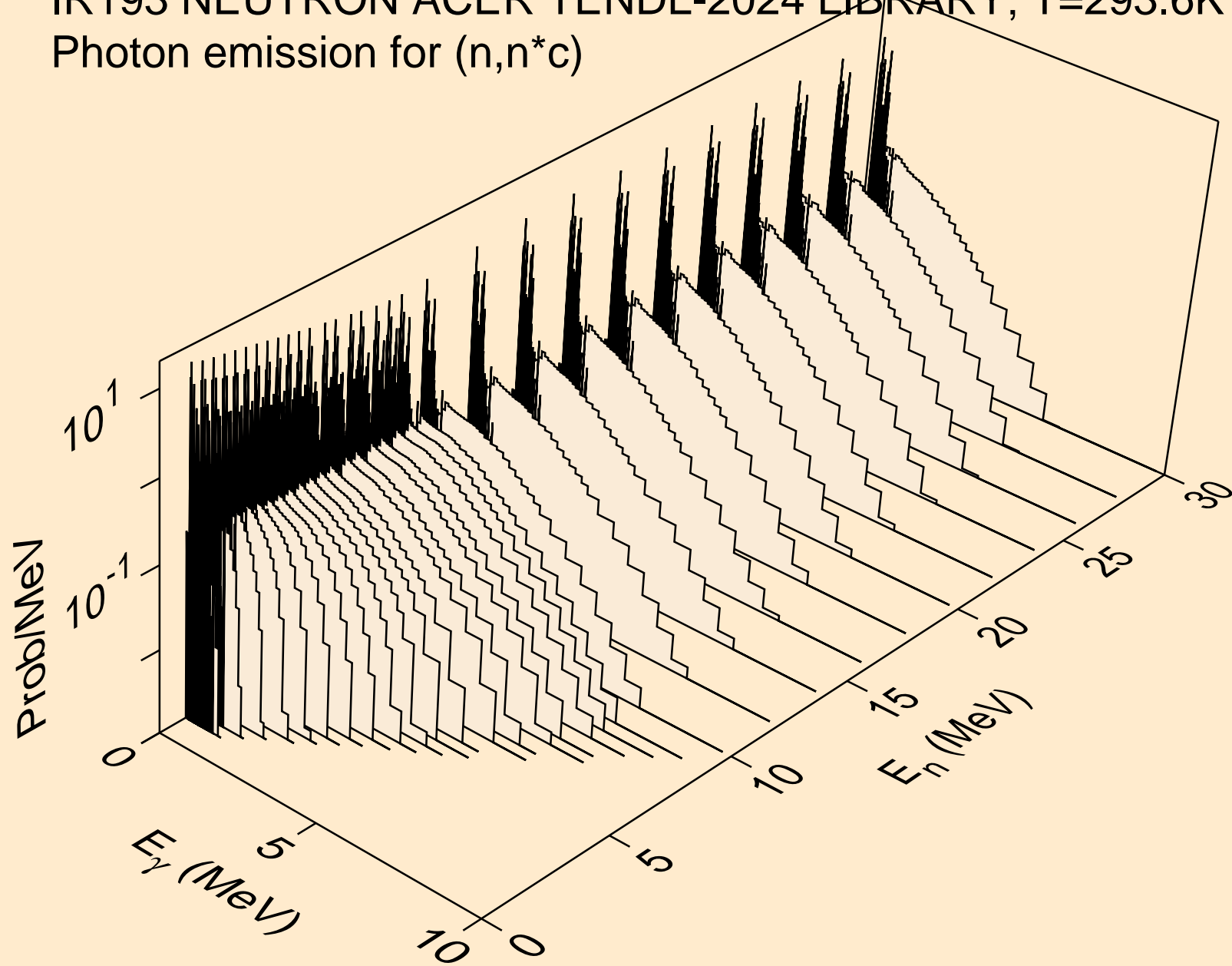

IR193 NEUTRON ACER TENDL-2024 LIBRARY; T=293.6K  
Photon emission for (n,gma)

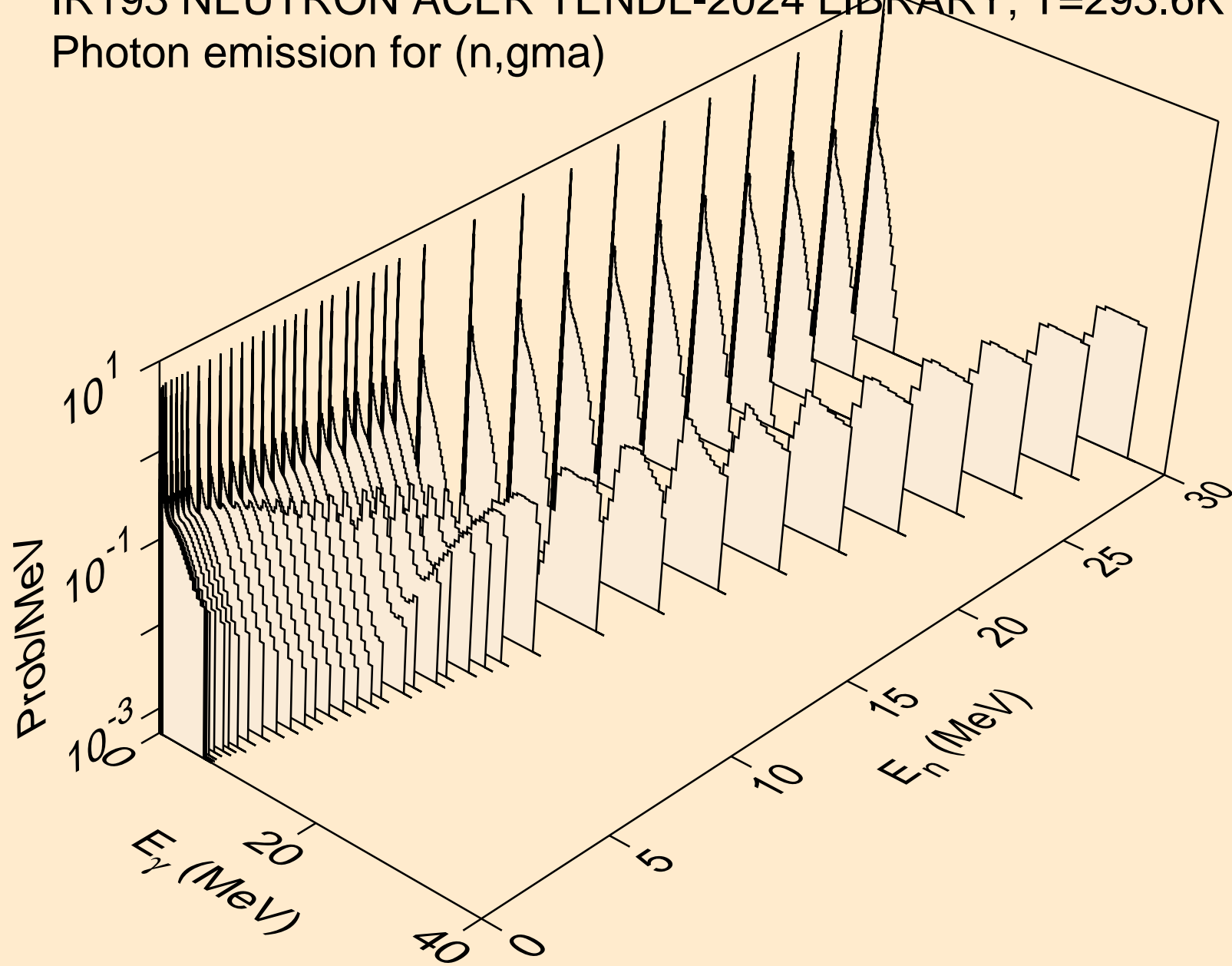

IR193 NEUTRON ACER TENDL-2024 LIBRARY; T=293.6K  
Photon emission for (n,p)

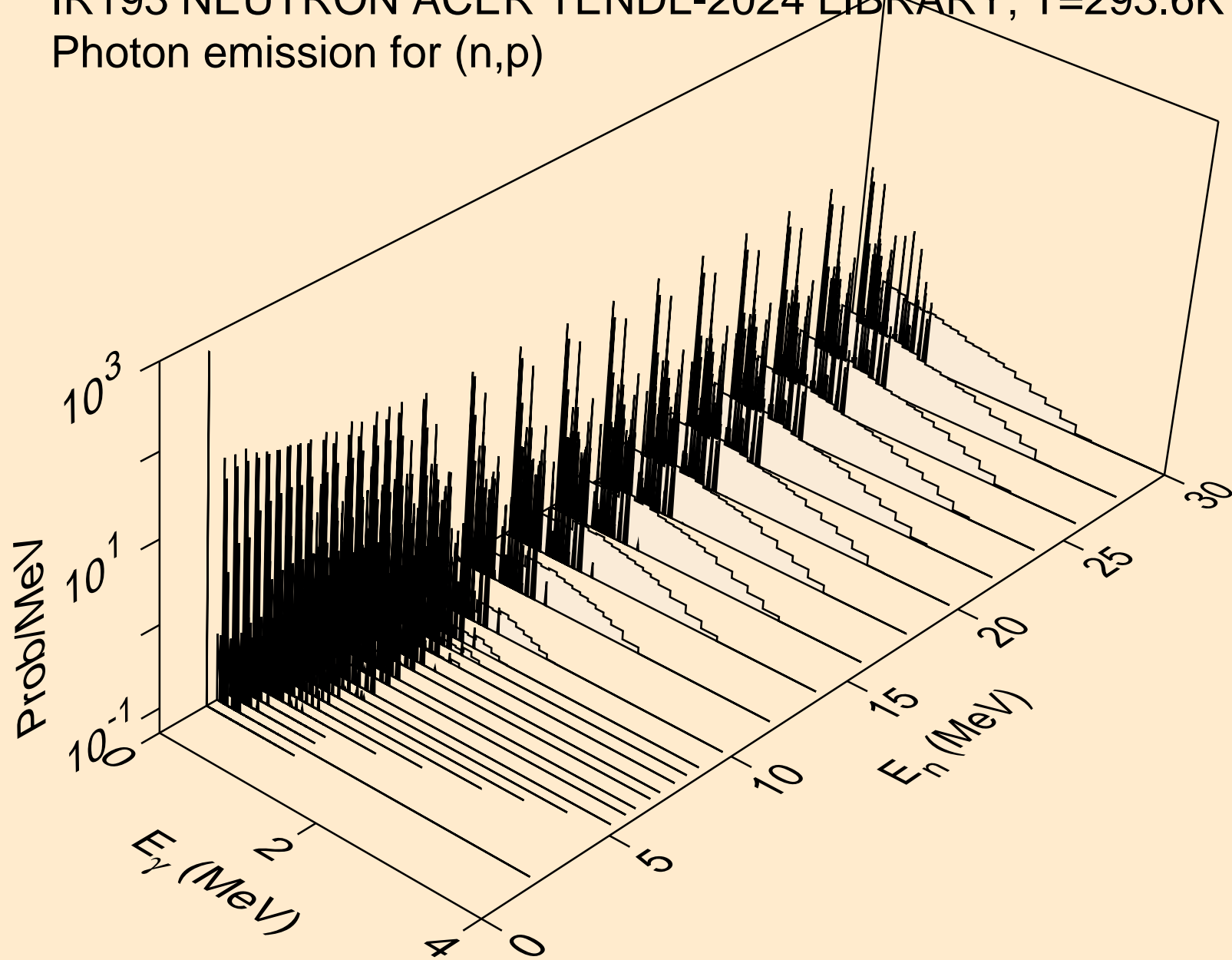

IR193 NEUTRON ACER TENDL-2024 LIBRARY; T=293.6K  
Photon emission for (n,d)

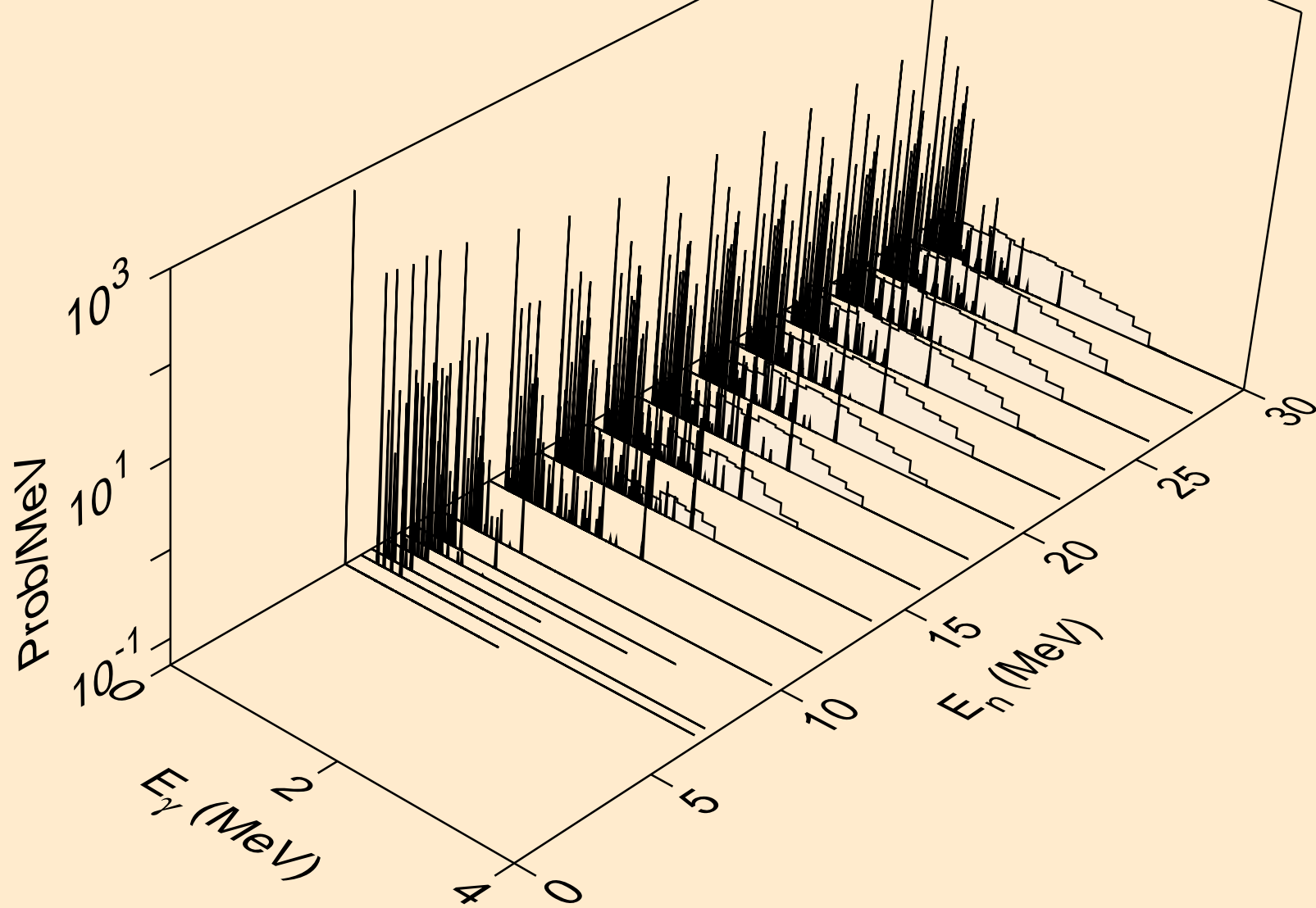

IR193 NEUTRON ACER TENDL-2024 LIBRARY; T=293.6K  
Photon emission for (n,t)

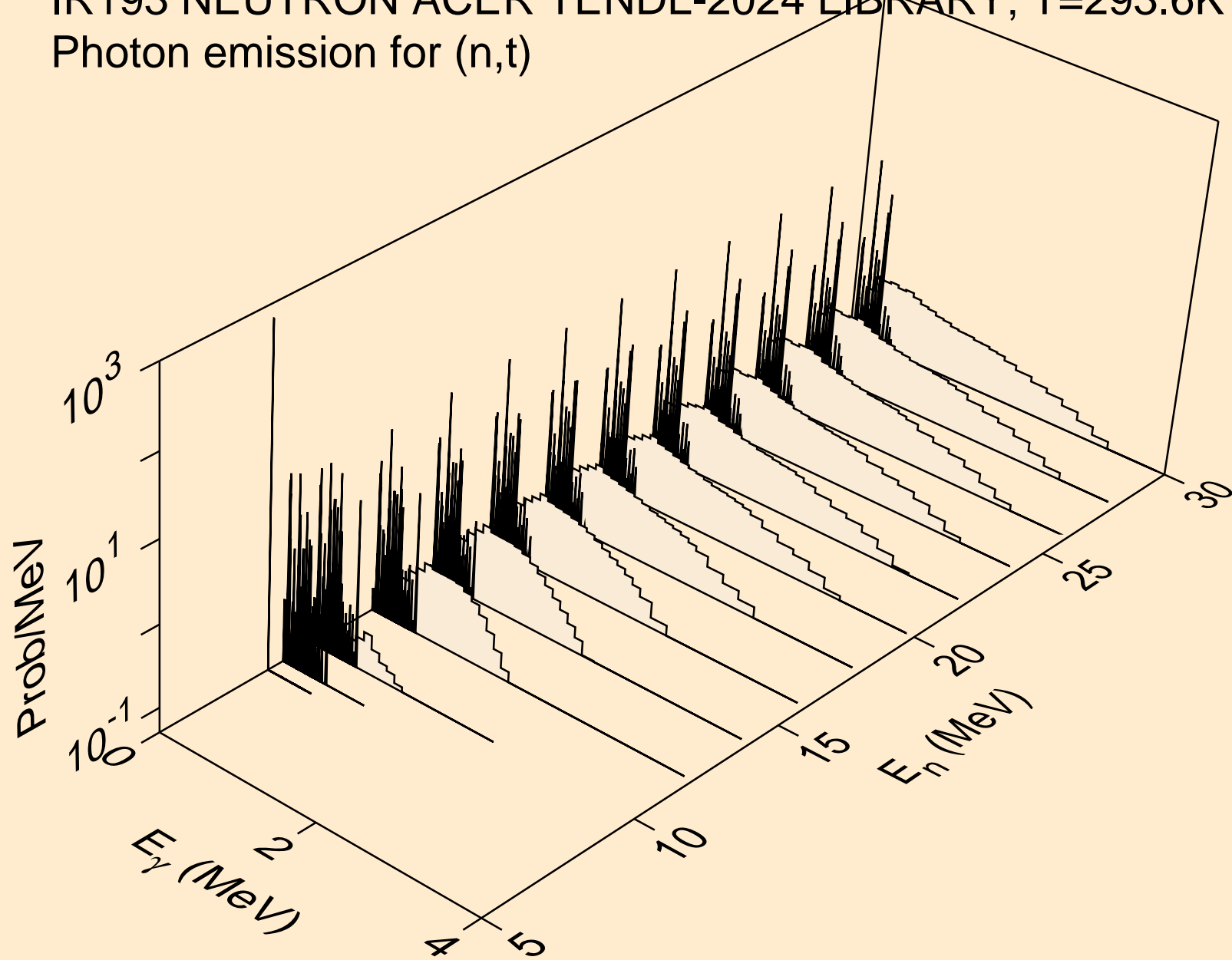

IR193 NEUTRON ACER TENDL-2024 LIBRARY; T=293.6K  
Photon emission for (n,he3)

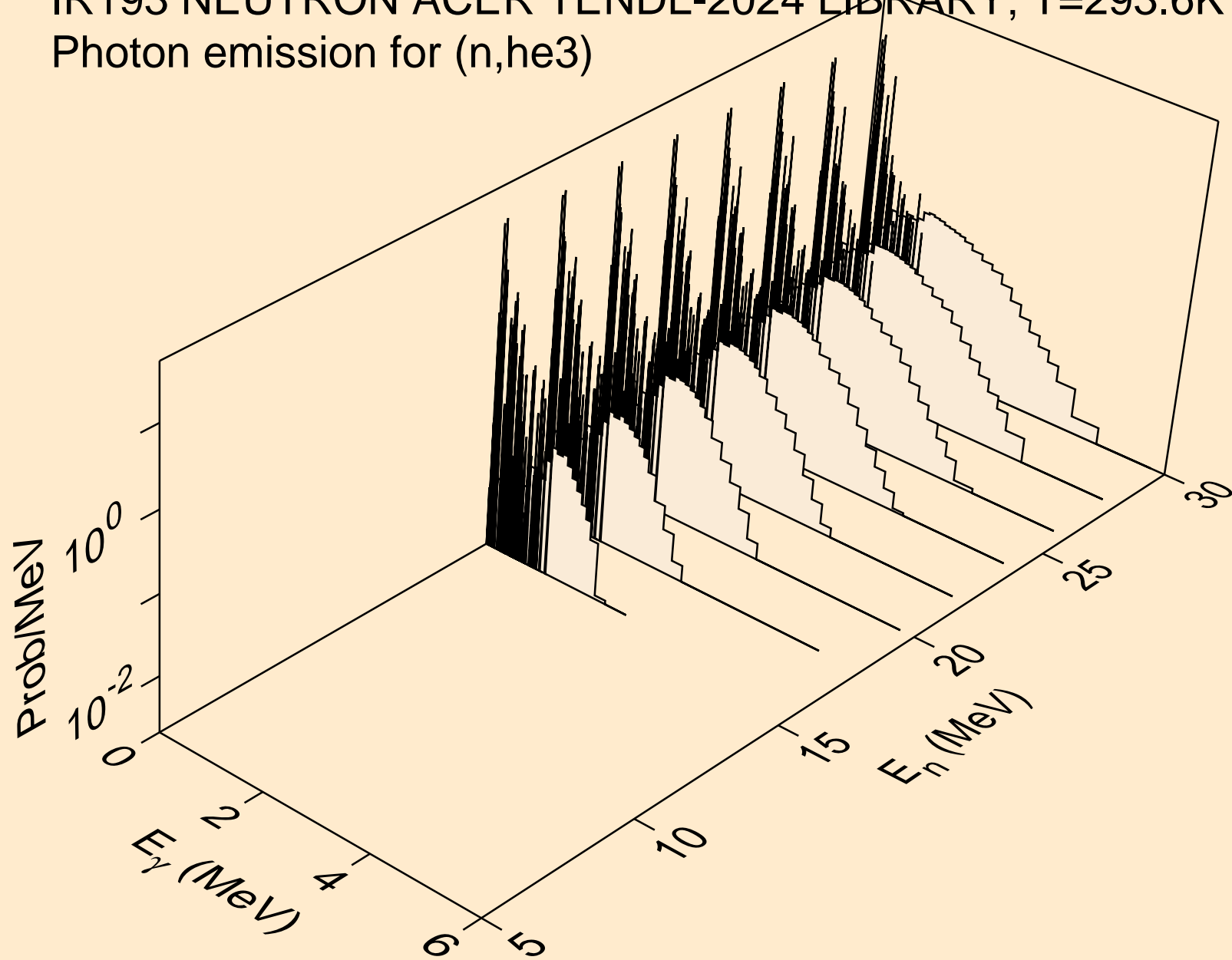

IR193 NEUTRON ACER TENDL-2024 LIBRARY; T=293.6K  
Photon emission for (n,a)

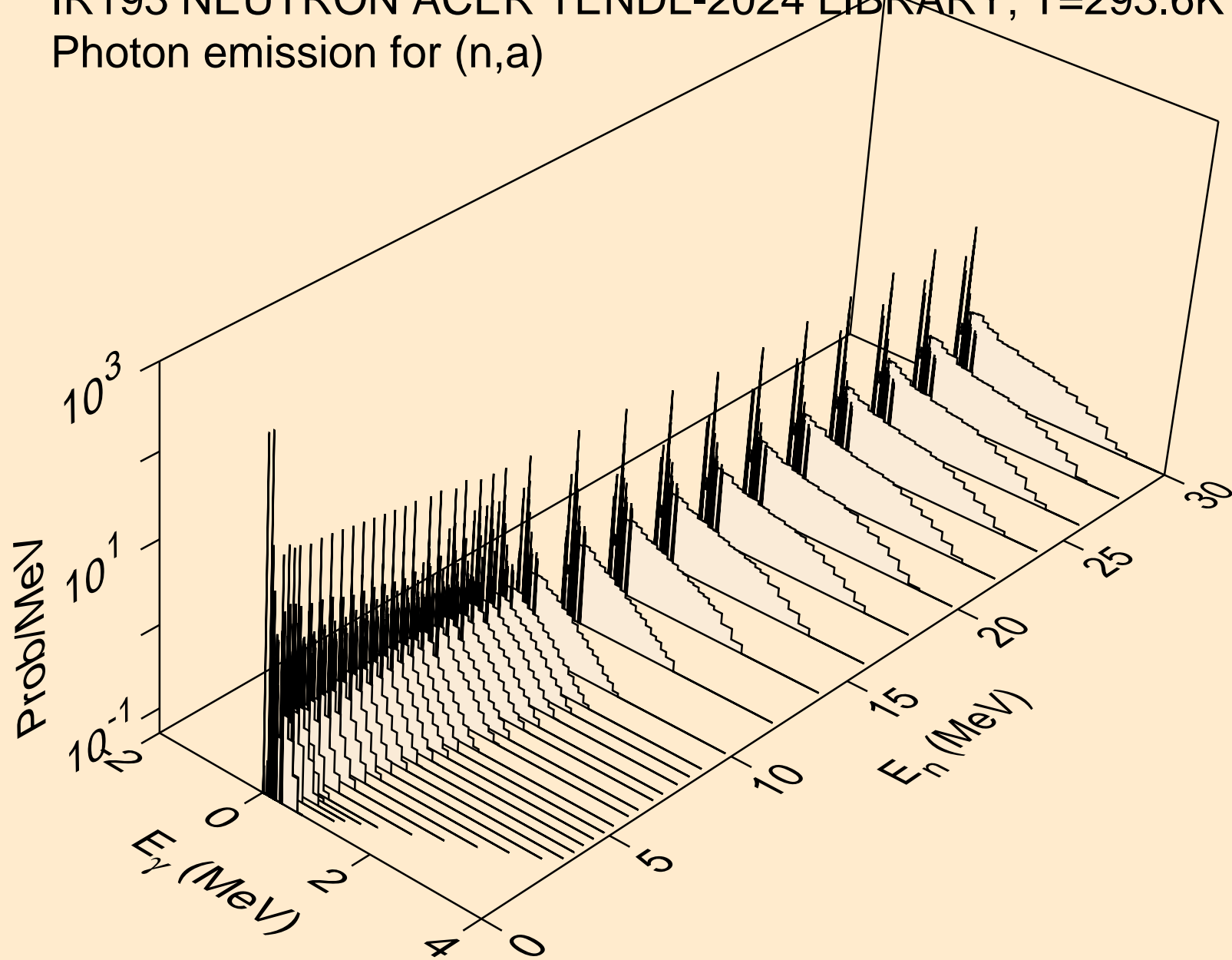

IR193 NEUTRON ACER TENDL-2024 LIBRARY; T=293.6K  
Photon emission for (n,2p)

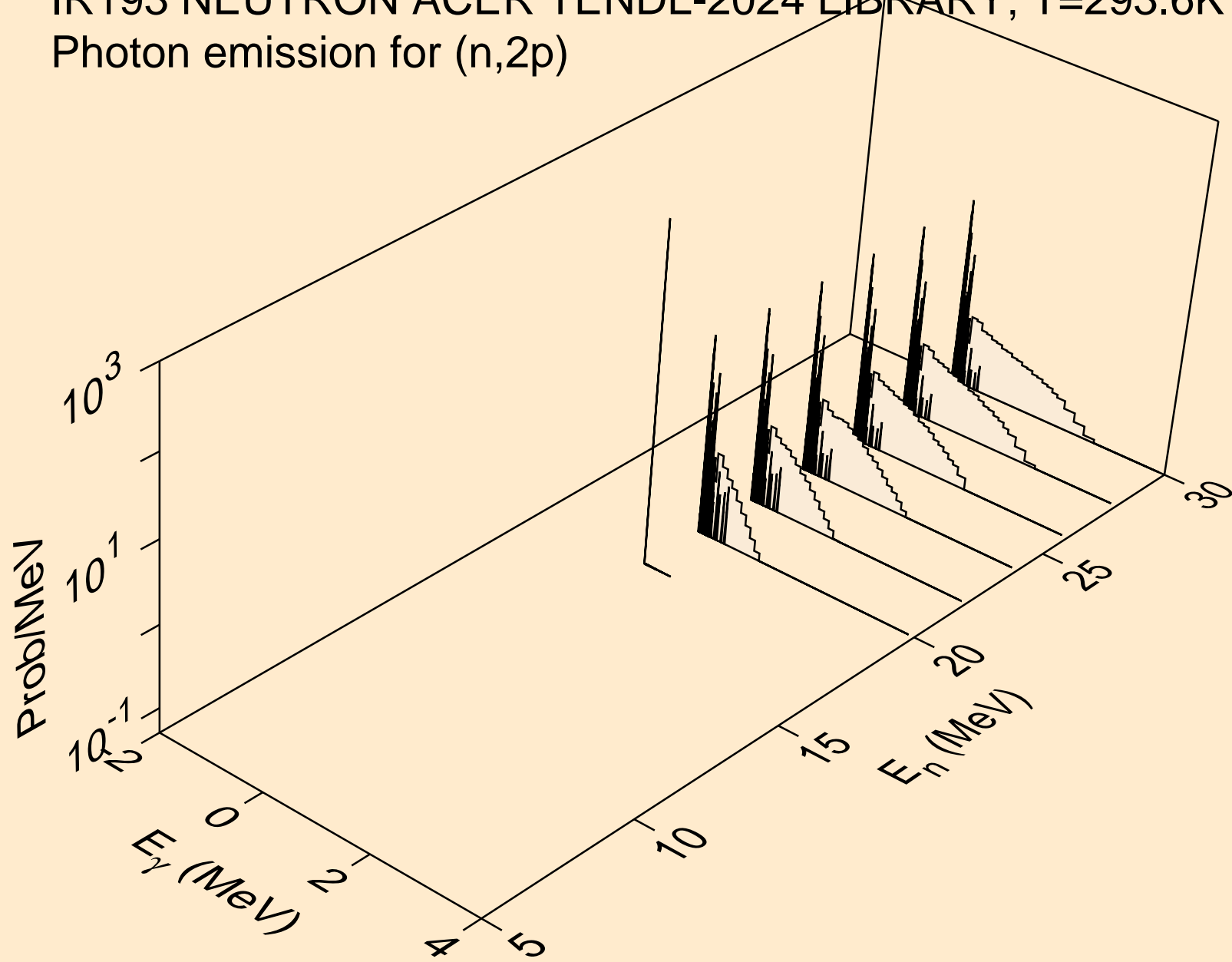

IR193 NEUTRON ACER TENDL-2024 LIBRARY; T=293.6K  
thermal capture photon spectrum

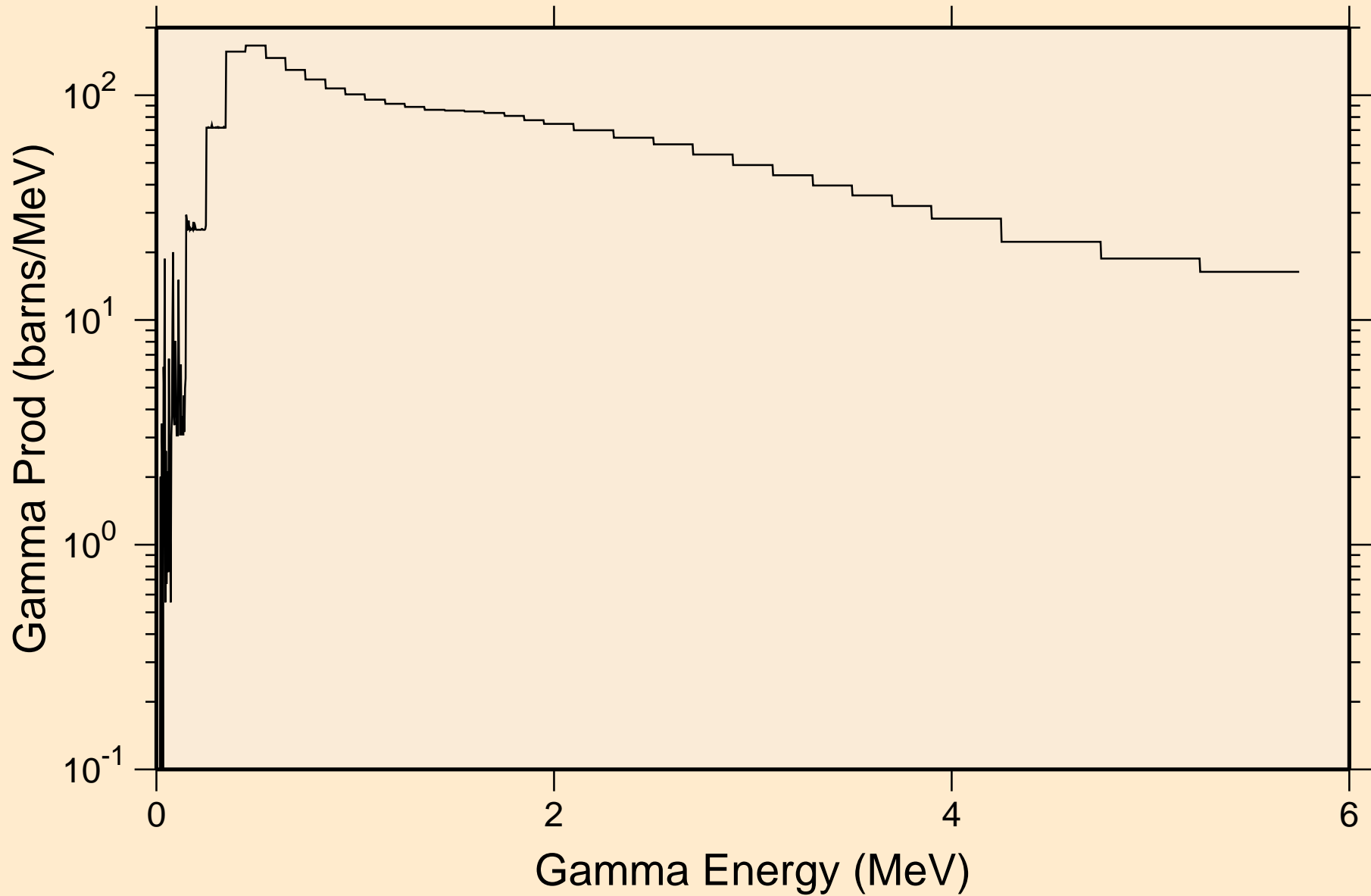

IR193 NEUTRON ACER TENDL-2024 LIBRARY; T=293.6K  
14 MeV photon spectrum

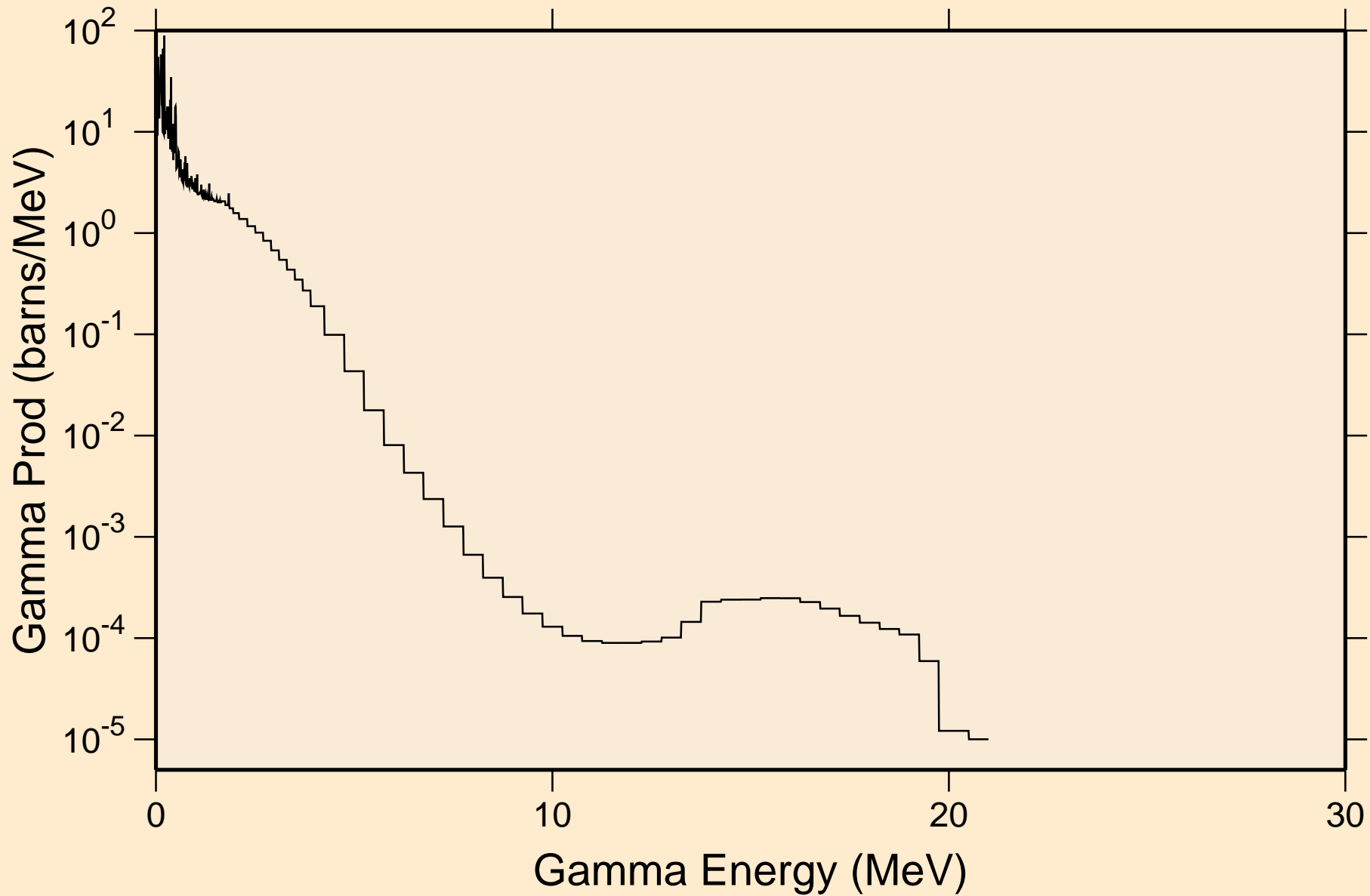

# IR193 NEUTRON ACER TENDL-2024 LIBRARY; T=293.6K

## Particle heating contributions

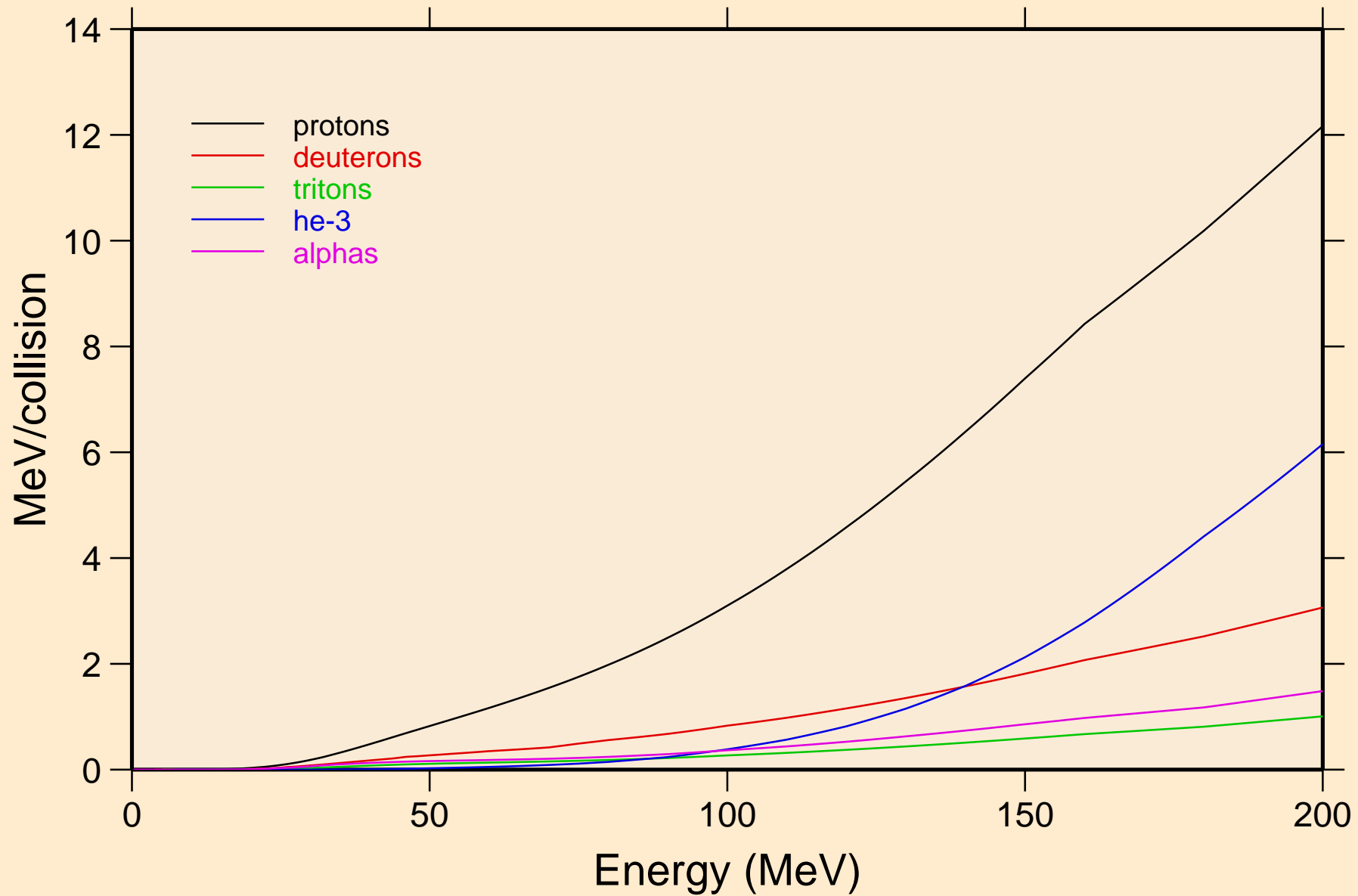

IR193 NEUTRON ACER TENDL-2024 LIBRARY; T=293.6K  
Recoil Heating

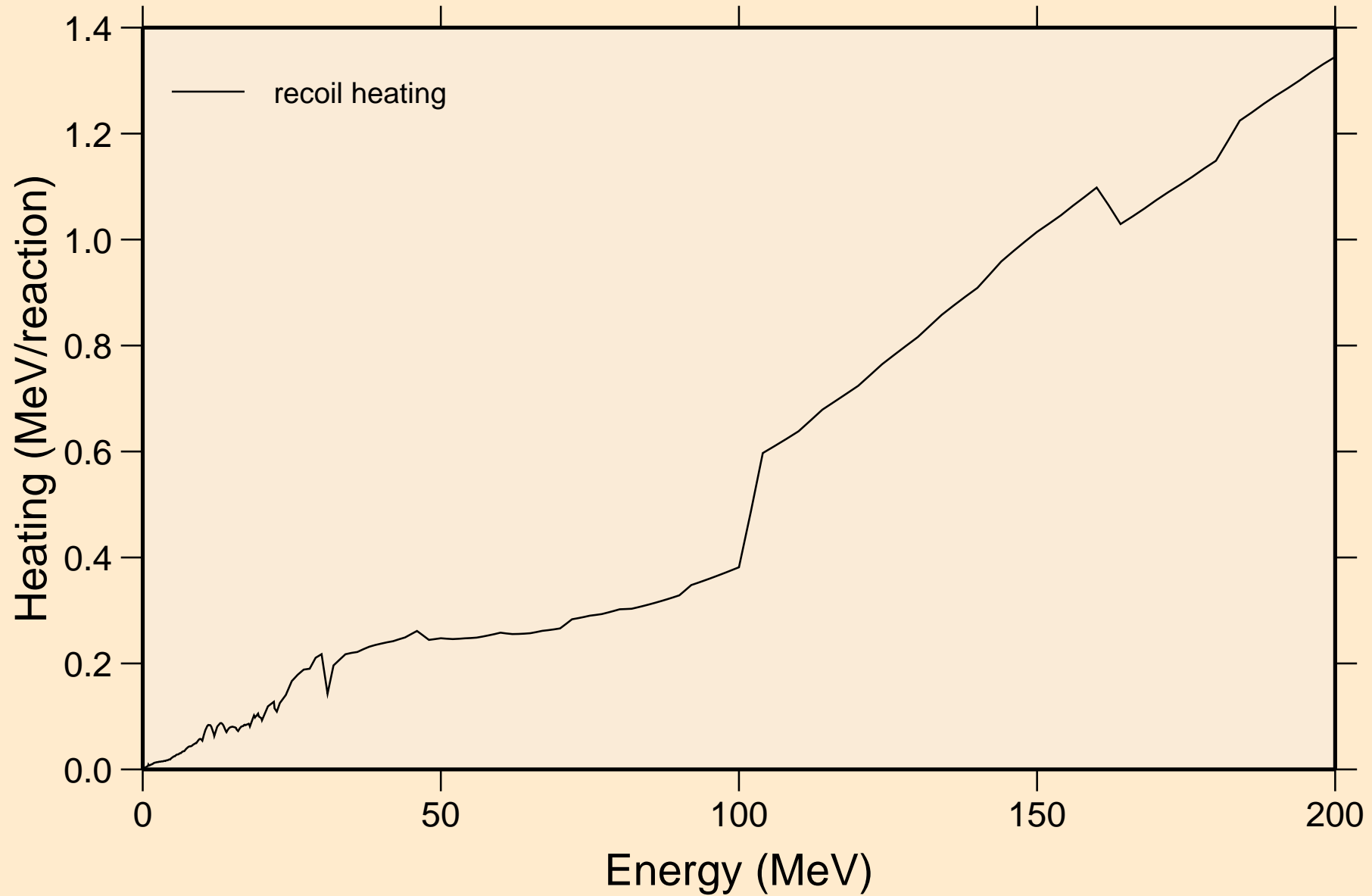

# IR193 NEUTRON ACER TENDL-2024 LIBRARY; T=293.6K

## Particle production cross sections

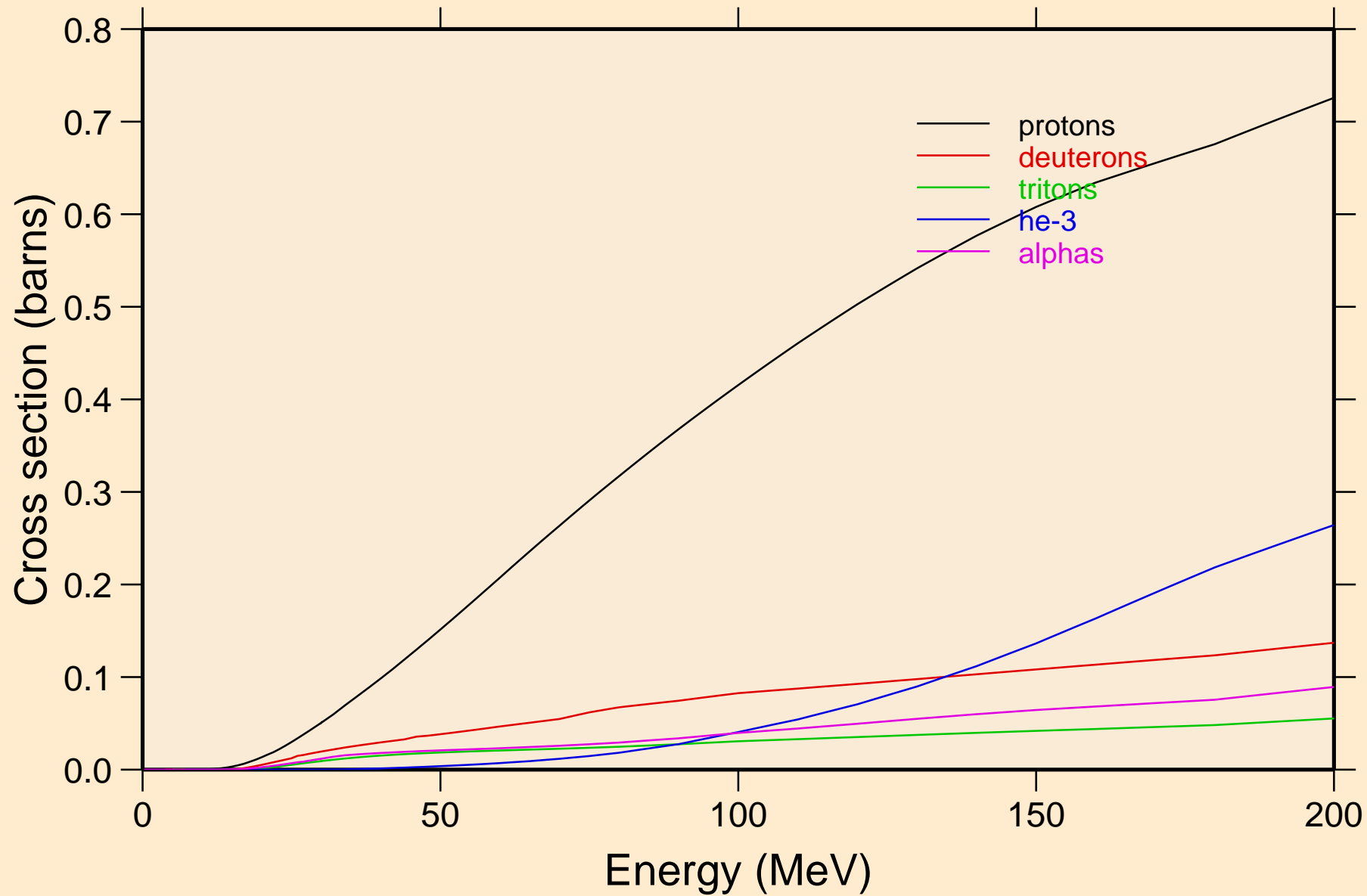

IR193 NEUTRON ACER TENDL-2024 LIBRARY; T=293.6K  
protons from (n,x)

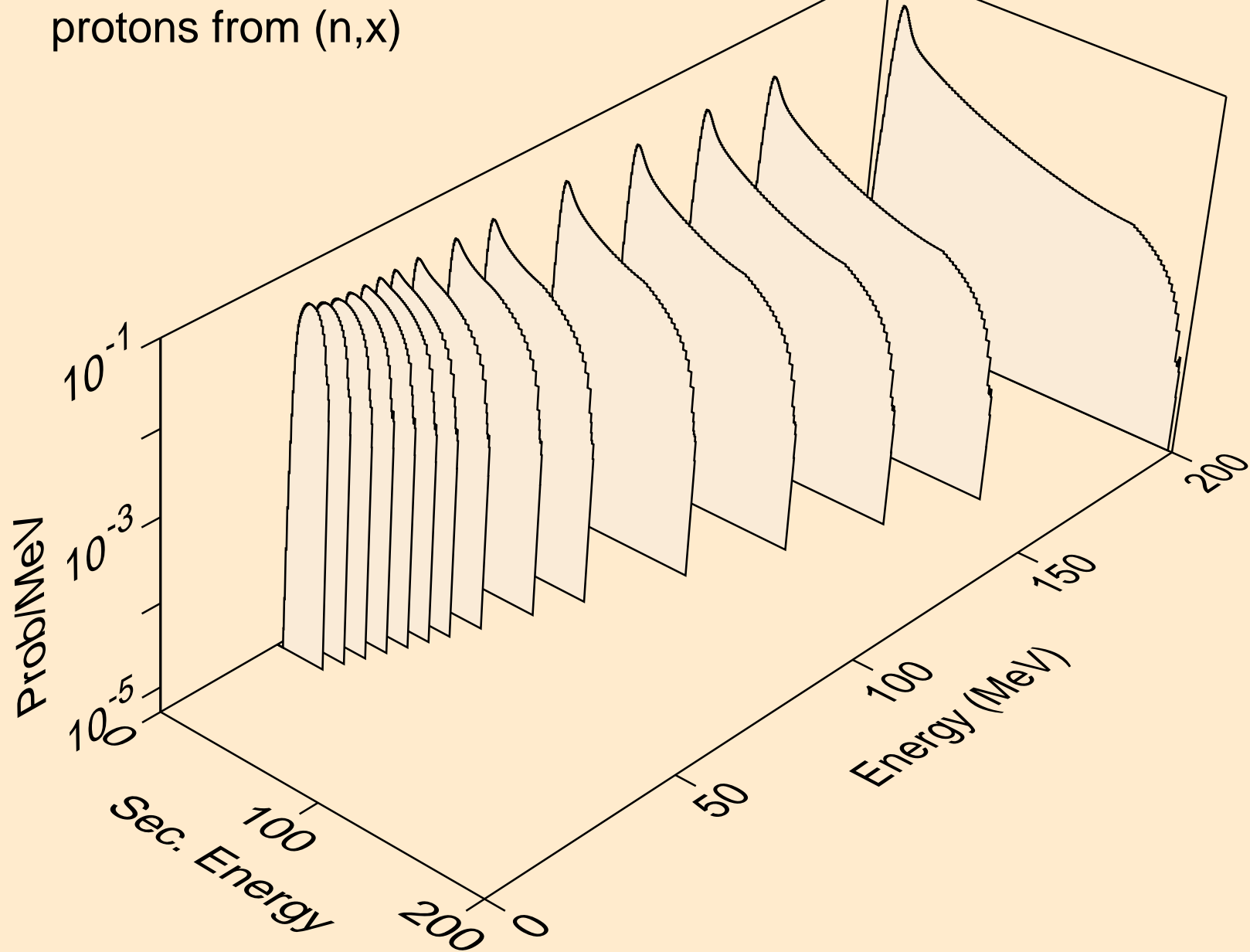

IR193 NEUTRON ACER TENDL-2024 LIBRARY; T=293.6K  
protons from (n,n\*)p

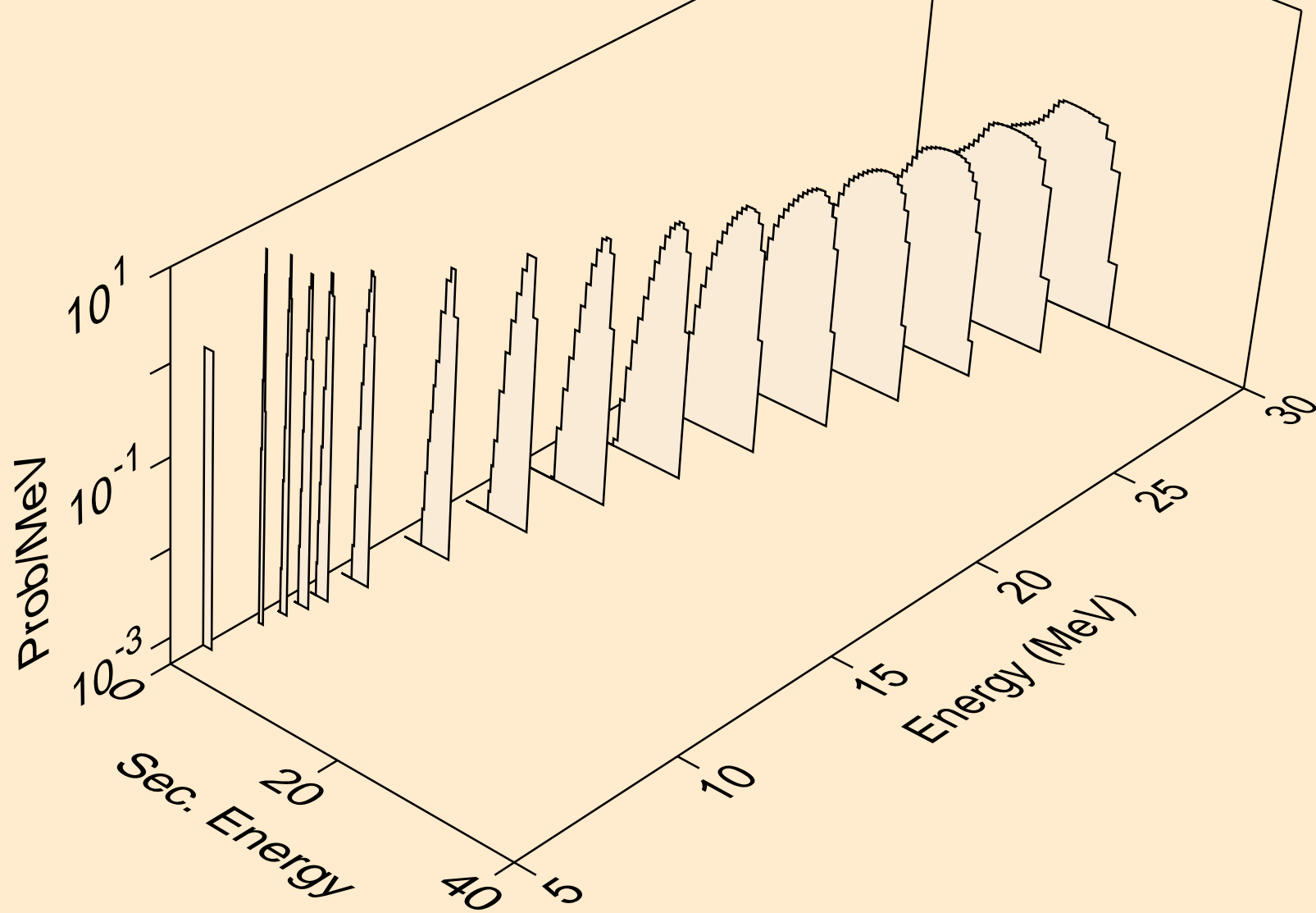

IR193 NEUTRON ACER TENDL-2024 LIBRARY; T=293.6K  
protons from (n,2np)

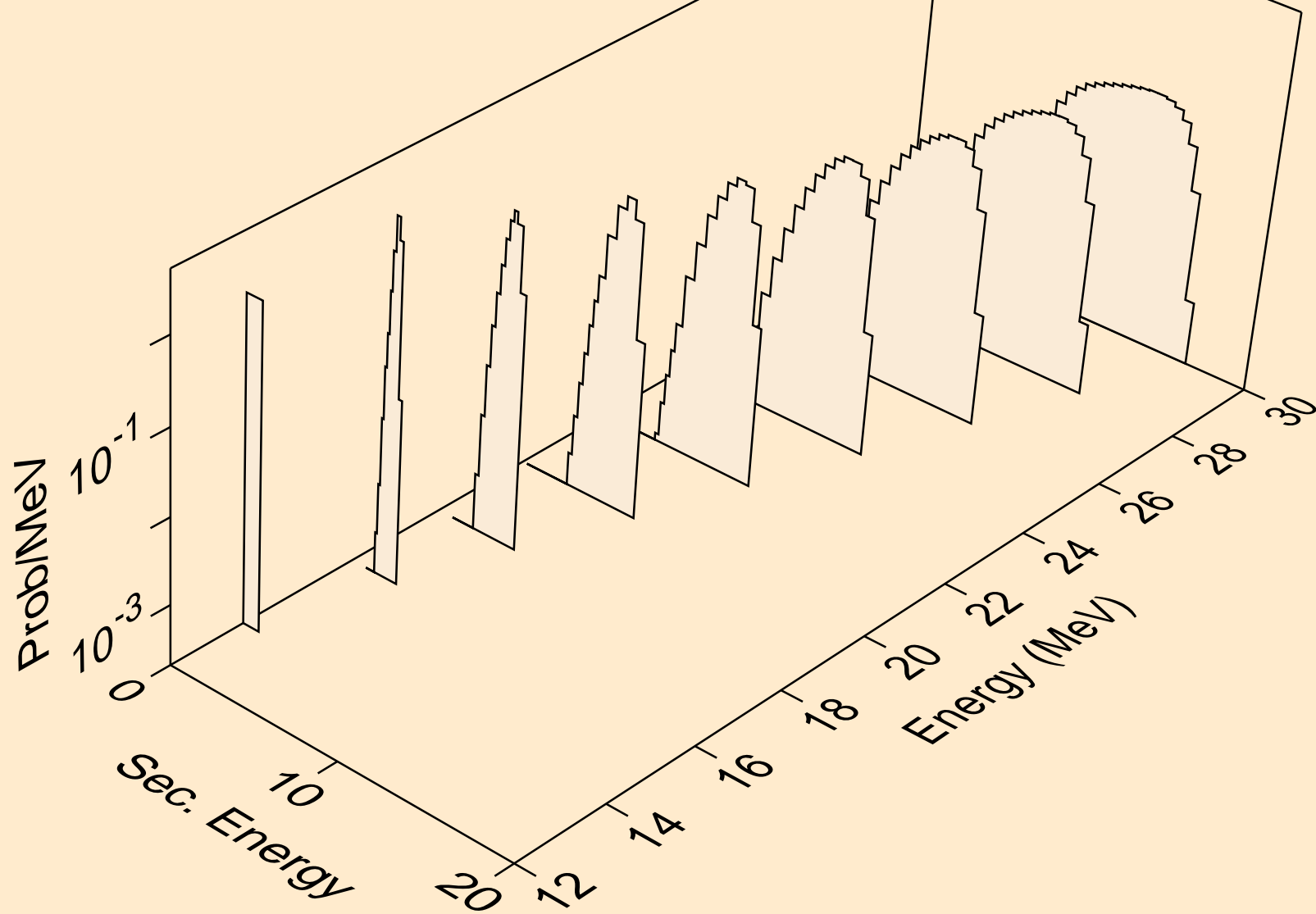

IR193 NEUTRON ACER TENDL-2024 LIBRARY; T=293.6K  
protons from (n,3np)

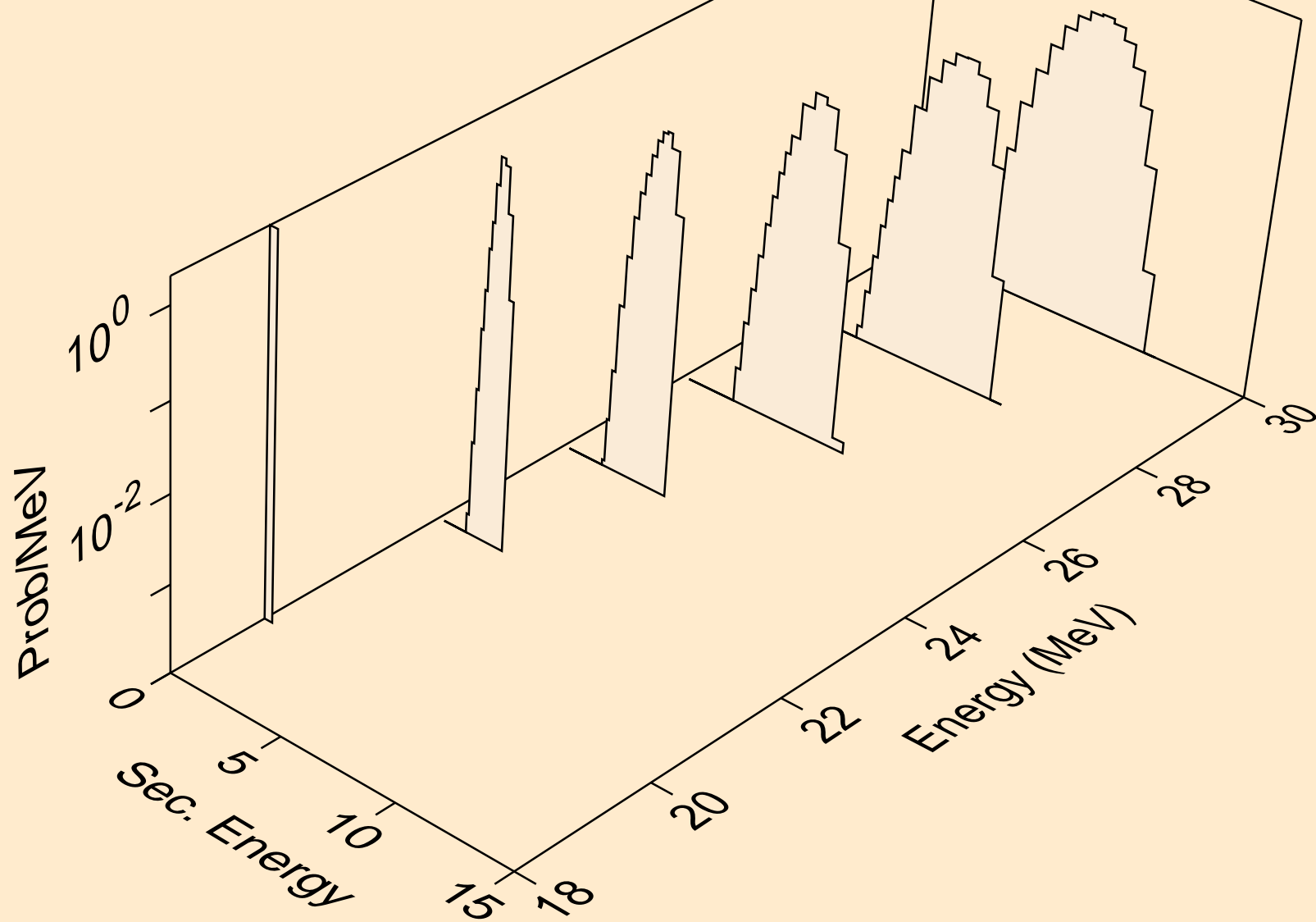

IR193 NEUTRON ACER TENDL-2024 LIBRARY; T=293.6K  
protons from (n,n2p)

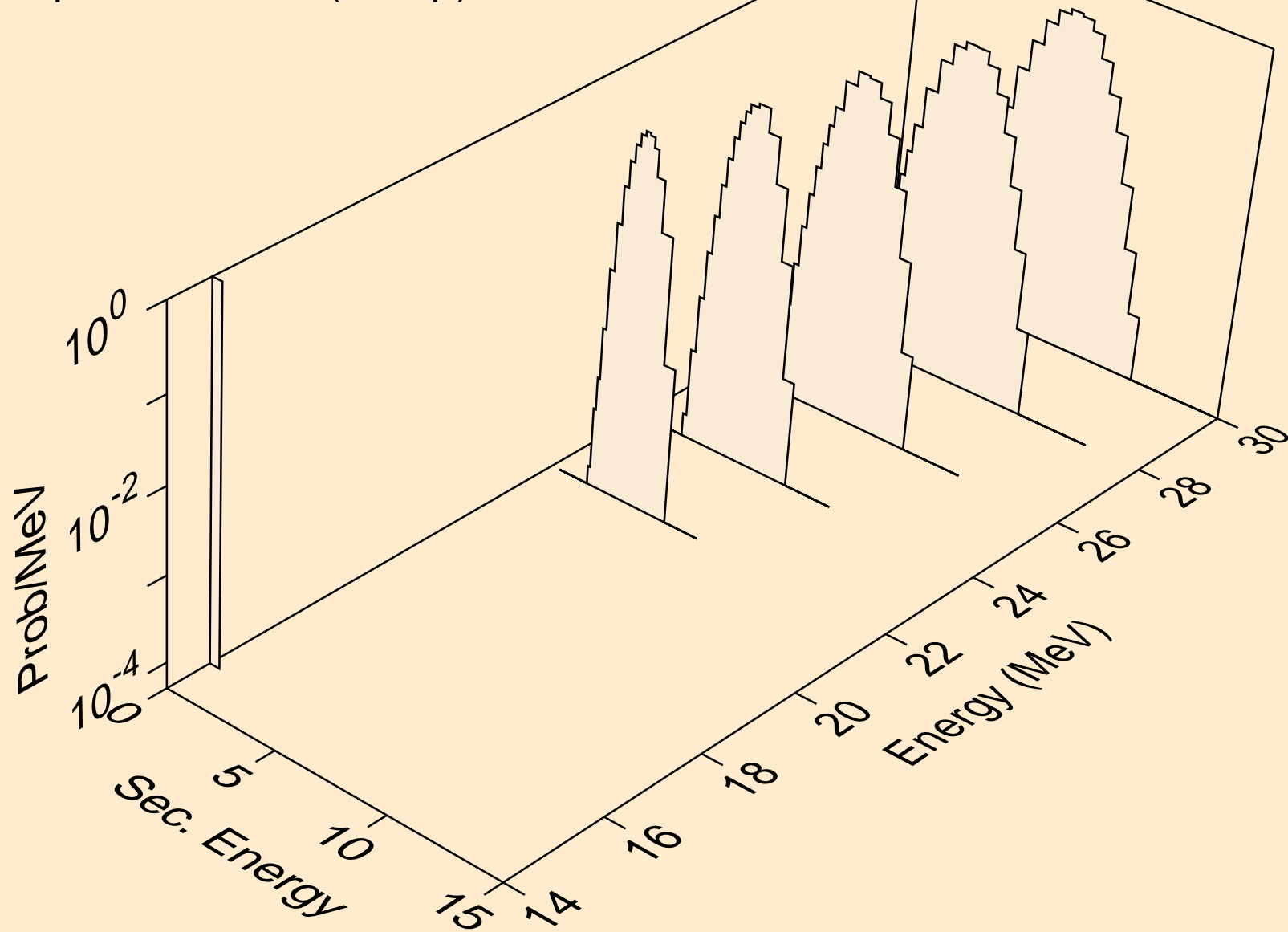

IR193 NEUTRON ACER TENDL-2024 LIBRARY; T=293.6K  
protons from (n,p)

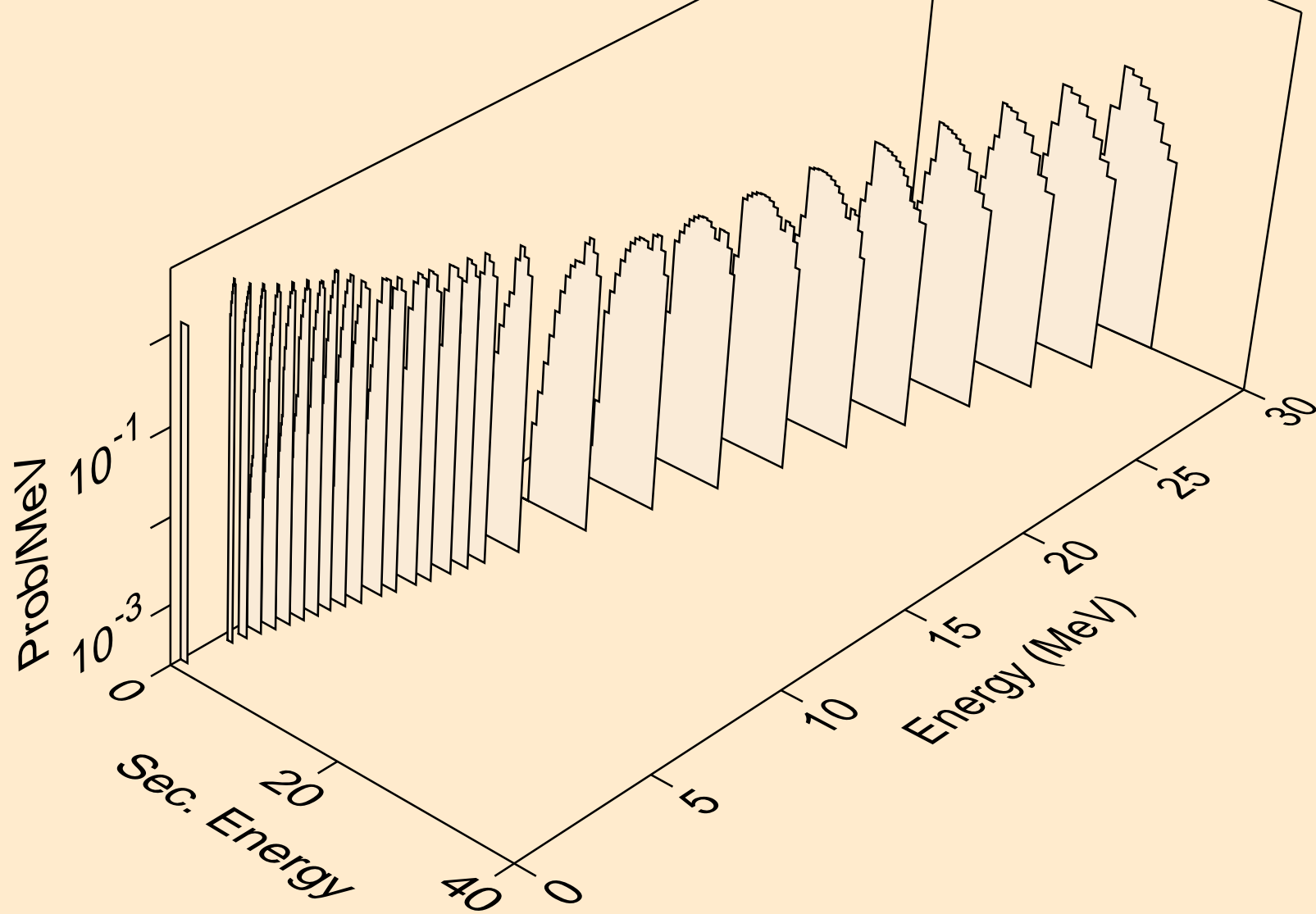

IR193 NEUTRON ACER TENDL-2024 LIBRARY; T=293.6K  
protons from (n,2p)

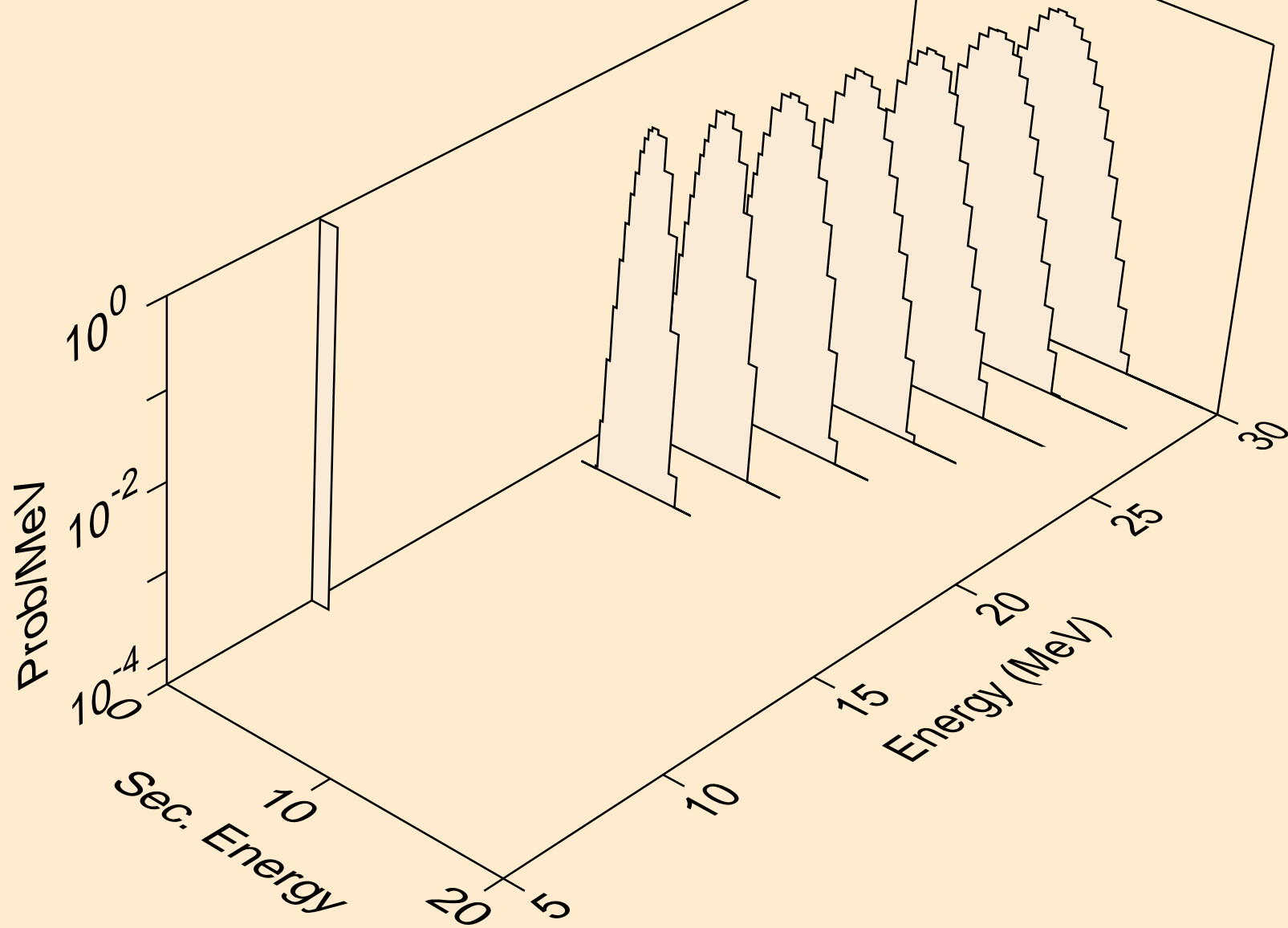

IR193 NEUTRON ACER TENDL-2024 LIBRARY; T=293.6K  
deuterons from (n,x)

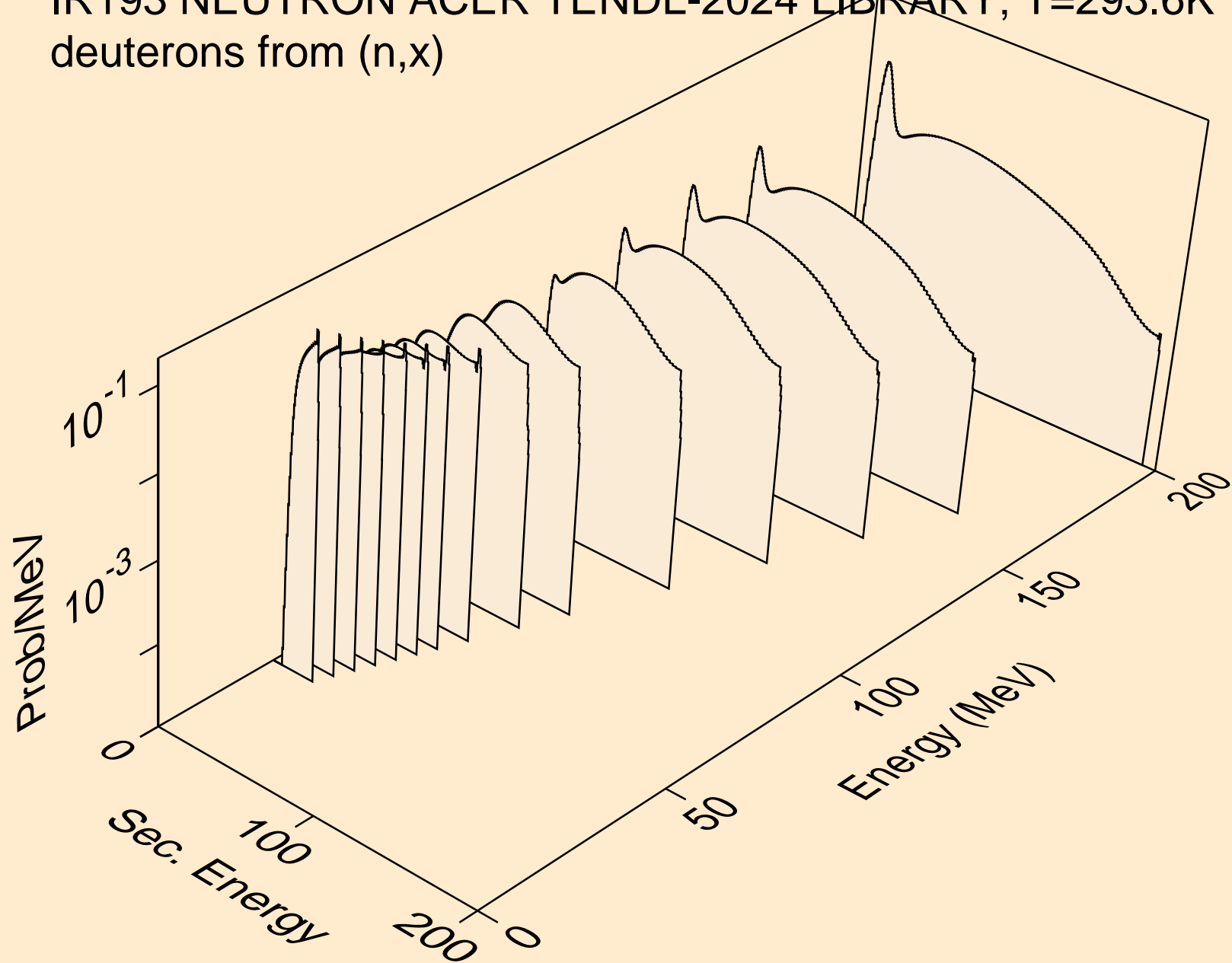

IR193 NEUTRON ACER TENDL-2024 LIBRARY; T=293.6K  
deuterons from (n,2nd)

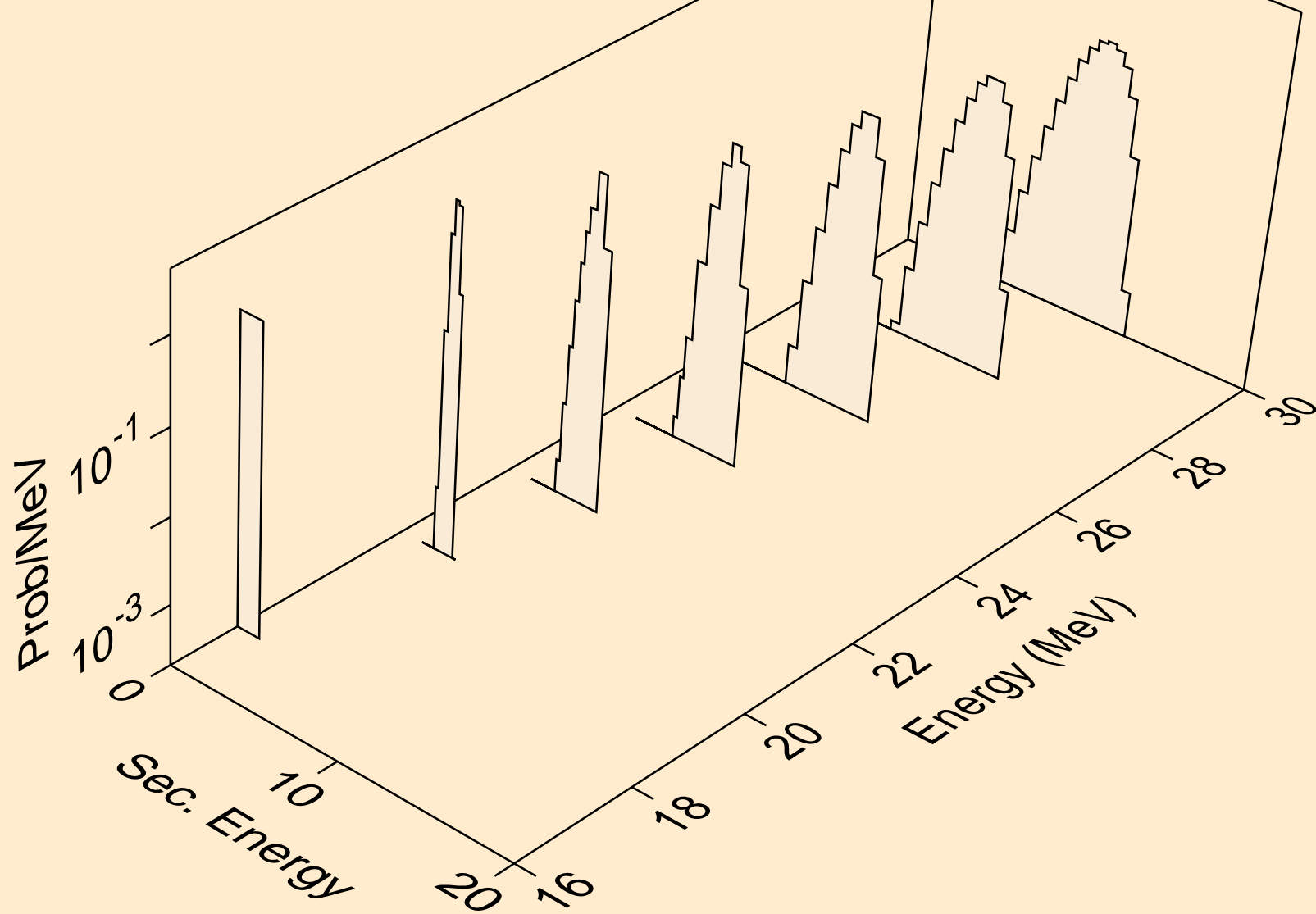

IR193 NEUTRON ACER TENDL-2024 LIBRARY; T=293.6K  
deuterons from (n,n\*)d

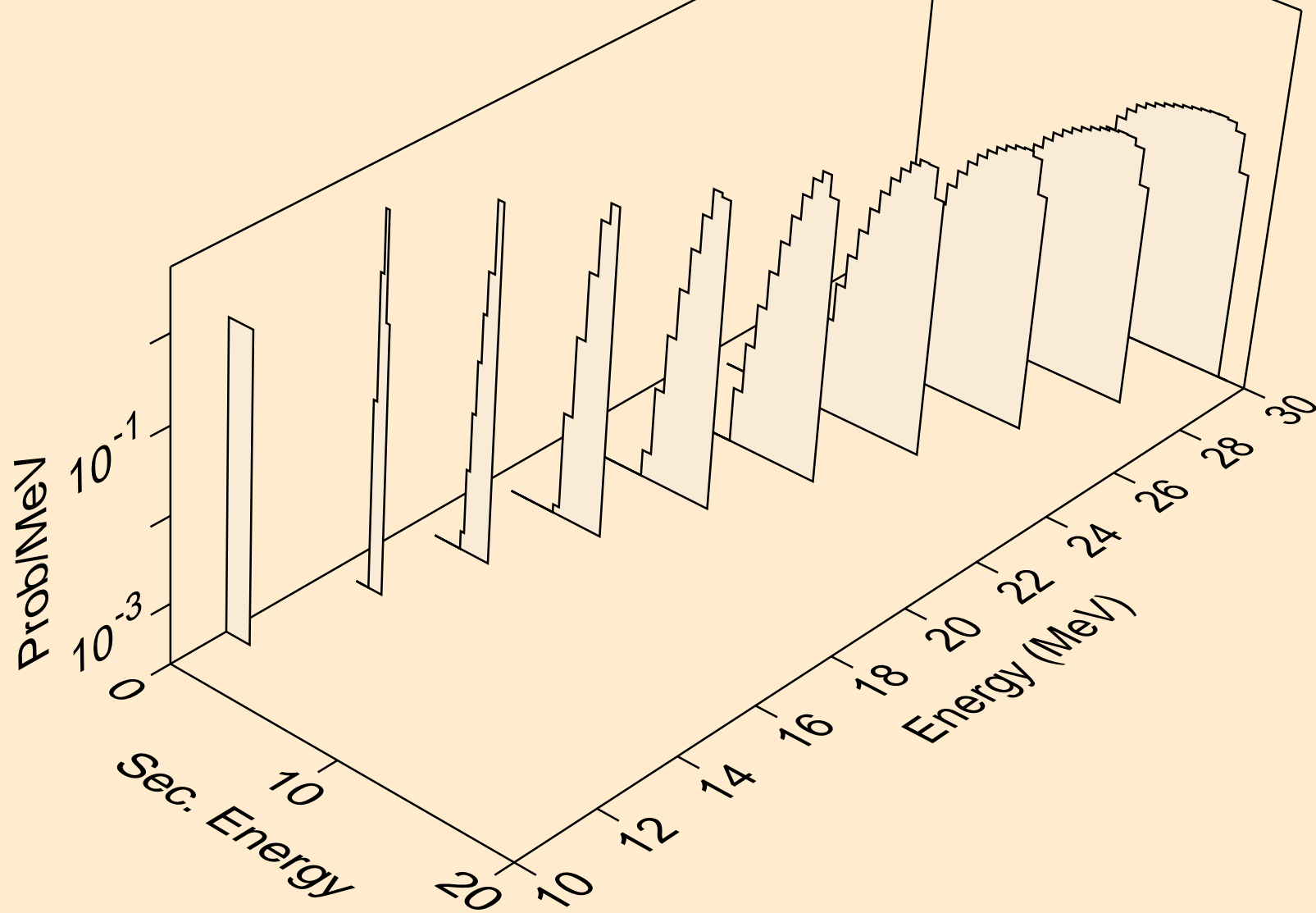

IR193 NEUTRON ACER TENDL-2024 LIBRARY; T=293.6K  
deuterons from (n,d)

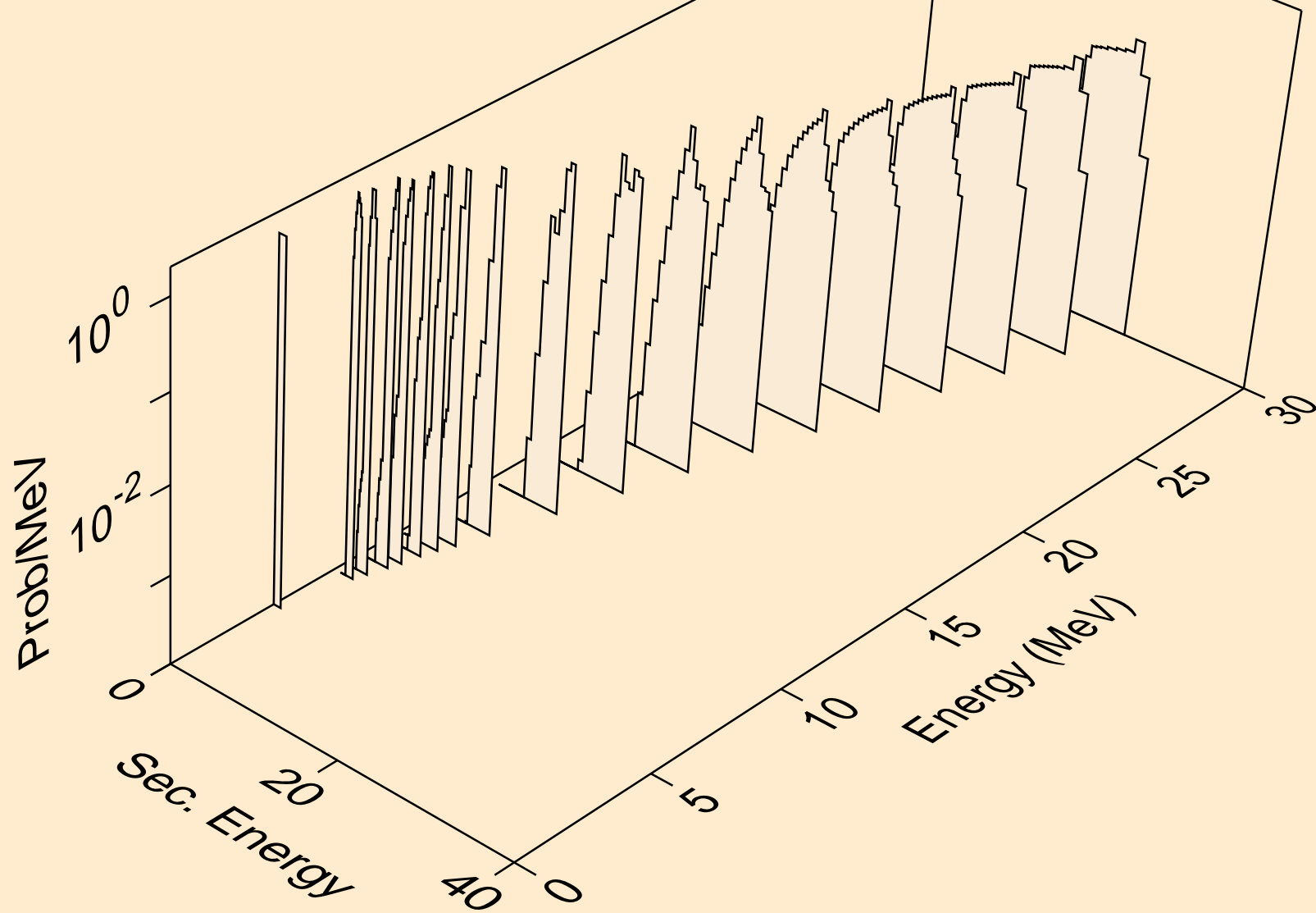

IR193 NEUTRON ACER TENDL-2024 LIBRARY; T=293.6K  
tritons from (n,x)

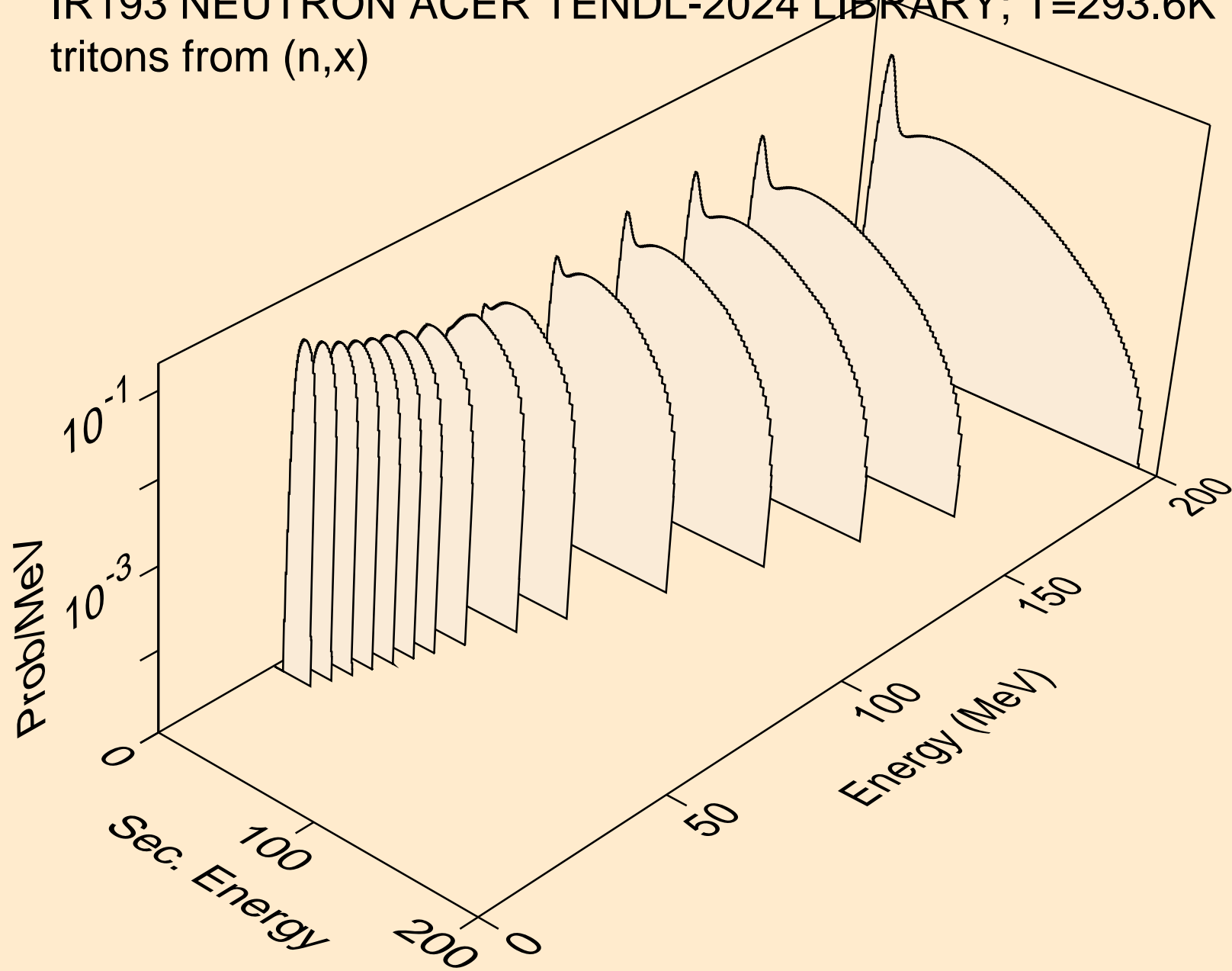

IR193 NEUTRON ACER TENDL-2024 LIBRARY; T=293.6K  
tritons from (n,n\*)t

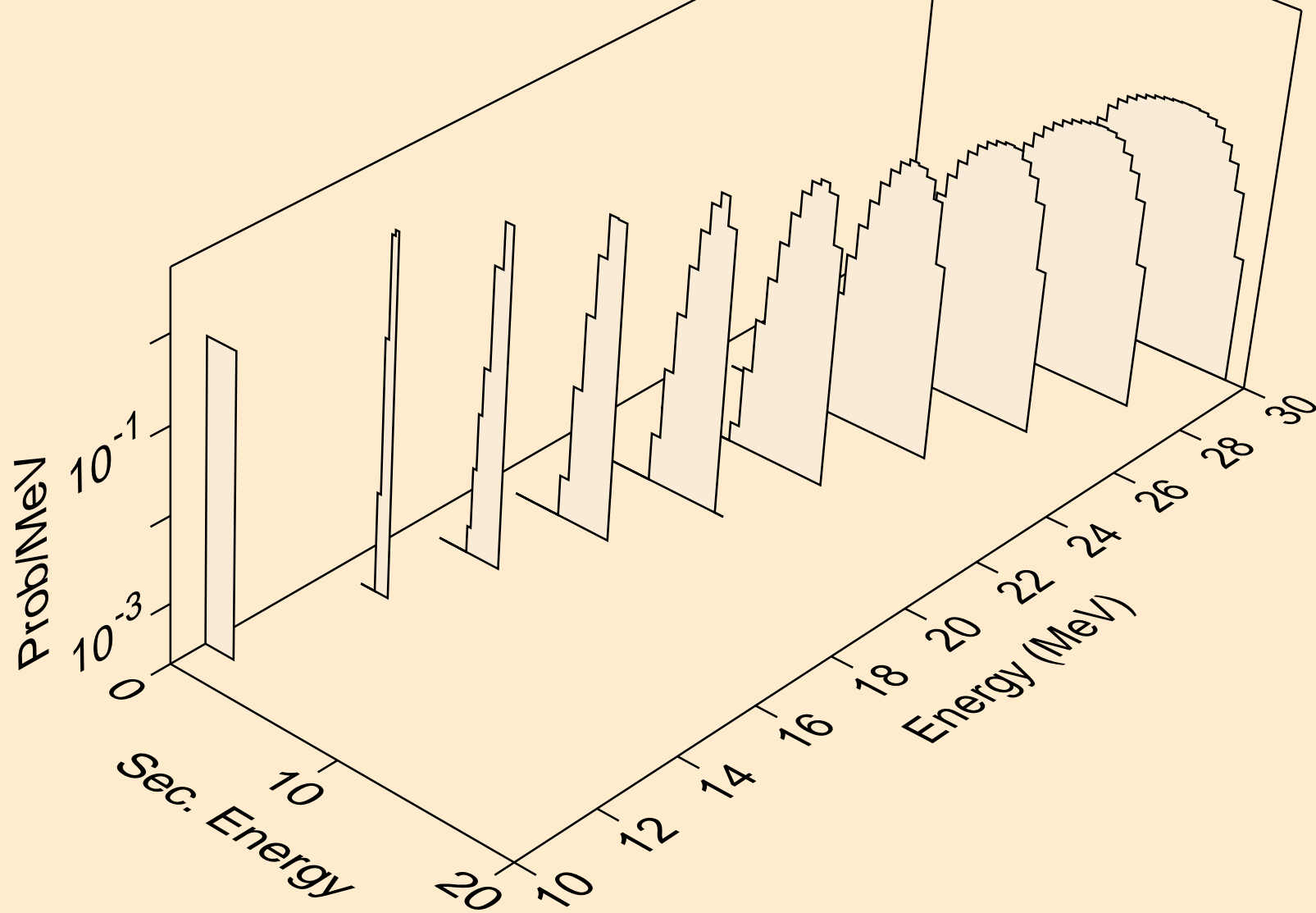

IR193 NEUTRON ACER TENDL-2024 LIBRARY; T=293.6K  
tritons from (n,t)

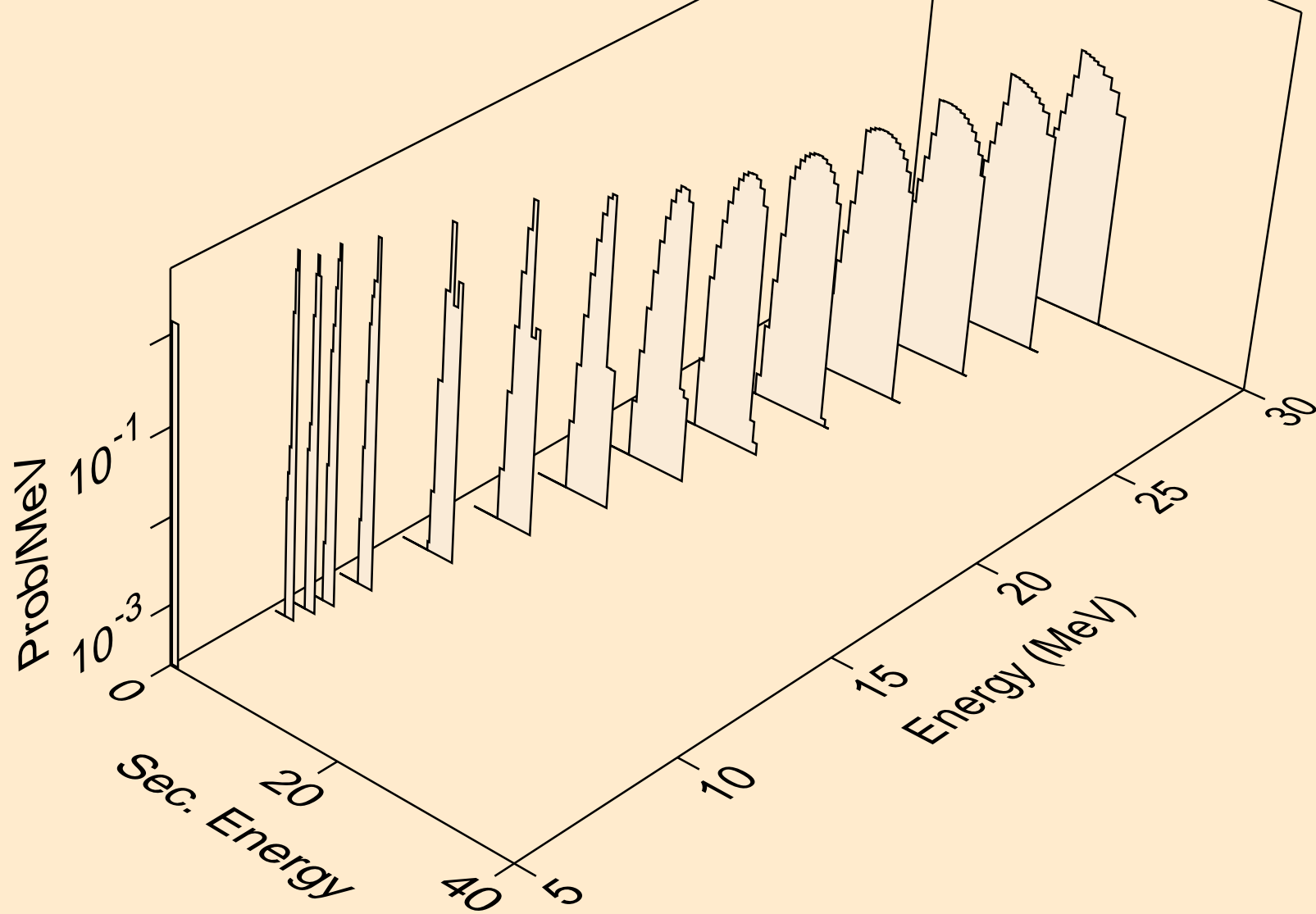

IR193 NEUTRON ACER TENDL-2024 LIBRARY; T=293.6K  
he3s from (n,x)

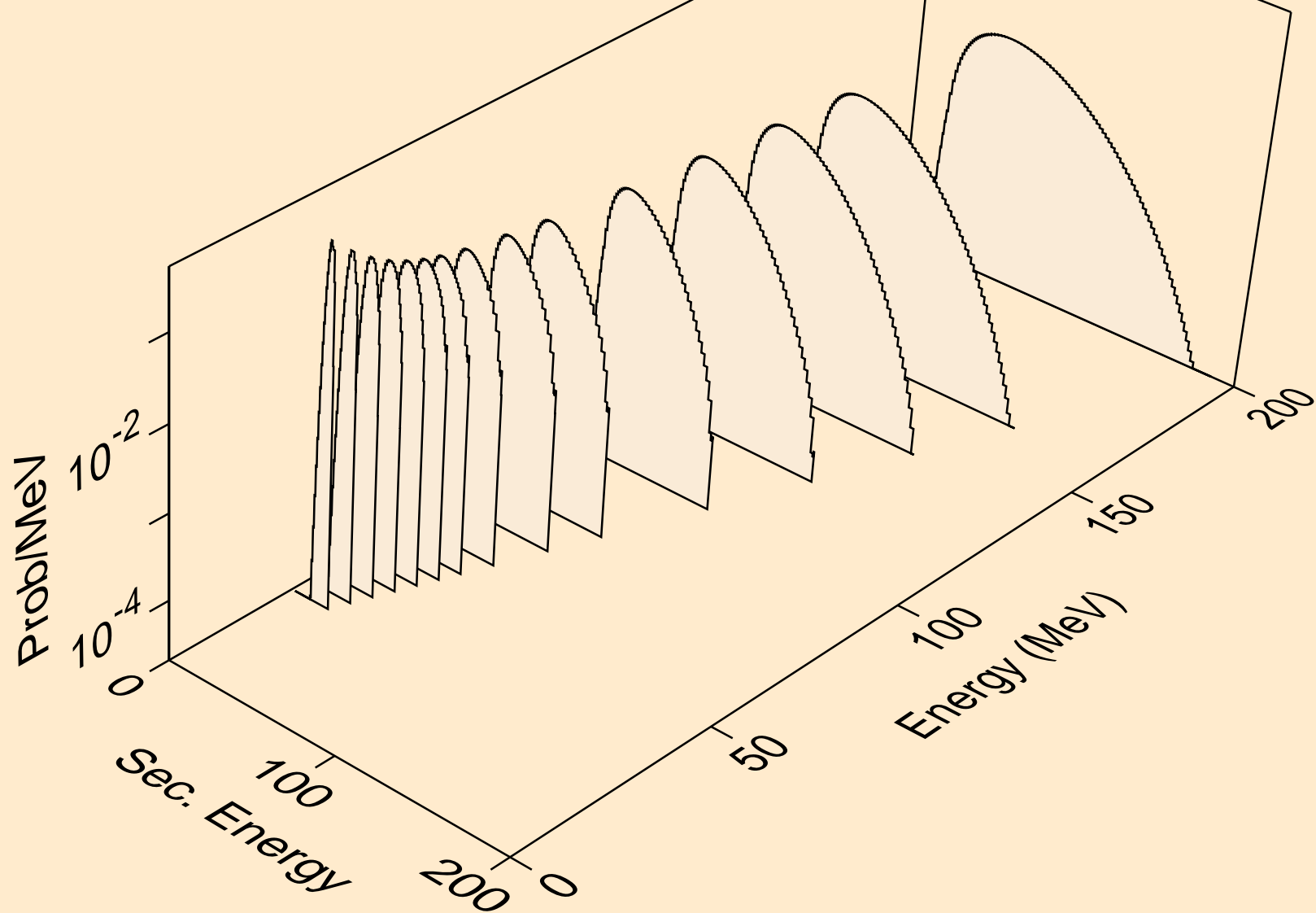

IR193 NEUTRON ACER TENDL-2024 LIBRARY; T=293.6K  
he3s from (n,n\*)he3

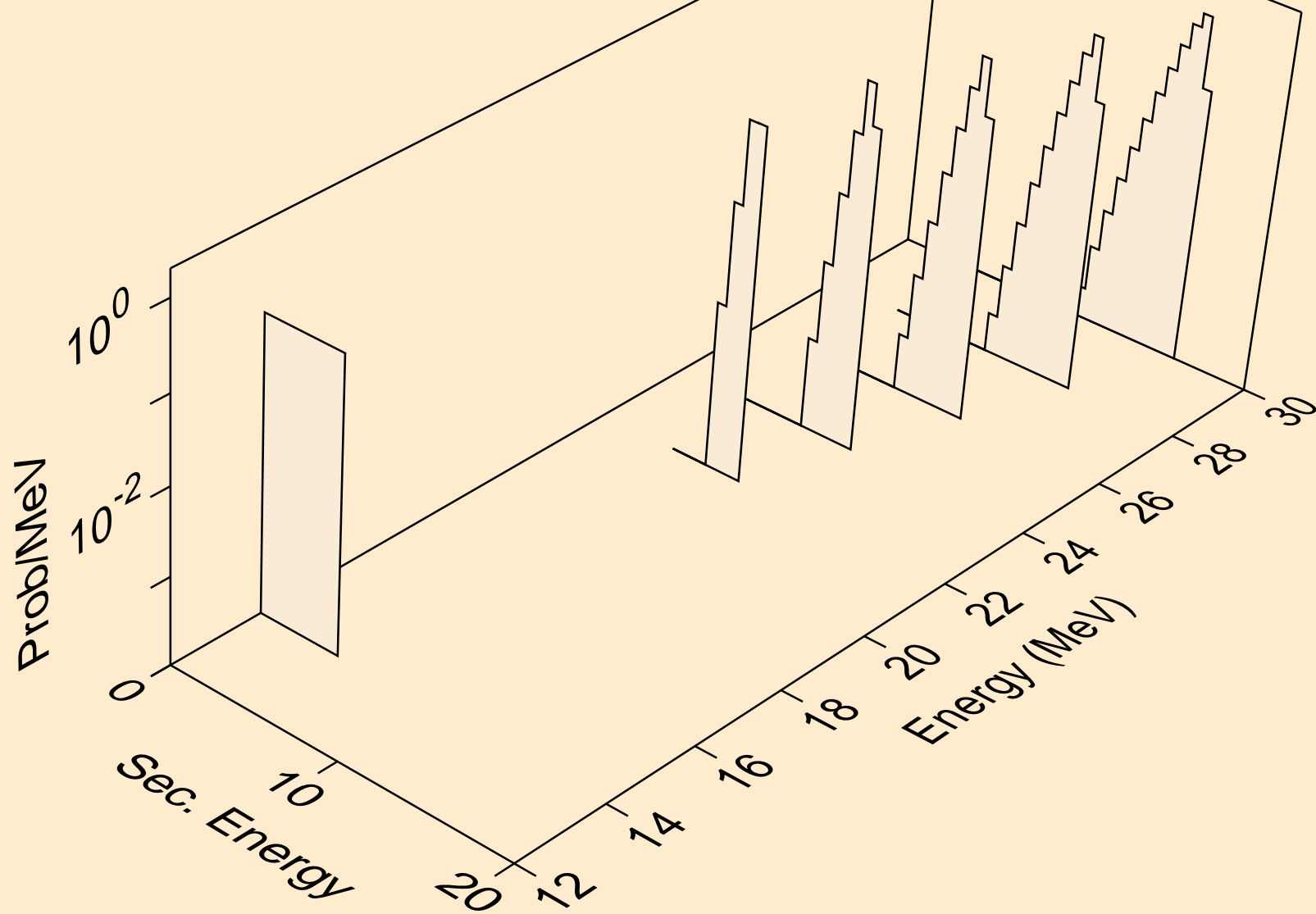

IR193 NEUTRON ACER TENDL-2024 LIBRARY; T=293.6K  
he3s from (n,he3)

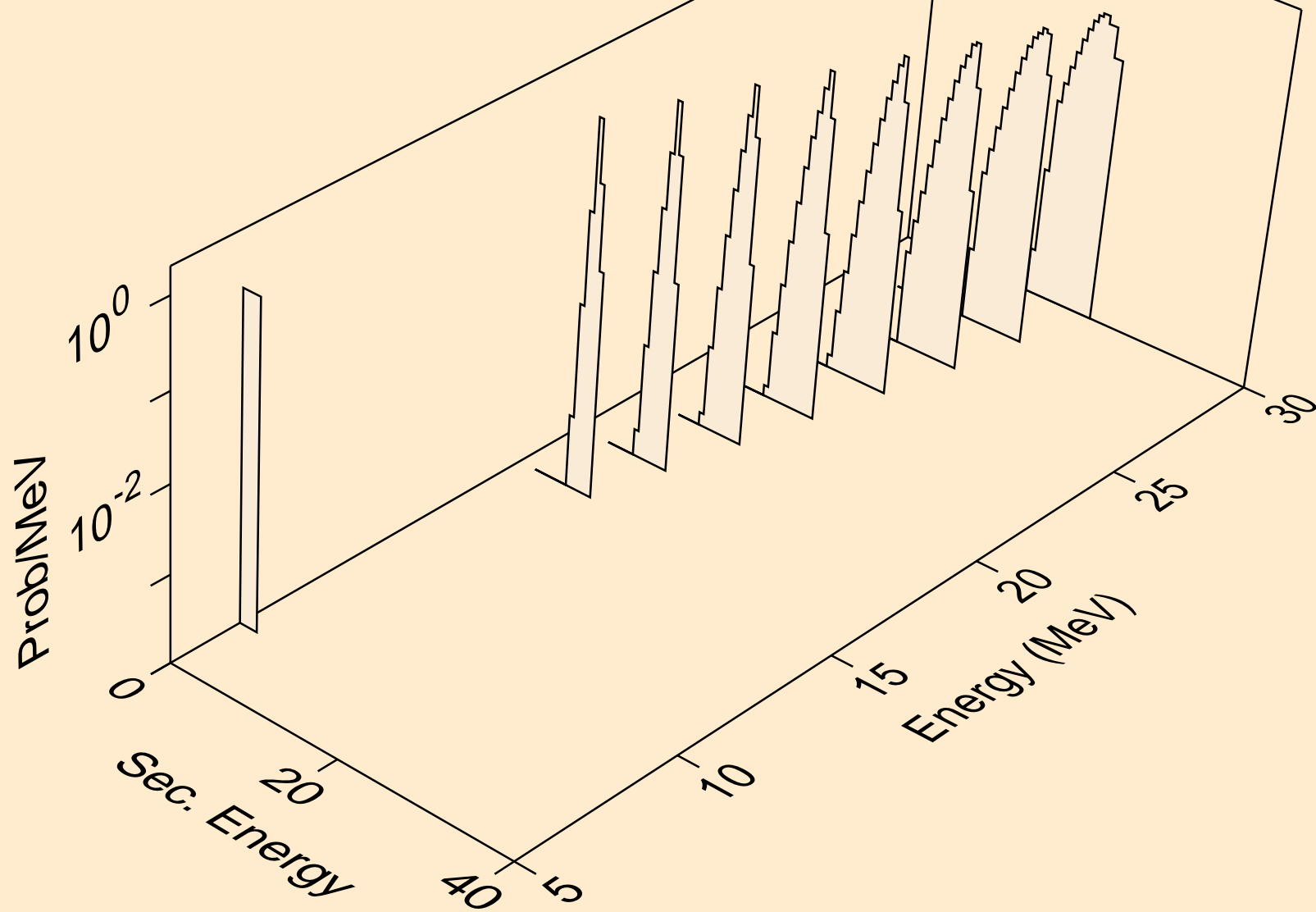

IR193 NEUTRON ACER TENDL-2024 LIBRARY; T=293.6K  
alphas from (n,x)

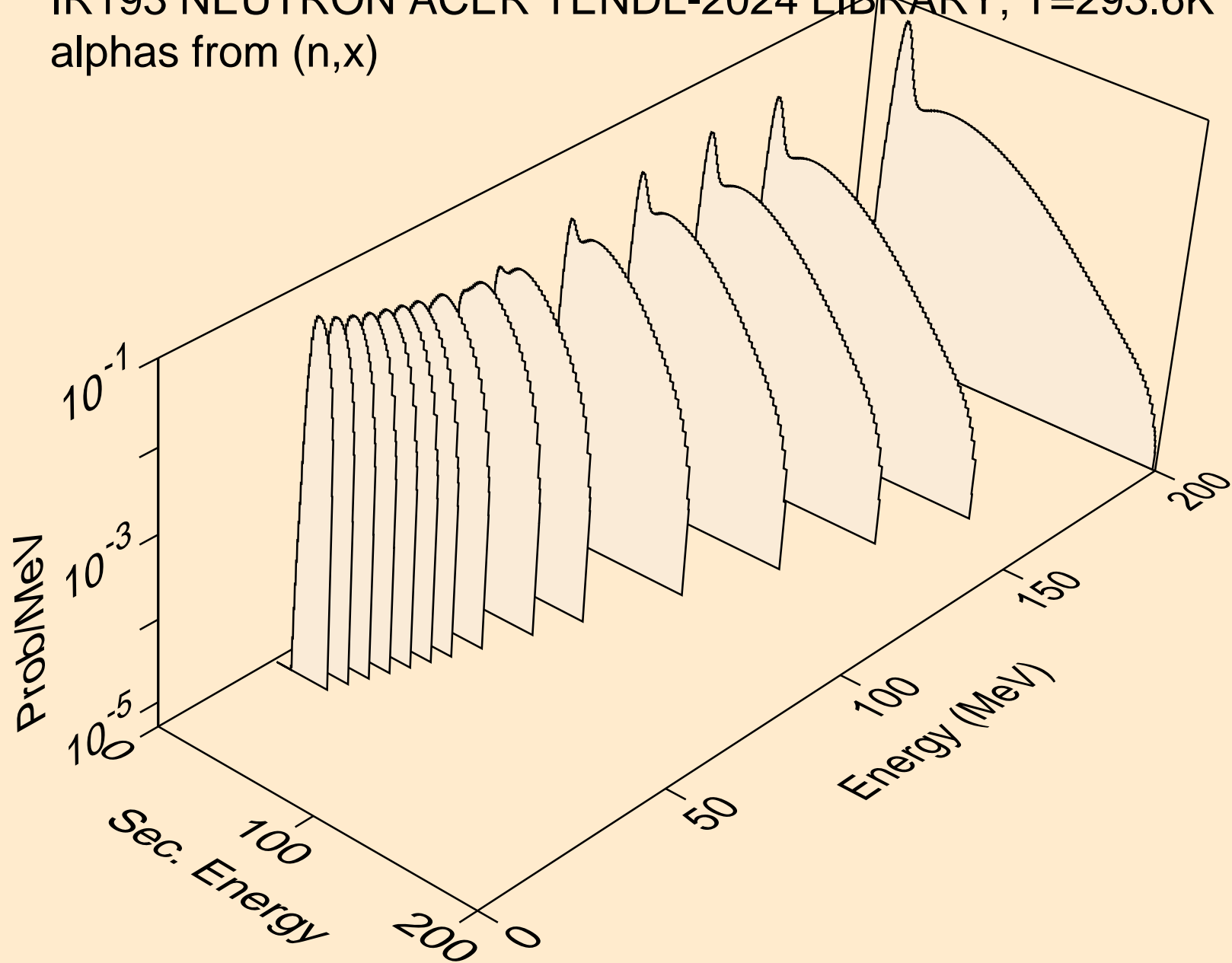

IR193 NEUTRON ACER TENDL-2024 LIBRARY; T=293.6K  
alphas from (n,n\*)a

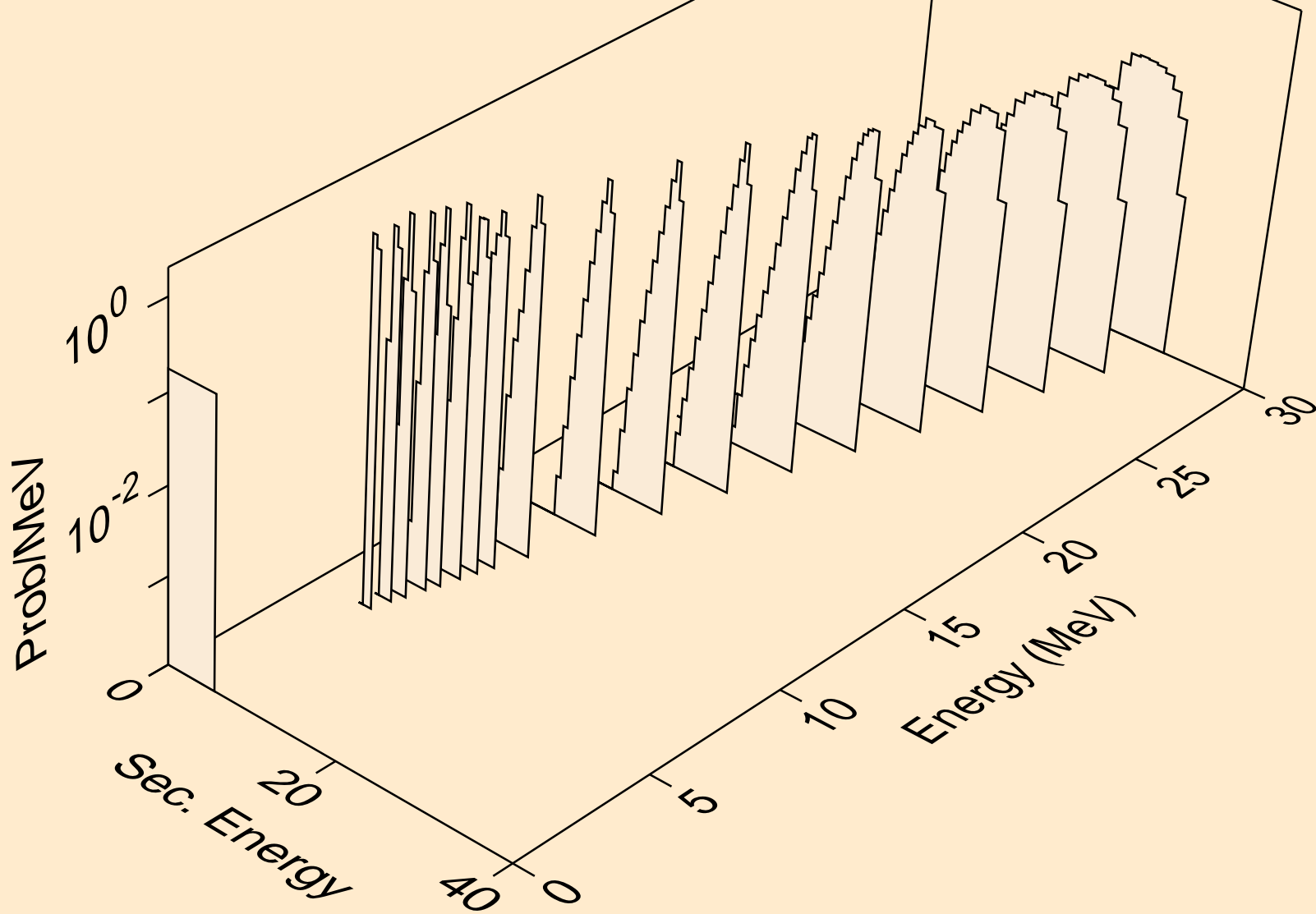

IR193 NEUTRON ACER TENDL-2024 LIBRARY; T=293.6K  
alphas from (n,2n)a

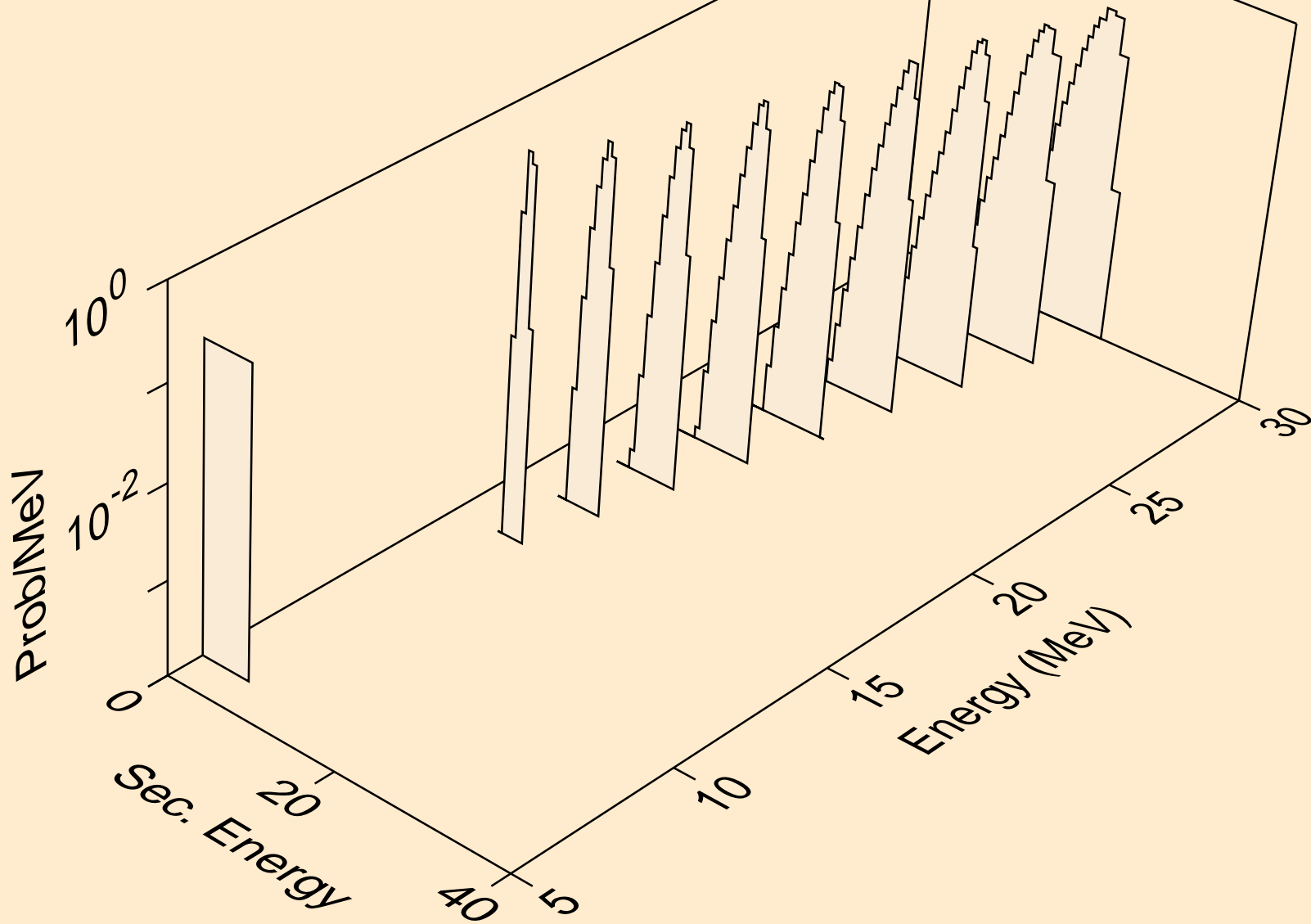

IR193 NEUTRON ACER TENDL-2024 LIBRARY; T=293.6K  
alphas from (n,3n)a

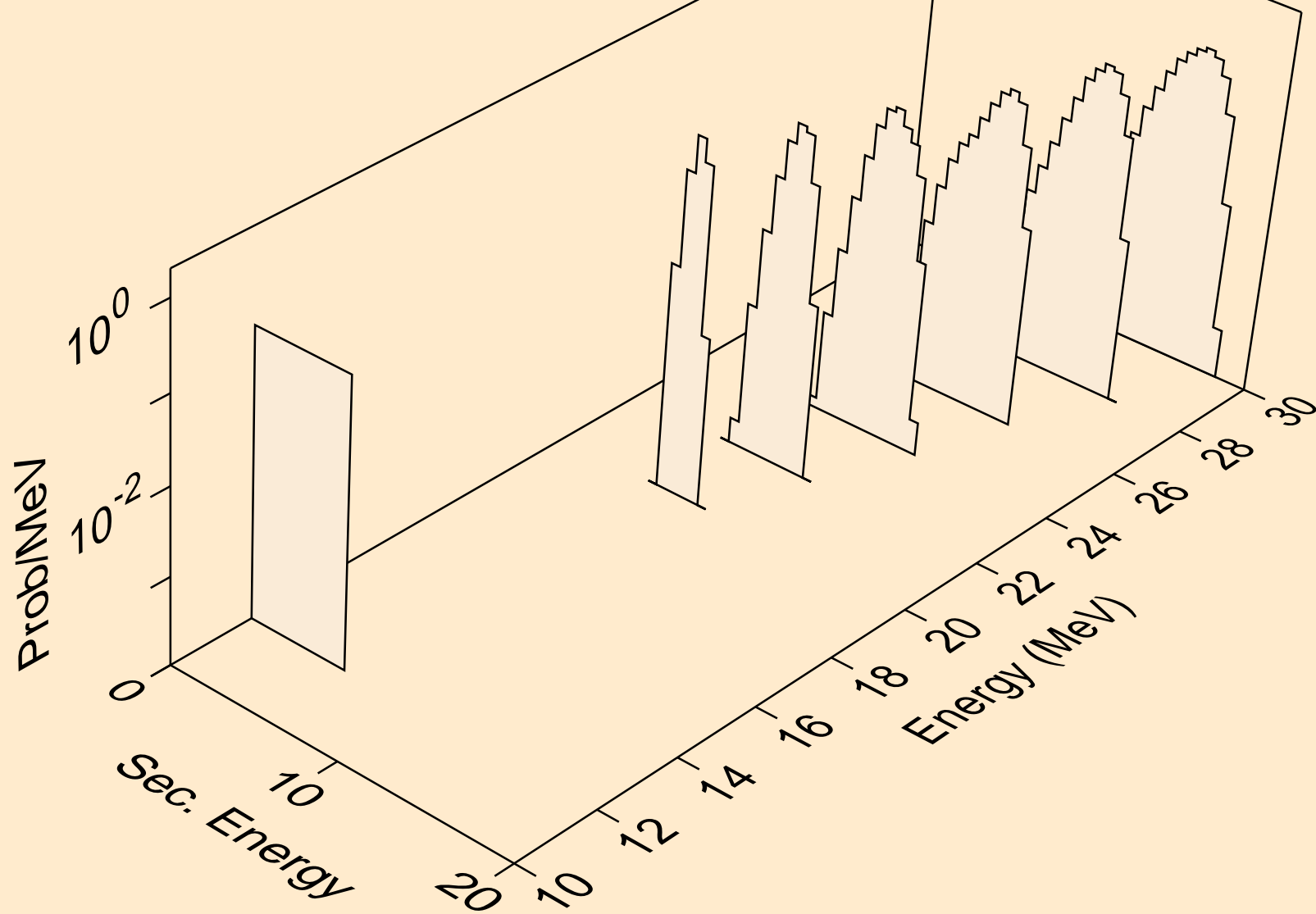

IR193 NEUTRON ACER TENDL-2024 LIBRARY; T=293.6K  
alphas from (n,a)

