

IR198 NEUTRON ACER TENDL-2024 LIBRARY; T=293.6K

Principal cross sections

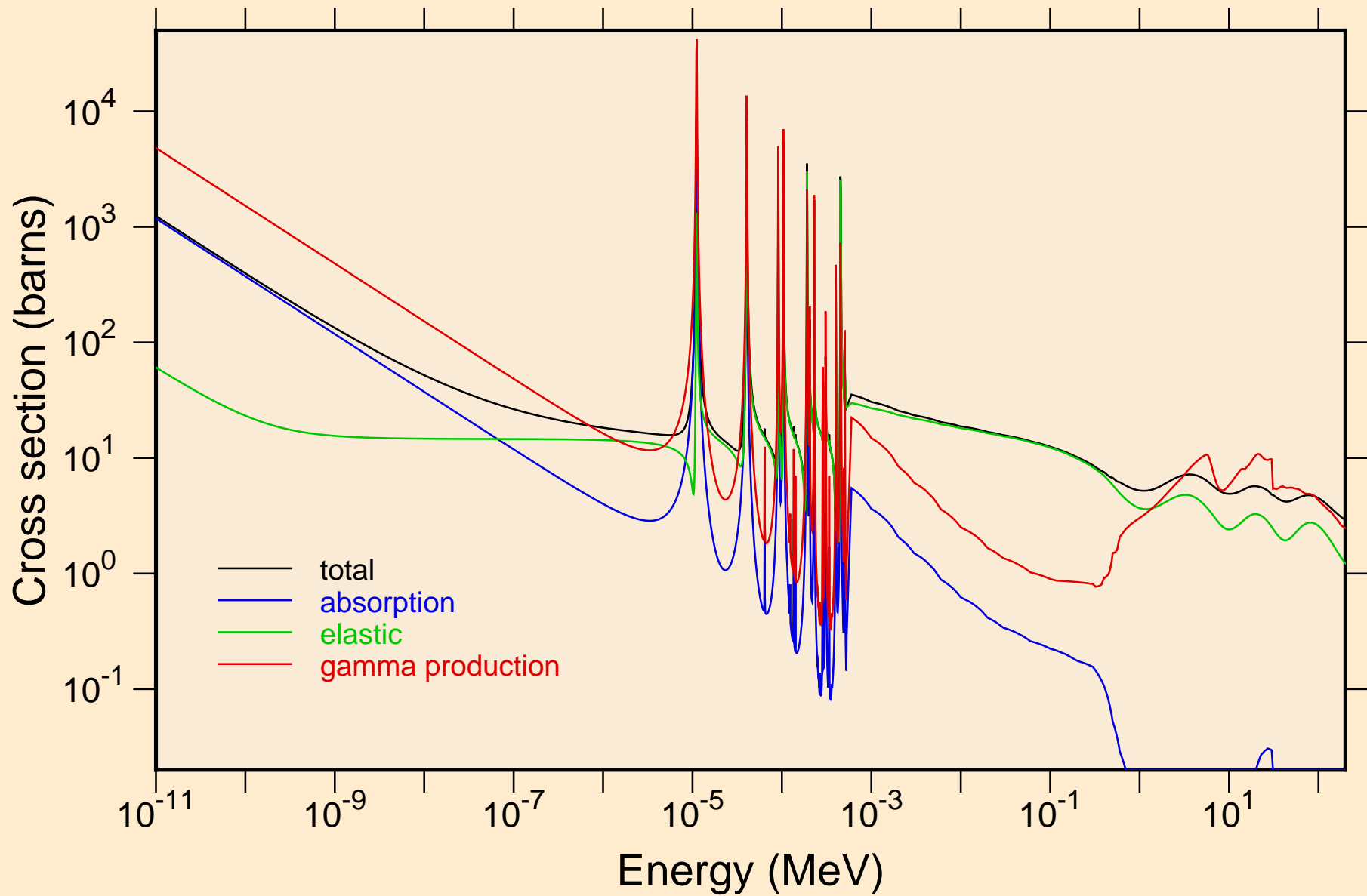

IR198 NEUTRON ACER TENDL-2024 LIBRARY; T=293.6K
resonance total cross section

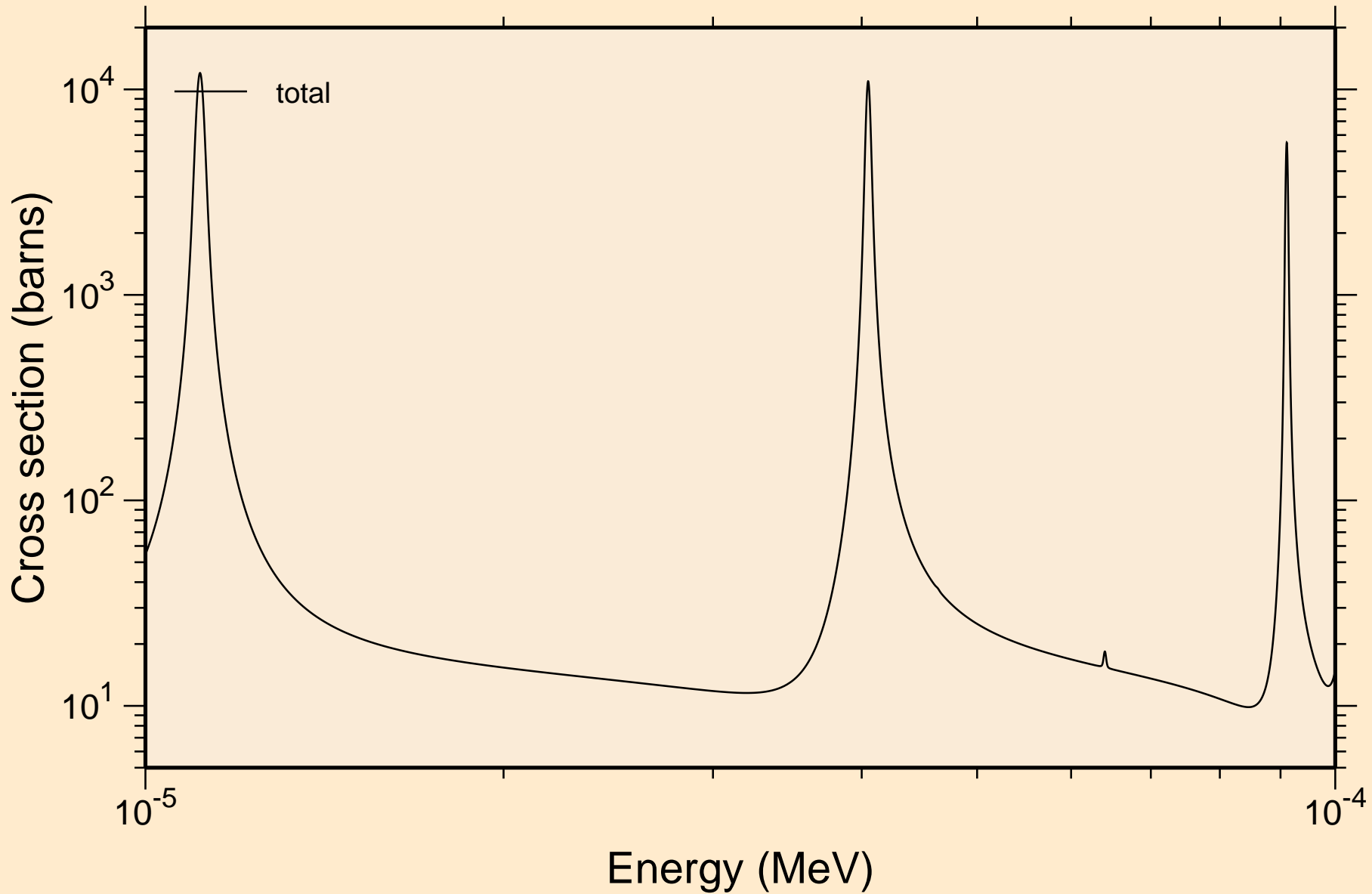

IR198 NEUTRON ACER TENDL-2024 LIBRARY; T=293.6K
resonance total cross section

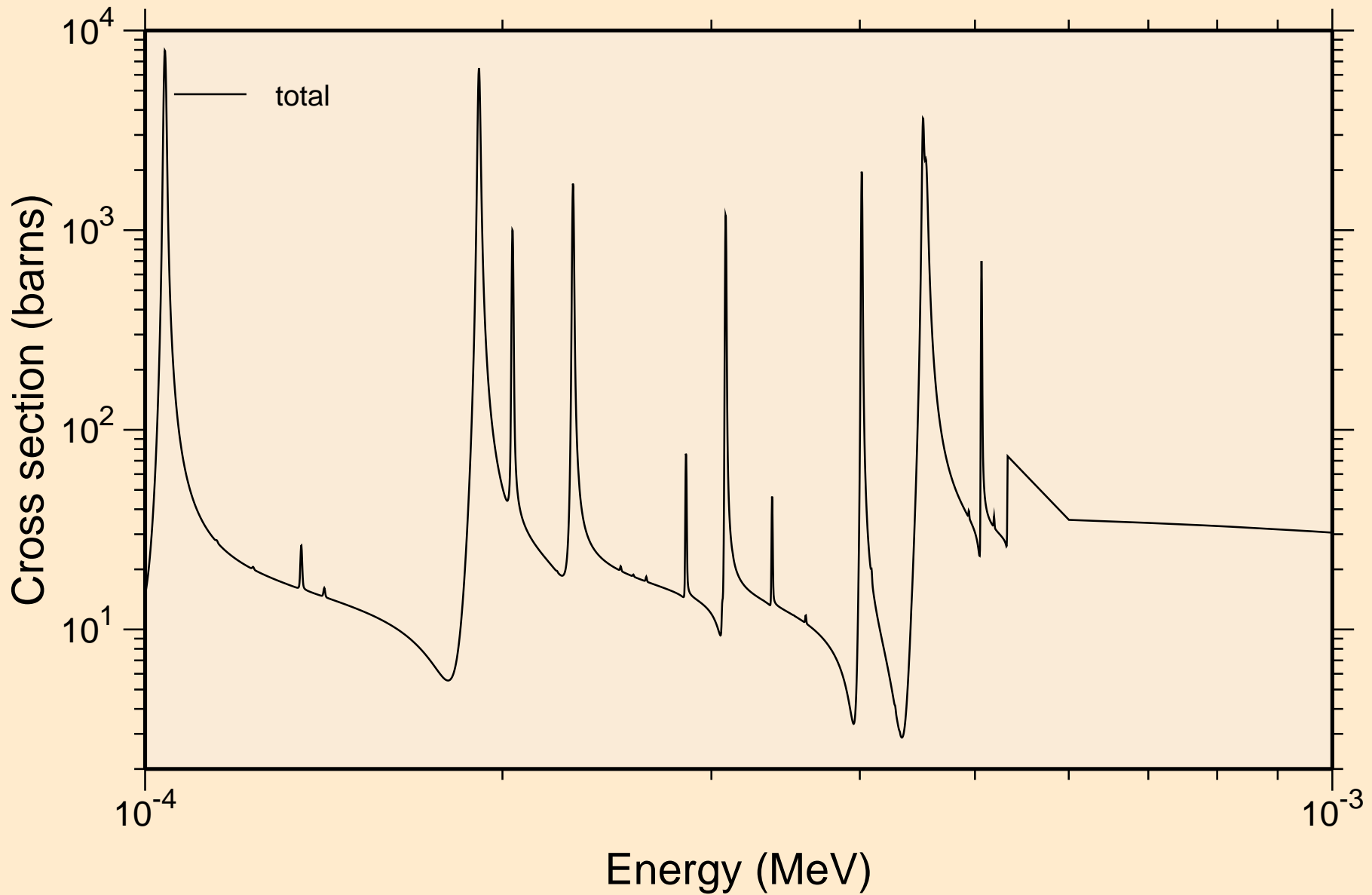

IR198 NEUTRON ACER TENDL-2024 LIBRARY; T=293.6K
resonance total cross section

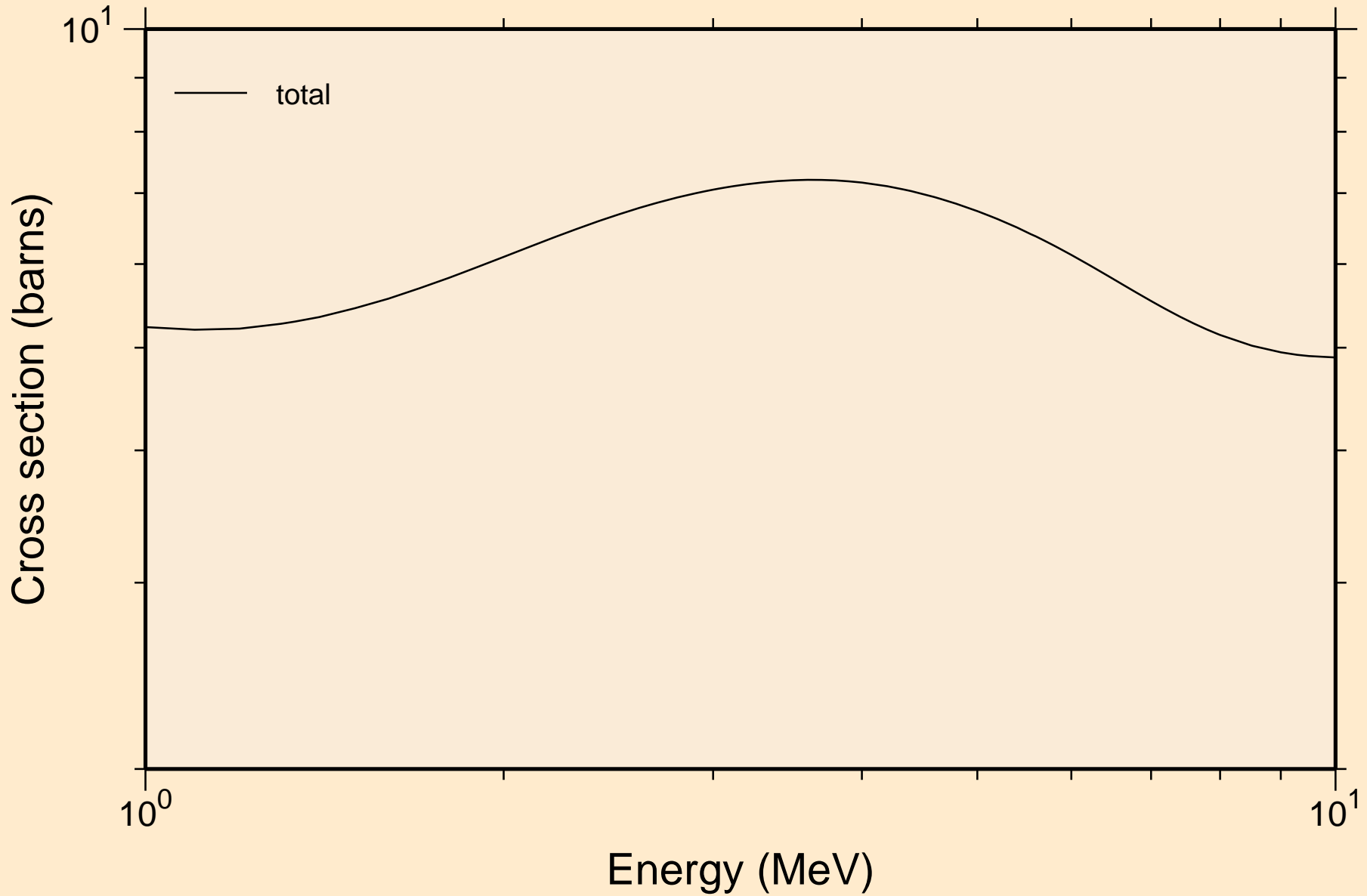

IR198 NEUTRON ACER TENDL-2024 LIBRARY; T=293.6K
resonance absorption cross sections

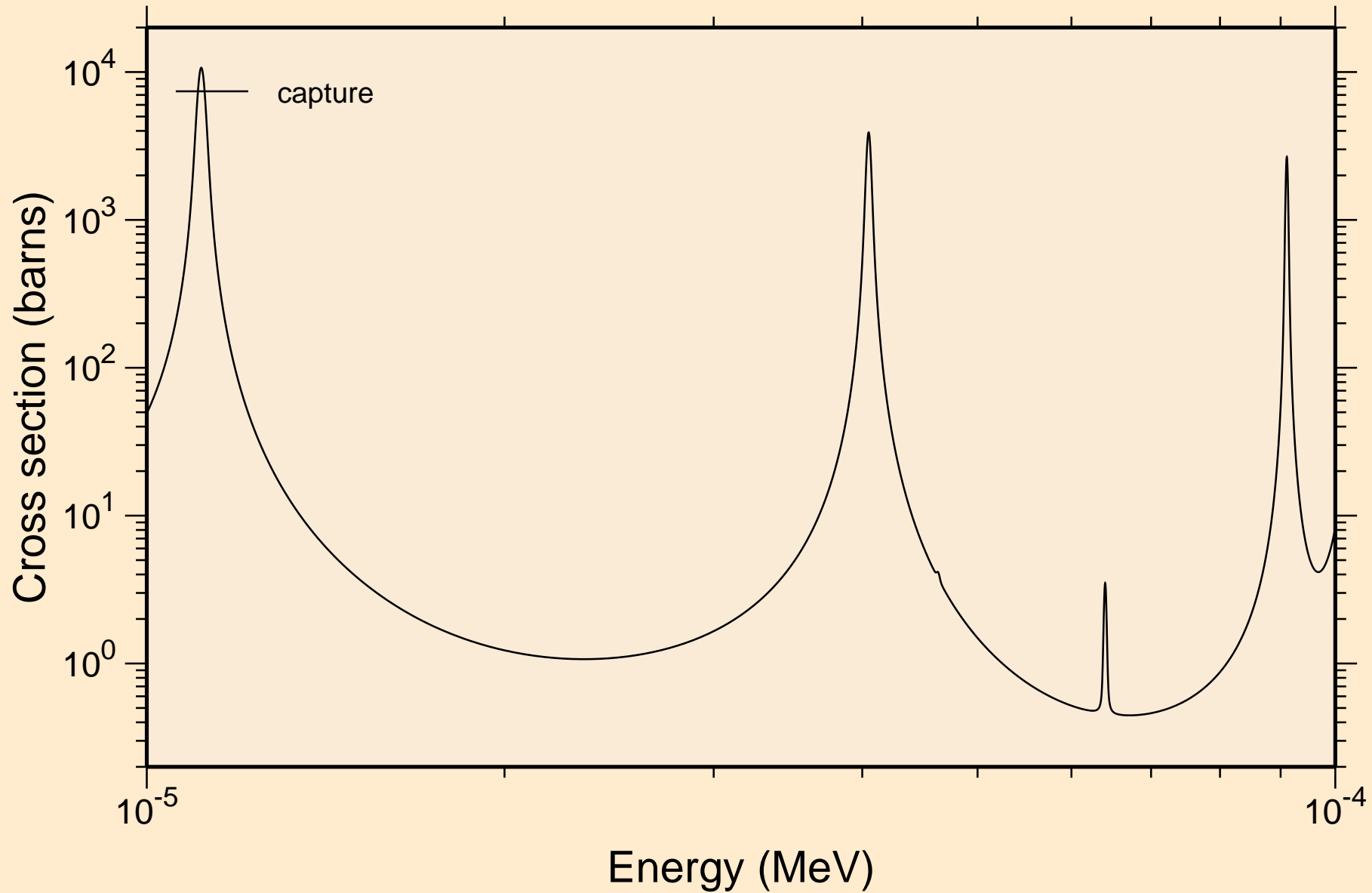

IR198 NEUTRON ACER TENDL-2024 LIBRARY; T=293.6K
resonance absorption cross sections

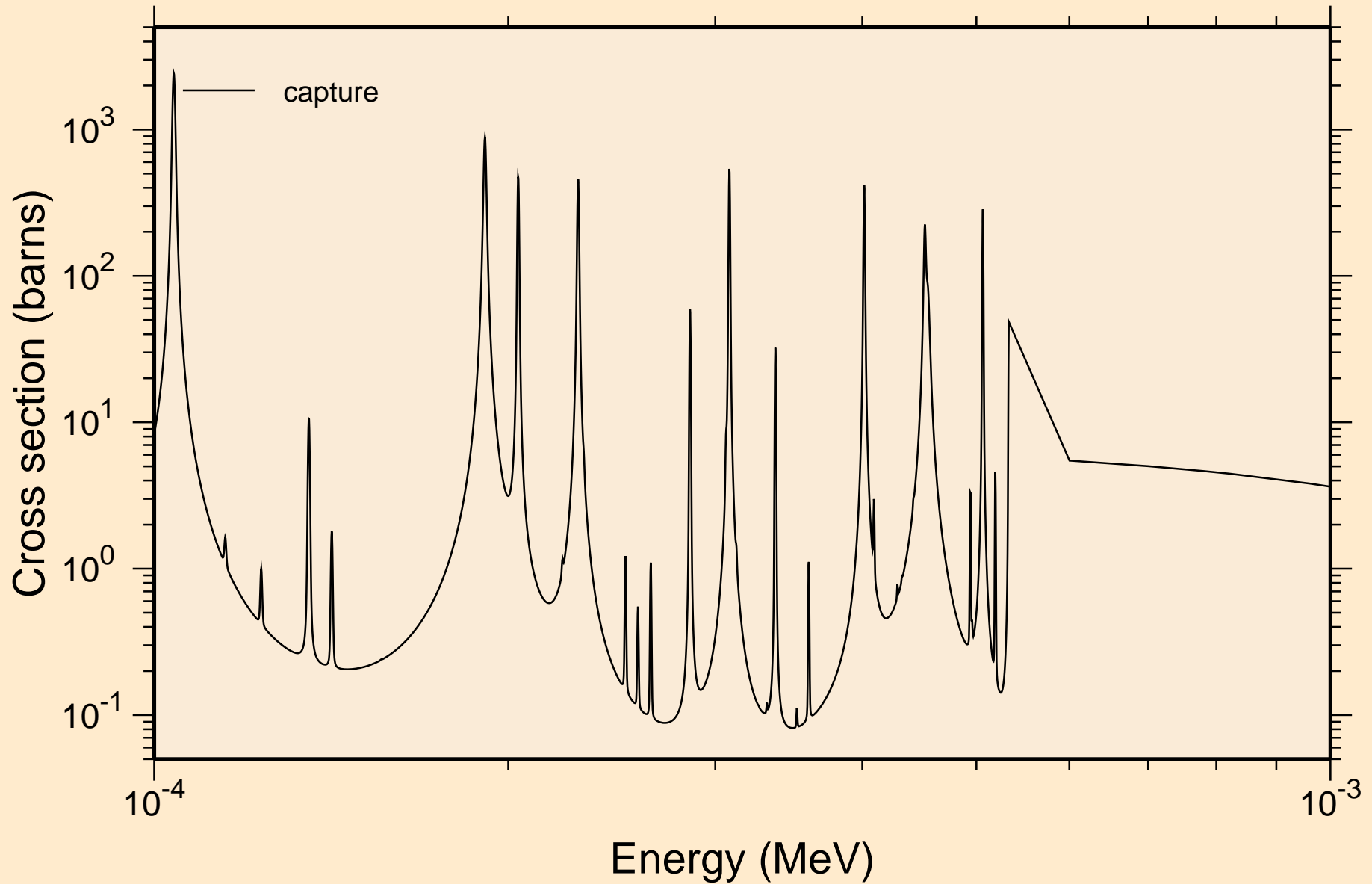

IR198 NEUTRON ACER TENDL-2024 LIBRARY; T=293.6K
resonance absorption cross sections

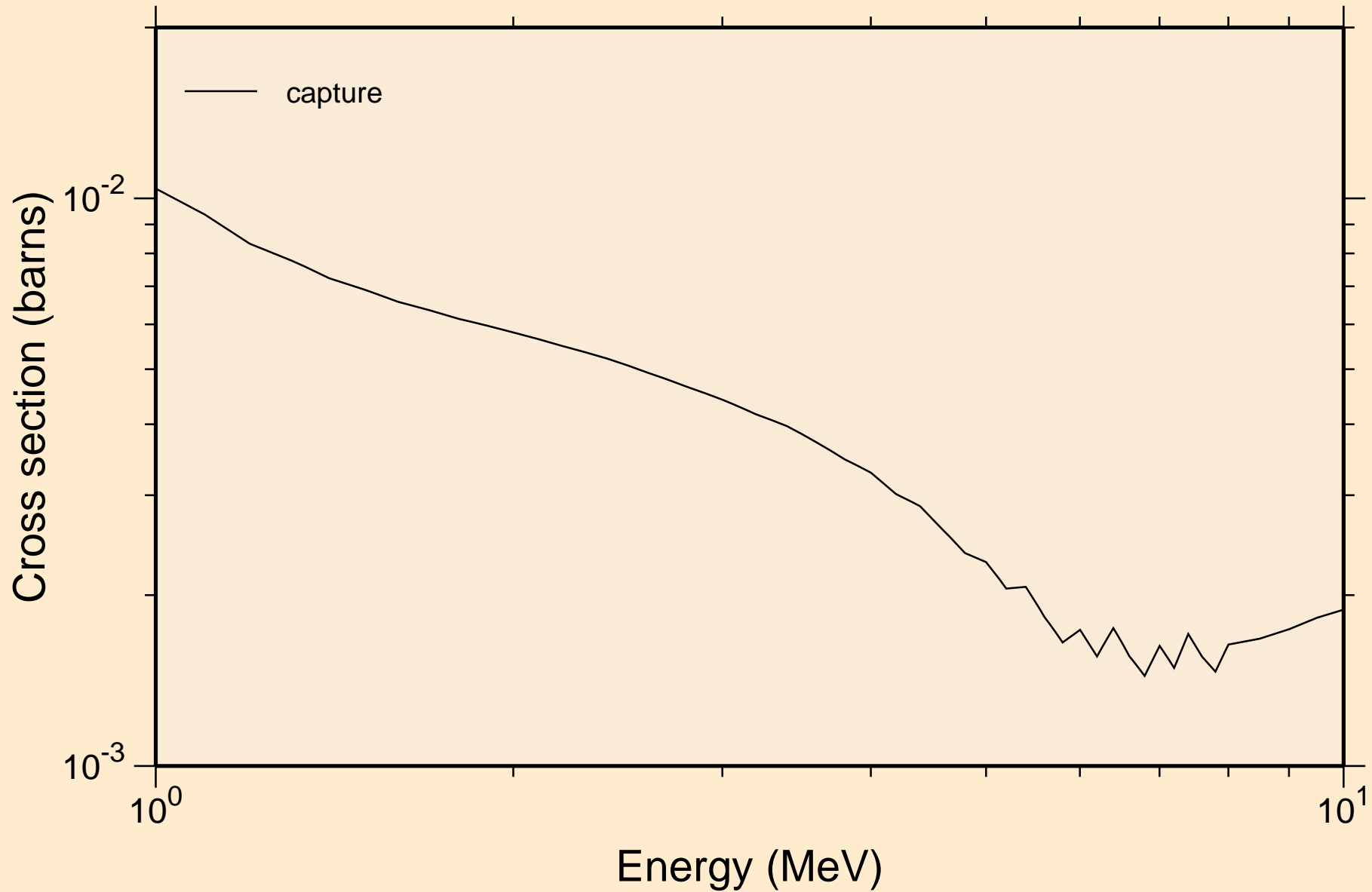

IR198 NEUTRON ACER TENDL-2024 LIBRARY; T=293.6K
Heating

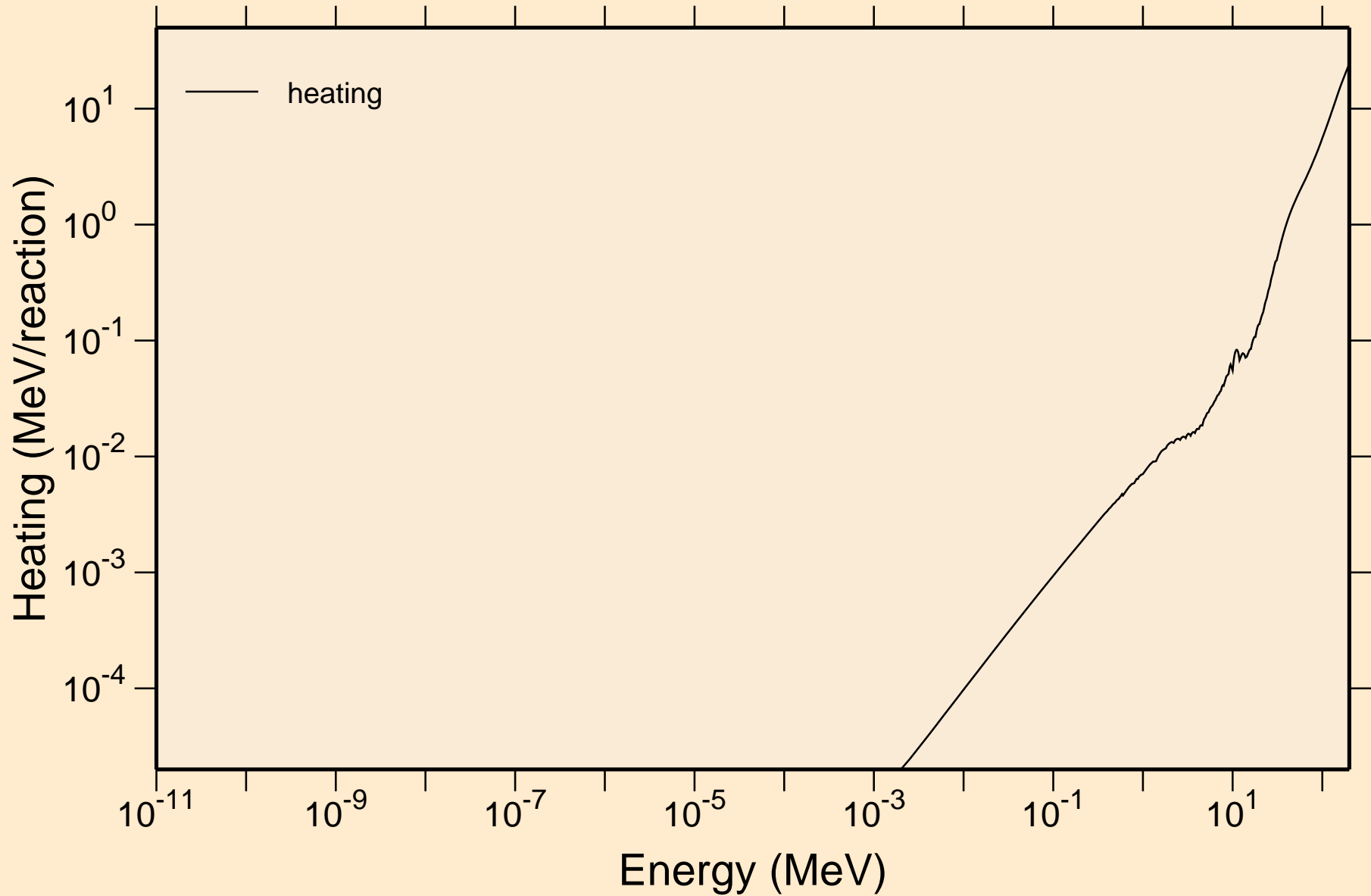

IR198 NEUTRON ACER TENDL-2024 LIBRARY; T=293.6K

Damage

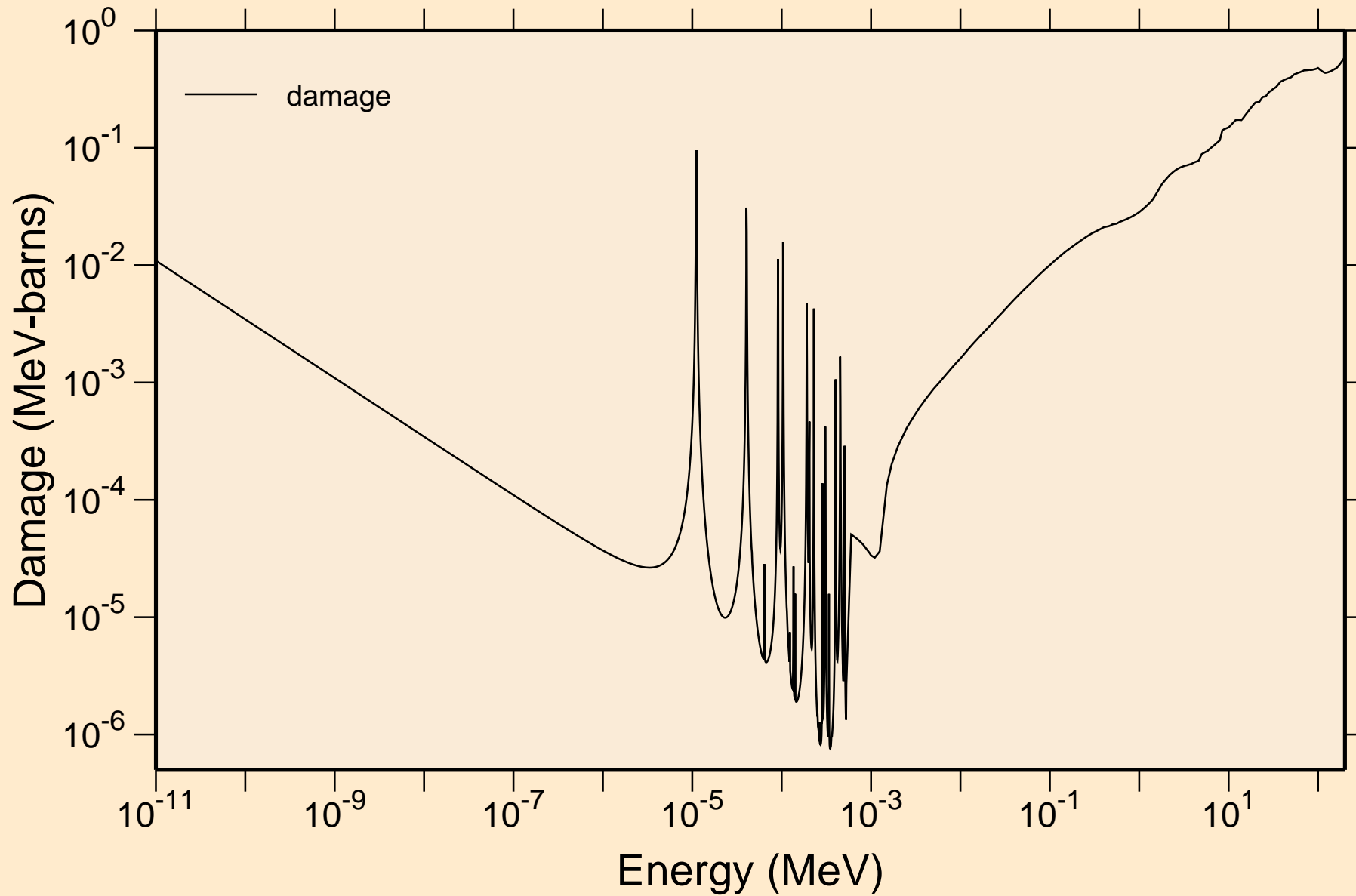

IR198 NEUTRON ACER TENDL-2024 LIBRARY; T=293.6K
Non-threshold reactions

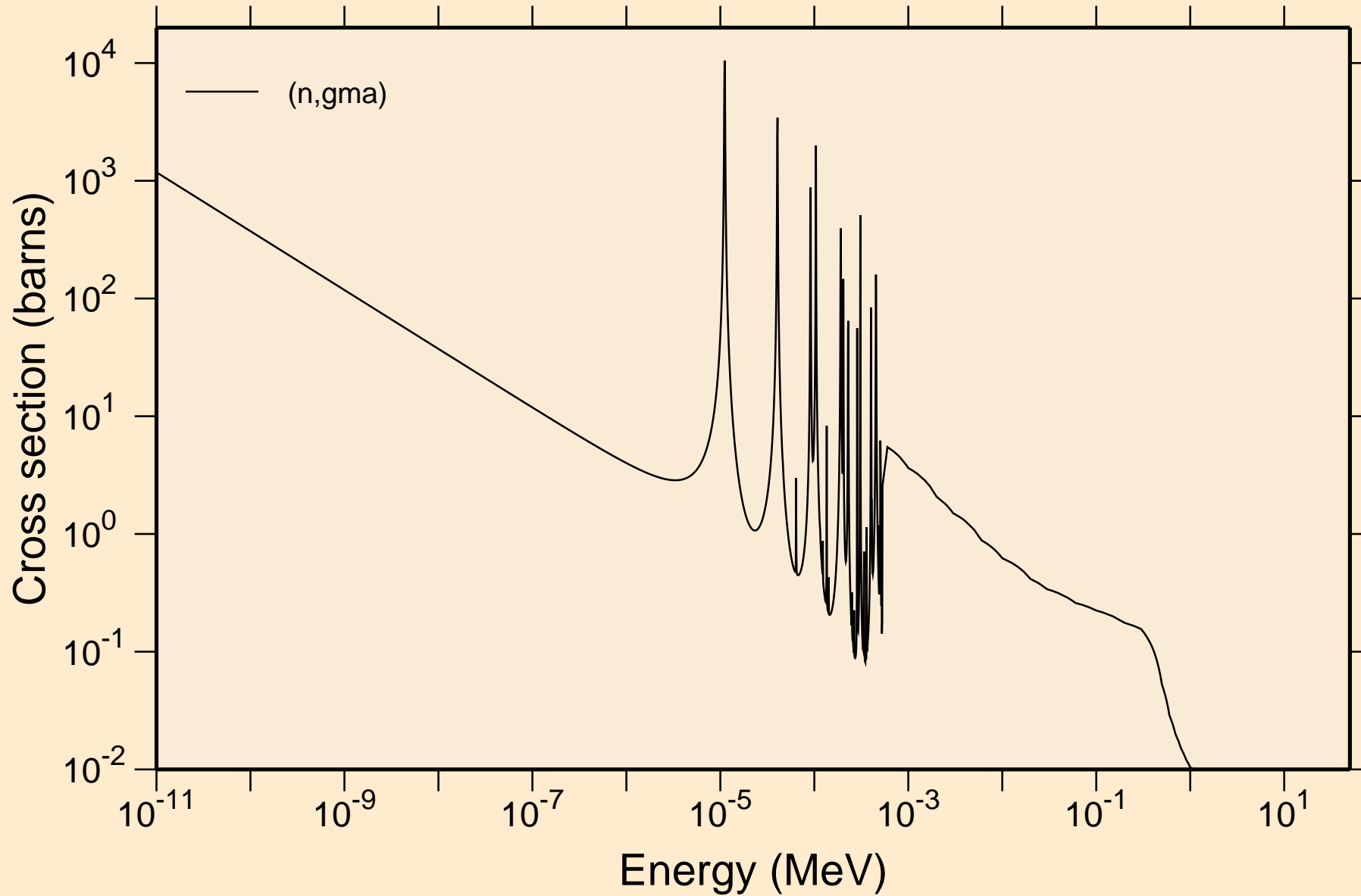

IR198 NEUTRON ACER TENDL-2024 LIBRARY; T=293.6K
Principal cross sections

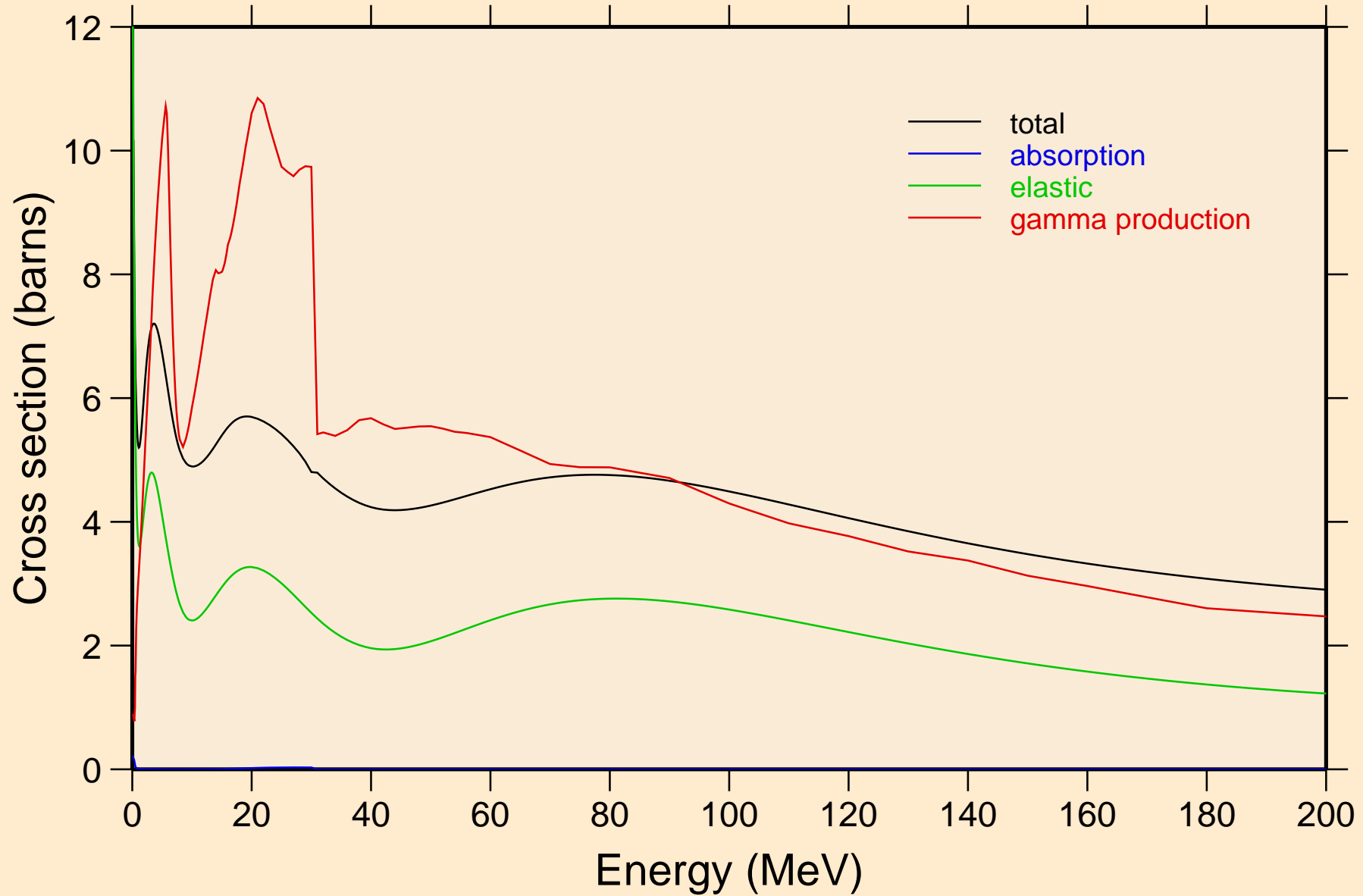

IR198 NEUTRON ACER TENDL-2024 LIBRARY; T=293.6K

Heating

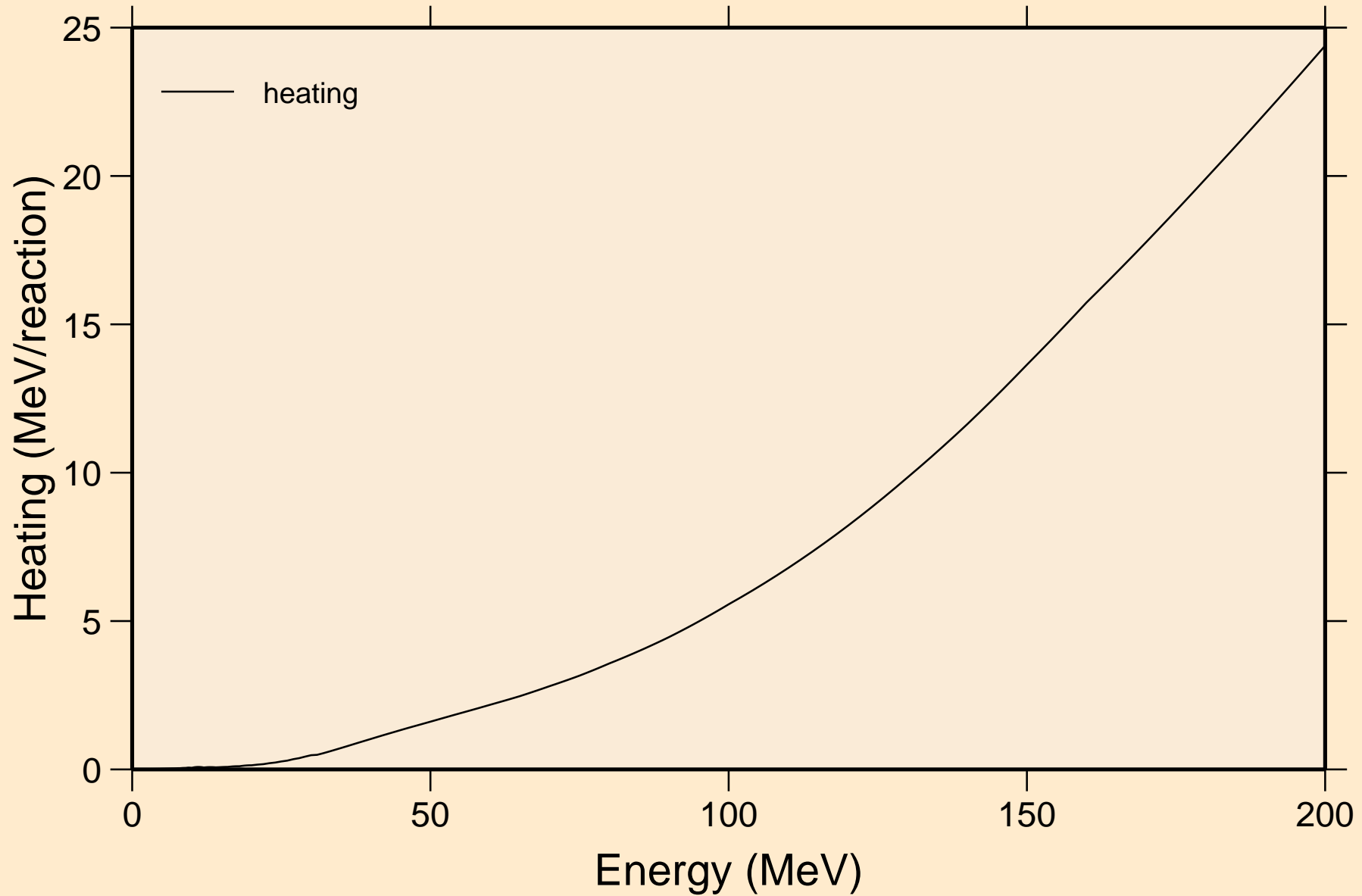

IR198 NEUTRON ACER TENDL-2024 LIBRARY; T=293.6K
Damage

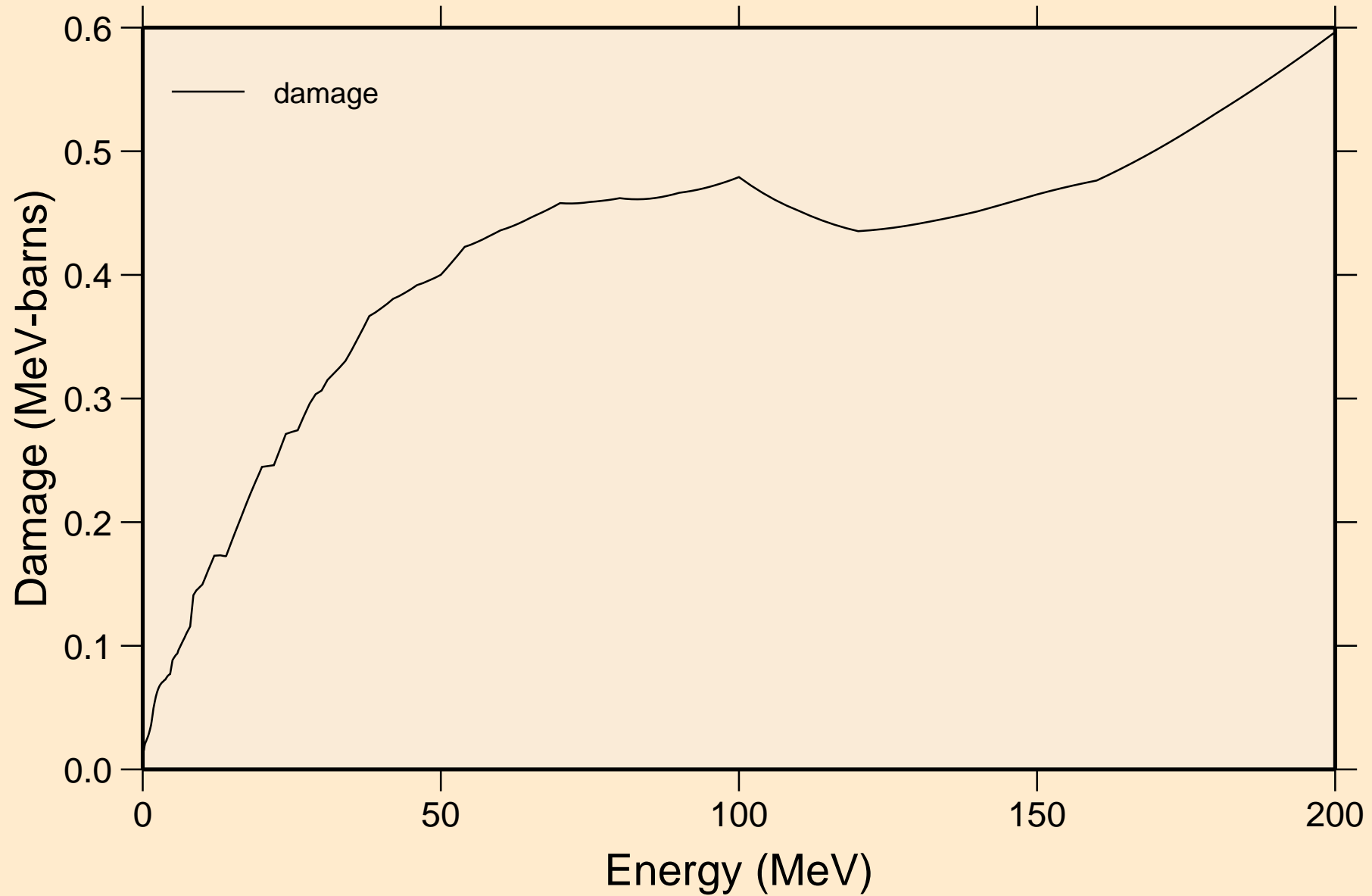

IR198 NEUTRON ACER TENDL-2024 LIBRARY; T=293.6K
Non-threshold reactions

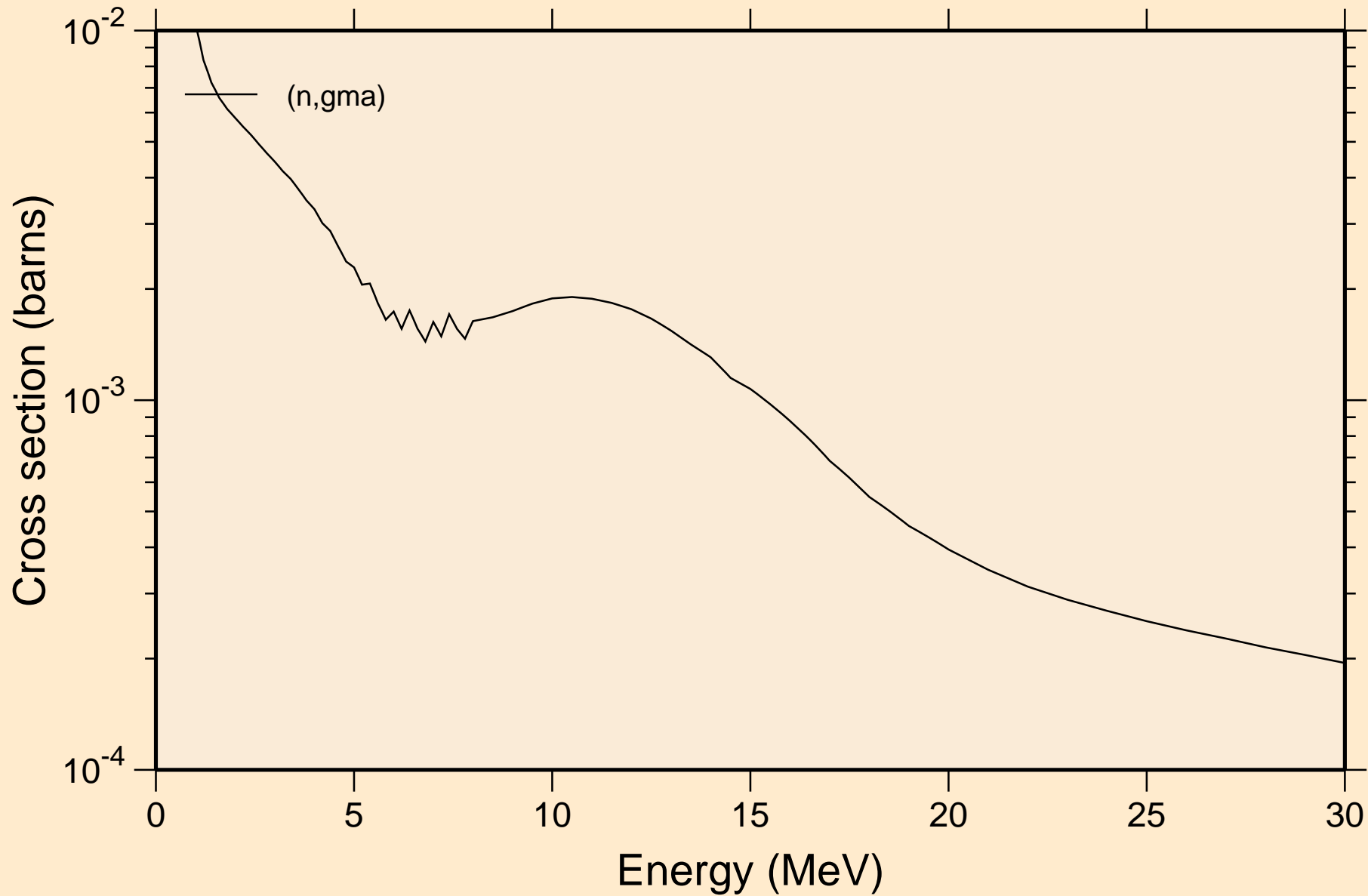

IR198 NEUTRON ACER TENDL-2024 LIBRARY; T=293.6K
Inelastic levels

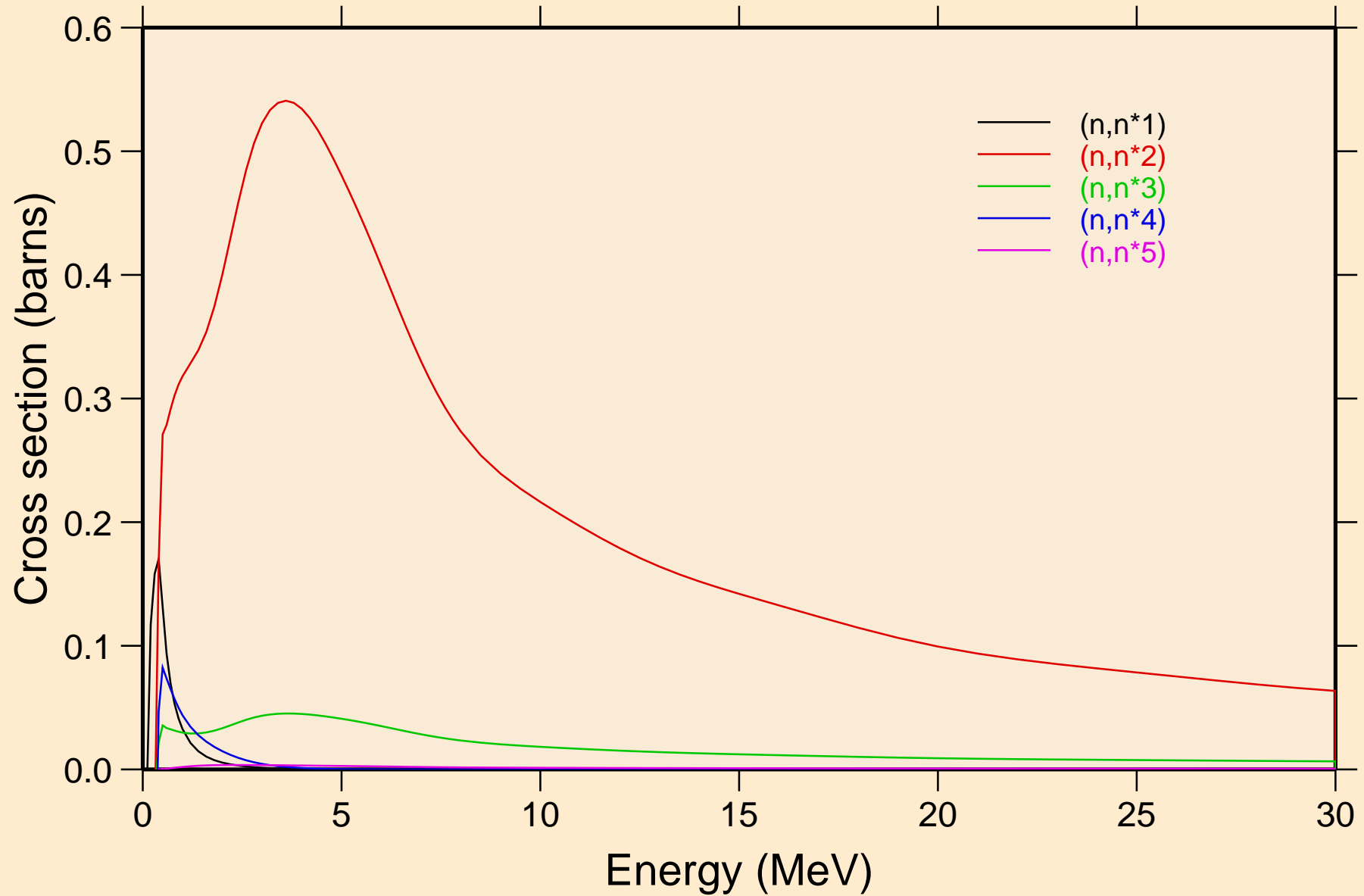

IR198 NEUTRON ACER TENDL-2024 LIBRARY; T=293.6K

Inelastic levels

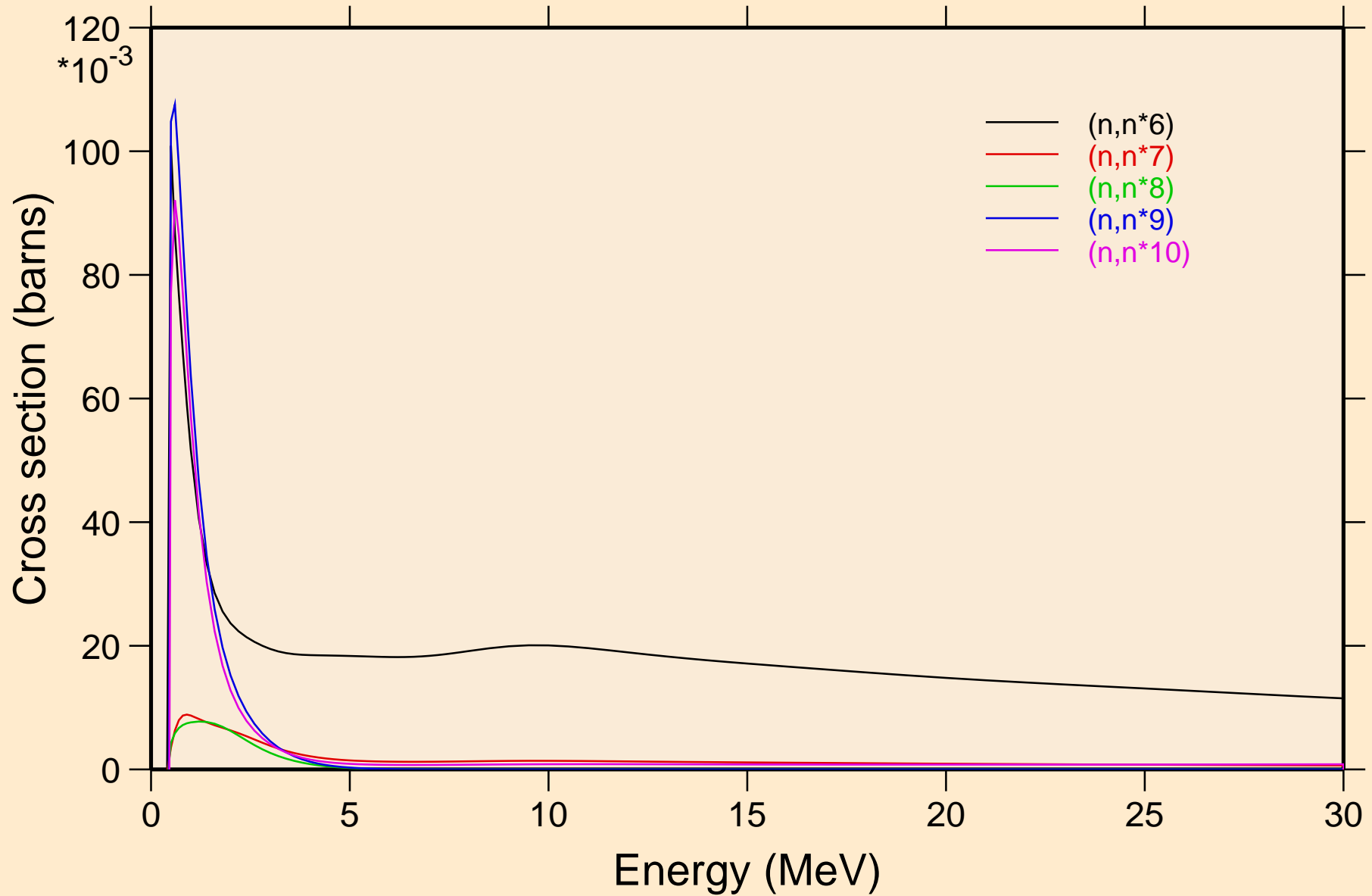

IR198 NEUTRON ACER TENDL-2024 LIBRARY; T=293.6K
Inelastic levels

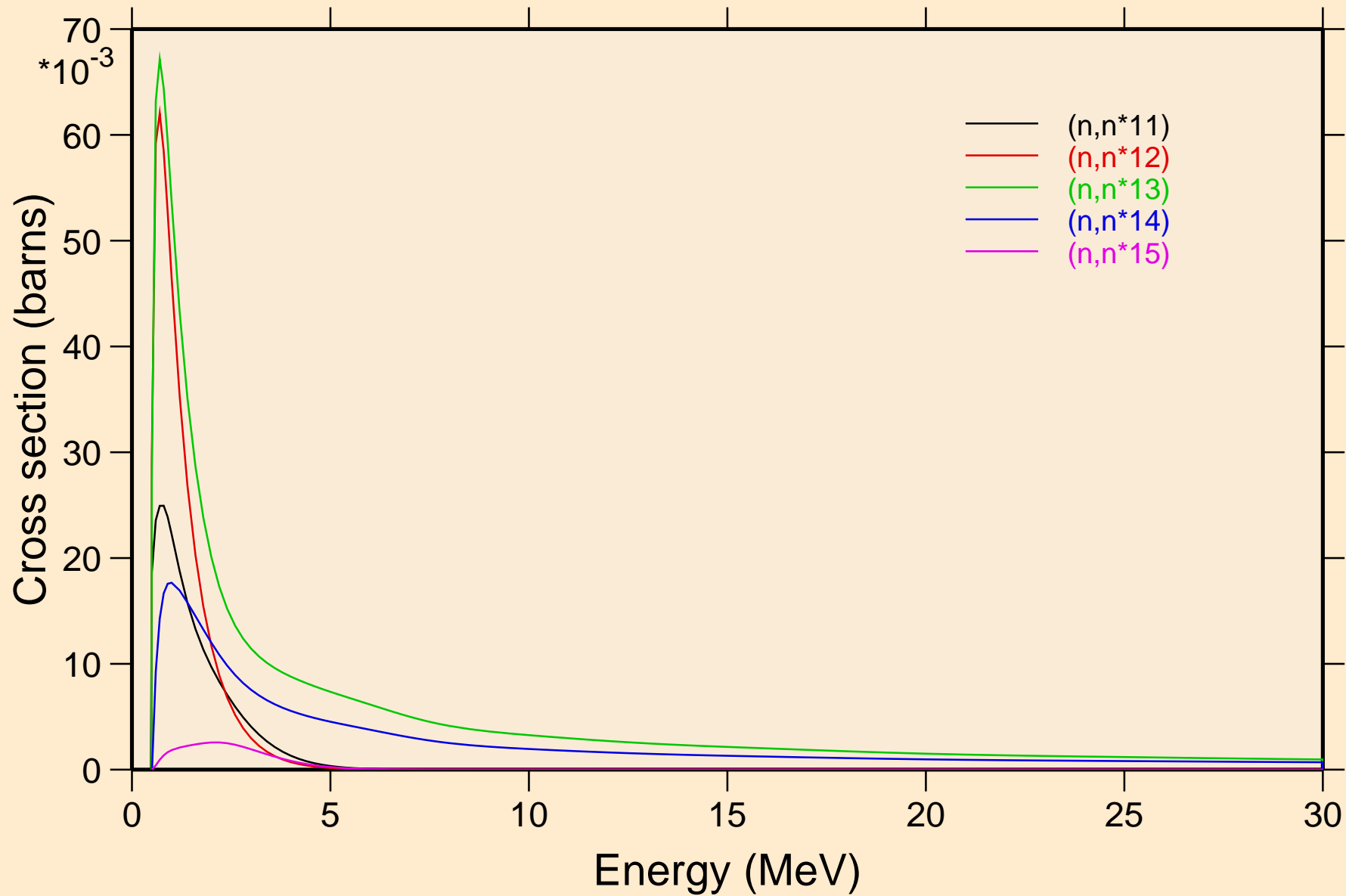

IR198 NEUTRON ACER TENDL-2024 LIBRARY; T=293.6K
Inelastic levels

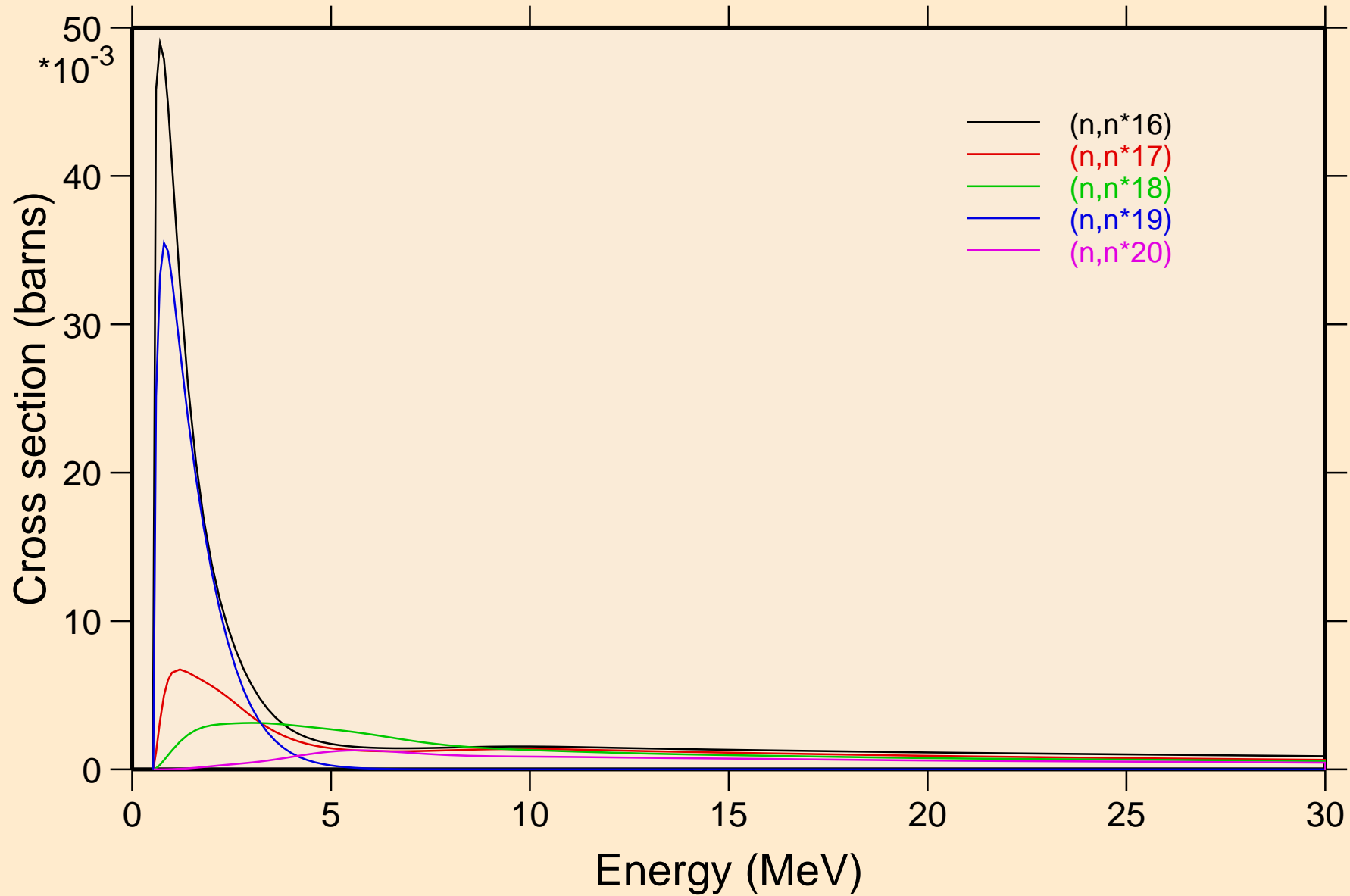

IR198 NEUTRON ACER TENDL-2024 LIBRARY; T=293.6K
Inelastic levels

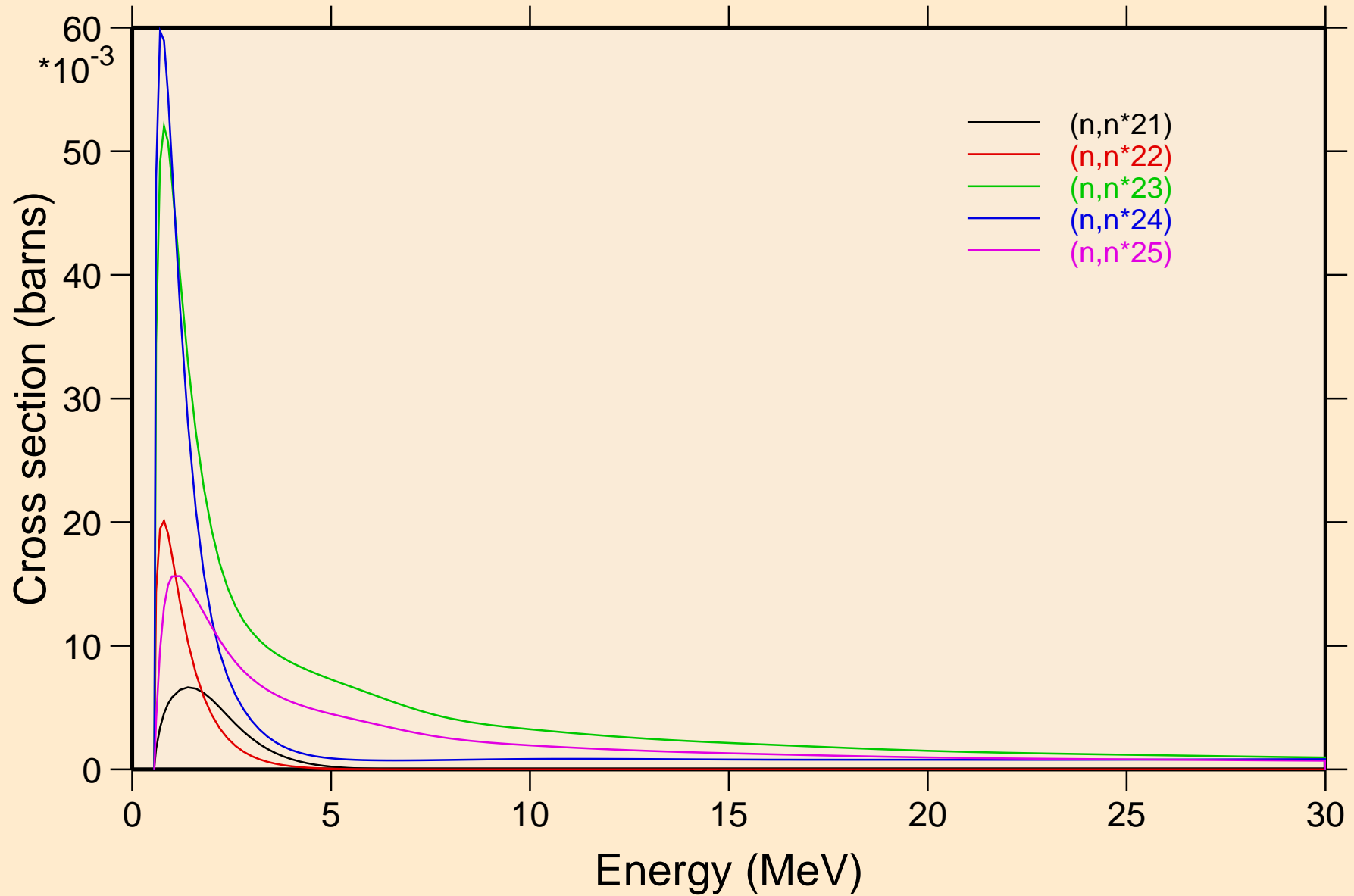

IR198 NEUTRON ACER TENDL-2024 LIBRARY; T=293.6K
Inelastic levels

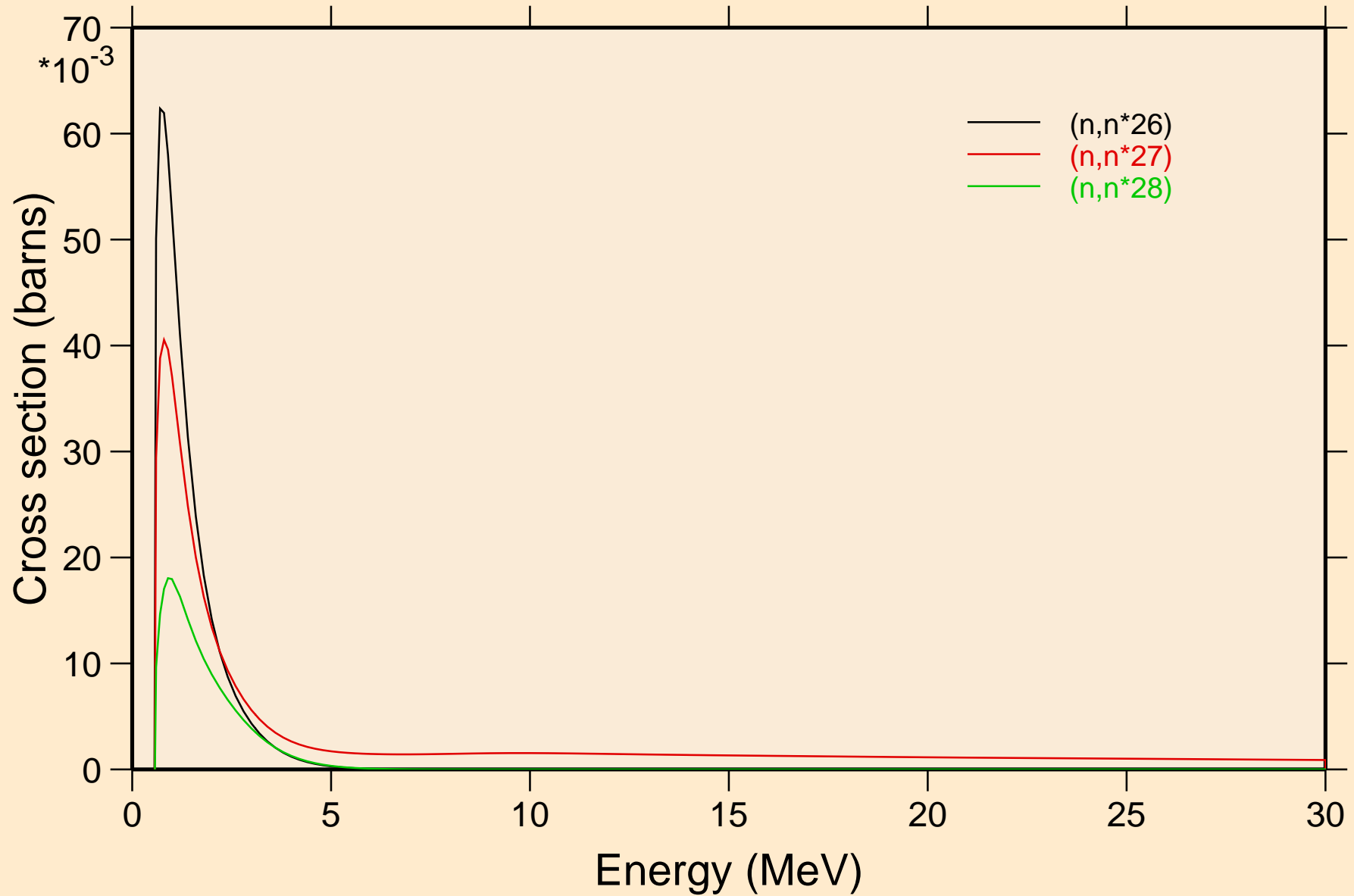

IR198 NEUTRON ACER TENDL-2024 LIBRARY; T=293.6K
Threshold reactions

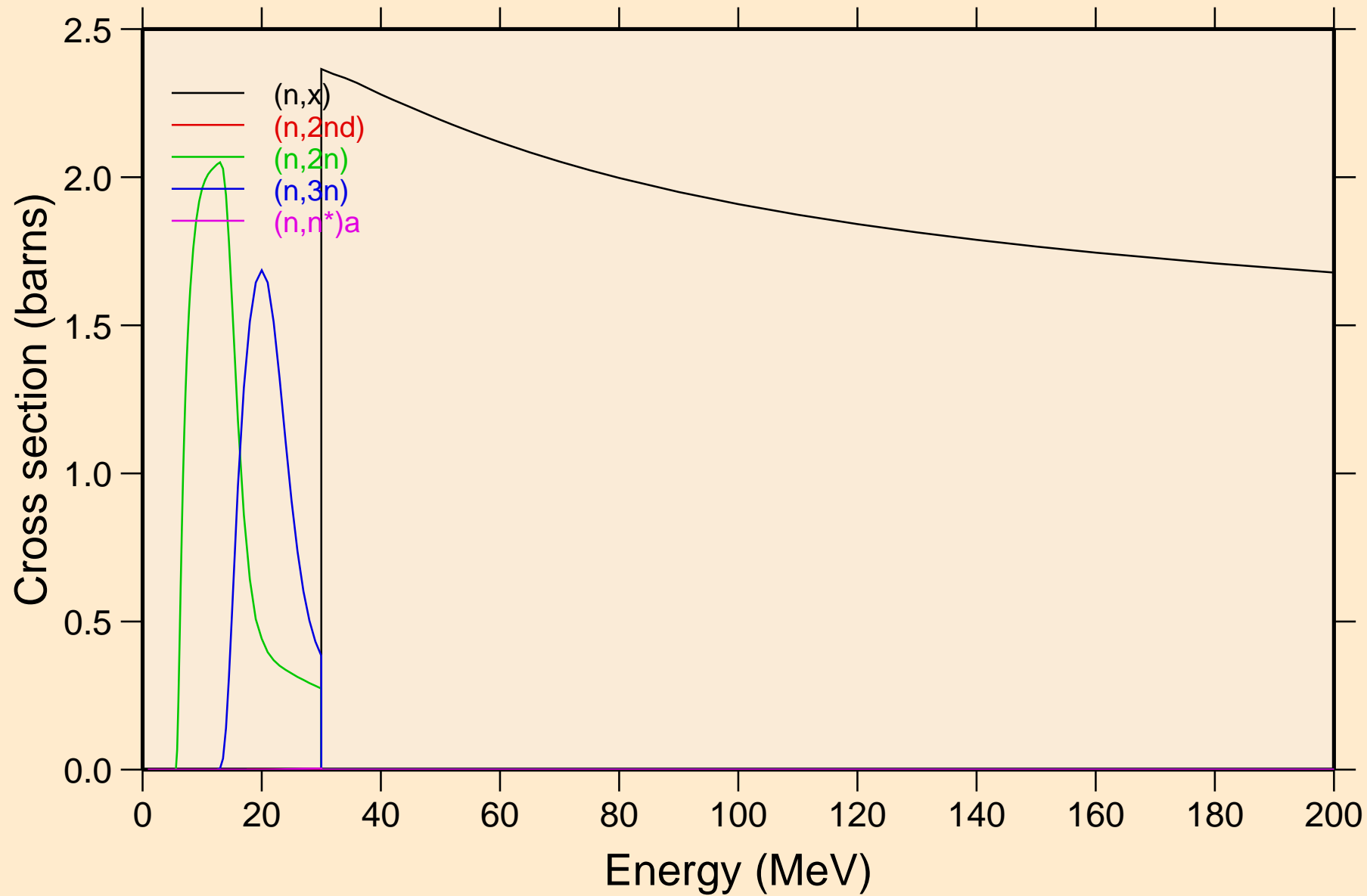

IR198 NEUTRON ACER TENDL-2024 LIBRARY; T=293.6K

Threshold reactions

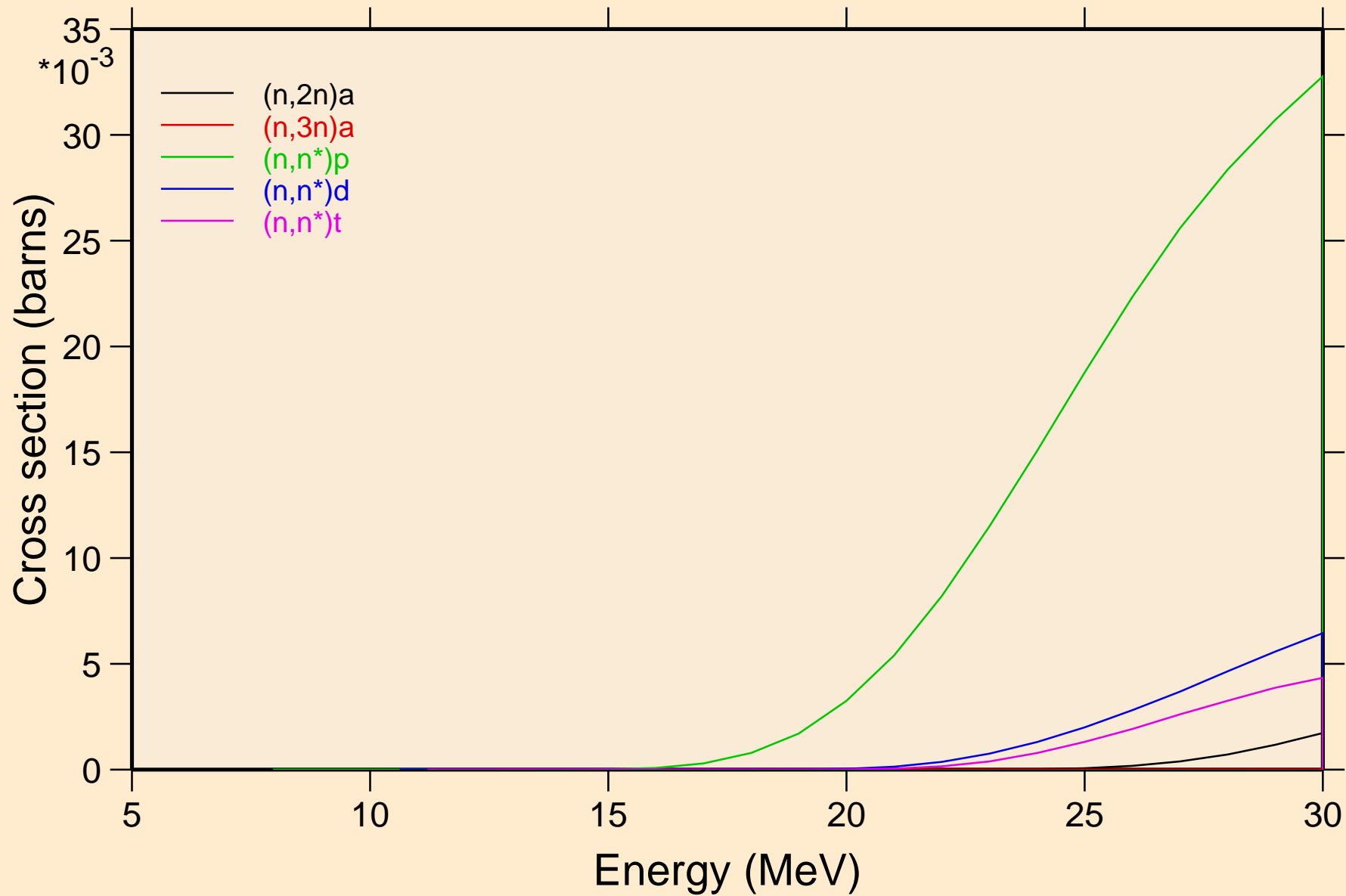

IR198 NEUTRON ACER TENDL-2024 LIBRARY; T=293.6K
Threshold reactions

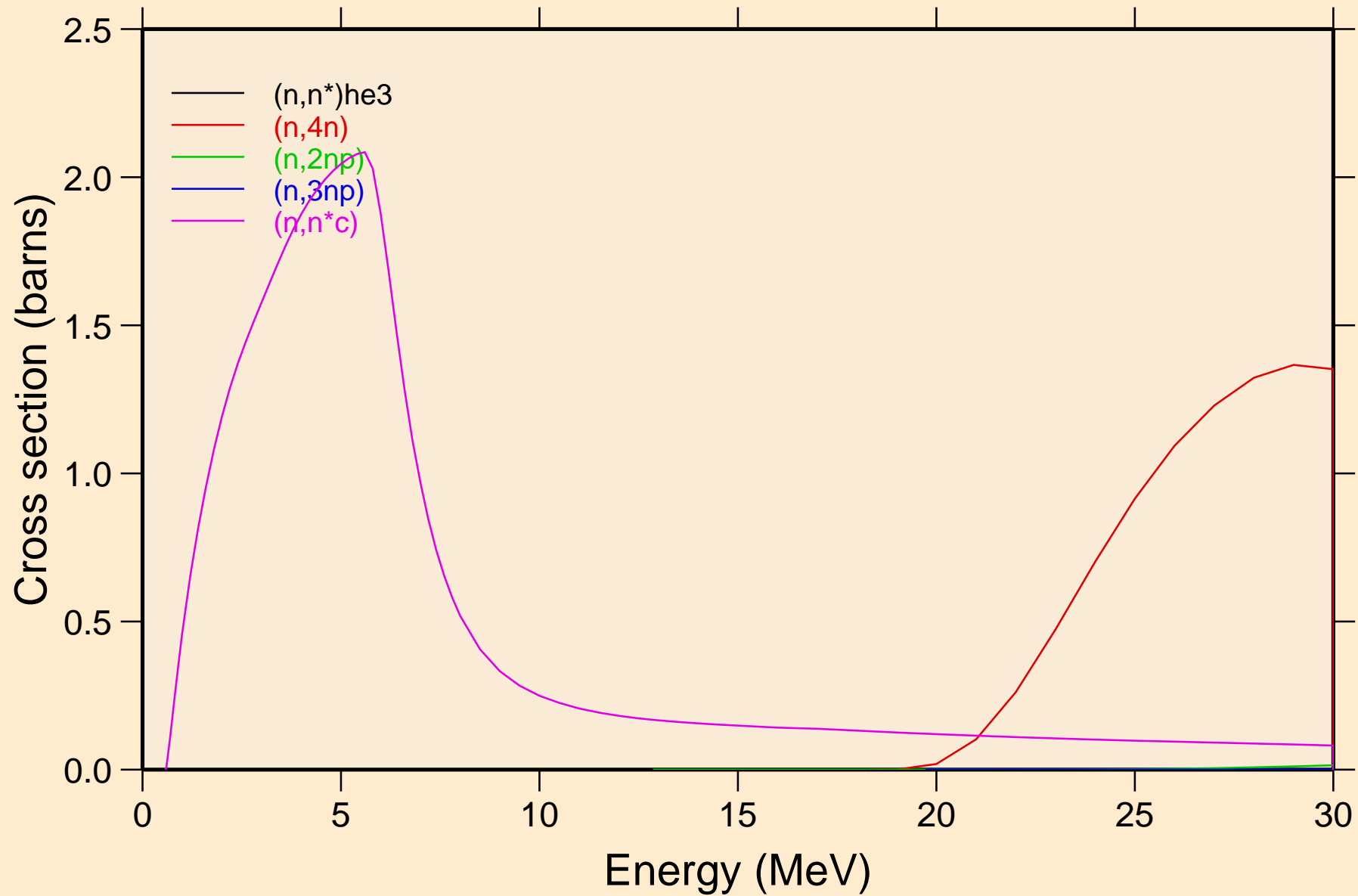

IR198 NEUTRON ACER TENDL-2024 LIBRARY; T=293.6K
Threshold reactions

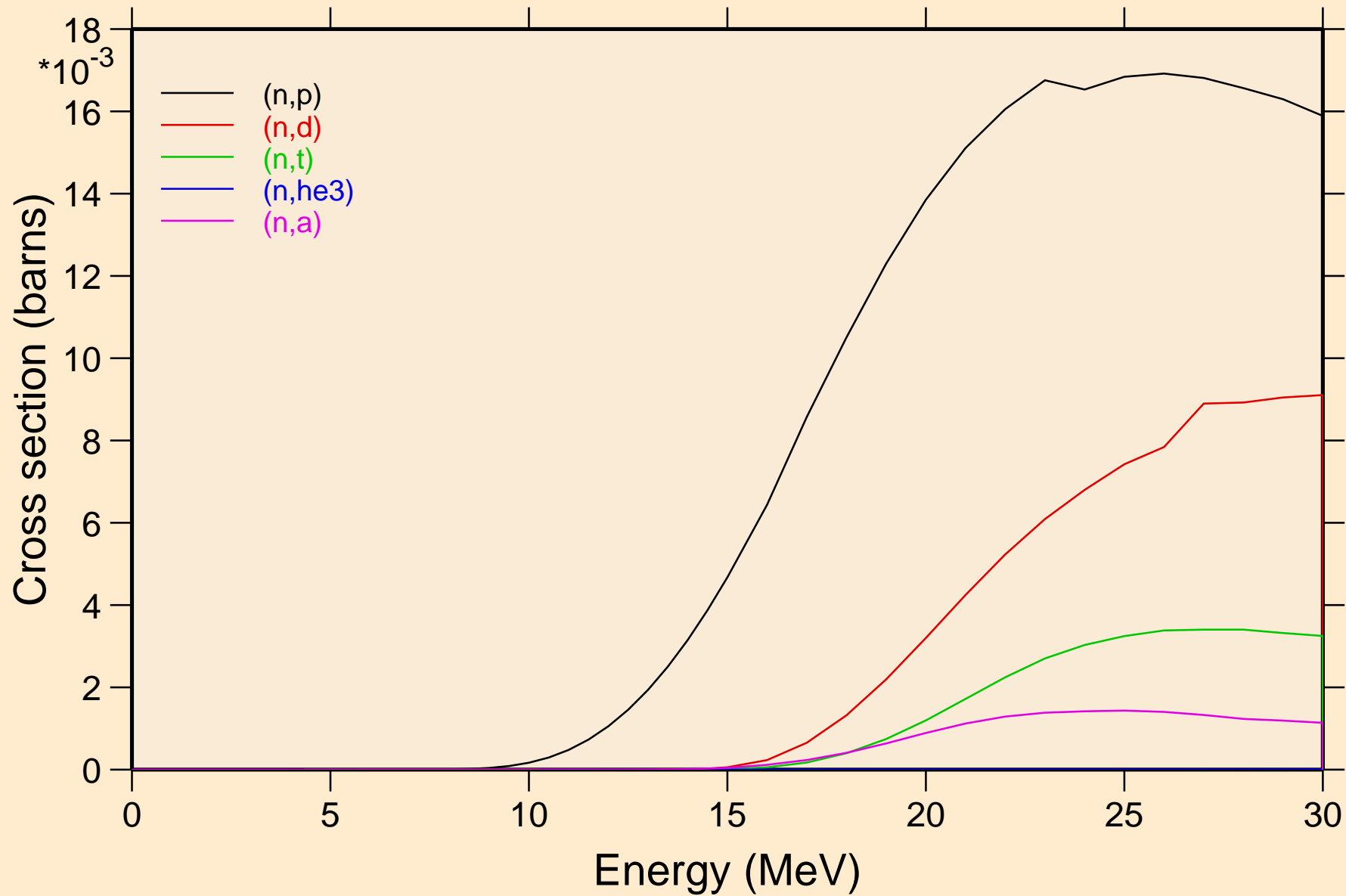

IR198 NEUTRON ACER TENDL-2024 LIBRARY; T=293.6K
Threshold reactions

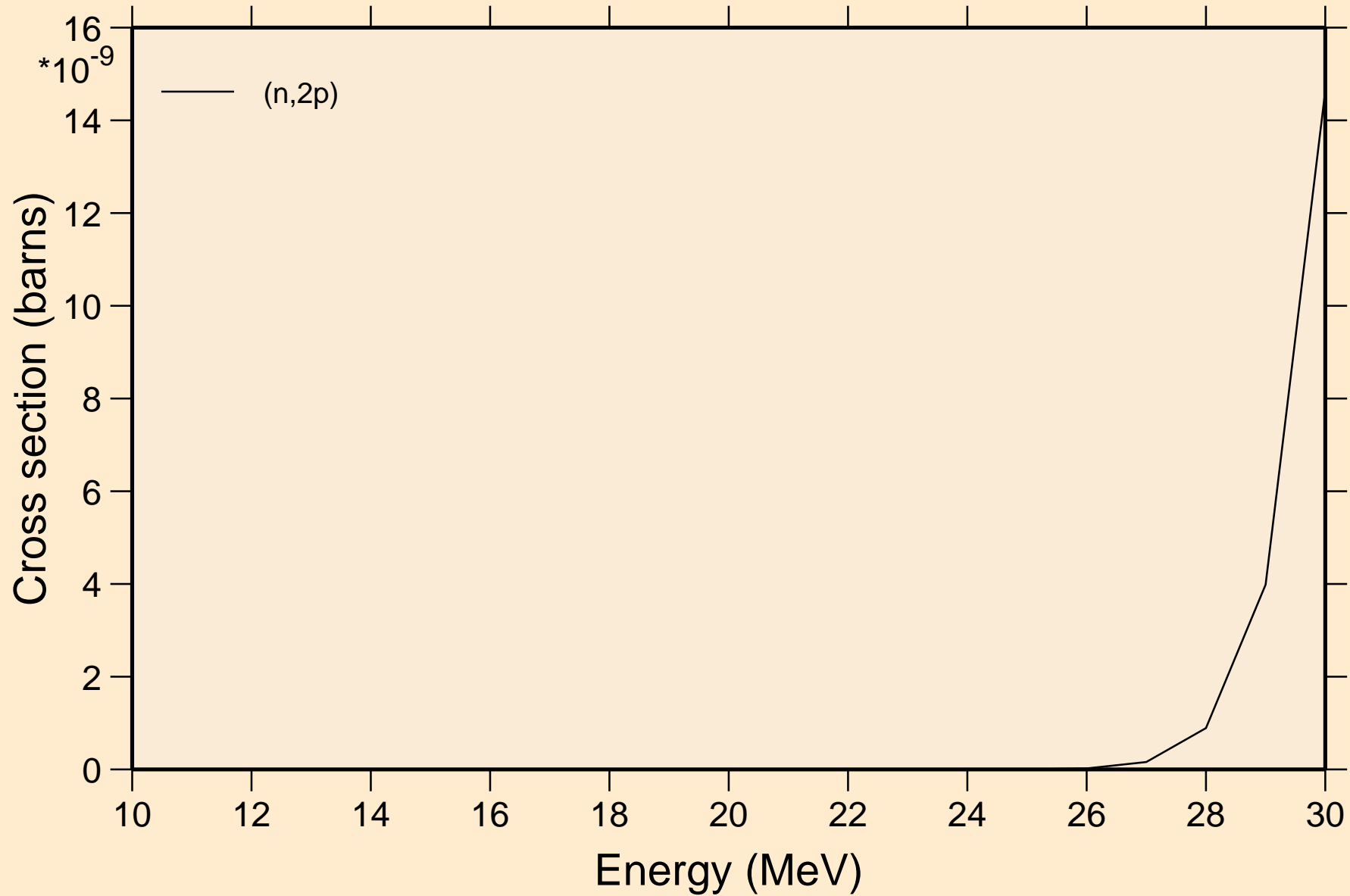

IR198 NEUTRON ACER TENDL-2024 LIBRARY; T=293.6K
Threshold reactions

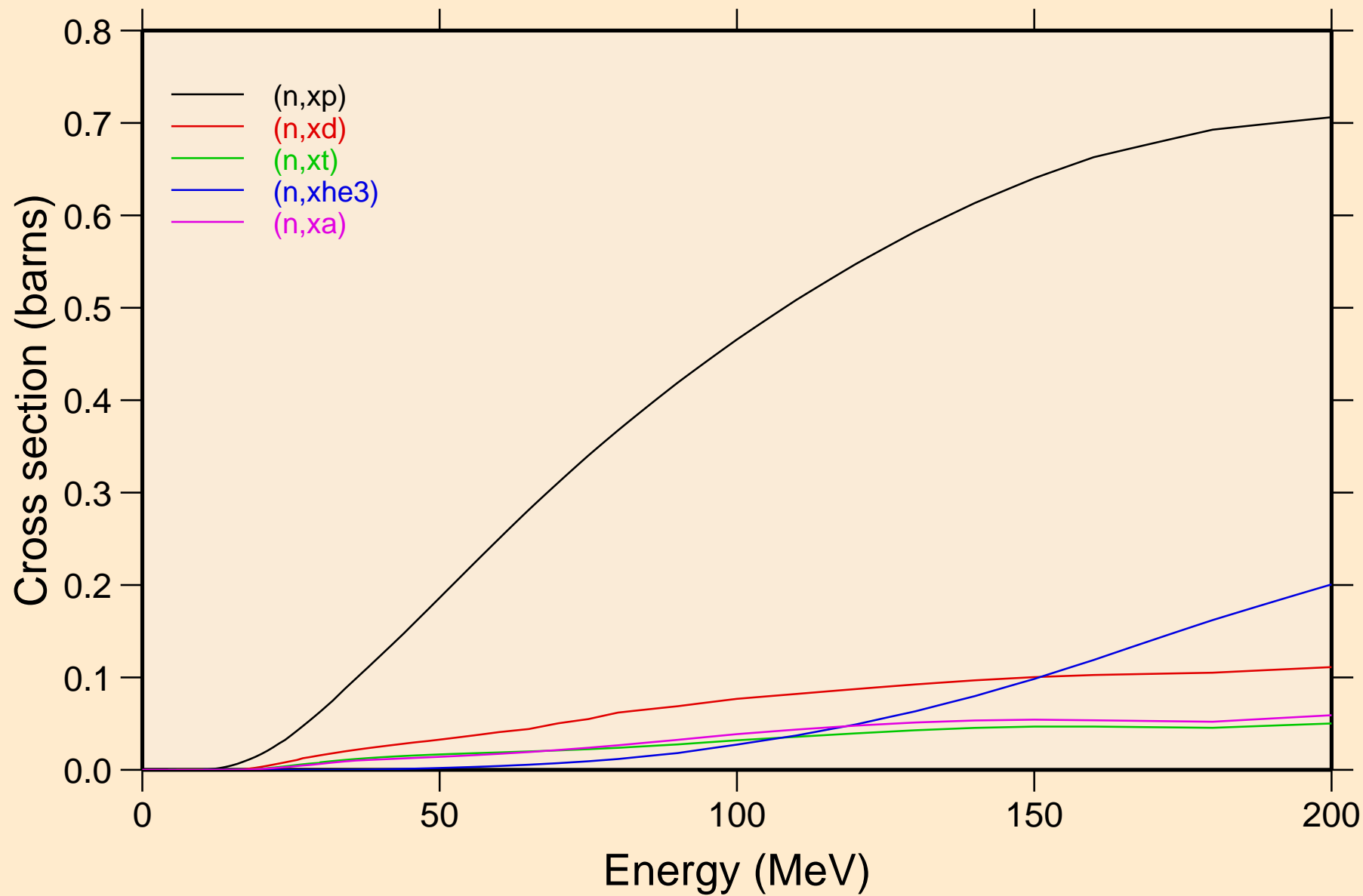

IR198 NEUTRON ACER TENDL-2024 LIBRARY; T=293.6K
angular distribution for elastic

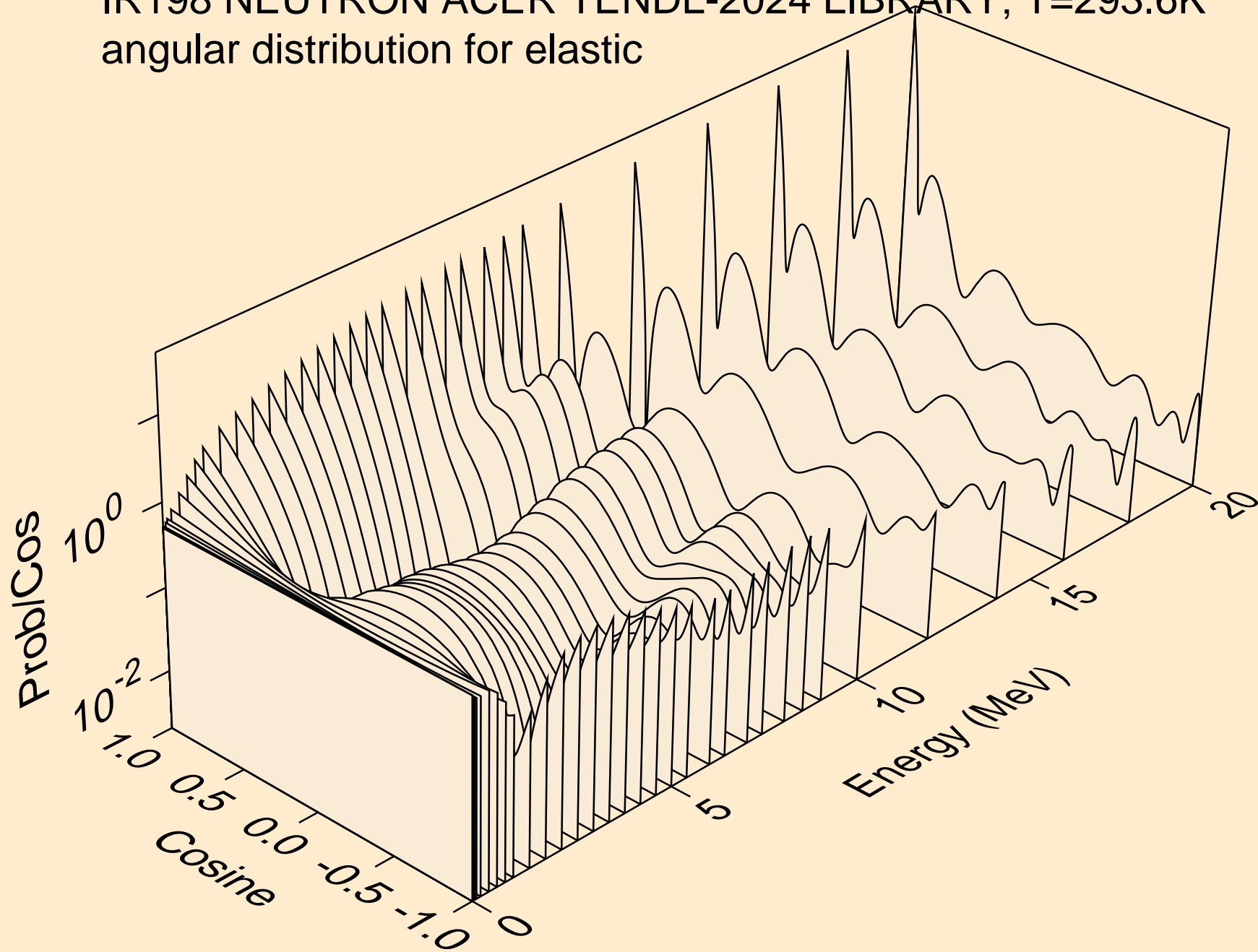

IR198 NEUTRON ACER TENDL-2024 LIBRARY; T=293.6K
angular distribution for elastic

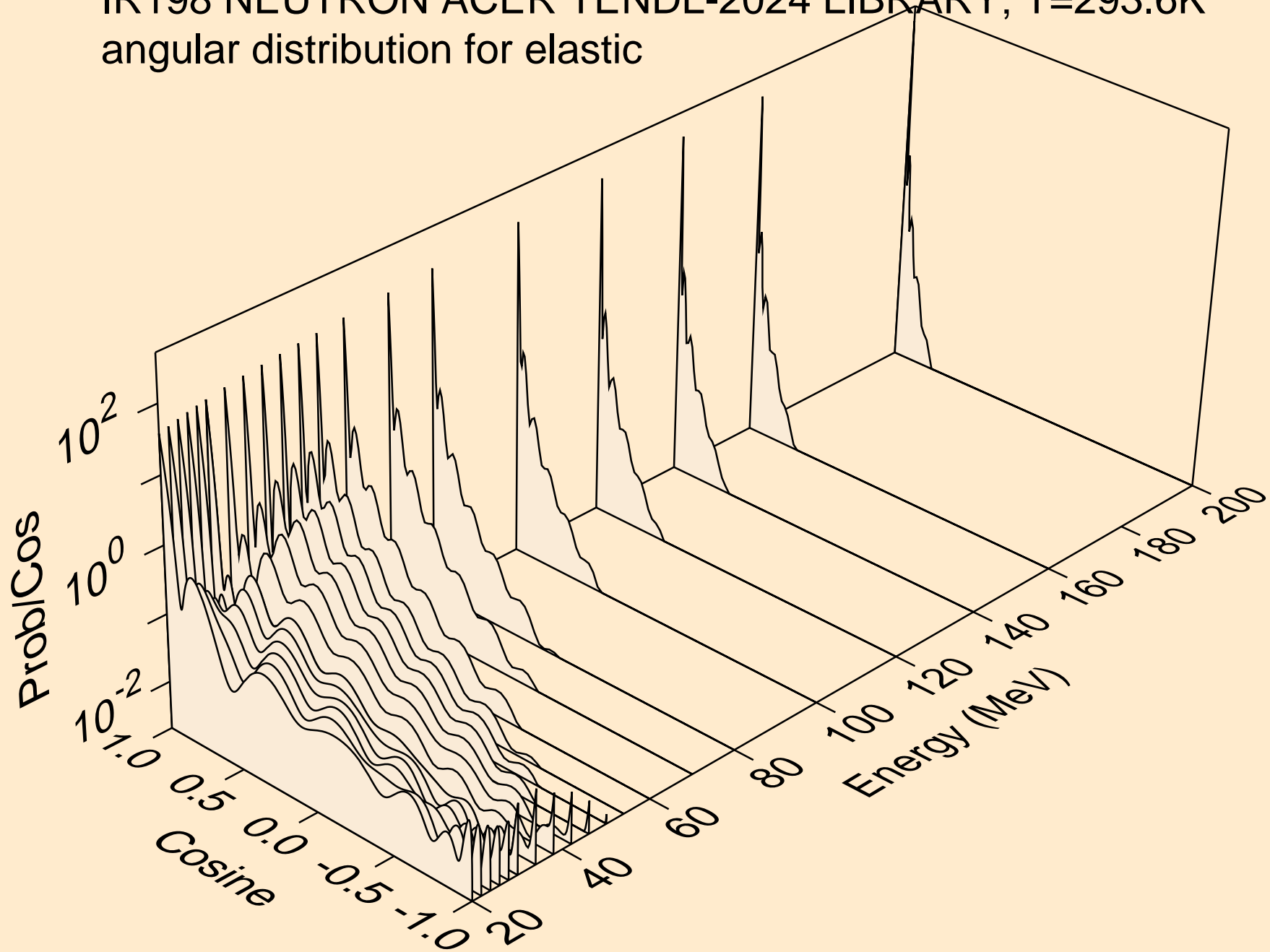

IR198 NEUTRON ACER TENDL-2024 LIBRARY; T=293.6K
angular distribution for (n,n*1)

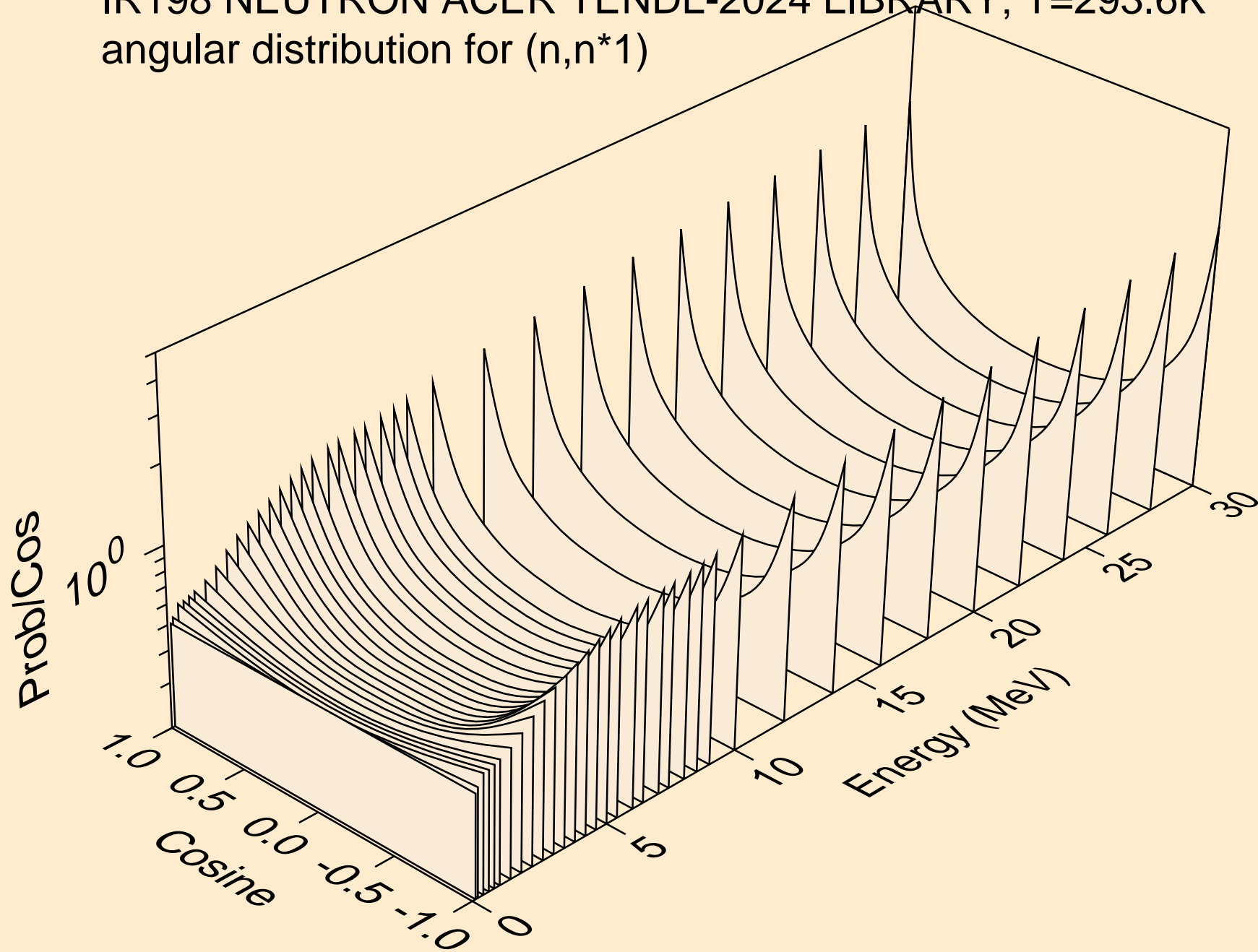

IR198 NEUTRON ACER TENDL-2024 LIBRARY; T=293.6K
angular distribution for (n,n*2)

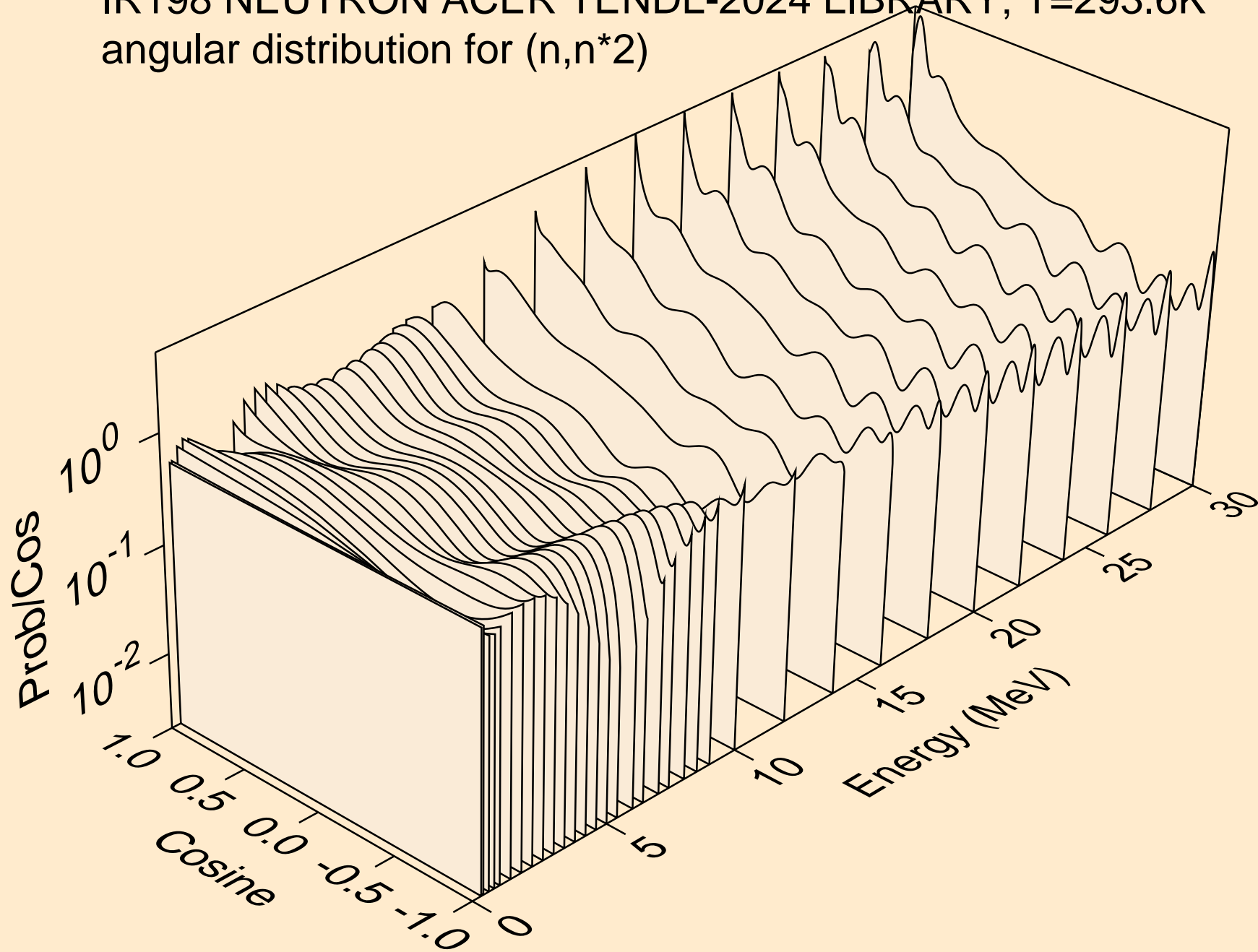

IR198 NEUTRON ACER TENDL-2024 LIBRARY; T=293.6K
angular distribution for (n,n*3)

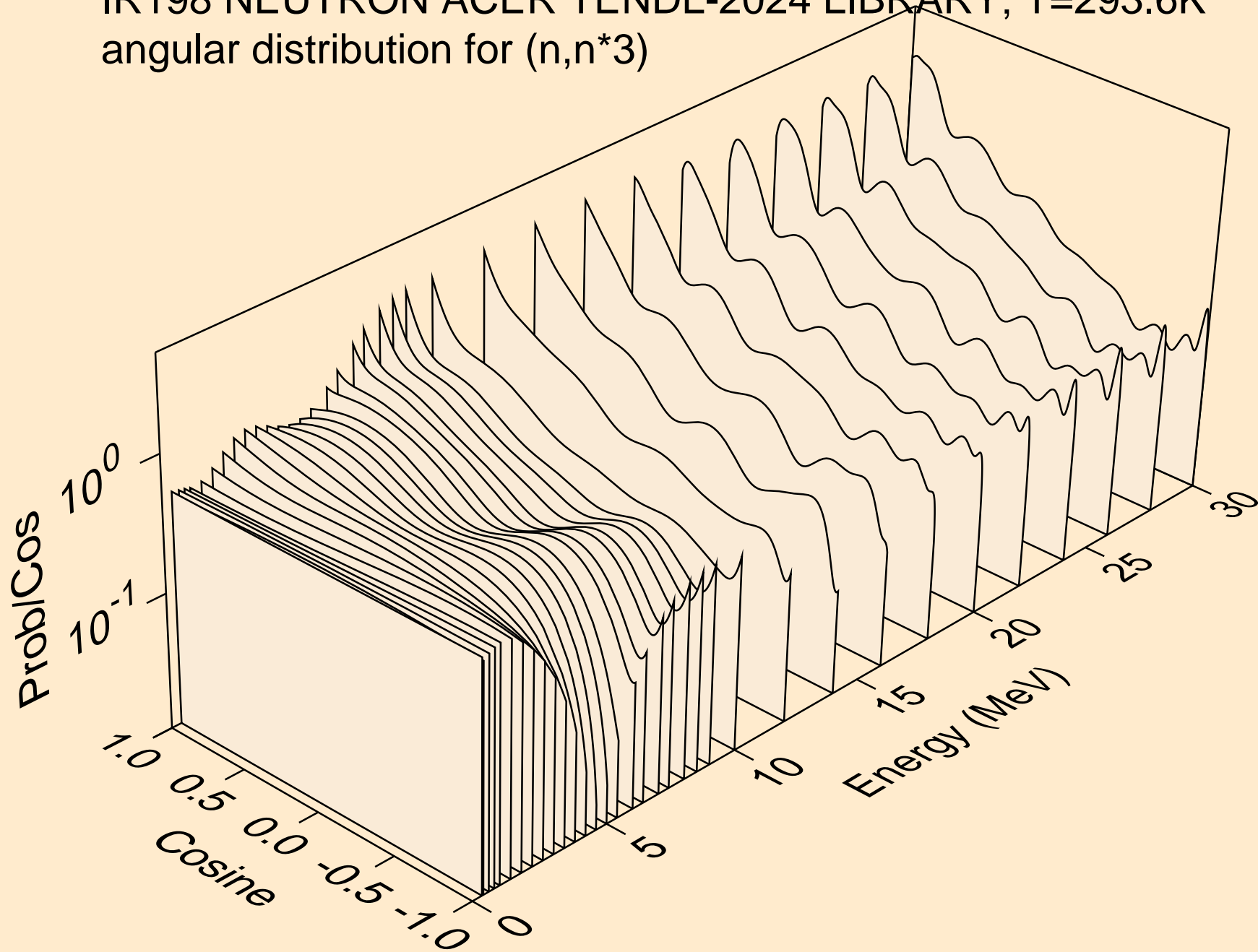

IR198 NEUTRON ACER TENDL-2024 LIBRARY; T=293.6K
angular distribution for (n,n*4)

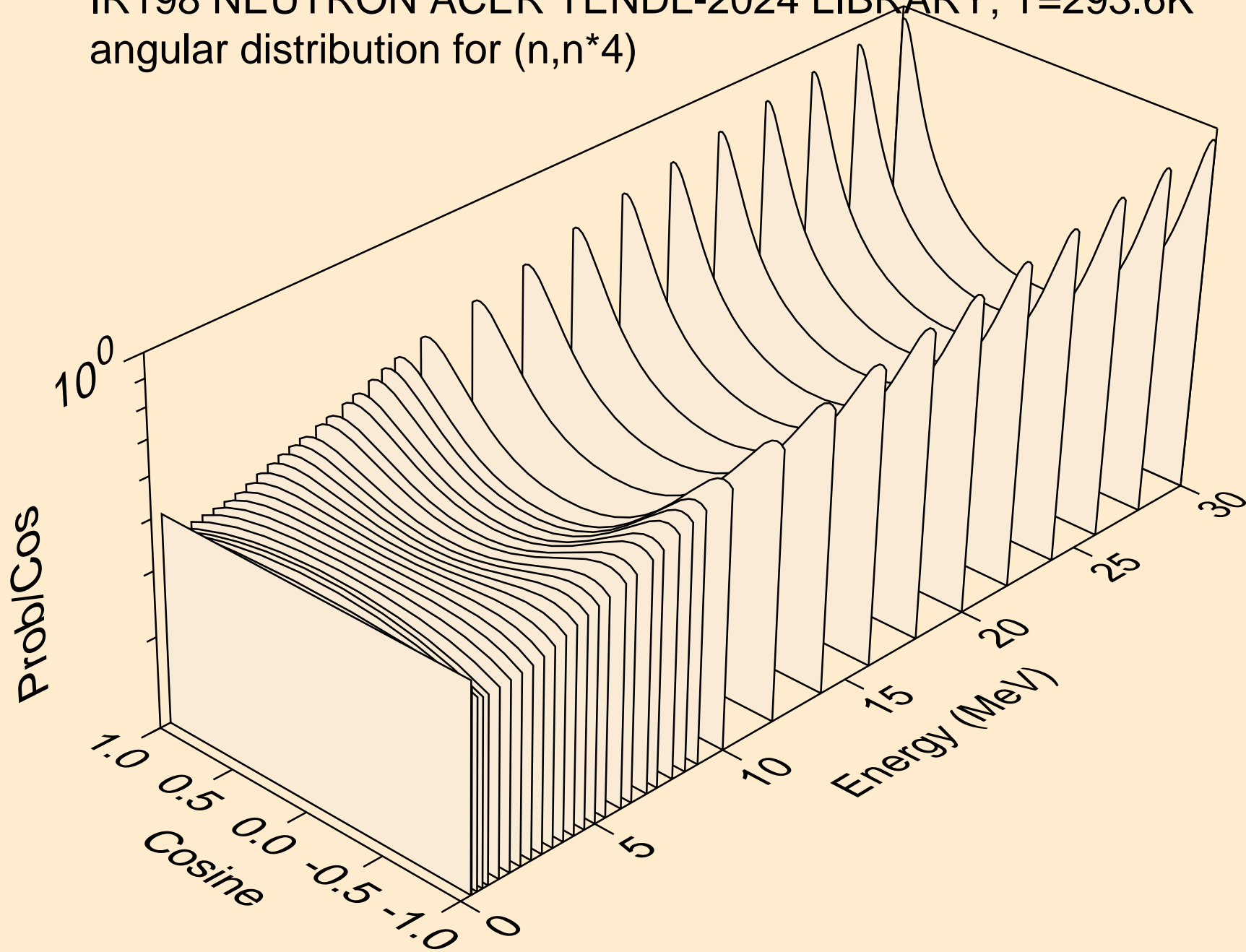

IR198 NEUTRON ACER TENDL-2024 LIBRARY; T=293.6K
angular distribution for (n,n*5)

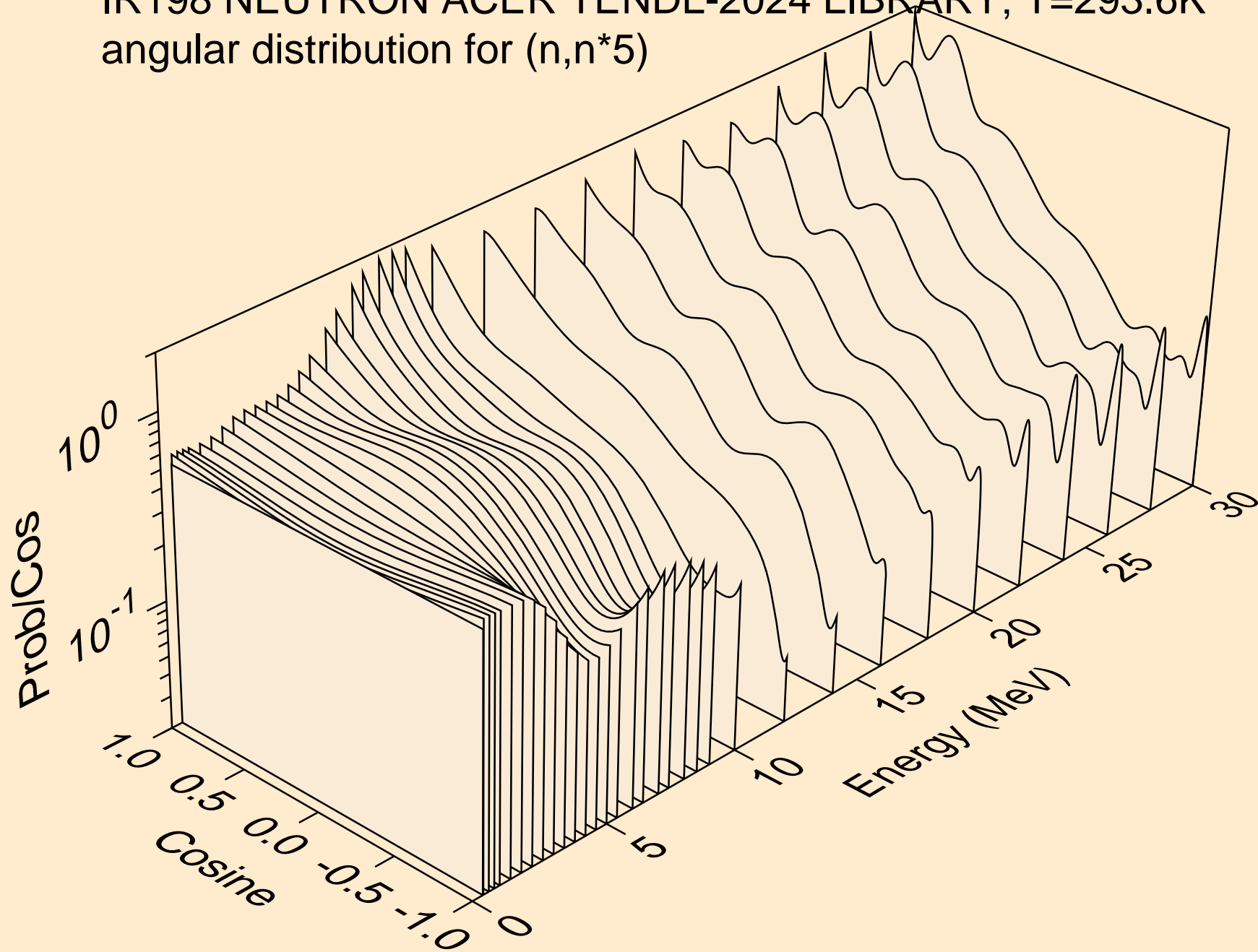

IR198 NEUTRON ACER TENDL-2024 LIBRARY; T=293.6K
angular distribution for (n,n*6)

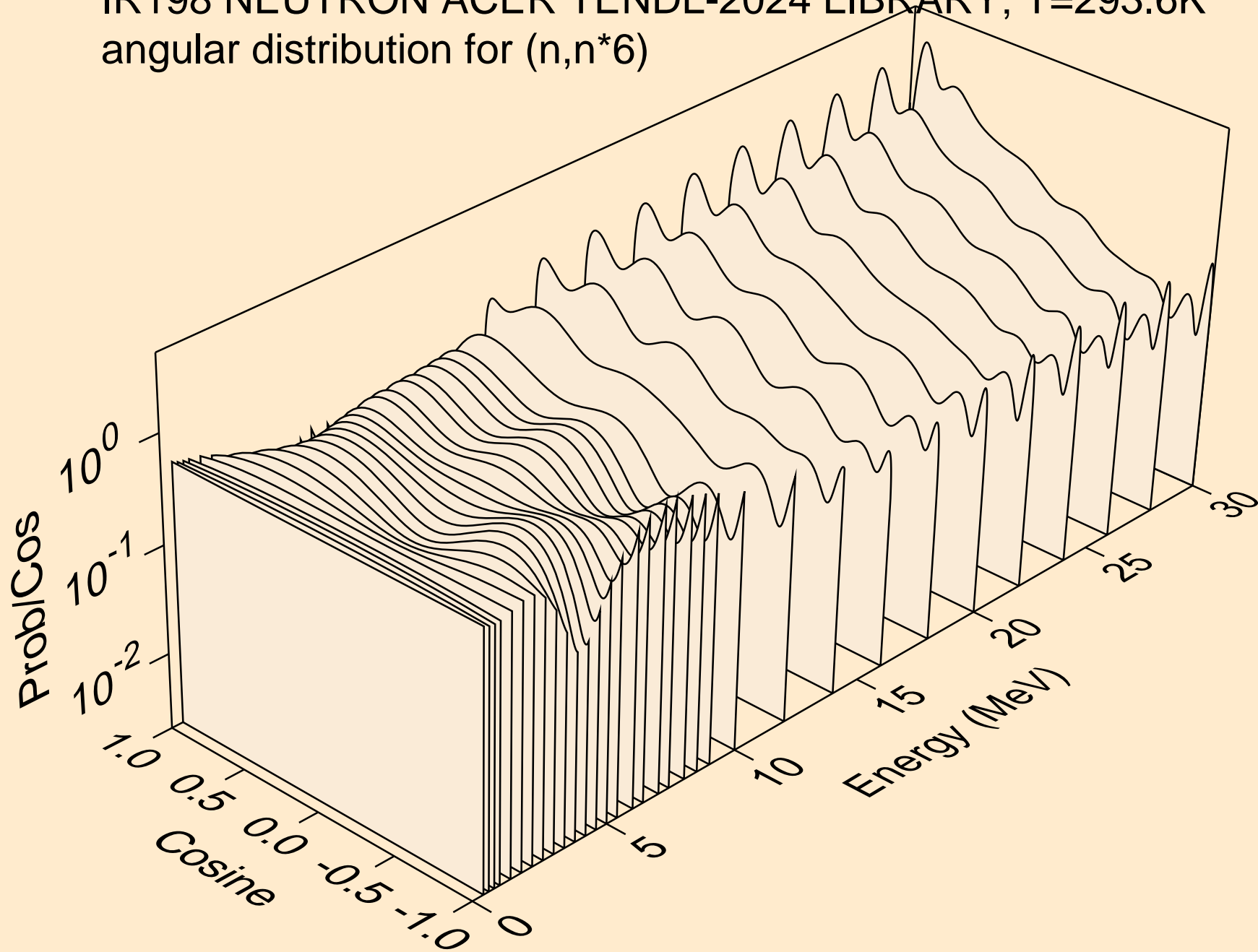

IR198 NEUTRON ACER TENDL-2024 LIBRARY; T=293.6K
angular distribution for (n,n*7)

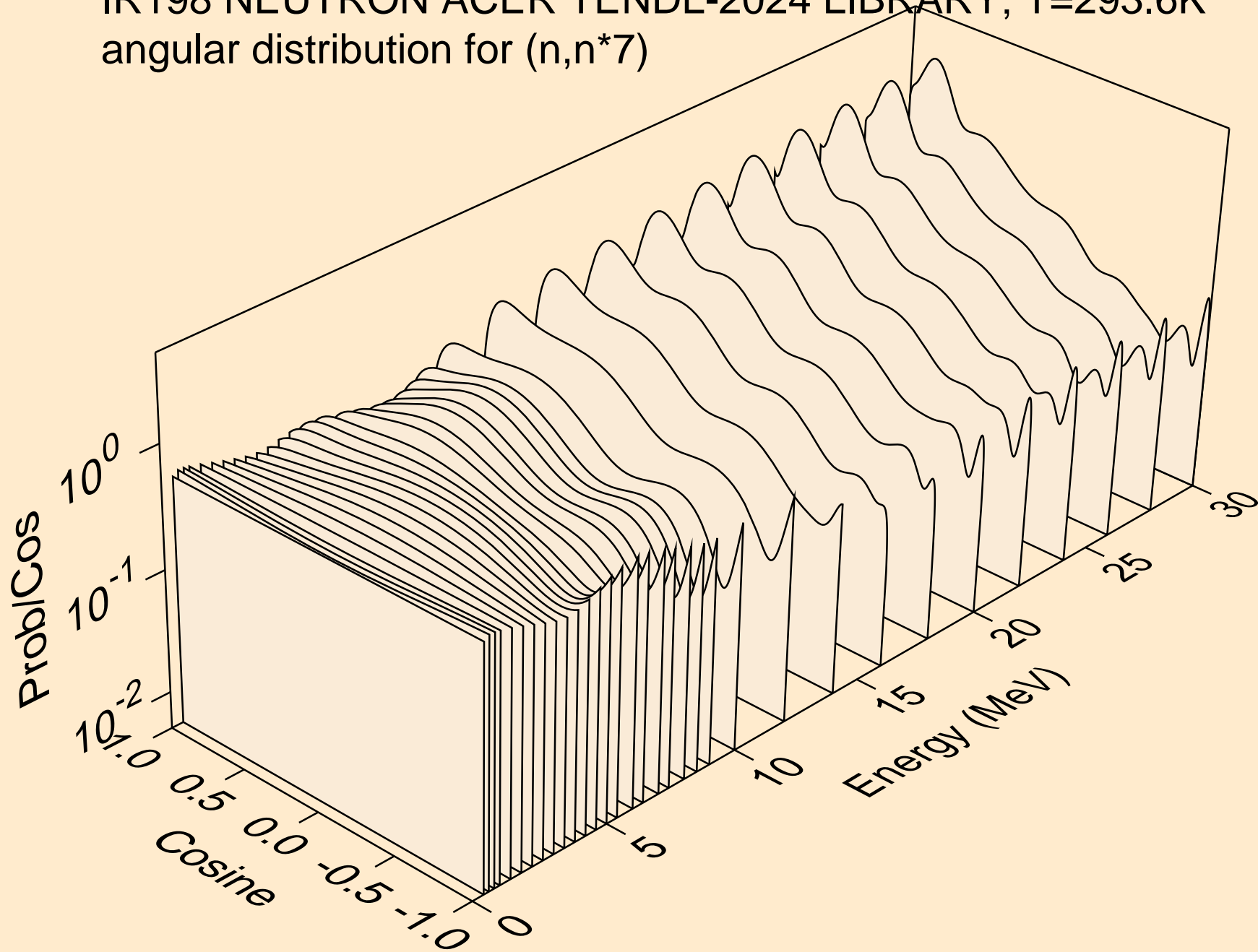

IR198 NEUTRON ACER TENDL-2024 LIBRARY; T=293.6K
angular distribution for (n,n*8)

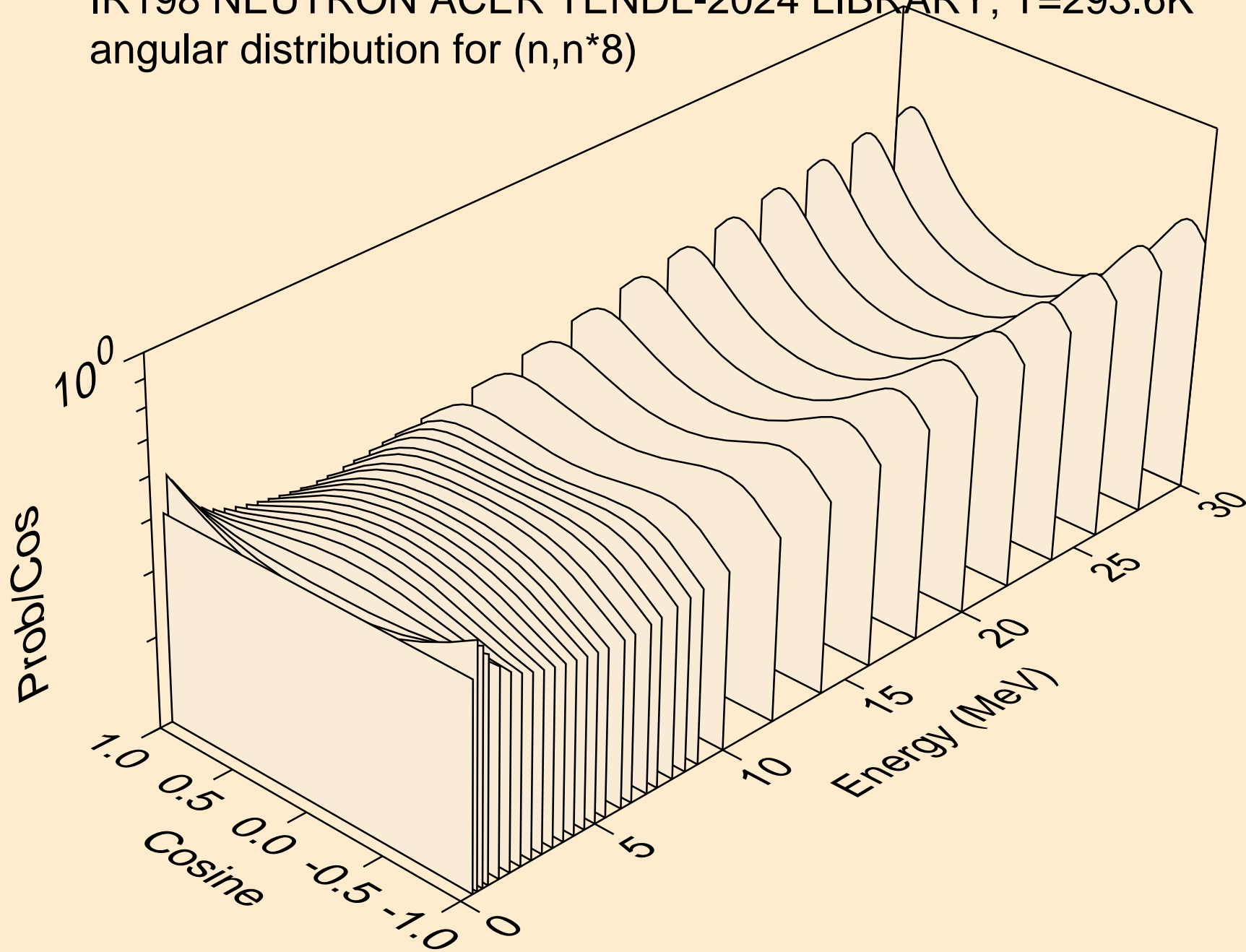

IR198 NEUTRON ACER TENDL-2024 LIBRARY; T=293.6K
angular distribution for (n,n*9)

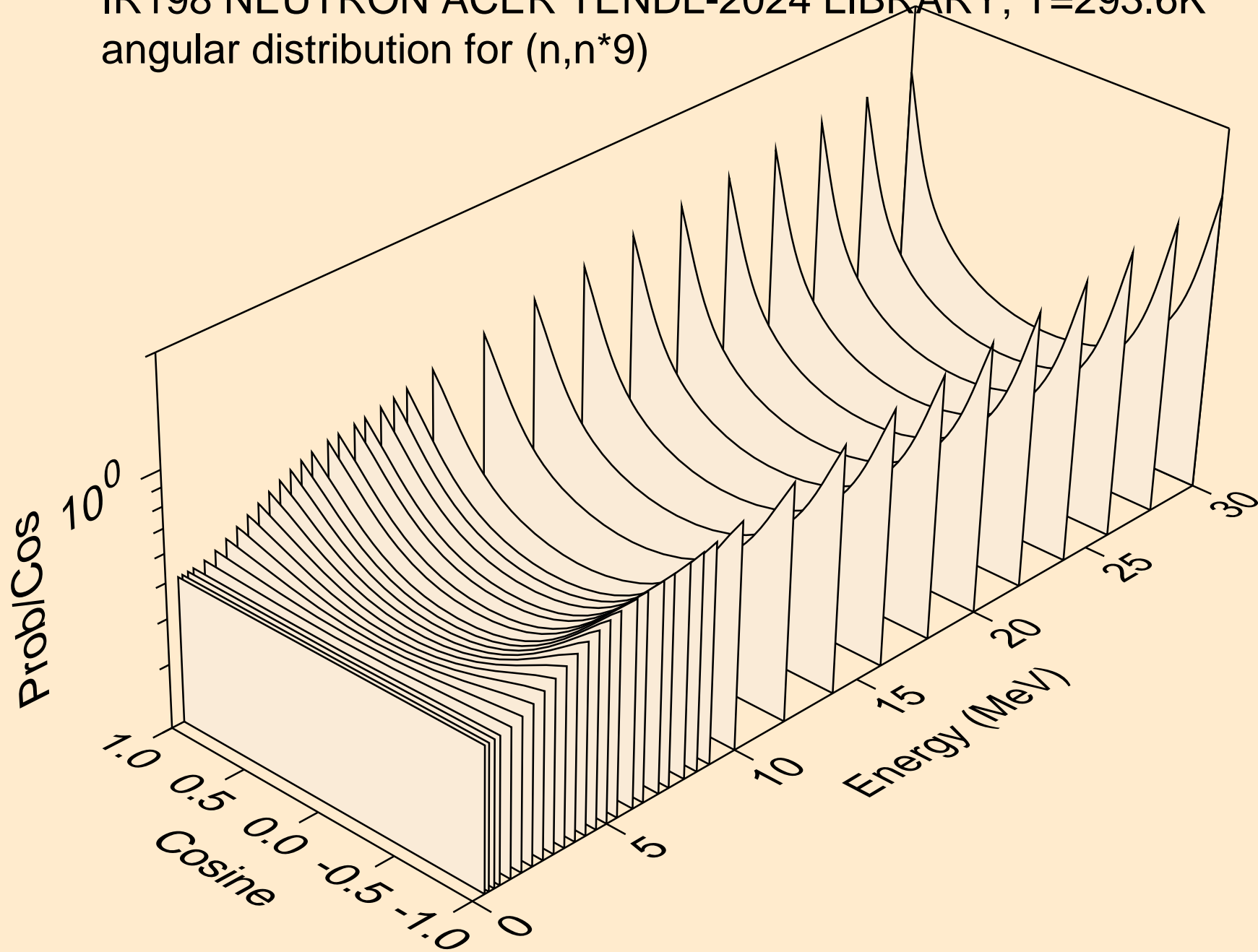

IR198 NEUTRON ACER TENDL-2024 LIBRARY; T=293.6K
angular distribution for (n,n*10)

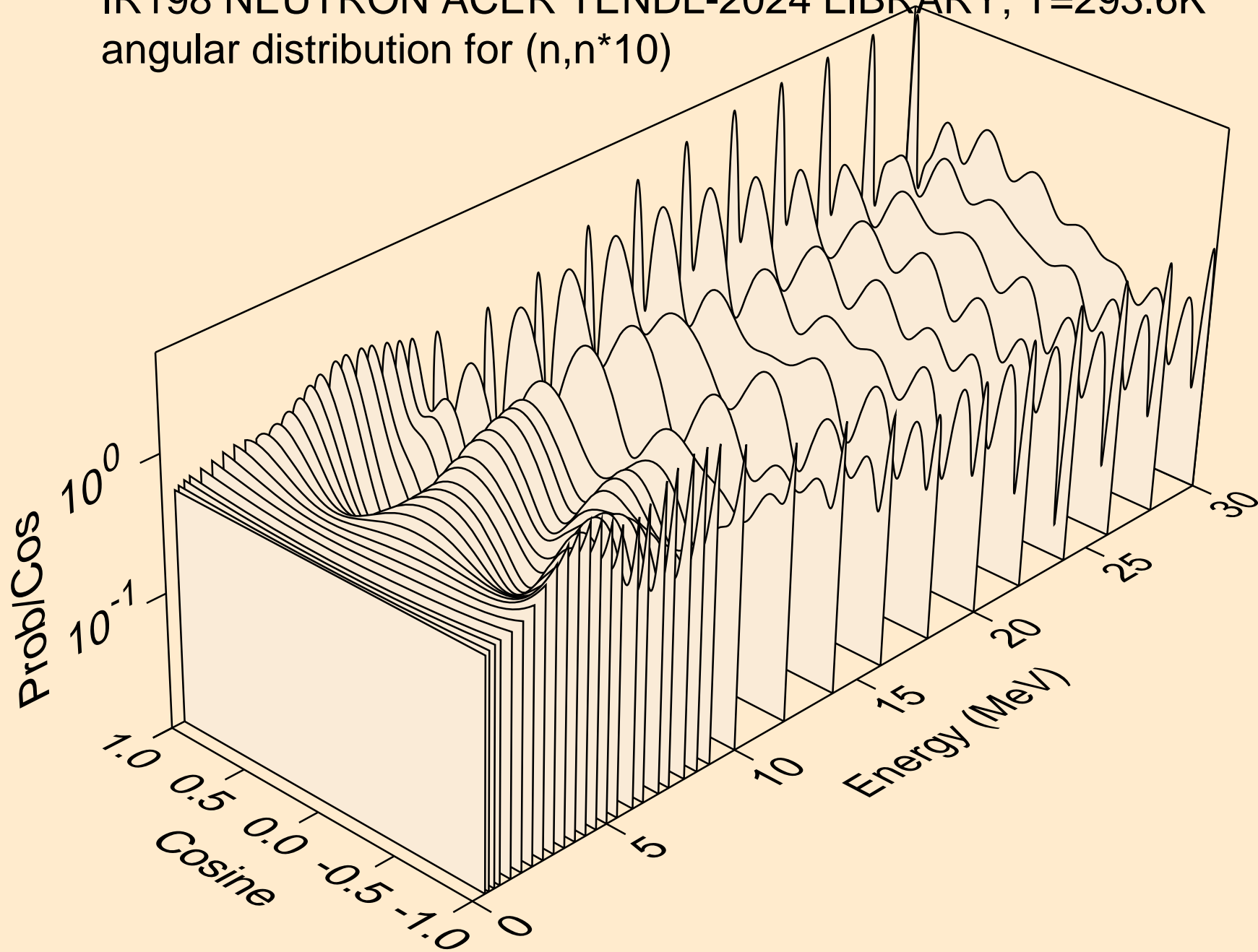

IR198 NEUTRON ACER TENDL-2024 LIBRARY; T=293.6K
angular distribution for (n,n*11)

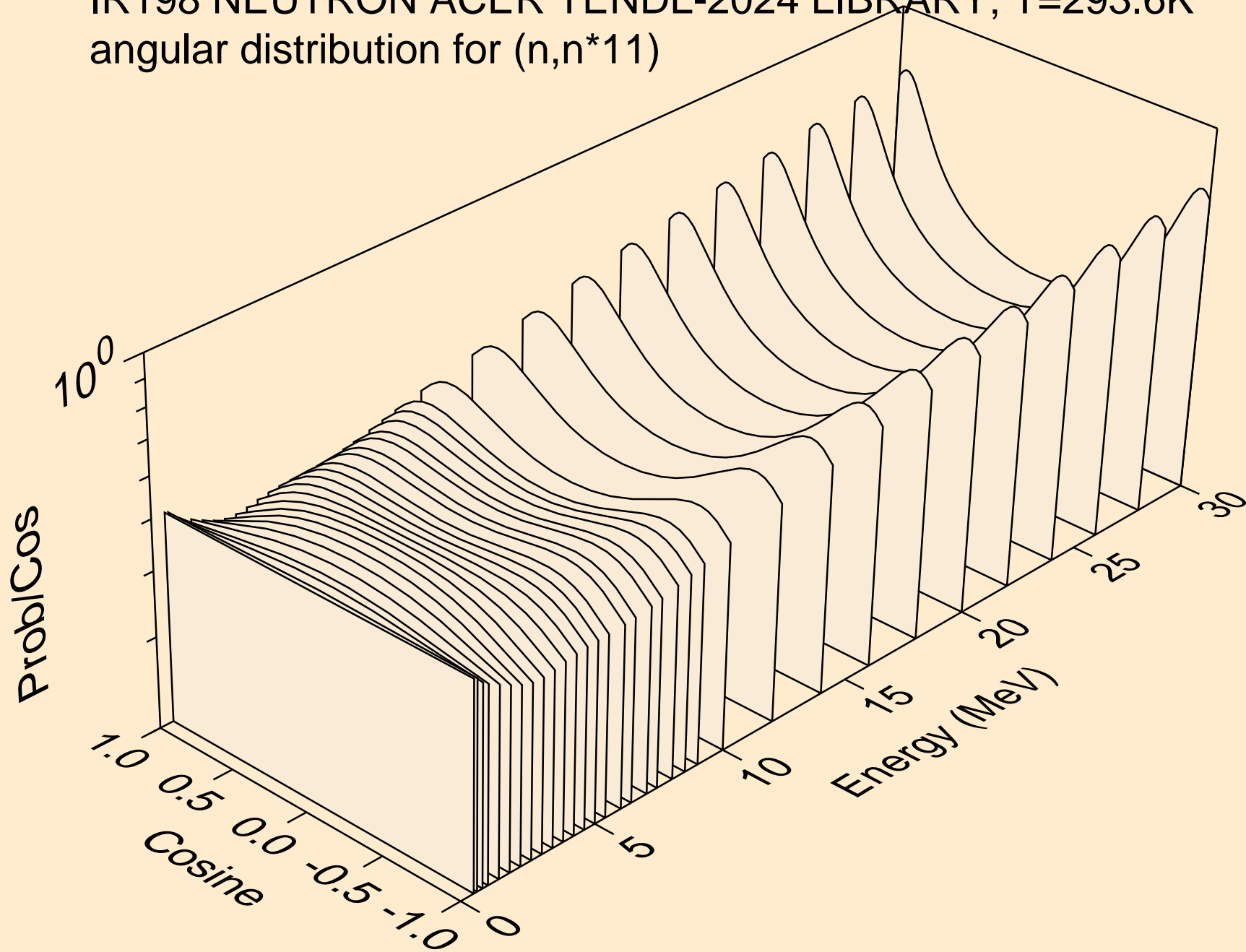

IR198 NEUTRON ACER TENDL-2024 LIBRARY; T=293.6K
angular distribution for (n,n*12)

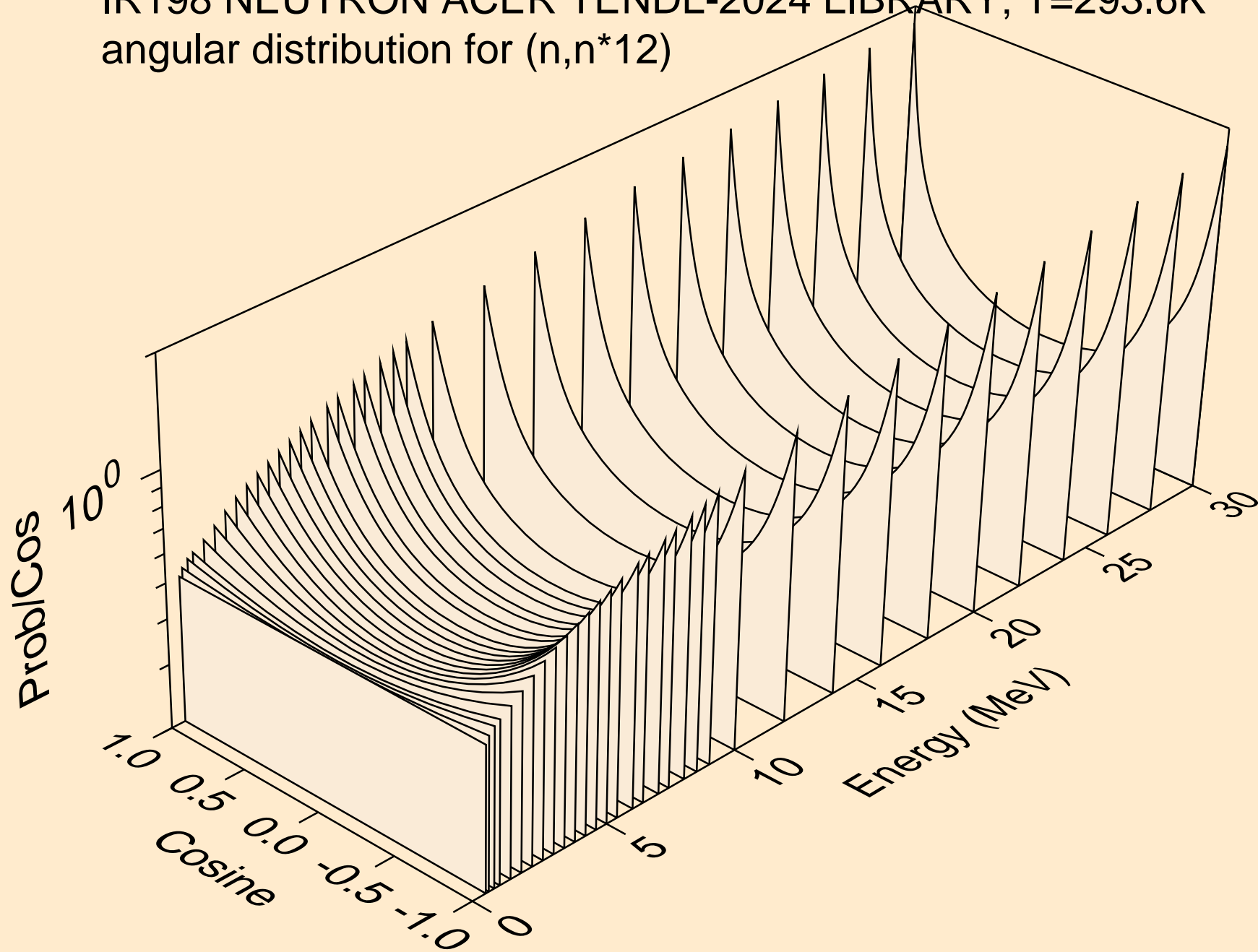

IR198 NEUTRON ACER TENDL-2024 LIBRARY; T=293.6K
angular distribution for (n,n*13)

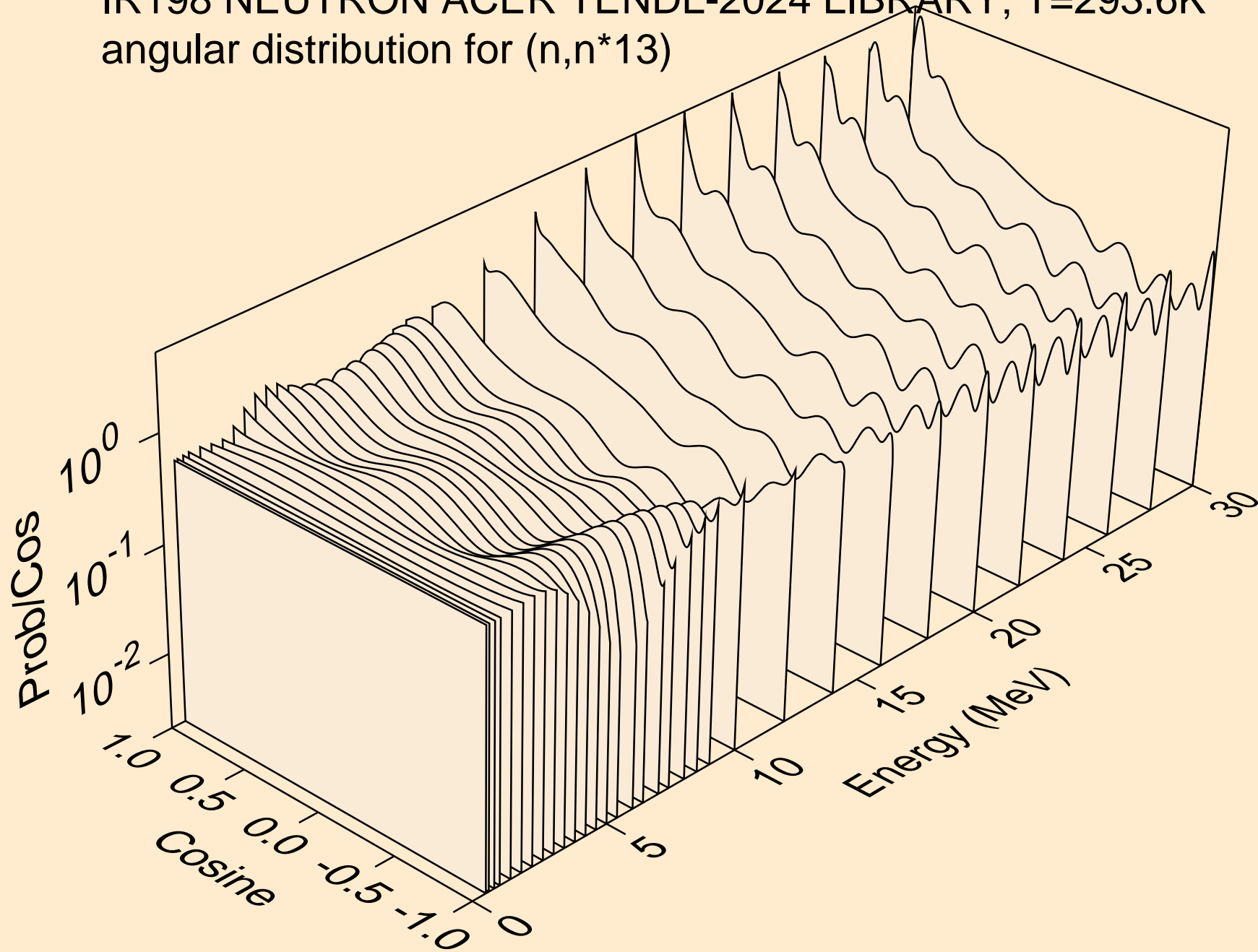

IR198 NEUTRON ACER TENDL-2024 LIBRARY; T=293.6K
angular distribution for (n,n*14)

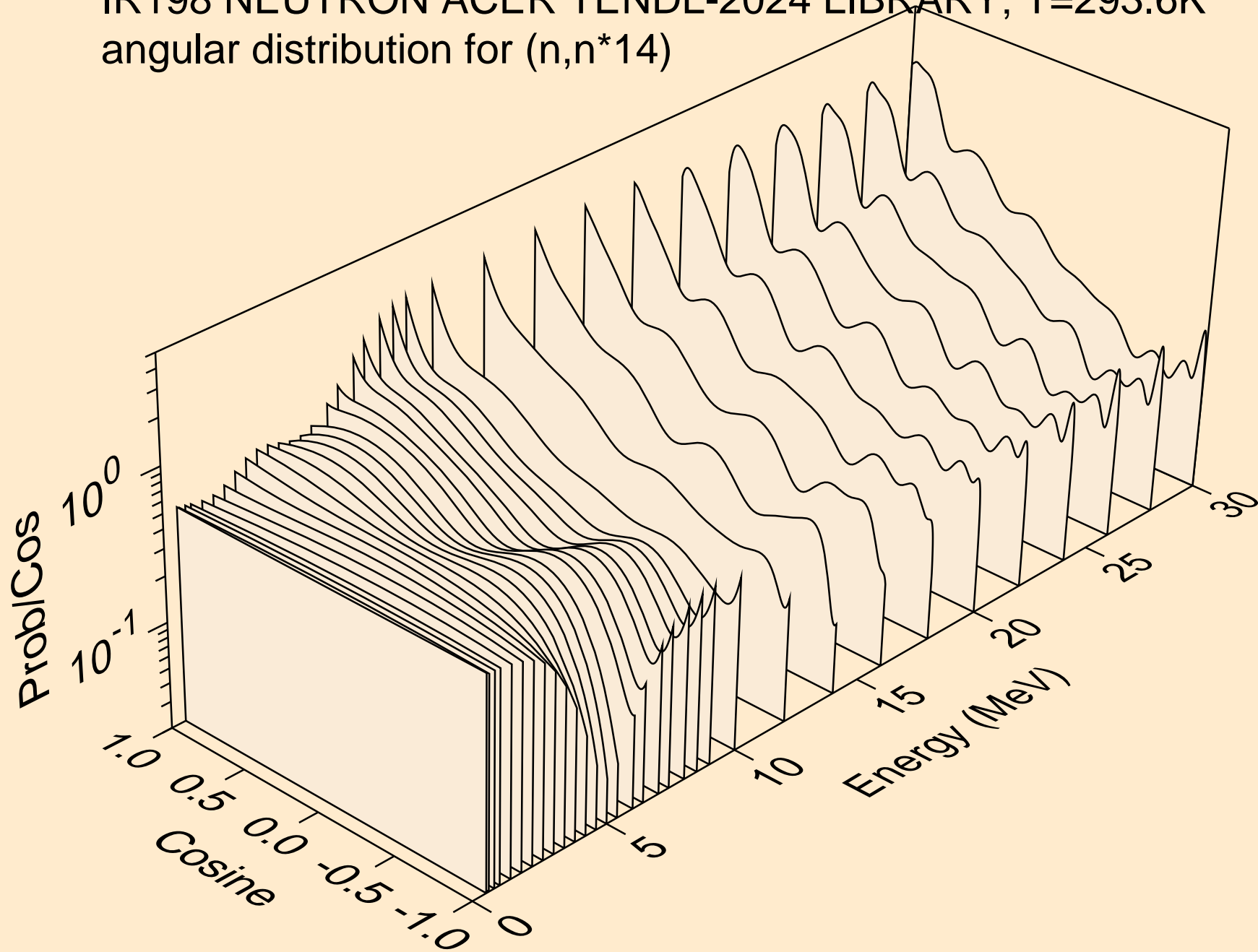

IR198 NEUTRON ACER TENDL-2024 LIBRARY; T=293.6K
angular distribution for (n,n*15)

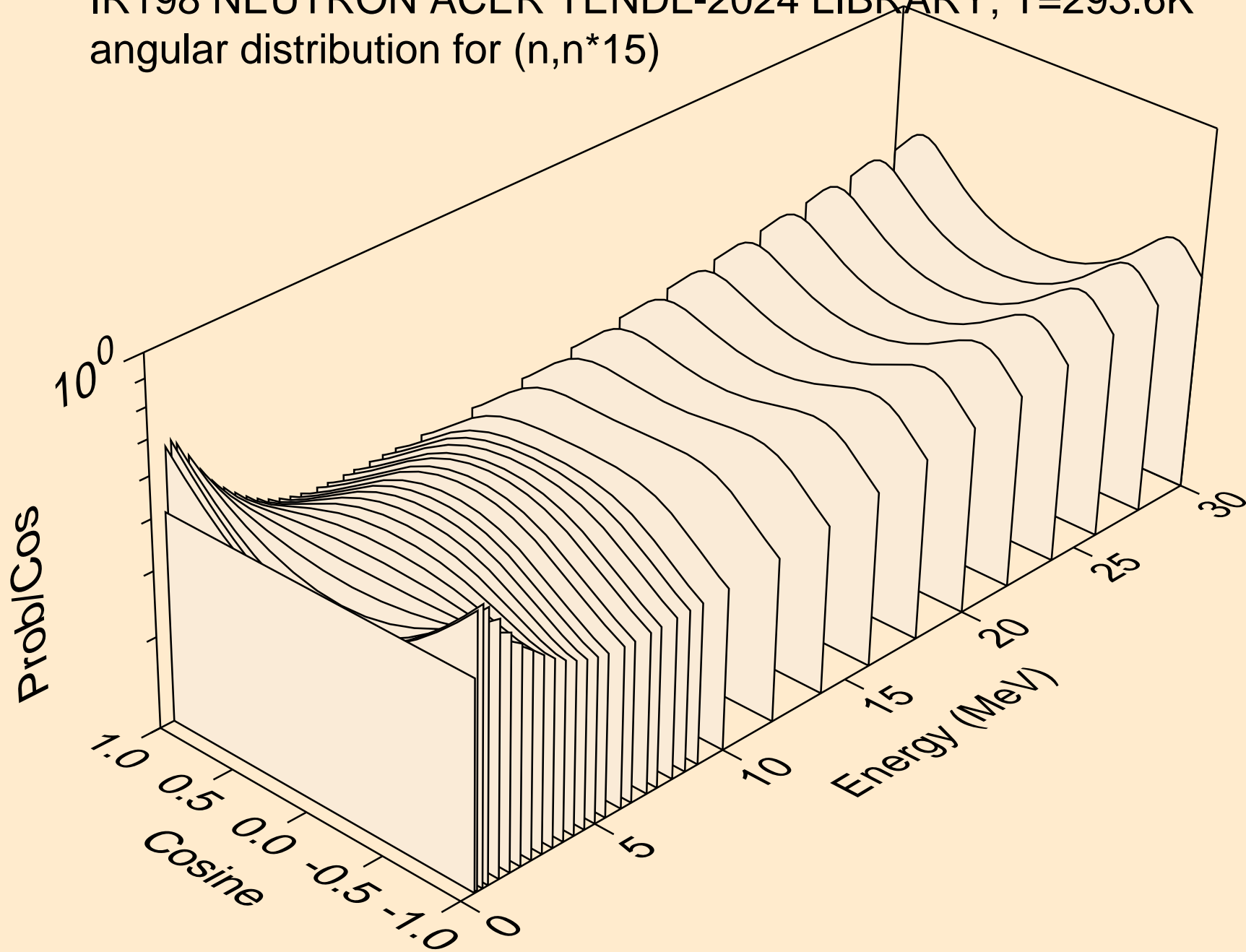

IR198 NEUTRON ACER TENDL-2024 LIBRARY; T=293.6K
angular distribution for (n,n*16)

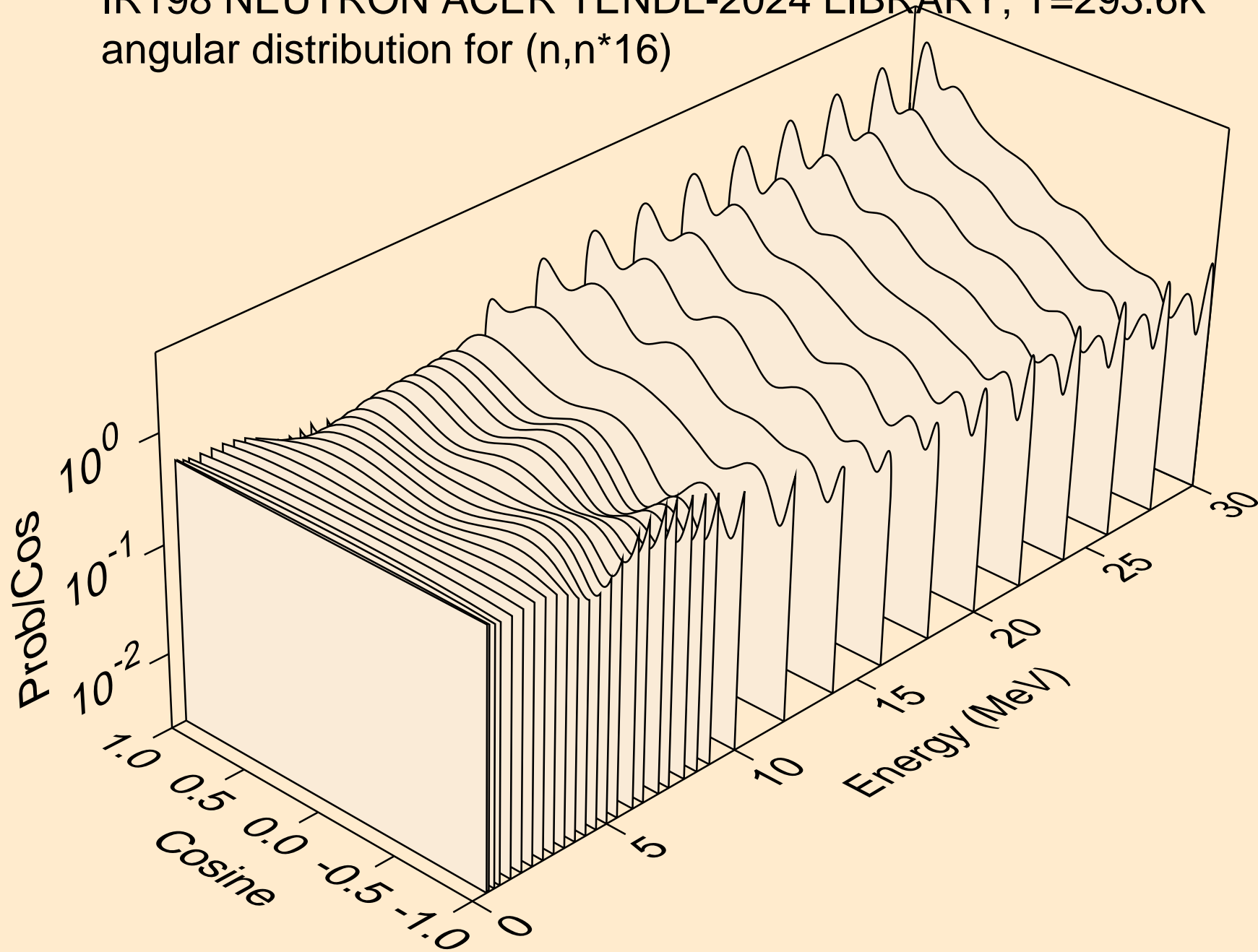

IR198 NEUTRON ACER TENDL-2024 LIBRARY; T=293.6K
angular distribution for (n,n*17)

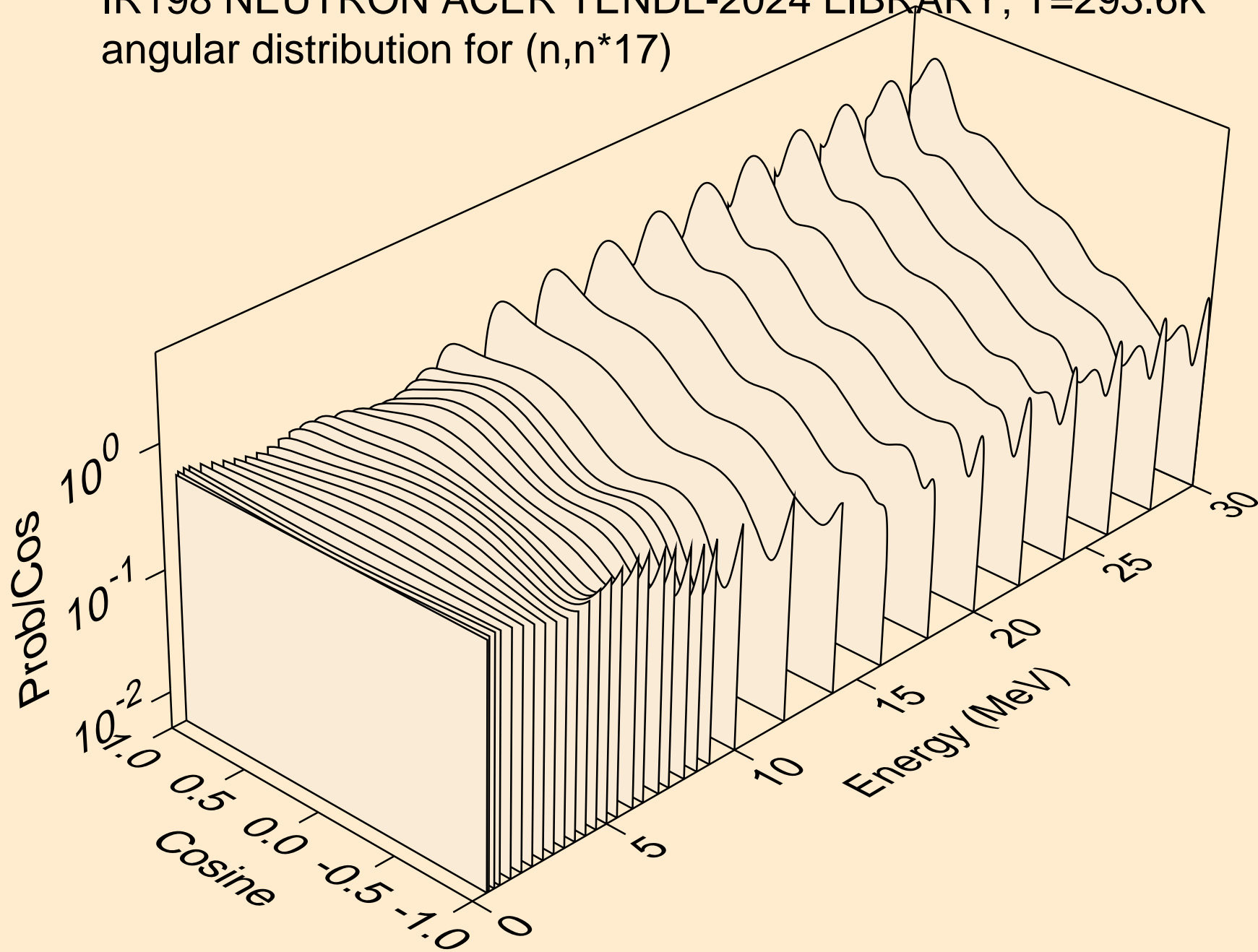

IR198 NEUTRON ACER TENDL-2024 LIBRARY; T=293.6K
angular distribution for (n,n*18)

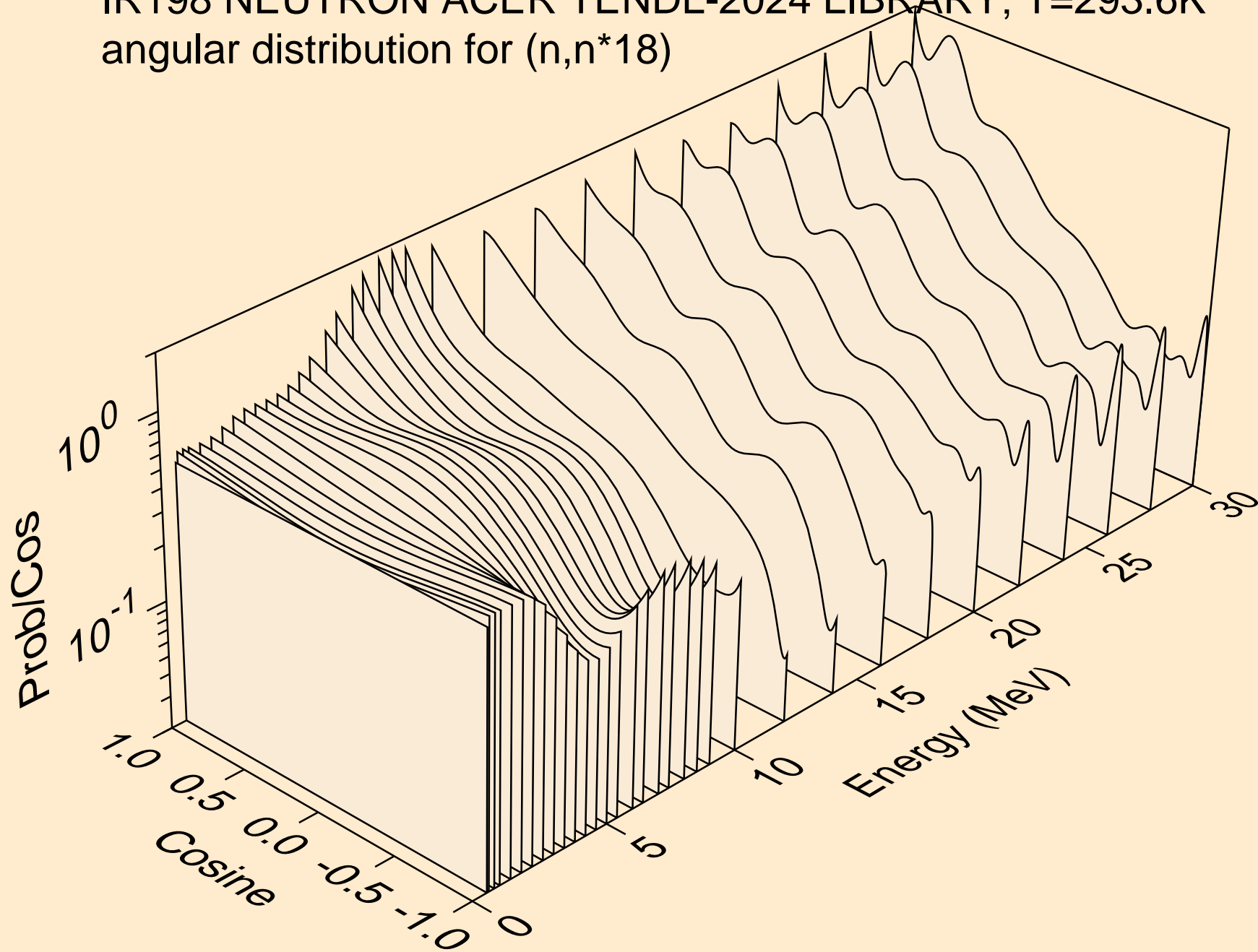

IR198 NEUTRON ACER TENDL-2024 LIBRARY; T=293.6K
angular distribution for (n,n*19)

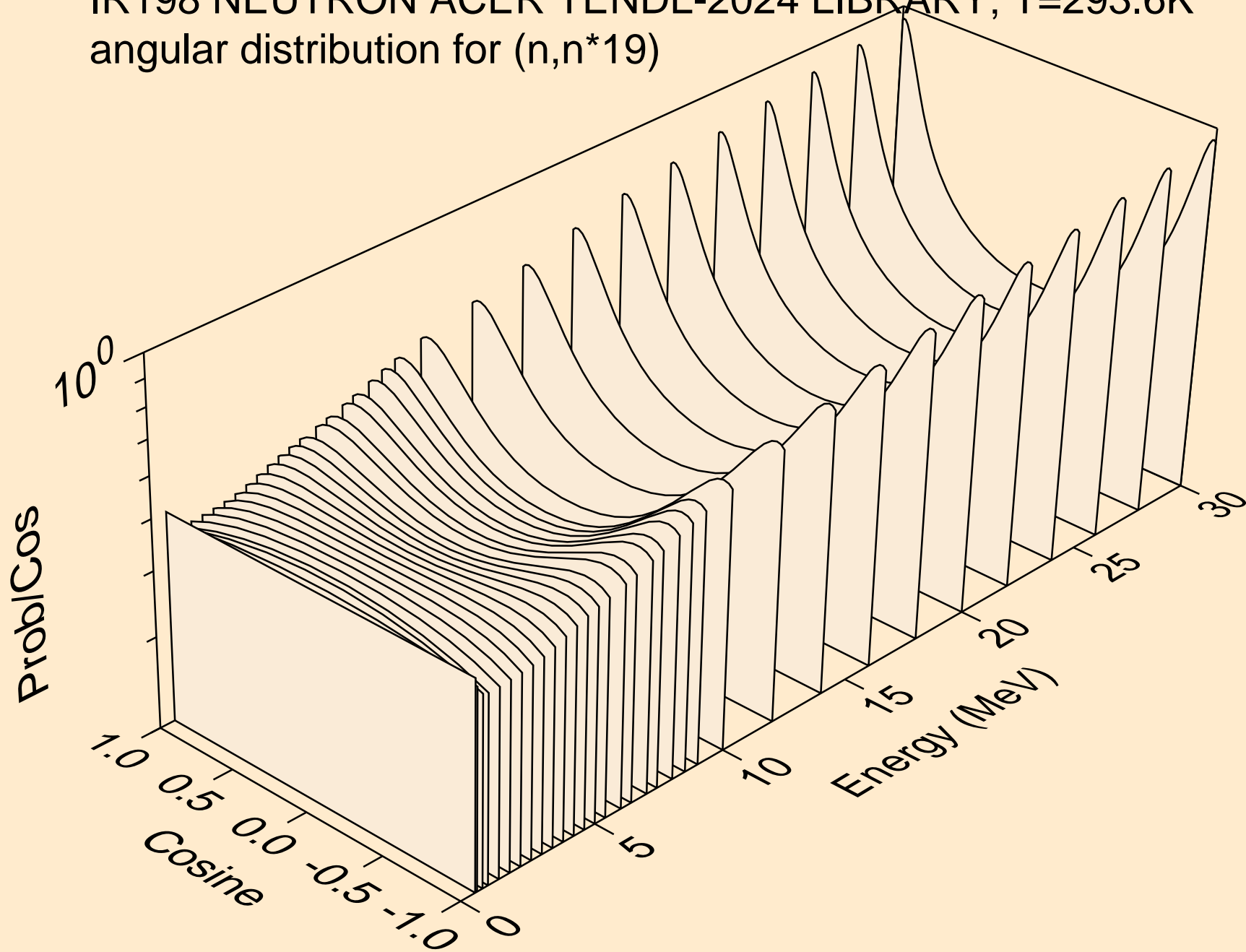

IR198 NEUTRON ACER TENDL-2024 LIBRARY; T=293.6K
angular distribution for (n,n*20)

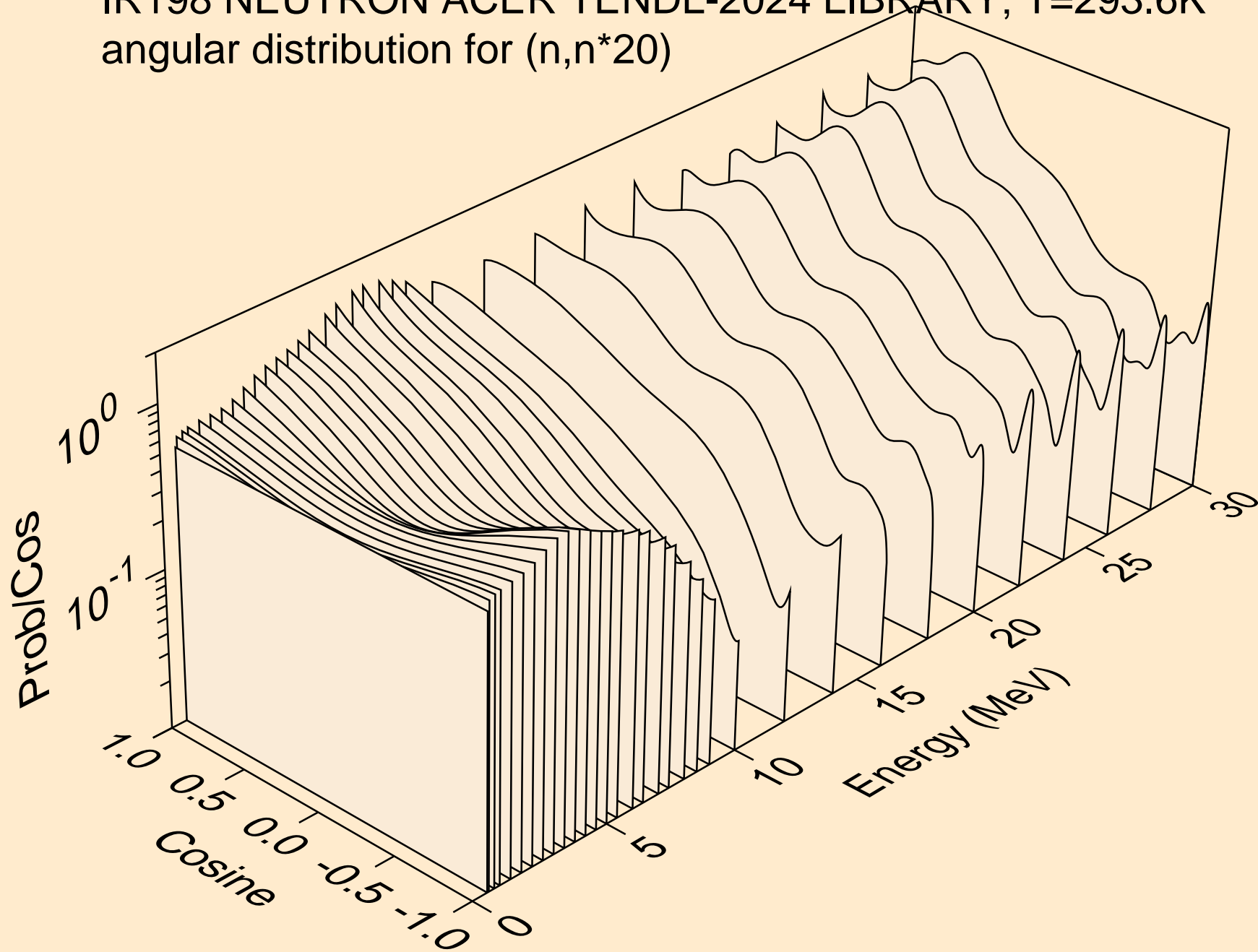

IR198 NEUTRON ACER TENDL-2024 LIBRARY; T=293.6K
angular distribution for (n,n*21)

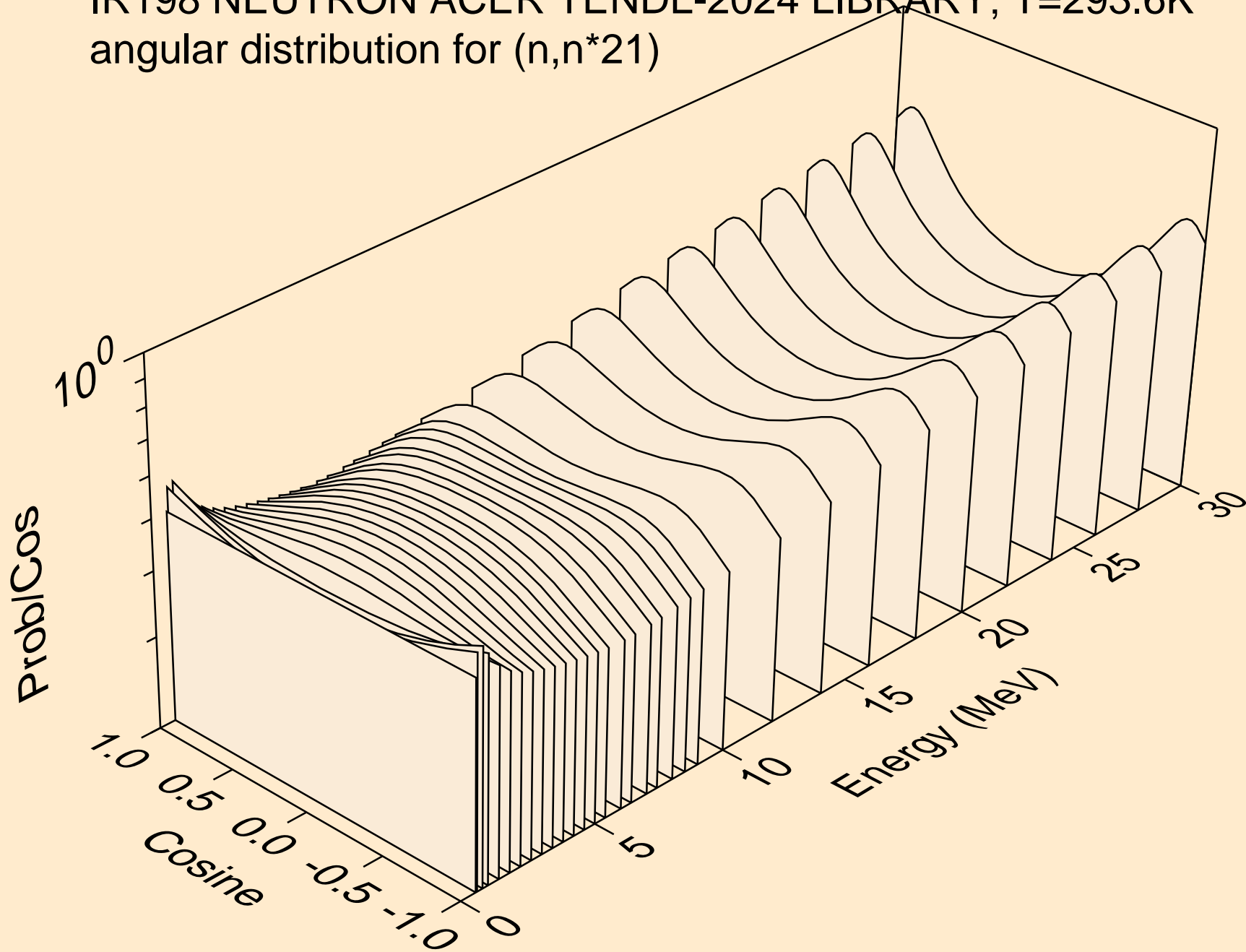

IR198 NEUTRON ACER TENDL-2024 LIBRARY; T=293.6K
angular distribution for (n,n*22)

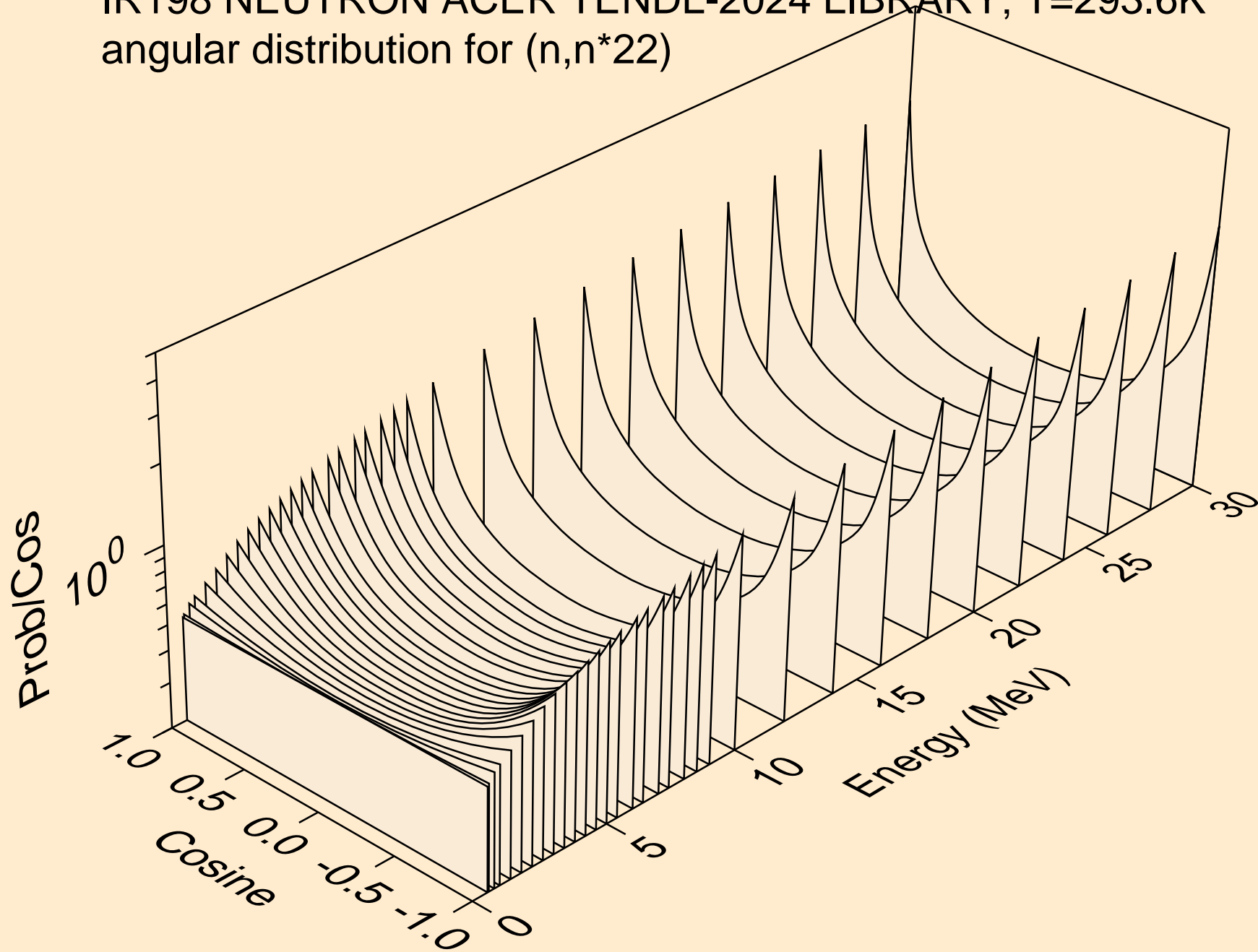

IR198 NEUTRON ACER TENDL-2024 LIBRARY; T=293.6K
angular distribution for (n,n*23)

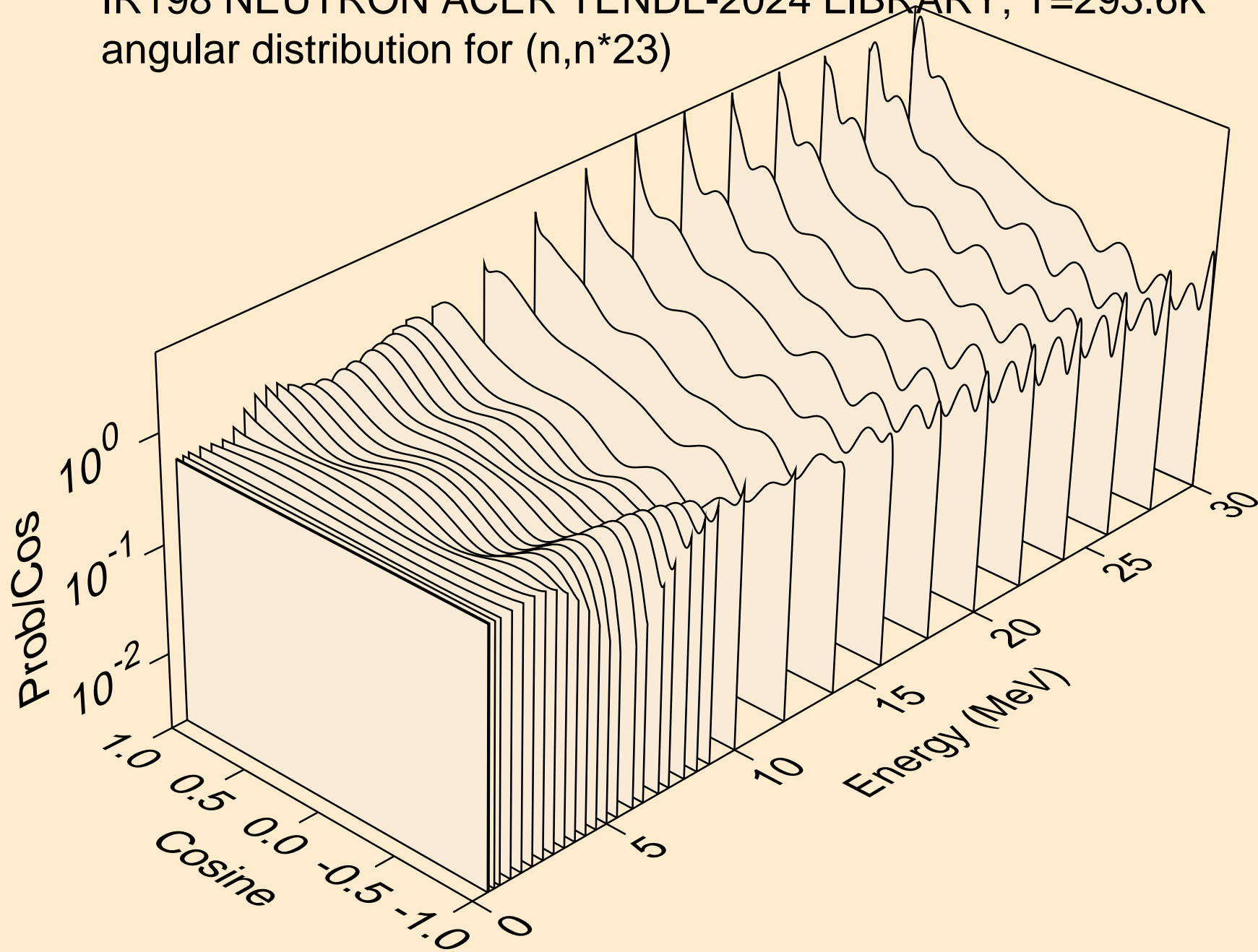

IR198 NEUTRON ACER TENDL-2024 LIBRARY; T=293.6K
angular distribution for (n,n*24)

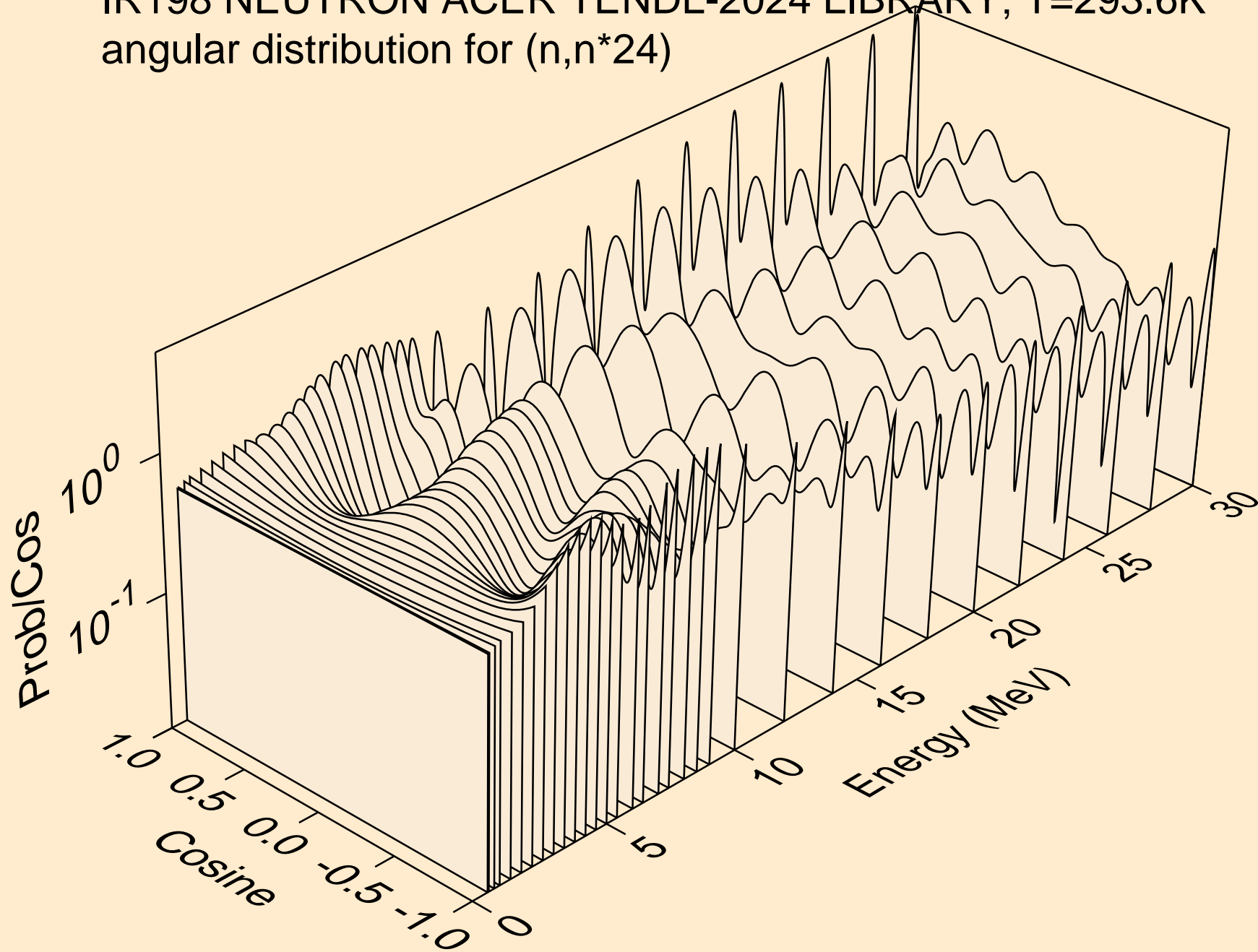

IR198 NEUTRON ACER TENDL-2024 LIBRARY; T=293.6K
angular distribution for (n,n*25)

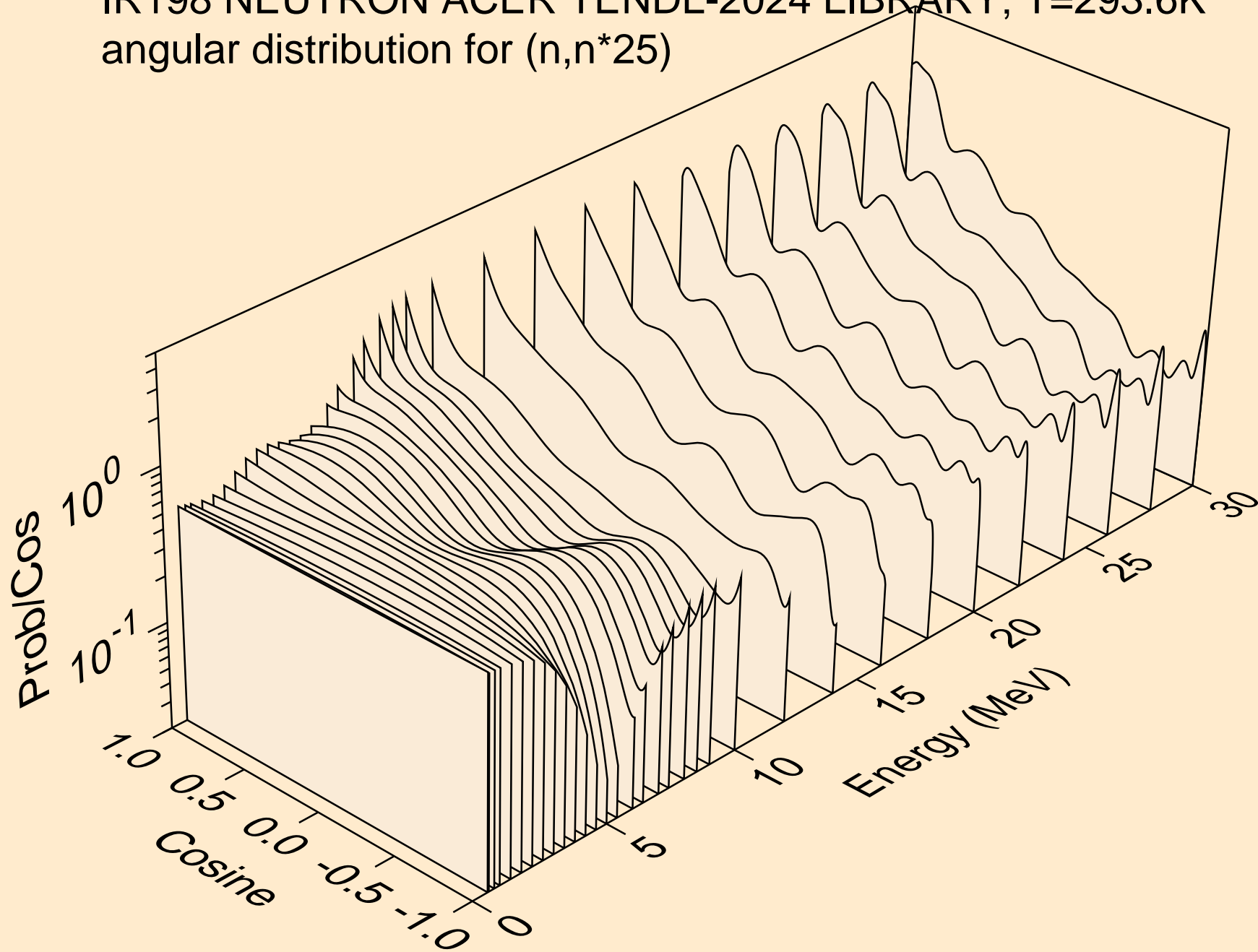

IR198 NEUTRON ACER TENDL-2024 LIBRARY; T=293.6K
angular distribution for (n,n*26)

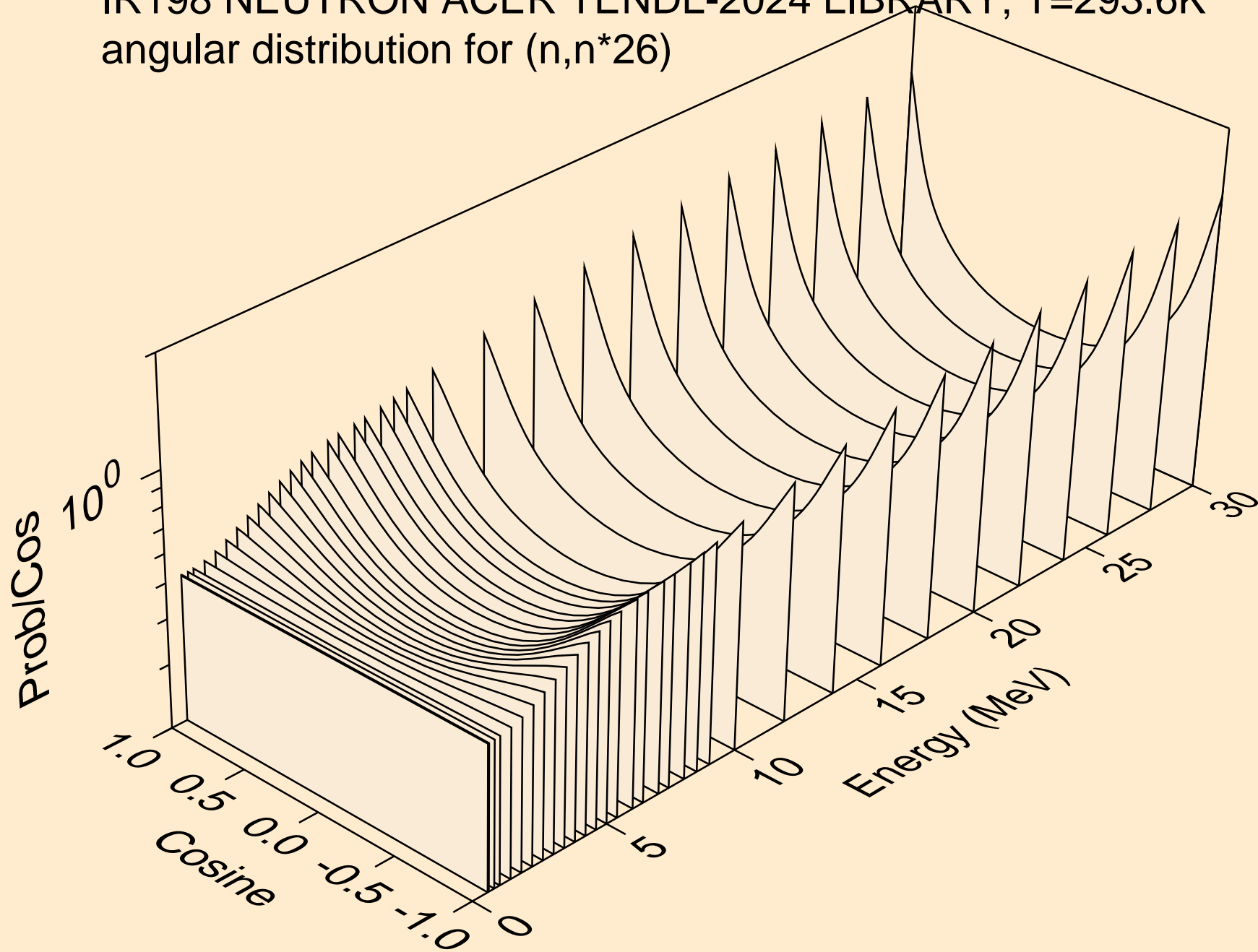

IR198 NEUTRON ACER TENDL-2024 LIBRARY; T=293.6K
angular distribution for (n,n*27)

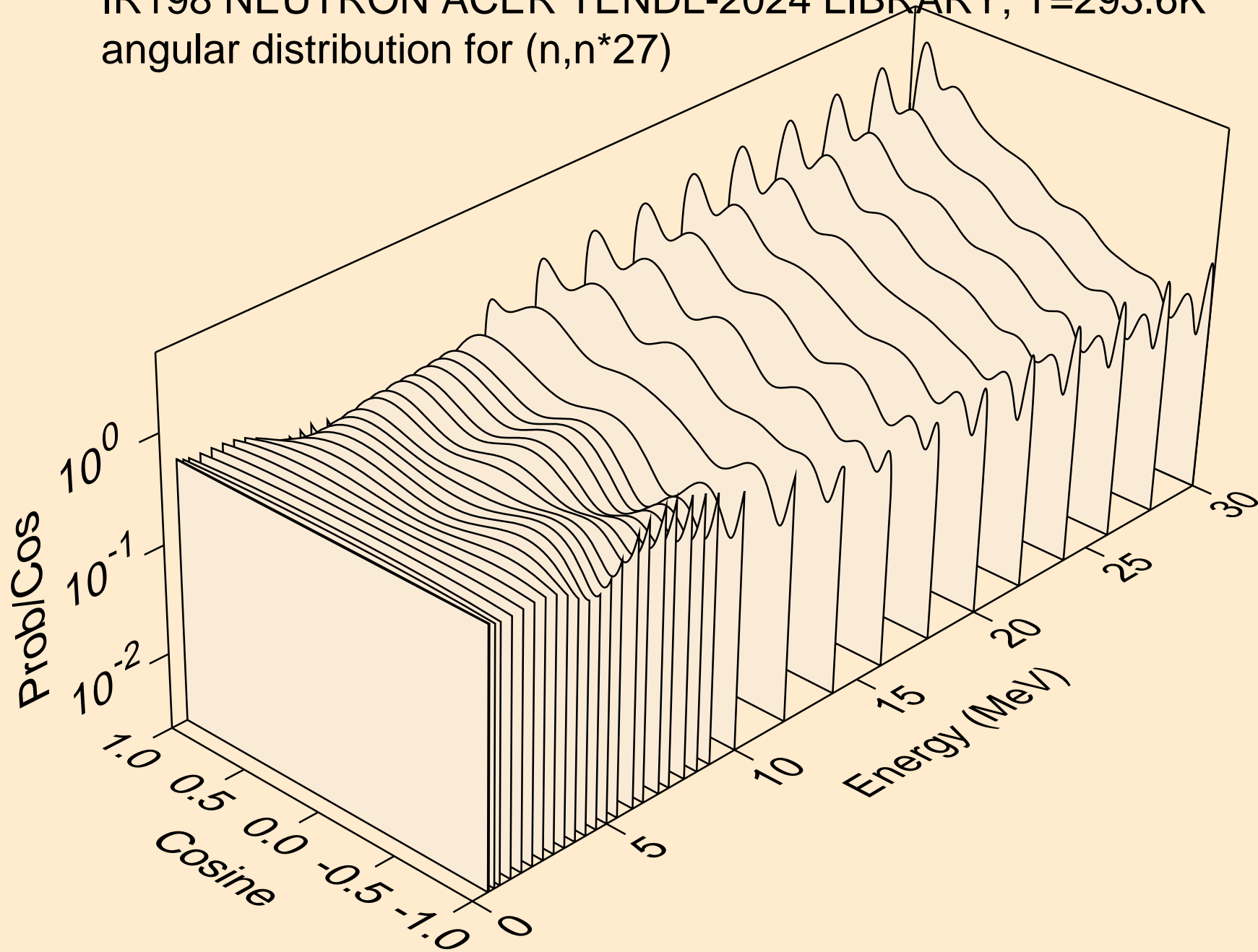

IR198 NEUTRON ACER TENDL-2024 LIBRARY; T=293.6K
angular distribution for (n,n*28)

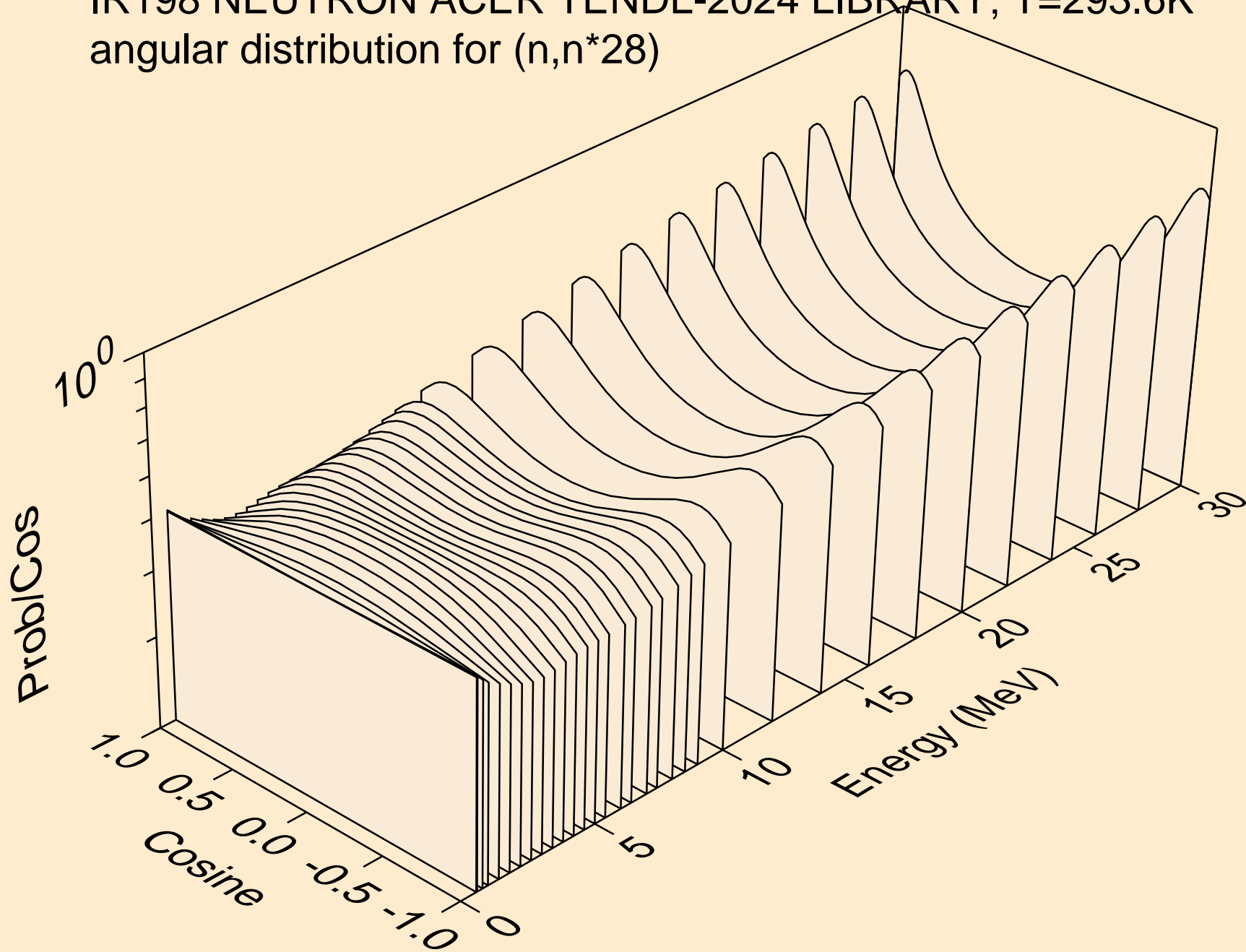

IR198 NEUTRON ACER TENDL-2024 LIBRARY; T=293.6K
Neutron emission for (n,x)

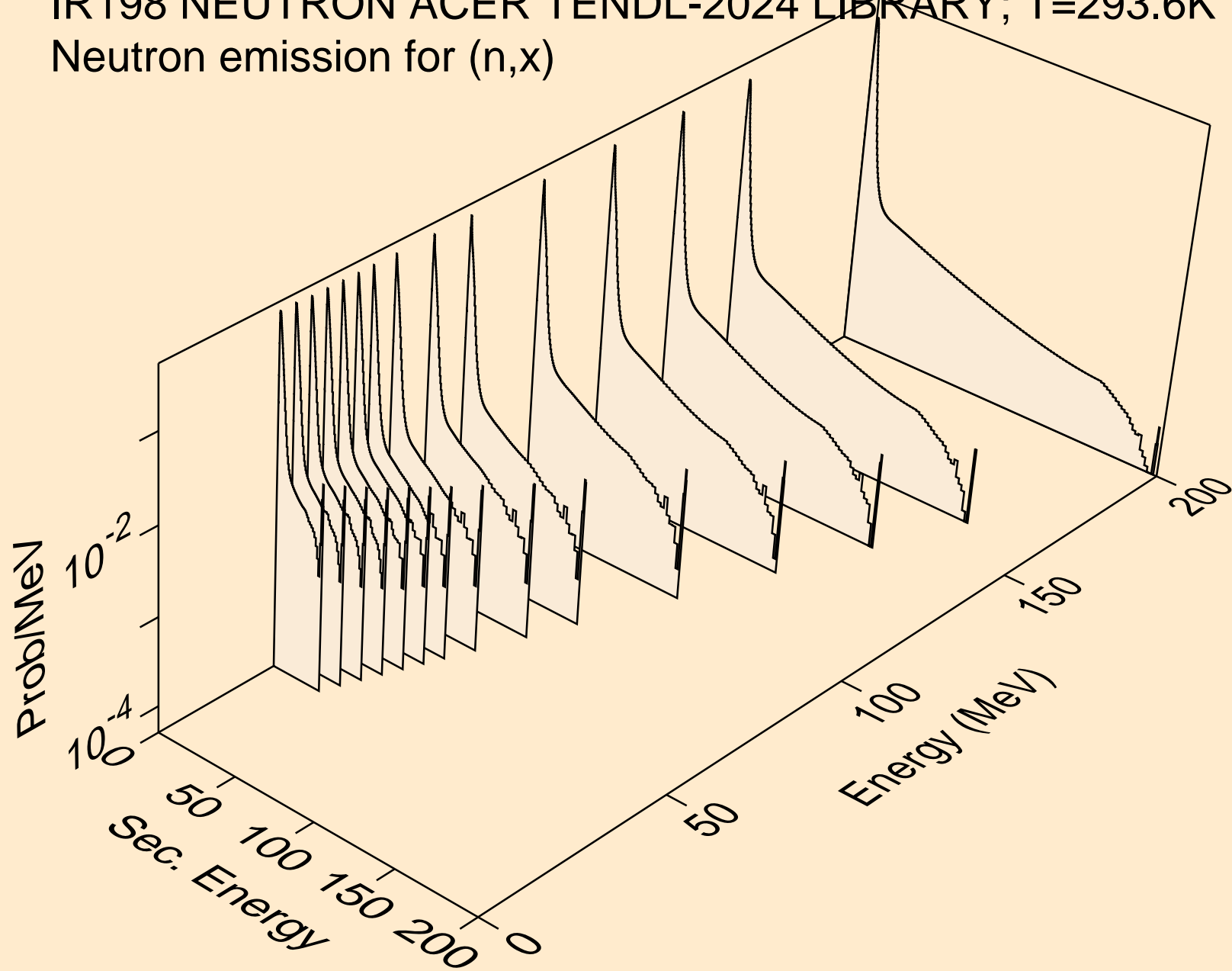

IR198 NEUTRON ACER TENDL-2024 LIBRARY; T=293.6K
Neutron emission for (n,2nd)

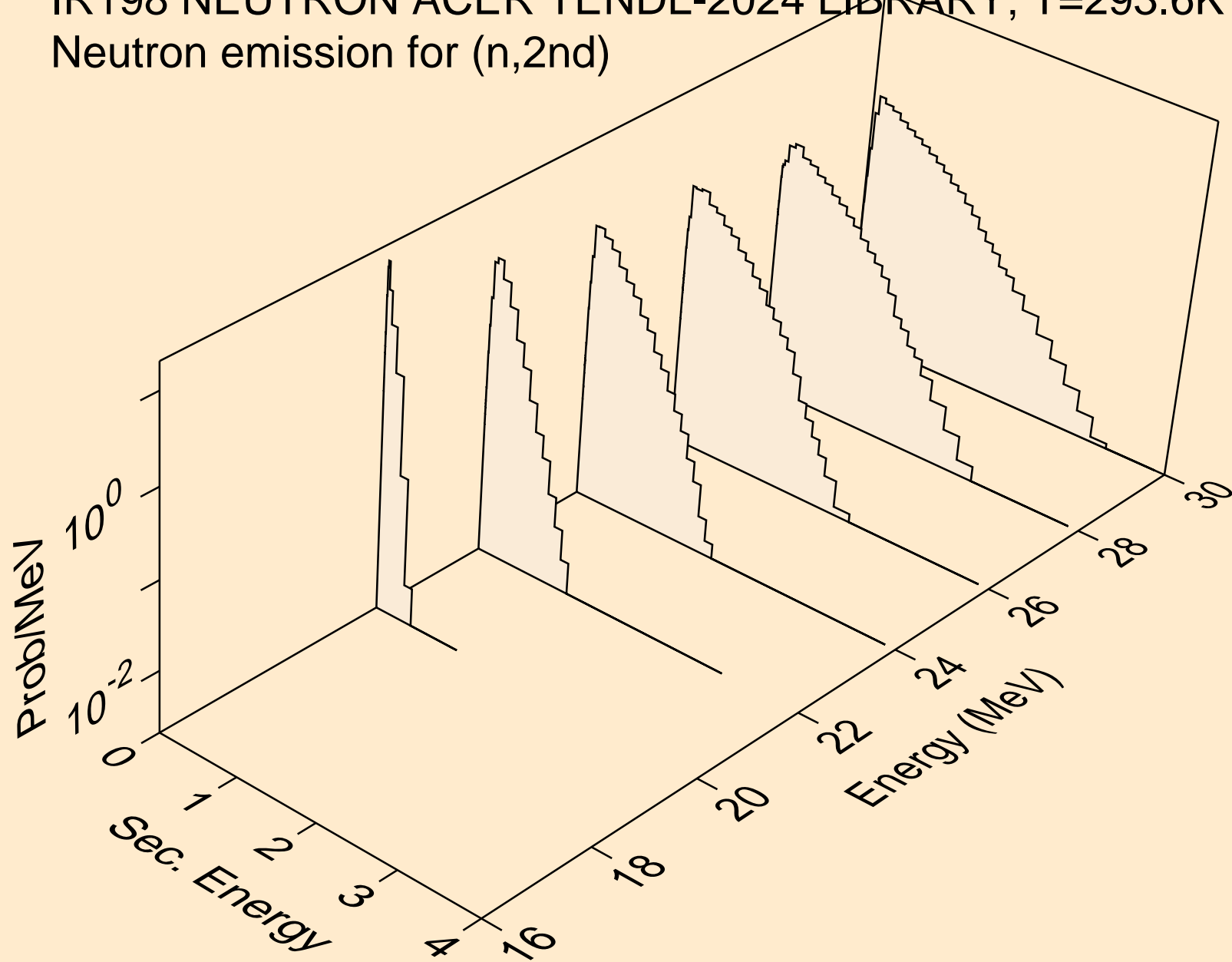

IR198 NEUTRON ACER TENDL-2024 LIBRARY; T=293.6K
Neutron emission for (n,2n)

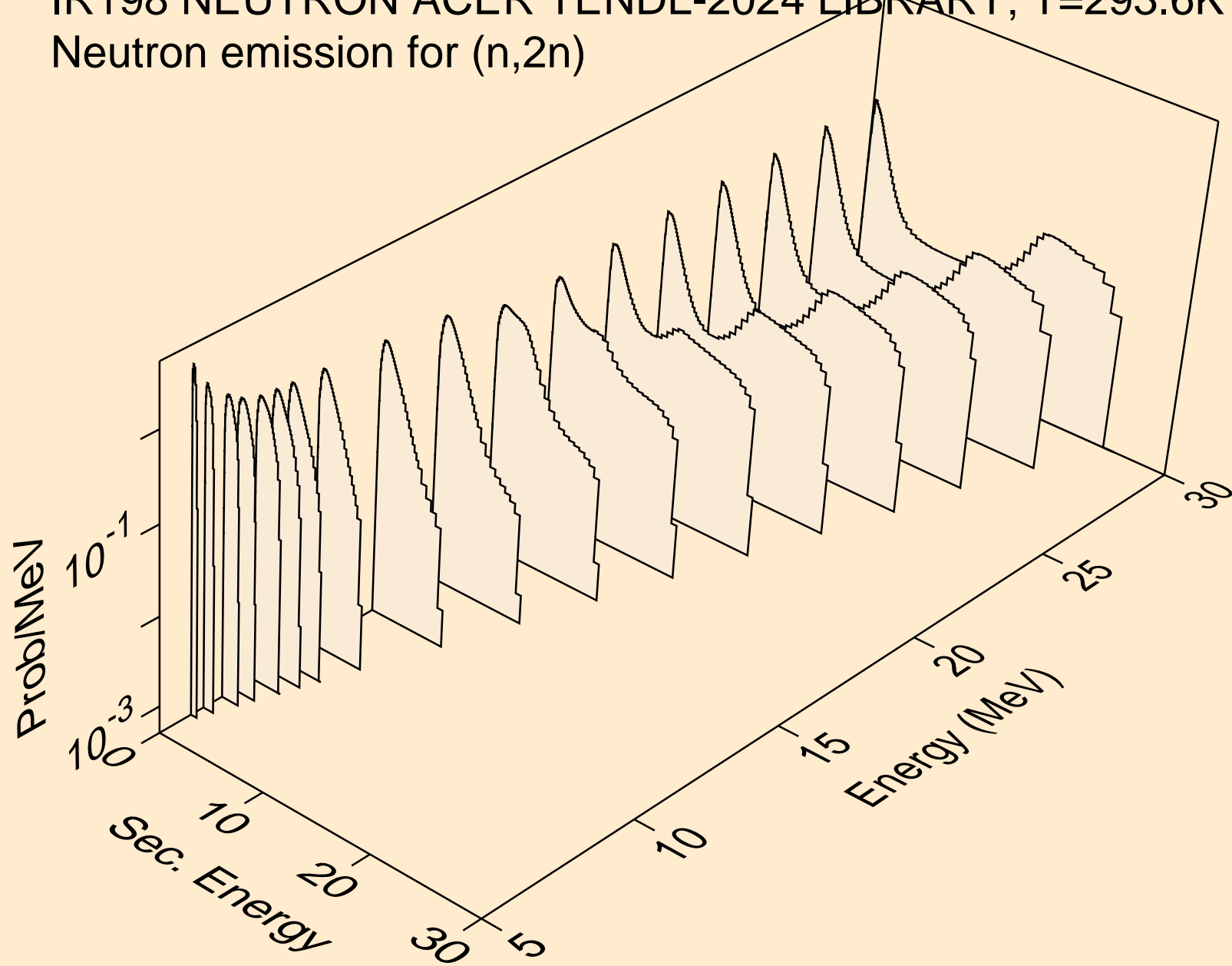

IR198 NEUTRON ACER TENDL-2024 LIBRARY; T=293.6K
Neutron emission for (n,3n)

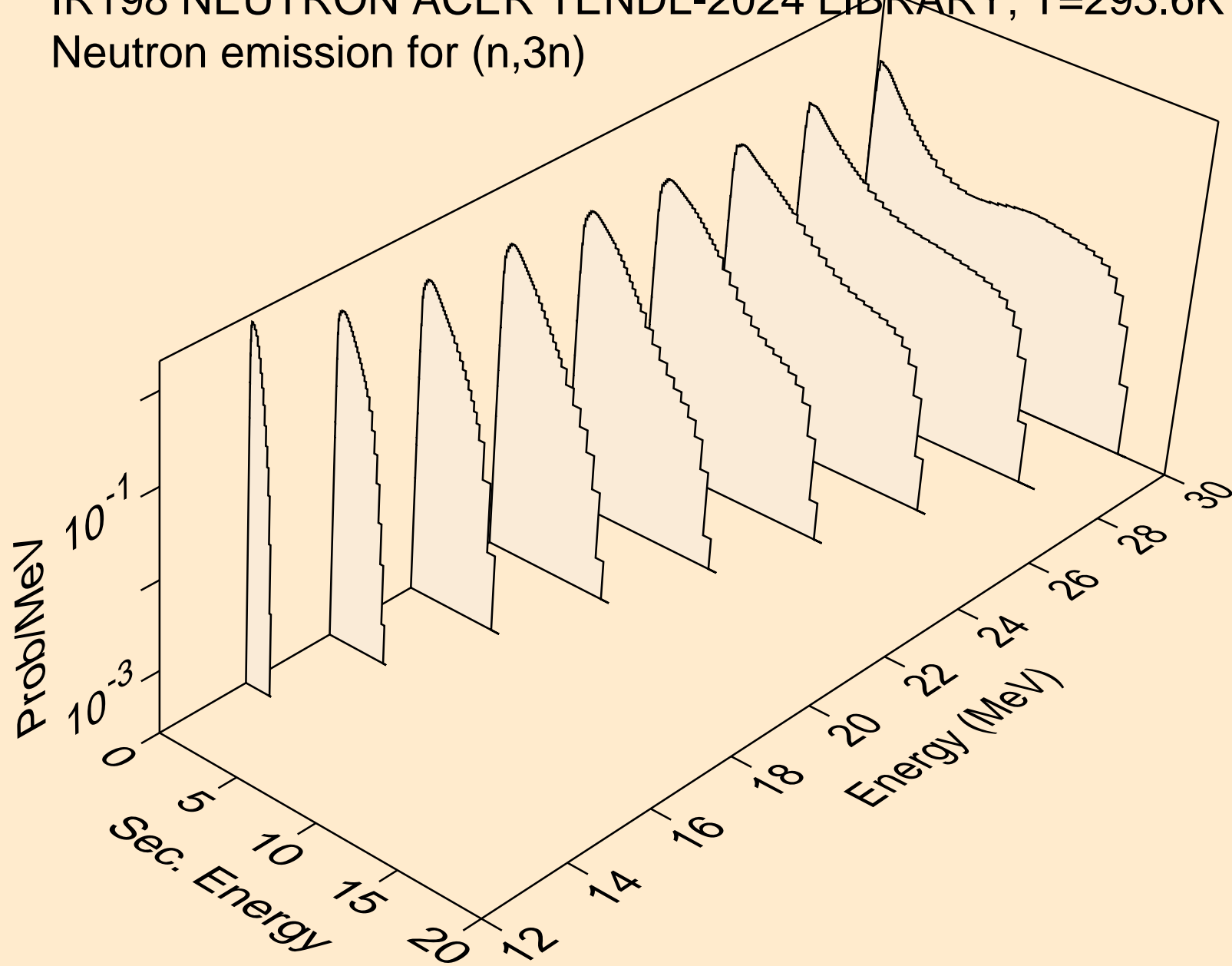

IR198 NEUTRON ACER TENDL-2024 LIBRARY; T=293.6K
Neutron emission for (n,n*)a

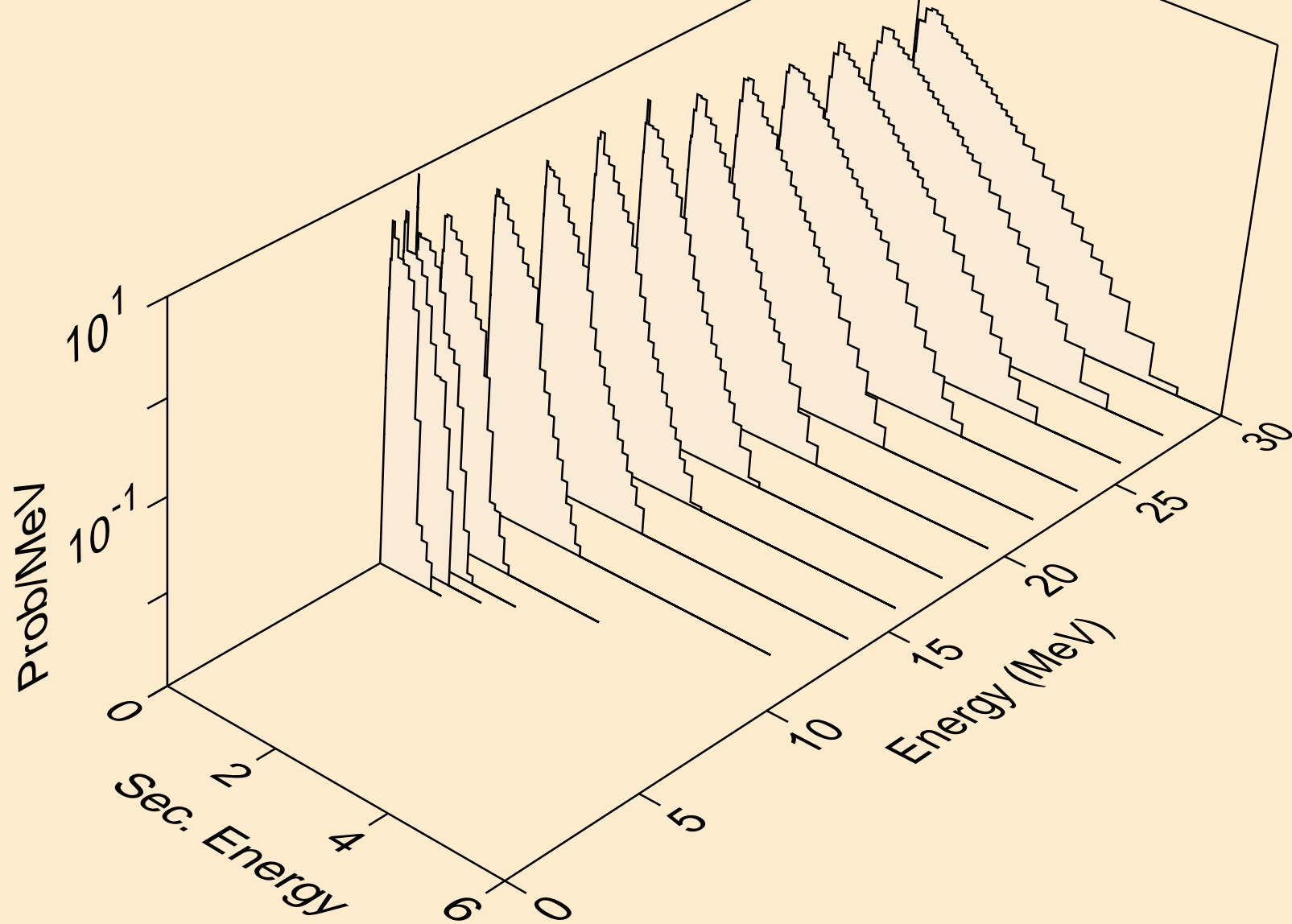

IR198 NEUTRON ACER TENDL-2024 LIBRARY; T=293.6K
Neutron emission for (n,2n)a

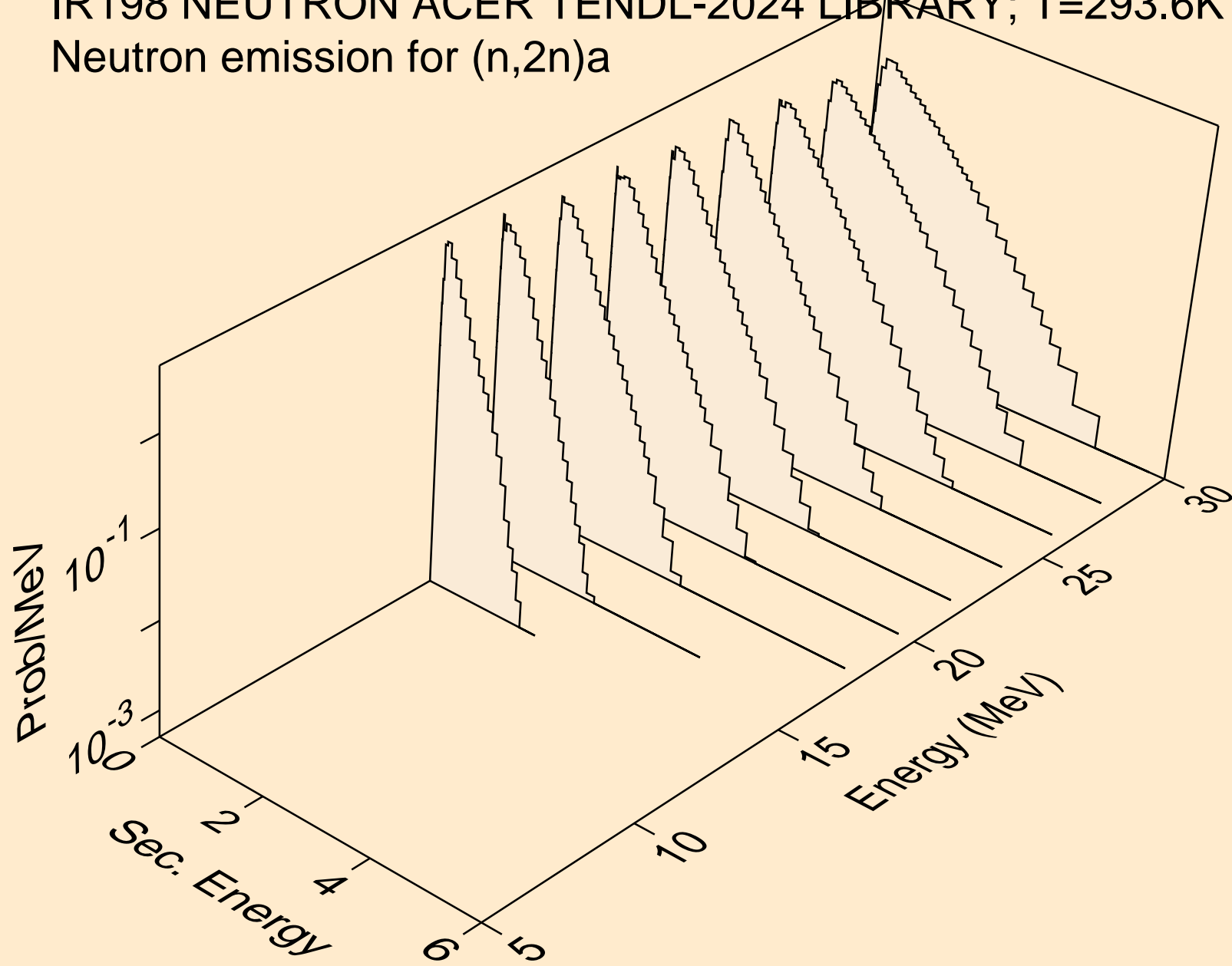

IR198 NEUTRON ACER TENDL-2024 LIBRARY; T=293.6K
Neutron emission for (n,3n)_a

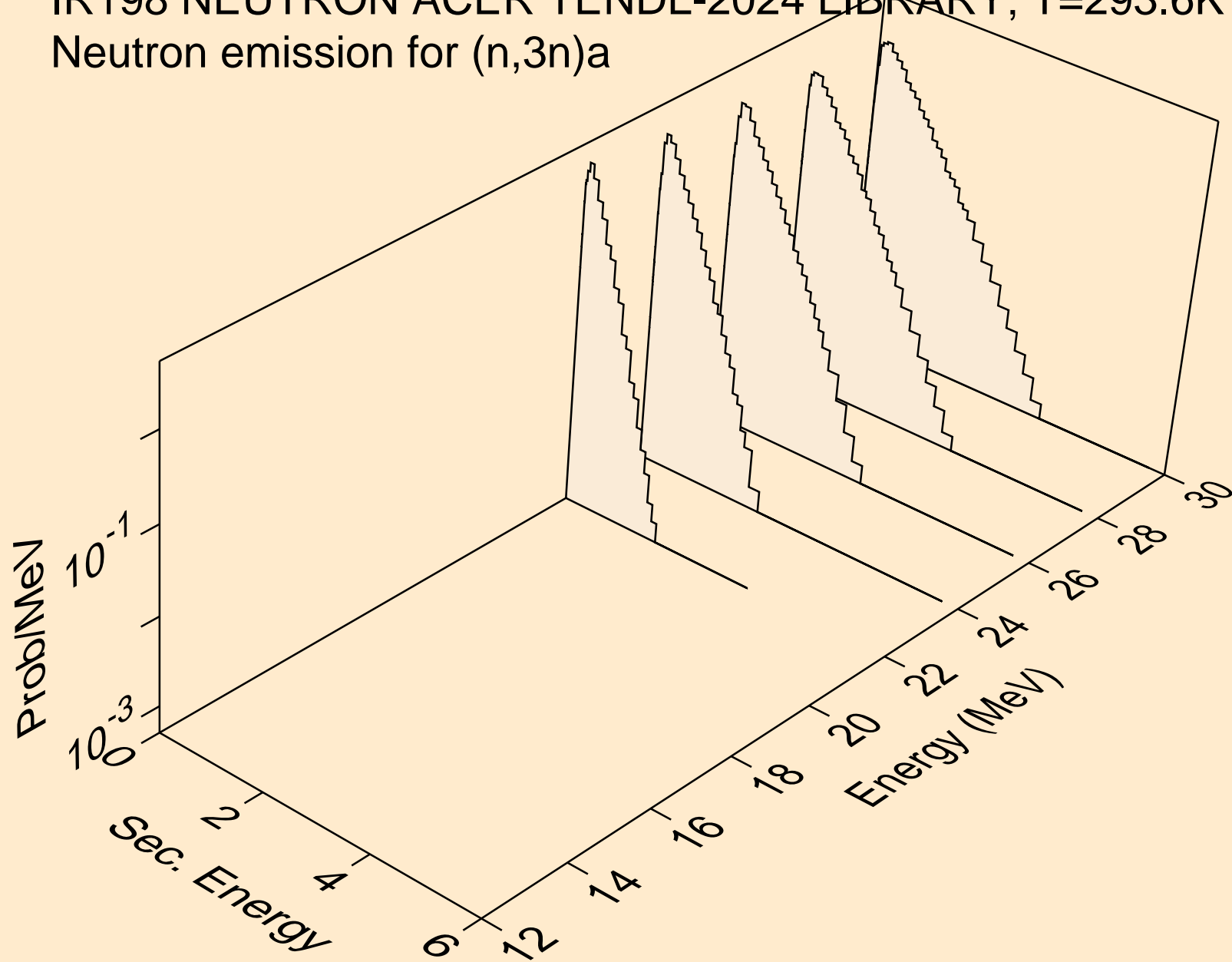

IR198 NEUTRON ACER TENDL-2024 LIBRARY; T=293.6K
Neutron emission for (n,n*)p

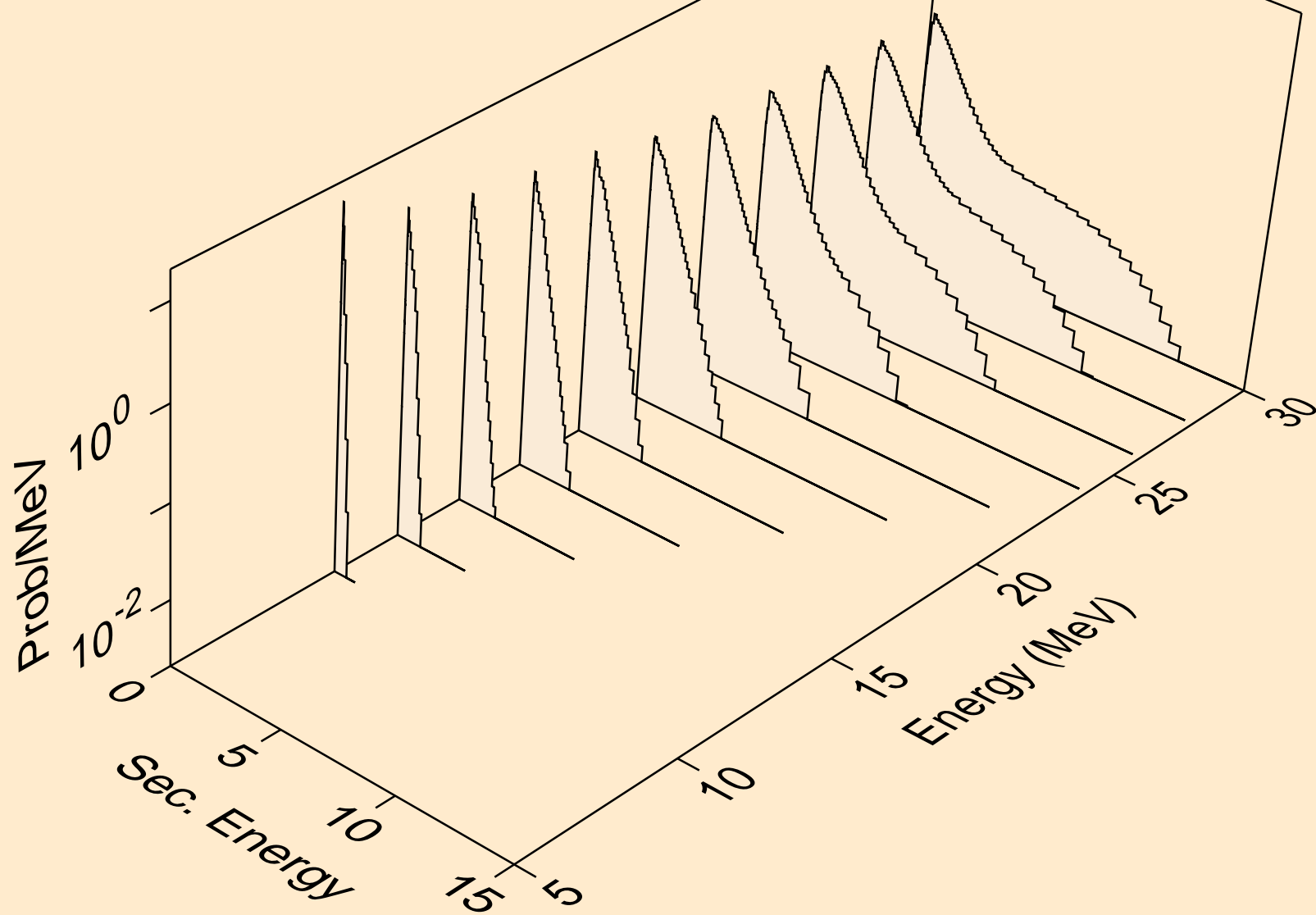

IR198 NEUTRON ACER TENDL-2024 LIBRARY; T=293.6K
Neutron emission for (n,n*)d

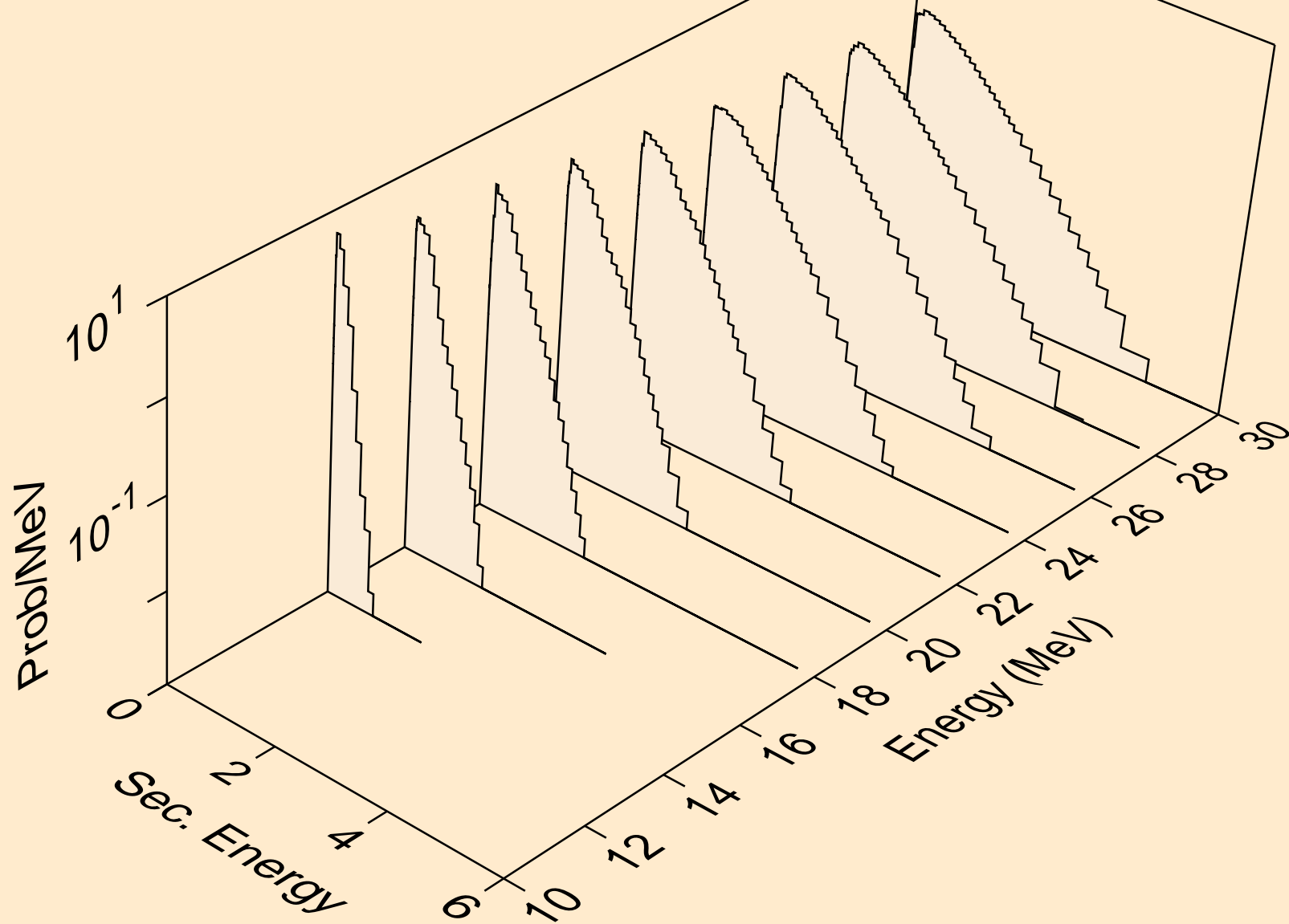

IR198 NEUTRON ACER TENDL-2024 LIBRARY; T=293.6K
Neutron emission for (n,n*)t

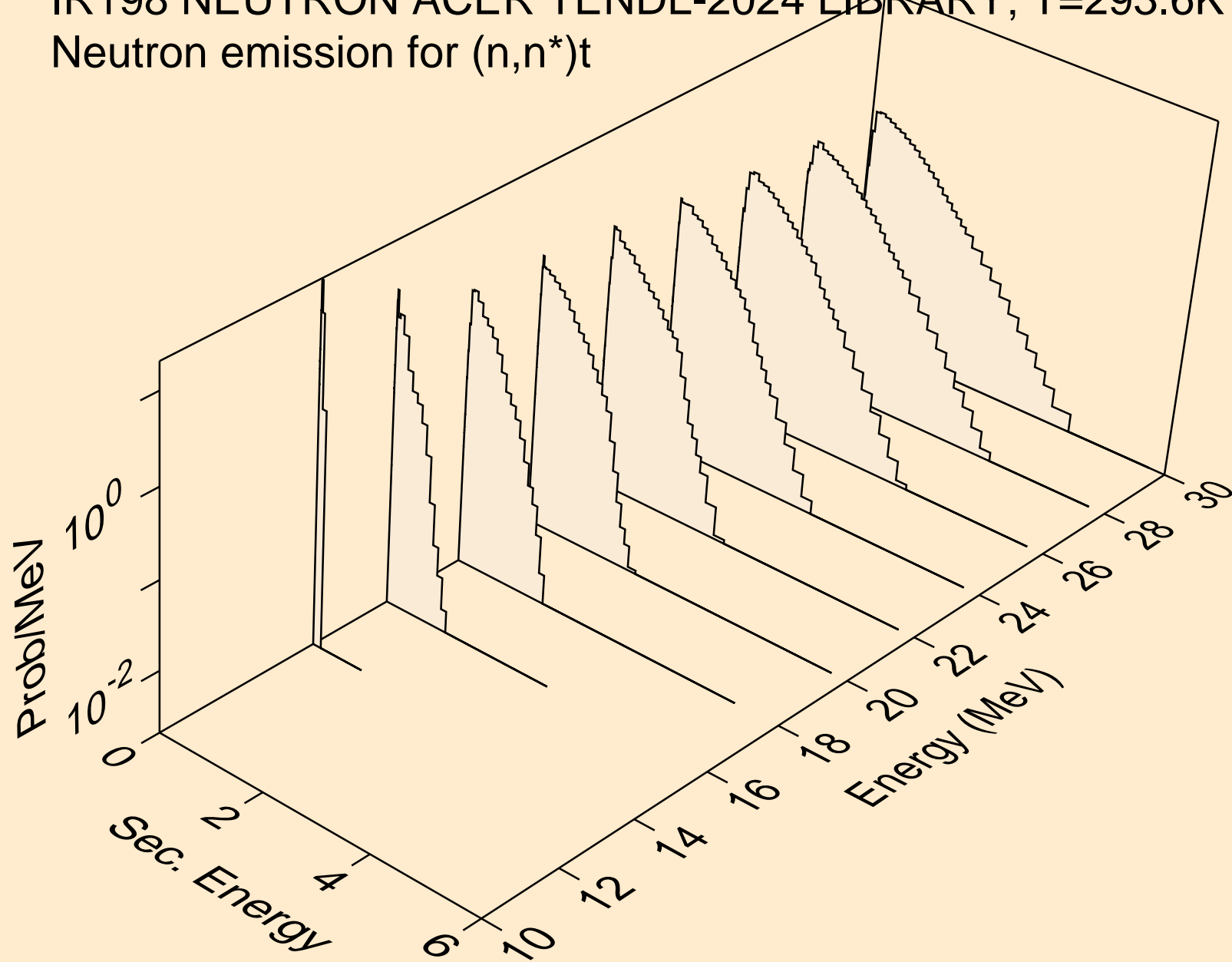

IR198 NEUTRON ACER TENDL-2024 LIBRARY; T=293.6K
Neutron emission for (n,n*)he3

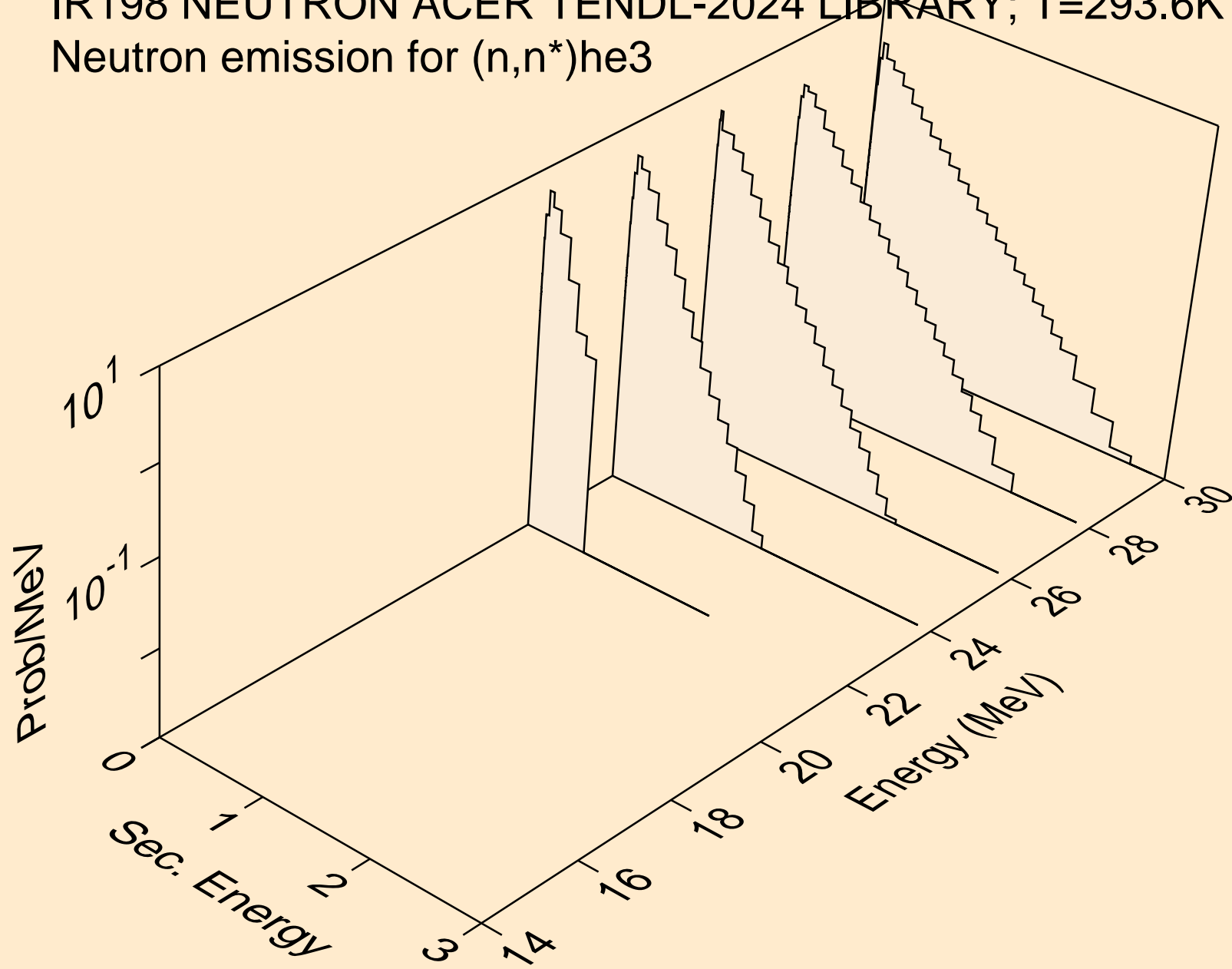

IR198 NEUTRON ACER TENDL-2024 LIBRARY; T=293.6K
Neutron emission for (n,4n)

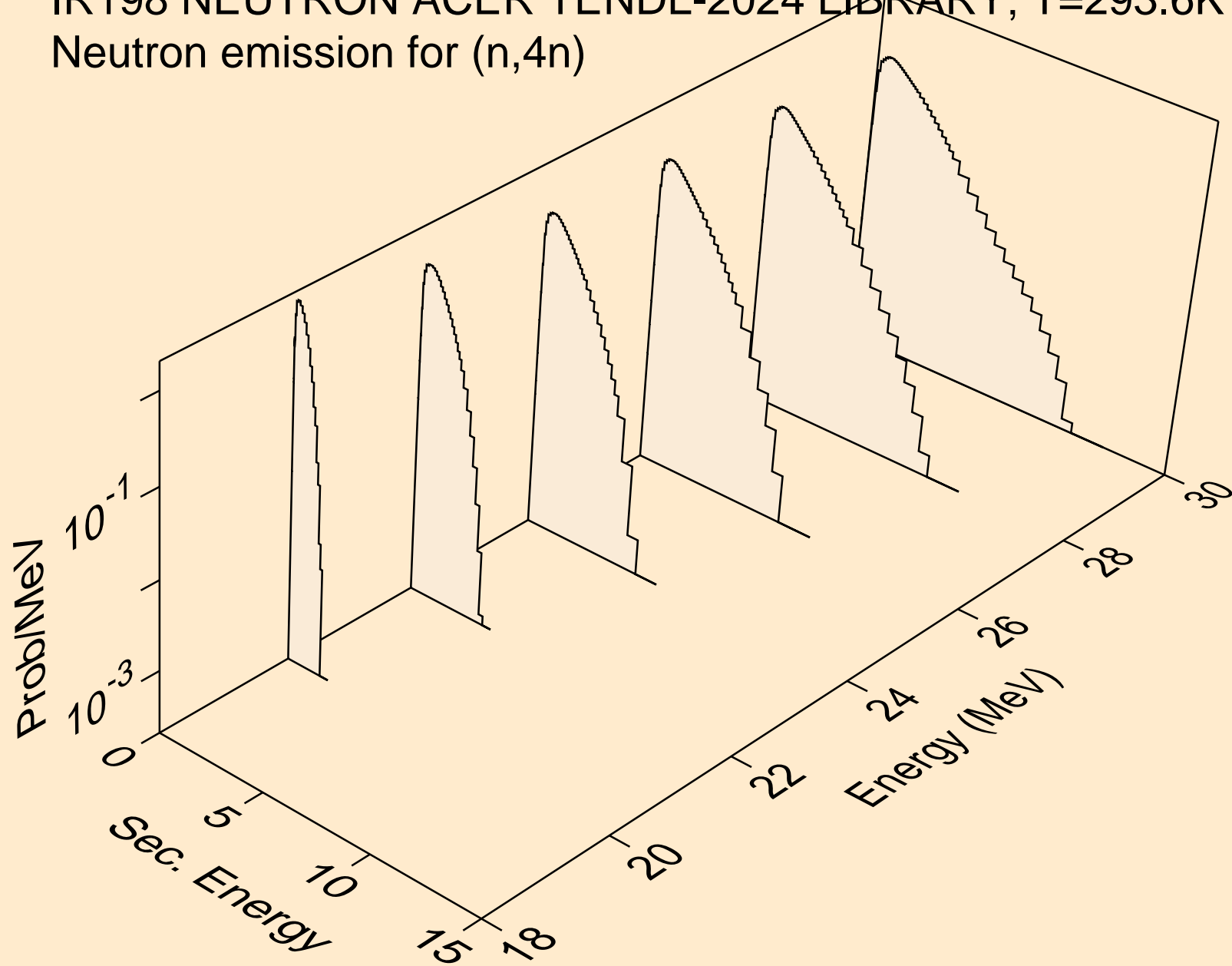

IR198 NEUTRON ACER TENDL-2024 LIBRARY; T=293.6K
Neutron emission for (n,2np)

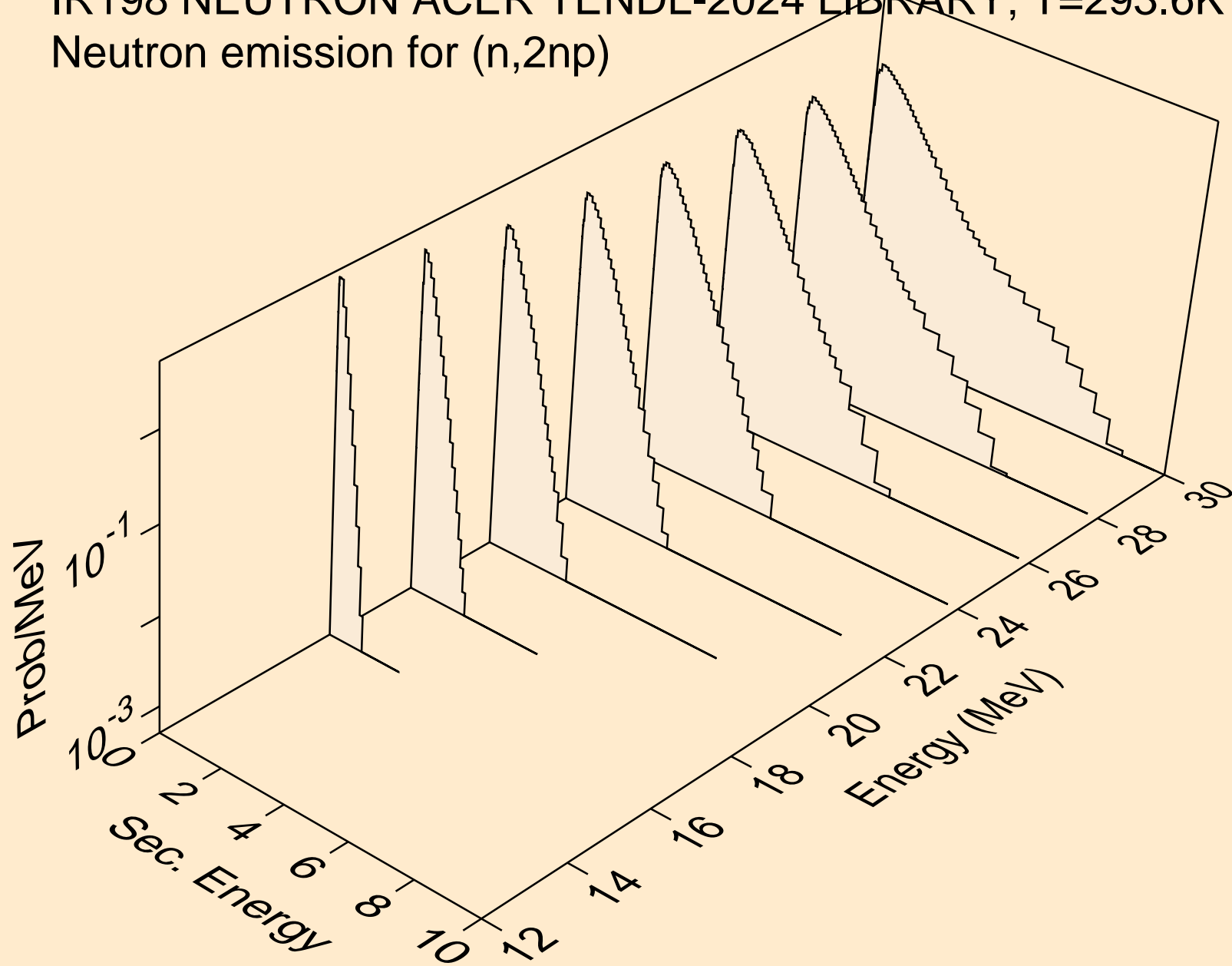

IR198 NEUTRON ACER TENDL-2024 LIBRARY; T=293.6K
Neutron emission for (n,3np)

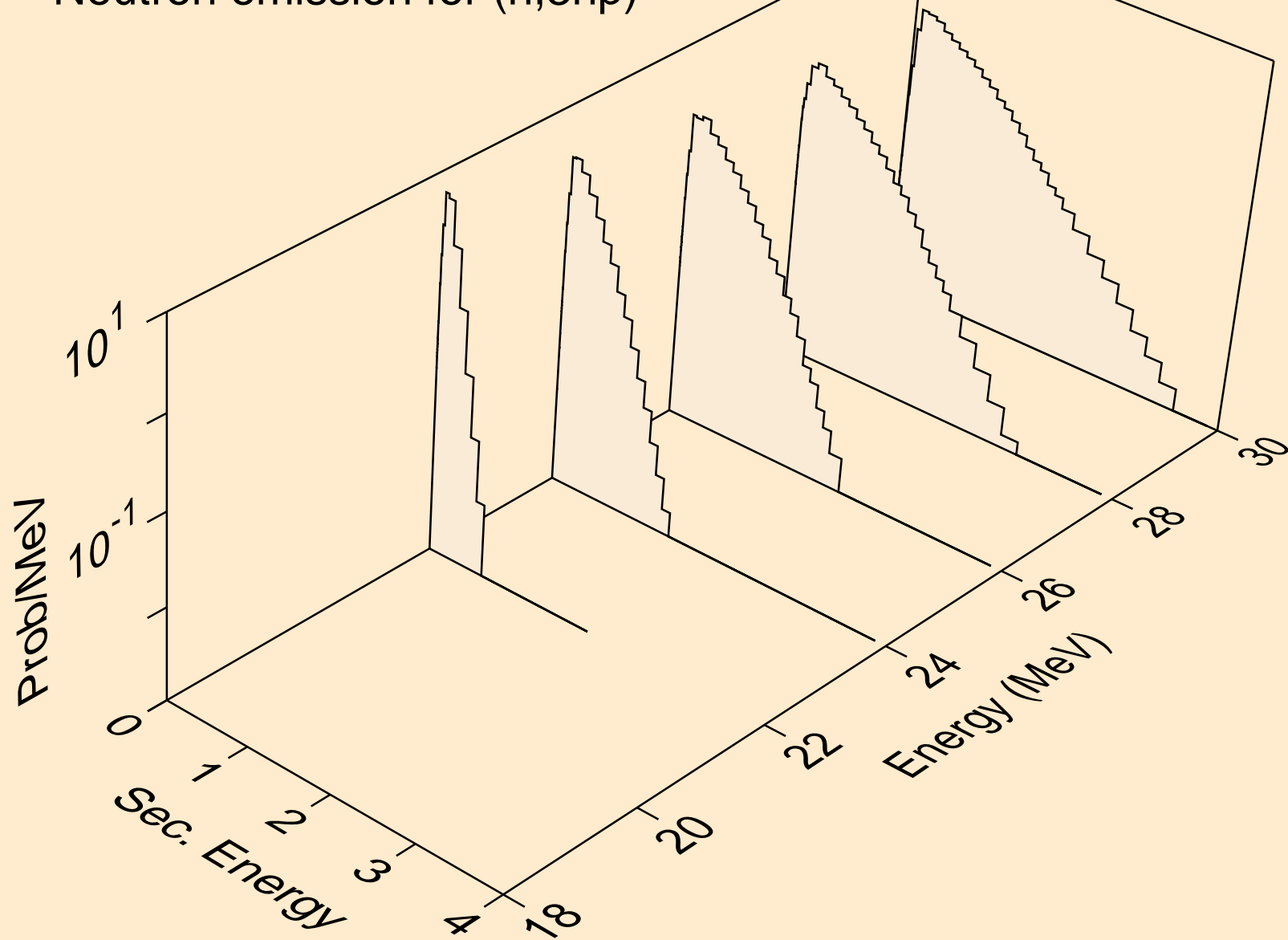

IR198 NEUTRON ACER TENDL-2024 LIBRARY; T=293.6K
Neutron emission for (n,n*c)

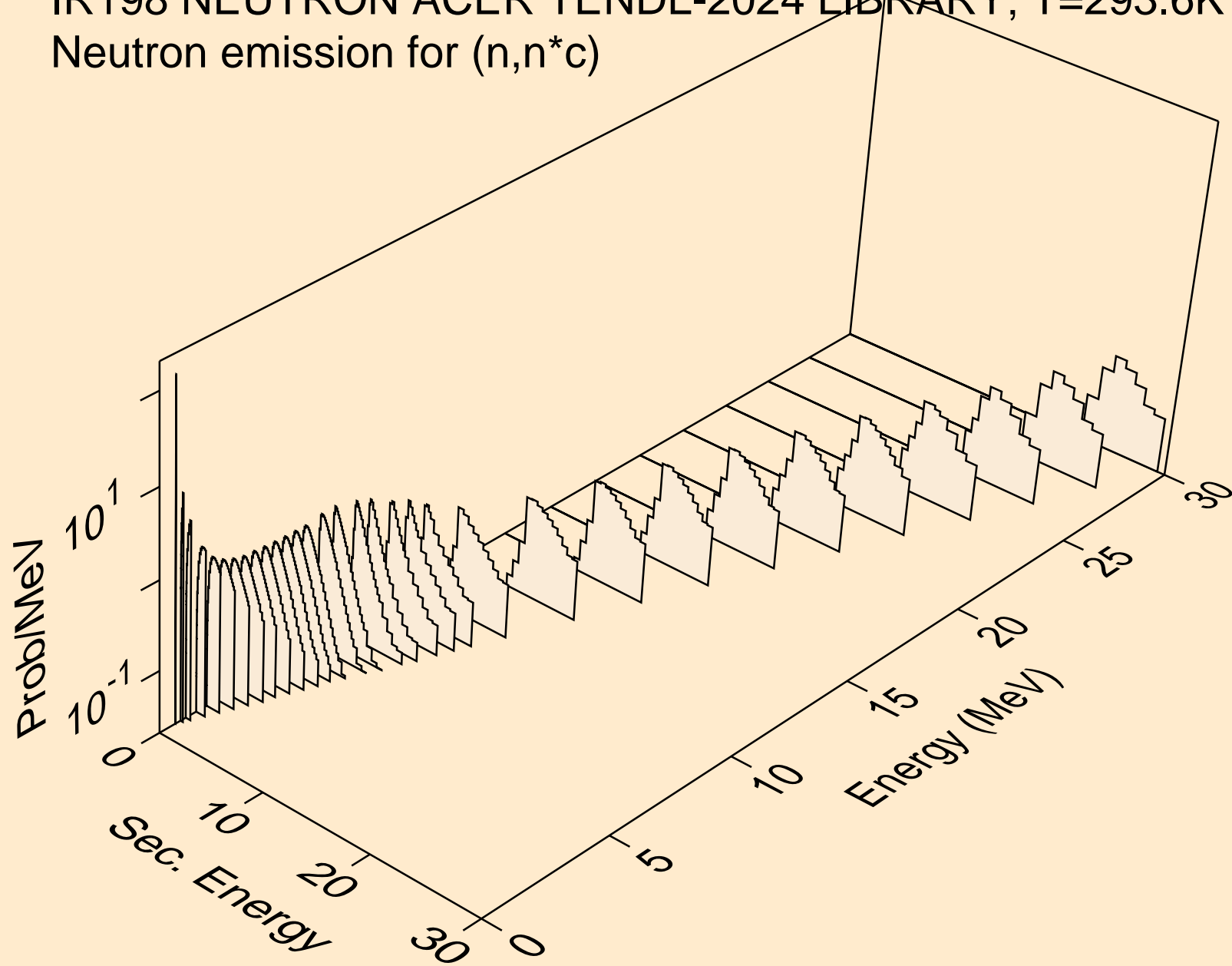

IR198 NEUTRON ACER TENDL-2024 LIBRARY; T=293.6K
Photon emission for (n,x)

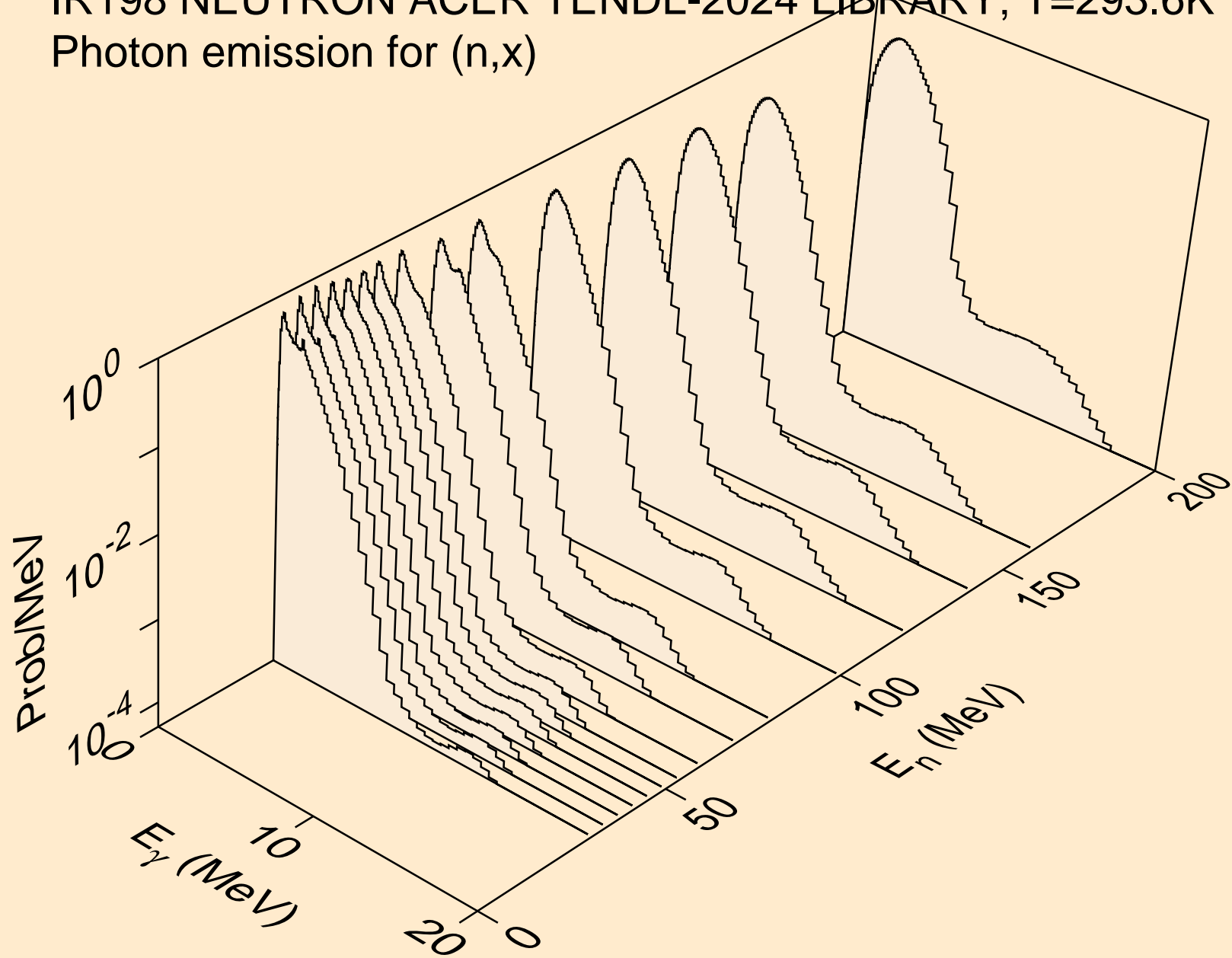

IR198 NEUTRON ACER TENDL-2024 LIBRARY; T=293.6K
Photon emission for (n,2nd)

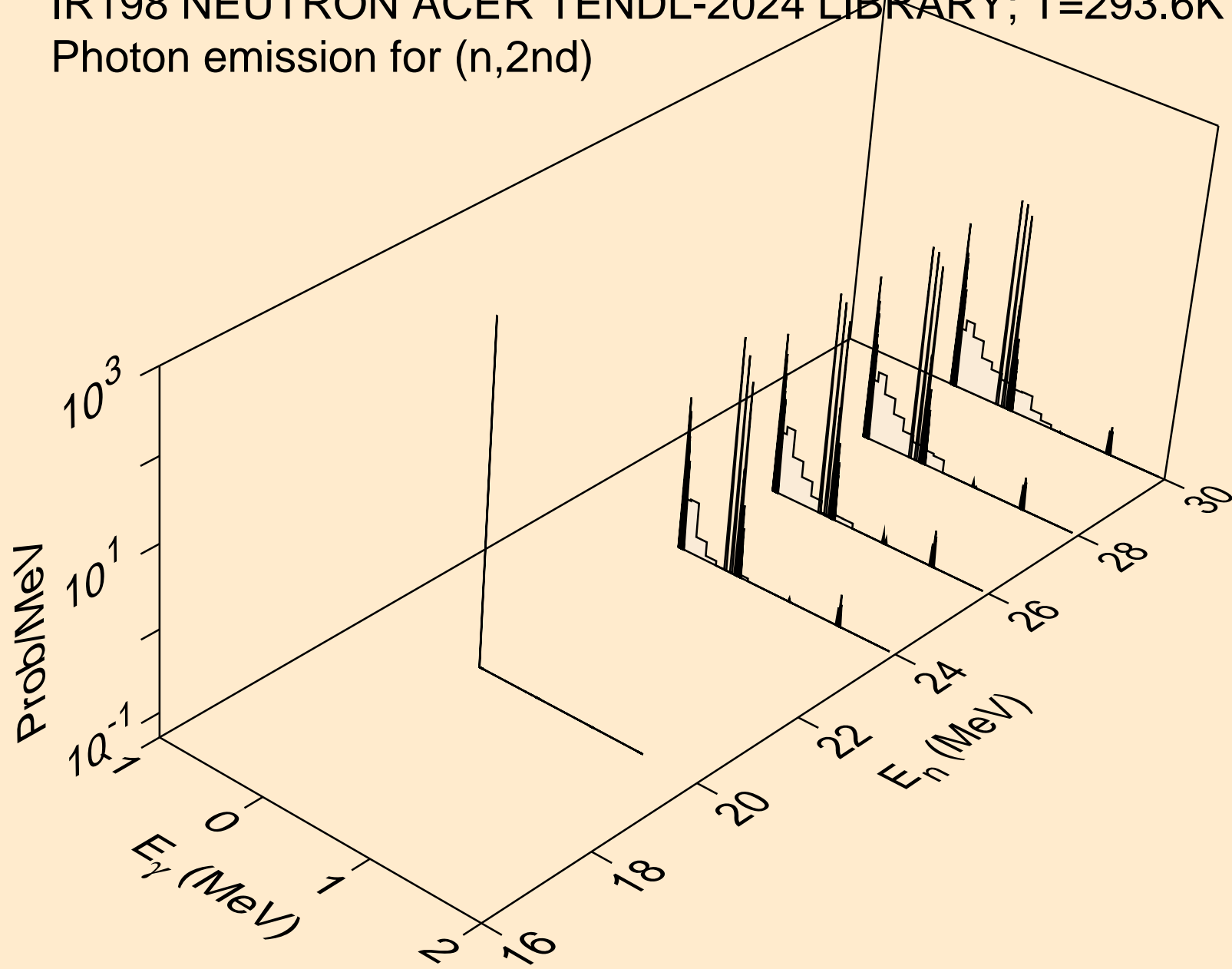

IR198 NEUTRON ACER TENDL-2024 LIBRARY; T=293.6K
Photon emission for (n,2n)

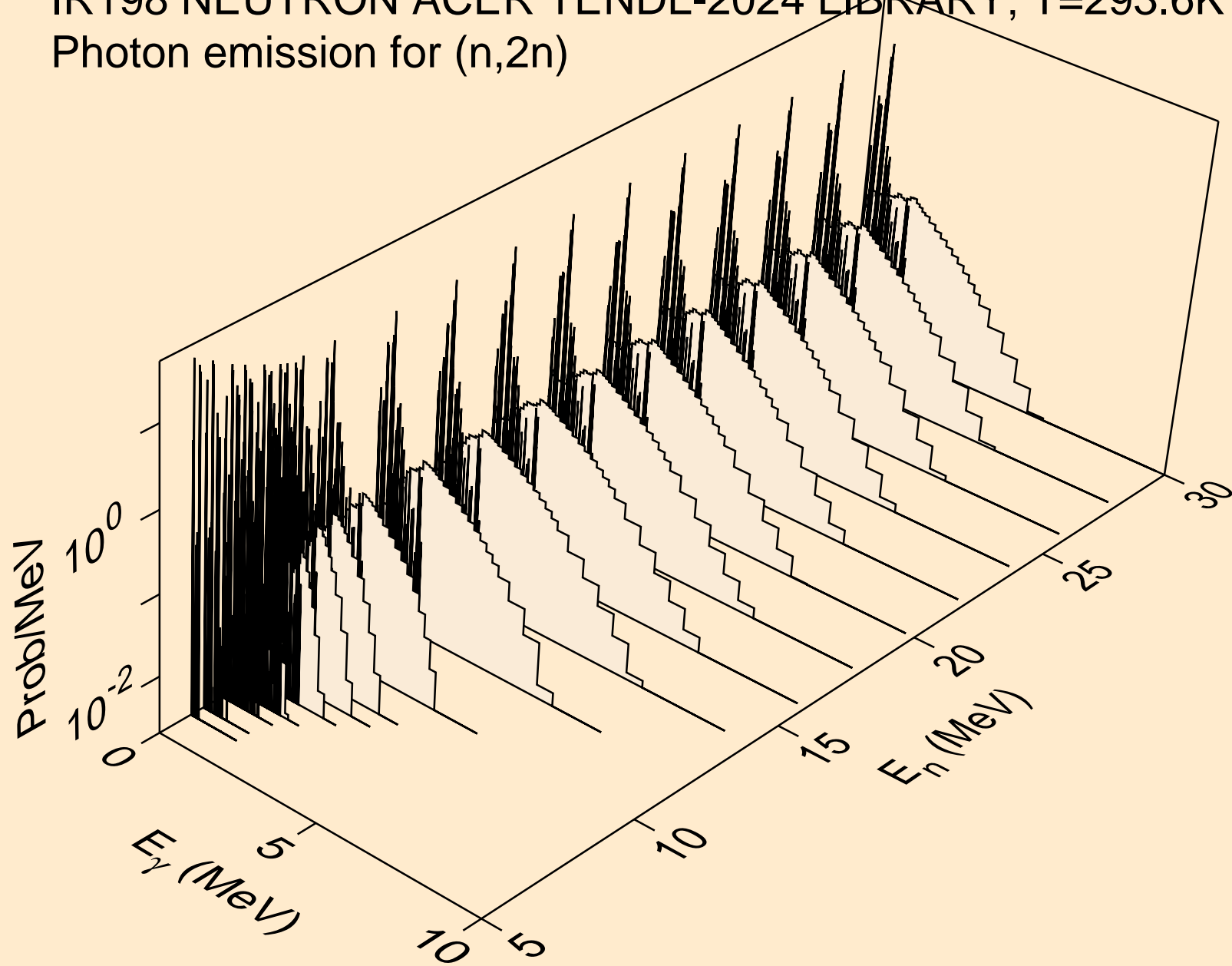

IR198 NEUTRON ACER TENDL-2024 LIBRARY; T=293.6K
Photon emission for (n,3n)

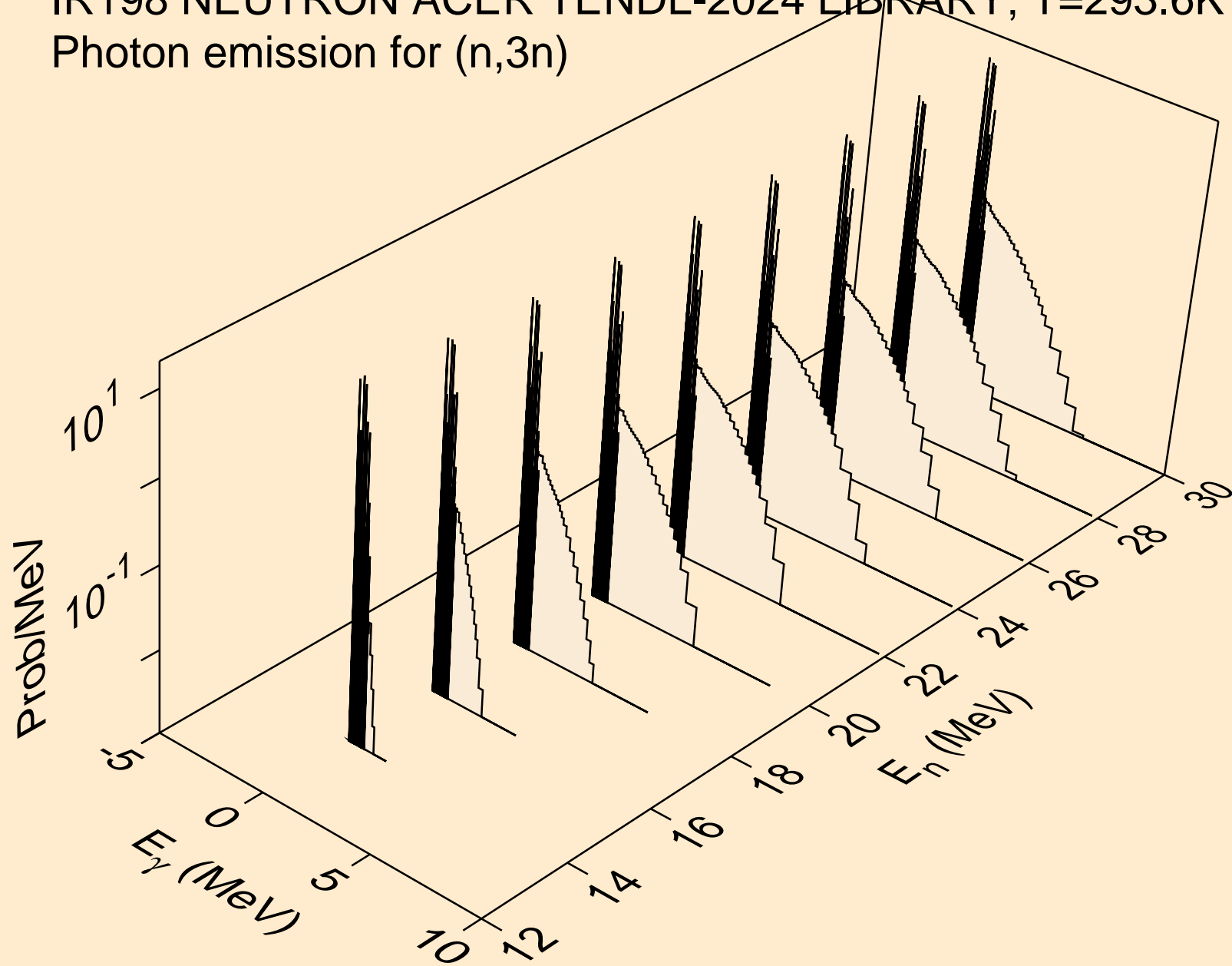

IR198 NEUTRON ACER TENDL-2024 LIBRARY; T=293.6K
Photon emission for (n,n*)a

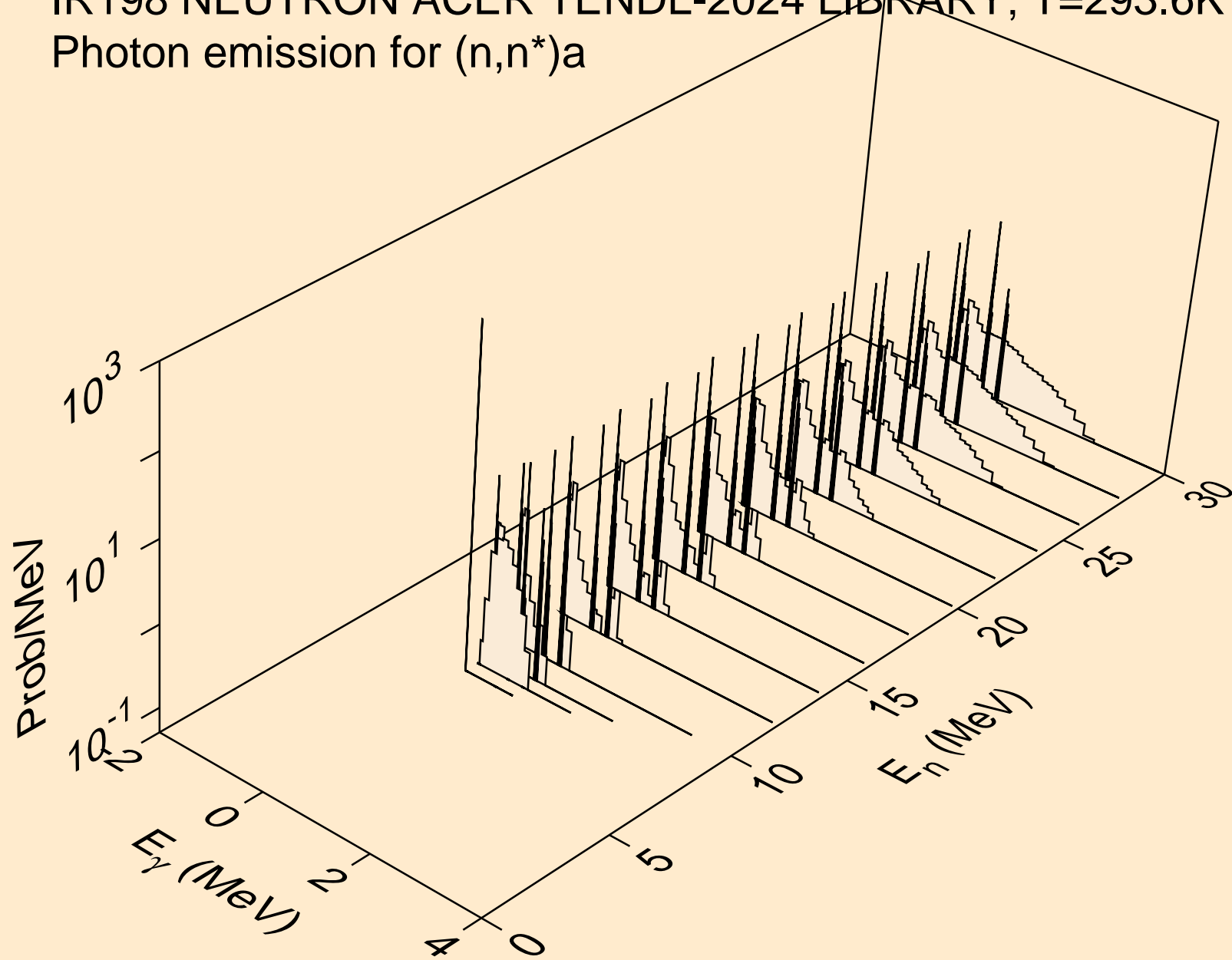

IR198 NEUTRON ACER TENDL-2024 LIBRARY; T=293.6K
Photon emission for (n,2n)a

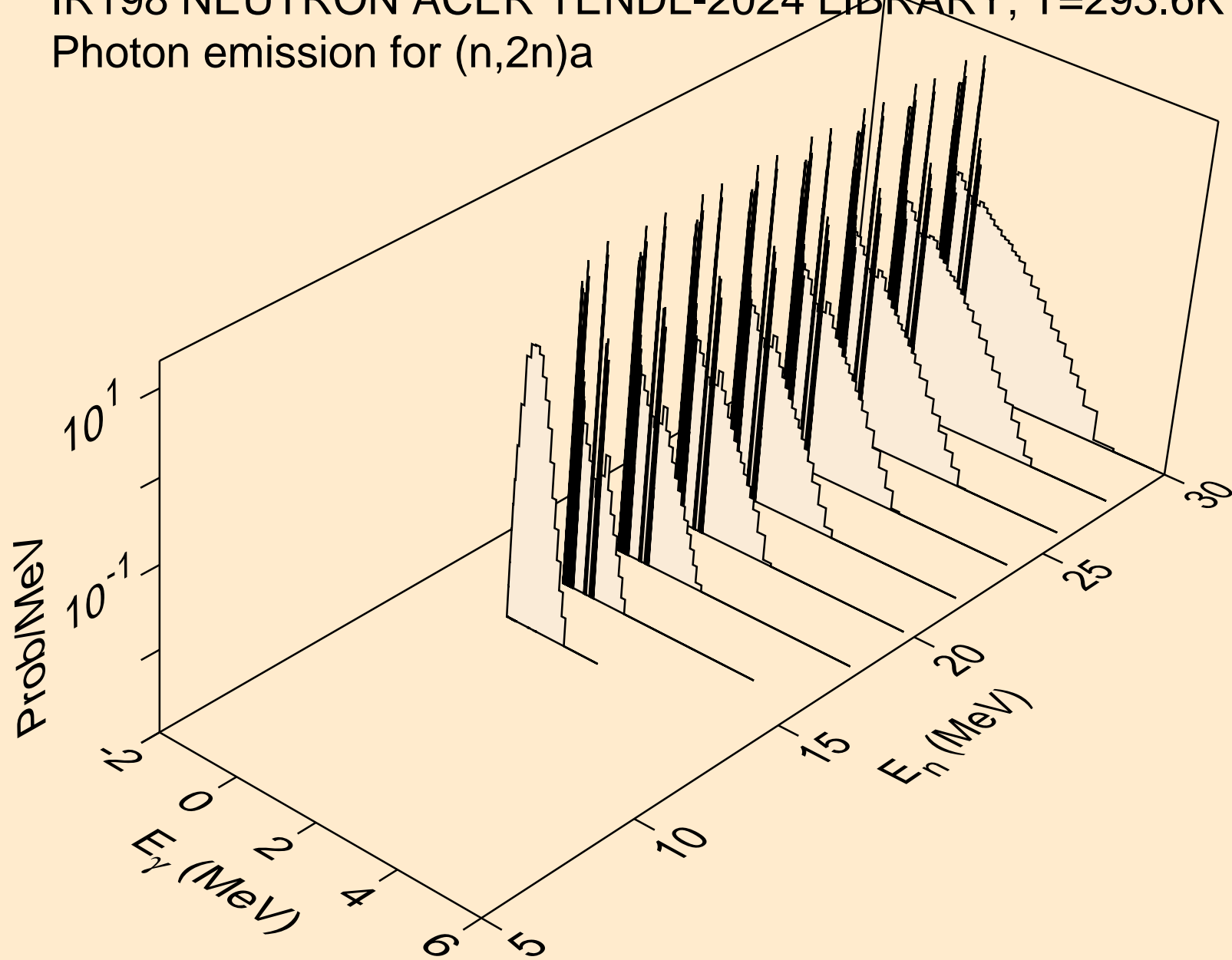

IR198 NEUTRON ACER TENDL-2024 LIBRARY; T=293.6K
Photon emission for (n,3n)a

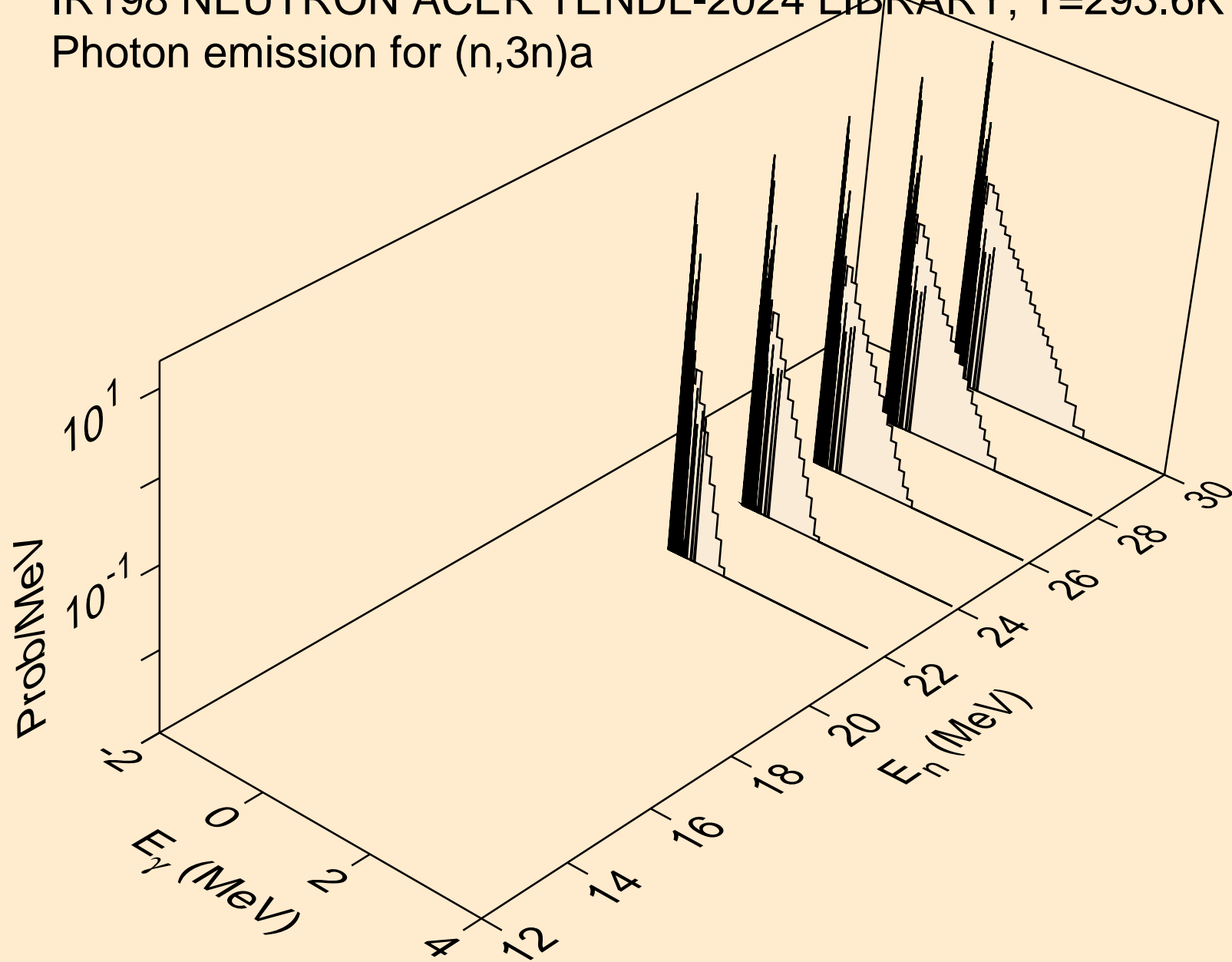

IR198 NEUTRON ACER TENDL-2024 LIBRARY; T=293.6K
Photon emission for (n,n*)p

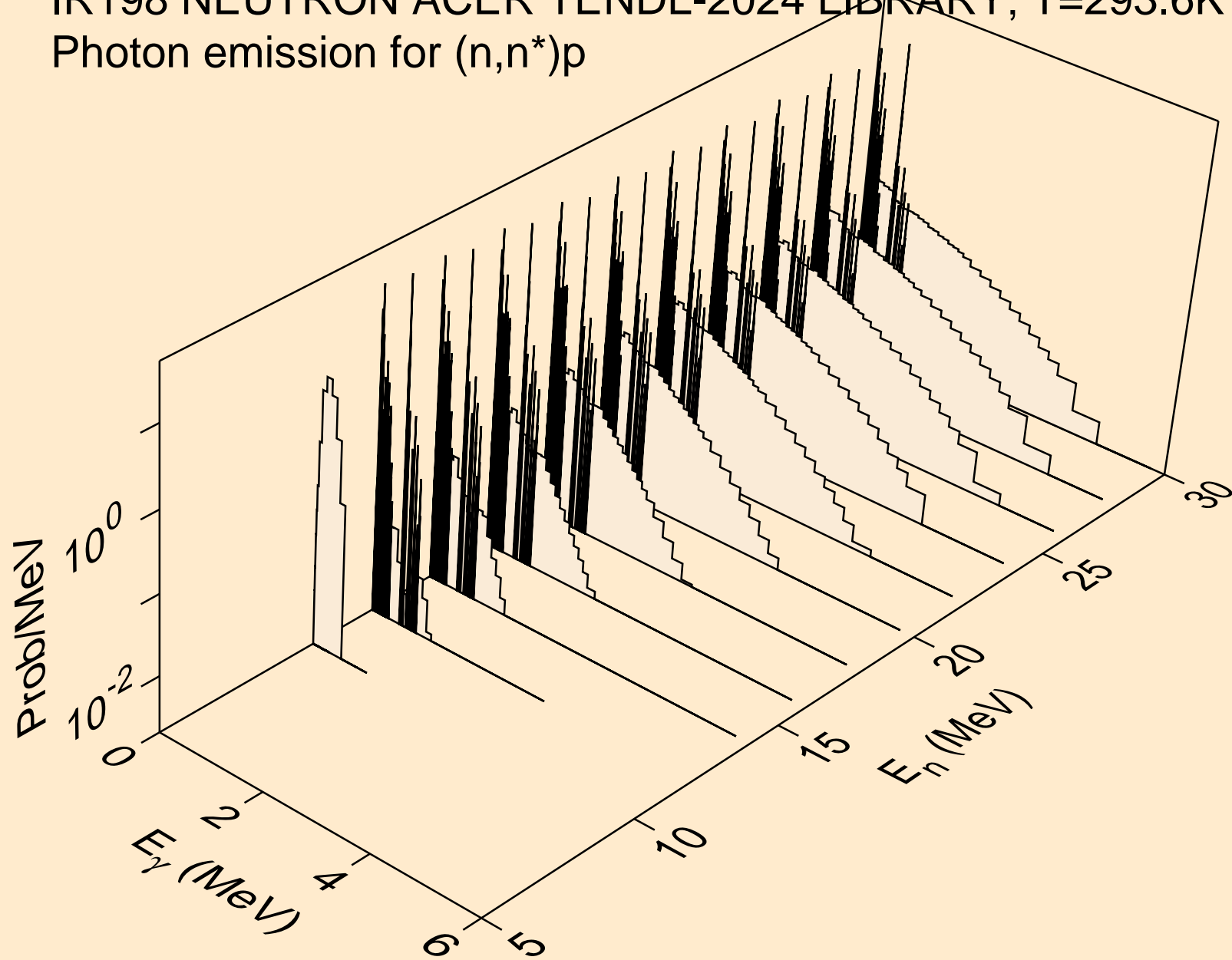

IR198 NEUTRON ACER TENDL-2024 LIBRARY; T=293.6K
Photon emission for (n,n*)d

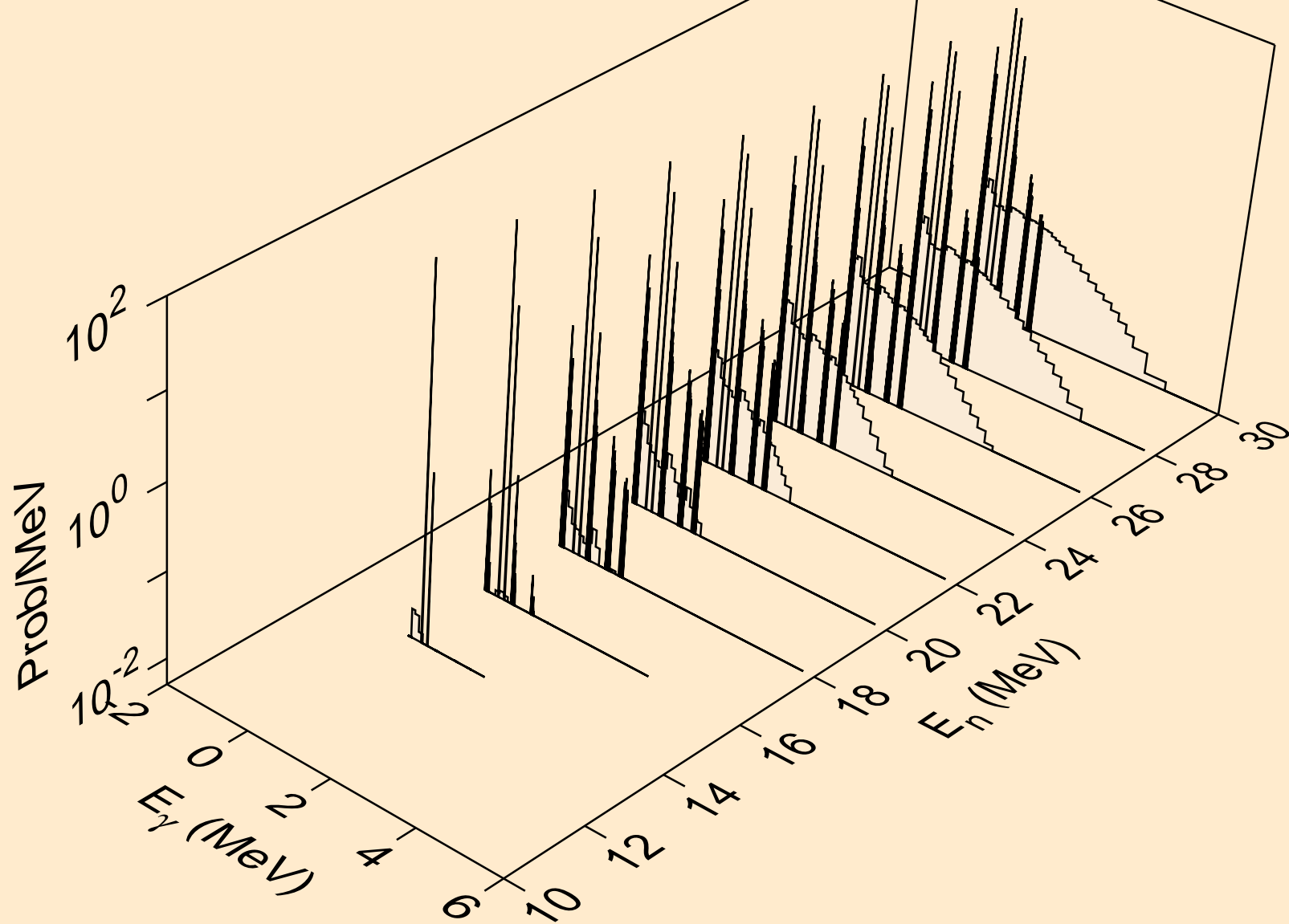

IR198 NEUTRON ACER TENDL-2024 LIBRARY; T=293.6K
Photon emission for (n,n*)t

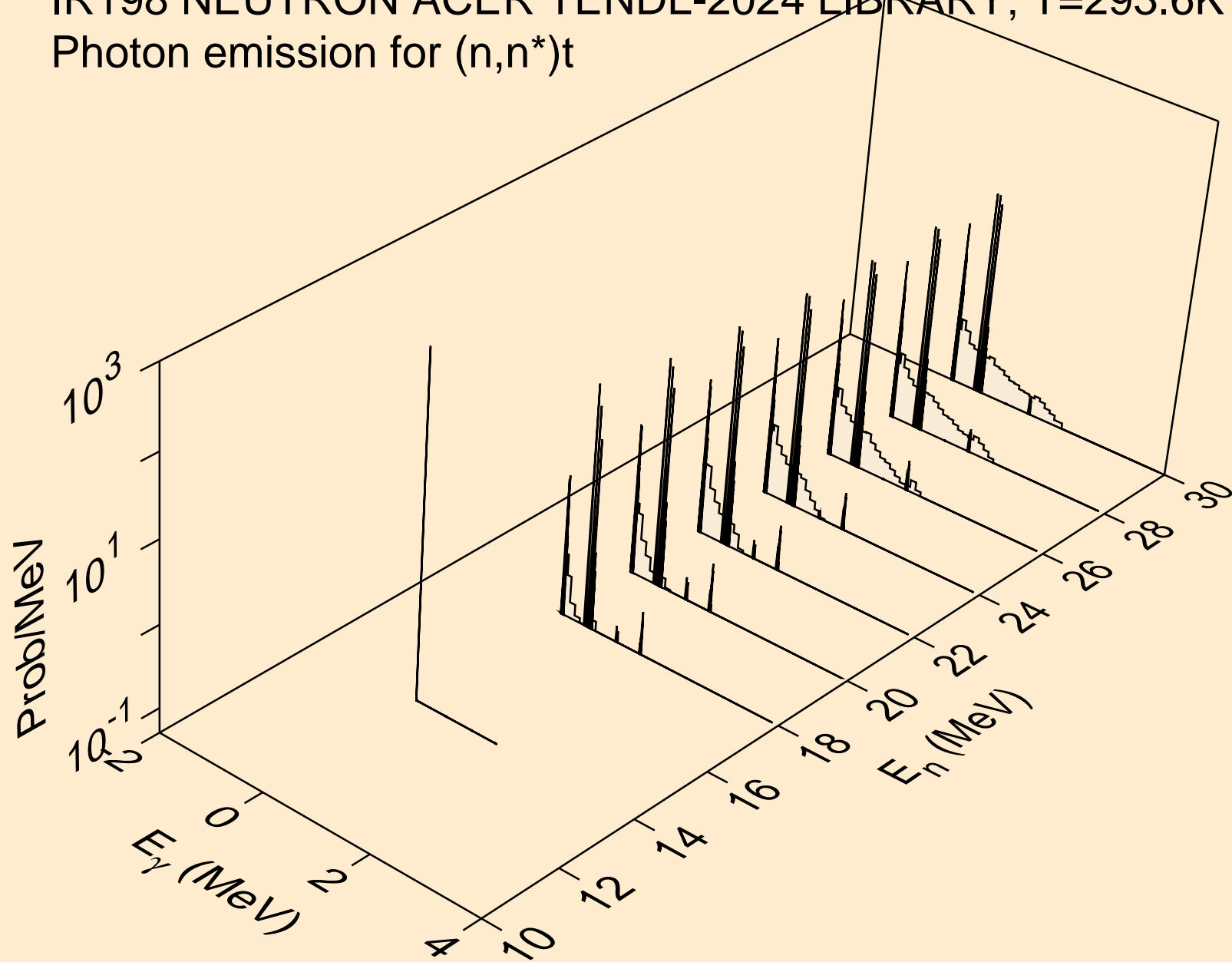

IR198 NEUTRON ACER TENDL-2024 LIBRARY; T=293.6K
Photon emission for (n,n*)he3

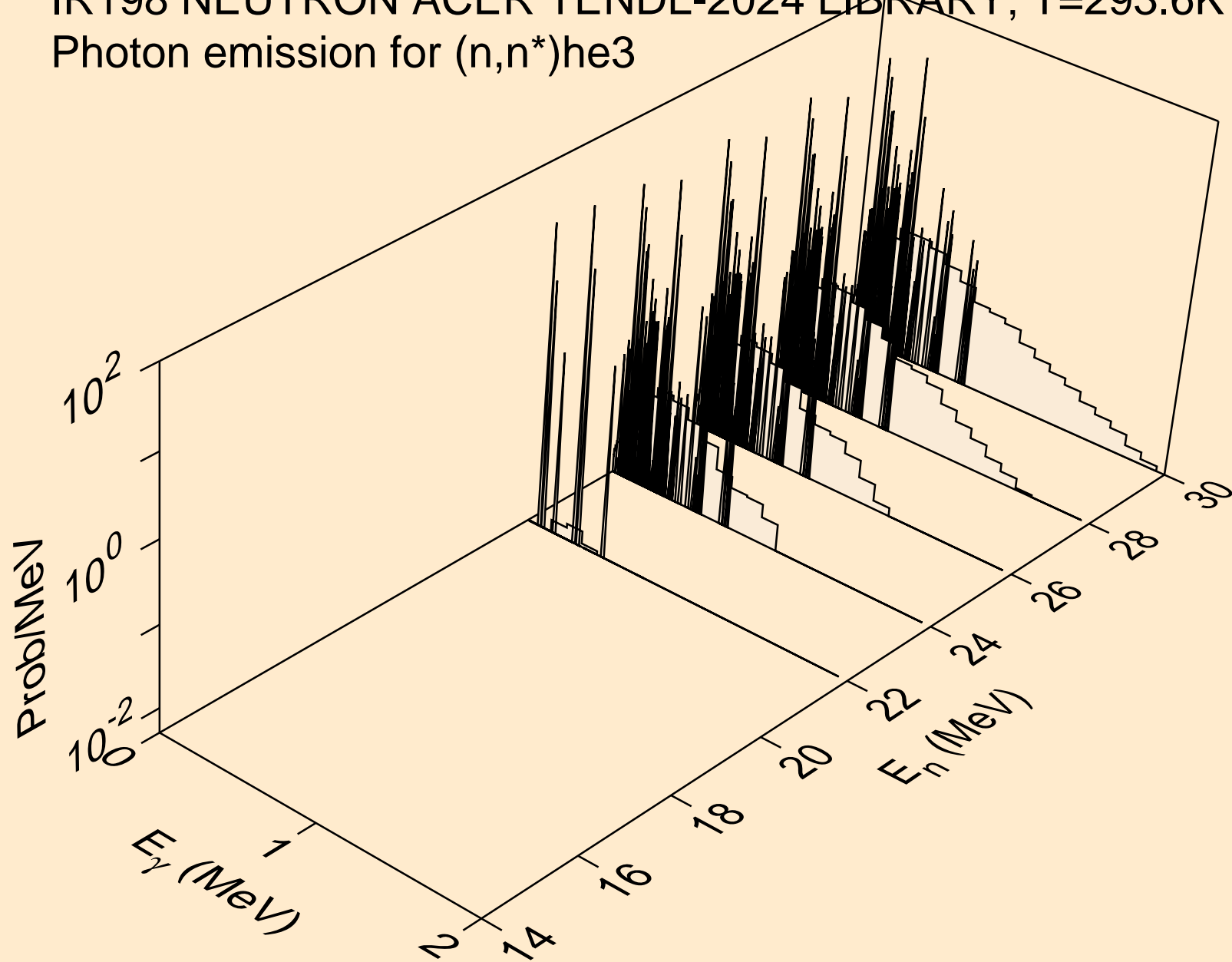

IR198 NEUTRON ACER TENDL-2024 LIBRARY; T=293.6K
Photon emission for (n,4n)

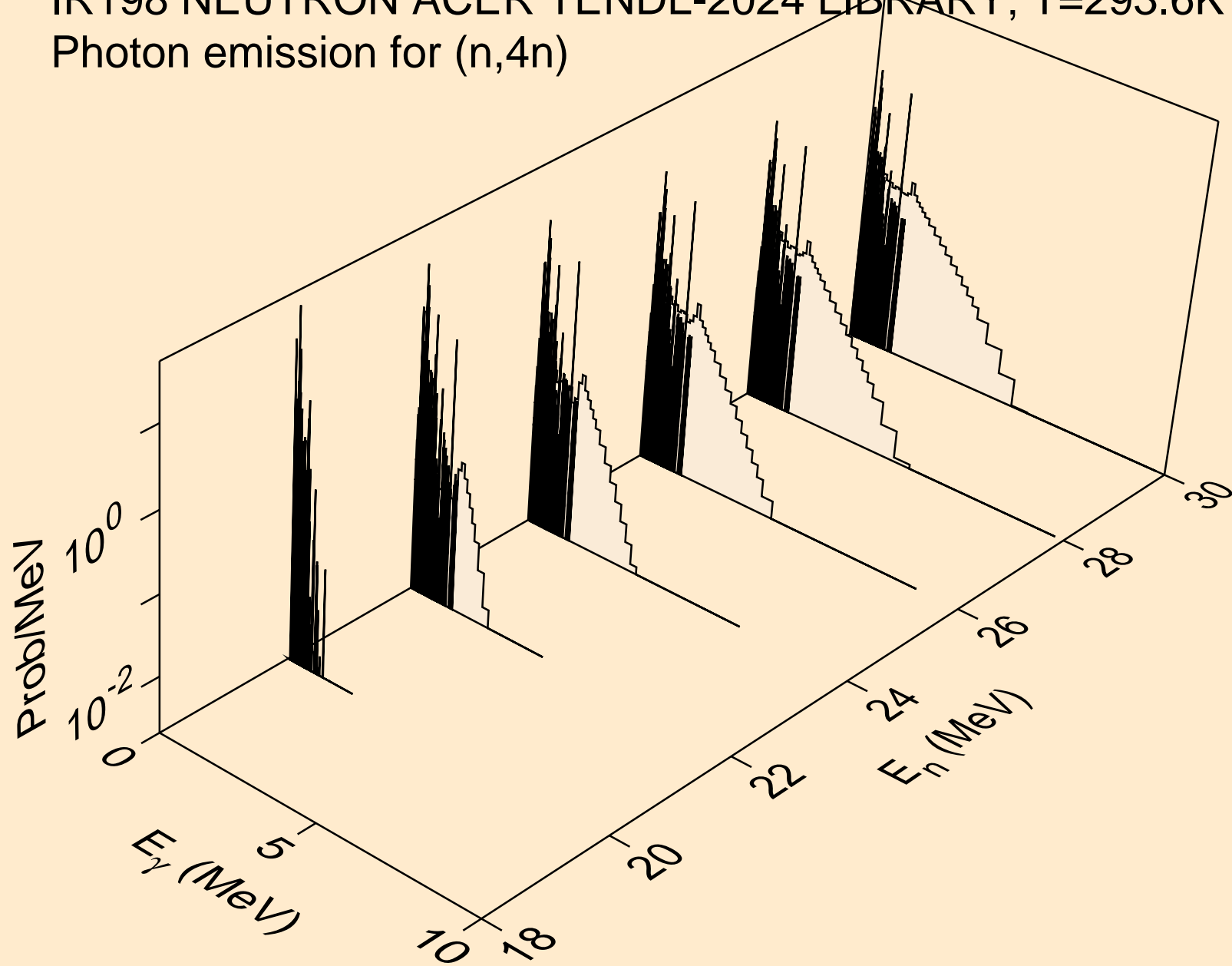

IR198 NEUTRON ACER TENDL-2024 LIBRARY; T=293.6K
Photon emission for (n,2np)

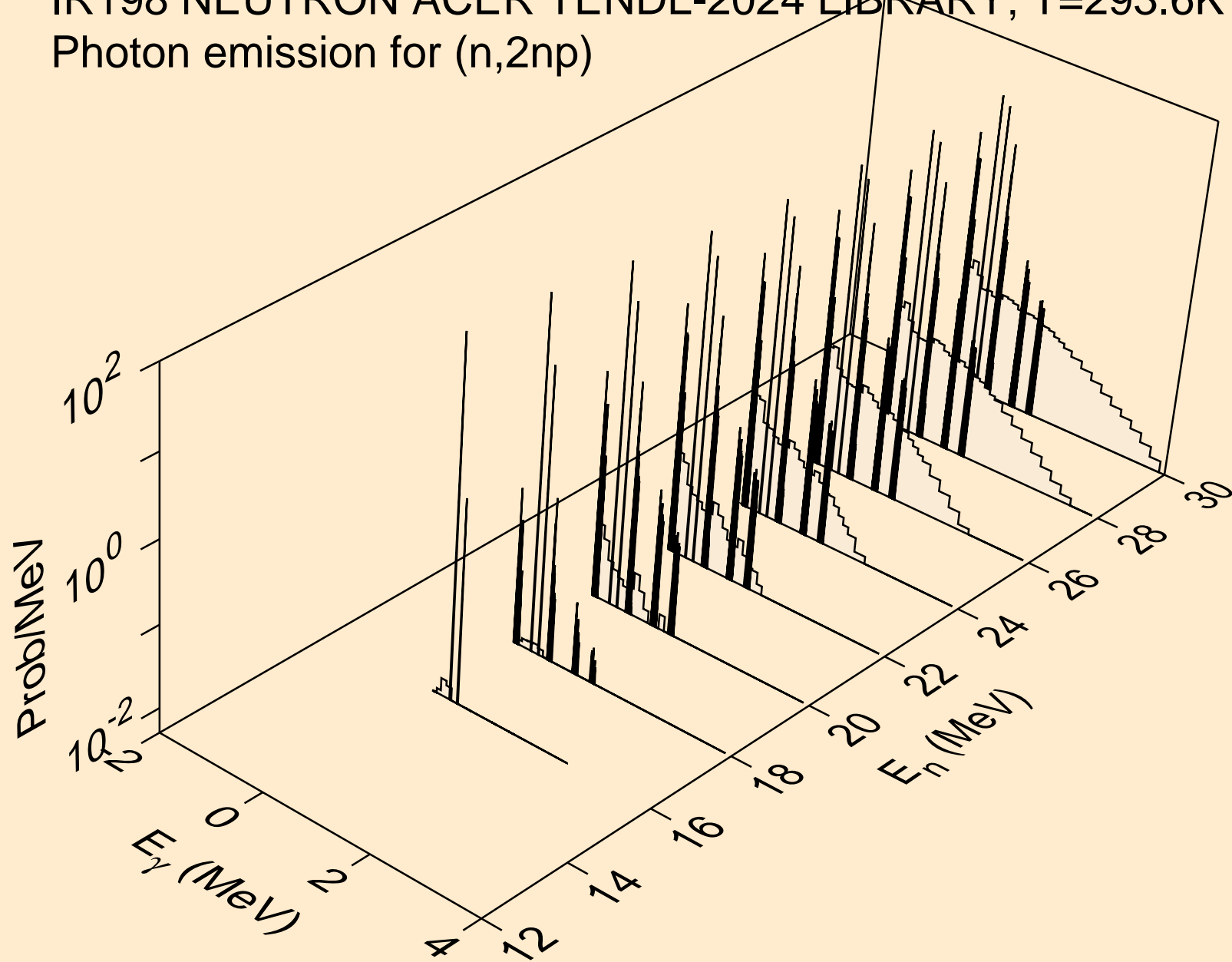

IR198 NEUTRON ACER TENDL-2024 LIBRARY; T=293.6K
Photon emission for (n,3np)

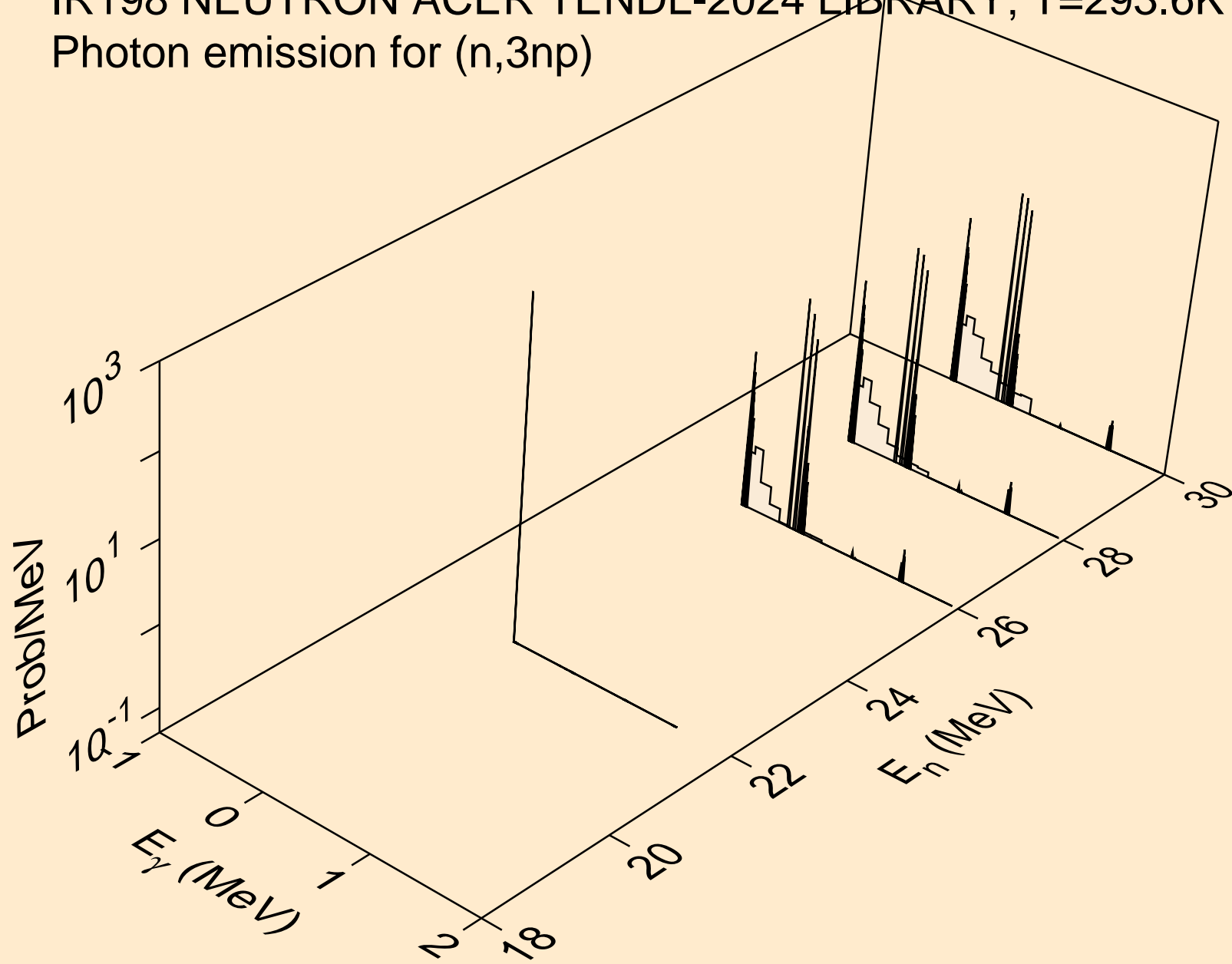

IR198 NEUTRON ACER TENDL-2024 LIBRARY; T=293.6K
Photon emission for (n,n*c)

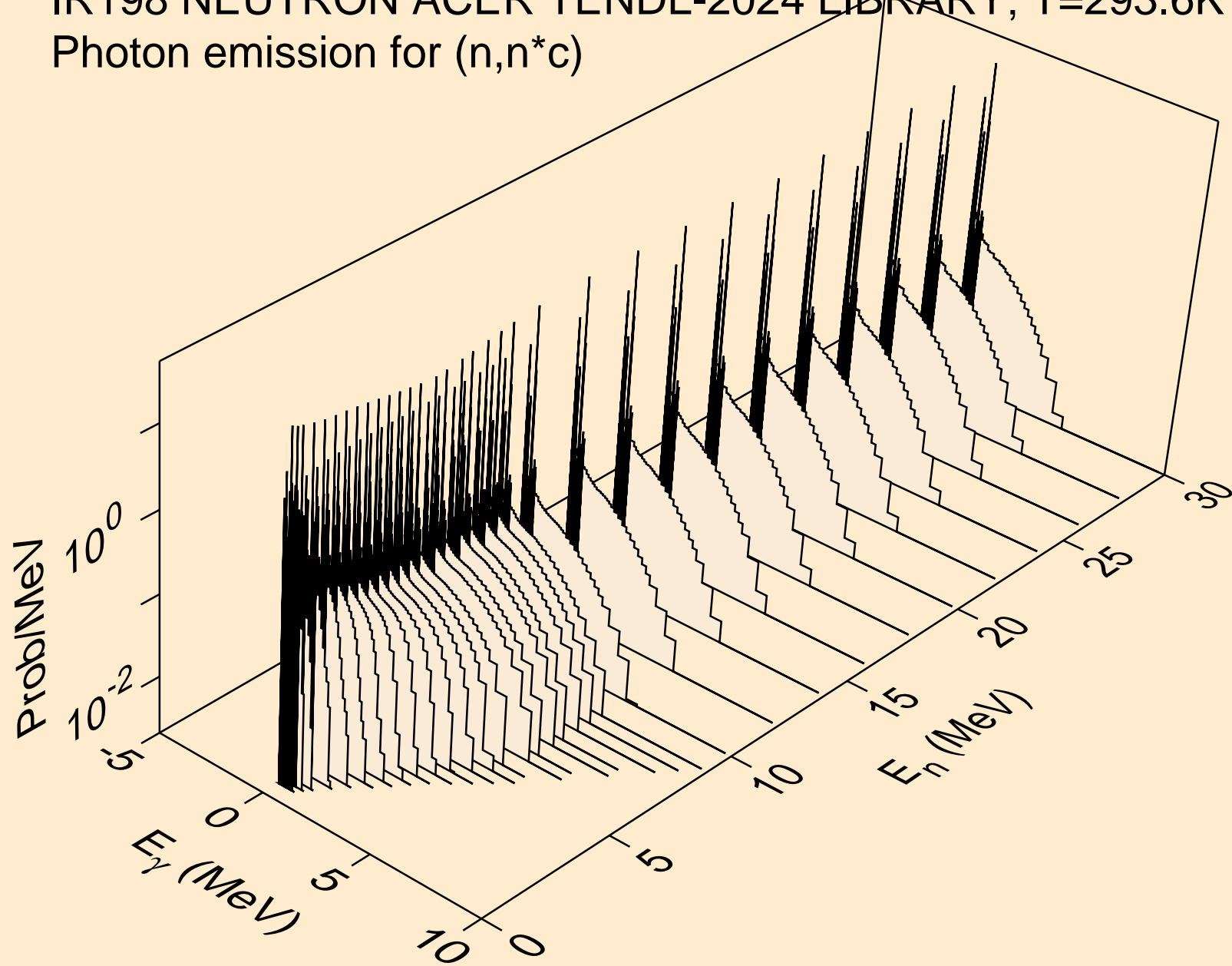

IR198 NEUTRON ACER TENDL-2024 LIBRARY; T=293.6K
Photon emission for (n,gma)

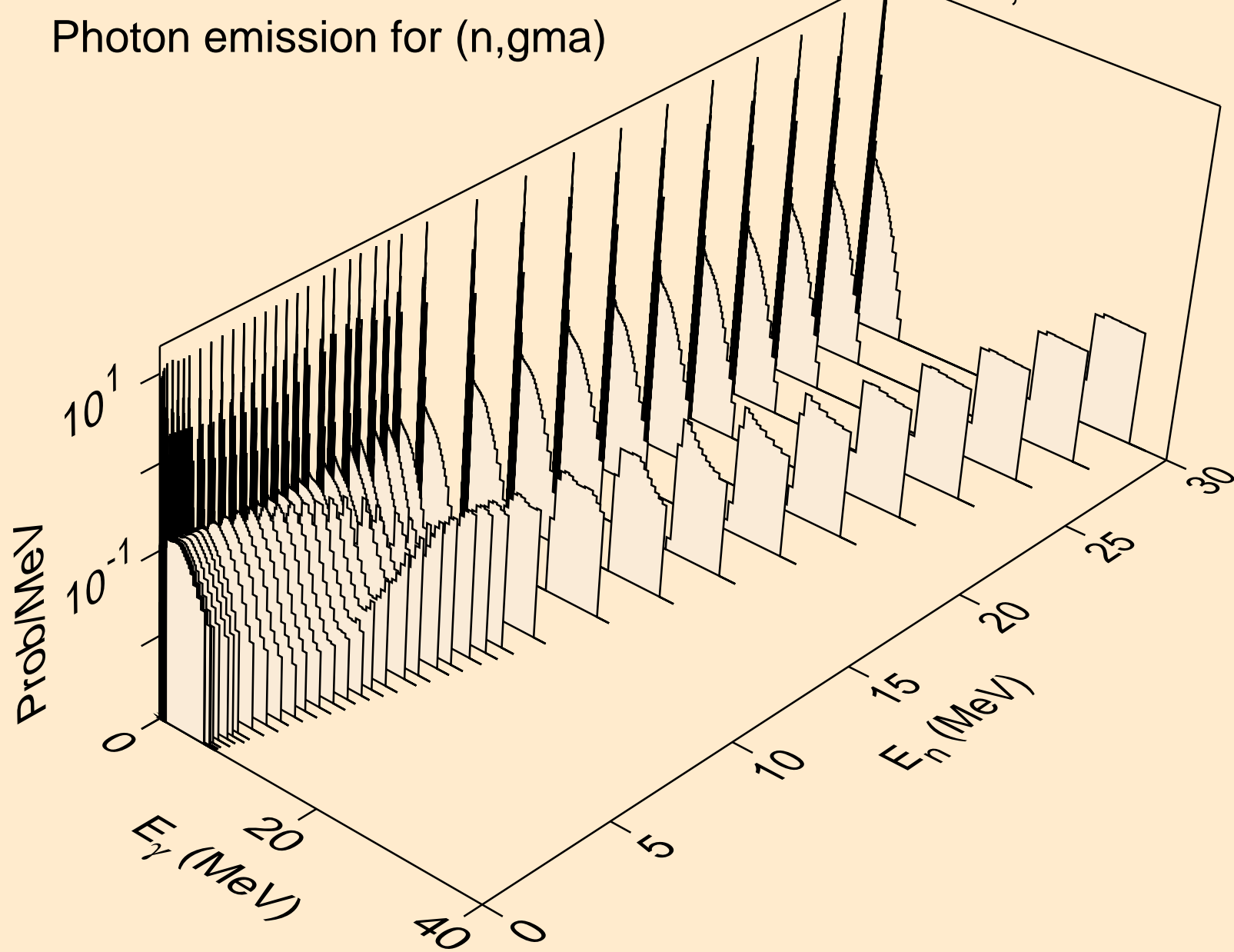

IR198 NEUTRON ACER TENDL-2024 LIBRARY; T=293.6K
Photon emission for (n,p)

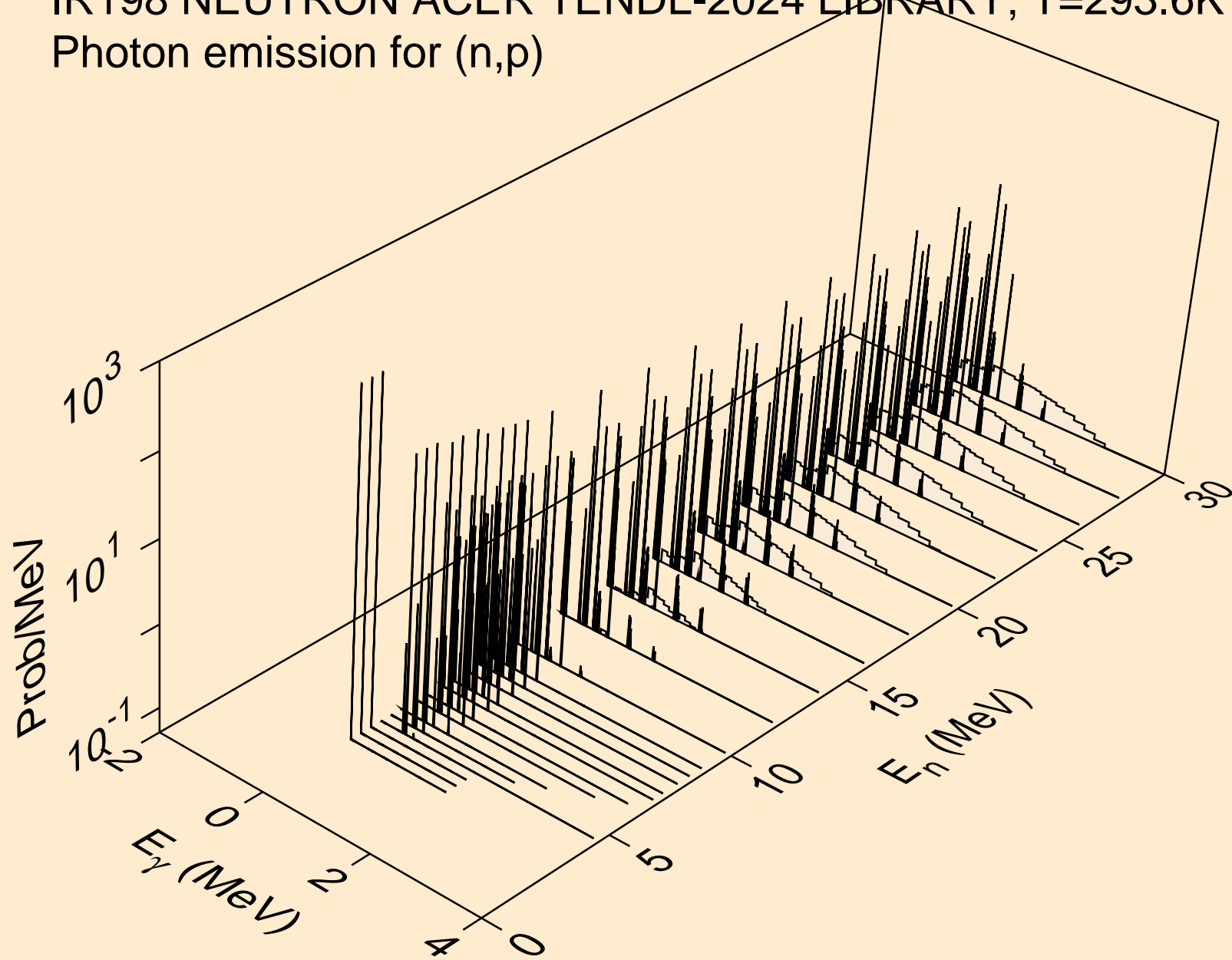

IR198 NEUTRON ACER TENDL-2024 LIBRARY; T=293.6K
Photon emission for (n,d)

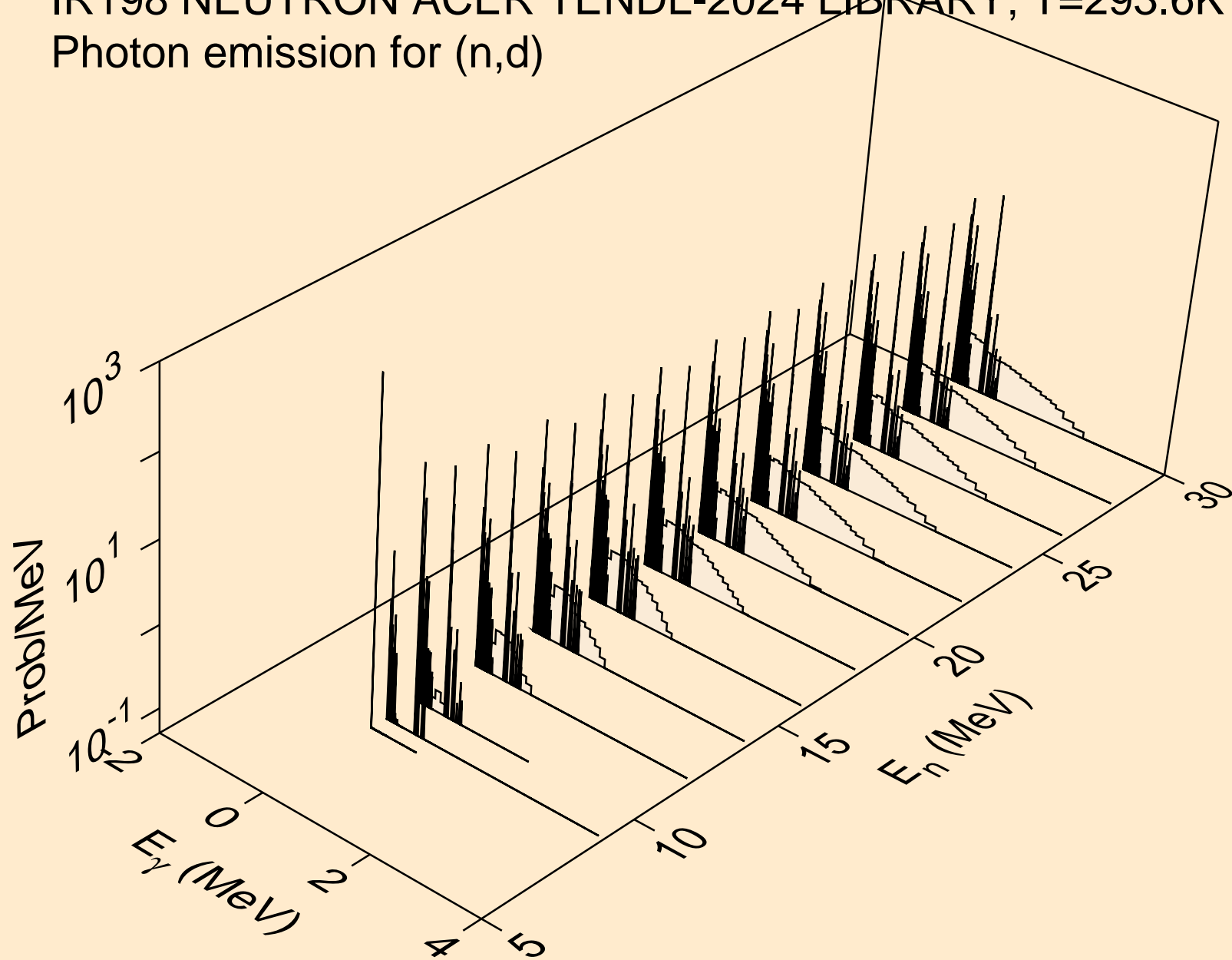

IR198 NEUTRON ACER TENDL-2024 LIBRARY; T=293.6K
Photon emission for (n,t)

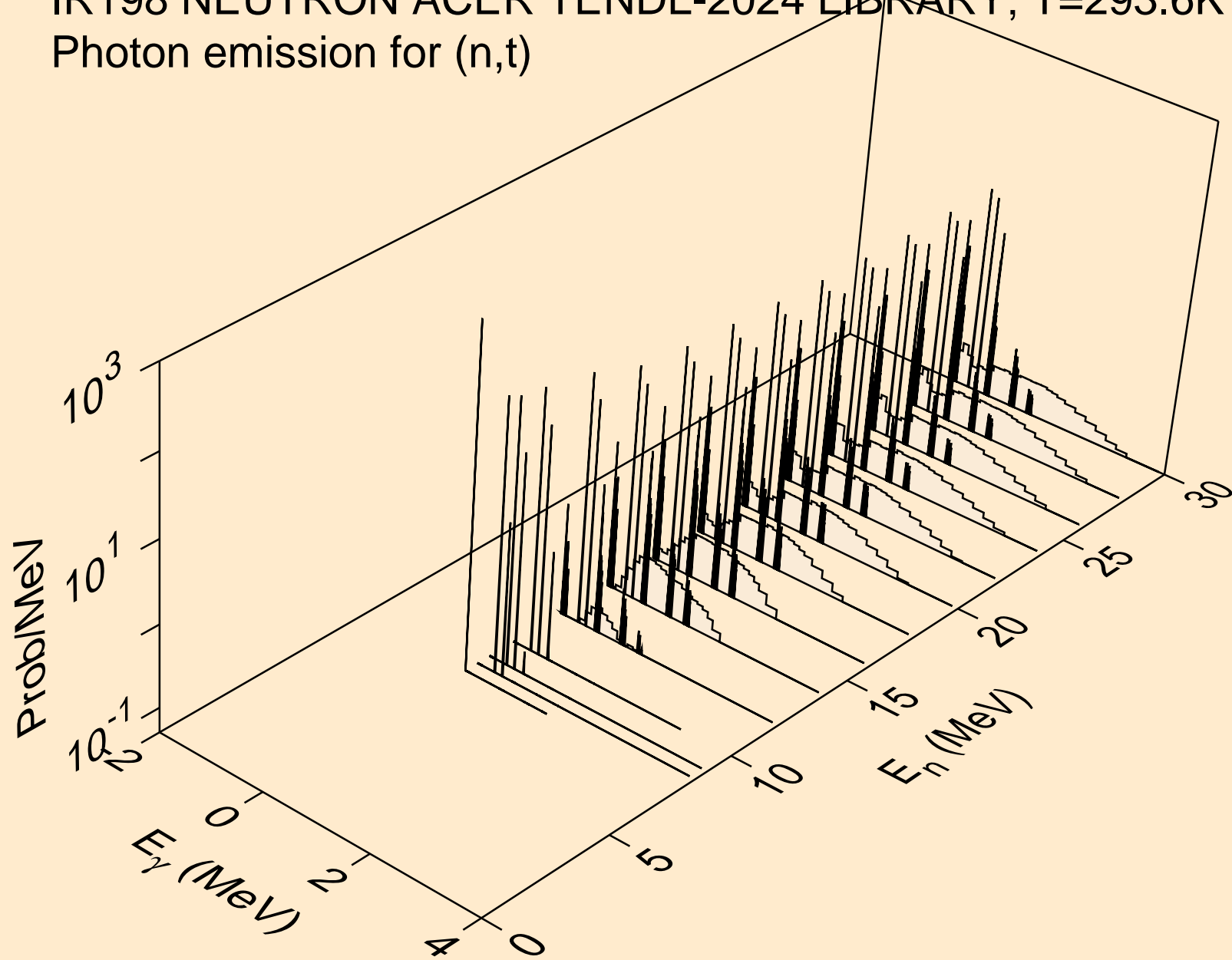

IR198 NEUTRON ACER TENDL-2024 LIBRARY; T=293.6K
Photon emission for (n,he3)

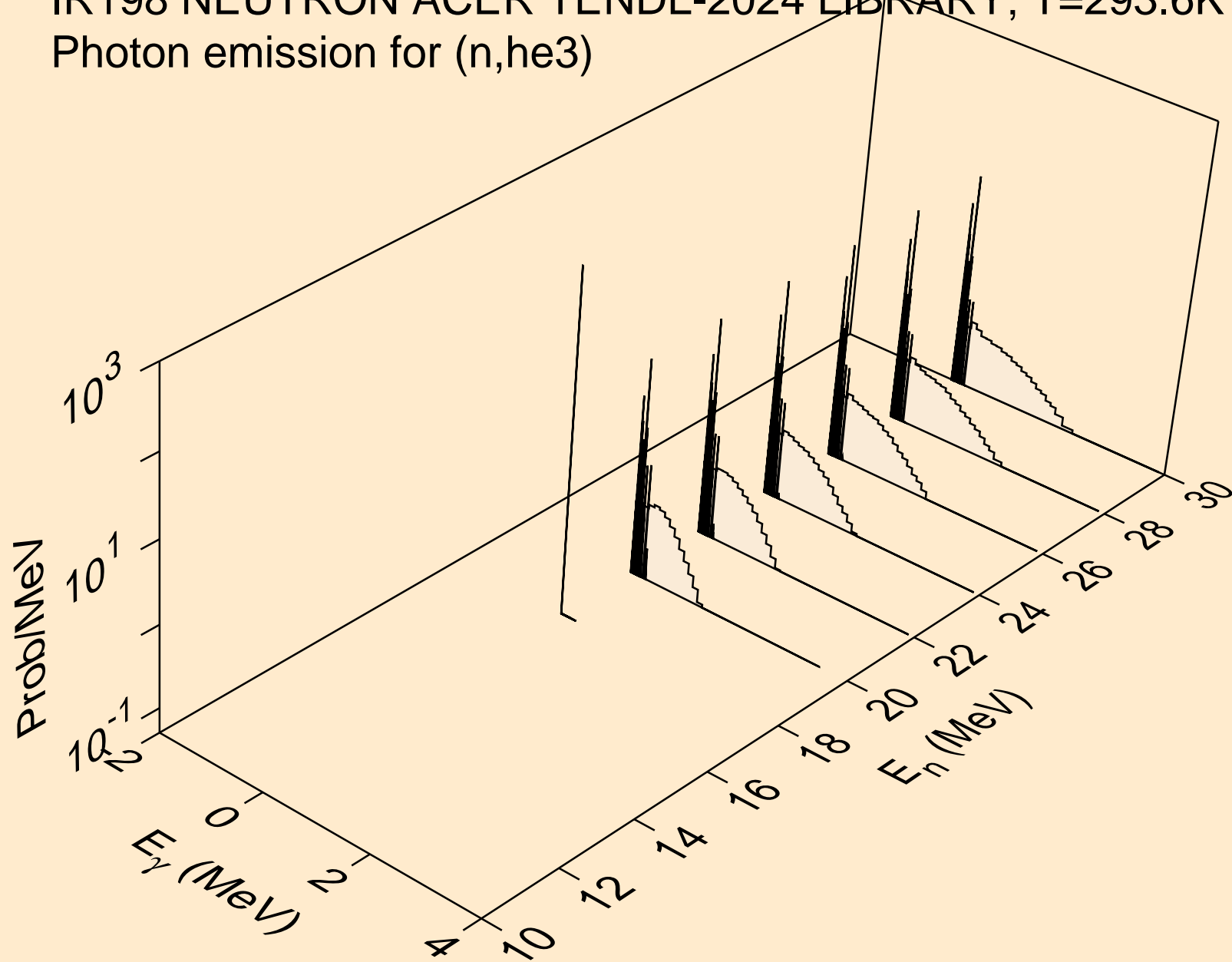

IR198 NEUTRON ACER TENDL-2024 LIBRARY; T=293.6K
Photon emission for (n,a)

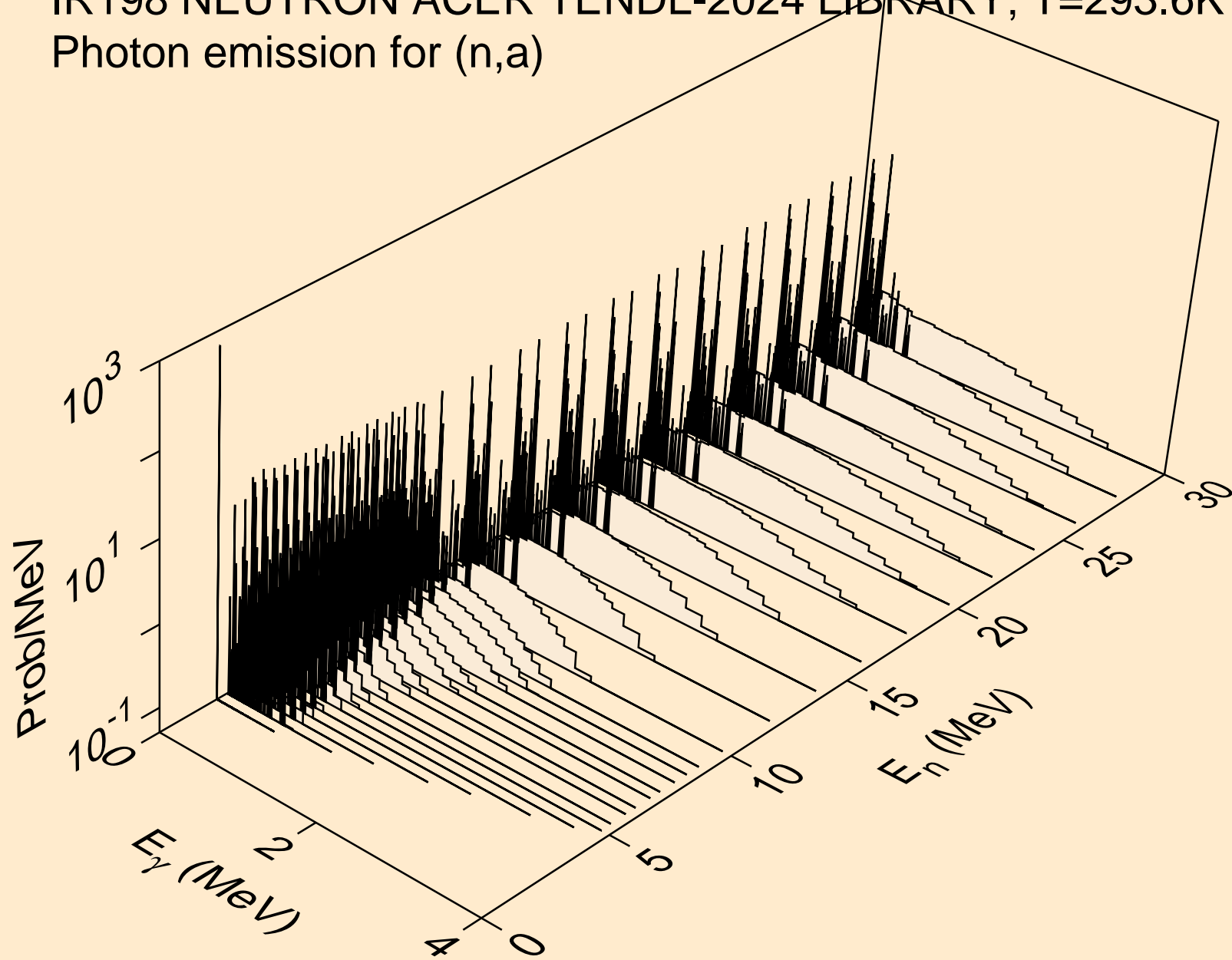

IR198 NEUTRON ACER TENDL-2024 LIBRARY; T=293.6K
Photon emission for (n,2p)

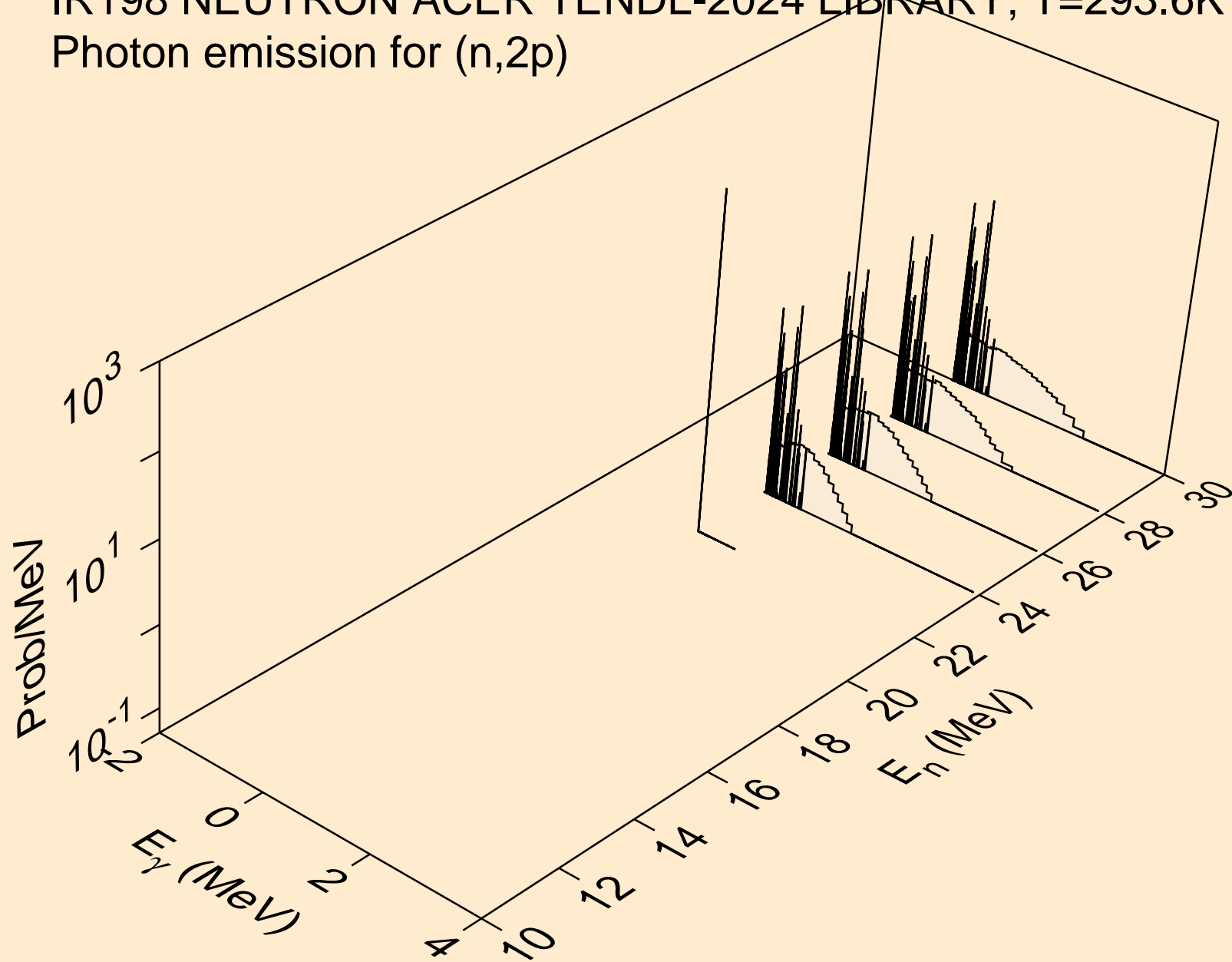

IR198 NEUTRON ACER TENDL-2024 LIBRARY; T=293.6K
thermal capture photon spectrum

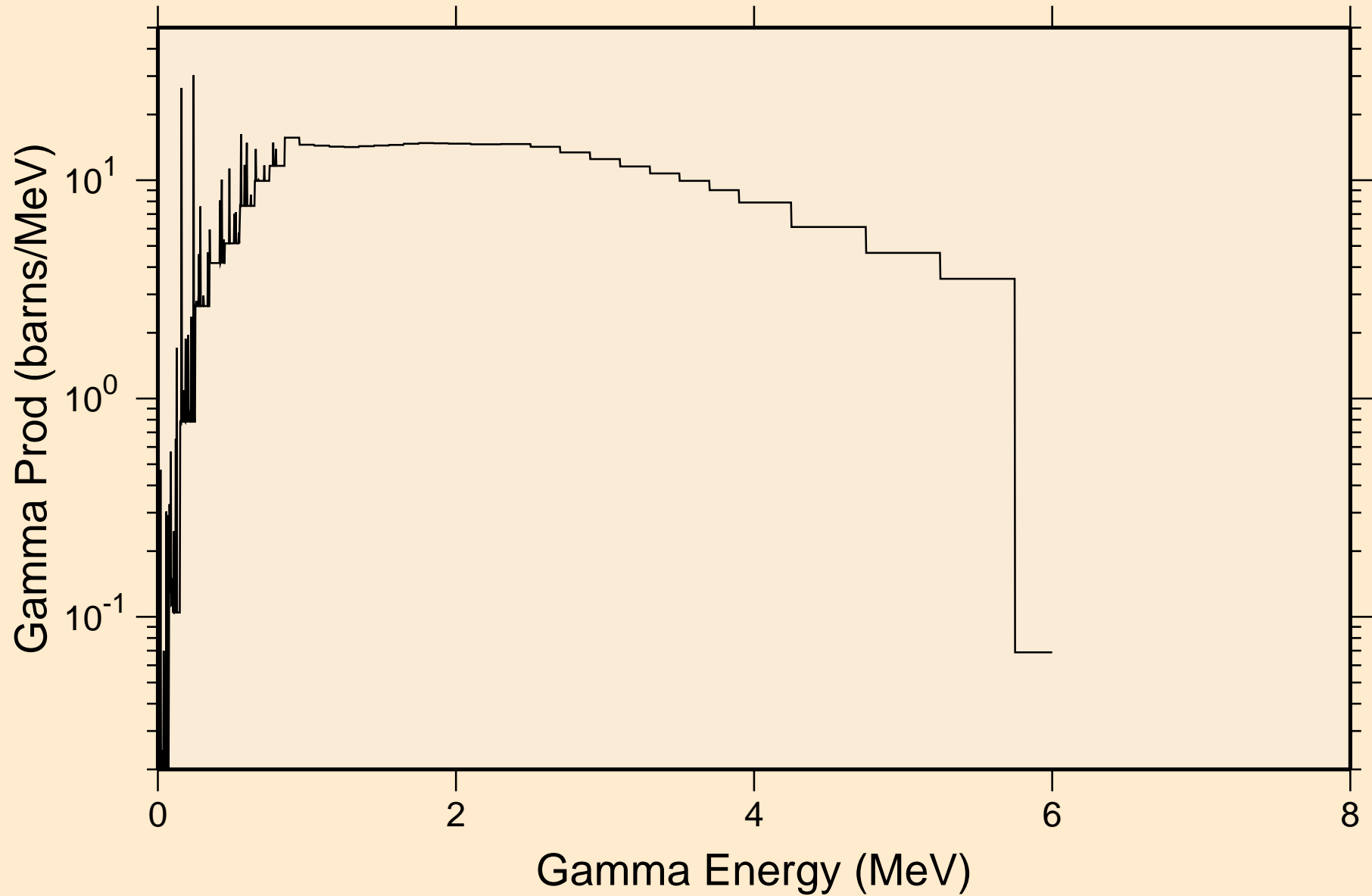

IR198 NEUTRON ACER TENDL-2024 LIBRARY; T=293.6K
14 MeV photon spectrum

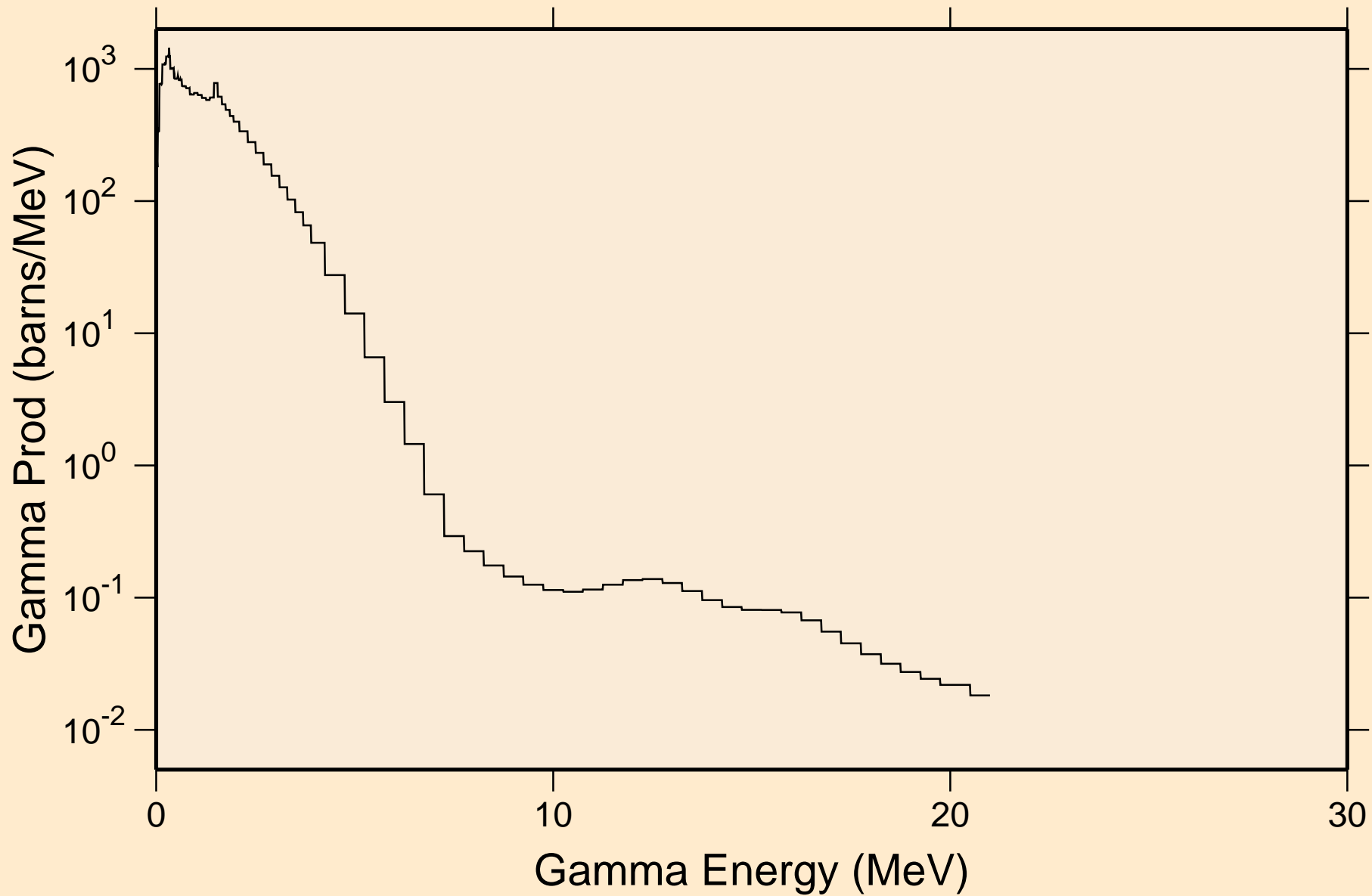

IR198 NEUTRON ACER TENDL-2024 LIBRARY; T=293.6K

Particle heating contributions

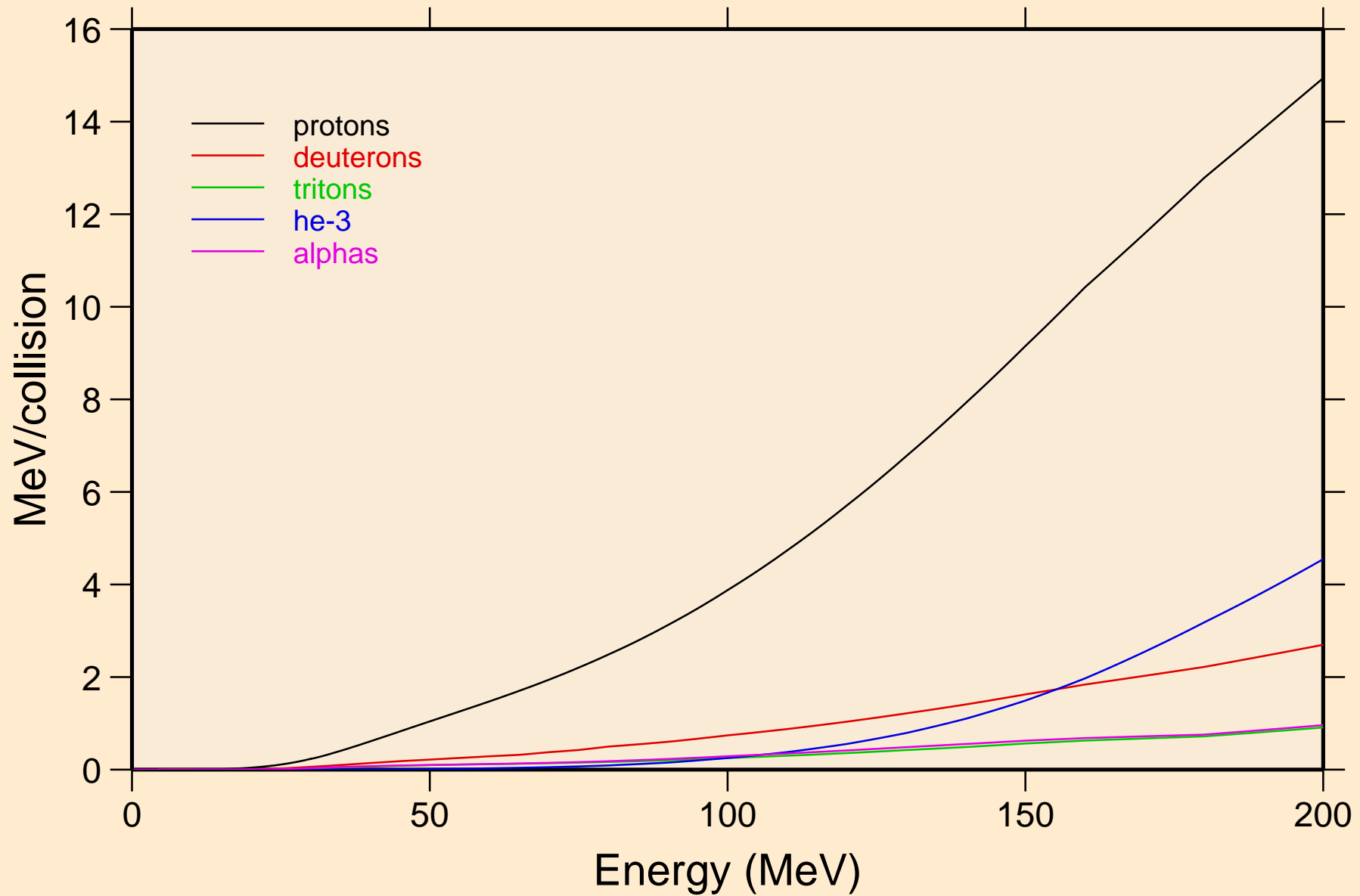

IR198 NEUTRON ACER TENDL-2024 LIBRARY; T=293.6K
Recoil Heating

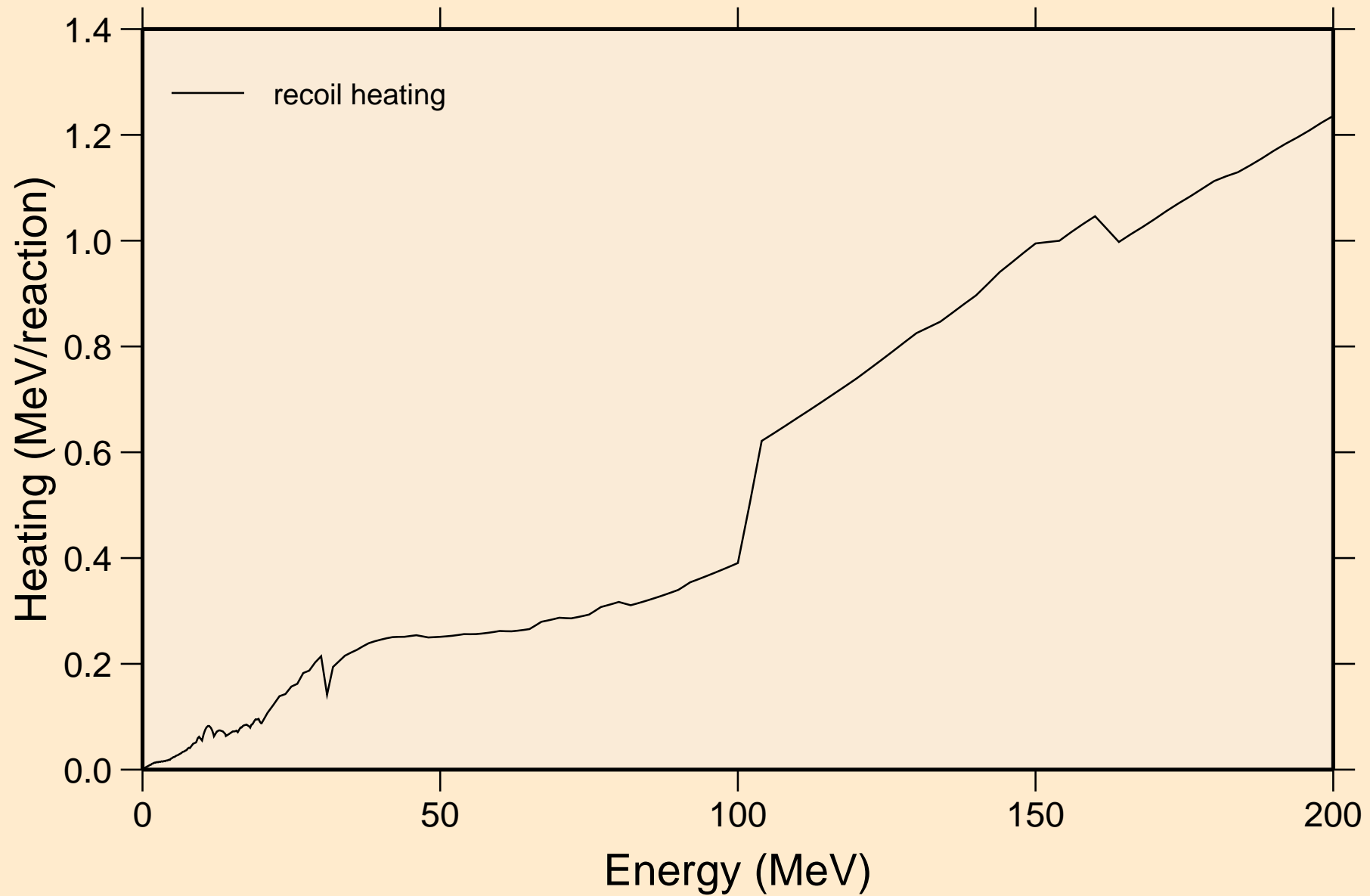

IR198 NEUTRON ACER TENDL-2024 LIBRARY; T=293.6K
Particle production cross sections

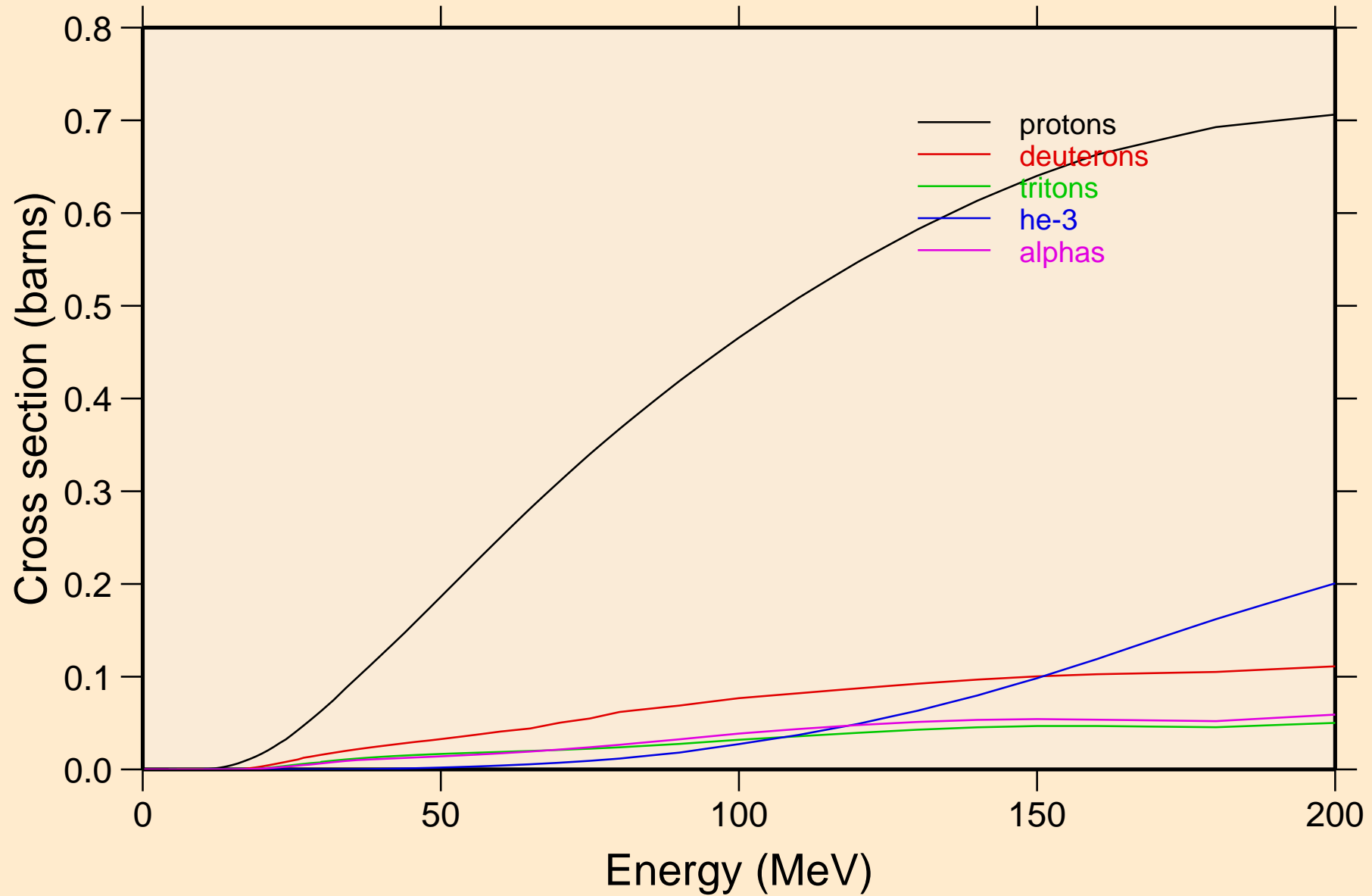

IR198 NEUTRON ACER TENDL-2024 LIBRARY; T=293.6K
protons from (n,x)

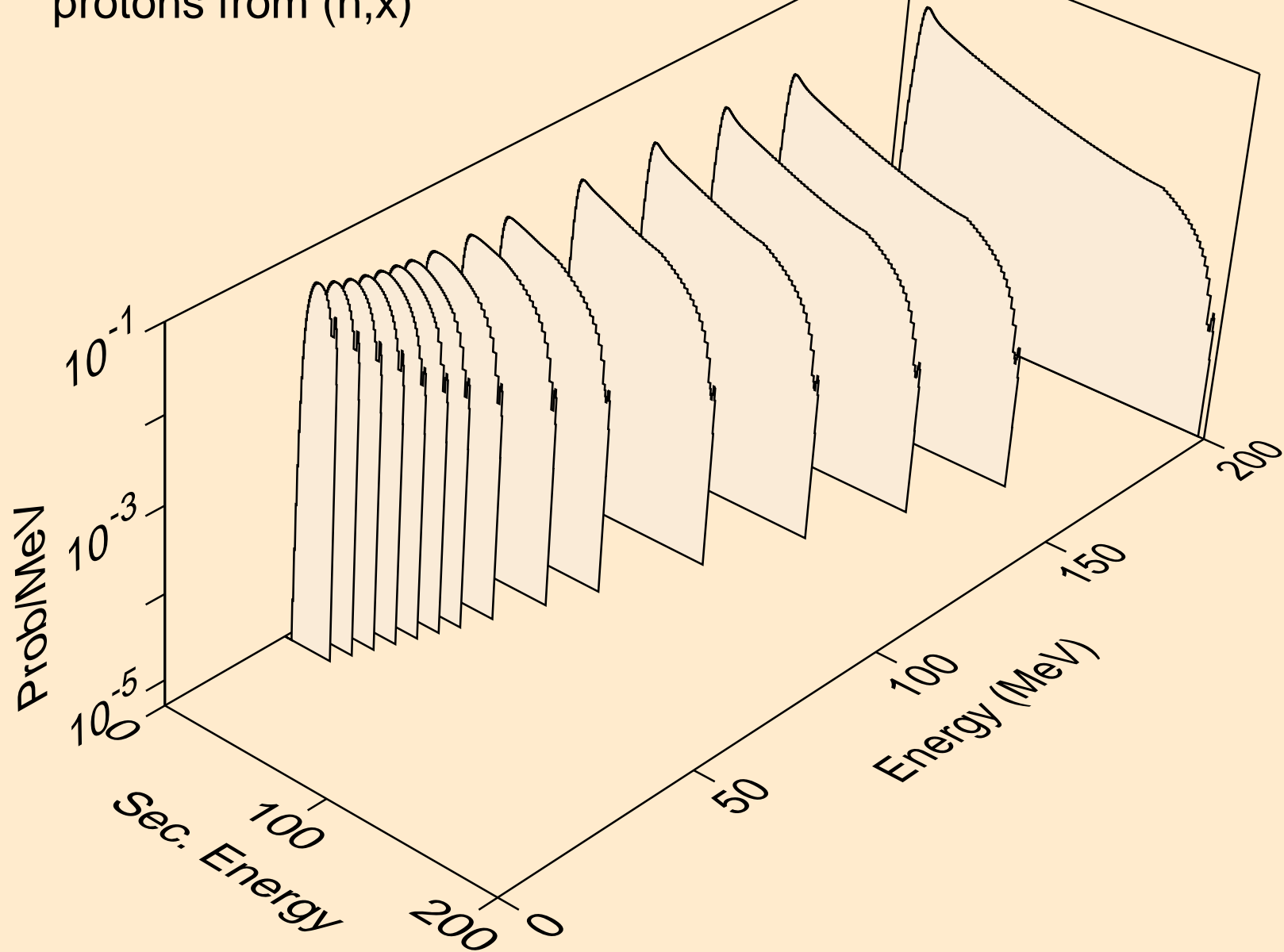

IR198 NEUTRON ACER TENDL-2024 LIBRARY; T=293.6K
protons from (n,n*)p

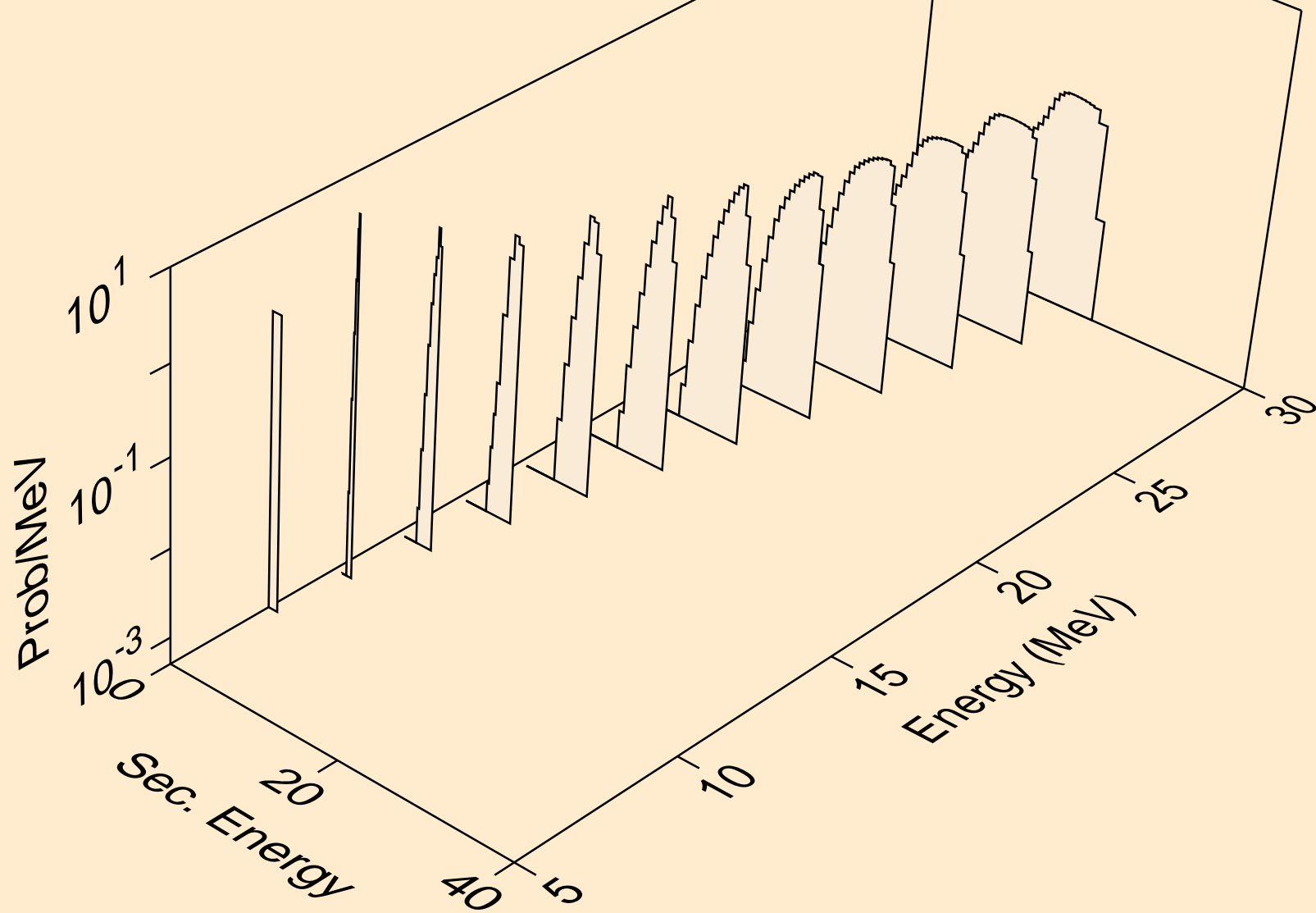

IR198 NEUTRON ACER TENDL-2024 LIBRARY; T=293.6K
protons from (n,2np)

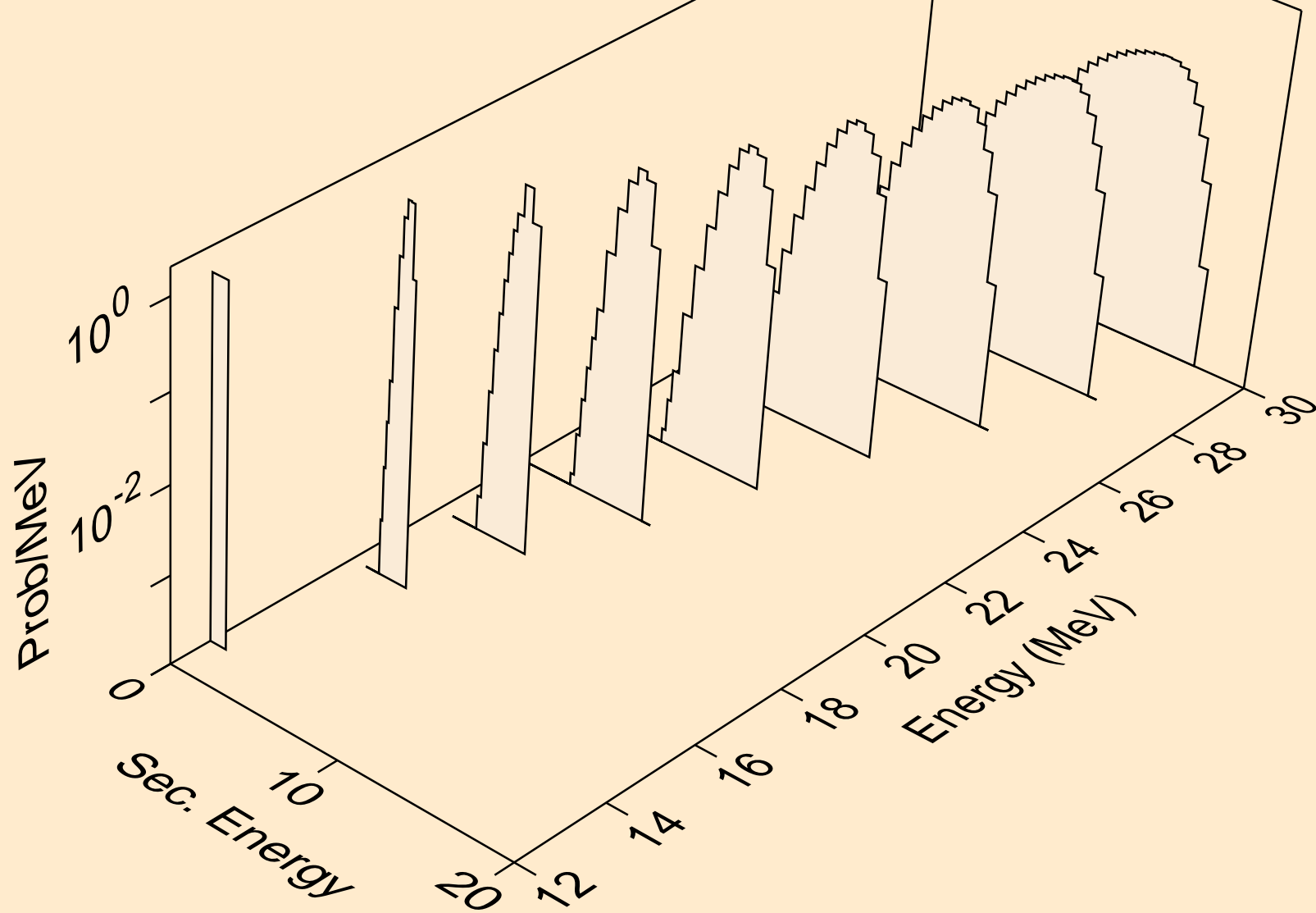

IR198 NEUTRON ACER TENDL-2024 LIBRARY; T=293.6K
protons from (n,3np)

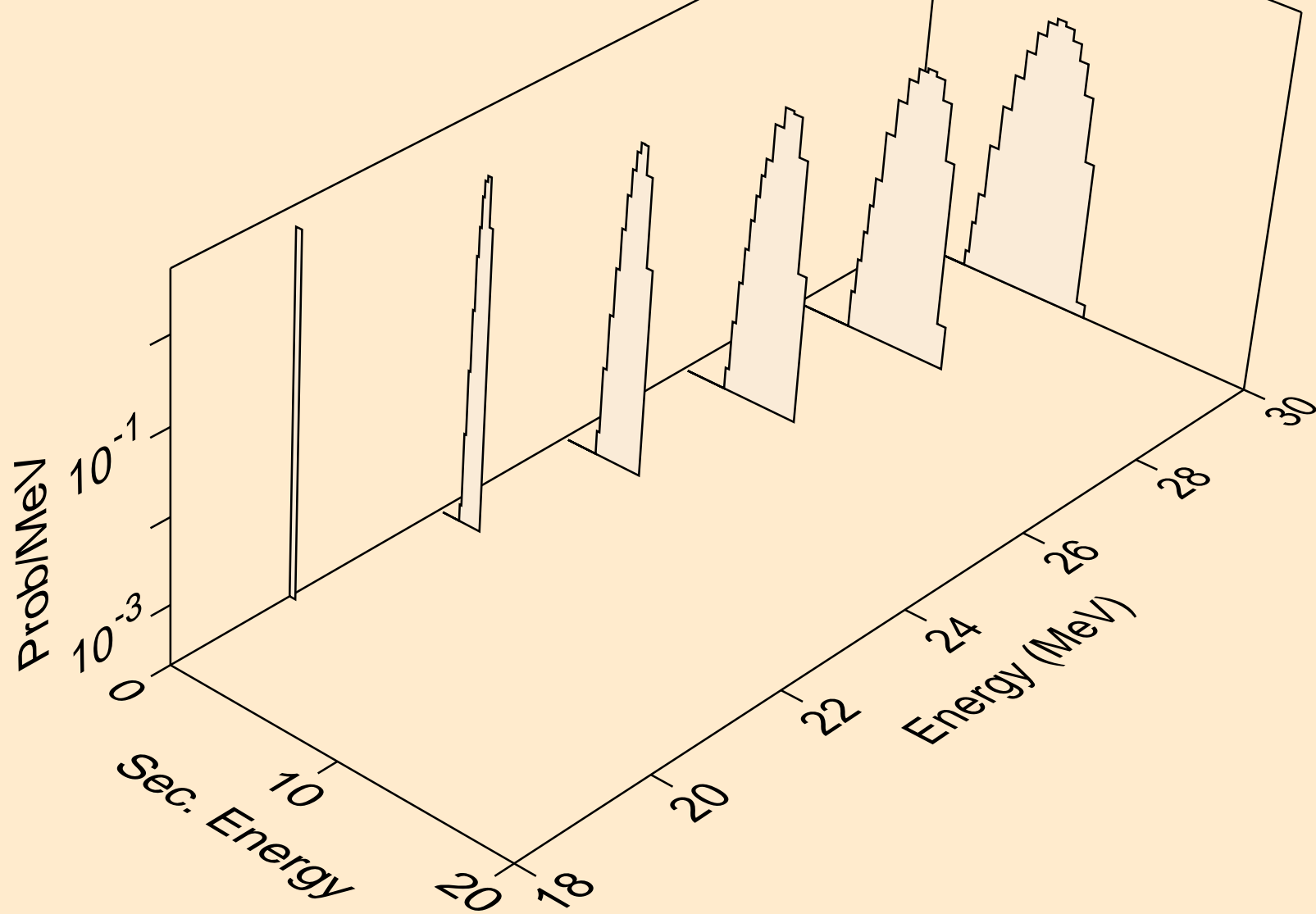

IR198 NEUTRON ACER TENDL-2024 LIBRARY; T=293.6K
protons from (n,p)

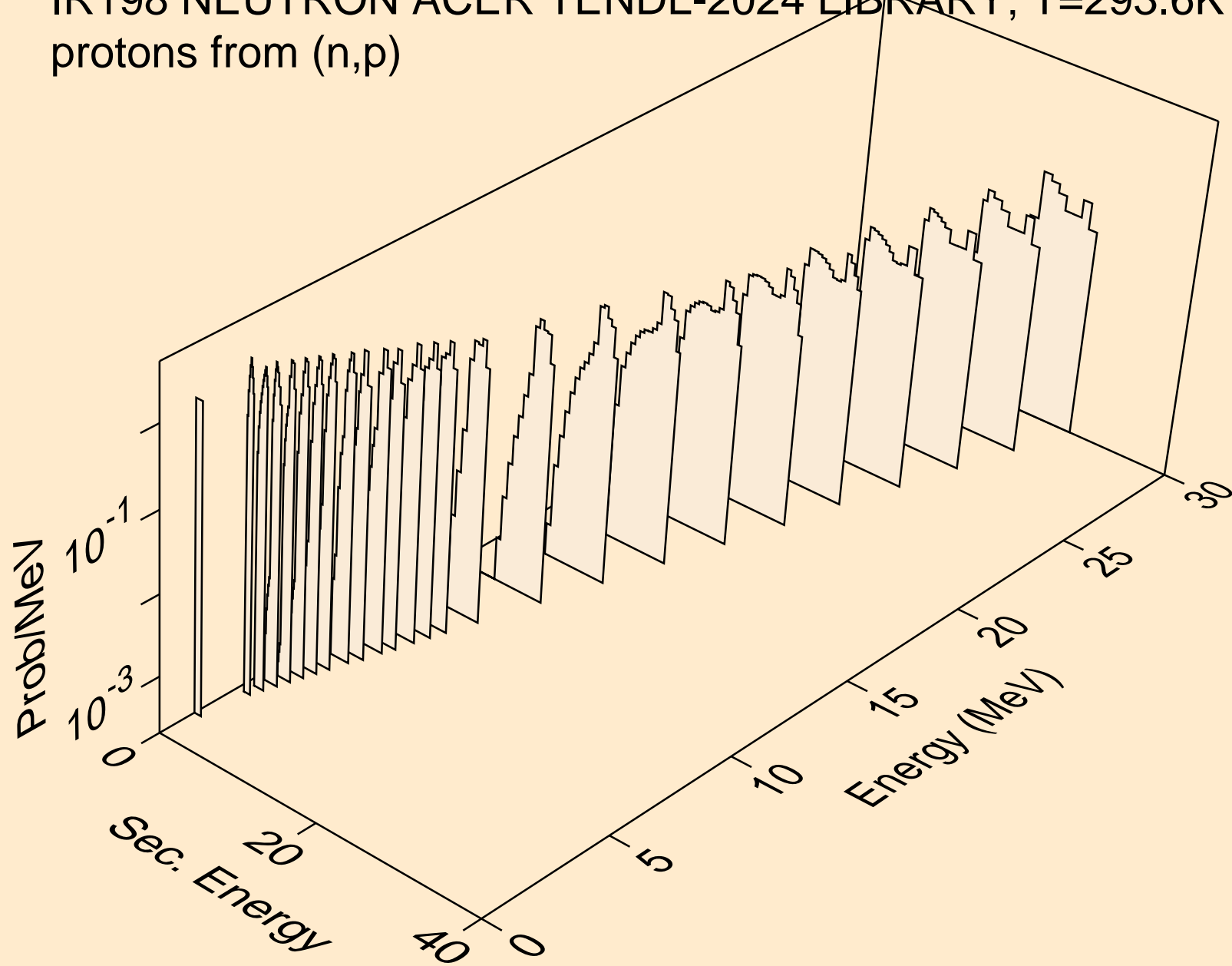

IR198 NEUTRON ACER TENDL-2024 LIBRARY; T=293.6K
protons from (n,2p)

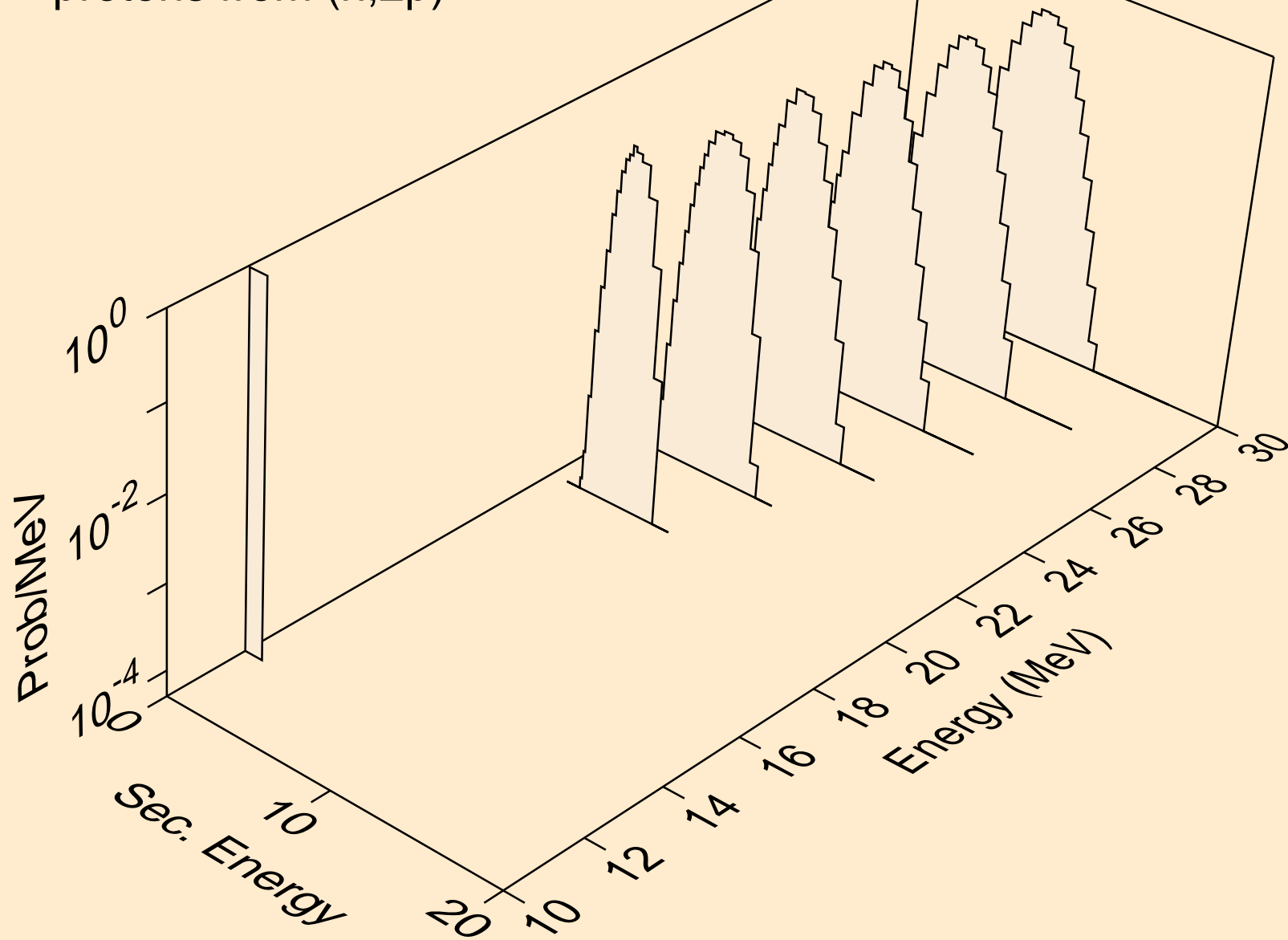

IR198 NEUTRON ACER TENDL-2024 LIBRARY; T=293.6K
deuterons from (n,x)

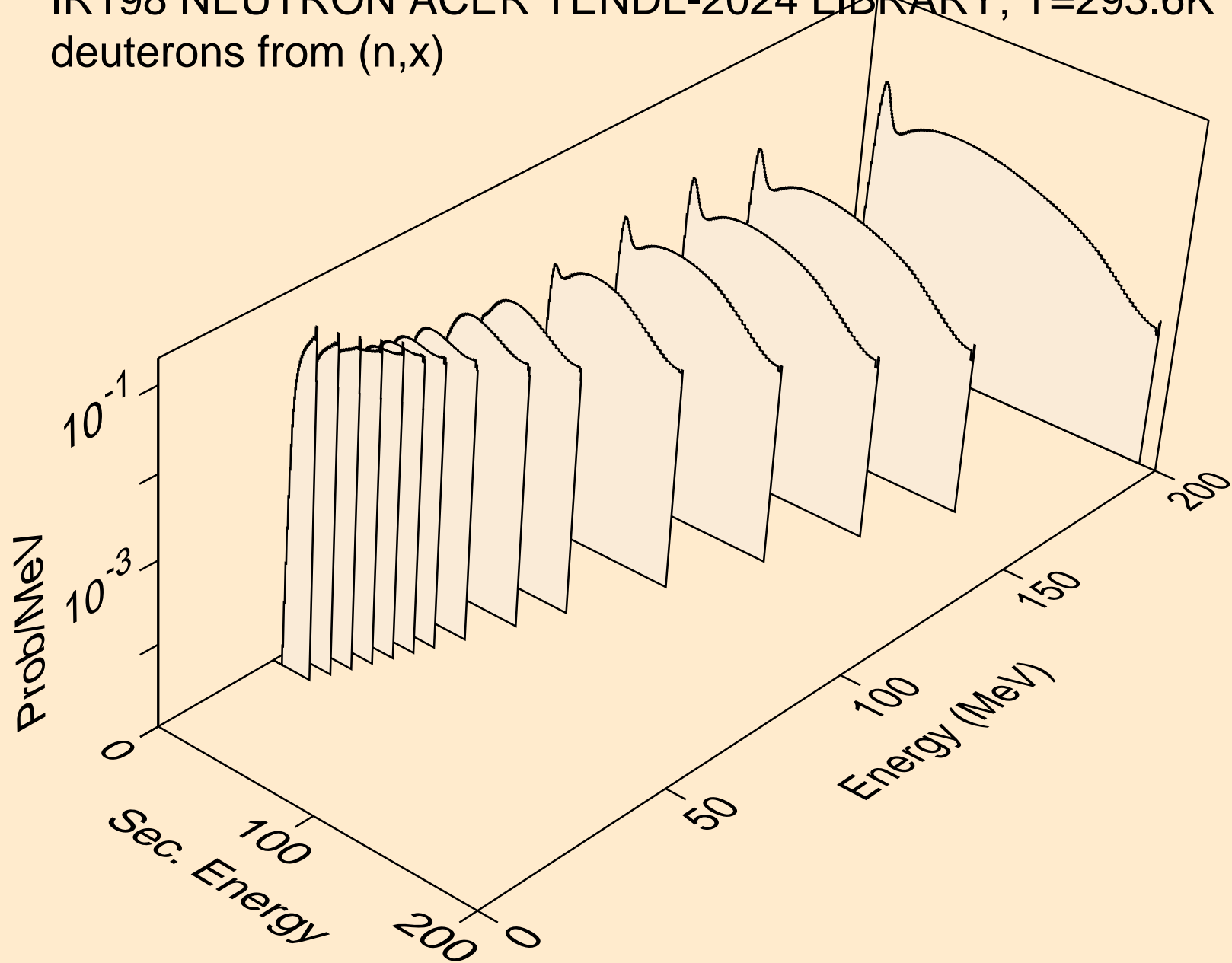

IR198 NEUTRON ACER TENDL-2024 LIBRARY; T=293.6K
deuterons from (n,2nd)

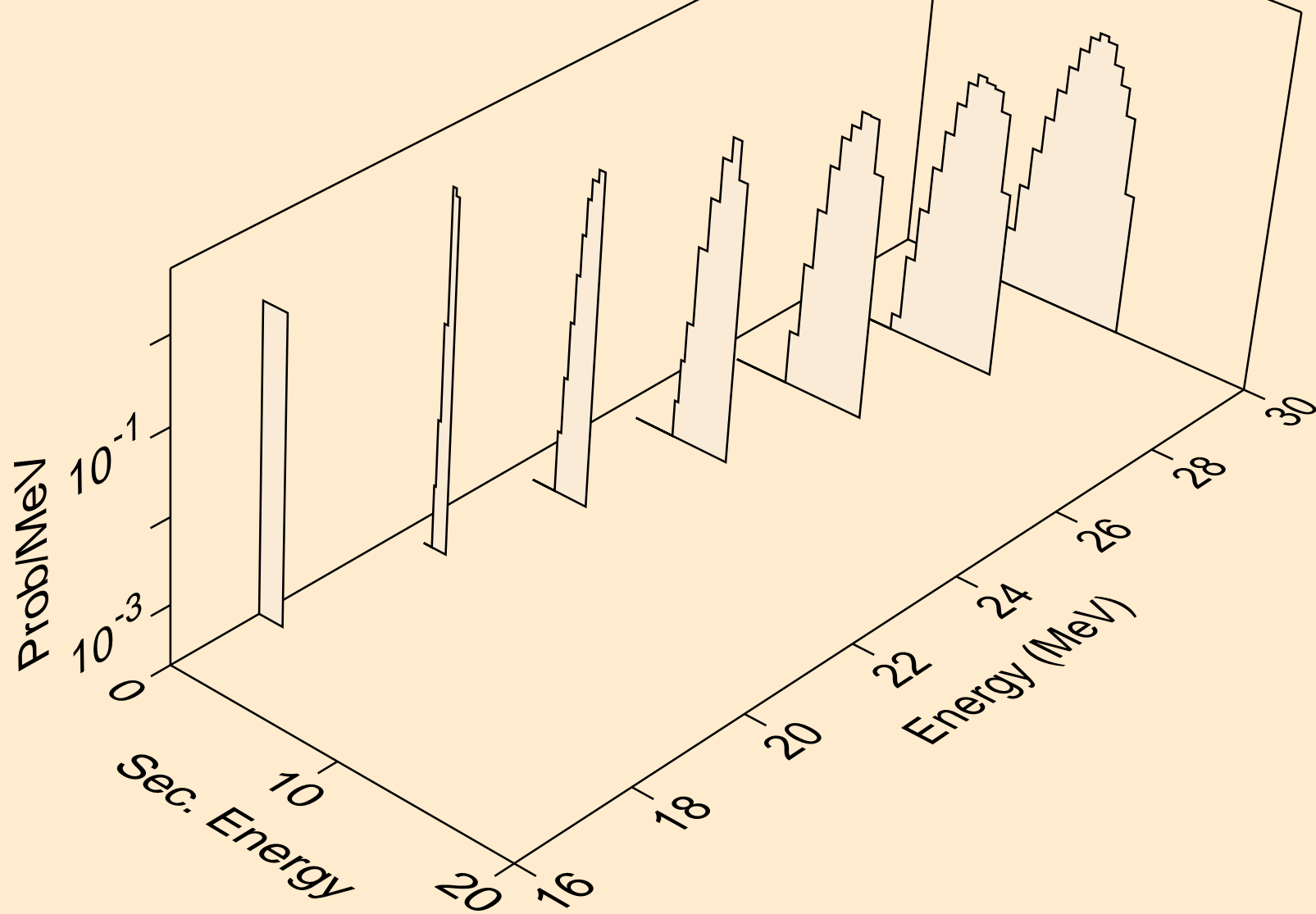

IR198 NEUTRON ACER TENDL-2024 LIBRARY; T=293.6K
deuterons from (n,n*)d

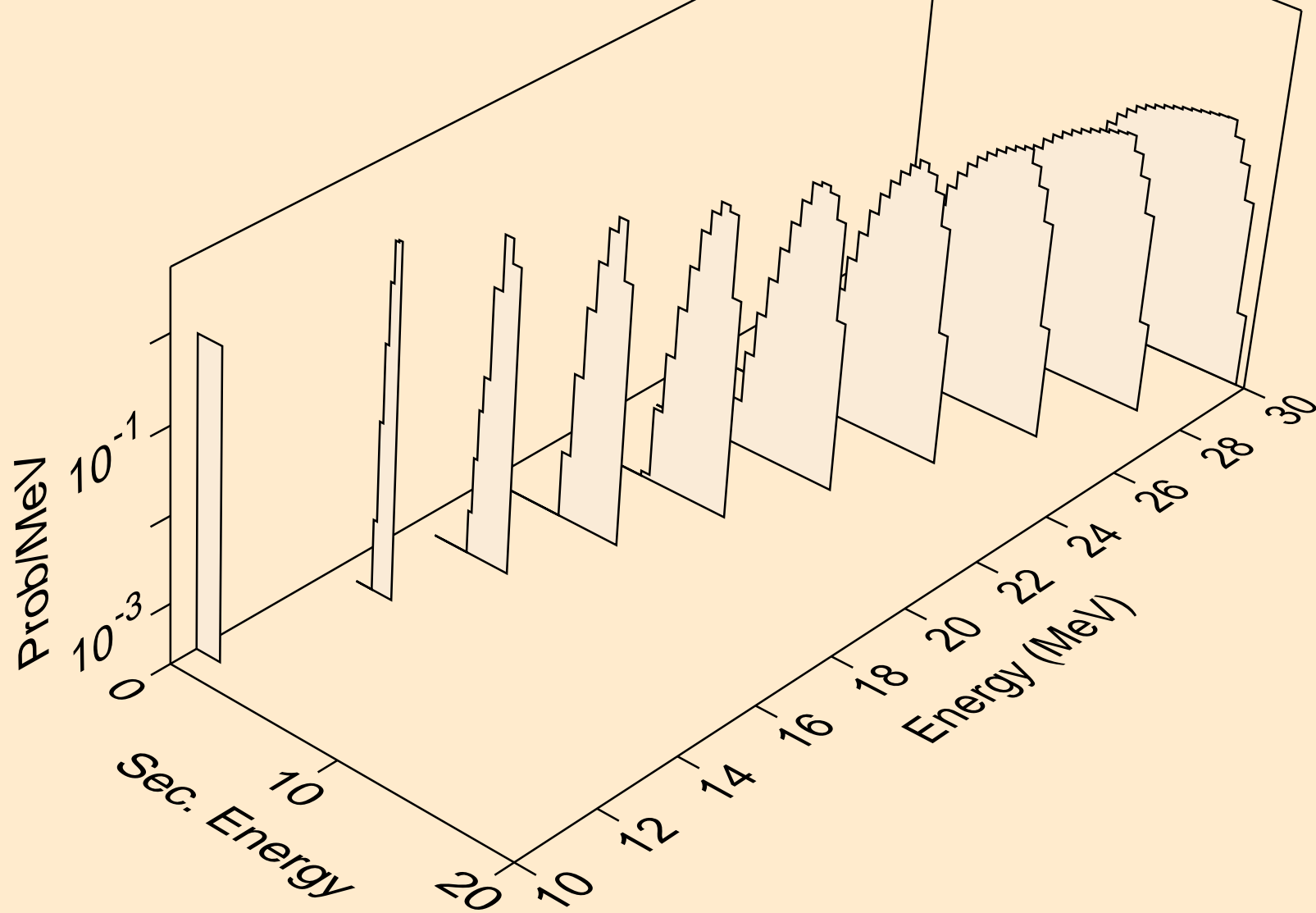

IR198 NEUTRON ACER TENDL-2024 LIBRARY; T=293.6K
deuterons from (n,d)

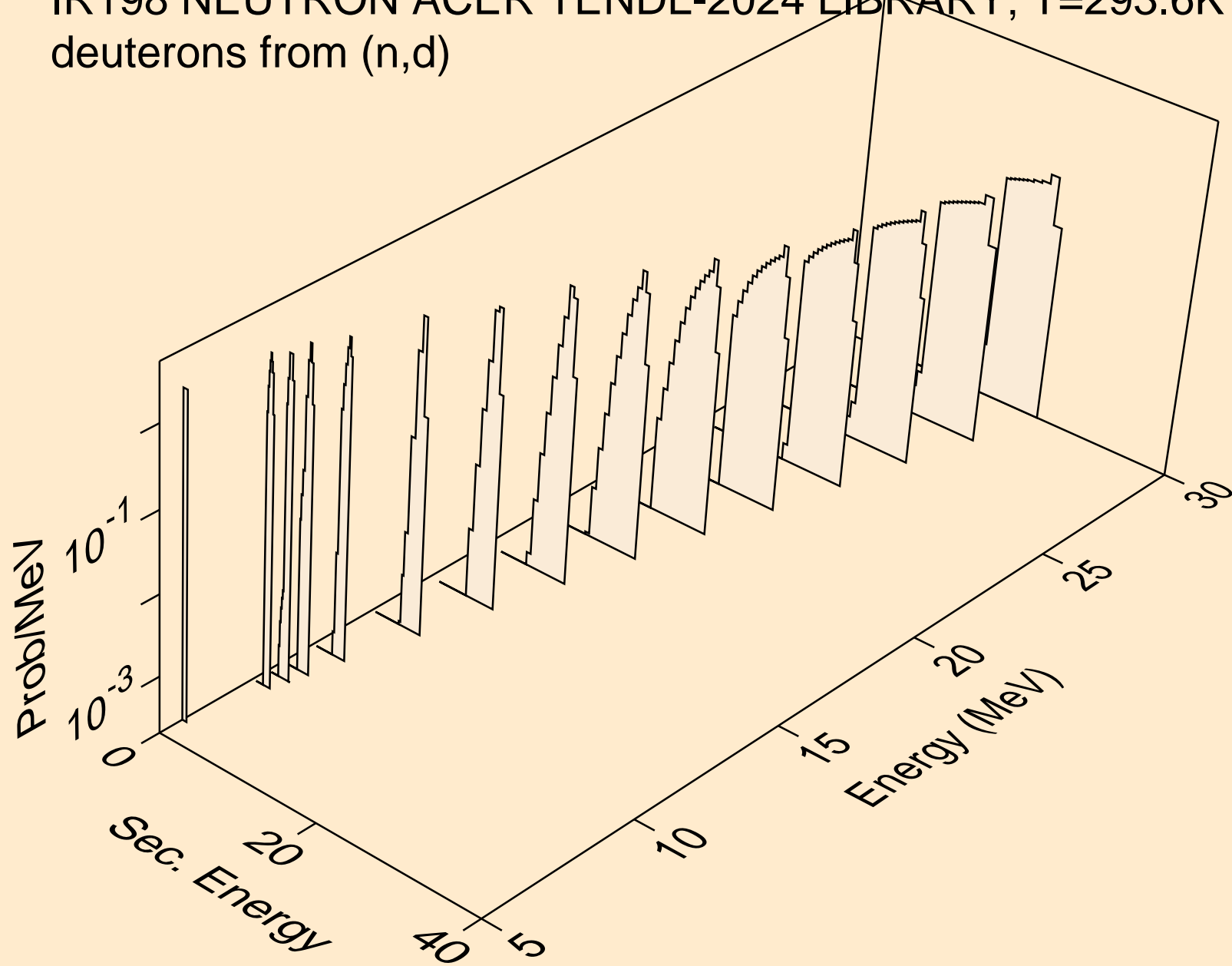

IR198 NEUTRON ACER TENDL-2024 LIBRARY; T=293.6K
tritons from (n,x)

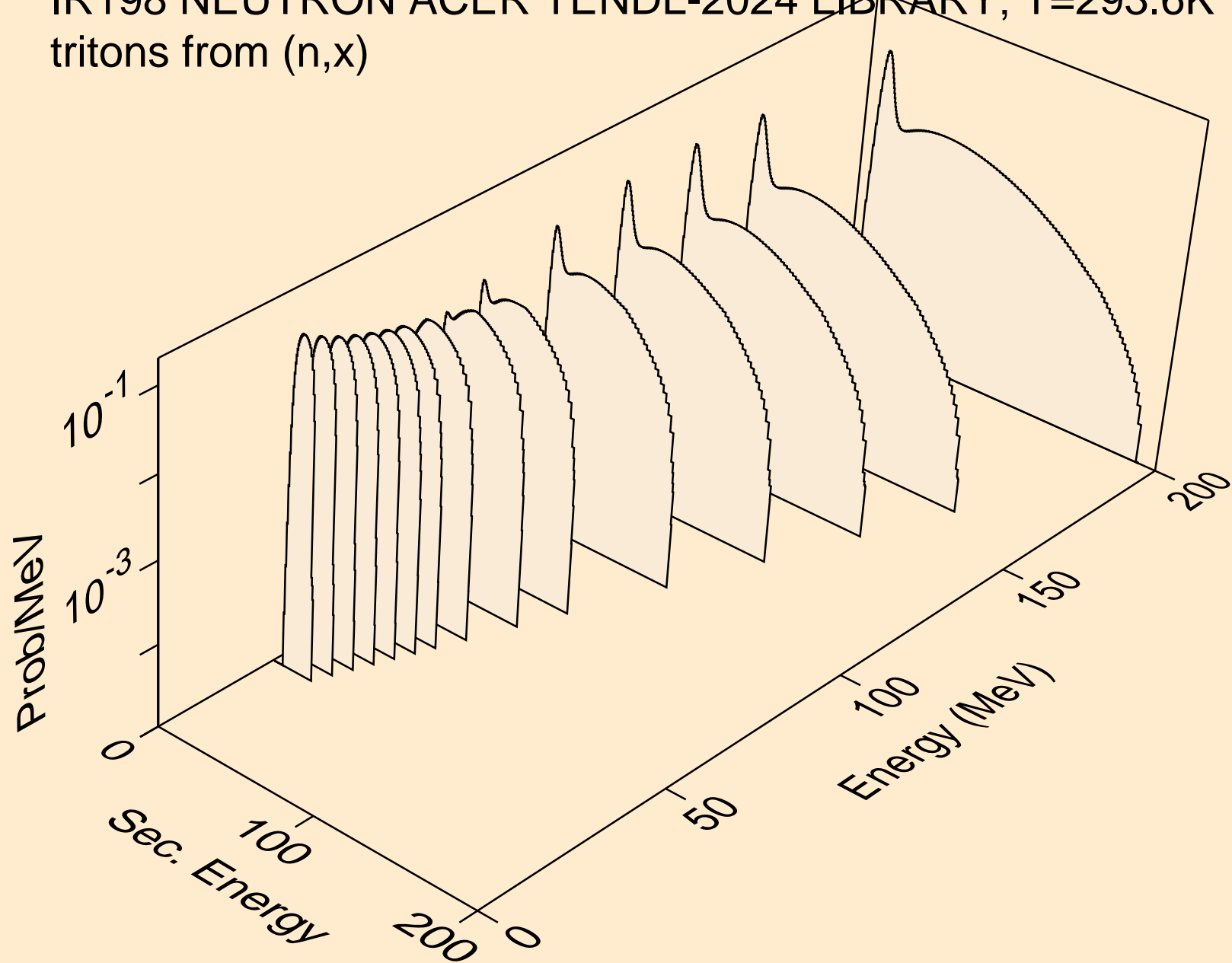

IR198 NEUTRON ACER TENDL-2024 LIBRARY; T=293.6K
tritons from (n,n*)t

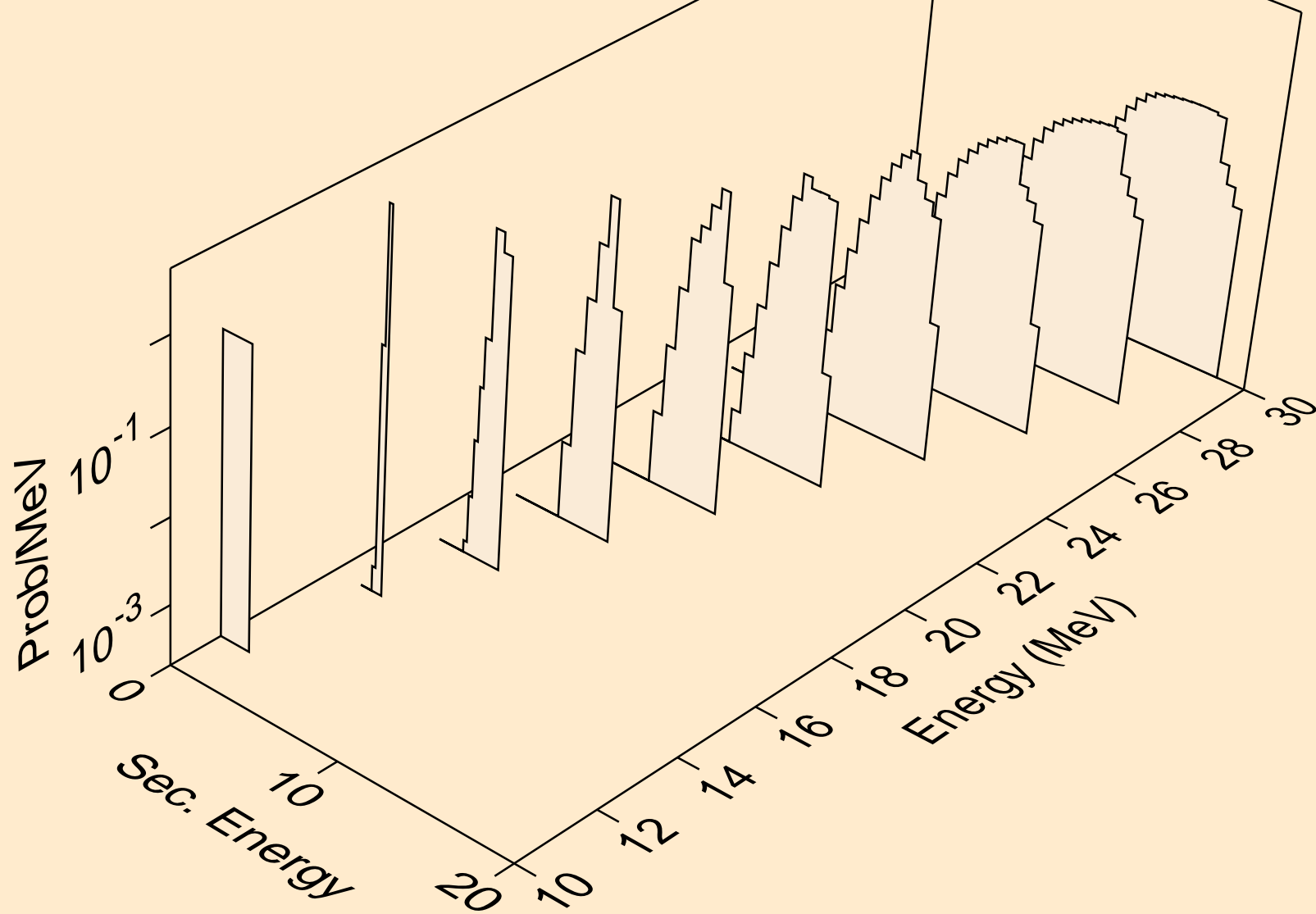

IR198 NEUTRON ACER TENDL-2024 LIBRARY; T=293.6K
tritons from (n,t)

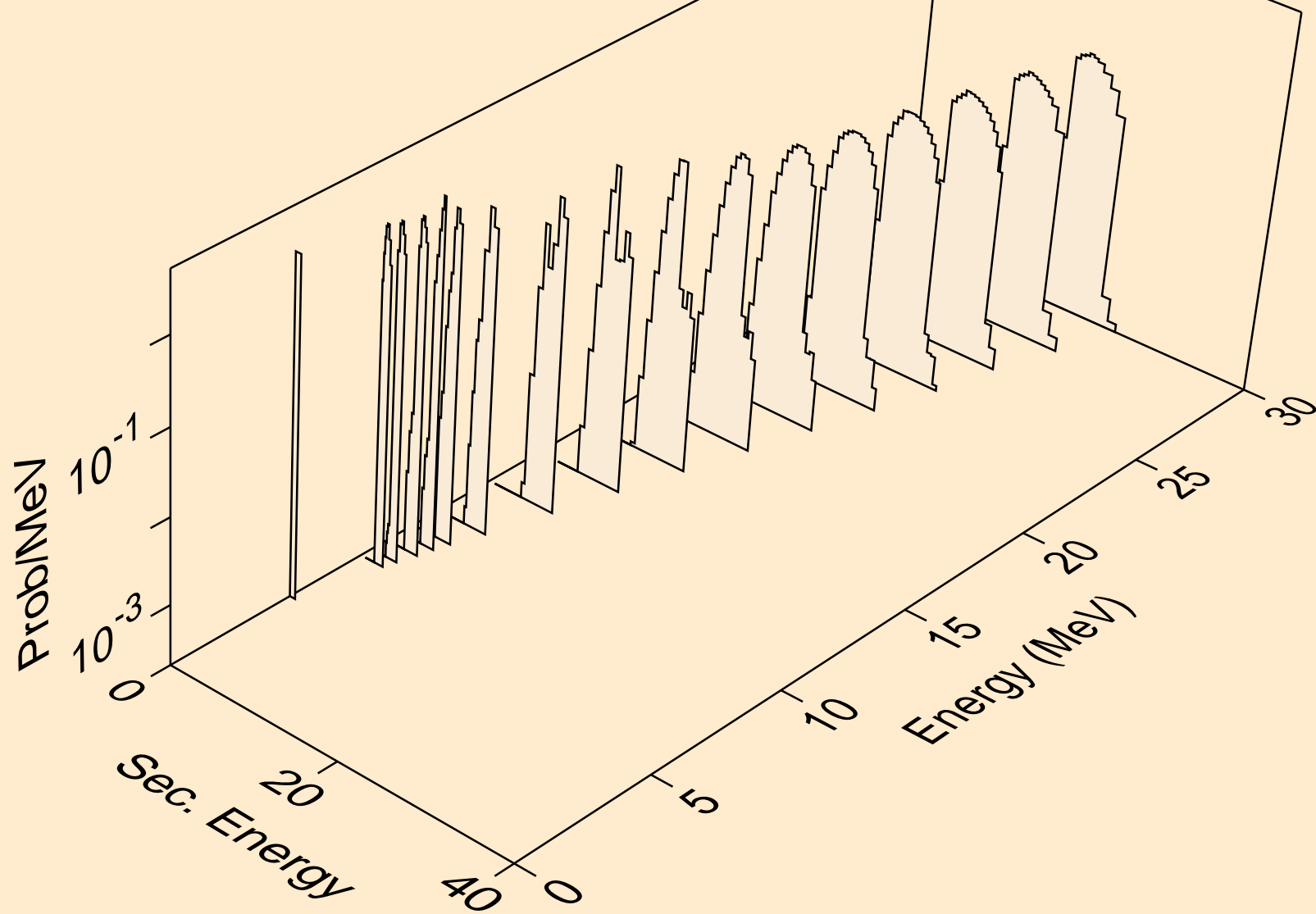

IR198 NEUTRON ACER TENDL-2024 LIBRARY; T=293.6K
he3s from (n,x)

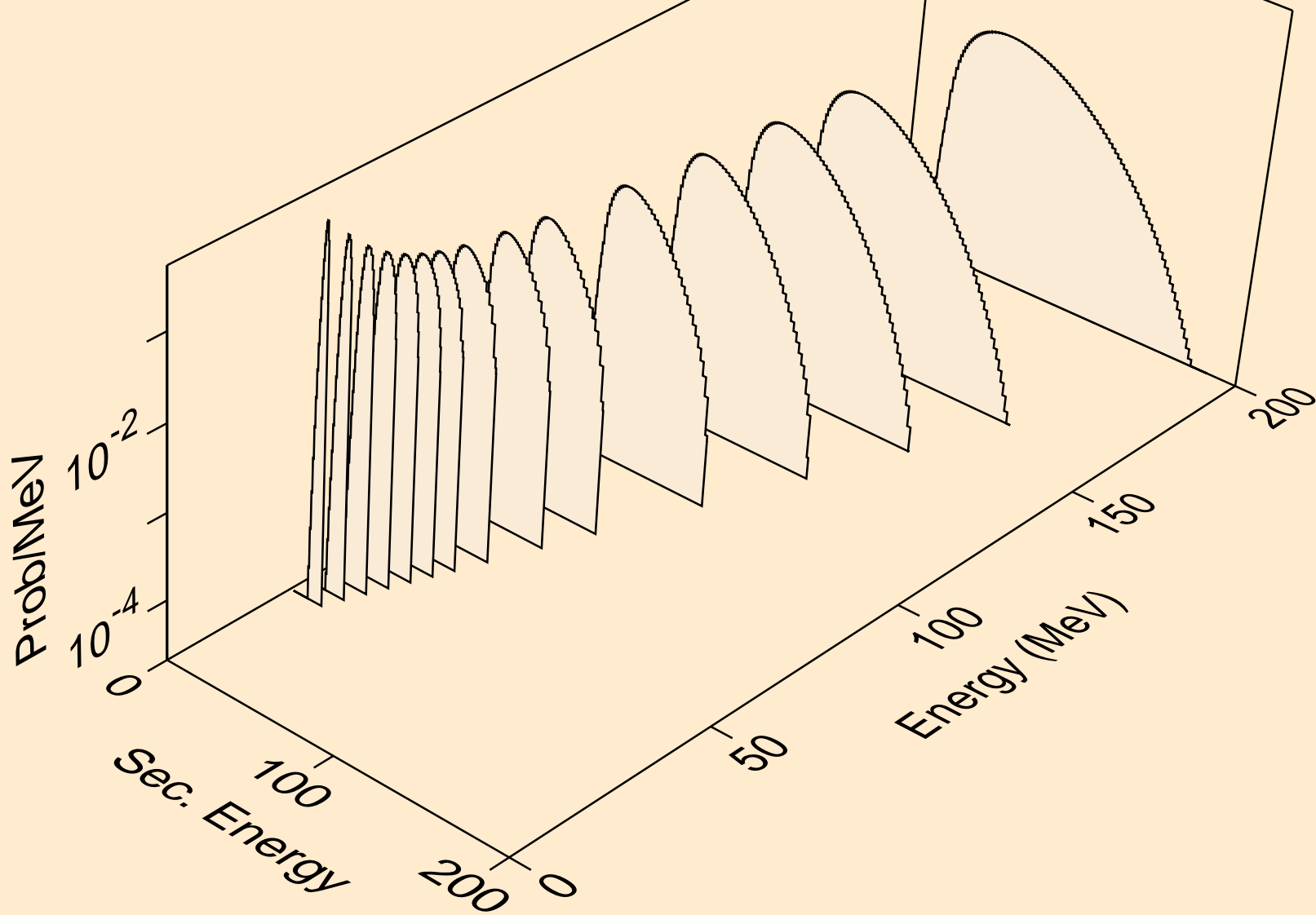

IR198 NEUTRON ACER TENDL-2024 LIBRARY; T=293.6K
he3s from (n,n*)he3

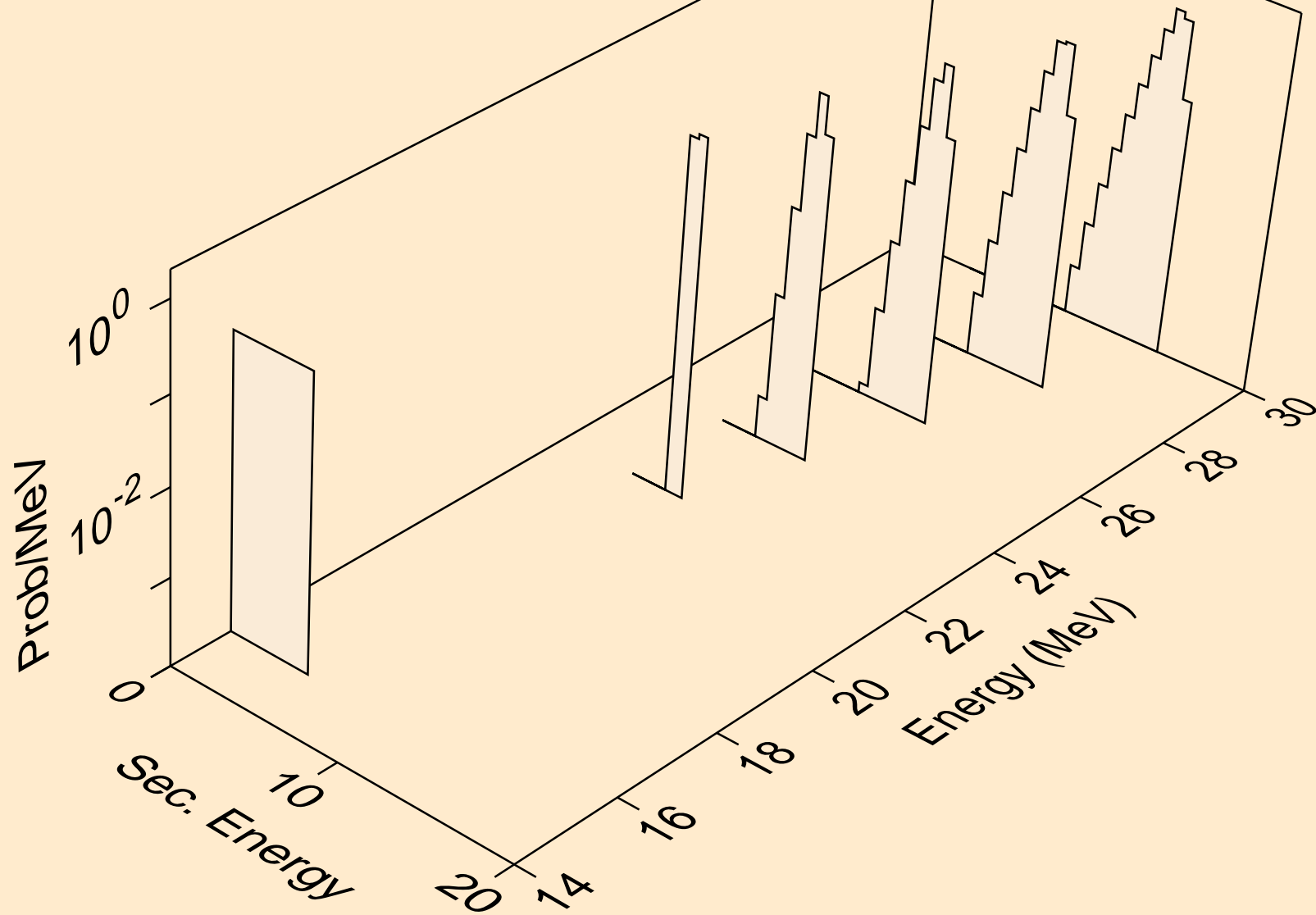

IR198 NEUTRON ACER TENDL-2024 LIBRARY; T=293.6K
he3s from (n,he3)

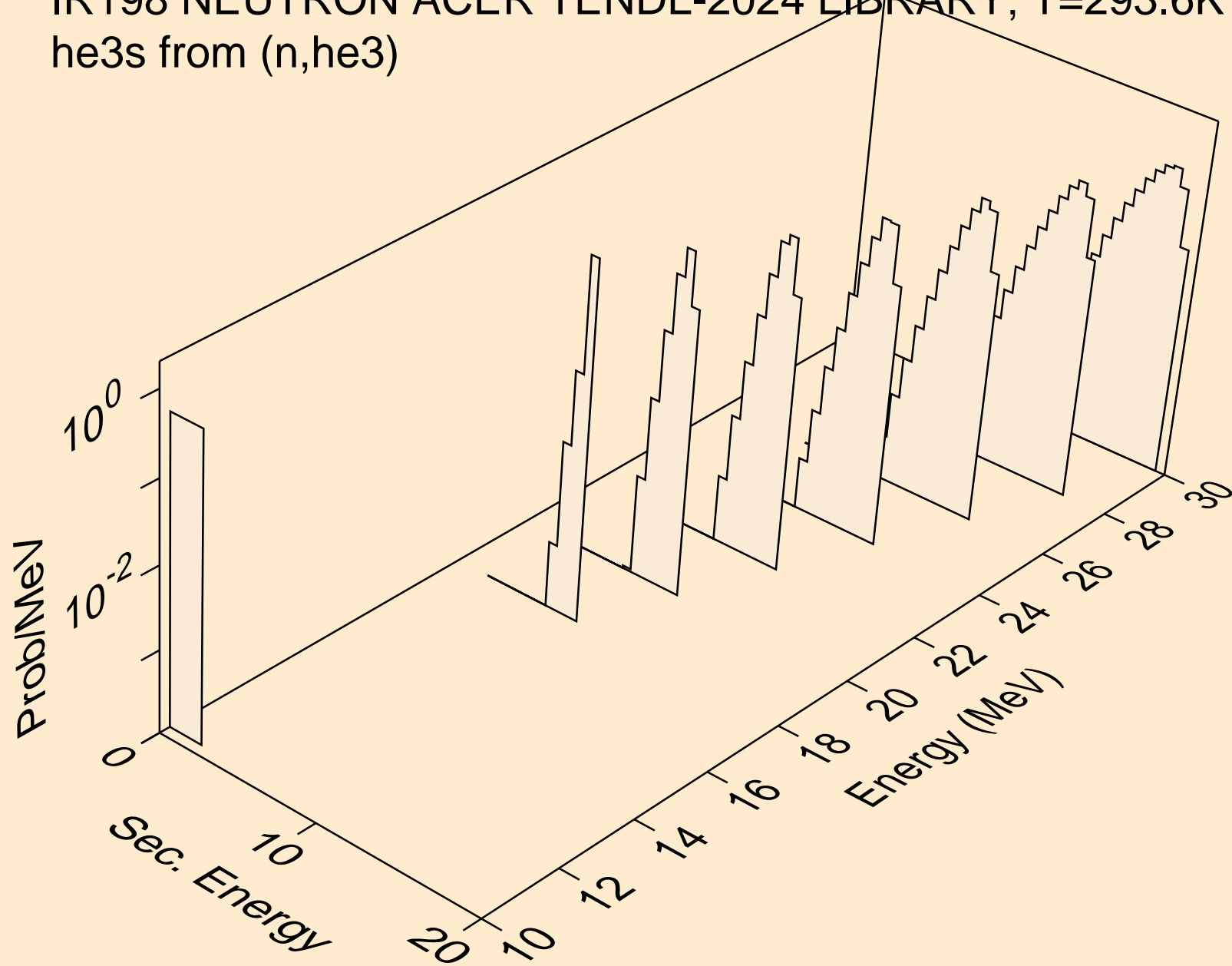

IR198 NEUTRON ACER TENDL-2024 LIBRARY; T=293.6K
alphas from (n,x)

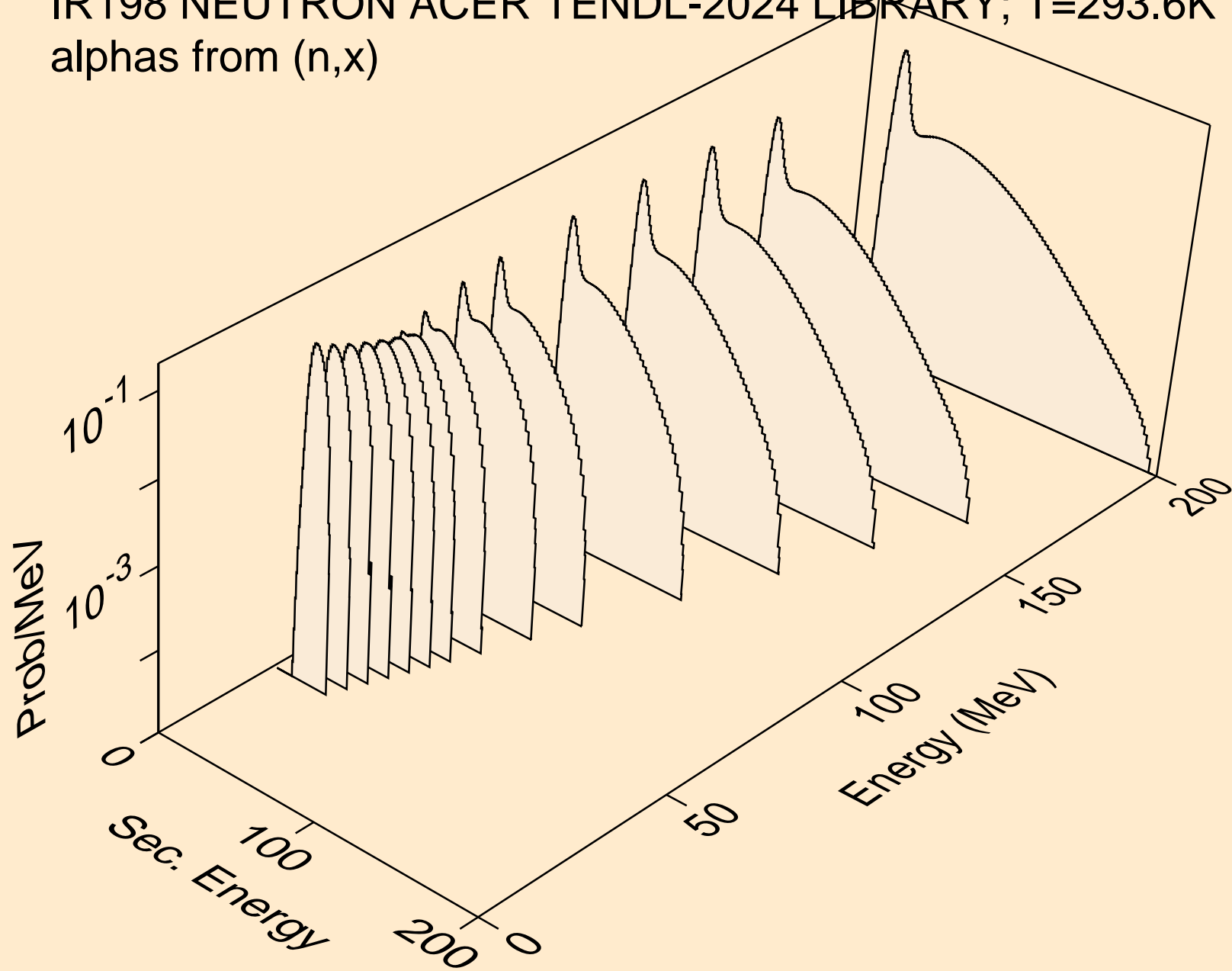

IR198 NEUTRON ACER TENDL-2024 LIBRARY; T=293.6K
alphas from (n,n*)a

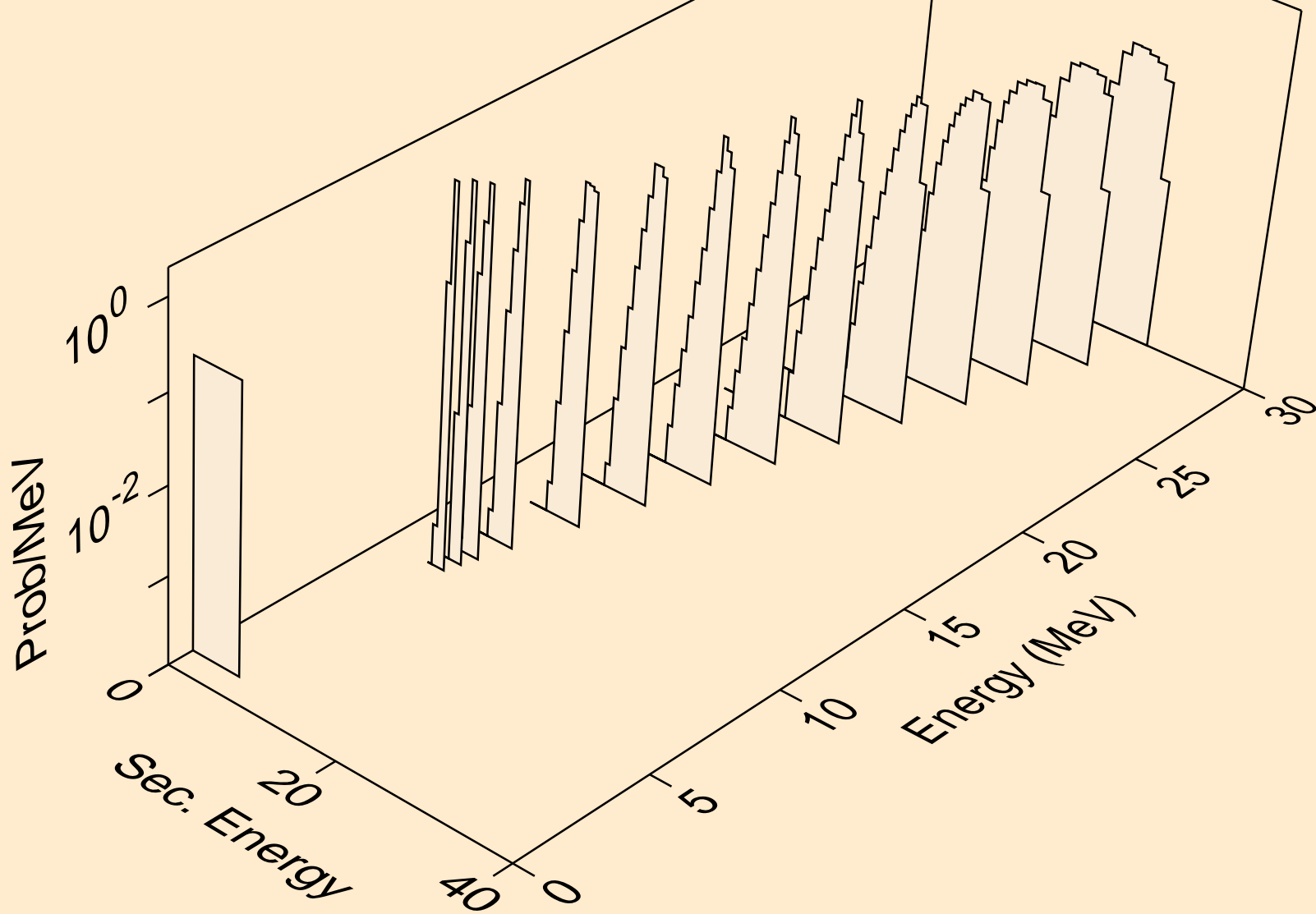

IR198 NEUTRON ACER TENDL-2024 LIBRARY; T=293.6K
alphas from (n,2n)a

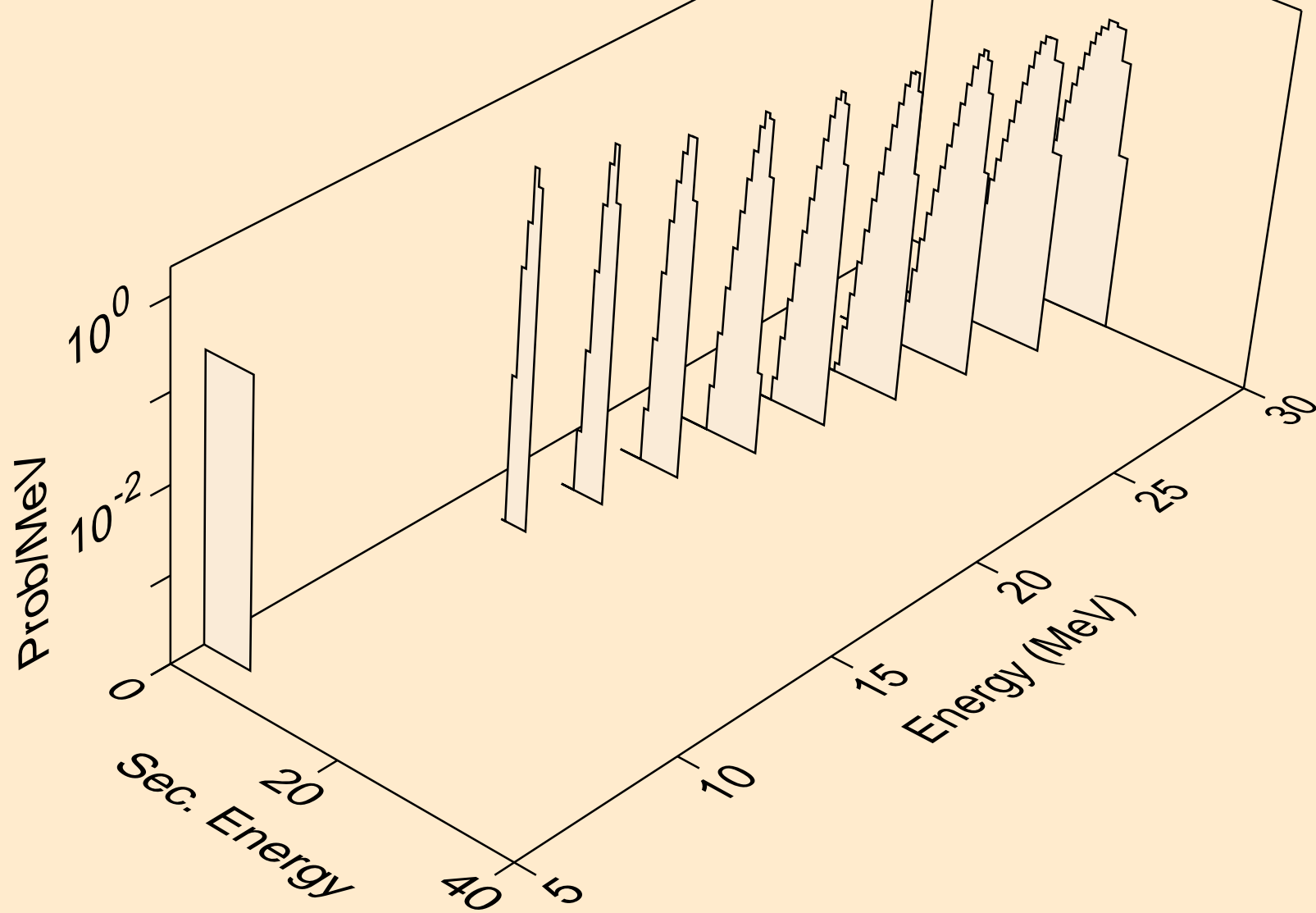

IR198 NEUTRON ACER TENDL-2024 LIBRARY; T=293.6K
alphas from (n,3n)a

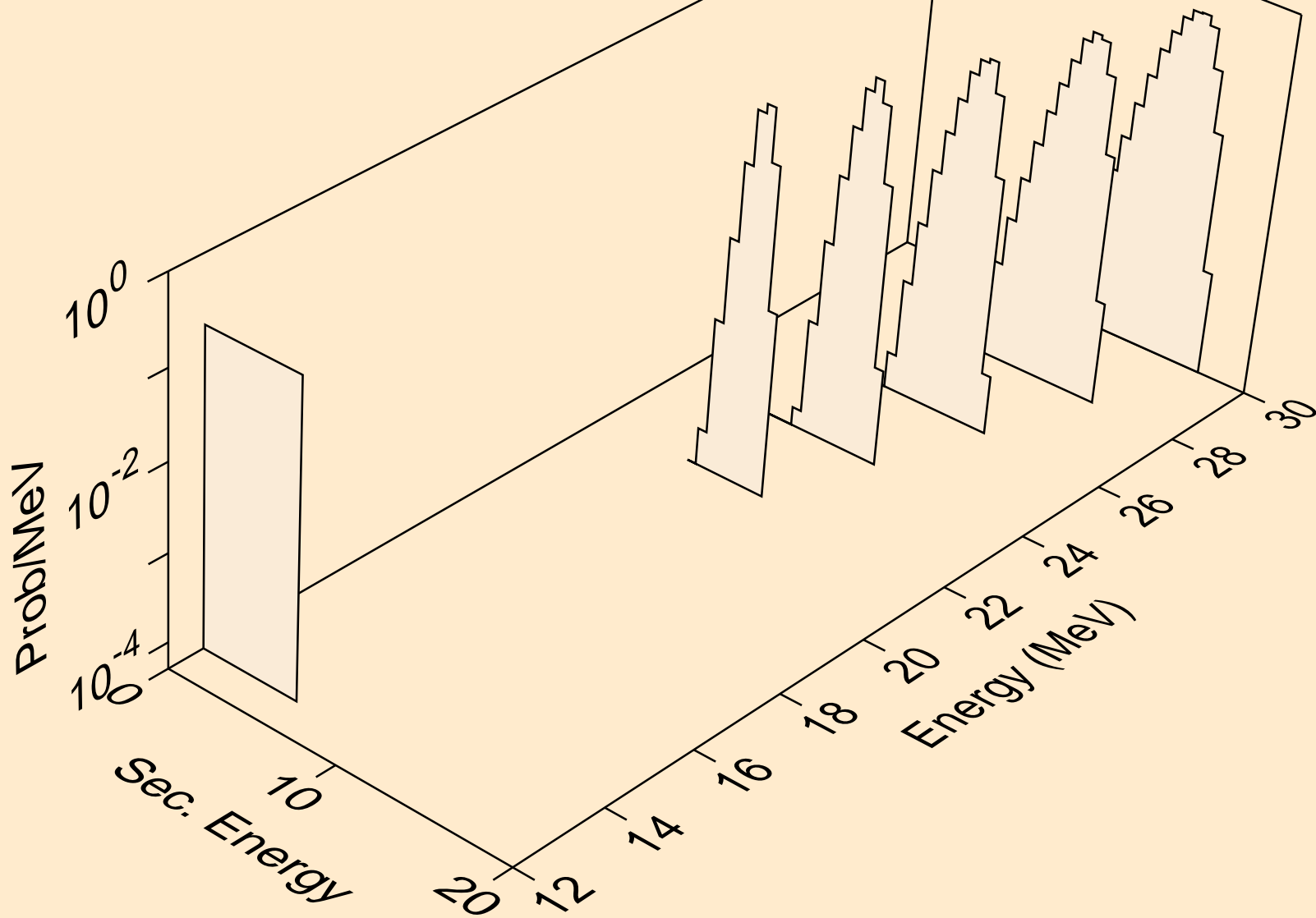

IR198 NEUTRON ACER TENDL-2024 LIBRARY; T=293.6K
alphas from (n,a)

