

K038 NEUTRON ACER TENDL-2024 LIBRARY; T=293.6K

Principal cross sections

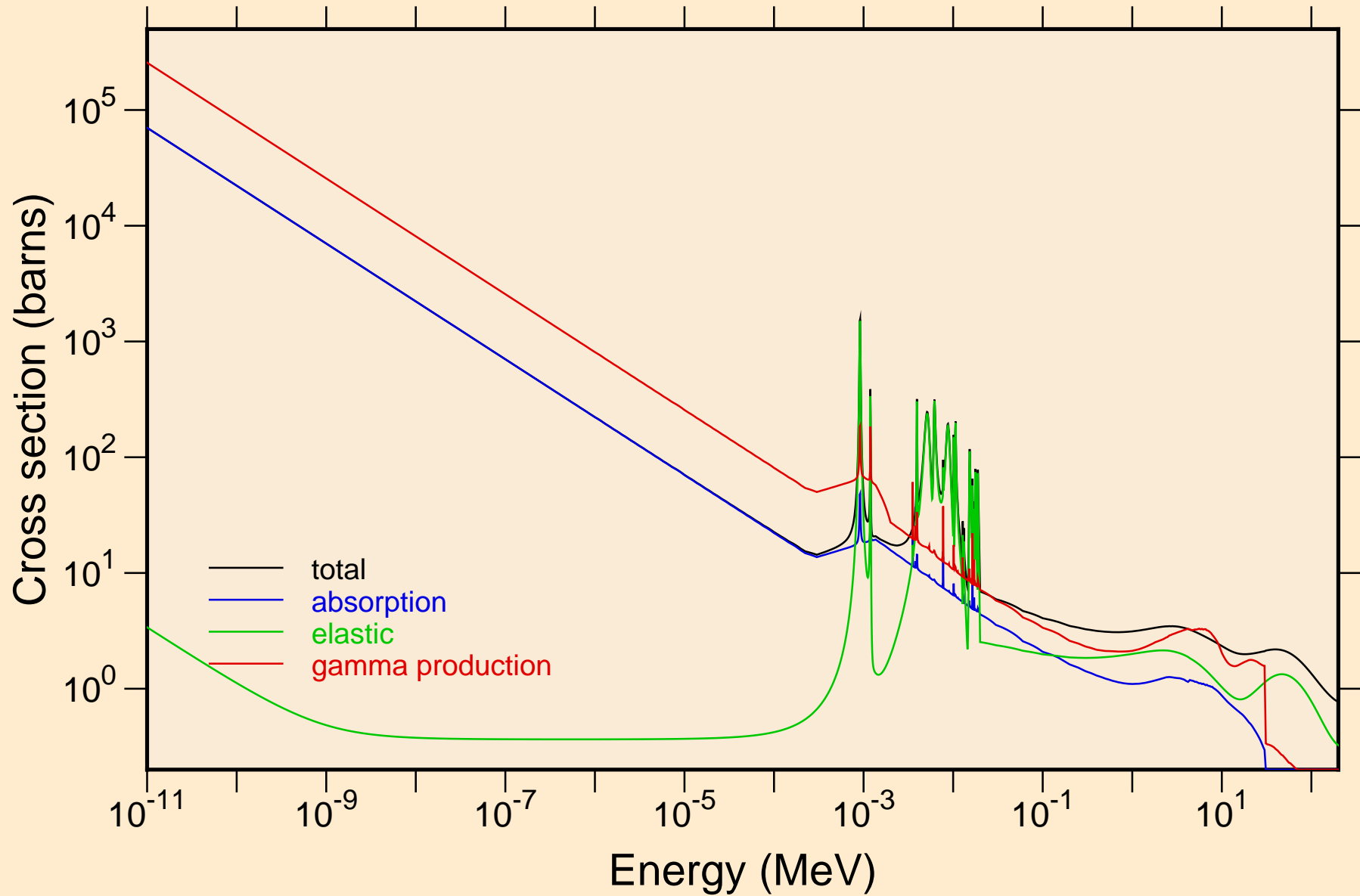

K038 NEUTRON ACER TENDL-2024 LIBRARY; T=293.6K
resonance total cross section

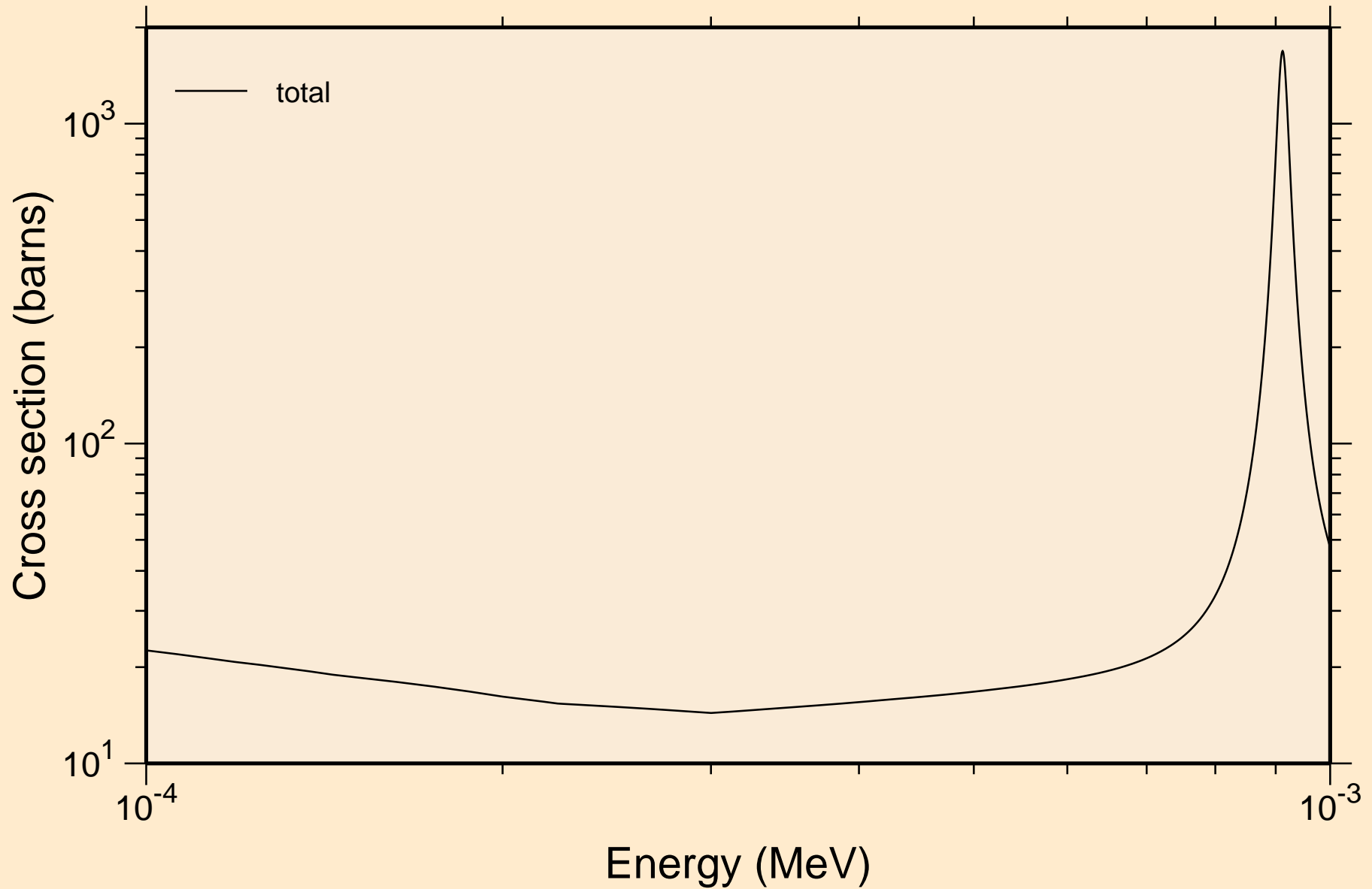

K038 NEUTRON ACER TENDL-2024 LIBRARY; T=293.6K
resonance total cross section

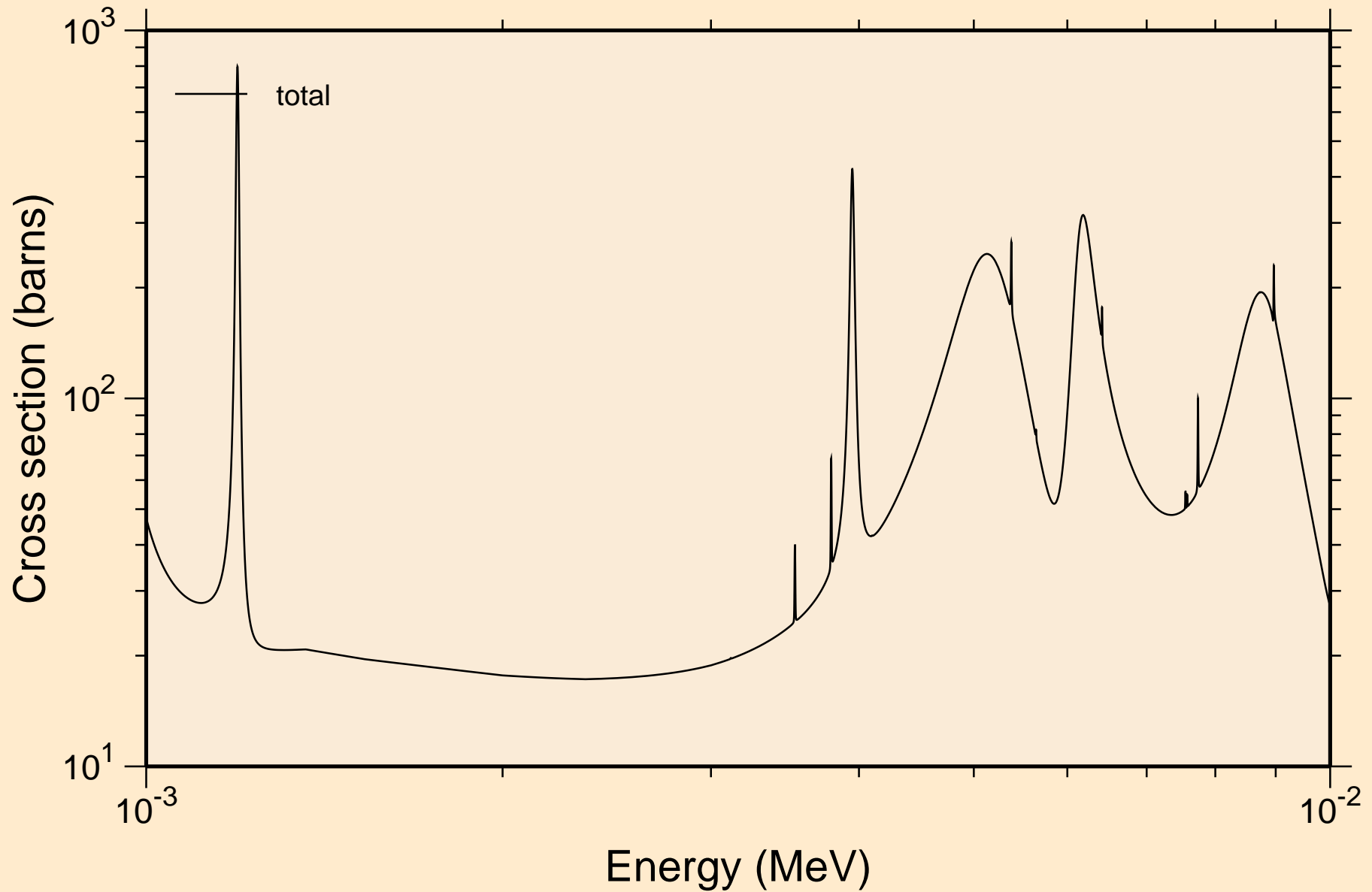

K038 NEUTRON ACER TENDL-2024 LIBRARY; T=293.6K
resonance total cross section

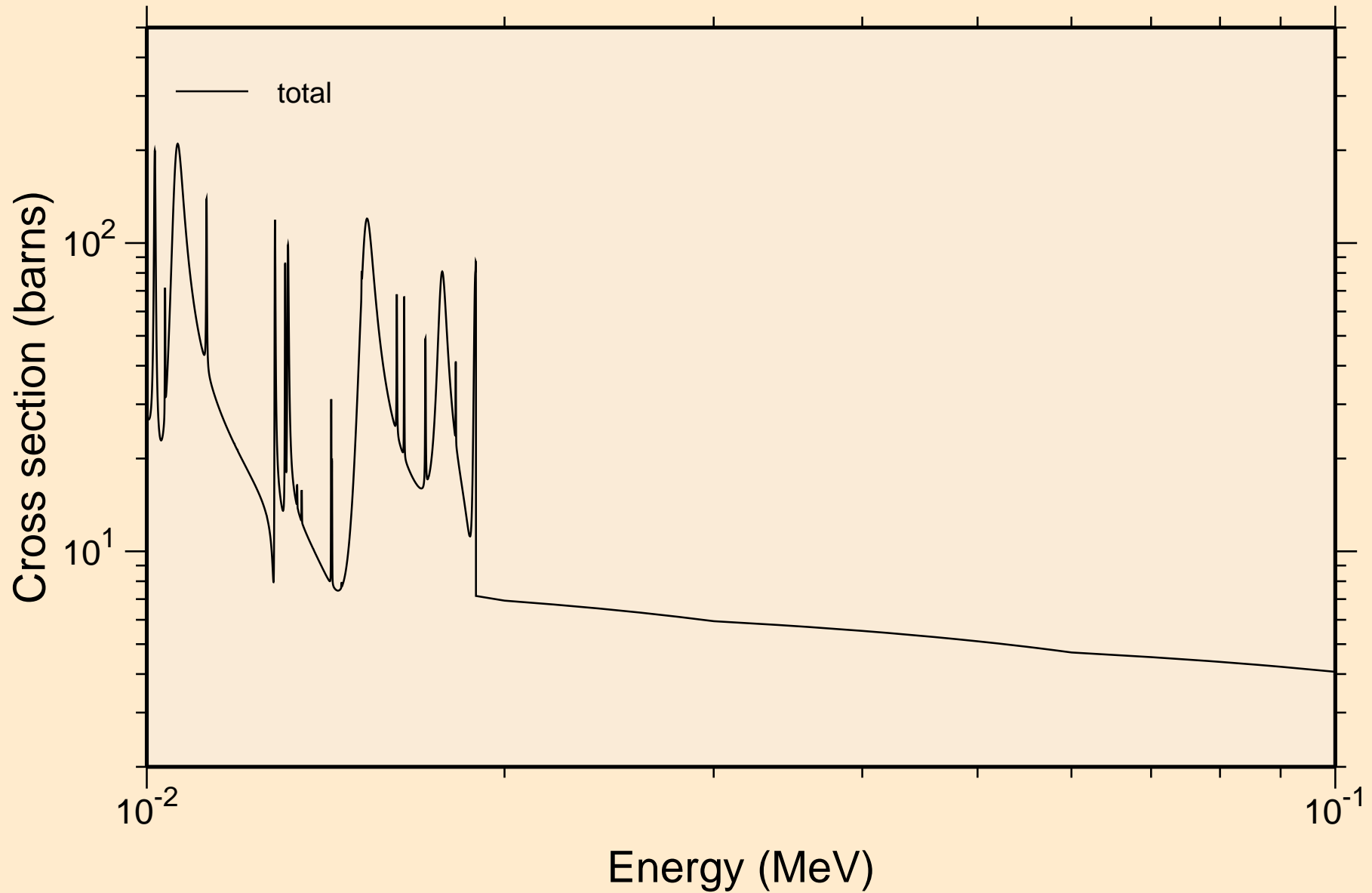

K038 NEUTRON ACER TENDL-2024 LIBRARY; T=293.6K
resonance total cross section

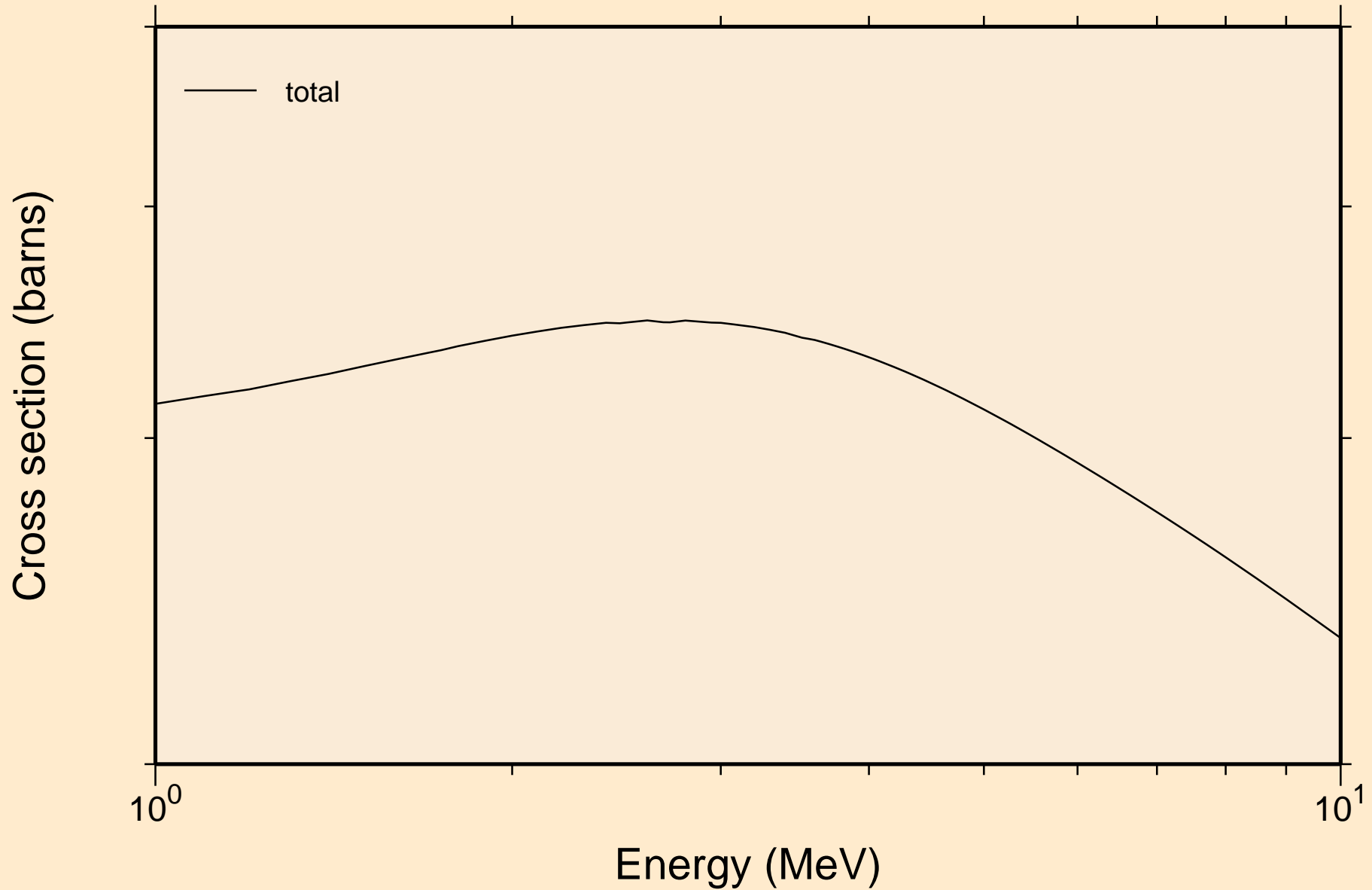

K038 NEUTRON ACER TENDL-2024 LIBRARY; T=293.6K
resonance absorption cross sections

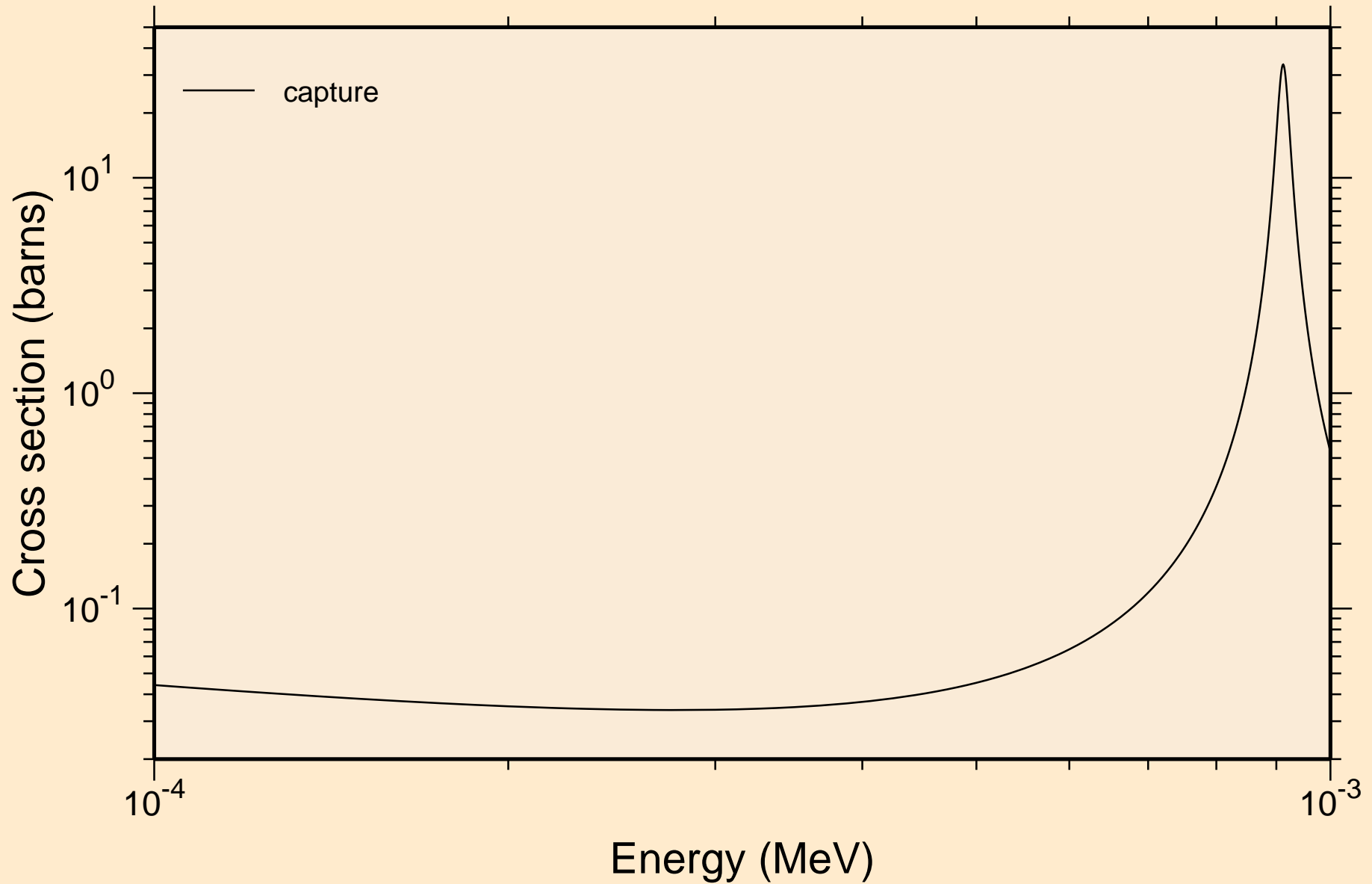

K038 NEUTRON ACER TENDL-2024 LIBRARY; T=293.6K
resonance absorption cross sections

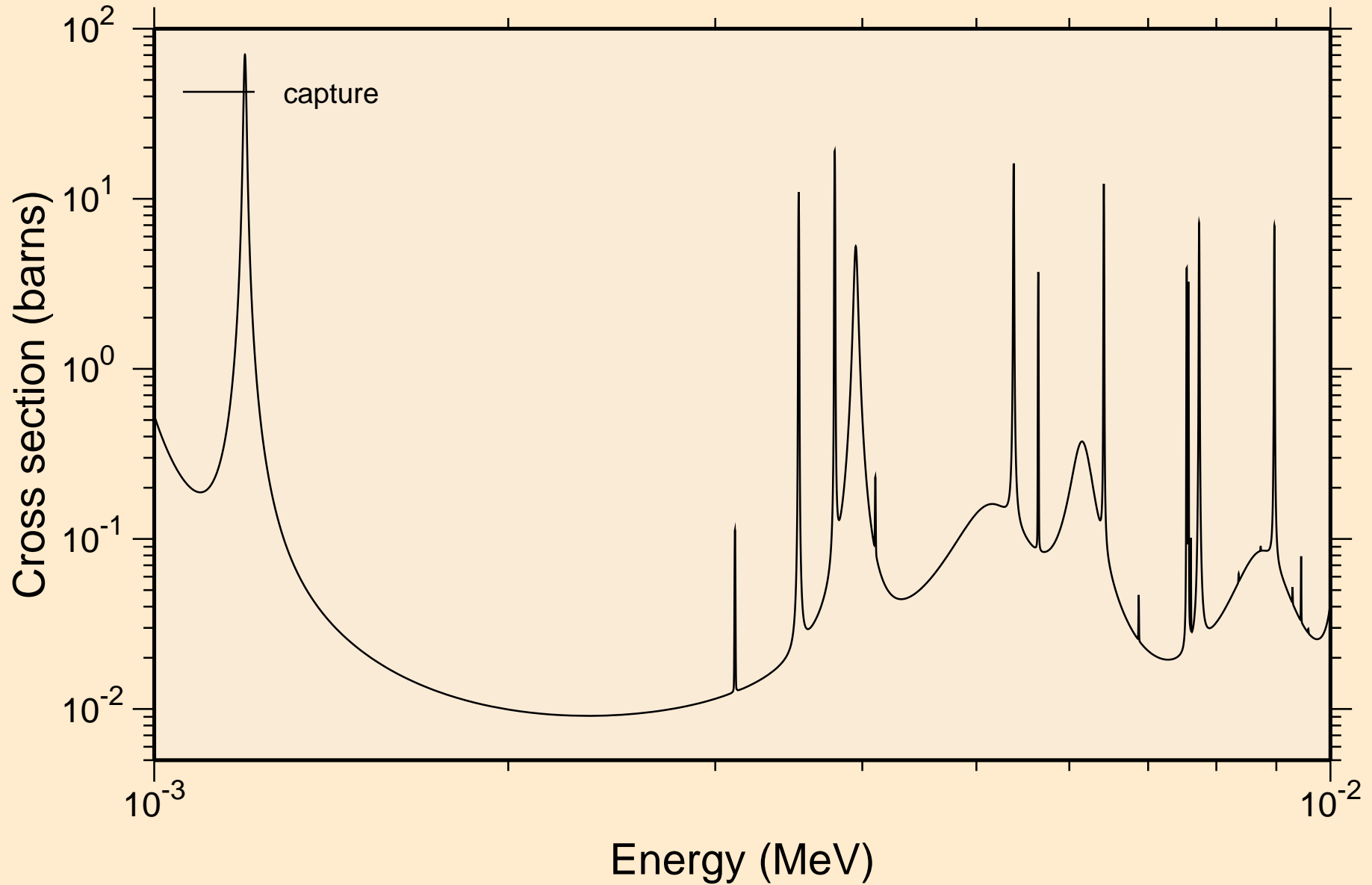

K038 NEUTRON ACER TENDL-2024 LIBRARY; T=293.6K
resonance absorption cross sections

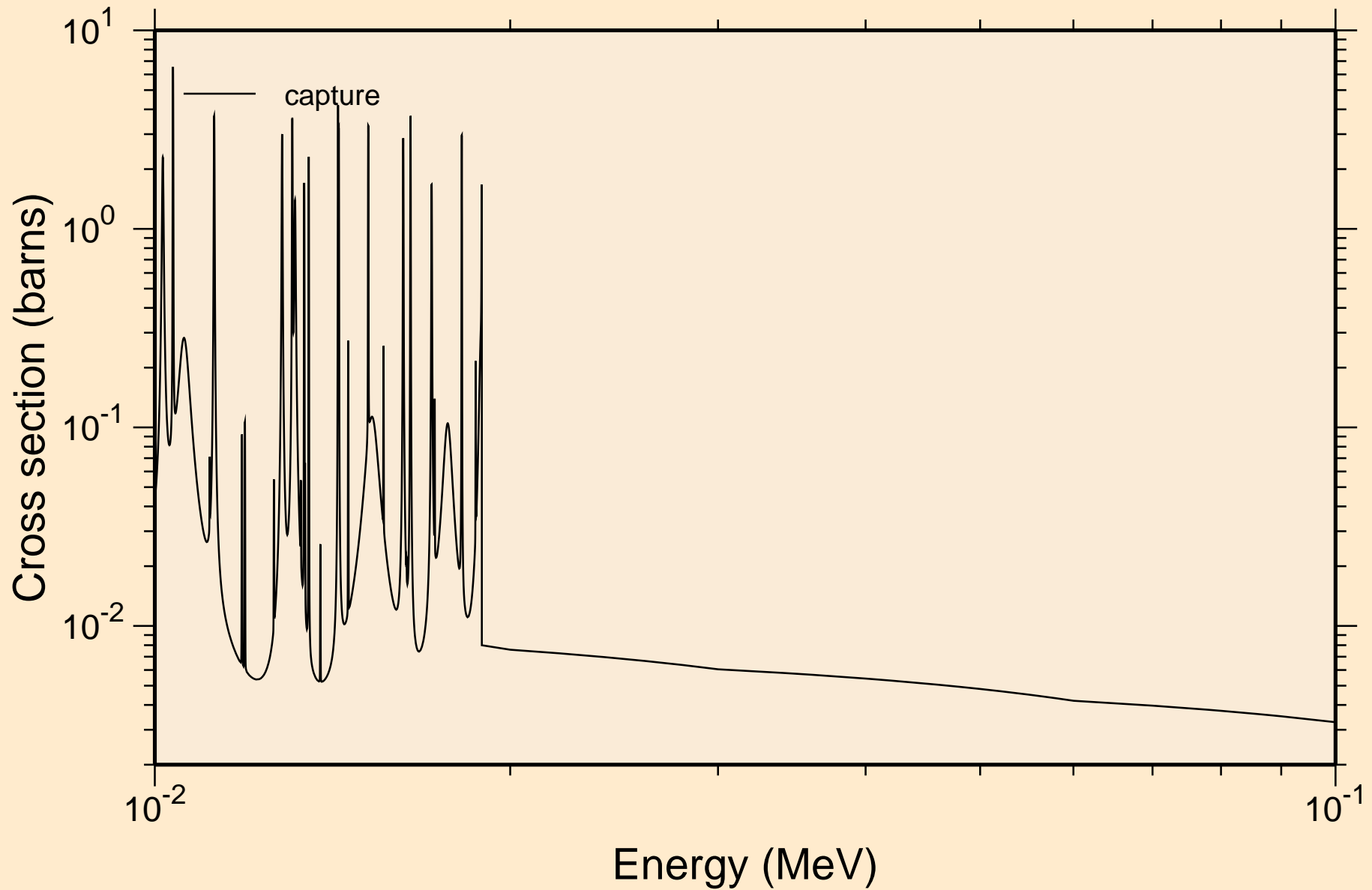

K038 NEUTRON ACER TENDL-2024 LIBRARY; T=293.6K
resonance absorption cross sections

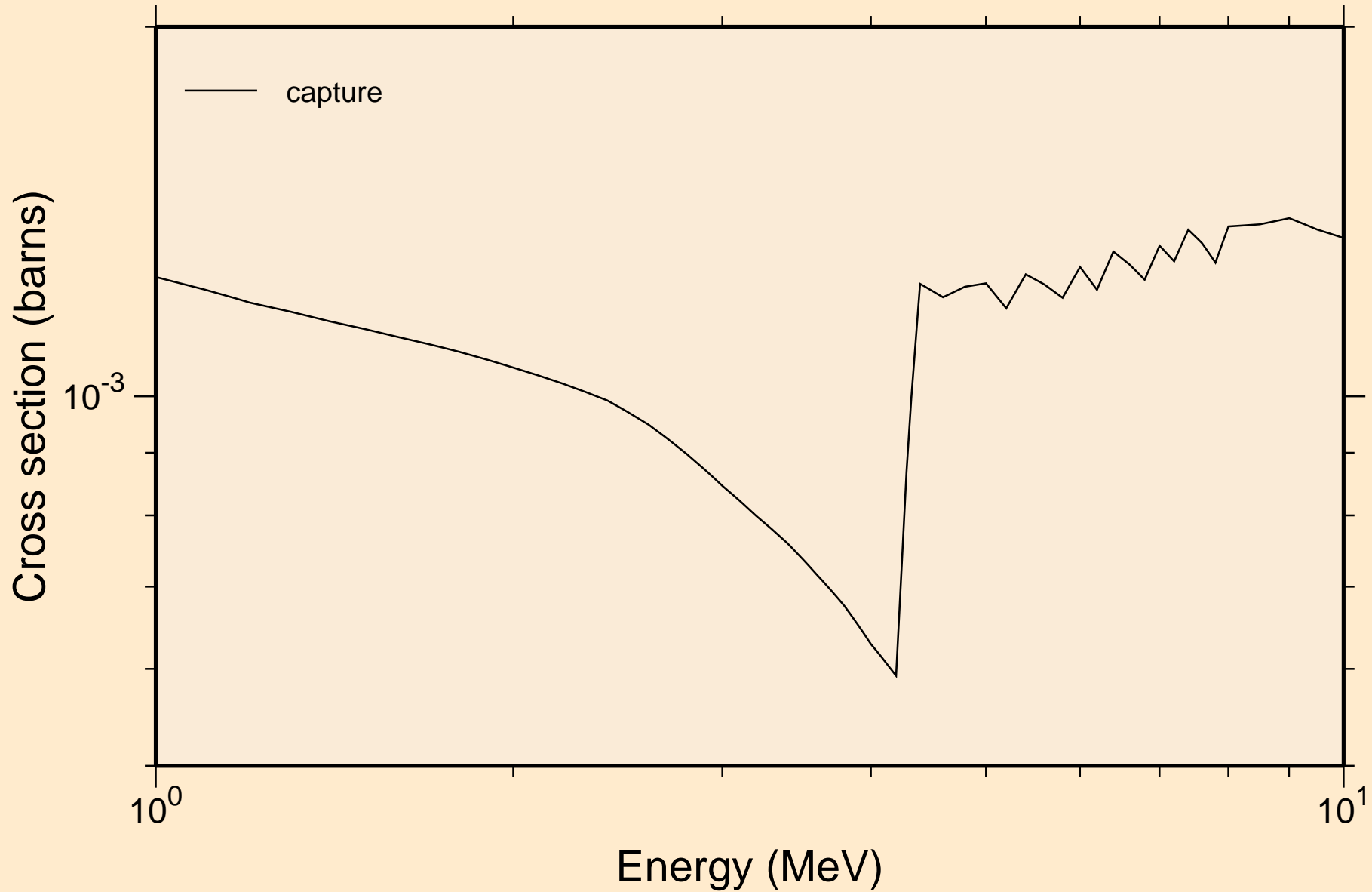

K038 NEUTRON ACER TENDL-2024 LIBRARY; T=293.6K
Heating

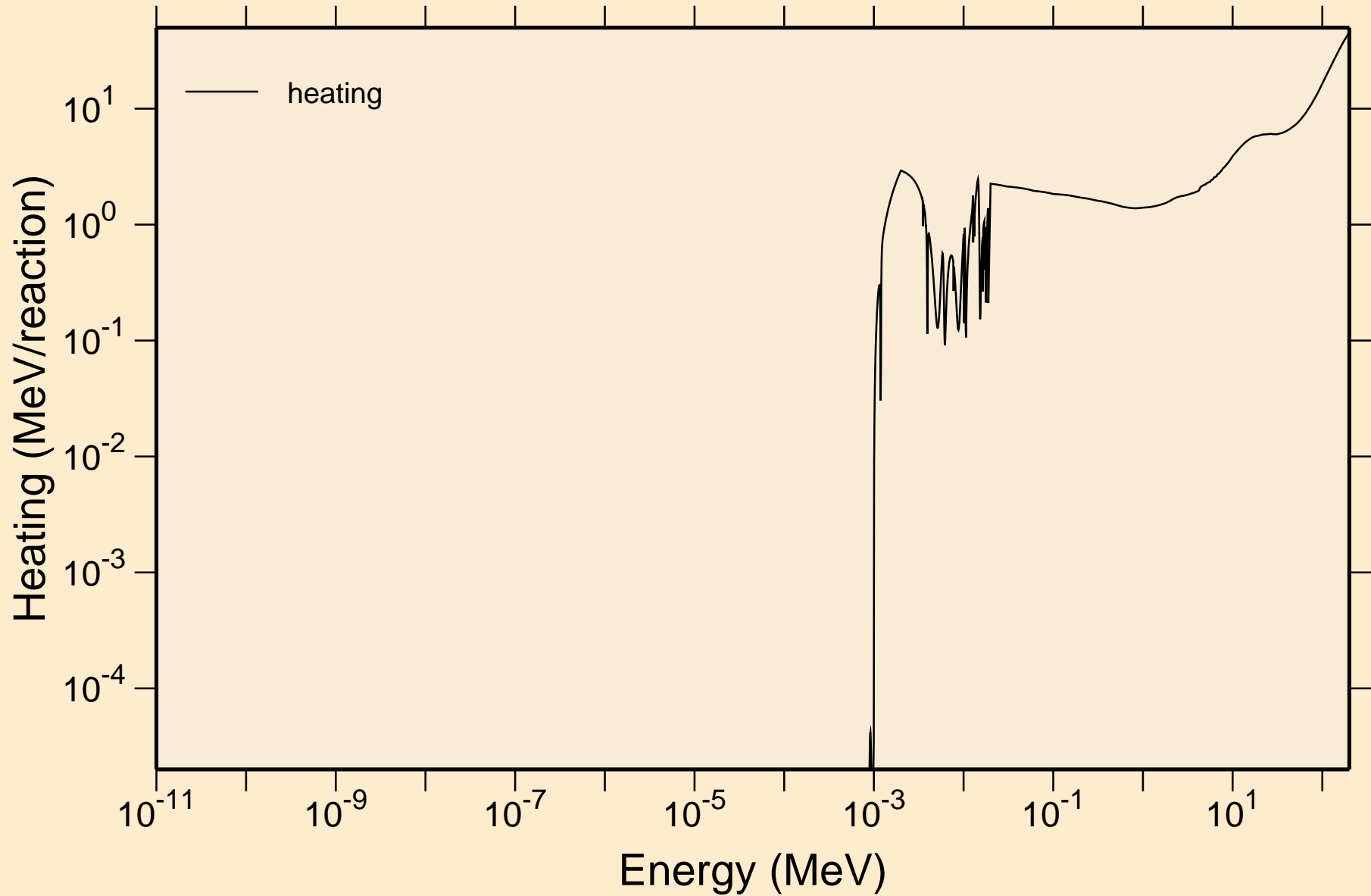

K038 NEUTRON ACER TENDL-2024 LIBRARY; T=293.6K
Damage

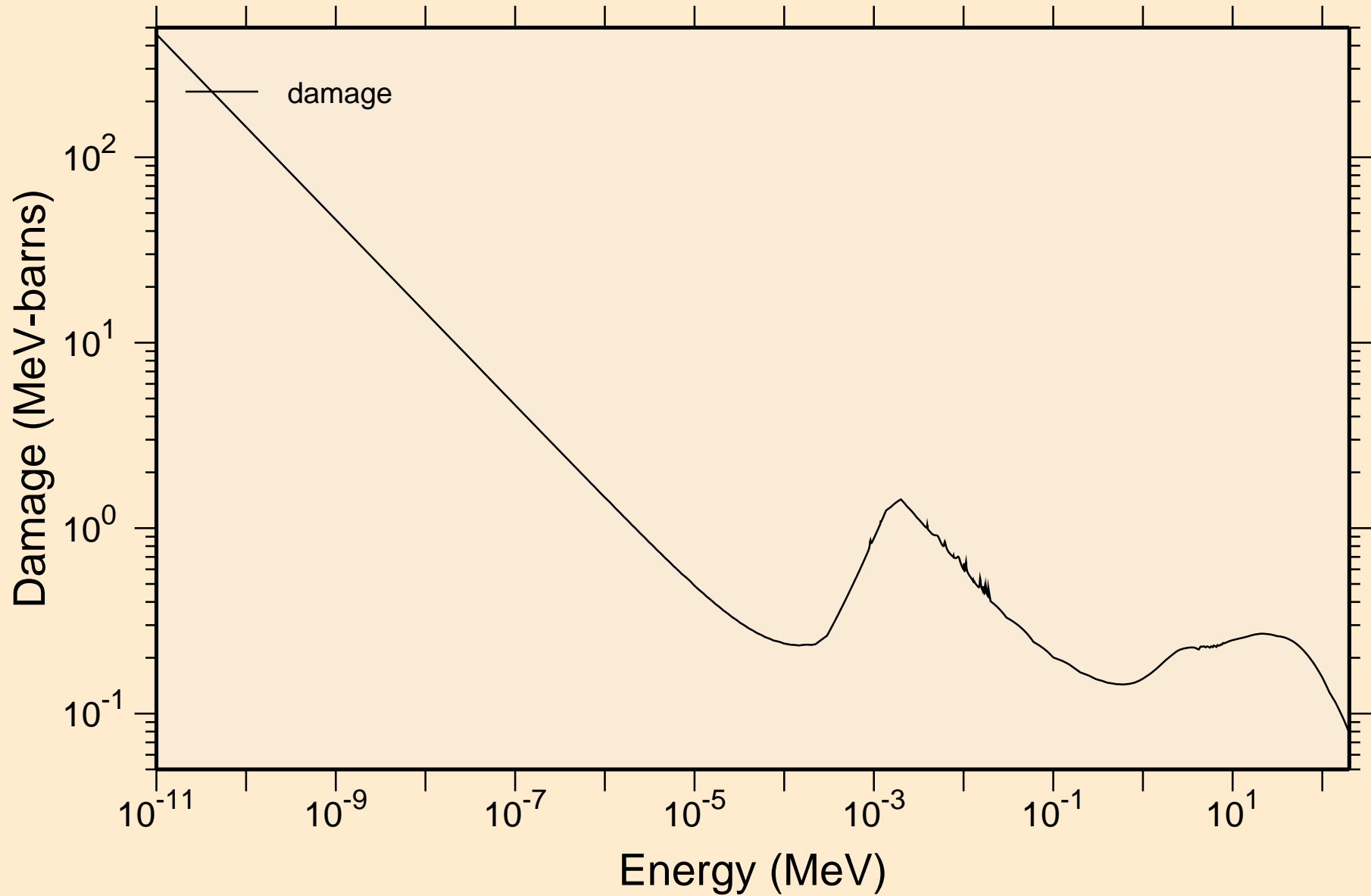

K038 NEUTRON ACER TENDL-2024 LIBRARY; T=293.6K

Non-threshold reactions

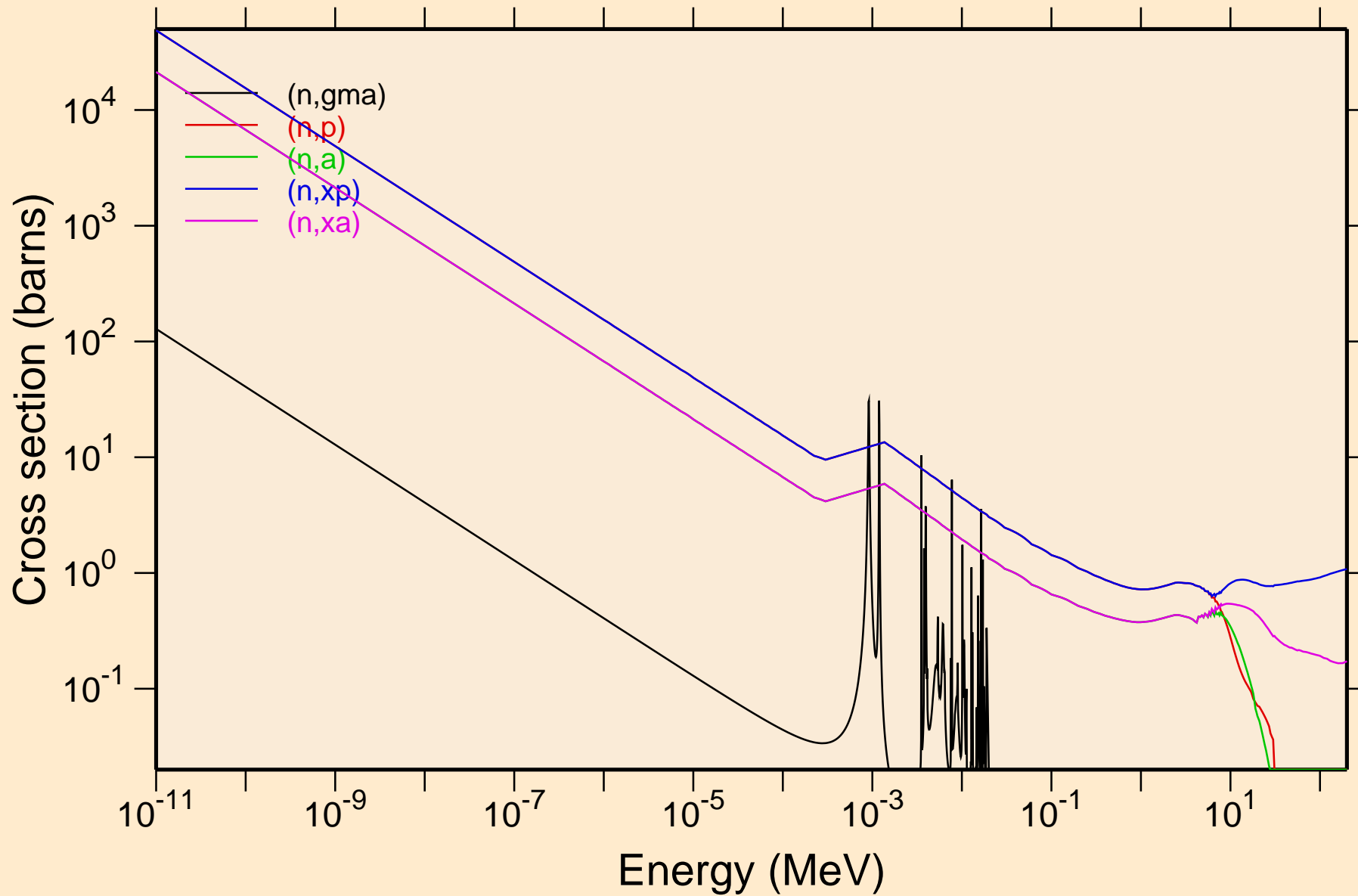

K038 NEUTRON ACER TENDL-2024 LIBRARY; T=293.6K

Principal cross sections

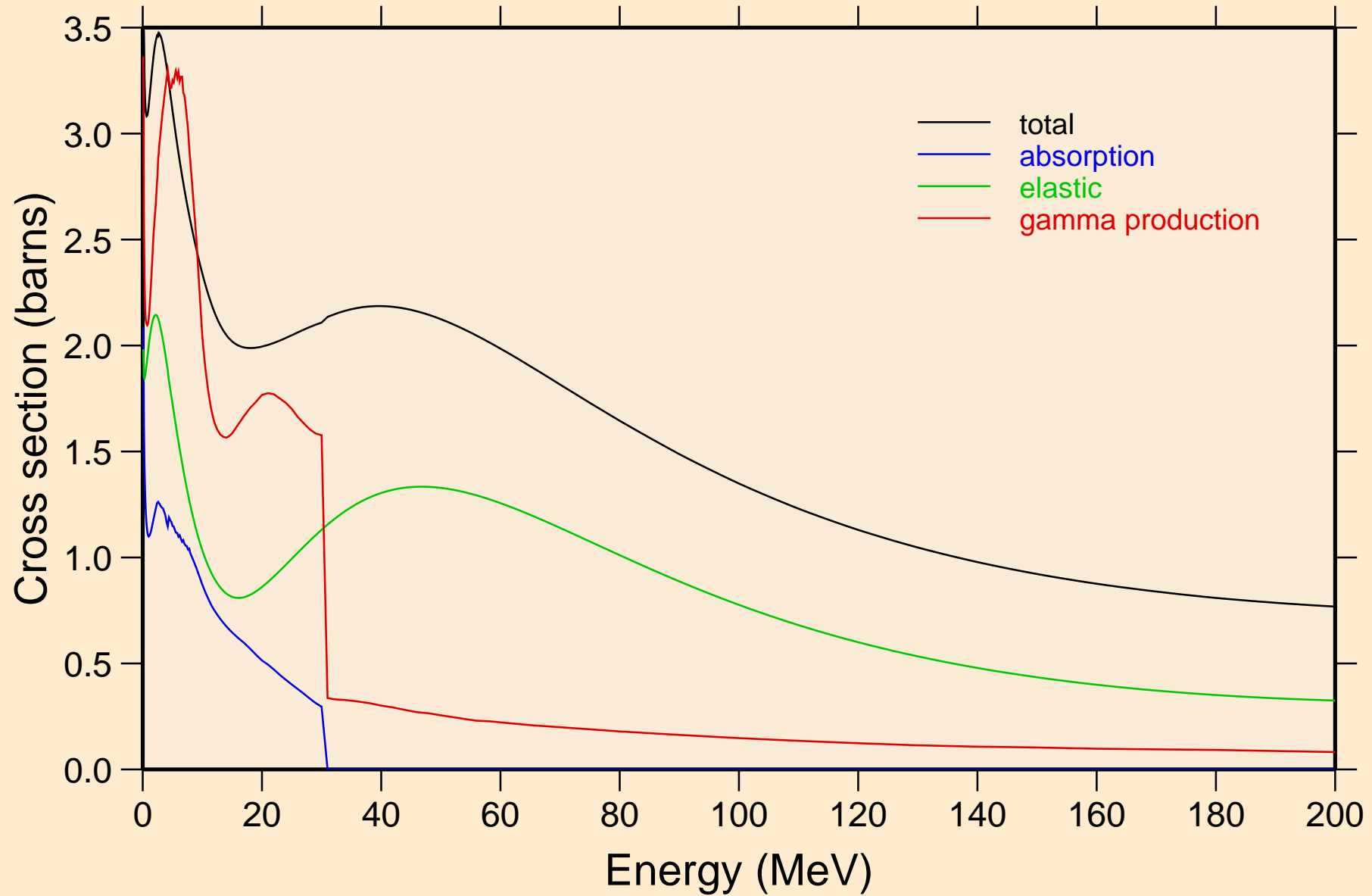

K038 NEUTRON ACER TENDL-2024 LIBRARY; T=293.6K

Heating

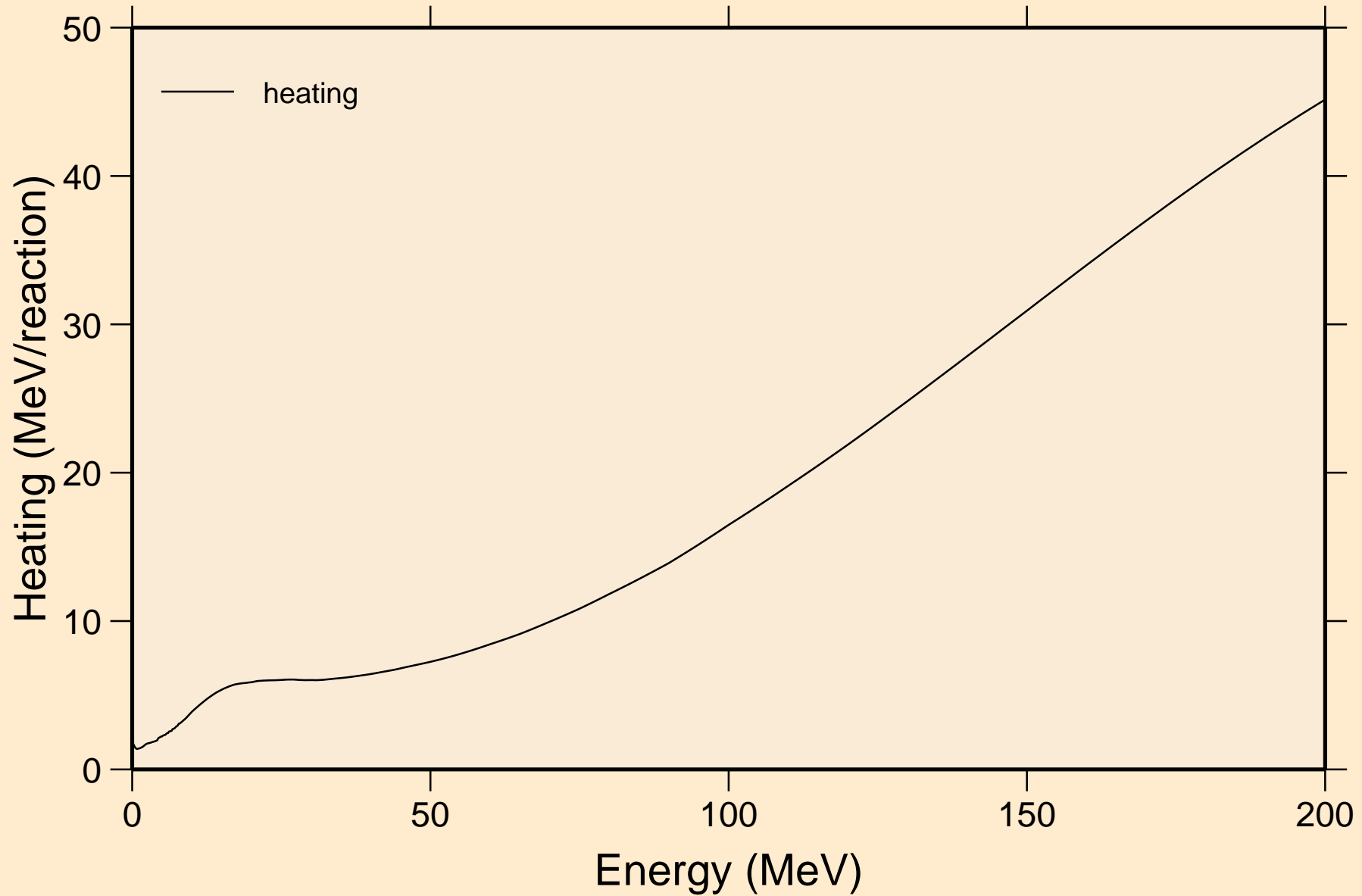

K038 NEUTRON ACER TENDL-2024 LIBRARY; T=293.6K

Damage

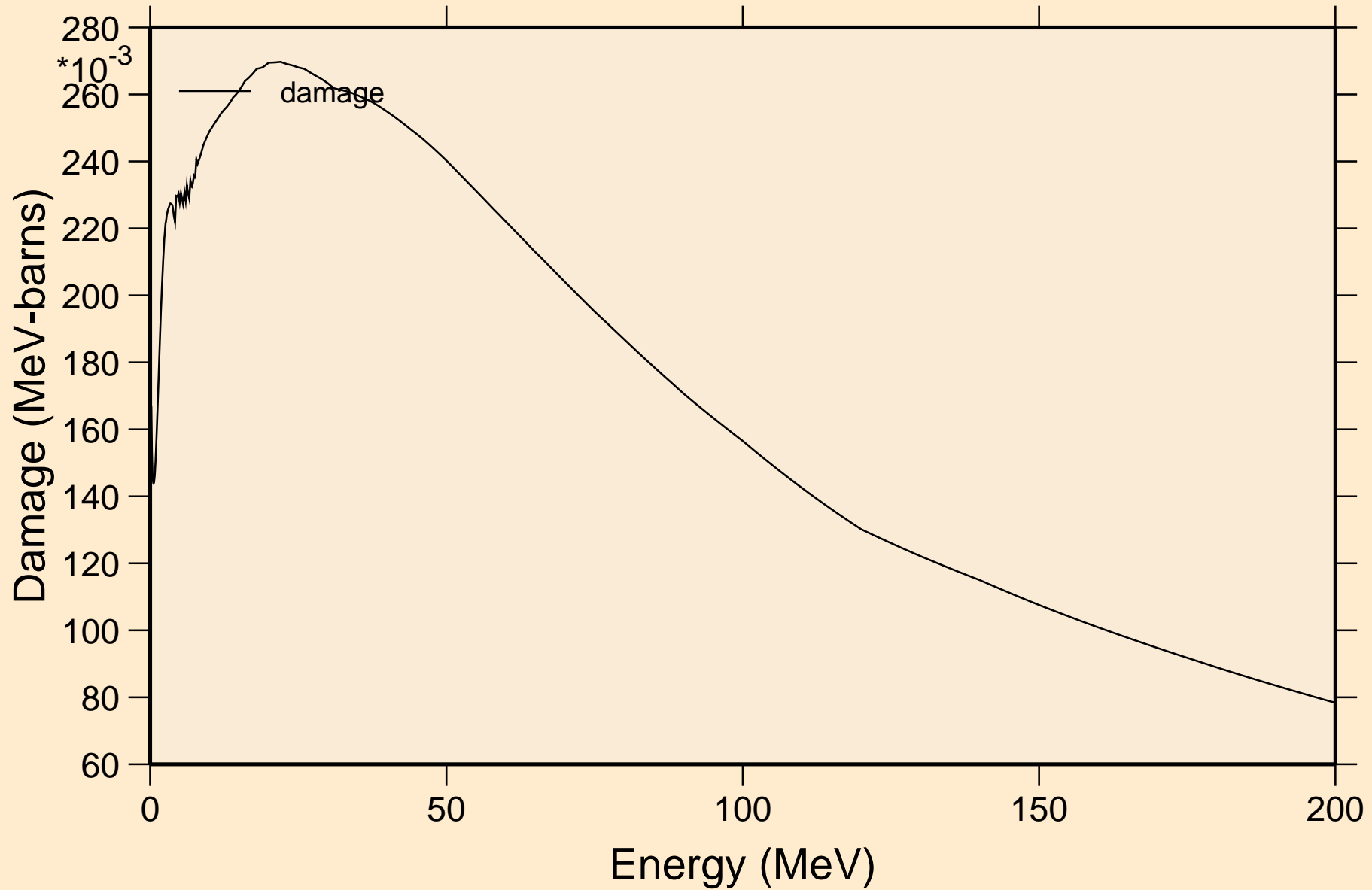

K038 NEUTRON ACER TENDL-2024 LIBRARY; T=293.6K
Non-threshold reactions

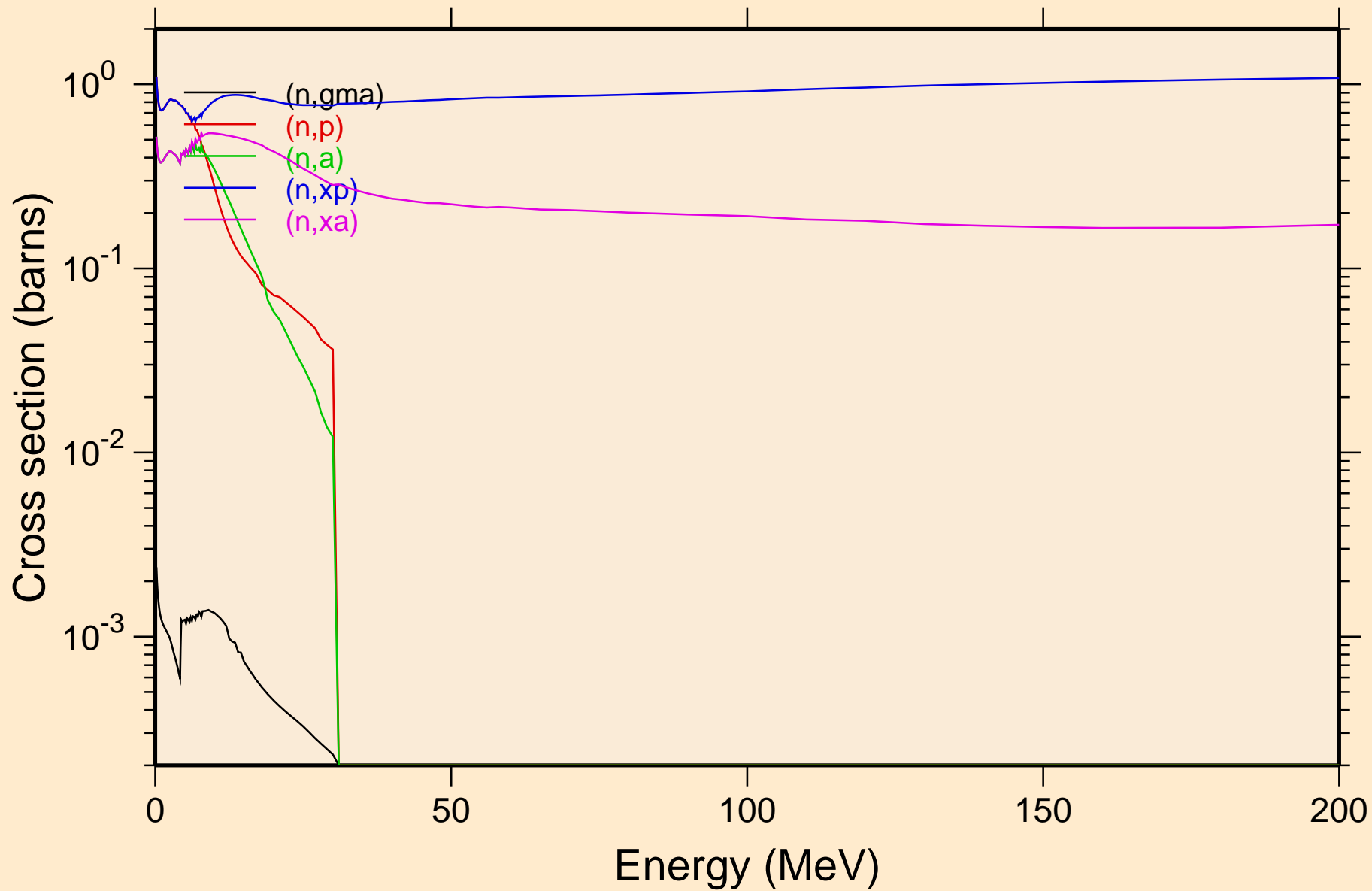

K038 NEUTRON ACER TENDL-2024 LIBRARY; T=293.6K
Inelastic levels

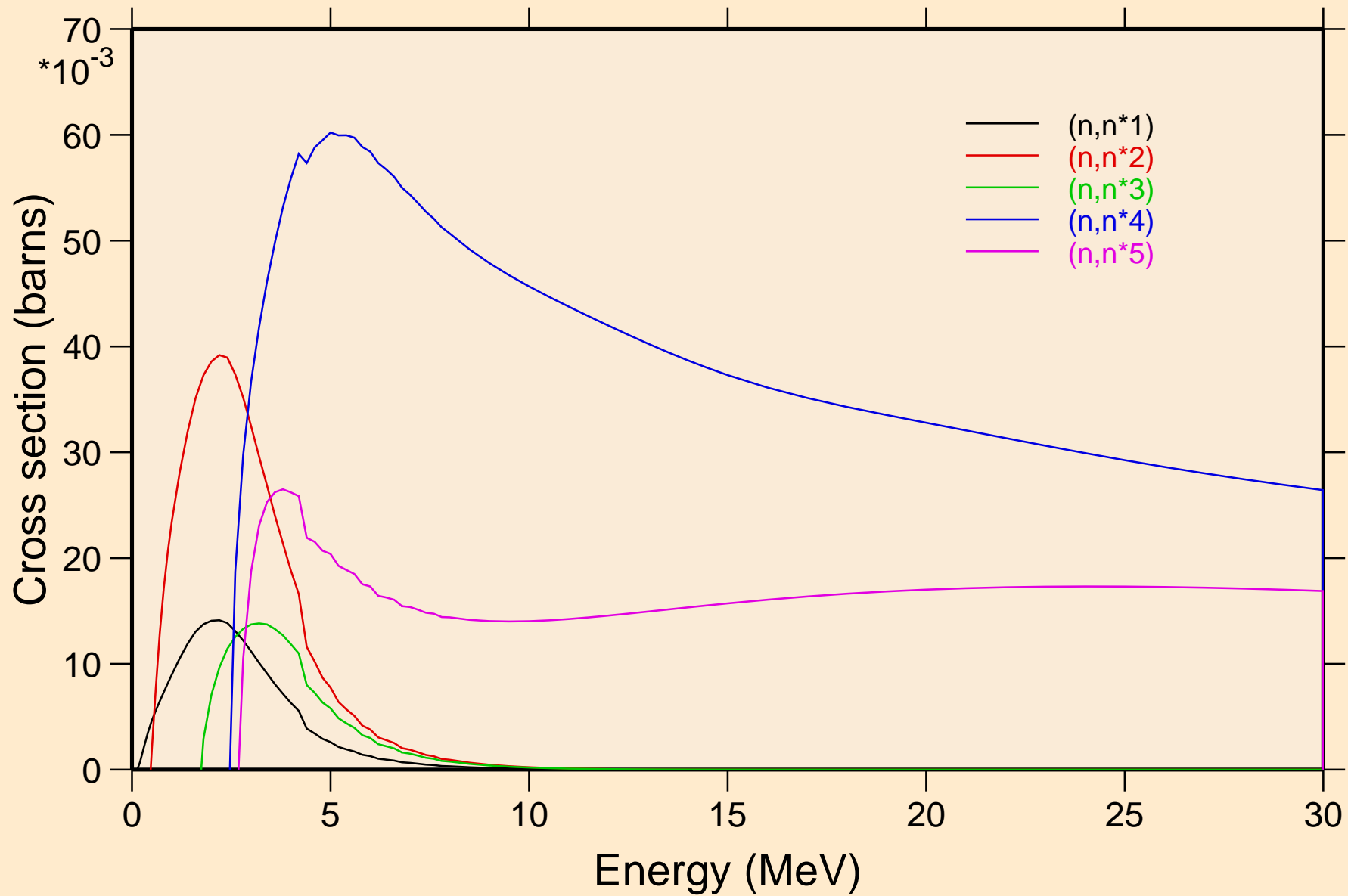

K038 NEUTRON ACER TENDL-2024 LIBRARY; T=293.6K
Inelastic levels

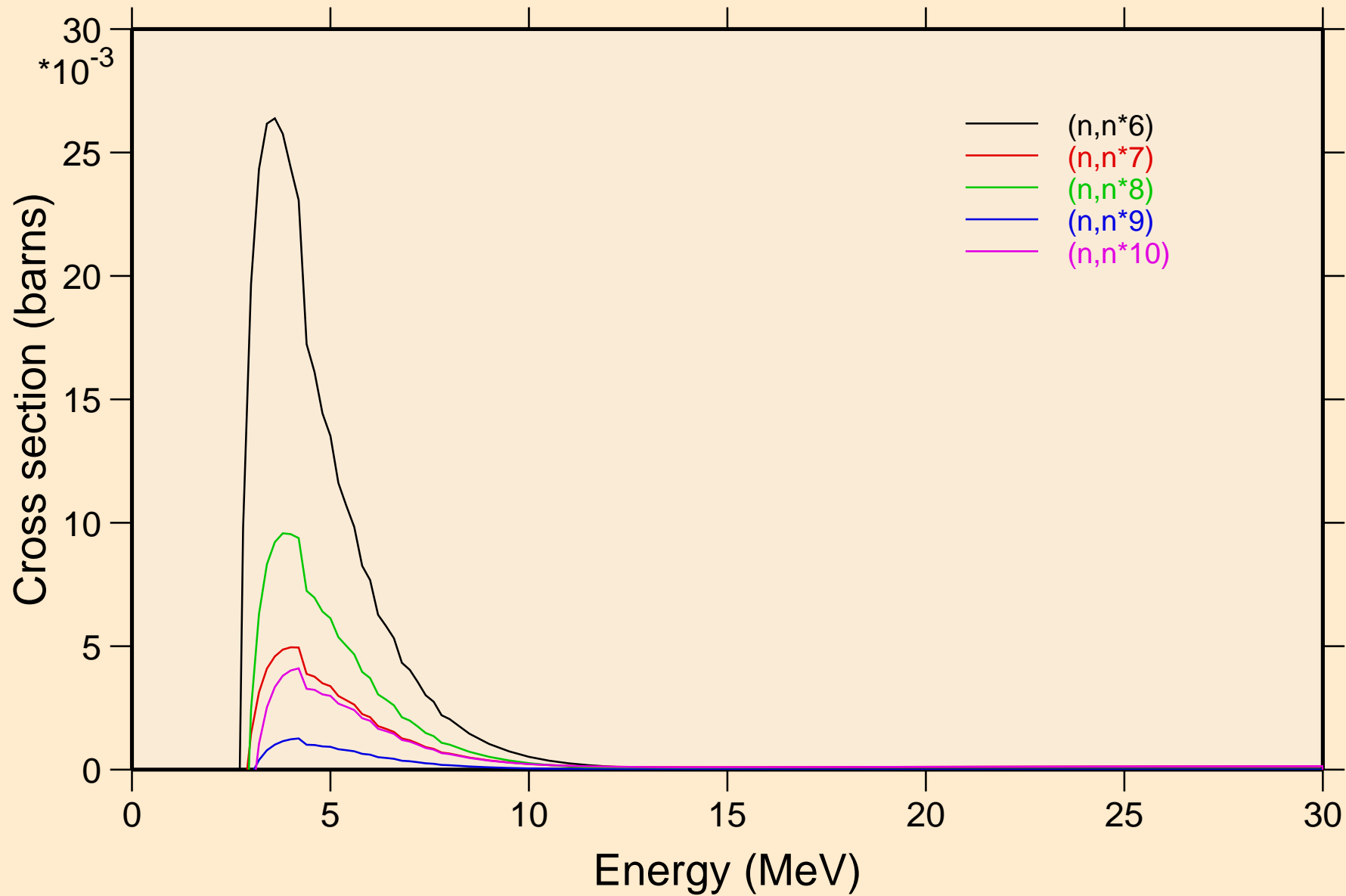

K038 NEUTRON ACER TENDL-2024 LIBRARY; T=293.6K
Inelastic levels

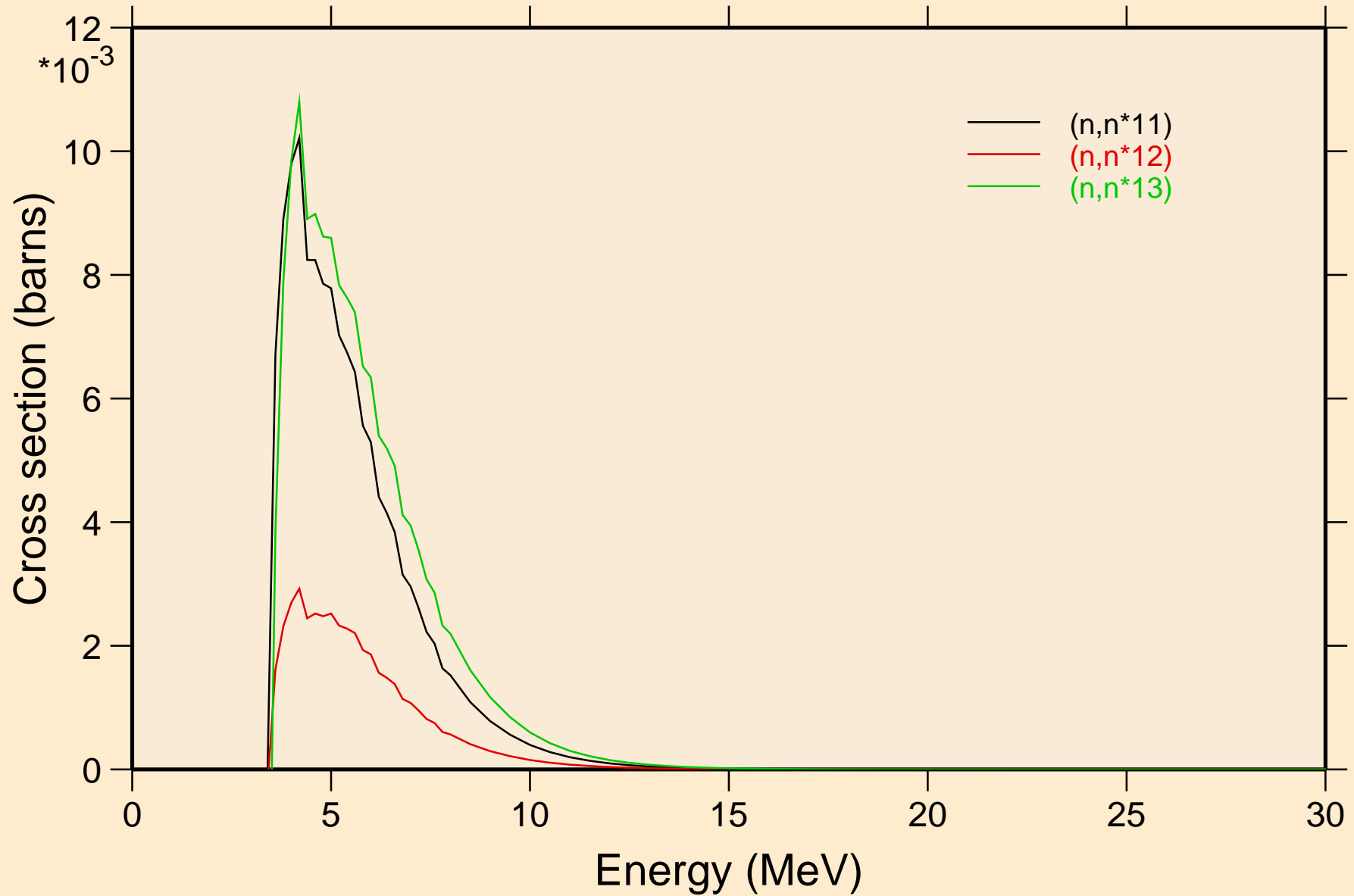

K038 NEUTRON ACER TENDL-2024 LIBRARY; T=293.6K

Threshold reactions

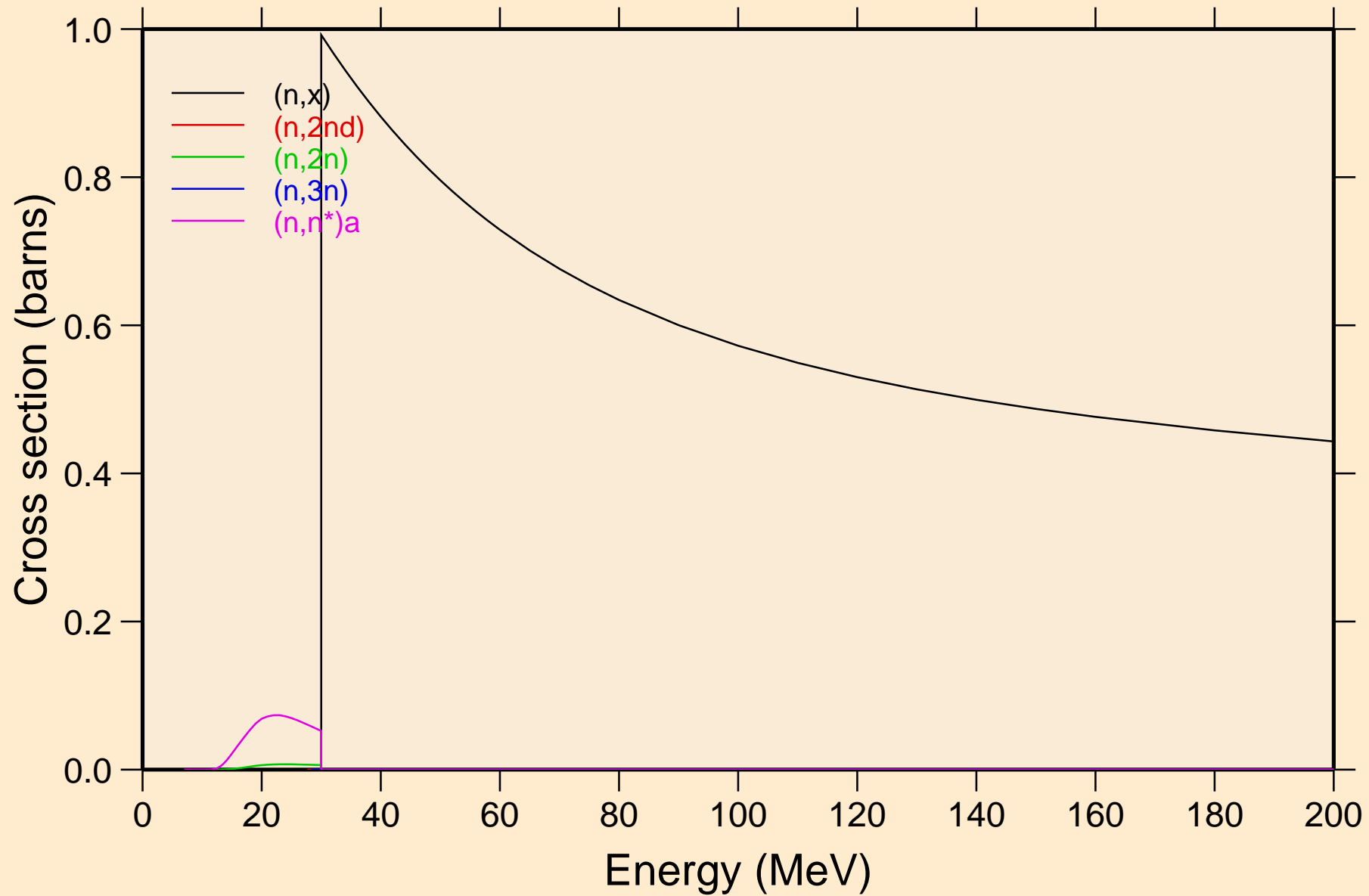

K038 NEUTRON ACER TENDL-2024 LIBRARY; T=293.6K

Threshold reactions

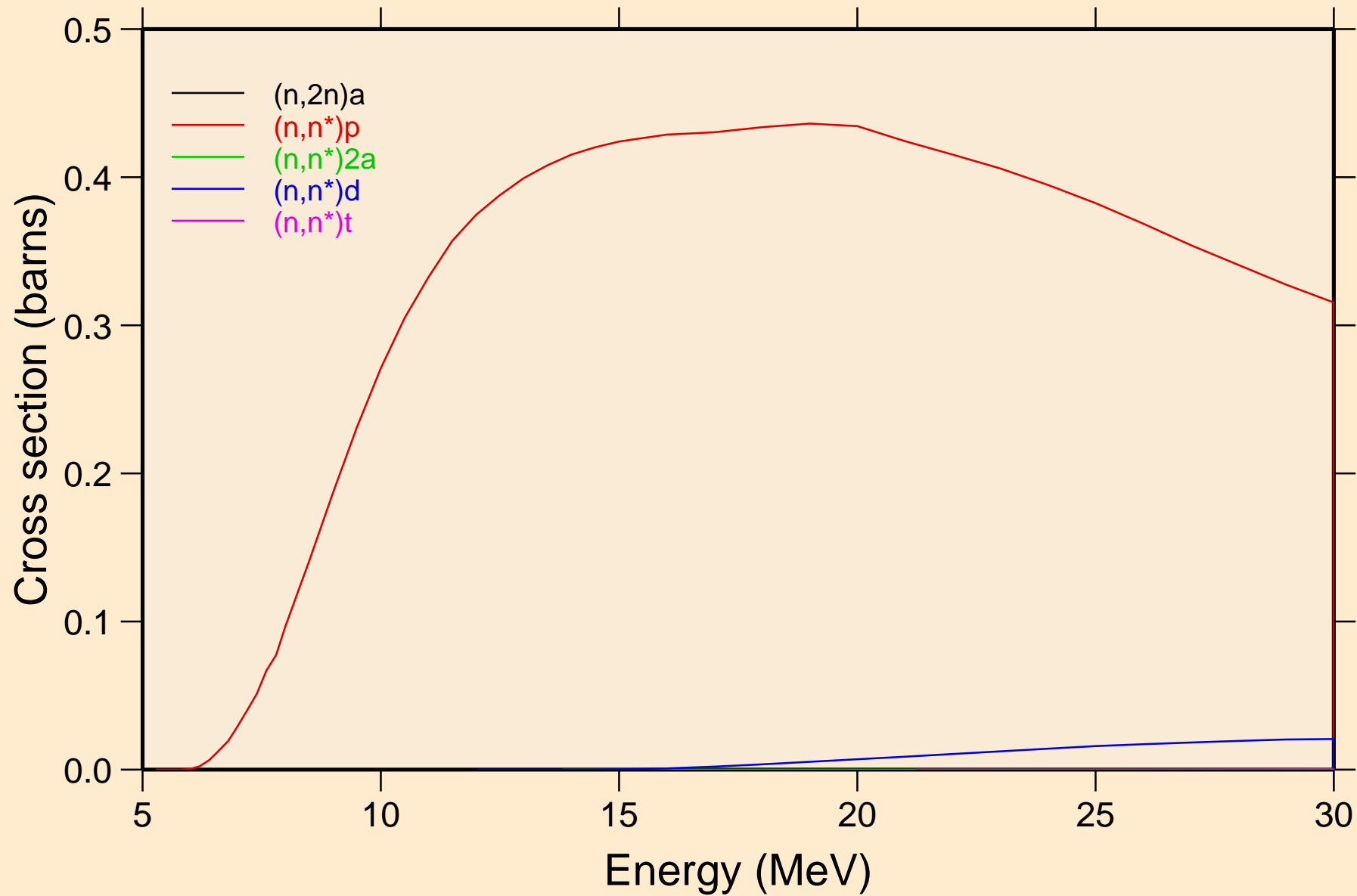

K038 NEUTRON ACER TENDL-2024 LIBRARY; T=293.6K

Threshold reactions

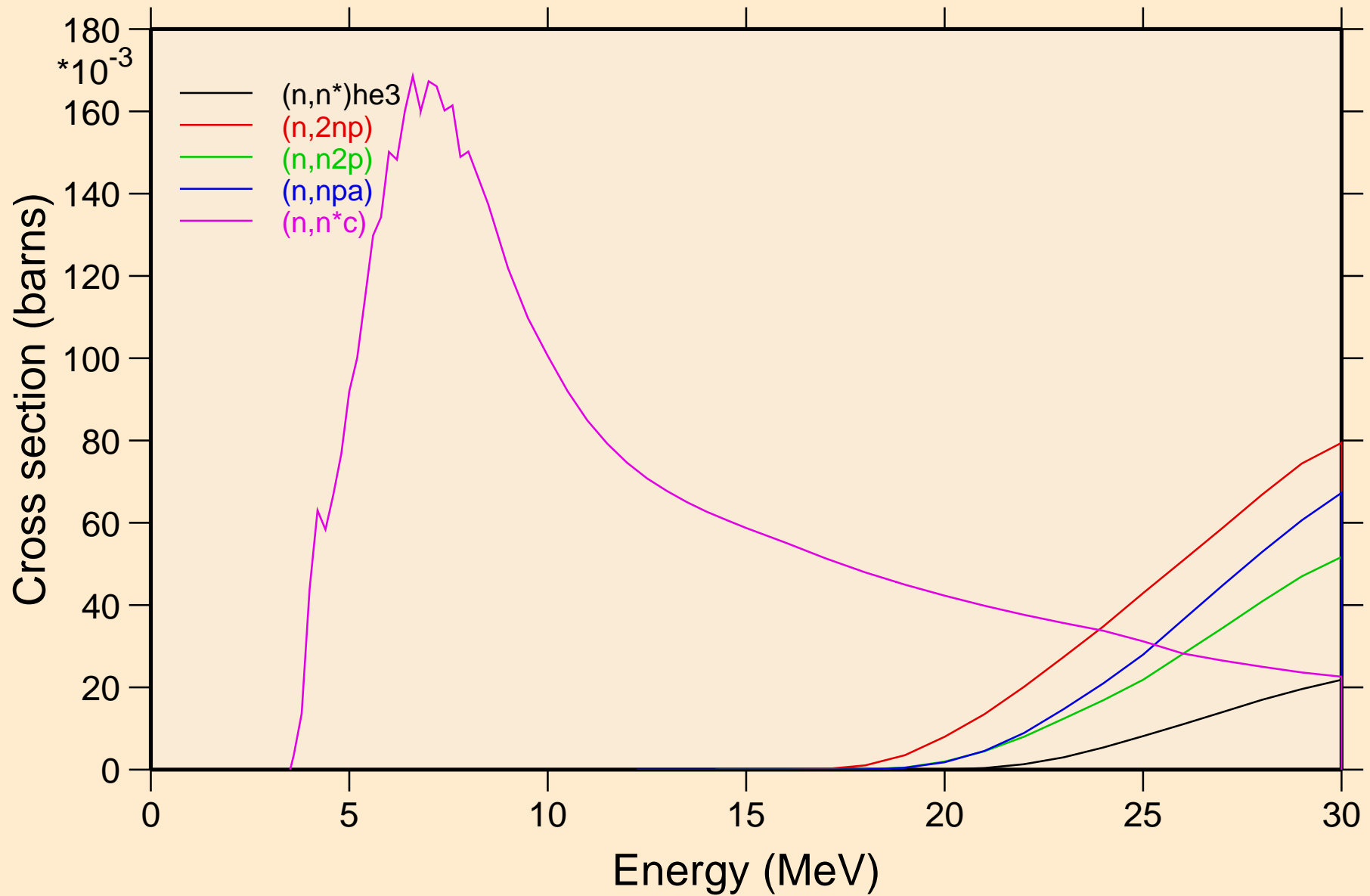

K038 NEUTRON ACER TENDL-2024 LIBRARY; T=293.6K
Threshold reactions

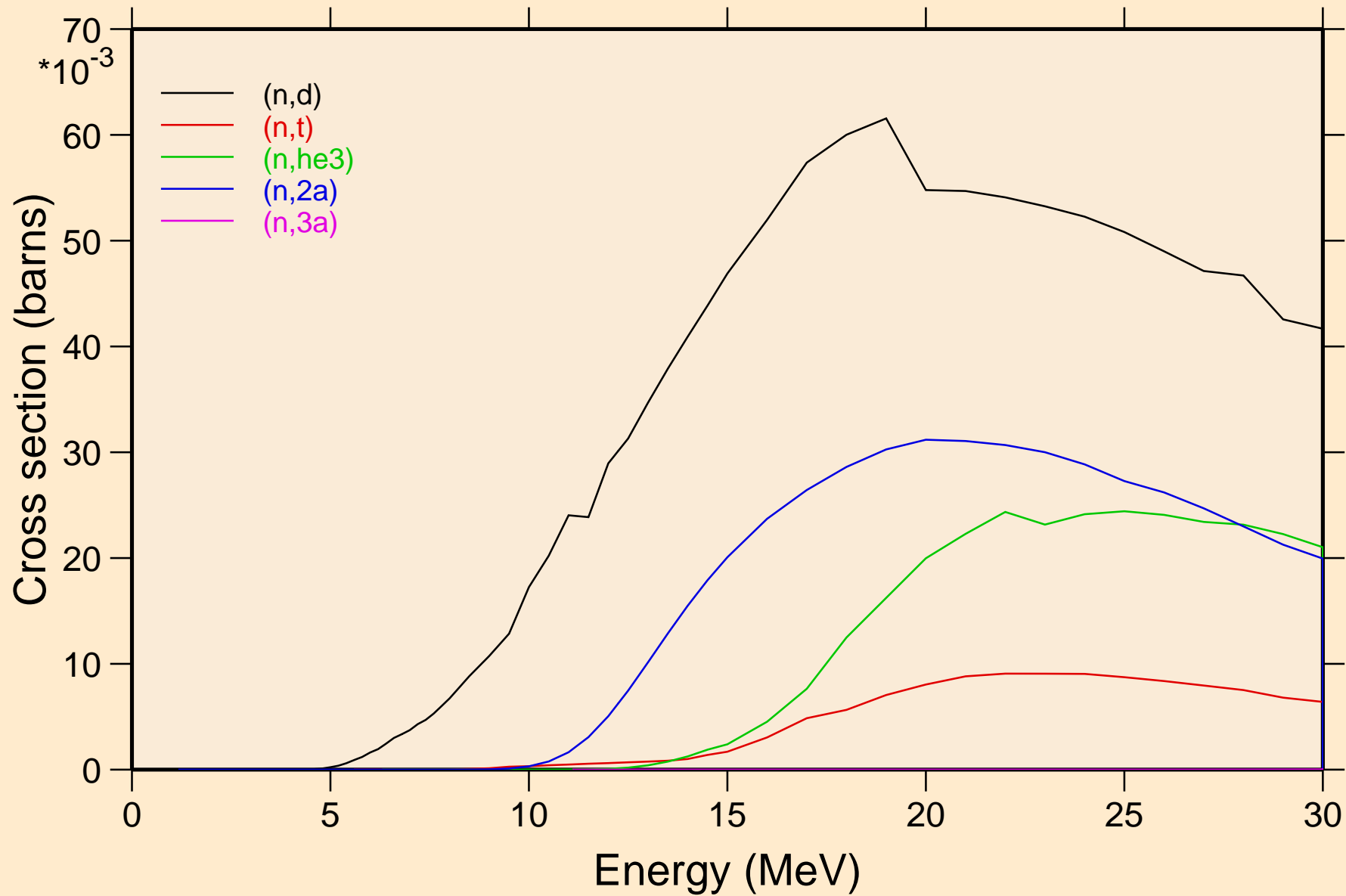

K038 NEUTRON ACER TENDL-2024 LIBRARY; T=293.6K

Threshold reactions

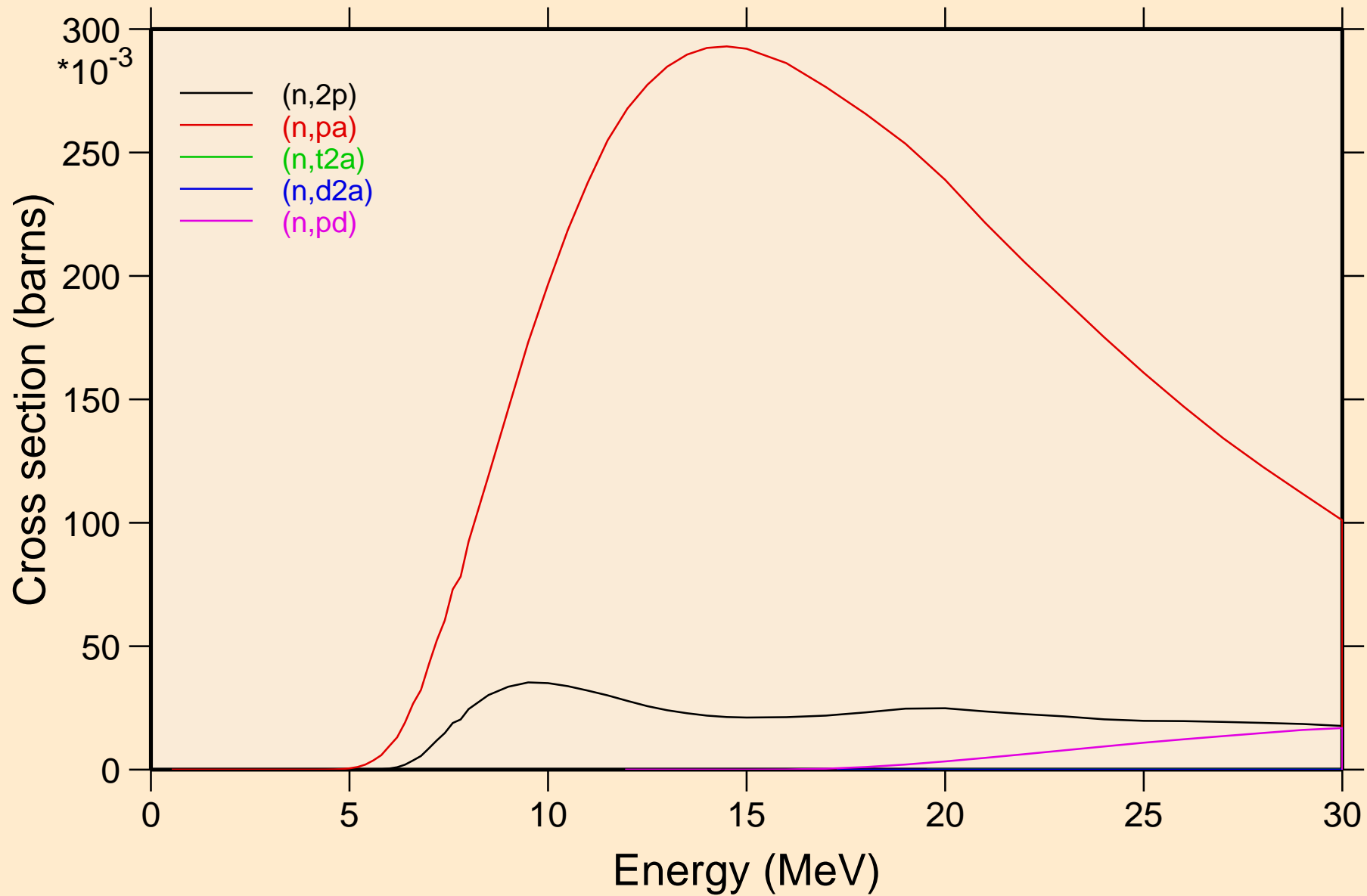

K038 NEUTRON ACER TENDL-2024 LIBRARY; T=293.6K
Threshold reactions

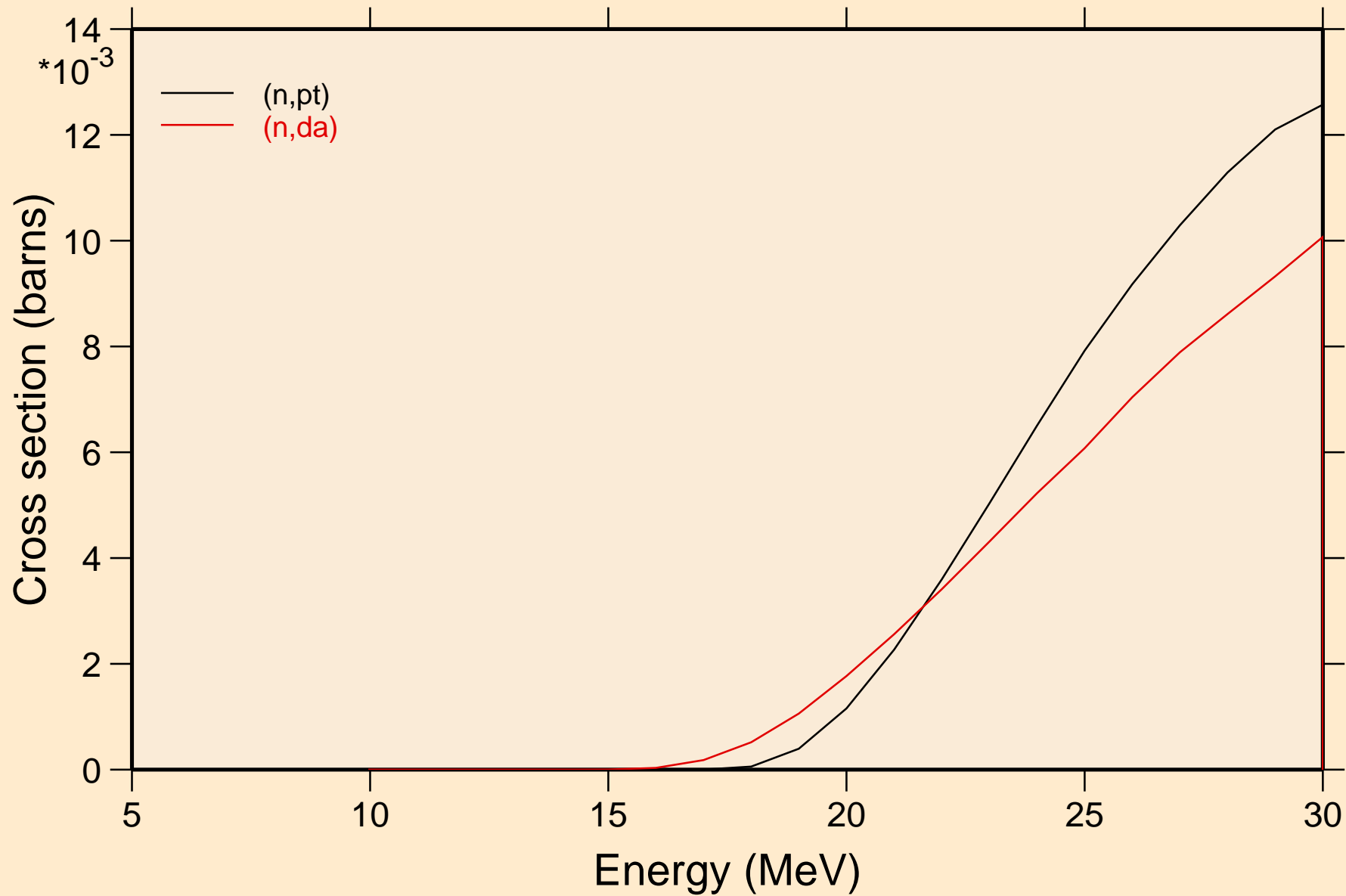

K038 NEUTRON ACER TENDL-2024 LIBRARY; T=293.6K

Threshold reactions

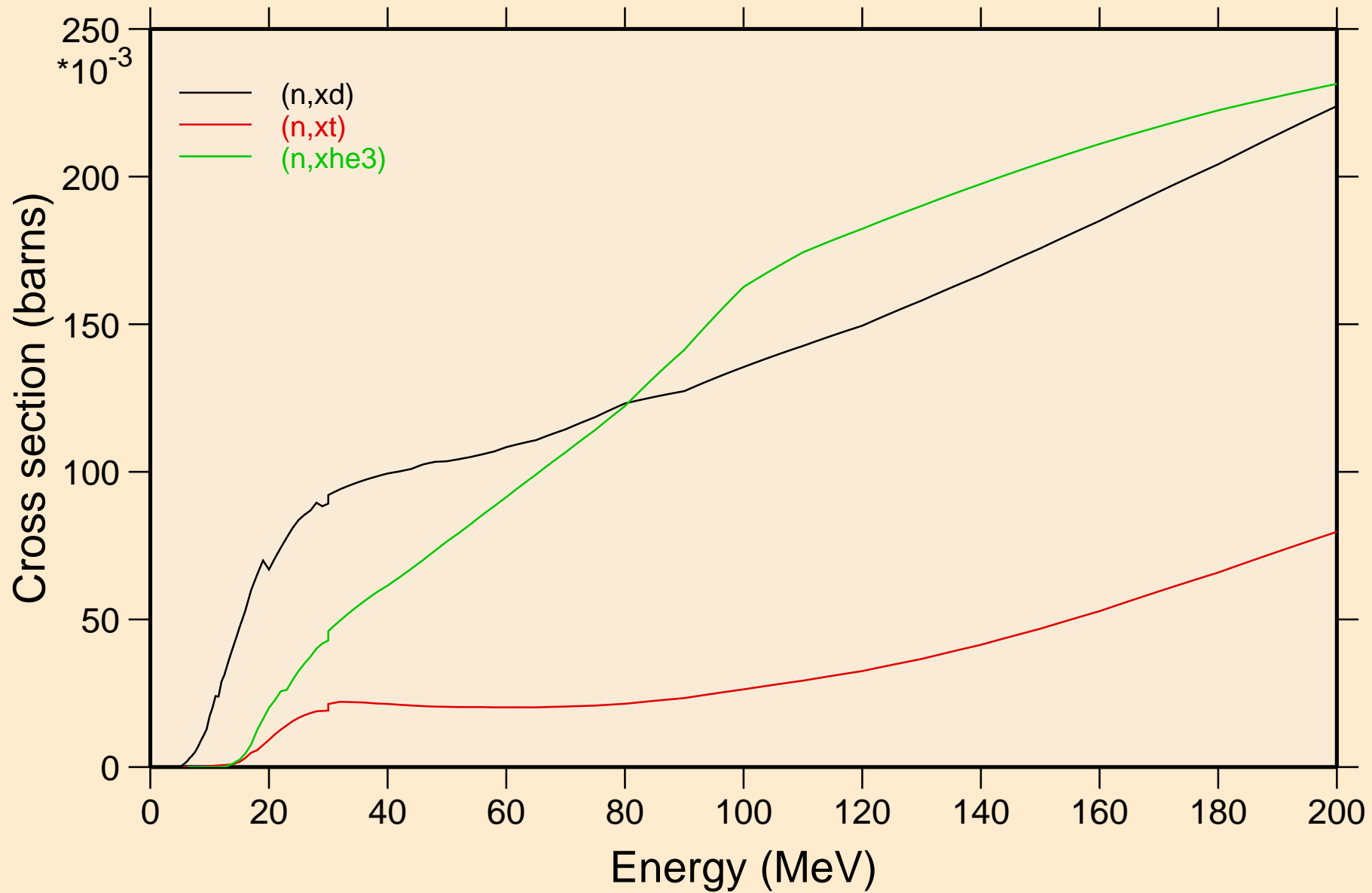

K038 NEUTRON ACER TENDL-2024 LIBRARY; T=293.6K
angular distribution for elastic

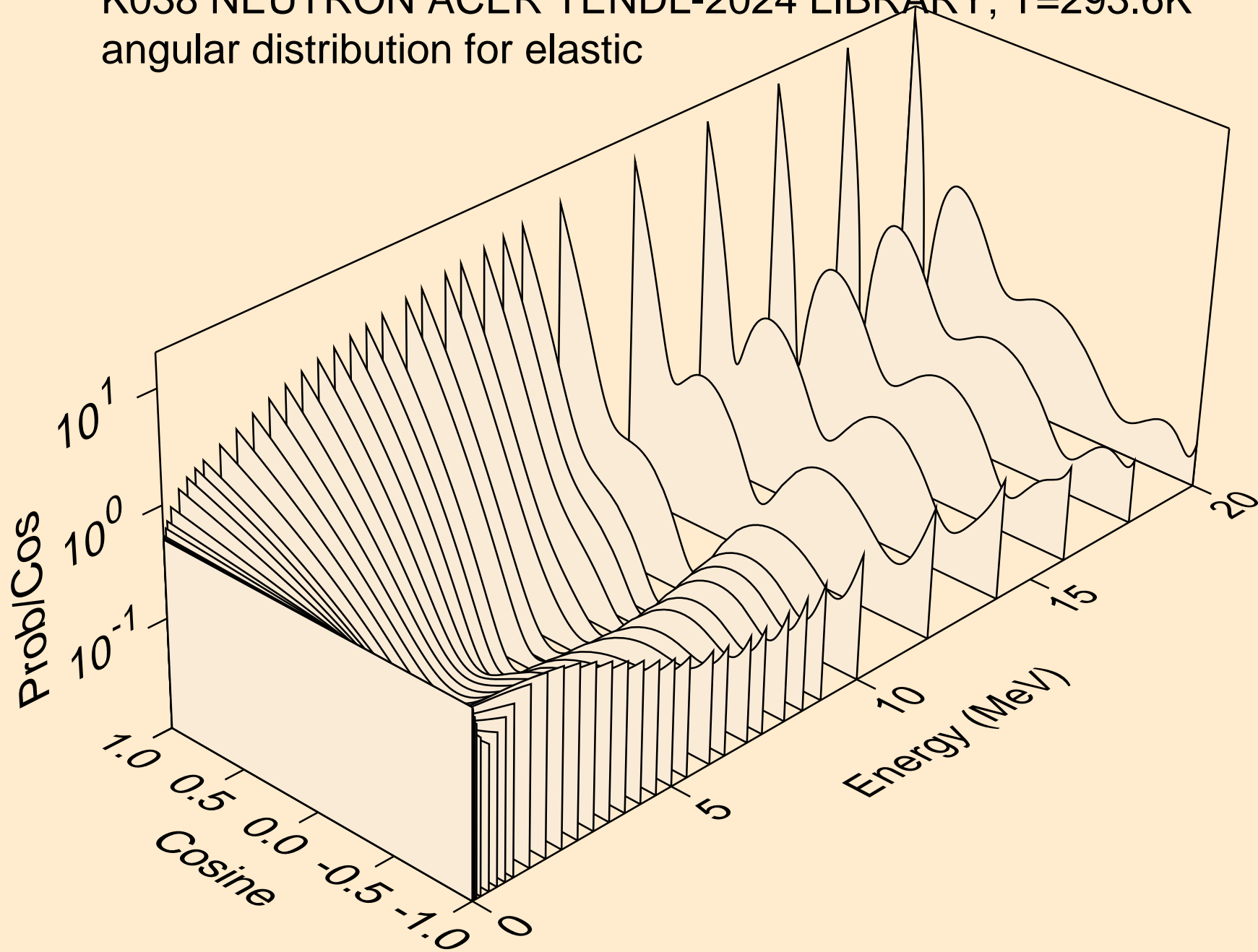

K038 NEUTRON ACER TENDL-2024 LIBRARY; T=293.6K
angular distribution for elastic

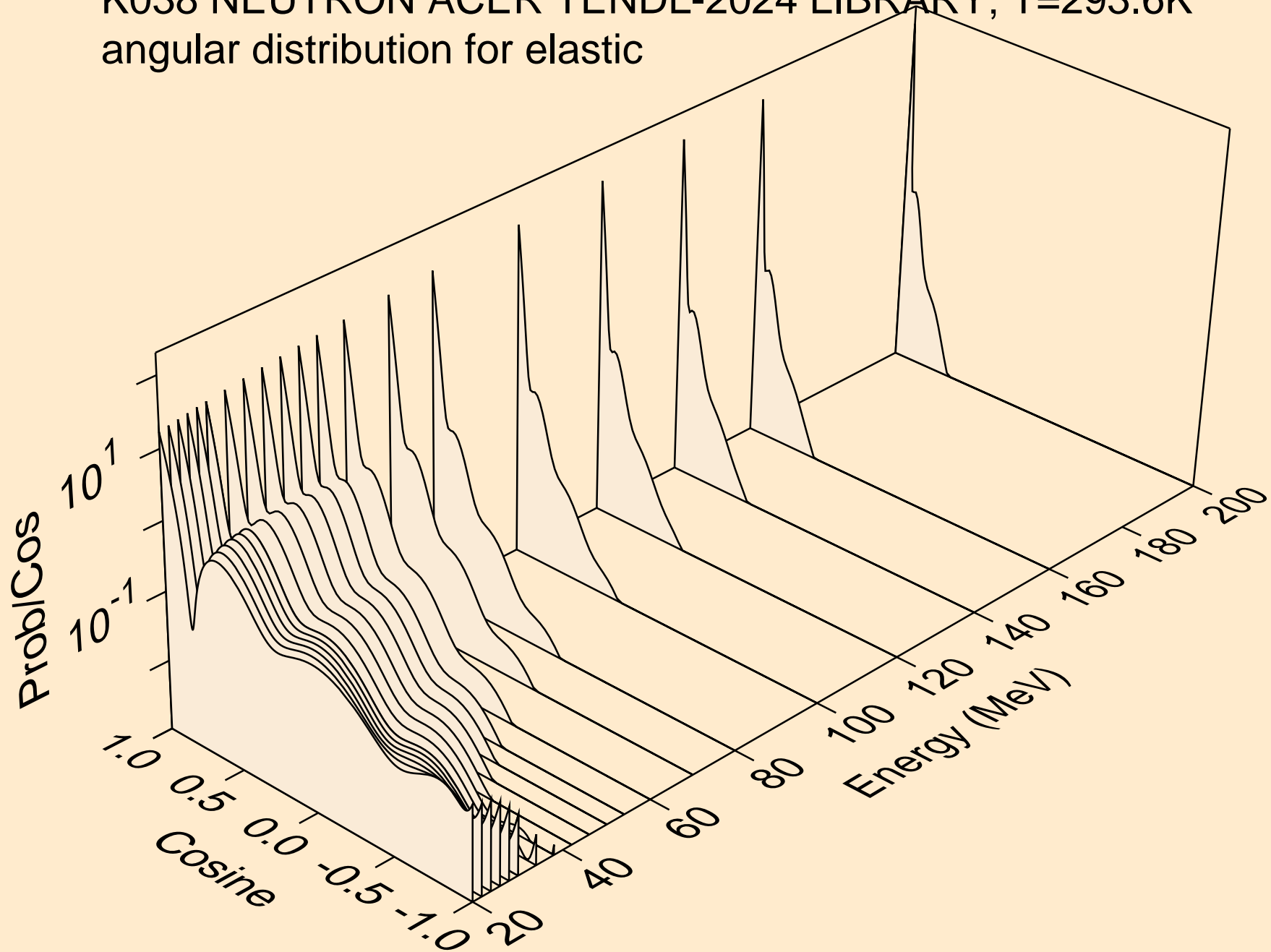

K038 NEUTRON ACER TENDL-2024 LIBRARY; T=293.6K
angular distribution for (n,n*1)

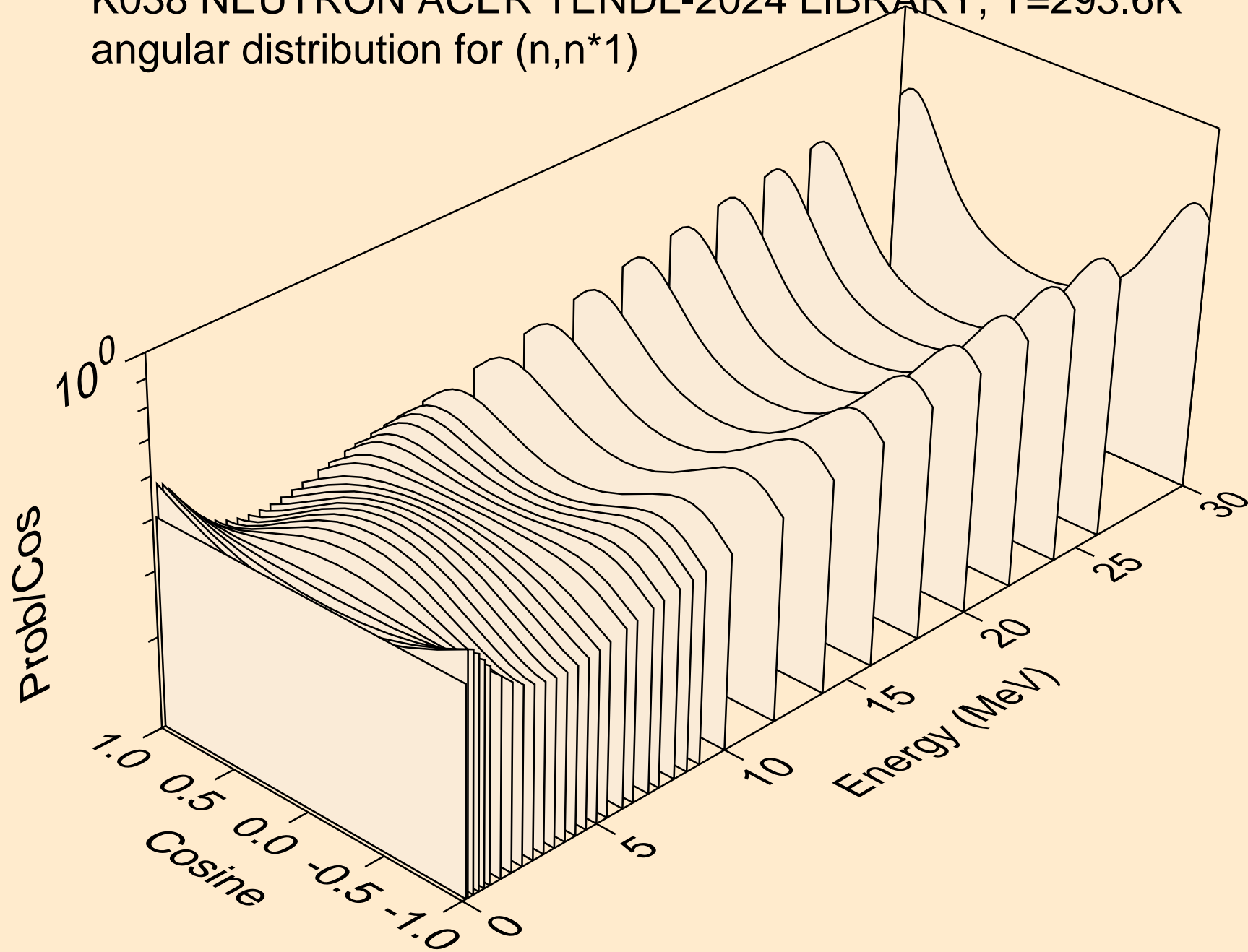

K038 NEUTRON ACER TENDL-2024 LIBRARY; T=293.6K
angular distribution for (n,n*2)

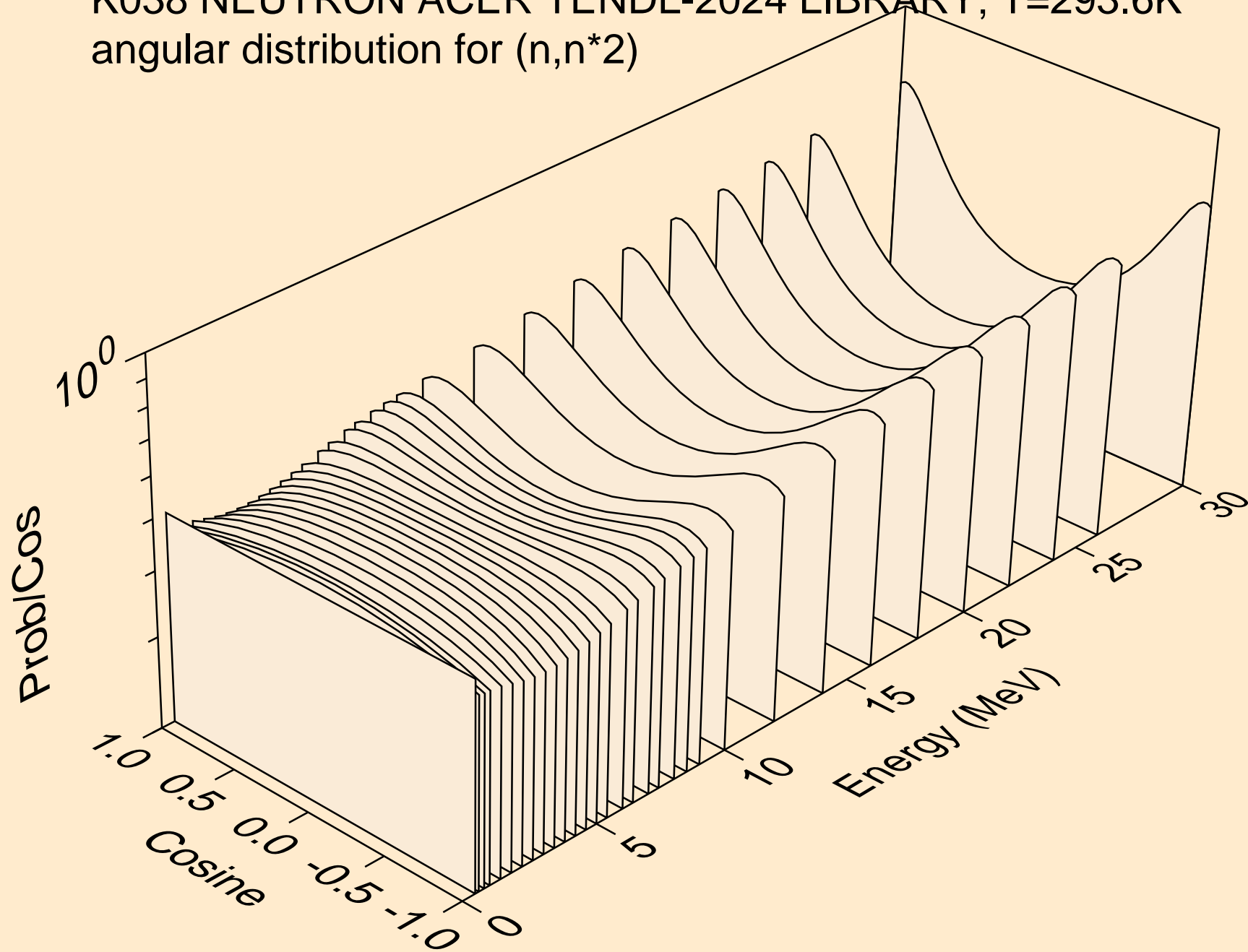

K038 NEUTRON ACER TENDL-2024 LIBRARY; T=293.6K
angular distribution for (n,n*3)

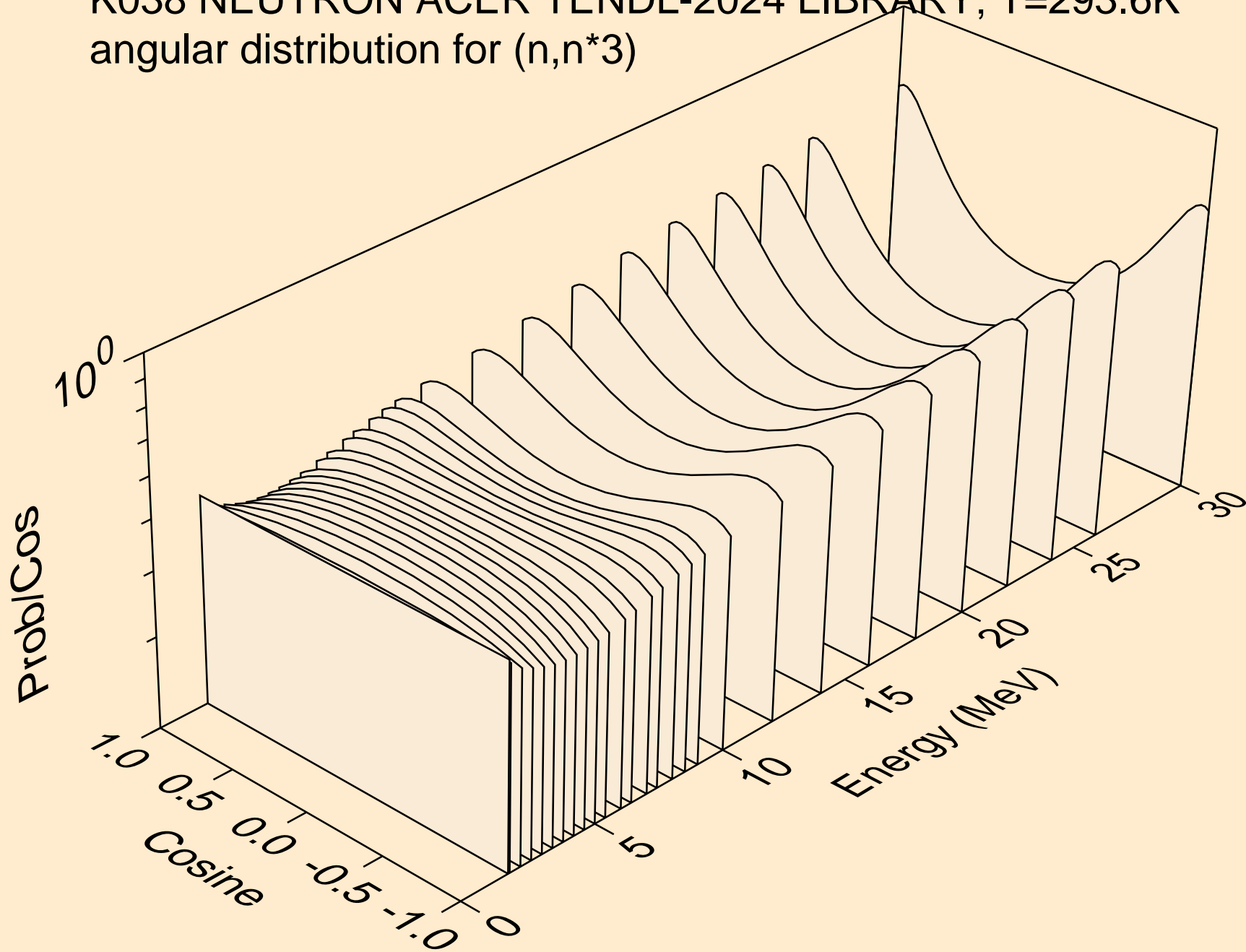

K038 NEUTRON ACER TENDL-2024 LIBRARY; T=293.6K
angular distribution for (n,n*4)

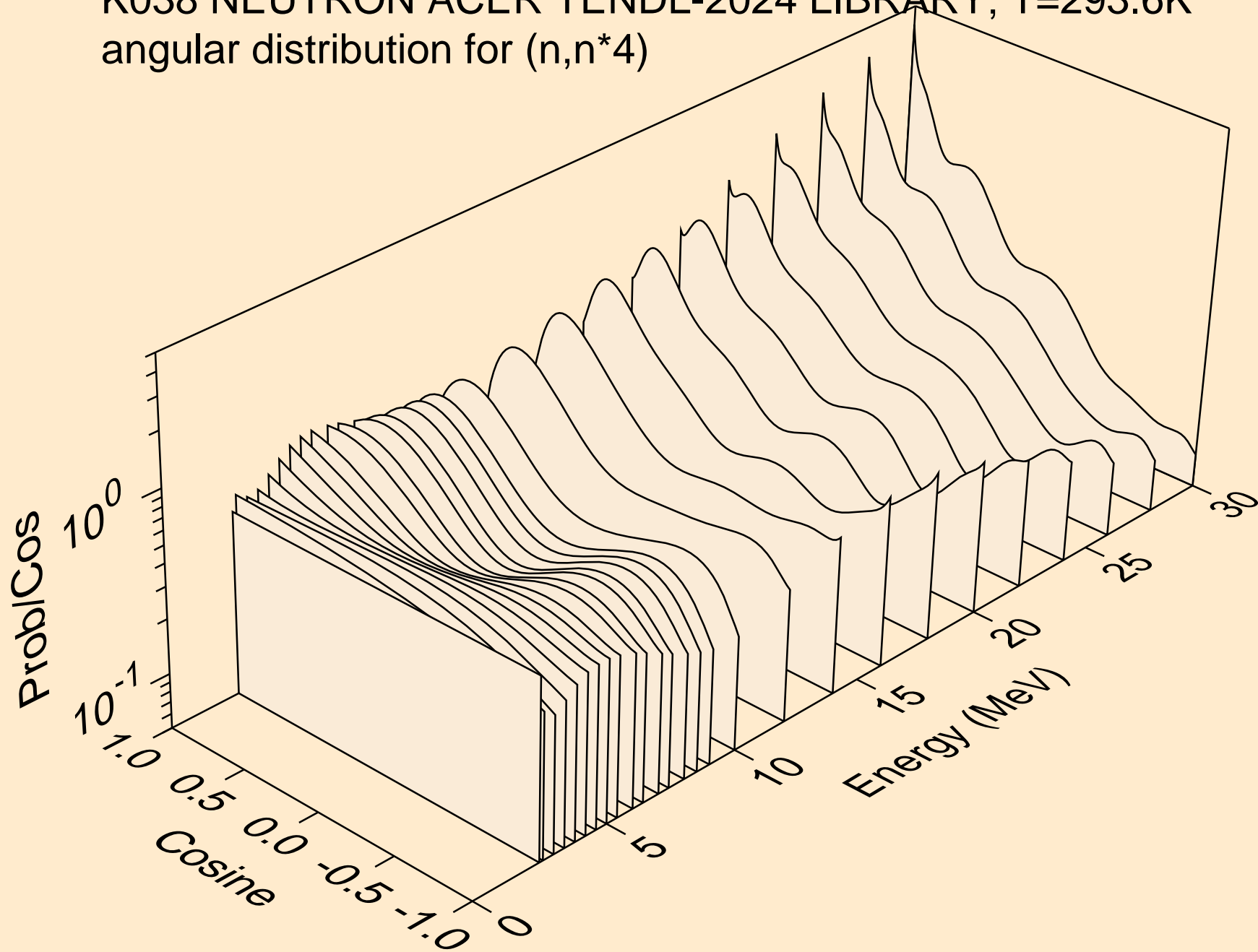

K038 NEUTRON ACER TENDL-2024 LIBRARY; T=293.6K
angular distribution for (n,n*5)

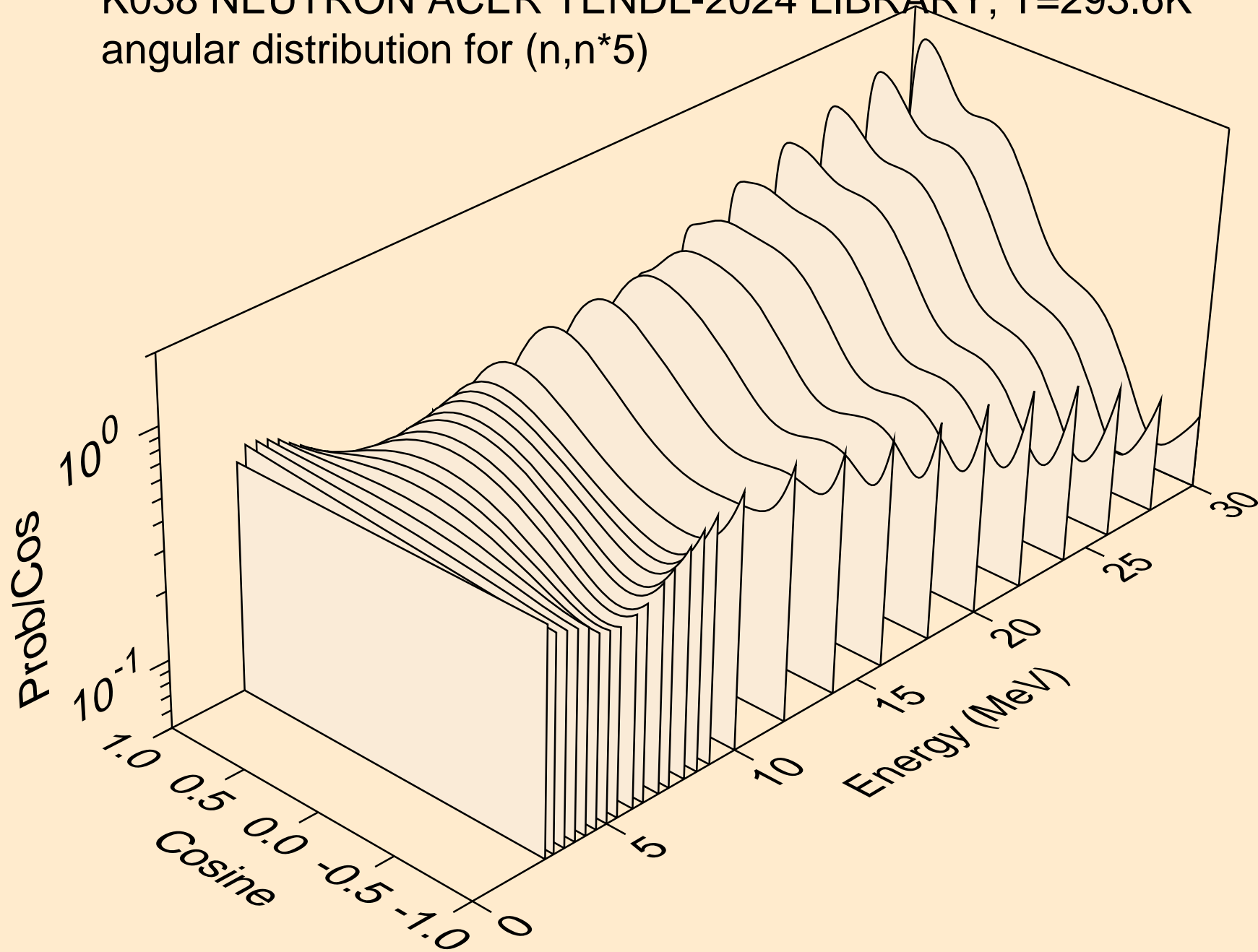

K038 NEUTRON ACER TENDL-2024 LIBRARY; T=293.6K
angular distribution for (n,n*6)

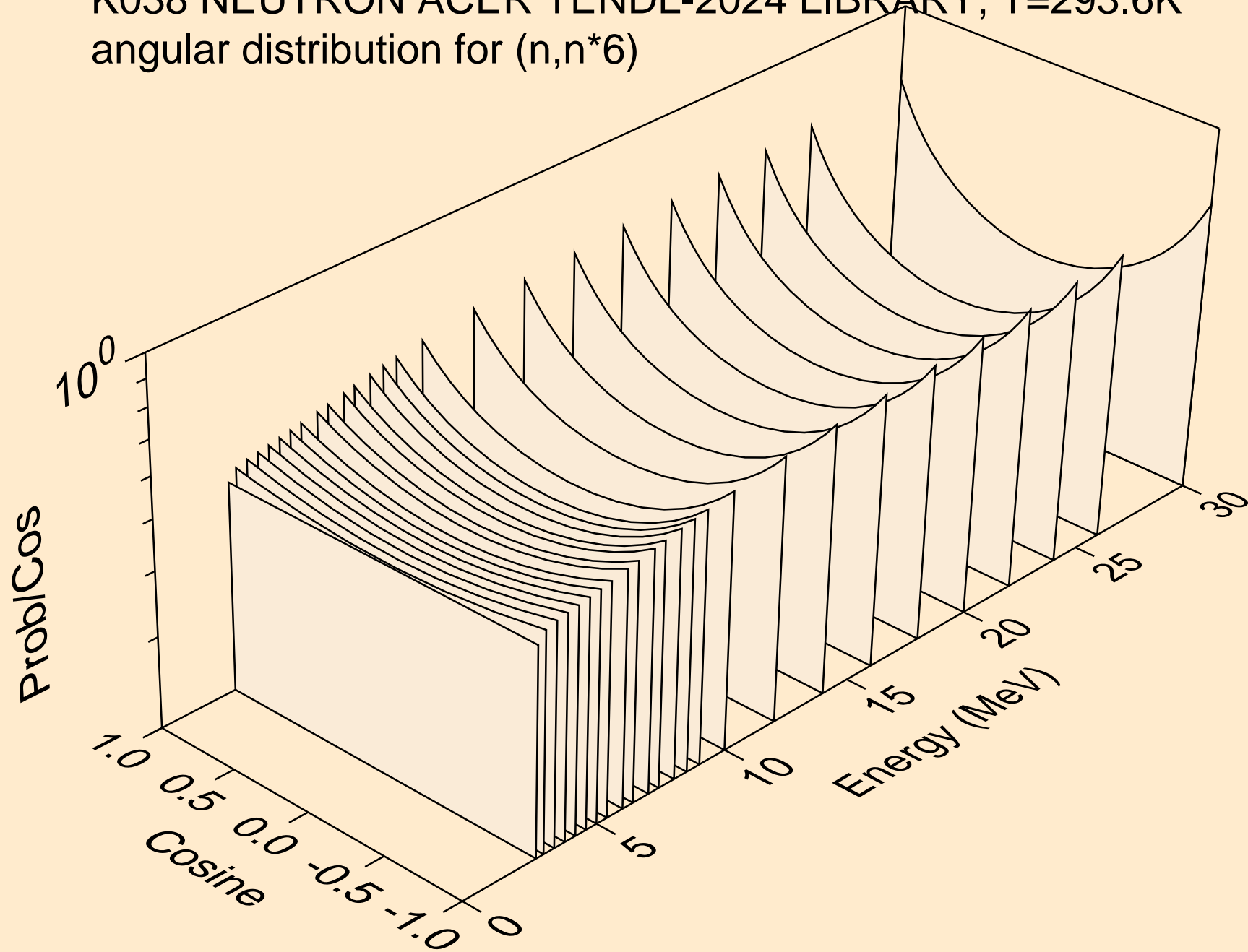

K038 NEUTRON ACER TENDL-2024 LIBRARY; T=293.6K
angular distribution for (n,n*7)

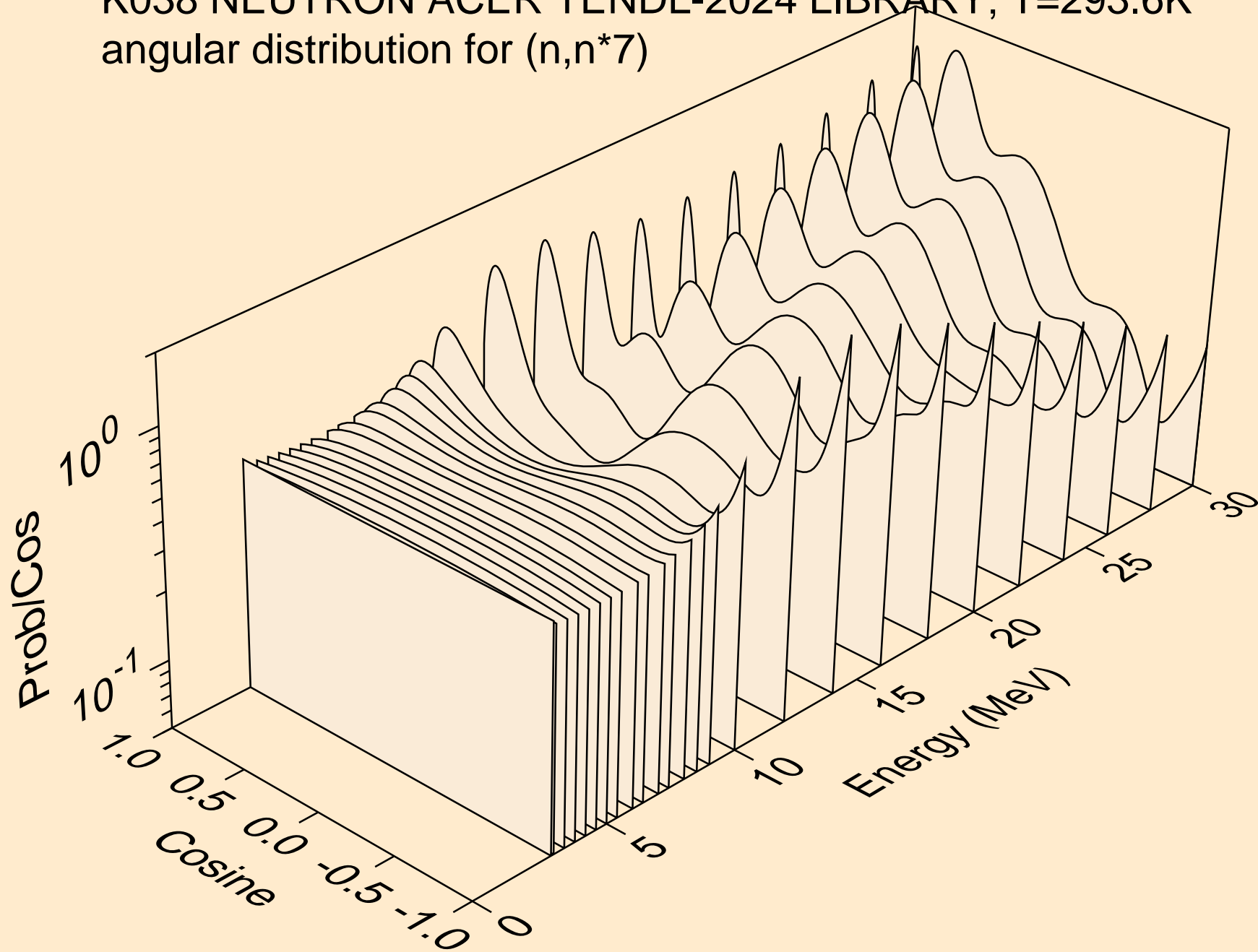

K038 NEUTRON ACER TENDL-2024 LIBRARY; T=293.6K
angular distribution for (n,n*8)

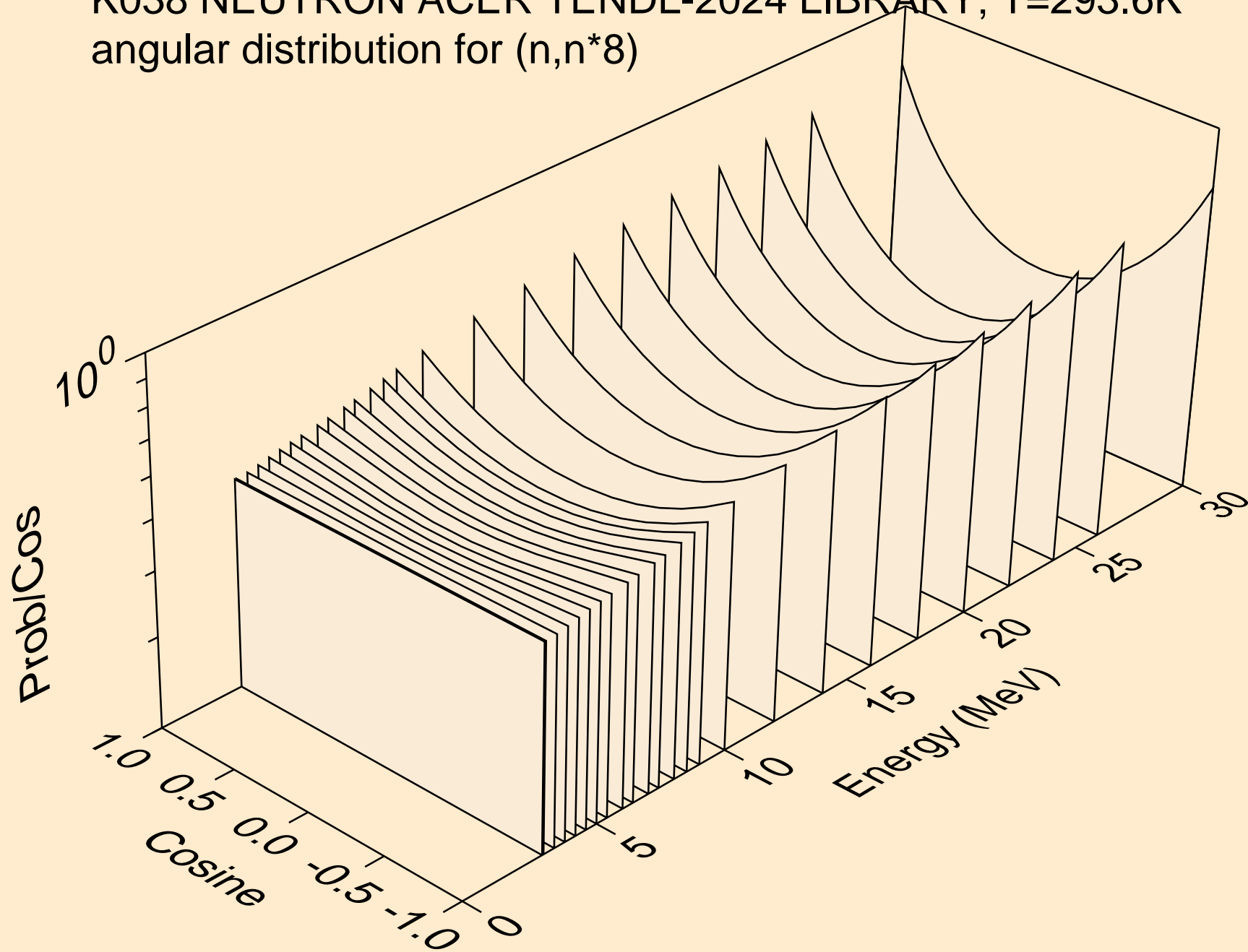

K038 NEUTRON ACER TENDL-2024 LIBRARY; T=293.6K
angular distribution for (n,n*9)

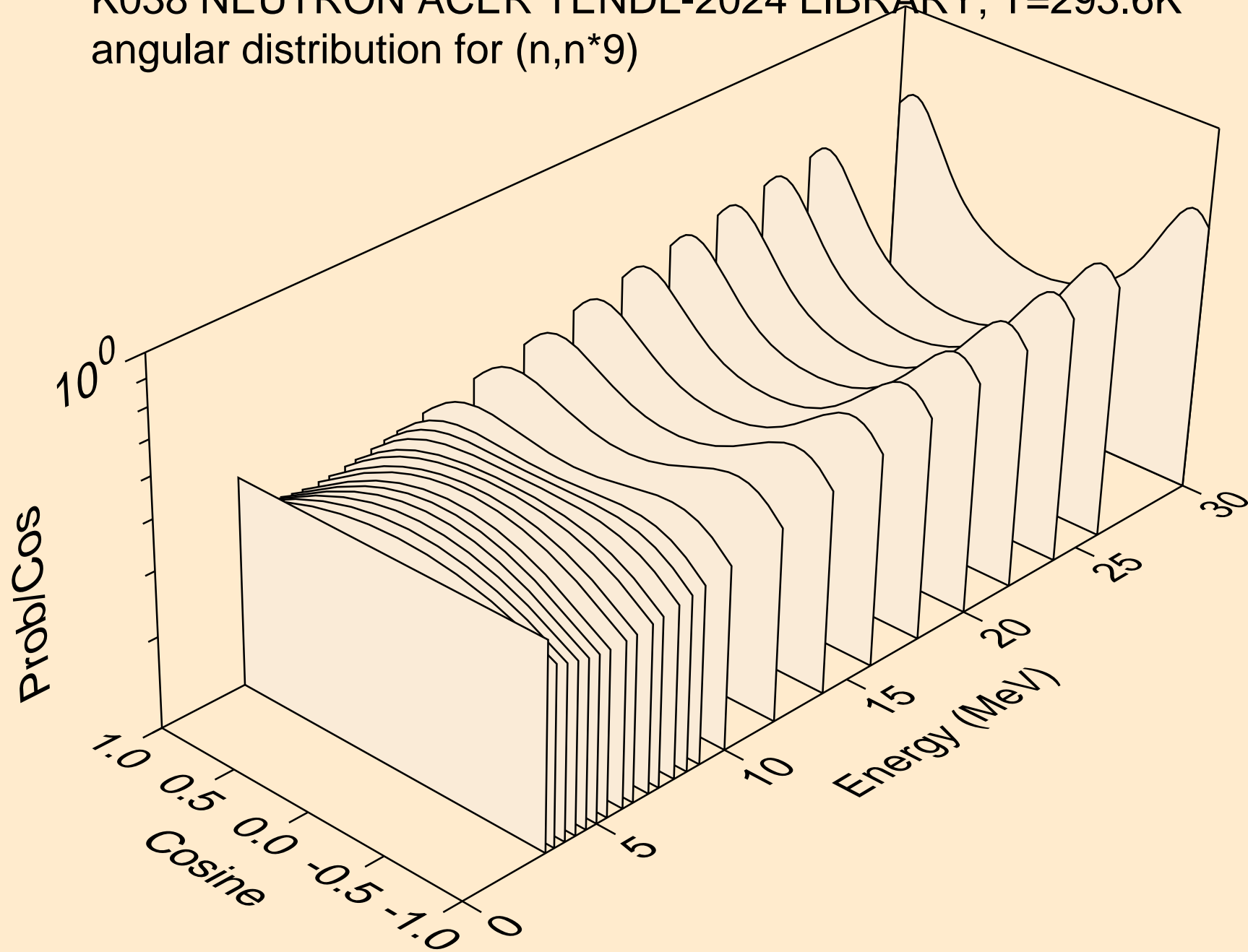

K038 NEUTRON ACER TENDL-2024 LIBRARY; T=293.6K
angular distribution for (n,n*10)

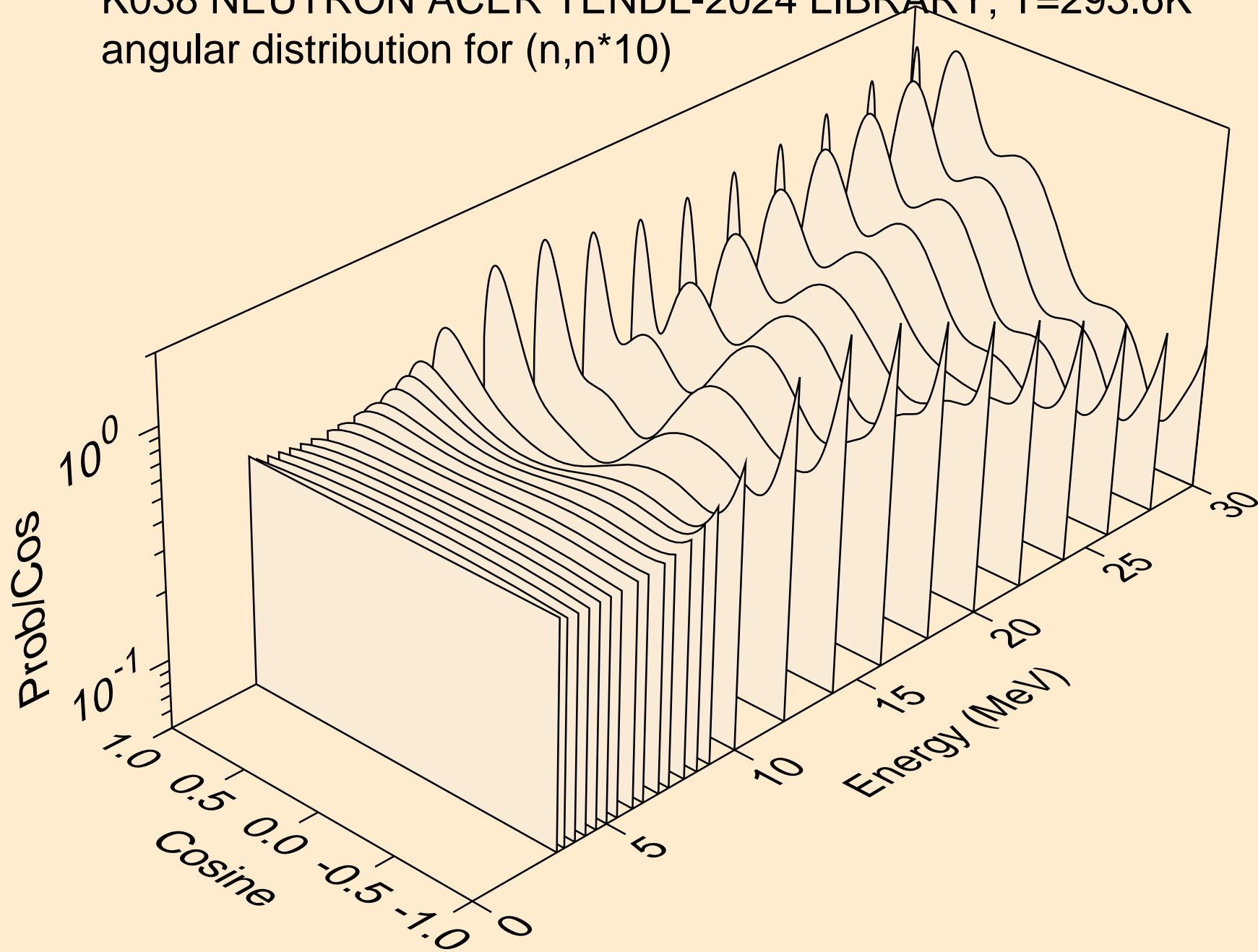

K038 NEUTRON ACER TENDL-2024 LIBRARY; T=293.6K
angular distribution for (n,n*11)

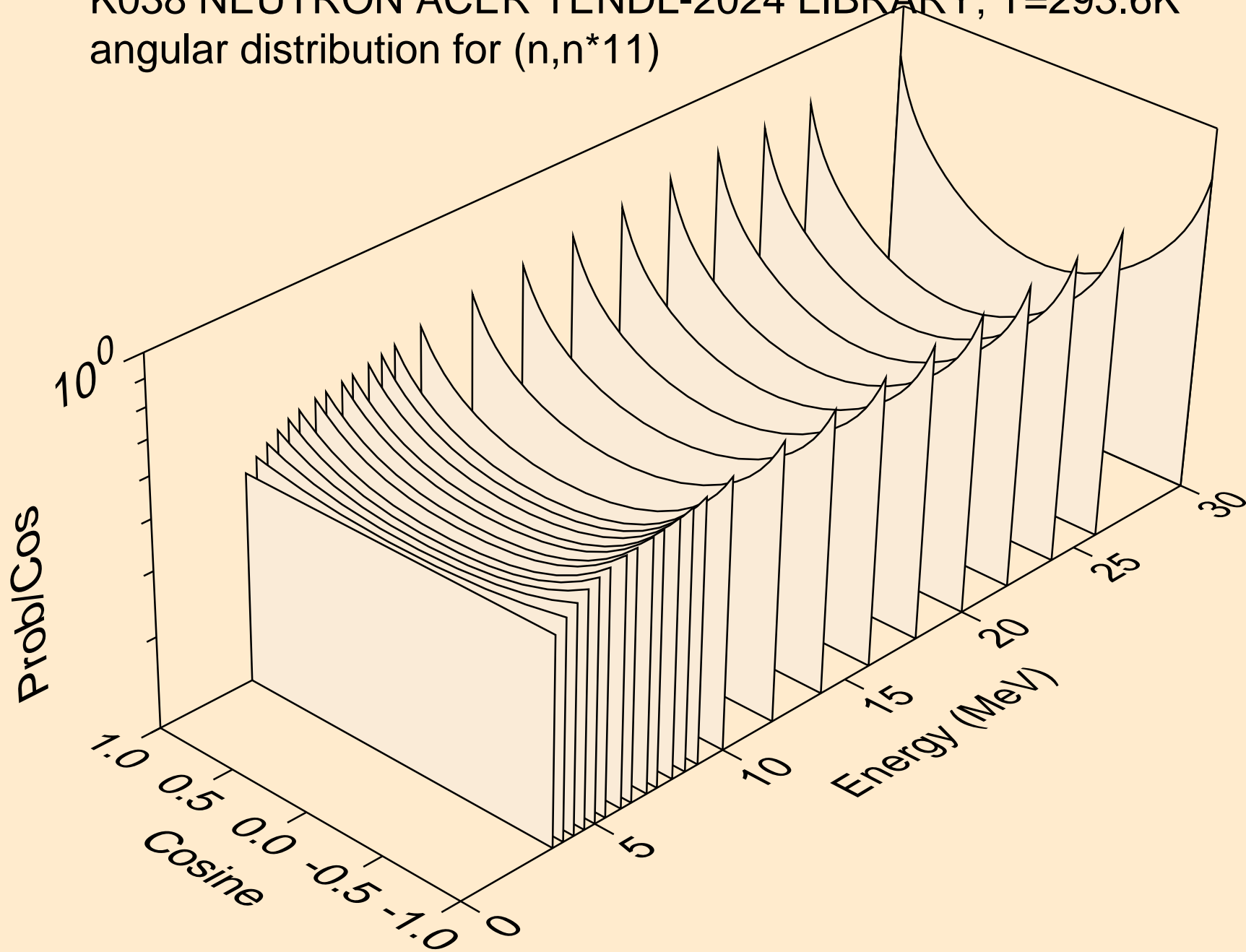

K038 NEUTRON ACER TENDL-2024 LIBRARY; T=293.6K
angular distribution for (n,n*12)

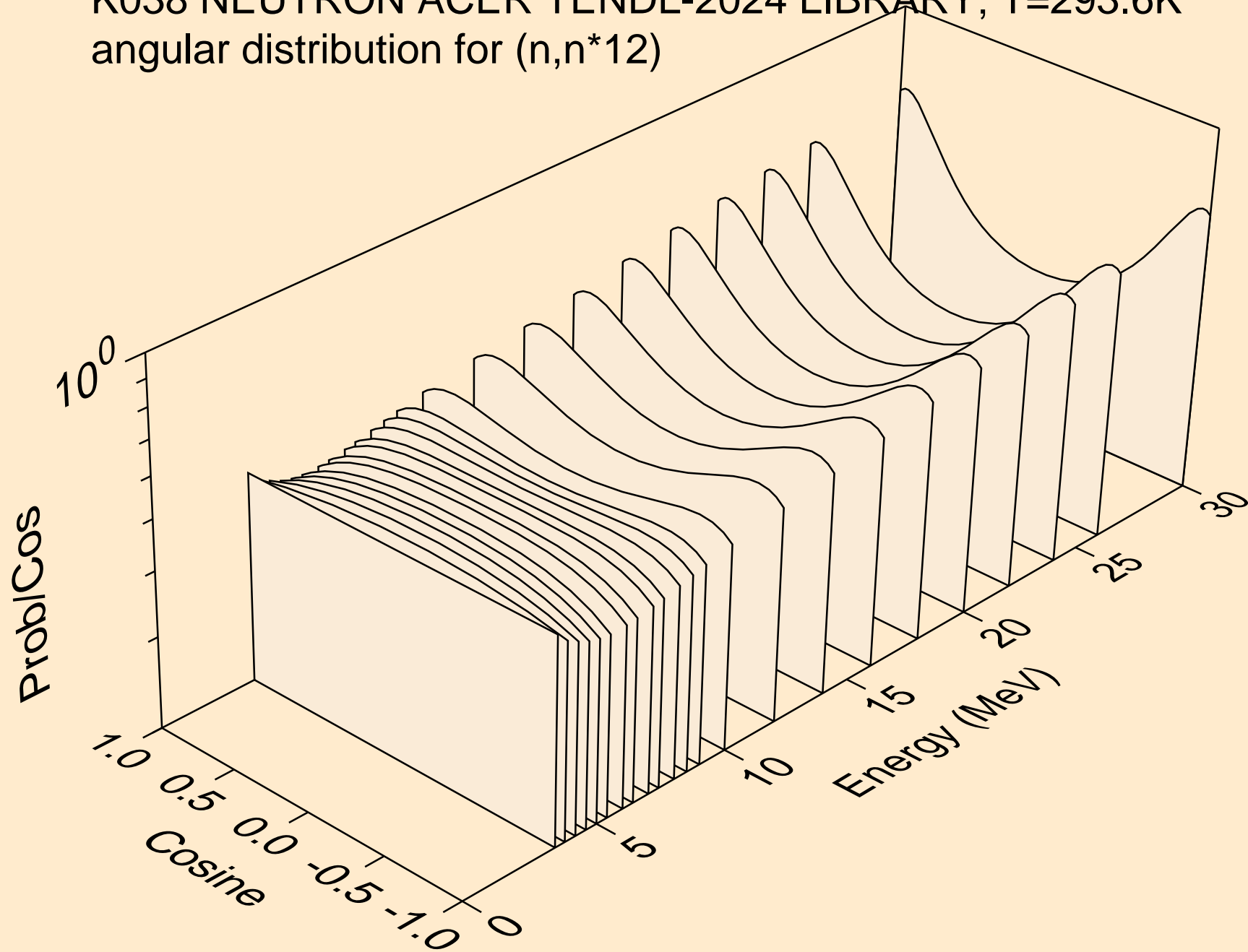

K038 NEUTRON ACER TENDL-2024 LIBRARY; T=293.6K
angular distribution for (n,n*13)

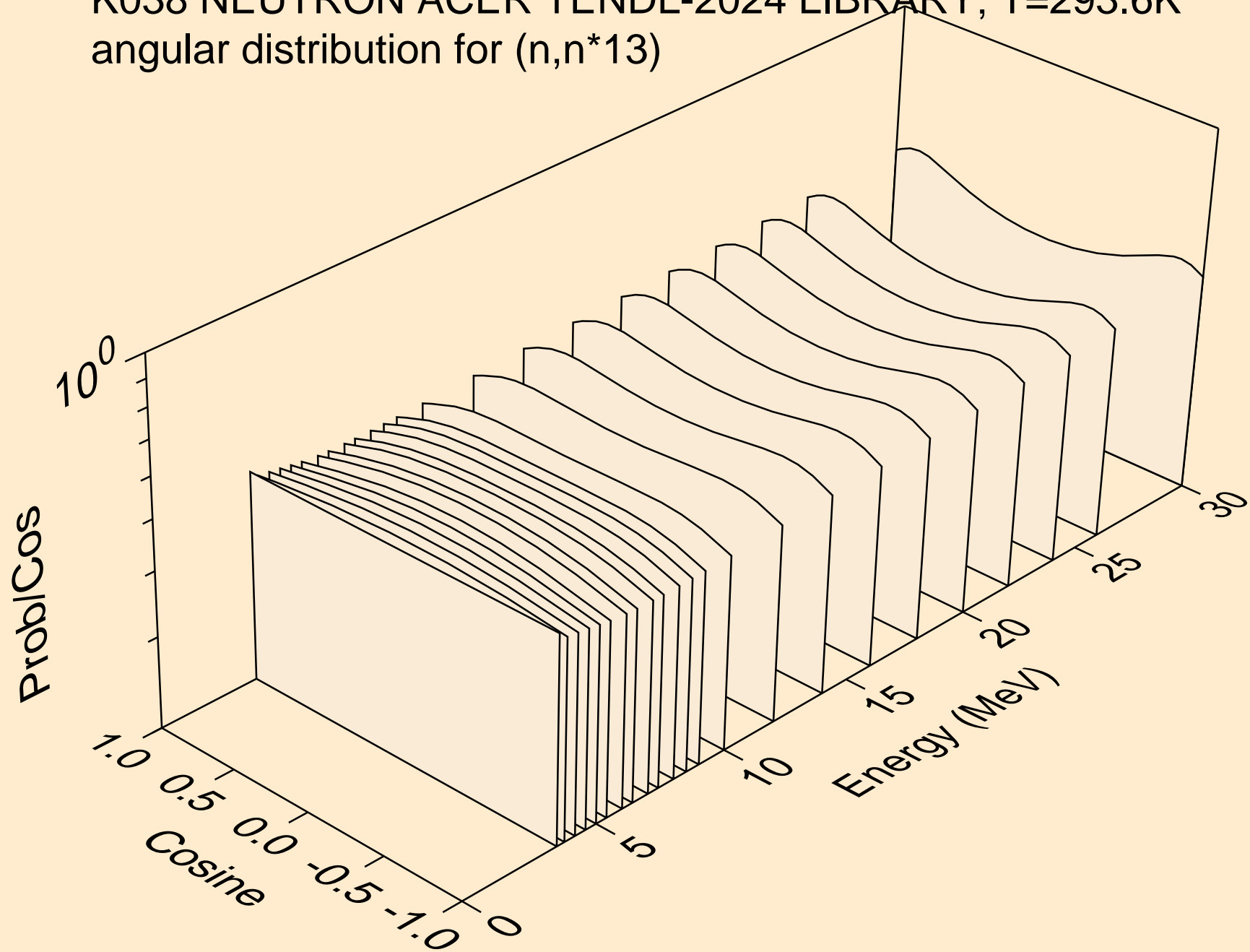

K038 NEUTRON ACER TENDL-2024 LIBRARY; T=293.6K
Neutron emission for (n,x)

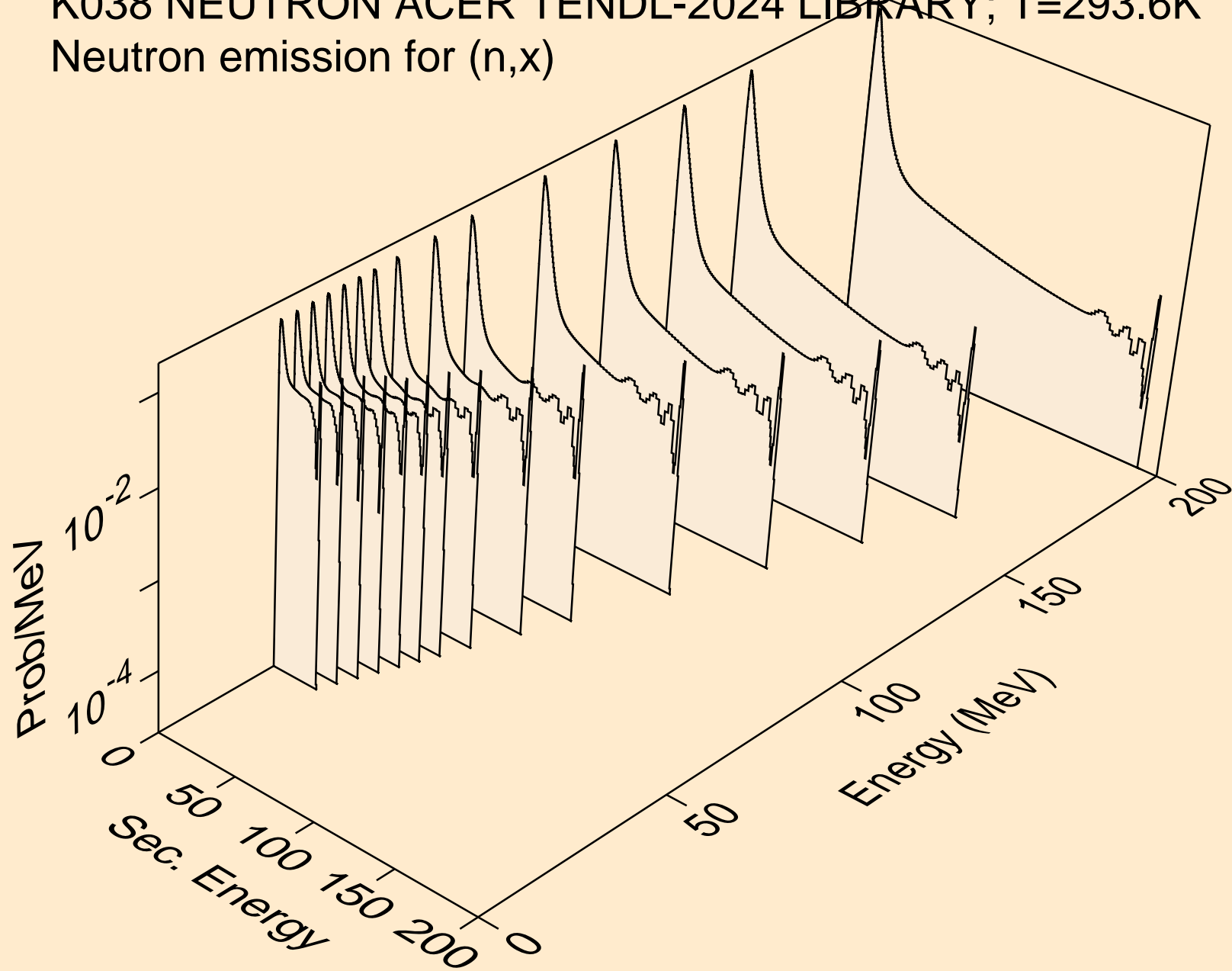

K038 NEUTRON ACER TENDL-2024 LIBRARY; T=293.6K
Neutron emission for (n,2nd)

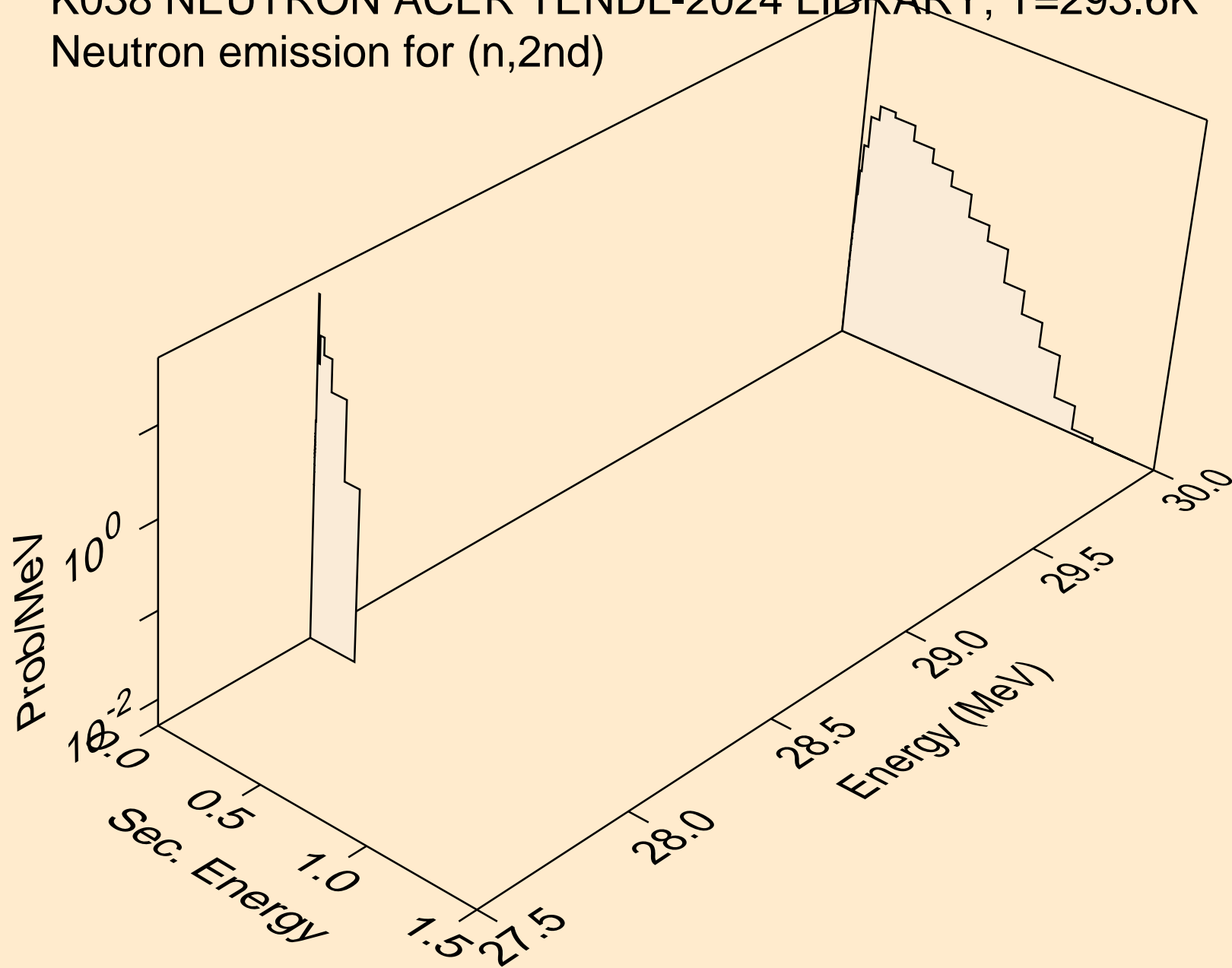

K038 NEUTRON ACER TENDL-2024 LIBRARY; T=293.6K
Neutron emission for (n,2n)

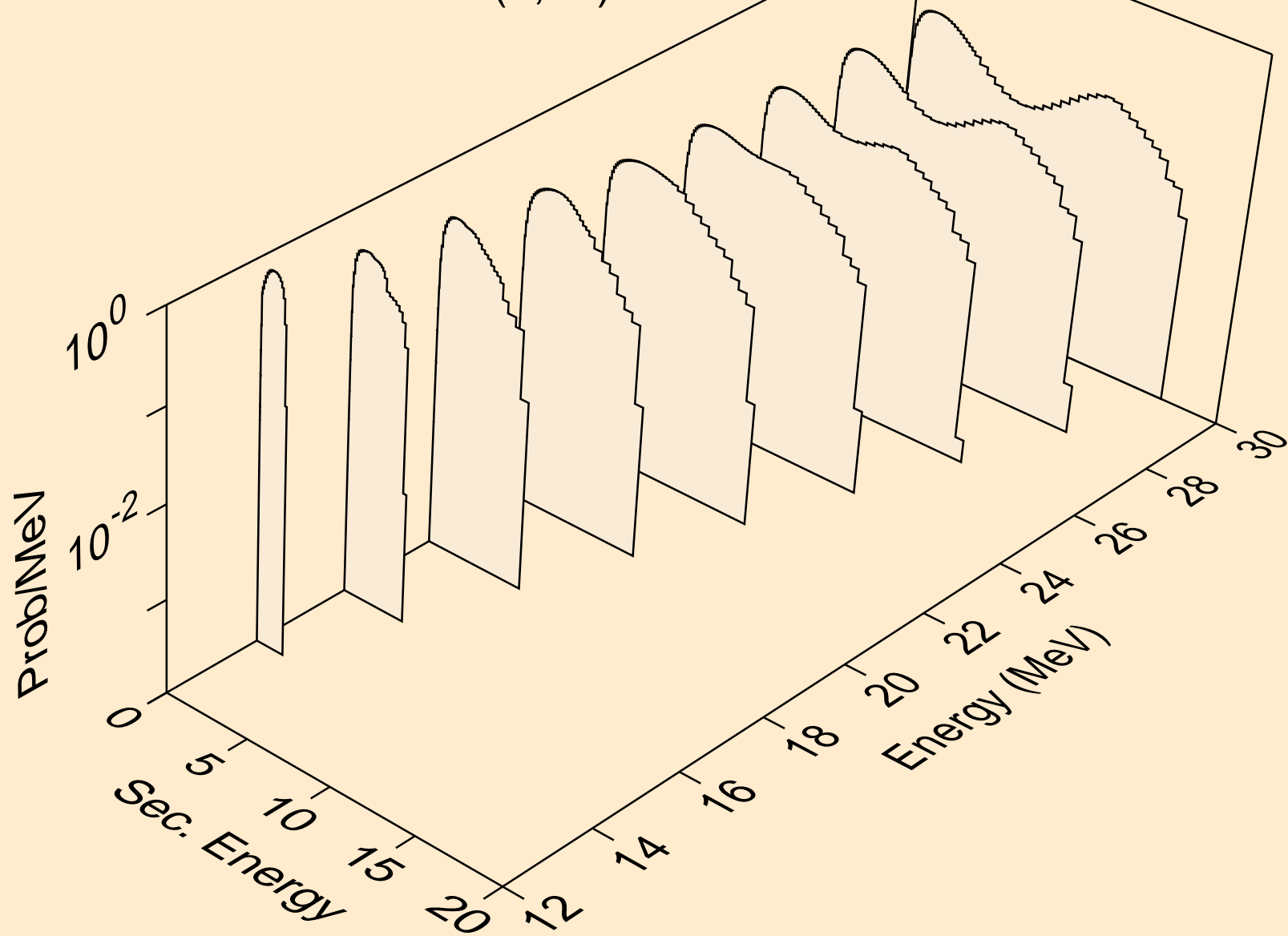

K038 NEUTRON ACER TENDL-2024 LIBRARY; T=293.6K
Neutron emission for (n,3n)

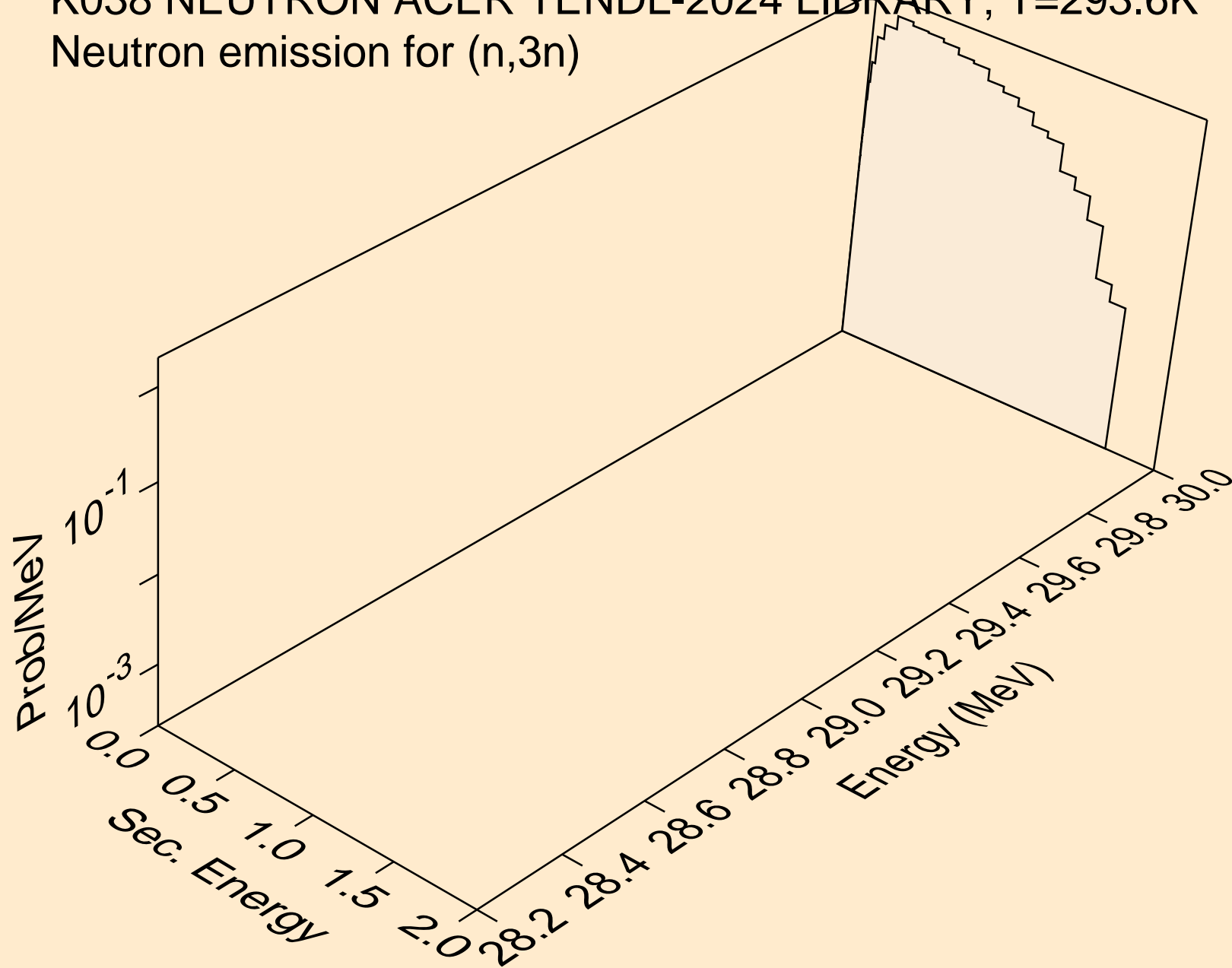

K038 NEUTRON ACER TENDL-2024 LIBRARY; T=293.6K
Neutron emission for (n,n*)a

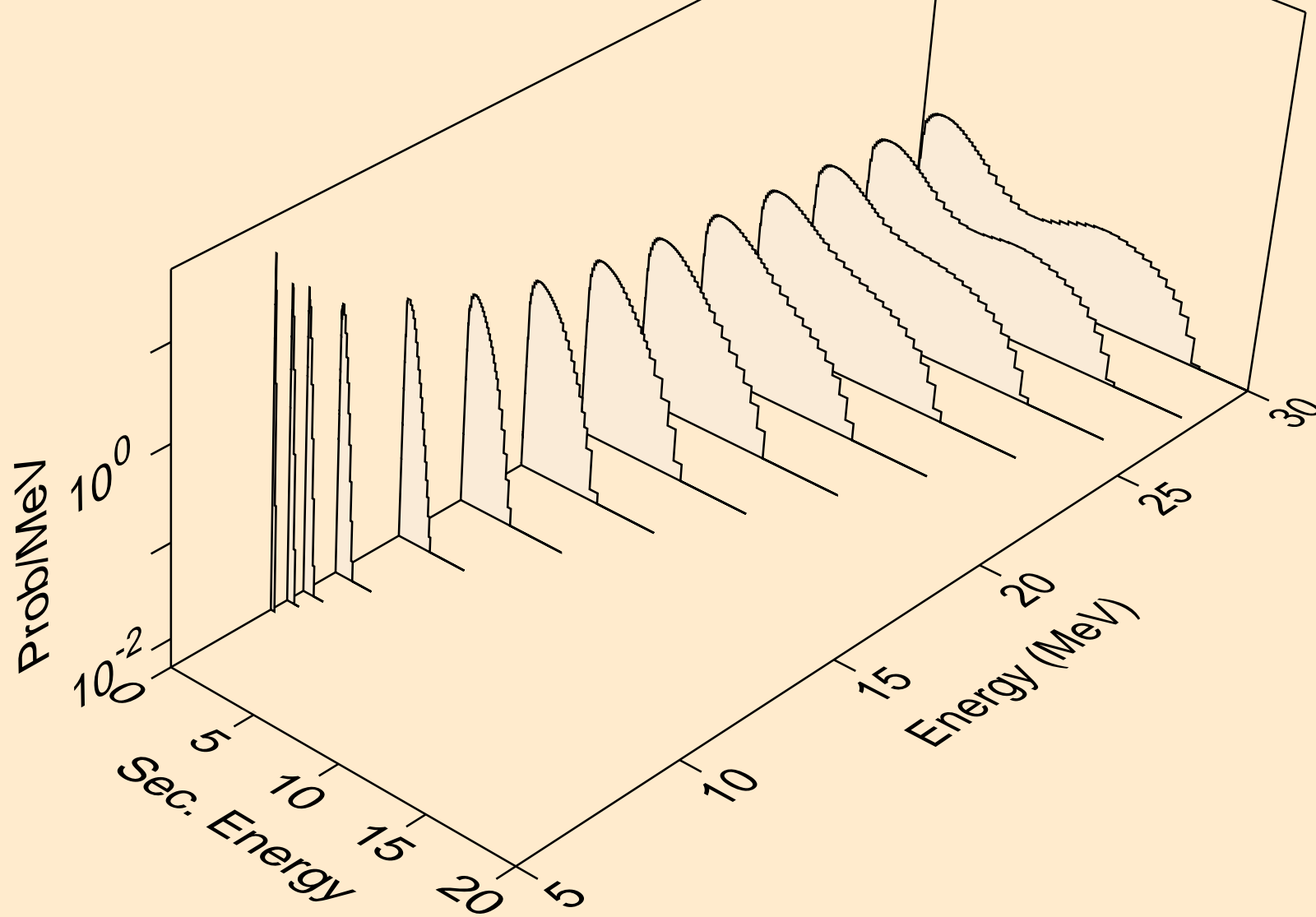

K038 NEUTRON ACER TENDL-2024 LIBRARY; T=293.6K
Neutron emission for (n,2n)a

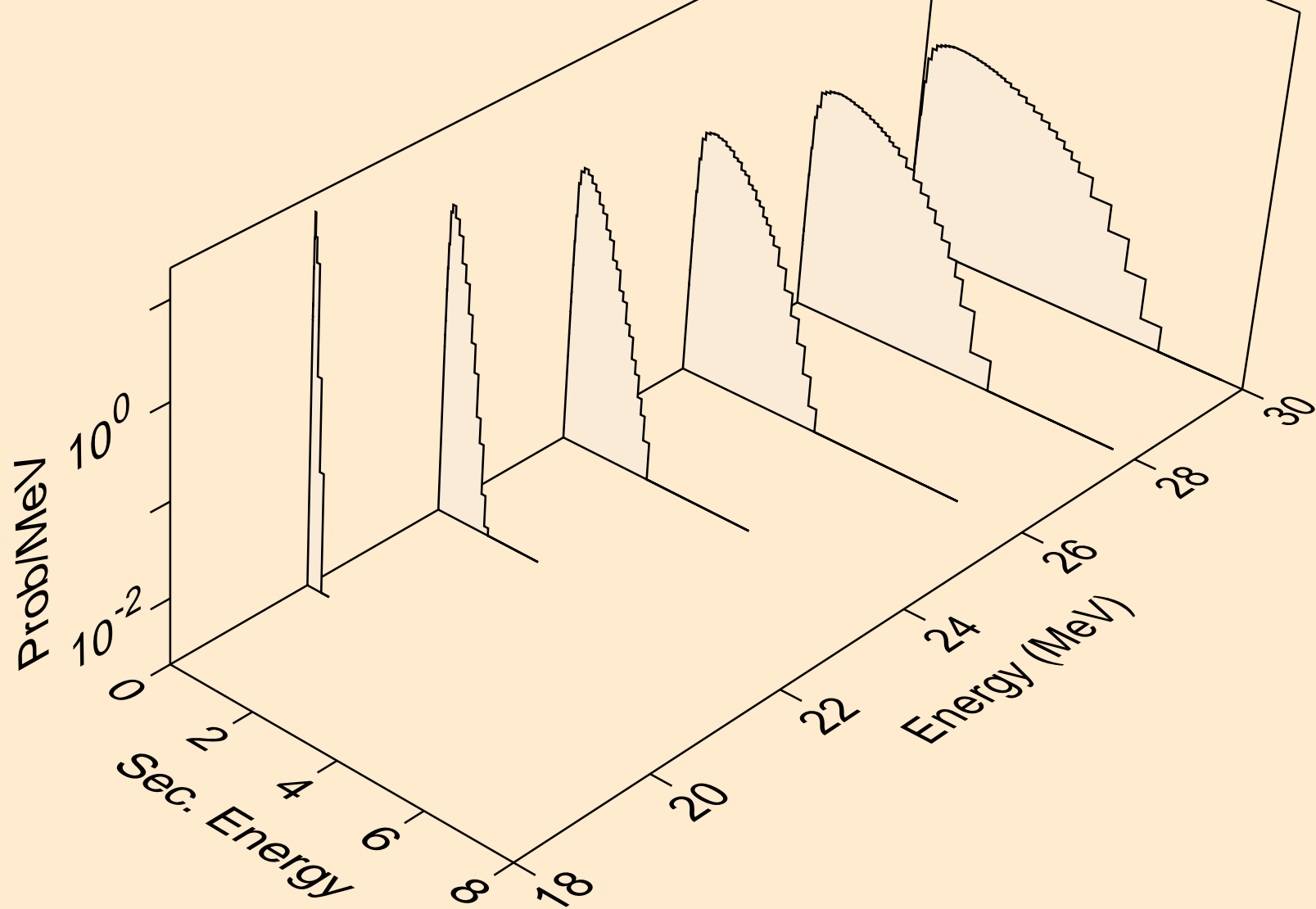

K038 NEUTRON ACER TENDL-2024 LIBRARY; T=293.6K
Neutron emission for (n,n*)p

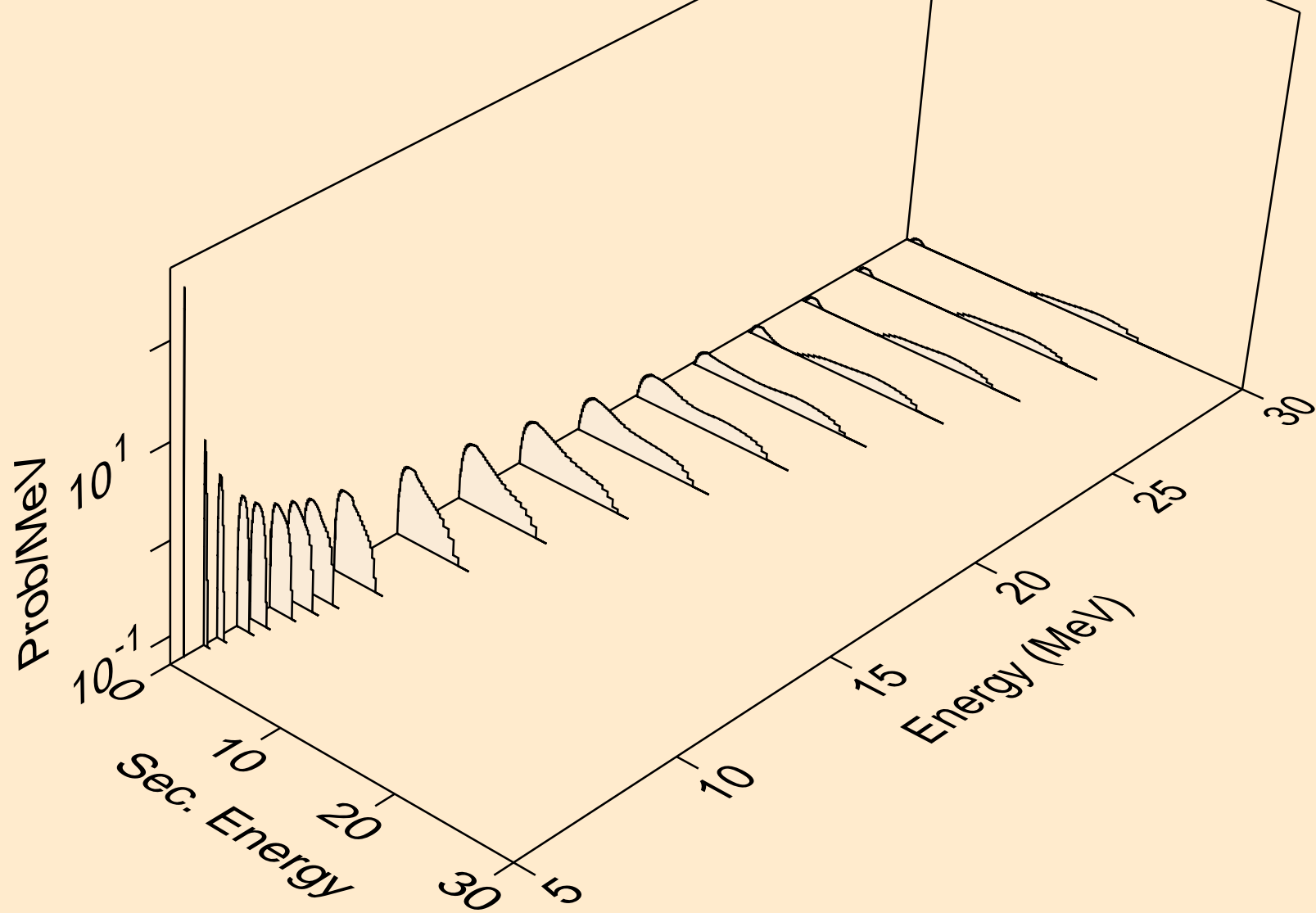

K038 NEUTRON ACER TENDL-2024 LIBRARY; T=293.6K
Neutron emission for (n,n*)2a

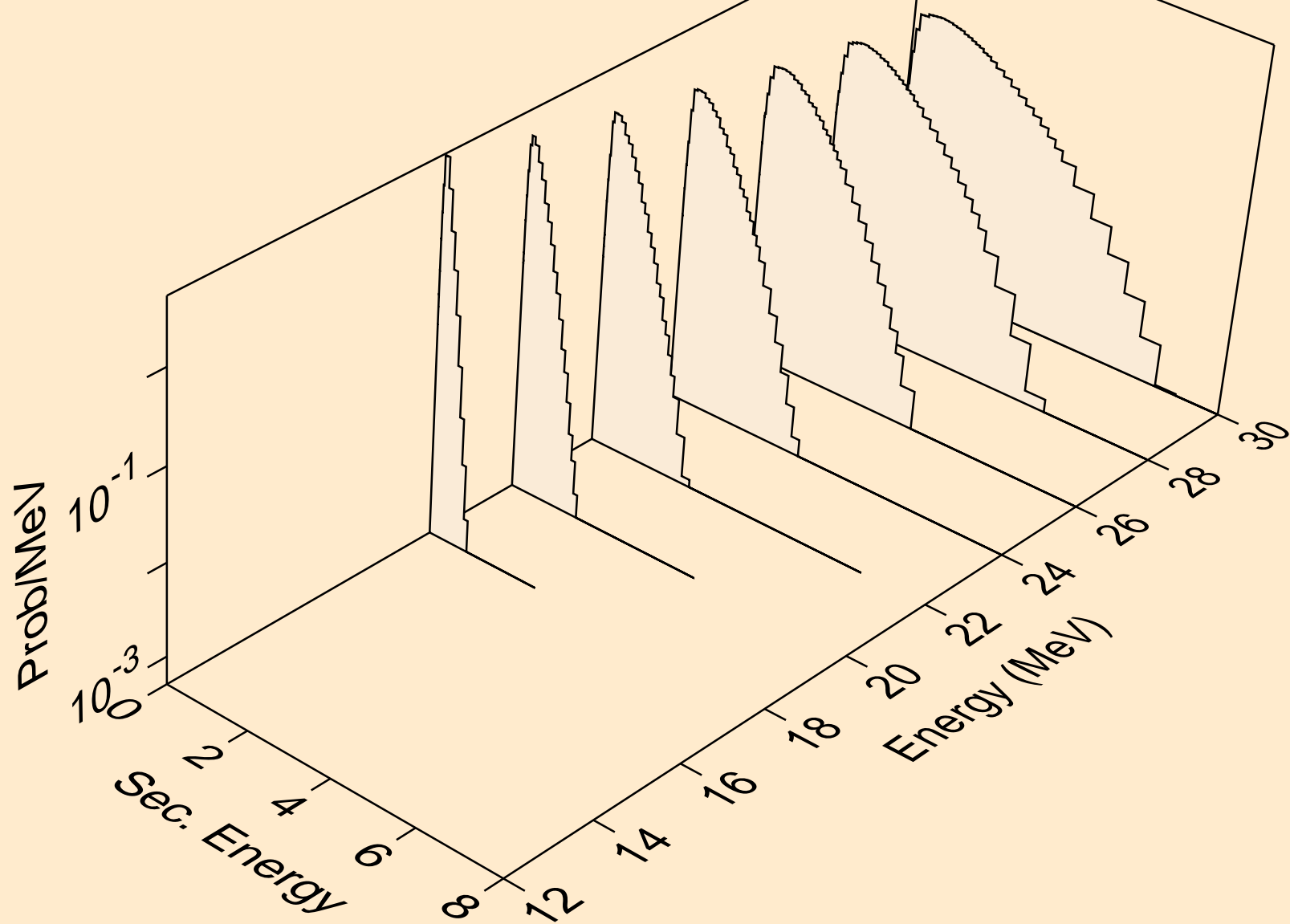

K038 NEUTRON ACER TENDL-2024 LIBRARY; T=293.6K
Neutron emission for (n,n*)d

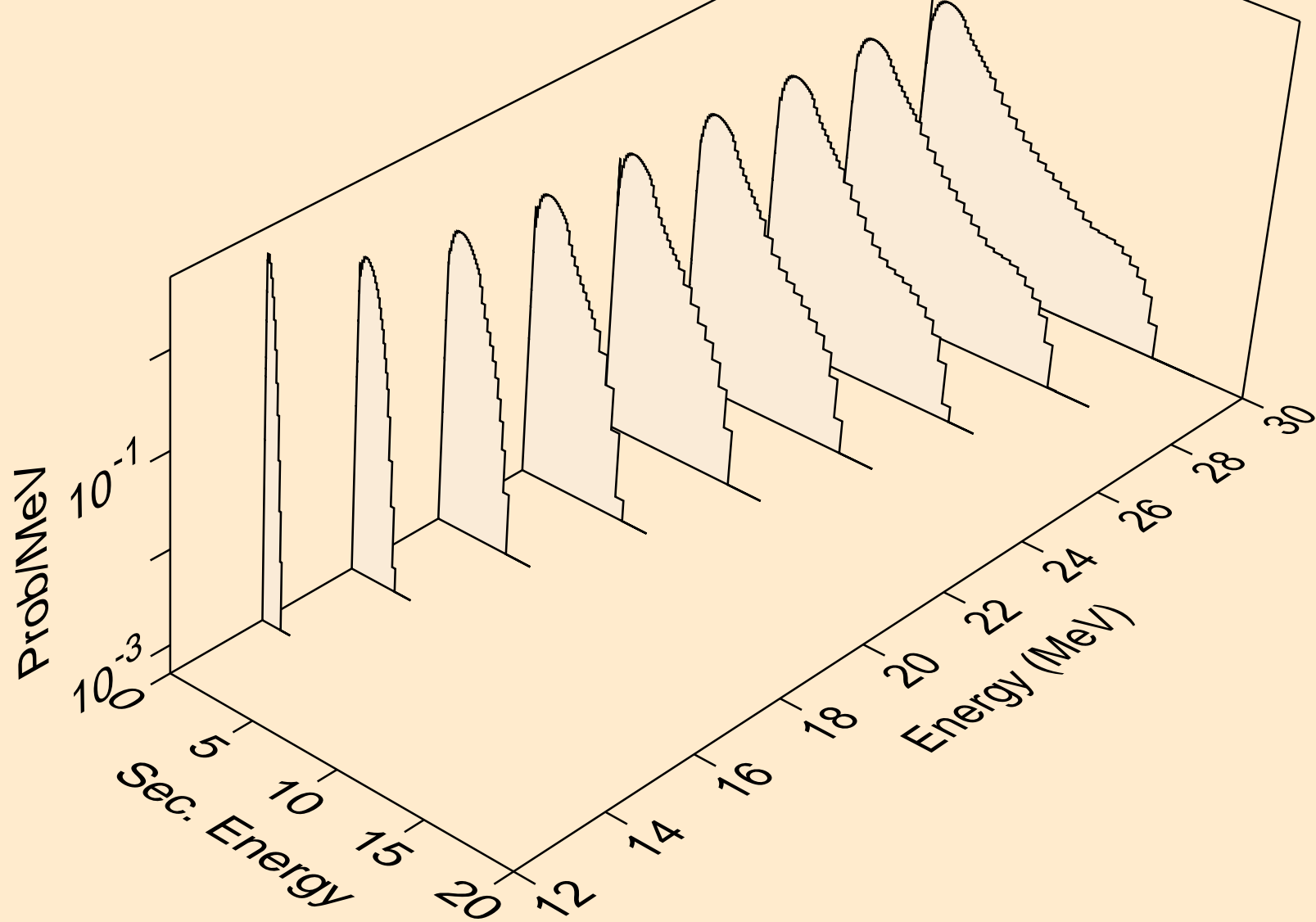

K038 NEUTRON ACER TENDL-2024 LIBRARY; T=293.6K
Neutron emission for (n,n*)t

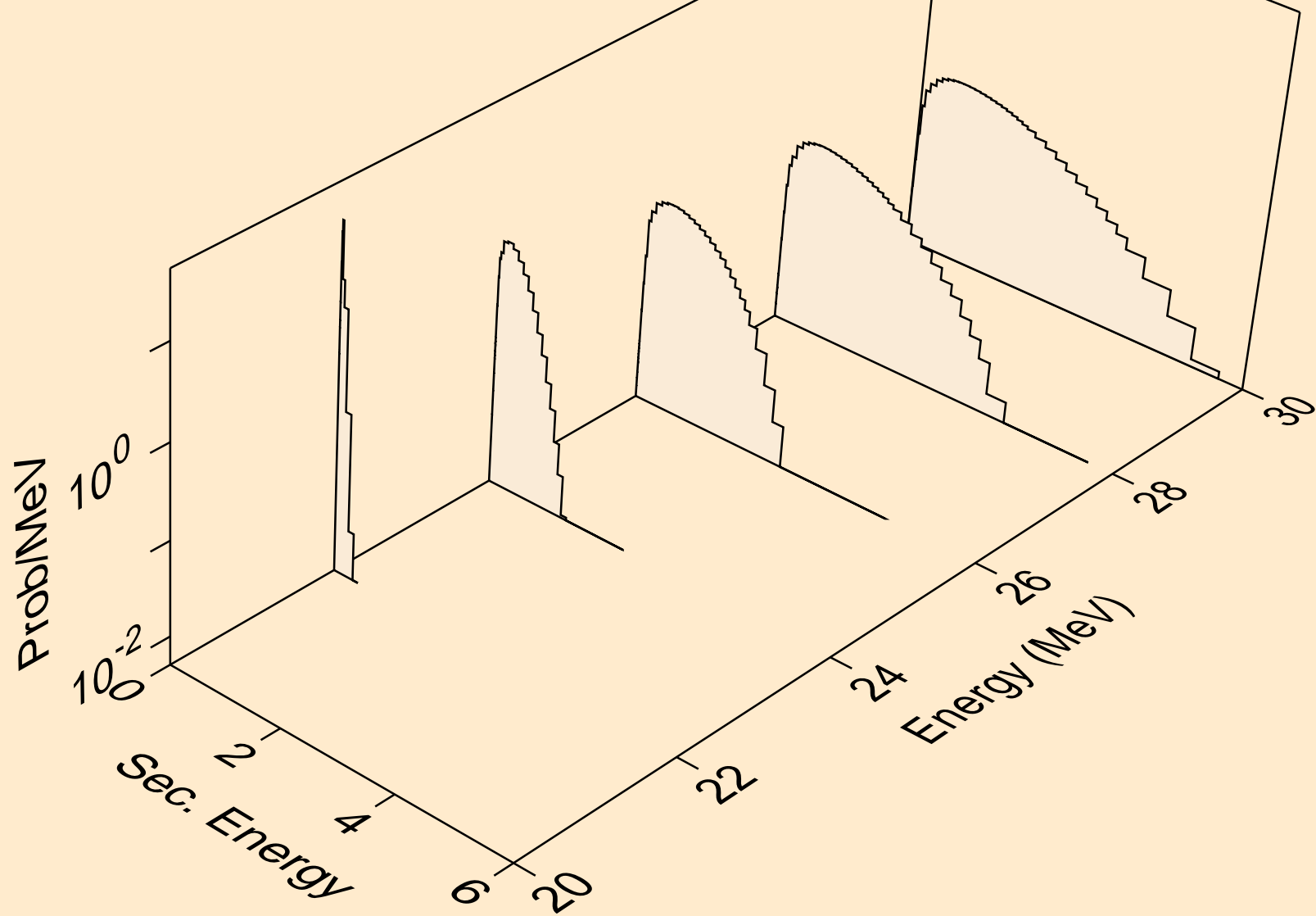

K038 NEUTRON ACER TENDL-2024 LIBRARY; T=293.6K
Neutron emission for (n,n*)he3

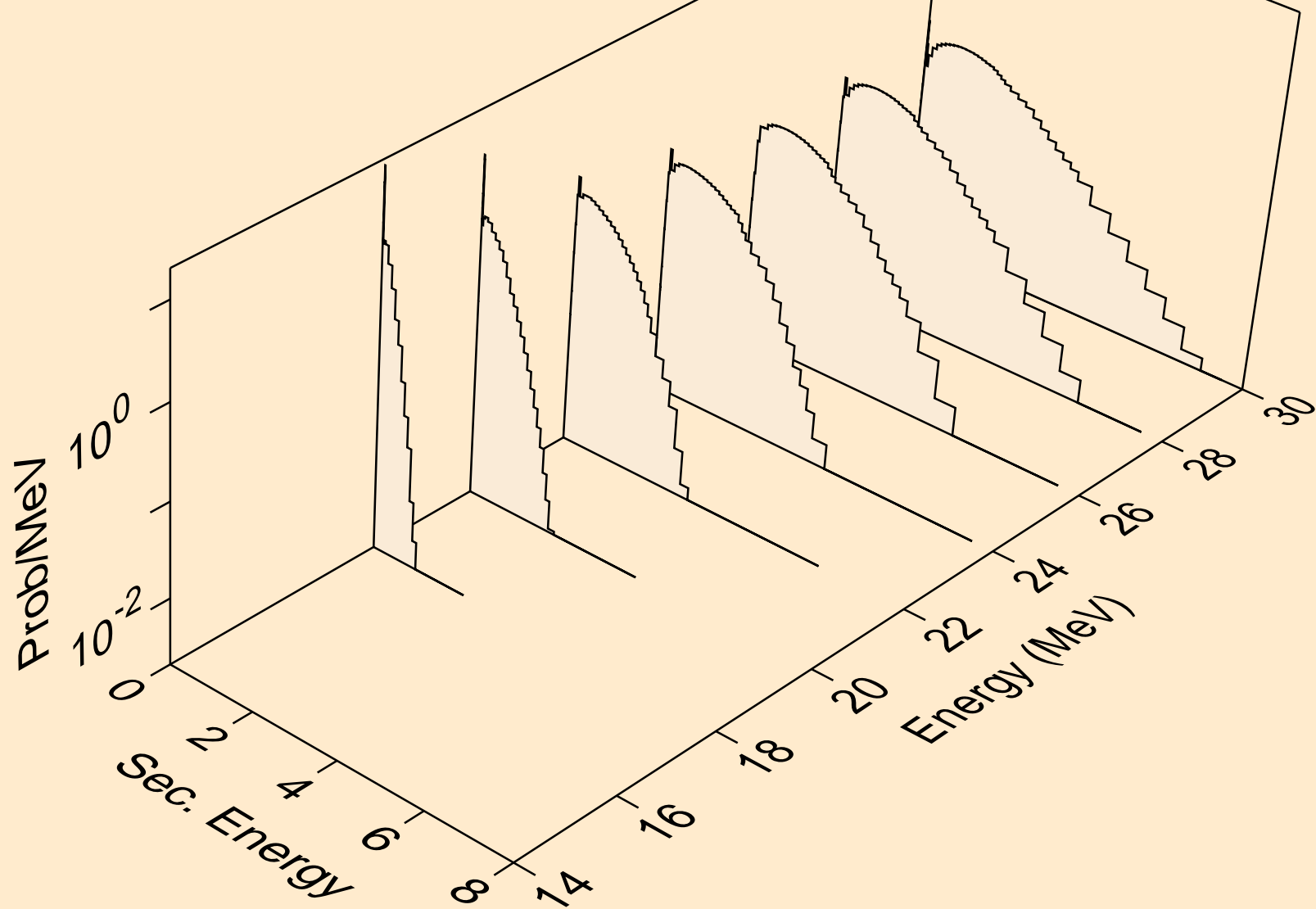

K038 NEUTRON ACER TENDL-2024 LIBRARY; T=293.6K
Neutron emission for (n,2np)

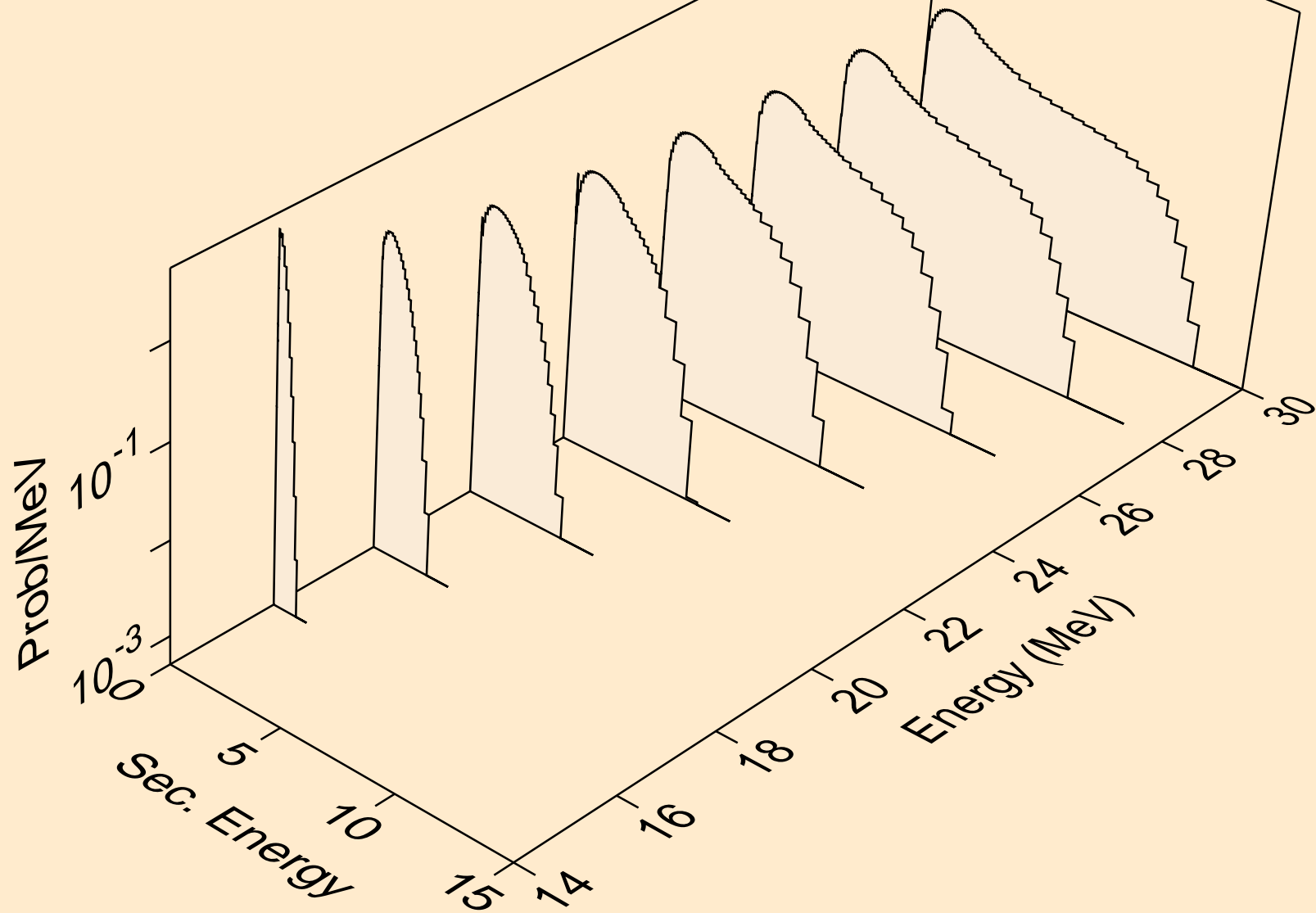

K038 NEUTRON ACER TENDL-2024 LIBRARY; T=293.6K
Neutron emission for (n,n2p)

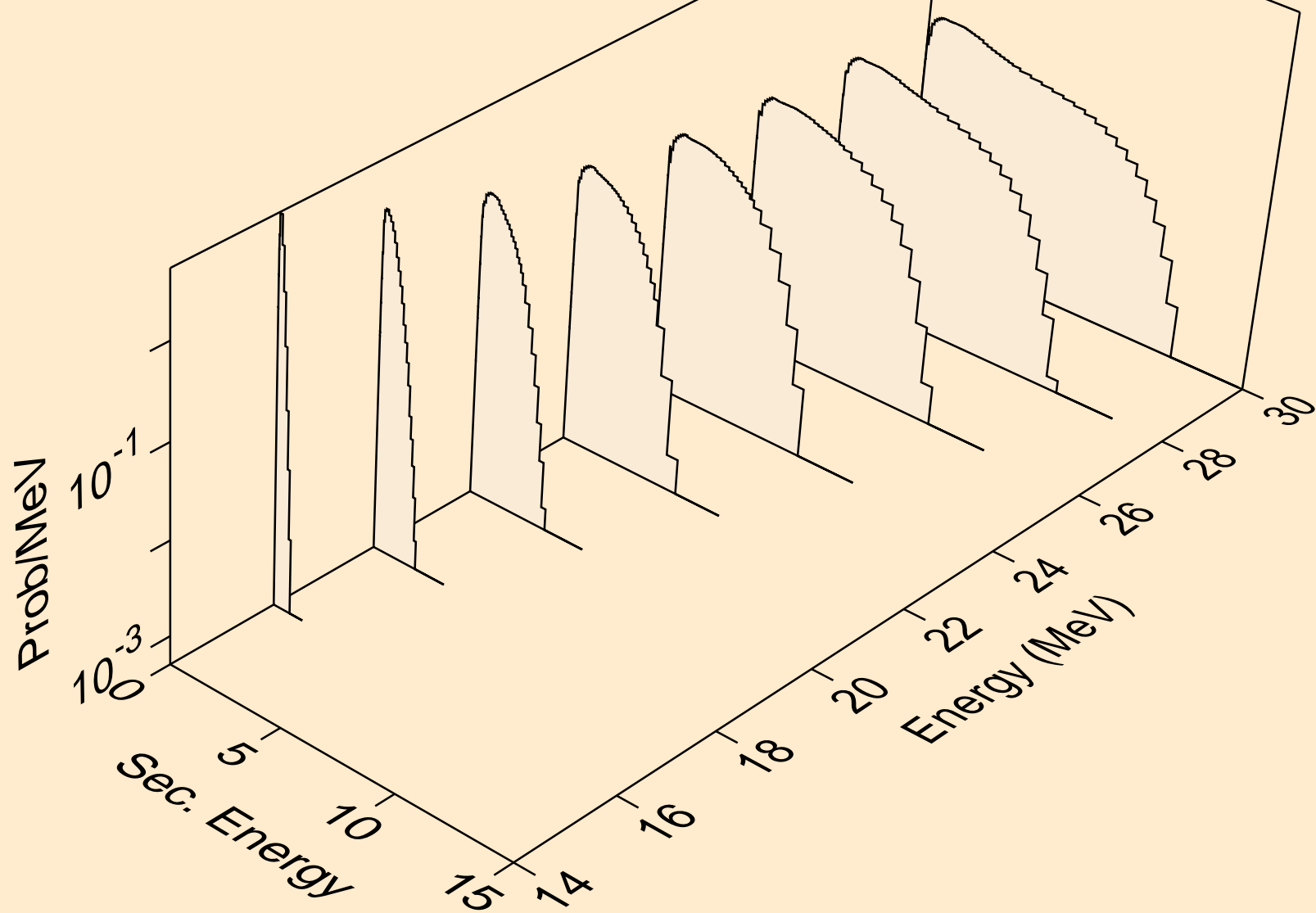

K038 NEUTRON ACER TENDL-2024 LIBRARY; T=293.6K
Neutron emission for (n,npa)

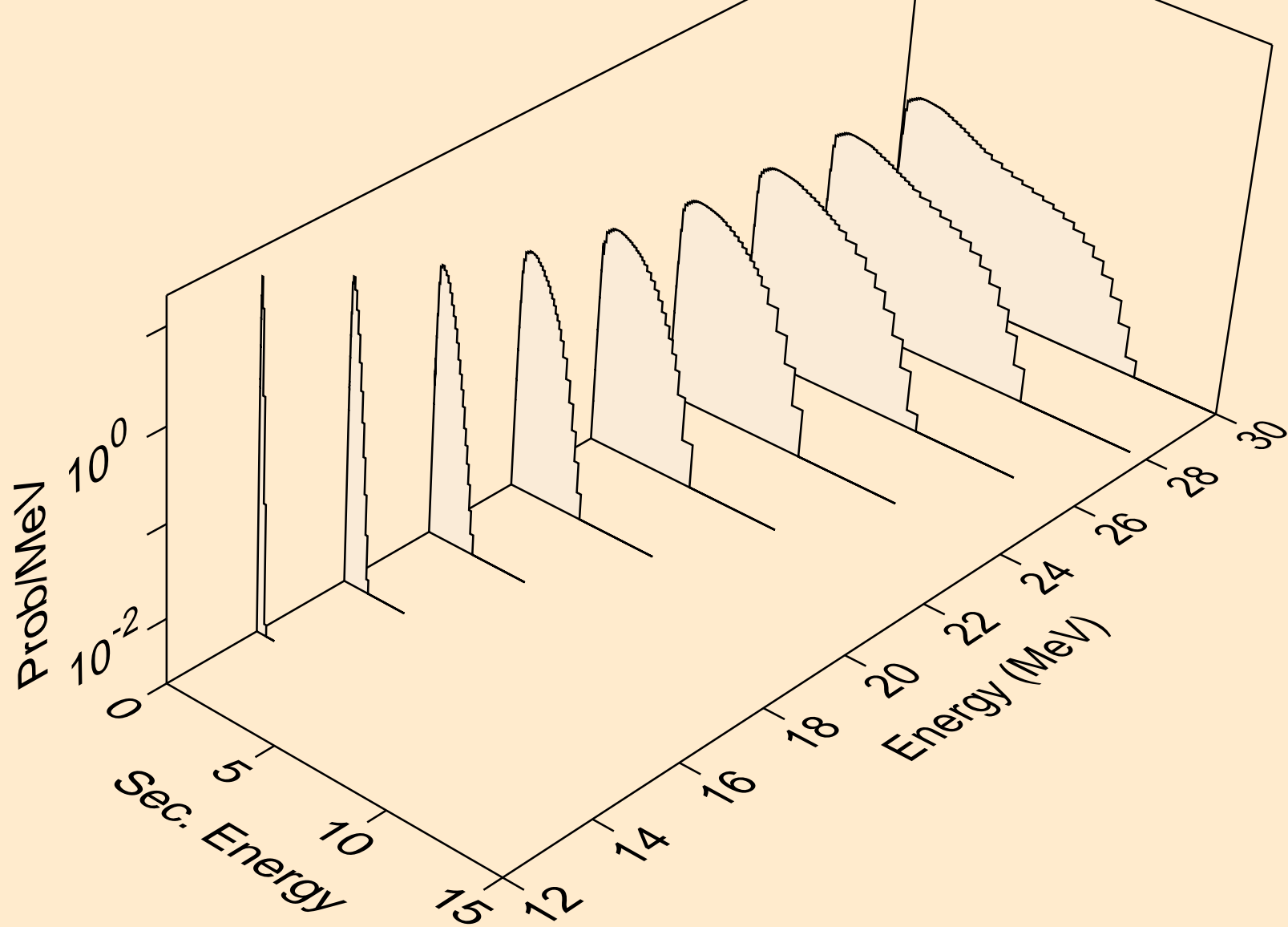

K038 NEUTRON ACER TENDL-2024 LIBRARY; T=293.6K
Neutron emission for (n,n*c)

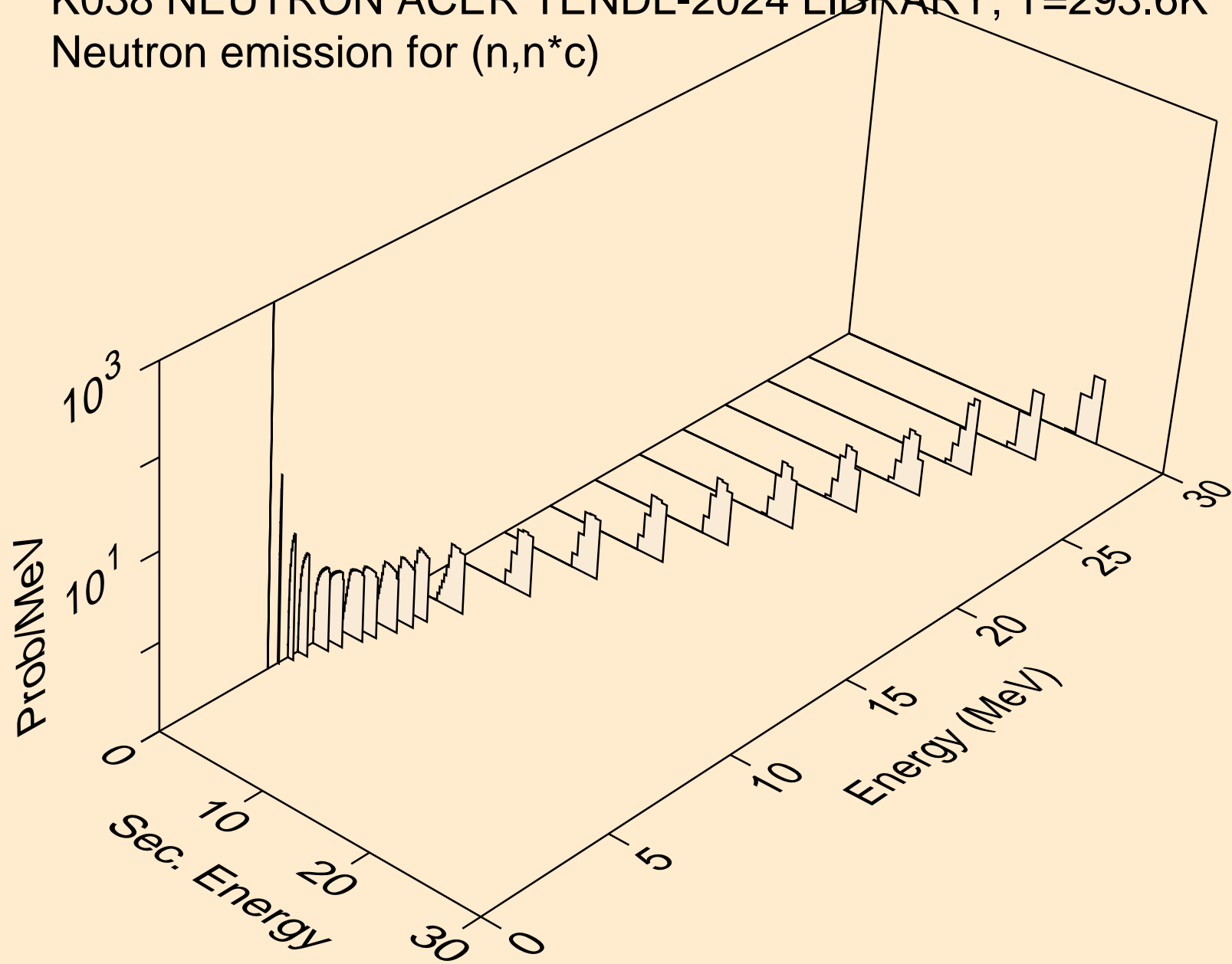

K038 NEUTRON ACER TENDL-2024 LIBRARY; T=293.6K
Photon emission for (n,x)

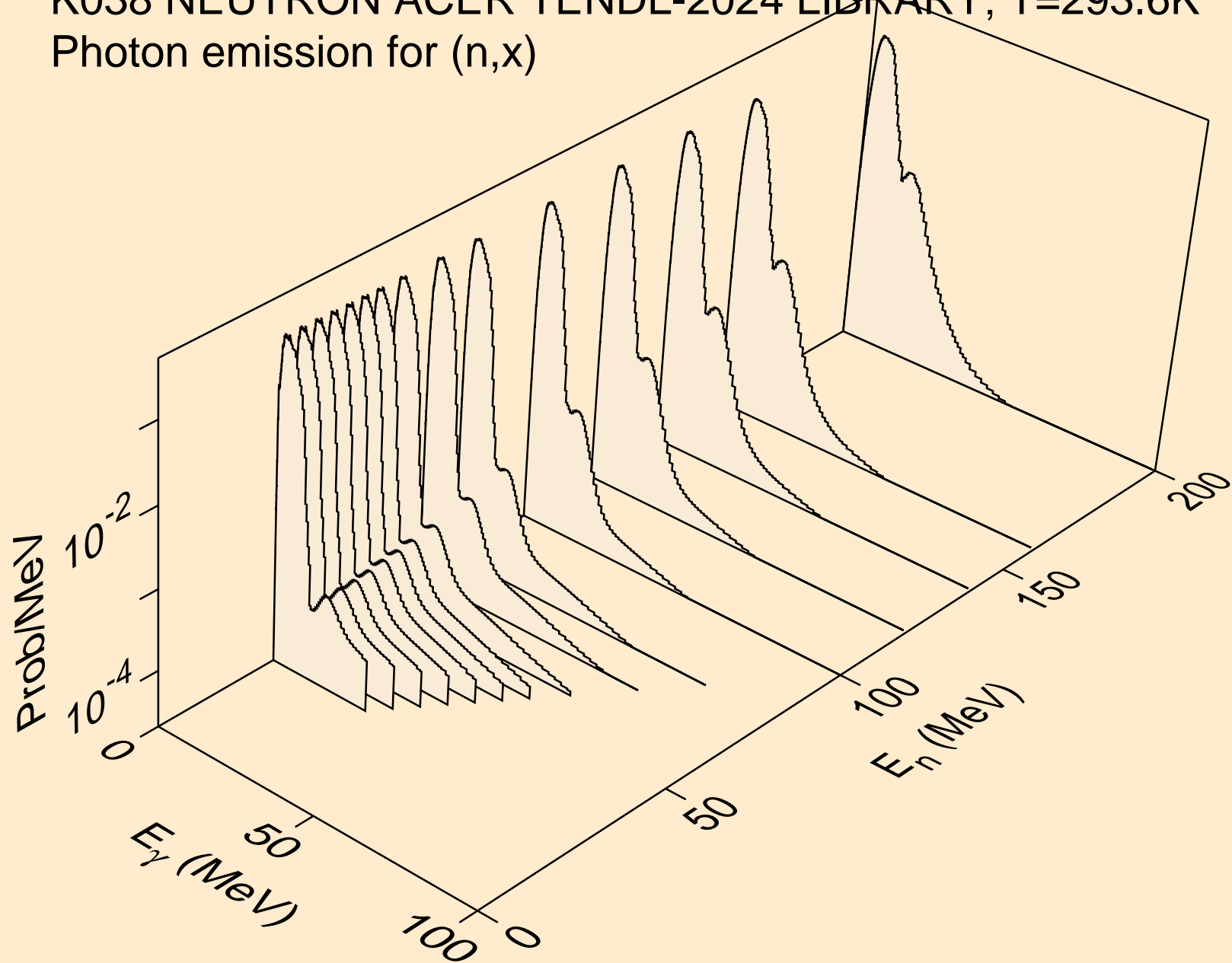

K038 NEUTRON ACER TENDL-2024 LIBRARY; T=293.6K
Photon emission for (n,2nd)

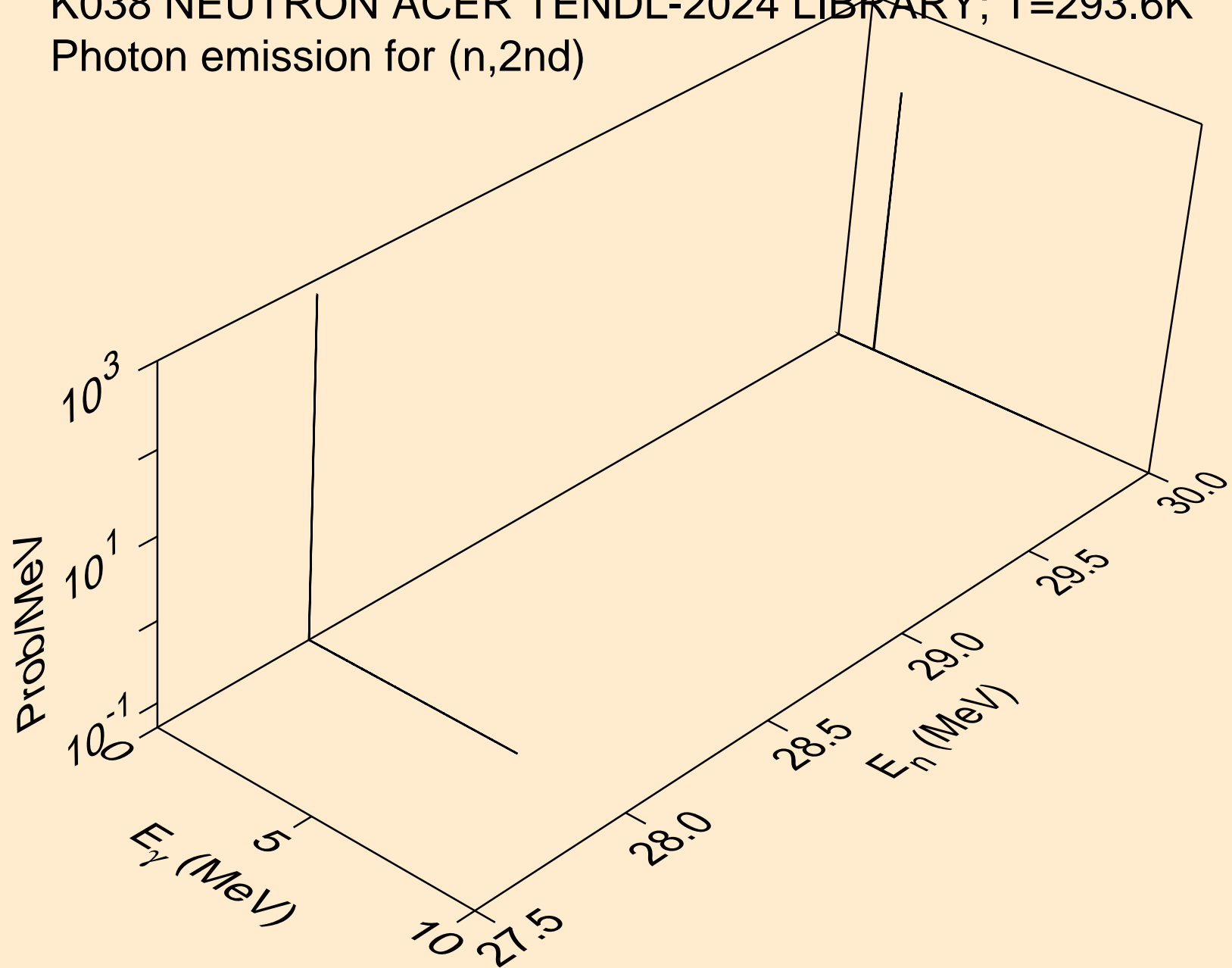

K038 NEUTRON ACER TENDL-2024 LIBRARY; T=293.6K
Photon emission for (n,2n)

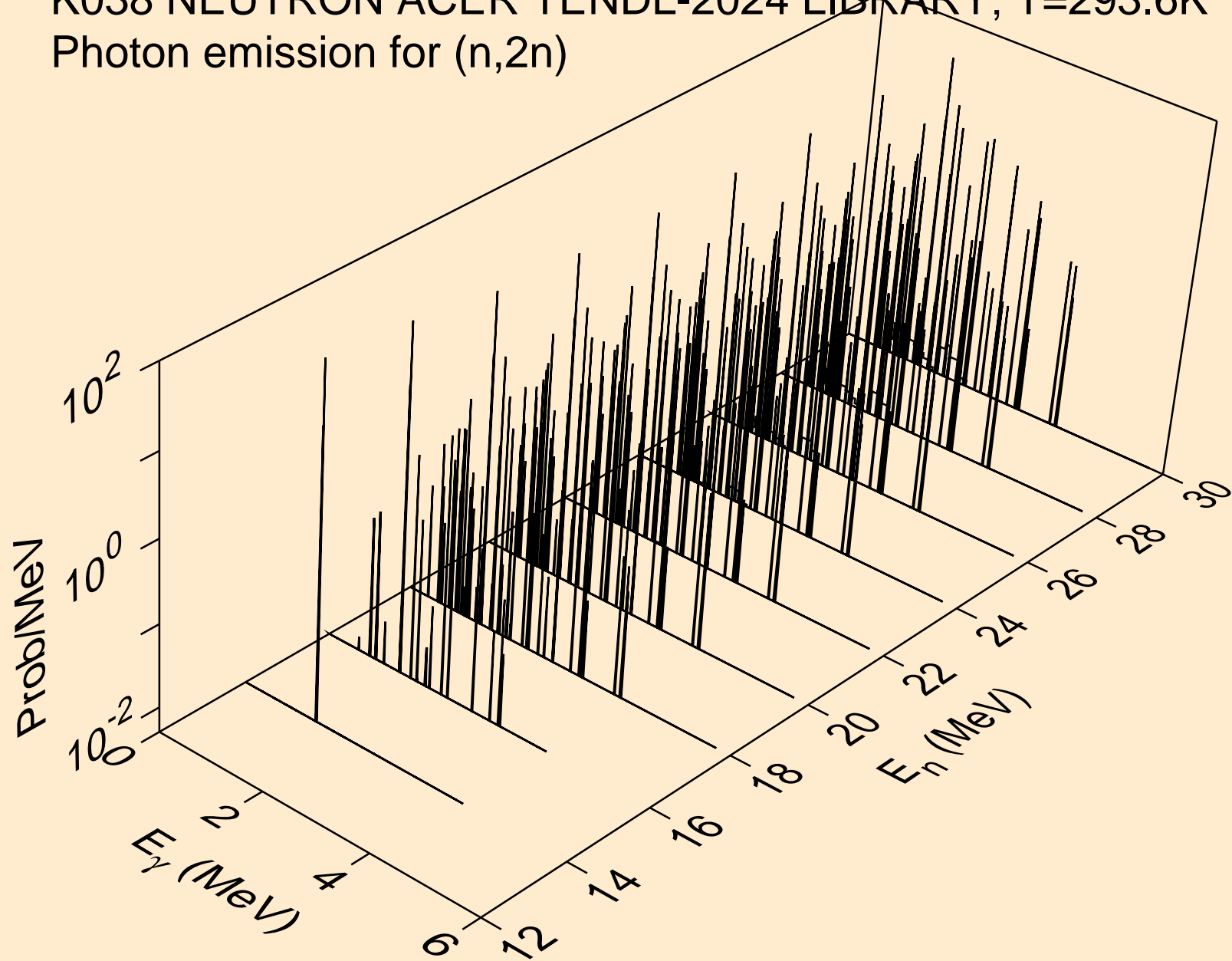

K038 NEUTRON ACER TENDL-2024 LIBRARY; T=293.6K
Photon emission for (n,3n)

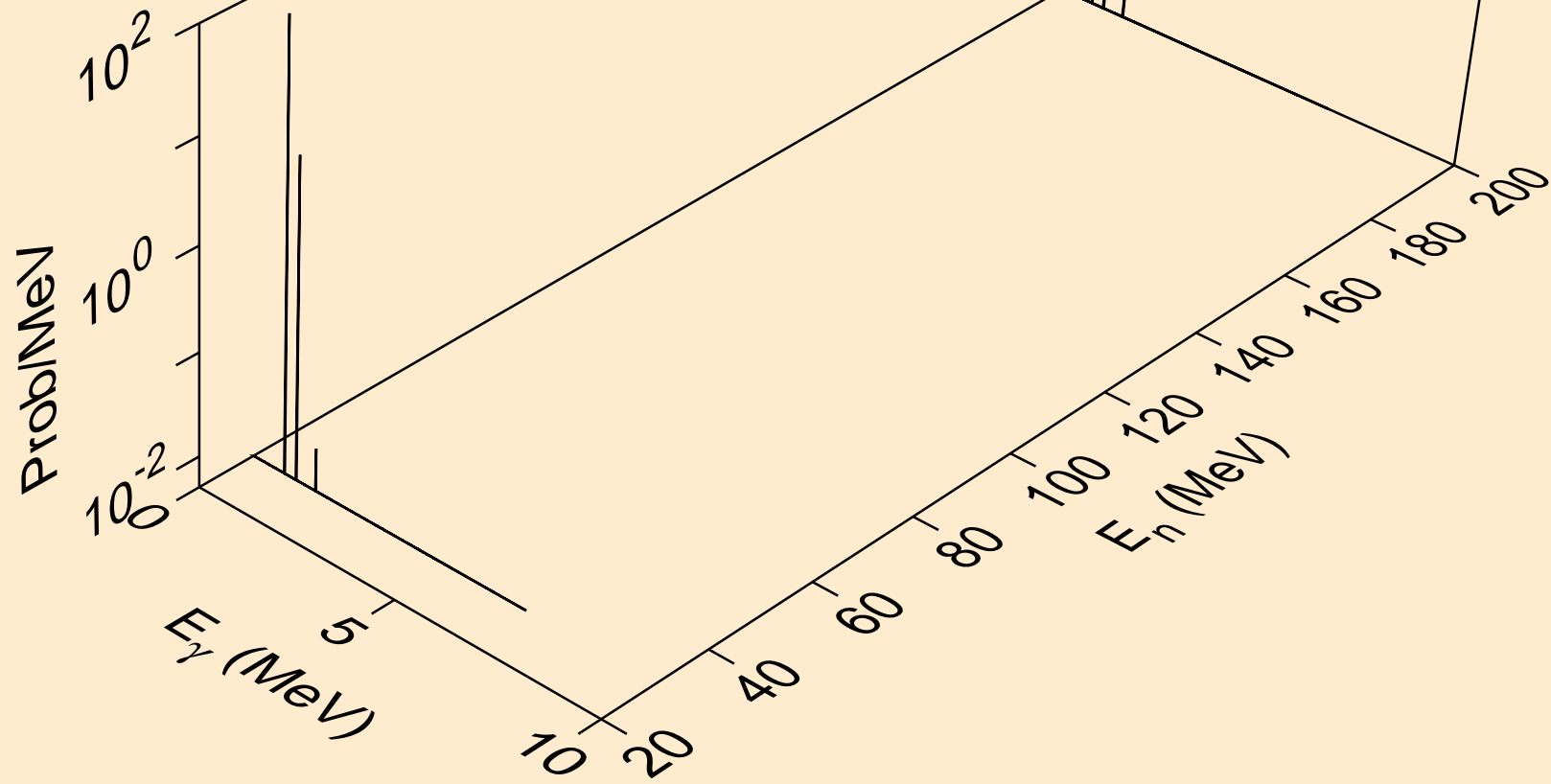

K038 NEUTRON ACER TENDL-2024 LIBRARY; T=293.6K
Photon emission for (n,n*)a

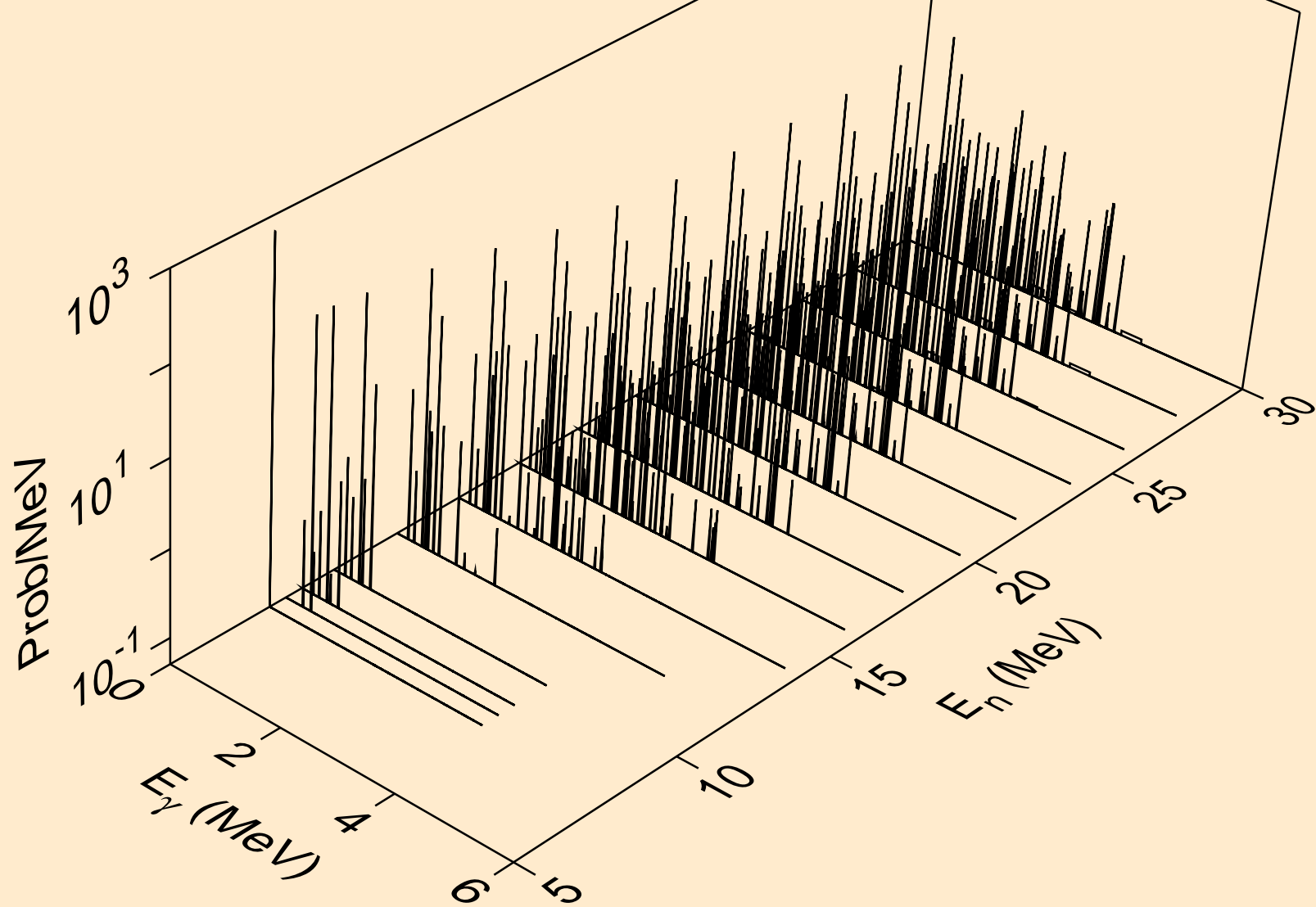

K038 NEUTRON ACER TENDL-2024 LIBRARY; T=293.6K
Photon emission for (n,2n)a

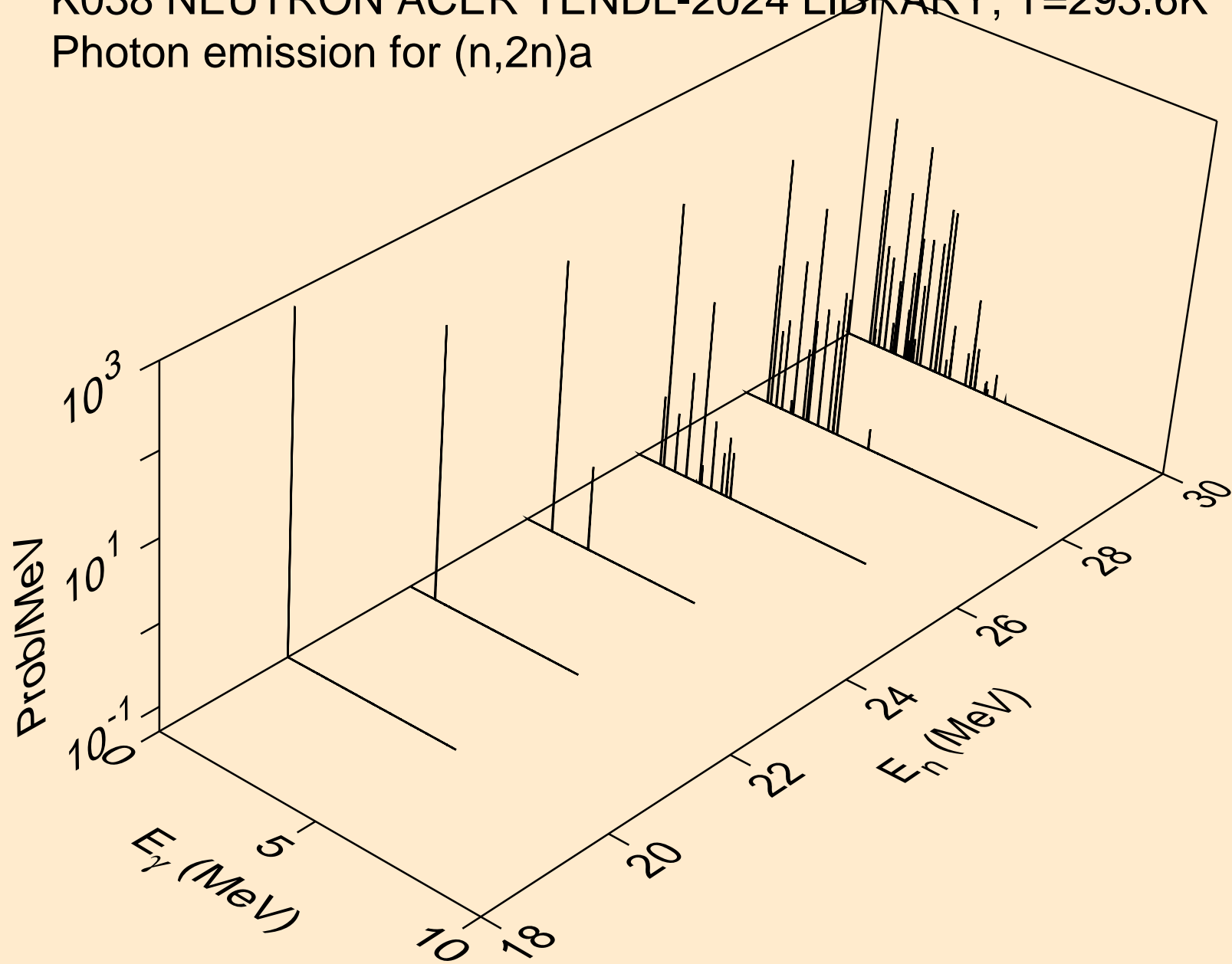

K038 NEUTRON ACER TENDL-2024 LIBRARY; T=293.6K
Photon emission for (n,n*)p

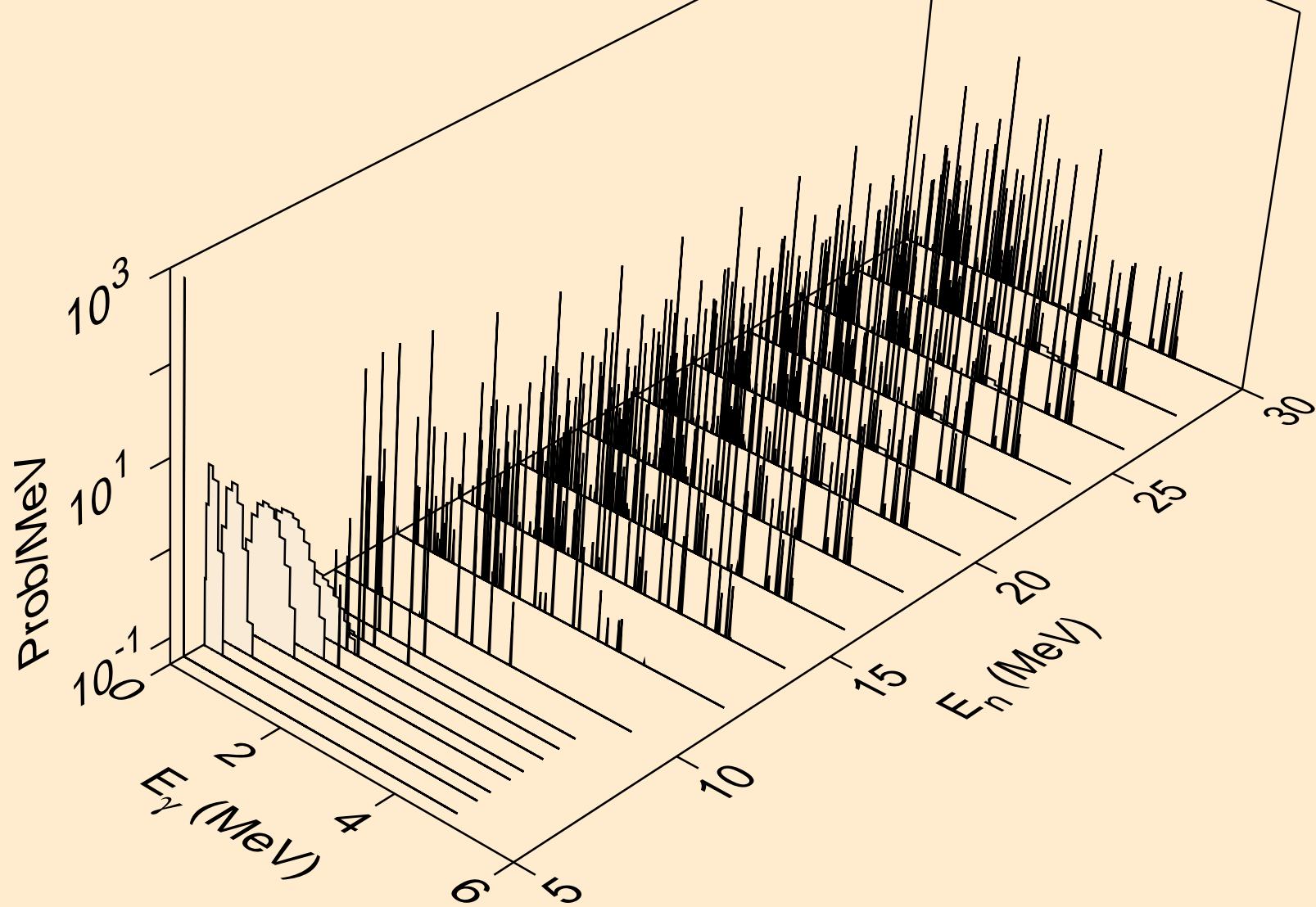

K038 NEUTRON ACER TENDL-2024 LIBRARY; T=293.6K
Photon emission for (n,n*)2a

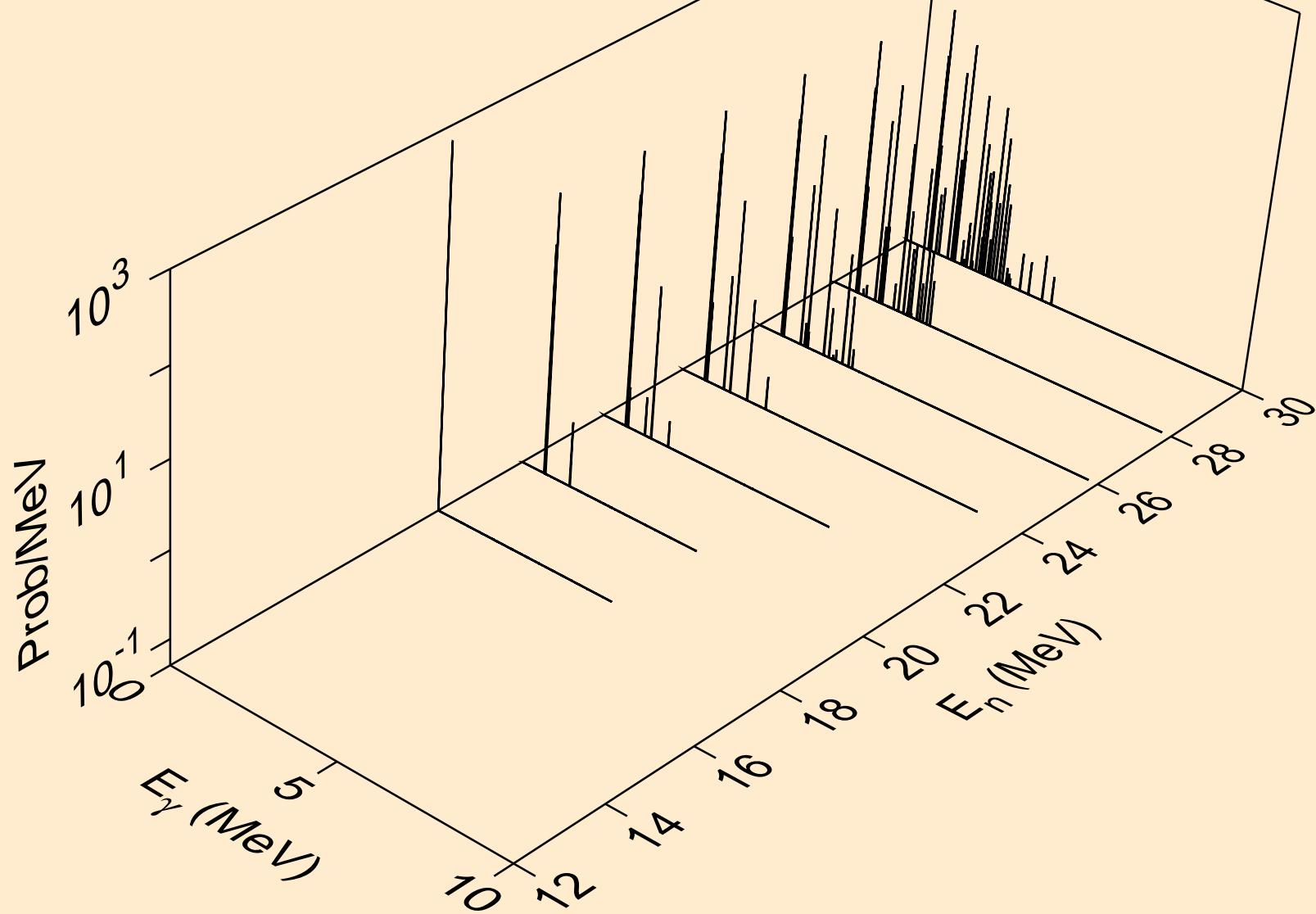

K038 NEUTRON ACER TENDL-2024 LIBRARY; T=293.6K
Photon emission for (n,n*)d

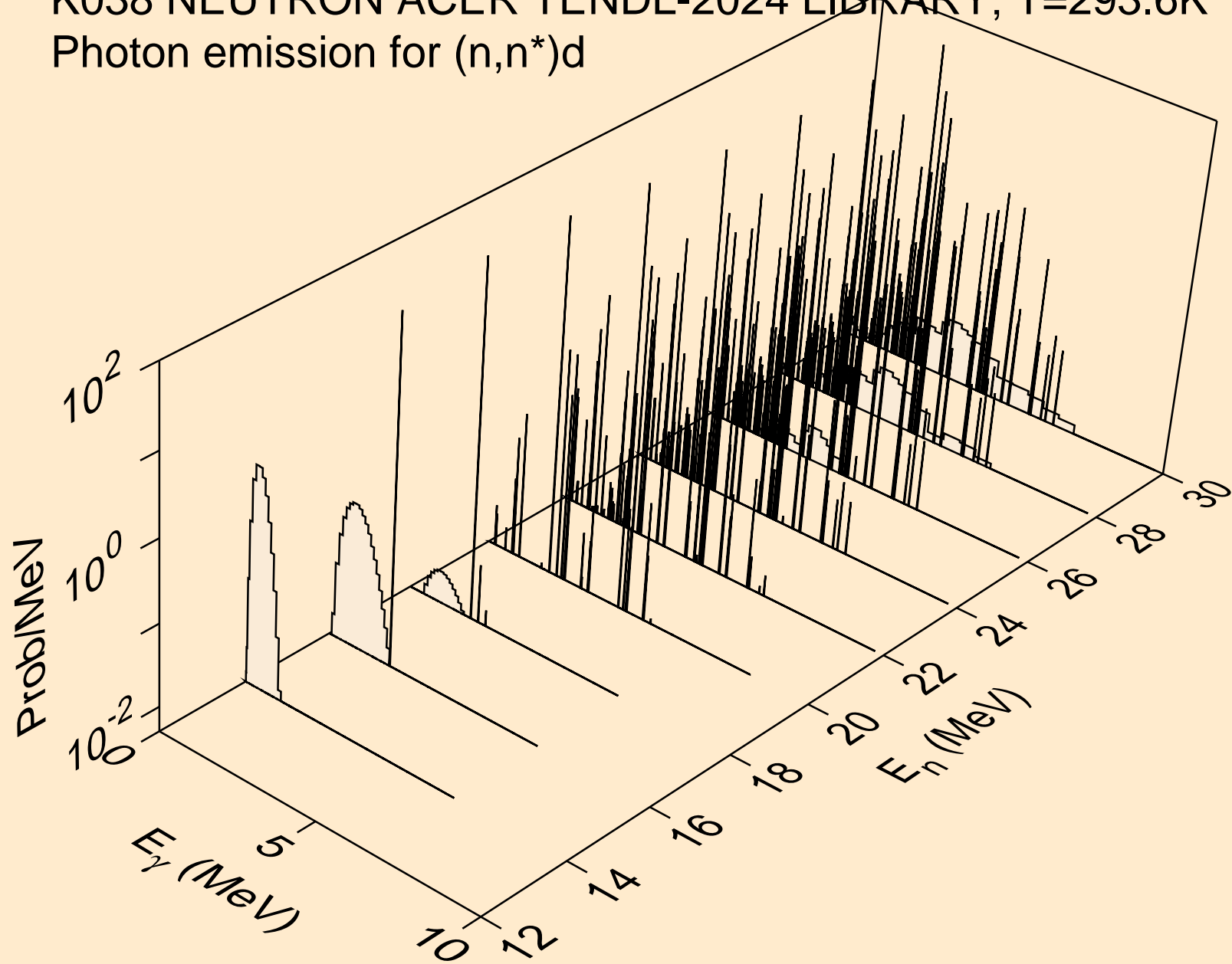

K038 NEUTRON ACER TENDL-2024 LIBRARY; T=293.6K
Photon emission for (n,n*)t

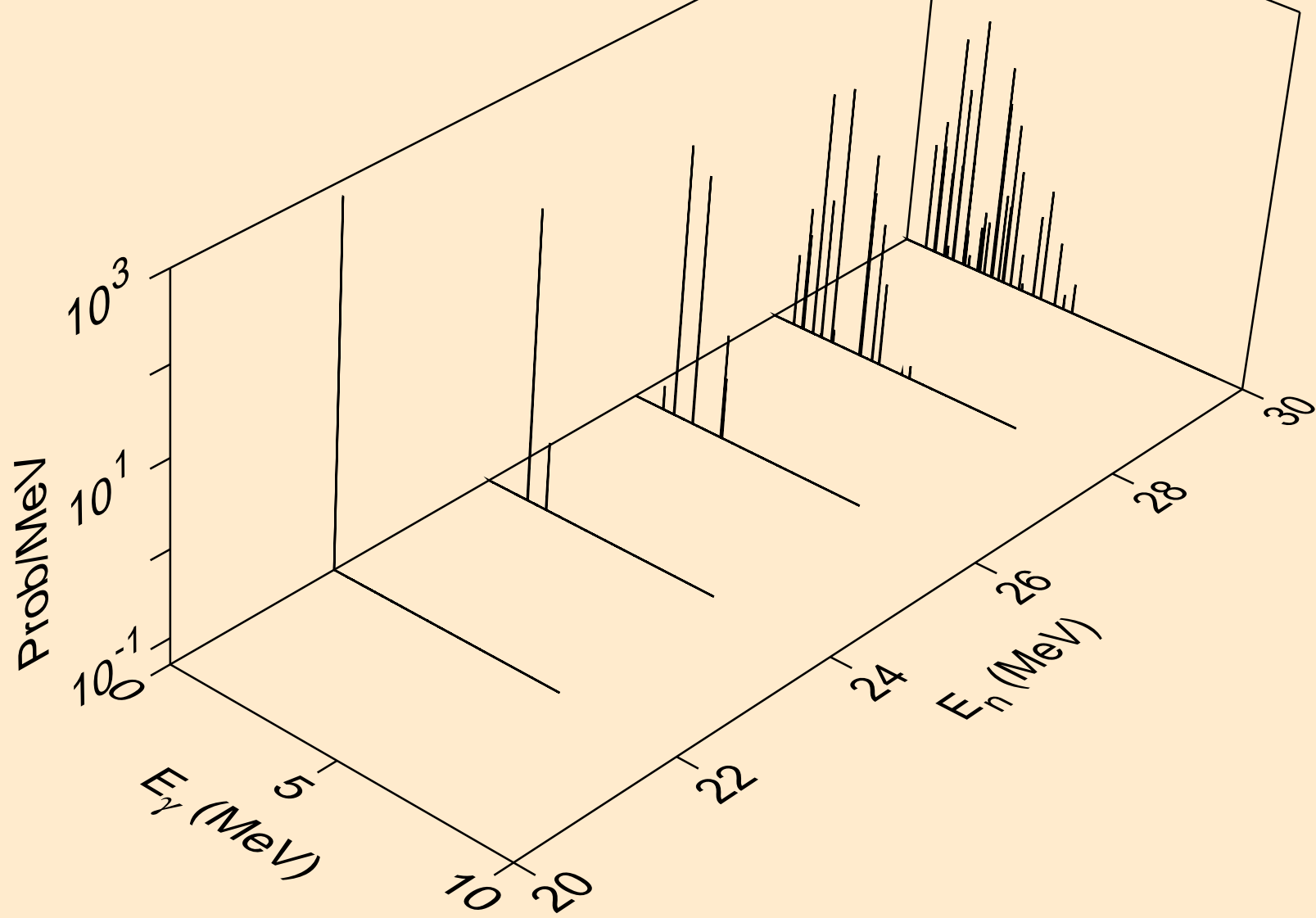

K038 NEUTRON ACER TENDL-2024 LIBRARY; T=293.6K
Photon emission for (n,n*)he3

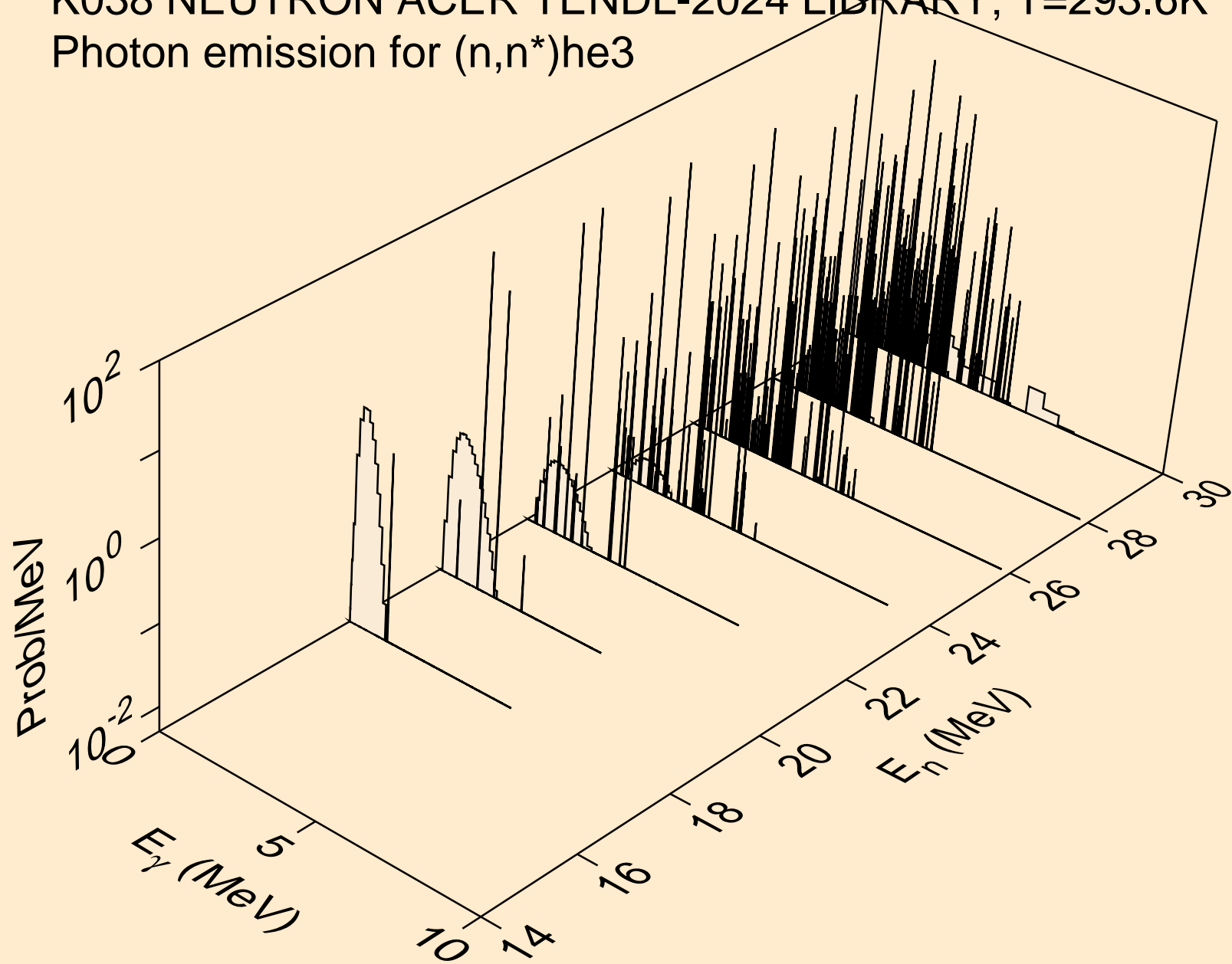

K038 NEUTRON ACER TENDL-2024 LIBRARY; T=293.6K
Photon emission for (n,2np)

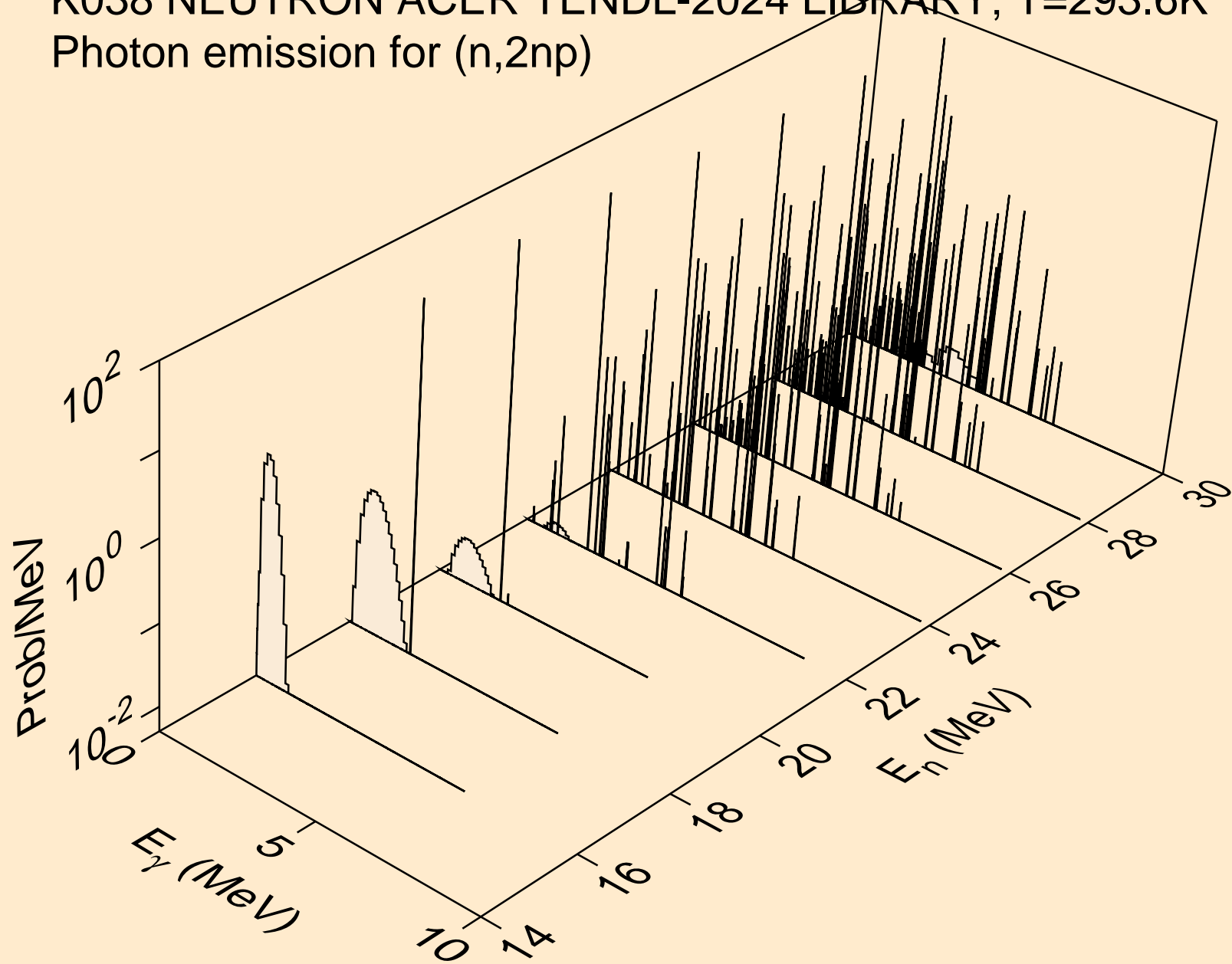

K038 NEUTRON ACER TENDL-2024 LIBRARY; T=293.6K
Photon emission for (n,n2p)

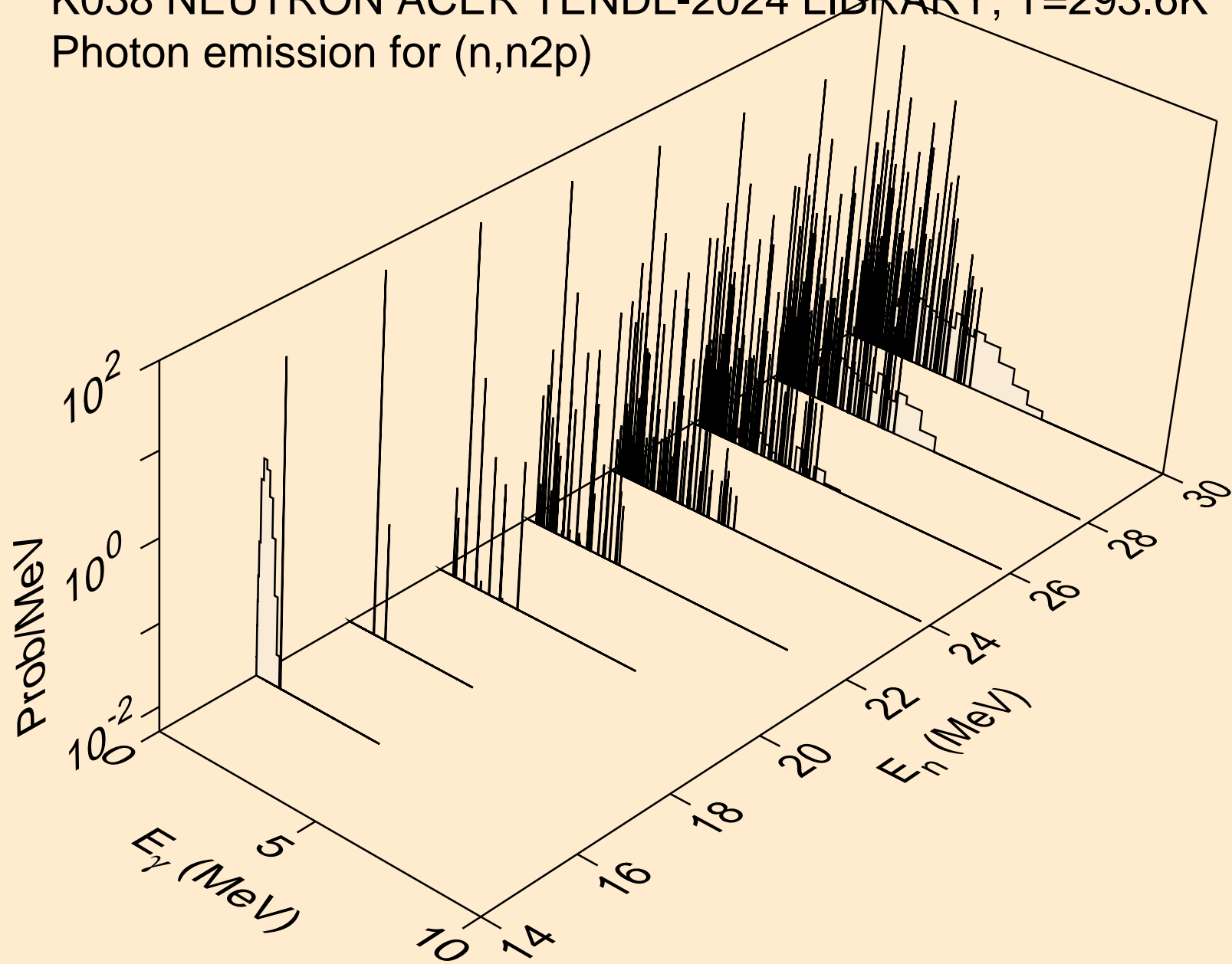

K038 NEUTRON ACER TENDL-2024 LIBRARY; T=293.6K
Photon emission for (n,npa)

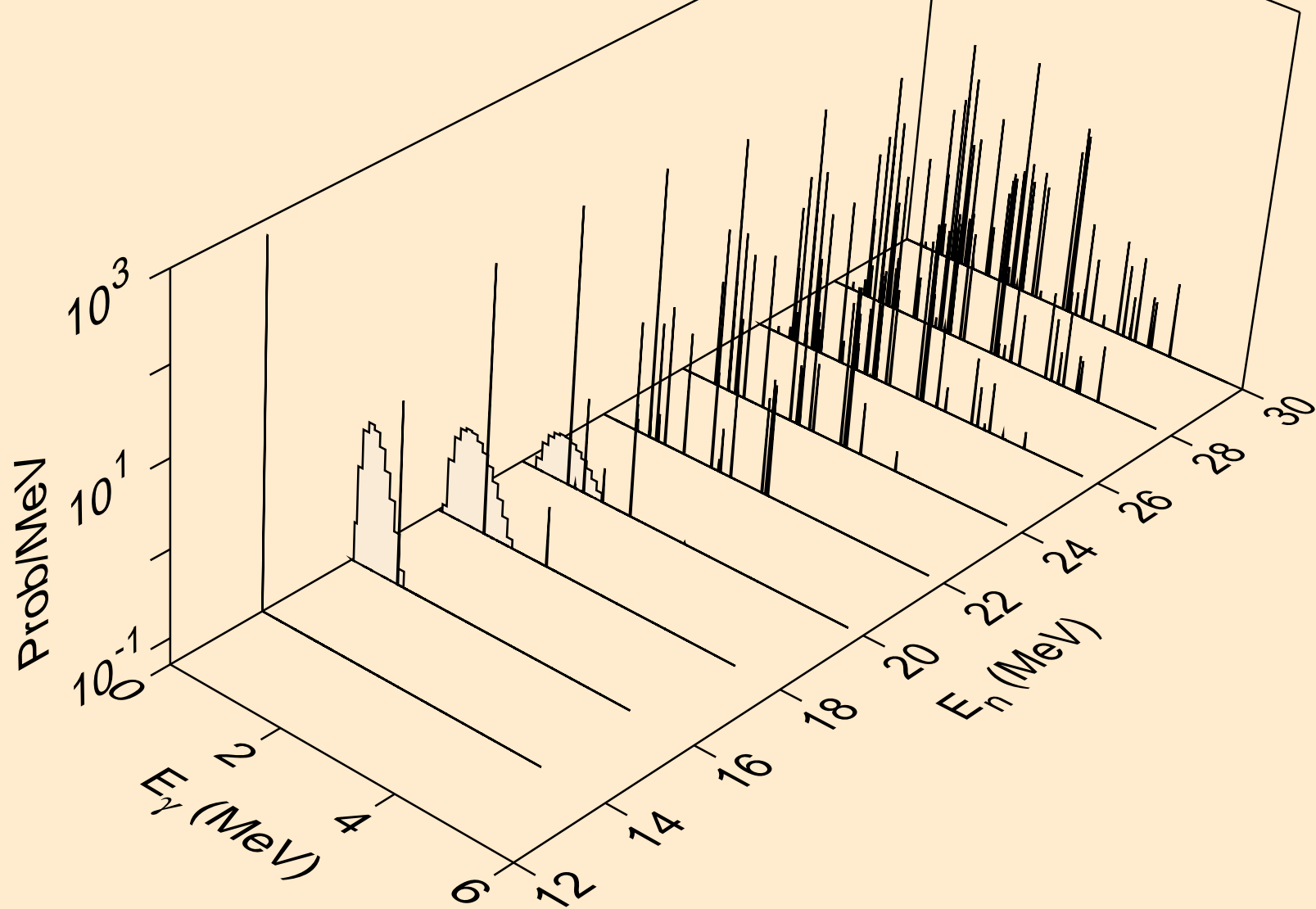

K038 NEUTRON ACER TENDL-2024 LIBRARY; T=293.6K
Photon emission for (n,n*c)

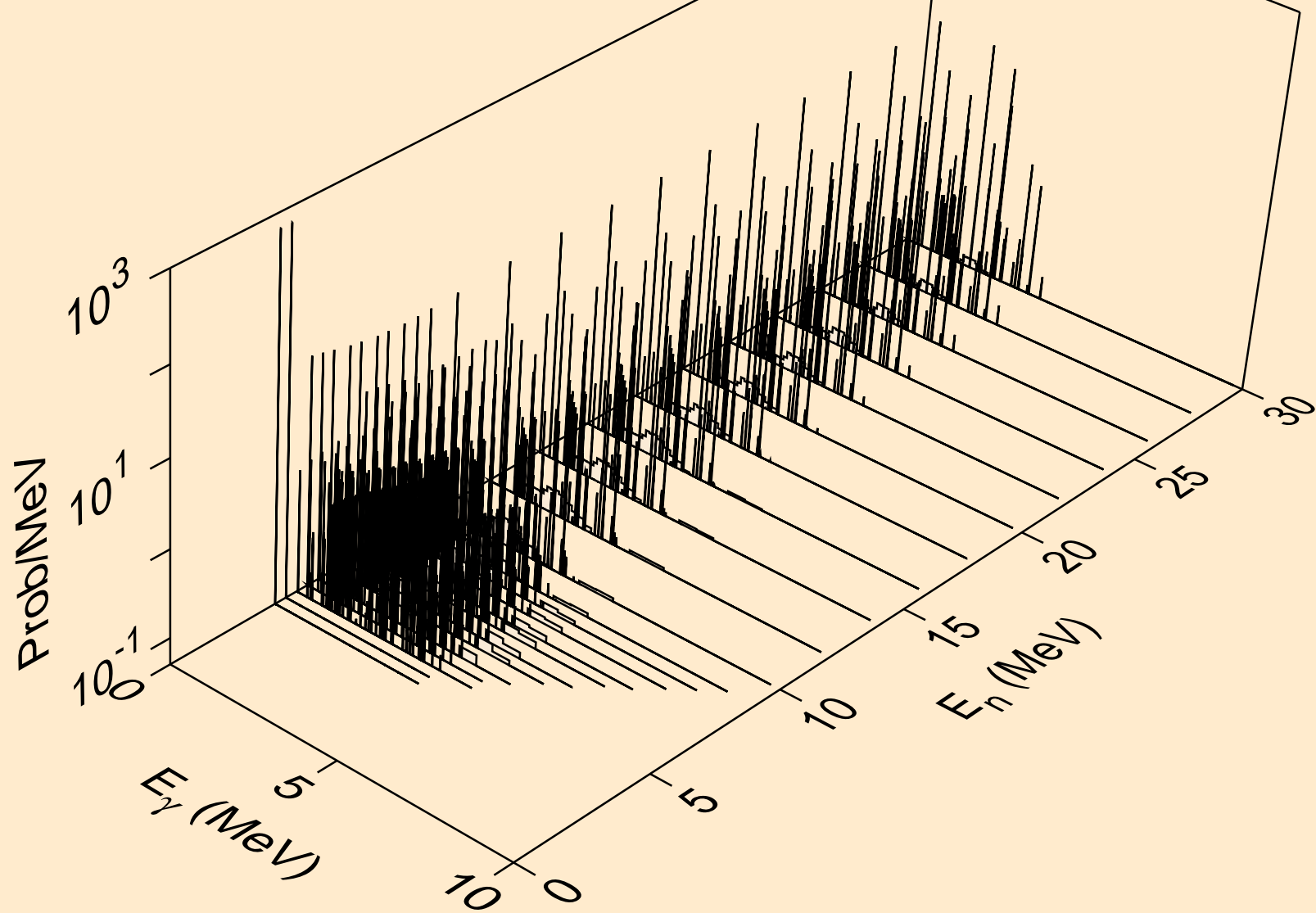

K038 NEUTRON ACER TENDL-2024 LIBRARY; T=293.6K
Photon emission for (n,gma)

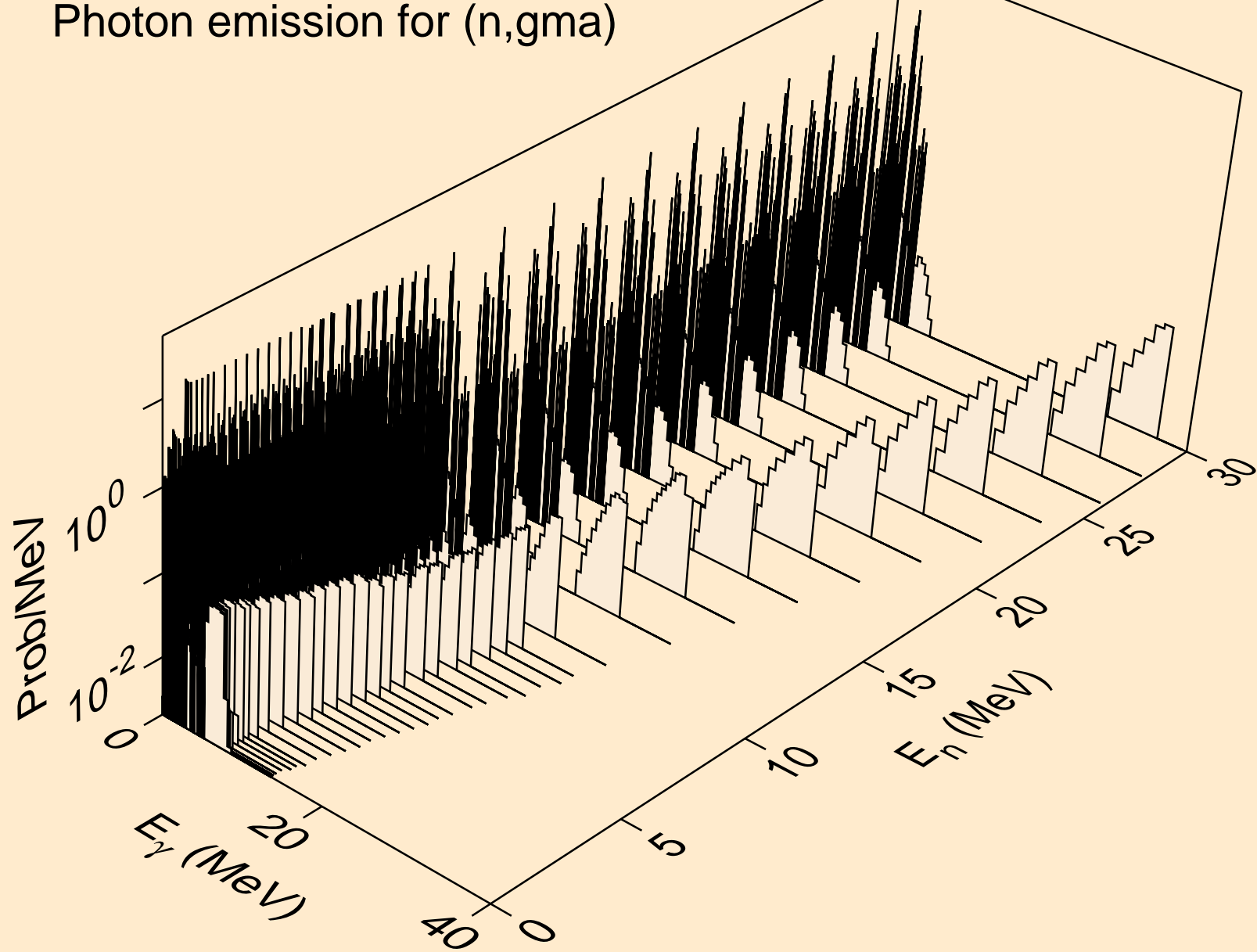

K038 NEUTRON ACER TENDL-2024 LIBRARY; T=293.6K
Photon emission for (n,p)

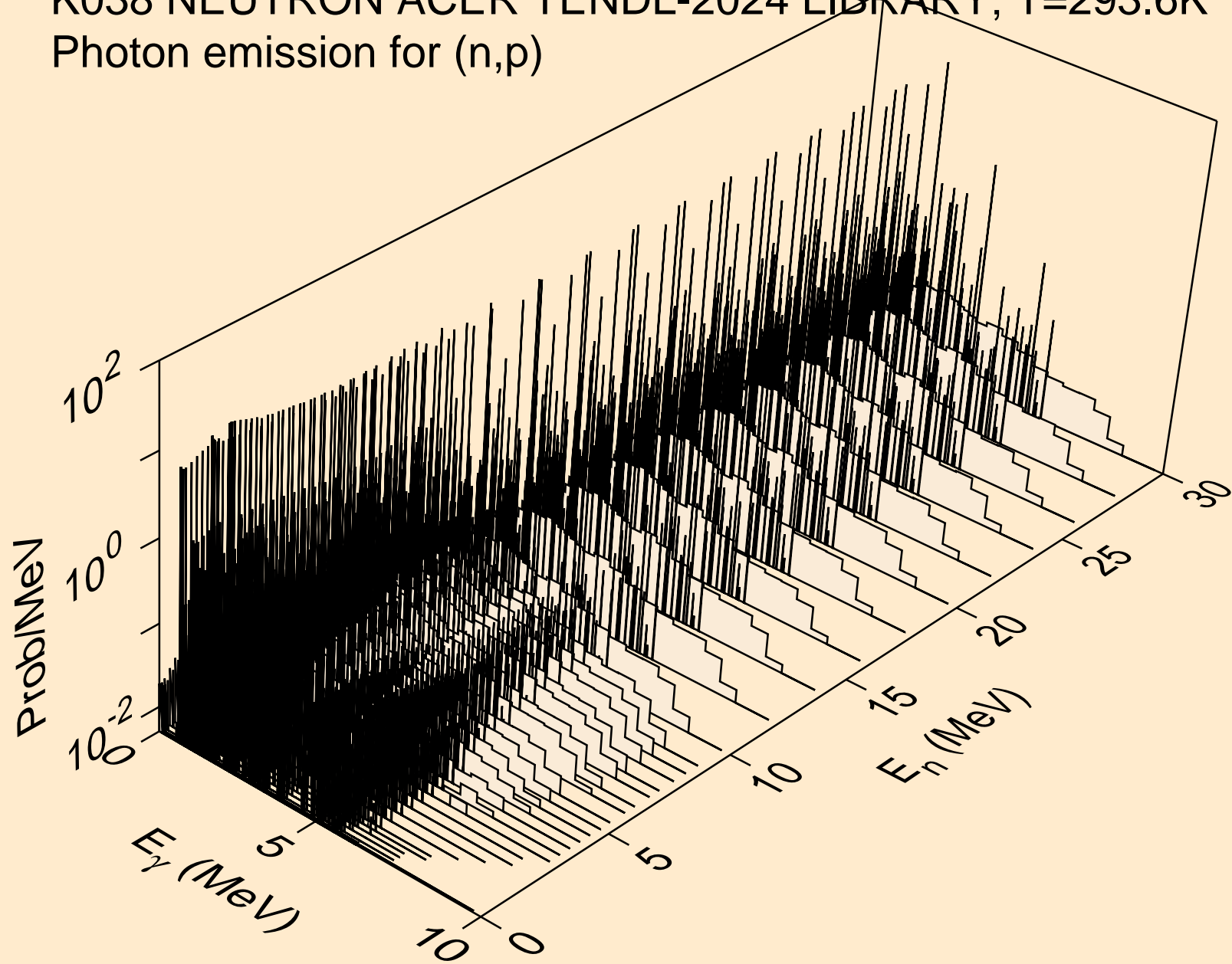

K038 NEUTRON ACER TENDL-2024 LIBRARY; T=293.6K
Photon emission for (n,d)

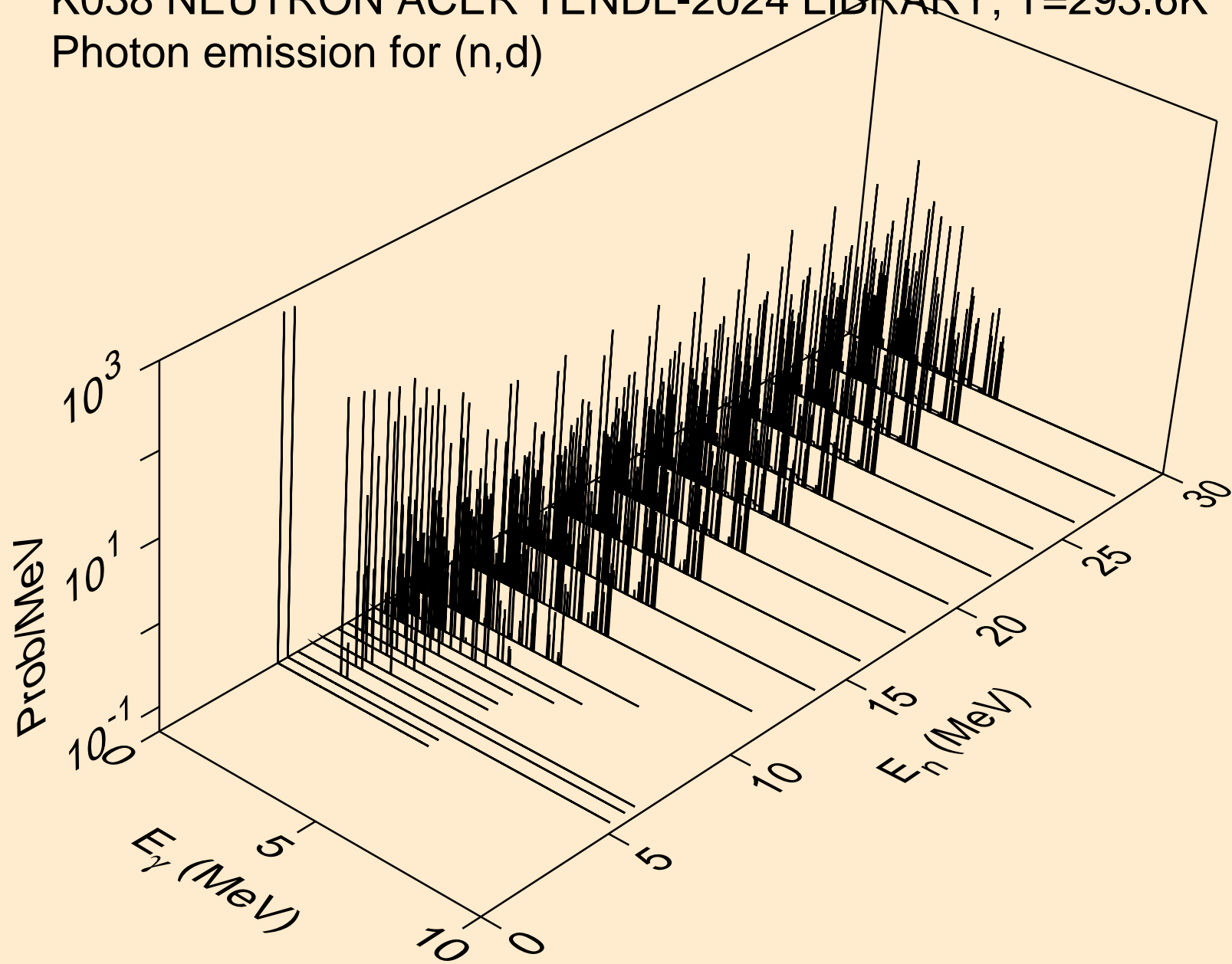

K038 NEUTRON ACER TENDL-2024 LIBRARY; T=293.6K
Photon emission for (n,t)

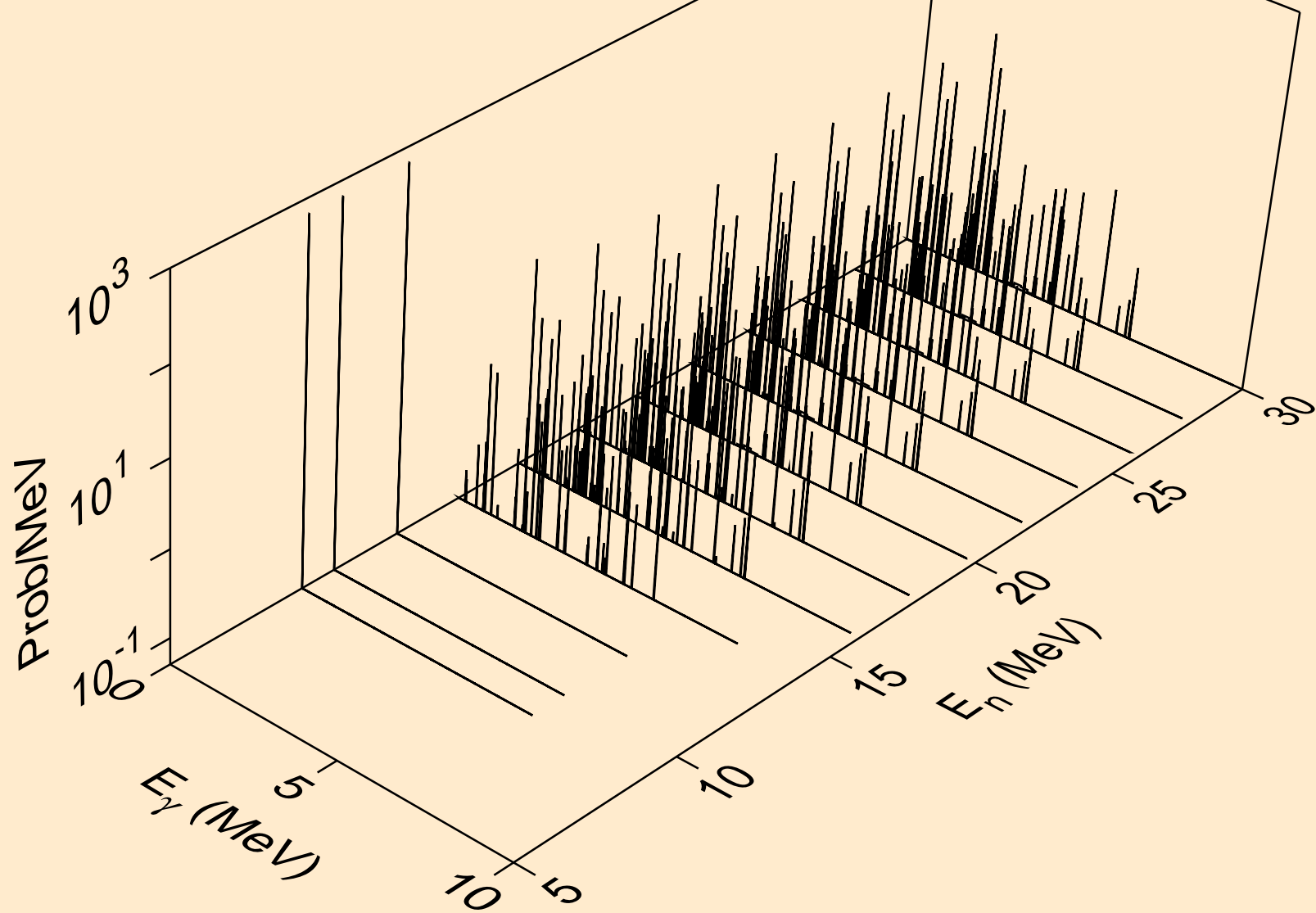

K038 NEUTRON ACER TENDL-2024 LIBRARY; T=293.6K
Photon emission for (n,he3)

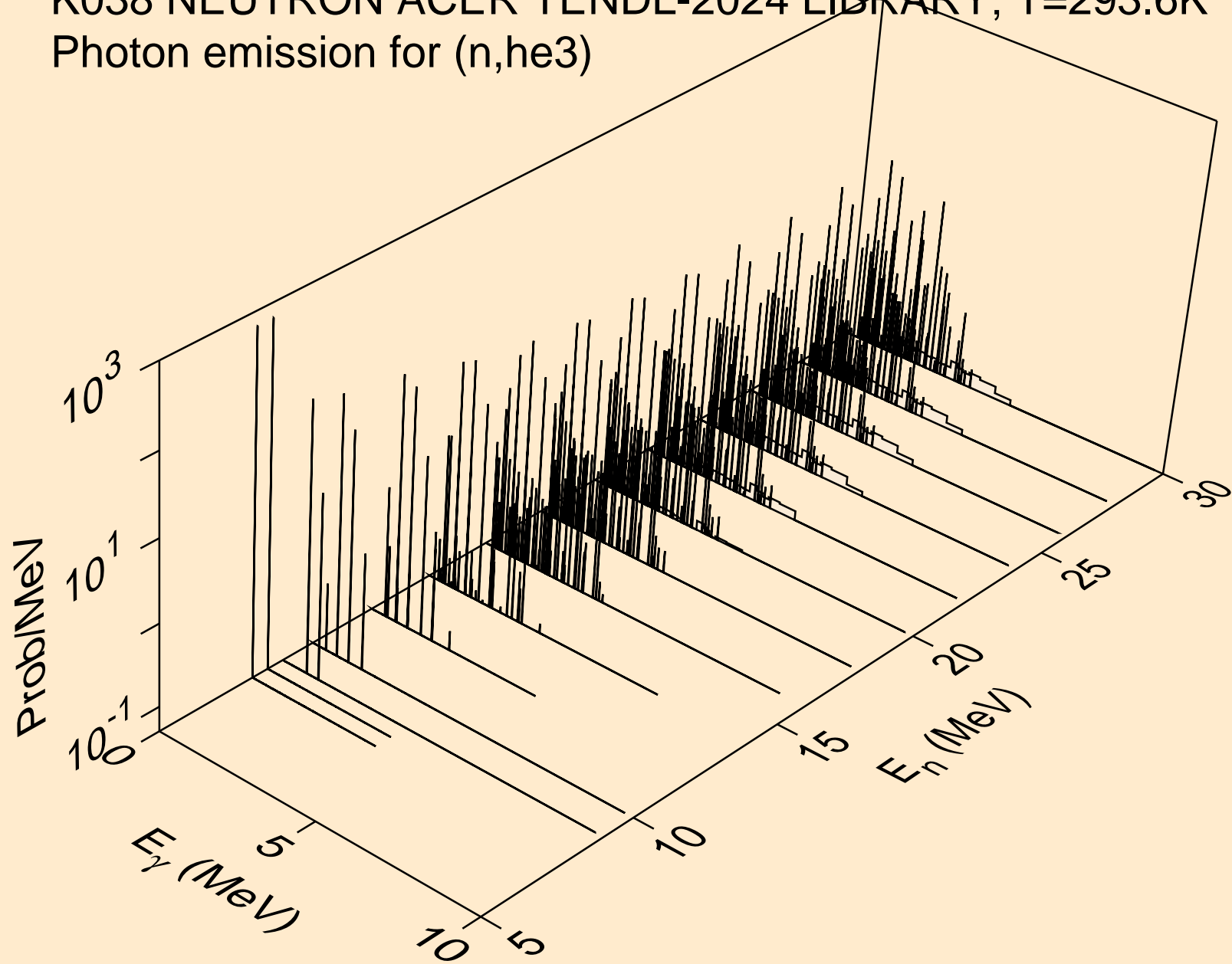

K038 NEUTRON ACER TENDL-2024 LIBRARY; T=293.6K
Photon emission for (n,a)

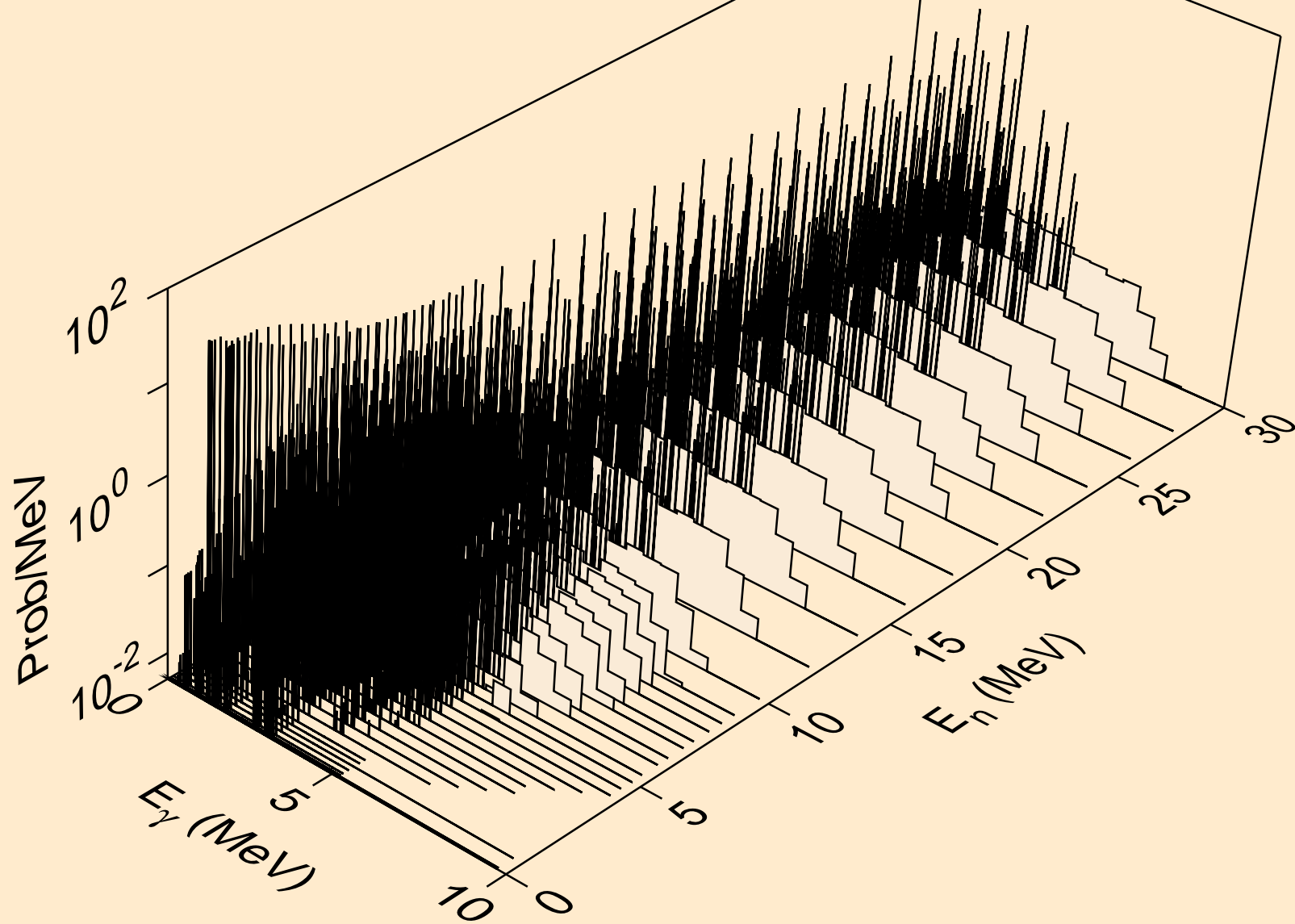

K038 NEUTRON ACER TENDL-2024 LIBRARY; T=293.6K
Photon emission for (n,2a)

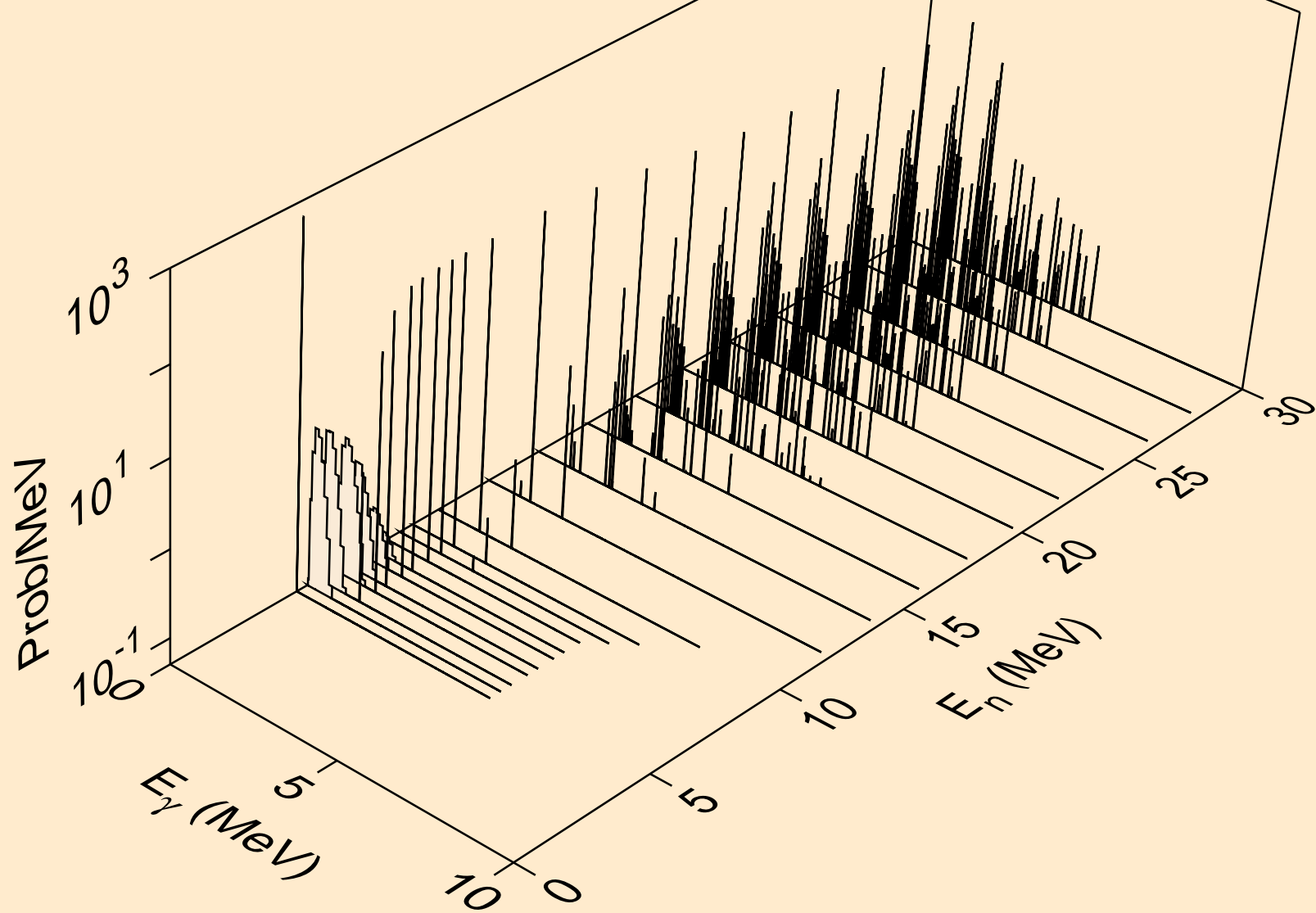

K038 NEUTRON ACER TENDL-2024 LIBRARY; T=293.6K
Photon emission for (n,3a)

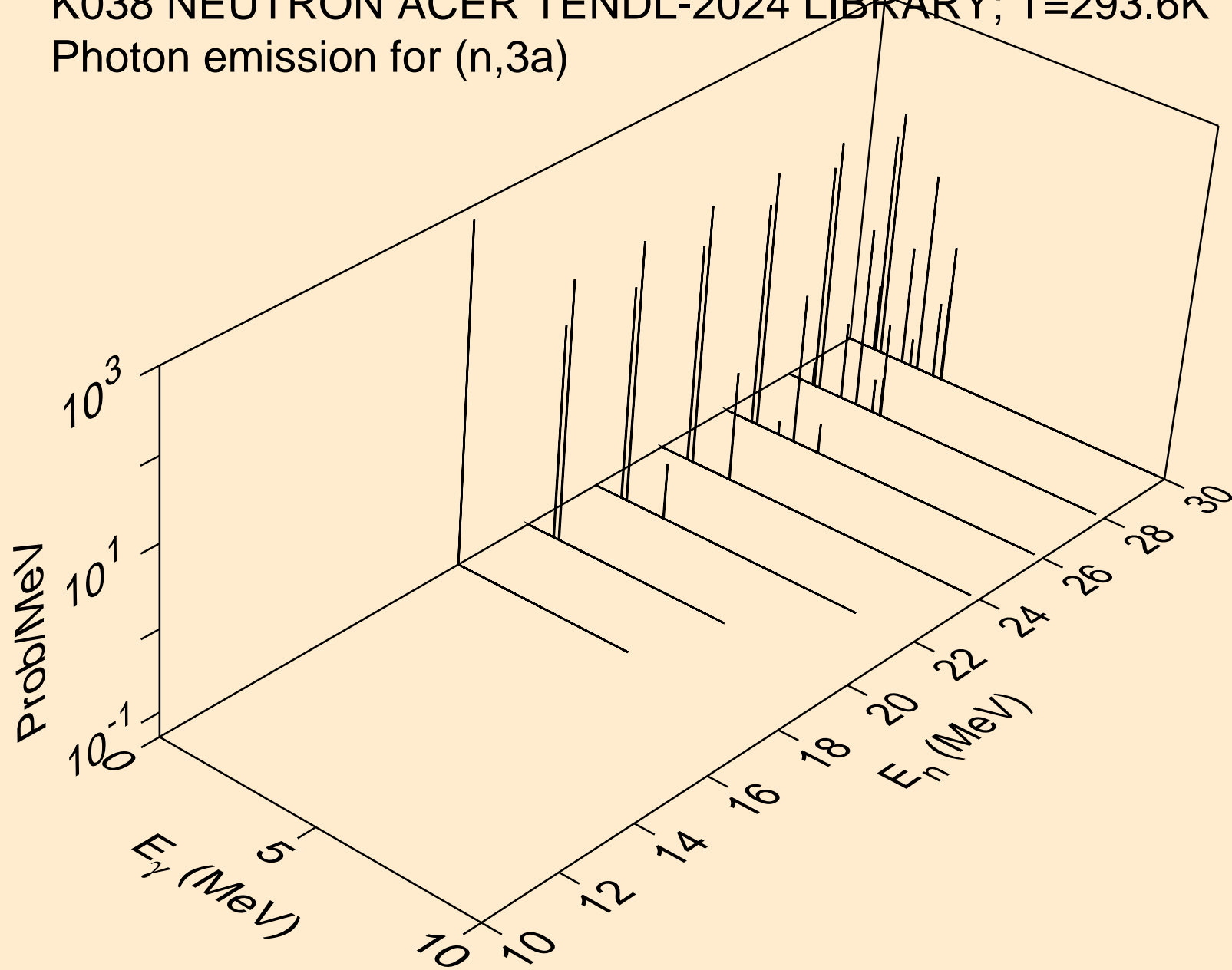

K038 NEUTRON ACER TENDL-2024 LIBRARY; T=293.6K
Photon emission for (n,2p)

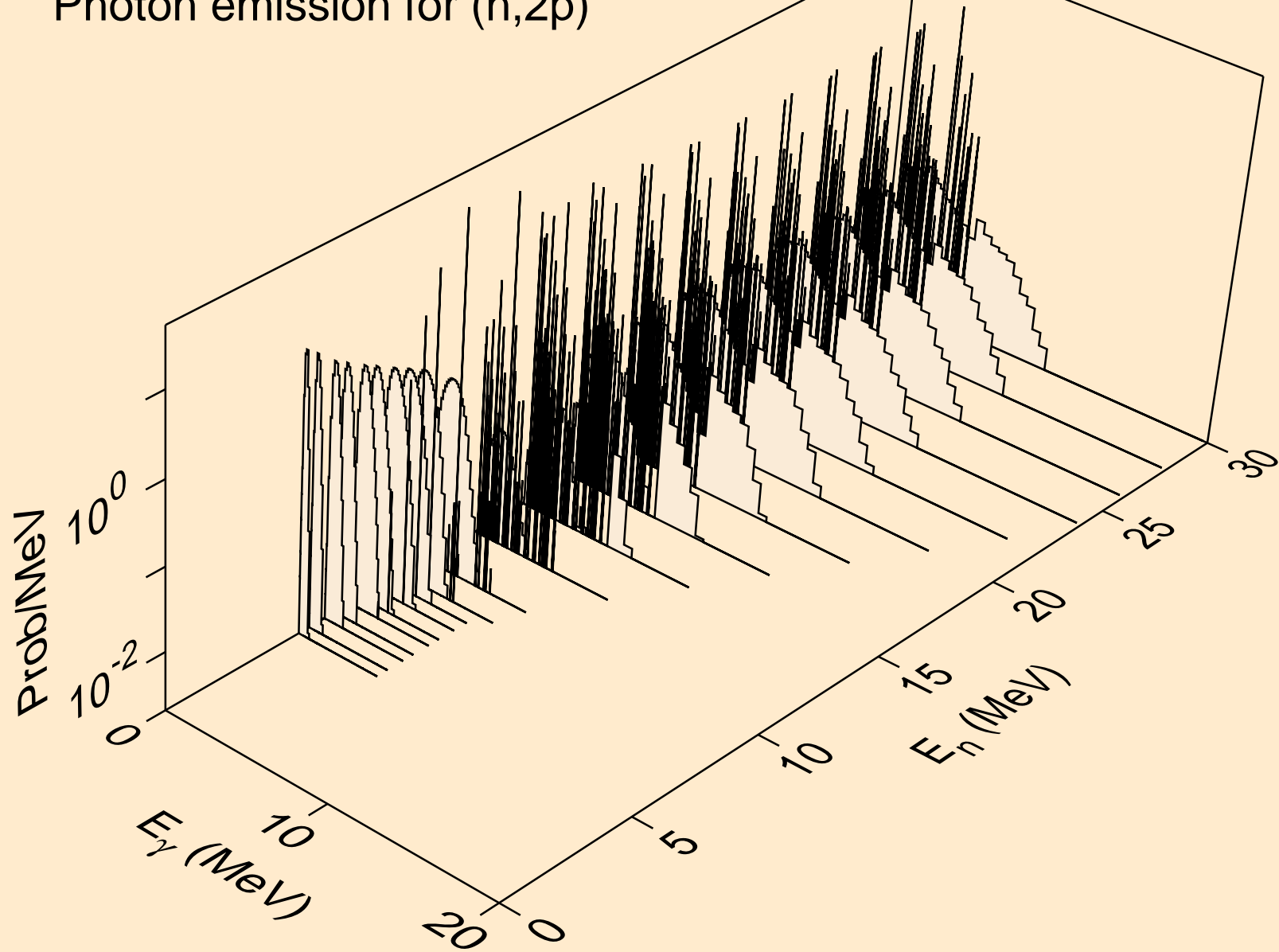

K038 NEUTRON ACER TENDL-2024 LIBRARY; T=293.6K
Photon emission for (n,p α)

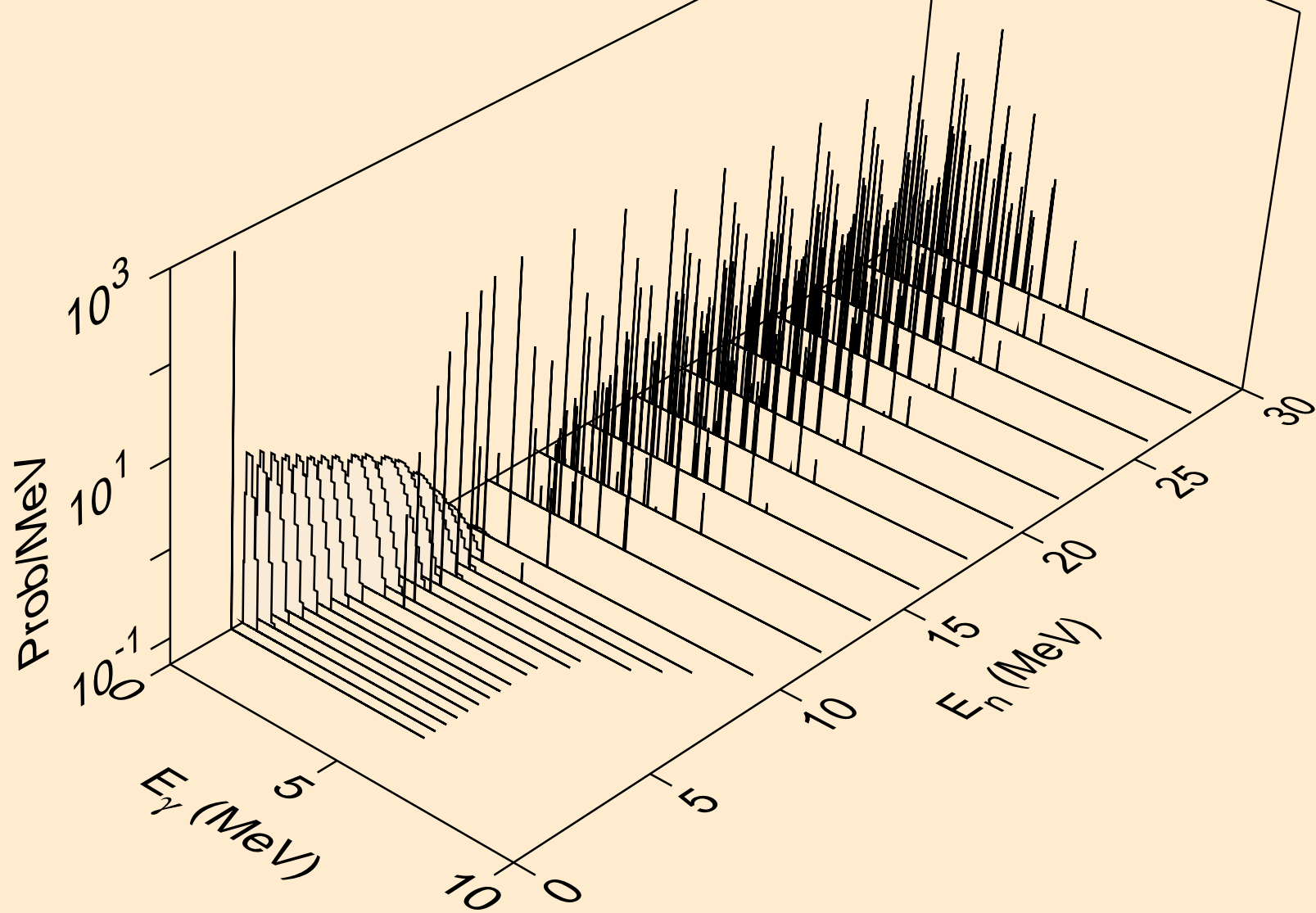

K038 NEUTRON ACER TENDL-2024 LIBRARY; T=293.6K
Photon emission for (n,t2a)

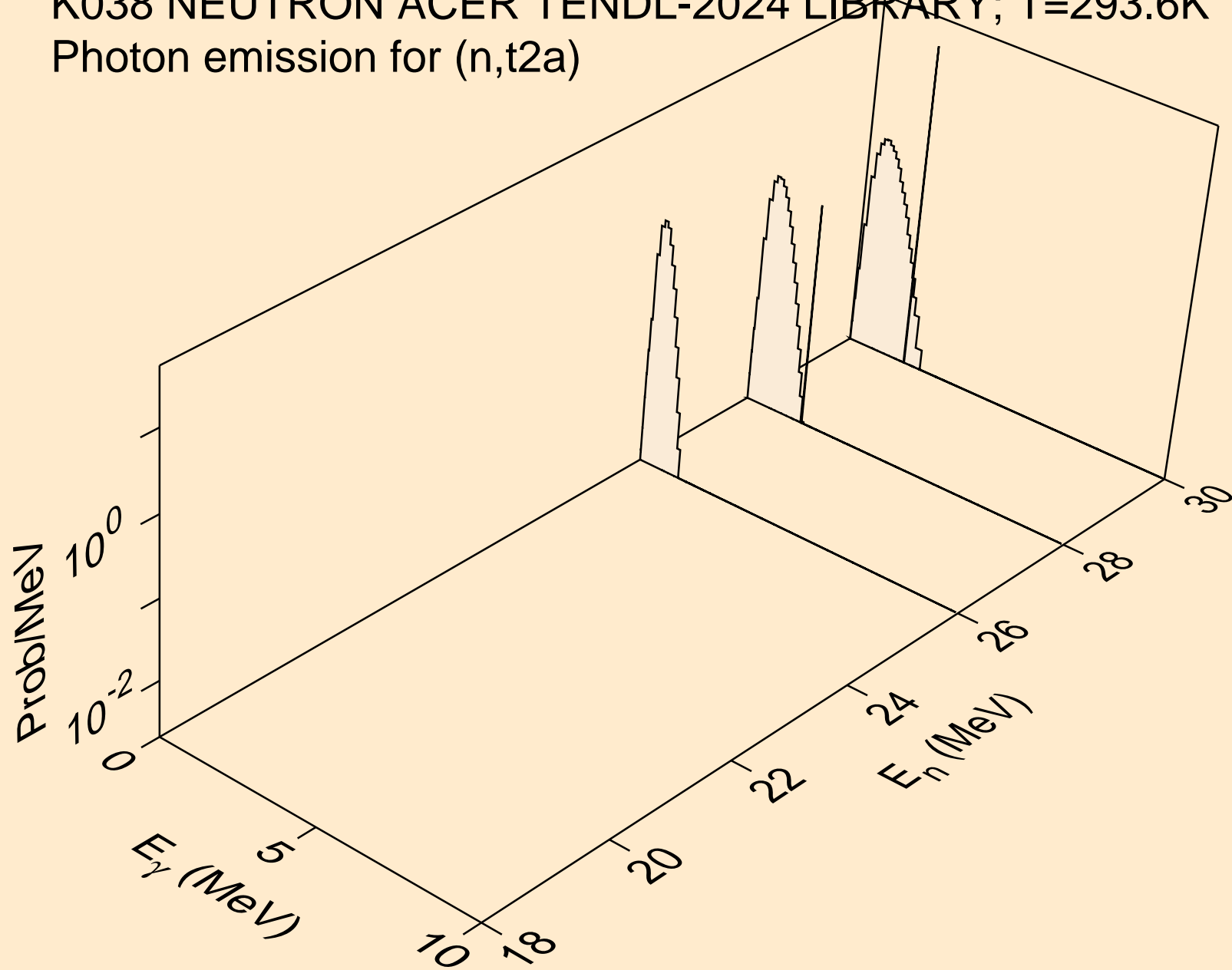

K038 NEUTRON ACER TENDL-2024 LIBRARY; T=293.6K
Photon emission for (n,d2a)

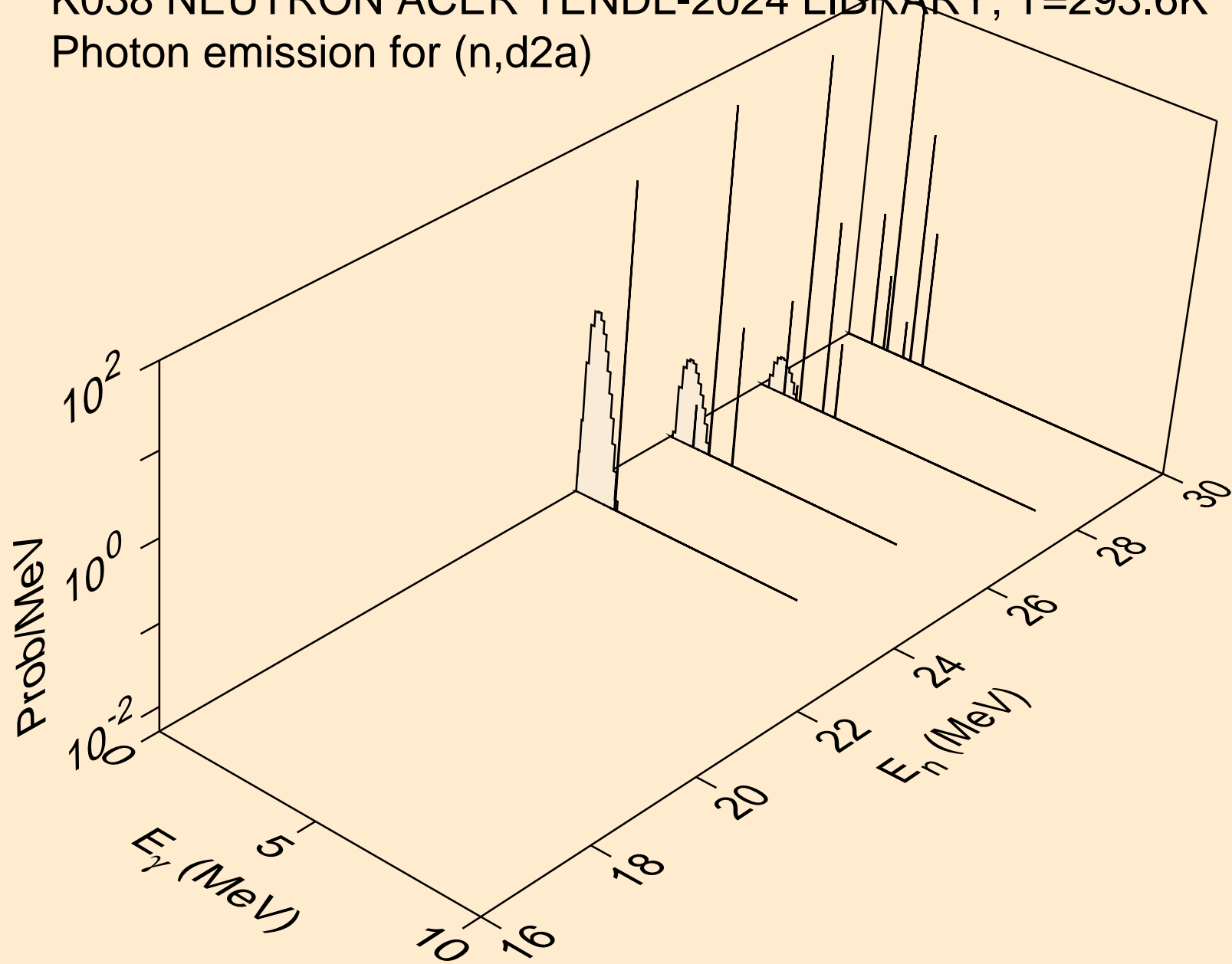

K038 NEUTRON ACER TENDL-2024 LIBRARY; T=293.6K
Photon emission for (n,pd)

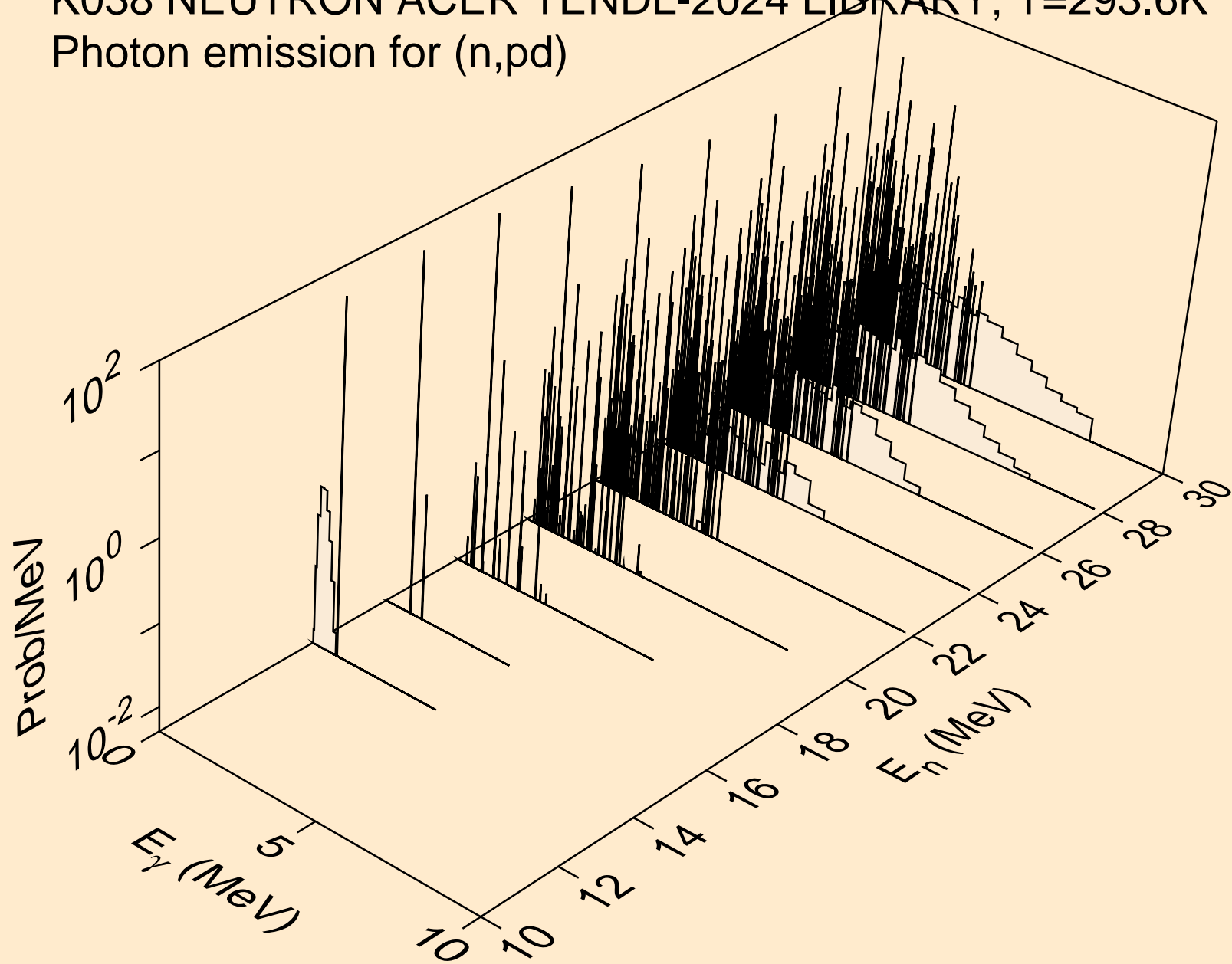

K038 NEUTRON ACER TENDL-2024 LIBRARY; T=293.6K
Photon emission for (n,pt)

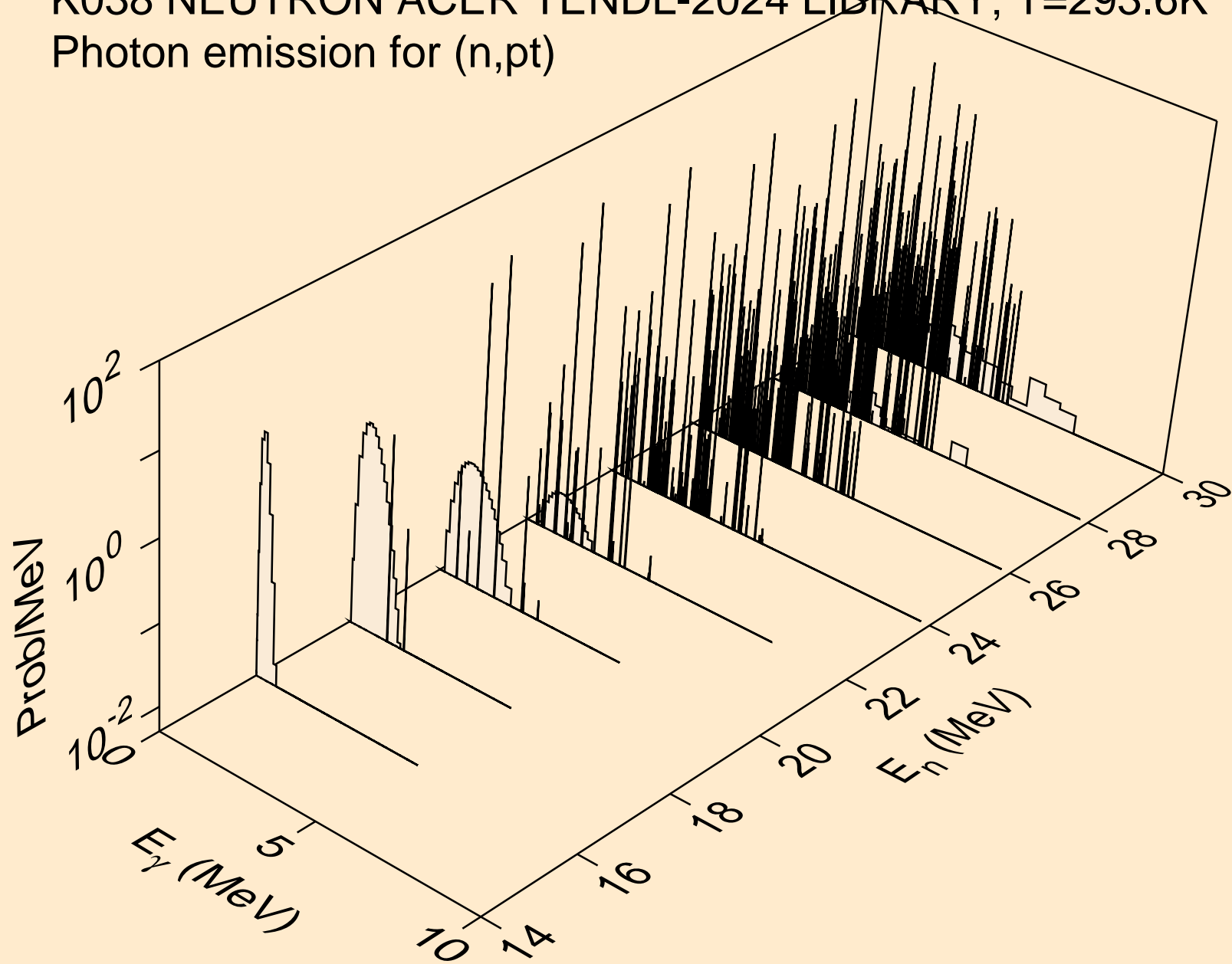

K038 NEUTRON ACER TENDL-2024 LIBRARY; T=293.6K
Photon emission for (n,da)

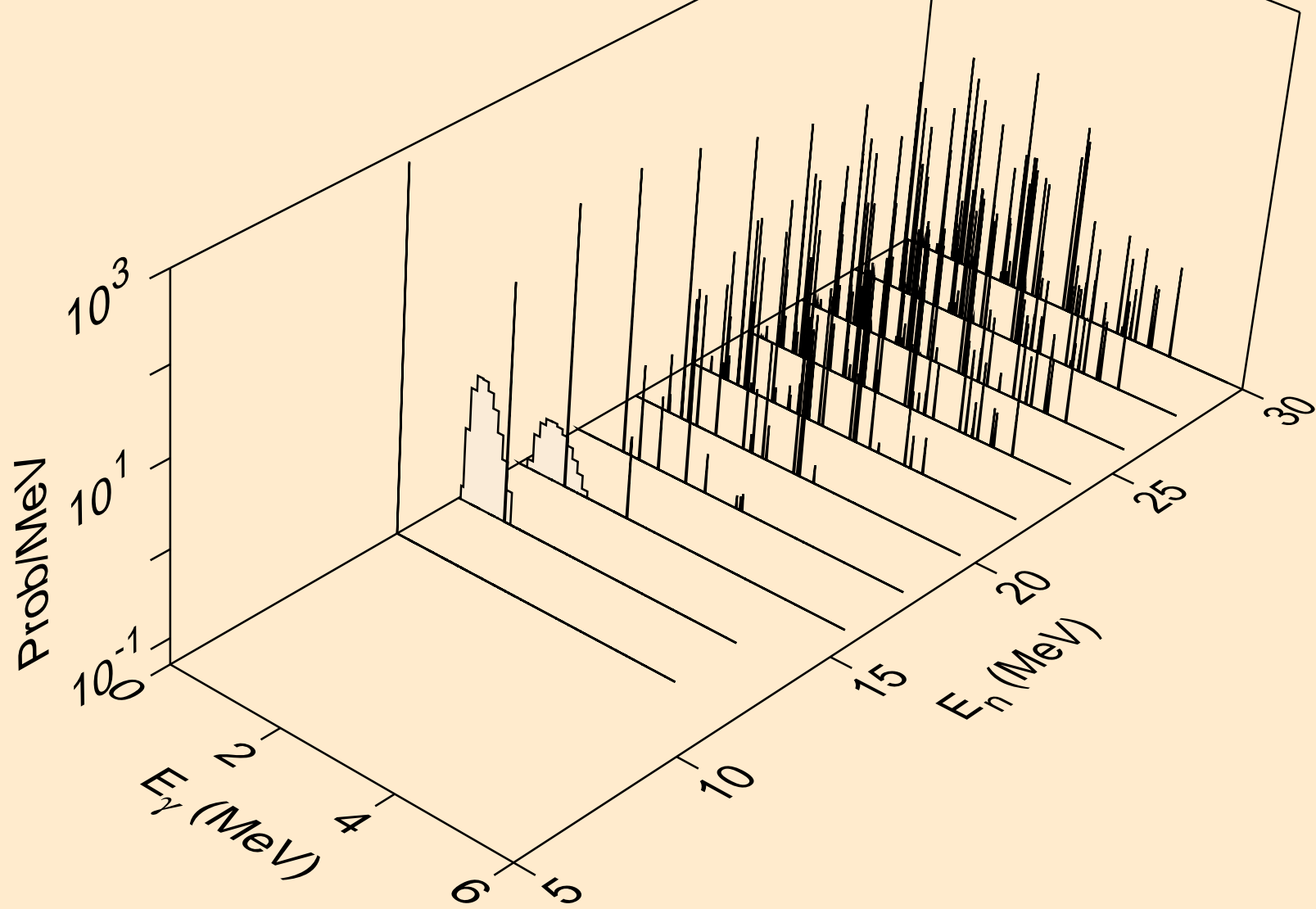

K038 NEUTRON ACER TENDL-2024 LIBRARY; T=293.6K
thermal capture photon spectrum

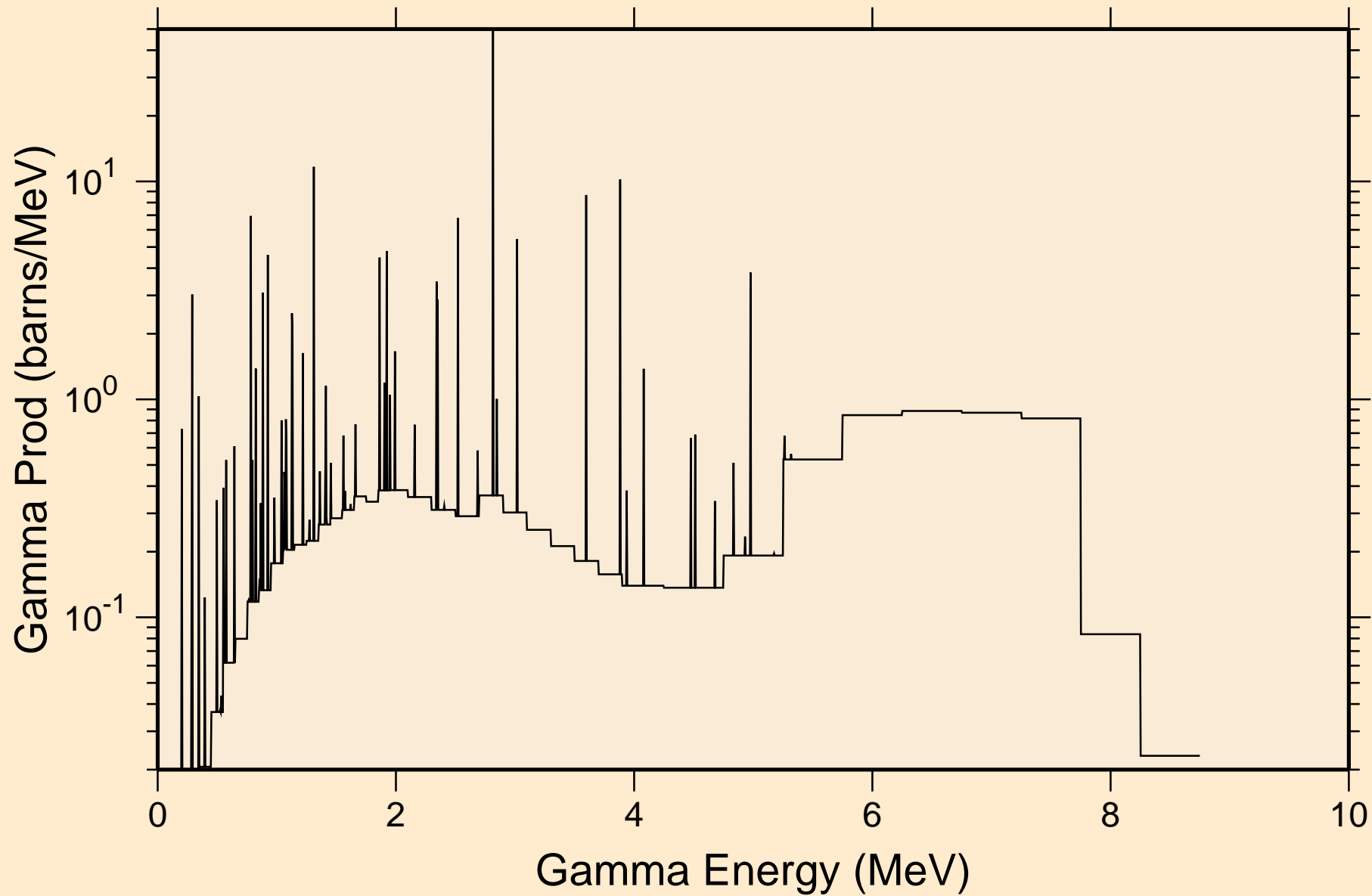

K038 NEUTRON ACER TENDL-2024 LIBRARY; T=293.6K
14 MeV photon spectrum

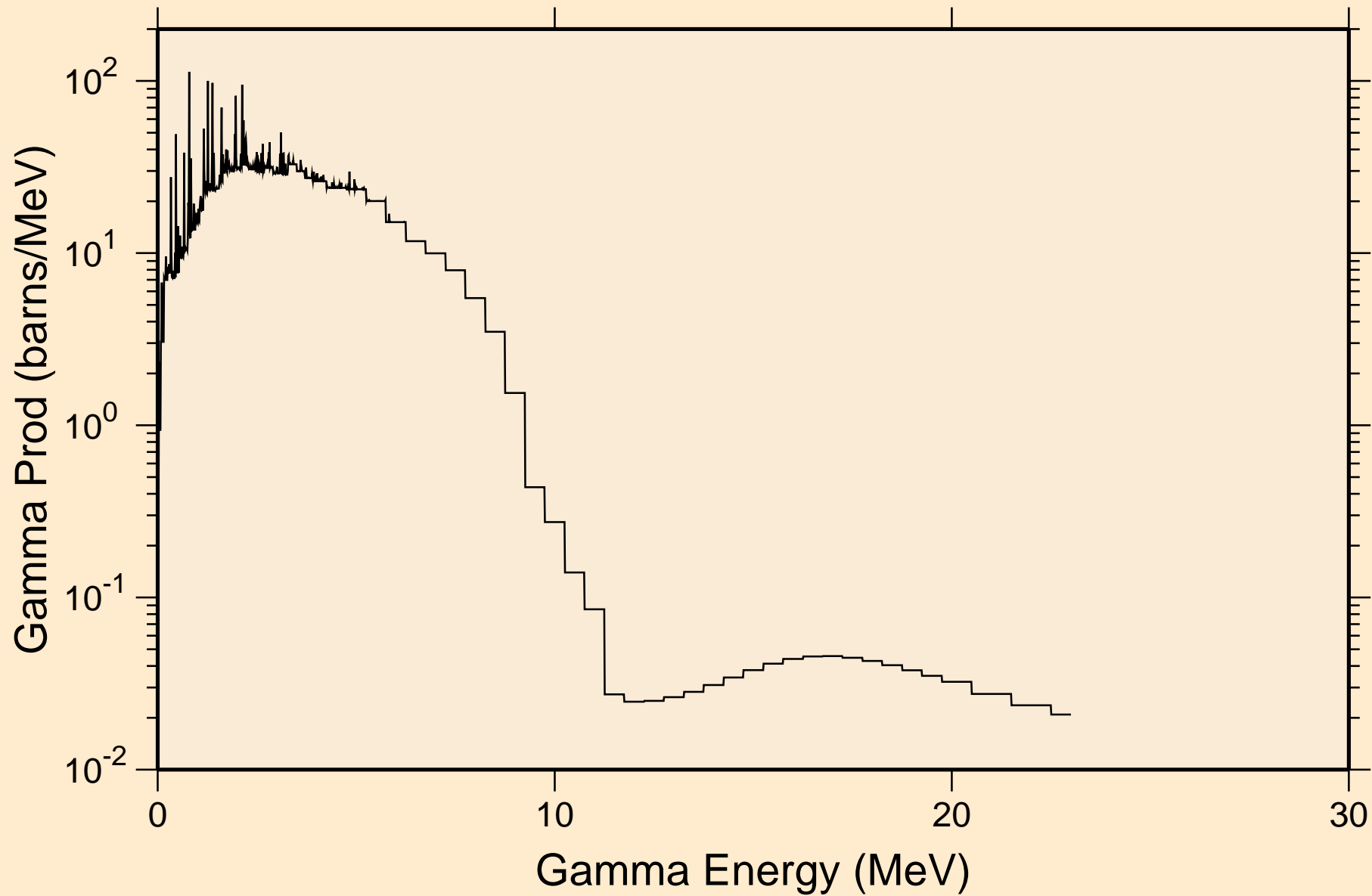

K038 NEUTRON ACER TENDL-2024 LIBRARY; T=293.6K

Particle heating contributions

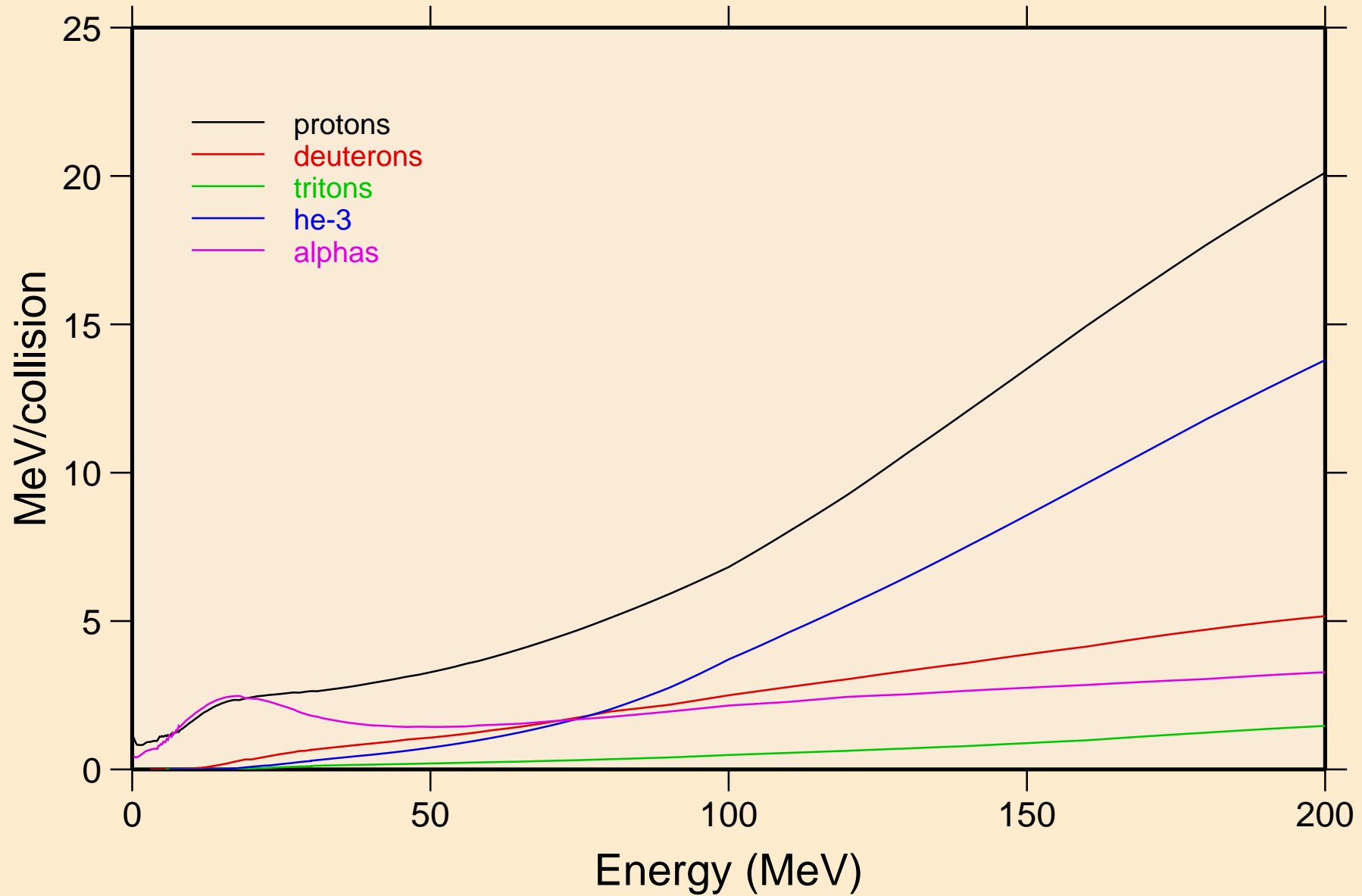

K038 NEUTRON ACER TENDL-2024 LIBRARY; T=293.6K
Recoil Heating

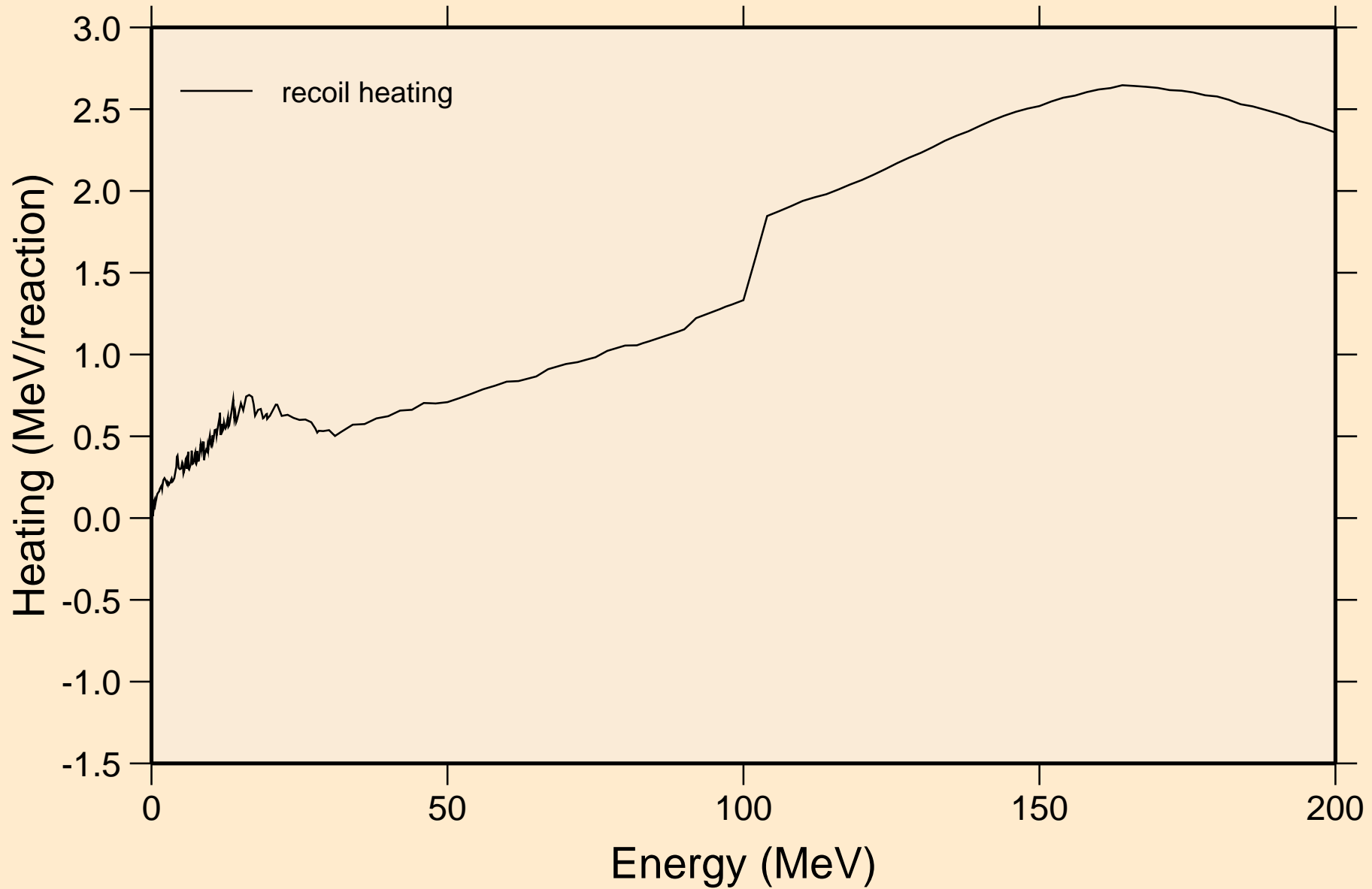

K038 NEUTRON ACER TENDL-2024 LIBRARY; T=293.6K

Particle production cross sections

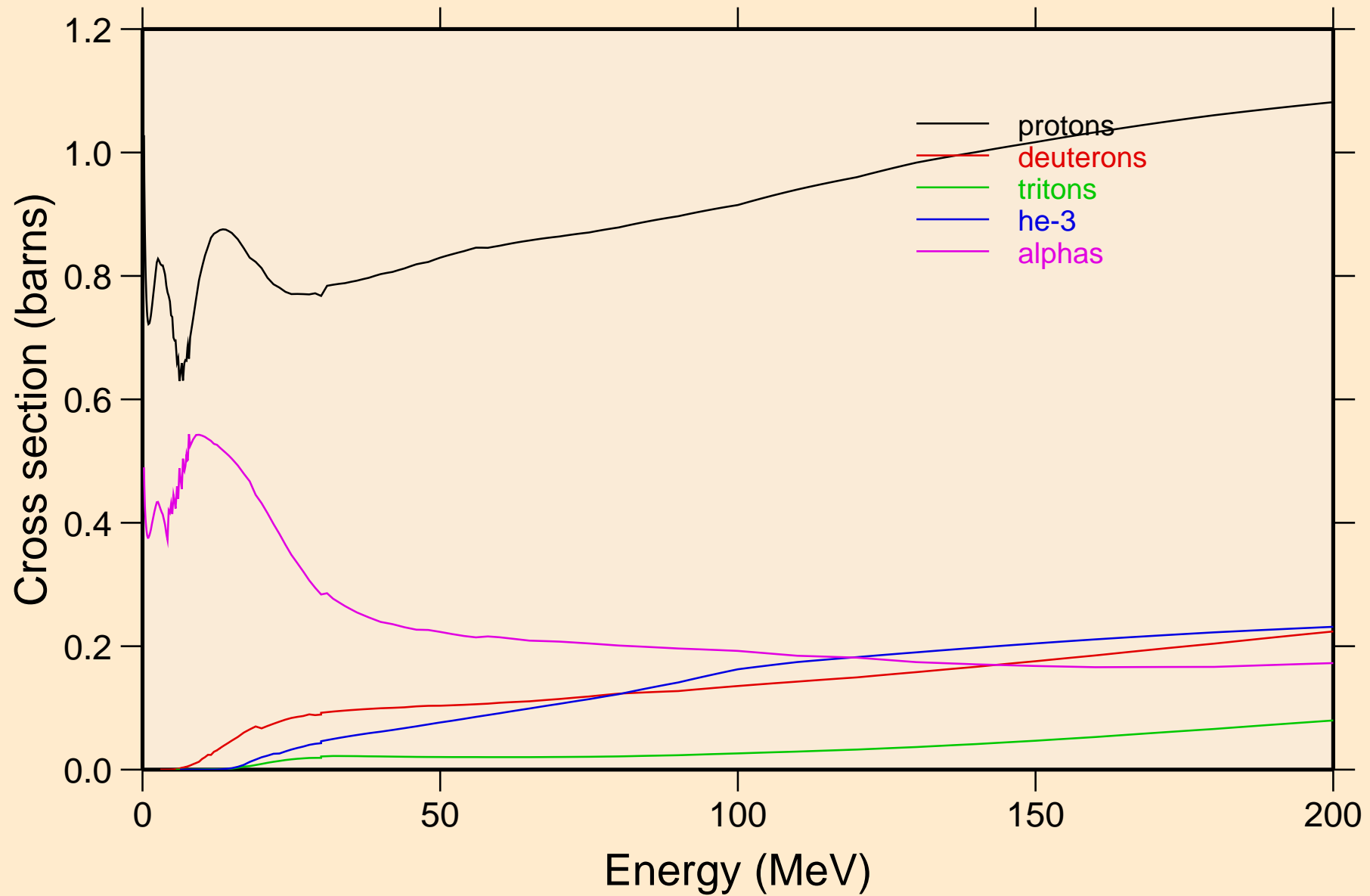

K038 NEUTRON ACER TENDL-2024 LIBRARY; T=293.6K
protons from (n,x)

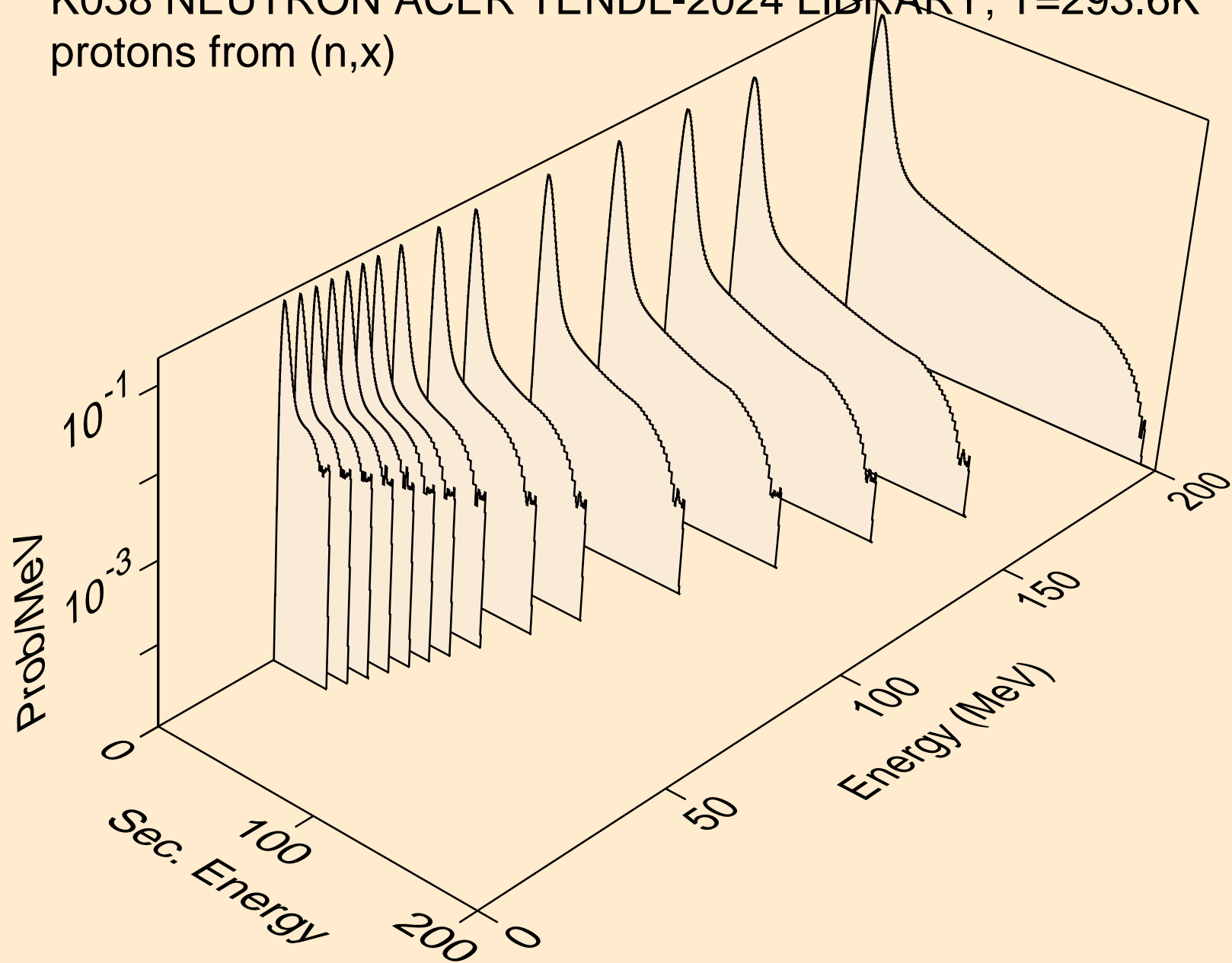

K038 NEUTRON ACER TENDL-2024 LIBRARY; T=293.6K
protons from (n,n*)p

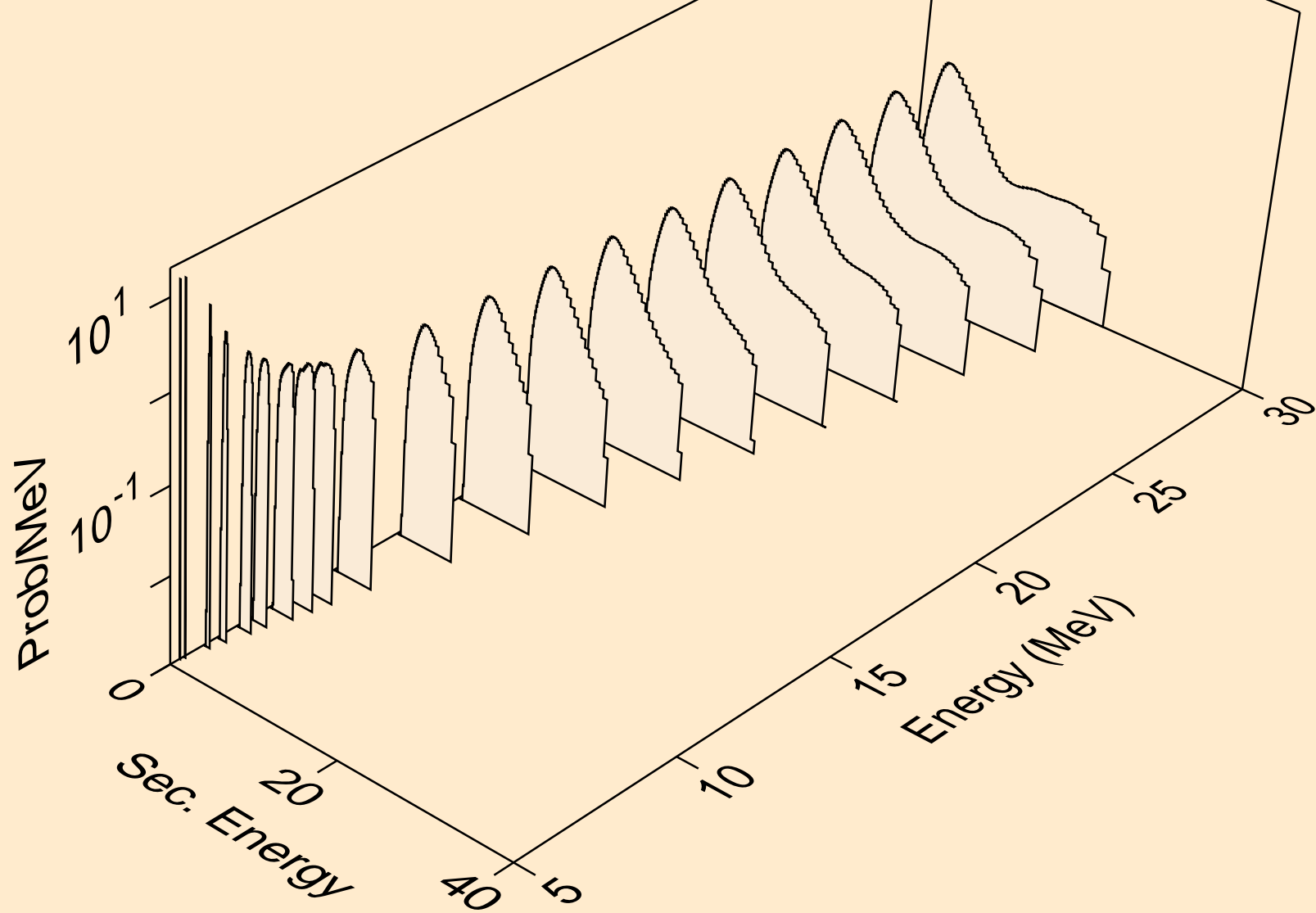

K038 NEUTRON ACER TENDL-2024 LIBRARY; T=293.6K
protons from (n,2np)

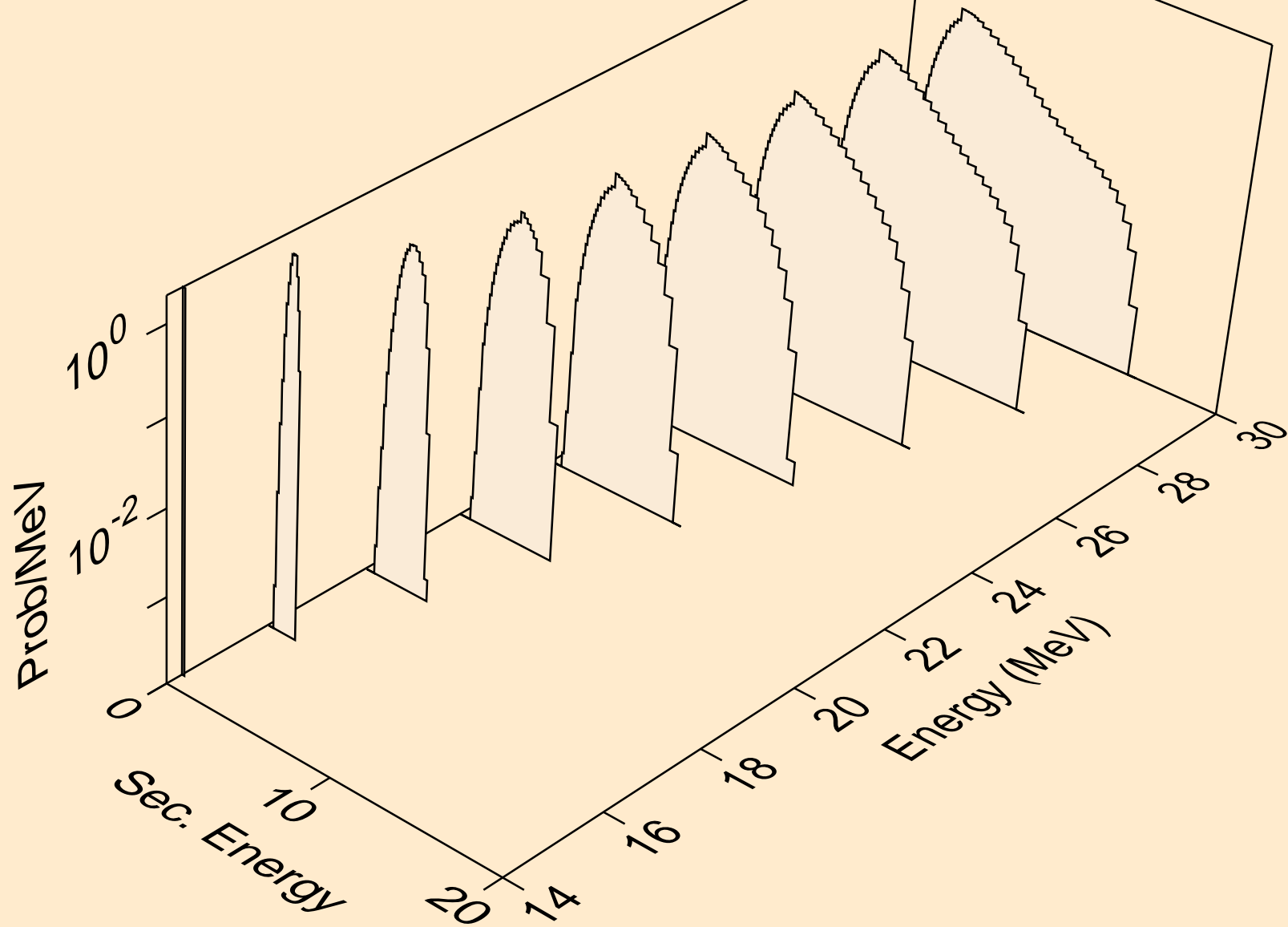

K038 NEUTRON ACER TENDL-2024 LIBRARY; T=293.6K
protons from (n,n2p)

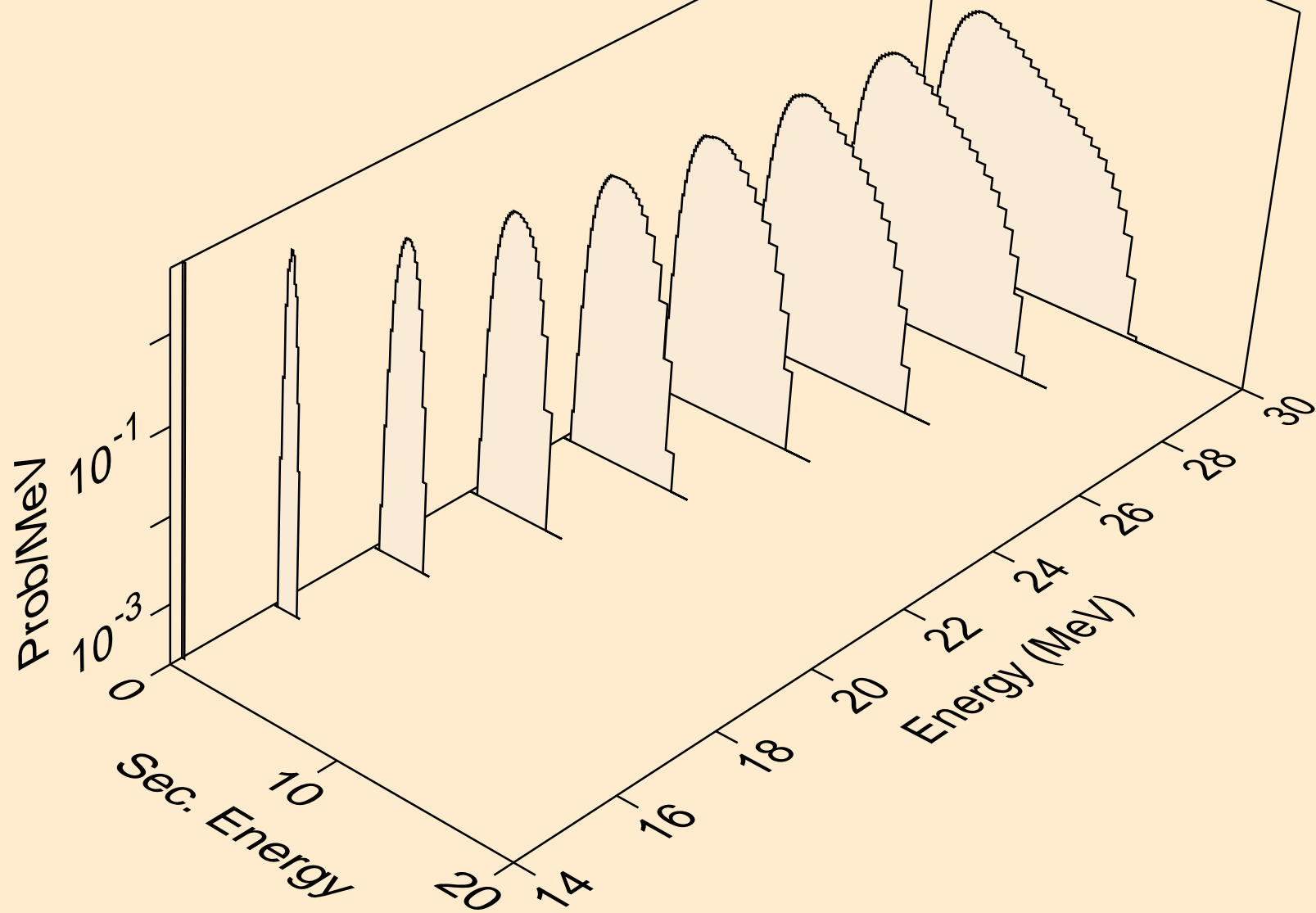

K038 NEUTRON ACER TENDL-2024 LIBRARY; T=293.6K
protons from (n,npa)

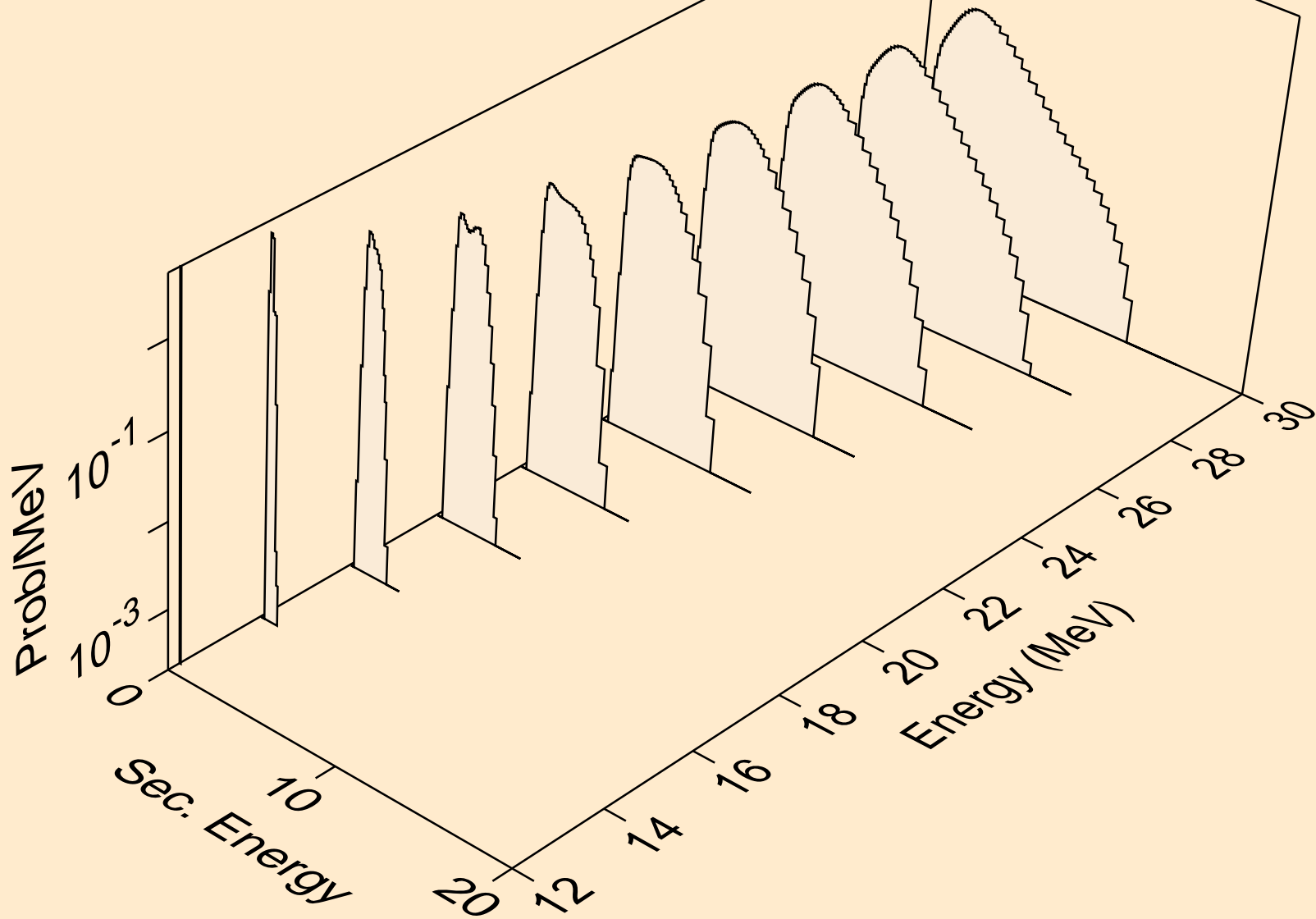

K038 NEUTRON ACER TENDL-2024 LIBRARY; T=293.6K
protons from (n,p)

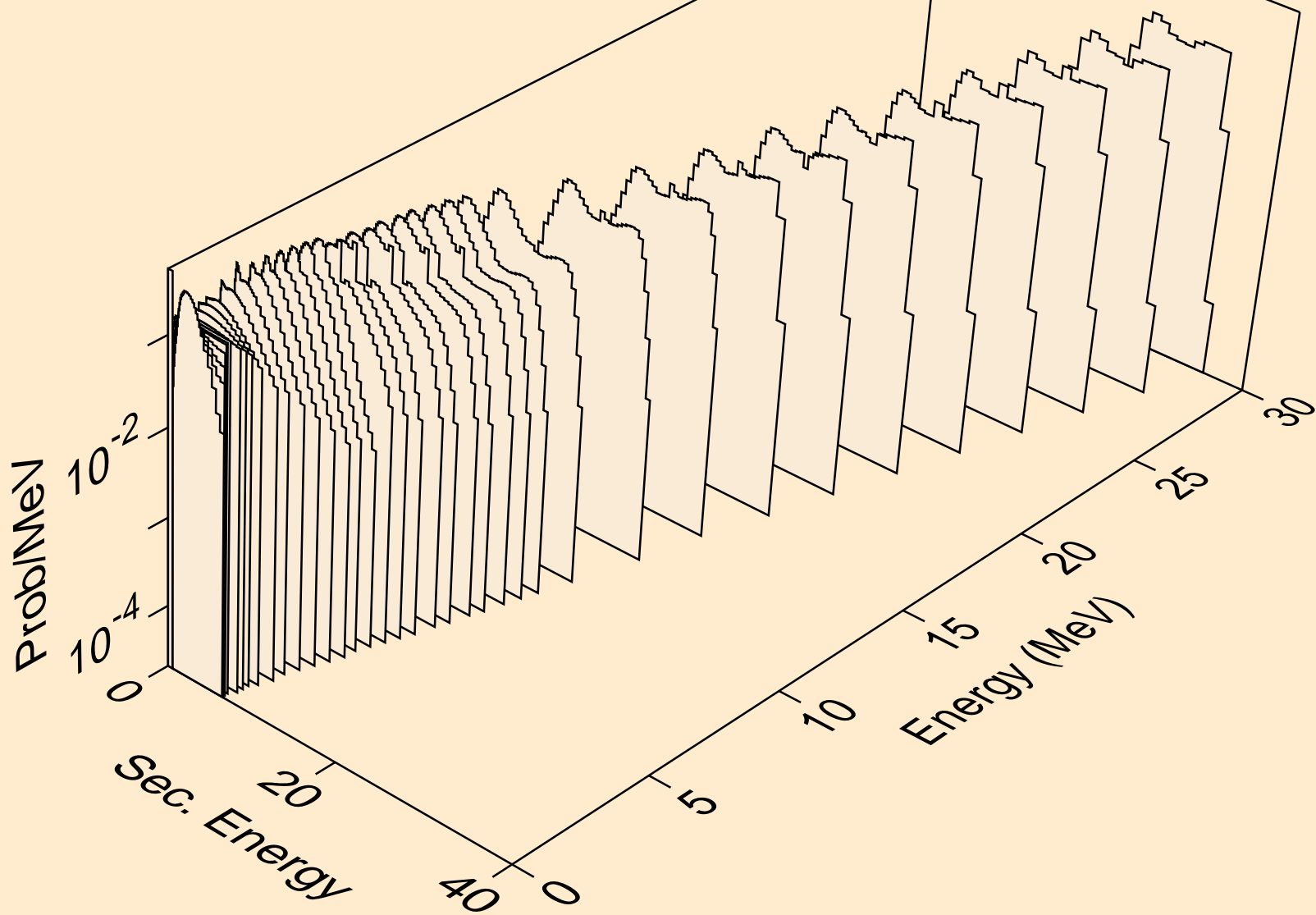

K038 NEUTRON ACER TENDL-2024 LIBRARY; T=293.6K
protons from (n,2p)

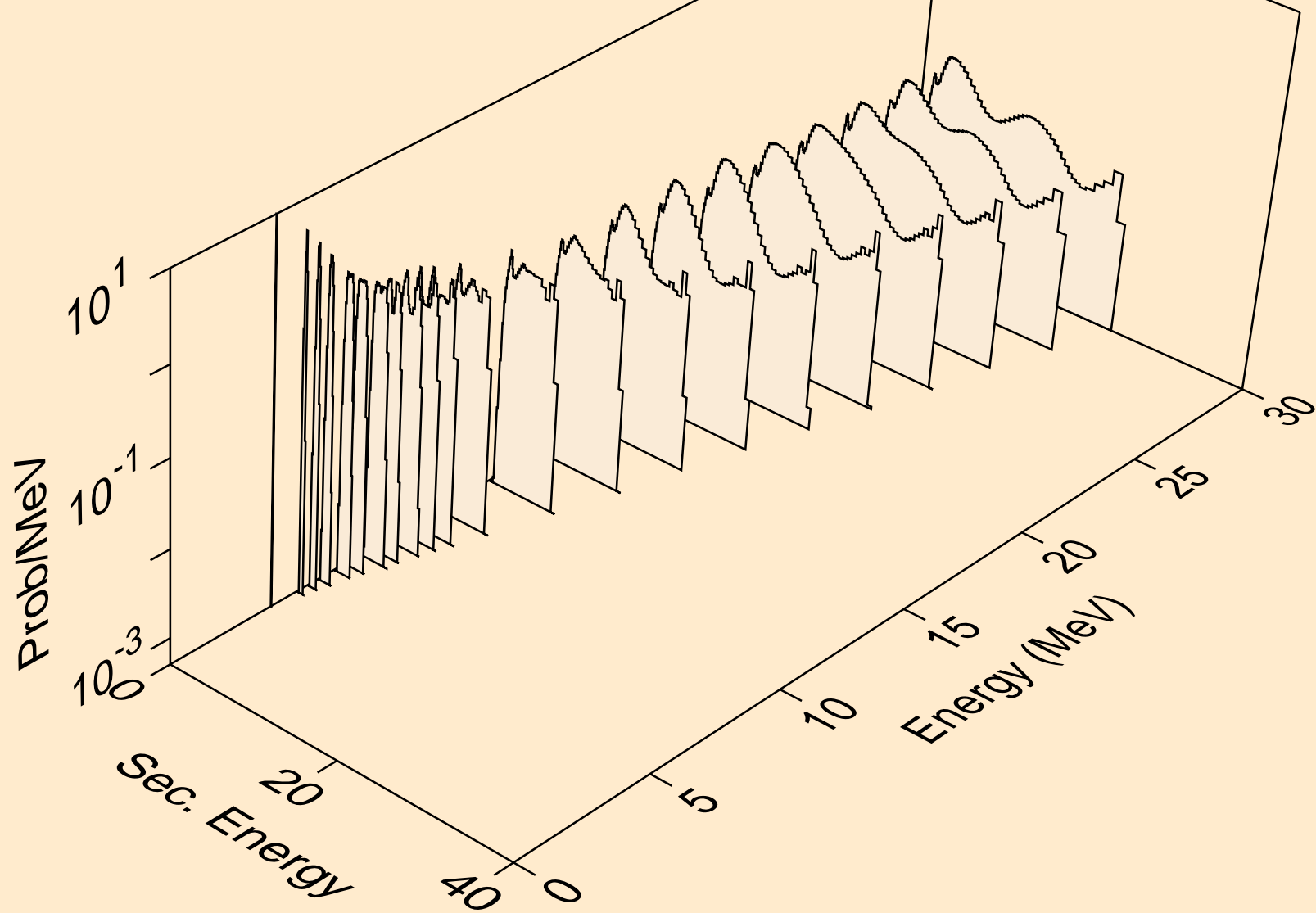

K038 NEUTRON ACER TENDL-2024 LIBRARY; T=293.6K
protons from (n,p)

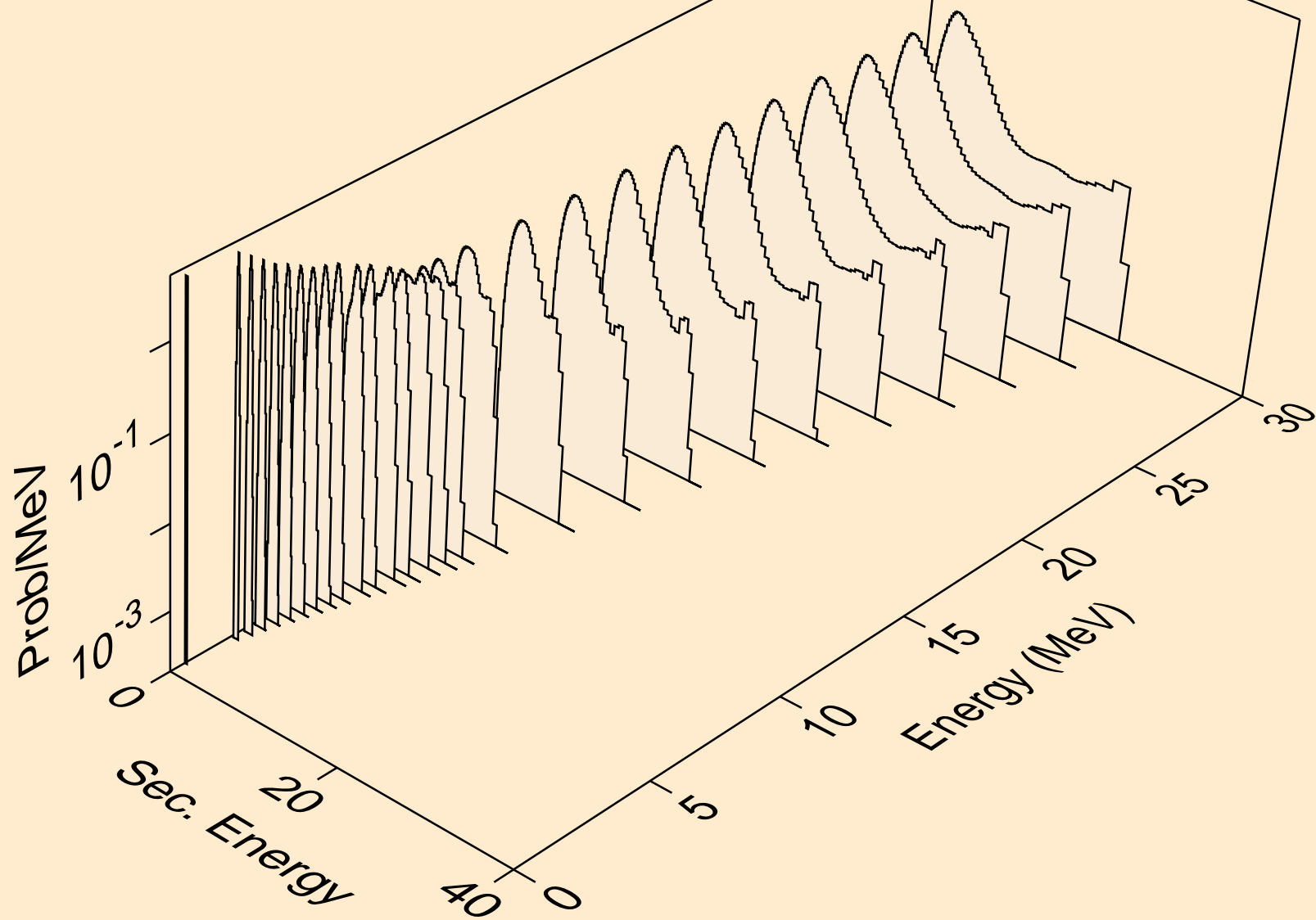

K038 NEUTRON ACER TENDL-2024 LIBRARY; T=293.6K
protons from (n,pd)

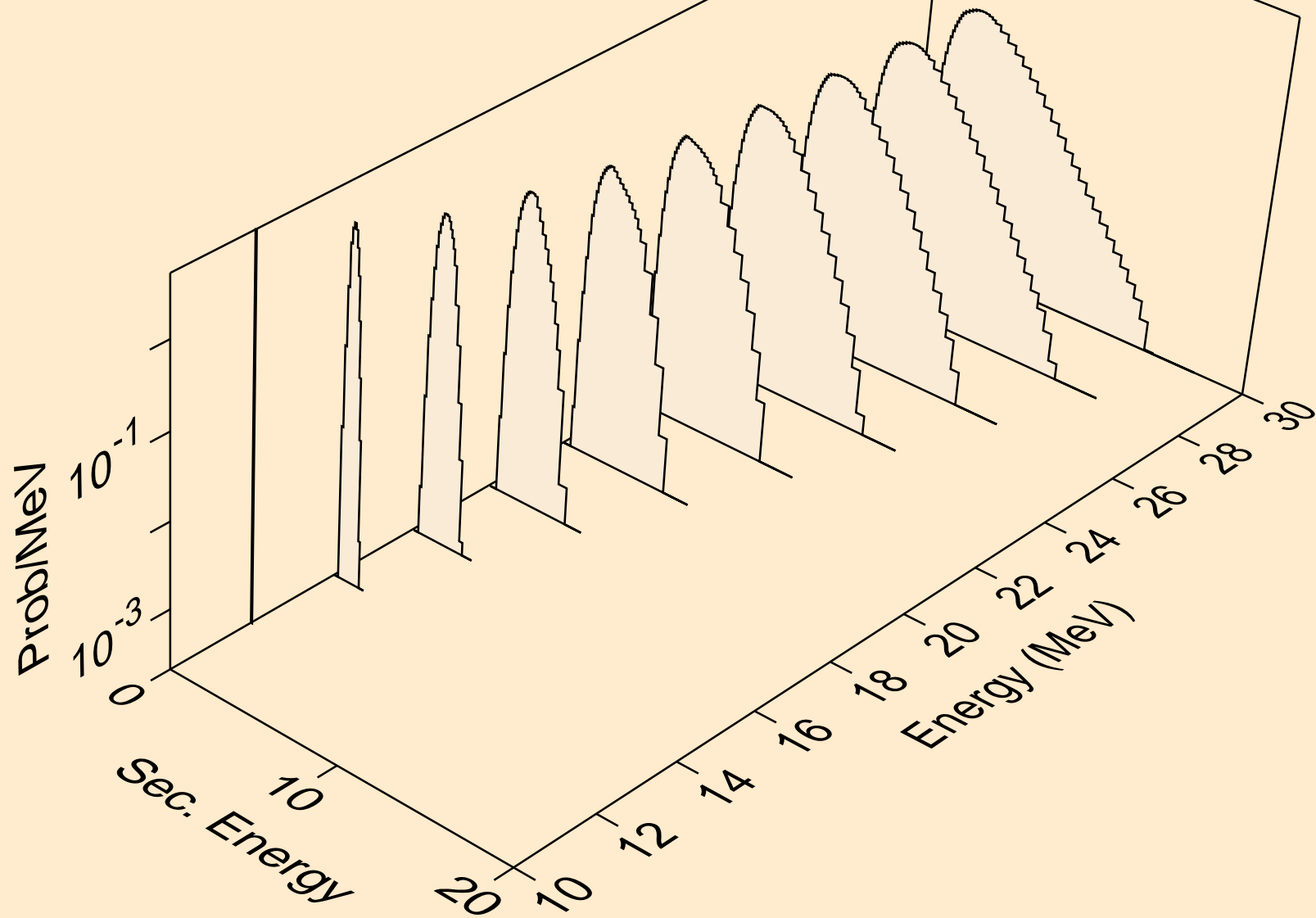

K038 NEUTRON ACER TENDL-2024 LIBRARY; T=293.6K
protons from (n,pt)

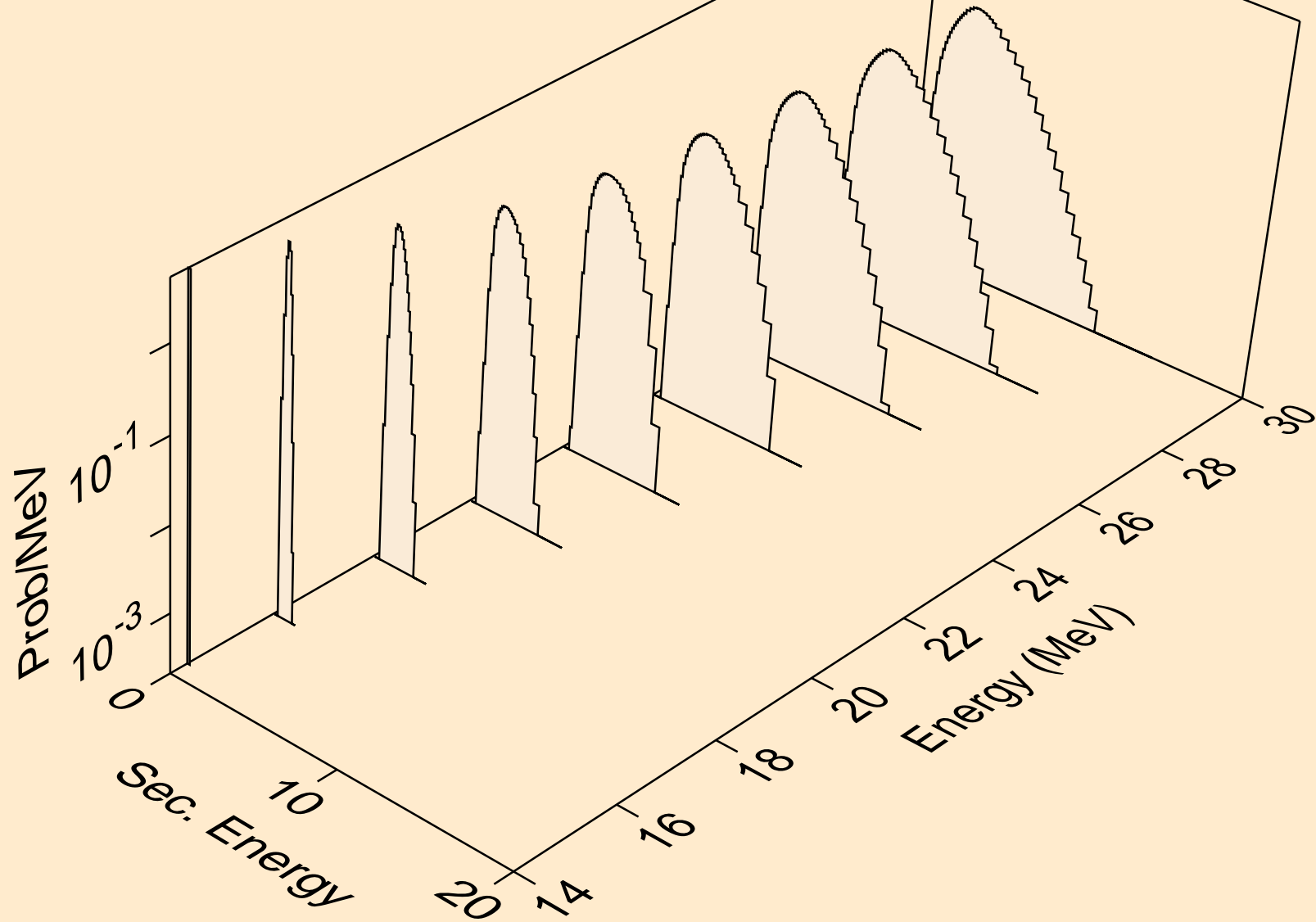

K038 NEUTRON ACER TENDL-2024 LIBRARY; T=293.6K
deuterons from (n,x)

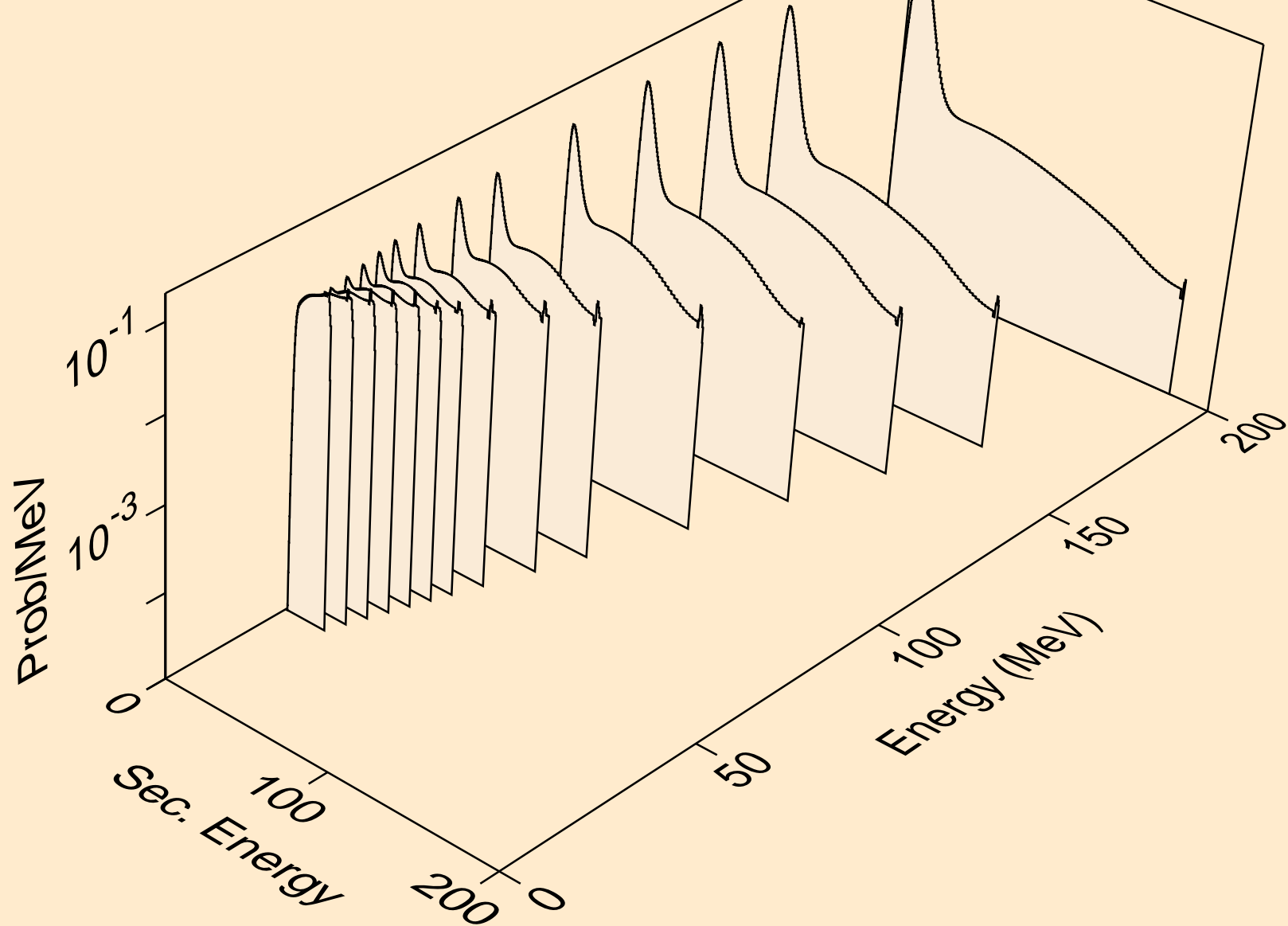

K038 NEUTRON ACER TENDL-2024 LIBRARY; T=293.6K
deuterons from (n,2nd)

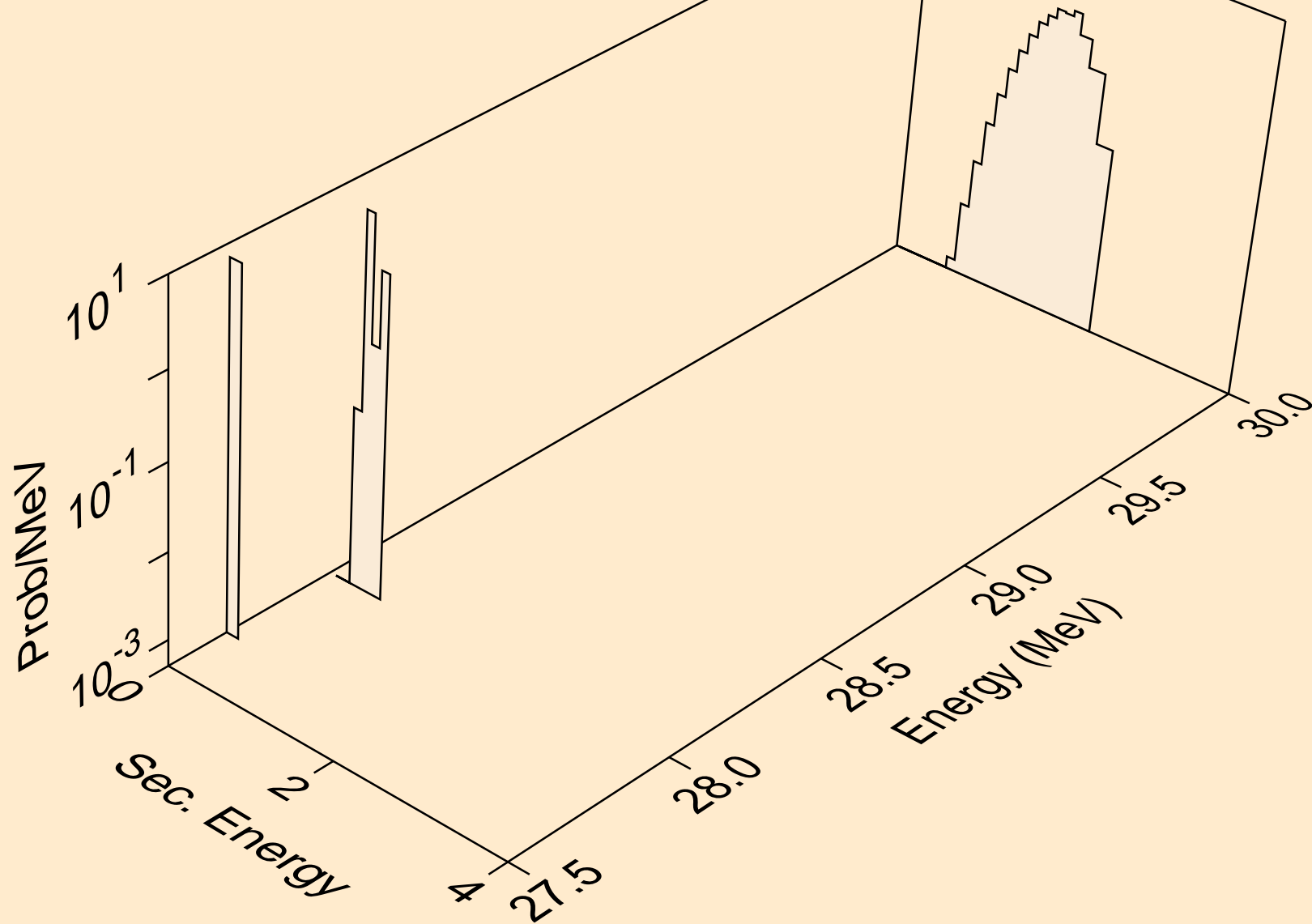

K038 NEUTRON ACER TENDL-2024 LIBRARY; T=293.6K
deuterons from (n,n*)d

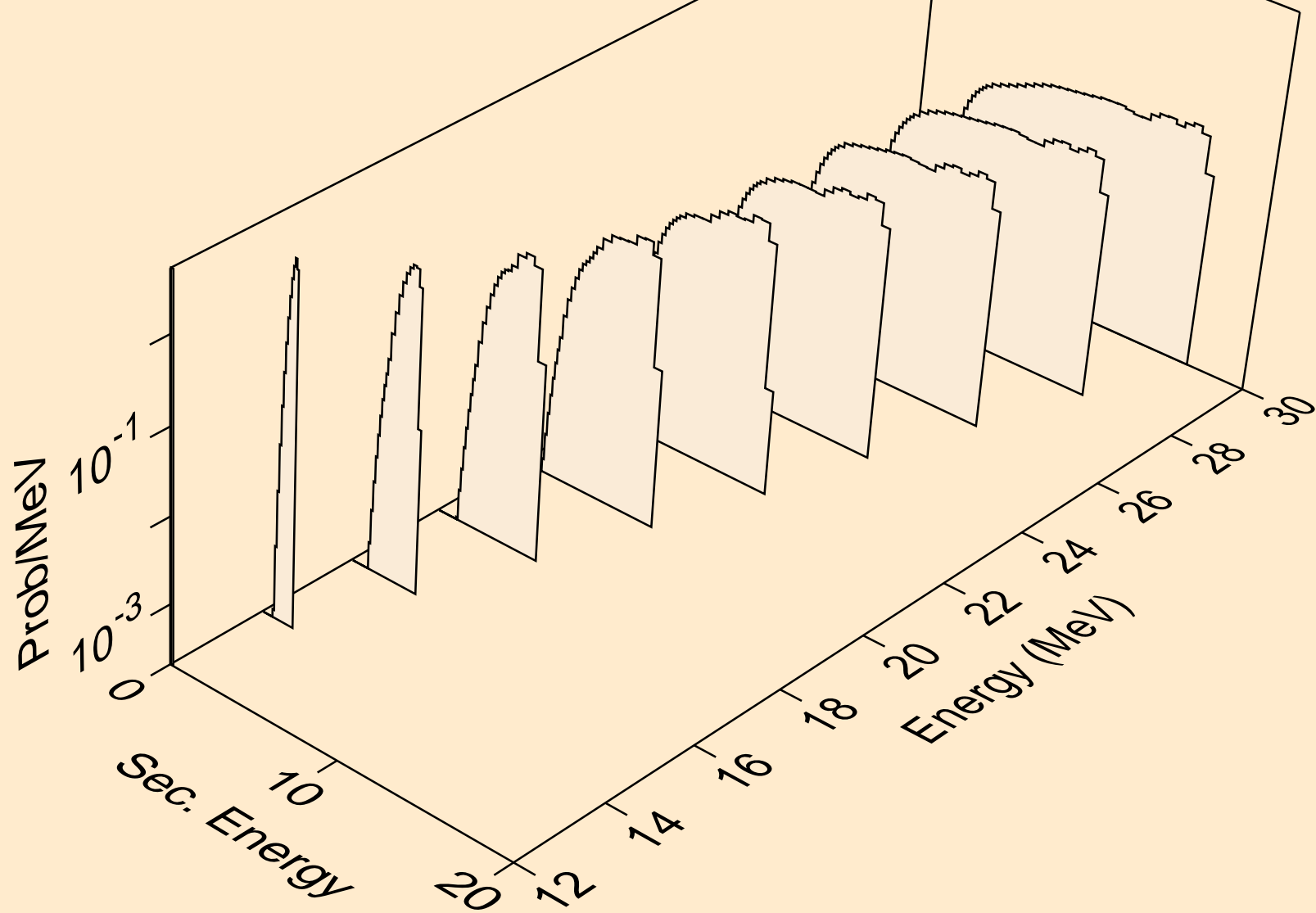

K038 NEUTRON ACER TENDL-2024 LIBRARY; T=293.6K
deuterons from (n,d)

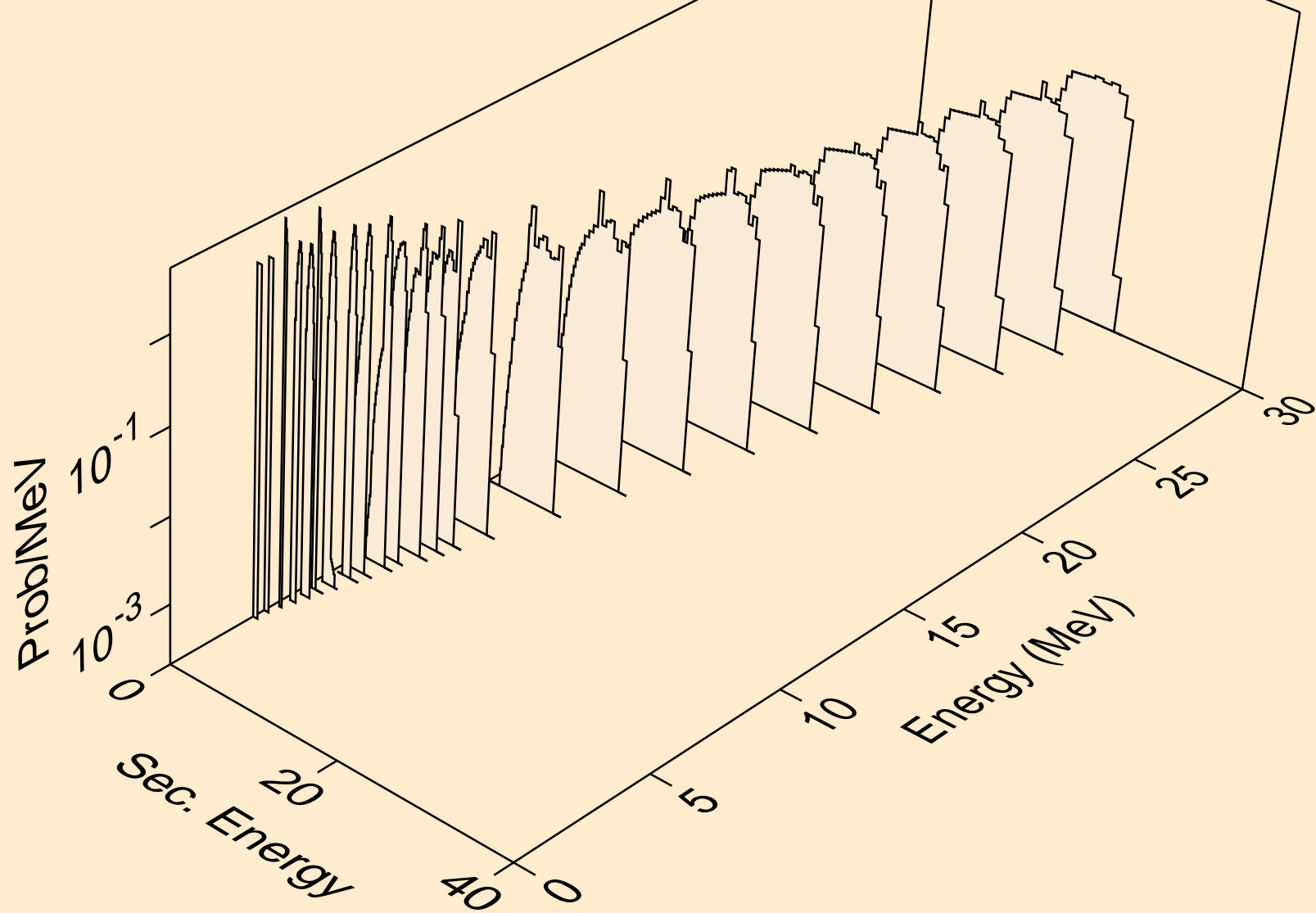

K038 NEUTRON ACER TENDL-2024 LIBRARY; T=293.6K
deuterons from (n,d2a)

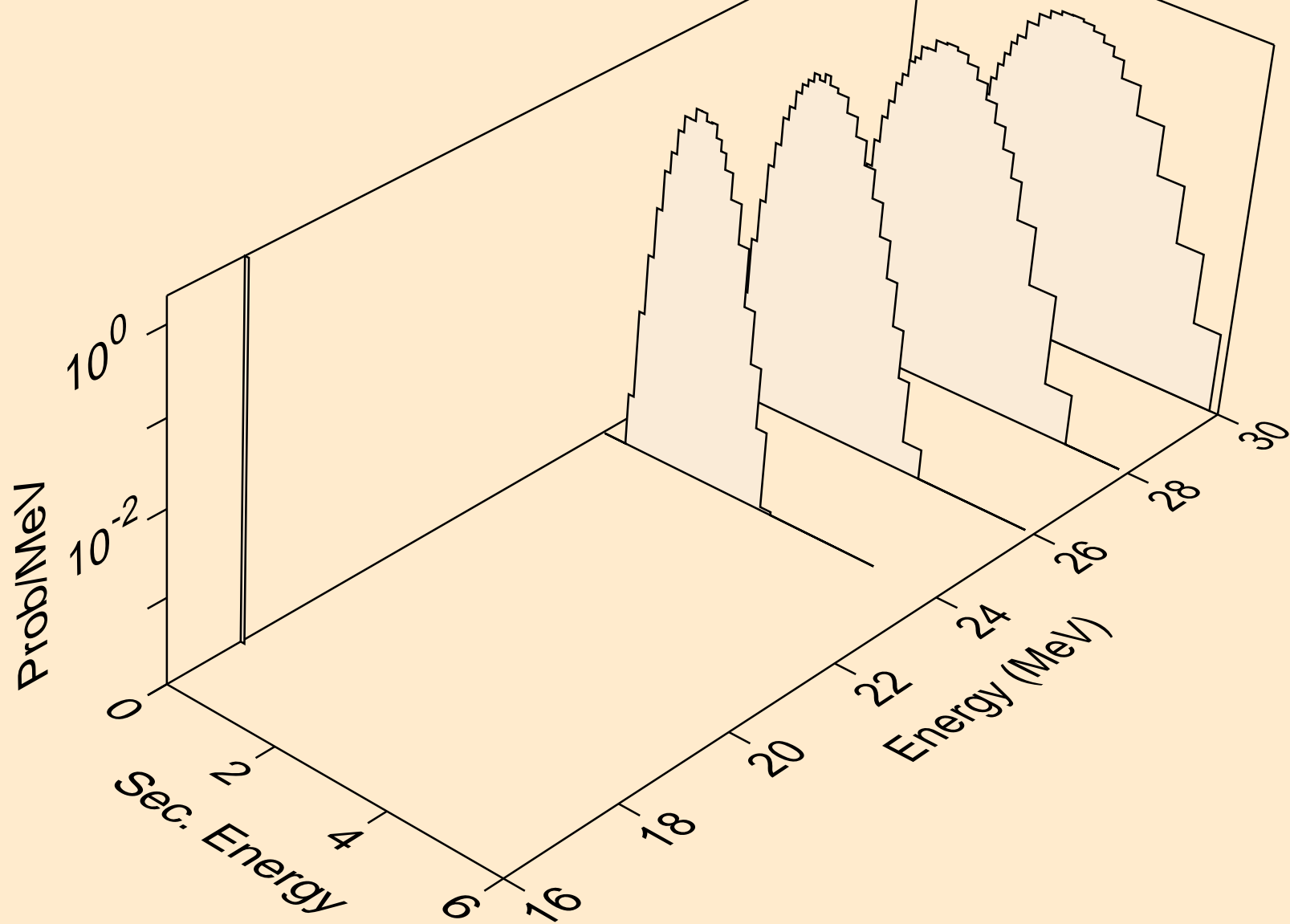

K038 NEUTRON ACER TENDL-2024 LIBRARY; T=293.6K
deuterons from (n,pd)

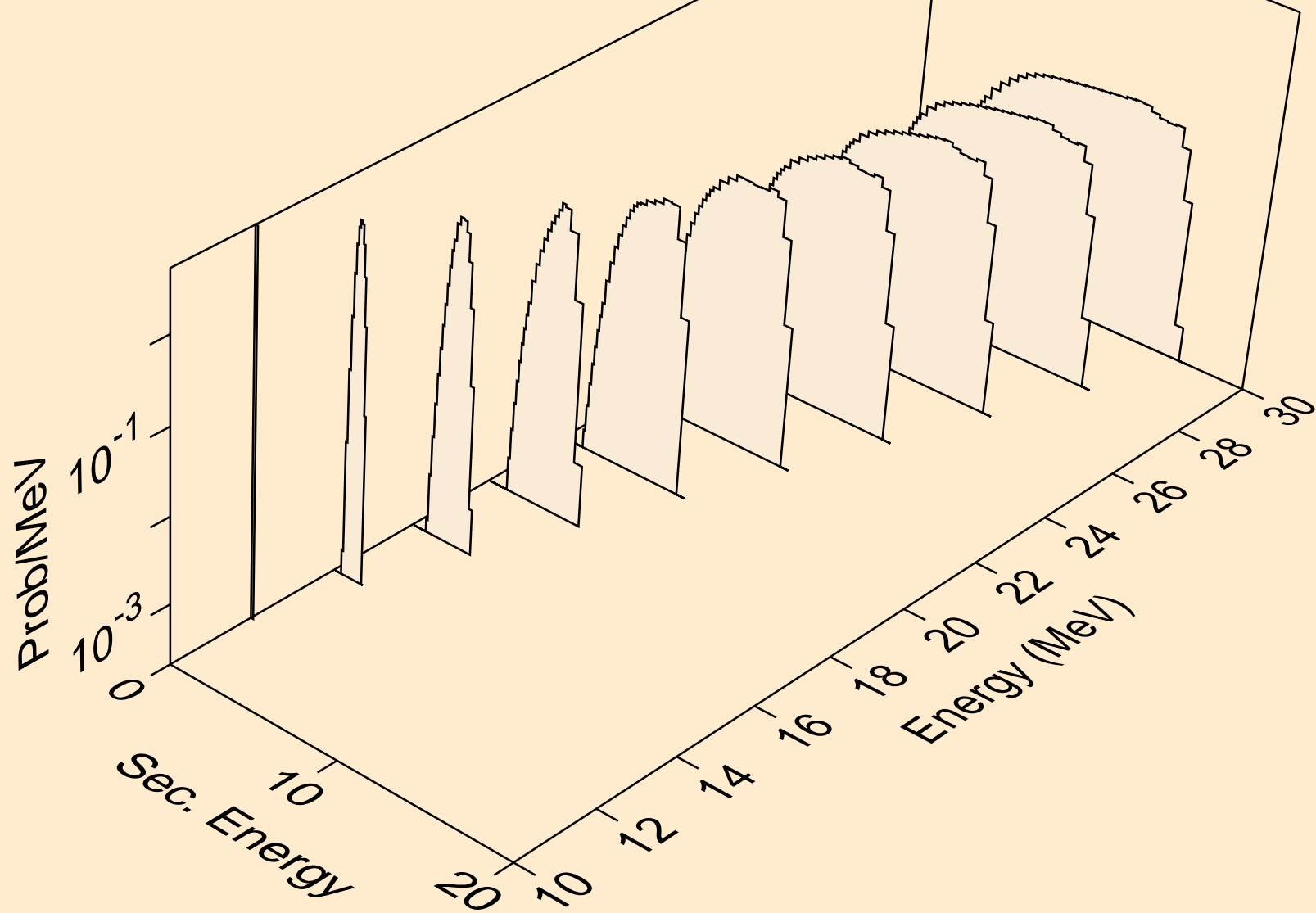

K038 NEUTRON ACER TENDL-2024 LIBRARY; T=293.6K
deuterons from (n,da)

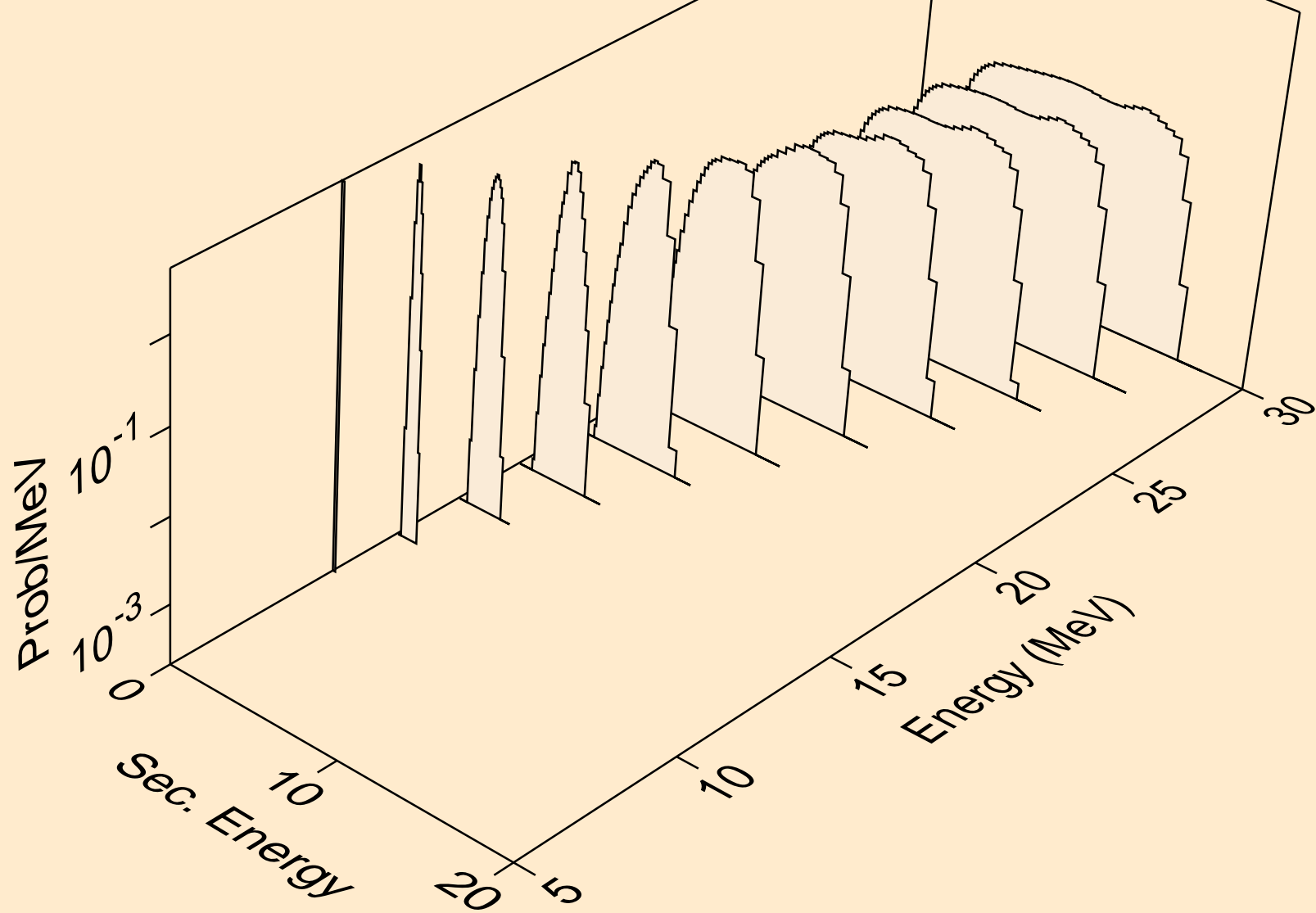

K038 NEUTRON ACER TENDL-2024 LIBRARY; T=293.6K
tritons from (n,x)

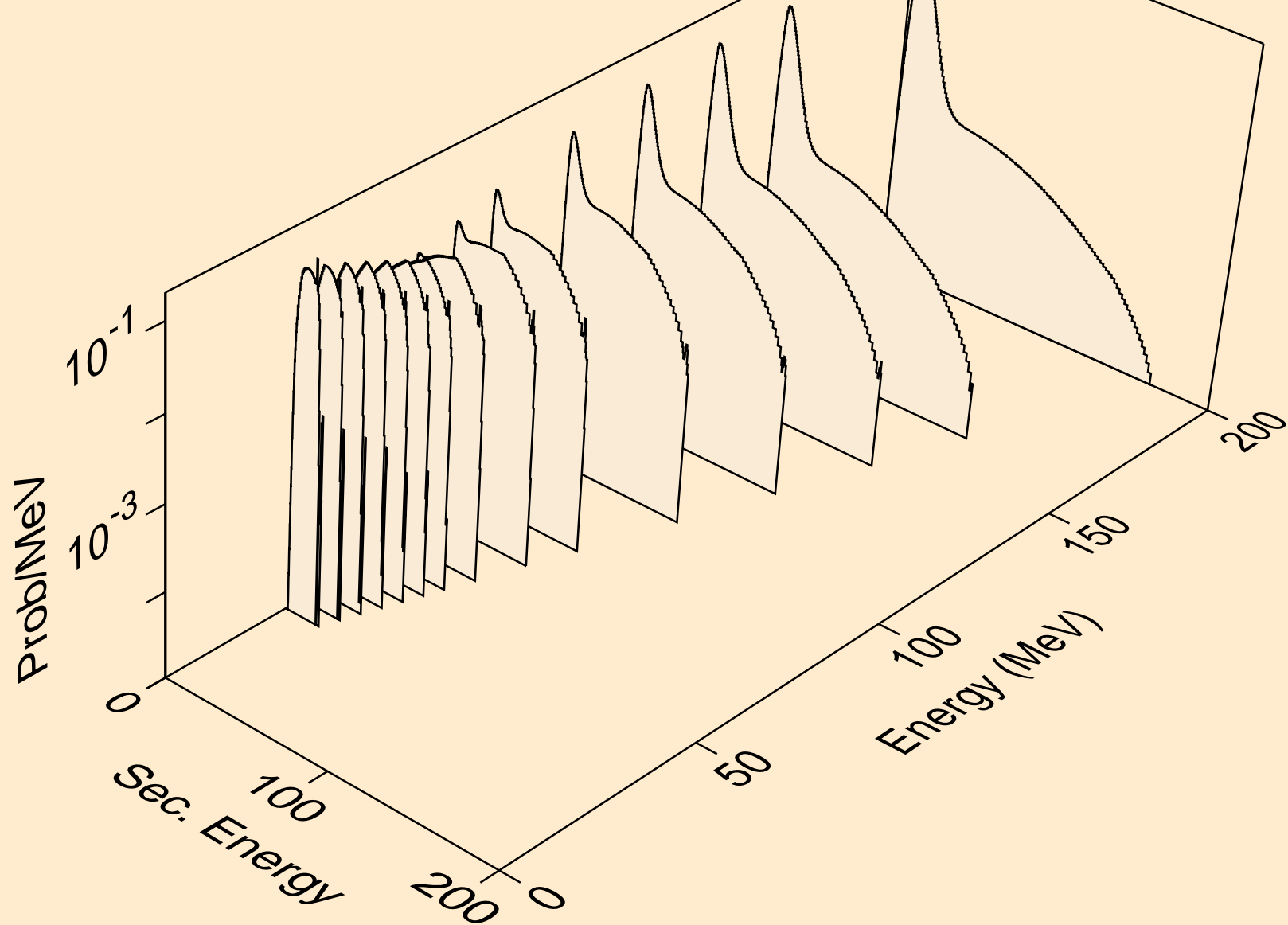

K038 NEUTRON ACER TENDL-2024 LIBRARY; T=293.6K
tritons from (n,n*)t

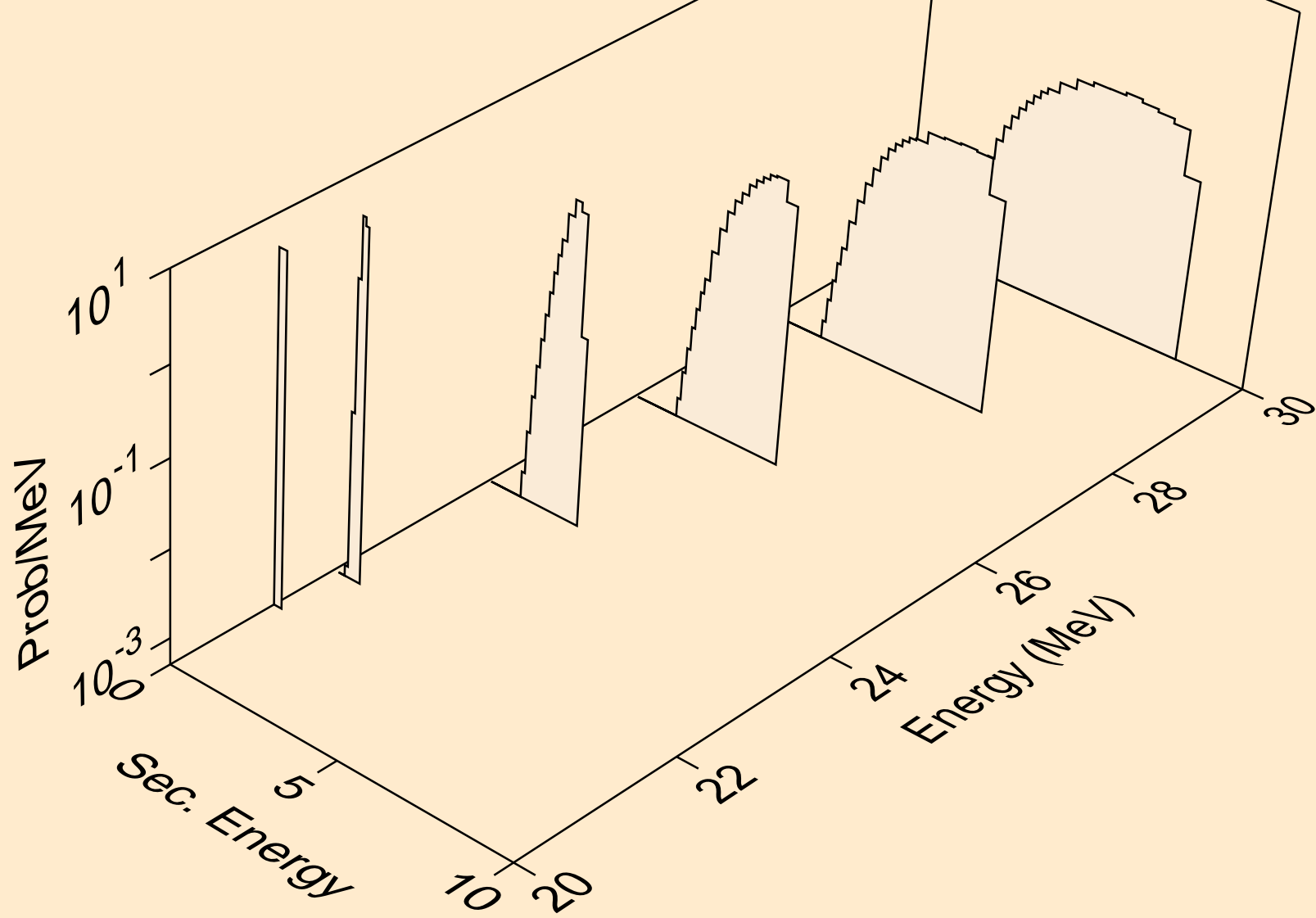

K038 NEUTRON ACER TENDL-2024 LIBRARY; T=293.6K
tritons from (n,t)

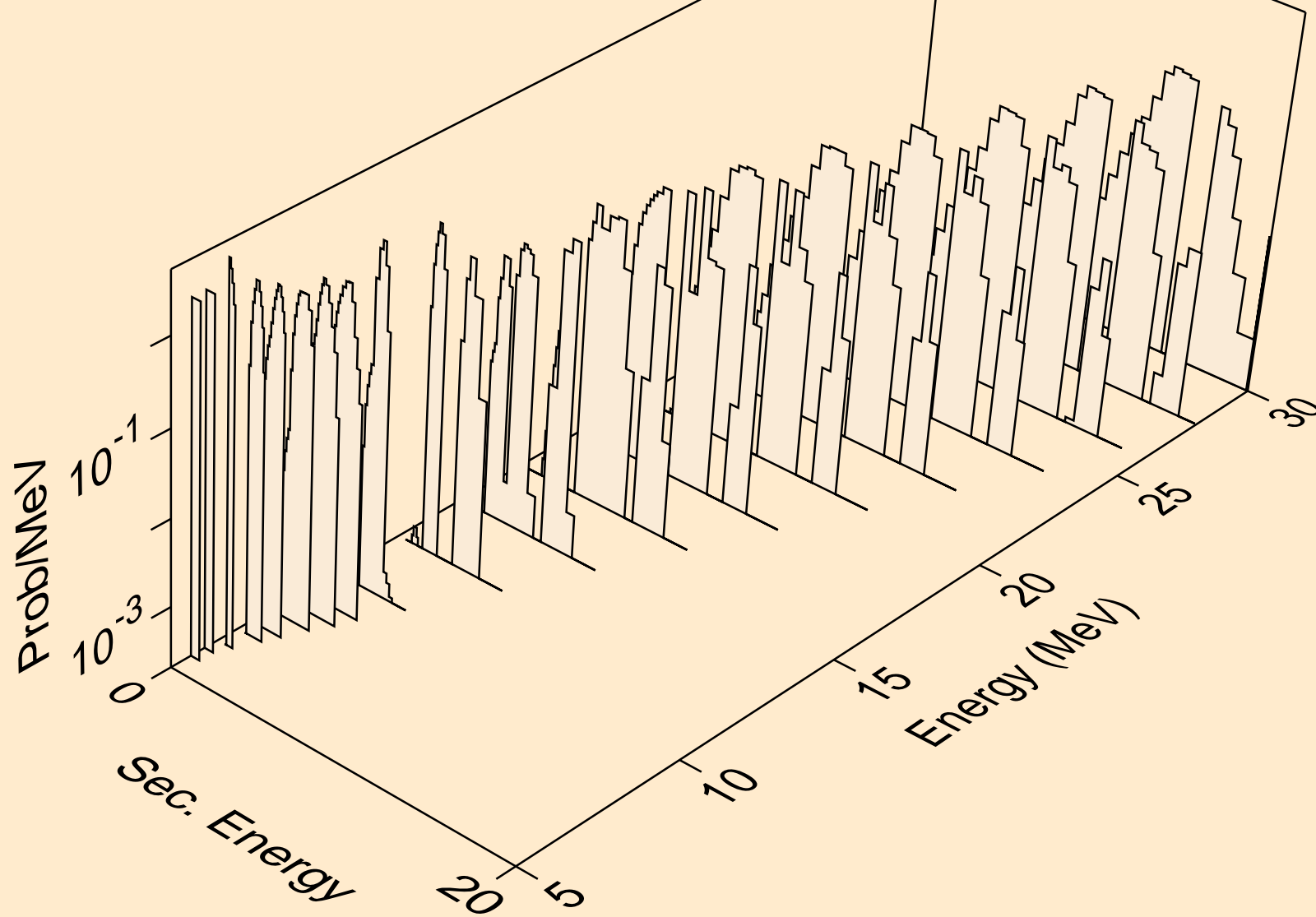

K038 NEUTRON ACER TENDL-2024 LIBRARY; T=293.6K
tritons from (n,t2a)

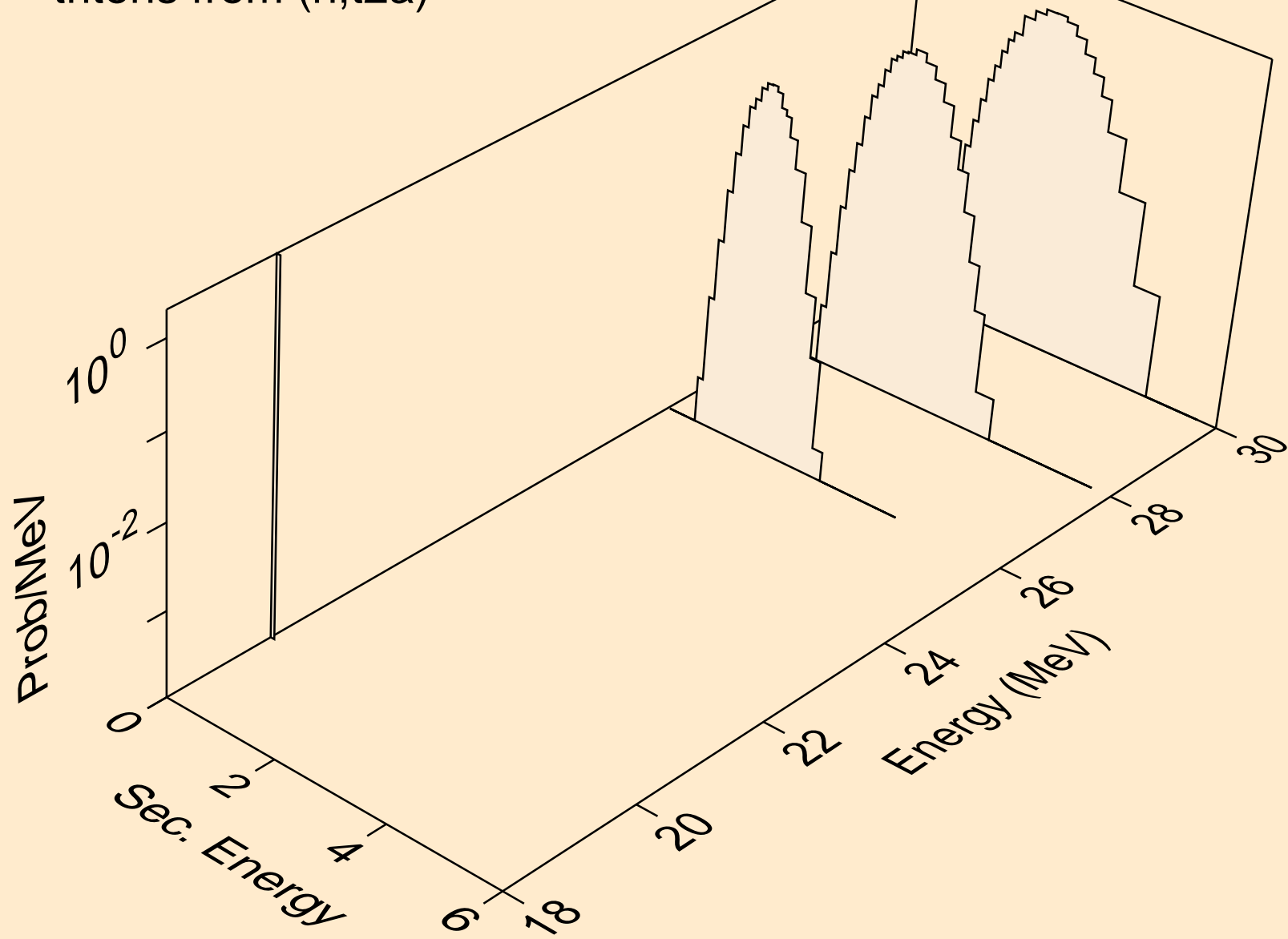

K038 NEUTRON ACER TENDL-2024 LIBRARY; T=293.6K
tritons from (n,pt)

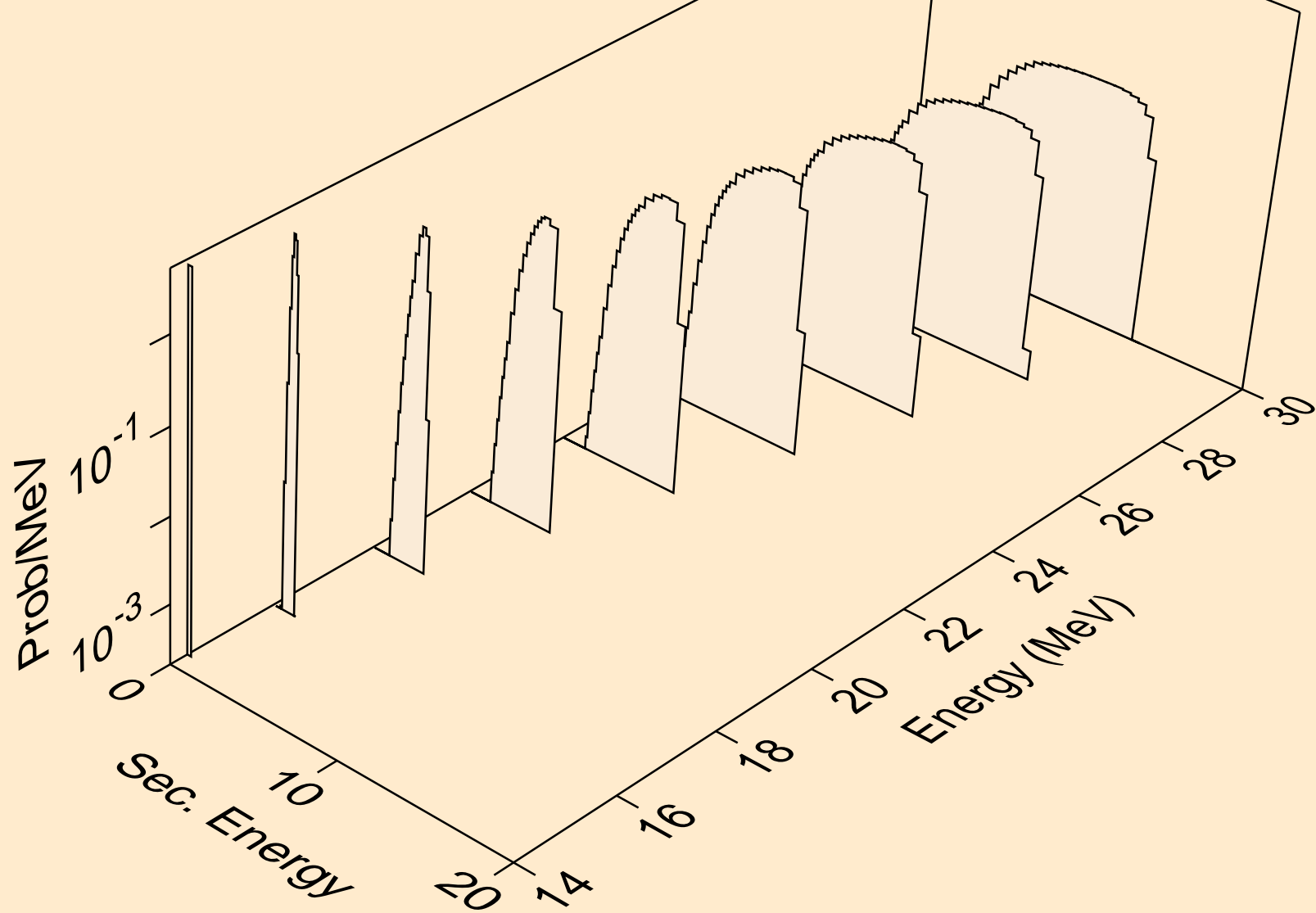

K038 NEUTRON ACER TENDL-2024 LIBRARY; T=293.6K
he3s from (n,x)

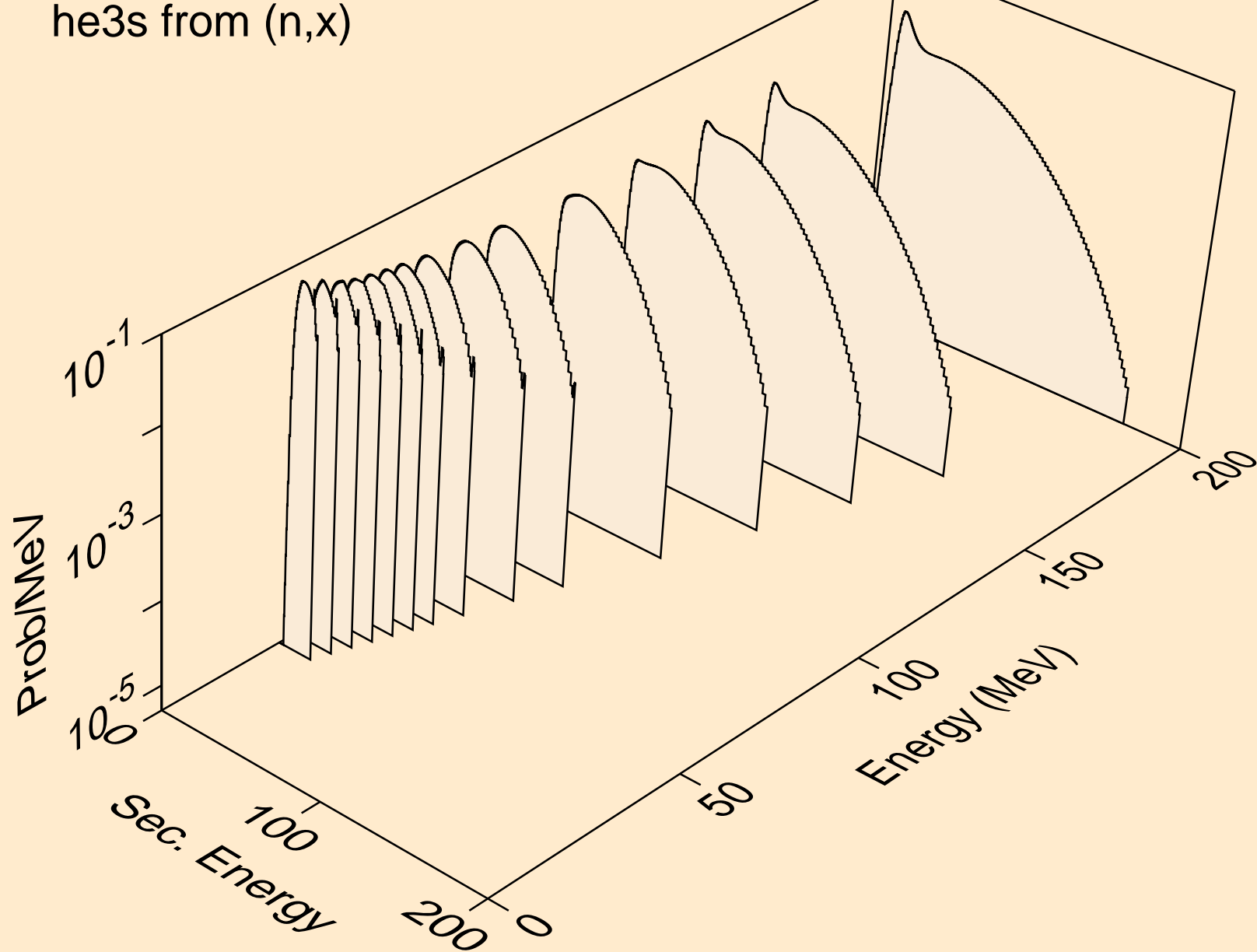

K038 NEUTRON ACER TENDL-2024 LIBRARY; T=293.6K
he3s from (n,n*)he3

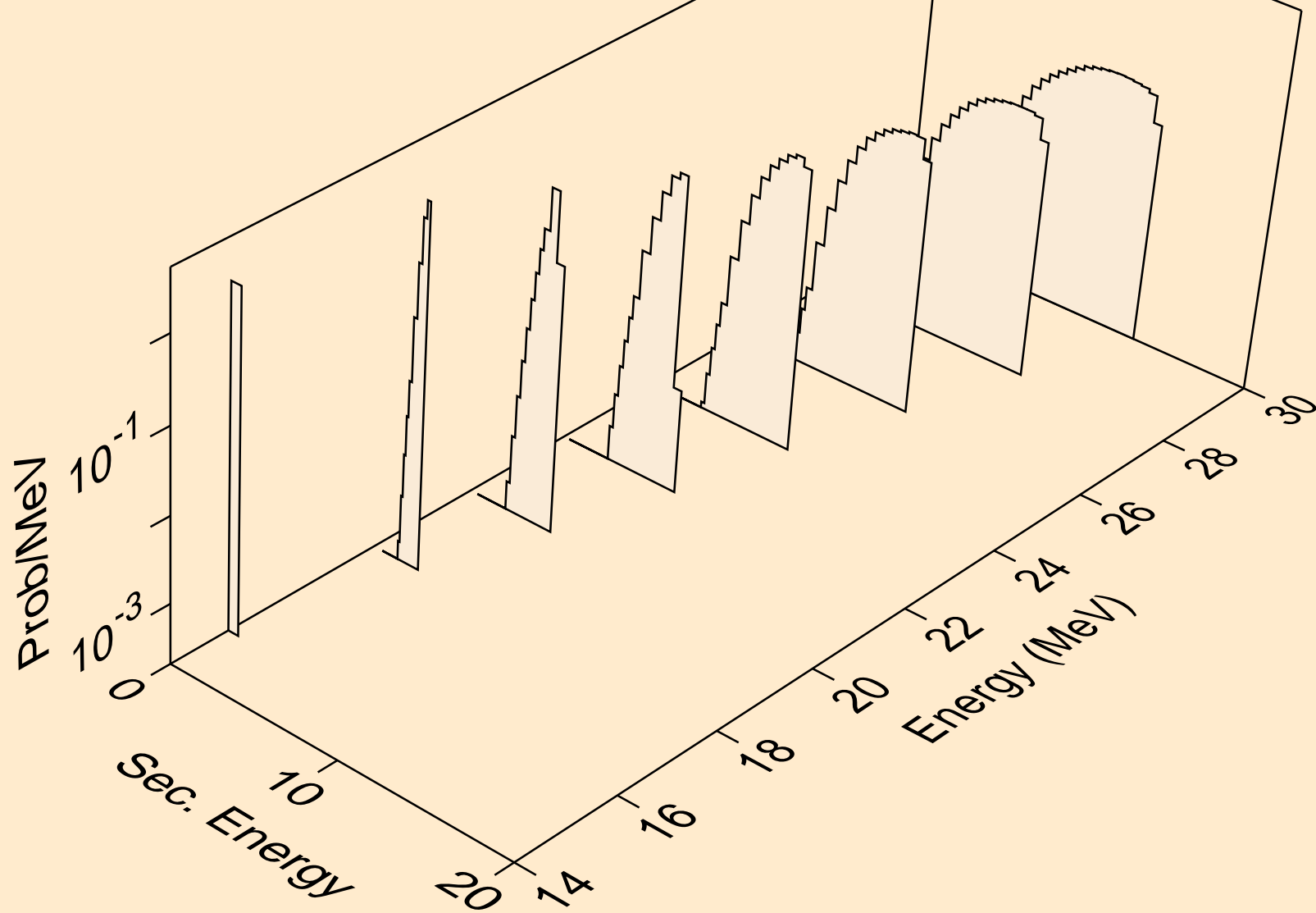

K038 NEUTRON ACER TENDL-2024 LIBRARY; T=293.6K
he3s from (n,he3)

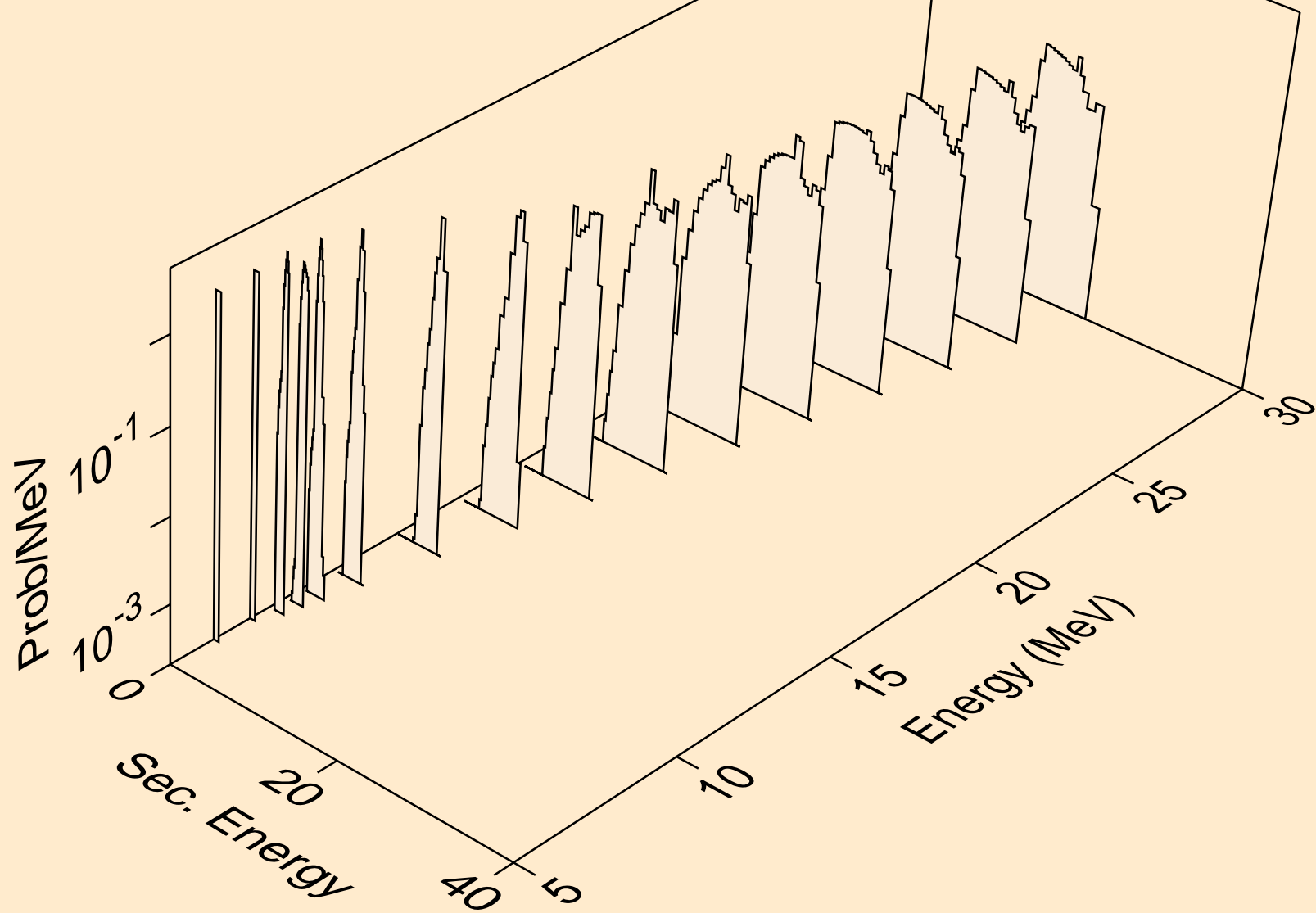

K038 NEUTRON ACER TENDL-2024 LIBRARY; T=293.6K
alphas from (n,x)

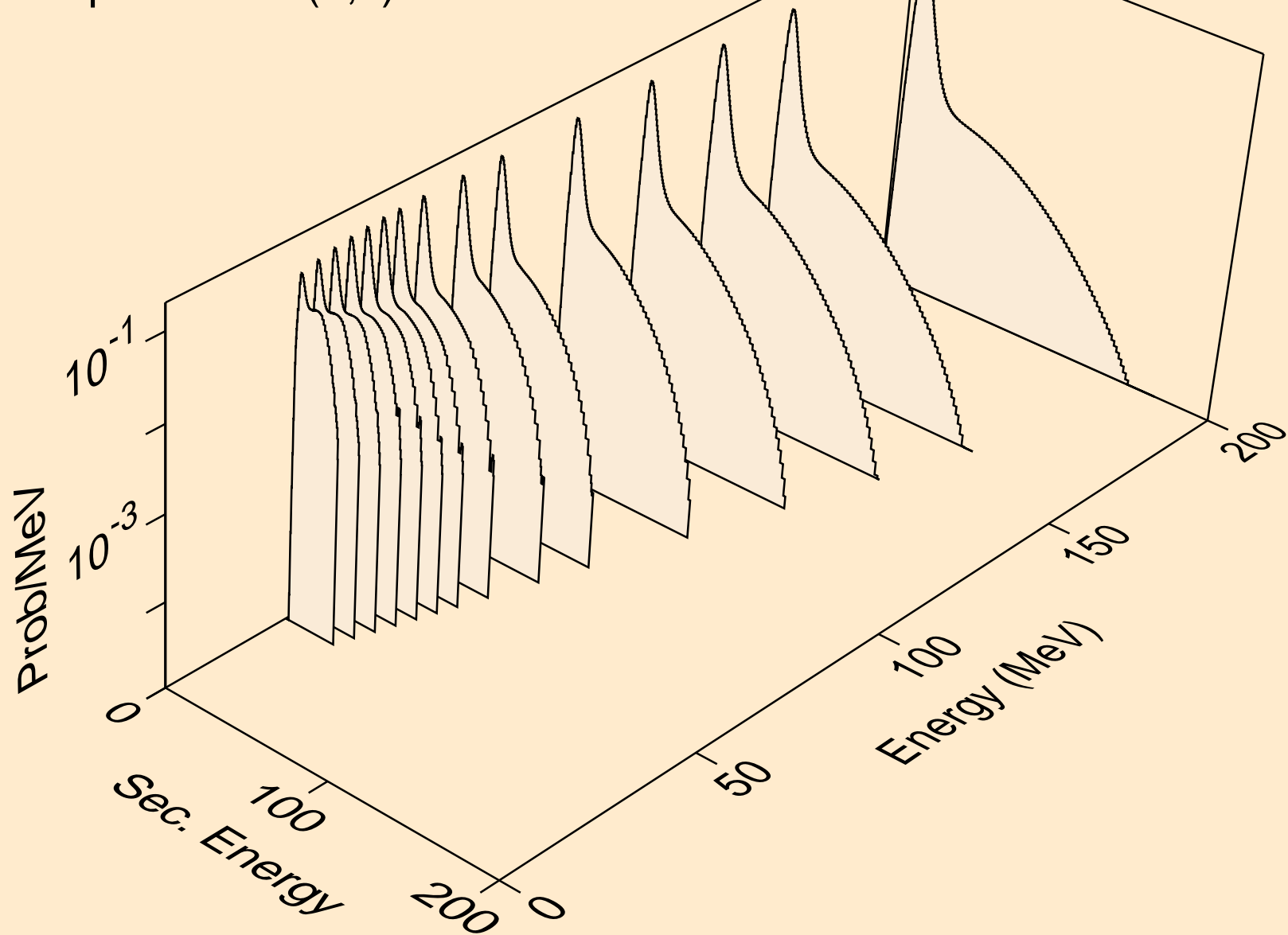

K038 NEUTRON ACER TENDL-2024 LIBRARY; T=293.6K
alphas from (n,n*)a

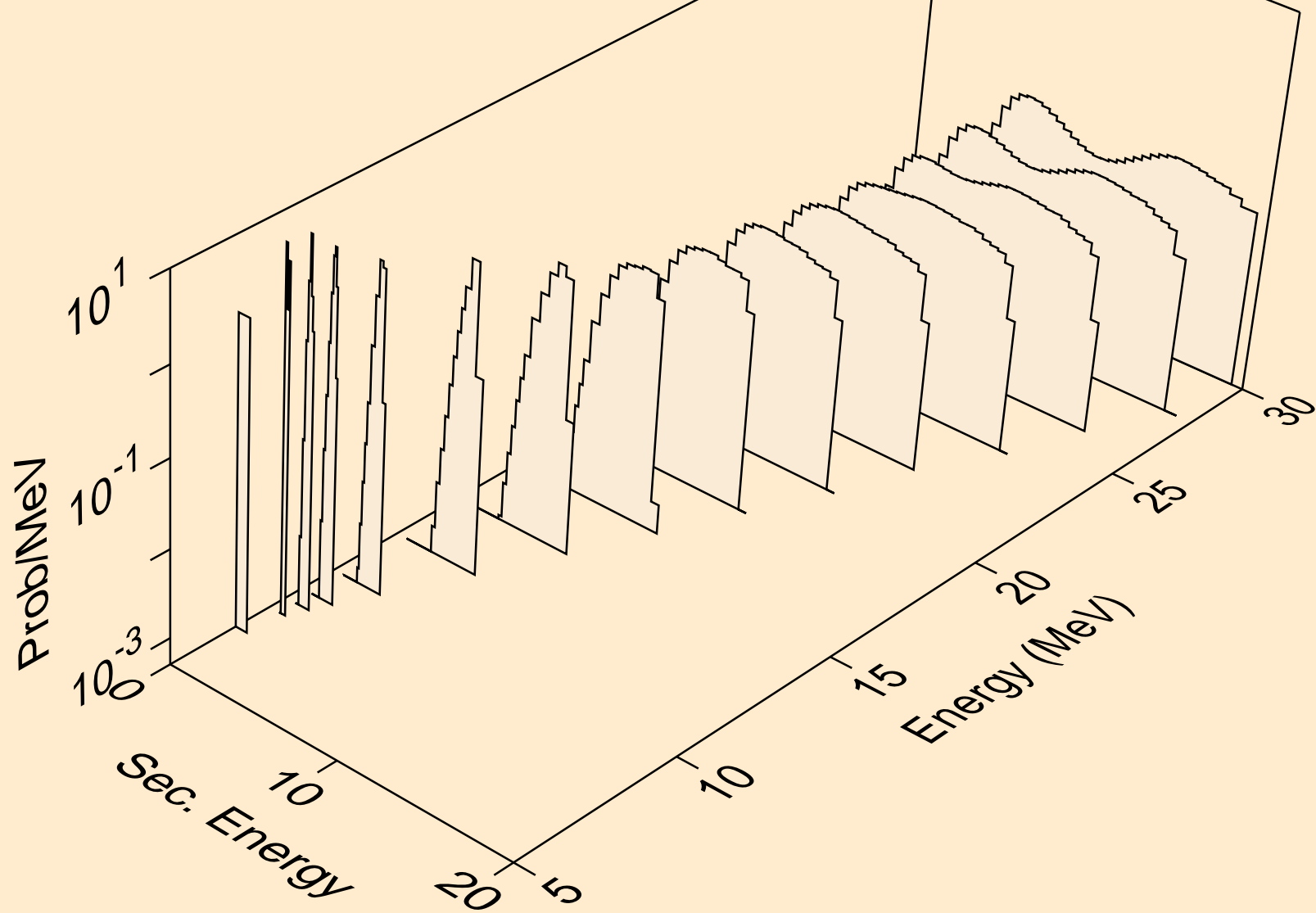

K038 NEUTRON ACER TENDL-2024 LIBRARY; T=293.6K
alphas from (n,2n)a

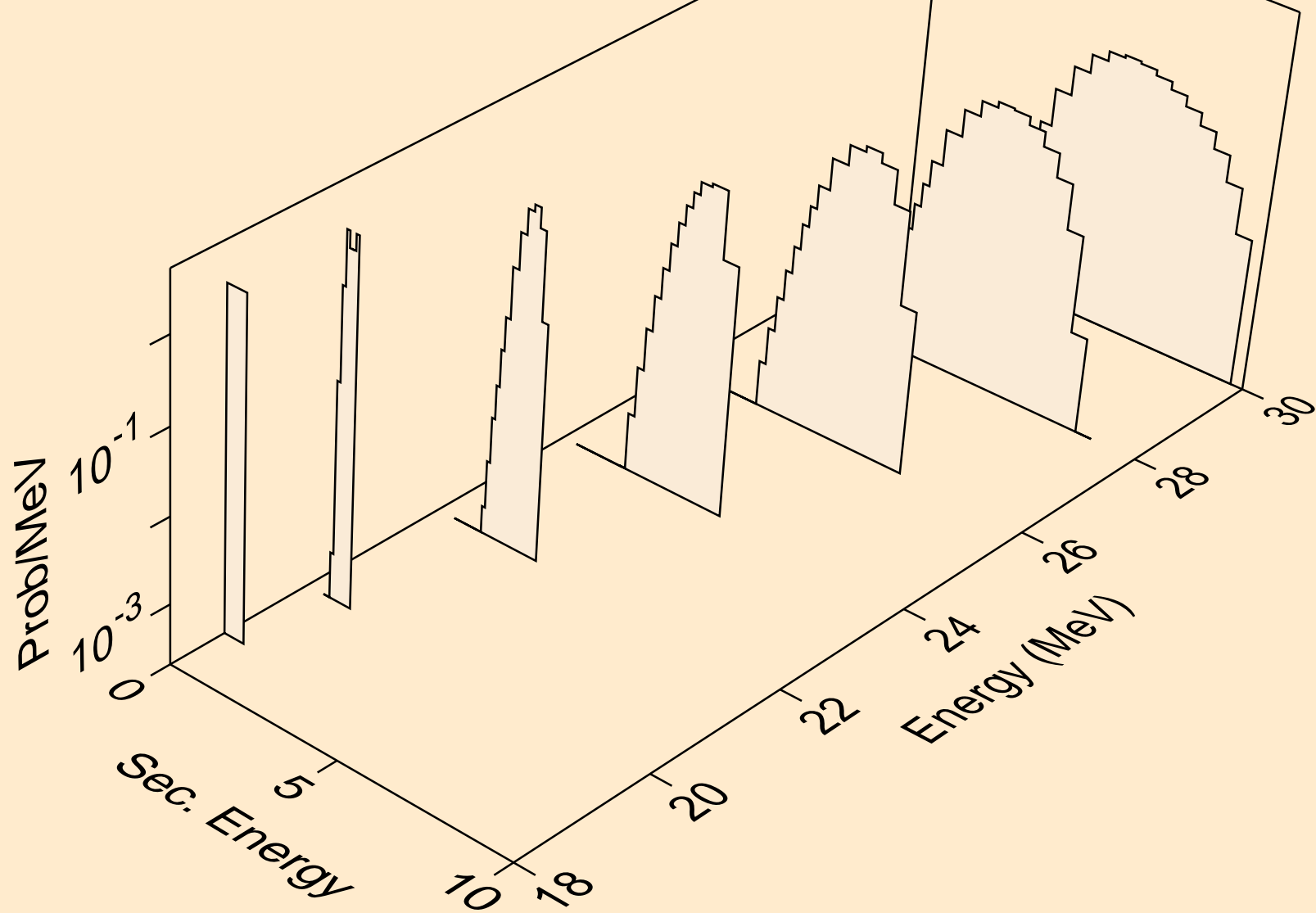

K038 NEUTRON ACER TENDL-2024 LIBRARY; T=293.6K
alphas from (n,n*)2a

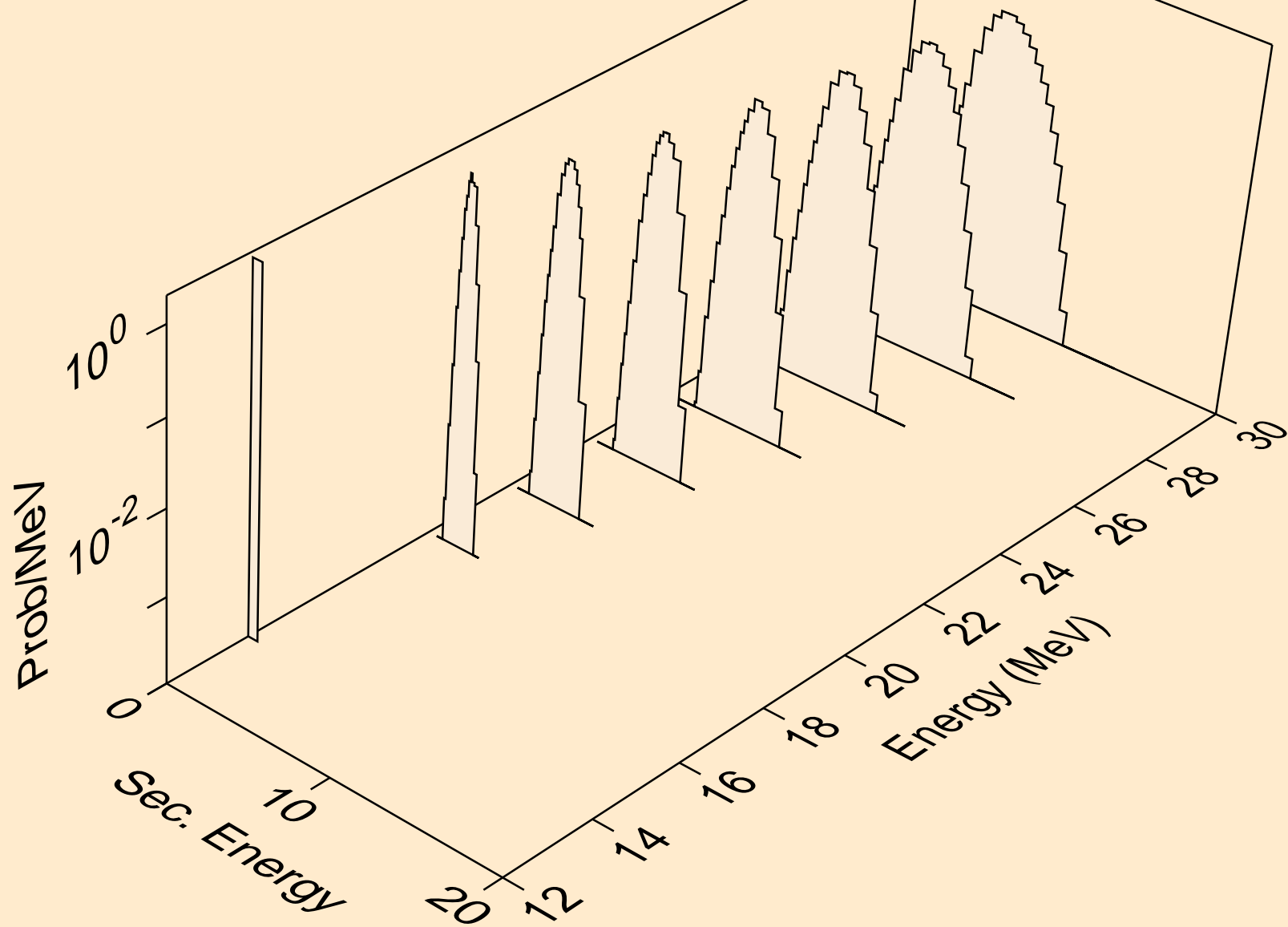

K038 NEUTRON ACER TENDL-2024 LIBRARY; T=293.6K
alphas from (n,npa)

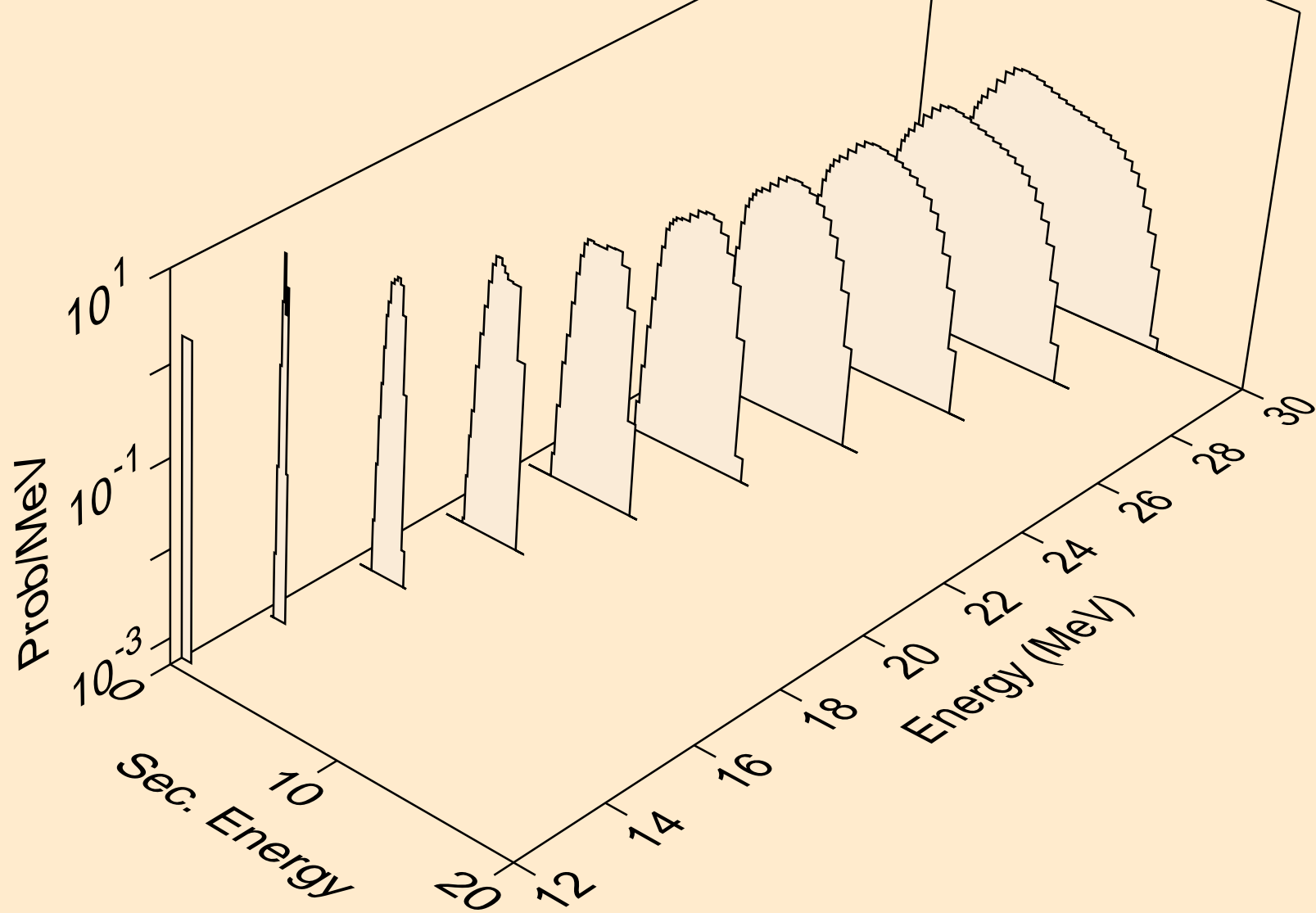

K038 NEUTRON ACER TENDL-2024 LIBRARY; T=293.6K
alphas from (n,a)

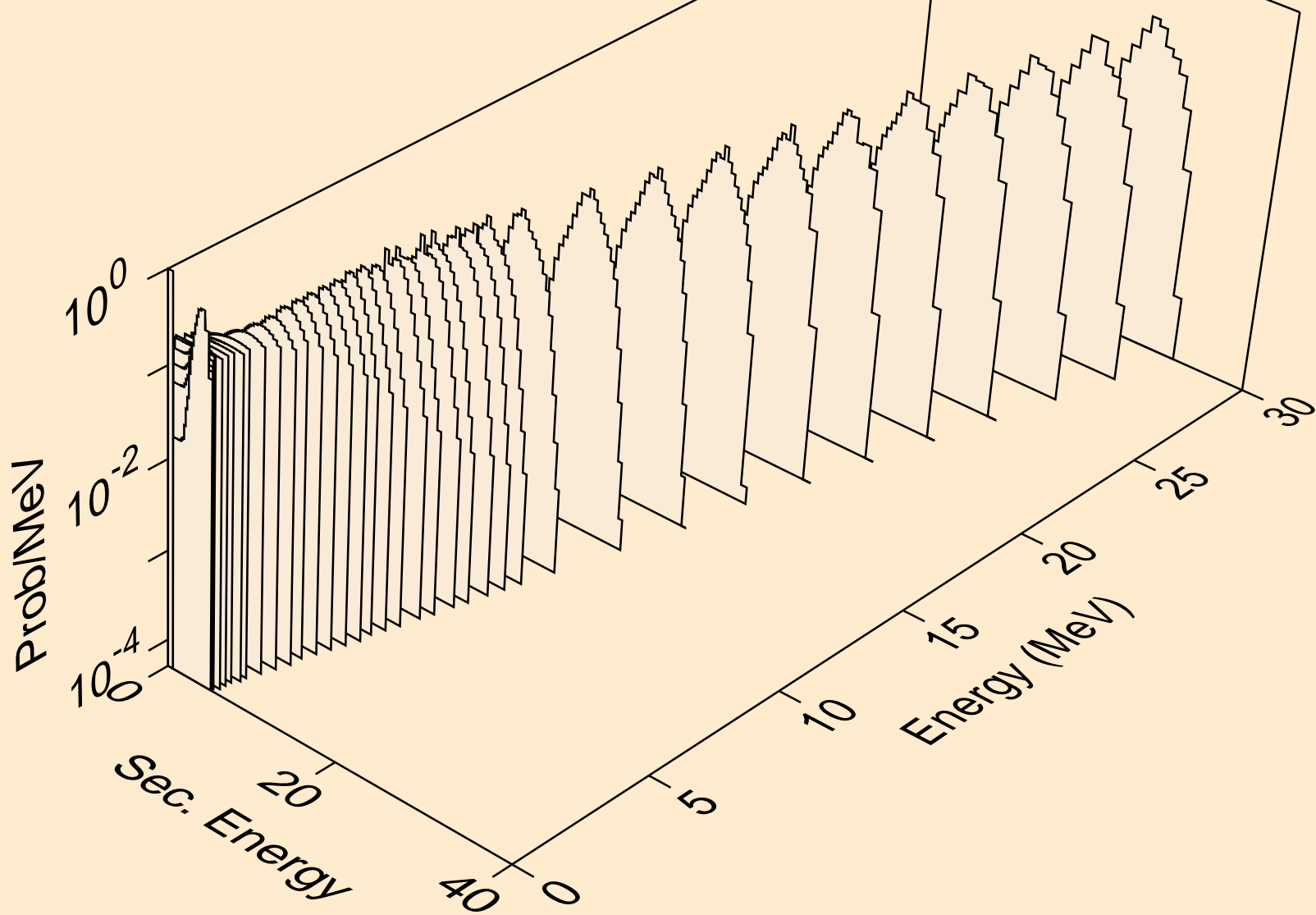

K038 NEUTRON ACER TENDL-2024 LIBRARY; T=293.6K
alphas from (n,2a)

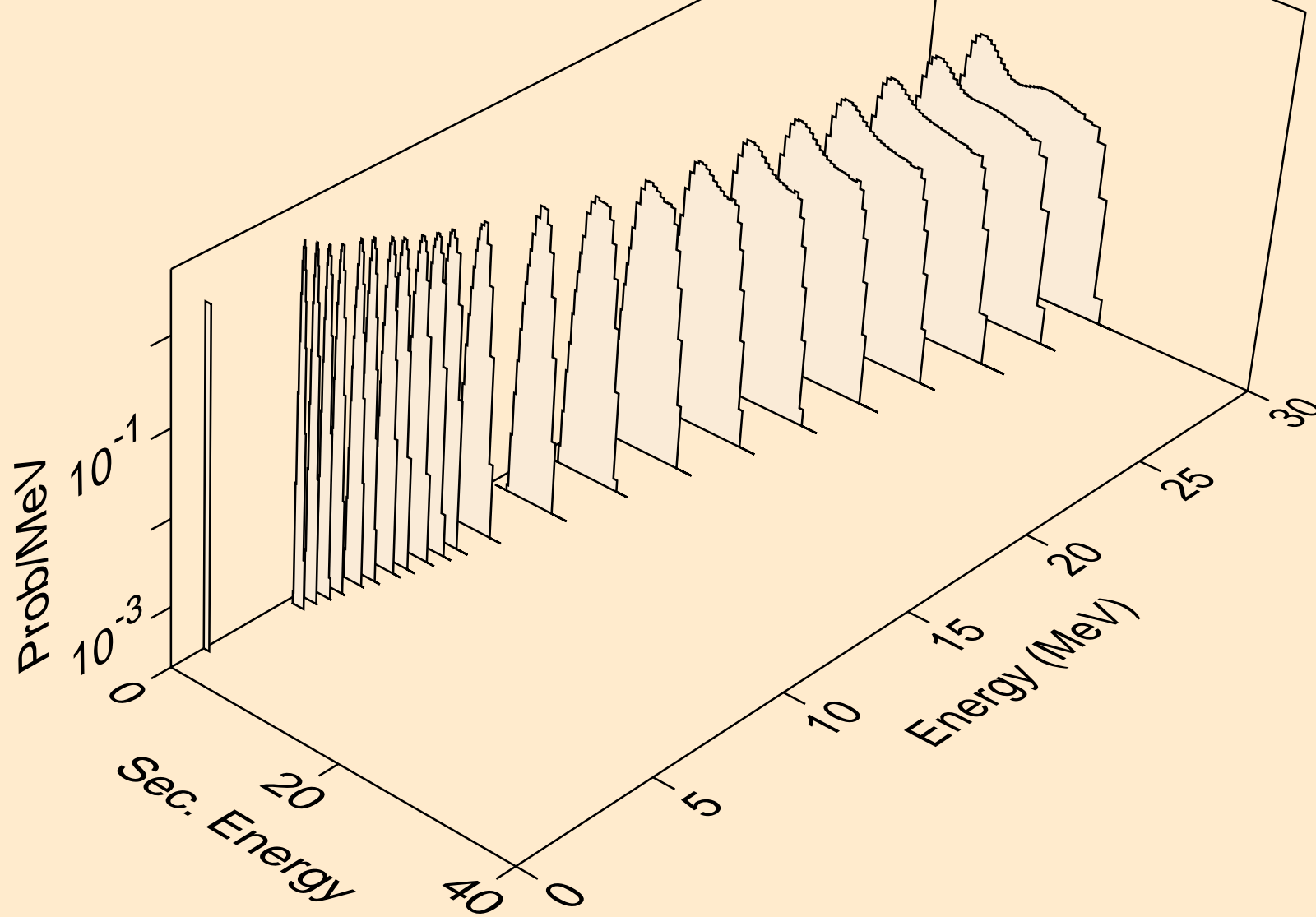

K038 NEUTRON ACER TENDL-2024 LIBRARY; T=293.6K
alphas from (n,3a)

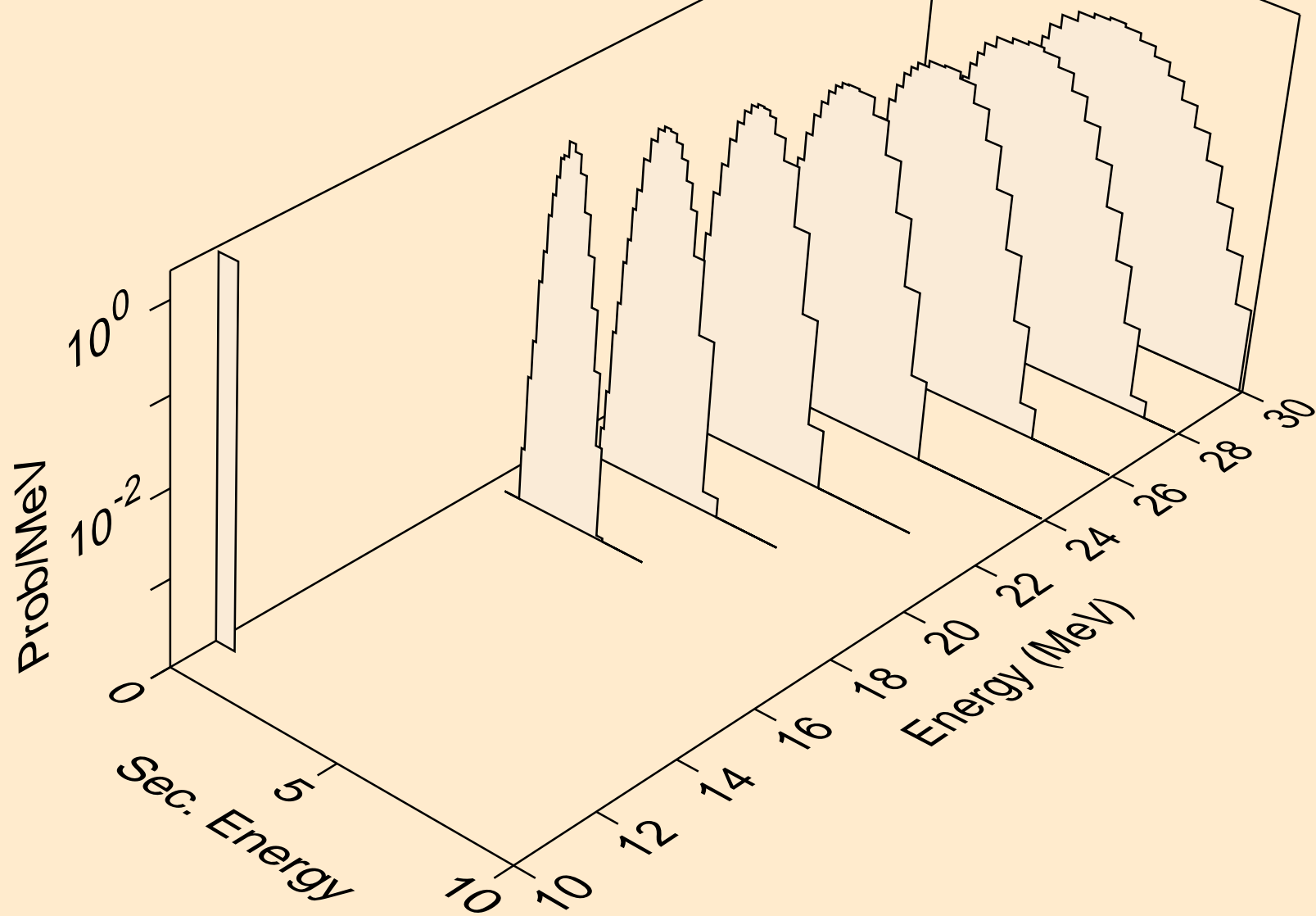

K038 NEUTRON ACER TENDL-2024 LIBRARY; T=293.6K
alphas from (n,pa)

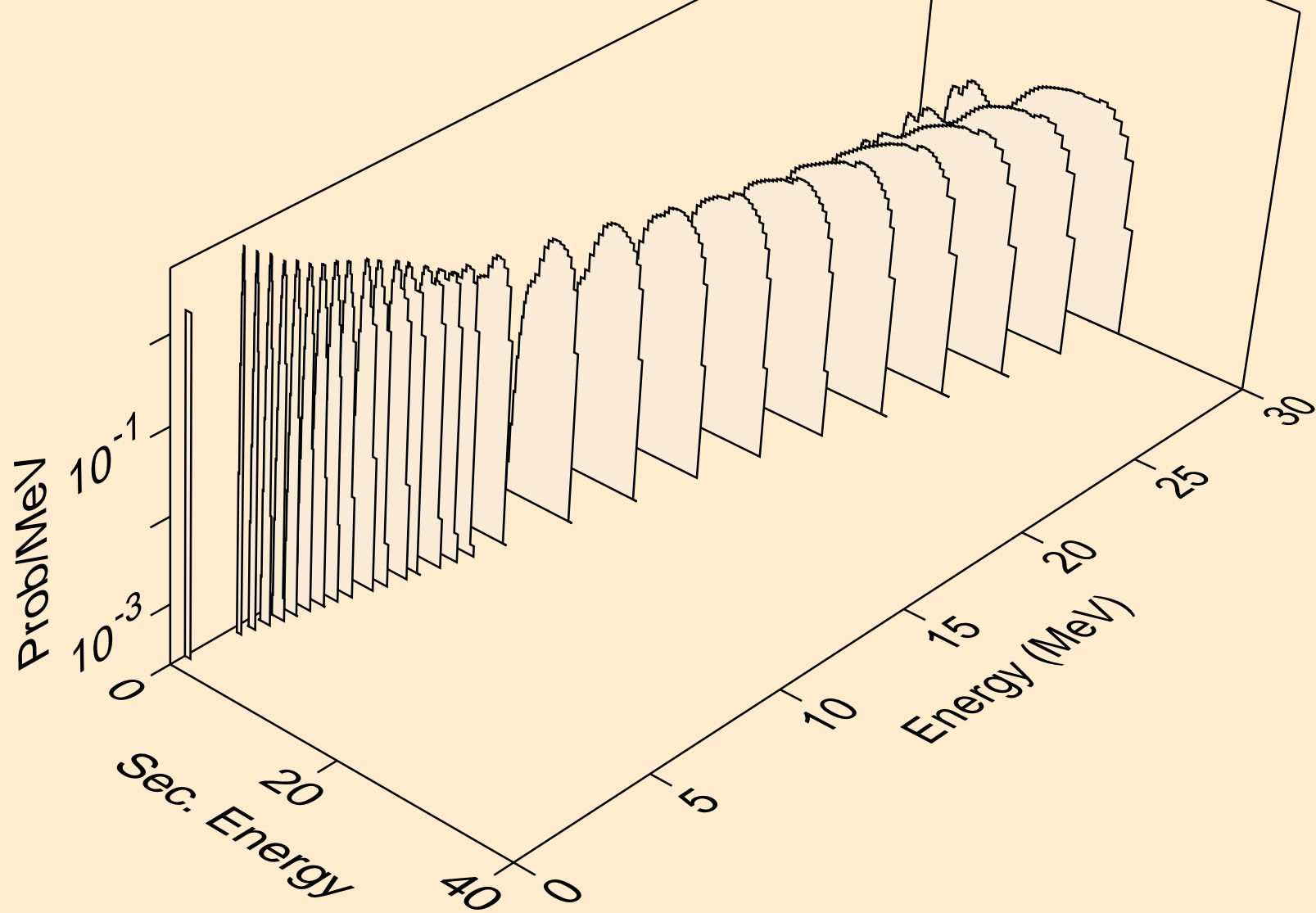

K038 NEUTRON ACER TENDL-2024 LIBRARY; T=293.6K
alphas from (n,t2a)

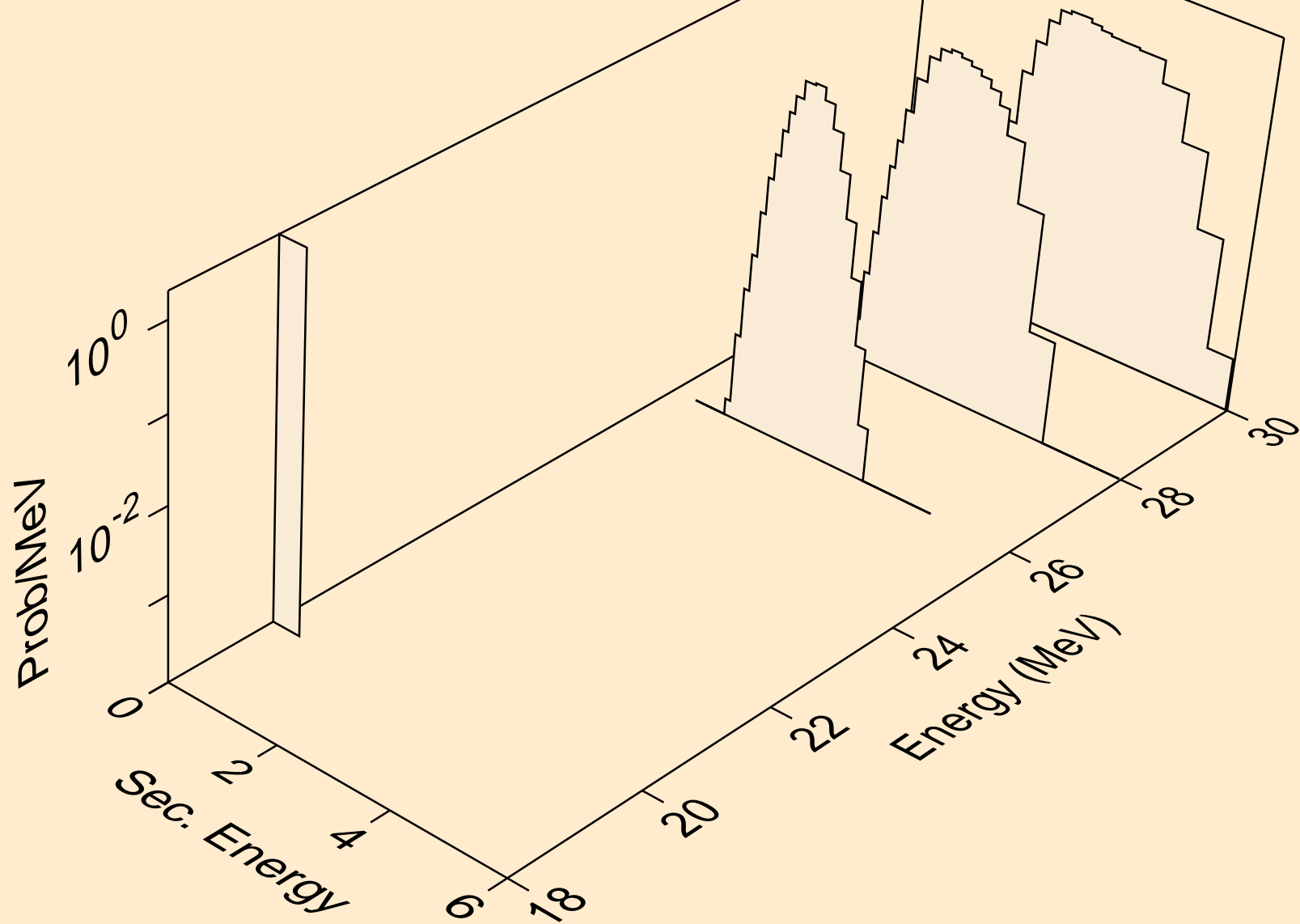

K038 NEUTRON ACER TENDL-2024 LIBRARY; T=293.6K
alphas from (n,d2a)

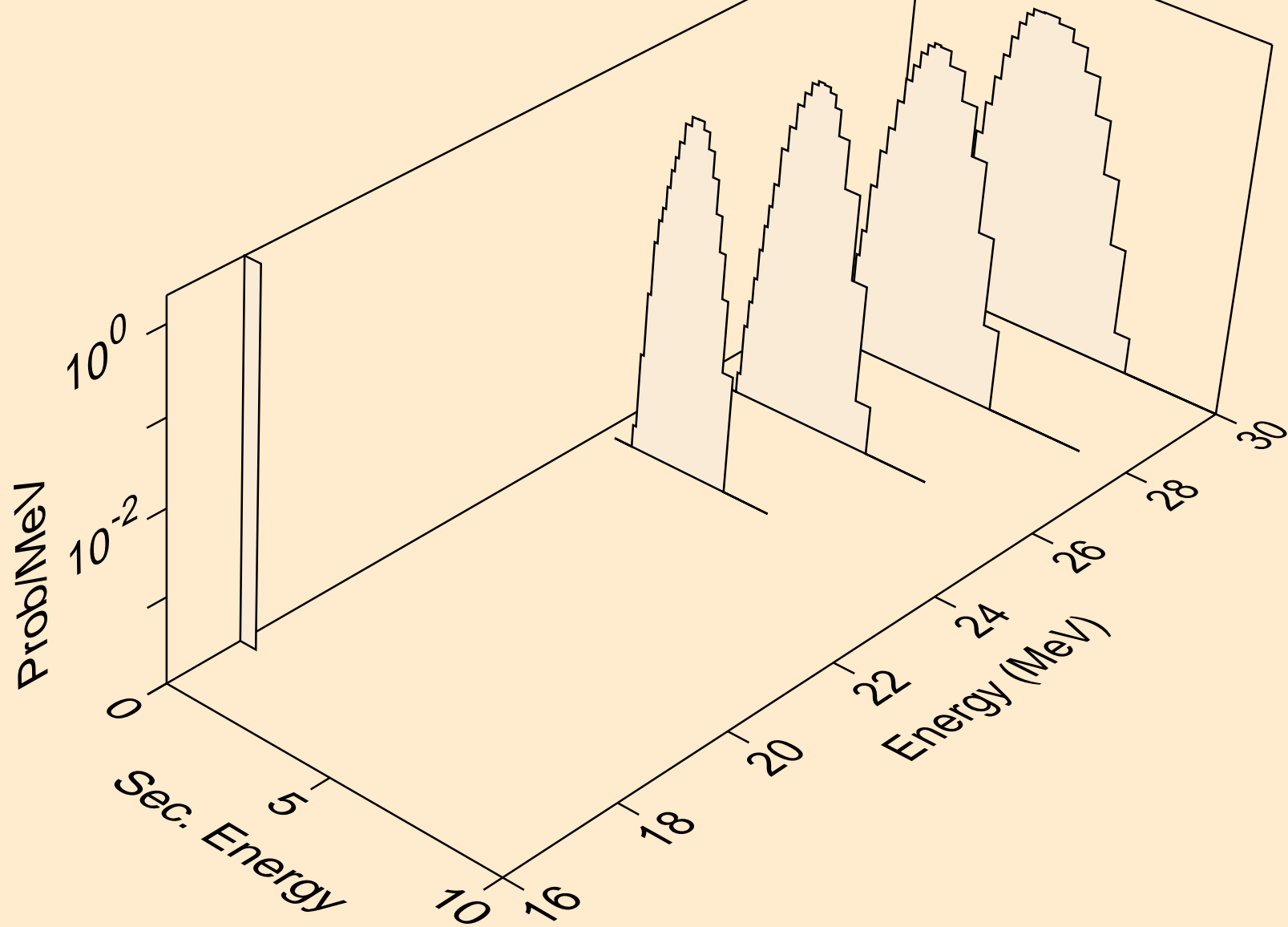

K038 NEUTRON ACER TENDL-2024 LIBRARY; T=293.6K
alphas from (n,da)

