

# LU160 NEUTRON ACER TENDL-2024 LIBRARY; T=293.6K

## Principal cross sections

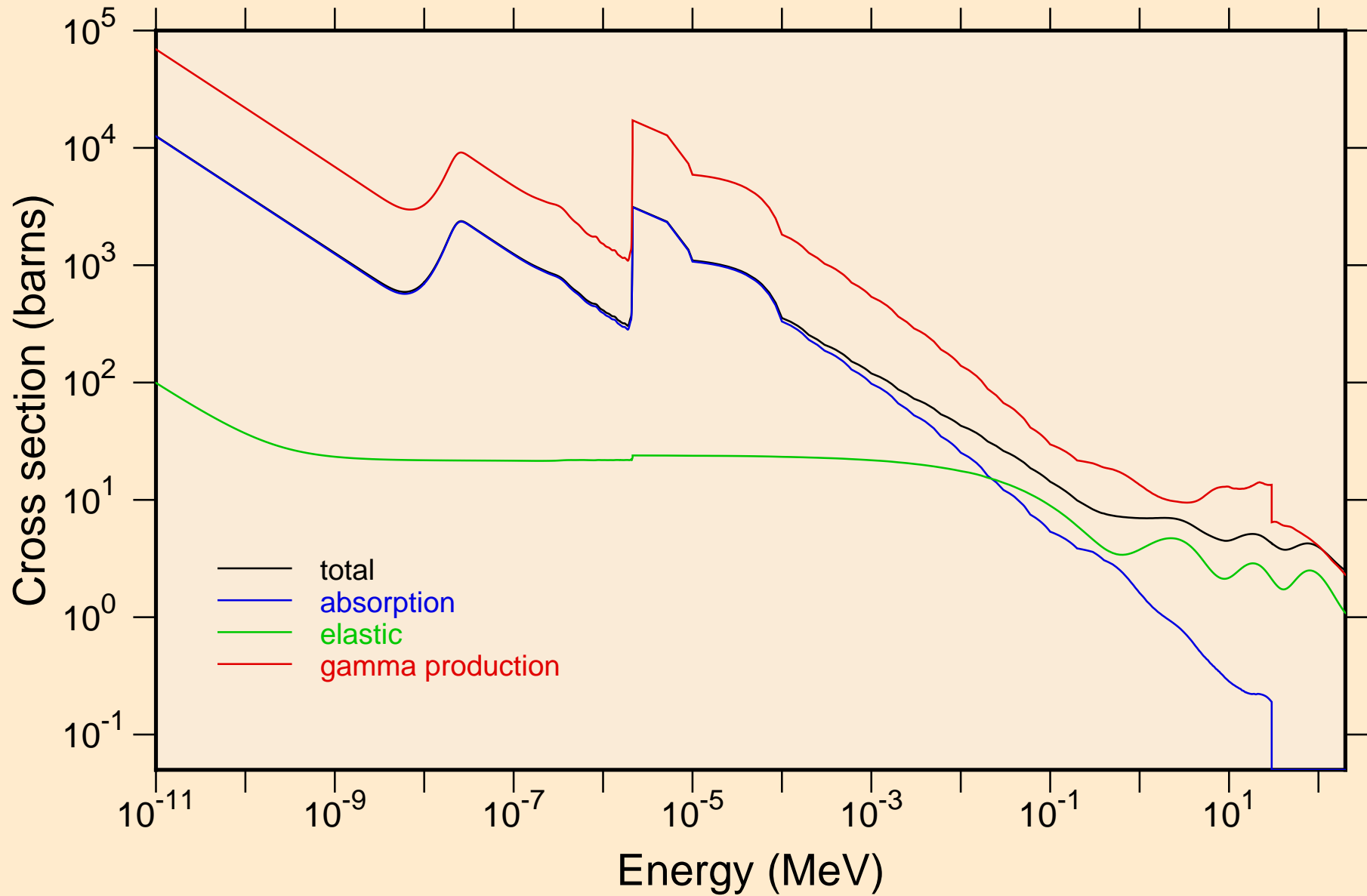

LU160 NEUTRON ACER TENDL-2024 LIBRARY; T=293.6K  
Heating

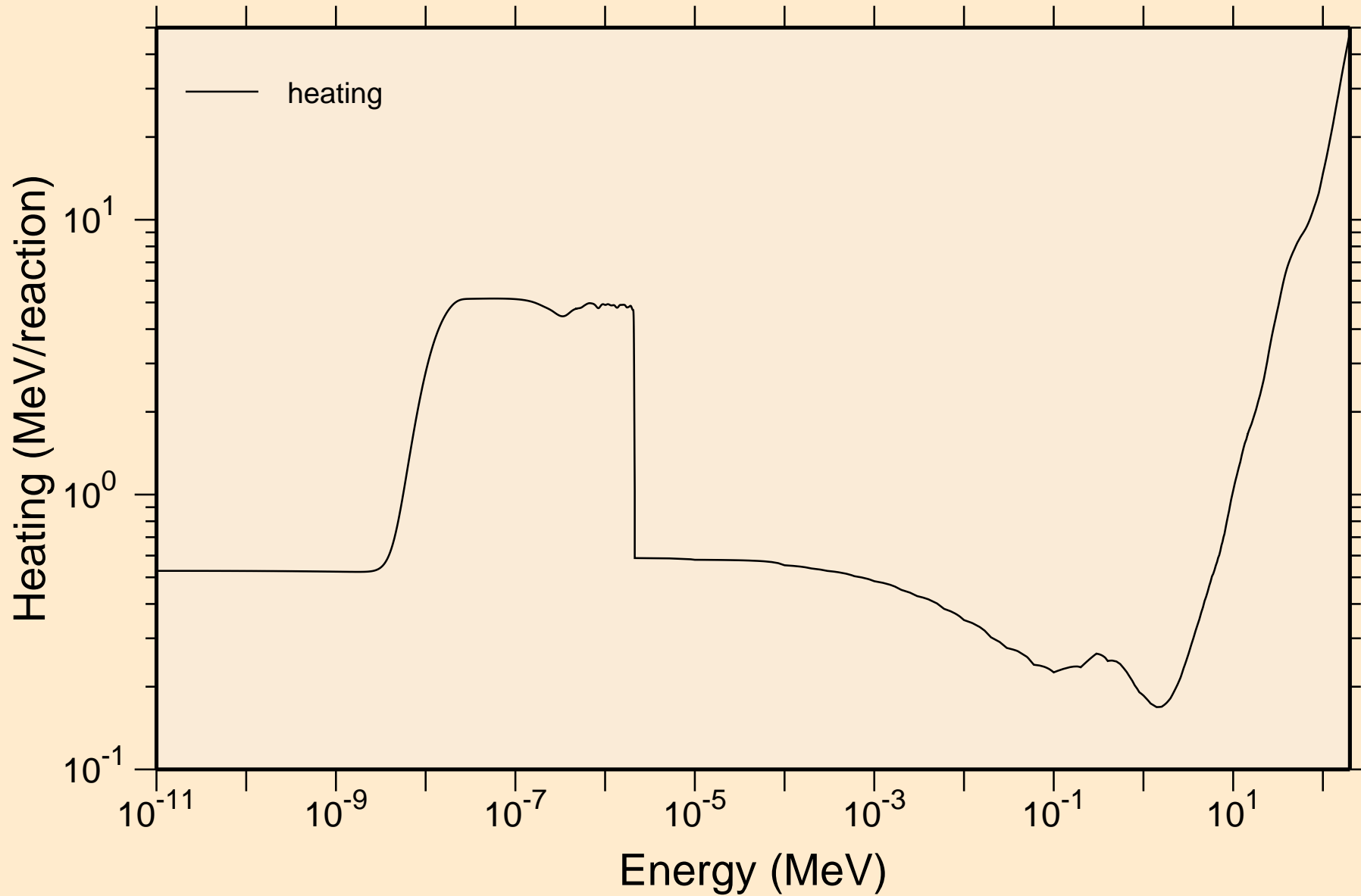

LU160 NEUTRON ACER TENDL-2024 LIBRARY; T=293.6K  
Damage

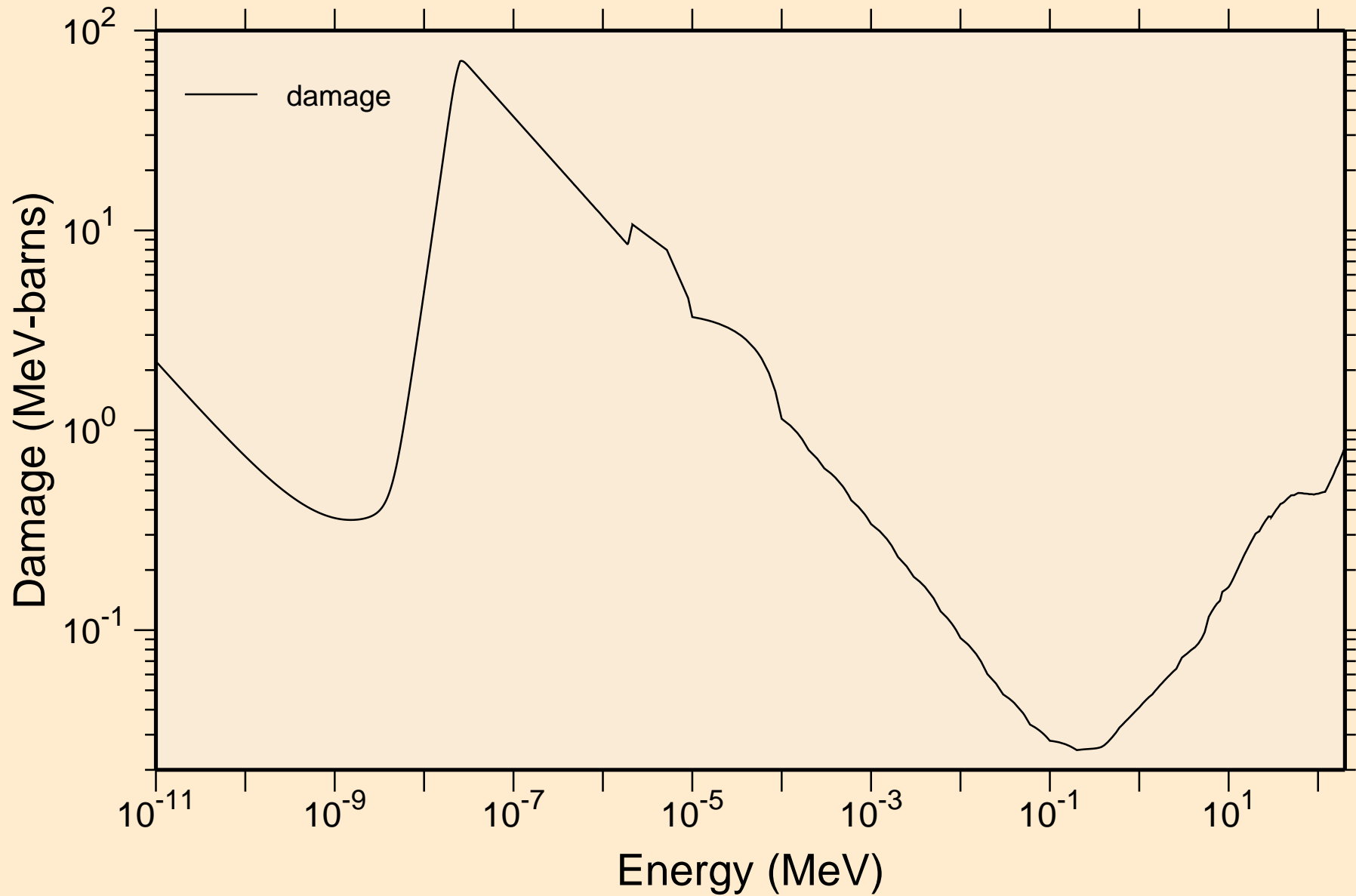

LU160 NEUTRON ACER TENDL-2024 LIBRARY; T=293.6K  
Non-threshold reactions

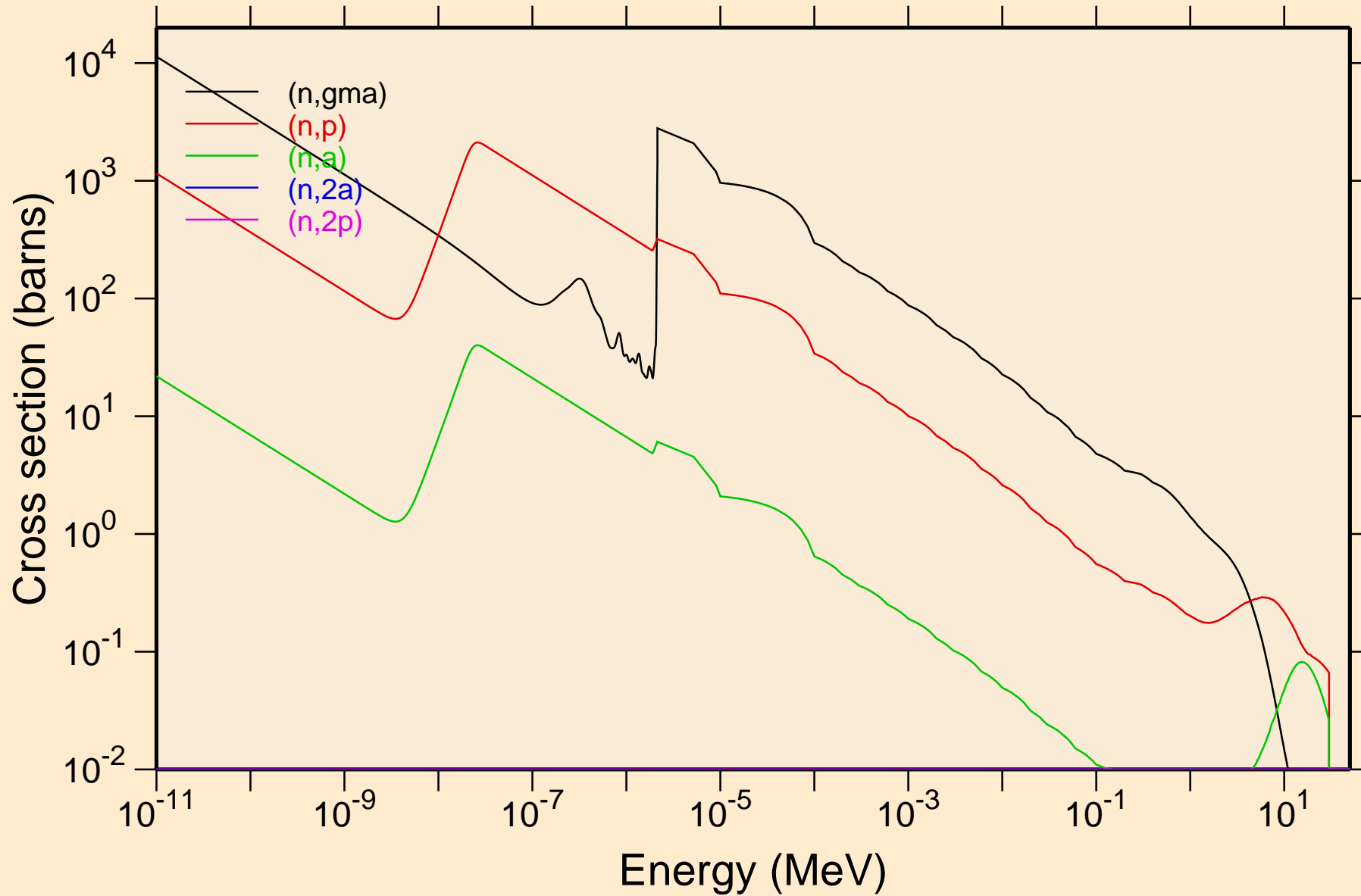

LU160 NEUTRON ACER TENDL-2024 LIBRARY; T=293.6K  
Non-threshold reactions

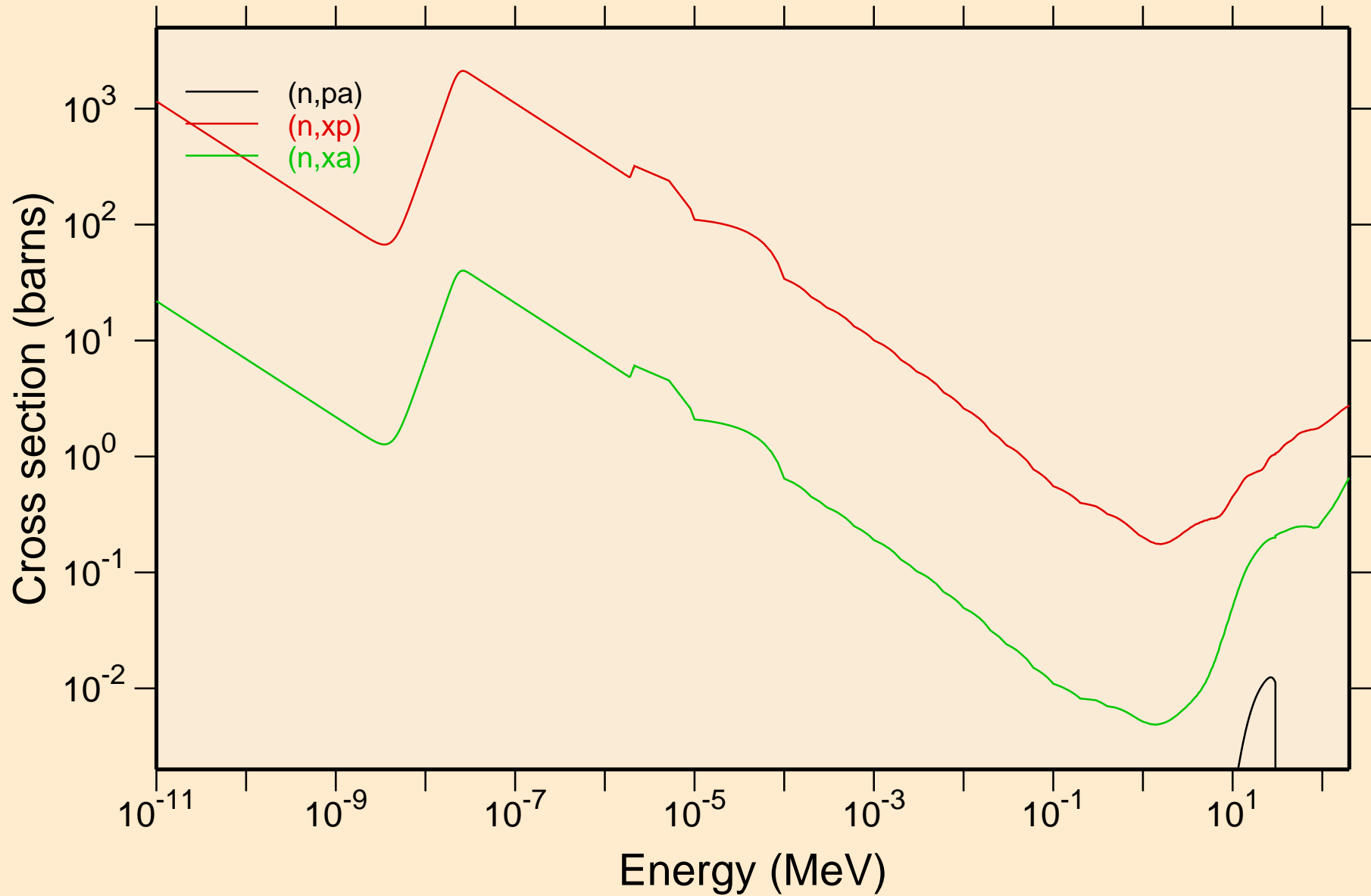

# LU160 NEUTRON ACER TENDL-2024 LIBRARY; T=293.6K

## Principal cross sections

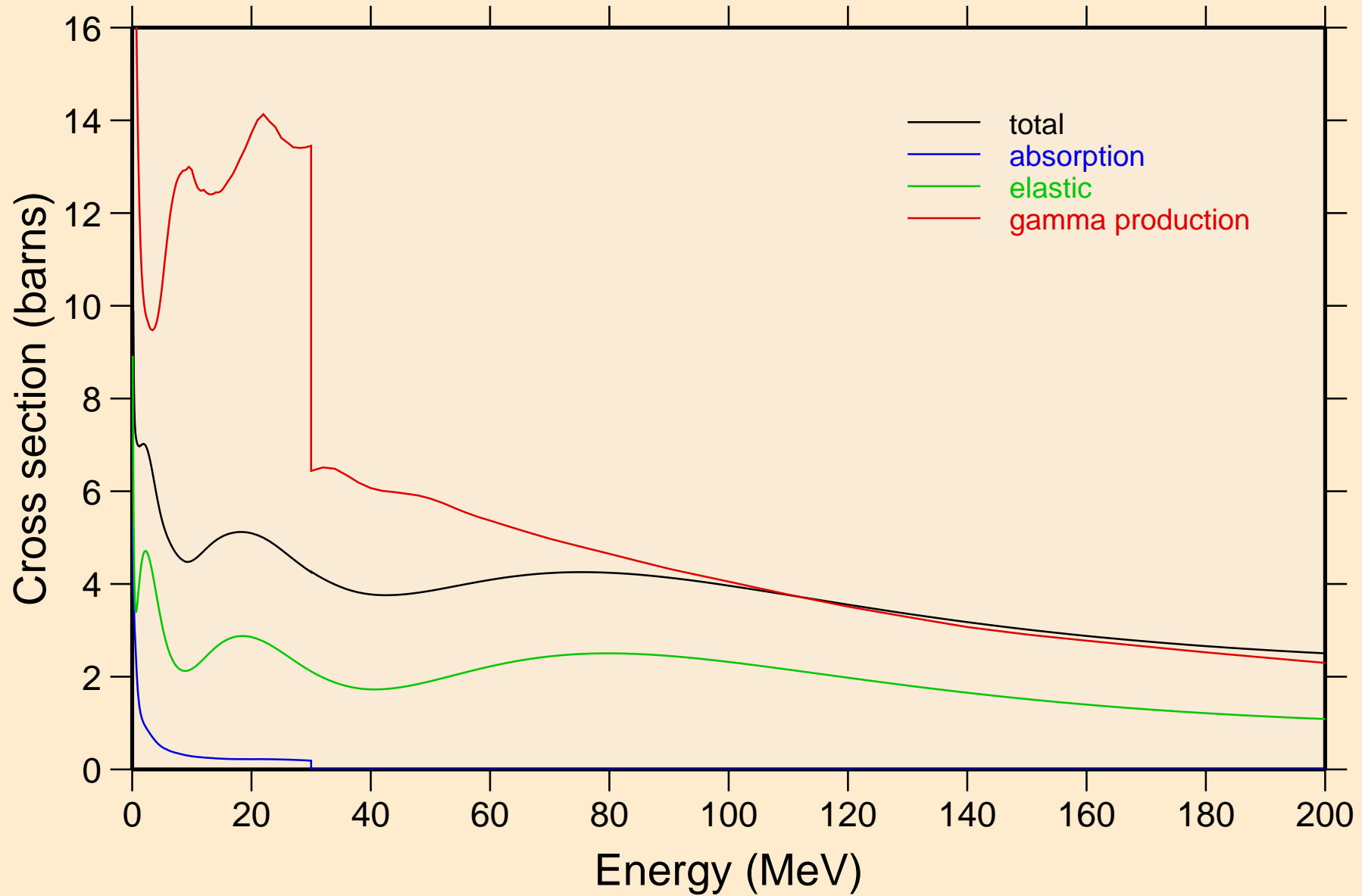

# LU160 NEUTRON ACER TENDL-2024 LIBRARY; T=293.6K

## Heating

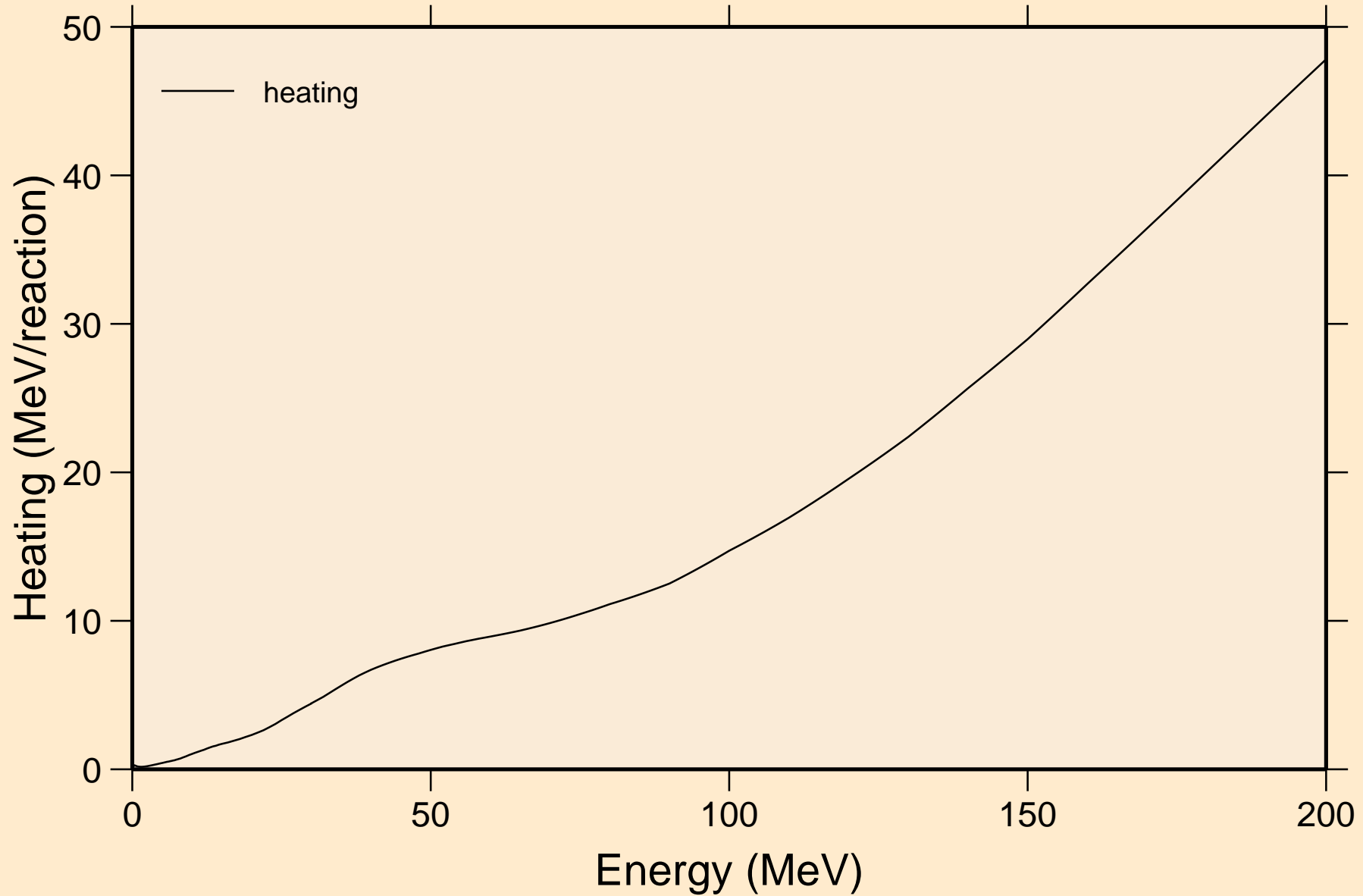

LU160 NEUTRON ACER TENDL-2024 LIBRARY; T=293.6K  
Damage

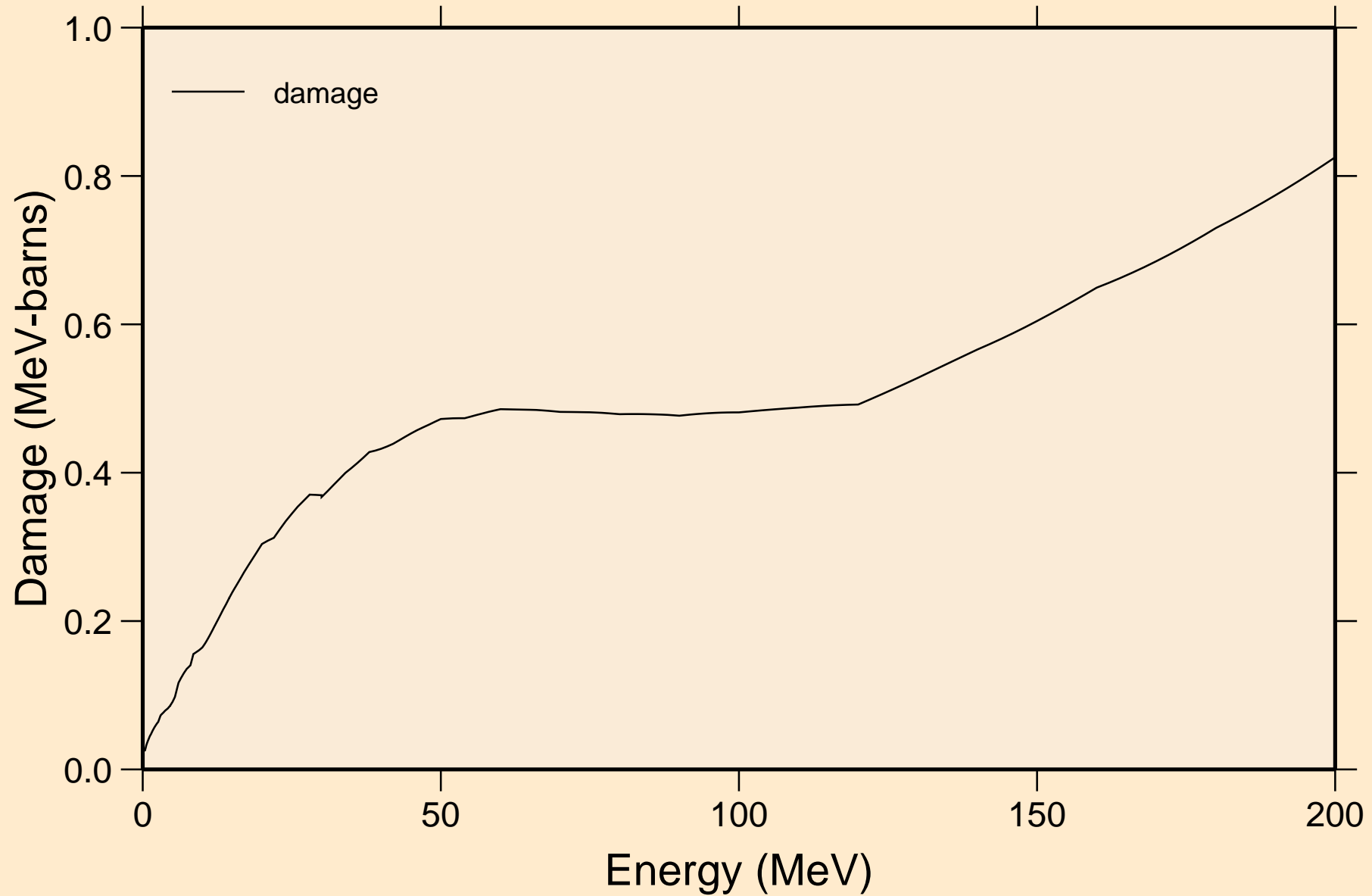

LU160 NEUTRON ACER TENDL-2024 LIBRARY; T=293.6K  
Non-threshold reactions

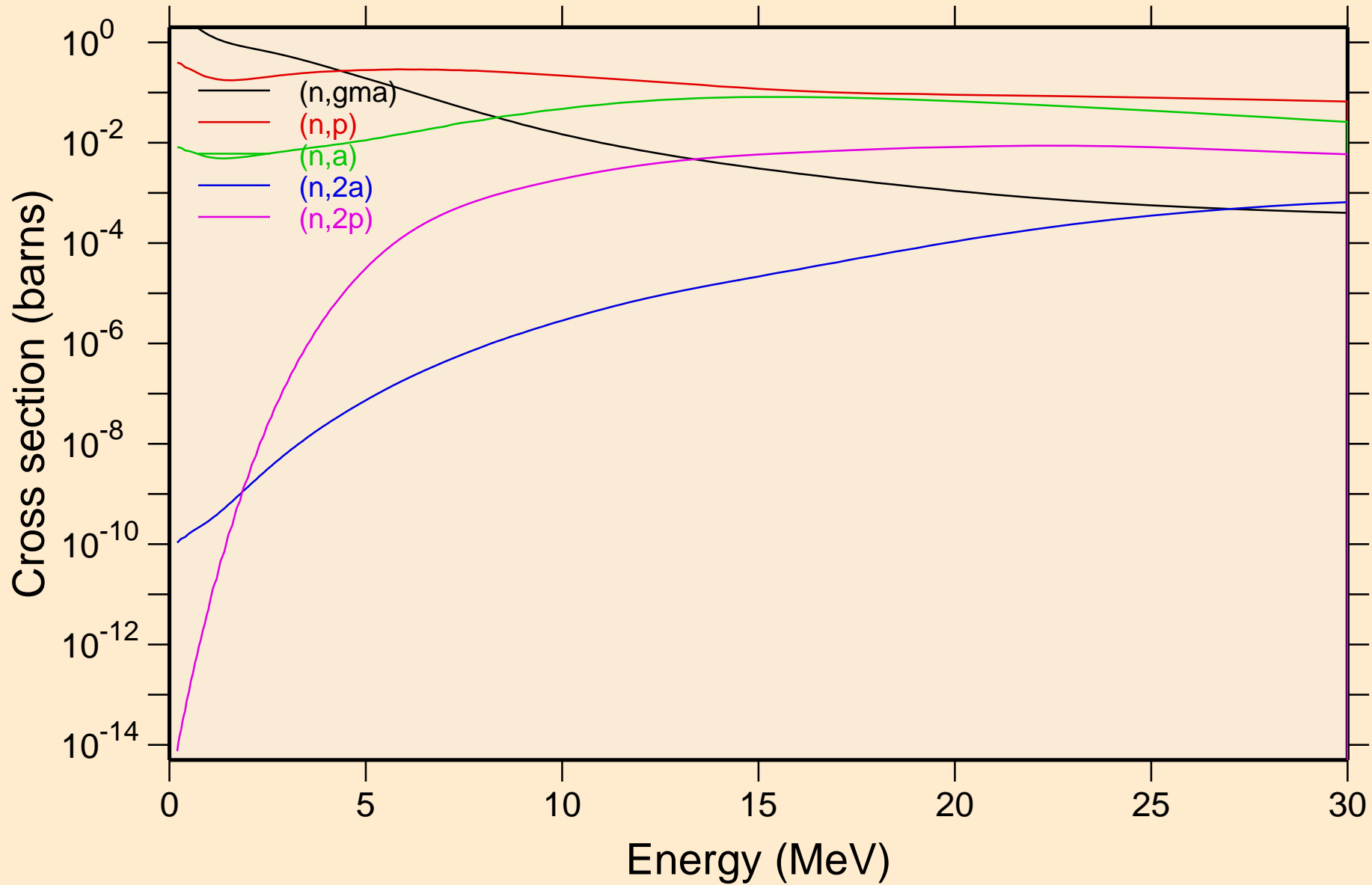

LU160 NEUTRON ACER TENDL-2024 LIBRARY; T=293.6K  
Non-threshold reactions

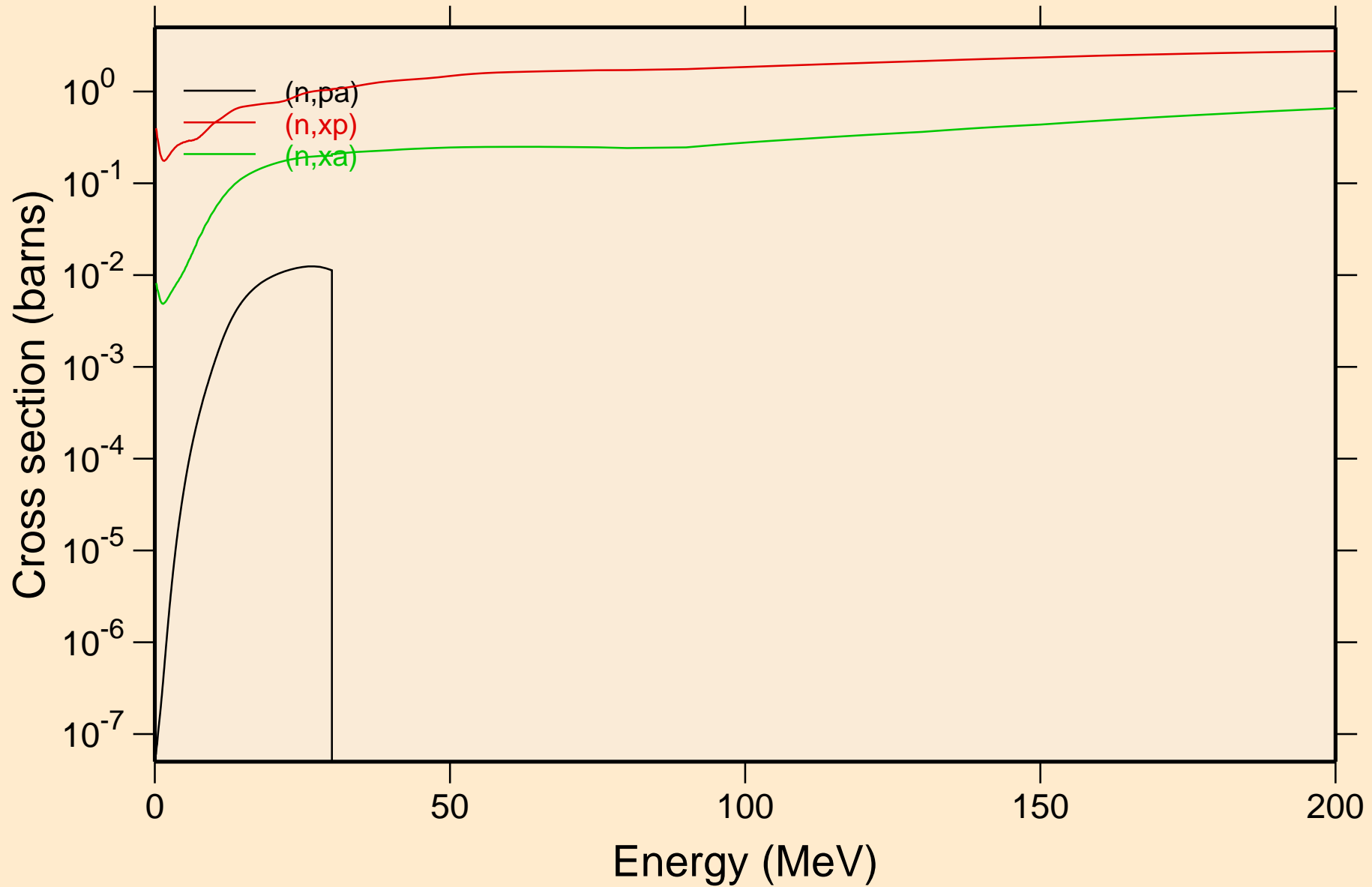

LU160 NEUTRON ACER TENDL-2024 LIBRARY; T=293.6K  
Inelastic levels

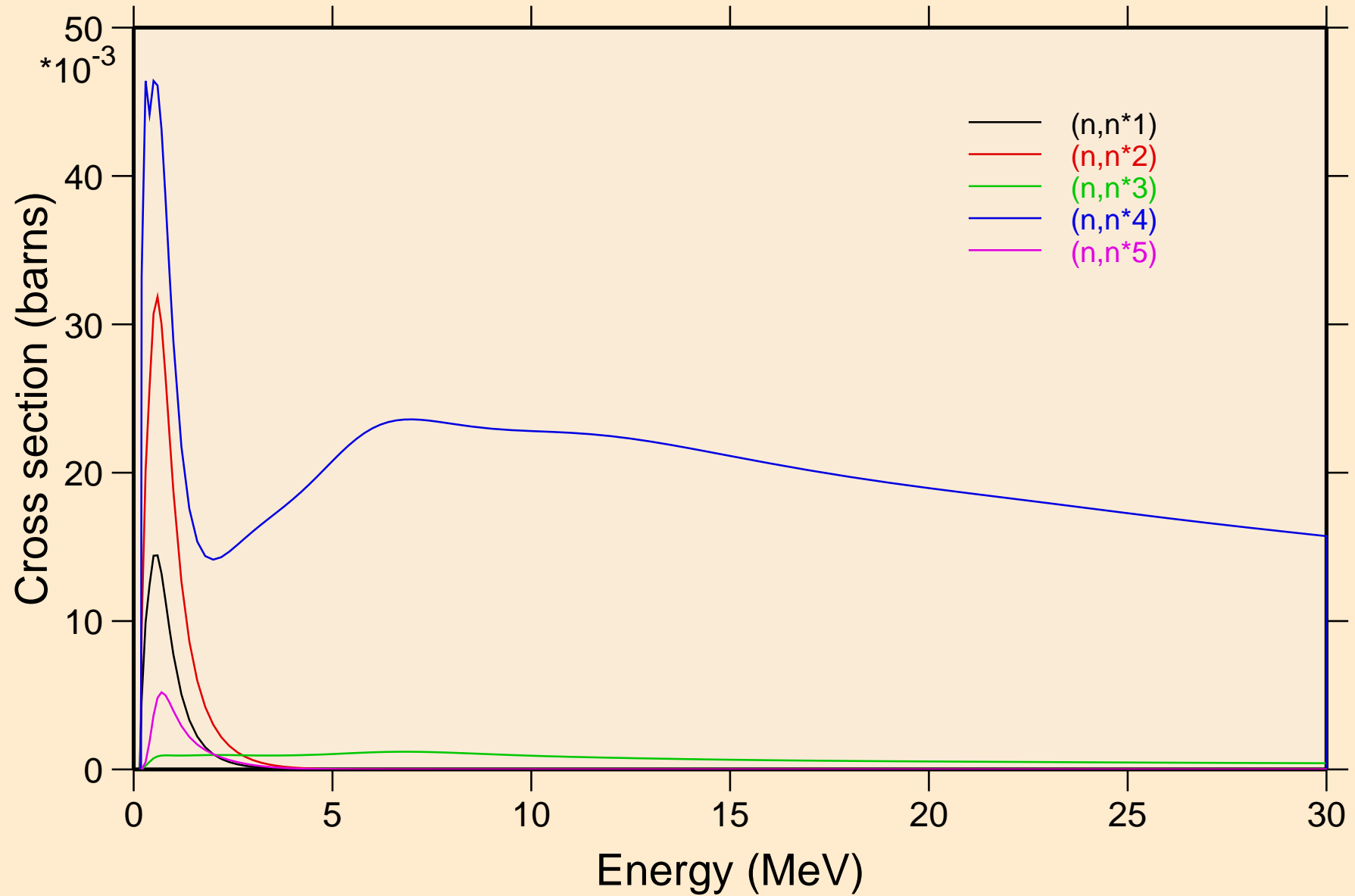

LU160 NEUTRON ACER TENDL-2024 LIBRARY; T=293.6K  
Inelastic levels

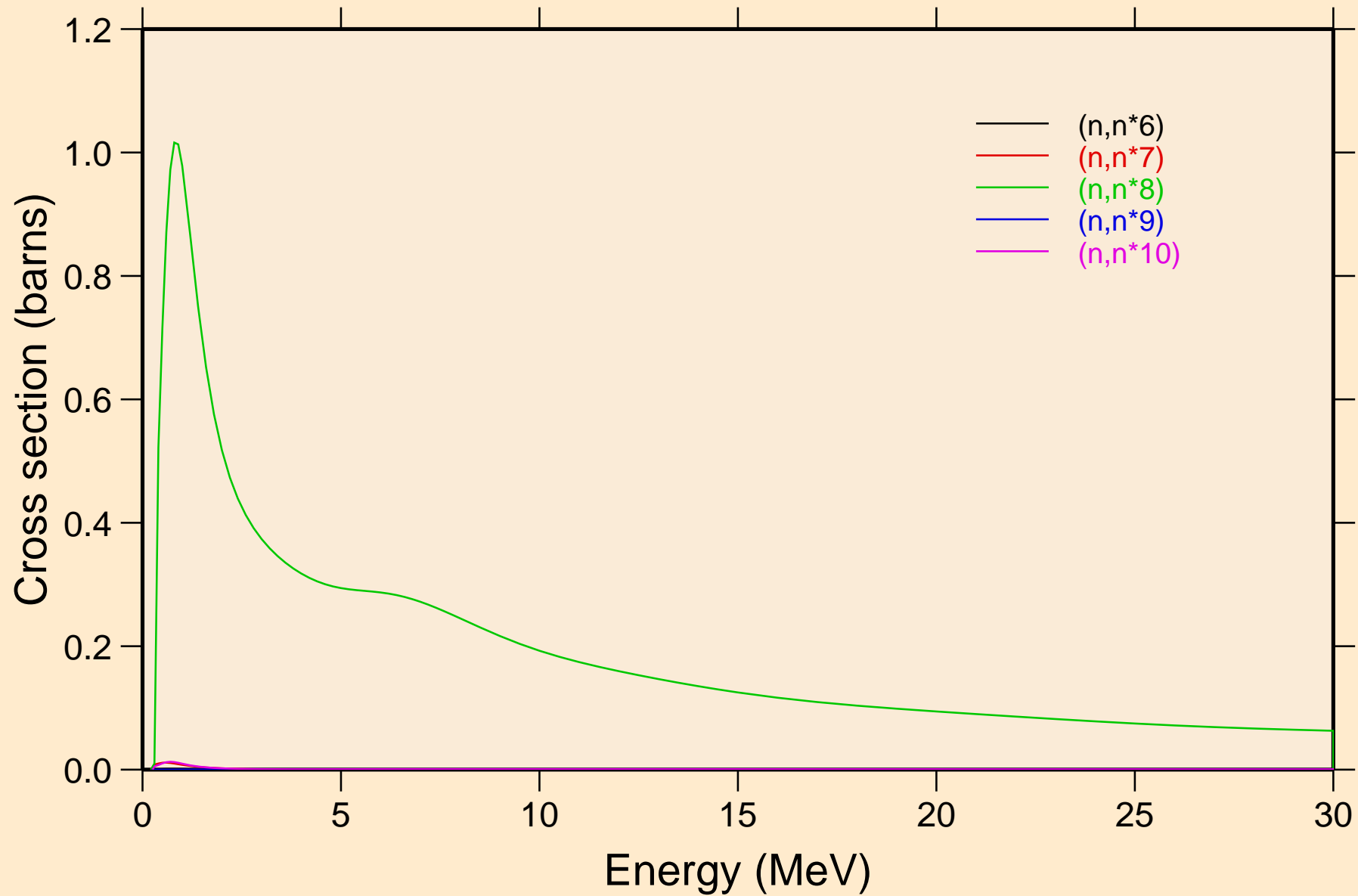

LU160 NEUTRON ACER TENDL-2024 LIBRARY; T=293.6K  
Inelastic levels

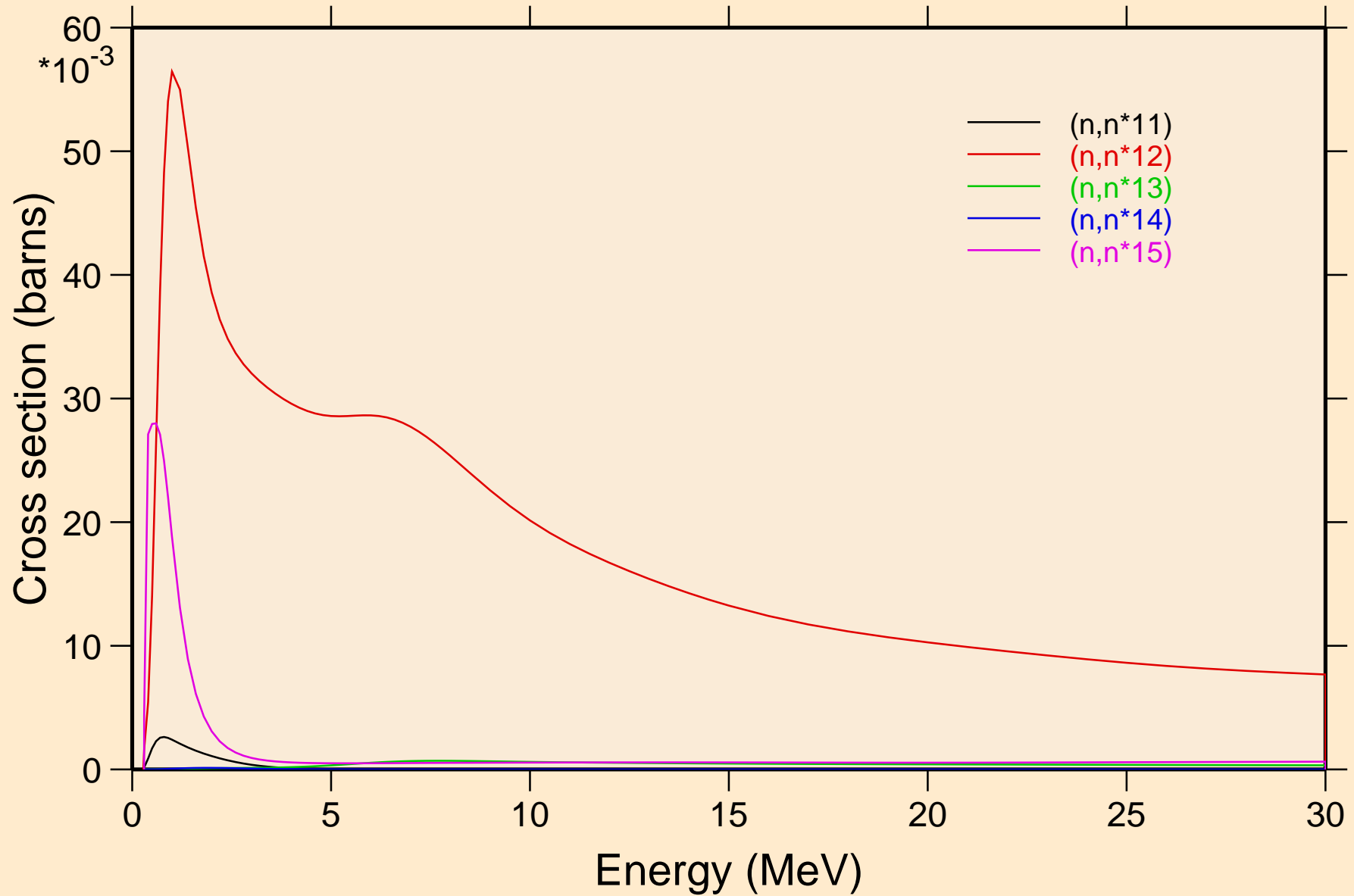

LU160 NEUTRON ACER TENDL-2024 LIBRARY; T=293.6K  
Inelastic levels

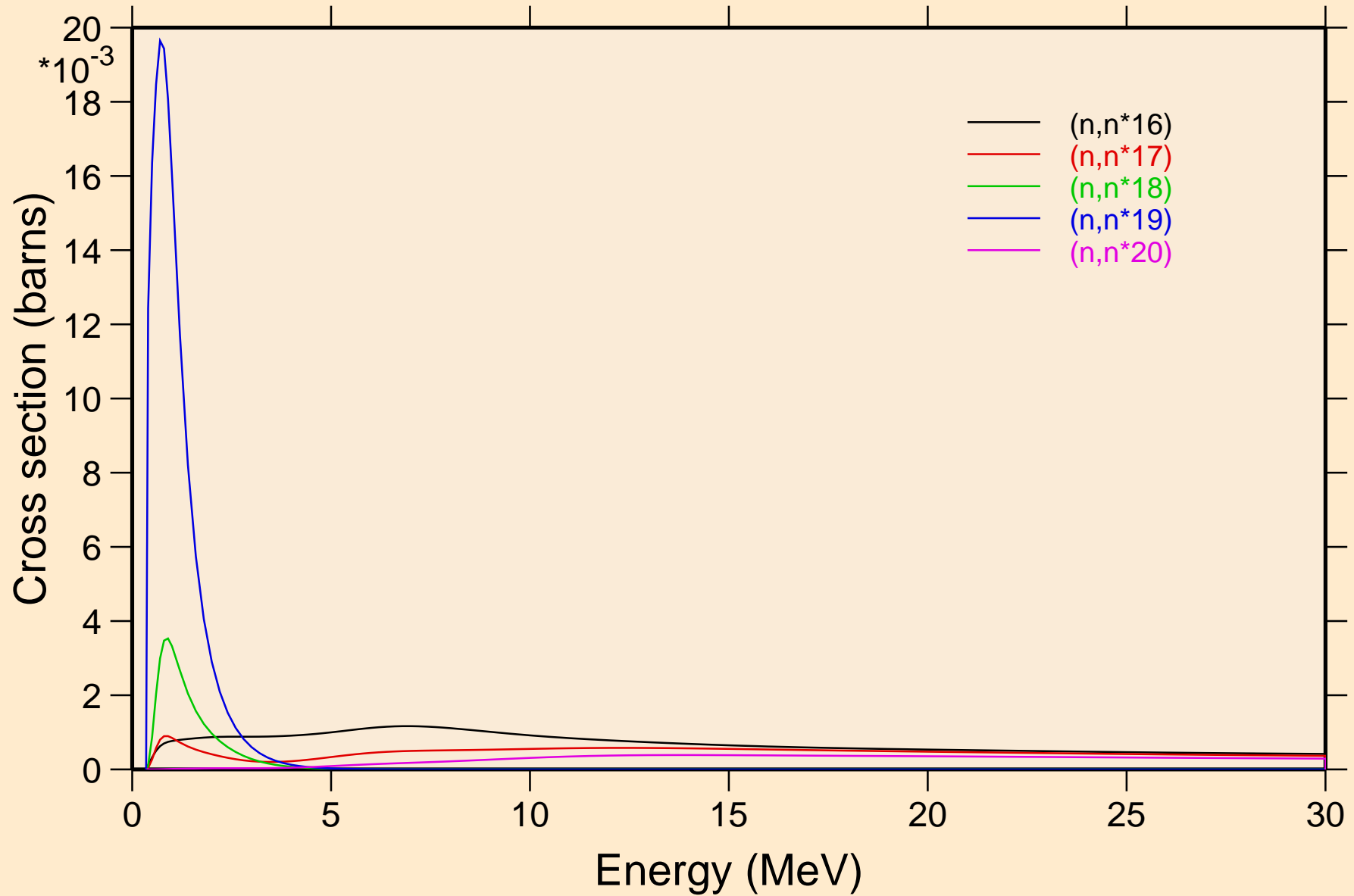

LU160 NEUTRON ACER TENDL-2024 LIBRARY; T=293.6K  
Inelastic levels

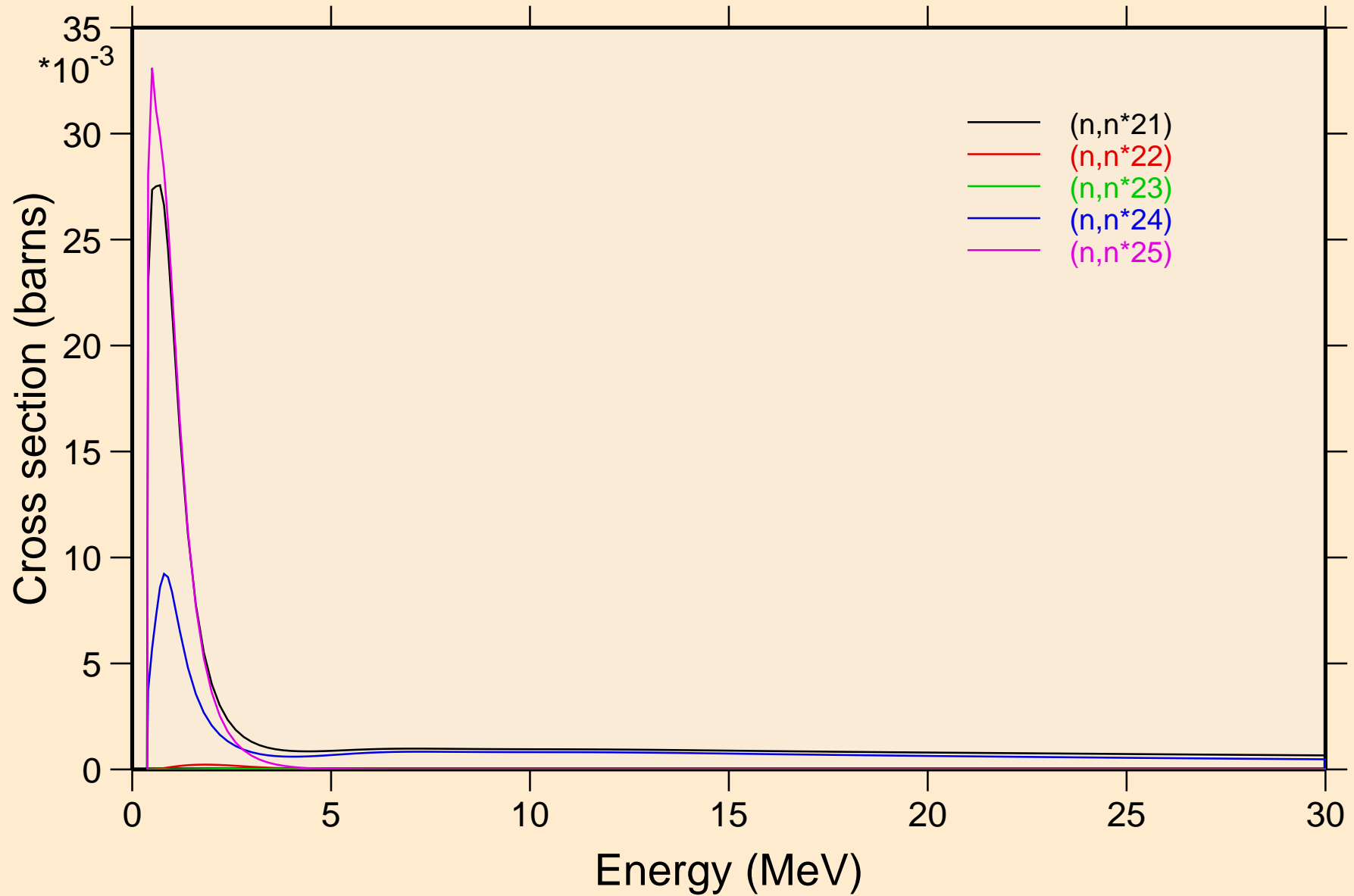

LU160 NEUTRON ACER TENDL-2024 LIBRARY; T=293.6K  
Inelastic levels

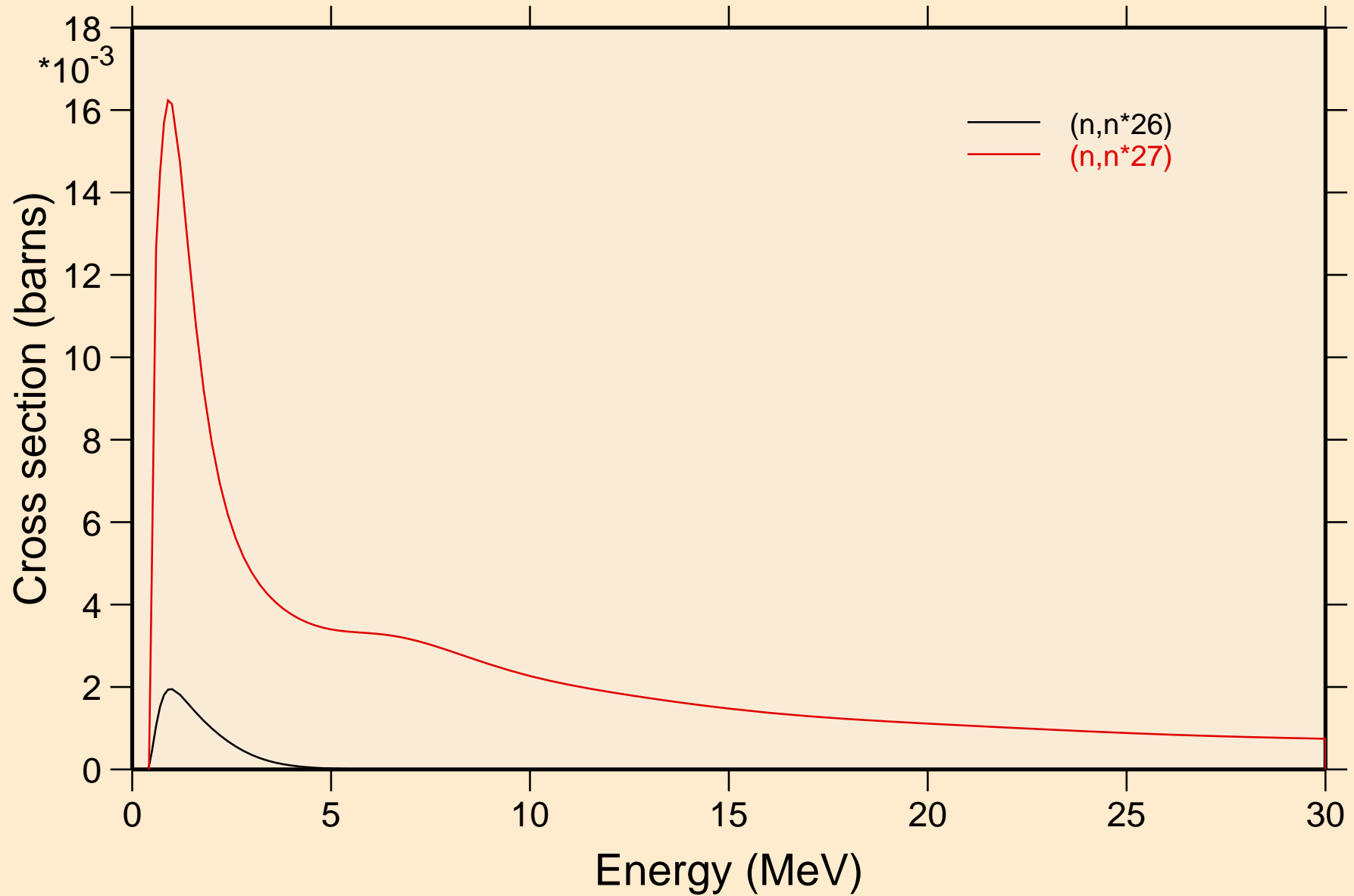

LU160 NEUTRON ACER TENDL-2024 LIBRARY; T=293.6K  
Threshold reactions

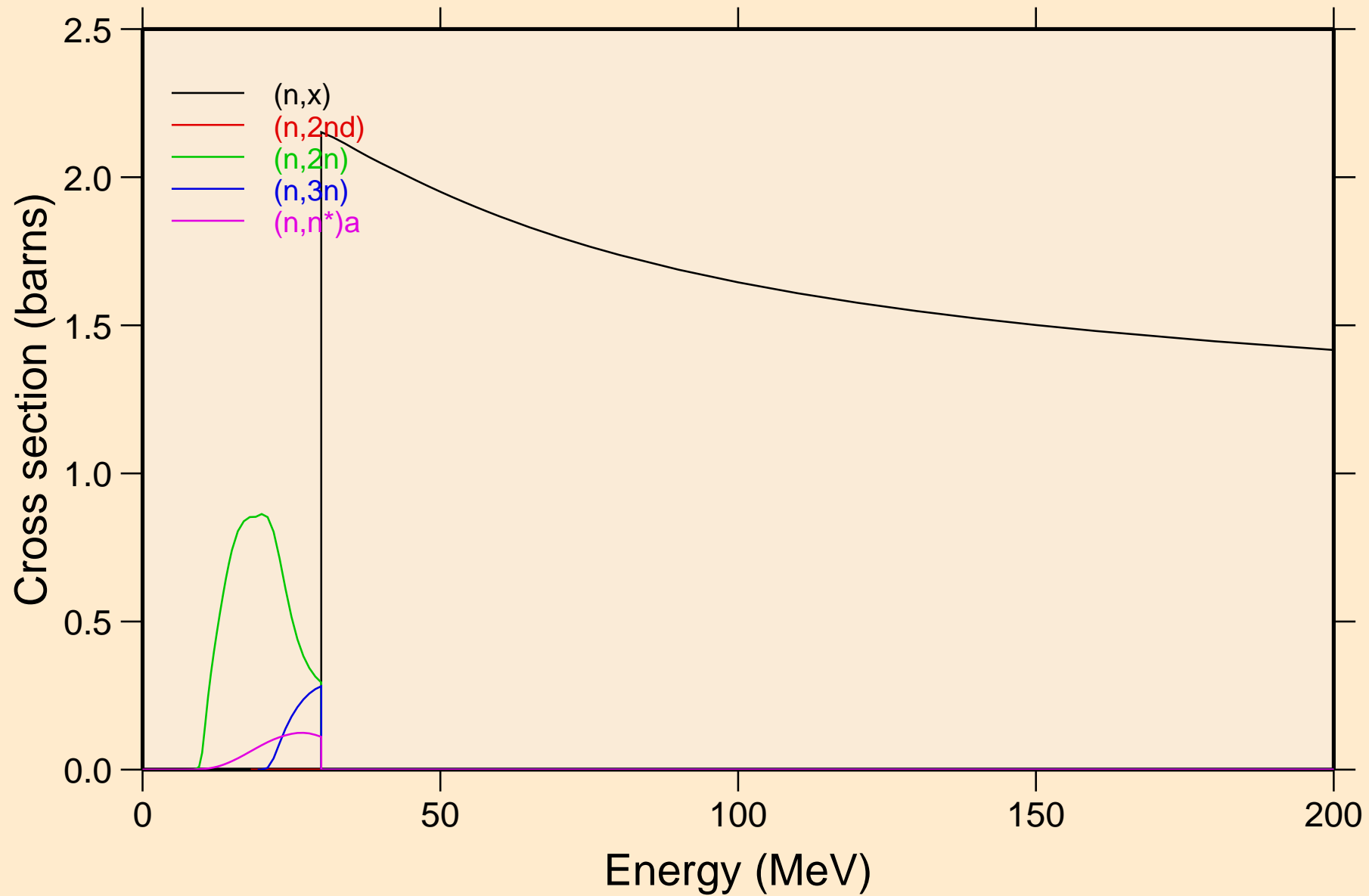

LU160 NEUTRON ACER TENDL-2024 LIBRARY; T=293.6K  
Threshold reactions

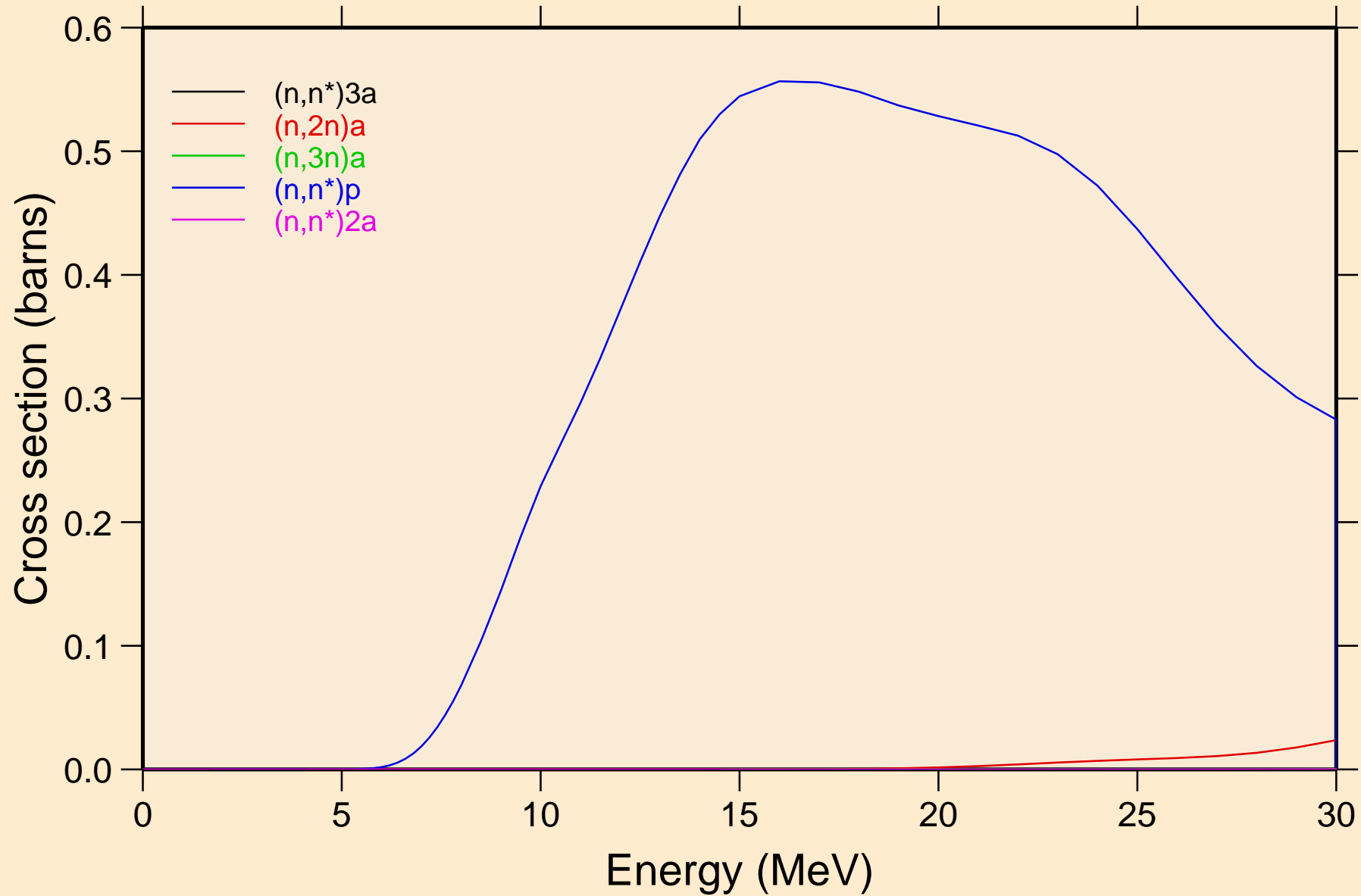

LU160 NEUTRON ACER TENDL-2024 LIBRARY; T=293.6K  
Threshold reactions

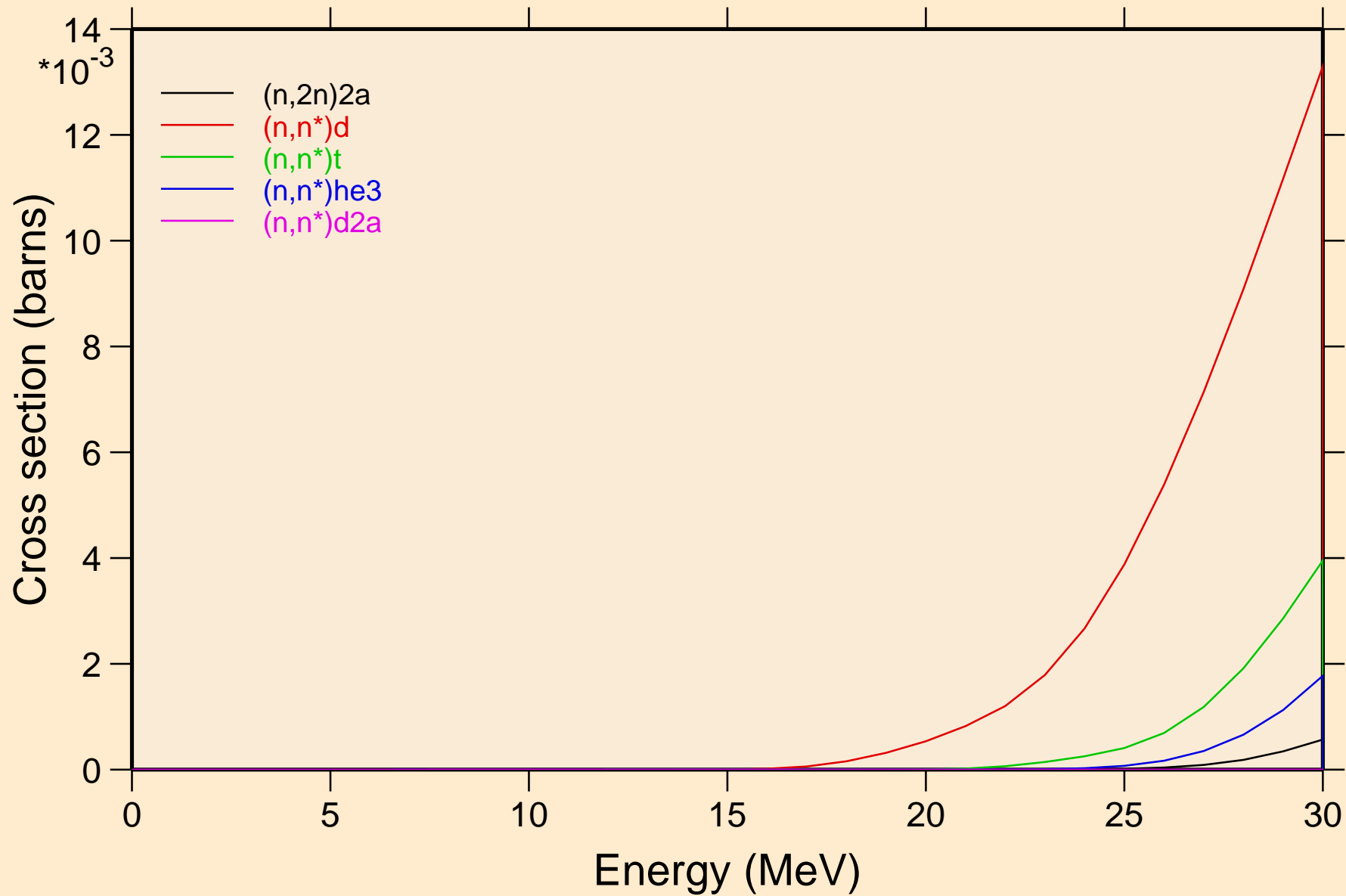

LU160 NEUTRON ACER TENDL-2024 LIBRARY; T=293.6K  
Threshold reactions

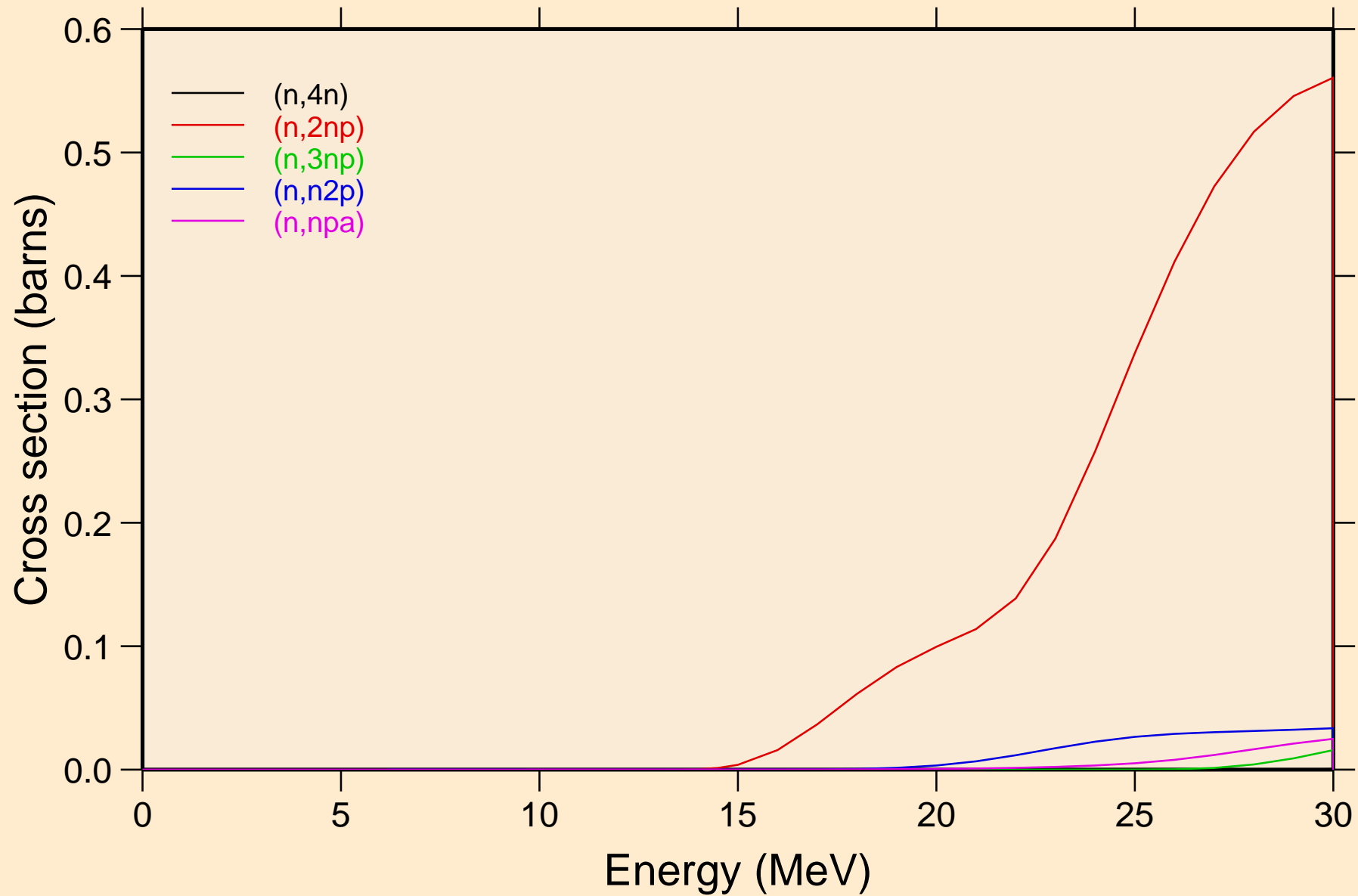

LU160 NEUTRON ACER TENDL-2024 LIBRARY; T=293.6K  
Threshold reactions

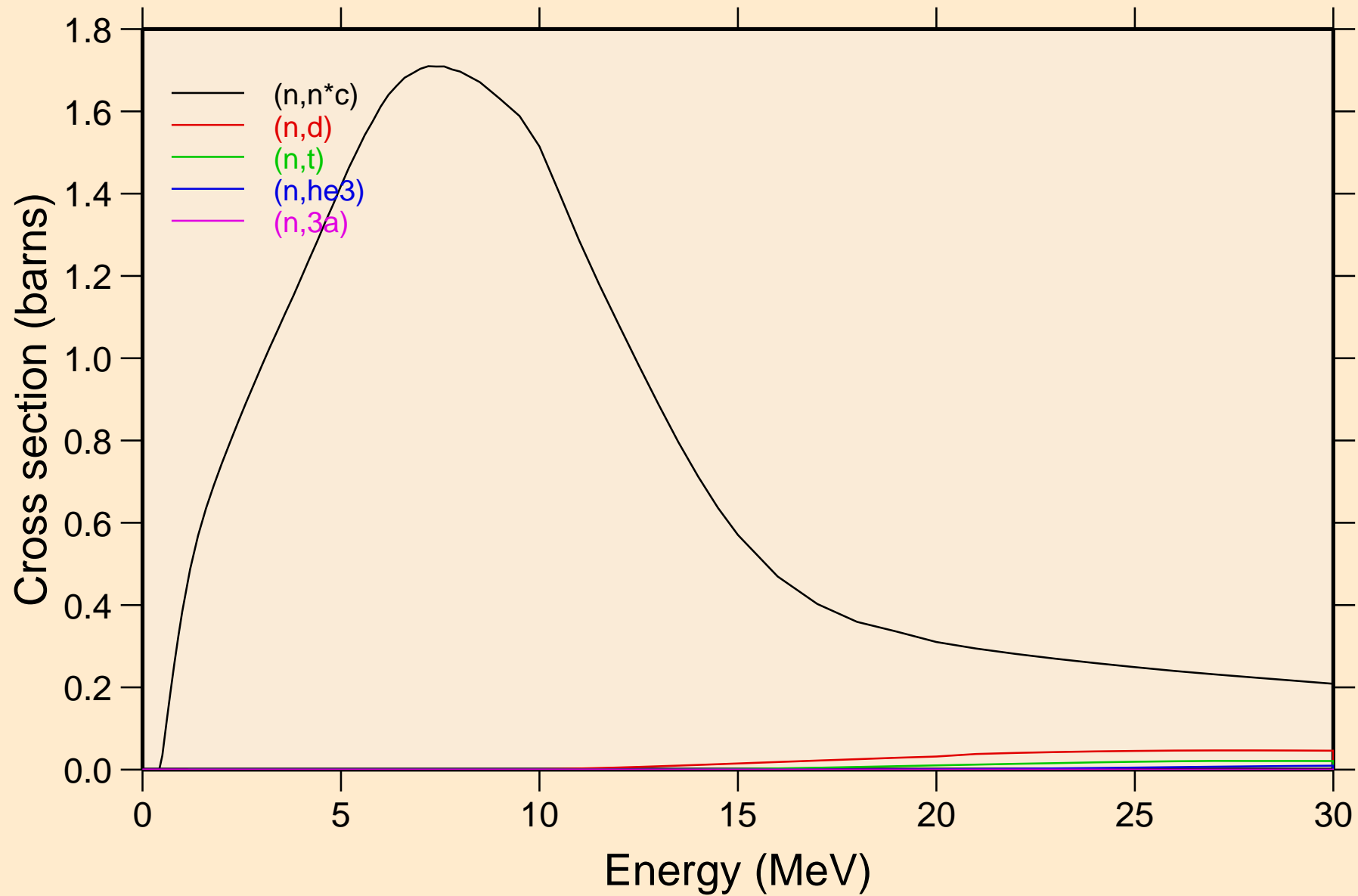

LU160 NEUTRON ACER TENDL-2024 LIBRARY; T=293.6K  
Threshold reactions

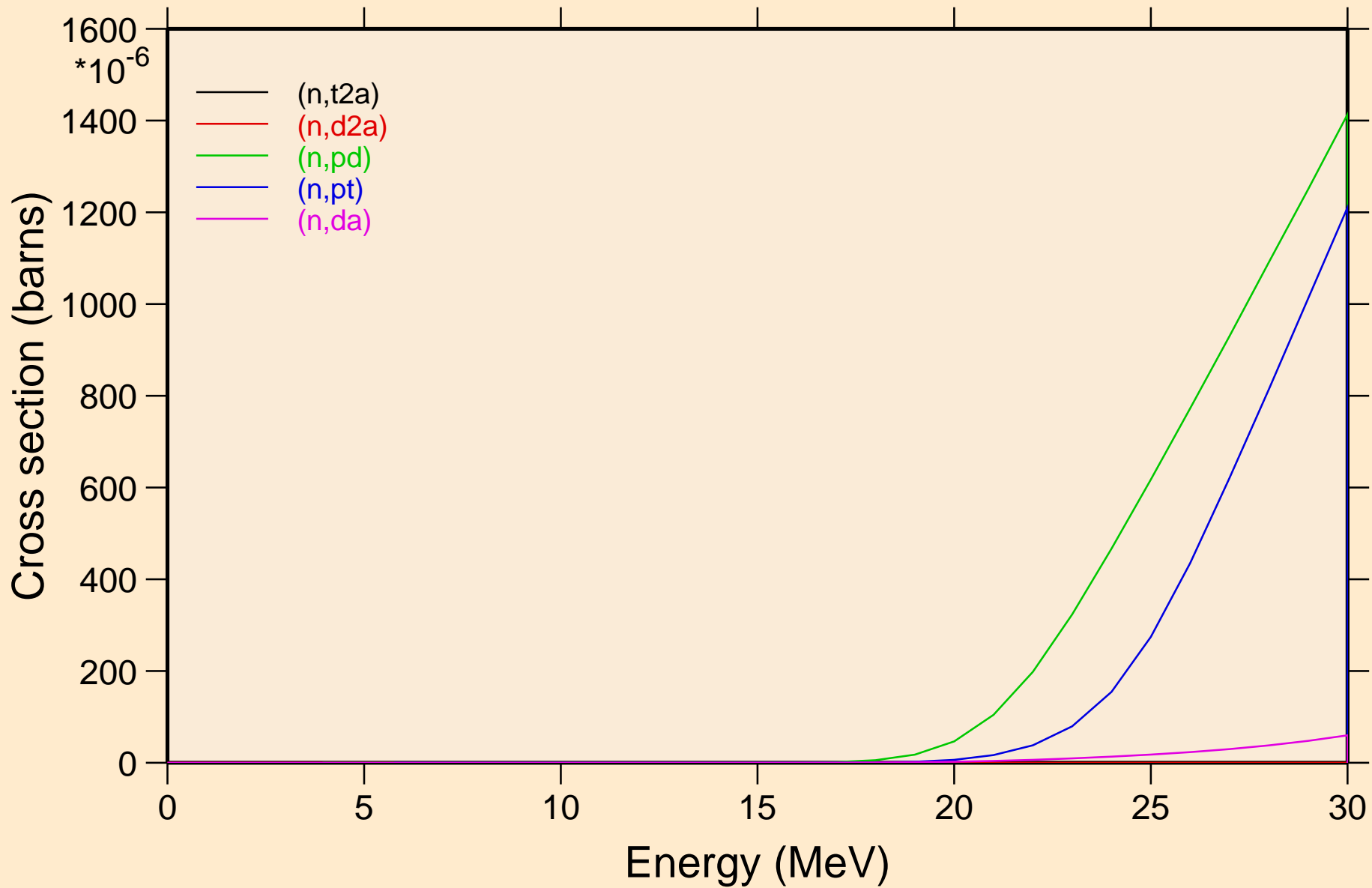

LU160 NEUTRON ACER TENDL-2024 LIBRARY; T=293.6K  
Threshold reactions

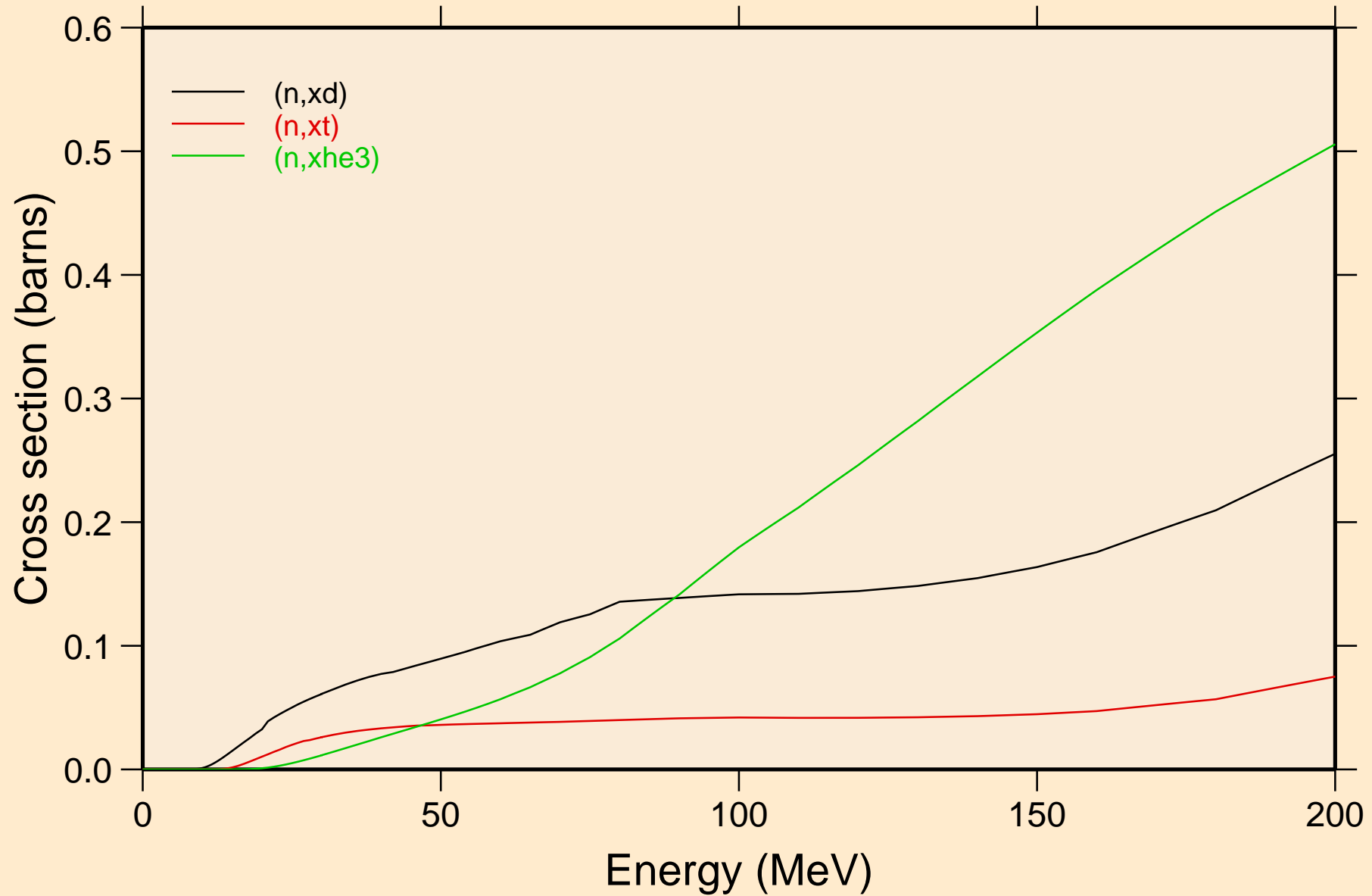

LU160 NEUTRON ACER TENDL-2024 LIBRARY; T=293.6K  
angular distribution for elastic

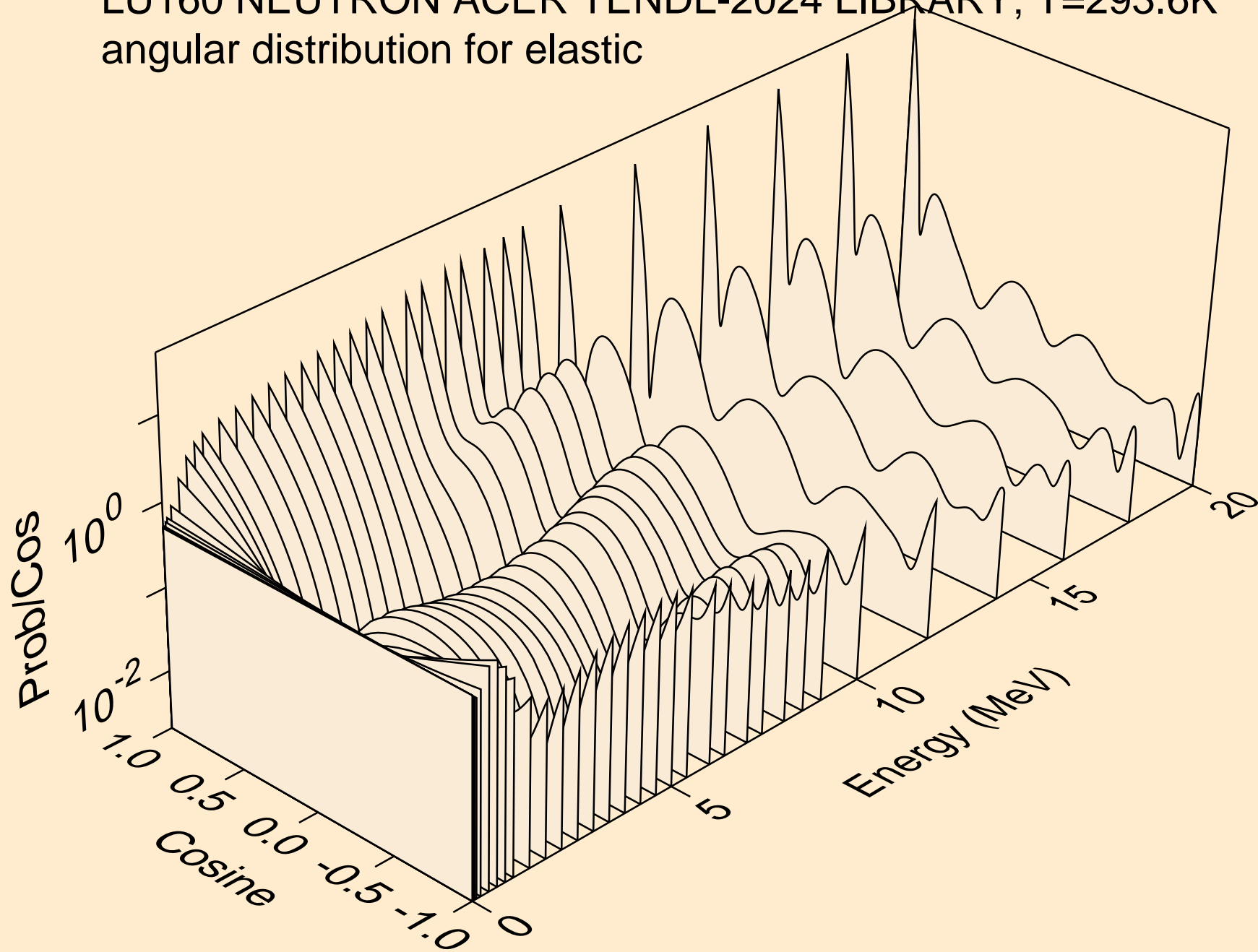

LU160 NEUTRON ACER TENDL-2024 LIBRARY; T=293.6K  
angular distribution for elastic

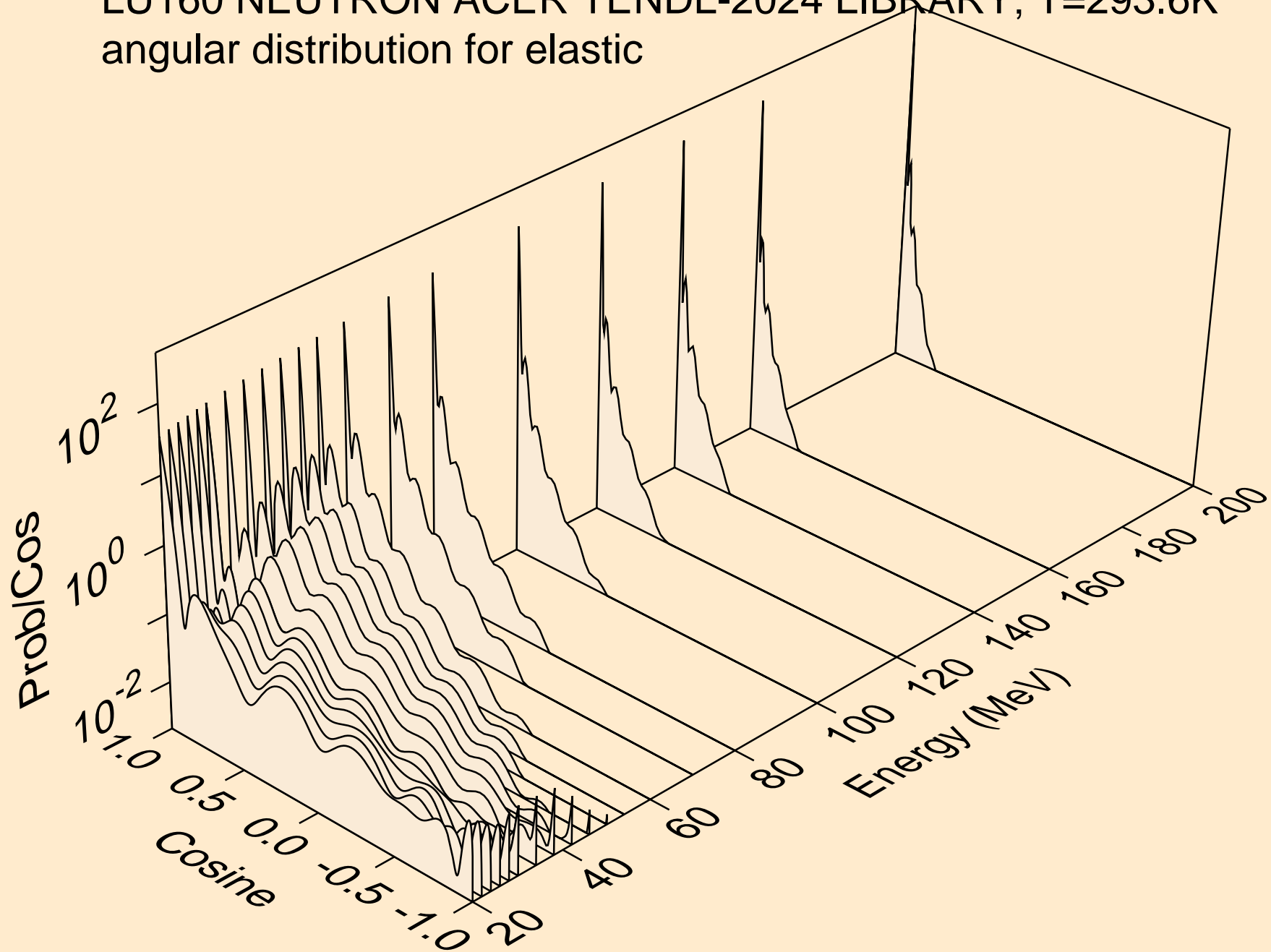

LU160 NEUTRON ACER TENDL-2024 LIBRARY; T=293.6K  
angular distribution for (n,n\*1)

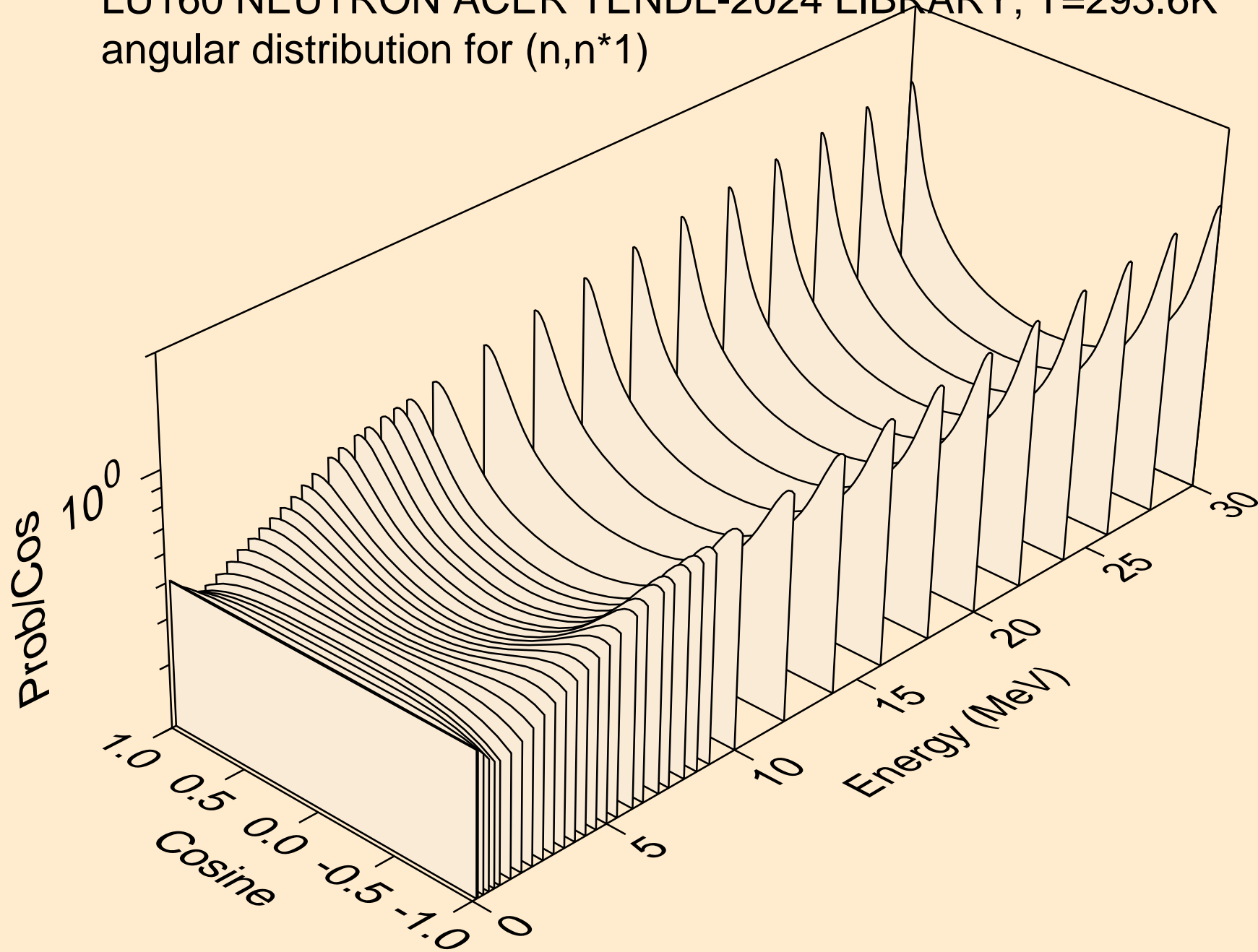

LU160 NEUTRON ACER TENDL-2024 LIBRARY; T=293.6K  
angular distribution for (n,n\*2)

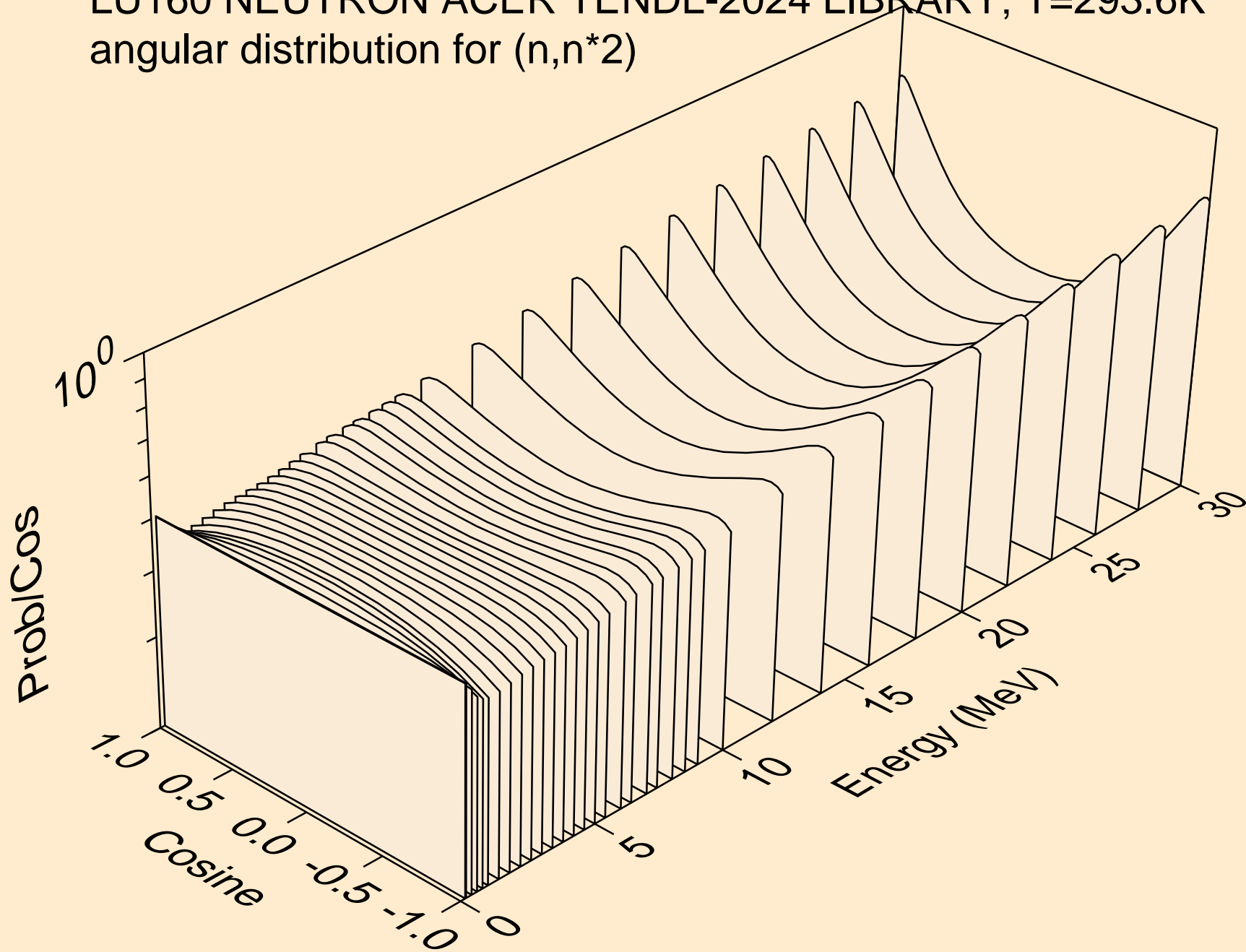

LU160 NEUTRON ACER TENDL-2024 LIBRARY; T=293.6K  
angular distribution for (n,n\*3)

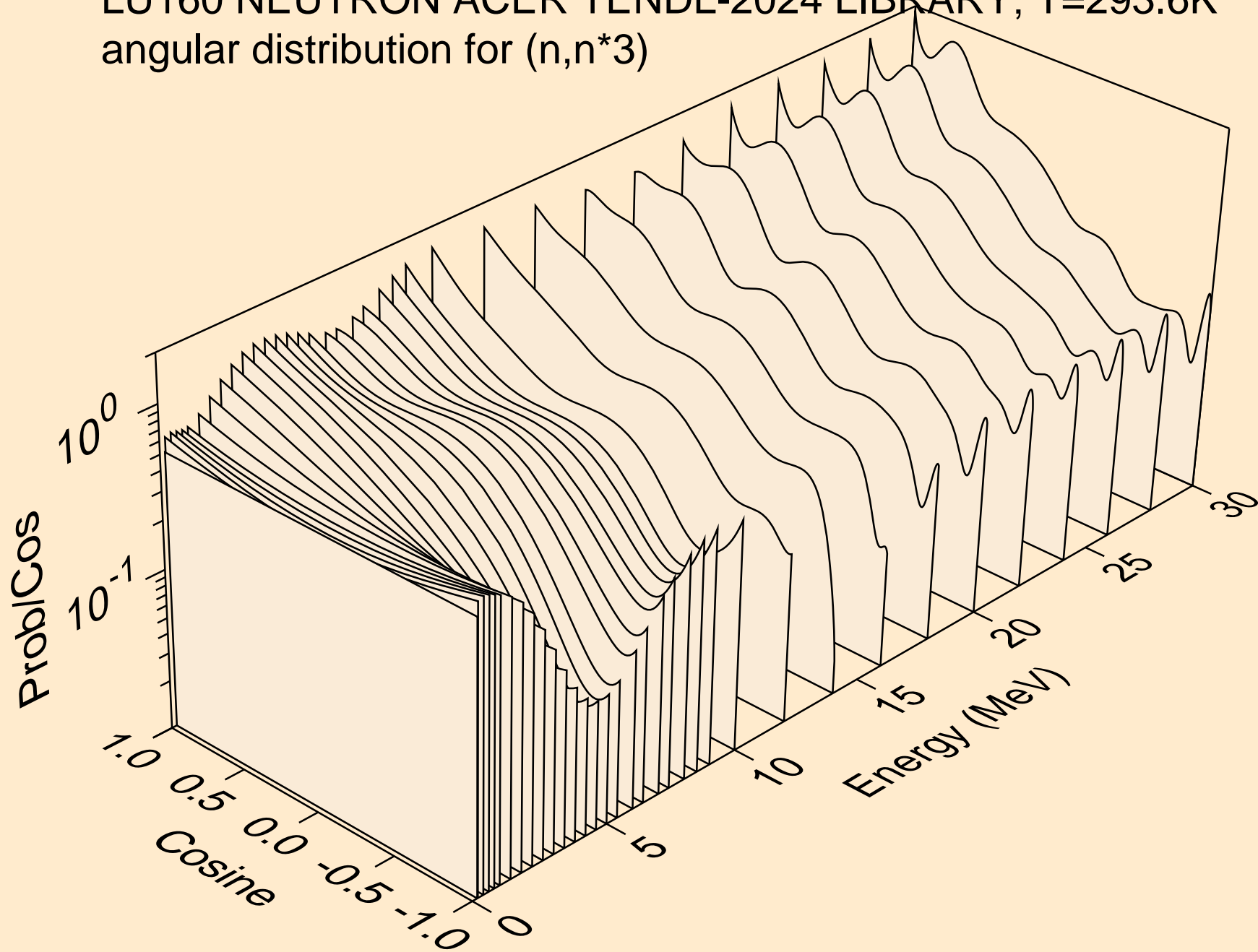

LU160 NEUTRON ACER TENDL-2024 LIBRARY; T=293.6K  
angular distribution for (n,n\*4)

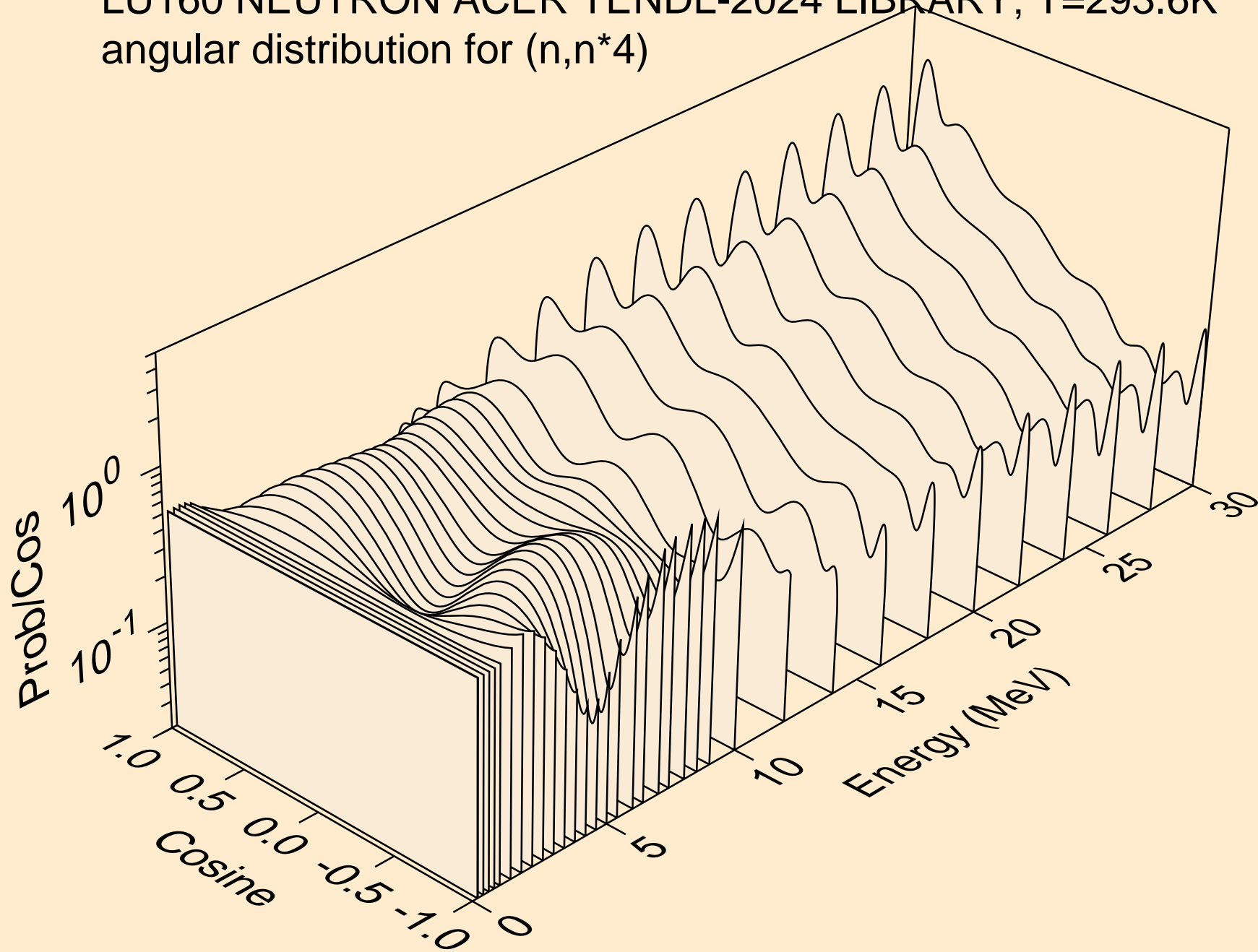

LU160 NEUTRON ACER TENDL-2024 LIBRARY; T=293.6K  
angular distribution for (n,n\*5)

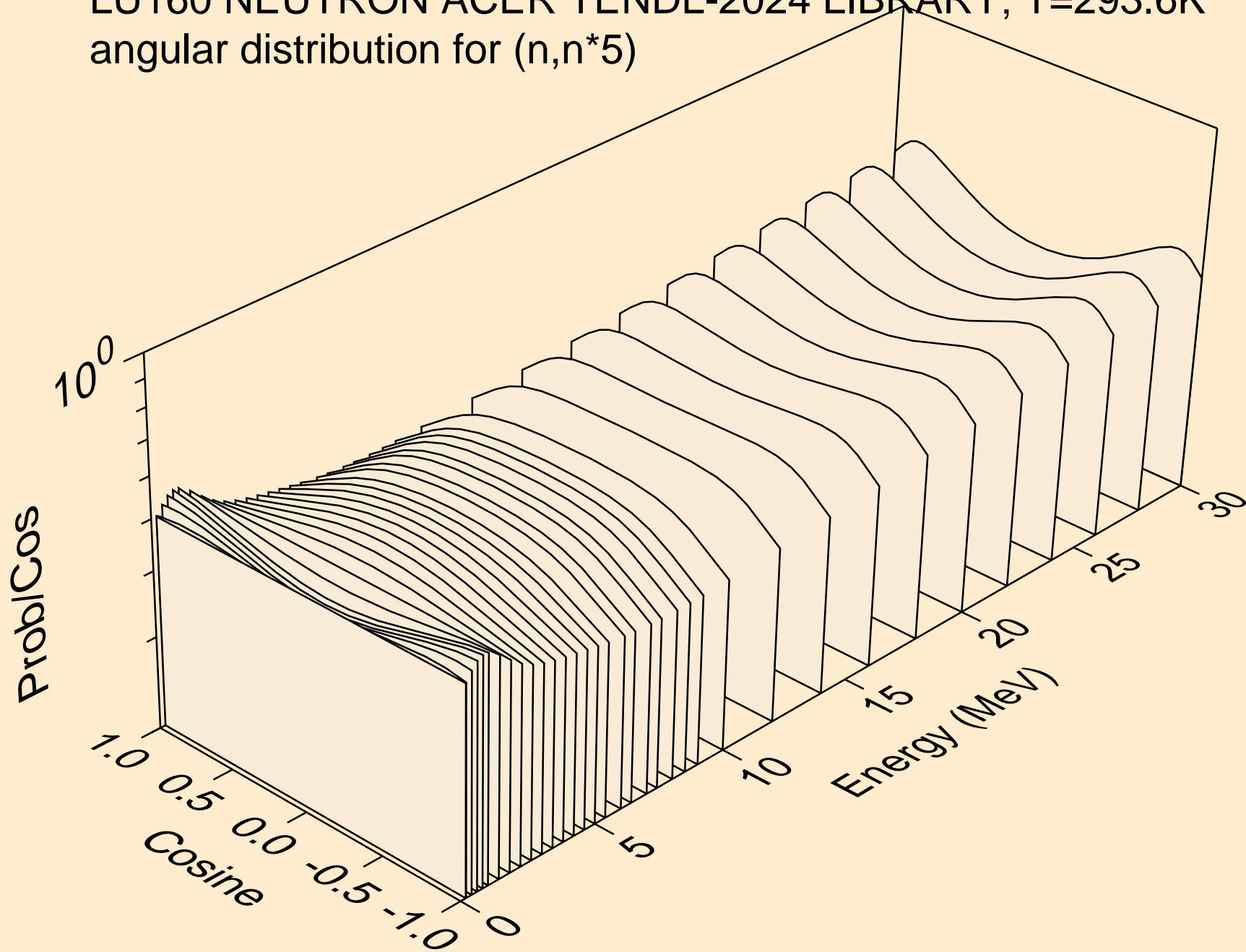

LU160 NEUTRON ACER TENDL-2024 LIBRARY; T=293.6K  
angular distribution for (n,n\*6)

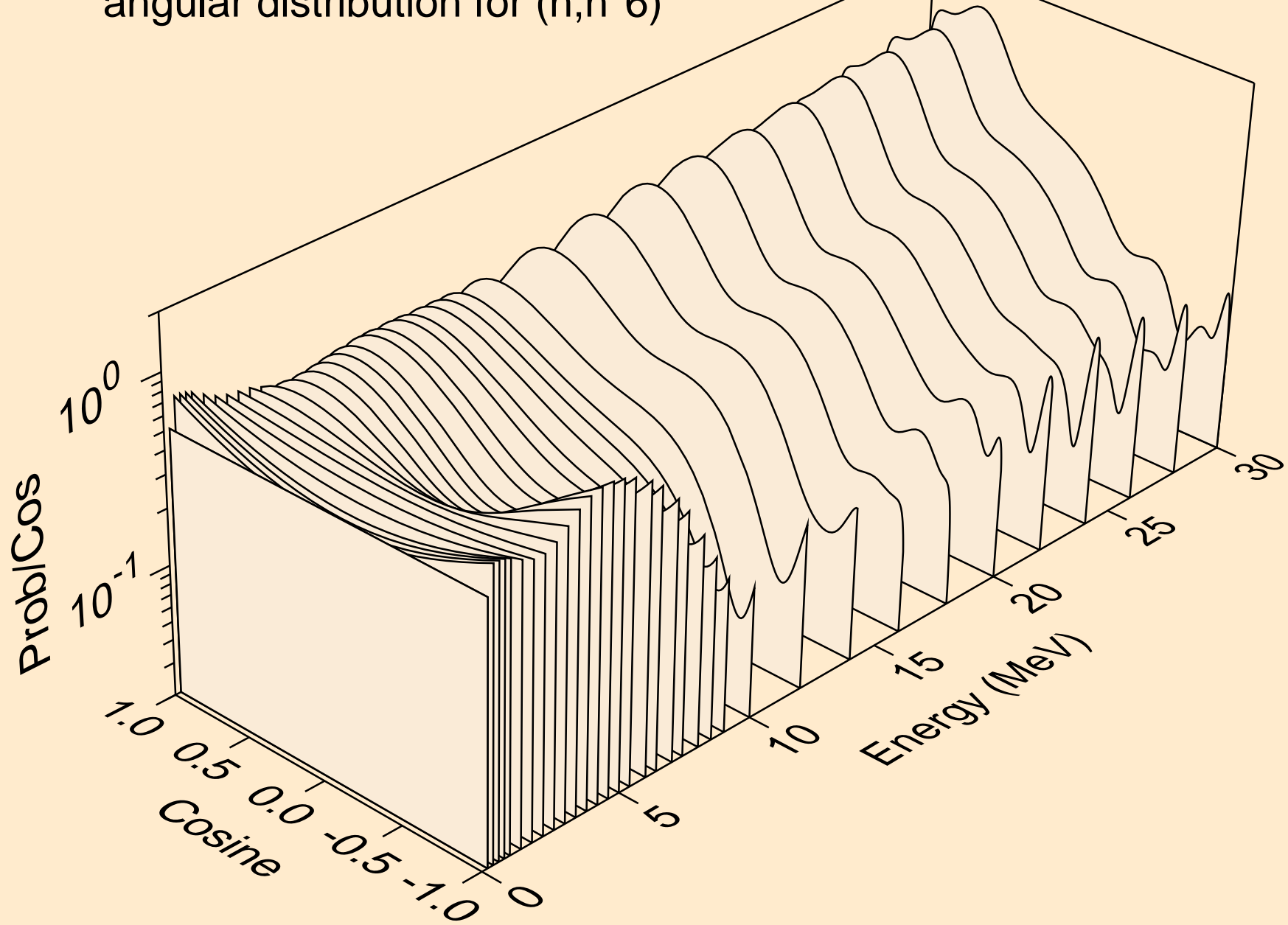

LU160 NEUTRON ACER TENDL-2024 LIBRARY; T=293.6K  
angular distribution for (n,n\*7)

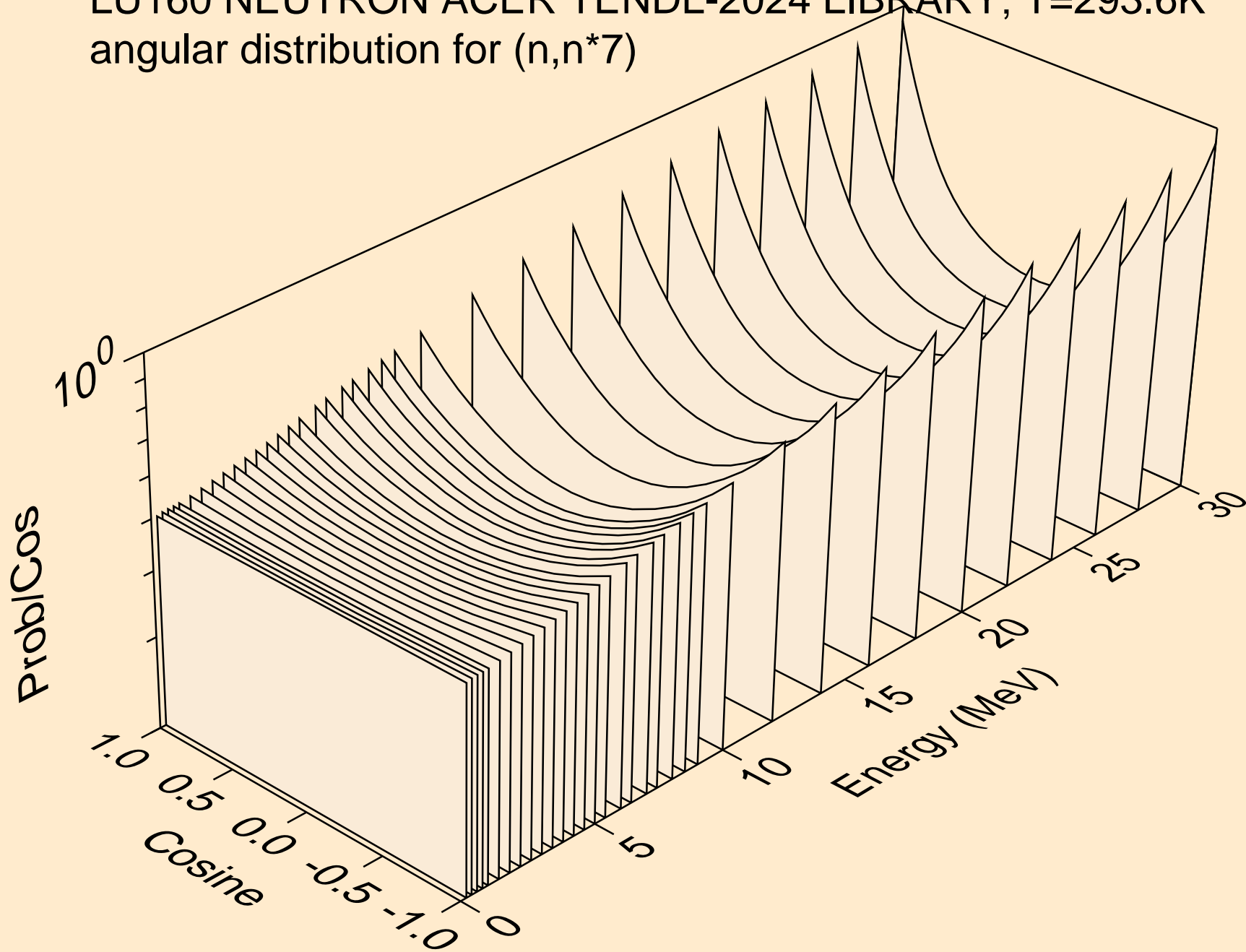

LU160 NEUTRON ACER TENDL-2024 LIBRARY; T=293.6K  
angular distribution for (n,n\*8)

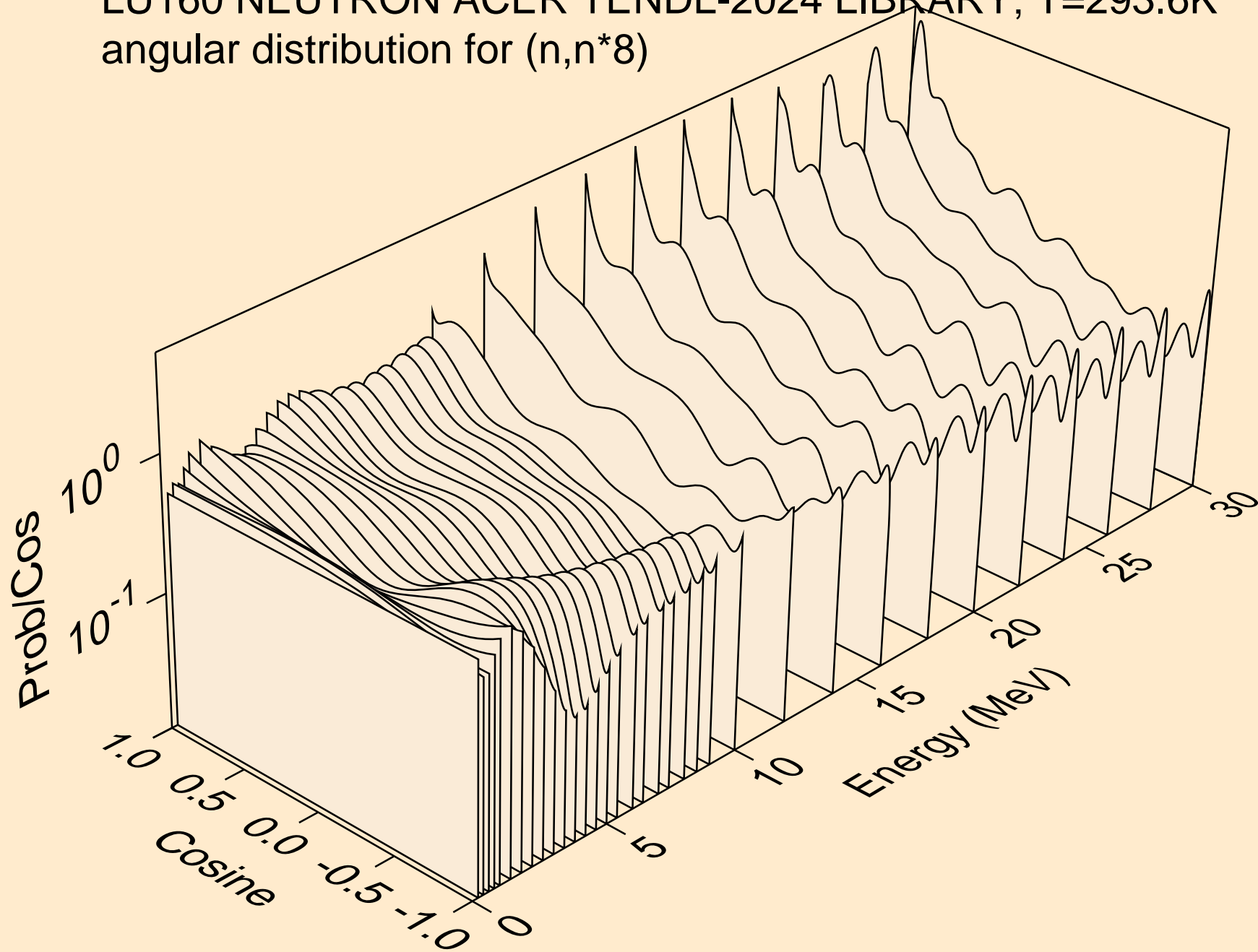

LU160 NEUTRON ACER TENDL-2024 LIBRARY; T=293.6K  
angular distribution for (n,n\*9)

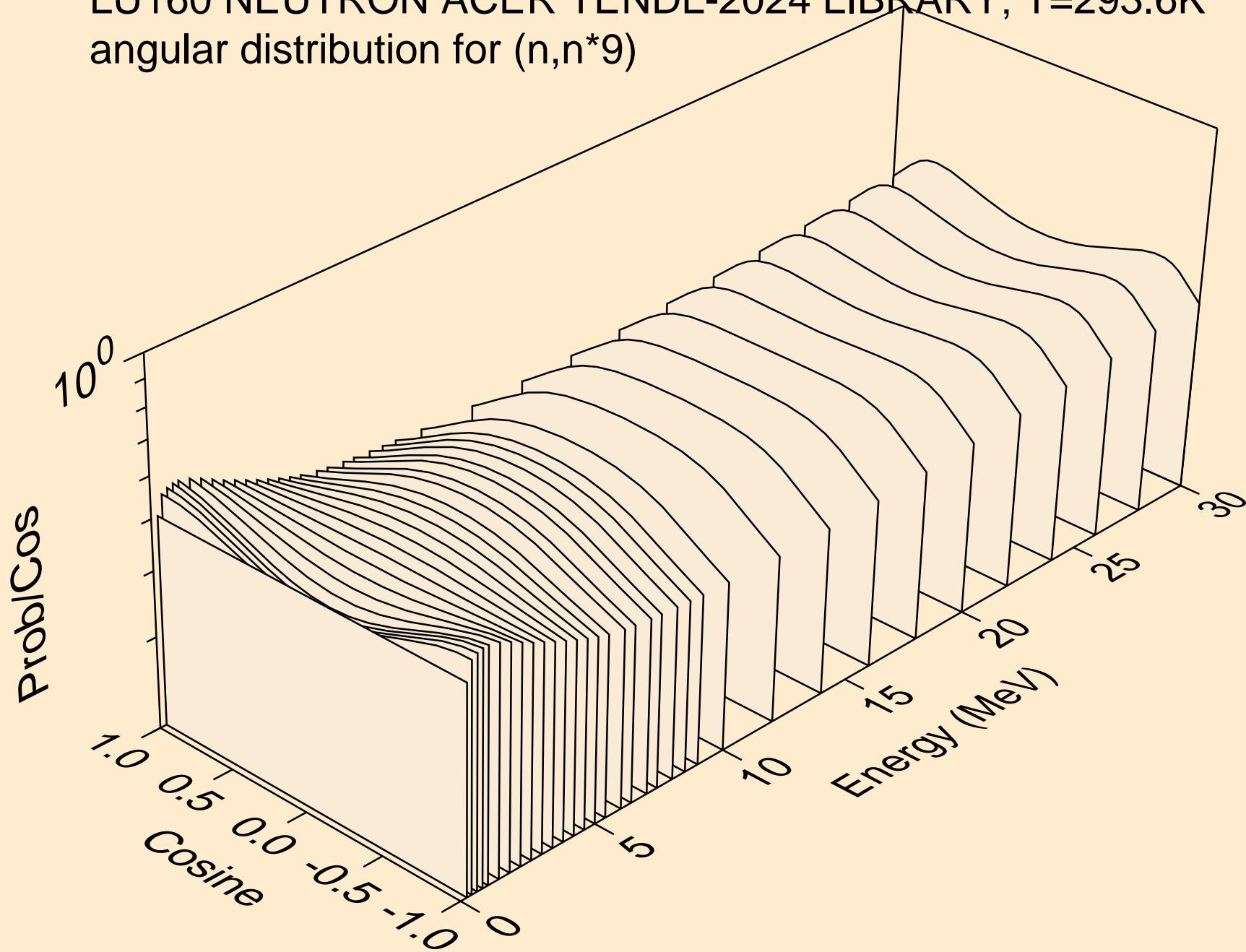

LU160 NEUTRON ACER TENDL-2024 LIBRARY; T=293.6K  
angular distribution for (n,n\*10)

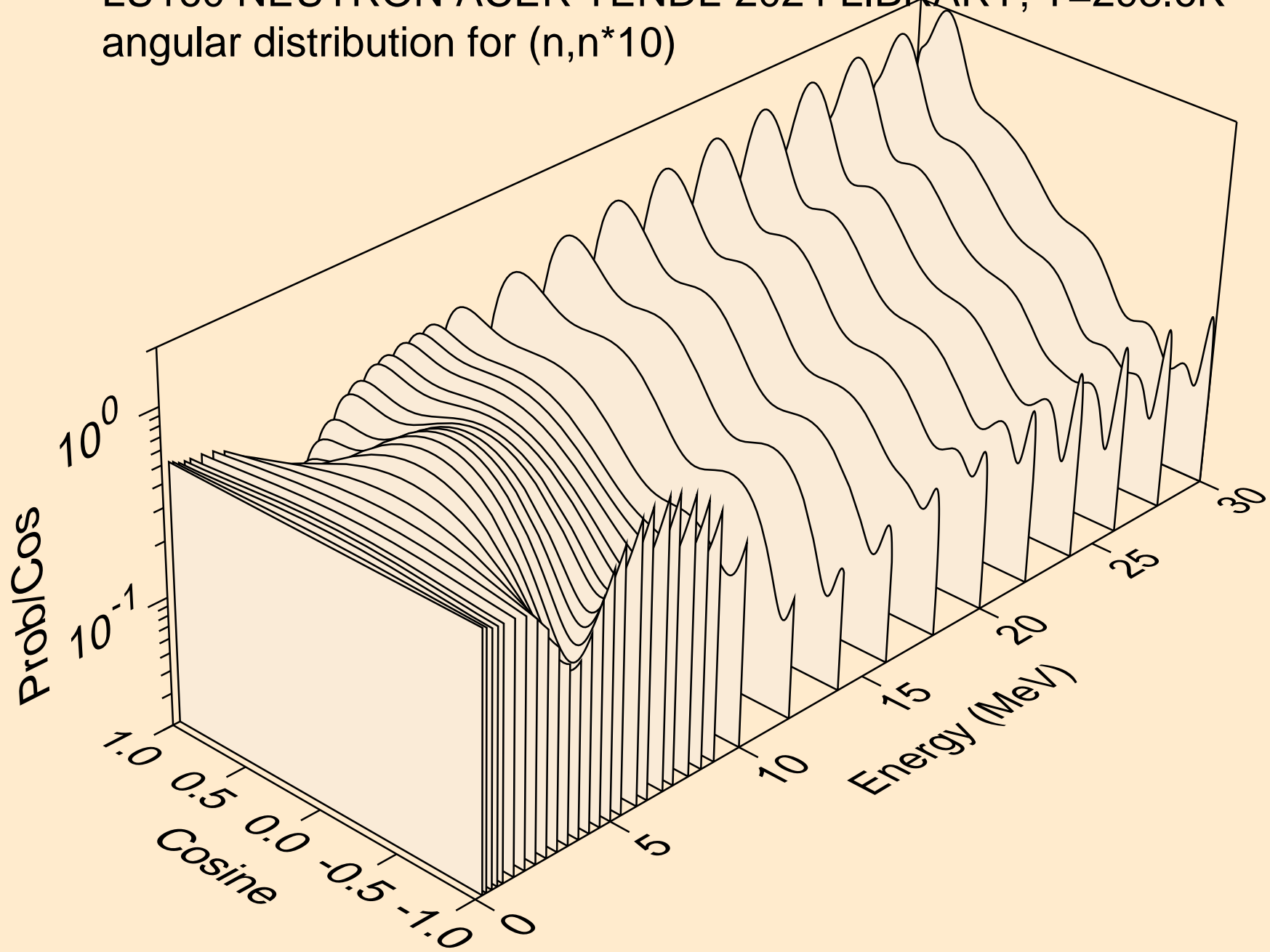

LU160 NEUTRON ACER TENDL-2024 LIBRARY; T=293.6K  
angular distribution for (n,n\*11)

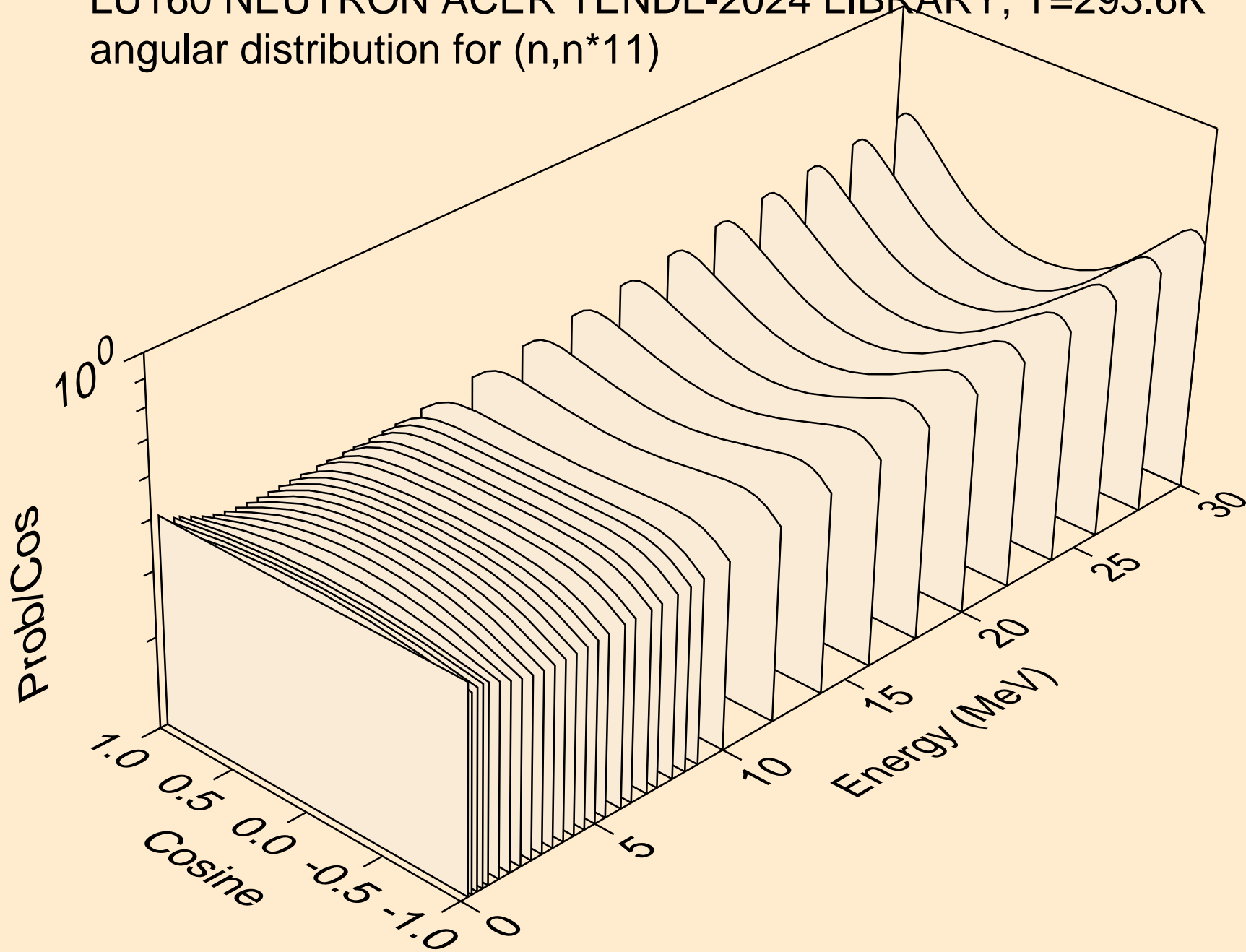

LU160 NEUTRON ACER TENDL-2024 LIBRARY; T=293.6K  
angular distribution for (n,n\*12)

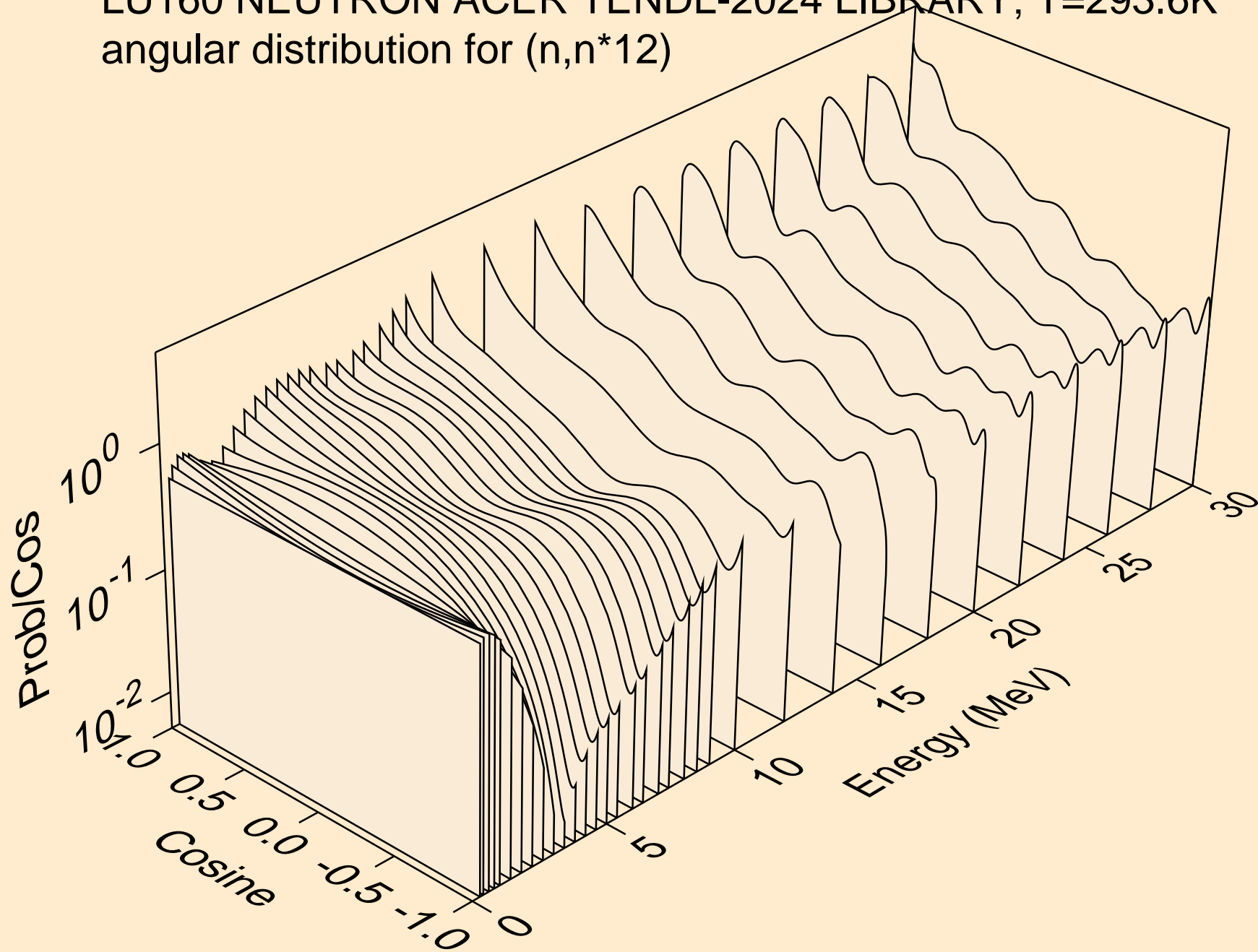

LU160 NEUTRON ACER TENDL-2024 LIBRARY; T=293.6K  
angular distribution for (n,n\*13)

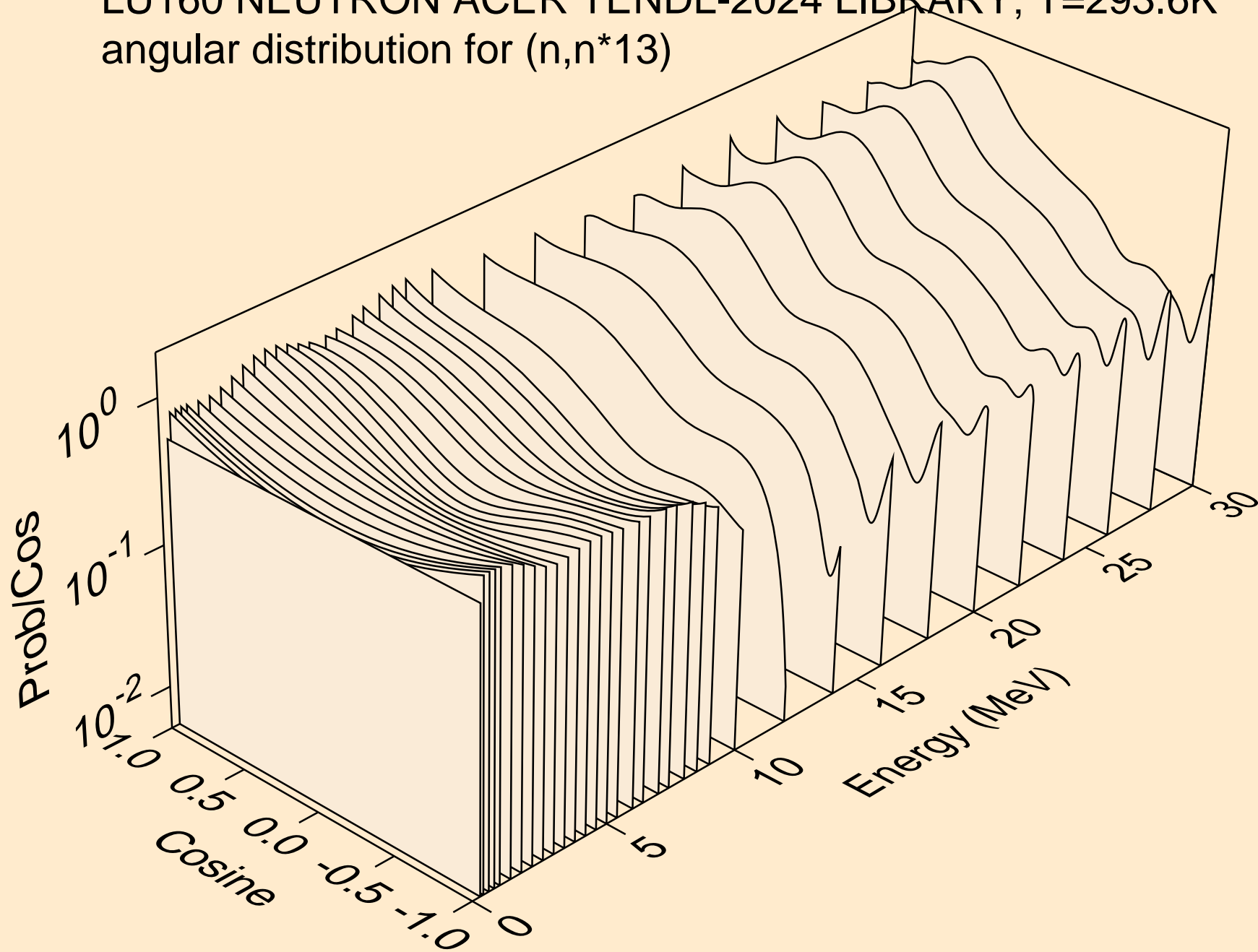

LU160 NEUTRON ACER TENDL-2024 LIBRARY; T=293.6K  
angular distribution for (n,n\*14)

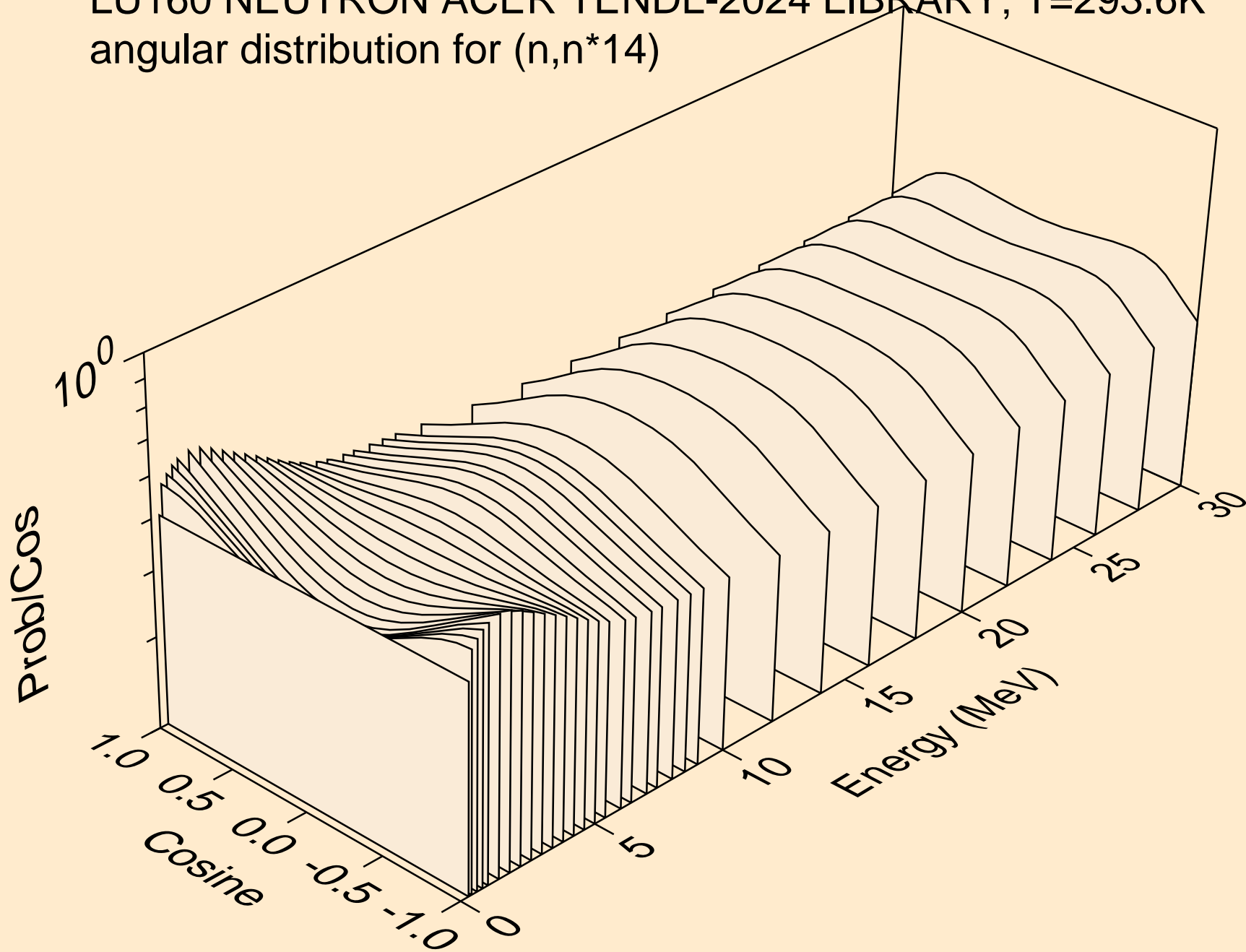

LU160 NEUTRON ACER TENDL-2024 LIBRARY; T=293.6K  
angular distribution for (n,n\*15)

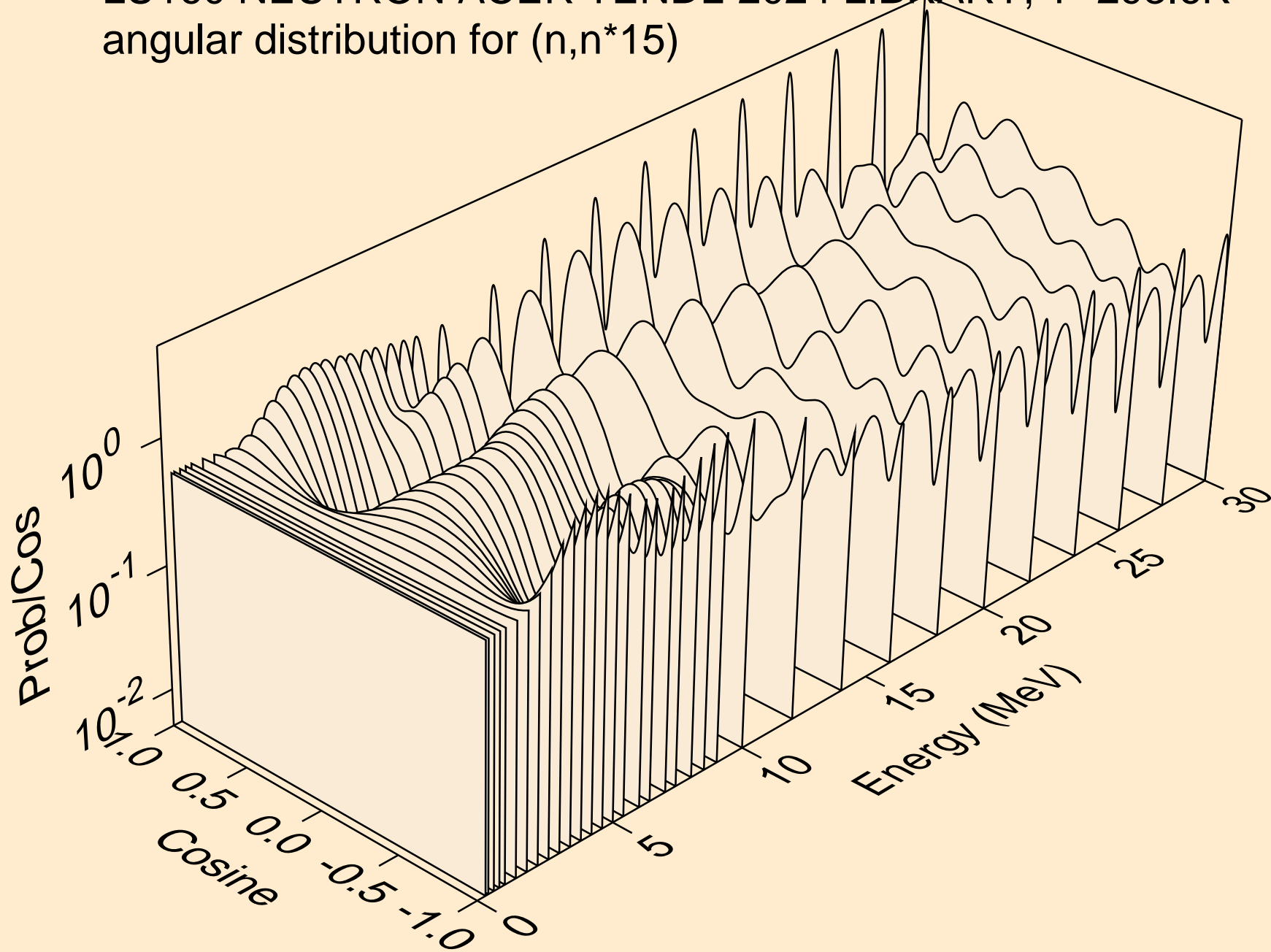

LU160 NEUTRON ACER TENDL-2024 LIBRARY; T=293.6K  
angular distribution for (n,n\*16)

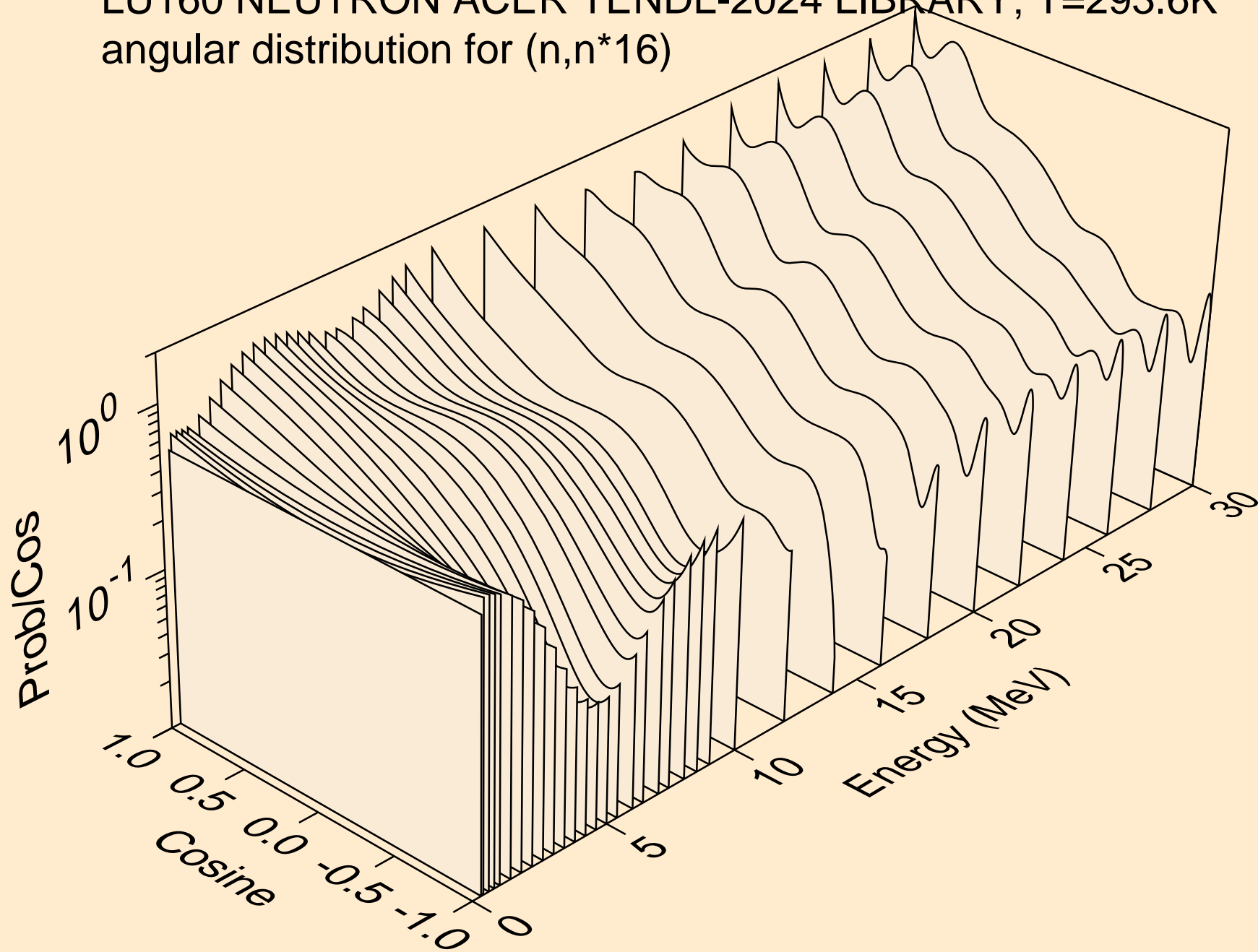

LU160 NEUTRON ACER TENDL-2024 LIBRARY; T=293.6K  
angular distribution for (n,n\*17)

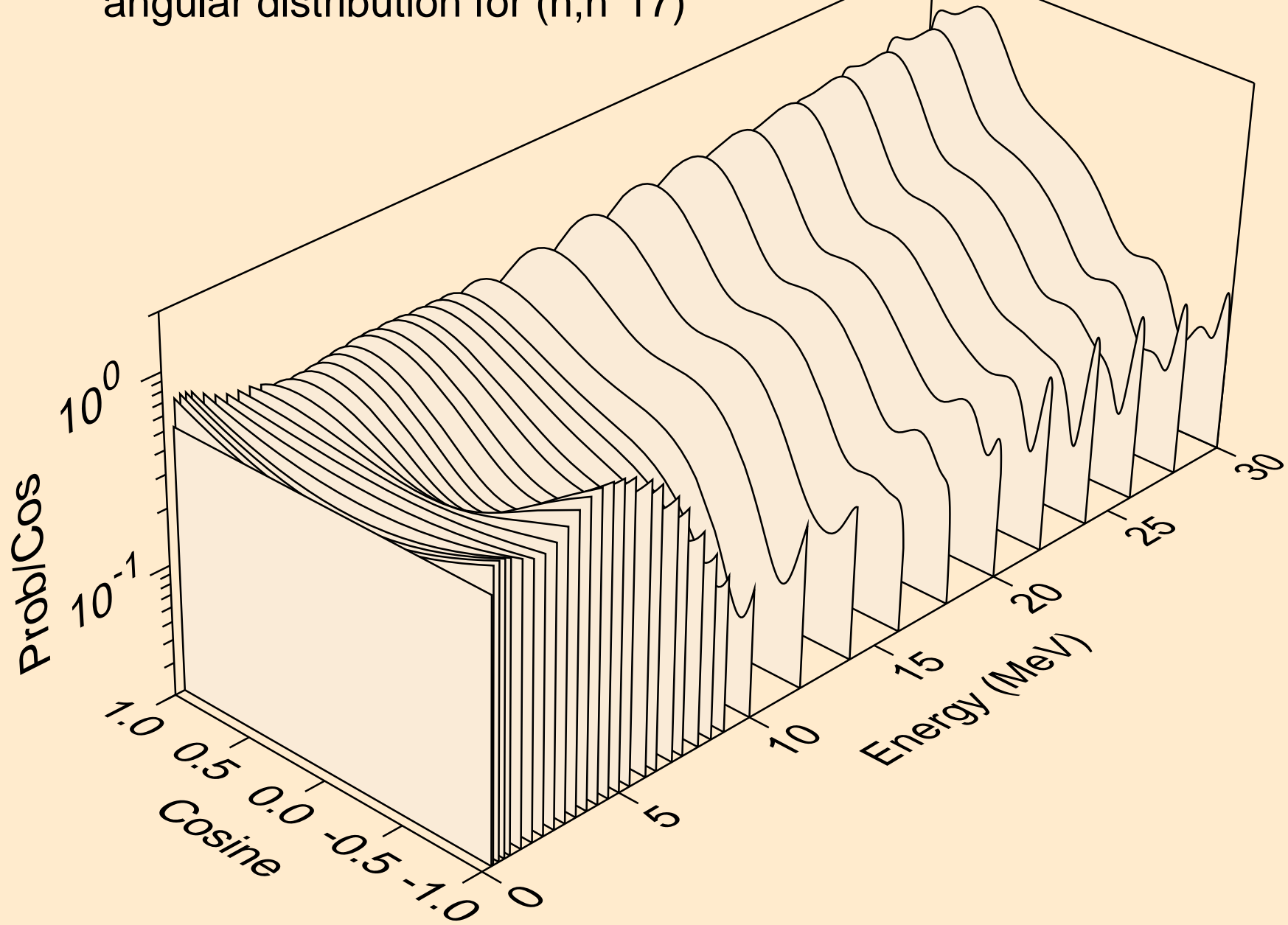

LU160 NEUTRON ACER TENDL-2024 LIBRARY; T=293.6K  
angular distribution for (n,n\*18)

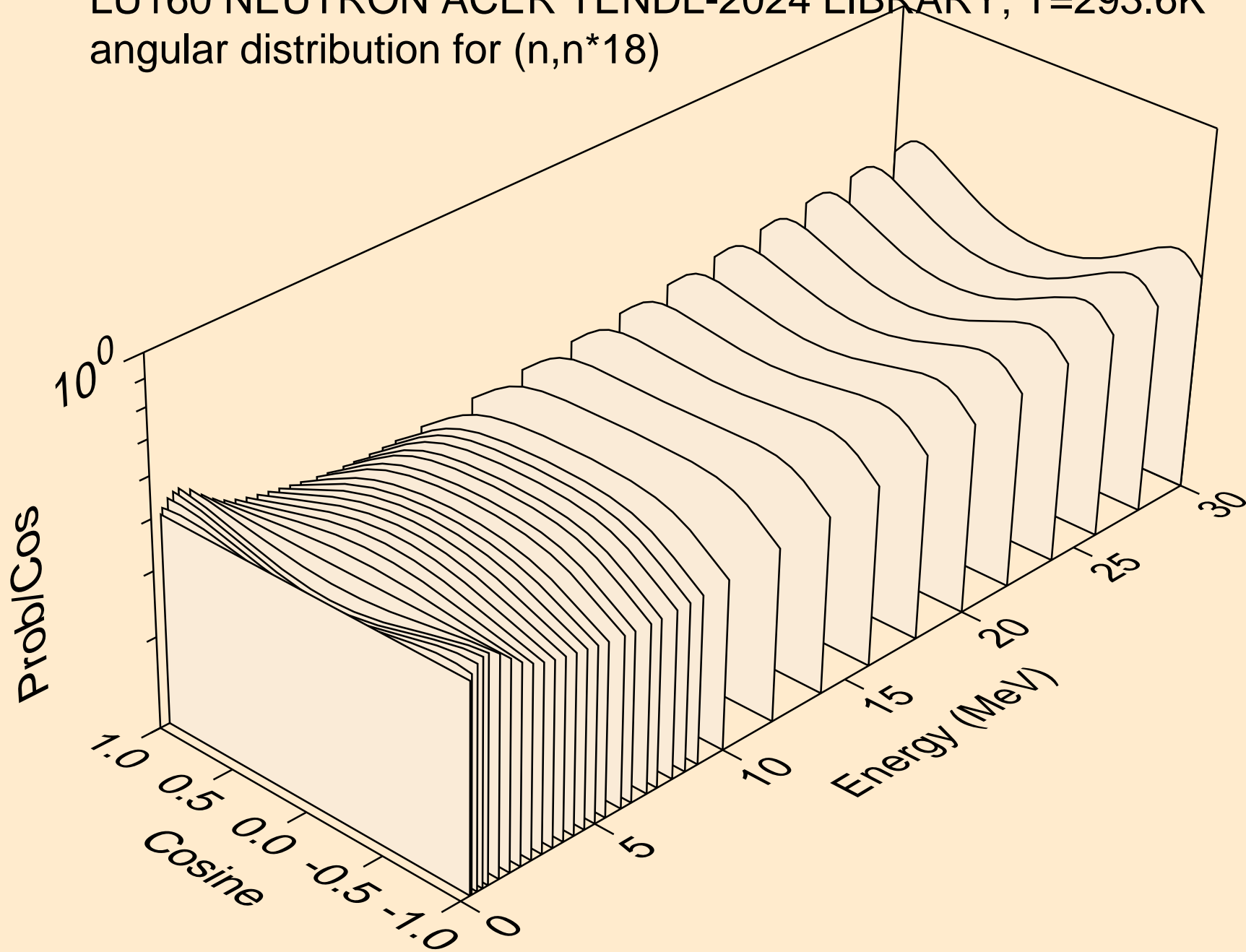

LU160 NEUTRON ACER TENDL-2024 LIBRARY; T=293.6K  
angular distribution for (n,n\*19)

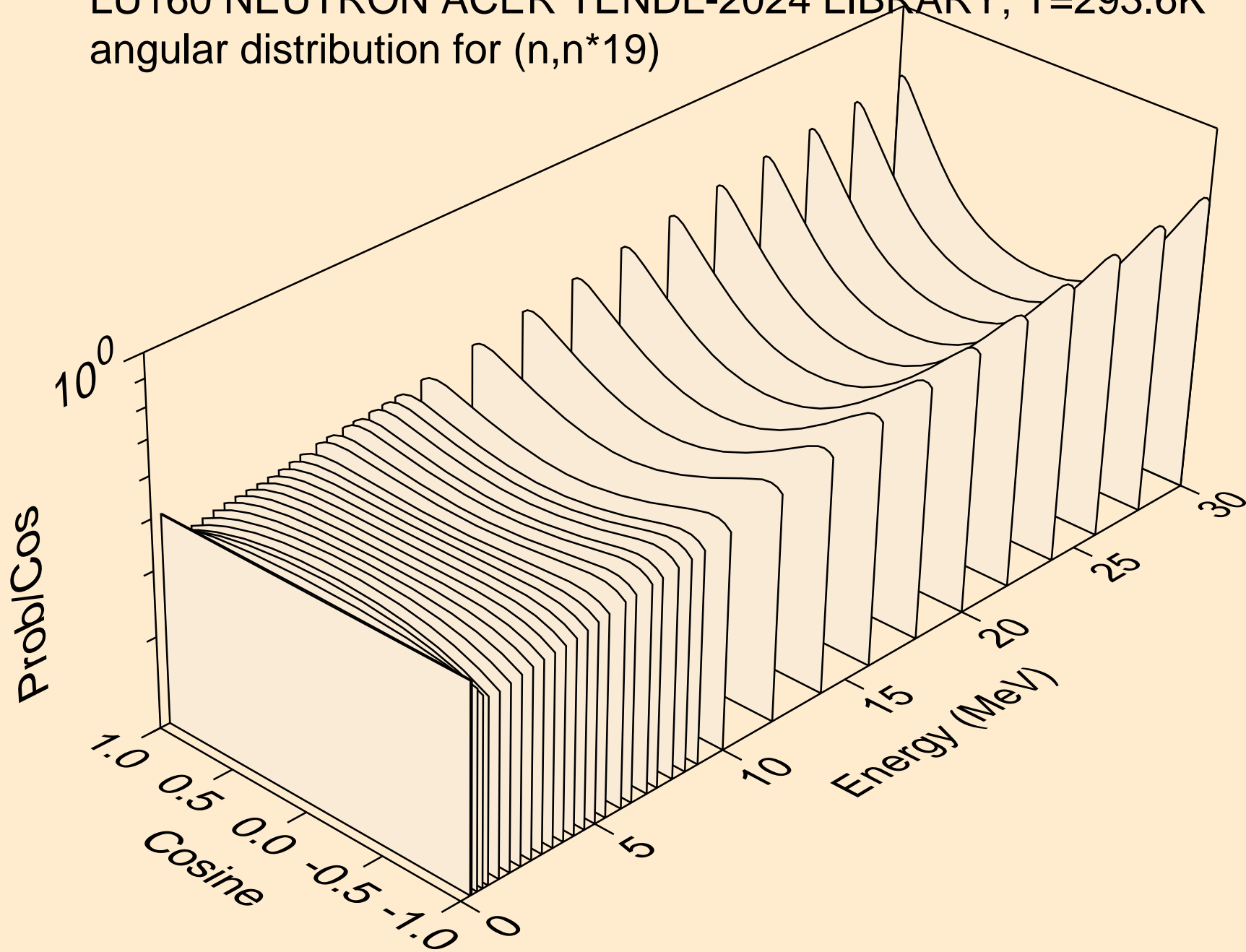

LU160 NEUTRON ACER TENDL-2024 LIBRARY; T=293.6K  
angular distribution for (n,n\*20)

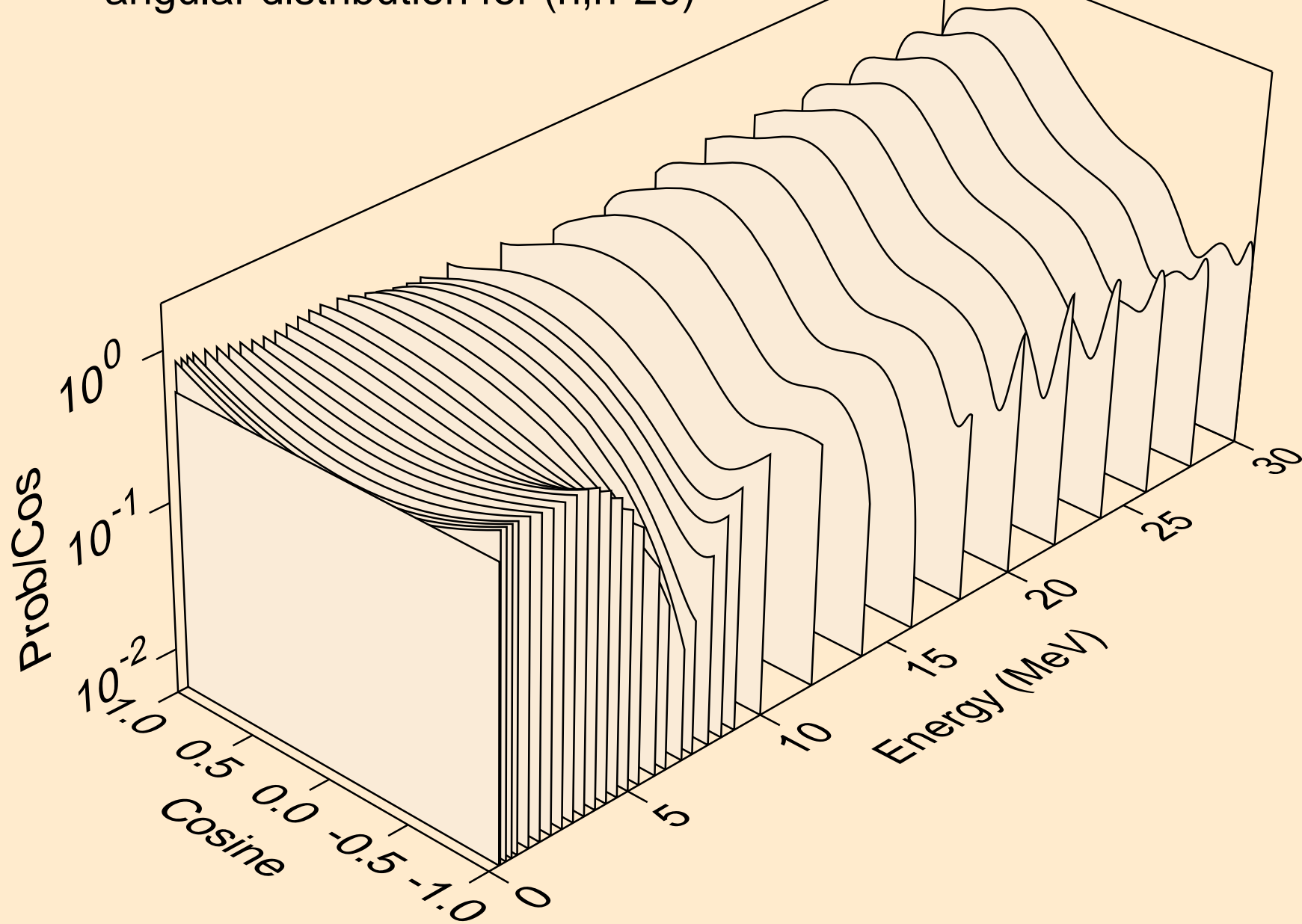

LU160 NEUTRON ACER TENDL-2024 LIBRARY; T=293.6K  
angular distribution for (n,n\*21)

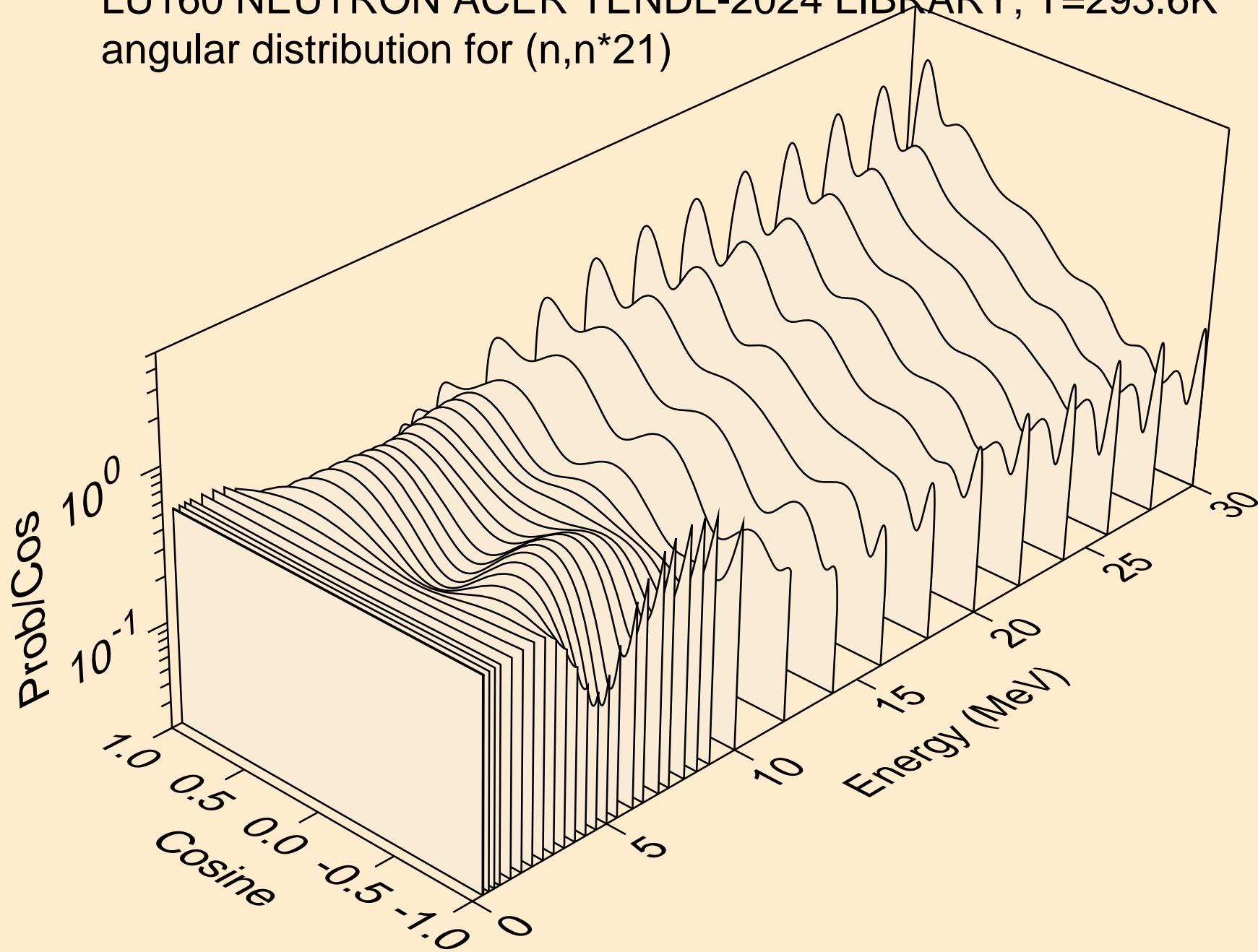

LU160 NEUTRON ACER TENDL-2024 LIBRARY; T=293.6K  
angular distribution for (n,n\*22)

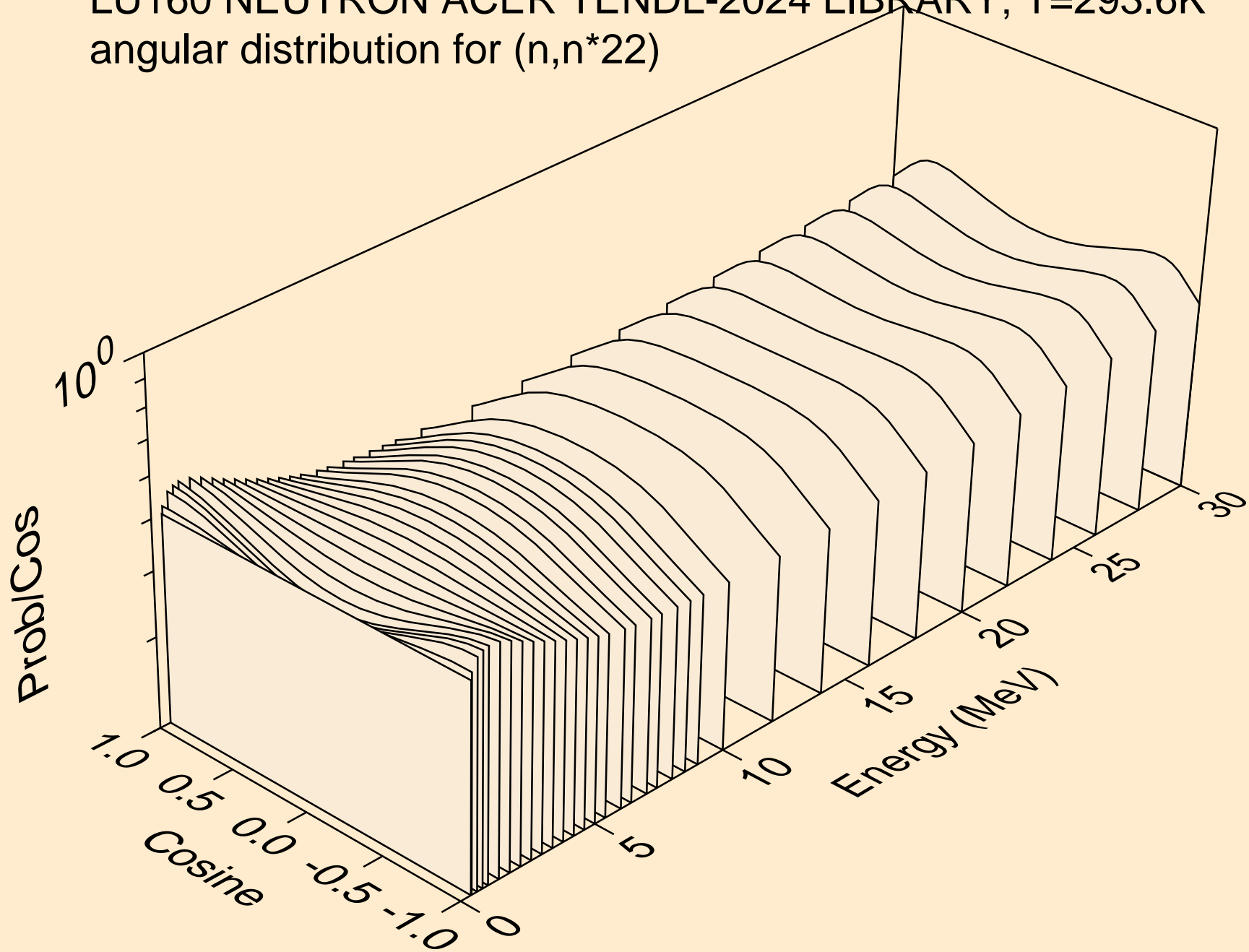

LU160 NEUTRON ACER TENDL-2024 LIBRARY; T=293.6K  
angular distribution for (n,n\*23)

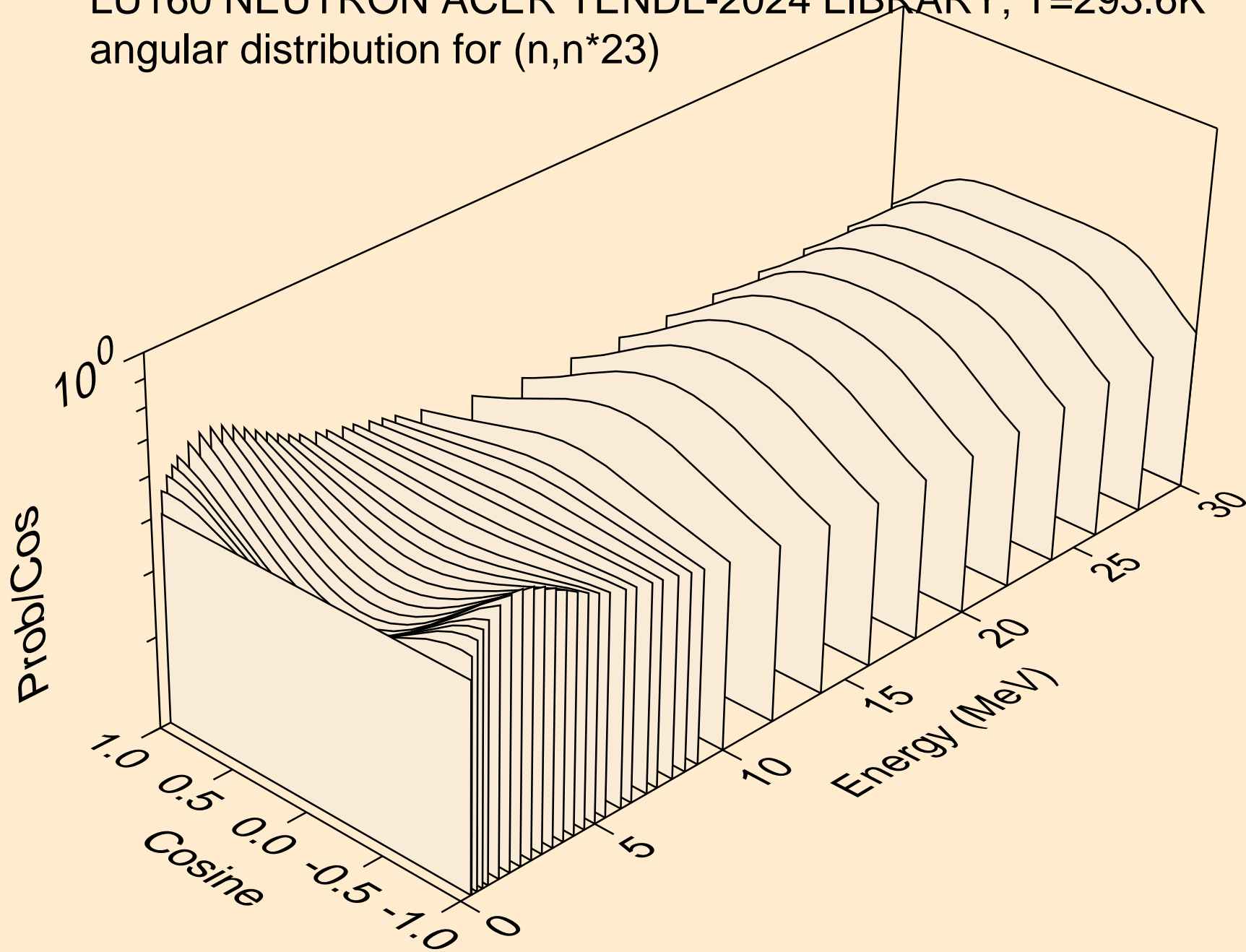

LU160 NEUTRON ACER TENDL-2024 LIBRARY; T=293.6K  
angular distribution for (n,n\*24)

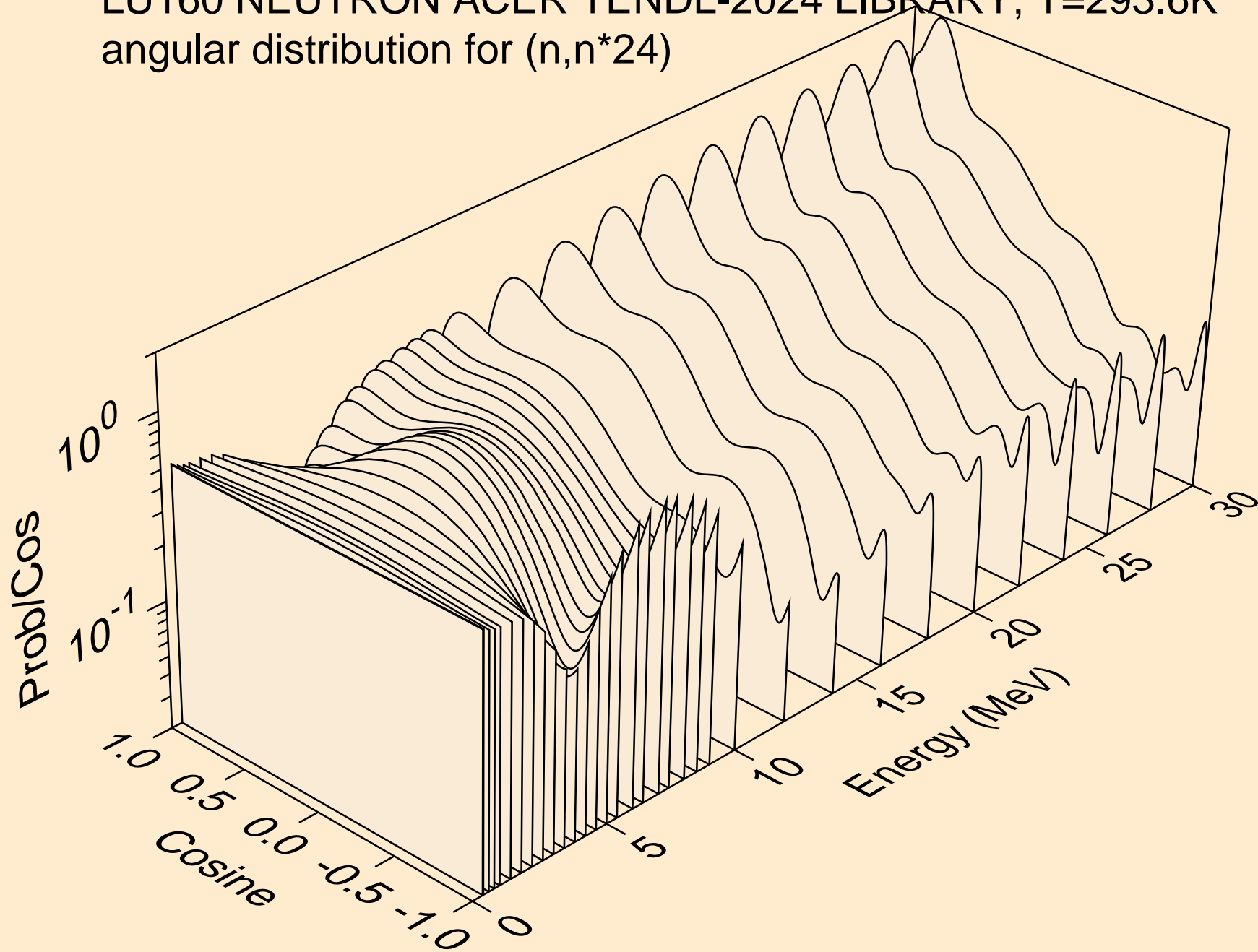

LU160 NEUTRON ACER TENDL-2024 LIBRARY; T=293.6K  
angular distribution for (n,n\*25)

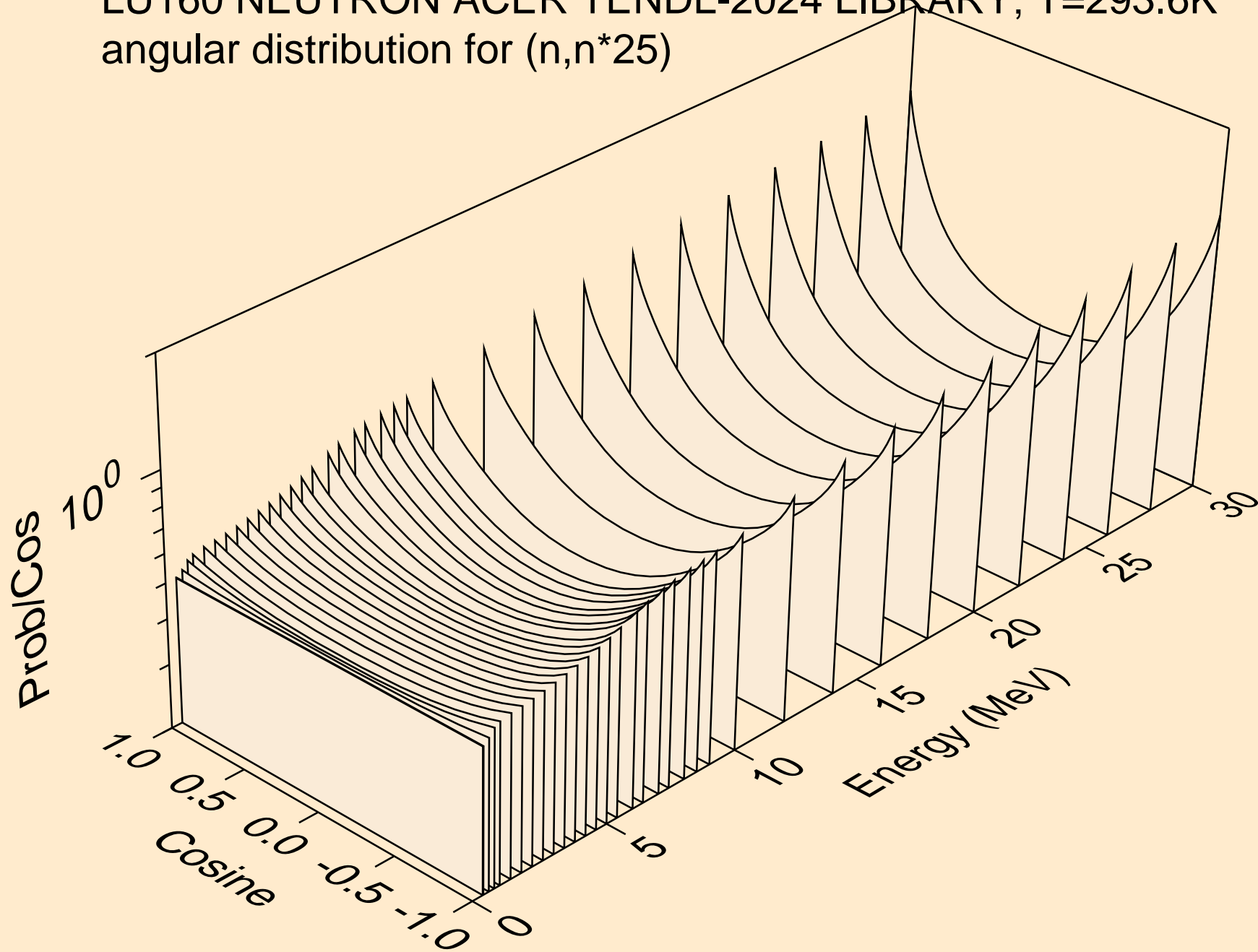

LU160 NEUTRON ACER TENDL-2024 LIBRARY; T=293.6K  
angular distribution for (n,n\*26)

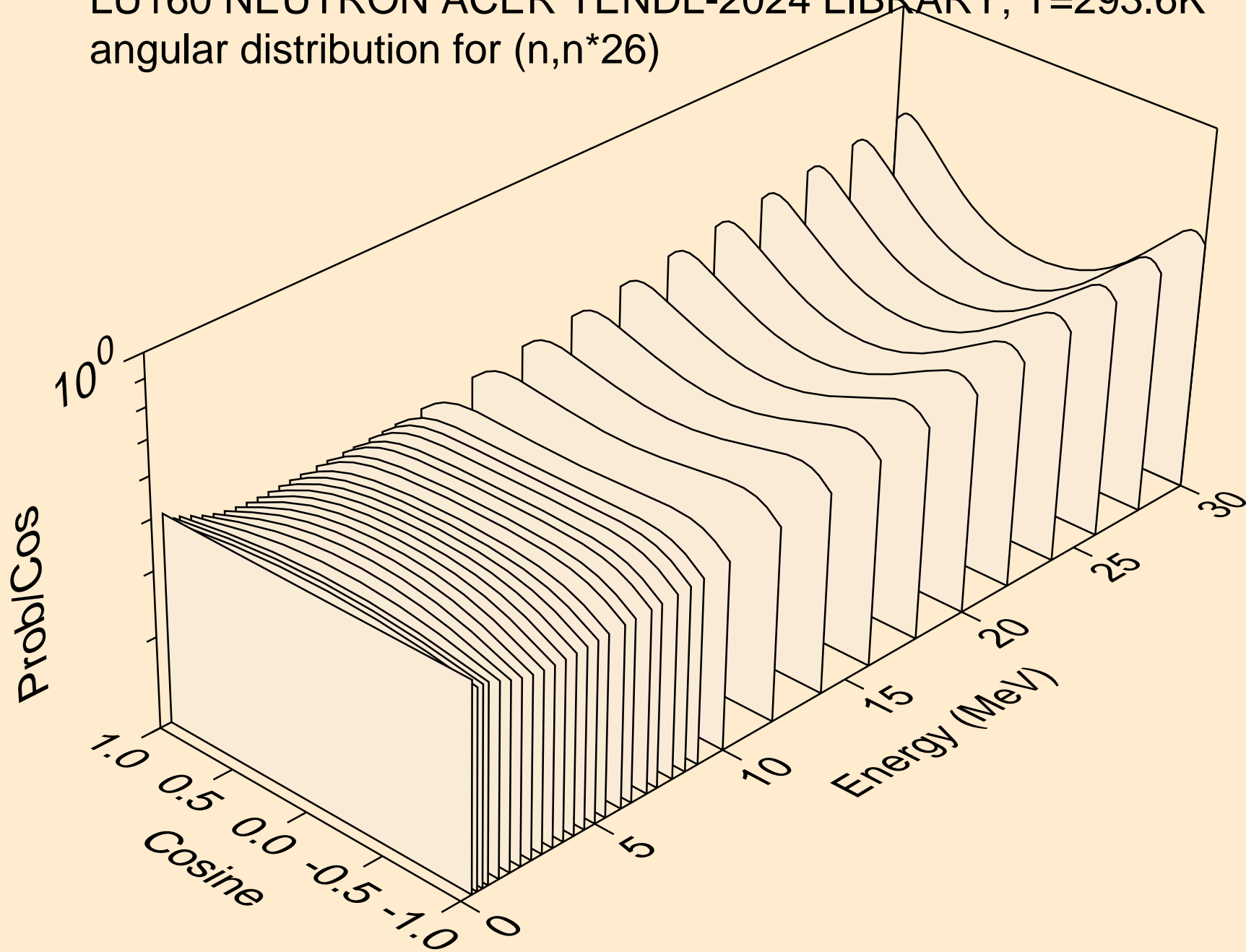

LU160 NEUTRON ACER TENDL-2024 LIBRARY; T=293.6K  
angular distribution for (n,n\*27)

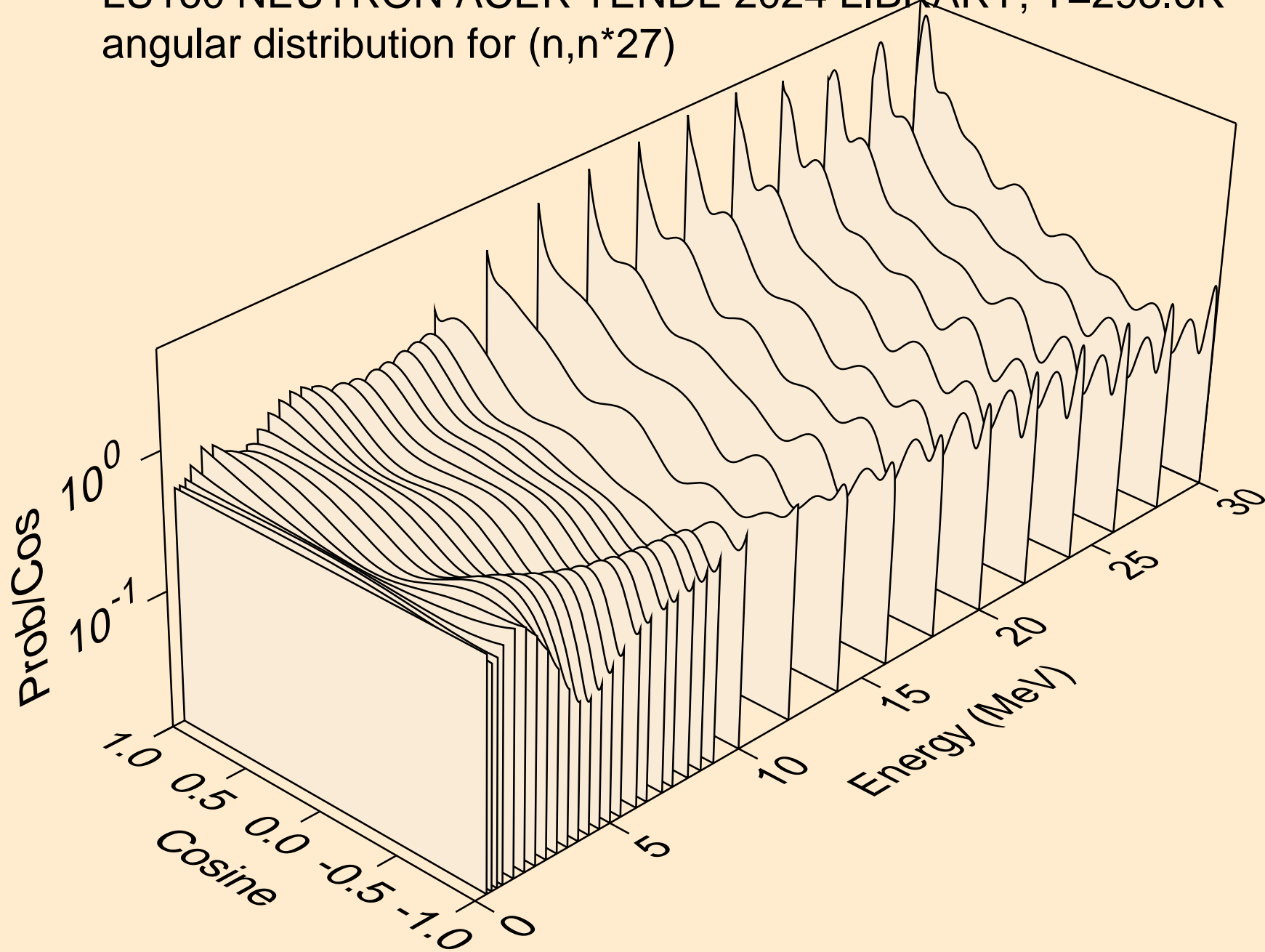

LU160 NEUTRON ACER TENDL-2024 LIBRARY; T=293.6K  
Neutron emission for (n,x)

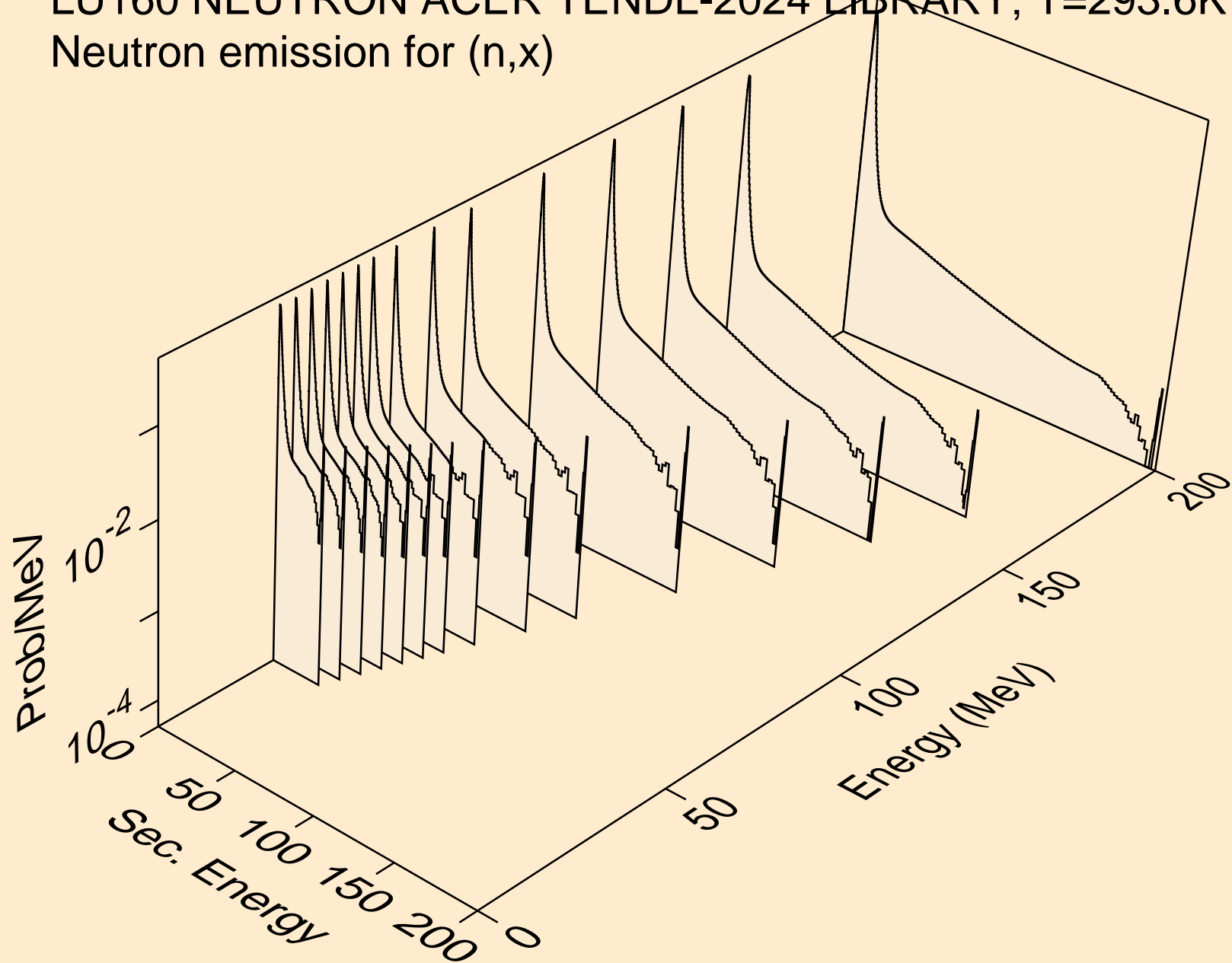

LU160 NEUTRON ACER TENDL-2024 LIBRARY; T=293.6K  
Neutron emission for (n,2nd)

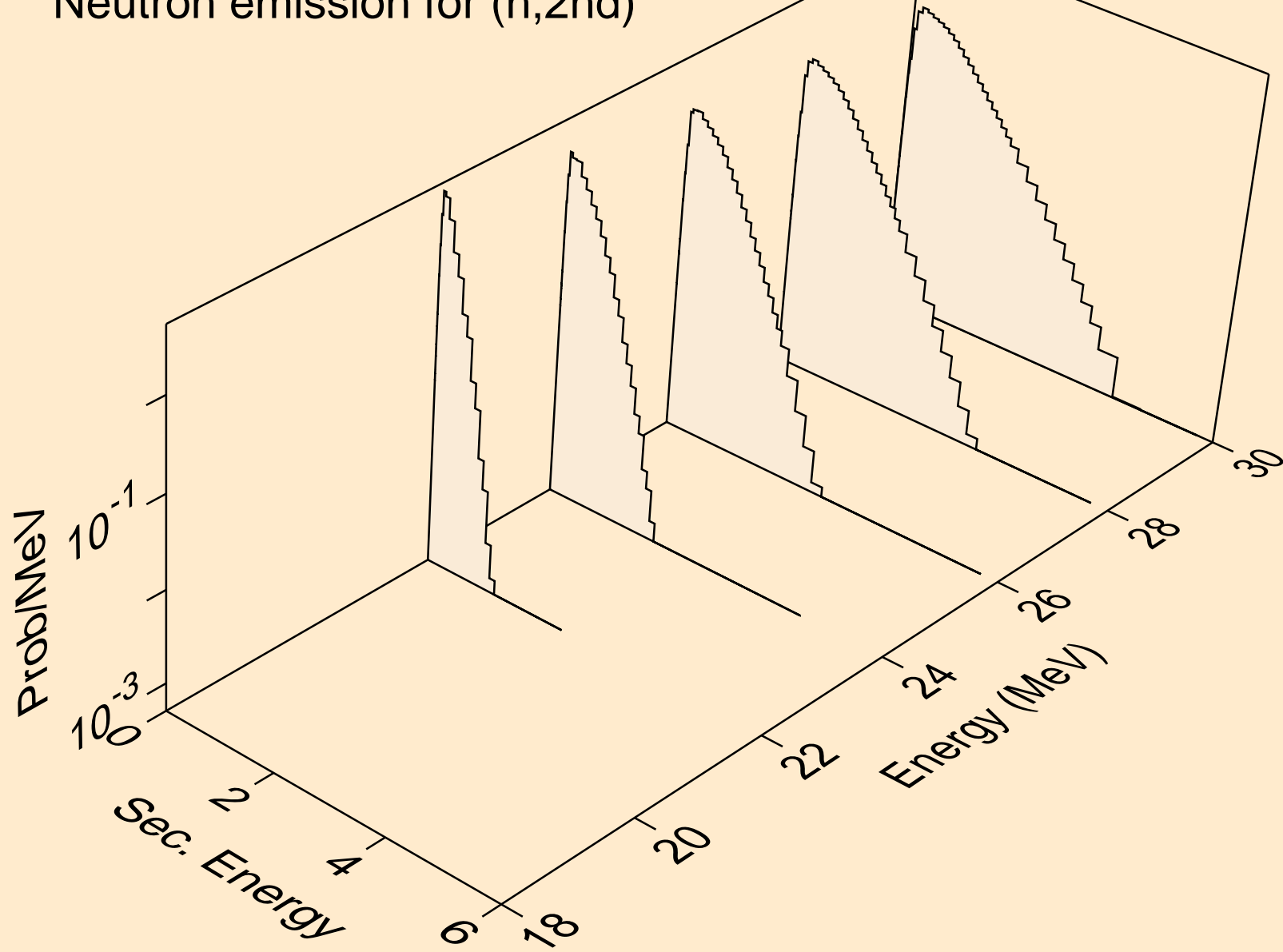

LU160 NEUTRON ACER TENDL-2024 LIBRARY; T=293.6K  
Neutron emission for (n,2n)

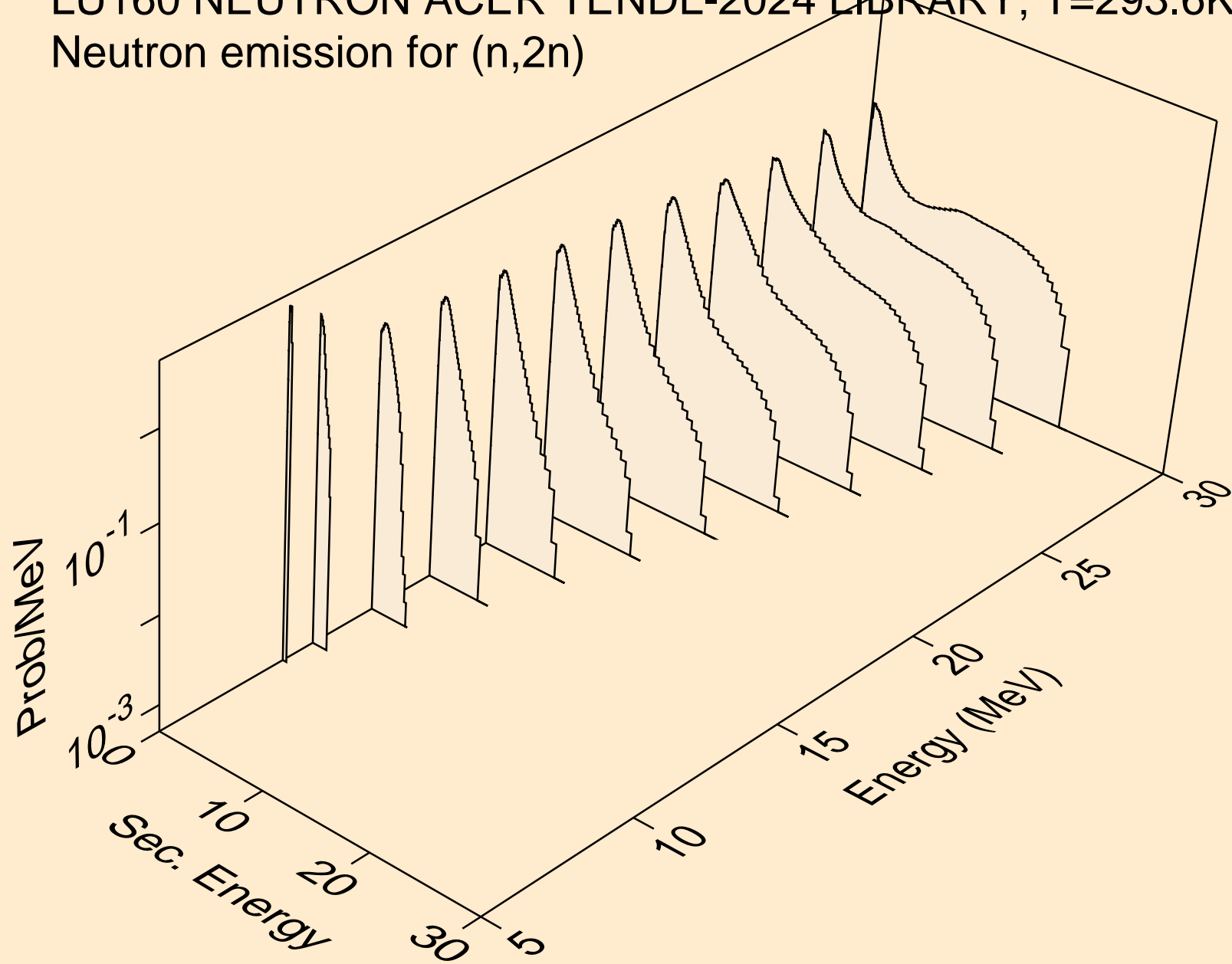

LU160 NEUTRON ACER TENDL-2024 LIBRARY; T=293.6K  
Neutron emission for (n,3n)

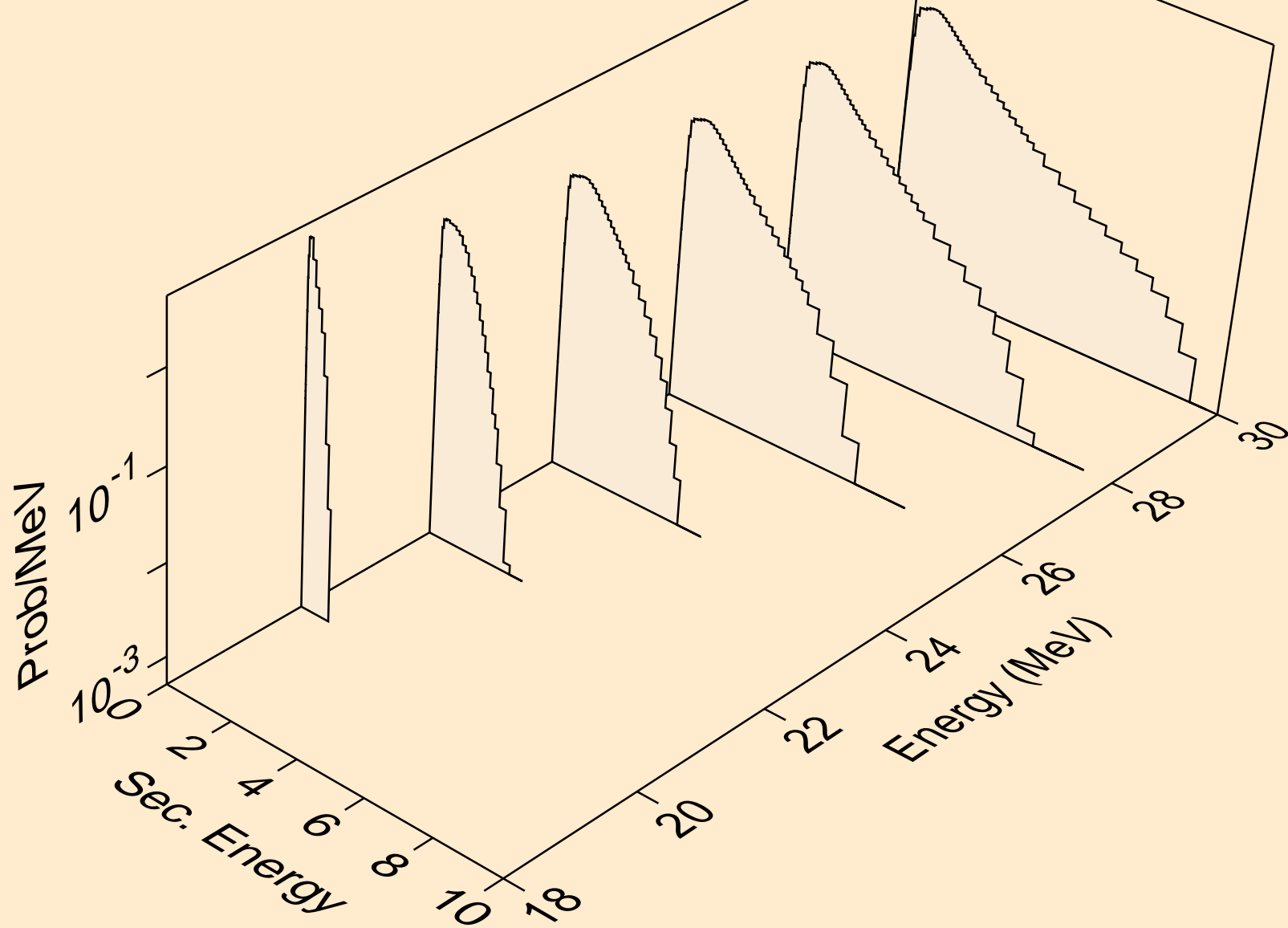

LU160 NEUTRON ACER TENDL-2024 LIBRARY; T=293.6K  
Neutron emission for (n,n\*)a

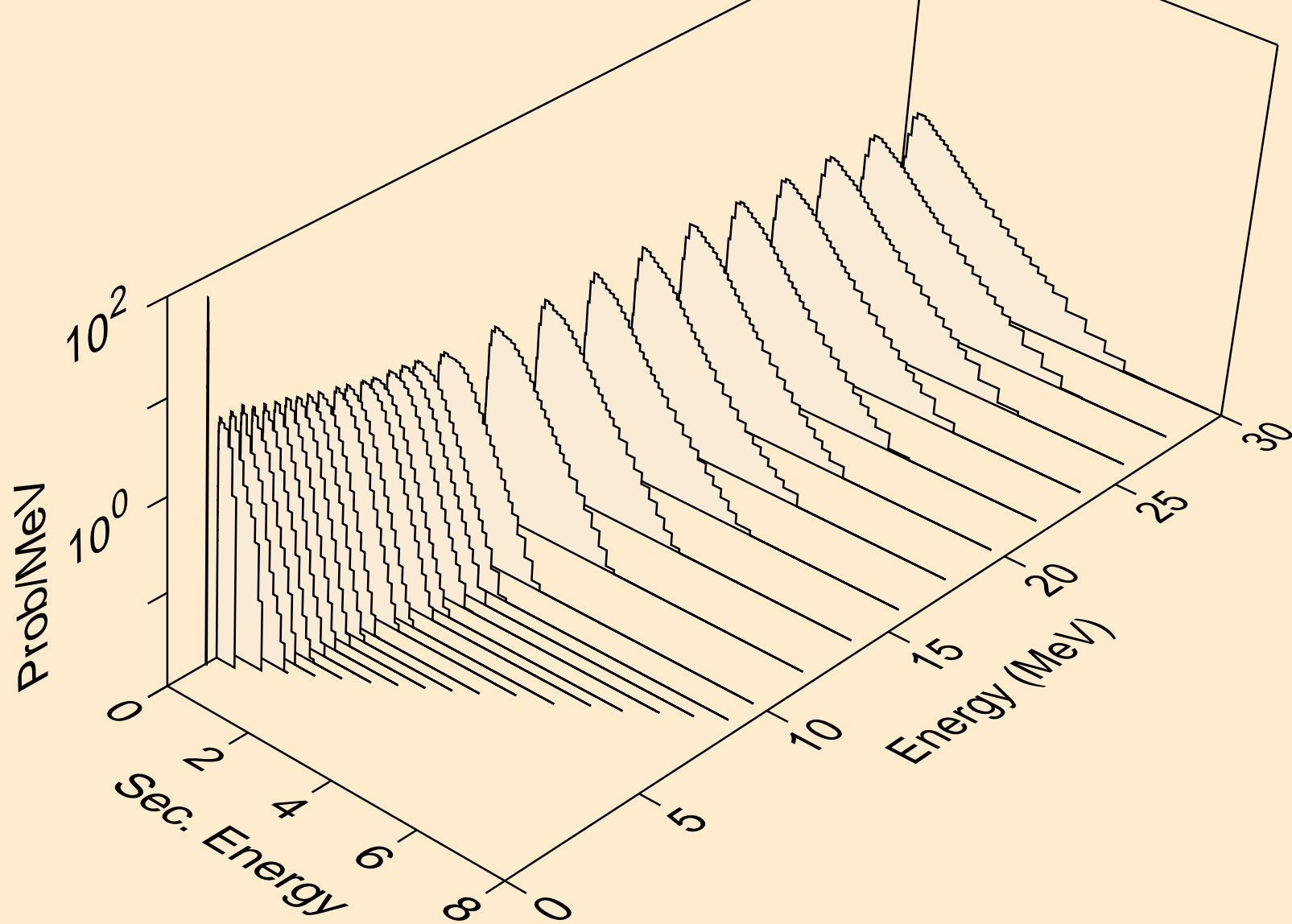

LU160 NEUTRON ACER TENDL-2024 LIBRARY; T=293.6K  
Neutron emission for (n,n\*)3a

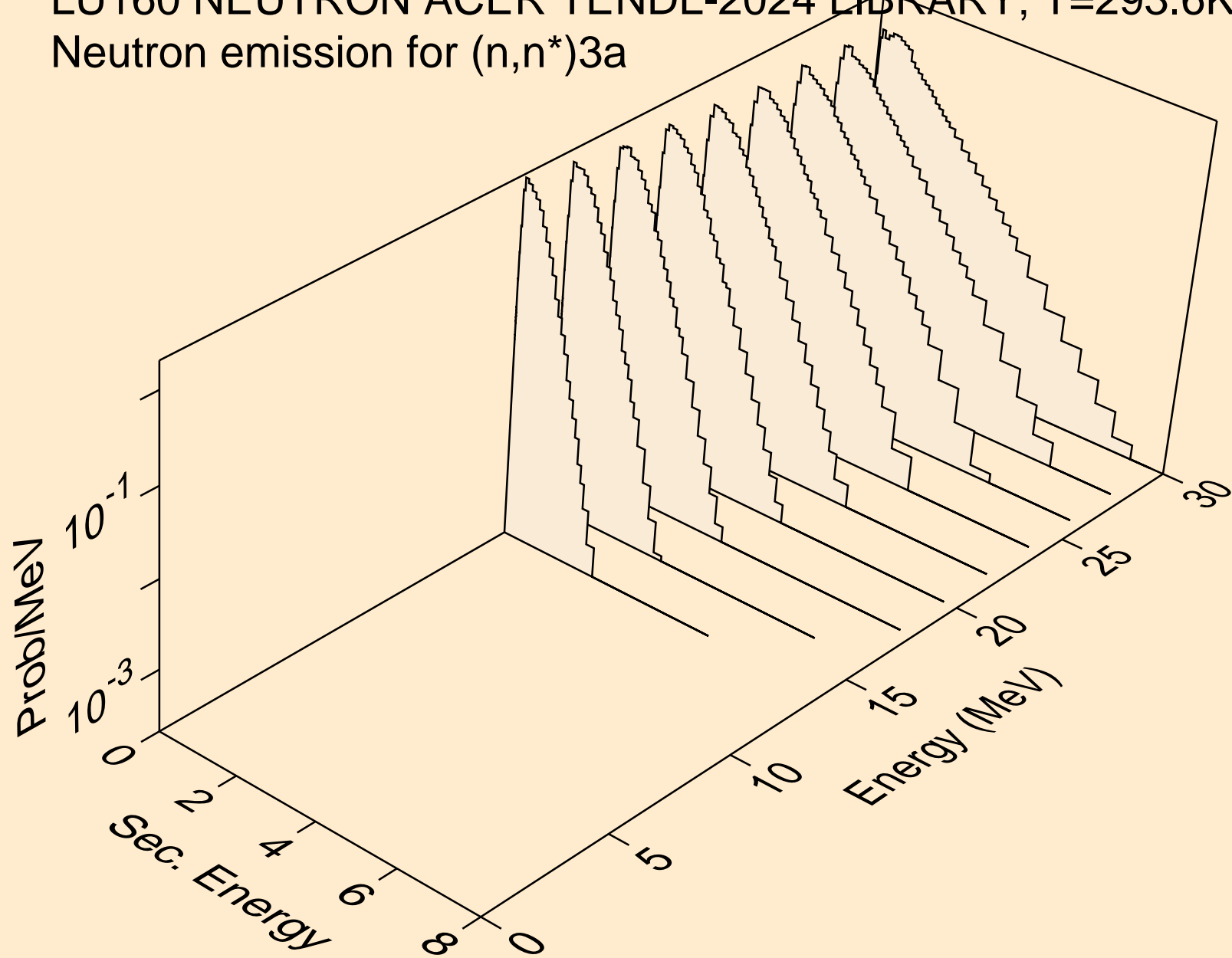

LU160 NEUTRON ACER TENDL-2024 LIBRARY; T=293.6K  
Neutron emission for (n,2n)a

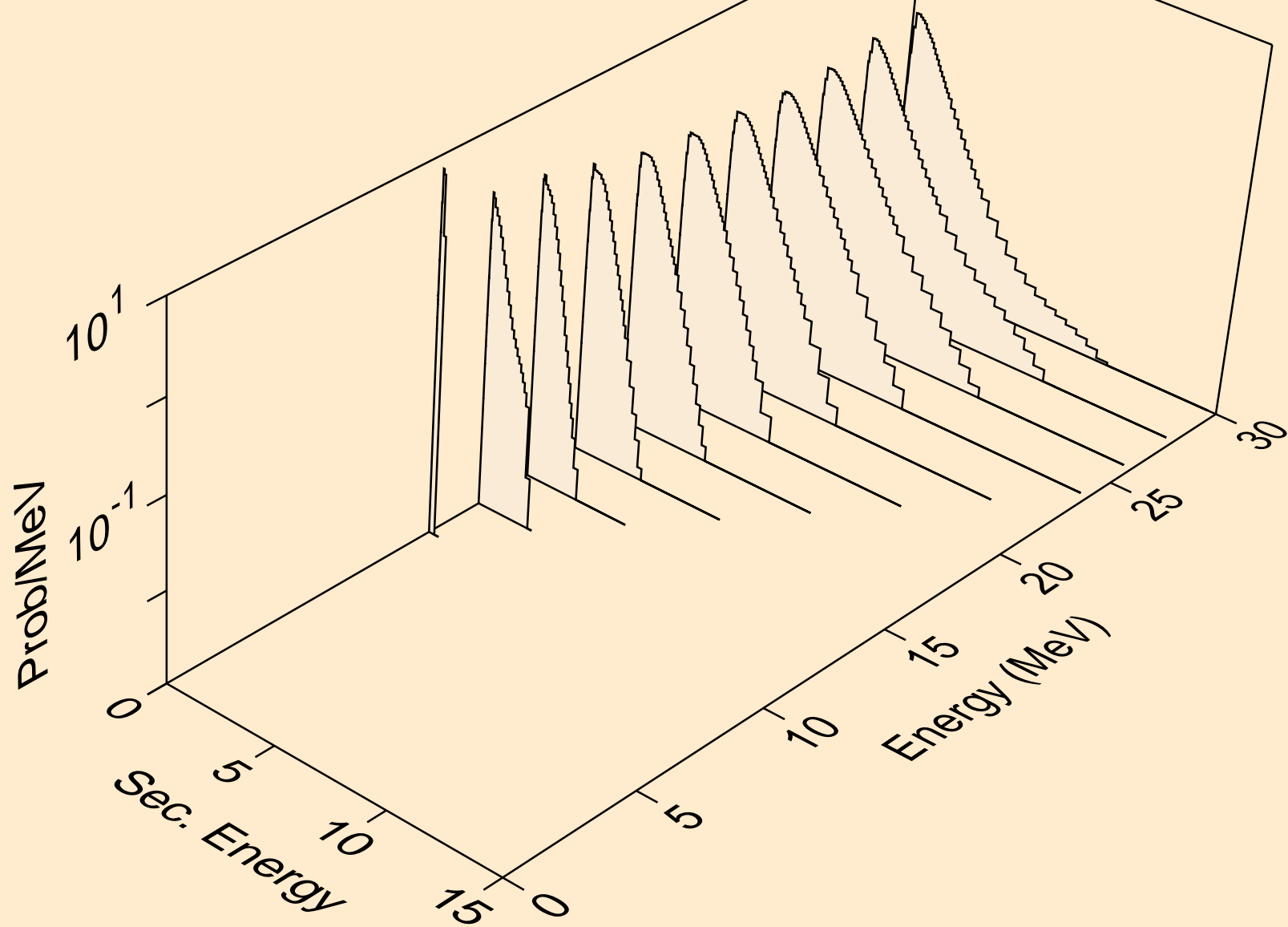

LU160 NEUTRON ACER TENDL-2024 LIBRARY; T=293.6K  
Neutron emission for (n,3n)a

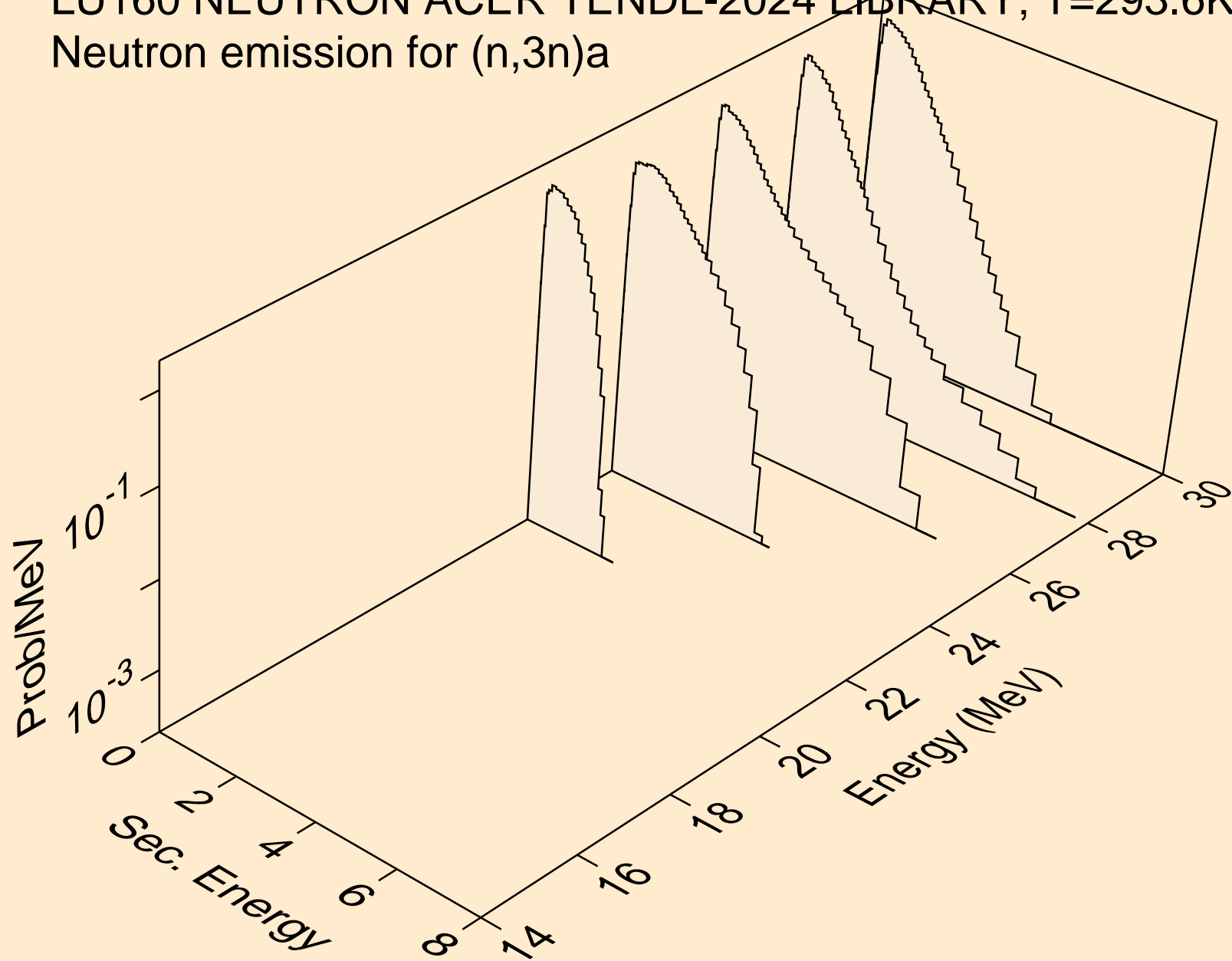

LU160 NEUTRON ACER TENDL-2024 LIBRARY; T=293.6K  
Neutron emission for (n,n\*)p

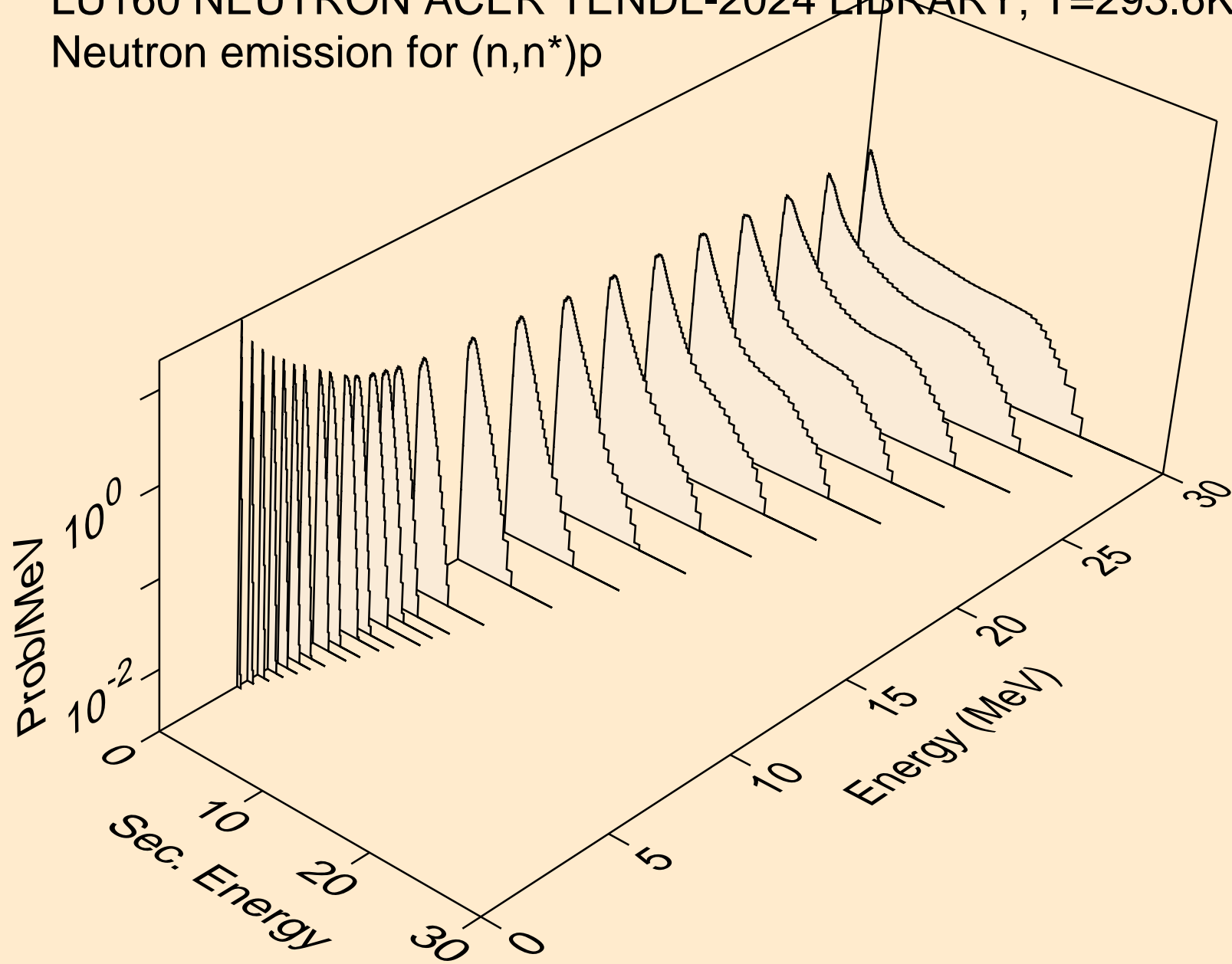

LU160 NEUTRON ACER TENDL-2024 LIBRARY; T=293.6K  
Neutron emission for (n,n\*)2a

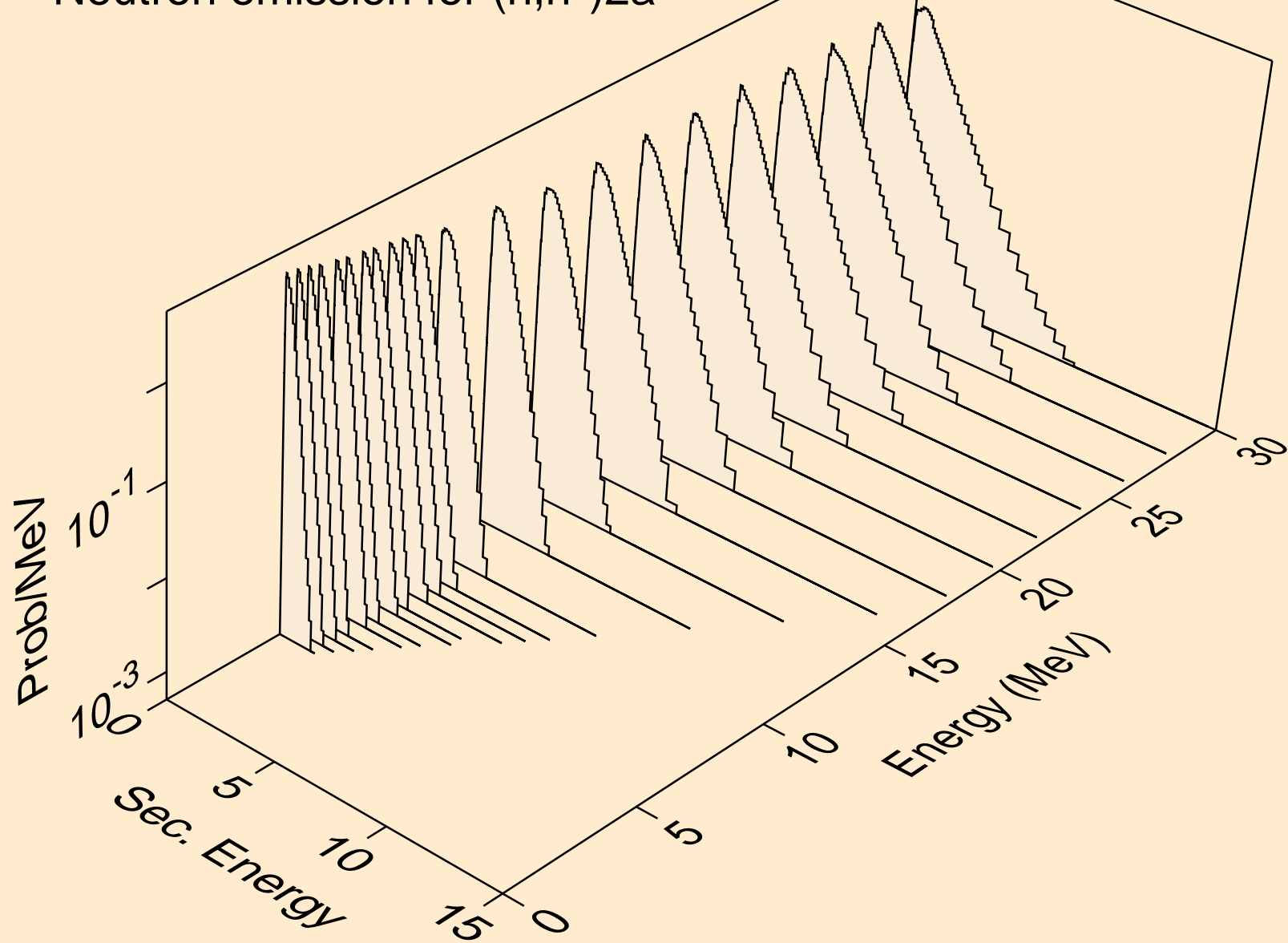

LU160 NEUTRON ACER TENDL-2024 LIBRARY; T=293.6K  
Neutron emission for (n,2n)2a

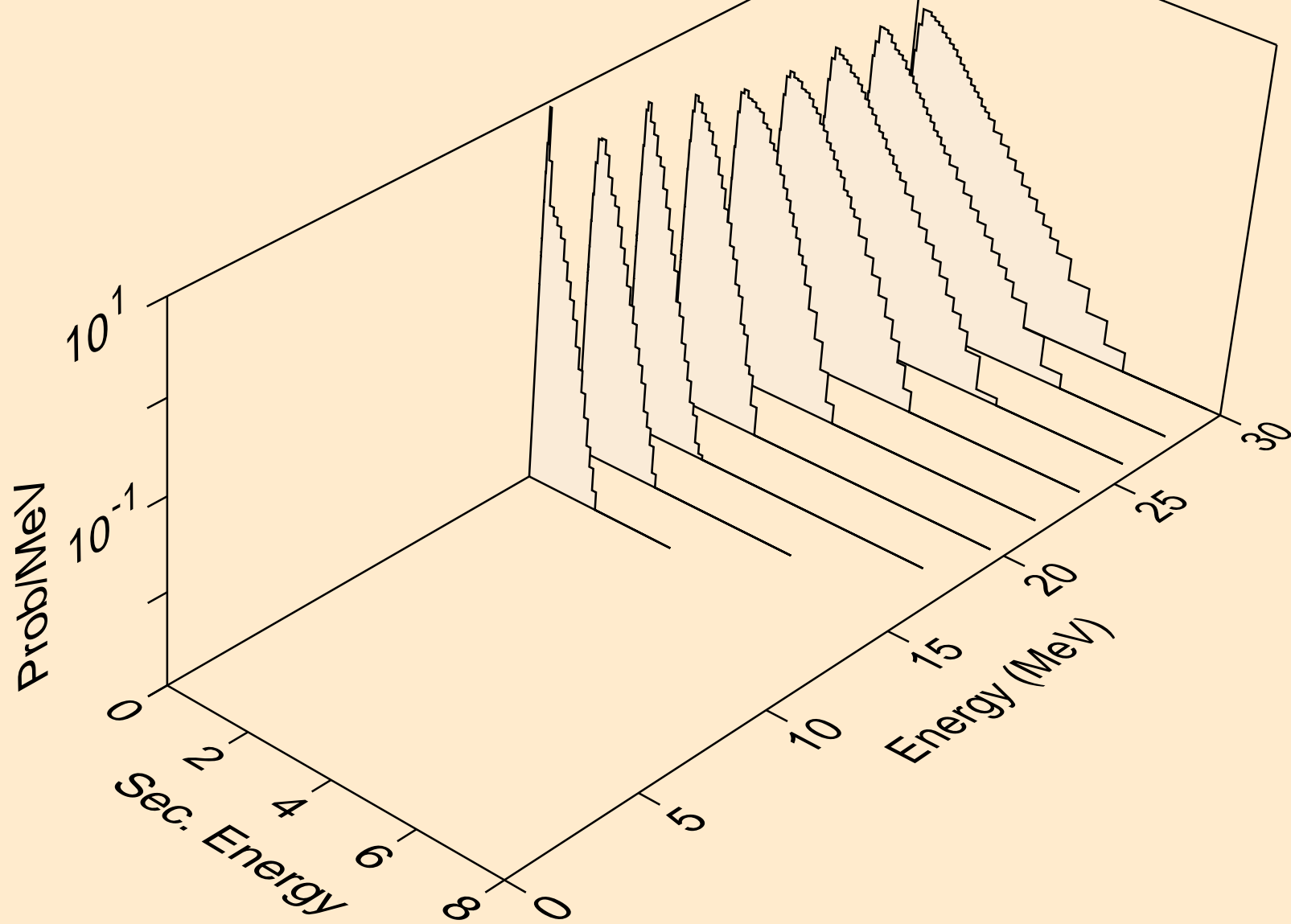

LU160 NEUTRON ACER TENDL-2024 LIBRARY; T=293.6K  
Neutron emission for (n,n\*)d

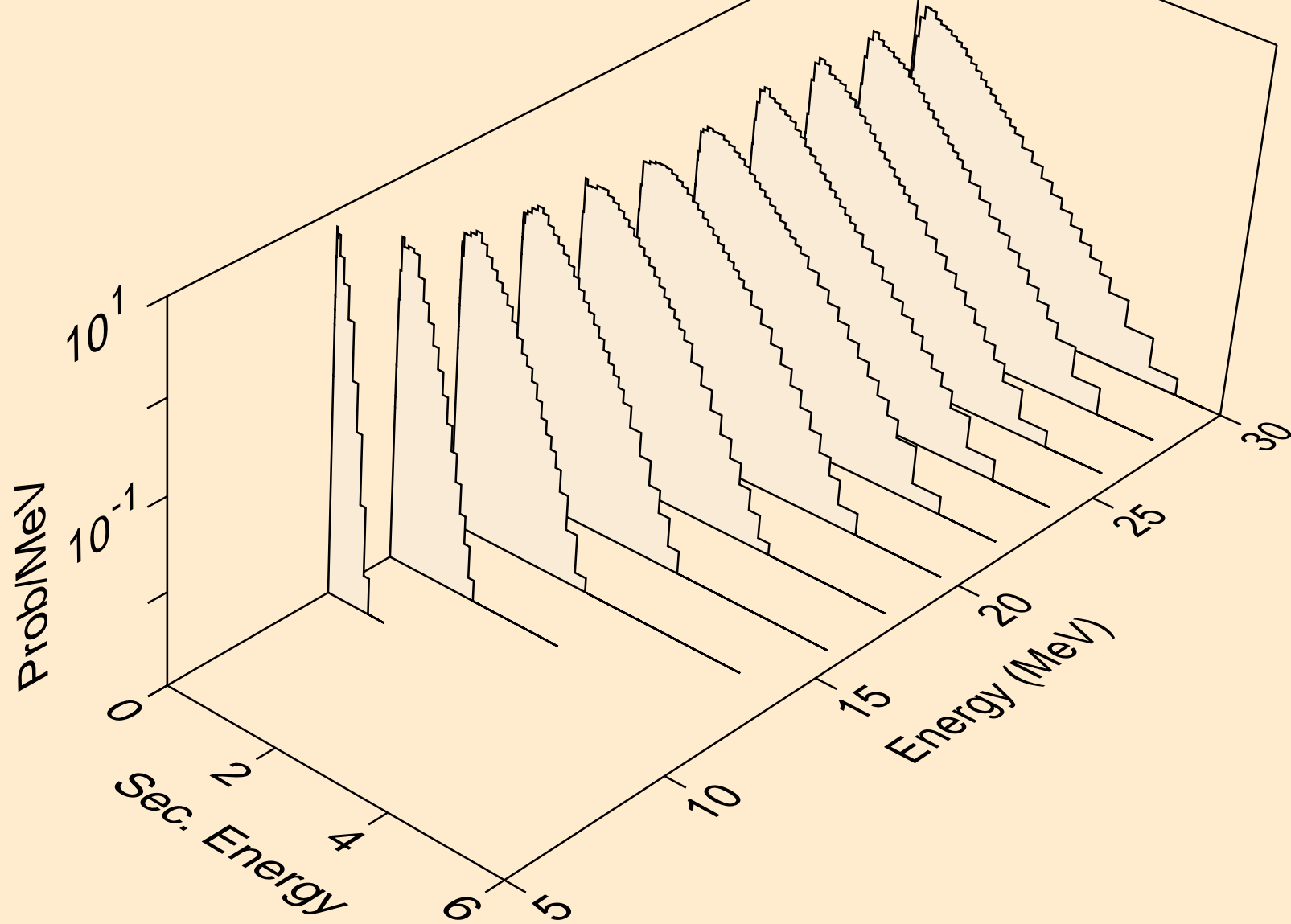

LU160 NEUTRON ACER TENDL-2024 LIBRARY; T=293.6K  
Neutron emission for (n,n\*)t

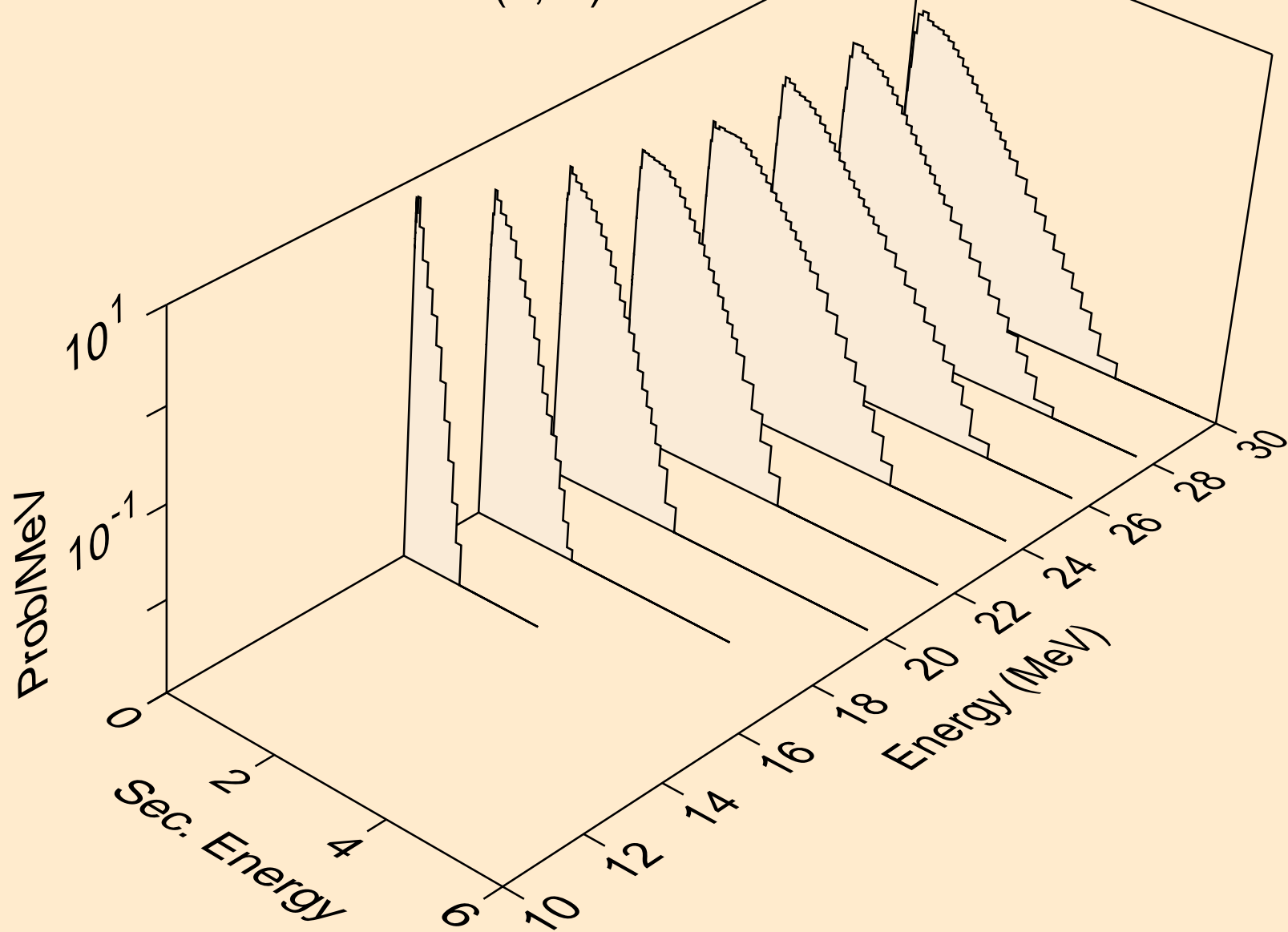

LU160 NEUTRON ACER TENDL-2024 LIBRARY; T=293.6K  
Neutron emission for (n,n\*)he3

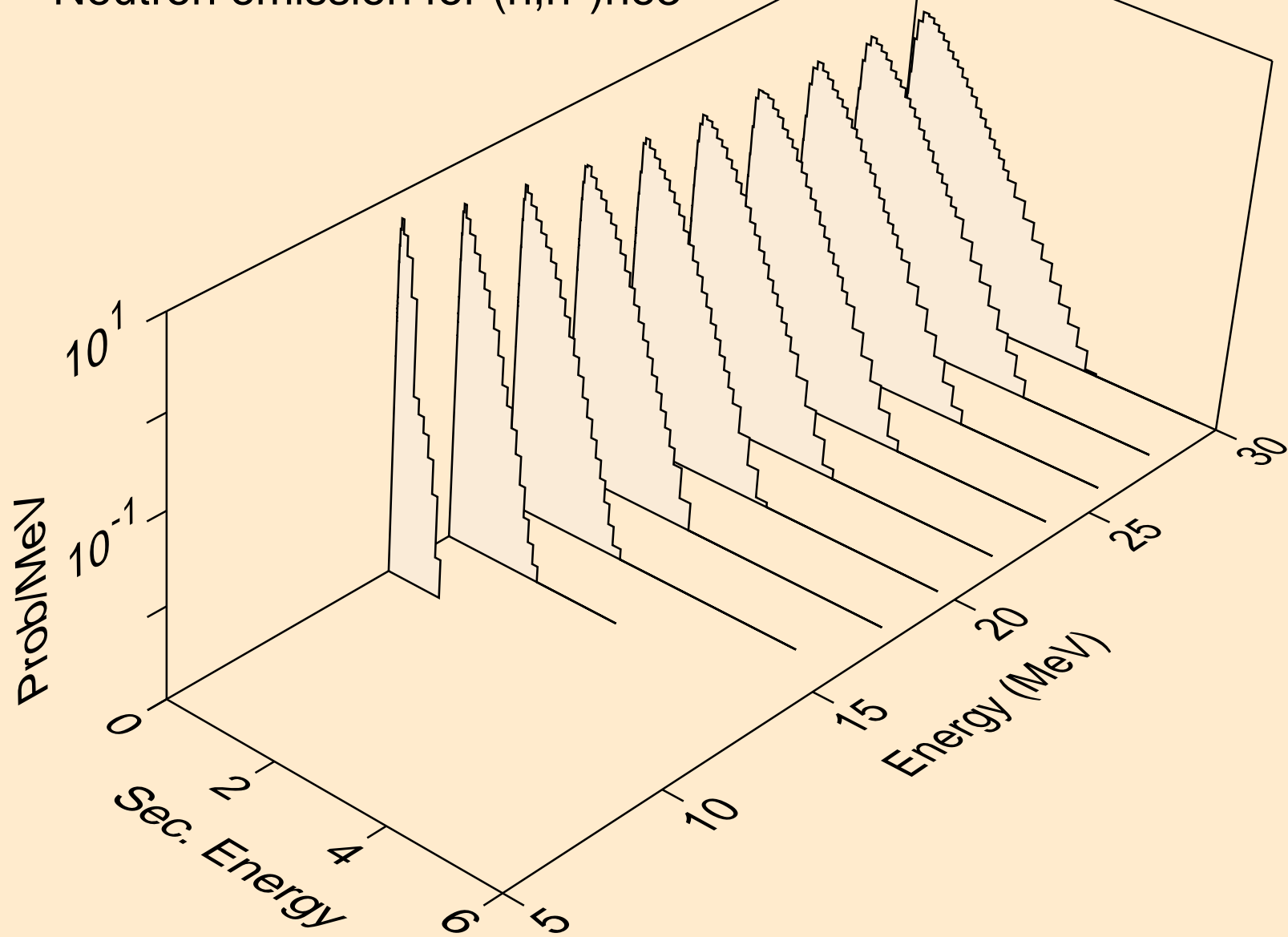

LU160 NEUTRON ACER TENDL-2024 LIBRARY; T=293.6K  
Neutron emission for (n,n\*)d2a

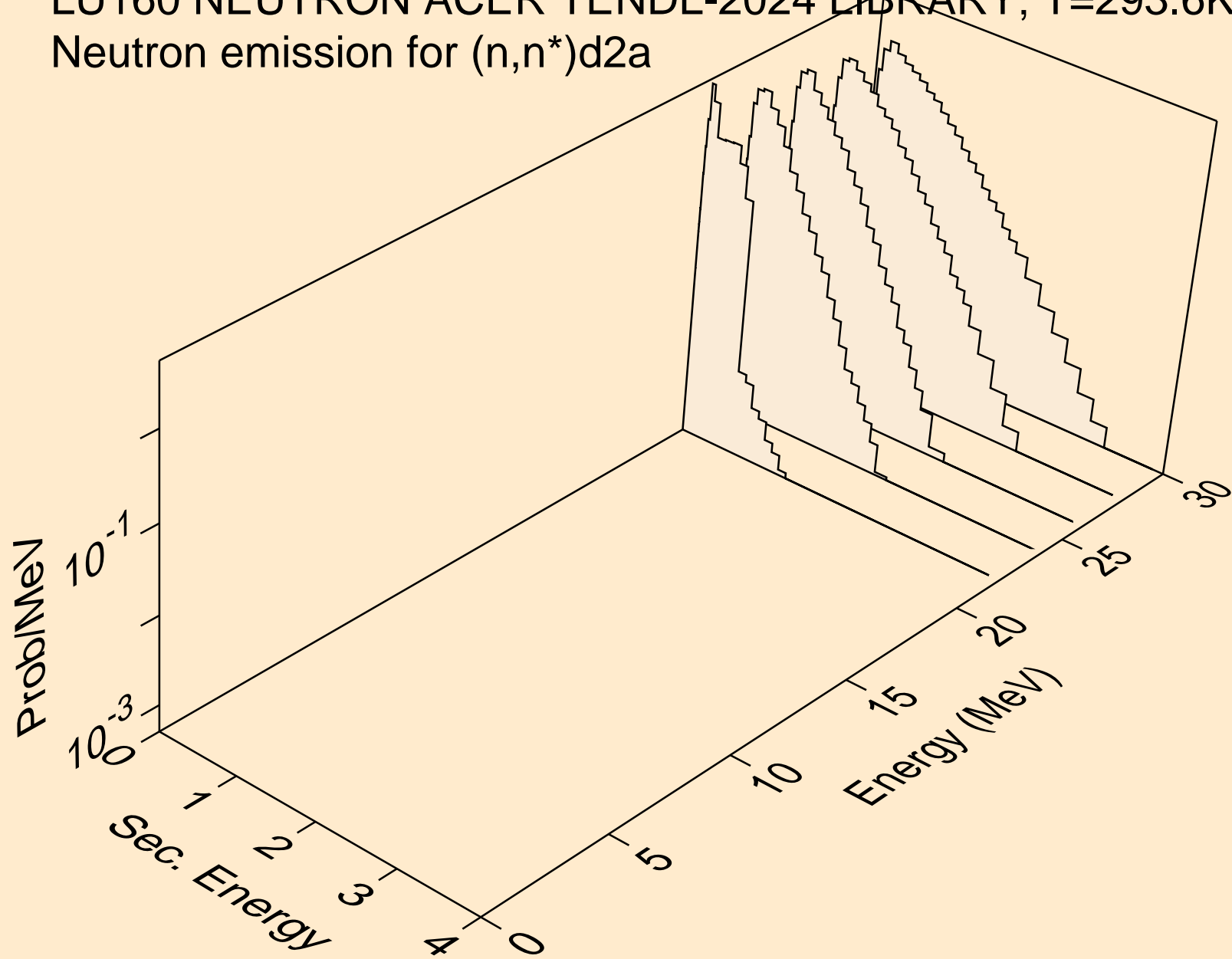

LU160 NEUTRON ACER TENDL-2024 LIBRARY; T=293.6K  
Neutron emission for (n,4n)

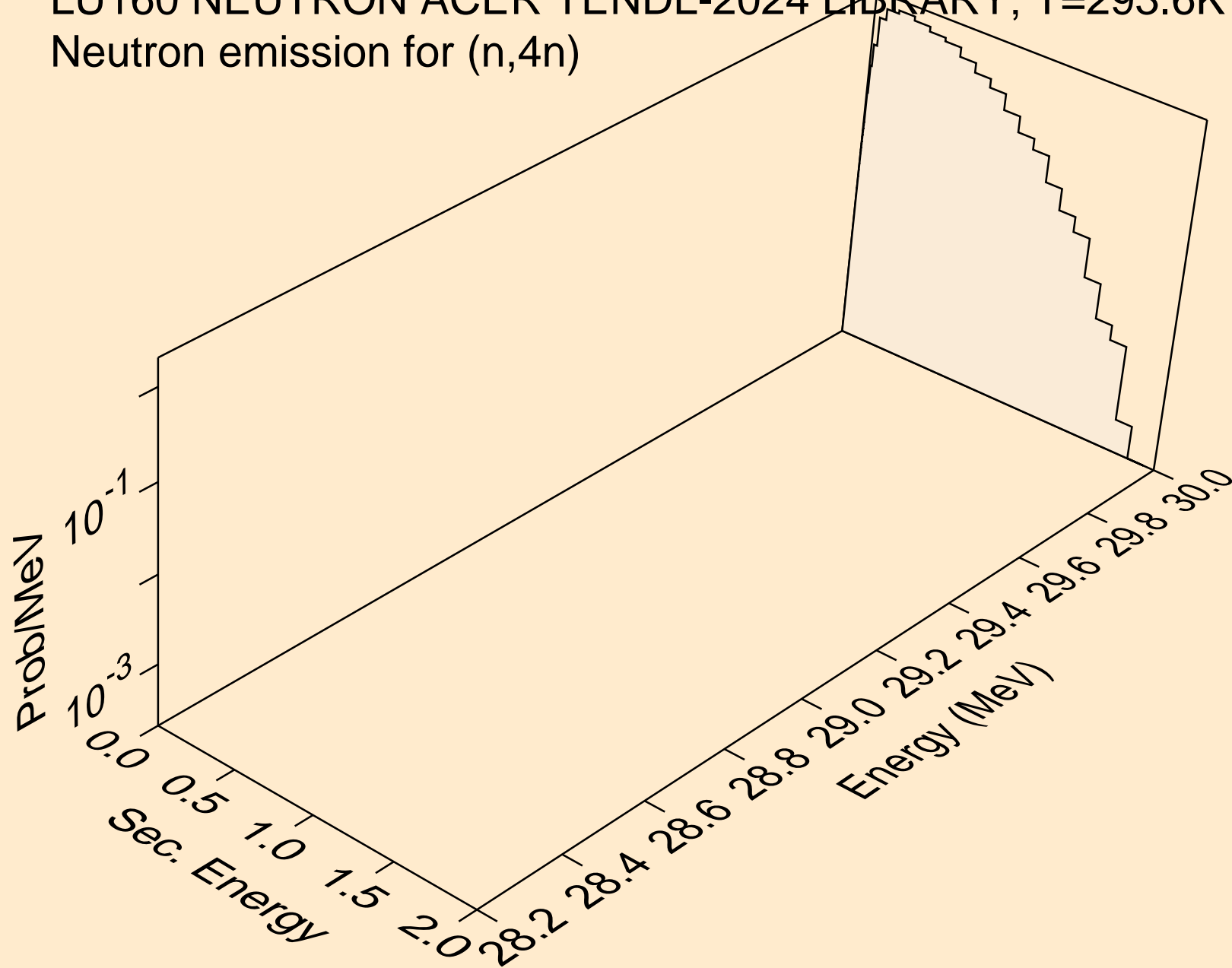

LU160 NEUTRON ACER TENDL-2024 LIBRARY; T=293.6K  
Neutron emission for (n,2np)

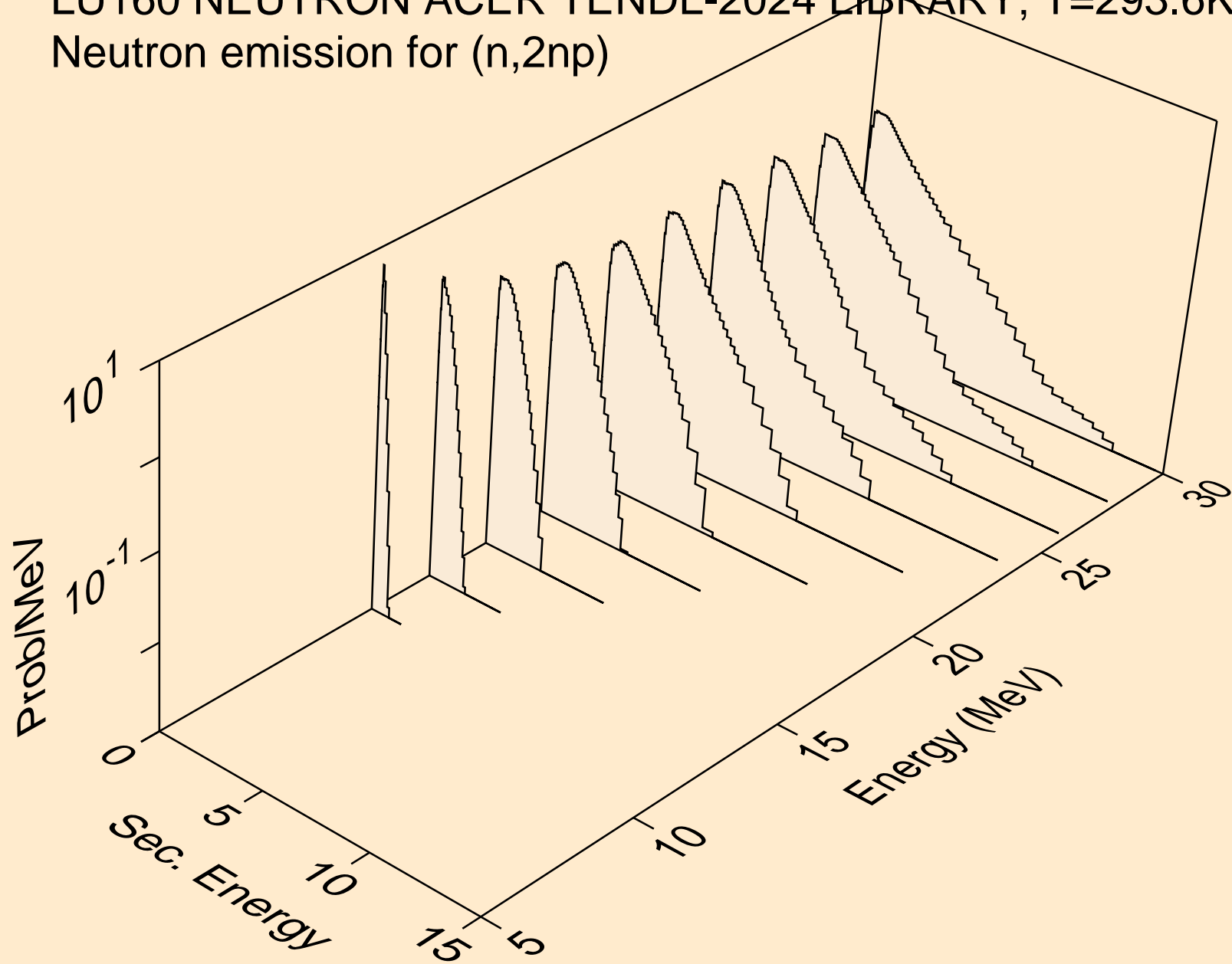

LU160 NEUTRON ACER TENDL-2024 LIBRARY; T=293.6K  
Neutron emission for (n,3np)

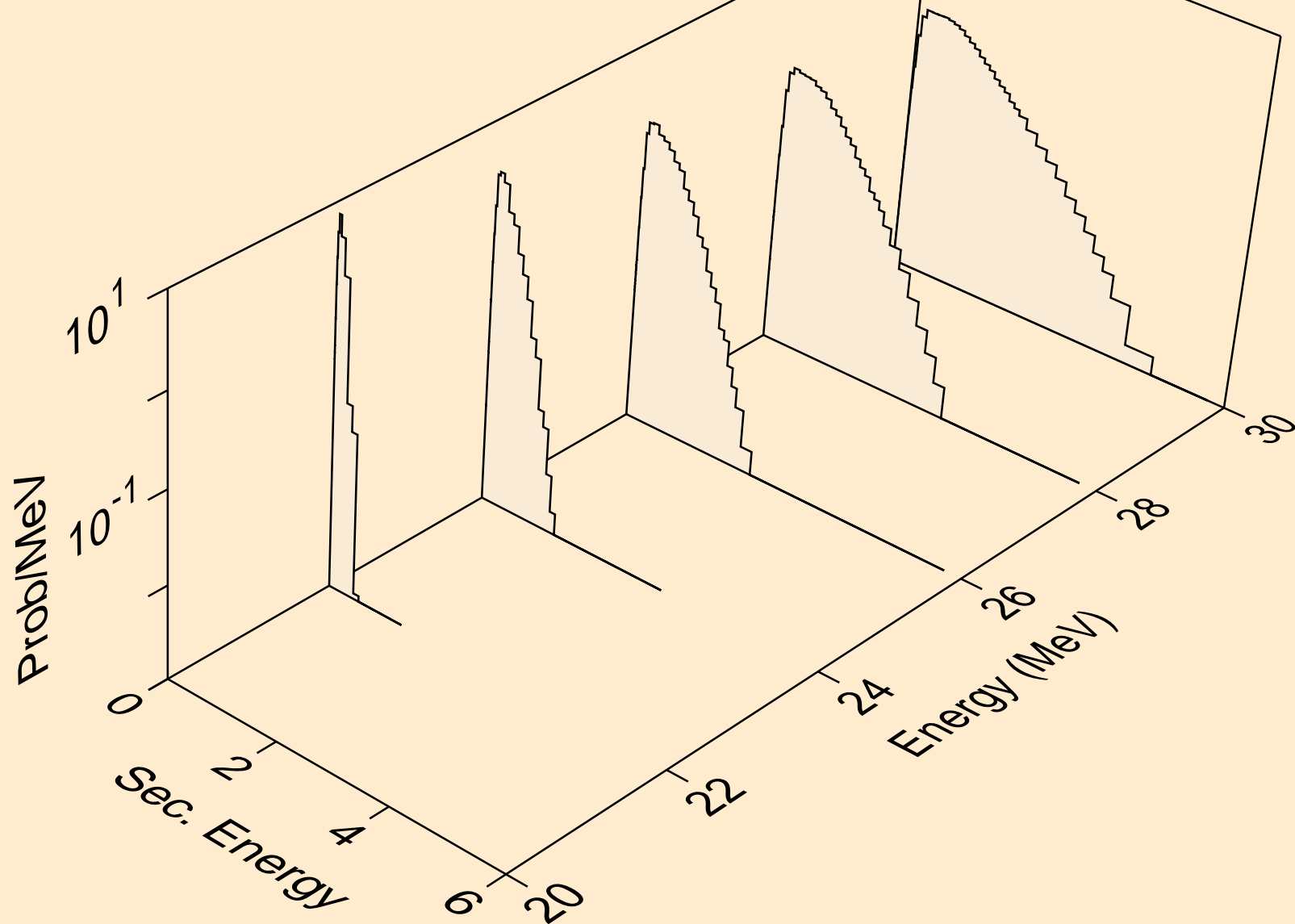

LU160 NEUTRON ACER TENDL-2024 LIBRARY; T=293.6K  
Neutron emission for (n,n2p)

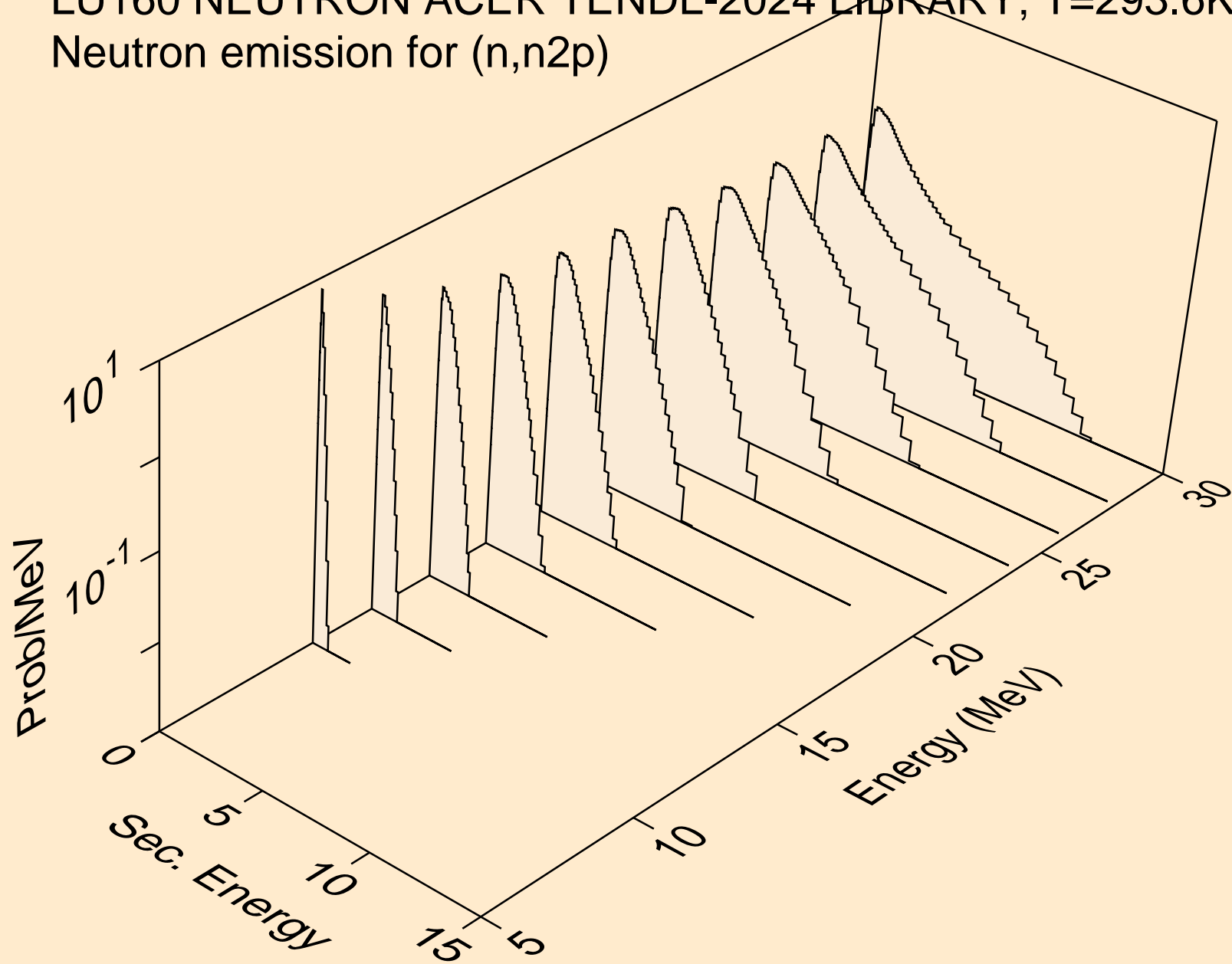

LU160 NEUTRON ACER TENDL-2024 LIBRARY; T=293.6K  
Neutron emission for (n,npa)

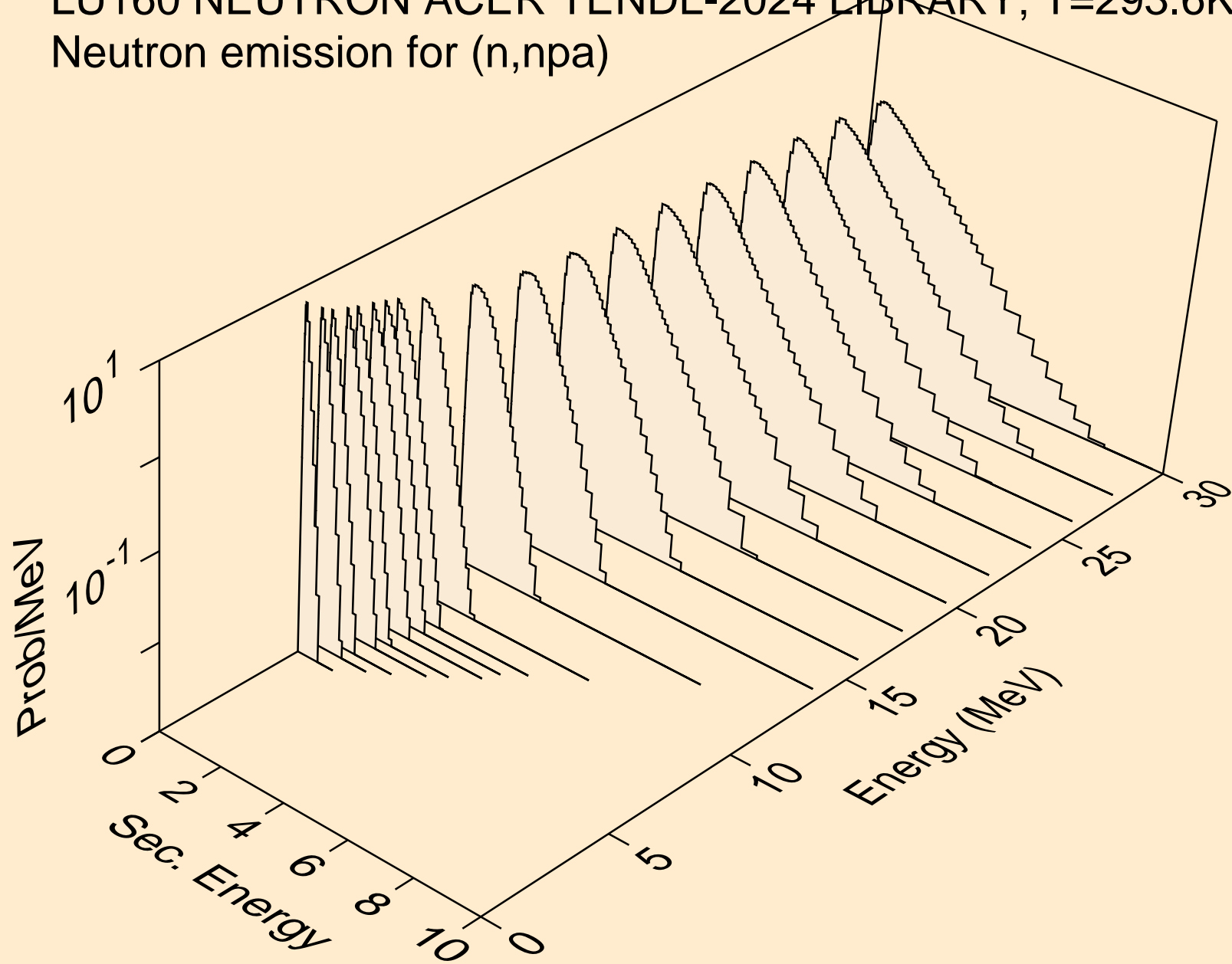

LU160 NEUTRON ACER TENDL-2024 LIBRARY; T=293.6K  
Neutron emission for (n,n\*c)

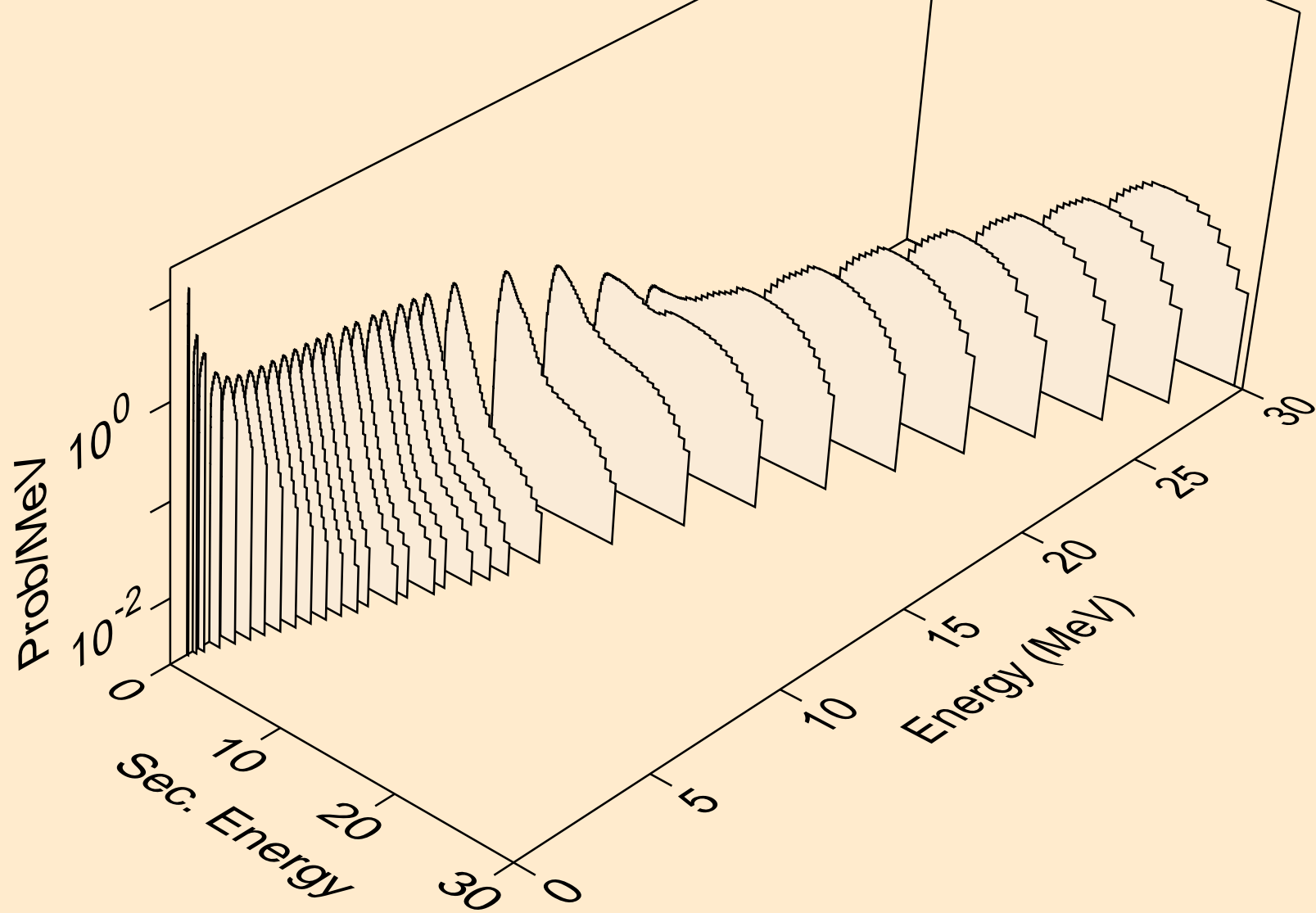

LU160 NEUTRON ACER TENDL-2024 LIBRARY; T=293.6K  
Photon emission for (n,x)

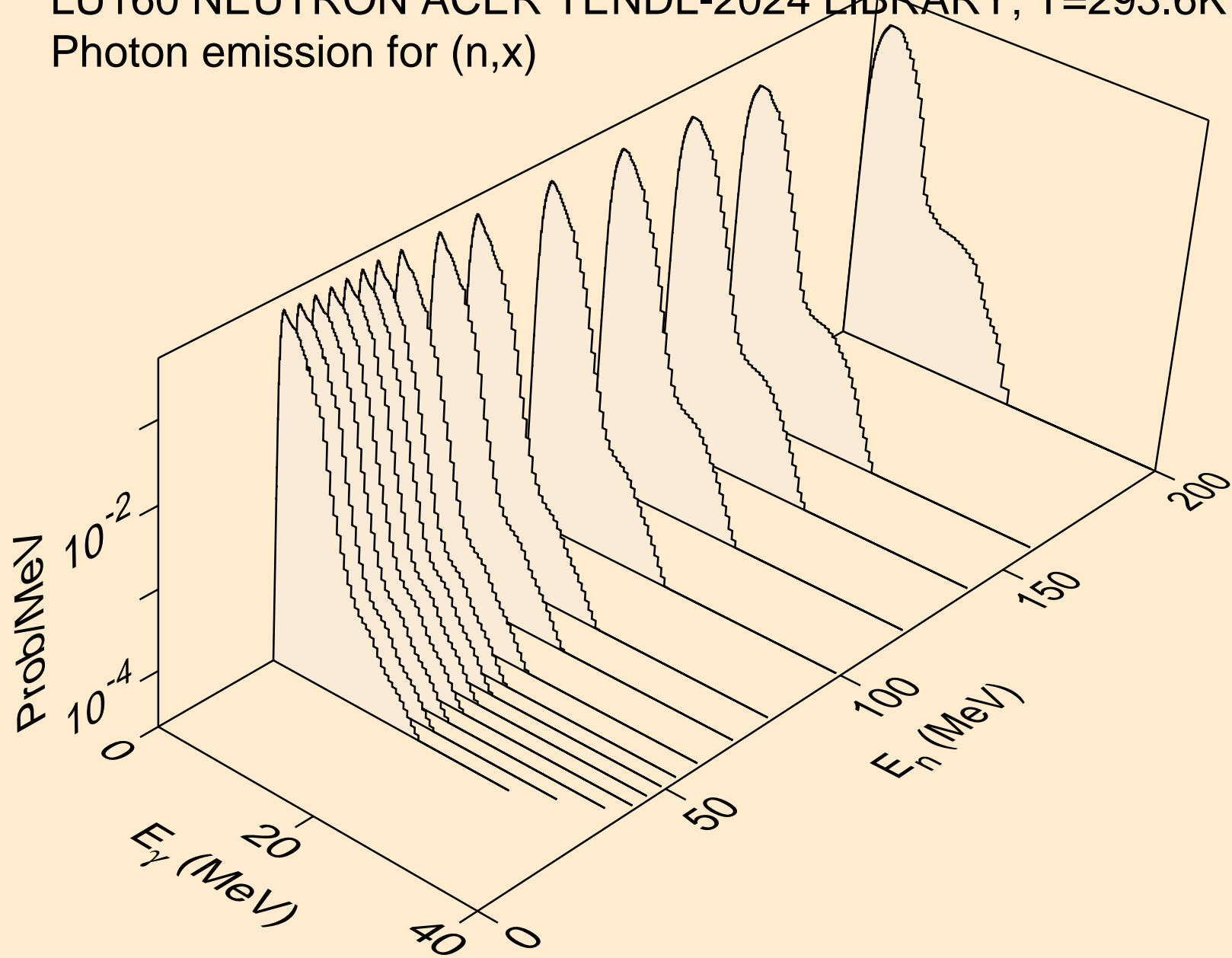

LU160 NEUTRON ACER TENDL-2024 LIBRARY; T=293.6K  
Photon emission for (n,2nd)

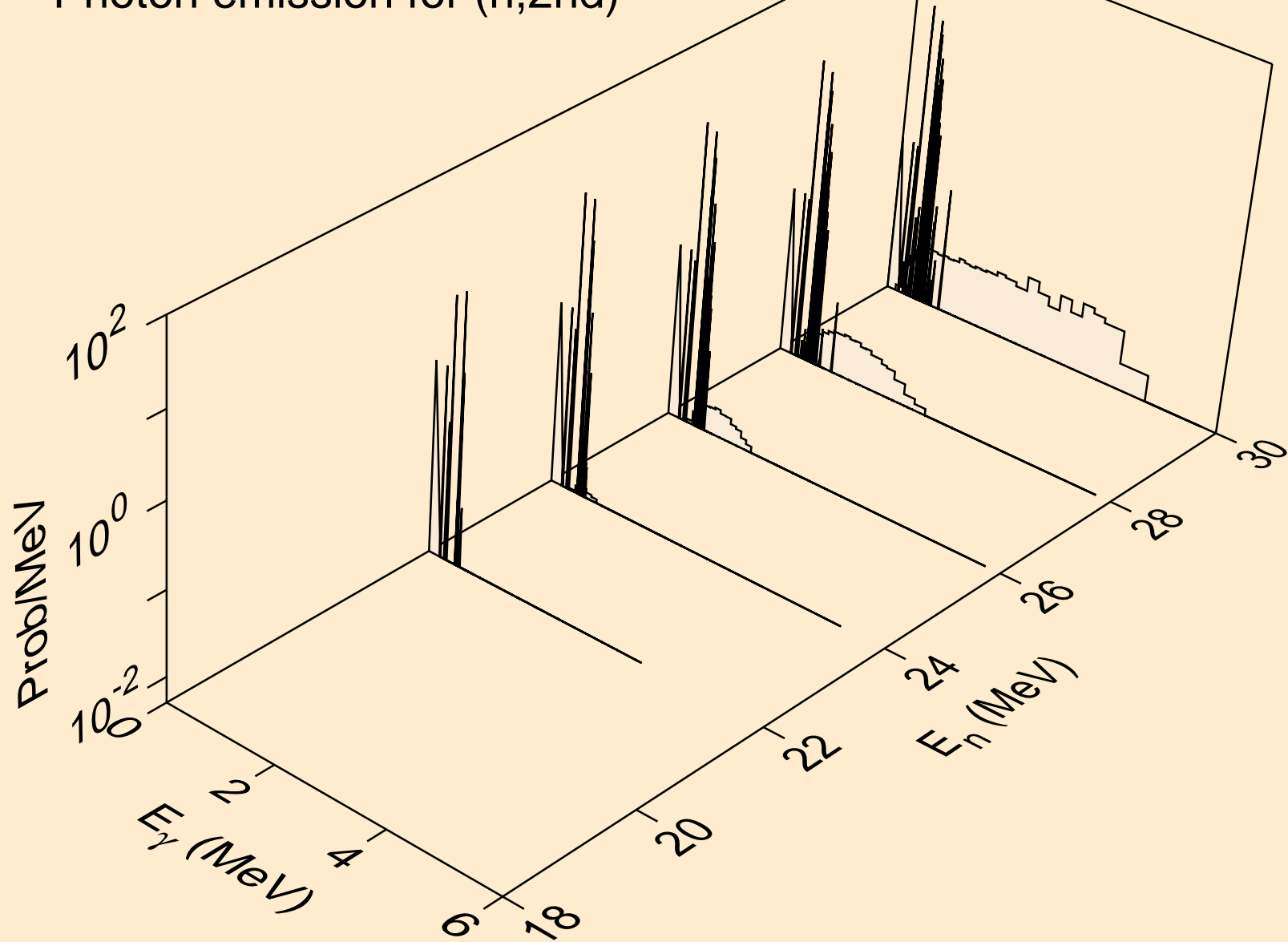

LU160 NEUTRON ACER TENDL-2024 LIBRARY; T=293.6K  
Photon emission for (n,2n)

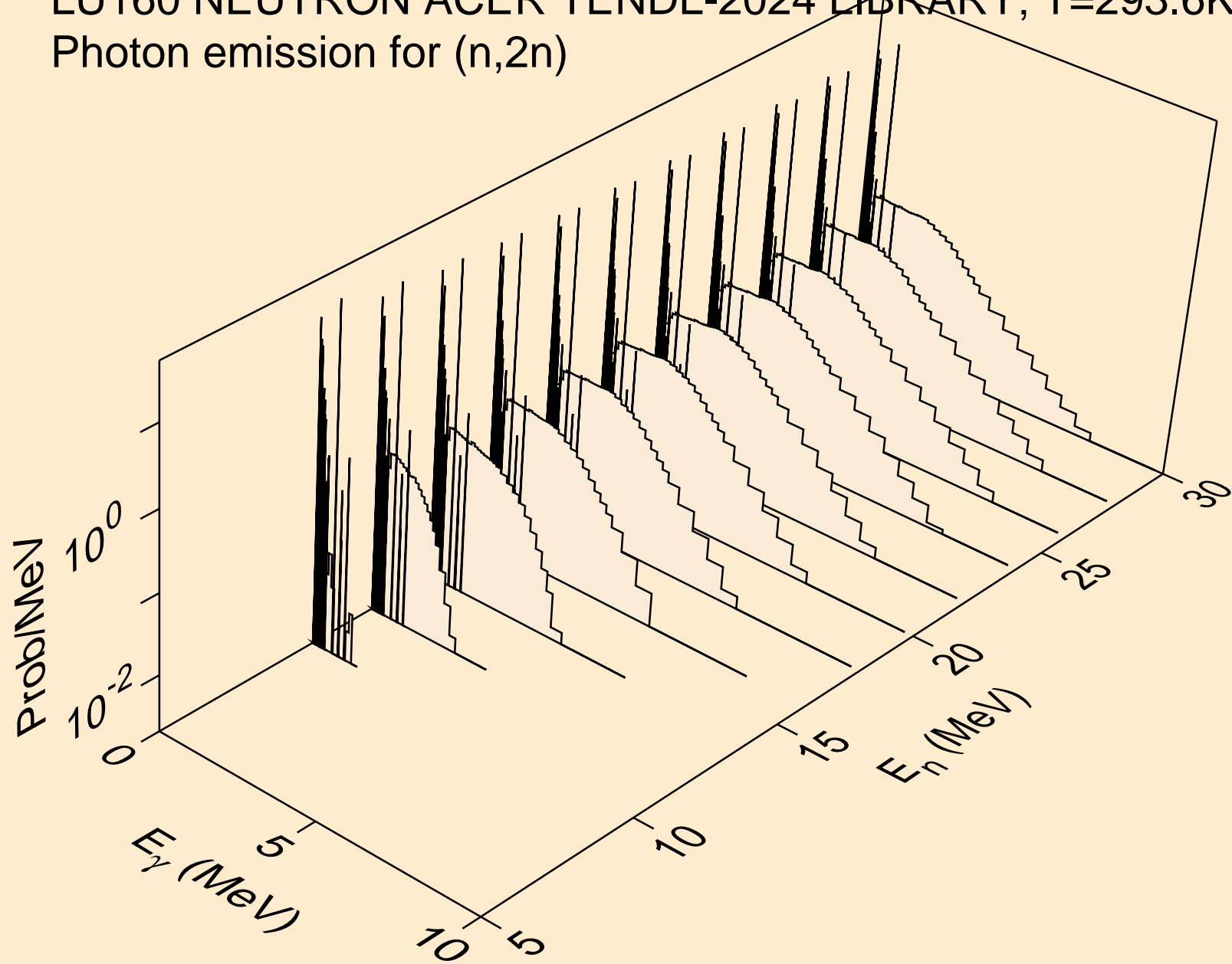

LU160 NEUTRON ACER TENDL-2024 LIBRARY; T=293.6K  
Photon emission for (n,3n)

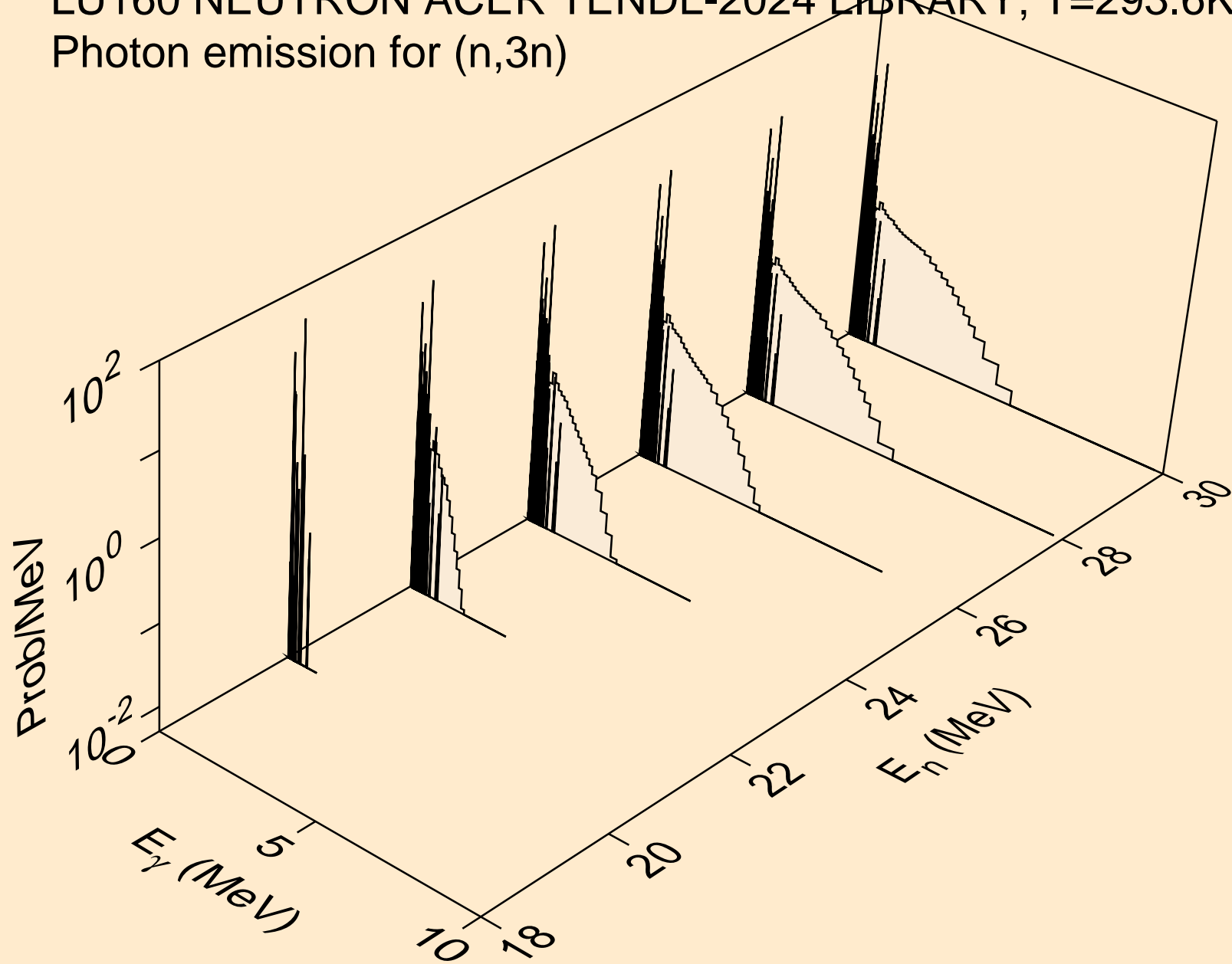

LU160 NEUTRON ACER TENDL-2024 LIBRARY; T=293.6K  
Photon emission for (n,n\*)a

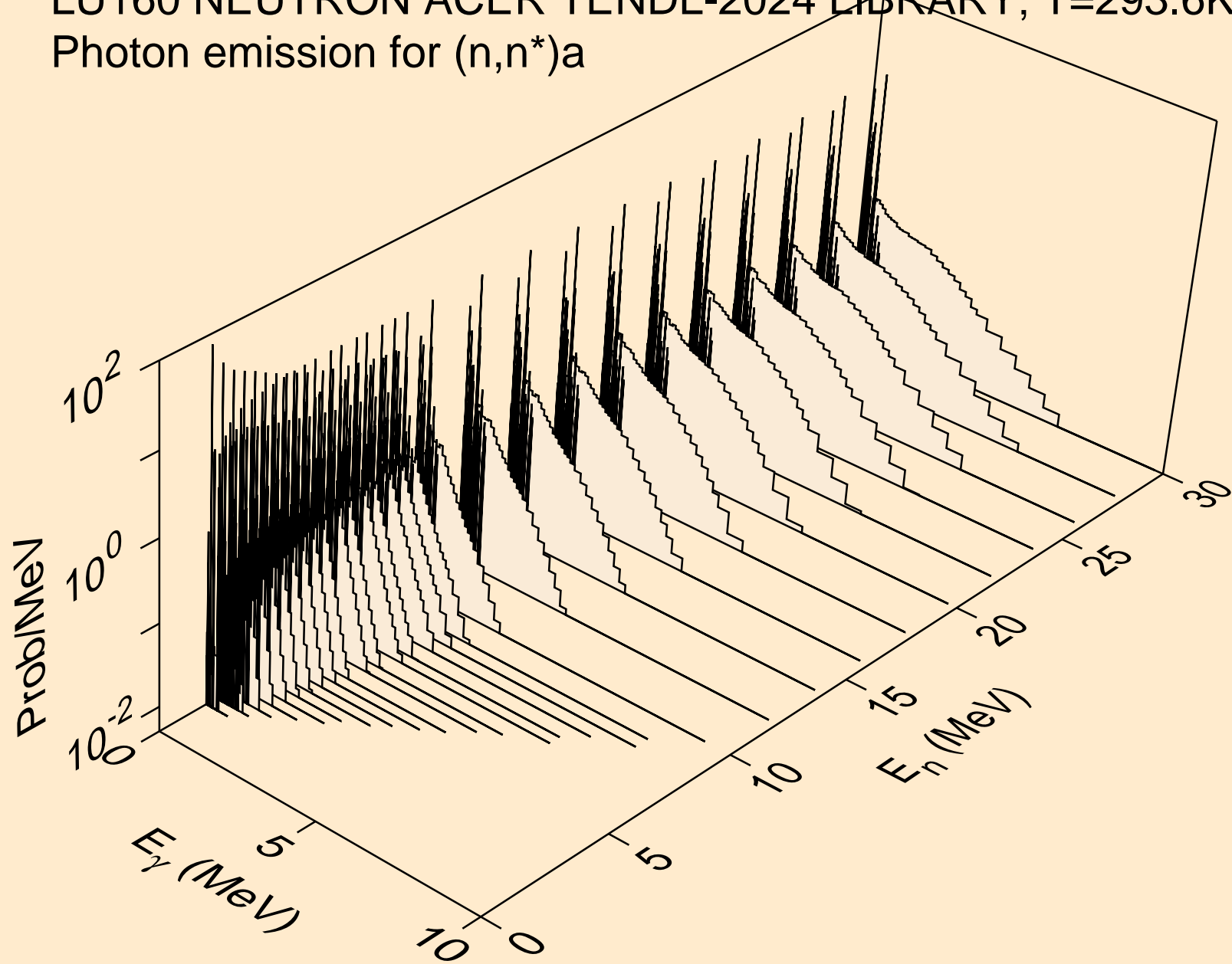

LU160 NEUTRON ACER TENDL-2024 LIBRARY; T=293.6K  
Photon emission for (n,n\*)3a

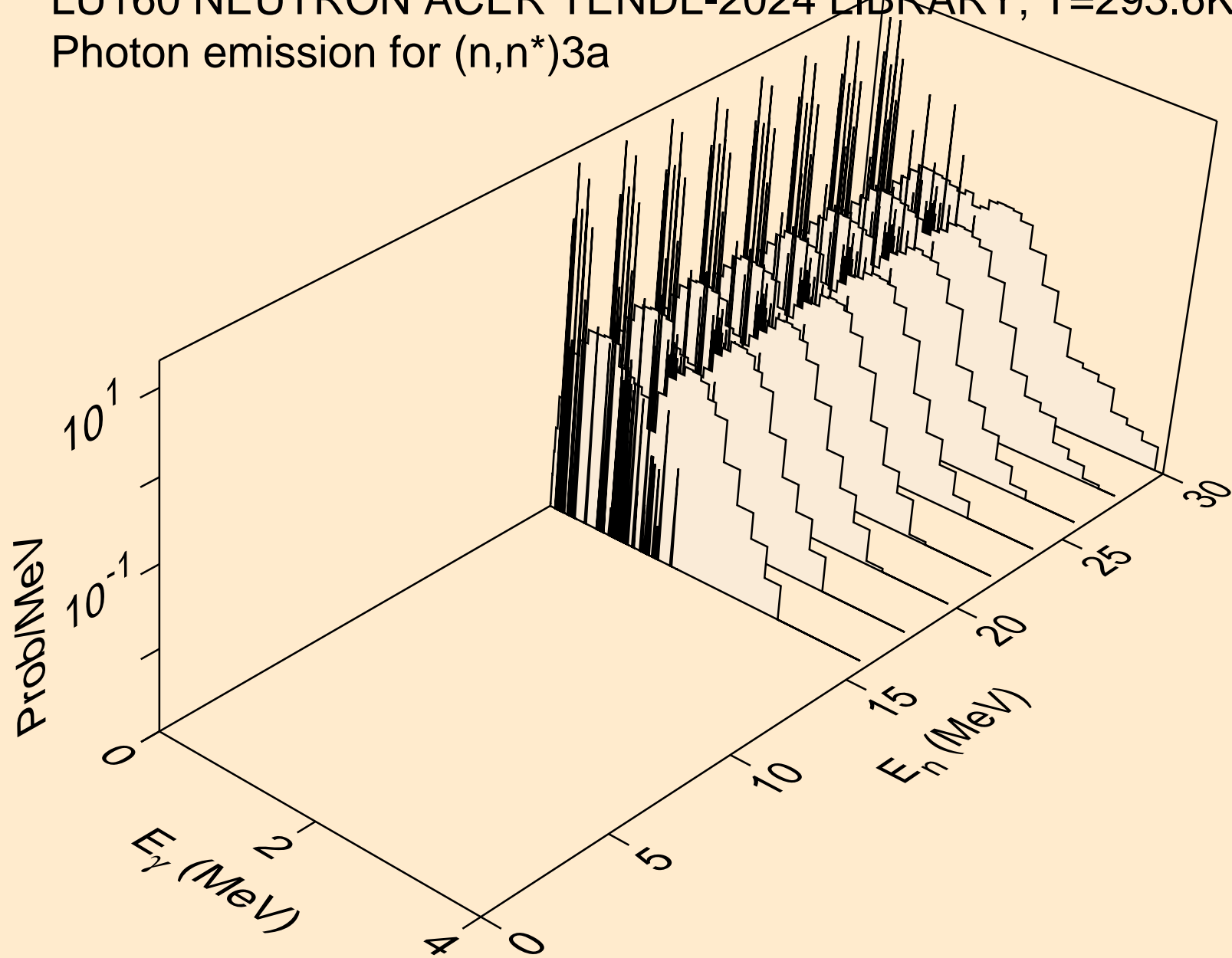

LU160 NEUTRON ACER TENDL-2024 LIBRARY; T=293.6K  
Photon emission for (n,2n)a

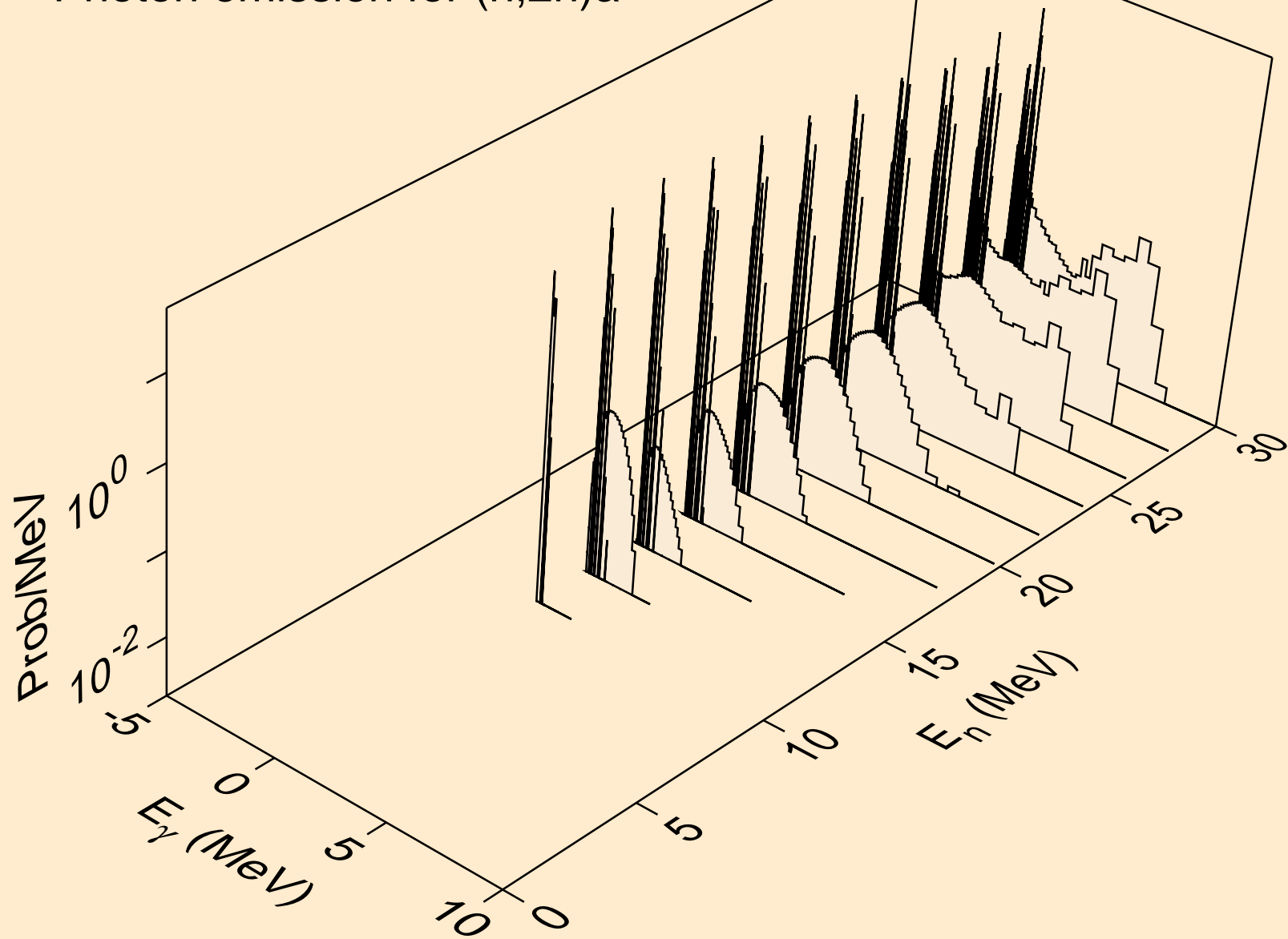

LU160 NEUTRON ACER TENDL-2024 LIBRARY; T=293.6K  
Photon emission for (n,3n)a

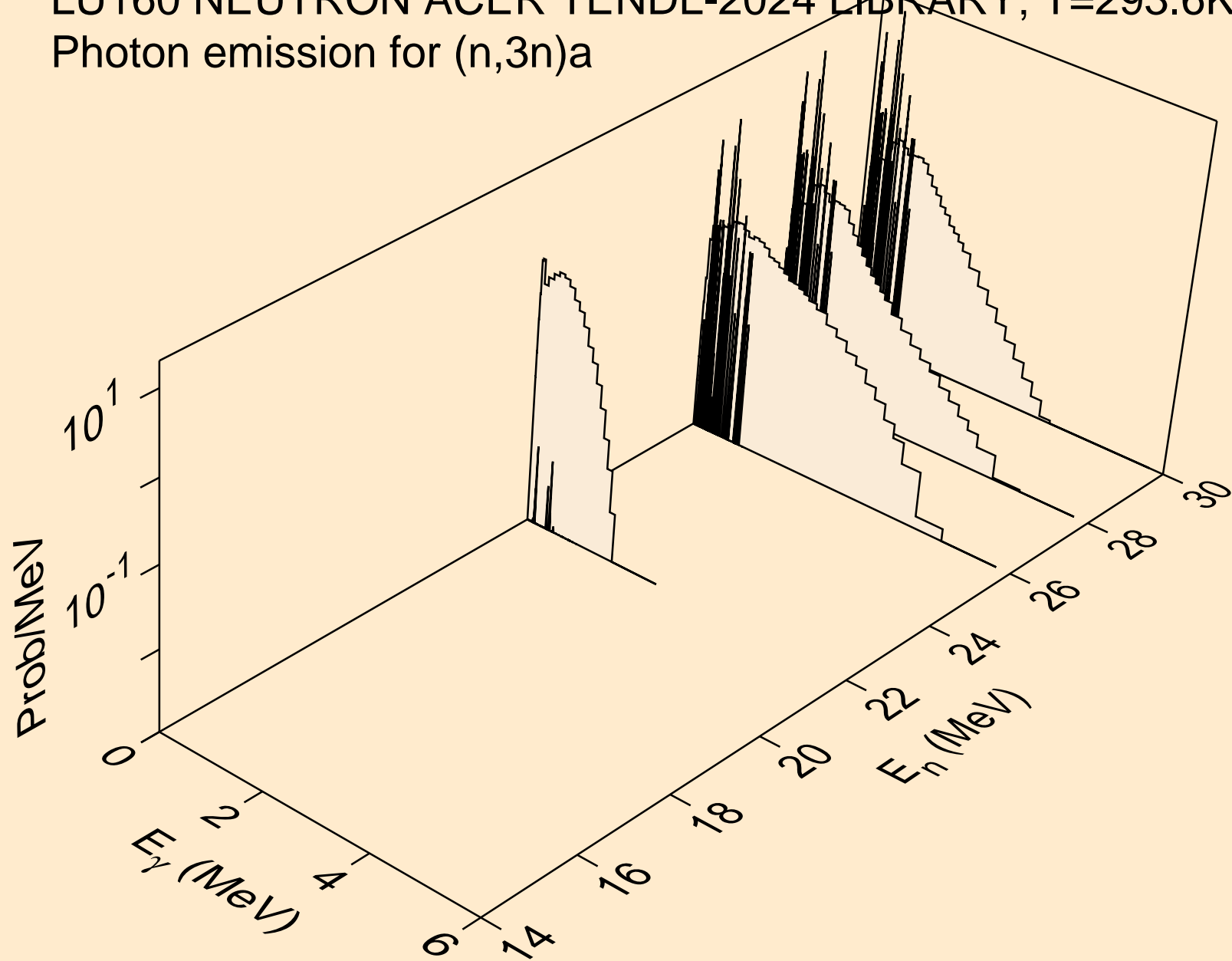

LU160 NEUTRON ACER TENDL-2024 LIBRARY; T=293.6K  
Photon emission for (n,n\*)p

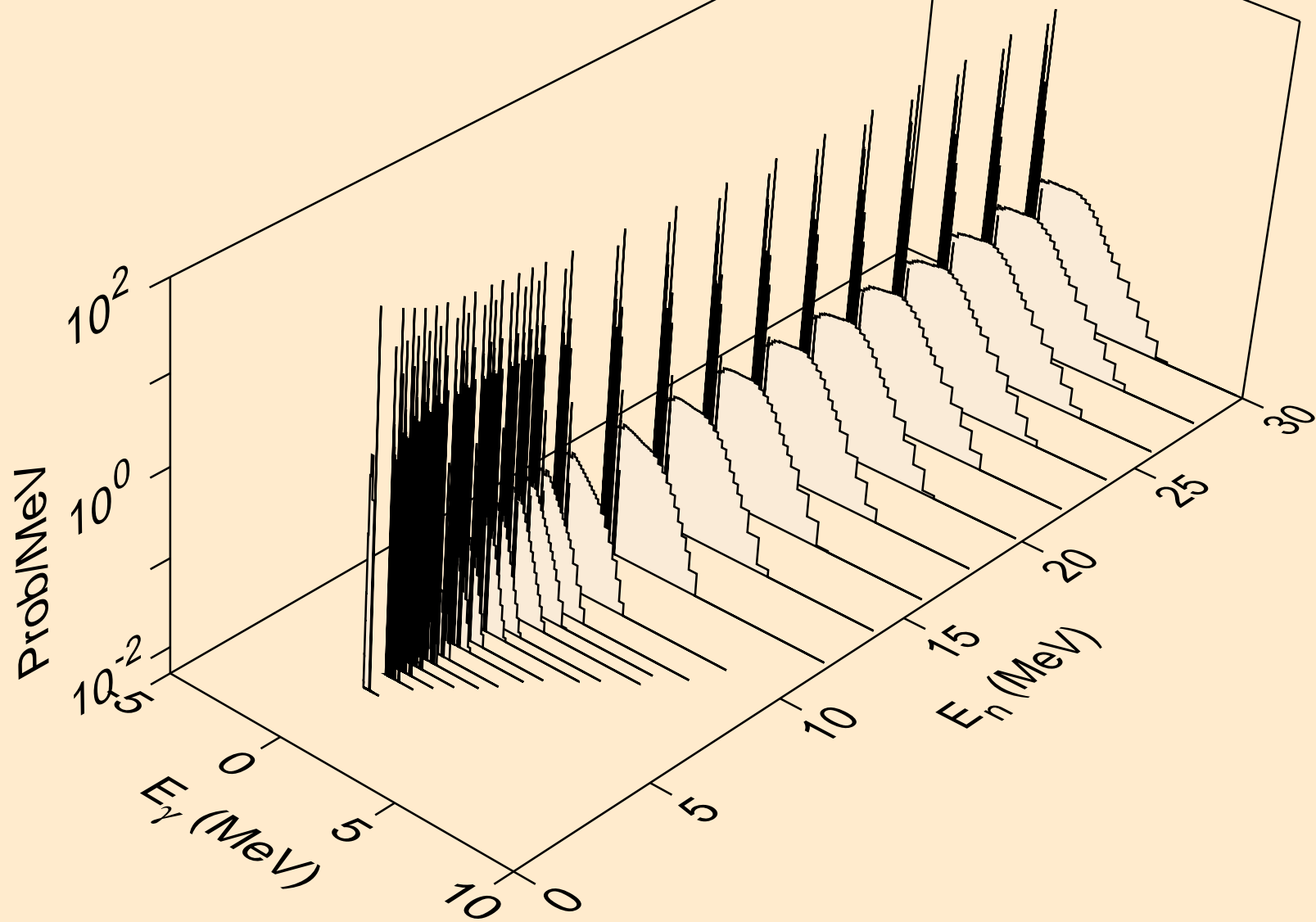

LU160 NEUTRON ACER TENDL-2024 LIBRARY; T=293.6K  
Photon emission for (n,n\*)2a

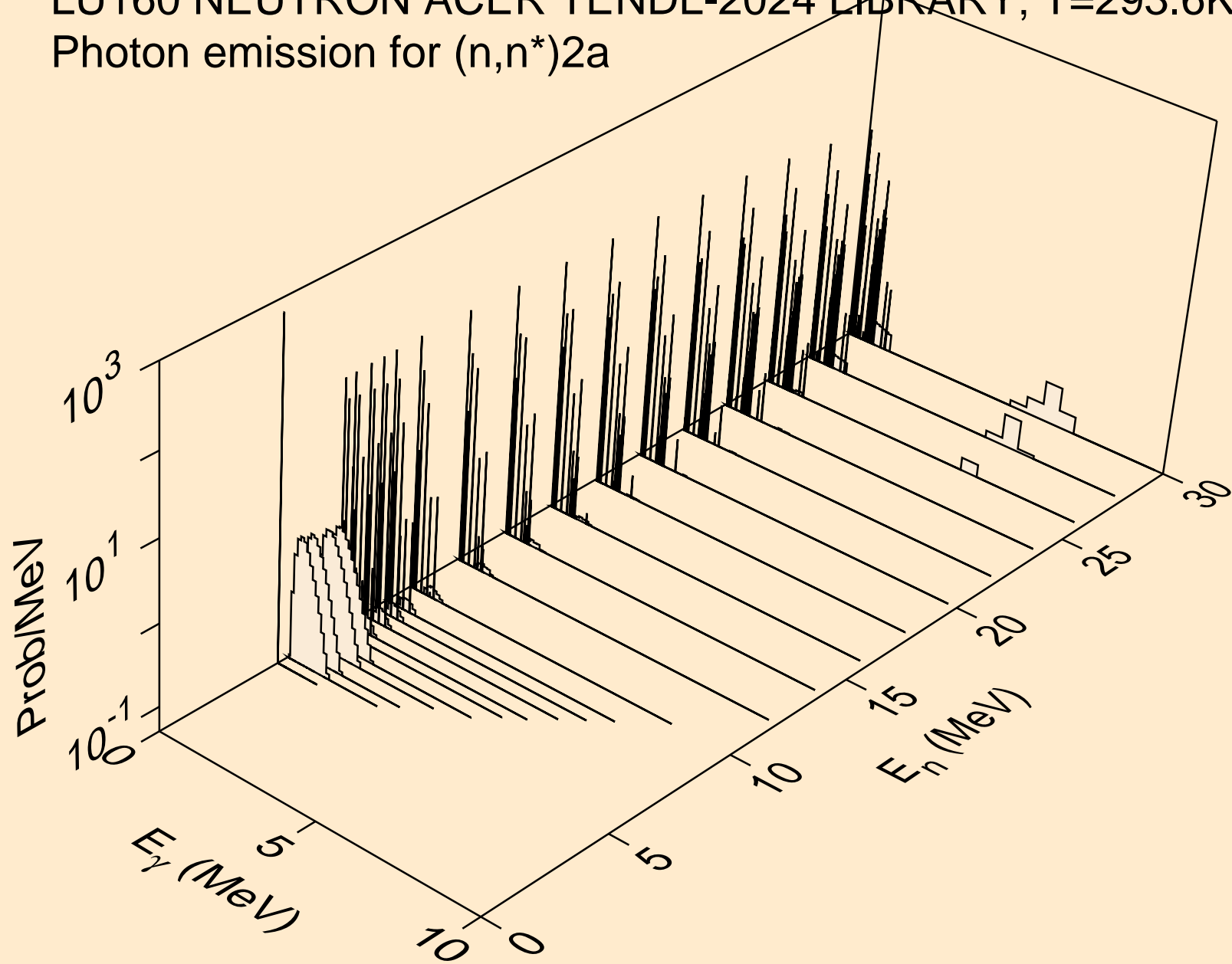

LU160 NEUTRON ACER TENDL-2024 LIBRARY; T=293.6K  
Photon emission for (n,2n)2a

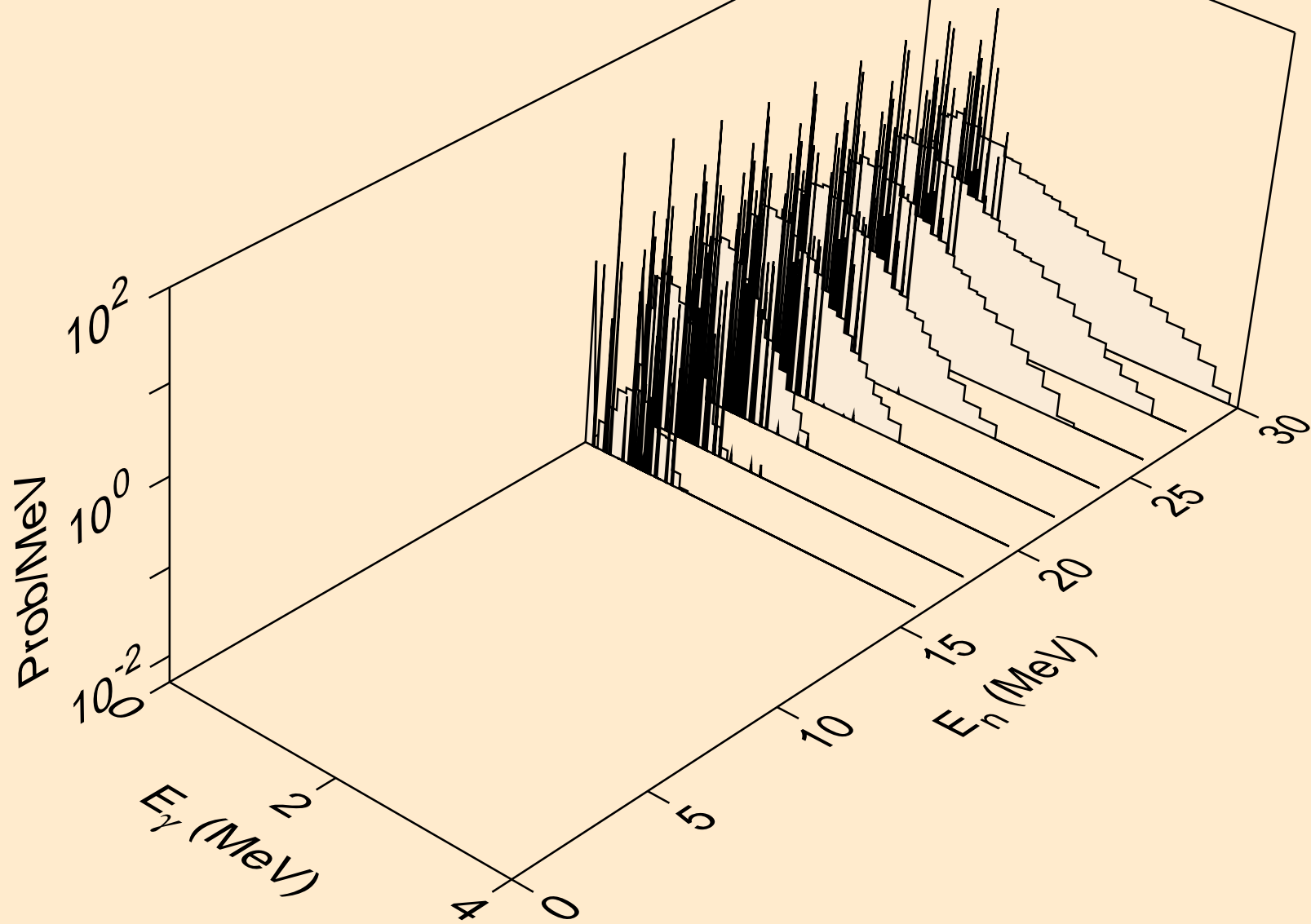

LU160 NEUTRON ACER TENDL-2024 LIBRARY; T=293.6K  
Photon emission for (n,n\*)d

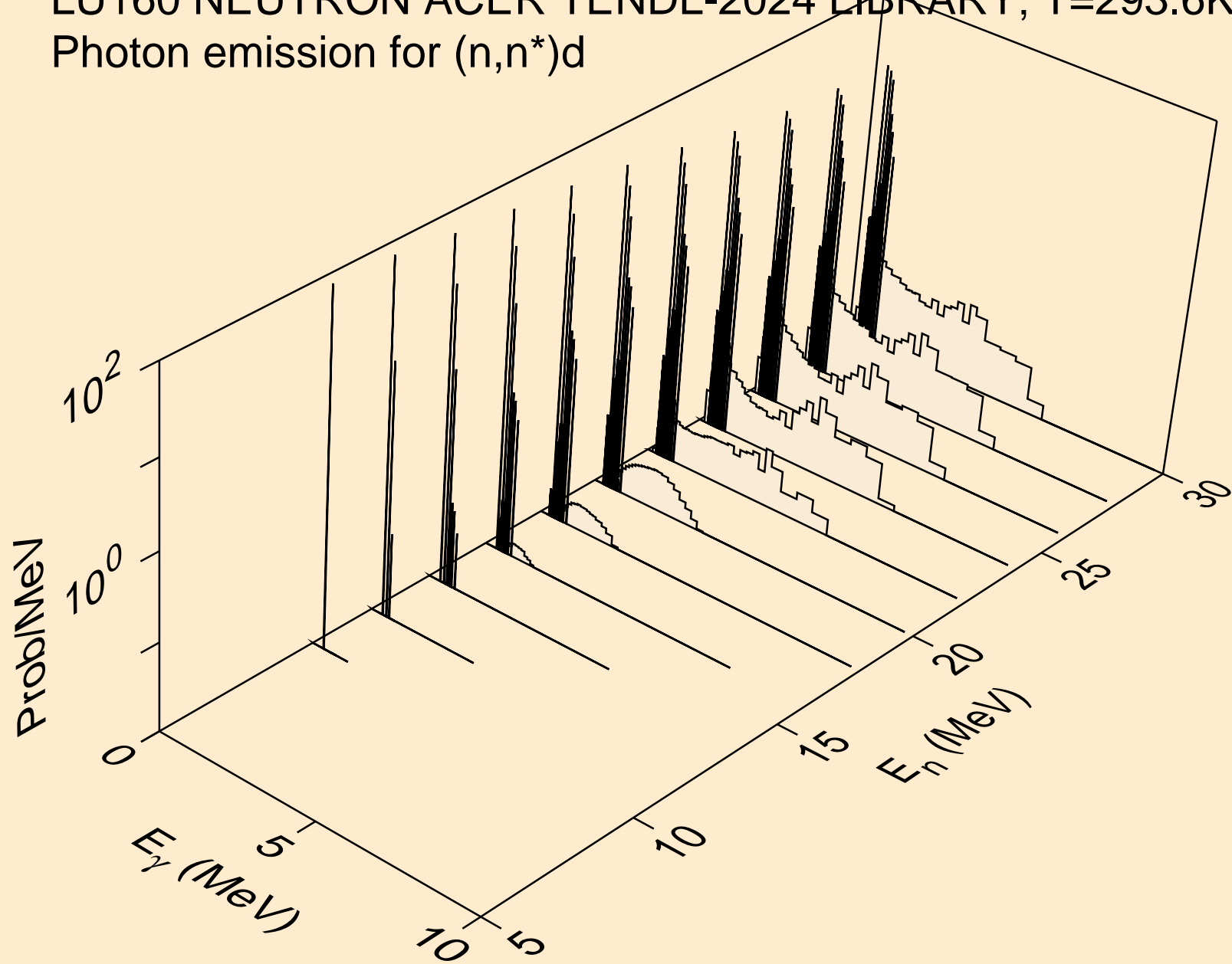

LU160 NEUTRON ACER TENDL-2024 LIBRARY; T=293.6K  
Photon emission for (n,n\*)t

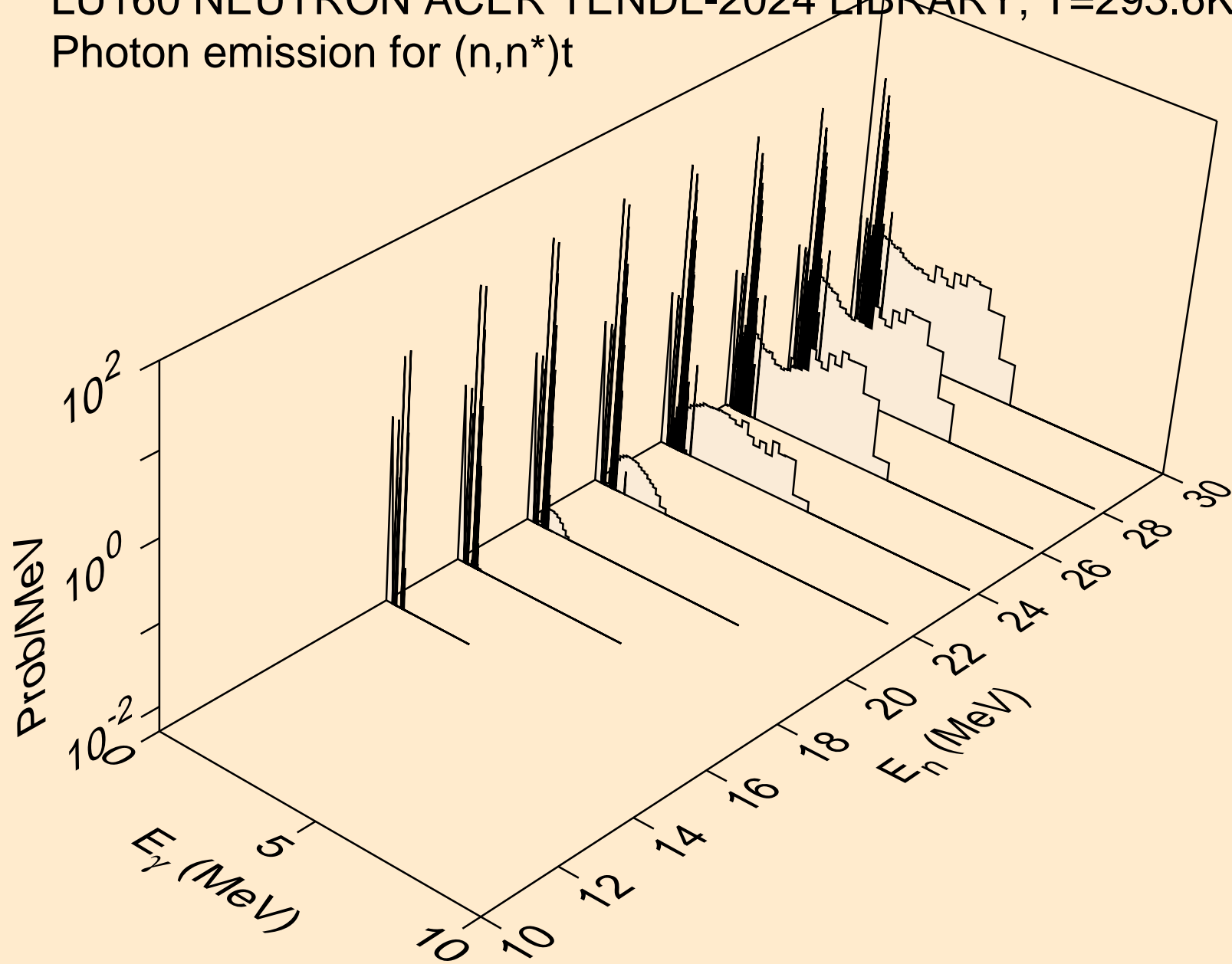

LU160 NEUTRON ACER TENDL-2024 LIBRARY; T=293.6K  
Photon emission for (n,n\*)he3

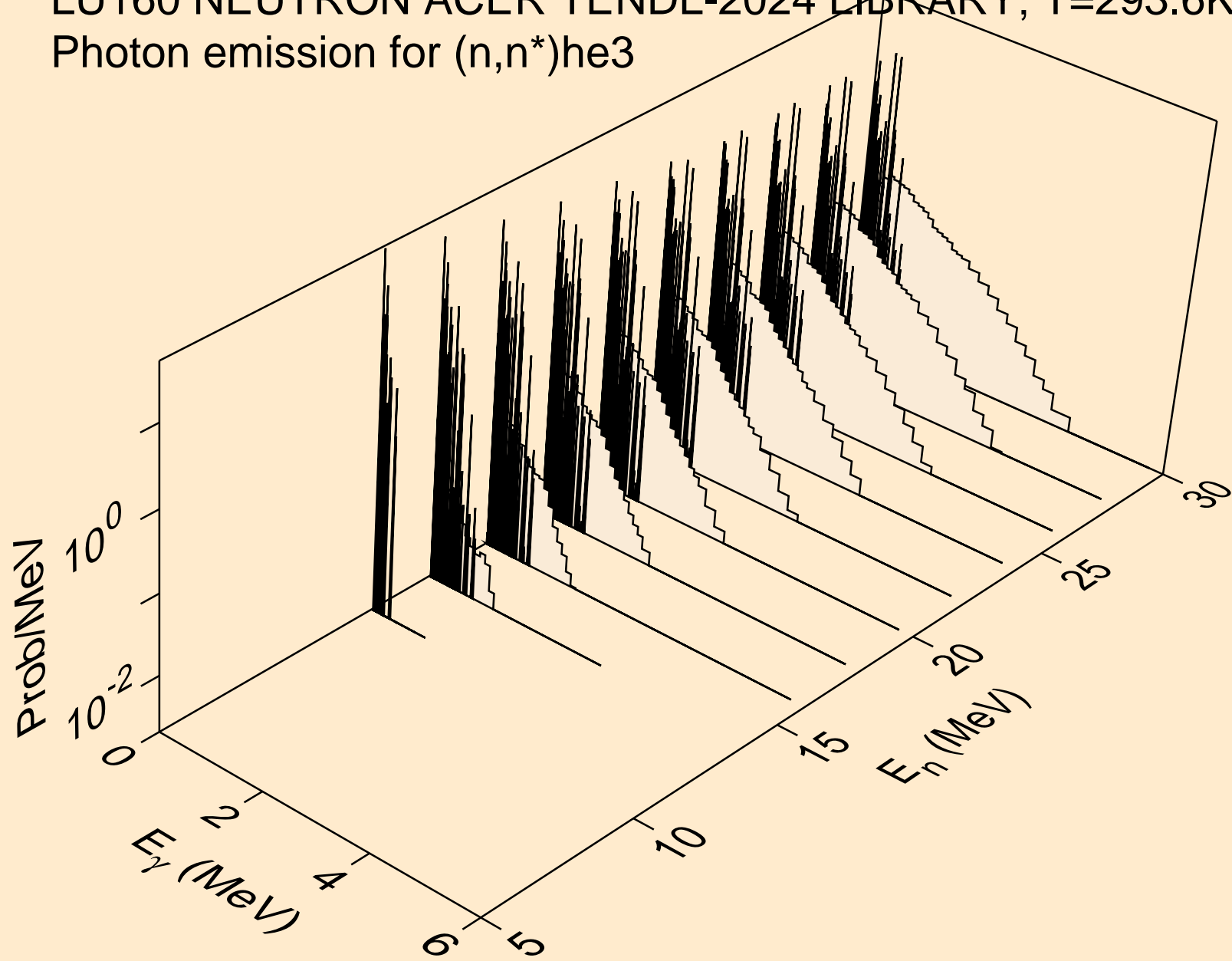

LU160 NEUTRON ACER TENDL-2024 LIBRARY; T=293.6K  
Photon emission for (n,n\*)d2a

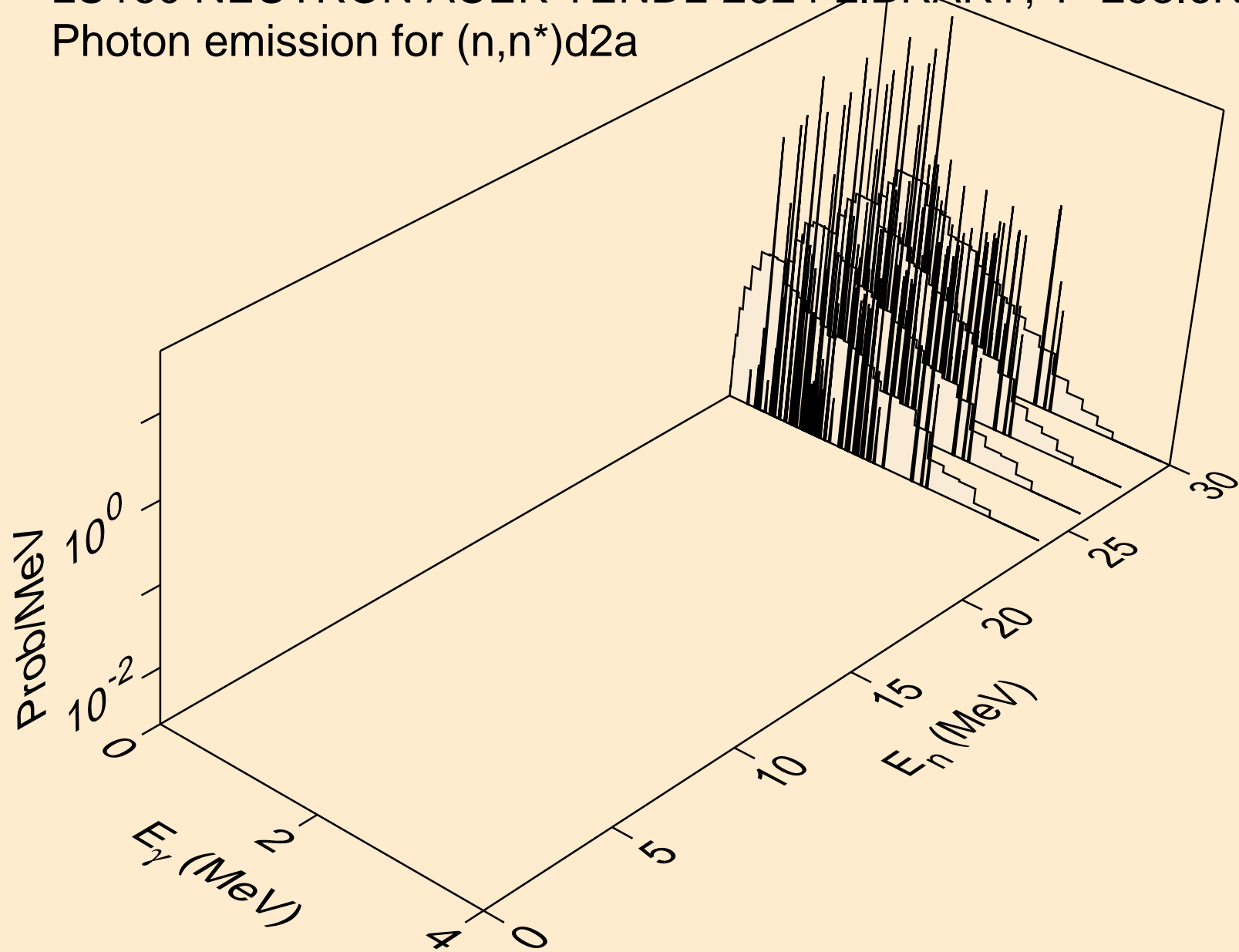

LU160 NEUTRON ACER TENDL-2024 LIBRARY; T=293.6K  
Photon emission for (n,4n)

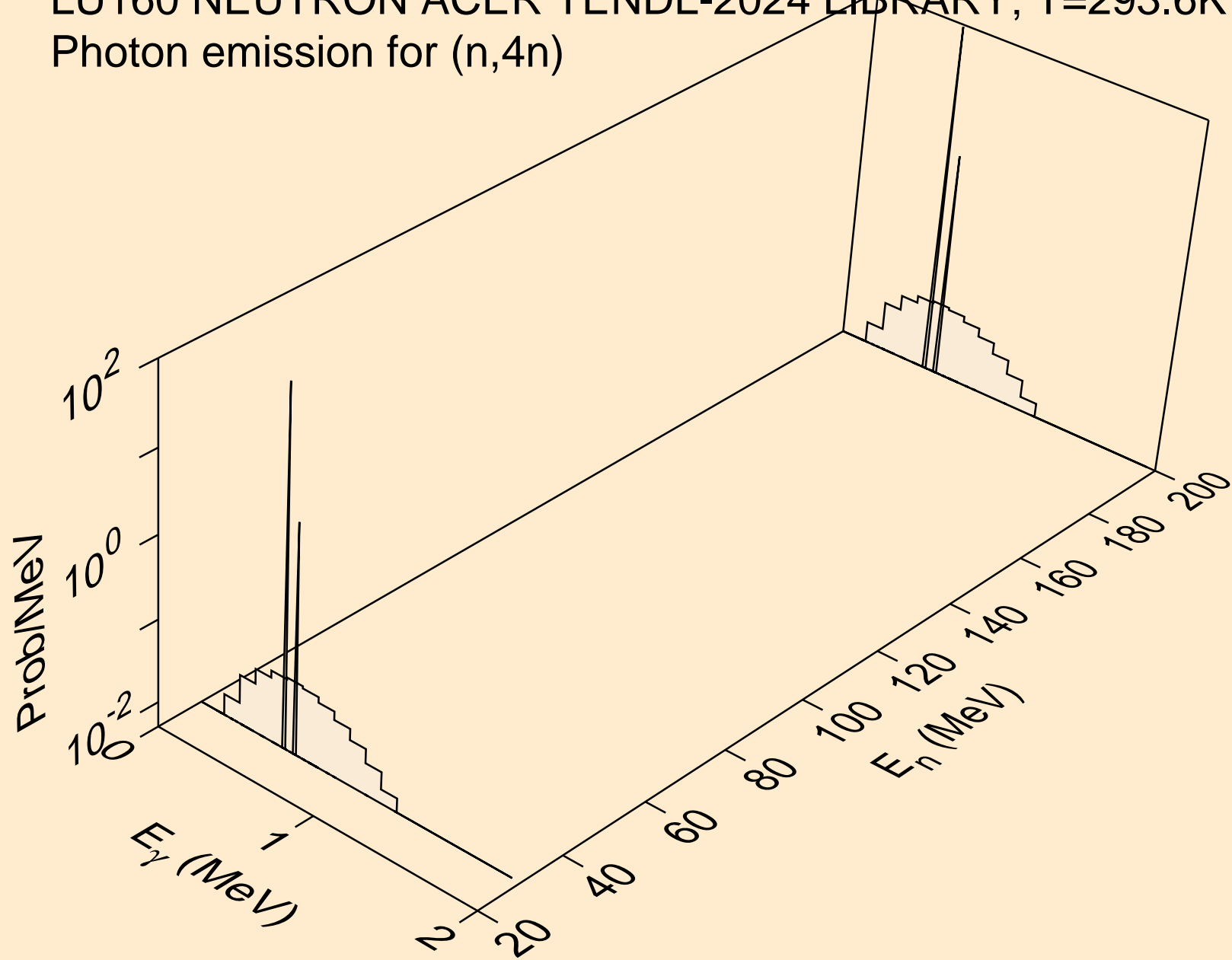

LU160 NEUTRON ACER TENDL-2024 LIBRARY; T=293.6K  
Photon emission for (n,2np)

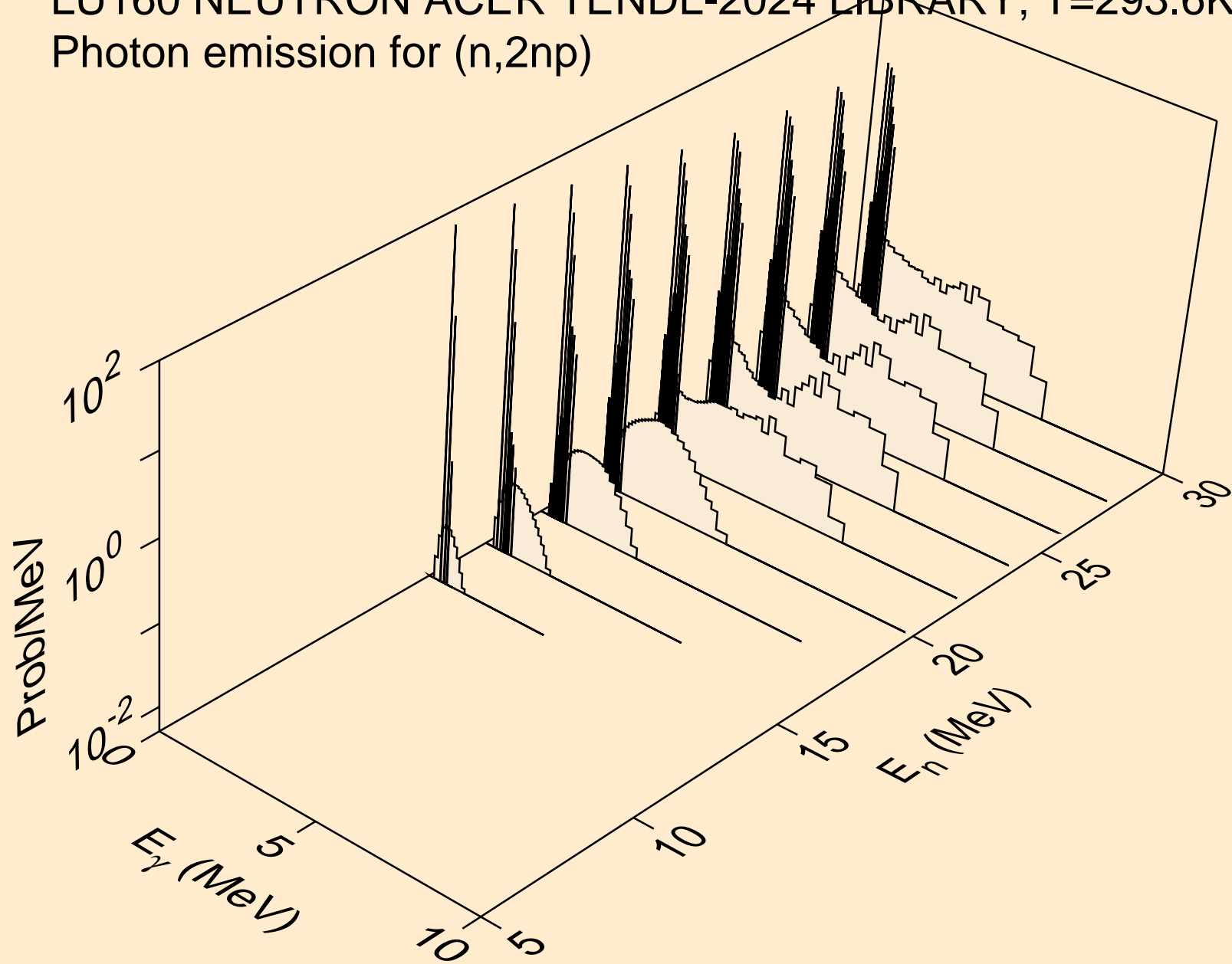

LU160 NEUTRON ACER TENDL-2024 LIBRARY; T=293.6K  
Photon emission for (n,3np)

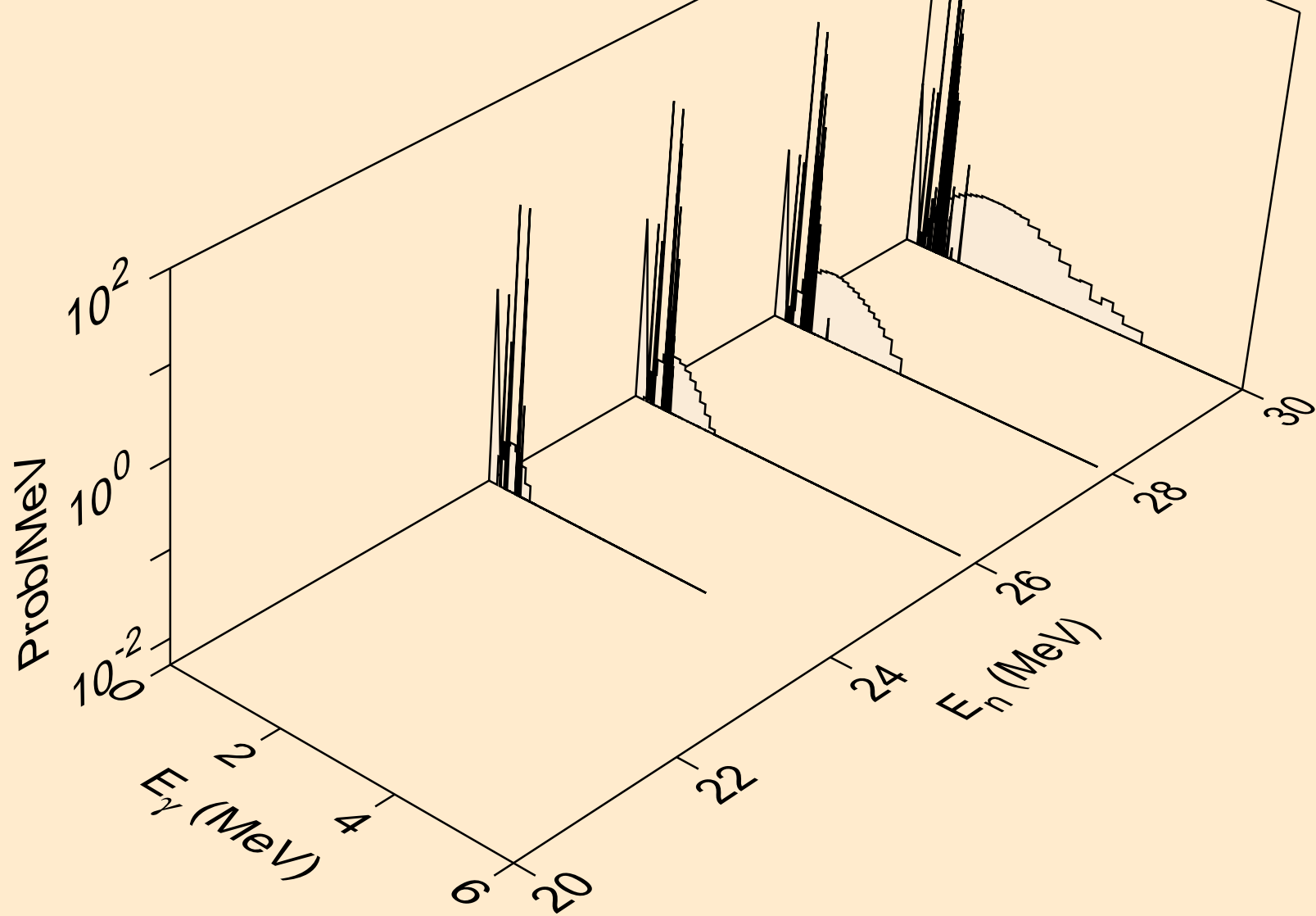

LU160 NEUTRON ACER TENDL-2024 LIBRARY; T=293.6K  
Photon emission for (n,n2p)

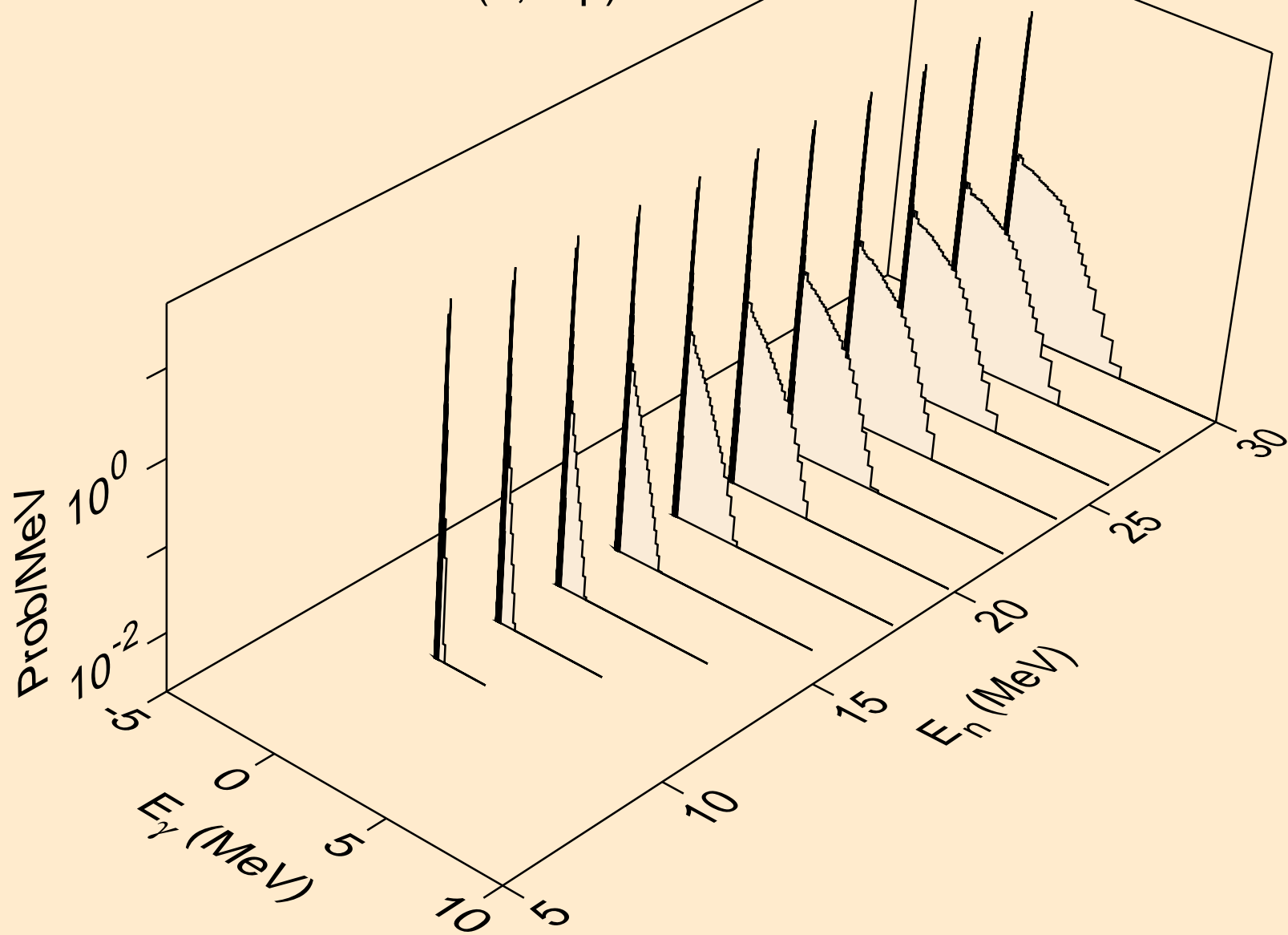

LU160 NEUTRON ACER TENDL-2024 LIBRARY; T=293.6K  
Photon emission for (n,npa)

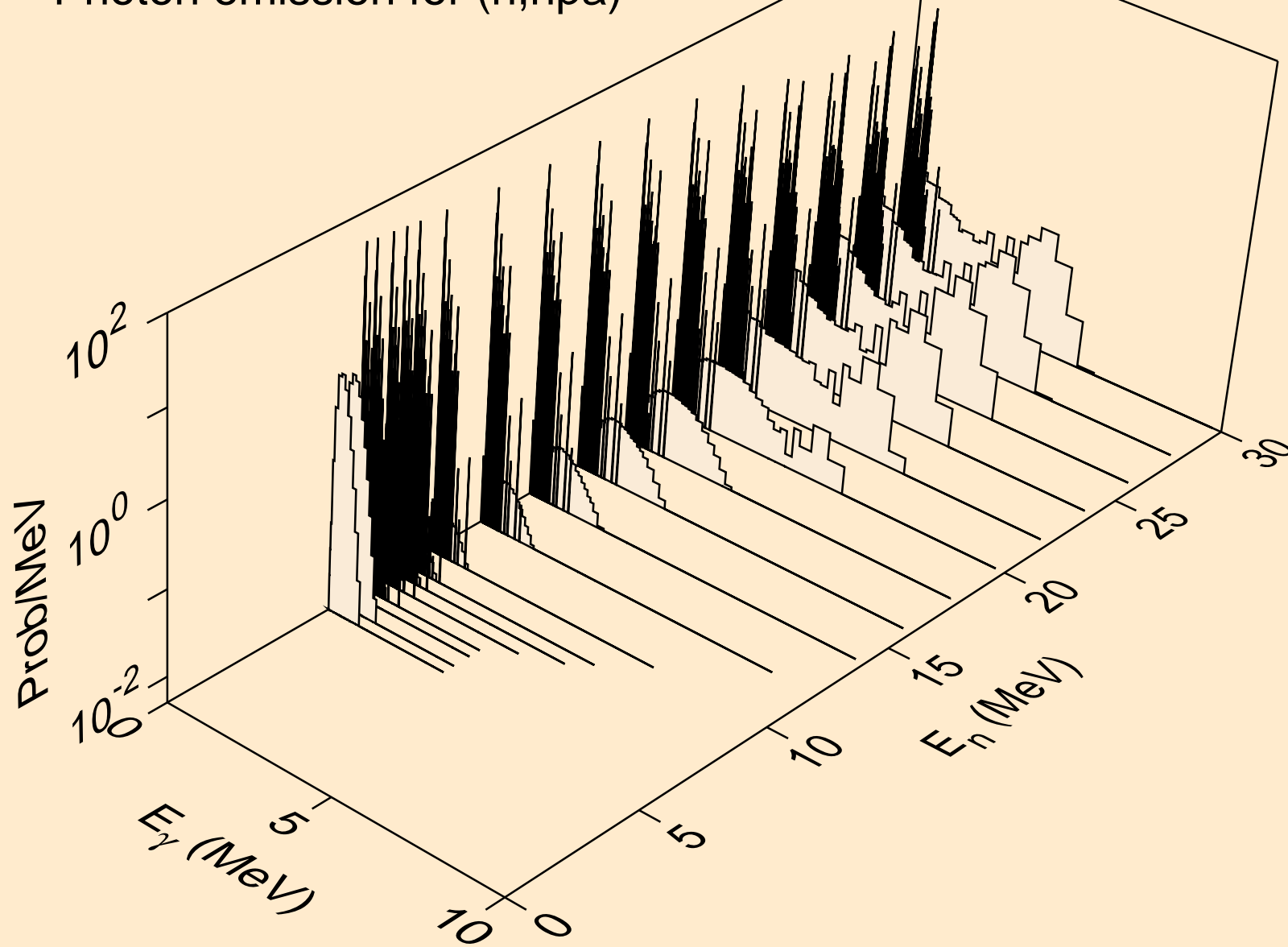

LU160 NEUTRON ACER TENDL-2024 LIBRARY; T=293.6K  
Photon emission for (n,n\*c)

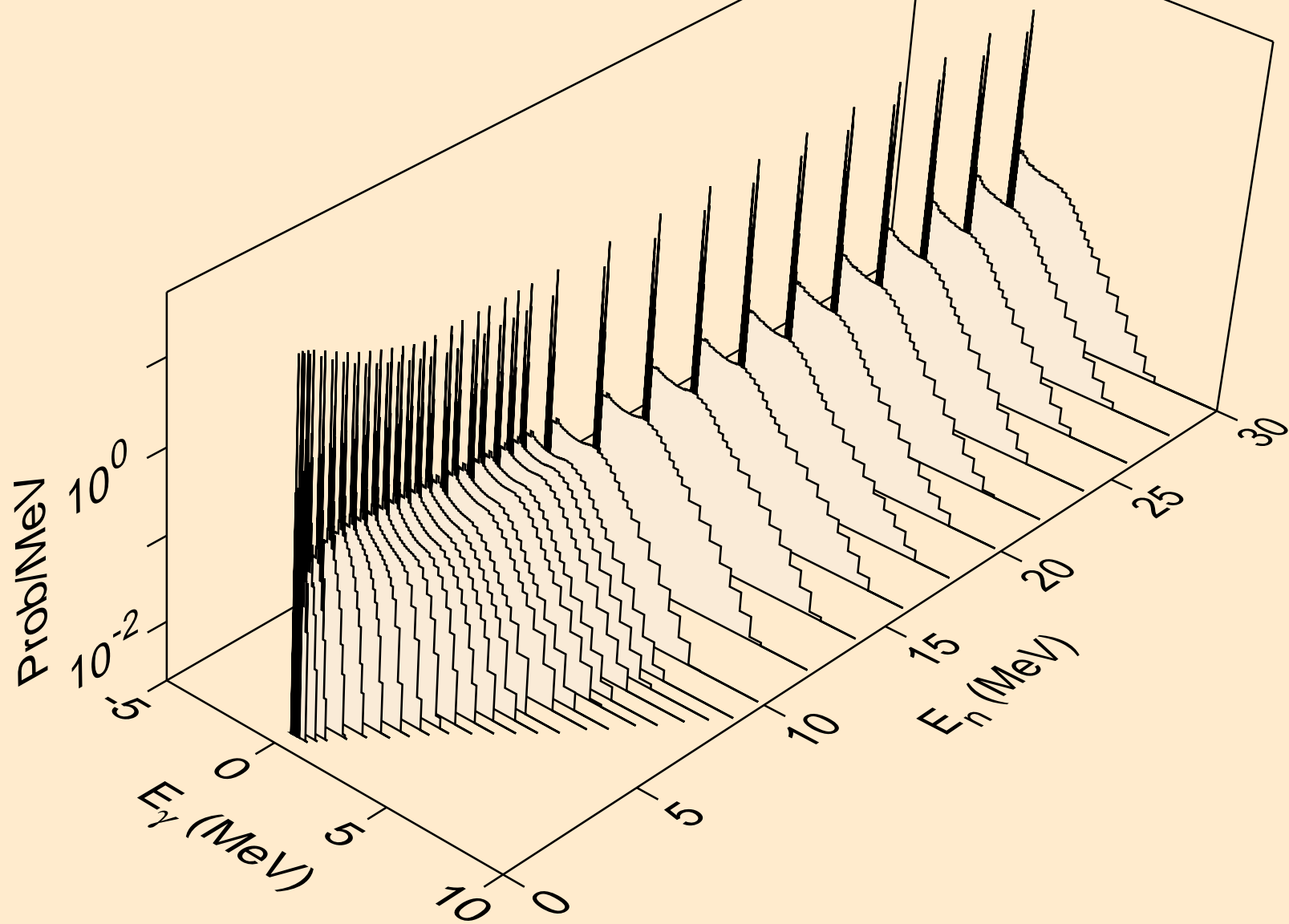

LU160 NEUTRON ACER TENDL-2024 LIBRARY; T=293.6K  
Photon emission for (n,gma)

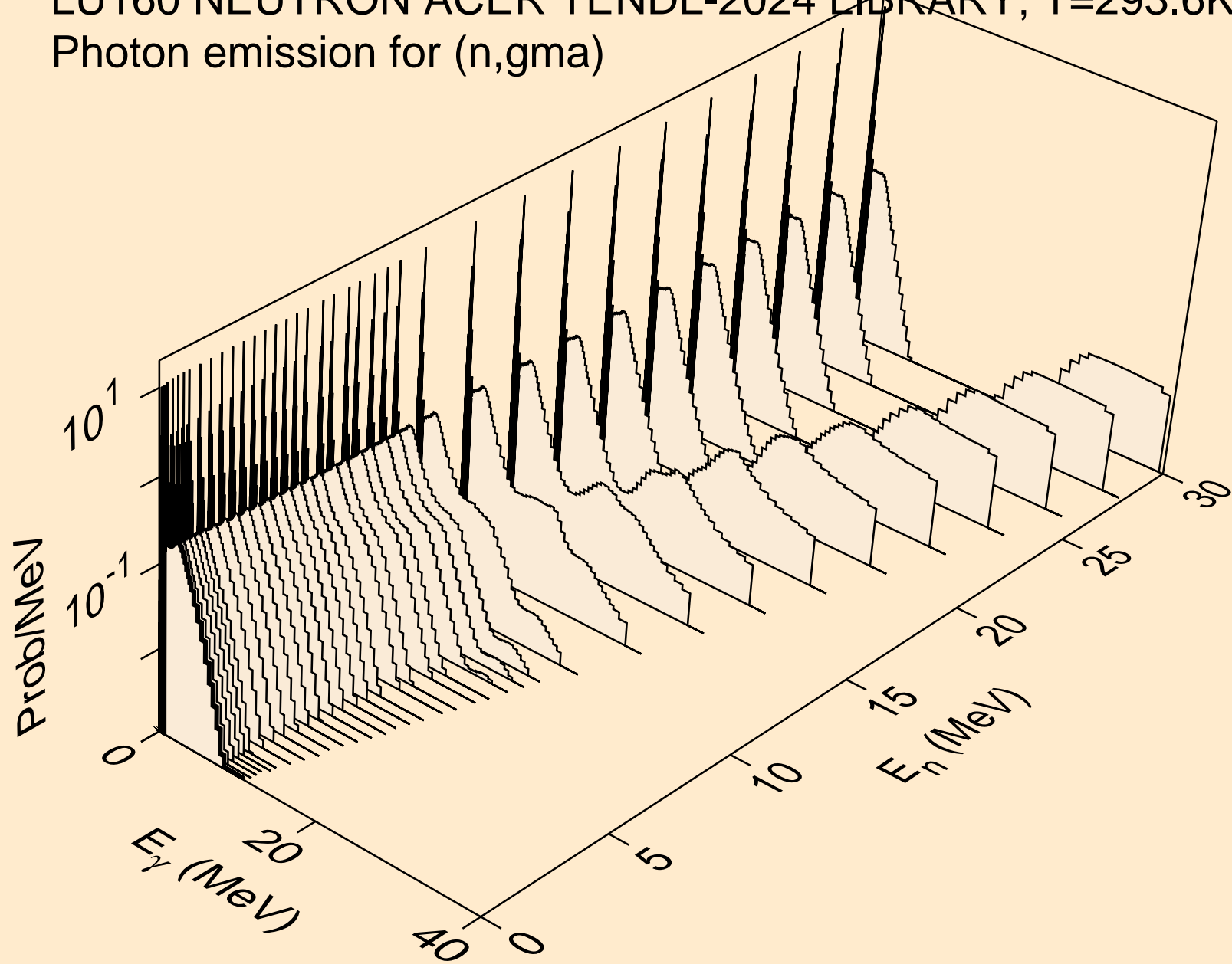

LU160 NEUTRON ACER TENDL-2024 LIBRARY; T=293.6K  
Photon emission for (n,p)

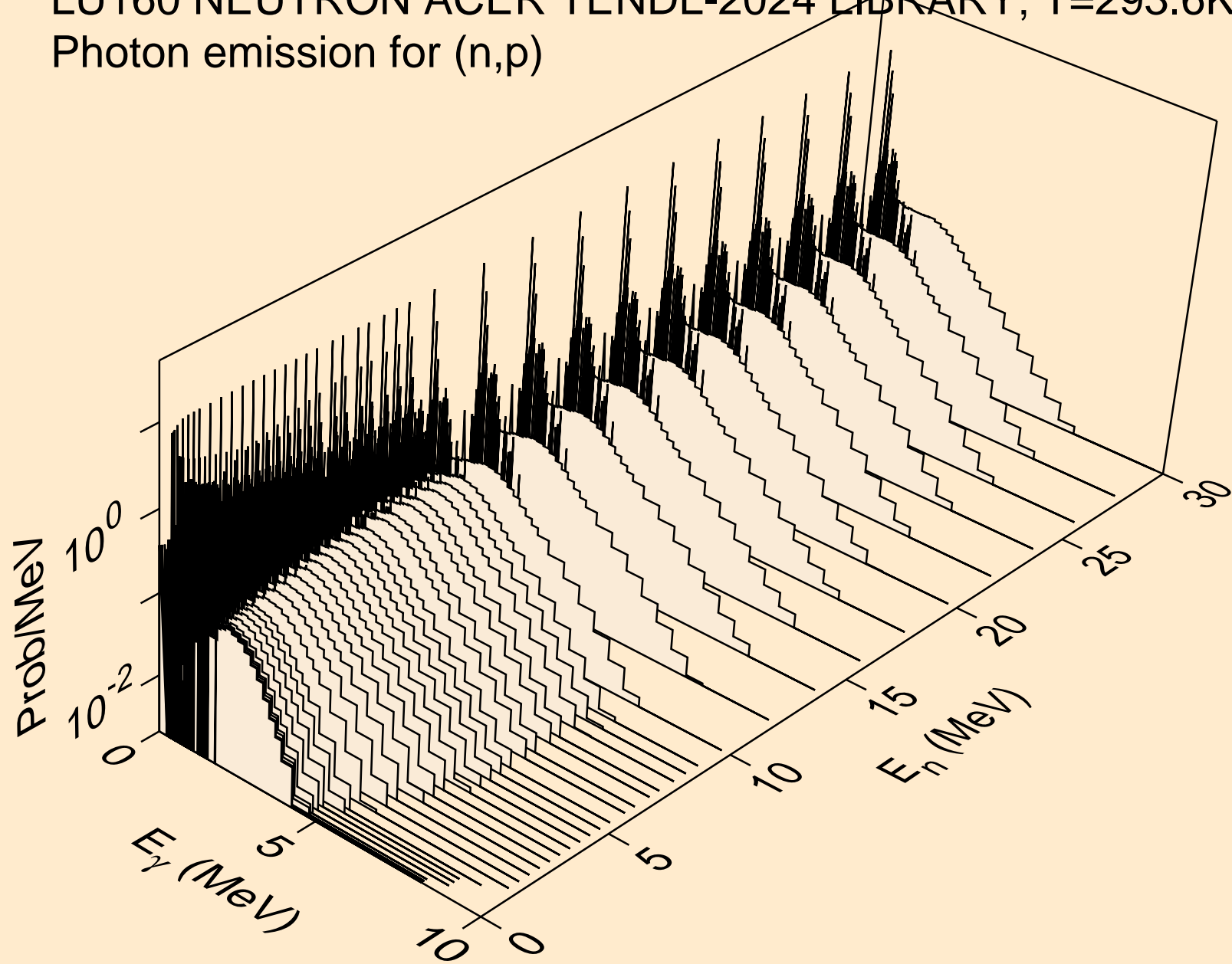

LU160 NEUTRON ACER TENDL-2024 LIBRARY; T=293.6K  
Photon emission for (n,d)

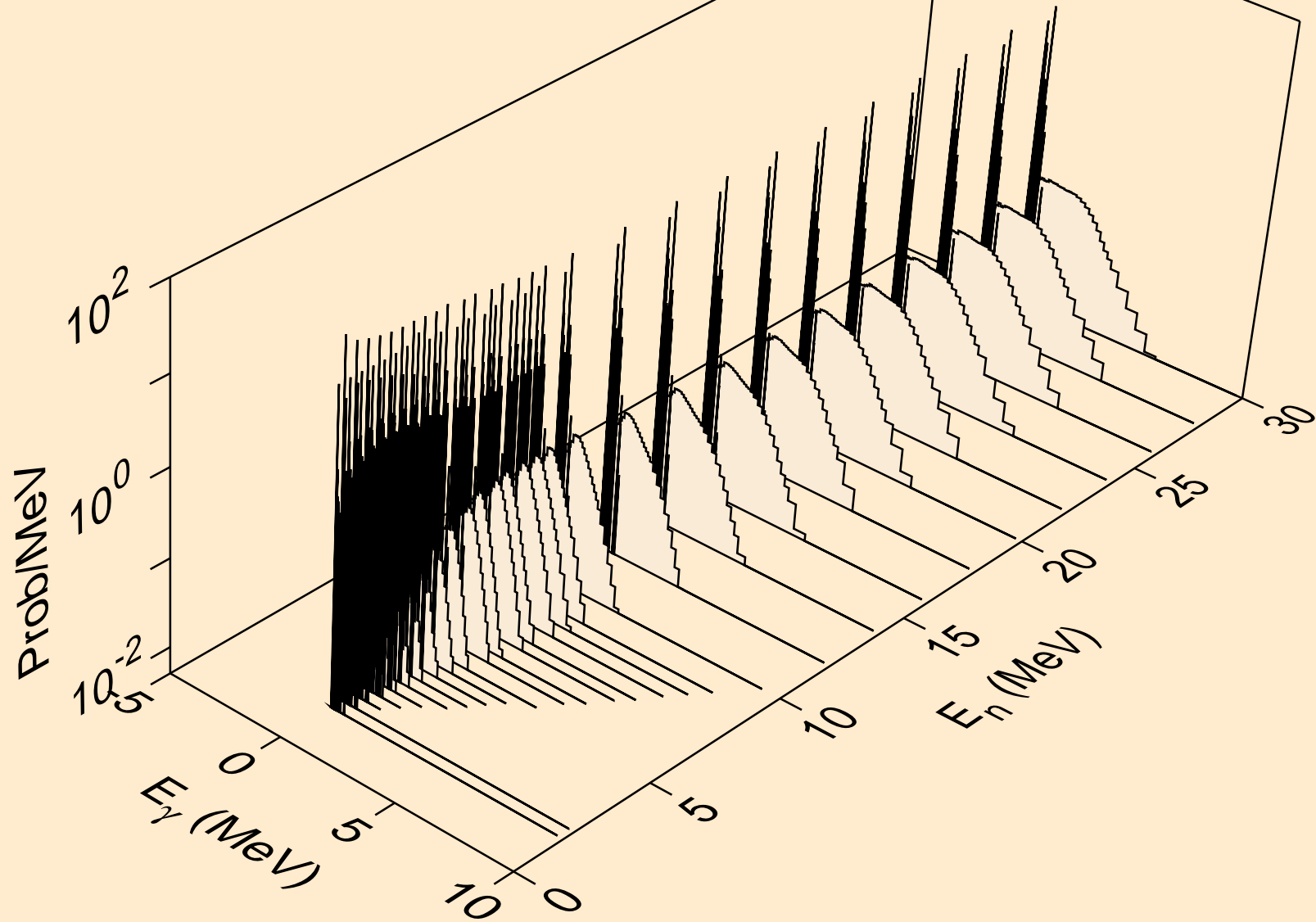

LU160 NEUTRON ACER TENDL-2024 LIBRARY; T=293.6K  
Photon emission for (n,t)

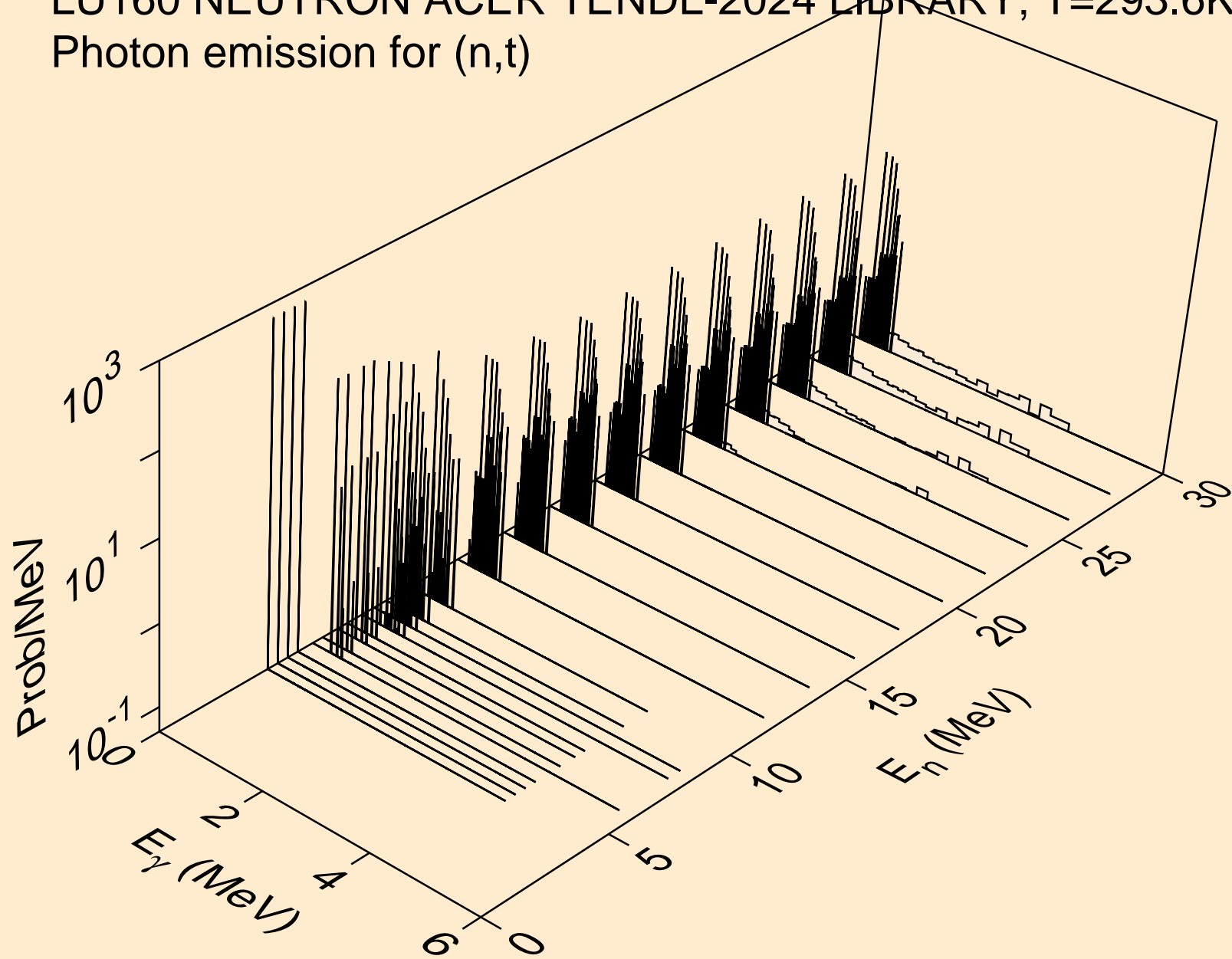

LU160 NEUTRON ACER TENDL-2024 LIBRARY; T=293.6K  
Photon emission for (n,he3)

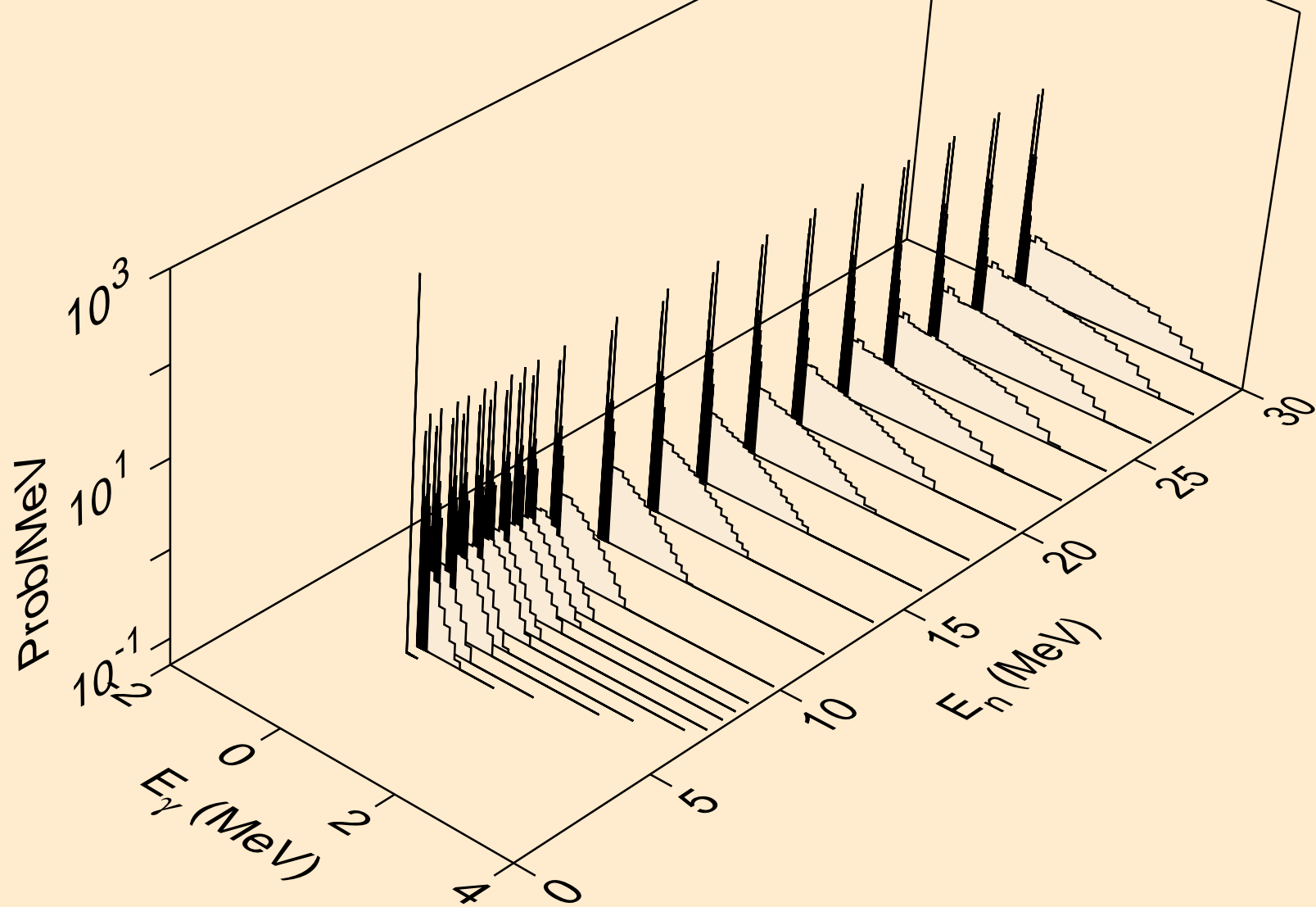

LU160 NEUTRON ACER TENDL-2024 LIBRARY; T=293.6K  
Photon emission for (n,a)

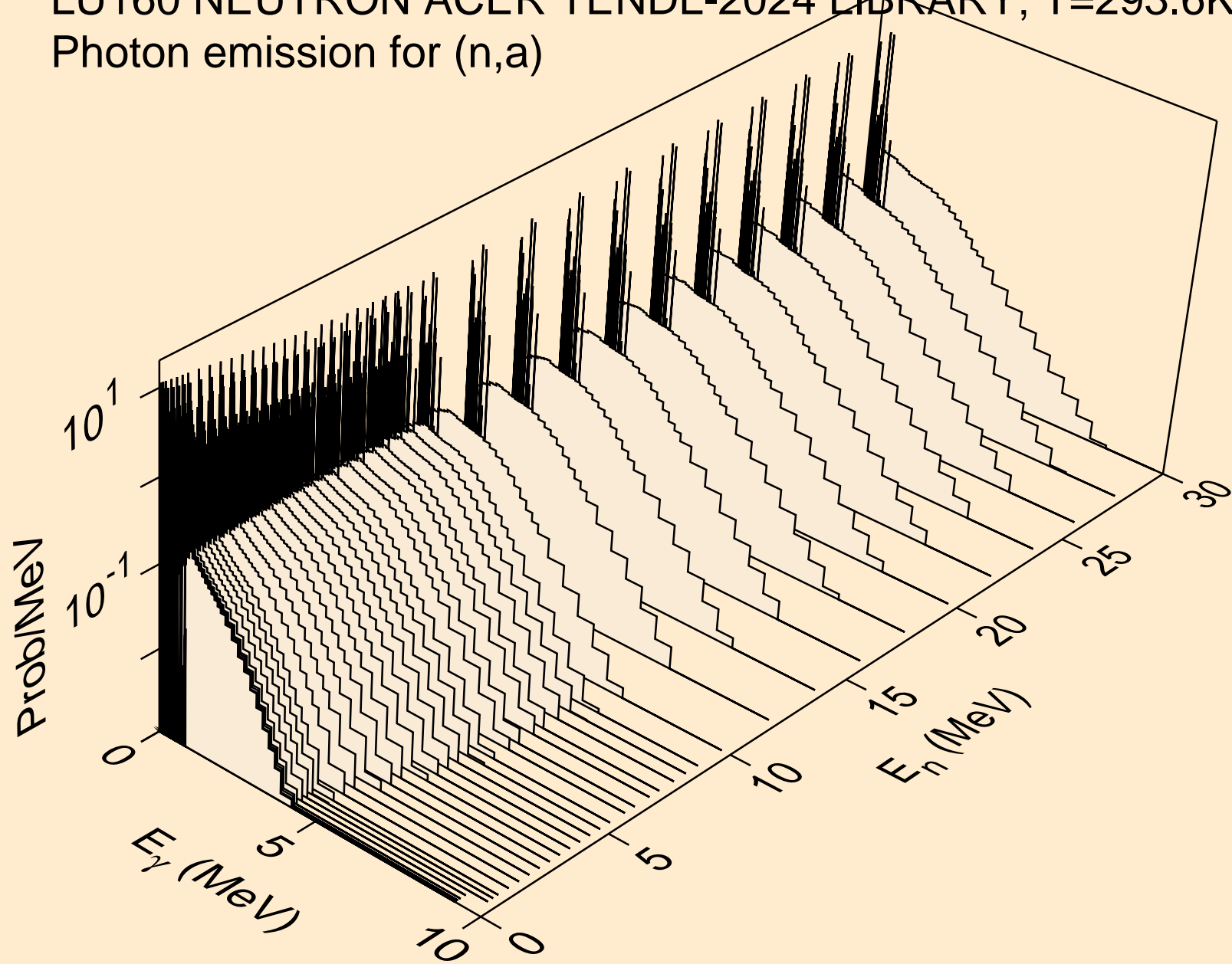

LU160 NEUTRON ACER TENDL-2024 LIBRARY; T=293.6K  
Photon emission for (n,2a)

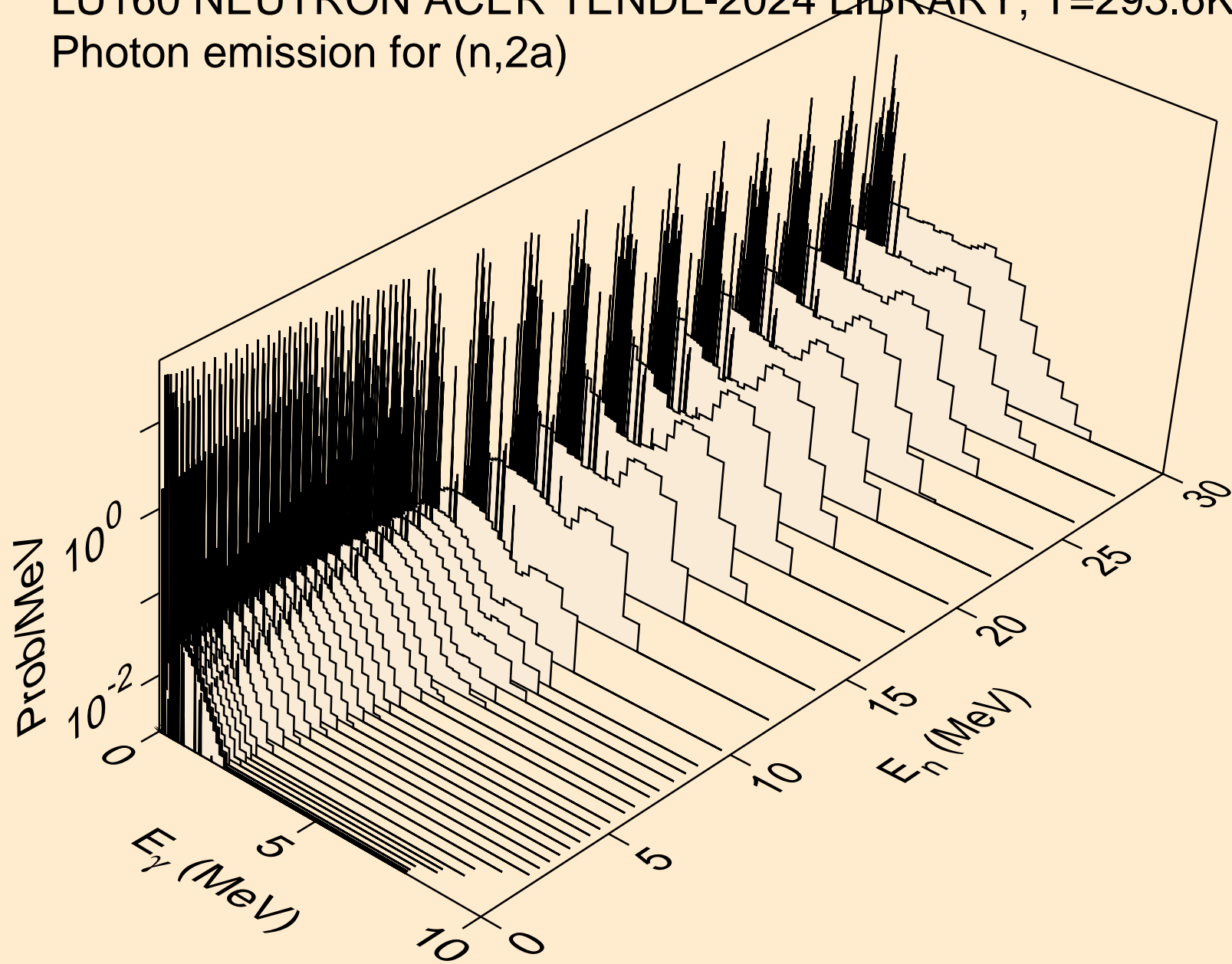

LU160 NEUTRON ACER TENDL-2024 LIBRARY; T=293.6K  
Photon emission for (n,3a)

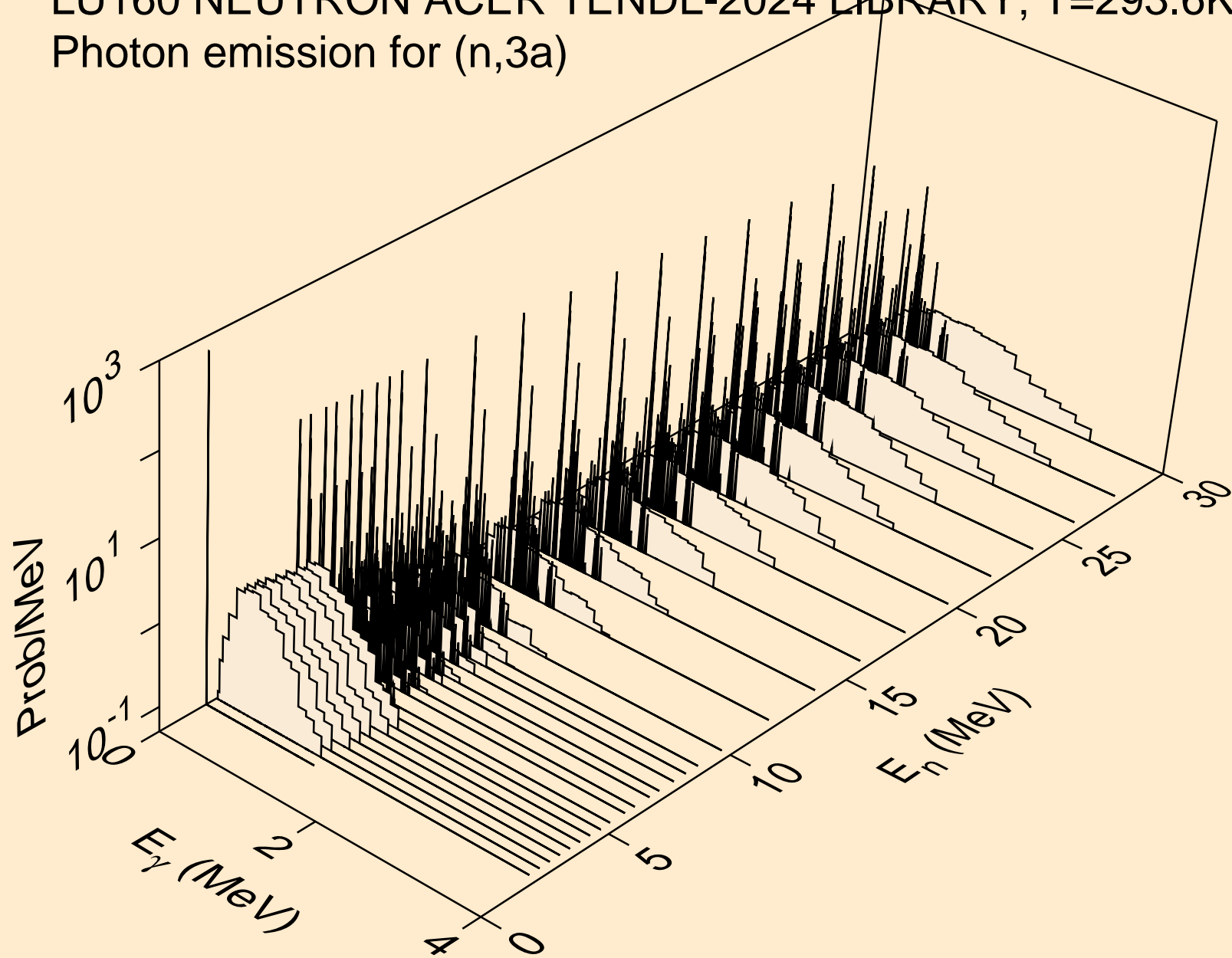

LU160 NEUTRON ACER TENDL-2024 LIBRARY; T=293.6K  
Photon emission for (n,2p)

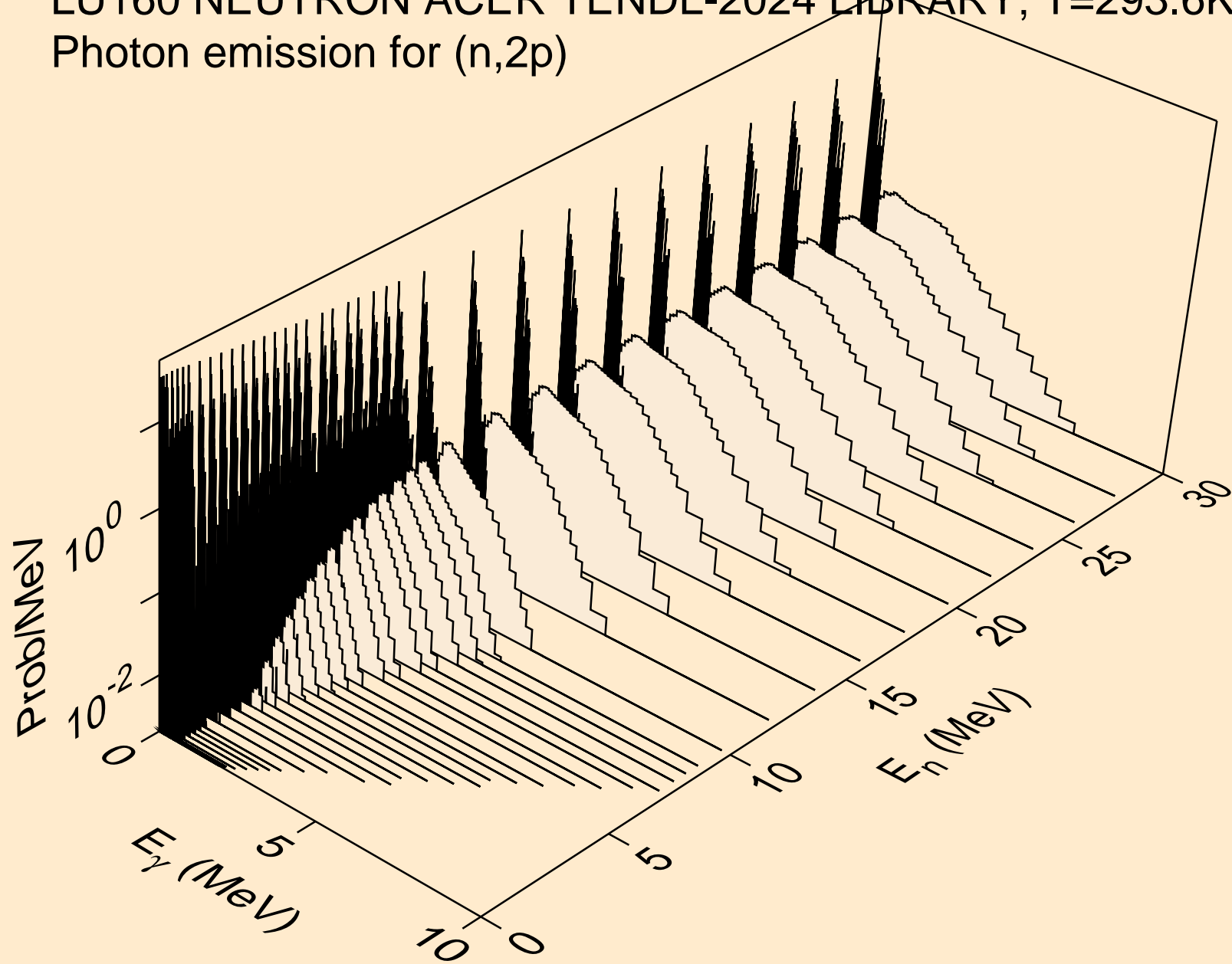

LU160 NEUTRON ACER TENDL-2024 LIBRARY; T=293.6K  
Photon emission for (n,p $\alpha$ )

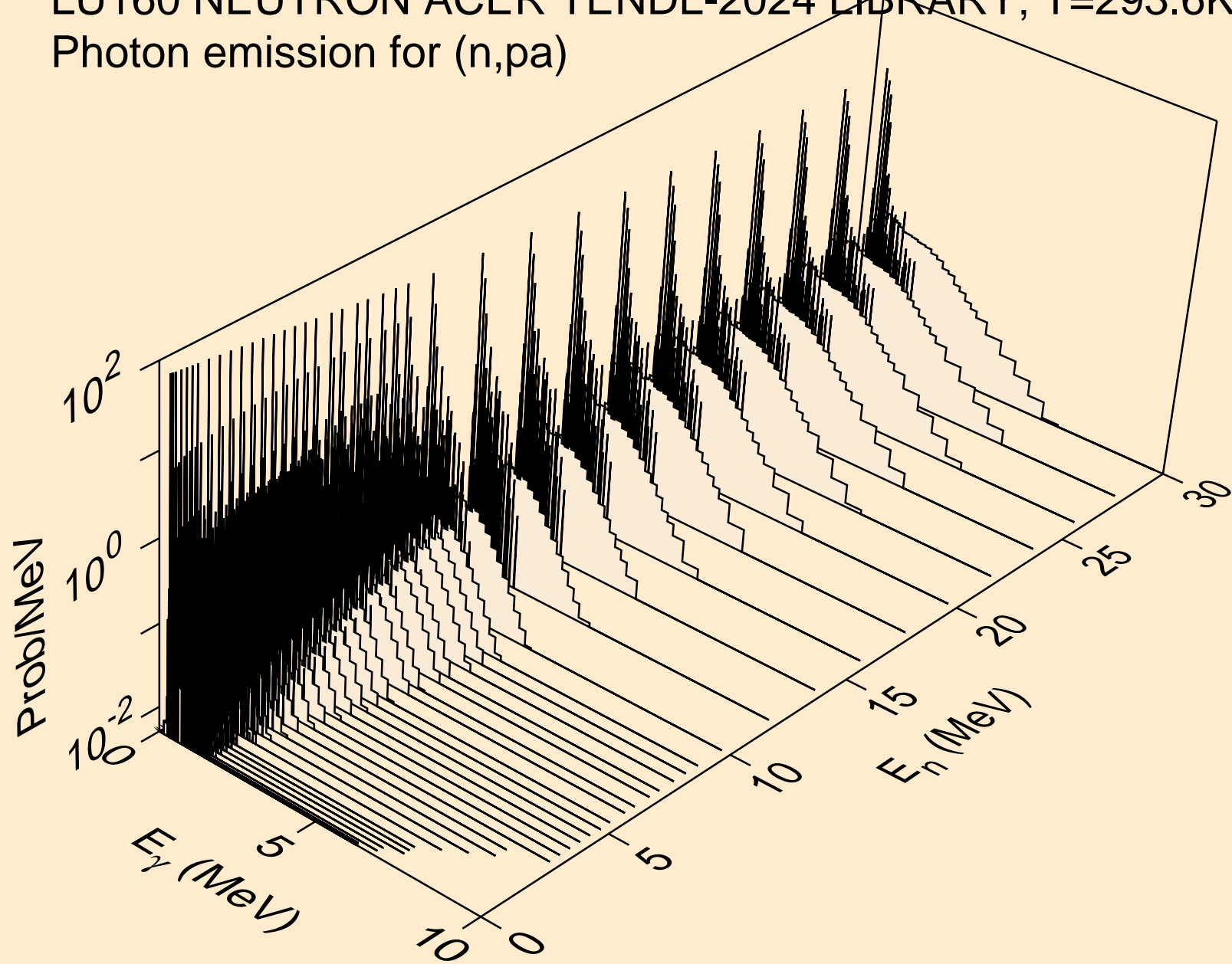

LU160 NEUTRON ACER TENDL-2024 LIBRARY; T=293.6K  
Photon emission for (n,t2a)

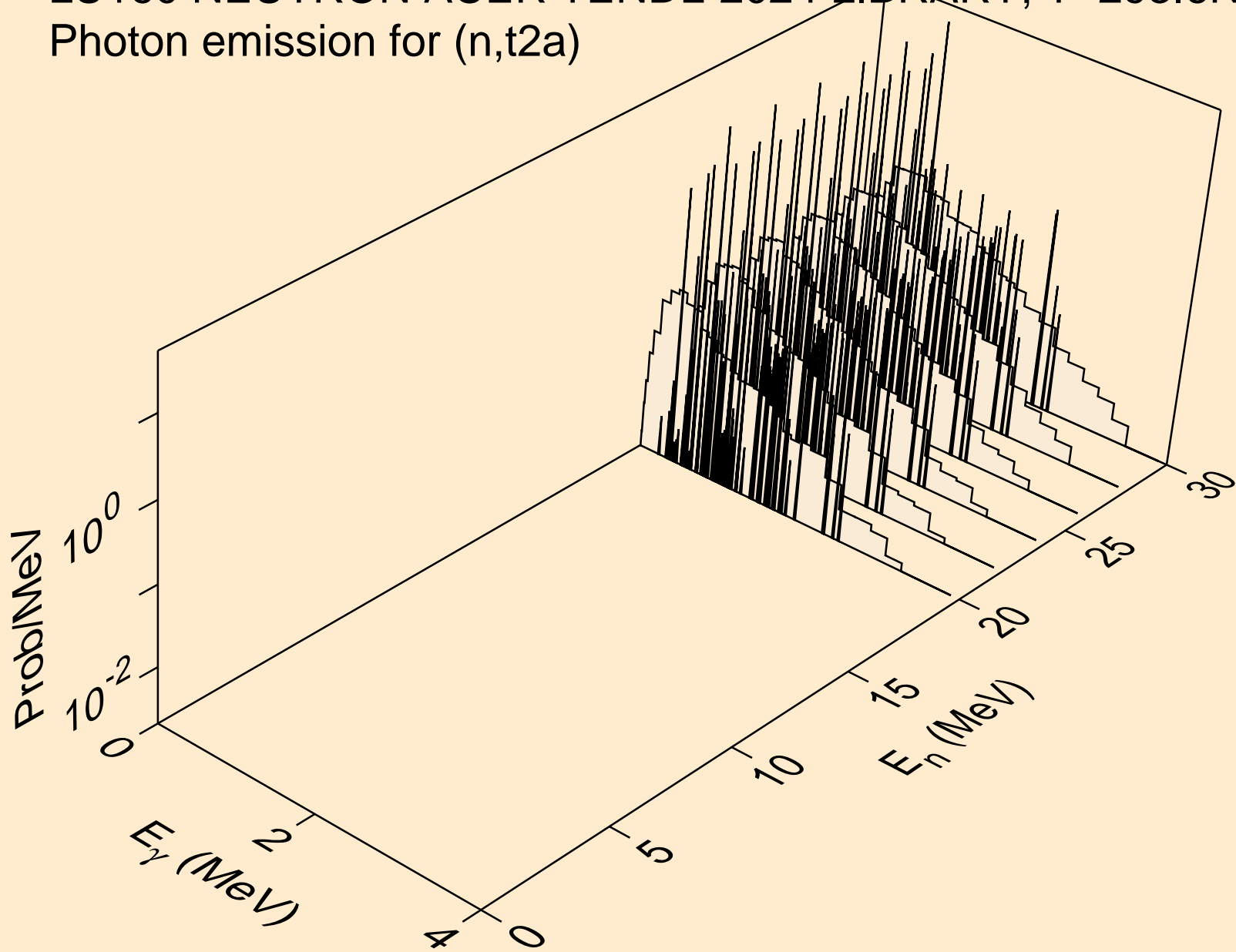

LU160 NEUTRON ACER TENDL-2024 LIBRARY; T=293.6K  
Photon emission for (n,d2a)

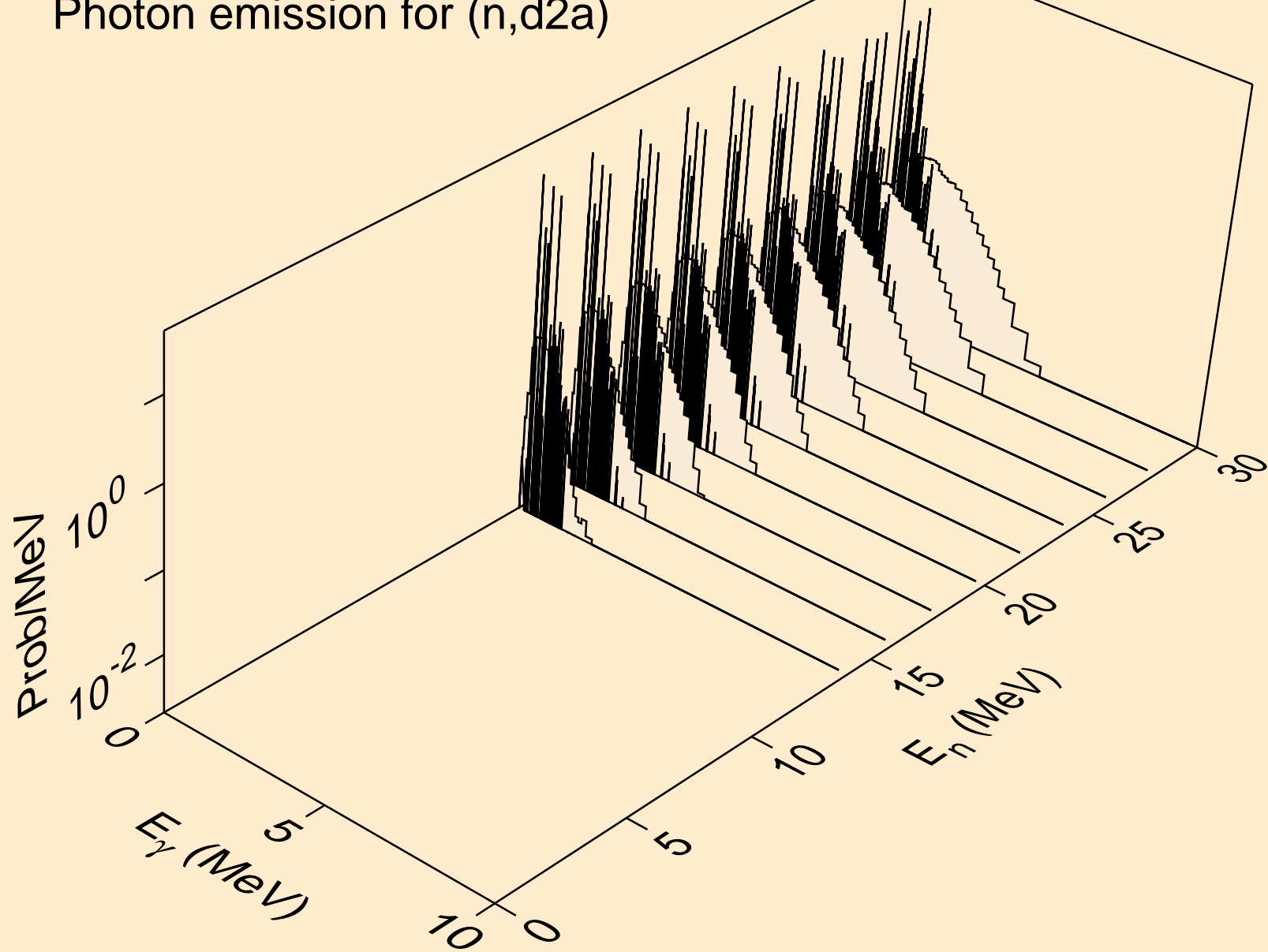

LU160 NEUTRON ACER TENDL-2024 LIBRARY; T=293.6K  
Photon emission for (n,pd)

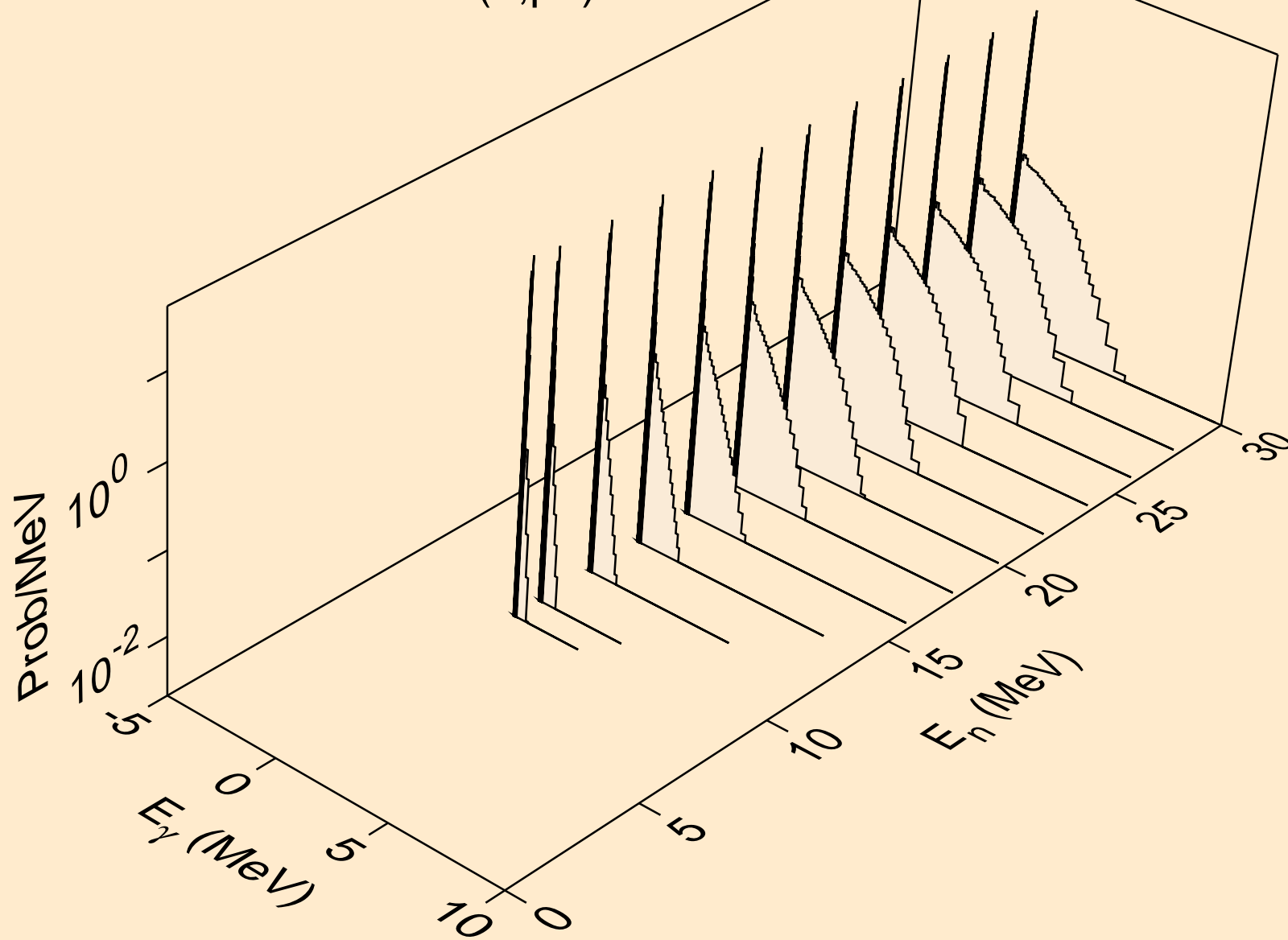

LU160 NEUTRON ACER TENDL-2024 LIBRARY; T=293.6K  
Photon emission for (n,pt)

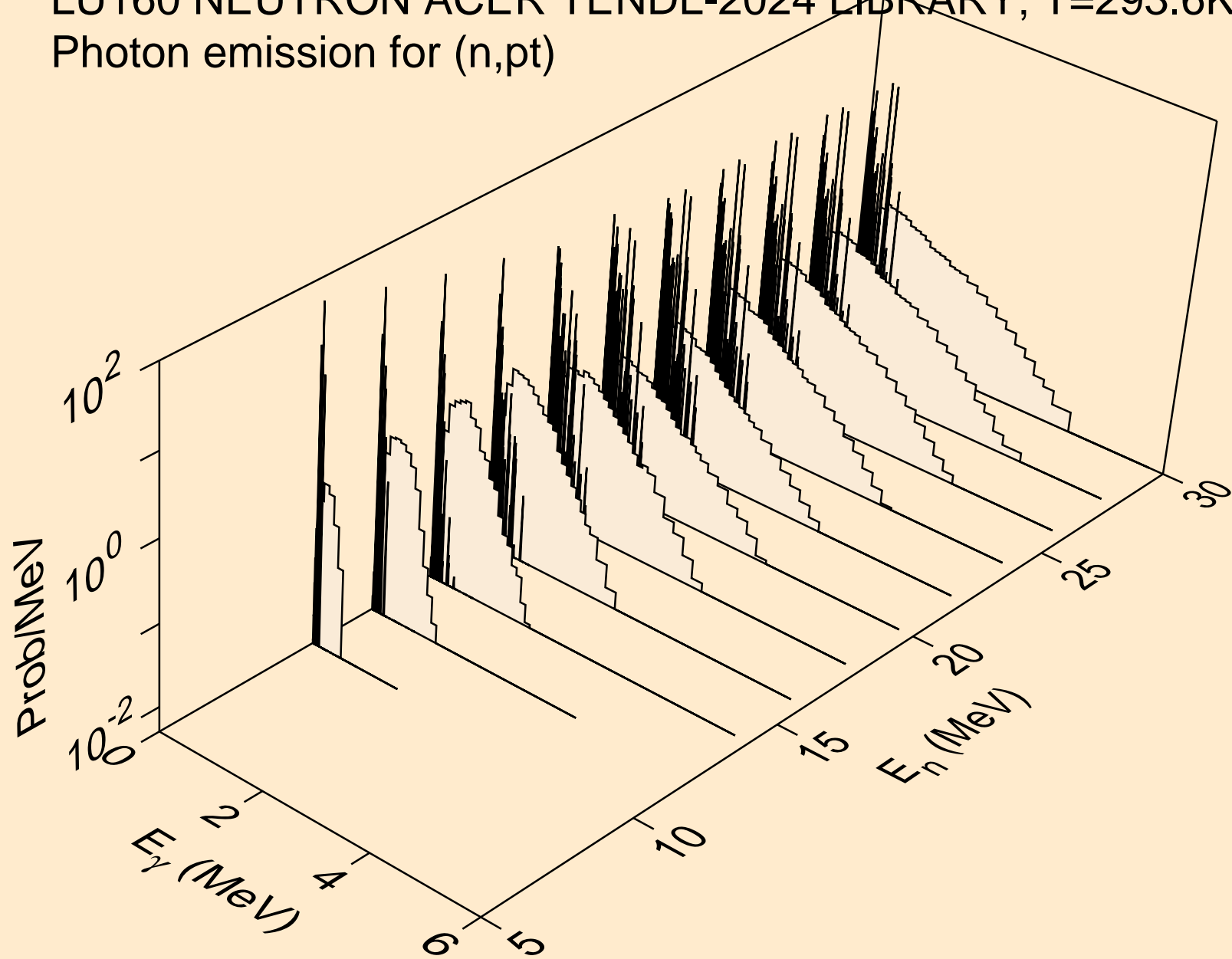

LU160 NEUTRON ACER TENDL-2024 LIBRARY; T=293.6K  
Photon emission for (n,da)

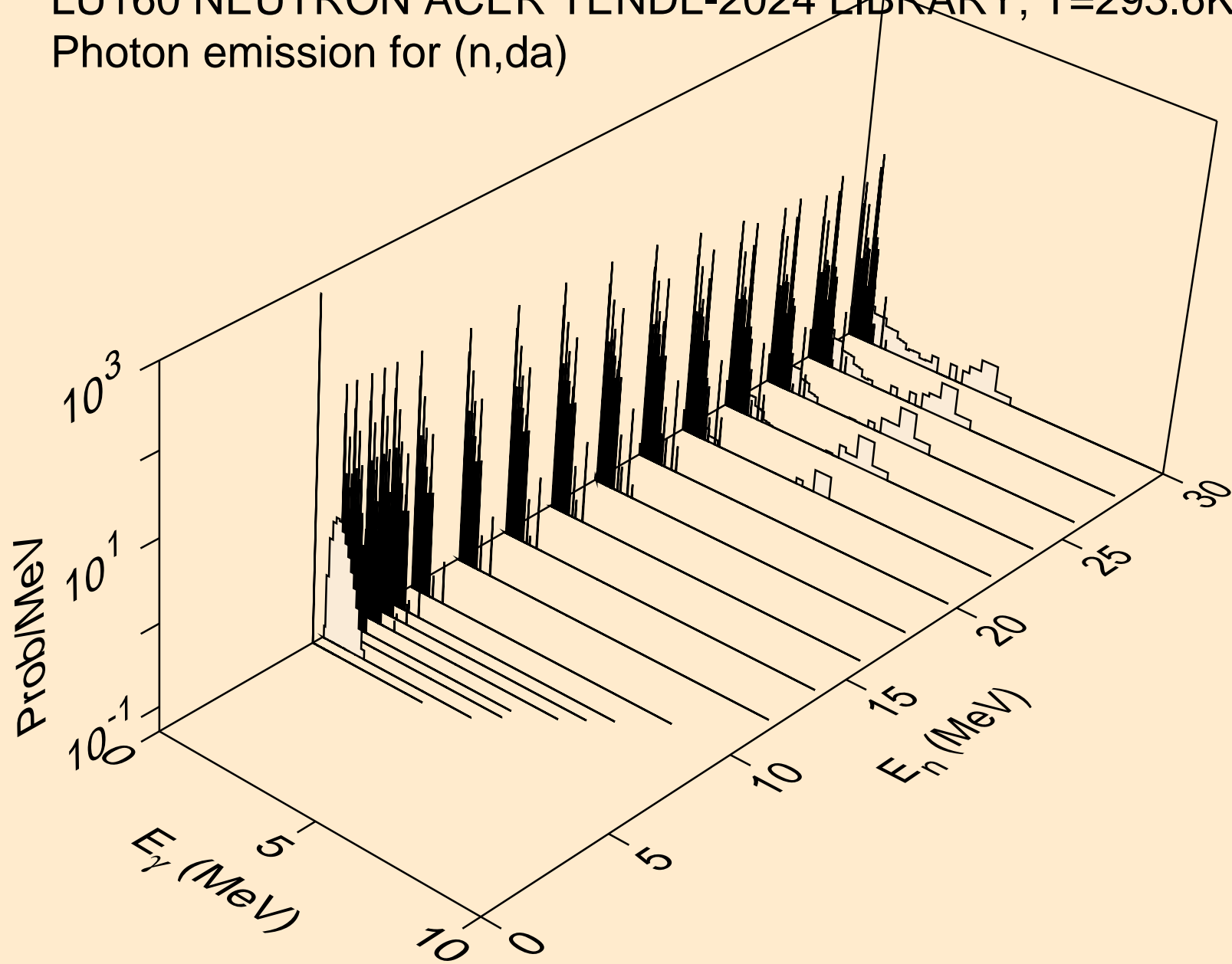

LU160 NEUTRON ACER TENDL-2024 LIBRARY; T=293.6K  
thermal capture photon spectrum

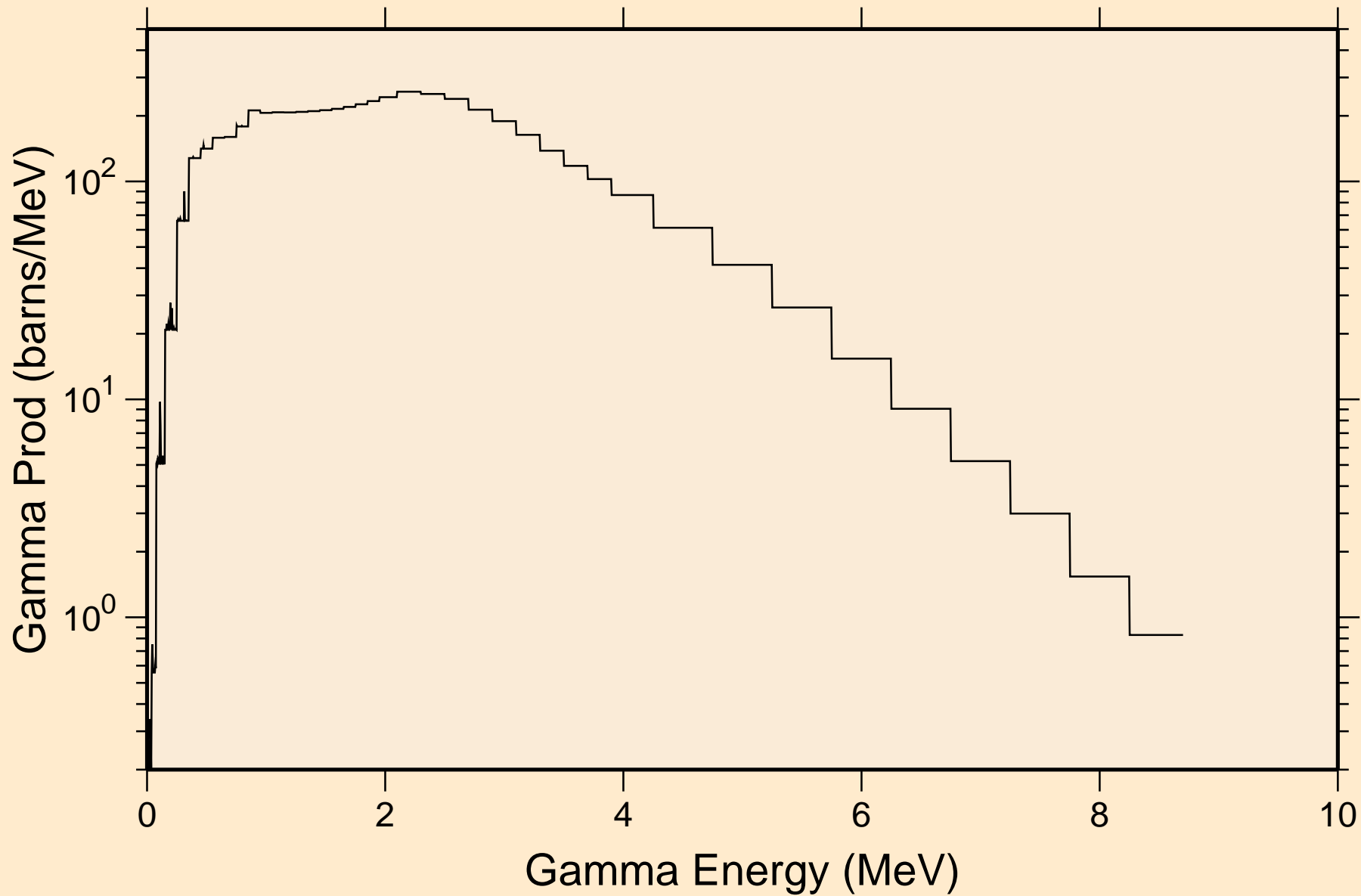

LU160 NEUTRON ACER TENDL-2024 LIBRARY; T=293.6K  
14 MeV photon spectrum

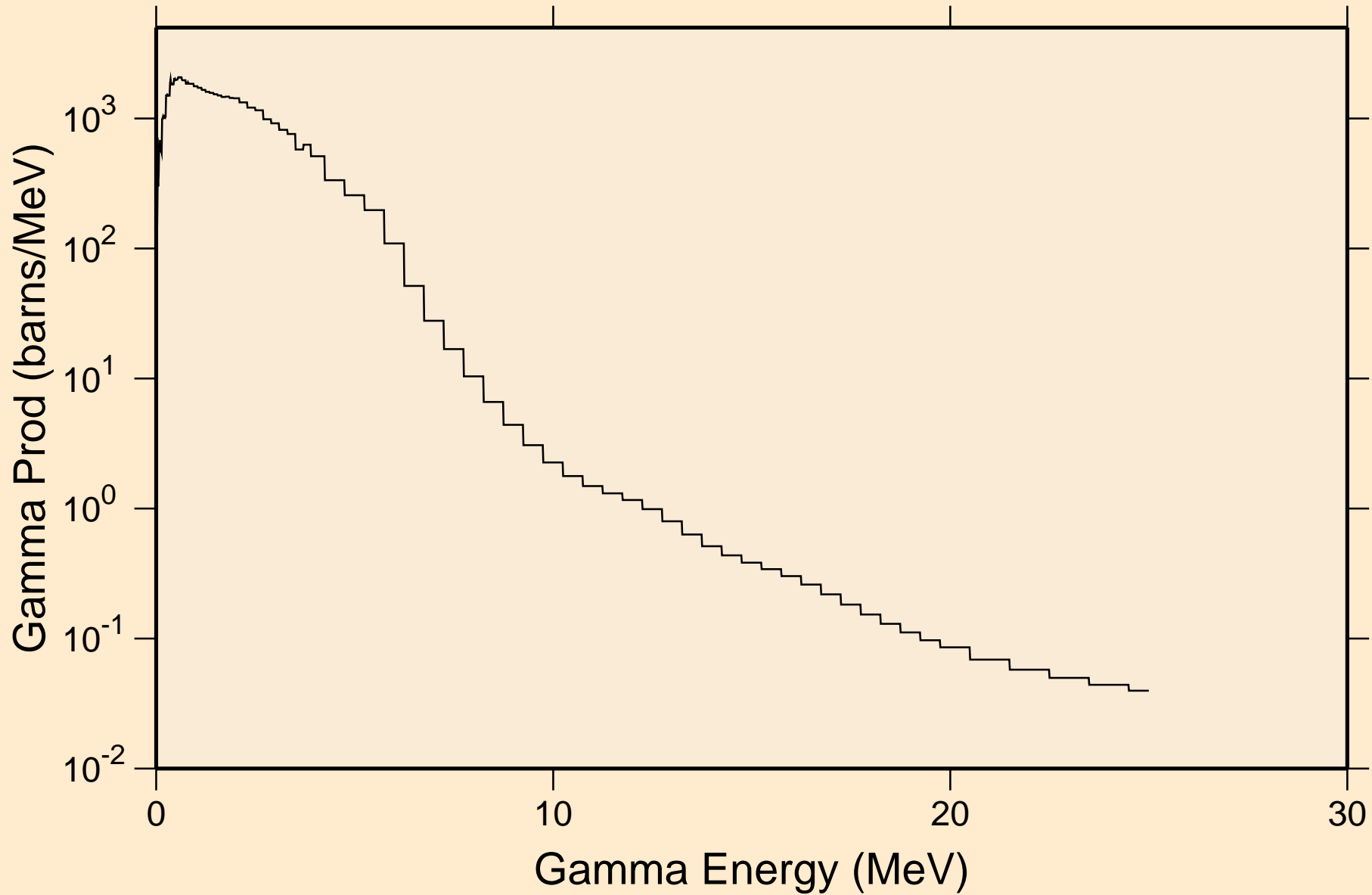

LU160 NEUTRON ACER TENDL-2024 LIBRARY; T=293.6K  
Particle heating contributions

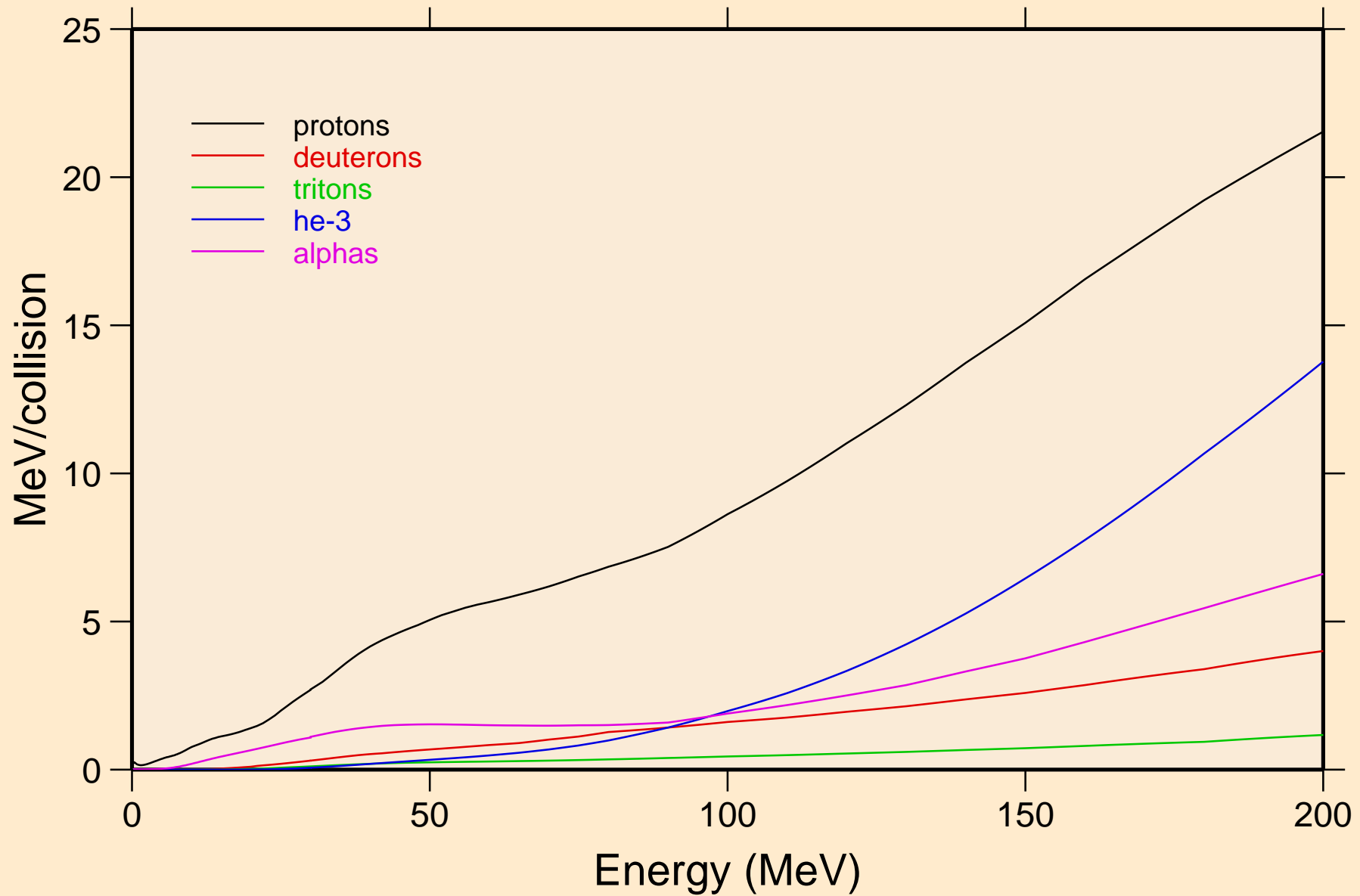

LU160 NEUTRON ACER TENDL-2024 LIBRARY; T=293.6K  
Recoil Heating

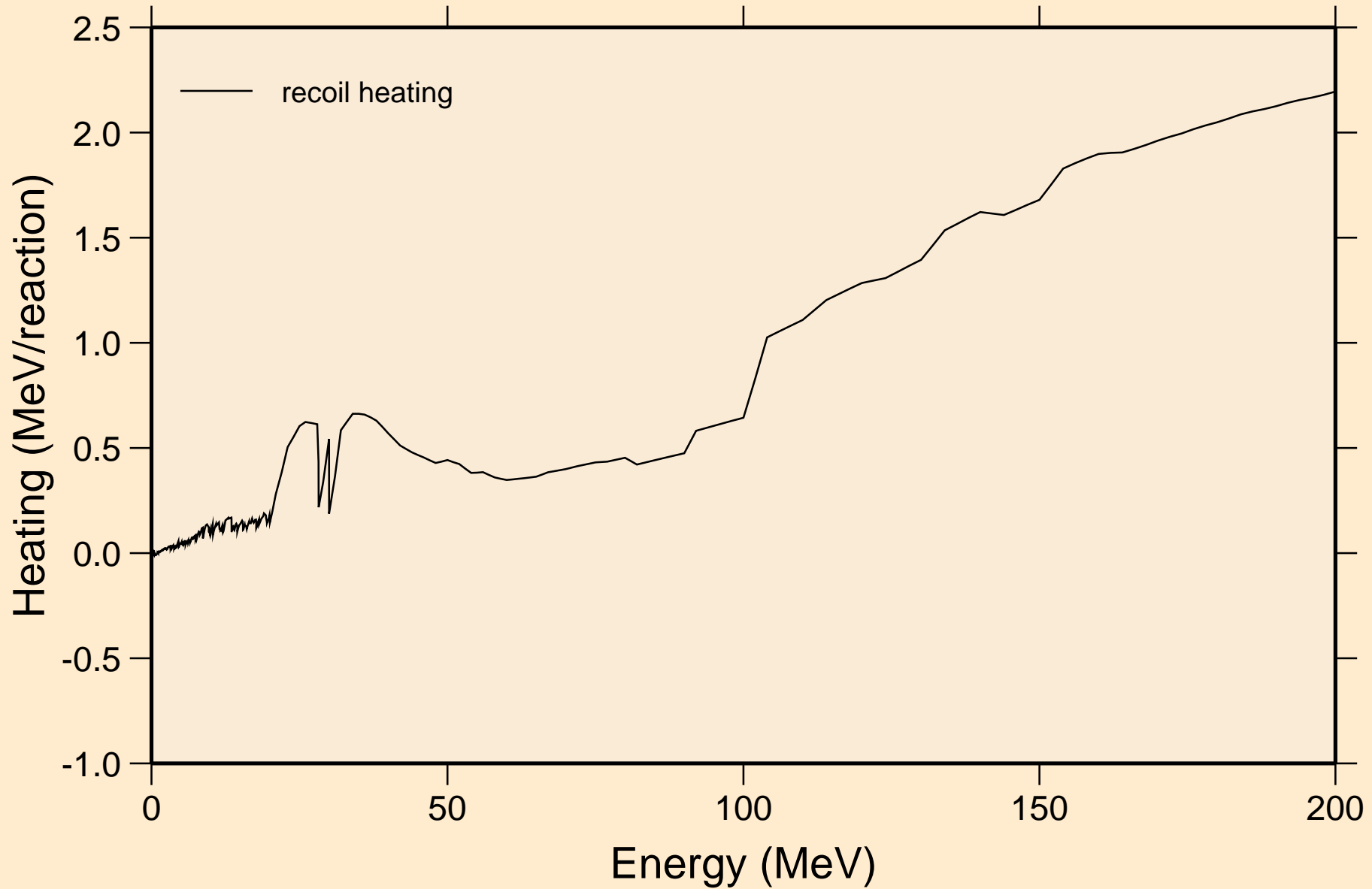

LU160 NEUTRON ACER TENDL-2024 LIBRARY; T=293.6K  
Particle production cross sections

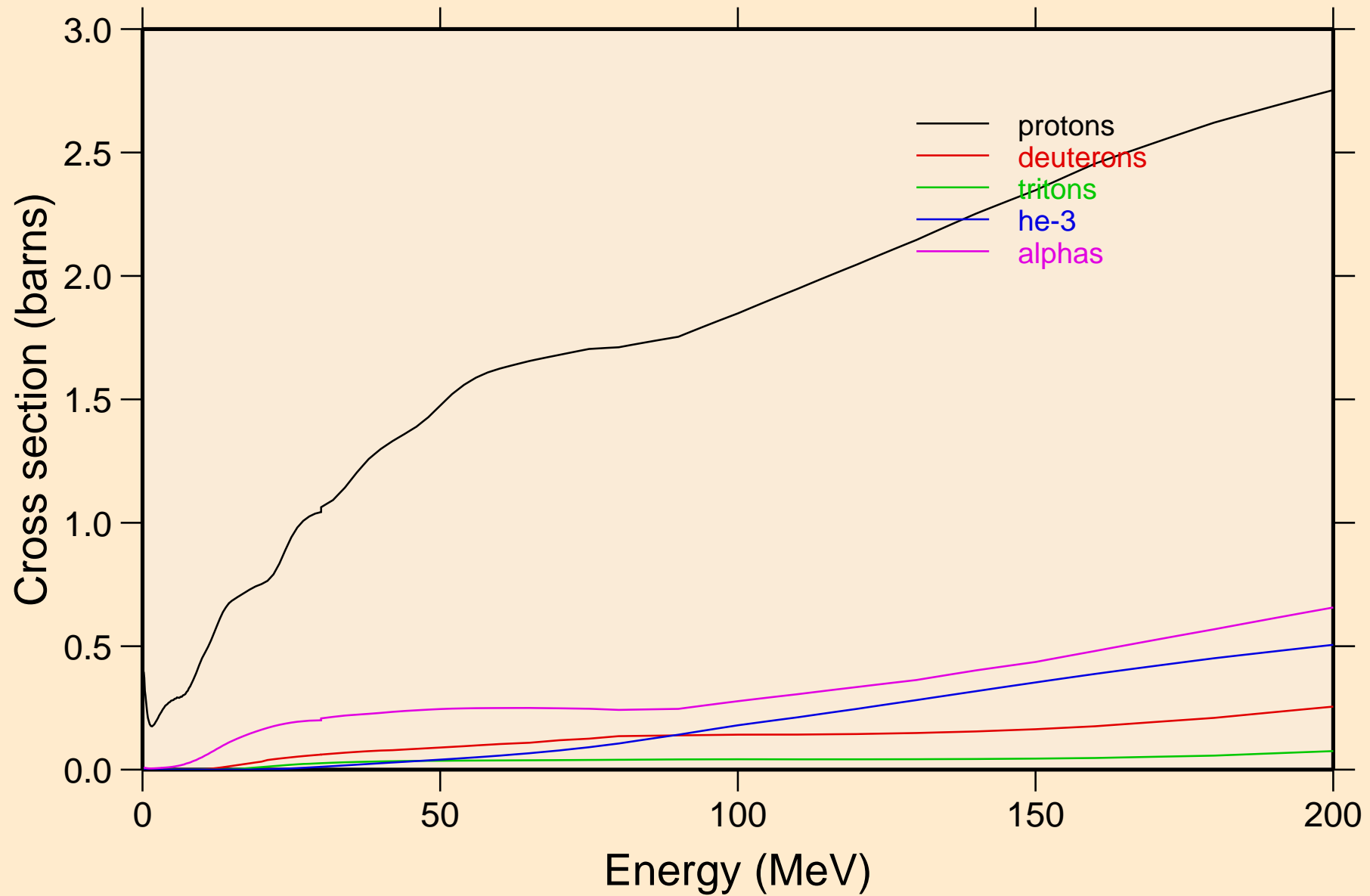

LU160 NEUTRON ACER TENDL-2024 LIBRARY; T=293.6K  
protons from (n,x)

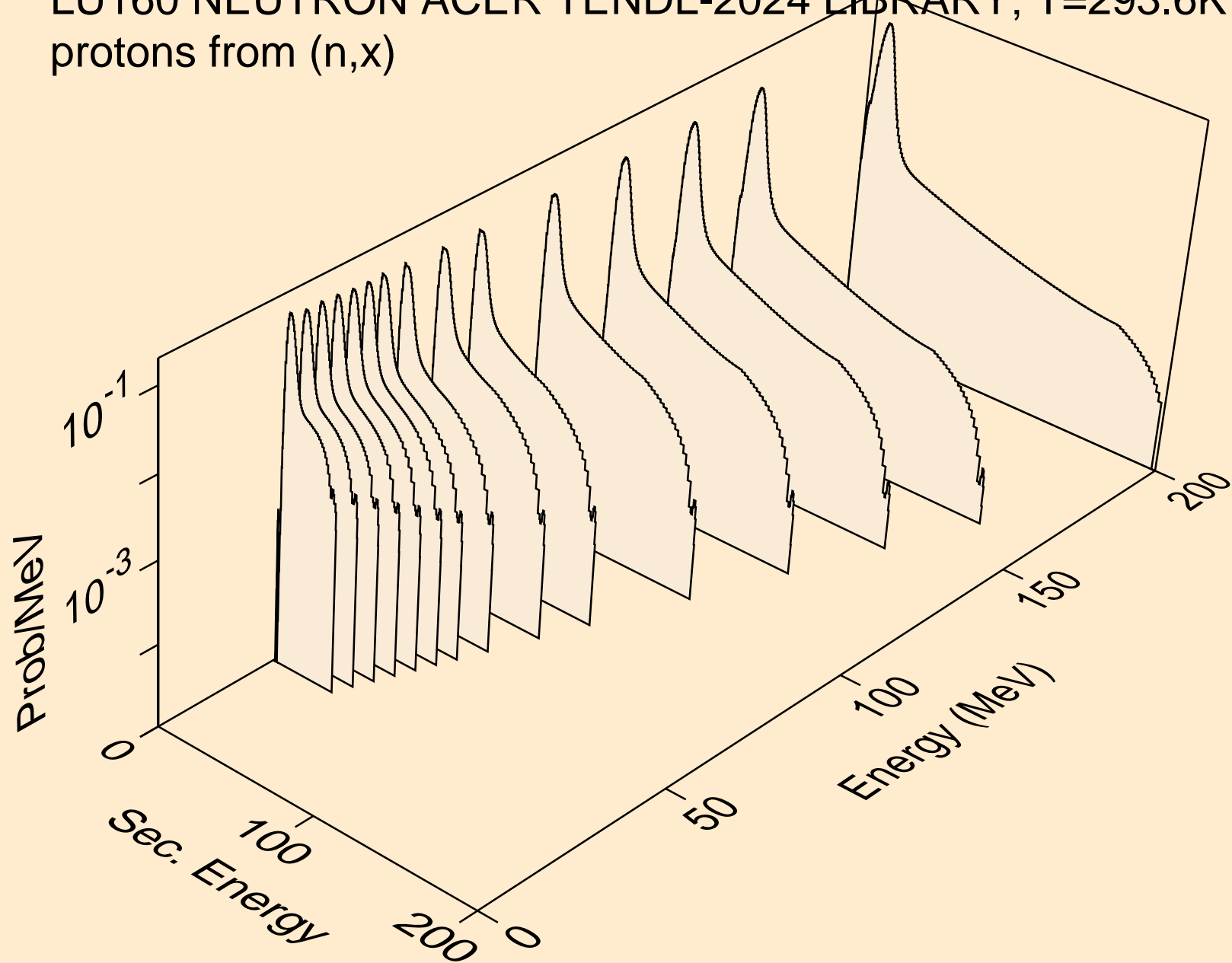

LU160 NEUTRON ACER TENDL-2024 LIBRARY; T=293.6K  
protons from (n,n\*)p

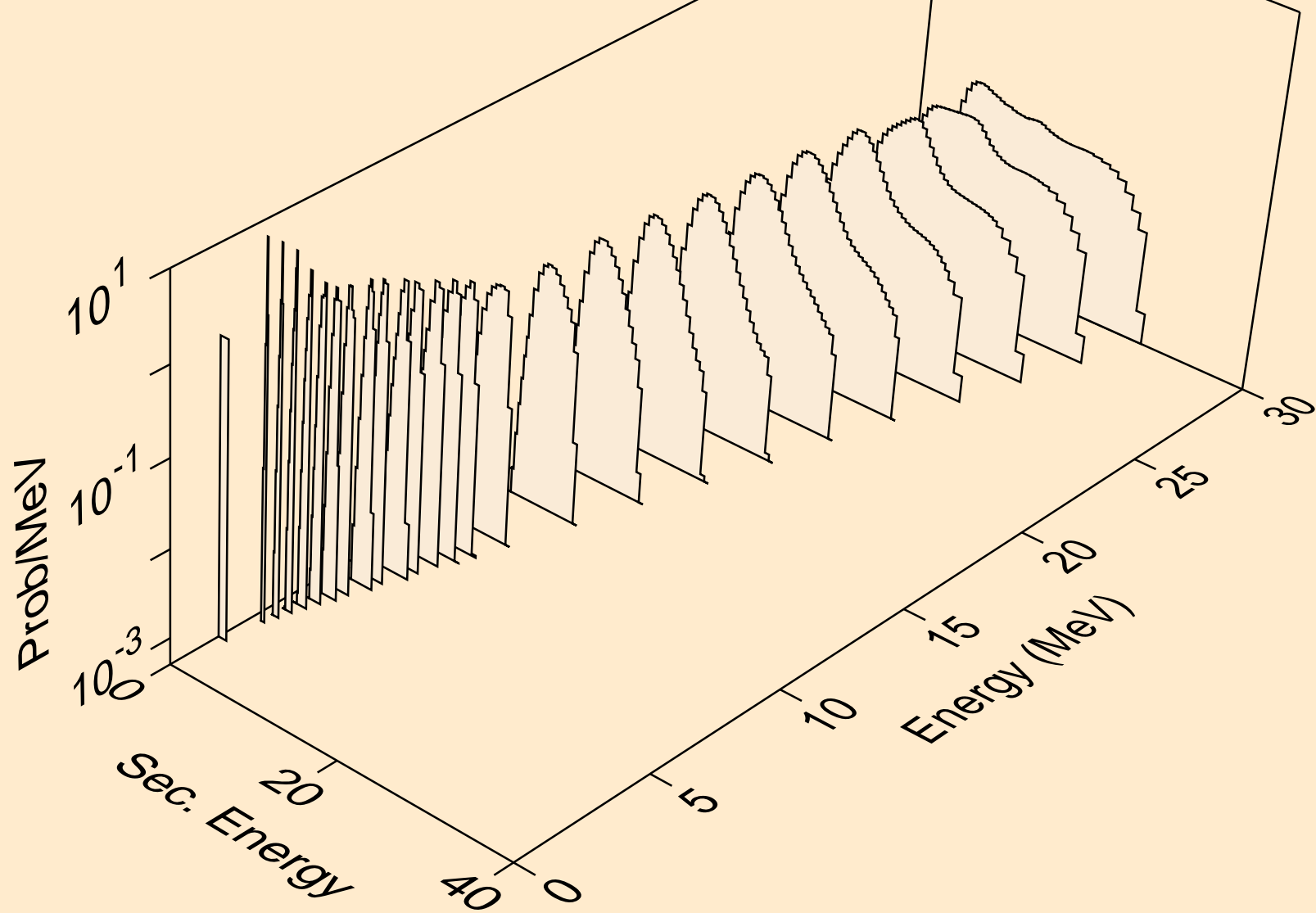

LU160 NEUTRON ACER TENDL-2024 LIBRARY; T=293.6K  
protons from (n,2np)

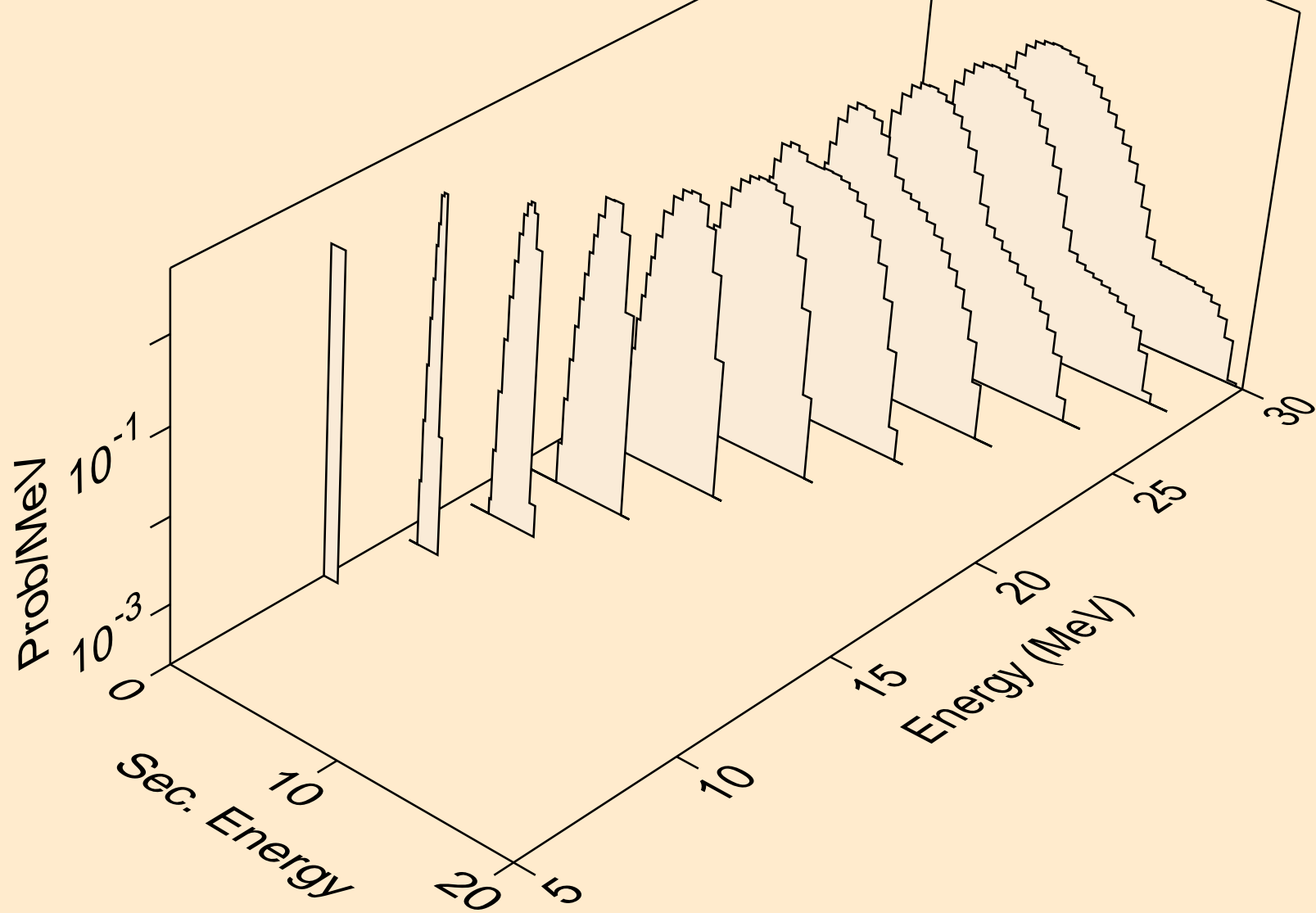

LU160 NEUTRON ACER TENDL-2024 LIBRARY; T=293.6K  
protons from (n,3np)

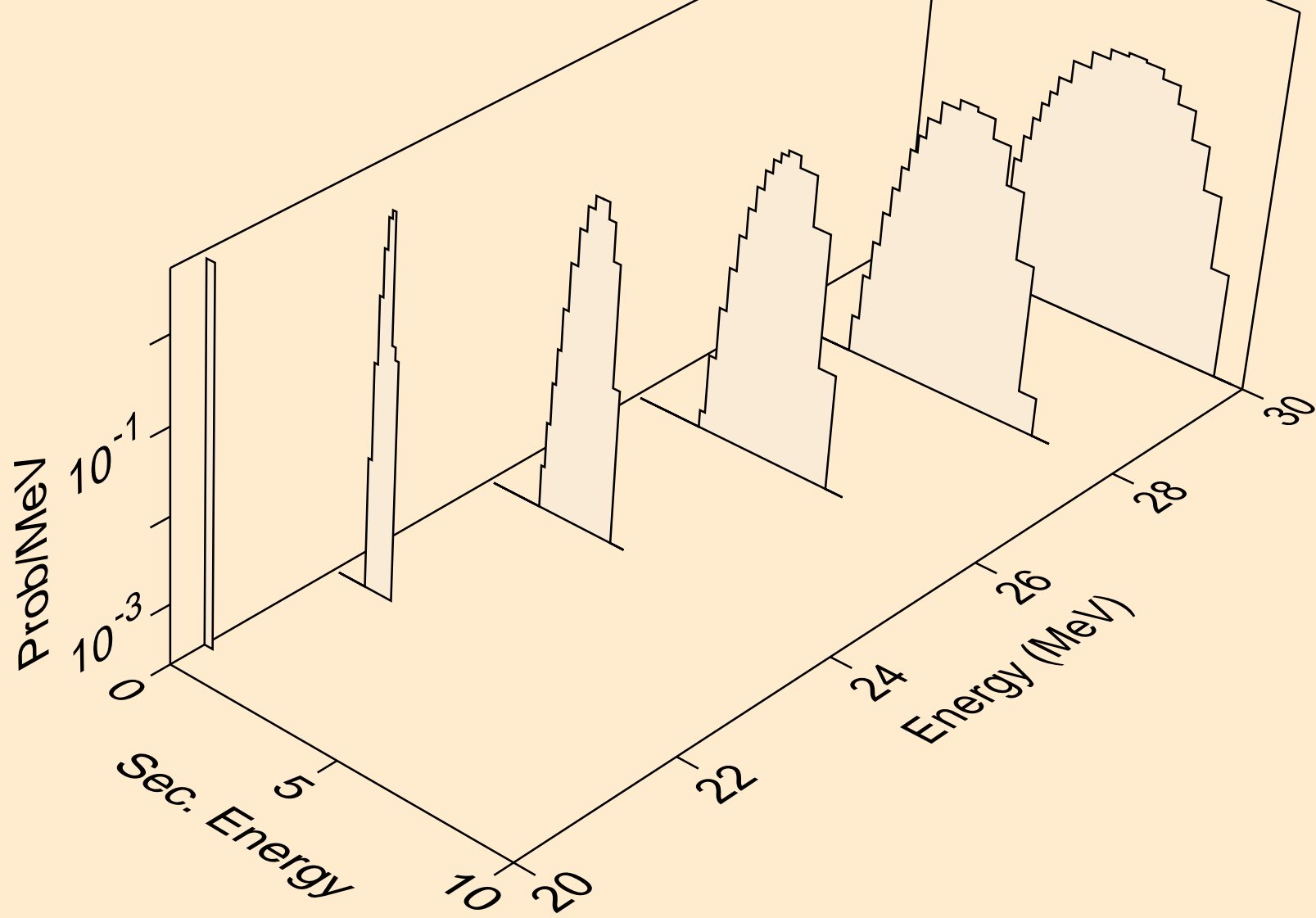

LU160 NEUTRON ACER TENDL-2024 LIBRARY; T=293.6K  
protons from (n,n2p)

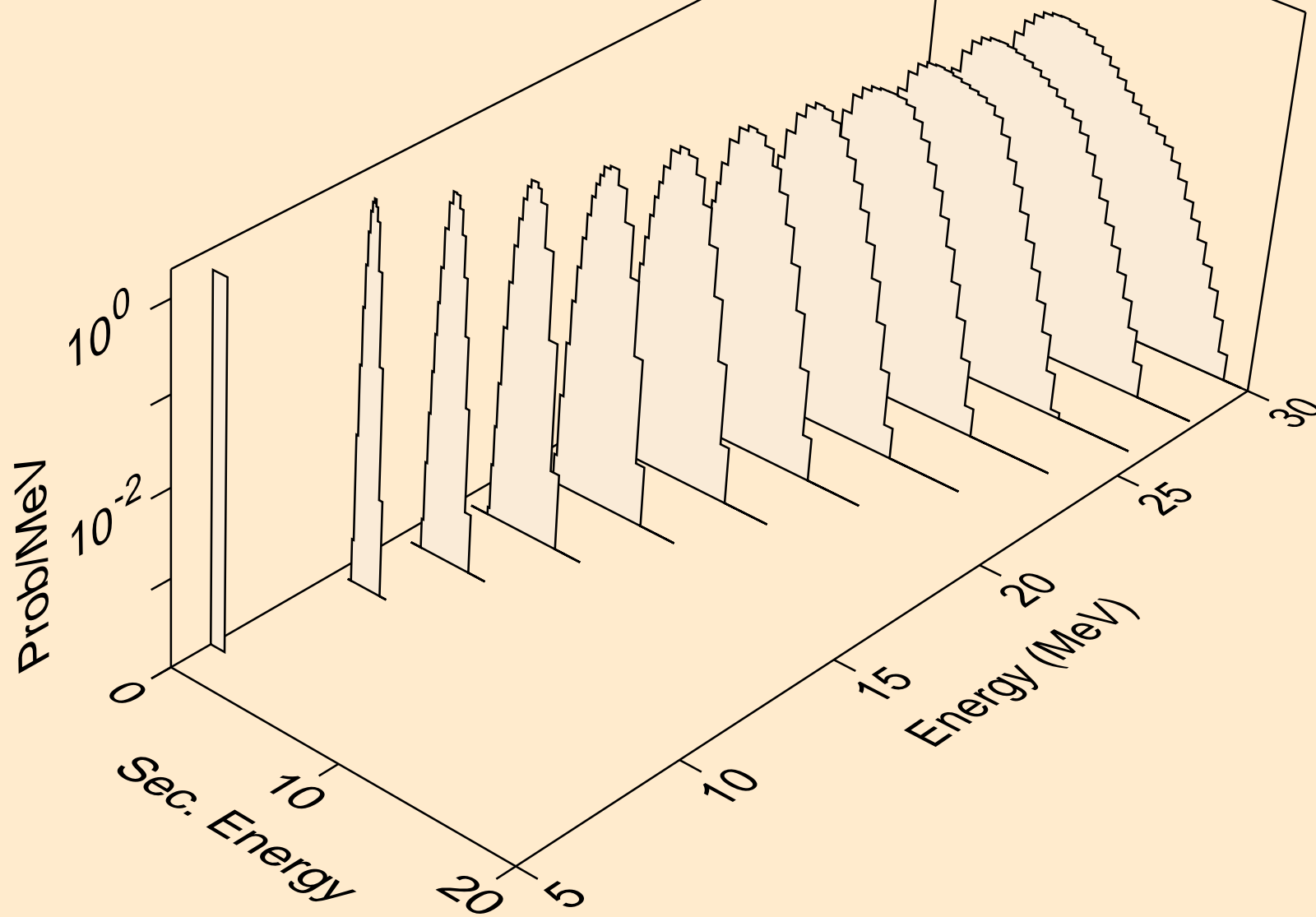

LU160 NEUTRON ACER TENDL-2024 LIBRARY; T=293.6K  
protons from (n,npa)

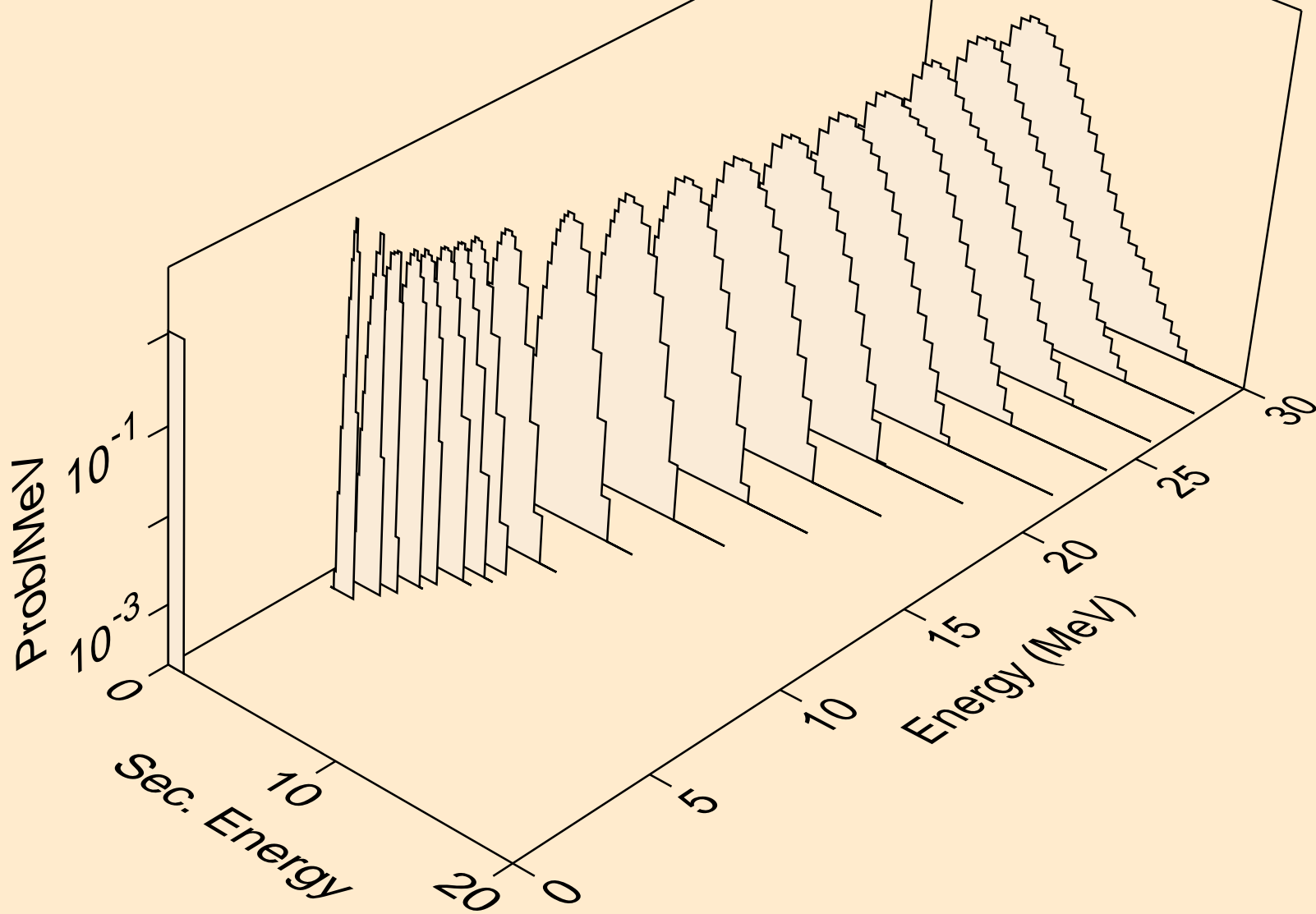

LU160 NEUTRON ACER TENDL-2024 LIBRARY; T=293.6K  
protons from (n,p)

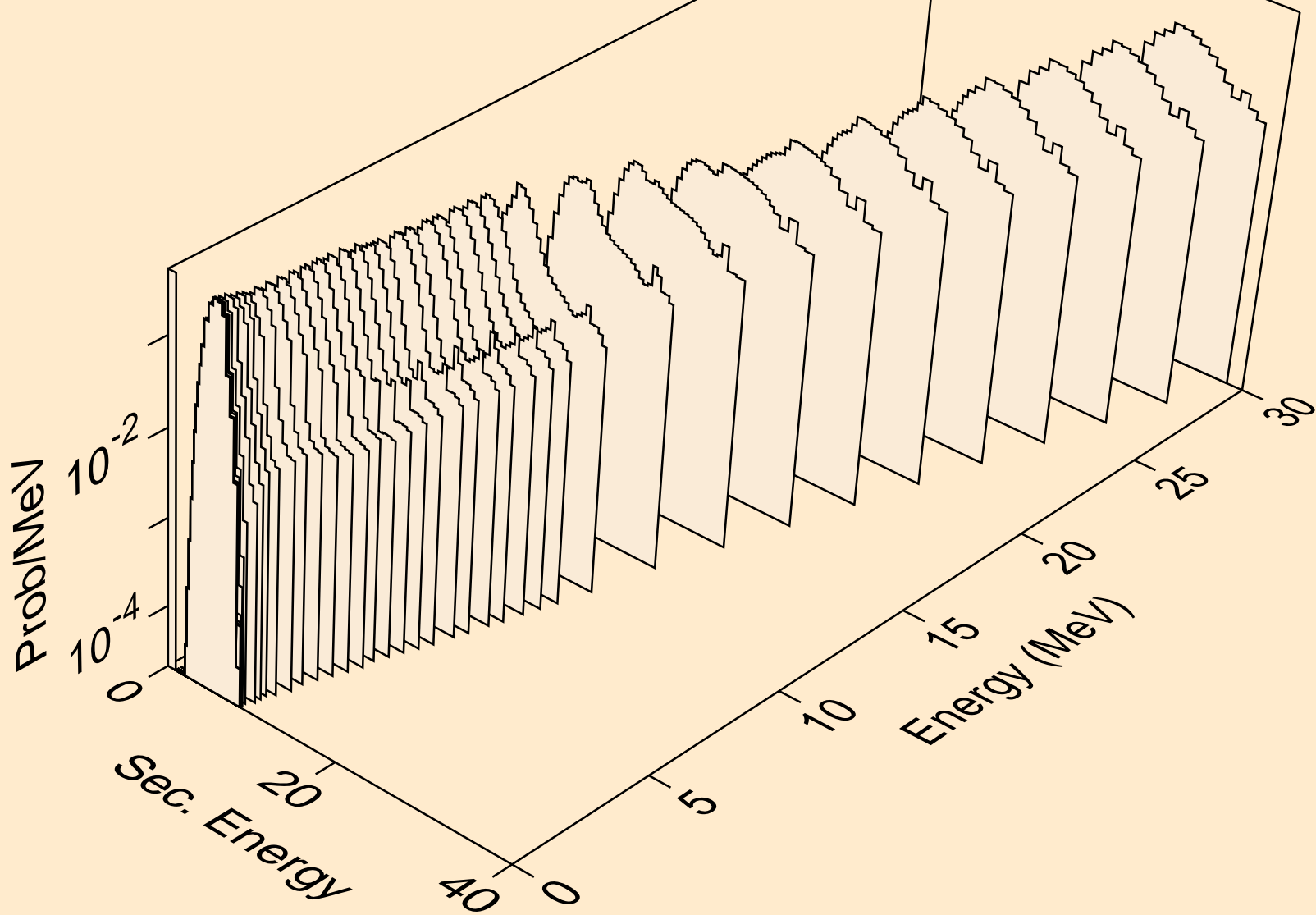

LU160 NEUTRON ACER TENDL-2024 LIBRARY; T=293.6K  
protons from (n,2p)

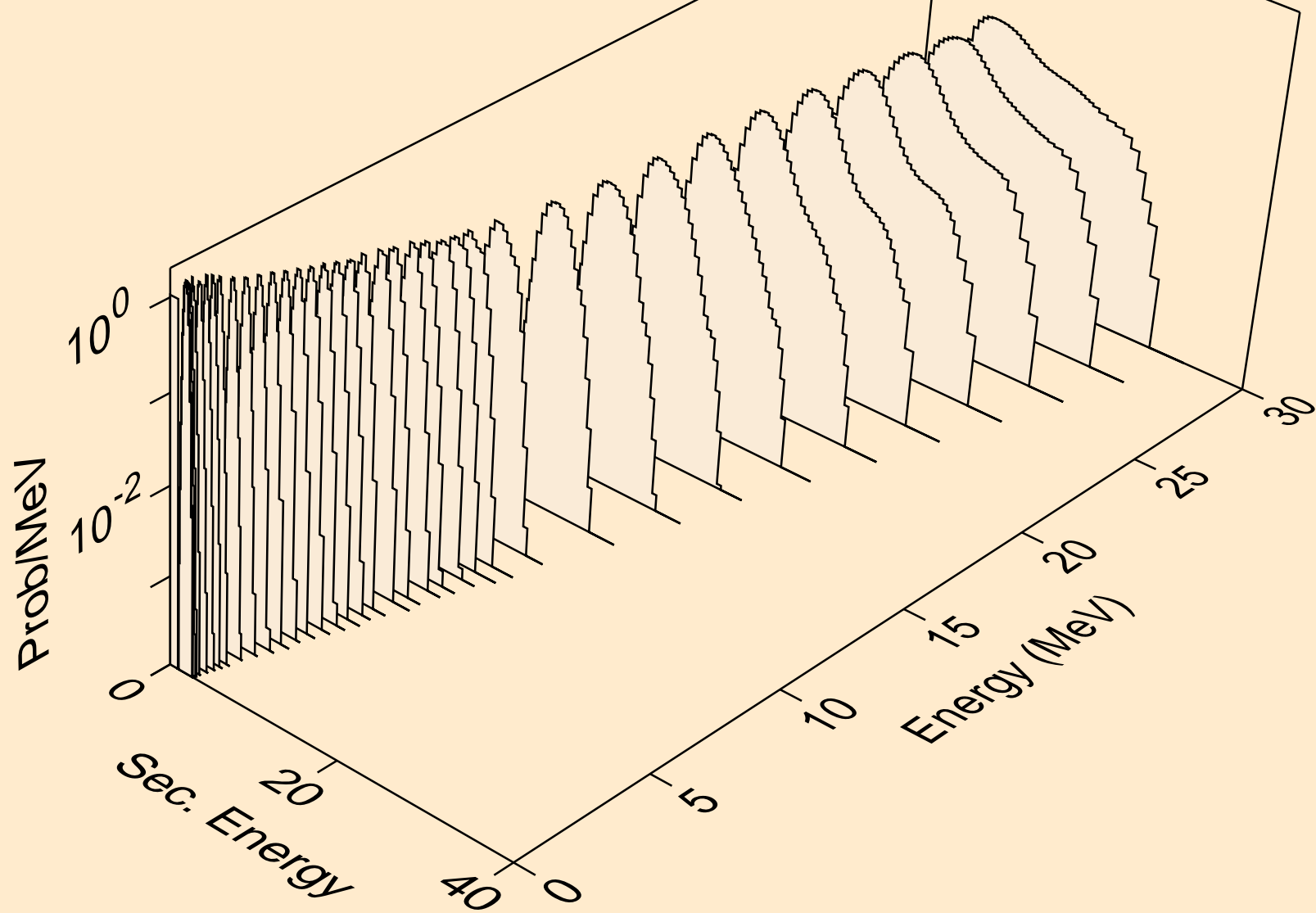

LU160 NEUTRON ACER TENDL-2024 LIBRARY; T=293.6K  
protons from (n,p)

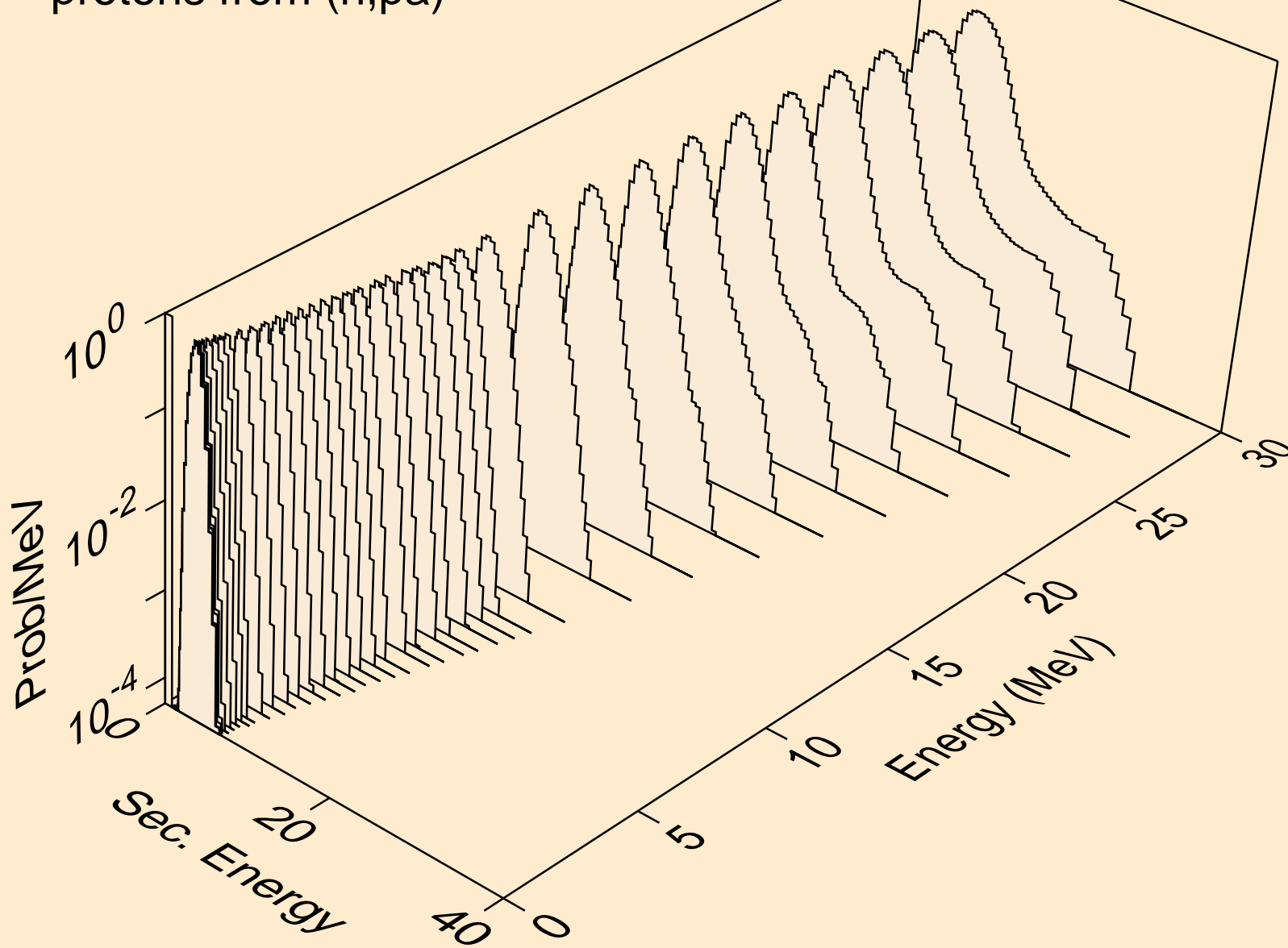

LU160 NEUTRON ACER TENDL-2024 LIBRARY; T=293.6K  
protons from (n,pd)

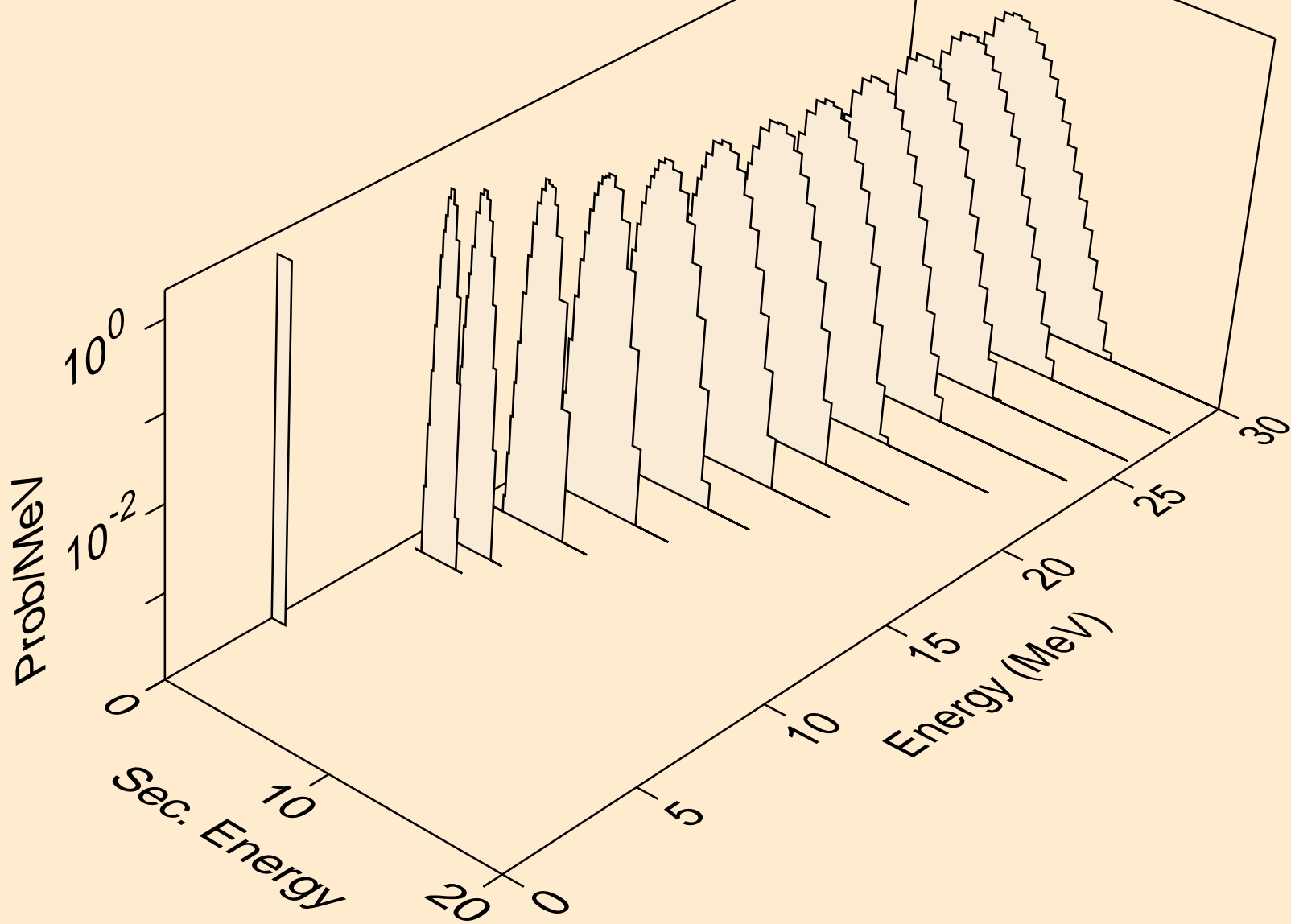

LU160 NEUTRON ACER TENDL-2024 LIBRARY; T=293.6K  
protons from (n,pt)

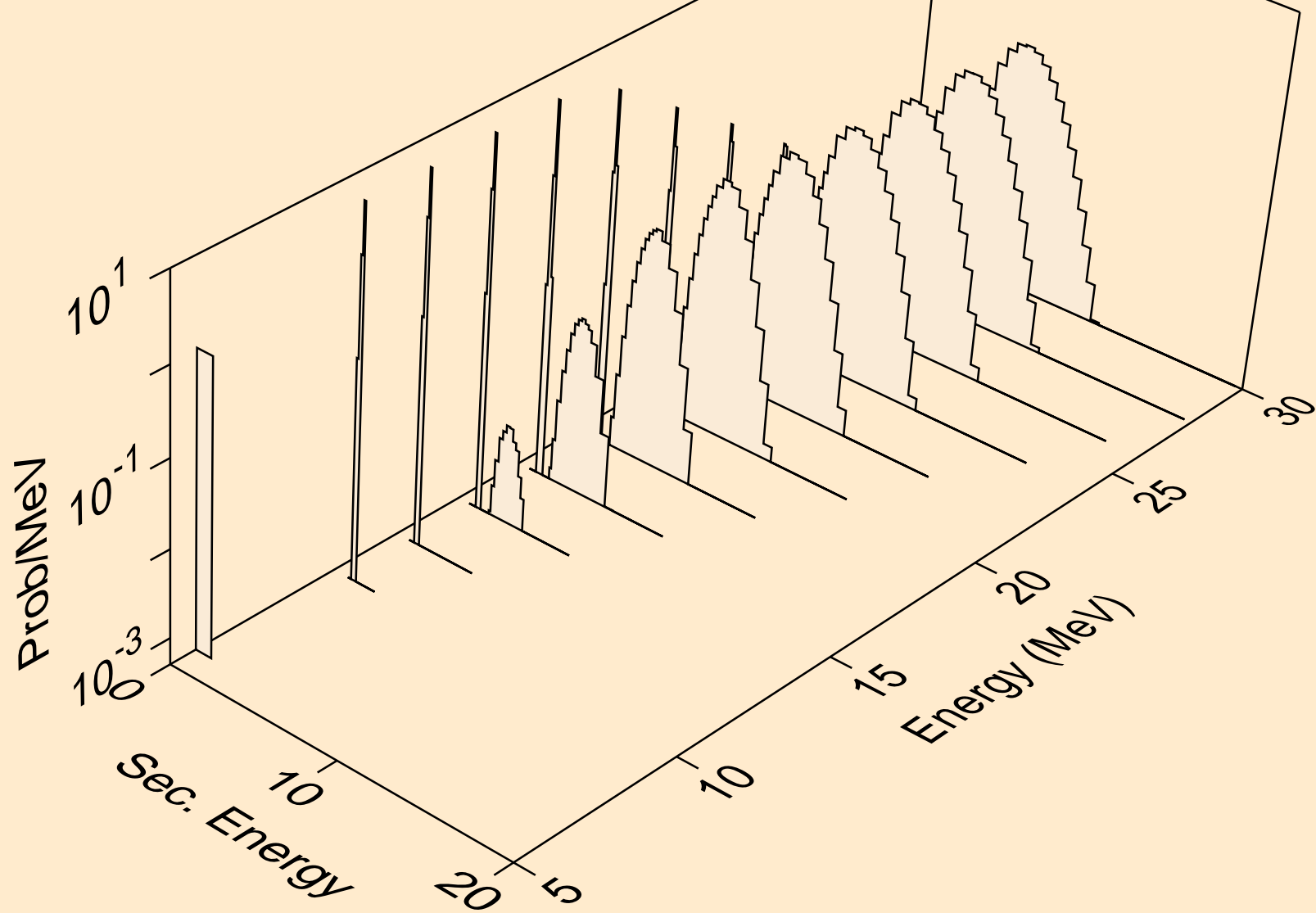

LU160 NEUTRON ACER TENDL-2024 LIBRARY; T=293.6K  
deuterons from (n,x)

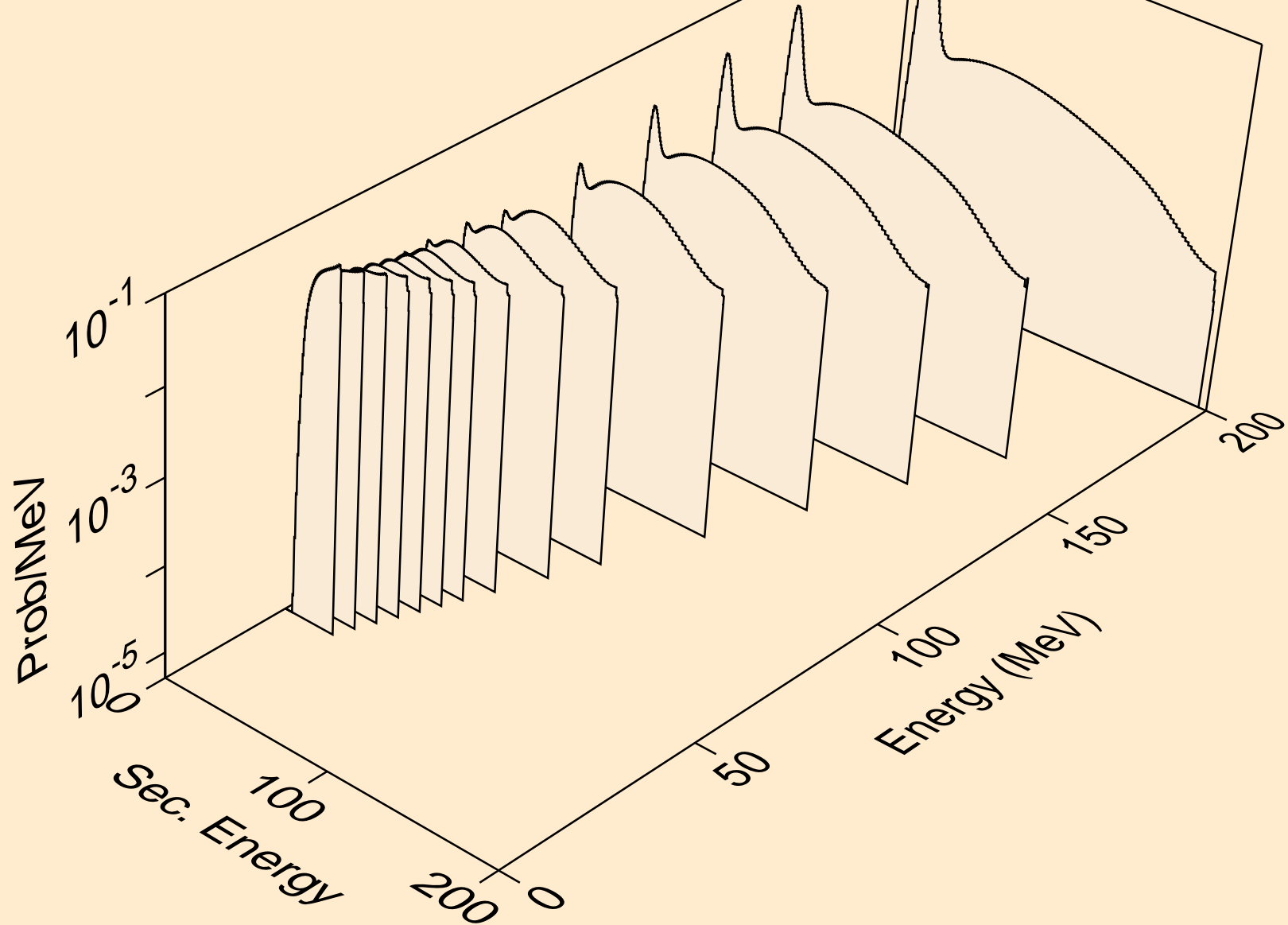

LU160 NEUTRON ACER TENDL-2024 LIBRARY; T=293.6K  
deuterons from (n,2nd)

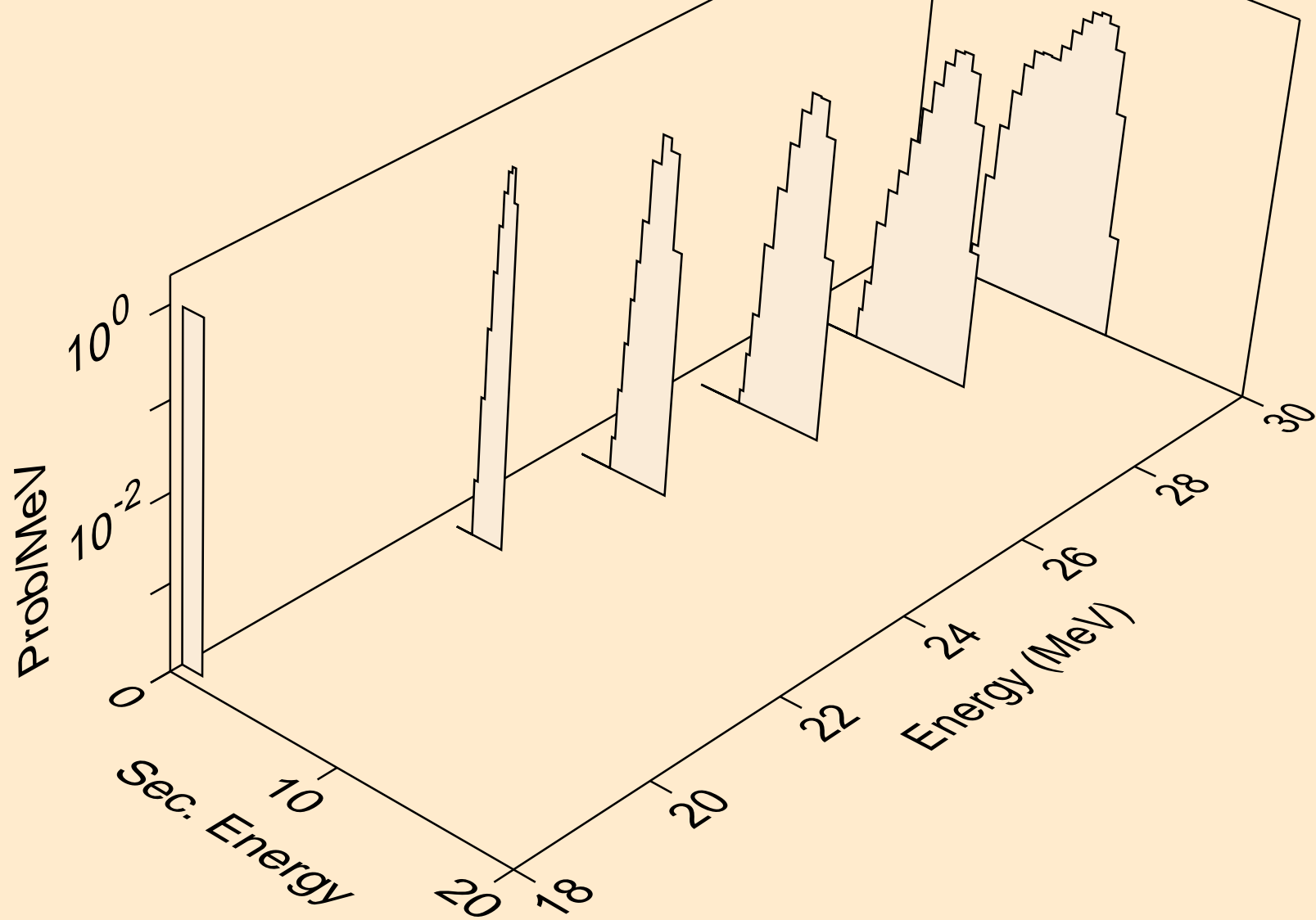

LU160 NEUTRON ACER TENDL-2024 LIBRARY; T=293.6K  
deuterons from (n,n\*)d

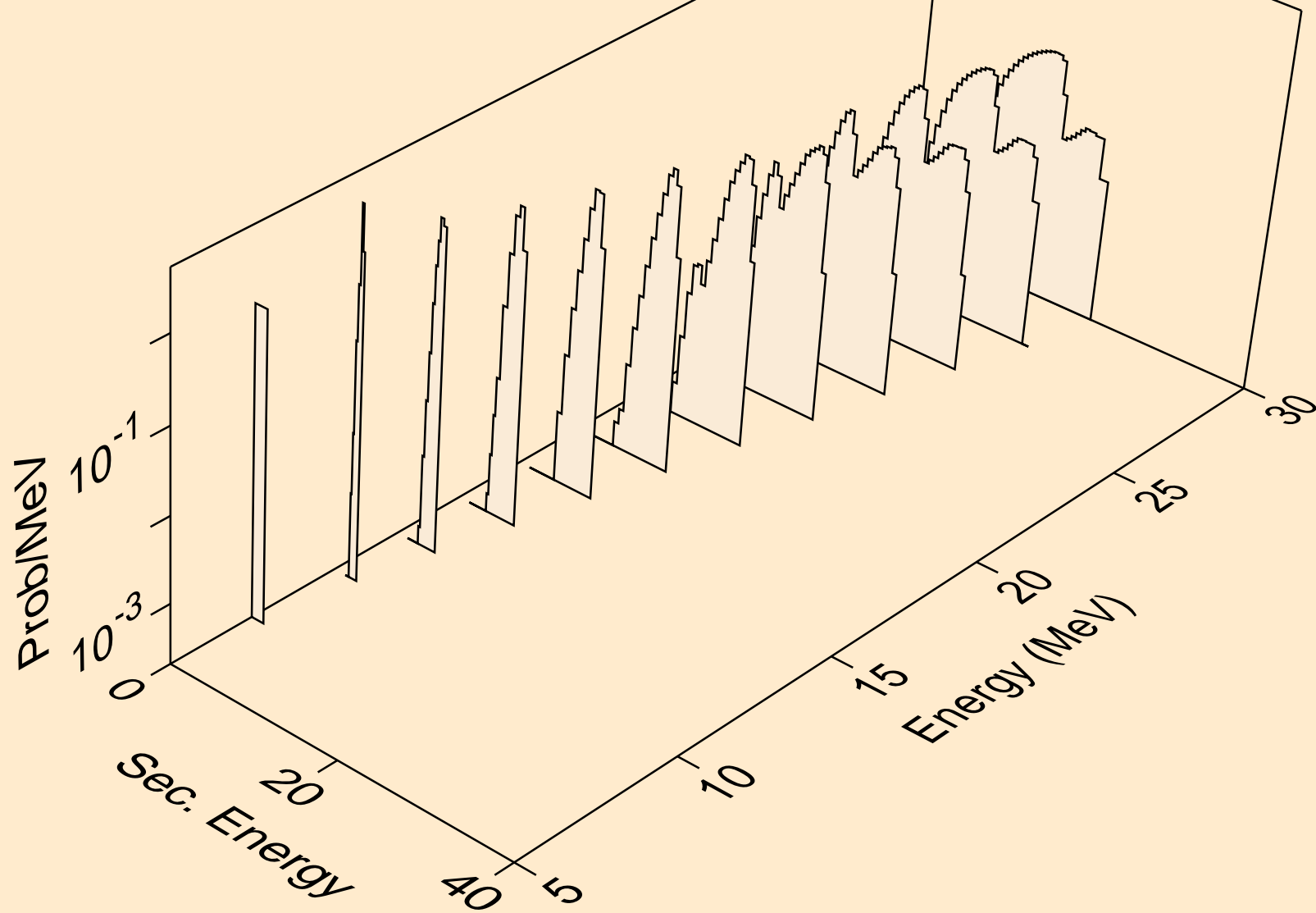

LU160 NEUTRON ACER TENDL-2024 LIBRARY; T=293.6K  
deuterons from (n,n\*)d2a

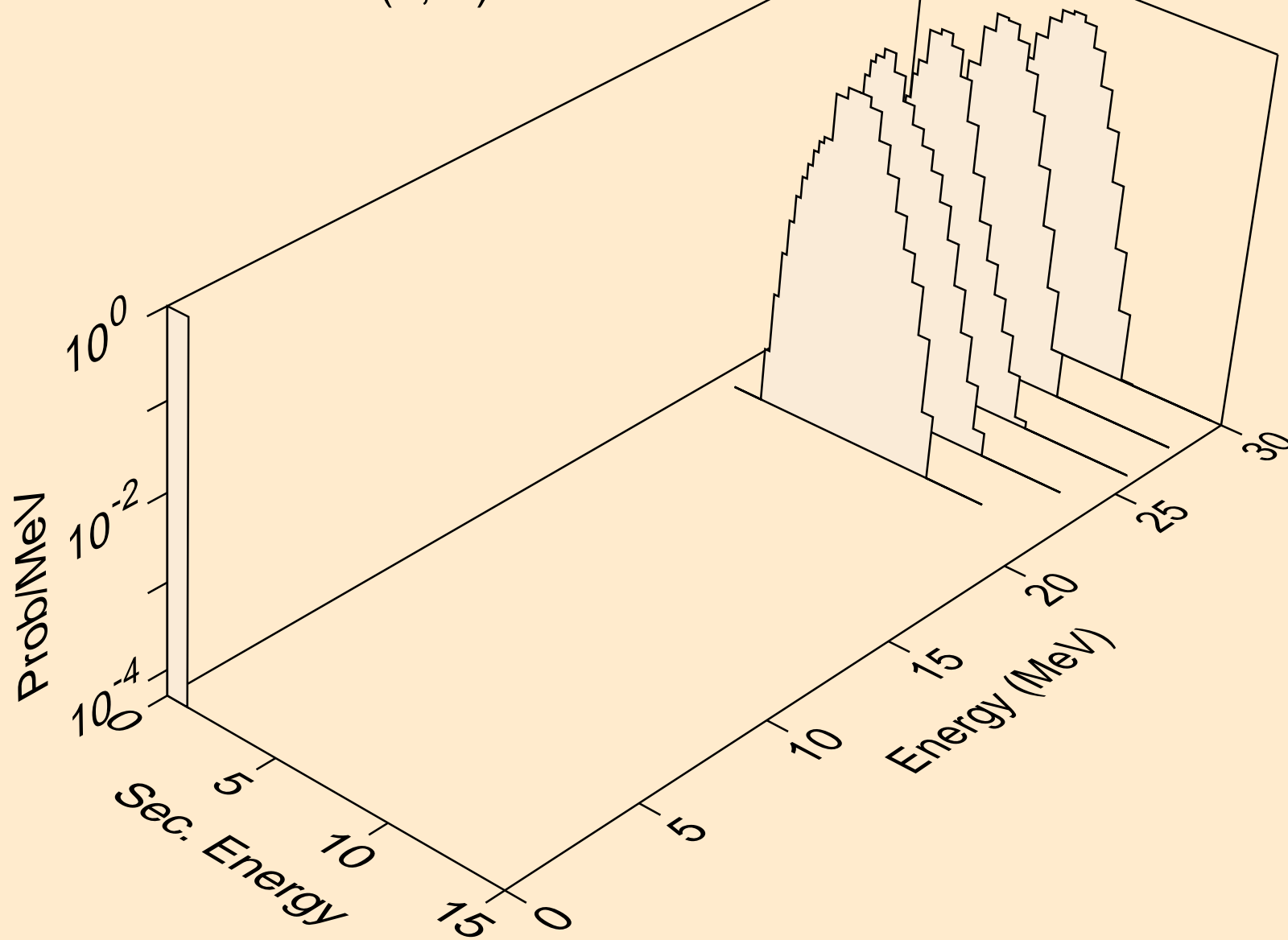

LU160 NEUTRON ACER TENDL-2024 LIBRARY; T=293.6K  
deuterons from (n,d)

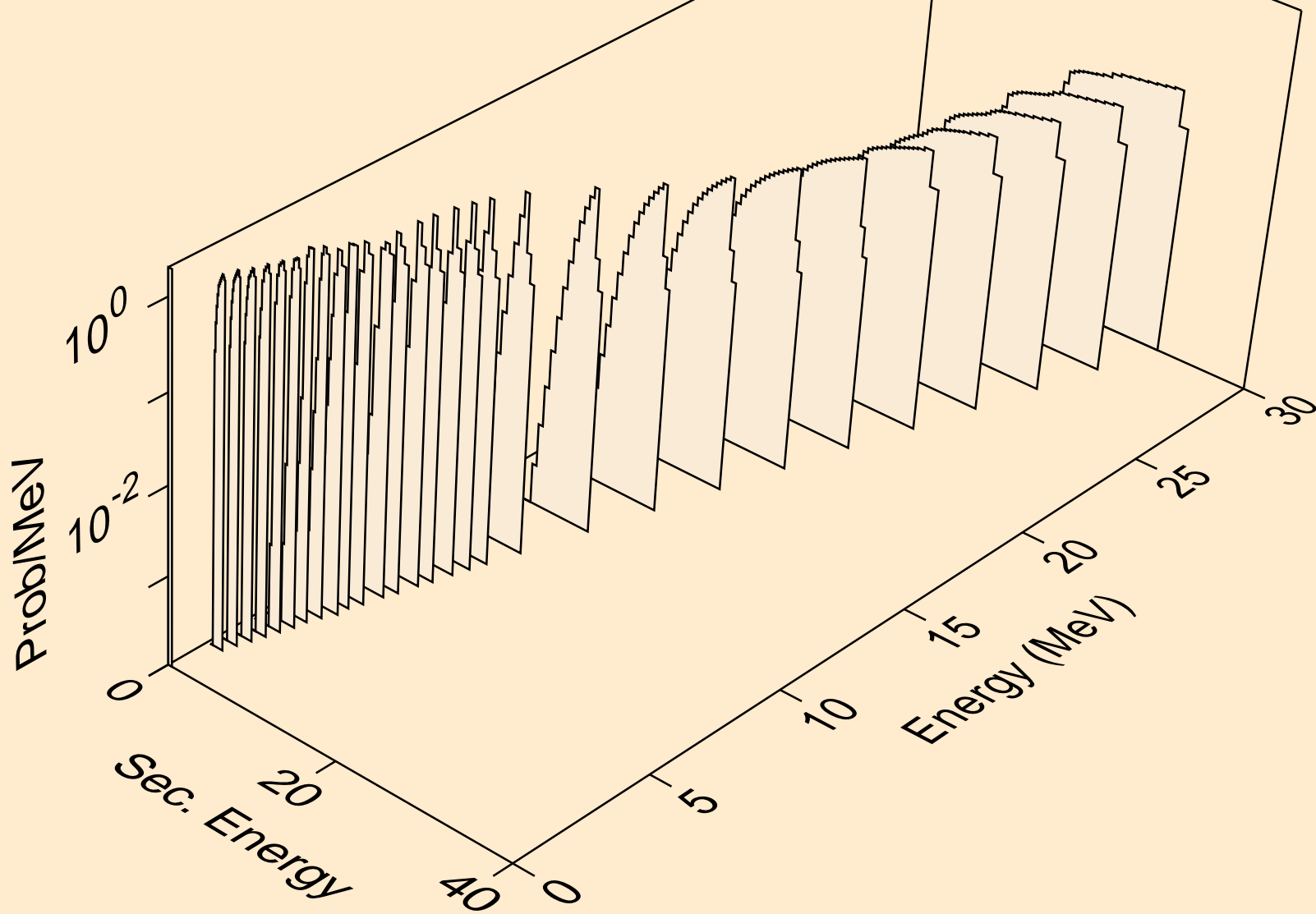

LU160 NEUTRON ACER TENDL-2024 LIBRARY; T=293.6K  
deuterons from (n,d2a)

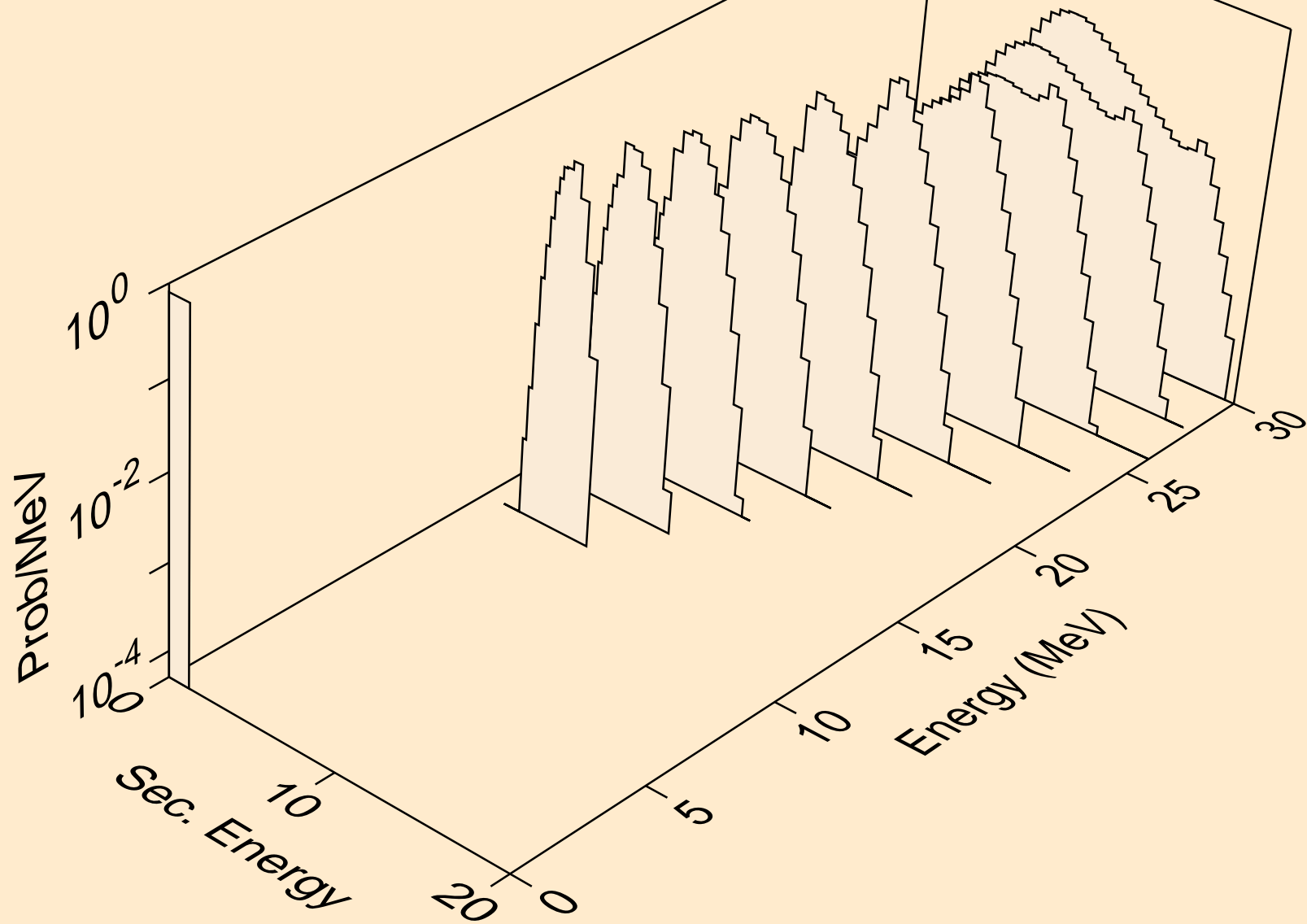

LU160 NEUTRON ACER TENDL-2024 LIBRARY; T=293.6K  
deuterons from (n,pd)

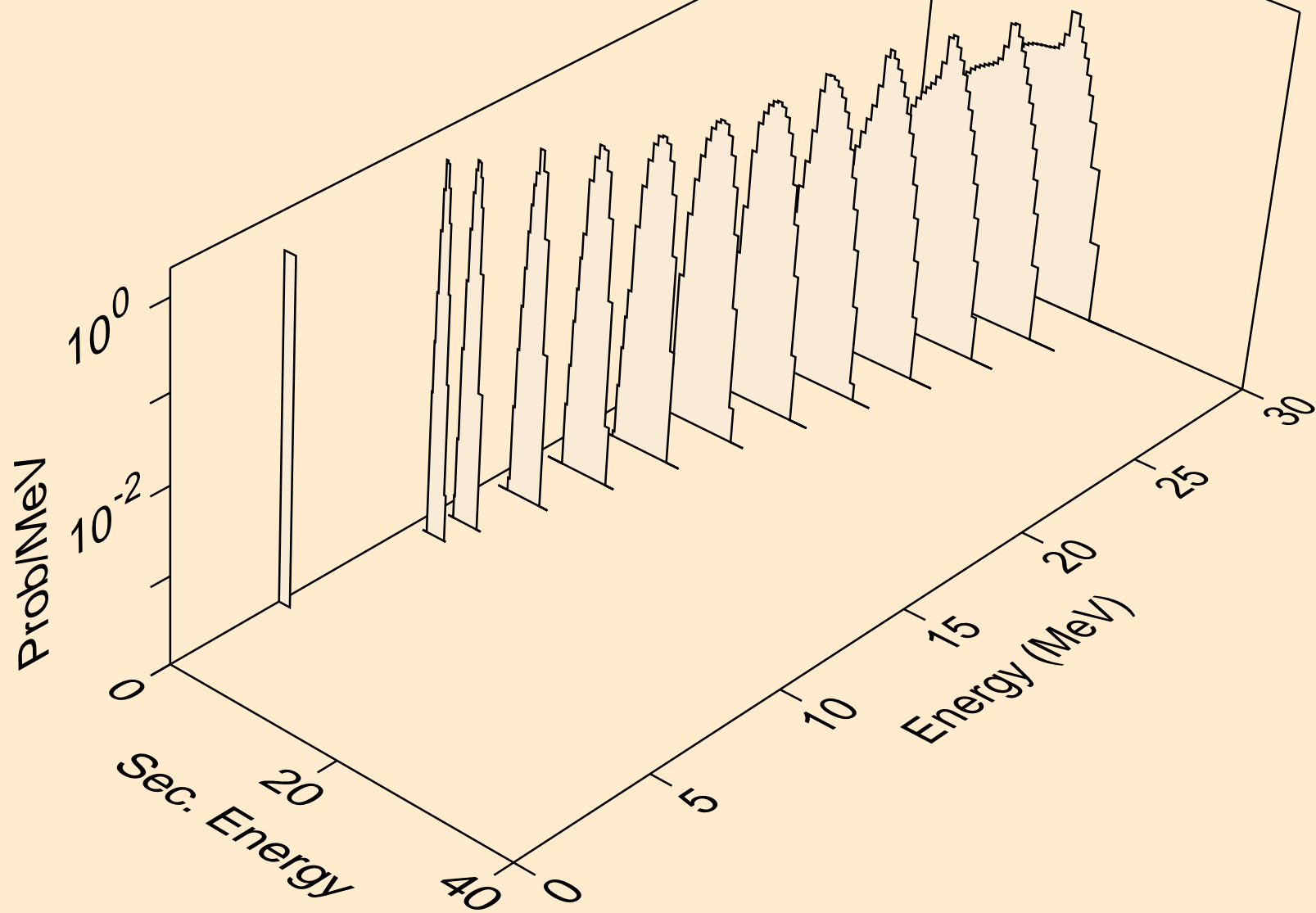

LU160 NEUTRON ACER TENDL-2024 LIBRARY; T=293.6K  
deuterons from (n,da)

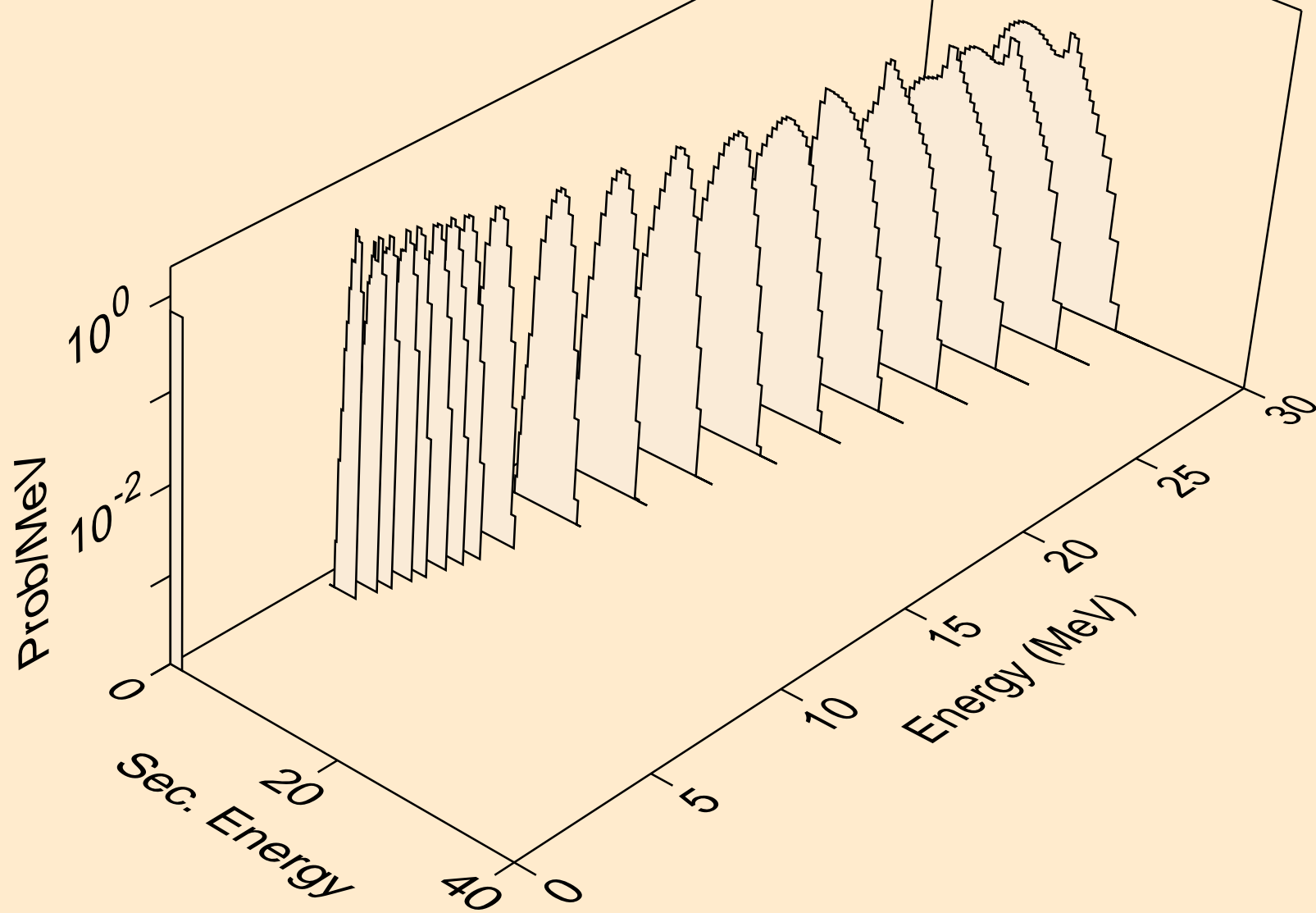

LU160 NEUTRON ACER TENDL-2024 LIBRARY; T=293.6K  
tritons from (n,x)

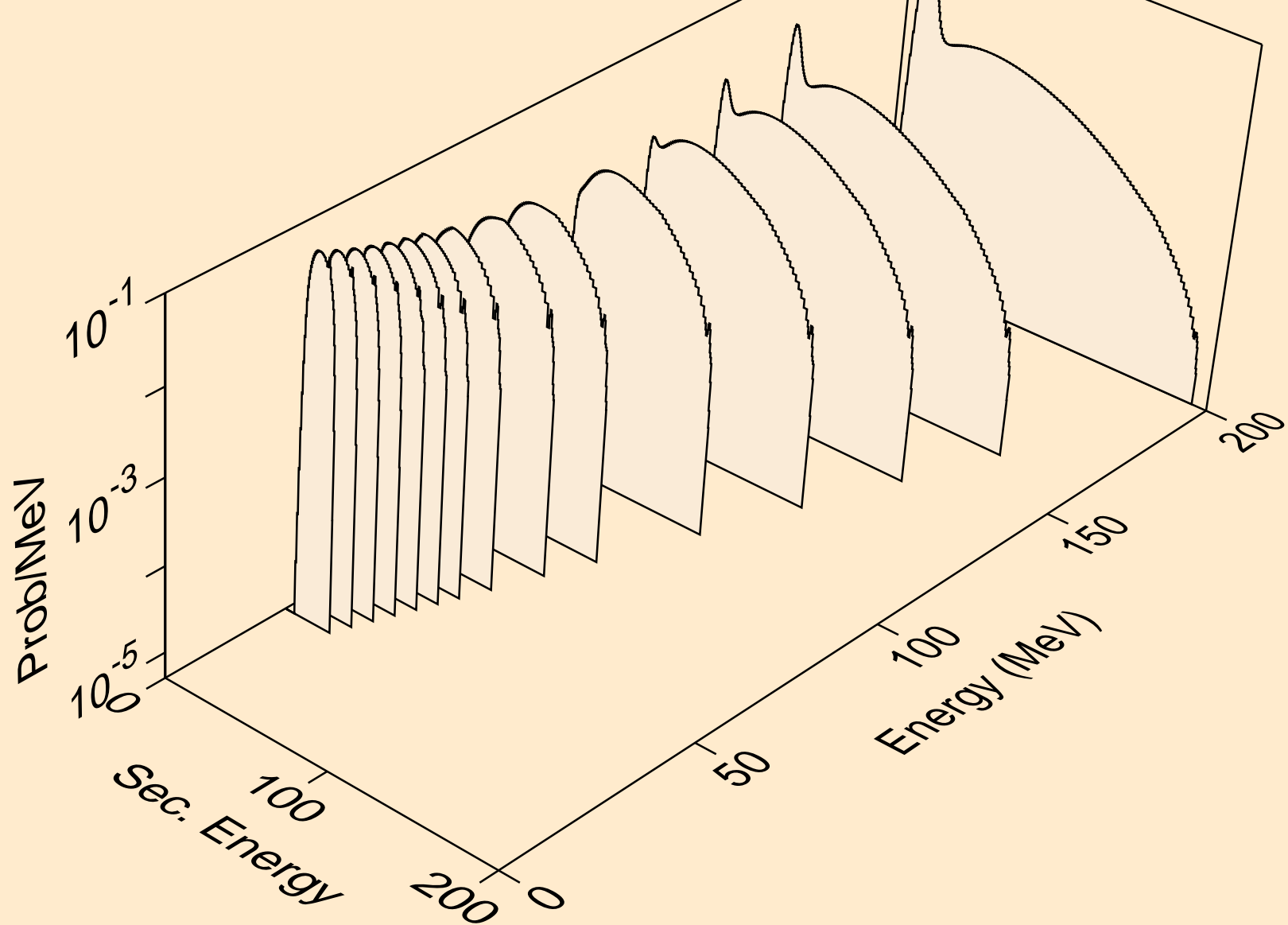

LU160 NEUTRON ACER TENDL-2024 LIBRARY; T=293.6K  
tritons from (n,n\*)t

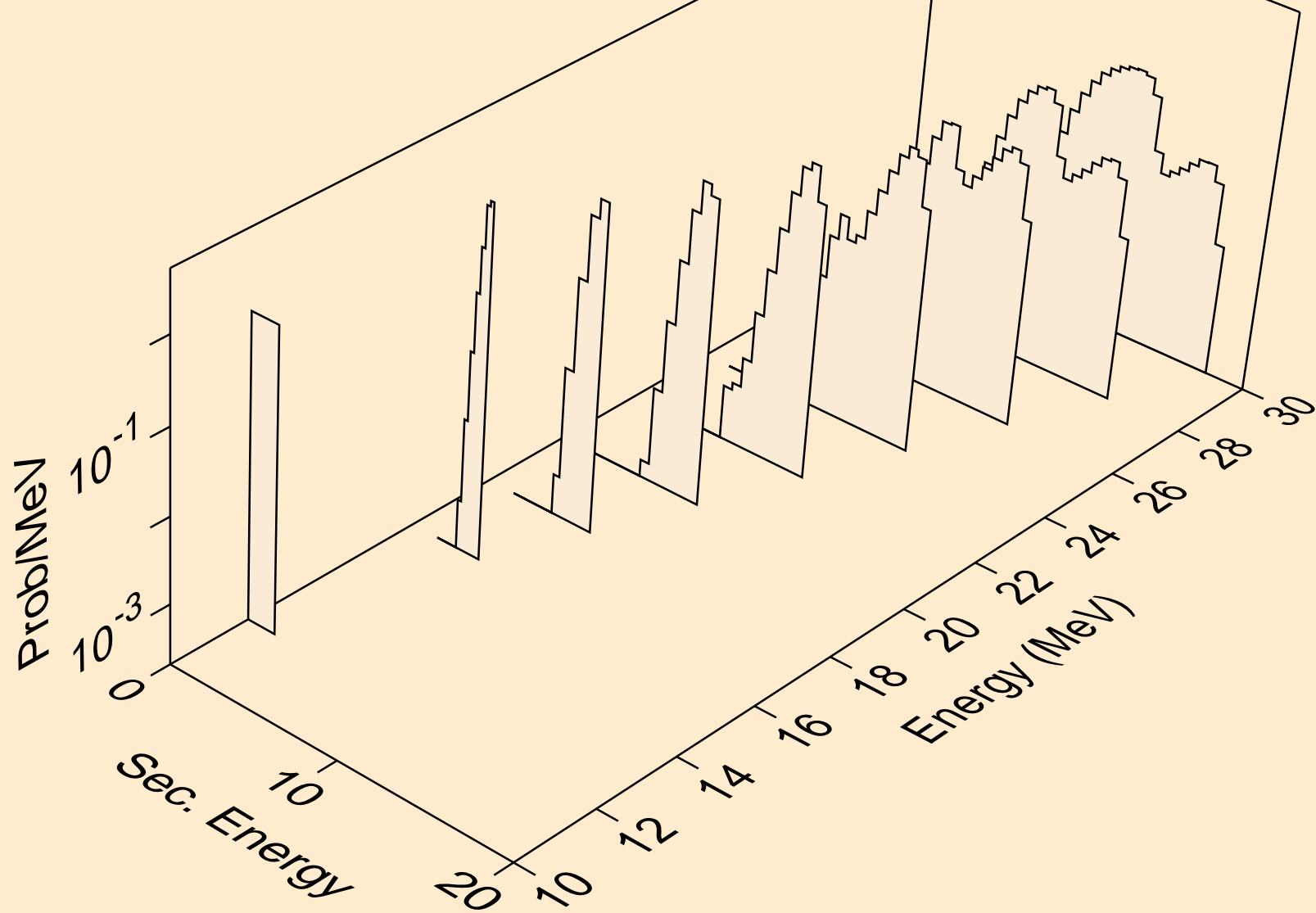

LU160 NEUTRON ACER TENDL-2024 LIBRARY; T=293.6K  
tritons from (n,t)

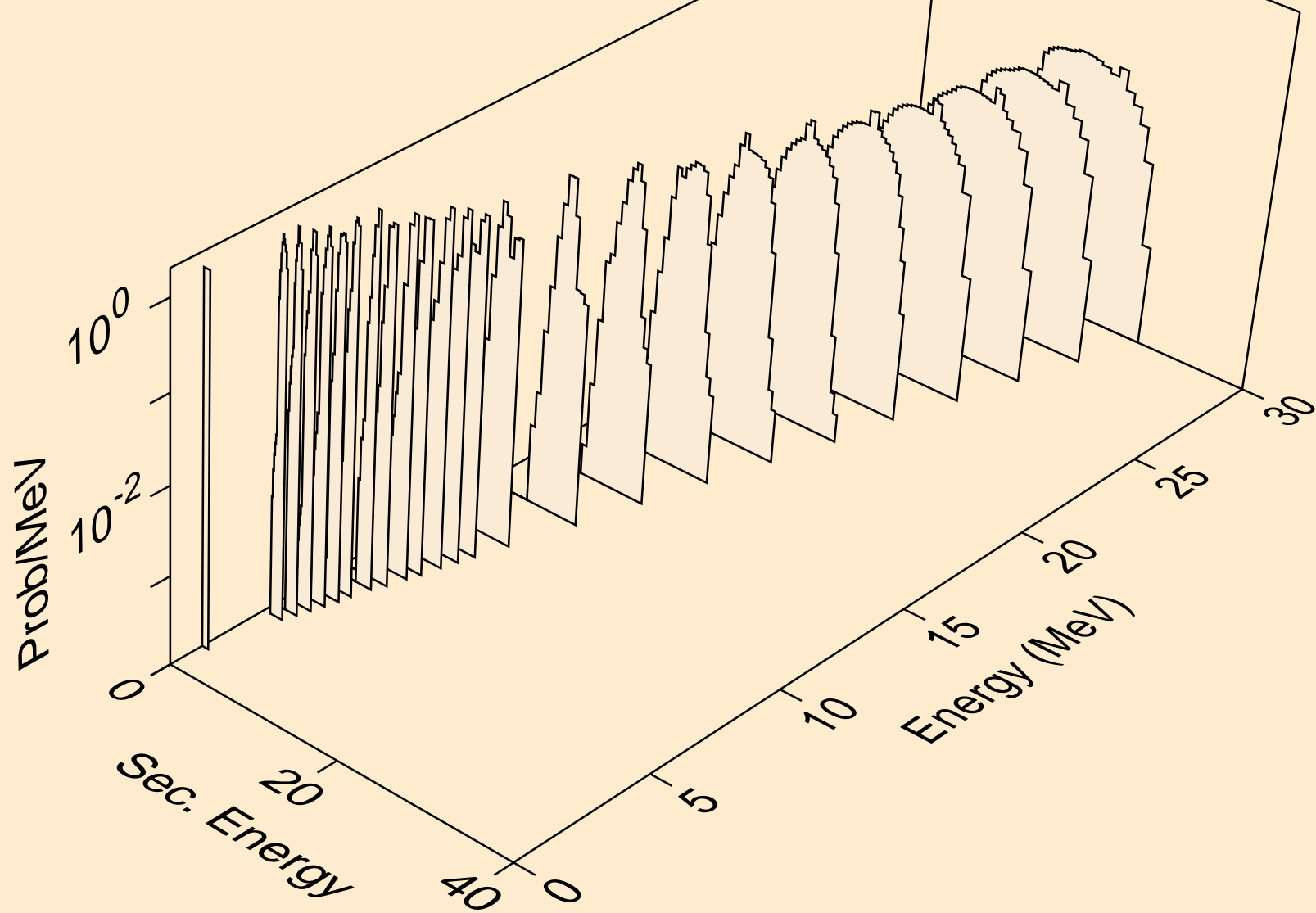

LU160 NEUTRON ACER TENDL-2024 LIBRARY; T=293.6K  
tritons from (n,t2a)

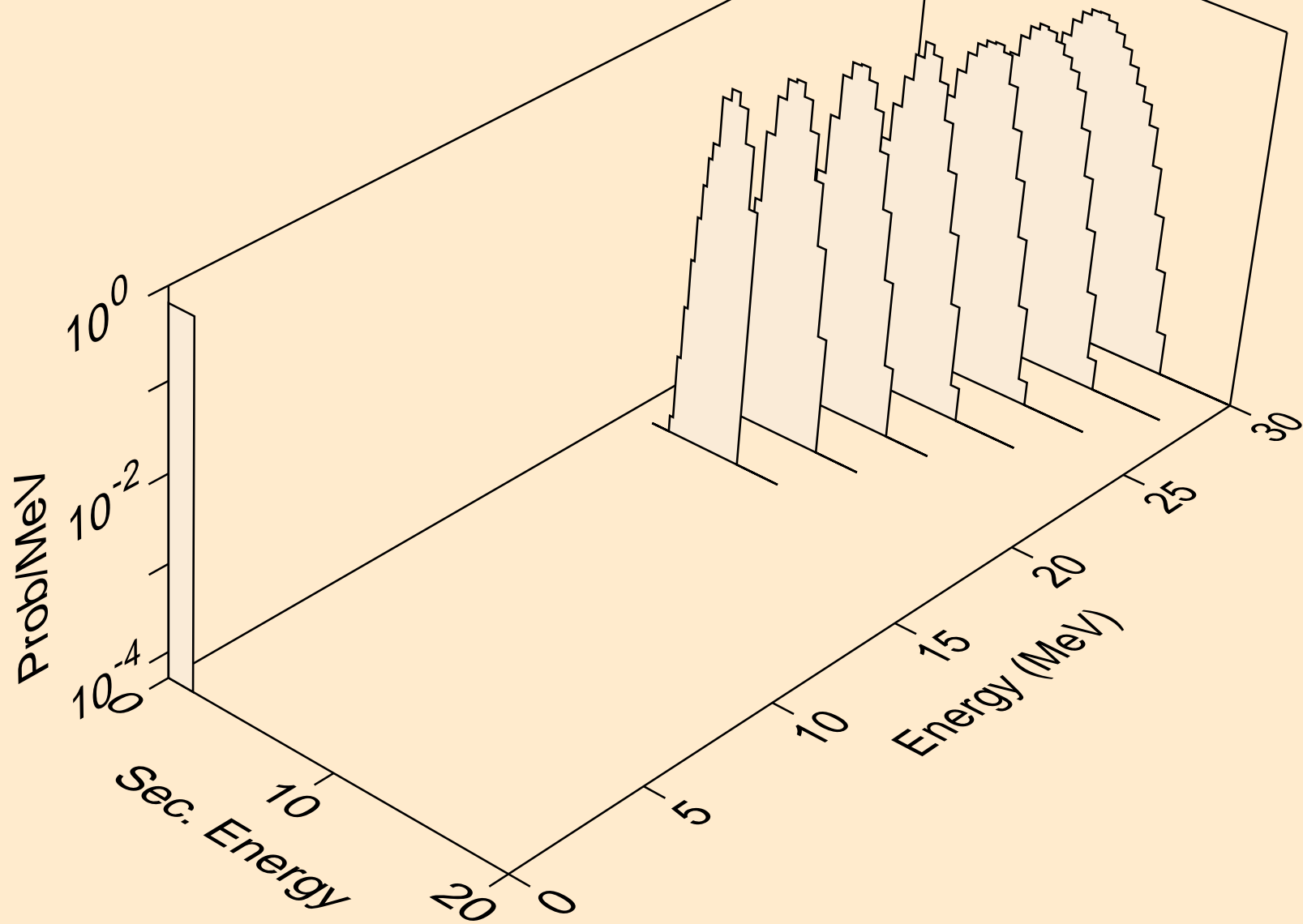

LU160 NEUTRON ACER TENDL-2024 LIBRARY; T=293.6K  
tritons from (n,pt)

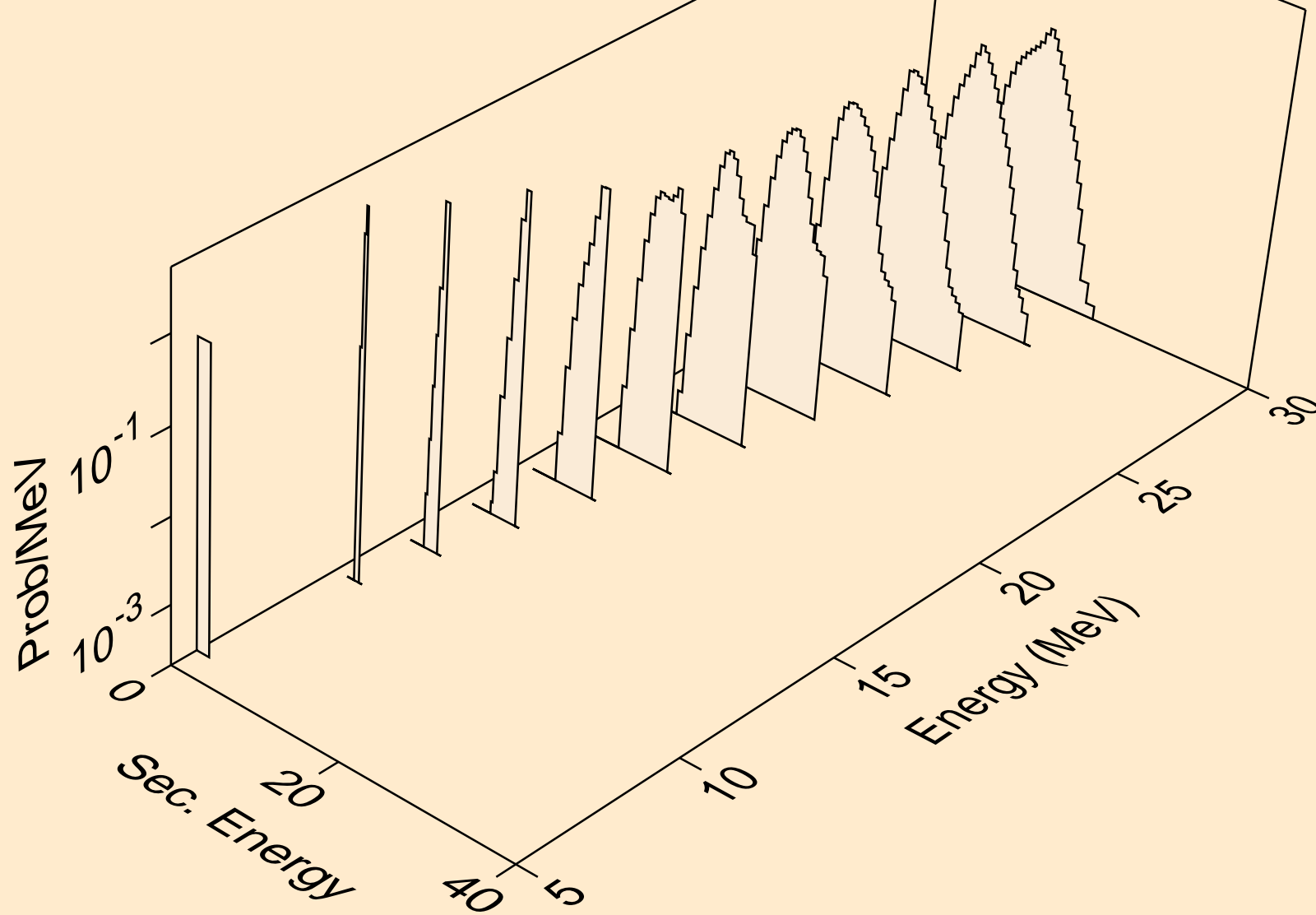

LU160 NEUTRON ACER TENDL-2024 LIBRARY; T=293.6K  
he3s from (n,x)

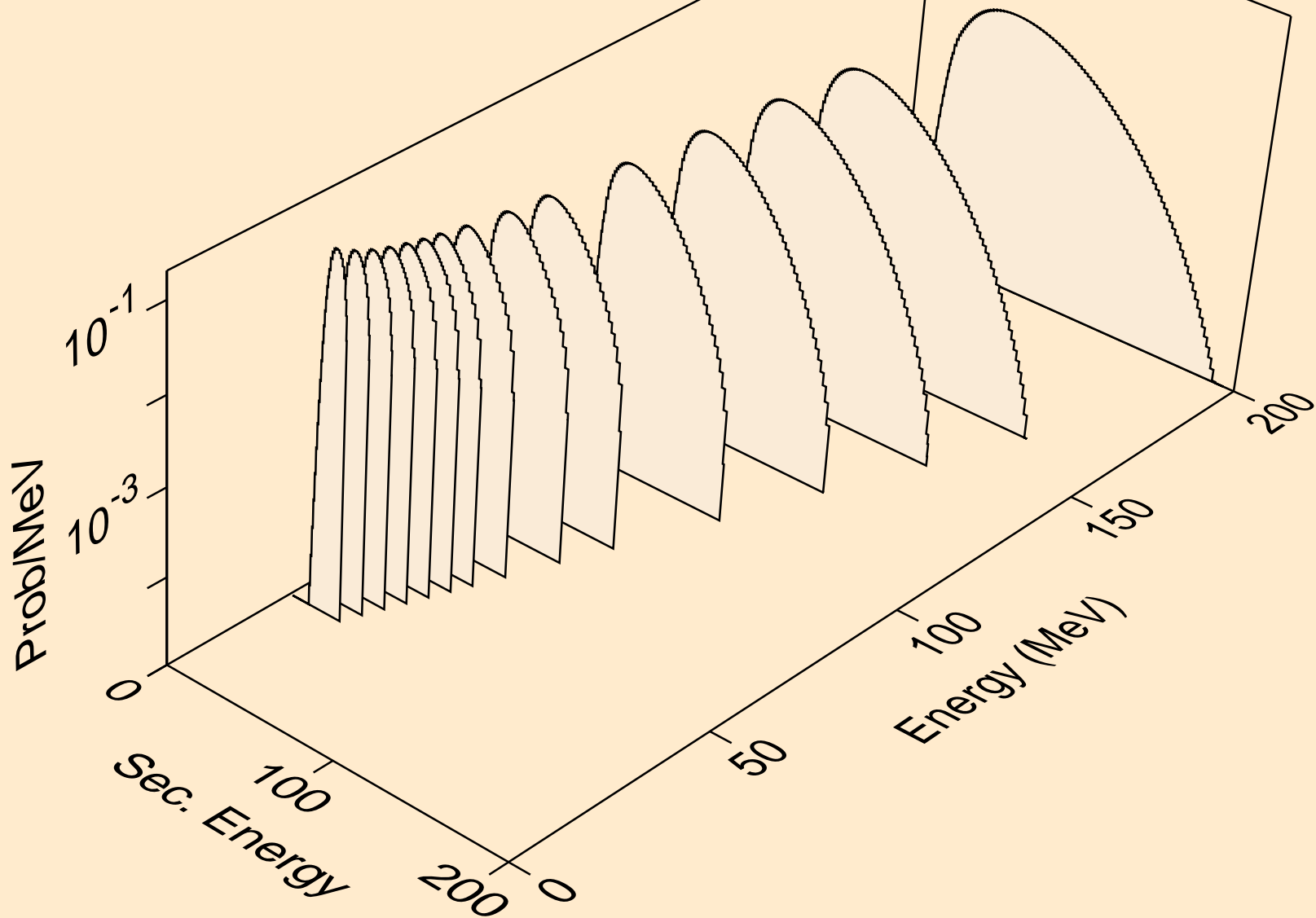

LU160 NEUTRON ACER TENDL-2024 LIBRARY; T=293.6K  
he3s from (n,n\*)he3

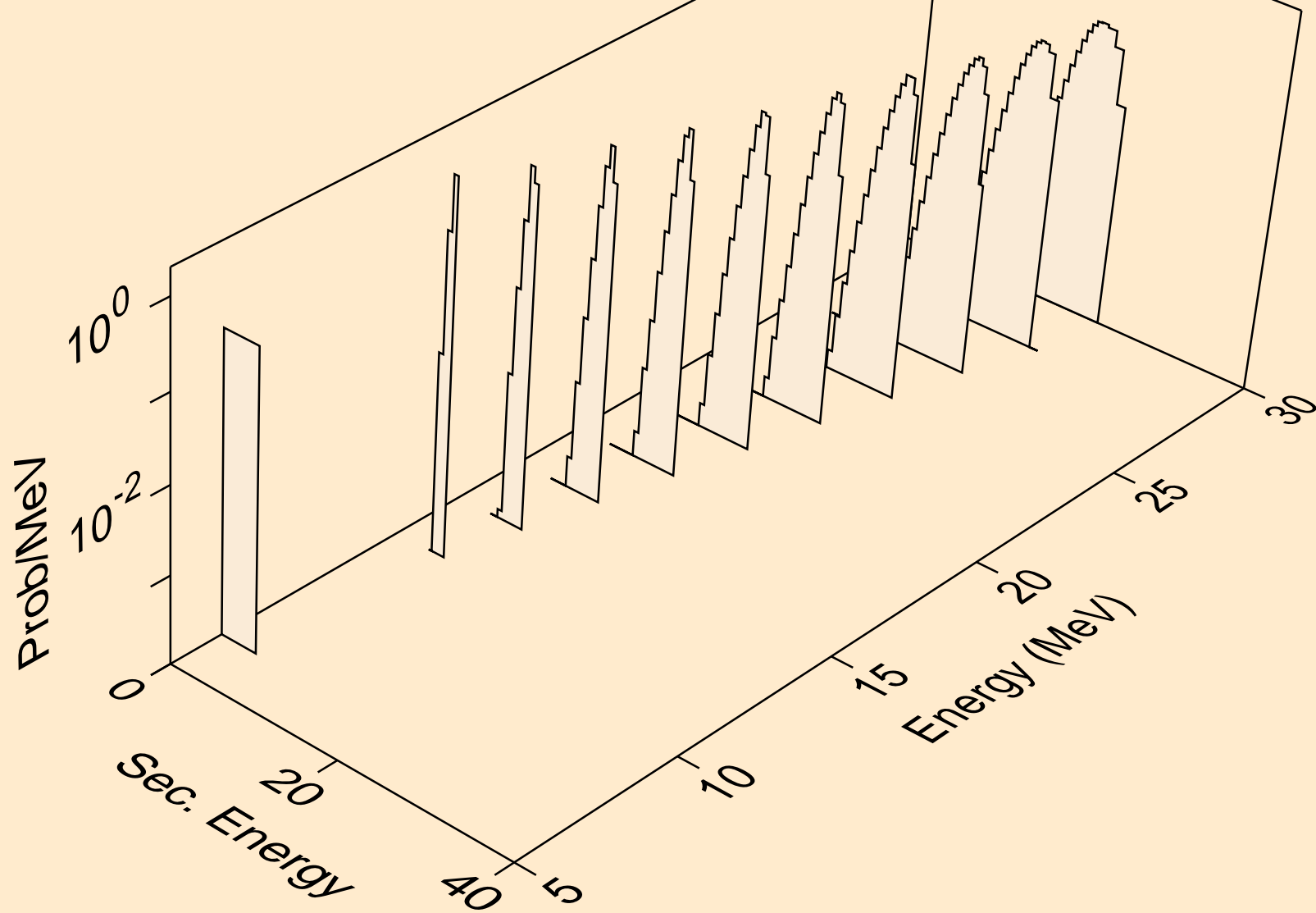

LU160 NEUTRON ACER TENDL-2024 LIBRARY; T=293.6K  
he3s from (n,he3)

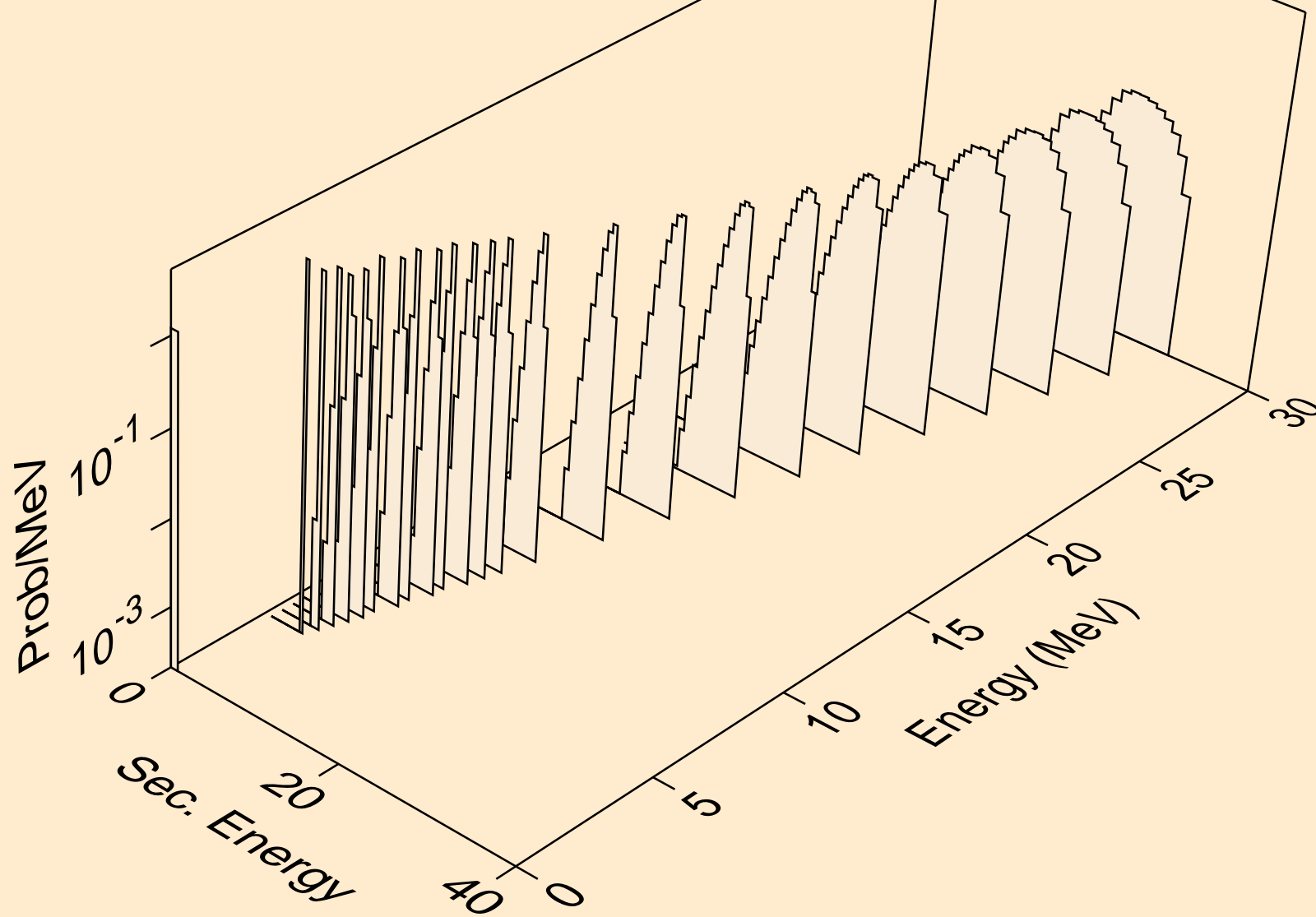

LU160 NEUTRON ACER TENDL-2024 LIBRARY; T=293.6K  
alphas from (n,x)

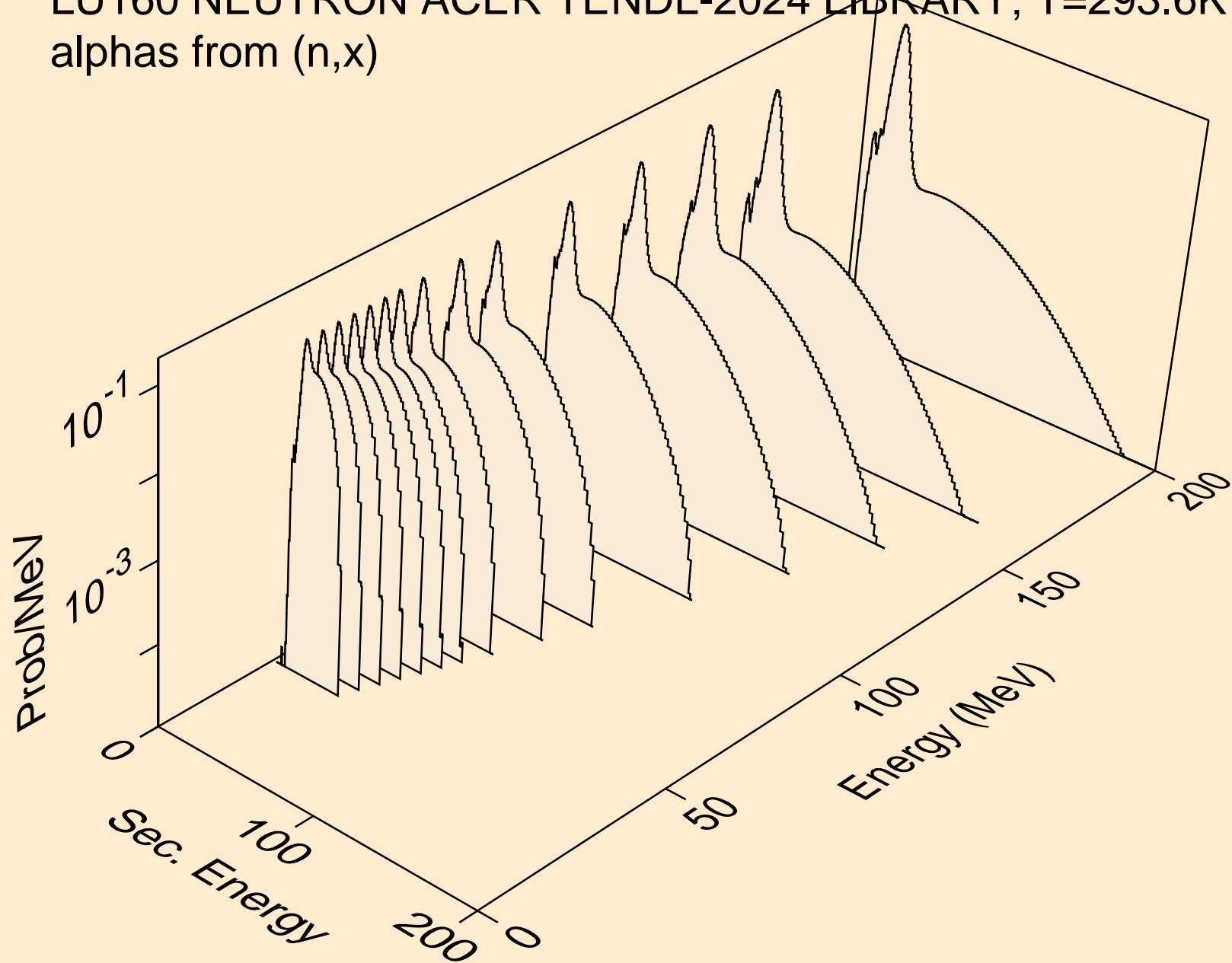

LU160 NEUTRON ACER TENDL-2024 LIBRARY; T=293.6K  
alphas from (n,n\*)a

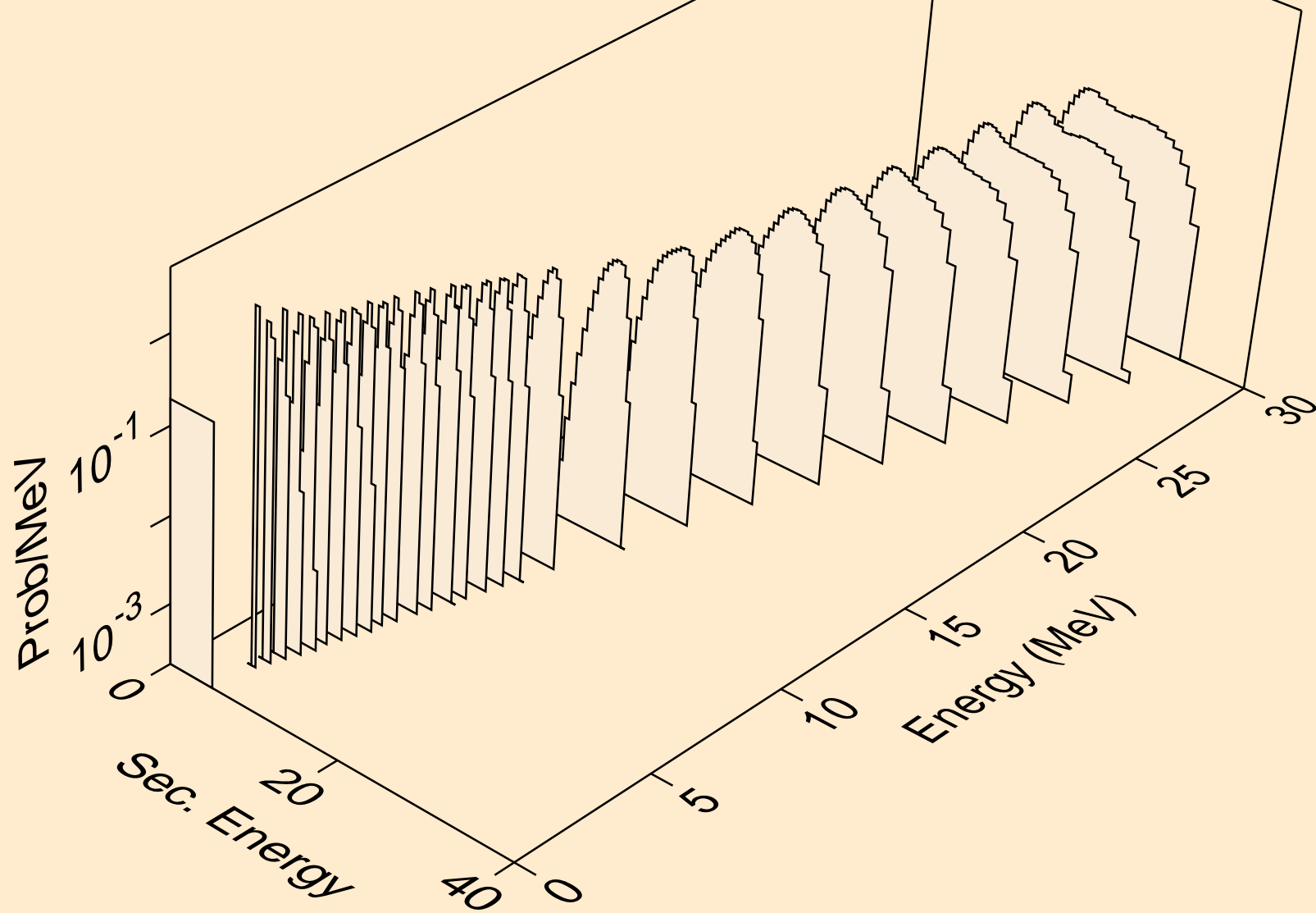

LU160 NEUTRON ACER TENDL-2024 LIBRARY; T=293.6K  
alphas from (n,n\*)3a

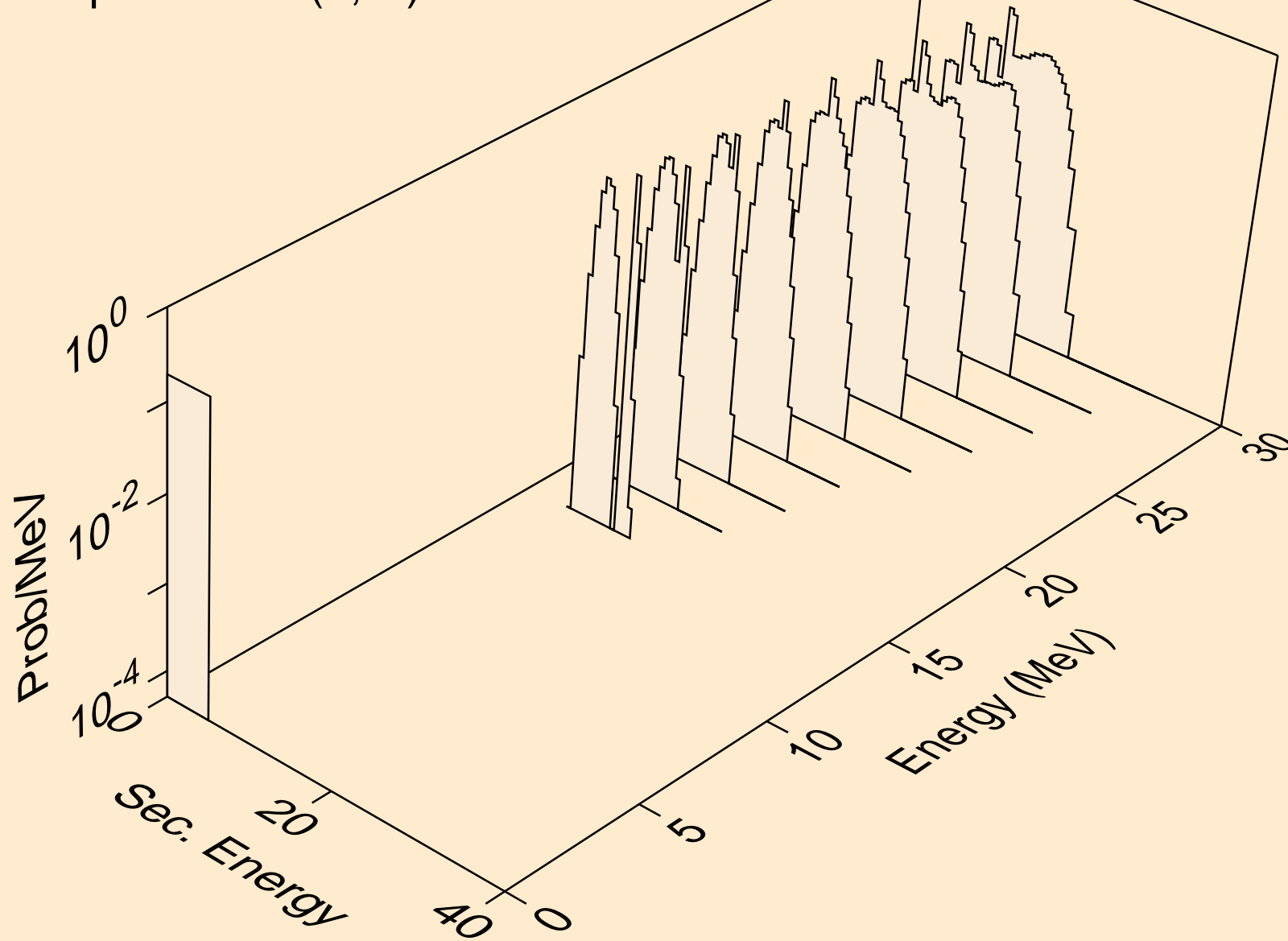

LU160 NEUTRON ACER TENDL-2024 LIBRARY; T=293.6K  
alphas from (n,2n)a

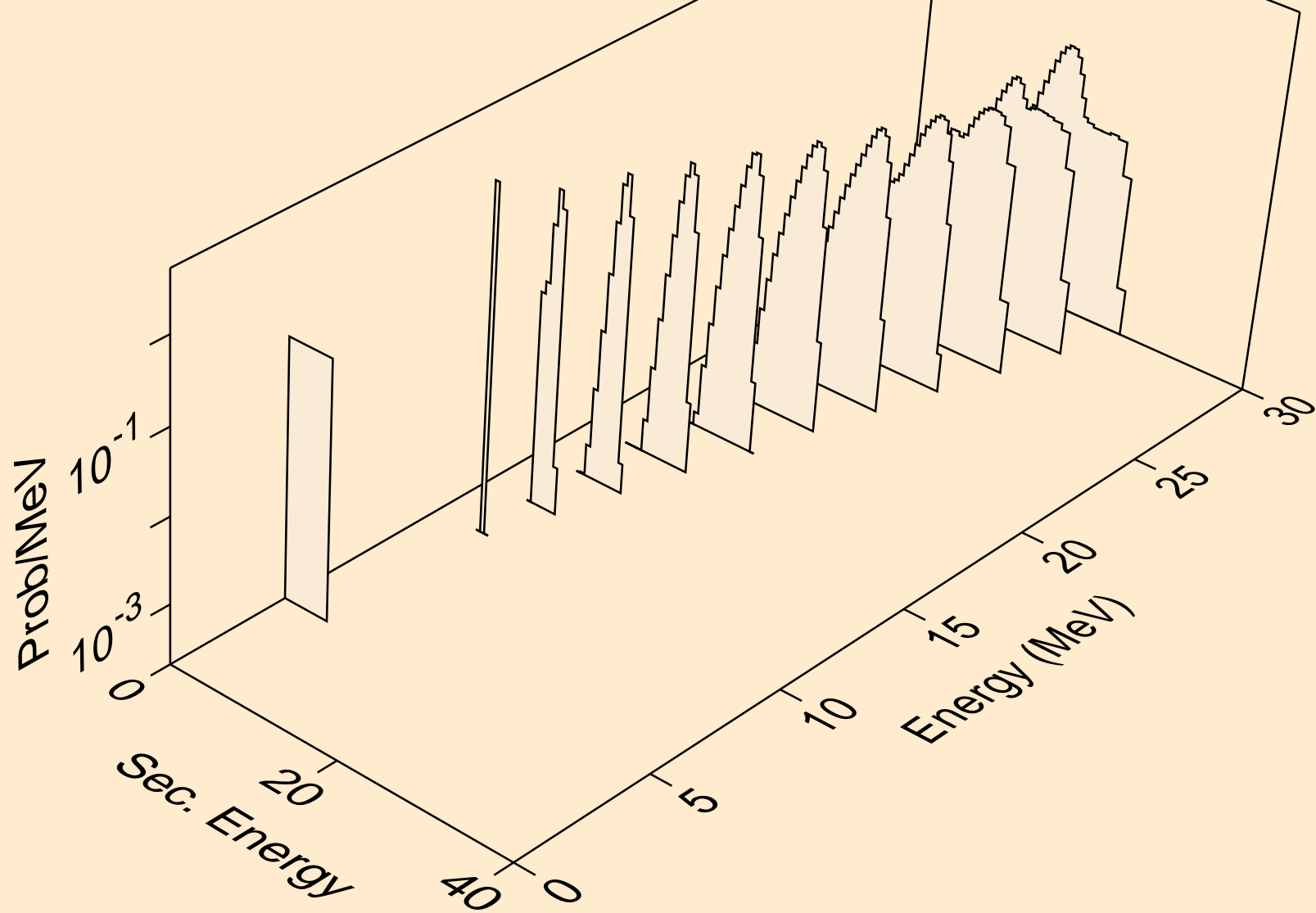

LU160 NEUTRON ACER TENDL-2024 LIBRARY; T=293.6K  
alphas from (n,3n)a



LU160 NEUTRON ACER TENDL-2024 LIBRARY; T=293.6K  
alphas from (n,n\*)2a

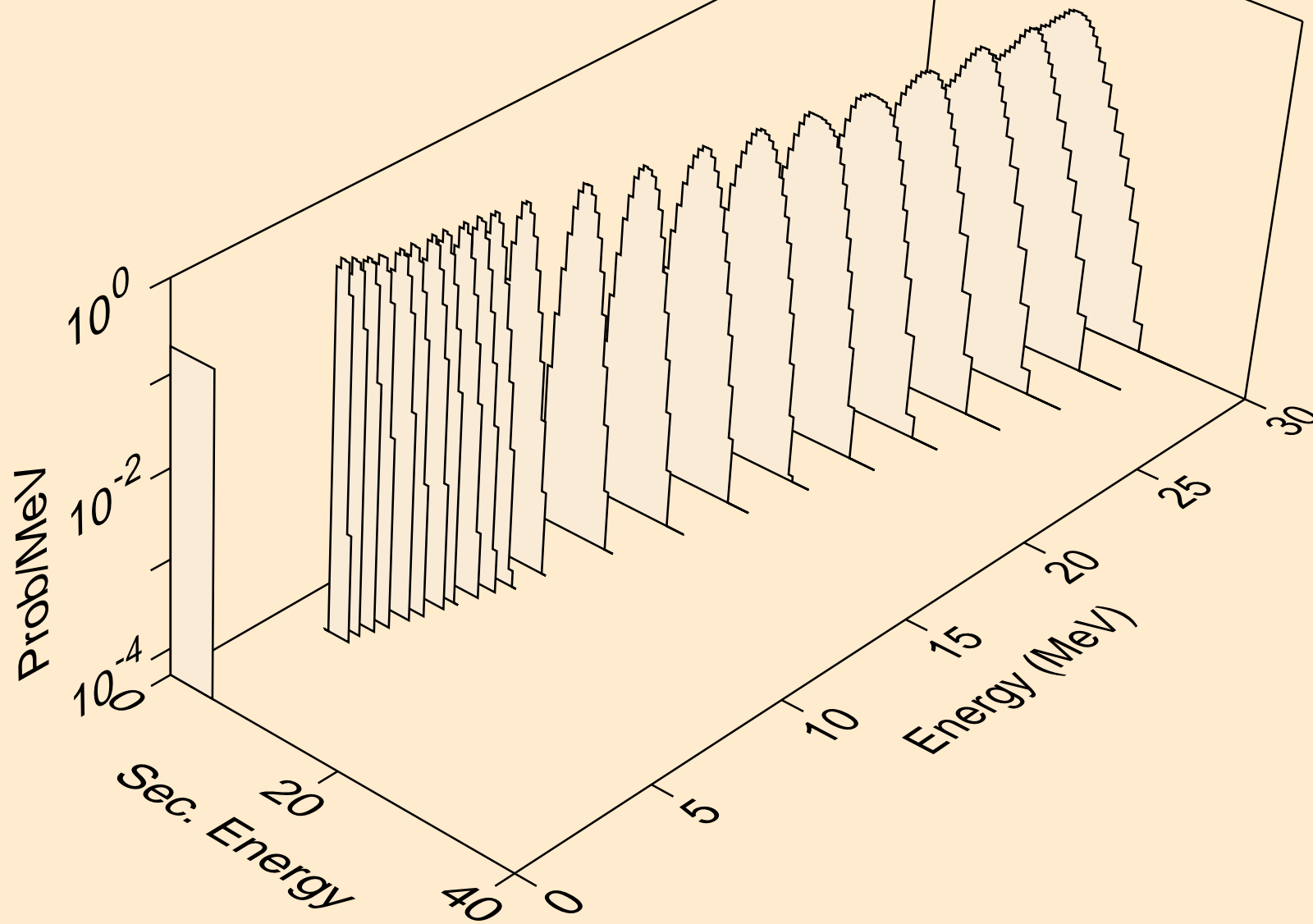

LU160 NEUTRON ACER TENDL-2024 LIBRARY; T=293.6K  
alphas from (n,2n)2a

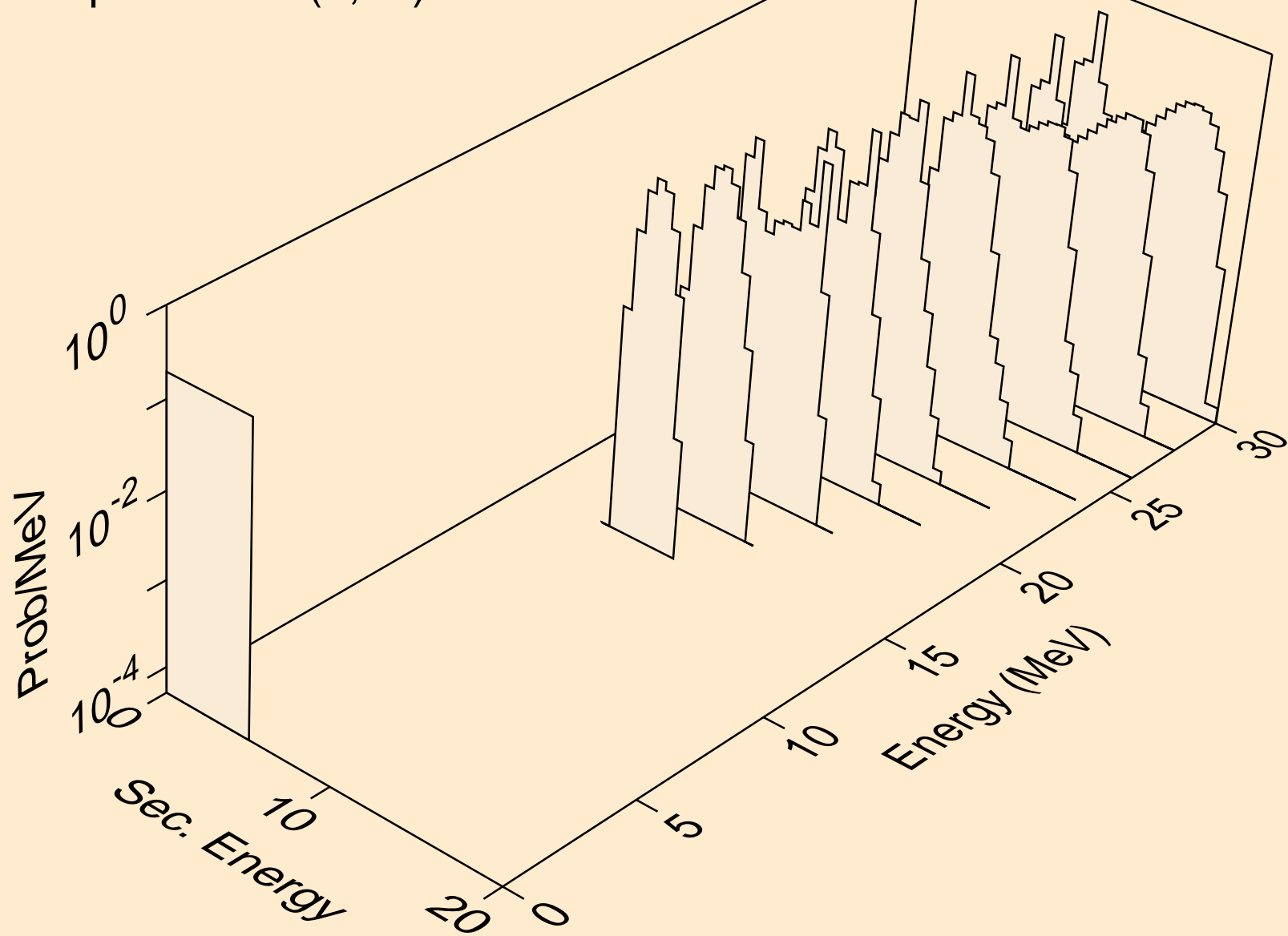

LU160 NEUTRON ACER TENDL-2024 LIBRARY; T=293.6K  
alphas from (n,n\*)d2a

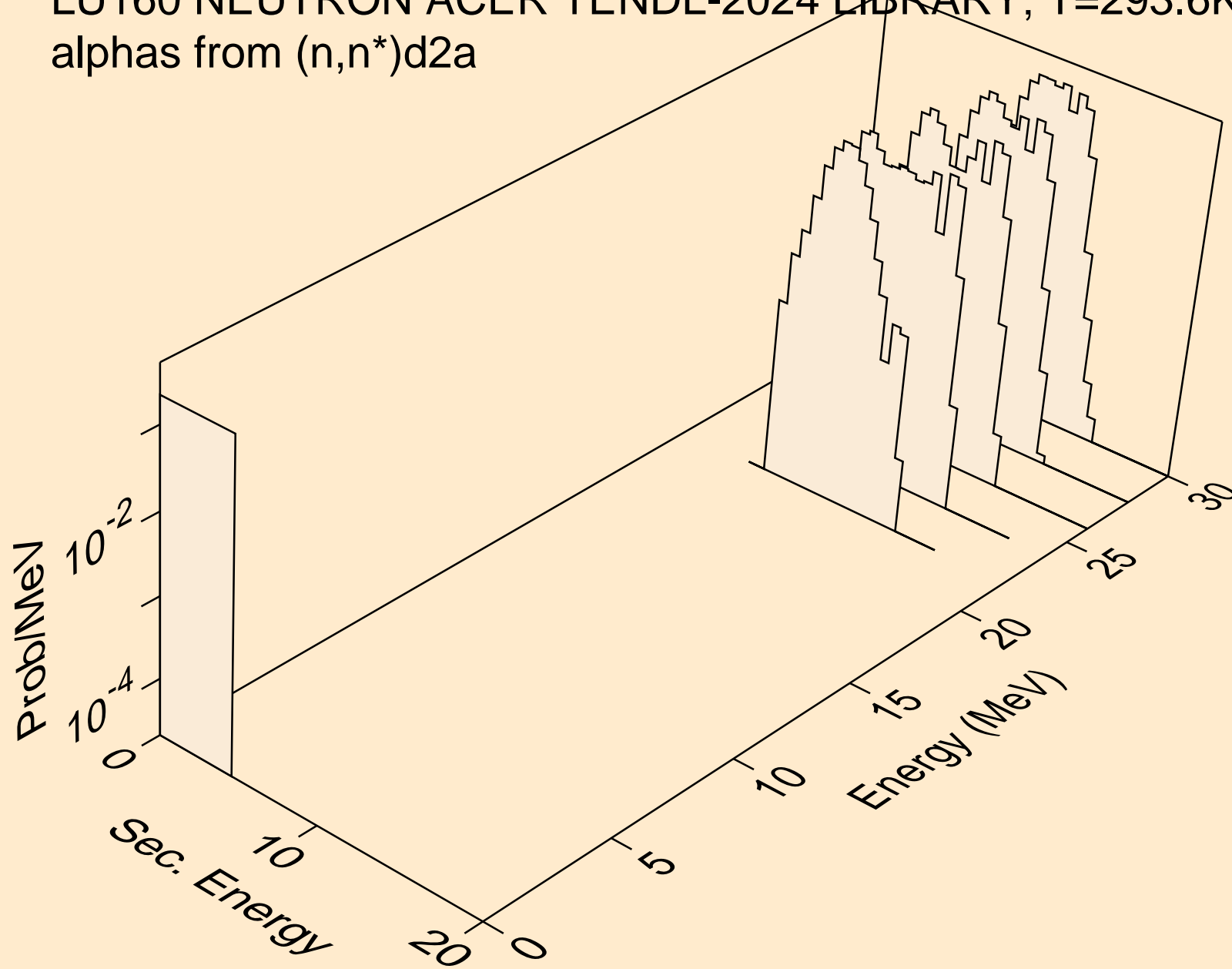

LU160 NEUTRON ACER TENDL-2024 LIBRARY; T=293.6K  
alphas from (n,npa)

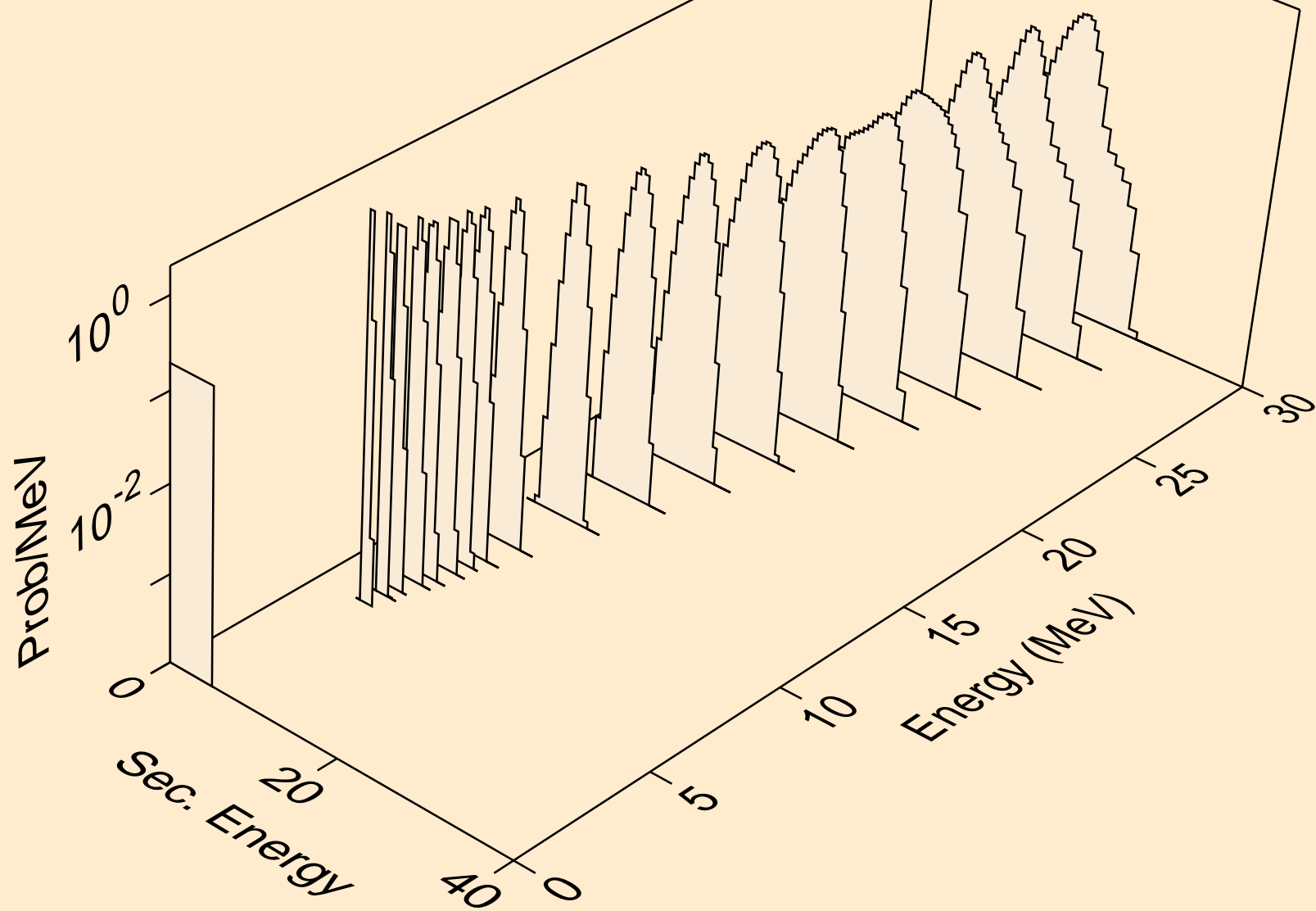

LU160 NEUTRON ACER TENDL-2024 LIBRARY; T=293.6K  
alphas from (n,a)

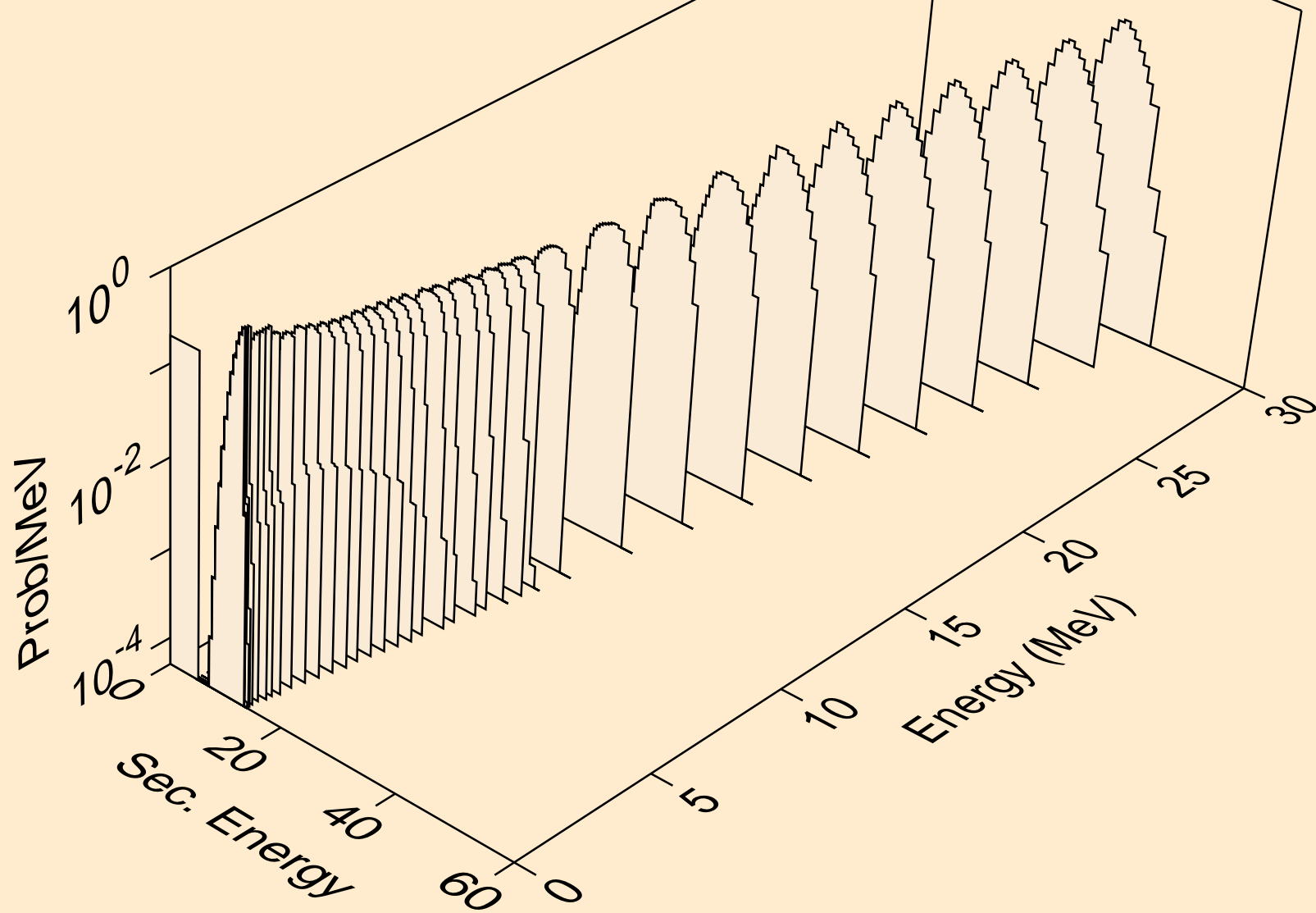

LU160 NEUTRON ACER TENDL-2024 LIBRARY; T=293.6K  
alphas from (n,2a)

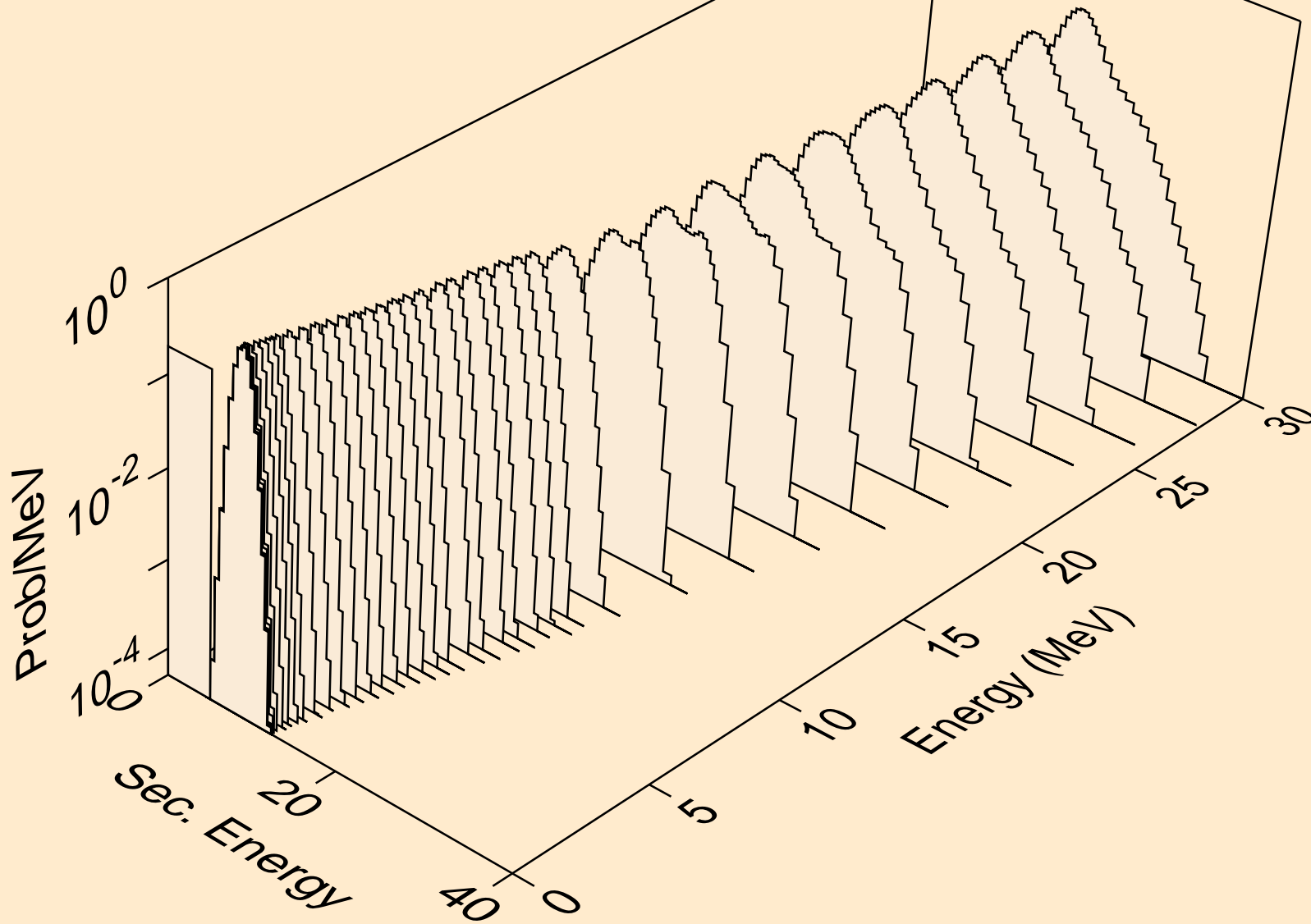

LU160 NEUTRON ACER TENDL-2024 LIBRARY; T=293.6K  
alphas from (n,3a)

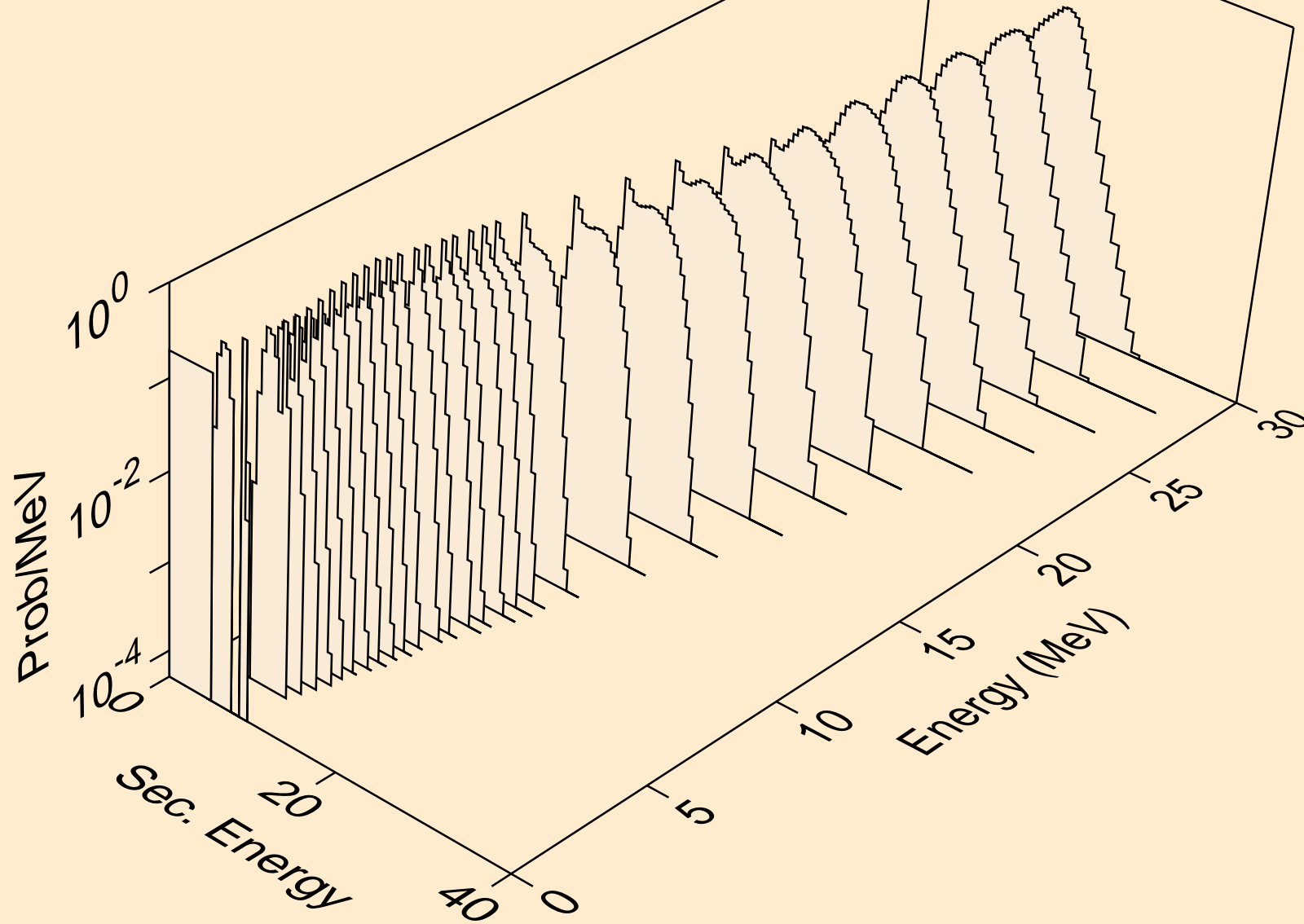

LU160 NEUTRON ACER TENDL-2024 LIBRARY; T=293.6K  
alphas from (n,pa)

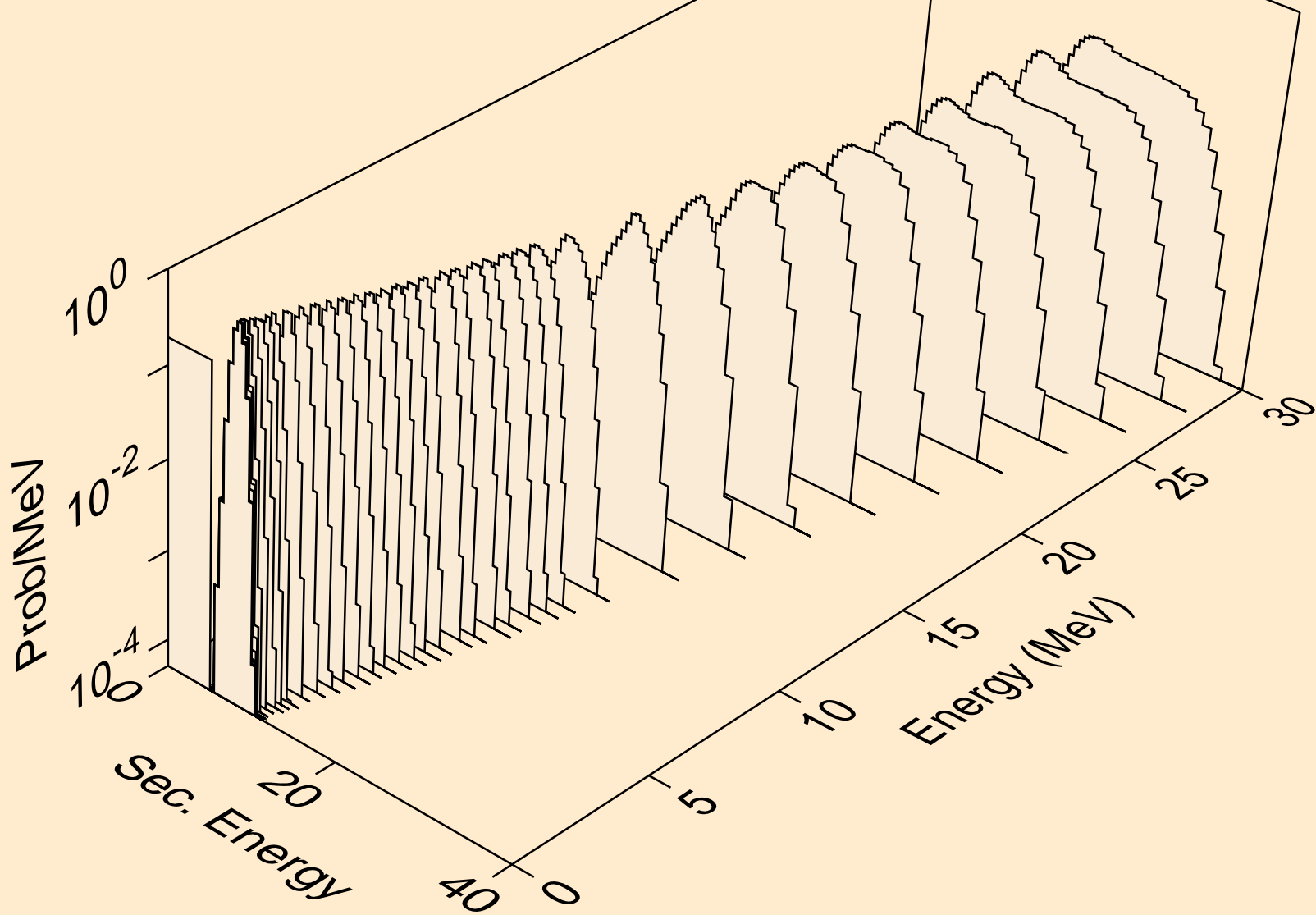

LU160 NEUTRON ACER TENDL-2024 LIBRARY; T=293.6K  
alphas from (n,t2a)

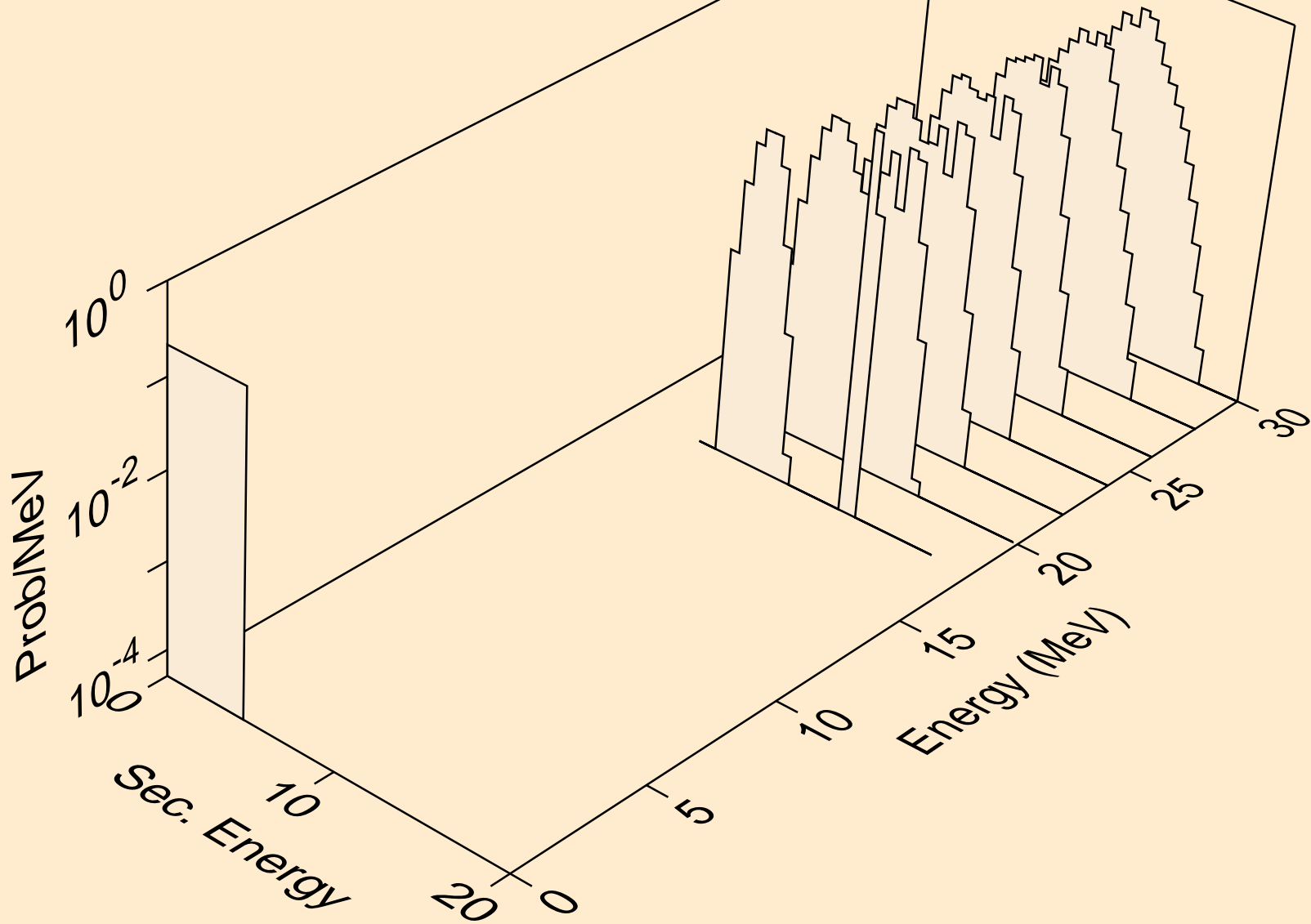

LU160 NEUTRON ACER TENDL-2024 LIBRARY; T=293.6K  
alphas from (n,d2a)

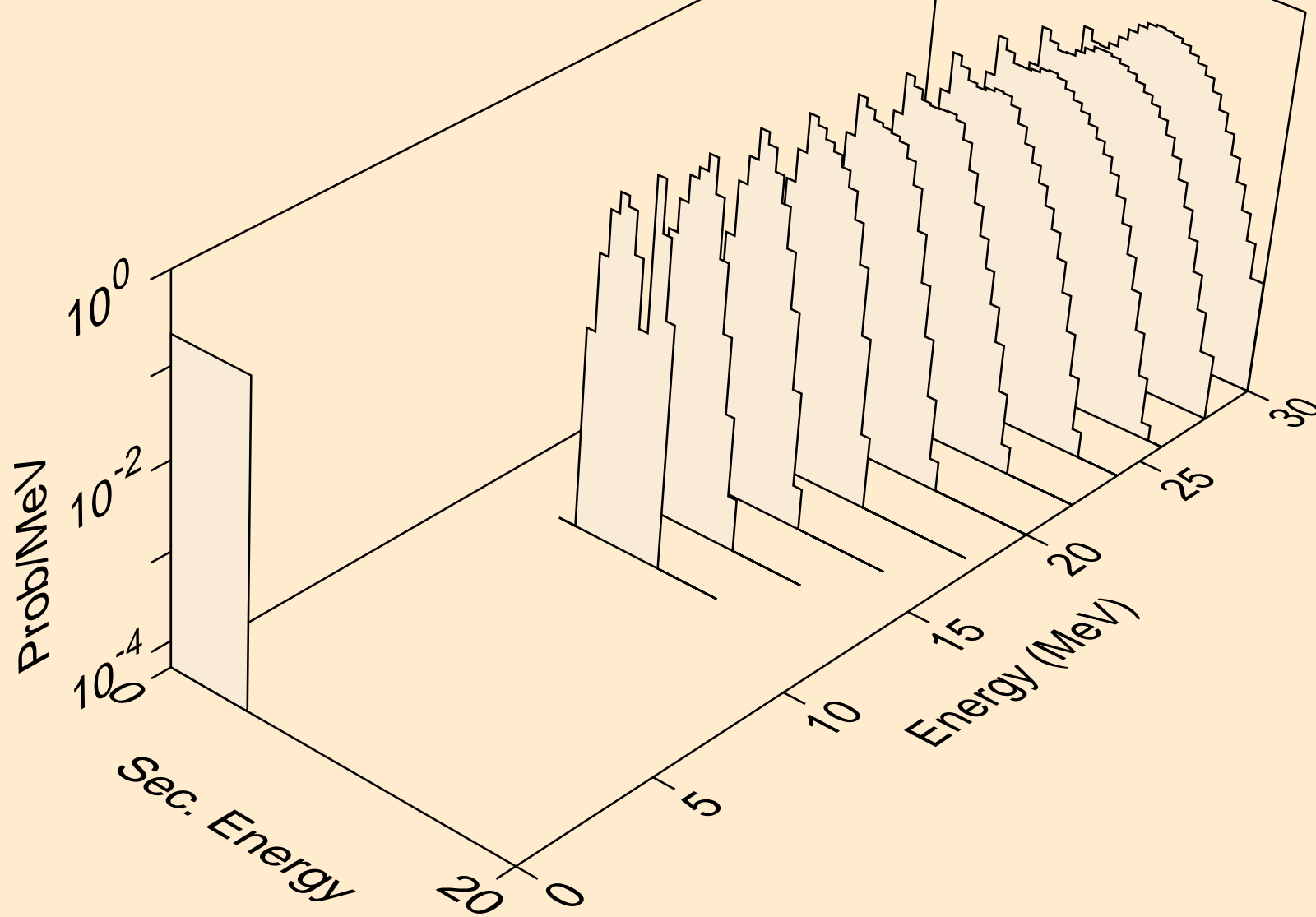

LU160 NEUTRON ACER TENDL-2024 LIBRARY; T=293.6K  
alphas from (n,da)

