

LU167M NEUTRON ACER TENDL-2024 LIBRARY; T=293.6K  
Principal cross sections

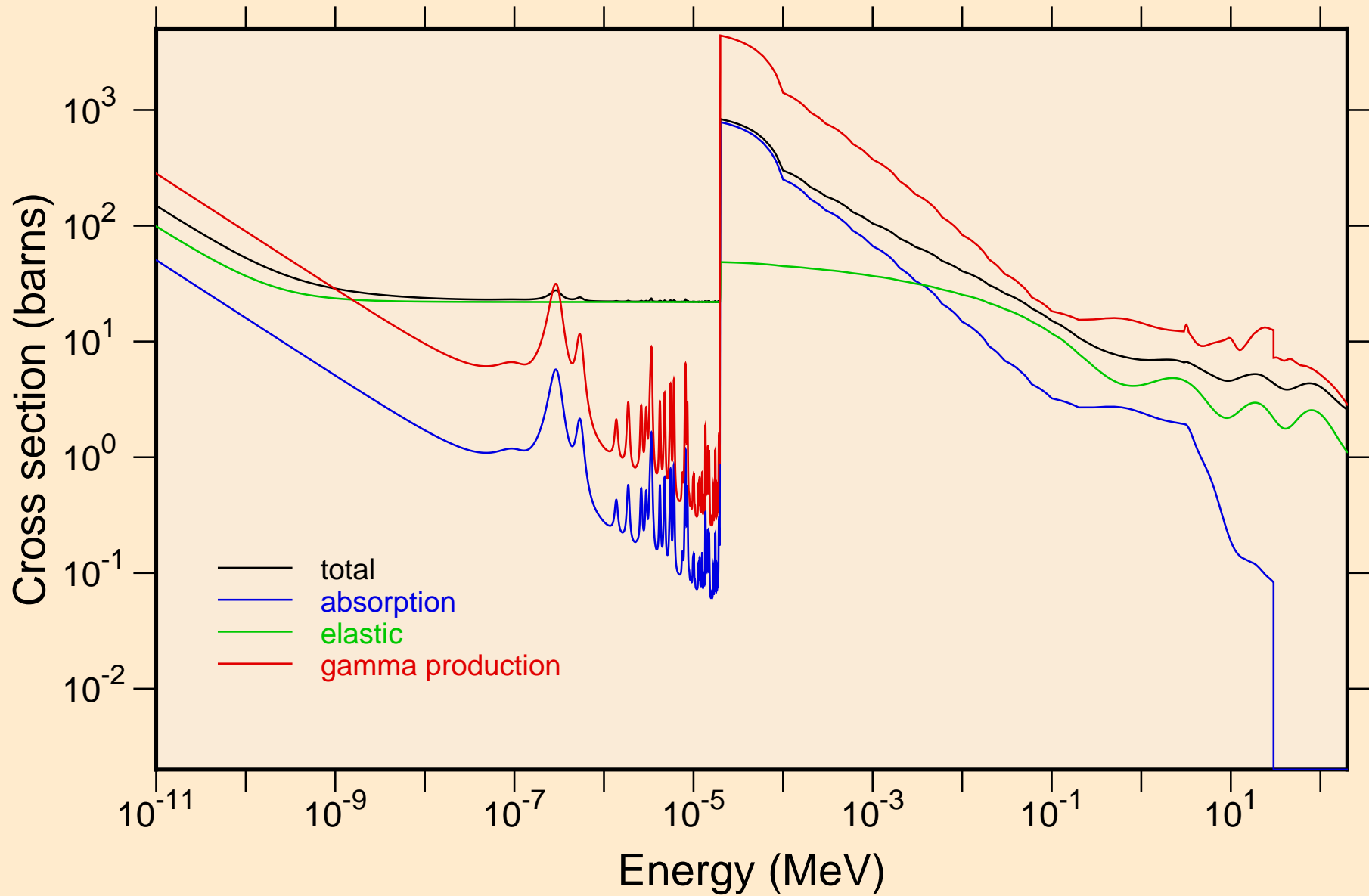

LÜ167M NEUTRON ACER TENDL-2024 LIBRARY; T=293.6K  
resonance total cross section

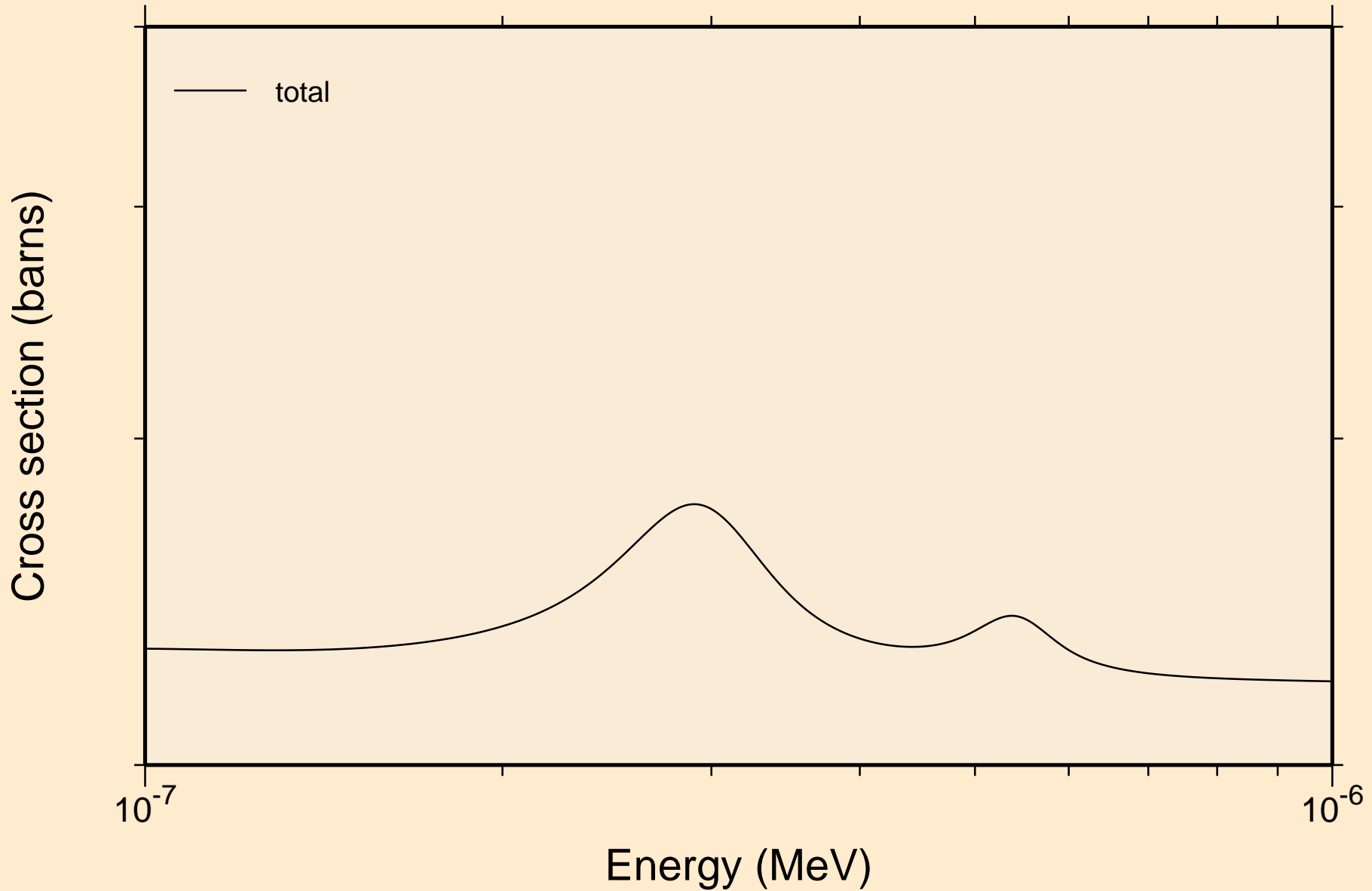

LÜ167M NEUTRON ACER TENDL-2024 LIBRARY; T=293.6K  
resonance total cross section

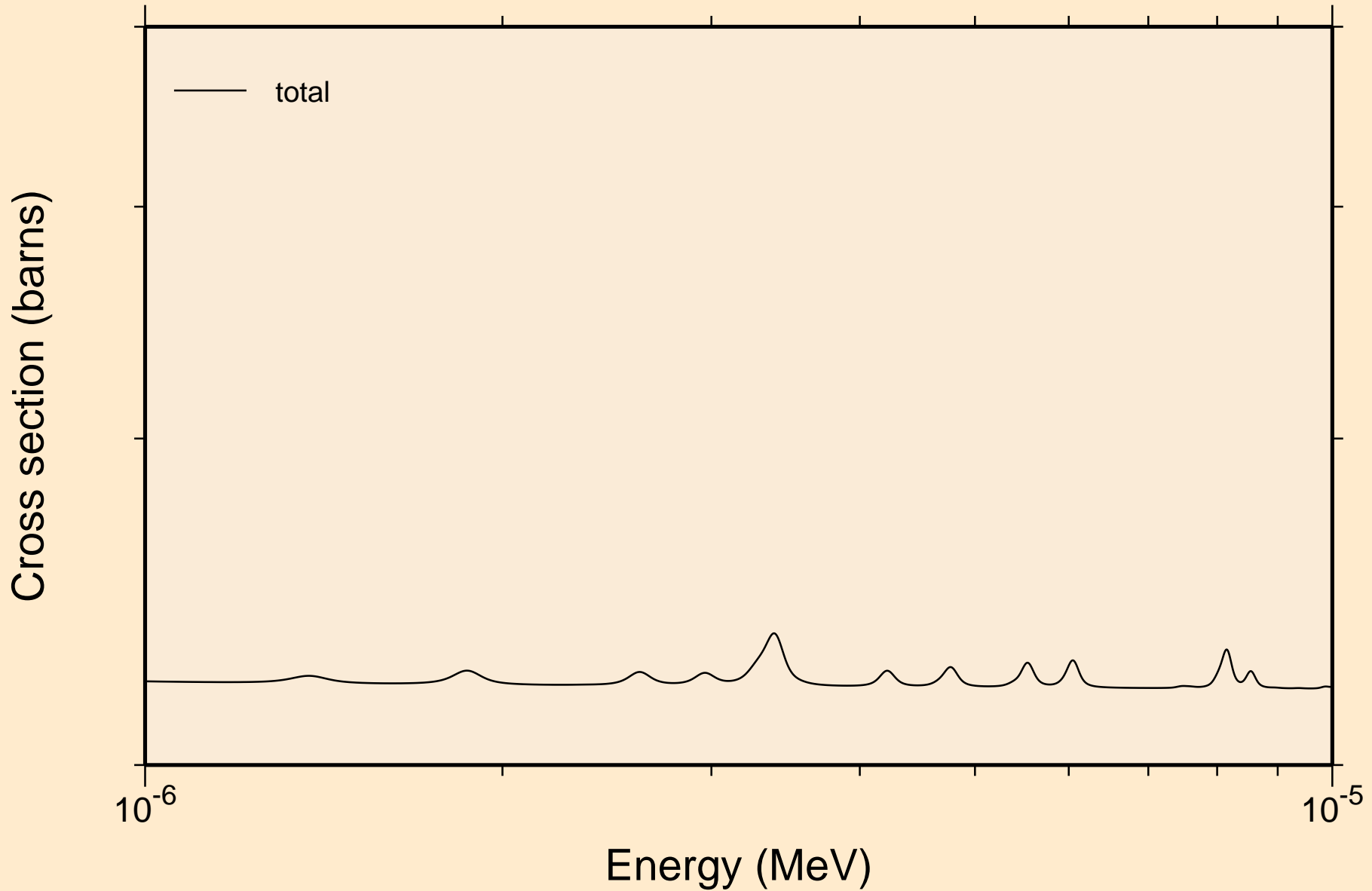

LU167M NEUTRON ACER TENDL-2024 LIBRARY; T=293.6K  
resonance total cross section

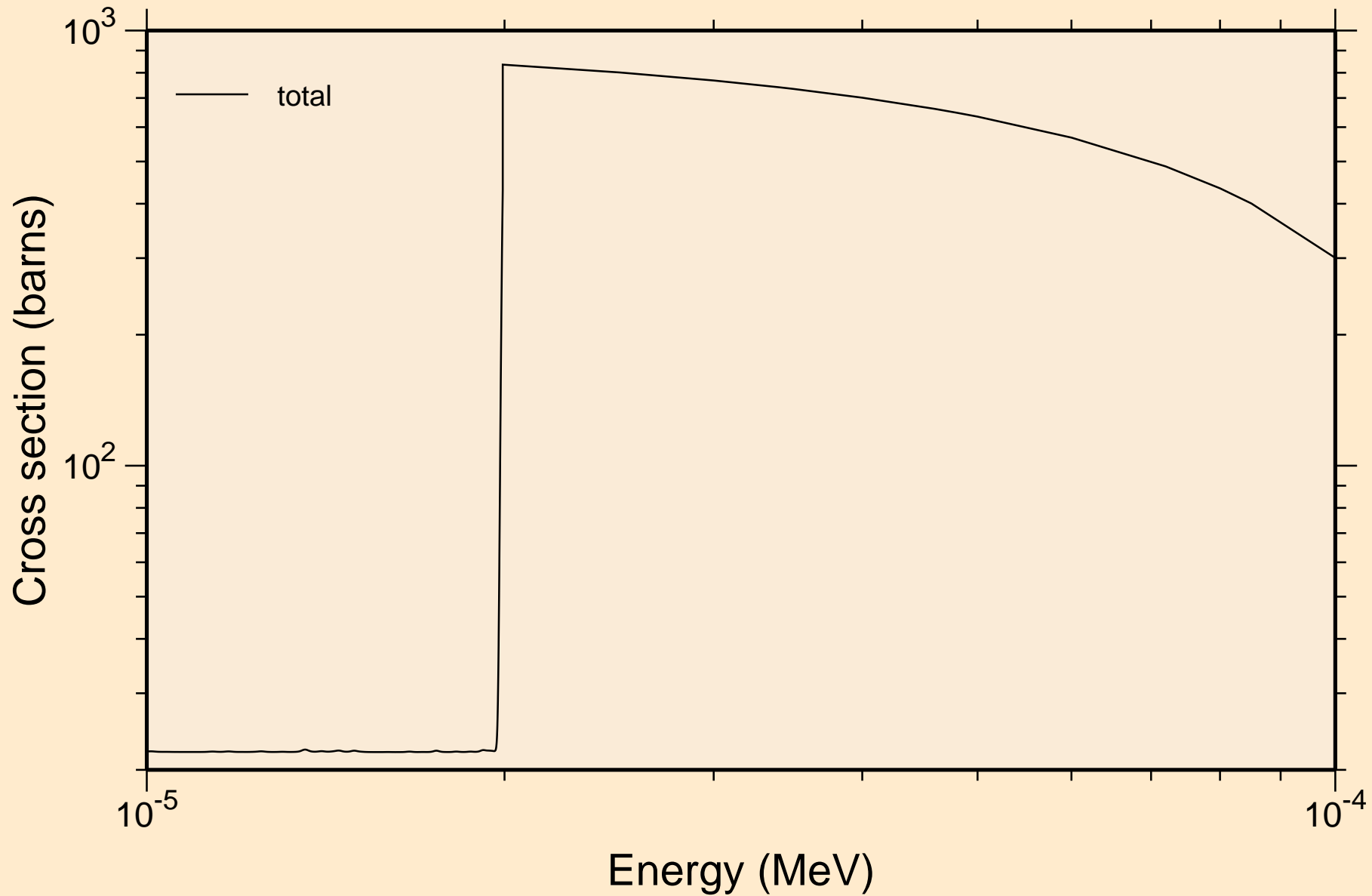

LU167M NEUTRON ACER TENDL-2024 LIBRARY; T=293.6K  
resonance total cross section

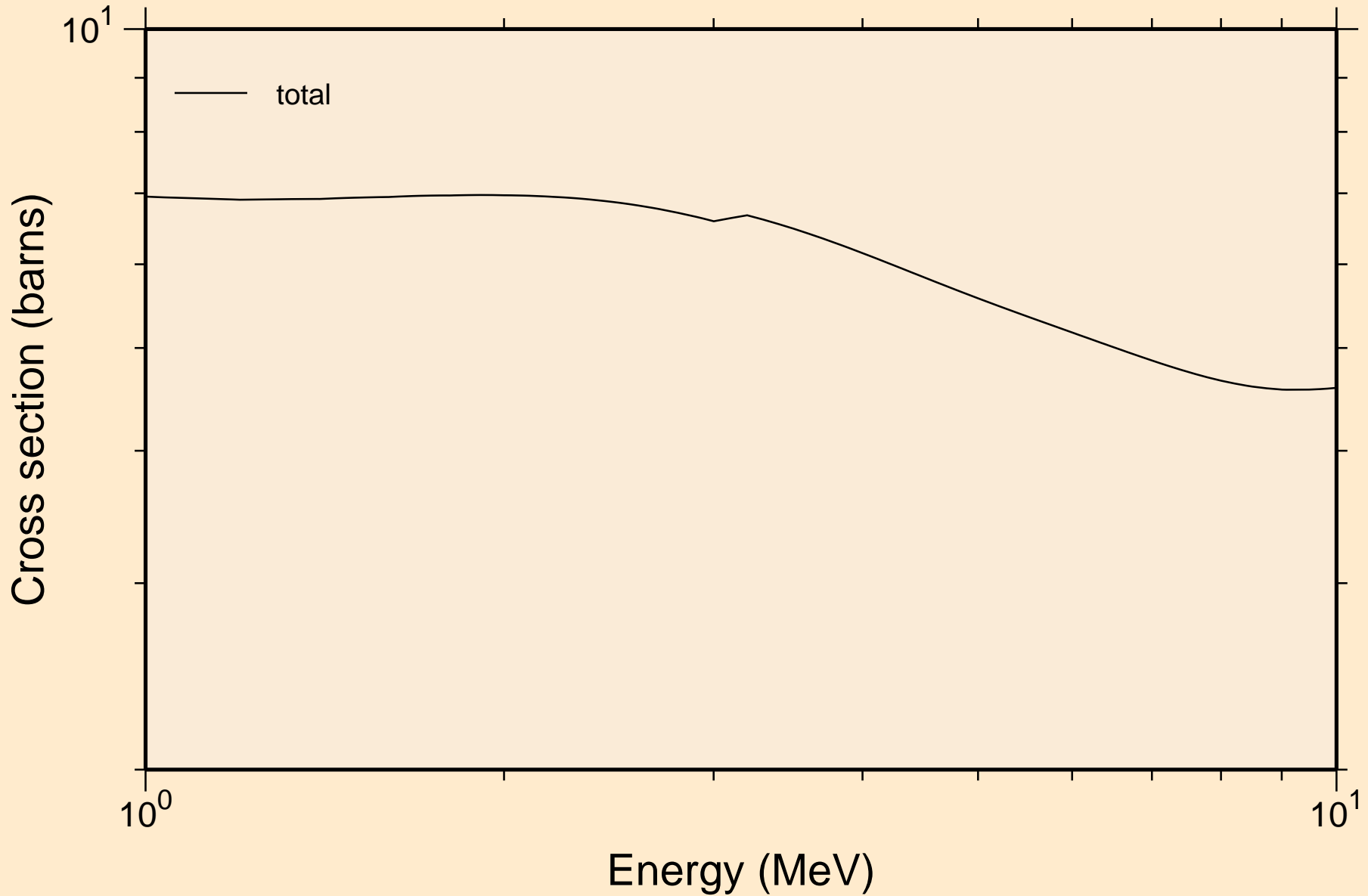

LU167M NEUTRON ACER TENDL-2024 LIBRARY; T=293.6K  
resonance absorption cross sections

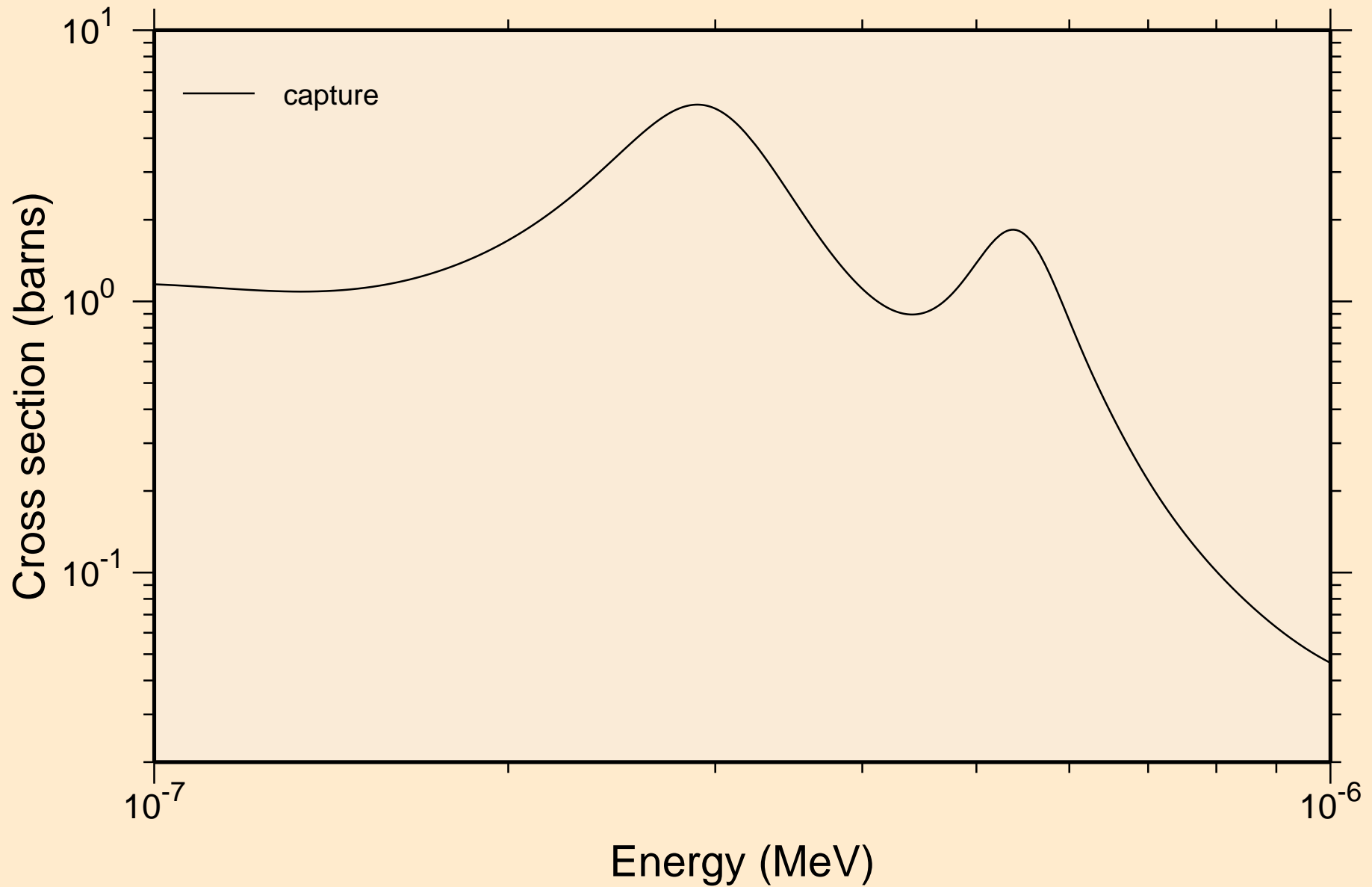

LU167M NEUTRON ACER TENDL-2024 LIBRARY; T=293.6K  
resonance absorption cross sections

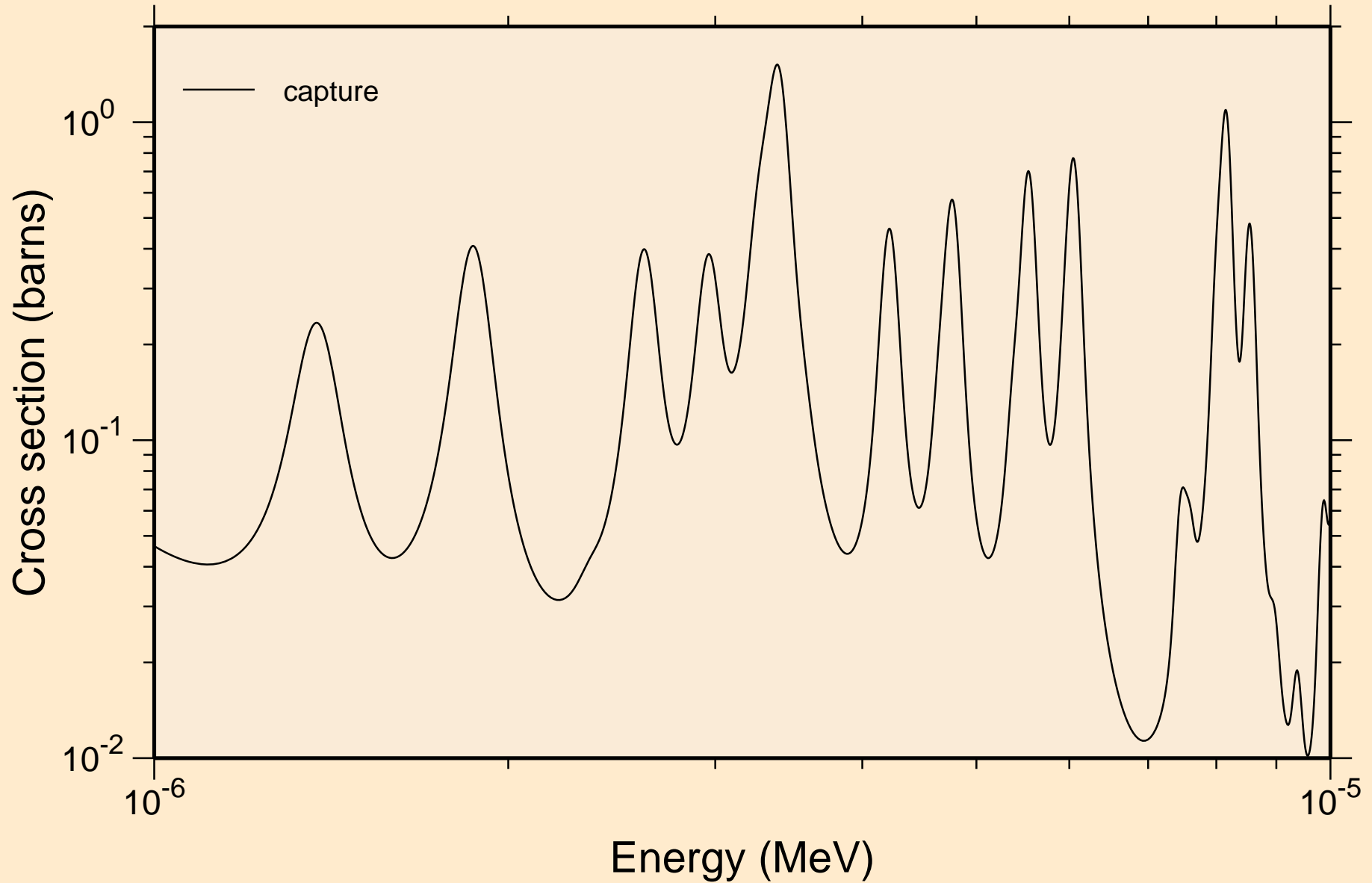

LU167M NEUTRON ACER TENDL-2024 LIBRARY; T=293.6K  
resonance absorption cross sections

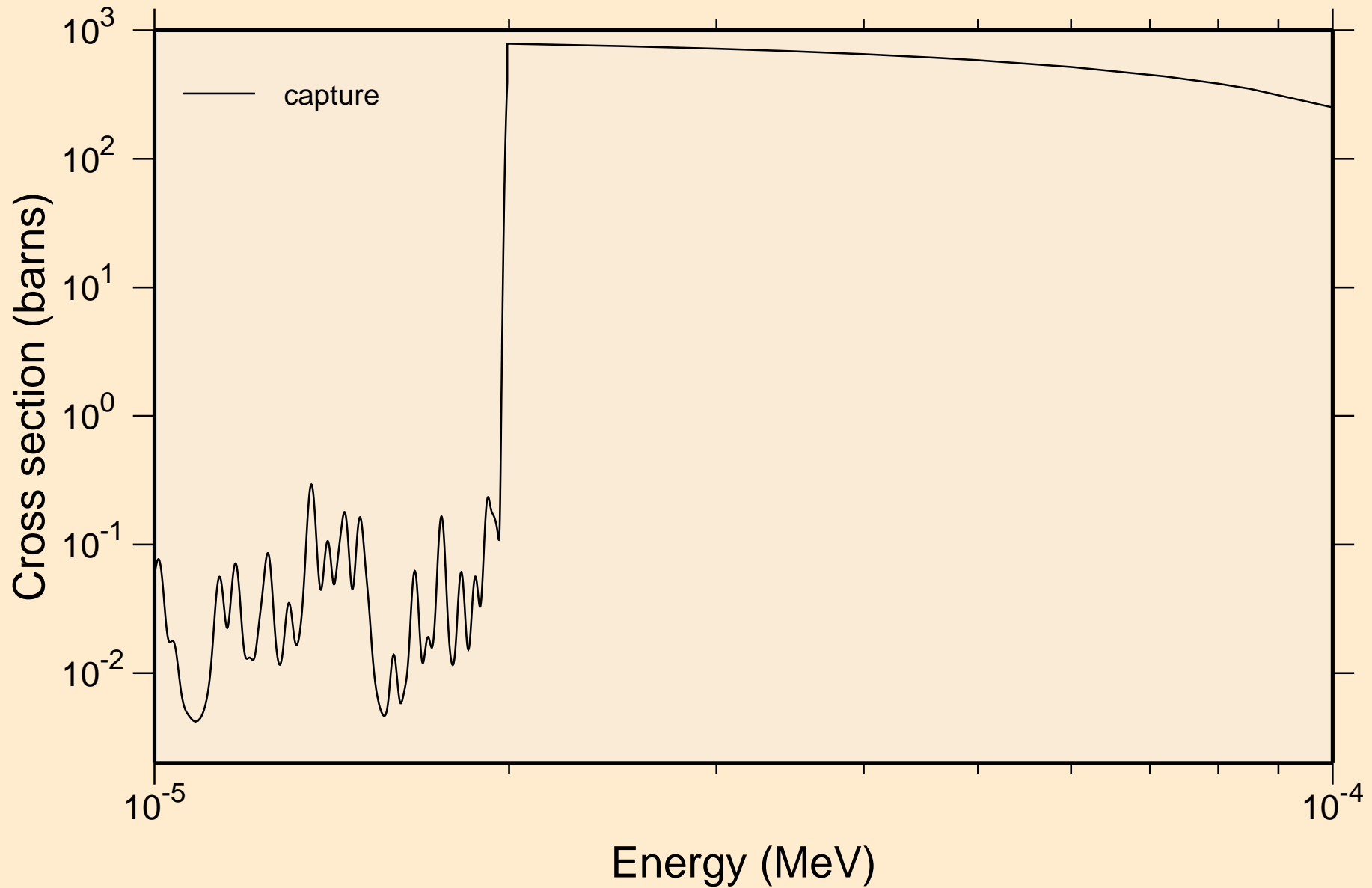

LU167M NEUTRON ACER TENDL-2024 LIBRARY; T=293.6K  
resonance absorption cross sections

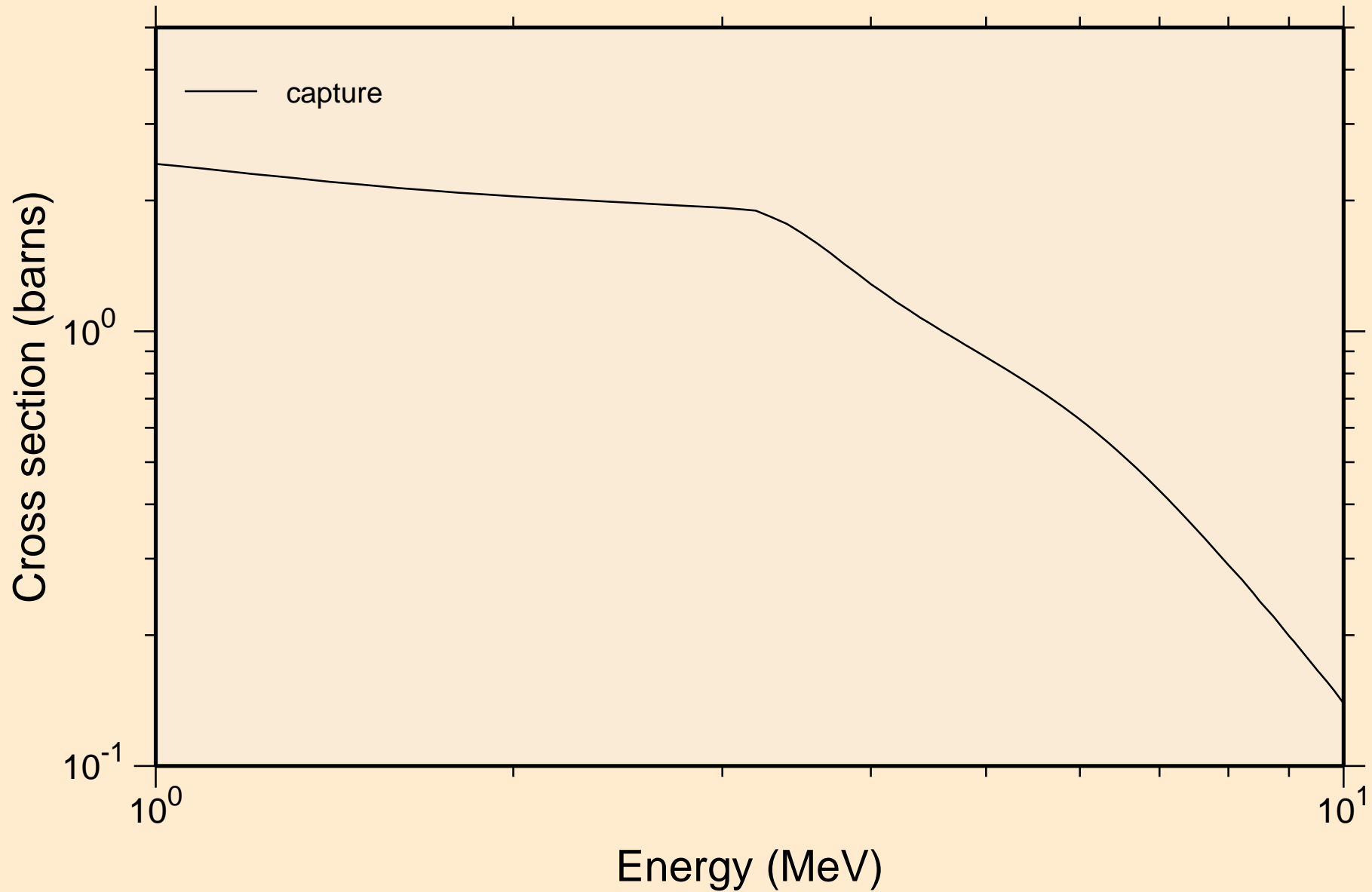

LU167M NEUTRON ACER TENDL-2024 LIBRARY; T=293.6K  
Heating

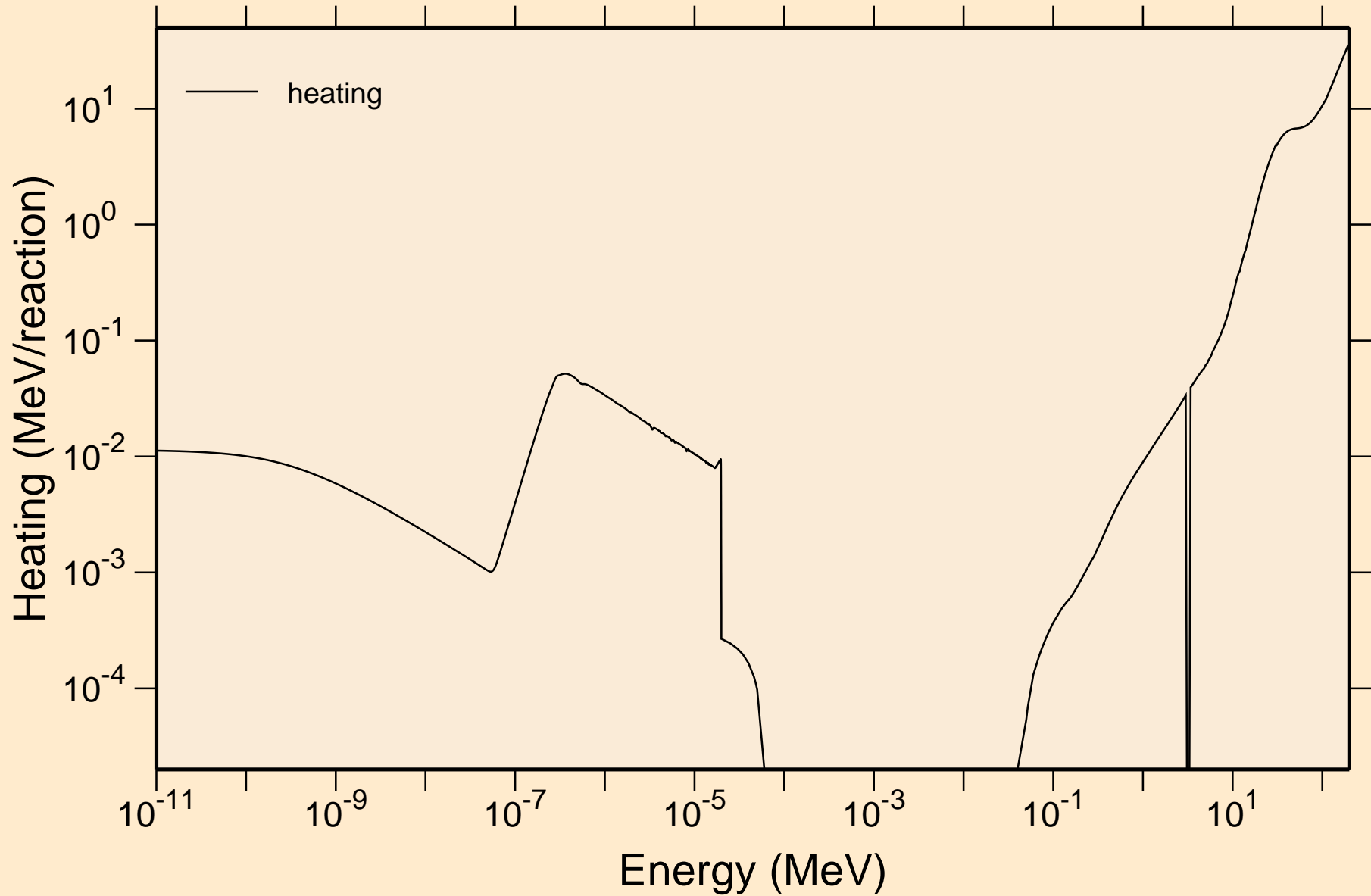

LU167M NEUTRON ACER TENDL-2024 LIBRARY; T=293.6K  
Damage

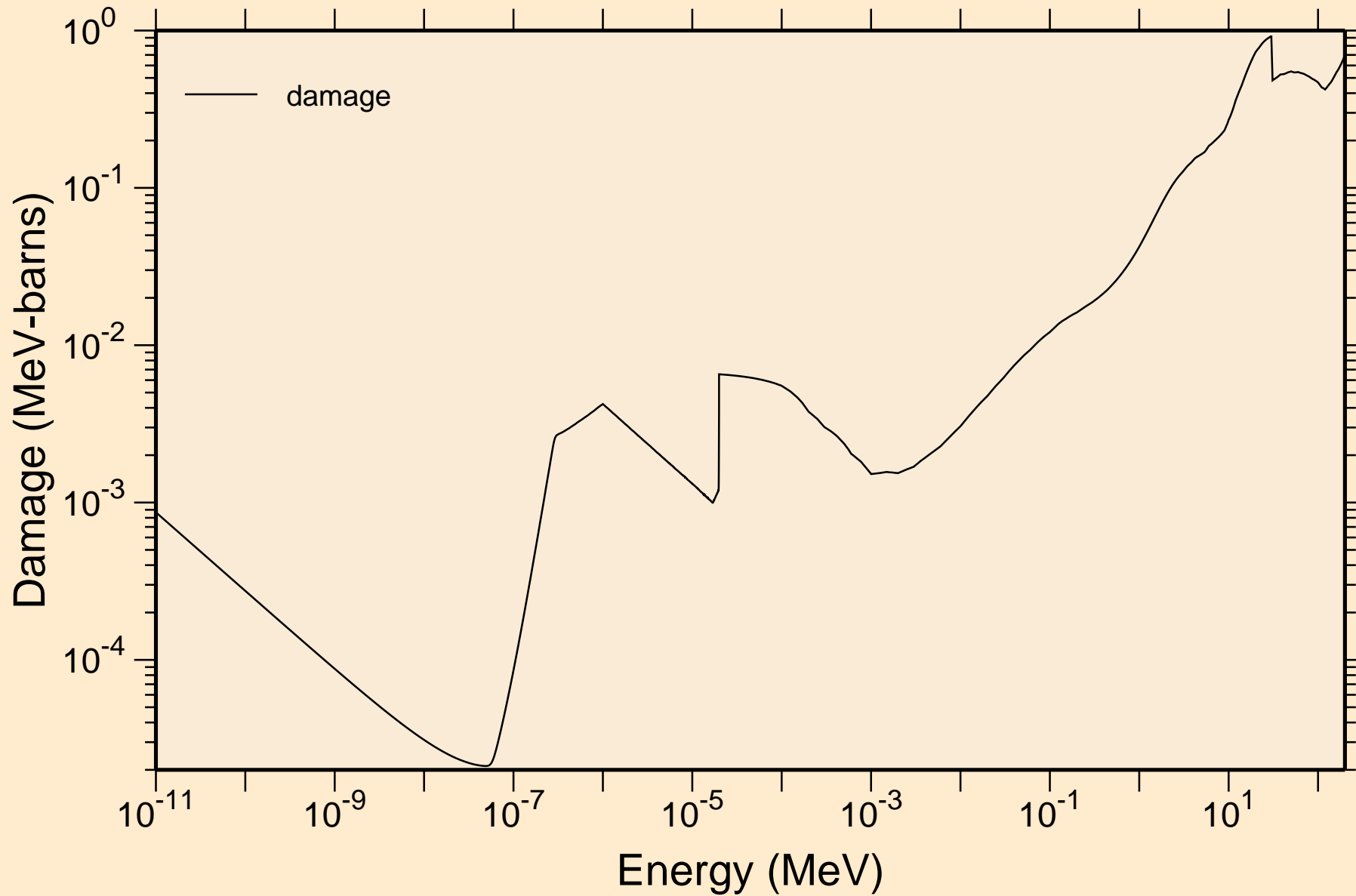

LU167M NEUTRON ACER TENDL-2024 LIBRARY; T=293.6K  
Non-threshold reactions

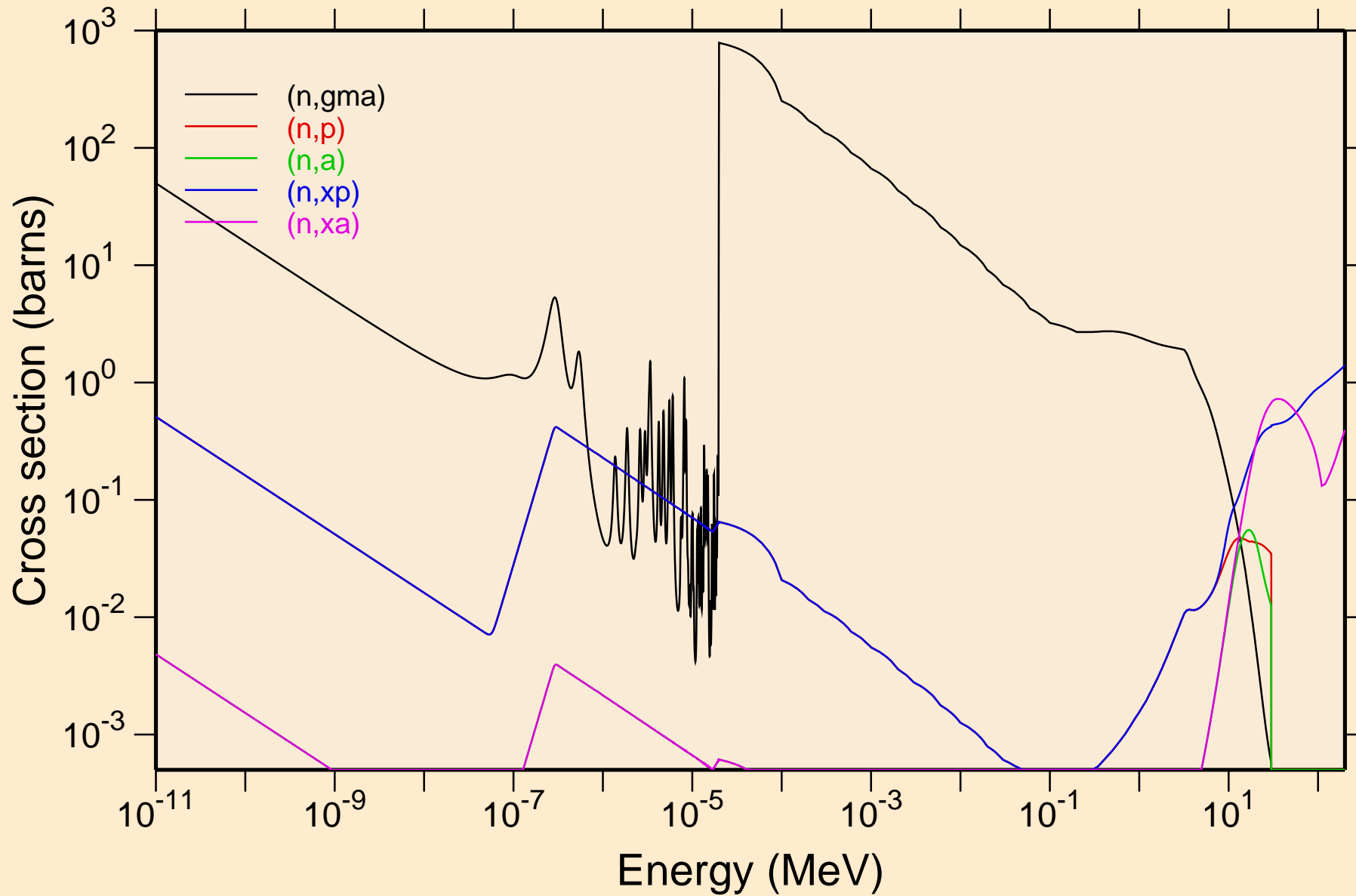

# LU167M NEUTRON ACER TENDL-2024 LIBRARY; T=293.6K

## Principal cross sections

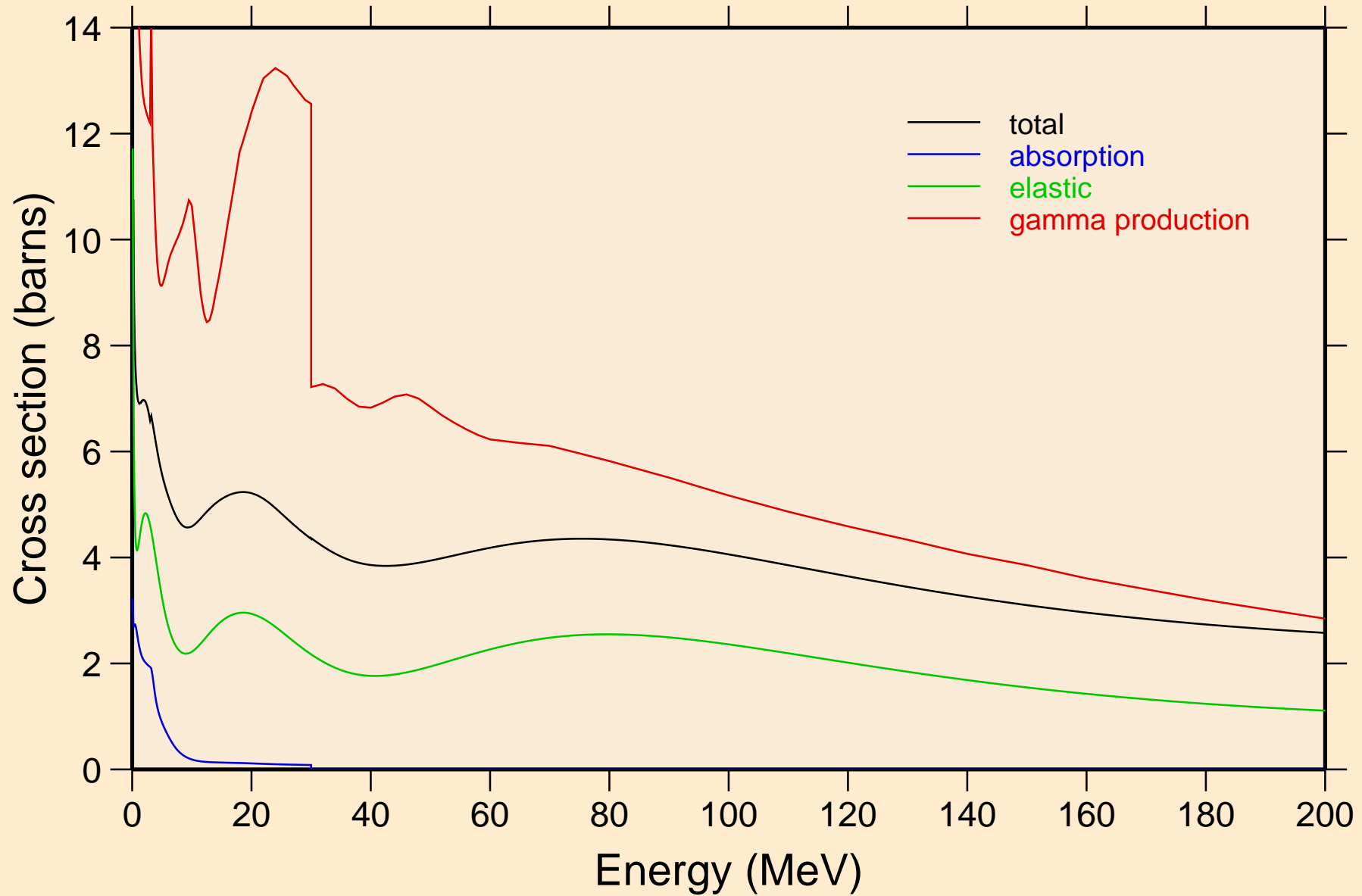

LU167M NEUTRON ACER TENDL-2024 LIBRARY; T=293.6K  
Heating

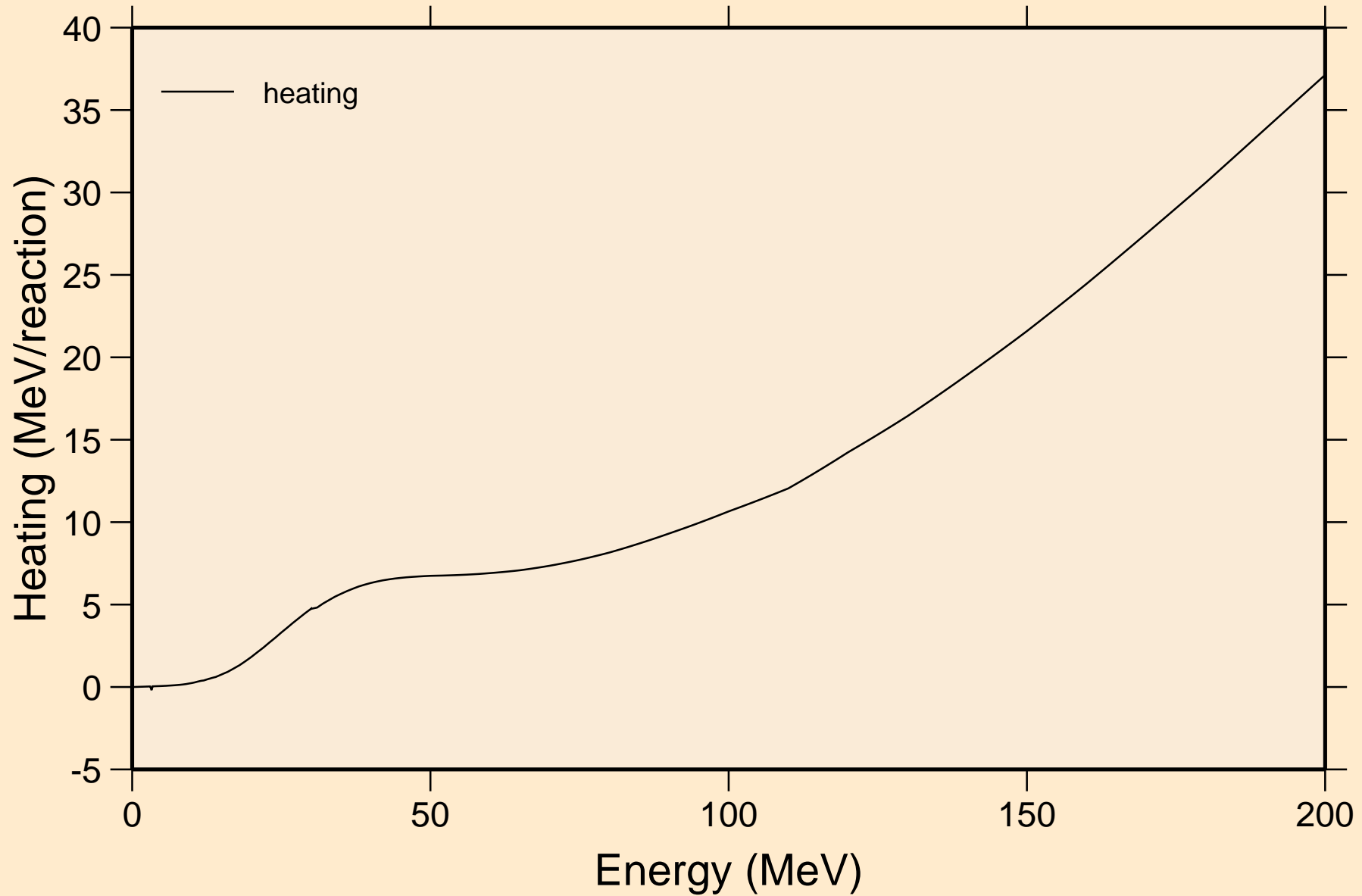

LU167M NEUTRON ACER TENDL-2024 LIBRARY; T=293.6K  
Damage

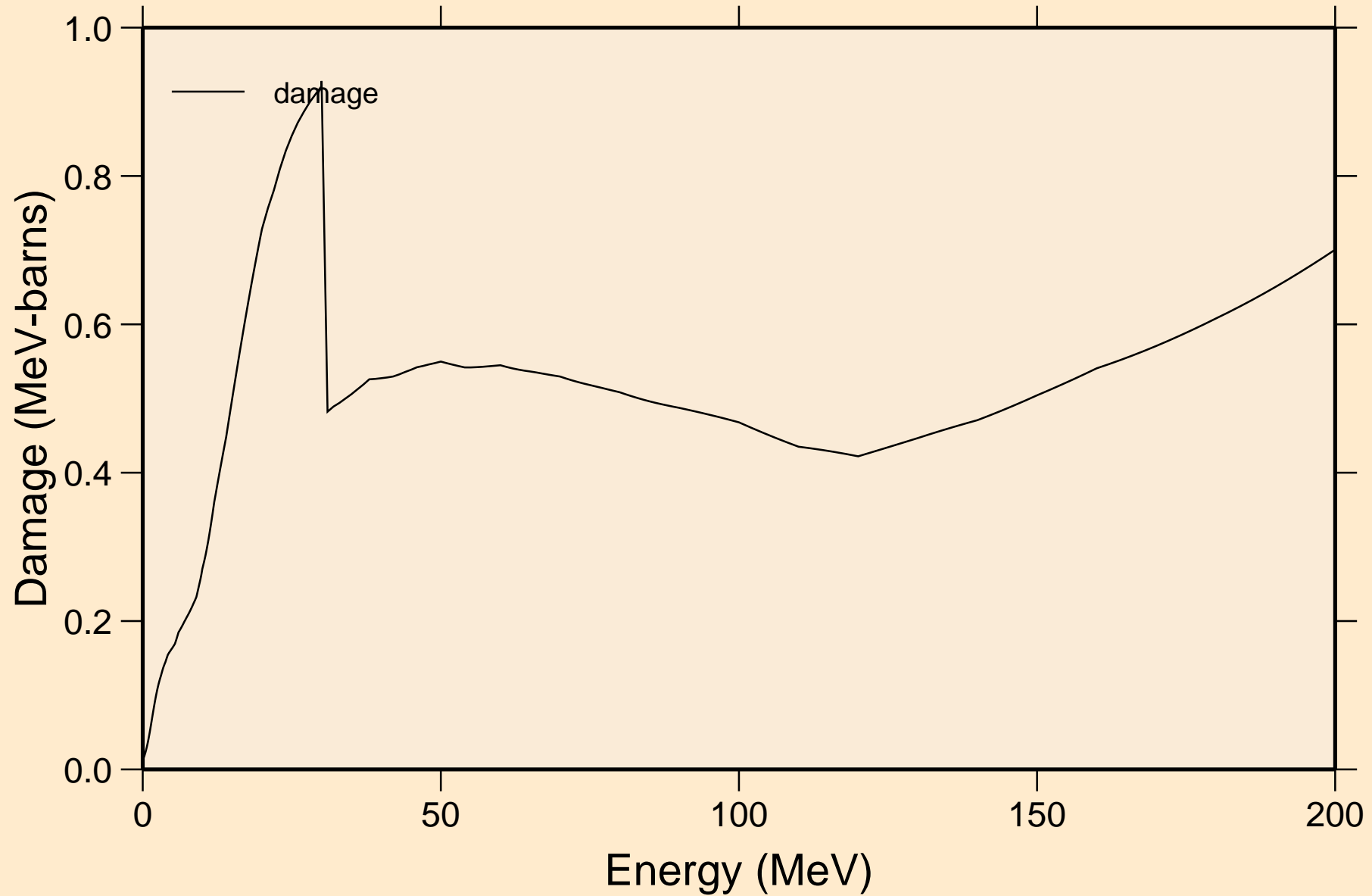

LU167M NEUTRON ACER TENDL-2024 LIBRARY; T=293.6K  
Non-threshold reactions

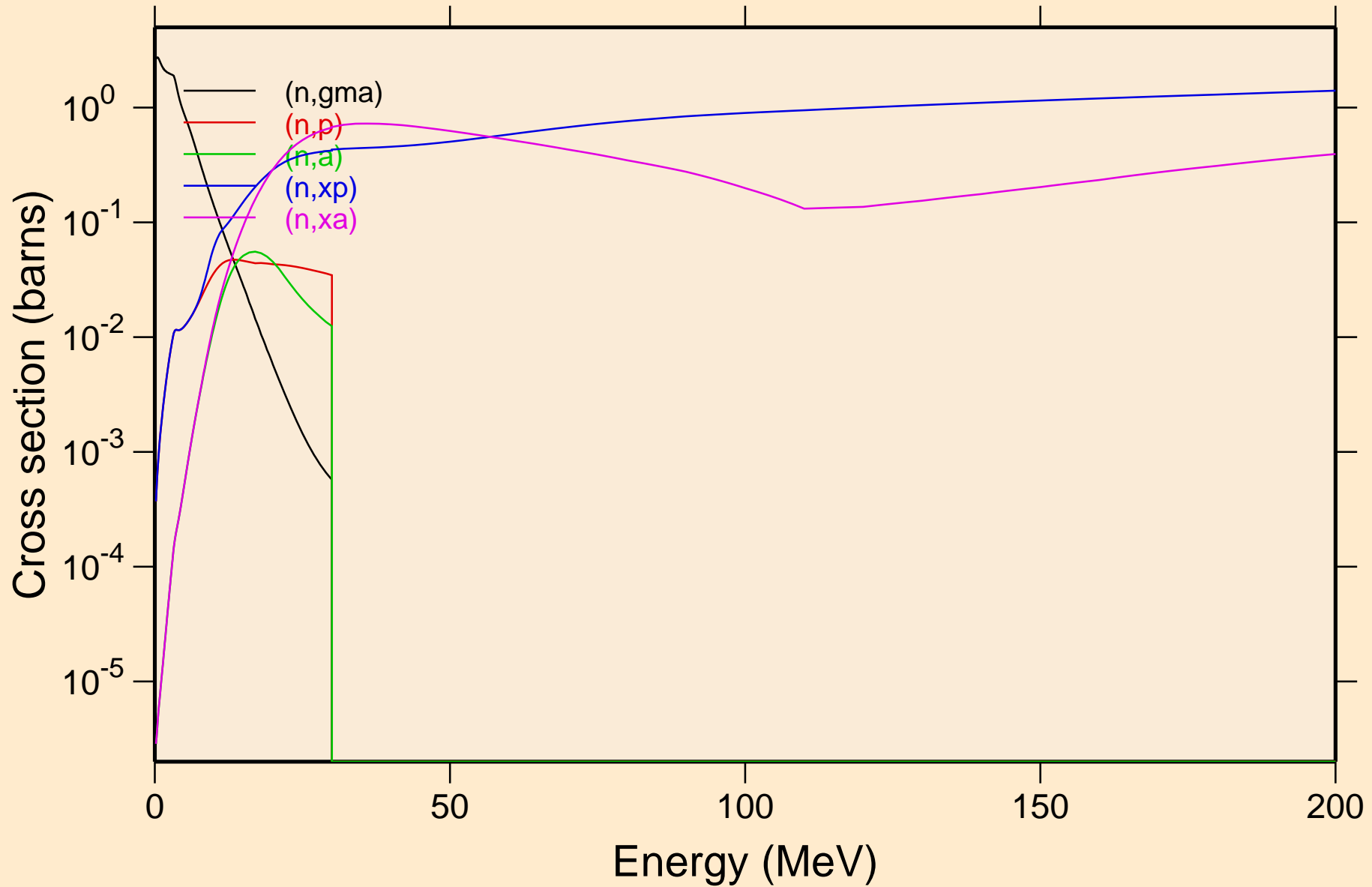

LU167M NEUTRON ACER TENDL-2024 LIBRARY; T=293.6K  
Inelastic levels

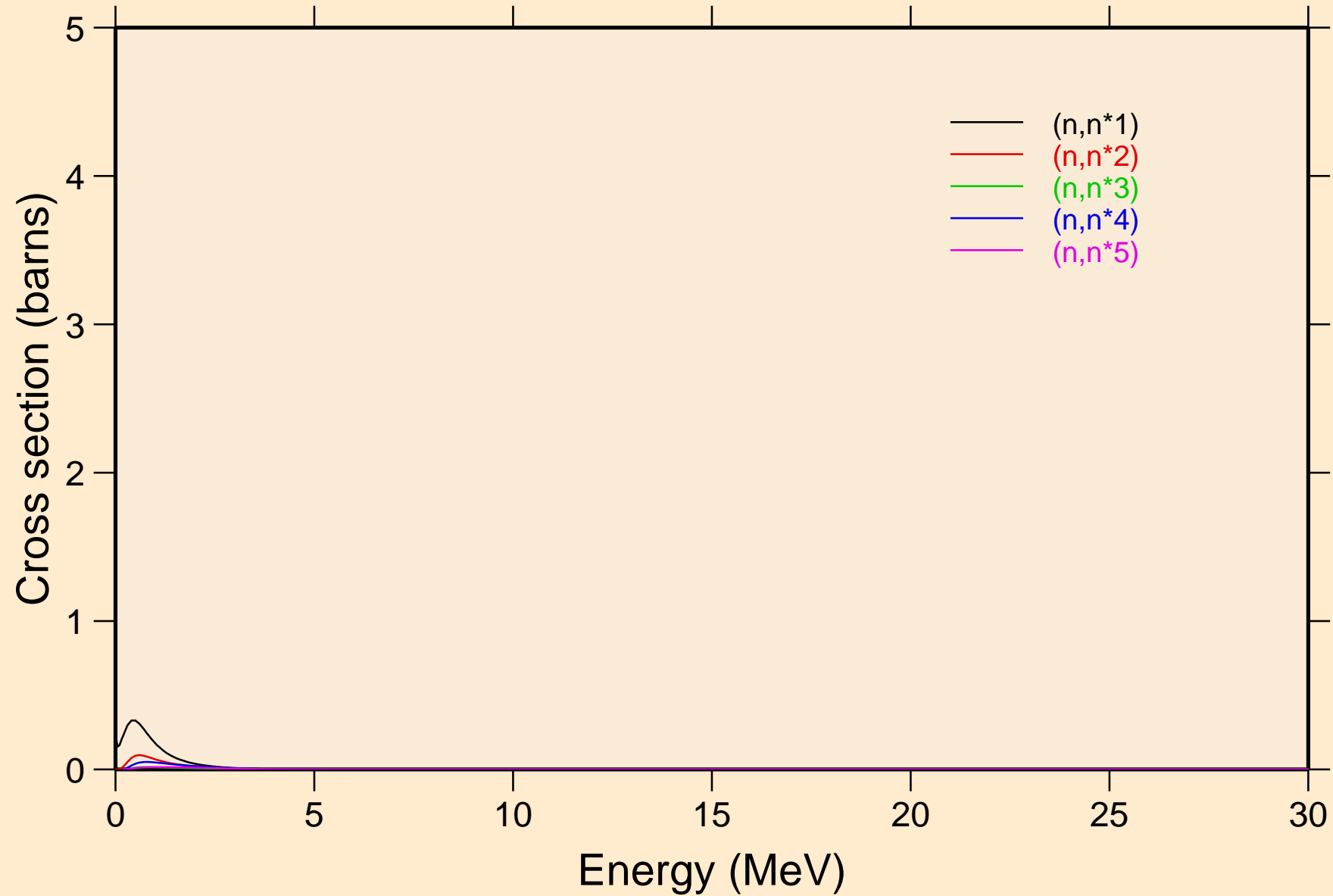

LU167M NEUTRON ACER TENDL-2024 LIBRARY; T=293.6K  
Threshold reactions

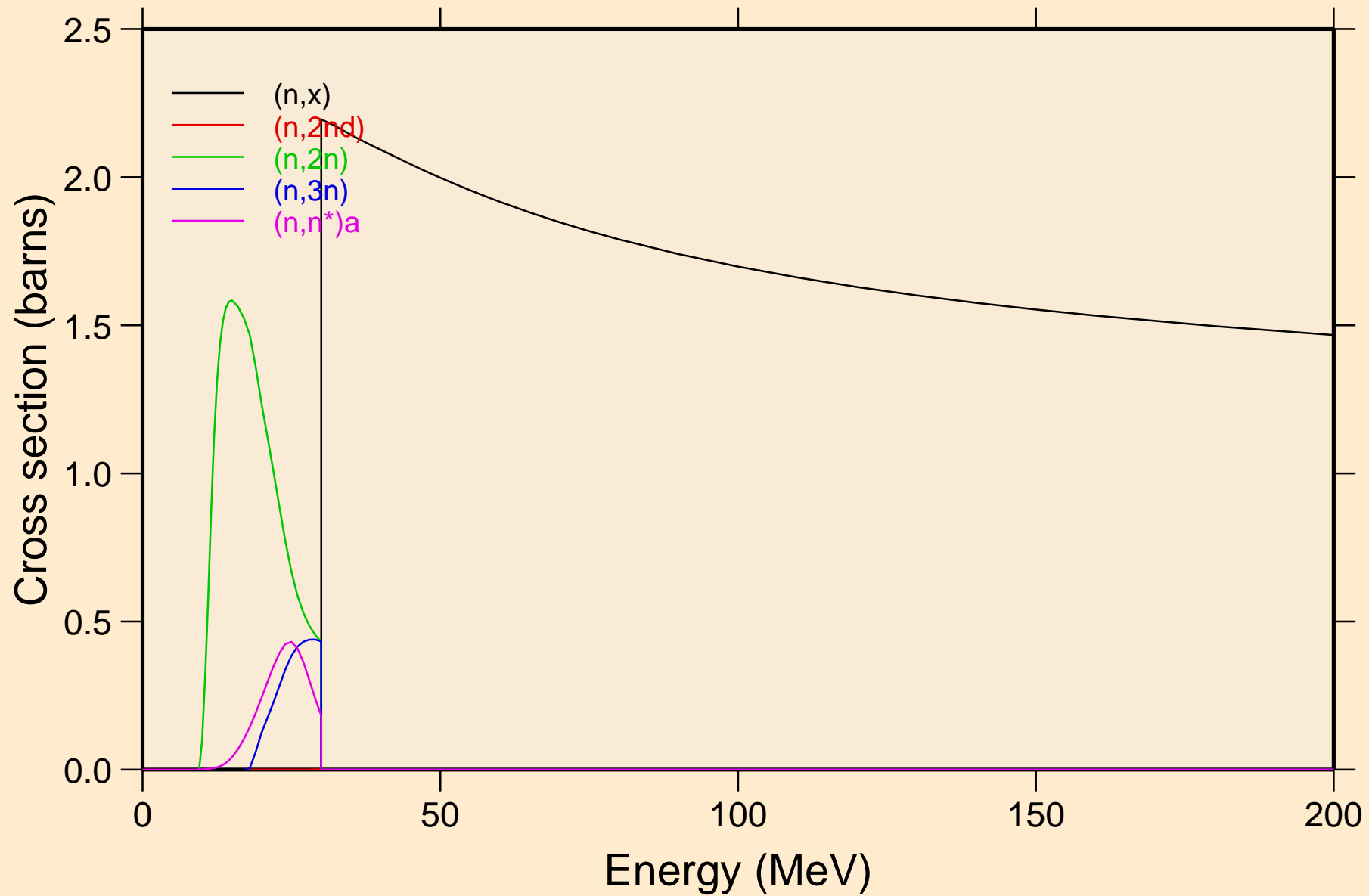

LU167M NEUTRON ACER TENDL-2024 LIBRARY; T=293.6K  
Threshold reactions

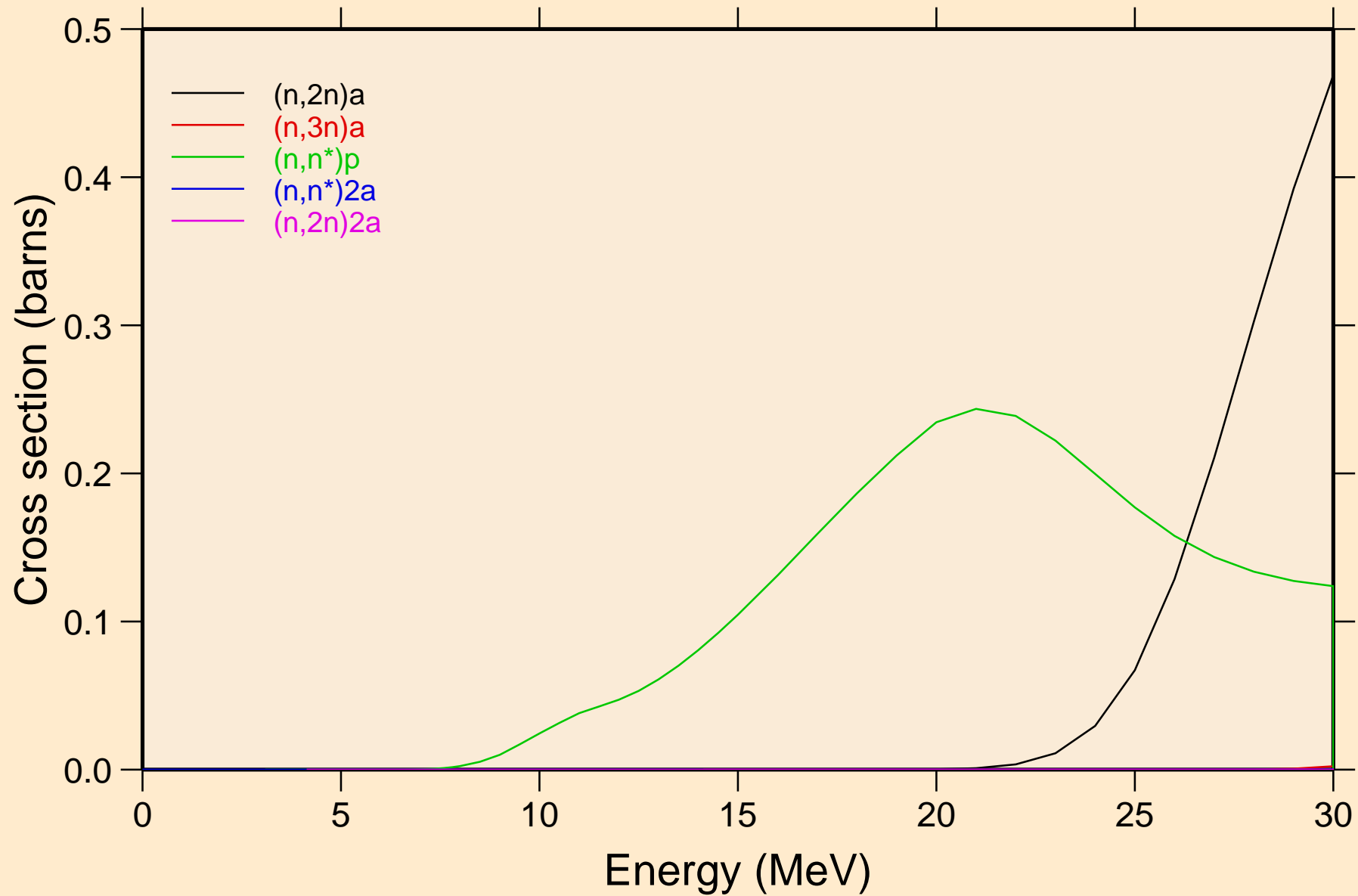

# LU167M NEUTRON ACER TENDL-2024 LIBRARY; T=293.6K

## Threshold reactions

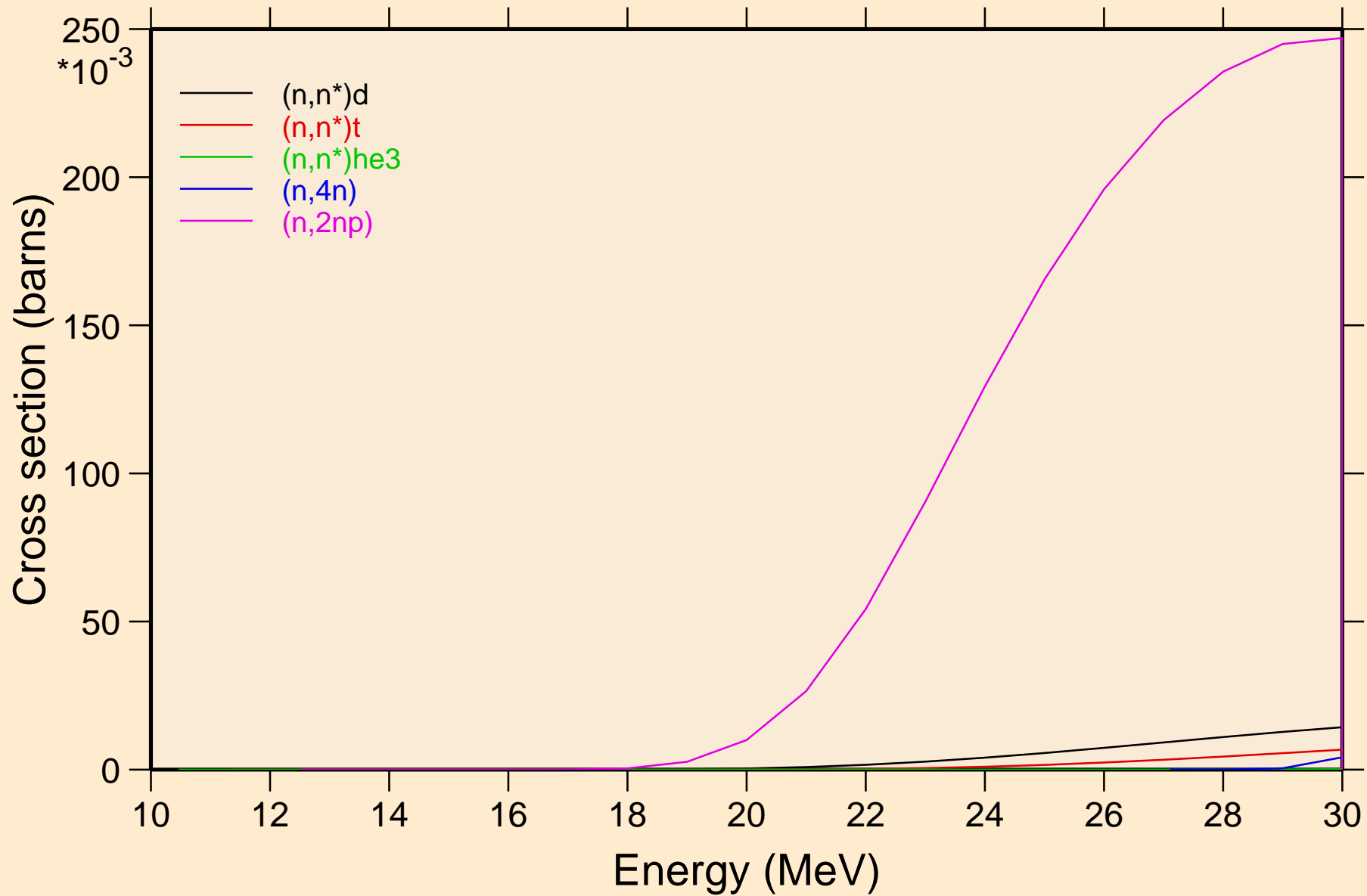

LU167M NEUTRON ACER TENDL-2024 LIBRARY; T=293.6K  
Threshold reactions

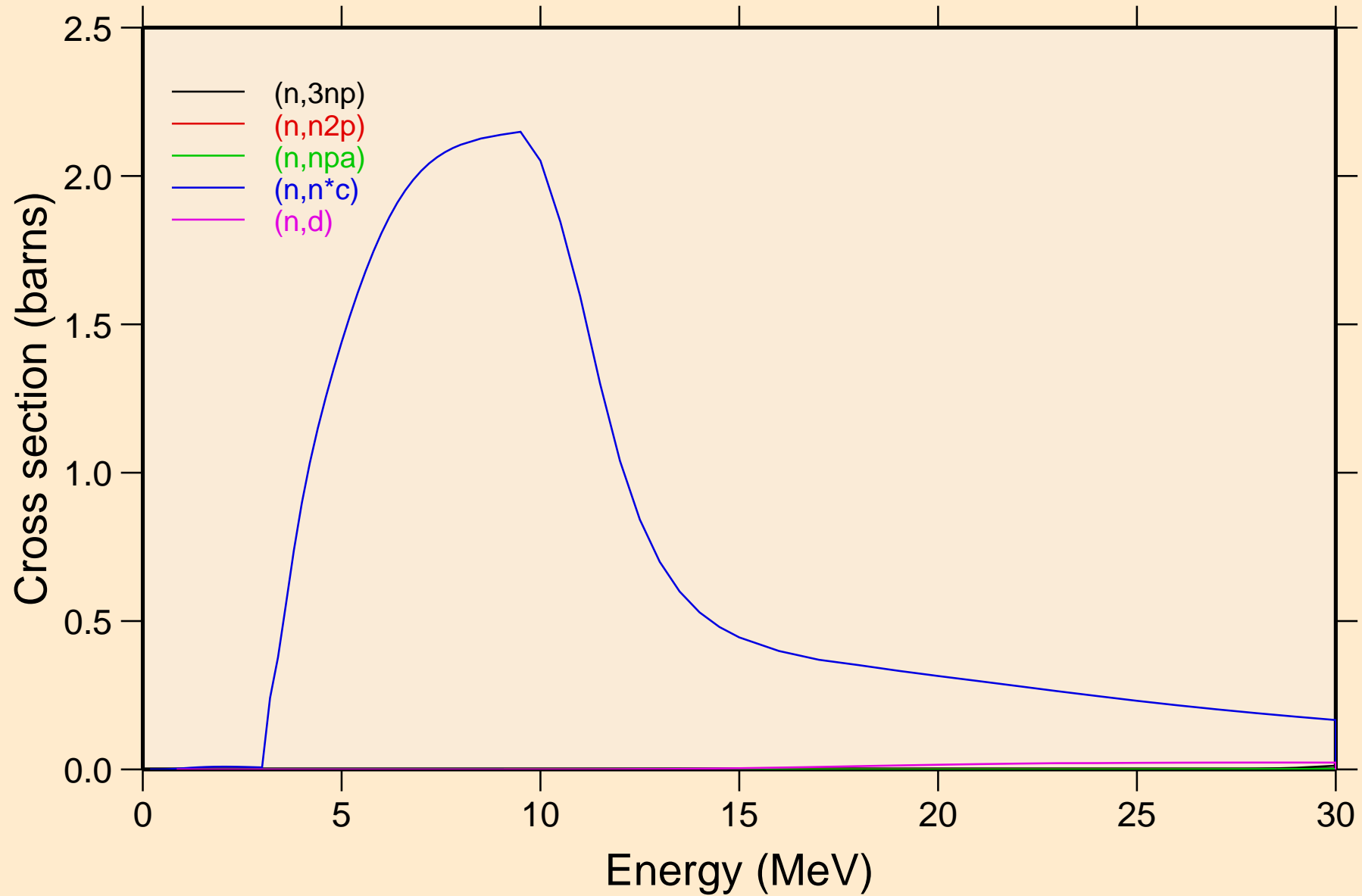

LU167M NEUTRON ACER TENDL-2024 LIBRARY; T=293.6K  
Threshold reactions

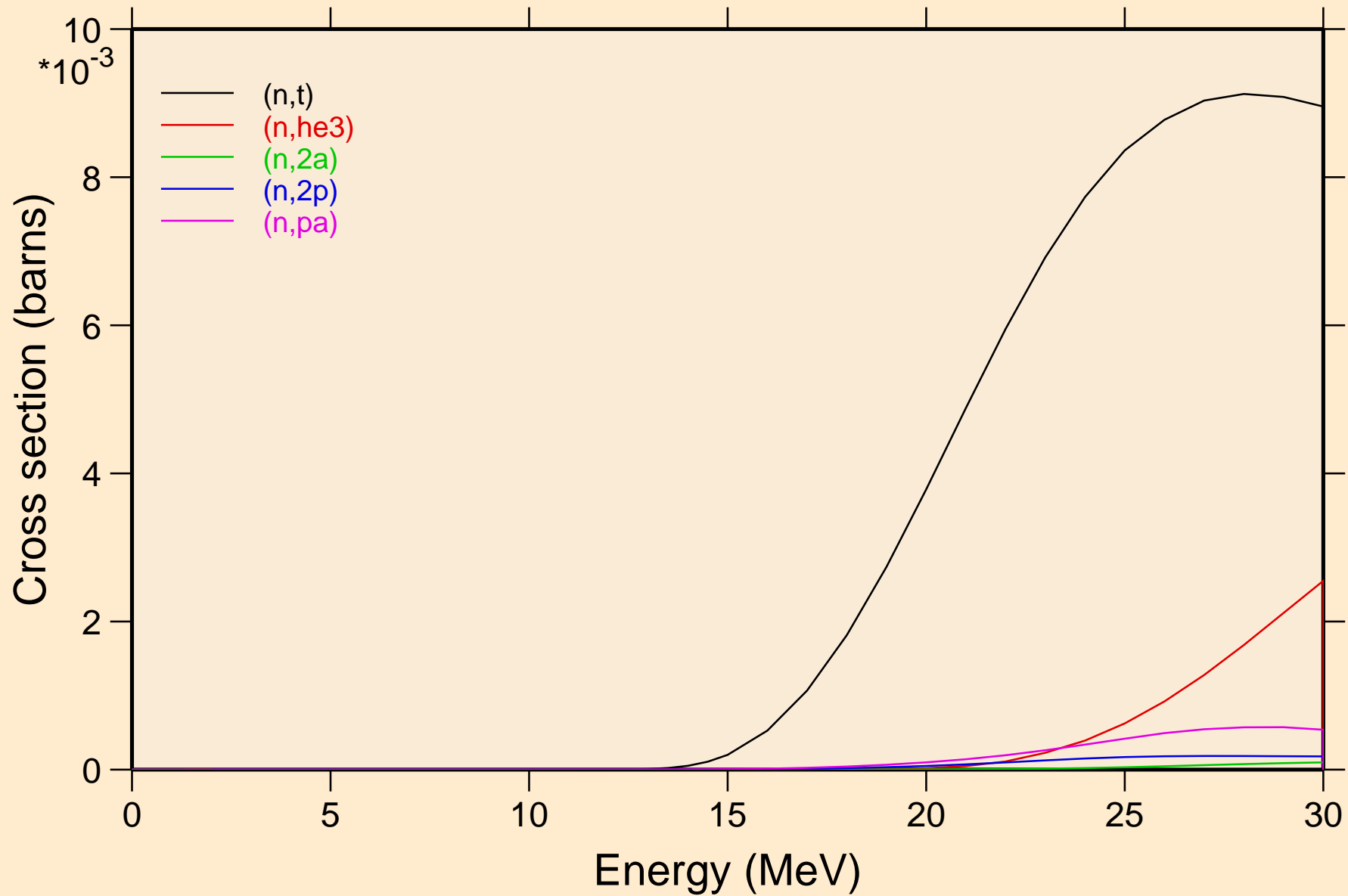

LU167M NEUTRON ACER TENDL-2024 LIBRARY; T=293.6K  
Threshold reactions

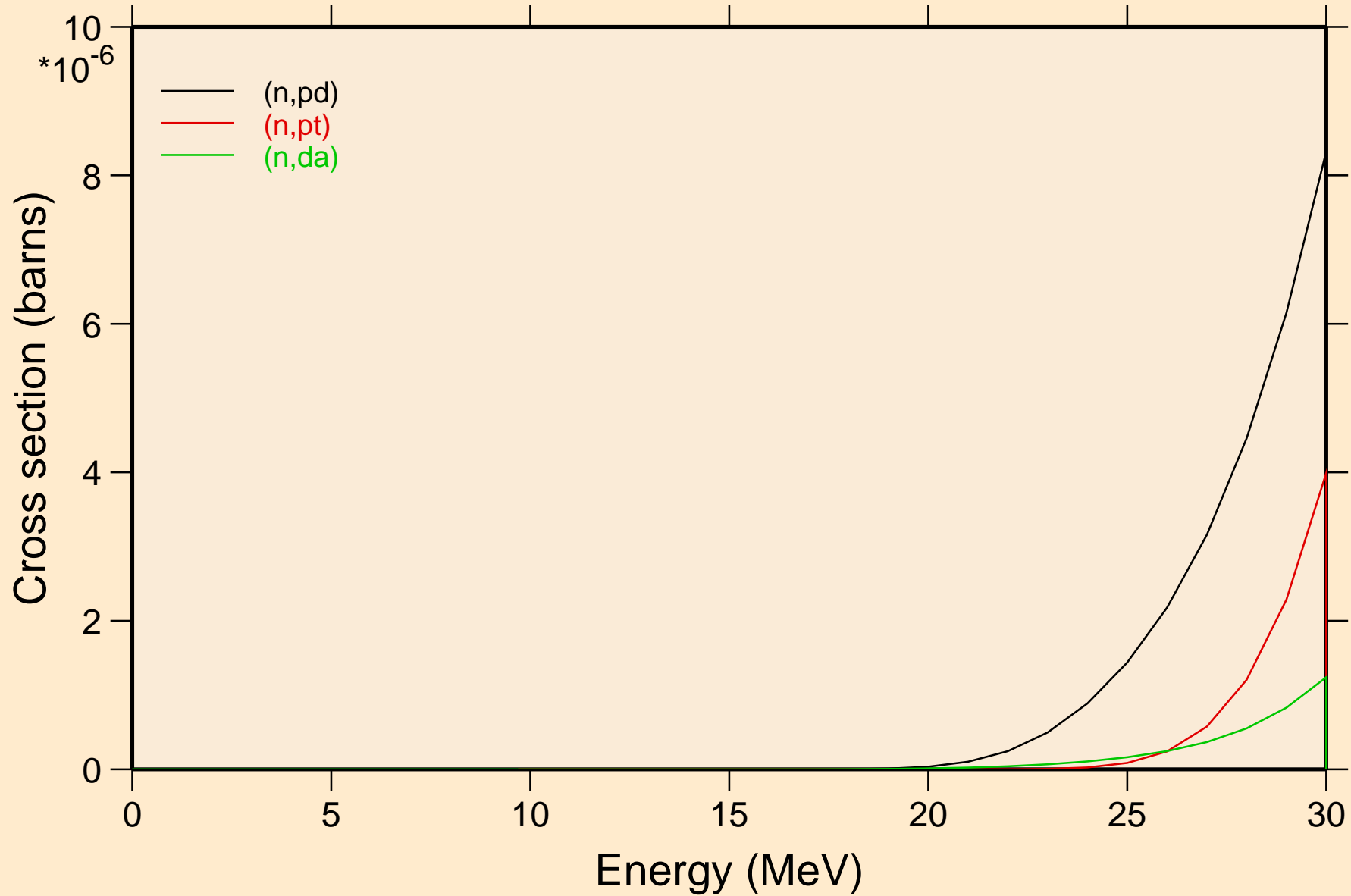

LU167M NEUTRON ACER TENDL-2024 LIBRARY; T=293.6K  
Threshold reactions

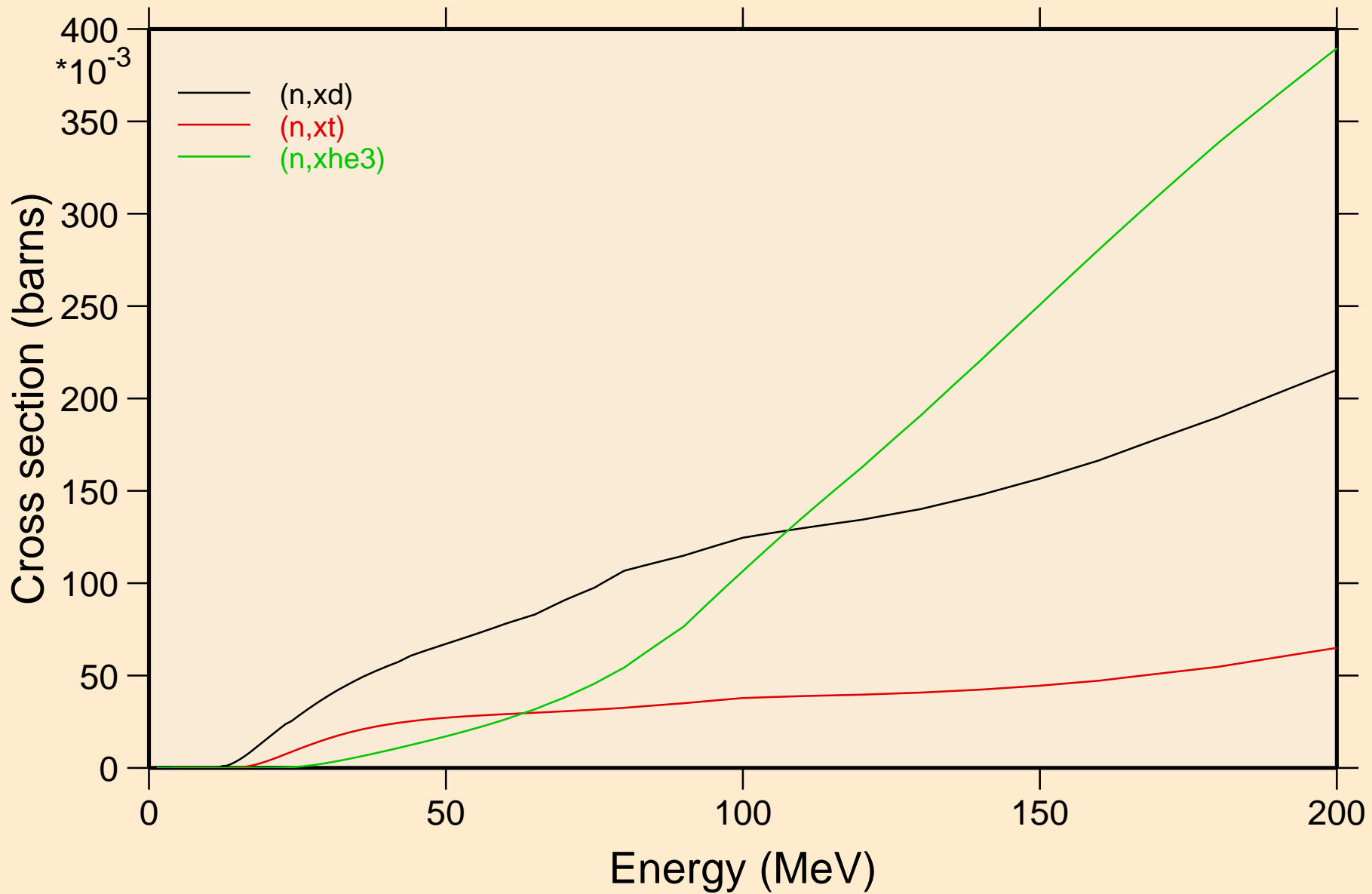

LU167M NEUTRON ACER TENDL-2024 LIBRARY; T=293.6K  
angular distribution for elastic

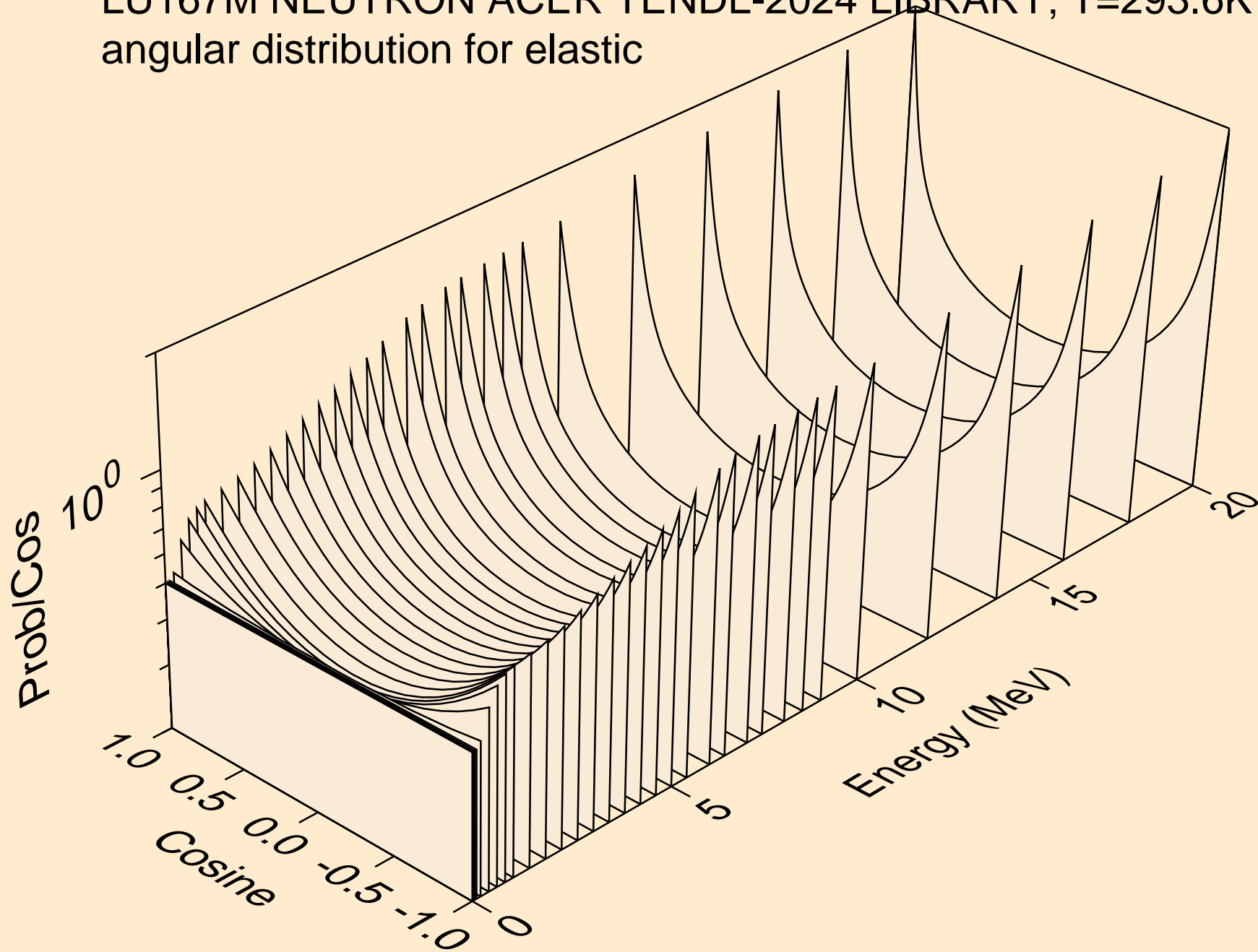

LU167M NEUTRON ACER TENDL-2024 LIBRARY; T=293.6K  
angular distribution for elastic

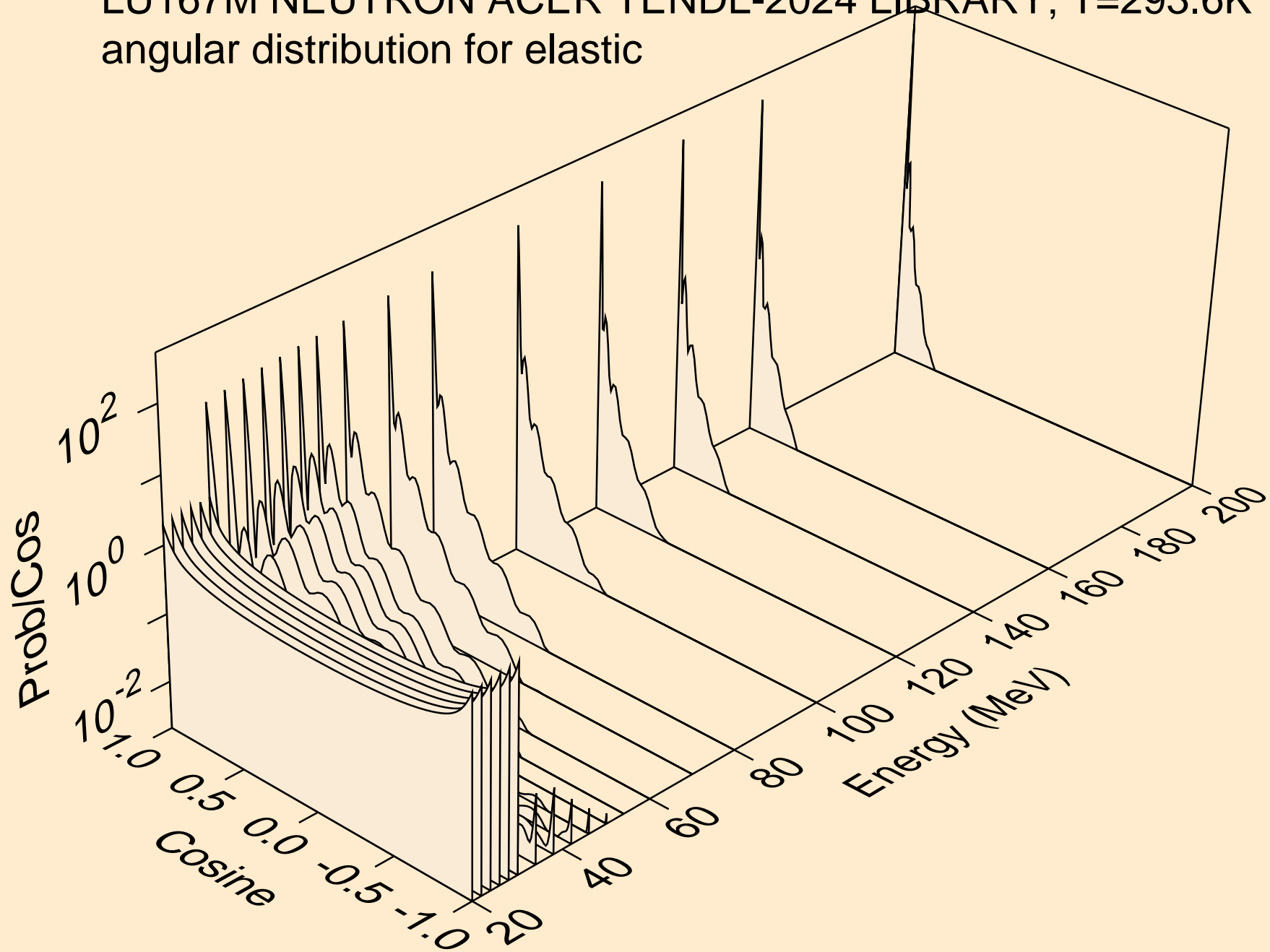

LU167M NEUTRON ACER TENDL-2024 LIBRARY; T=293.6K  
angular distribution for (n,n\*1)

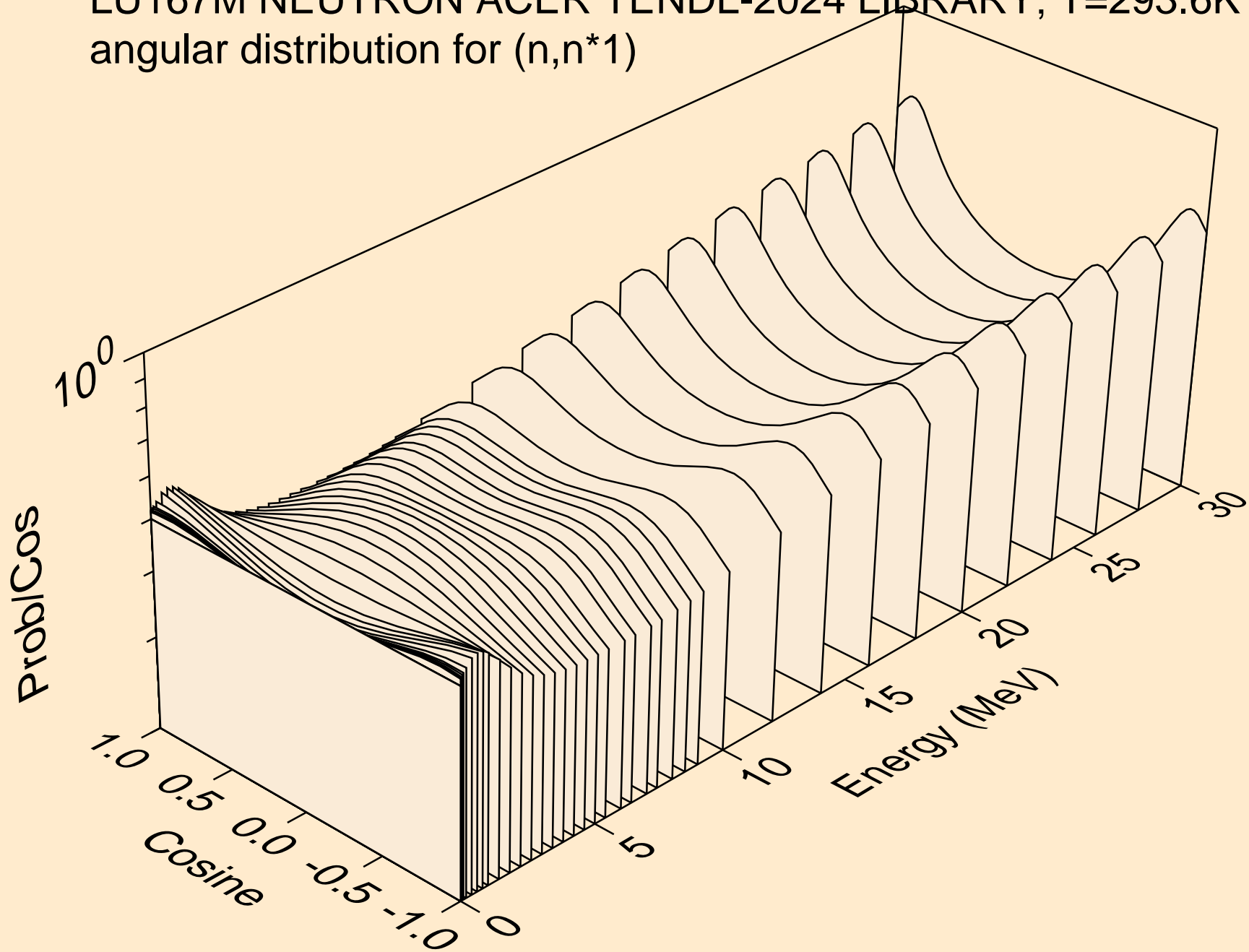

LU167M NEUTRON ACER TENDL-2024 LIBRARY; T=293.6K  
angular distribution for (n,n\*2)

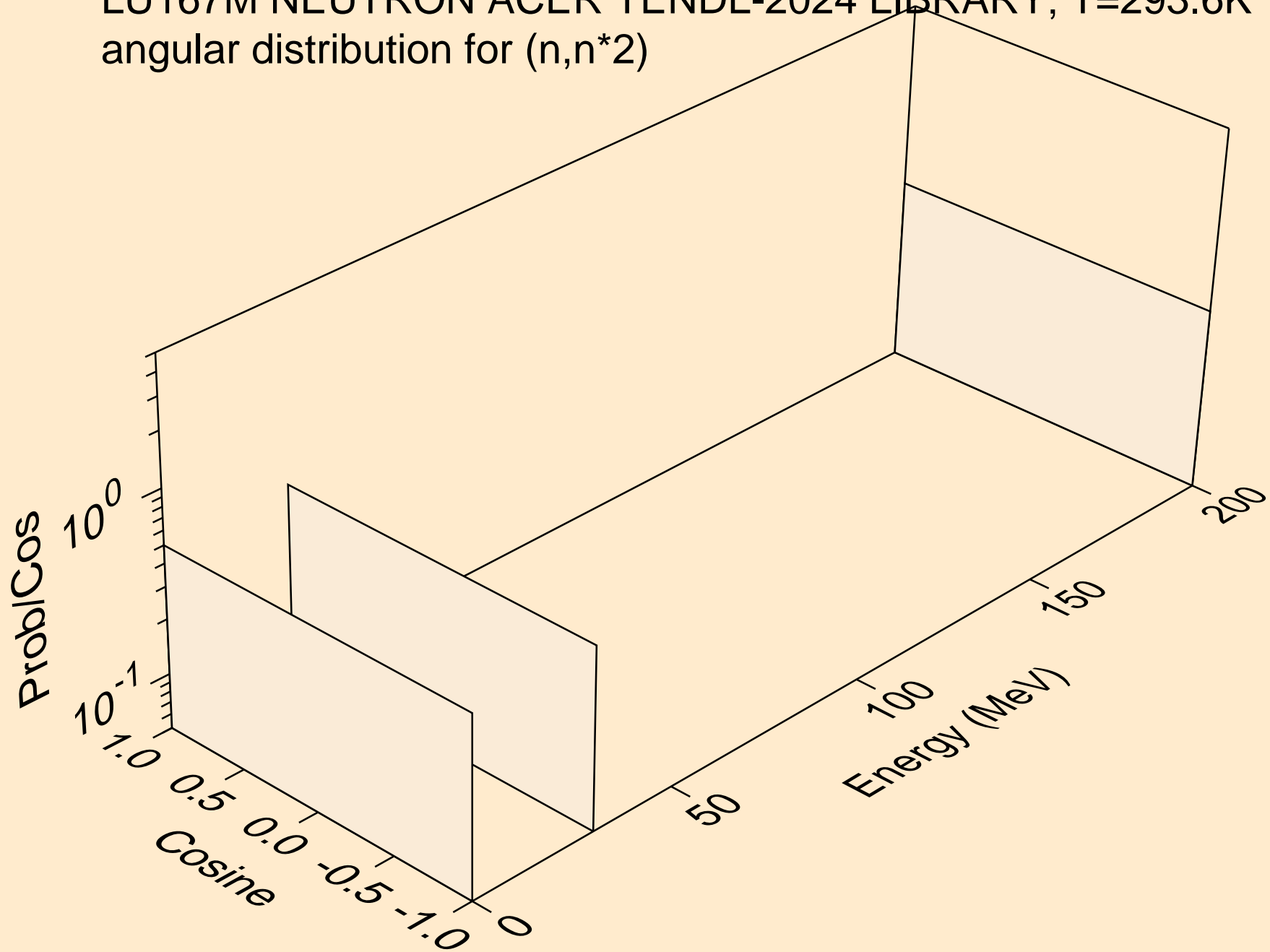

LU167M NEUTRON ACER TENDL-2024 LIBRARY; T=293.6K  
angular distribution for (n,n\*3)

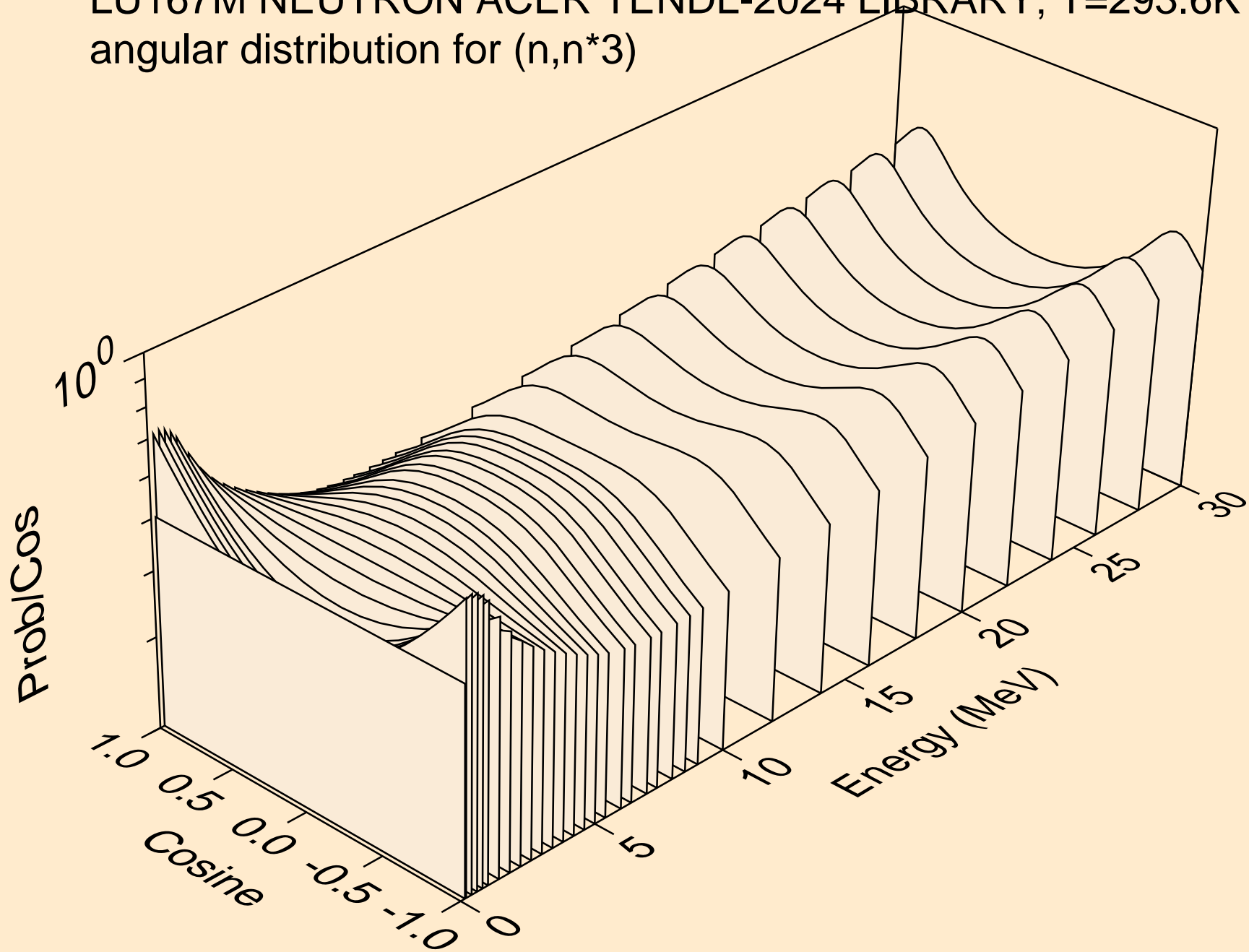

LU167M NEUTRON ACER TENDL-2024 LIBRARY; T=293.6K  
angular distribution for (n,n\*4)

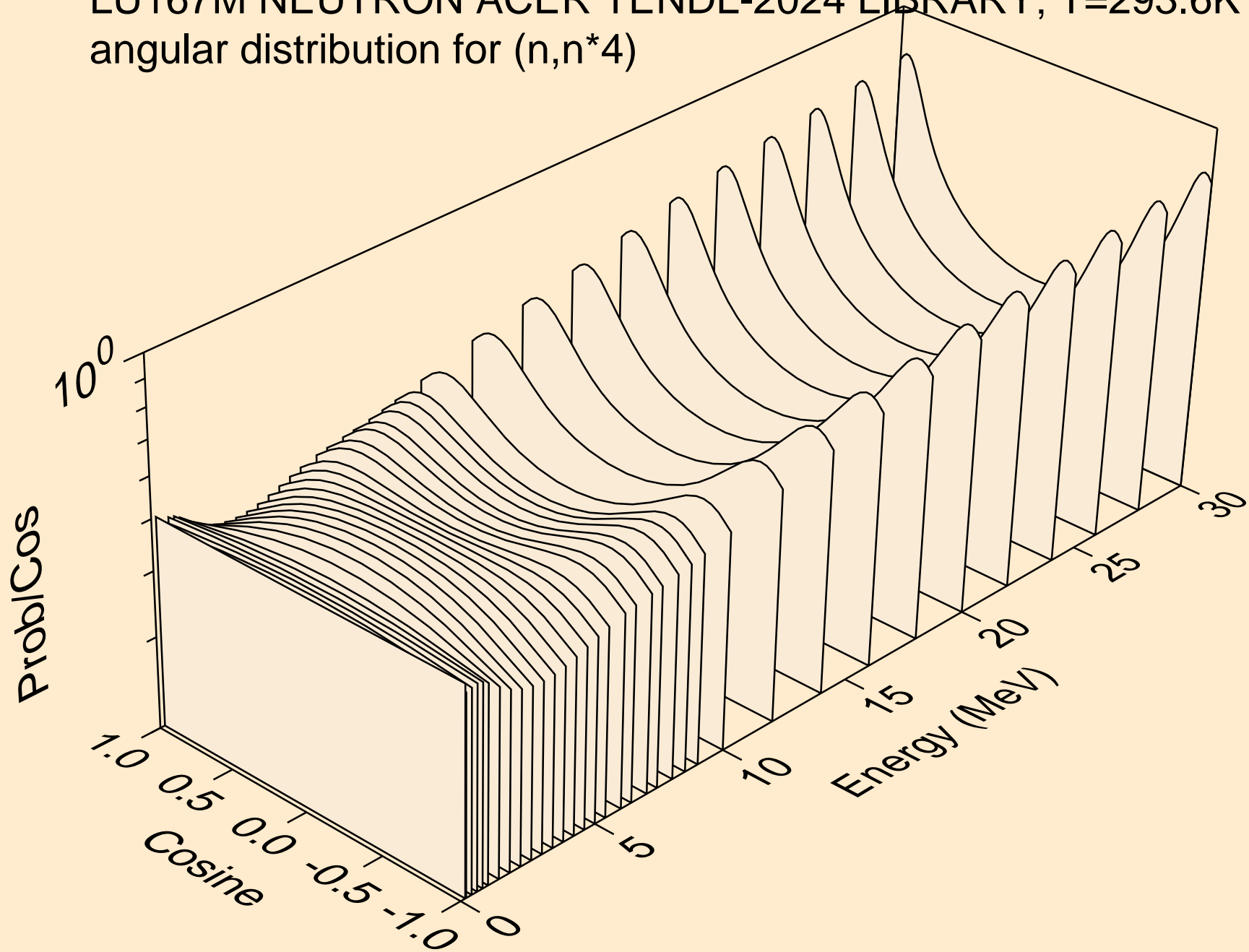

LU167M NEUTRON ACER TENDL-2024 LIBRARY; T=293.6K  
angular distribution for (n,n\*5)

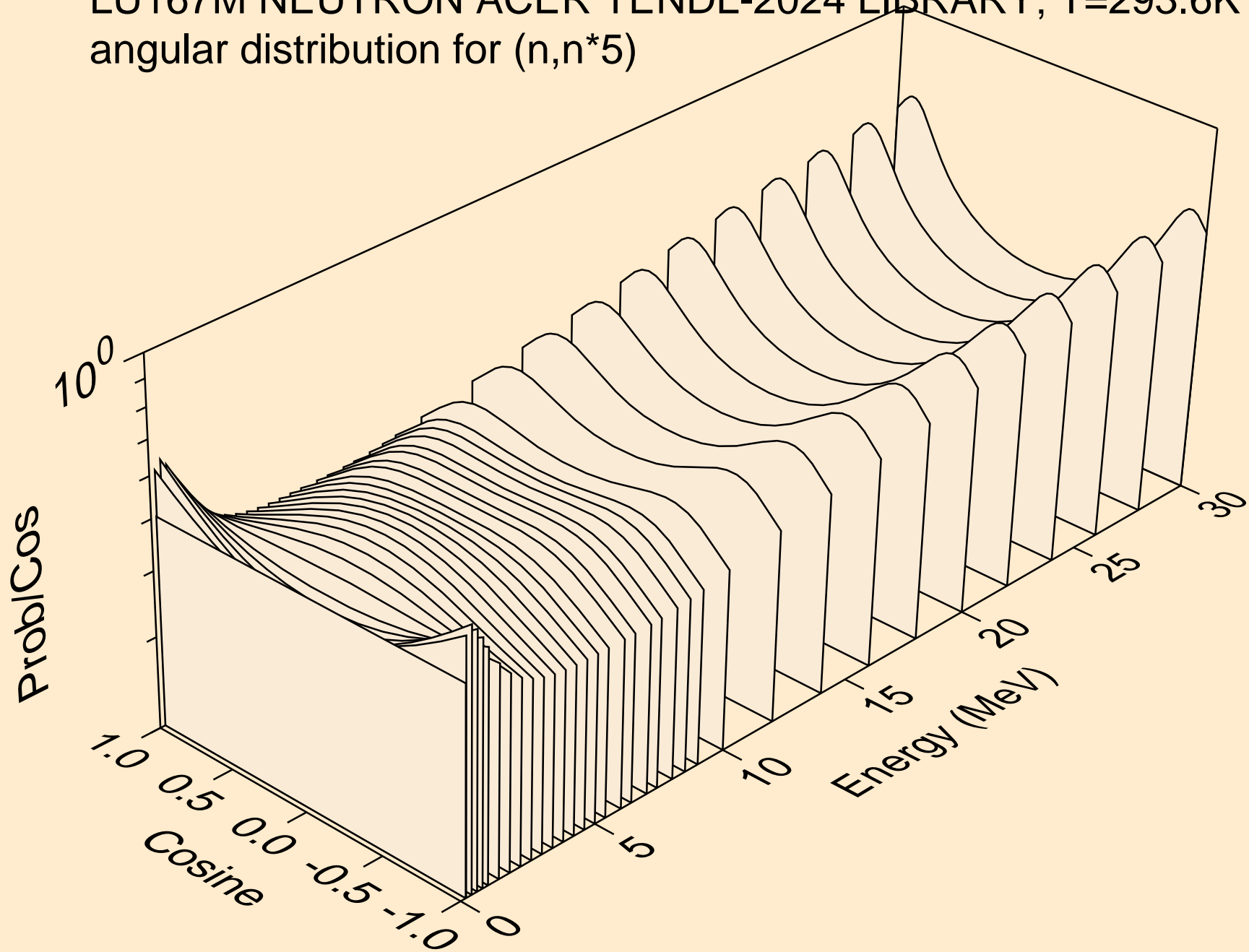

LU167M NEUTRON ACER TENDL-2024 LIBRARY; T=293.6K  
Neutron emission for (n,x)

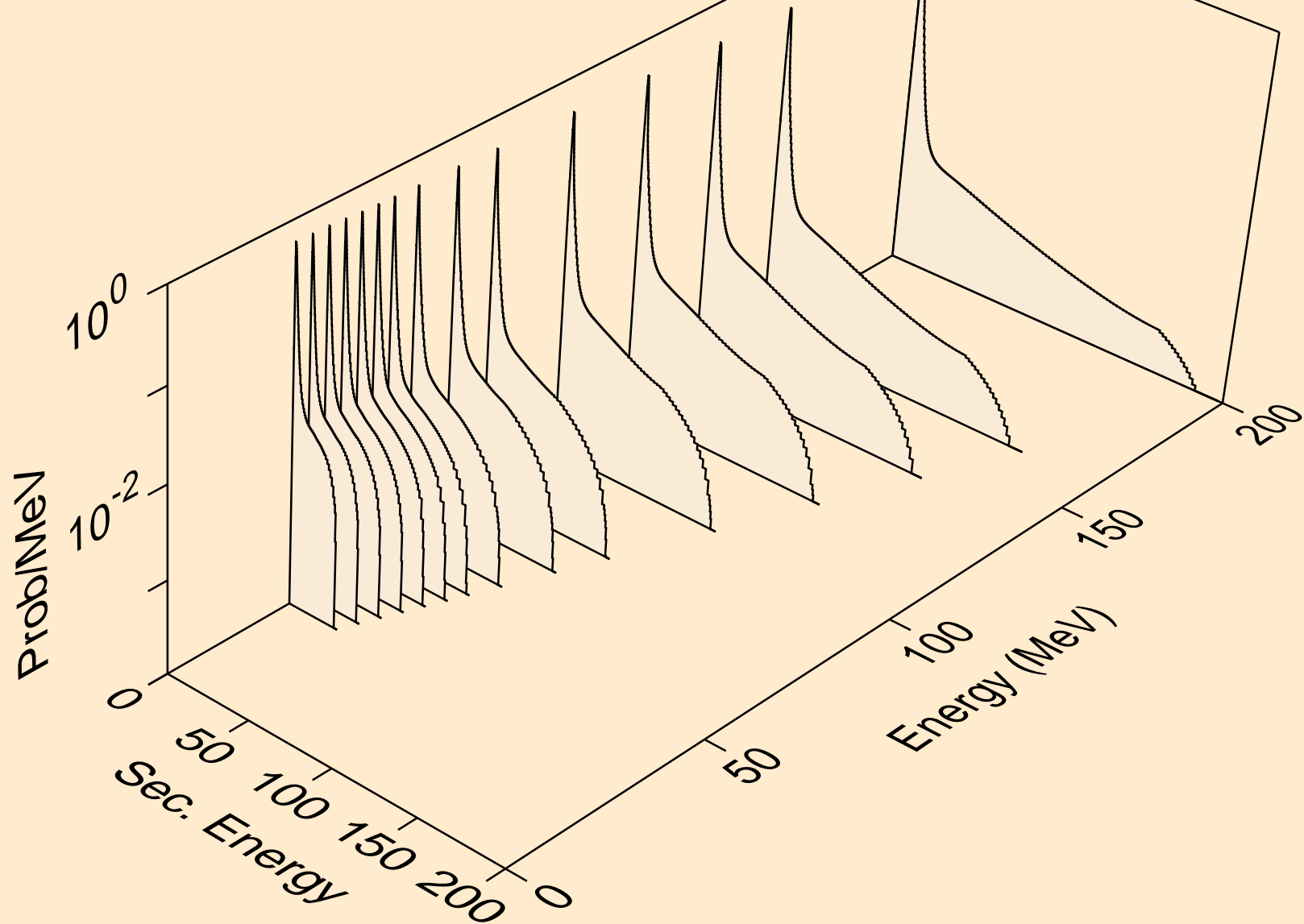

LU167M NEUTRON ACER TENDL-2024 LIBRARY; T=293.6K  
Neutron emission for (n,2nd)

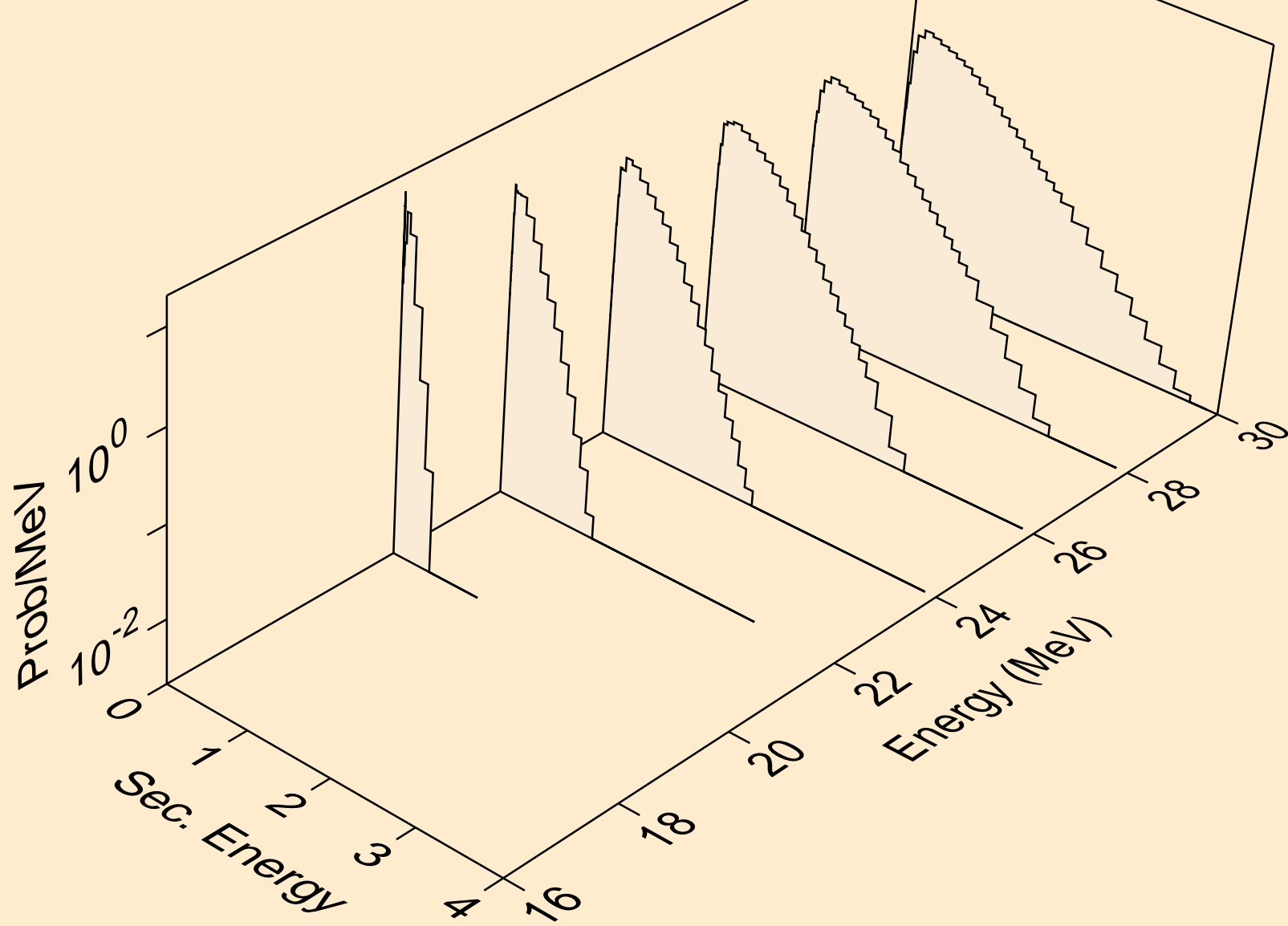

LU167M NEUTRON ACER TENDL-2024 LIBRARY; T=293.6K  
Neutron emission for (n,2n)

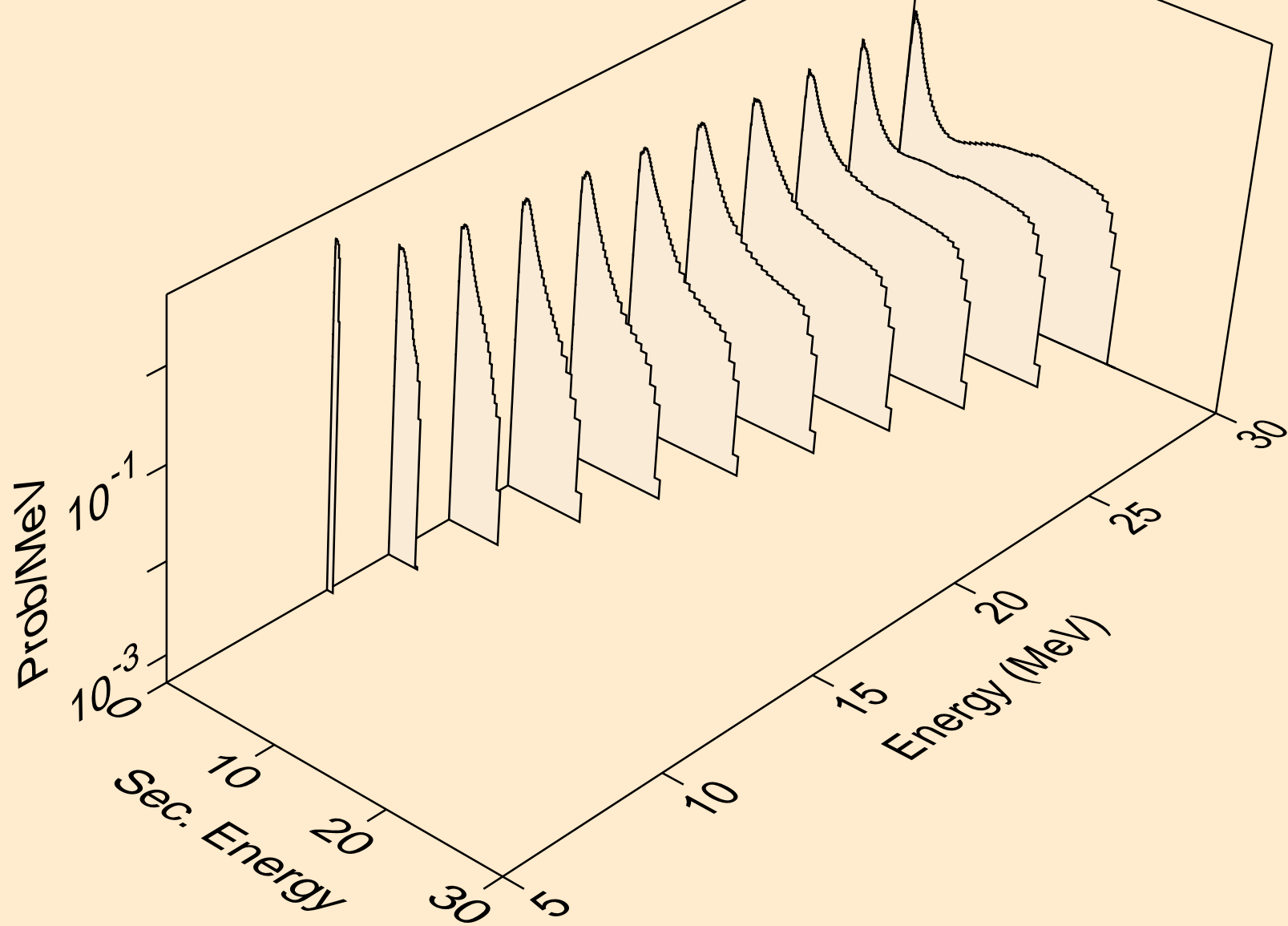

LU167M NEUTRON ACER TENDL-2024 LIBRARY; T=293.6K  
Neutron emission for (n,3n)

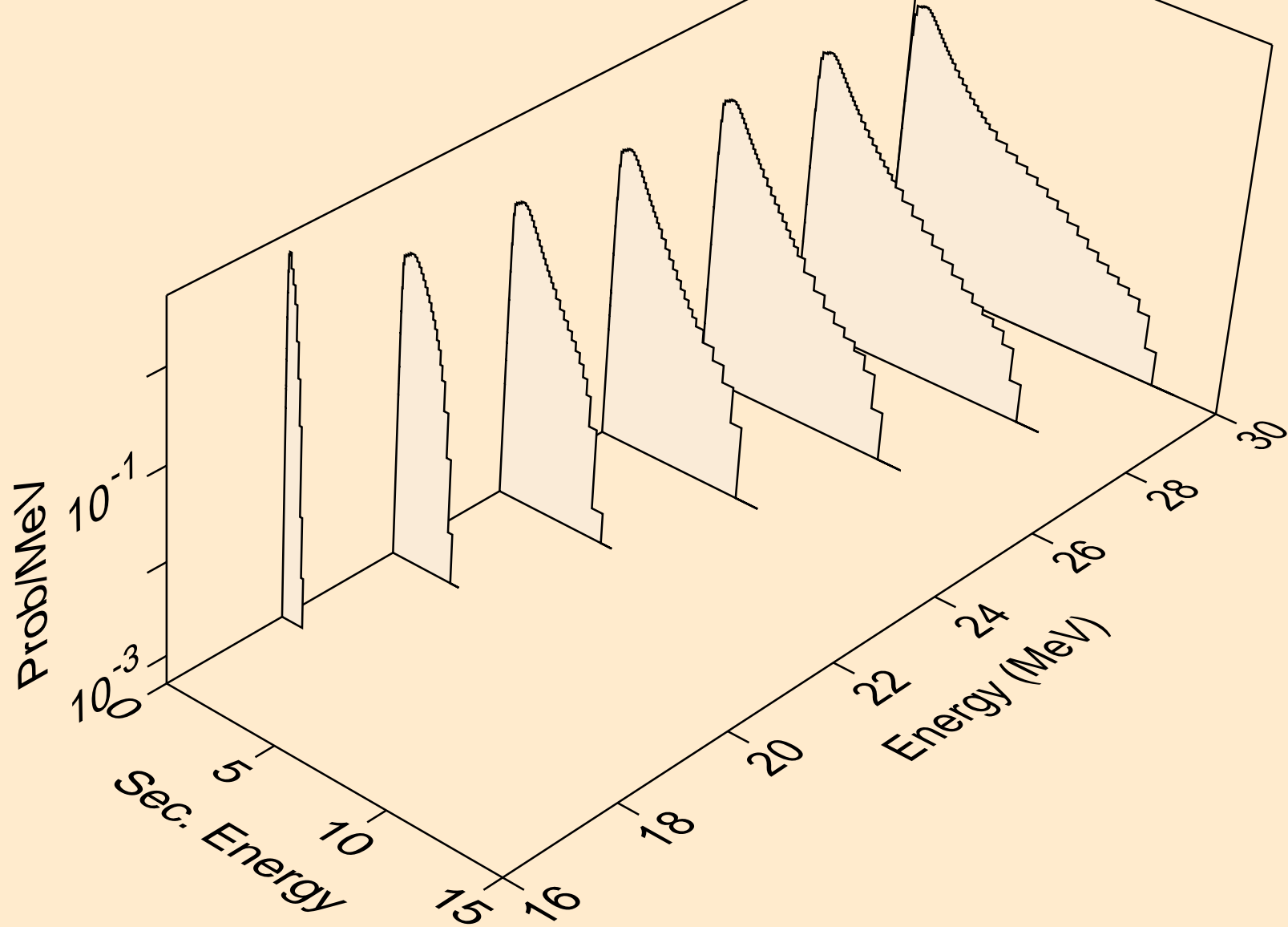

LU167M NEUTRON ACER TENDL-2024 LIBRARY; T=293.6K  
Neutron emission for (n,n\*)a

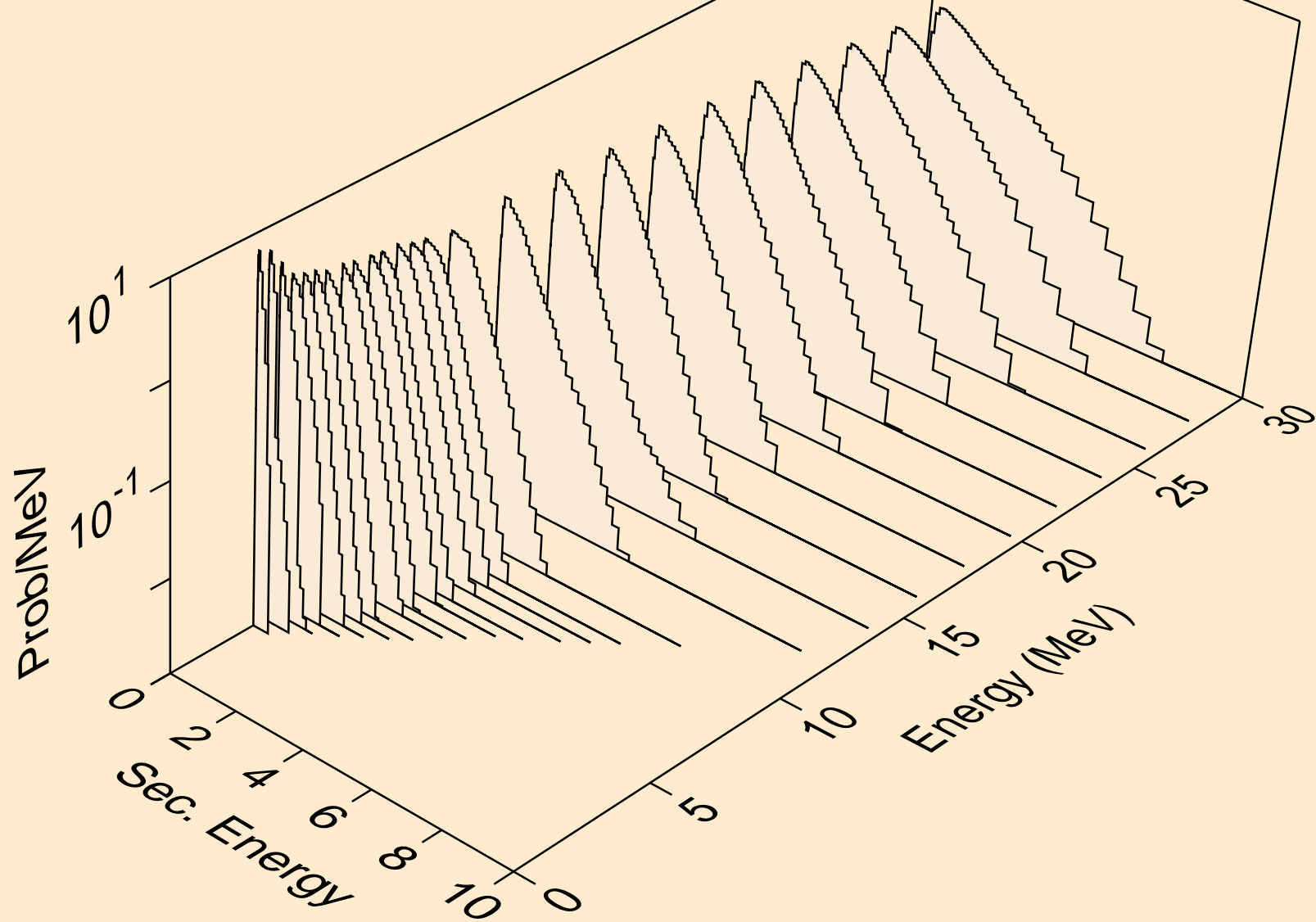

LU167M NEUTRON ACER TENDL-2024 LIBRARY; T=293.6K  
Neutron emission for (n,2n)a

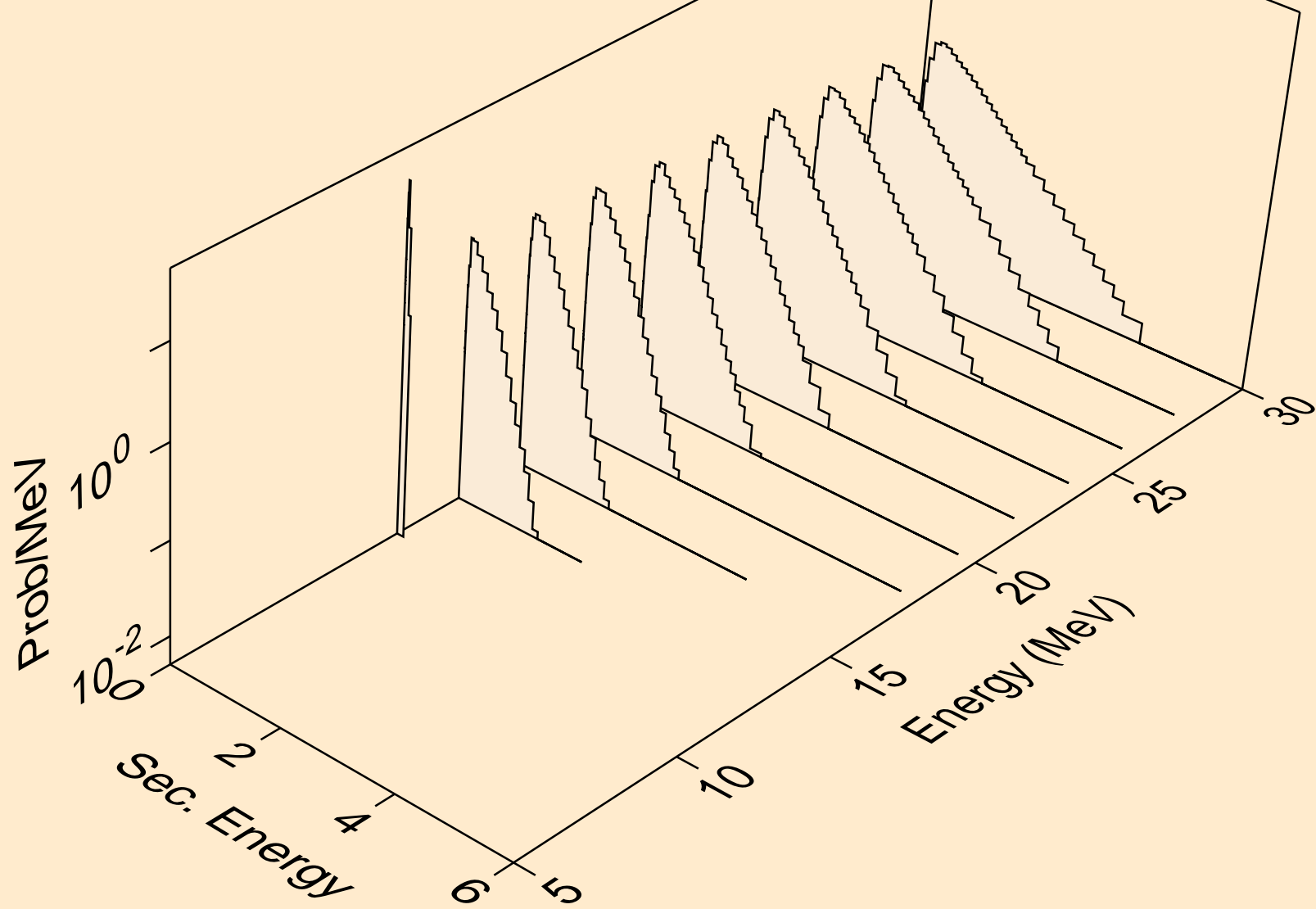

LU167M NEUTRON ACER TENDL-2024 LIBRARY; T=293.6K  
Neutron emission for (n,3n)<sub>a</sub>

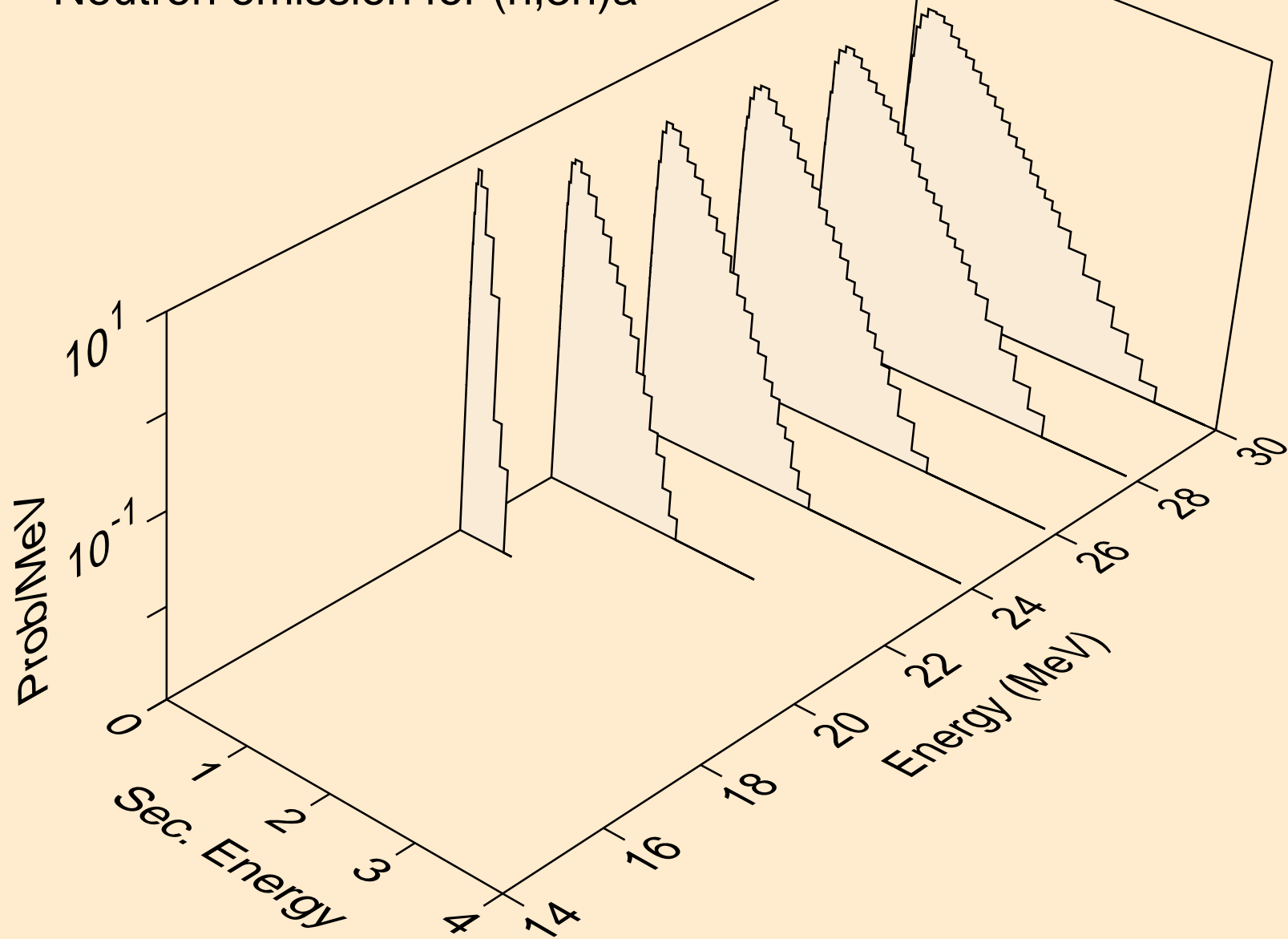

LU167M NEUTRON ACER TENDL-2024 LIBRARY; T=293.6K  
Neutron emission for (n,n\*)p

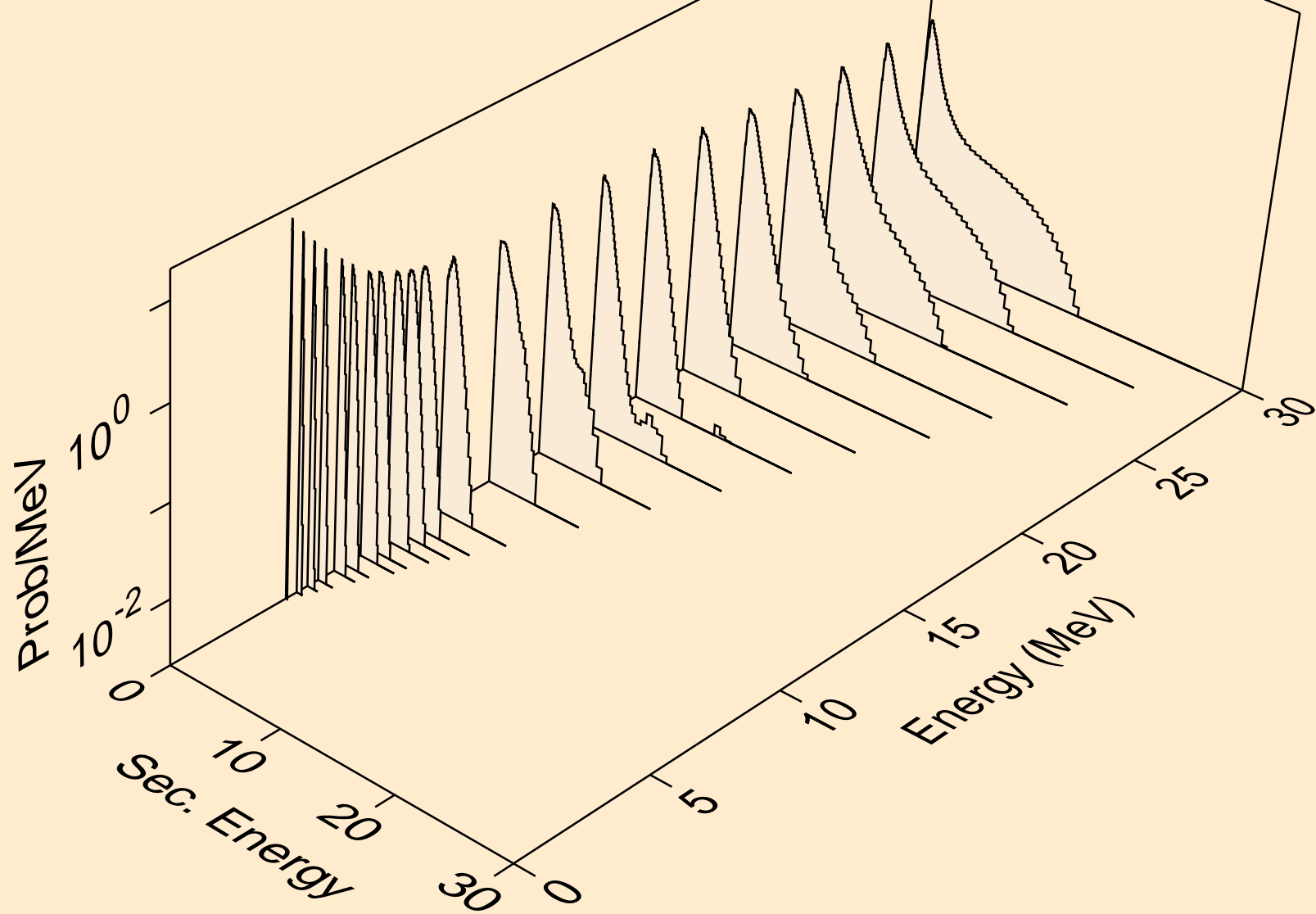

LU167M NEUTRON ACER TENDL-2024 LIBRARY; T=293.6K  
Neutron emission for (n,n\*)2a

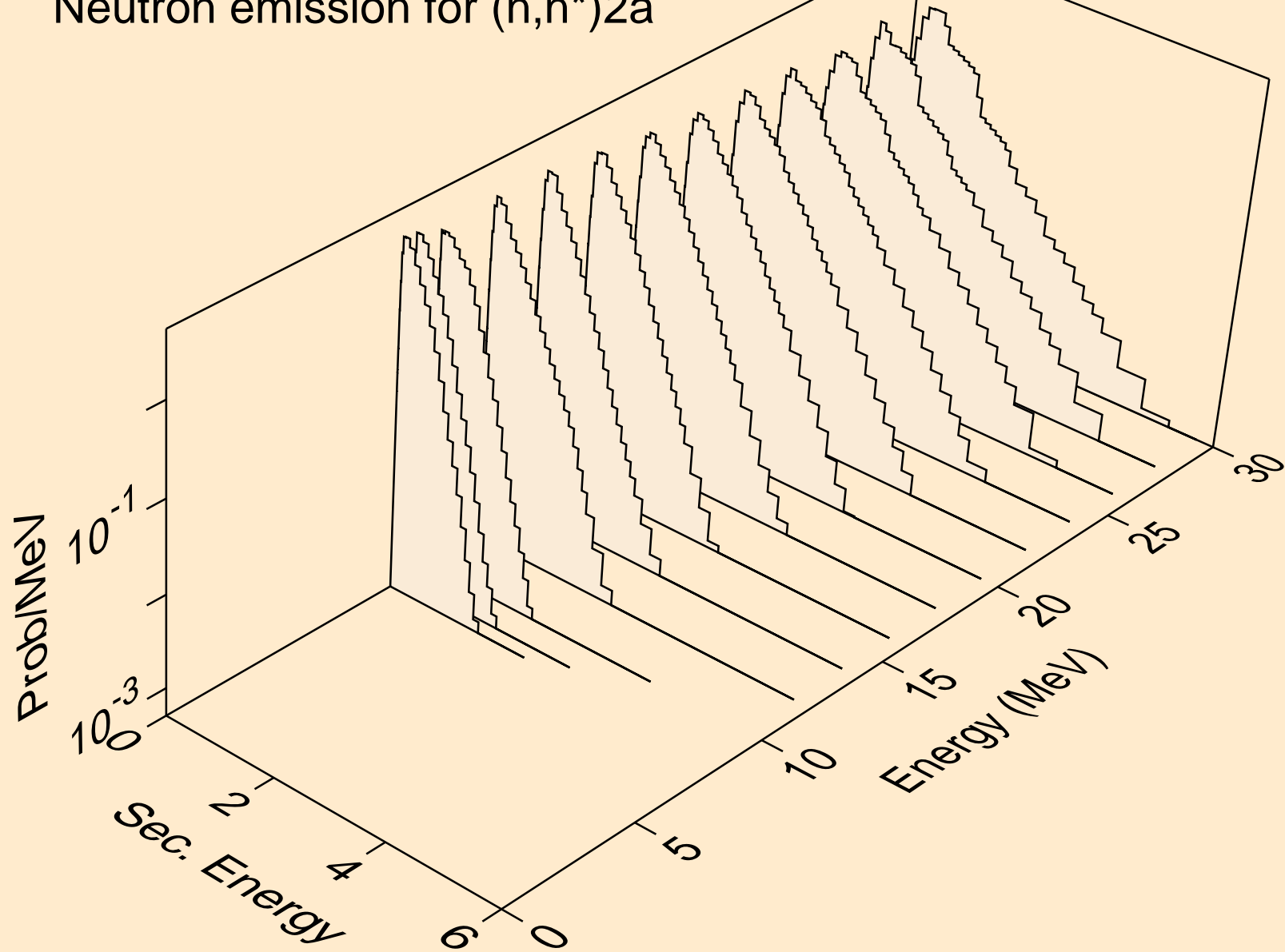

LU167M NEUTRON ACER TENDL-2024 LIBRARY; T=293.6K  
Neutron emission for (n,2n)2a

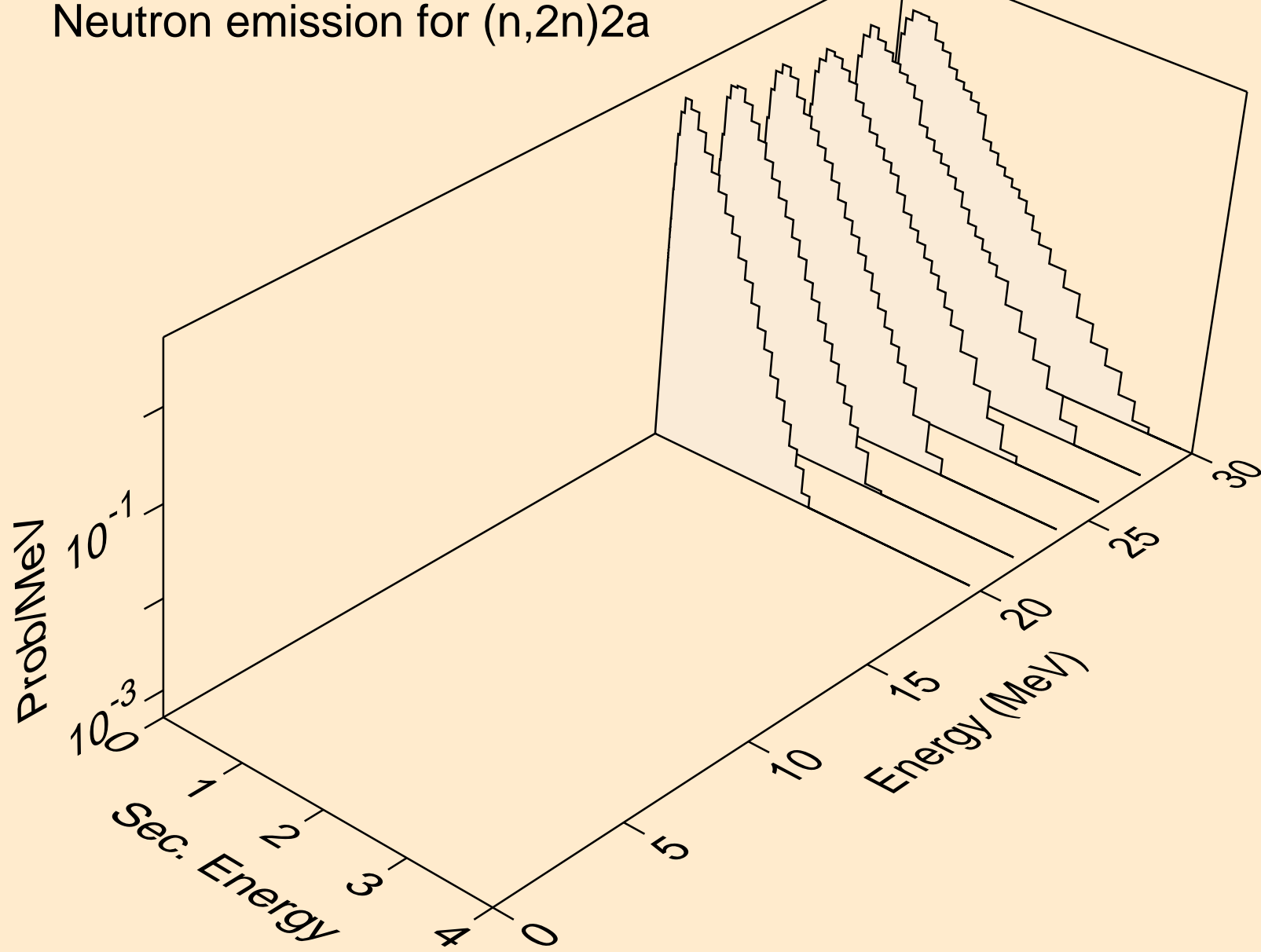

LU167M NEUTRON ACER TENDL-2024 LIBRARY; T=293.6K  
Neutron emission for (n,n\*)d

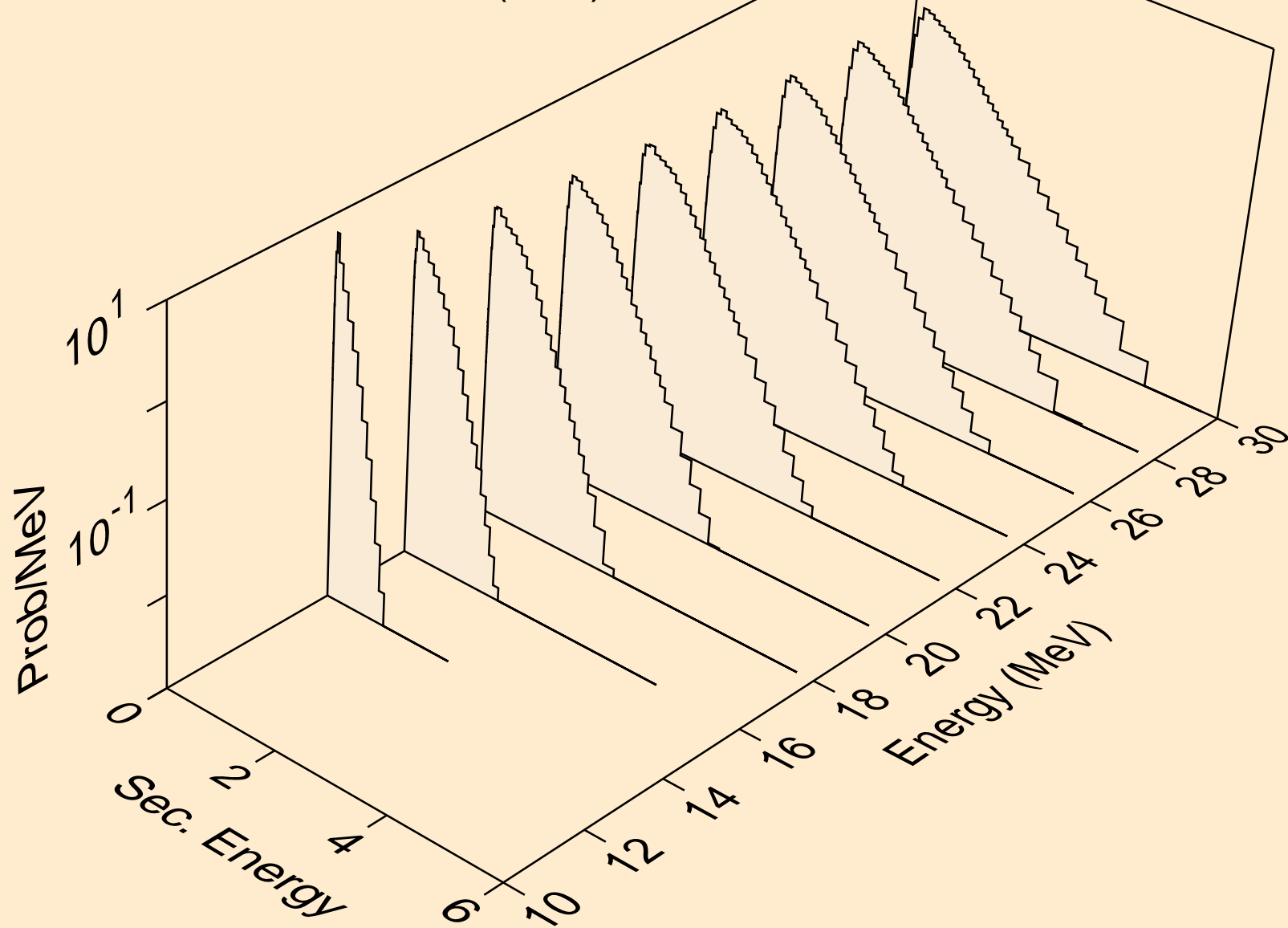

LU167M NEUTRON ACER TENDL-2024 LIBRARY; T=293.6K  
Neutron emission for (n,n\*)t

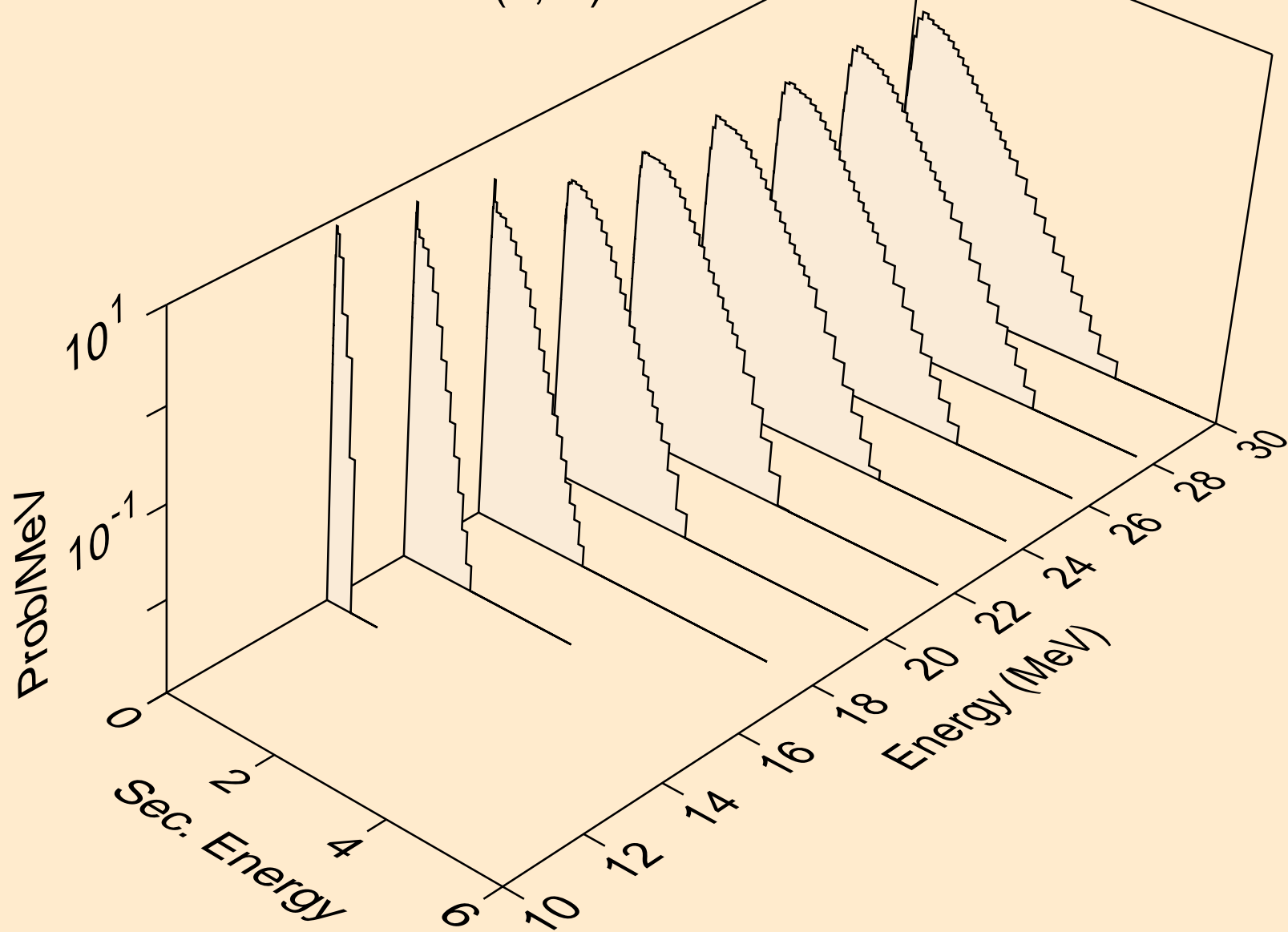

LU167M NEUTRON ACER TENDL-2024 LIBRARY; T=293.6K  
Neutron emission for (n,n\*)he3

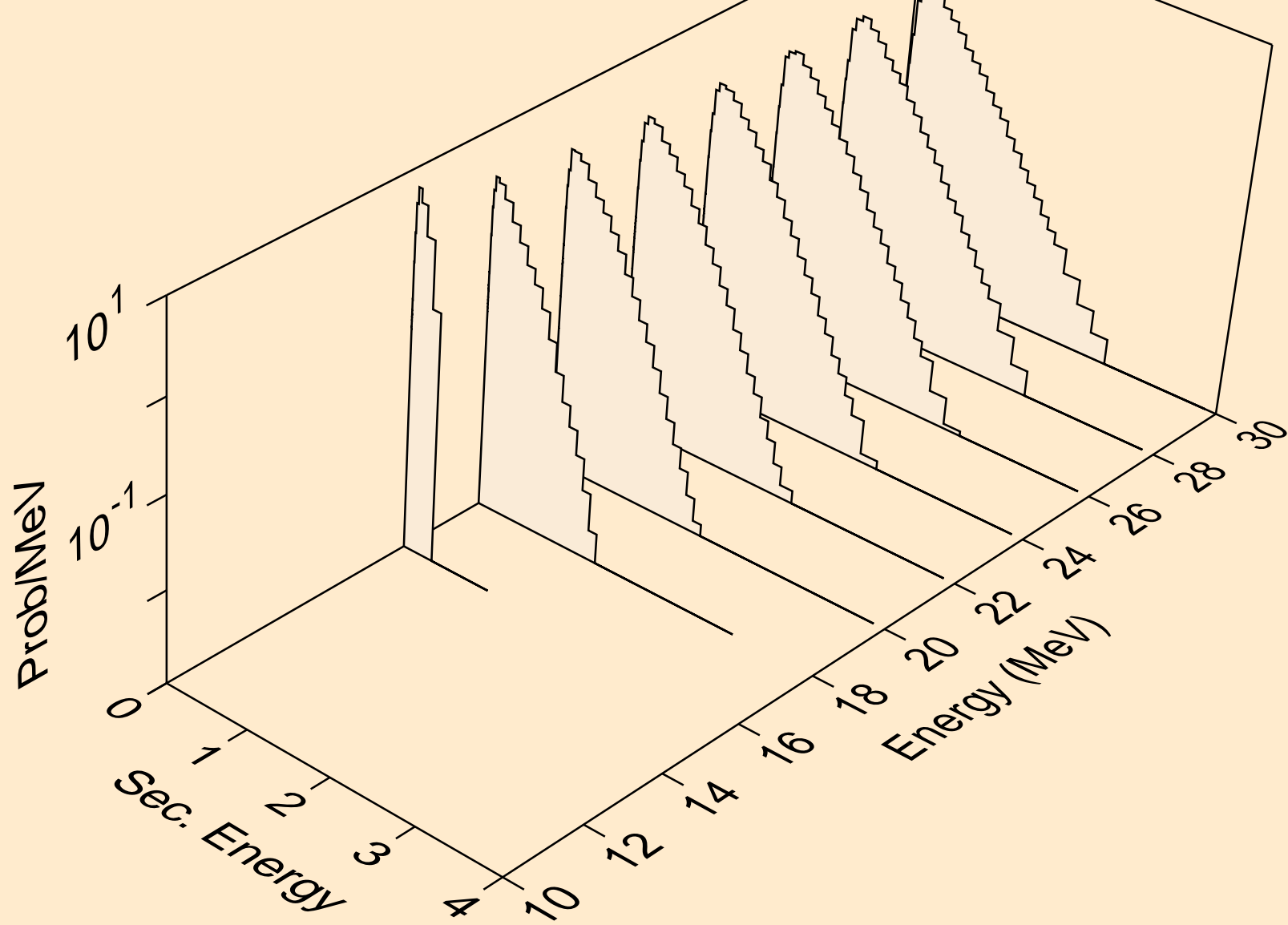

LU167M NEUTRON ACER TENDL-2024 LIBRARY; T=293.6K  
Neutron emission for (n,4n)

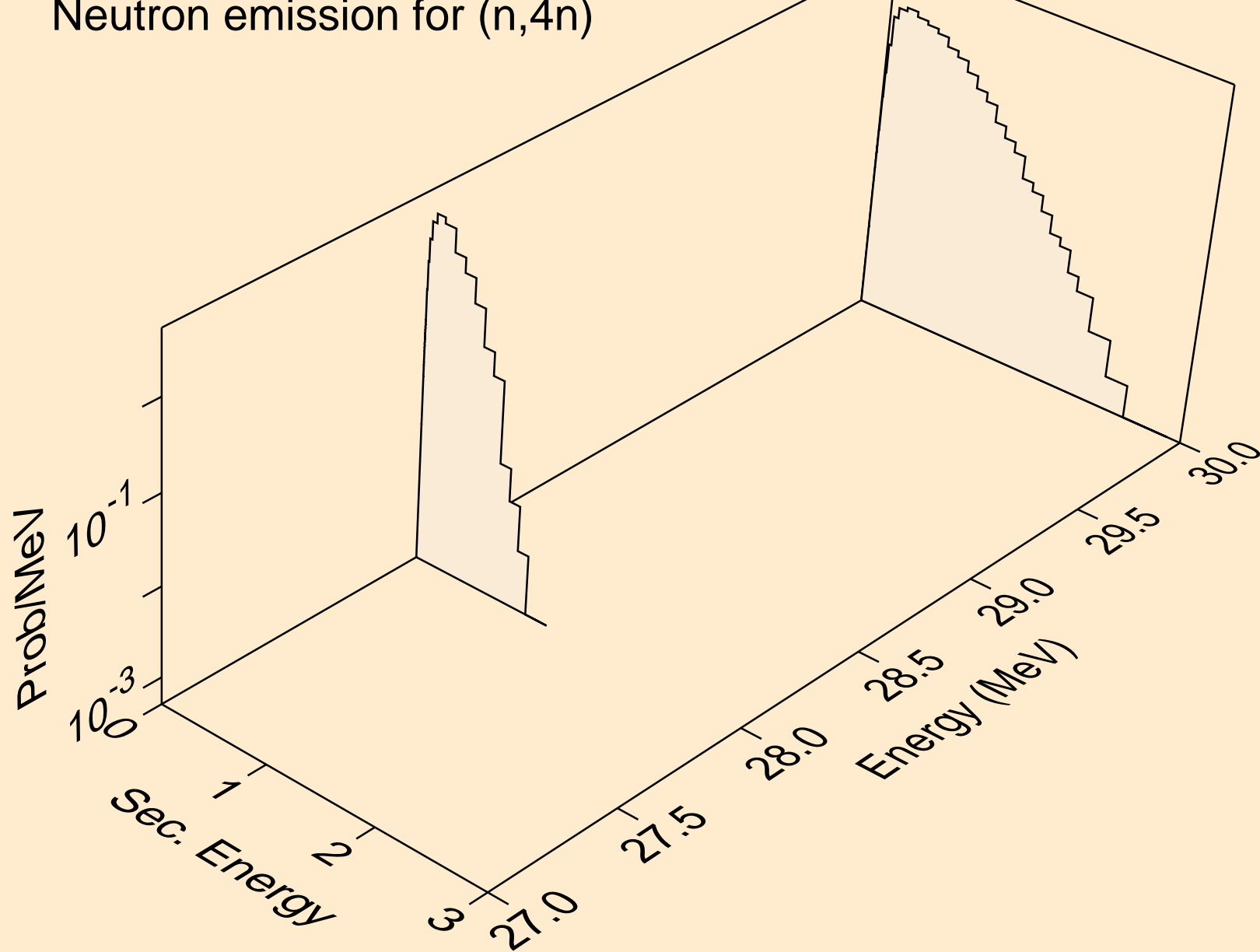

LU167M NEUTRON ACER TENDL-2024 LIBRARY; T=293.6K  
Neutron emission for (n,2np)

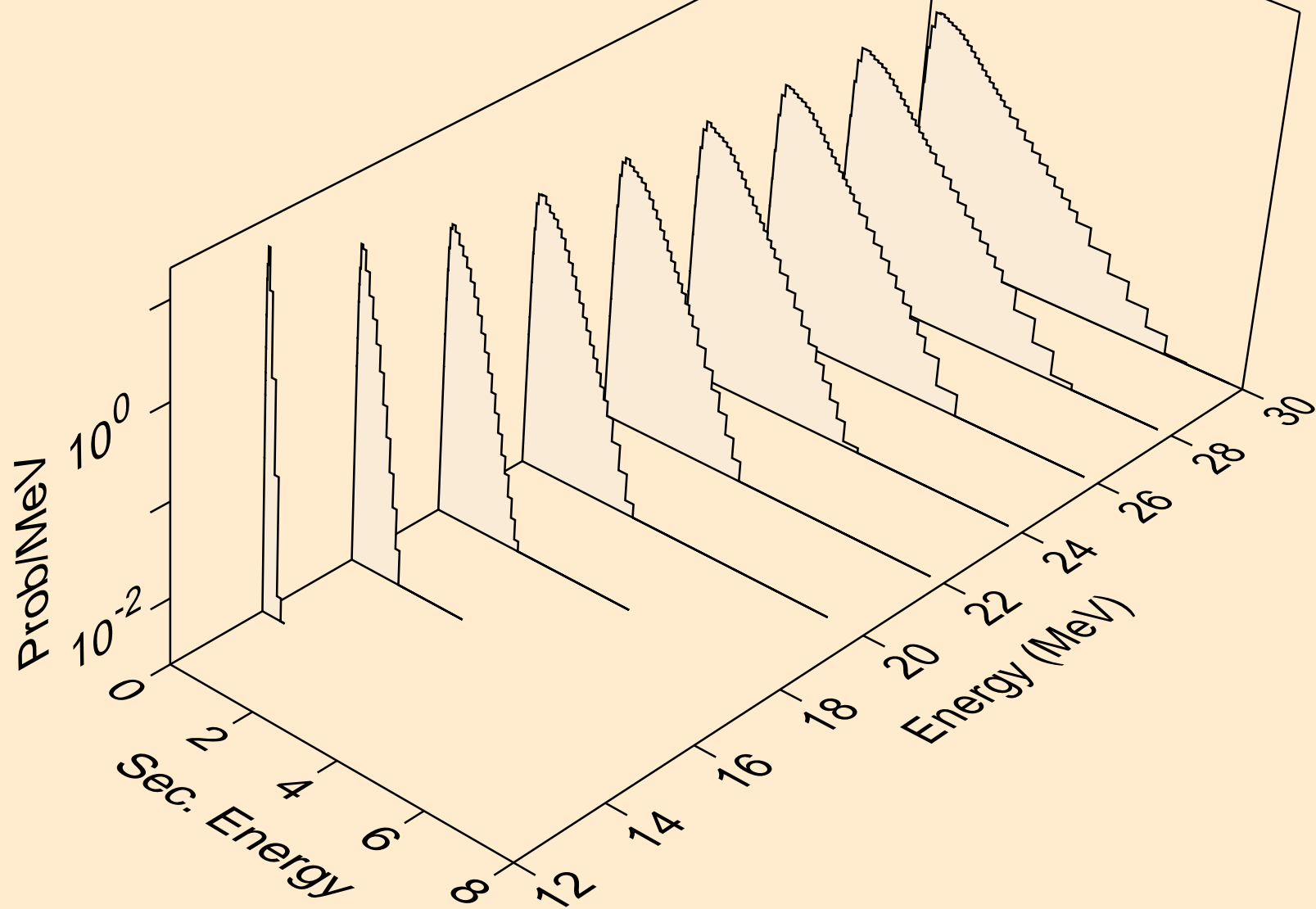

LU167M NEUTRON ACER TENDL-2024 LIBRARY; T=293.6K  
Neutron emission for (n,3np)

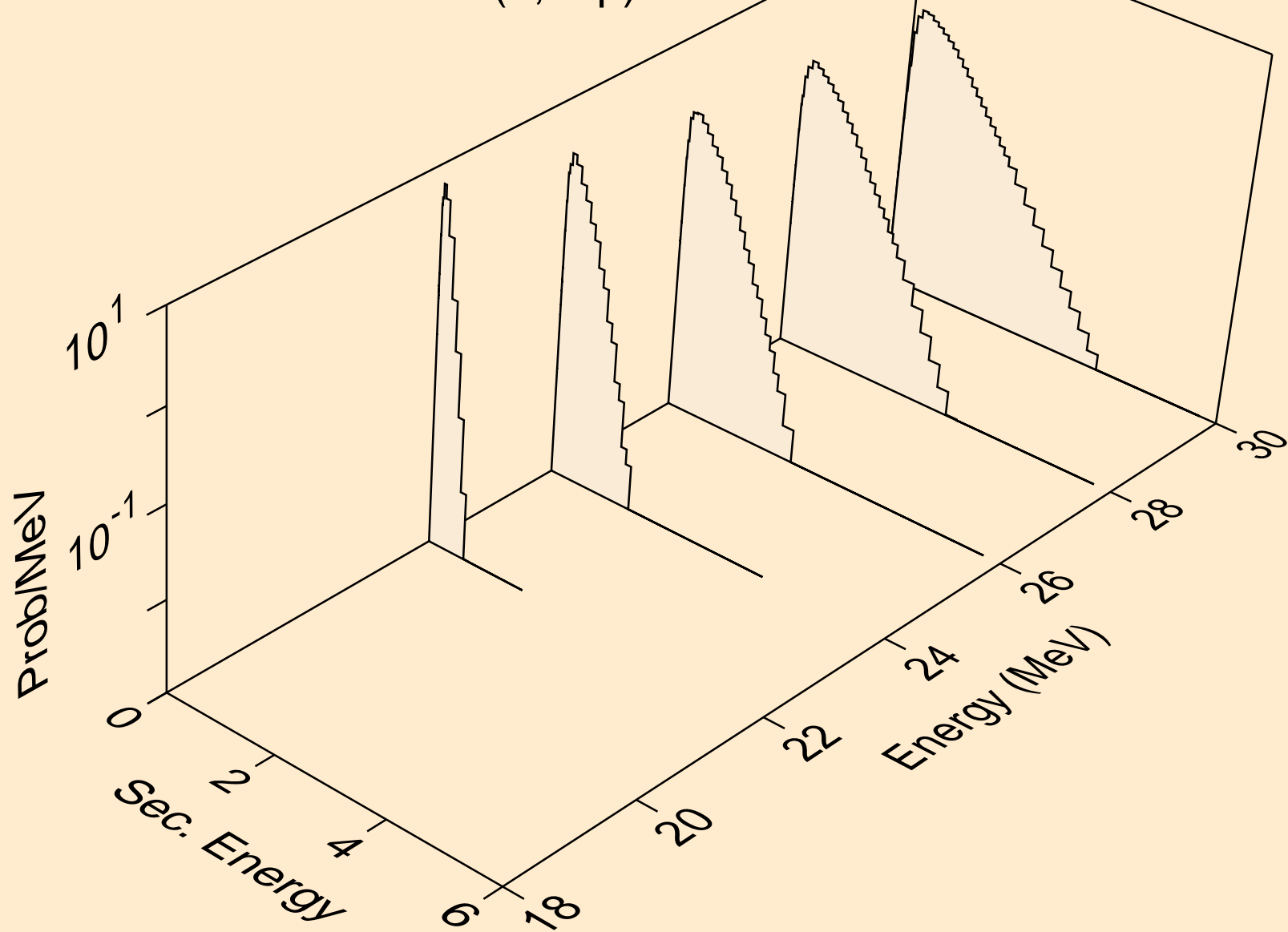

LU167M NEUTRON ACER TENDL-2024 LIBRARY; T=293.6K  
Neutron emission for (n,n2p)

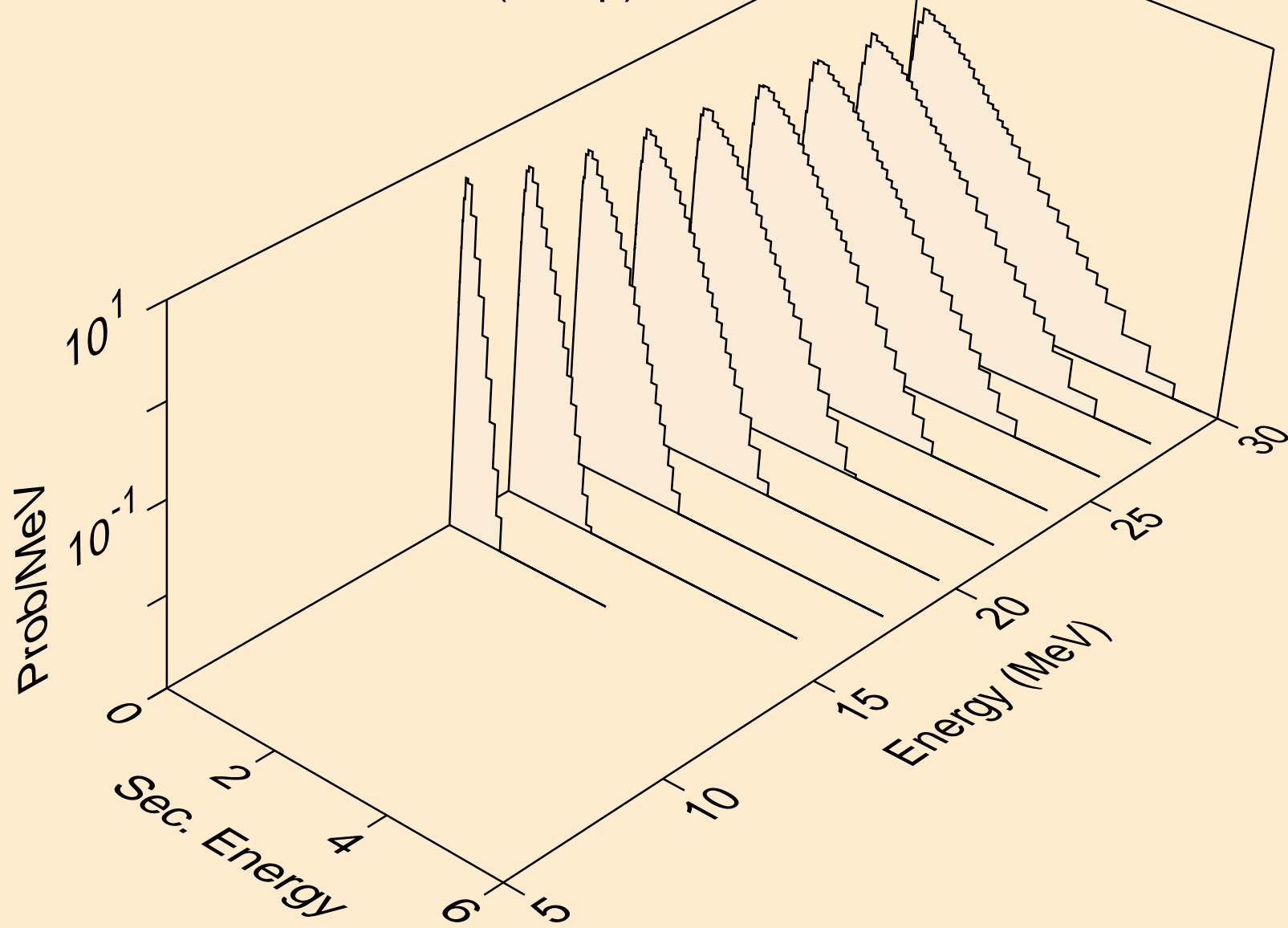

LU167M NEUTRON ACER TENDL-2024 LIBRARY; T=293.6K  
Neutron emission for (n,npa)

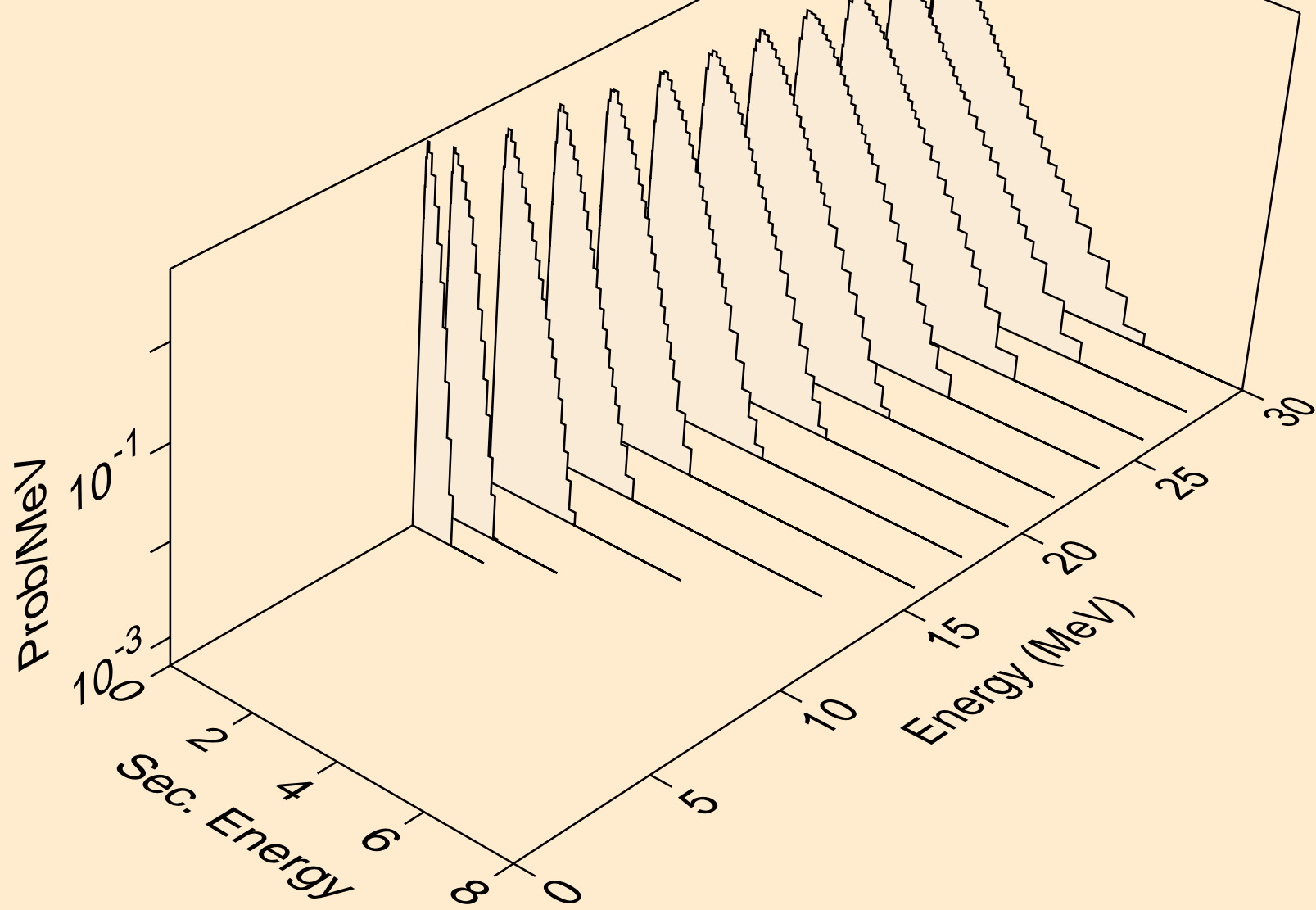

LU167M NEUTRON ACER TENDL-2024 LIBRARY; T=293.6K  
Neutron emission for (n,n\*c)

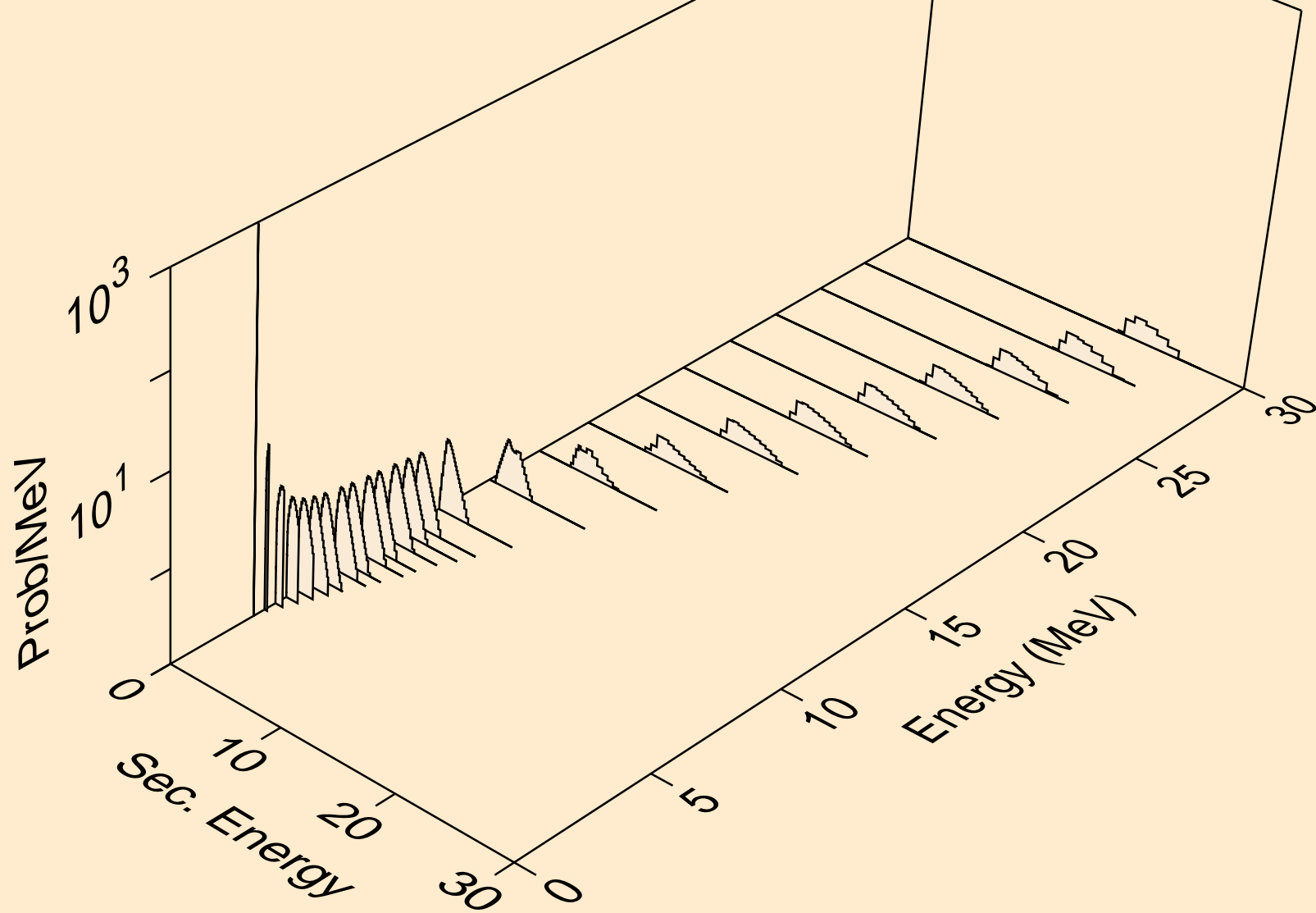

LU167M NEUTRON ACER TENDL-2024 LIBRARY; T=293.6K  
Photon emission for (n,x)

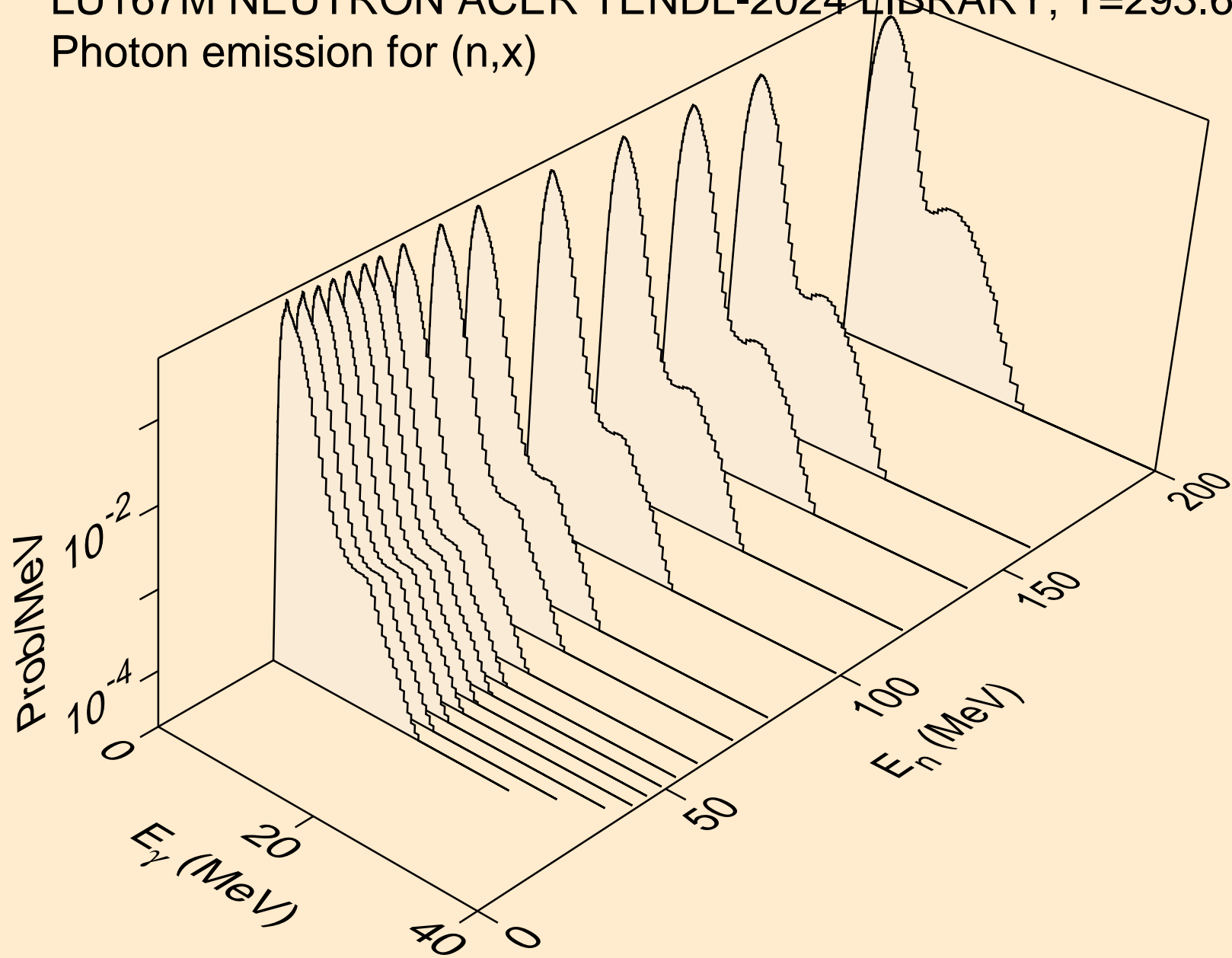

LU167M NEUTRON ACER TENDL-2024 LIBRARY; T=293.6K  
Photon emission for (n,2nd)

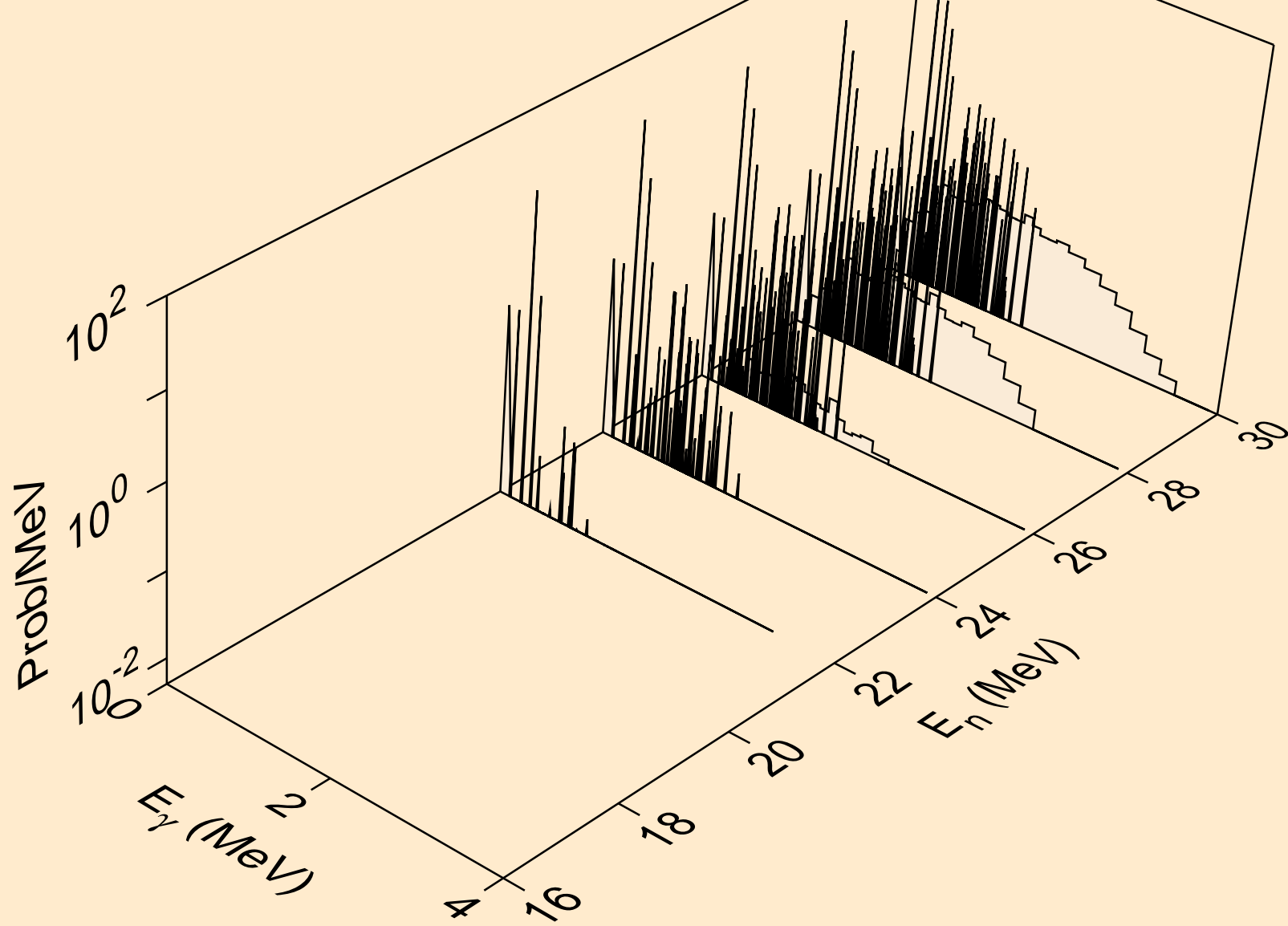

LU167M NEUTRON ACER TENDL-2024 LIBRARY; T=293.6K  
Photon emission for (n,2n)

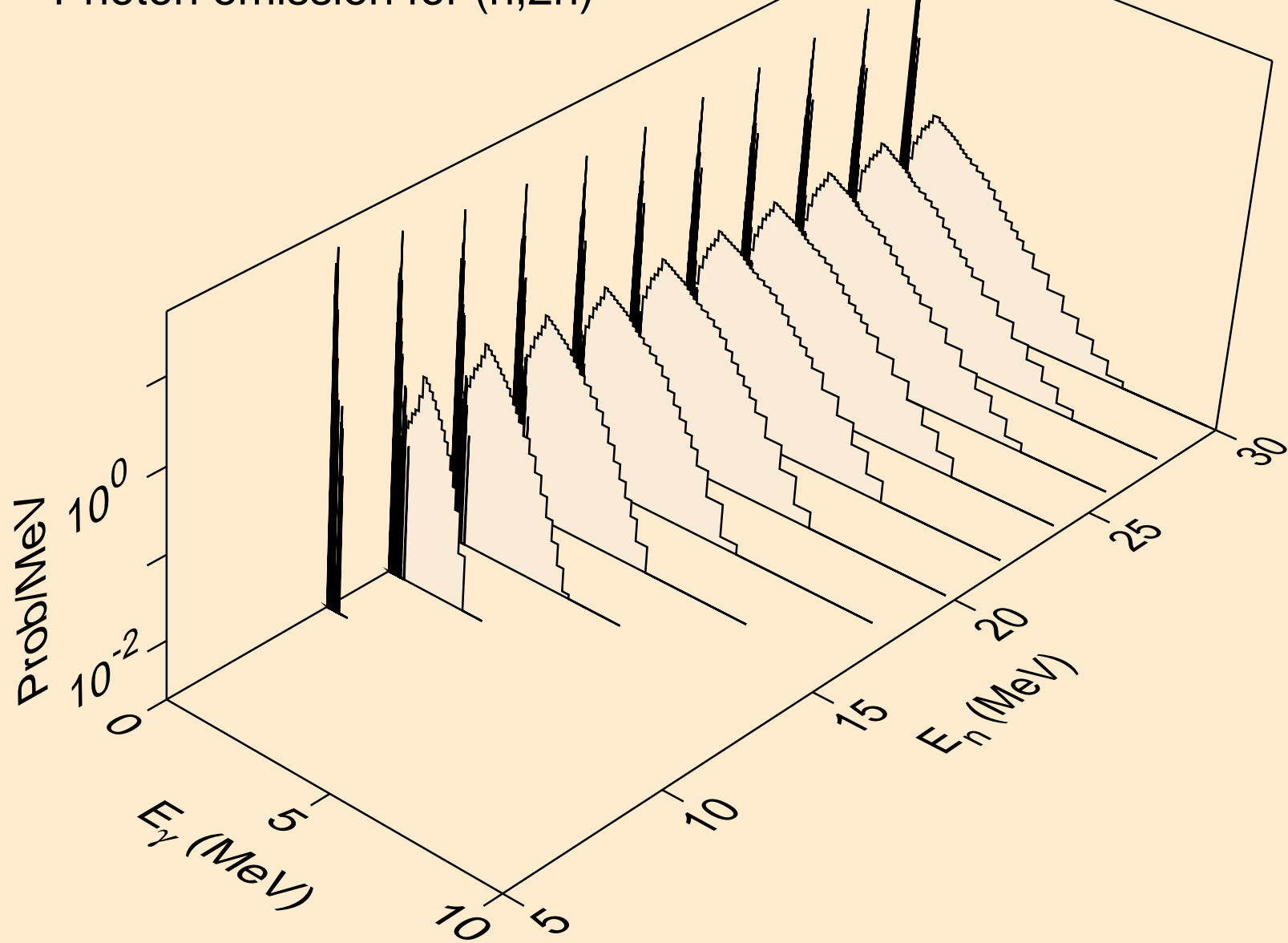

LU167M NEUTRON ACER TENDL-2024 LIBRARY; T=293.6K  
Photon emission for (n,3n)

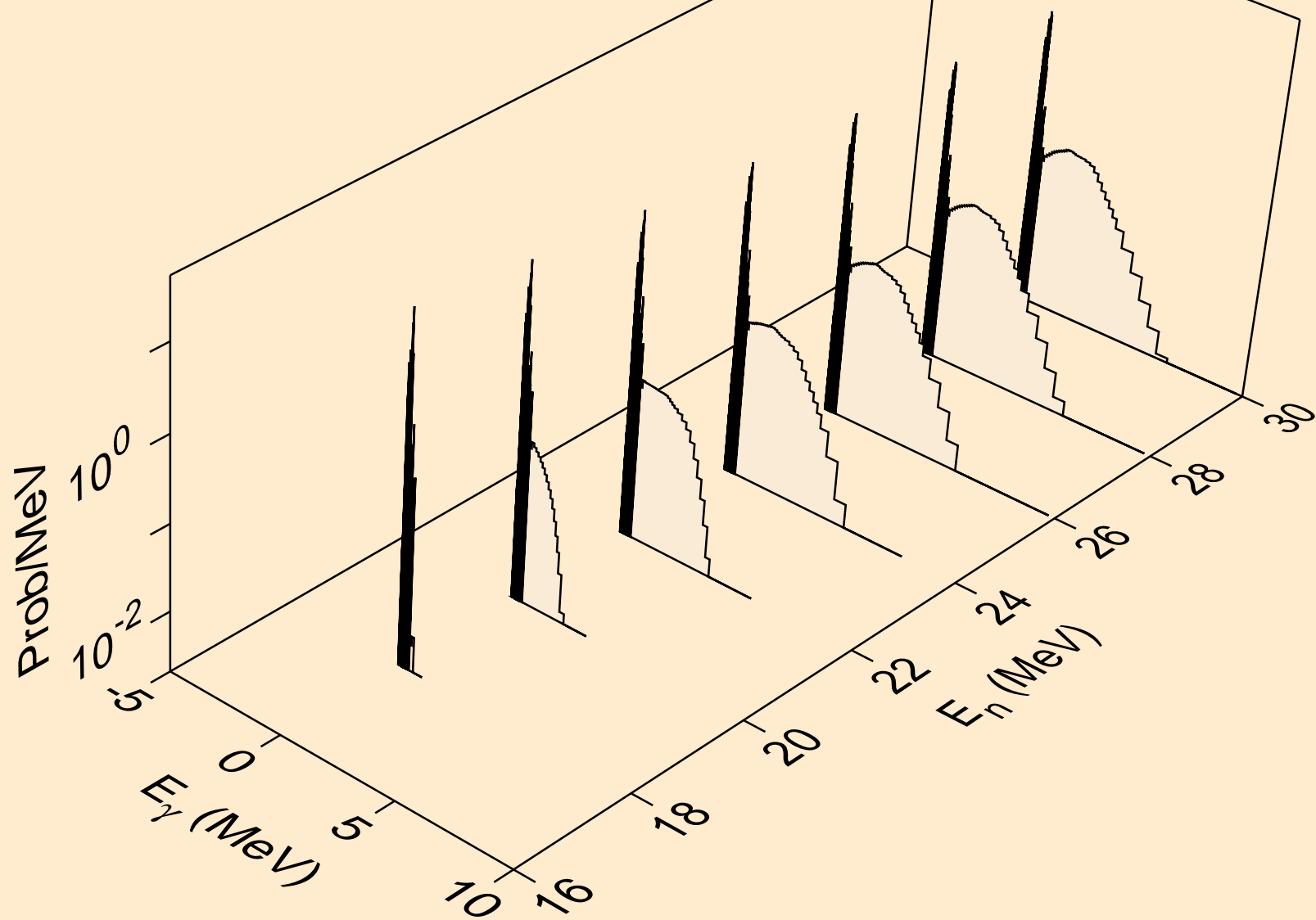

LU167M NEUTRON ACER TENDL-2024 LIBRARY; T=293.6K  
Photon emission for (n,n\*)a

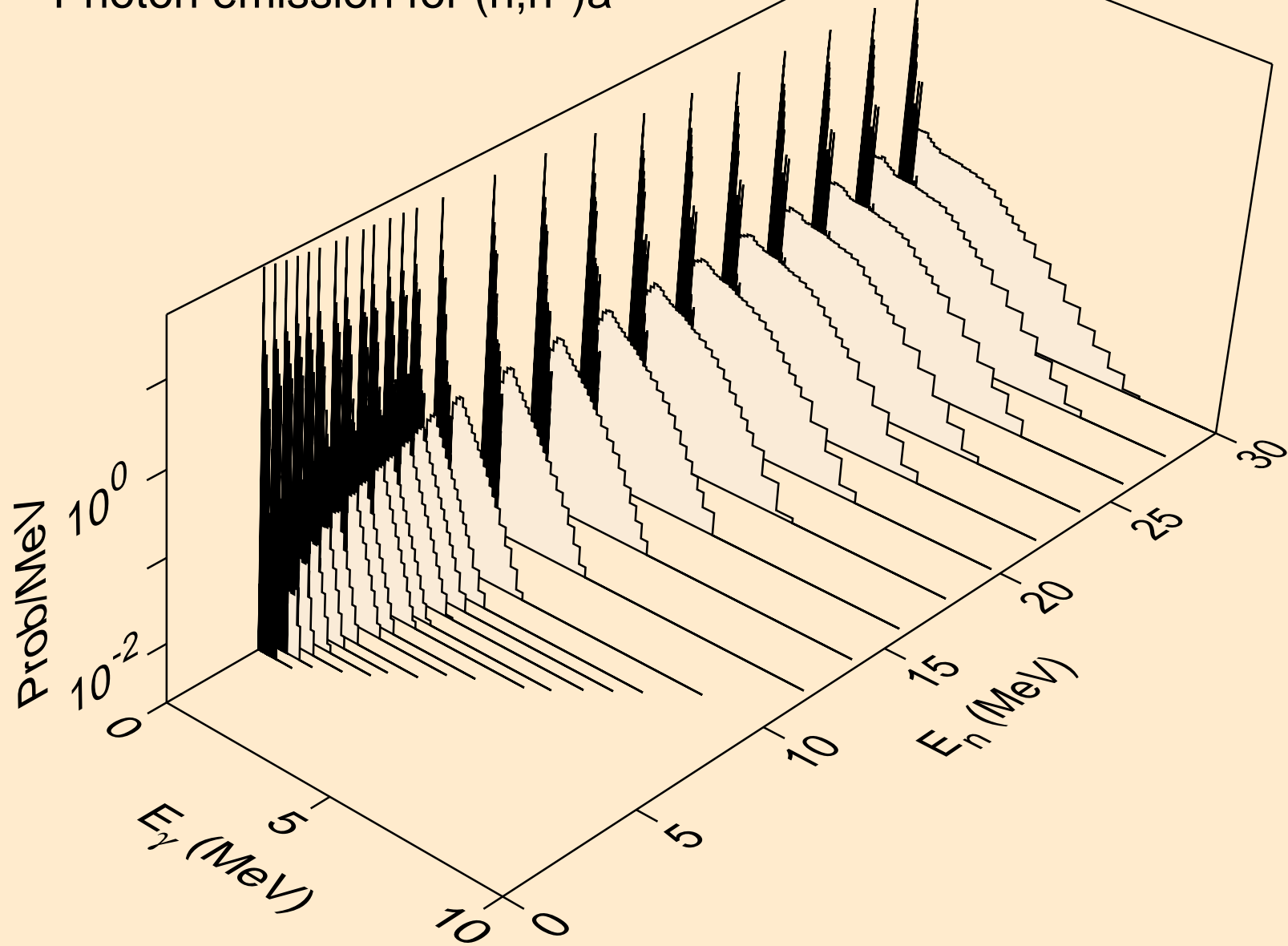

LU167M NEUTRON ACER TENDL-2024 LIBRARY; T=293.6K  
Photon emission for (n,2n)a

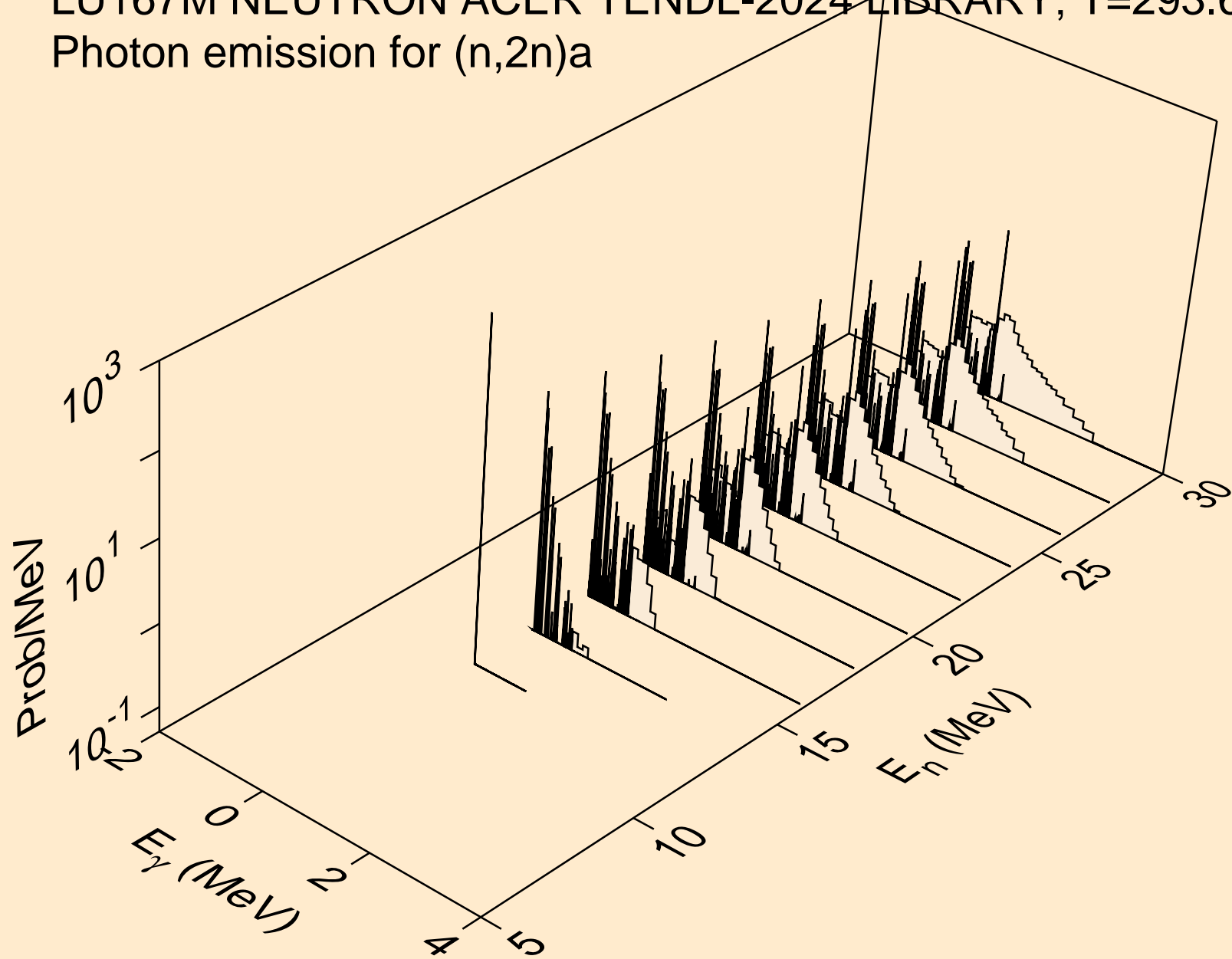

LU167M NEUTRON ACER TENDL-2024 LIBRARY; T=293.6K  
Photon emission for (n,3n)a

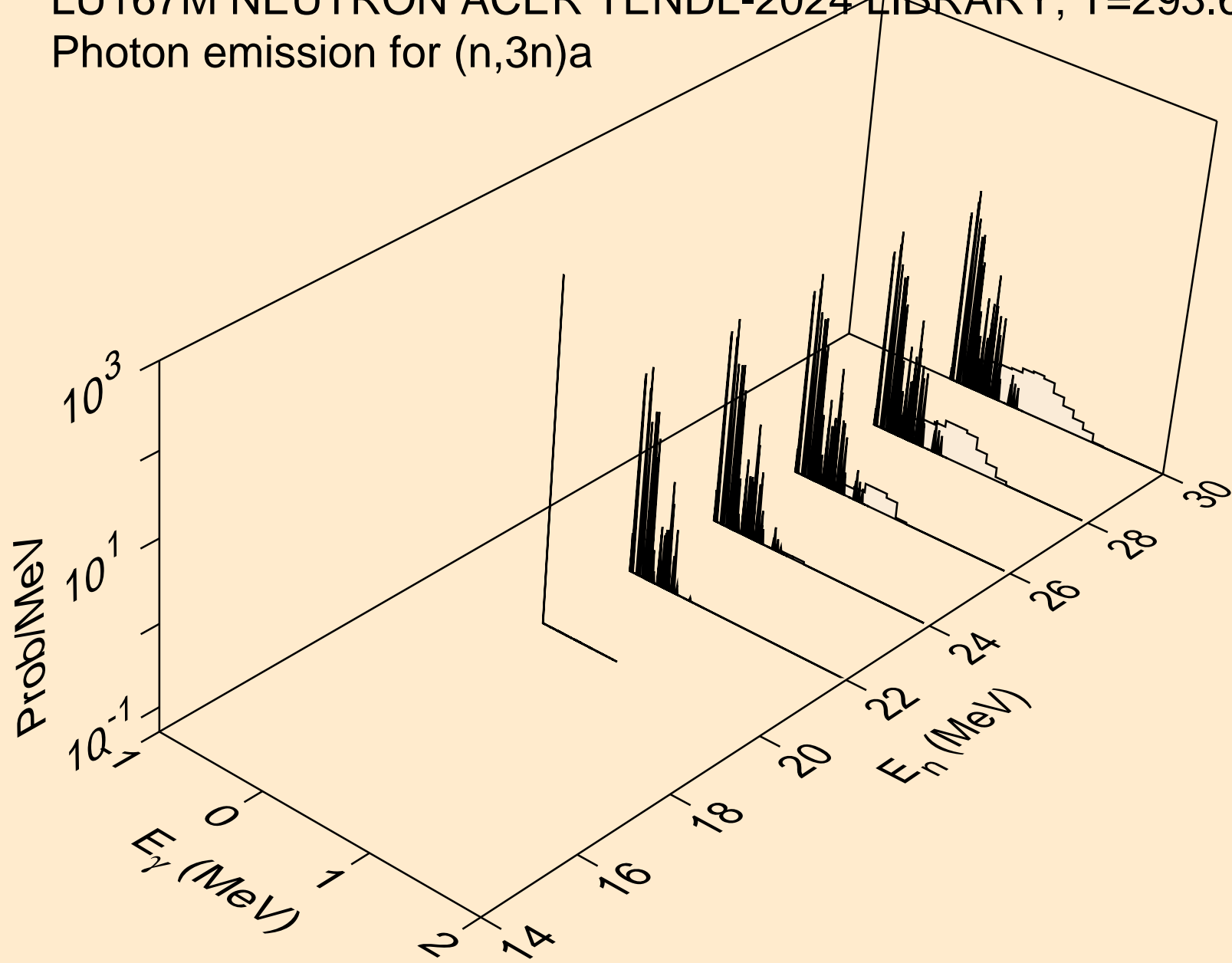

LU167M NEUTRON ACER TENDL-2024 LIBRARY; T=293.6K  
Photon emission for (n,n\*)p

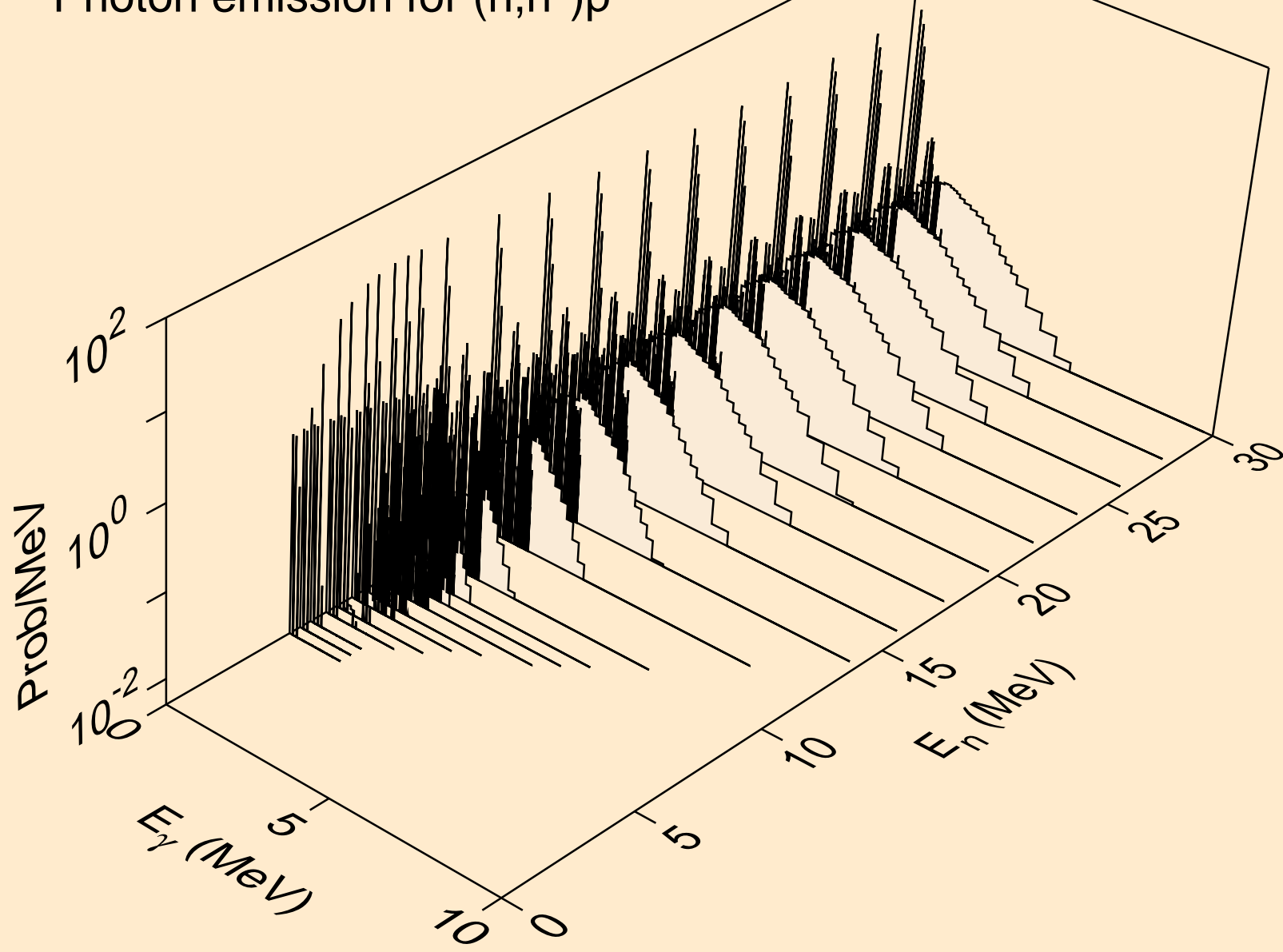

LU167M NEUTRON ACER TENDL-2024 LIBRARY; T=293.6K  
Photon emission for (n,n\*)2a

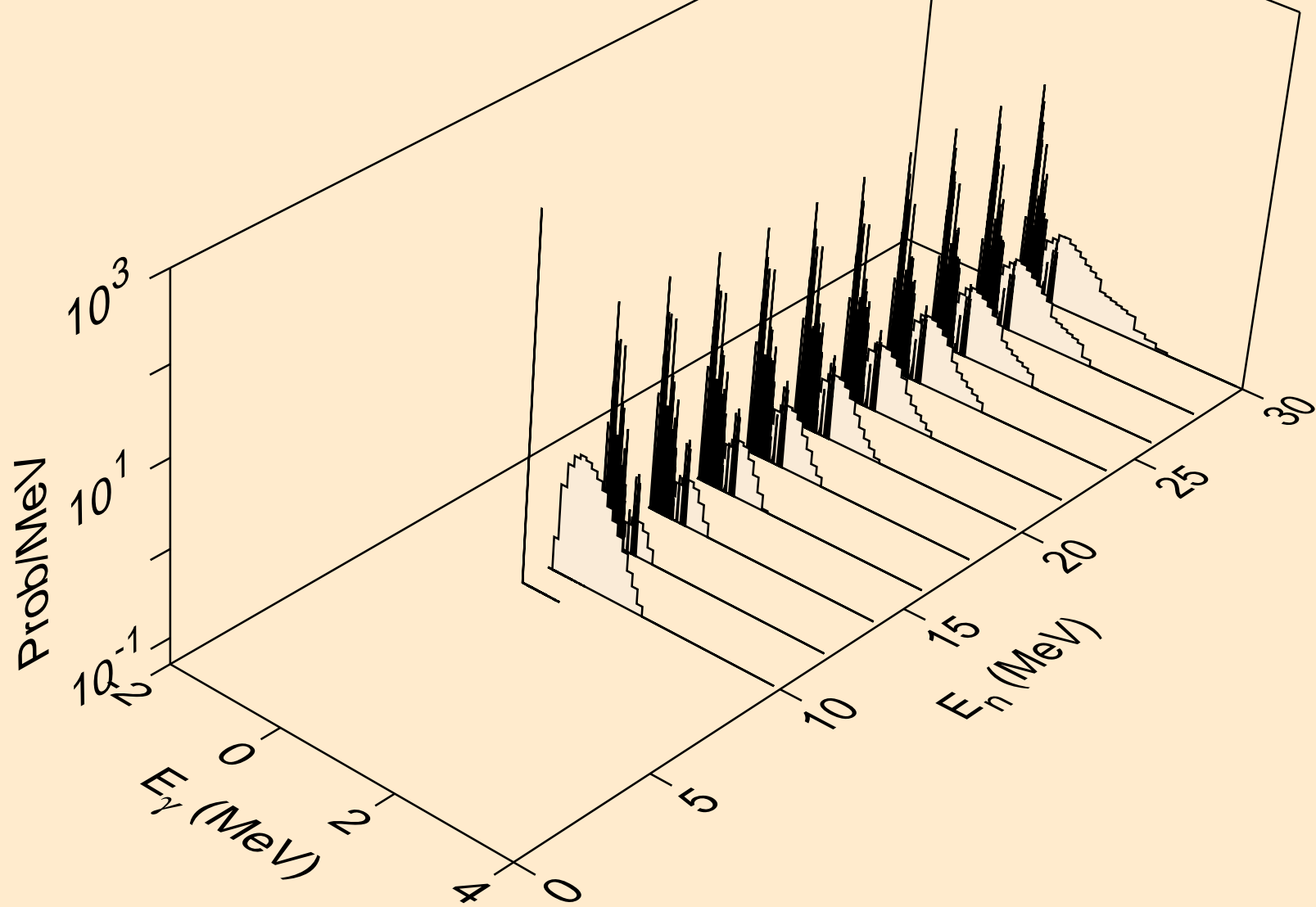

LU167M NEUTRON ACER TENDL-2024 LIBRARY; T=293.6K  
Photon emission for (n,2n)2a

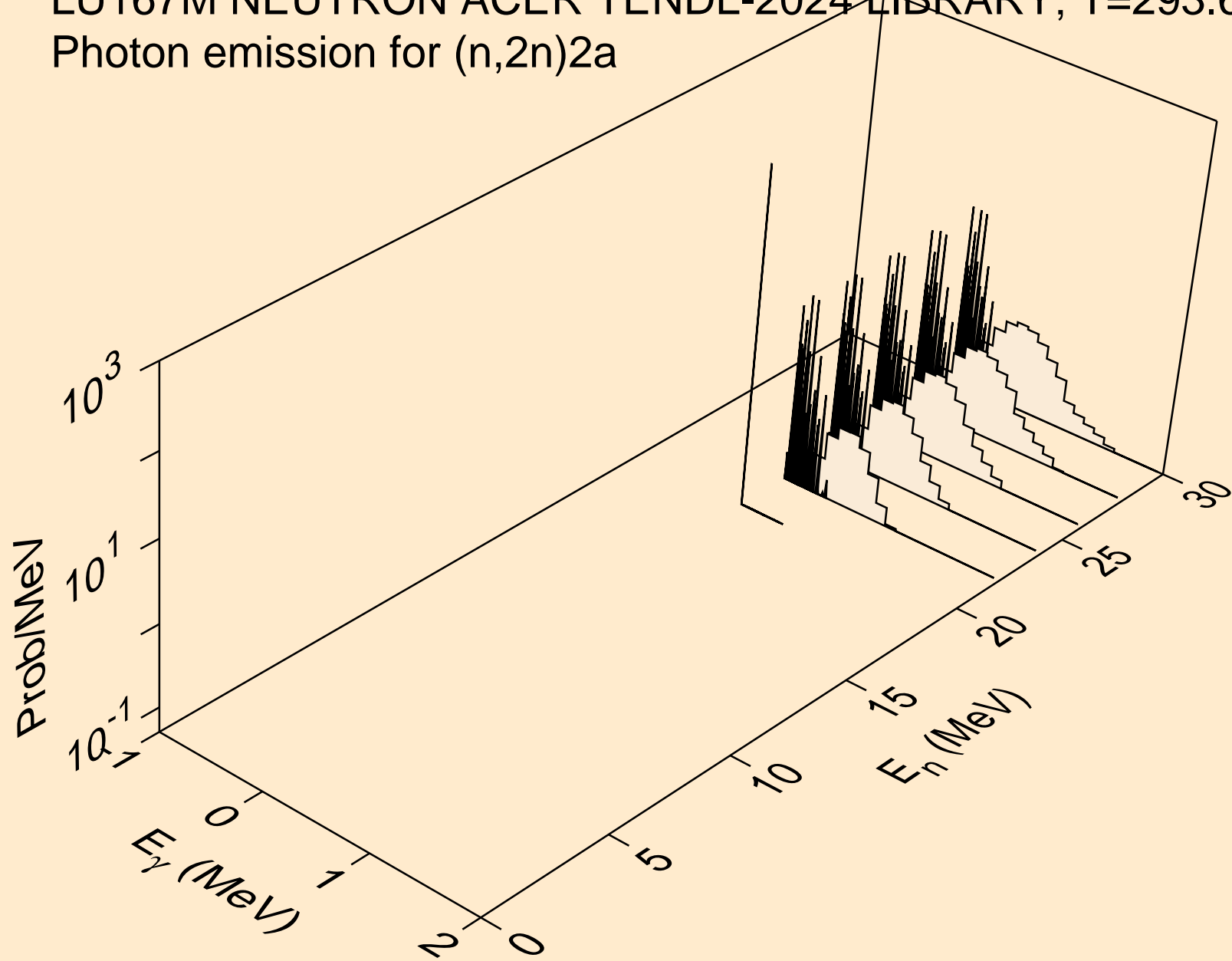

LU167M NEUTRON ACER TENDL-2024 LIBRARY; T=293.6K  
Photon emission for (n,n\*)d

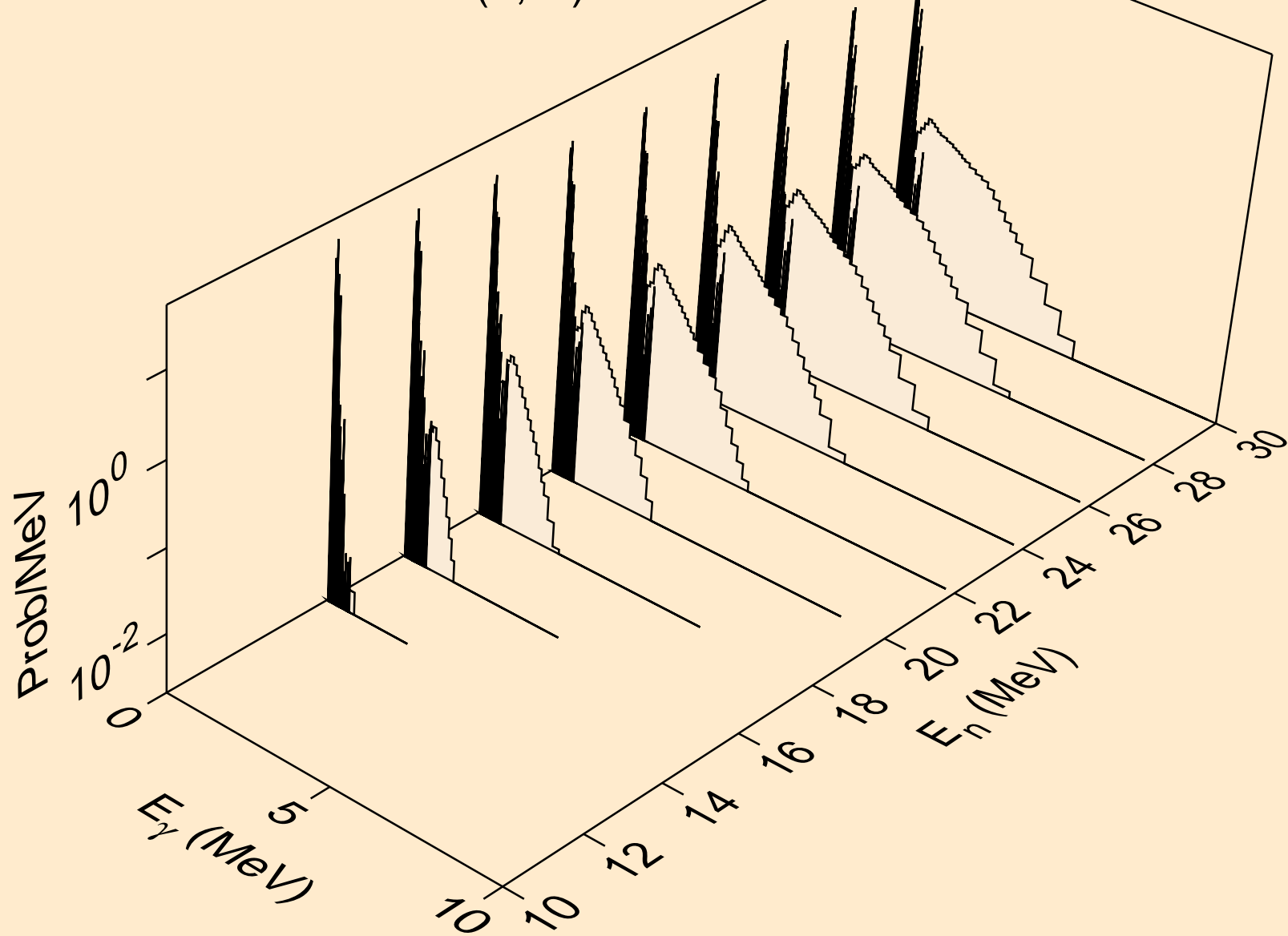

LU167M NEUTRON ACER TENDL-2024 LIBRARY; T=293.6K  
Photon emission for (n,n\*)t

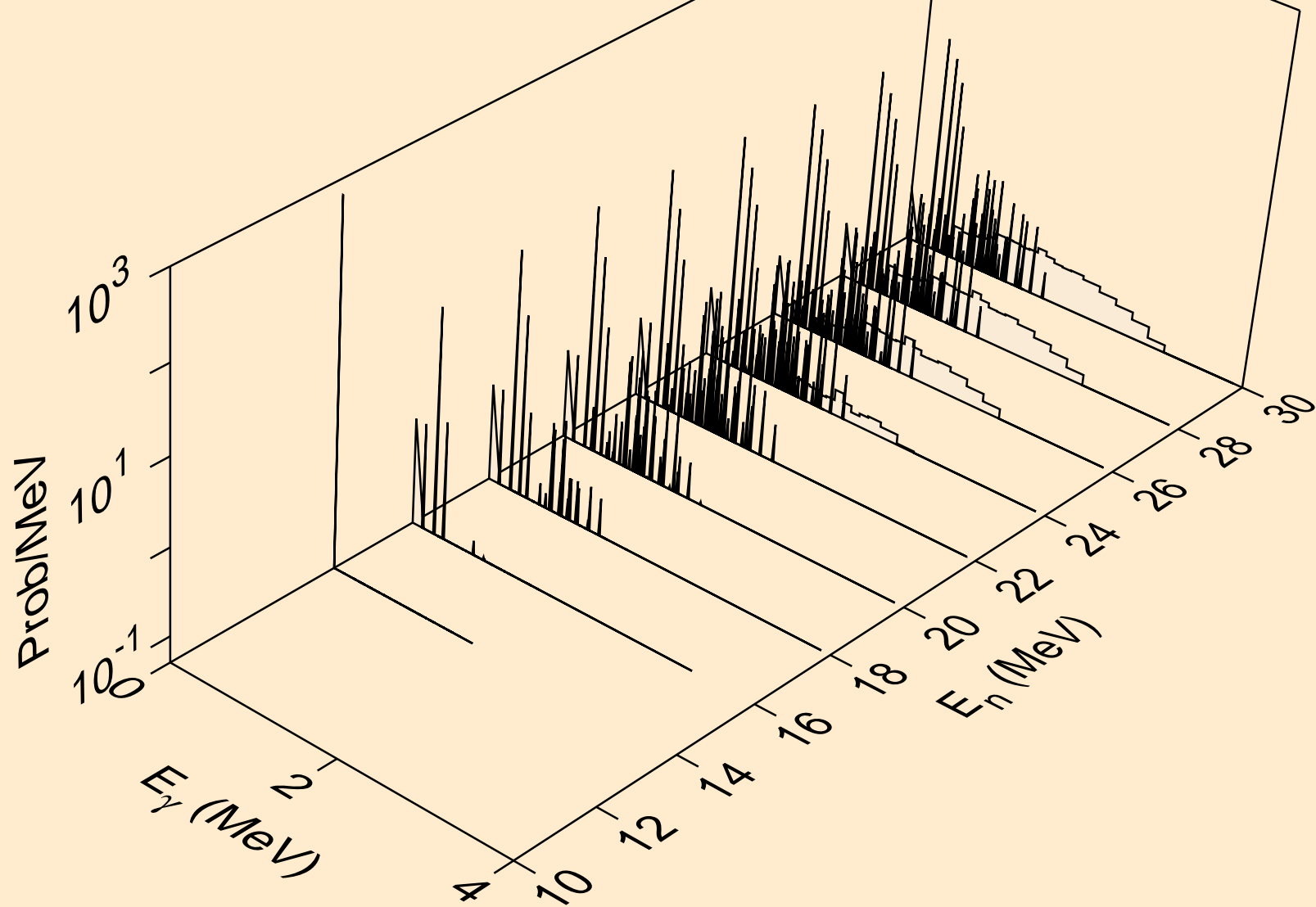

LU167M NEUTRON ACER TENDL-2024 LIBRARY; T=293.6K  
Photon emission for (n,n\*)he3

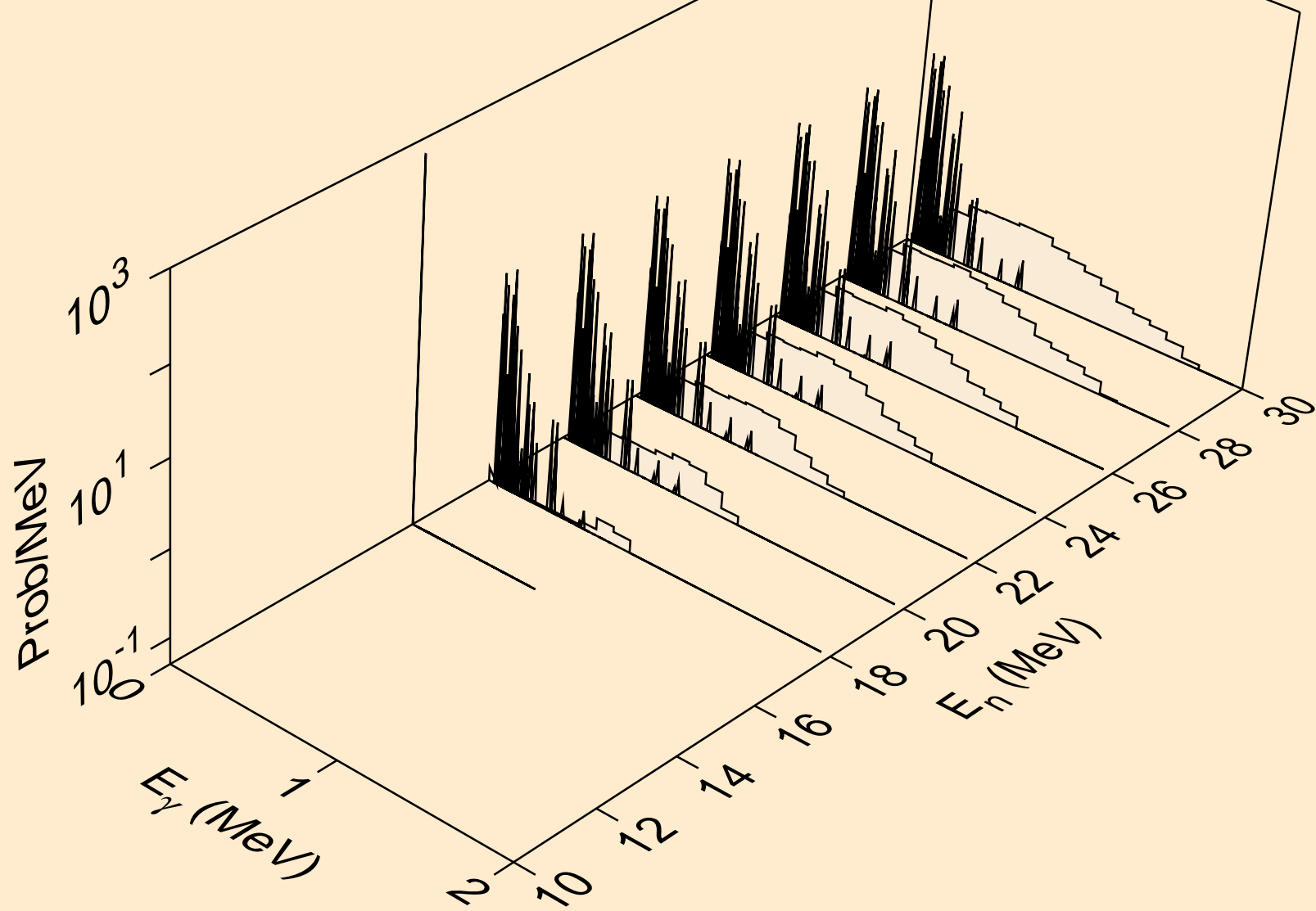

LU167M NEUTRON ACER TENDL-2024 LIBRARY; T=293.6K  
Photon emission for (n,4n)

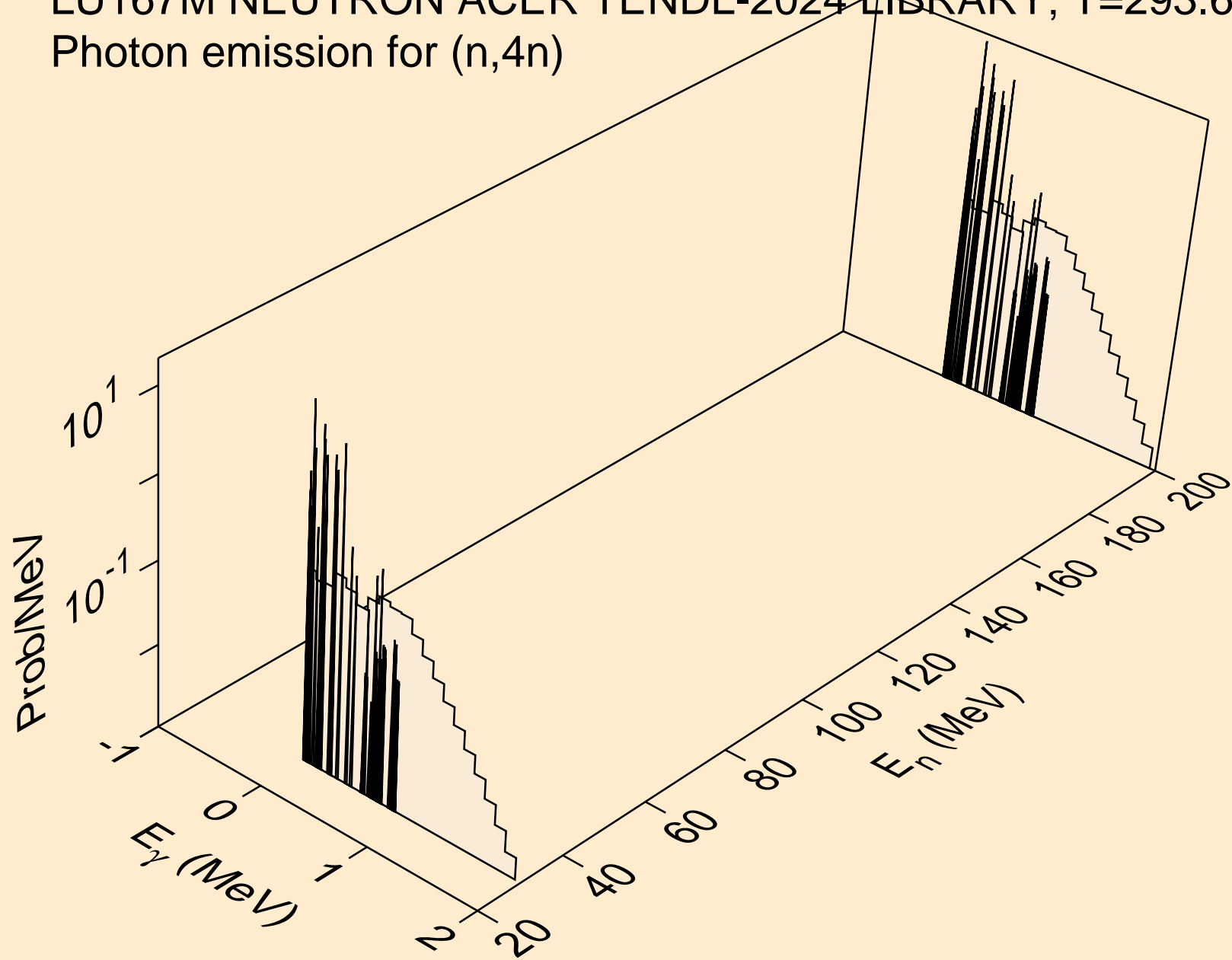

LU167M NEUTRON ACER TENDL-2024 LIBRARY; T=293.6K  
Photon emission for (n,2np)

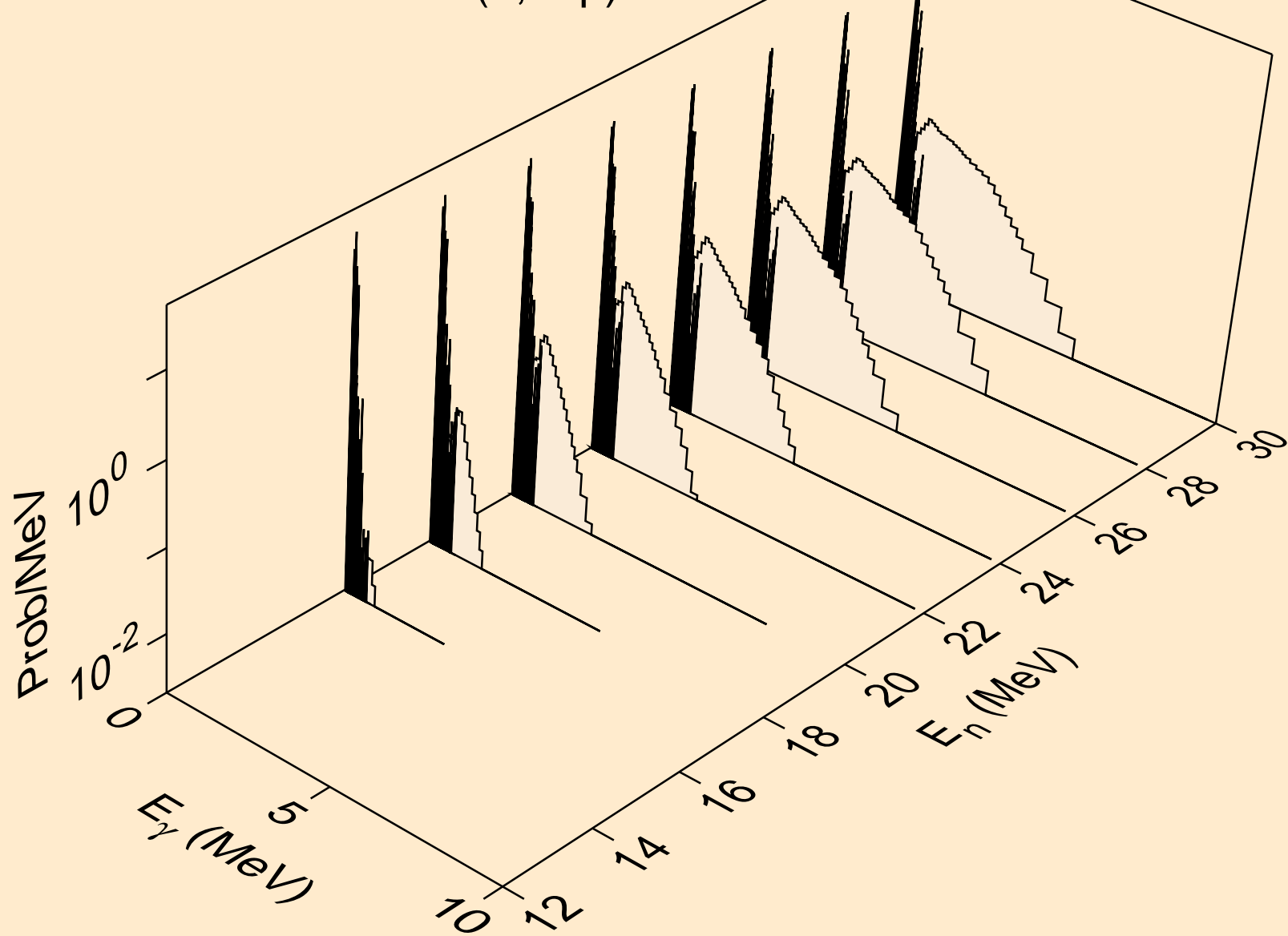

LU167M NEUTRON ACER TENDL-2024 LIBRARY; T=293.6K  
Photon emission for (n,3np)

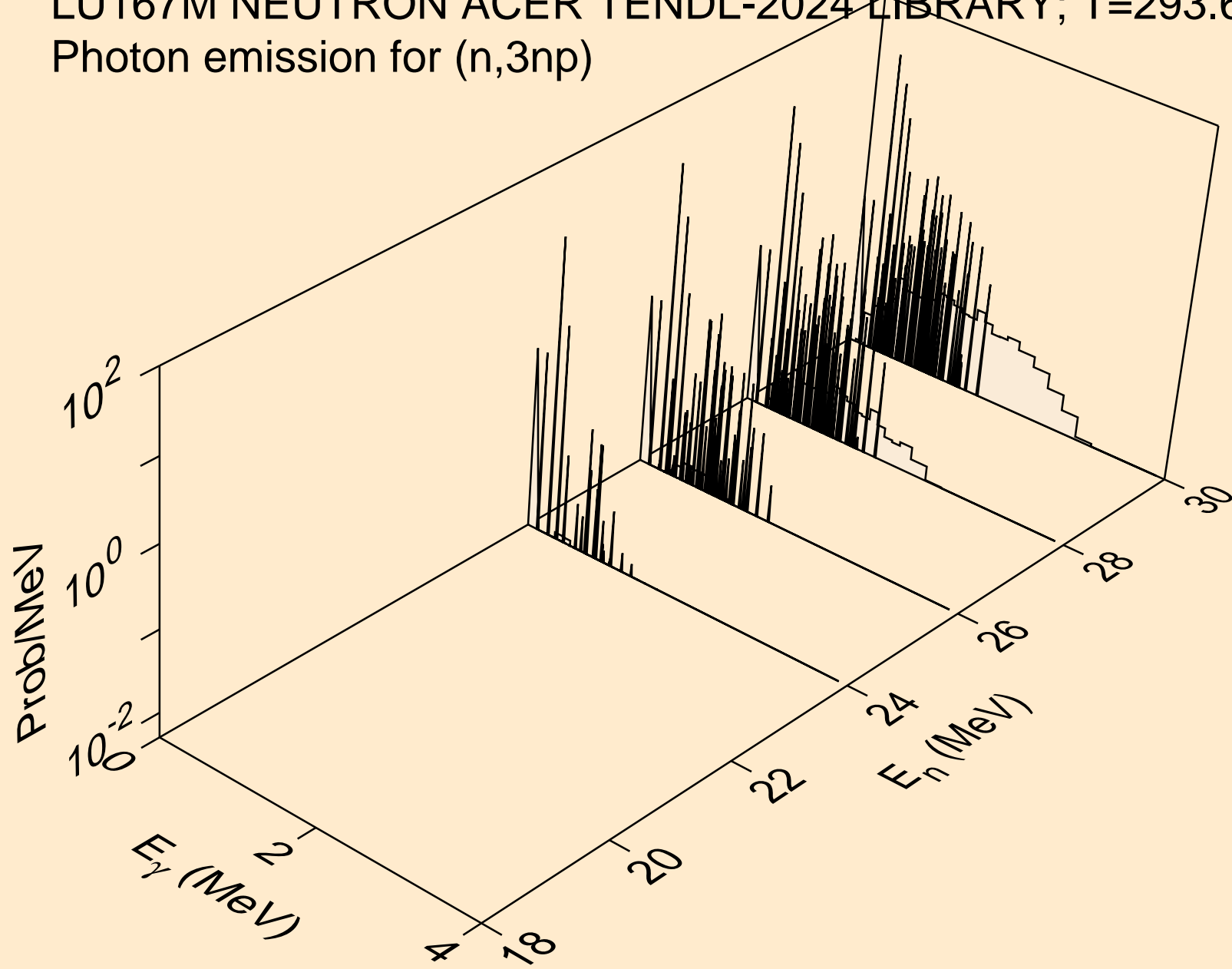

LU167M NEUTRON ACER TENDL-2024 LIBRARY; T=293.6K  
Photon emission for (n,n2p)

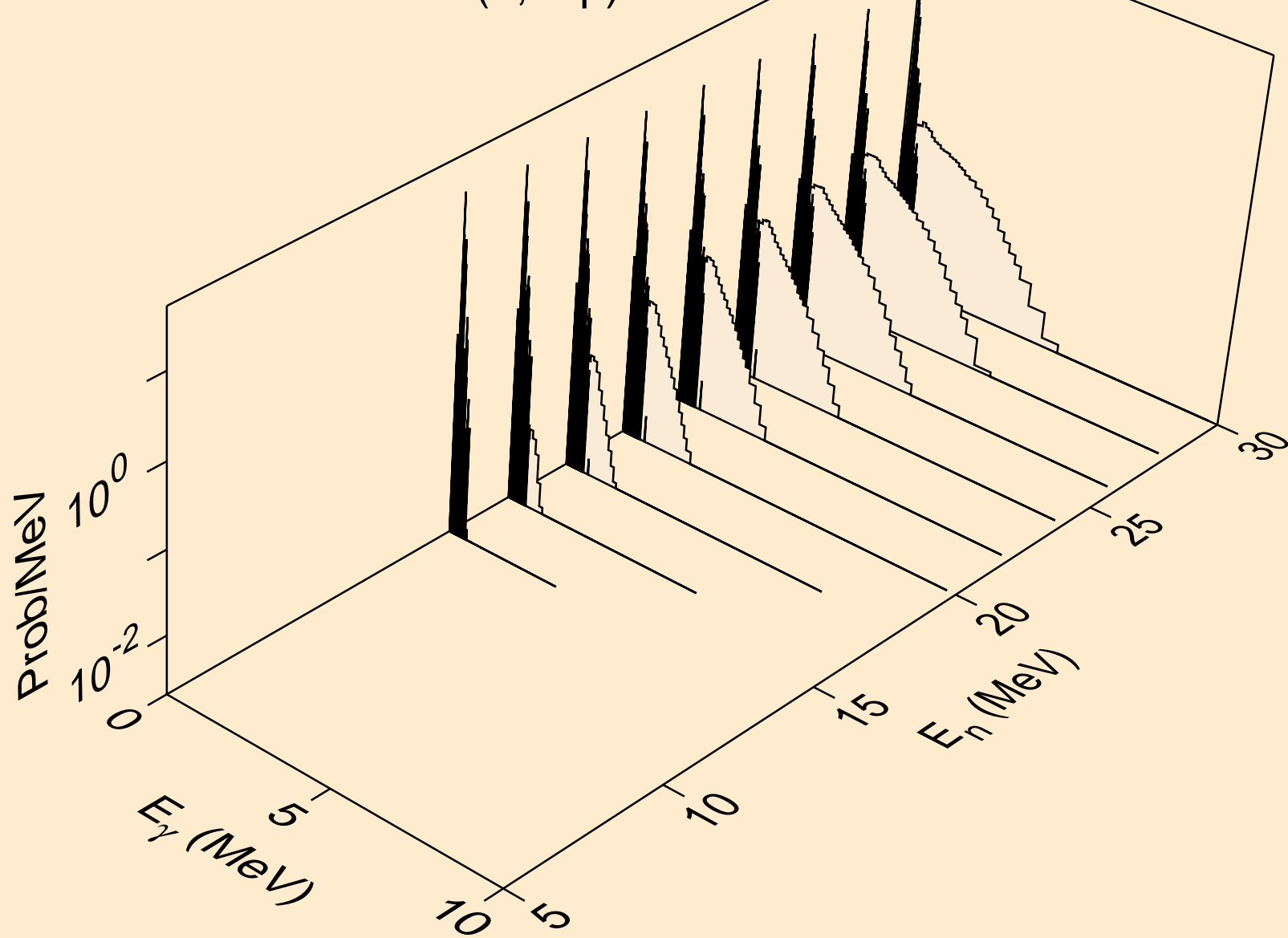

LU167M NEUTRON ACER TENDL-2024 LIBRARY; T=293.6K  
Photon emission for (n,npa)

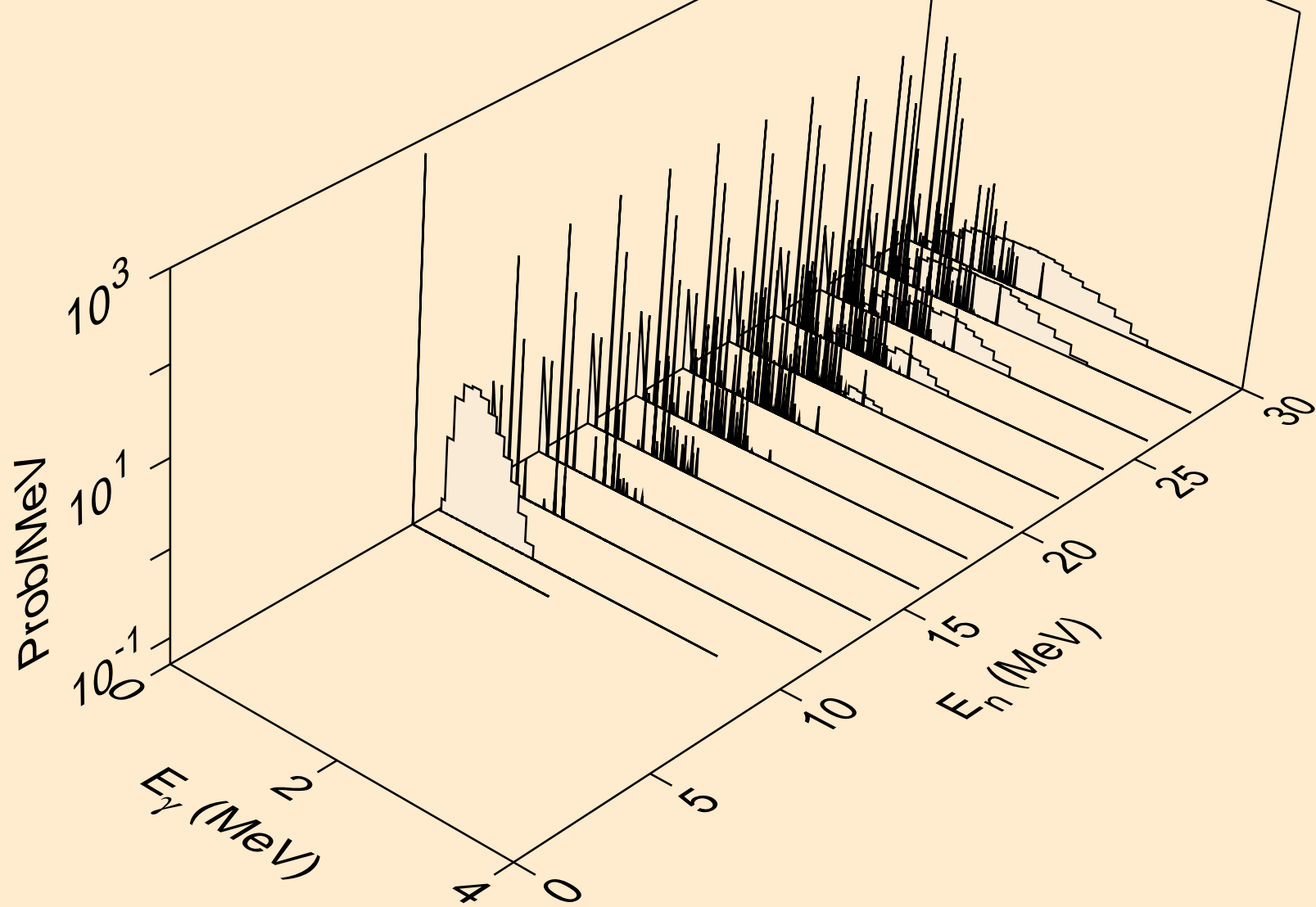

LU167M NEUTRON ACER TENDL-2024 LIBRARY; T=293.6K  
Photon emission for (n,n\*1)

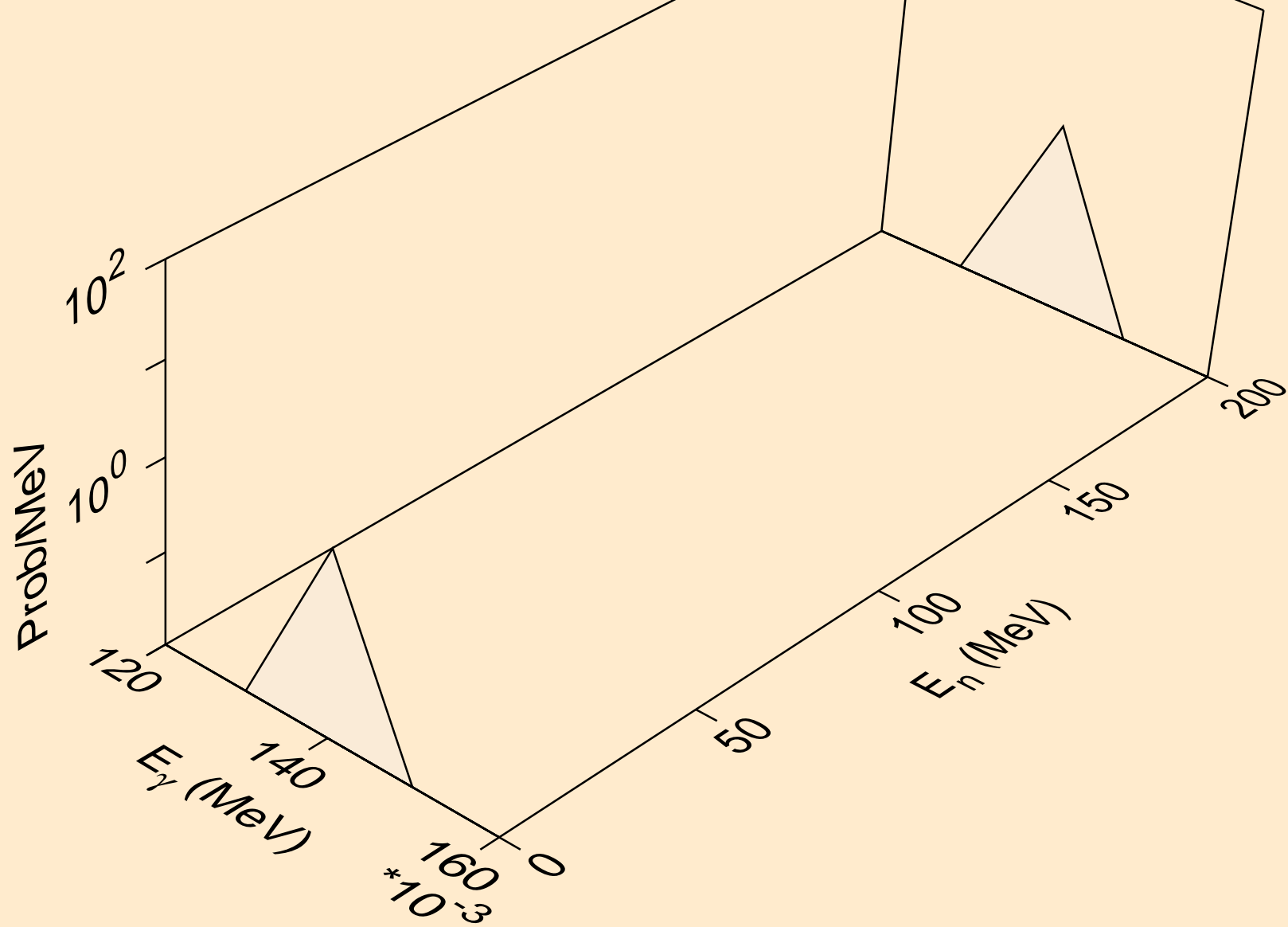

LU167M NEUTRON ACER TENDL-2024 LIBRARY; T=293.6K  
Photon emission for (n,n\*3)

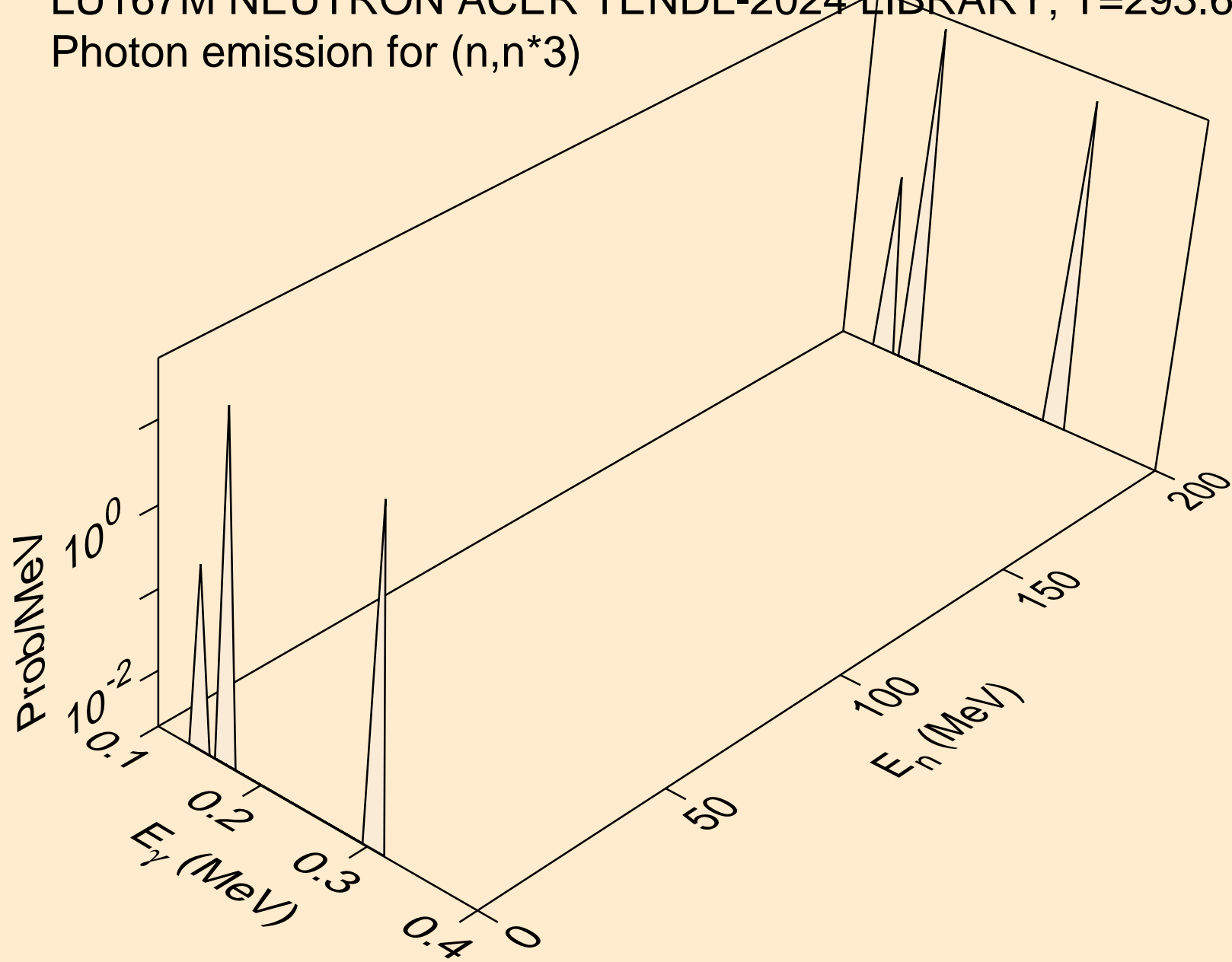

LU167M NEUTRON ACER TENDL-2024 LIBRARY; T=293.6K  
Photon emission for (n,n\*4)

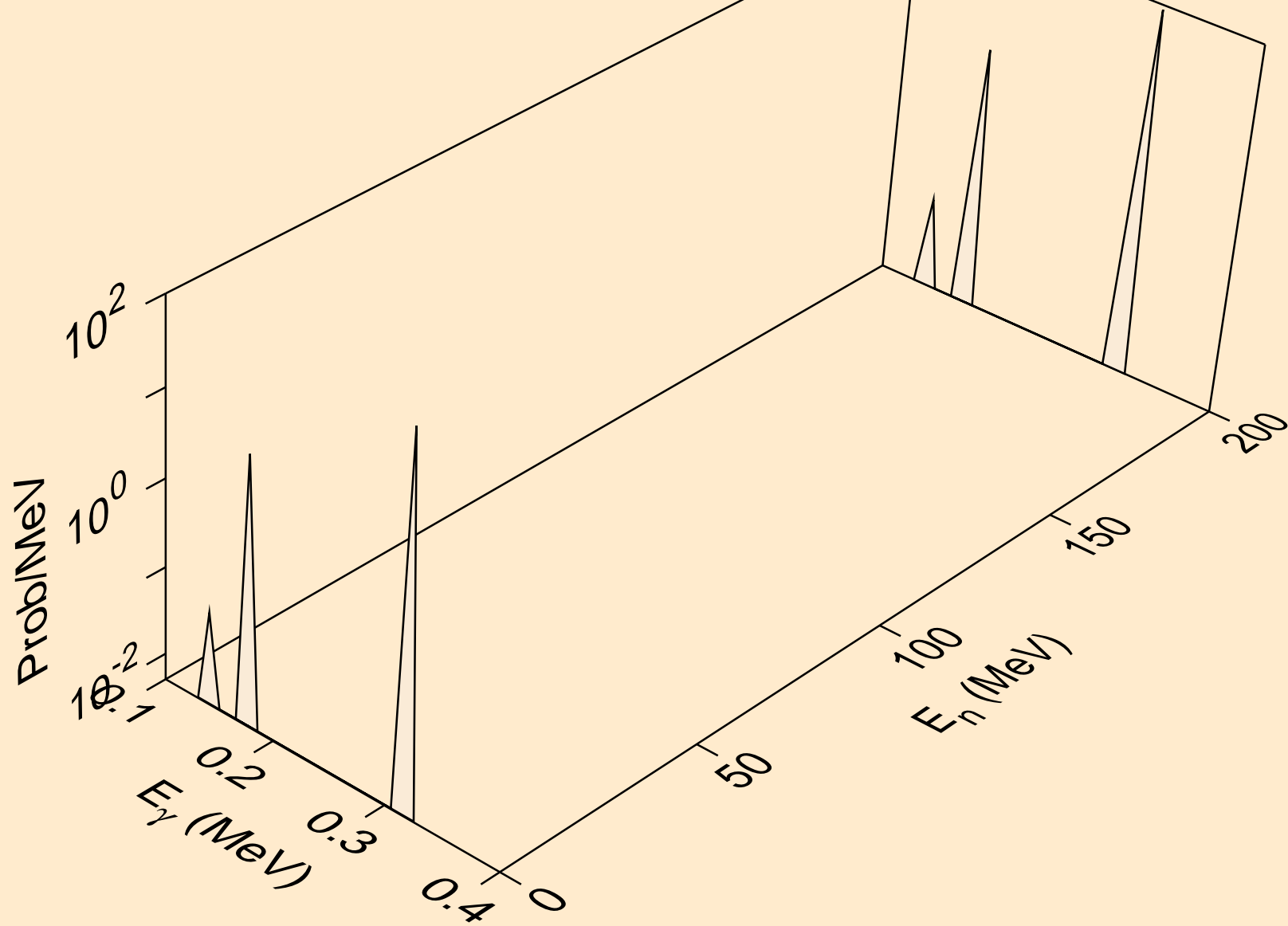

LU167M NEUTRON ACER TENDL-2024 LIBRARY; T=293.6K  
Photon emission for (n,n\*5)

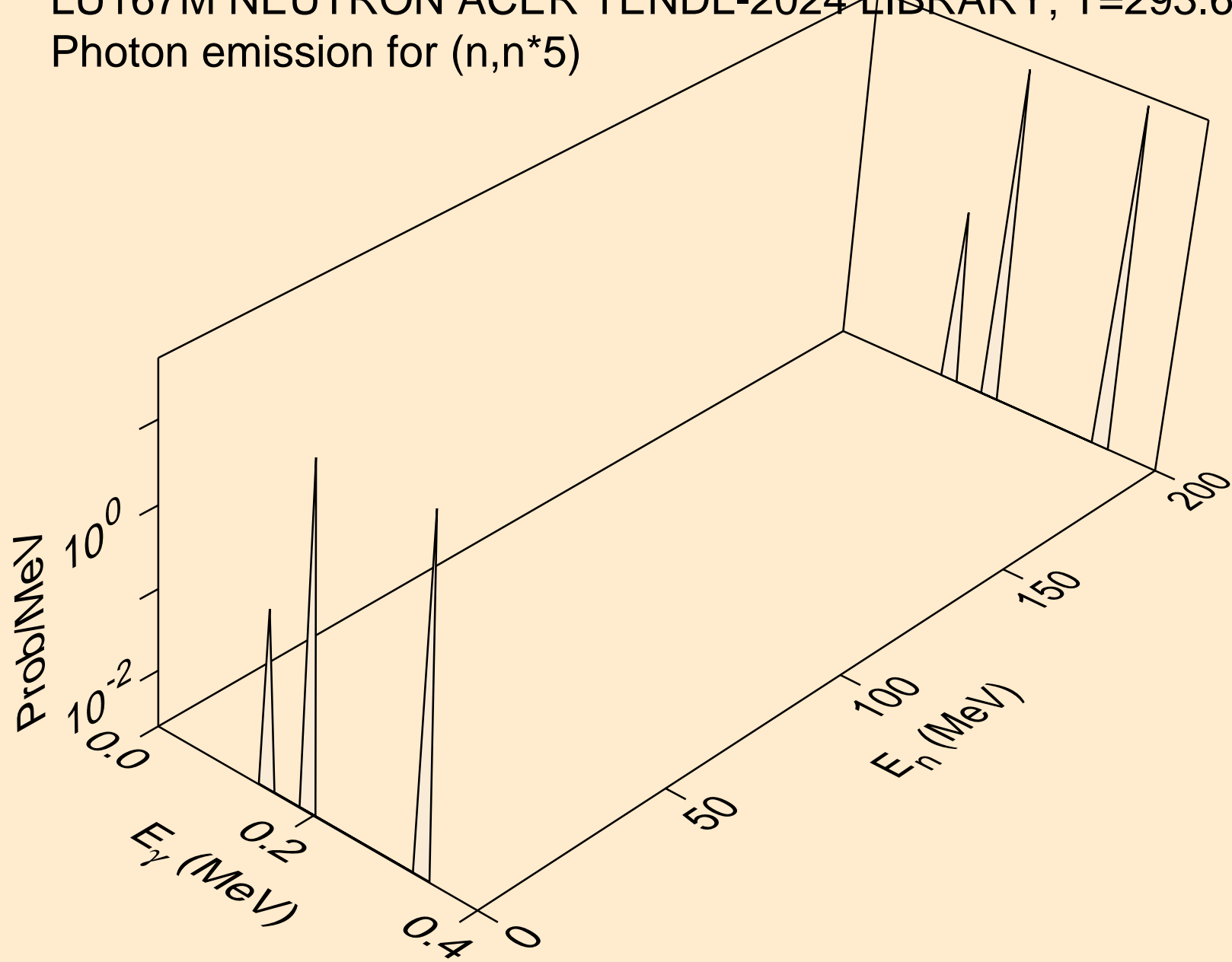

LU167M NEUTRON ACER TENDL-2024 LIBRARY; T=293.6K  
Photon emission for (n,n\*c)

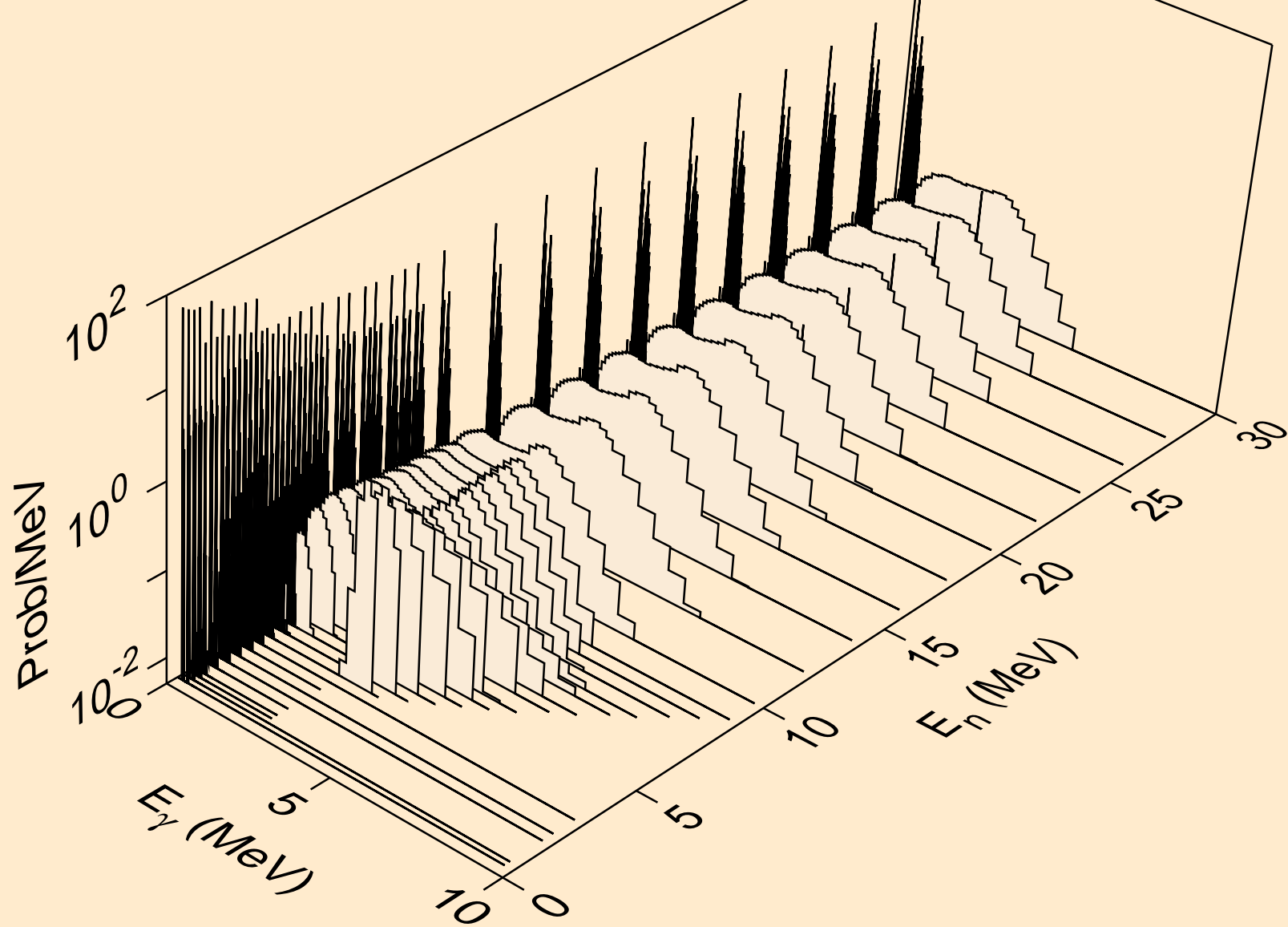

LU167M NEUTRON ACER TENDL-2024 LIBRARY; T=293.6K  
Photon emission for (n,gma)

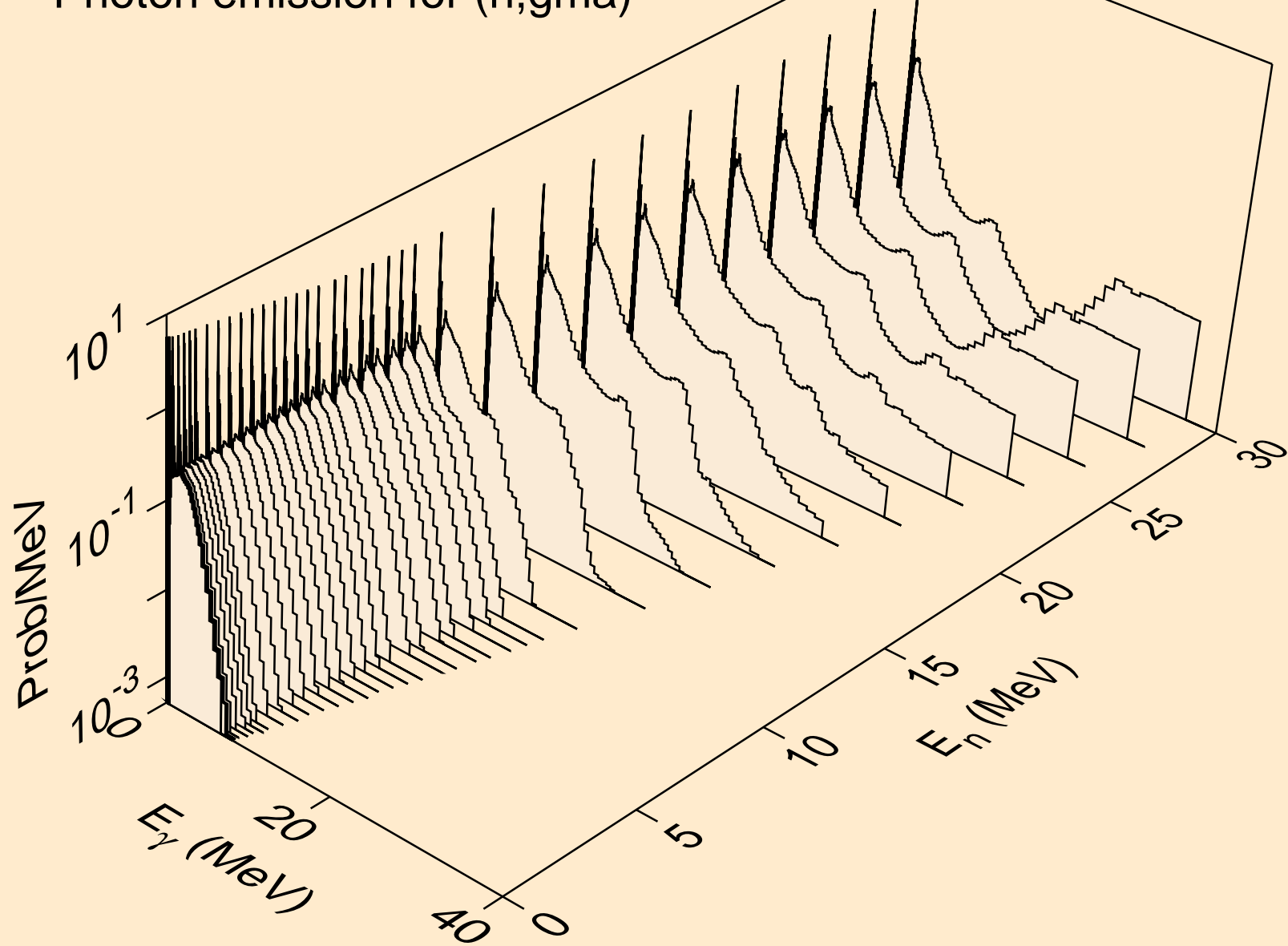

LU167M NEUTRON ACER TENDL-2024 LIBRARY; T=293.6K  
Photon emission for (n,p)

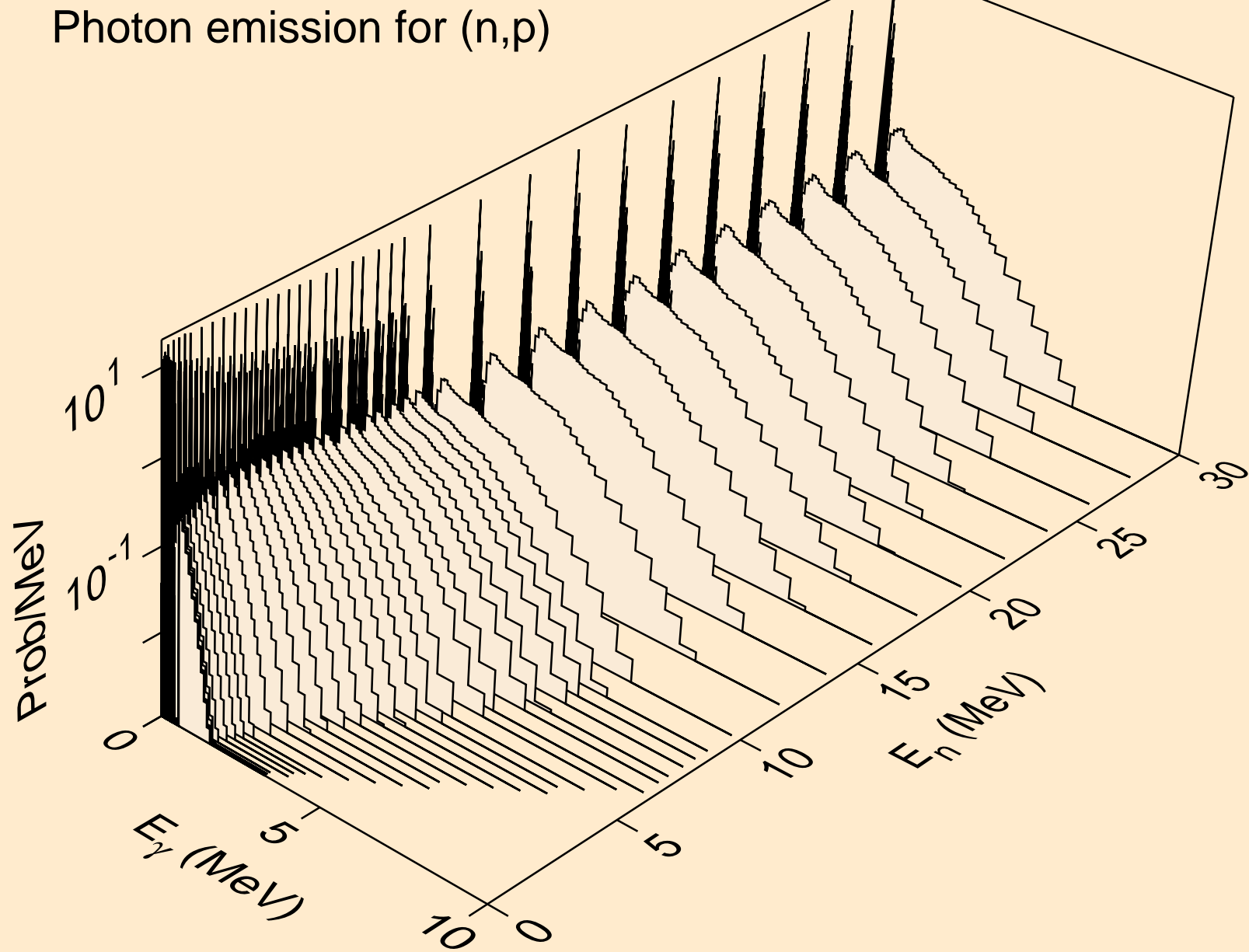

LU167M NEUTRON ACER TENDL-2024 LIBRARY; T=293.6K  
Photon emission for (n,d)

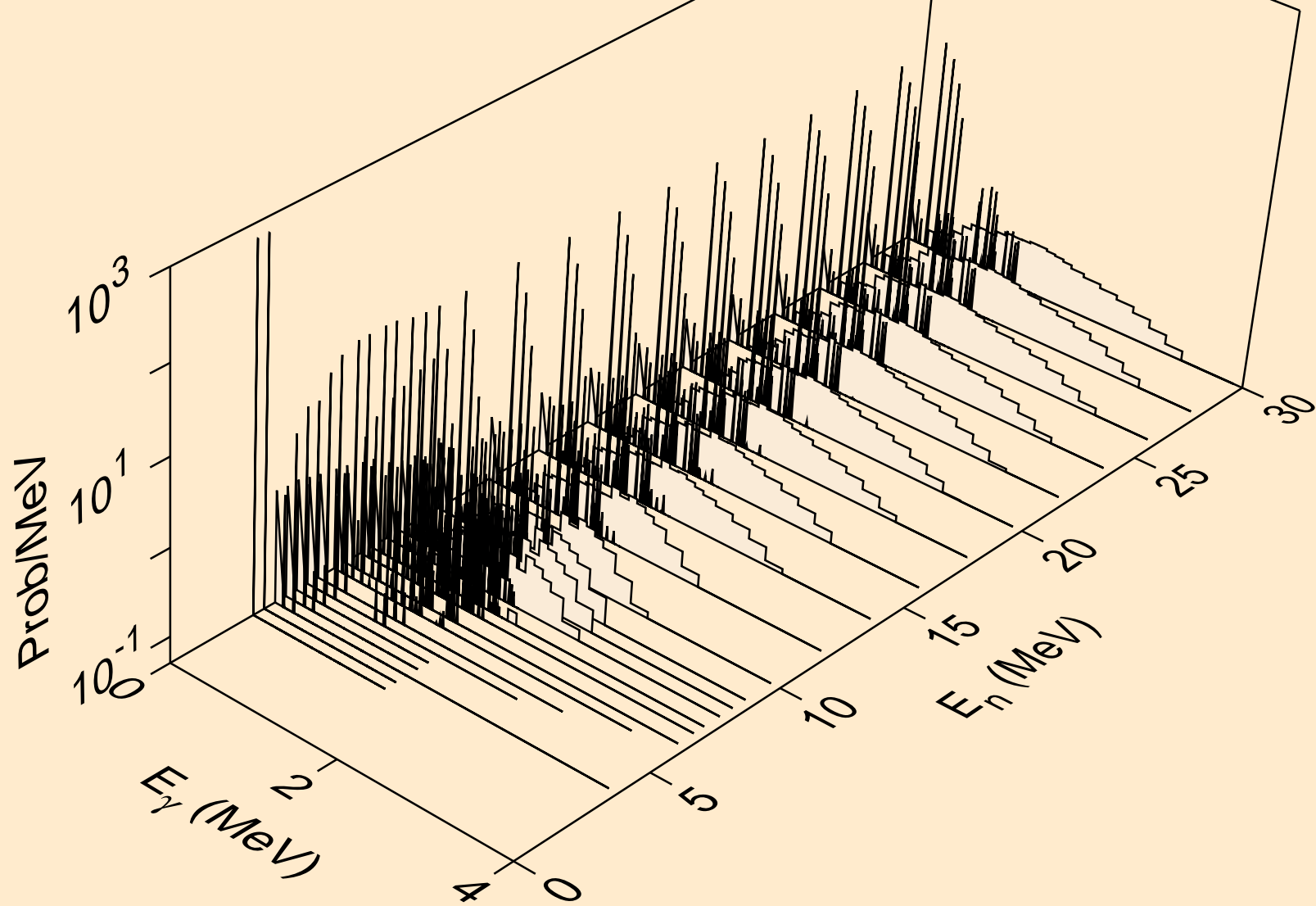

LU167M NEUTRON ACER TENDL-2024 LIBRARY; T=293.6K  
Photon emission for (n,t)

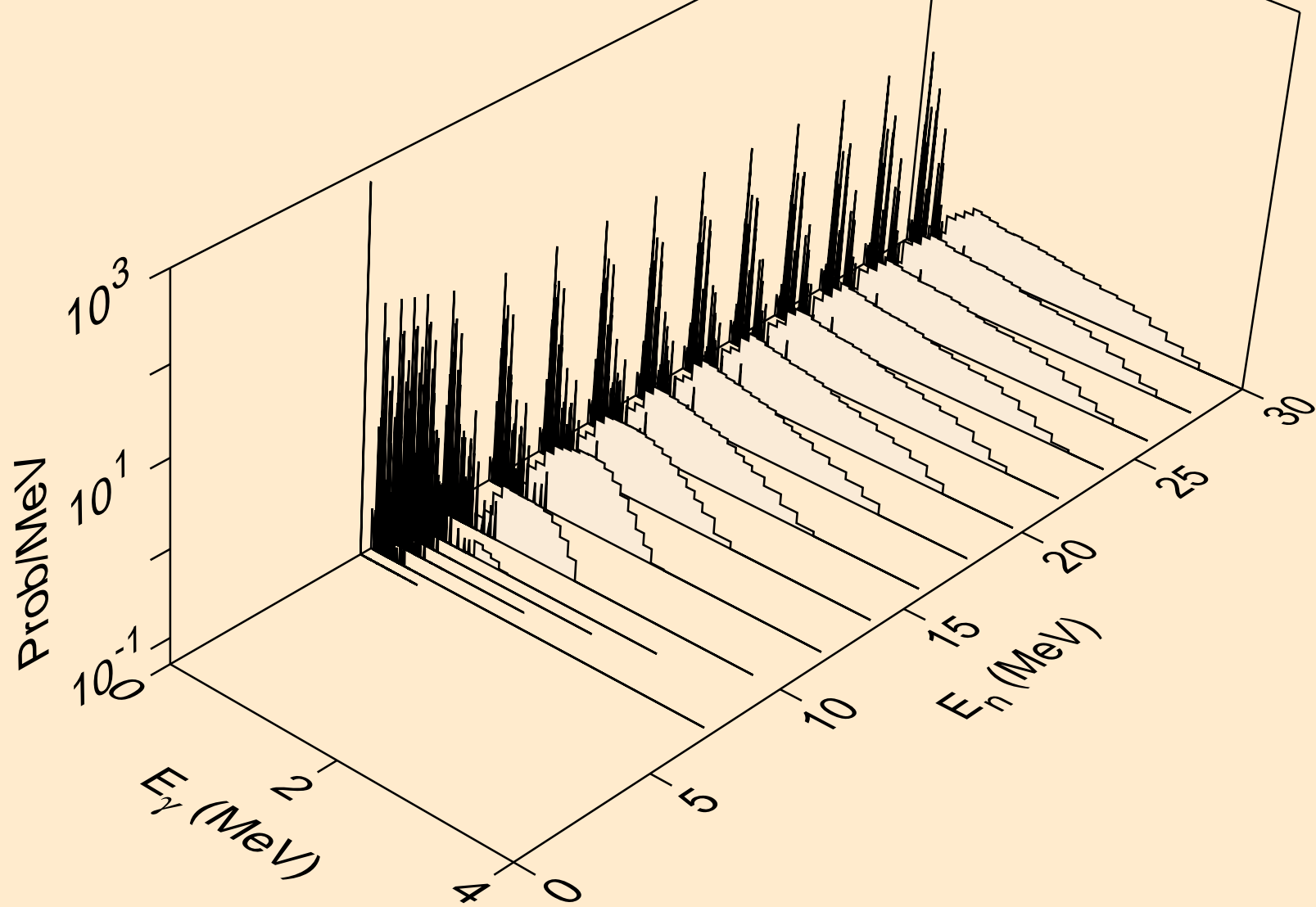

LU167M NEUTRON ACER TENDL-2024 LIBRARY; T=293.6K  
Photon emission for (n,he3)

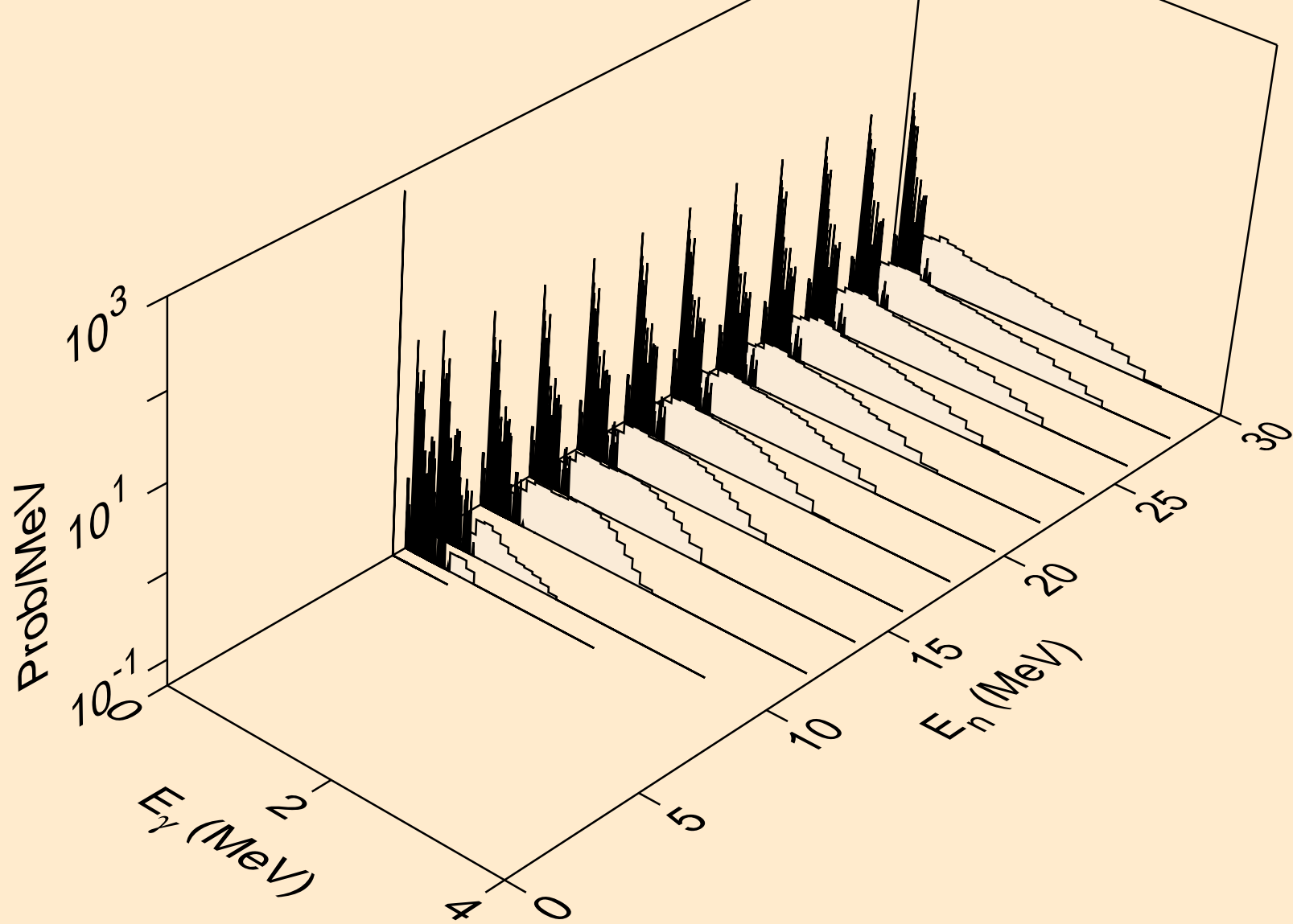

LU167M NEUTRON ACER TENDL-2024 LIBRARY; T=293.6K  
Photon emission for (n,a)

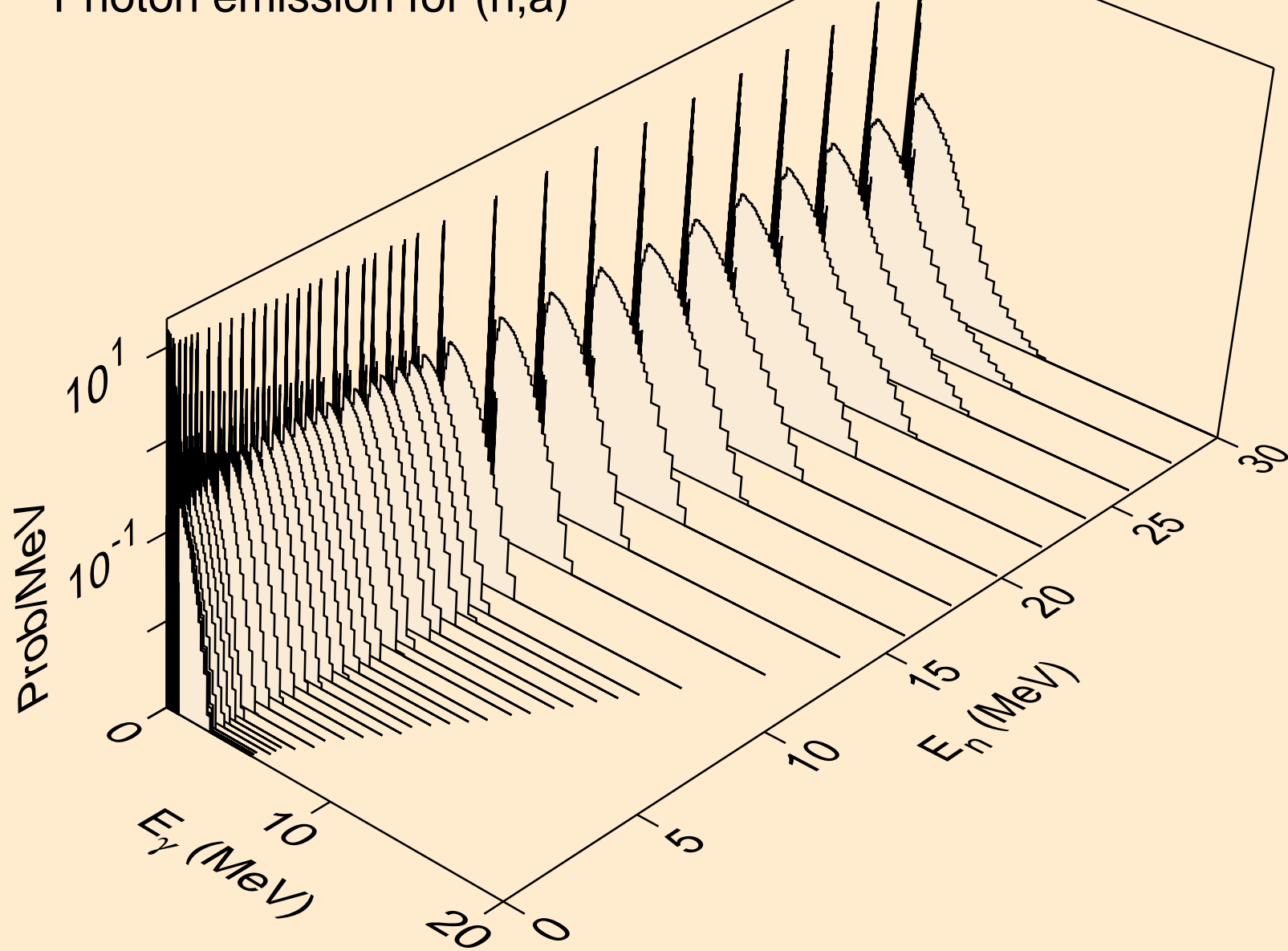

LU167M NEUTRON ACER TENDL-2024 LIBRARY; T=293.6K  
Photon emission for (n,2a)

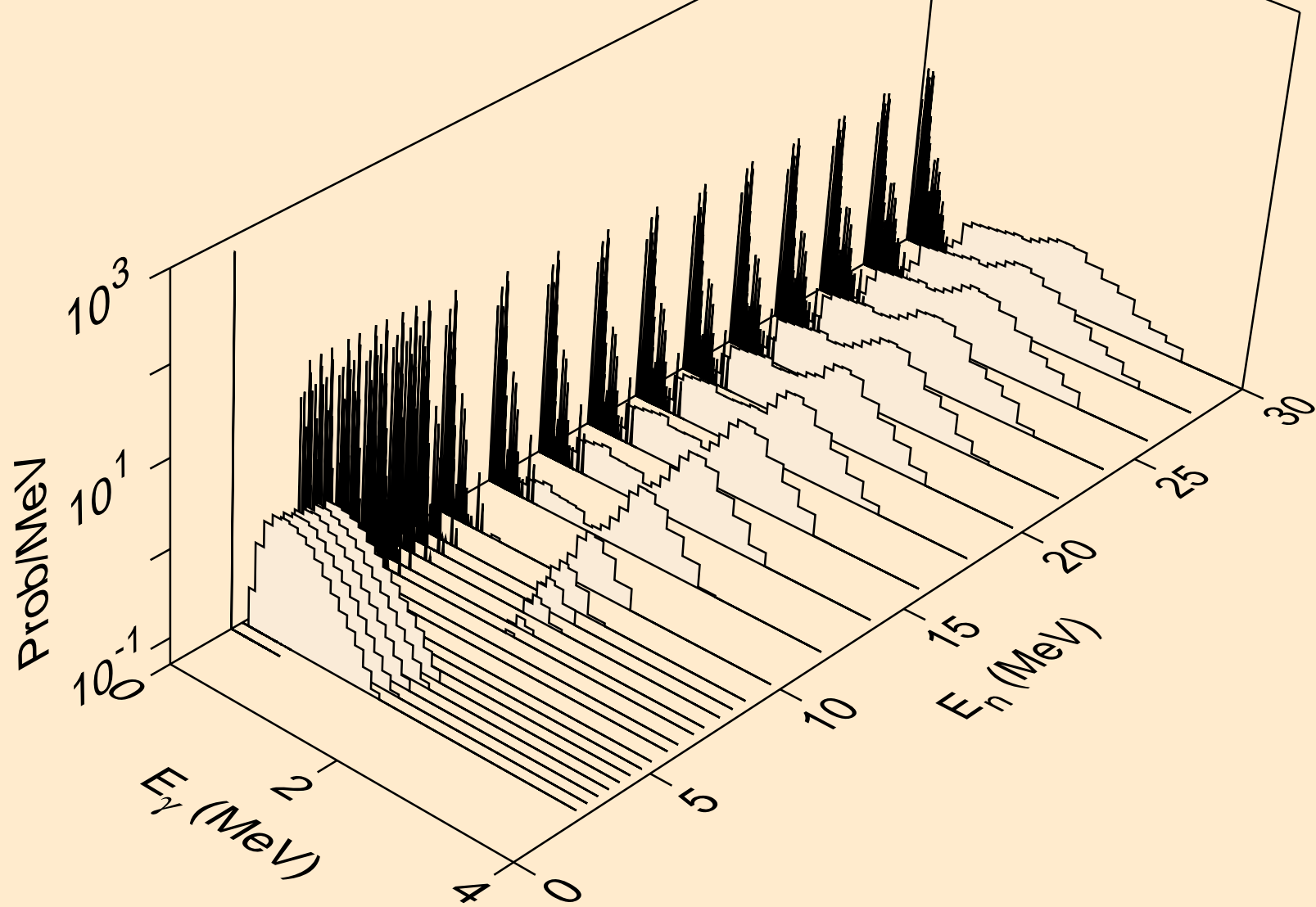

LU167M NEUTRON ACER TENDL-2024 LIBRARY; T=293.6K  
Photon emission for (n,2p)

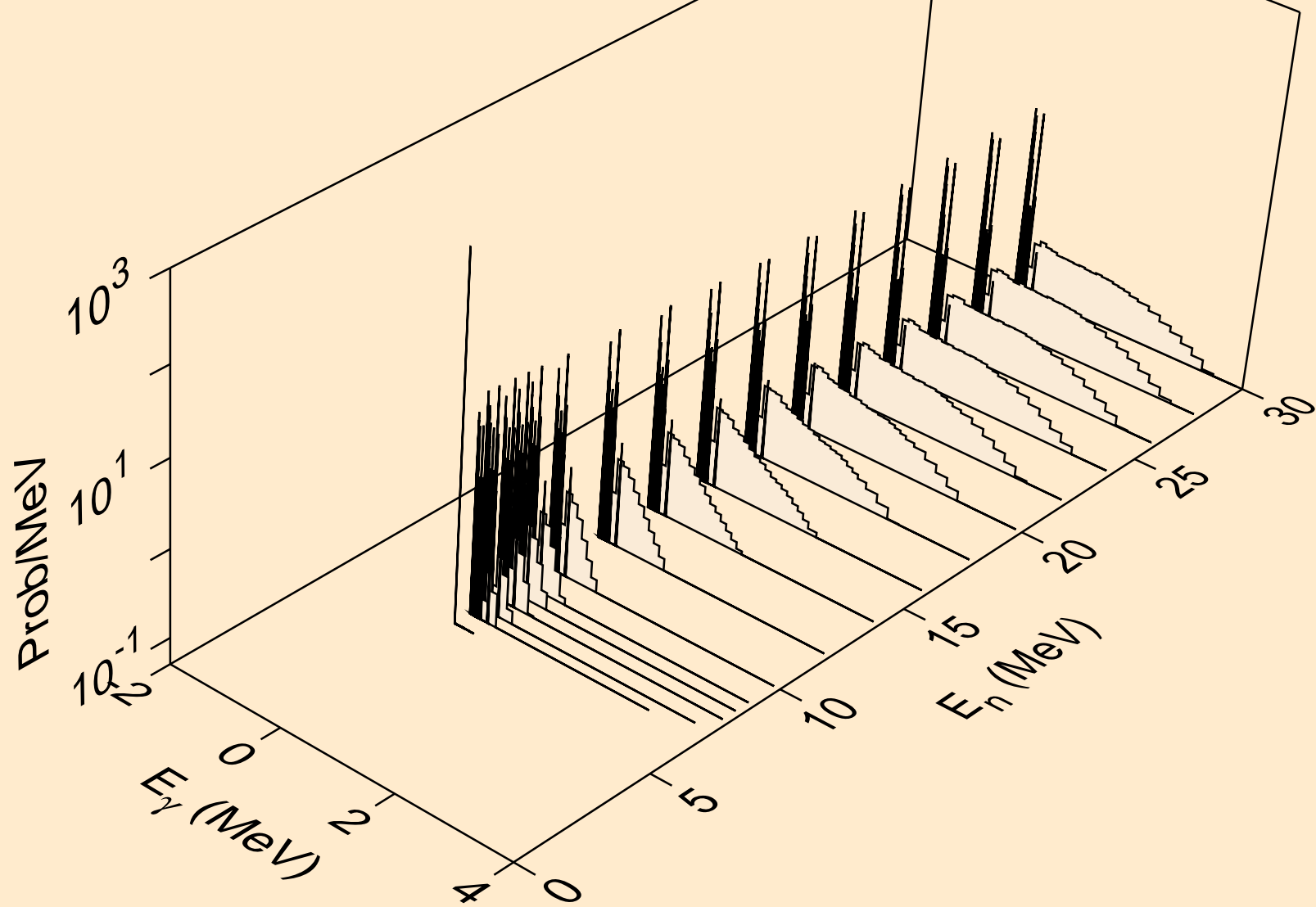

LU167M NEUTRON ACER TENDL-2024 LIBRARY; T=293.6K  
Photon emission for (n,p $\alpha$ )

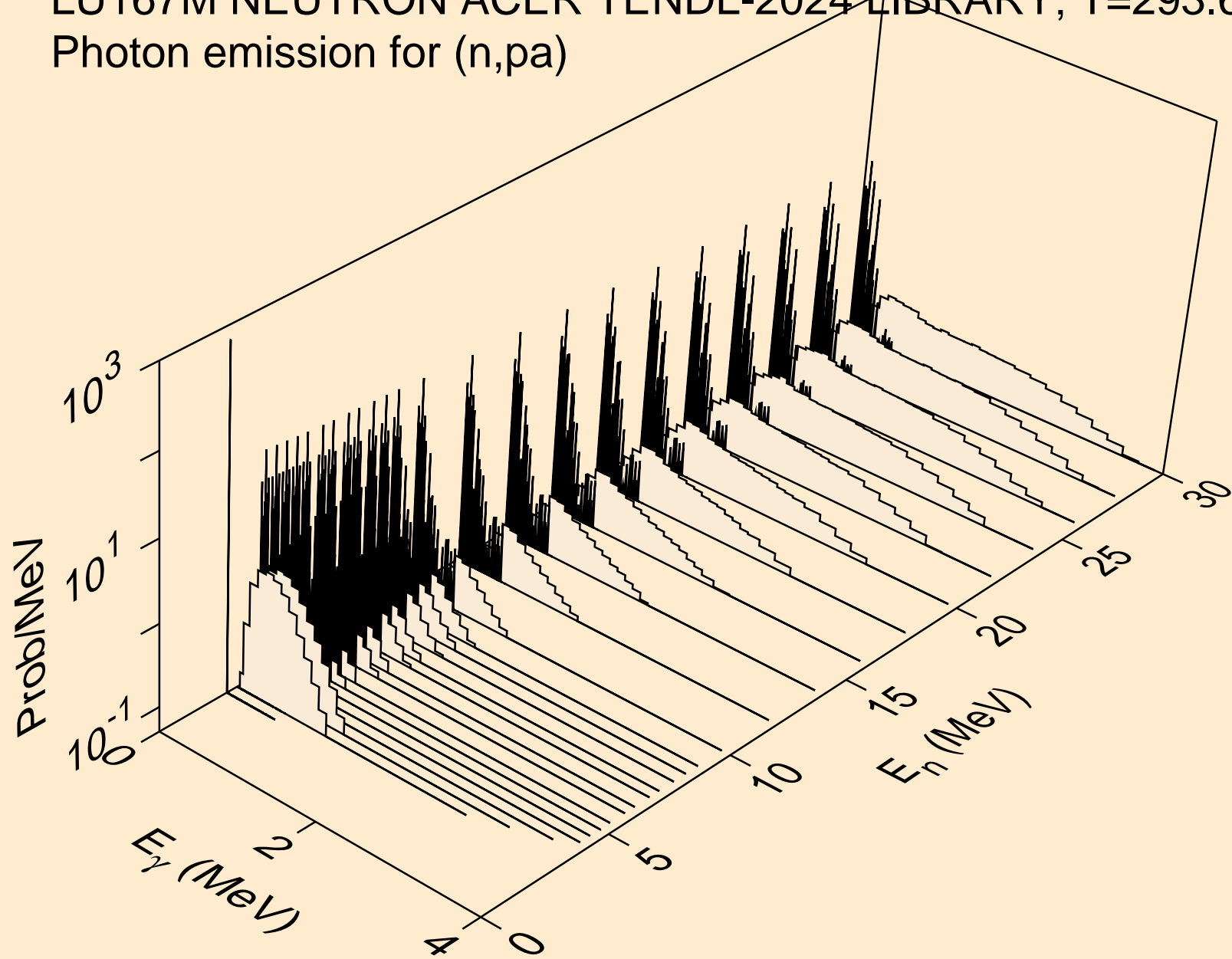

LU167M NEUTRON ACER TENDL-2024 LIBRARY; T=293.6K  
Photon emission for (n,pd)

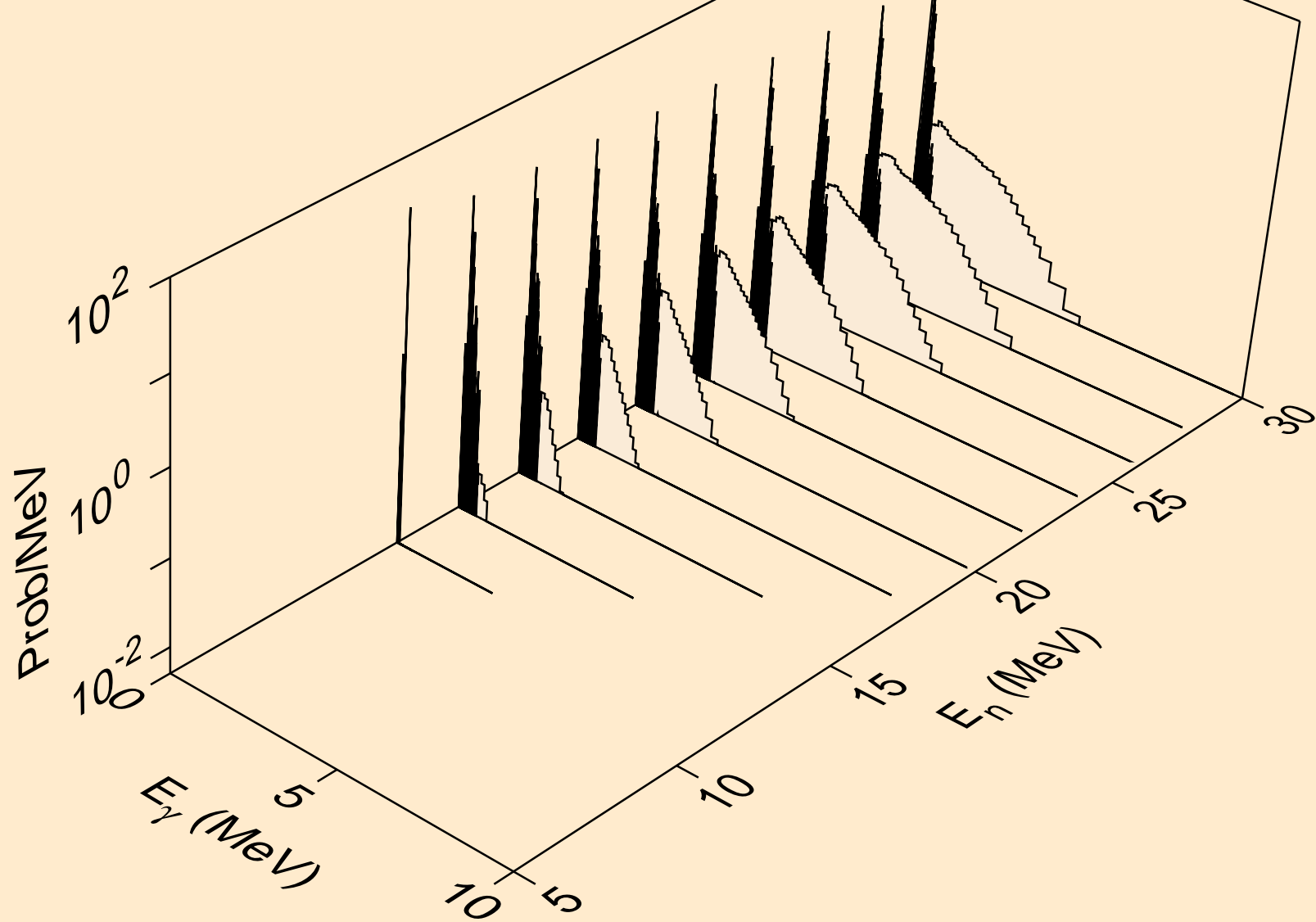

LU167M NEUTRON ACER TENDL-2024 LIBRARY; T=293.6K  
Photon emission for (n,pt)

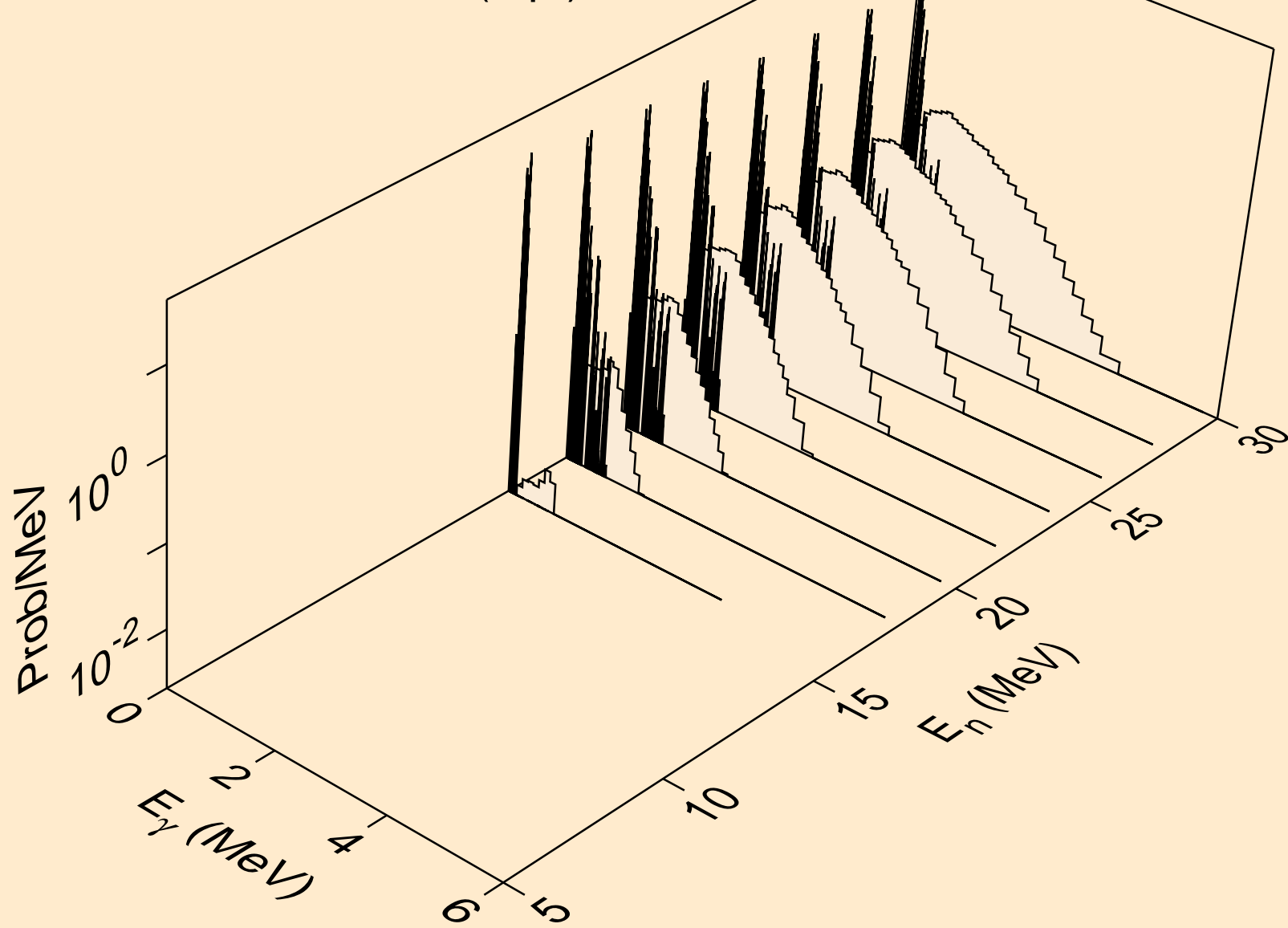

LU167M NEUTRON ACER TENDL-2024 LIBRARY; T=293.6K  
Photon emission for (n,da)

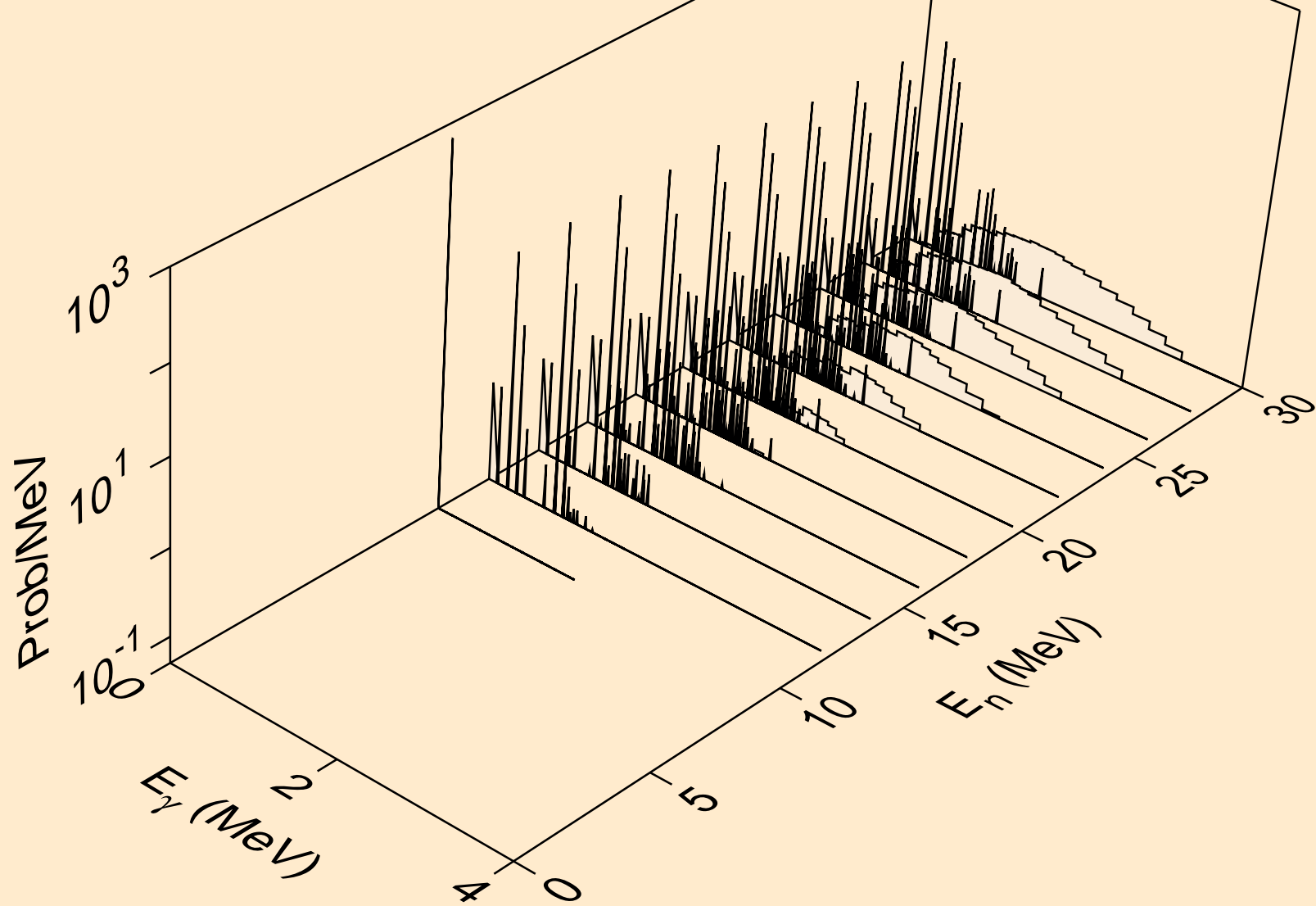

LU167M NEUTRON ACER TENDL-2024 LIBRARY; T=293.6K  
thermal capture photon spectrum

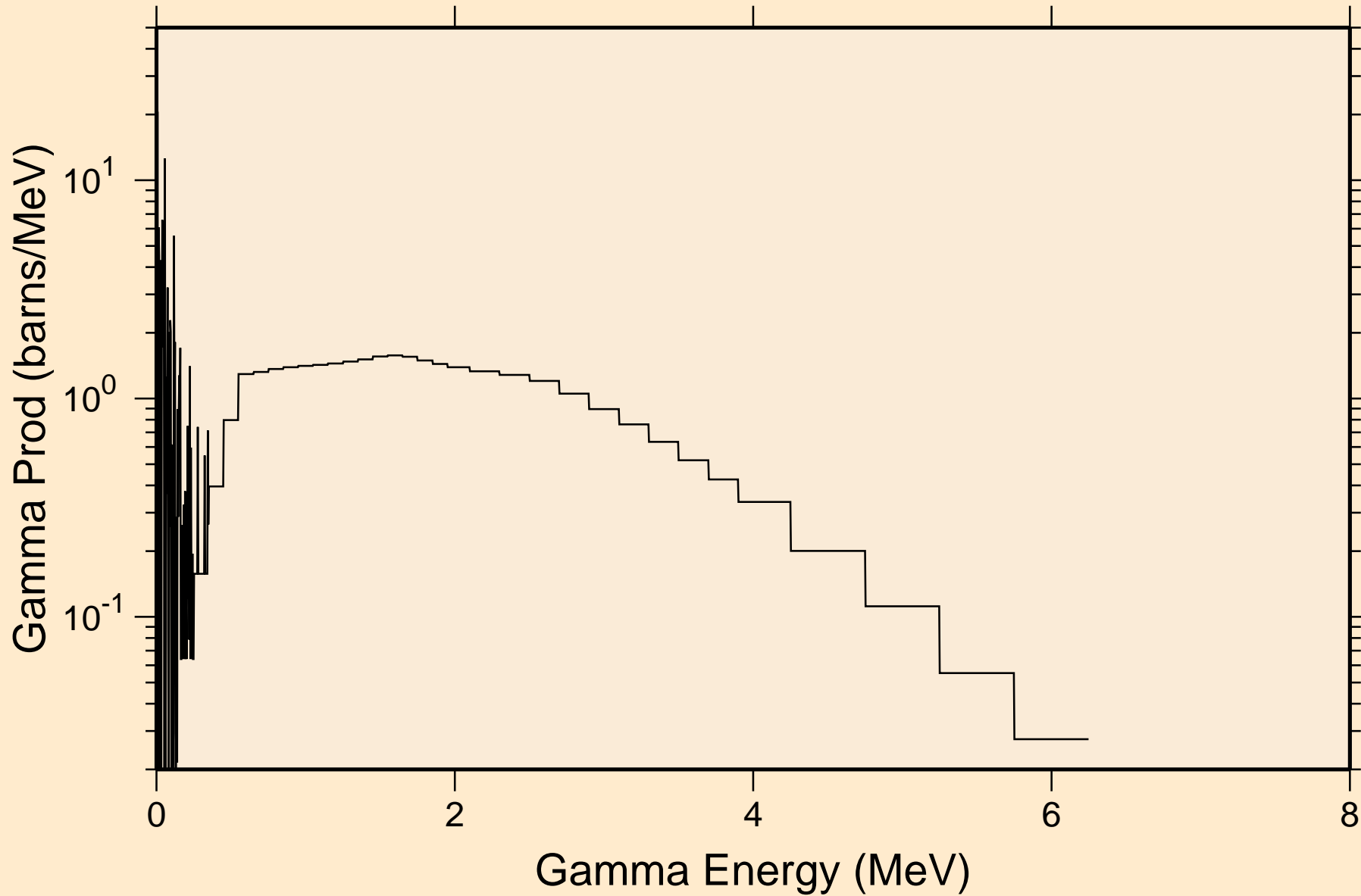

LU167M NEUTRON ACER TENDL-2024 LIBRARY; T=293.6K  
14 MeV photon spectrum

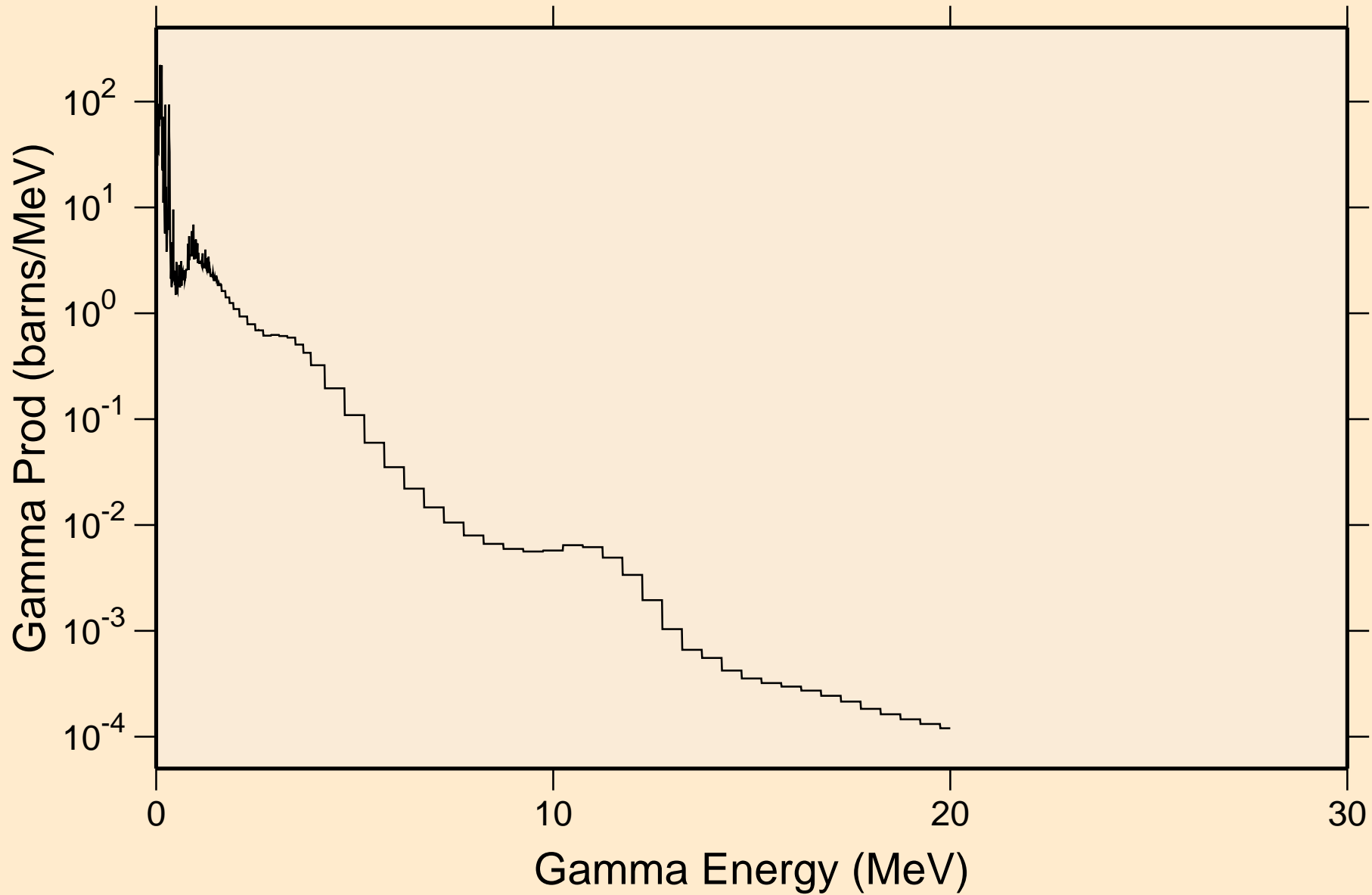

LU167M NEUTRON ACER TENDL-2024 LIBRARY; T=293.6K  
Particle heating contributions

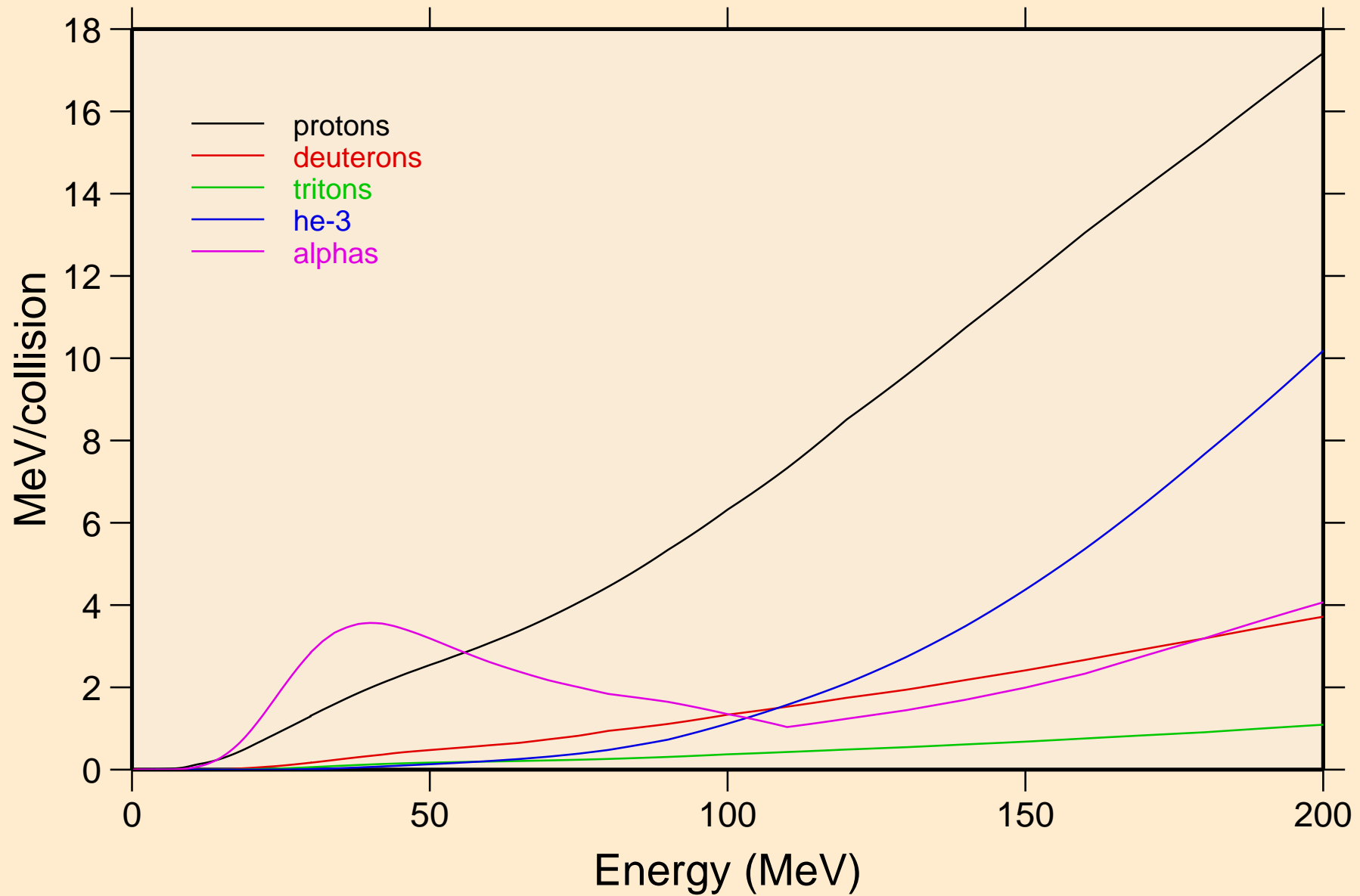

LU167M NEUTRON ACER TENDL-2024 LIBRARY; T=293.6K  
Recoil Heating

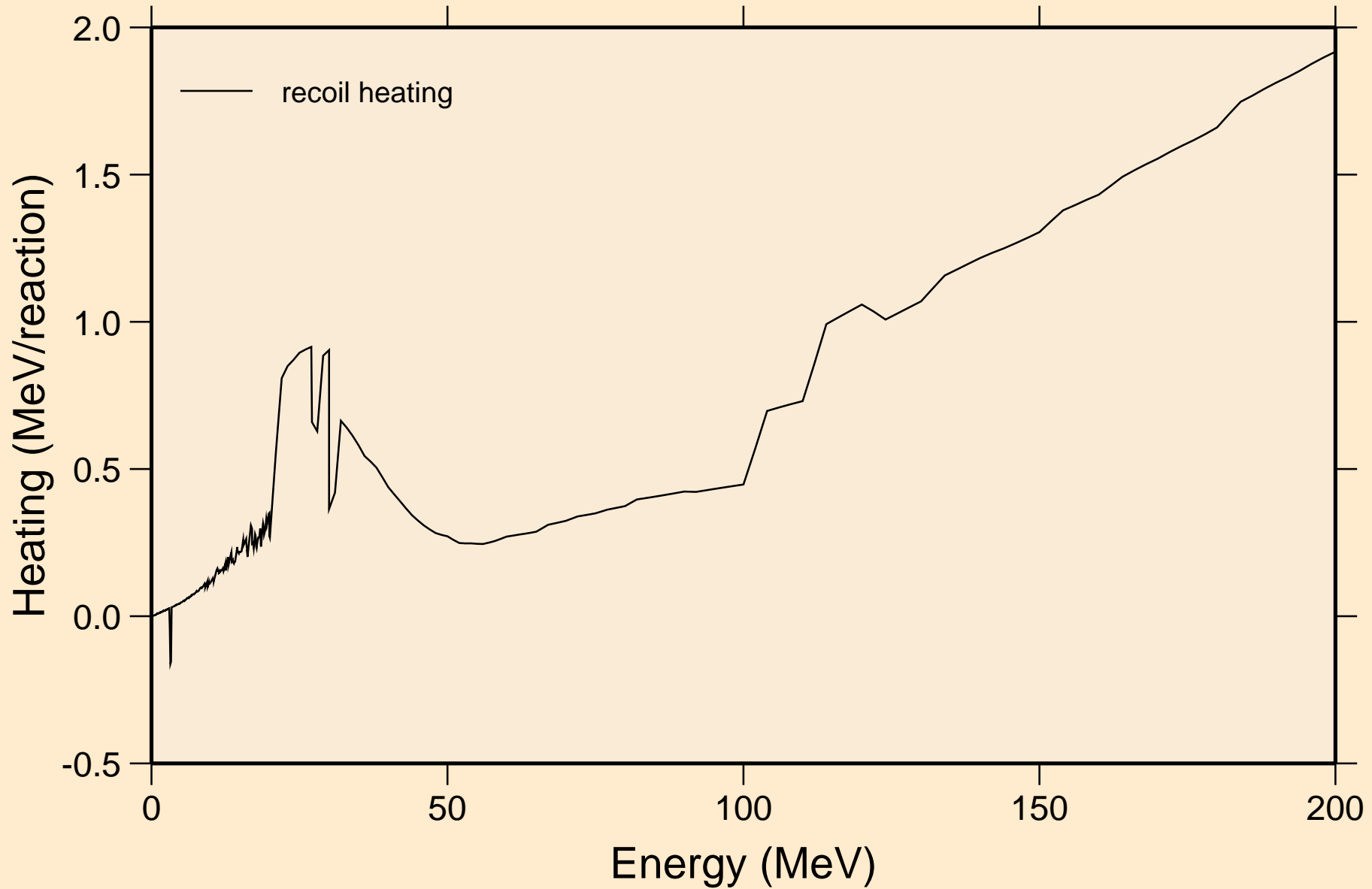

LU167M NEUTRON ACER TENDL-2024 LIBRARY; T=293.6K  
Particle production cross sections

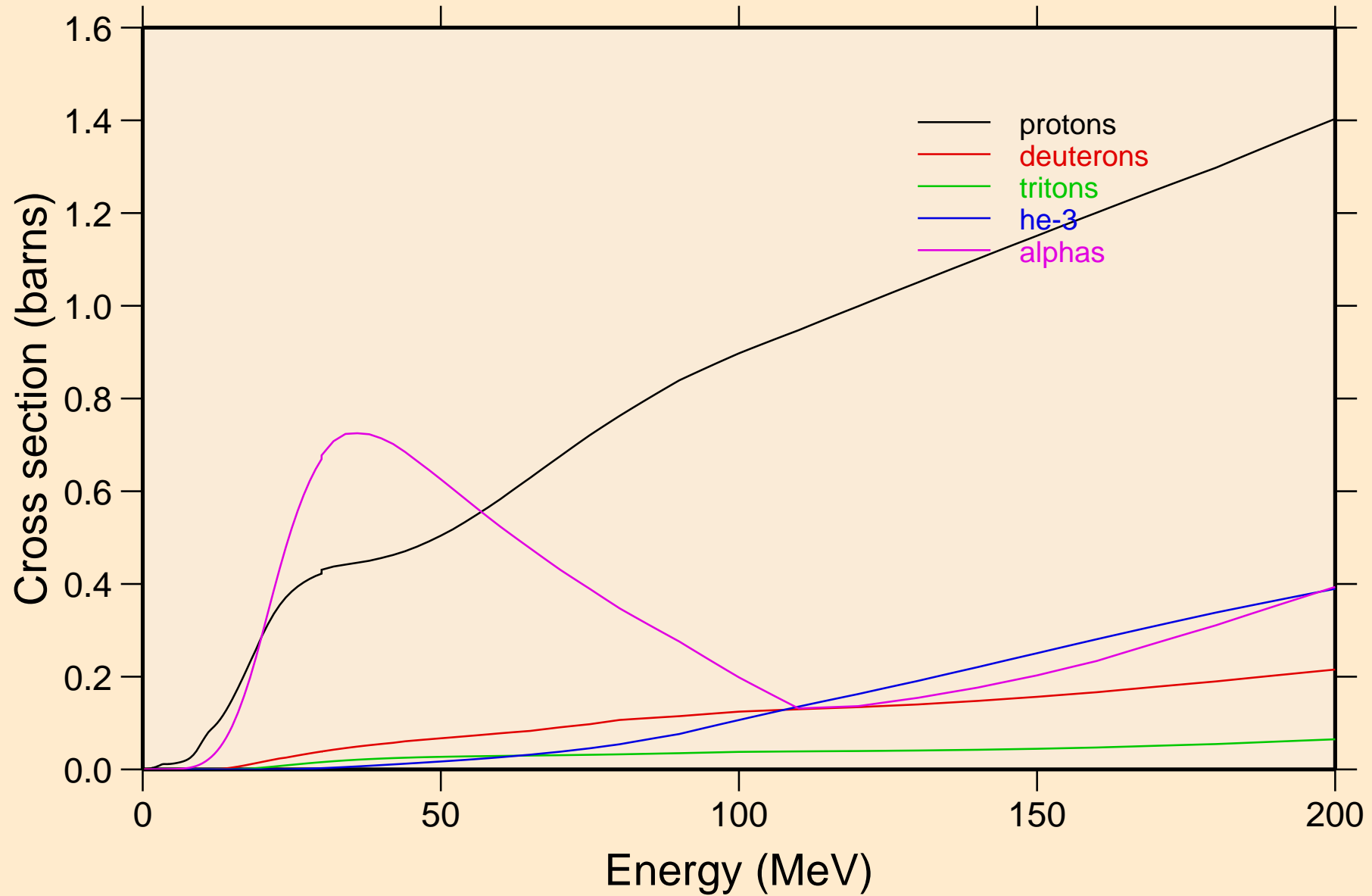

LU167M NEUTRON ACER TENDL-2024 LIBRARY; T=293.6K  
protons from (n,x)

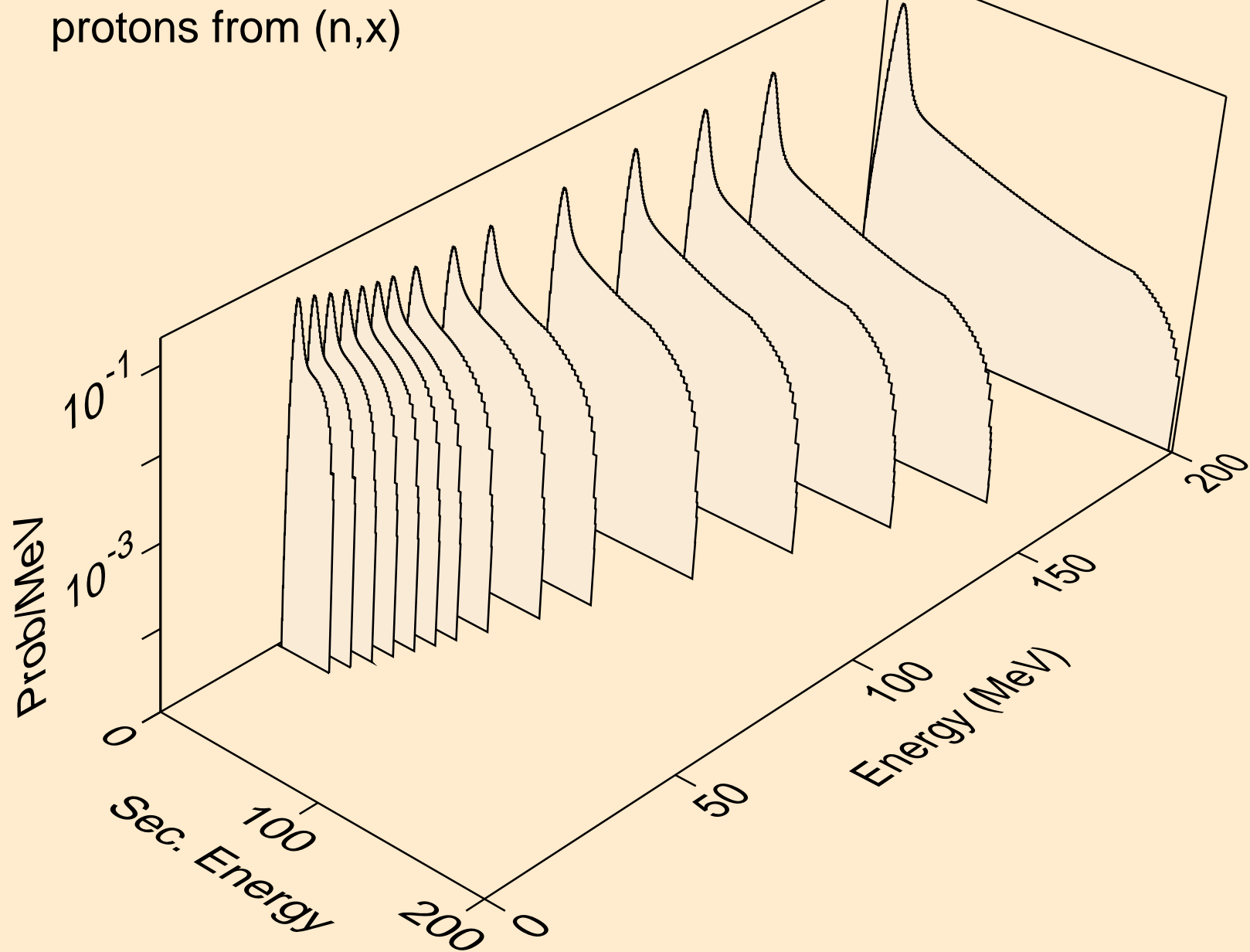

LU167M NEUTRON ACER TENDL-2024 LIBRARY; T=293.6K  
protons from (n,n\*)p

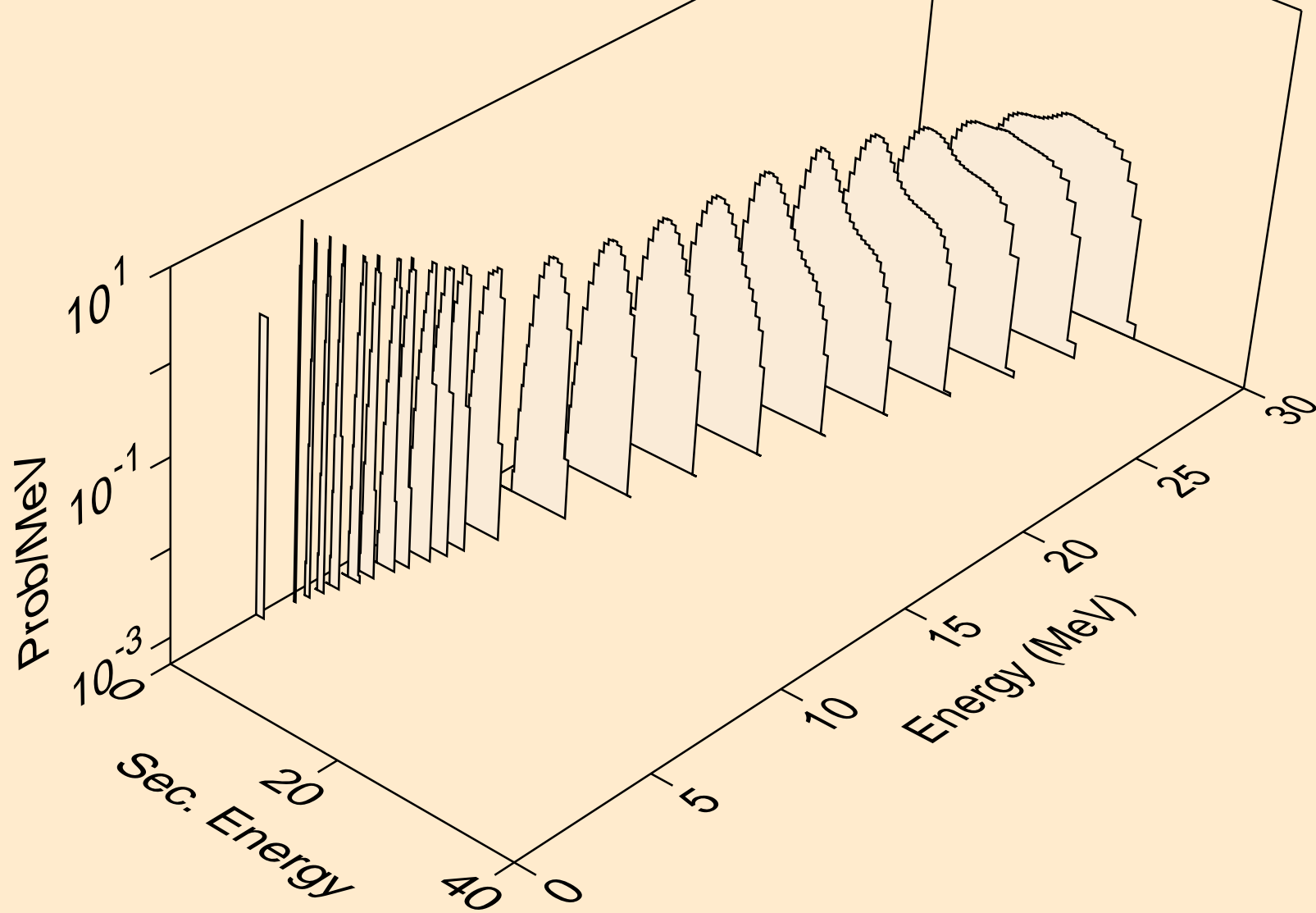

LU167M NEUTRON ACER TENDL-2024 LIBRARY; T=293.6K  
protons from (n,2np)

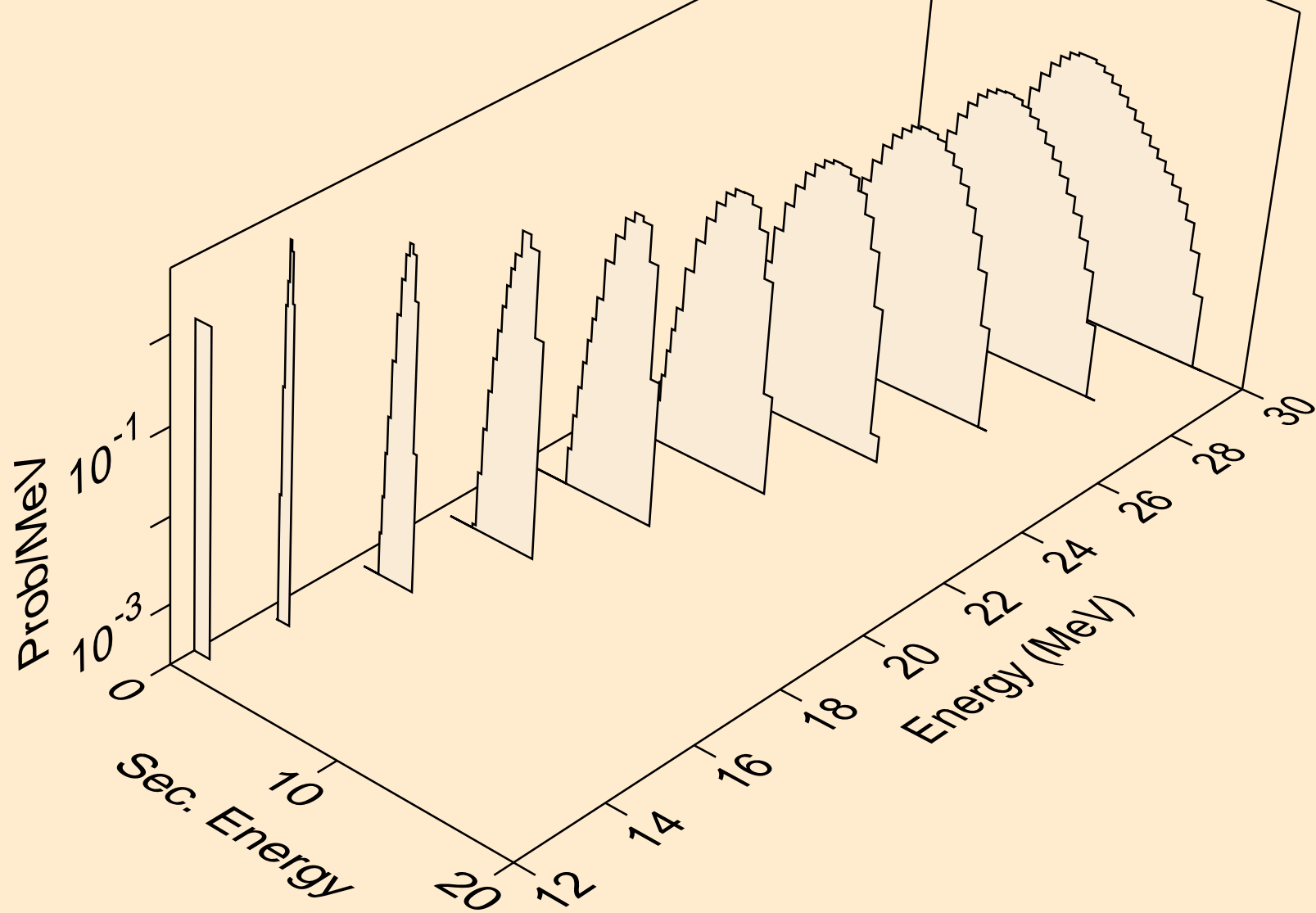

LU167M NEUTRON ACER TENDL-2024 LIBRARY; T=293.6K  
protons from (n,3np)

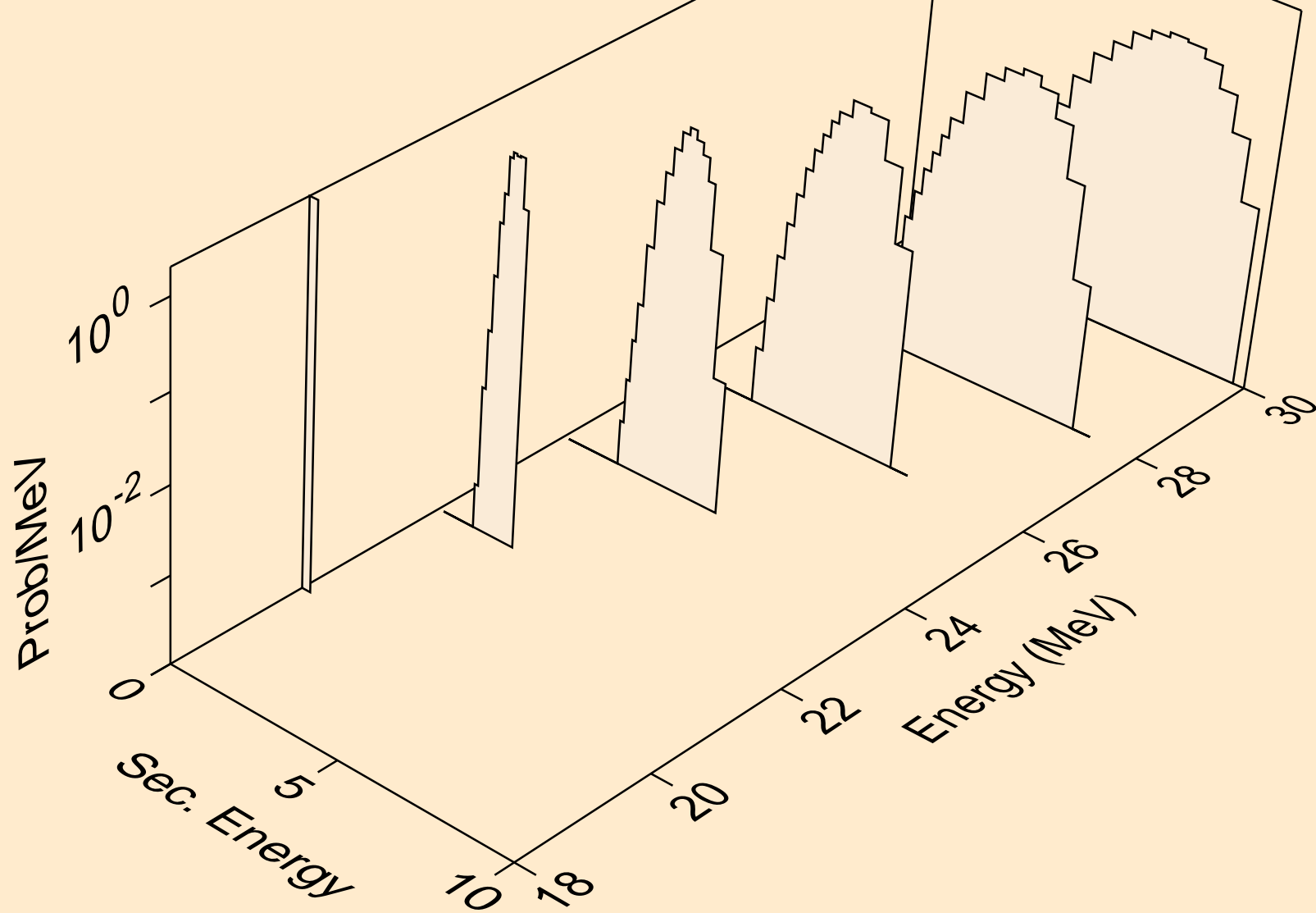

LU167M NEUTRON ACER TENDL-2024 LIBRARY; T=293.6K  
protons from (n,n2p)

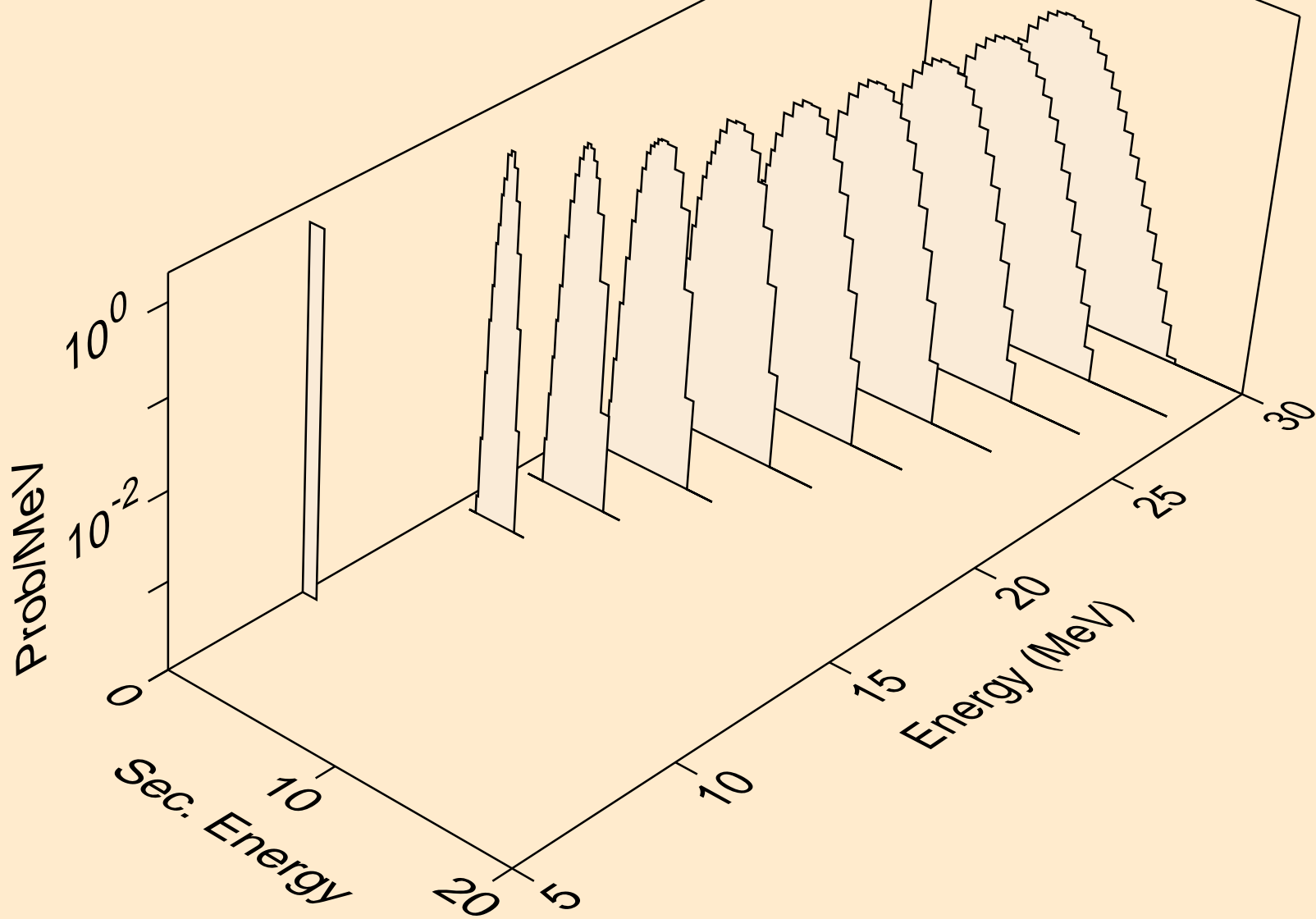

LU167M NEUTRON ACER TENDL-2024 LIBRARY; T=293.6K  
protons from (n,npa)

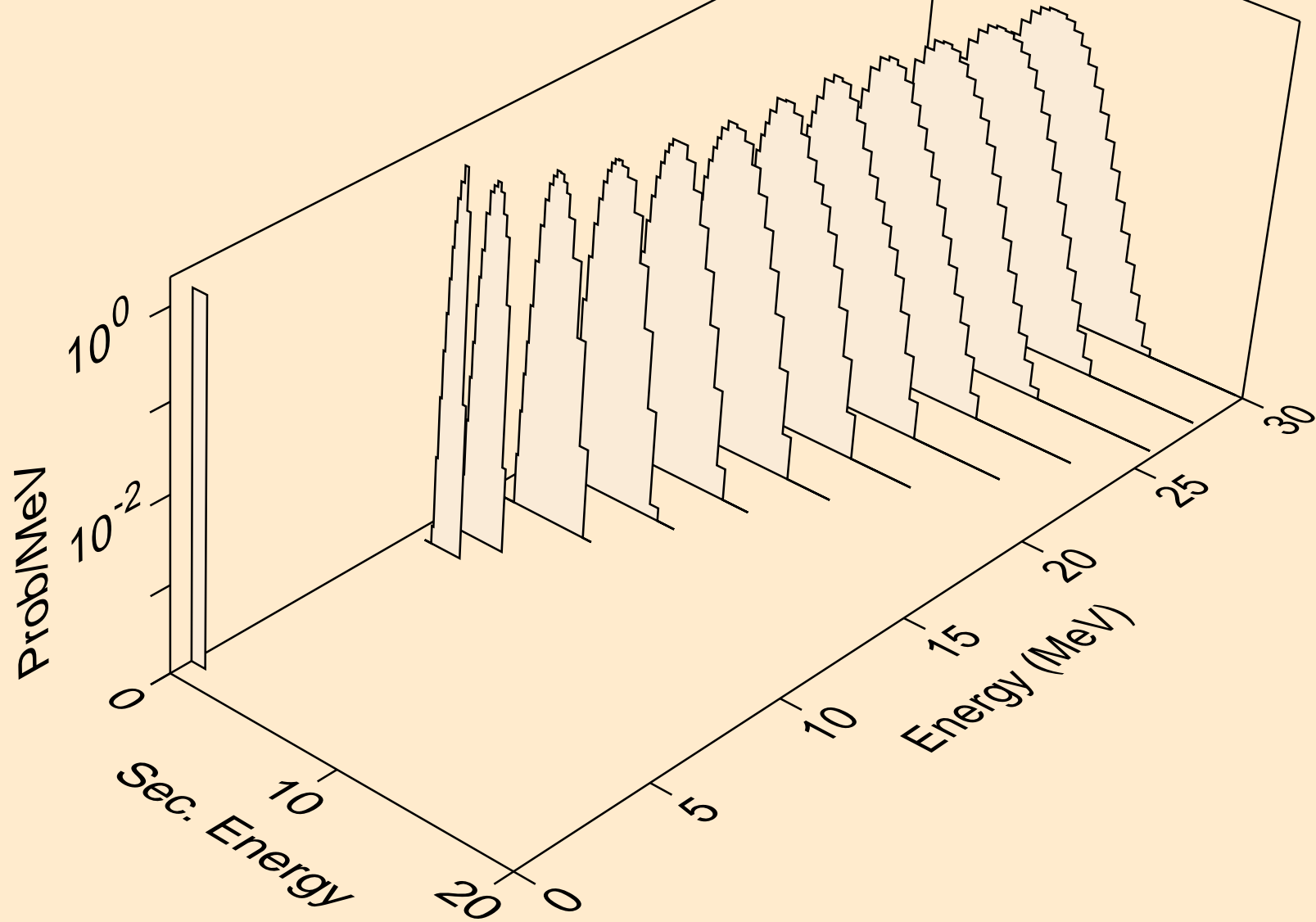

LU167M NEUTRON ACER TENDL-2024 LIBRARY; T=293.6K  
protons from (n,p)

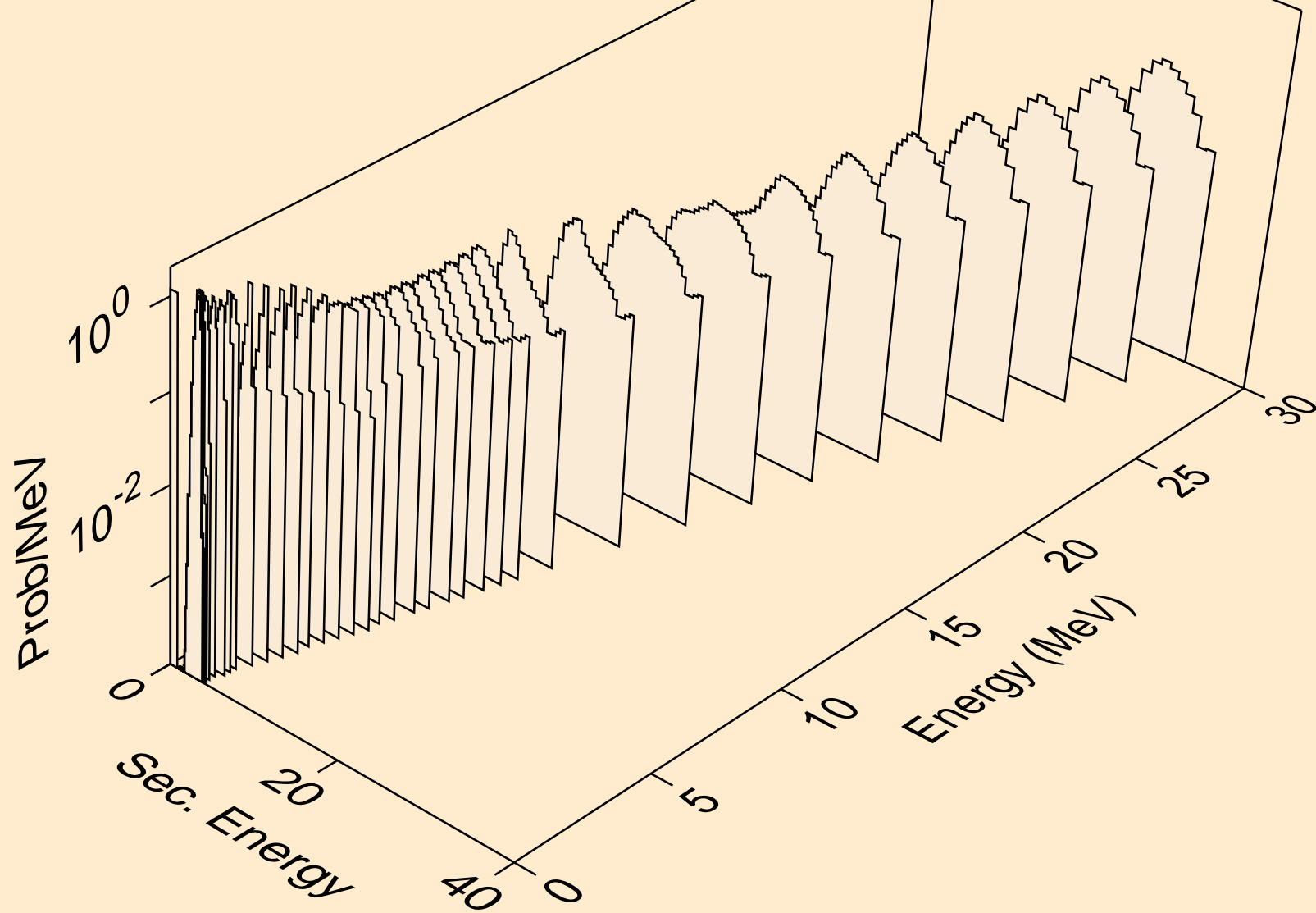

LU167M NEUTRON ACER TENDL-2024 LIBRARY; T=293.6K  
protons from (n,2p)

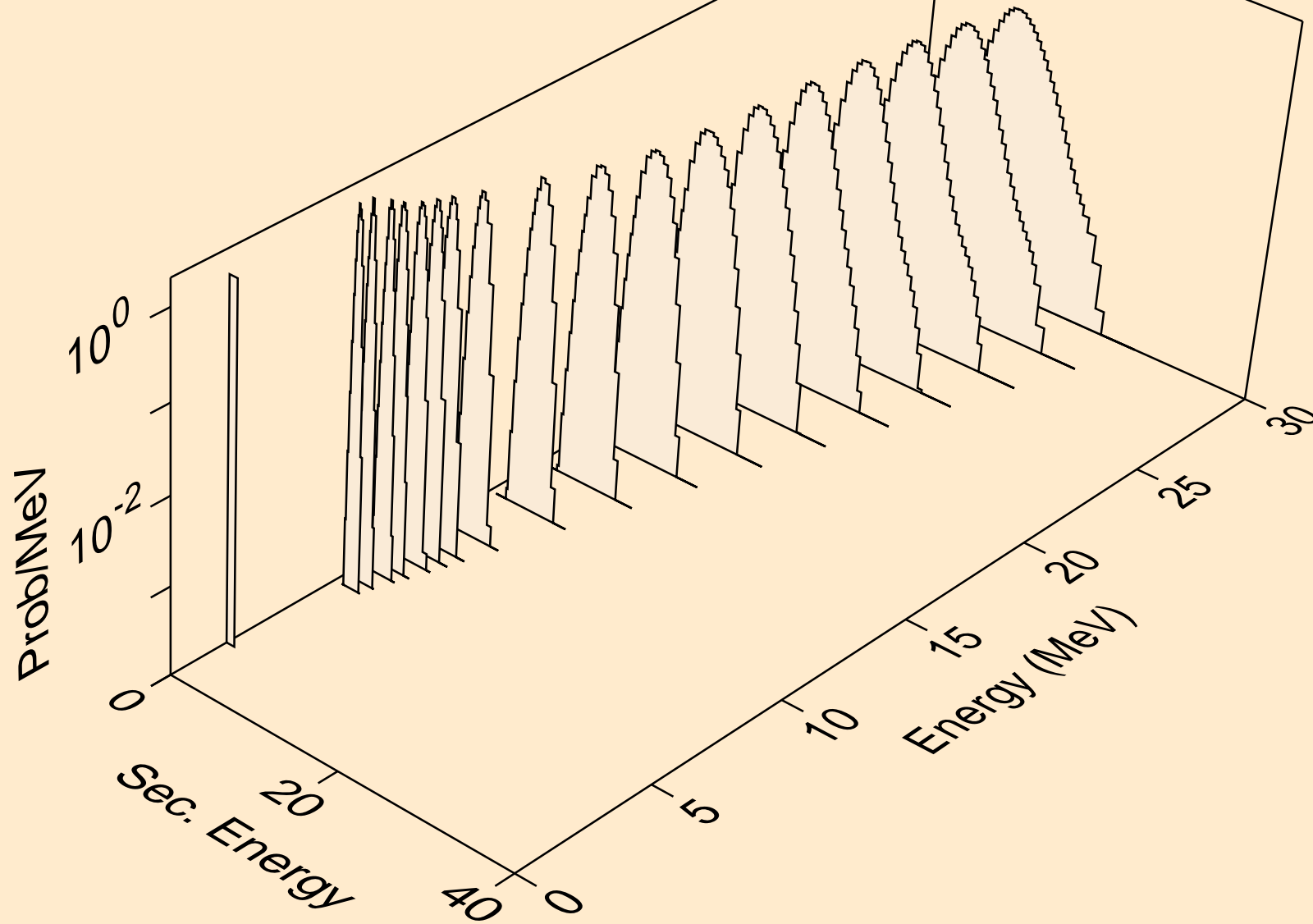

LU167M NEUTRON ACER TENDL-2024 LIBRARY; T=293.6K  
protons from (n,p)

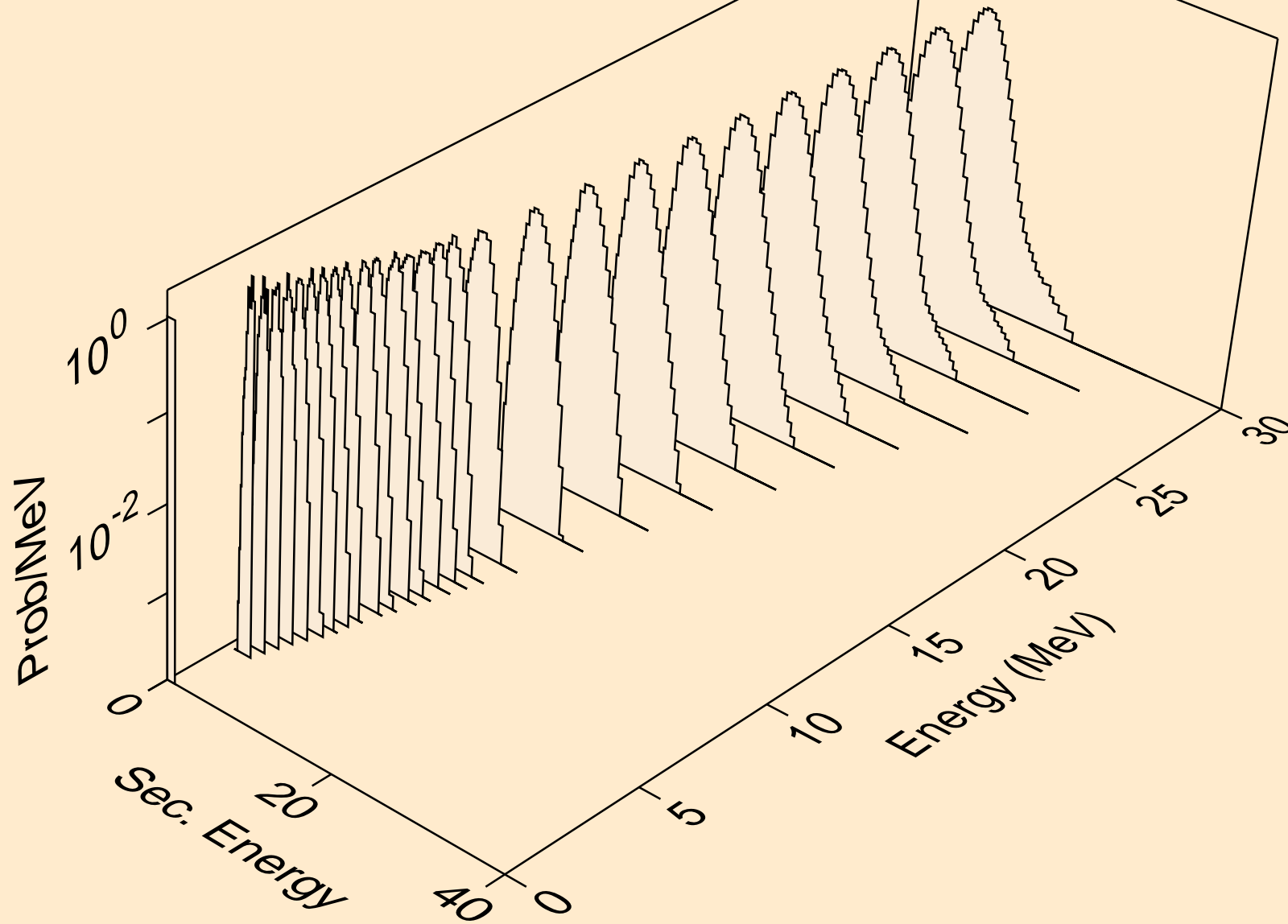

LU167M NEUTRON ACER TENDL-2024 LIBRARY; T=293.6K  
protons from (n,pd)

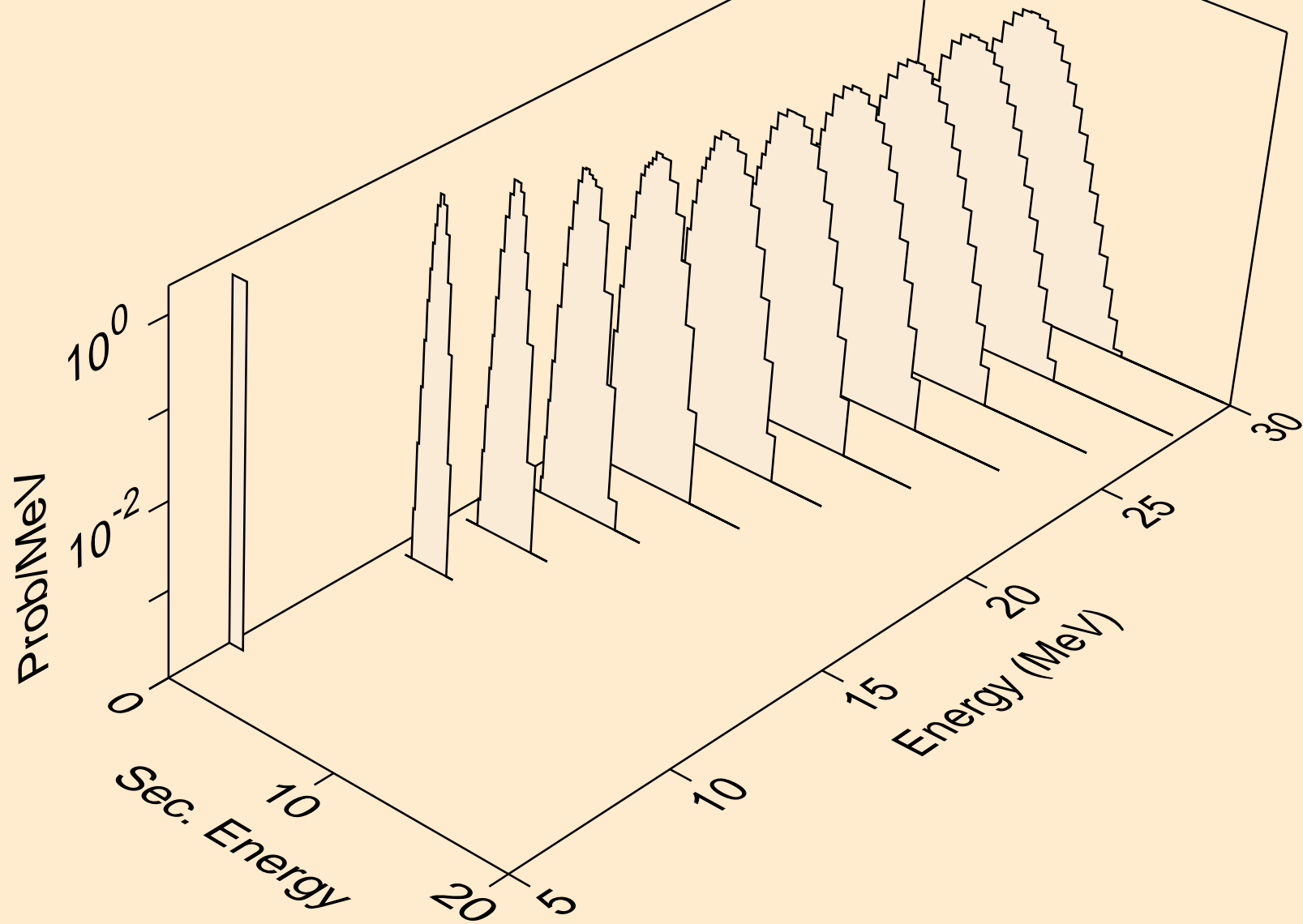

LU167M NEUTRON ACER TENDL-2024 LIBRARY; T=293.6K  
protons from (n,pt)

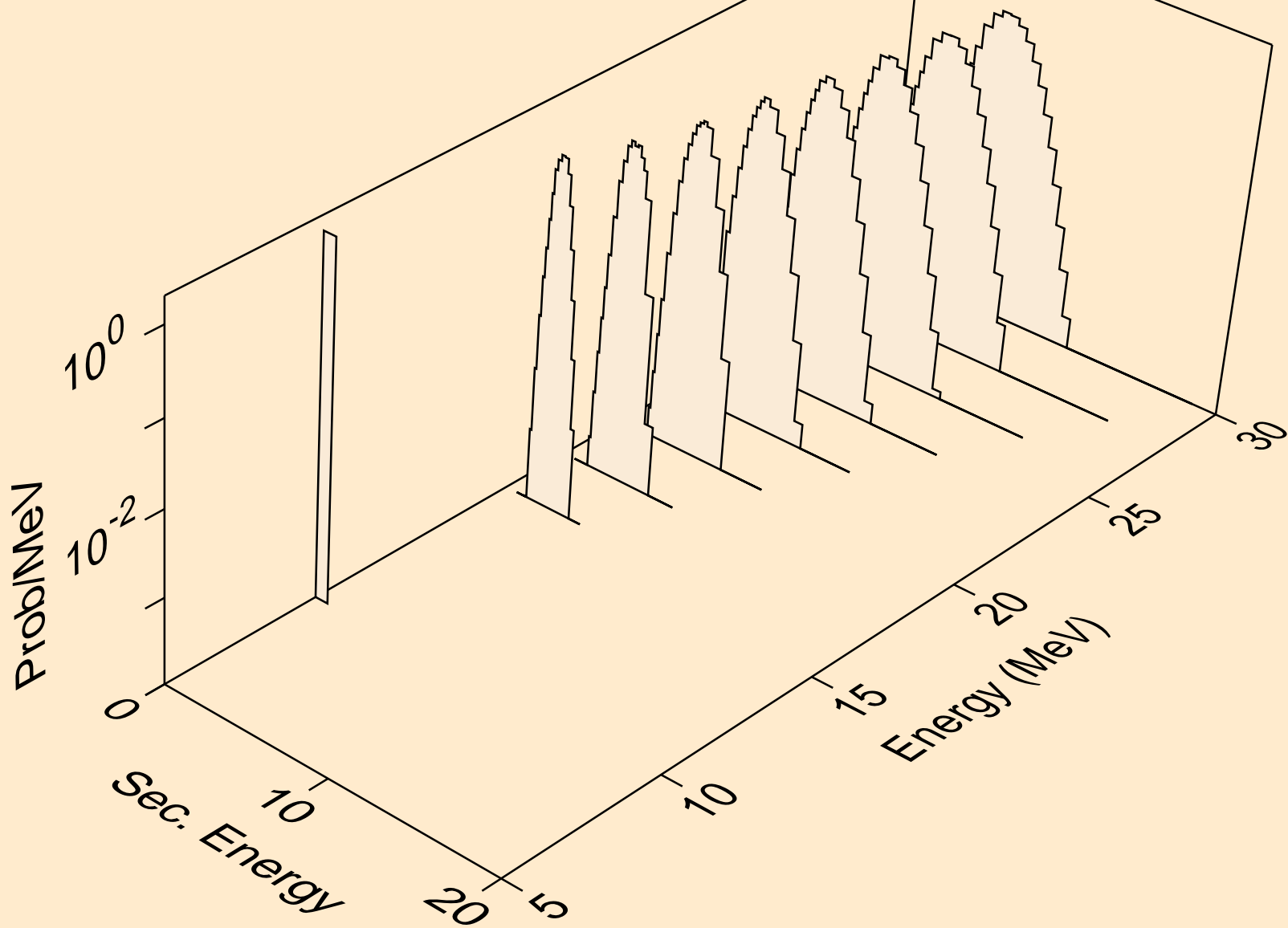

LU167M NEUTRON ACER TENDL-2024 LIBRARY; T=293.6K  
deuterons from (n,x)

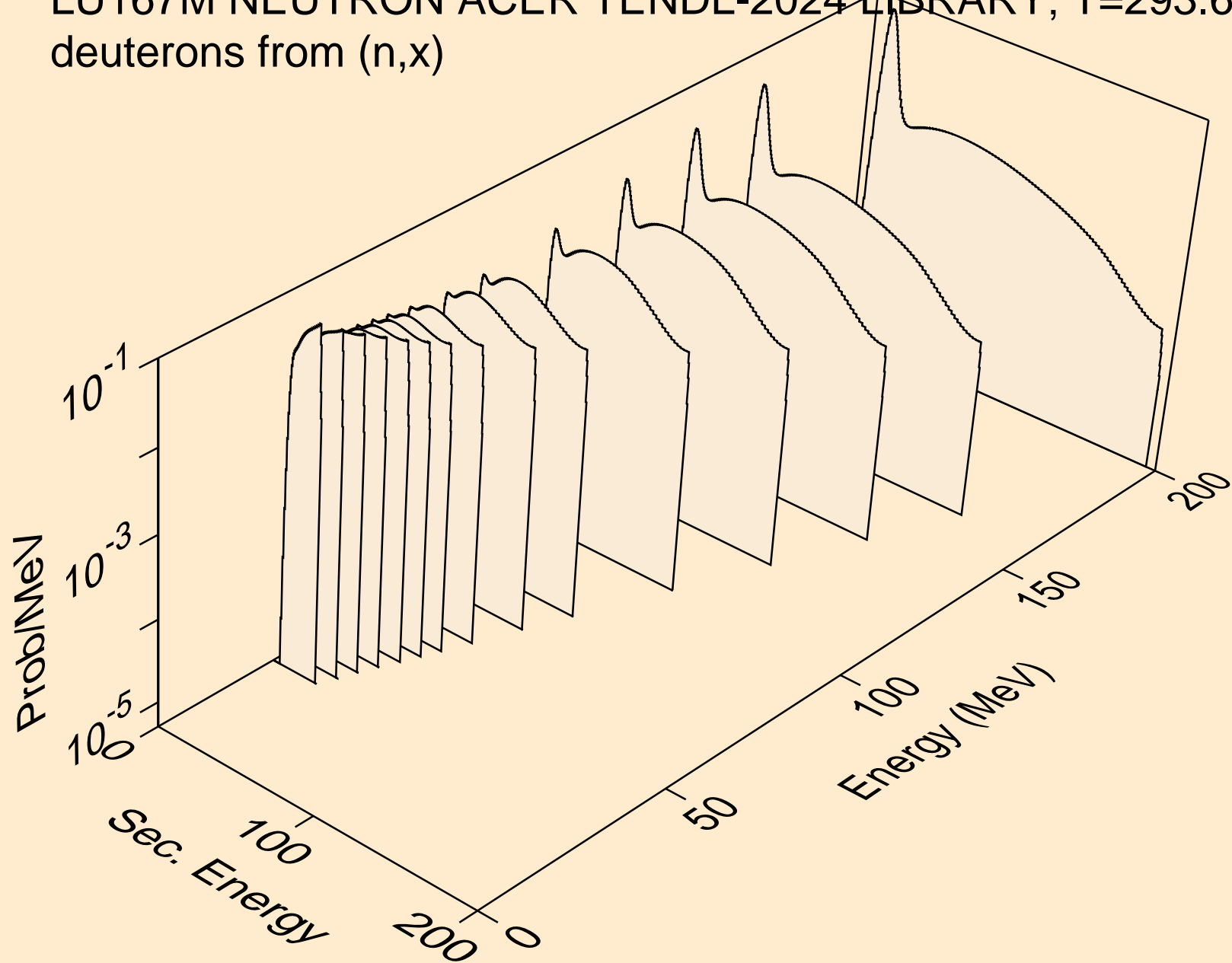

LU167M NEUTRON ACER TENDL-2024 LIBRARY; T=293.6K  
deuterons from (n,2nd)

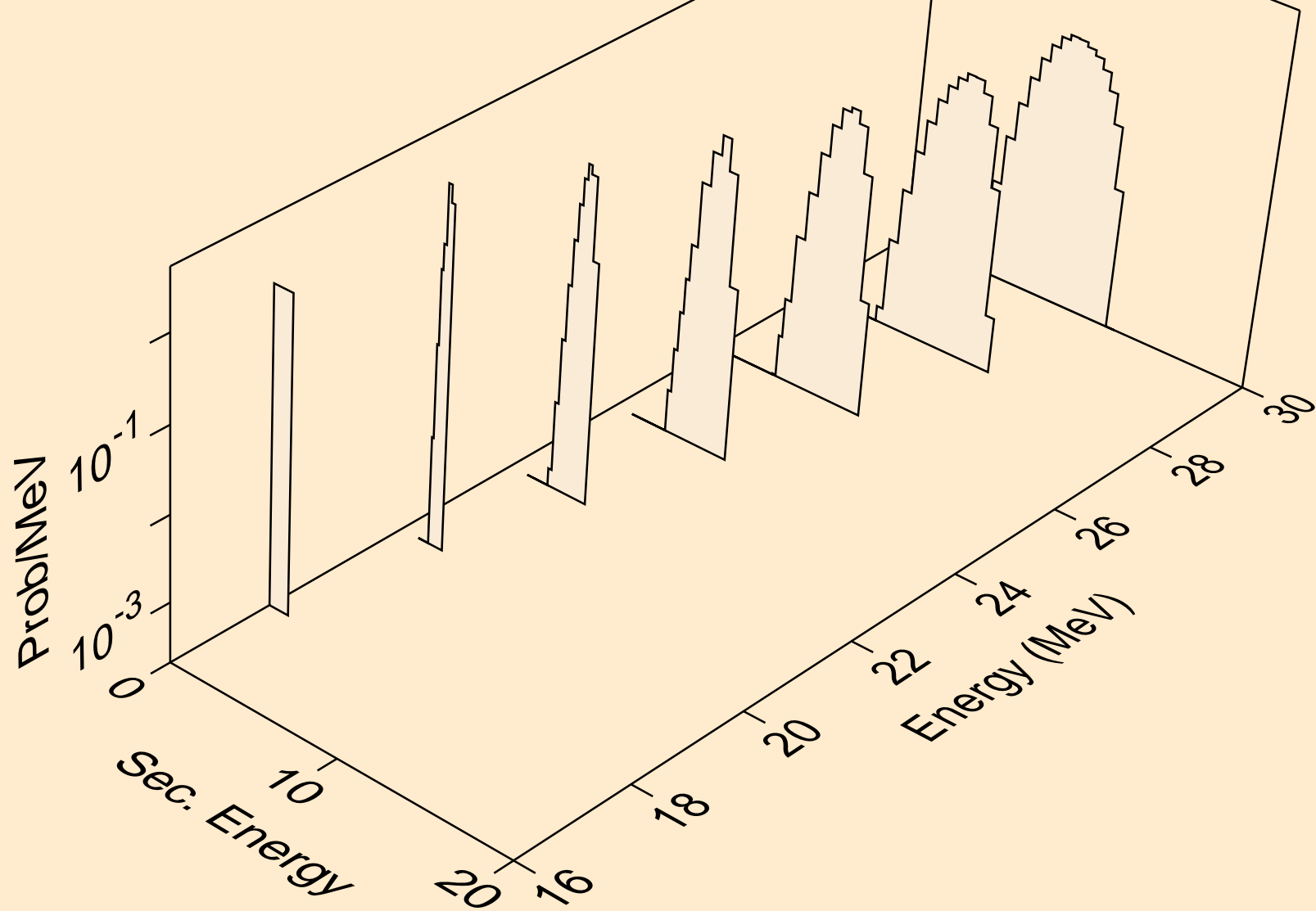

LU167M NEUTRON ACER TENDL-2024 LIBRARY; T=293.6K  
deuterons from (n,n\*)d

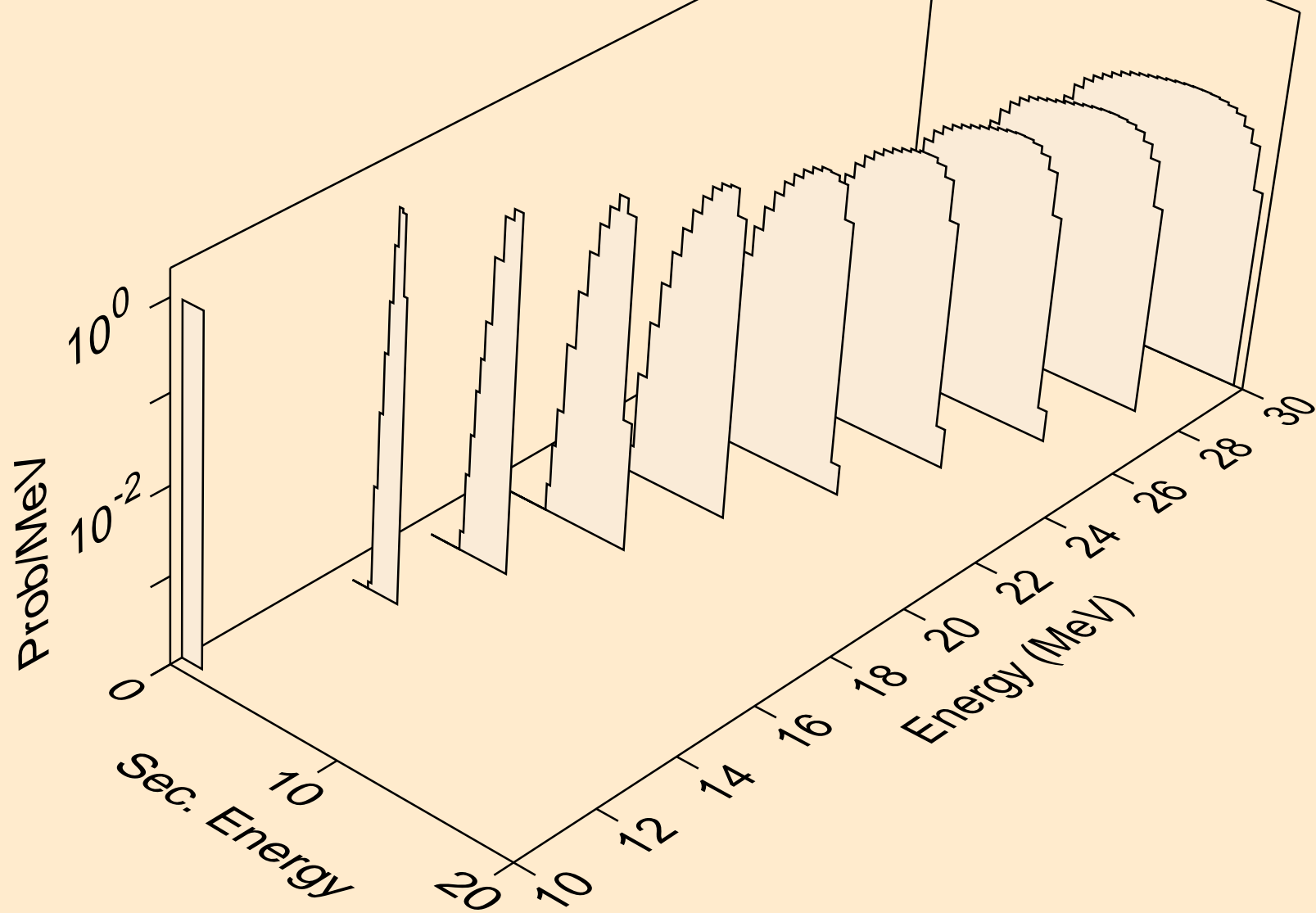

LU167M NEUTRON ACER TENDL-2024 LIBRARY; T=293.6K  
deuterons from (n,d)

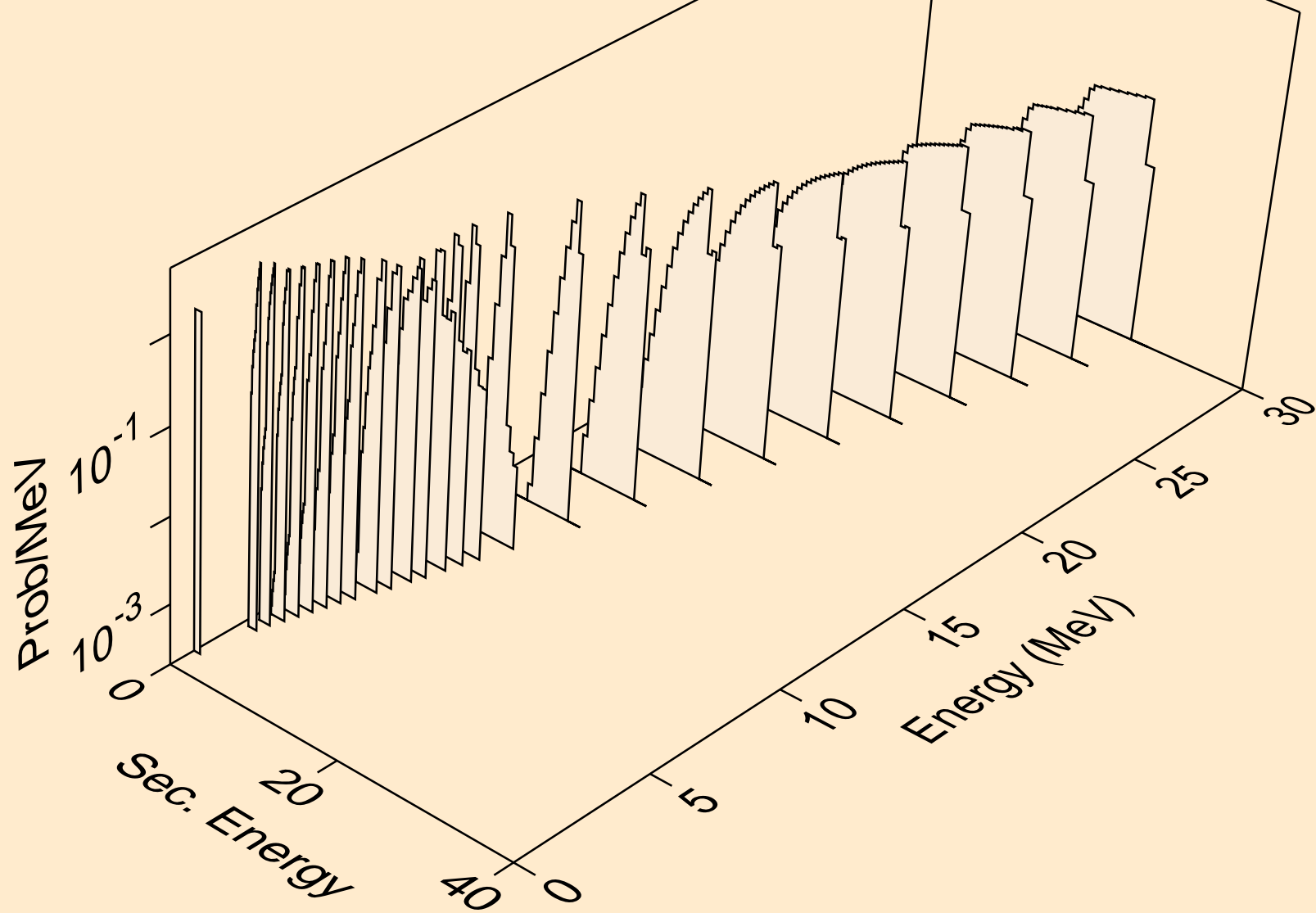

LU167M NEUTRON ACER TENDL-2024 LIBRARY; T=293.6K  
deuterons from (n,pd)

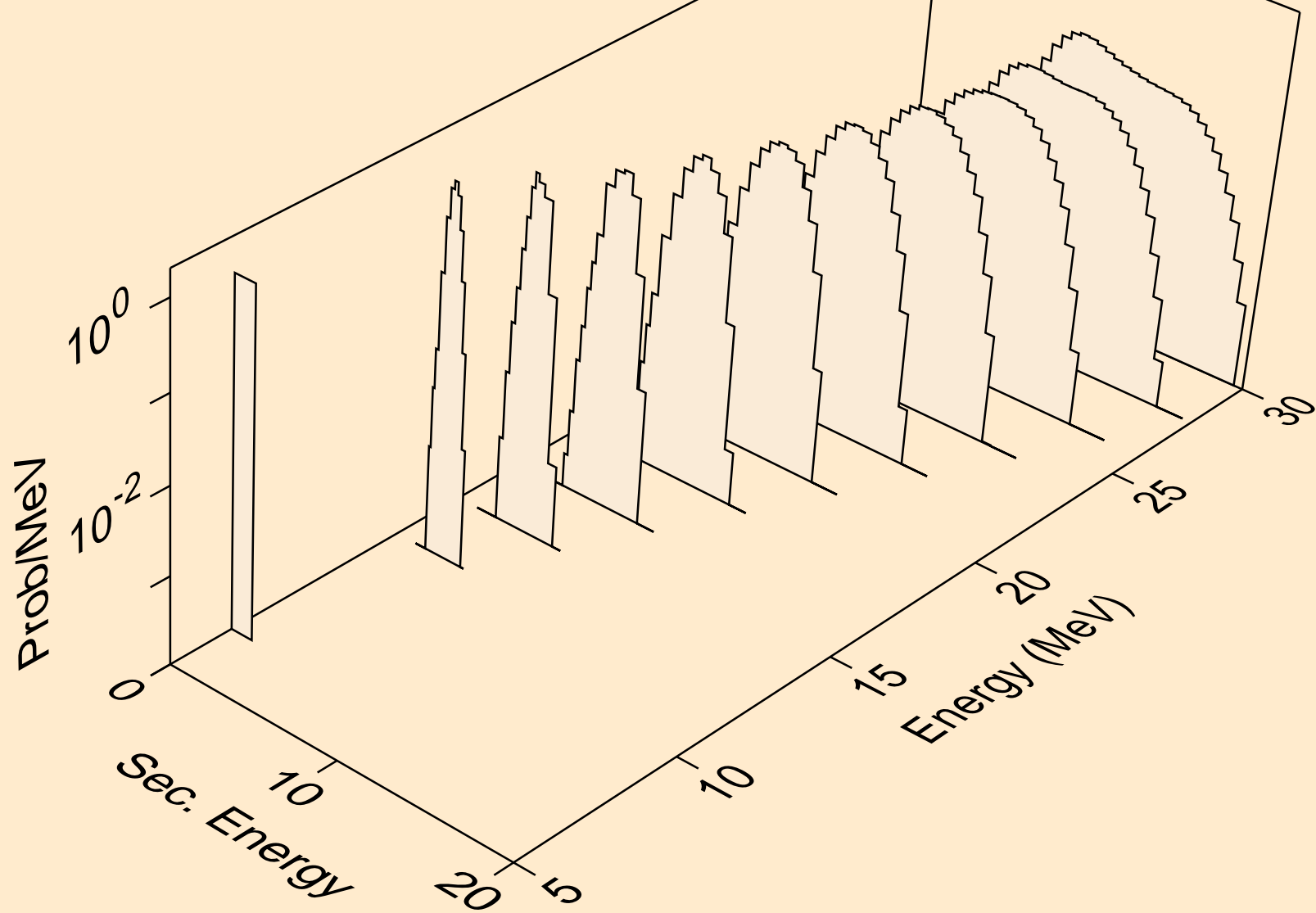

LU167M NEUTRON ACER TENDL-2024 LIBRARY; T=293.6K  
deuterons from (n,da)

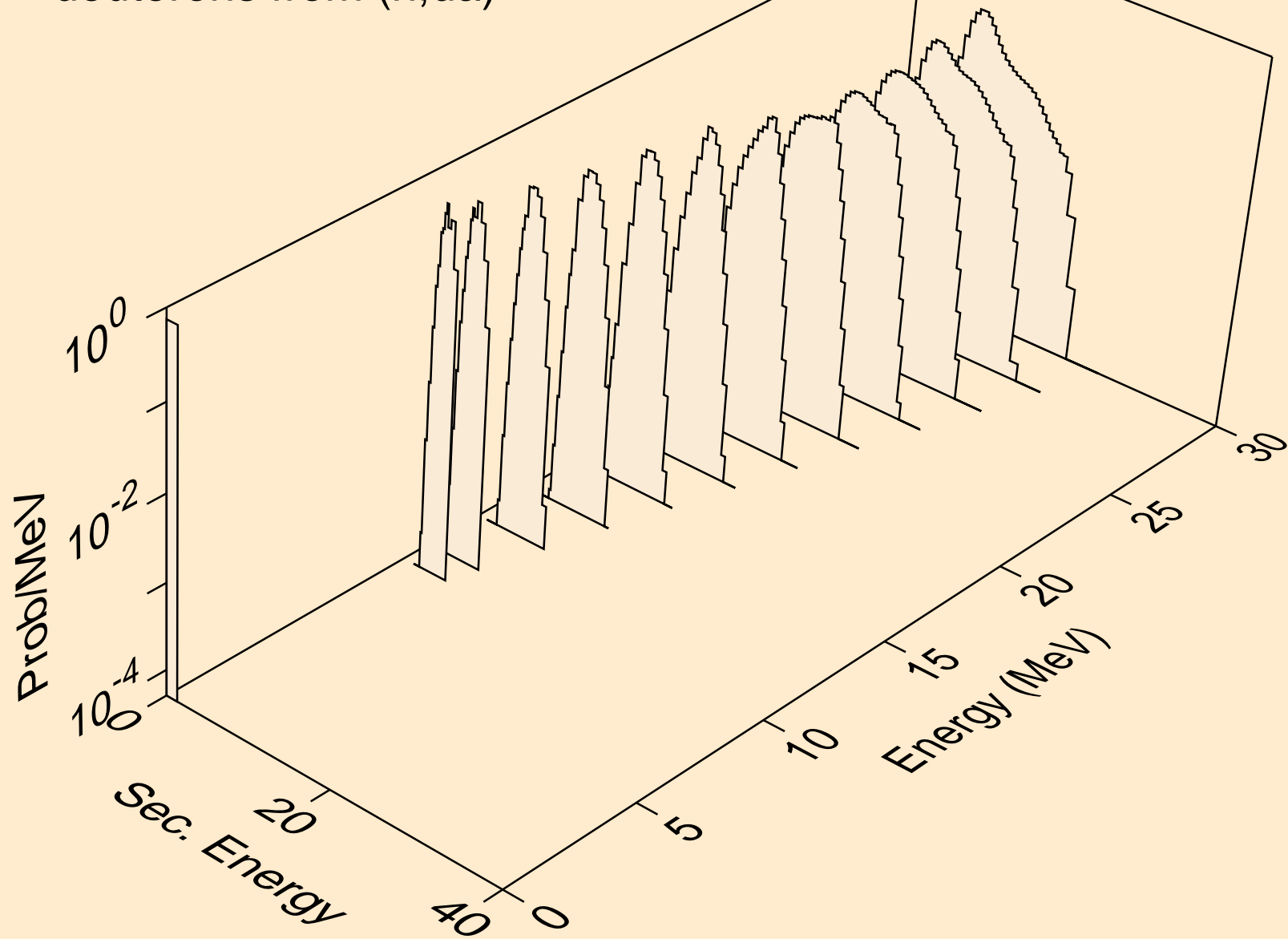

LU167M NEUTRON ACER TENDL-2024 LIBRARY; T=293.6K  
tritons from (n,x)

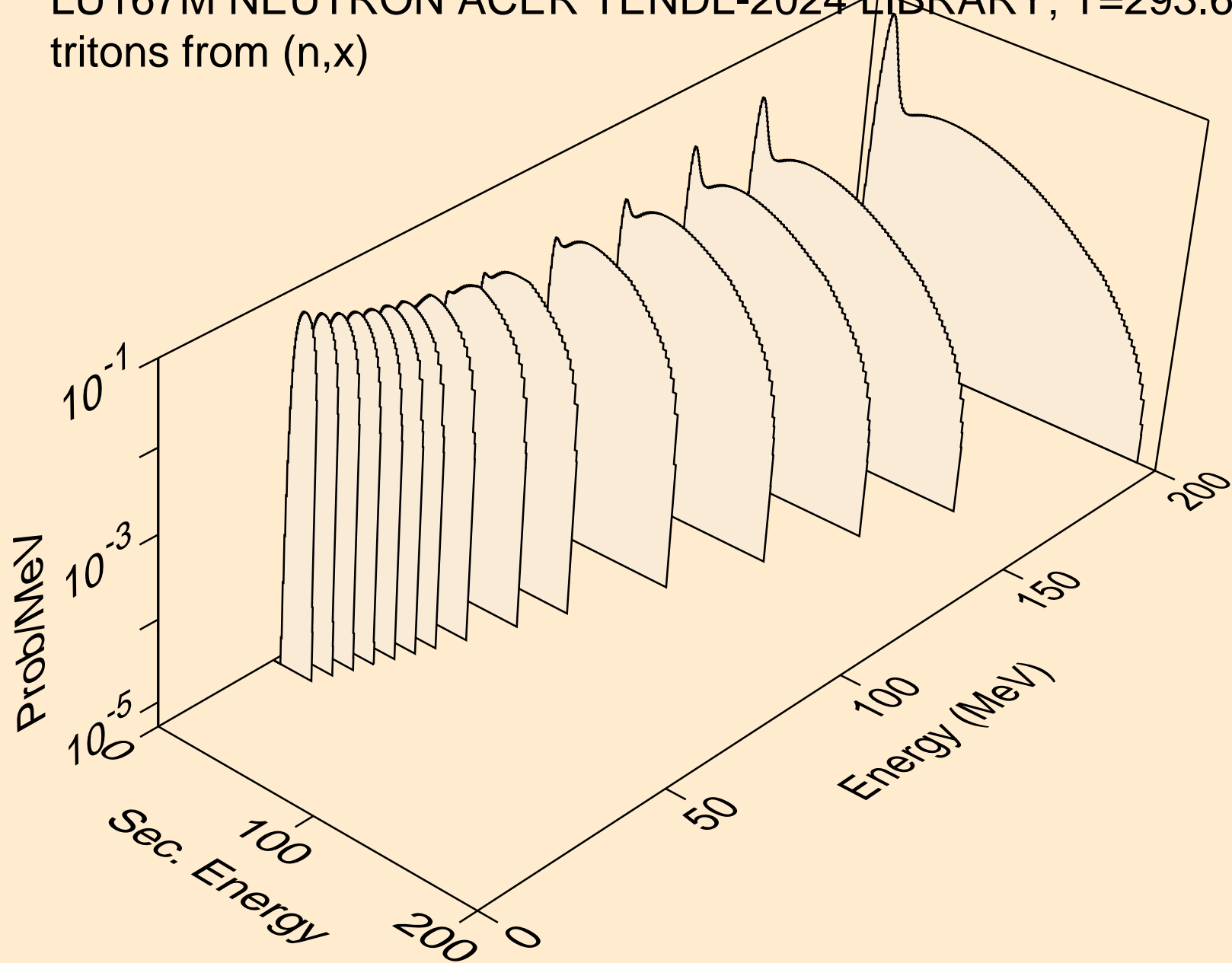

LU167M NEUTRON ACER TENDL-2024 LIBRARY; T=293.6K  
tritons from (n,n\*)t

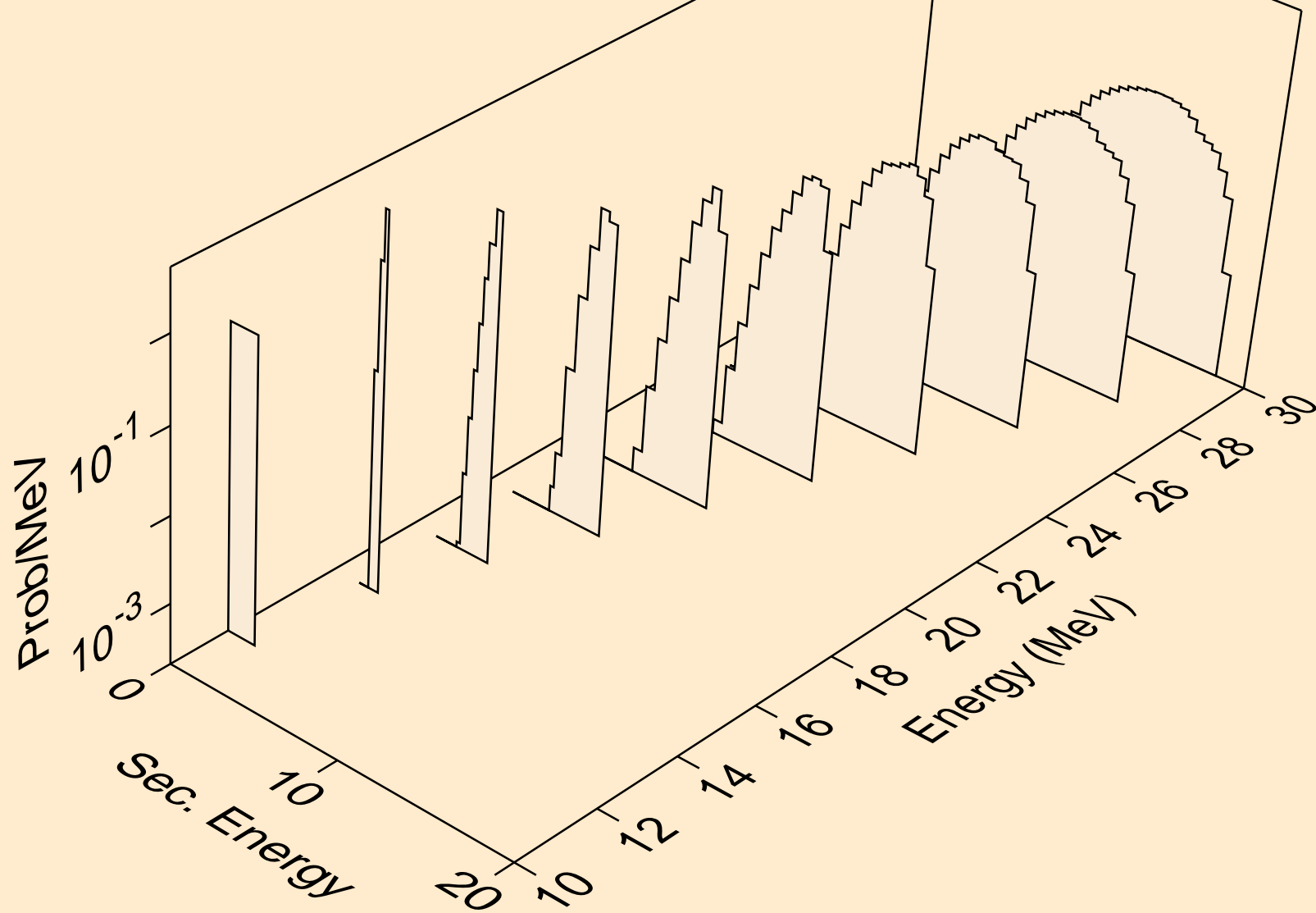

LU167M NEUTRON ACER TENDL-2024 LIBRARY; T=293.6K  
tritons from (n,t)

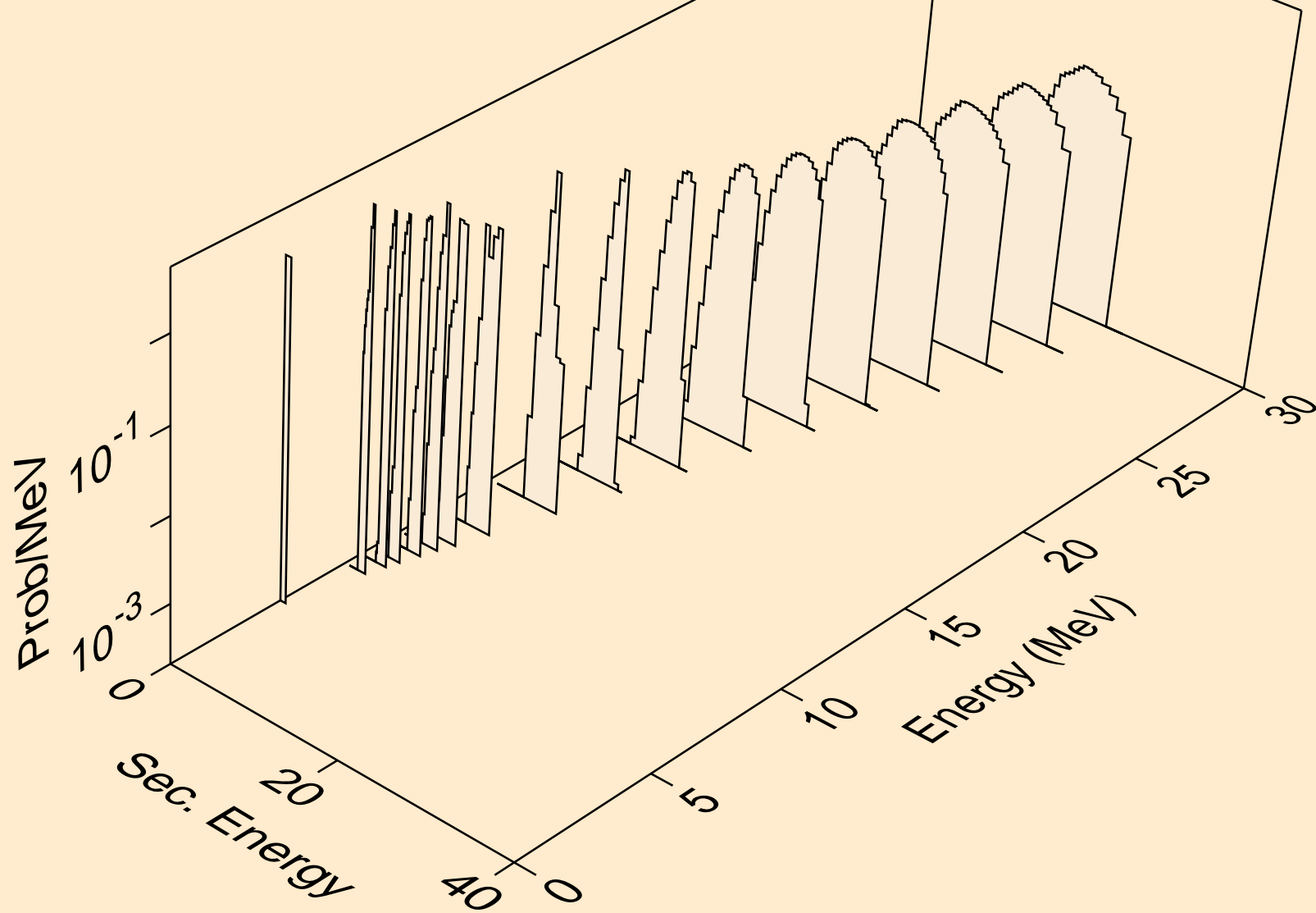

LU167M NEUTRON ACER TENDL-2024 LIBRARY; T=293.6K  
tritons from (n,pt)

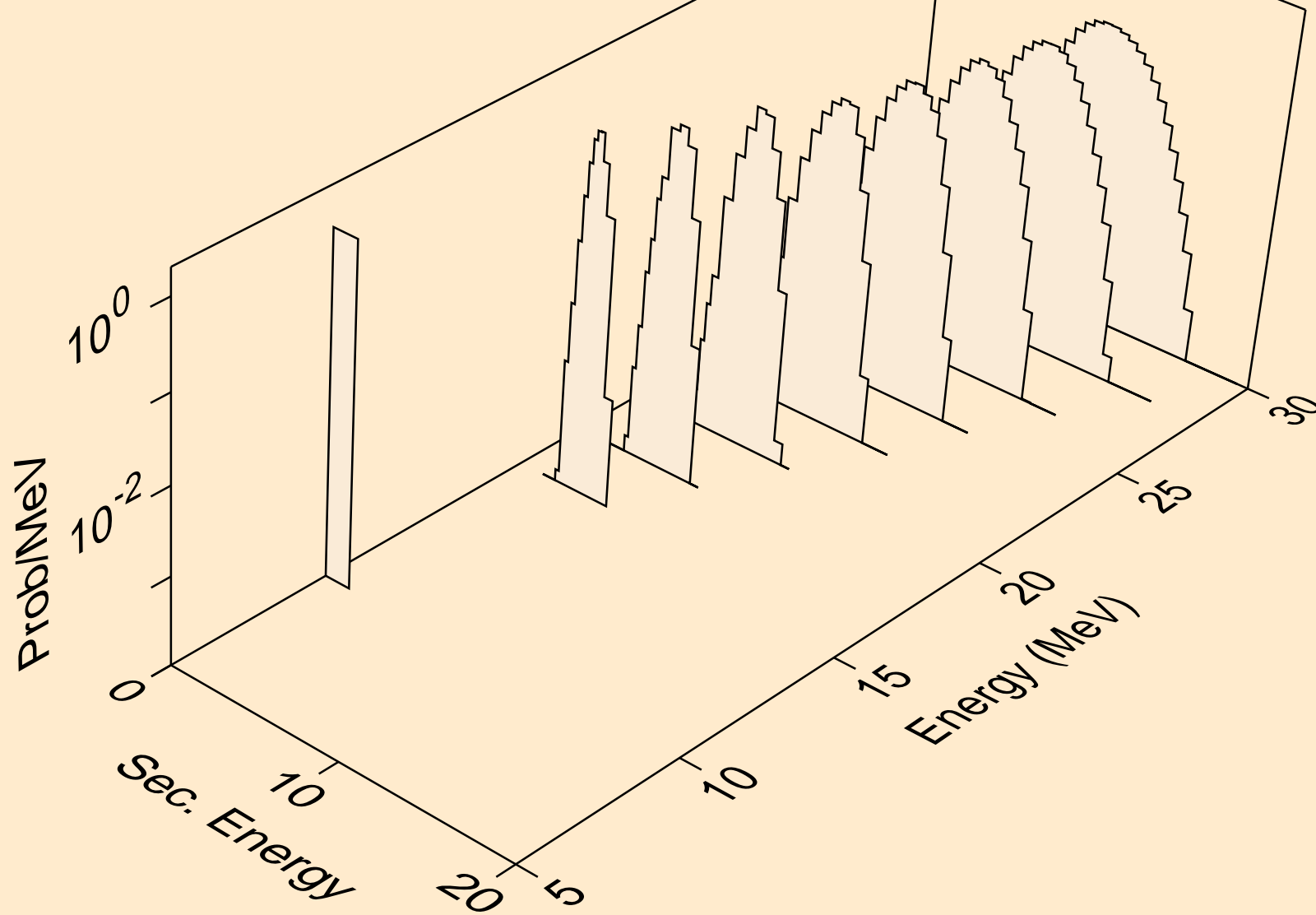

LU167M NEUTRON ACER TENDL-2024 LIBRARY; T=293.6K  
he3s from (n,x)

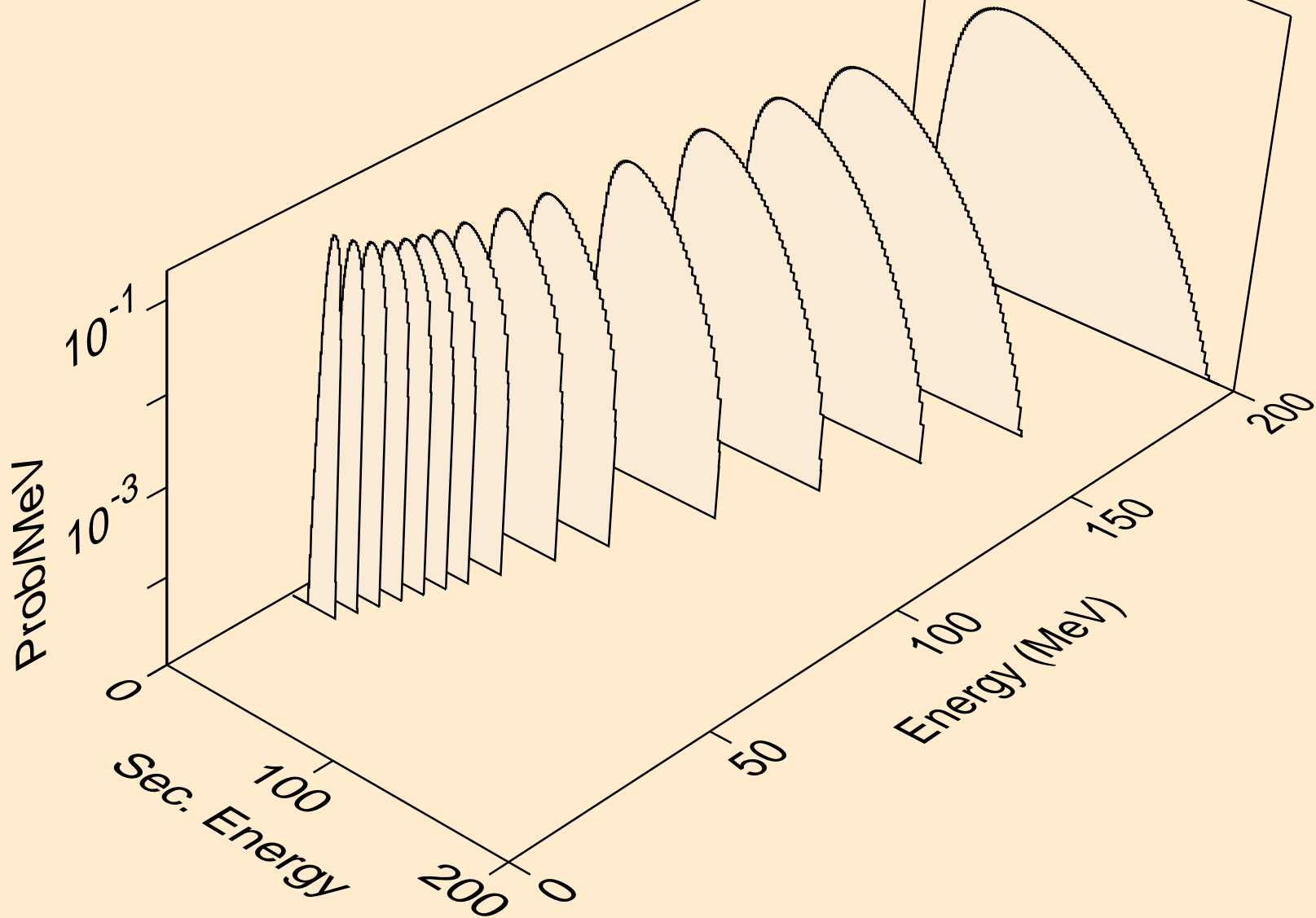

LU167M NEUTRON ACER TENDL-2024 LIBRARY; T=293.6K  
he3s from (n,n\*)he3

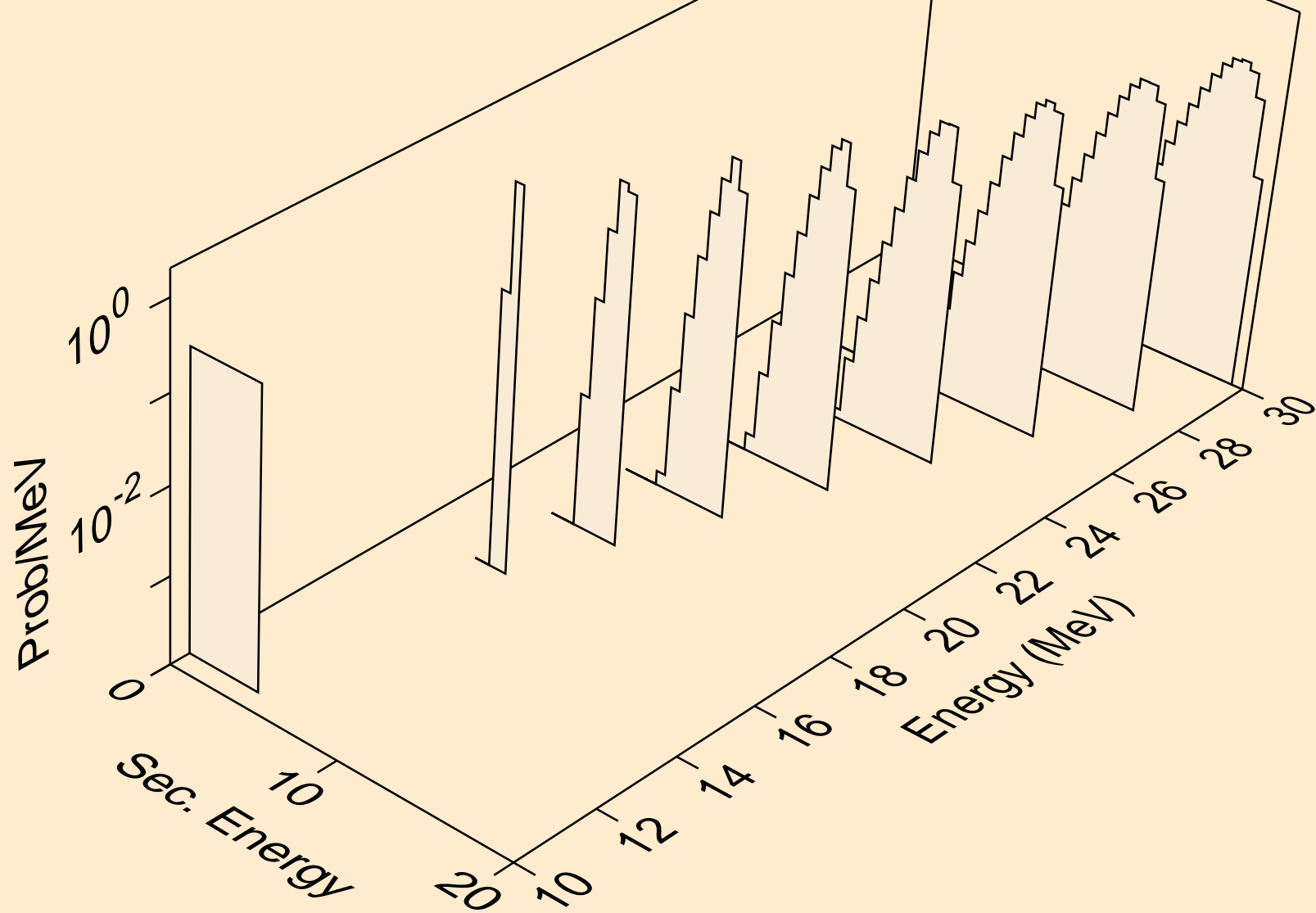

LU167M NEUTRON ACER TENDL-2024 LIBRARY; T=293.6K  
he3s from (n,he3)

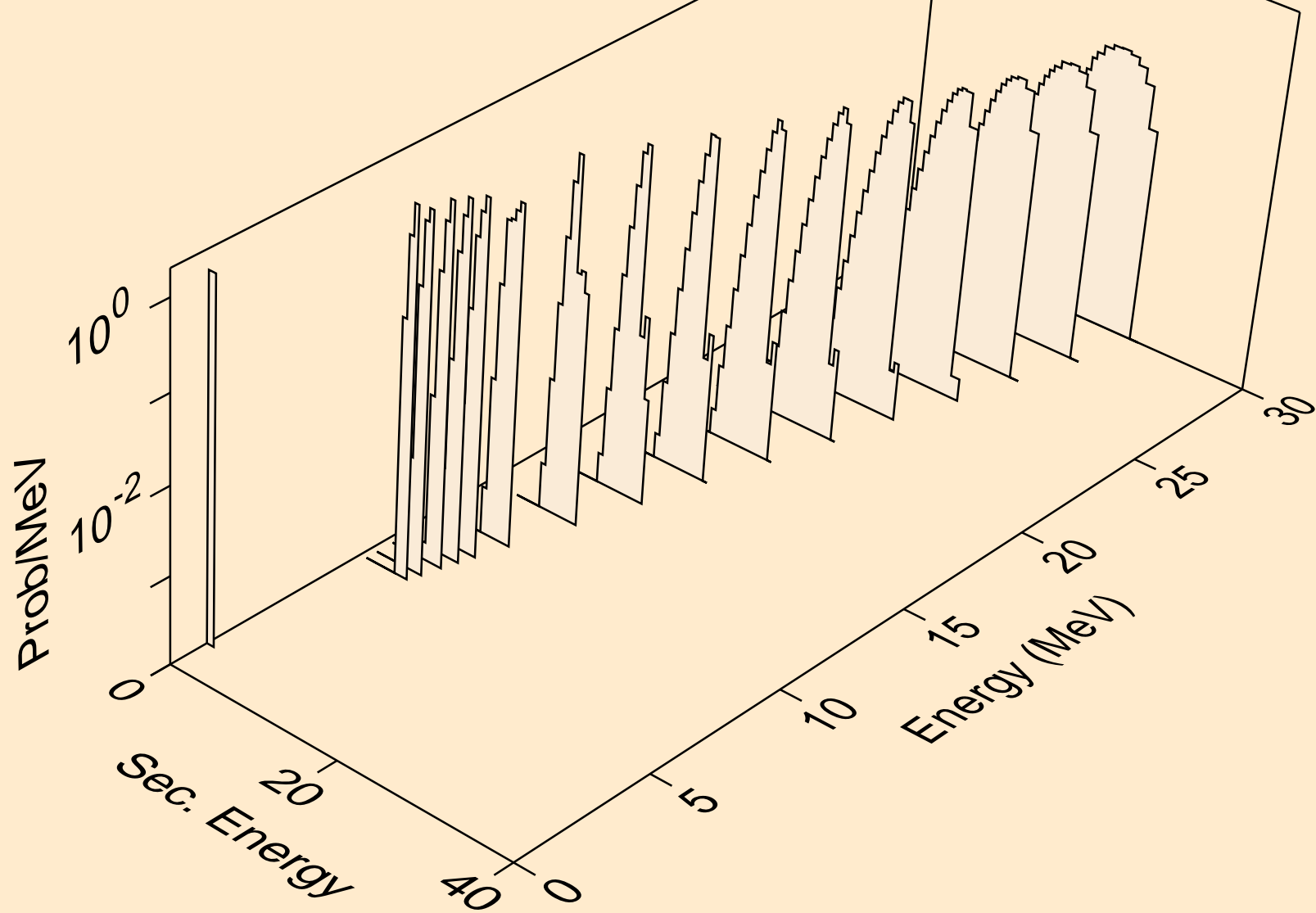

LU167M NEUTRON ACER TENDL-2024 LIBRARY; T=293.6K  
alphas from (n,x)

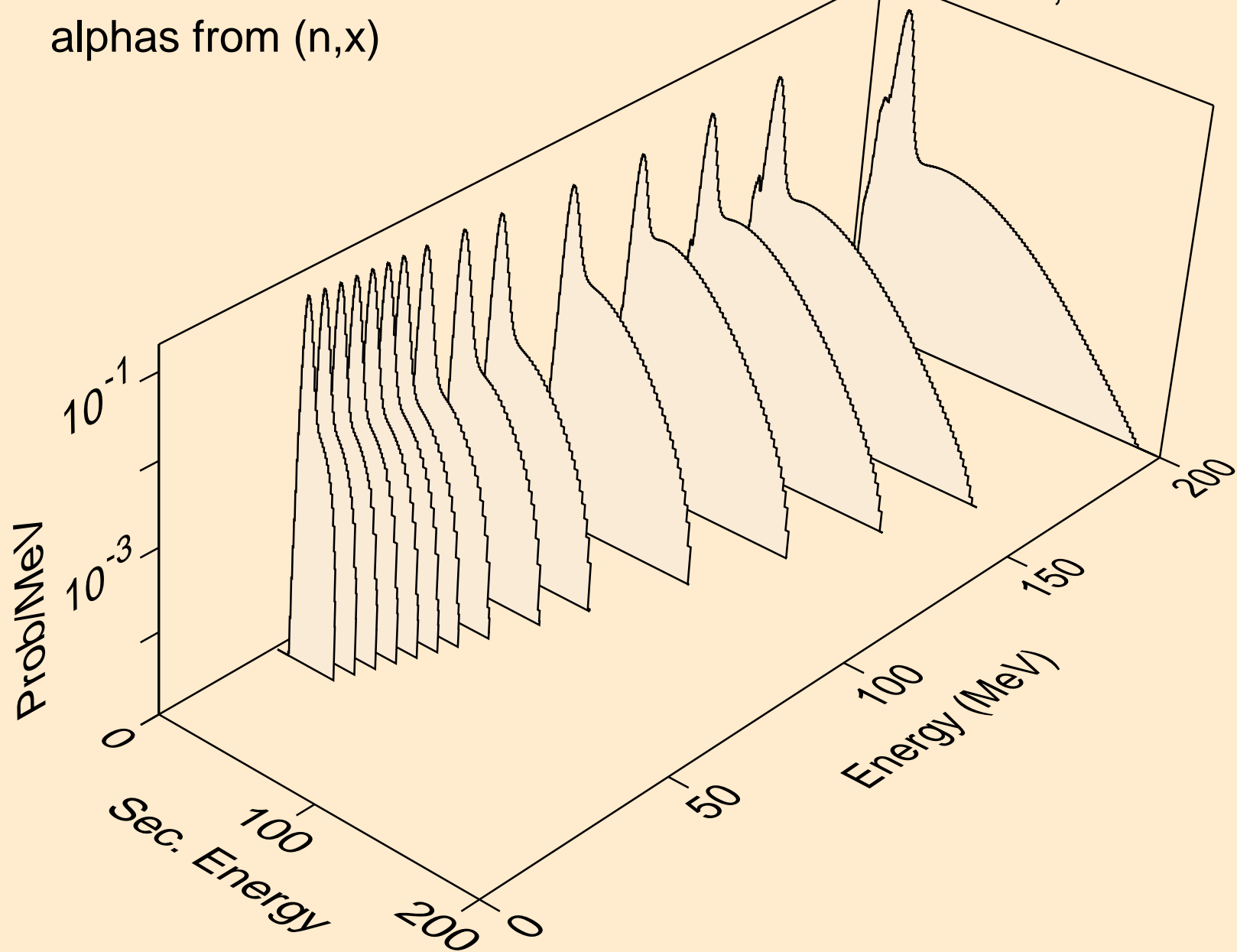

LU167M NEUTRON ACER TENDL-2024 LIBRARY; T=293.6K  
alphas from (n,n\*)a

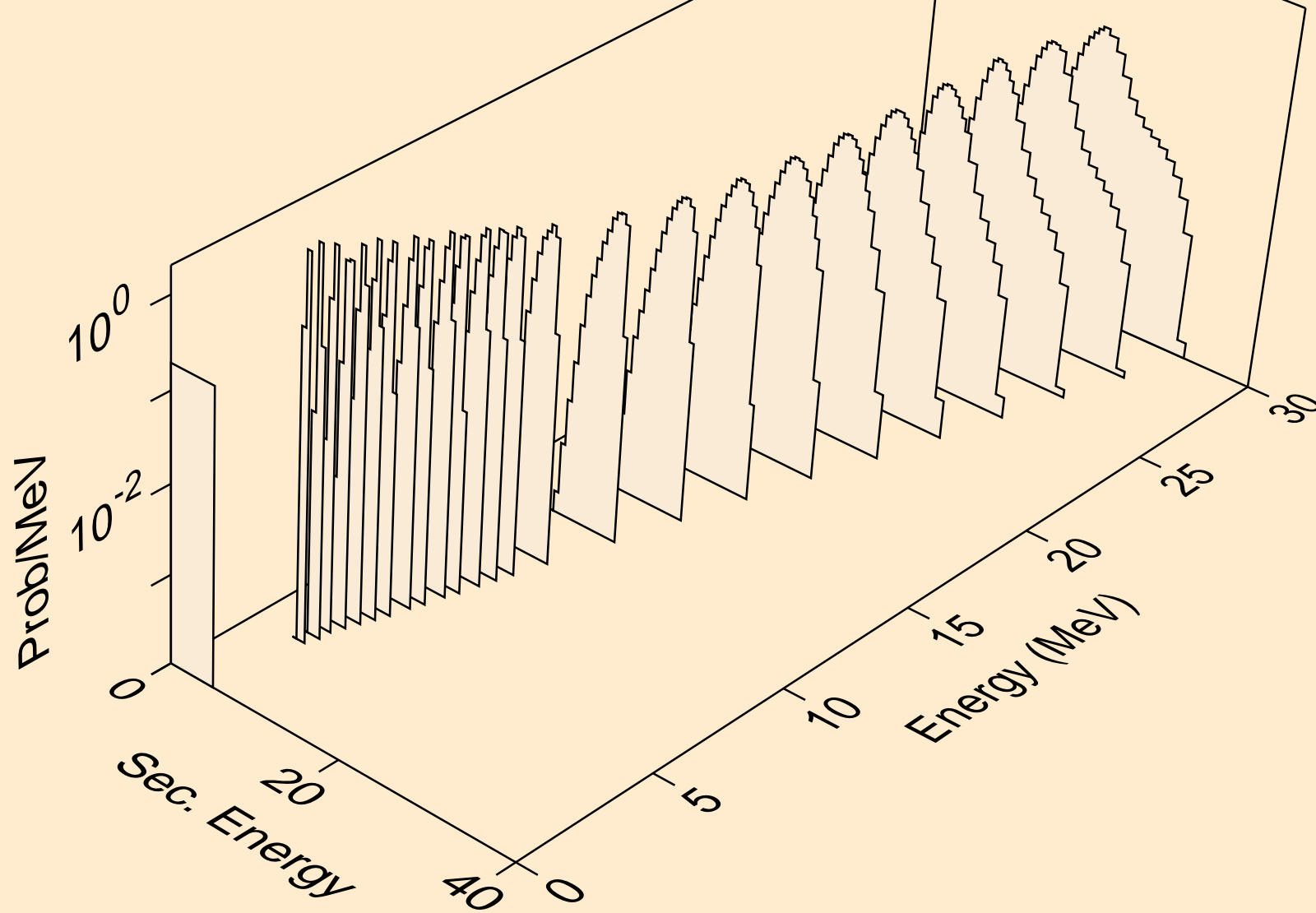

LU167M NEUTRON ACER TENDL-2024 LIBRARY; T=293.6K  
alphas from (n,2n)a

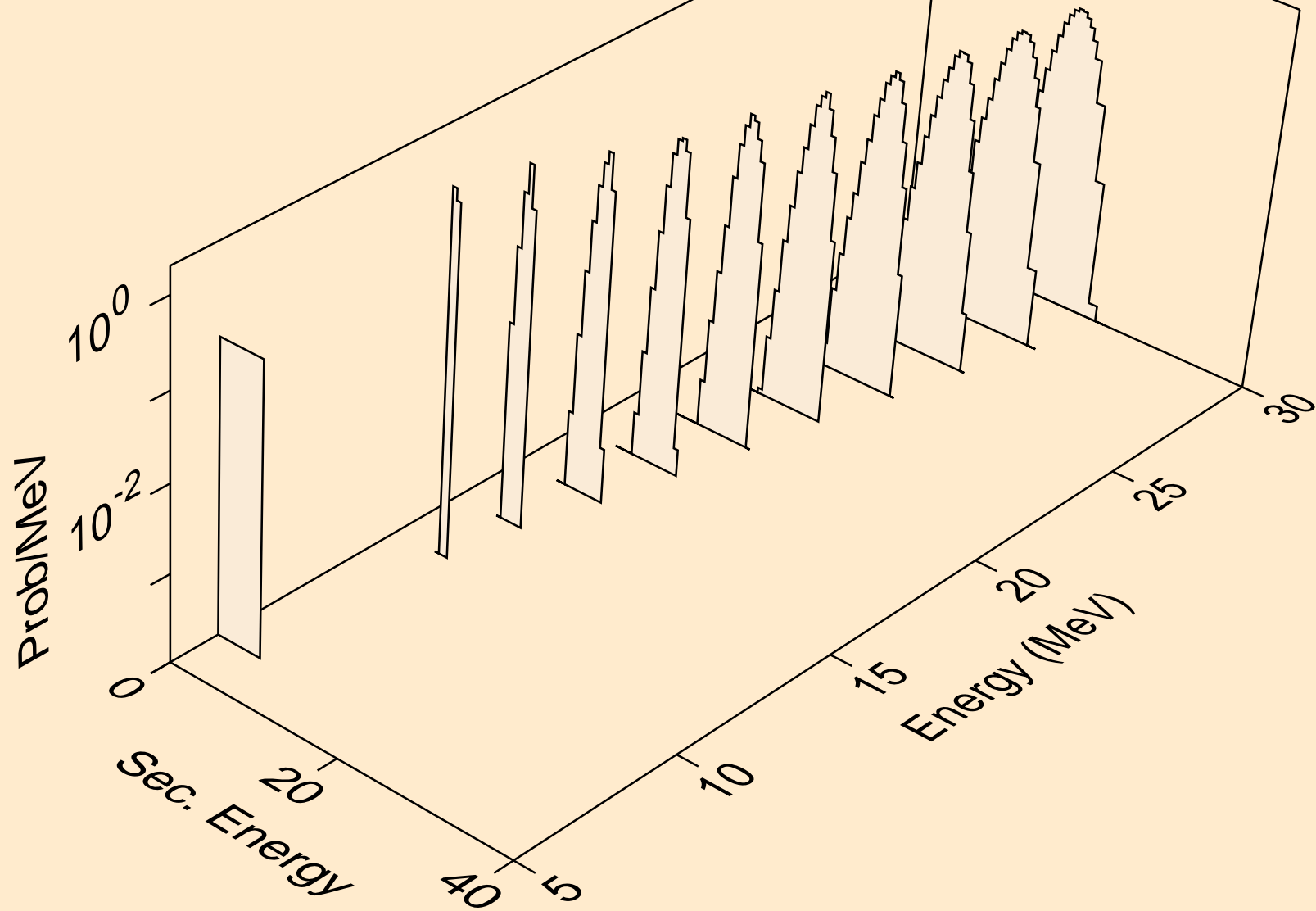

LU167M NEUTRON ACER TENDL-2024 LIBRARY; T=293.6K  
alphas from (n,3n)a

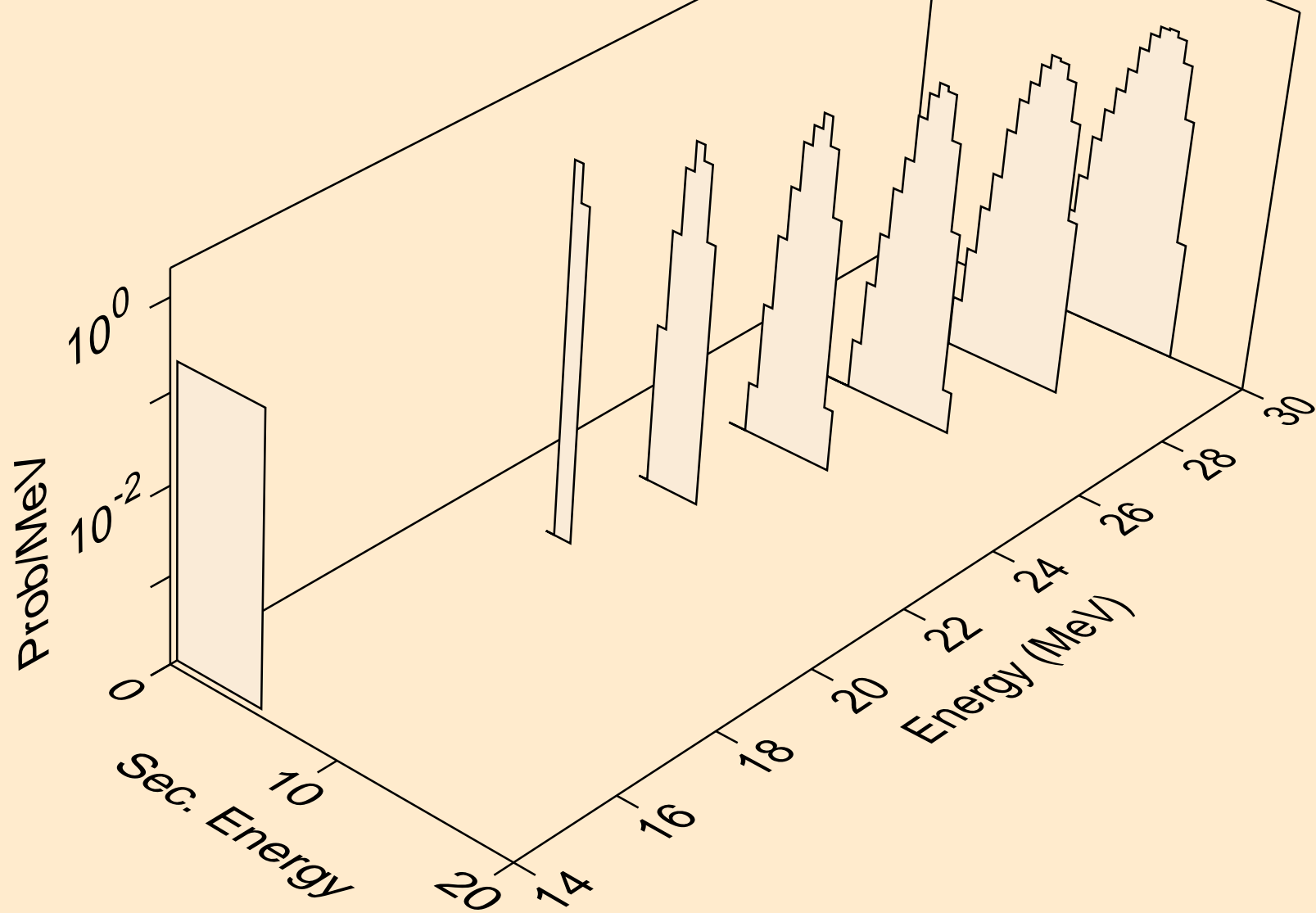

LU167M NEUTRON ACER TENDL-2024 LIBRARY; T=293.6K  
alphas from (n,n\*)2a

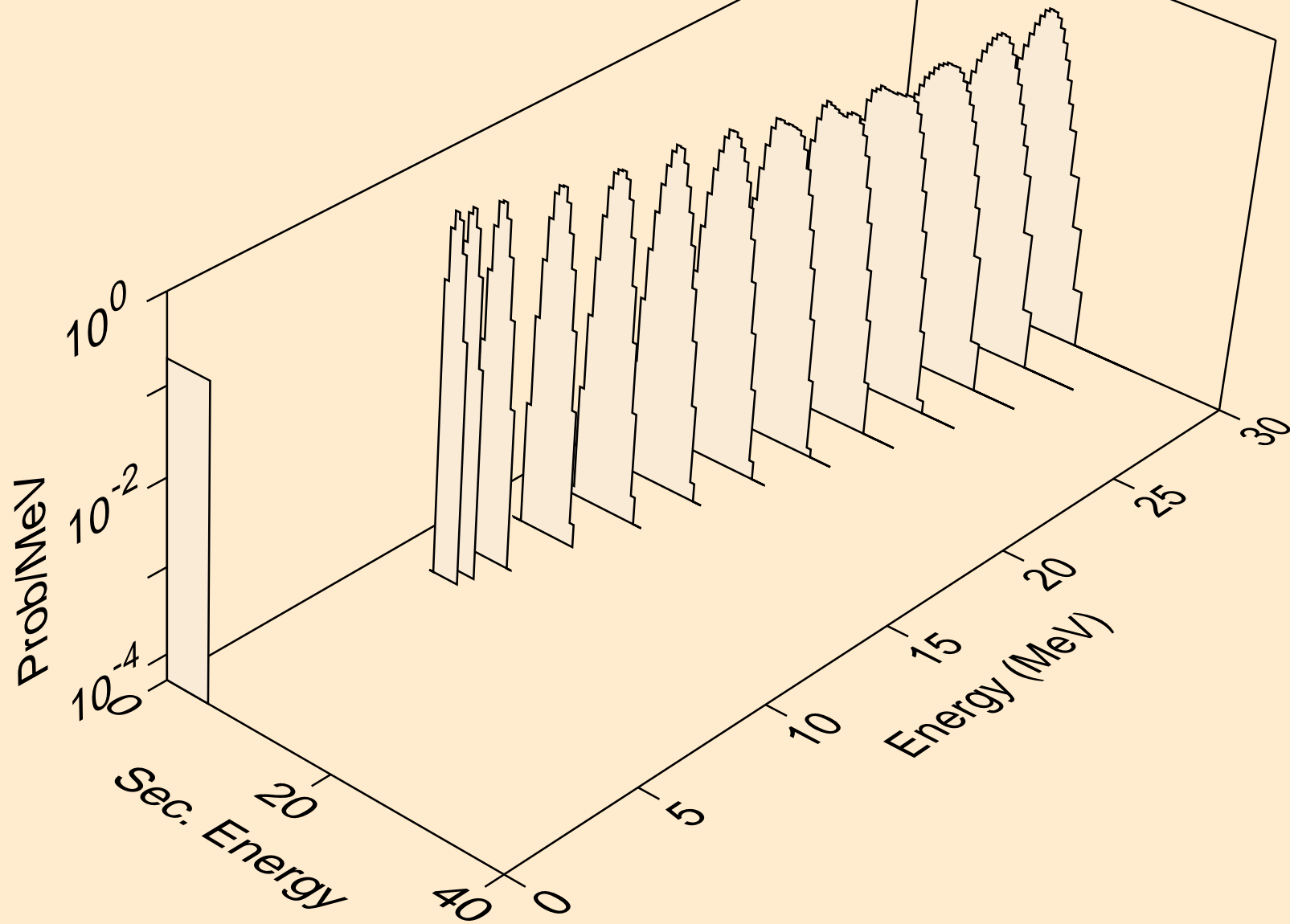

LU167M NEUTRON ACER TENDL-2024 LIBRARY; T=293.6K  
alphas from (n,2n)2a

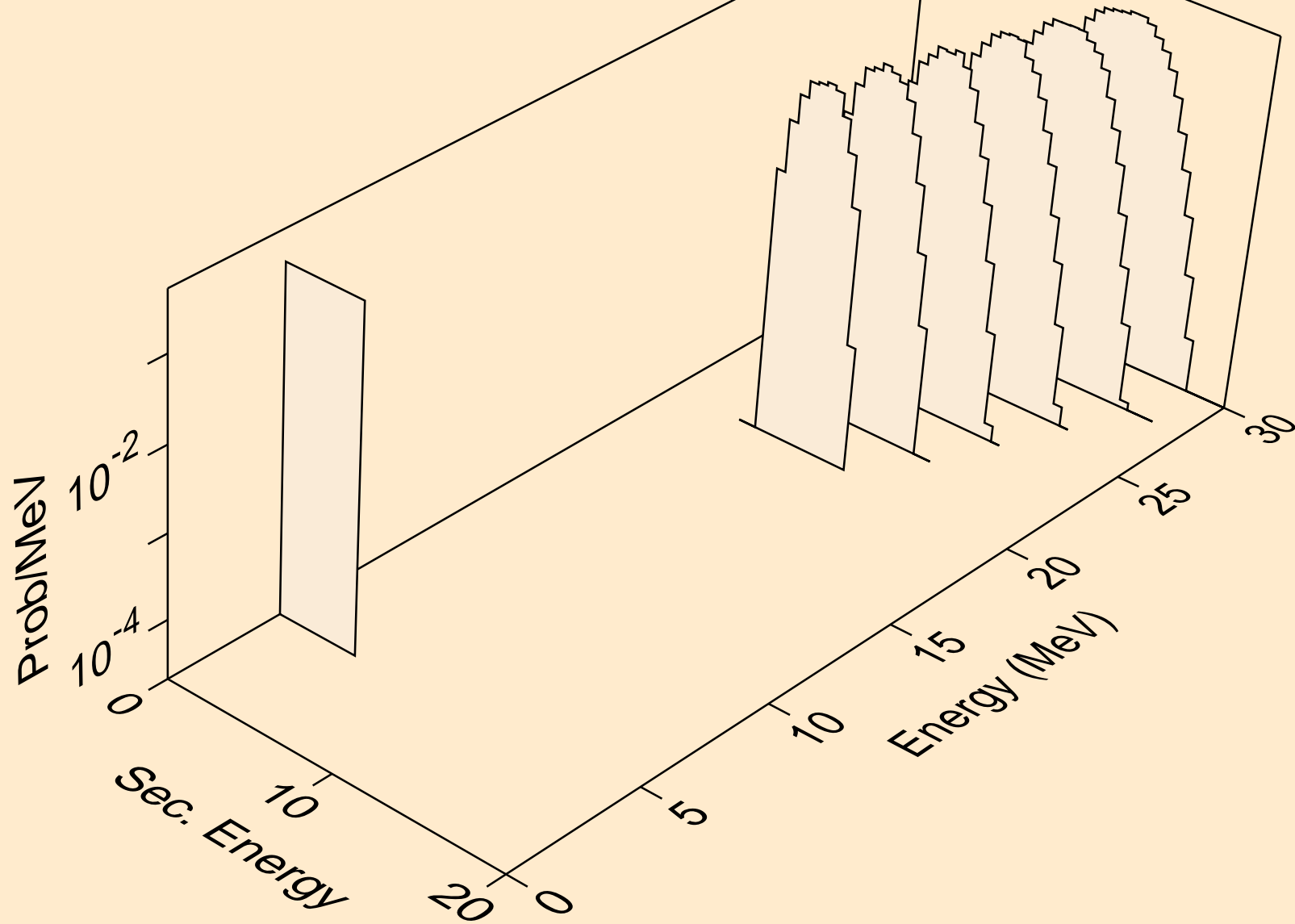

LU167M NEUTRON ACER TENDL-2024 LIBRARY; T=293.6K  
alphas from (n,npa)

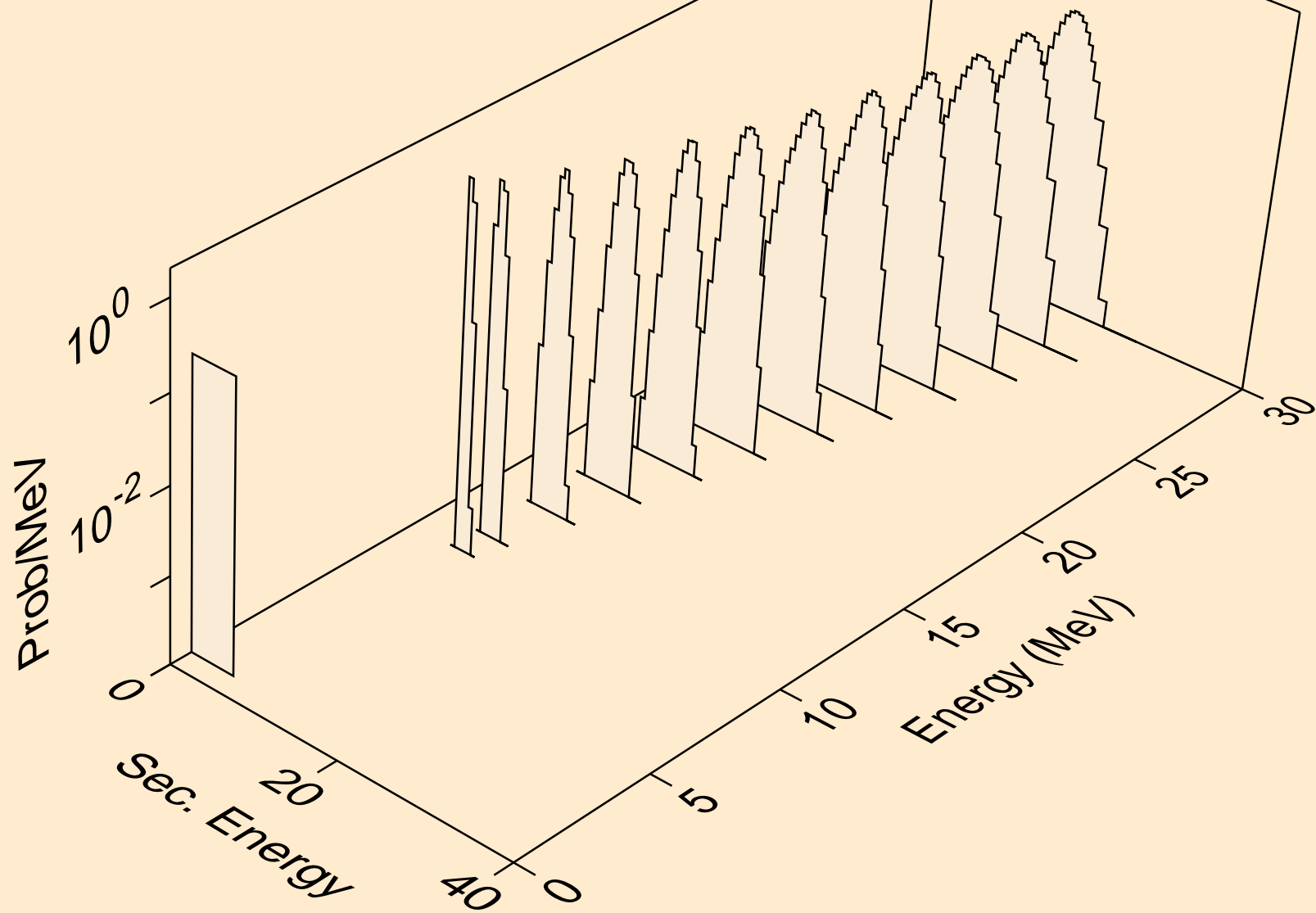

LU167M NEUTRON ACER TENDL-2024 LIBRARY; T=293.6K  
alphas from (n,a)

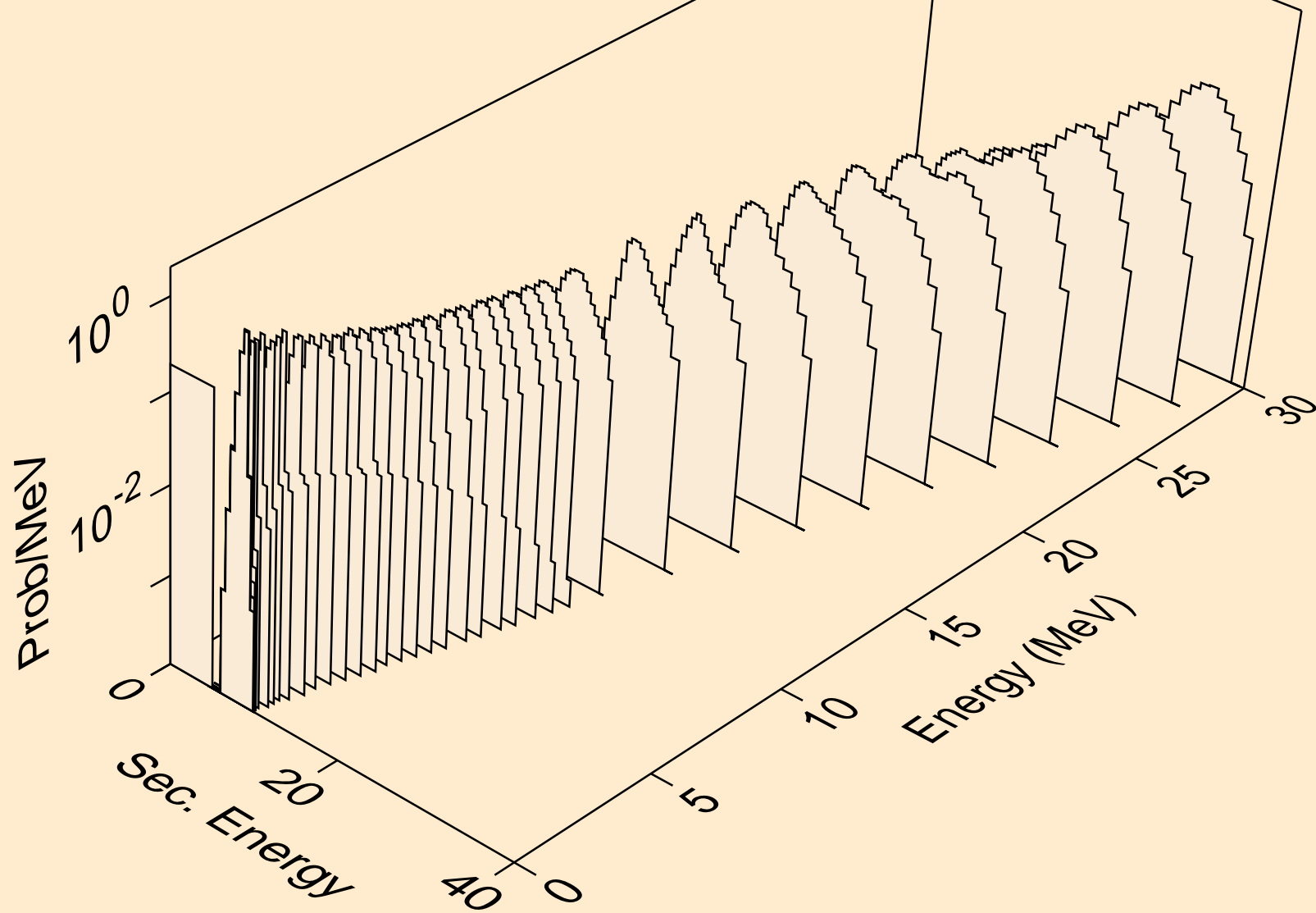

LU167M NEUTRON ACER TENDL-2024 LIBRARY; T=293.6K  
alphas from (n,2a)

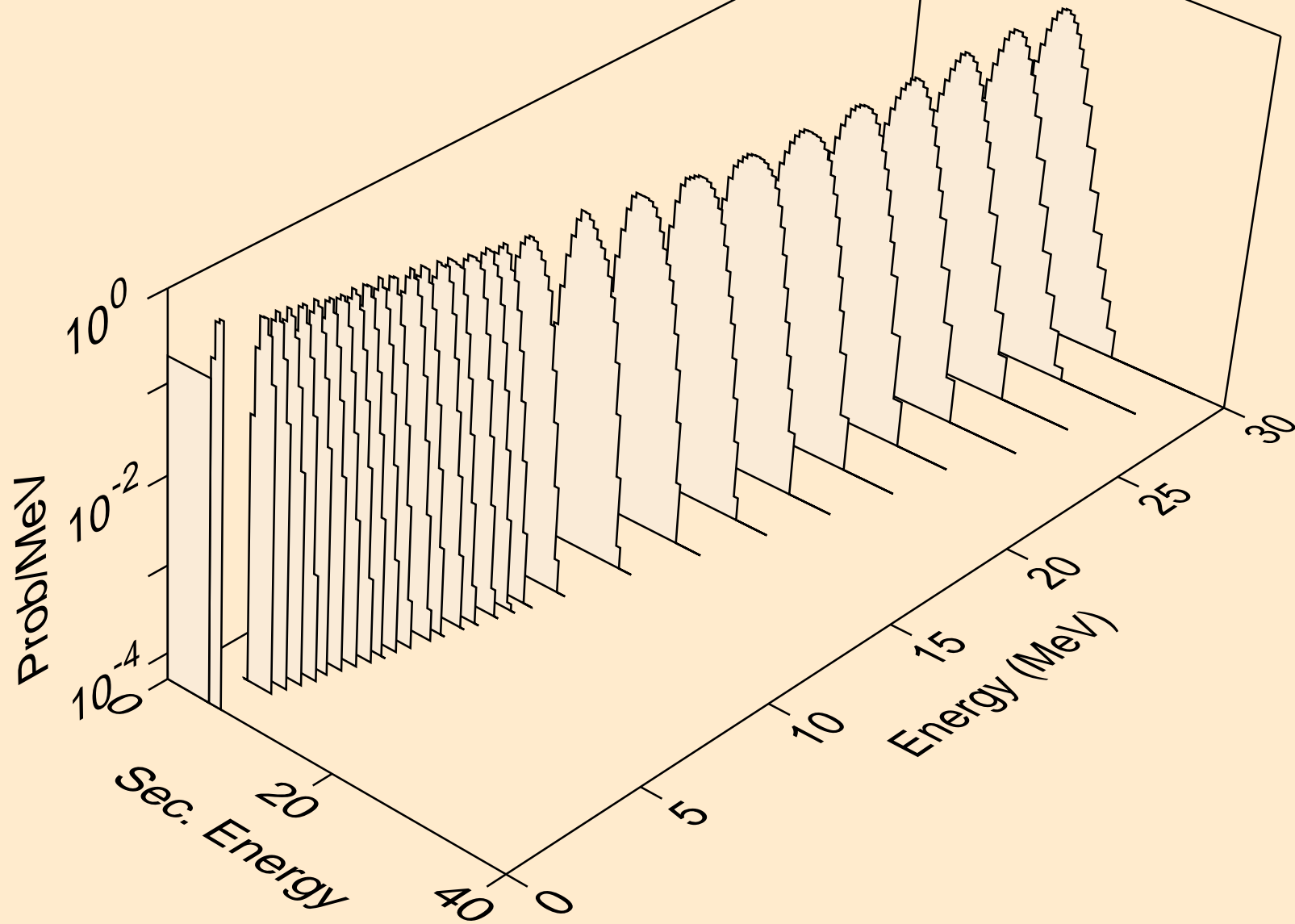

LU167M NEUTRON ACER TENDL-2024 LIBRARY; T=293.6K  
alphas from (n,pa)

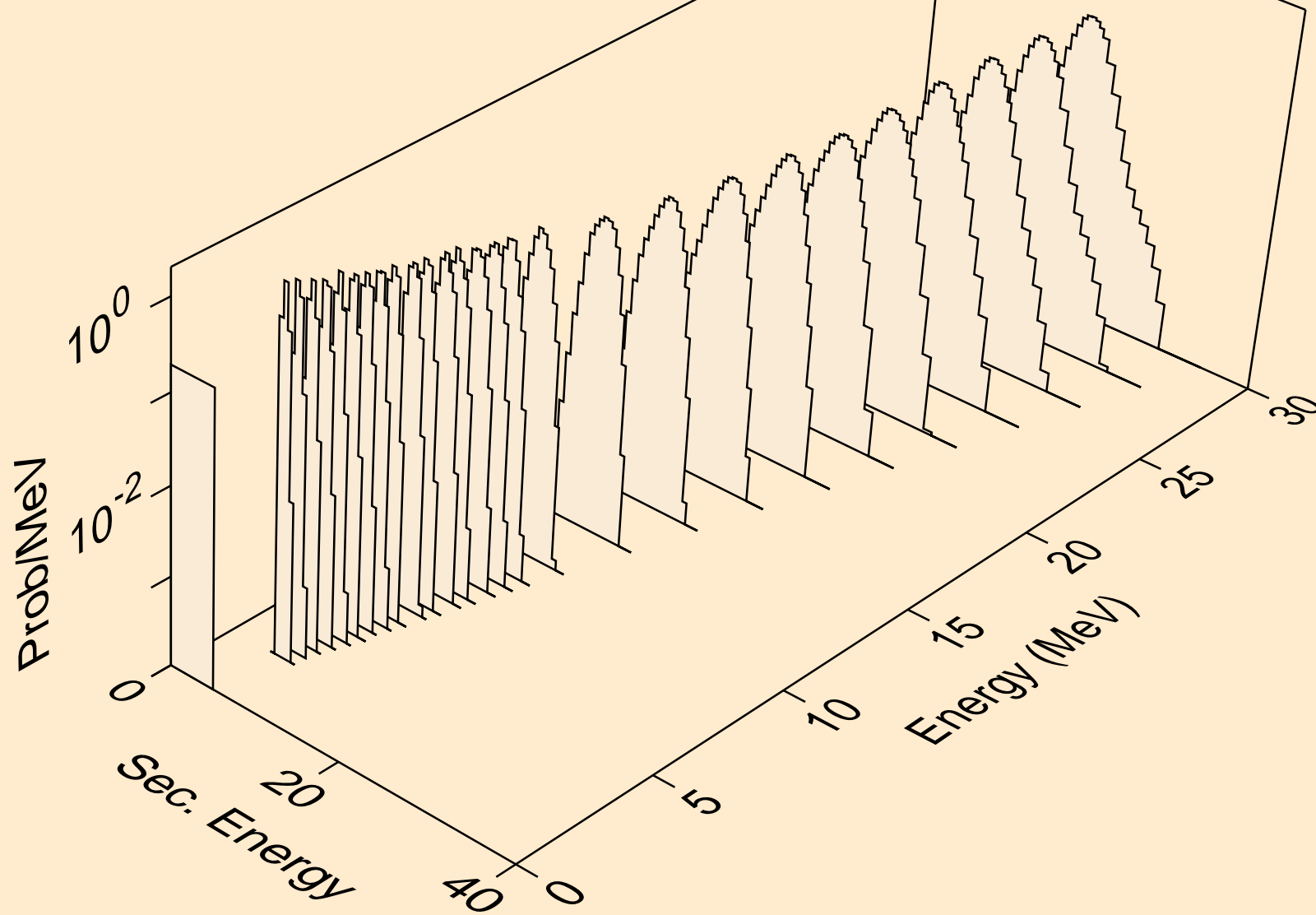

LU167M NEUTRON ACER TENDL-2024 LIBRARY; T=293.6K  
alphas from (n,da)

