

# LU186 NEUTRON ACER TENDL-2024 LIBRARY; T=293.6K

## Principal cross sections

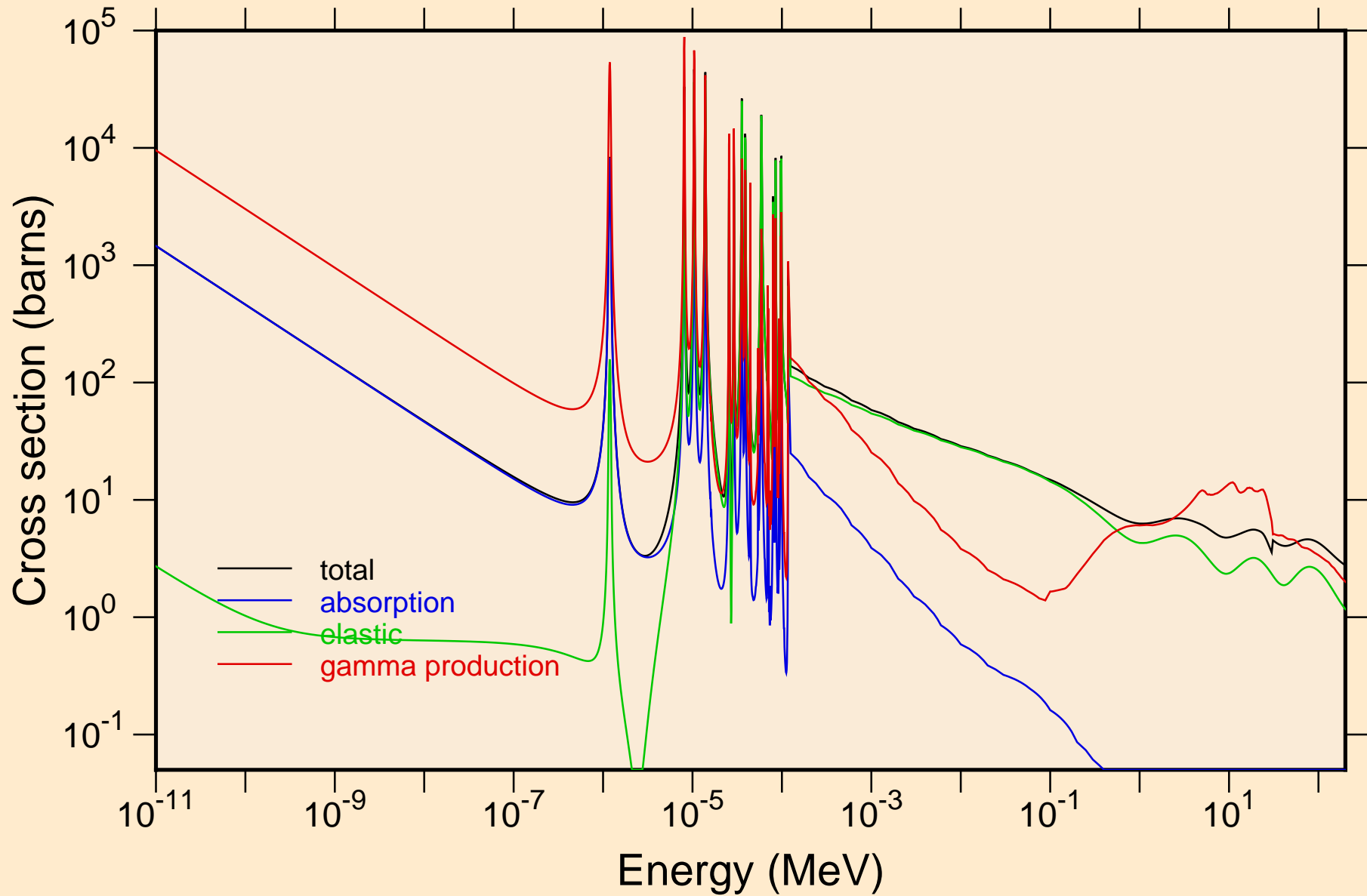

LU186 NEUTRON ACER TENDL-2024 LIBRARY; T=293.6K  
resonance total cross section

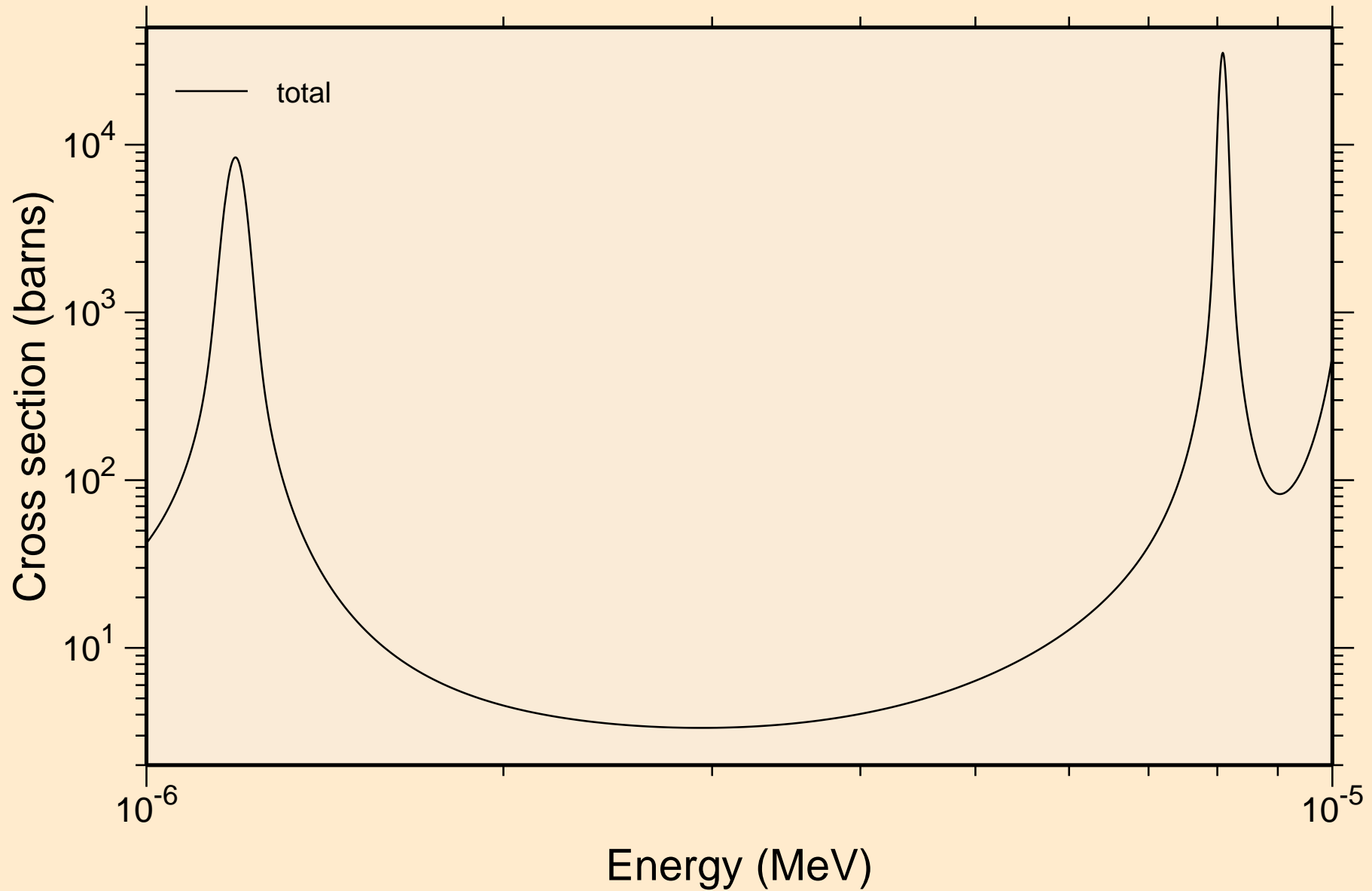

LU186 NEUTRON ACER TENDL-2024 LIBRARY; T=293.6K  
resonance total cross section

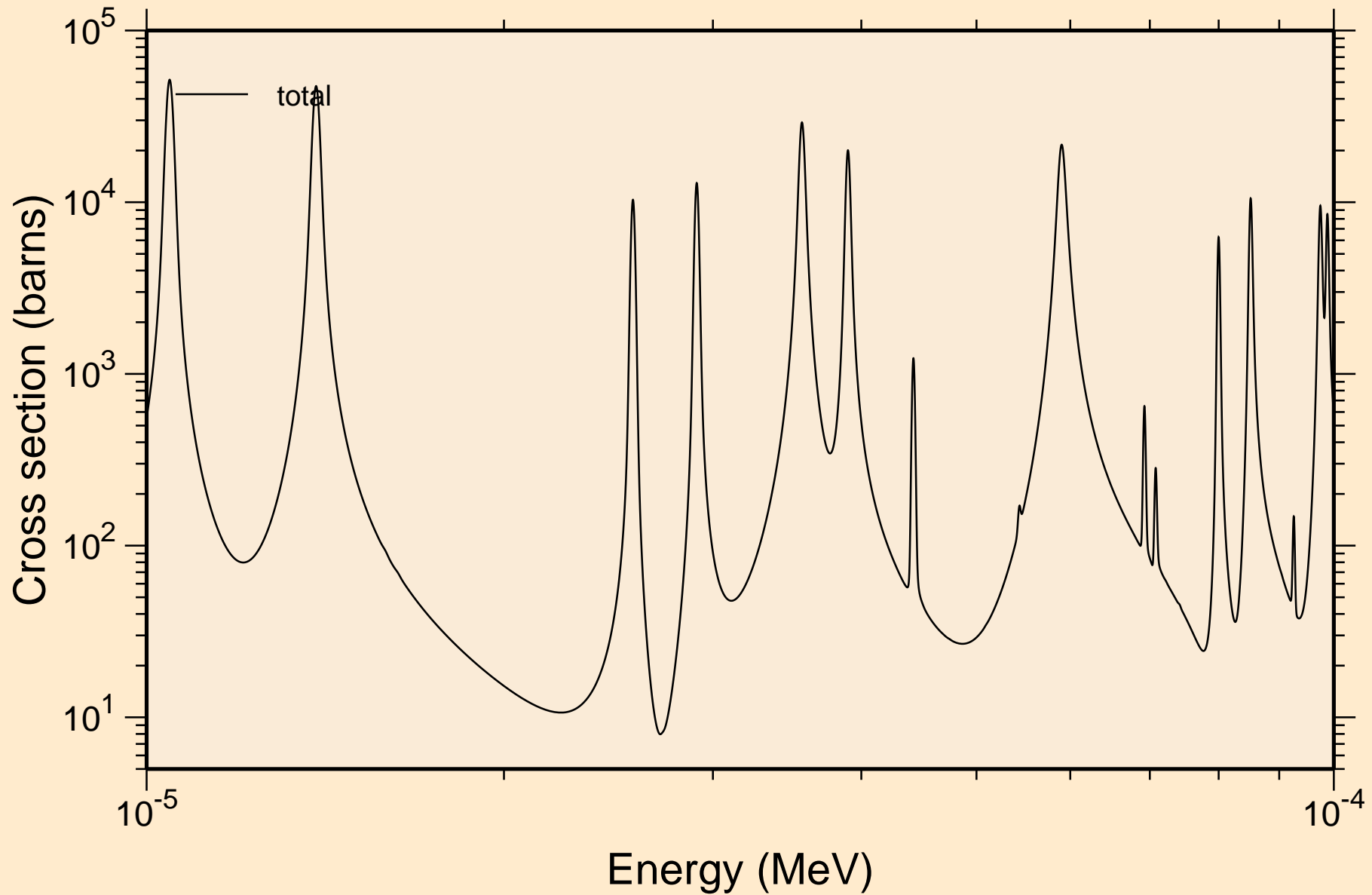

LU186 NEUTRON ACER TENDL-2024 LIBRARY; T=293.6K  
resonance total cross section

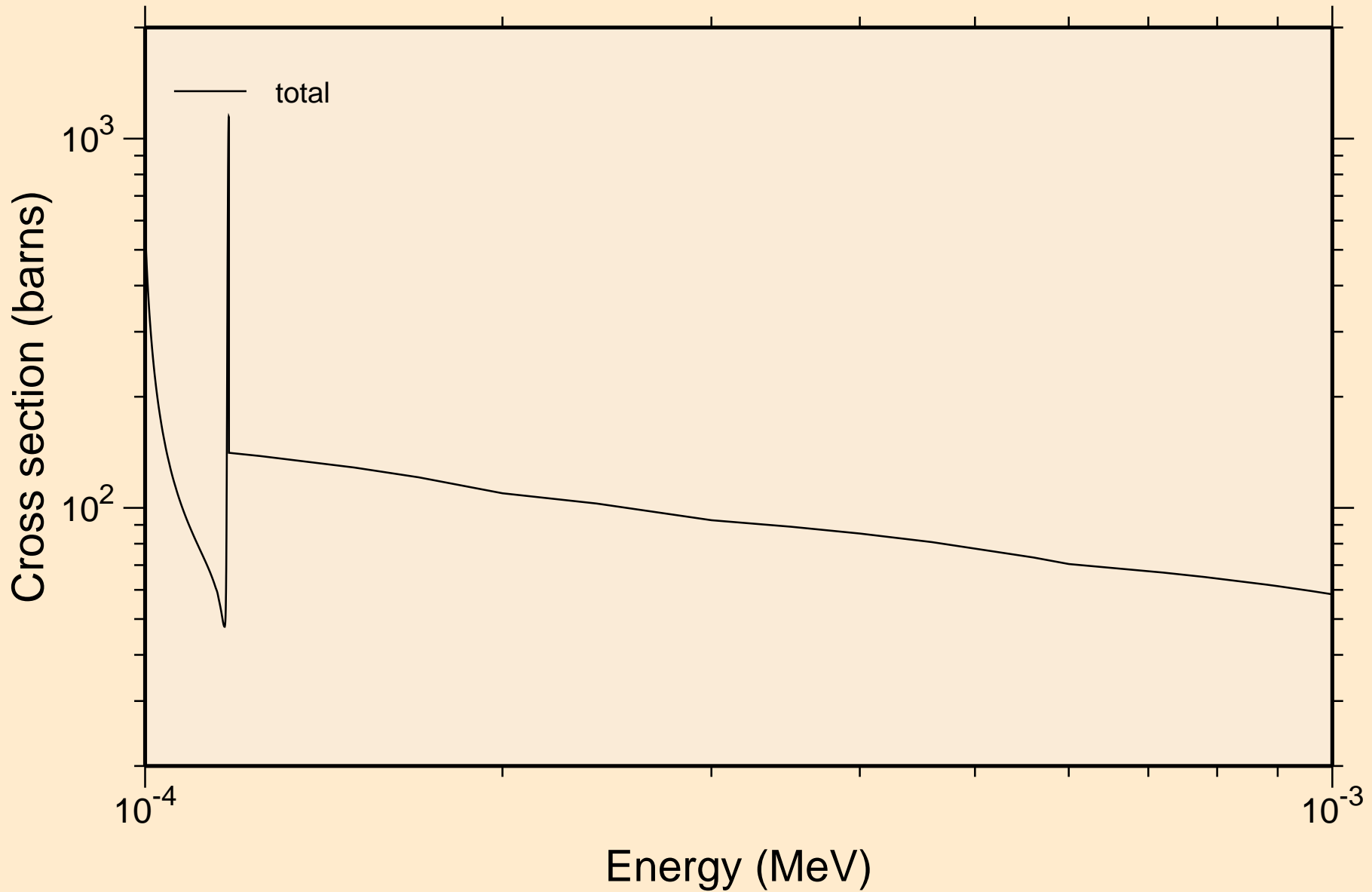

LU186 NEUTRON ACER TENDL-2024 LIBRARY; T=293.6K  
resonance total cross section

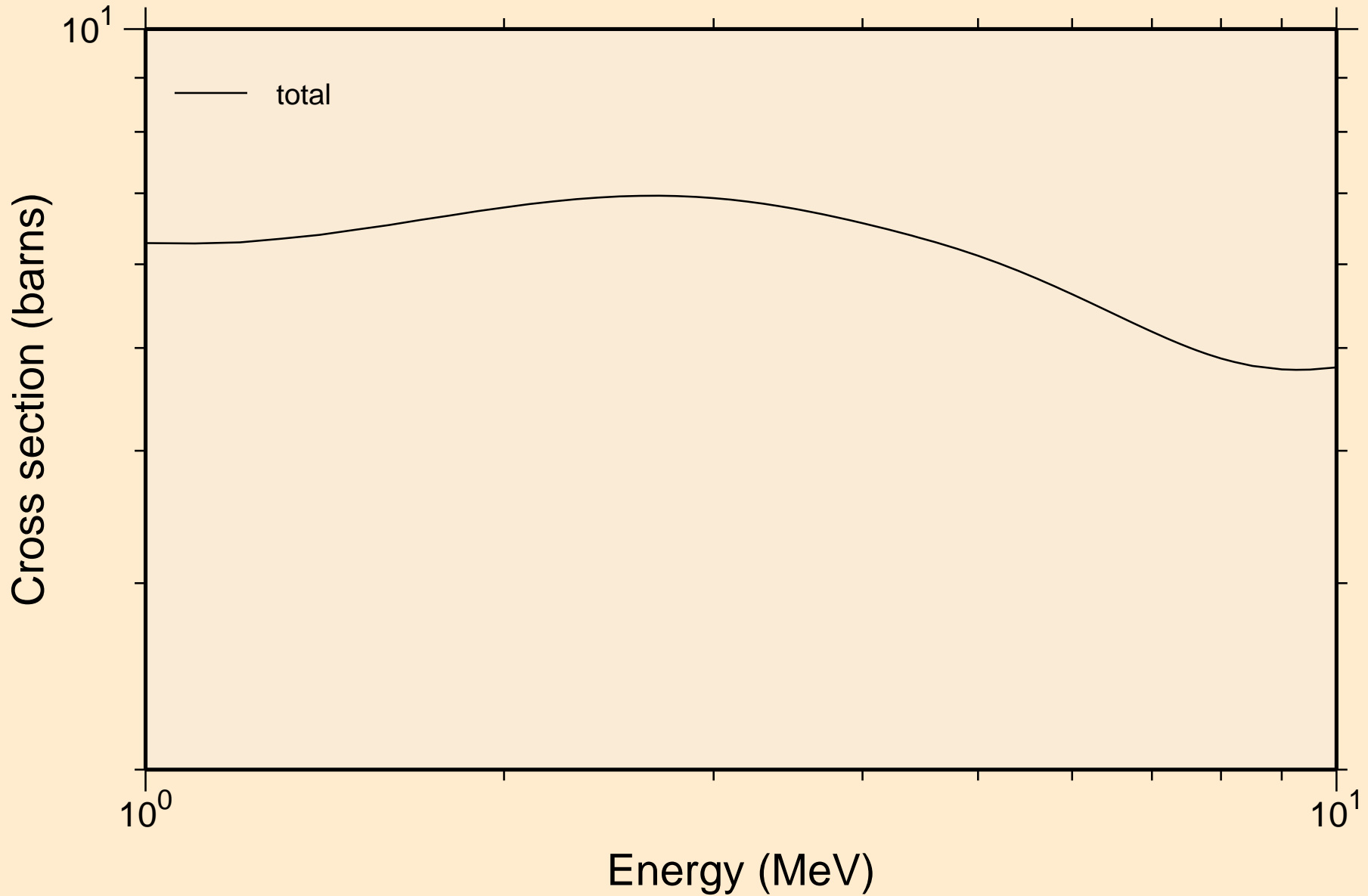

LU186 NEUTRON ACER TENDL-2024 LIBRARY; T=293.6K  
resonance absorption cross sections

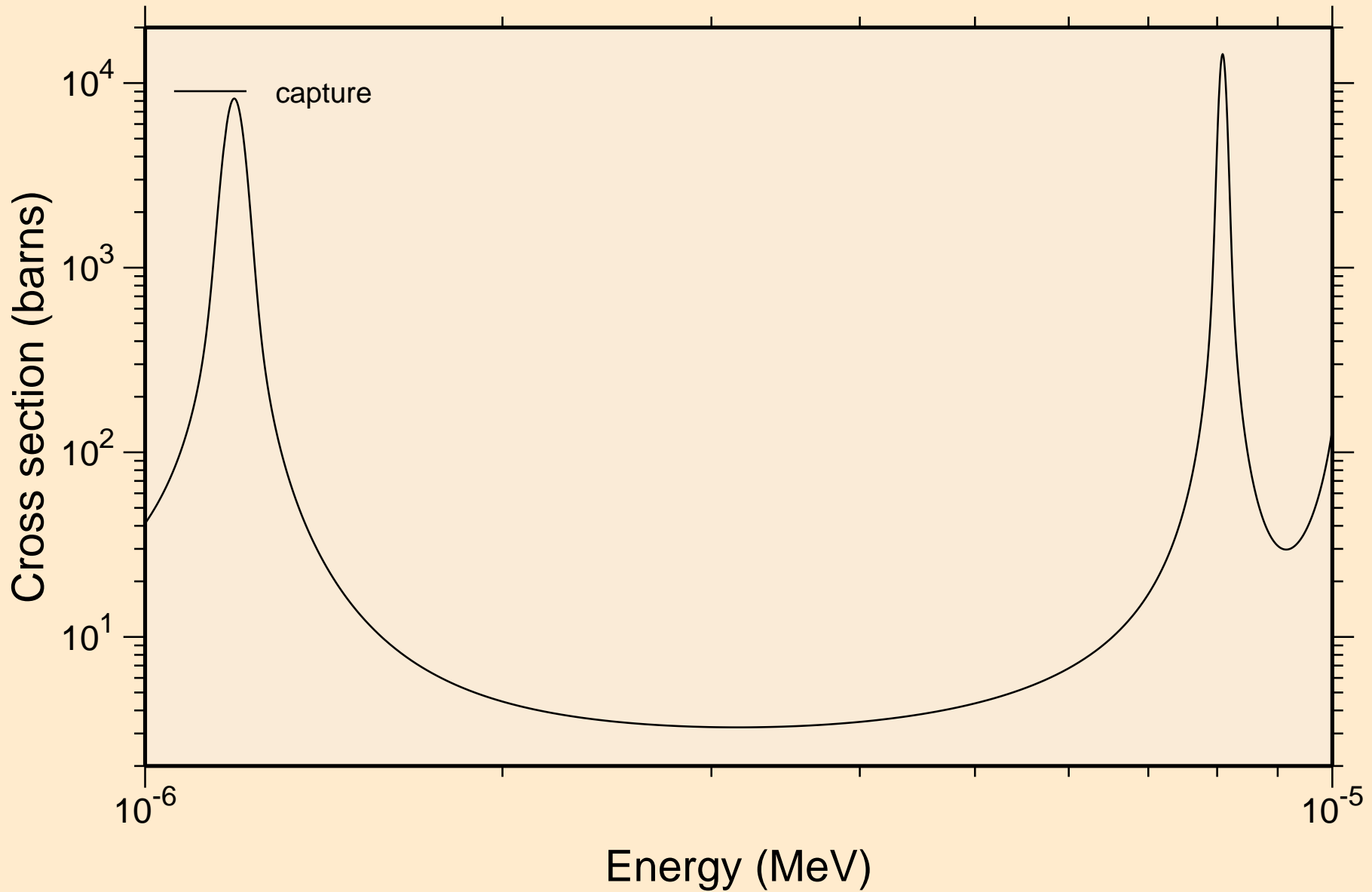

LU186 NEUTRON ACER TENDL-2024 LIBRARY; T=293.6K  
resonance absorption cross sections

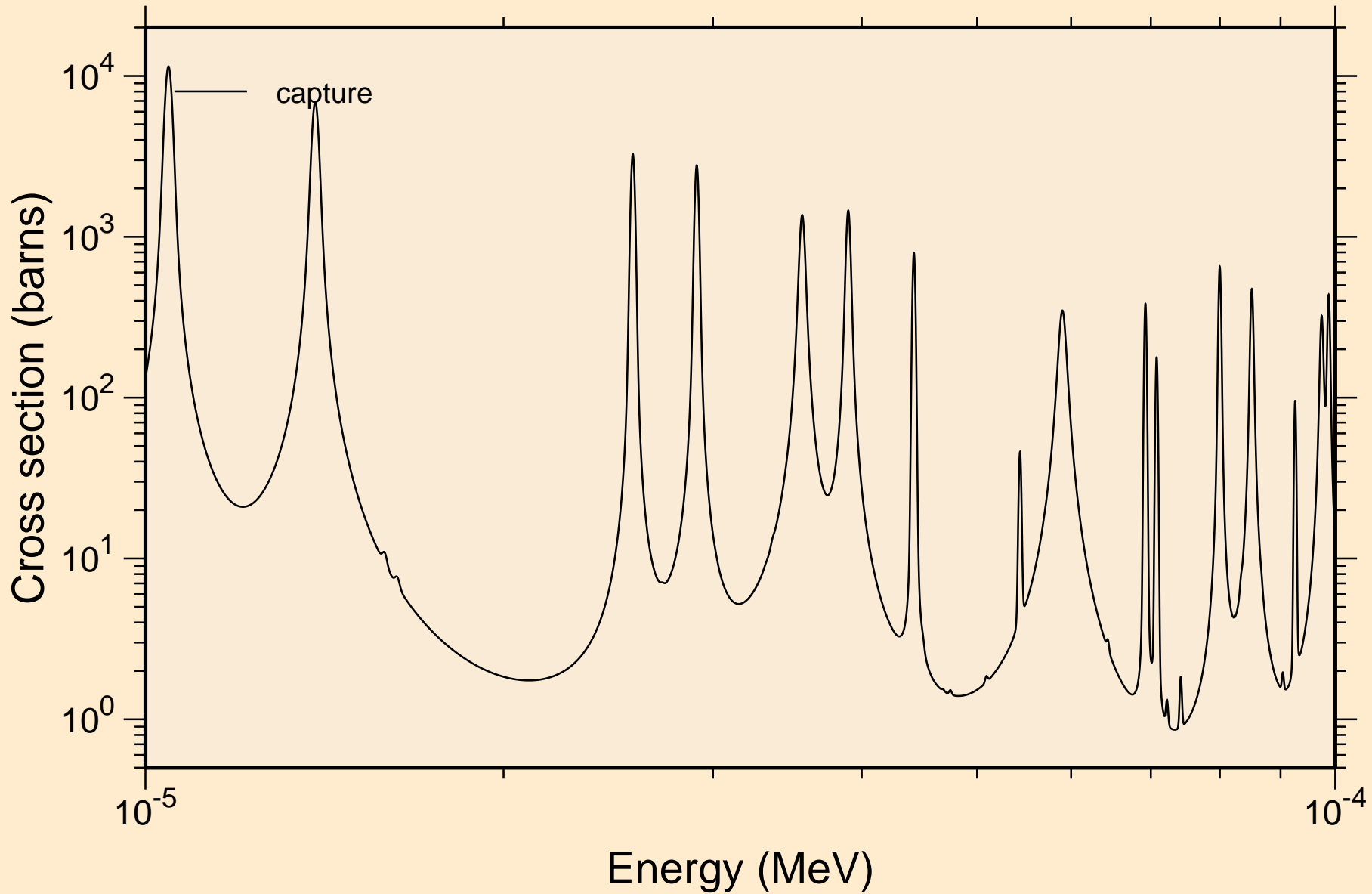

LU186 NEUTRON ACER TENDL-2024 LIBRARY; T=293.6K  
resonance absorption cross sections

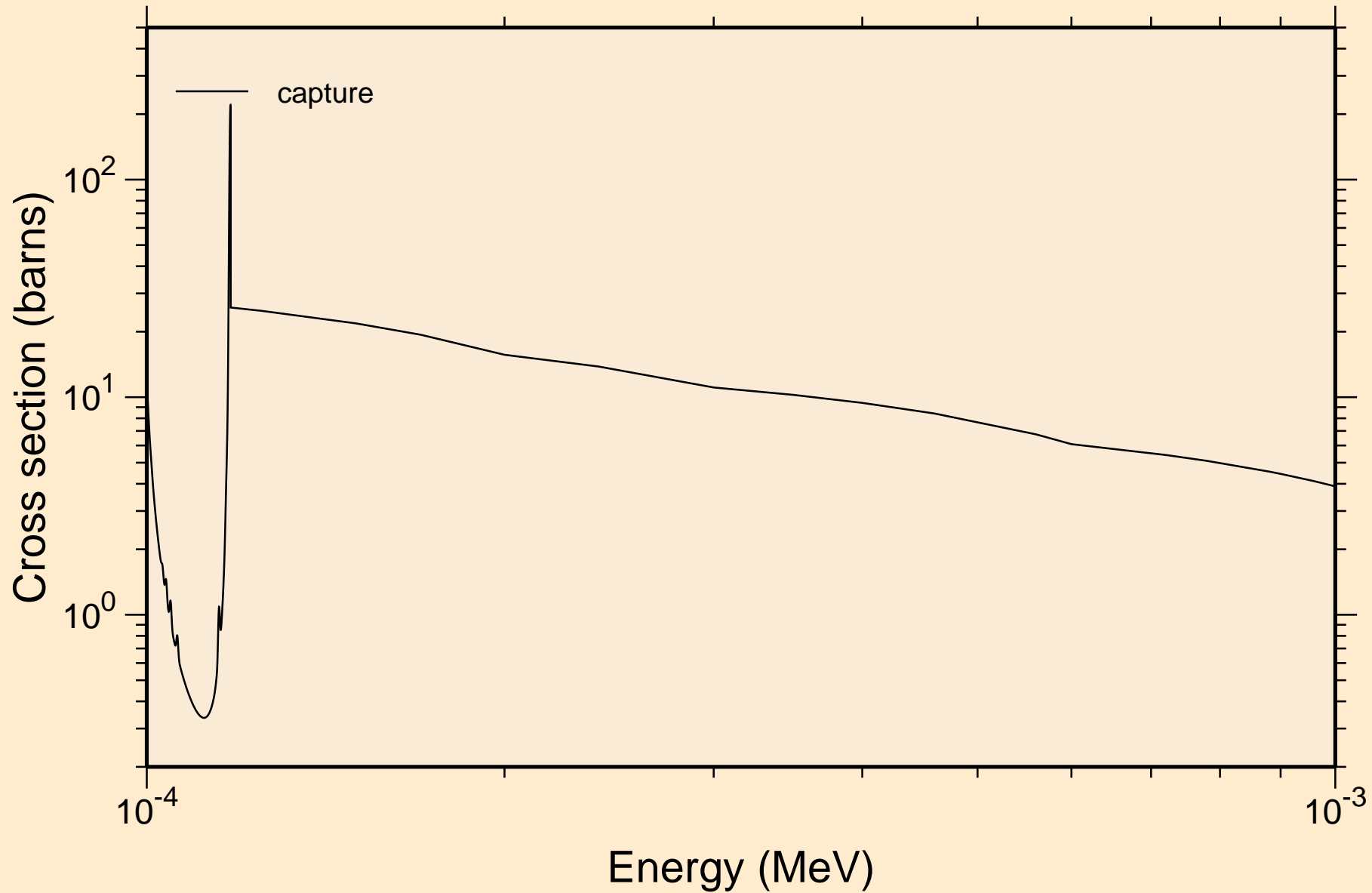

LU186 NEUTRON ACER TENDL-2024 LIBRARY; T=293.6K  
resonance absorption cross sections

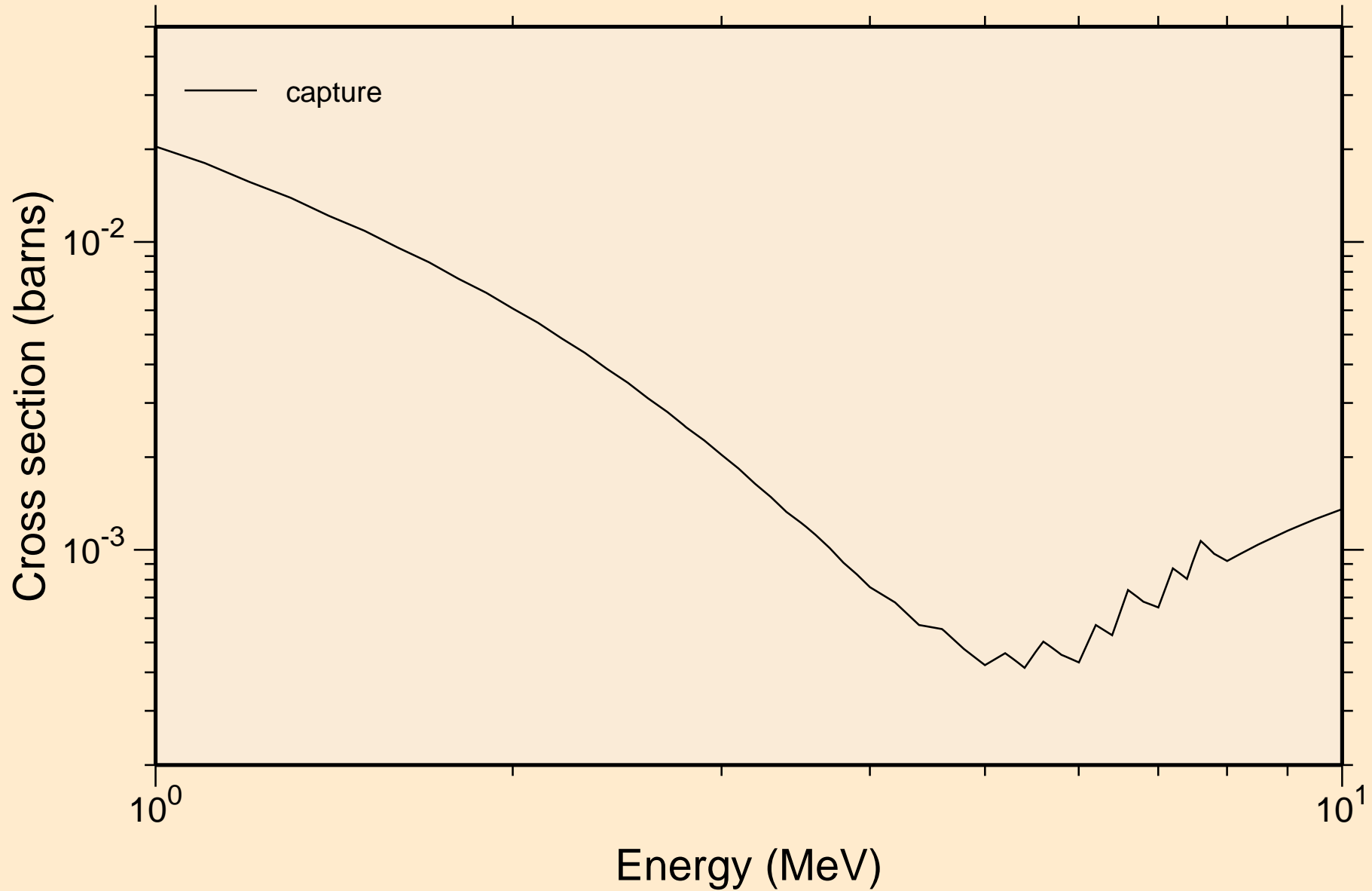

LU186 NEUTRON ACER TENDL-2024 LIBRARY; T=293.6K  
Heating

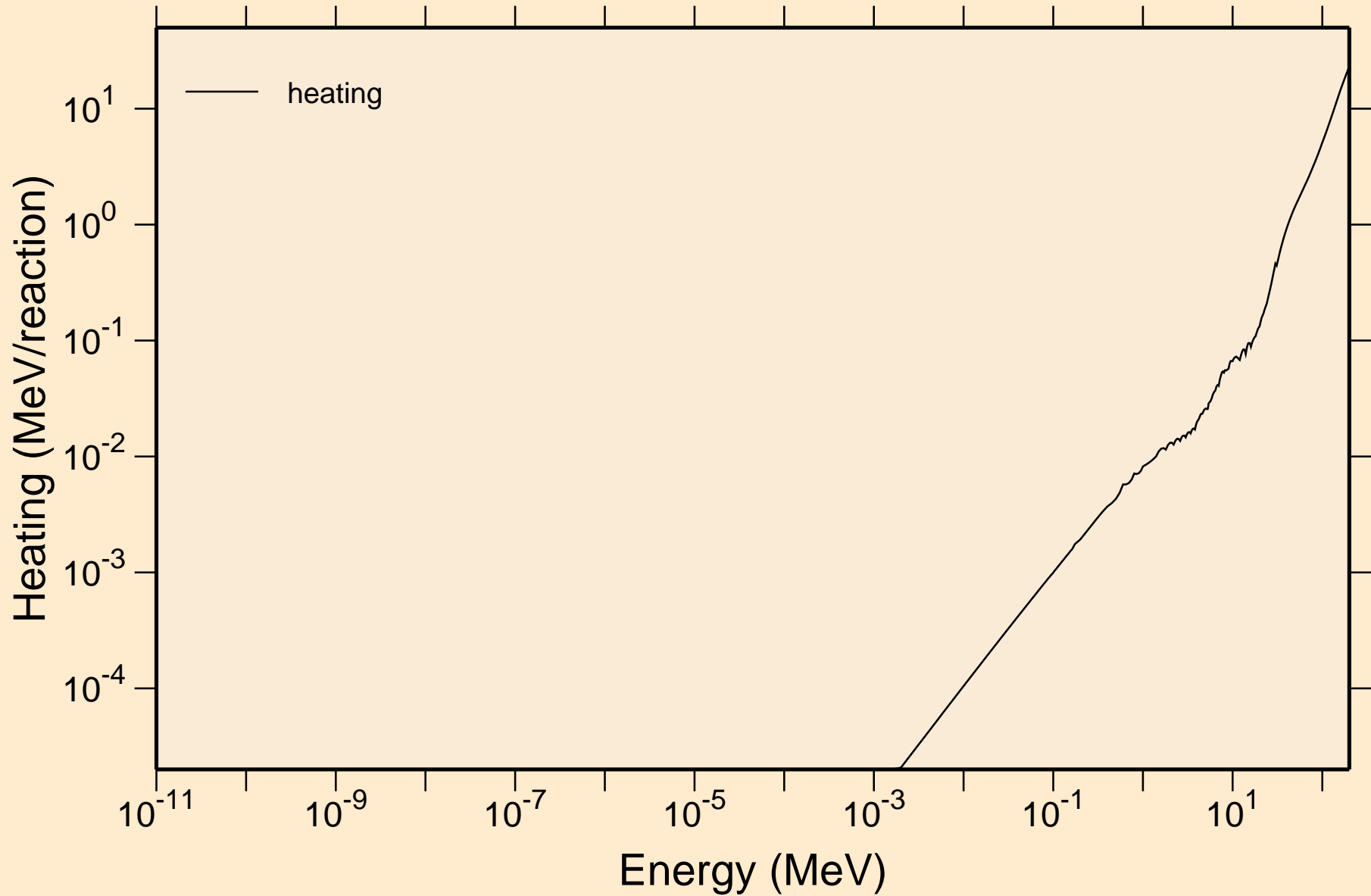

LU186 NEUTRON ACER TENDL-2024 LIBRARY; T=293.6K  
Damage

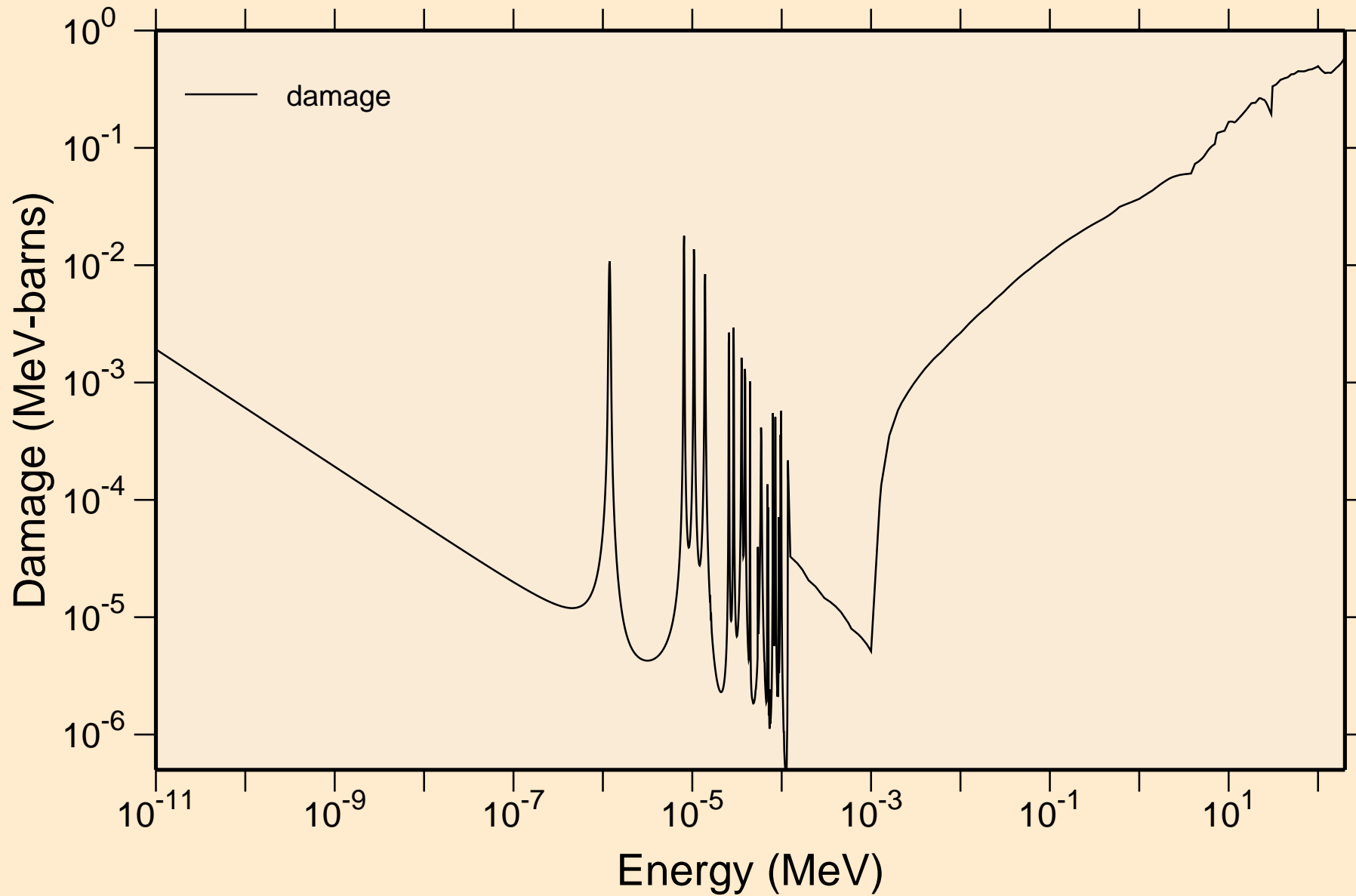

LU186 NEUTRON ACER TENDL-2024 LIBRARY; T=293.6K  
Non-threshold reactions

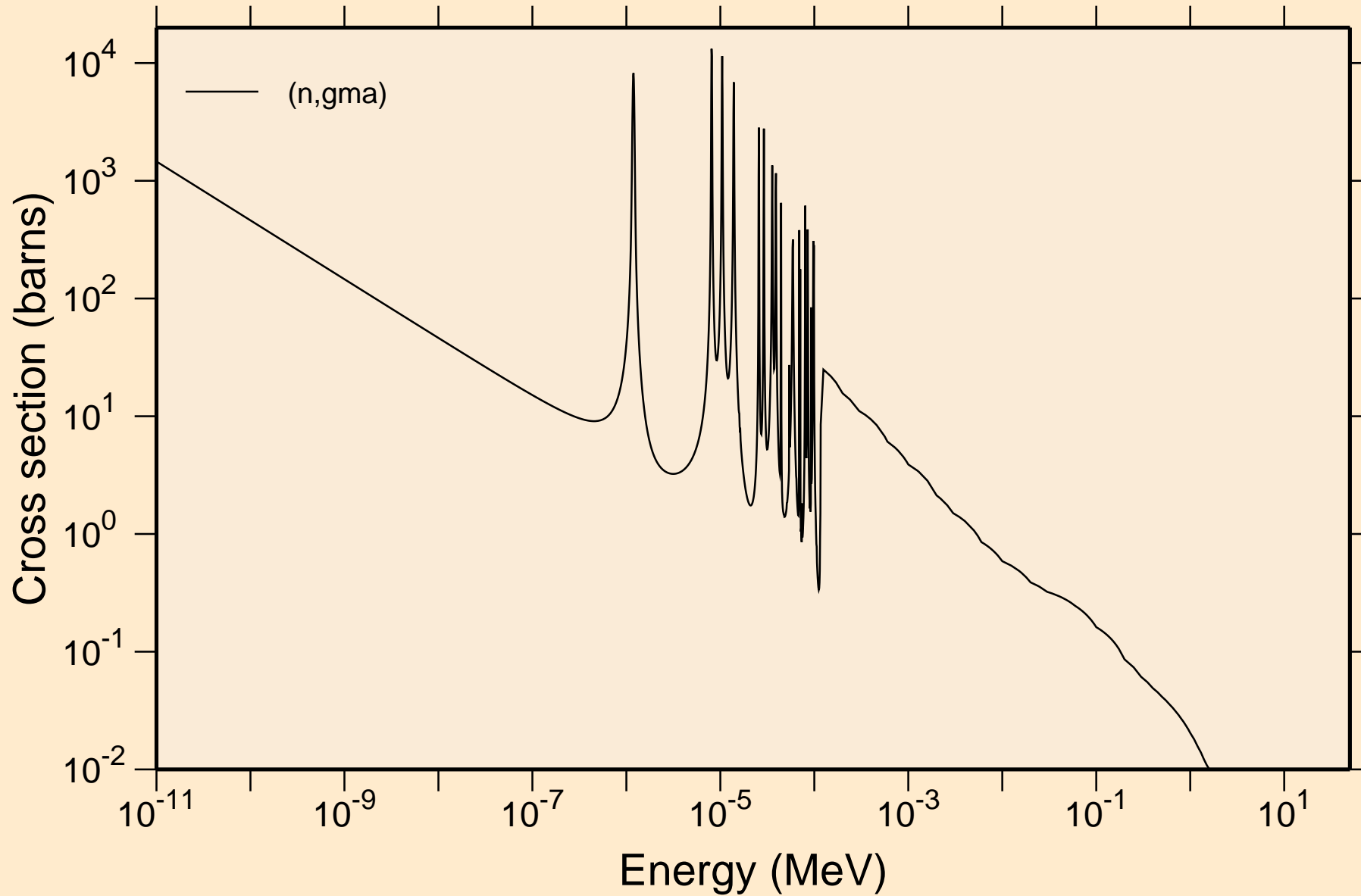

LU186 NEUTRON ACER TENDL-2024 LIBRARY; T=293.6K  
Principal cross sections

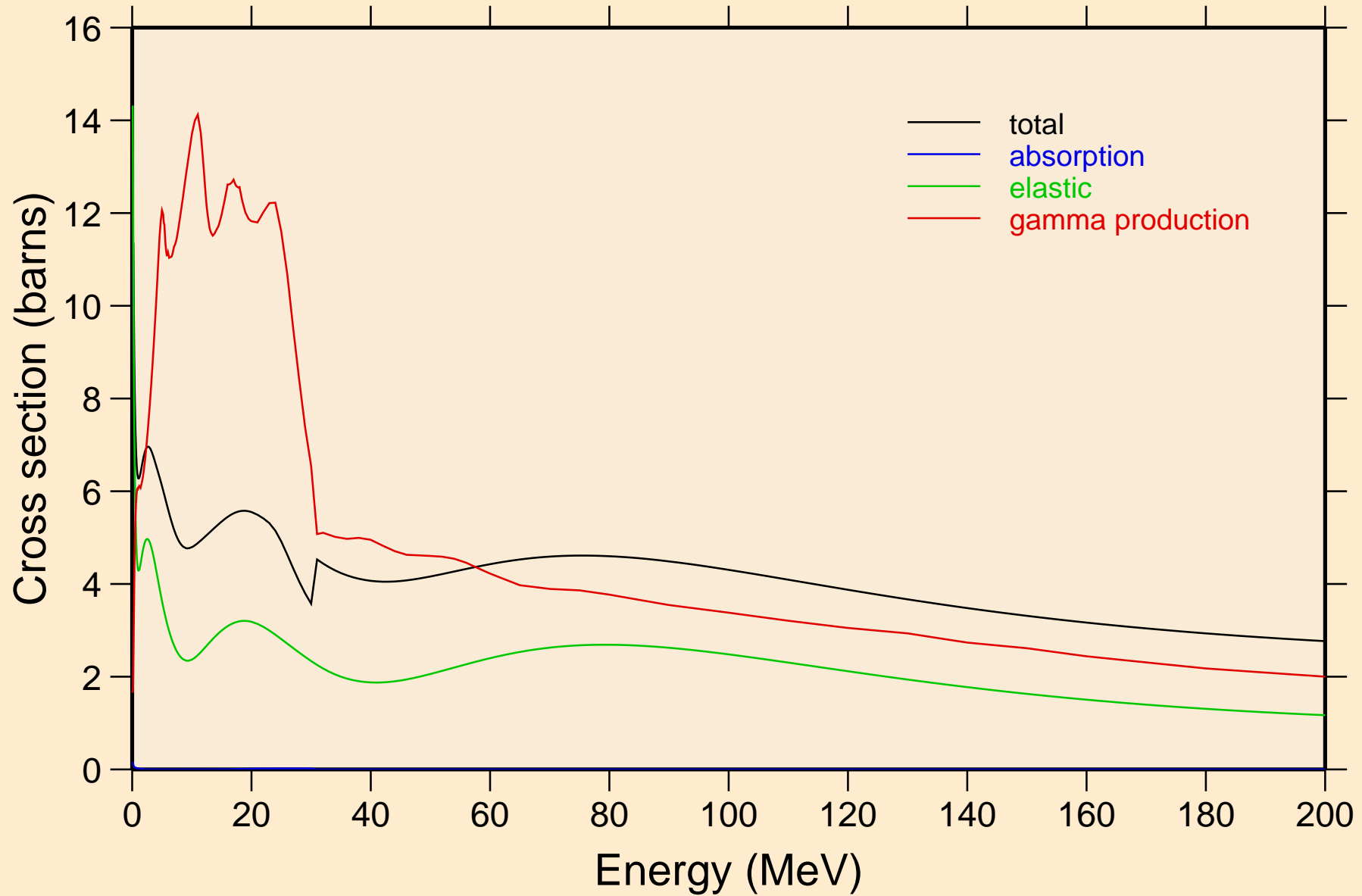

LU186 NEUTRON ACER TENDL-2024 LIBRARY; T=293.6K  
Heating

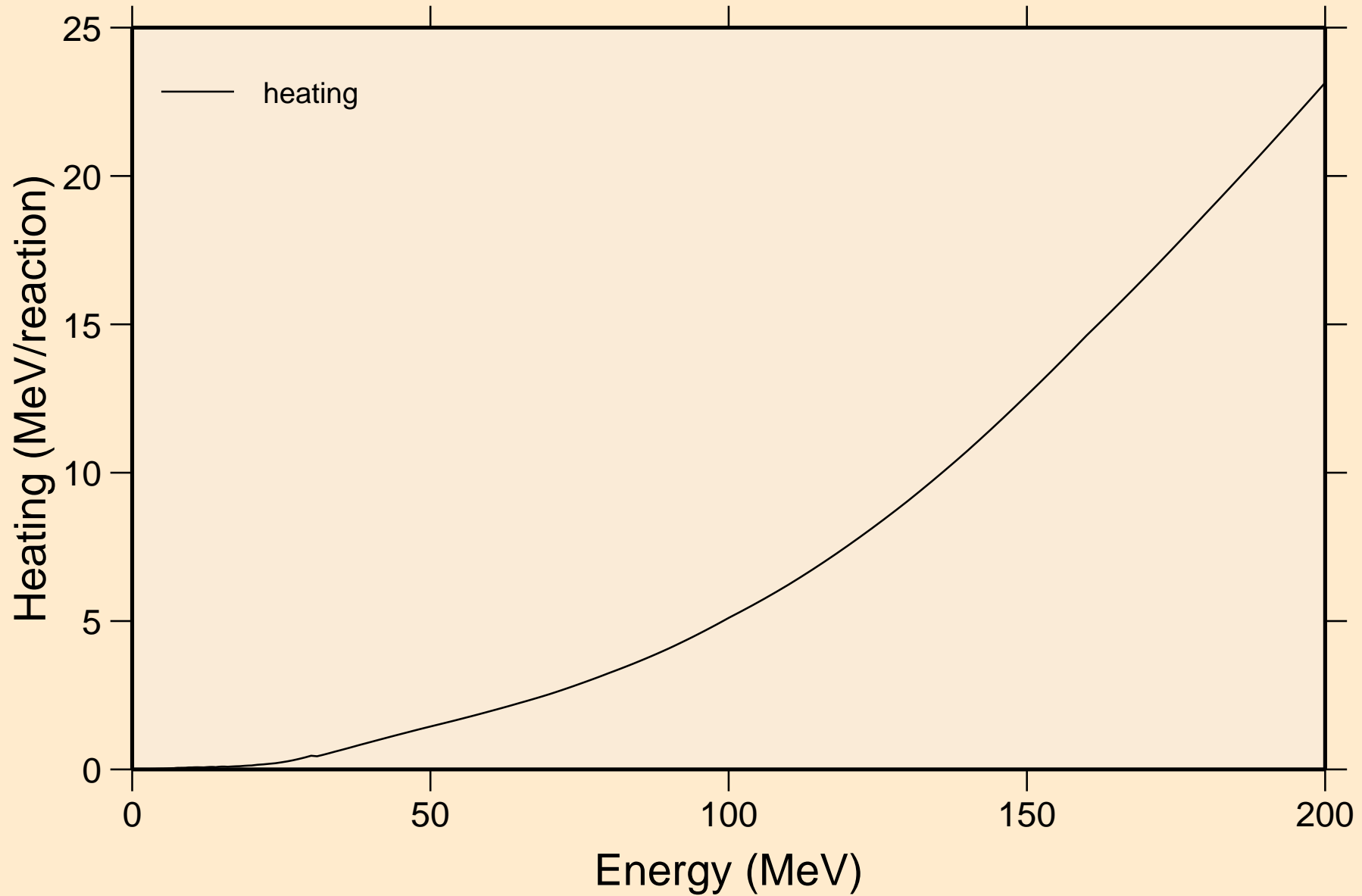

LU186 NEUTRON ACER TENDL-2024 LIBRARY; T=293.6K  
Damage

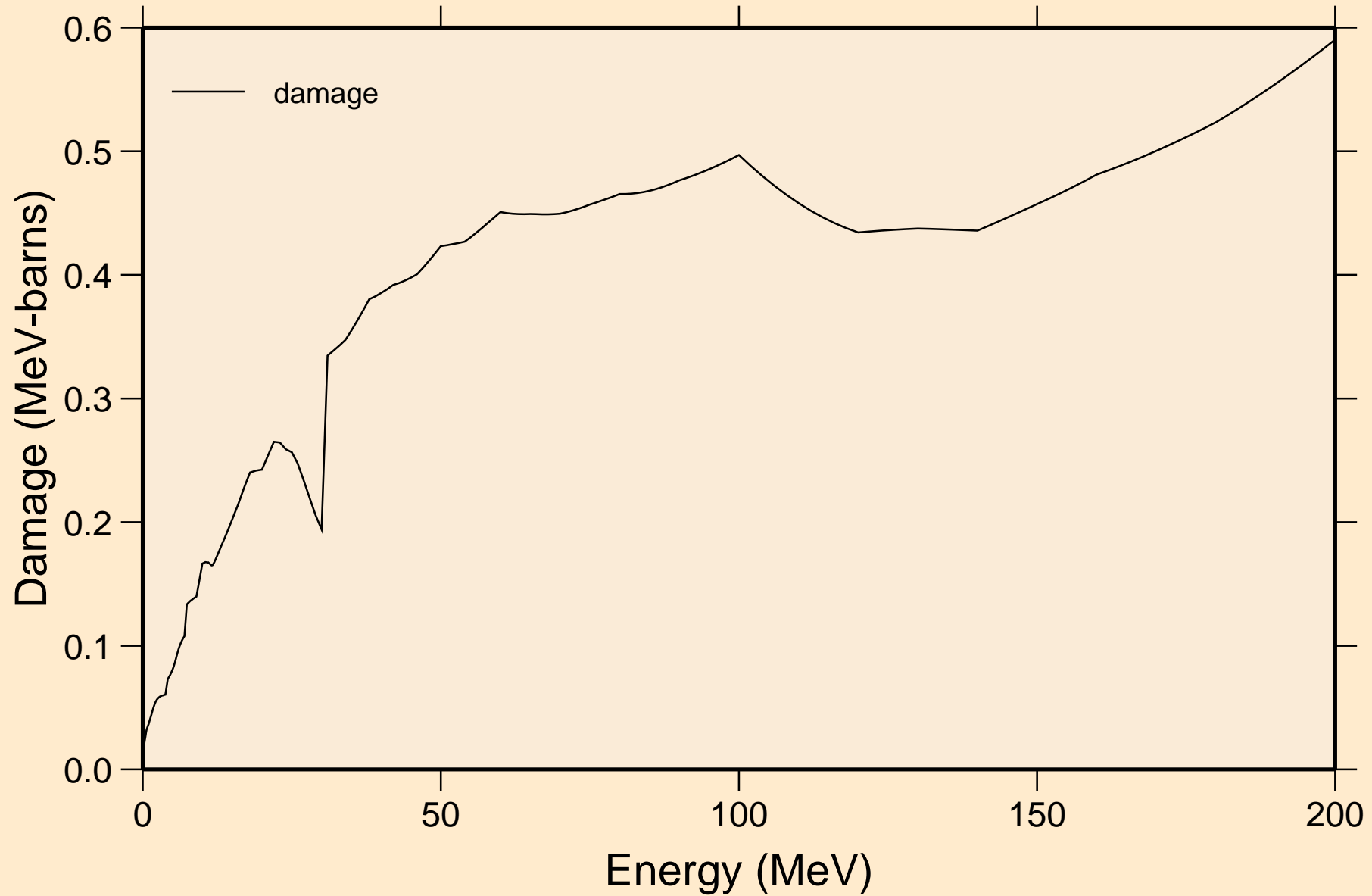

LU186 NEUTRON ACER TENDL-2024 LIBRARY; T=293.6K  
Non-threshold reactions

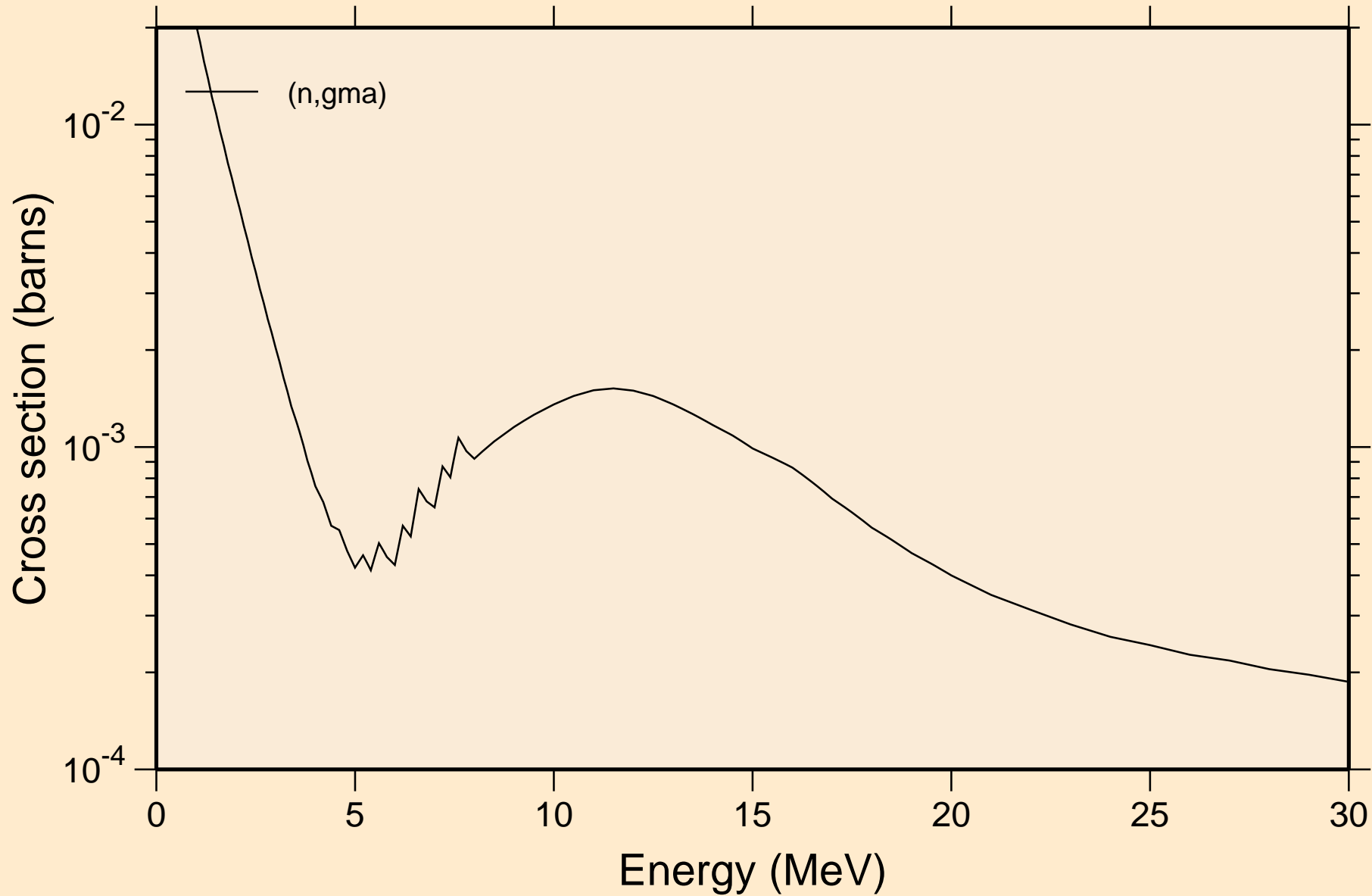

LU186 NEUTRON ACER TENDL-2024 LIBRARY; T=293.6K  
Inelastic levels

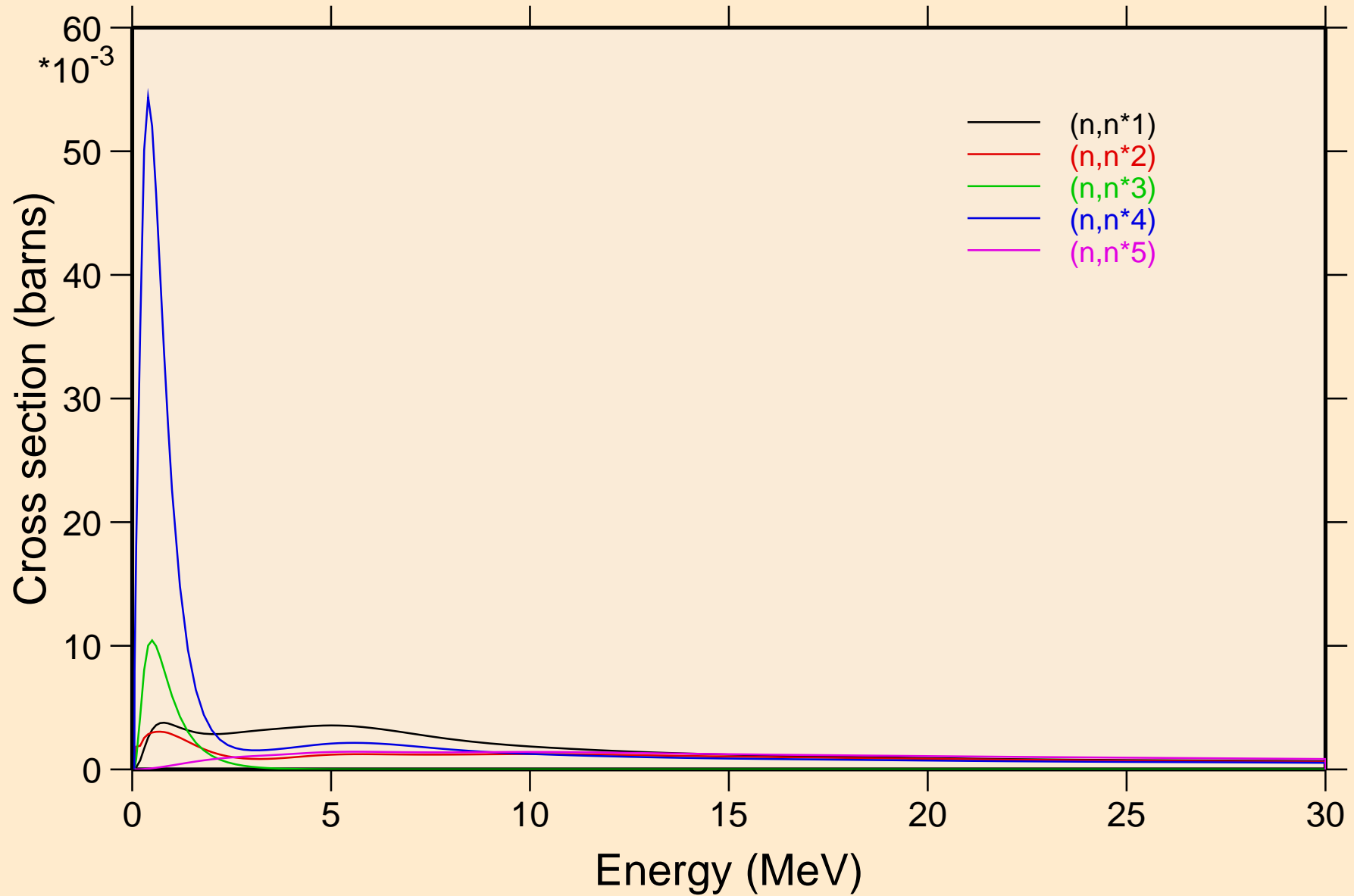

LU186 NEUTRON ACER TENDL-2024 LIBRARY; T=293.6K  
Inelastic levels

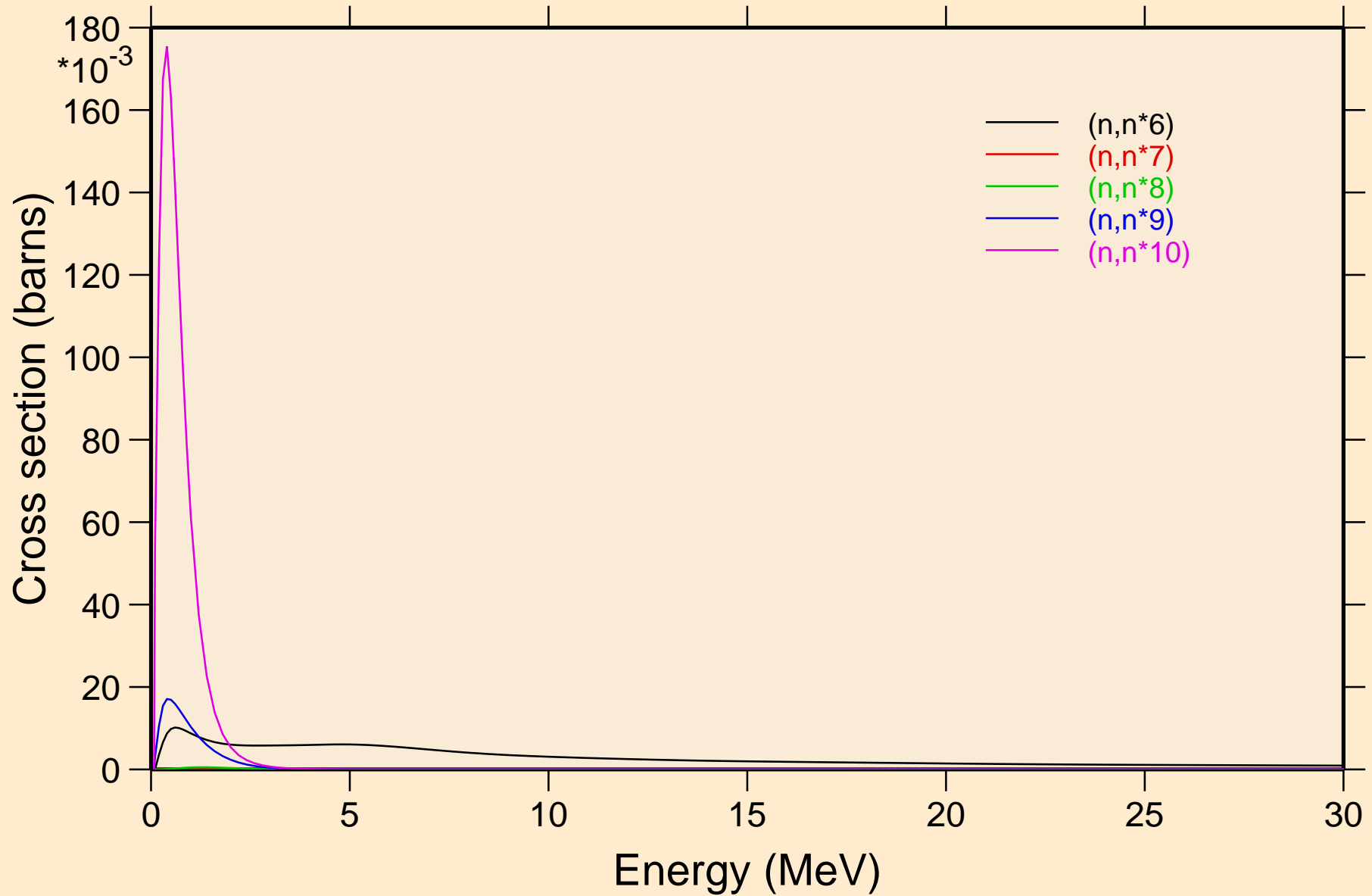

LU186 NEUTRON ACER TENDL-2024 LIBRARY; T=293.6K  
Inelastic levels

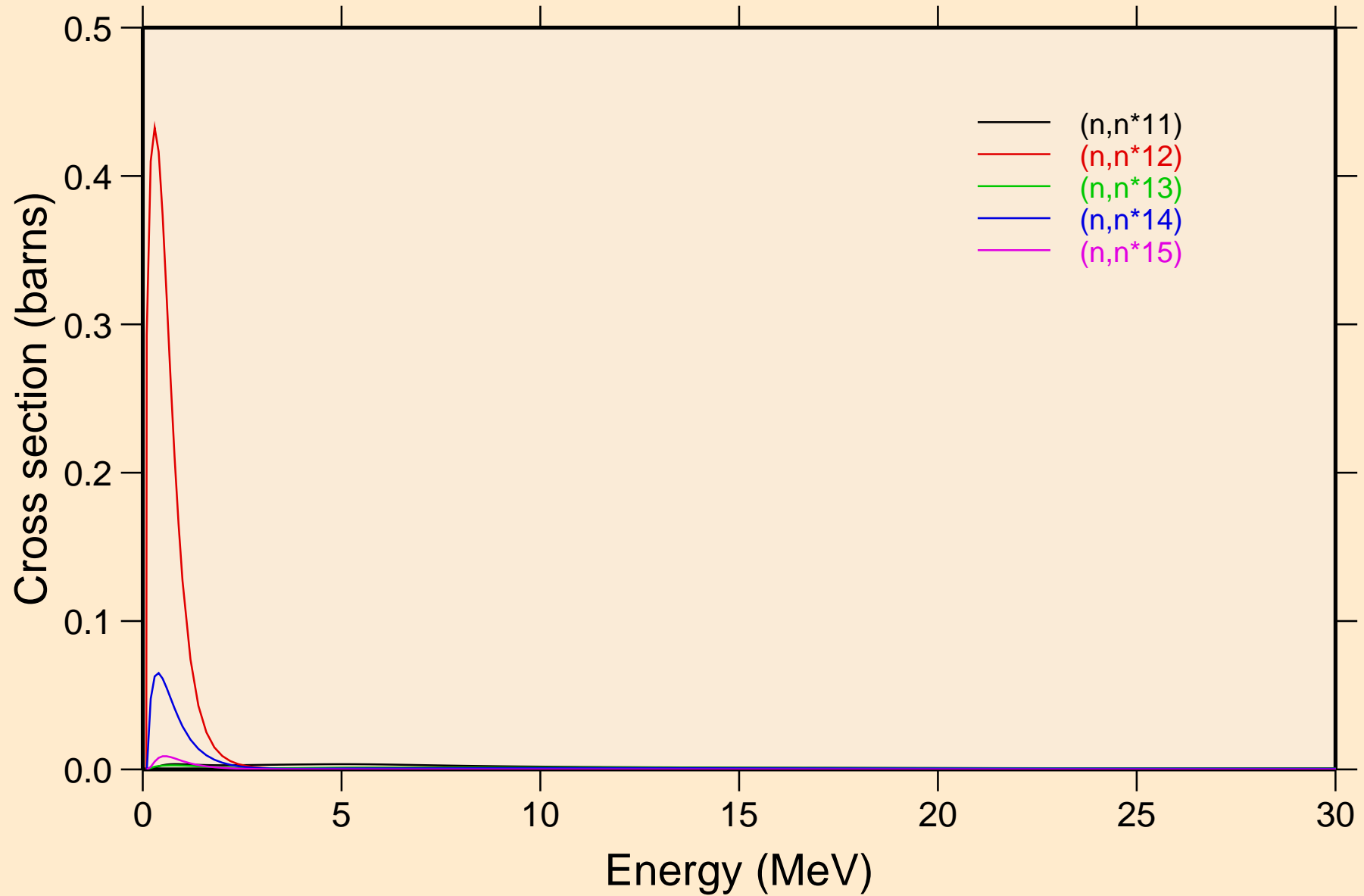

LU186 NEUTRON ACER TENDL-2024 LIBRARY; T=293.6K  
Inelastic levels

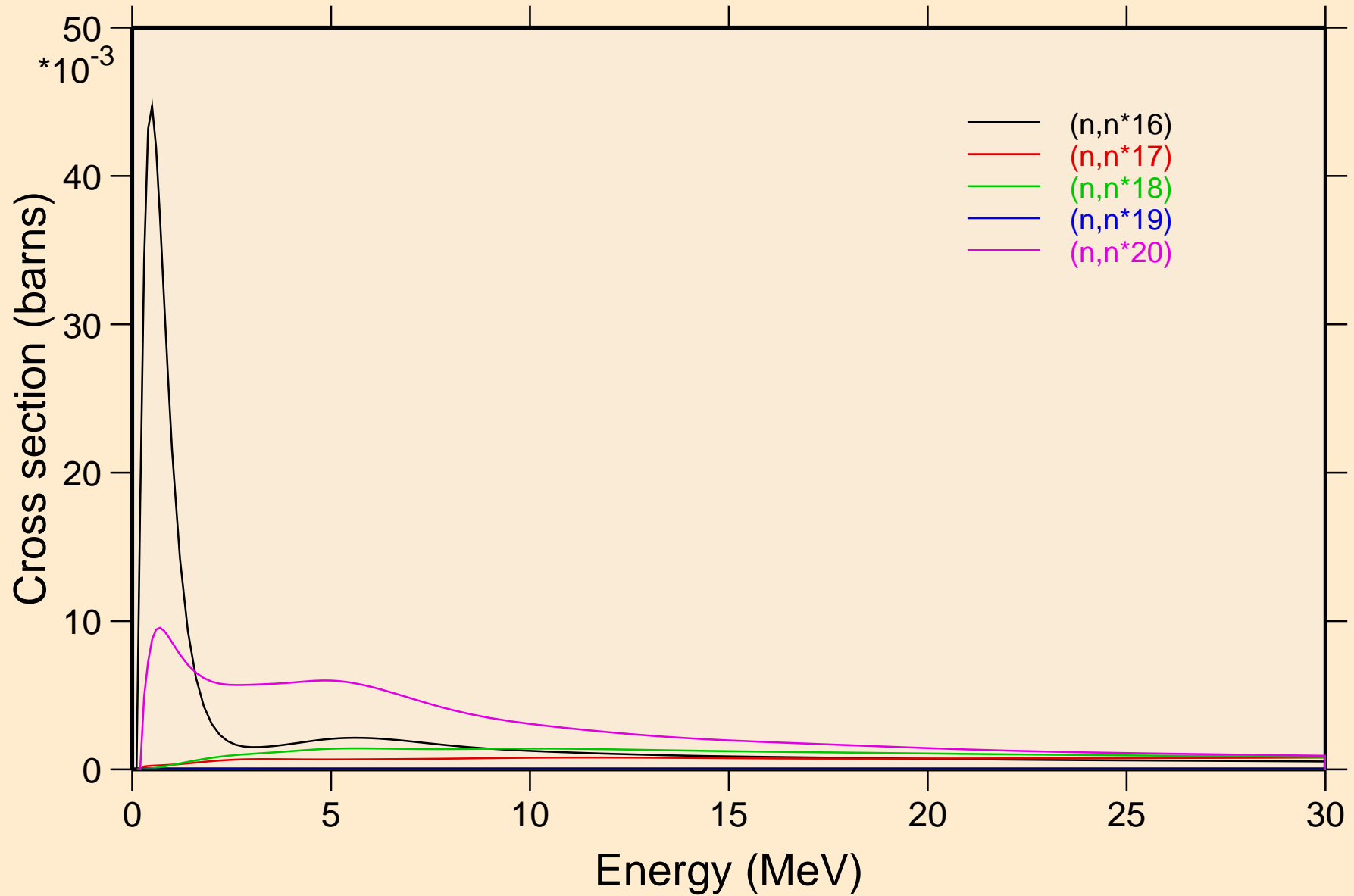

LU186 NEUTRON ACER TENDL-2024 LIBRARY; T=293.6K  
Inelastic levels

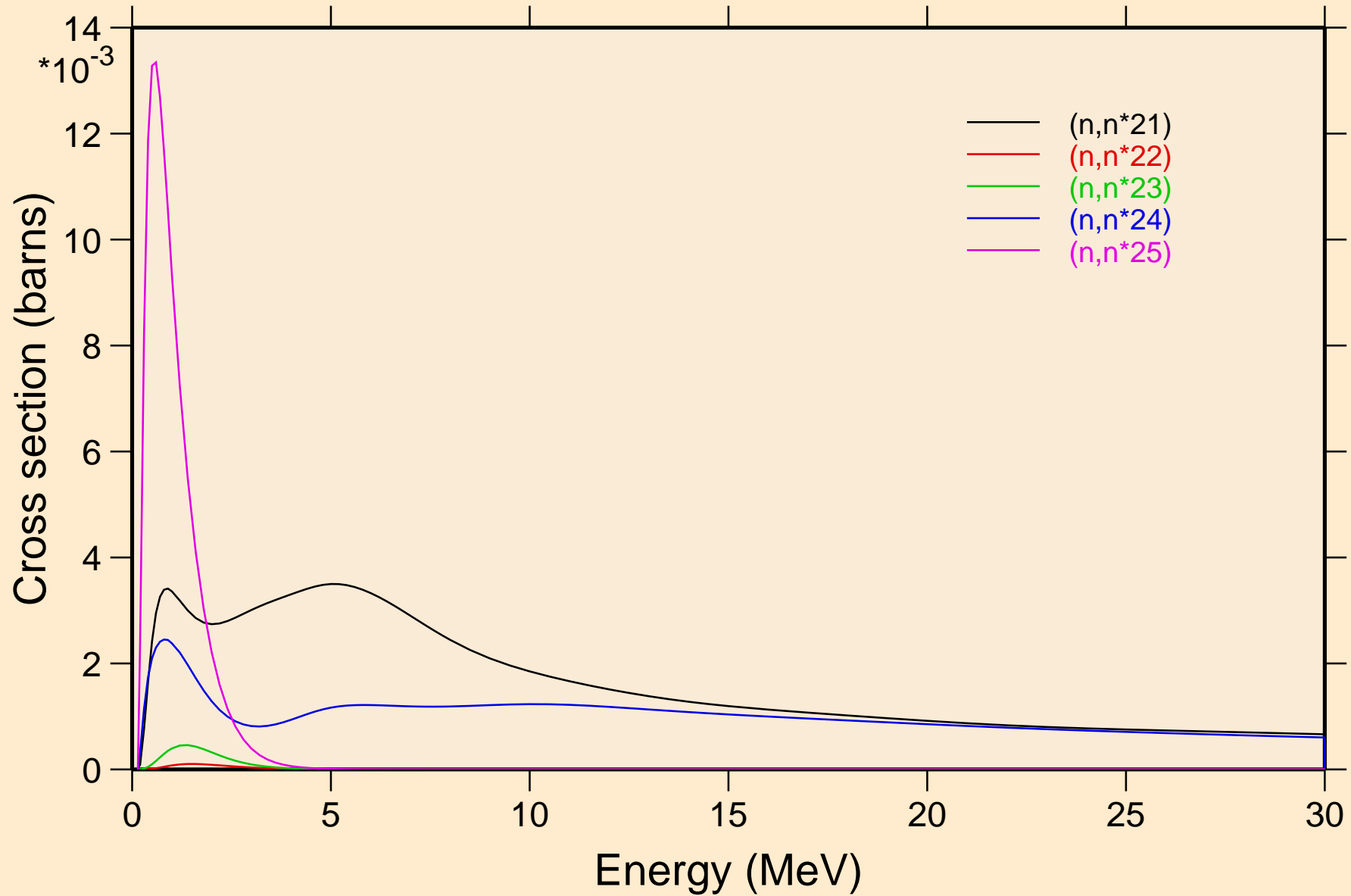

LU186 NEUTRON ACER TENDL-2024 LIBRARY; T=293.6K  
Inelastic levels

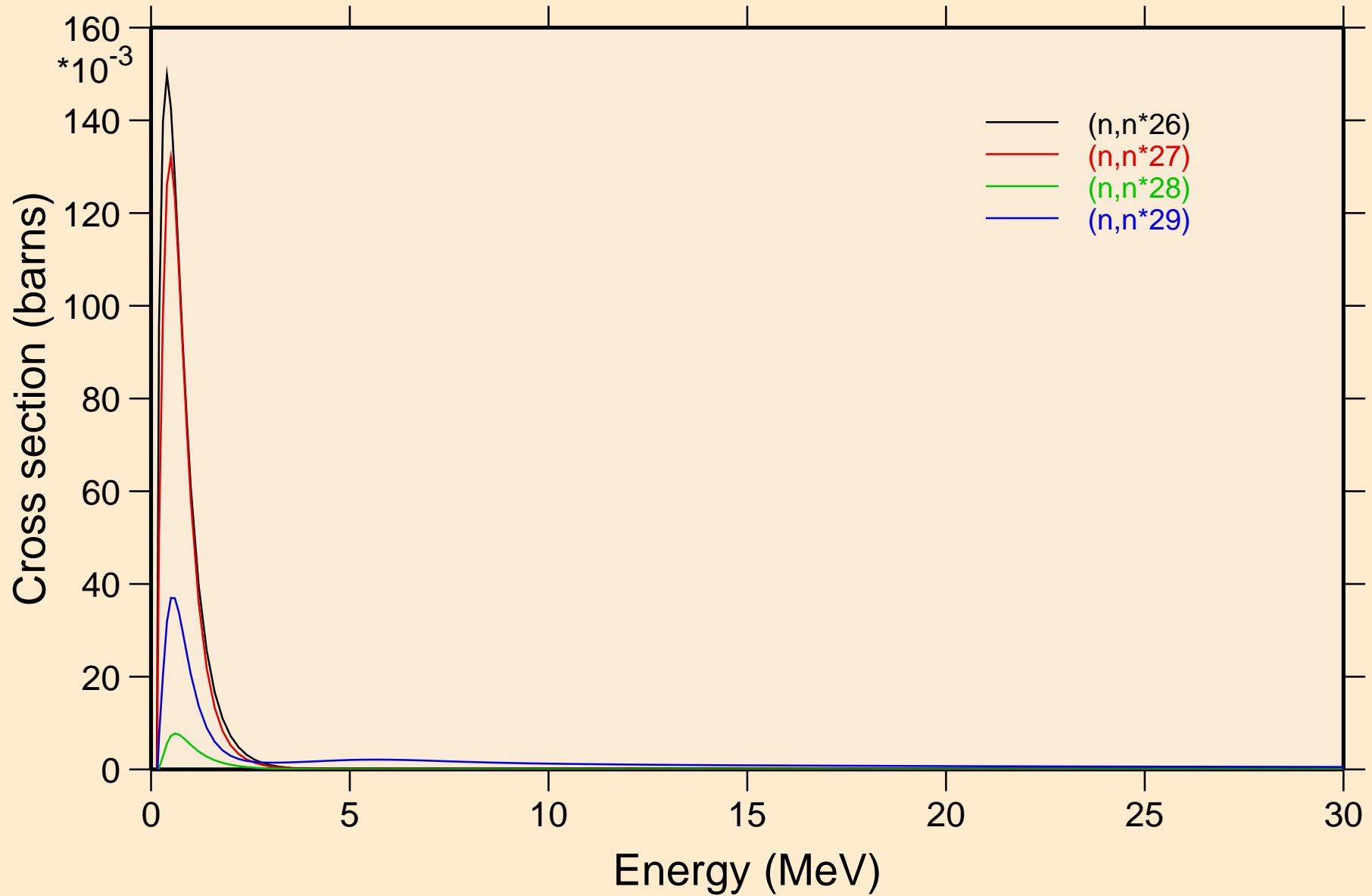

LU186 NEUTRON ACER TENDL-2024 LIBRARY; T=293.6K  
Threshold reactions

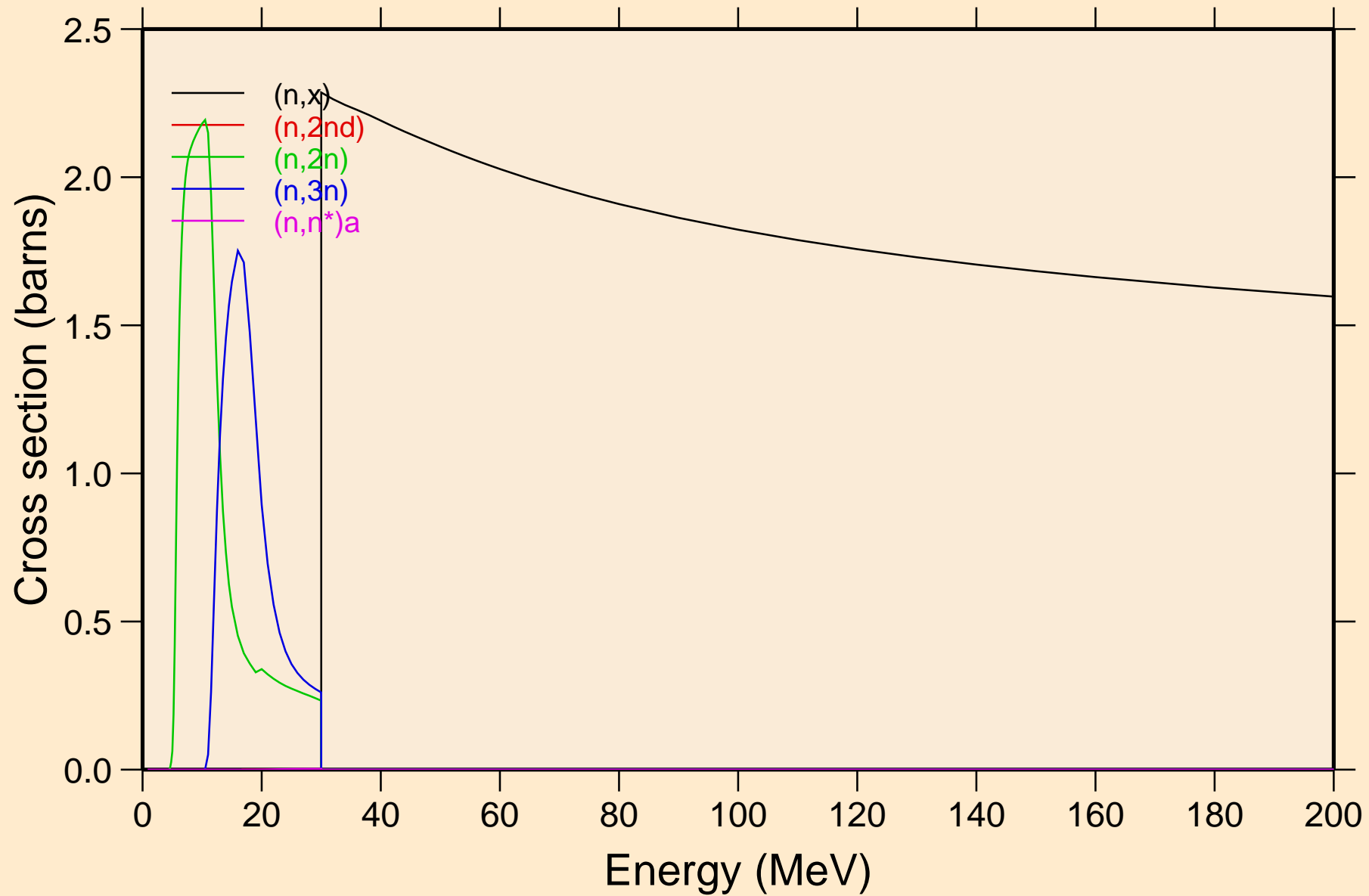

LU186 NEUTRON ACER TENDL-2024 LIBRARY; T=293.6K  
Threshold reactions

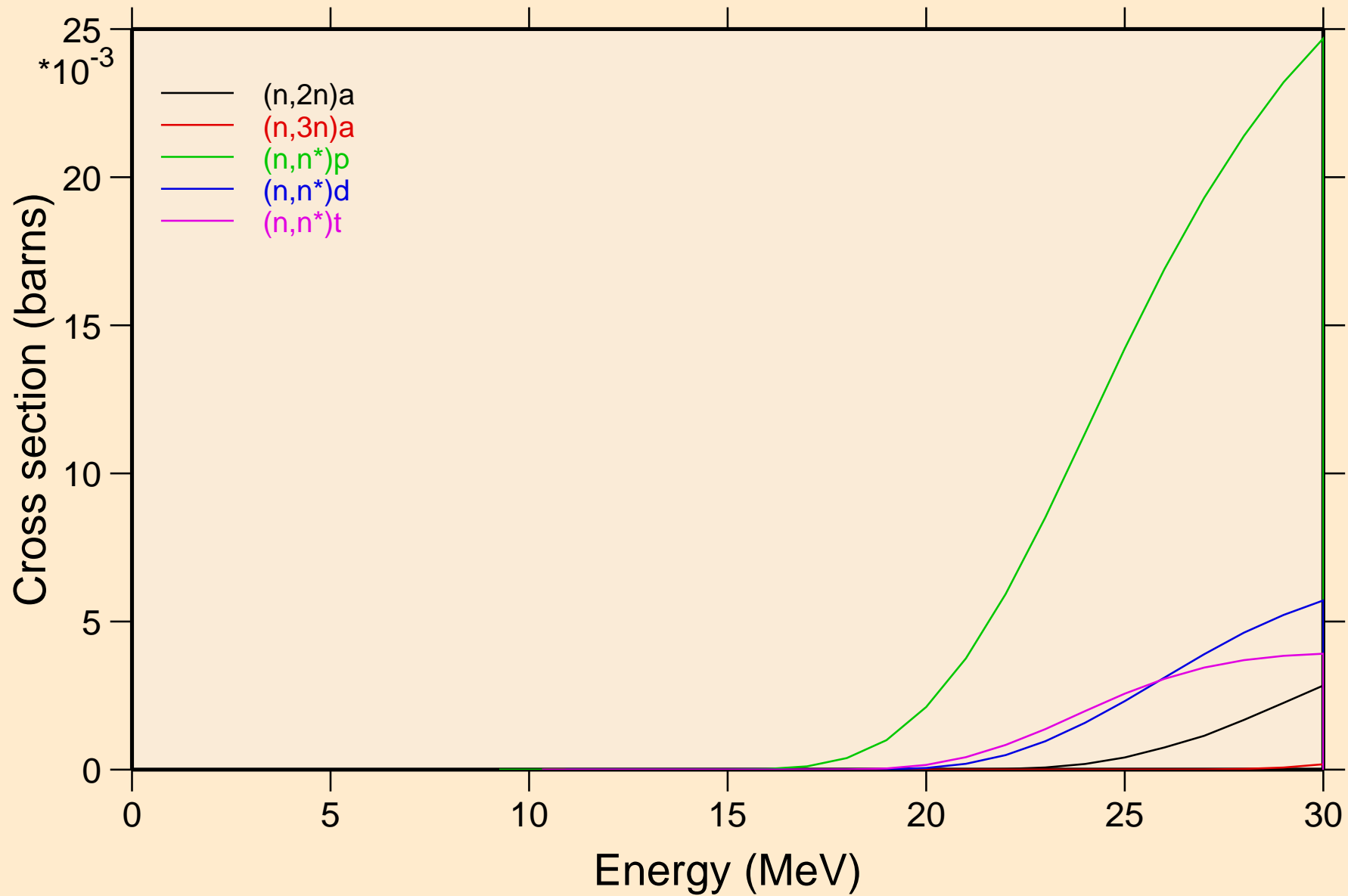

LU186 NEUTRON ACER TENDL-2024 LIBRARY; T=293.6K  
Threshold reactions

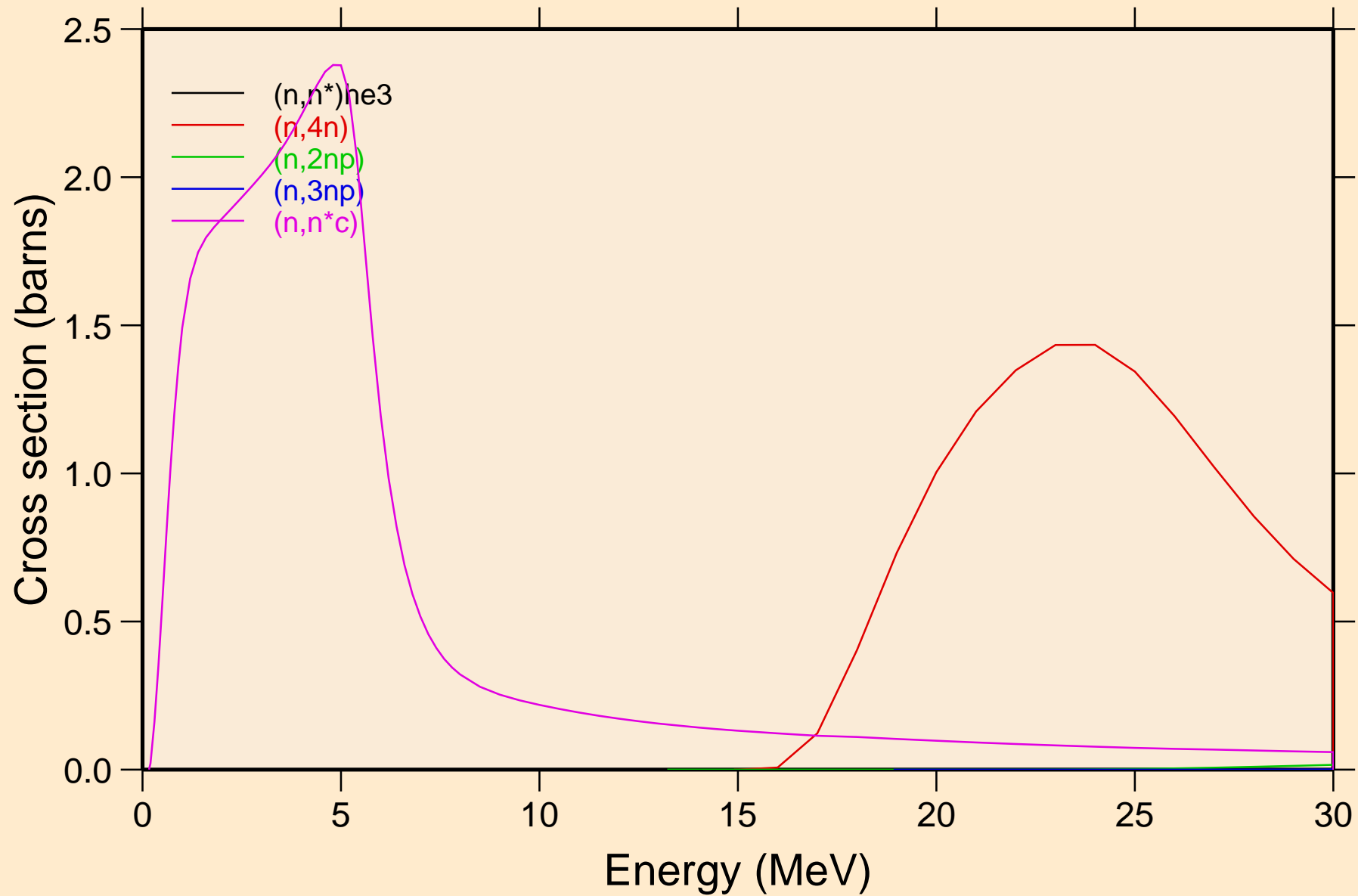

LU186 NEUTRON ACER TENDL-2024 LIBRARY; T=293.6K  
Threshold reactions

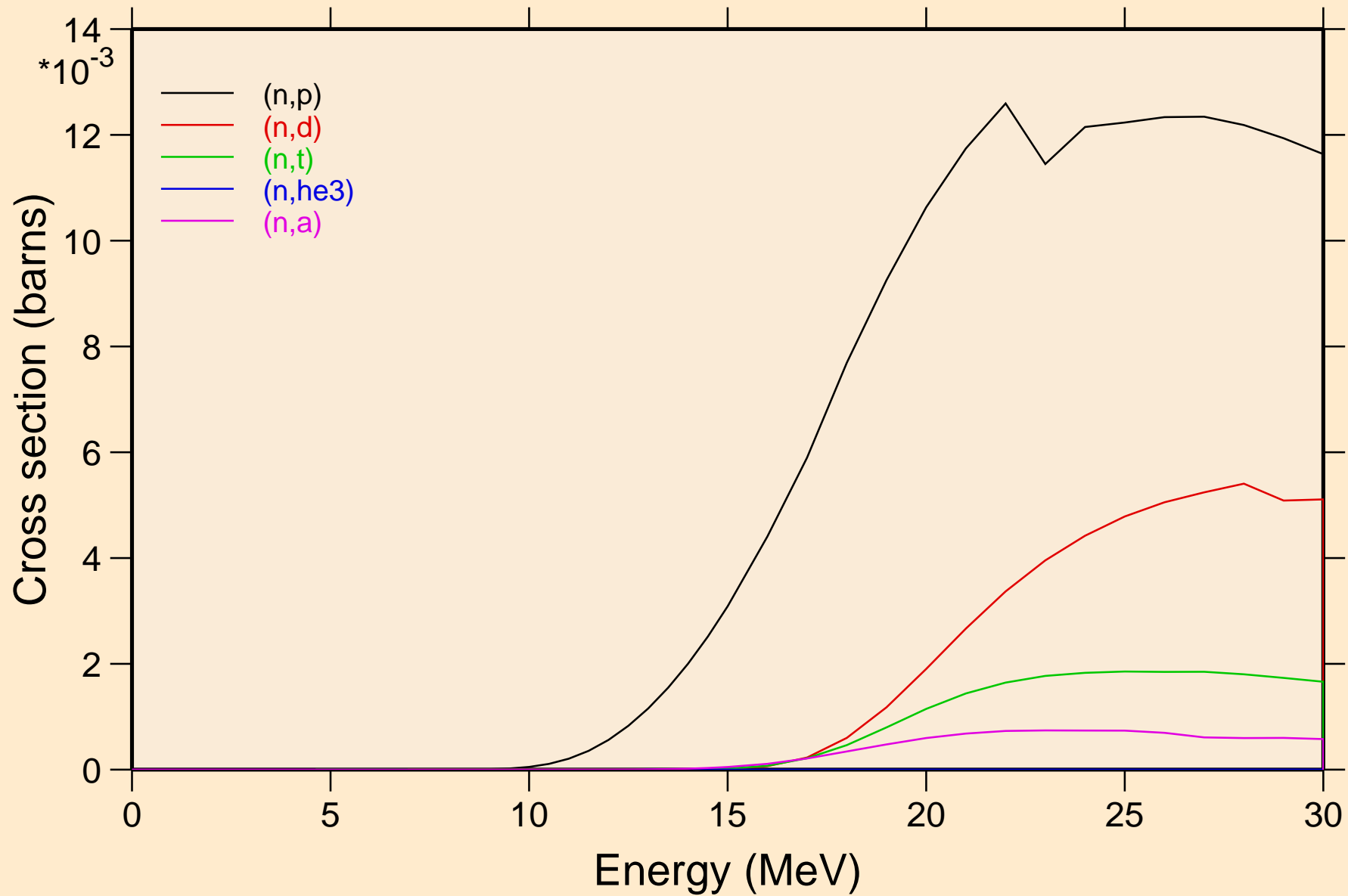

LU186 NEUTRON ACER TENDL-2024 LIBRARY; T=293.6K  
Threshold reactions

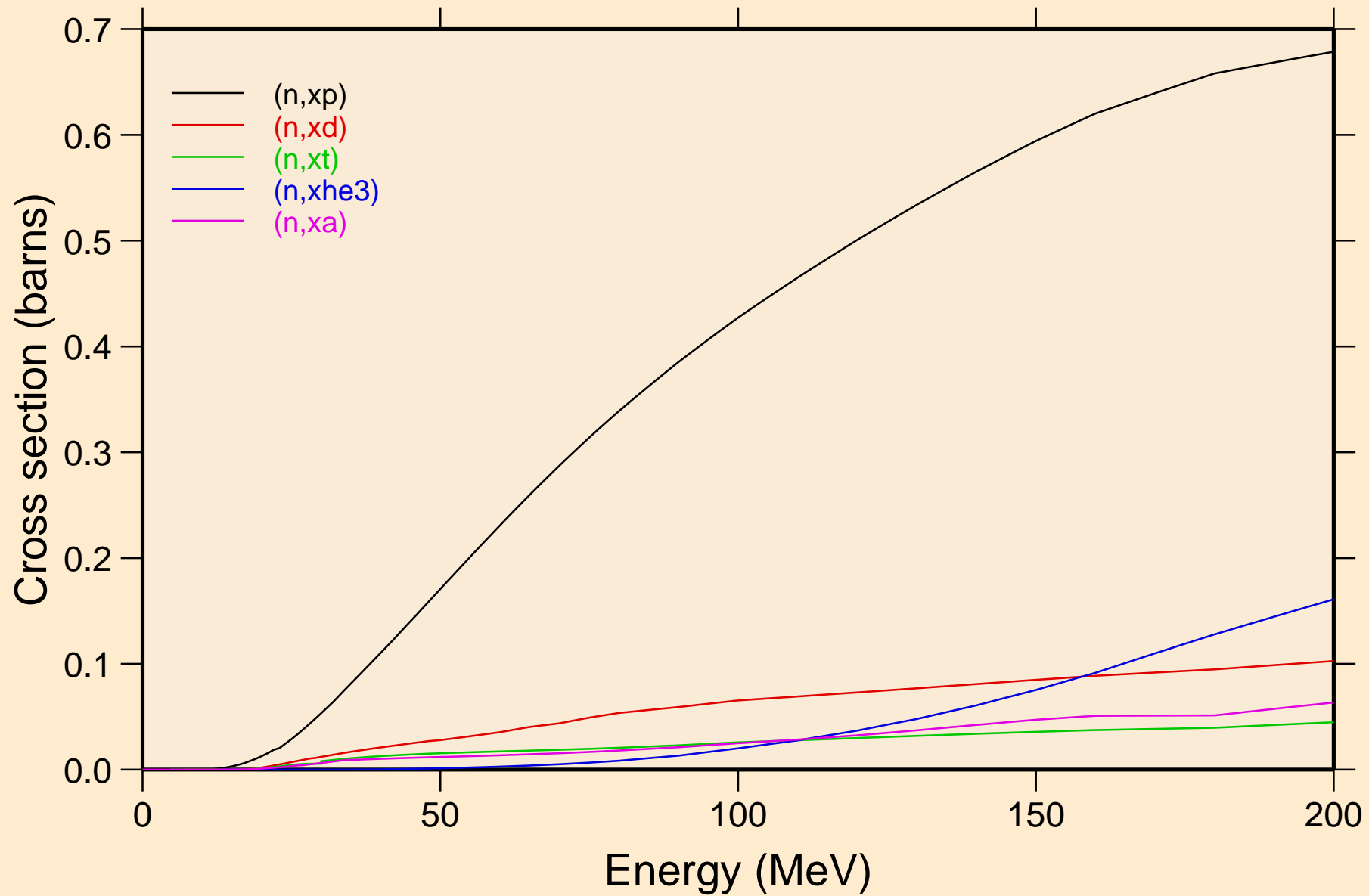

LU186 NEUTRON ACER TENDL-2024 LIBRARY; T=293.6K  
angular distribution for elastic

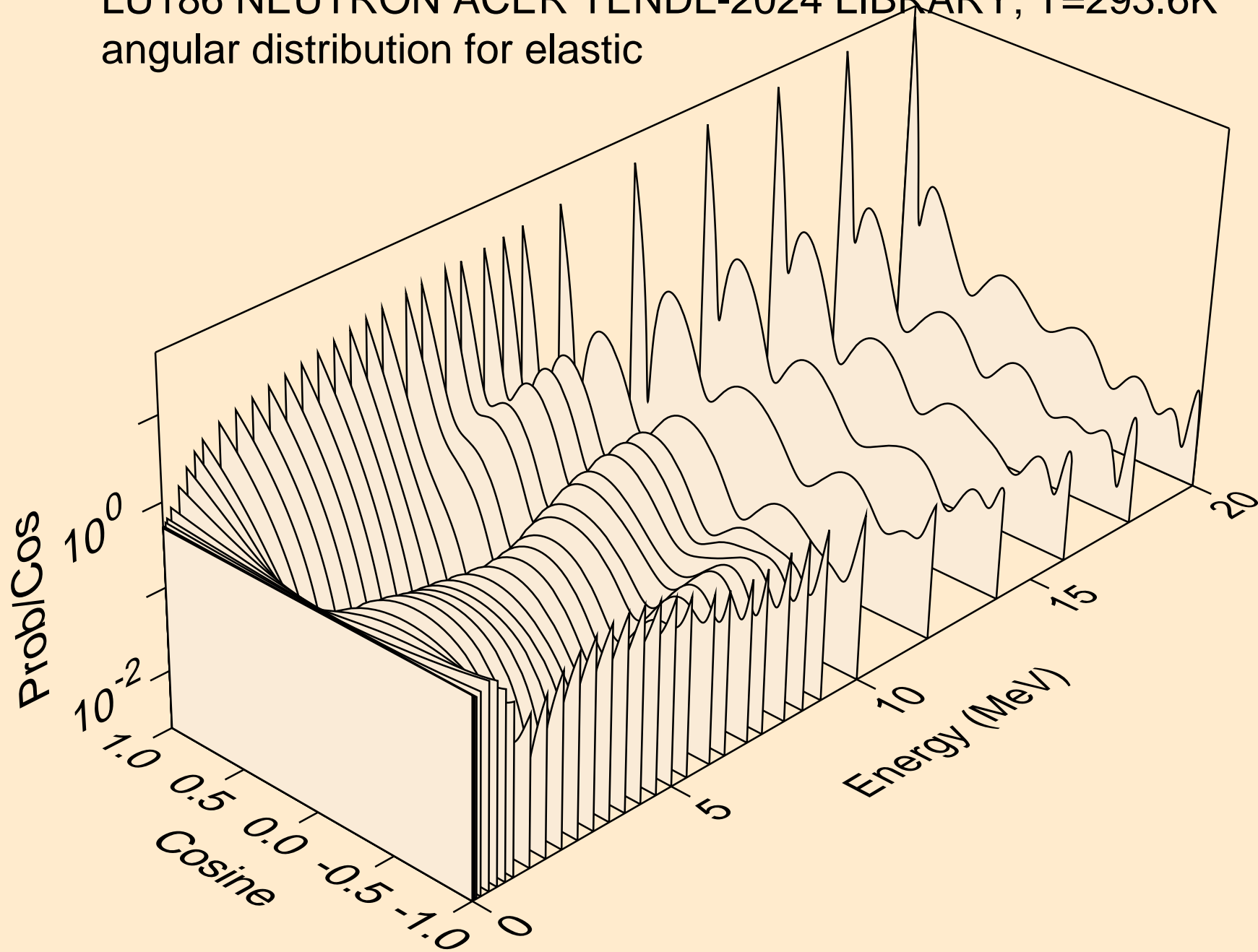

LU186 NEUTRON ACER TENDL-2024 LIBRARY; T=293.6K  
angular distribution for elastic

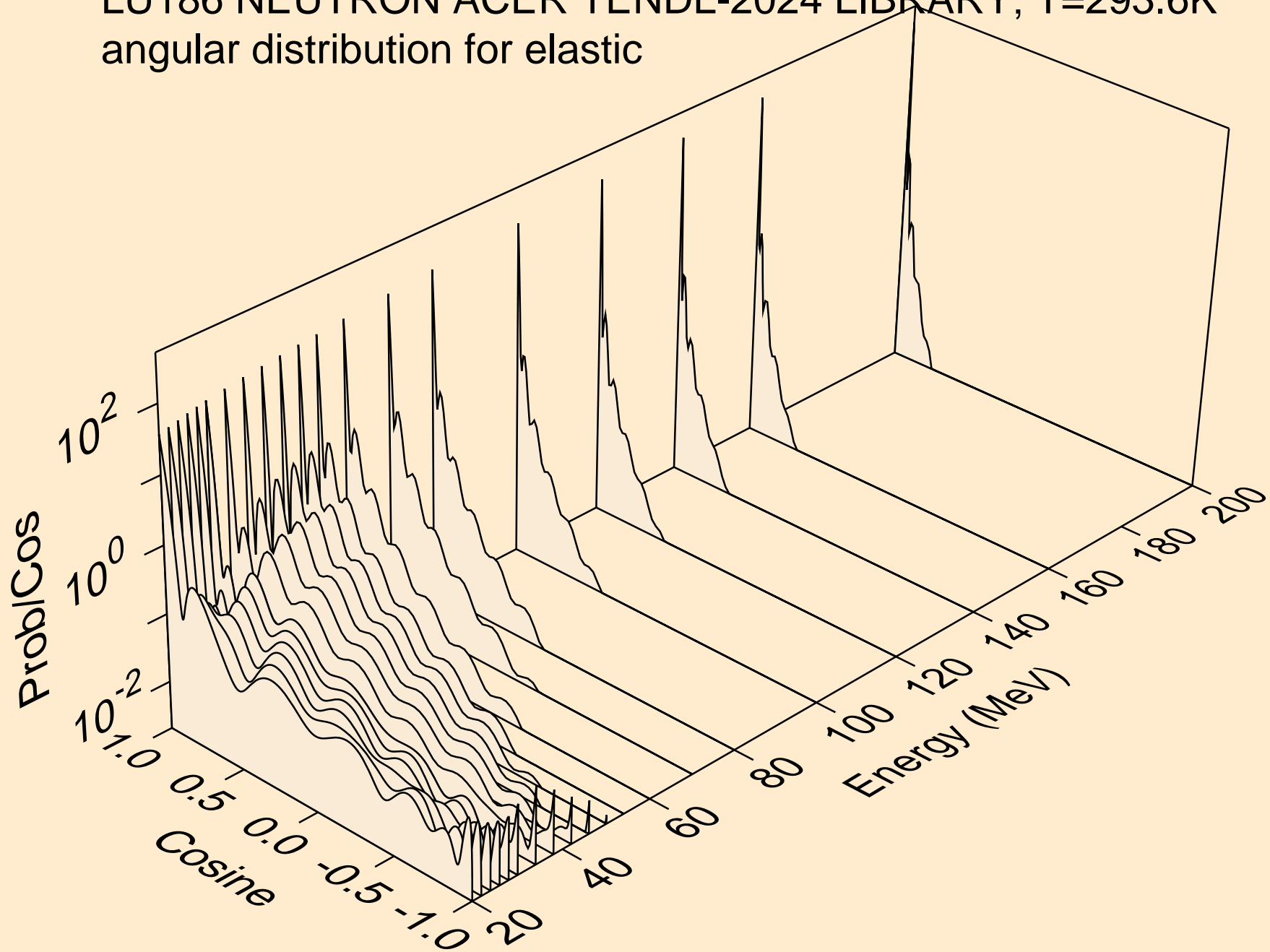

LU186 NEUTRON ACER TENDL-2024 LIBRARY; T=293.6K  
angular distribution for (n,n\*1)

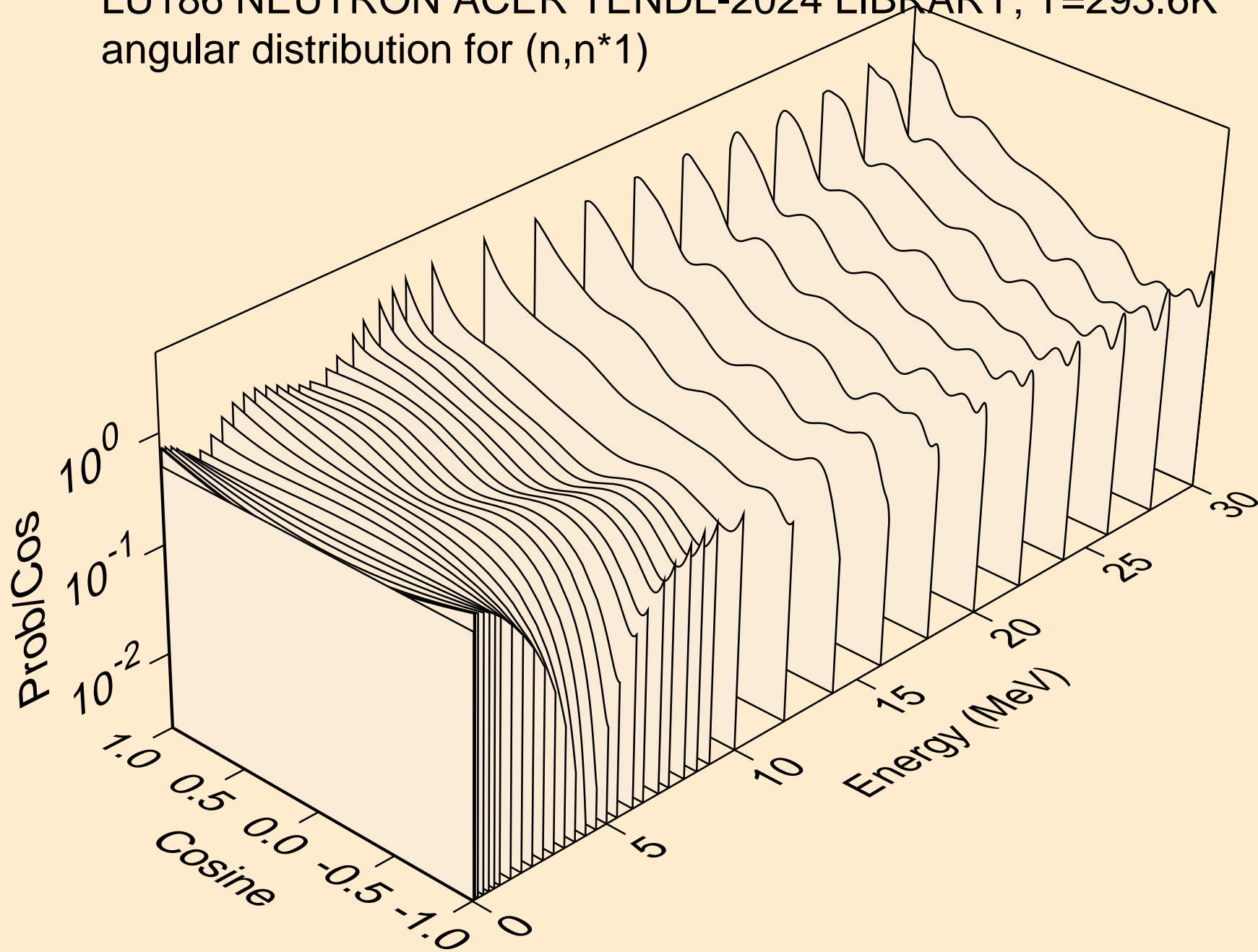

LU186 NEUTRON ACER TENDL-2024 LIBRARY; T=293.6K  
angular distribution for (n,n\*2)

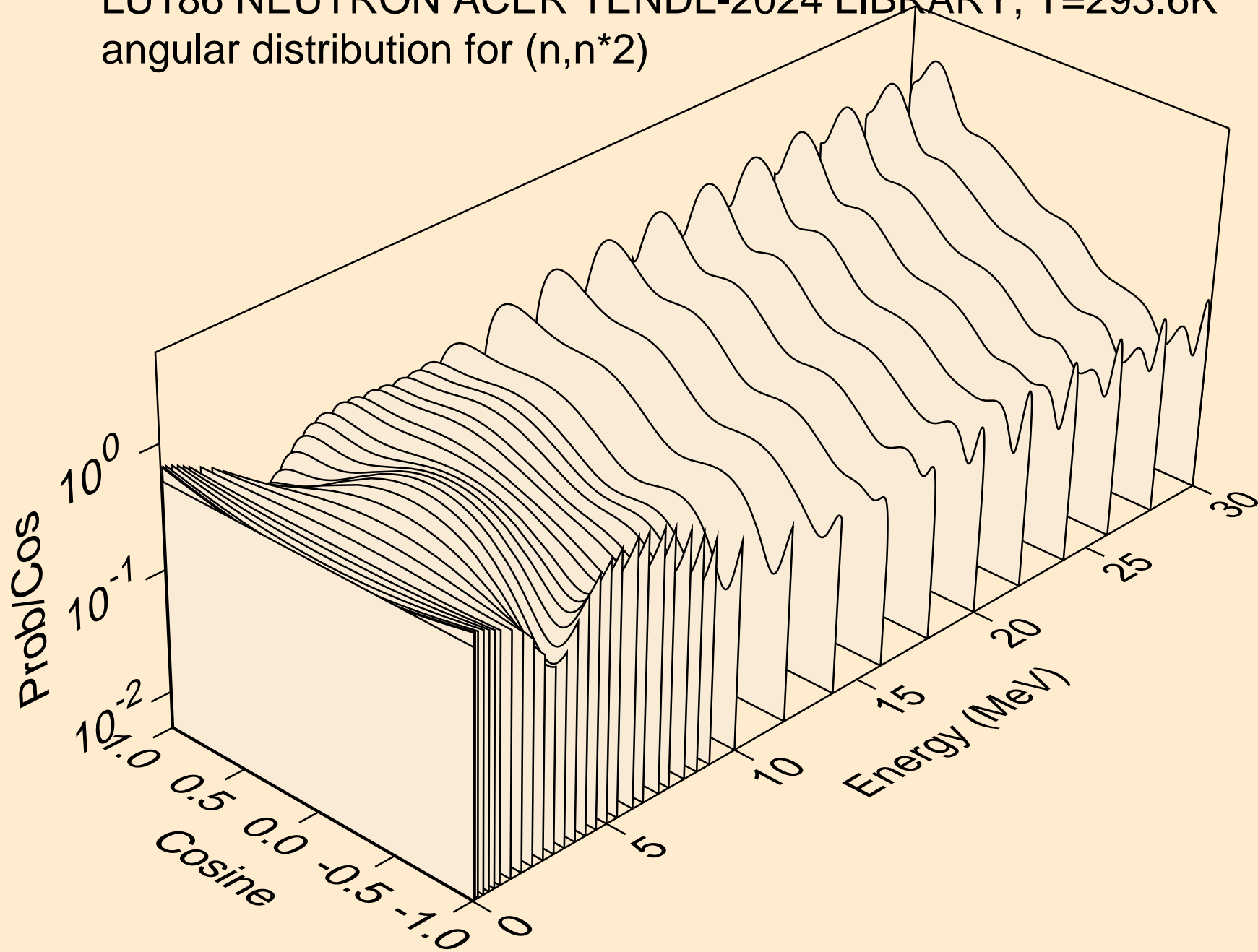

LU186 NEUTRON ACER TENDL-2024 LIBRARY; T=293.6K  
angular distribution for (n,n\*3)

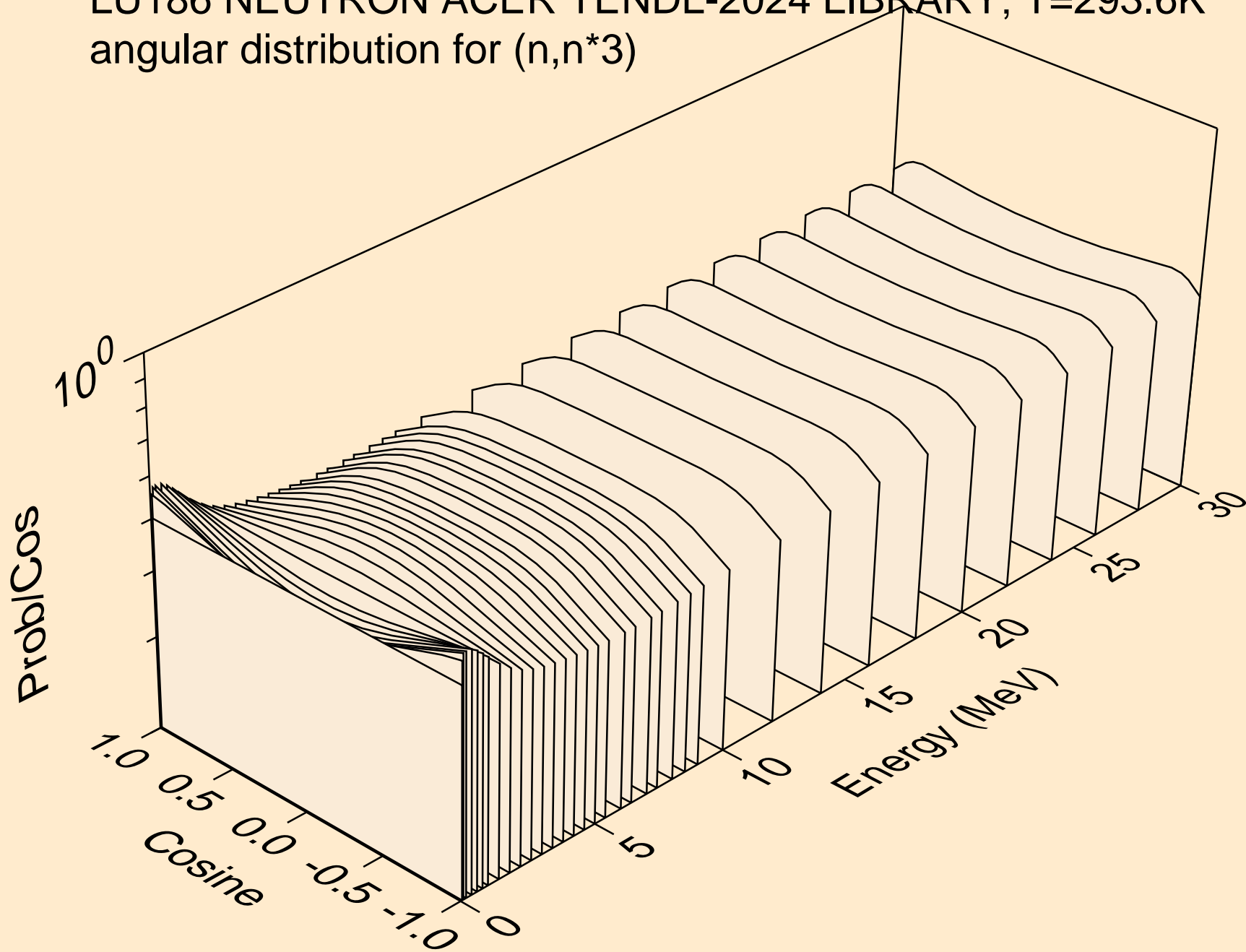

LU186 NEUTRON ACER TENDL-2024 LIBRARY; T=293.6K  
angular distribution for (n,n\*4)

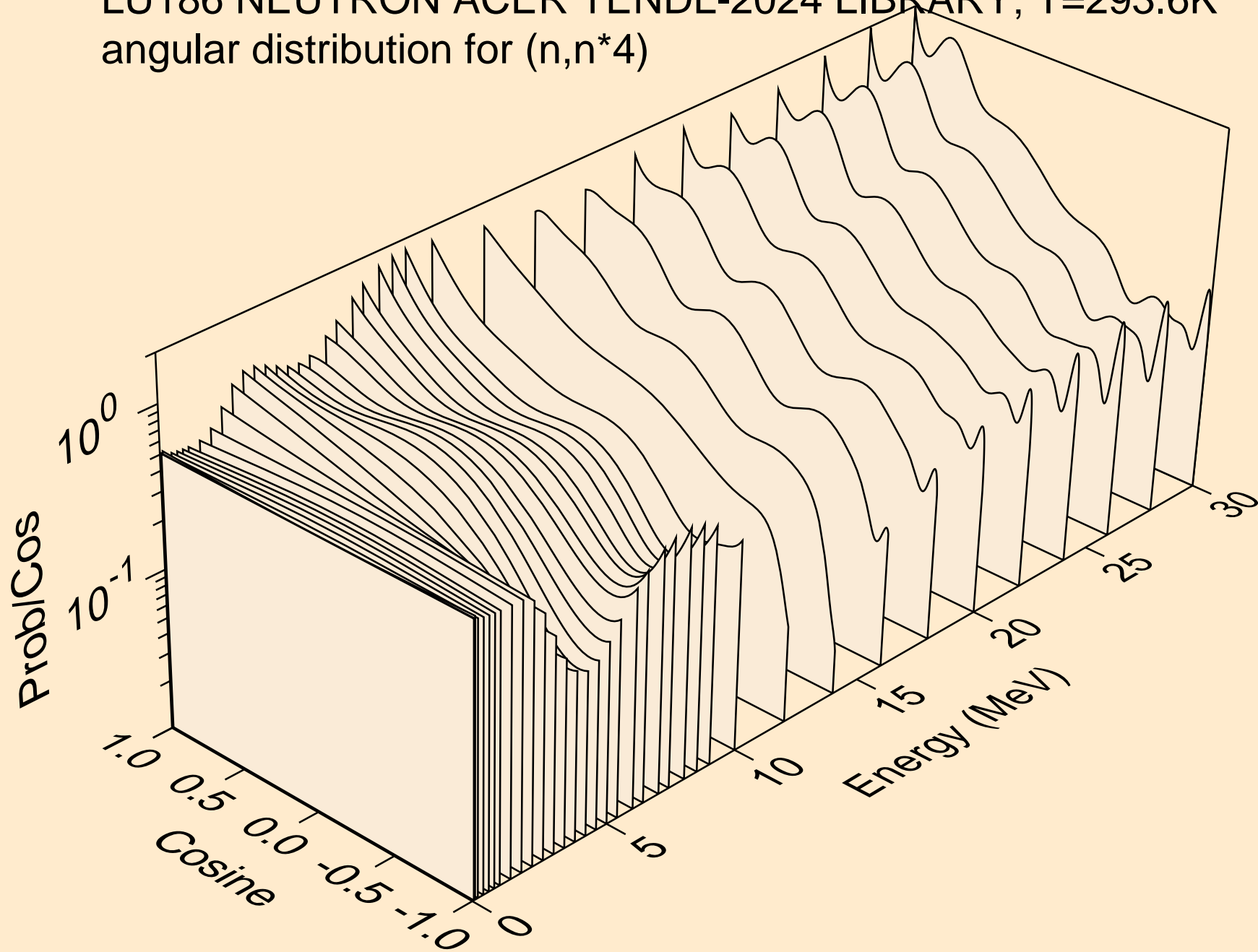

LU186 NEUTRON ACER TENDL-2024 LIBRARY; T=293.6K  
angular distribution for (n,n\*5)

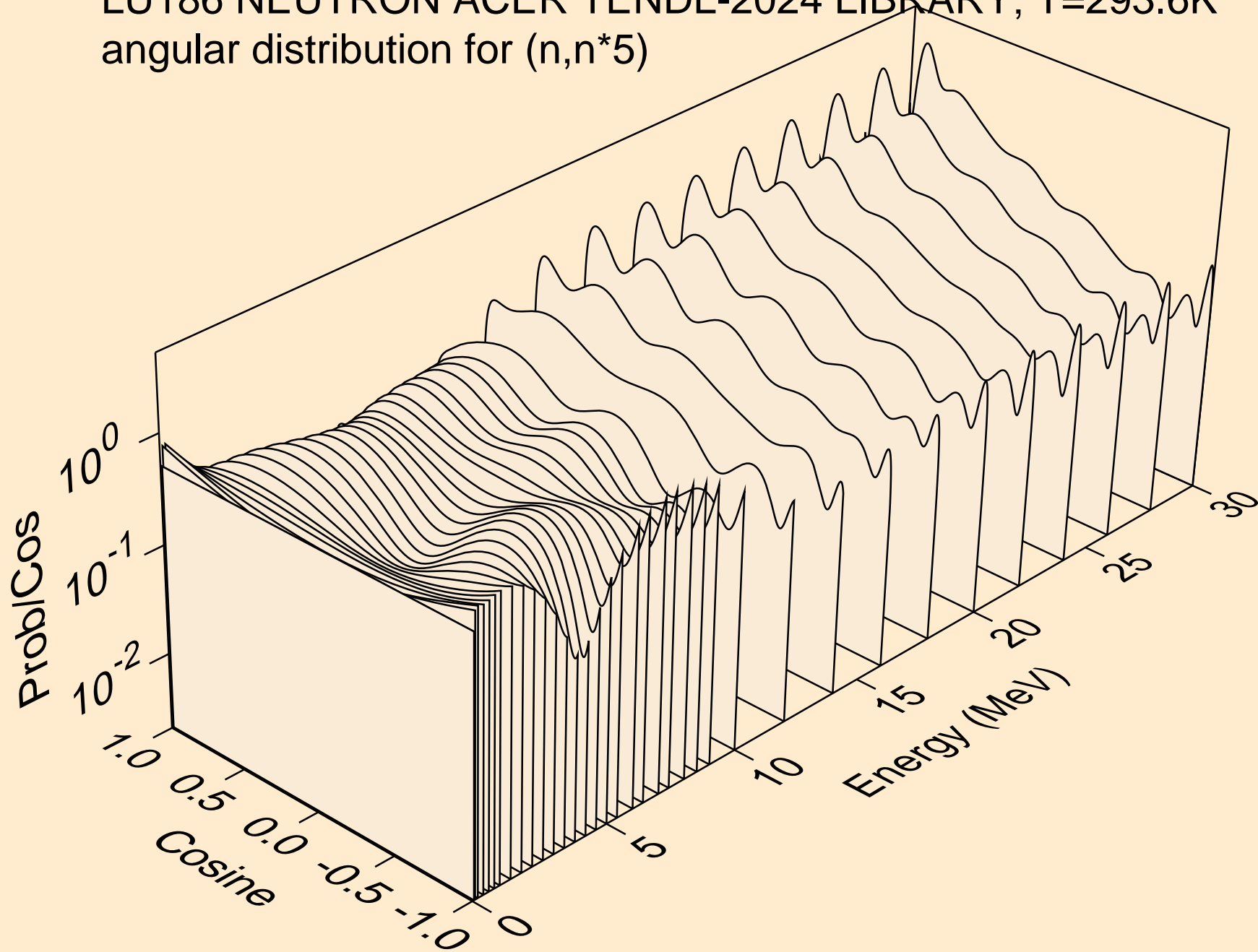

LU186 NEUTRON ACER TENDL-2024 LIBRARY; T=293.6K  
angular distribution for (n,n\*6)

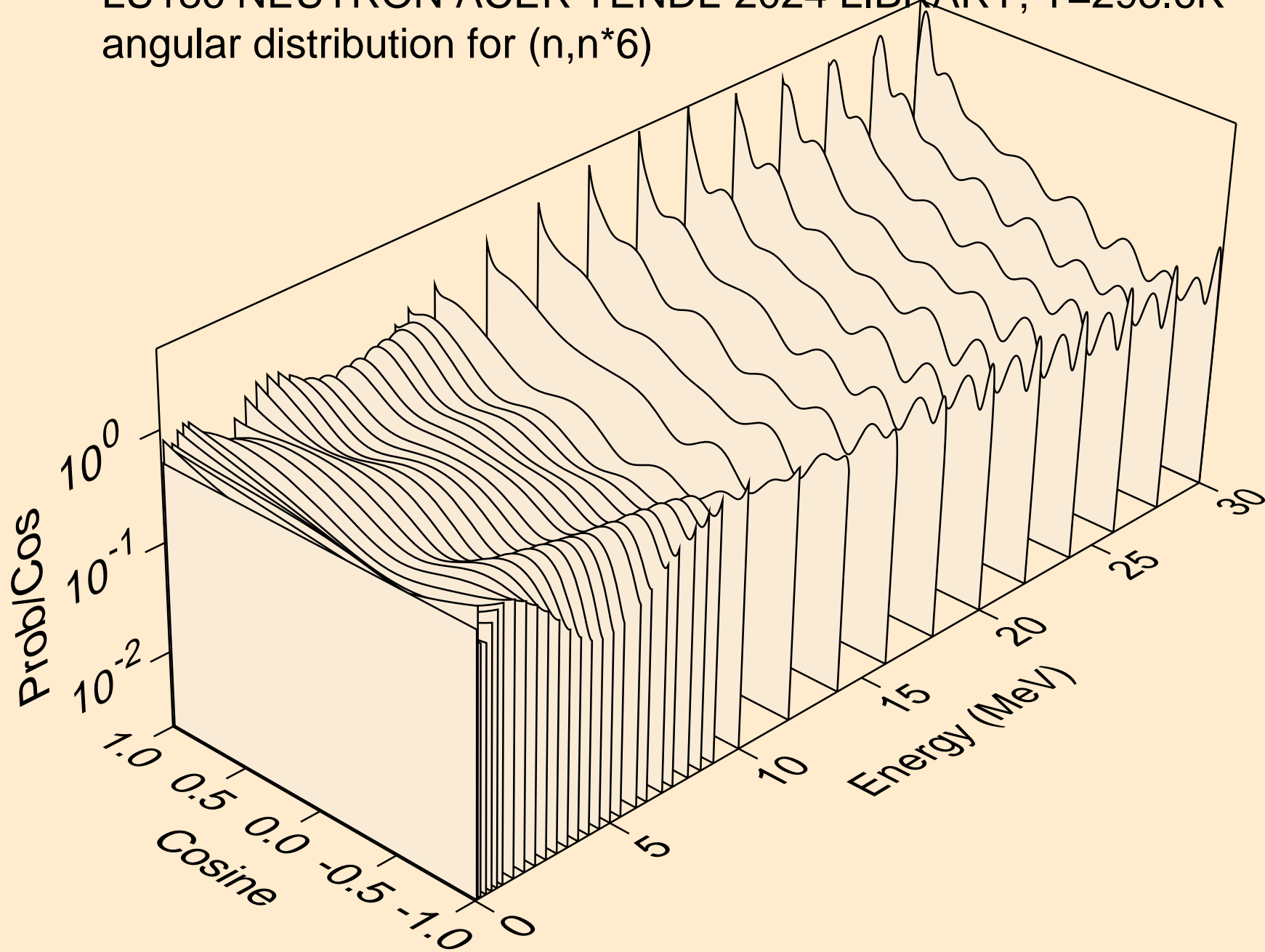

LU186 NEUTRON ACER TENDL-2024 LIBRARY; T=293.6K  
angular distribution for (n,n\*7)

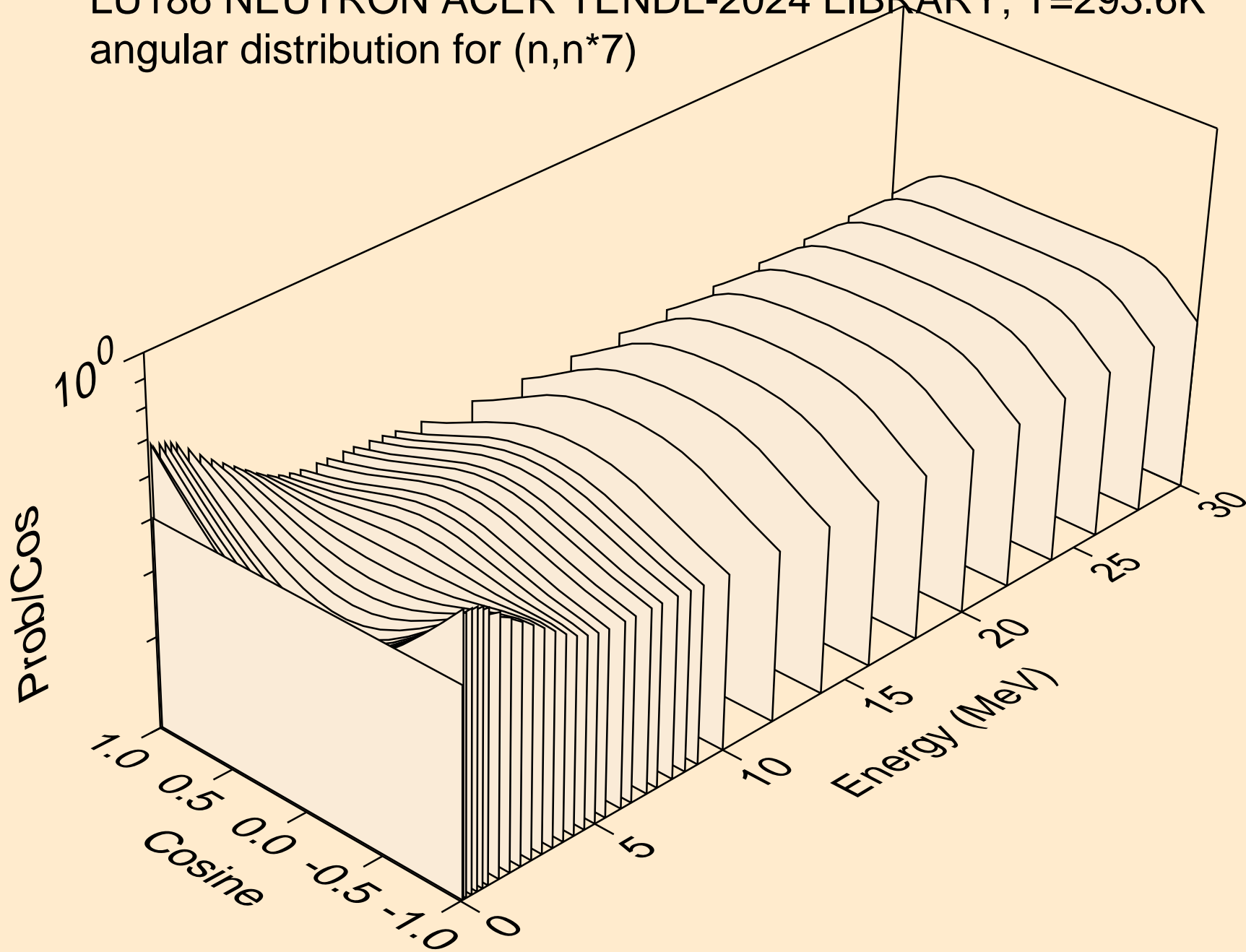

LU186 NEUTRON ACER TENDL-2024 LIBRARY; T=293.6K  
angular distribution for (n,n\*8)

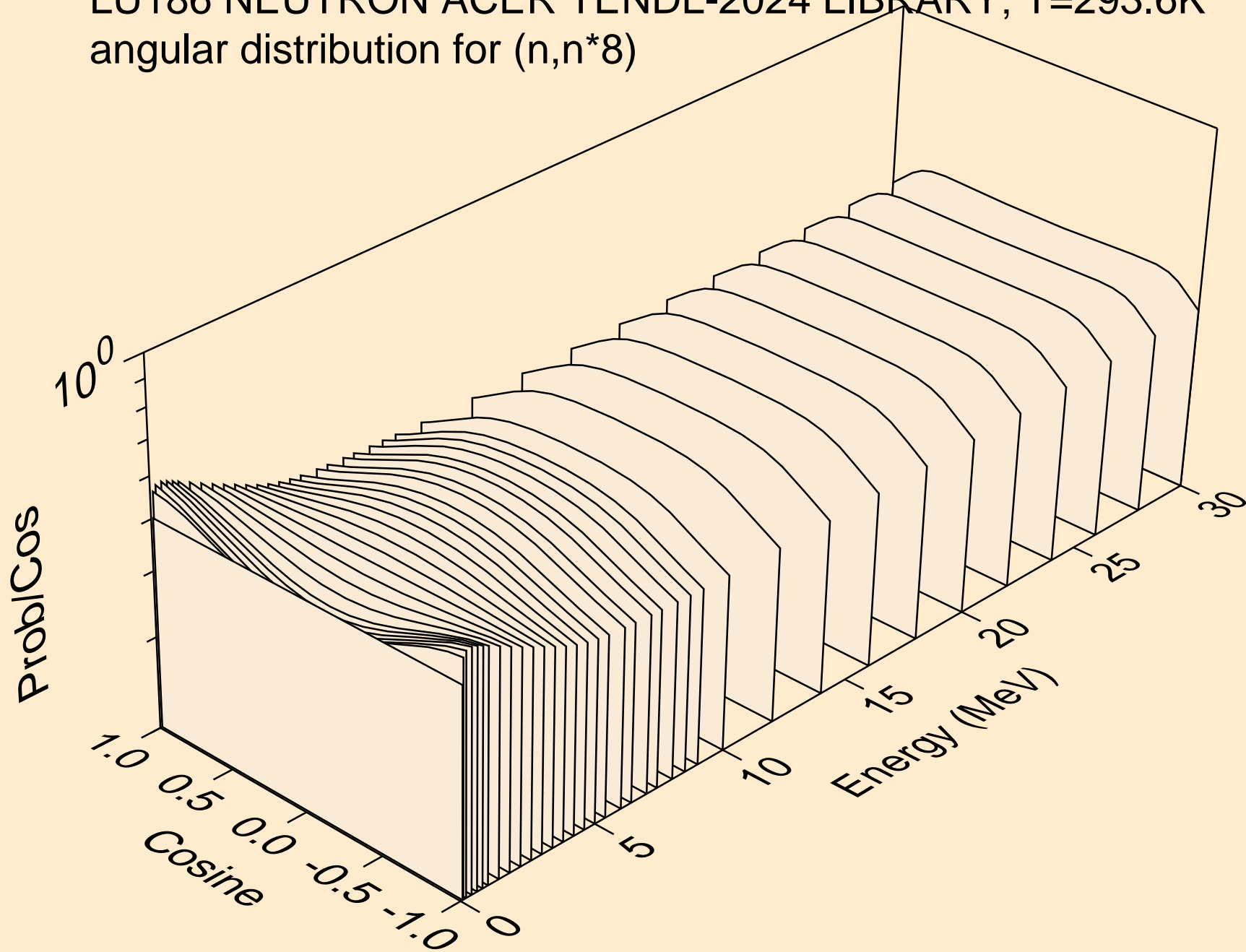

LU186 NEUTRON ACER TENDL-2024 LIBRARY; T=293.6K  
angular distribution for (n,n\*9)

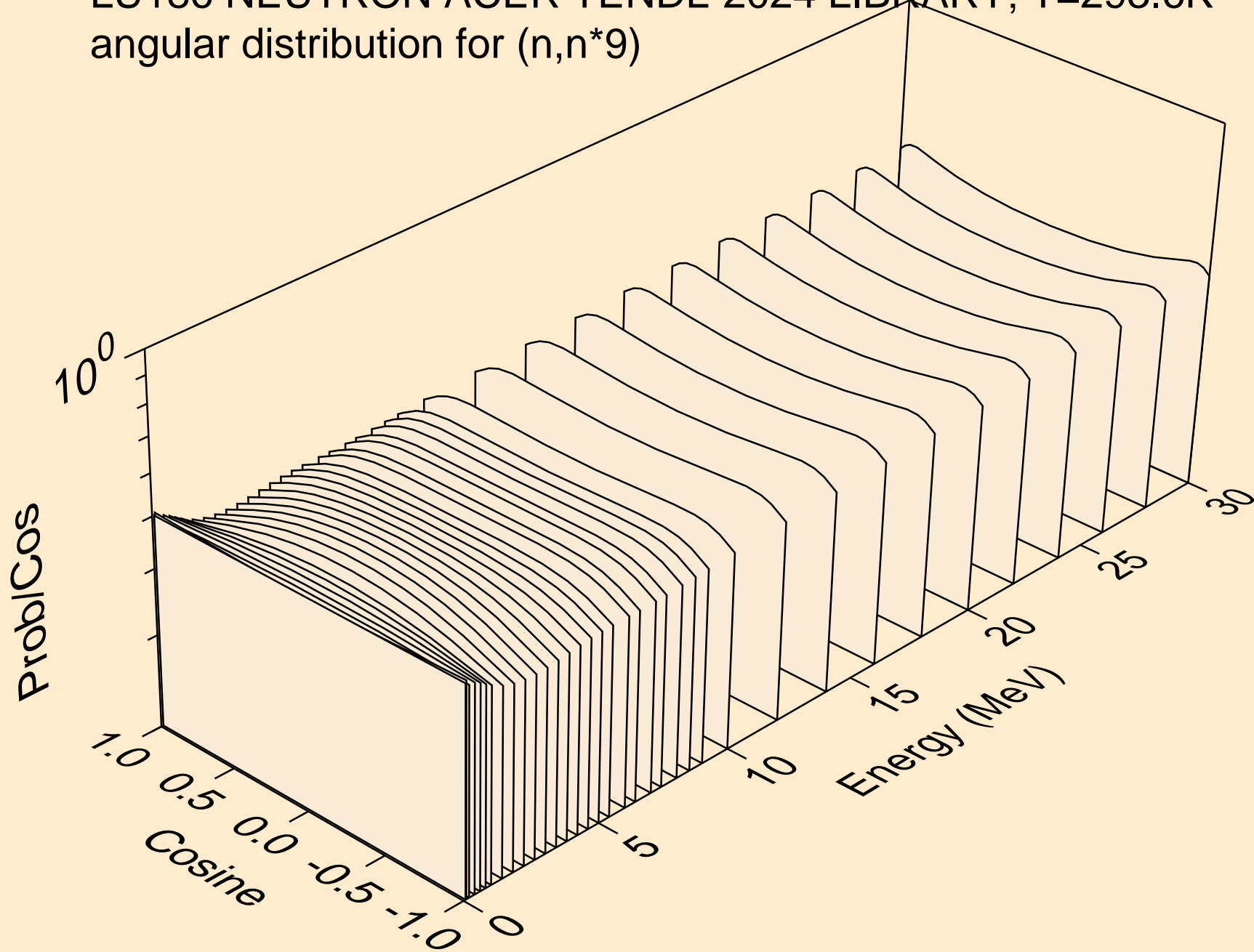

LU186 NEUTRON ACER TENDL-2024 LIBRARY; T=293.6K  
angular distribution for (n,n\*10)

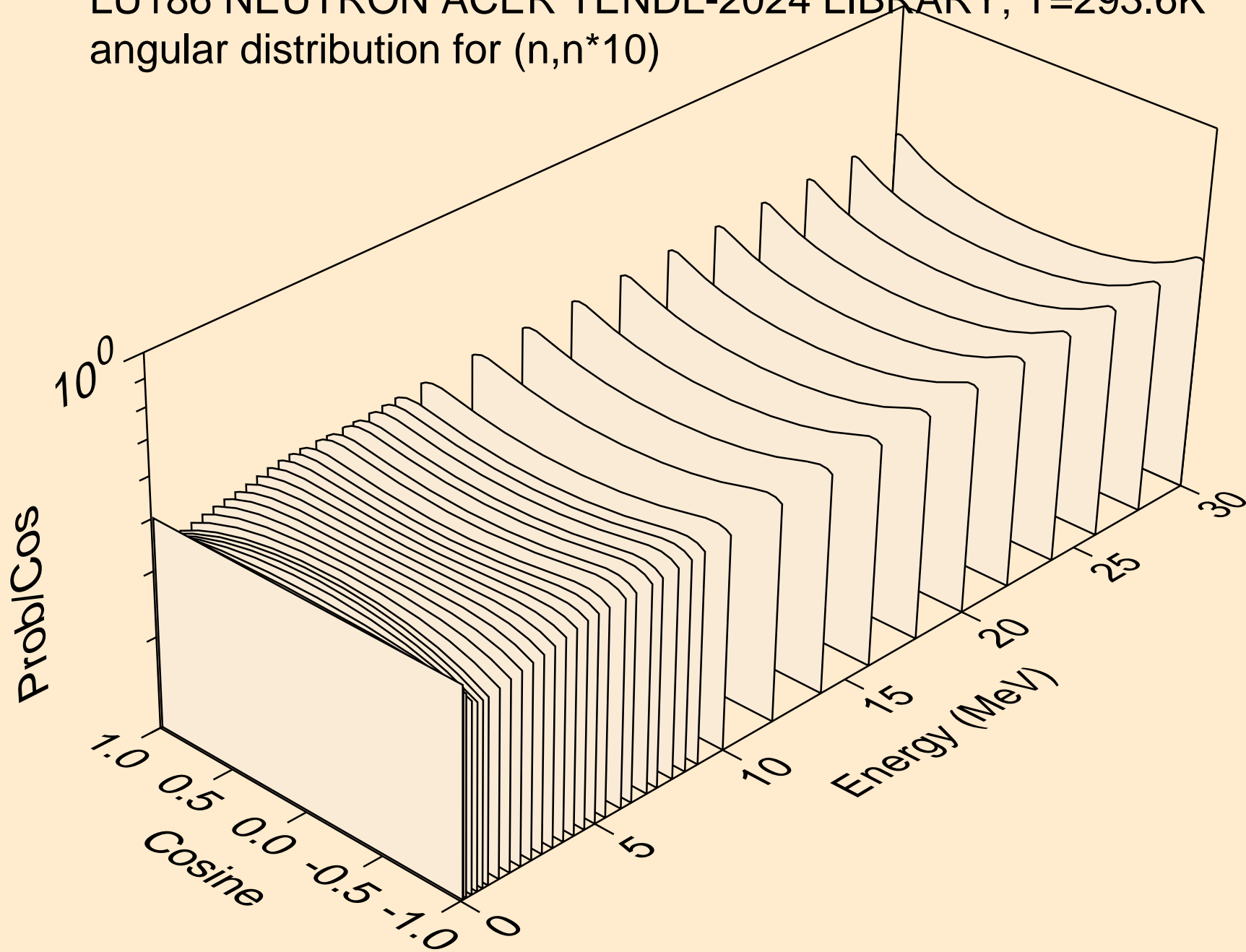

LU186 NEUTRON ACER TENDL-2024 LIBRARY; T=293.6K  
angular distribution for (n,n\*11)

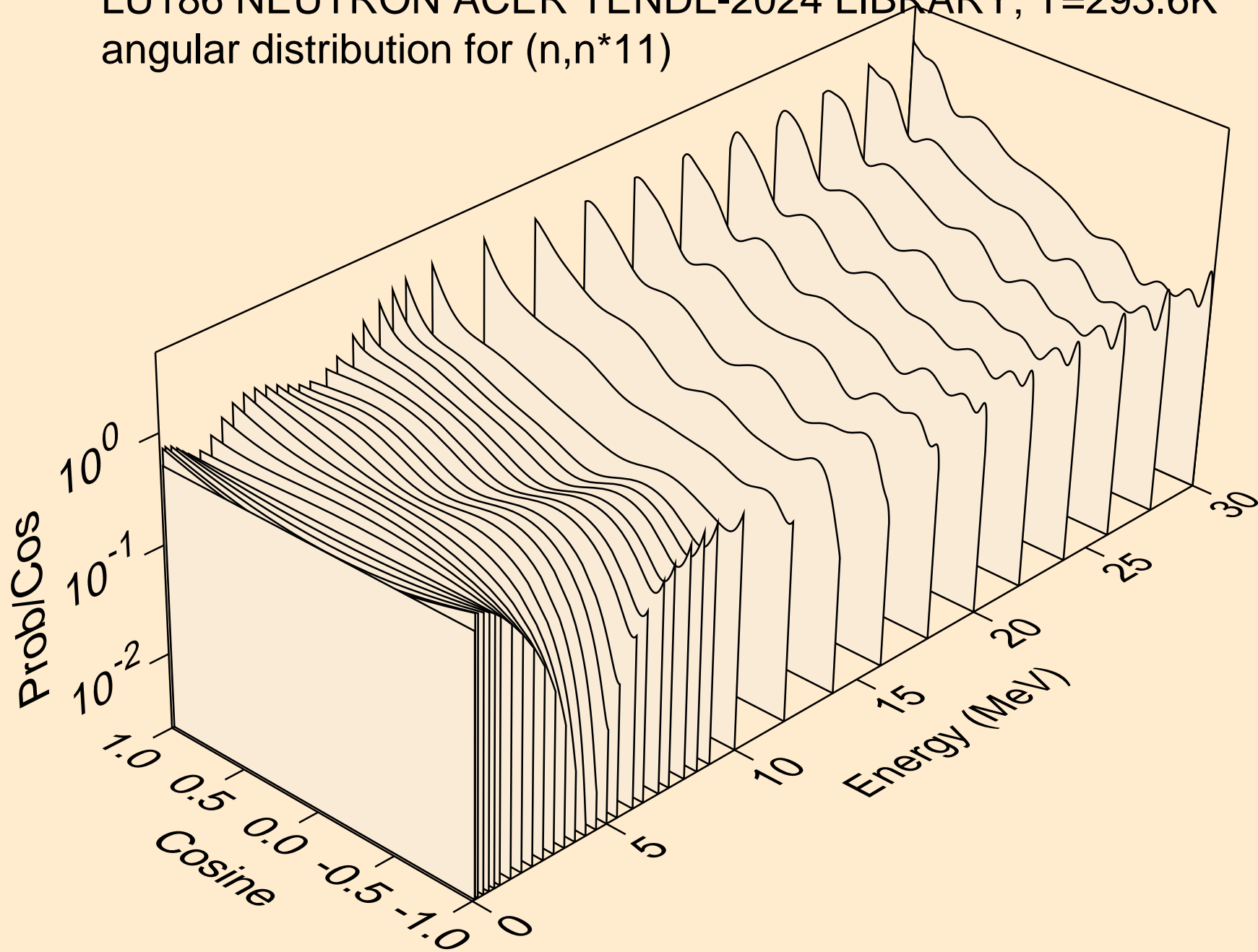

LU186 NEUTRON ACER TENDL-2024 LIBRARY; T=293.6K  
angular distribution for (n,n\*12)

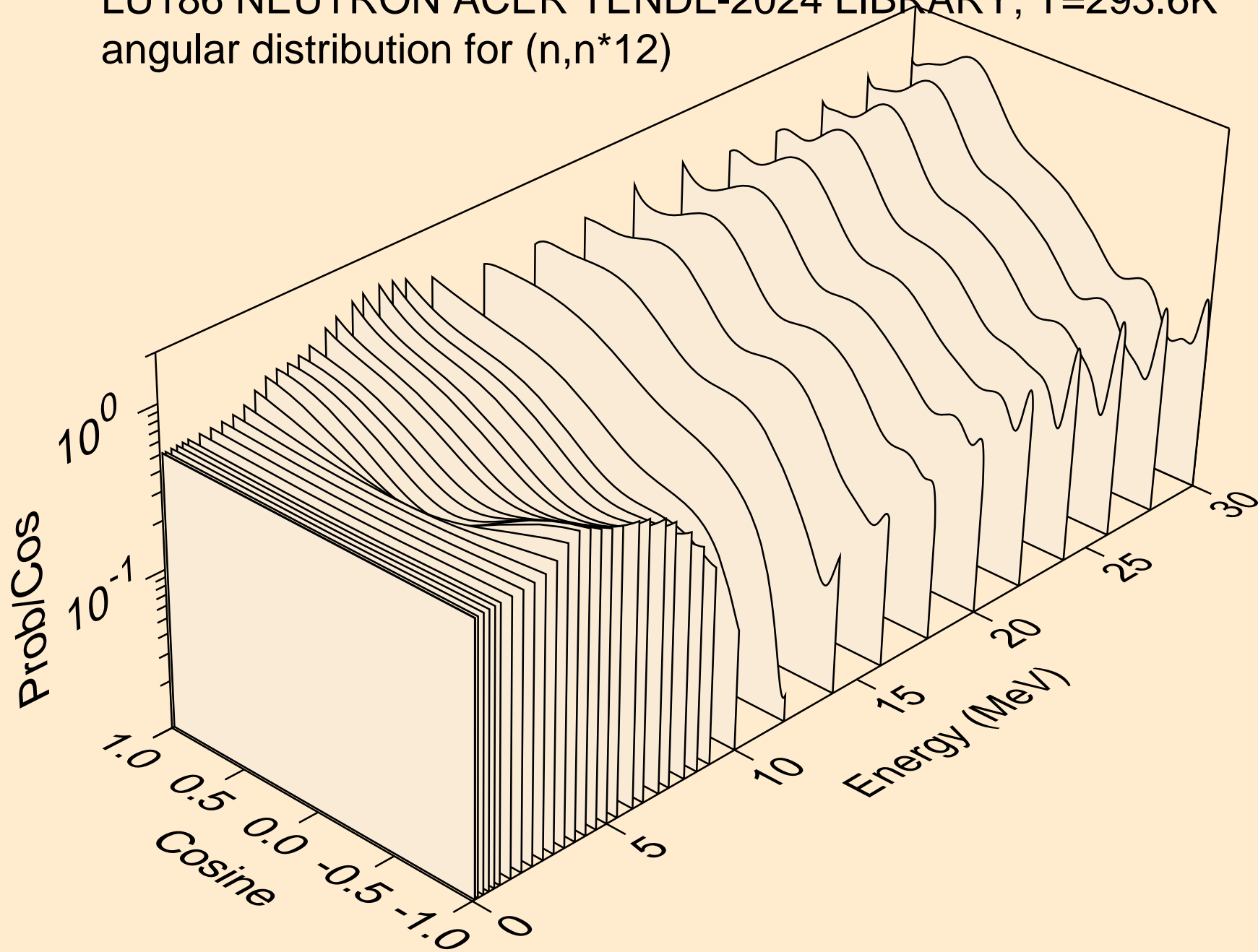

LU186 NEUTRON ACER TENDL-2024 LIBRARY; T=293.6K  
angular distribution for (n,n\*13)

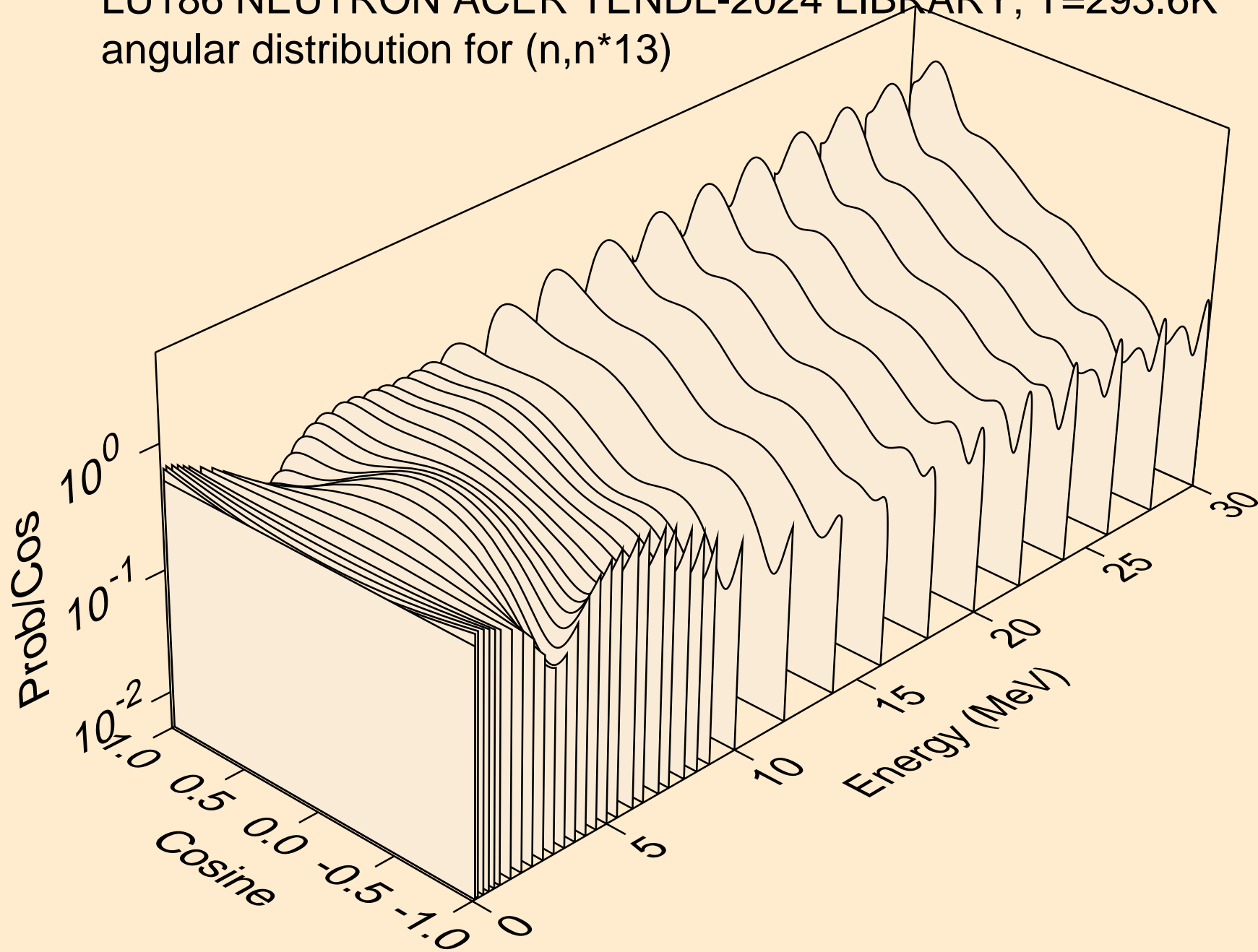

LU186 NEUTRON ACER TENDL-2024 LIBRARY; T=293.6K  
angular distribution for (n,n\*14)

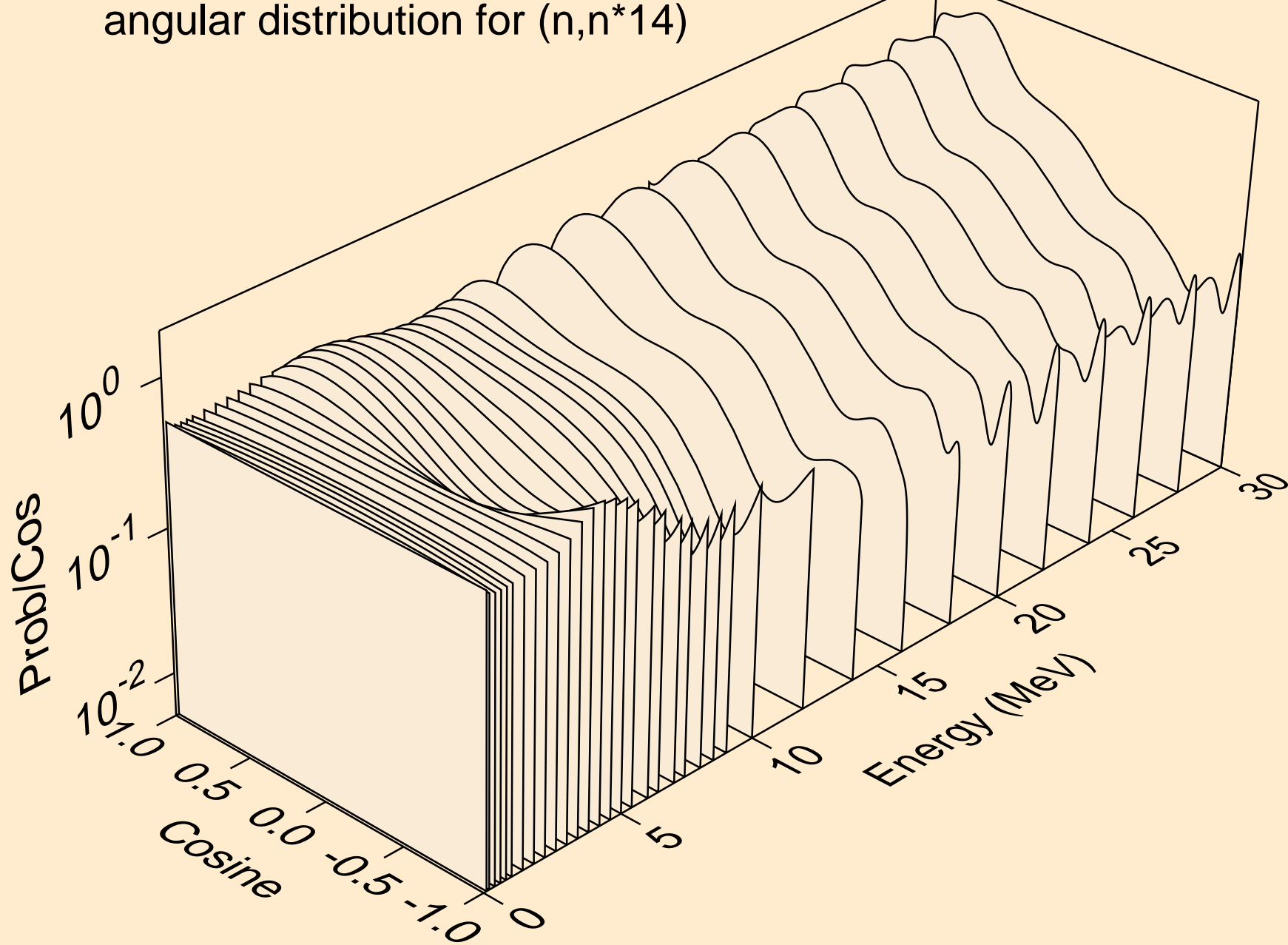

LU186 NEUTRON ACER TENDL-2024 LIBRARY; T=293.6K  
angular distribution for (n,n\*15)

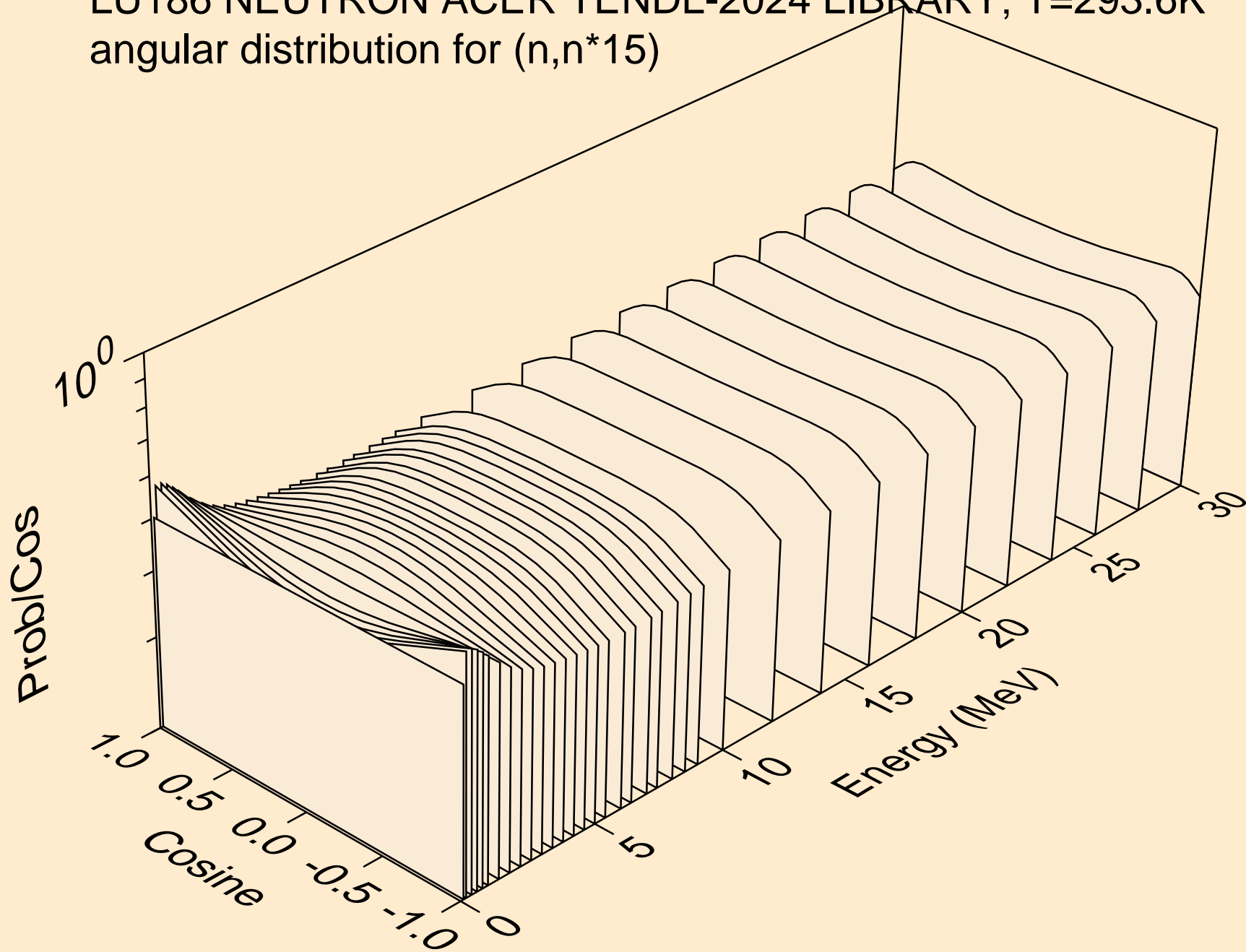

LU186 NEUTRON ACER TENDL-2024 LIBRARY; T=293.6K  
angular distribution for (n,n\*16)

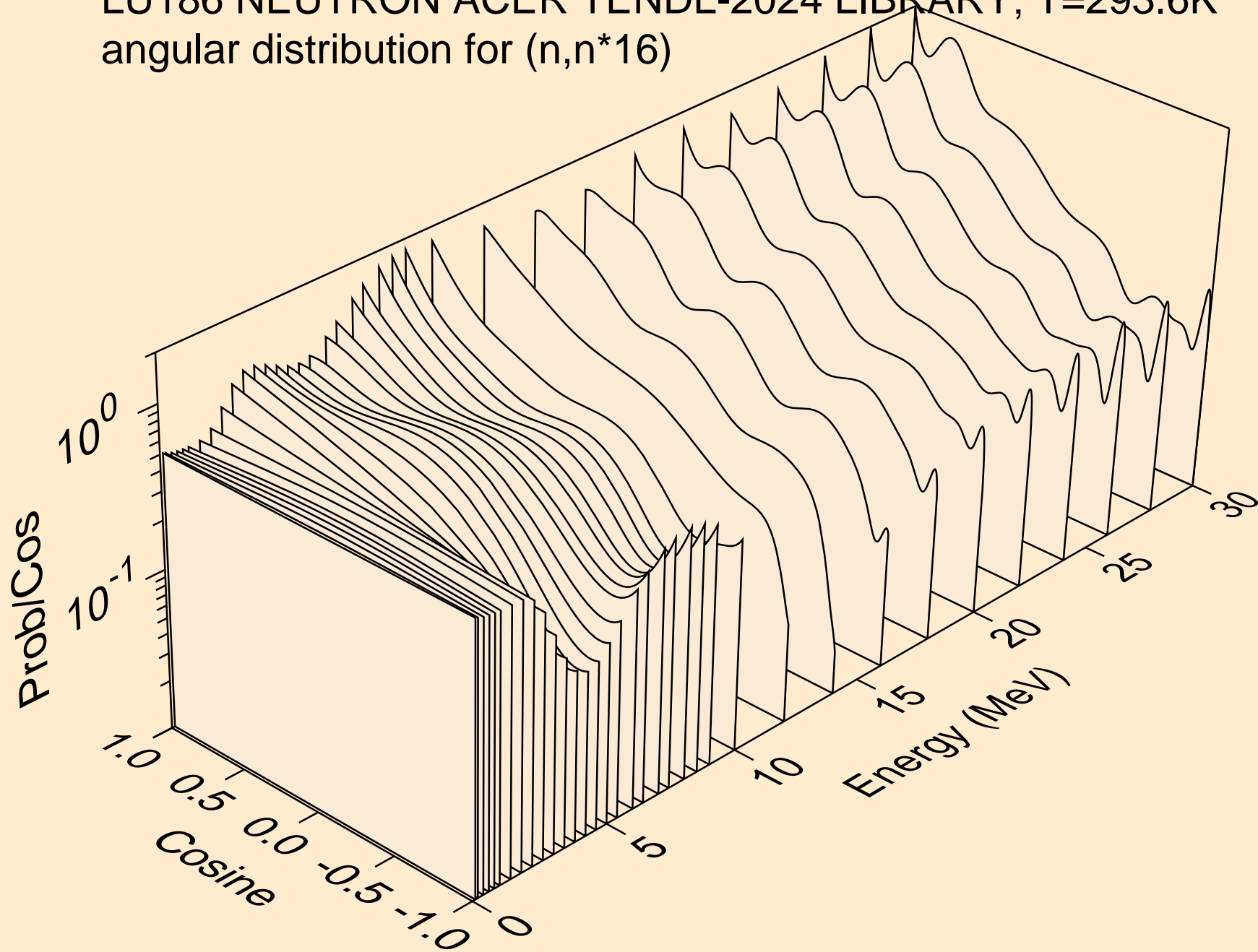

LU186 NEUTRON ACER TENDL-2024 LIBRARY; T=293.6K  
angular distribution for (n,n\*17)

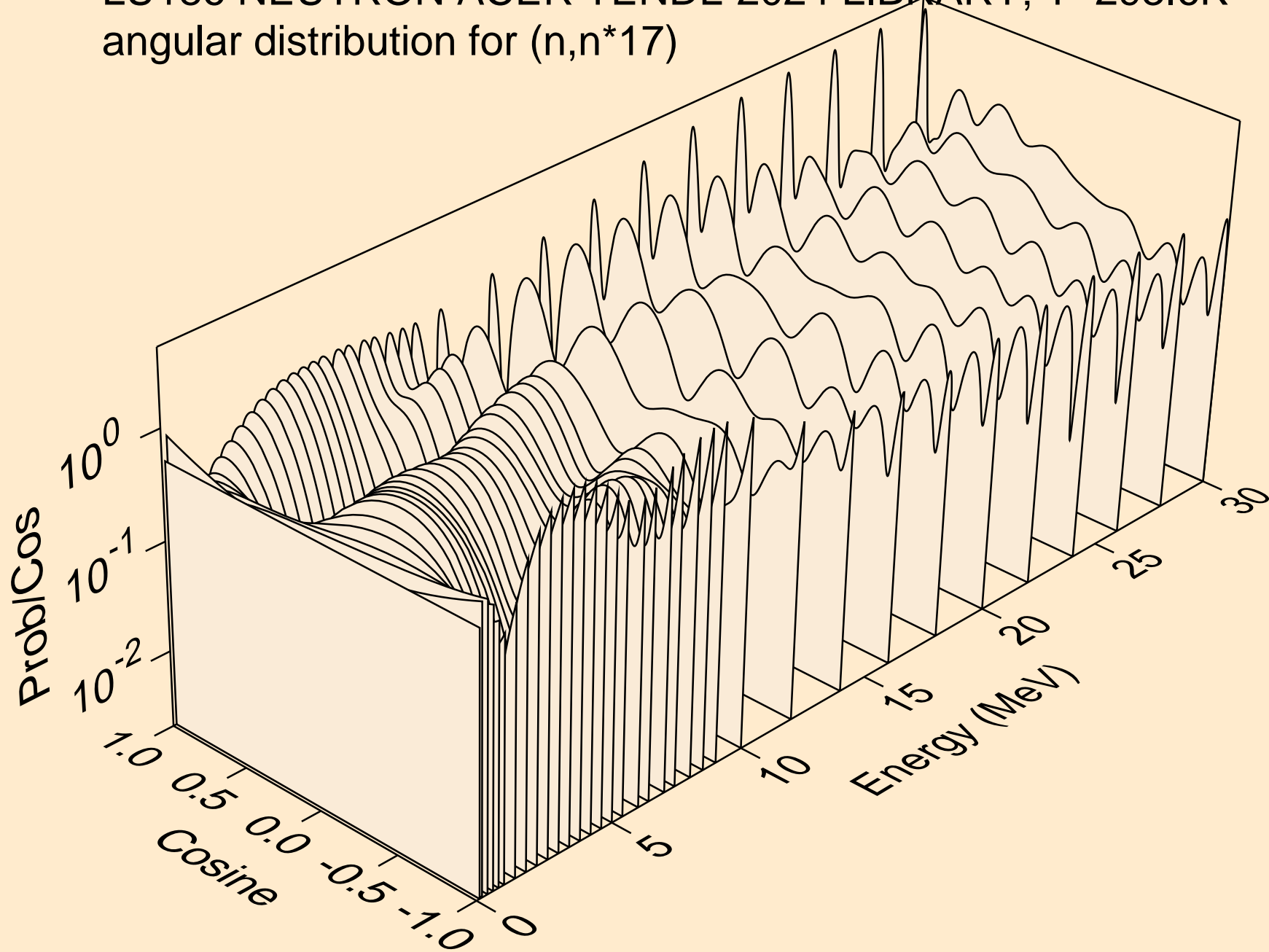

LU186 NEUTRON ACER TENDL-2024 LIBRARY; T=293.6K  
angular distribution for (n,n\*18)

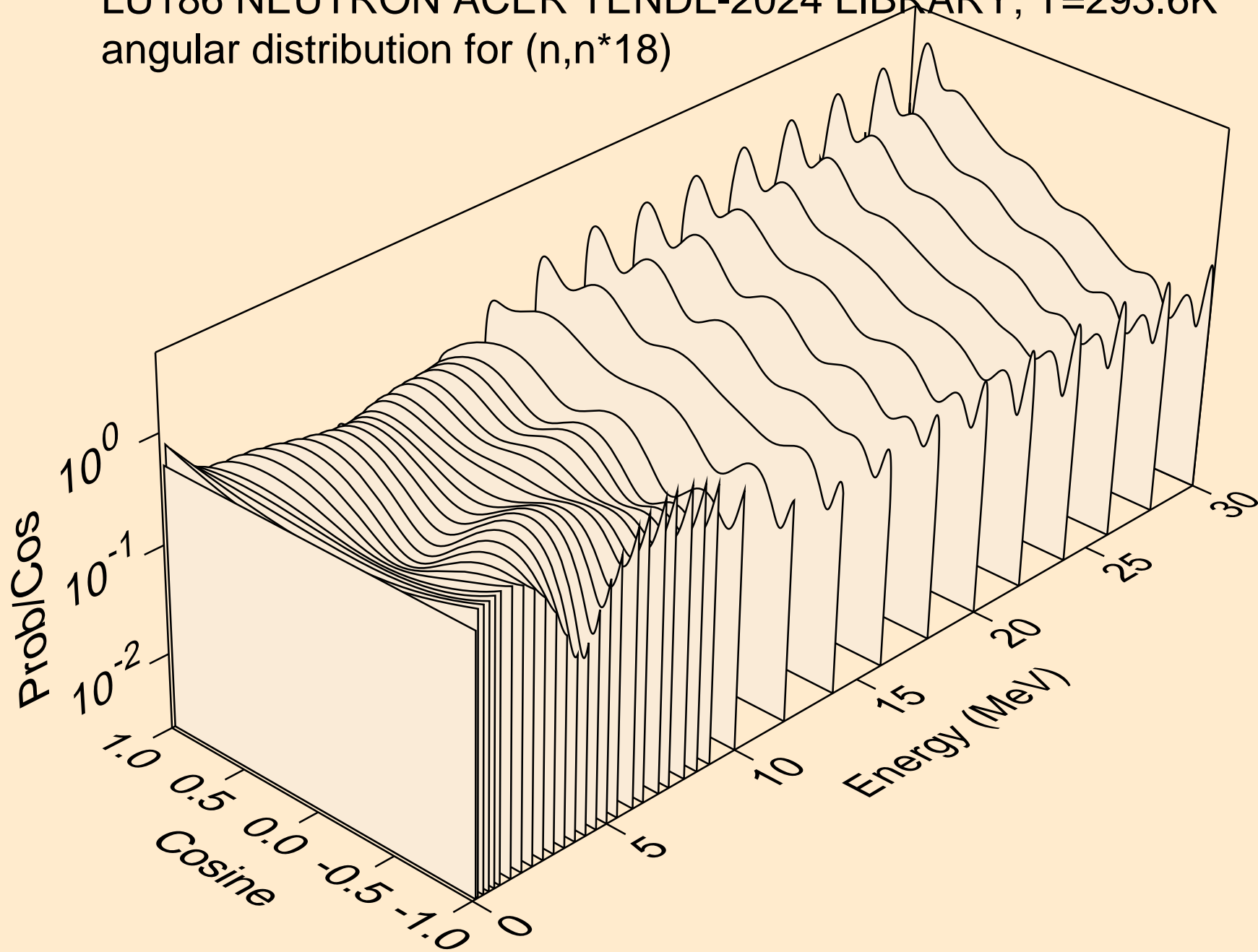

LU186 NEUTRON ACER TENDL-2024 LIBRARY; T=293.6K  
angular distribution for (n,n\*19)

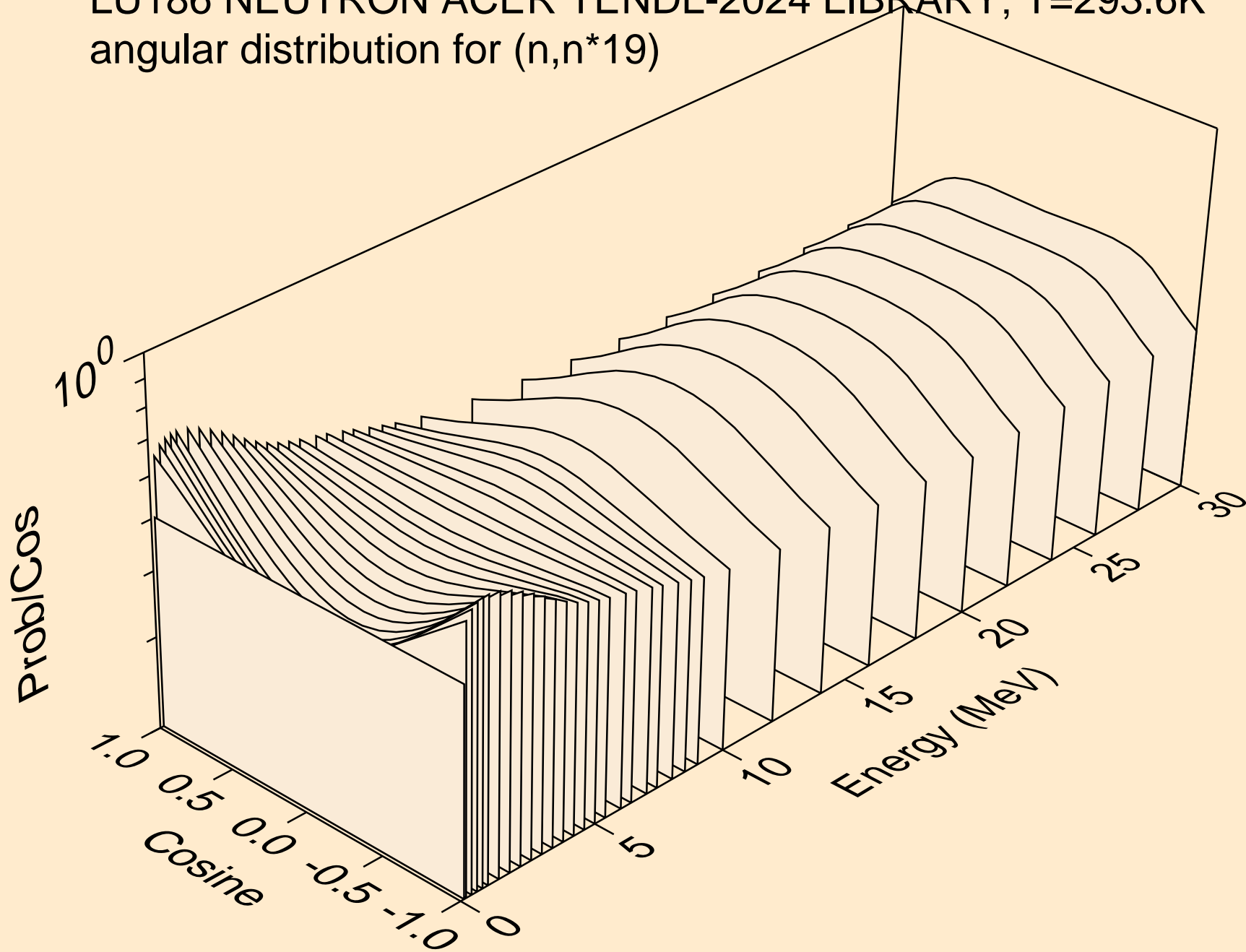

LU186 NEUTRON ACER TENDL-2024 LIBRARY; T=293.6K  
angular distribution for (n,n\*20)

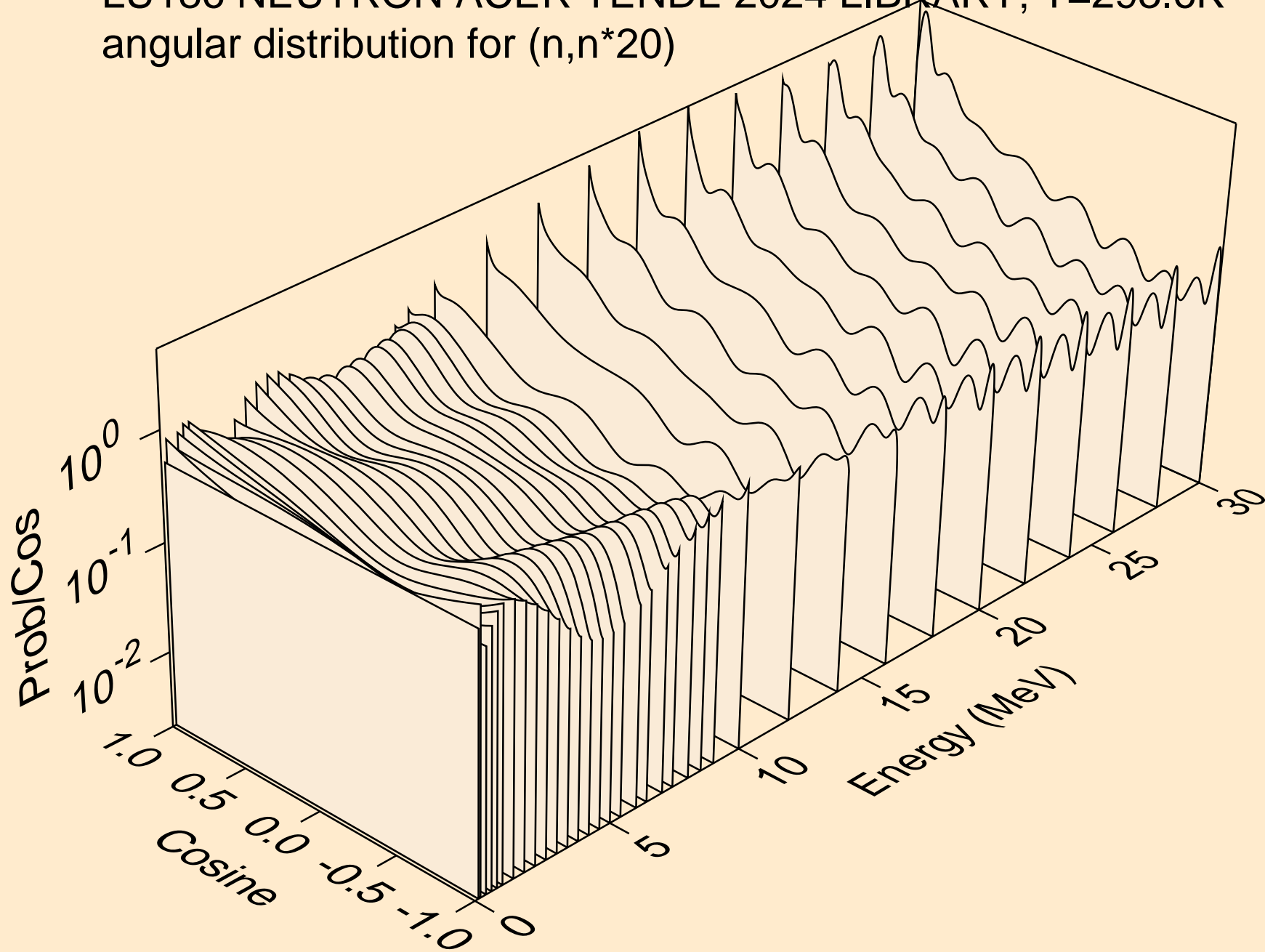

LU186 NEUTRON ACER TENDL-2024 LIBRARY; T=293.6K  
angular distribution for (n,n\*21)

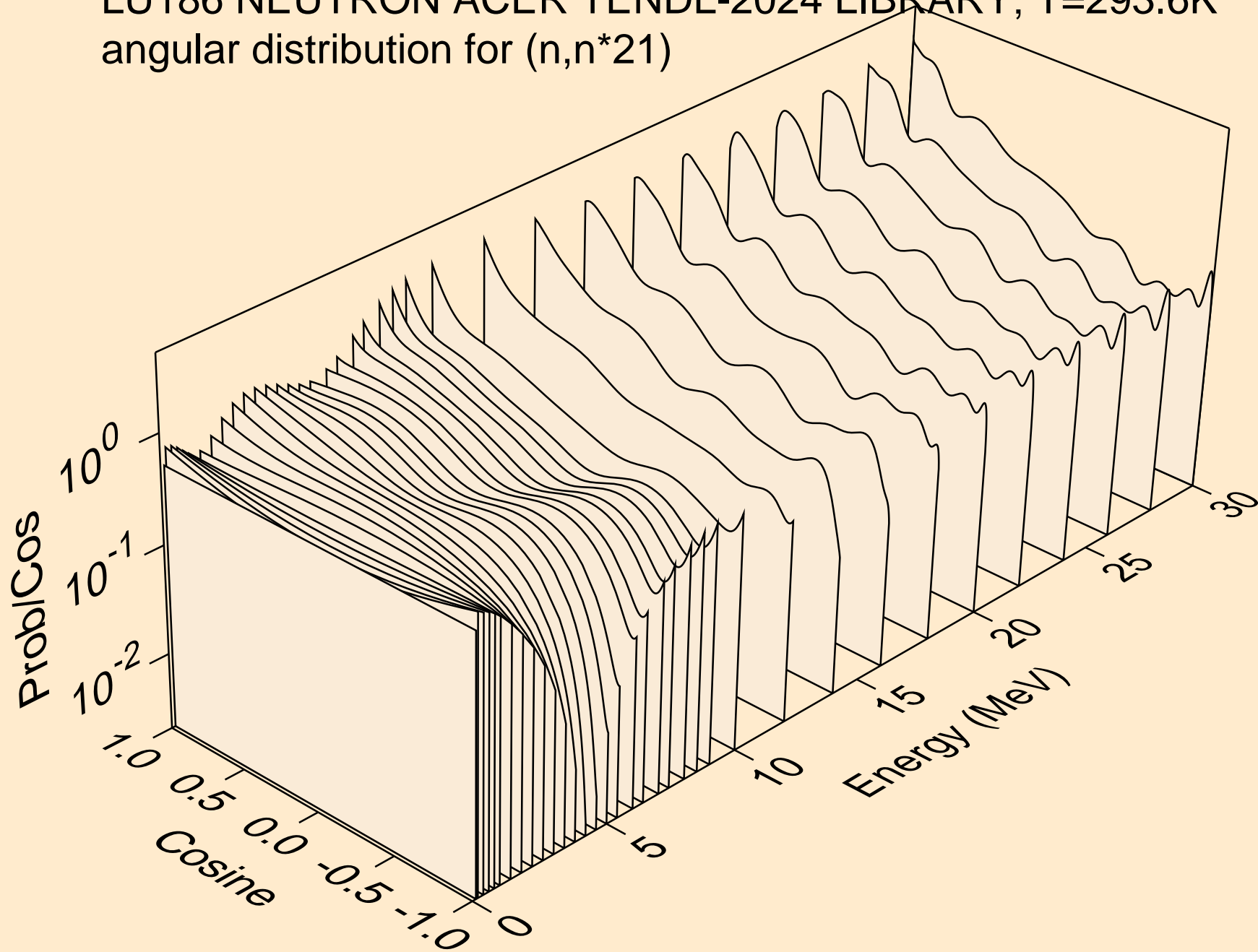

LU186 NEUTRON ACER TENDL-2024 LIBRARY; T=293.6K  
angular distribution for (n,n\*22)

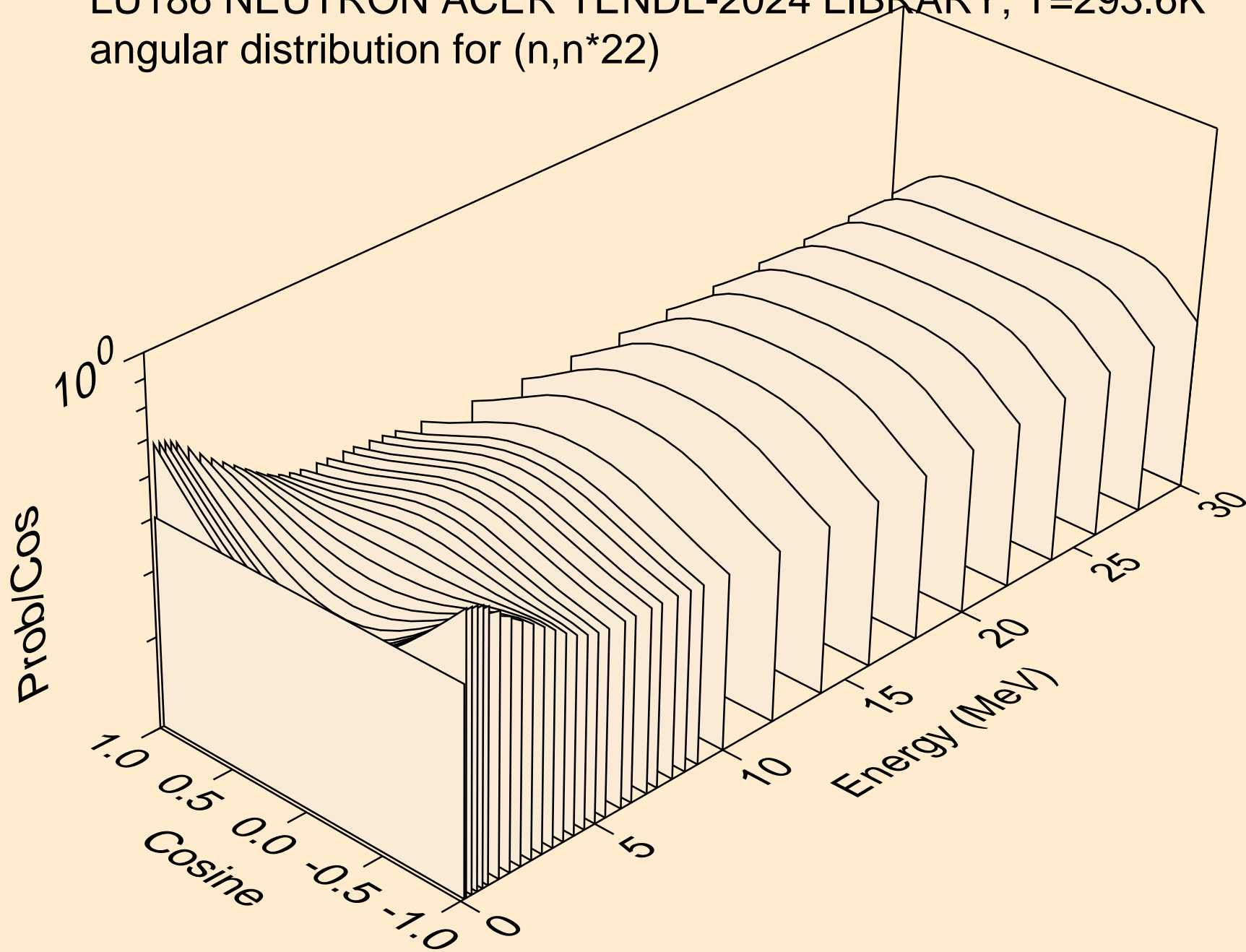

LU186 NEUTRON ACER TENDL-2024 LIBRARY; T=293.6K  
angular distribution for (n,n\*23)

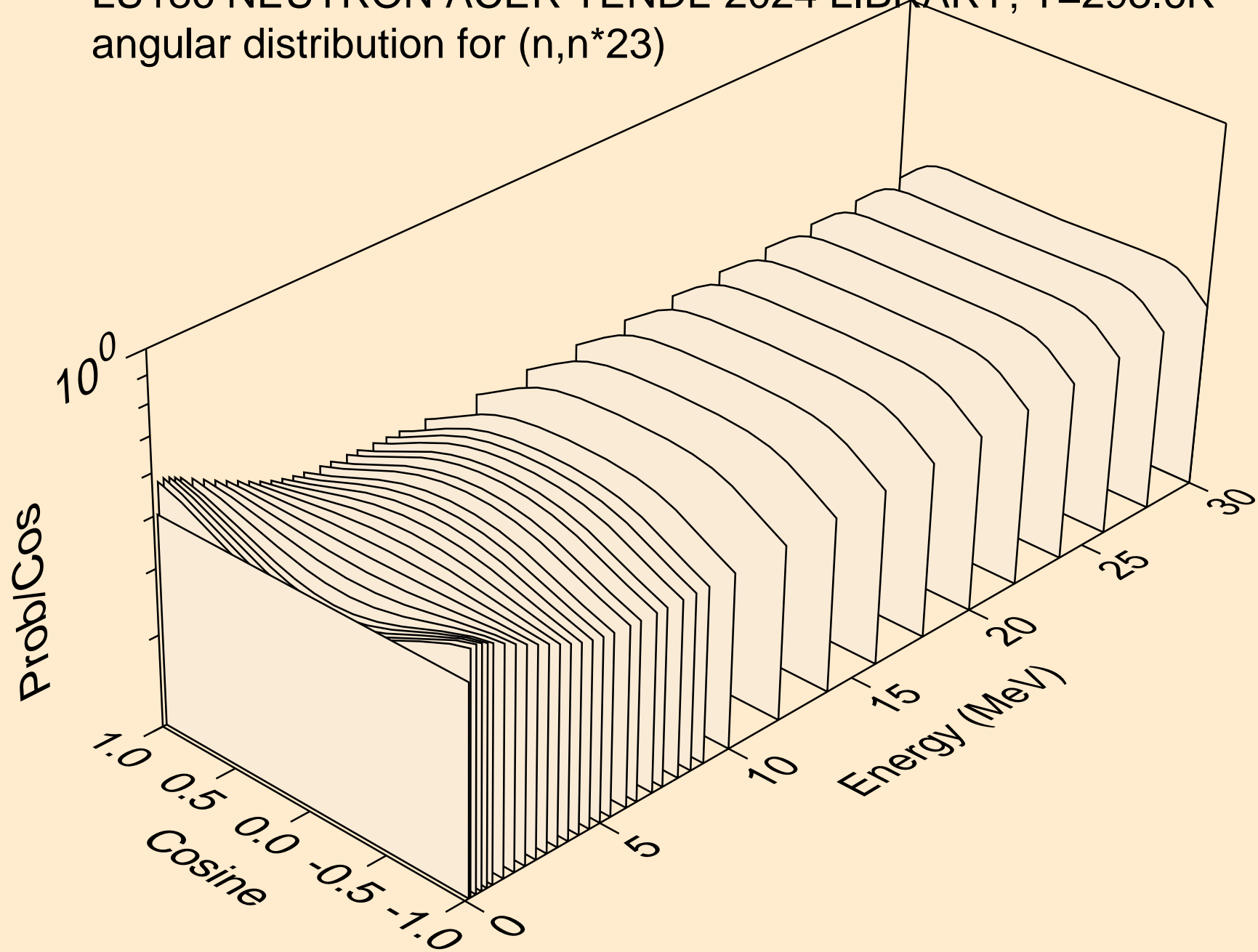

LU186 NEUTRON ACER TENDL-2024 LIBRARY; T=293.6K  
angular distribution for (n,n\*24)

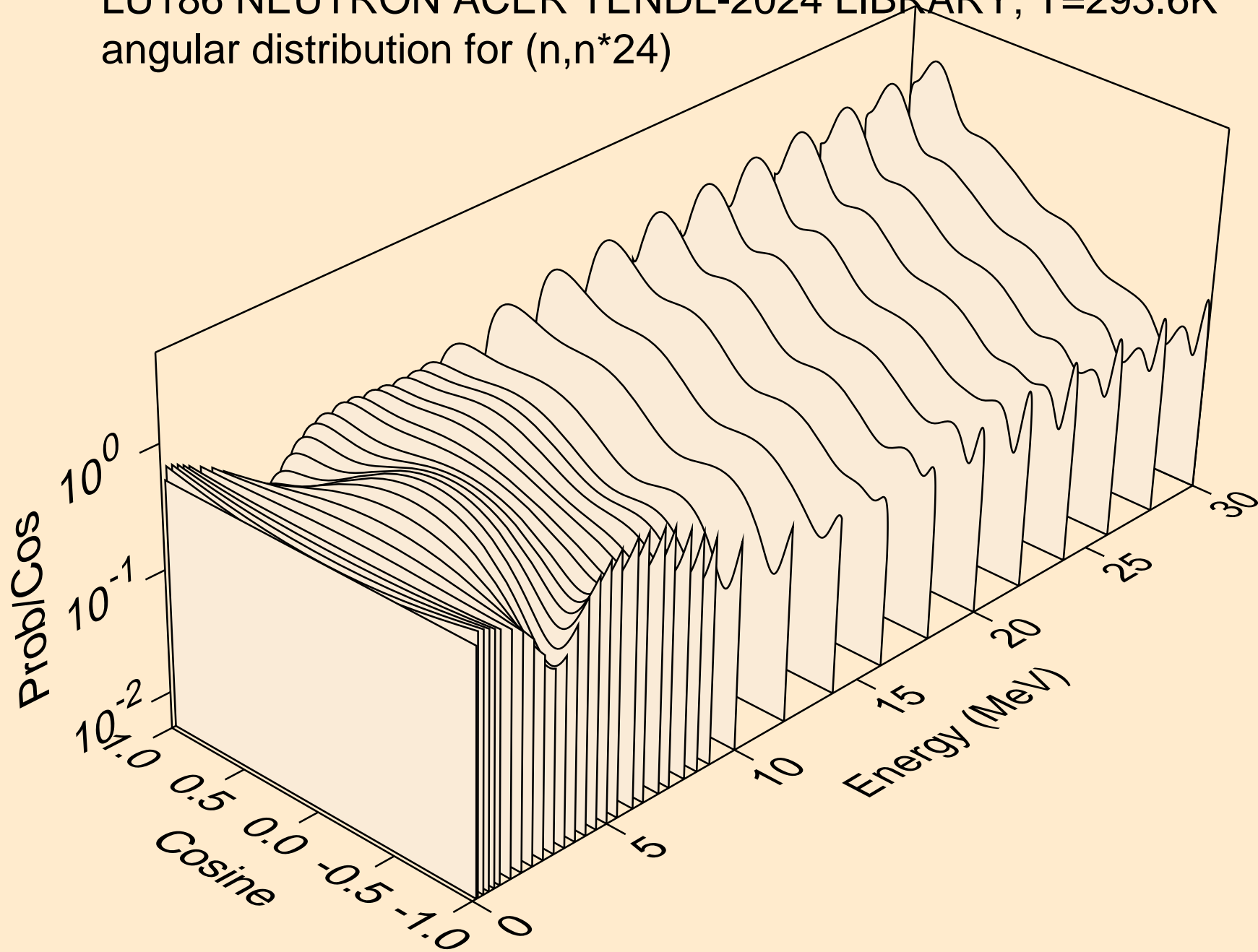

LU186 NEUTRON ACER TENDL-2024 LIBRARY; T=293.6K  
angular distribution for (n,n\*25)

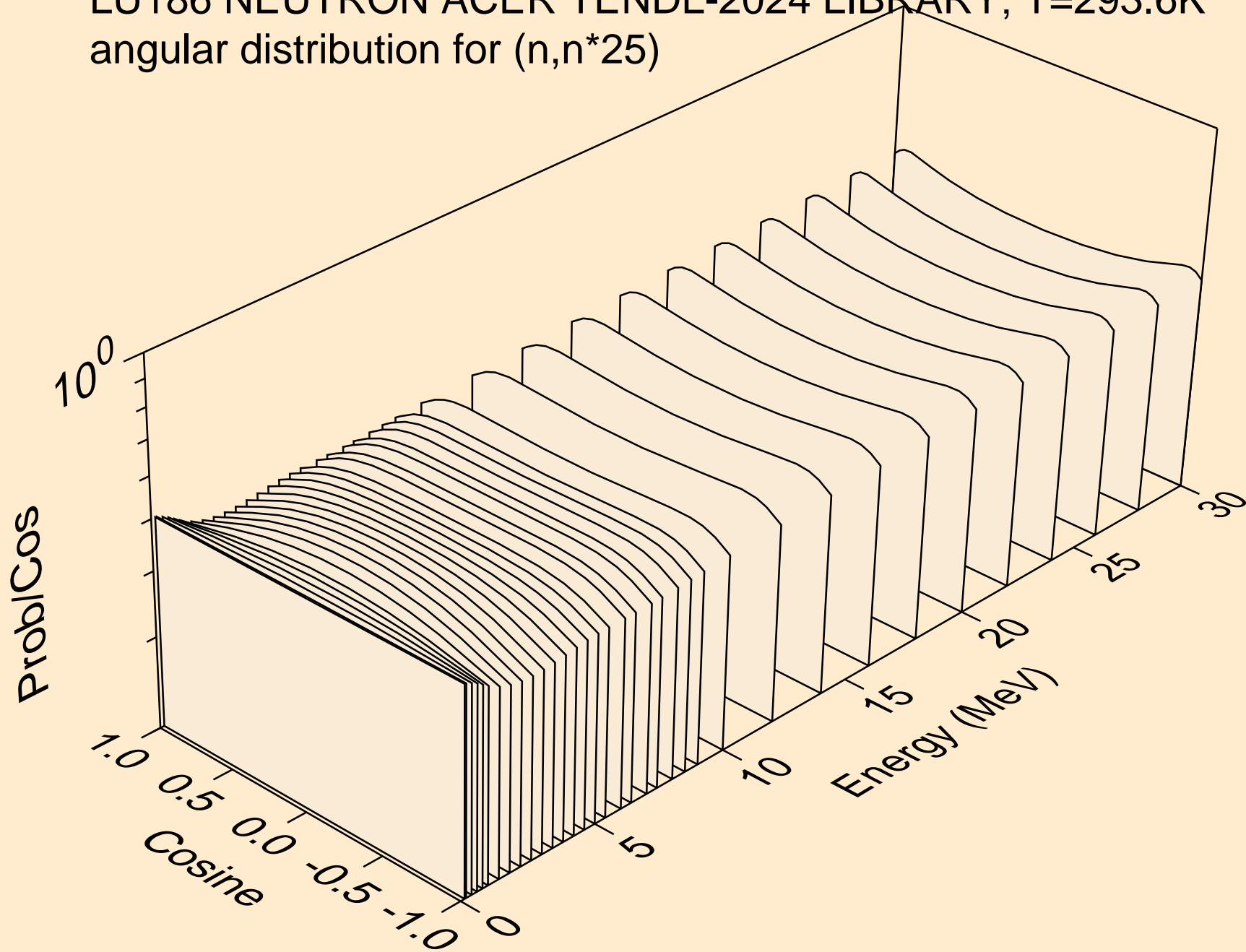

LU186 NEUTRON ACER TENDL-2024 LIBRARY; T=293.6K  
angular distribution for (n,n\*26)

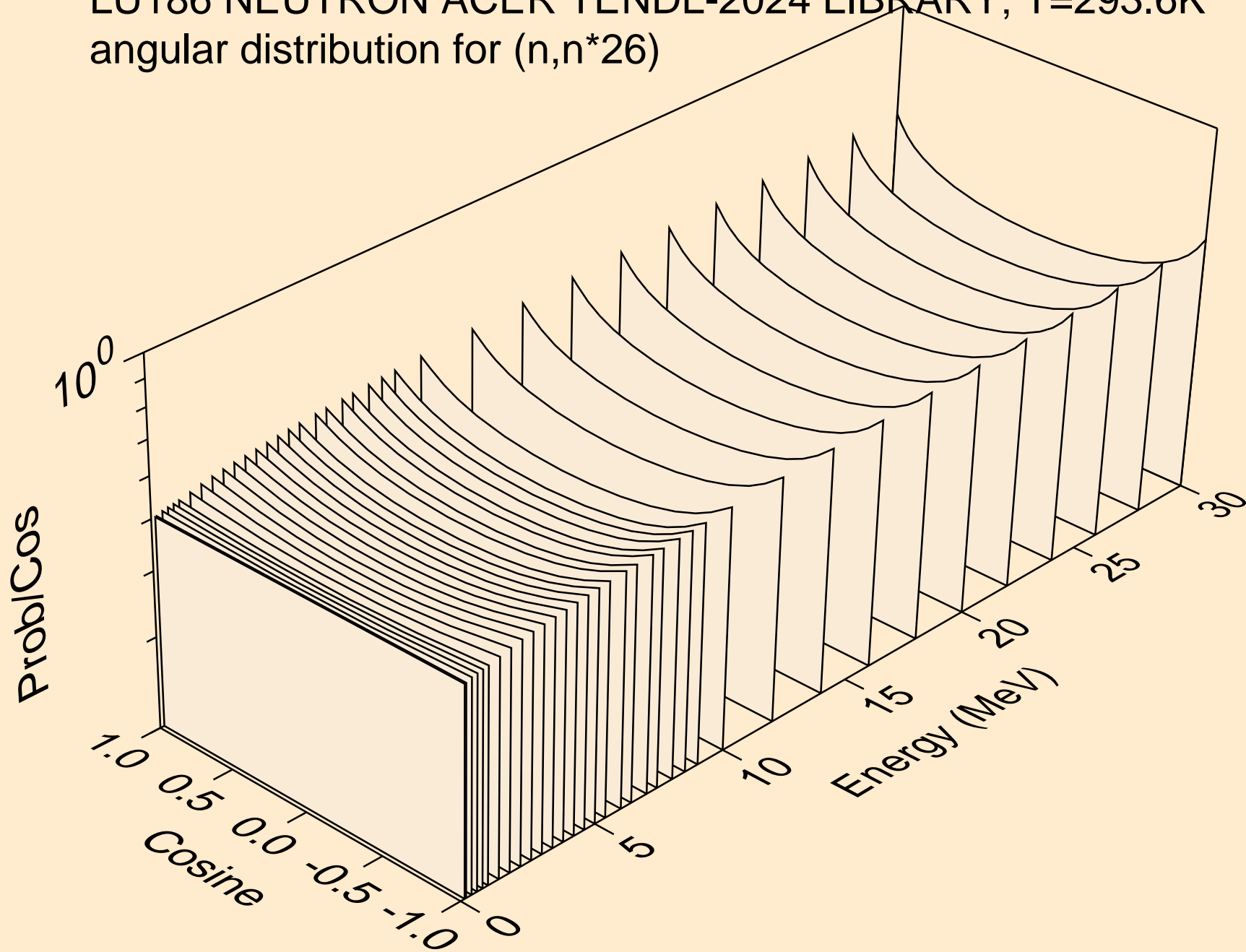

LU186 NEUTRON ACER TENDL-2024 LIBRARY; T=293.6K  
angular distribution for (n,n\*27)

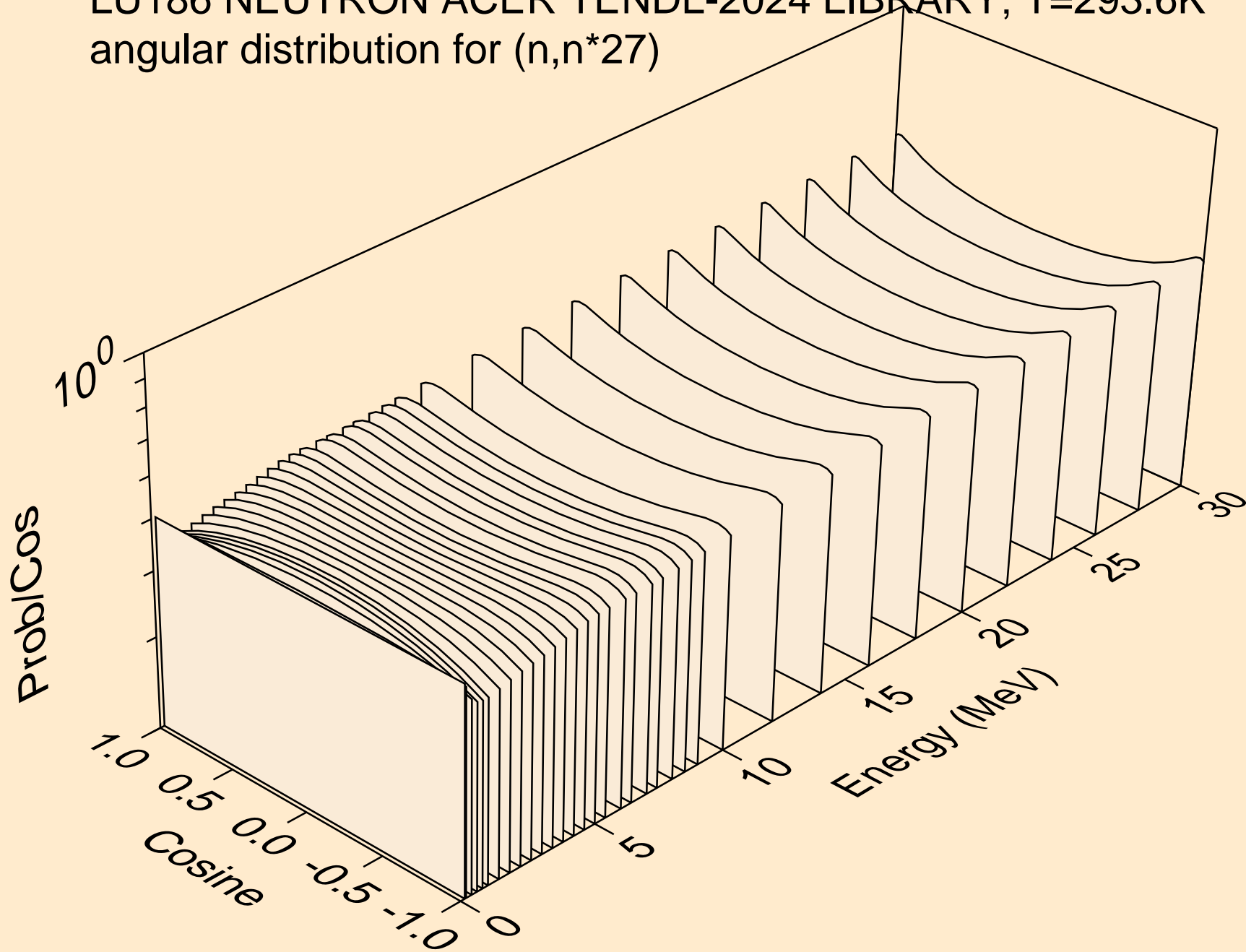

LU186 NEUTRON ACER TENDL-2024 LIBRARY; T=293.6K  
angular distribution for (n,n\*28)

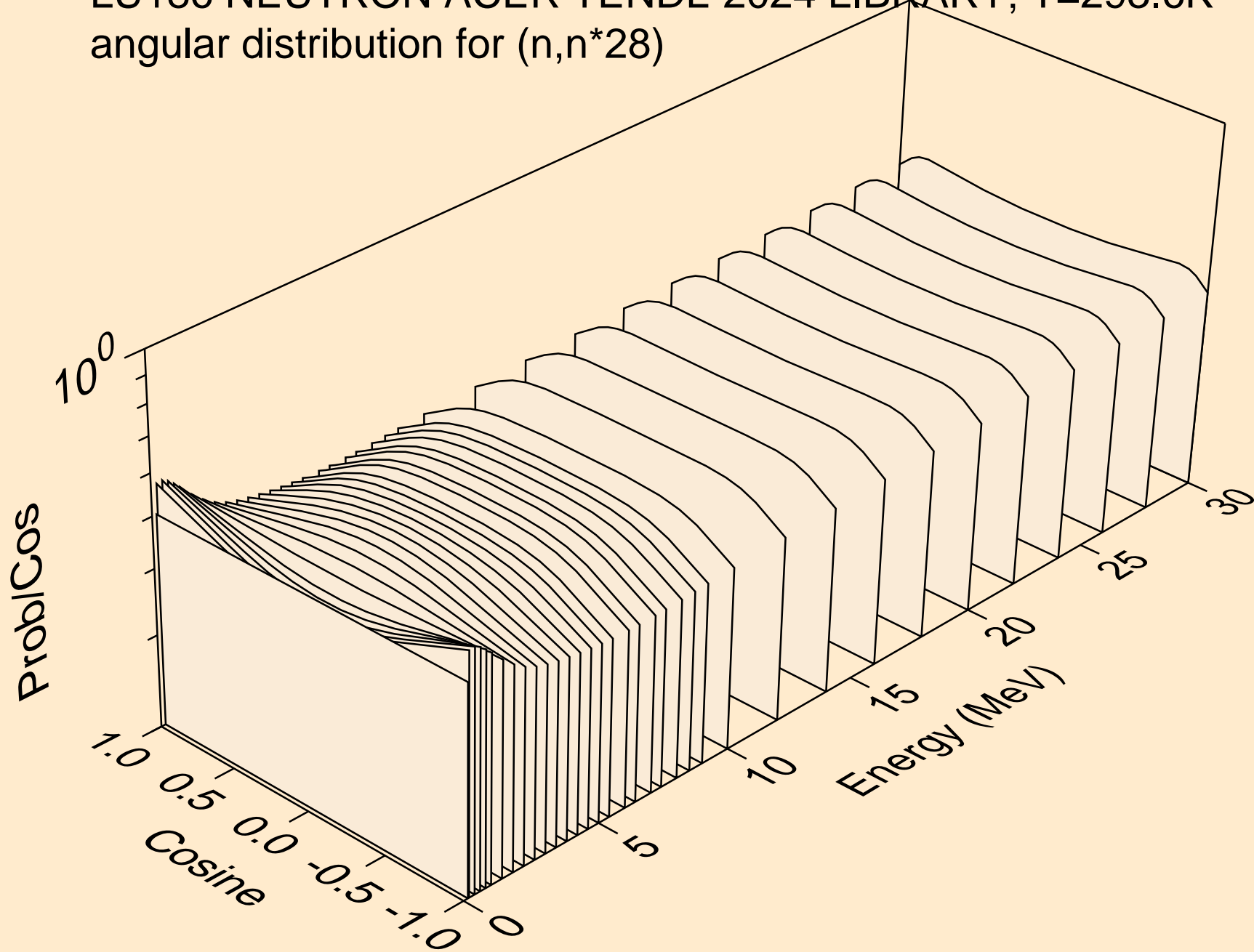

LU186 NEUTRON ACER TENDL-2024 LIBRARY; T=293.6K  
angular distribution for (n,n\*29)

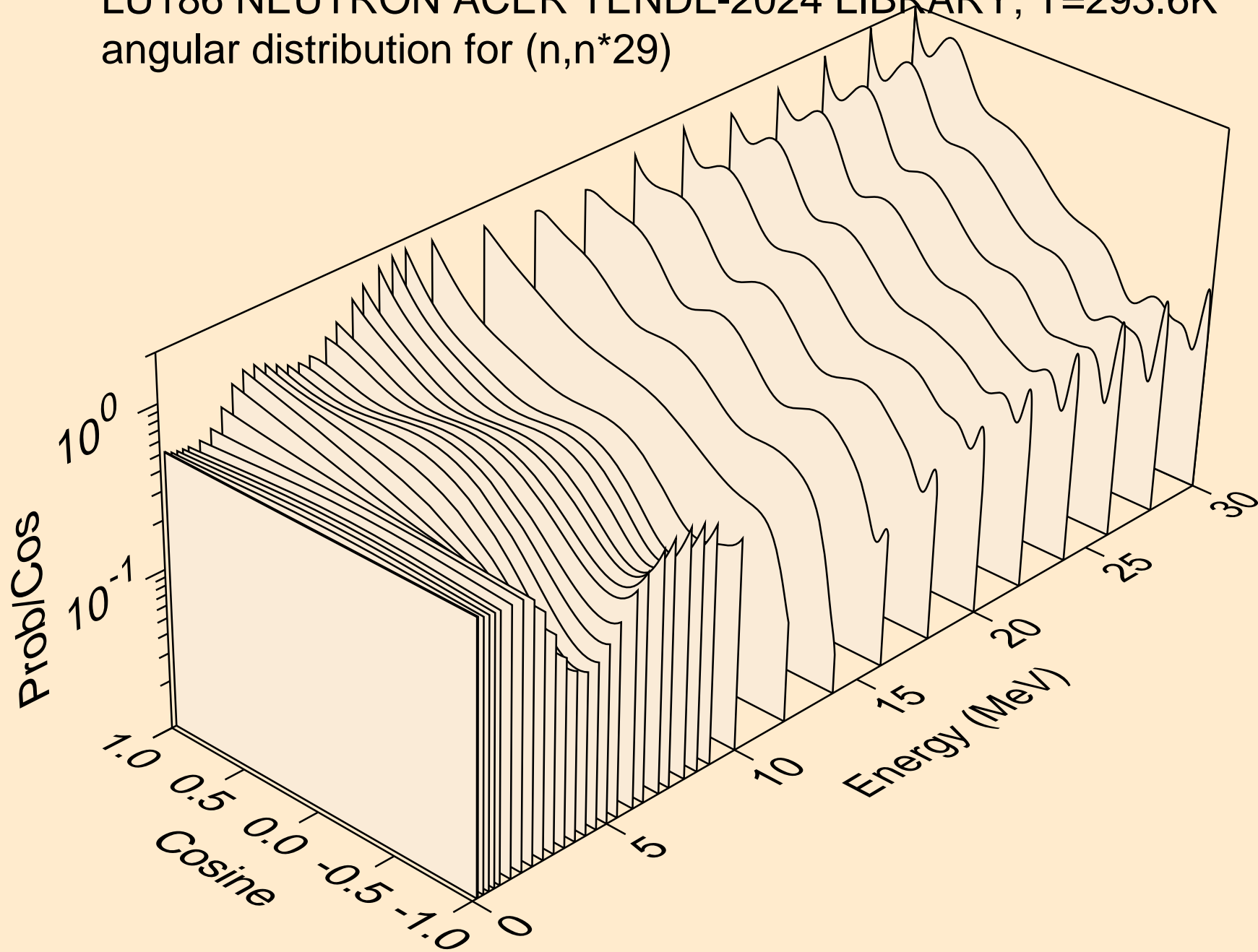

LU186 NEUTRON ACER TENDL-2024 LIBRARY; T=293.6K  
Neutron emission for (n,x)

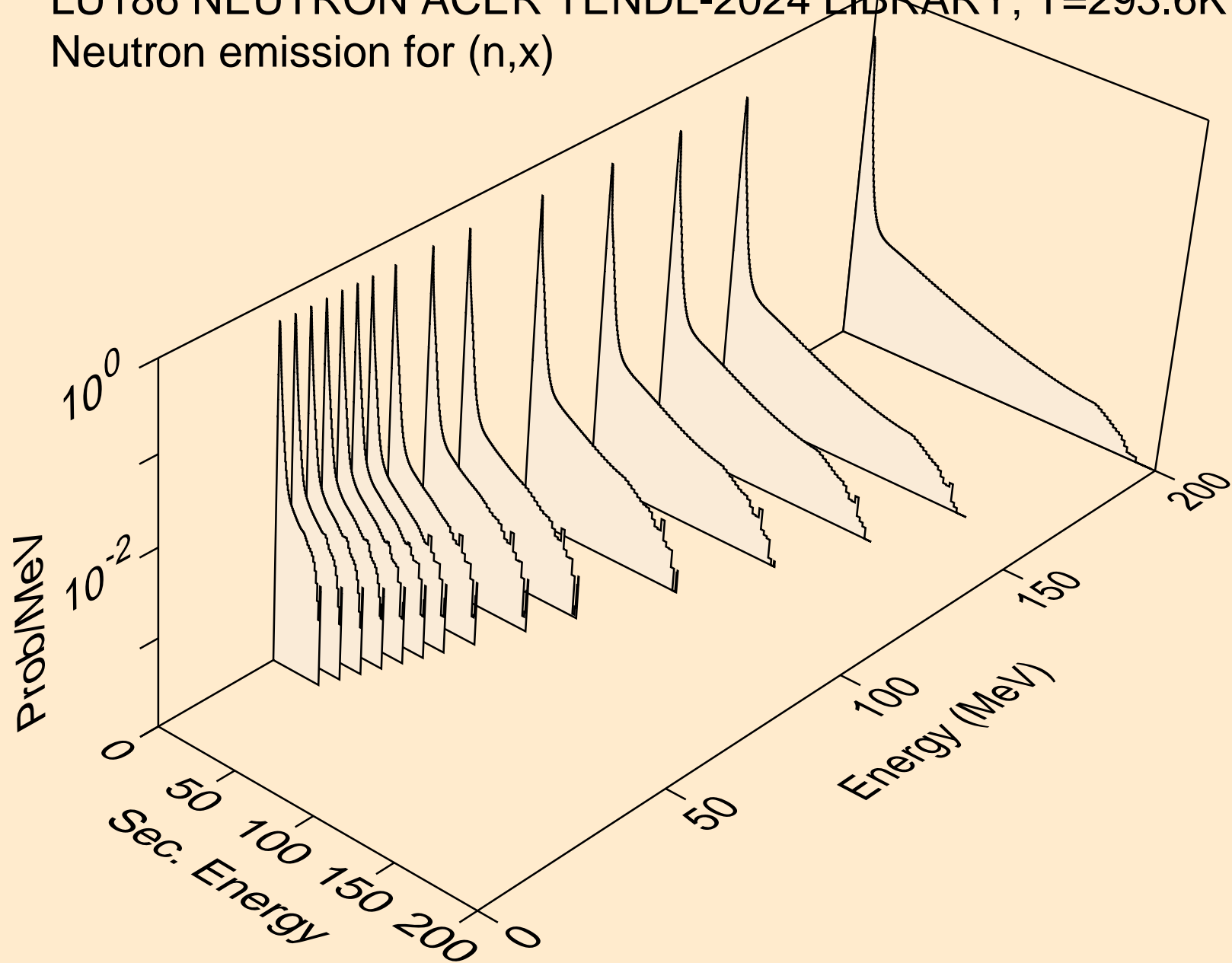

LU186 NEUTRON ACER TENDL-2024 LIBRARY; T=293.6K  
Neutron emission for (n,2nd)

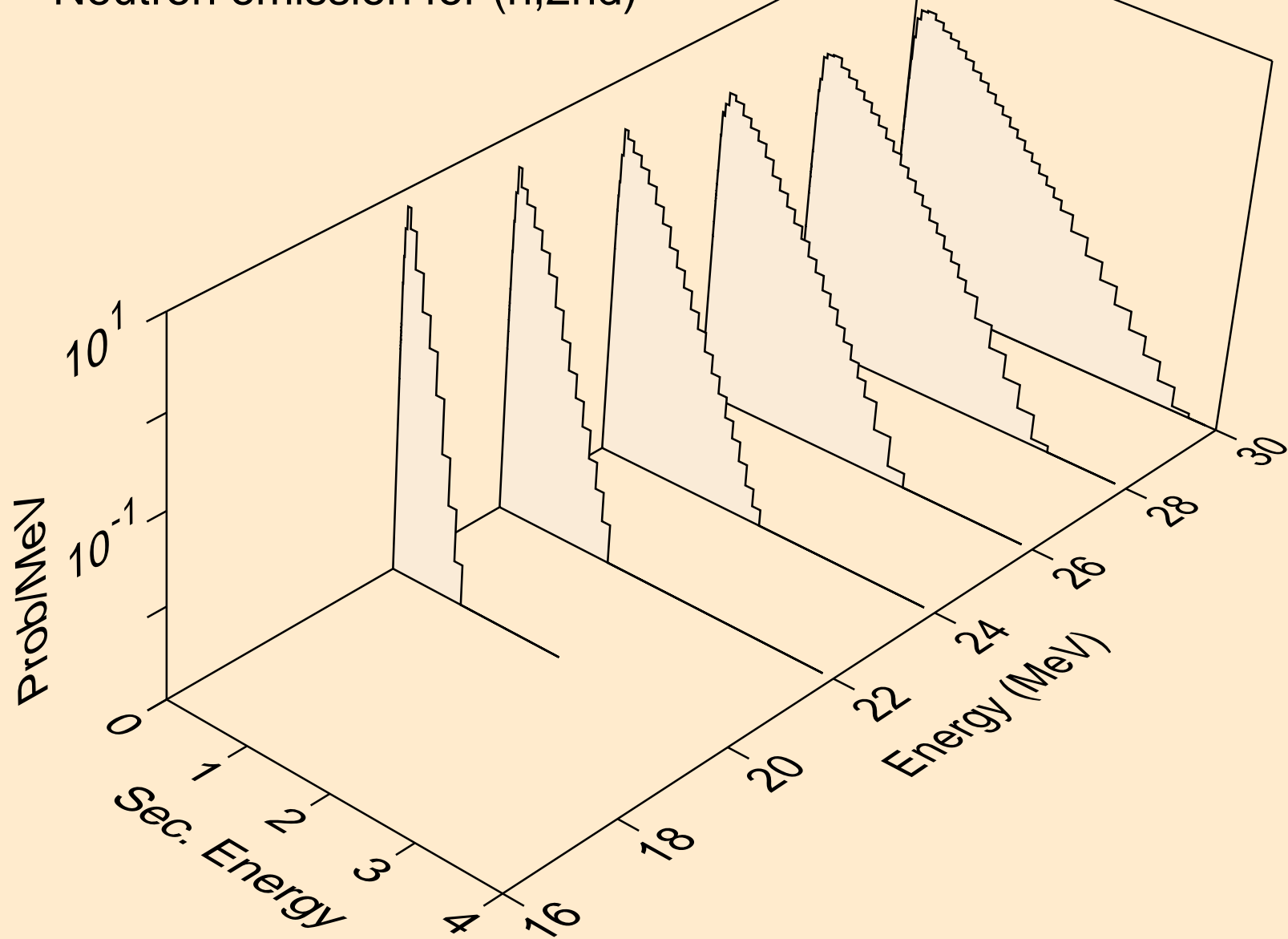

LU186 NEUTRON ACER TENDL-2024 LIBRARY; T=293.6K  
Neutron emission for (n,2n)

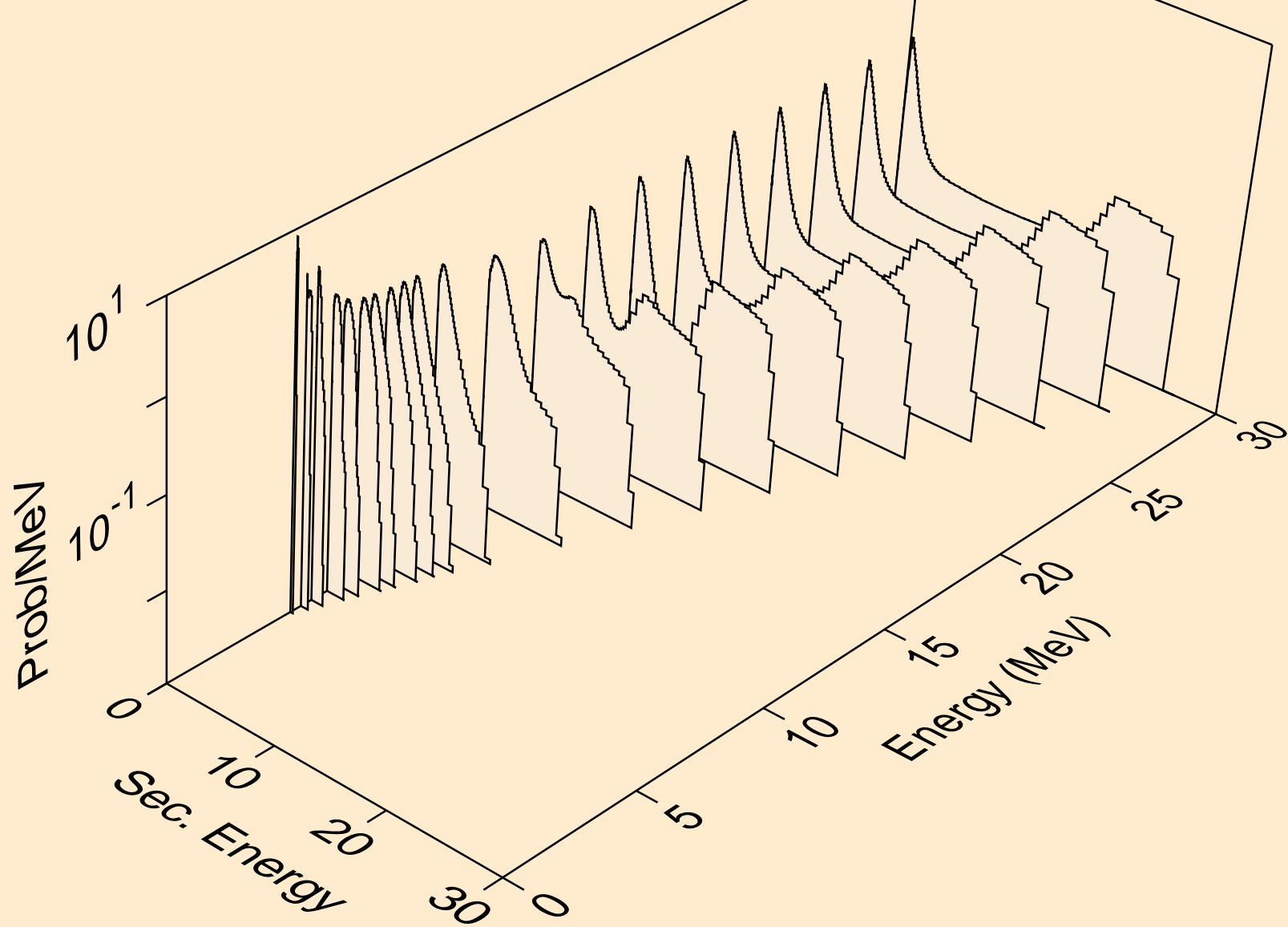

LU186 NEUTRON ACER TENDL-2024 LIBRARY; T=293.6K  
Neutron emission for (n,3n)

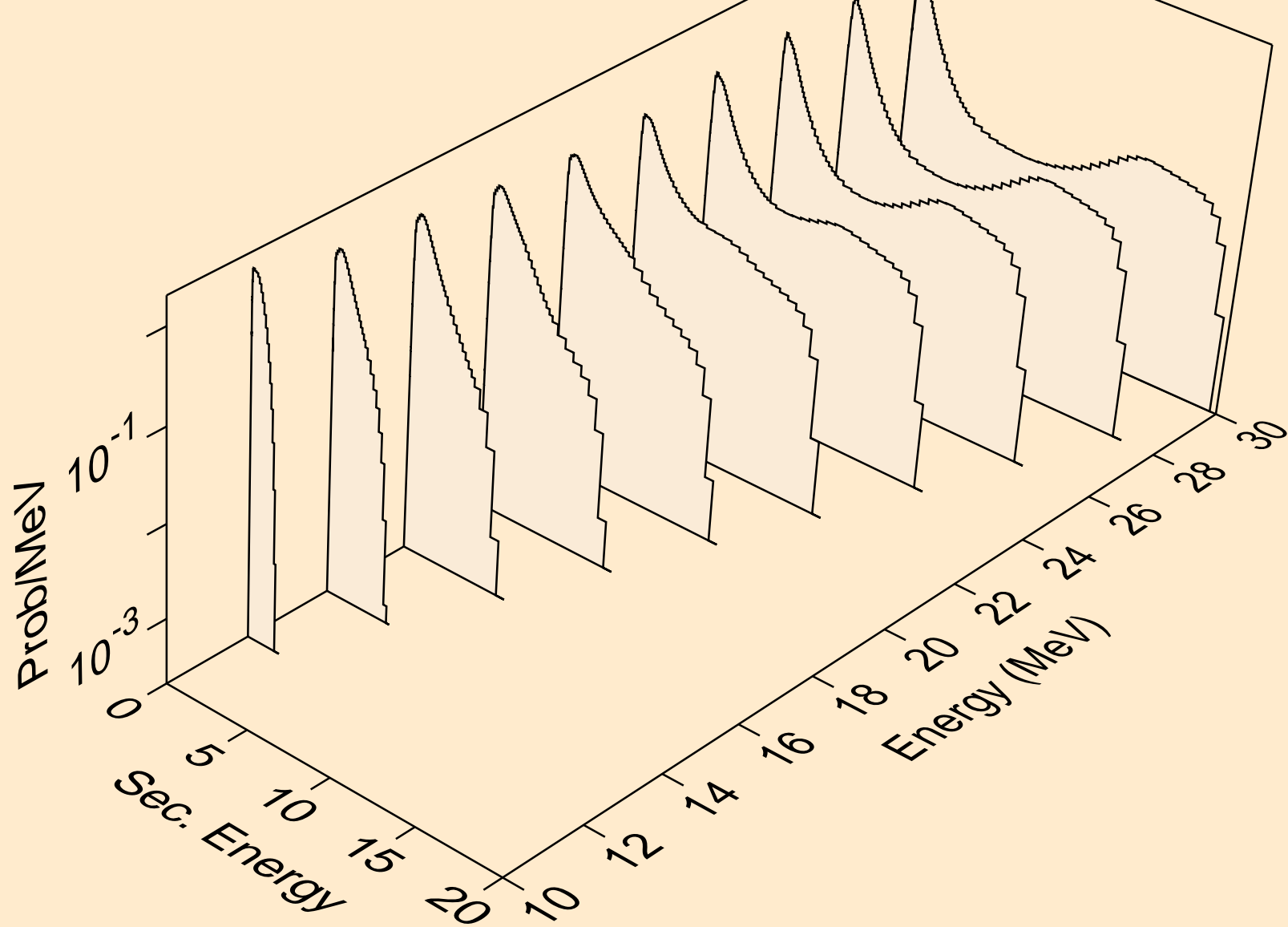

LU186 NEUTRON ACER TENDL-2024 LIBRARY; T=293.6K  
Neutron emission for (n,n\*)a

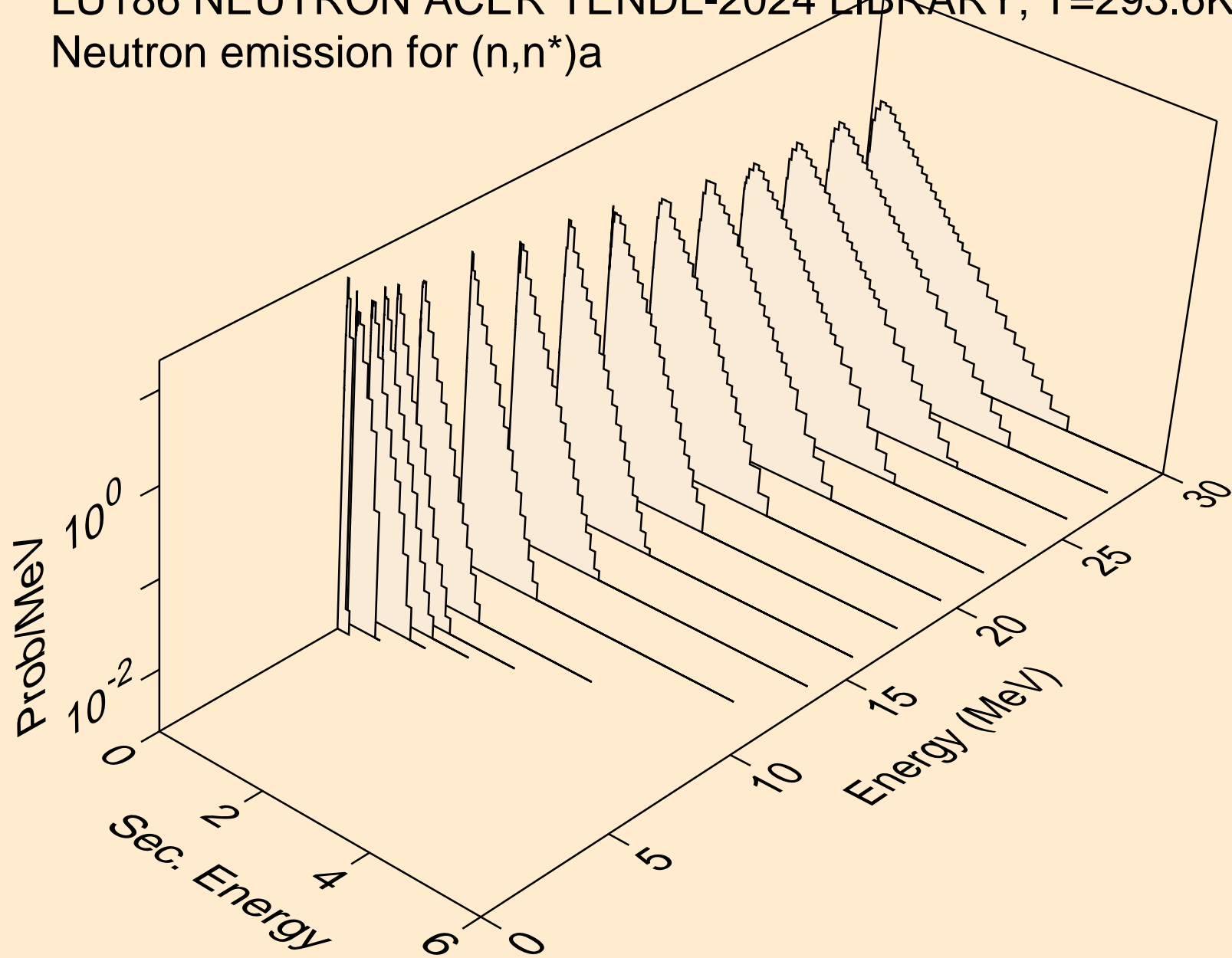

LU186 NEUTRON ACER TENDL-2024 LIBRARY; T=293.6K  
Neutron emission for (n,2n)a

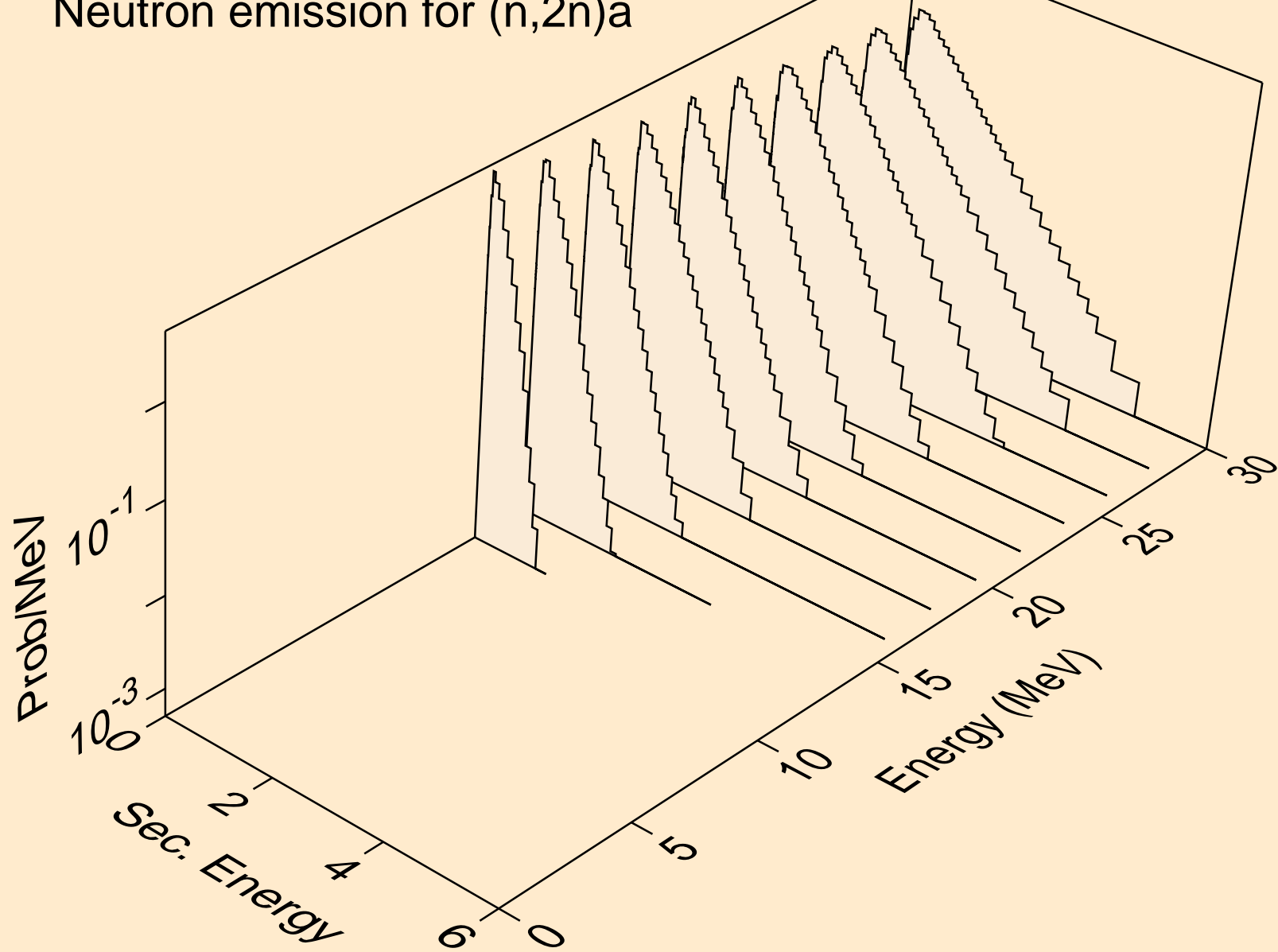

LU186 NEUTRON ACER TENDL-2024 LIBRARY; T=293.6K  
Neutron emission for (n,3n)a

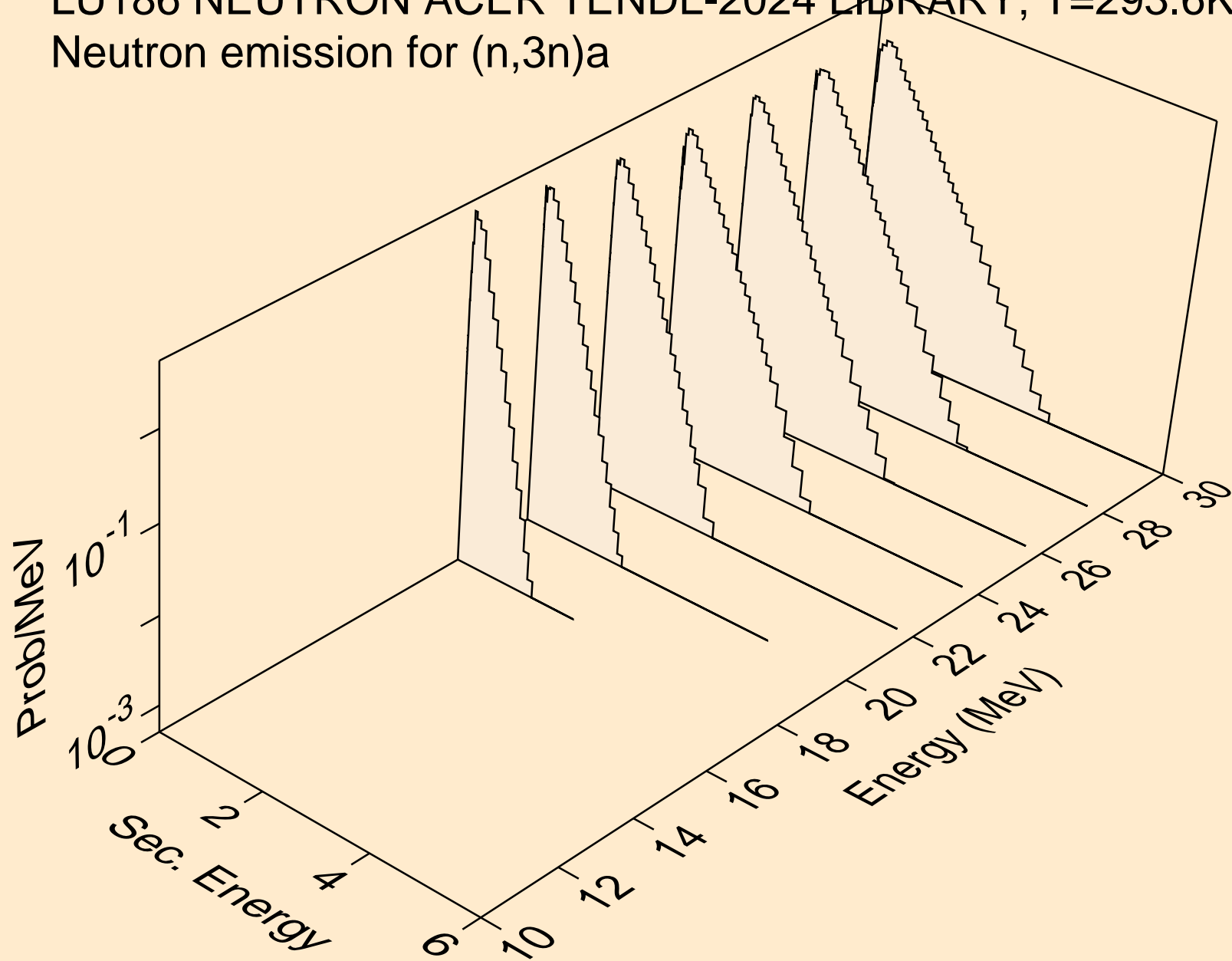

LU186 NEUTRON ACER TENDL-2024 LIBRARY; T=293.6K  
Neutron emission for (n,n\*)p

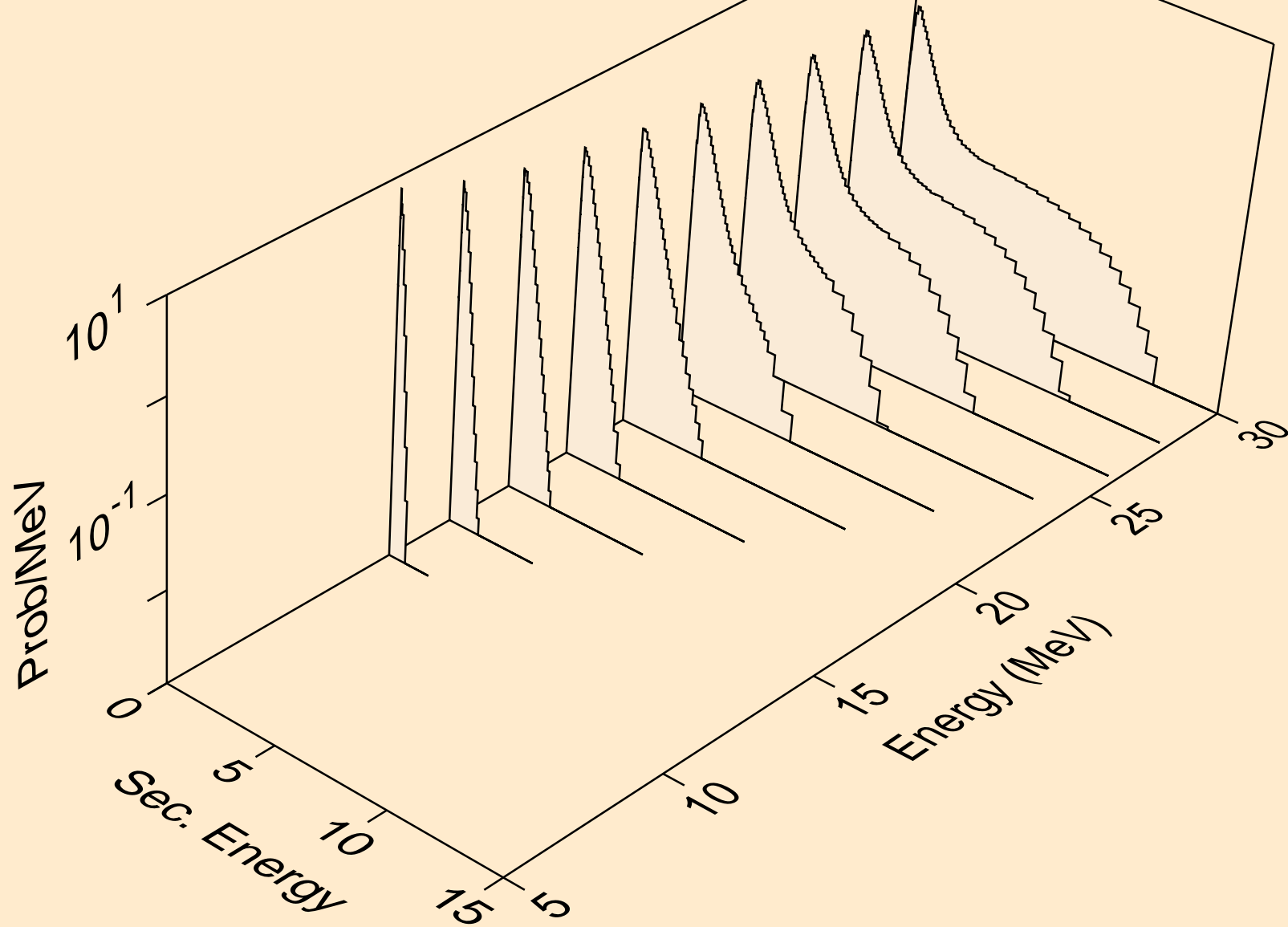

LU186 NEUTRON ACER TENDL-2024 LIBRARY; T=293.6K  
Neutron emission for (n,n\*)d

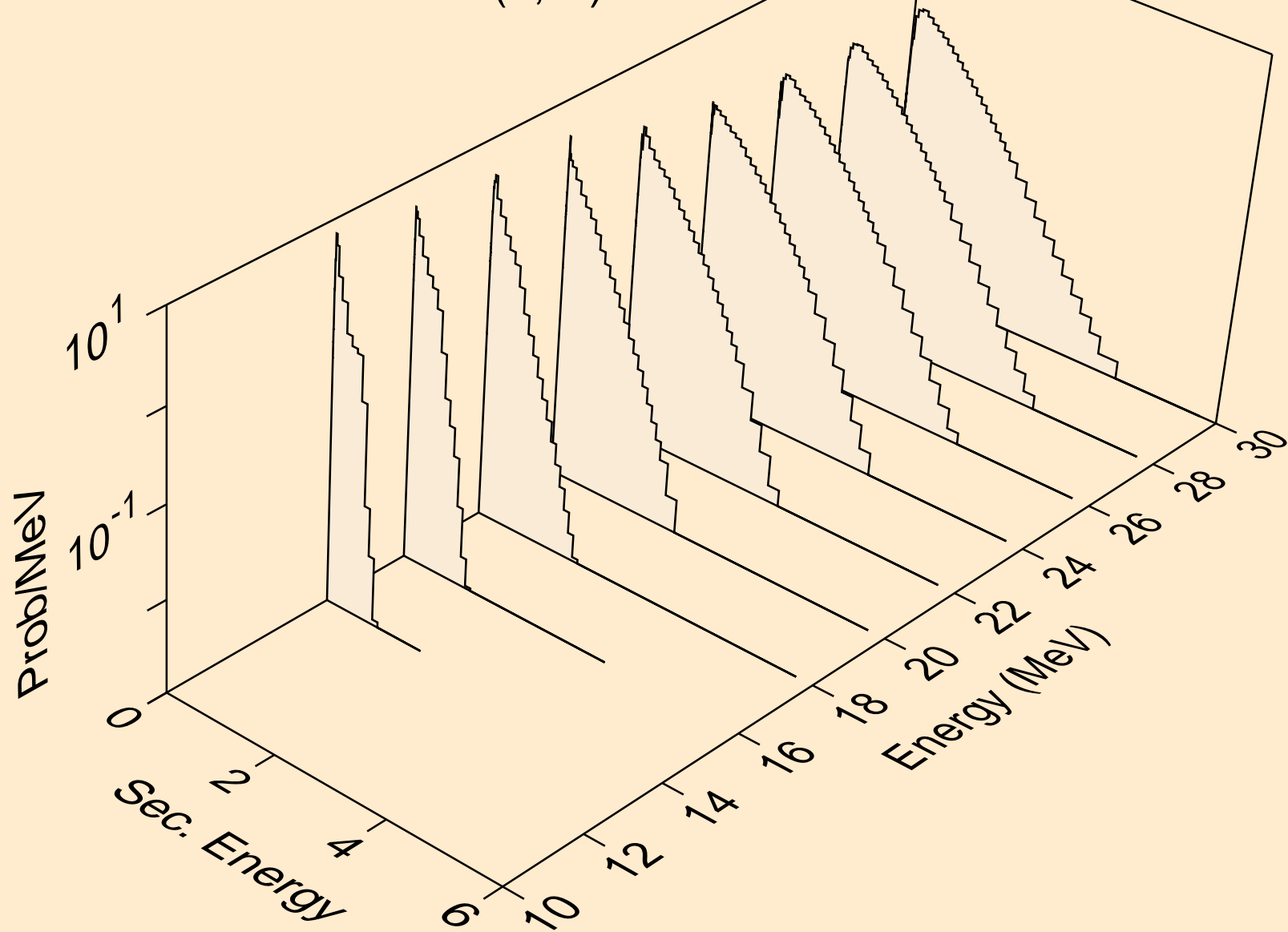

LU186 NEUTRON ACER TENDL-2024 LIBRARY; T=293.6K  
Neutron emission for (n,n\*)t

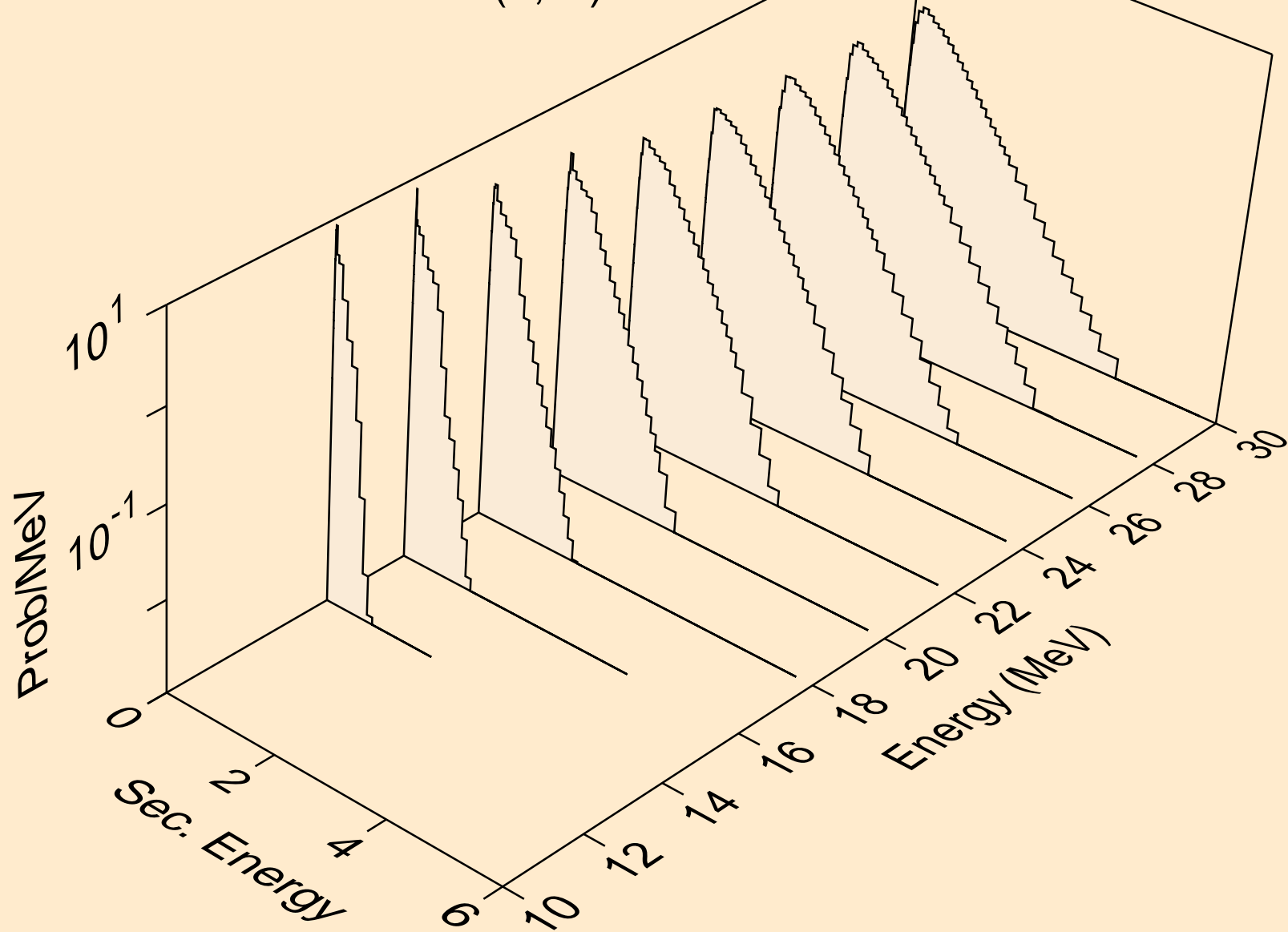

LU186 NEUTRON ACER TENDL-2024 LIBRARY; T=293.6K  
Neutron emission for (n,n\*)he3

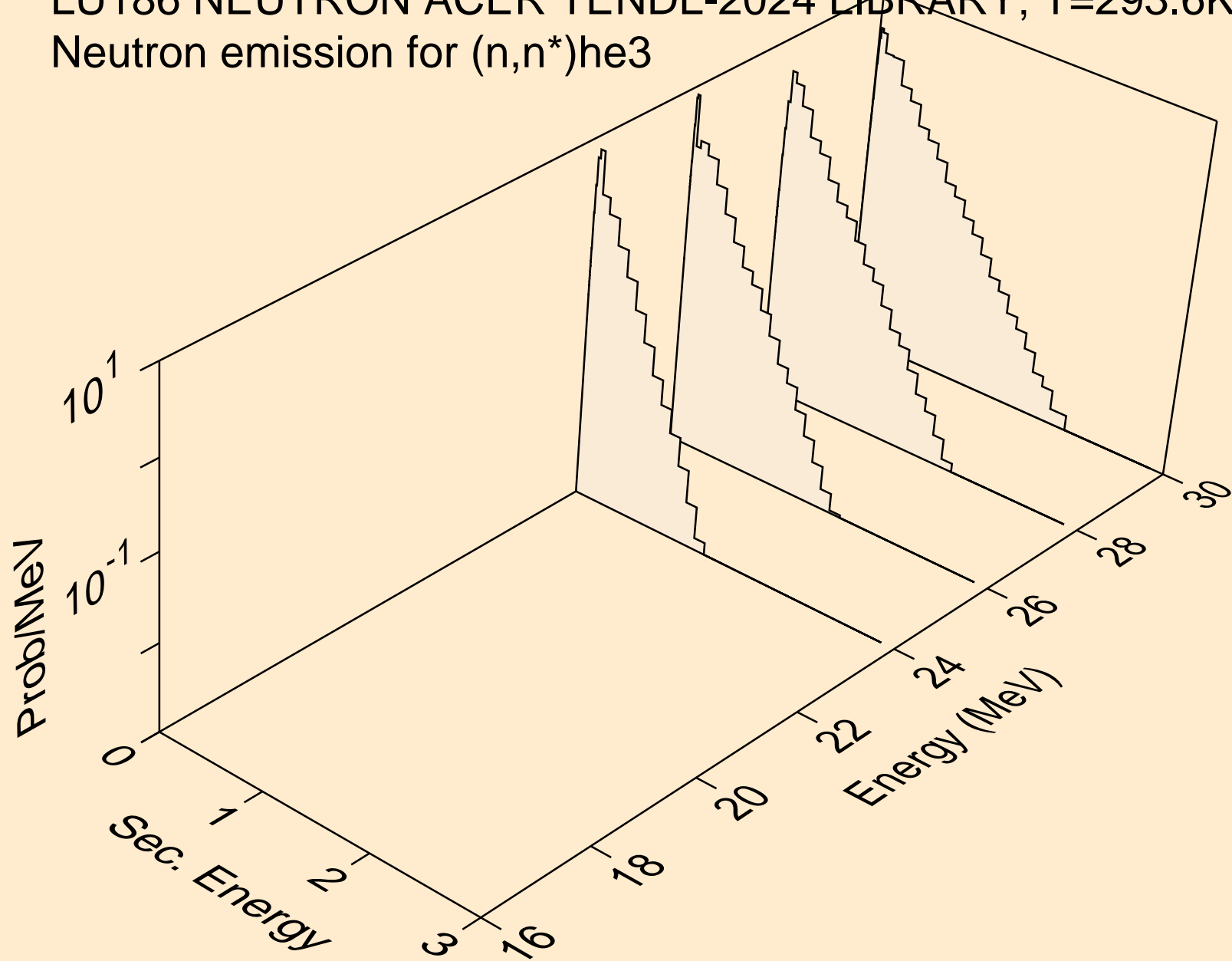

LU186 NEUTRON ACER TENDL-2024 LIBRARY; T=293.6K  
Neutron emission for (n,4n)

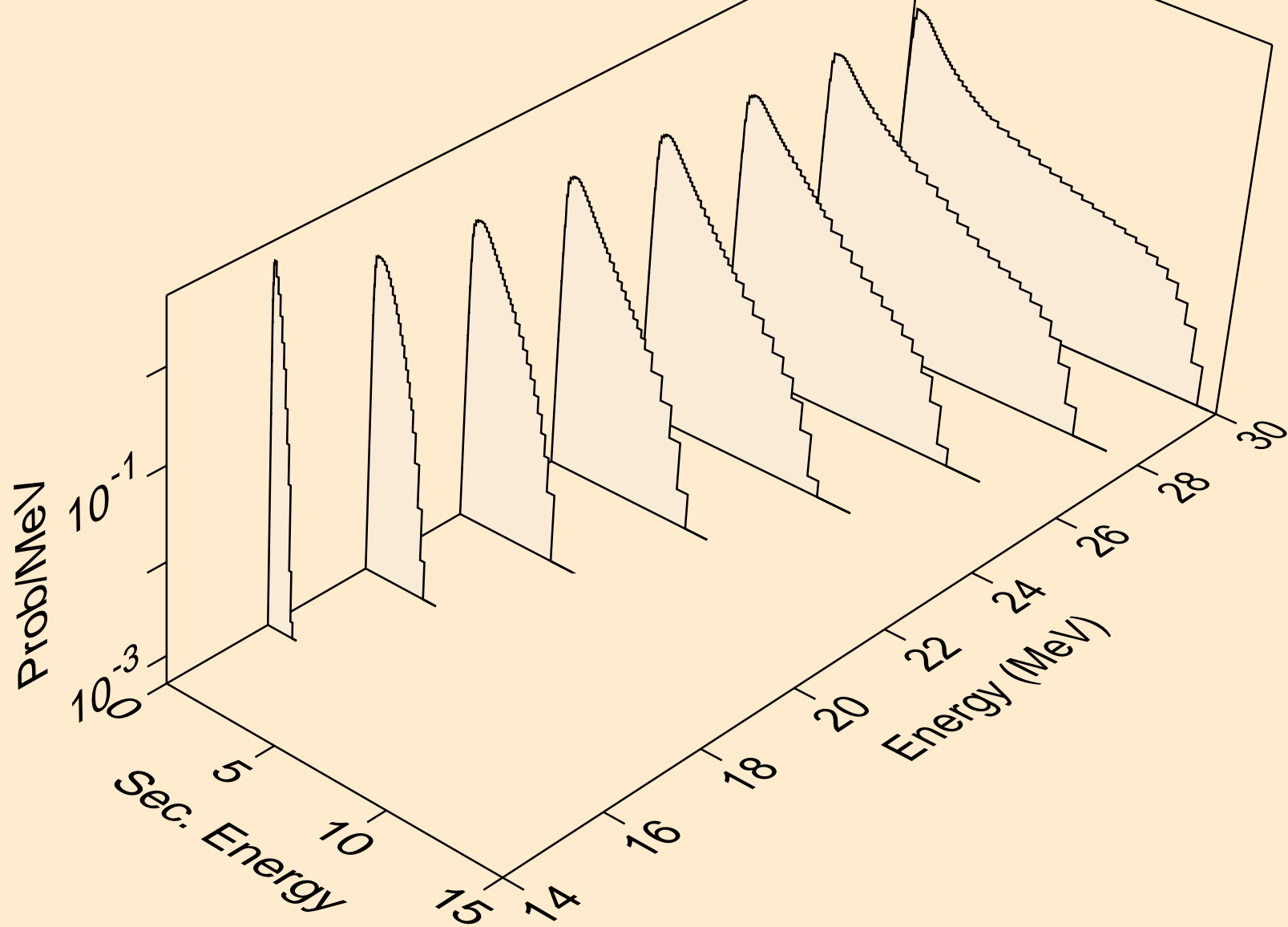

LU186 NEUTRON ACER TENDL-2024 LIBRARY; T=293.6K  
Neutron emission for (n,2np)

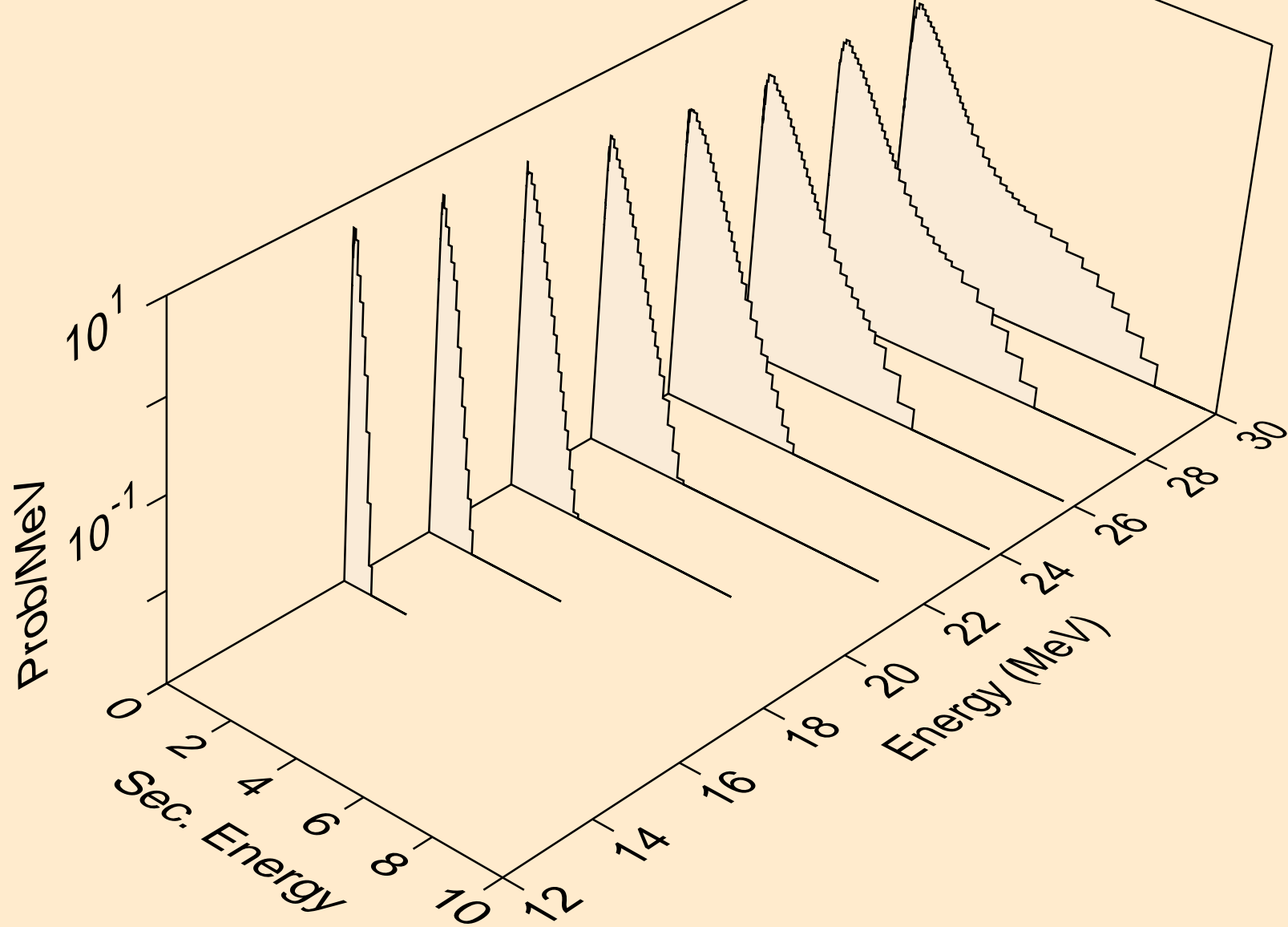

LU186 NEUTRON ACER TENDL-2024 LIBRARY; T=293.6K  
Neutron emission for (n,3np)

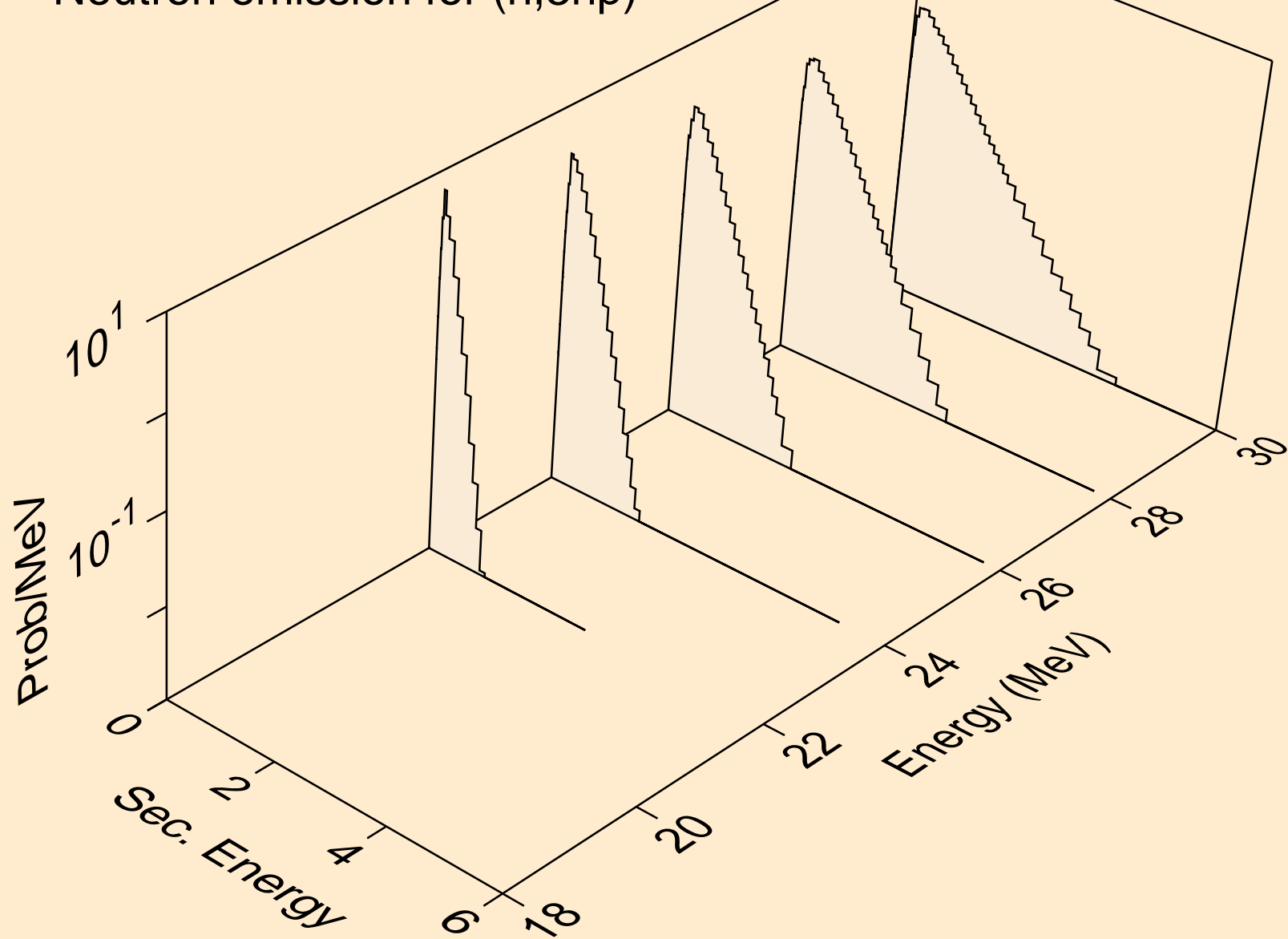

LU186 NEUTRON ACER TENDL-2024 LIBRARY; T=293.6K  
Neutron emission for (n,n\*c)

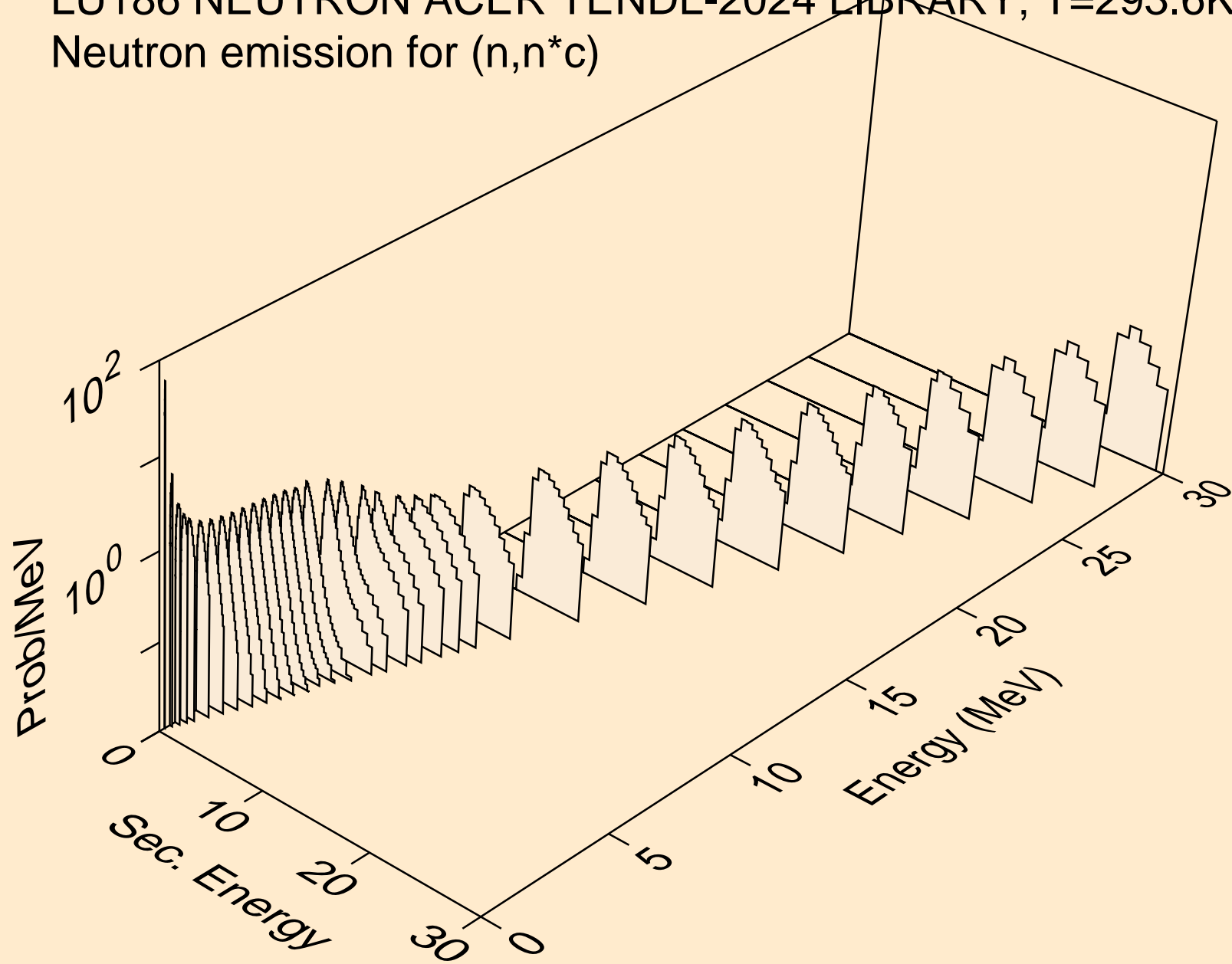

LU186 NEUTRON ACER TENDL-2024 LIBRARY; T=293.6K  
Photon emission for (n,x)

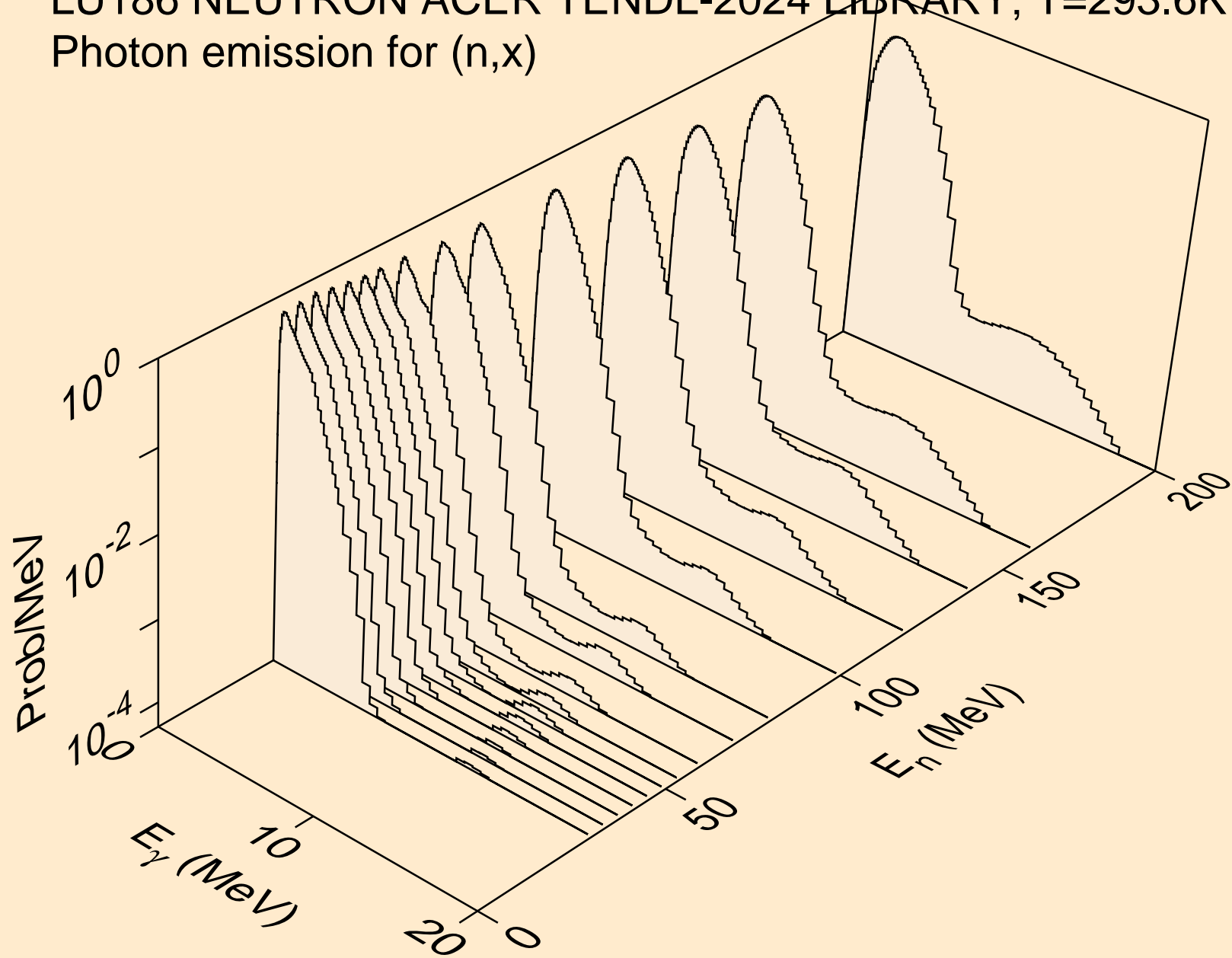

LU186 NEUTRON ACER TENDL-2024 LIBRARY; T=293.6K  
Photon emission for (n,2nd)

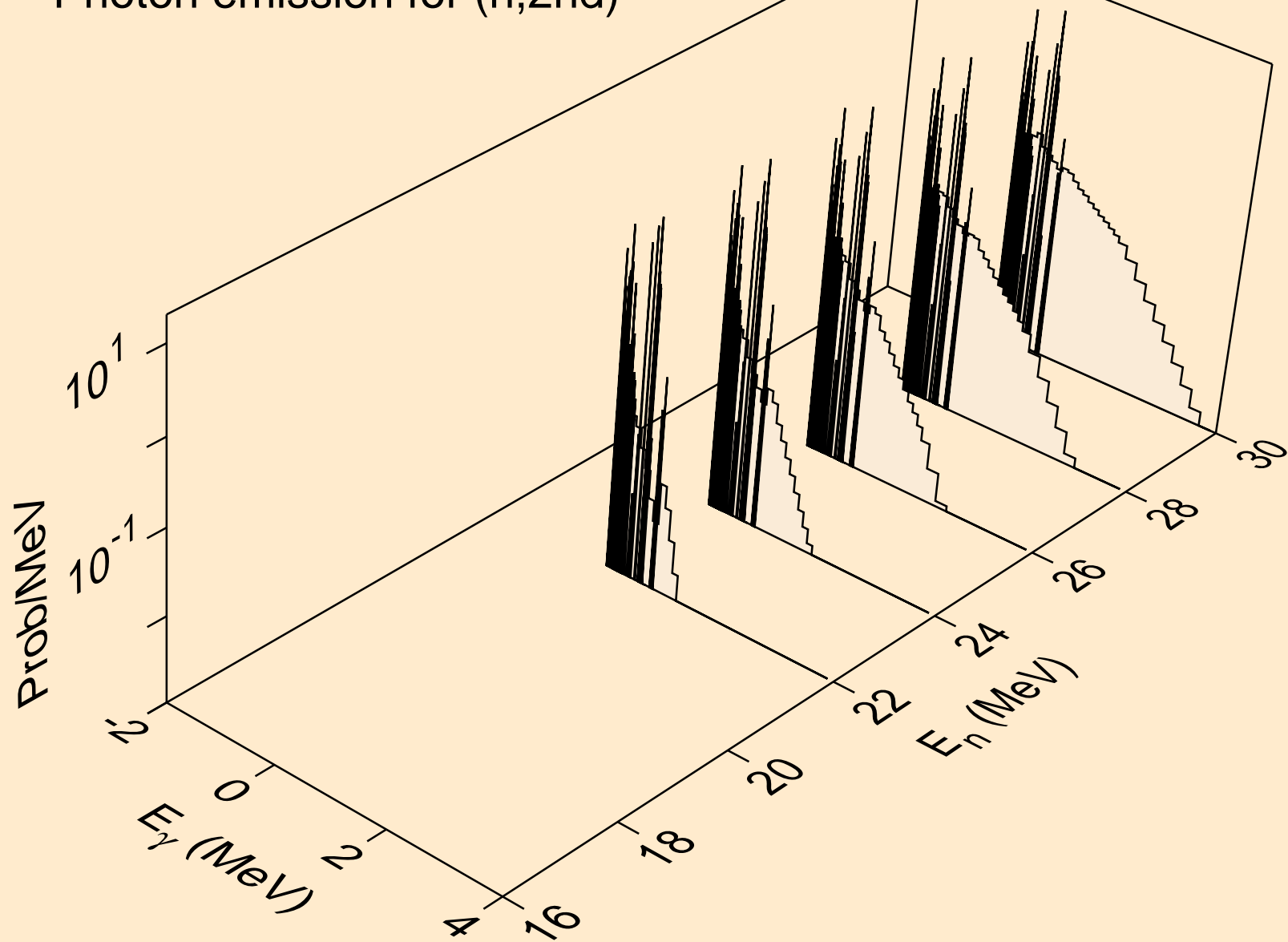

LU186 NEUTRON ACER TENDL-2024 LIBRARY; T=293.6K  
Photon emission for (n,2n)

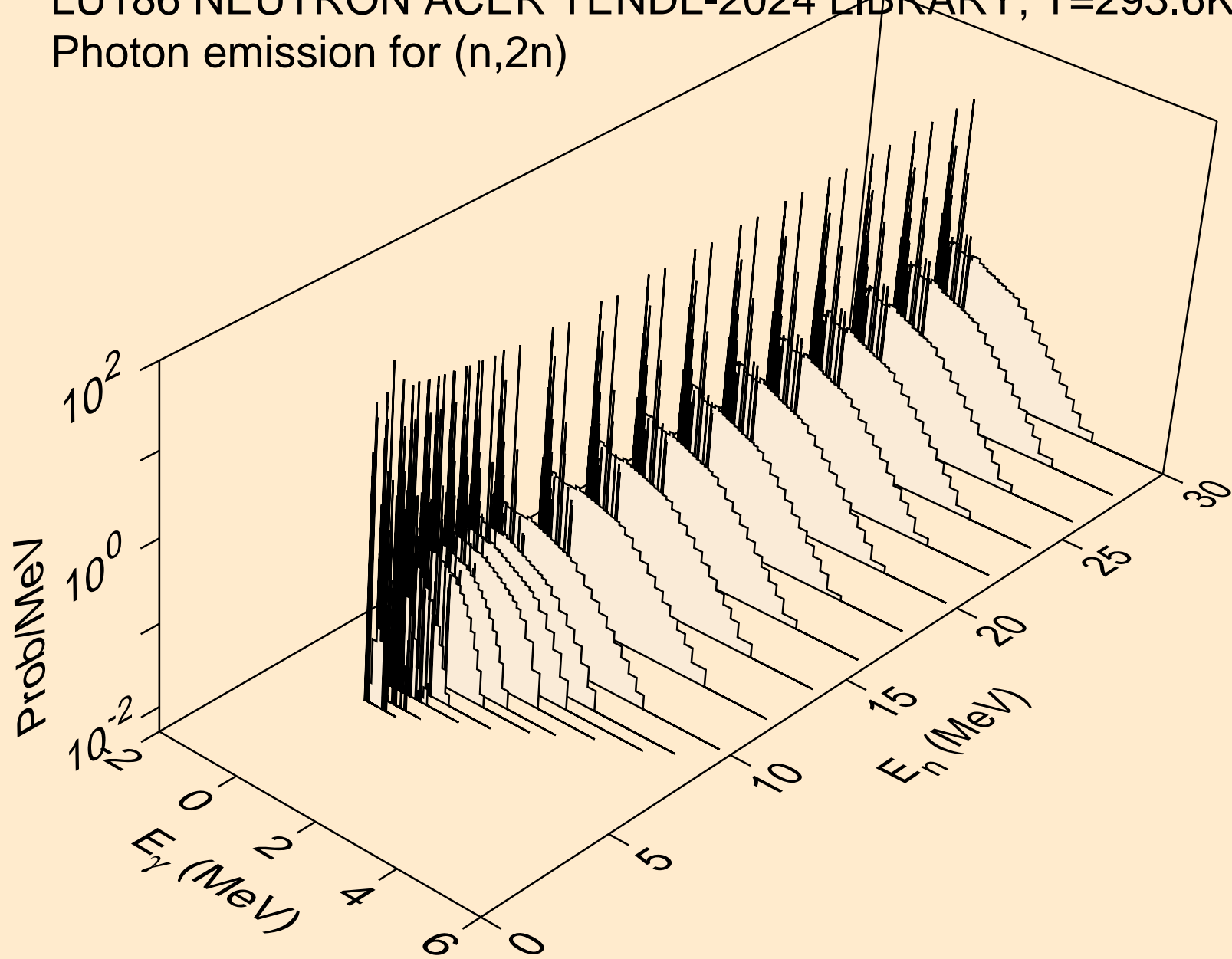

LU186 NEUTRON ACER TENDL-2024 LIBRARY; T=293.6K  
Photon emission for (n,3n)

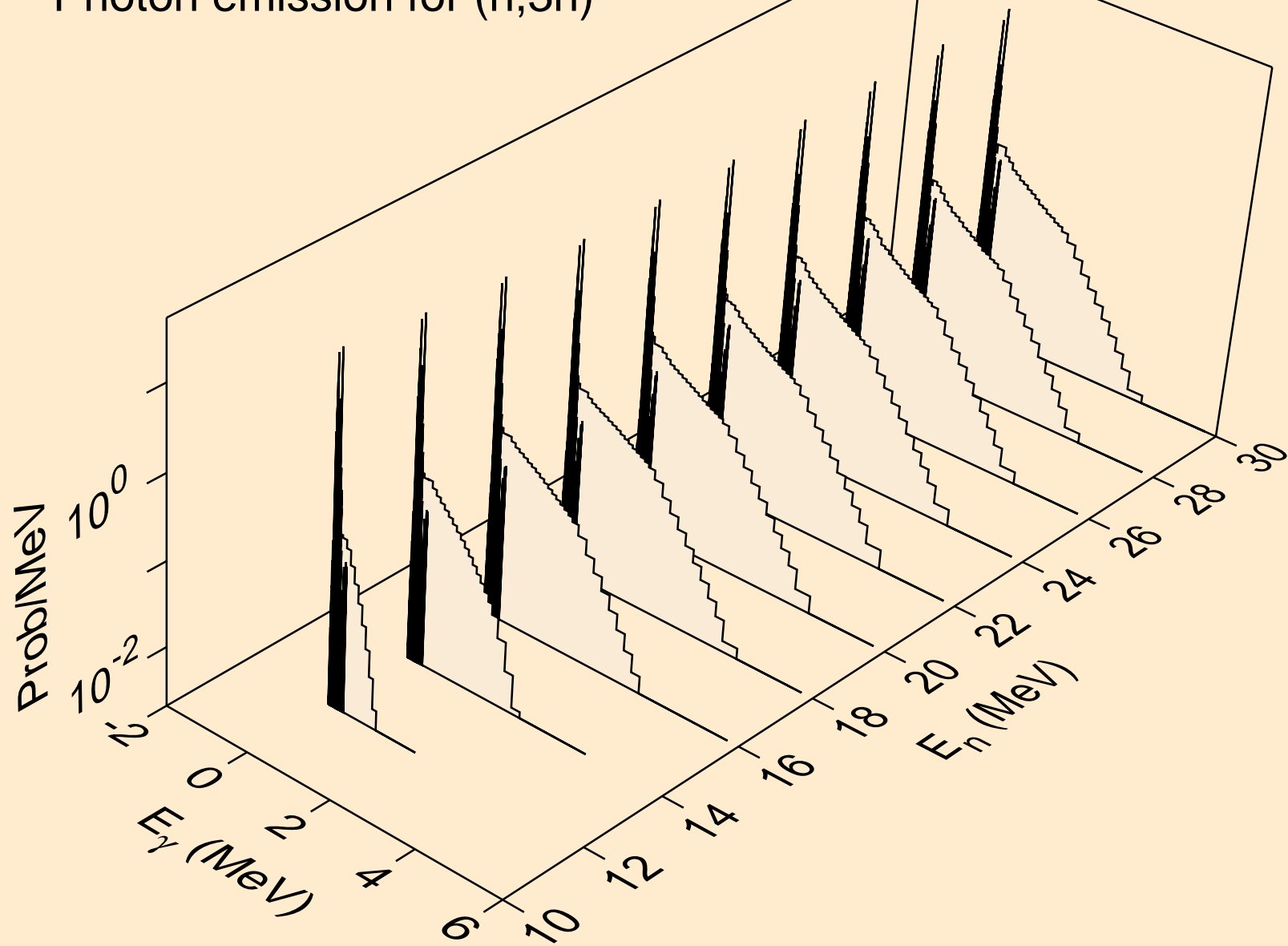

LU186 NEUTRON ACER TENDL-2024 LIBRARY; T=293.6K  
Photon emission for (n,n\*)a

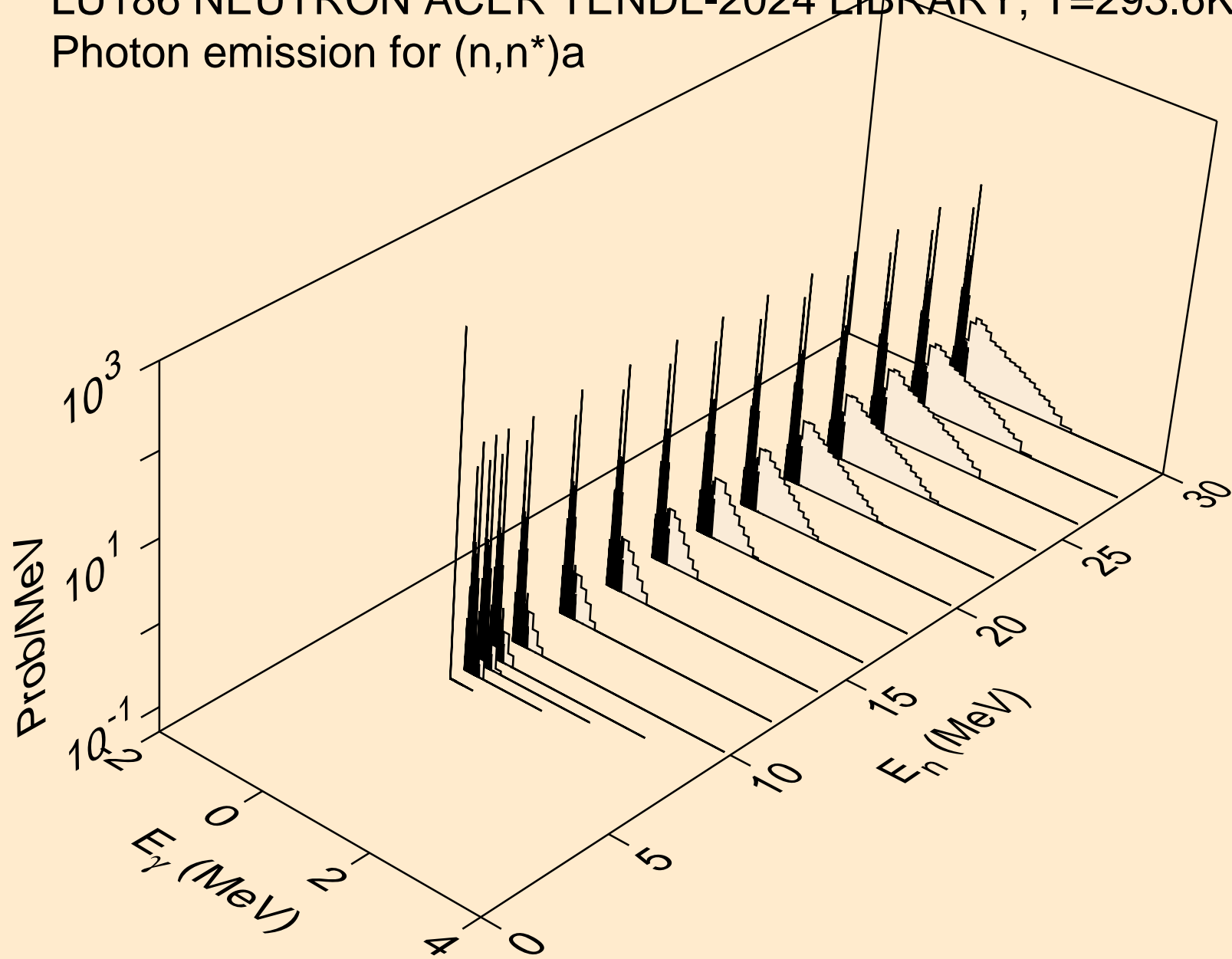

LU186 NEUTRON ACER TENDL-2024 LIBRARY; T=293.6K  
Photon emission for (n,2n)a

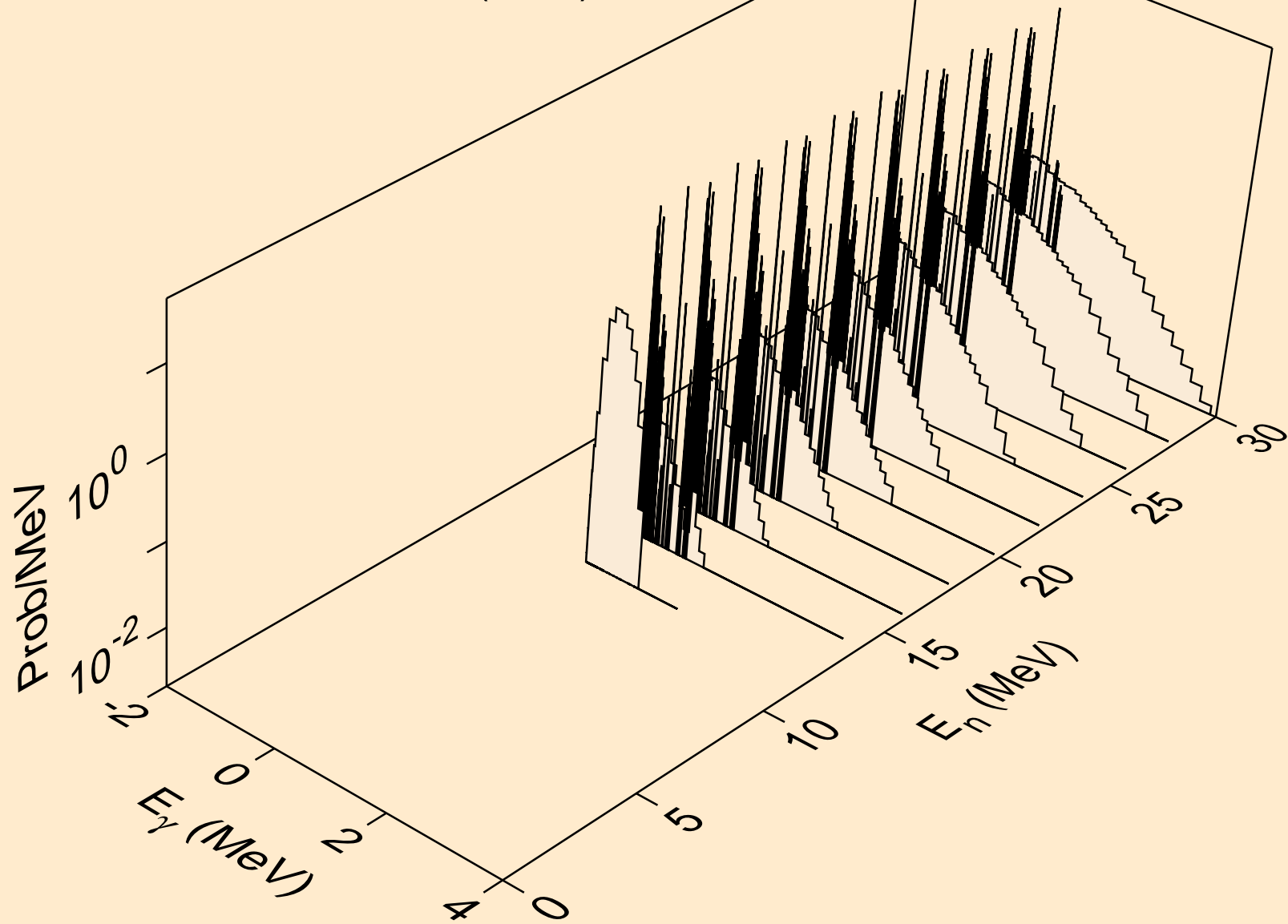

LU186 NEUTRON ACER TENDL-2024 LIBRARY; T=293.6K  
Photon emission for (n,3n)a

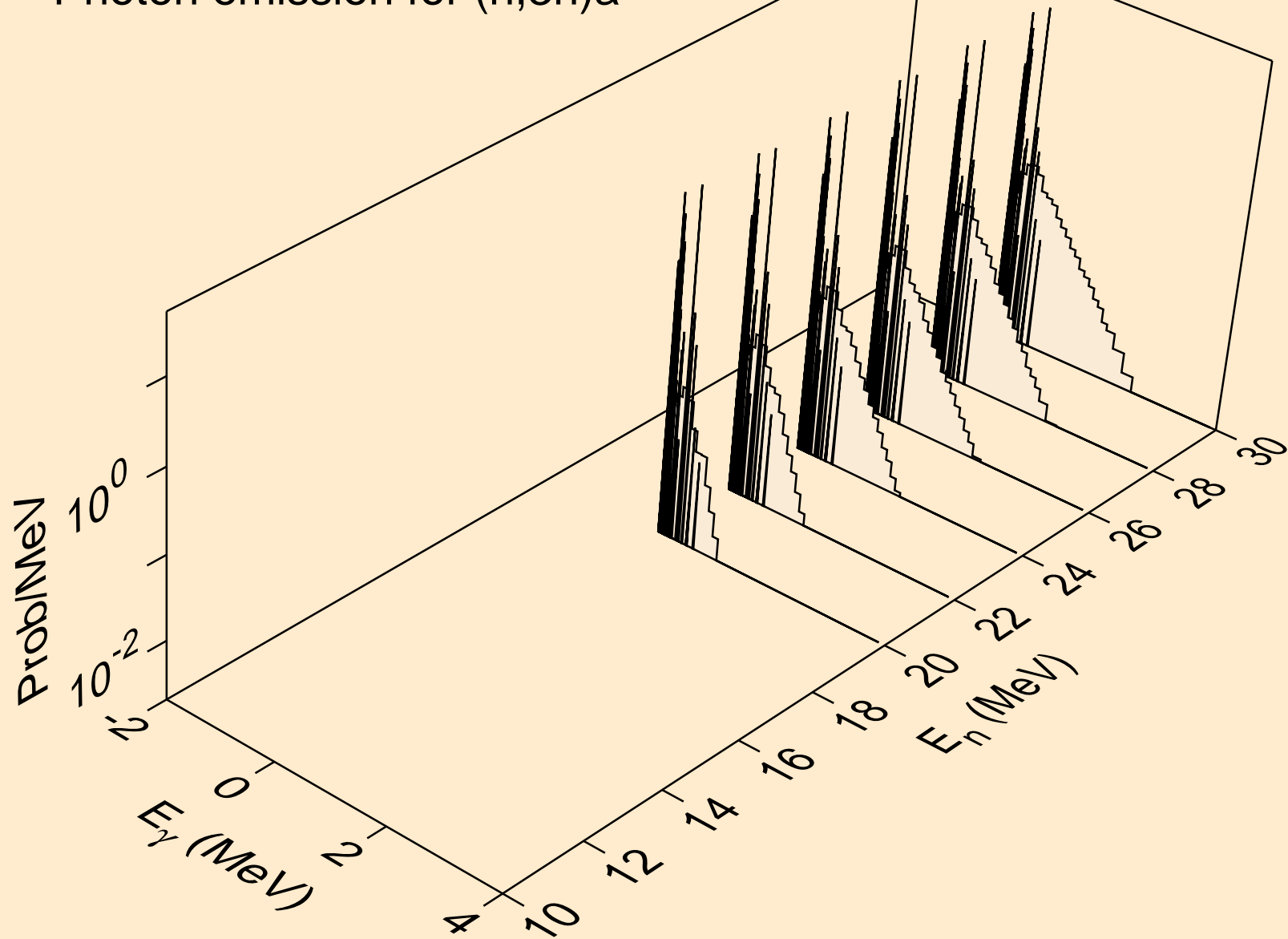

LU186 NEUTRON ACER TENDL-2024 LIBRARY; T=293.6K  
Photon emission for (n,n\*)p

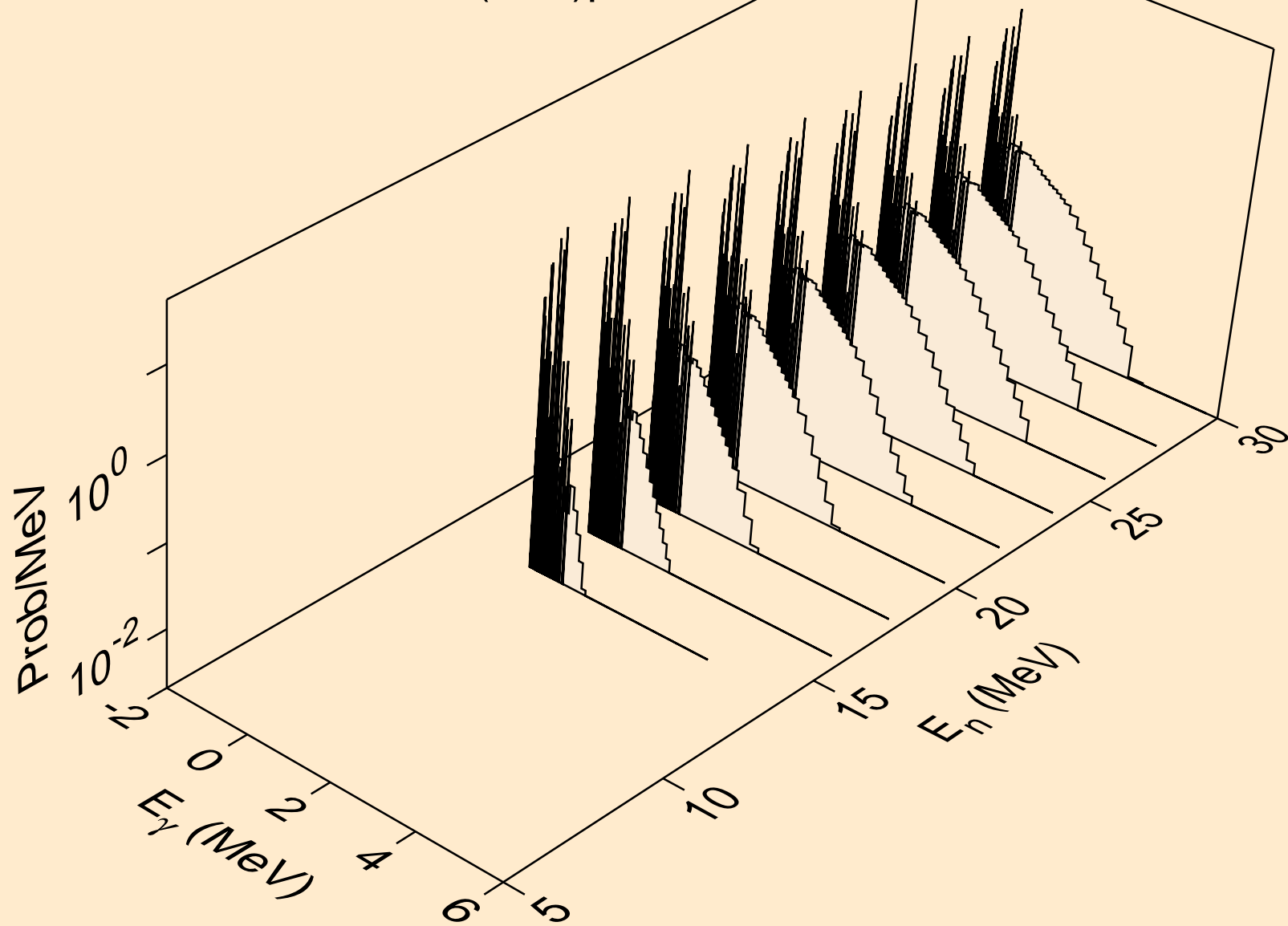

LU186 NEUTRON ACER TENDL-2024 LIBRARY; T=293.6K  
Photon emission for (n,n\*)d

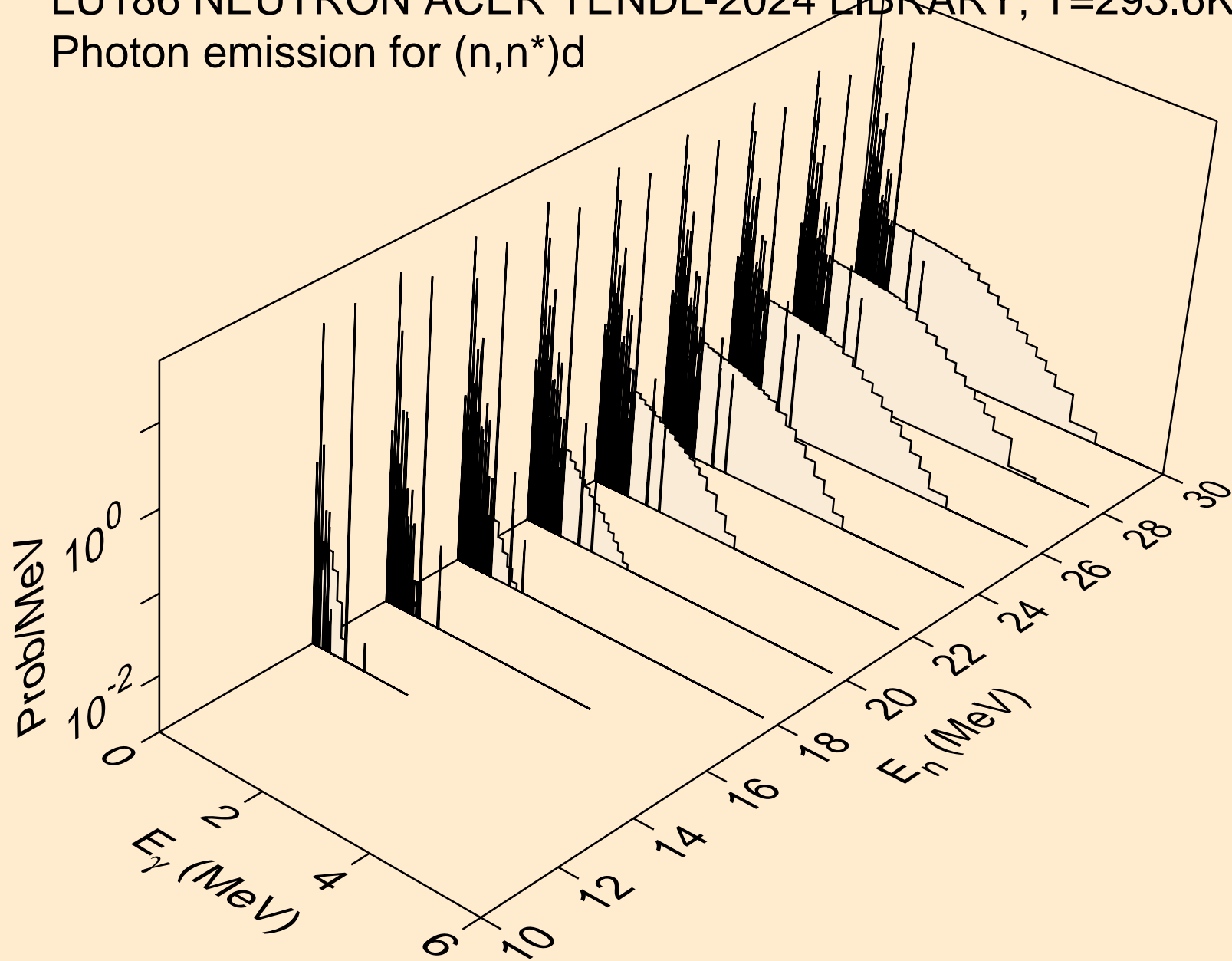

LU186 NEUTRON ACER TENDL-2024 LIBRARY; T=293.6K  
Photon emission for (n,n\*)t

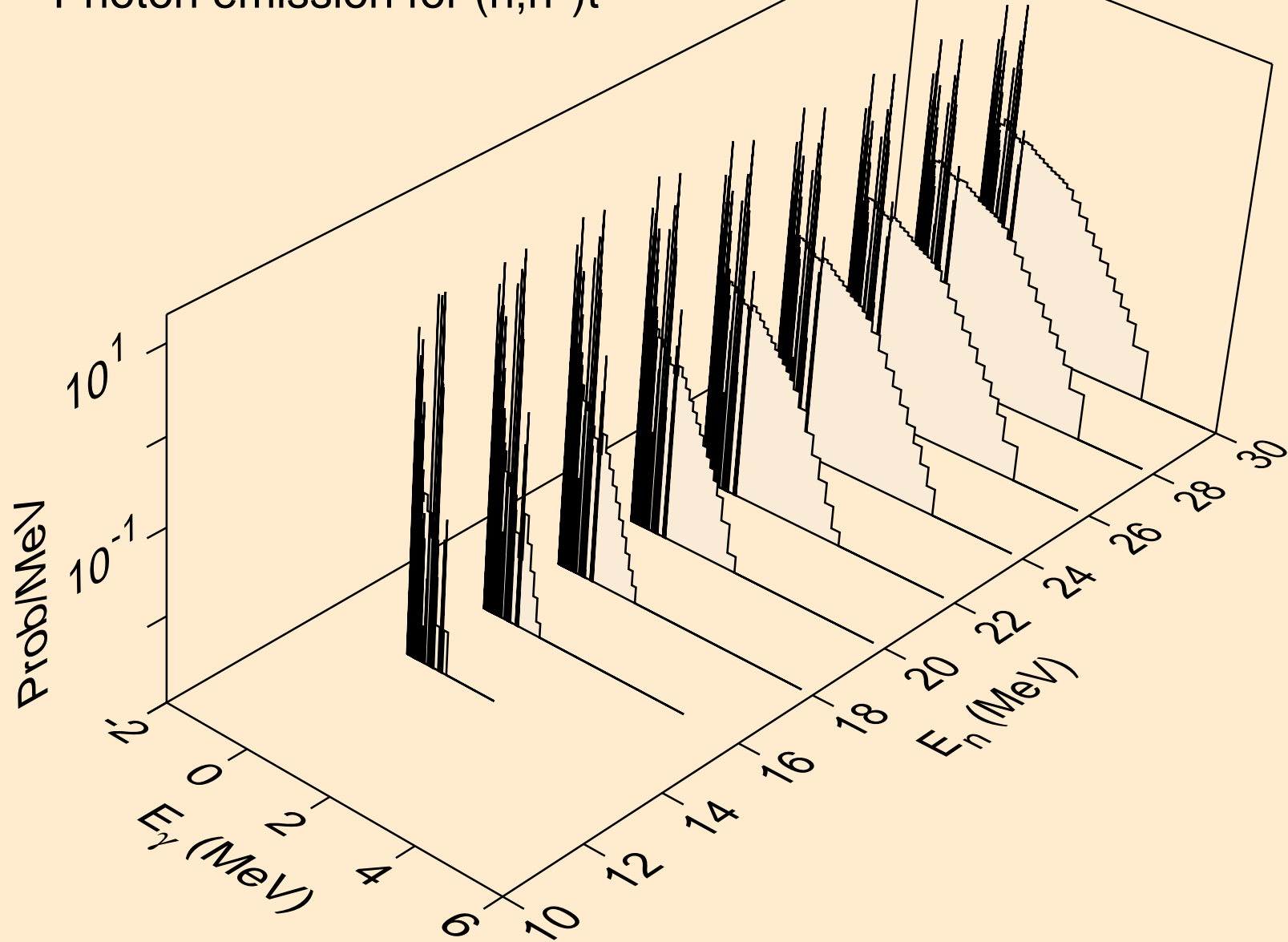

LU186 NEUTRON ACER TENDL-2024 LIBRARY; T=293.6K  
Photon emission for (n,n\*)he3

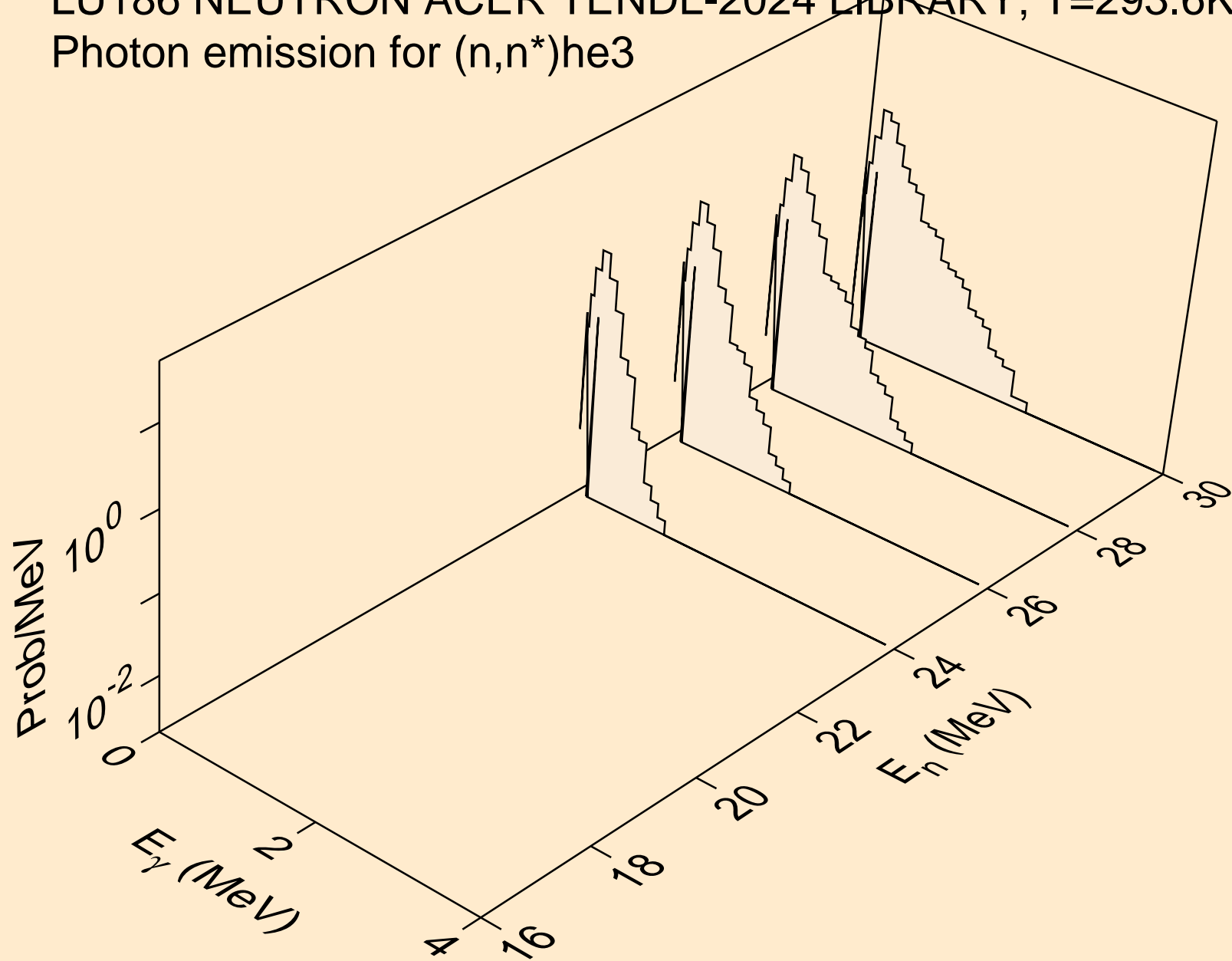

LU186 NEUTRON ACER TENDL-2024 LIBRARY; T=293.6K  
Photon emission for (n,4n)

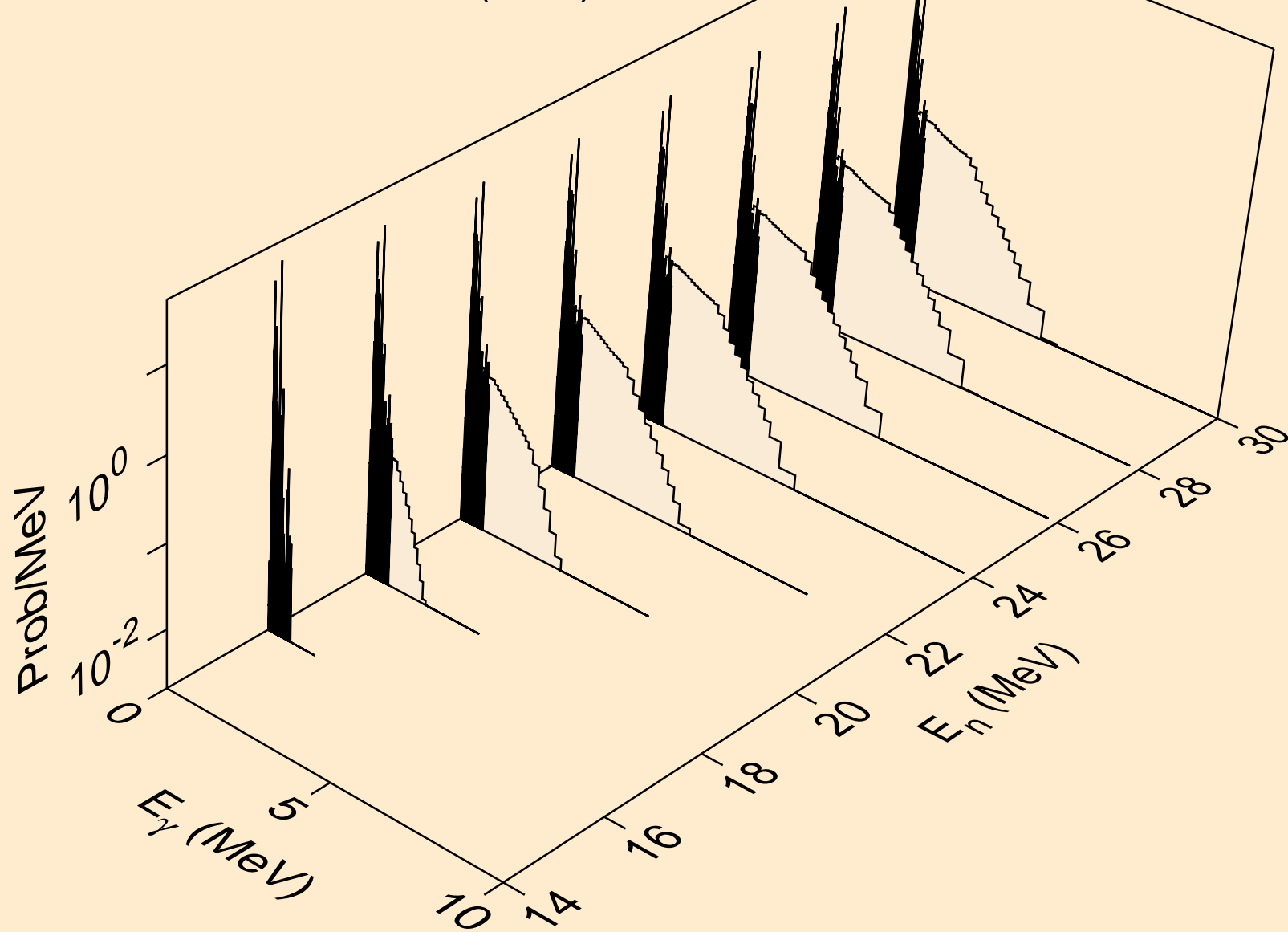

LU186 NEUTRON ACER TENDL-2024 LIBRARY; T=293.6K  
Photon emission for (n,2np)

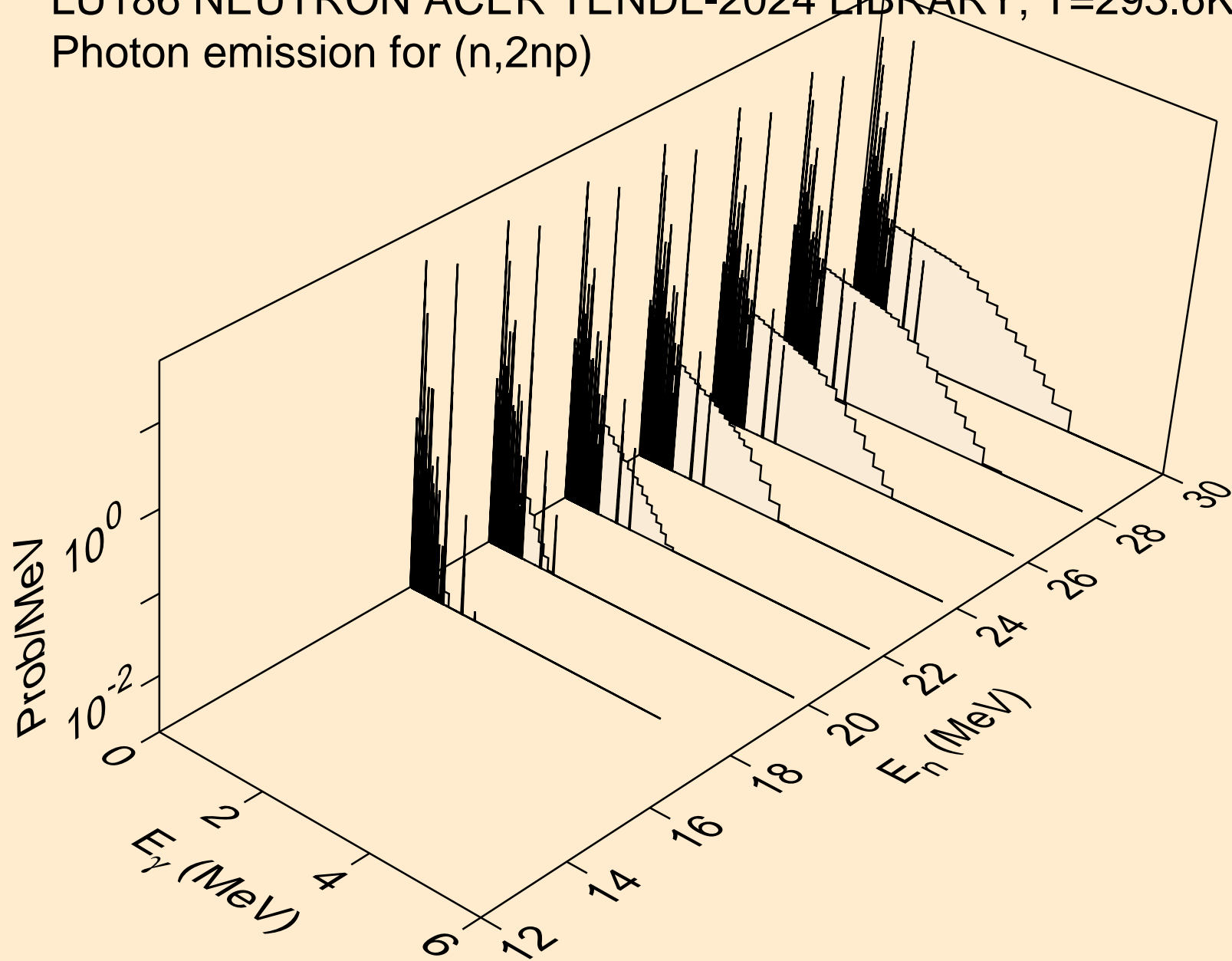

LU186 NEUTRON ACER TENDL-2024 LIBRARY; T=293.6K  
Photon emission for (n,3np)

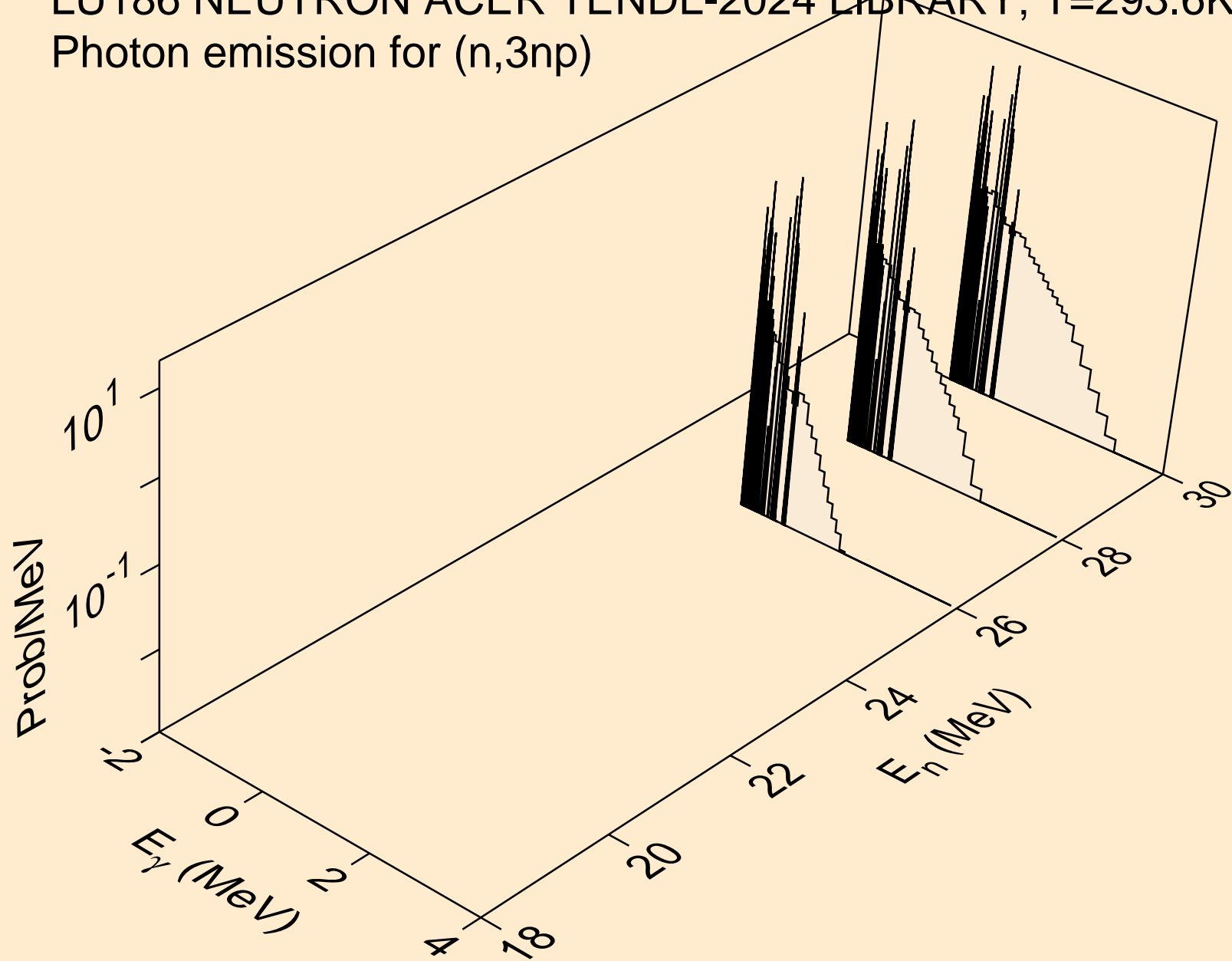

LU186 NEUTRON ACER TENDL-2024 LIBRARY; T=293.6K  
Photon emission for (n,n\*c)

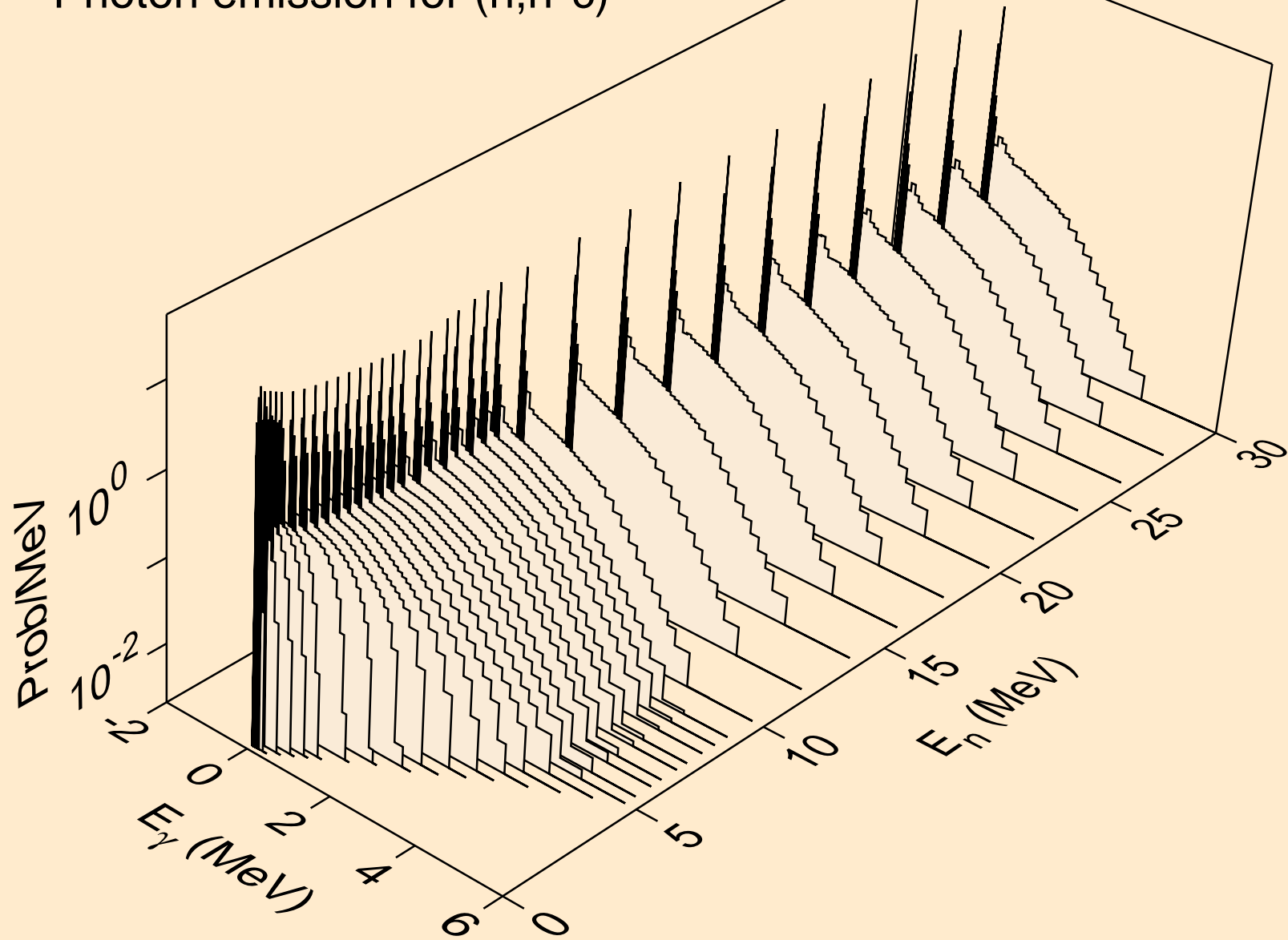

LU186 NEUTRON ACER TENDL-2024 LIBRARY; T=293.6K  
Photon emission for (n,gma)

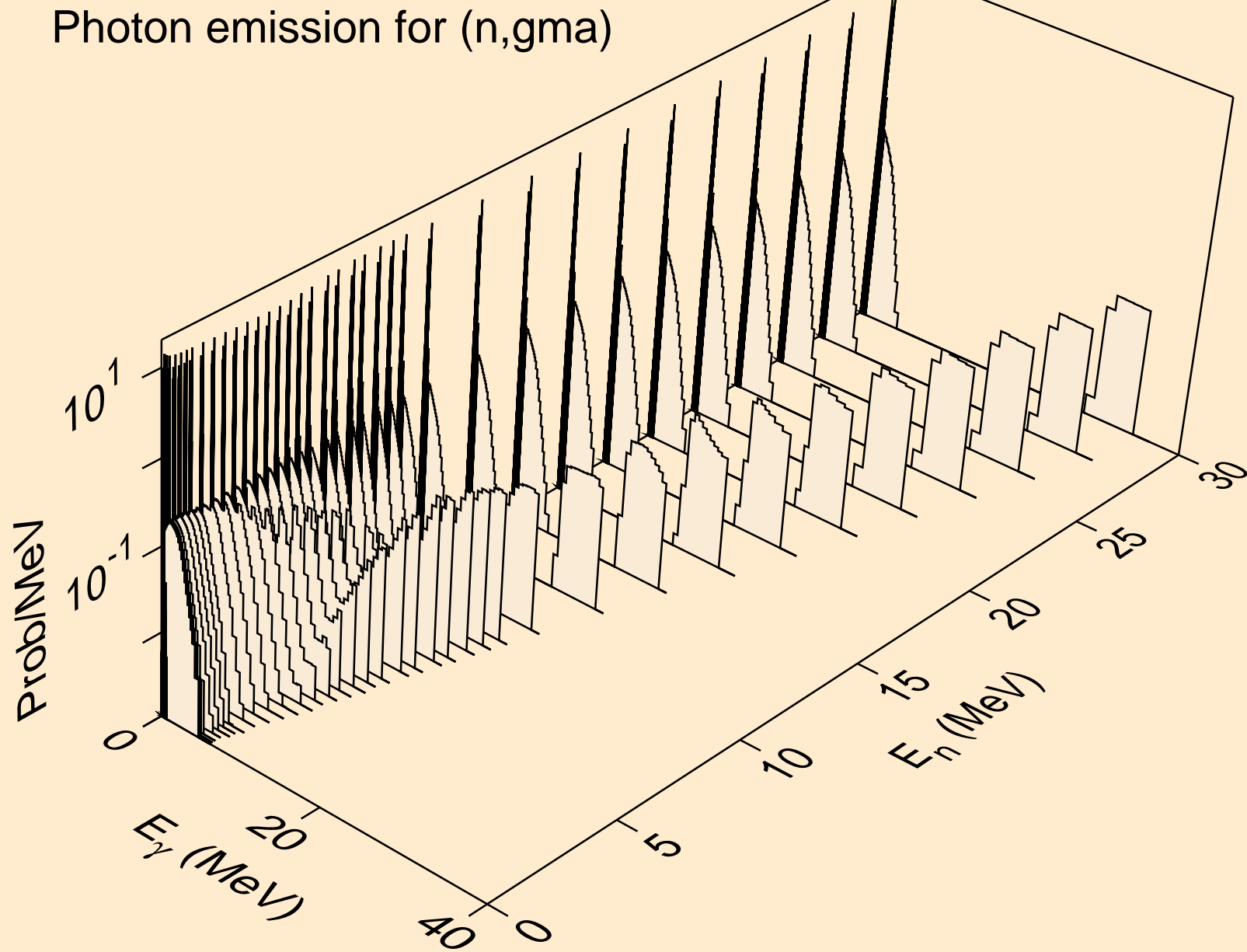

LU186 NEUTRON ACER TENDL-2024 LIBRARY; T=293.6K  
Photon emission for (n,p)

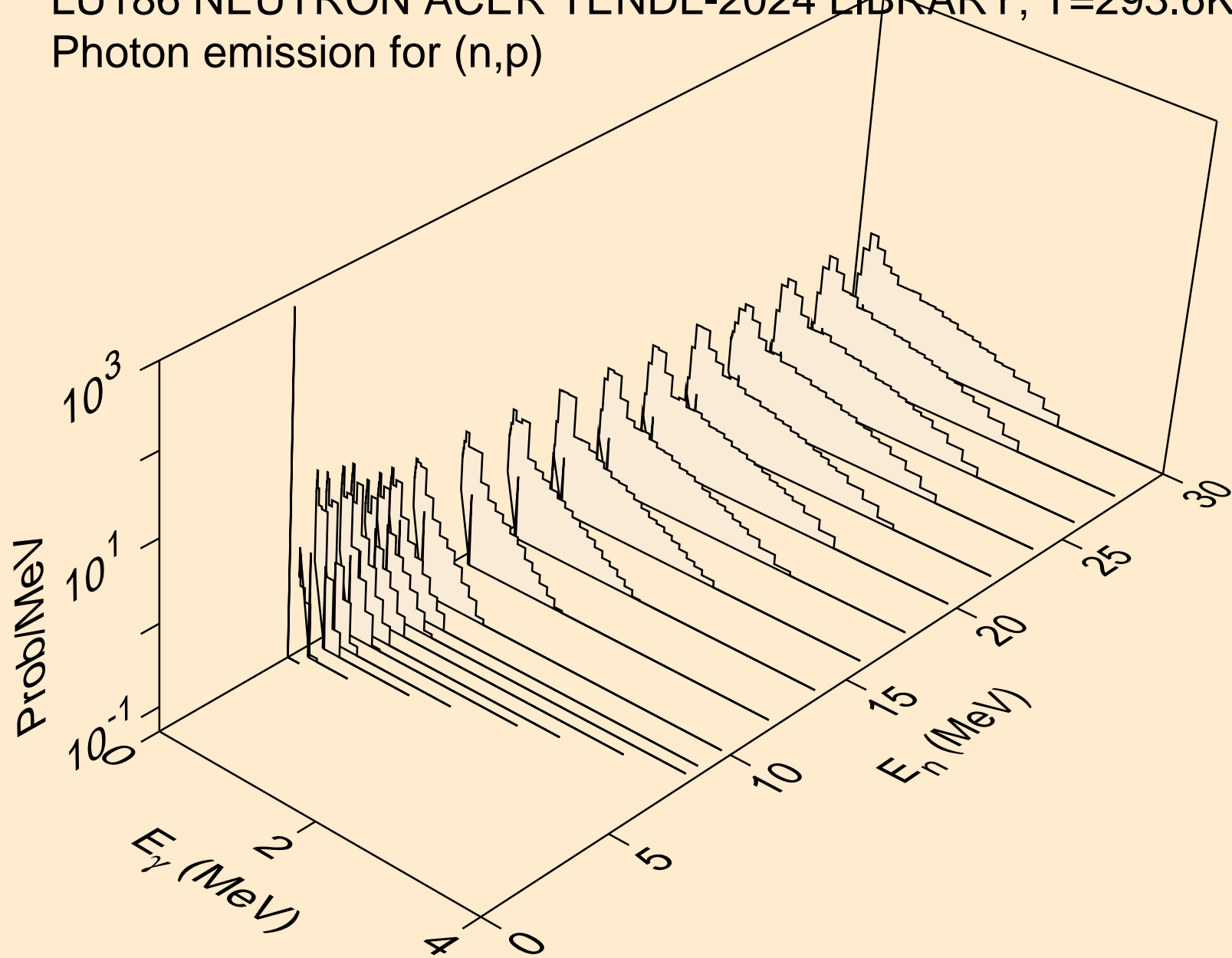

LU186 NEUTRON ACER TENDL-2024 LIBRARY; T=293.6K  
Photon emission for (n,d)

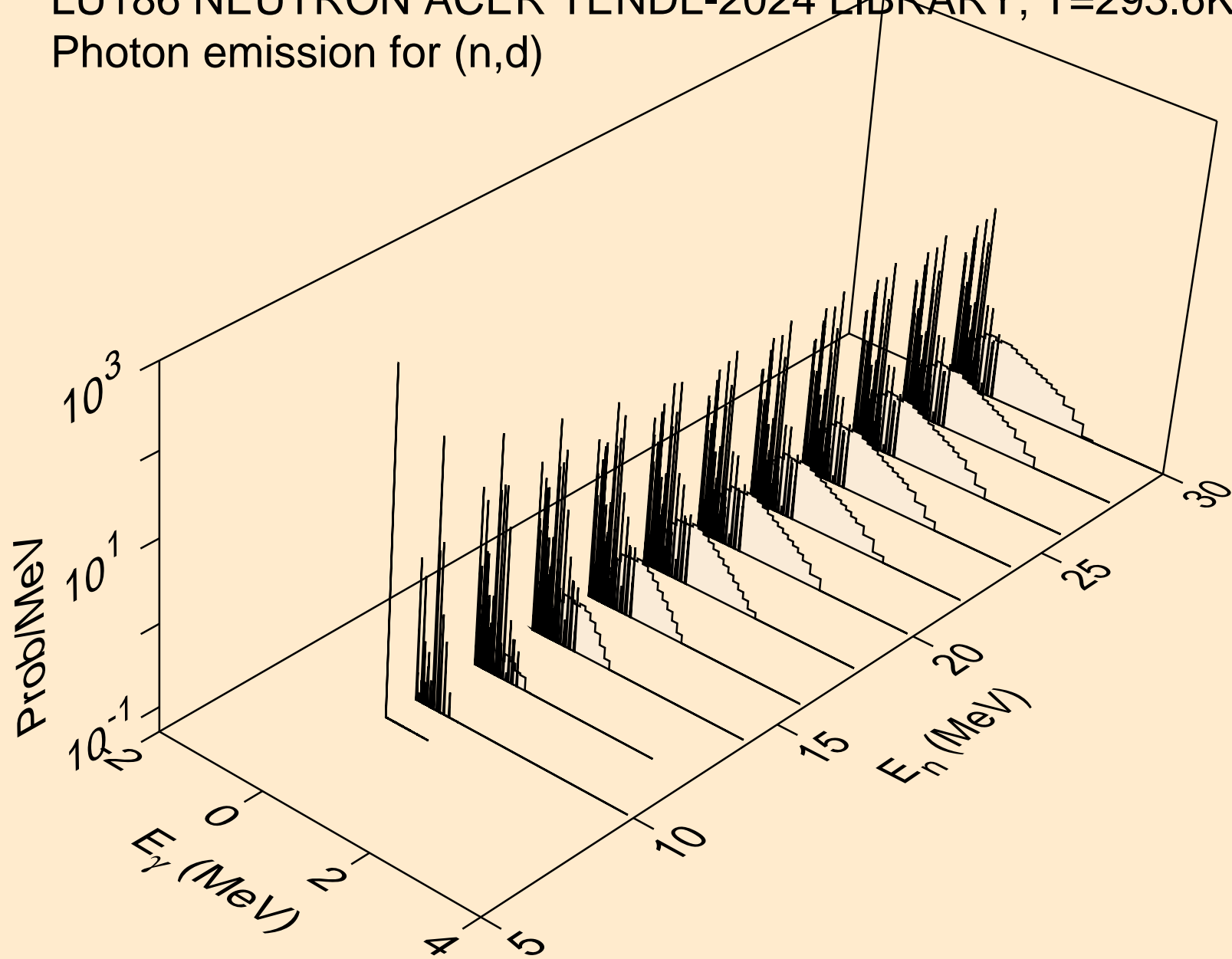

LU186 NEUTRON ACER TENDL-2024 LIBRARY; T=293.6K  
Photon emission for (n,t)

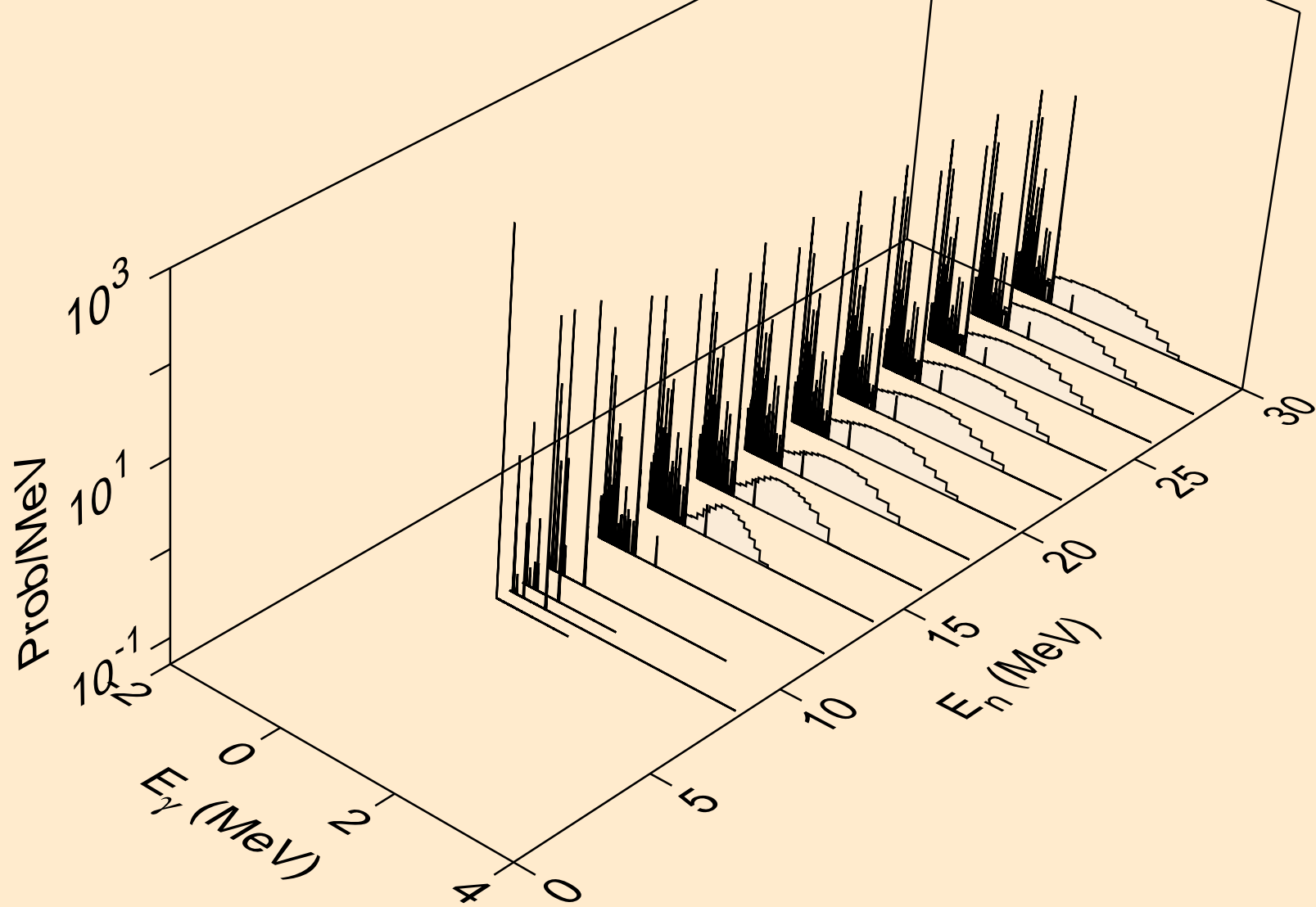

LU186 NEUTRON ACER TENDL-2024 LIBRARY; T=293.6K  
Photon emission for (n,he3)

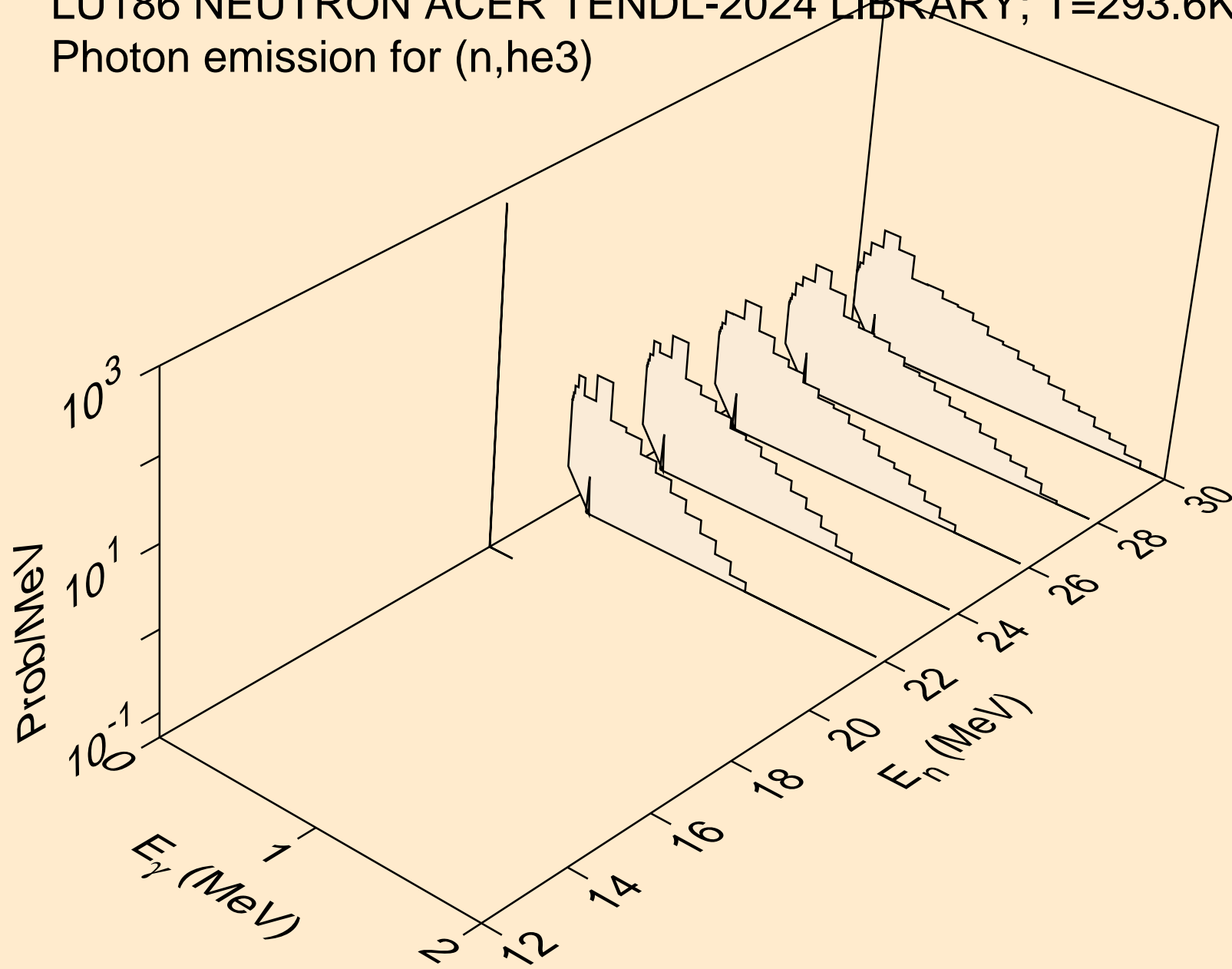

LU186 NEUTRON ACER TENDL-2024 LIBRARY; T=293.6K  
Photon emission for (n,a)

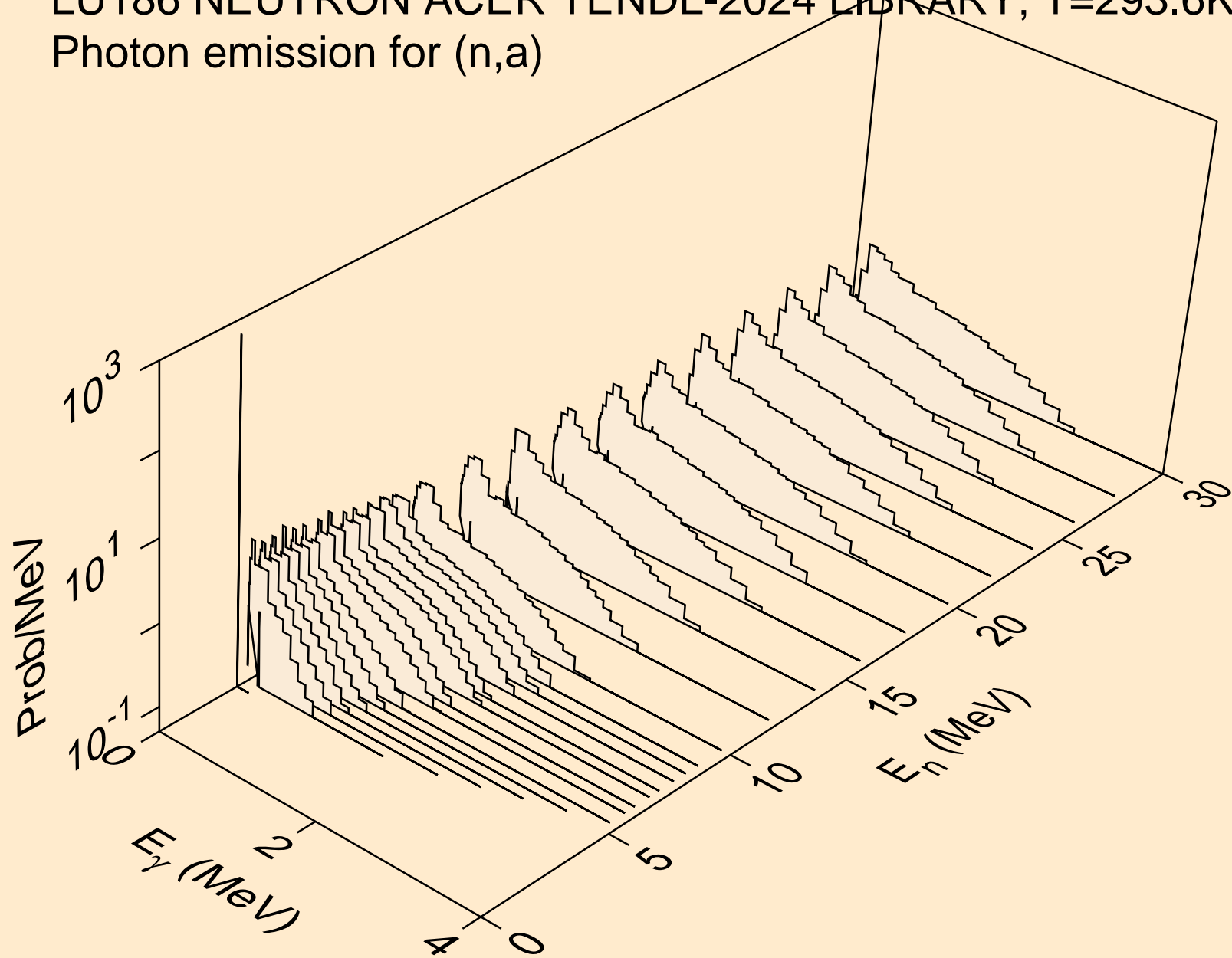

LU186 NEUTRON ACER TENDL-2024 LIBRARY; T=293.6K  
thermal capture photon spectrum

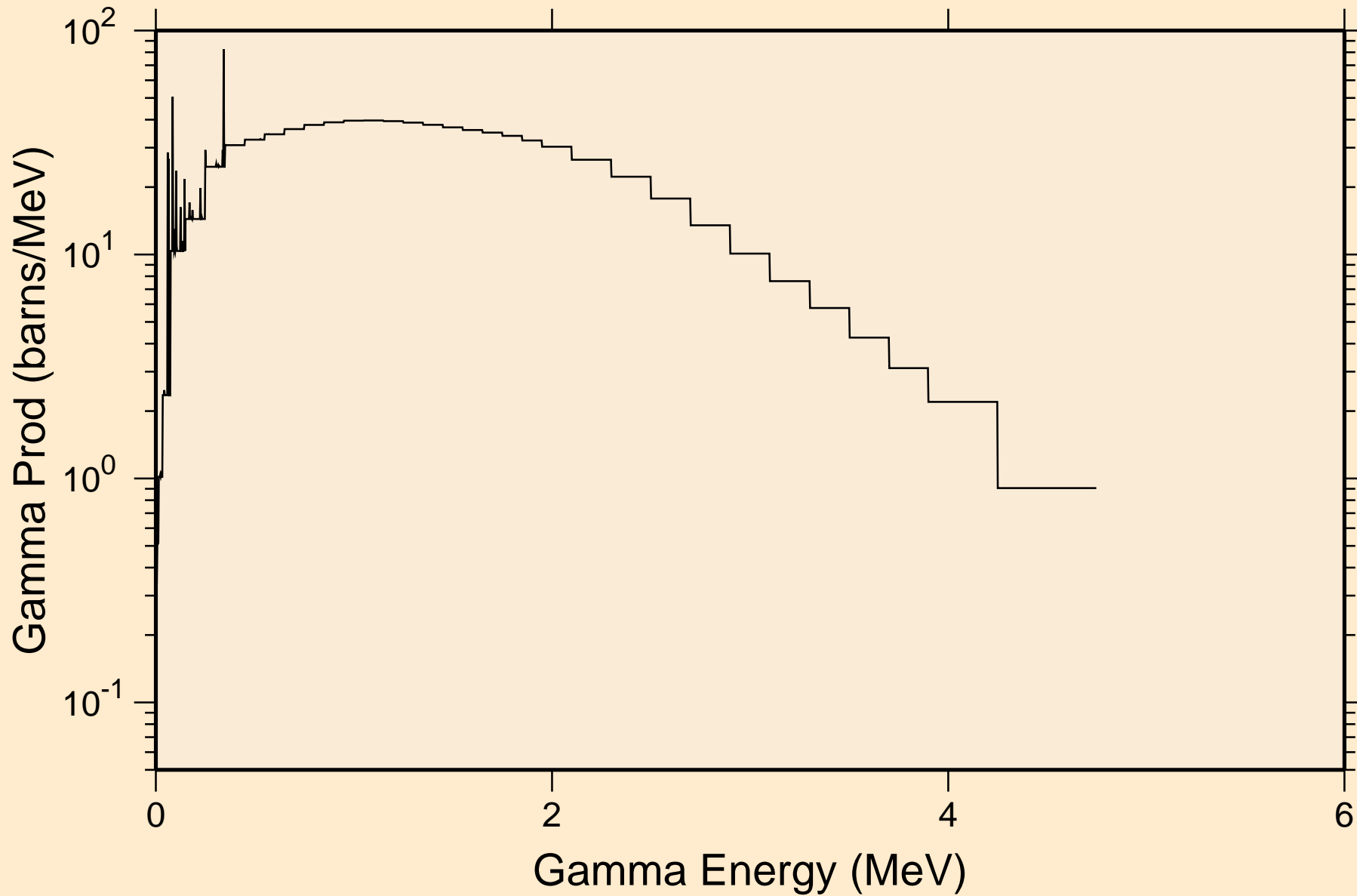

LU186 NEUTRON ACER TENDL-2024 LIBRARY; T=293.6K  
14 MeV photon spectrum

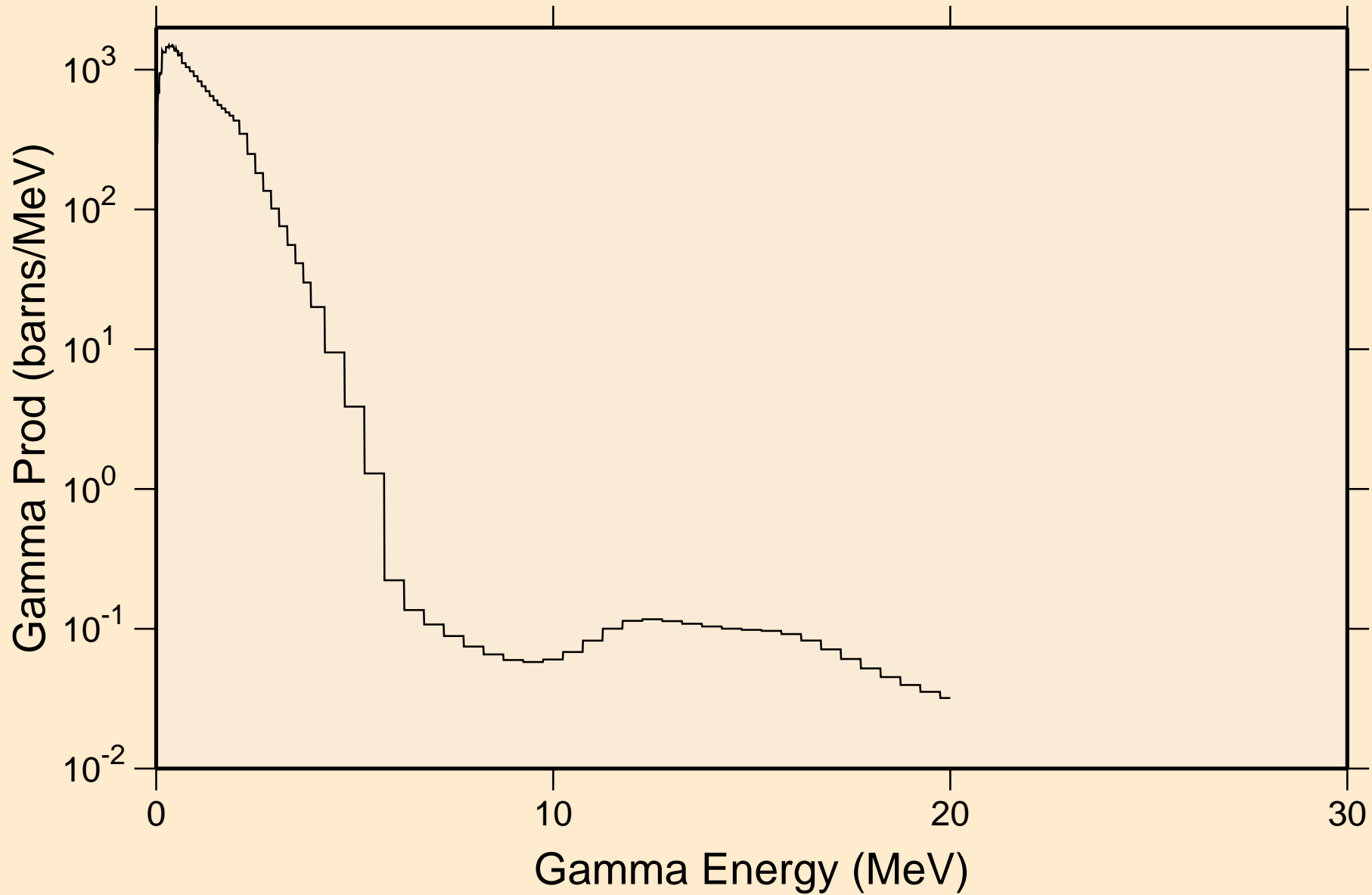

LU186 NEUTRON ACER TENDL-2024 LIBRARY; T=293.6K  
Particle heating contributions

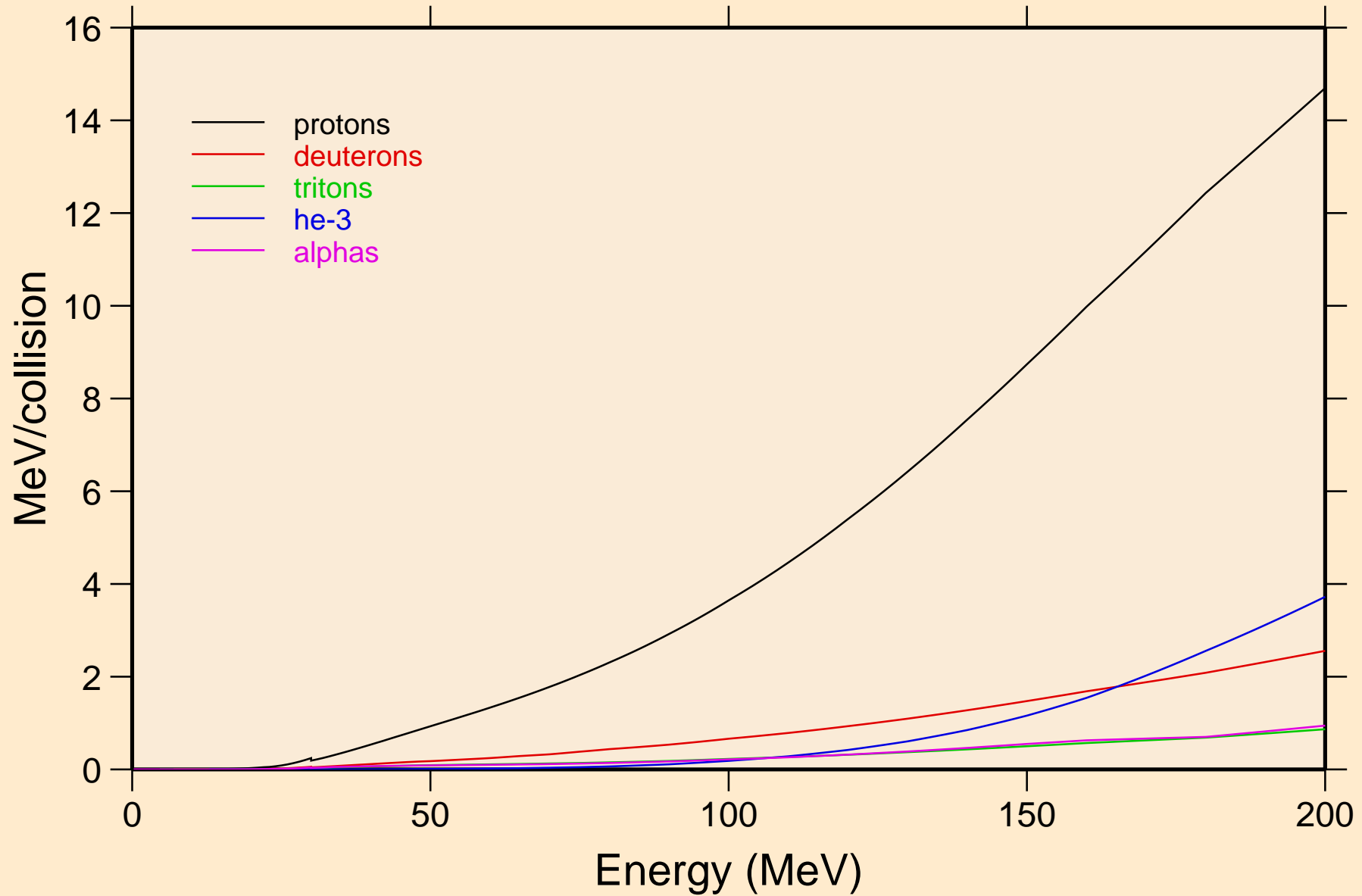

LU186 NEUTRON ACER TENDL-2024 LIBRARY; T=293.6K  
Recoil Heating

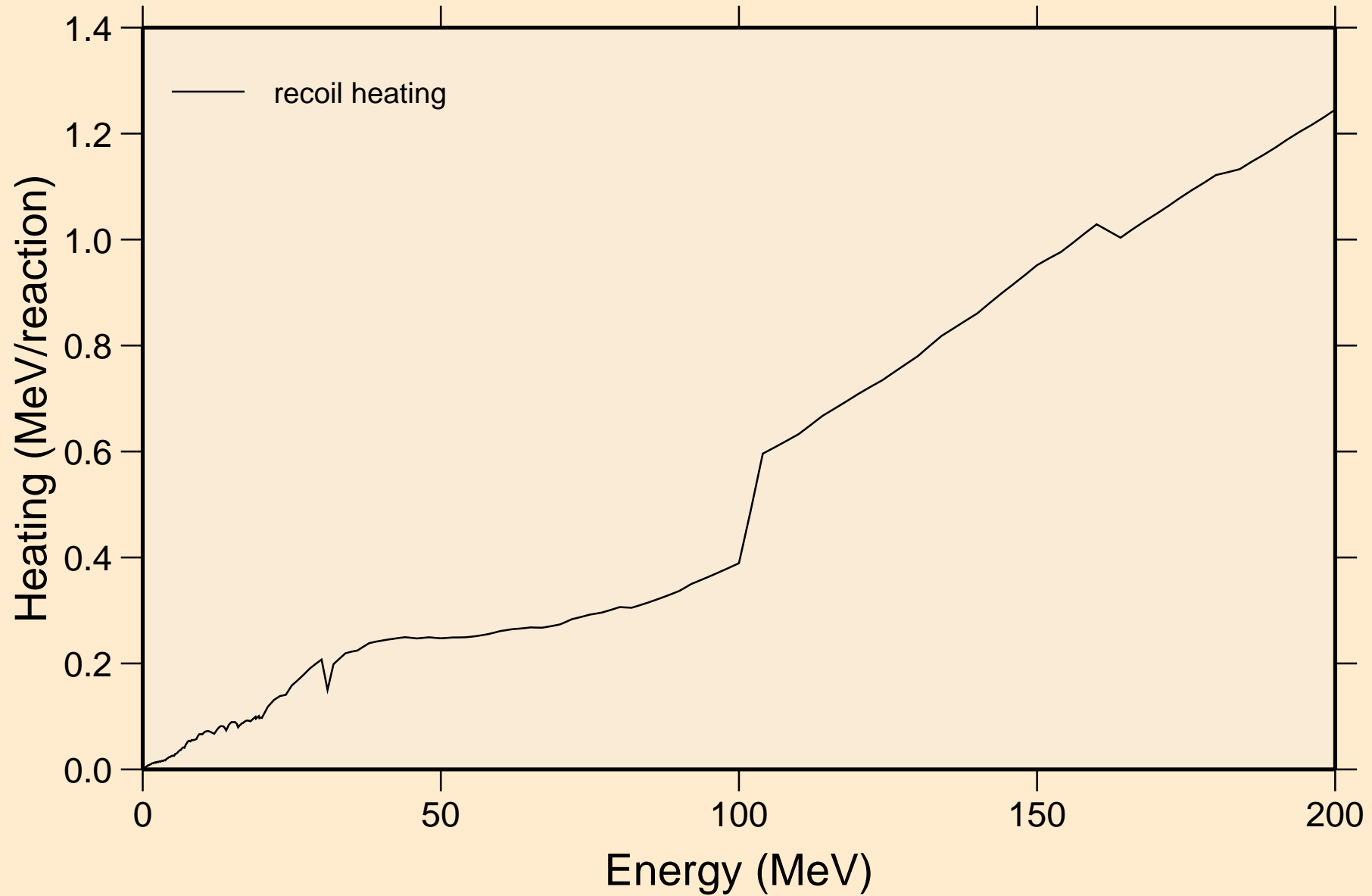

LU186 NEUTRON ACER TENDL-2024 LIBRARY; T=293.6K  
Particle production cross sections

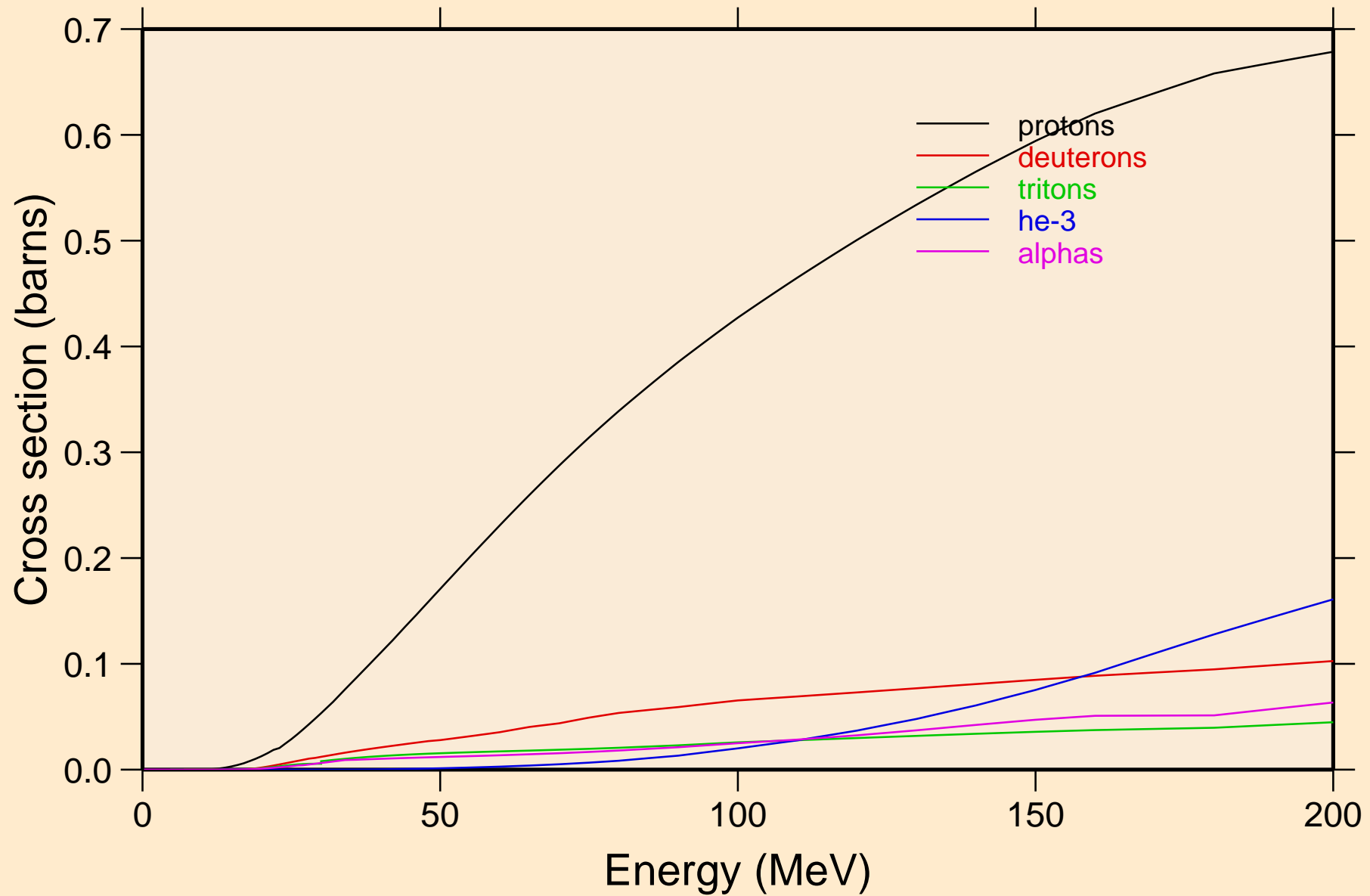

LU186 NEUTRON ACER TENDL-2024 LIBRARY; T=293.6K  
protons from (n,x)

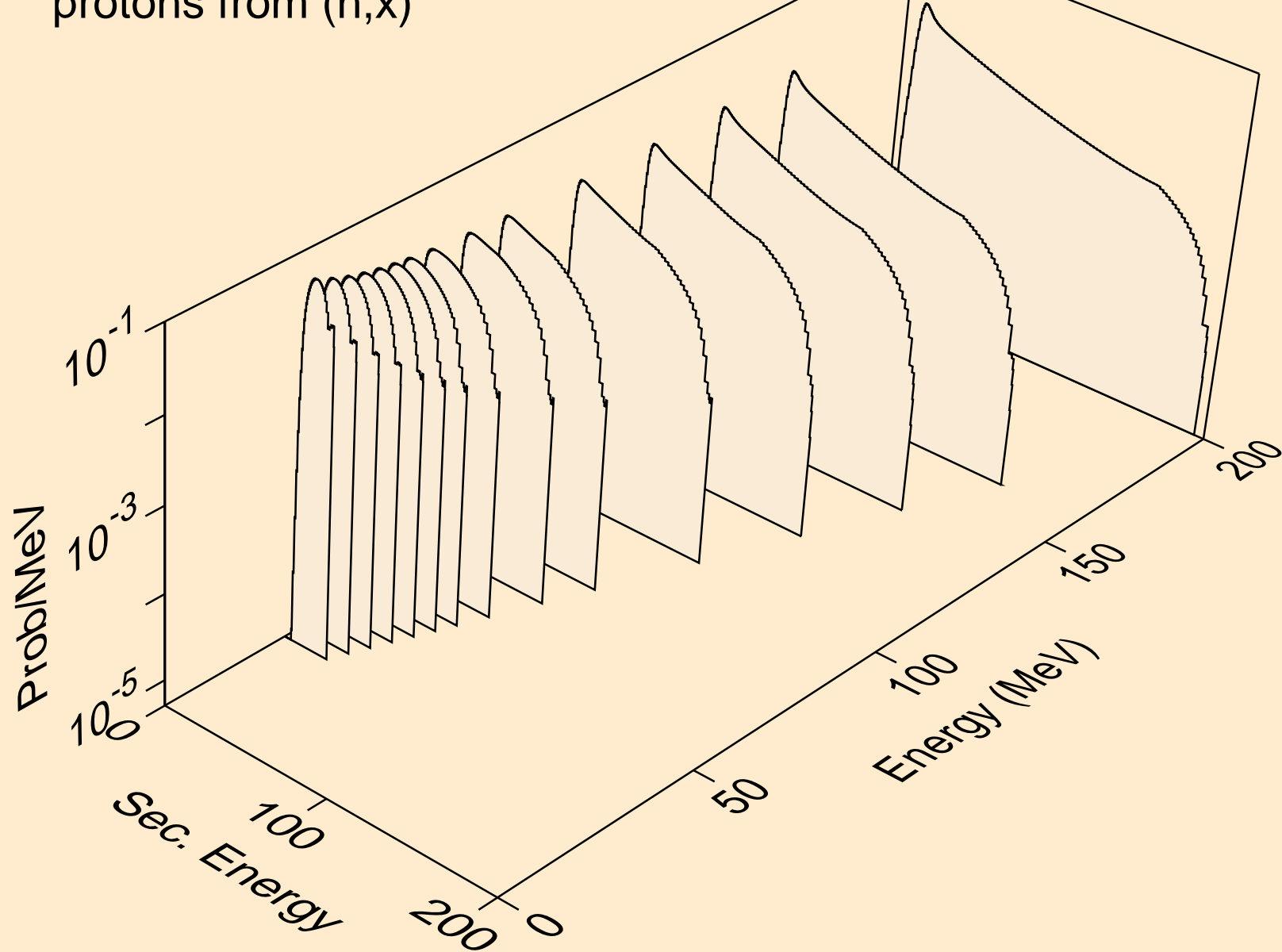

LU186 NEUTRON ACER TENDL-2024 LIBRARY; T=293.6K  
protons from (n,n\*)p

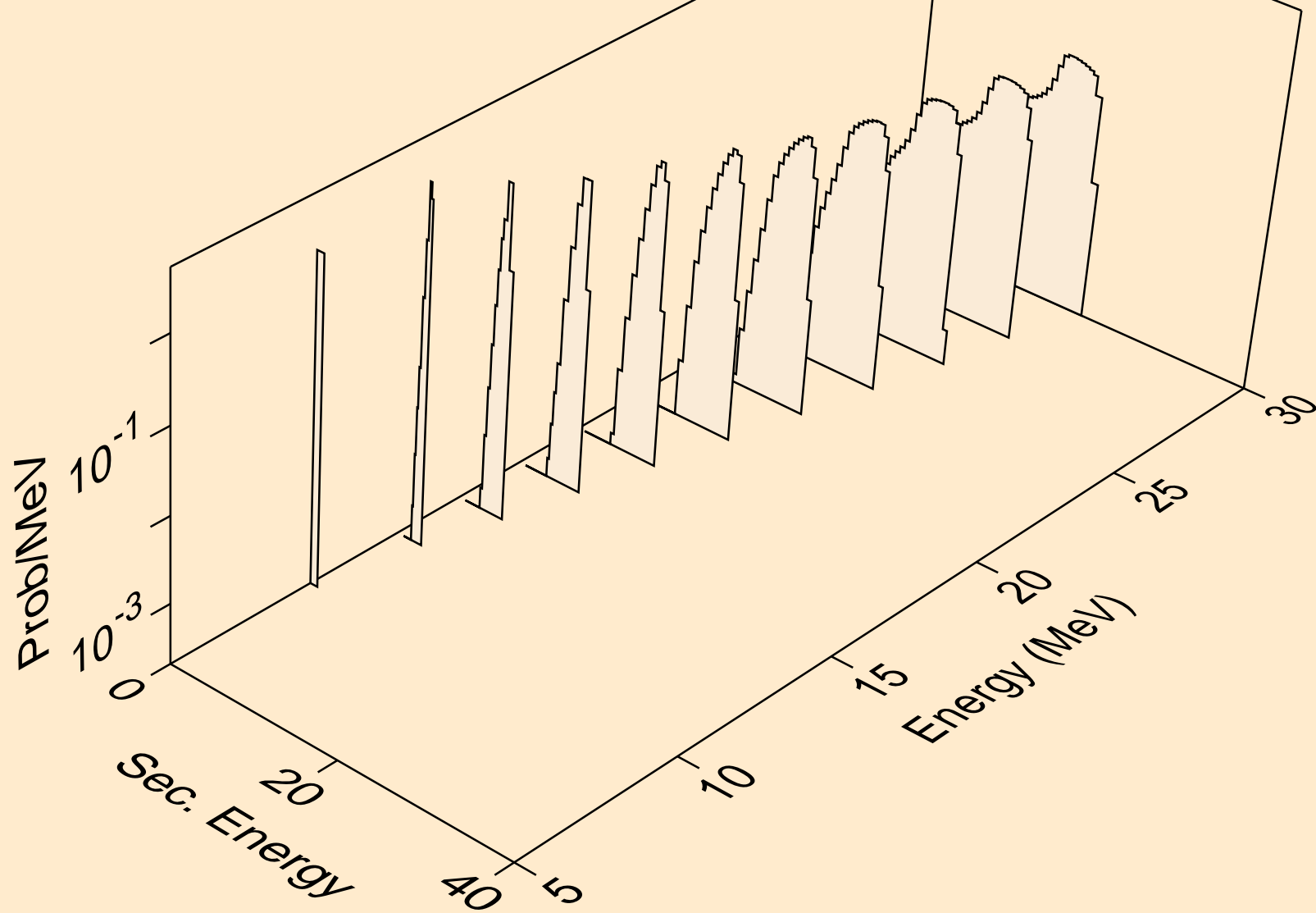

LU186 NEUTRON ACER TENDL-2024 LIBRARY; T=293.6K  
protons from (n,2np)

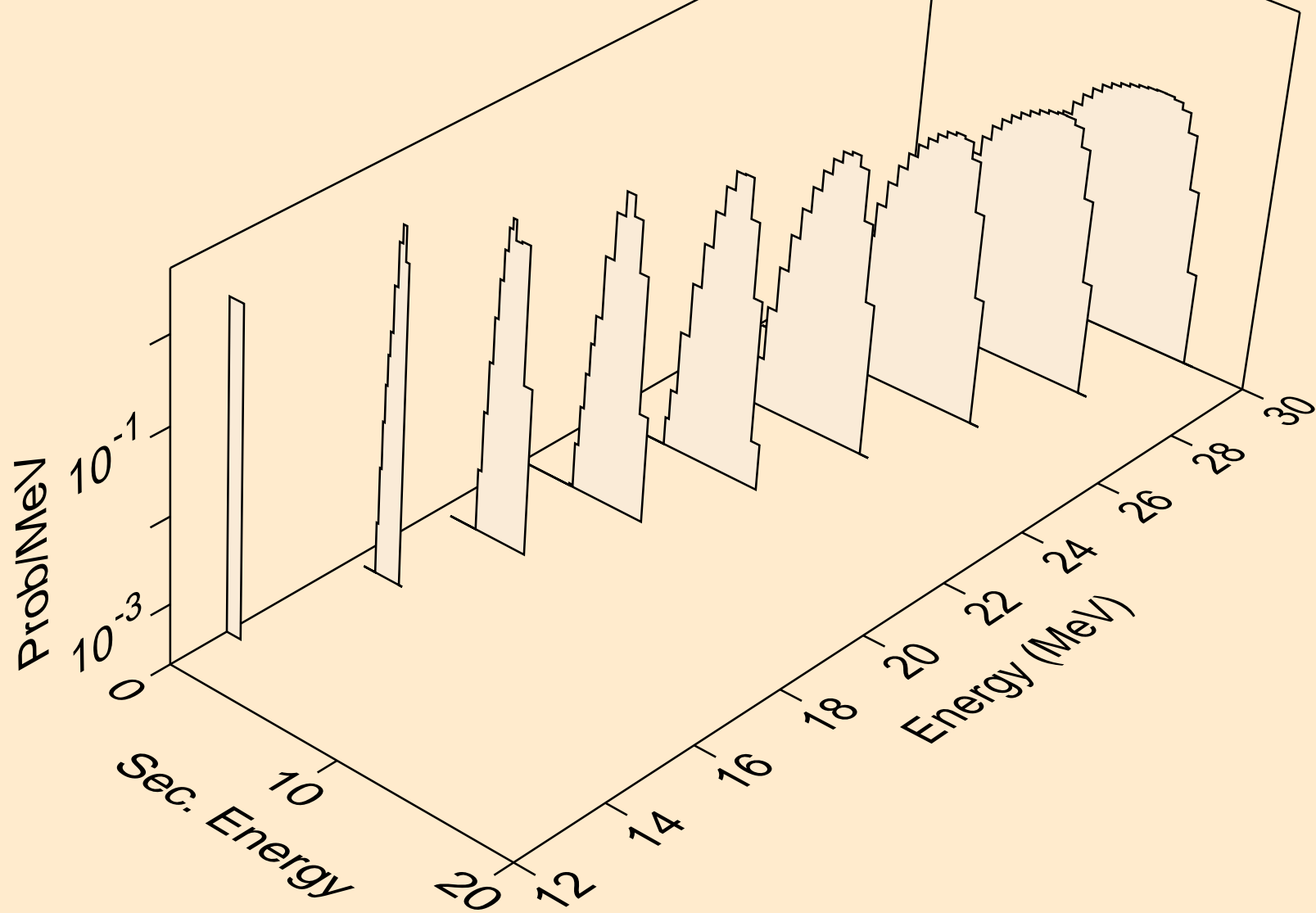

LU186 NEUTRON ACER TENDL-2024 LIBRARY; T=293.6K  
protons from (n,3np)

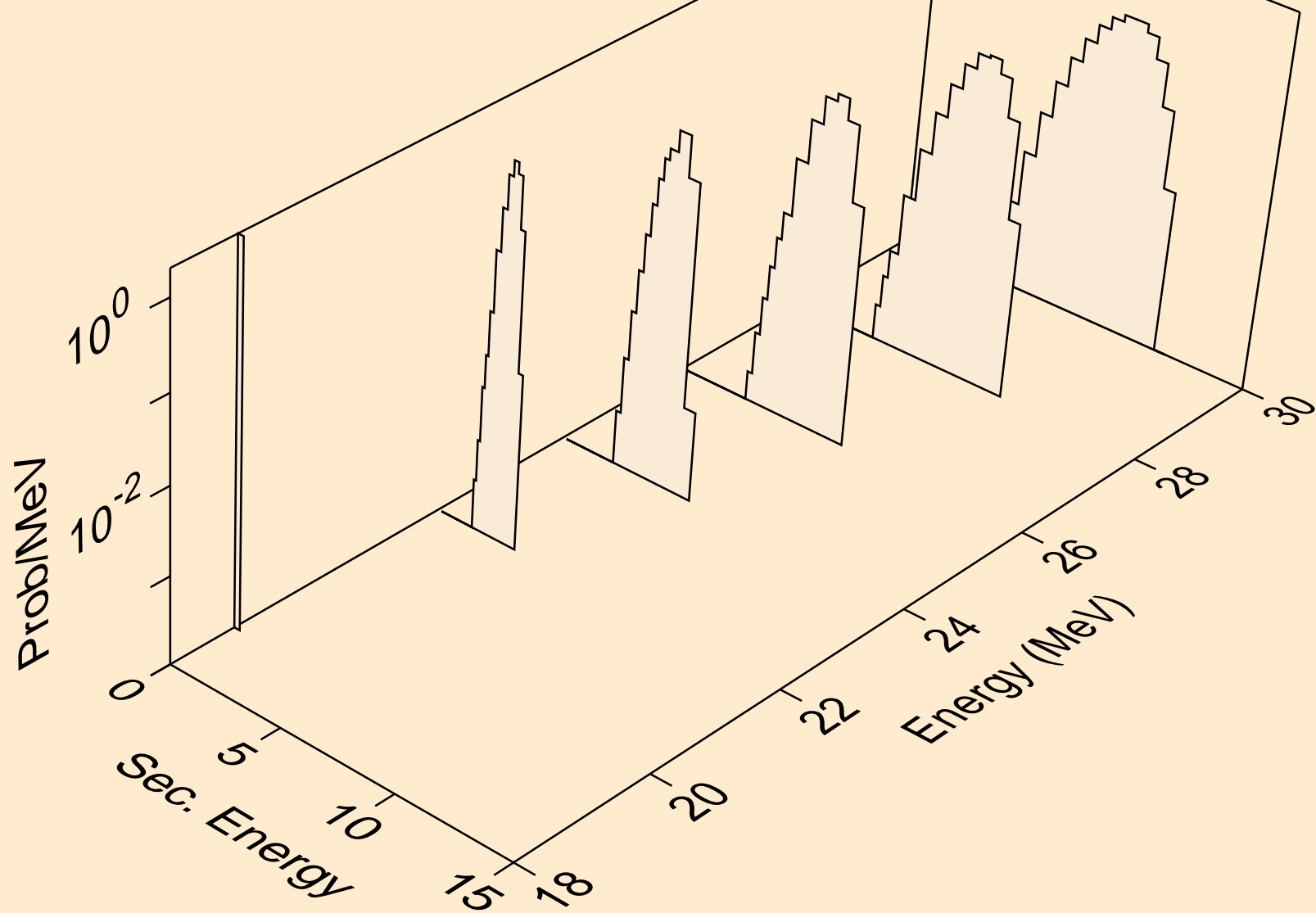

LU186 NEUTRON ACER TENDL-2024 LIBRARY; T=293.6K  
protons from (n,p)

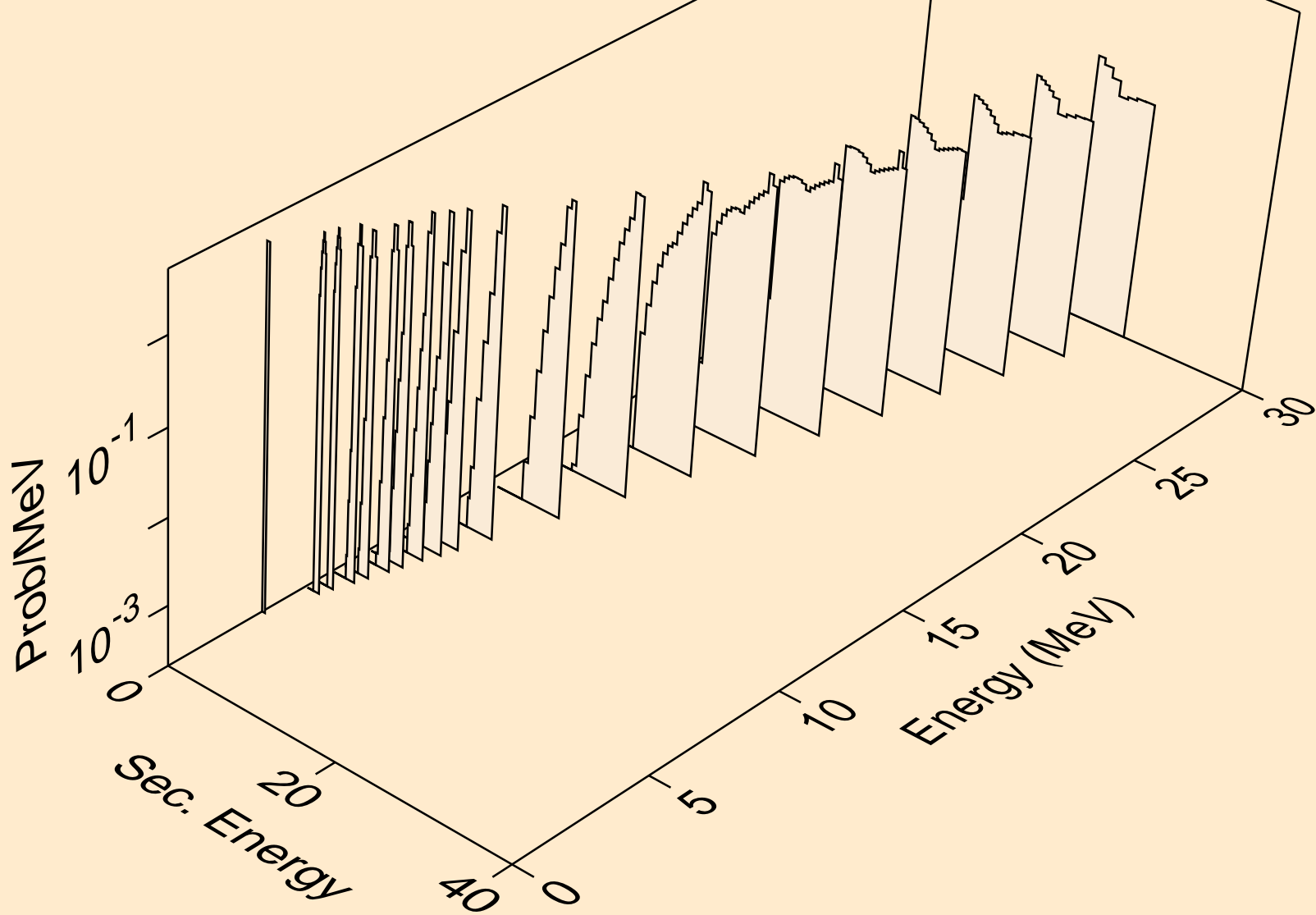

LU186 NEUTRON ACER TENDL-2024 LIBRARY; T=293.6K  
deuterons from (n,x)

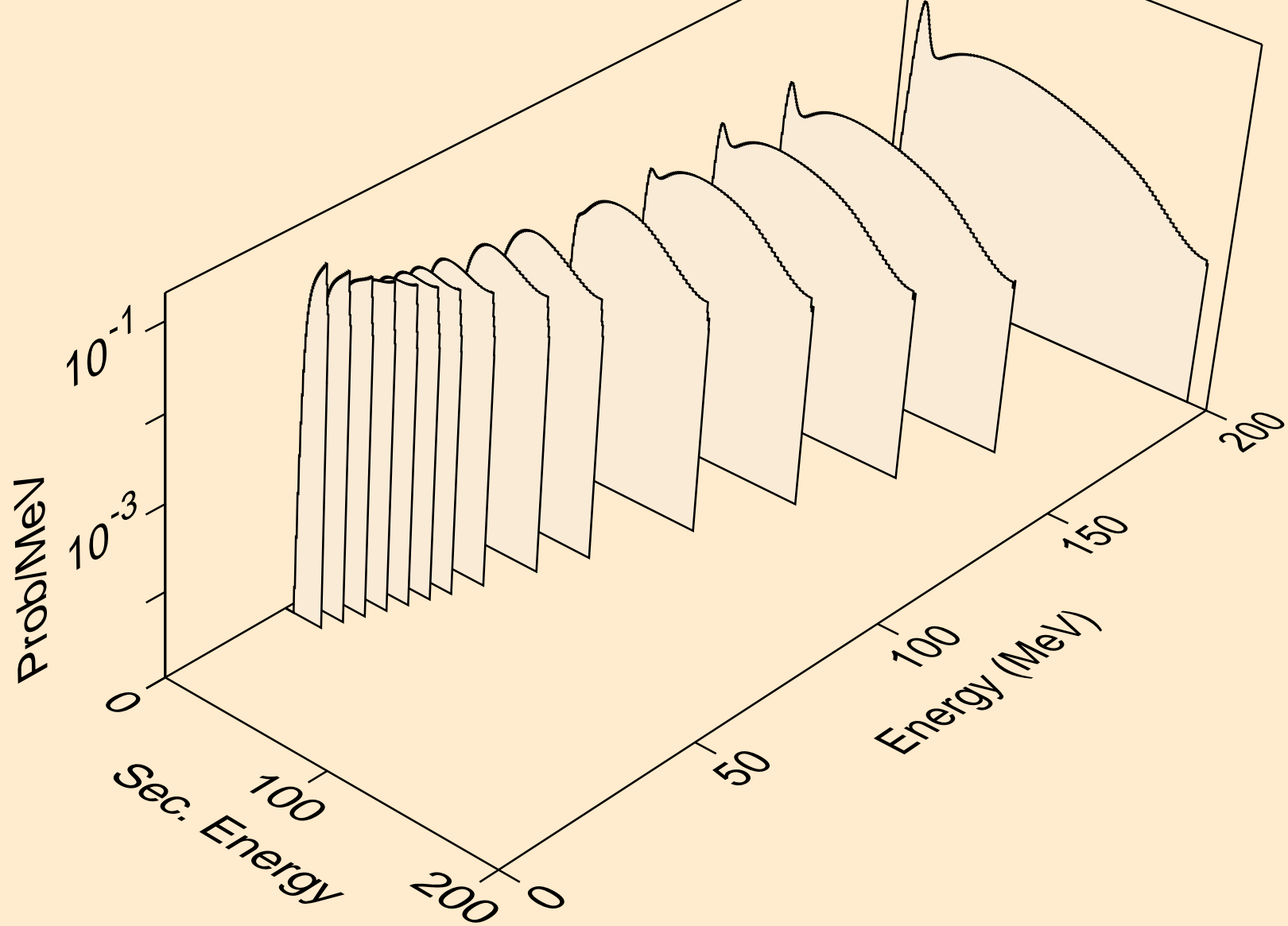

LU186 NEUTRON ACER TENDL-2024 LIBRARY; T=293.6K  
deuterons from (n,2nd)

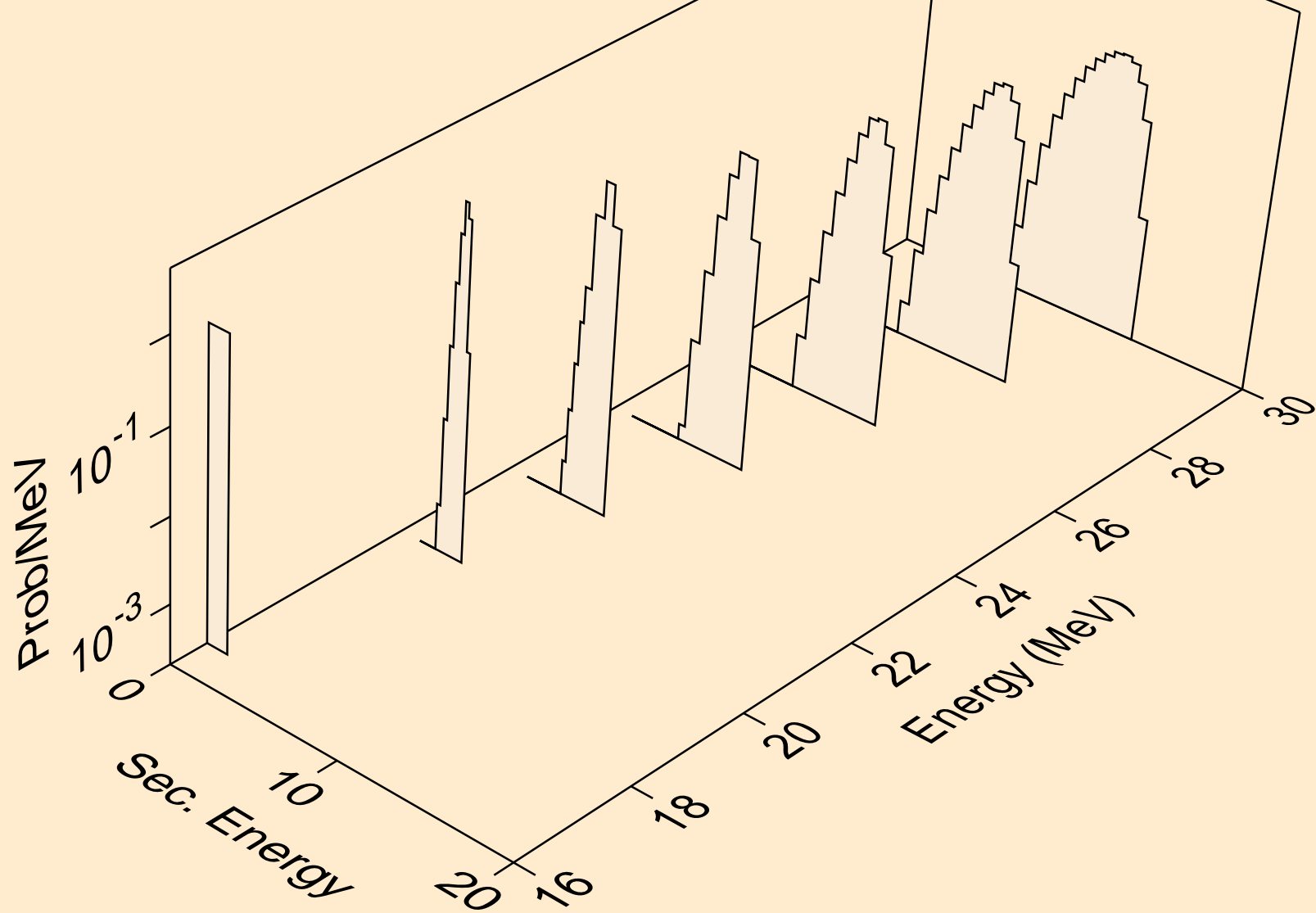

LU186 NEUTRON ACER TENDL-2024 LIBRARY; T=293.6K  
deuterons from (n,n\*)d

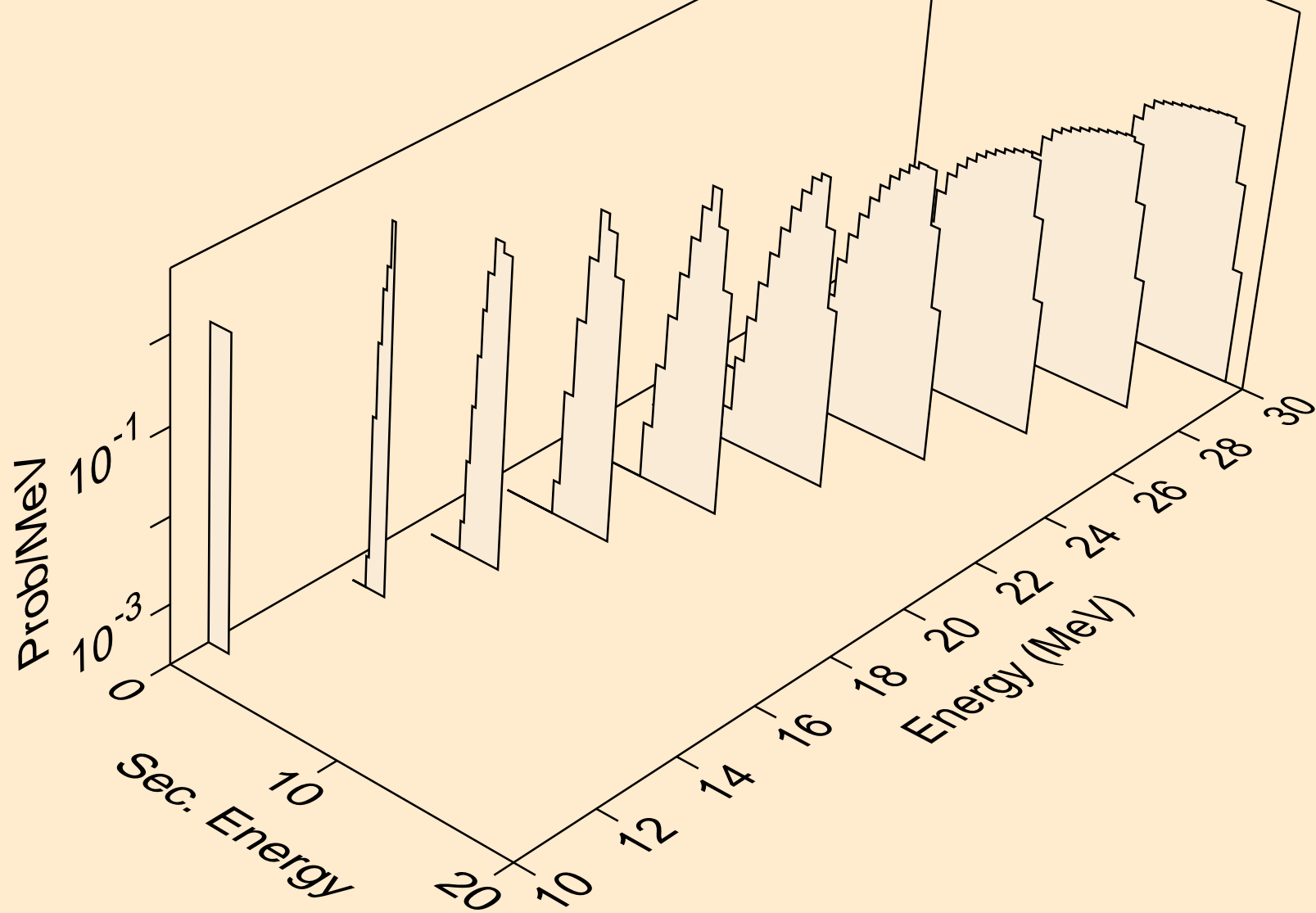

LU186 NEUTRON ACER TENDL-2024 LIBRARY; T=293.6K  
deuterons from (n,d)

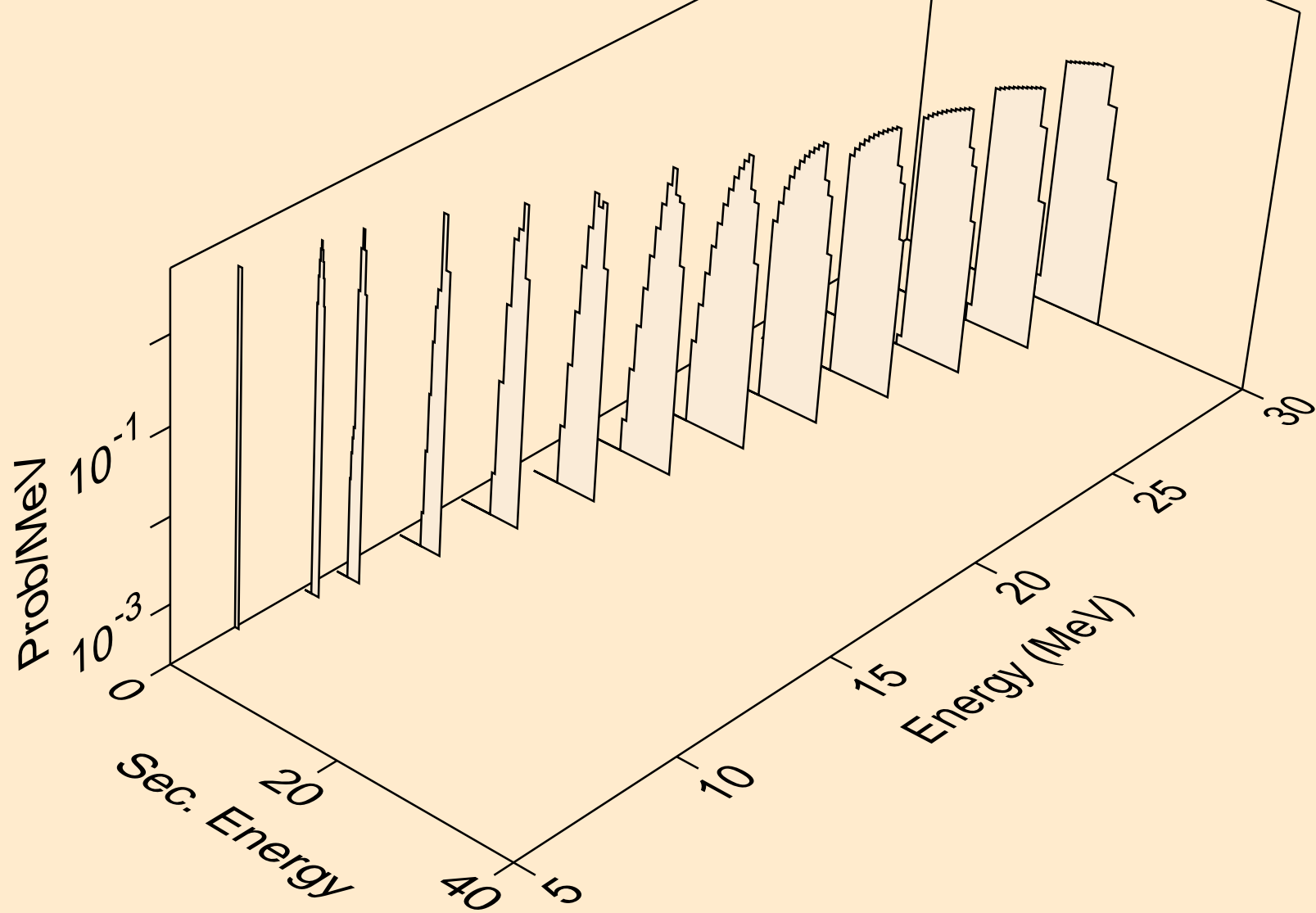

LU186 NEUTRON ACER TENDL-2024 LIBRARY; T=293.6K  
tritons from (n,x)

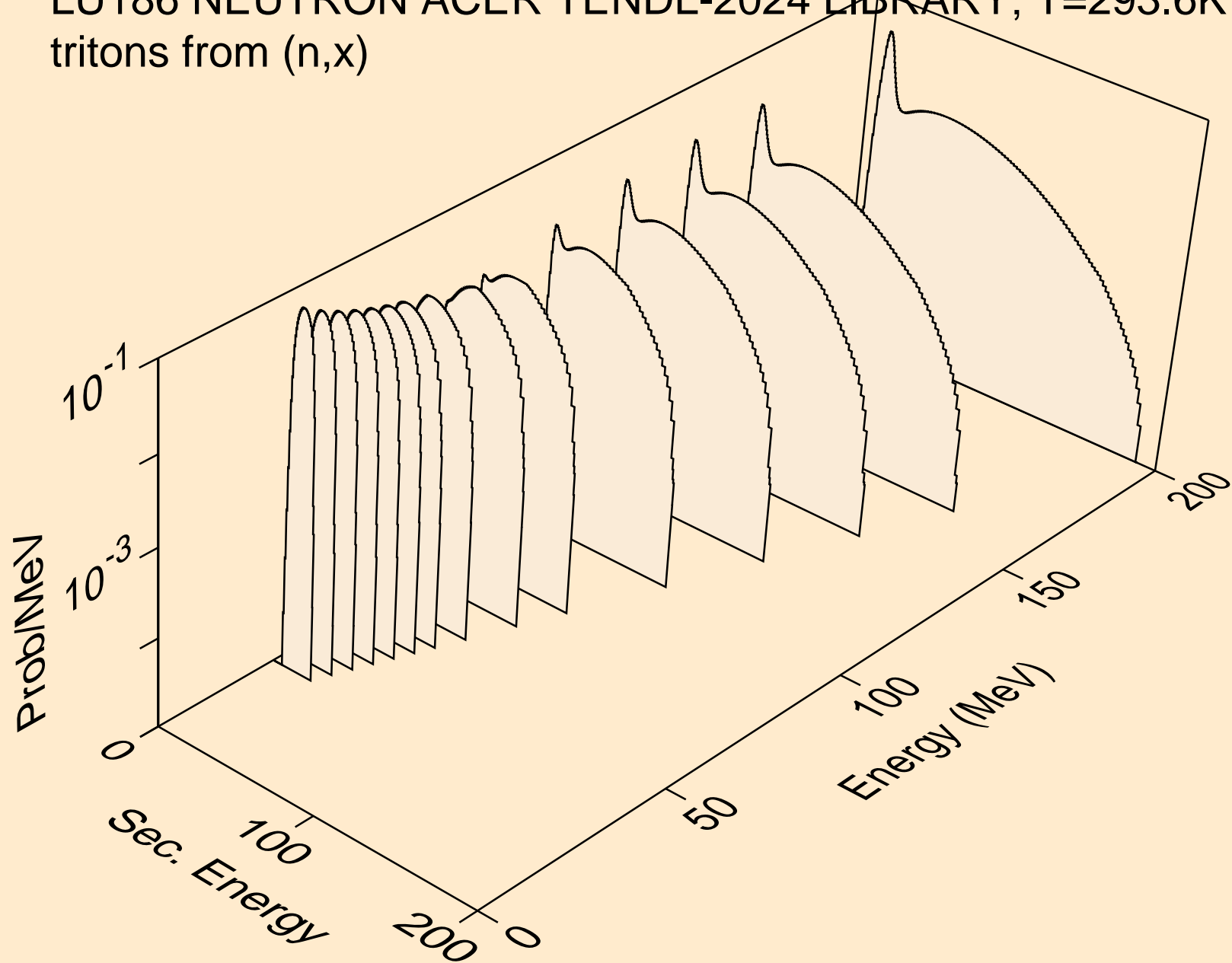

LU186 NEUTRON ACER TENDL-2024 LIBRARY; T=293.6K  
tritons from (n,n\*)t

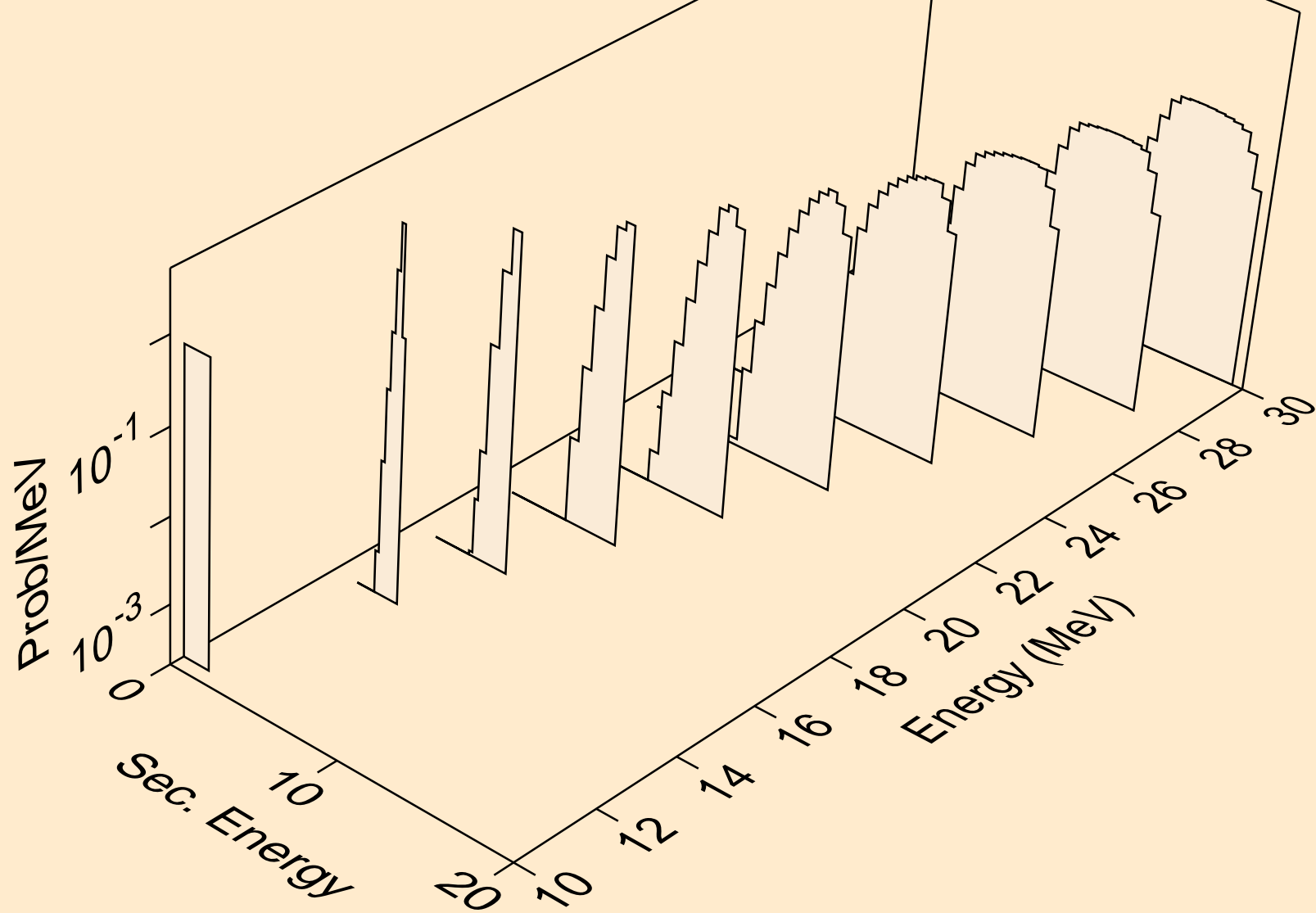

LU186 NEUTRON ACER TENDL-2024 LIBRARY; T=293.6K  
tritons from (n,t)

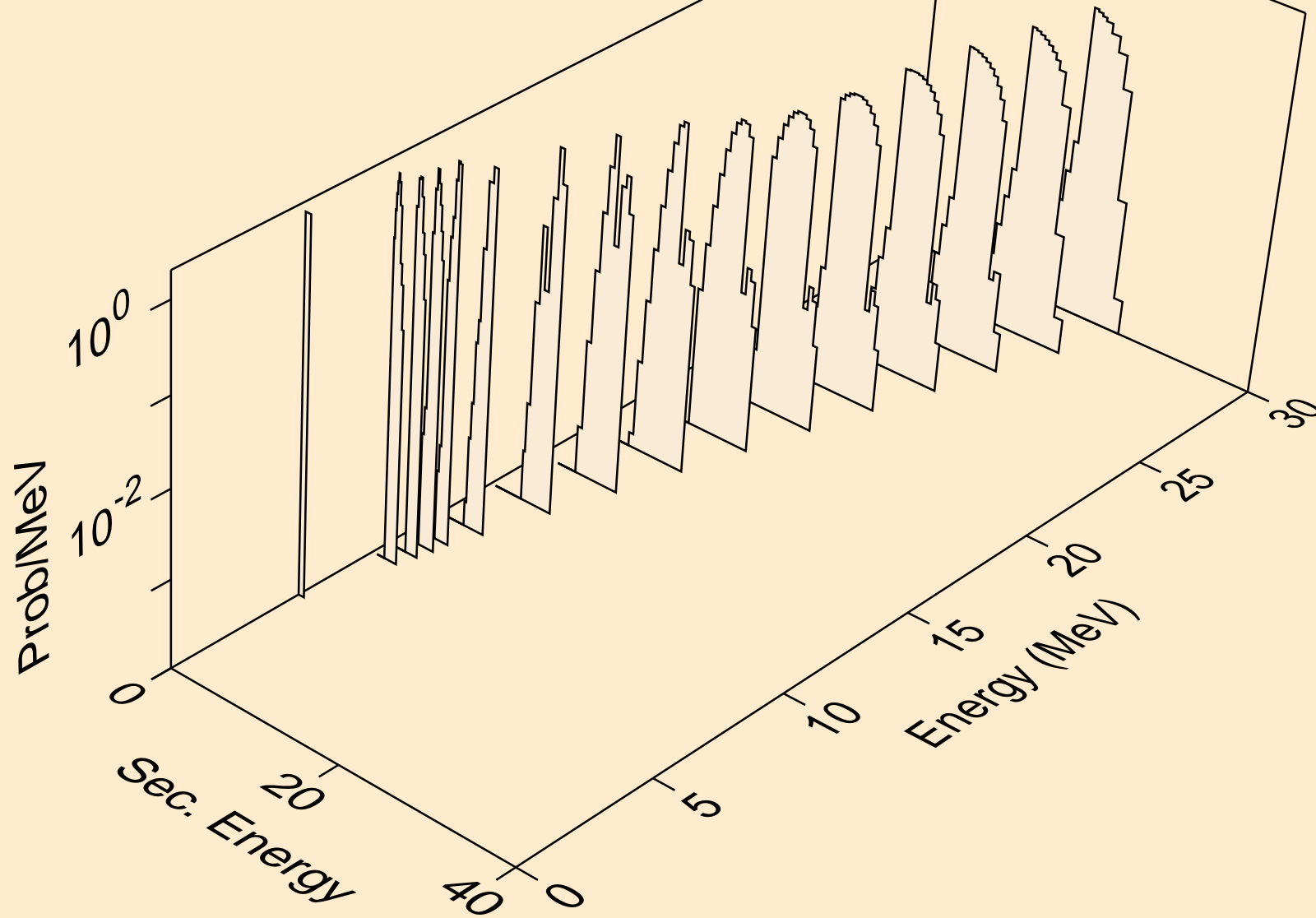

LU186 NEUTRON ACER TENDL-2024 LIBRARY; T=293.6K  
he3s from (n,x)

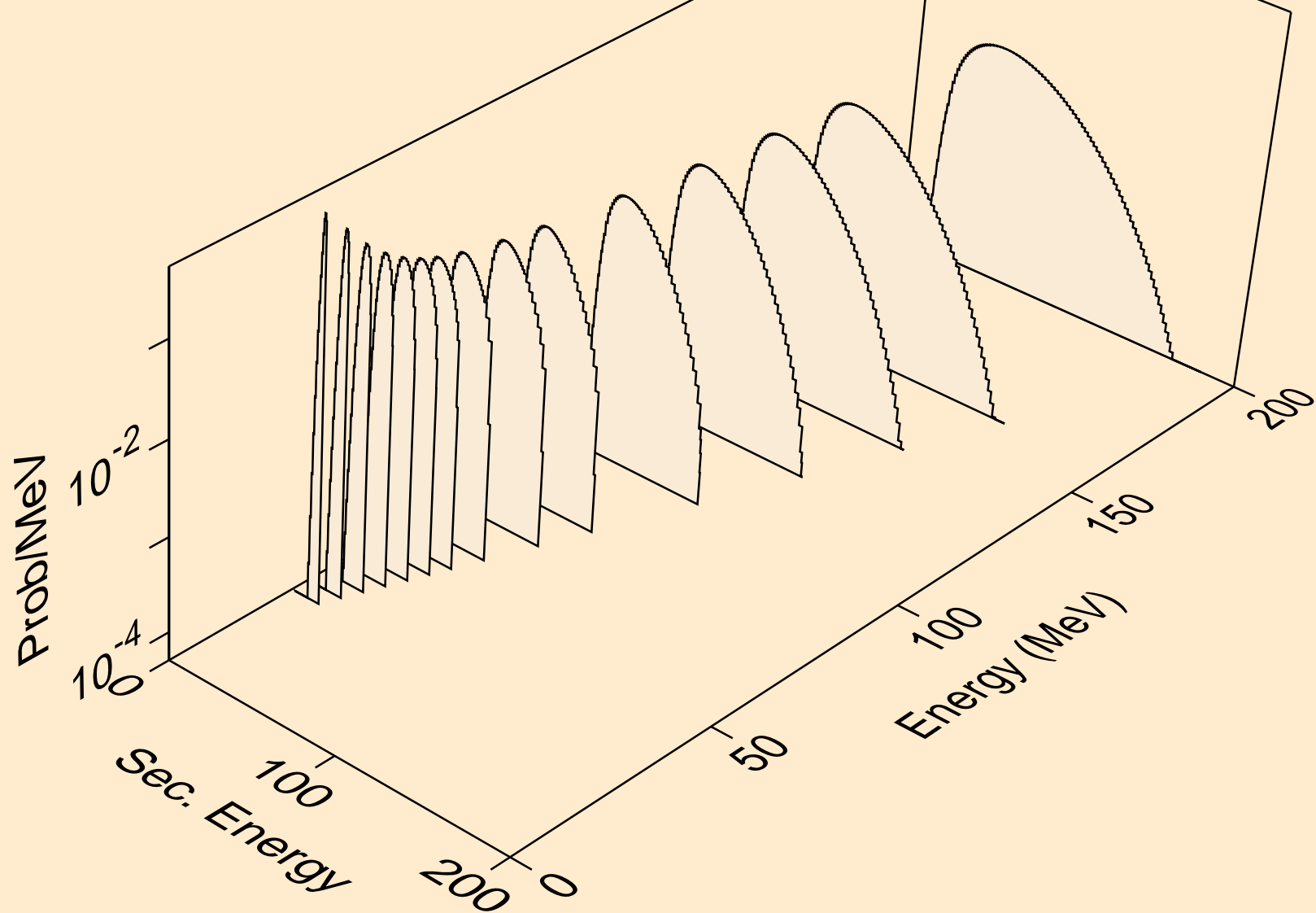

LU186 NEUTRON ACER TENDL-2024 LIBRARY; T=293.6K  
he3s from (n,n\*)he3

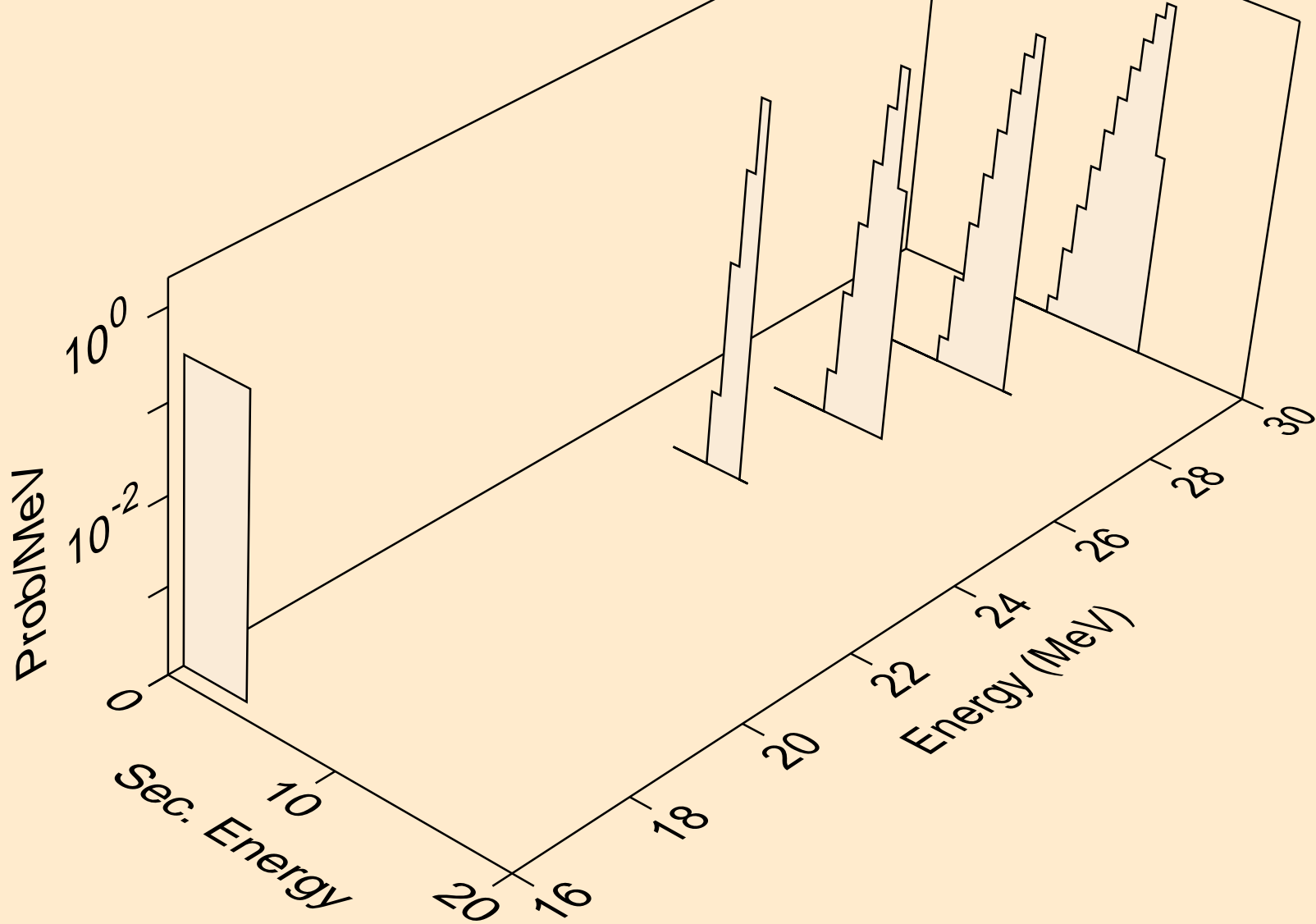

LU186 NEUTRON ACER TENDL-2024 LIBRARY; T=293.6K  
he3s from (n,he3)

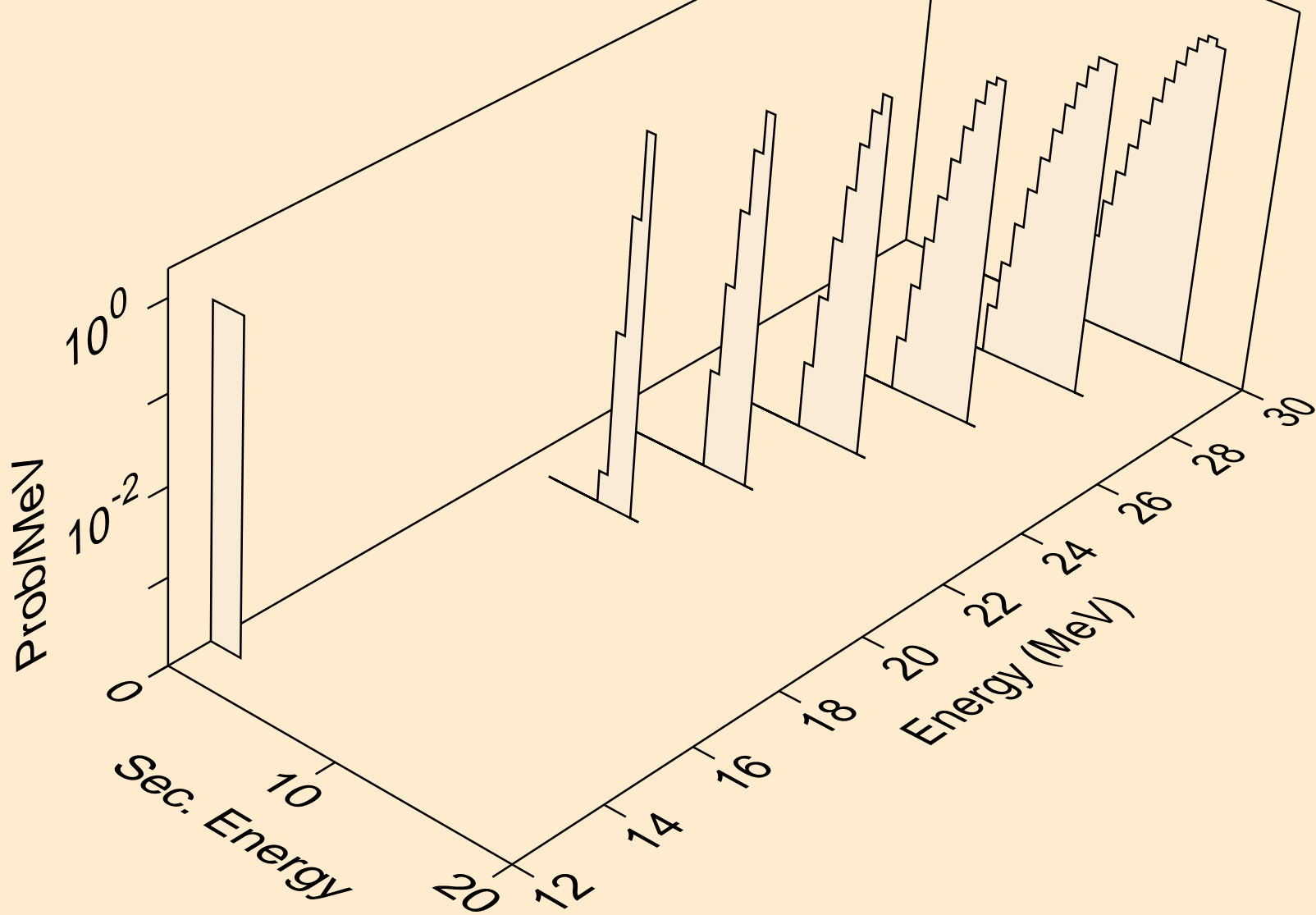

LU186 NEUTRON ACER TENDL-2024 LIBRARY; T=293.6K  
alphas from (n,x)

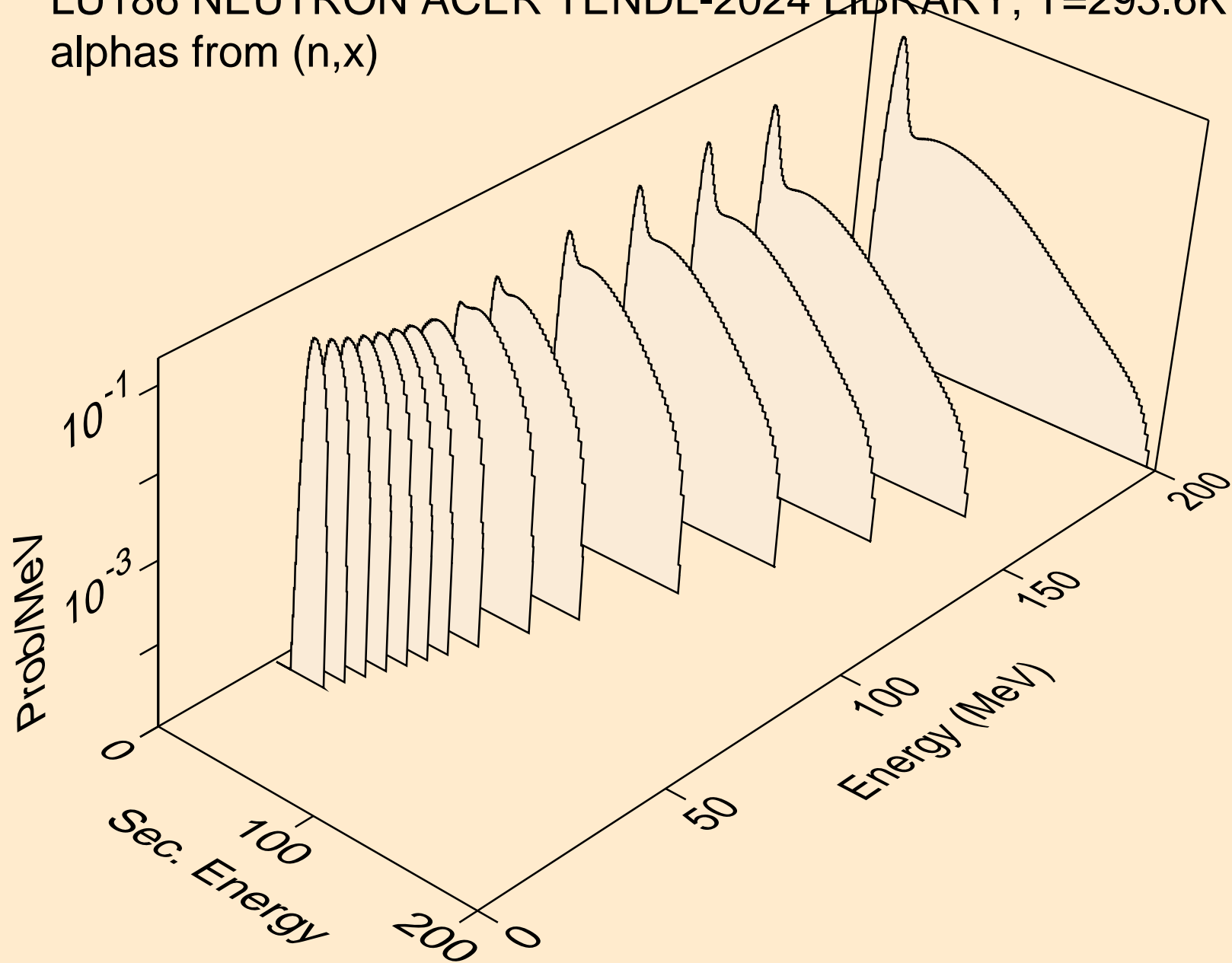

LU186 NEUTRON ACER TENDL-2024 LIBRARY; T=293.6K  
alphas from (n,n\*)a

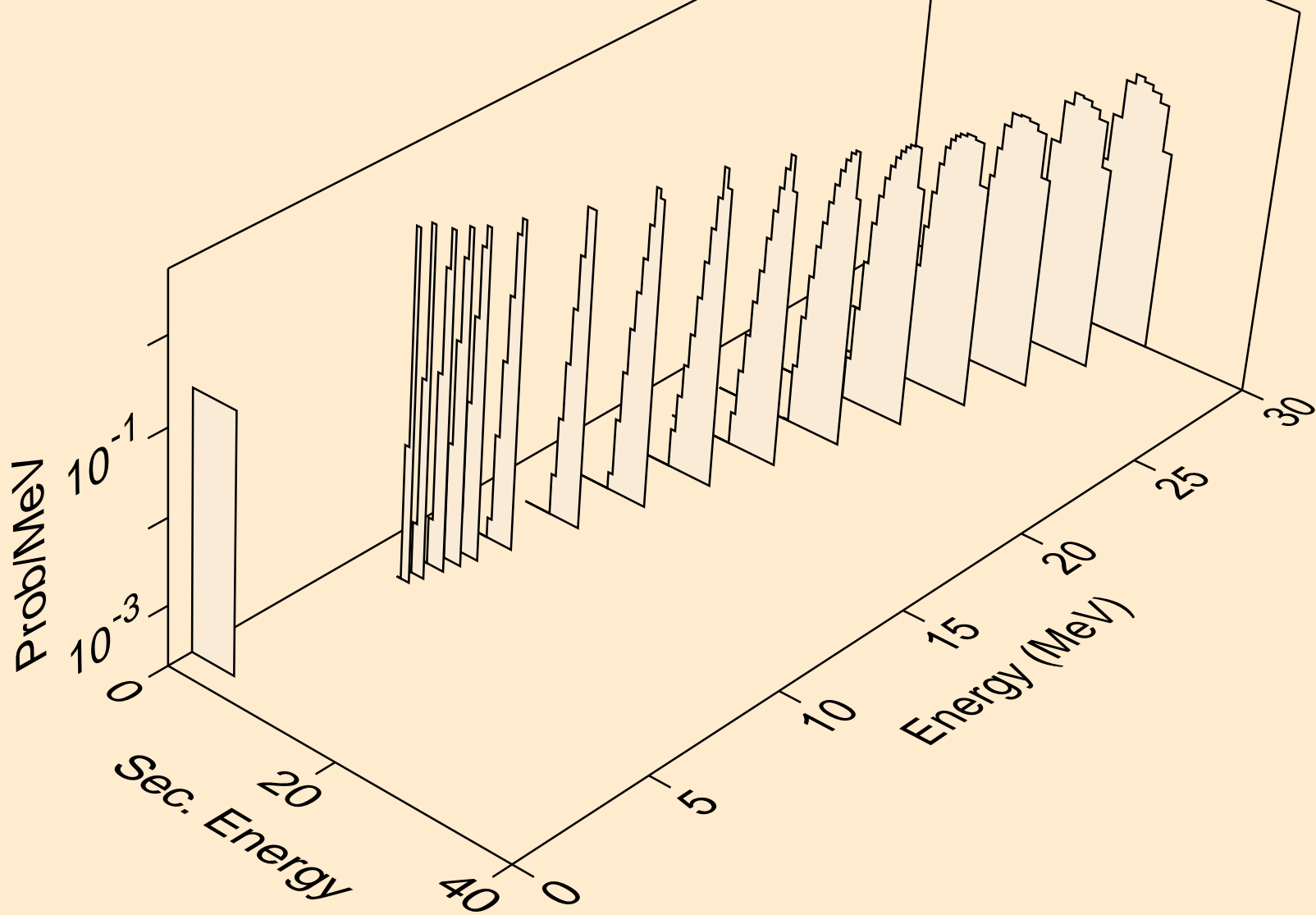

LU186 NEUTRON ACER TENDL-2024 LIBRARY; T=293.6K  
alphas from (n,2n)a

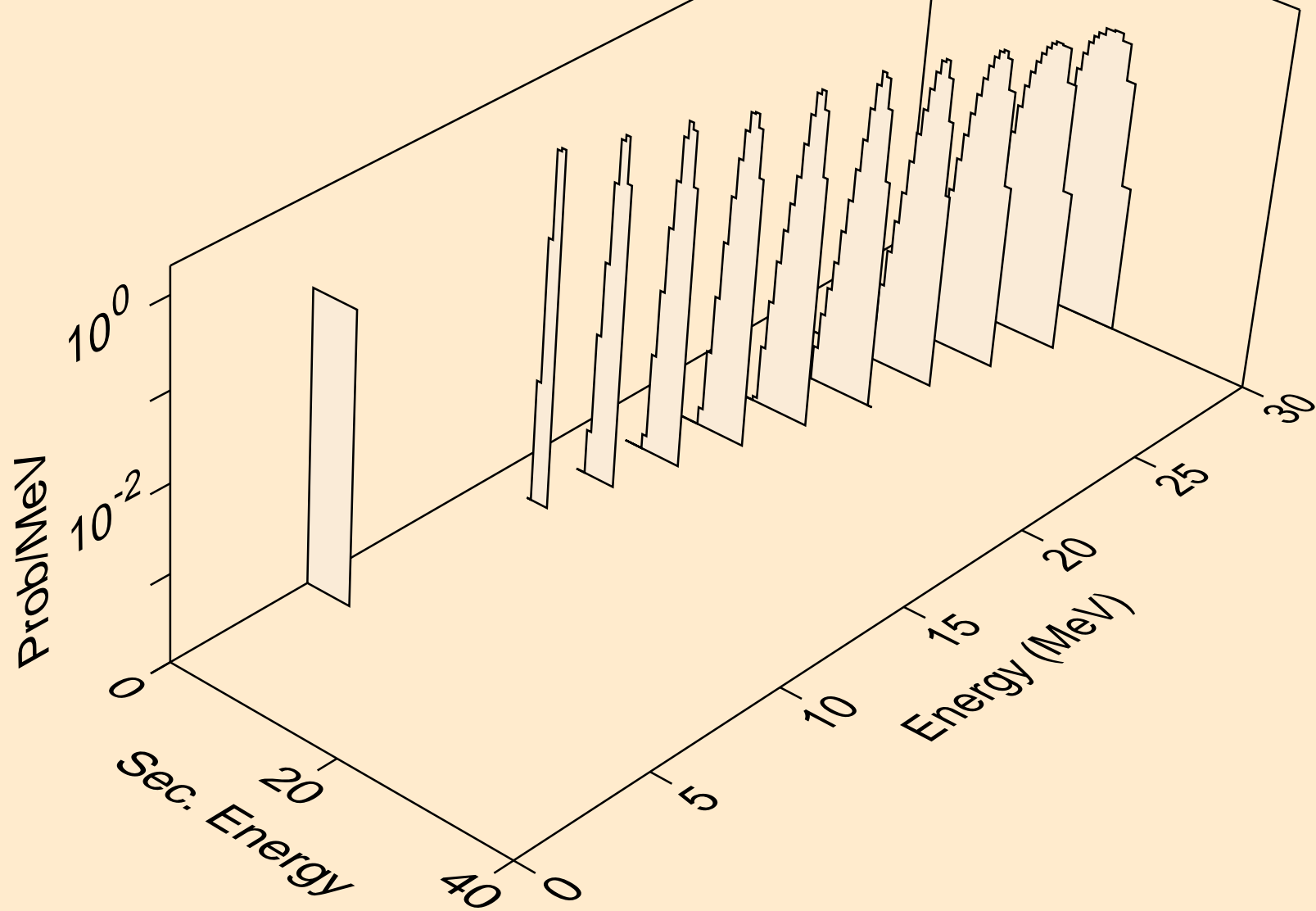

LU186 NEUTRON ACER TENDL-2024 LIBRARY; T=293.6K  
alphas from (n,3n)a

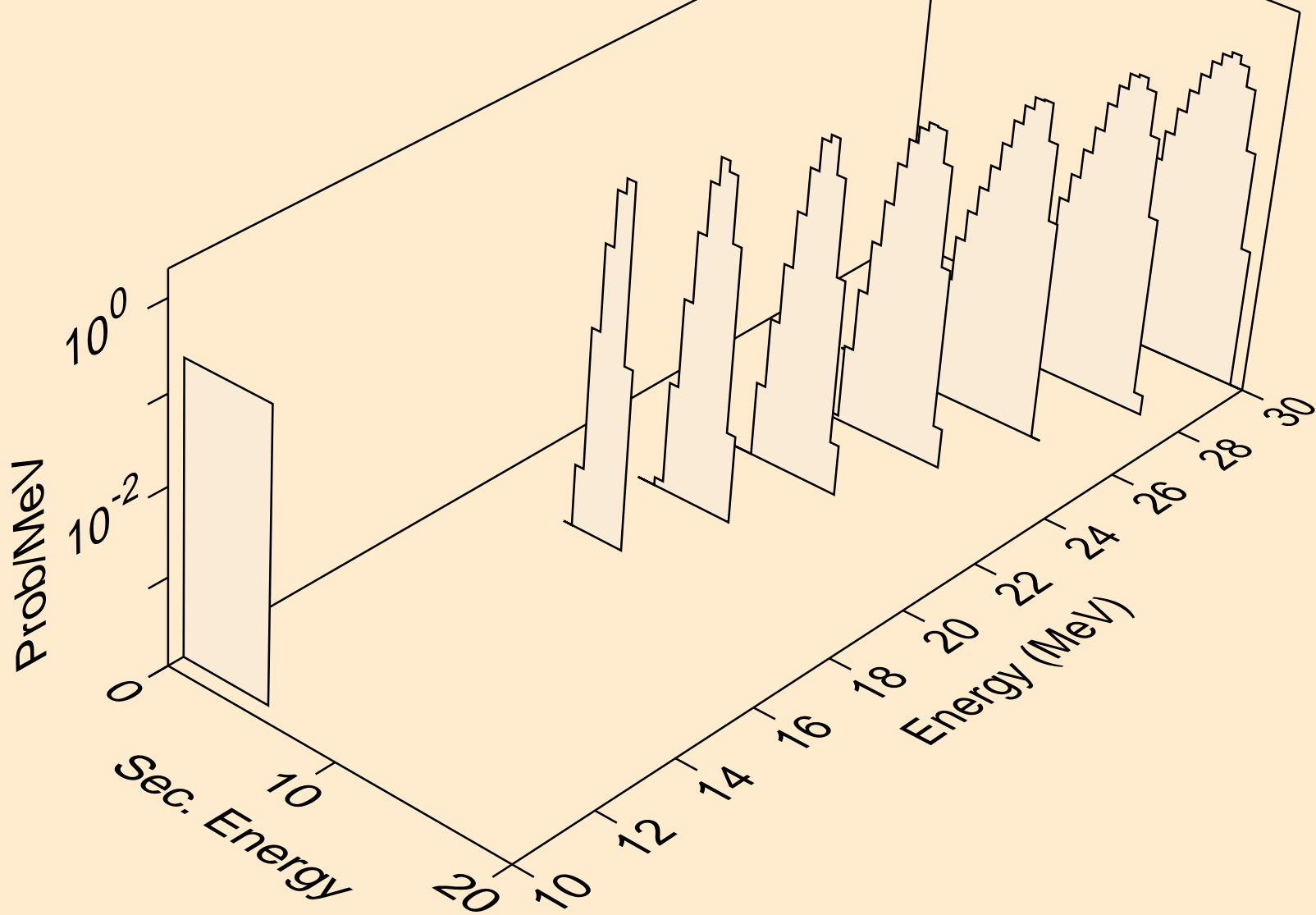

LU186 NEUTRON ACER TENDL-2024 LIBRARY; T=293.6K  
alphas from (n,a)

