

LU187 NEUTRON ACER TENDL-2024 LIBRARY; T=293.6K

Principal cross sections

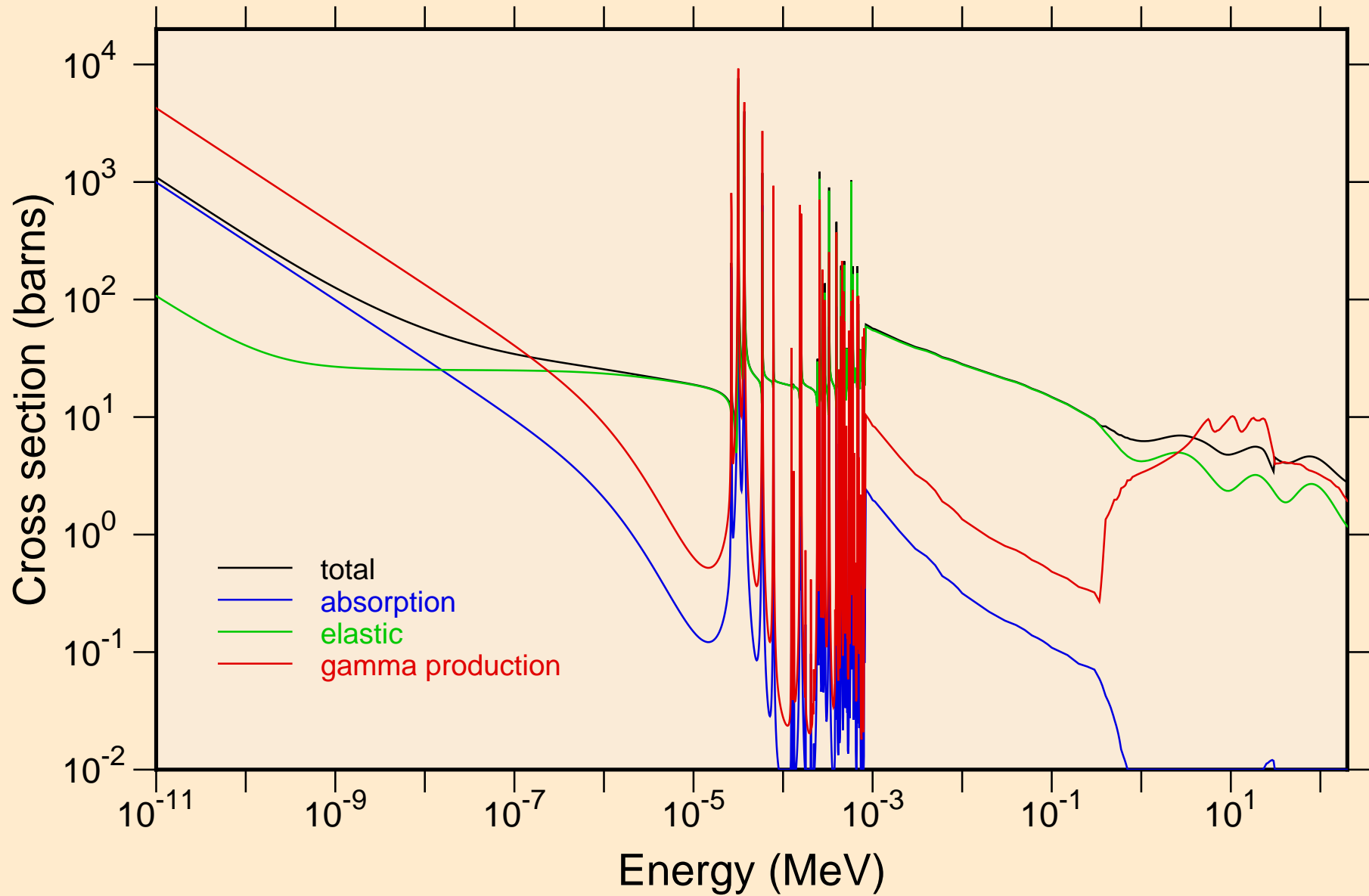

LU187 NEUTRON ACER TENDL-2024 LIBRARY; T=293.6K
resonance total cross section

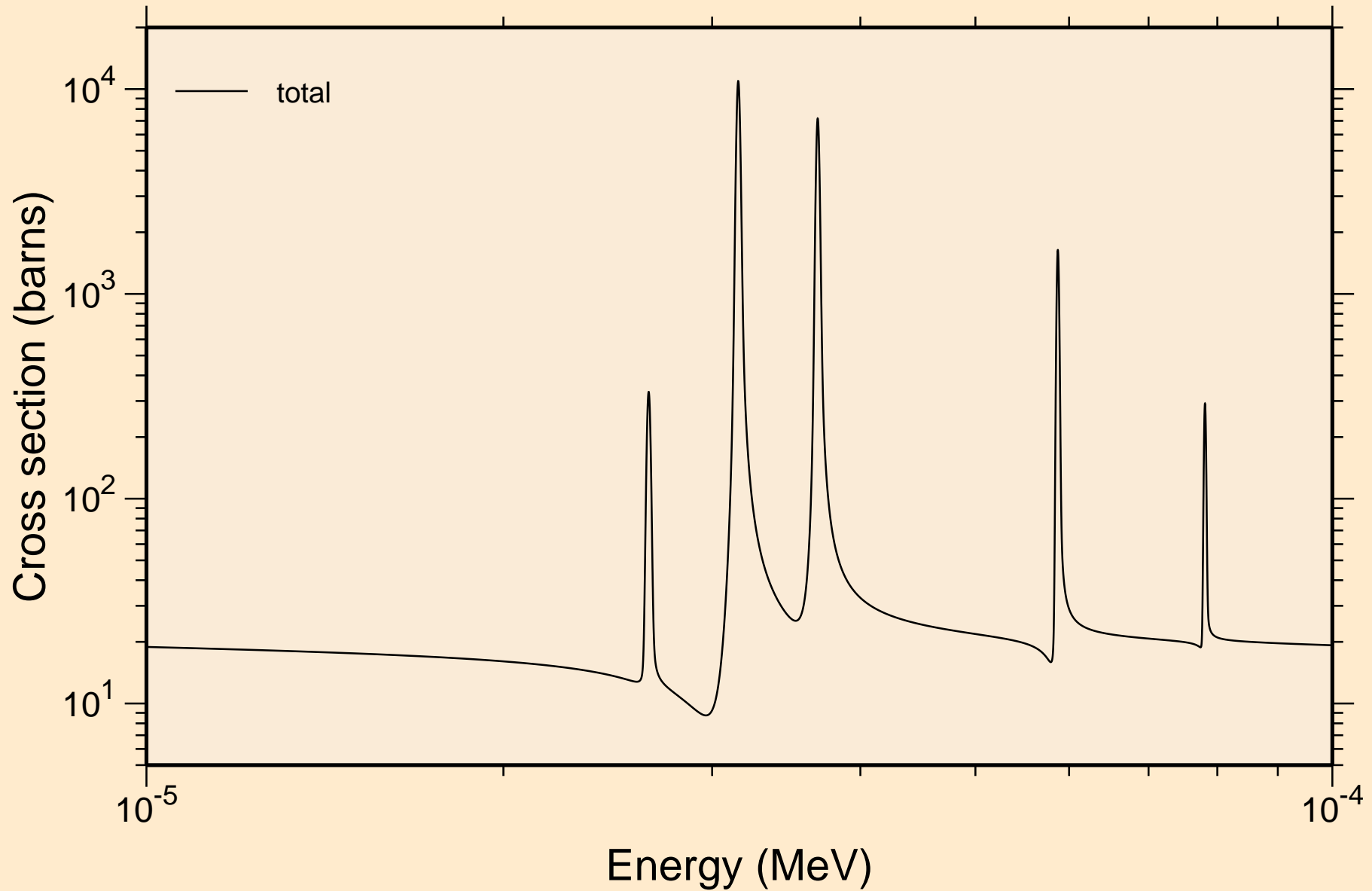

LU187 NEUTRON ACER TENDL-2024 LIBRARY; T=293.6K
resonance total cross section

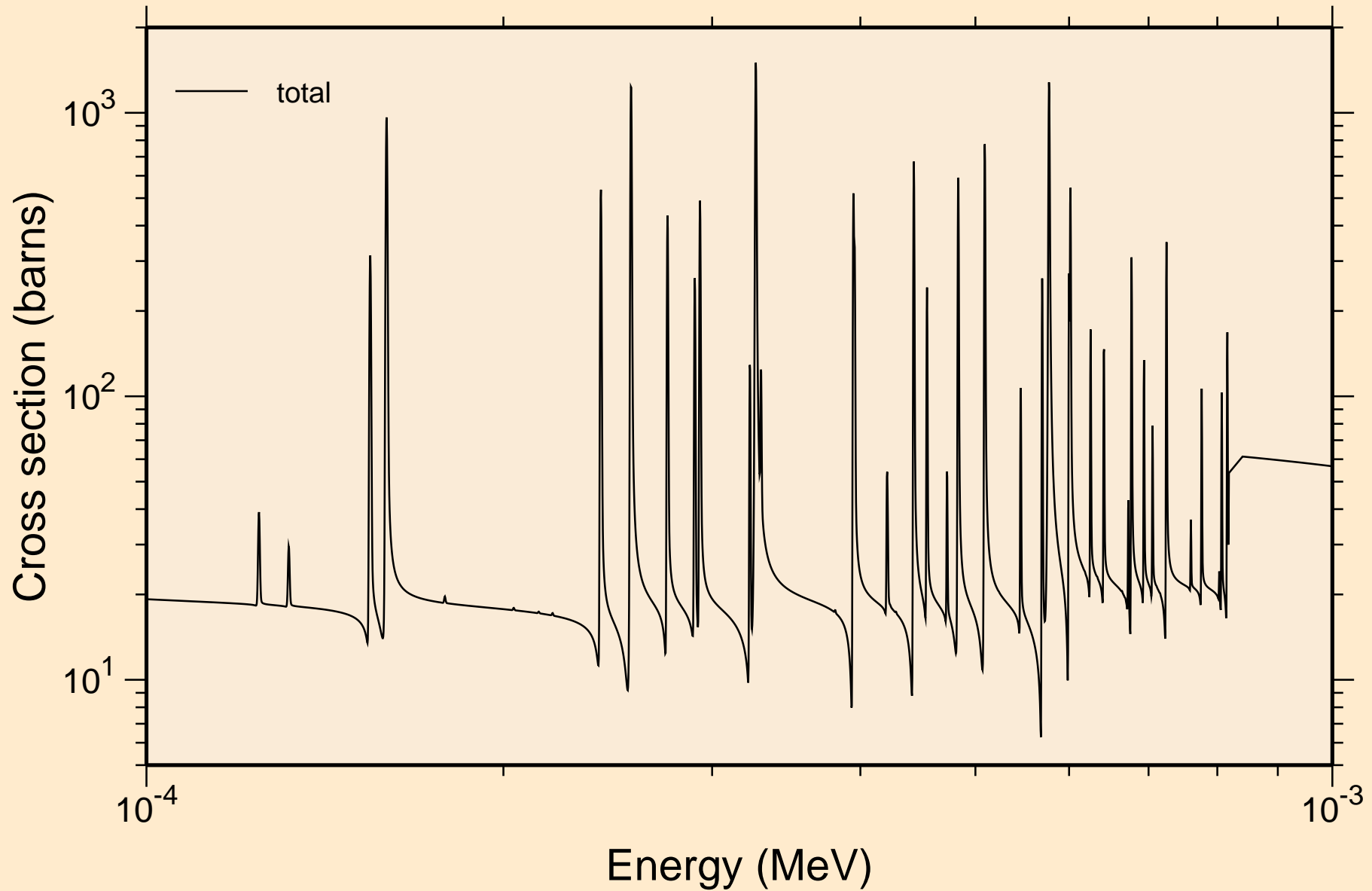

LU187 NEUTRON ACER TENDL-2024 LIBRARY; T=293.6K
resonance total cross section

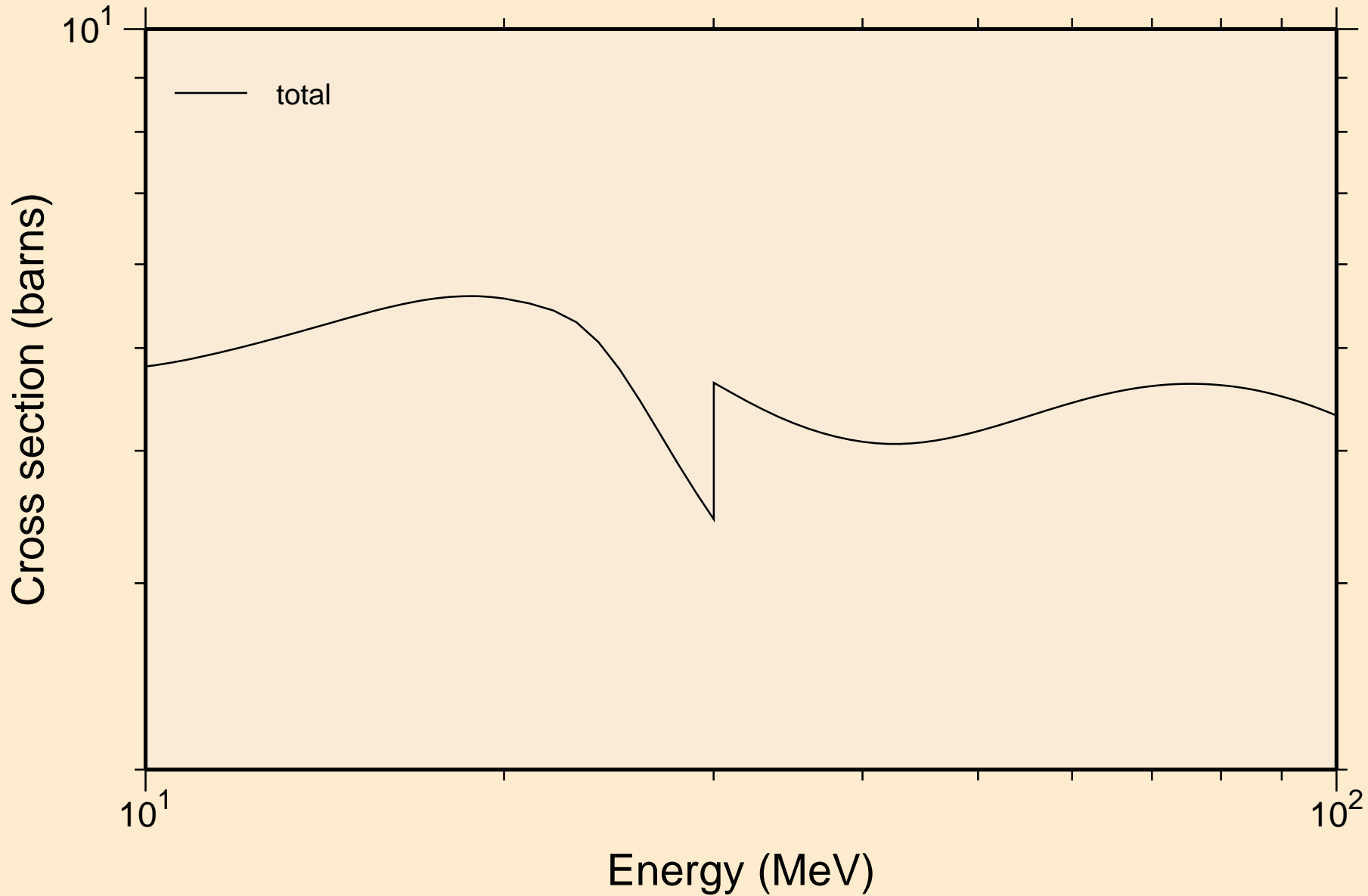

LU187 NEUTRON ACER TENDL-2024 LIBRARY; T=293.6K
resonance absorption cross sections

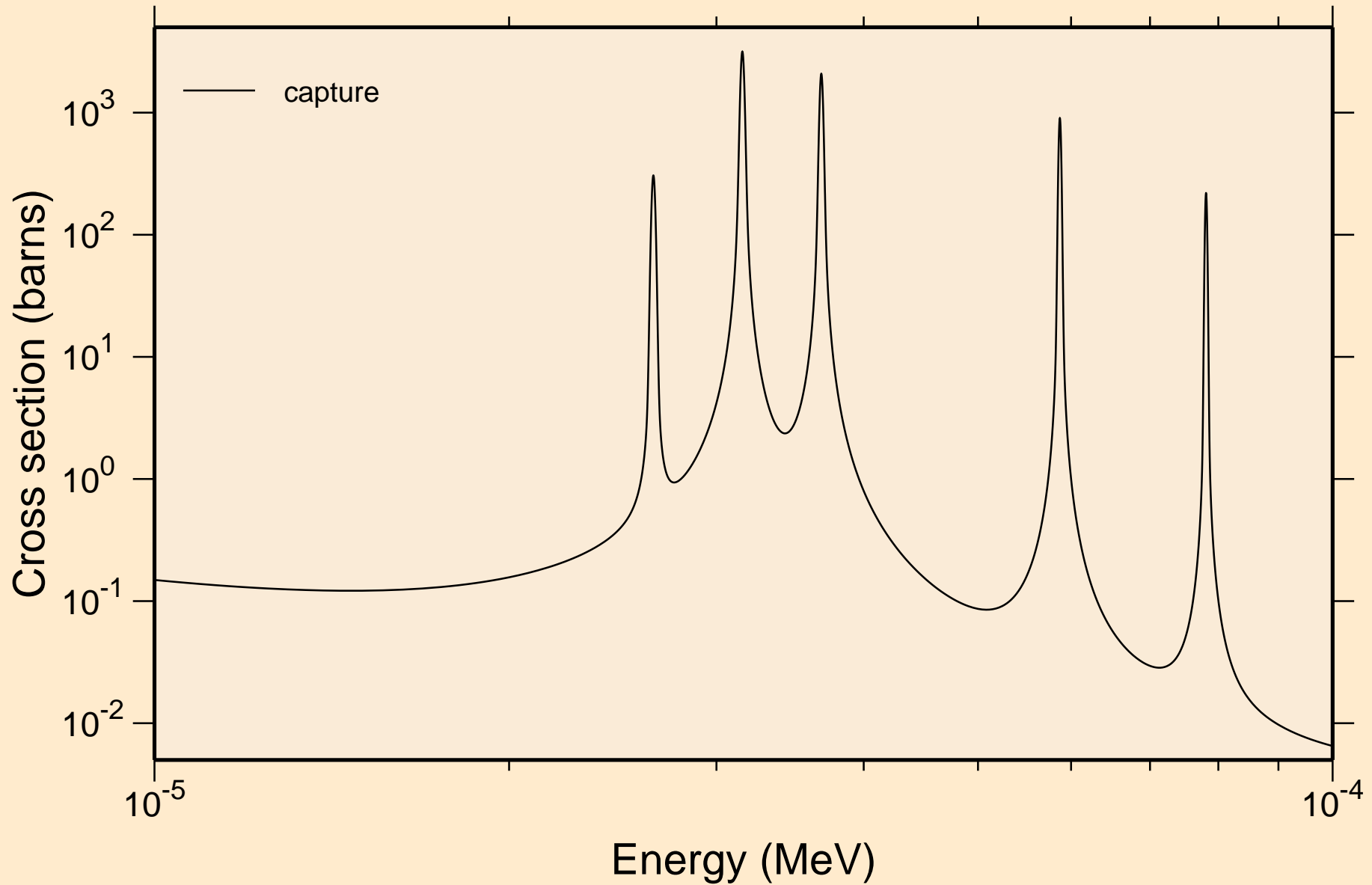

LU187 NEUTRON ACER TENDL-2024 LIBRARY; T=293.6K
resonance absorption cross sections

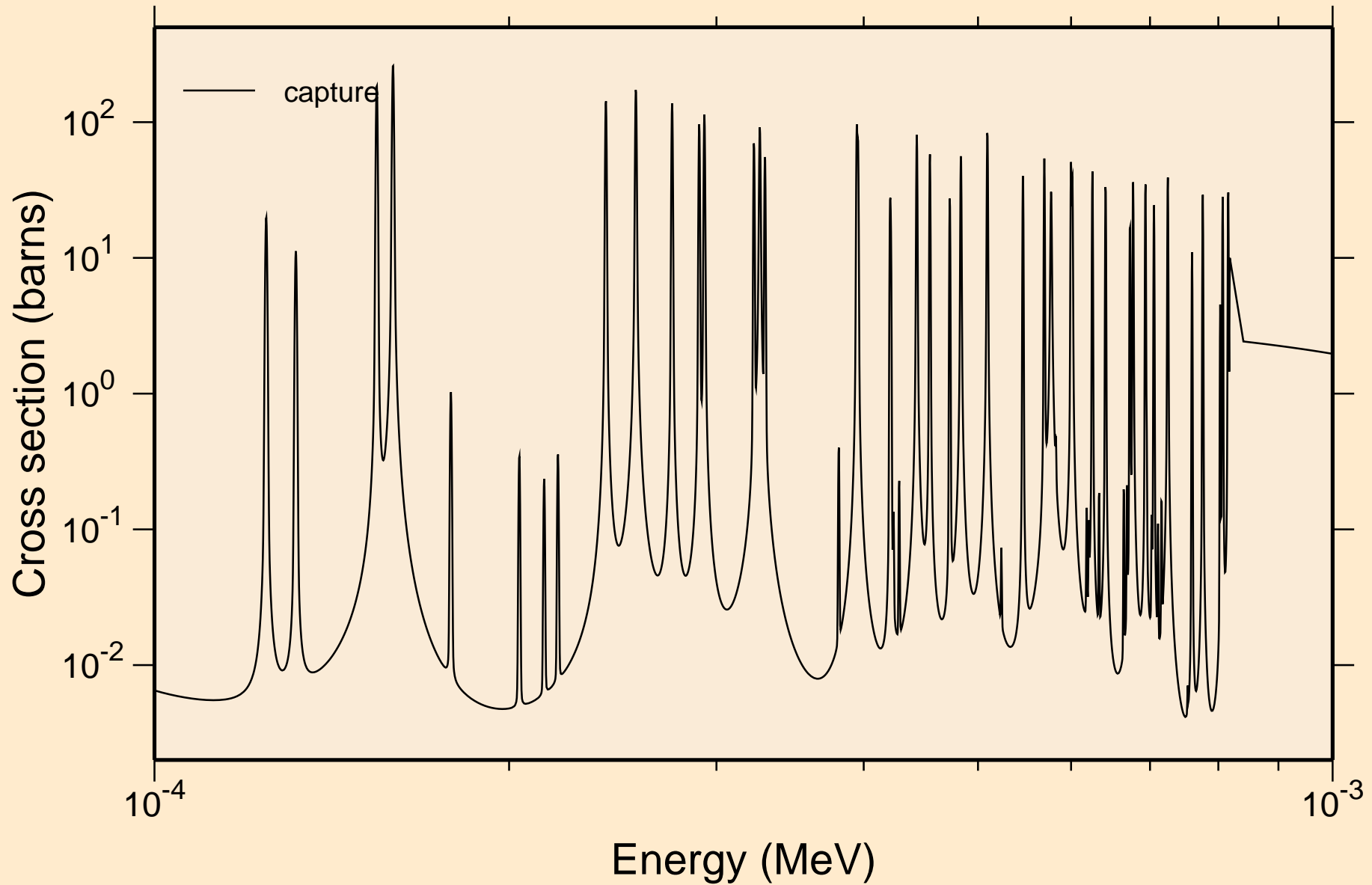

LU187 NEUTRON ACER TENDL-2024 LIBRARY; T=293.6K
resonance absorption cross sections

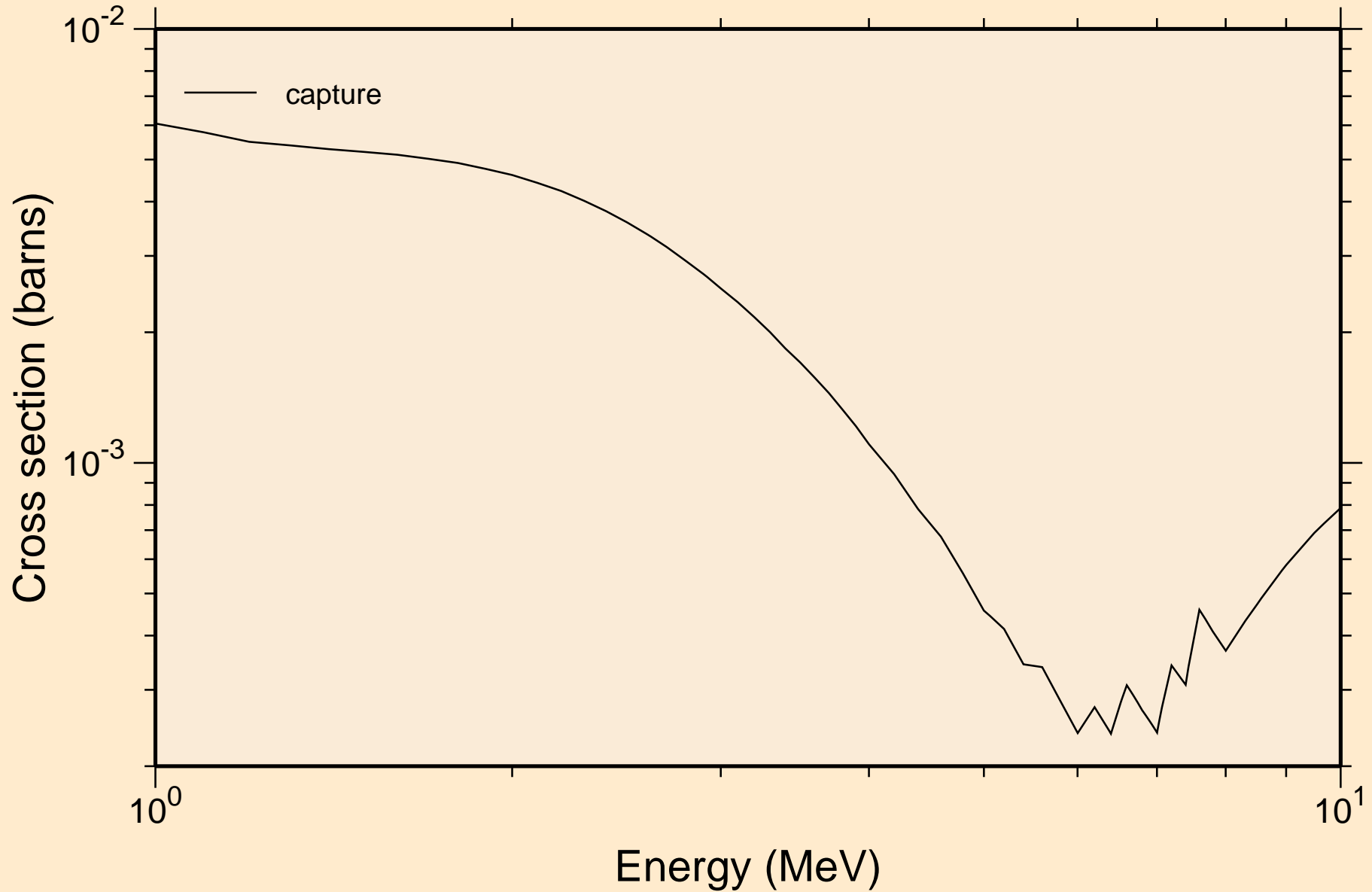

LU187 NEUTRON ACER TENDL-2024 LIBRARY; T=293.6K
Heating

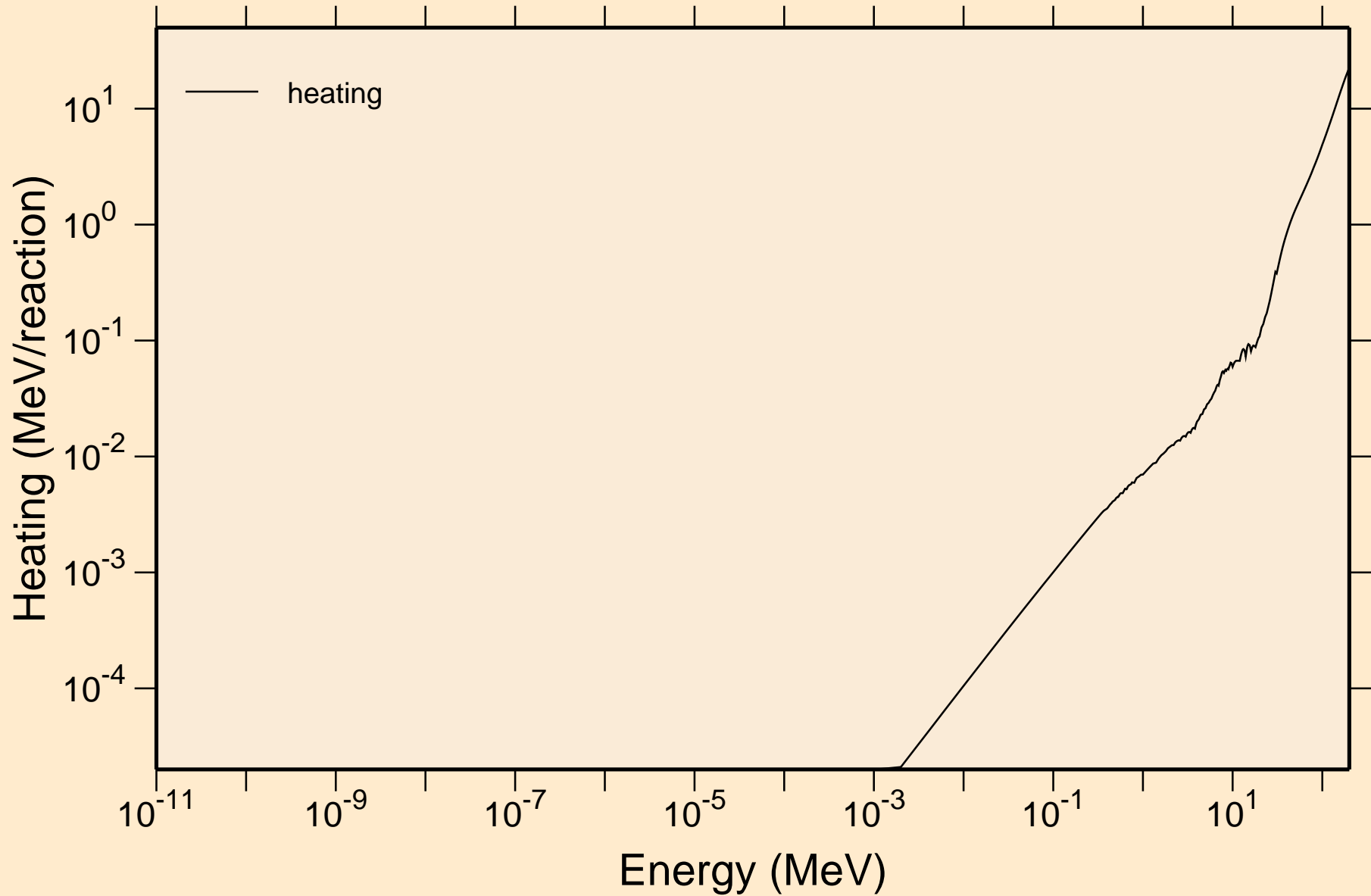

LU187 NEUTRON ACER TENDL-2024 LIBRARY; T=293.6K
Damage

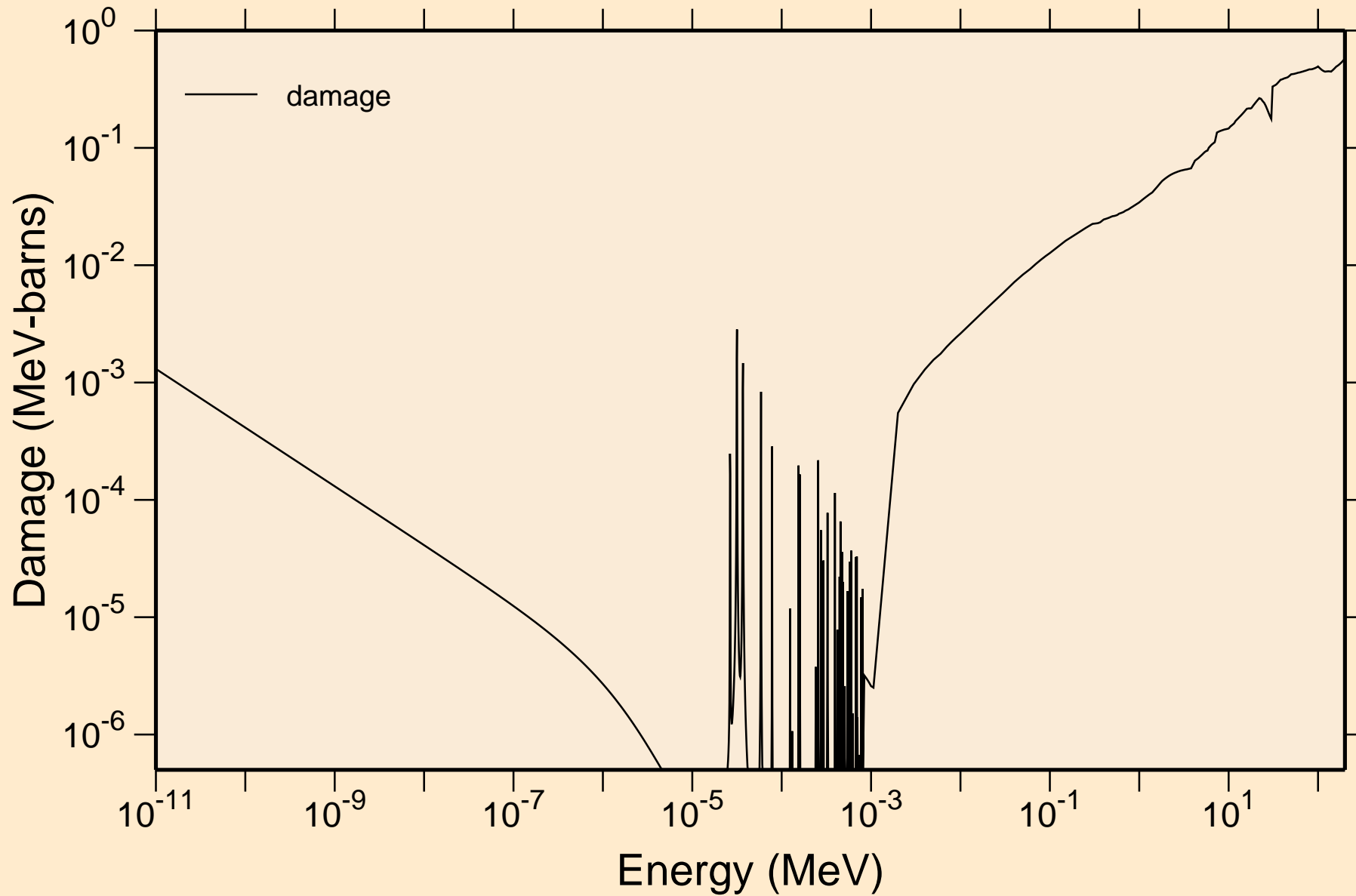

LU187 NEUTRON ACER TENDL-2024 LIBRARY; T=293.6K
Non-threshold reactions

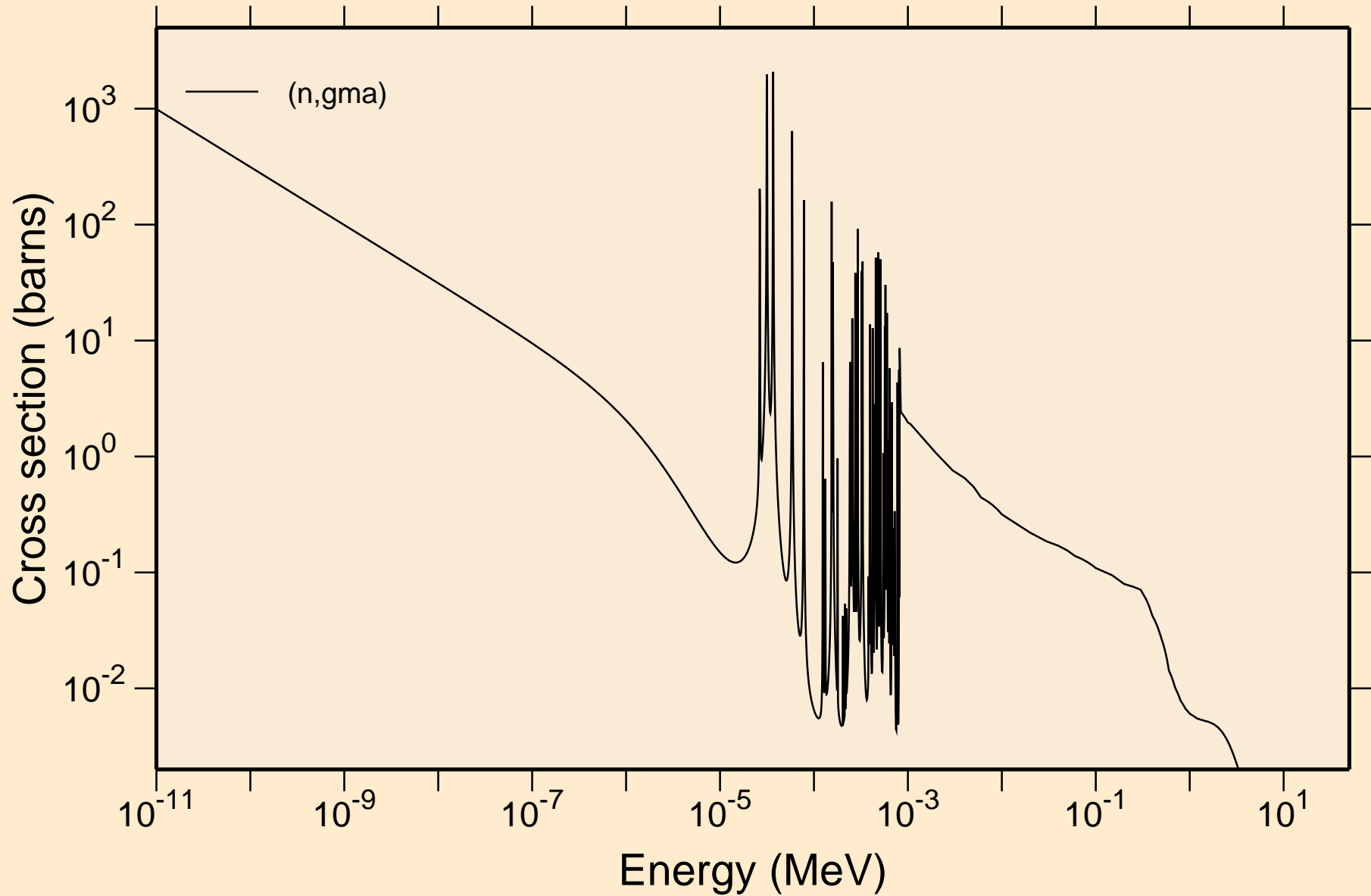

LU187 NEUTRON ACER TENDL-2024 LIBRARY; T=293.6K
Principal cross sections

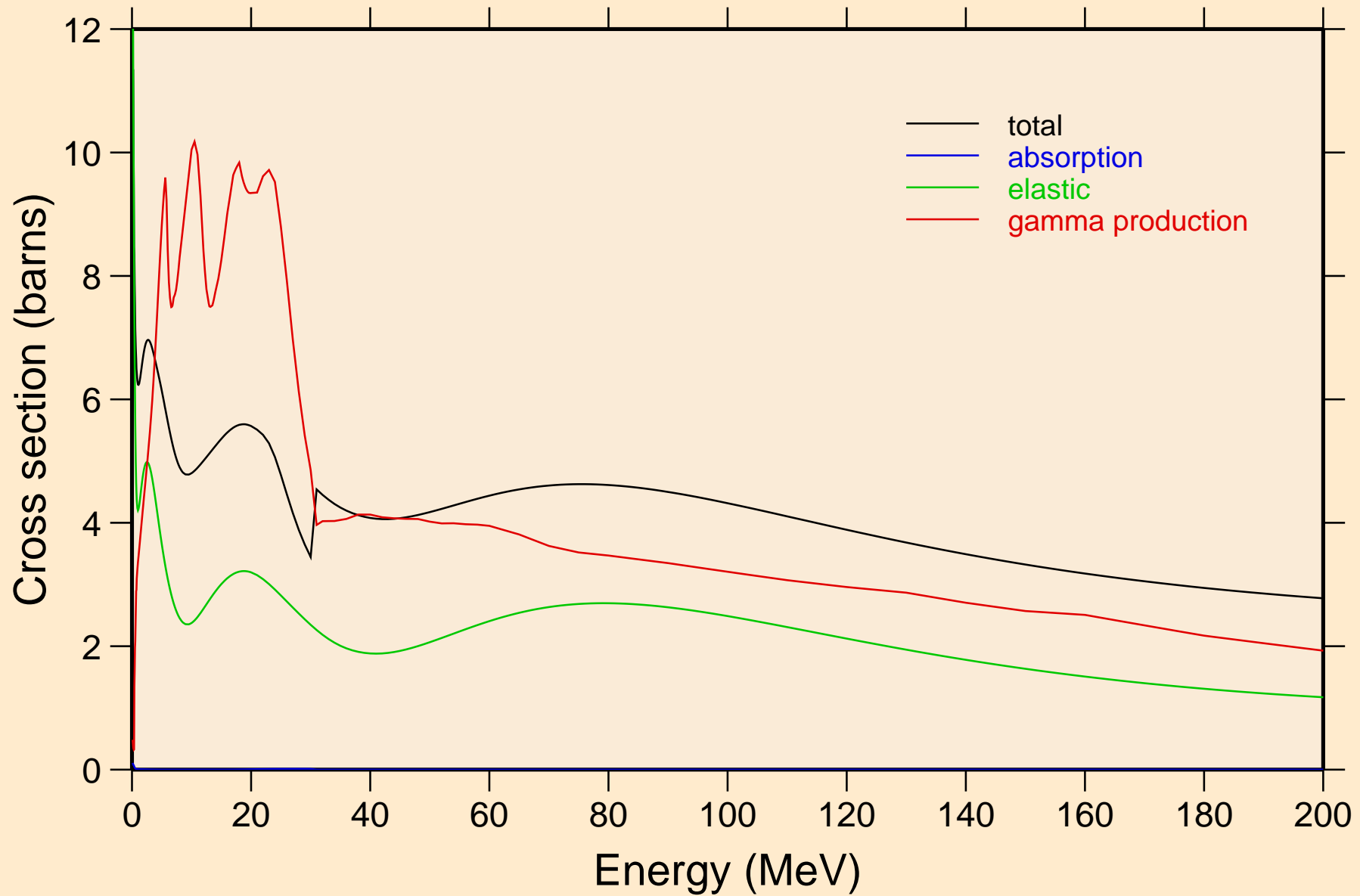

LU187 NEUTRON ACER TENDL-2024 LIBRARY; T=293.6K
Heating

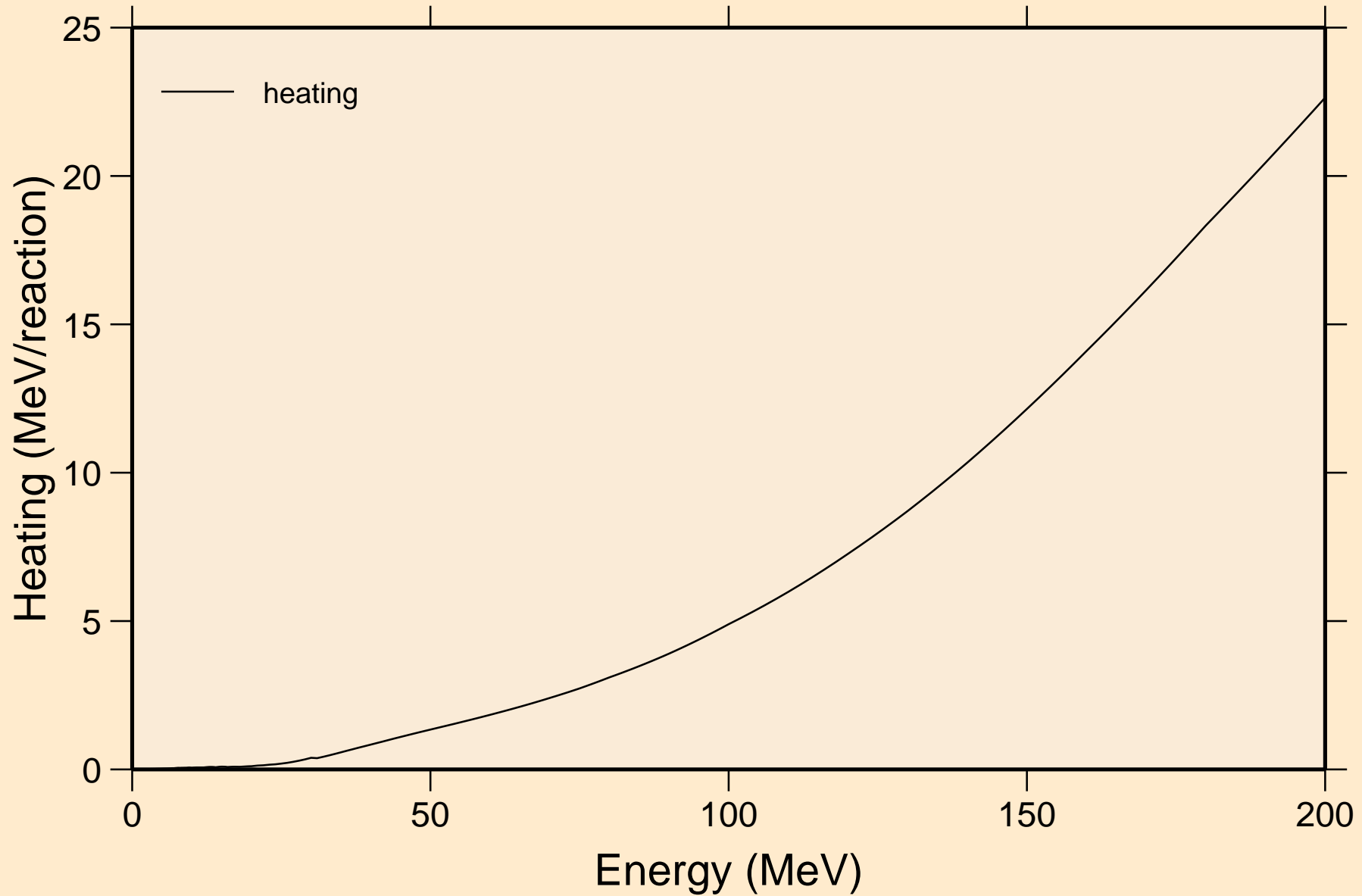

LU187 NEUTRON ACER TENDL-2024 LIBRARY; T=293.6K
Damage

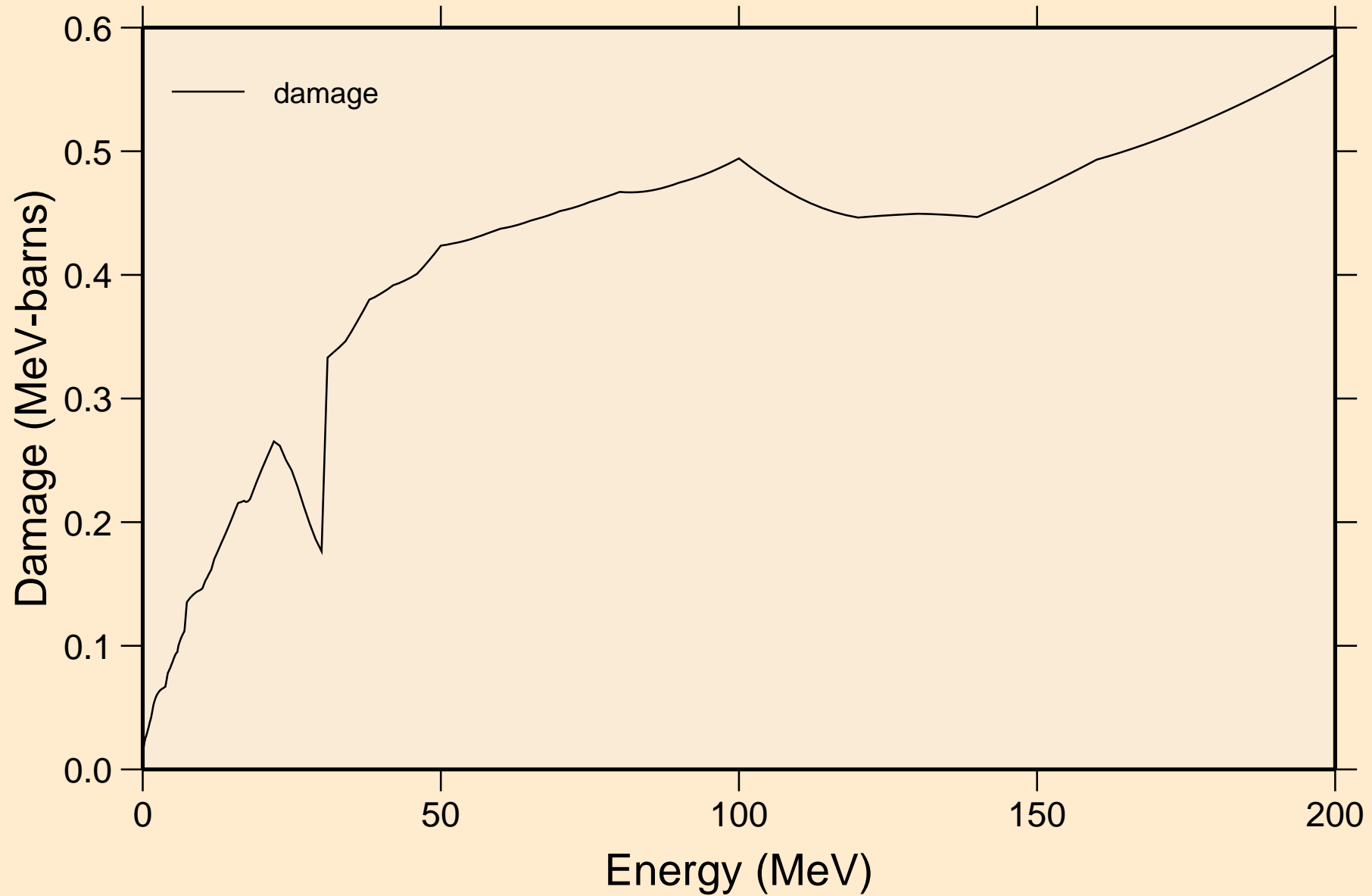

LU187 NEUTRON ACER TENDL-2024 LIBRARY; T=293.6K
Non-threshold reactions

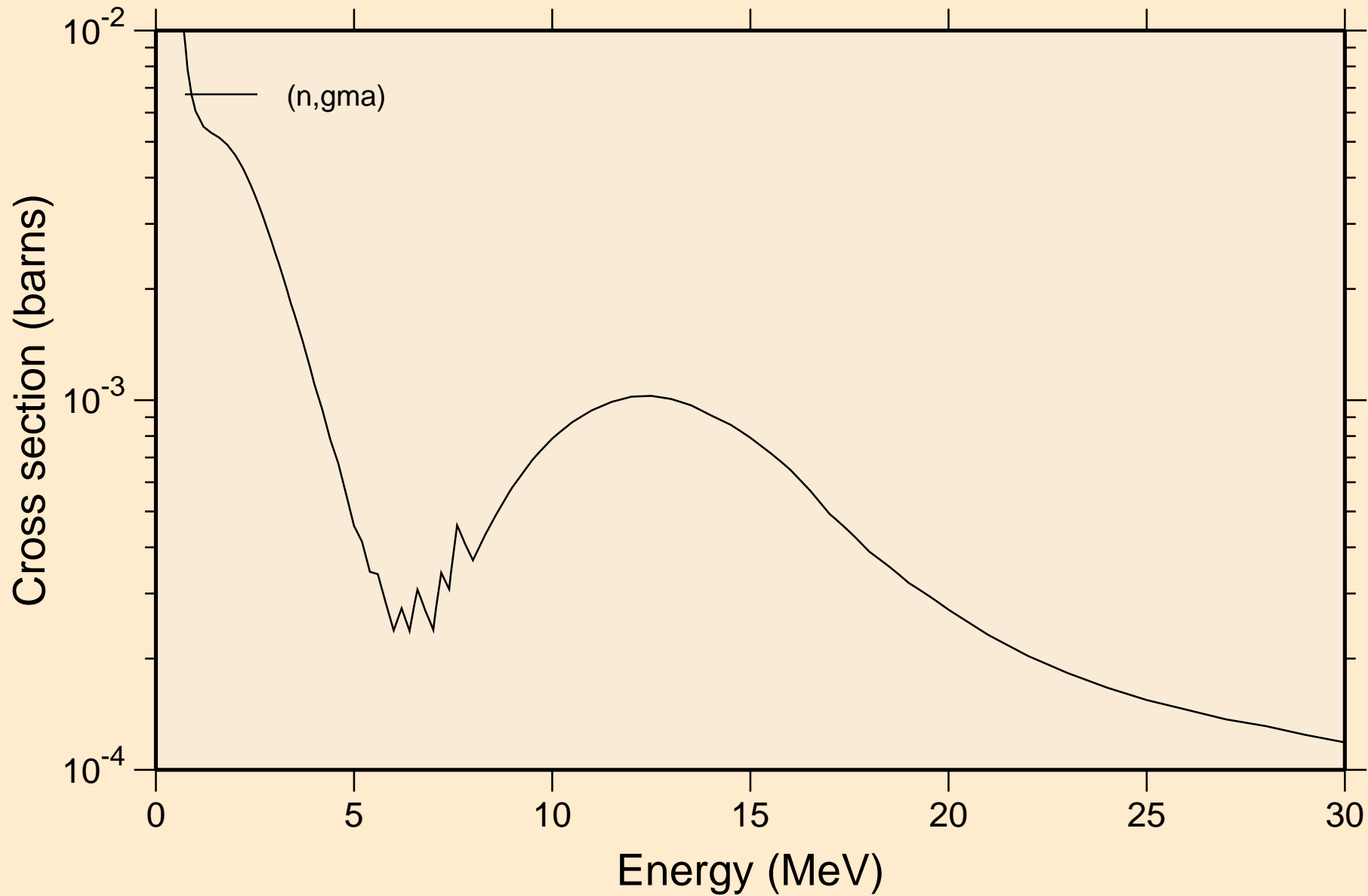

LU187 NEUTRON ACER TENDL-2024 LIBRARY; T=293.6K
Inelastic levels

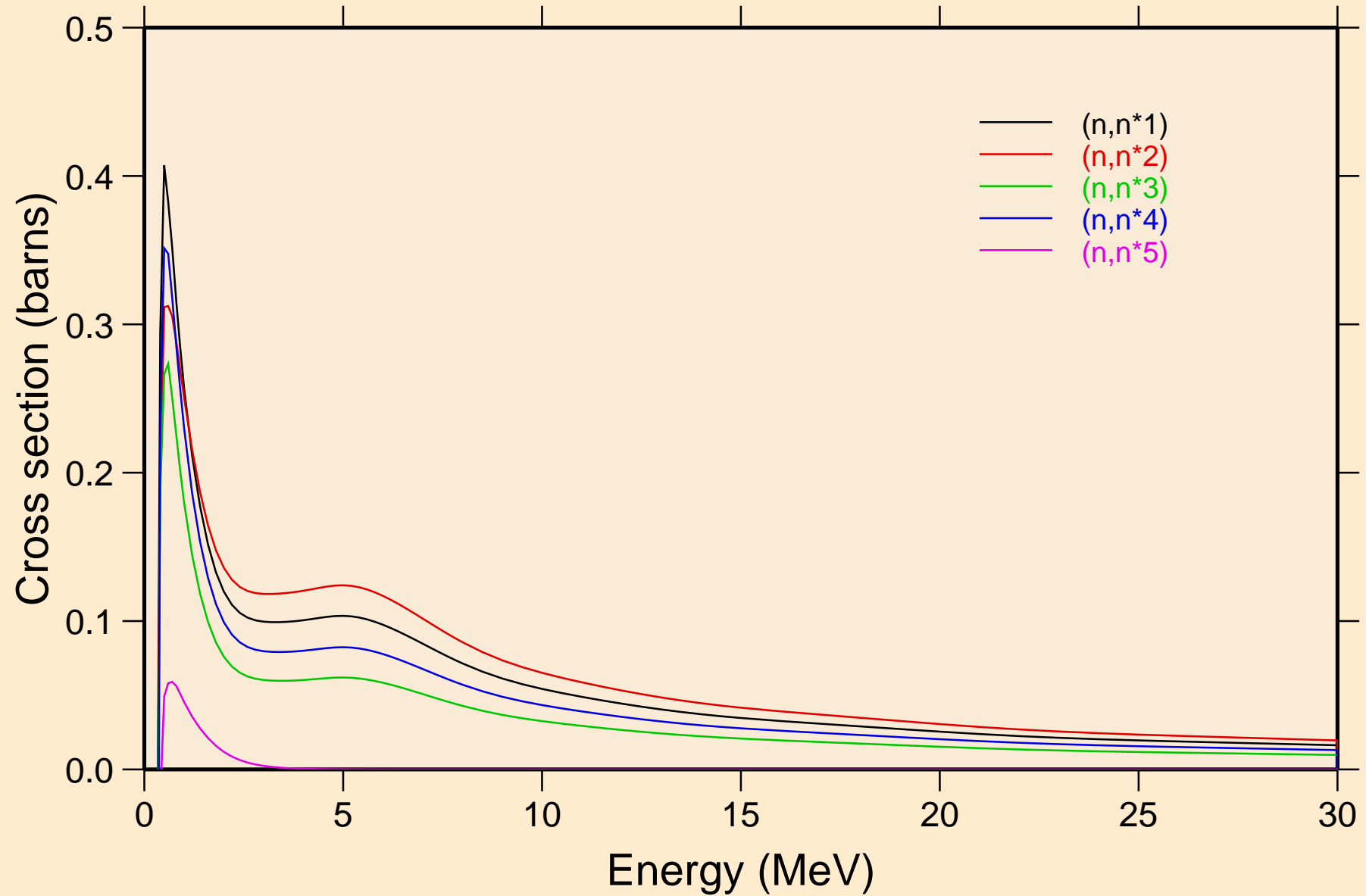

LU187 NEUTRON ACER TENDL-2024 LIBRARY; T=293.6K
Inelastic levels

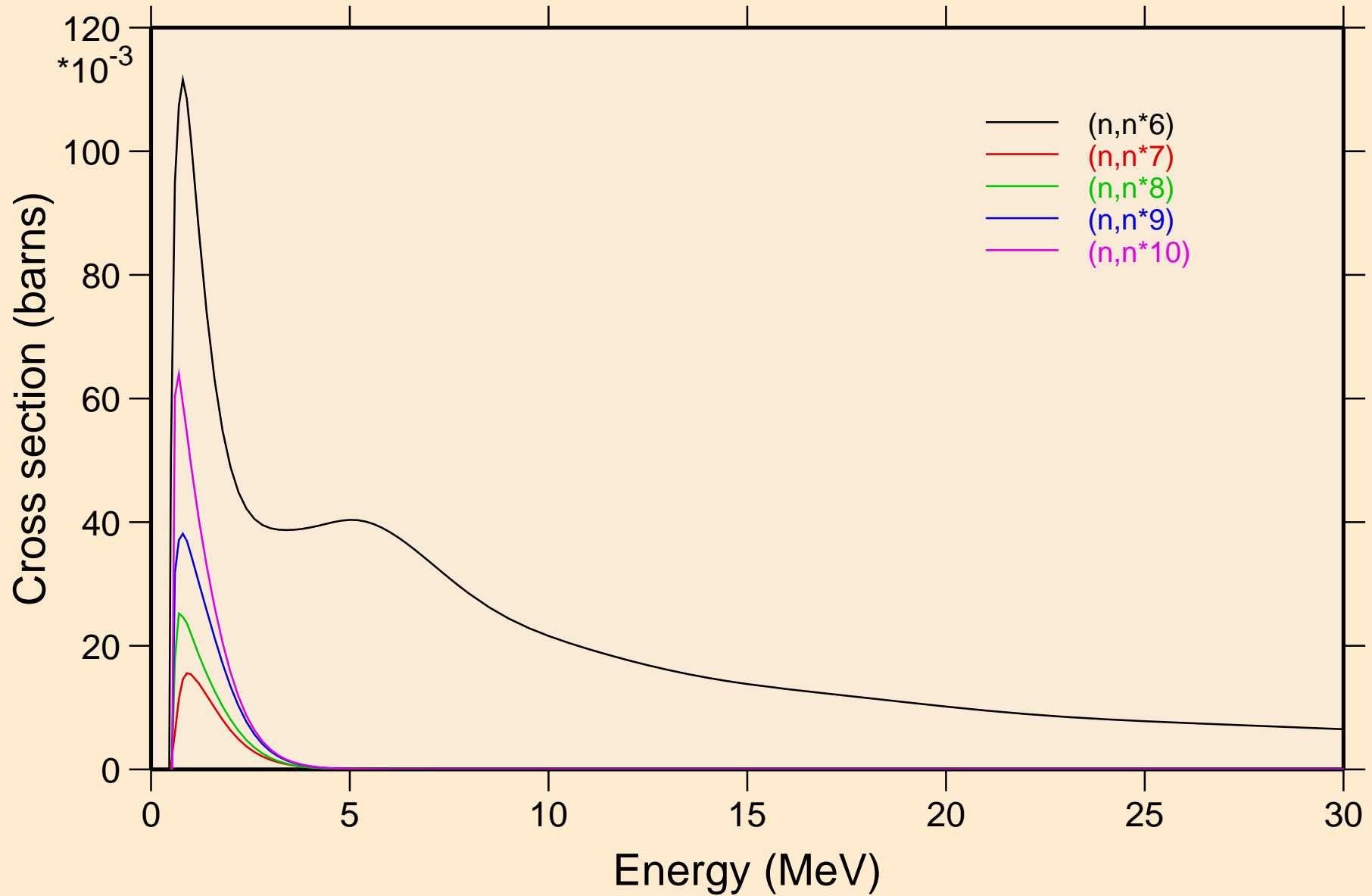

LU187 NEUTRON ACER TENDL-2024 LIBRARY; T=293.6K
Inelastic levels

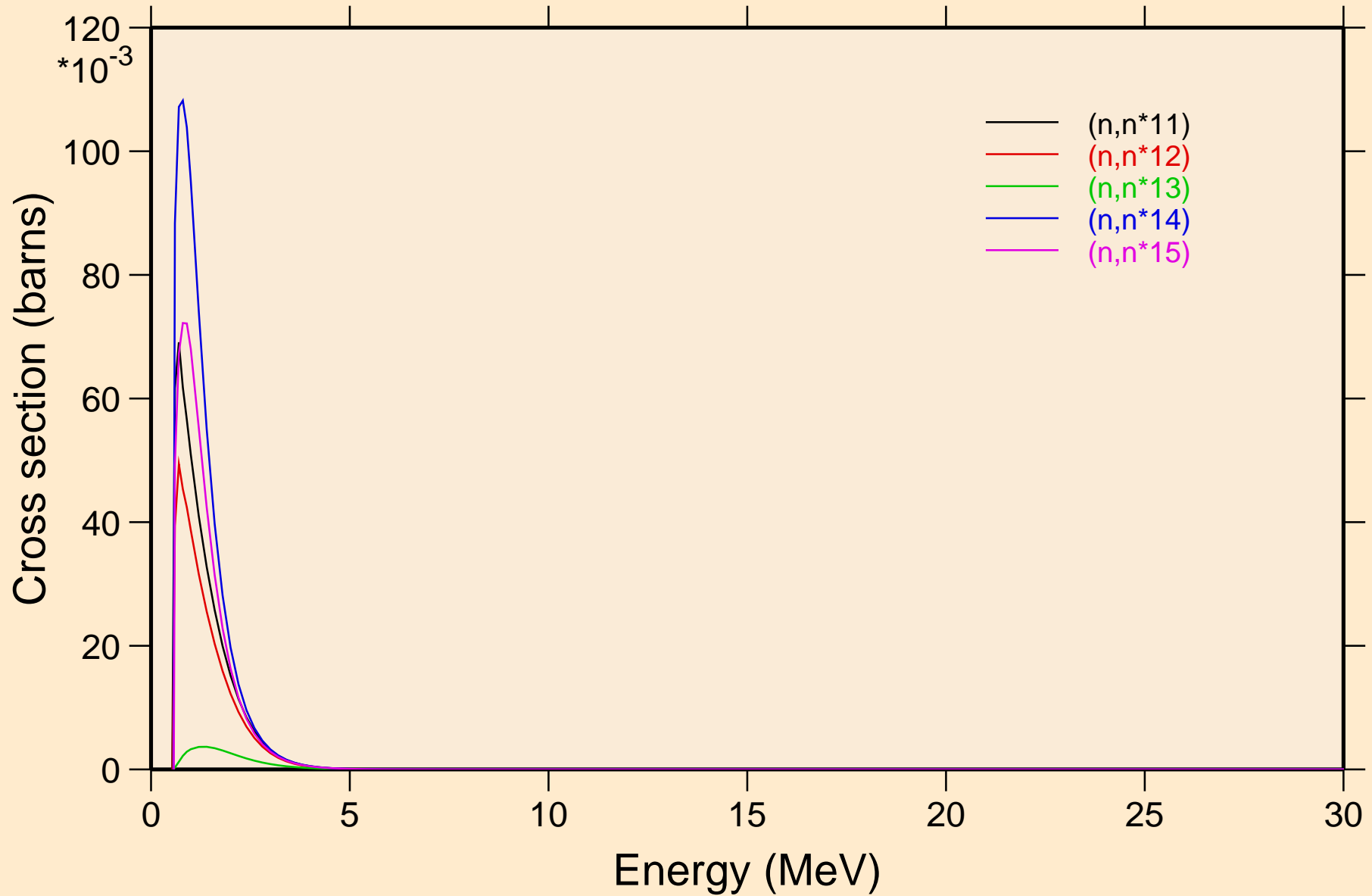

LU187 NEUTRON ACER TENDL-2024 LIBRARY; T=293.6K
Inelastic levels

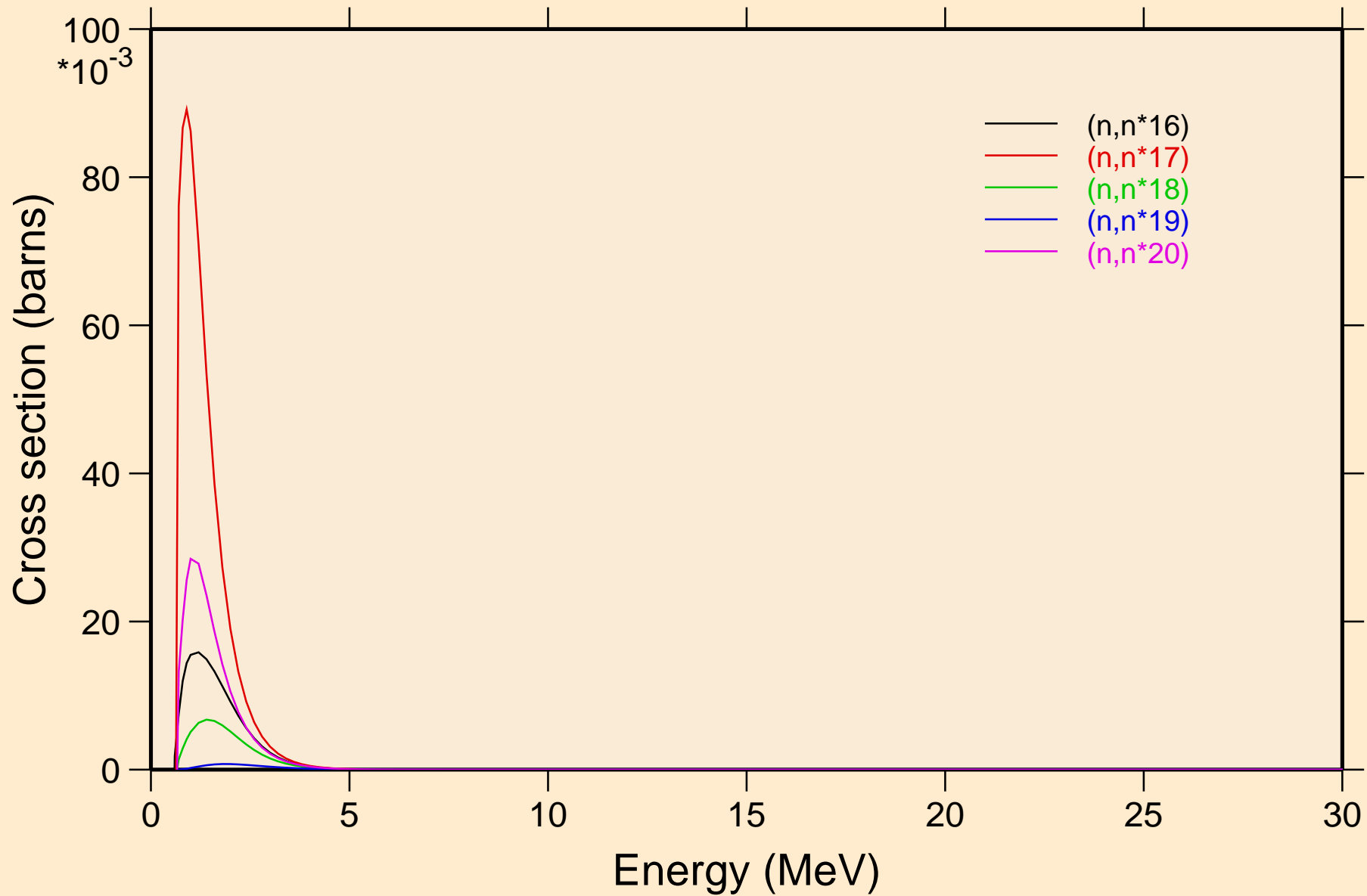

LU187 NEUTRON ACER TENDL-2024 LIBRARY; T=293.6K
Inelastic levels

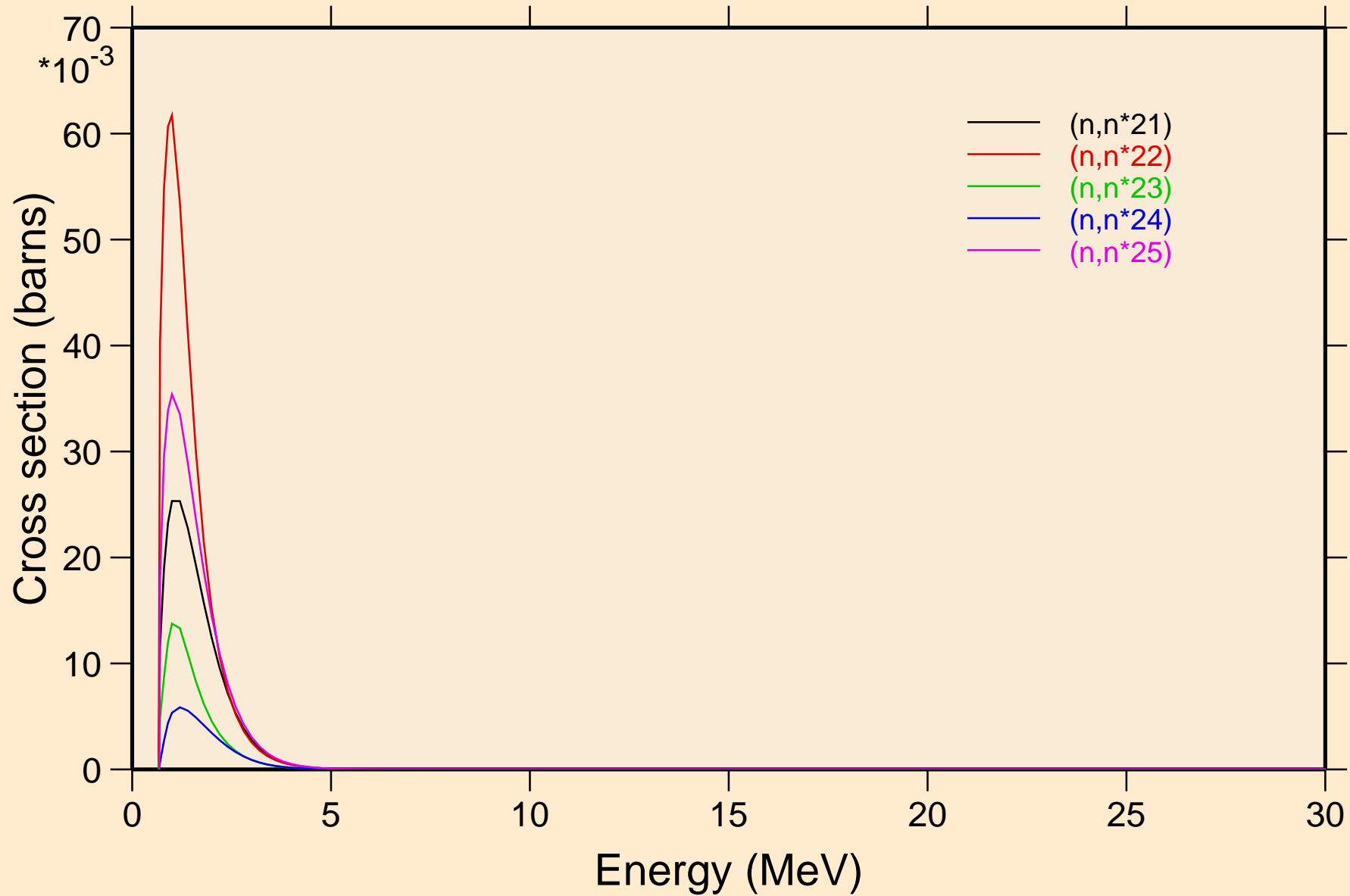

LU187 NEUTRON ACER TENDL-2024 LIBRARY; T=293.6K
Inelastic levels

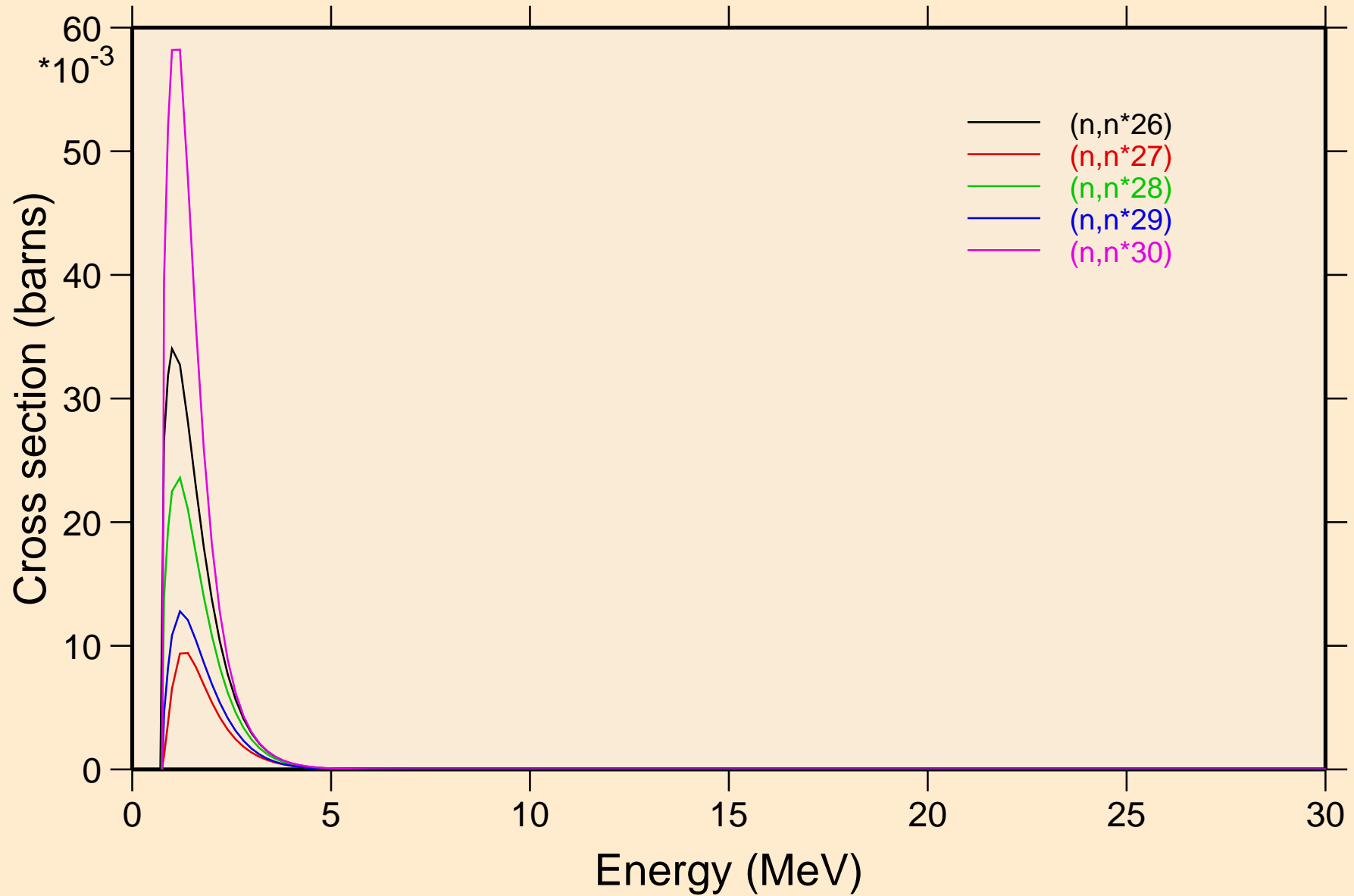

LU187 NEUTRON ACER TENDL-2024 LIBRARY; T=293.6K
Threshold reactions

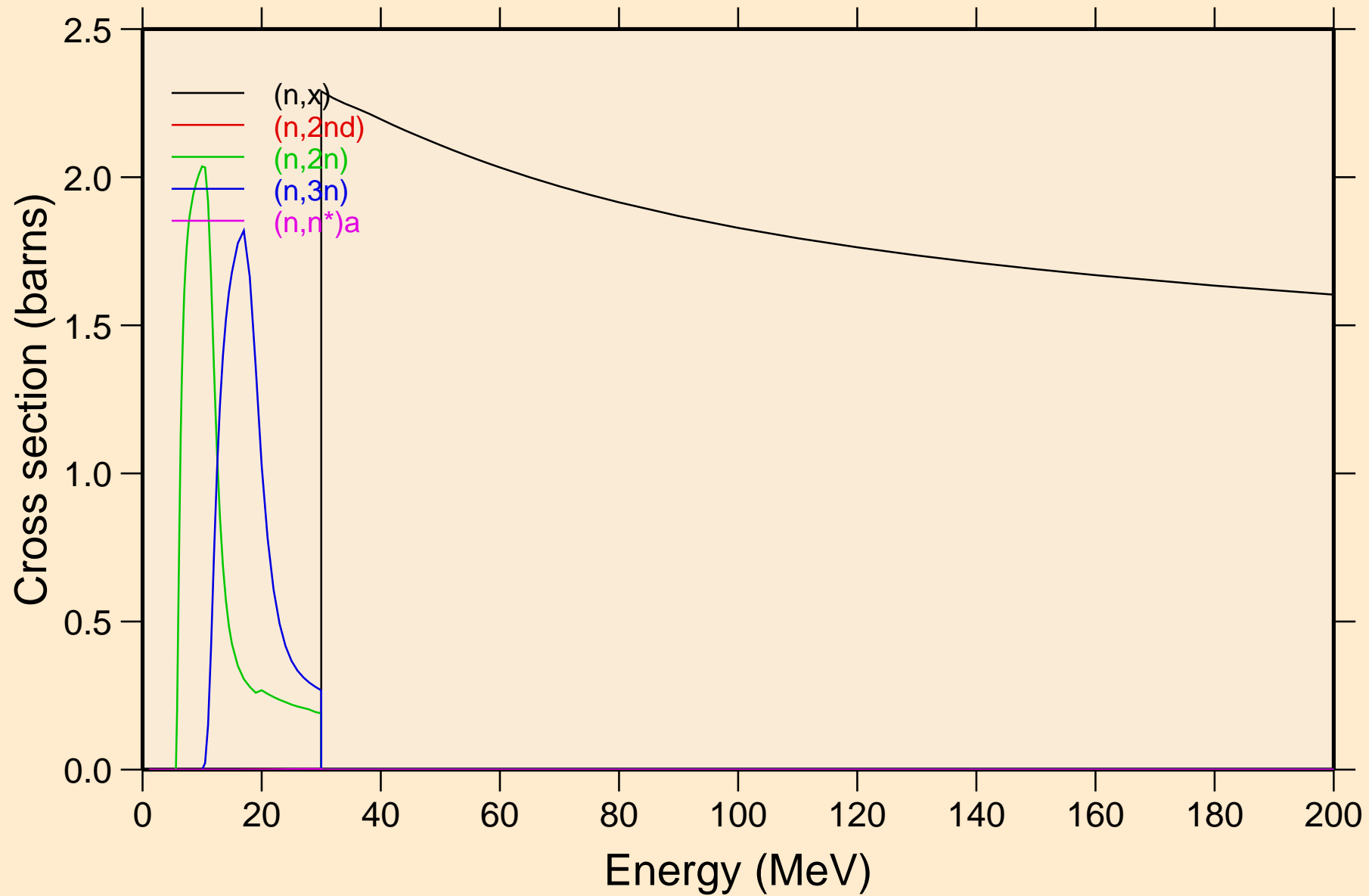

LU187 NEUTRON ACER TENDL-2024 LIBRARY; T=293.6K
Threshold reactions

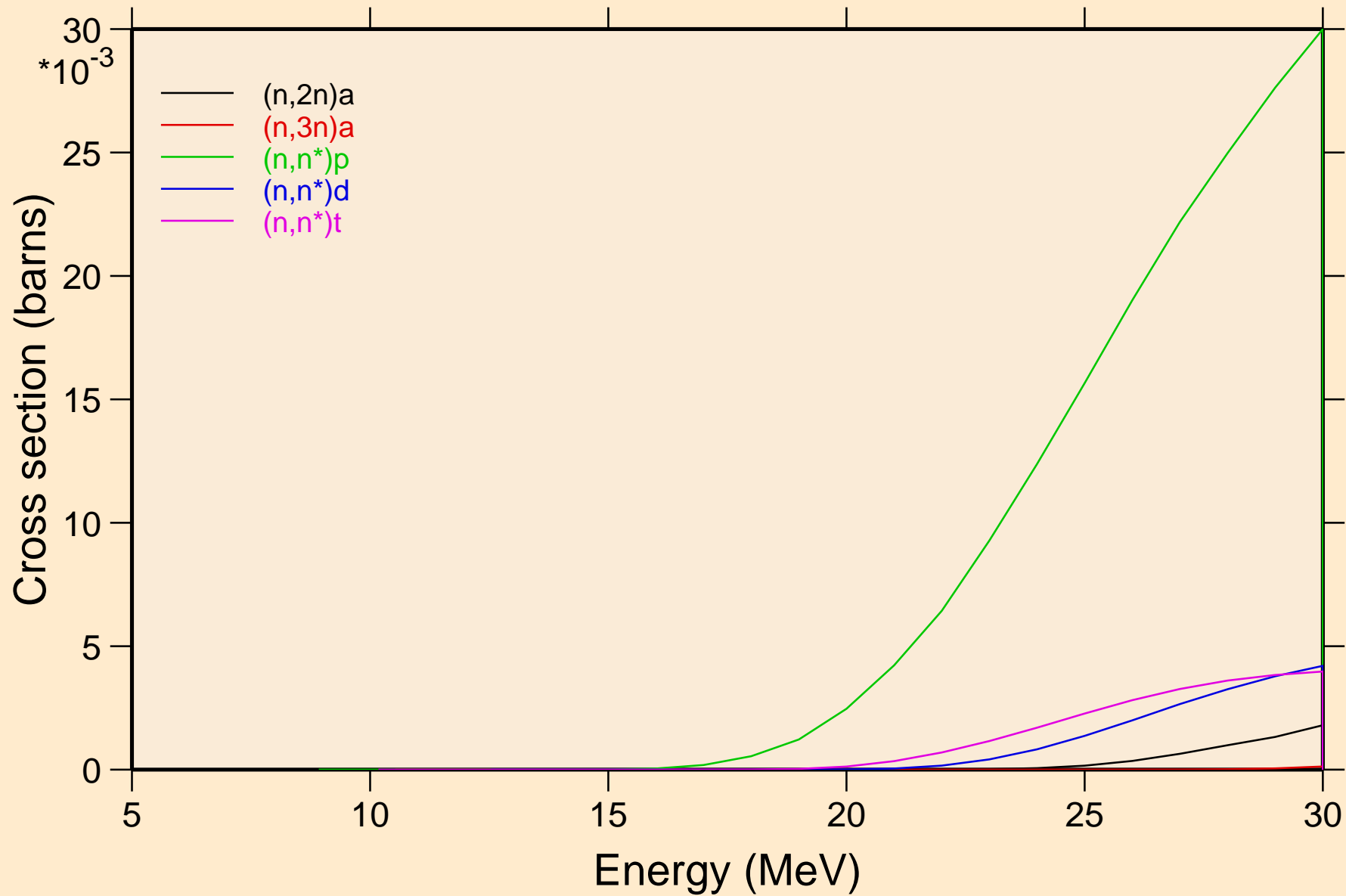

LU187 NEUTRON ACER TENDL-2024 LIBRARY; T=293.6K
Threshold reactions

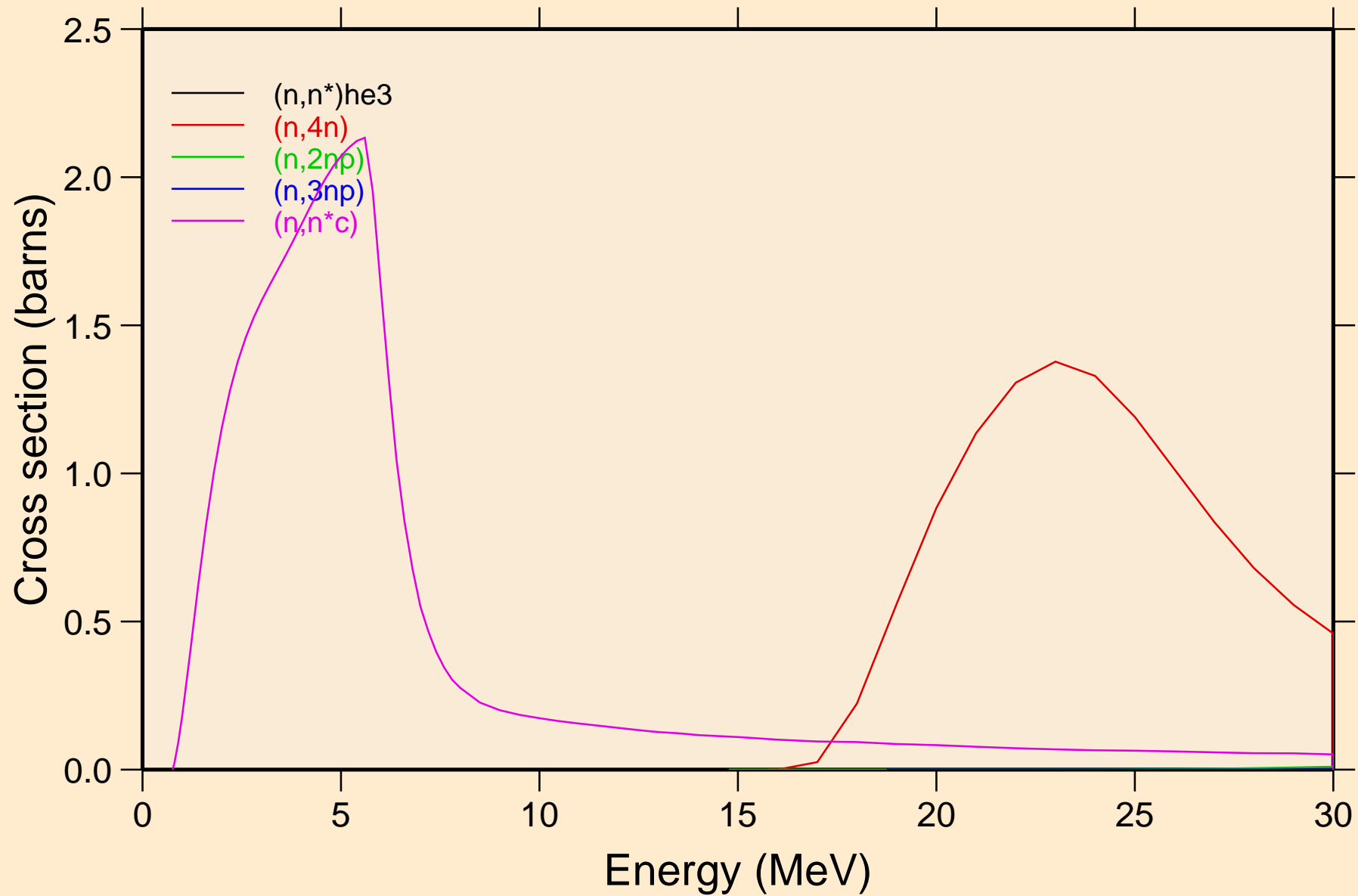

LU187 NEUTRON ACER TENDL-2024 LIBRARY; T=293.6K
Threshold reactions

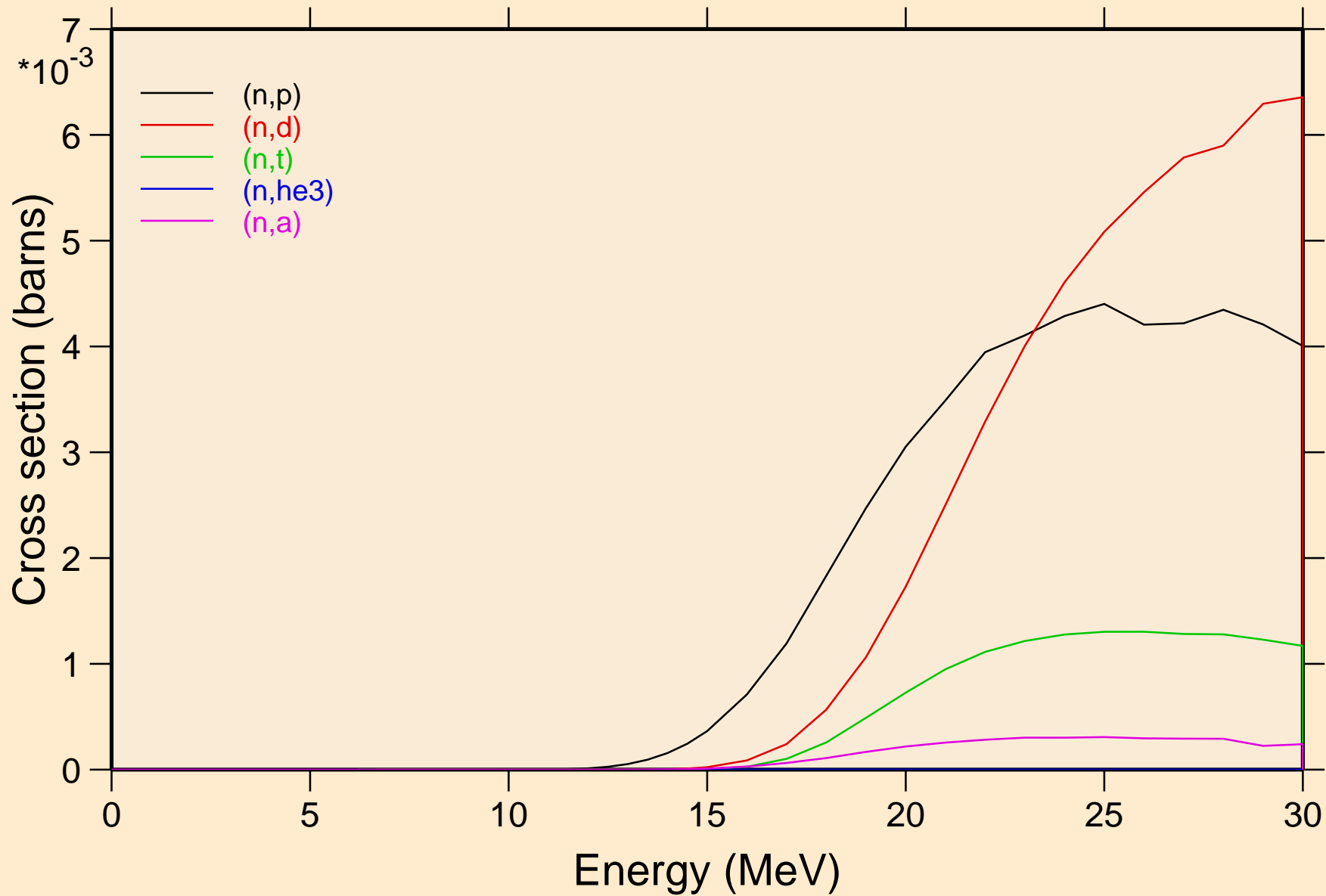

LU187 NEUTRON ACER TENDL-2024 LIBRARY; T=293.6K
Threshold reactions

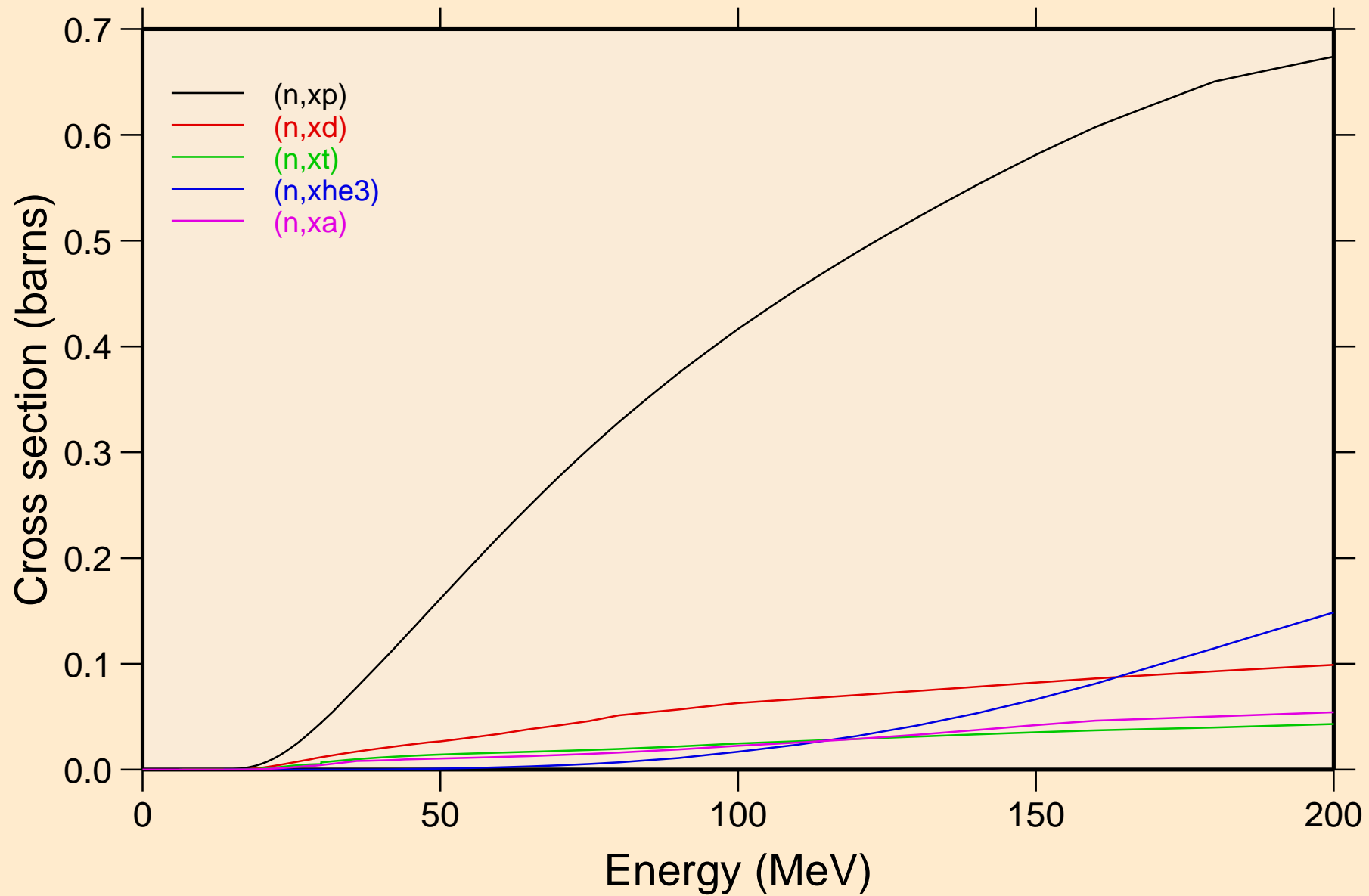

LU187 NEUTRON ACER TENDL-2024 LIBRARY; T=293.6K
angular distribution for elastic

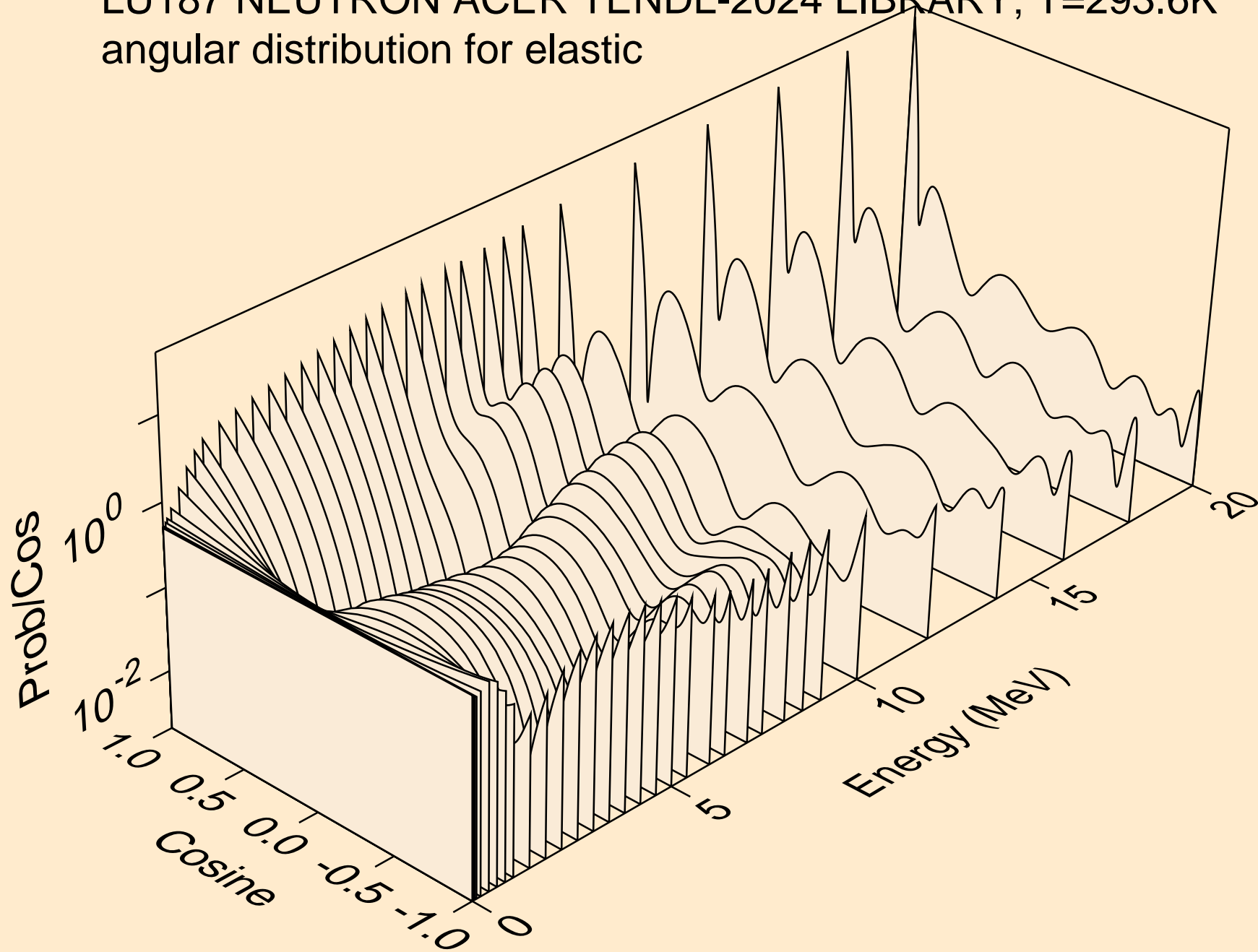

LU187 NEUTRON ACER TENDL-2024 LIBRARY; T=293.6K
angular distribution for elastic

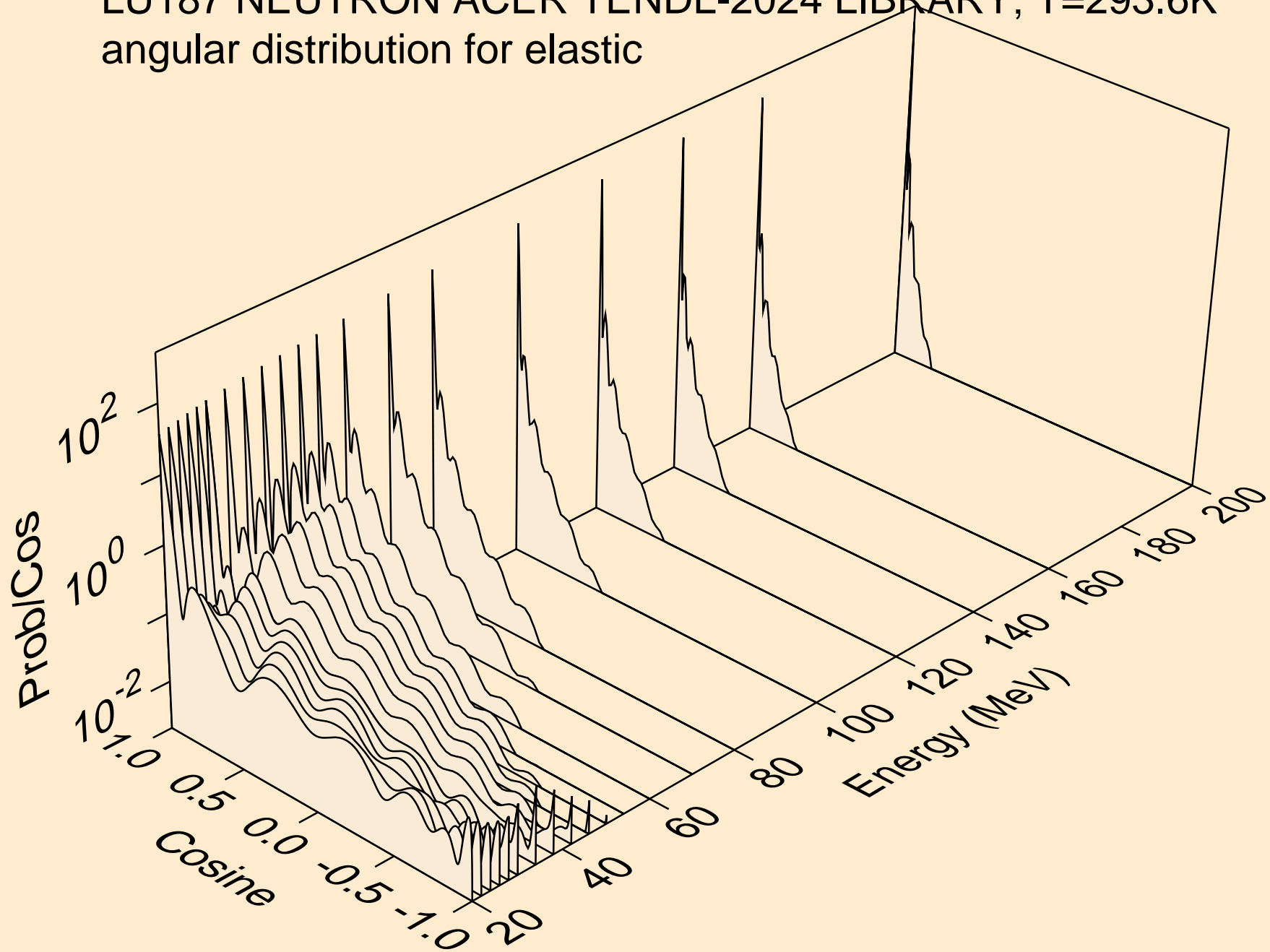

LU187 NEUTRON ACER TENDL-2024 LIBRARY; T=293.6K
angular distribution for (n,n*1)

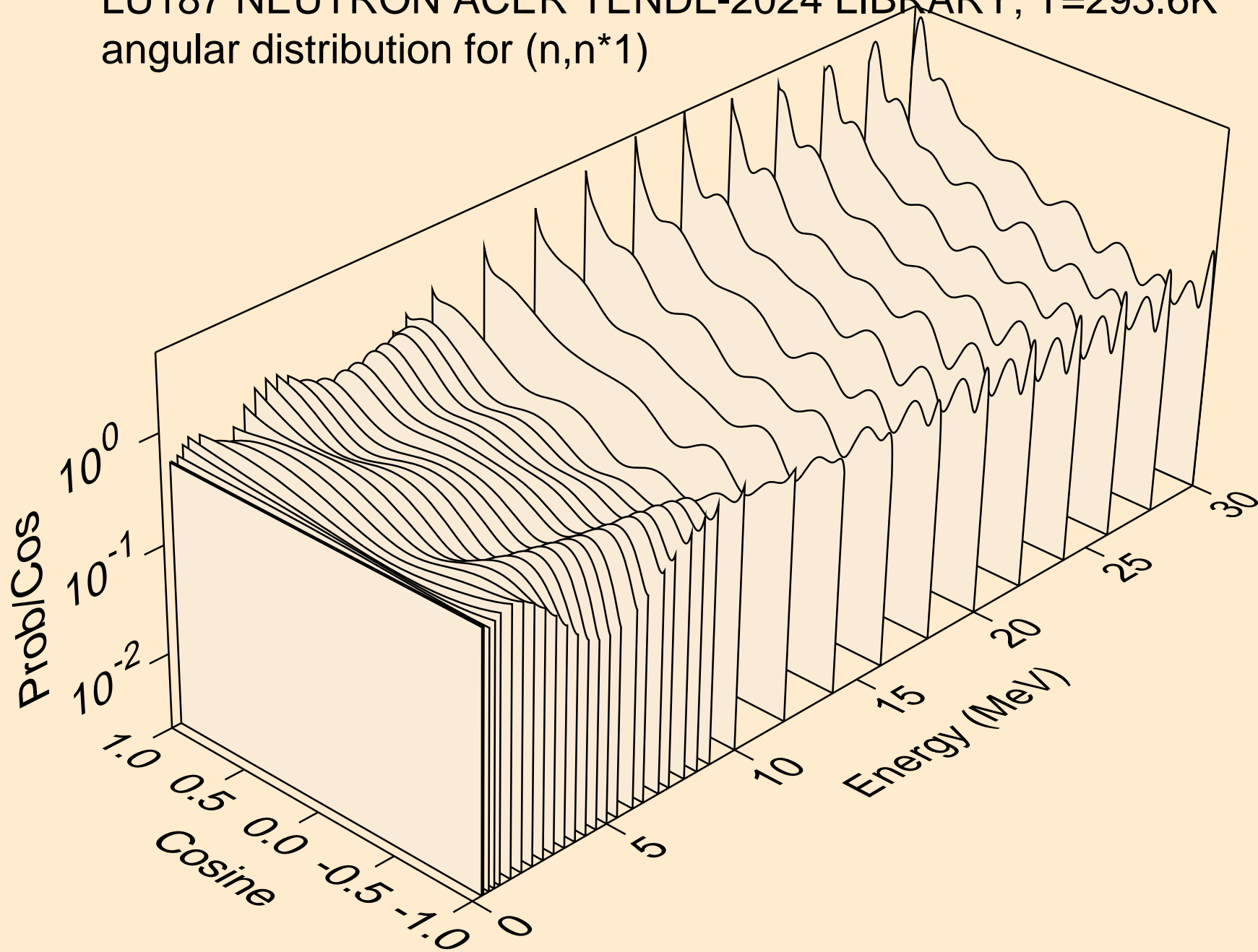

LU187 NEUTRON ACER TENDL-2024 LIBRARY; T=293.6K
angular distribution for (n,n*2)

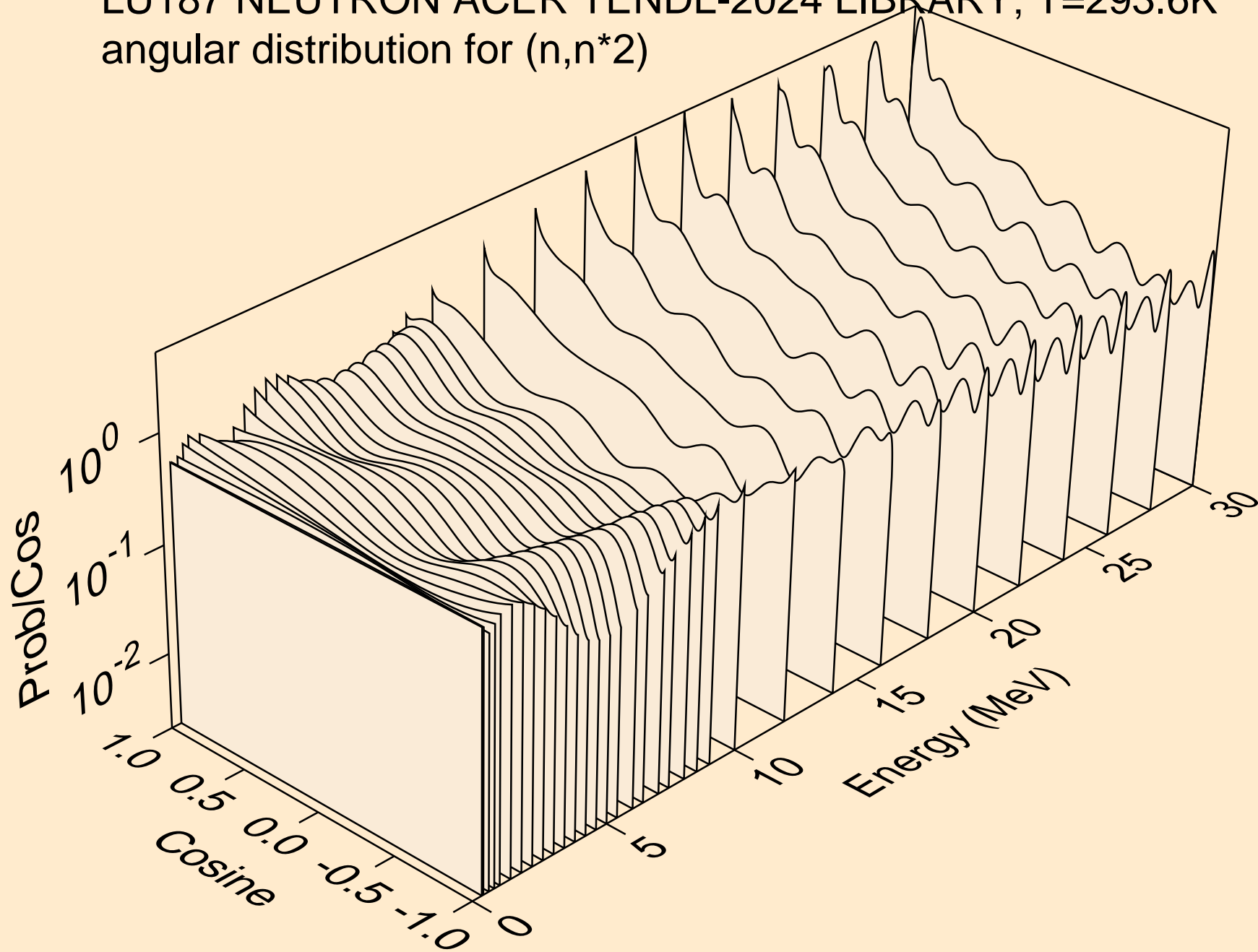

LU187 NEUTRON ACER TENDL-2024 LIBRARY; T=293.6K
angular distribution for (n,n*3)

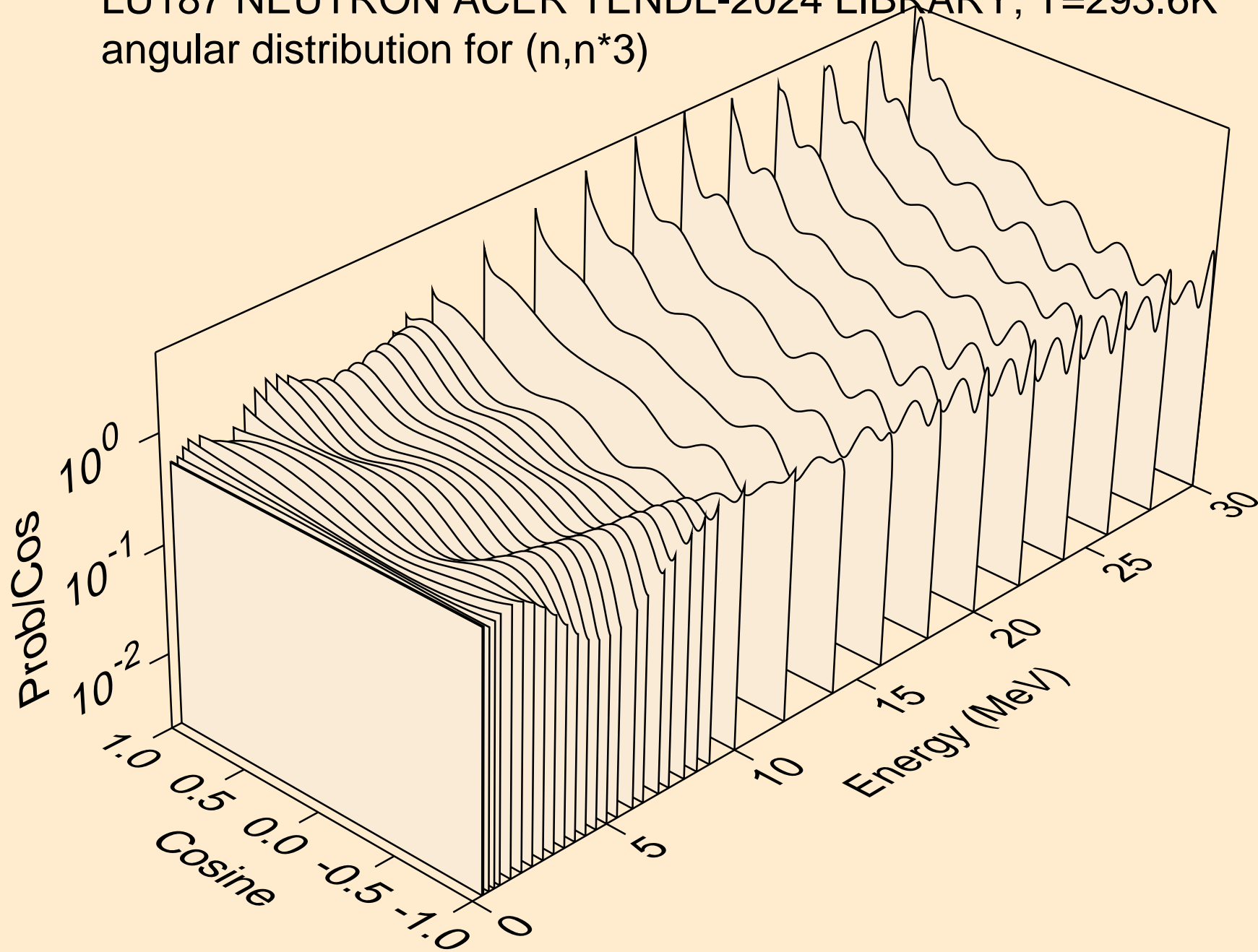

LU187 NEUTRON ACER TENDL-2024 LIBRARY; T=293.6K
angular distribution for (n,n*4)

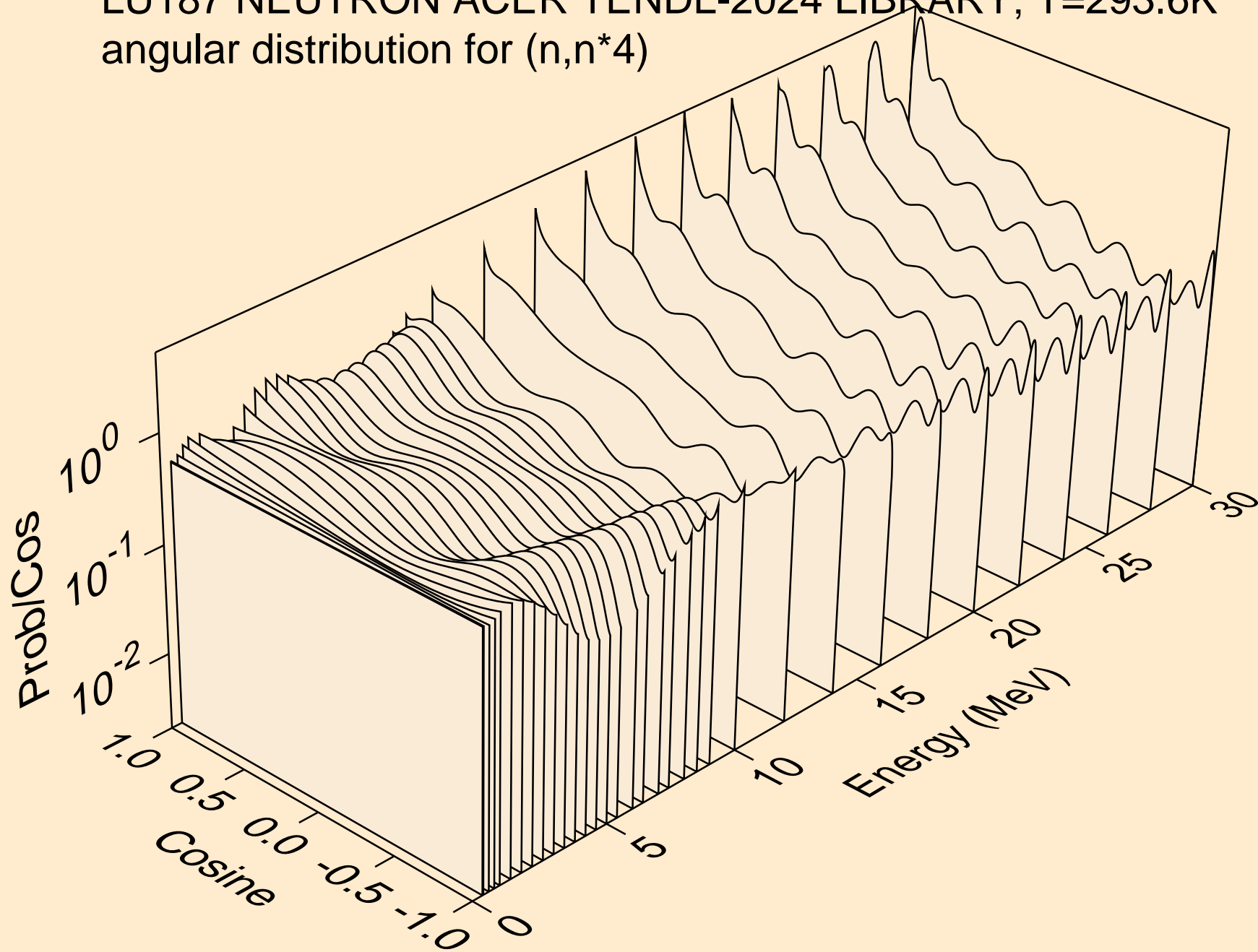

LU187 NEUTRON ACER TENDL-2024 LIBRARY; T=293.6K
angular distribution for (n,n*5)

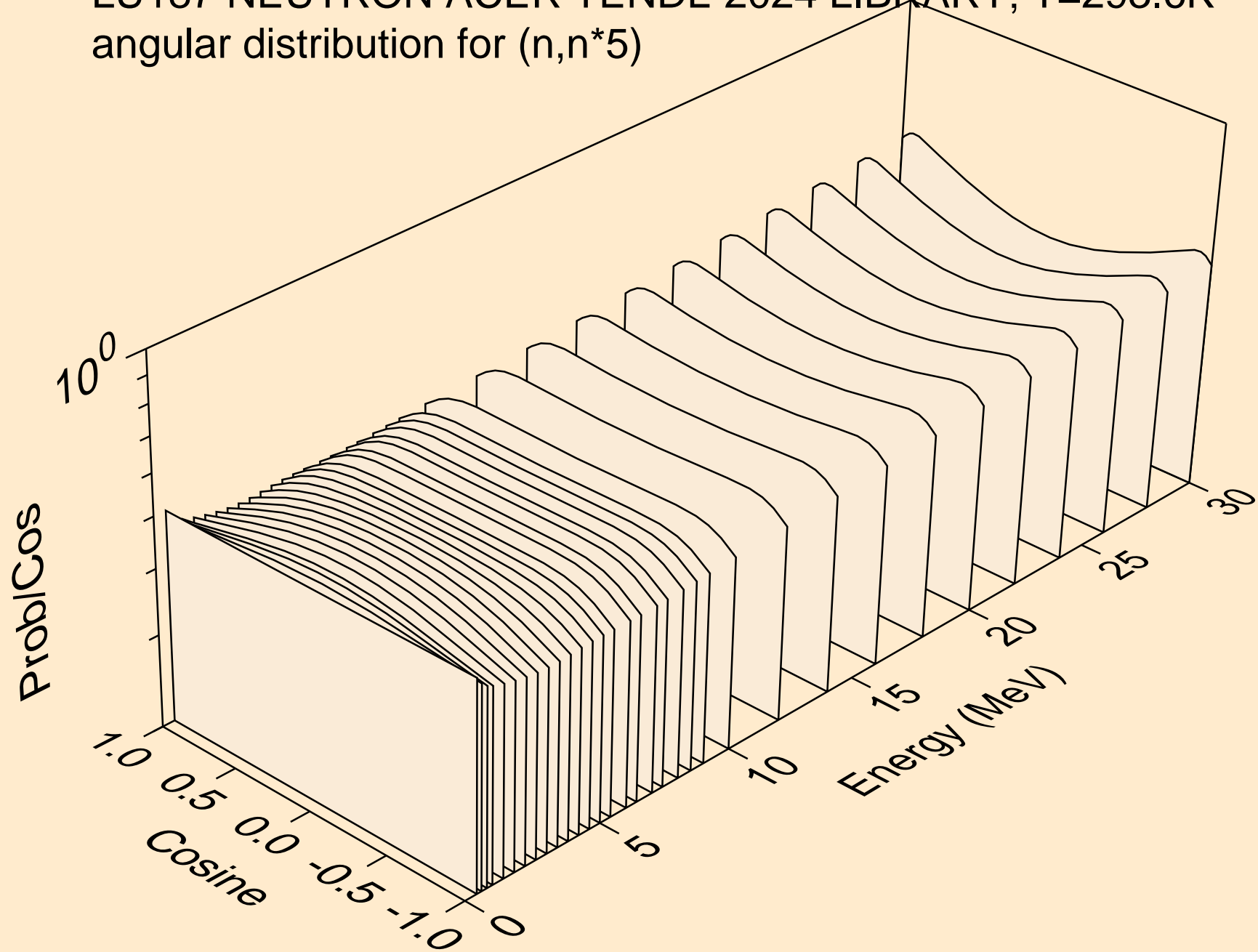

LU187 NEUTRON ACER TENDL-2024 LIBRARY; T=293.6K
angular distribution for (n,n*6)

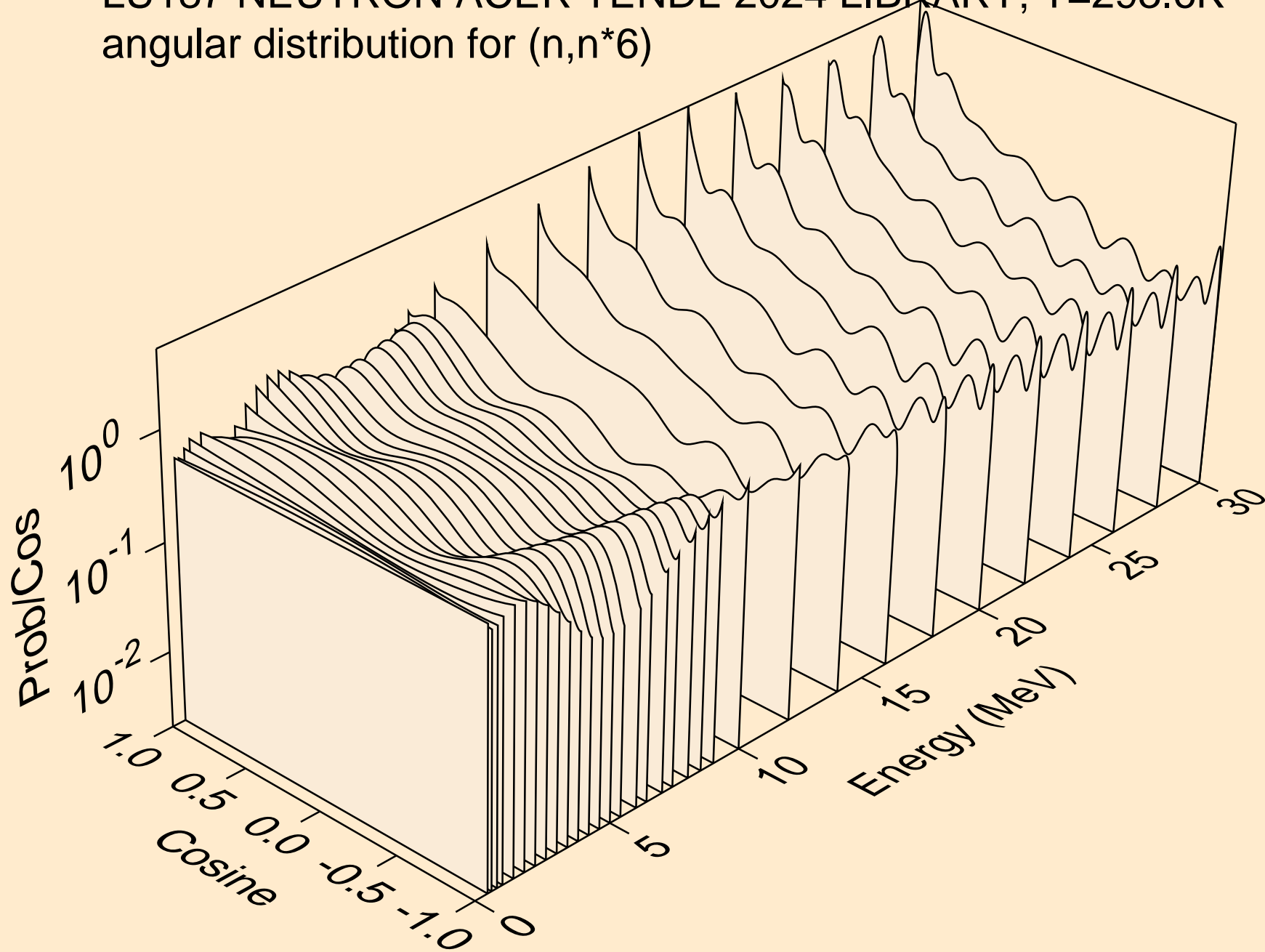

LU187 NEUTRON ACER TENDL-2024 LIBRARY; T=293.6K
angular distribution for (n,n*7)

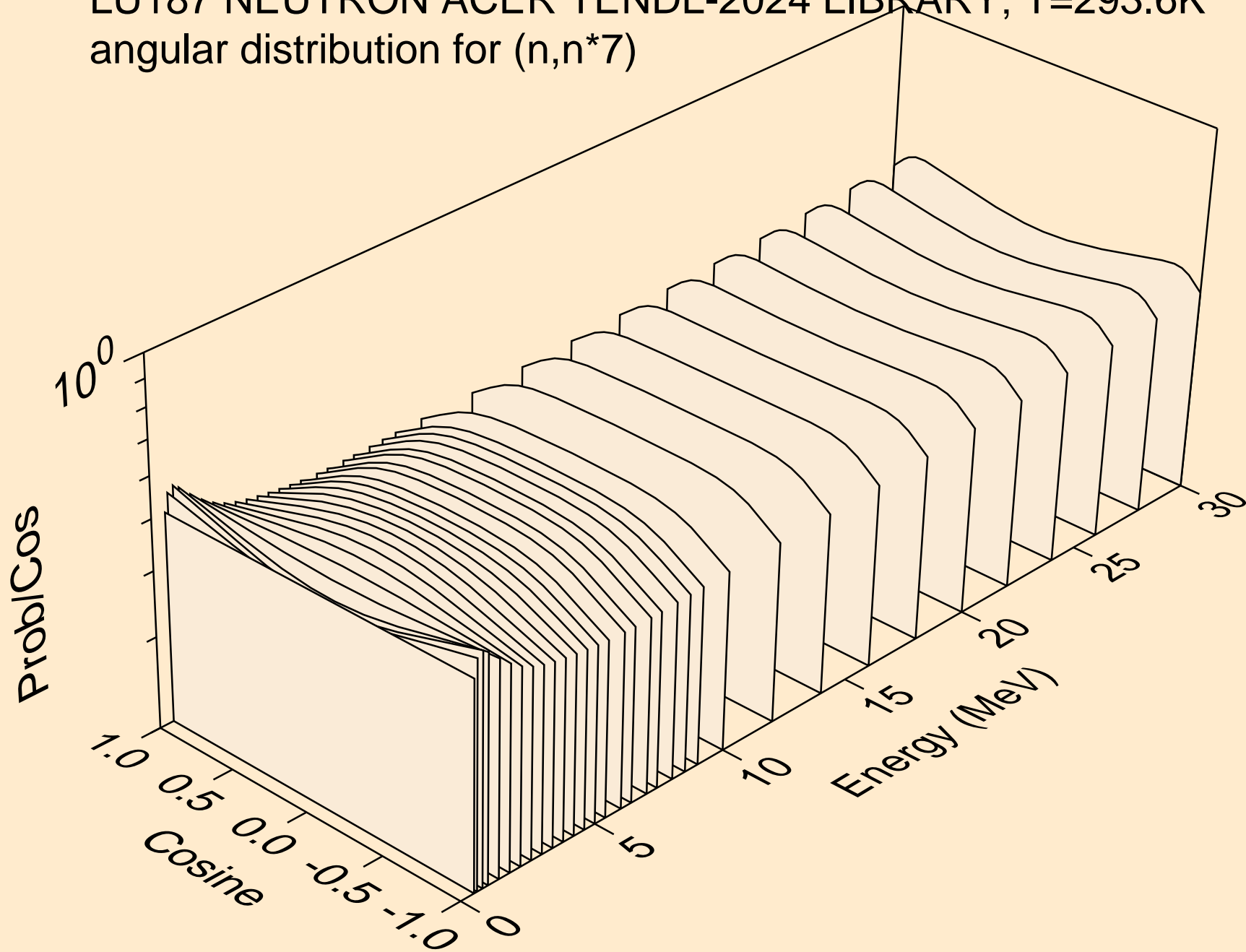

LU187 NEUTRON ACER TENDL-2024 LIBRARY; T=293.6K
angular distribution for (n,n*8)

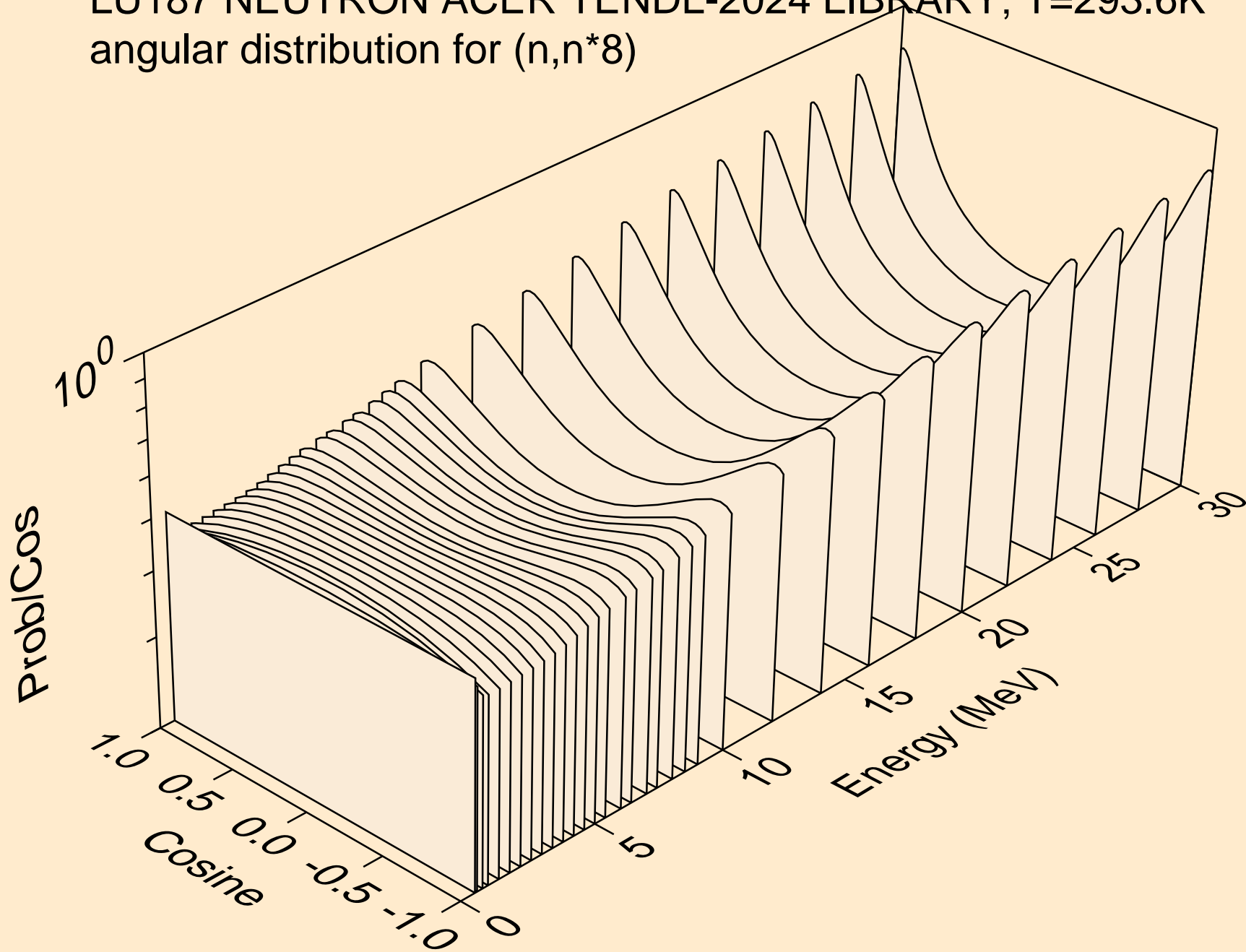

LU187 NEUTRON ACER TENDL-2024 LIBRARY; T=293.6K
angular distribution for (n,n*9)

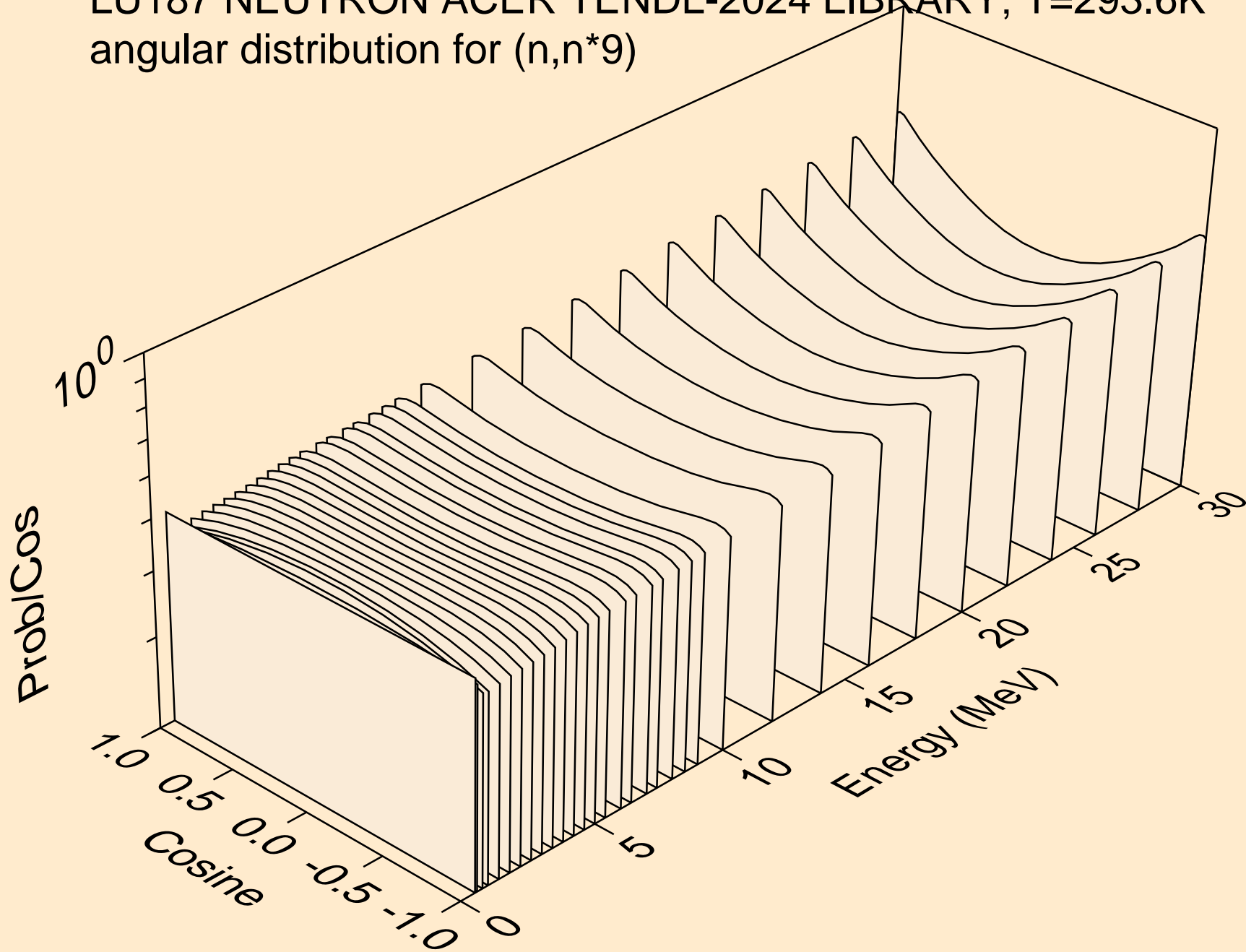

LU187 NEUTRON ACER TENDL-2024 LIBRARY; T=293.6K
angular distribution for (n,n*10)

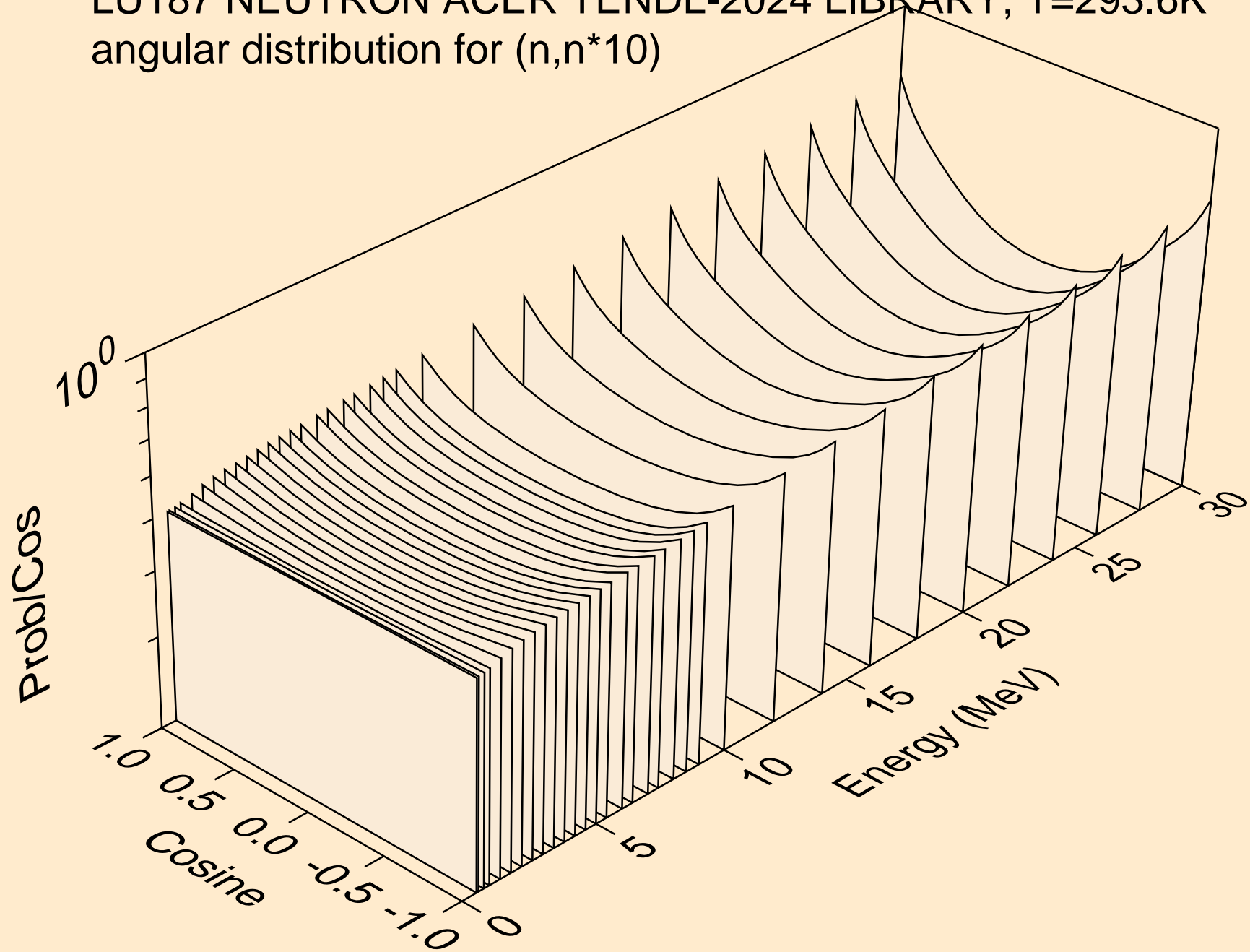

LU187 NEUTRON ACER TENDL-2024 LIBRARY; T=293.6K
angular distribution for (n,n*11)

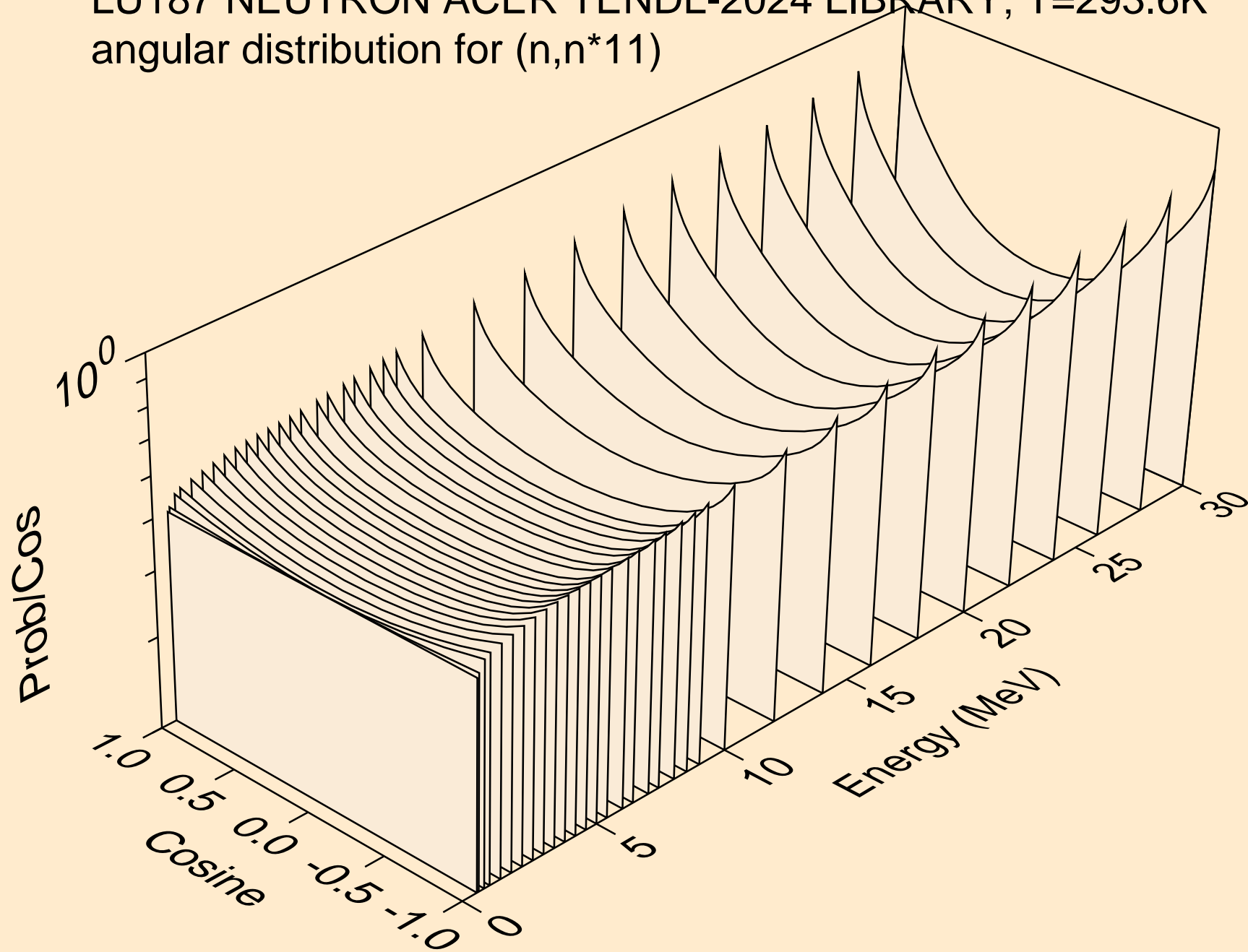

LU187 NEUTRON ACER TENDL-2024 LIBRARY; T=293.6K
angular distribution for (n,n*12)

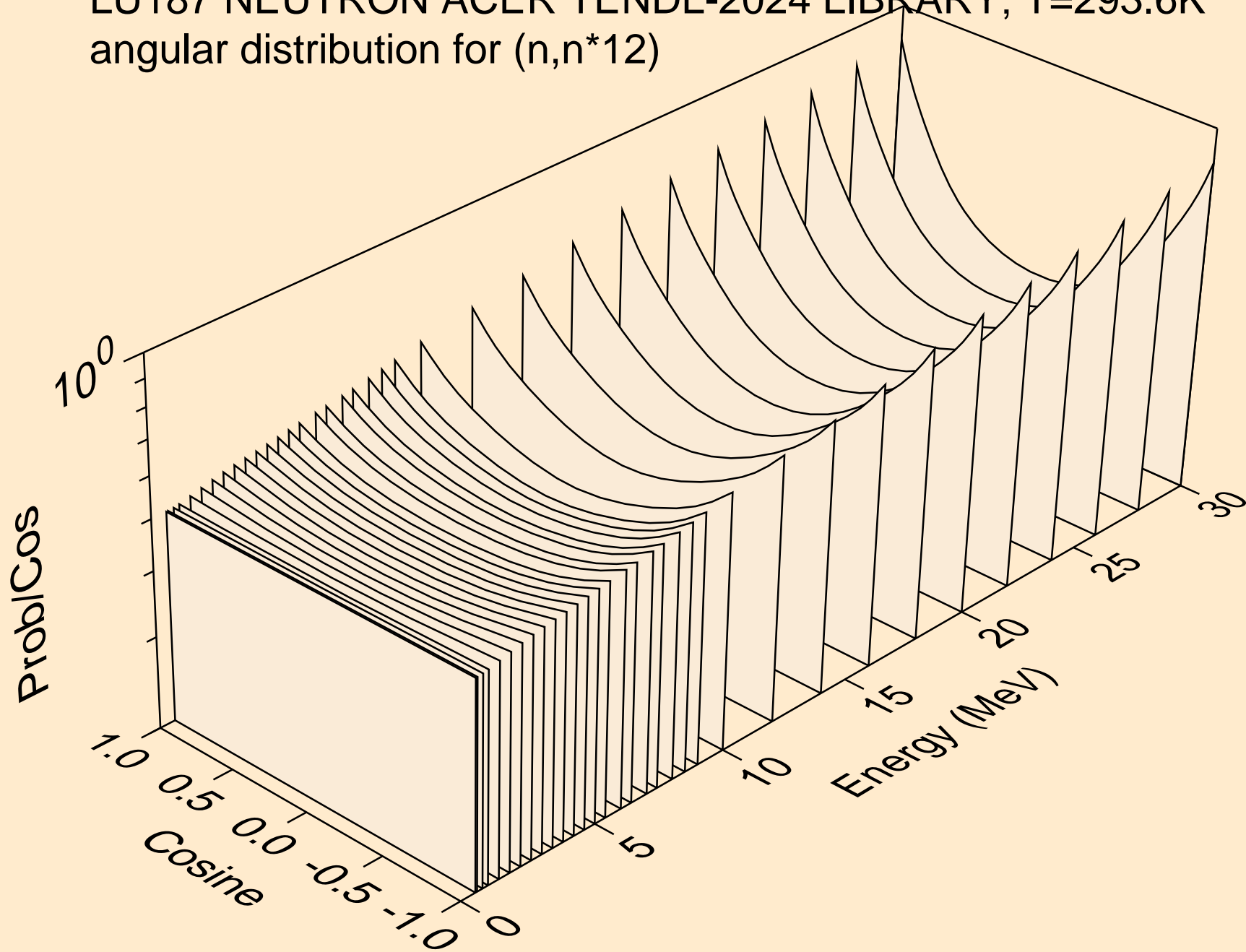

LU187 NEUTRON ACER TENDL-2024 LIBRARY; T=293.6K
angular distribution for (n,n*13)

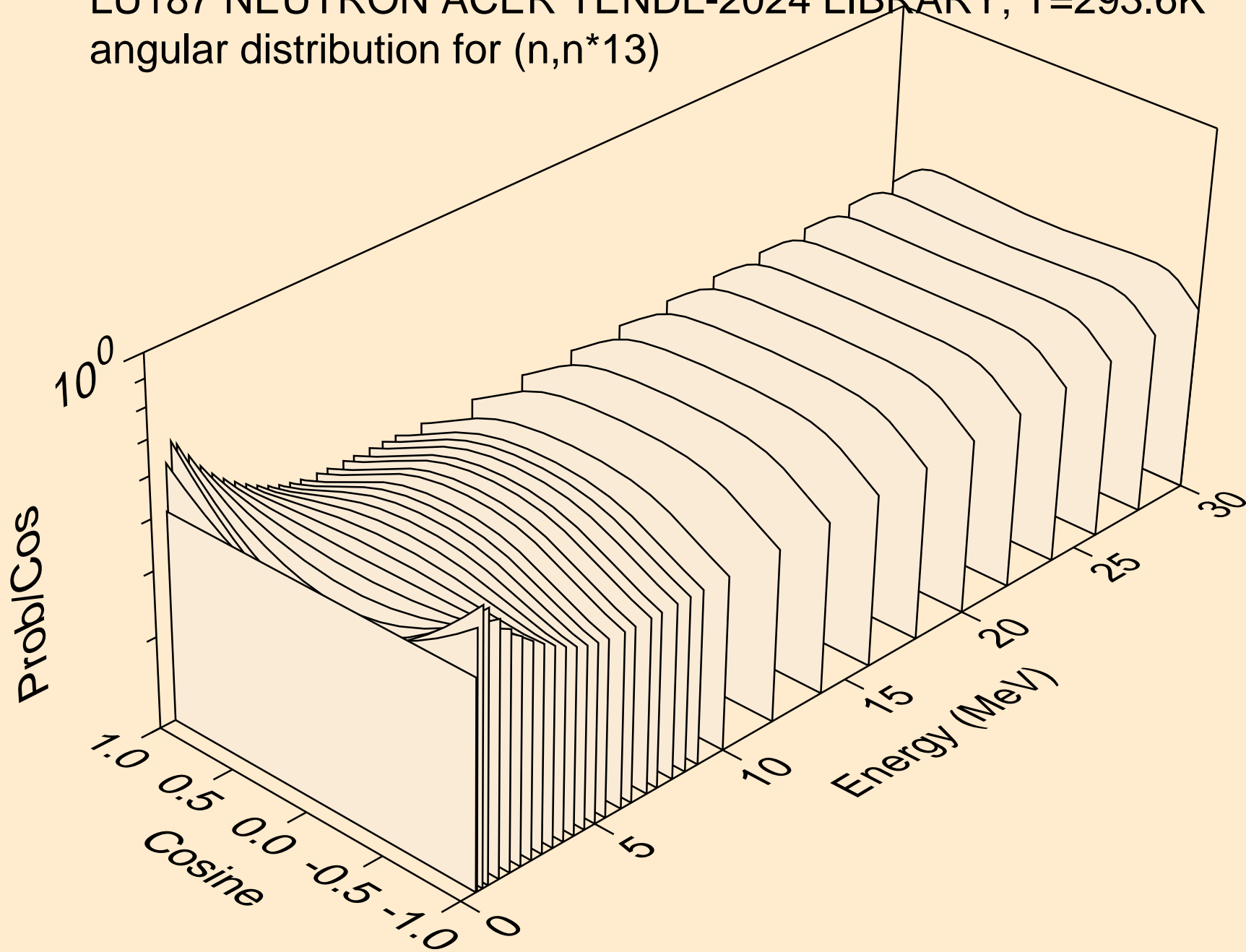

LU187 NEUTRON ACER TENDL-2024 LIBRARY; T=293.6K
angular distribution for (n,n*14)

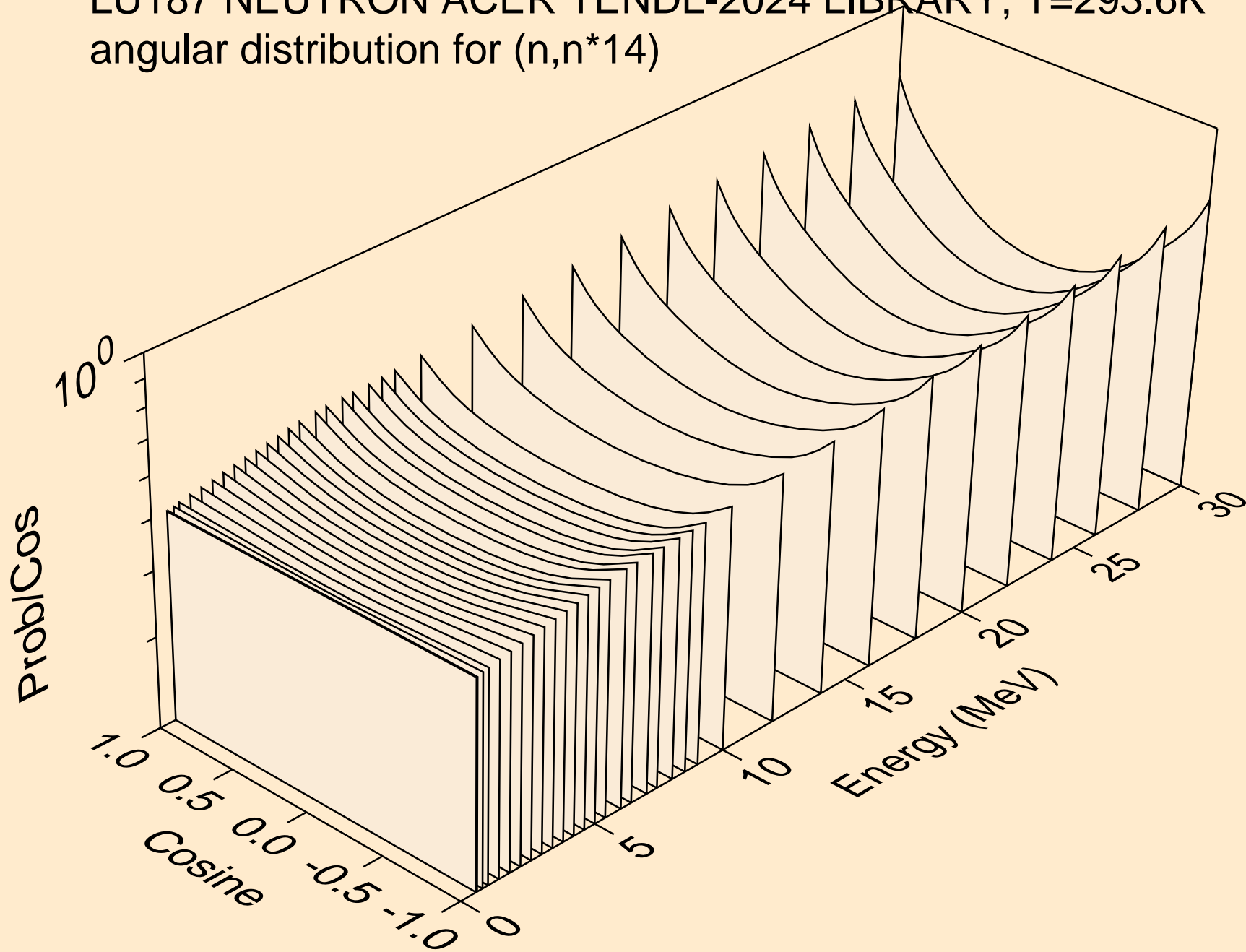

LU187 NEUTRON ACER TENDL-2024 LIBRARY; T=293.6K
angular distribution for (n,n*15)

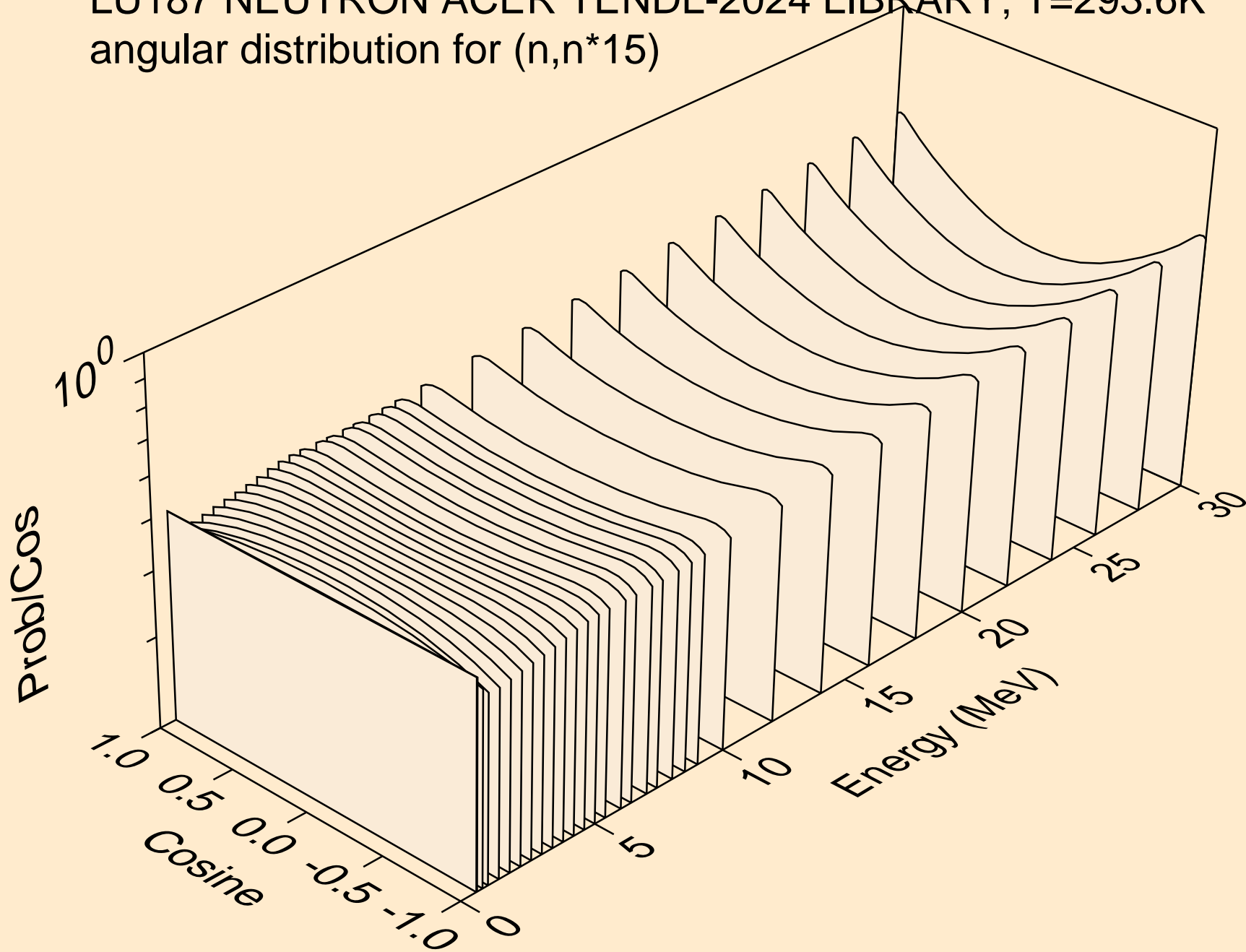

LU187 NEUTRON ACER TENDL-2024 LIBRARY; T=293.6K
angular distribution for (n,n*16)

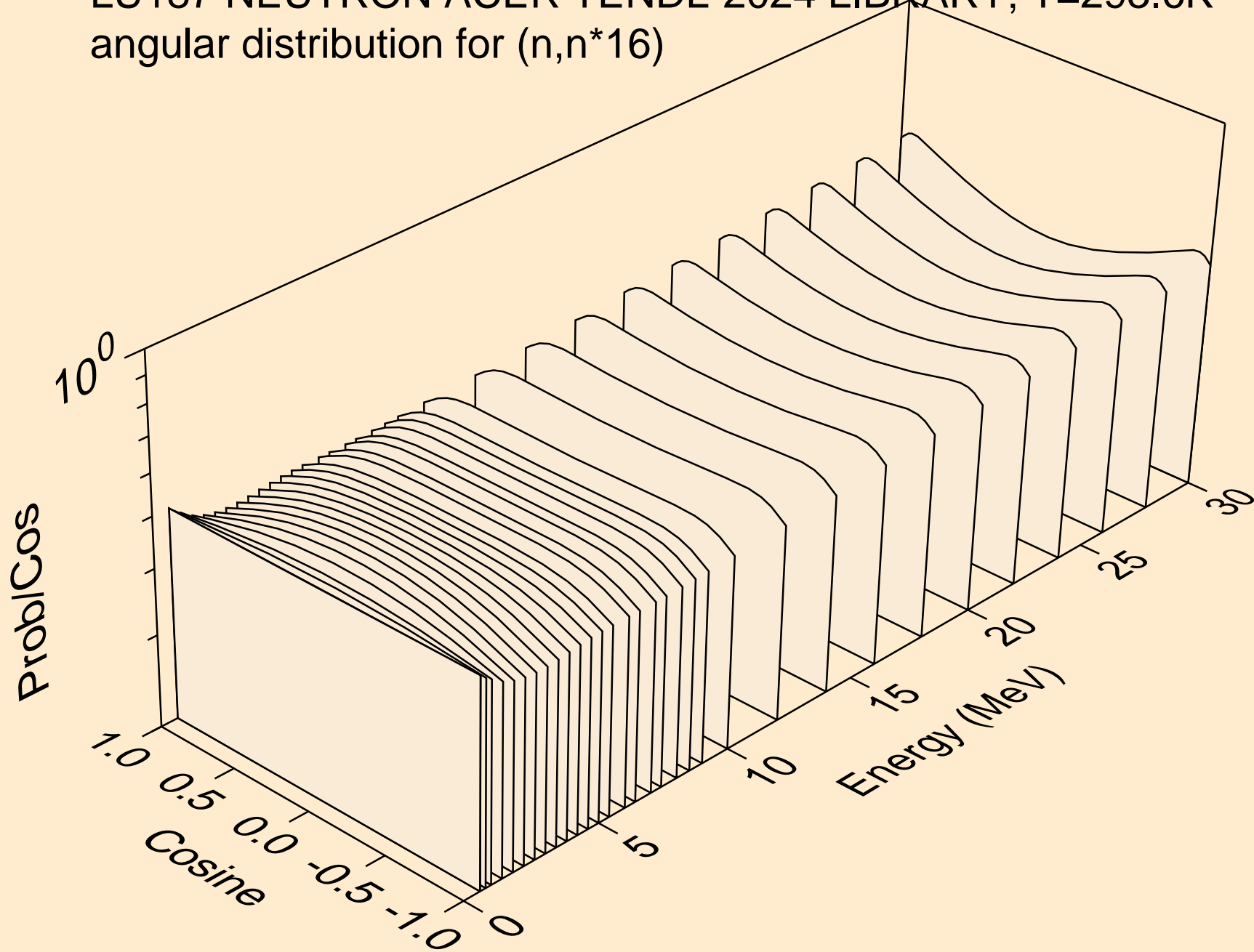

LU187 NEUTRON ACER TENDL-2024 LIBRARY; T=293.6K
angular distribution for (n,n*17)

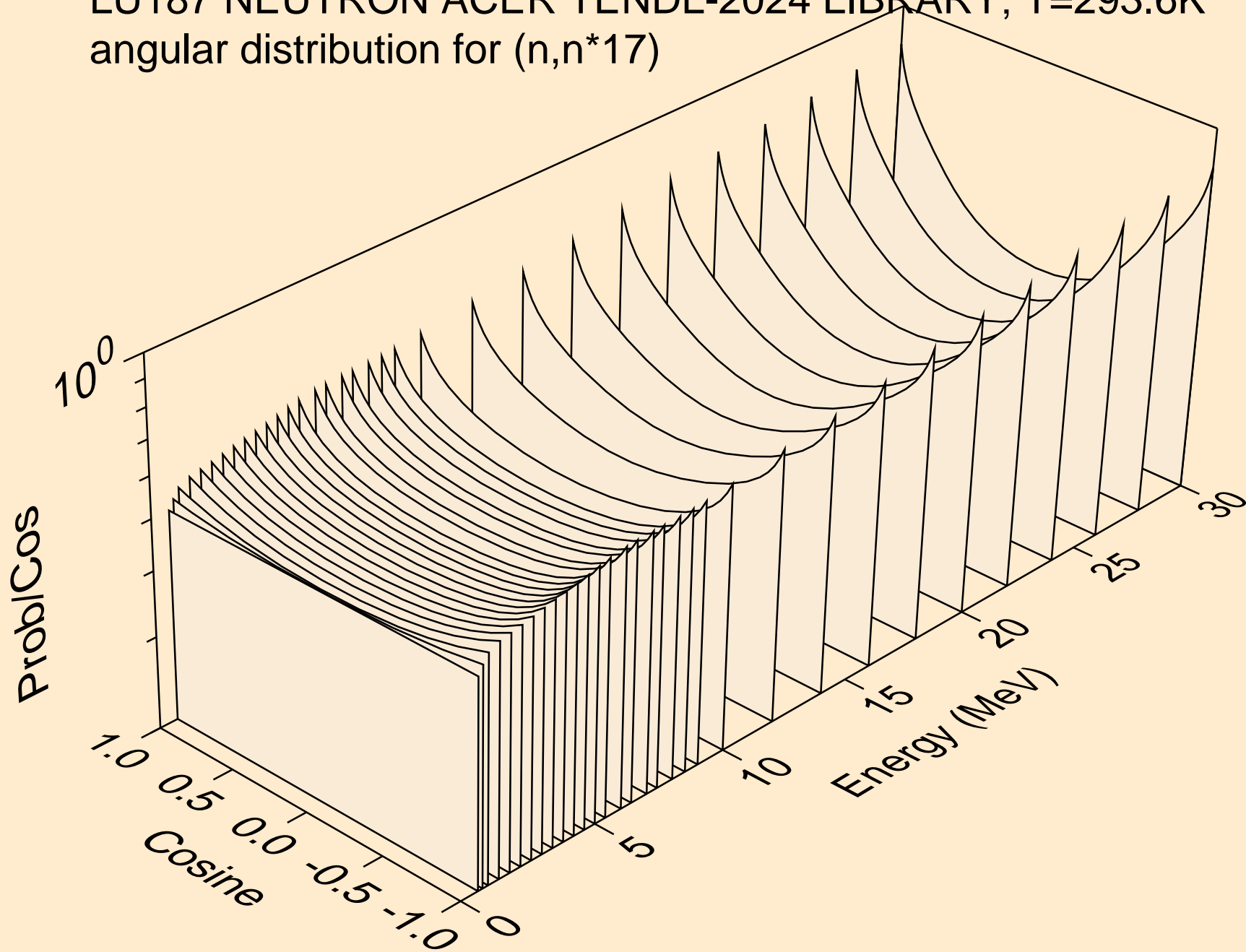

LU187 NEUTRON ACER TENDL-2024 LIBRARY; T=293.6K
angular distribution for (n,n*18)

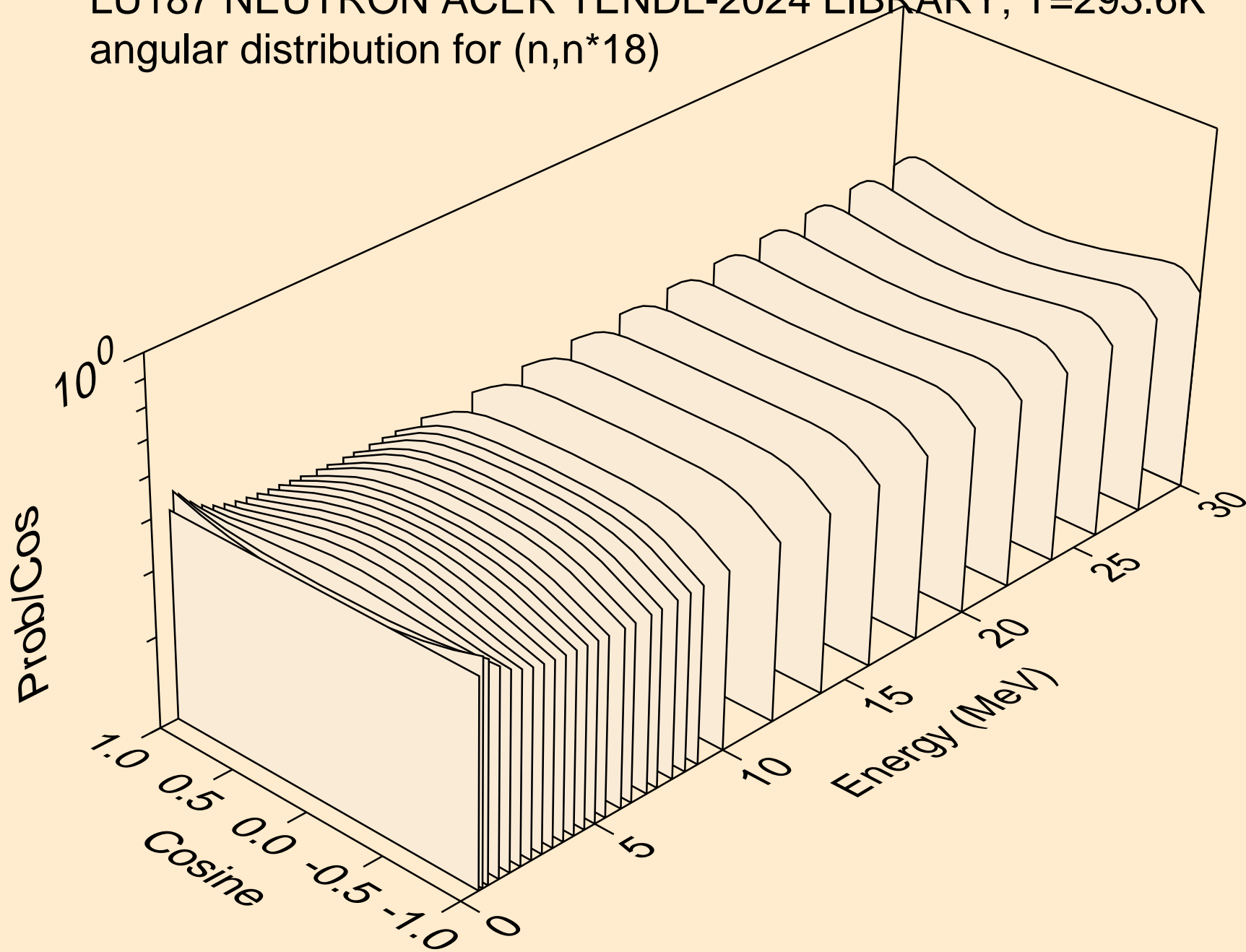

LU187 NEUTRON ACER TENDL-2024 LIBRARY; T=293.6K
angular distribution for (n,n*19)

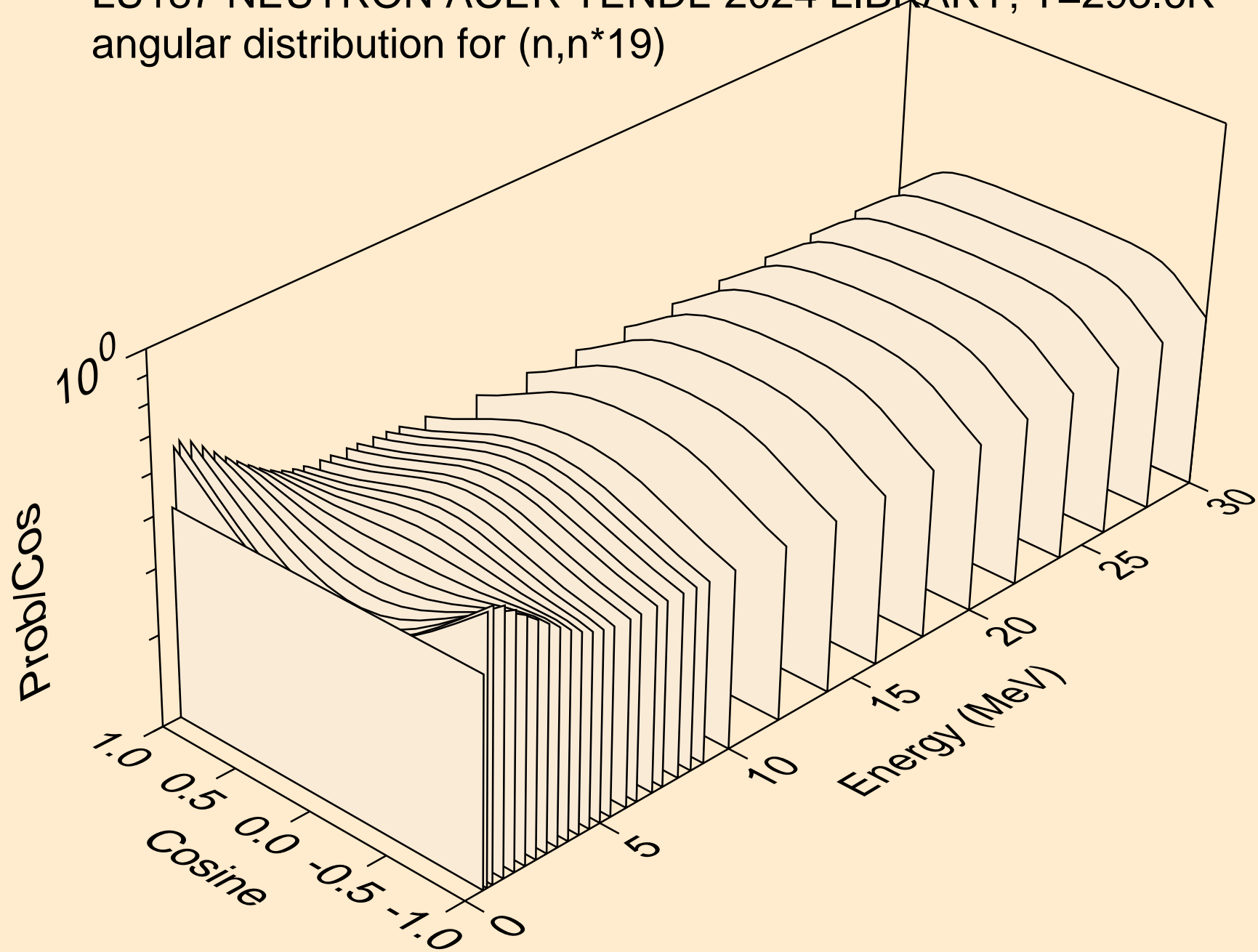

LU187 NEUTRON ACER TENDL-2024 LIBRARY; T=293.6K
angular distribution for (n,n*20)

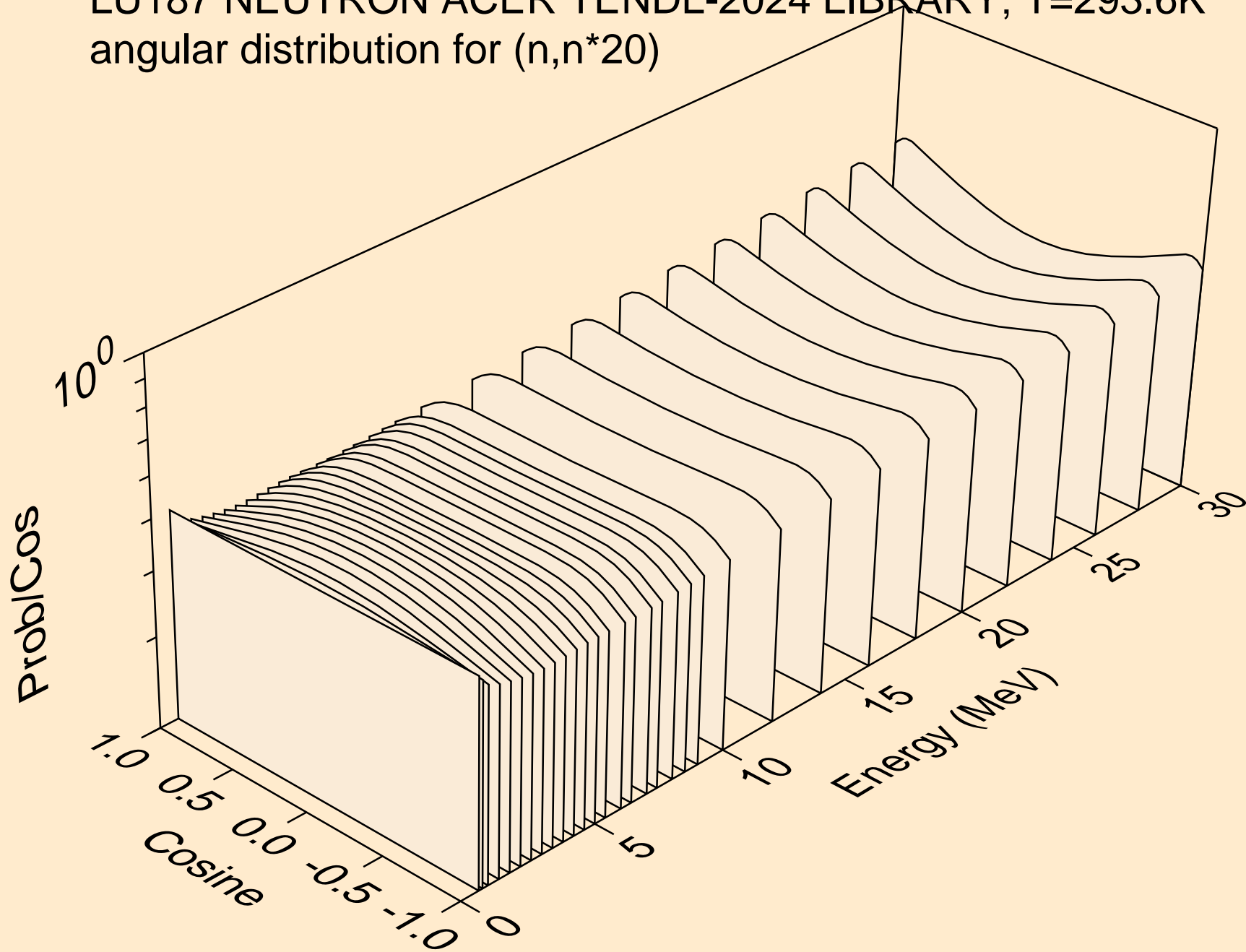

LU187 NEUTRON ACER TENDL-2024 LIBRARY; T=293.6K
angular distribution for (n,n*21)

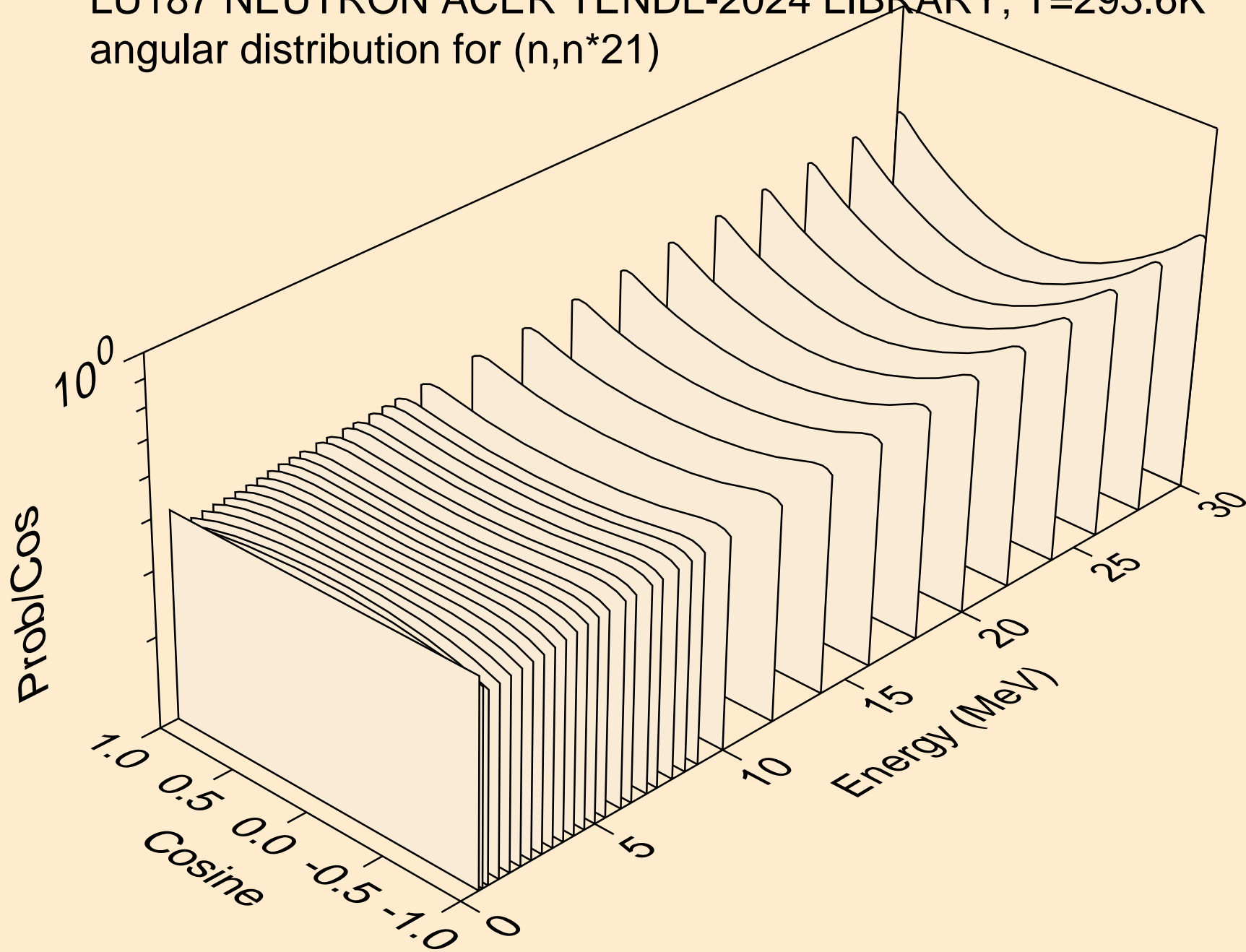

LU187 NEUTRON ACER TENDL-2024 LIBRARY; T=293.6K
angular distribution for (n,n*22)

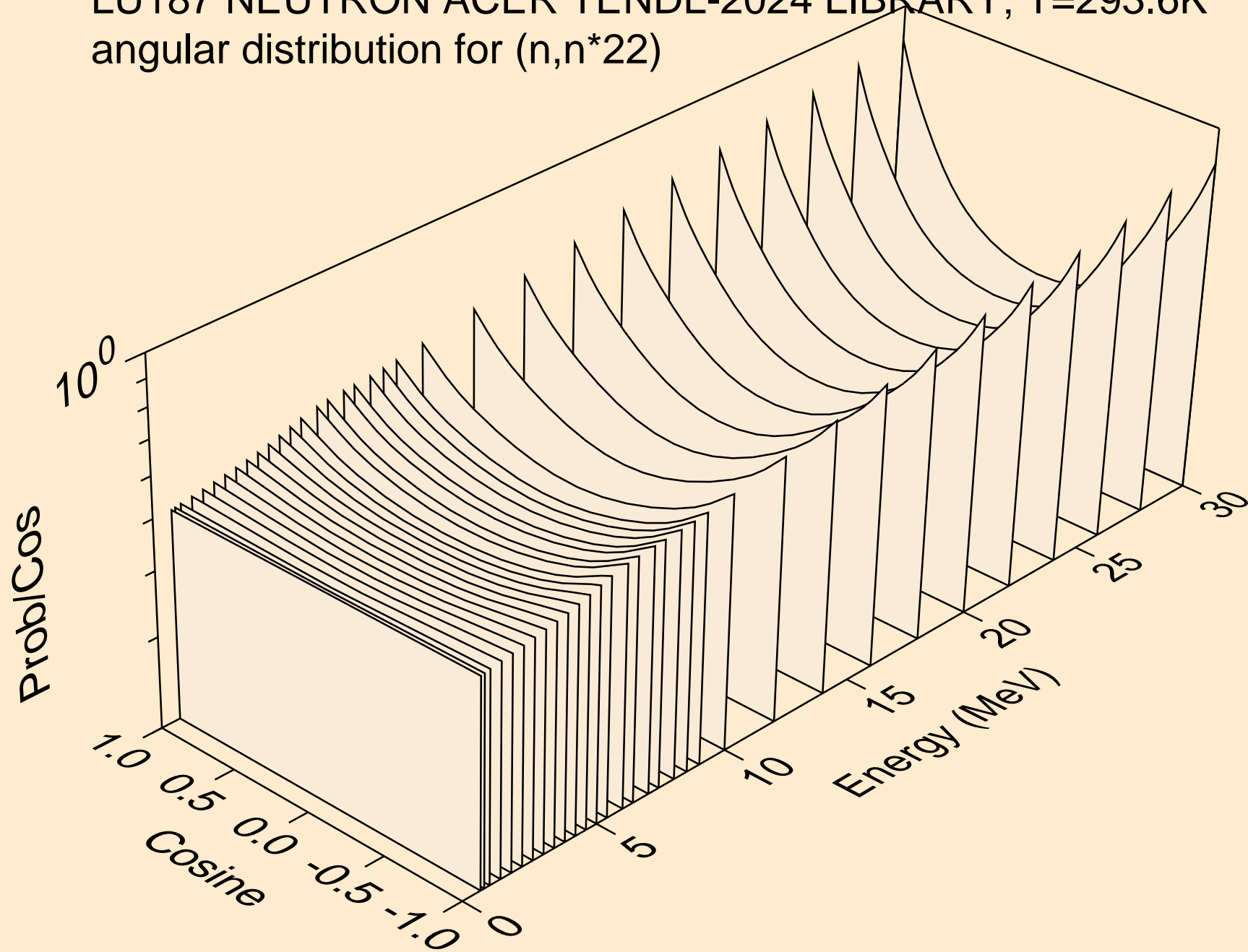

LU187 NEUTRON ACER TENDL-2024 LIBRARY; T=293.6K
angular distribution for (n,n*23)

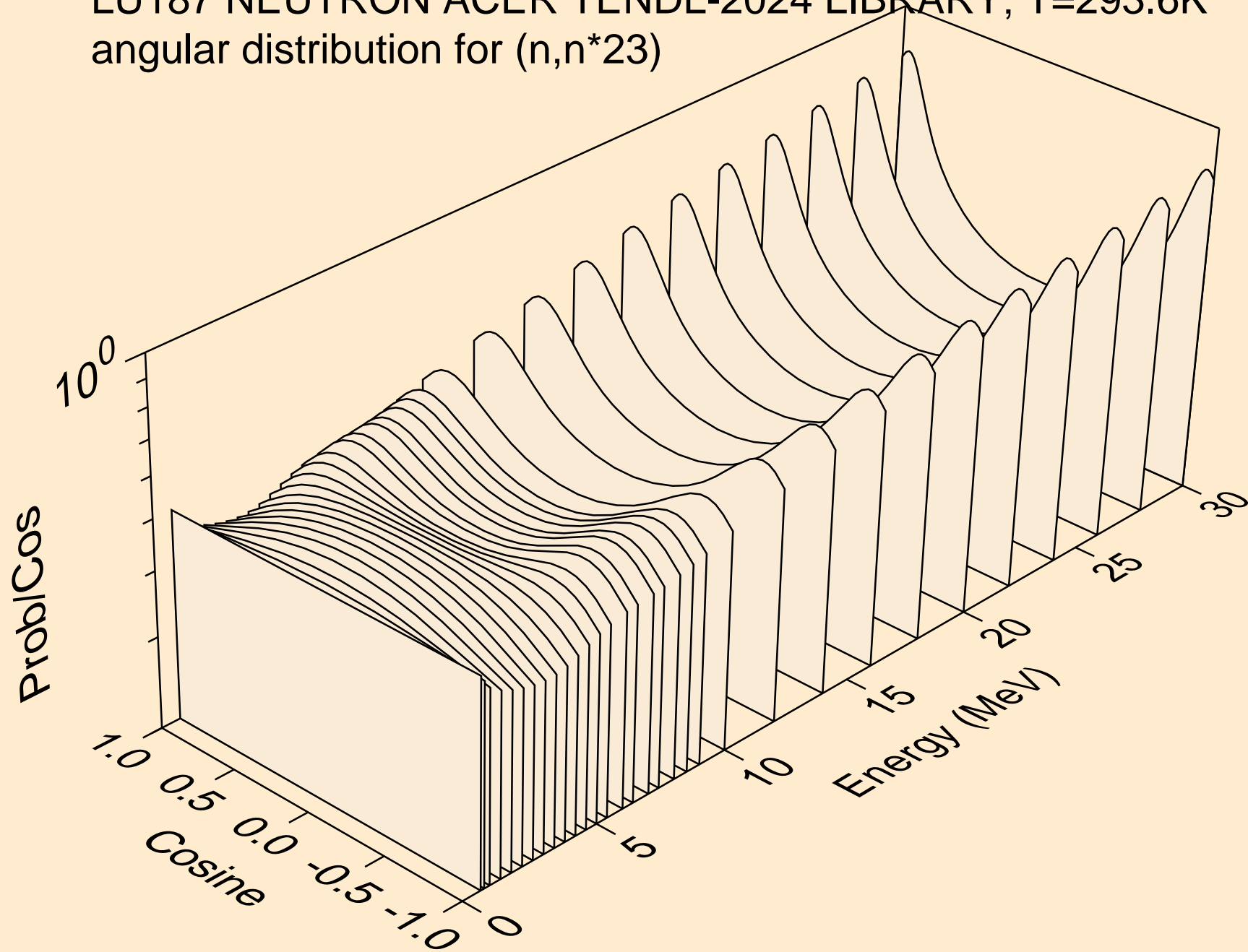

LU187 NEUTRON ACER TENDL-2024 LIBRARY; T=293.6K
angular distribution for (n,n*24)

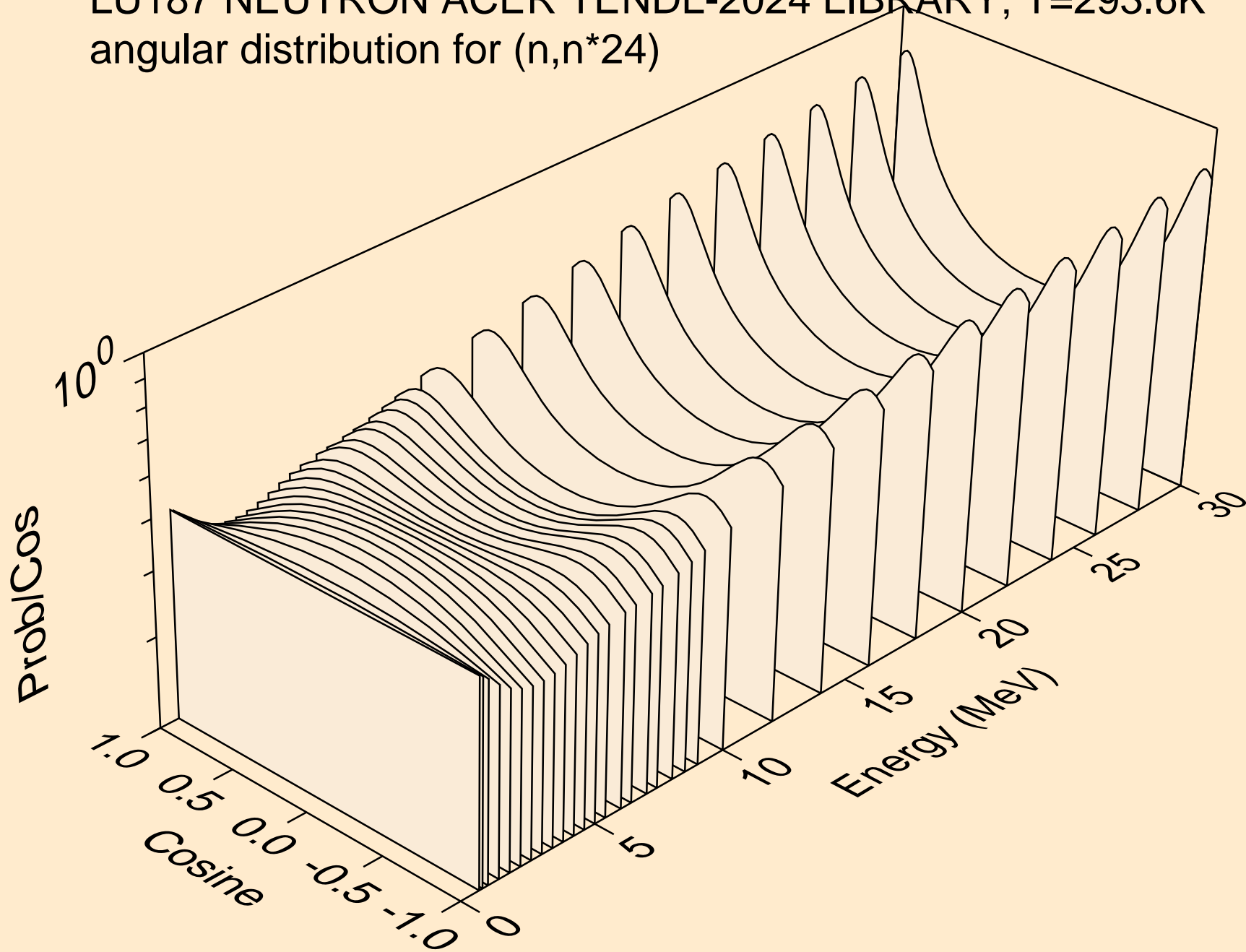

LU187 NEUTRON ACER TENDL-2024 LIBRARY; T=293.6K
angular distribution for (n,n*25)

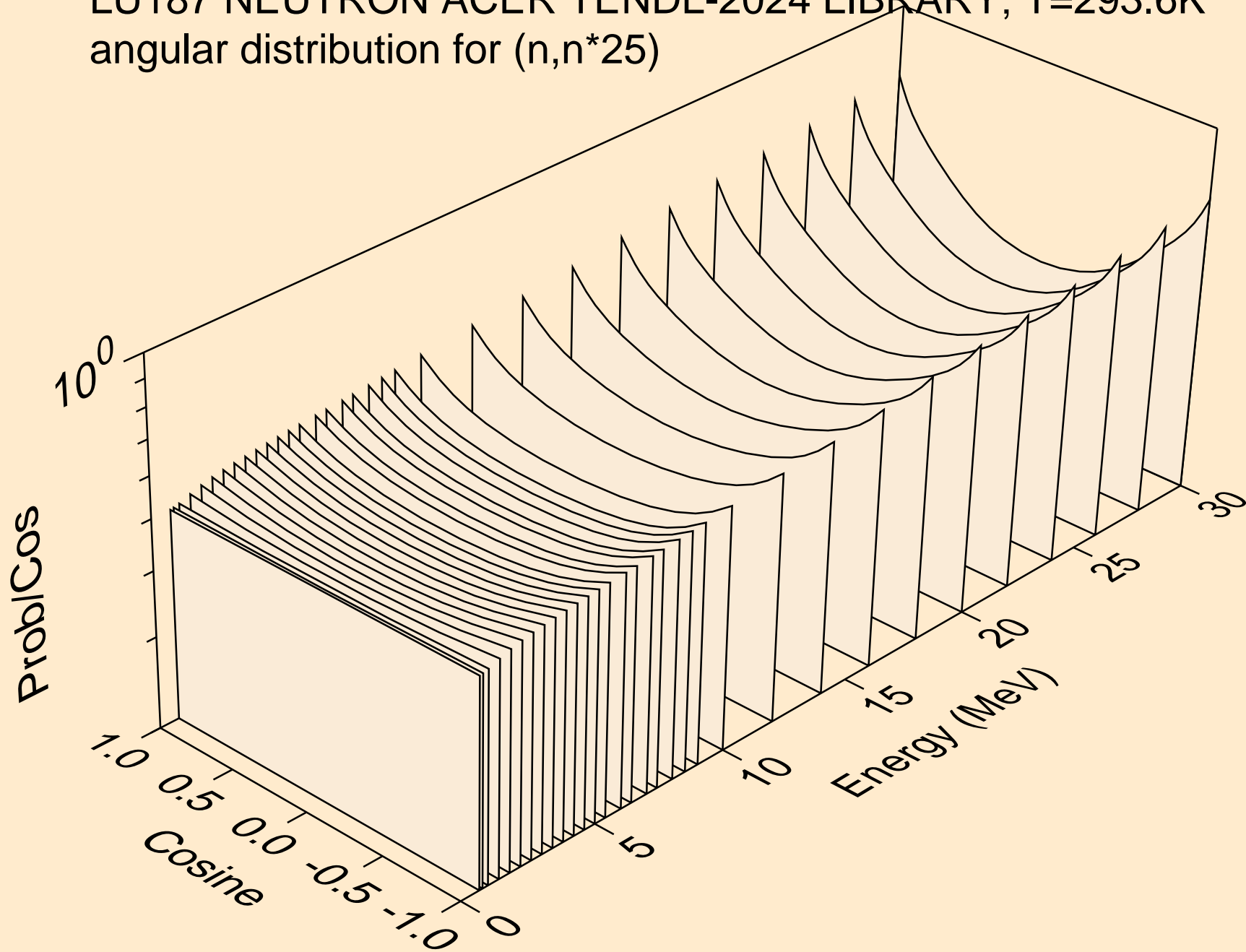

LU187 NEUTRON ACER TENDL-2024 LIBRARY; T=293.6K
angular distribution for (n,n*26)

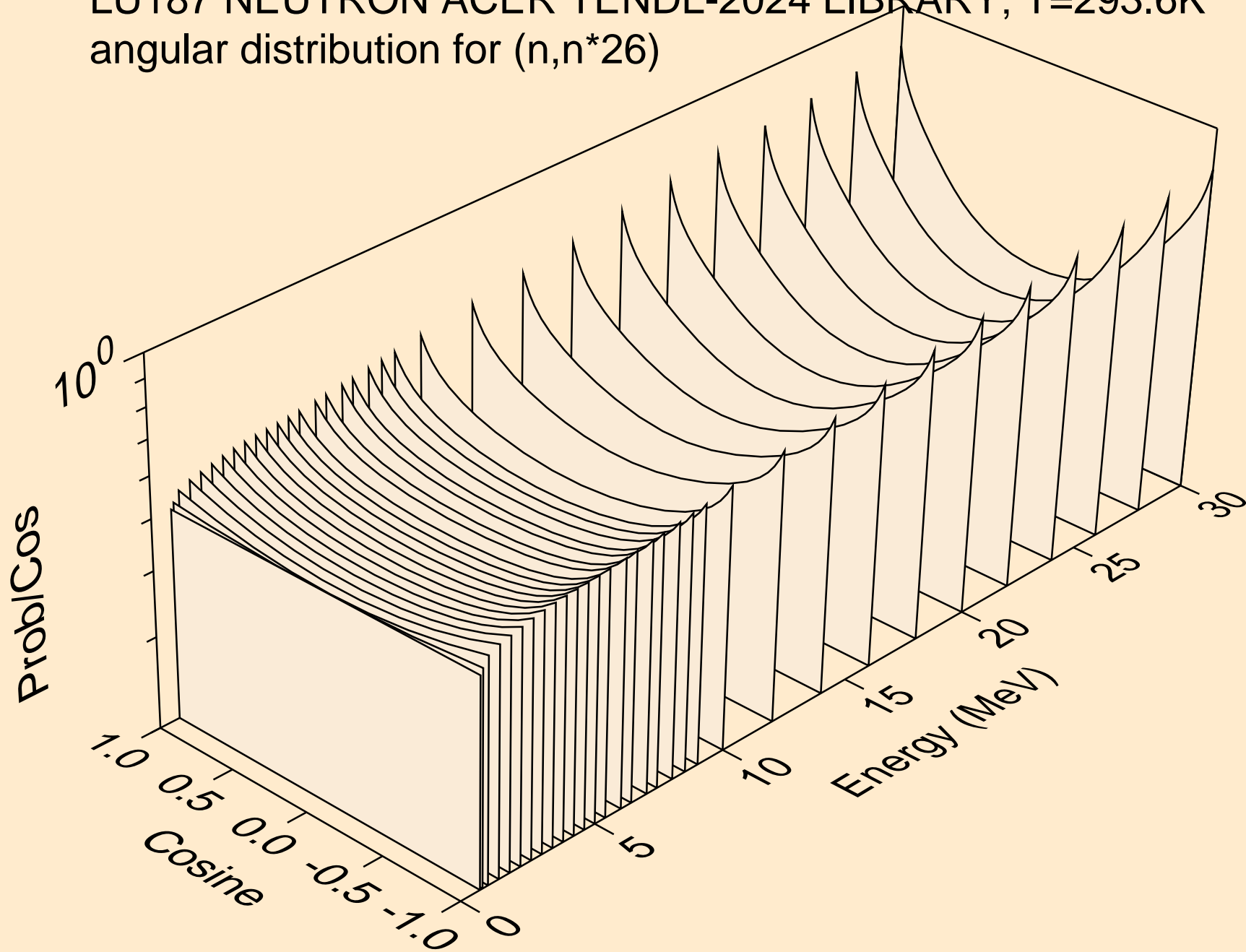

LU187 NEUTRON ACER TENDL-2024 LIBRARY; T=293.6K
angular distribution for (n,n*27)

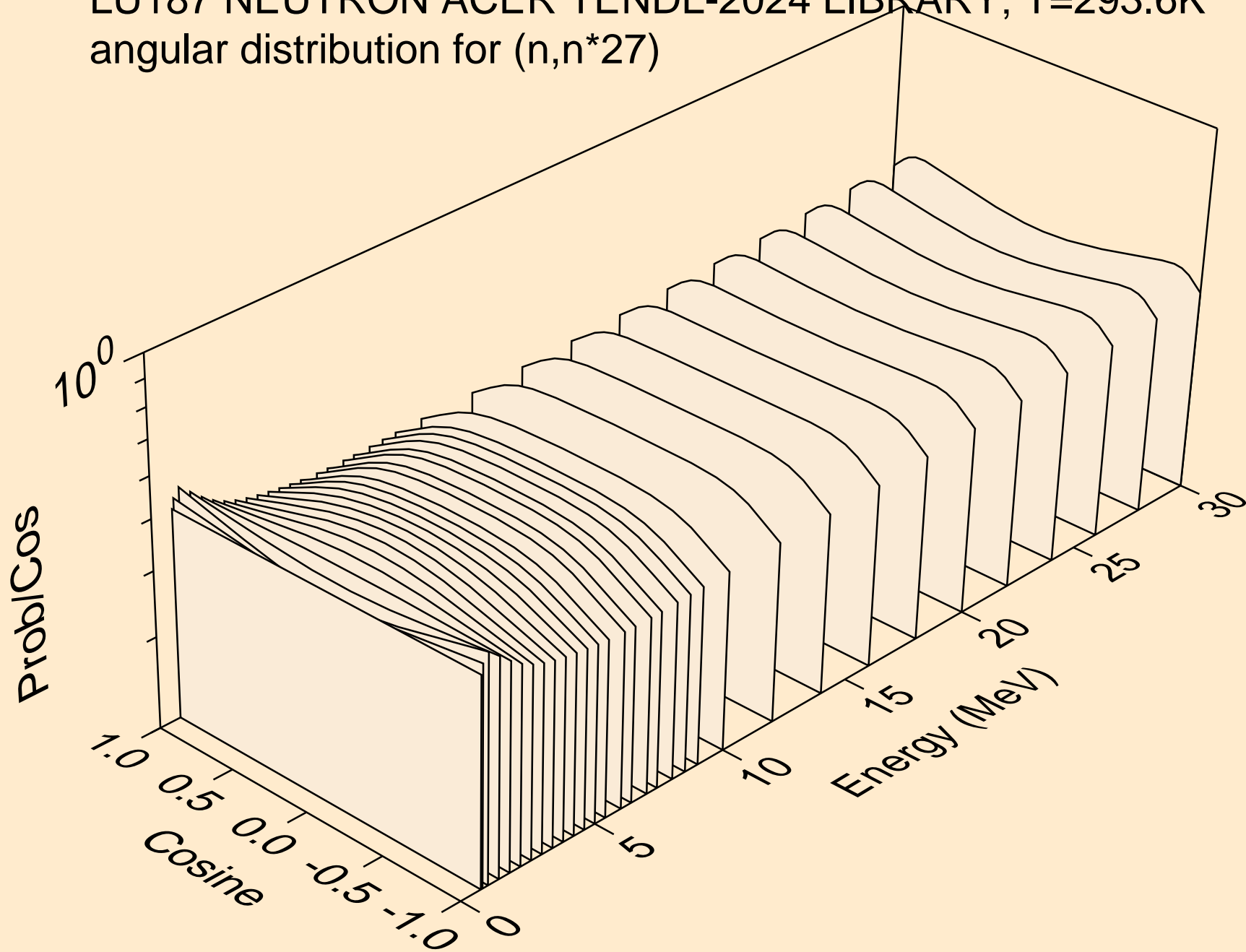

LU187 NEUTRON ACER TENDL-2024 LIBRARY; T=293.6K
angular distribution for (n,n*28)

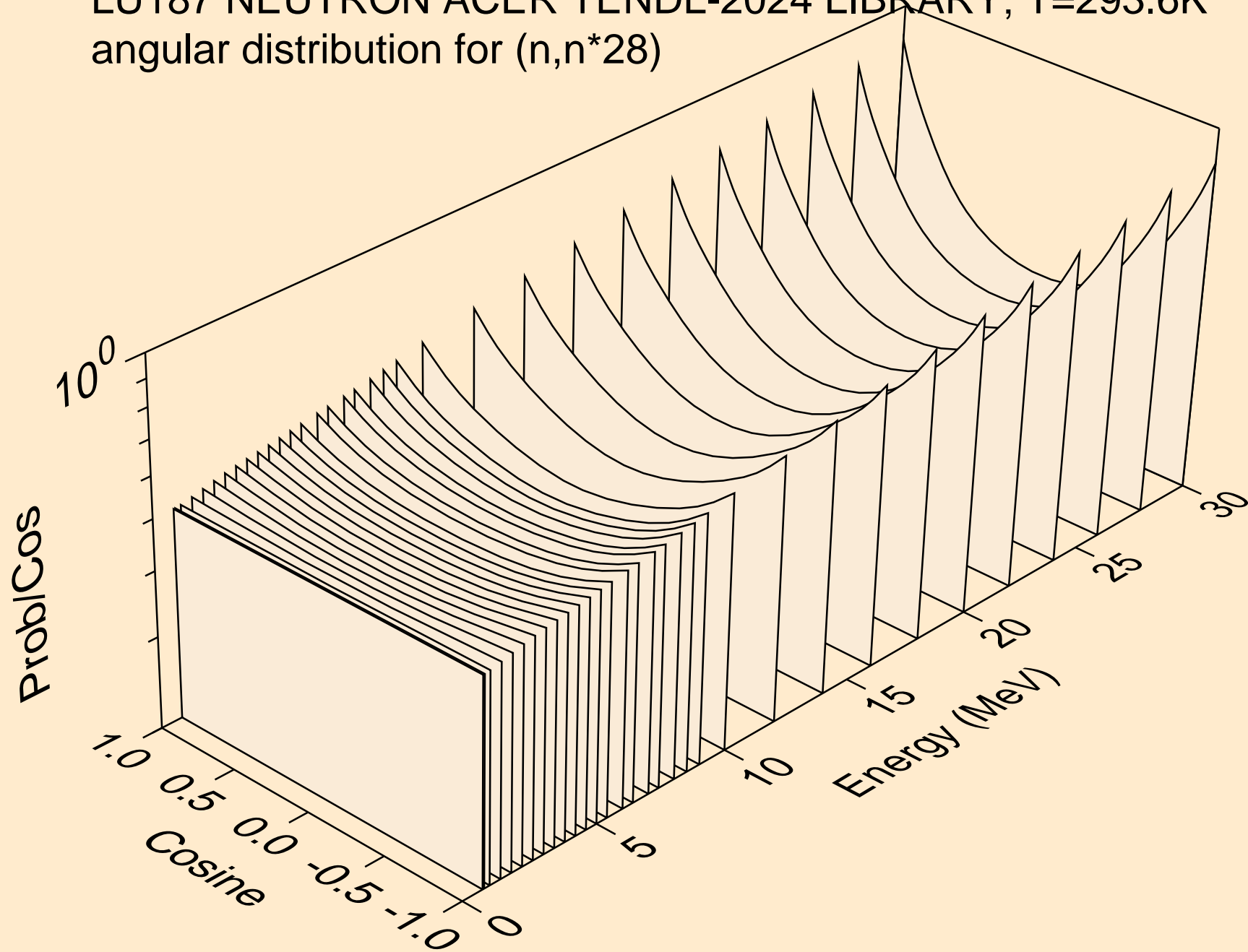

LU187 NEUTRON ACER TENDL-2024 LIBRARY; T=293.6K
angular distribution for (n,n*29)

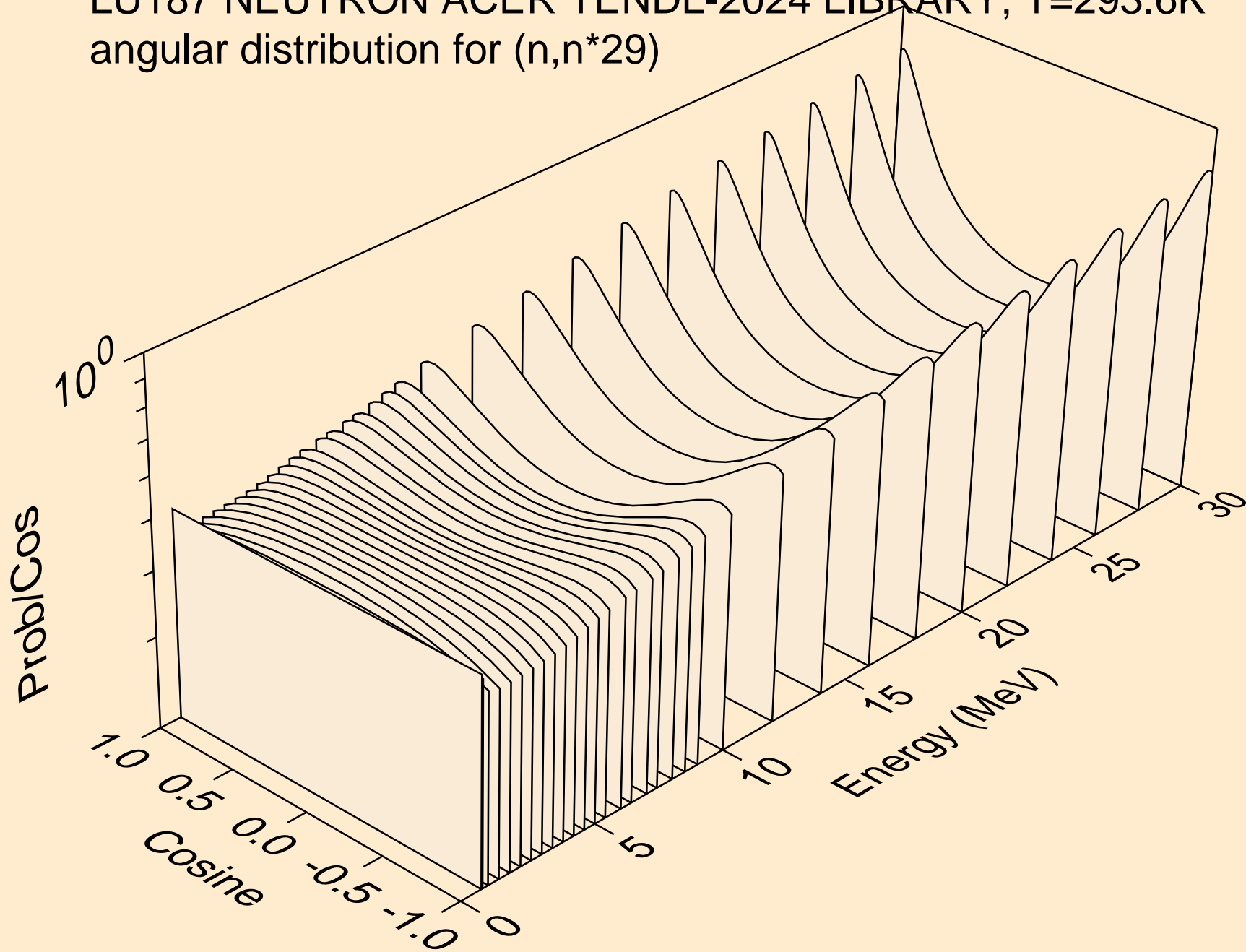

LU187 NEUTRON ACER TENDL-2024 LIBRARY; T=293.6K
angular distribution for (n,n*30)

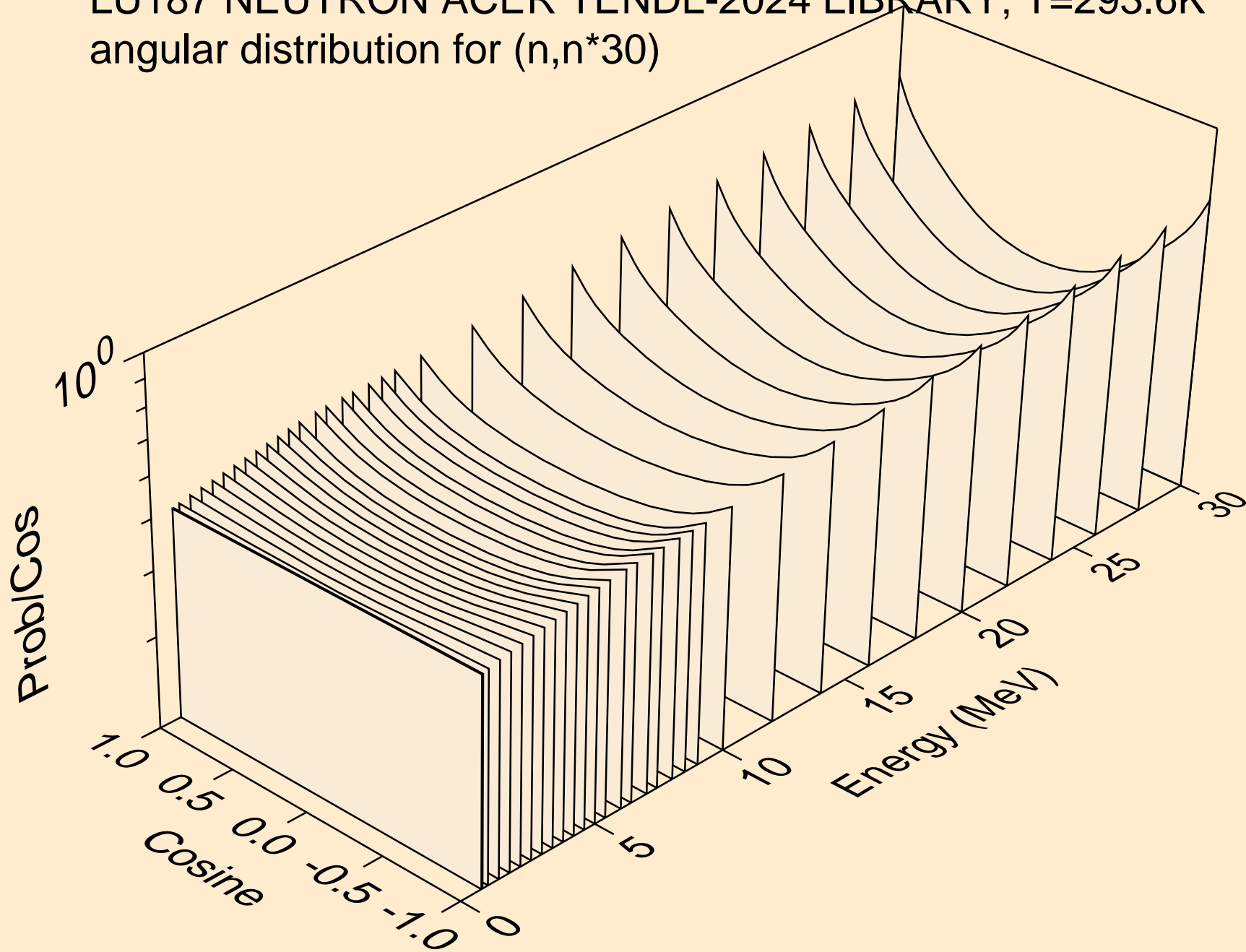

LU187 NEUTRON ACER TENDL-2024 LIBRARY; T=293.6K
Neutron emission for (n,x)

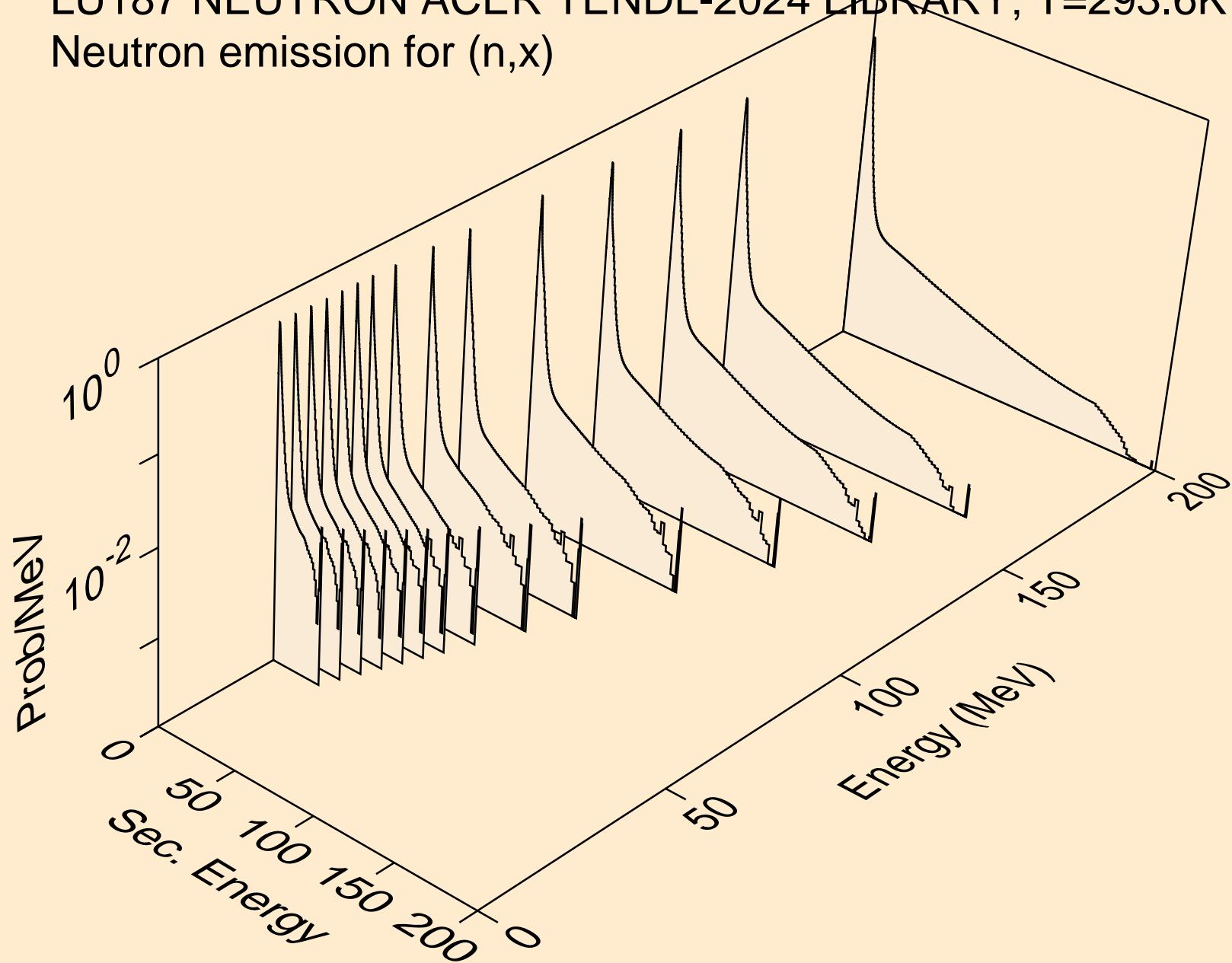

LU187 NEUTRON ACER TENDL-2024 LIBRARY; T=293.6K
Neutron emission for (n,2nd)

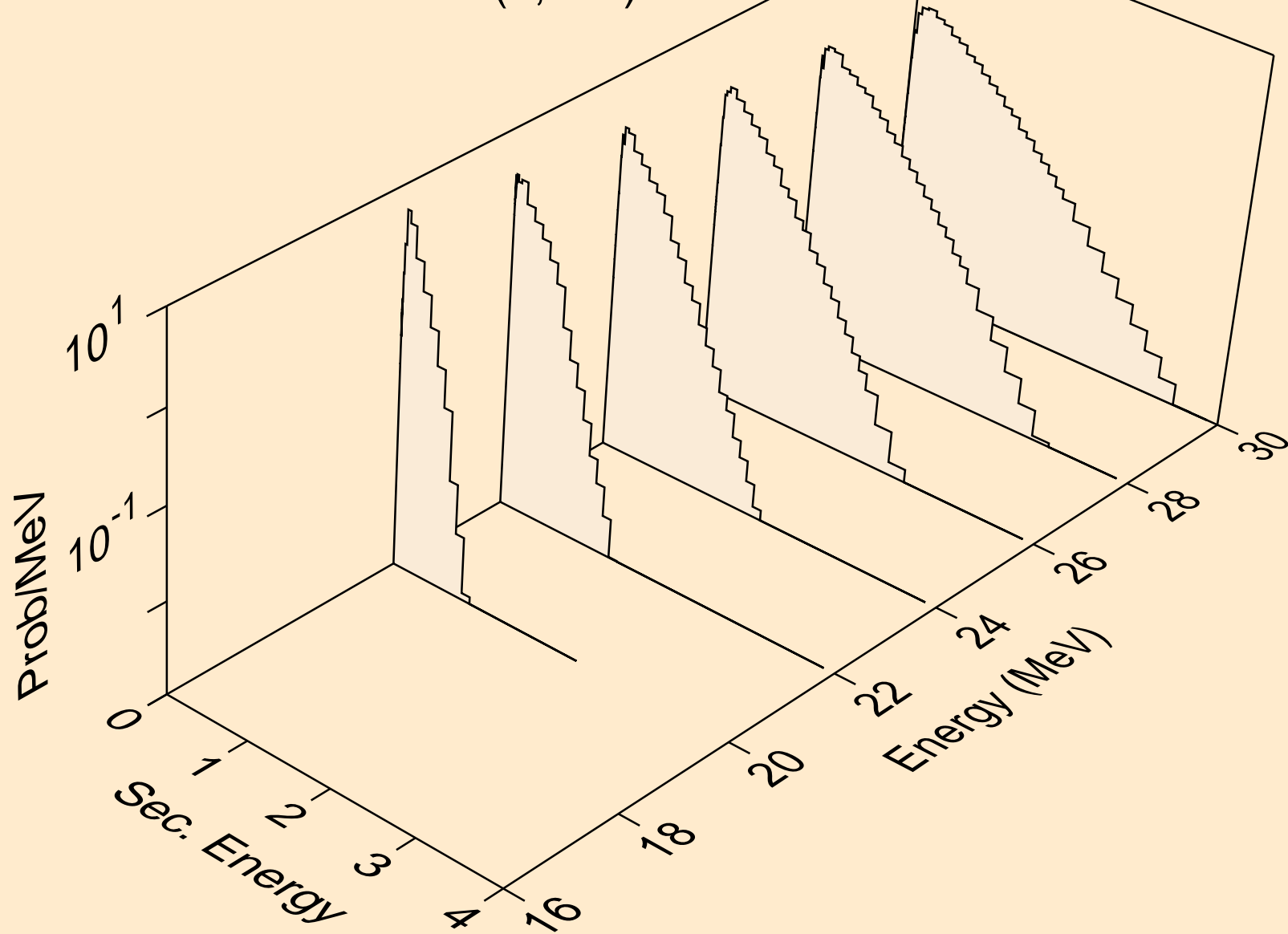

LU187 NEUTRON ACER TENDL-2024 LIBRARY; T=293.6K
Neutron emission for (n,2n)

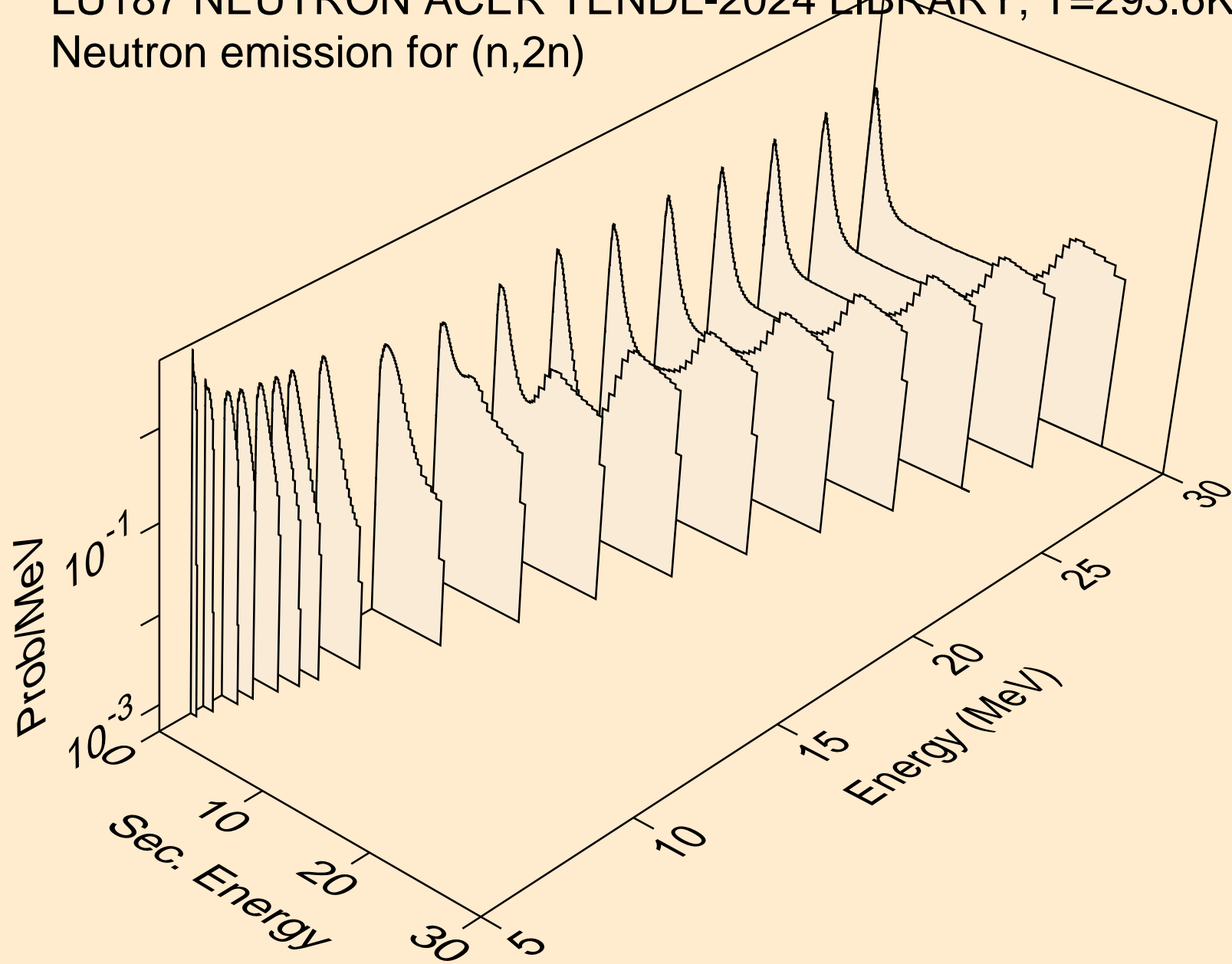

LU187 NEUTRON ACER TENDL-2024 LIBRARY; T=293.6K
Neutron emission for (n,3n)

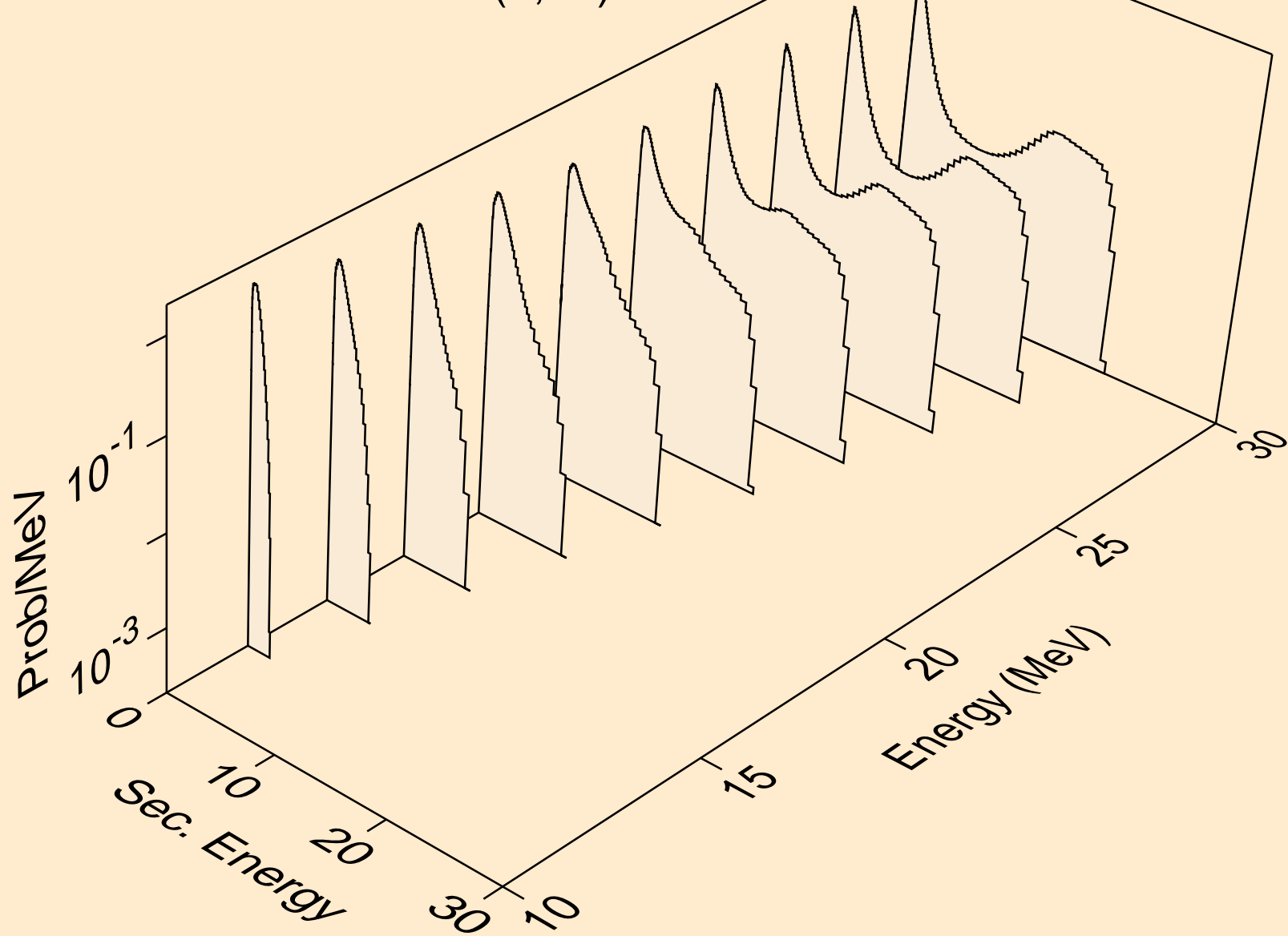

LU187 NEUTRON ACER TENDL-2024 LIBRARY; T=293.6K
Neutron emission for (n,n*)a

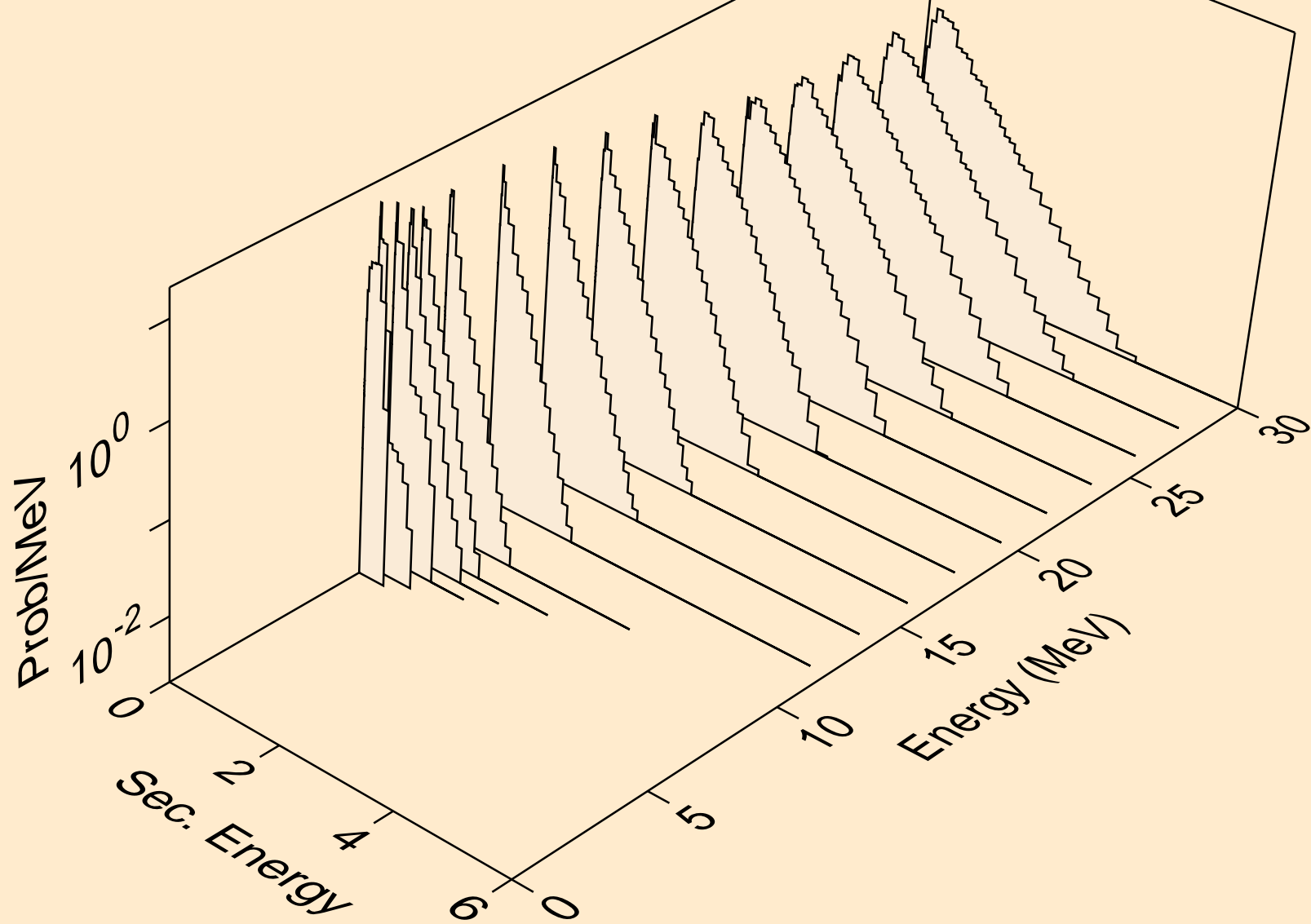

LU187 NEUTRON ACER TENDL-2024 LIBRARY; T=293.6K
Neutron emission for (n,2n)_a

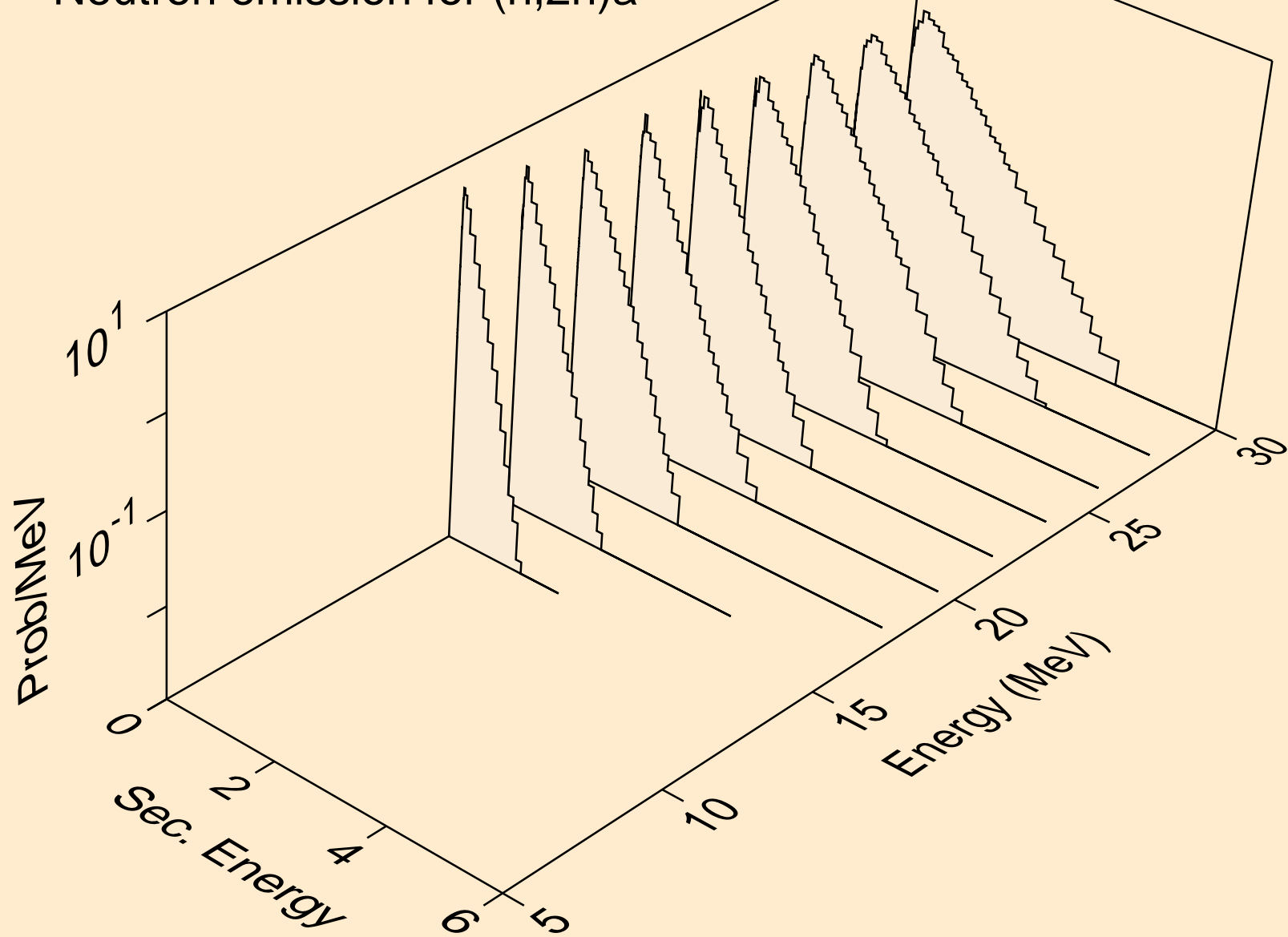

LU187 NEUTRON ACER TENDL-2024 LIBRARY; T=293.6K
Neutron emission for (n,3n)a

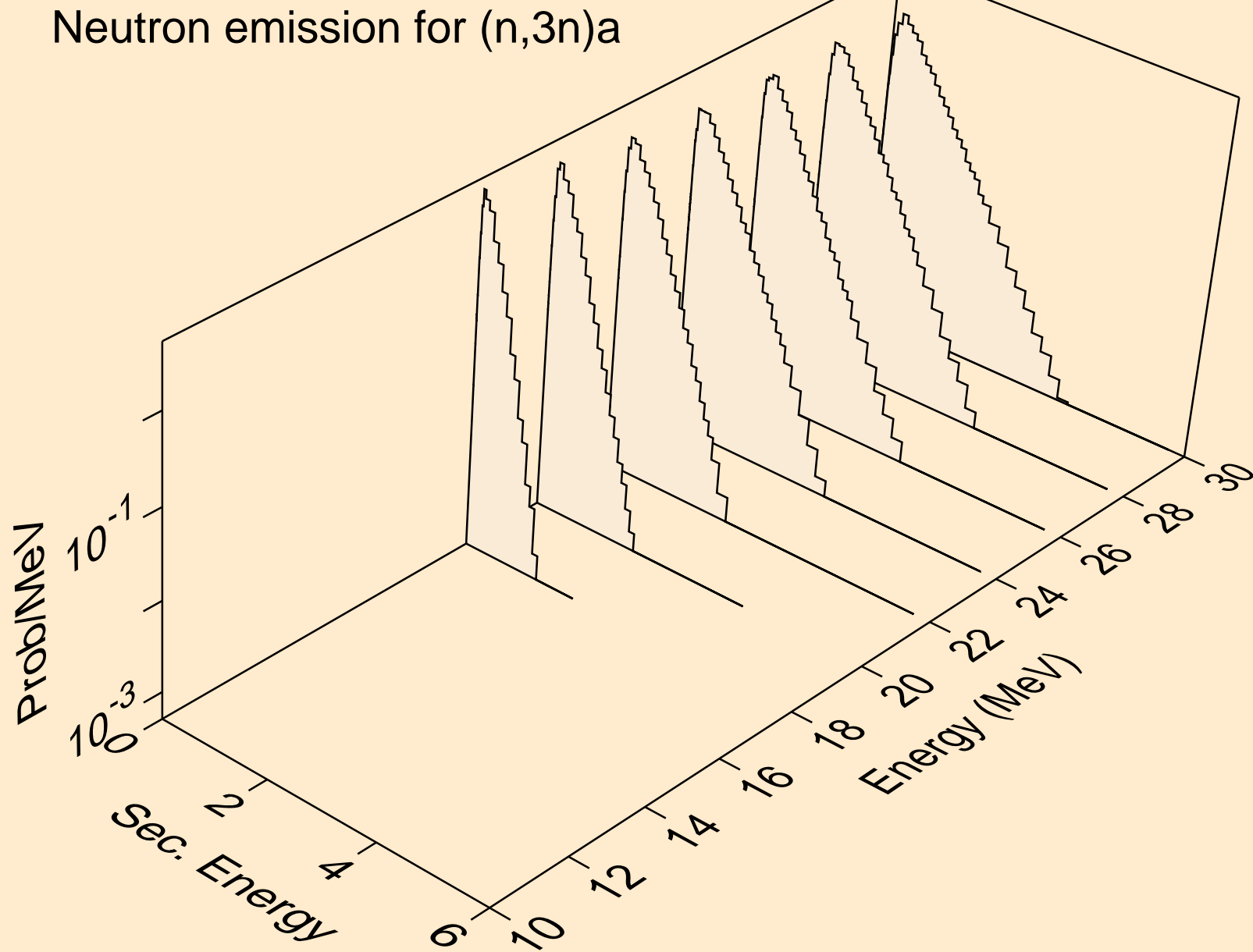

LU187 NEUTRON ACER TENDL-2024 LIBRARY; T=293.6K
Neutron emission for (n,n*)p

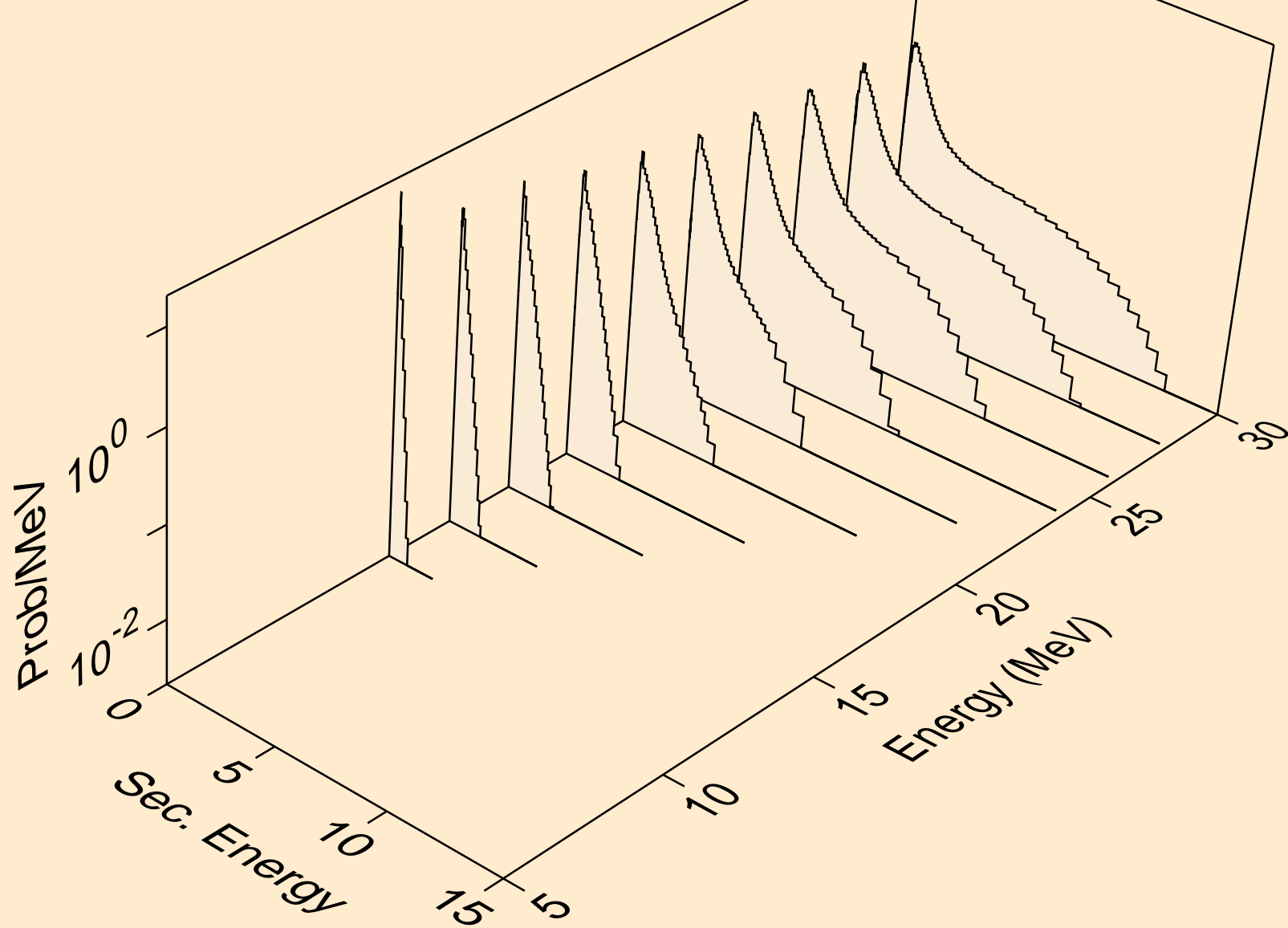

LU187 NEUTRON ACER TENDL-2024 LIBRARY; T=293.6K
Neutron emission for (n,n*)d

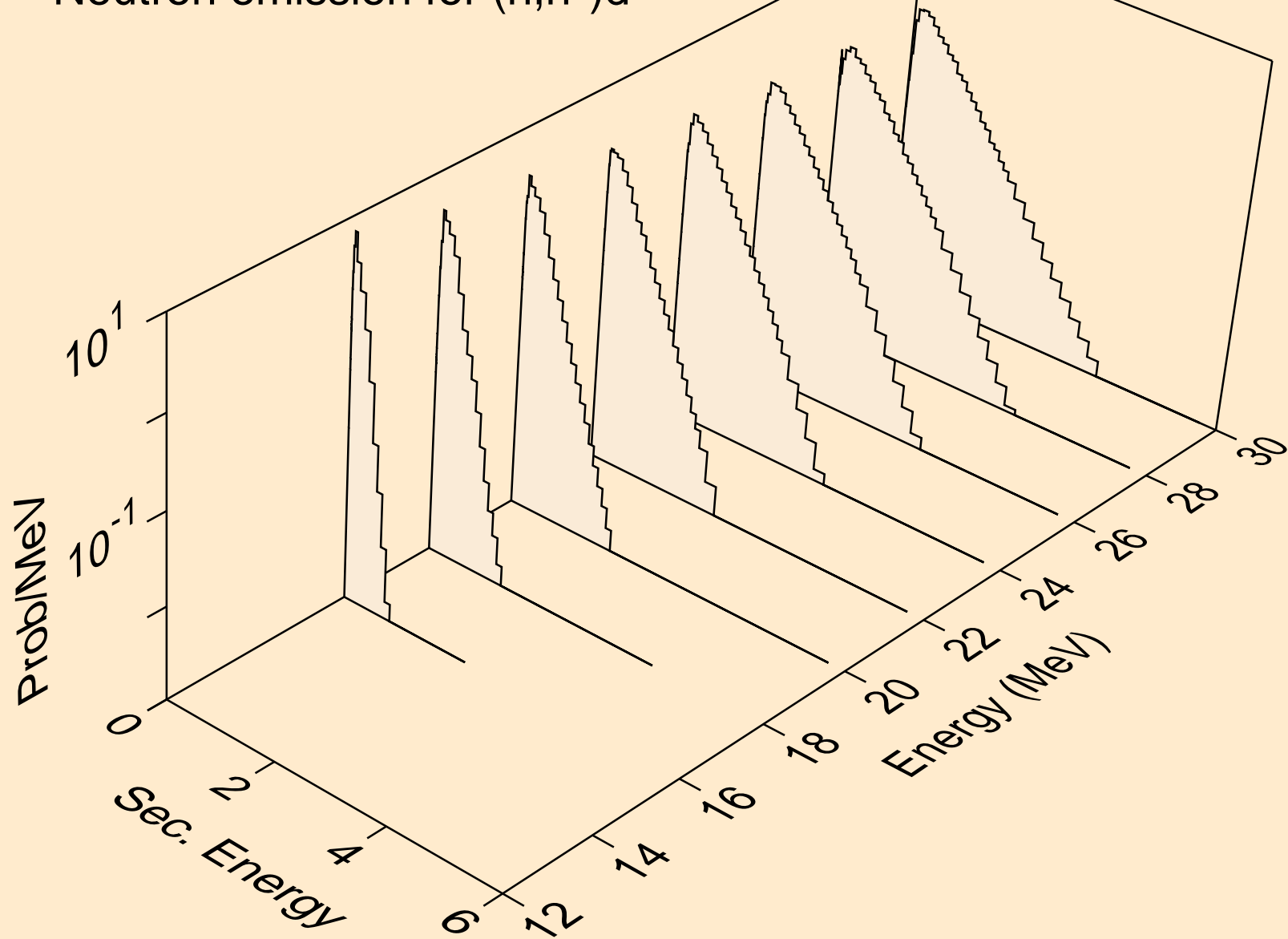

LU187 NEUTRON ACER TENDL-2024 LIBRARY; T=293.6K
Neutron emission for (n,n*)t

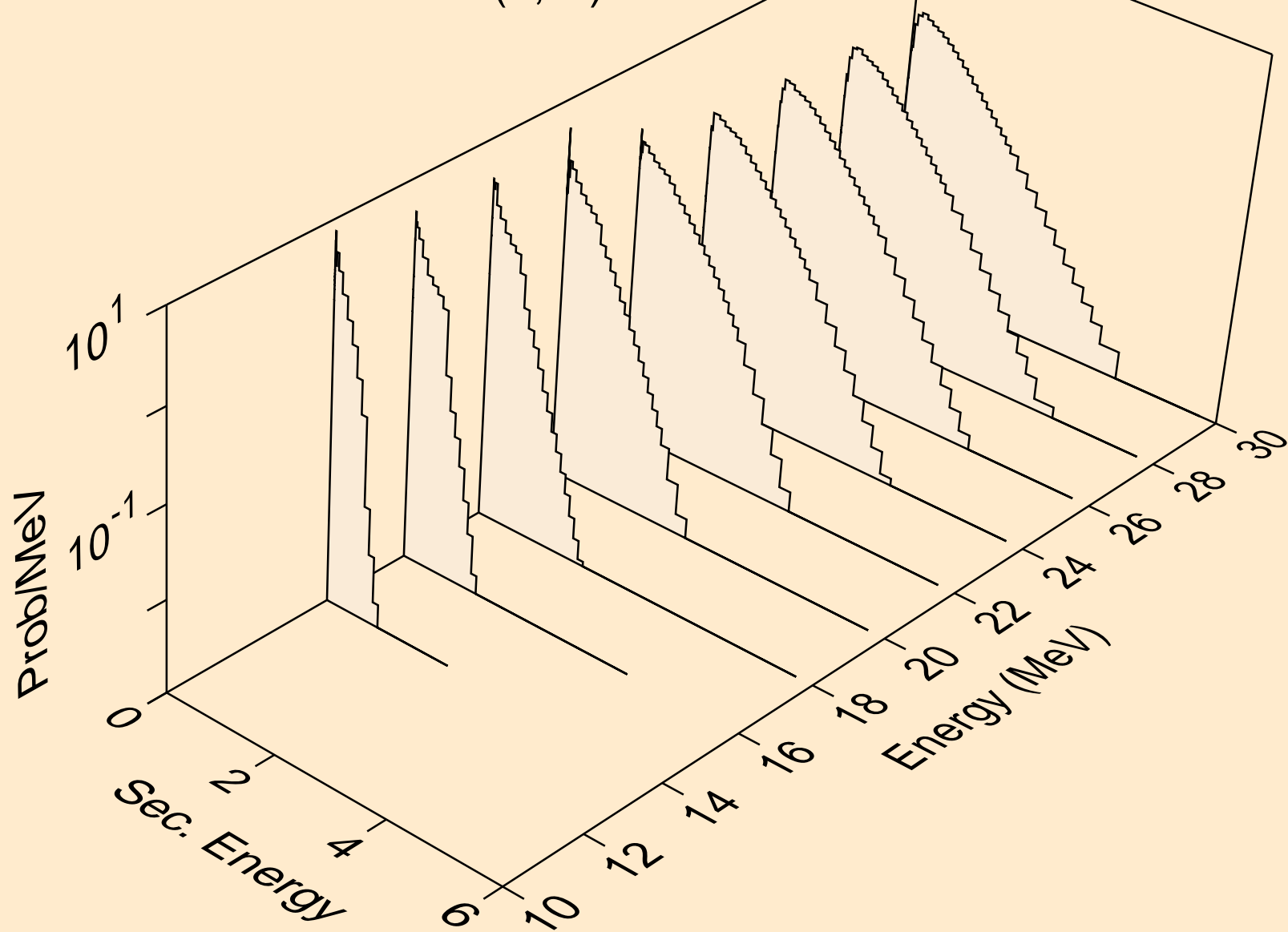

LU187 NEUTRON ACER TENDL-2024 LIBRARY; T=293.6K
Neutron emission for (n,n*)he3

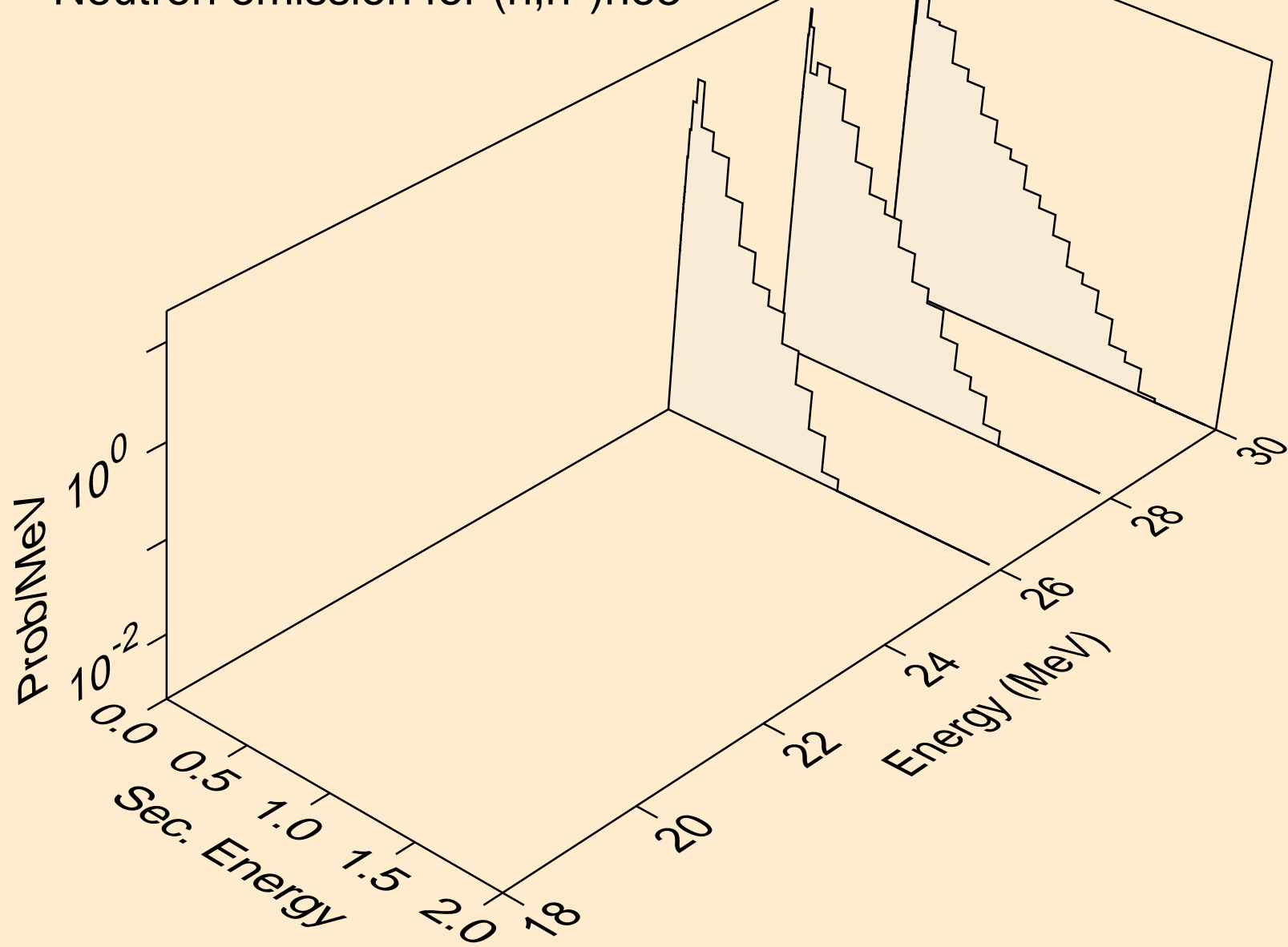

LU187 NEUTRON ACER TENDL-2024 LIBRARY; T=293.6K
Neutron emission for (n,4n)

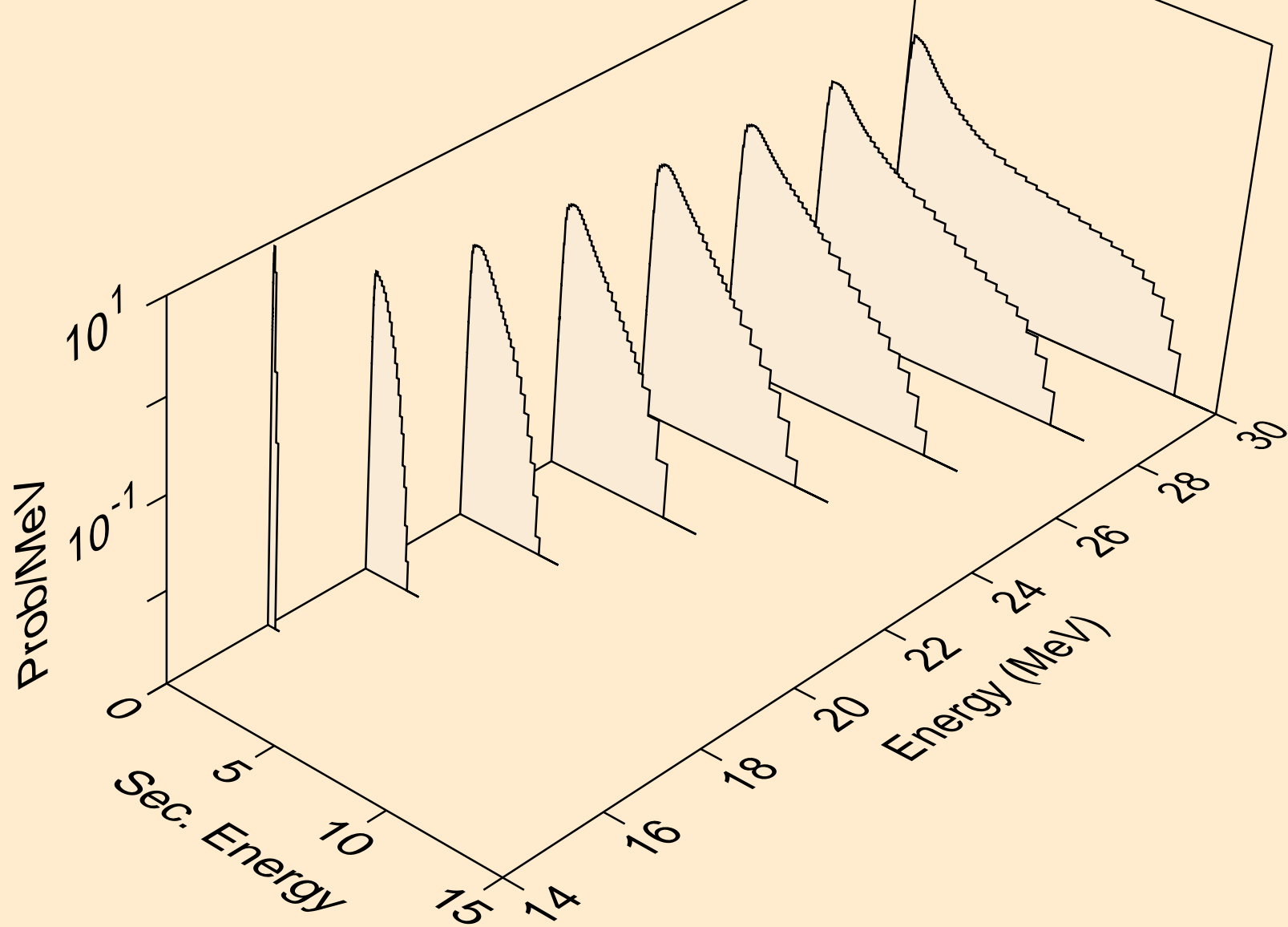

LU187 NEUTRON ACER TENDL-2024 LIBRARY; T=293.6K
Neutron emission for (n,2np)

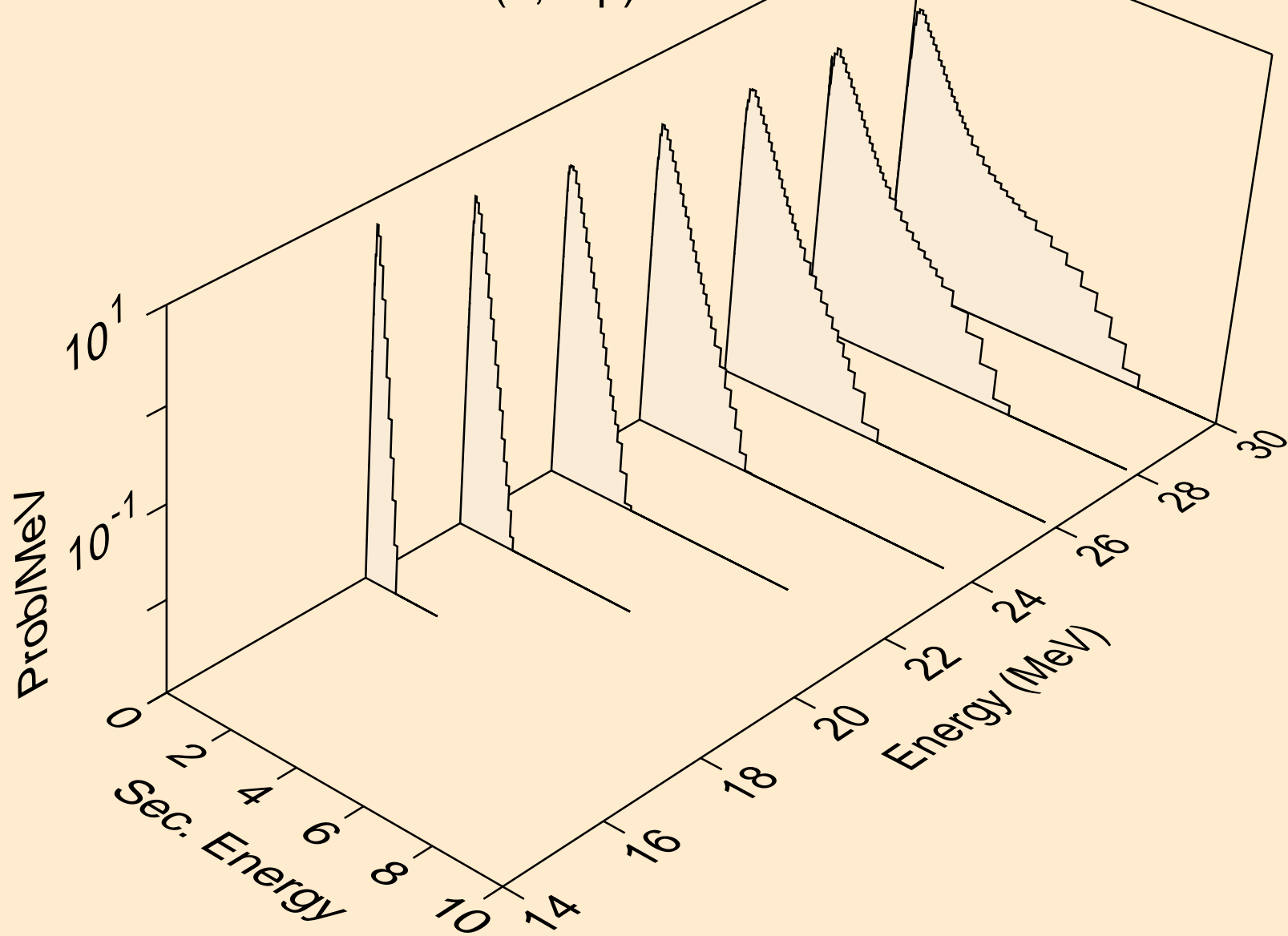

LU187 NEUTRON ACER TENDL-2024 LIBRARY; T=293.6K
Neutron emission for (n,3np)

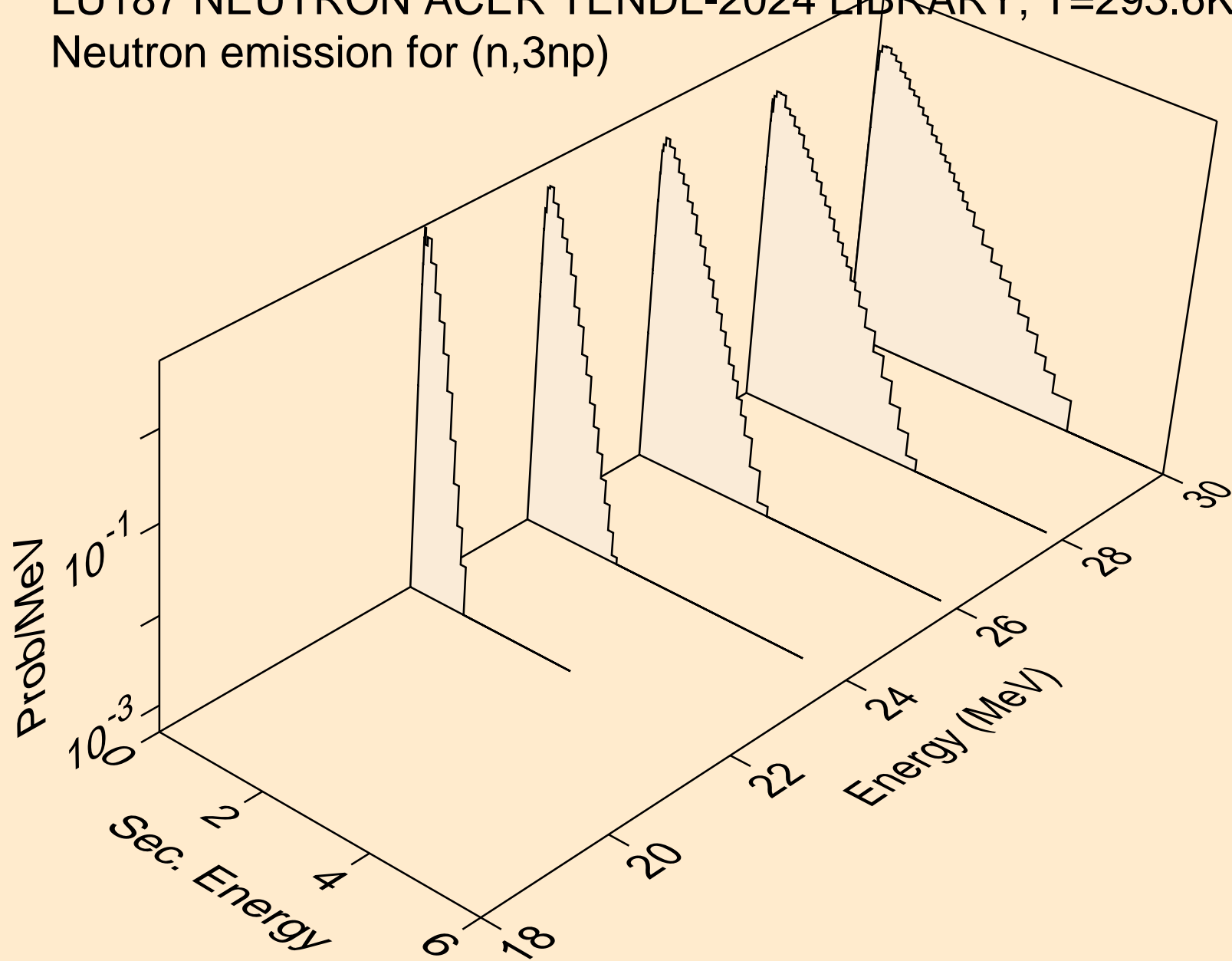

LU187 NEUTRON ACER TENDL-2024 LIBRARY; T=293.6K
Neutron emission for (n,n*c)

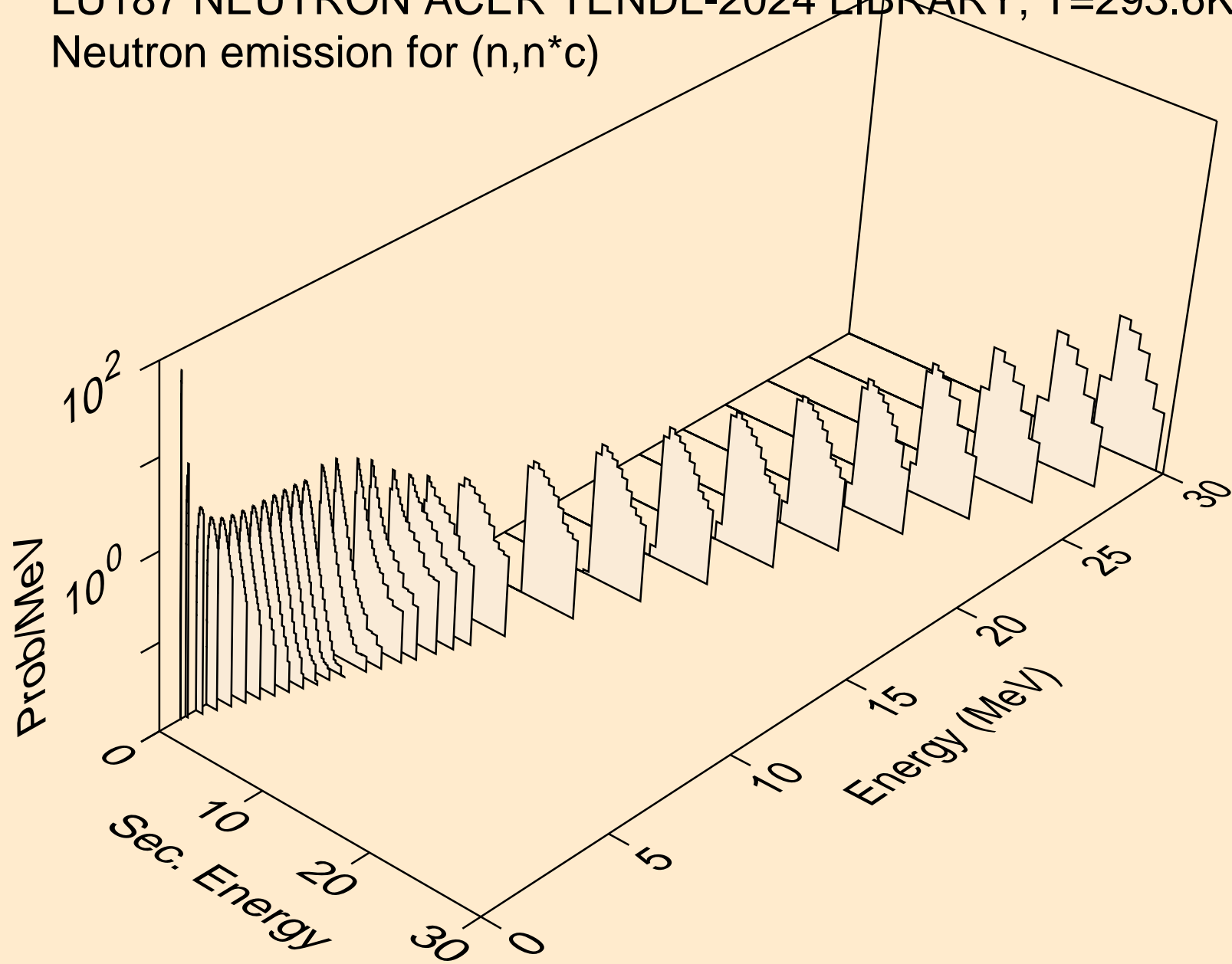

LU187 NEUTRON ACER TENDL-2024 LIBRARY; T=293.6K
Photon emission for (n,x)

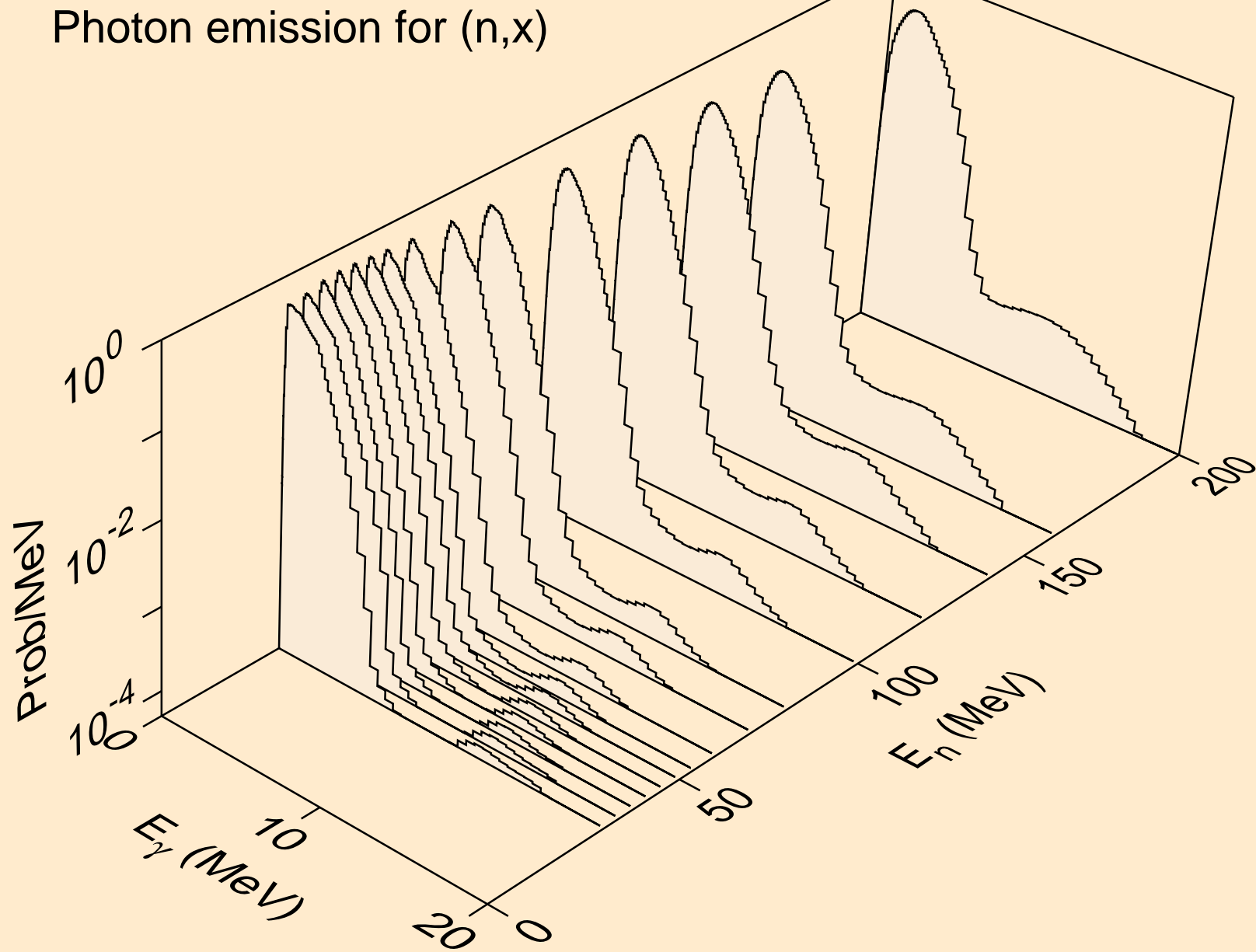

LU187 NEUTRON ACER TENDL-2024 LIBRARY; T=293.6K
Photon emission for (n,2nd)

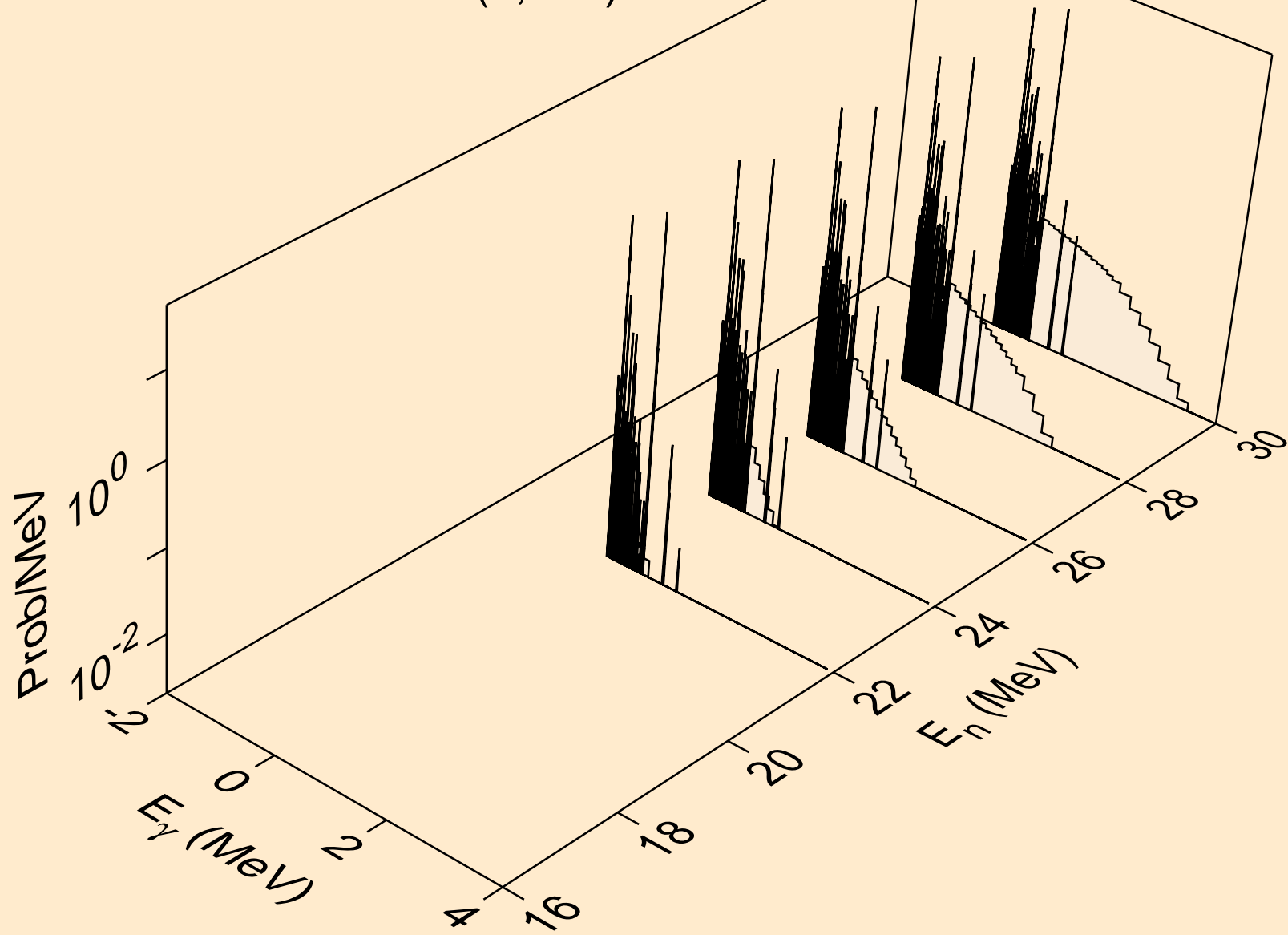

LU187 NEUTRON ACER TENDL-2024 LIBRARY; T=293.6K
Photon emission for (n,2n)

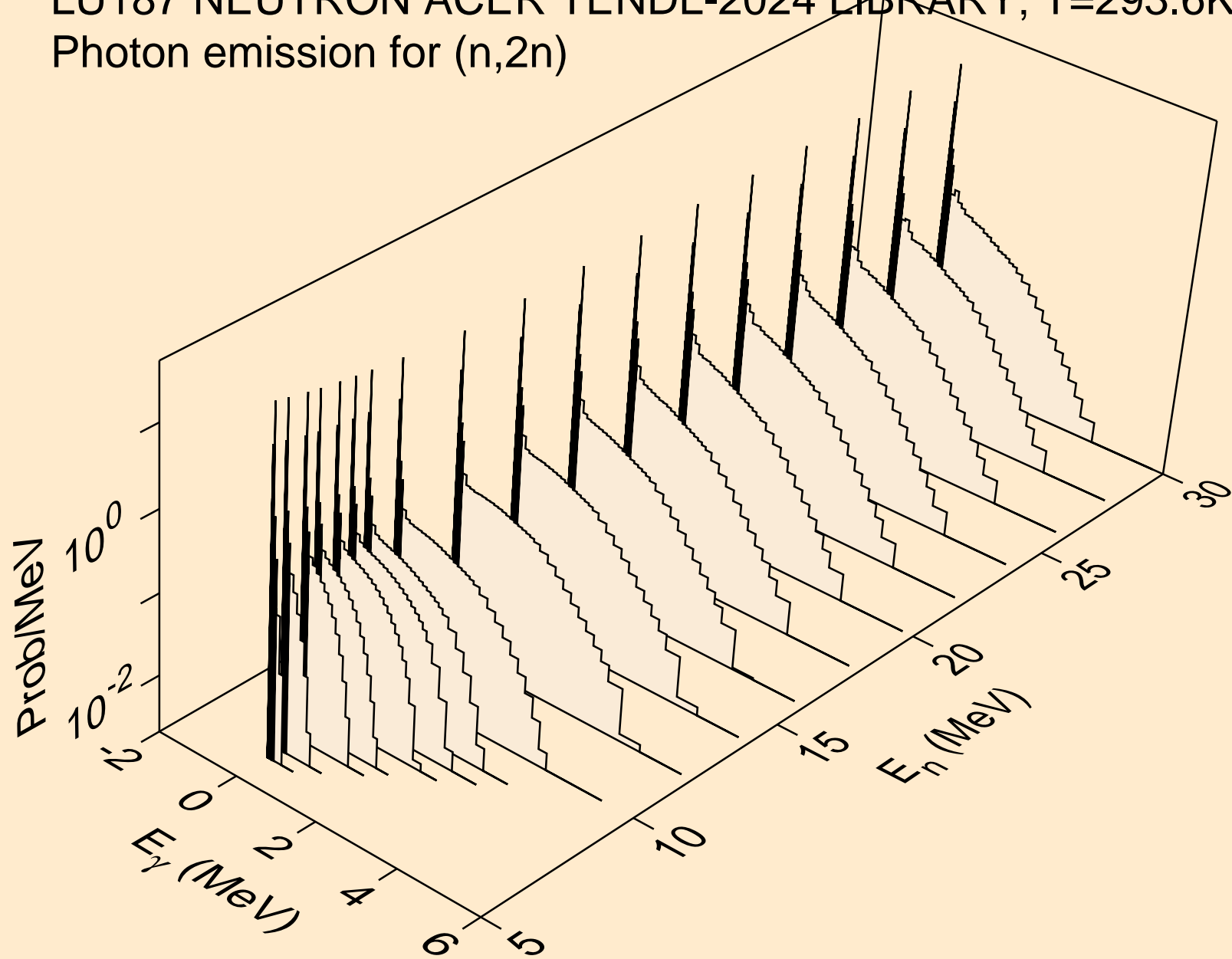

LU187 NEUTRON ACER TENDL-2024 LIBRARY; T=293.6K
Photon emission for (n,3n)

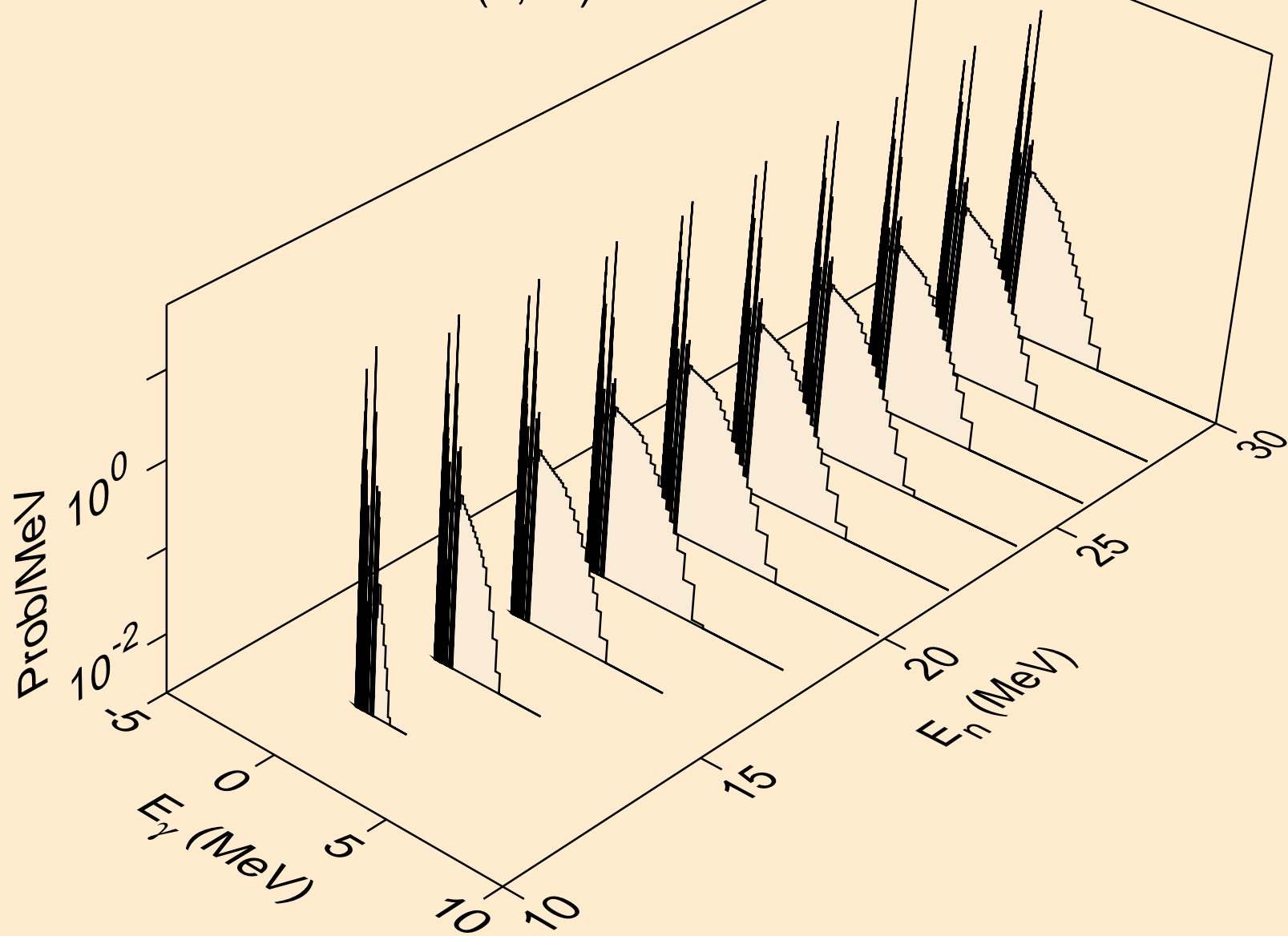

LU187 NEUTRON ACER TENDL-2024 LIBRARY; T=293.6K
Photon emission for (n,n*)a

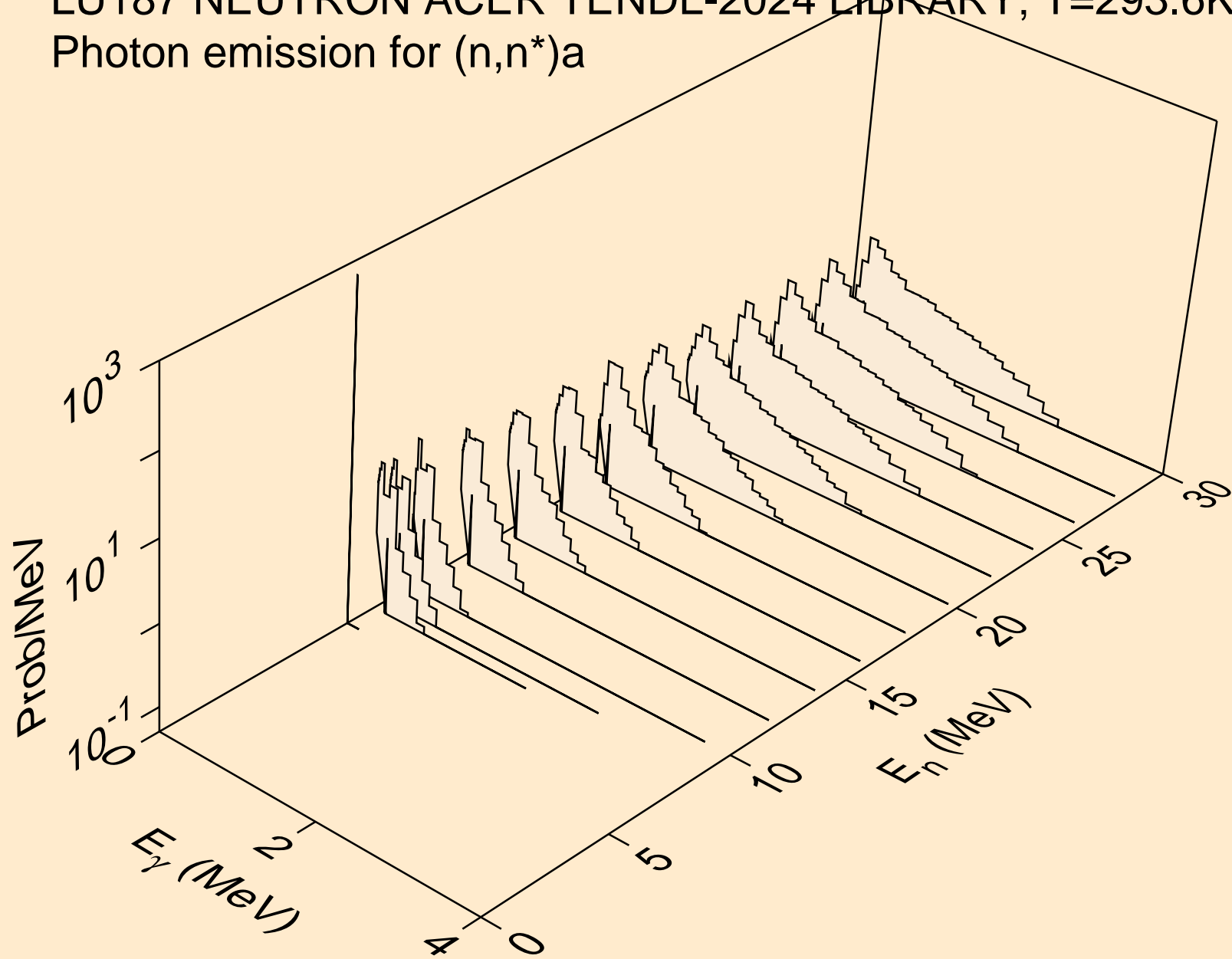

LU187 NEUTRON ACER TENDL-2024 LIBRARY; T=293.6K
Photon emission for (n,2n)a

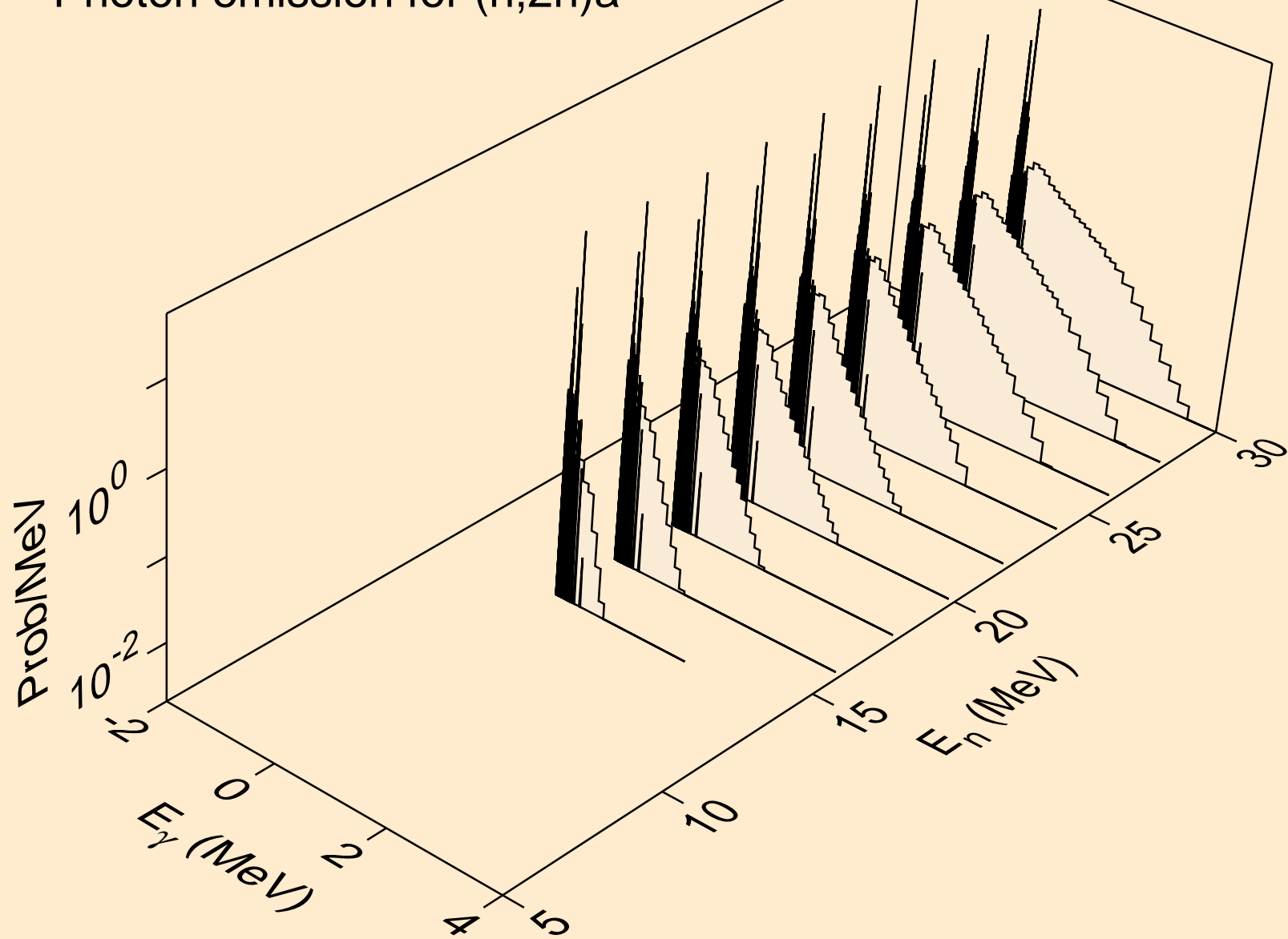

LU187 NEUTRON ACER TENDL-2024 LIBRARY; T=293.6K
Photon emission for (n,3n)a

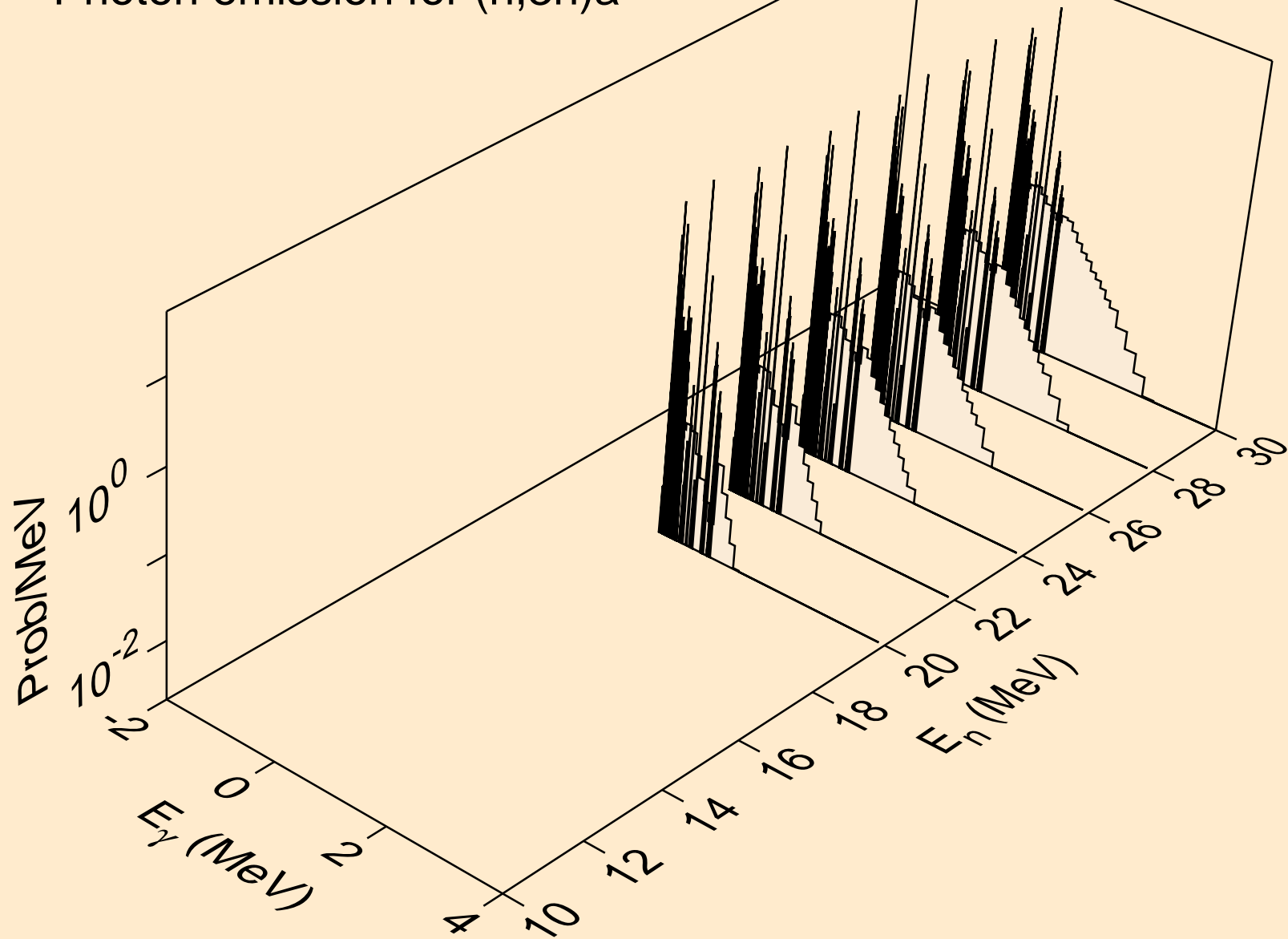

LU187 NEUTRON ACER TENDL-2024 LIBRARY; T=293.6K
Photon emission for (n,n*)p

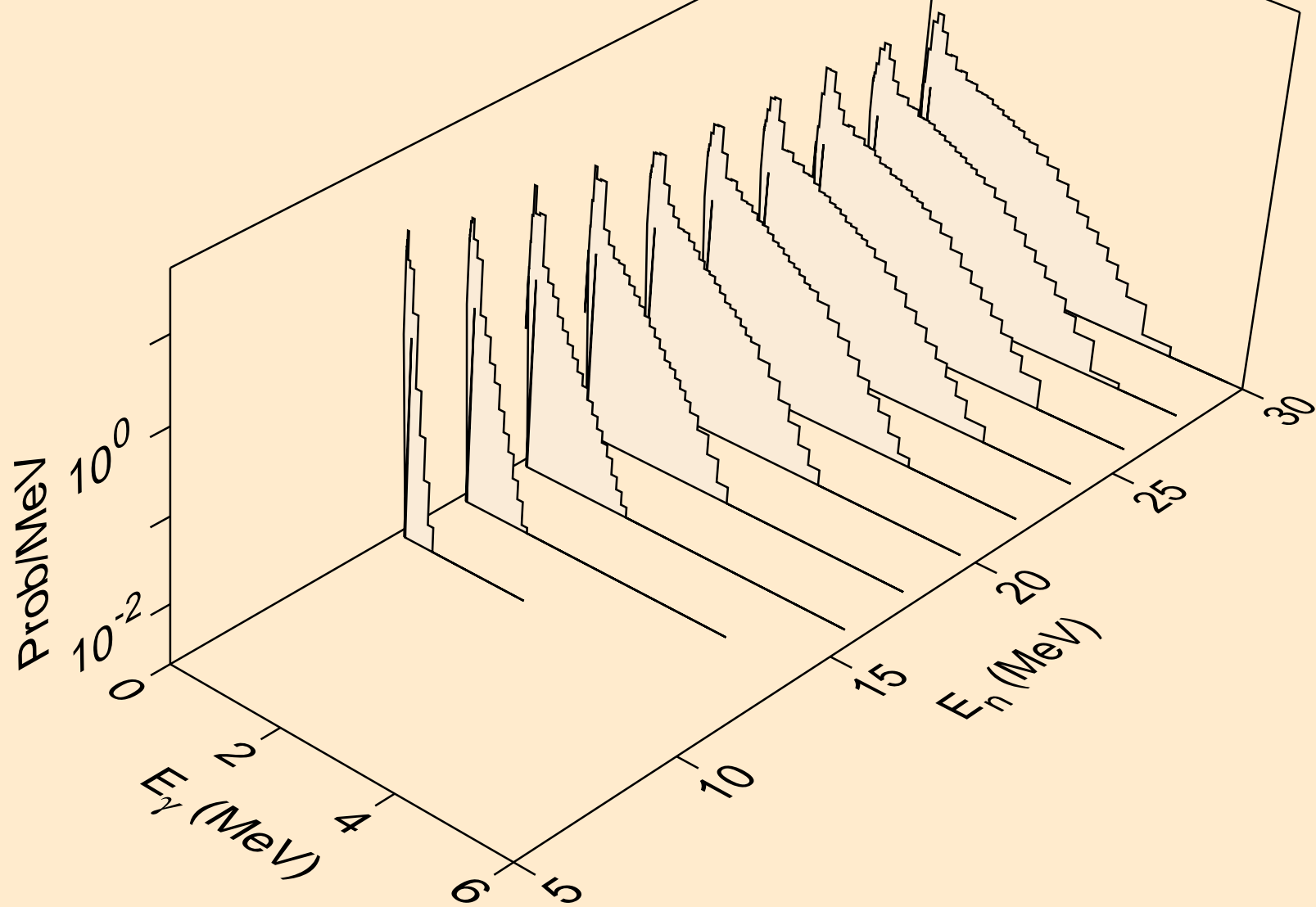

LU187 NEUTRON ACER TENDL-2024 LIBRARY; T=293.6K
Photon emission for (n,n*)d

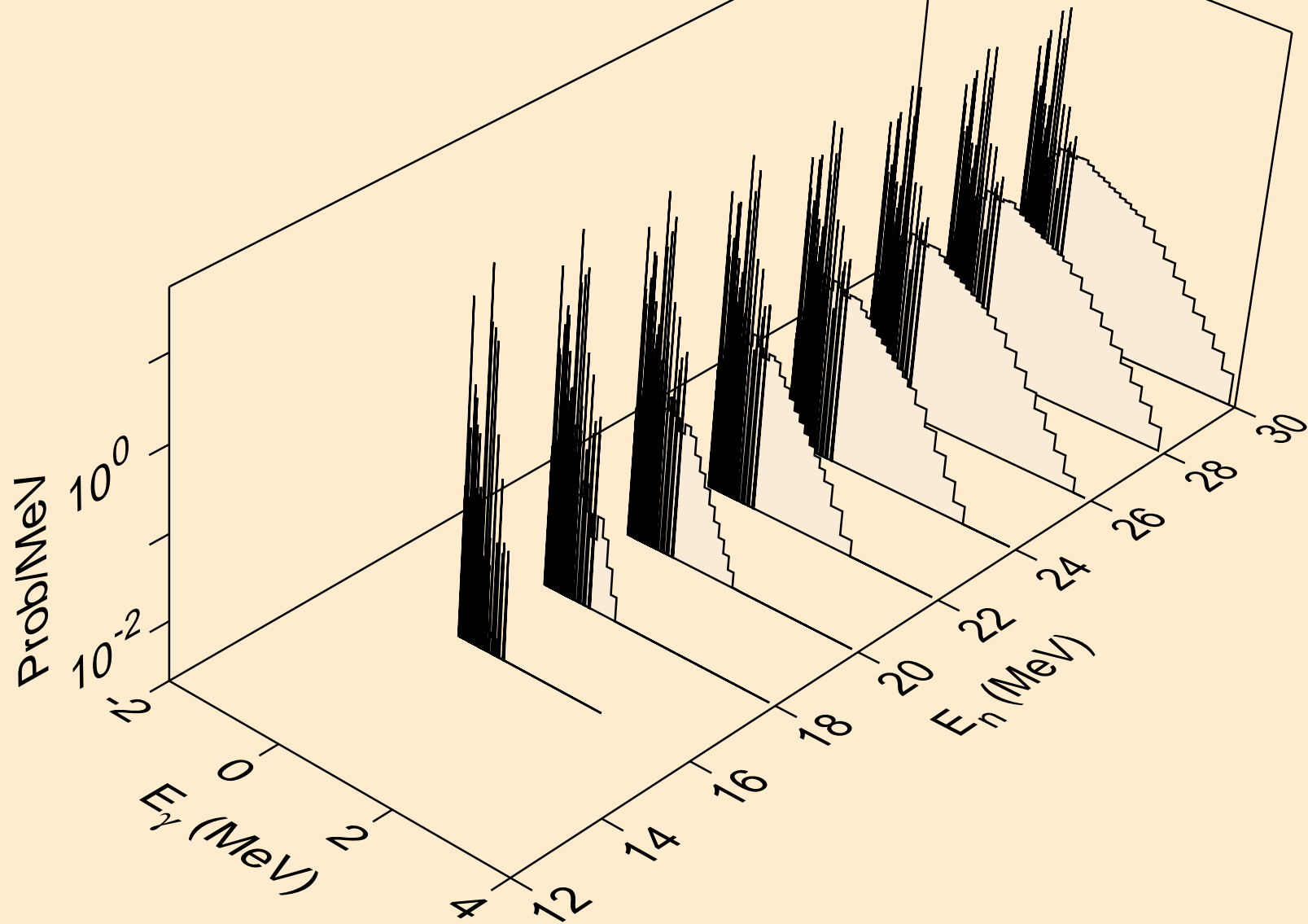

LU187 NEUTRON ACER TENDL-2024 LIBRARY; T=293.6K
Photon emission for (n,n*)t

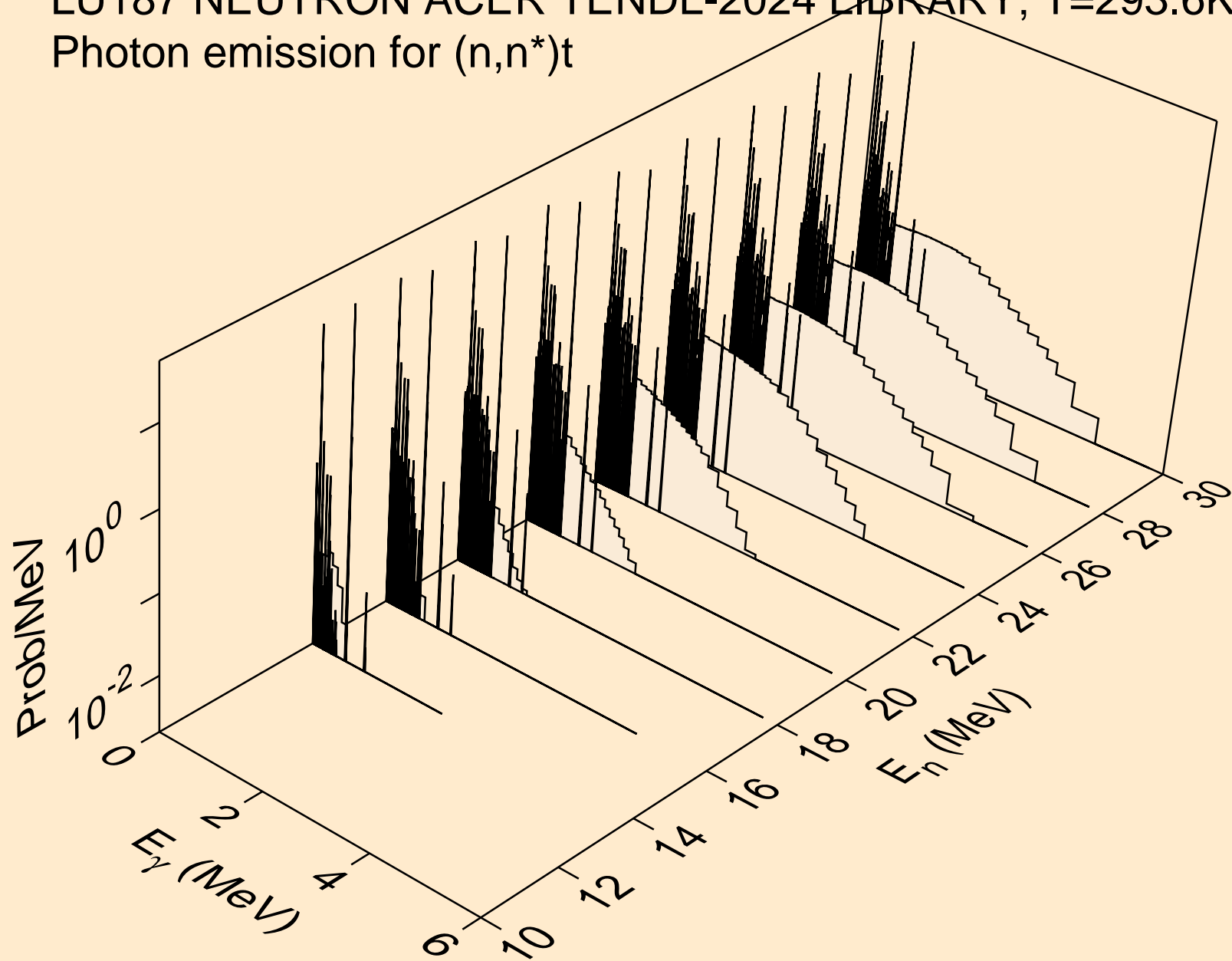

LU187 NEUTRON ACER TENDL-2024 LIBRARY; T=293.6K
Photon emission for (n,n*)he3

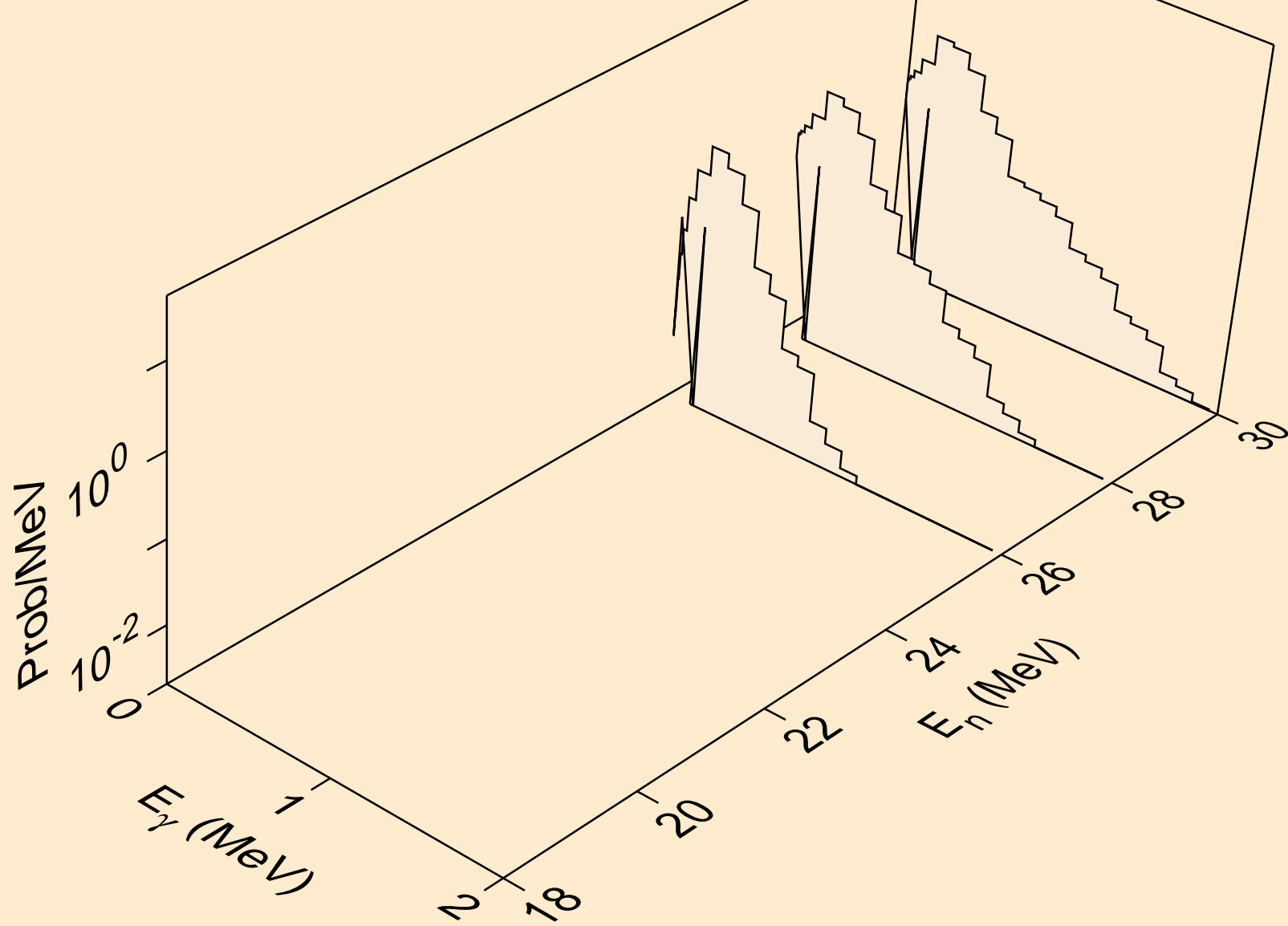

LU187 NEUTRON ACER TENDL-2024 LIBRARY; T=293.6K
Photon emission for (n,4n)

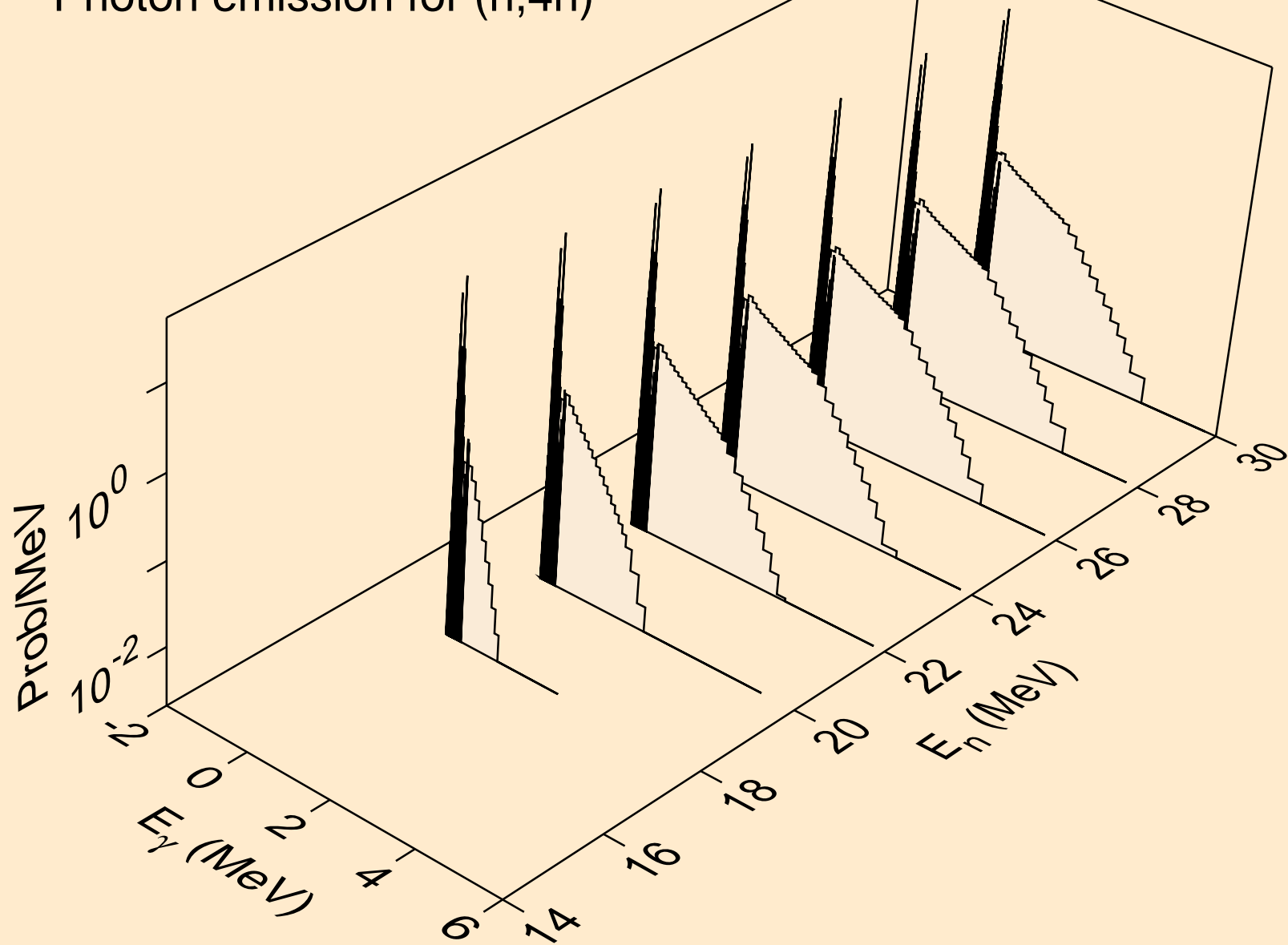

LU187 NEUTRON ACER TENDL-2024 LIBRARY; T=293.6K
Photon emission for (n,2np)

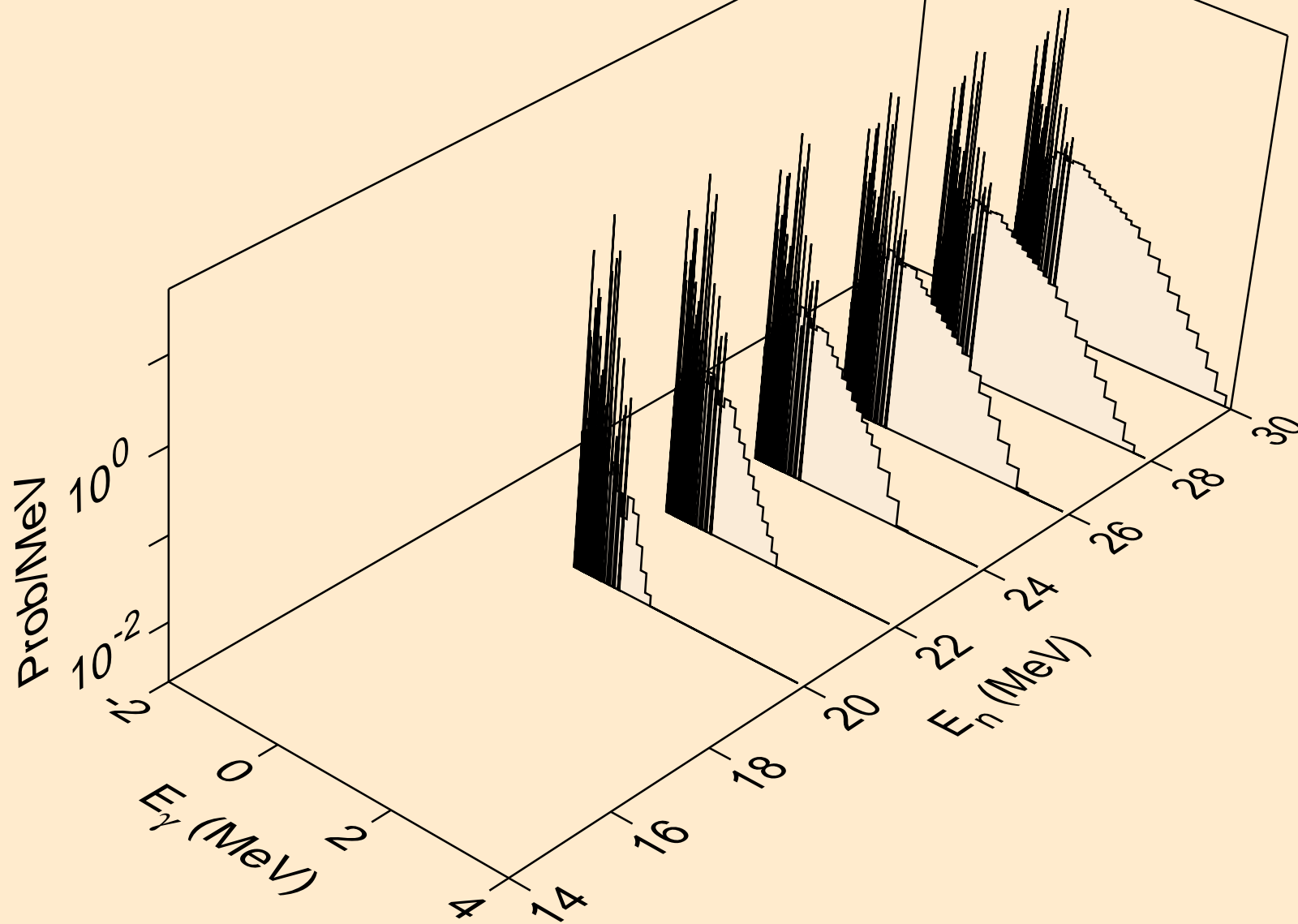

LU187 NEUTRON ACER TENDL-2024 LIBRARY; T=293.6K
Photon emission for (n,3np)

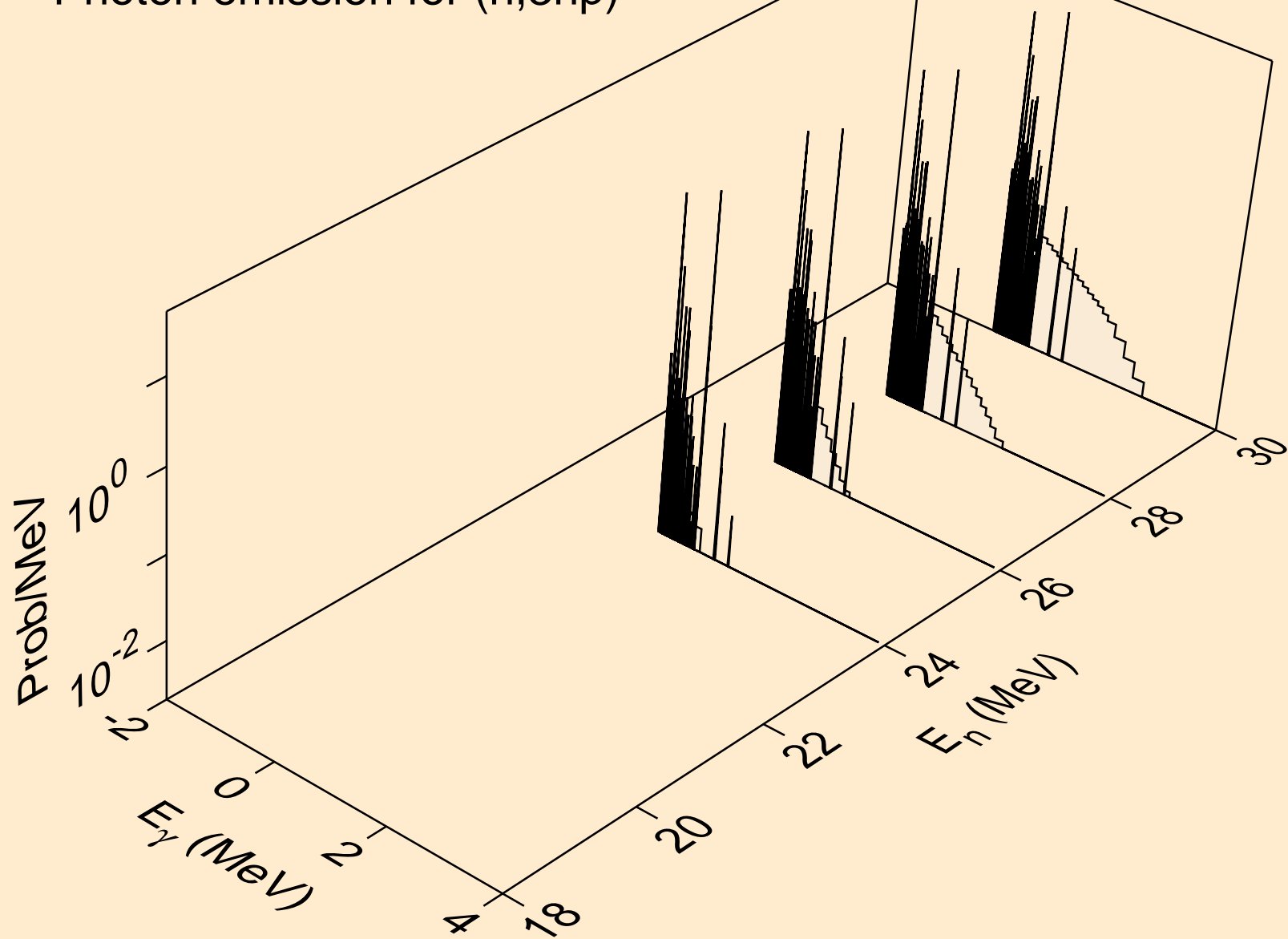

LU187 NEUTRON ACER TENDL-2024 LIBRARY; T=293.6K
Photon emission for (n,n*c)

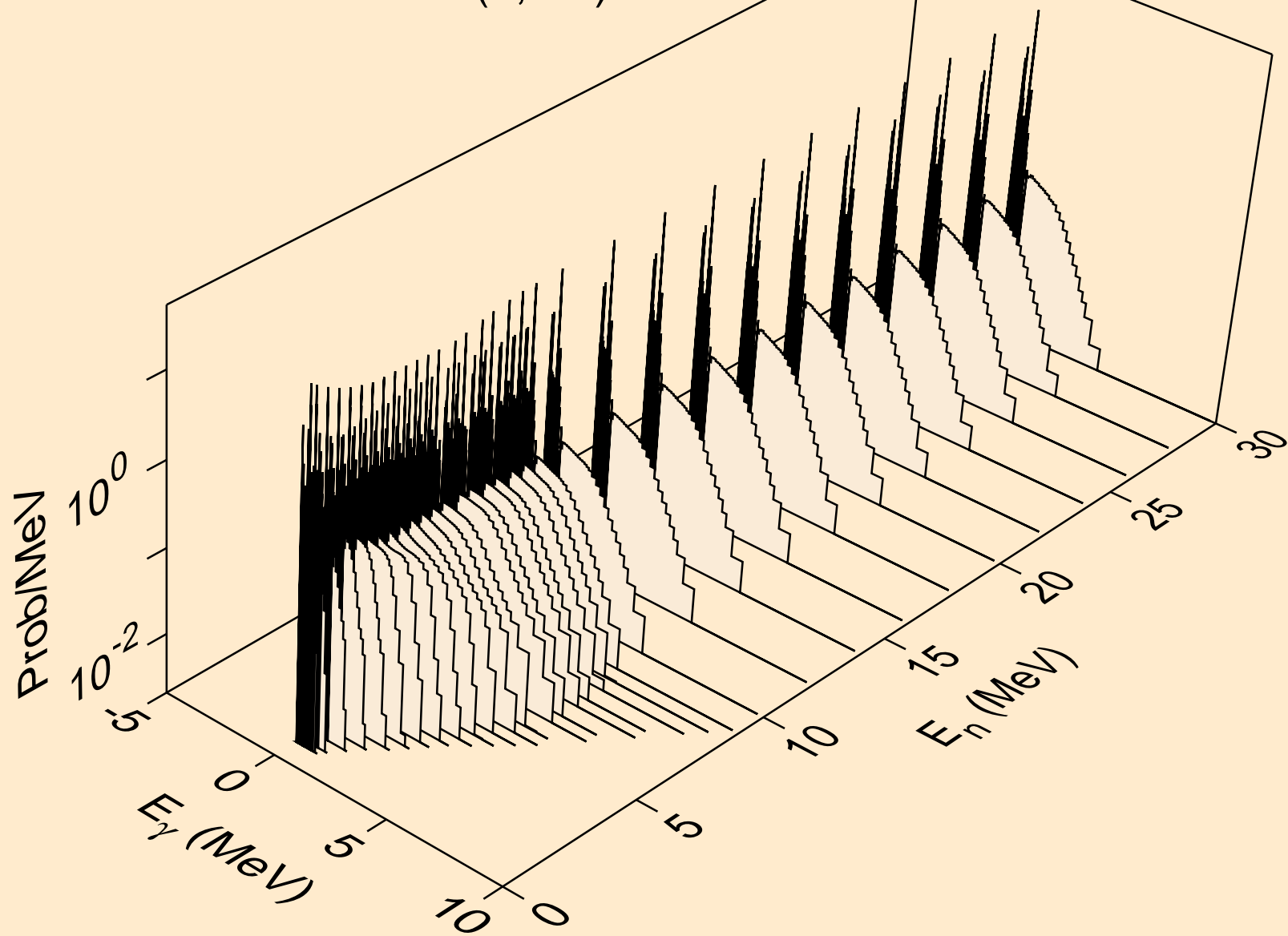

LU187 NEUTRON ACER TENDL-2024 LIBRARY; T=293.6K
Photon emission for (n,gma)

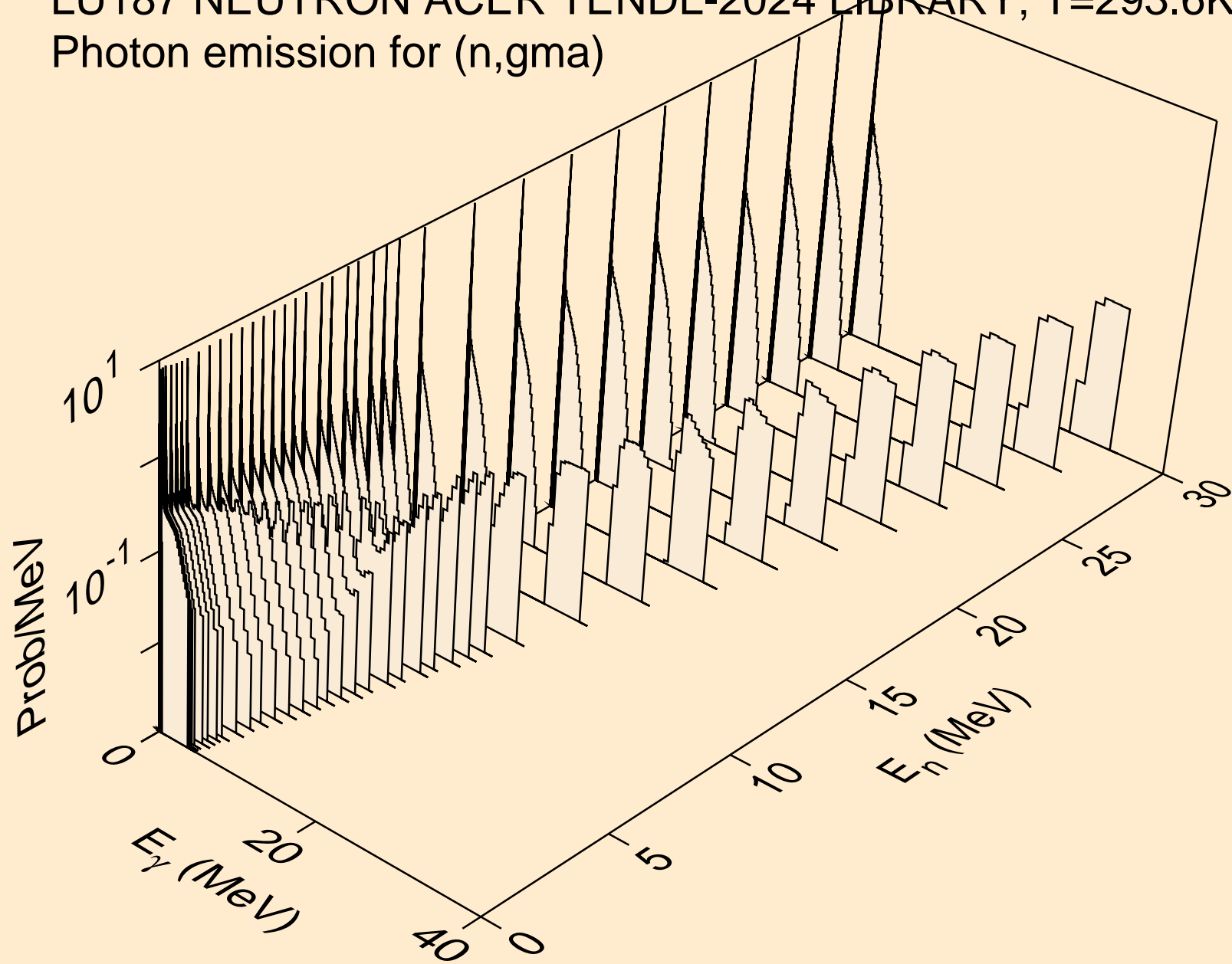

LU187 NEUTRON ACER TENDL-2024 LIBRARY; T=293.6K
Photon emission for (n,p)

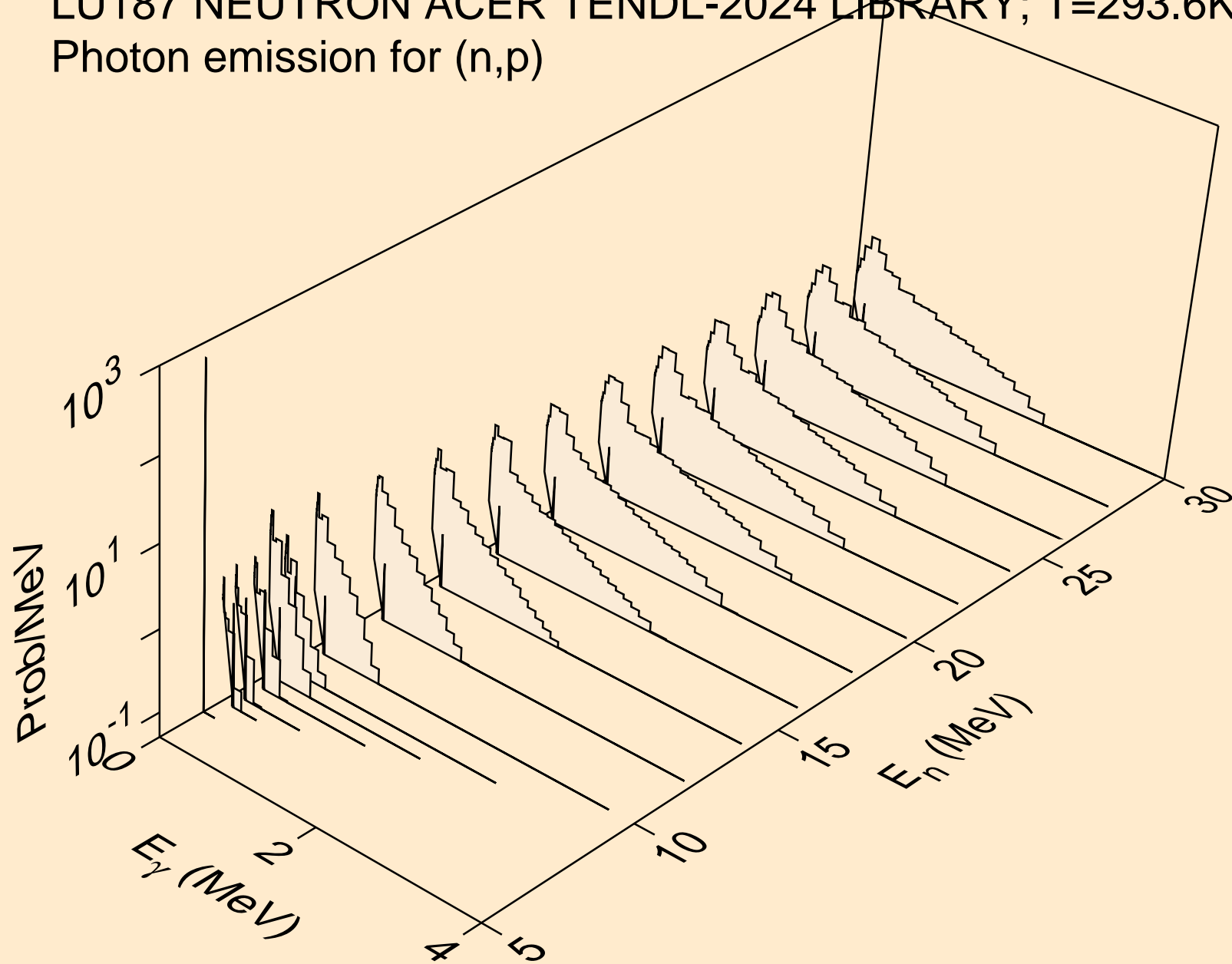

LU187 NEUTRON ACER TENDL-2024 LIBRARY; T=293.6K
Photon emission for (n,d)

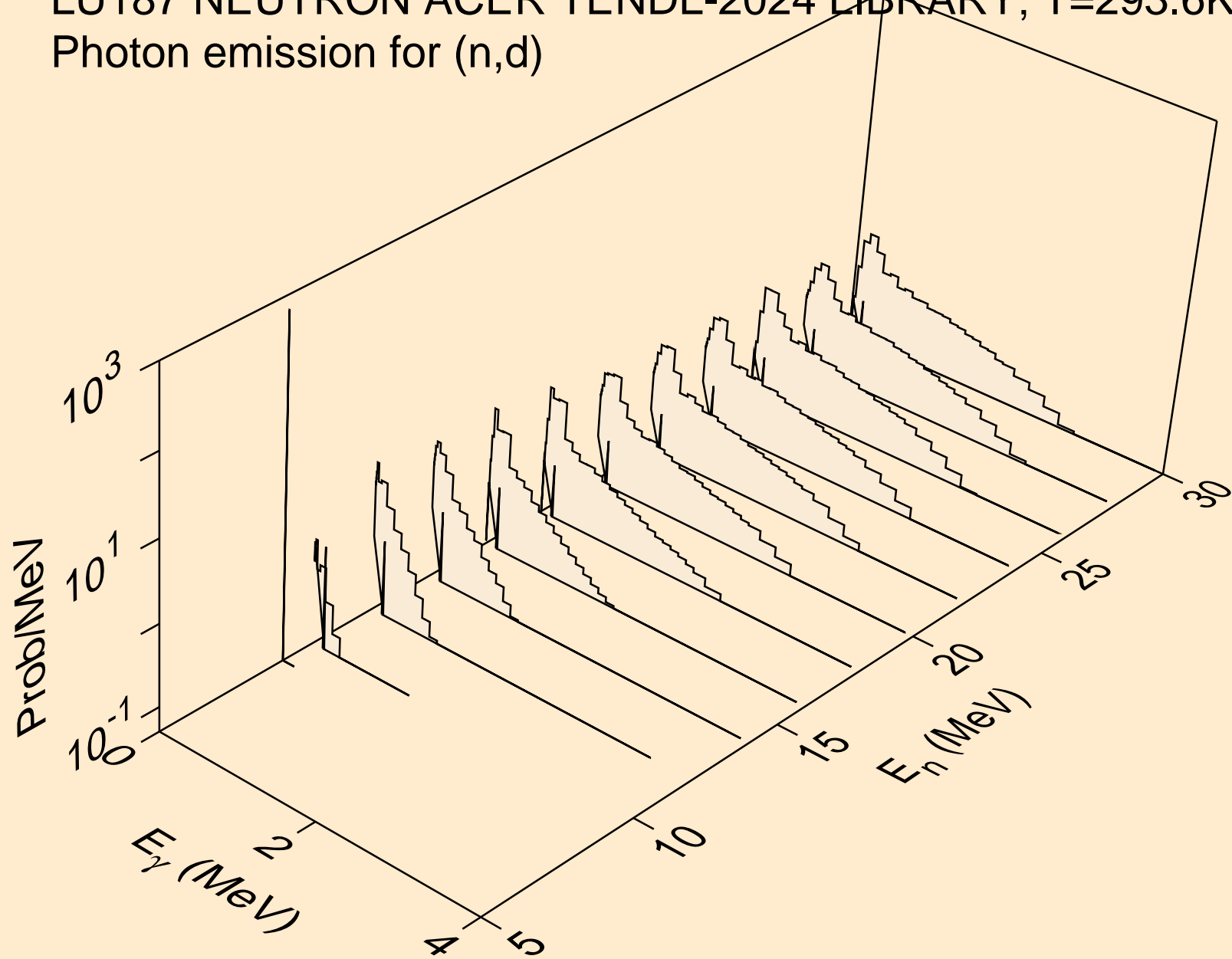

LU187 NEUTRON ACER TENDL-2024 LIBRARY; T=293.6K
Photon emission for (n,t)

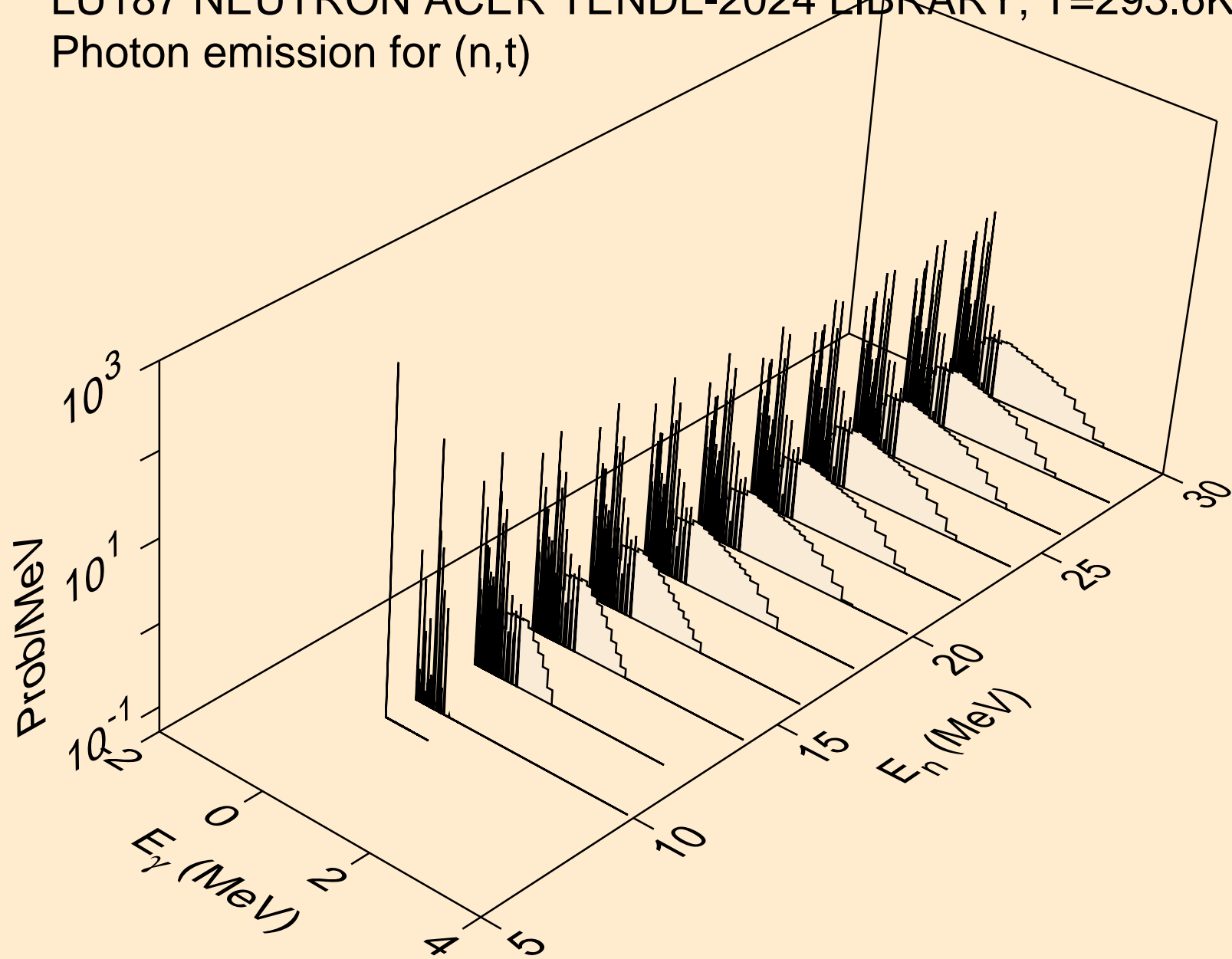

LU187 NEUTRON ACER TENDL-2024 LIBRARY; T=293.6K
Photon emission for (n,he3)

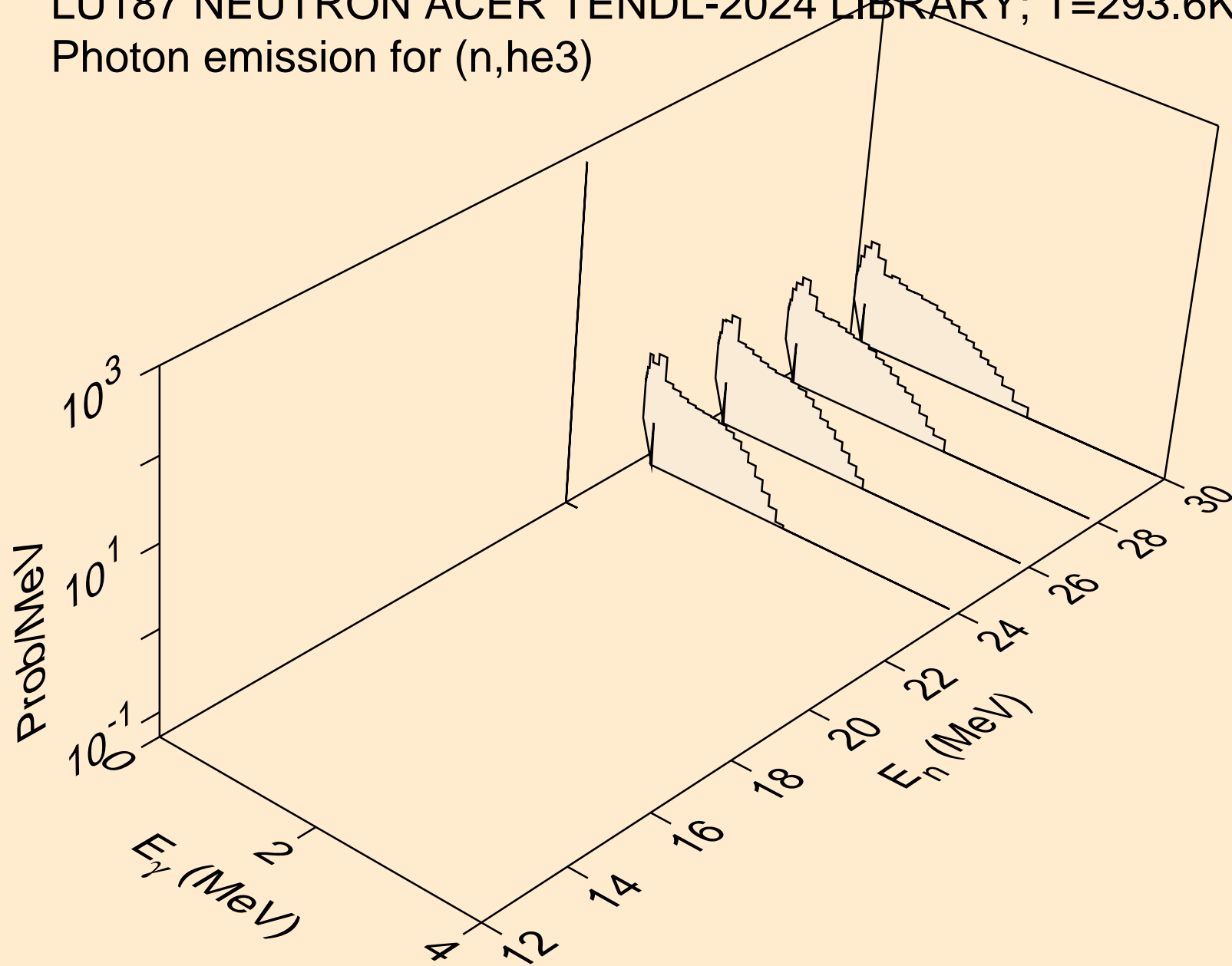

LU187 NEUTRON ACER TENDL-2024 LIBRARY; T=293.6K
Photon emission for (n,a)

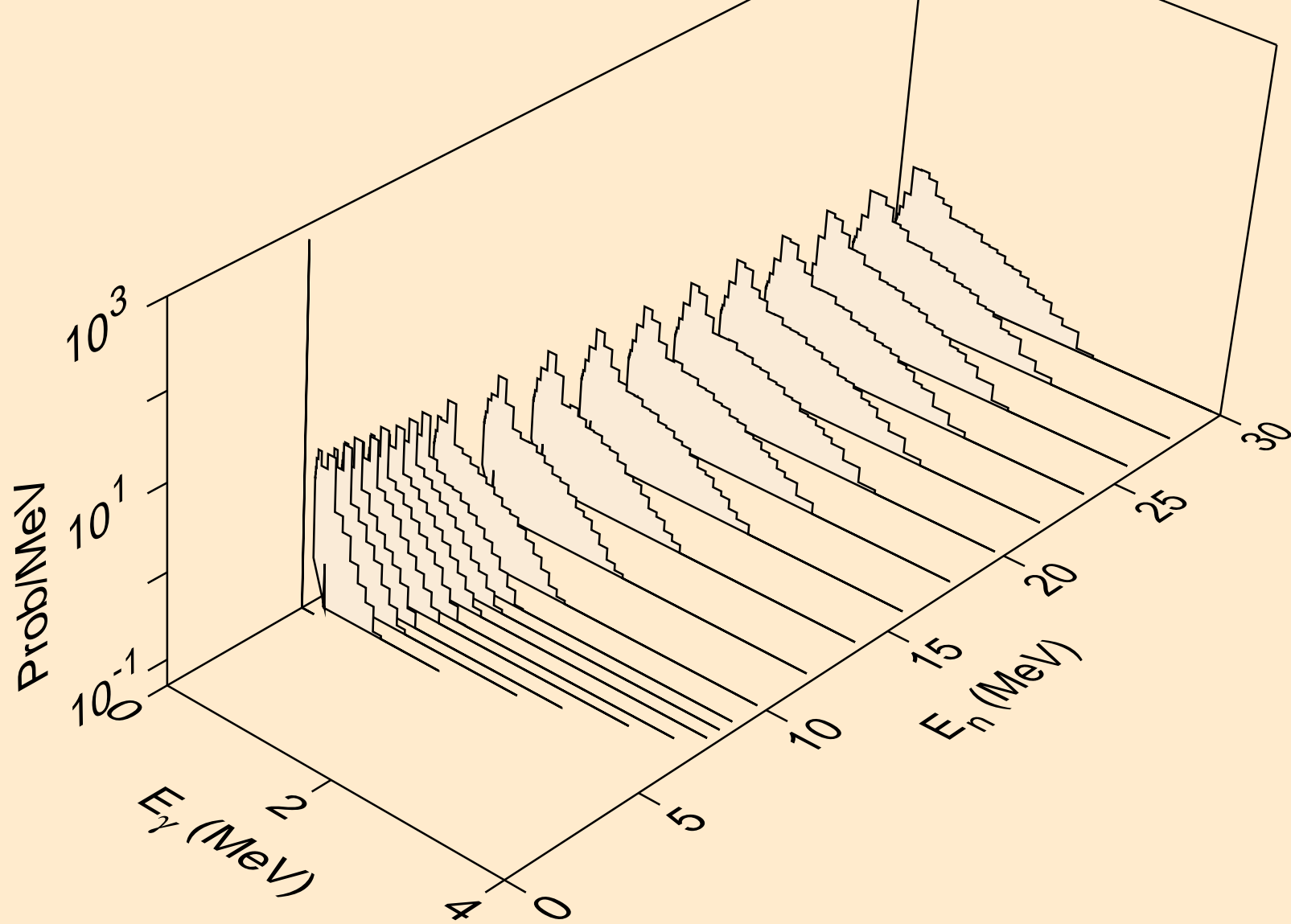

LU187 NEUTRON ACER TENDL-2024 LIBRARY; T=293.6K
thermal capture photon spectrum

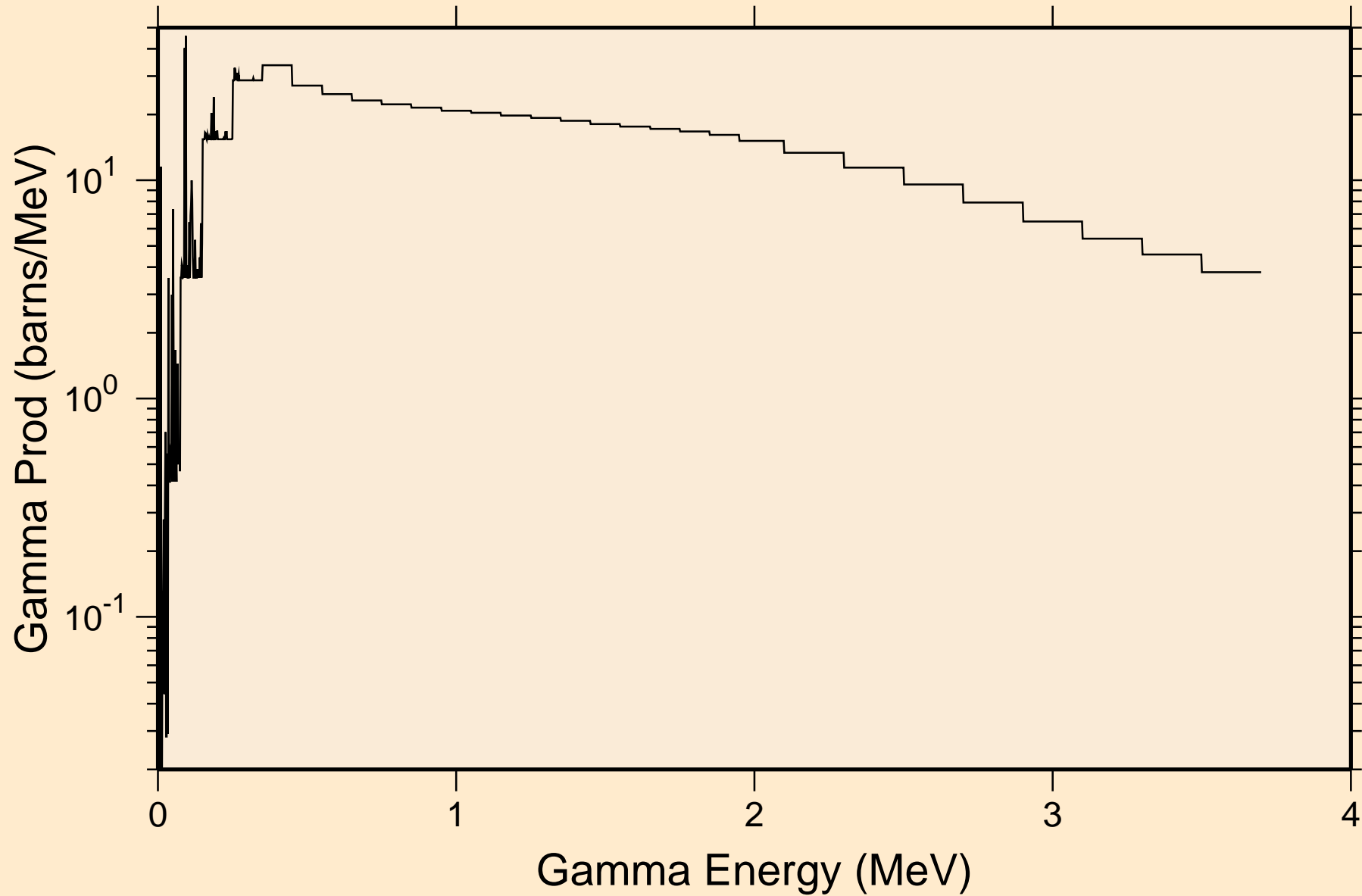

LU187 NEUTRON ACER TENDL-2024 LIBRARY; T=293.6K
14 MeV photon spectrum

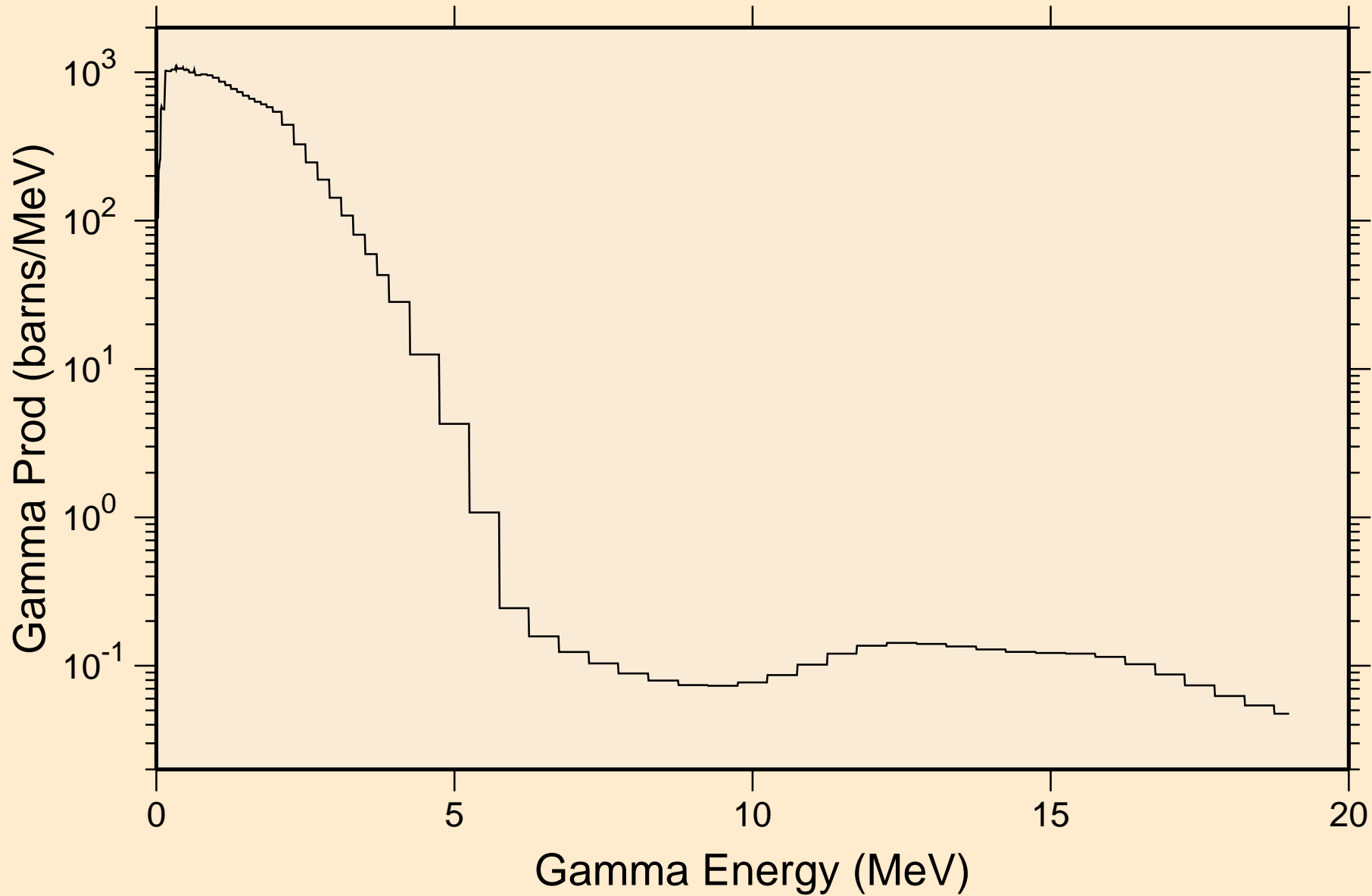

LU187 NEUTRON ACER TENDL-2024 LIBRARY; T=293.6K
Particle heating contributions

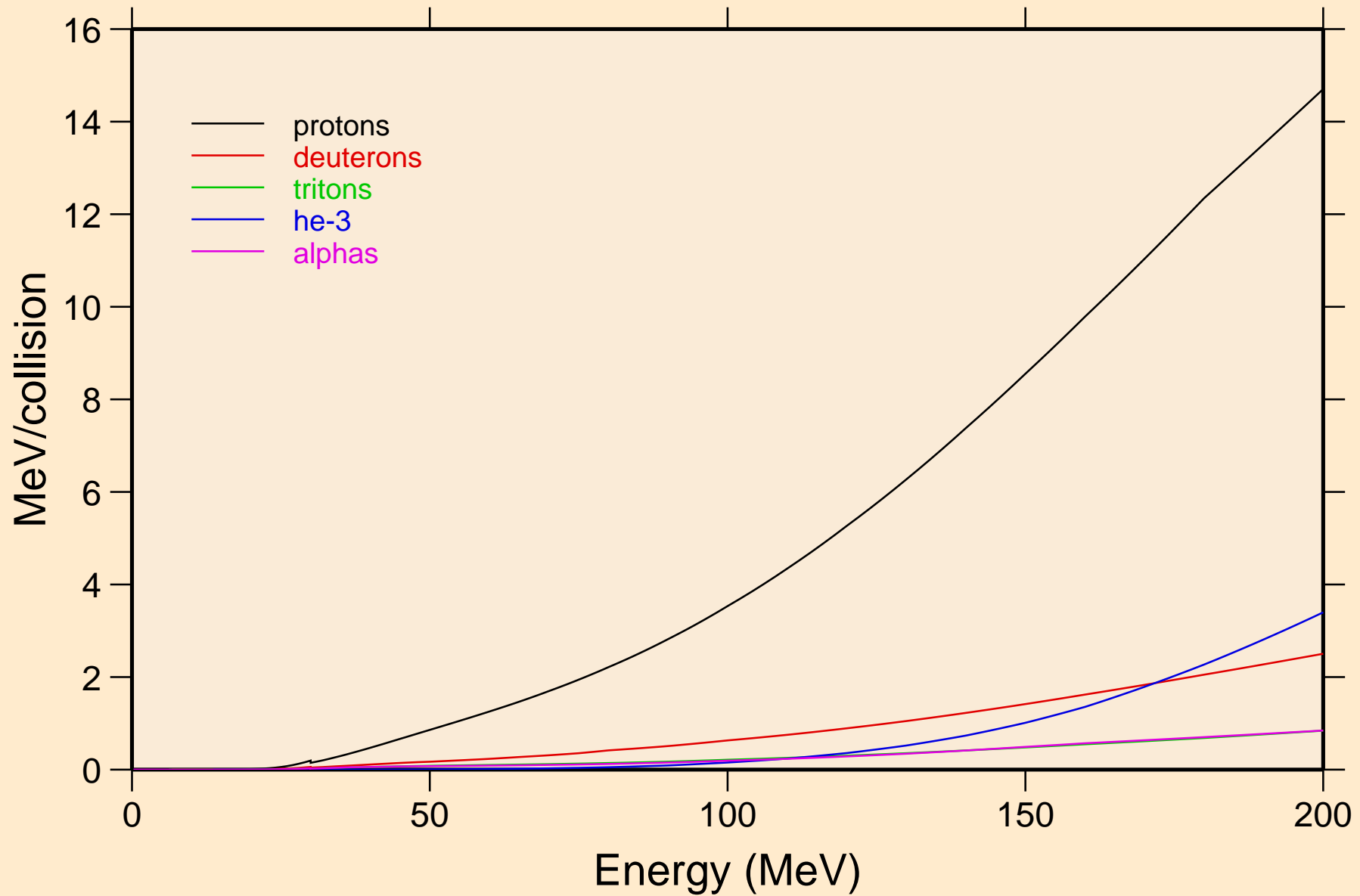

LU187 NEUTRON ACER TENDL-2024 LIBRARY; T=293.6K
Recoil Heating

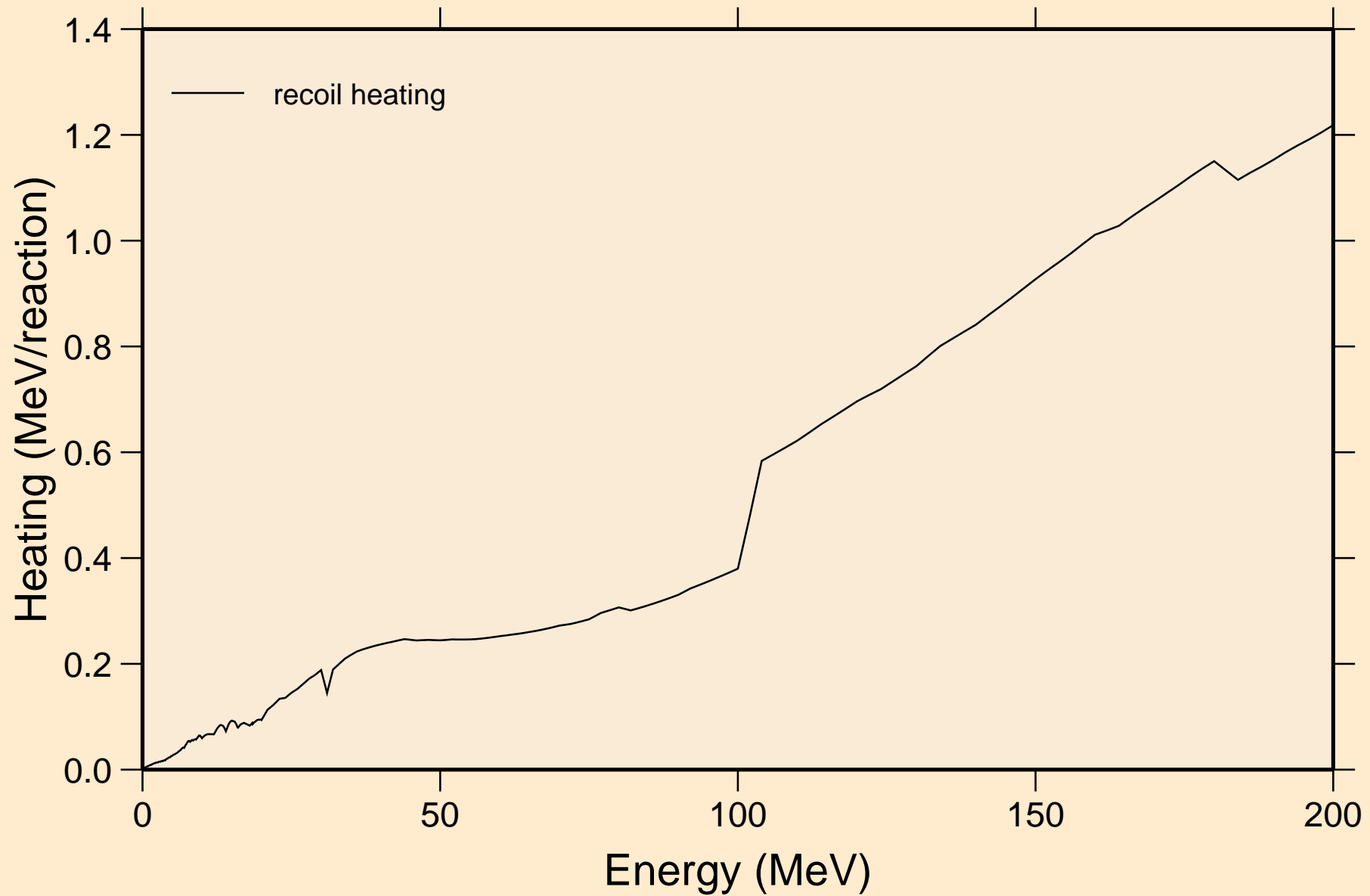

LU187 NEUTRON ACER TENDL-2024 LIBRARY; T=293.6K
Particle production cross sections

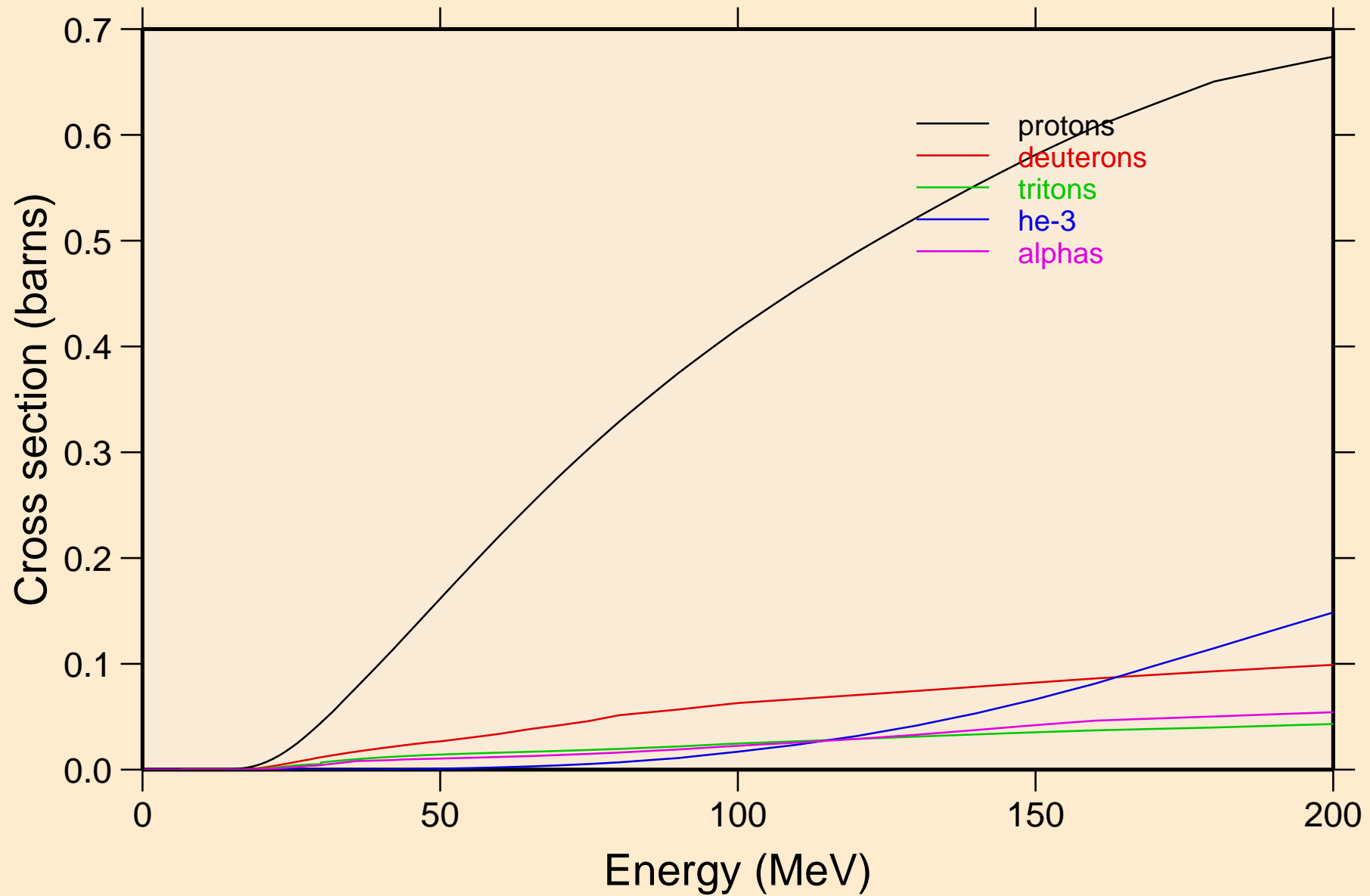

LU187 NEUTRON ACER TENDL-2024 LIBRARY; T=293.6K
protons from (n,x)

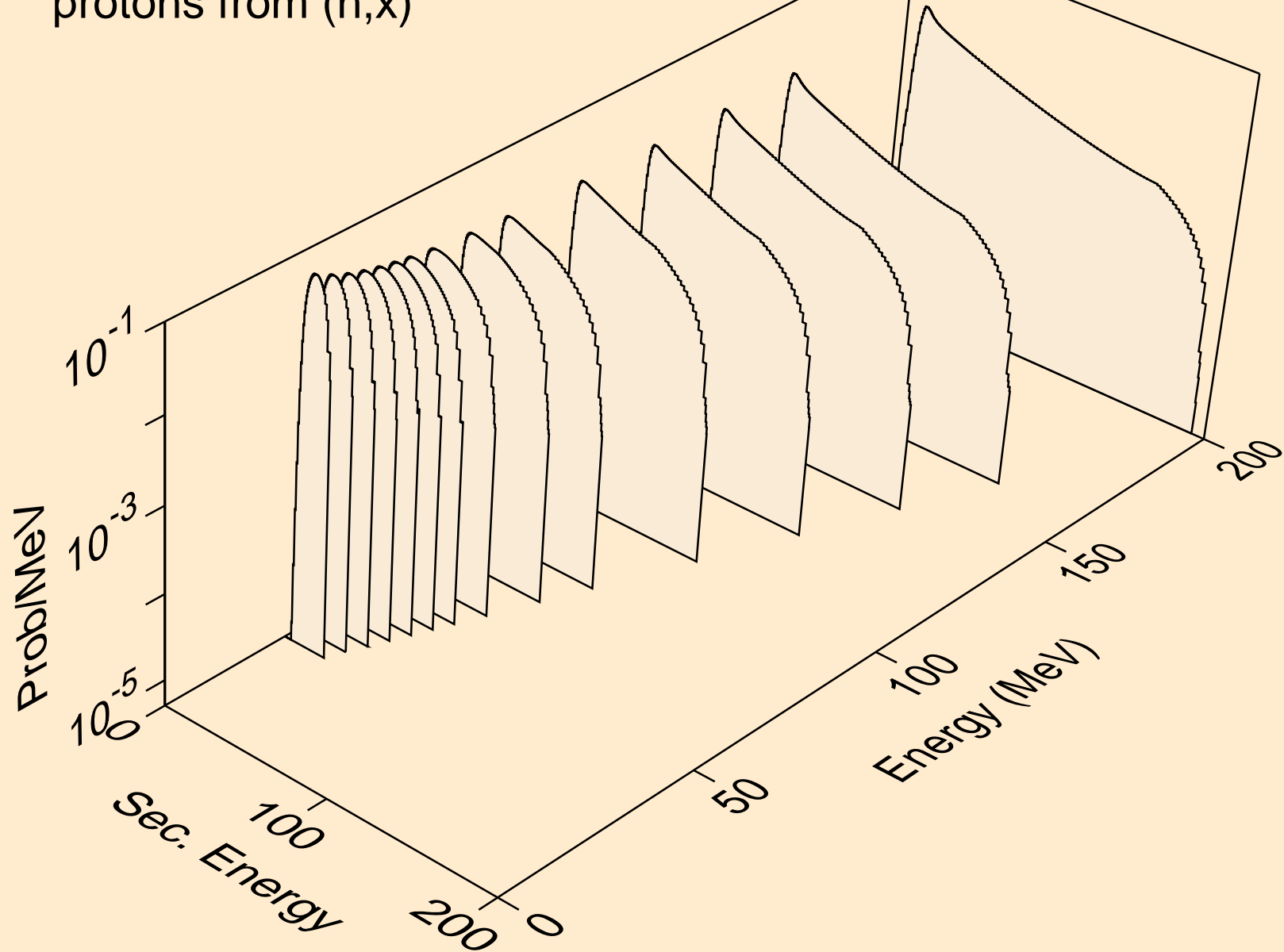

LU187 NEUTRON ACER TENDL-2024 LIBRARY; T=293.6K
protons from (n,n*)p

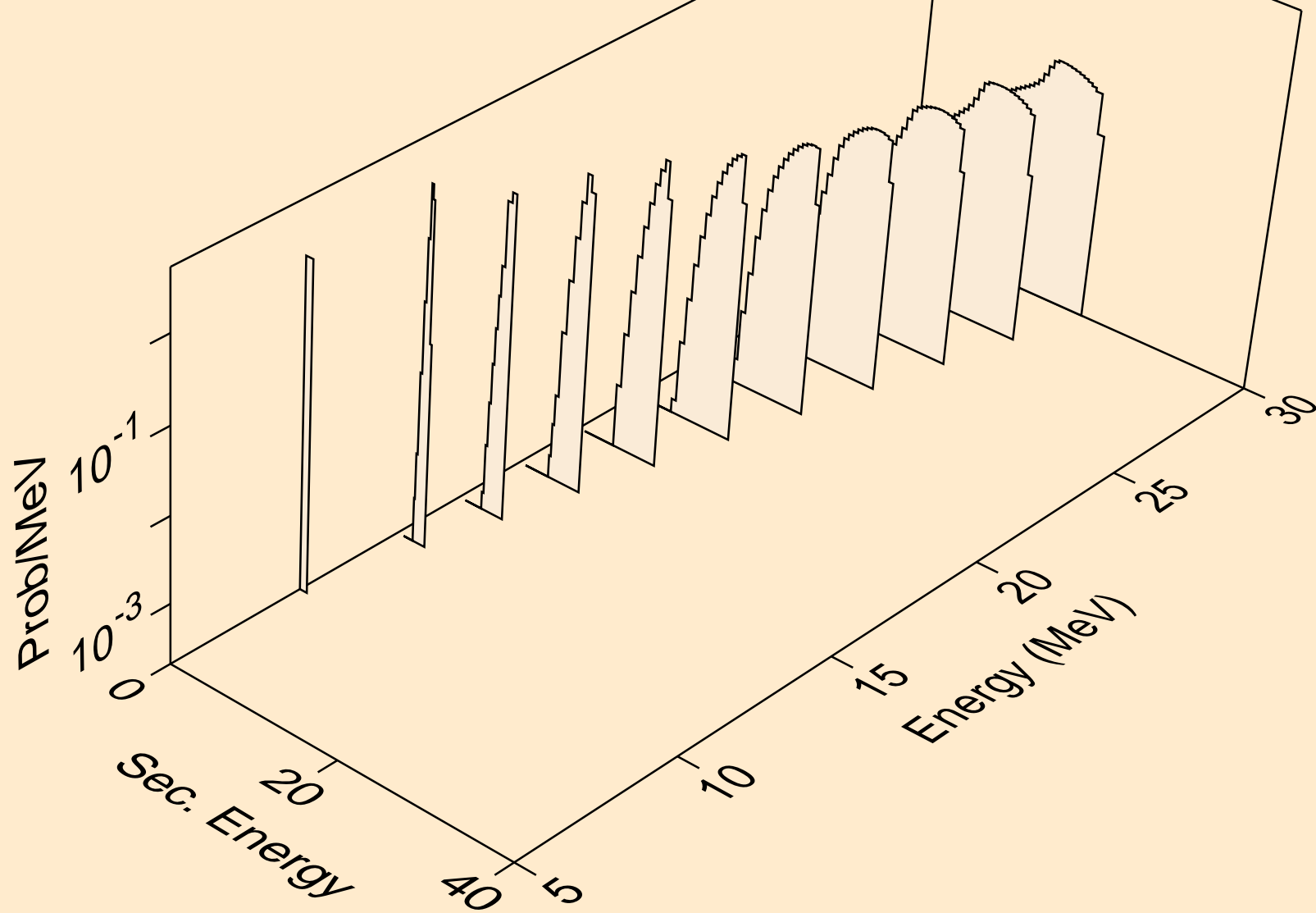

LU187 NEUTRON ACER TENDL-2024 LIBRARY; T=293.6K
protons from (n,2np)

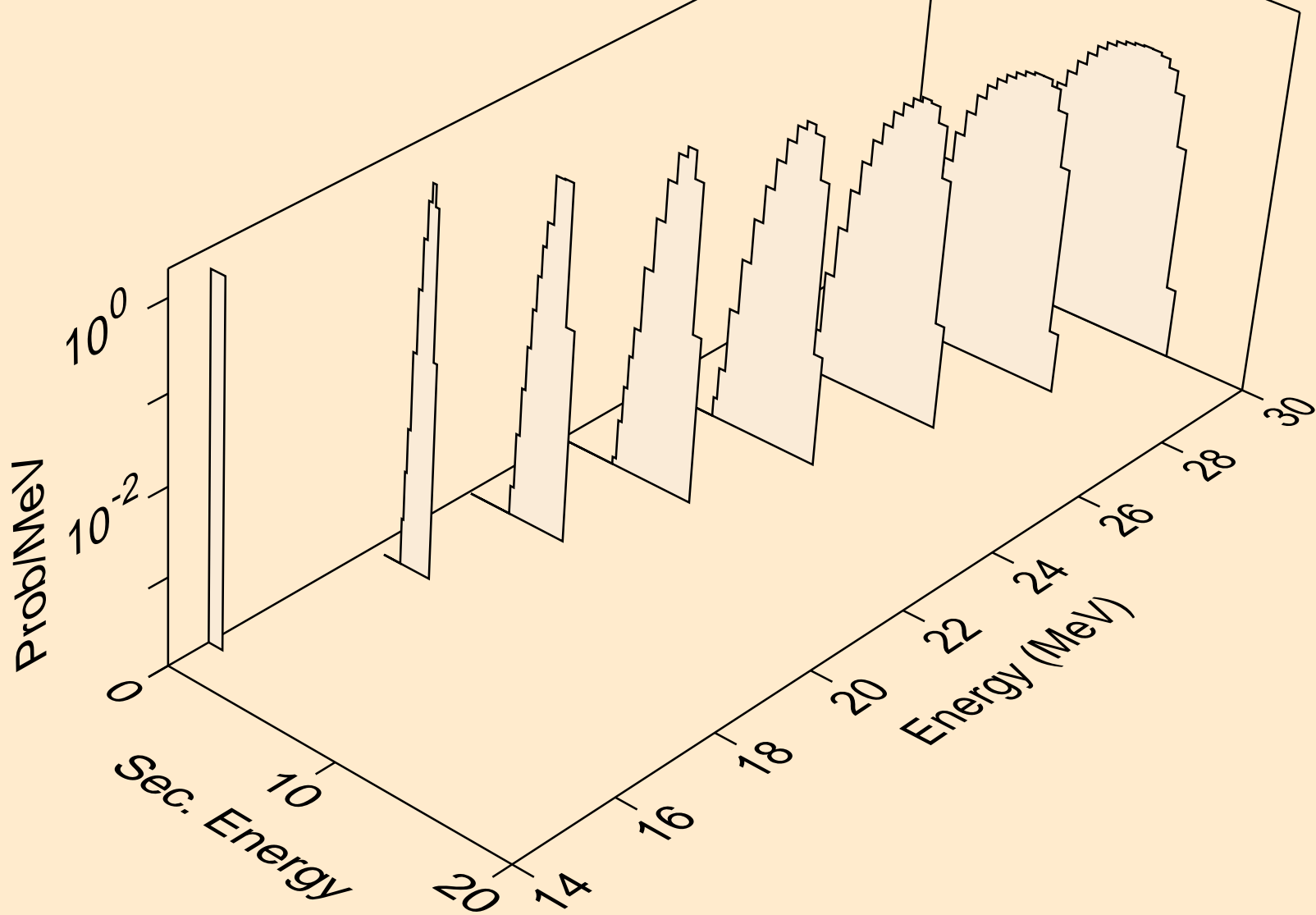

LU187 NEUTRON ACER TENDL-2024 LIBRARY; T=293.6K
protons from (n,3np)

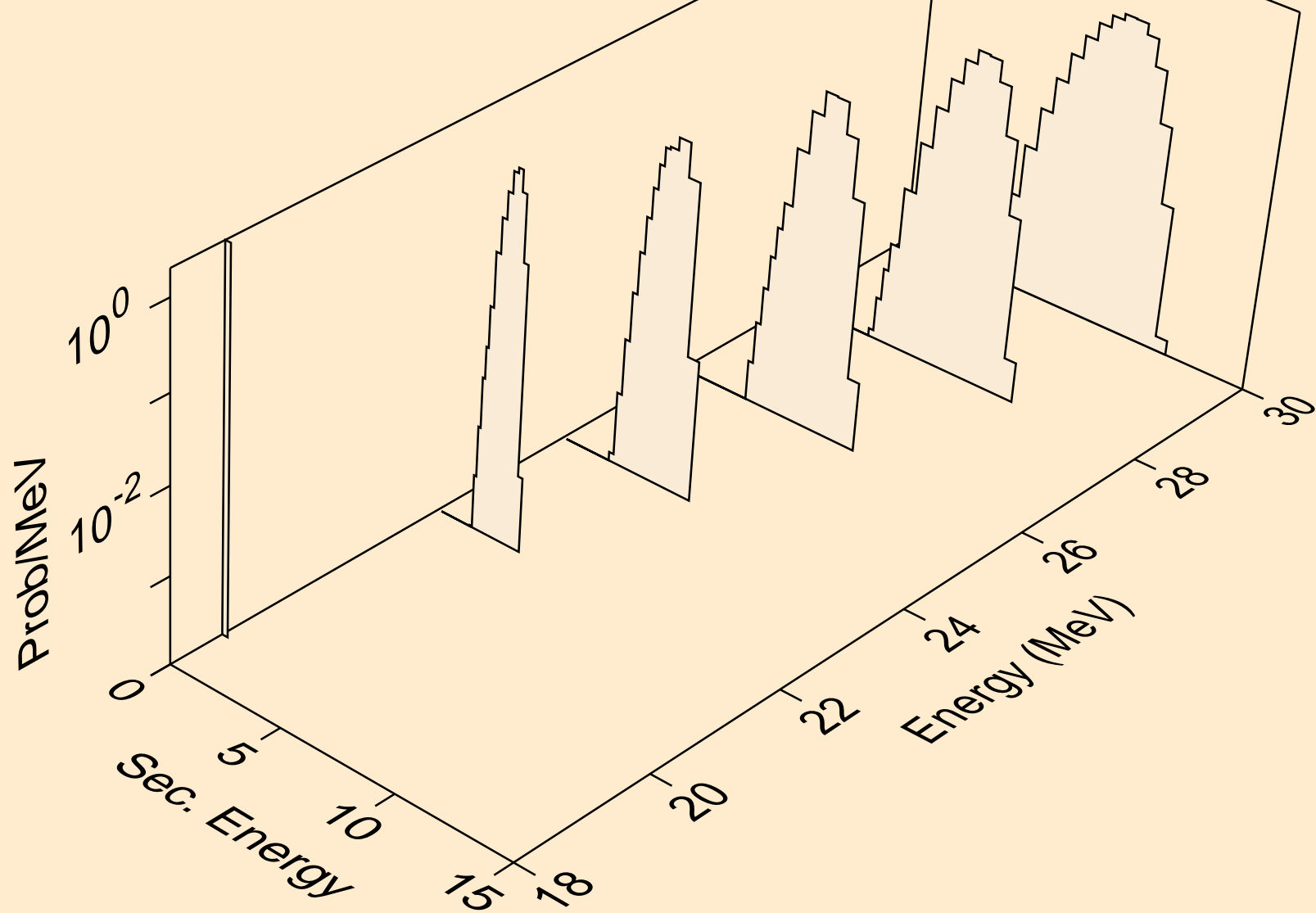

LU187 NEUTRON ACER TENDL-2024 LIBRARY; T=293.6K
protons from (n,p)

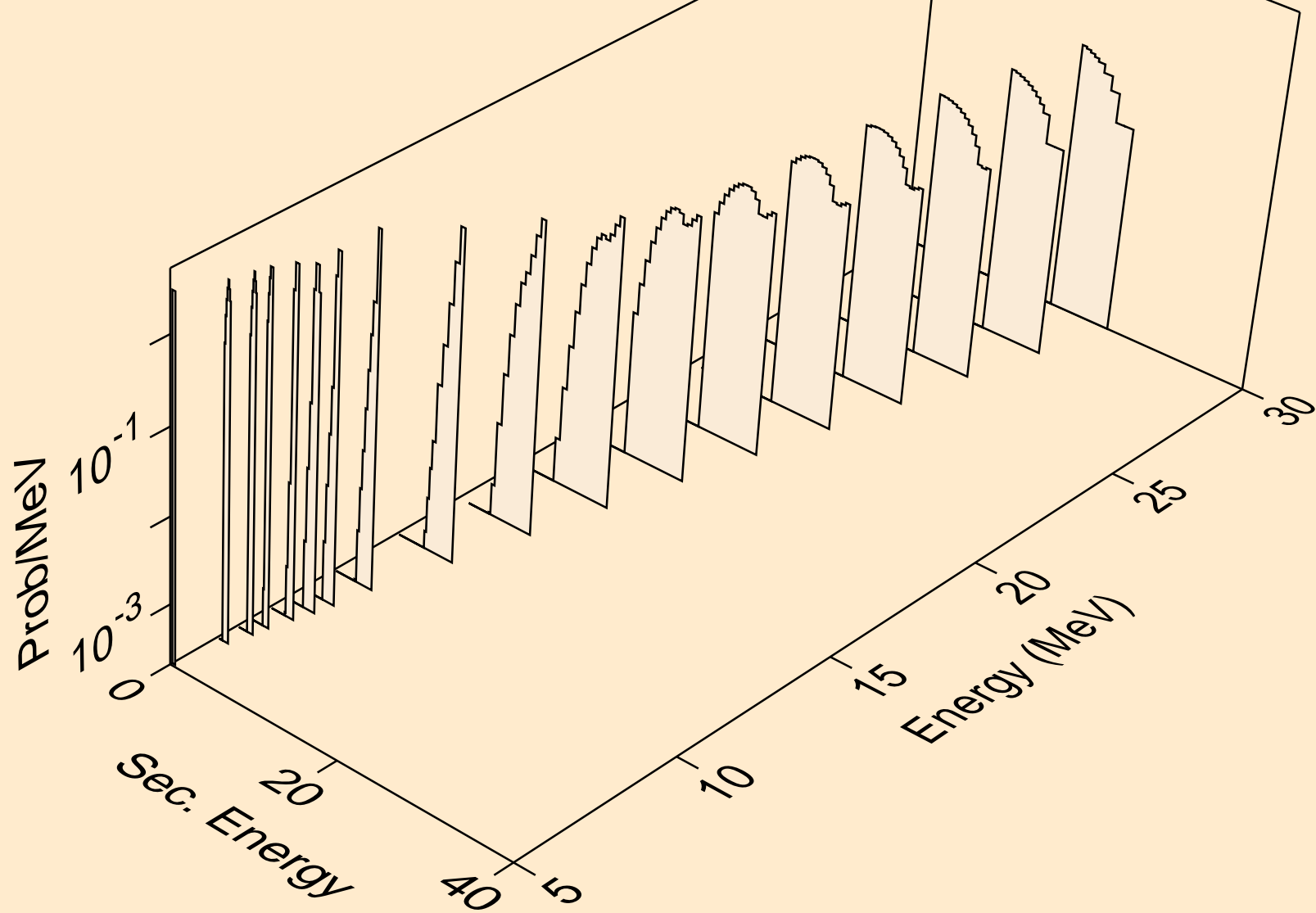

LU187 NEUTRON ACER TENDL-2024 LIBRARY; T=293.6K
deuterons from (n,x)

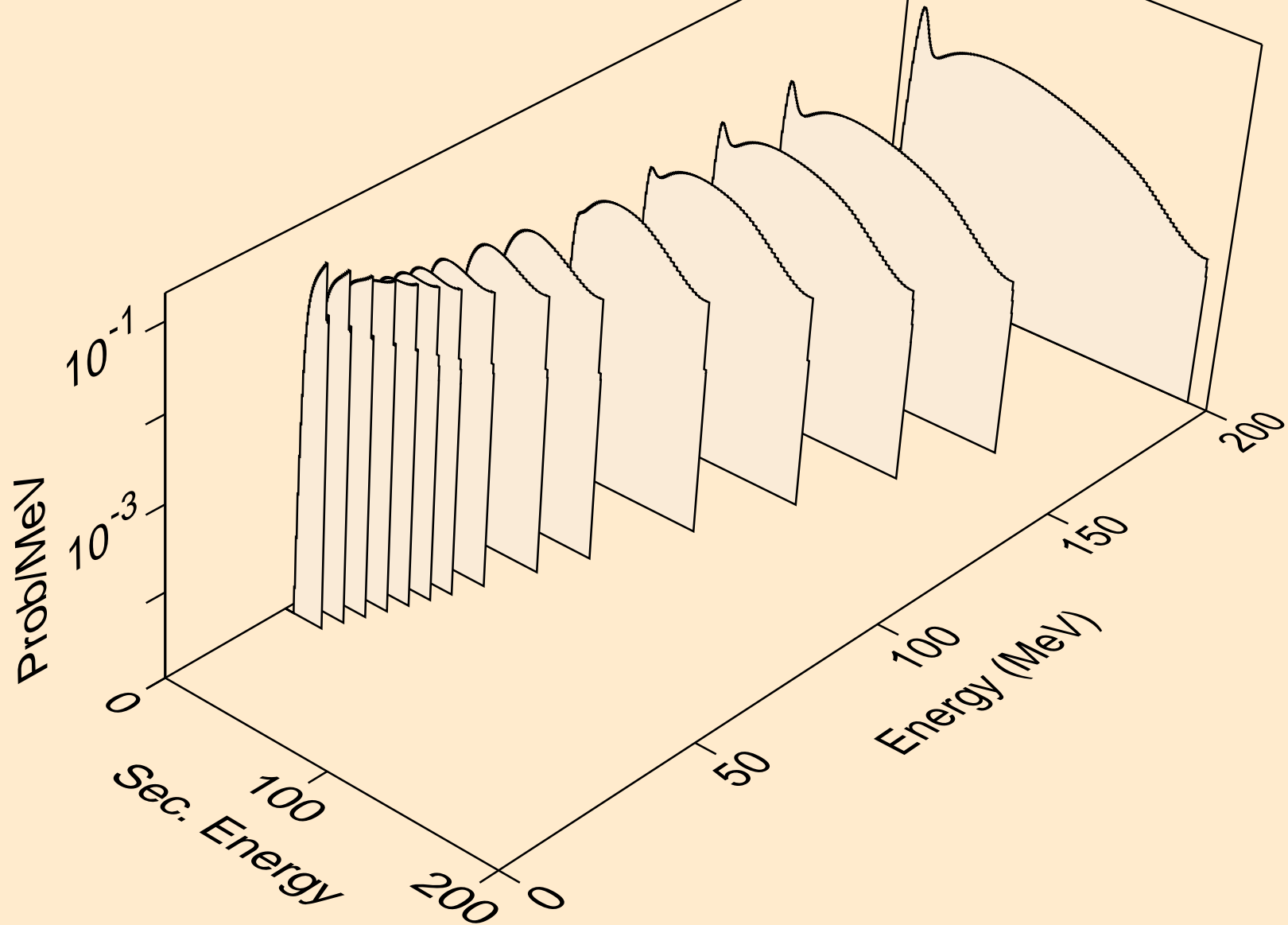

LU187 NEUTRON ACER TENDL-2024 LIBRARY; T=293.6K
deuterons from (n,2nd)

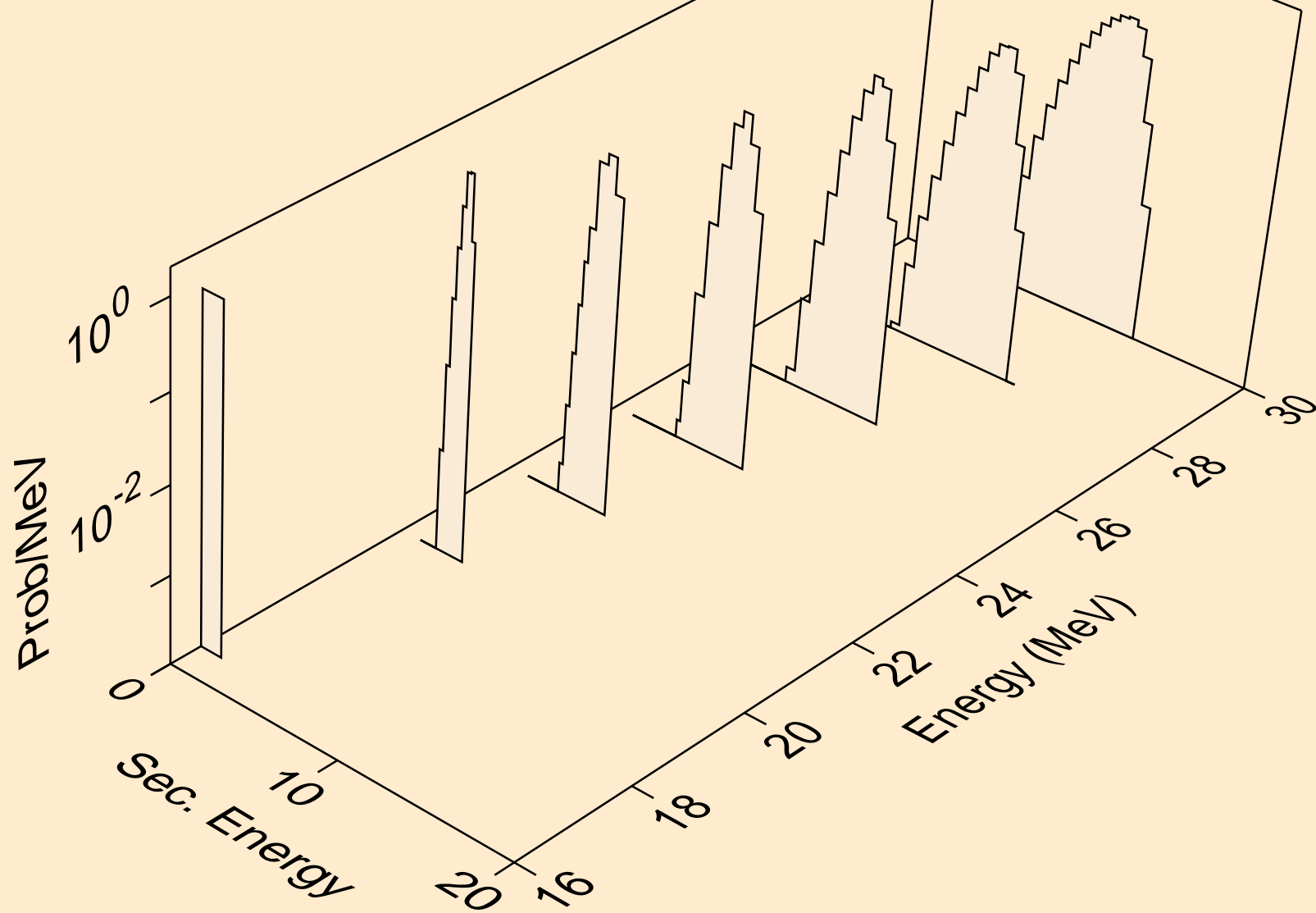

LU187 NEUTRON ACER TENDL-2024 LIBRARY; T=293.6K
deuterons from (n,n*)d

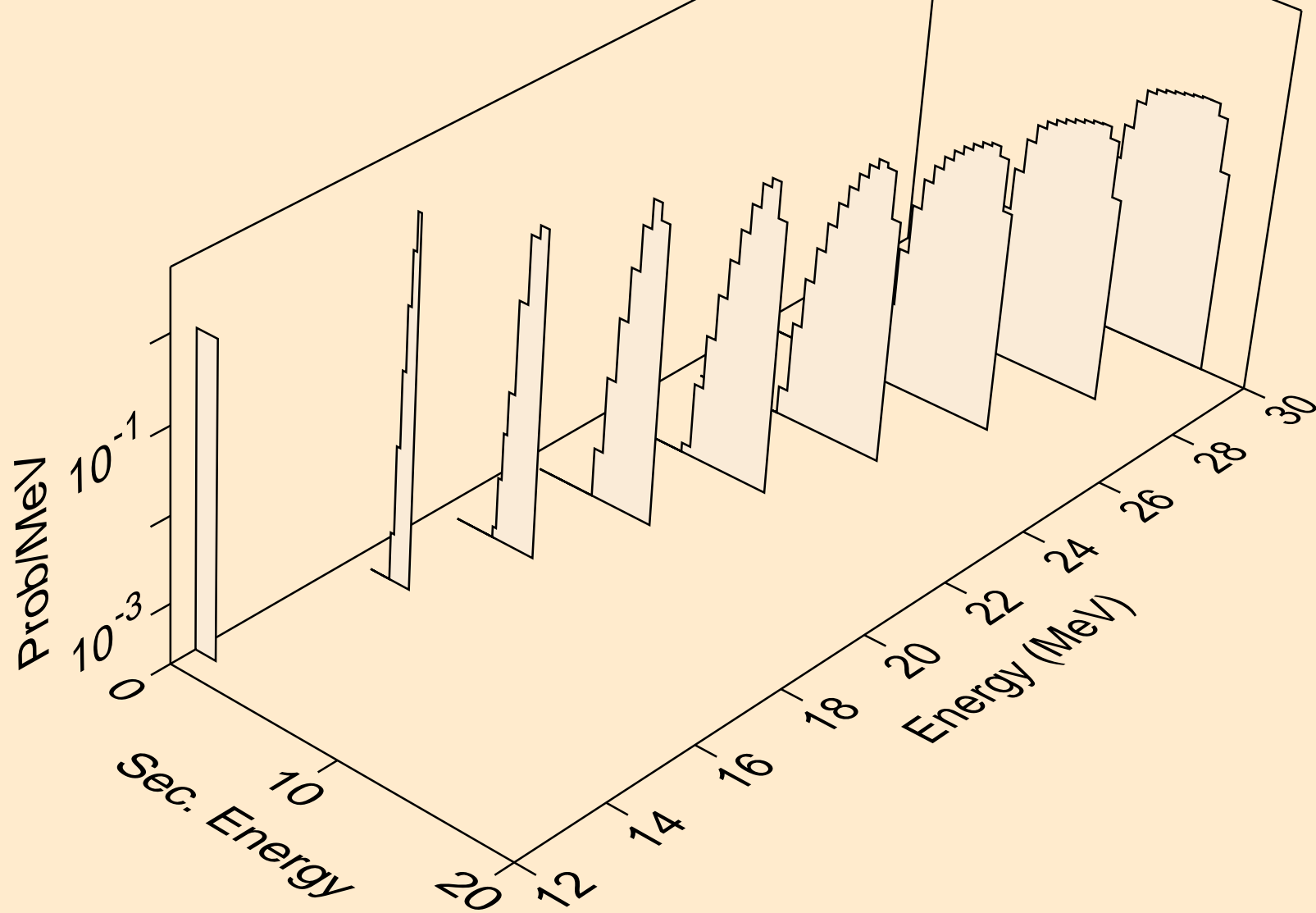

LU187 NEUTRON ACER TENDL-2024 LIBRARY; T=293.6K
deuterons from (n,d)

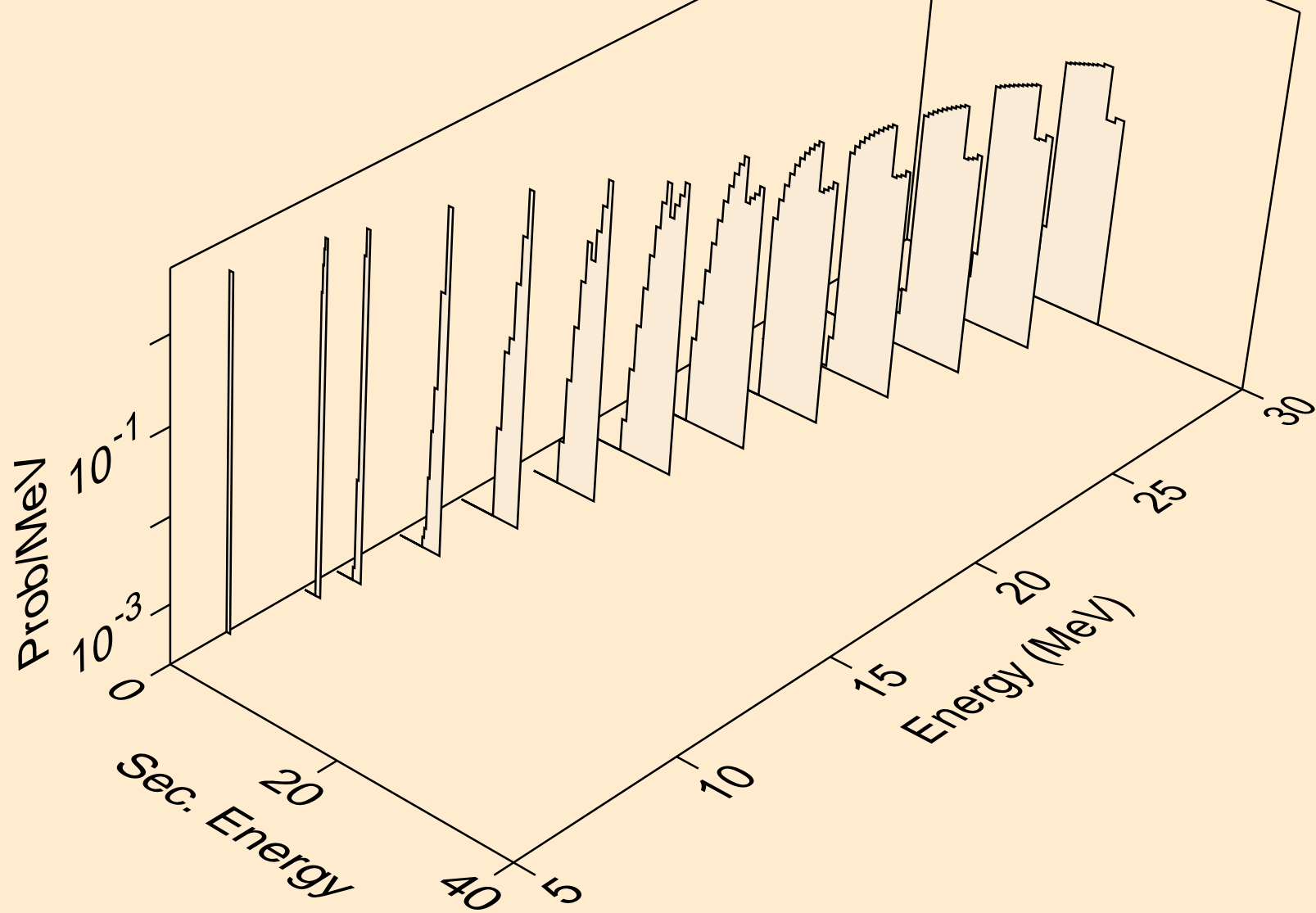

LU187 NEUTRON ACER TENDL-2024 LIBRARY; T=293.6K
tritons from (n,x)

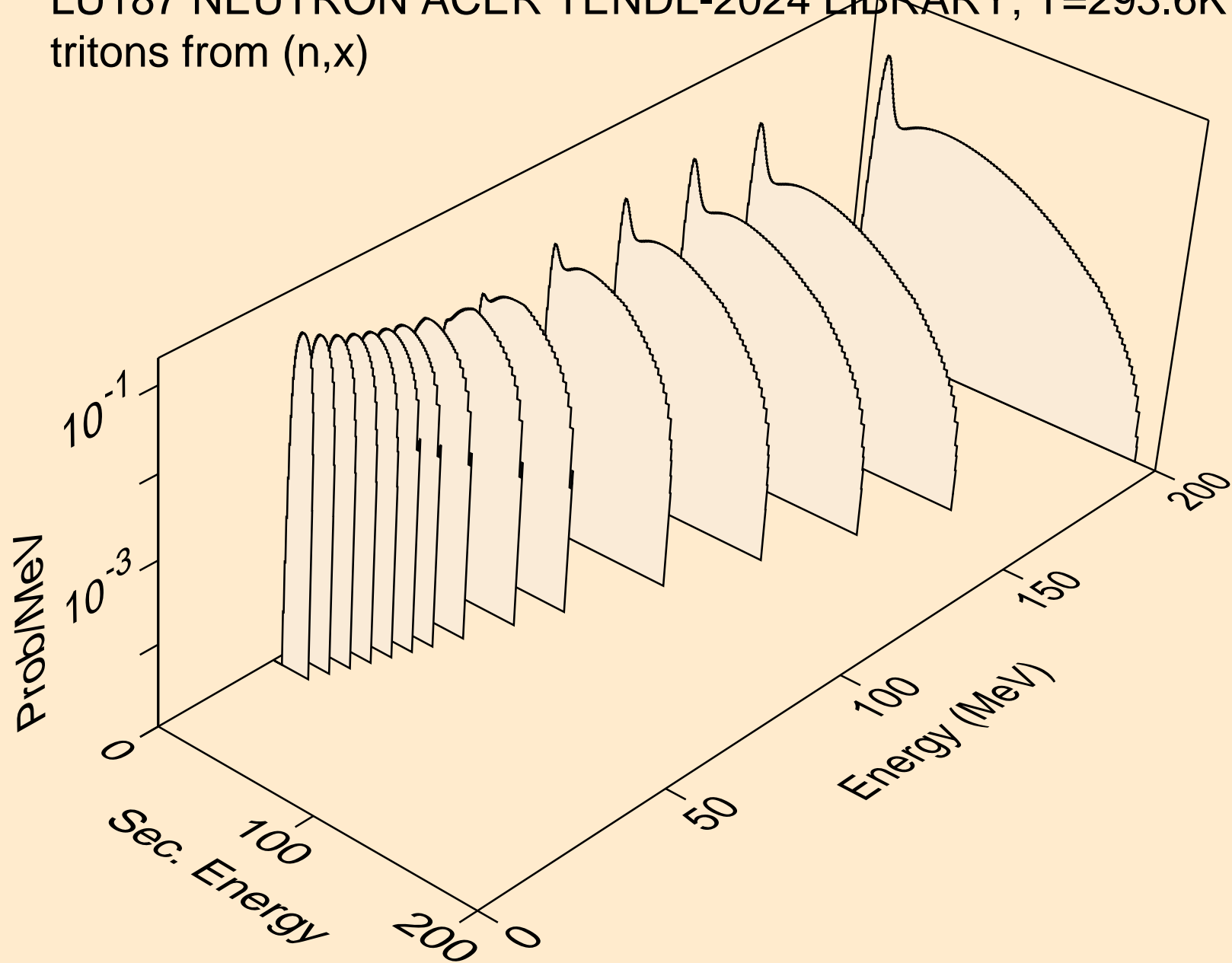

LU187 NEUTRON ACER TENDL-2024 LIBRARY; T=293.6K
tritons from (n,n*)t

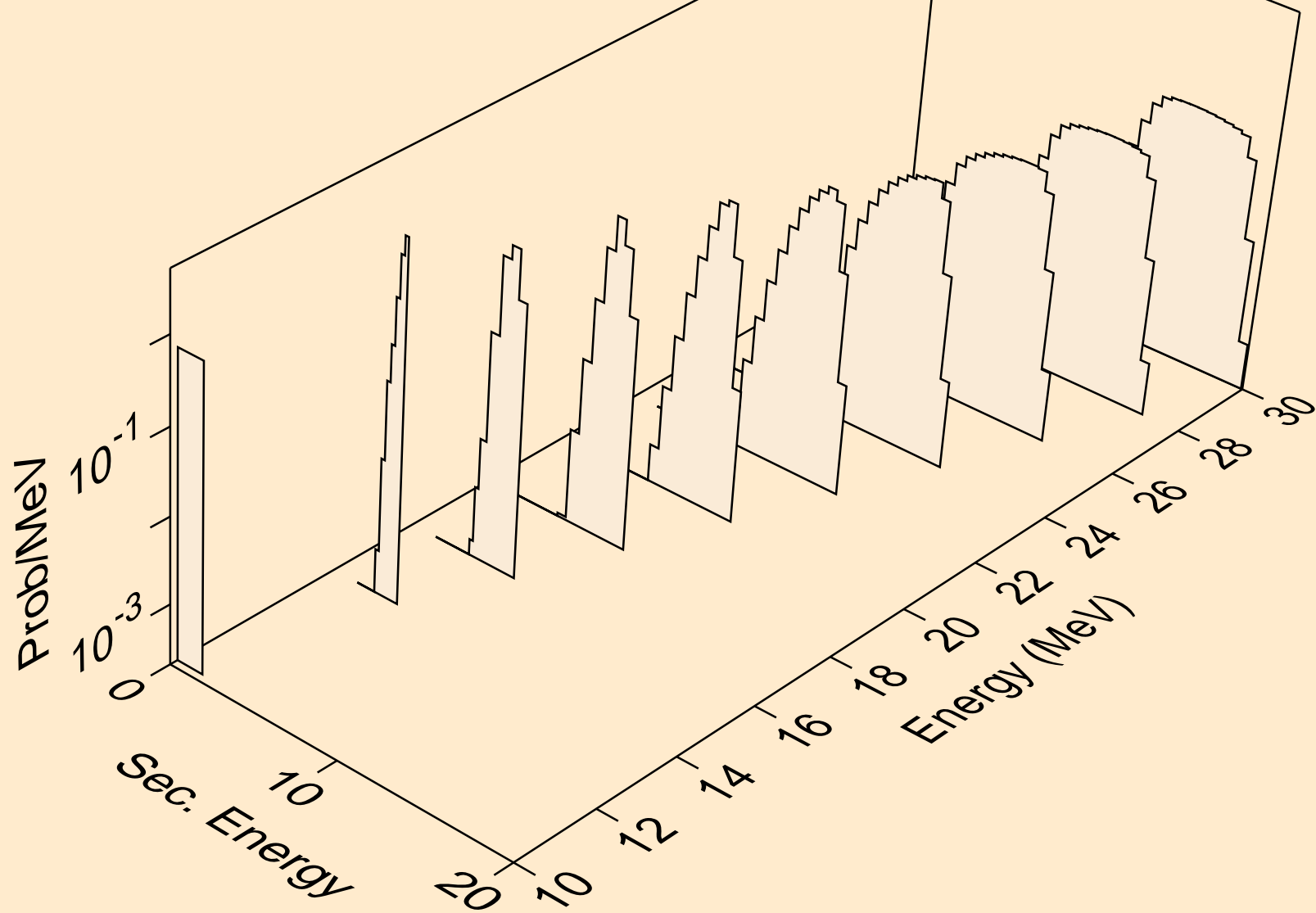

LU187 NEUTRON ACER TENDL-2024 LIBRARY; T=293.6K
tritons from (n,t)

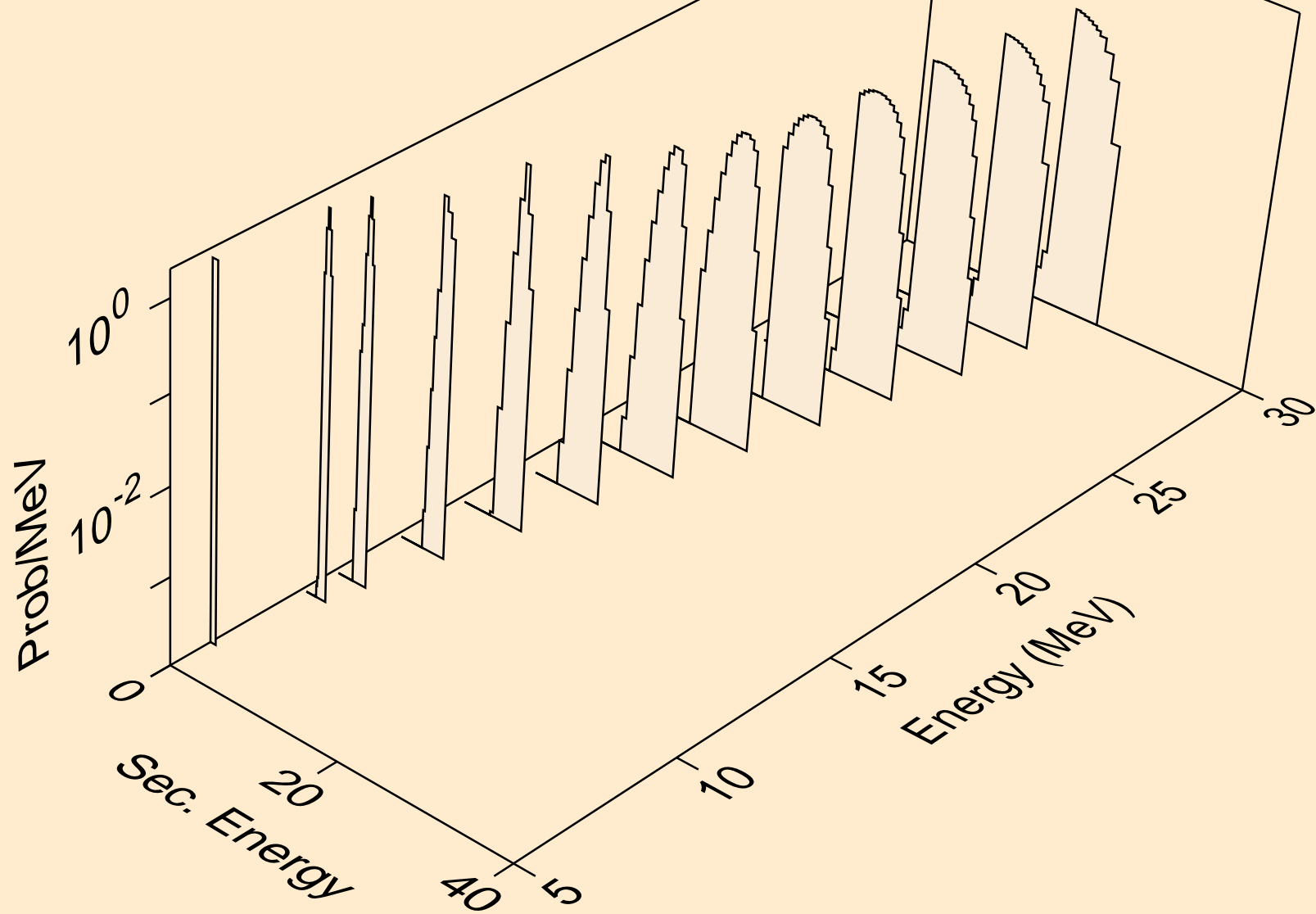

LU187 NEUTRON ACER TENDL-2024 LIBRARY; T=293.6K
he3s from (n,x)

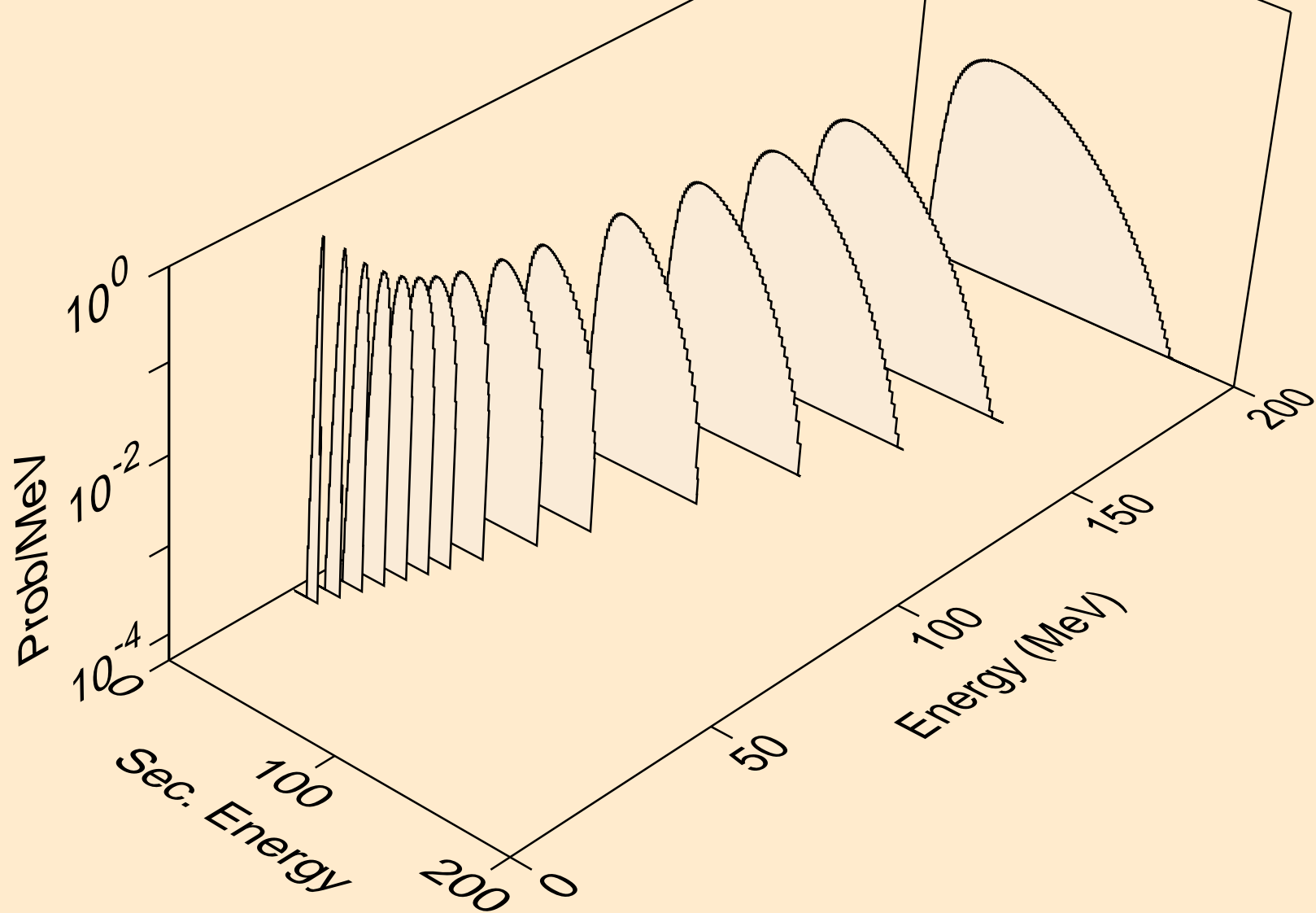

LU187 NEUTRON ACER TENDL-2024 LIBRARY; T=293.6K
he3s from (n,n*)he3

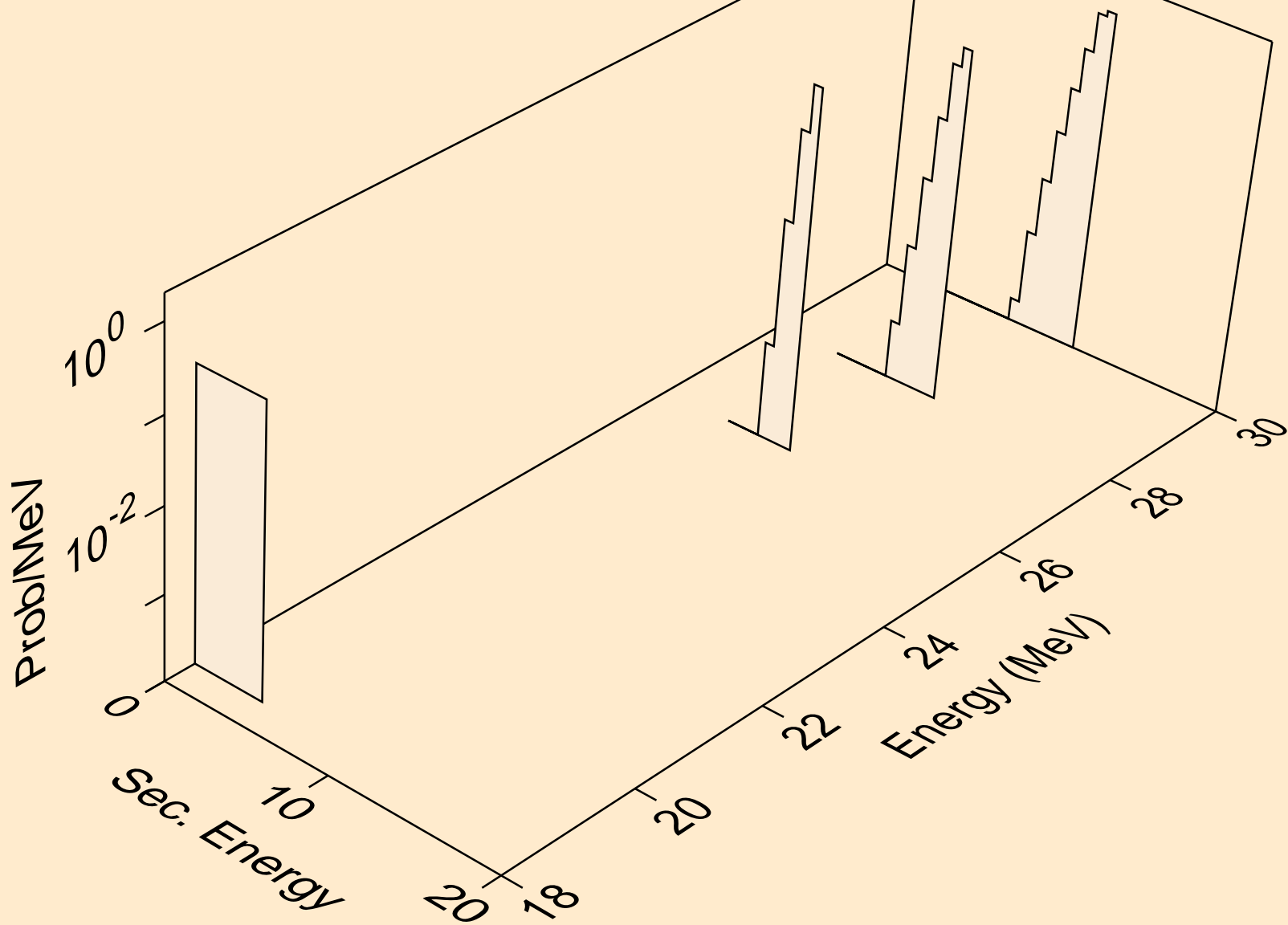

LU187 NEUTRON ACER TENDL-2024 LIBRARY; T=293.6K
he3s from (n,he3)

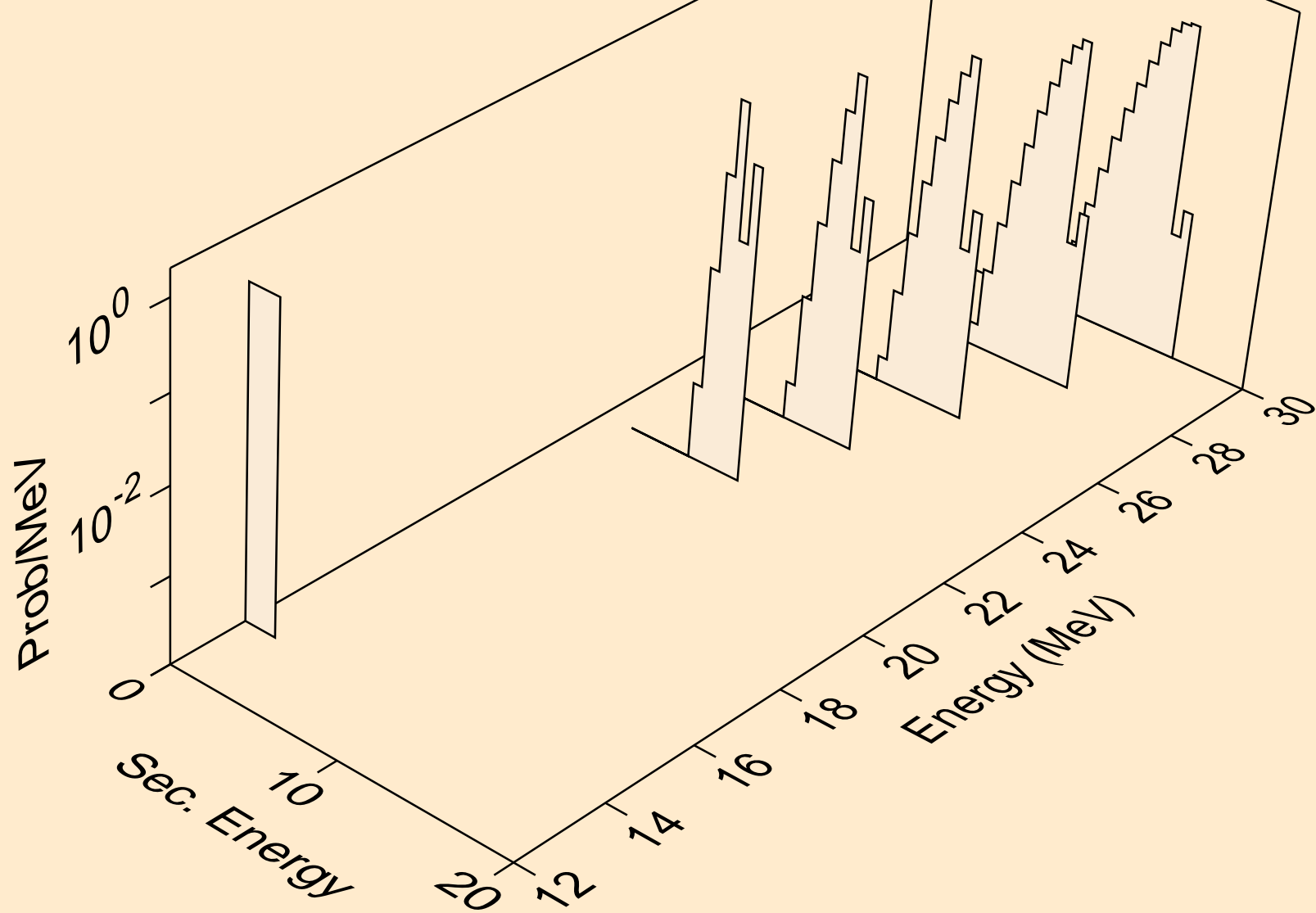

LU187 NEUTRON ACER TENDL-2024 LIBRARY; T=293.6K
alphas from (n,x)

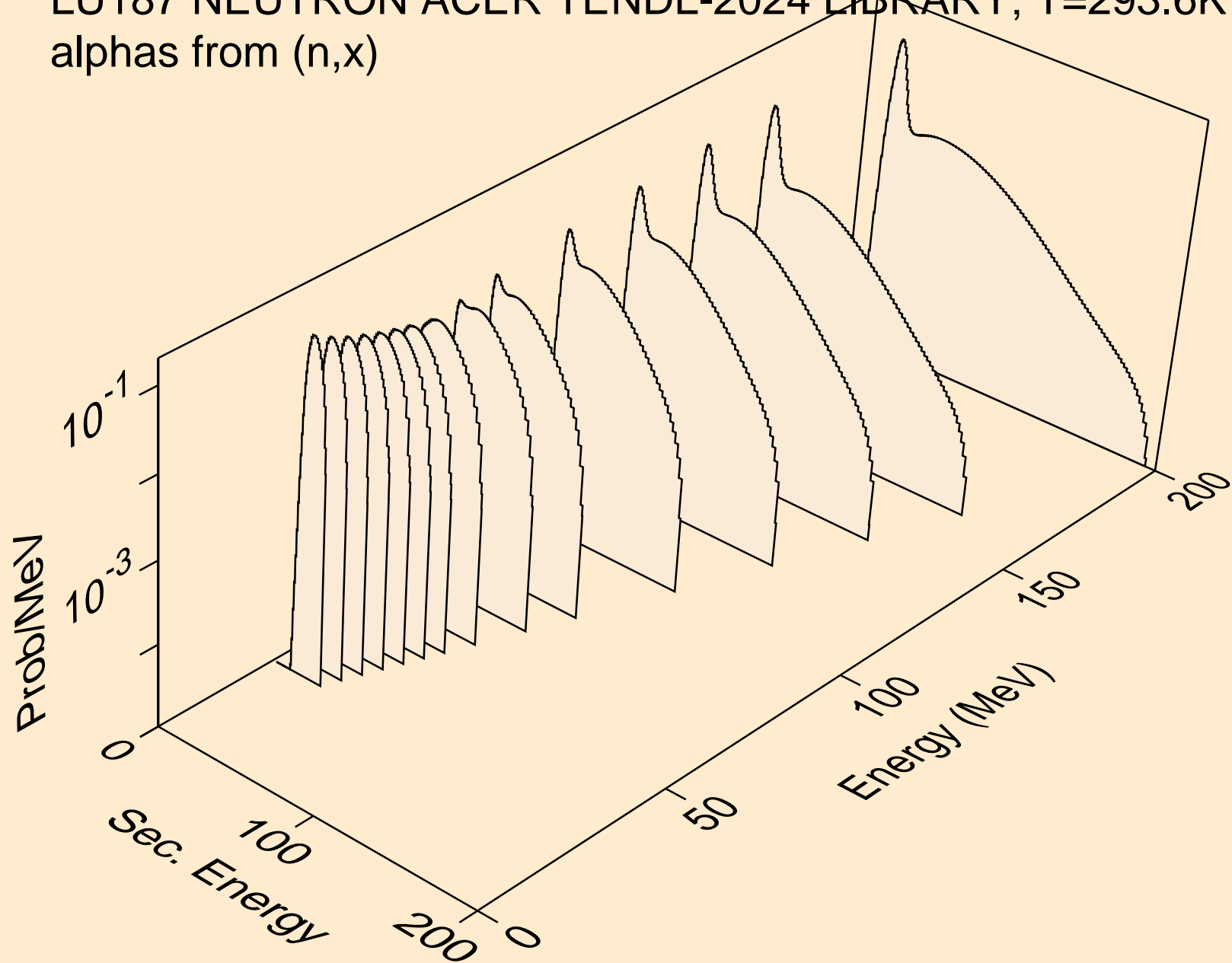

LU187 NEUTRON ACER TENDL-2024 LIBRARY; T=293.6K
alphas from (n,n*)a

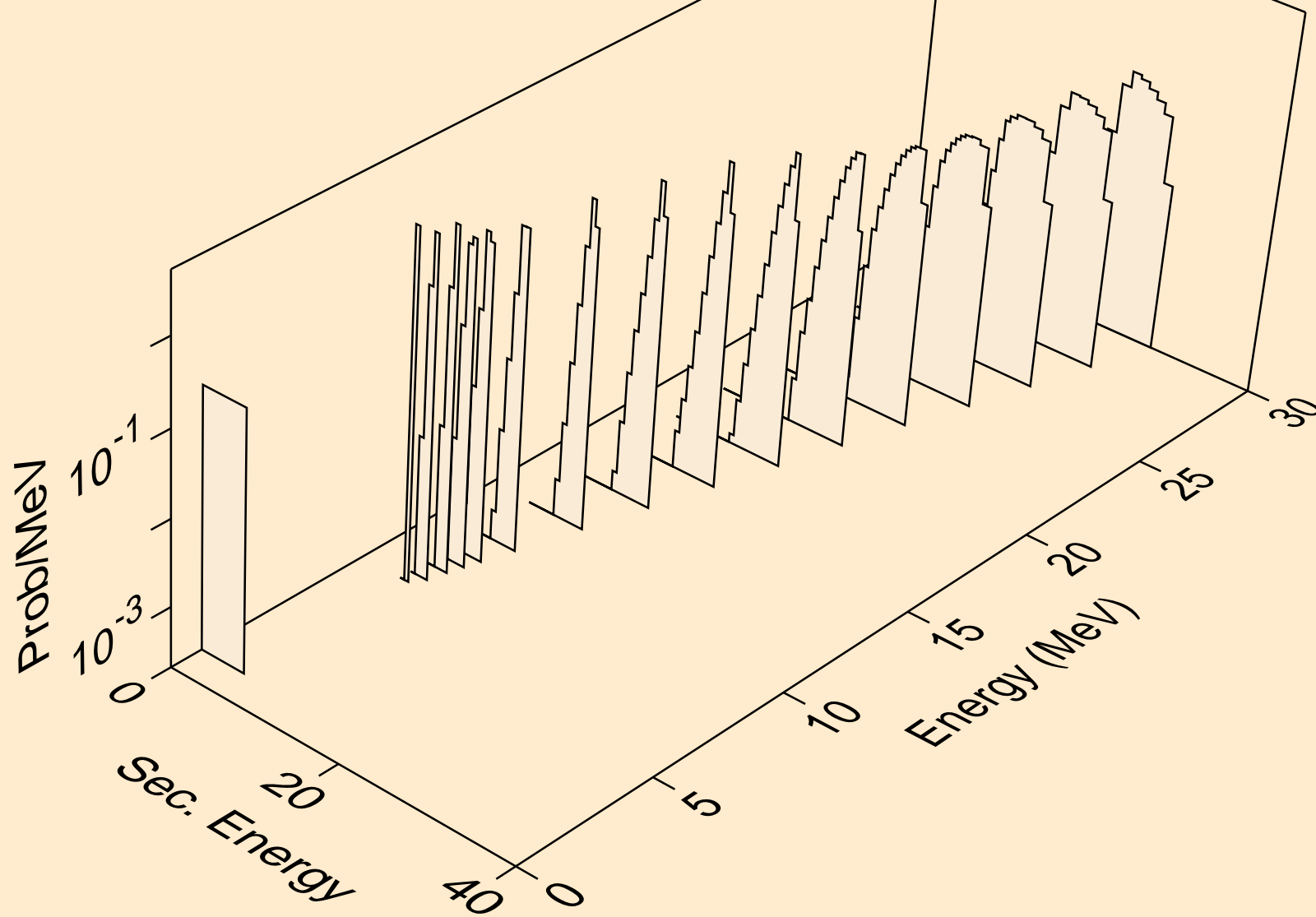

LU187 NEUTRON ACER TENDL-2024 LIBRARY; T=293.6K
alphas from (n,2n)a

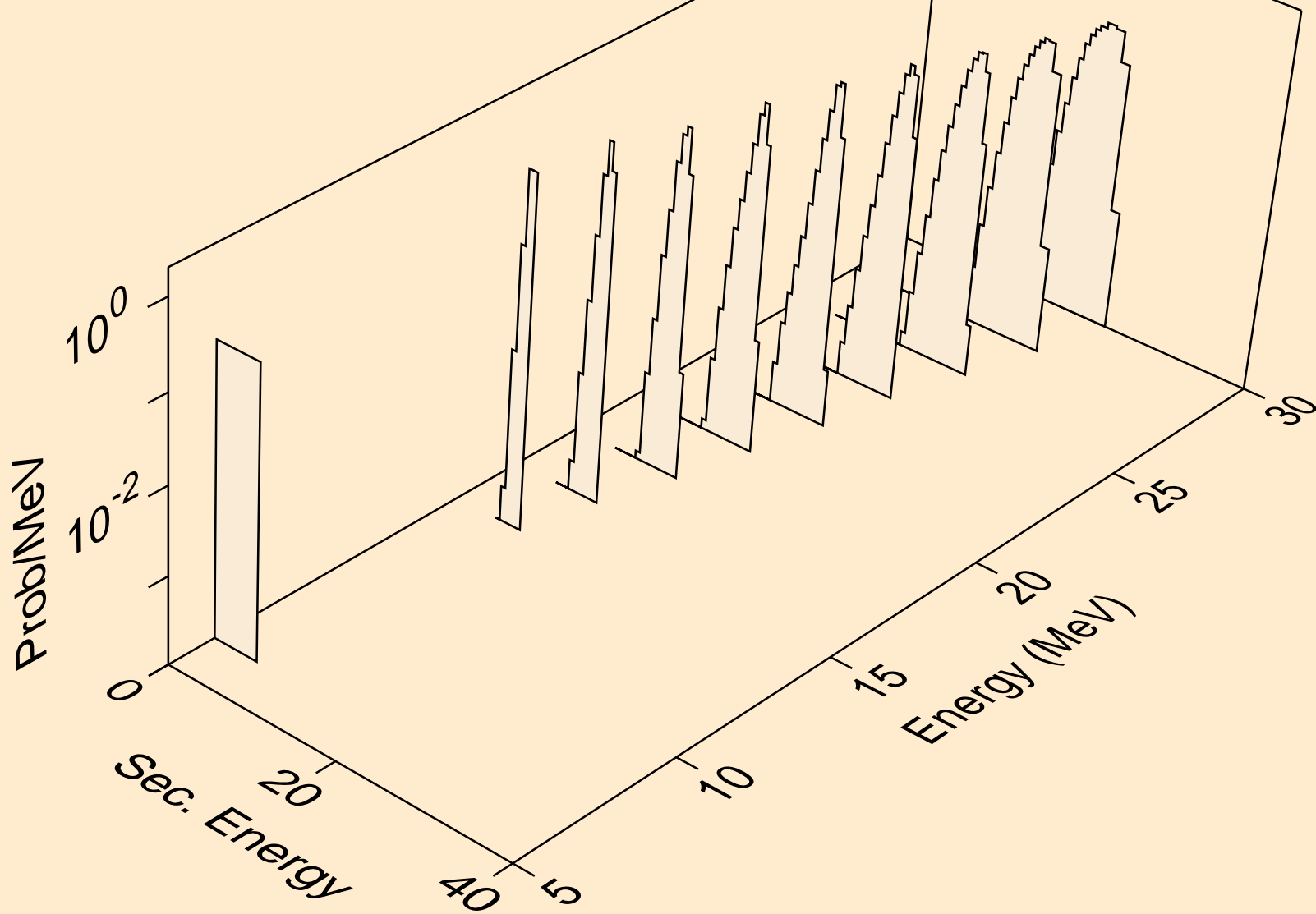

LU187 NEUTRON ACER TENDL-2024 LIBRARY; T=293.6K
alphas from (n,3n)a

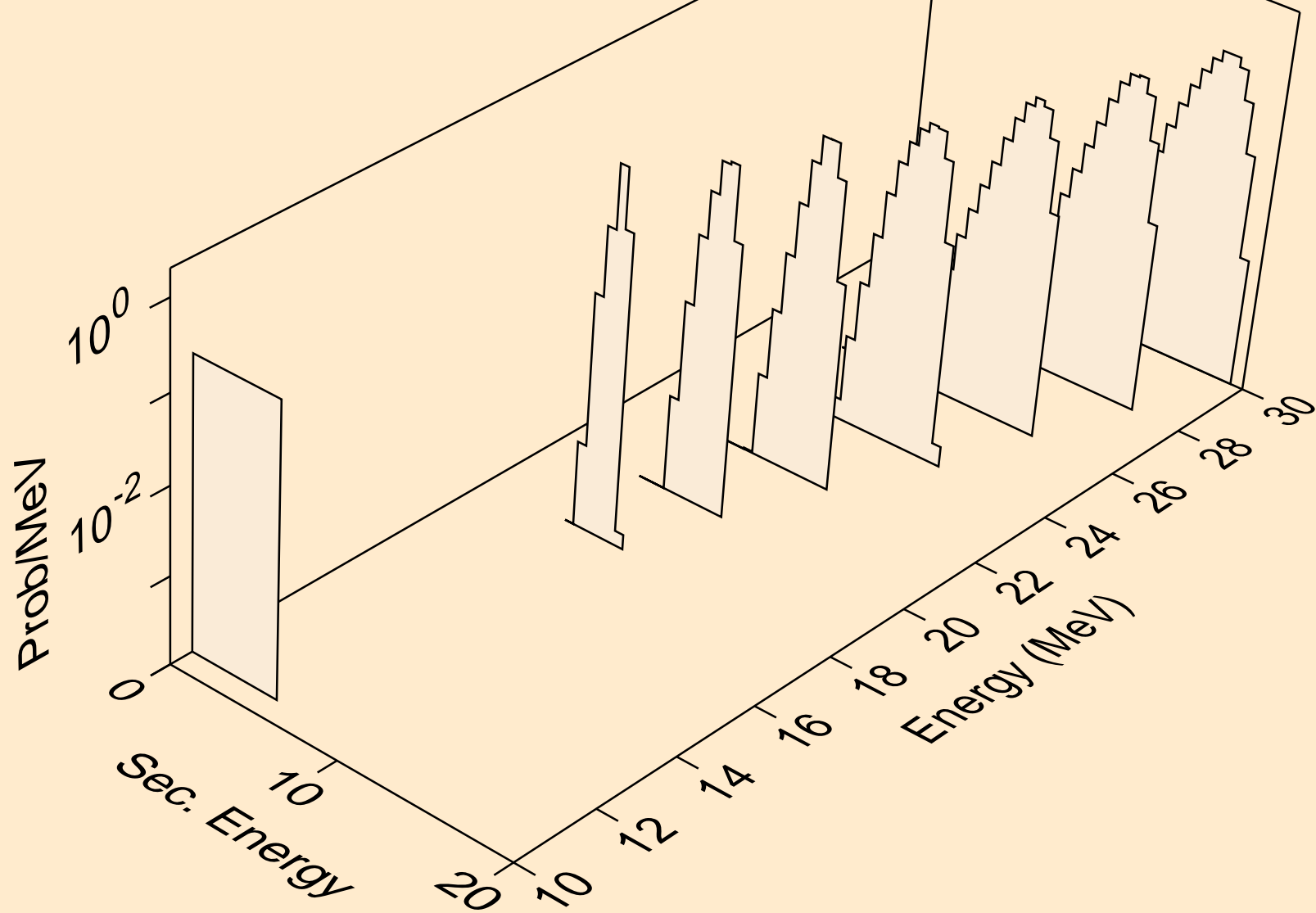

LU187 NEUTRON ACER TENDL-2024 LIBRARY; T=293.6K
alphas from (n,a)

