

MN052 NEUTRON ACER TENDL-2024 LIBRARY; T=293.6K

Principal cross sections

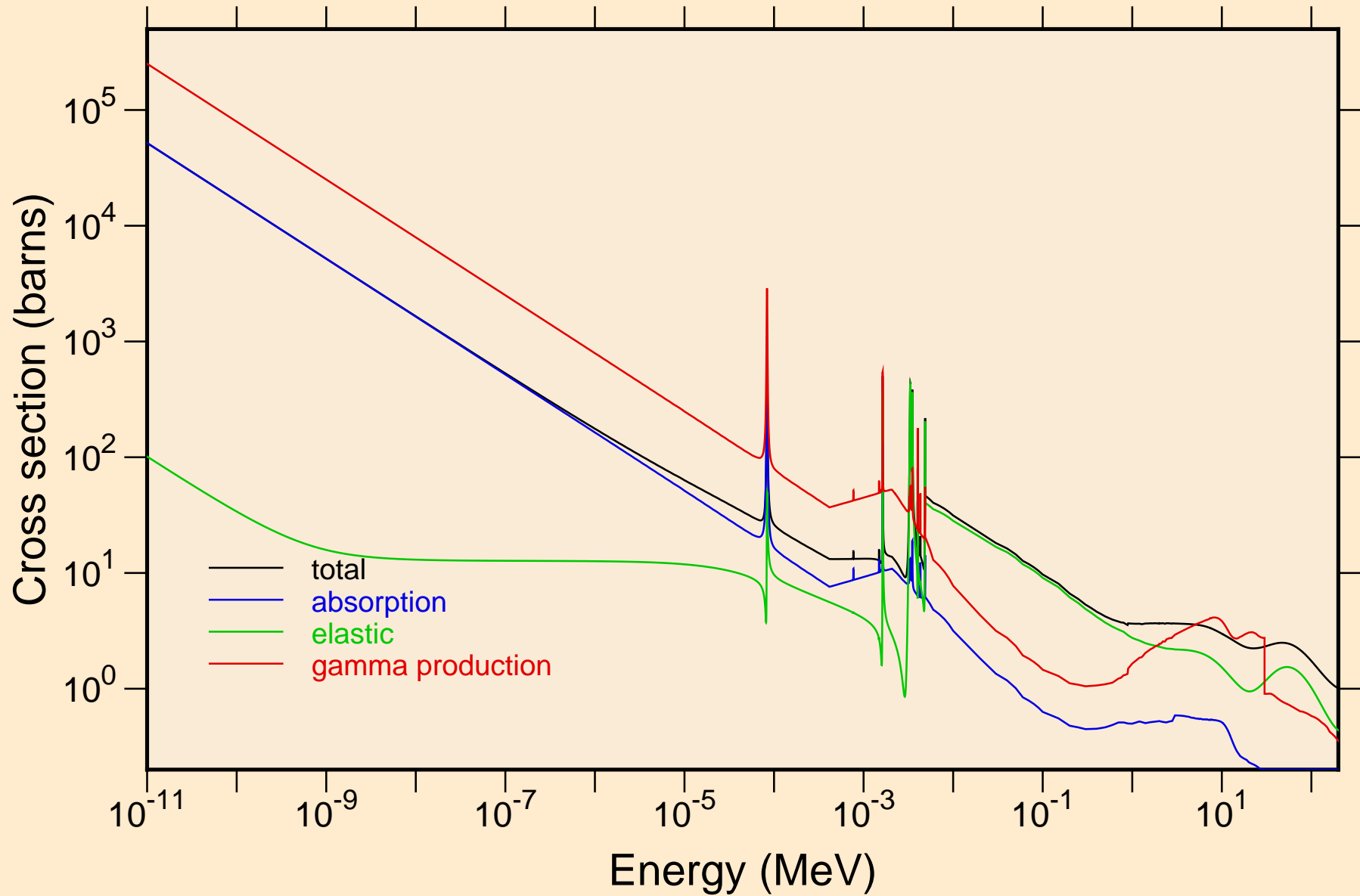

MN052 NEUTRON ACER TENDL-2024 LIBRARY; T=293.6K
resonance total cross section

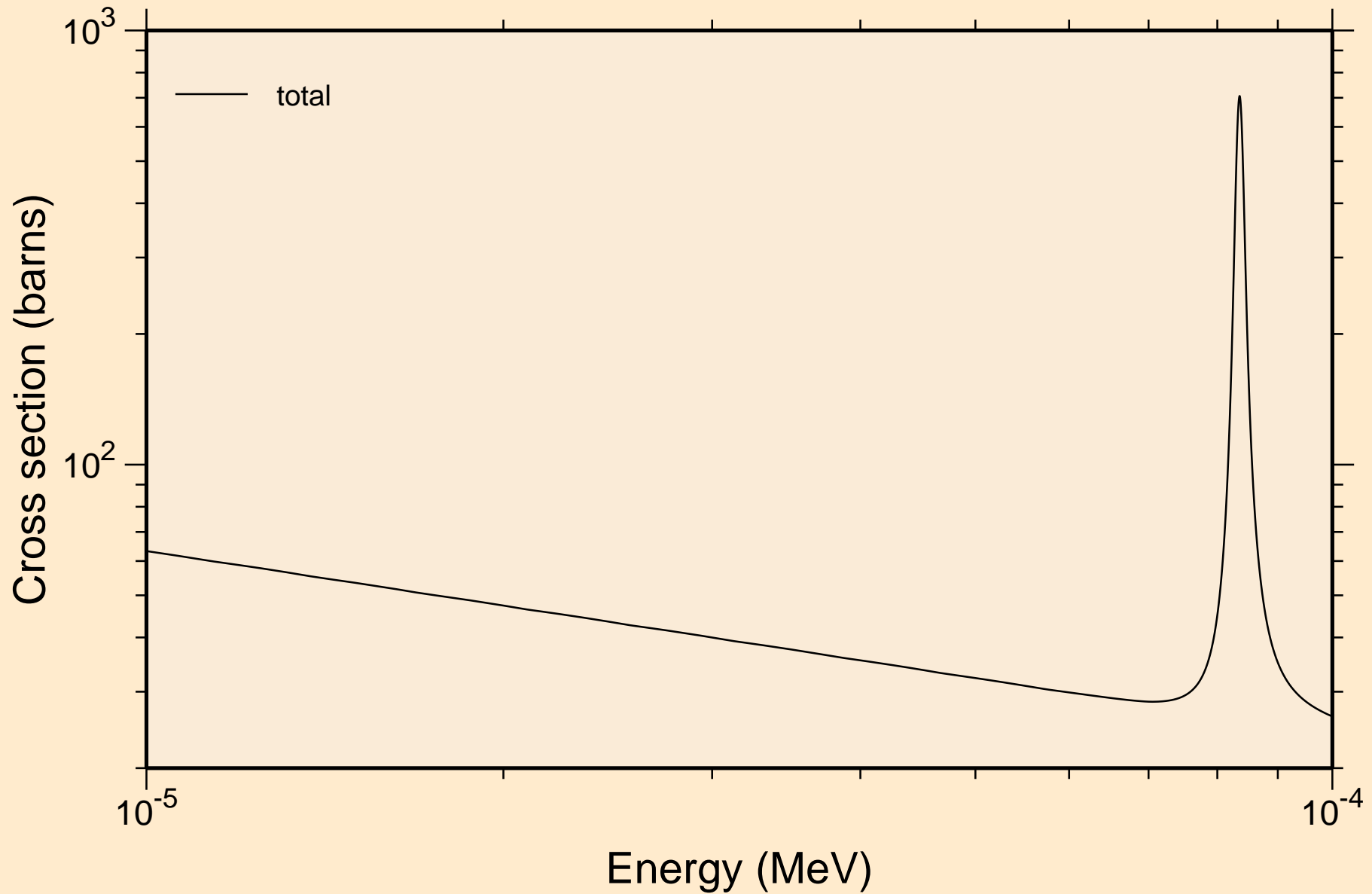

MN052 NEUTRON ACER TENDL-2024 LIBRARY; T=293.6K
resonance total cross section

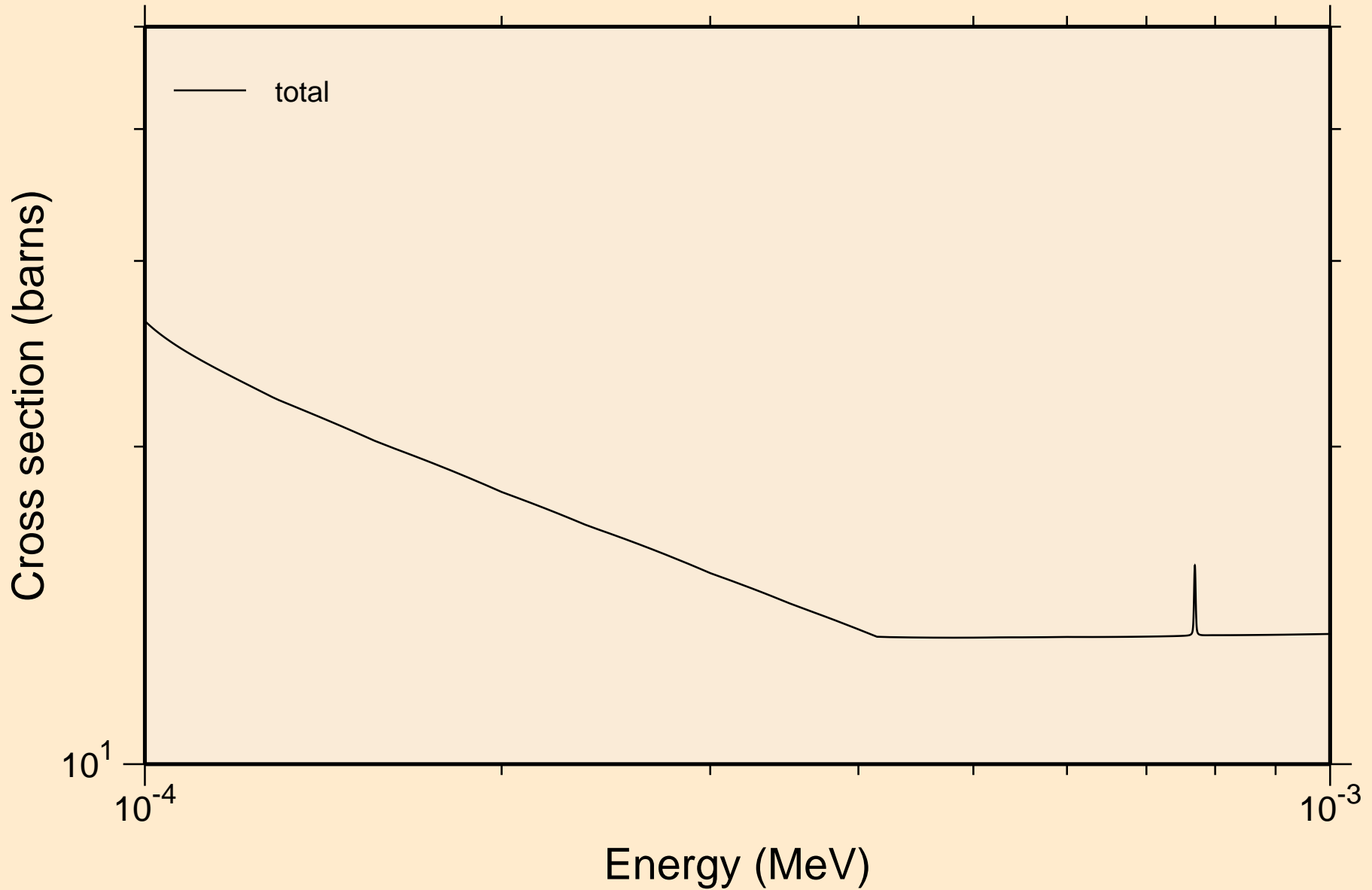

MN052 NEUTRON ACER TENDL-2024 LIBRARY; T=293.6K
resonance total cross section

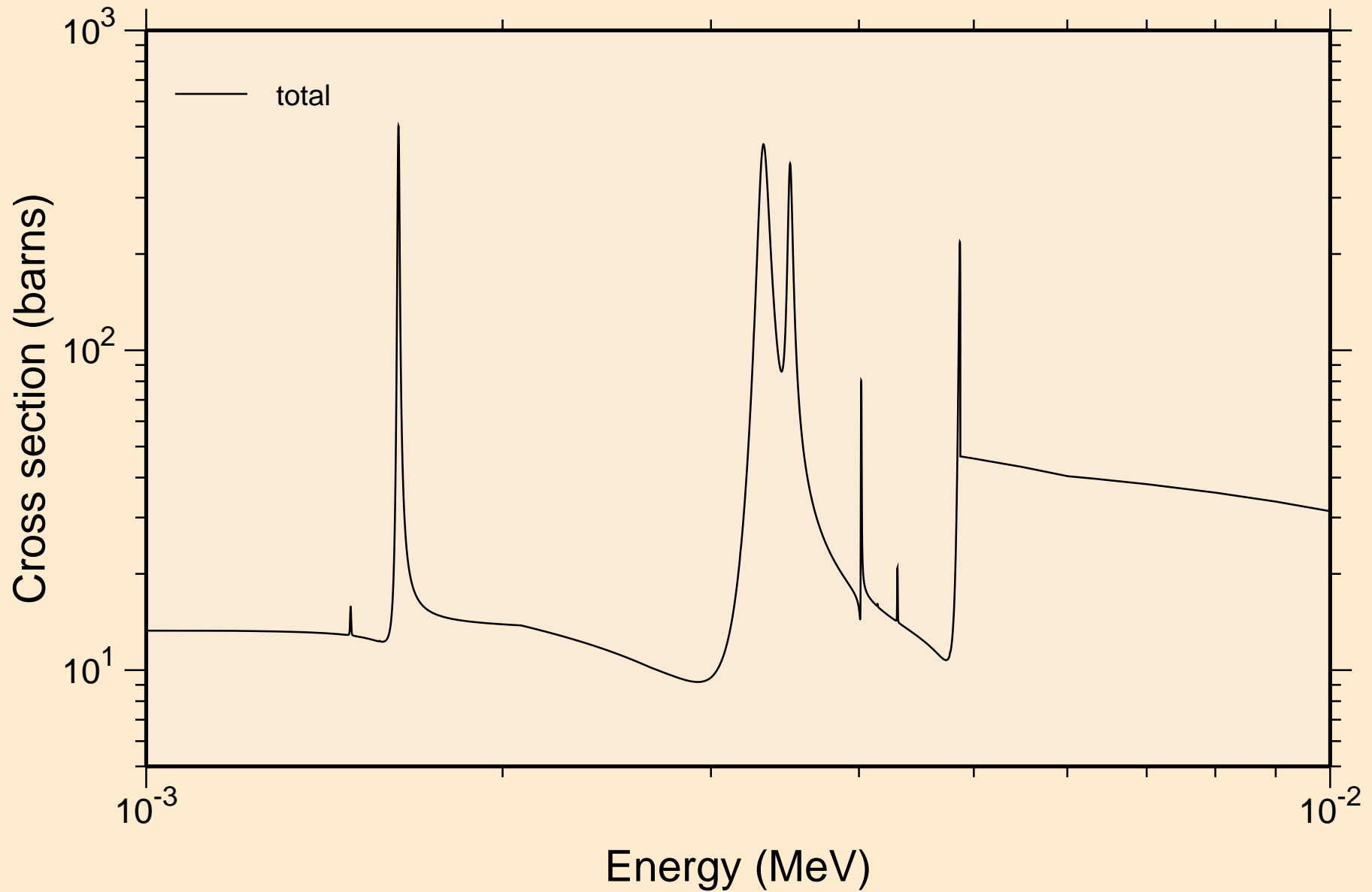

MN052 NEUTRON ACER TENDL-2024 LIBRARY; T=293.6K
resonance total cross section

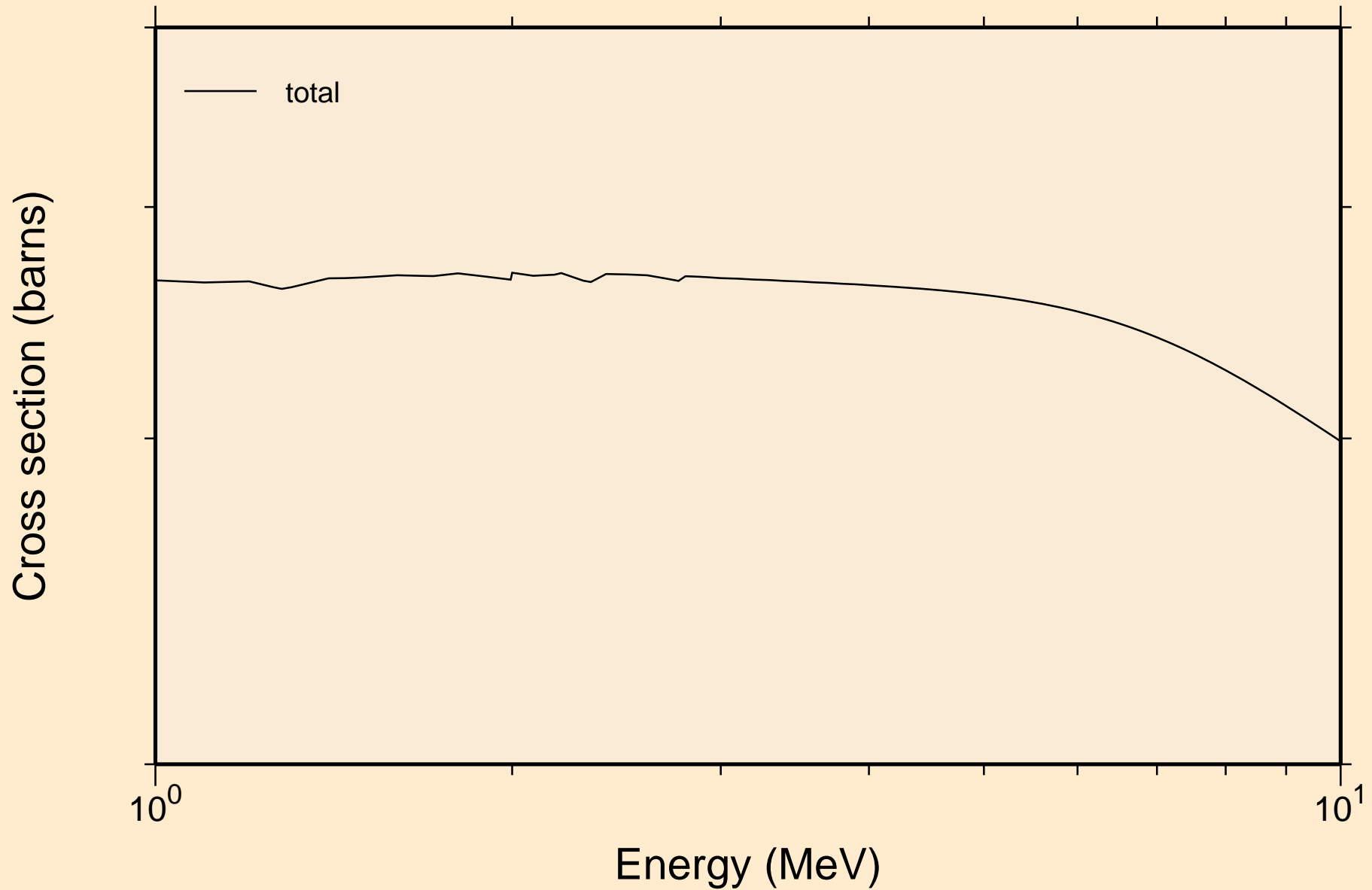

MN052 NEUTRON ACER TENDL-2024 LIBRARY; T=293.6K
resonance absorption cross sections

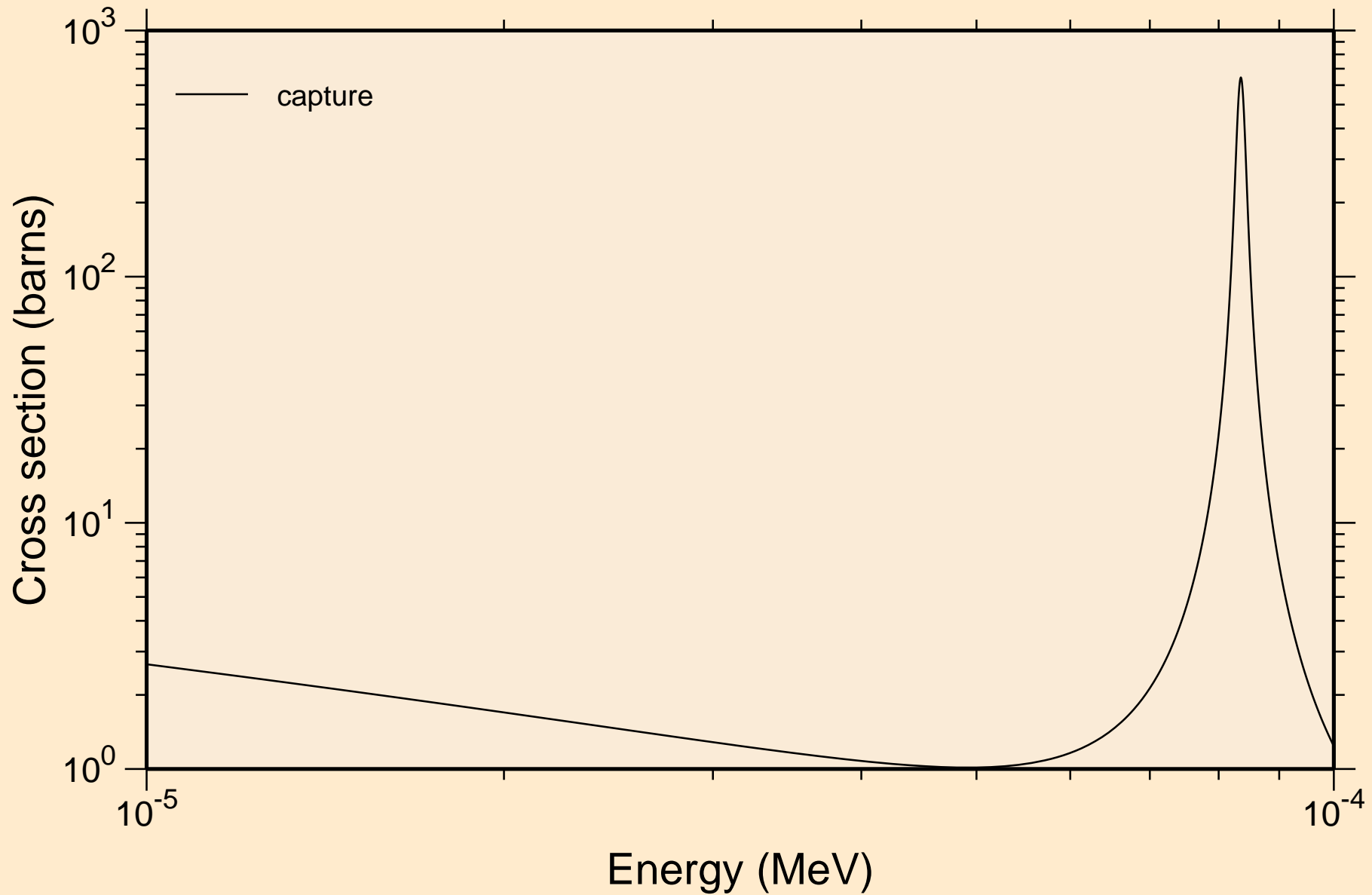

MN052 NEUTRON ACER TENDL-2024 LIBRARY; T=293.6K
resonance absorption cross sections

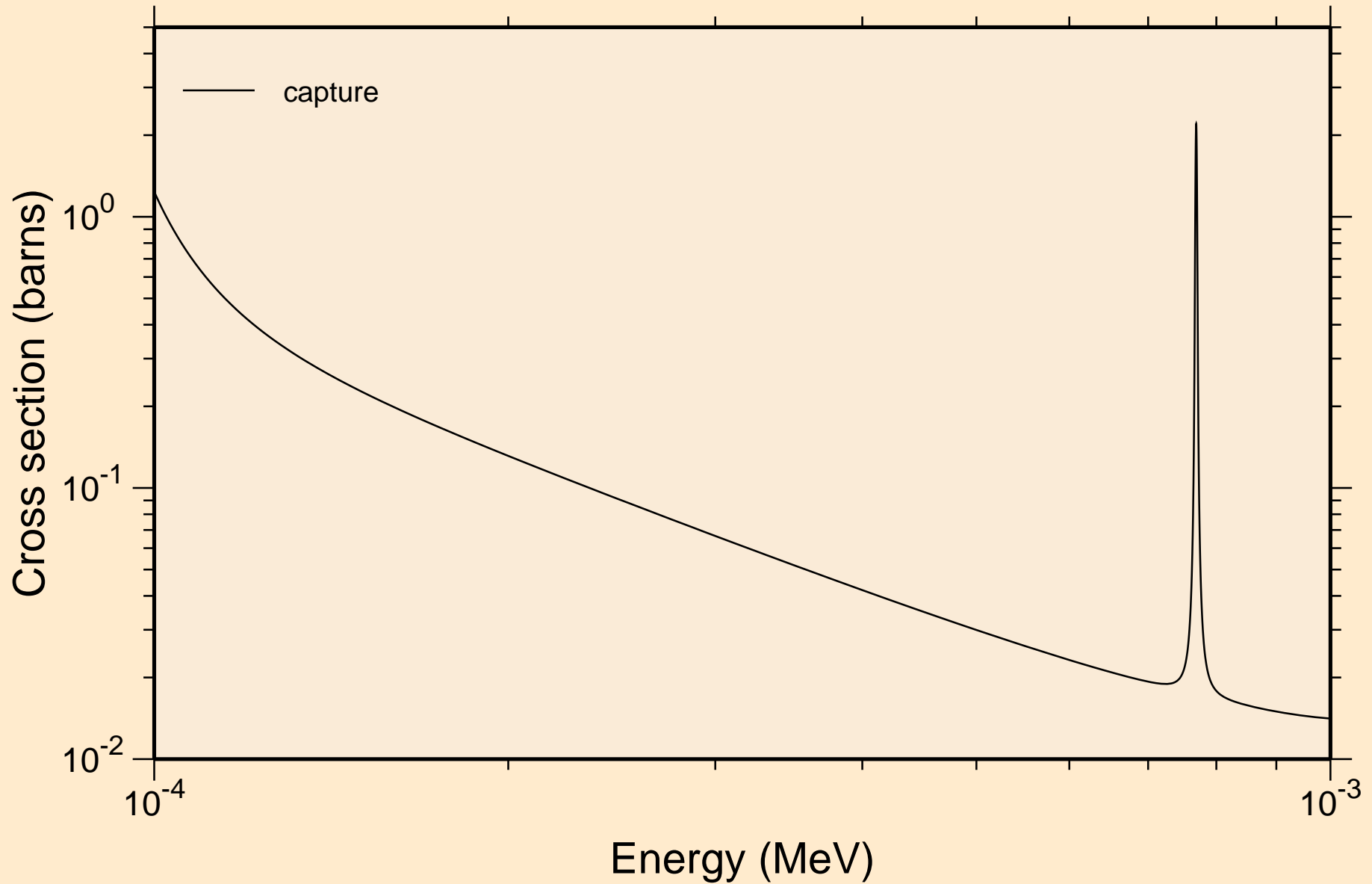

MN052 NEUTRON ACER TENDL-2024 LIBRARY; T=293.6K
resonance absorption cross sections

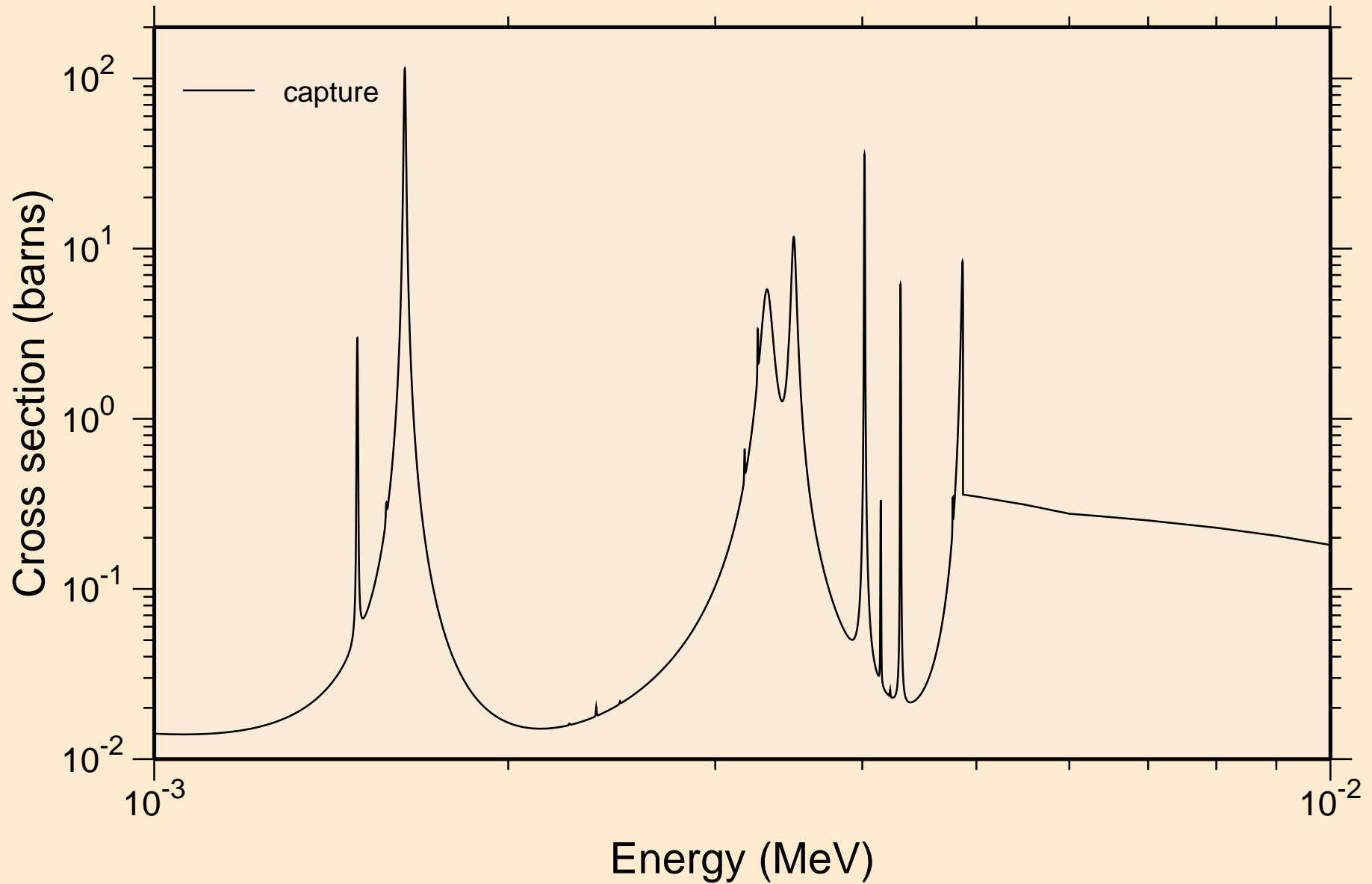

MN052 NEUTRON ACER TENDL-2024 LIBRARY; T=293.6K
resonance absorption cross sections

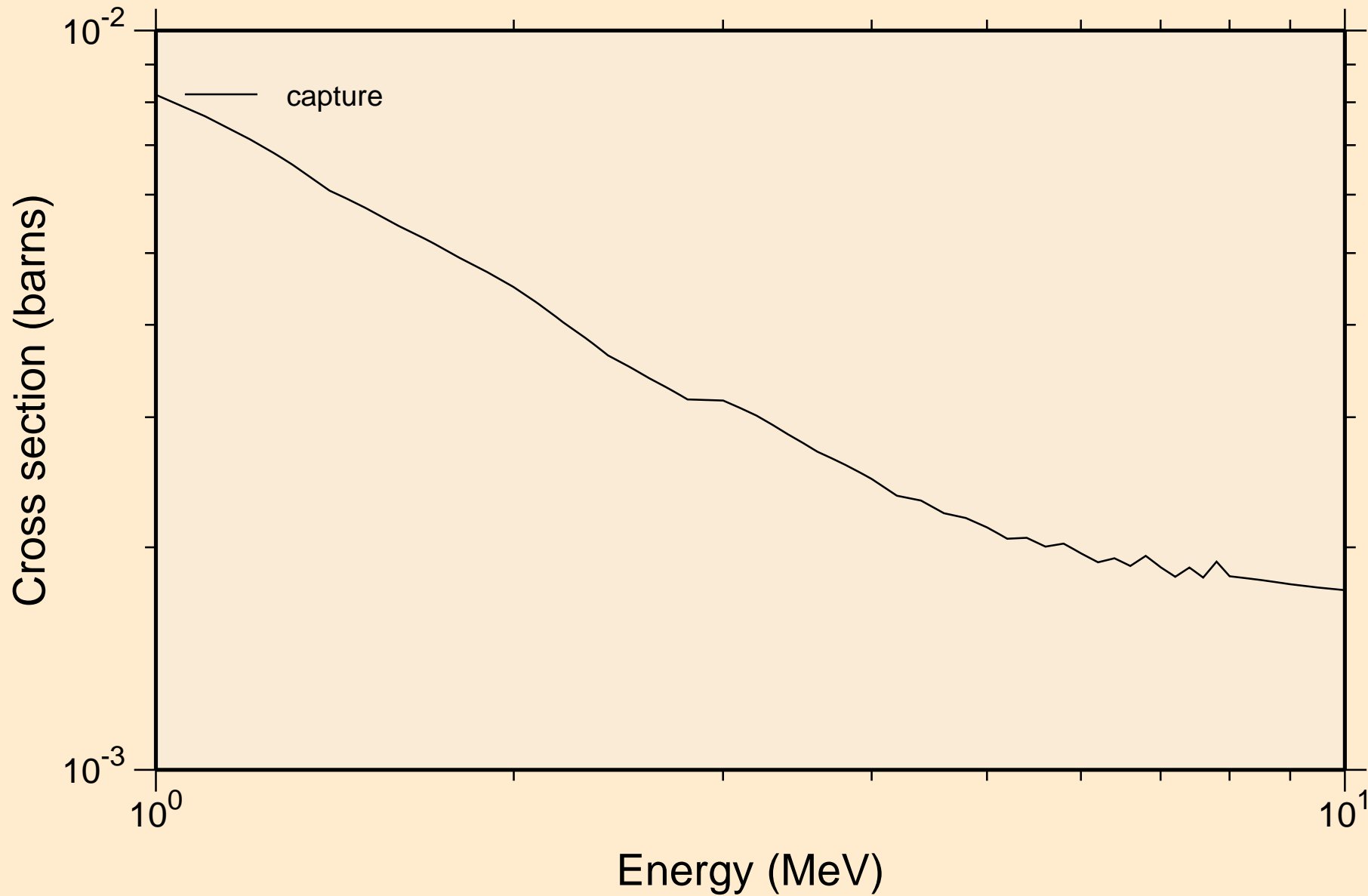

MN052 NEUTRON ACER TENDL-2024 LIBRARY; T=293.6K
Heating

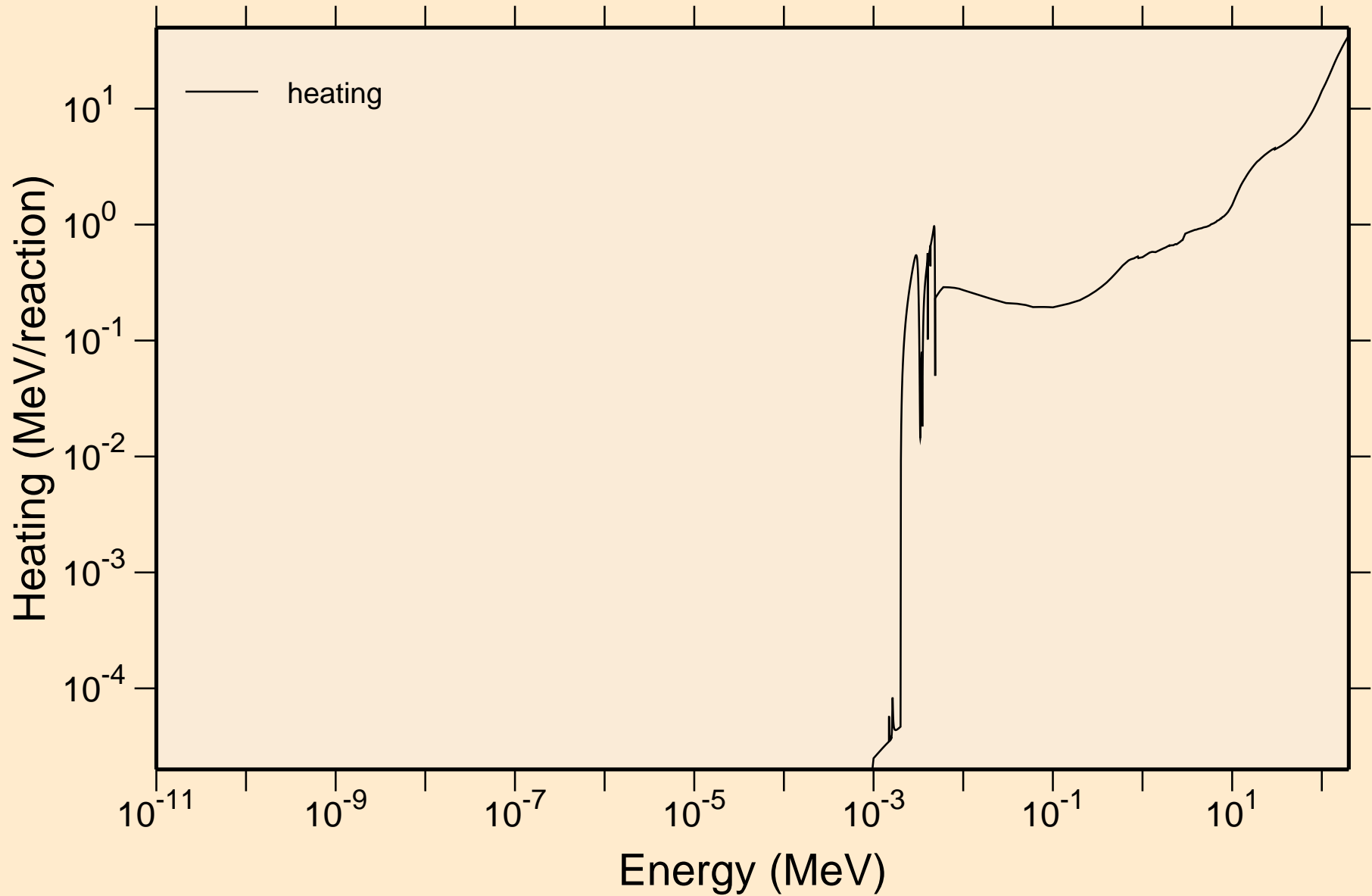

MN052 NEUTRON ACER TENDL-2024 LIBRARY; T=293.6K Damage

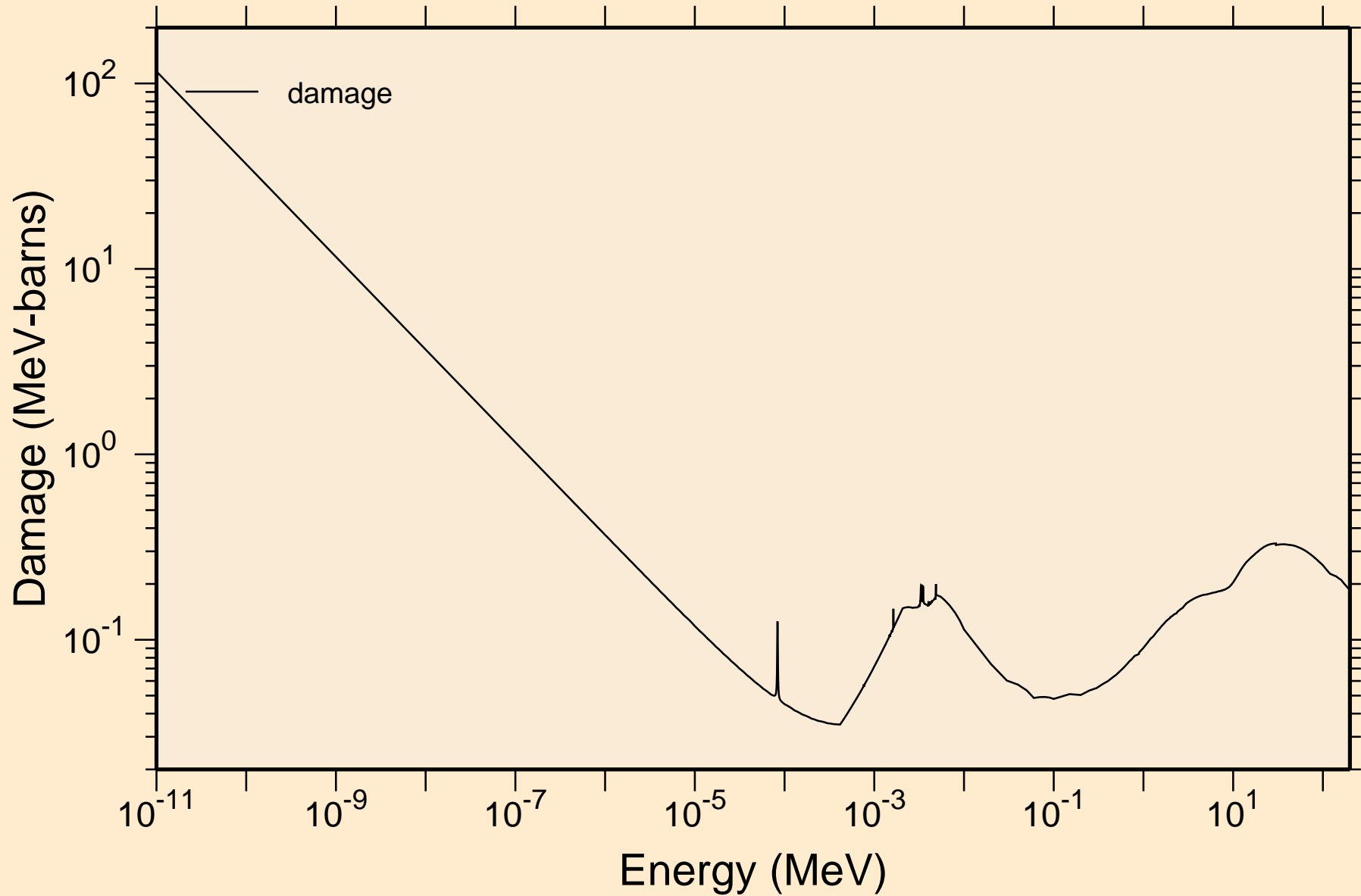

MN052 NEUTRON ACER TENDL-2024 LIBRARY; T=293.6K

Non-threshold reactions

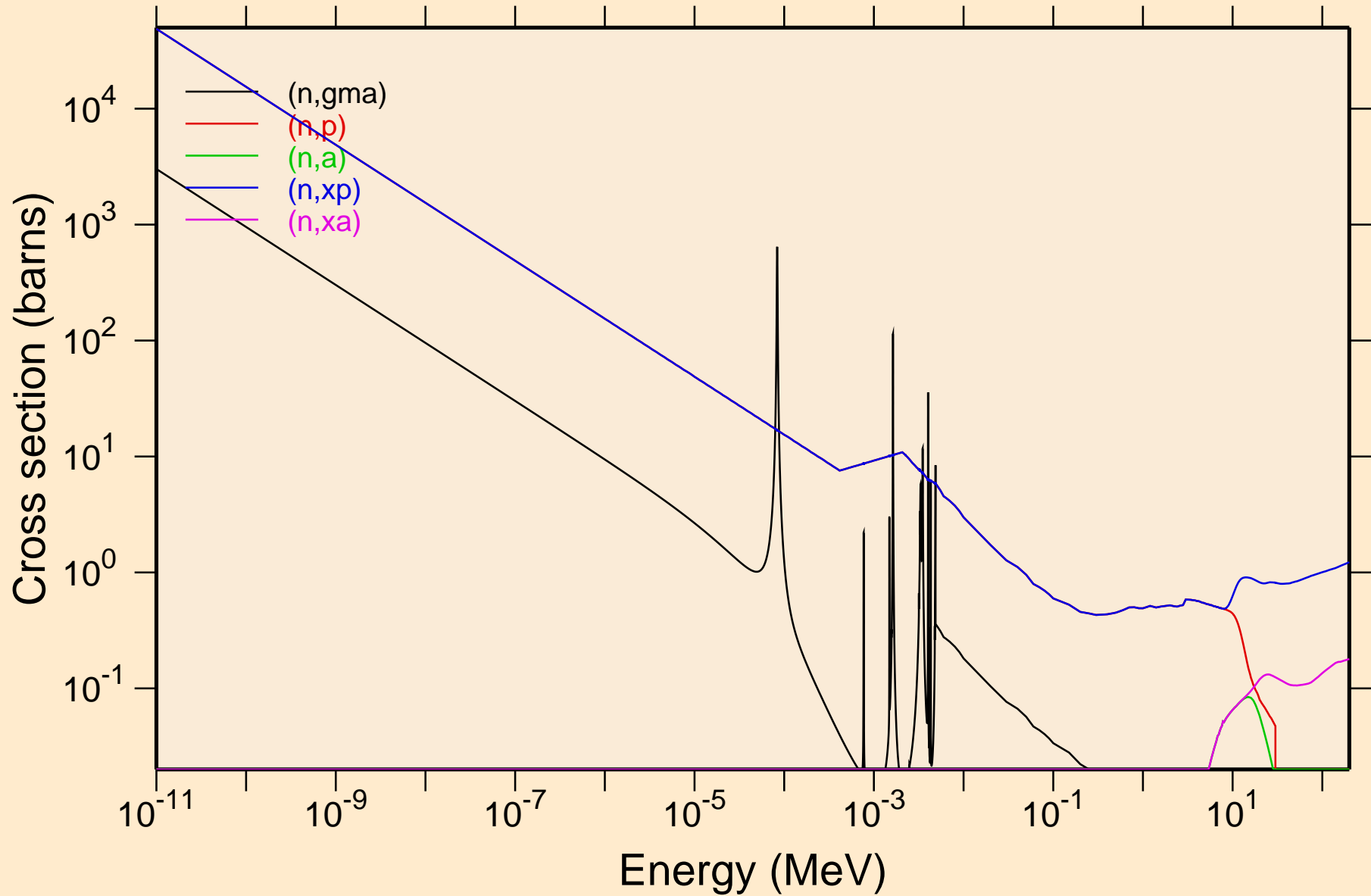

MN052 NEUTRON ACER TENDL-2024 LIBRARY; T=293.6K
Principal cross sections

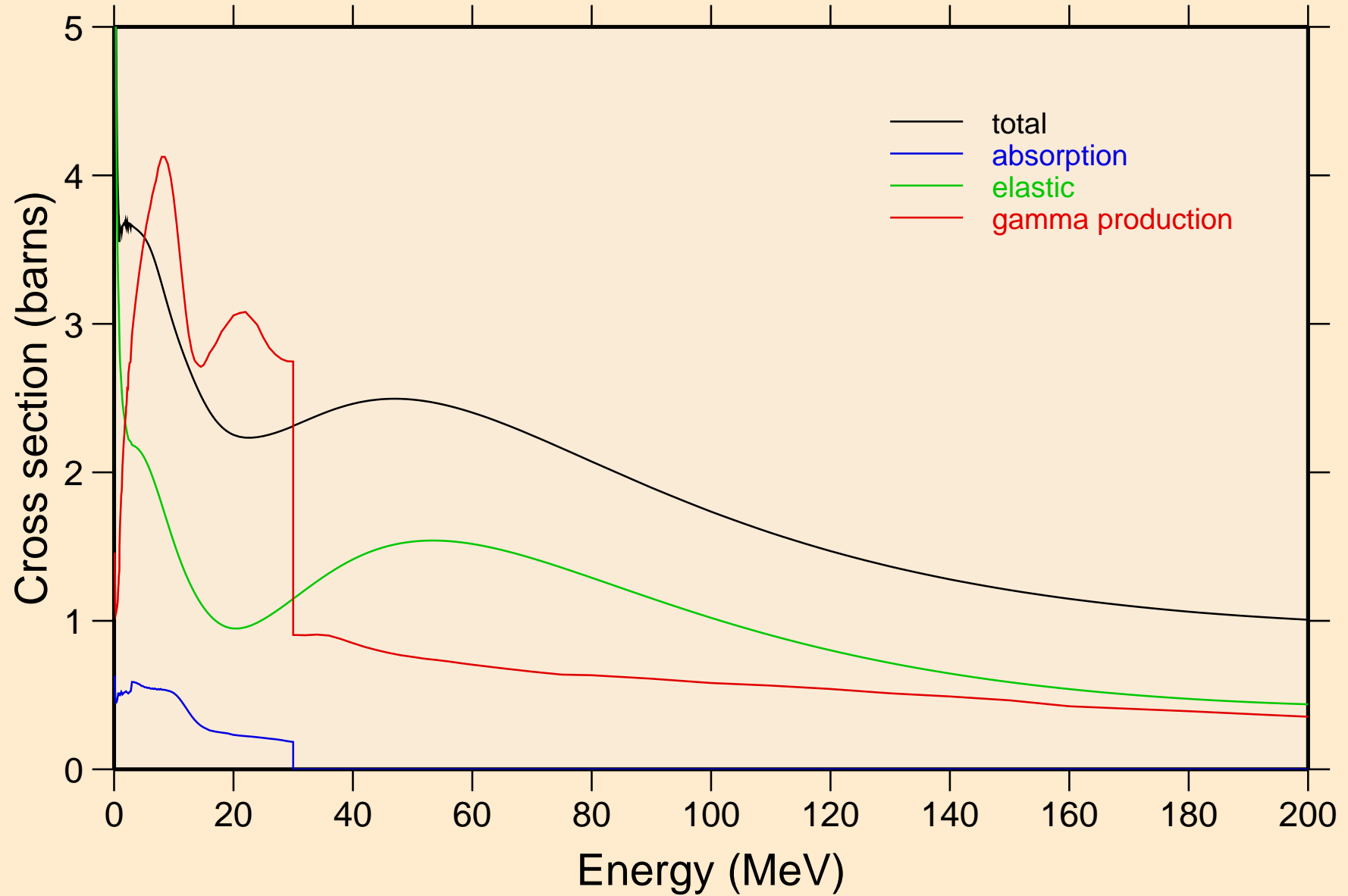

MN052 NEUTRON ACER TENDL-2024 LIBRARY; T=293.6K
Heating

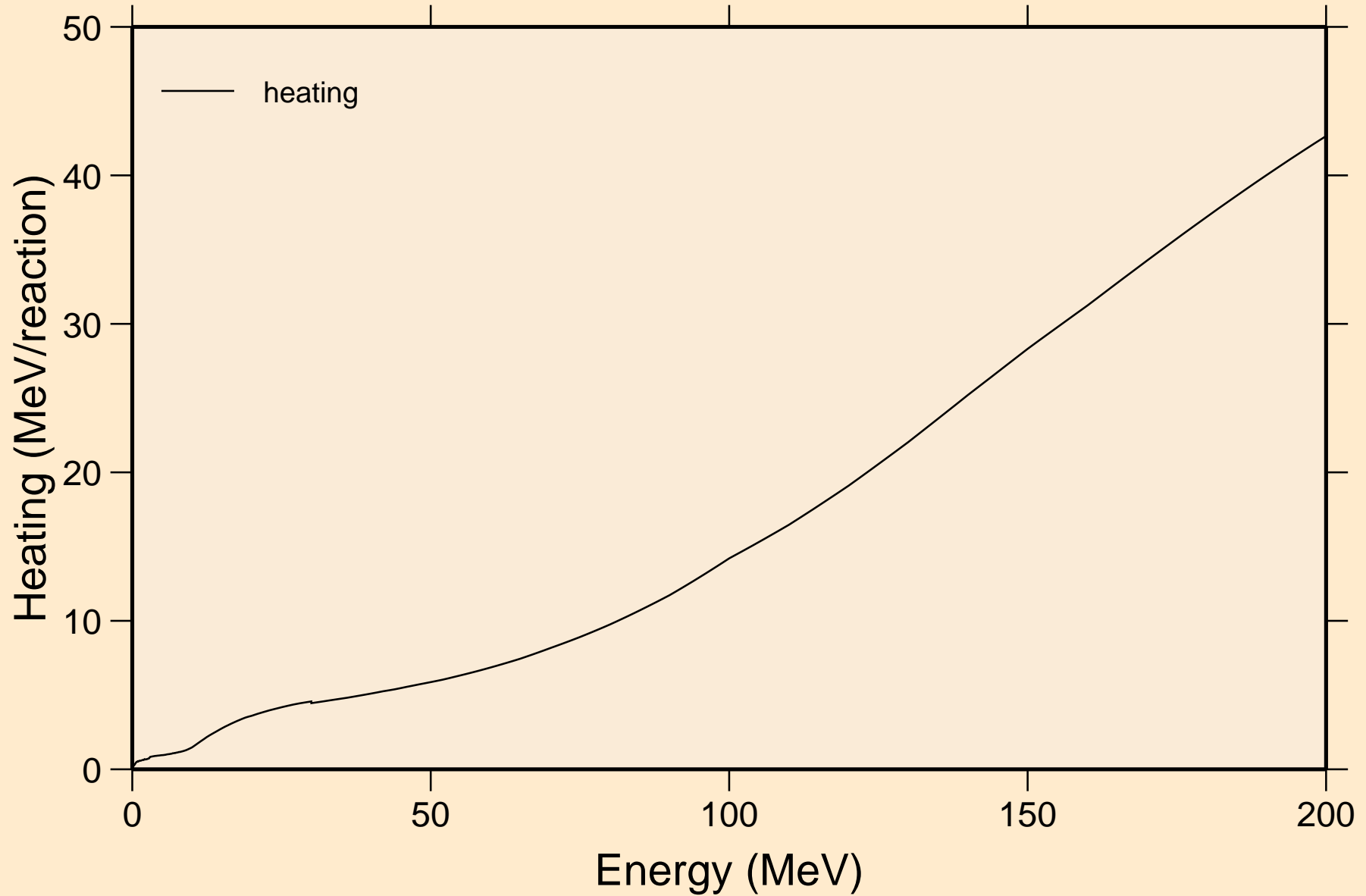

MN052 NEUTRON ACER TENDL-2024 LIBRARY; T=293.6K
Damage

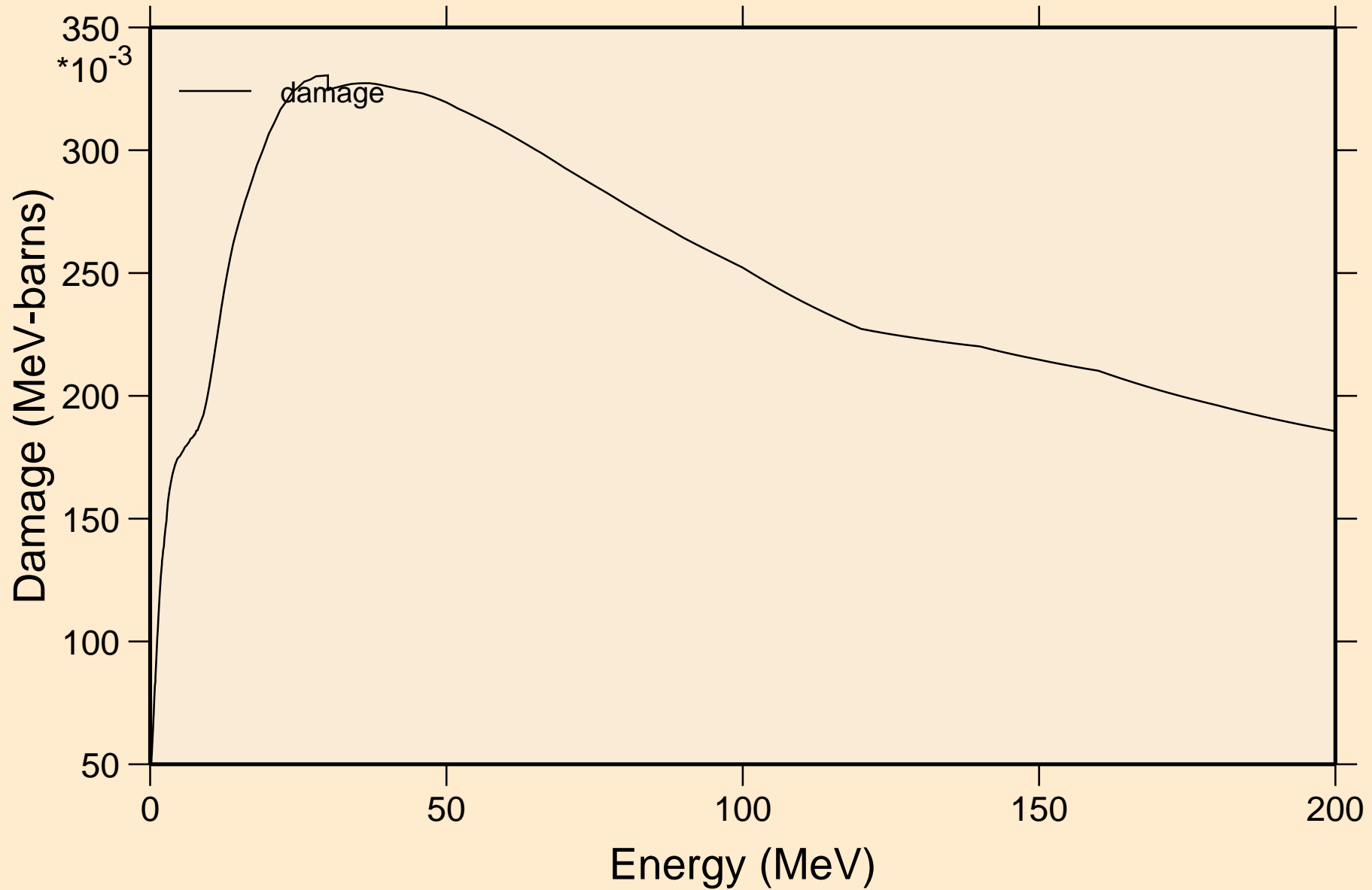

MN052 NEUTRON ACER TENDL-2024 LIBRARY; T=293.6K
Non-threshold reactions

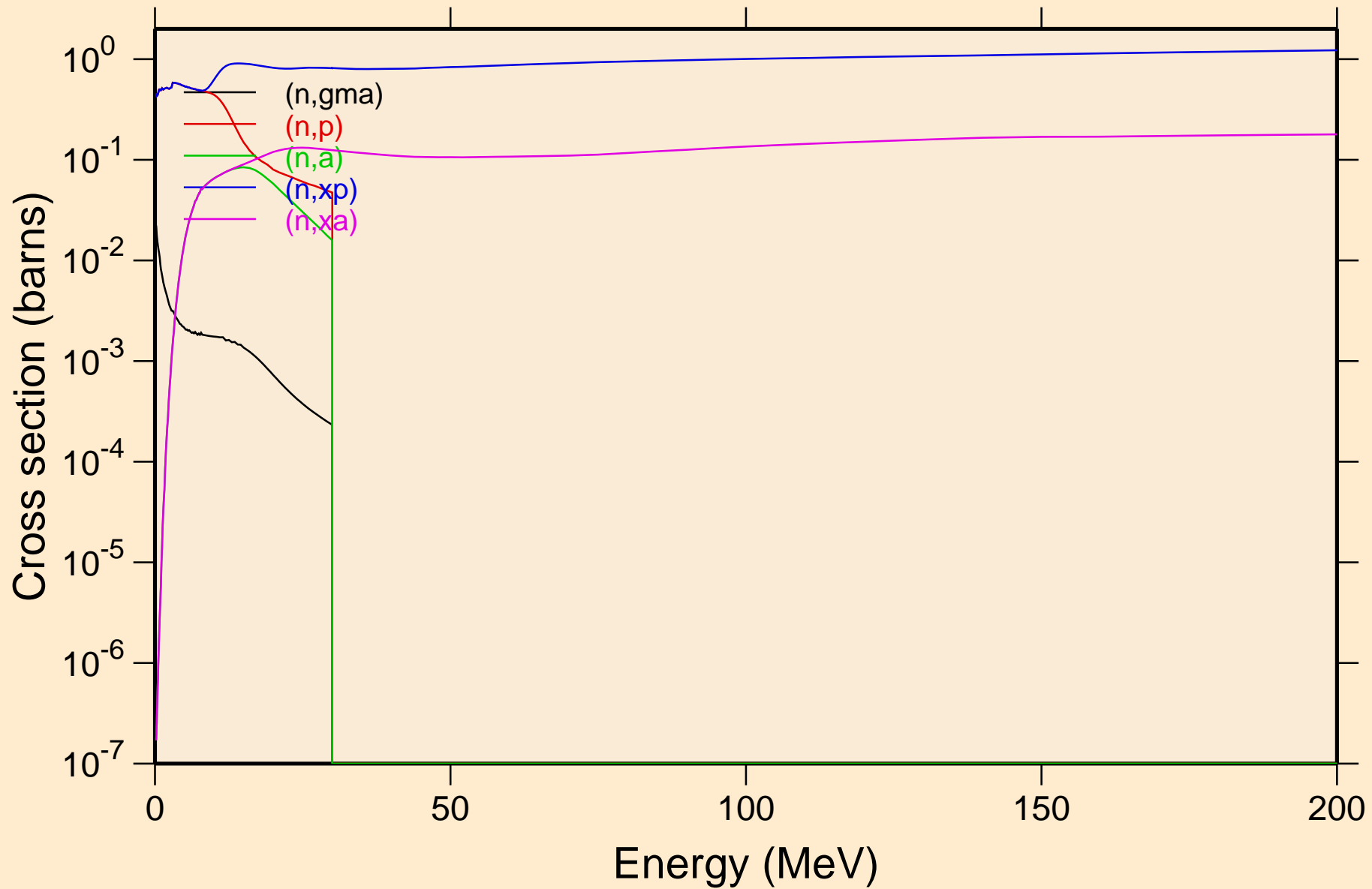

MN052 NEUTRON ACER TENDL-2024 LIBRARY; T=293.6K
Inelastic levels

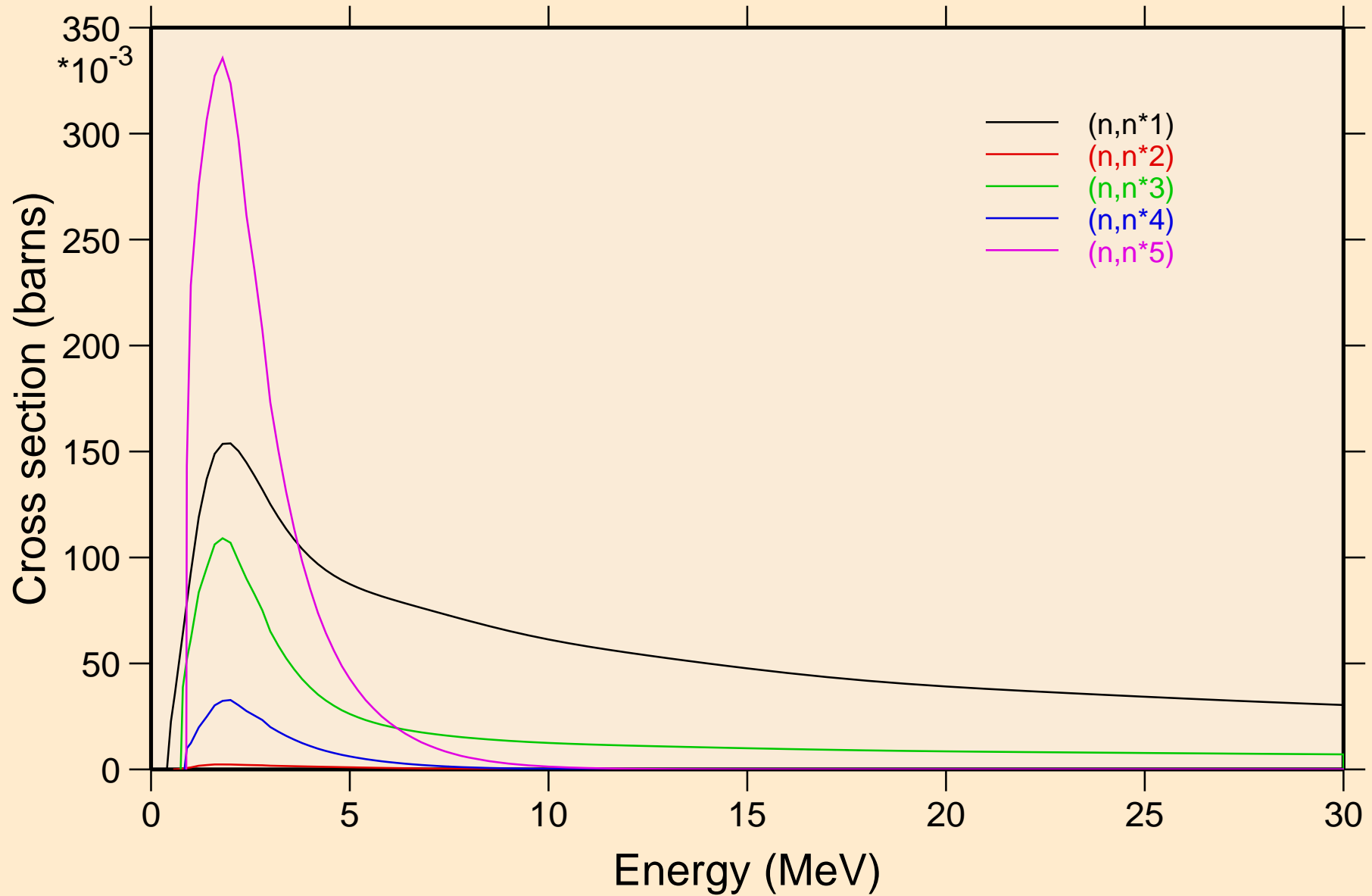

MN052 NEUTRON ACER TENDL-2024 LIBRARY; T=293.6K
Inelastic levels

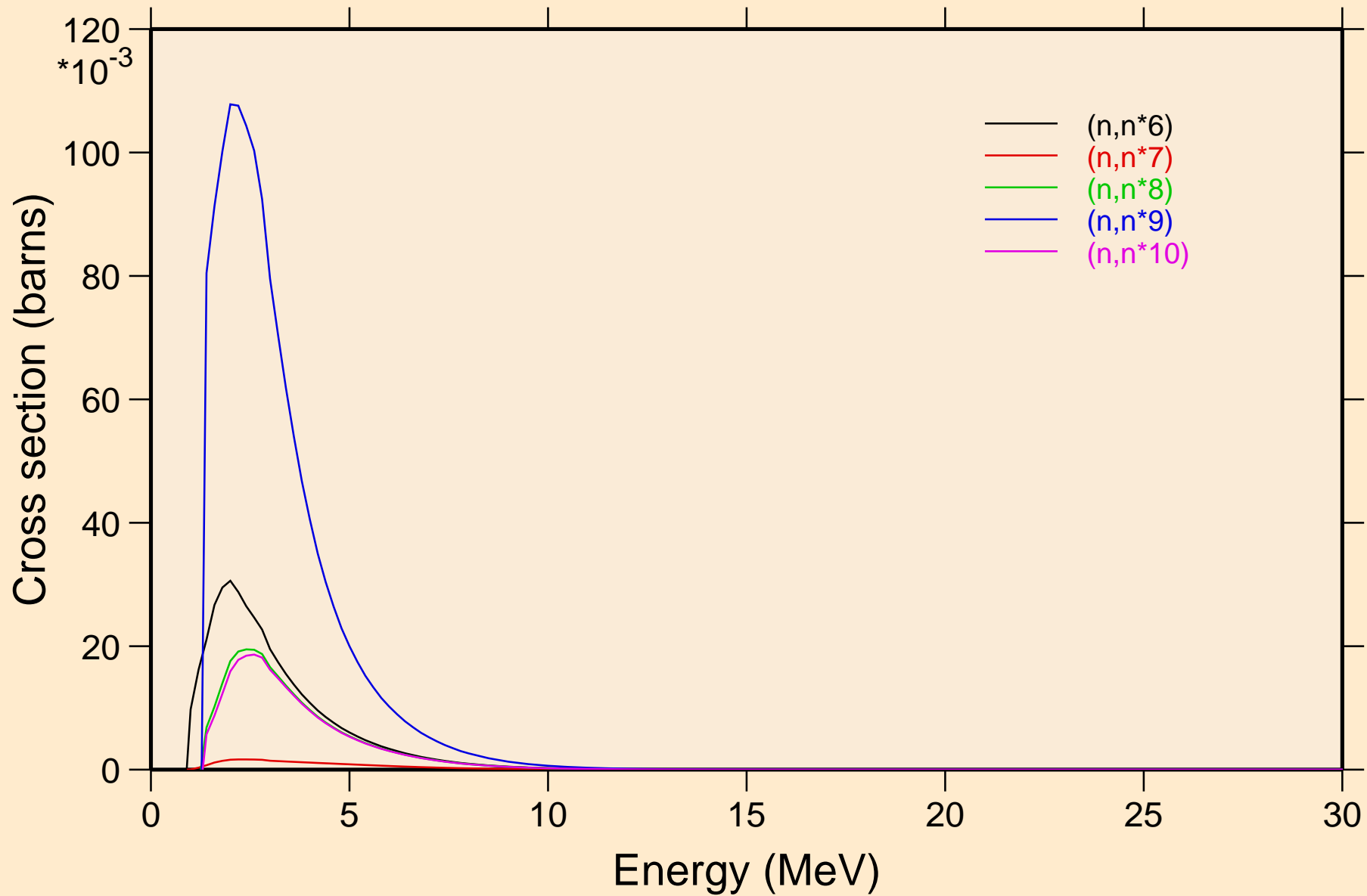

MN052 NEUTRON ACER TENDL-2024 LIBRARY; T=293.6K
Inelastic levels

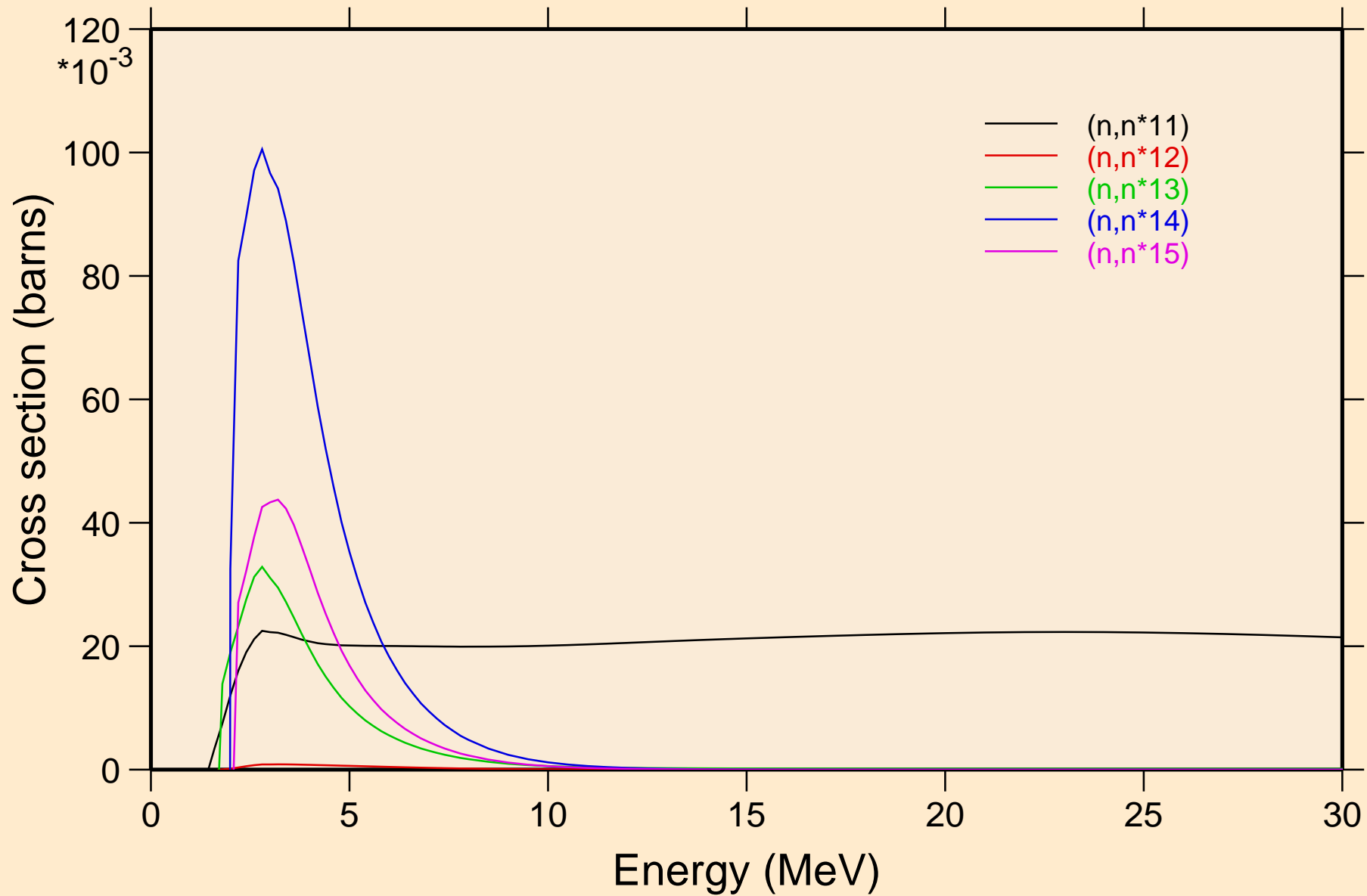

MN052 NEUTRON ACER TENDL-2024 LIBRARY; T=293.6K
Inelastic levels

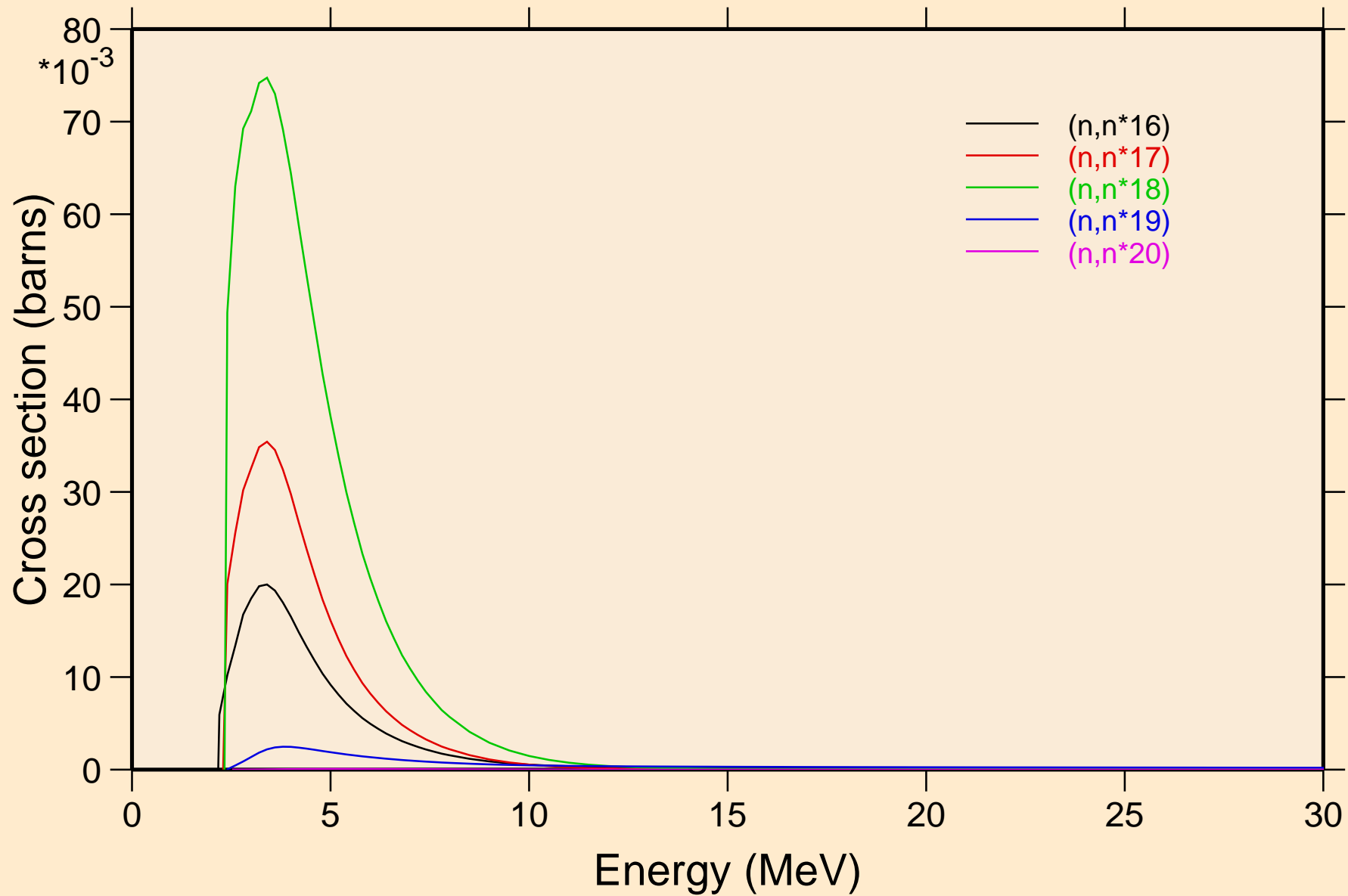

MN052 NEUTRON ACER TENDL-2024 LIBRARY; T=293.6K
Inelastic levels

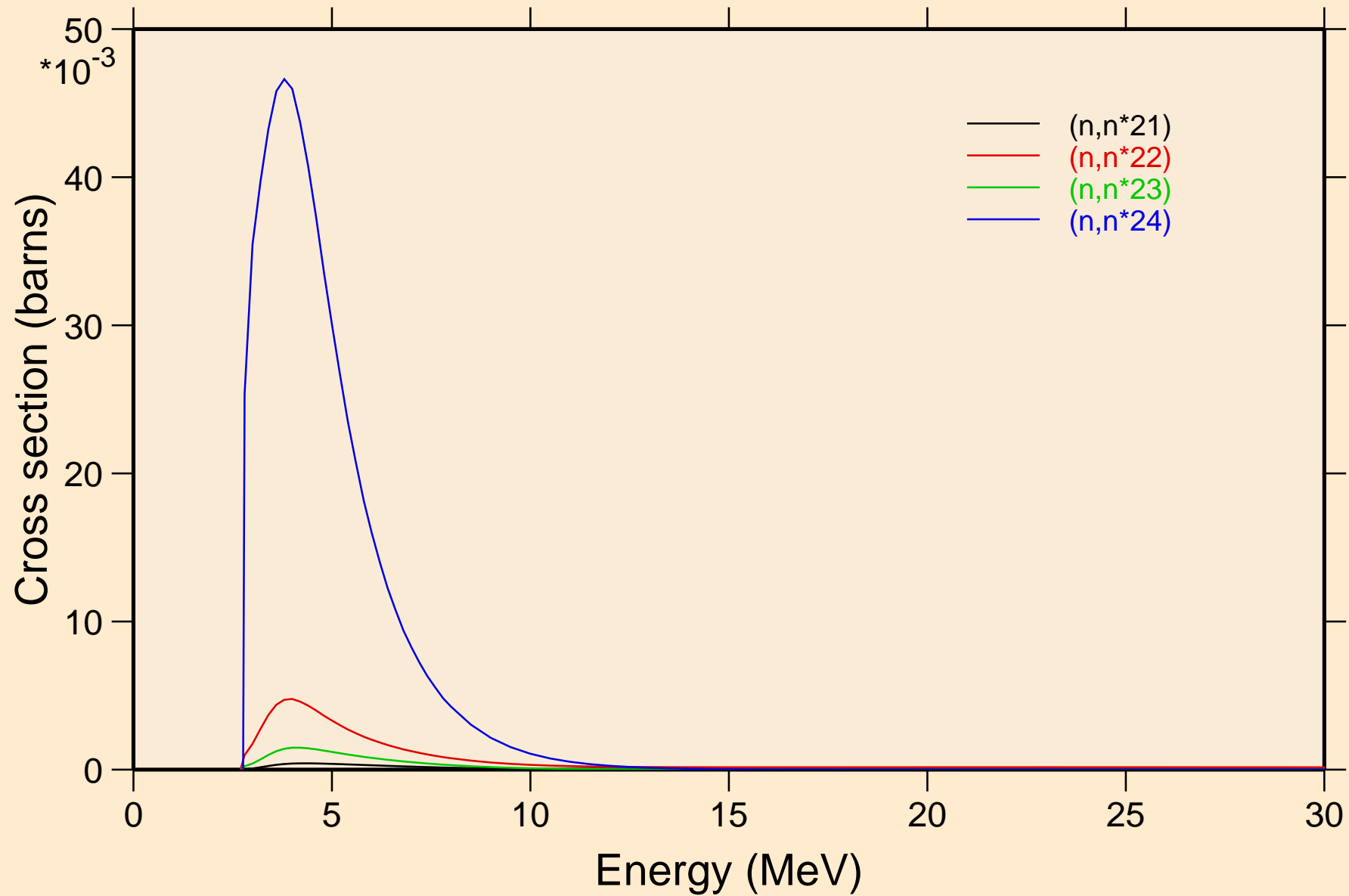

MN052 NEUTRON ACER TENDL-2024 LIBRARY; T=293.6K
Threshold reactions

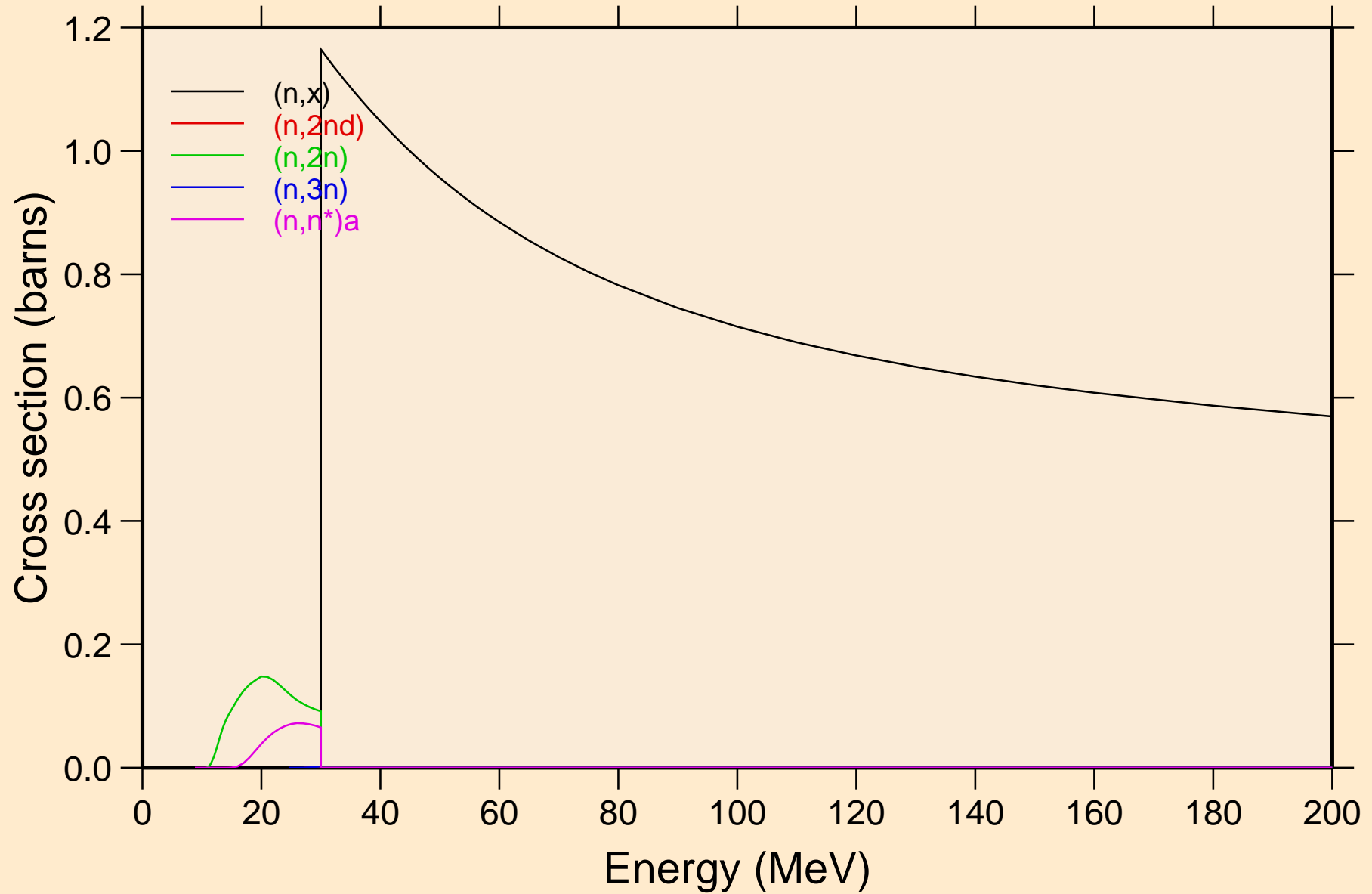

MN052 NEUTRON ACER TENDL-2024 LIBRARY; T=293.6K
Threshold reactions

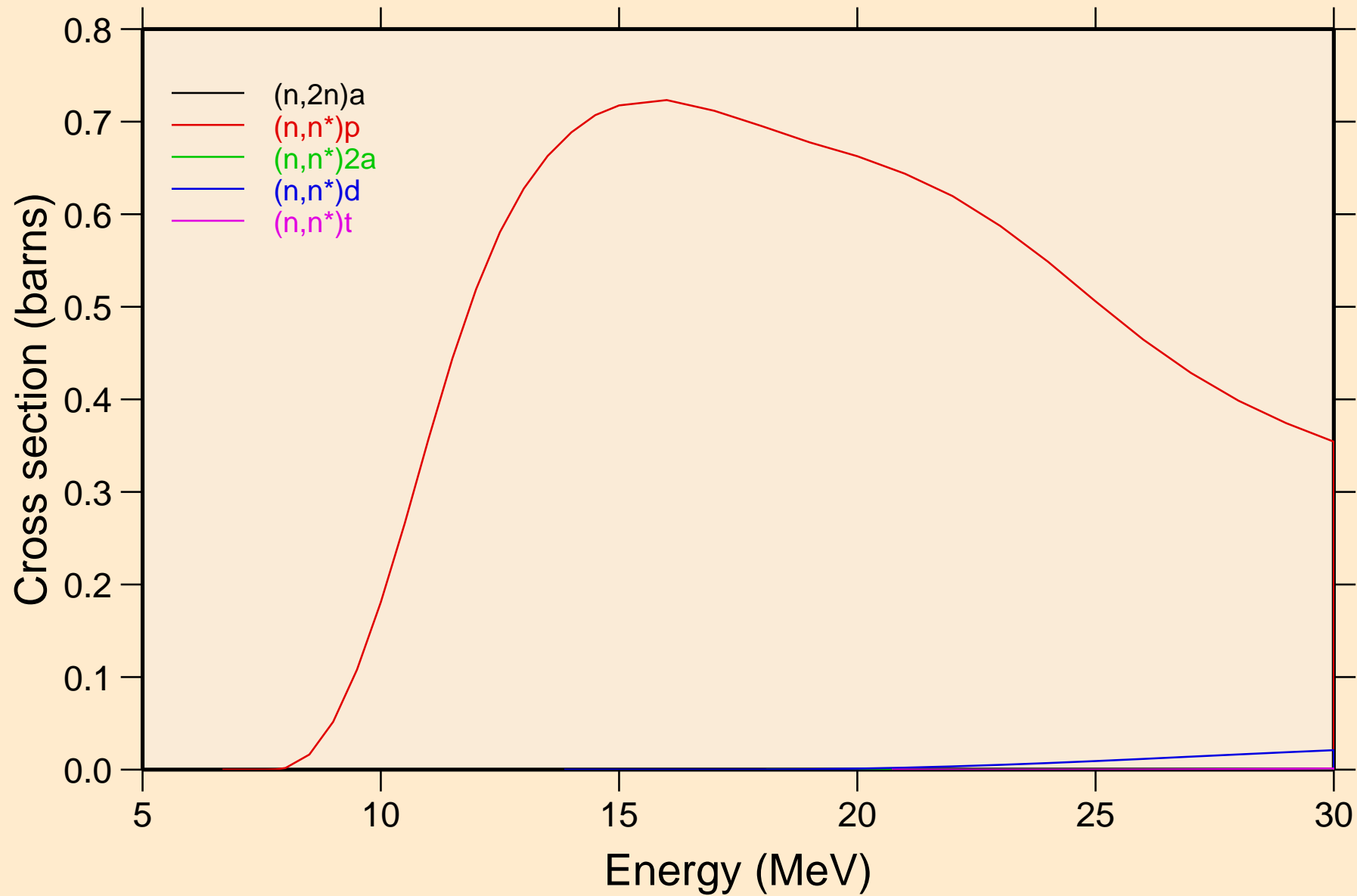

MN052 NEUTRON ACER TENDL-2024 LIBRARY; T=293.6K
Threshold reactions

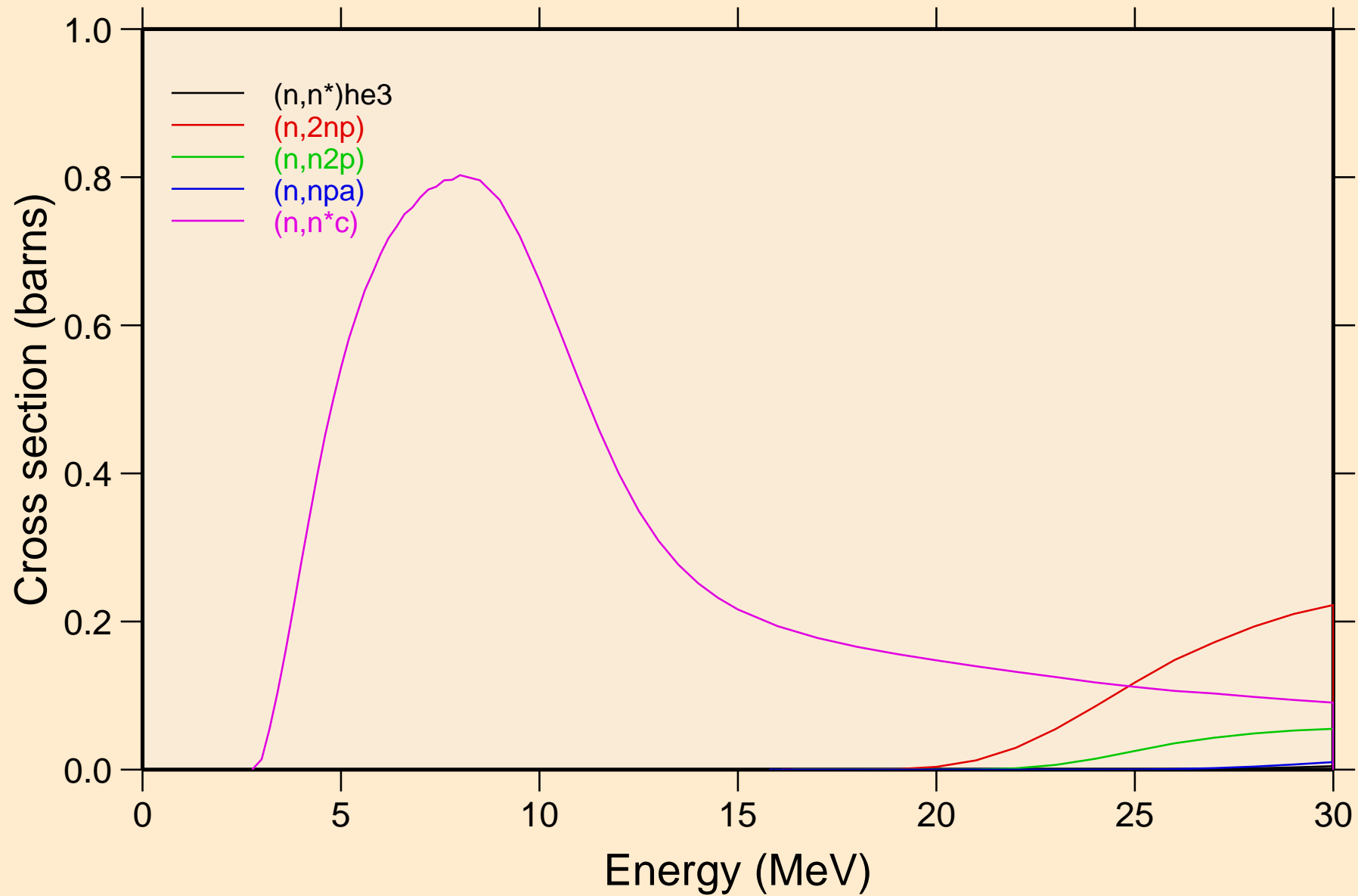

MN052 NEUTRON ACER TENDL-2024 LIBRARY; T=293.6K
Threshold reactions

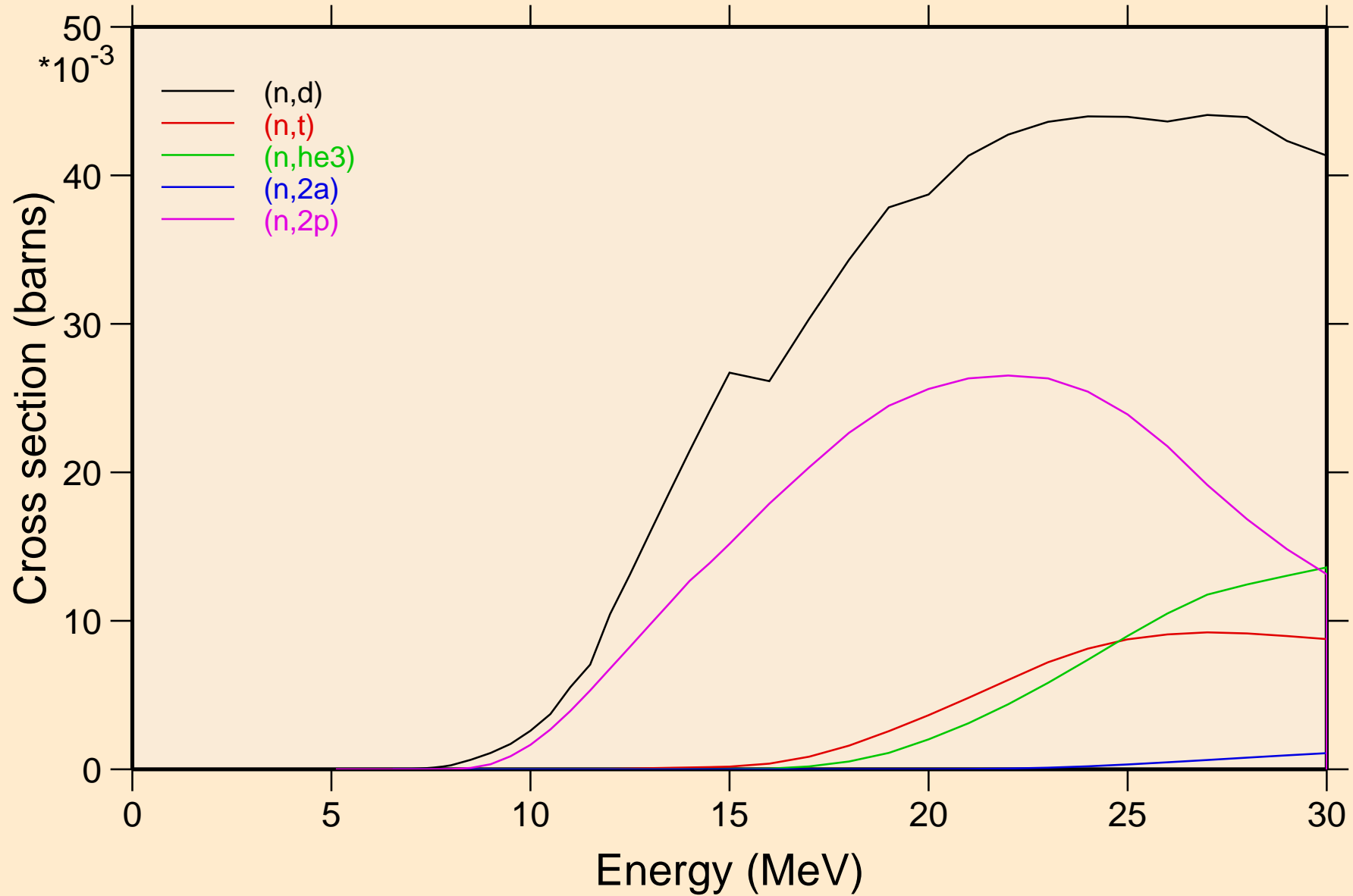

MN052 NEUTRON ACER TENDL-2024 LIBRARY; T=293.6K
Threshold reactions

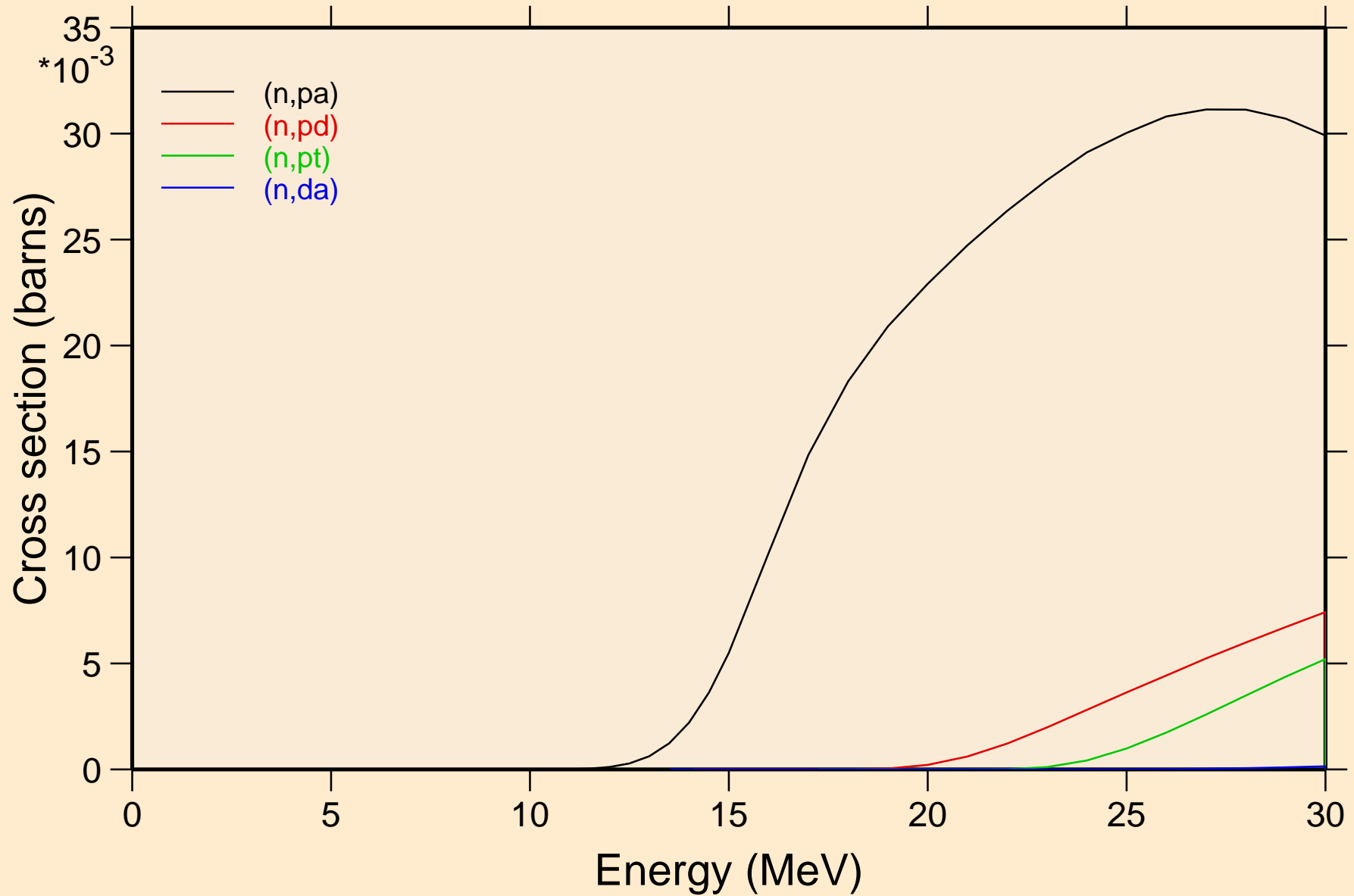

MN052 NEUTRON ACER TENDL-2024 LIBRARY; T=293.6K
Threshold reactions

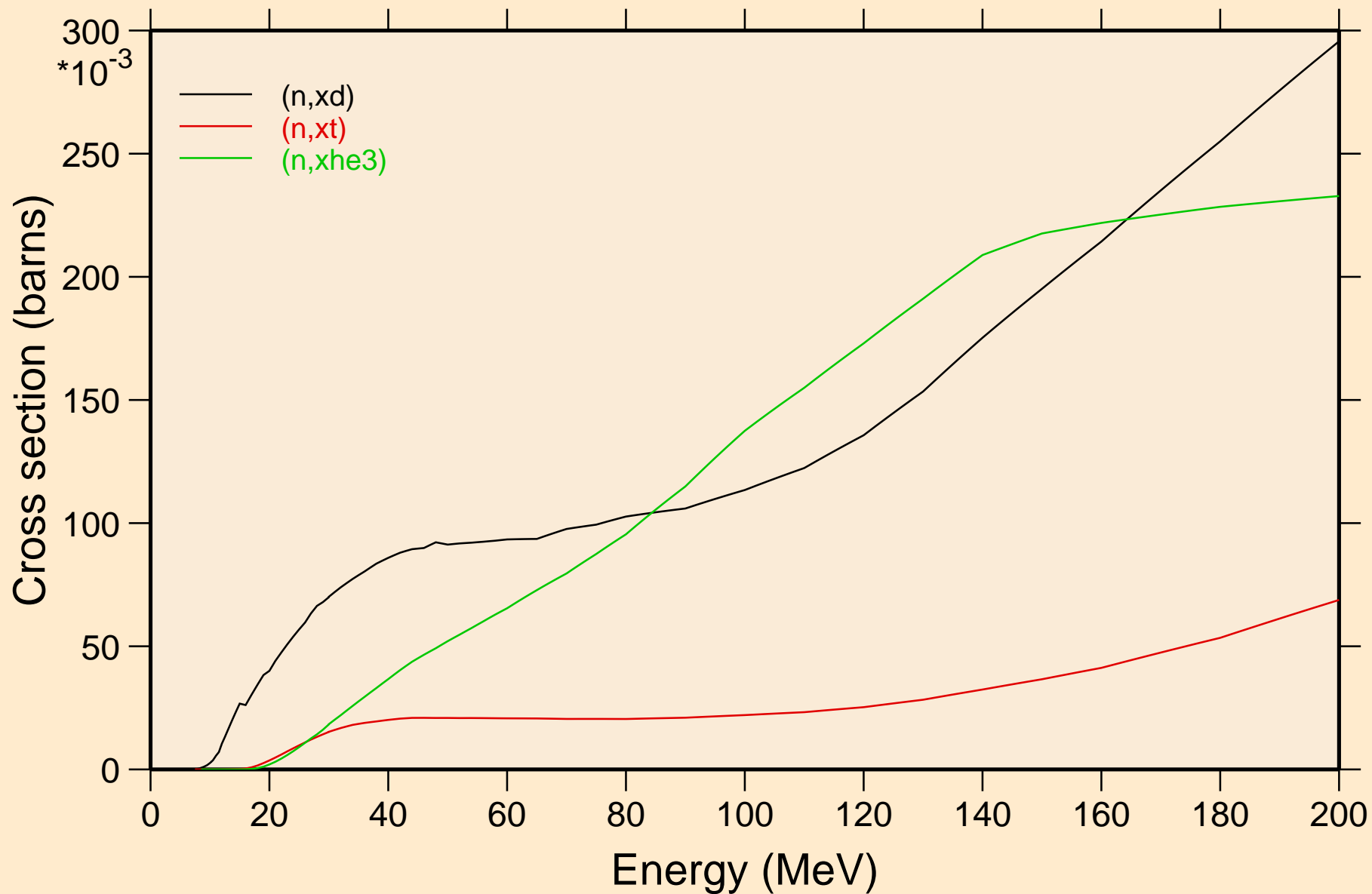

MN052 NEUTRON ACER TENDL-2024 LIBRARY; T=293.6K
angular distribution for elastic

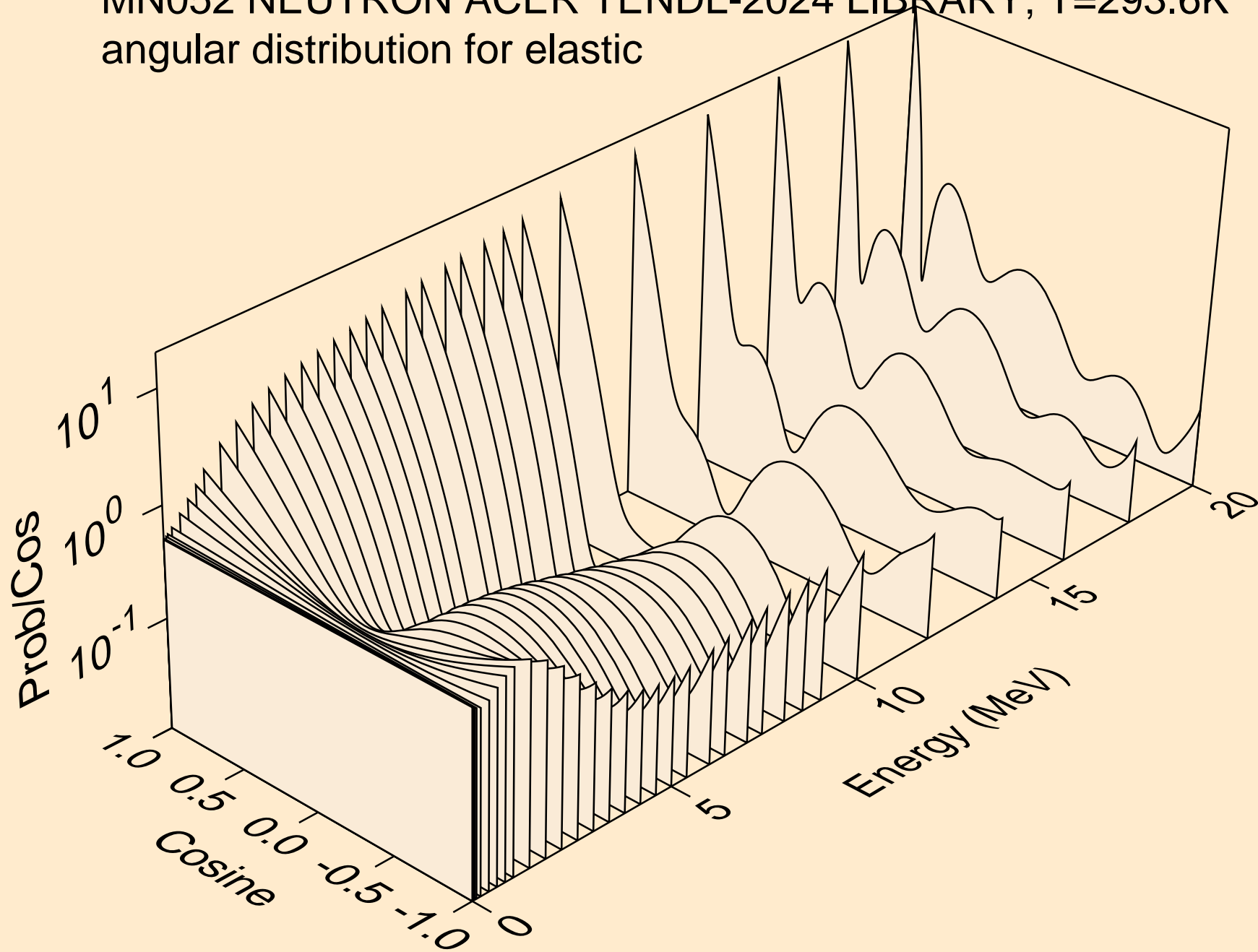

MN052 NEUTRON ACER TENDL-2024 LIBRARY; T=293.6K
angular distribution for elastic

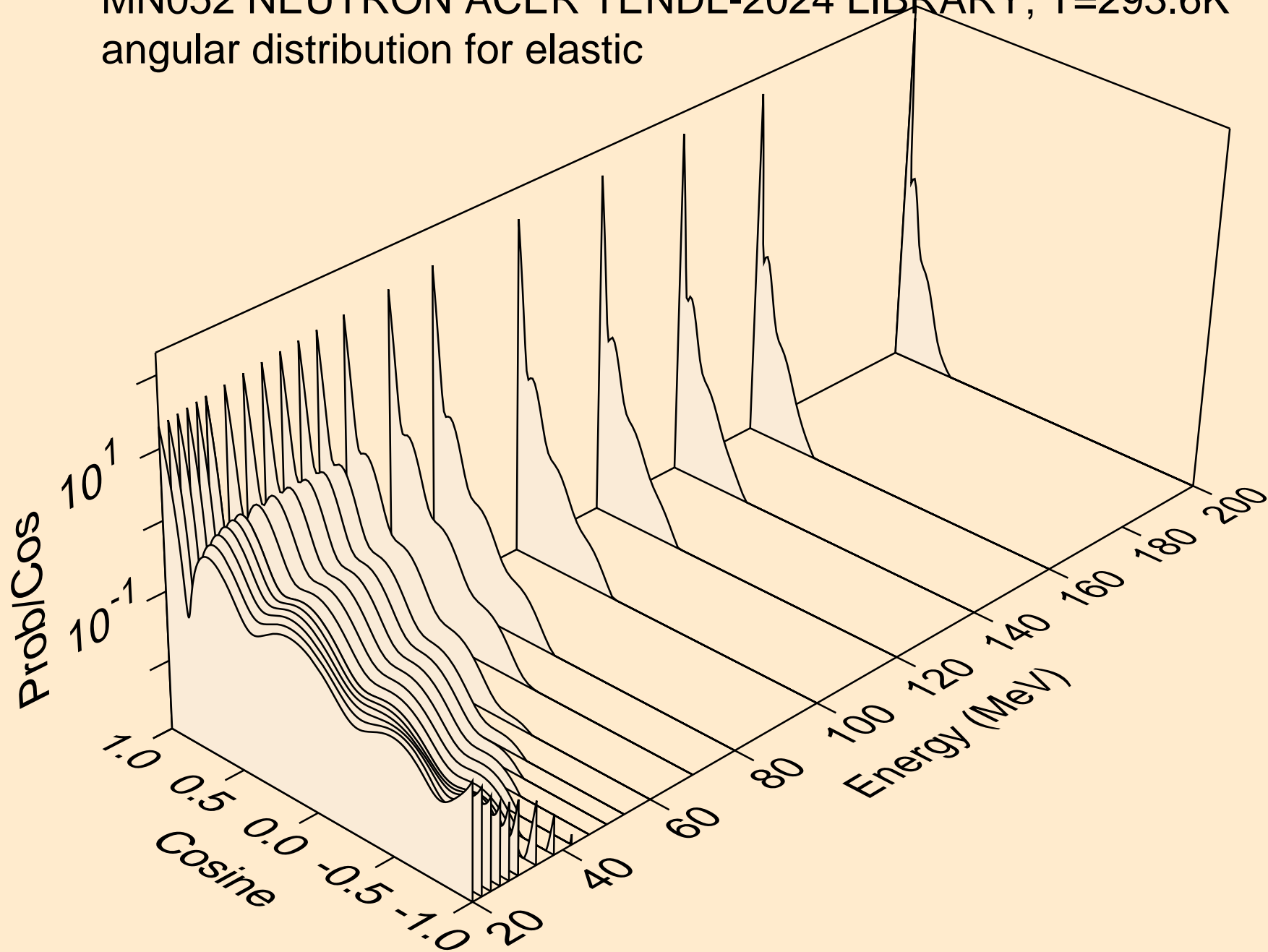

MN052 NEUTRON ACER TENDL-2024 LIBRARY; T=293.6K
angular distribution for (n,n*1)

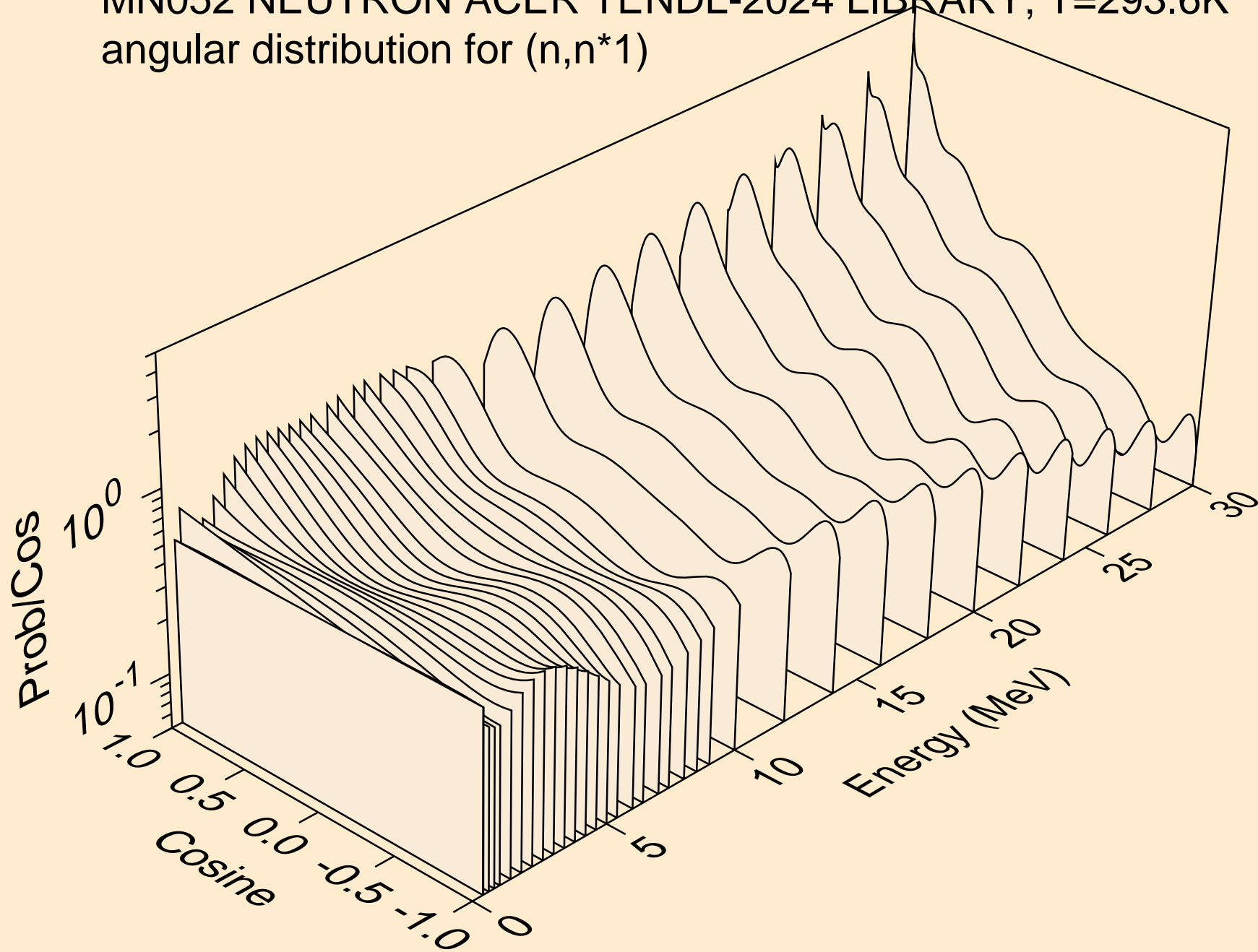

MN052 NEUTRON ACER TENDL-2024 LIBRARY; T=293.6K
angular distribution for (n,n*2)

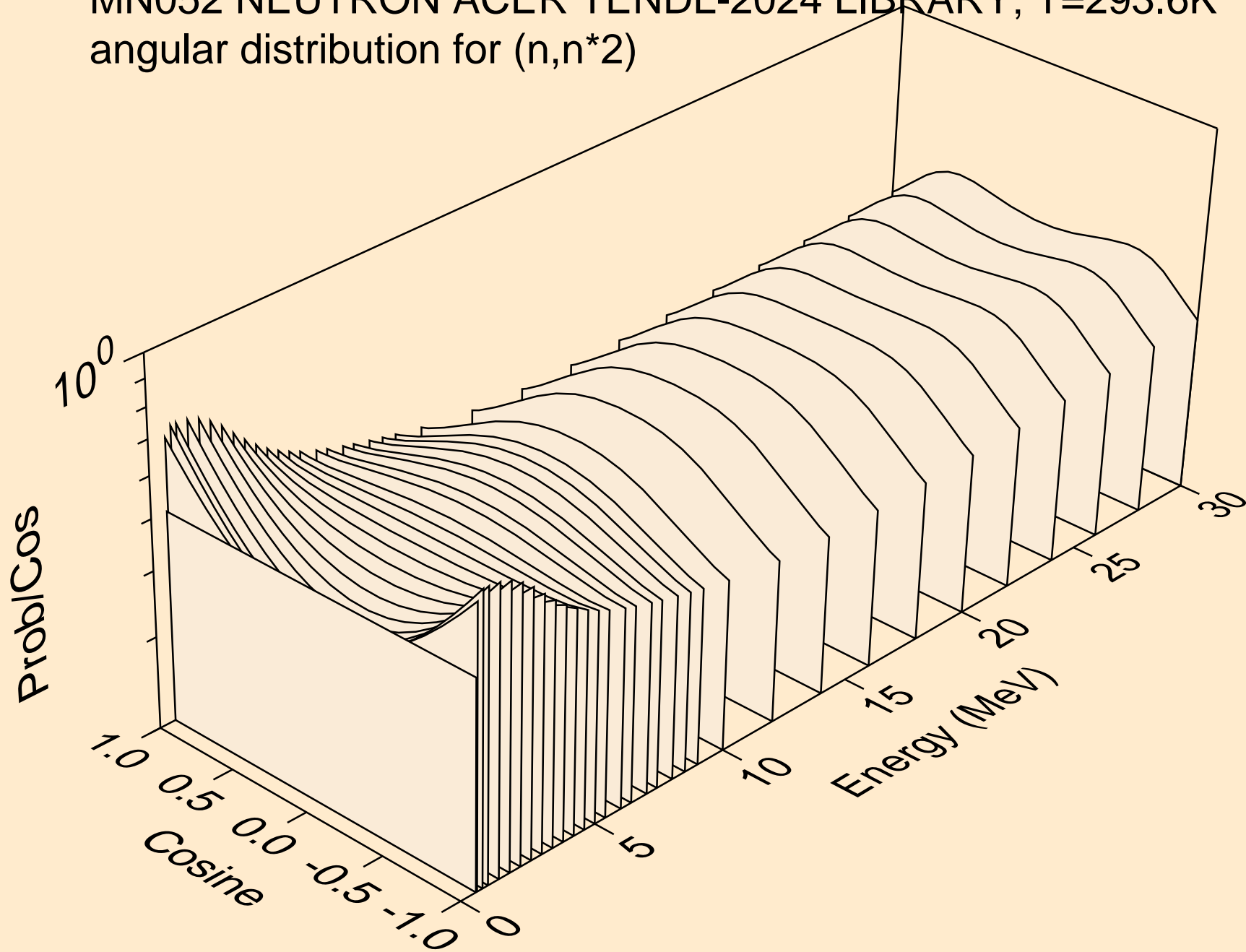

MN052 NEUTRON ACER TENDL-2024 LIBRARY; T=293.6K
angular distribution for (n,n*3)

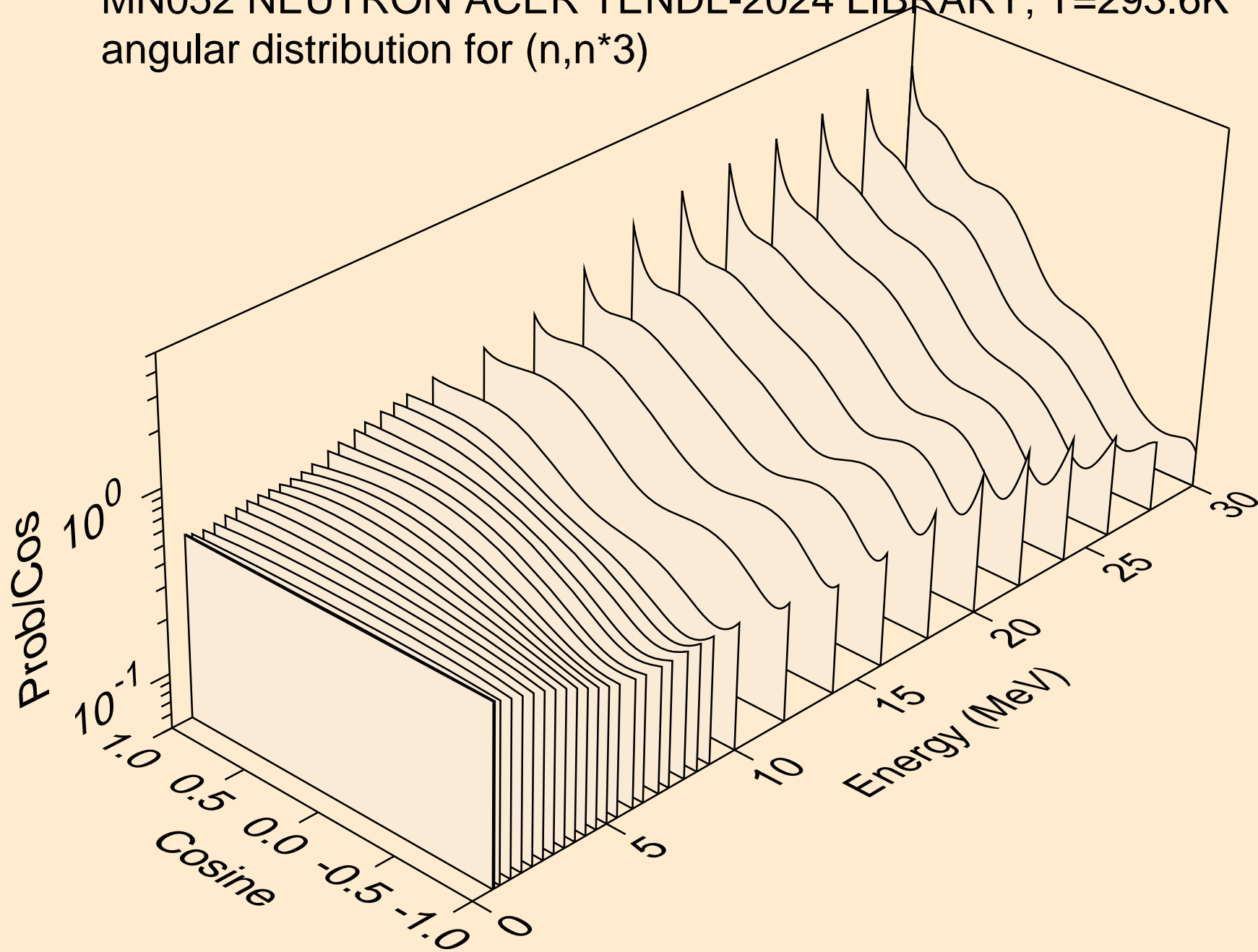

MN052 NEUTRON ACER TENDL-2024 LIBRARY; T=293.6K
angular distribution for (n,n*4)

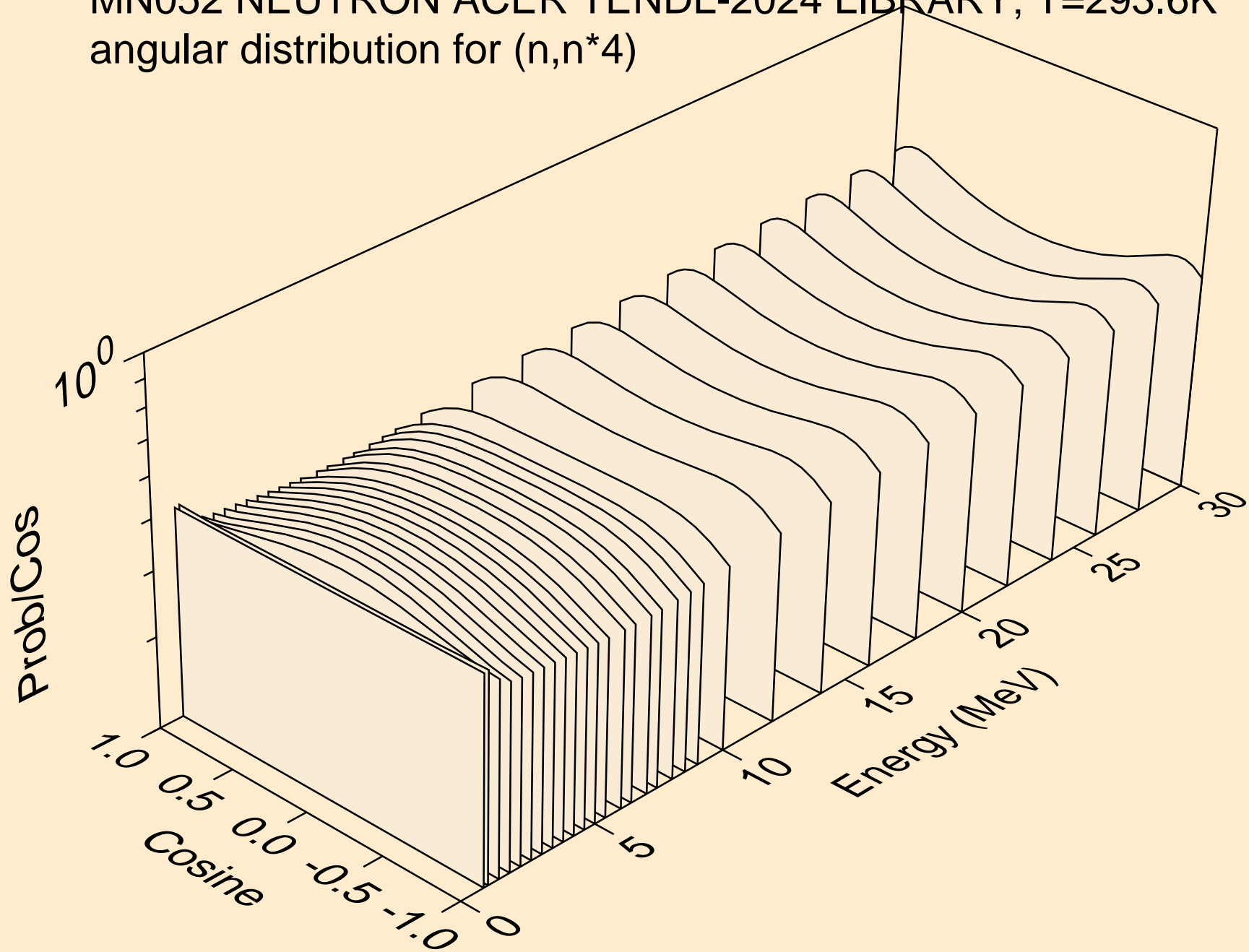

MN052 NEUTRON ACER TENDL-2024 LIBRARY; T=293.6K
angular distribution for (n,n*5)

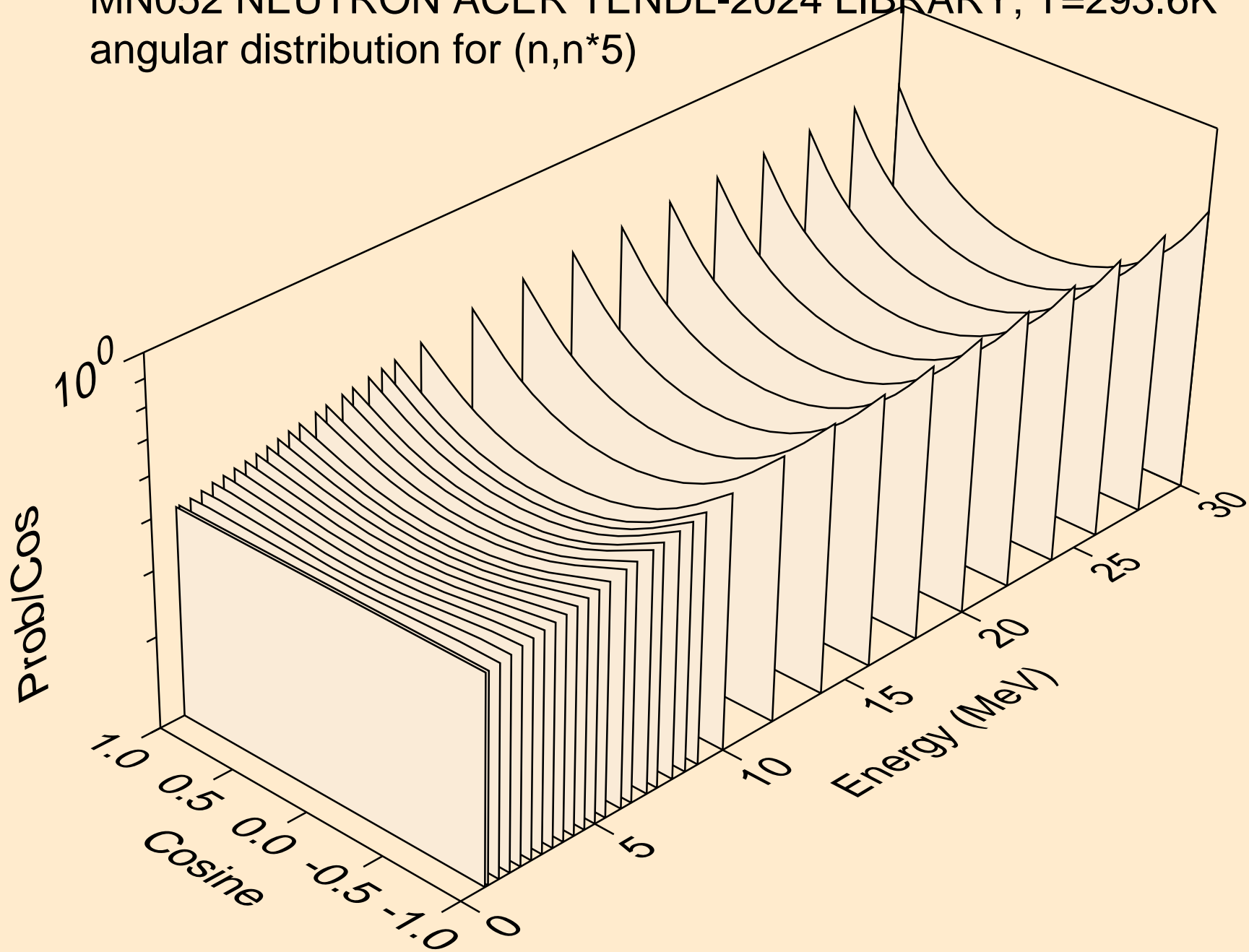

MN052 NEUTRON ACER TENDL-2024 LIBRARY; T=293.6K
angular distribution for (n,n*6)

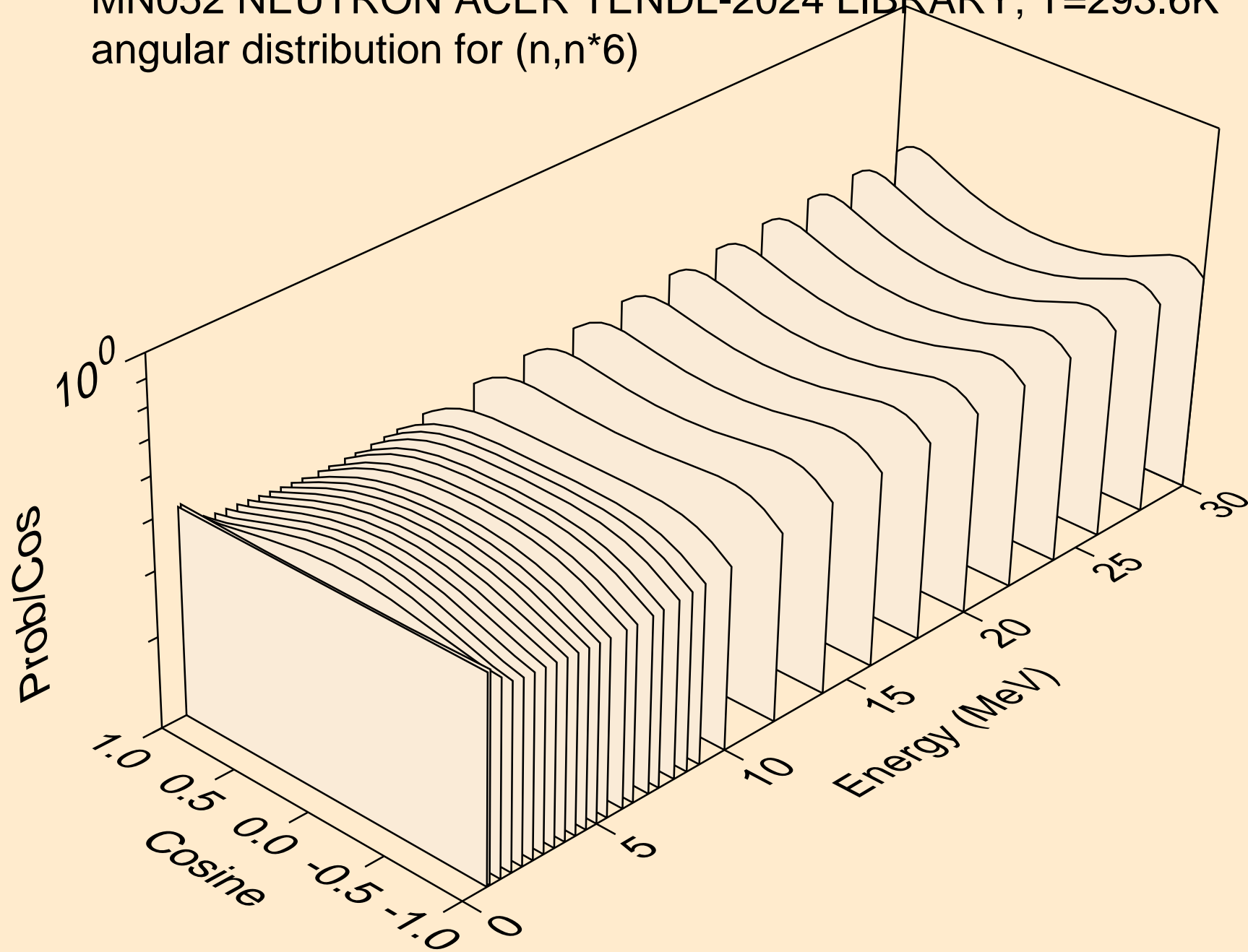

MN052 NEUTRON ACER TENDL-2024 LIBRARY; T=293.6K
angular distribution for (n,n*7)

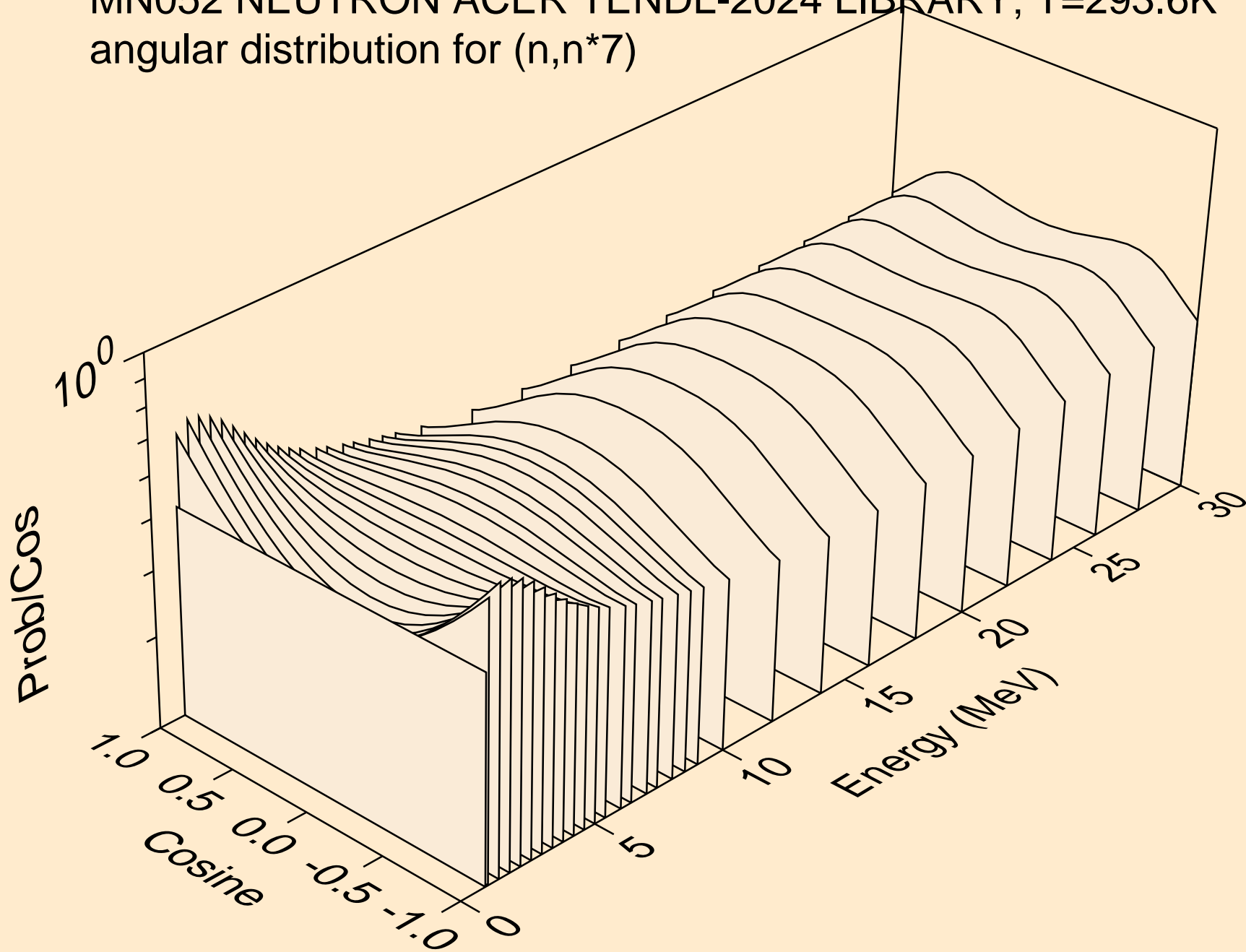

MN052 NEUTRON ACER TENDL-2024 LIBRARY; T=293.6K
angular distribution for (n,n*8)

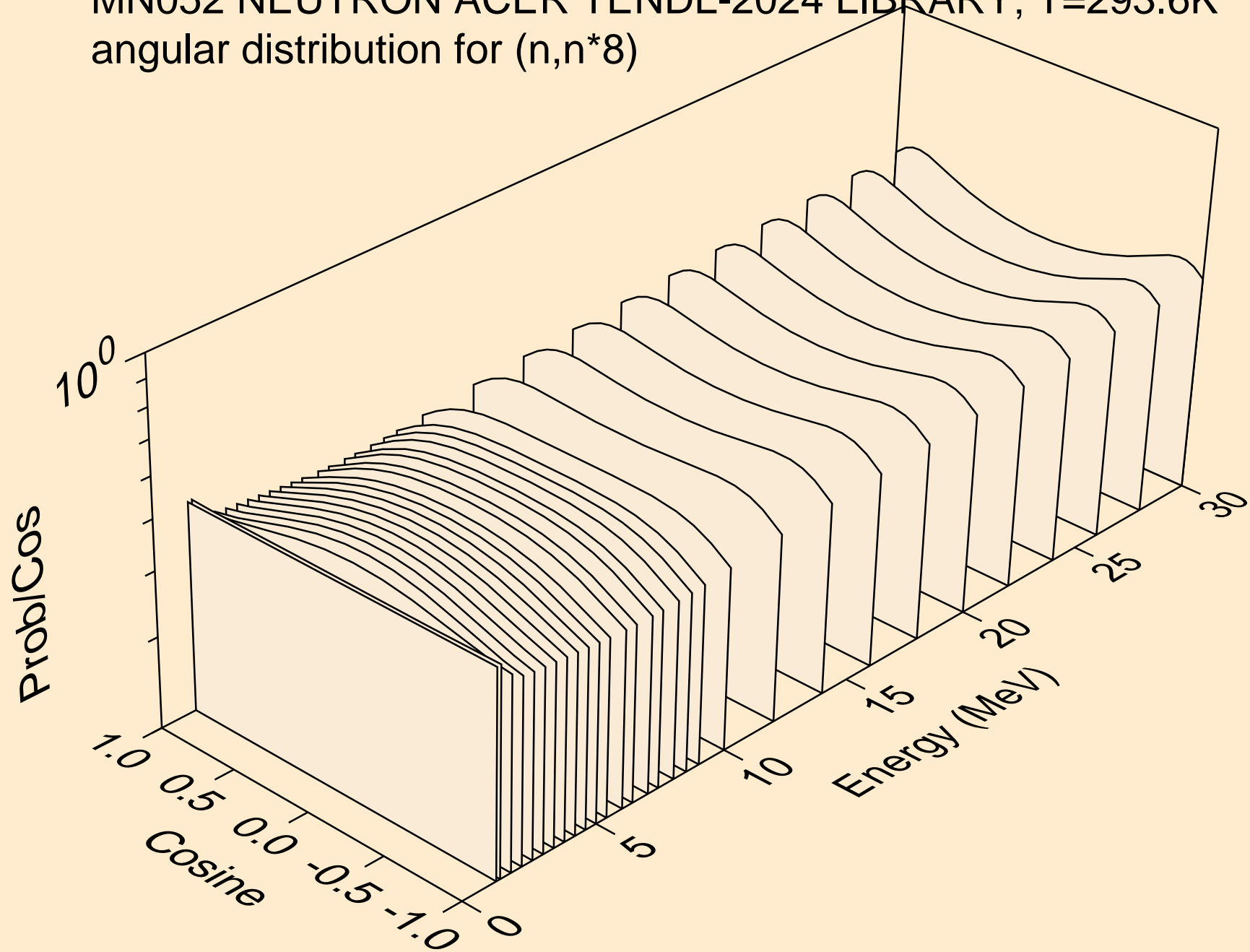

MN052 NEUTRON ACER TENDL-2024 LIBRARY; T=293.6K
angular distribution for (n,n*9)

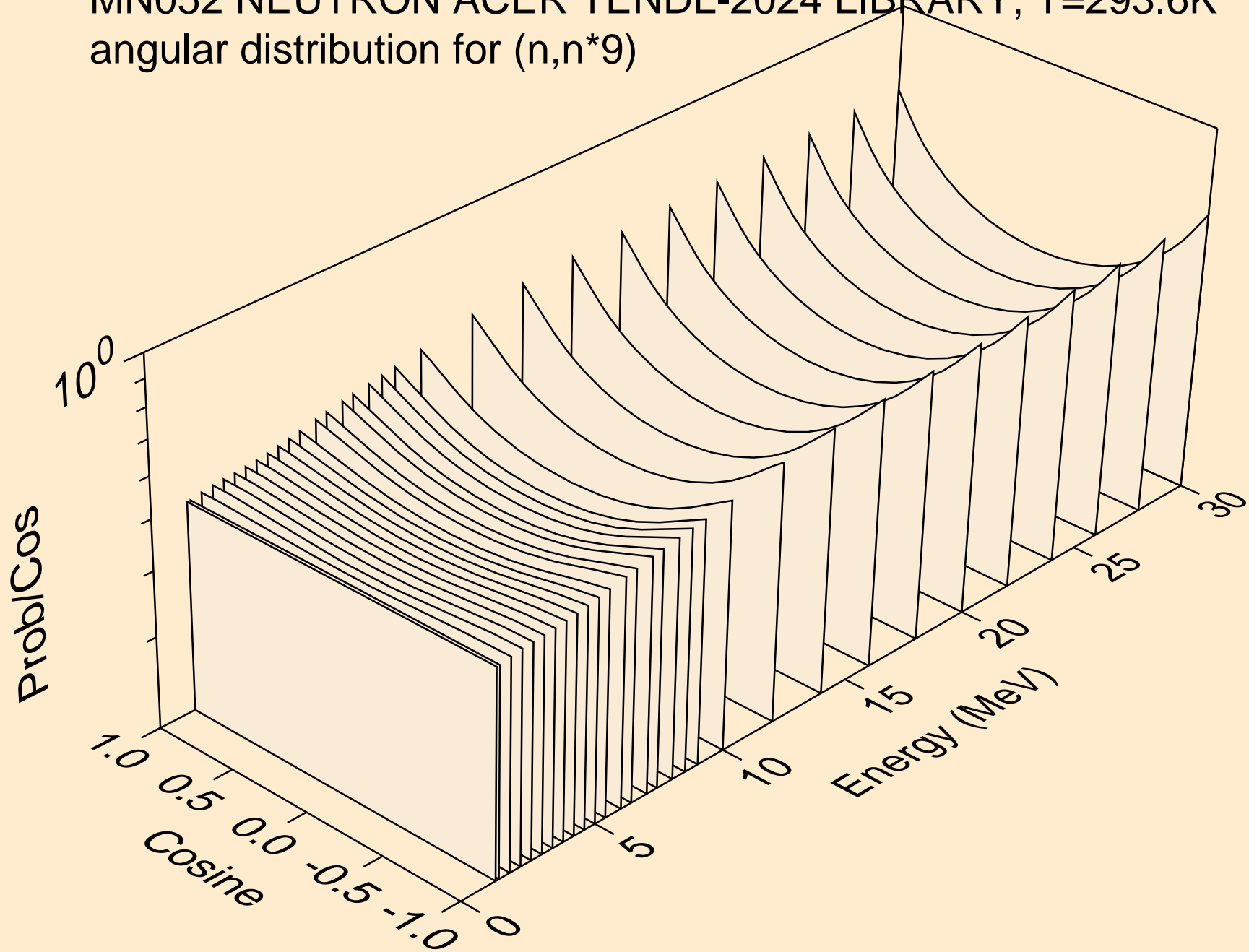

MN052 NEUTRON ACER TENDL-2024 LIBRARY; T=293.6K
angular distribution for (n,n*10)

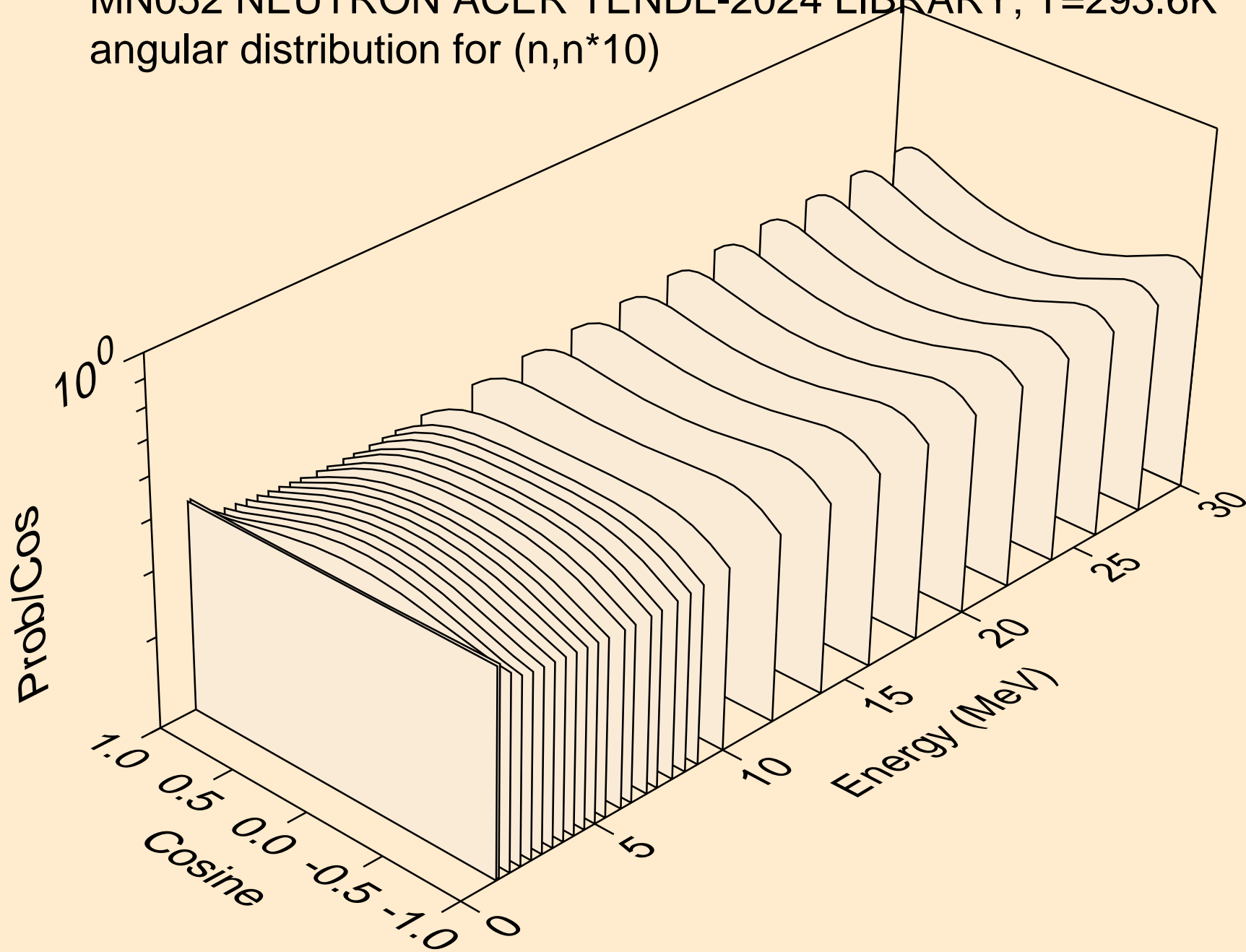

MN052 NEUTRON ACER TENDL-2024 LIBRARY; T=293.6K
angular distribution for (n,n*11)

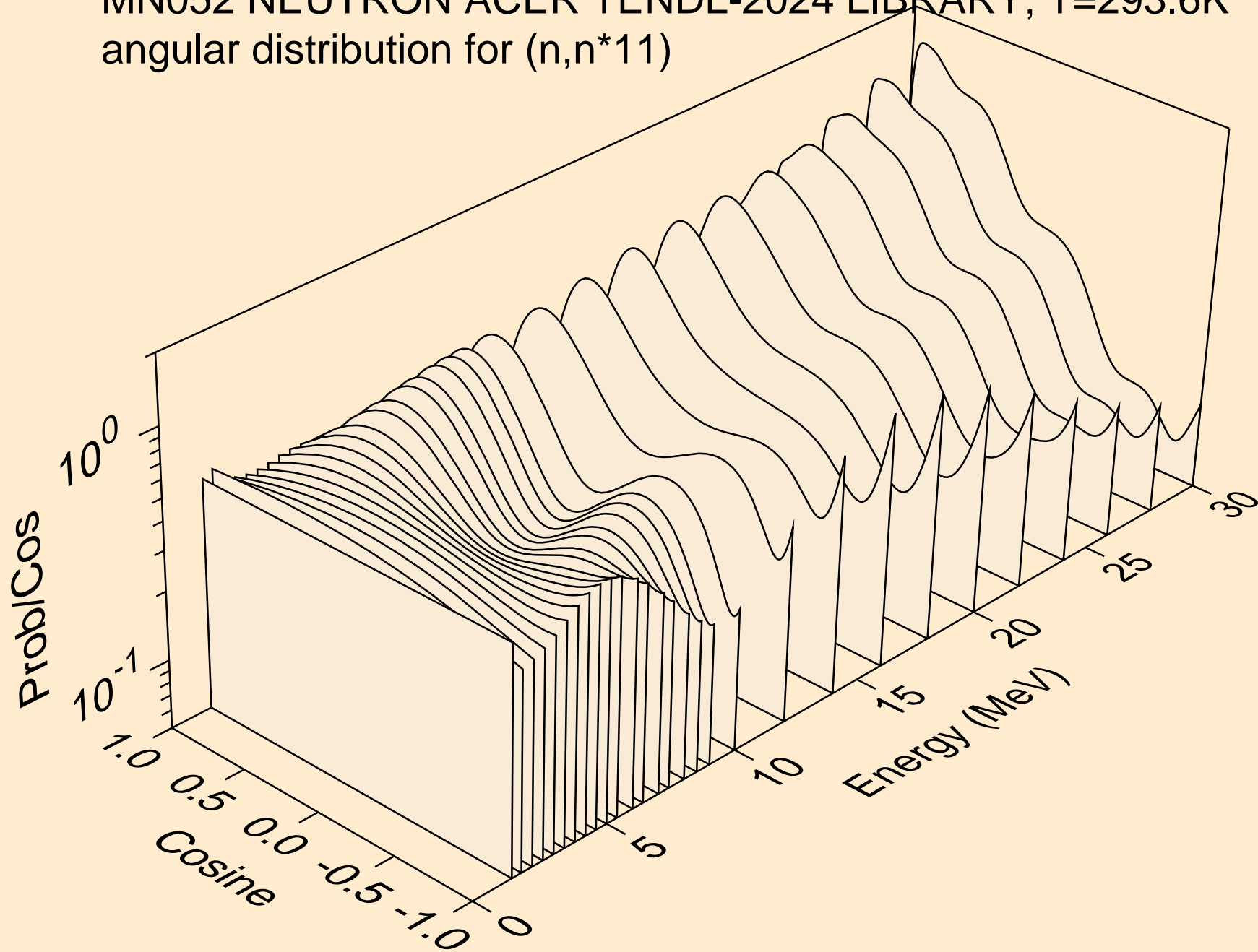

MN052 NEUTRON ACER TENDL-2024 LIBRARY; T=293.6K
angular distribution for (n,n*12)

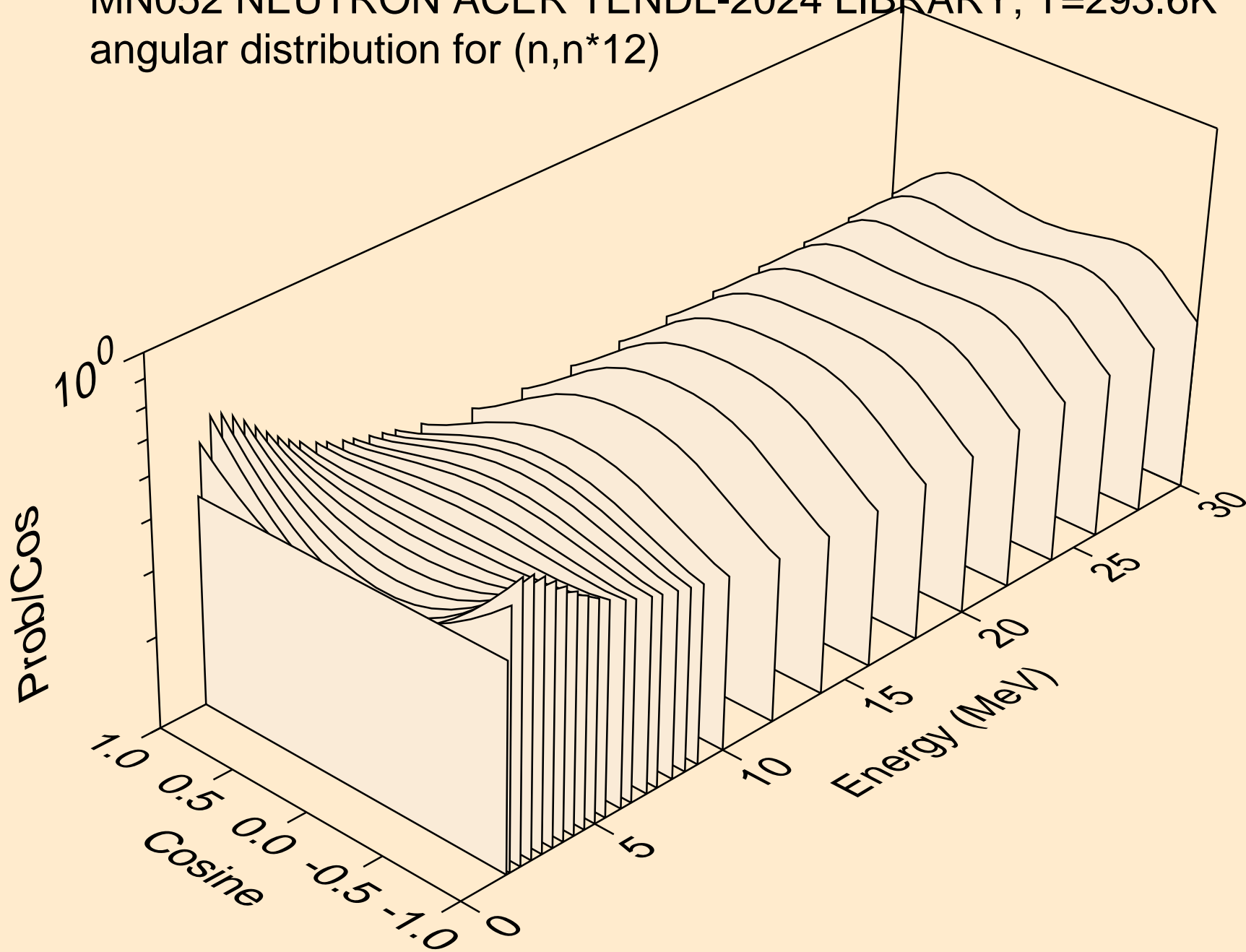

MN052 NEUTRON ACER TENDL-2024 LIBRARY; T=293.6K
angular distribution for (n,n*13)

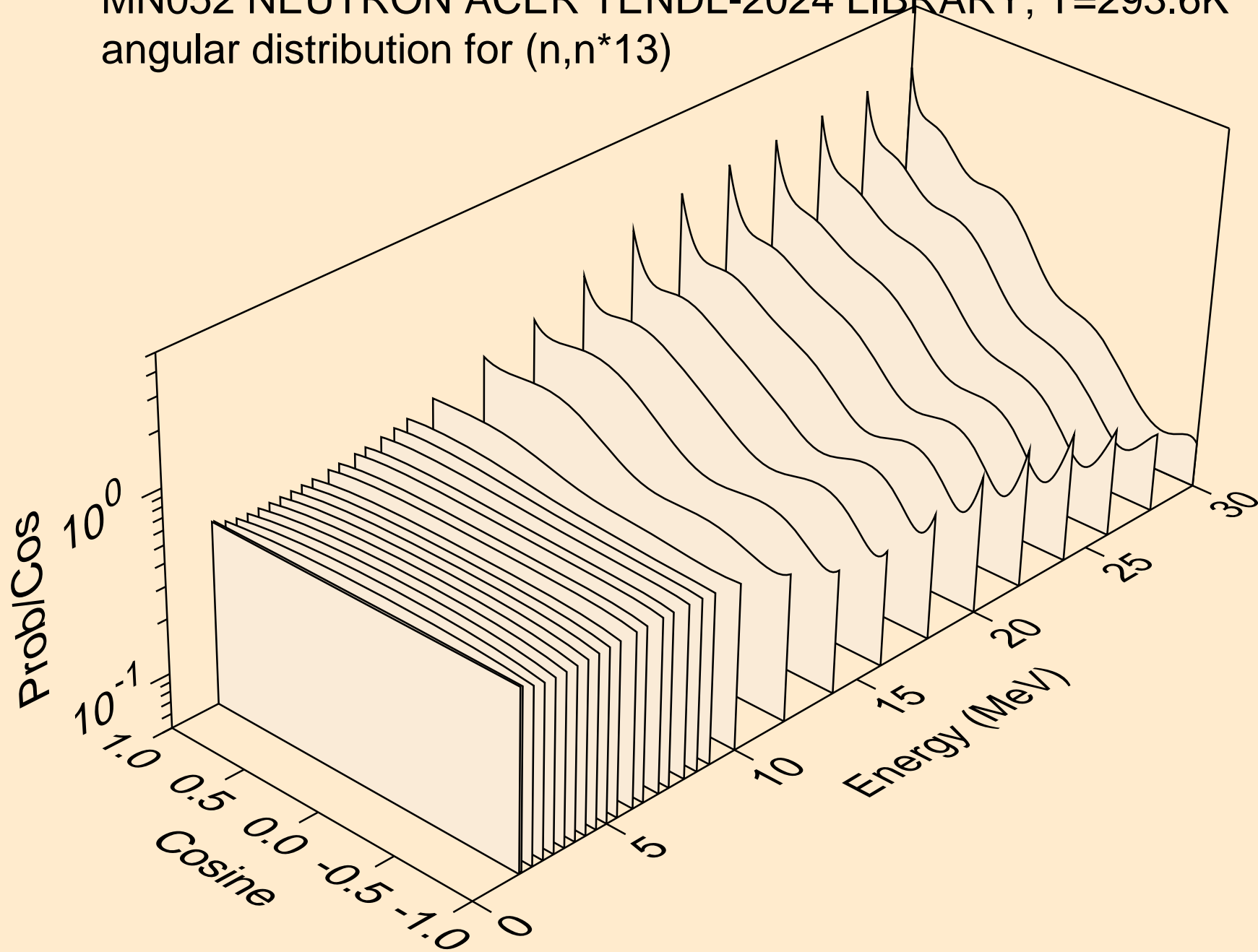

MN052 NEUTRON ACER TENDL-2024 LIBRARY; T=293.6K
angular distribution for (n,n*14)

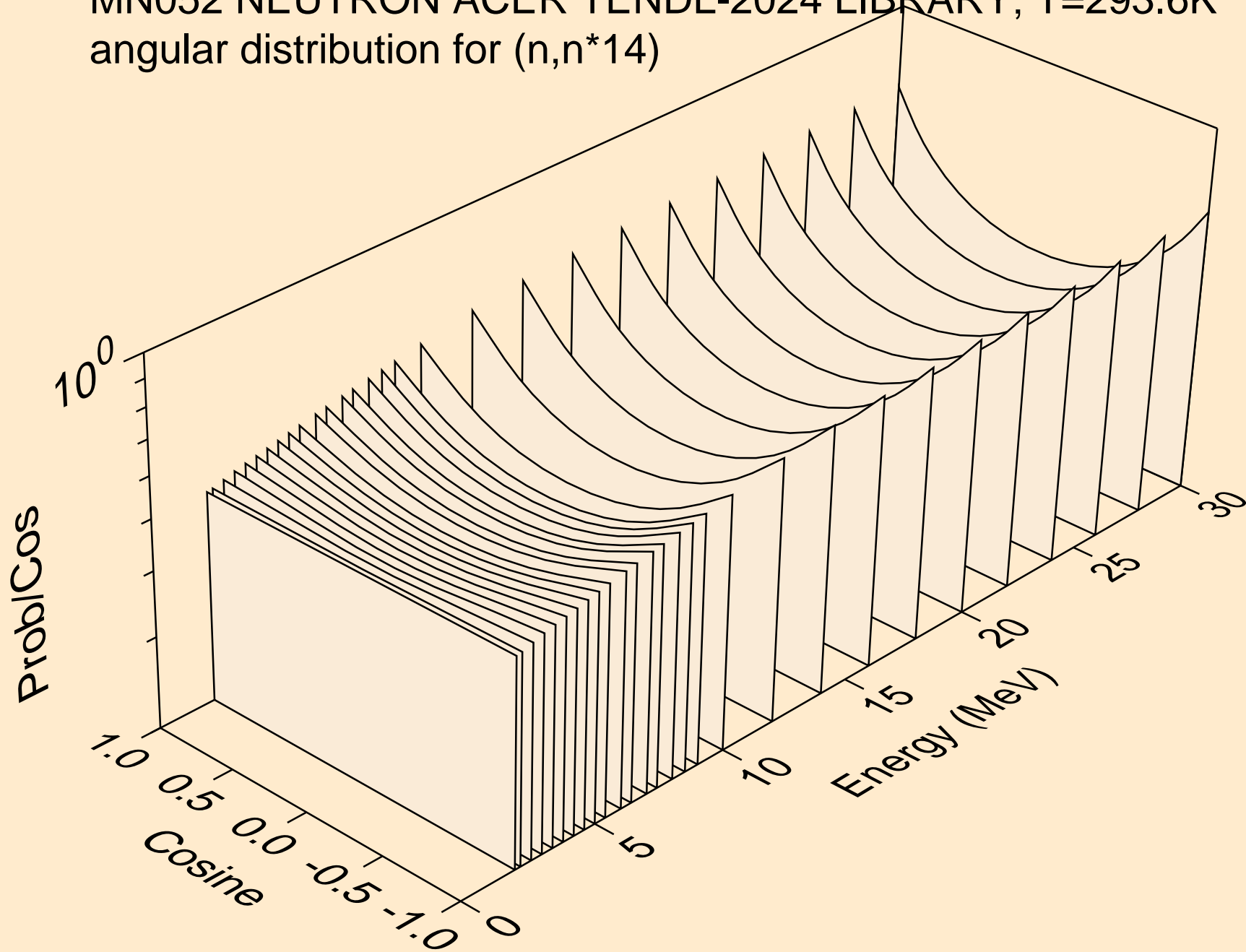

MN052 NEUTRON ACER TENDL-2024 LIBRARY; T=293.6K
angular distribution for (n,n*15)

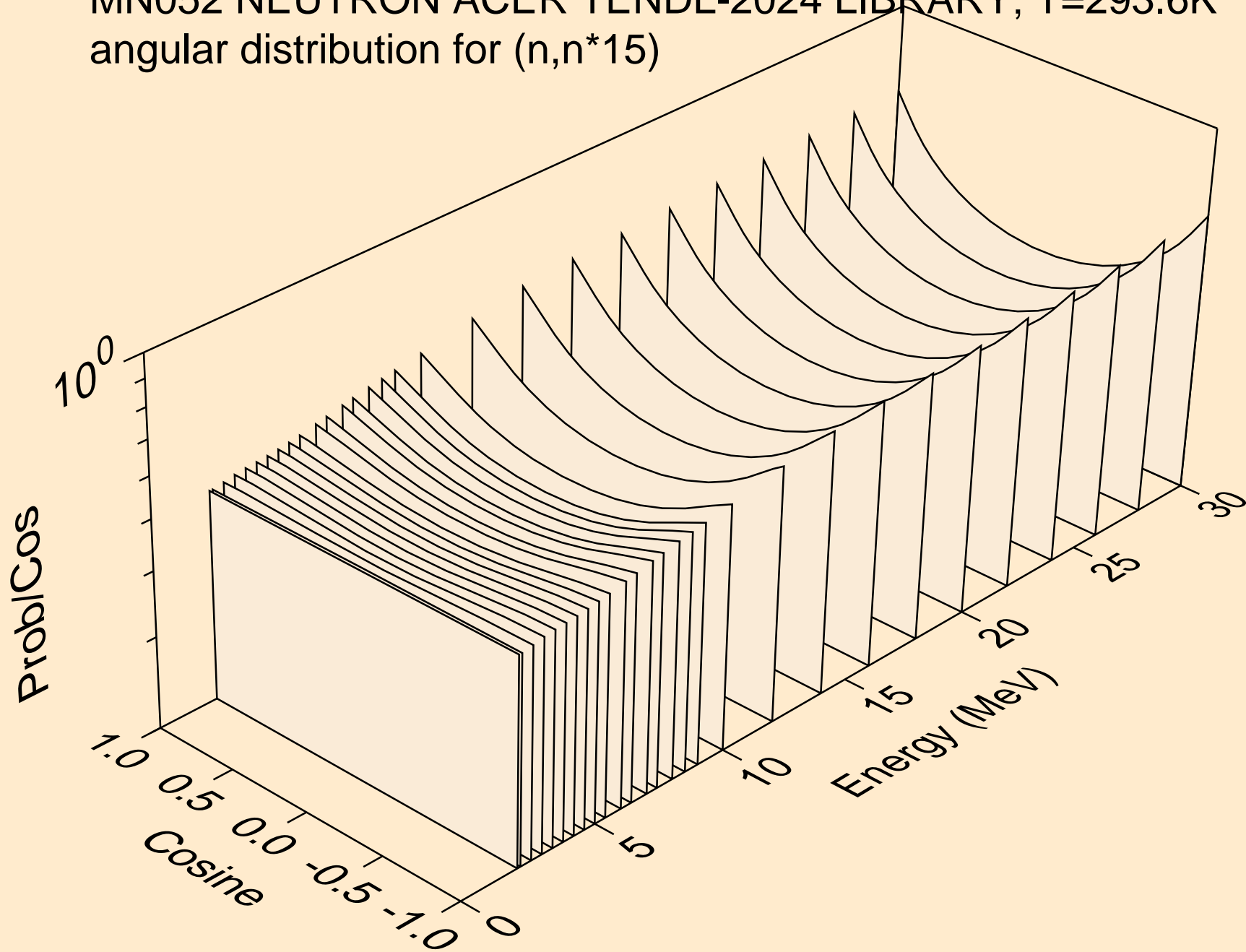

MN052 NEUTRON ACER TENDL-2024 LIBRARY; T=293.6K
angular distribution for (n,n*16)

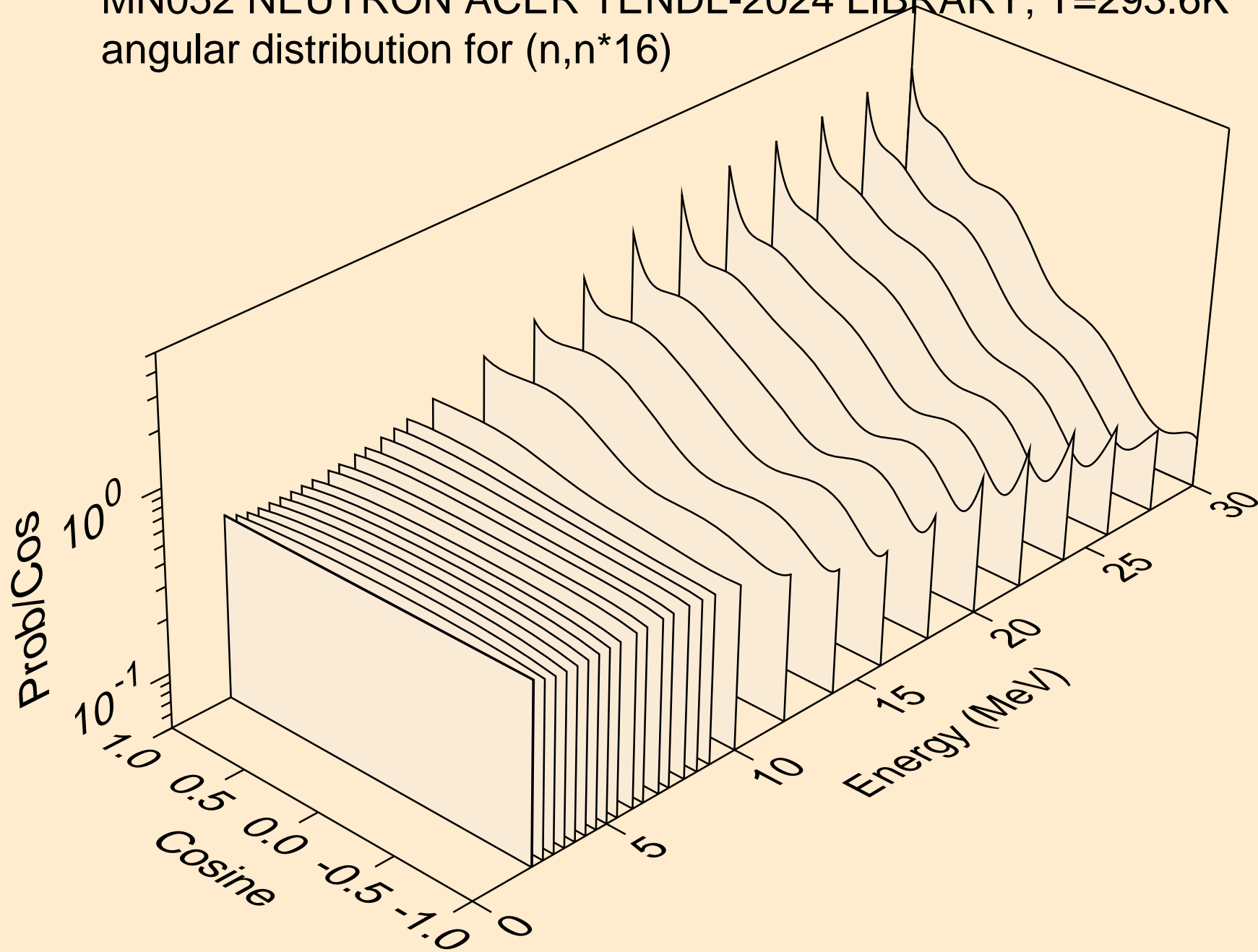

MN052 NEUTRON ACER TENDL-2024 LIBRARY; T=293.6K
angular distribution for (n,n*17)

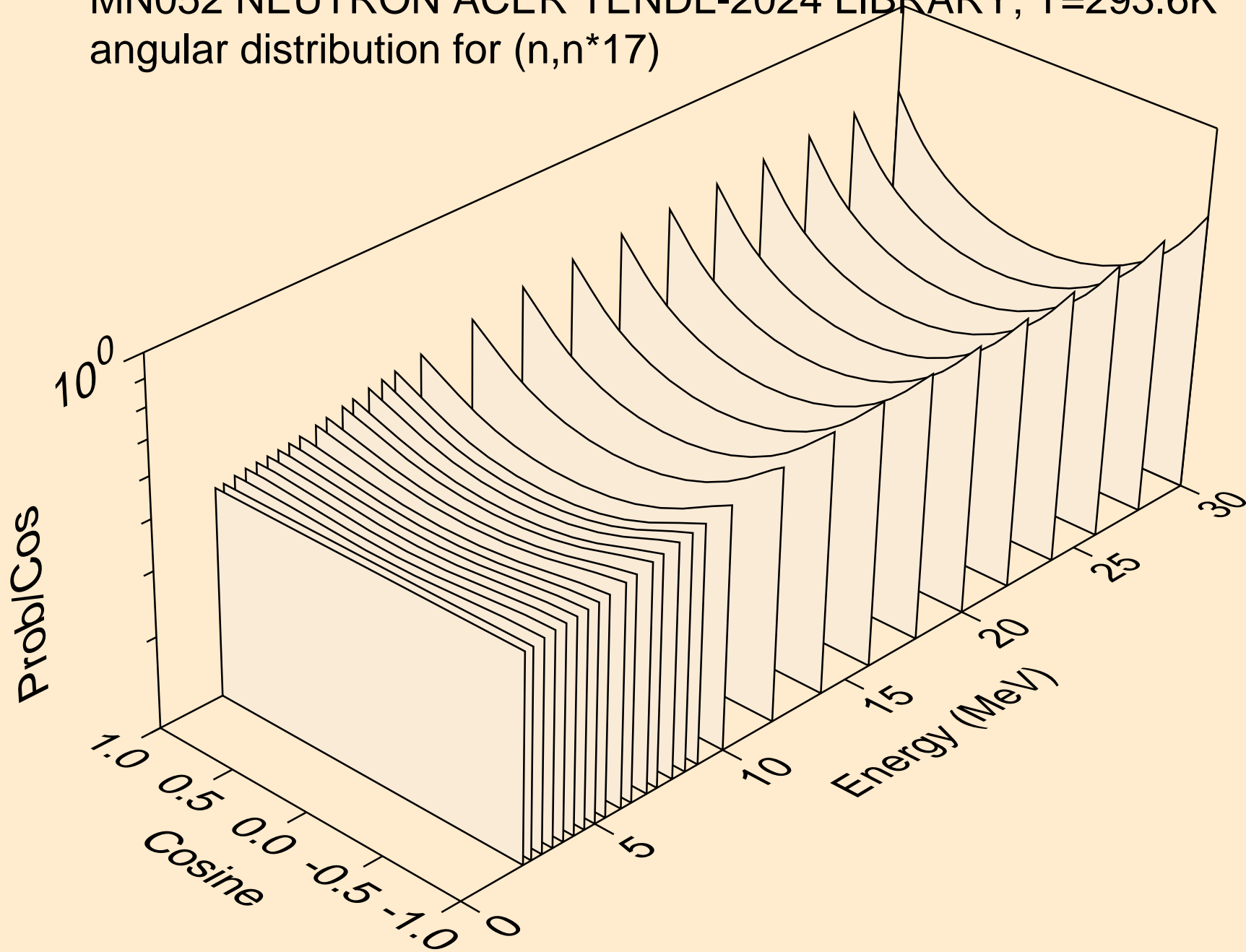

MN052 NEUTRON ACER TENDL-2024 LIBRARY; T=293.6K
angular distribution for (n,n*18)

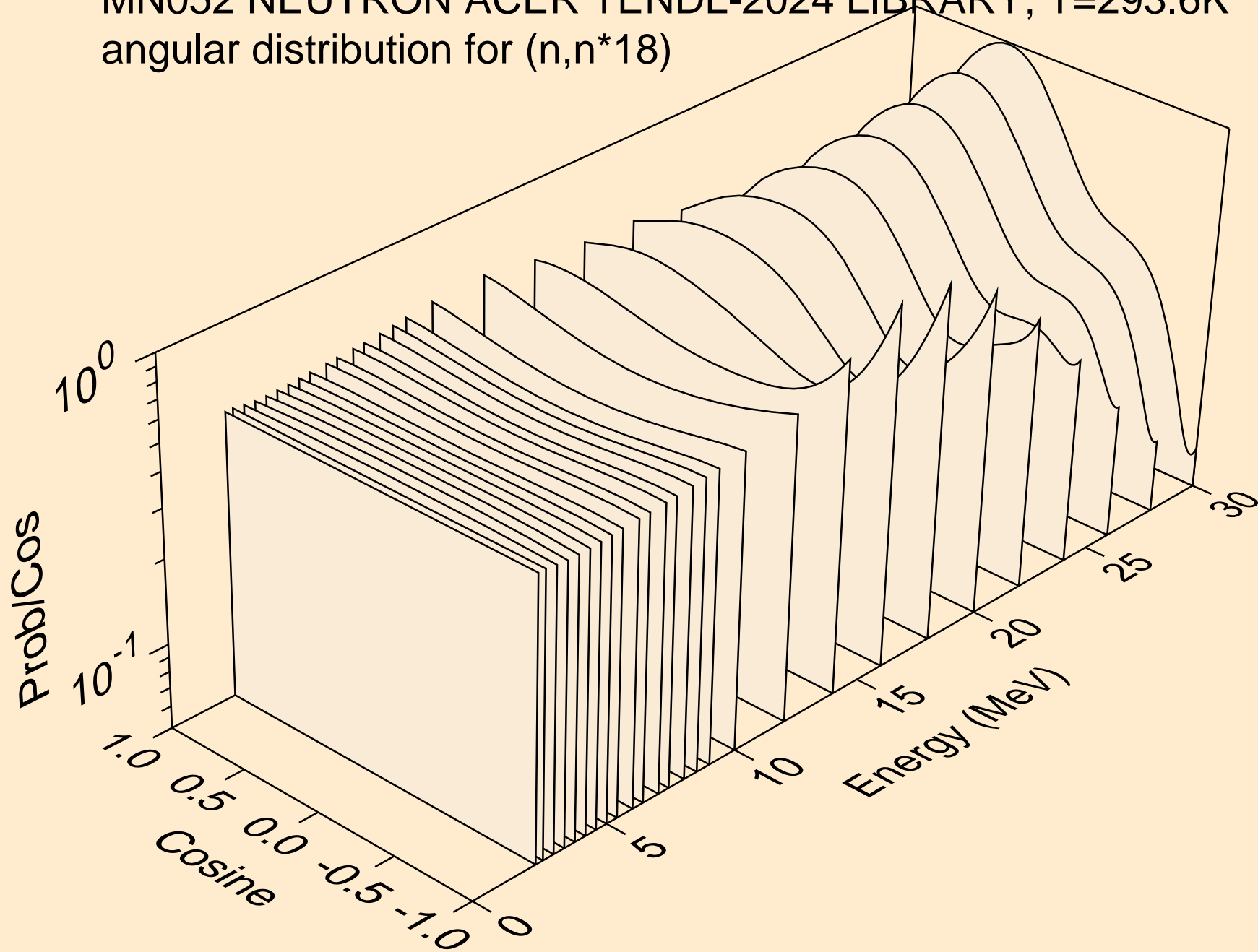

MN052 NEUTRON ACER TENDL-2024 LIBRARY; T=293.6K
angular distribution for (n,n*19)

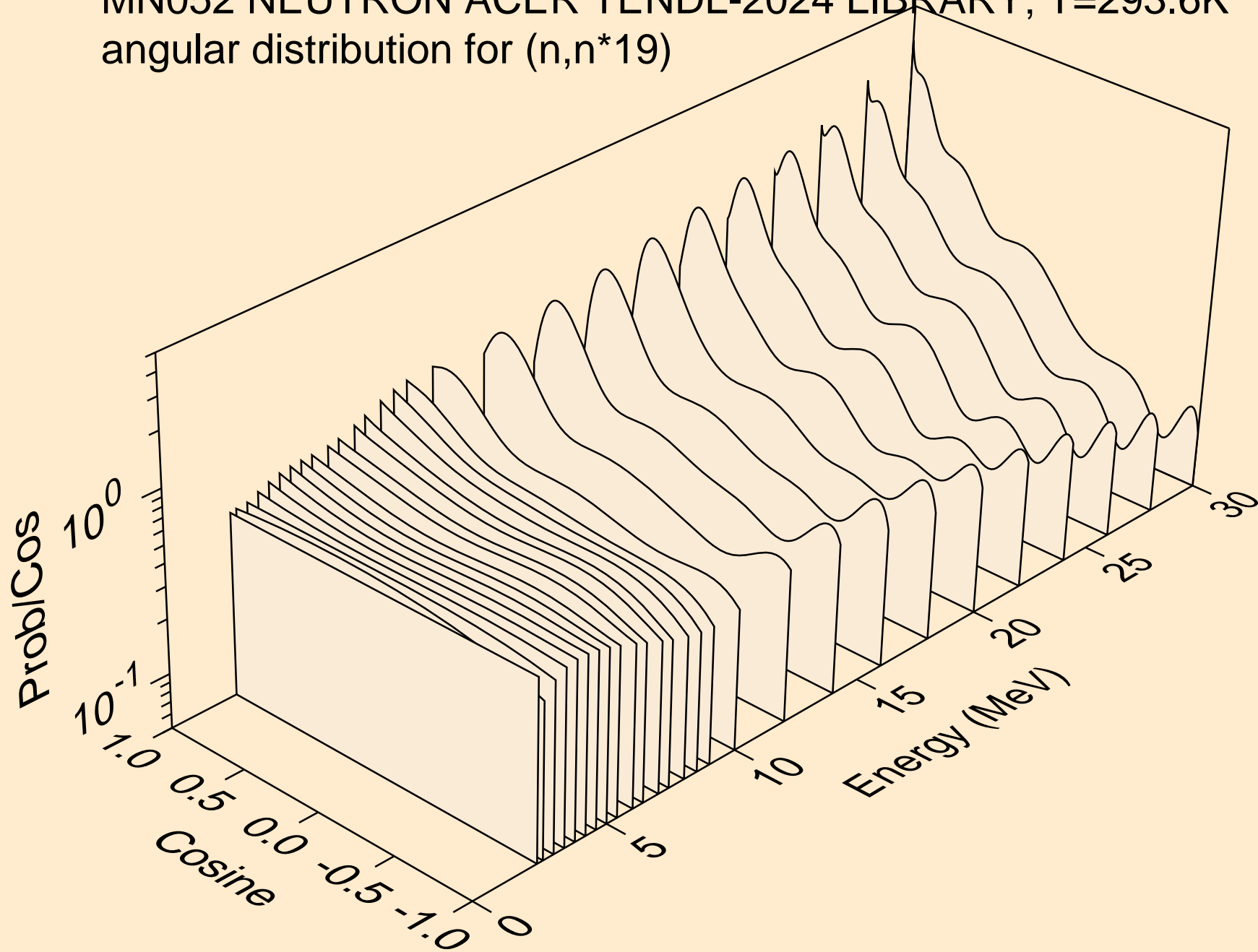

MN052 NEUTRON ACER TENDL-2024 LIBRARY; T=293.6K
angular distribution for (n,n*20)

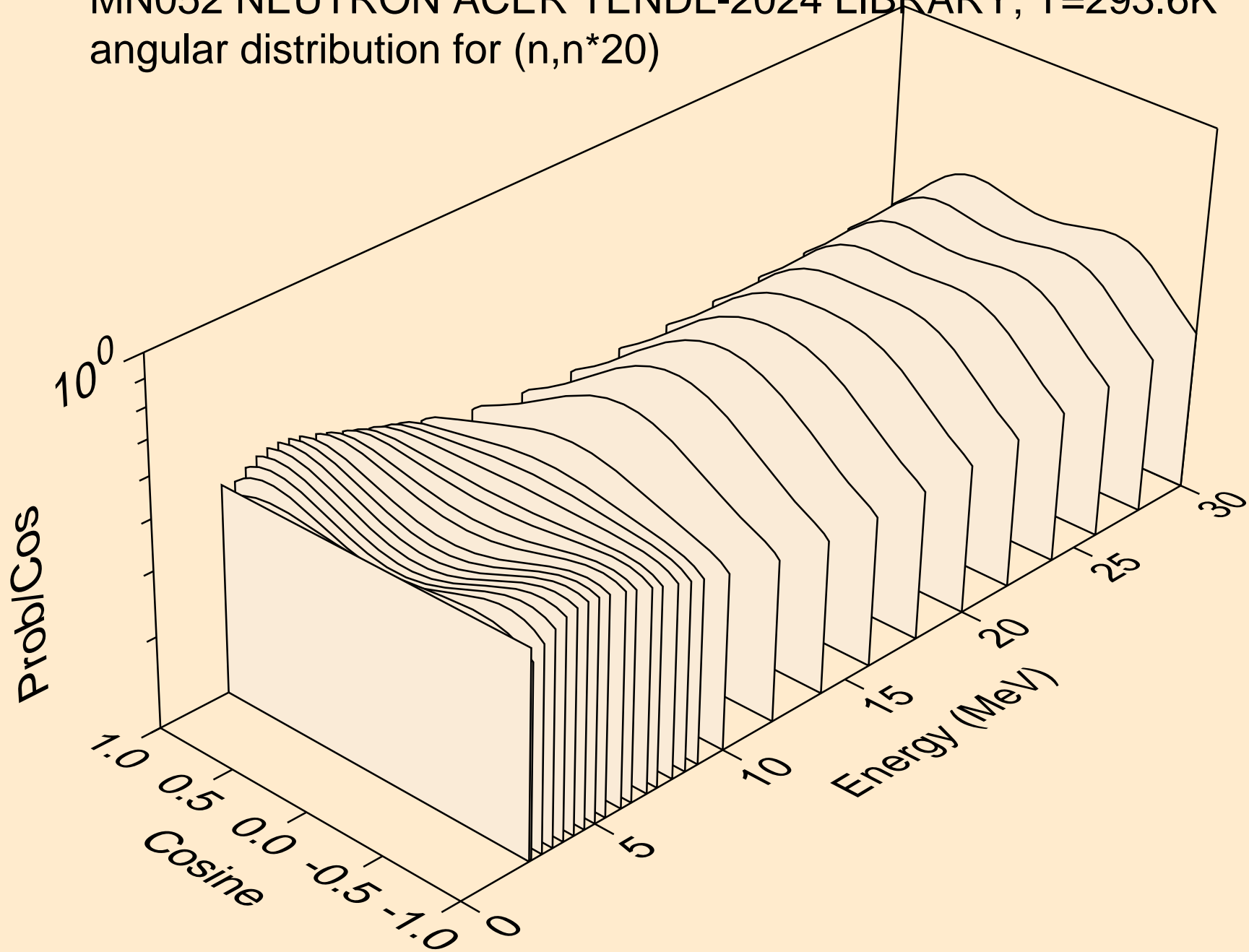

MN052 NEUTRON ACER TENDL-2024 LIBRARY; T=293.6K
angular distribution for (n,n*21)

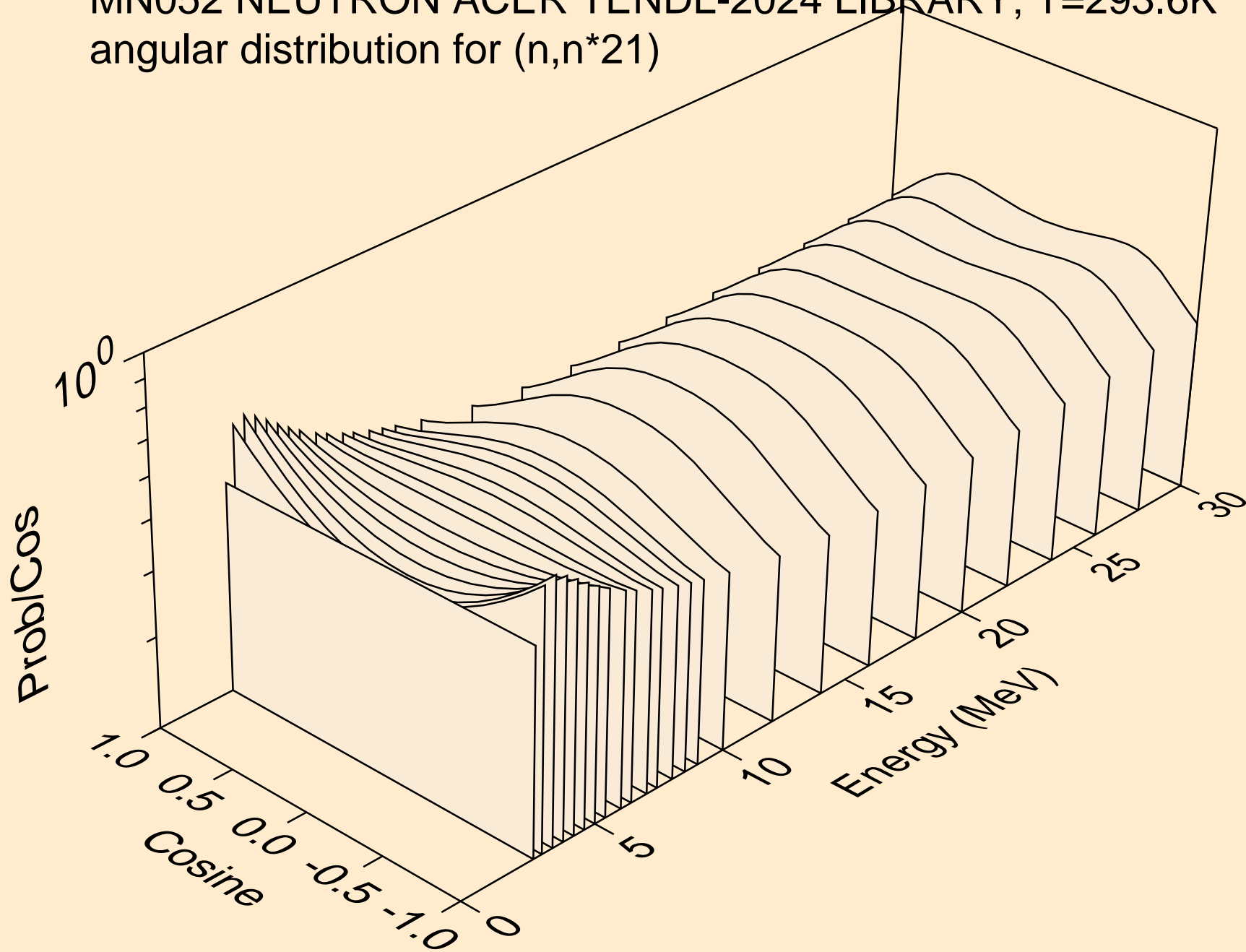

MN052 NEUTRON ACER TENDL-2024 LIBRARY; T=293.6K
angular distribution for (n,n*22)

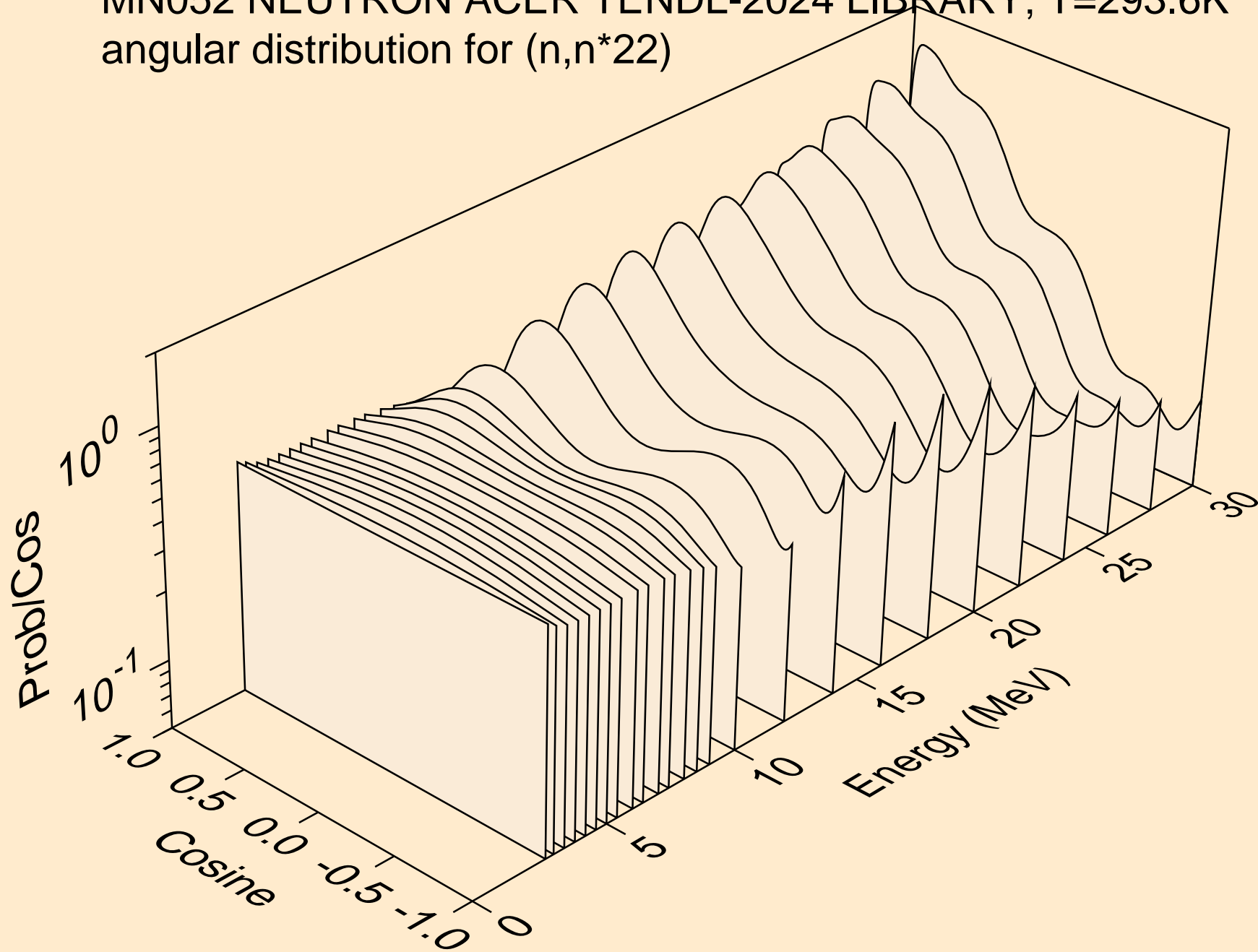

MN052 NEUTRON ACER TENDL-2024 LIBRARY; T=293.6K
angular distribution for (n,n*23)

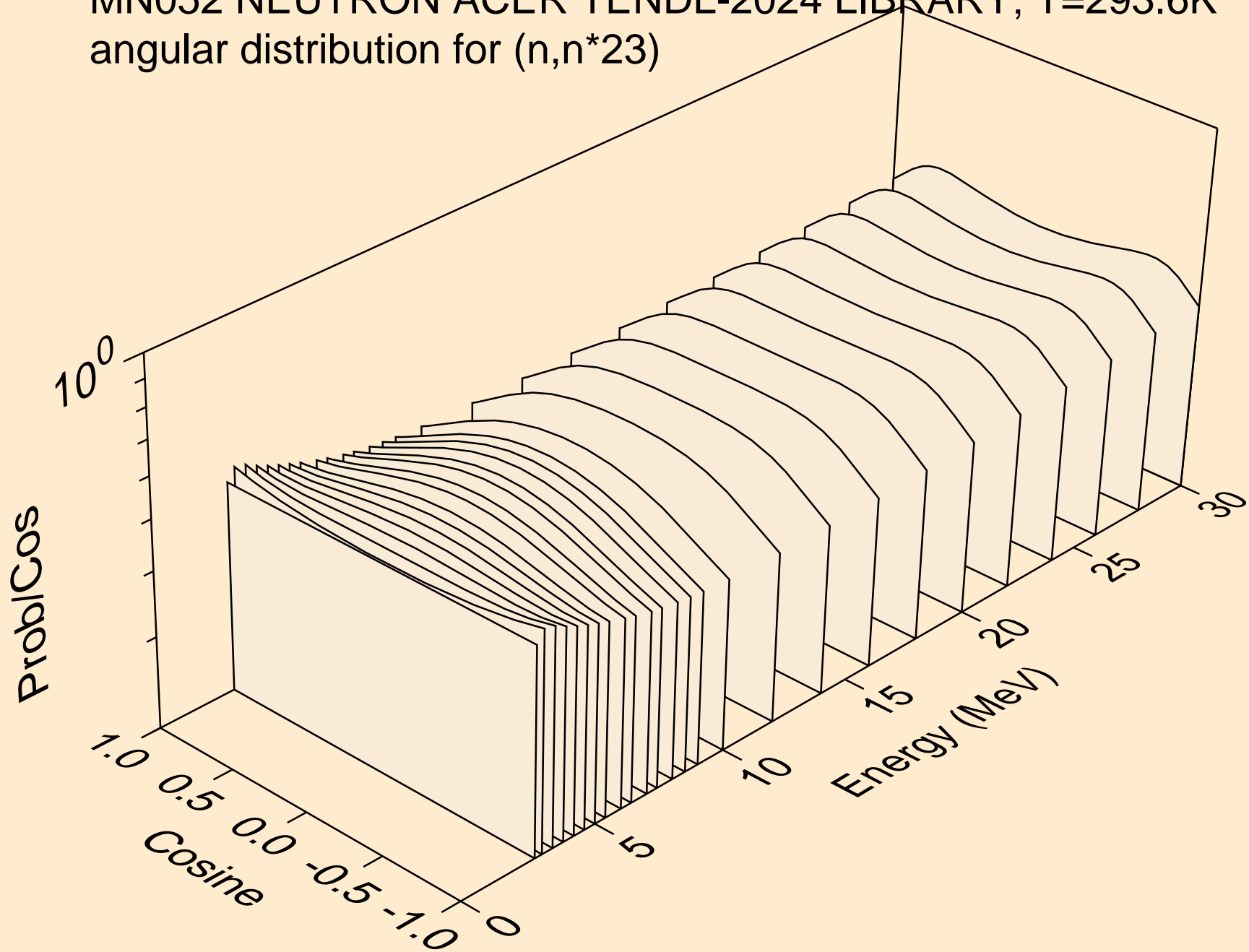

MN052 NEUTRON ACER TENDL-2024 LIBRARY; T=293.6K
angular distribution for (n,n*24)

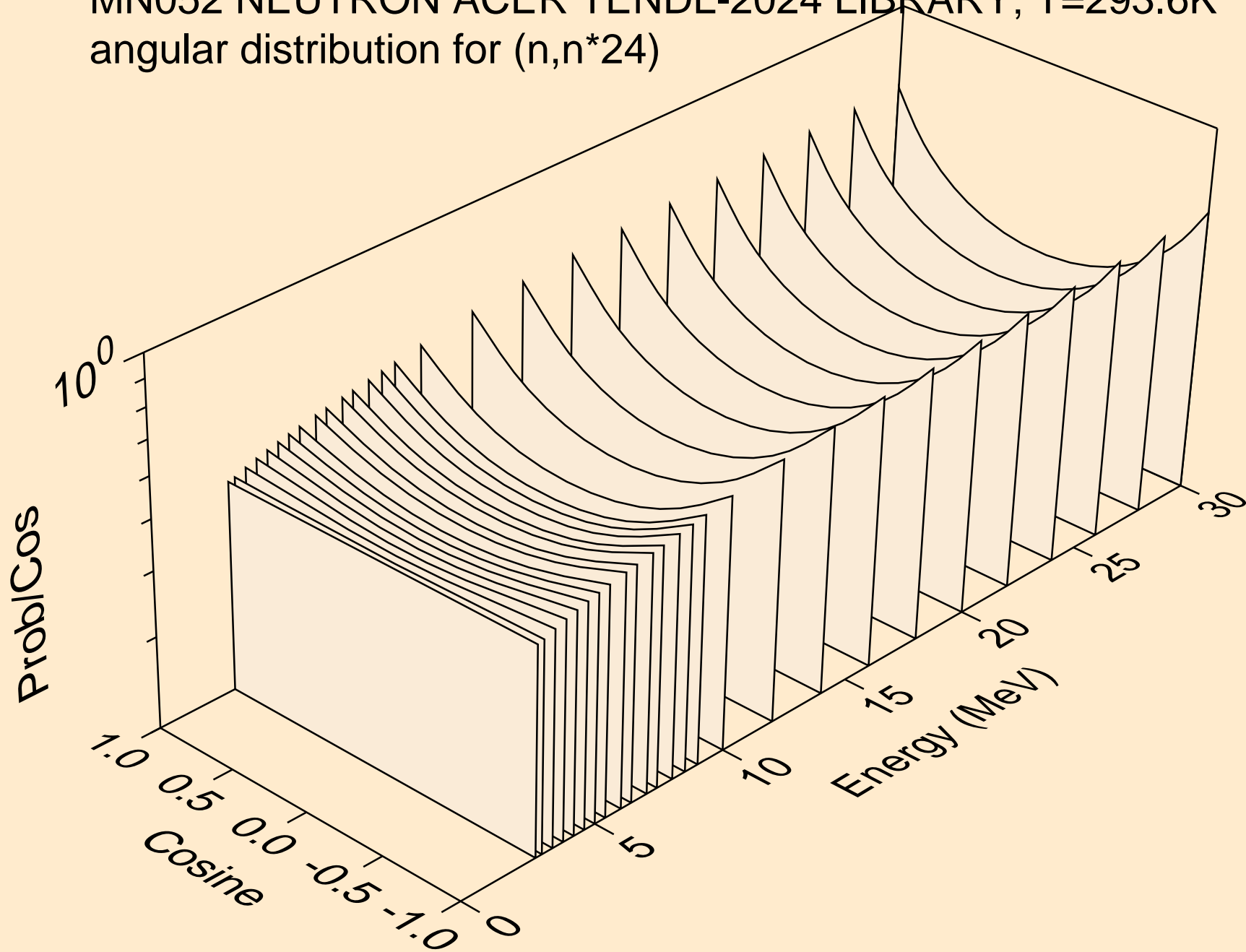

MN052 NEUTRON ACER TENDL-2024 LIBRARY; T=293.6K
Neutron emission for (n,x)

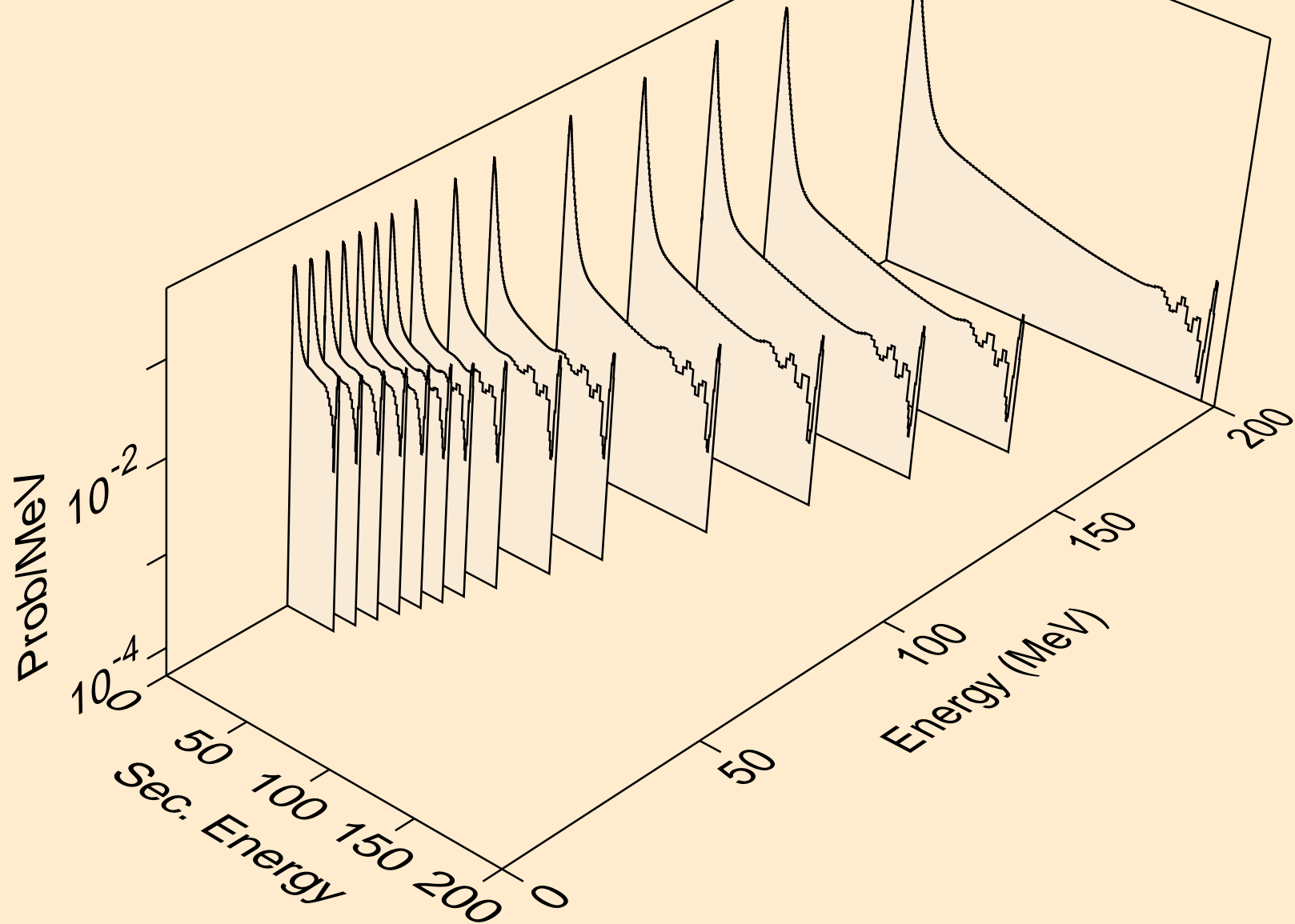

MN052 NEUTRON ACER TENDL-2024 LIBRARY; T=293.6K
Neutron emission for (n,2nd)

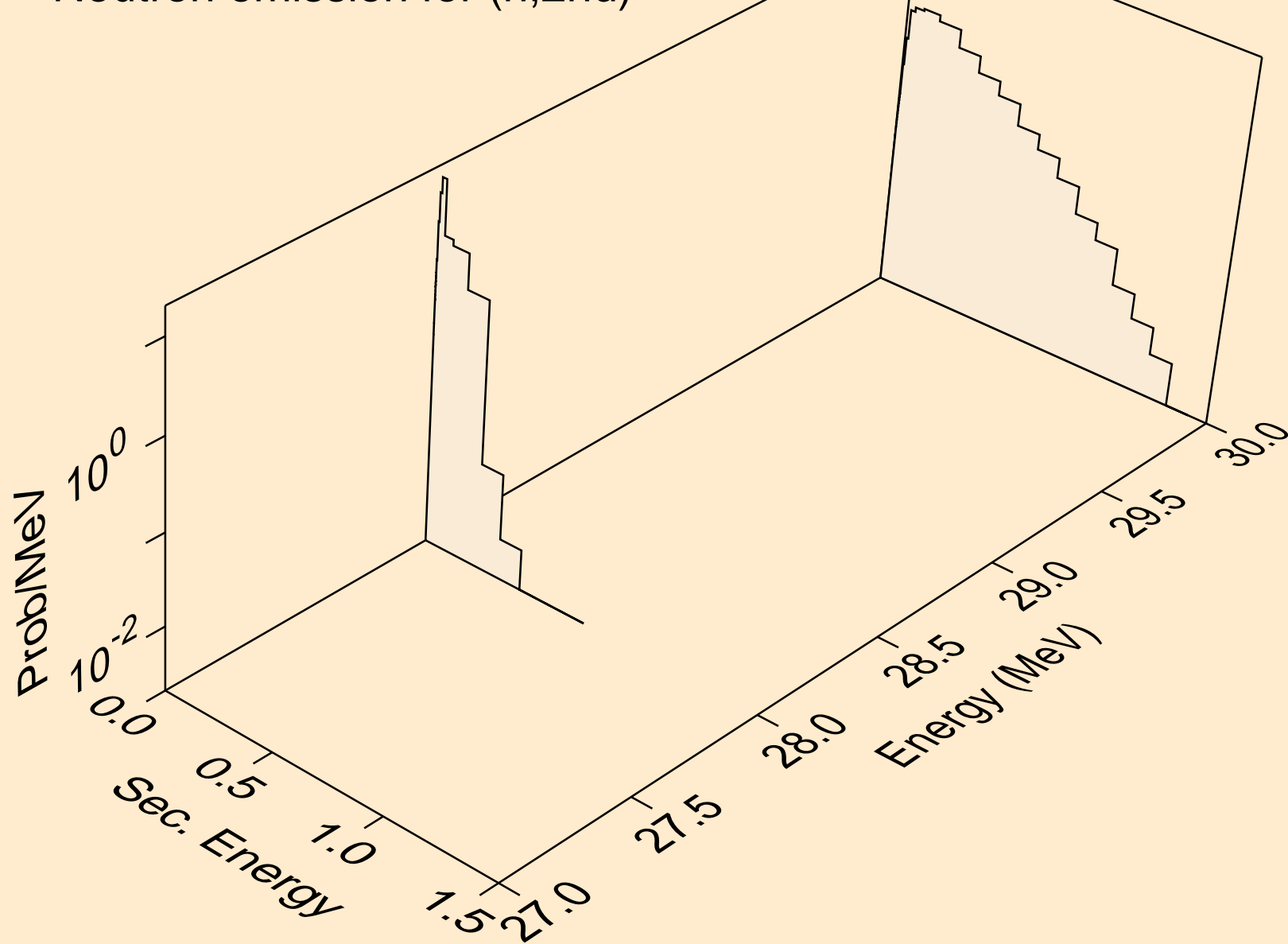

MN052 NEUTRON ACER TENDL-2024 LIBRARY; T=293.6K
Neutron emission for (n,2n)

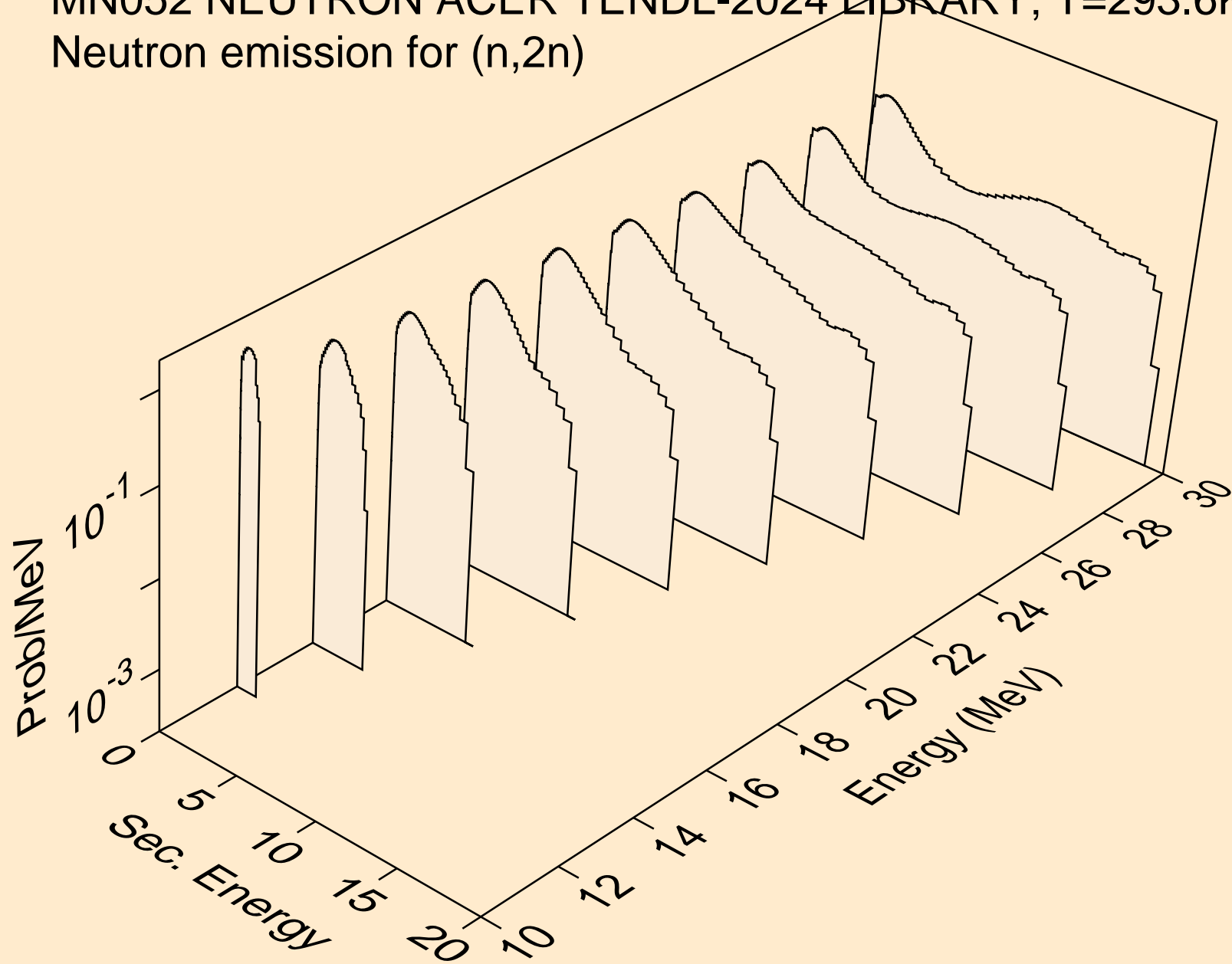

MN052 NEUTRON ACER TENDL-2024 LIBRARY; T=293.6K
Neutron emission for (n,3n)

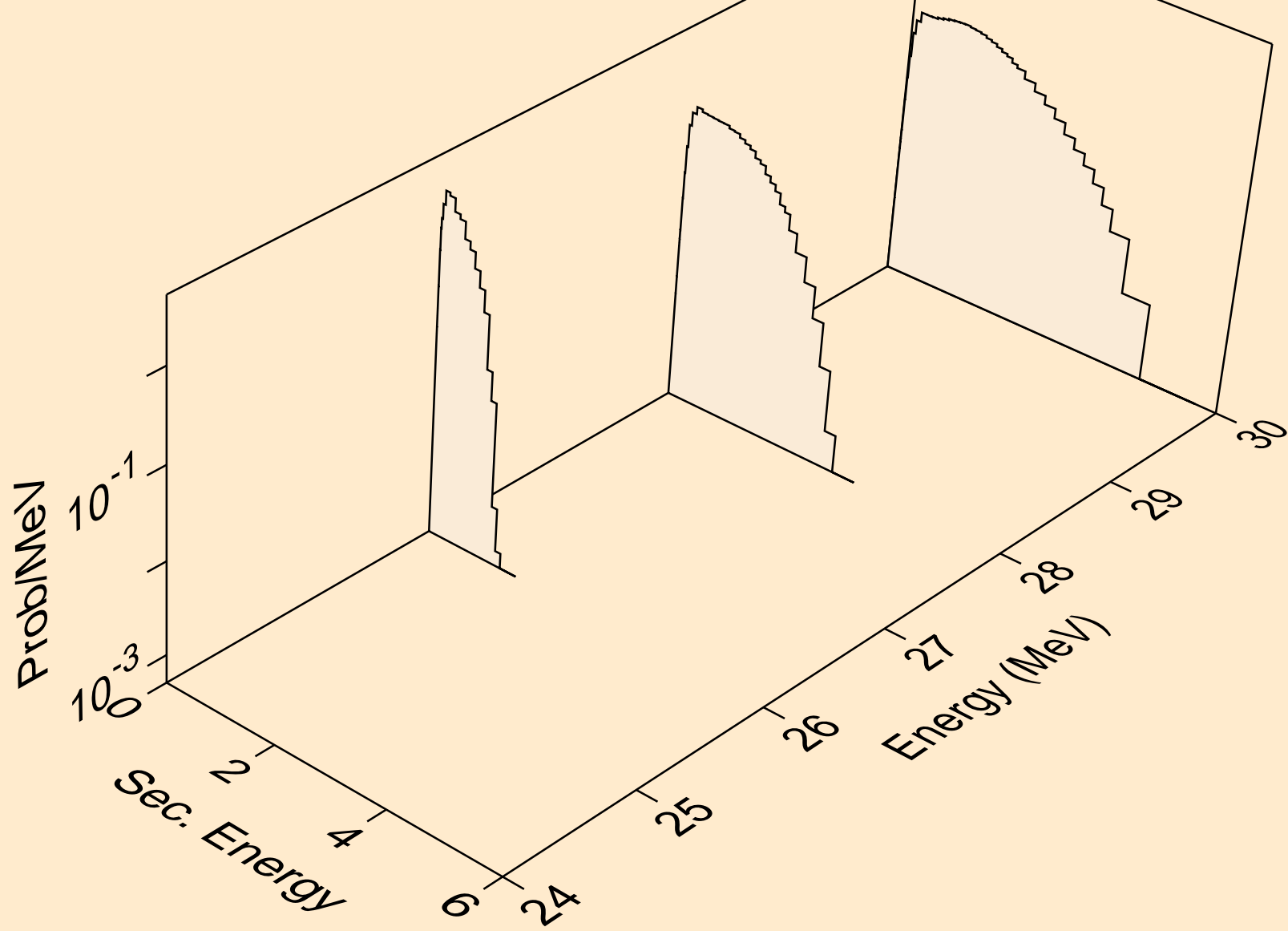

MN052 NEUTRON ACER TENDL-2024 LIBRARY; T=293.6K
Neutron emission for (n,n*)a

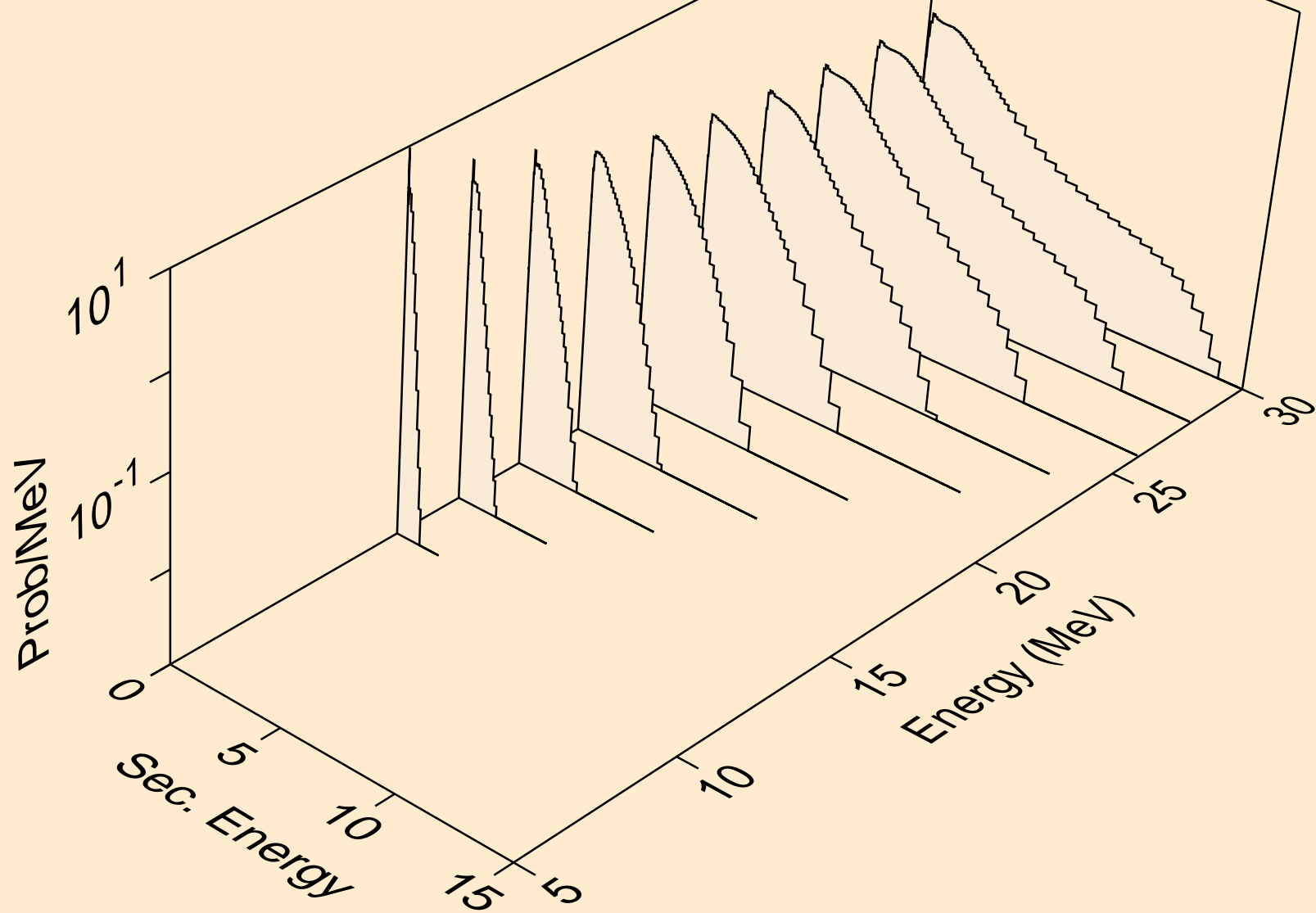

MN052 NEUTRON ACER TENDL-2024 LIBRARY; T=293.6K
Neutron emission for (n,2n)a

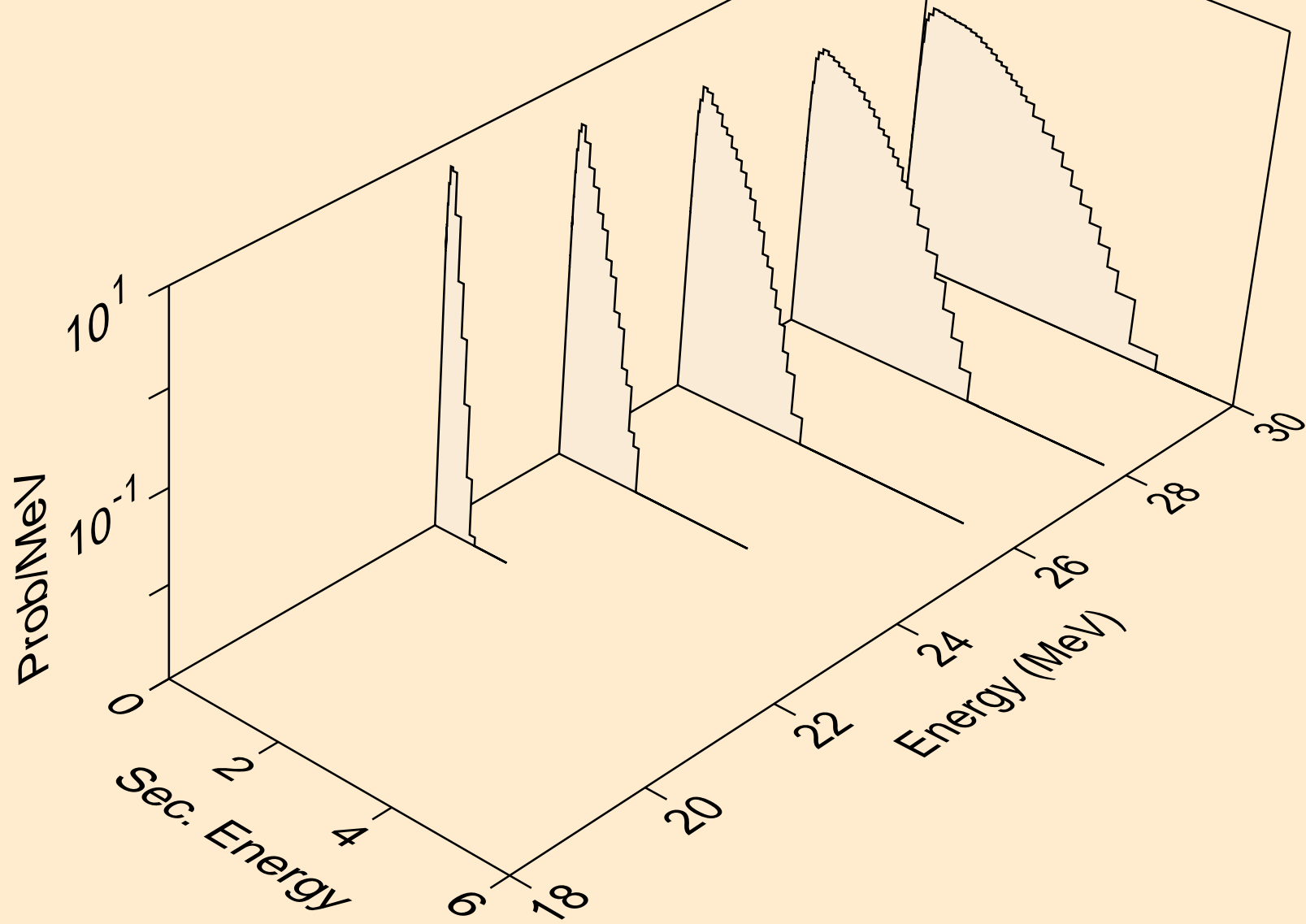

MN052 NEUTRON ACER TENDL-2024 LIBRARY; T=293.6K
Neutron emission for (n,n*)p

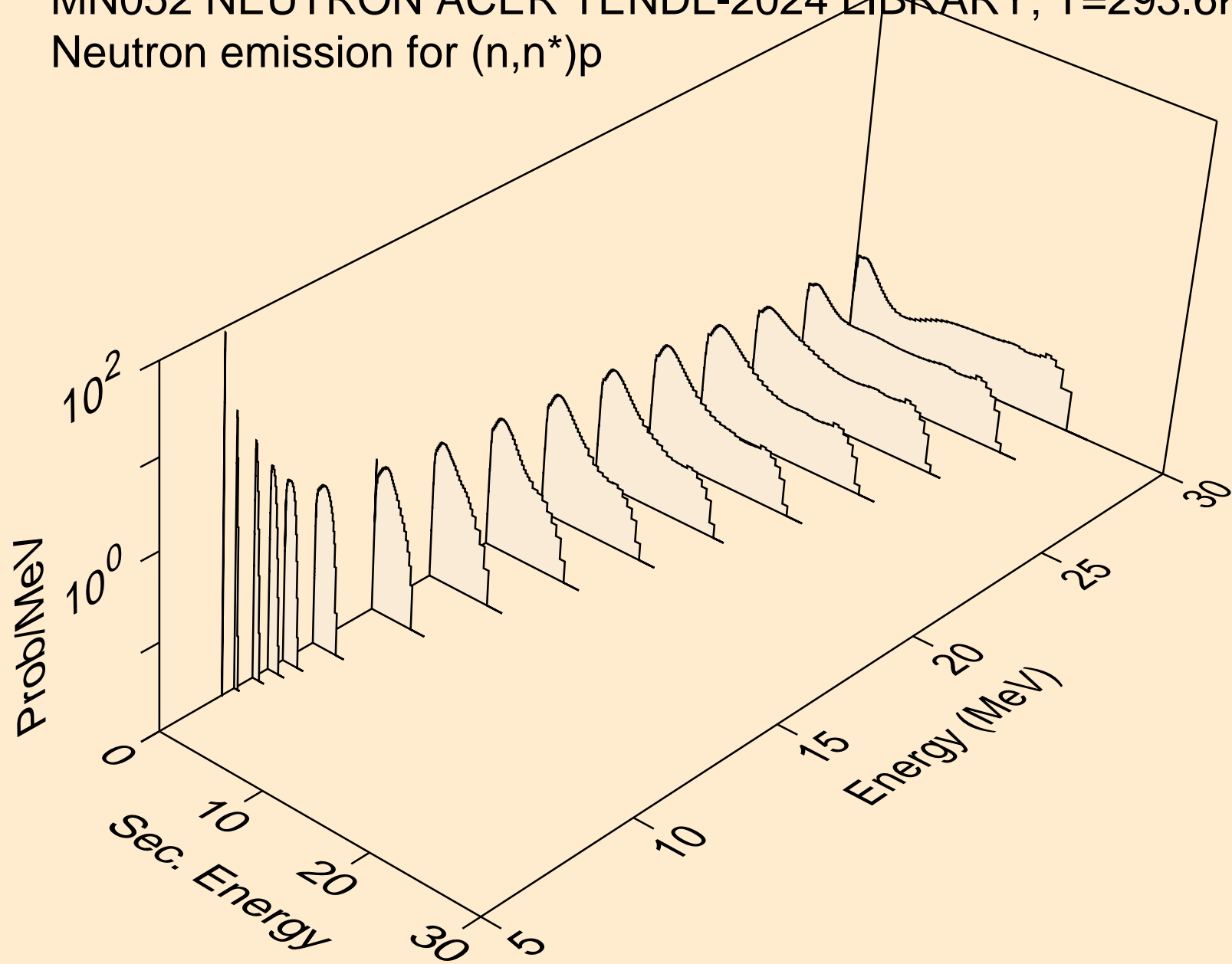

MN052 NEUTRON ACER TENDL-2024 LIBRARY; T=293.6K
Neutron emission for (n,n*)2a

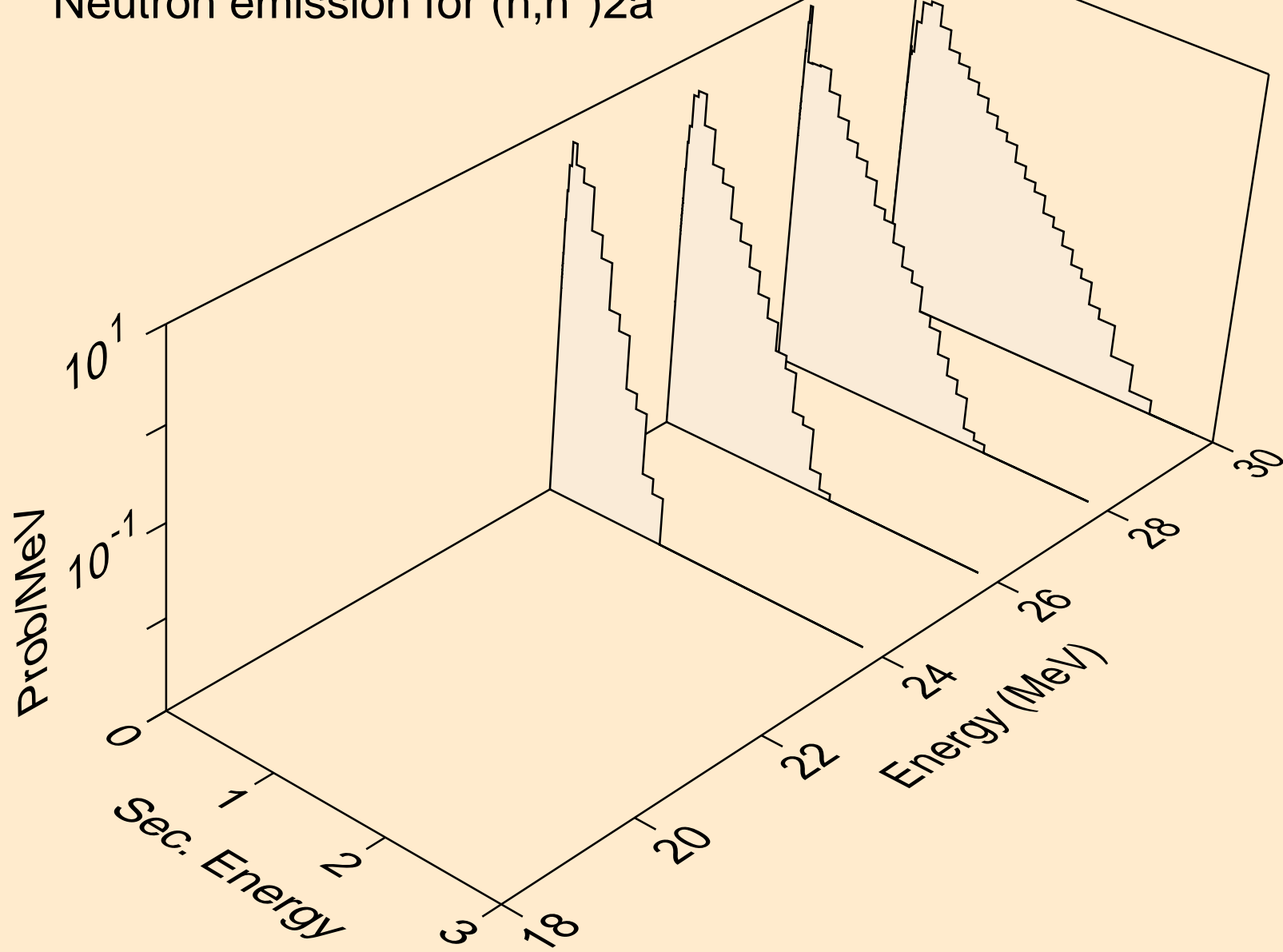

MN052 NEUTRON ACER TENDL-2024 LIBRARY; T=293.6K
Neutron emission for (n,n*)d

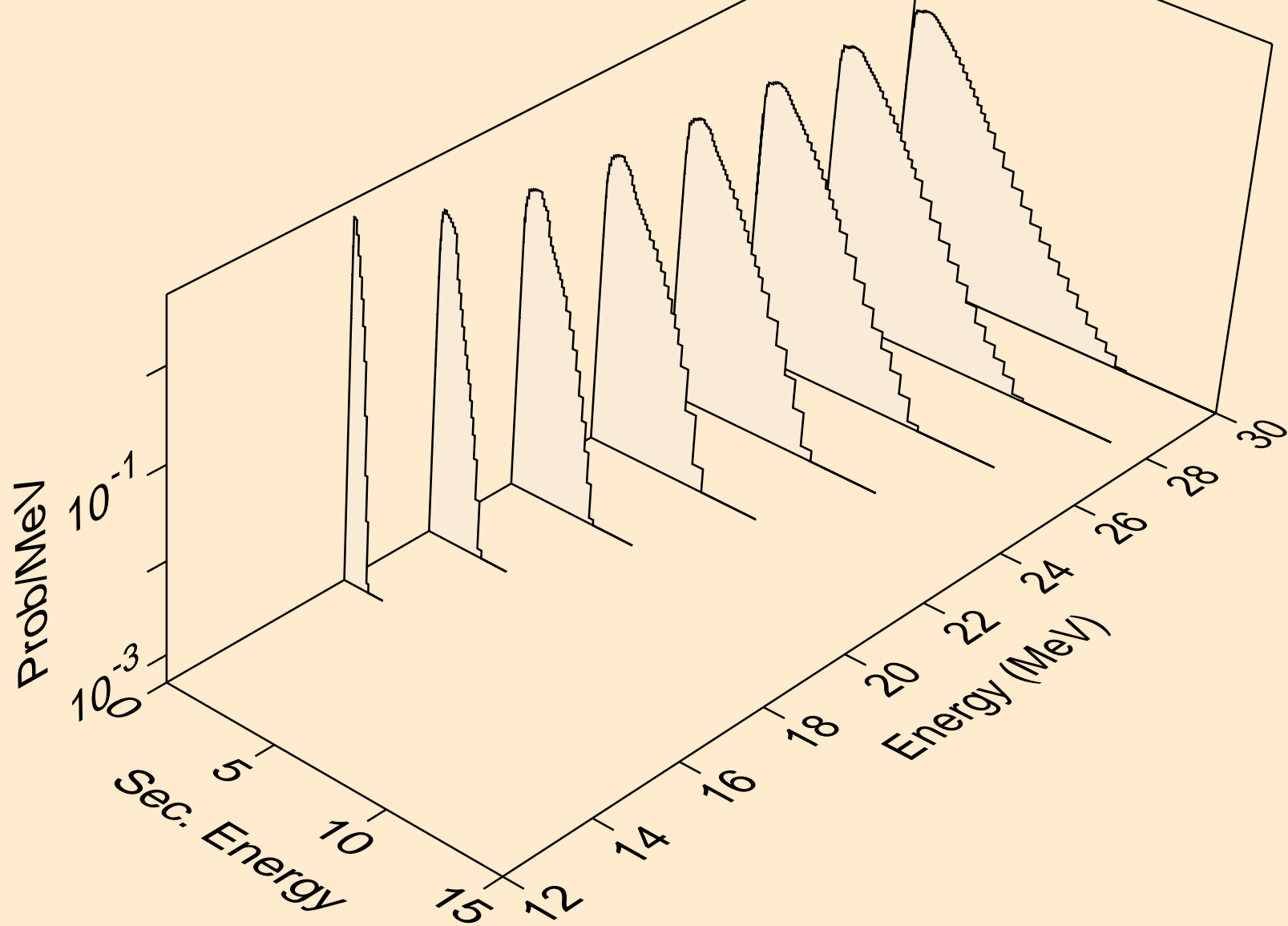

MN052 NEUTRON ACER TENDL-2024 LIBRARY; T=293.6K
Neutron emission for (n,n*)t

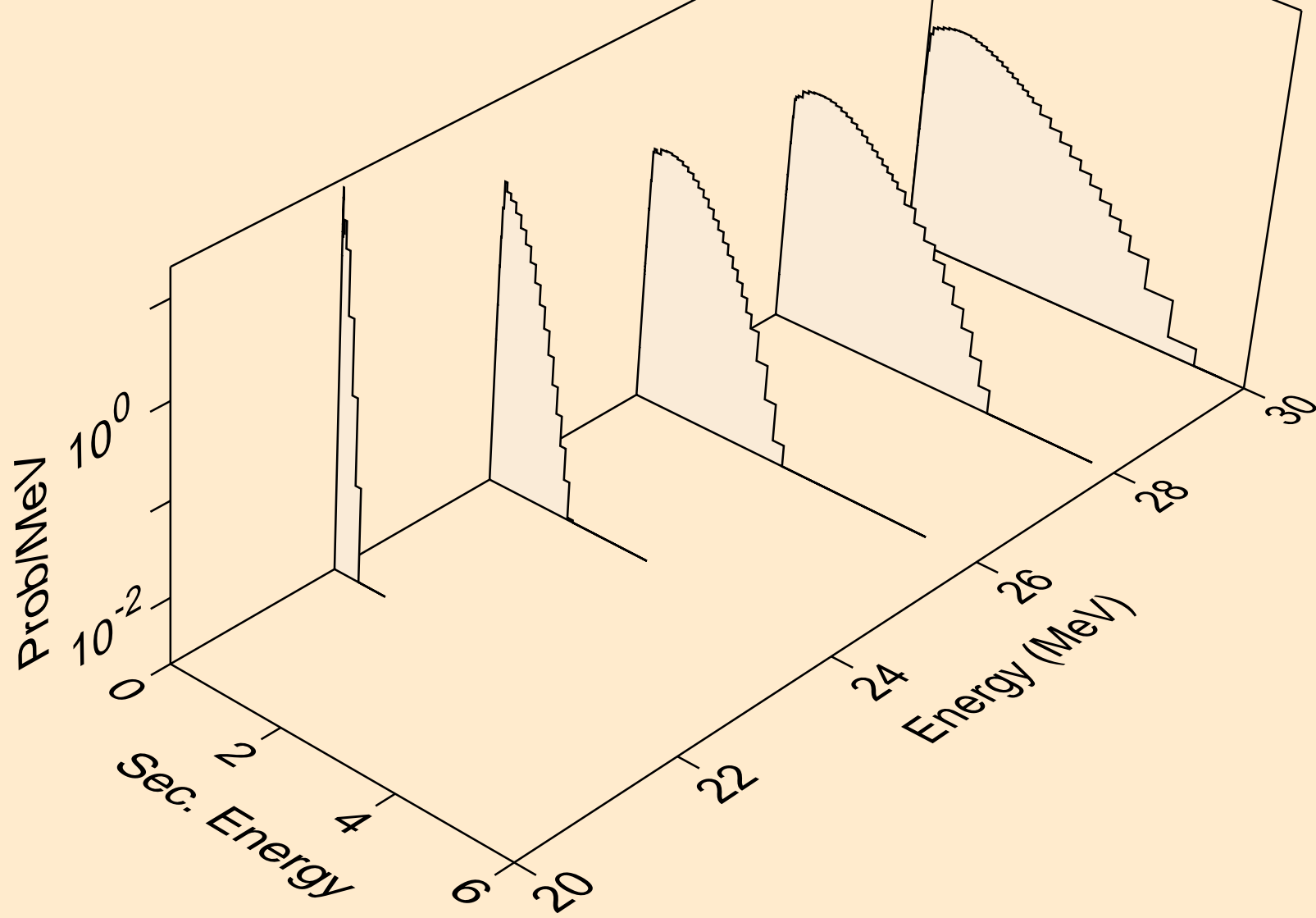

MN052 NEUTRON ACER TENDL-2024 LIBRARY; T=293.6K
Neutron emission for (n,n*)he3

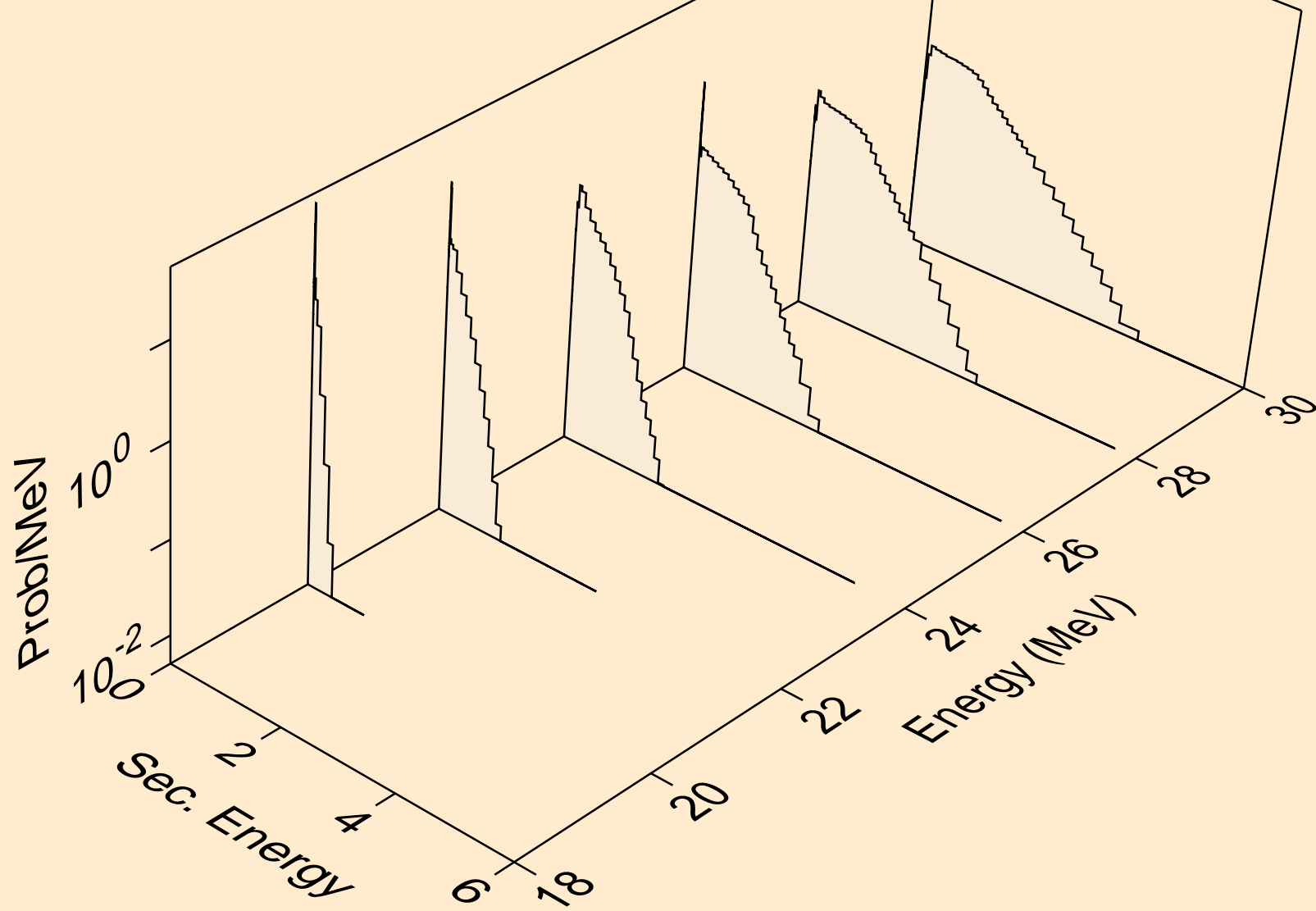

MN052 NEUTRON ACER TENDL-2024 LIBRARY; T=293.6K
Neutron emission for (n,2np)

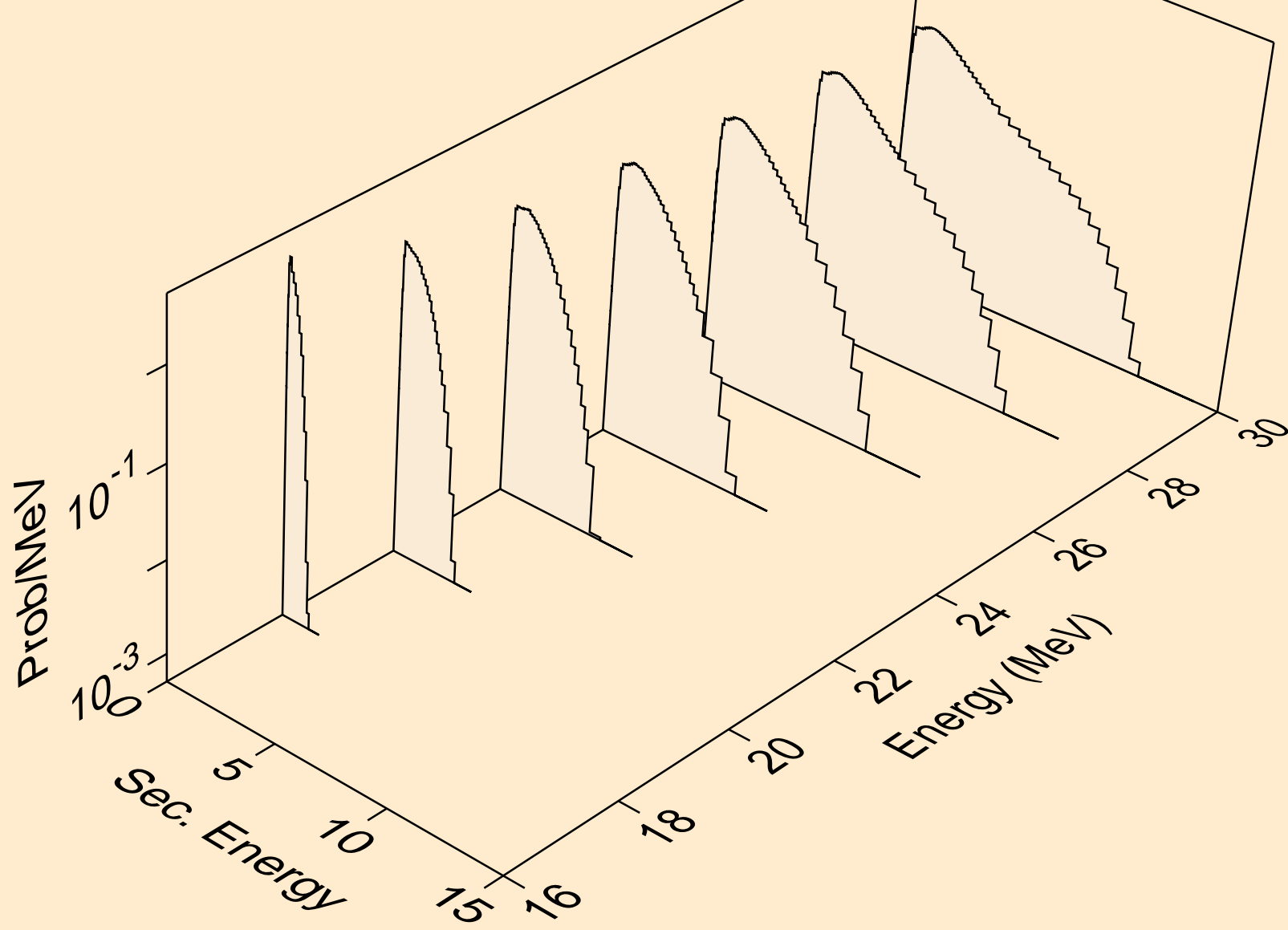

MN052 NEUTRON ACER TENDL-2024 LIBRARY; T=293.6K
Neutron emission for (n,n2p)

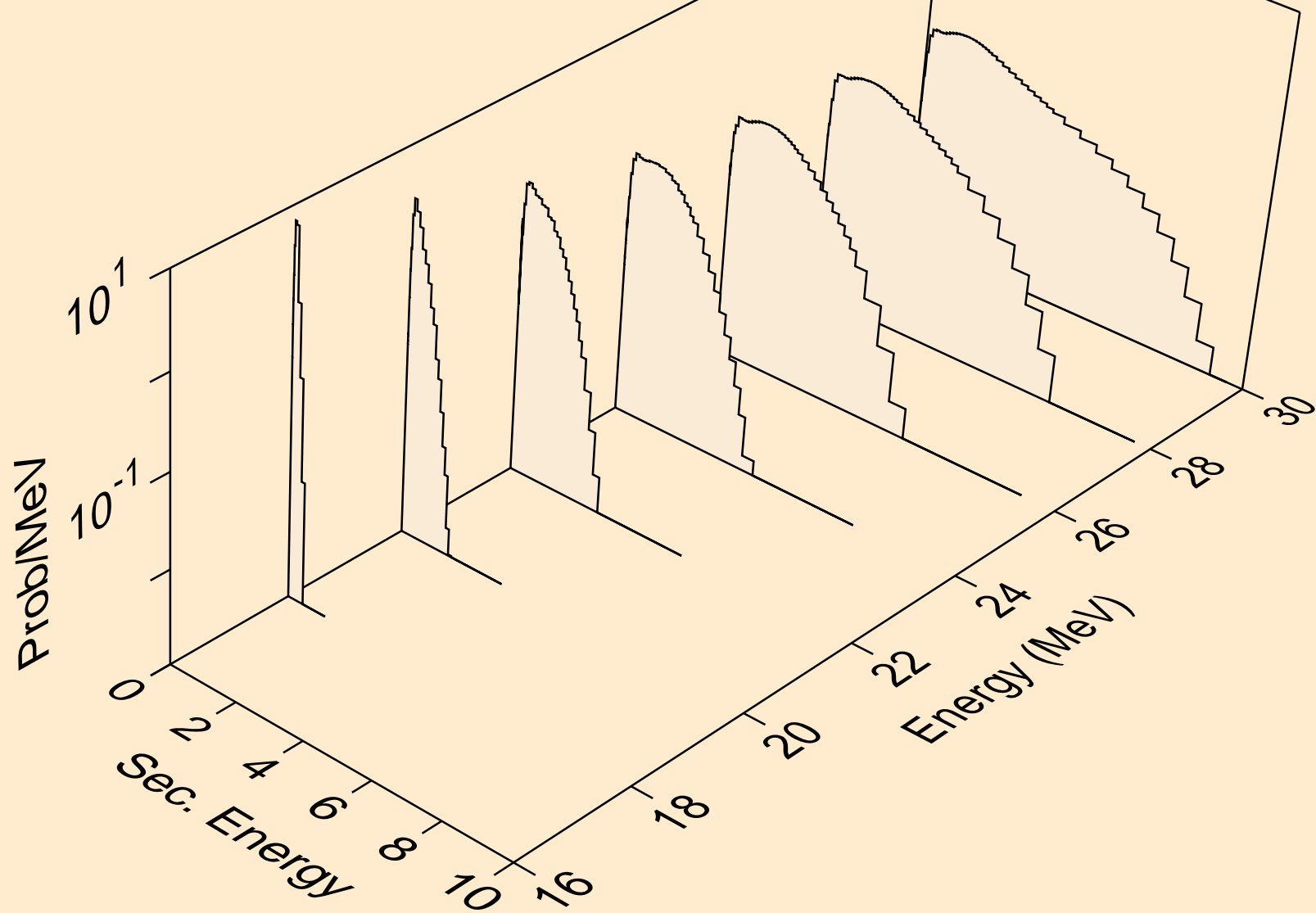

MN052 NEUTRON ACER TENDL-2024 LIBRARY; T=293.6K
Neutron emission for (n,npa)

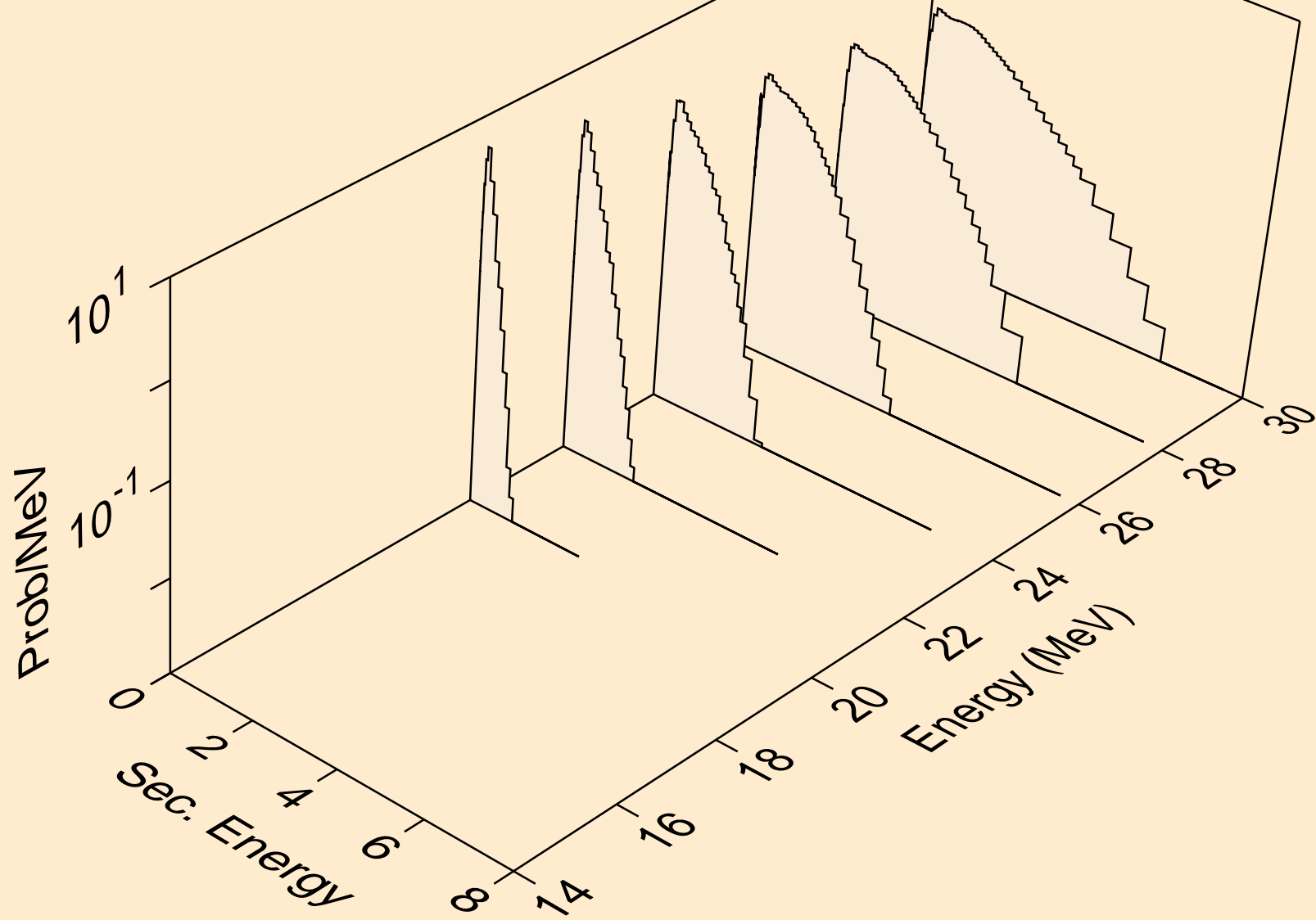

MN052 NEUTRON ACER TENDL-2024 LIBRARY; T=293.6K
Neutron emission for (n,n*c)

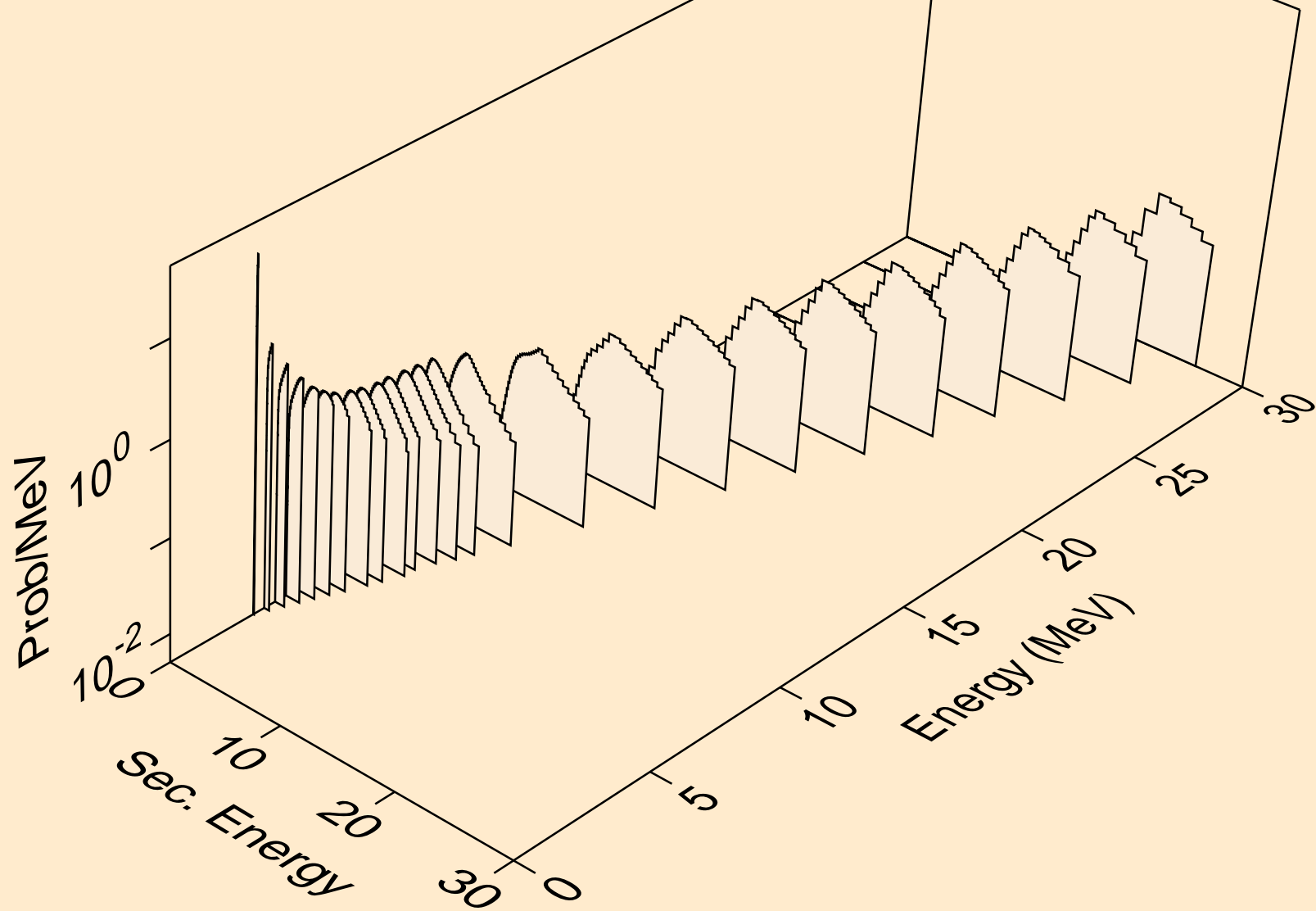

MN052 NEUTRON ACER TENDL-2024 LIBRARY; T=293.6K
Photon emission for (n,x)

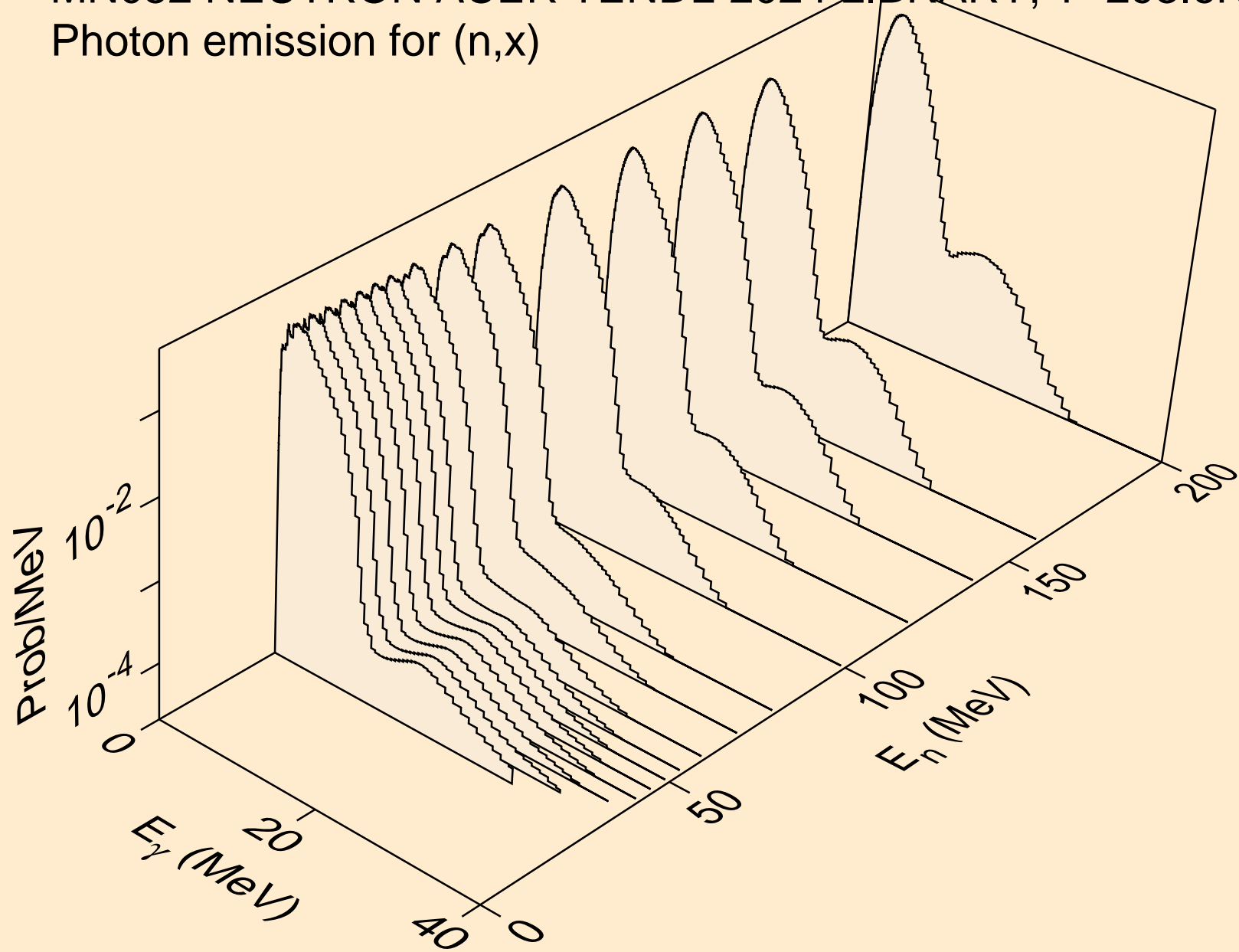

MN052 NEUTRON ACER TENDL-2024 LIBRARY; T=293.6K
Photon emission for (n,2nd)

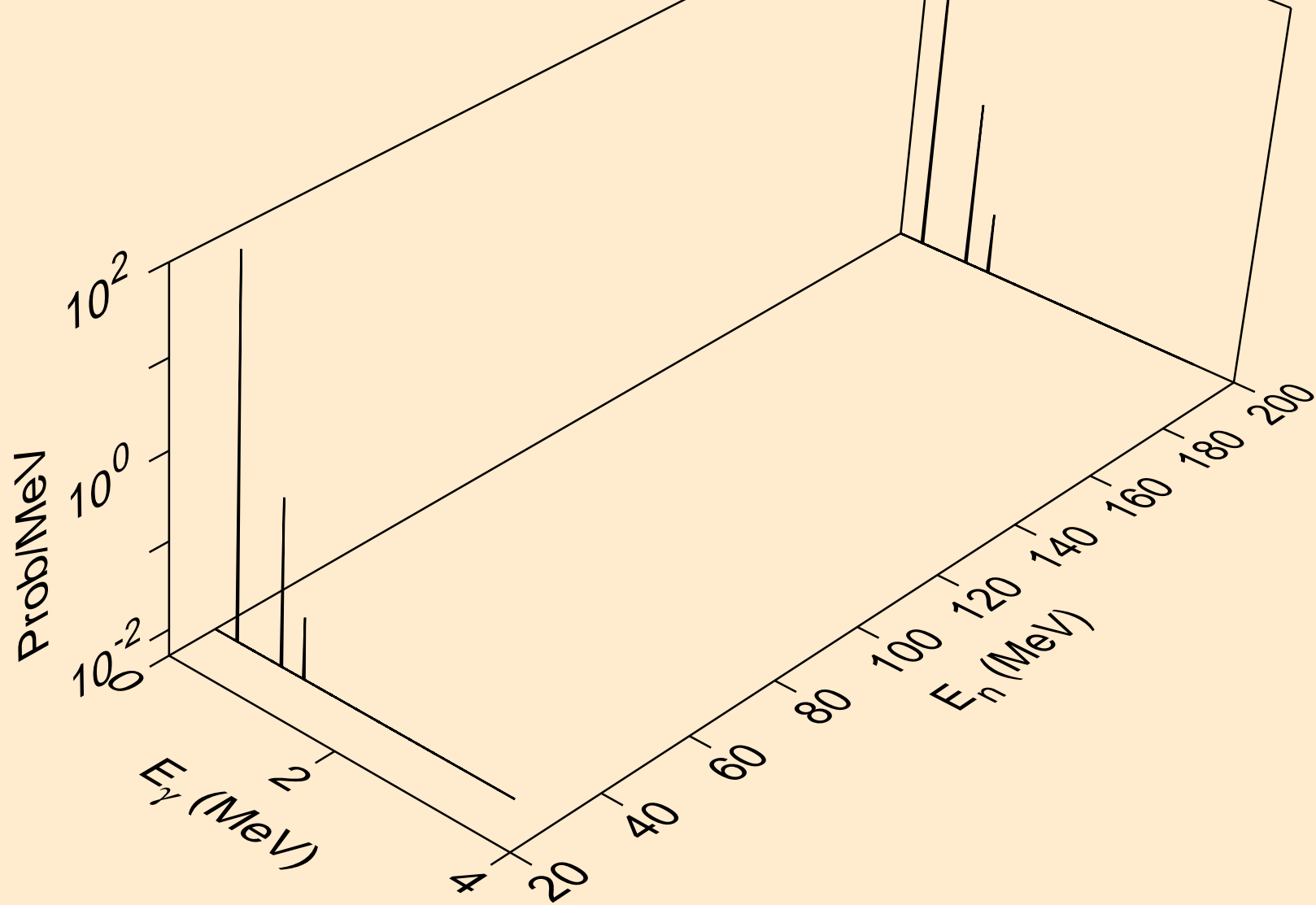

MN052 NEUTRON ACER TENDL-2024 LIBRARY; T=293.6K
Photon emission for (n,2n)

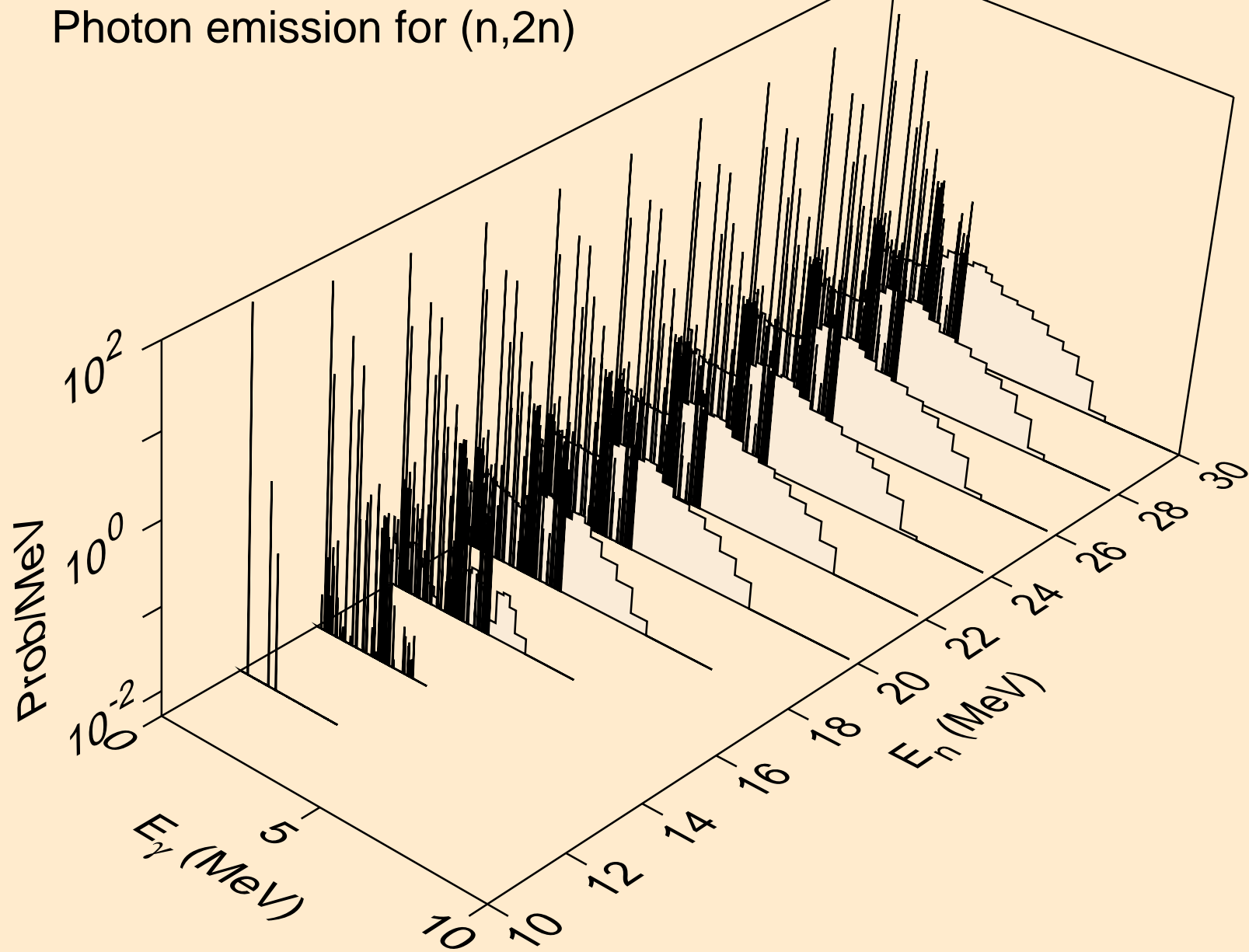

MN052 NEUTRON ACER TENDL-2024 LIBRARY; T=293.6K
Photon emission for (n,3n)

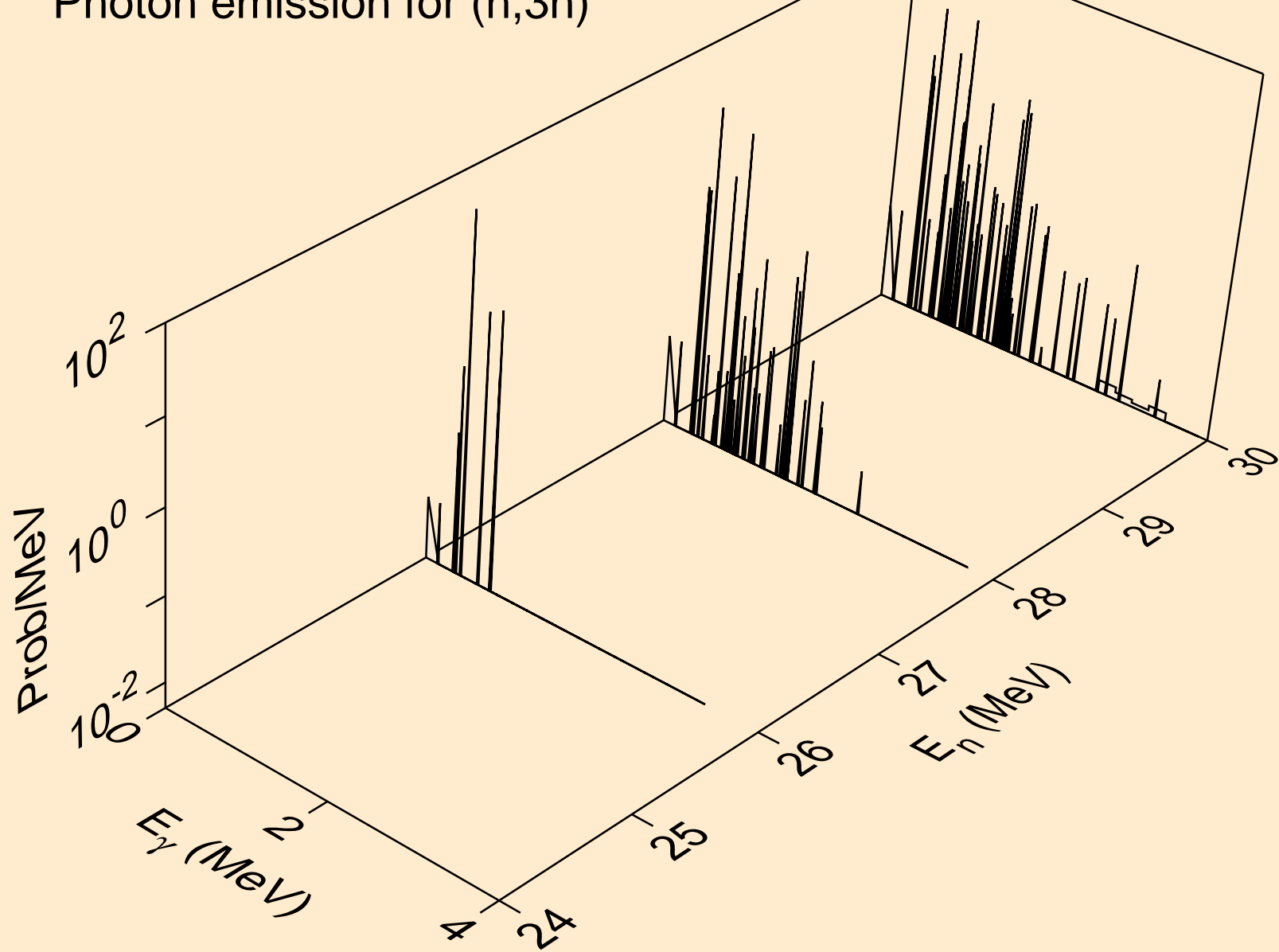

MN052 NEUTRON ACER TENDL-2024 LIBRARY; T=293.6K
Photon emission for (n,n*)a

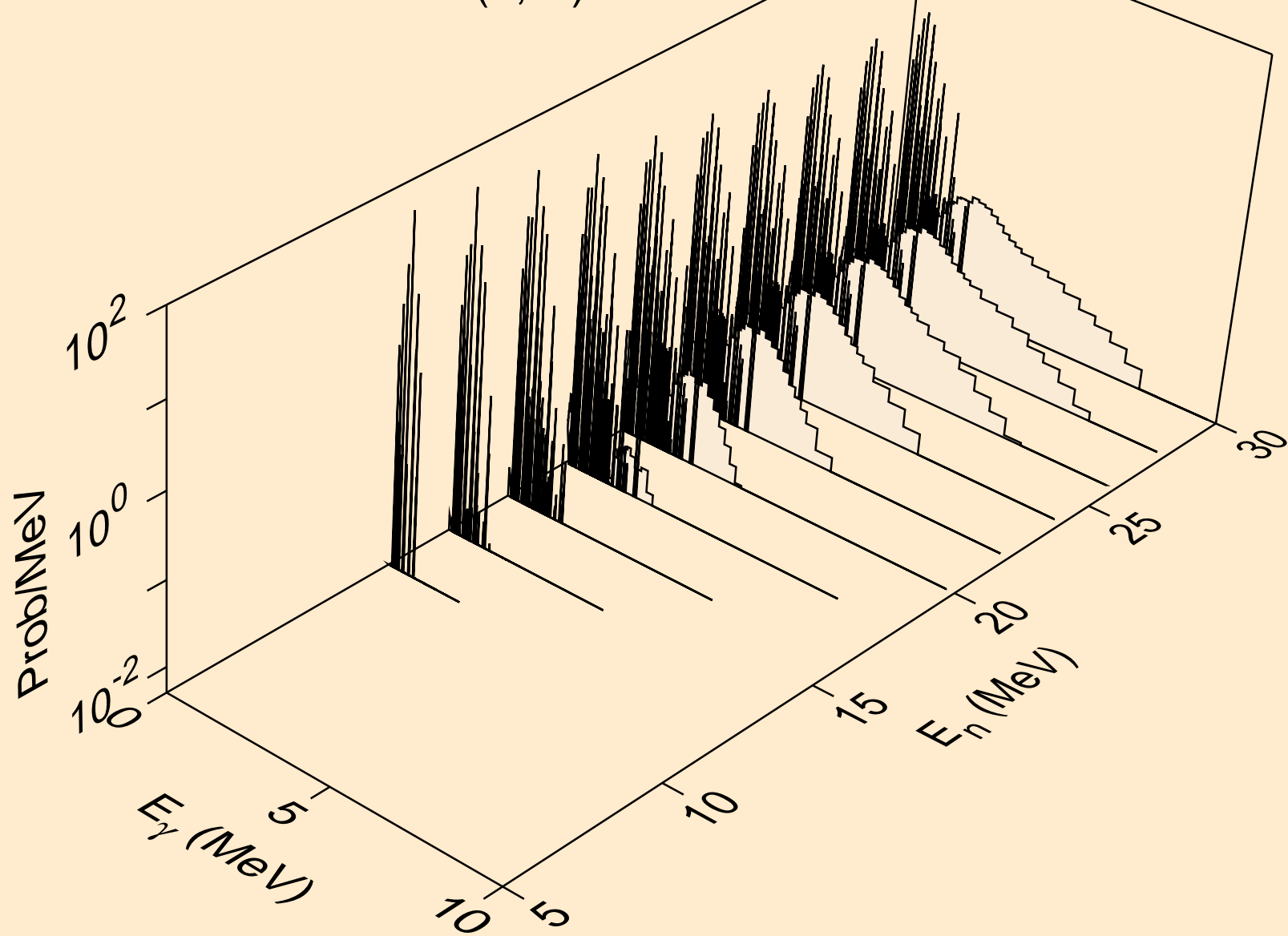

MN052 NEUTRON ACER TENDL-2024 LIBRARY; T=293.6K
Photon emission for (n,2n)a

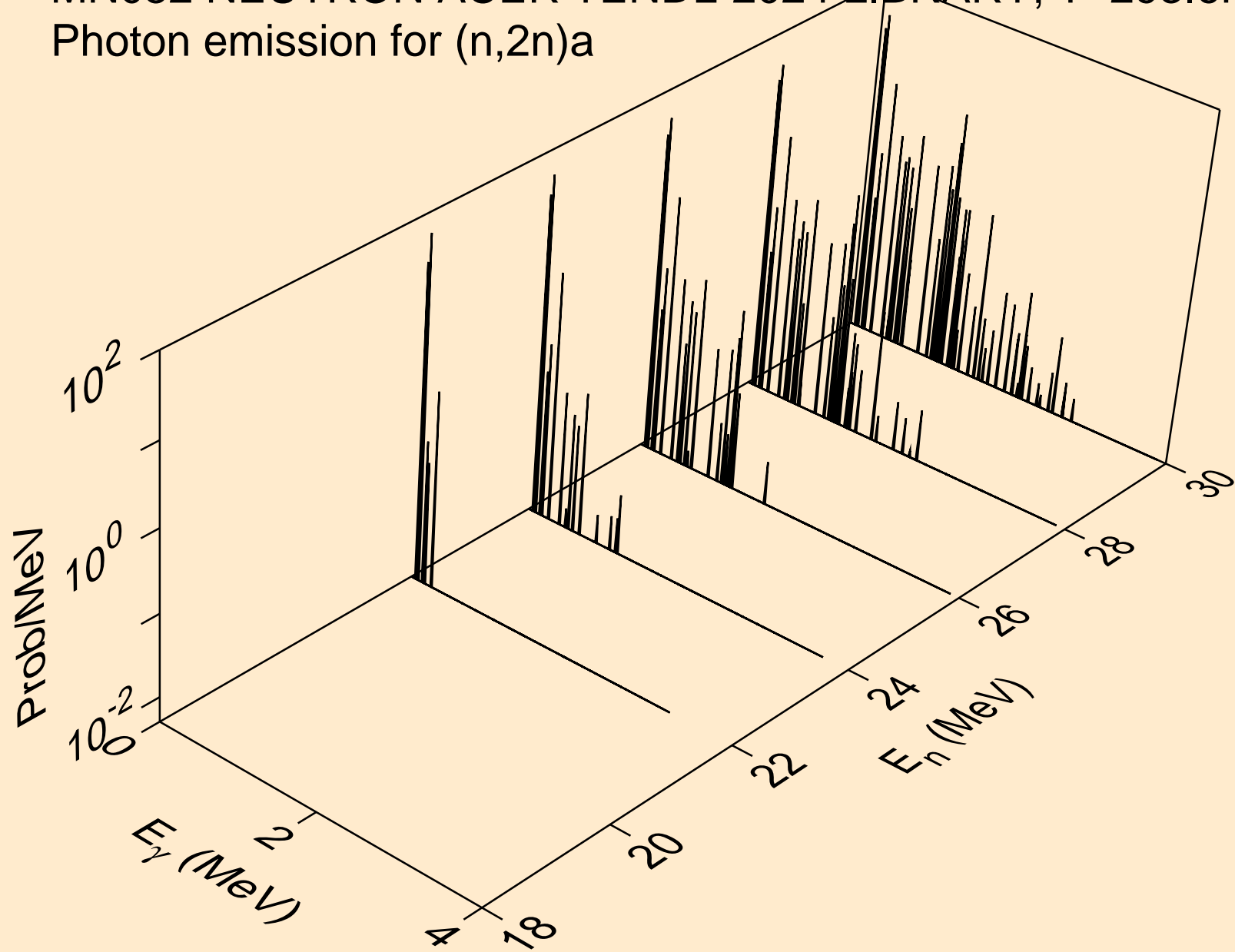

MN052 NEUTRON ACER TENDL-2024 LIBRARY; T=293.6K
Photon emission for (n,n*)p

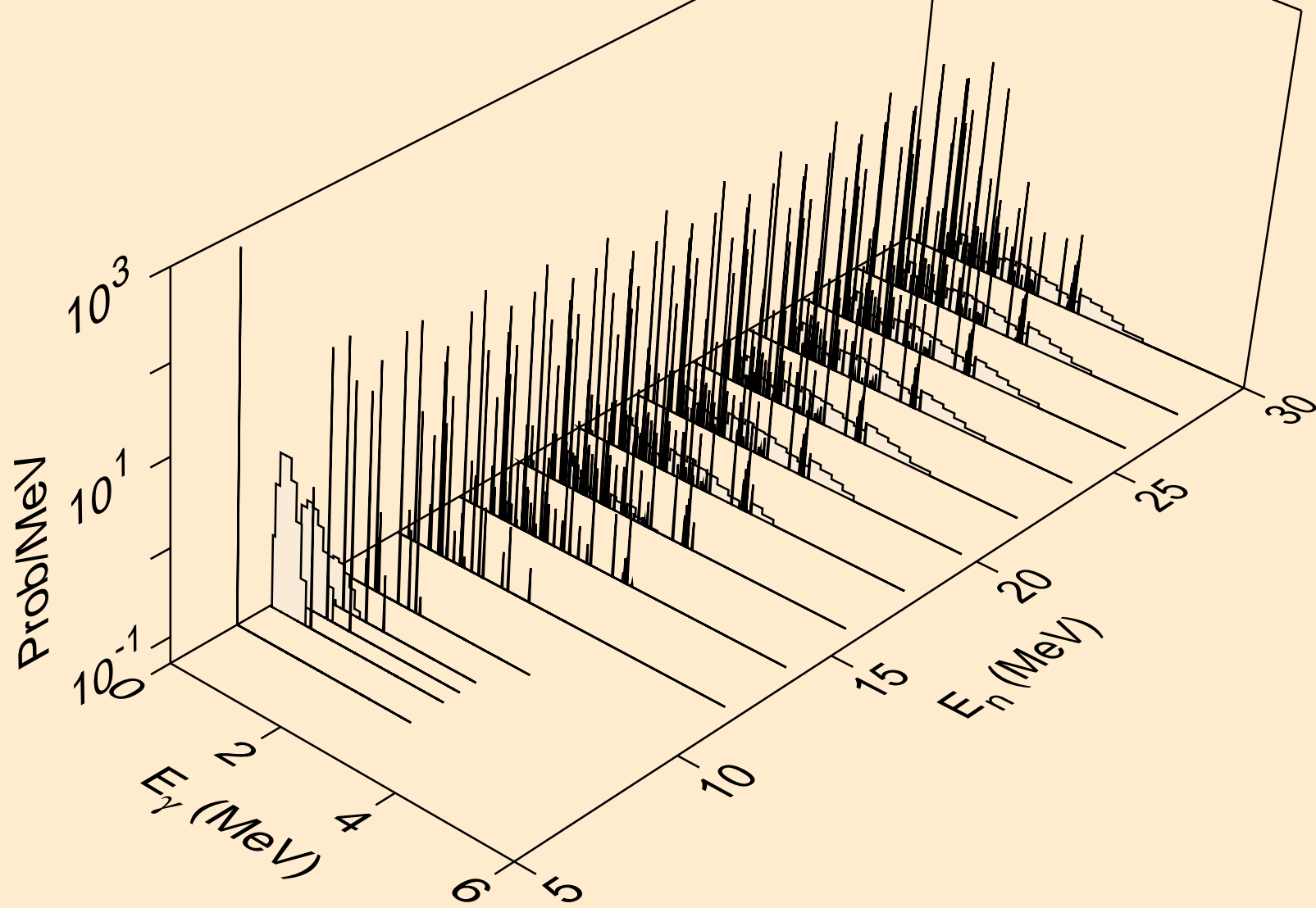

MN052 NEUTRON ACER TENDL-2024 LIBRARY; T=293.6K
Photon emission for (n,n*)2a

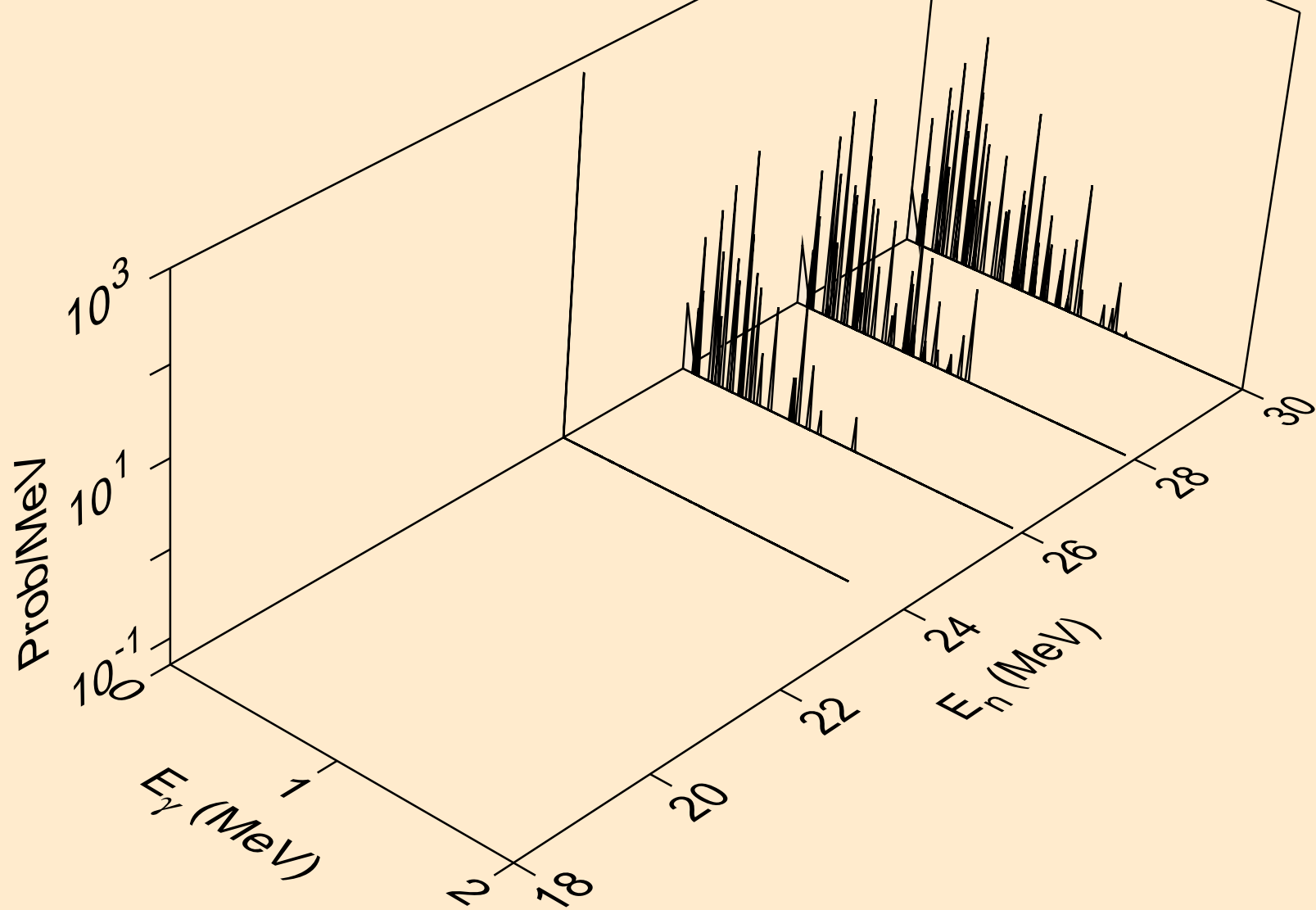

MN052 NEUTRON ACER TENDL-2024 LIBRARY; T=293.6K
Photon emission for (n,n*)d

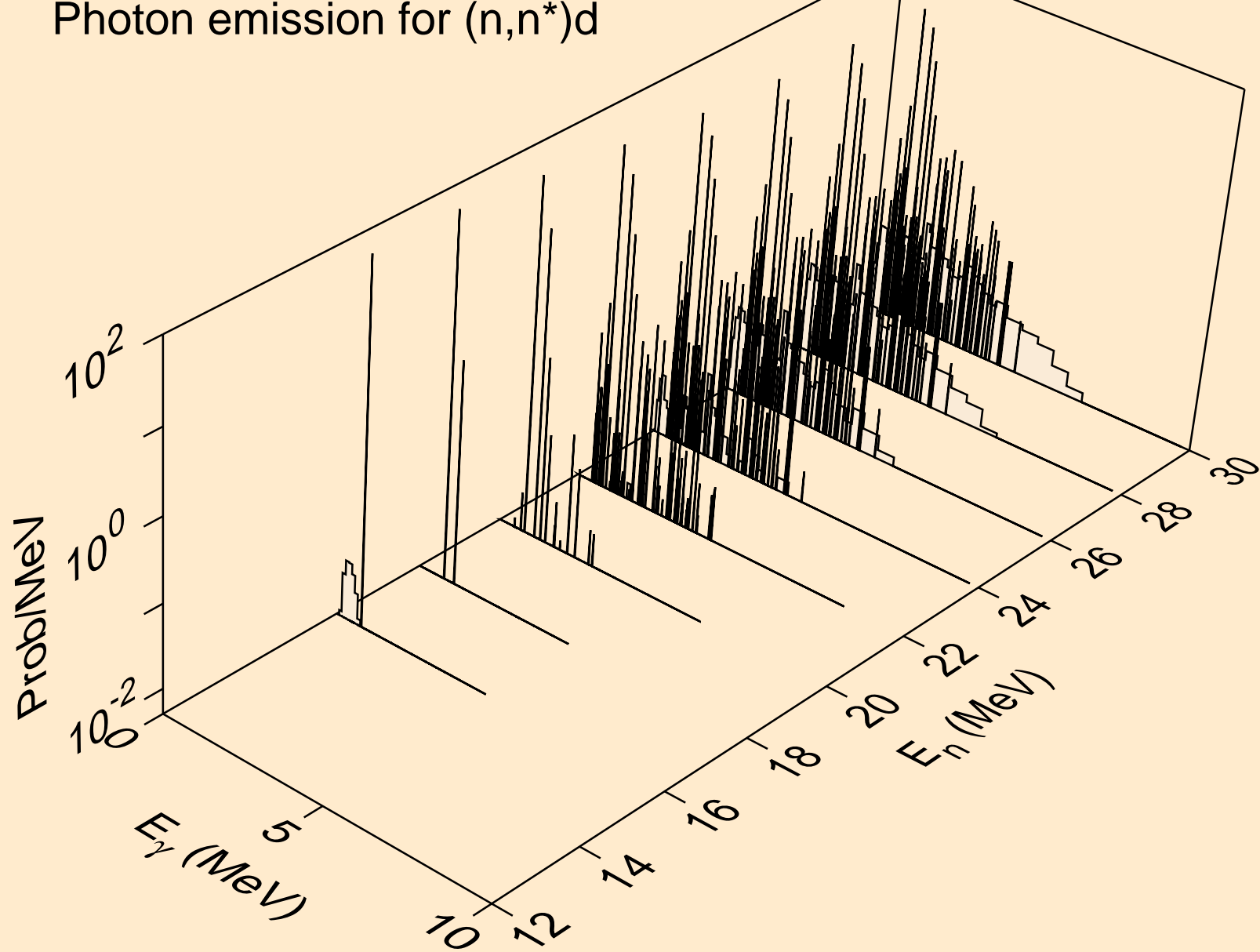

MN052 NEUTRON ACER TENDL-2024 LIBRARY; T=293.6K
Photon emission for (n,n*)t

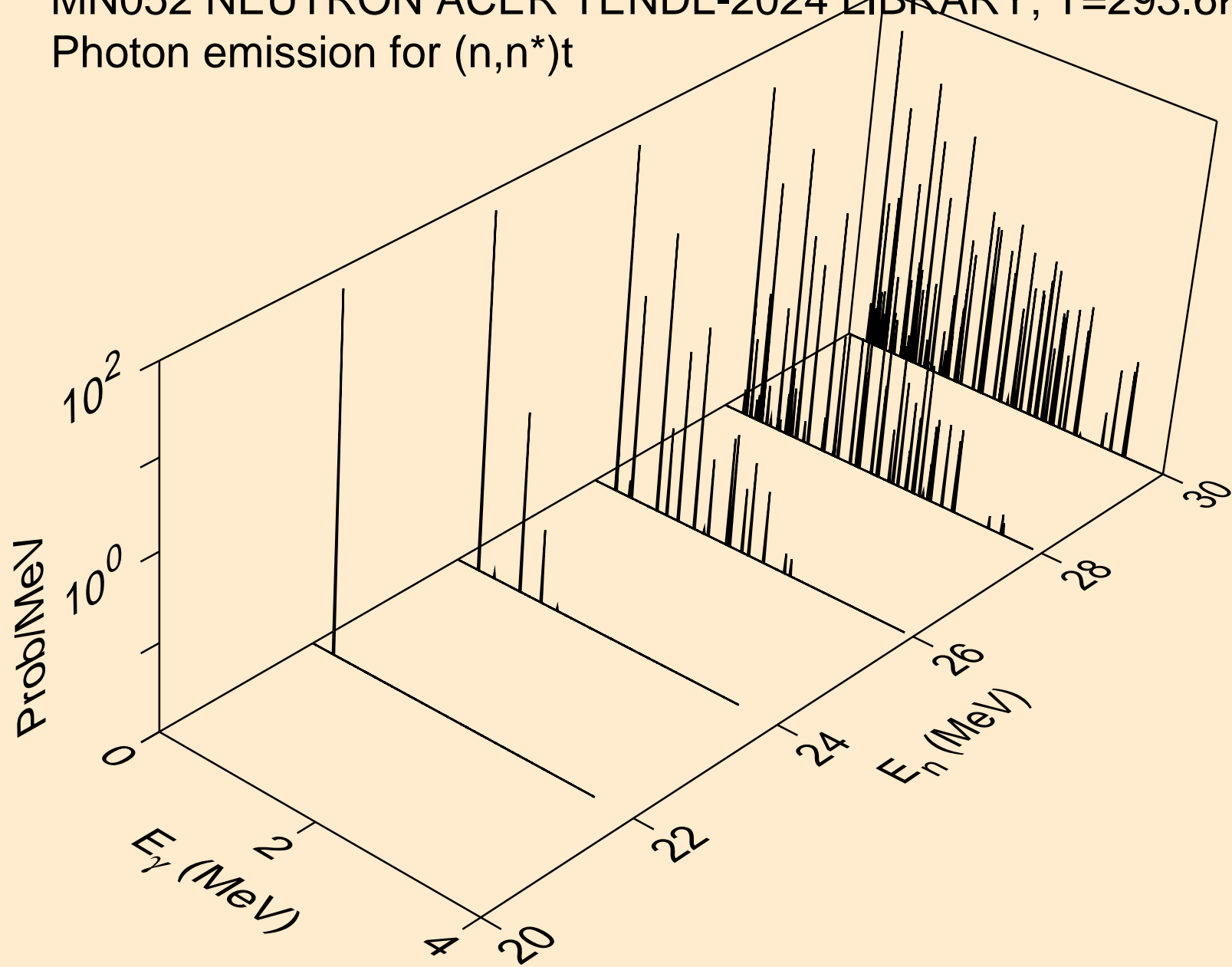

MN052 NEUTRON ACER TENDL-2024 LIBRARY; T=293.6K
Photon emission for (n,n*)he3

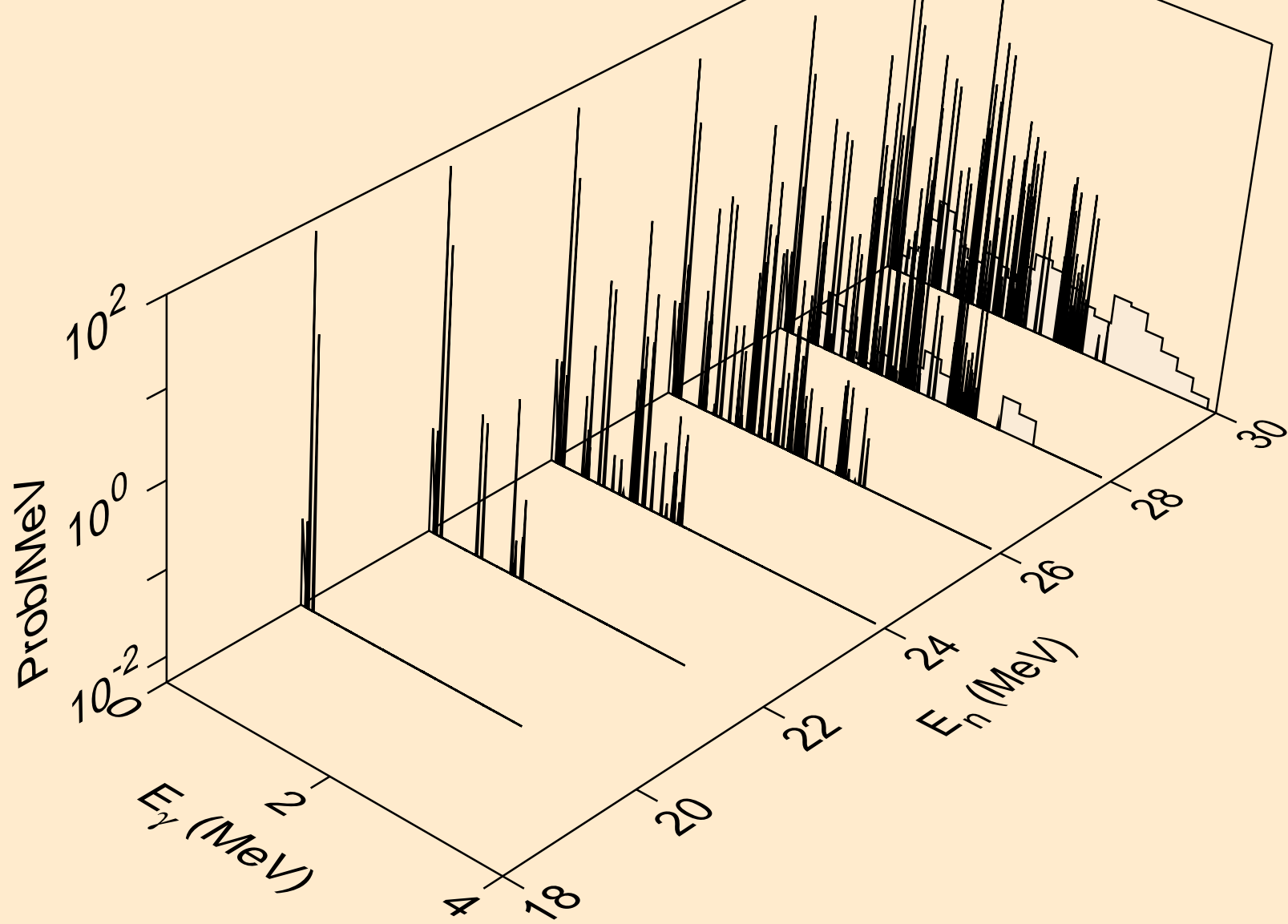

MN052 NEUTRON ACER TENDL-2024 LIBRARY; T=293.6K
Photon emission for (n,2np)

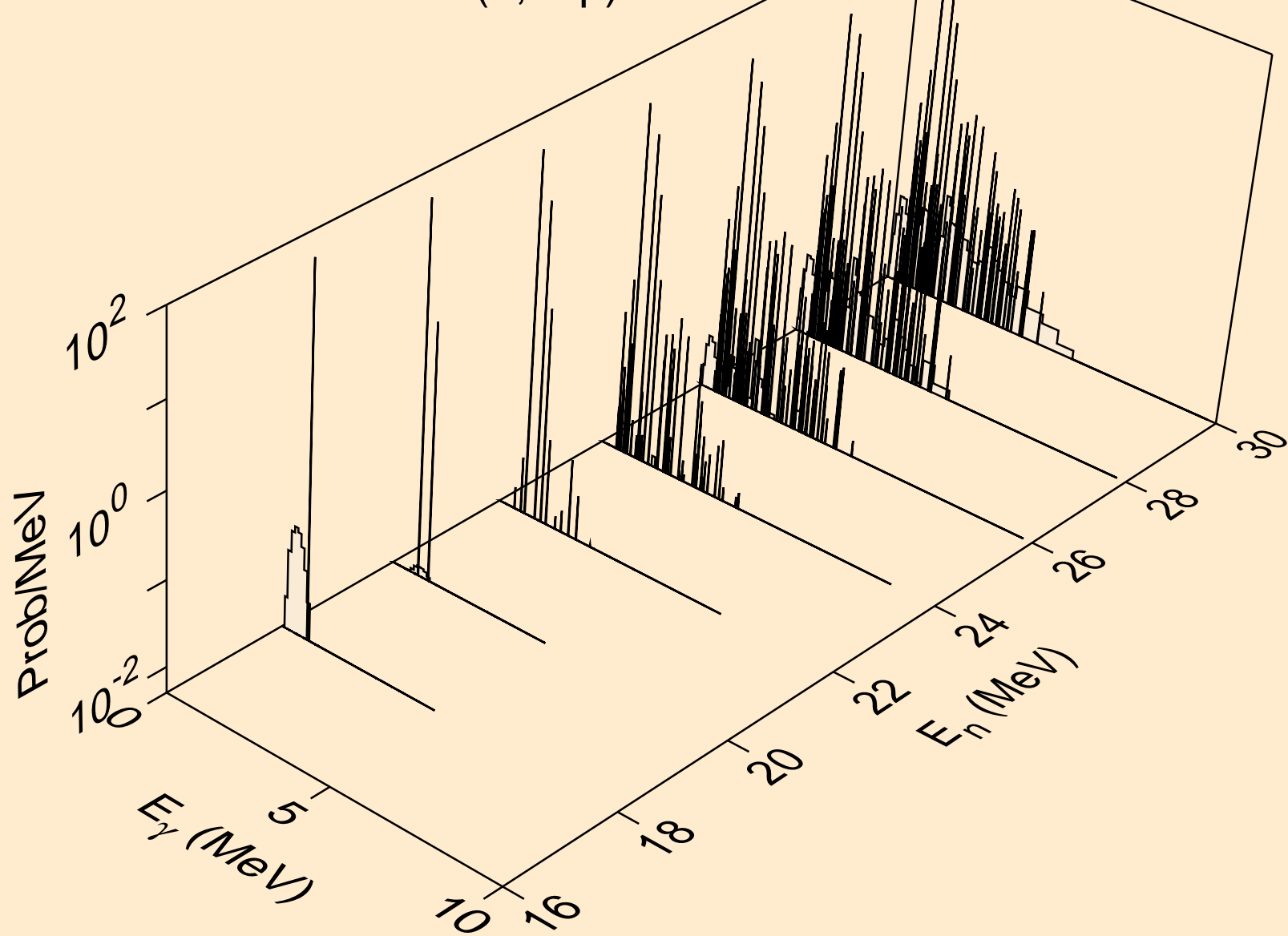

MN052 NEUTRON ACER TENDL-2024 LIBRARY; T=293.6K
Photon emission for (n,n2p)

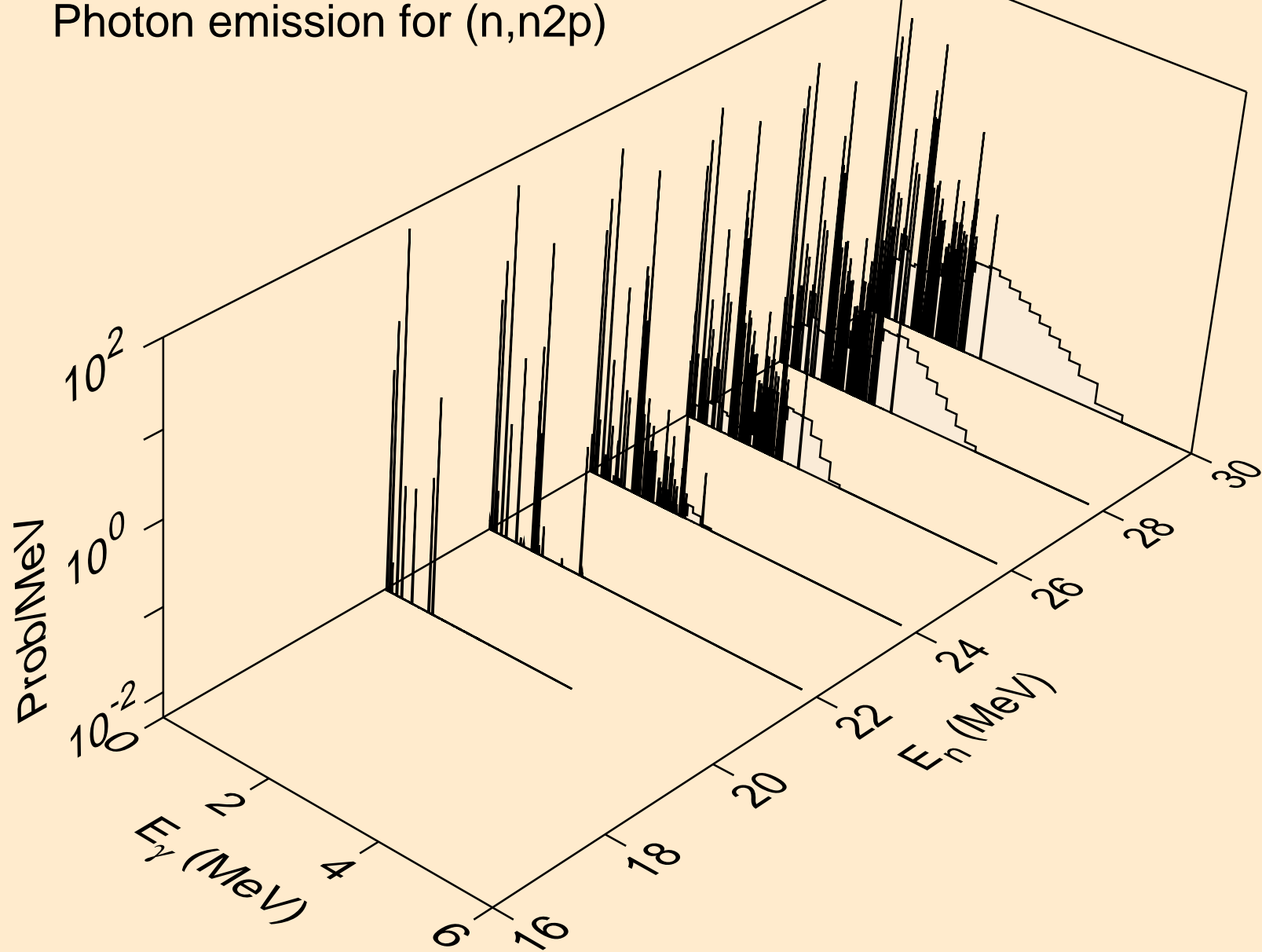

MN052 NEUTRON ACER TENDL-2024 LIBRARY; T=293.6K
Photon emission for (n,npa)

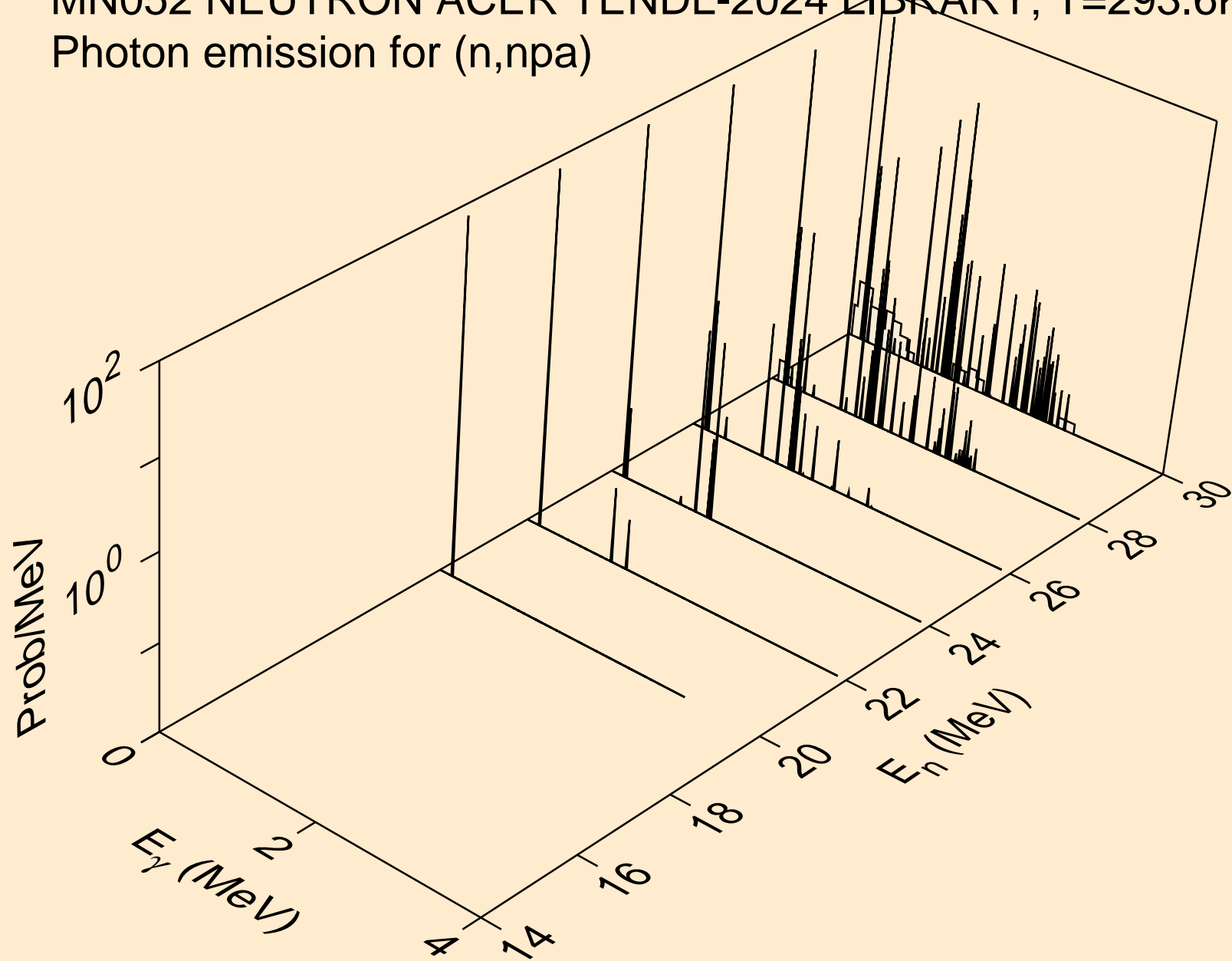

MN052 NEUTRON ACER TENDL-2024 LIBRARY; T=293.6K
Photon emission for (n,n*c)

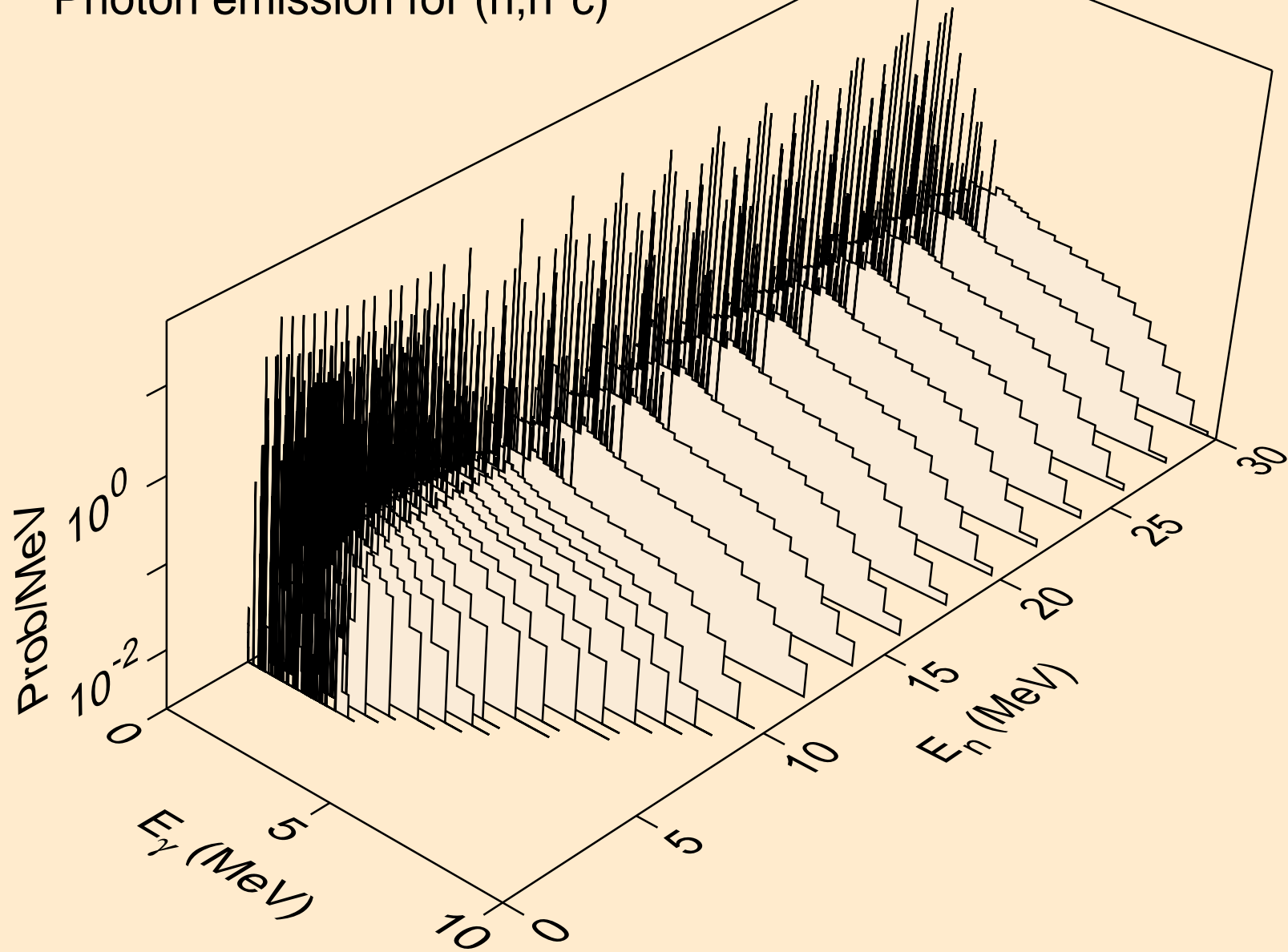

MN052 NEUTRON ACER TENDL-2024 LIBRARY; T=293.6K
Photon emission for (n,gma)

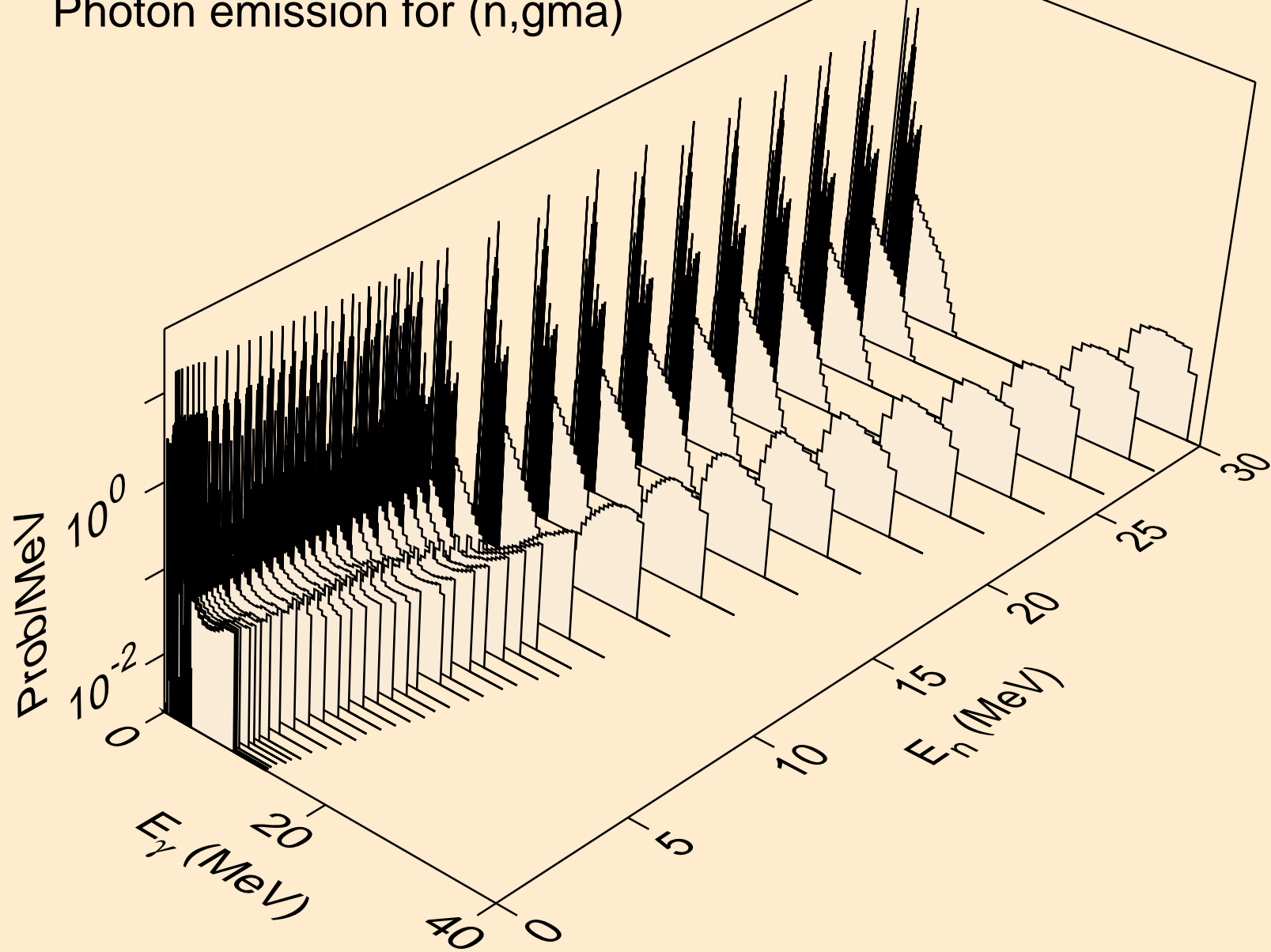

MN052 NEUTRON ACER TENDL-2024 LIBRARY; T=293.6K
Photon emission for (n,p)

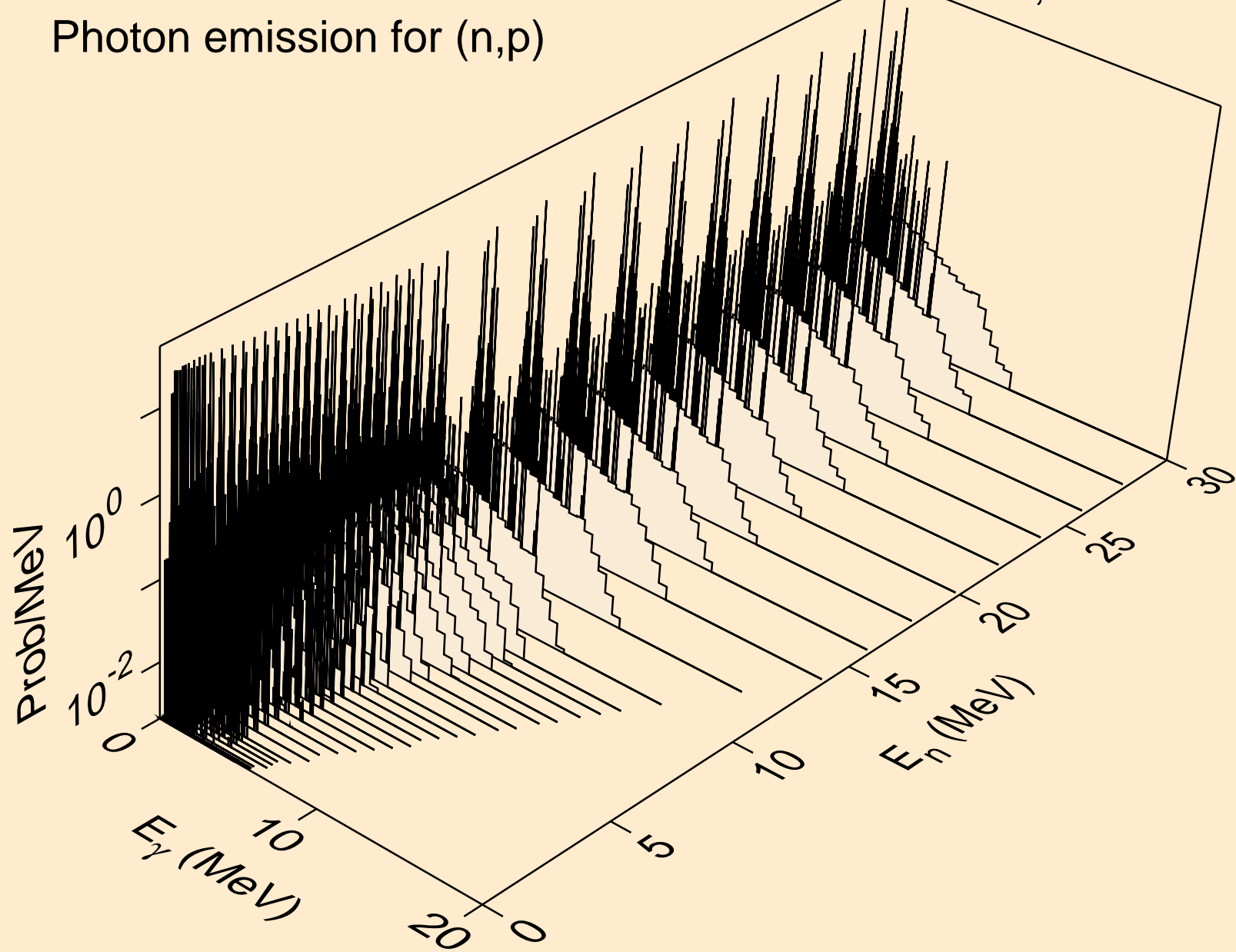

MN052 NEUTRON ACER TENDL-2024 LIBRARY; T=293.6K
Photon emission for (n,d)

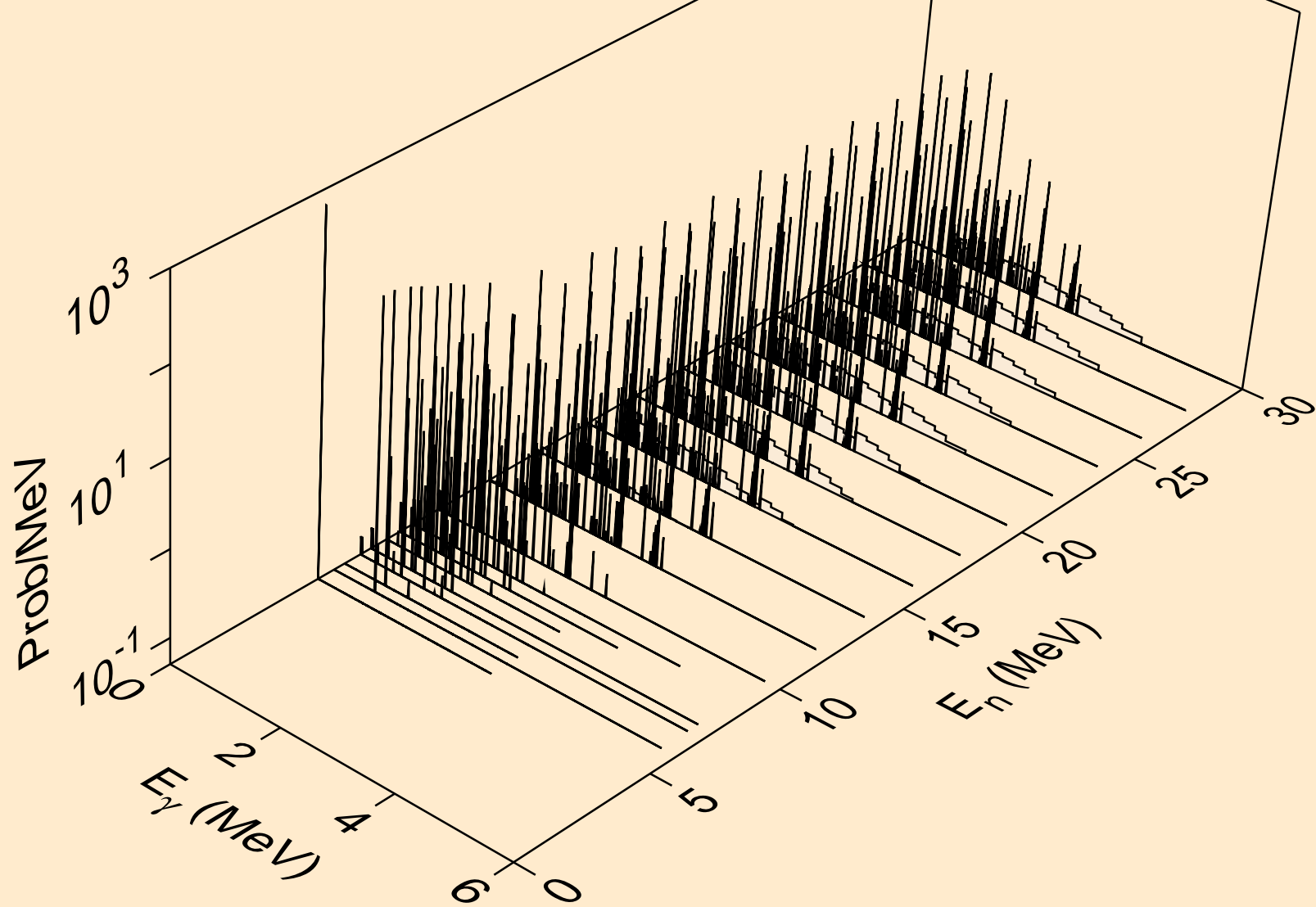

MN052 NEUTRON ACER TENDL-2024 LIBRARY; T=293.6K
Photon emission for (n,t)

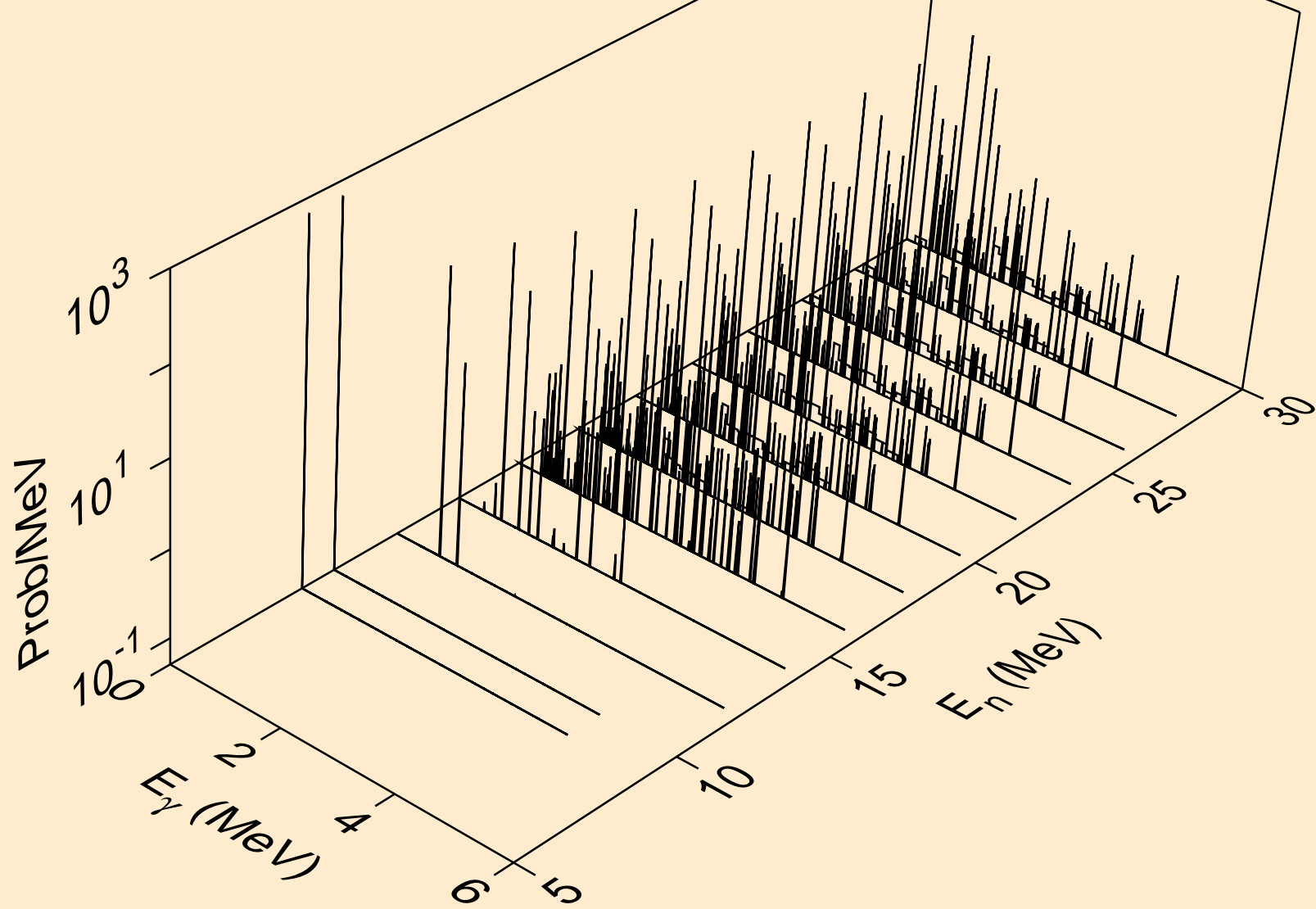

MN052 NEUTRON ACER TENDL-2024 LIBRARY; T=293.6K
Photon emission for (n,he3)

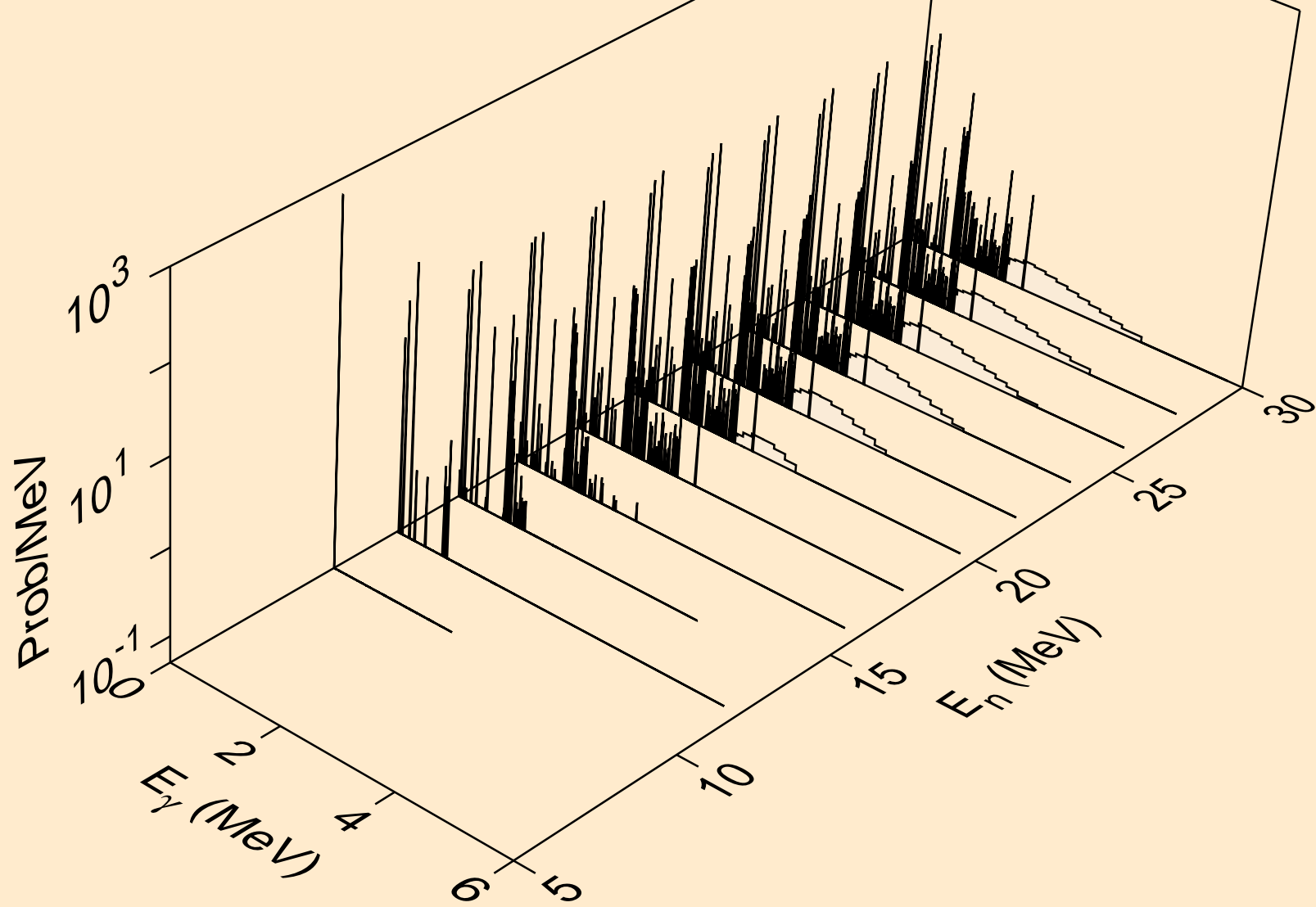

MN052 NEUTRON ACER TENDL-2024 LIBRARY; T=293.6K
Photon emission for (n,a)

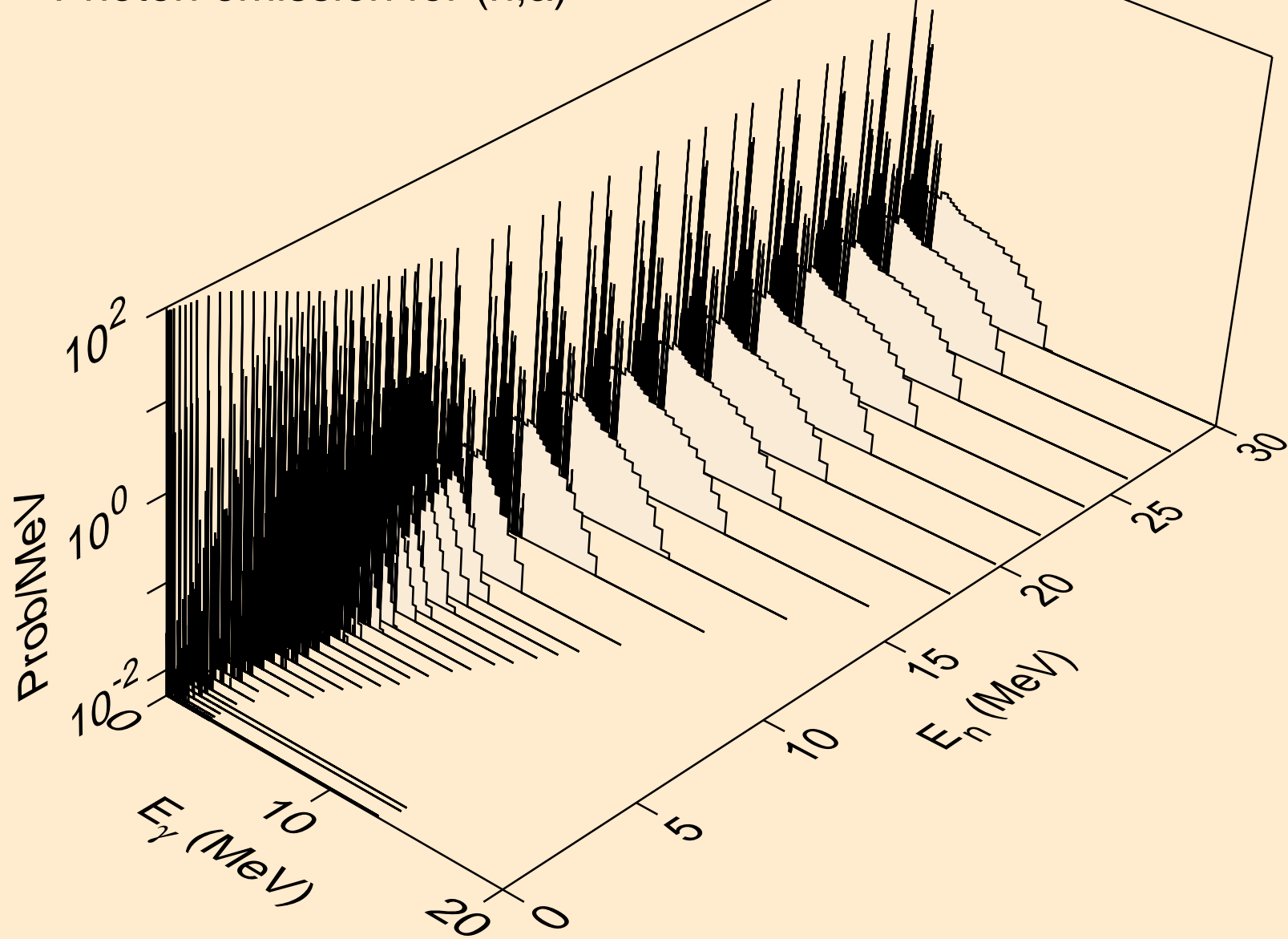

MN052 NEUTRON ACER TENDL-2024 LIBRARY; T=293.6K
Photon emission for (n,2a)

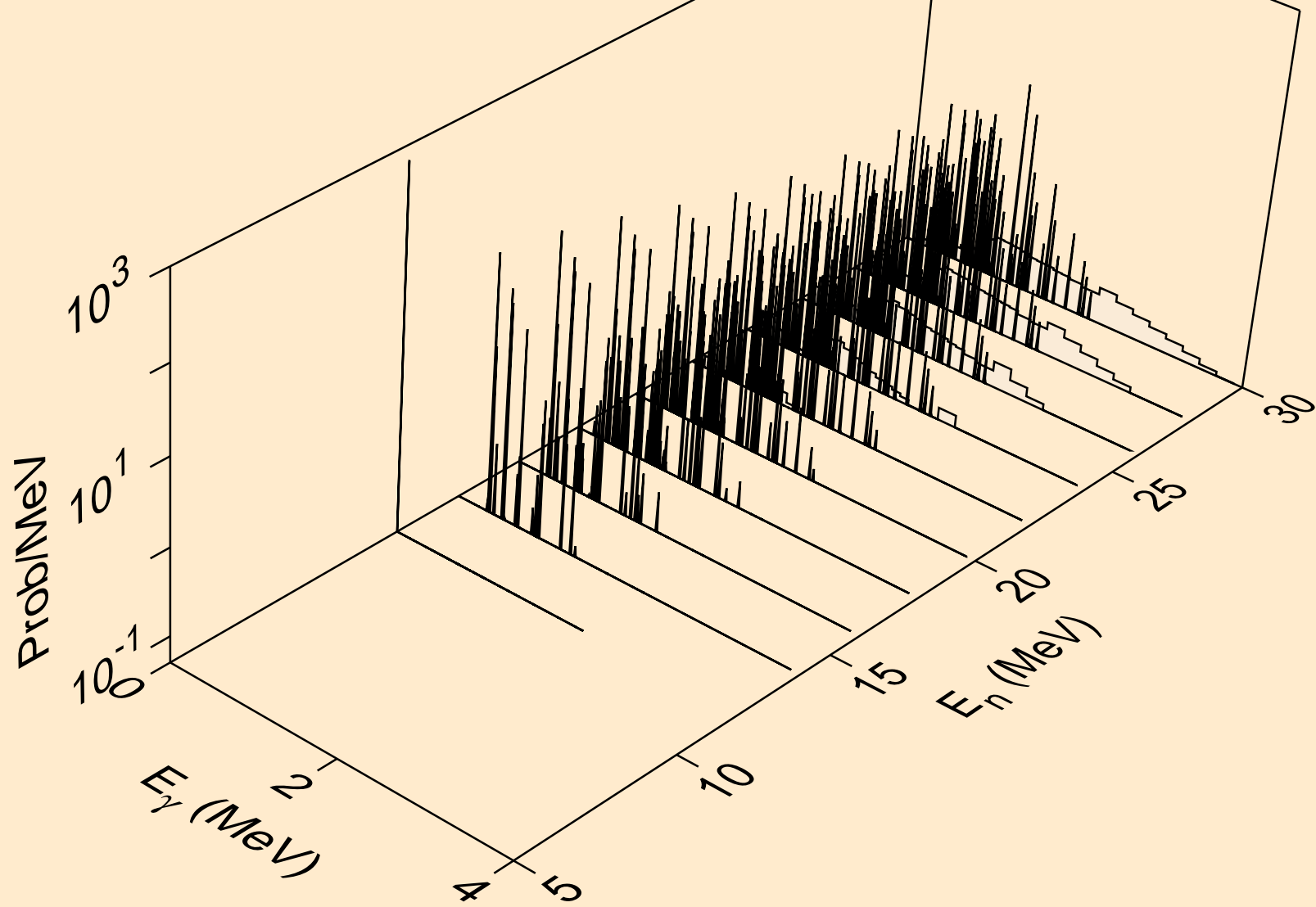

MN052 NEUTRON ACER TENDL-2024 LIBRARY; T=293.6K
Photon emission for (n,2p)

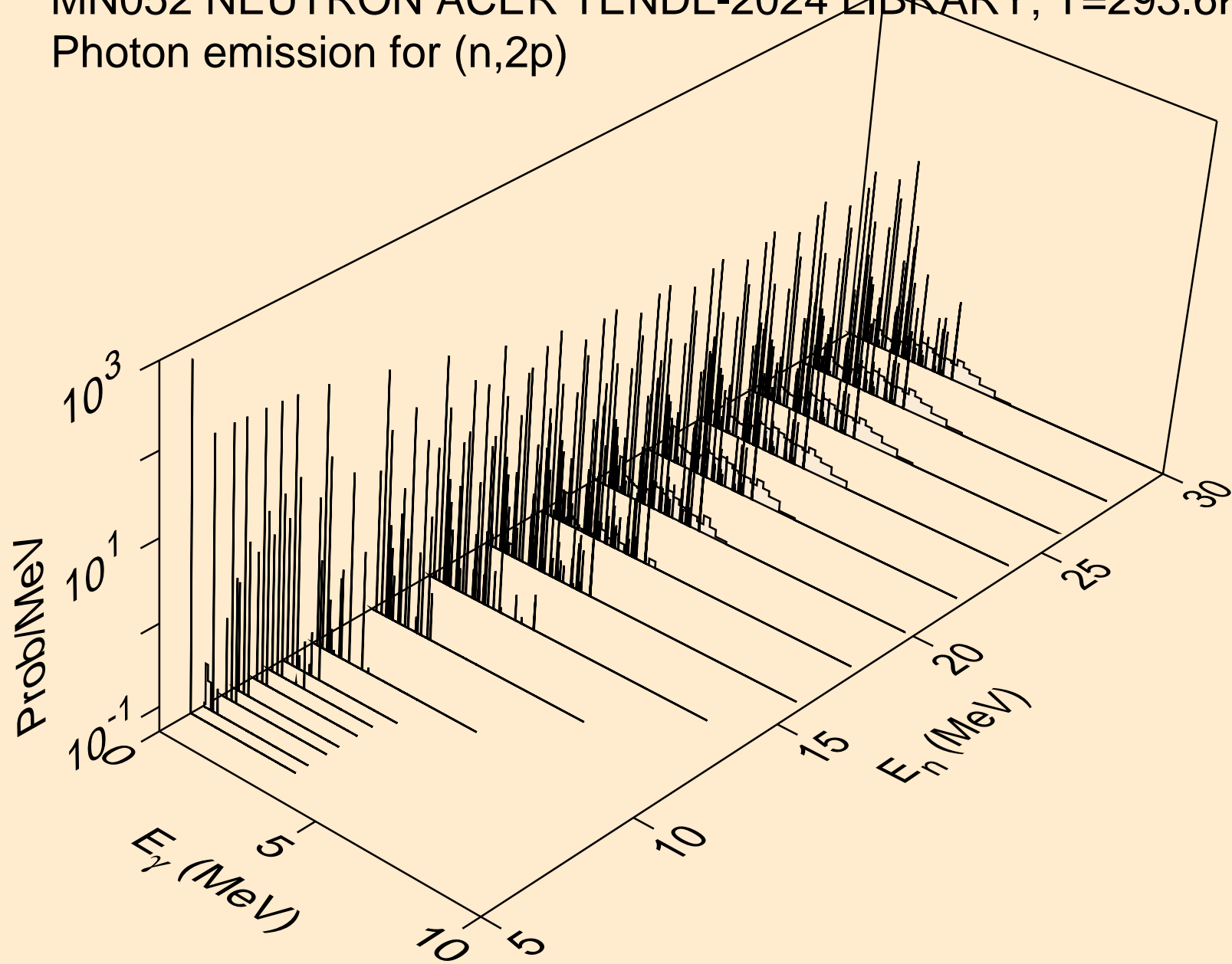

MN052 NEUTRON ACER TENDL-2024 LIBRARY; T=293.6K
Photon emission for (n,p α)

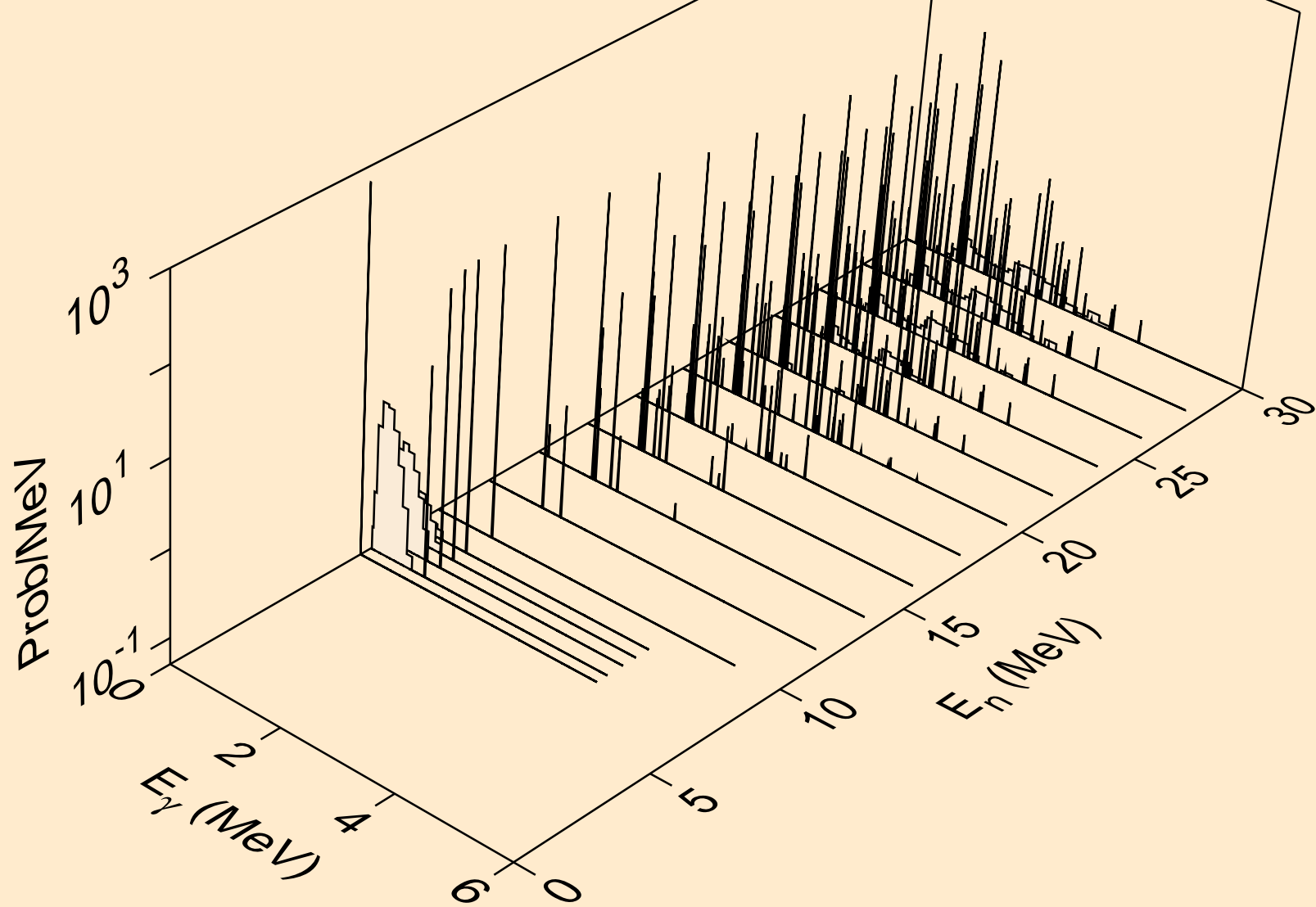

MN052 NEUTRON ACER TENDL-2024 LIBRARY; T=293.6K
Photon emission for (n,pd)

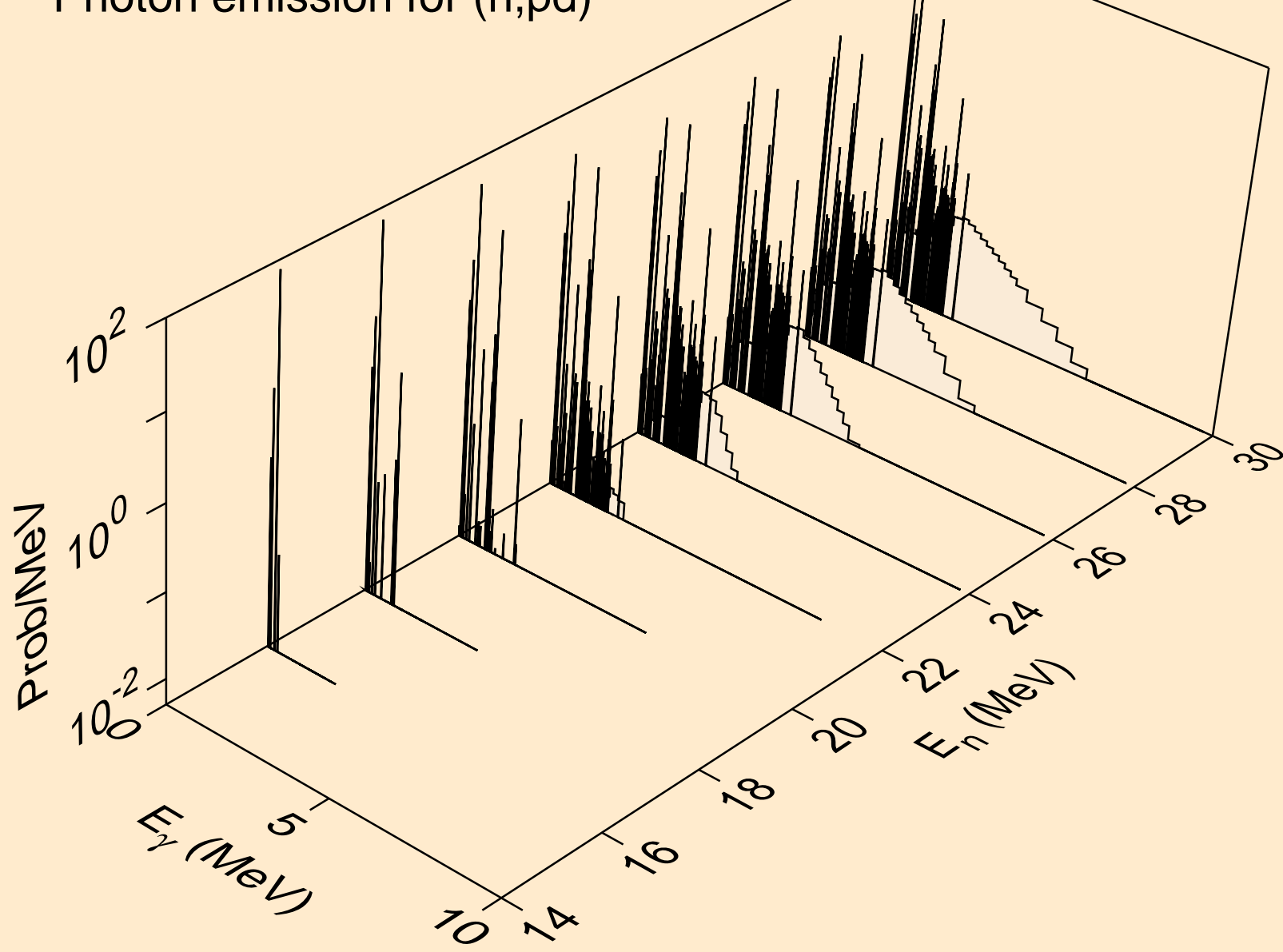

MN052 NEUTRON ACER TENDL-2024 LIBRARY; T=293.6K
Photon emission for (n,pt)

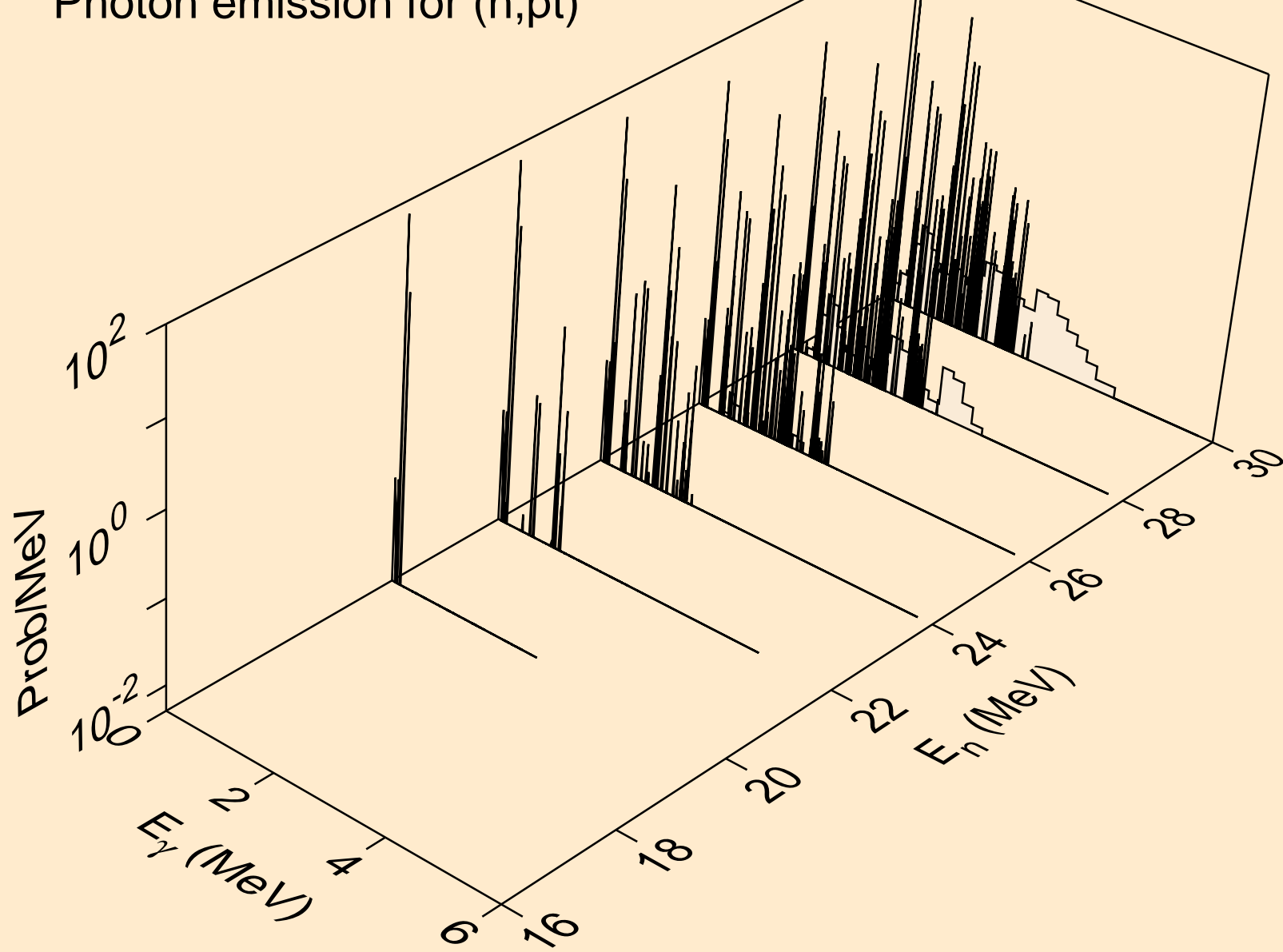

MN052 NEUTRON ACER TENDL-2024 LIBRARY; T=293.6K
Photon emission for (n,da)

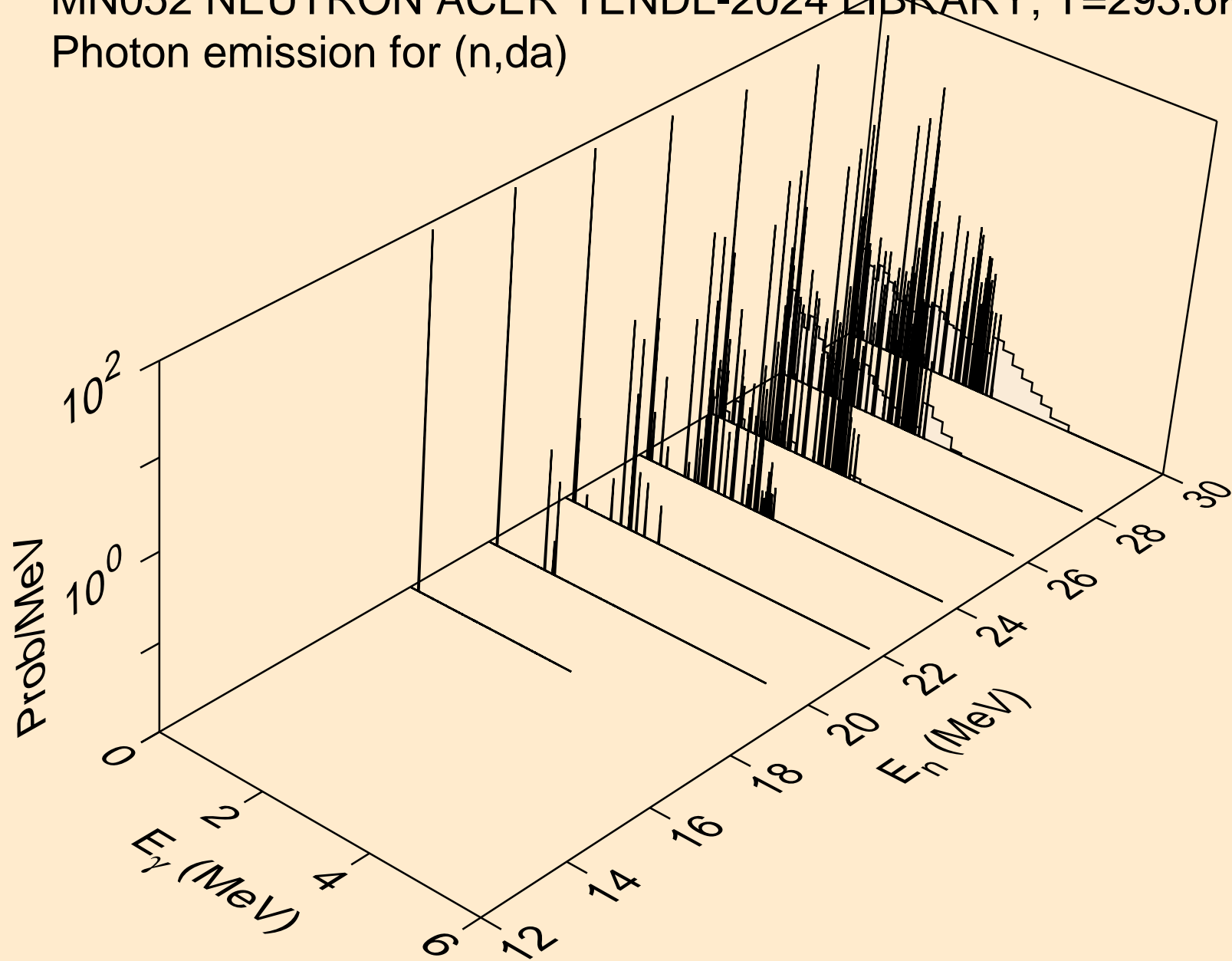

MN052 NEUTRON ACER TENDL-2024 LIBRARY; T=293.6K
thermal capture photon spectrum

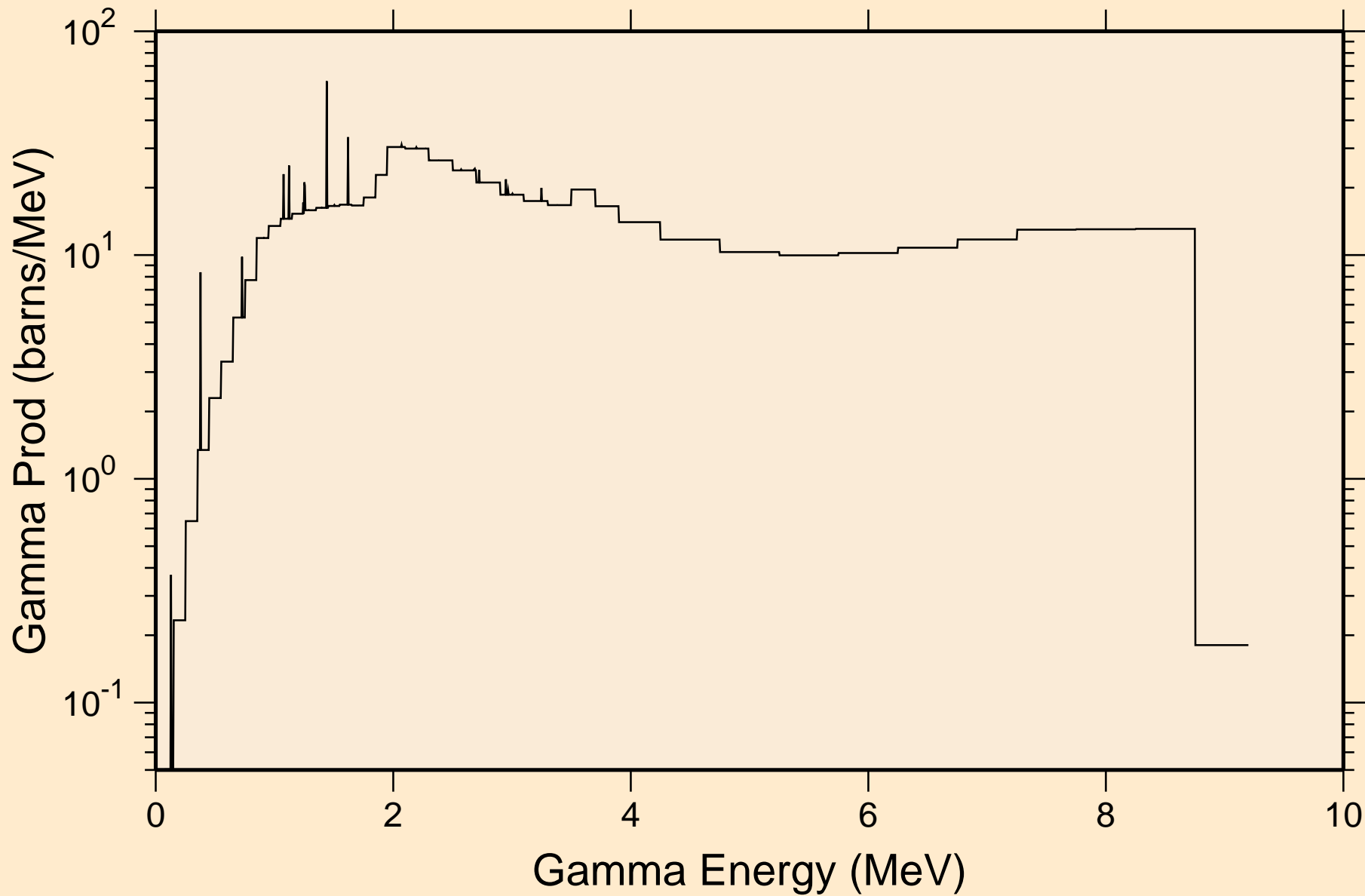

MN052 NEUTRON ACER TENDL-2024 LIBRARY; T=293.6K
14 MeV photon spectrum

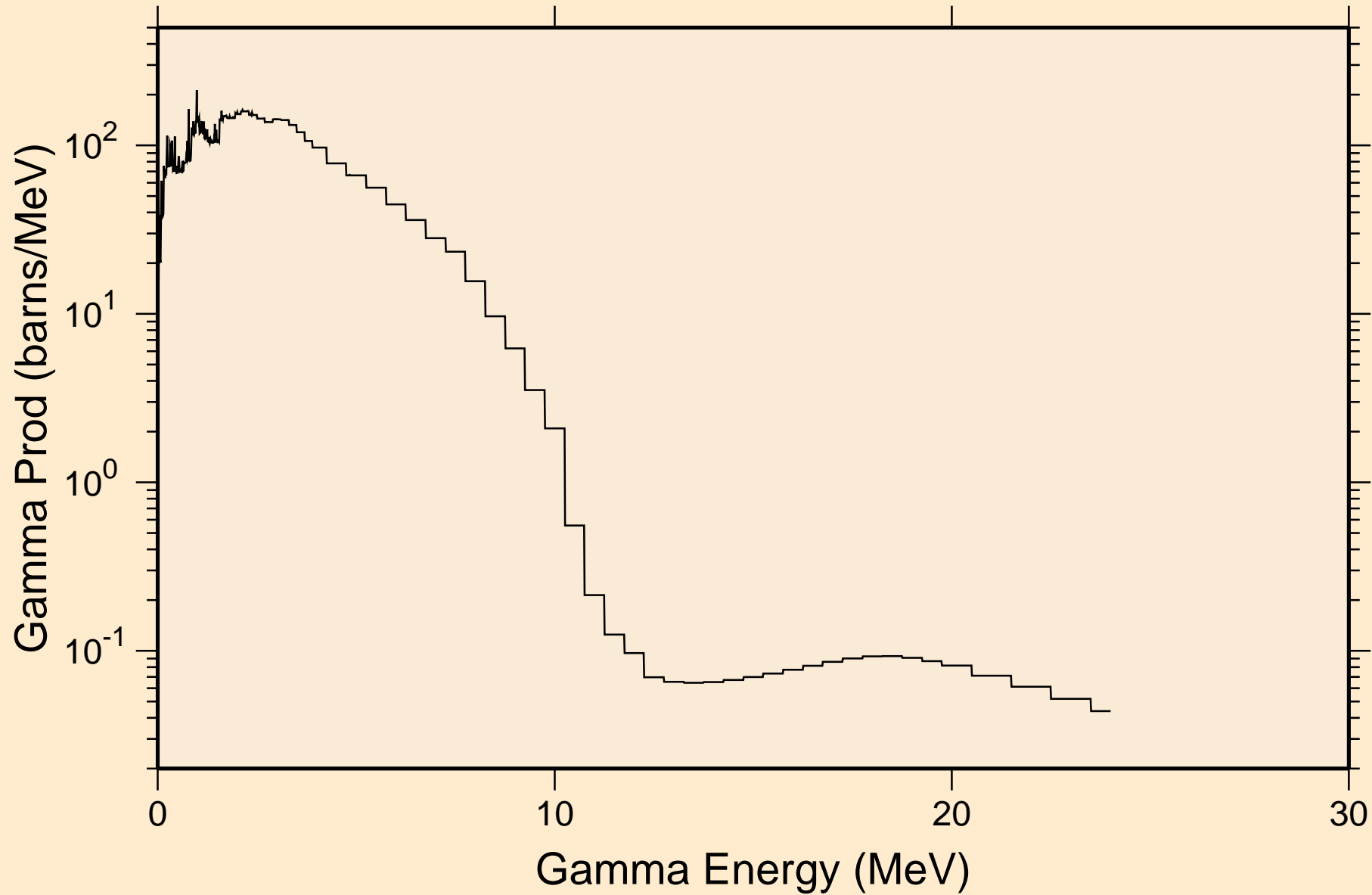

MN052 NEUTRON ACER TENDL-2024 LIBRARY; T=293.6K
Particle heating contributions

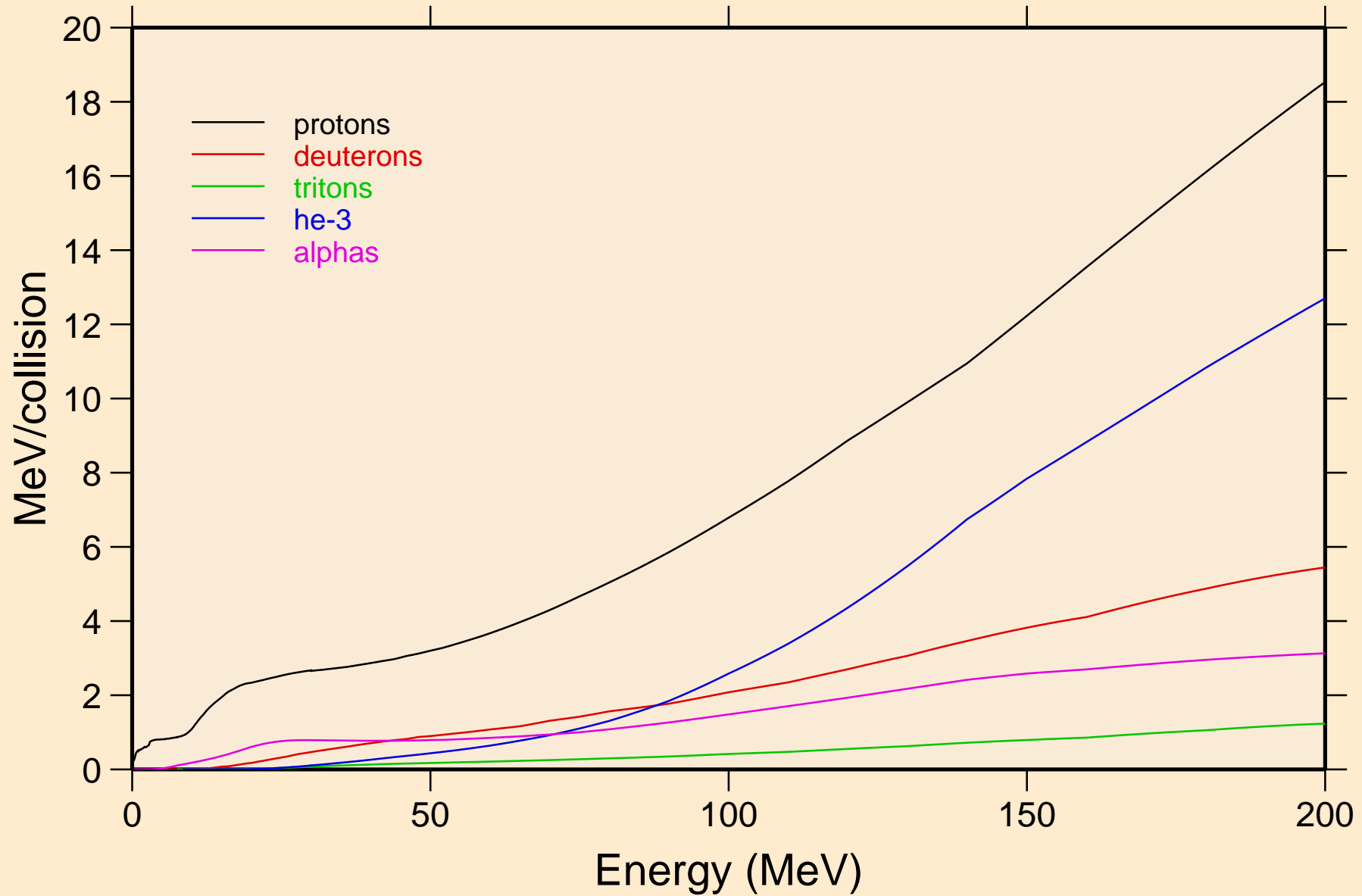

MN052 NEUTRON ACER TENDL-2024 LIBRARY; T=293.6K
Recoil Heating

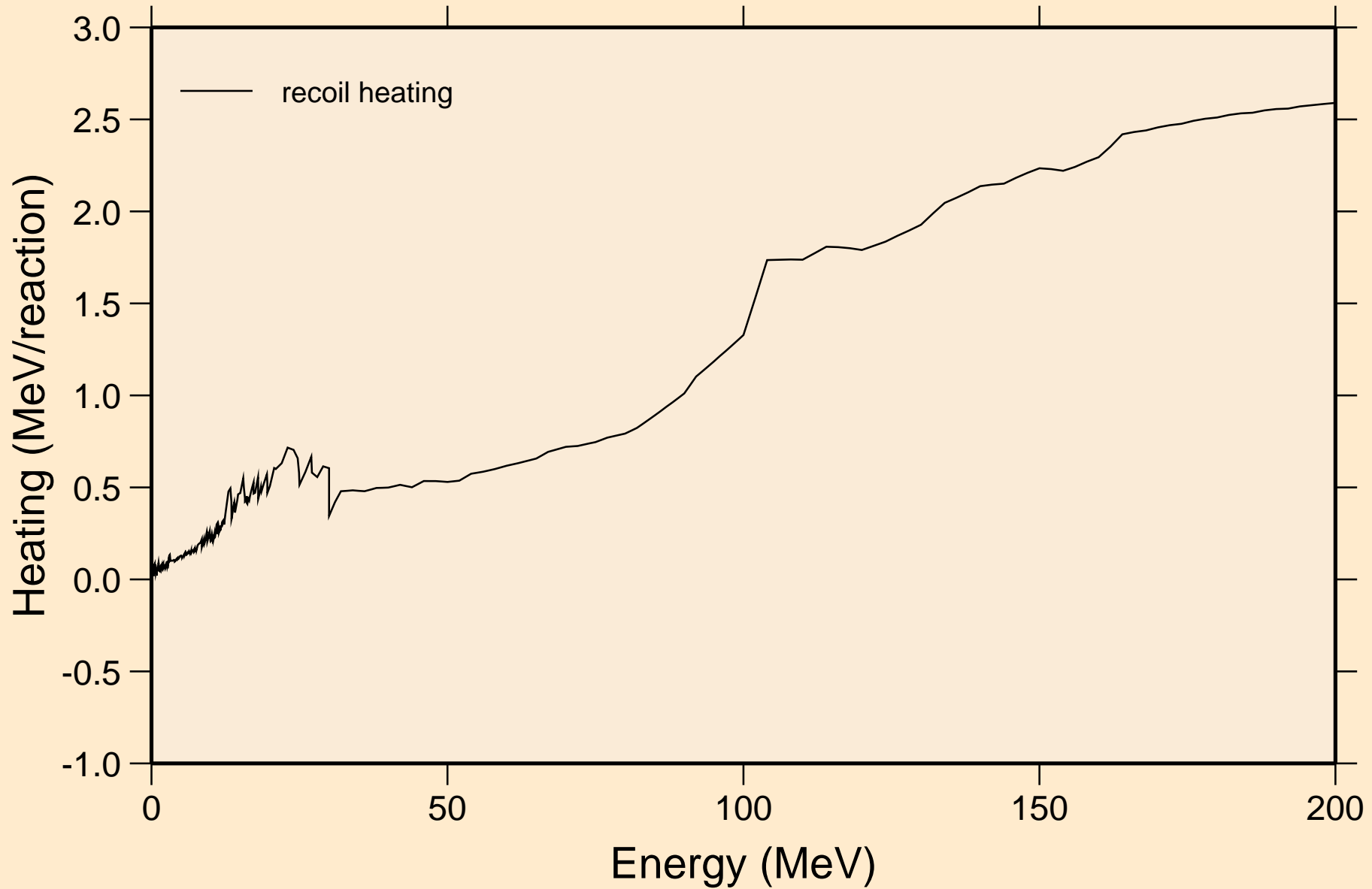

MN052 NEUTRON ACER TENDL-2024 LIBRARY; T=293.6K
Particle production cross sections

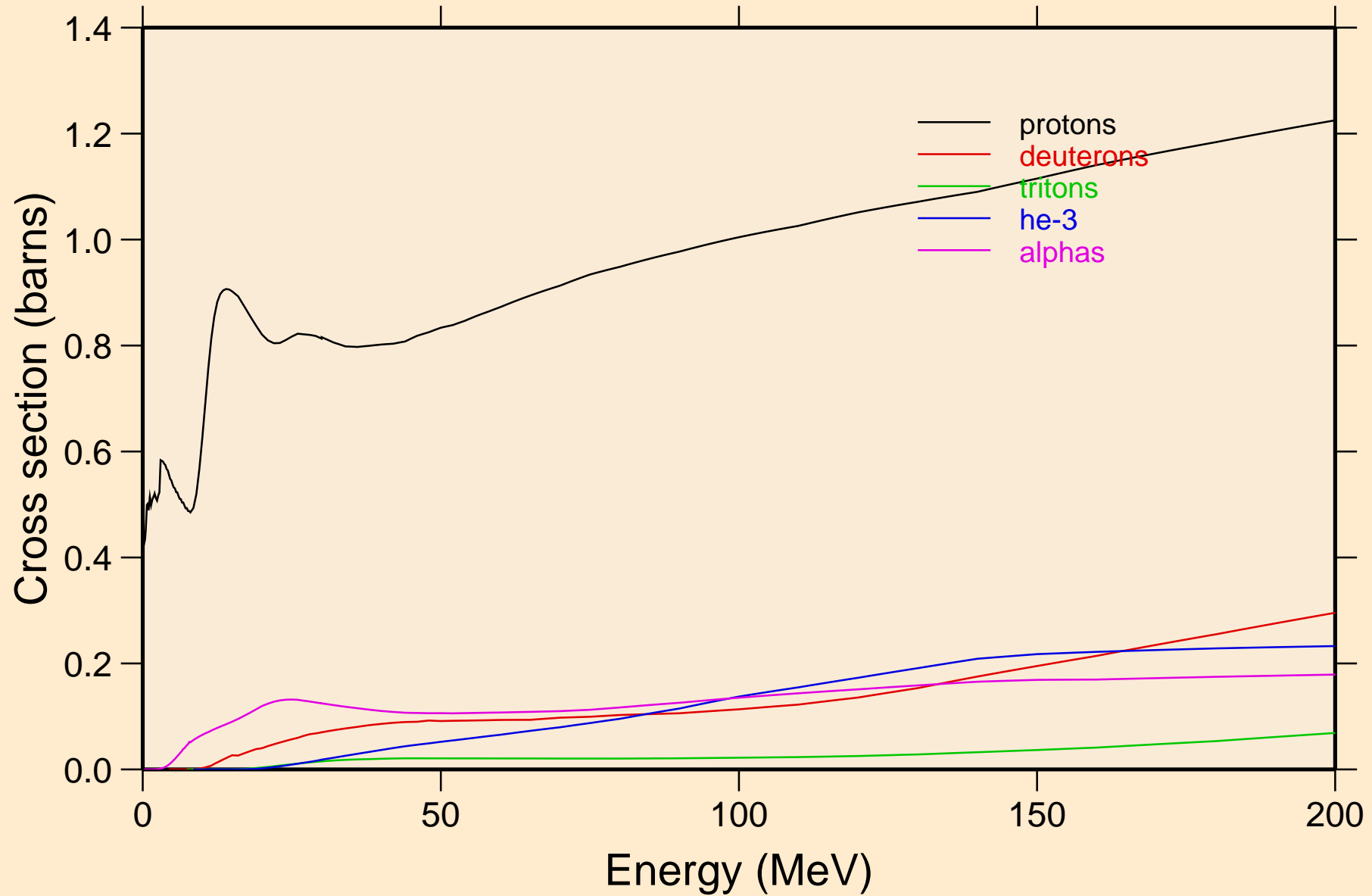

MN052 NEUTRON ACER TENDL-2024 LIBRARY; T=293.6K
protons from (n,x)

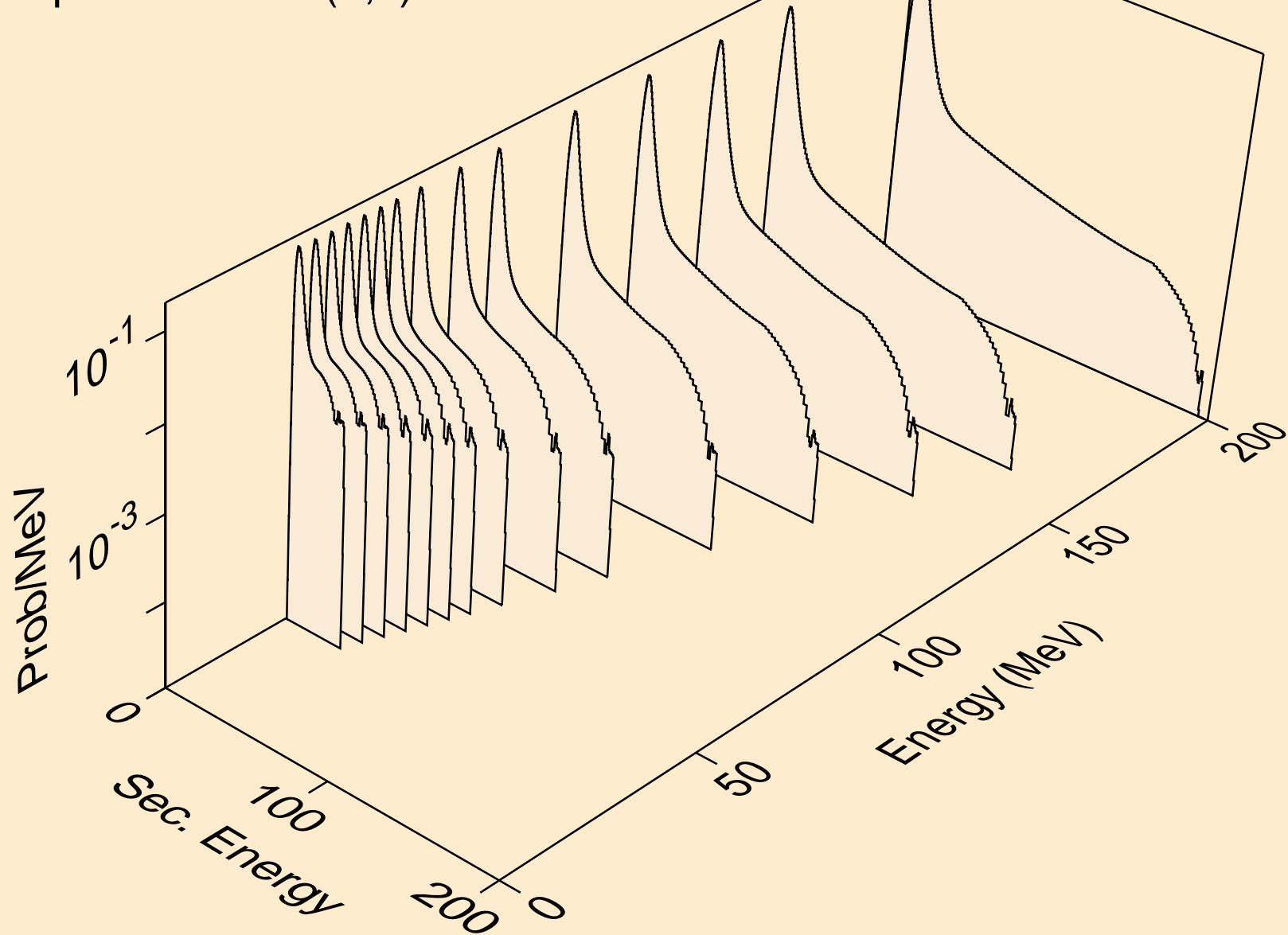

MN052 NEUTRON ACER TENDL-2024 LIBRARY; T=293.6K
protons from (n,n*)p

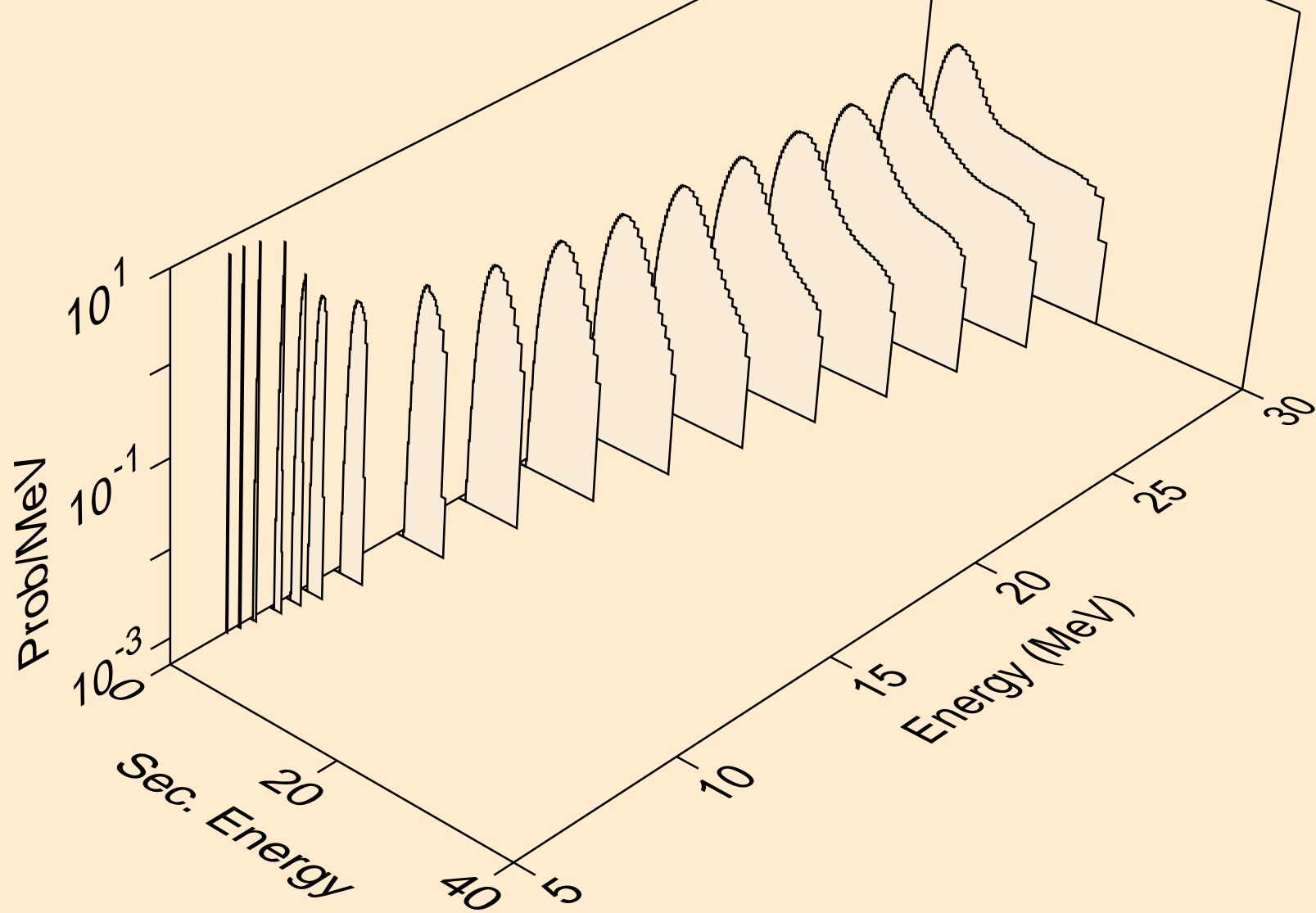

MN052 NEUTRON ACER TENDL-2024 LIBRARY; T=293.6K
protons from (n,2np)

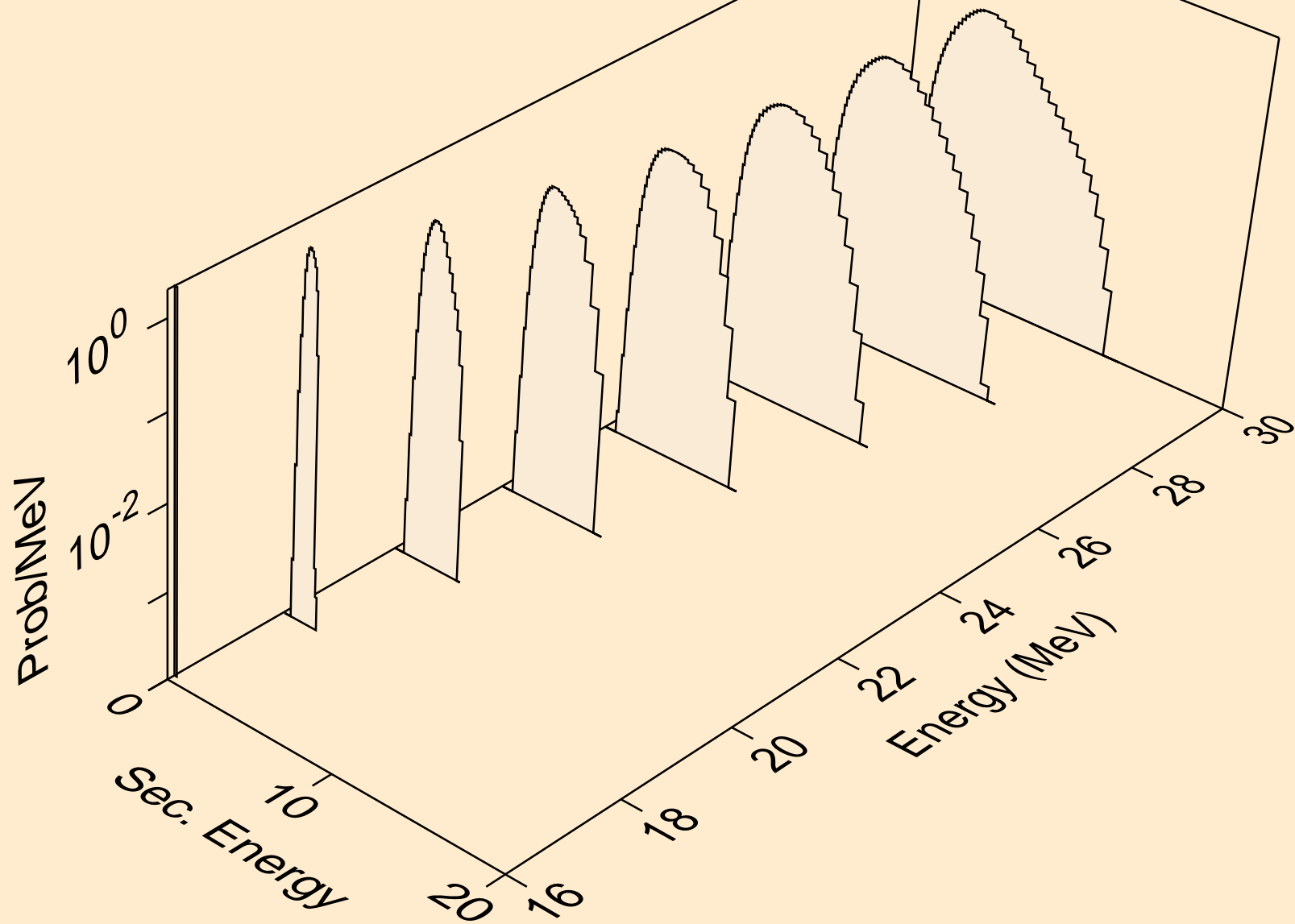

MN052 NEUTRON ACER TENDL-2024 LIBRARY; T=293.6K
protons from (n,n2p)

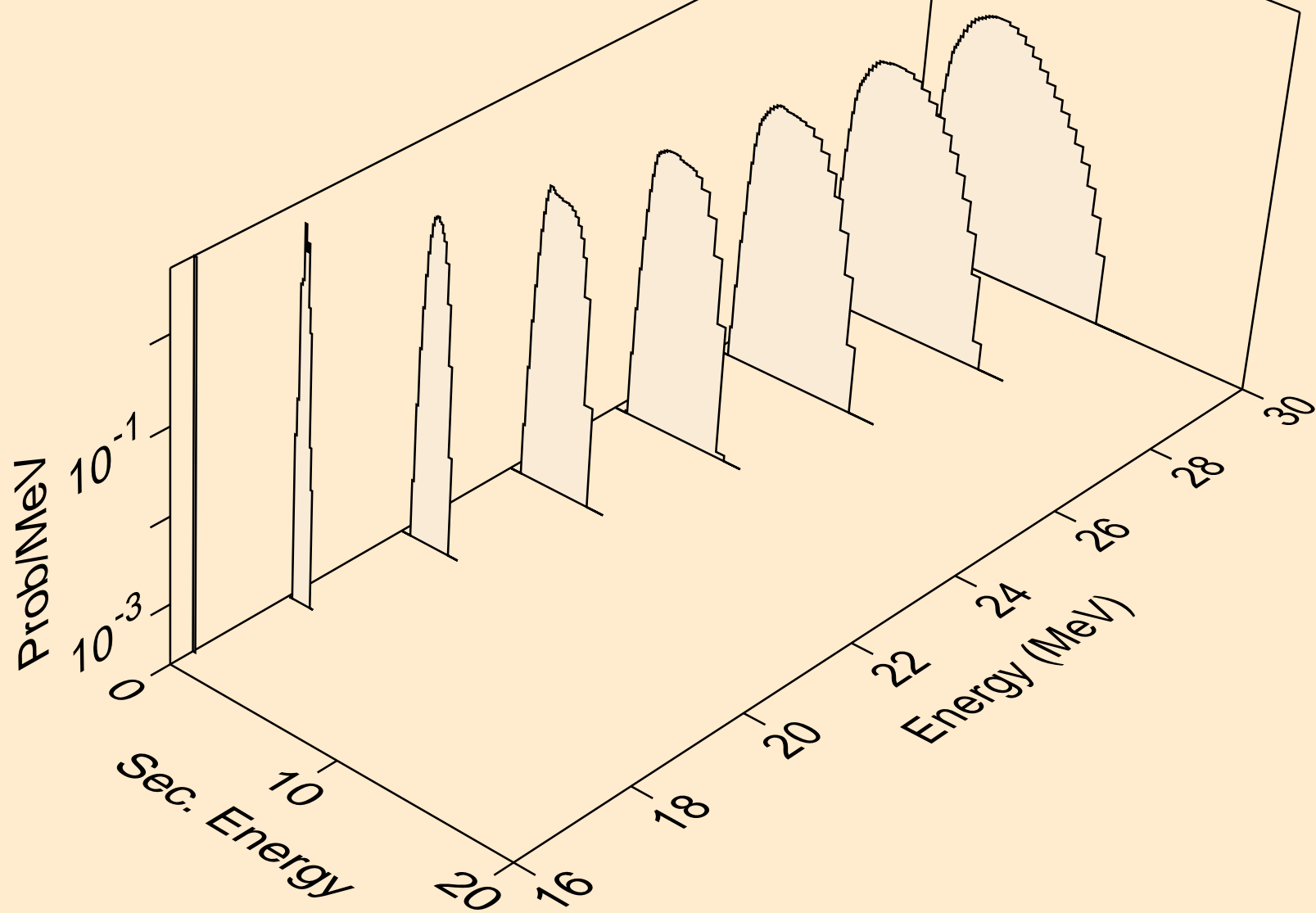

MN052 NEUTRON ACER TENDL-2024 LIBRARY; T=293.6K
protons from (n,npa)

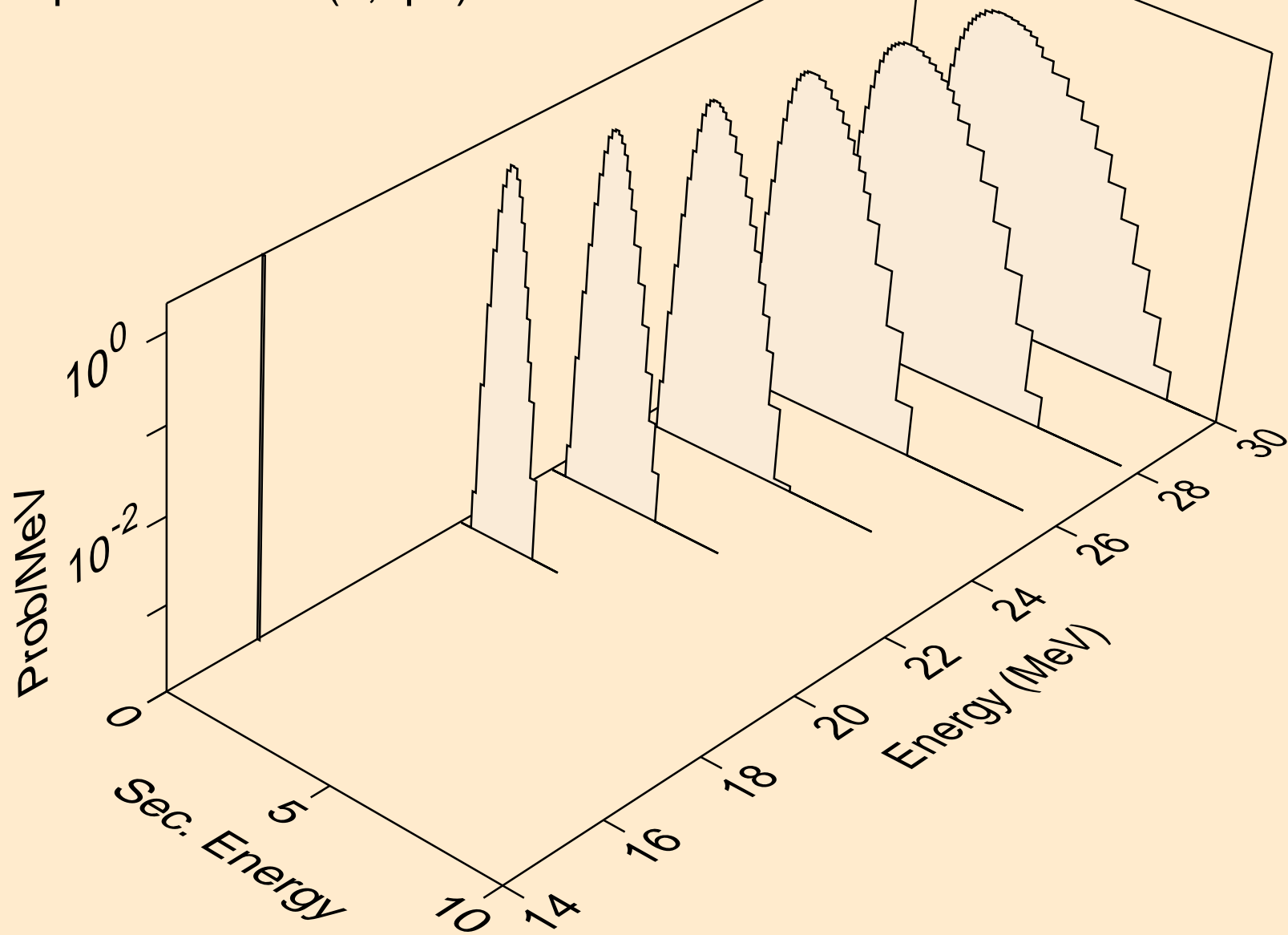

MN052 NEUTRON ACER TENDL-2024 LIBRARY; T=293.6K
protons from (n,p)

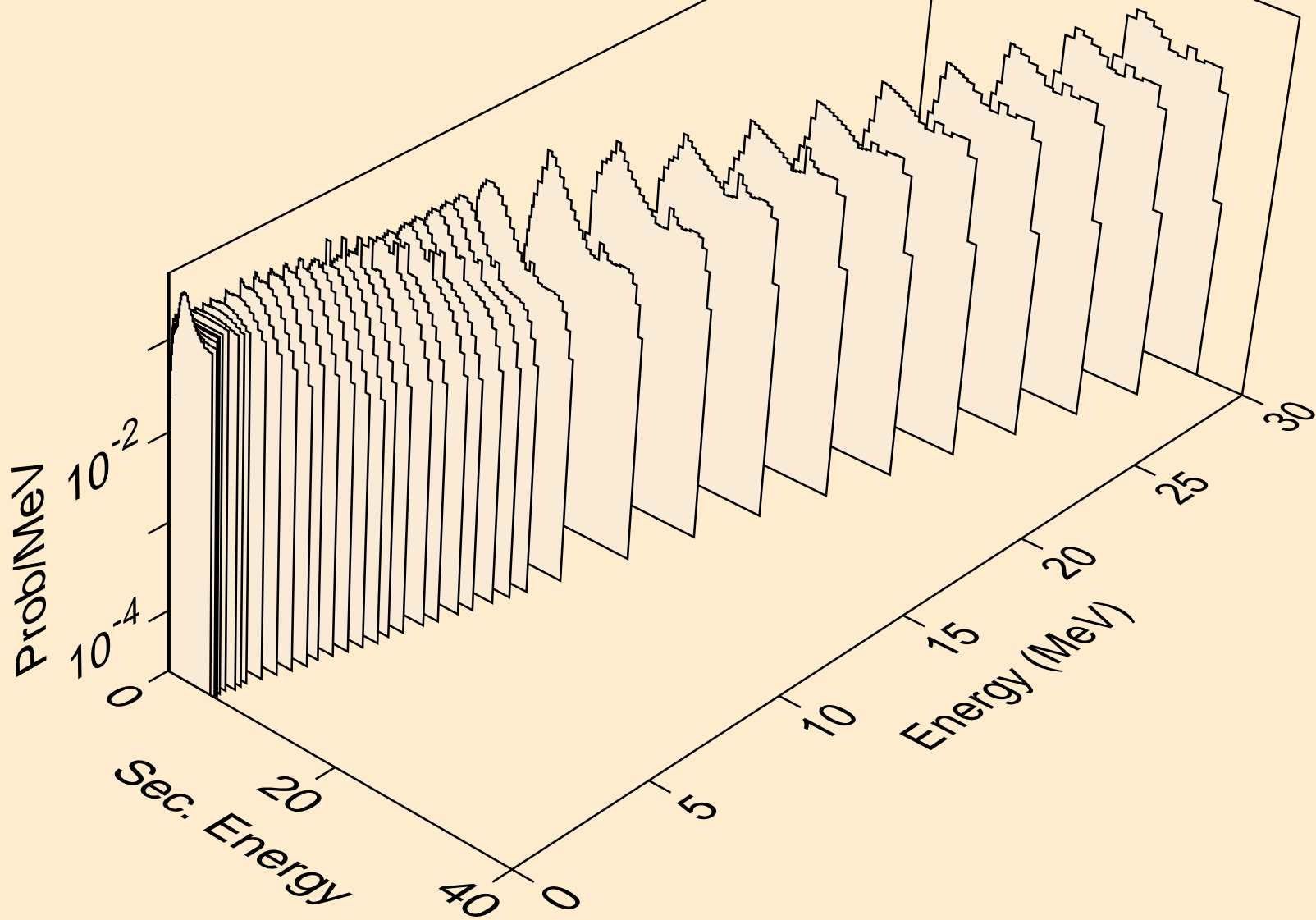

MN052 NEUTRON ACER TENDL-2024 LIBRARY; T=293.6K
protons from (n,2p)

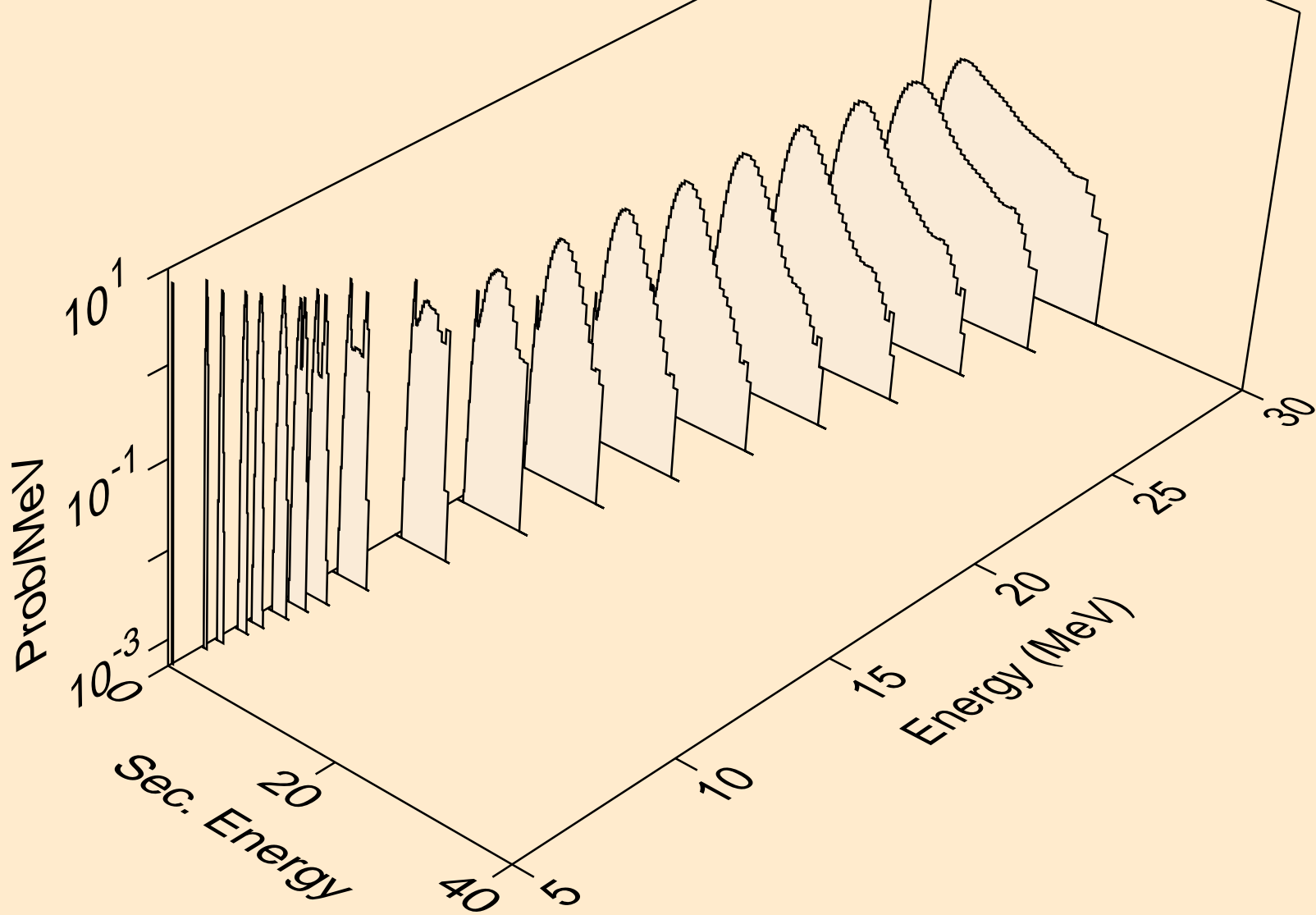

MN052 NEUTRON ACER TENDL-2024 LIBRARY; T=293.6K
protons from (n,p)

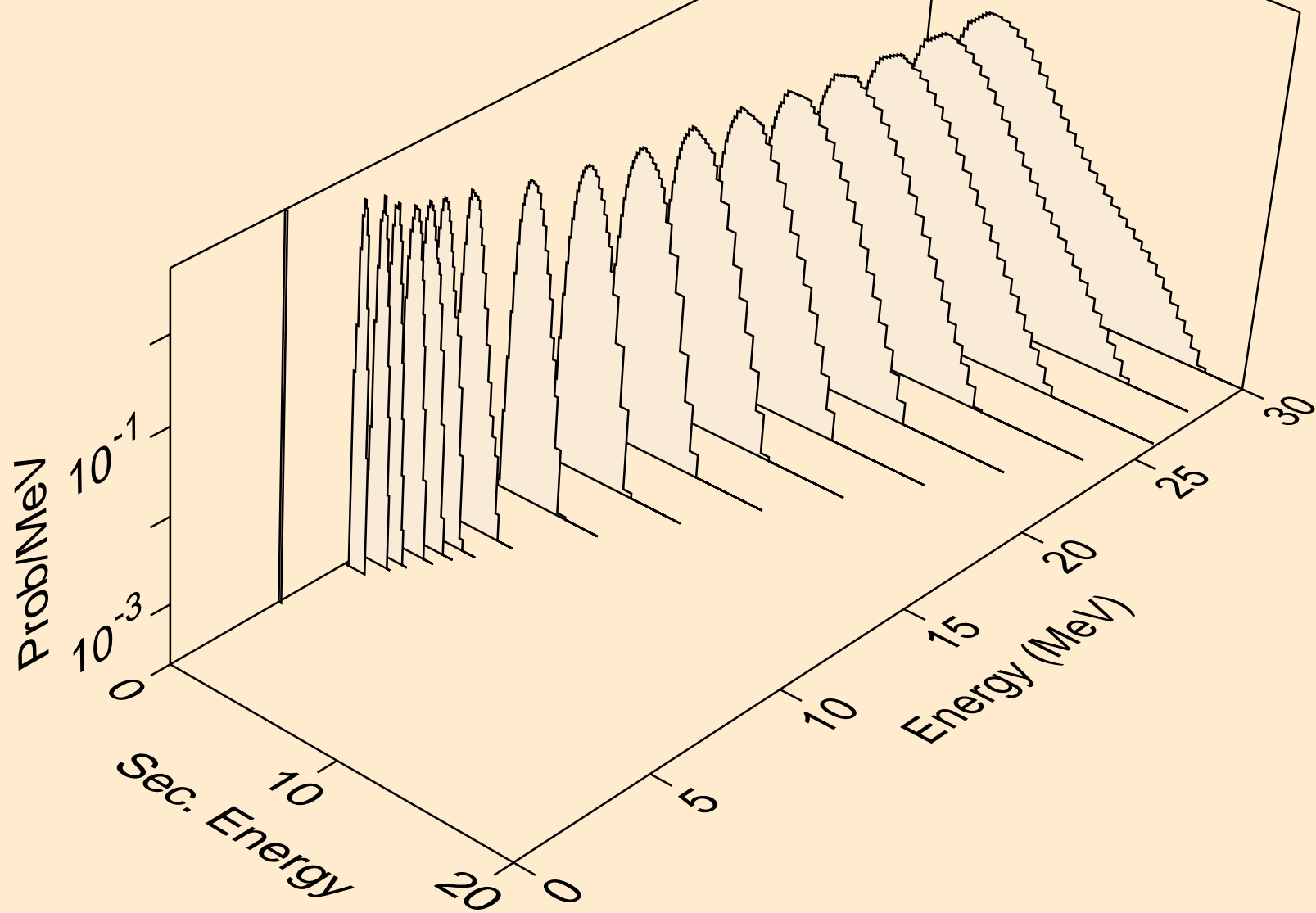

MN052 NEUTRON ACER TENDL-2024 LIBRARY; T=293.6K
protons from (n,pd)

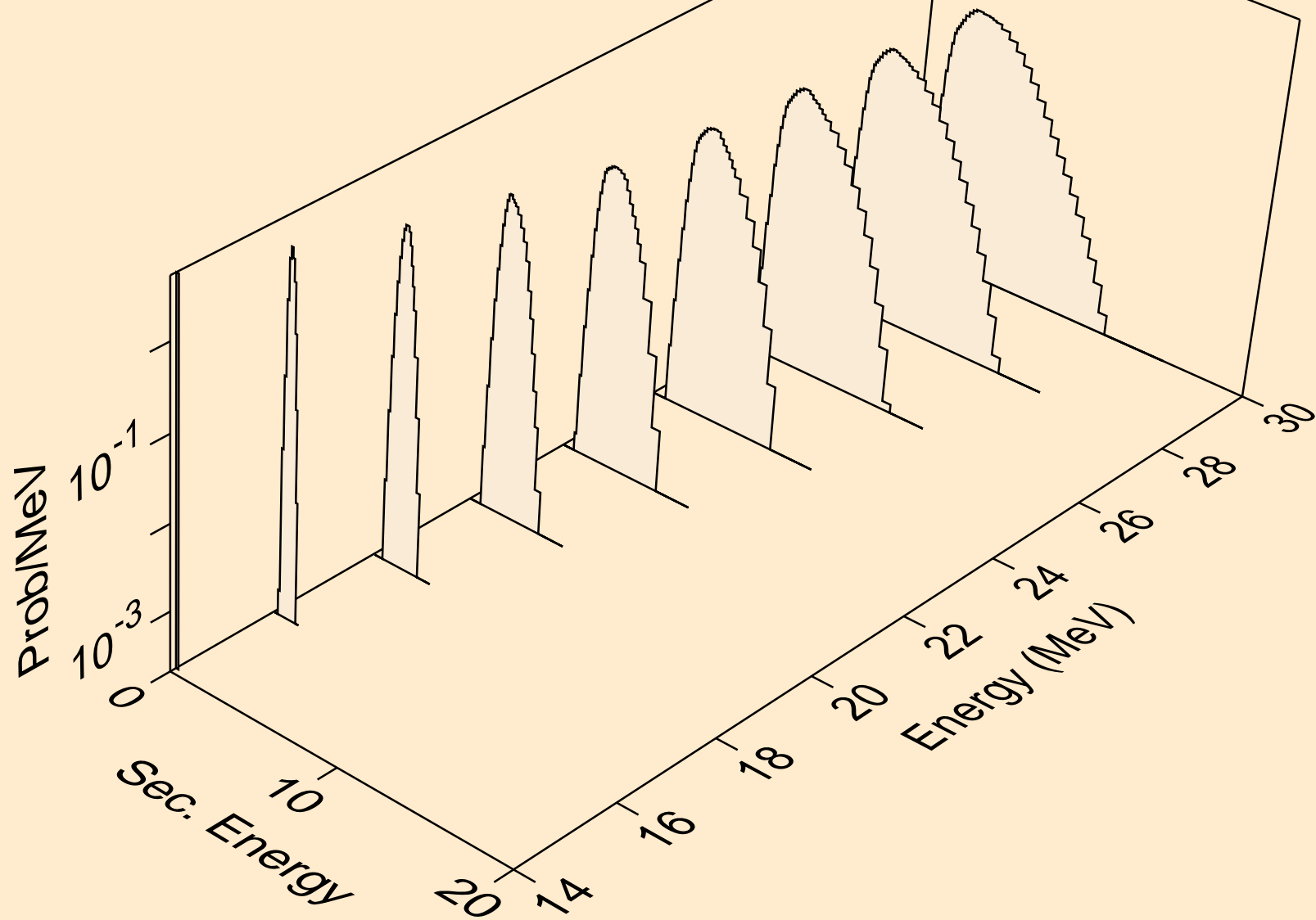

MN052 NEUTRON ACER TENDL-2024 LIBRARY; T=293.6K
protons from (n,pt)

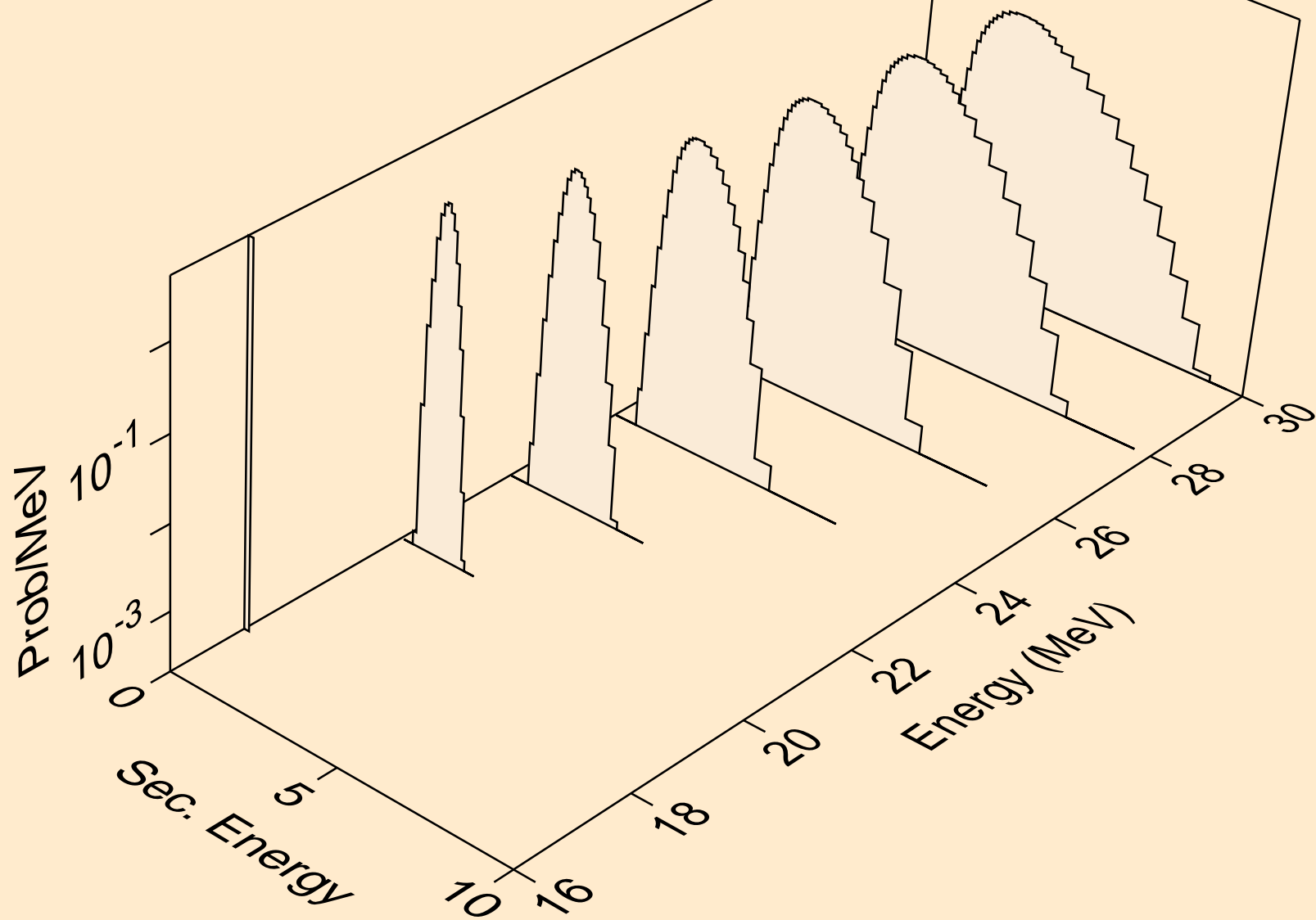

MN052 NEUTRON ACER TENDL-2024 LIBRARY; T=293.6K
deuterons from (n,x)

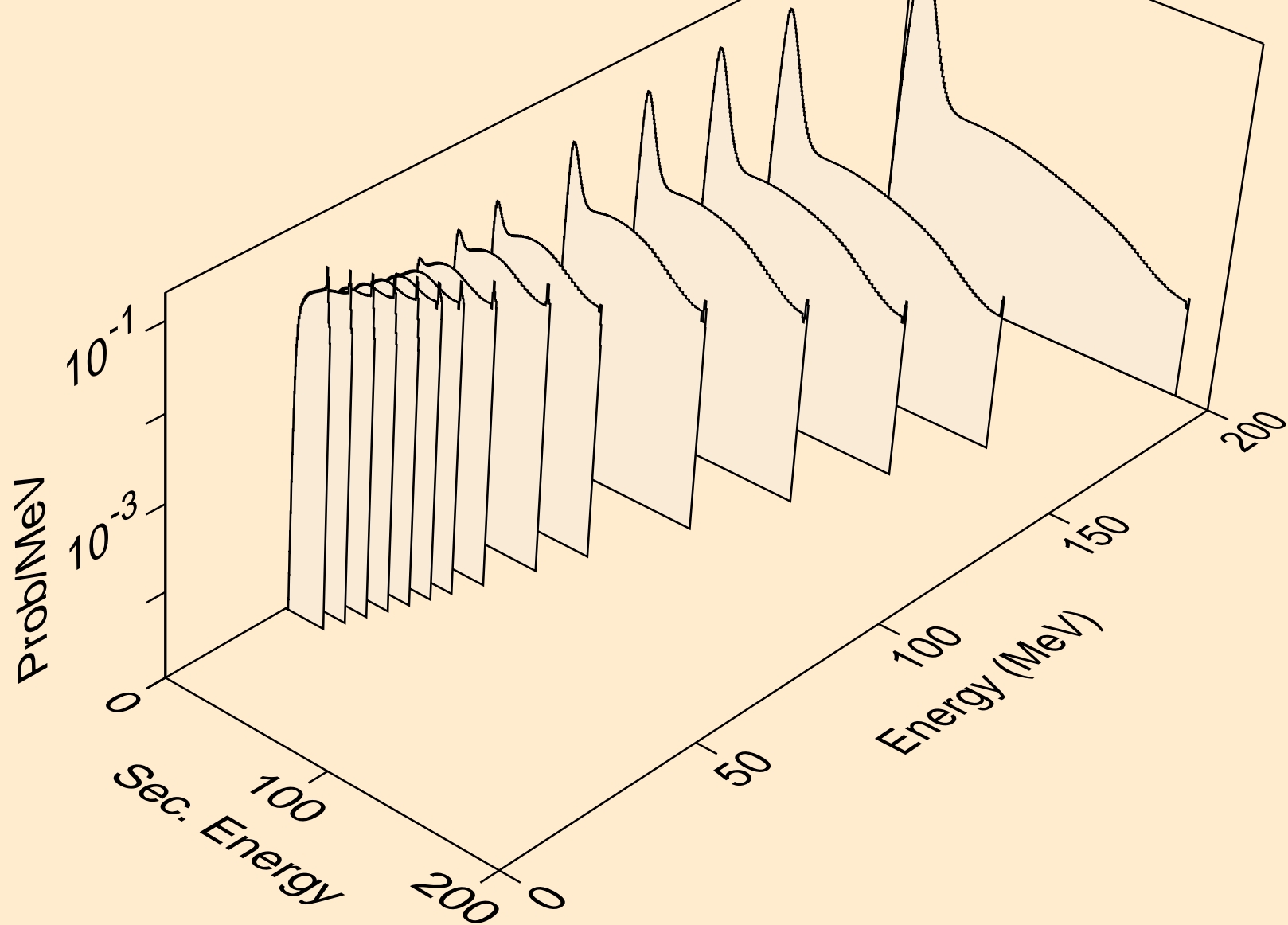

MN052 NEUTRON ACER TENDL-2024 LIBRARY; T=293.6K
deuterons from (n,2nd)

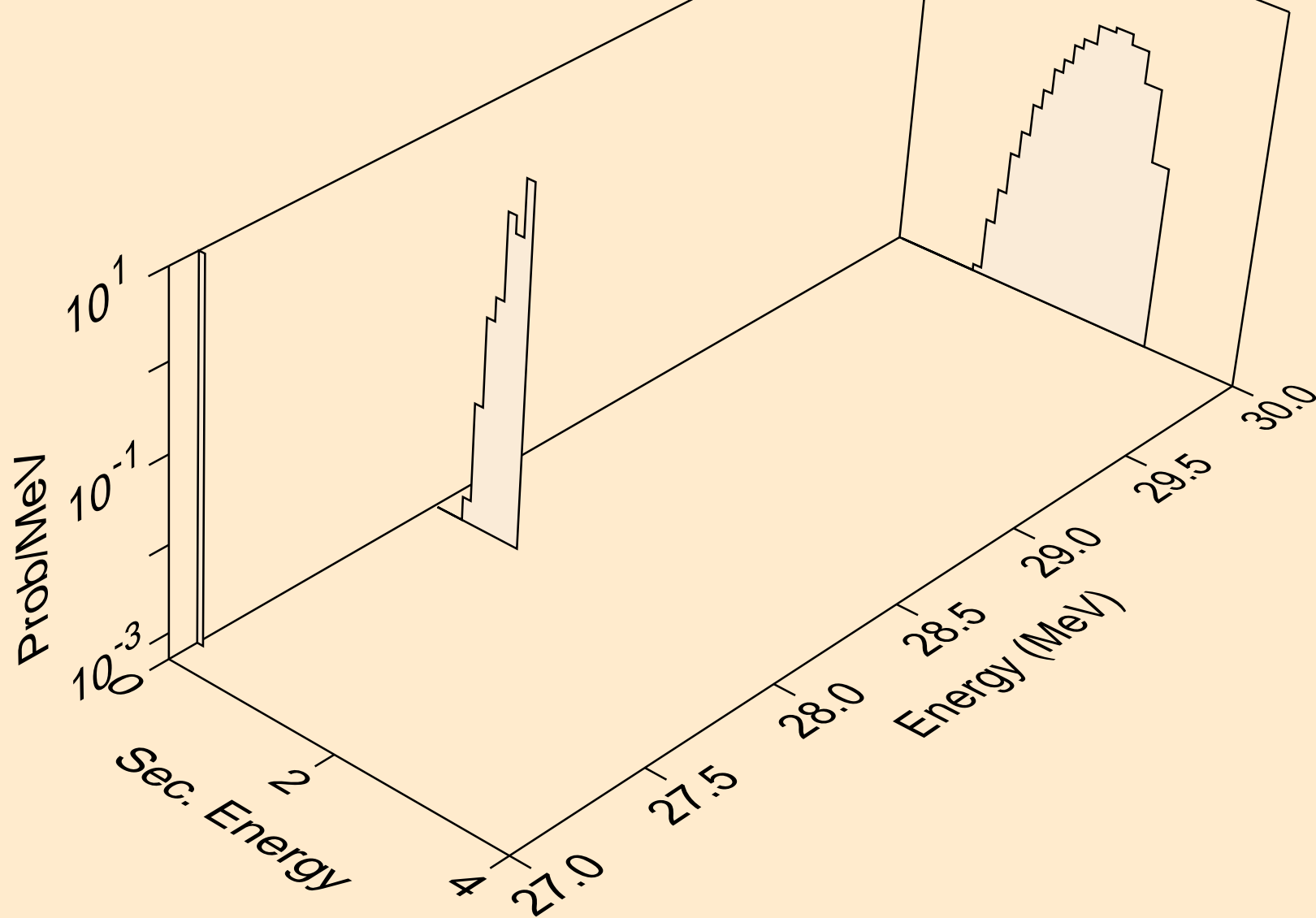

MN052 NEUTRON ACER TENDL-2024 LIBRARY; T=293.6K
deuterons from (n,n*)d

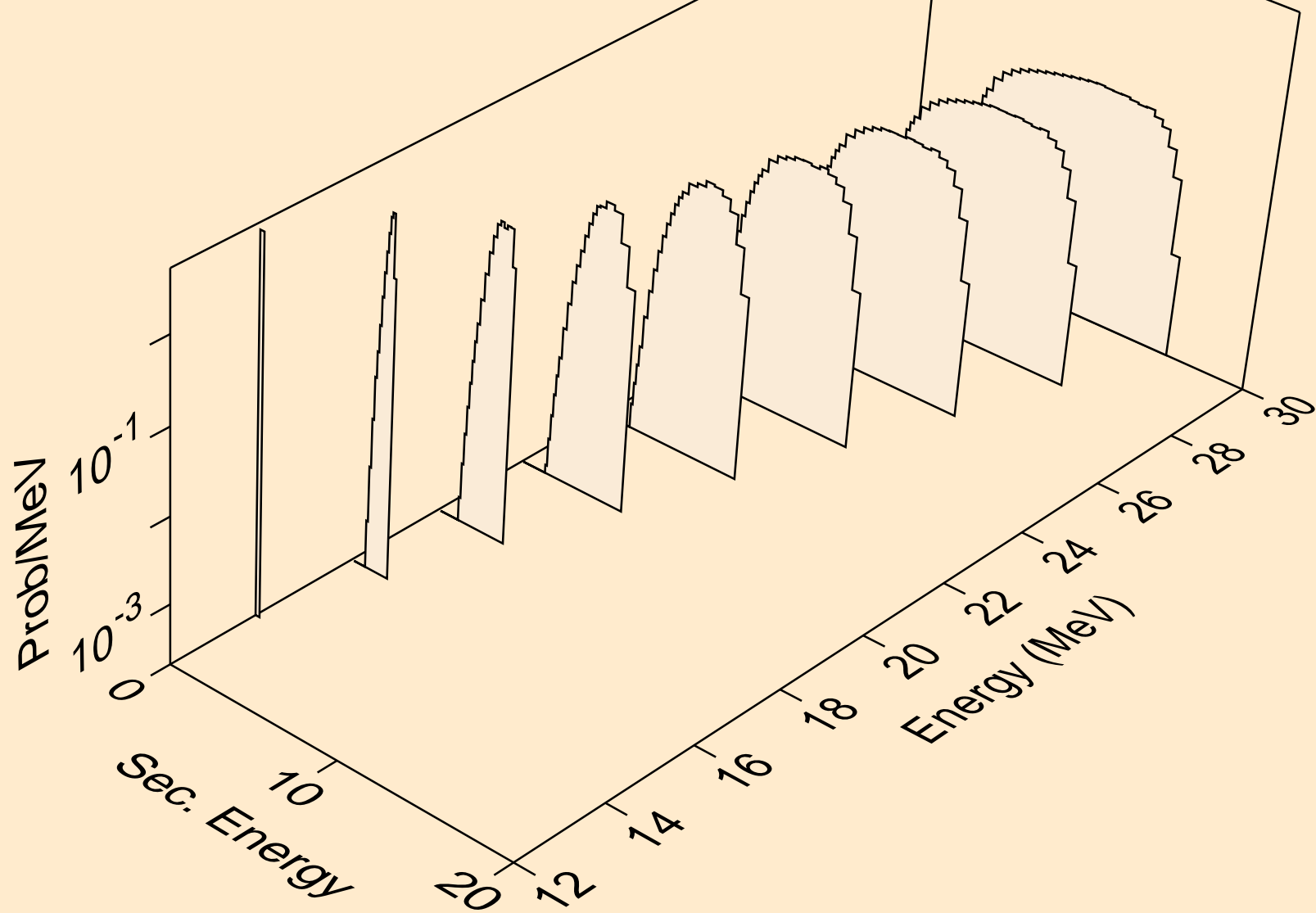

MN052 NEUTRON ACER TENDL-2024 LIBRARY; T=293.6K
deuterons from (n,d)

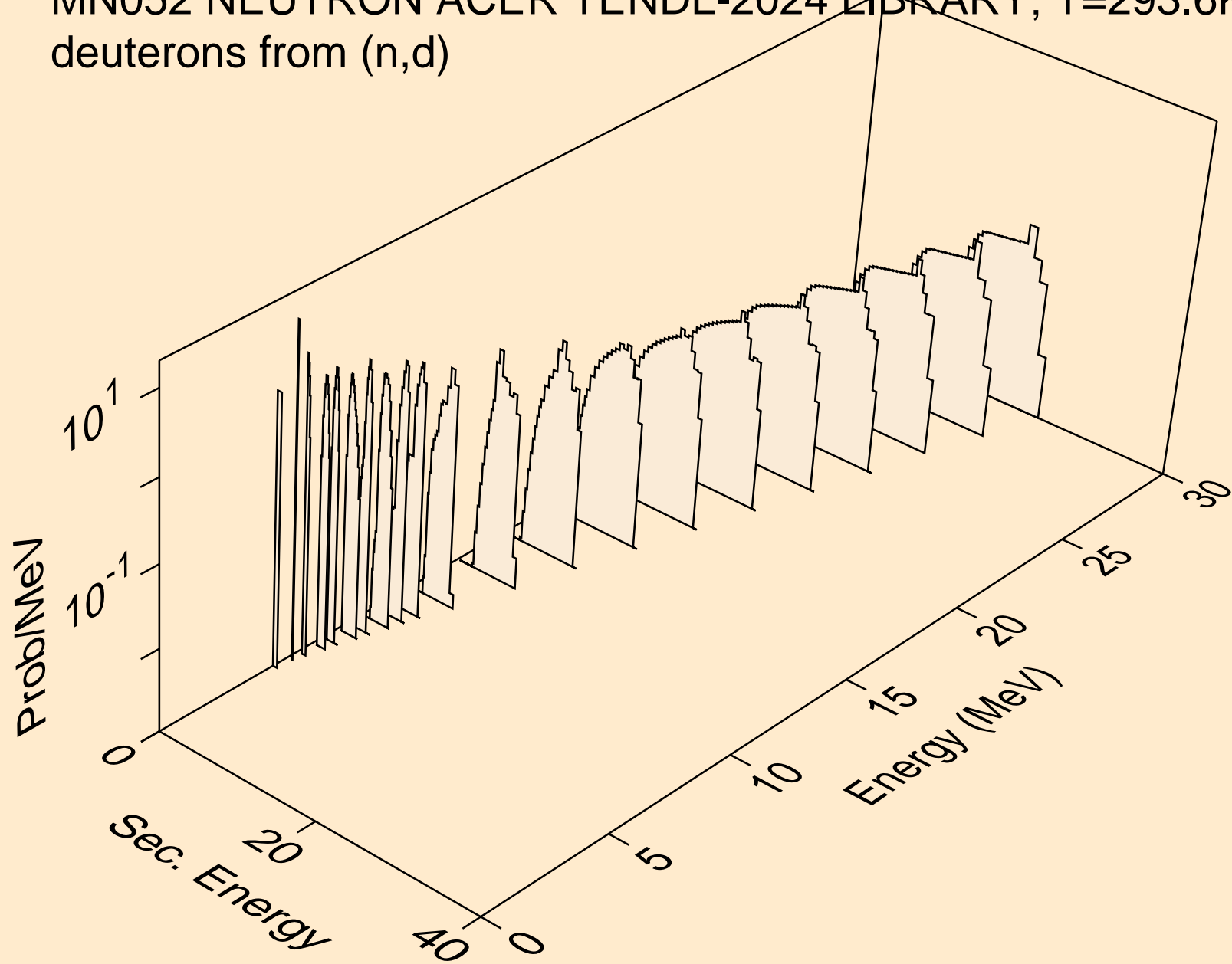

MN052 NEUTRON ACER TENDL-2024 LIBRARY; T=293.6K
deuterons from (n,pd)

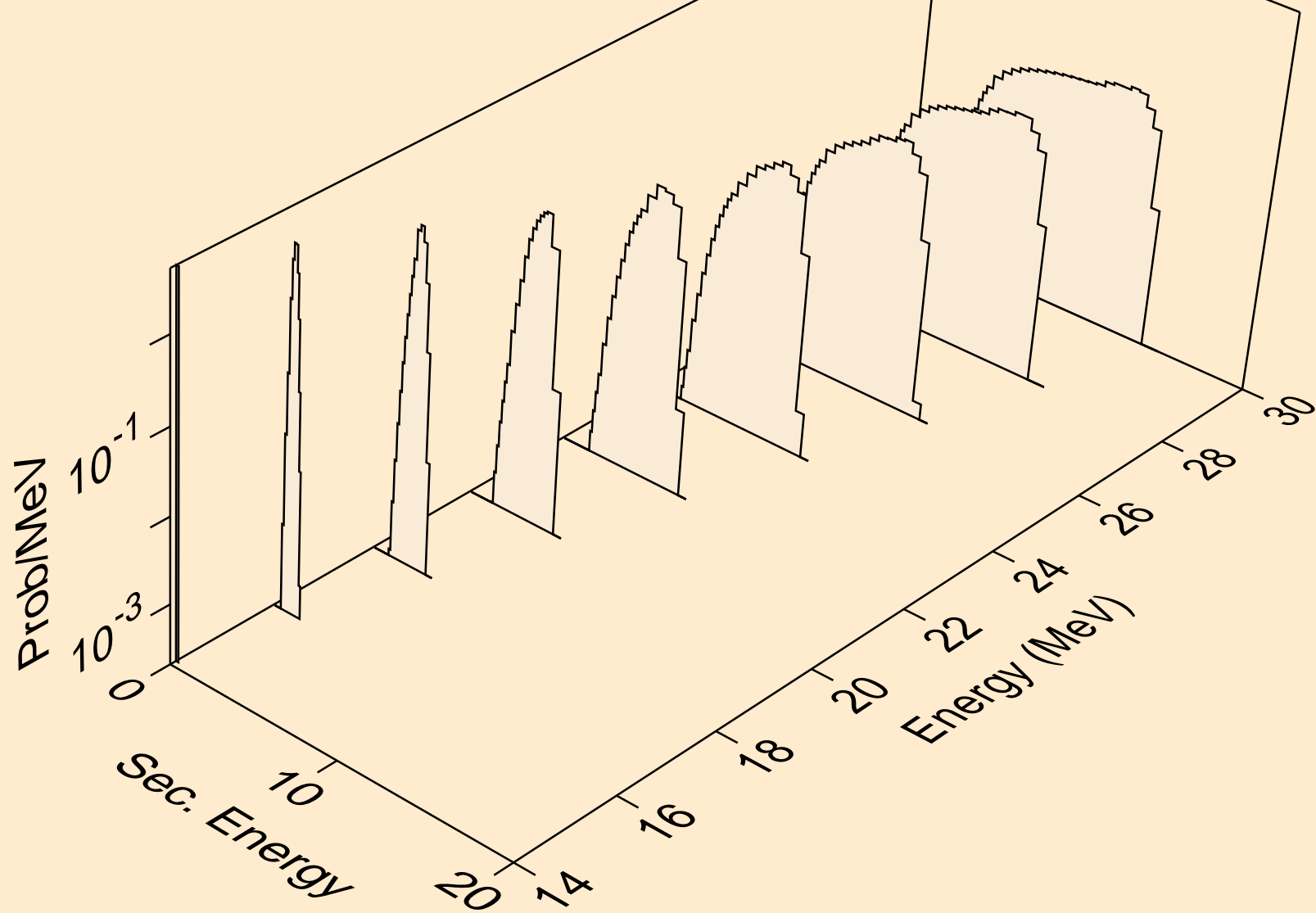

MN052 NEUTRON ACER TENDL-2024 LIBRARY; T=293.6K
deuterons from (n,da)

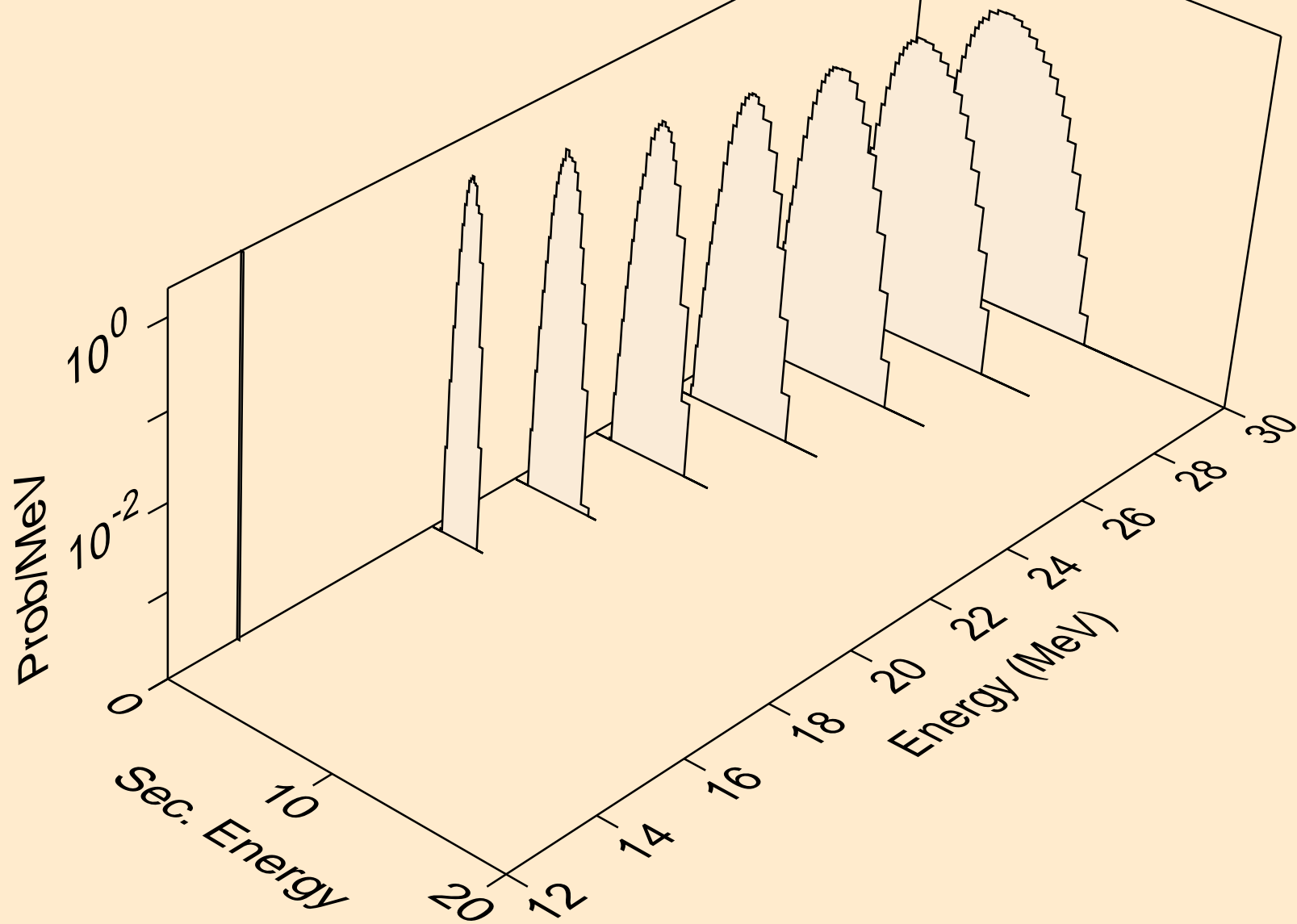

MN052 NEUTRON ACER TENDL-2024 LIBRARY; T=293.6K
tritons from (n,x)

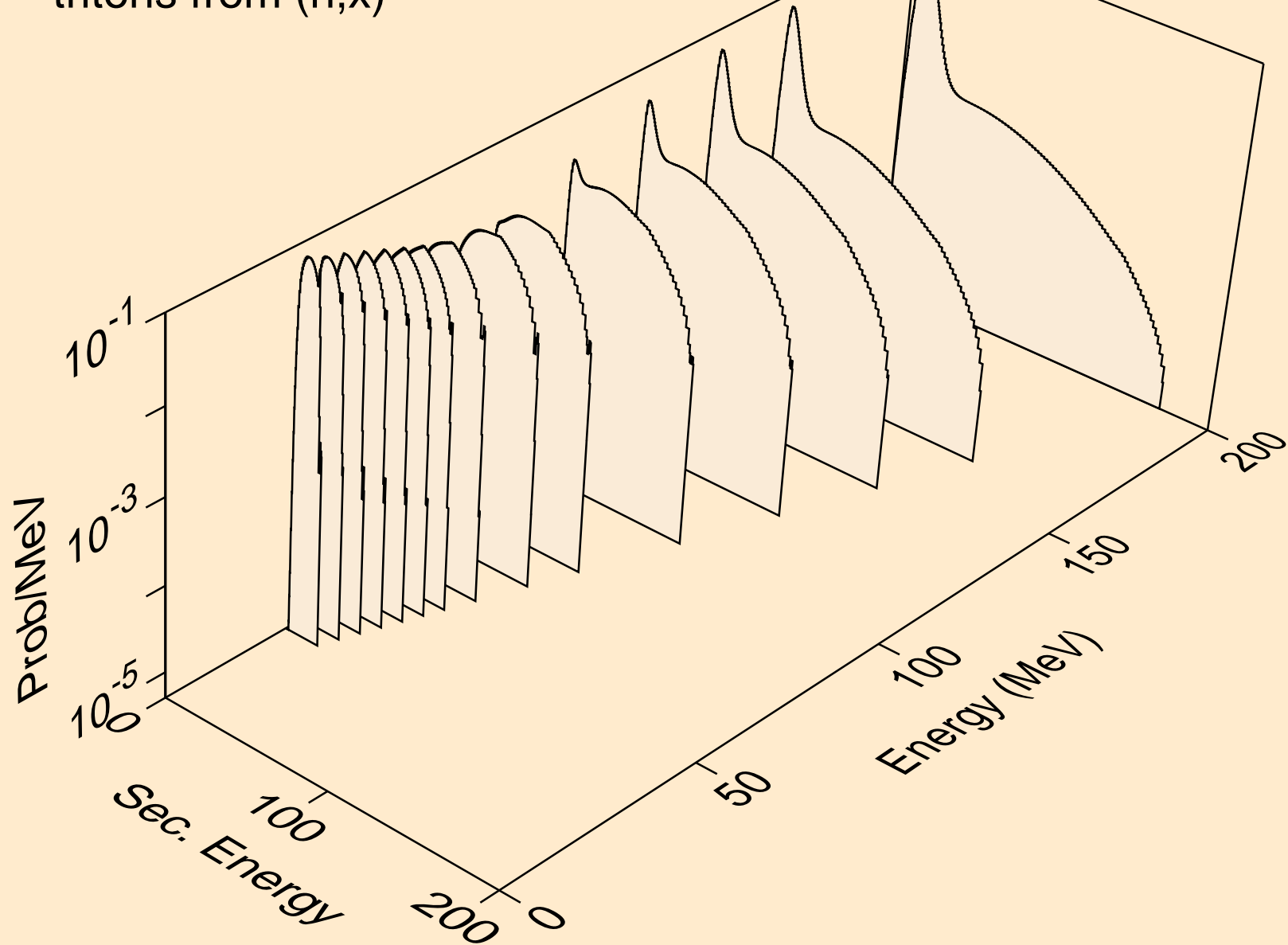

MN052 NEUTRON ACER TENDL-2024 LIBRARY; T=293.6K
tritons from (n,n*)t

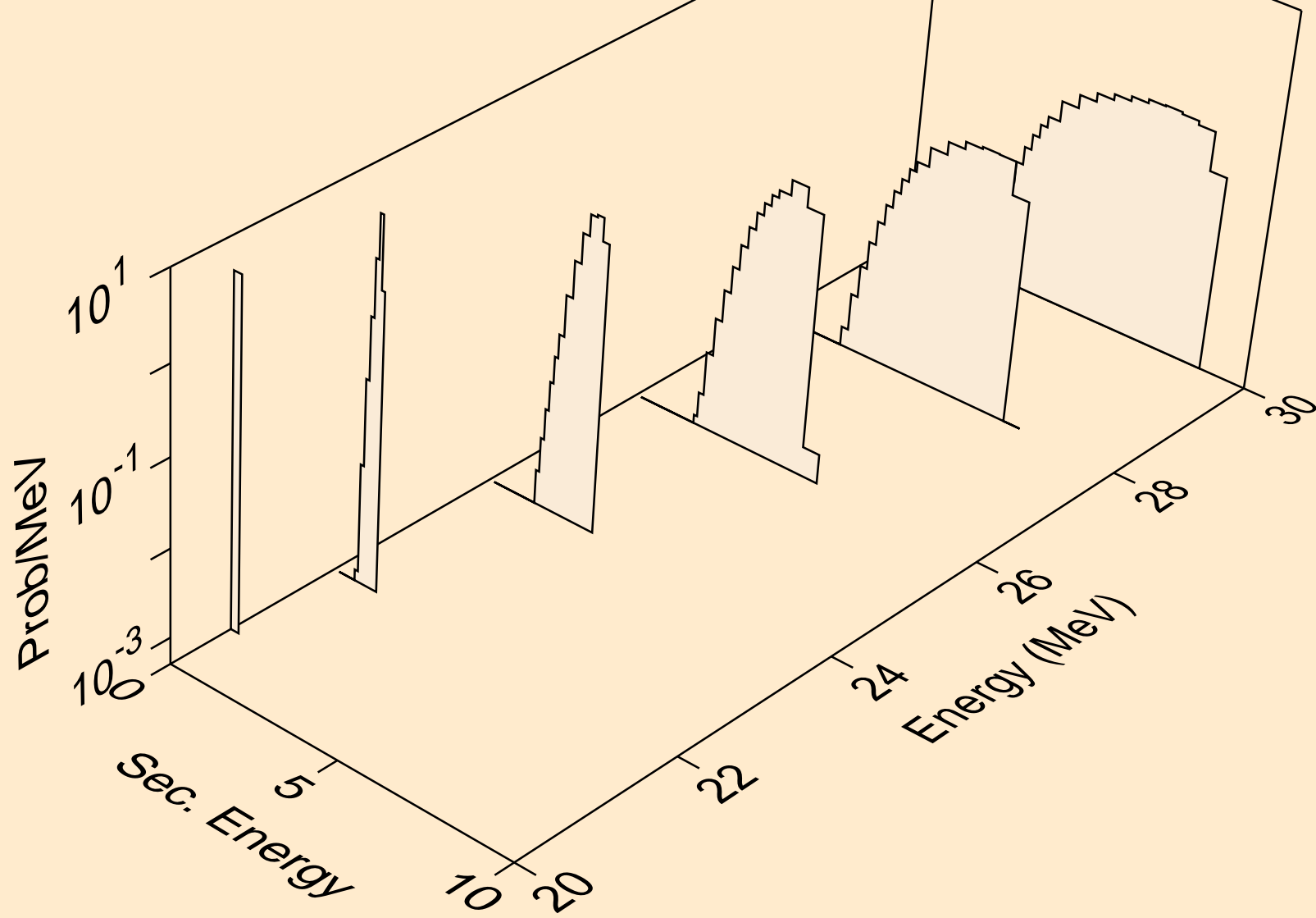

MN052 NEUTRON ACER TENDL-2024 LIBRARY; T=293.6K
tritons from (n,t)

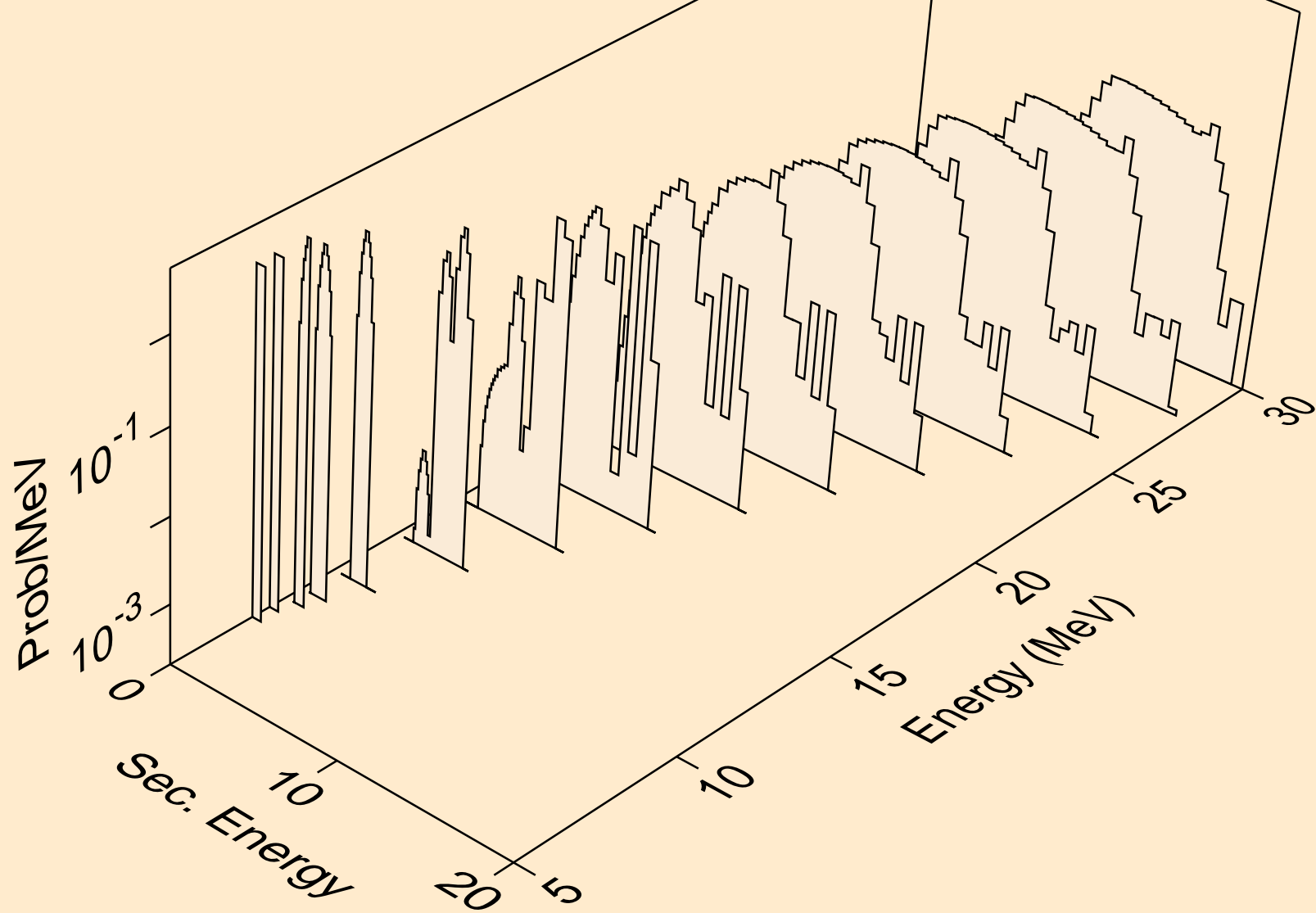

MN052 NEUTRON ACER TENDL-2024 LIBRARY; T=293.6K
tritons from (n,pt)

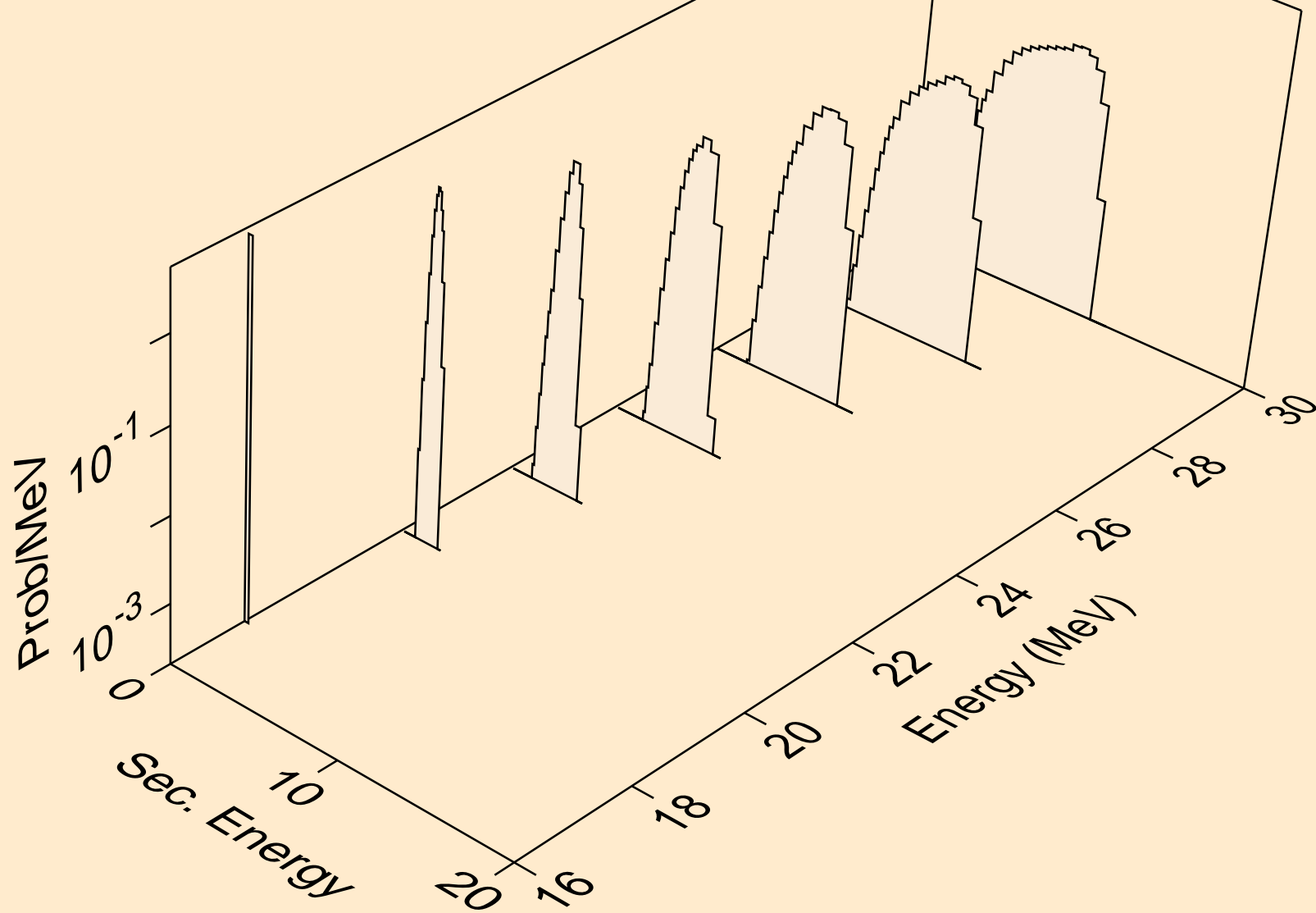

MN052 NEUTRON ACER TENDL-2024 LIBRARY; T=293.6K
he3s from (n,x)

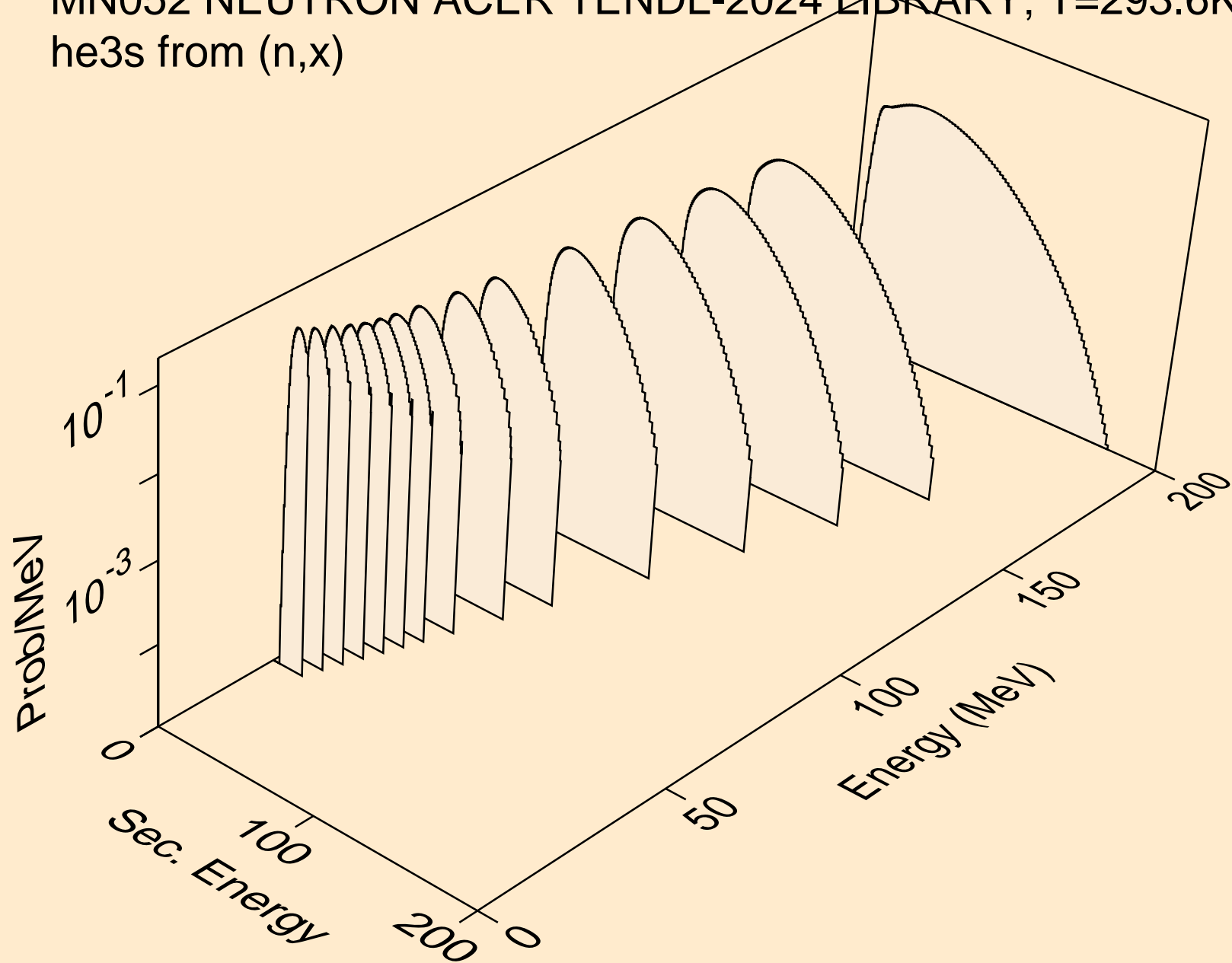

MN052 NEUTRON ACER TENDL-2024 LIBRARY; T=293.6K
he3s from (n,n*)he3

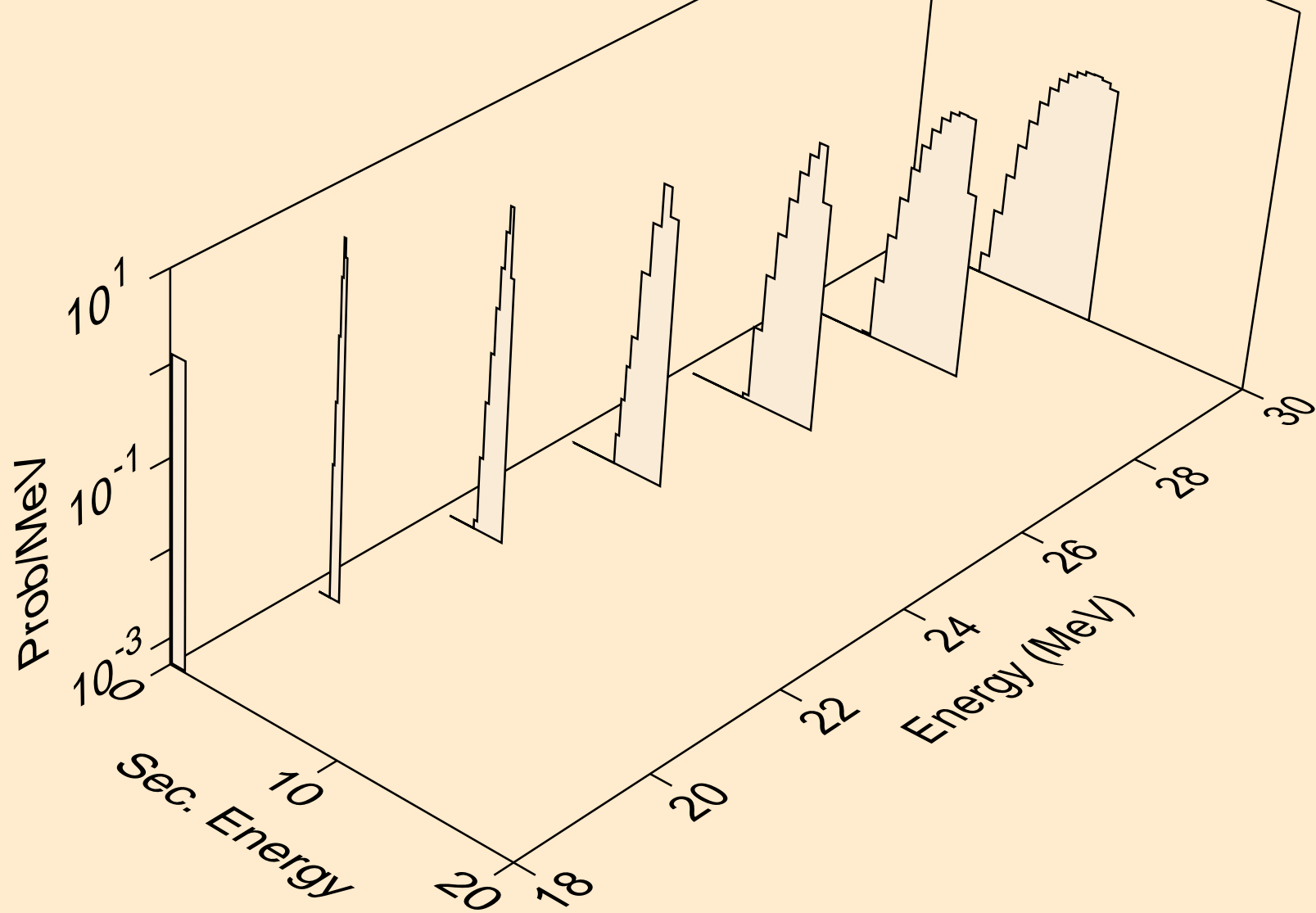

MN052 NEUTRON ACER TENDL-2024 LIBRARY; T=293.6K
he3s from (n,he3)

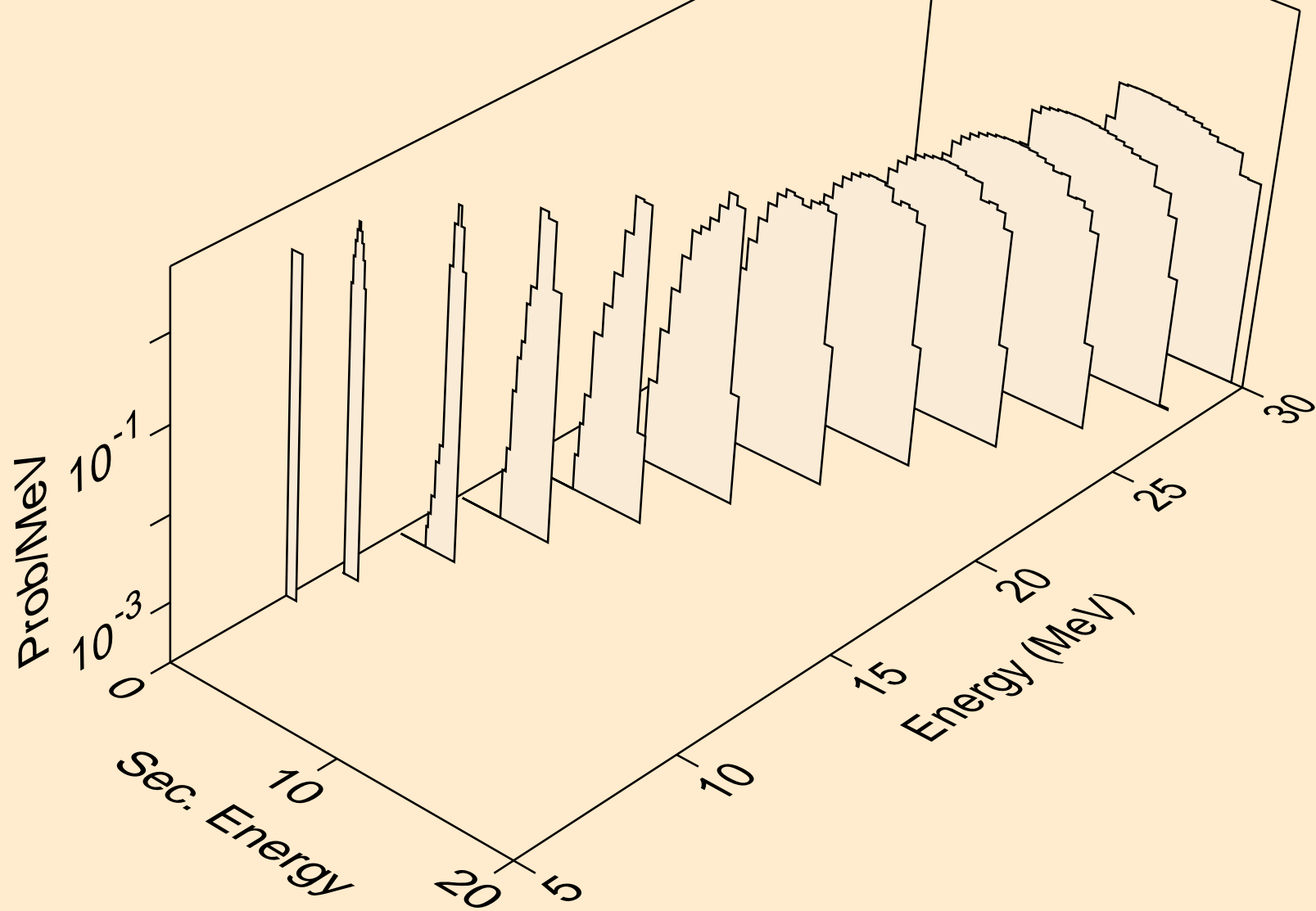

MN052 NEUTRON ACER TENDL-2024 LIBRARY; T=293.6K
alphas from (n,x)

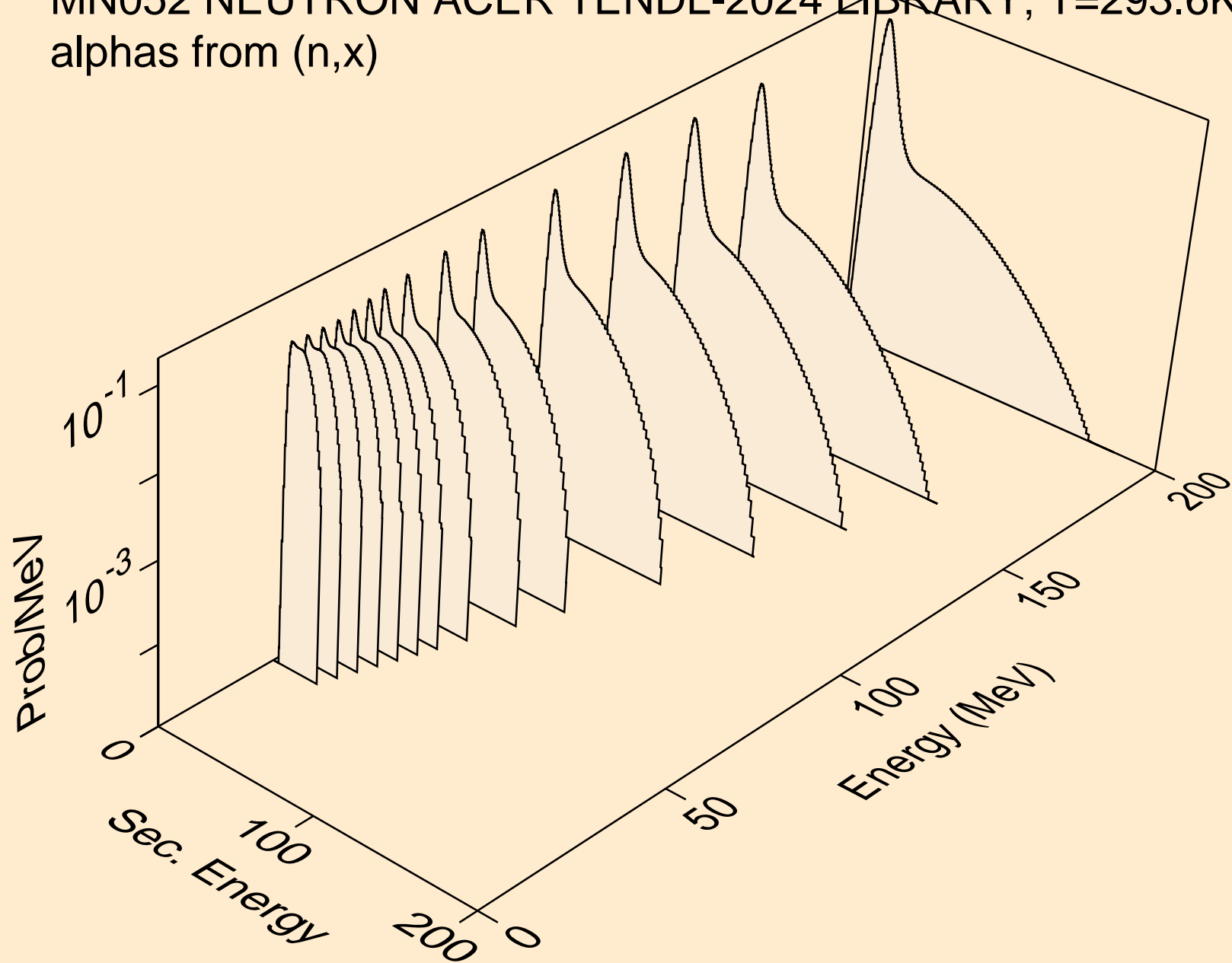

MN052 NEUTRON ACER TENDL-2024 LIBRARY; T=293.6K
alphas from (n,n*)a

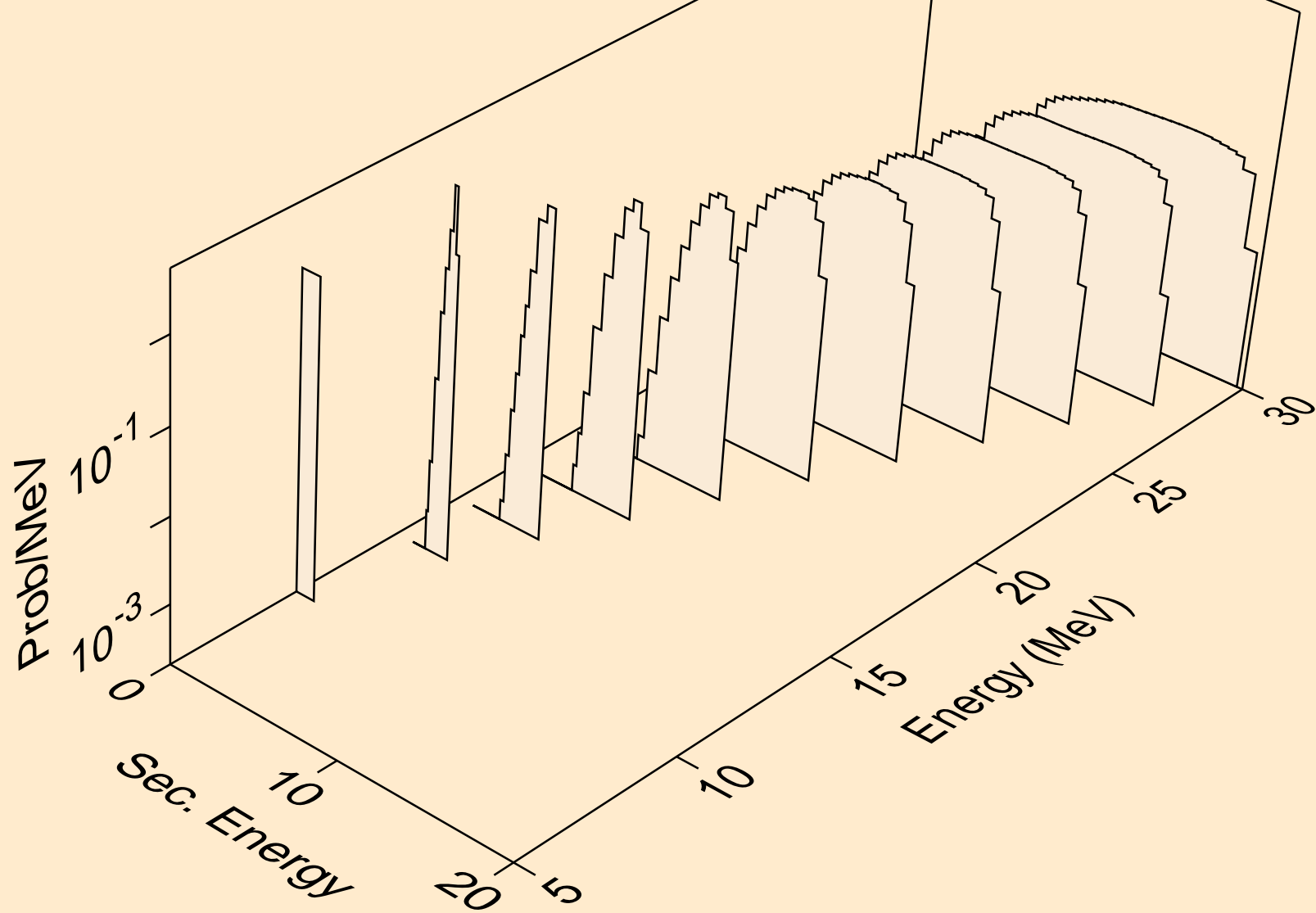

MN052 NEUTRON ACER TENDL-2024 LIBRARY; T=293.6K
alphas from (n,2n)a

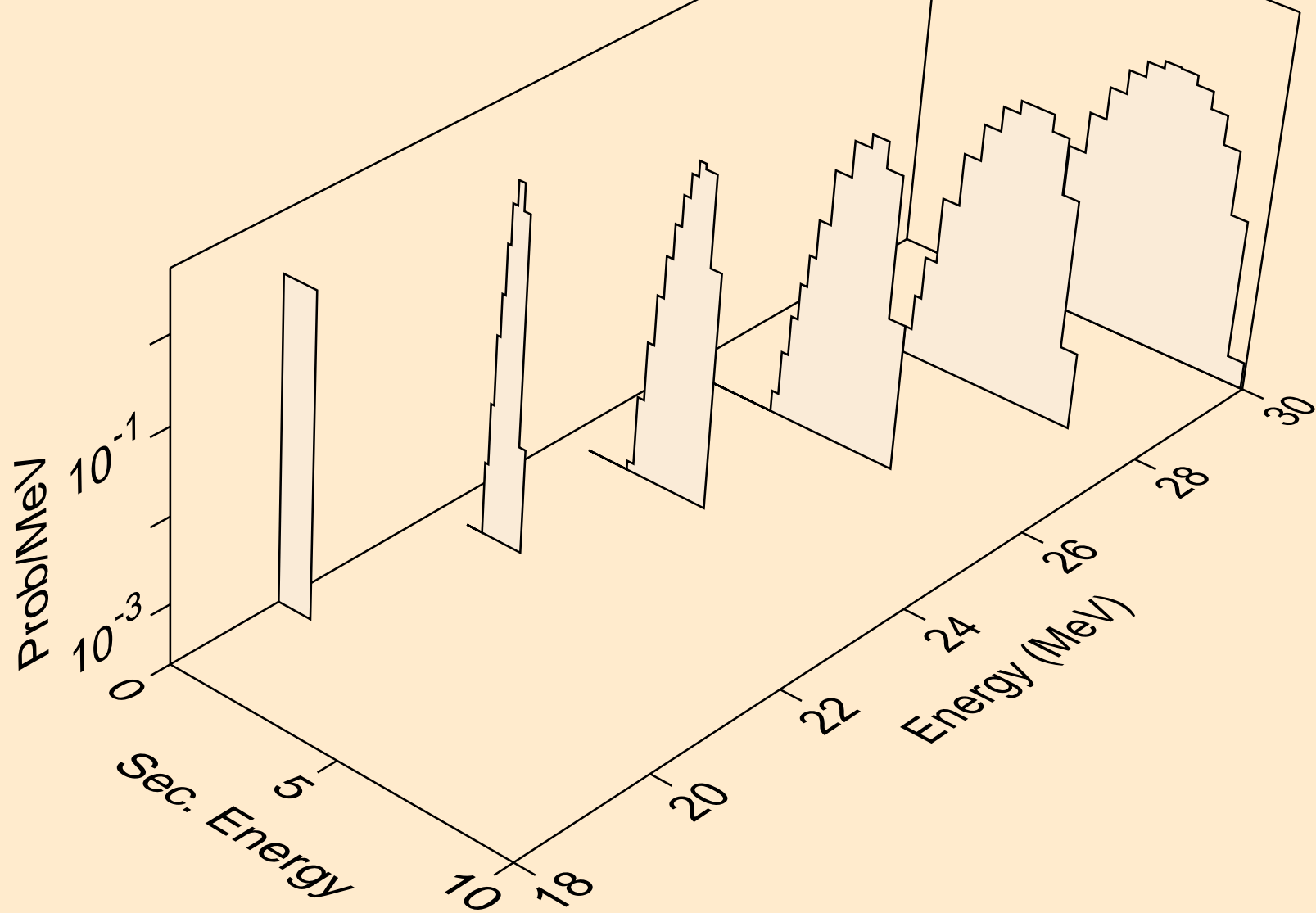

MN052 NEUTRON ACER TENDL-2024 LIBRARY; T=293.6K
alphas from (n,n*)2a

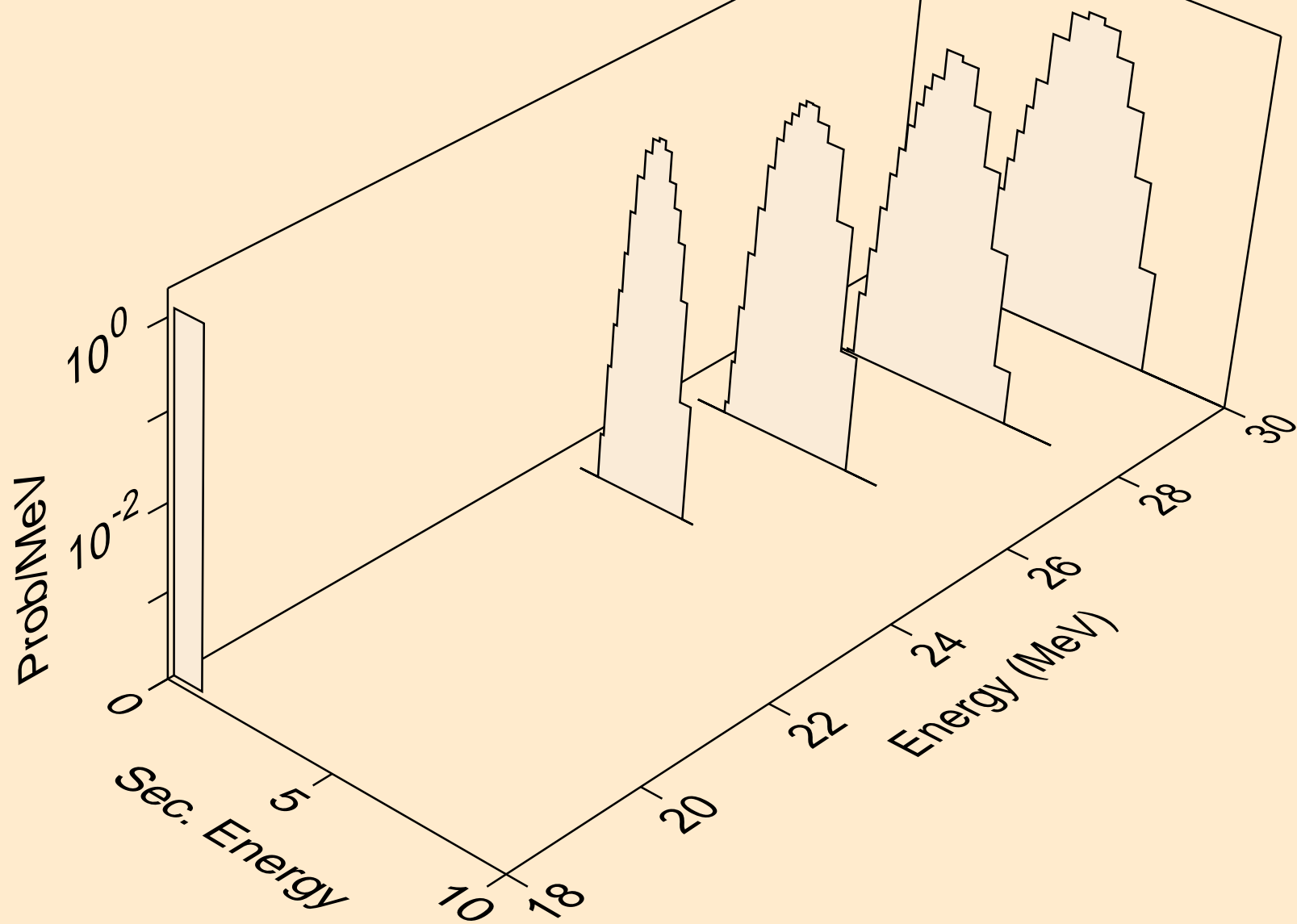

MN052 NEUTRON ACER TENDL-2024 LIBRARY; T=293.6K
alphas from (n,npa)

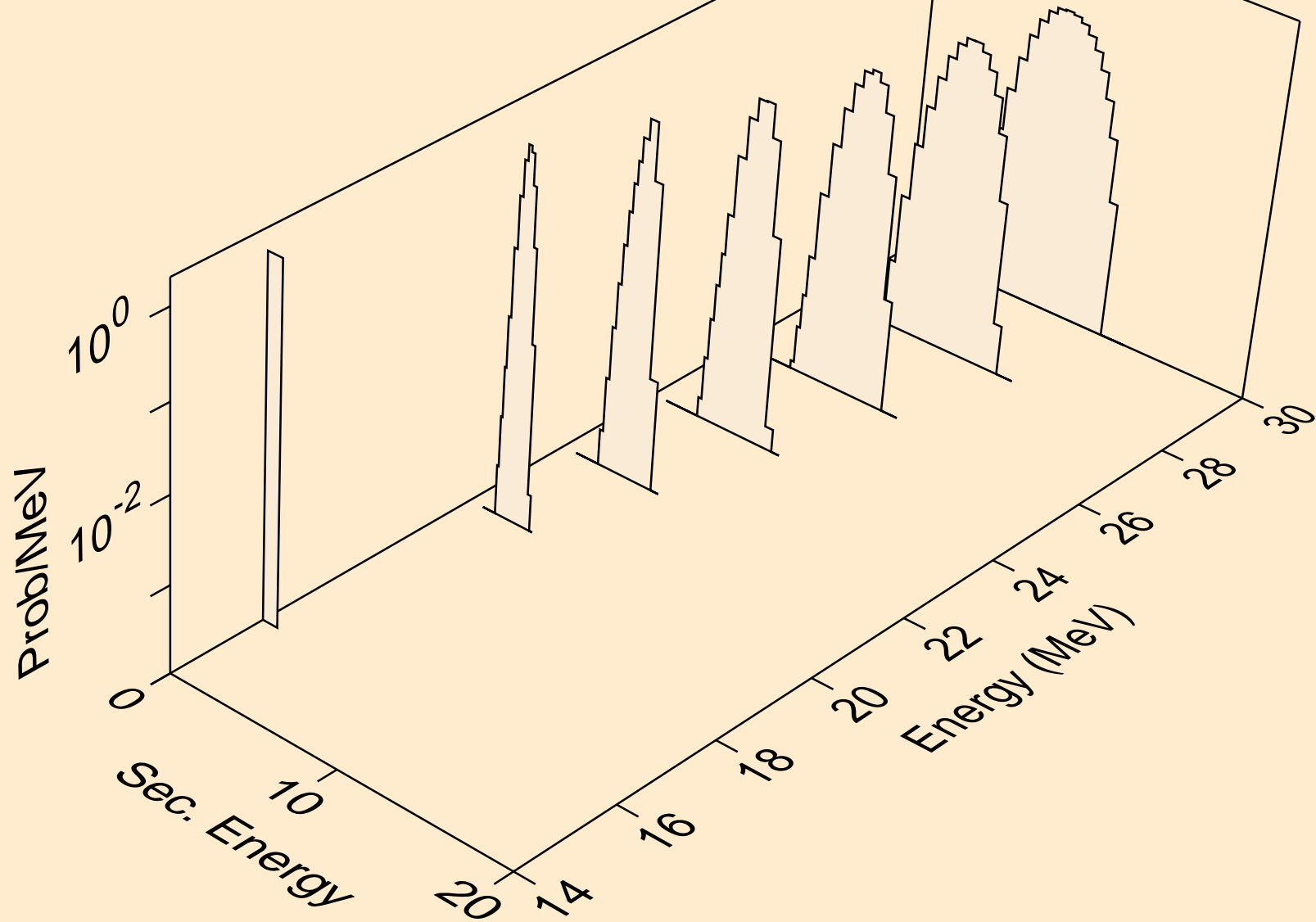

MN052 NEUTRON ACER TENDL-2024 LIBRARY; T=293.6K
alphas from (n,a)

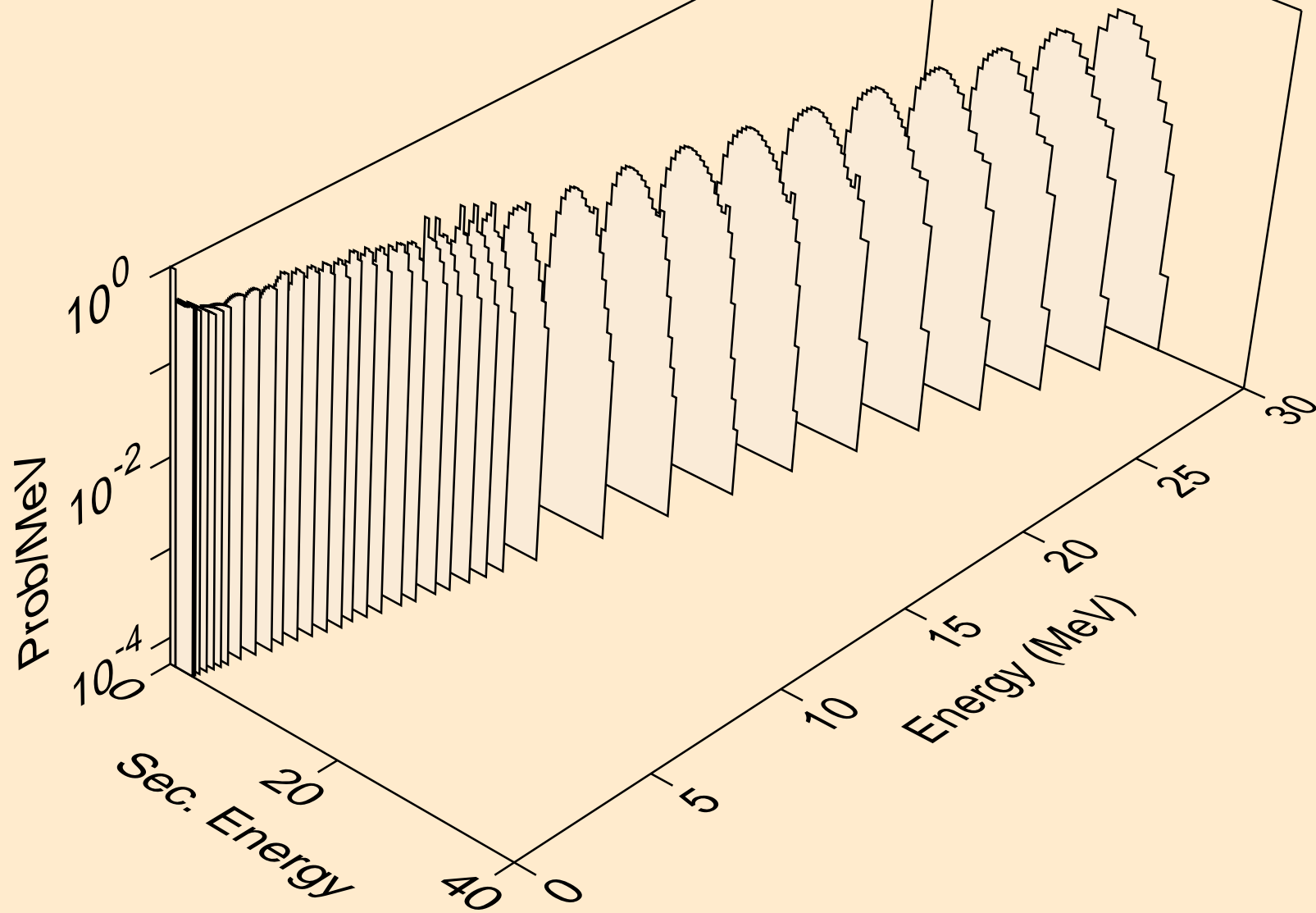

MN052 NEUTRON ACER TENDL-2024 LIBRARY; T=293.6K
alphas from (n,2a)

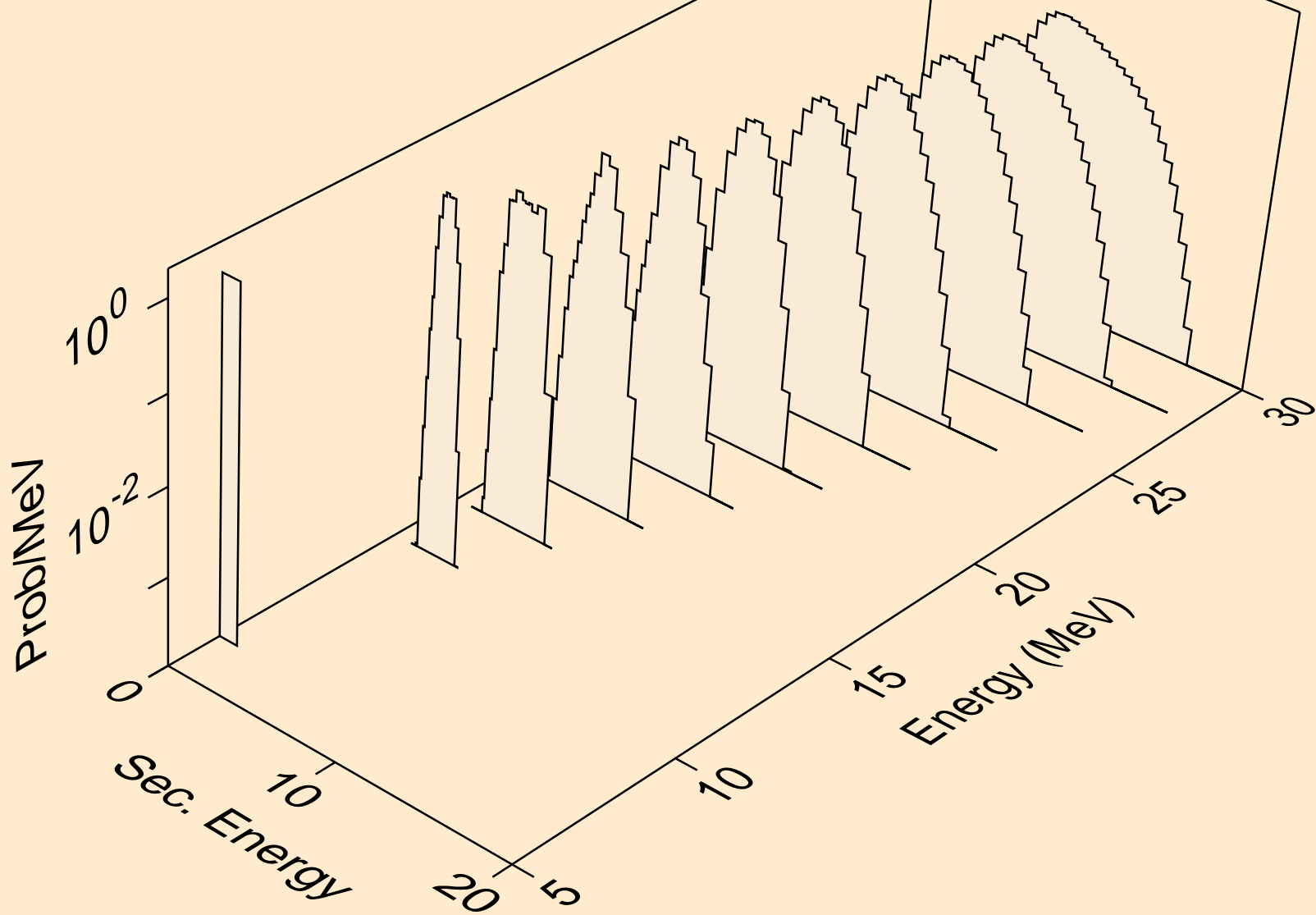

MN052 NEUTRON ACER TENDL-2024 LIBRARY; T=293.6K
alphas from (n,pa)

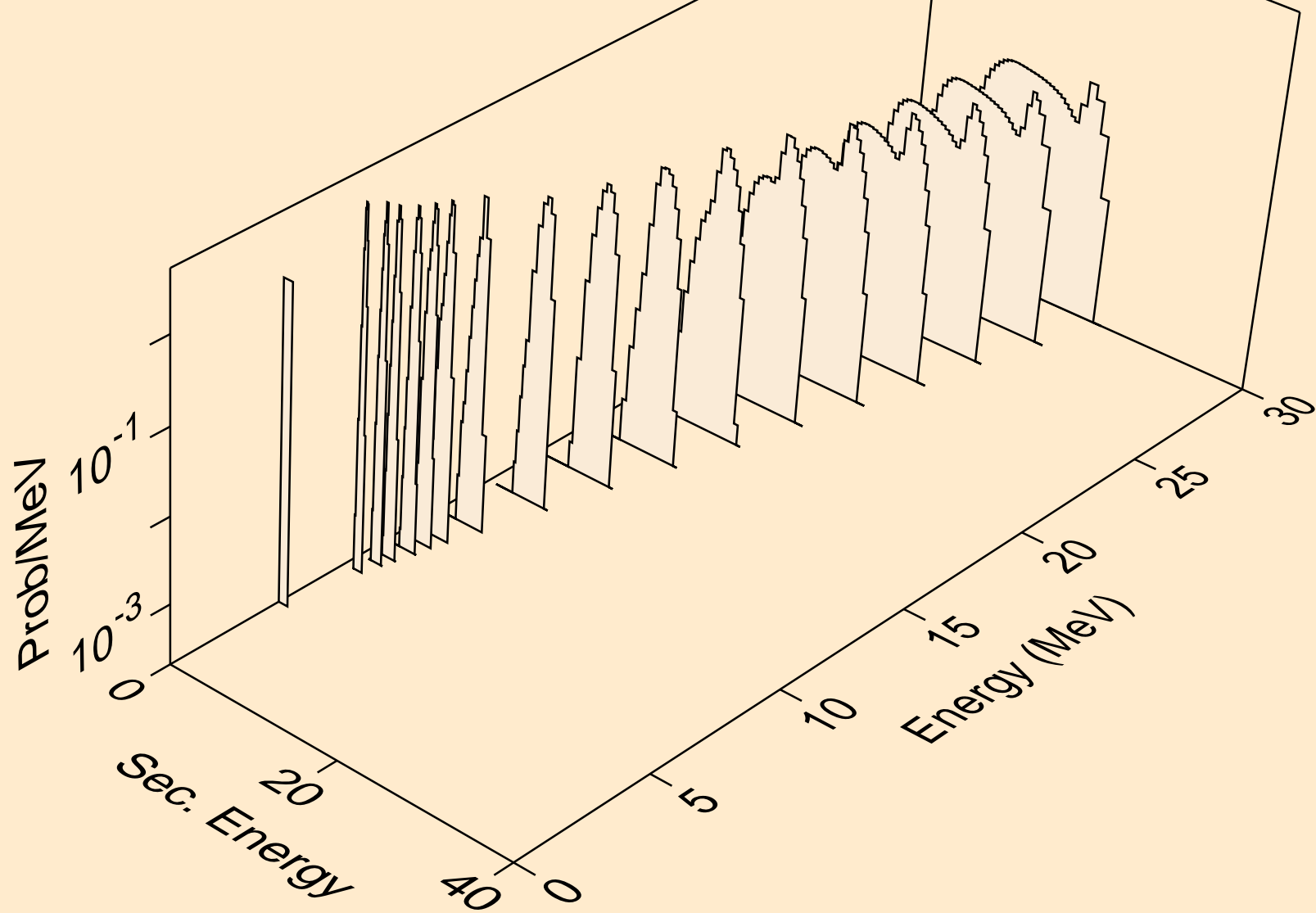

MN052 NEUTRON ACER TENDL-2024 LIBRARY; T=293.6K
alphas from (n,da)

