

# NA025 NEUTRON ACER TENDL-2024 LIBRARY; T=293.6K

## Principal cross sections

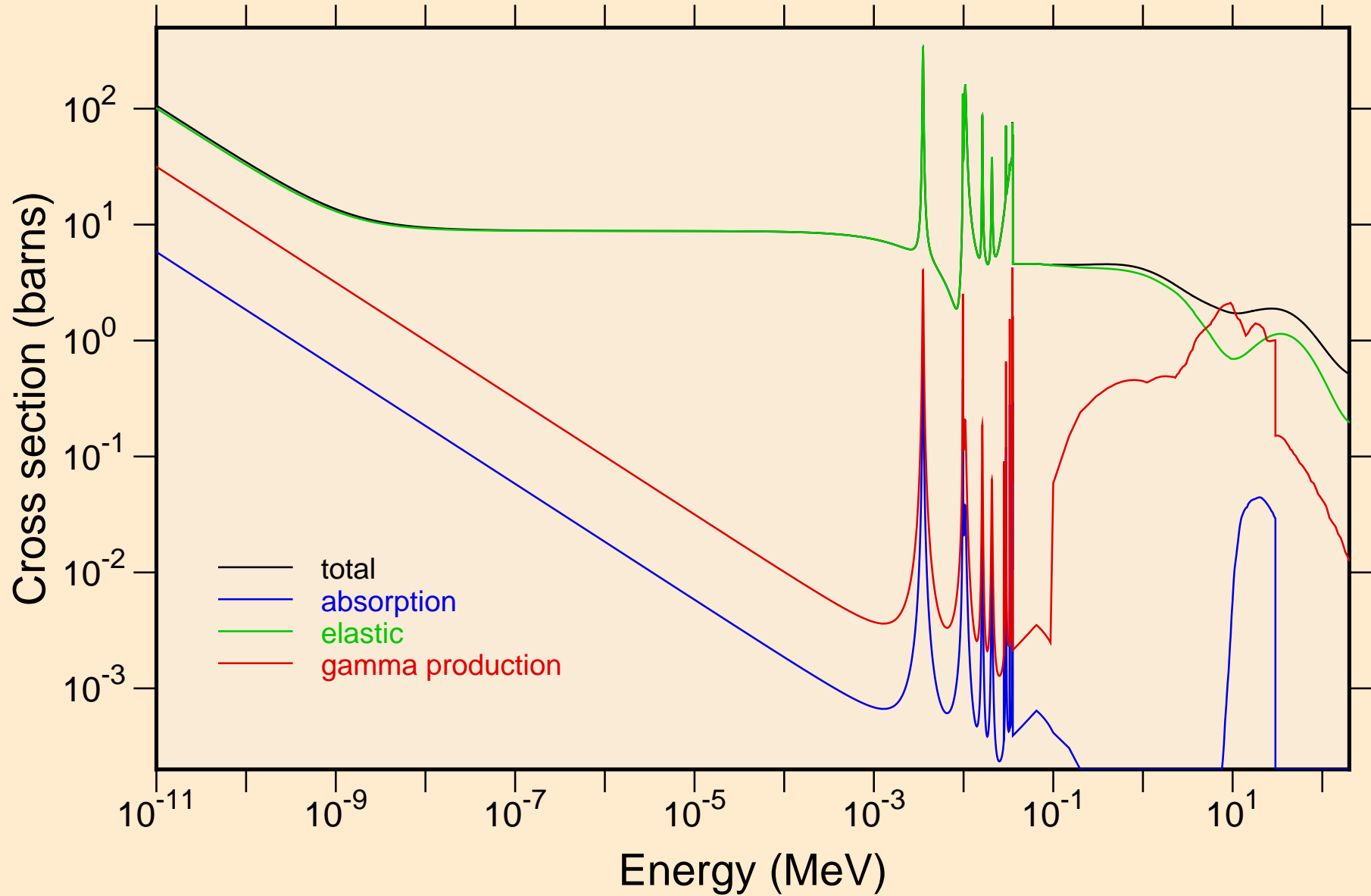

NA025 NEUTRON ACER TENDL-2024 LIBRARY; T=293.6K  
resonance total cross section

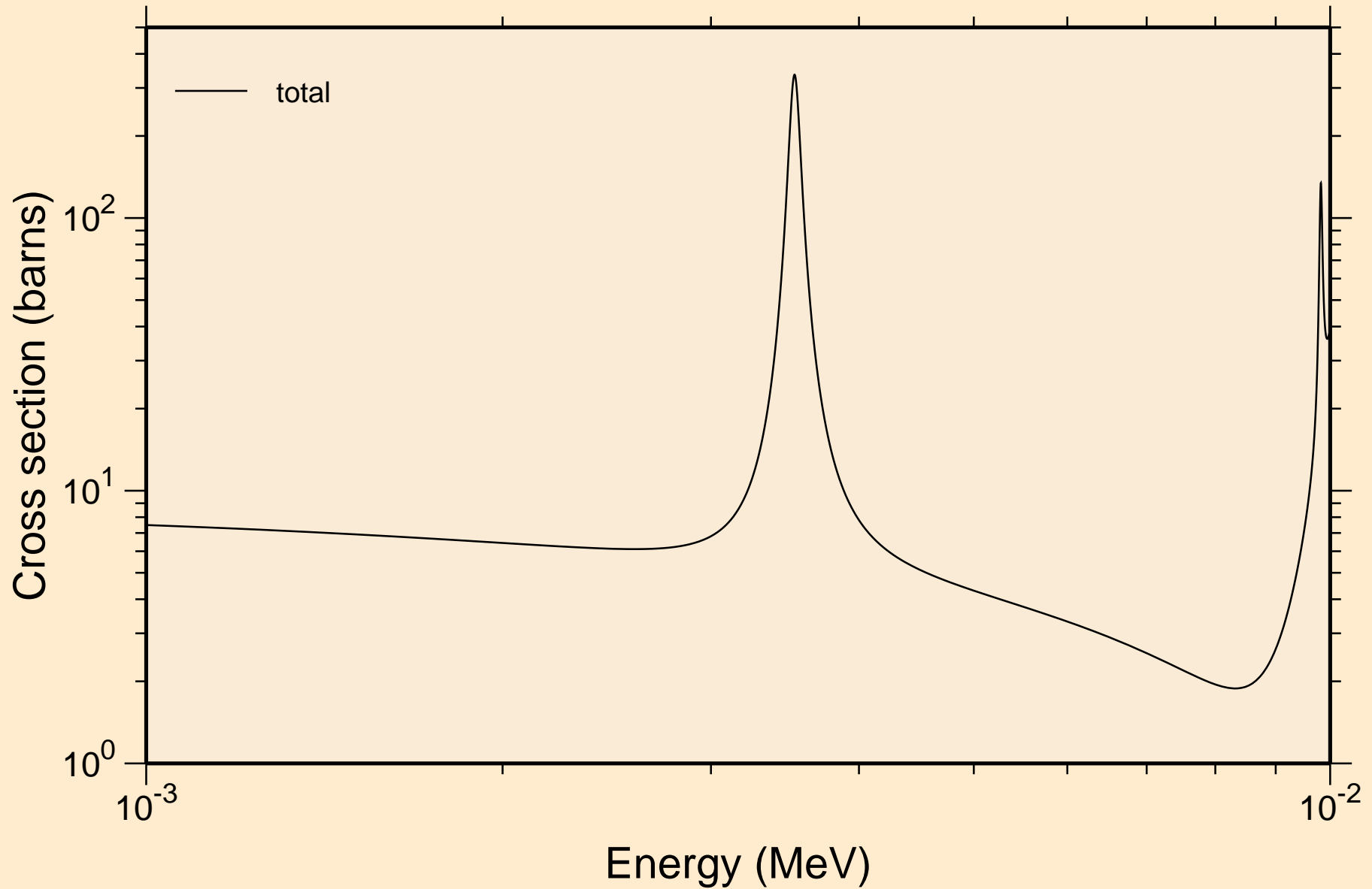

NA025 NEUTRON ACER TENDL-2024 LIBRARY; T=293.6K  
resonance total cross section

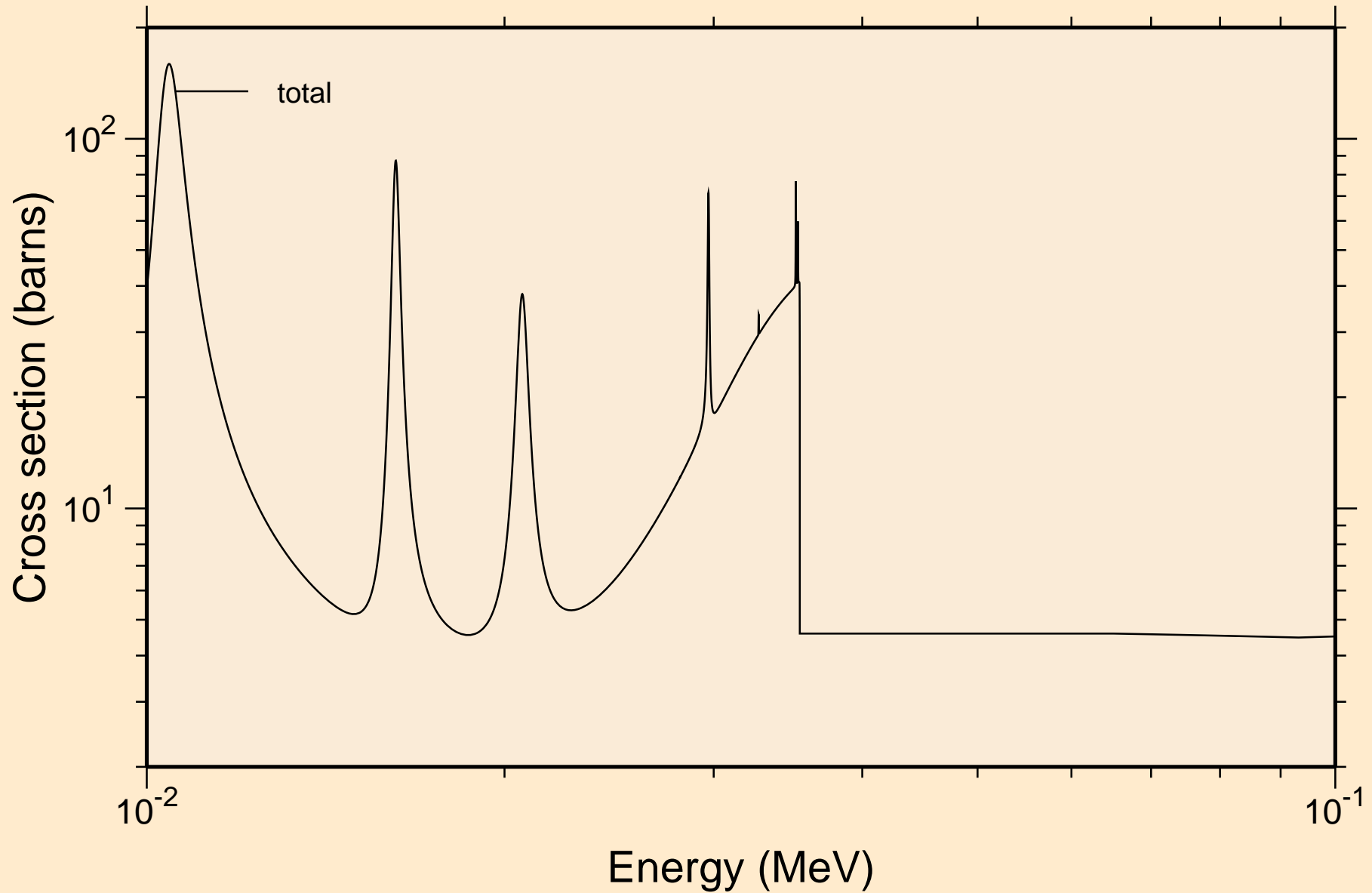

NA025 NEUTRON ACER TENDL-2024 LIBRARY; T=293.6K  
resonance total cross section

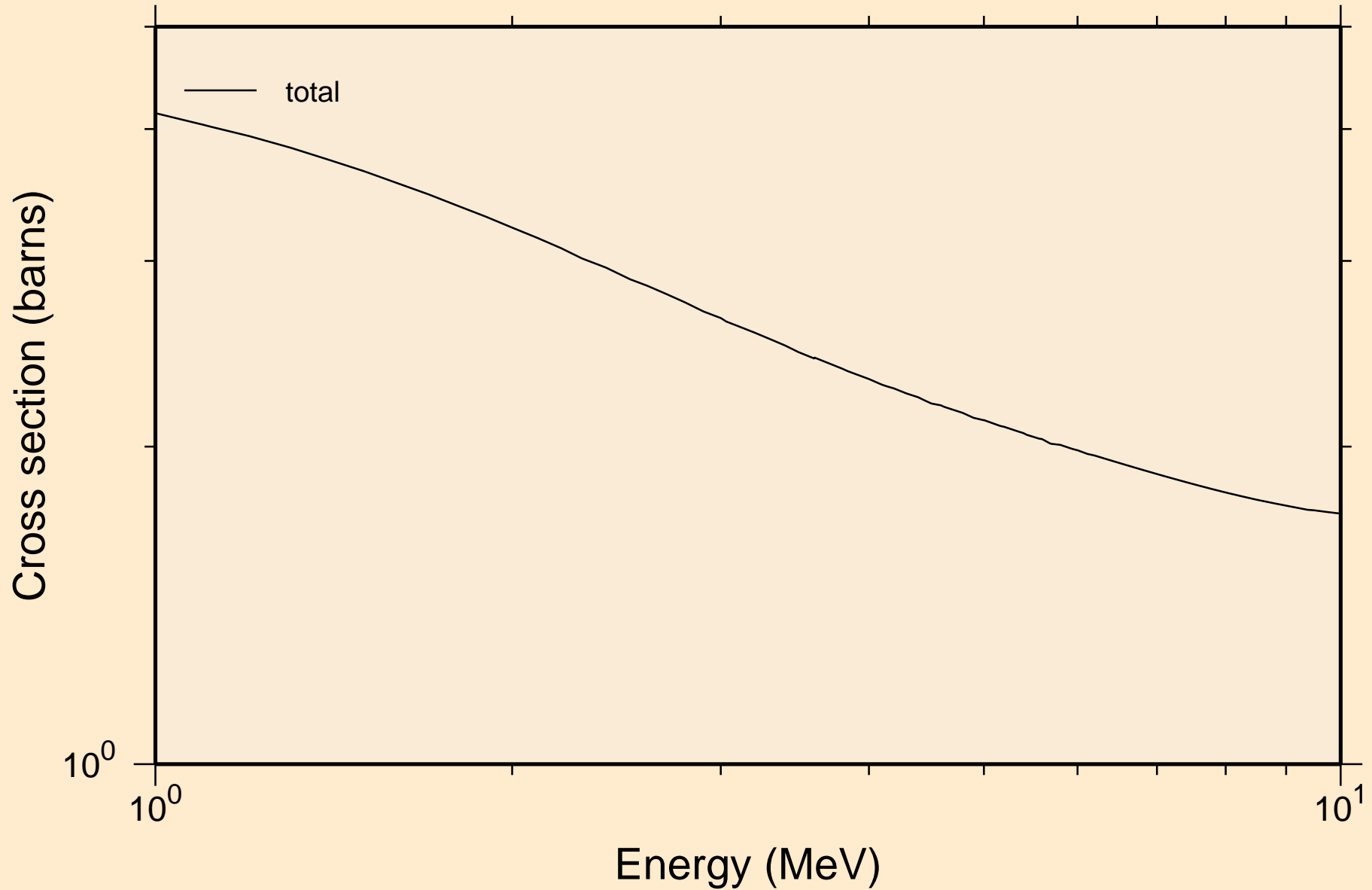

NA025 NEUTRON ACER TENDL-2024 LIBRARY; T=293.6K  
resonance absorption cross sections

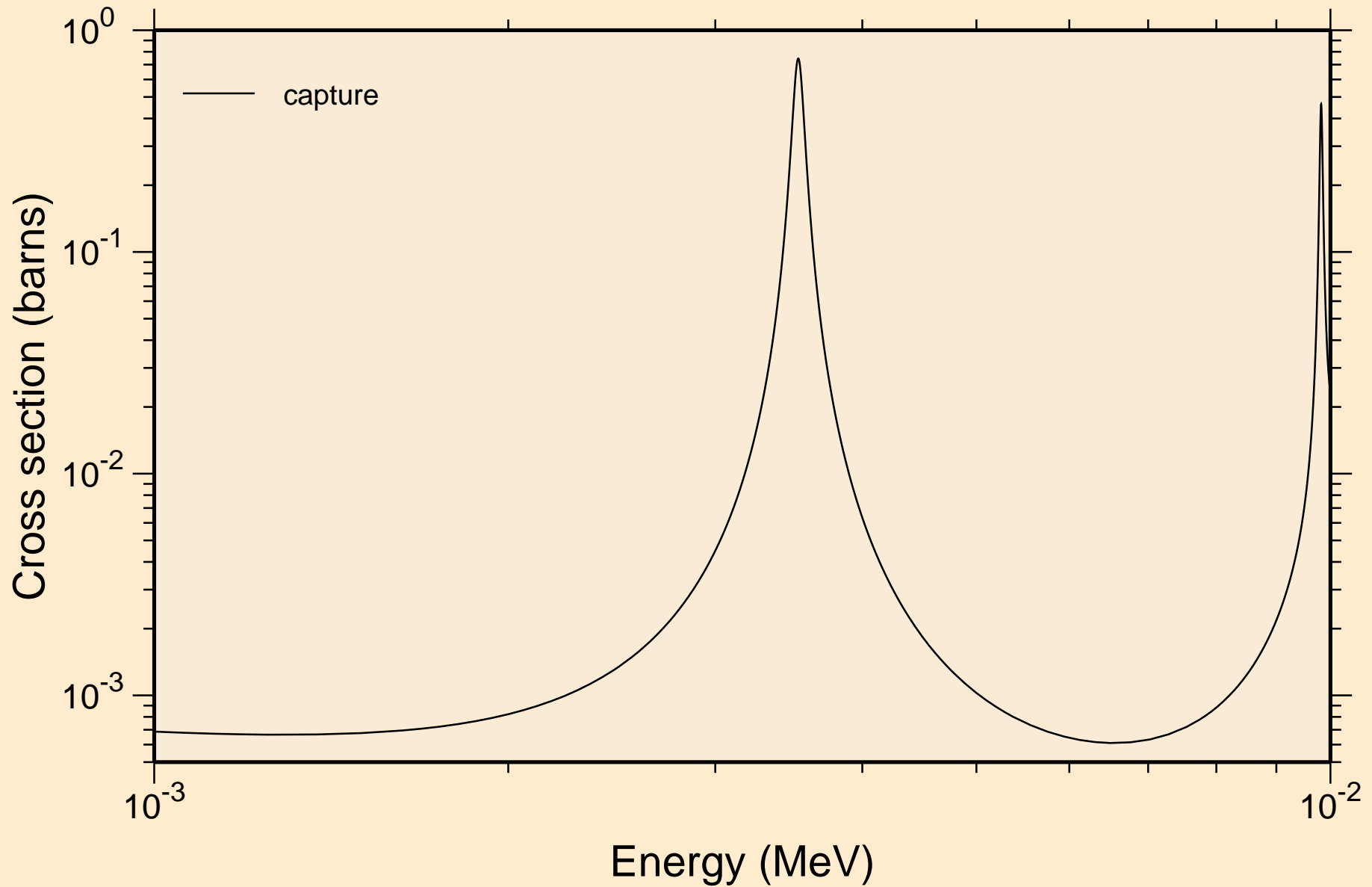

NA025 NEUTRON ACER TENDL-2024 LIBRARY; T=293.6K  
resonance absorption cross sections

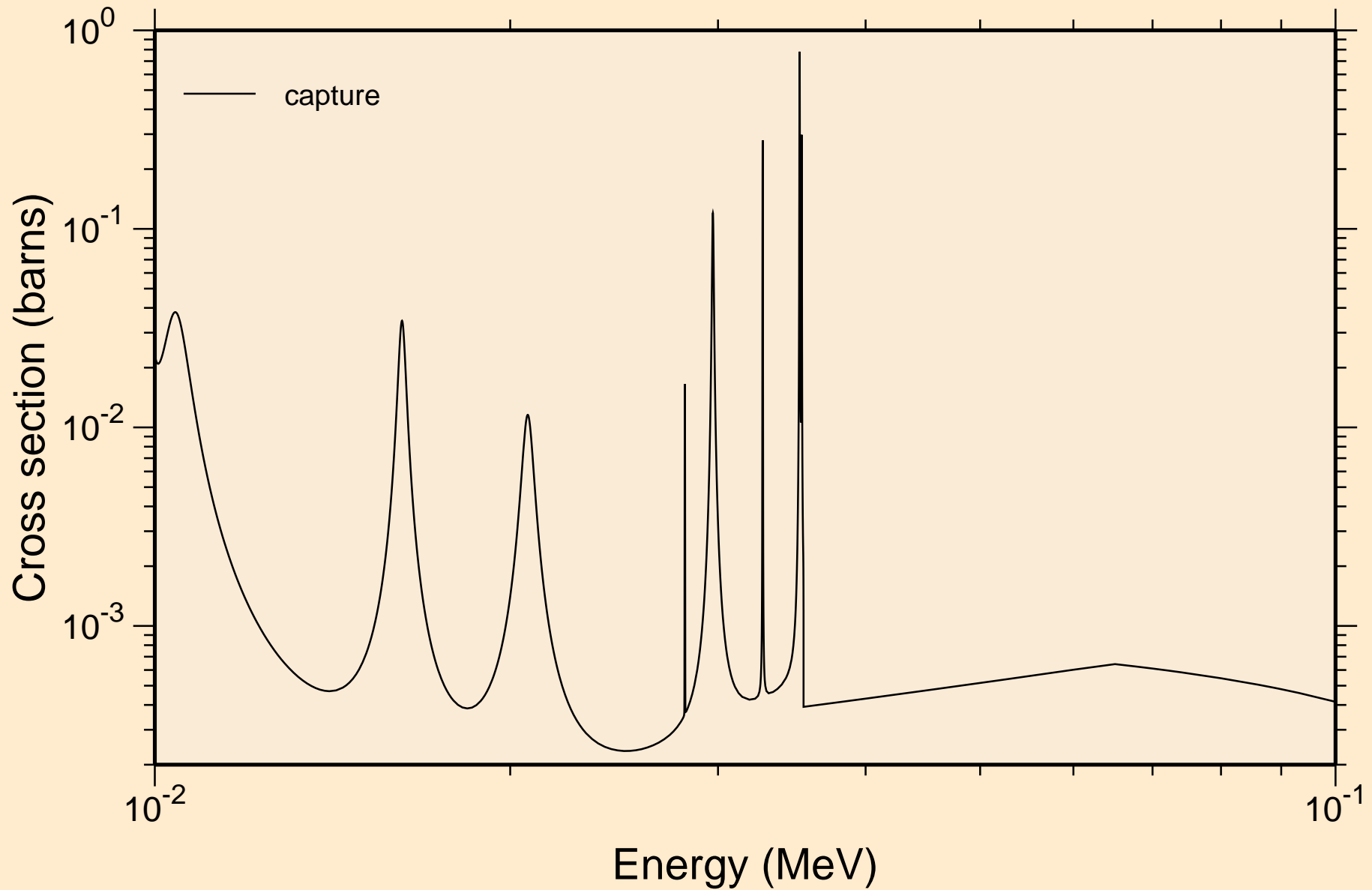

NA025 NEUTRON ACER TENDL-2024 LIBRARY; T=293.6K  
resonance absorption cross sections

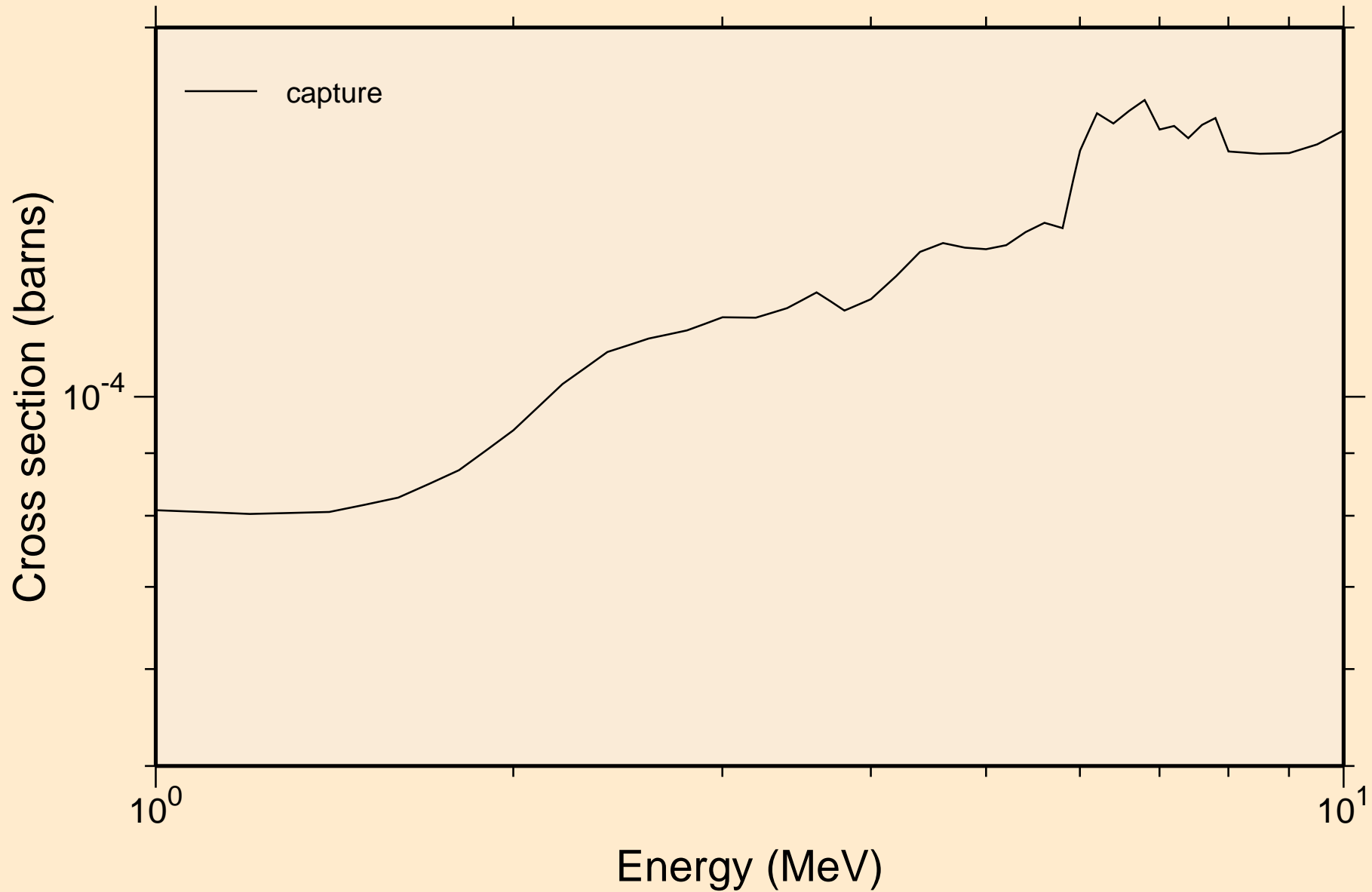

NA025 NEUTRON ACER TENDL-2024 LIBRARY; T=293.6K  
Heating

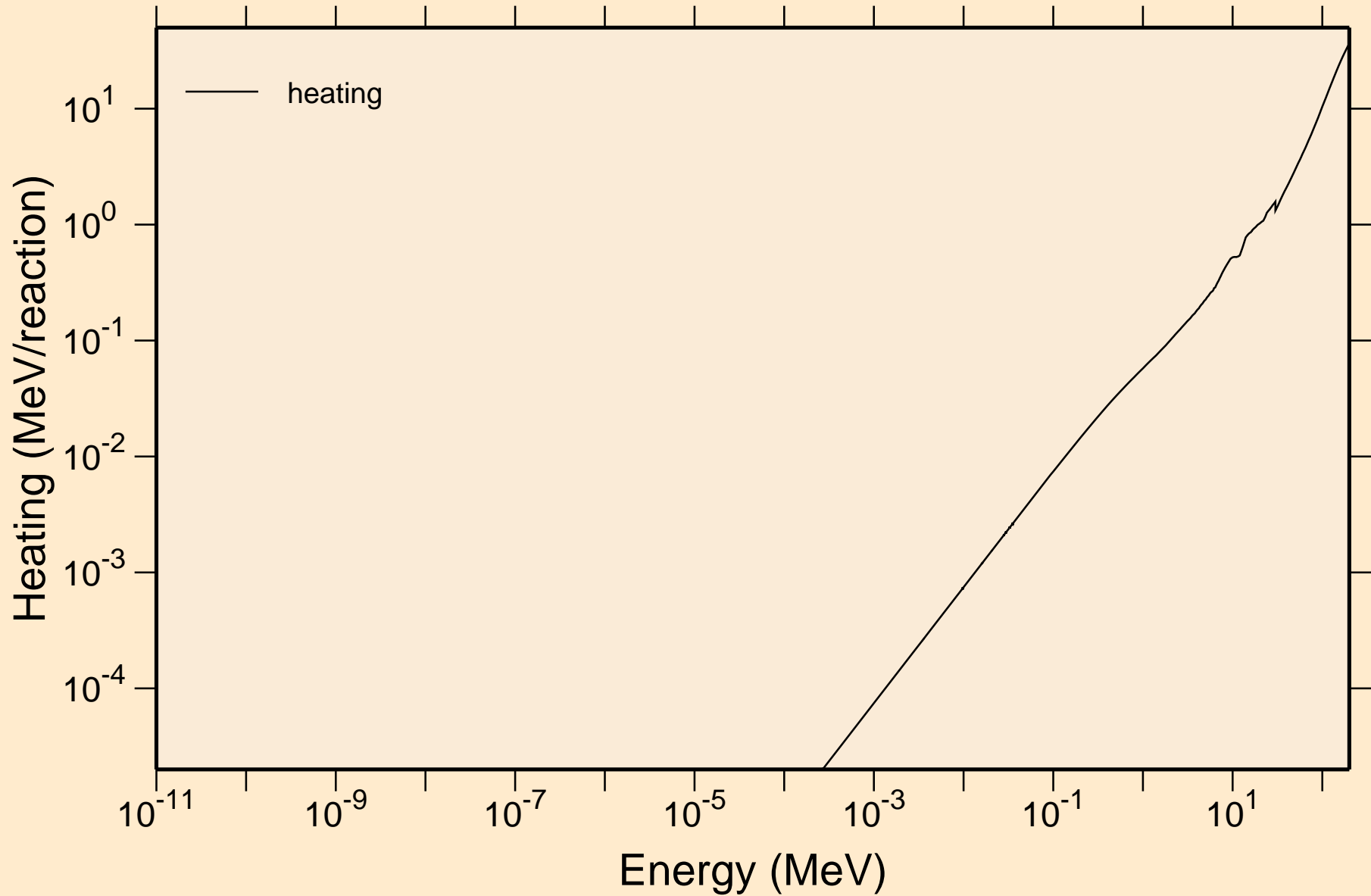

# NA025 NEUTRON ACER TENDL-2024 LIBRARY; T=293.6K

## Damage

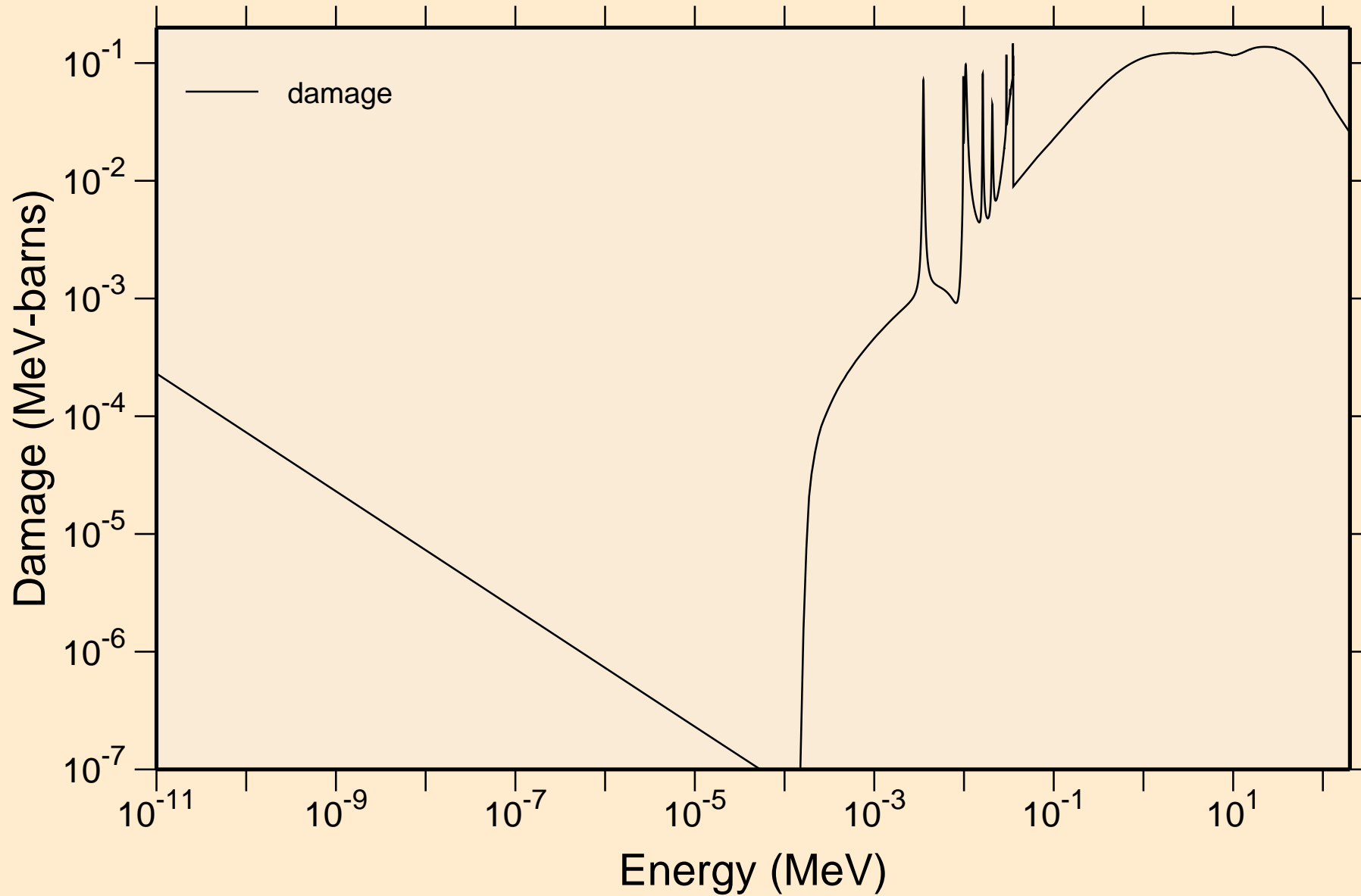

NA025 NEUTRON ACER TENDL-2024 LIBRARY; T=293.6K  
Non-threshold reactions

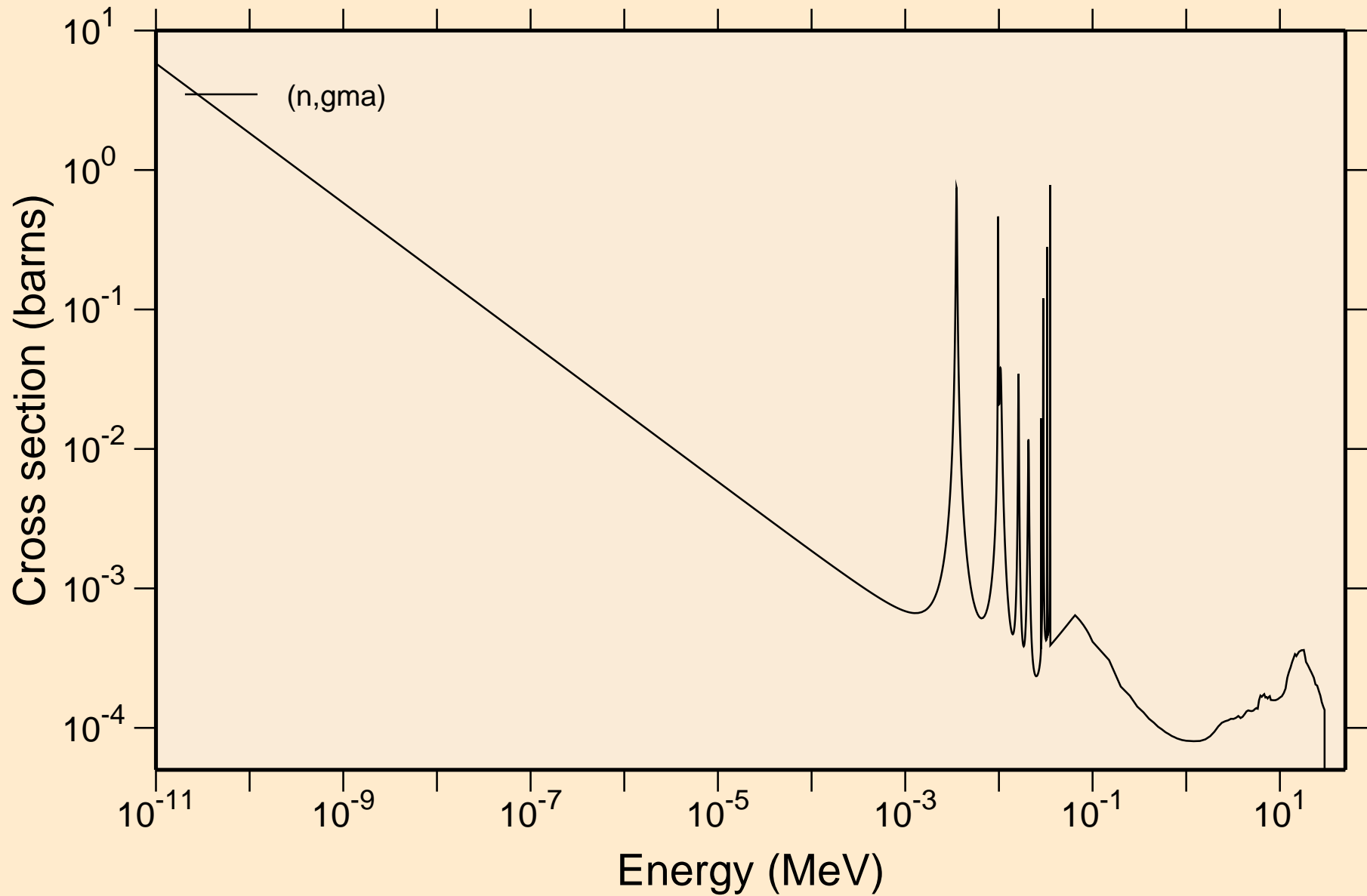

# NA025 NEUTRON ACER TENDL-2024 LIBRARY; T=293.6K

## Principal cross sections

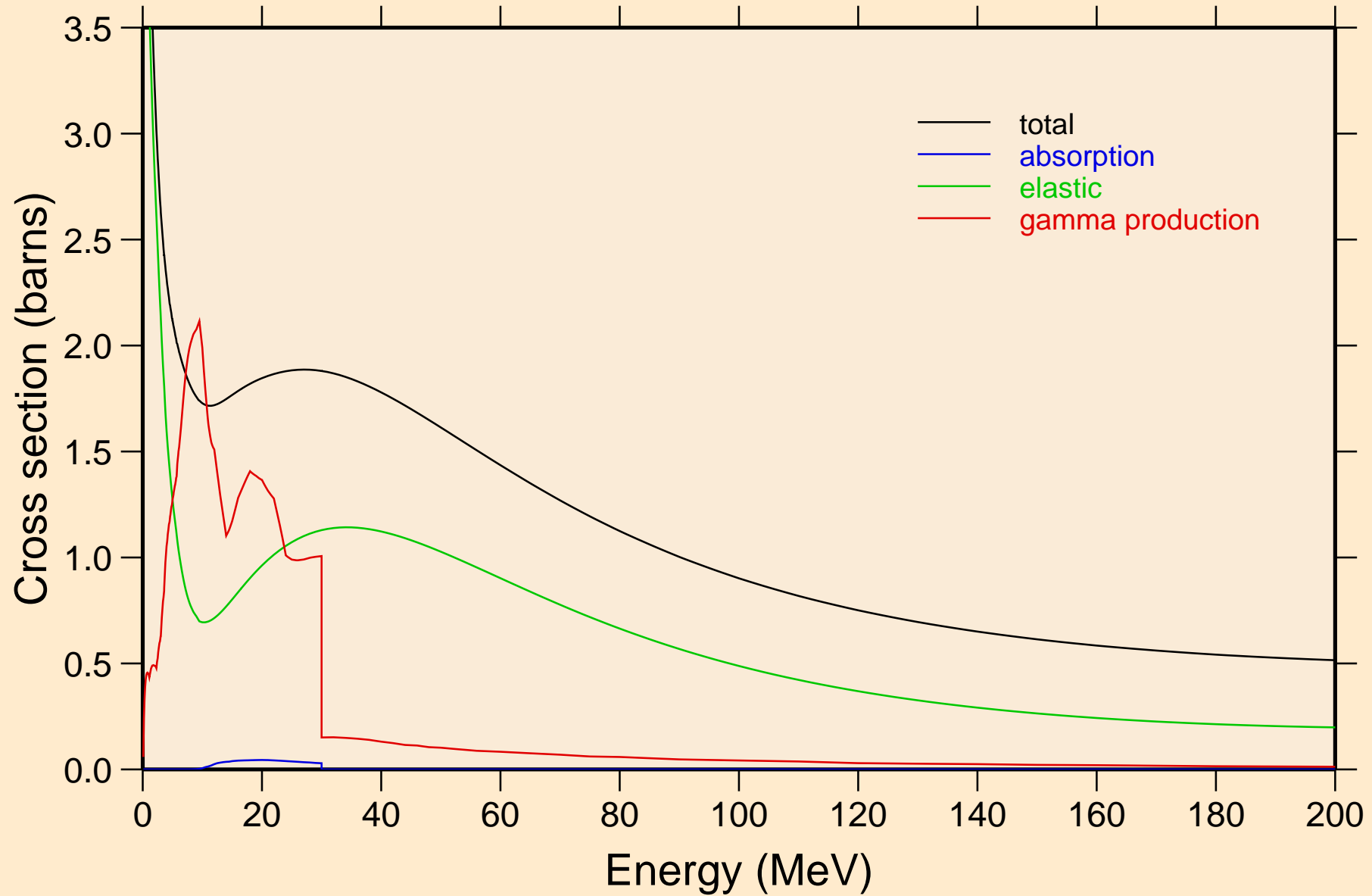

NA025 NEUTRON ACER TENDL-2024 LIBRARY; T=293.6K  
Heating

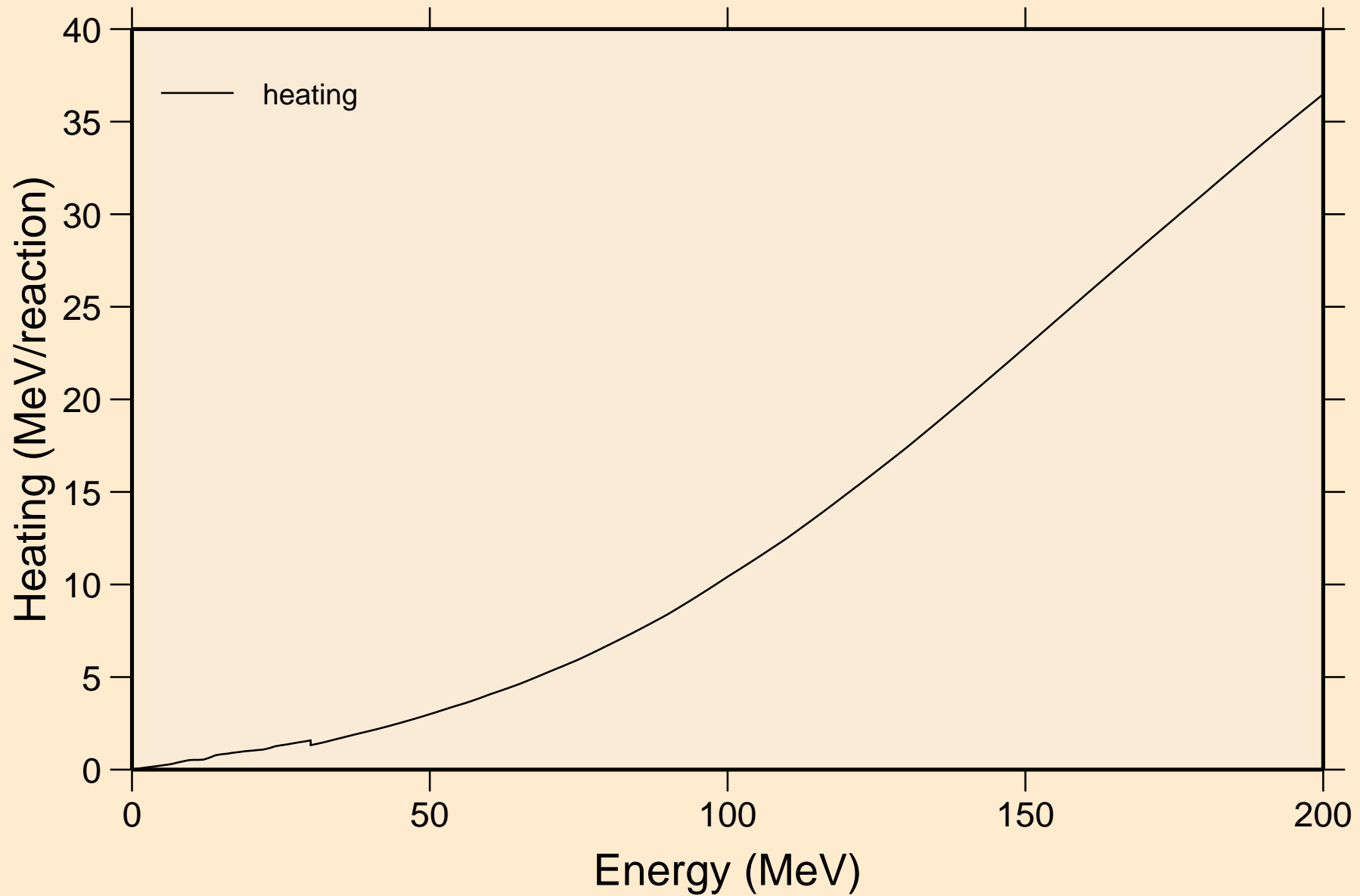

NA025 NEUTRON ACER TENDL-2024 LIBRARY; T=293.6K  
Damage

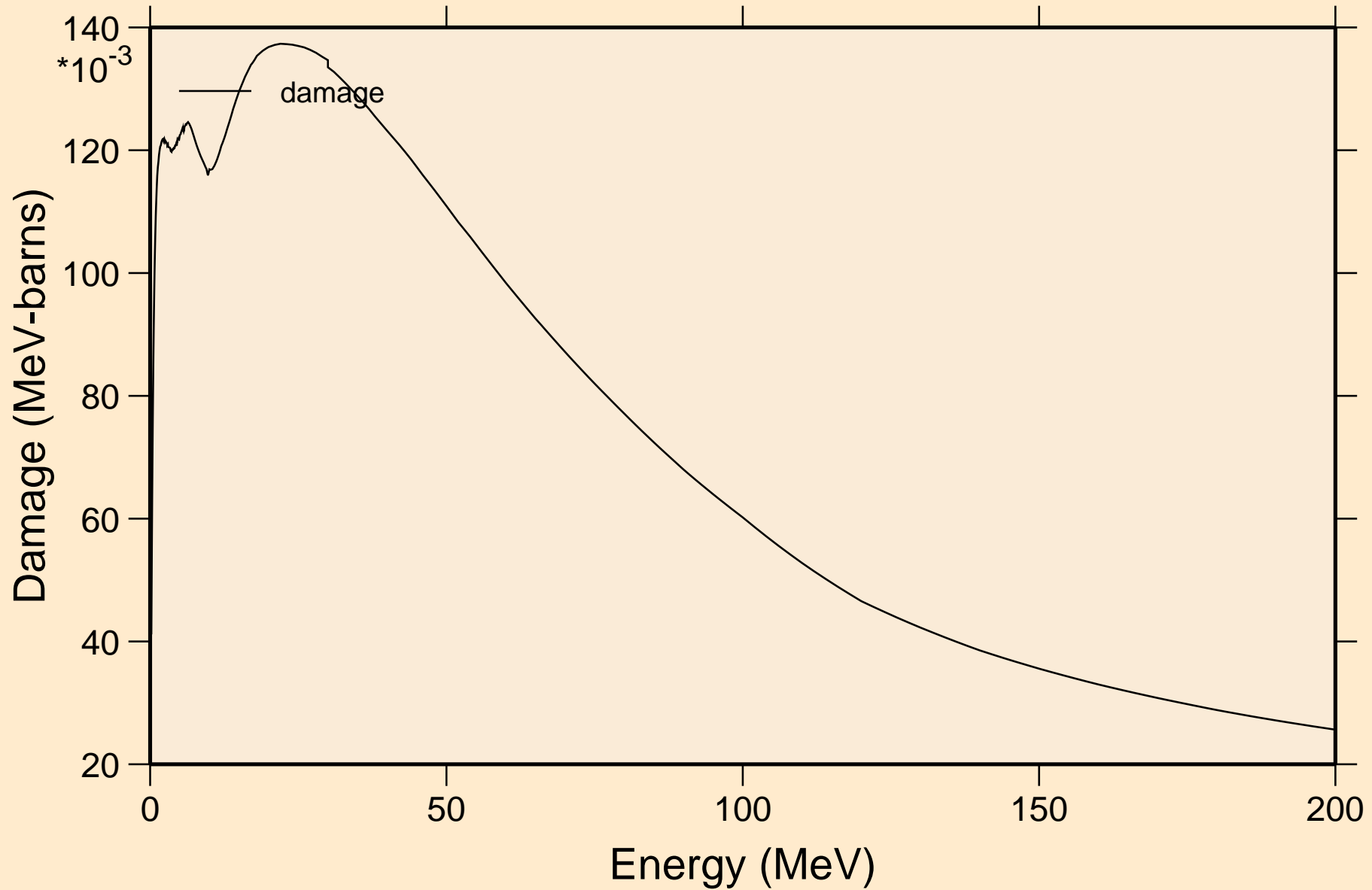

NA025 NEUTRON ACER TENDL-2024 LIBRARY; T=293.6K  
Non-threshold reactions

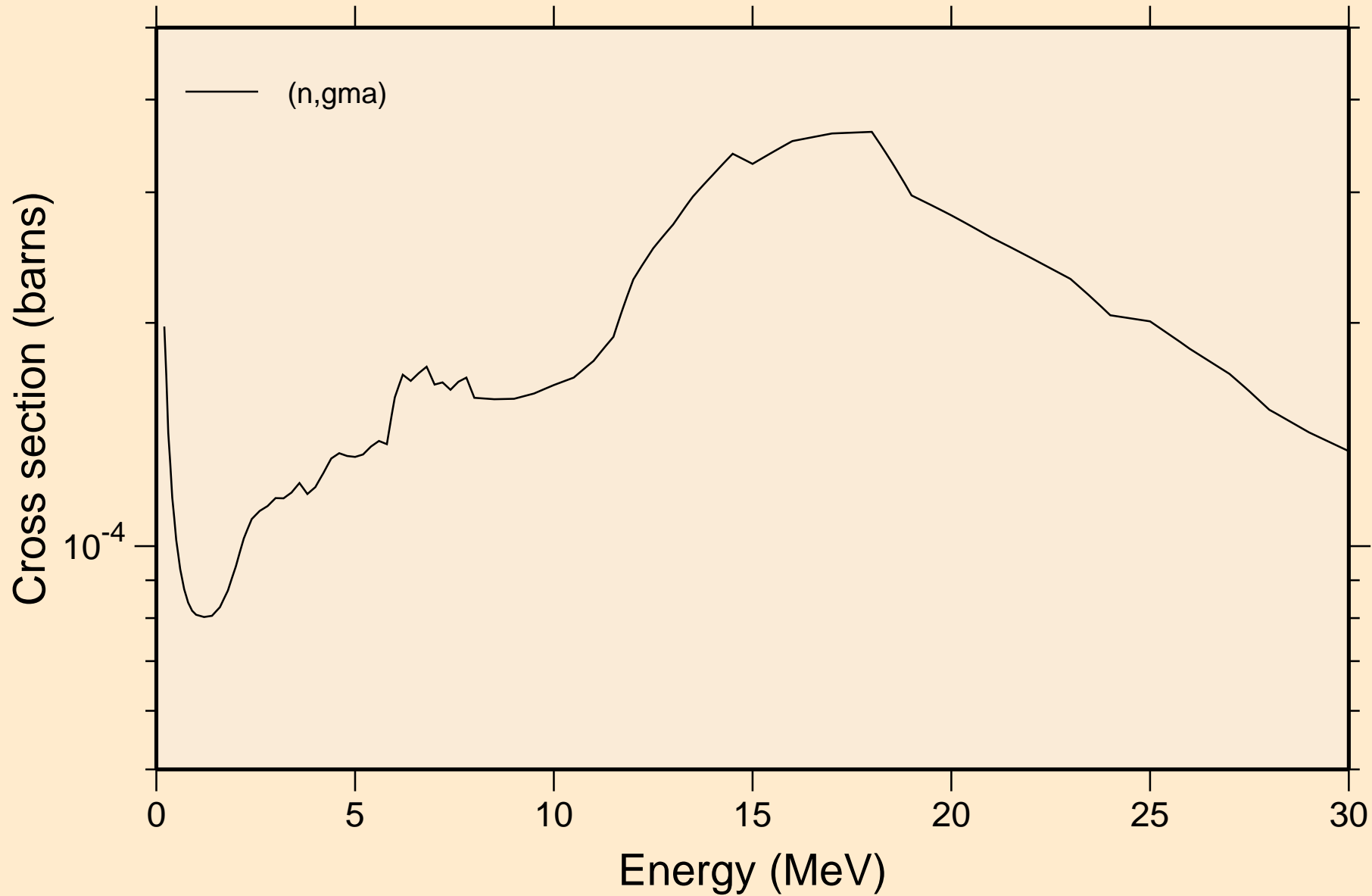

NA025 NEUTRON ACER TENDL-2024 LIBRARY; T=293.6K  
Inelastic levels

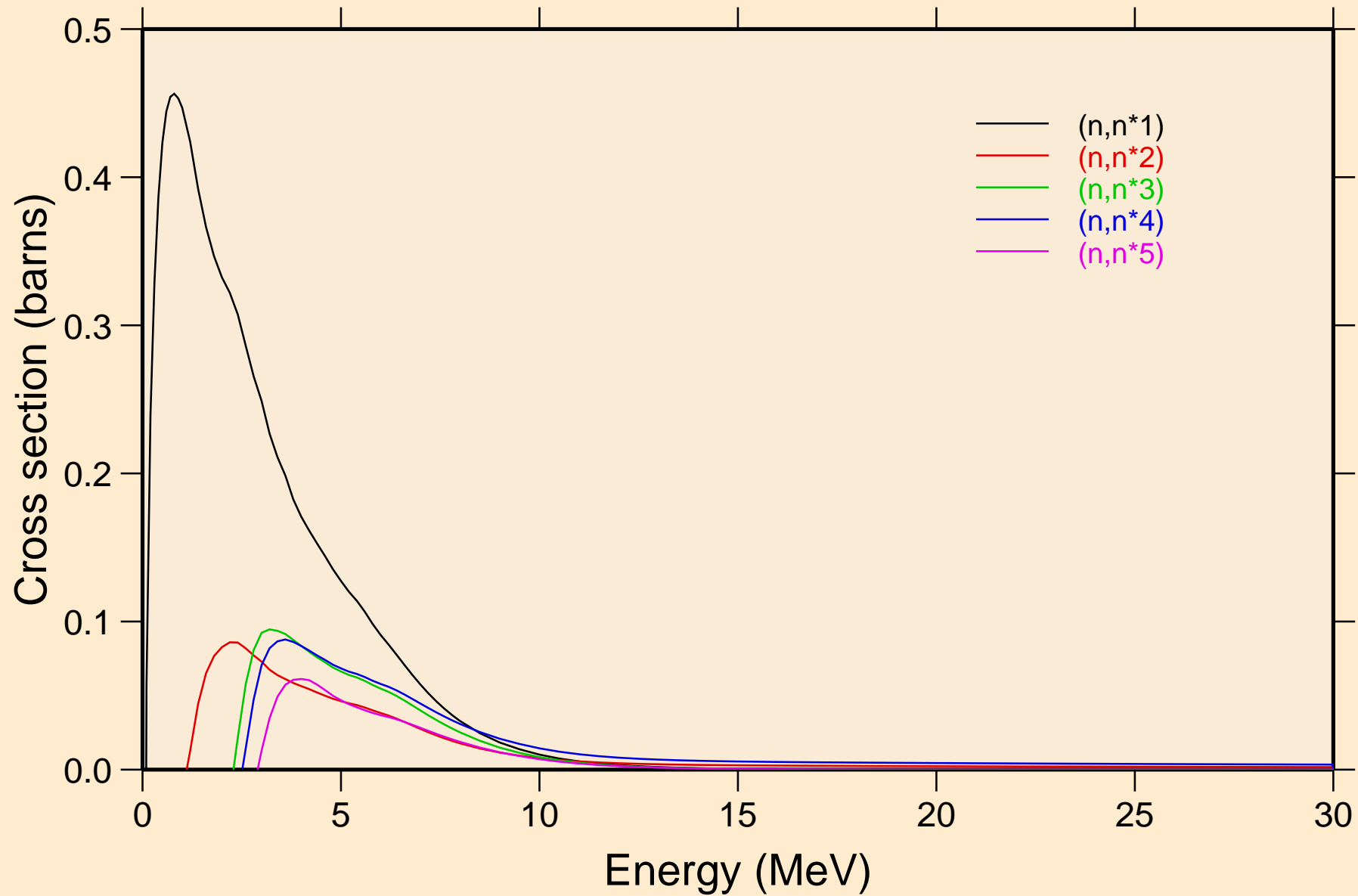

NA025 NEUTRON ACER TENDL-2024 LIBRARY; T=293.6K  
Inelastic levels

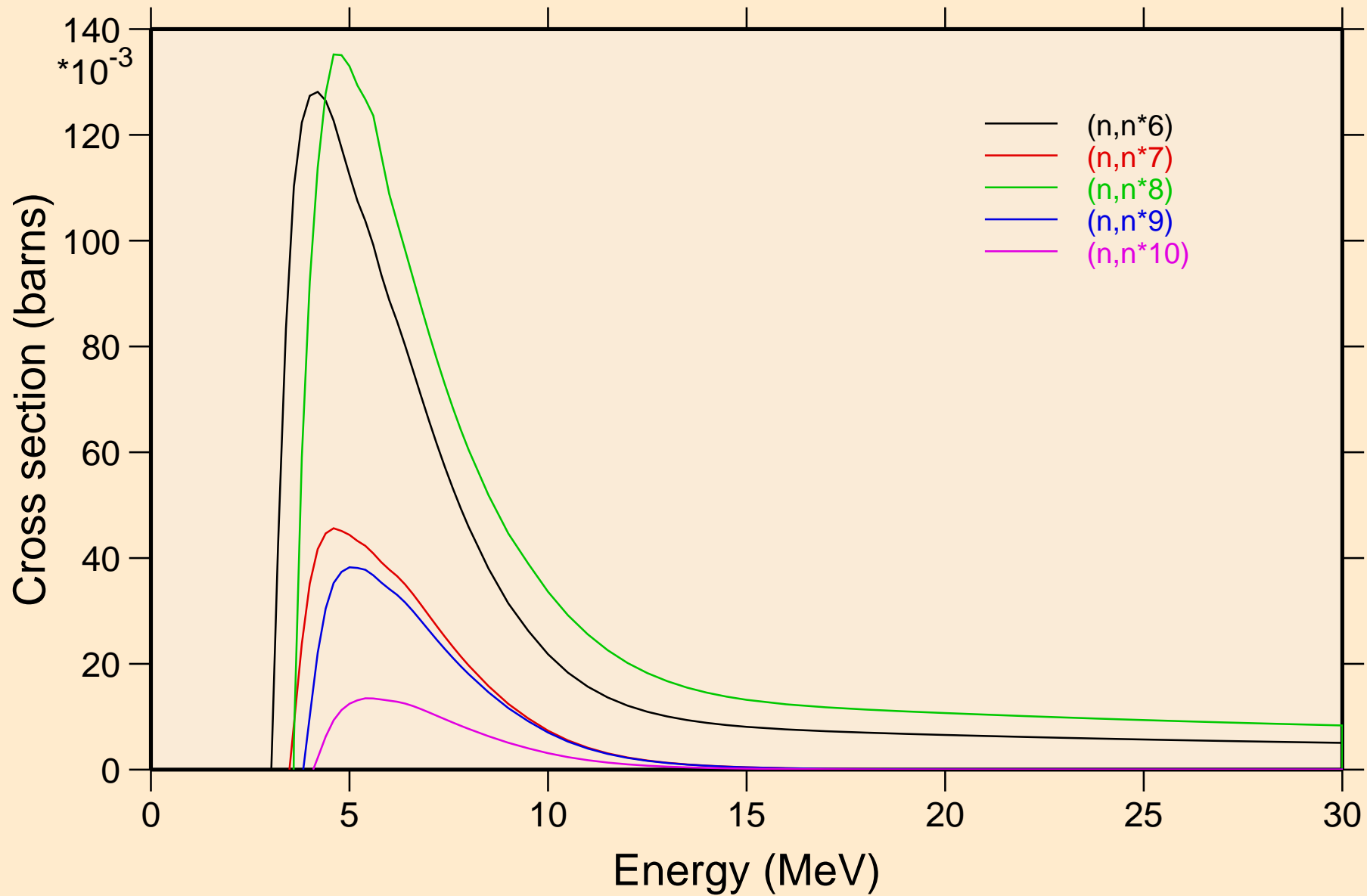

NA025 NEUTRON ACER TENDL-2024 LIBRARY; T=293.6K  
Inelastic levels

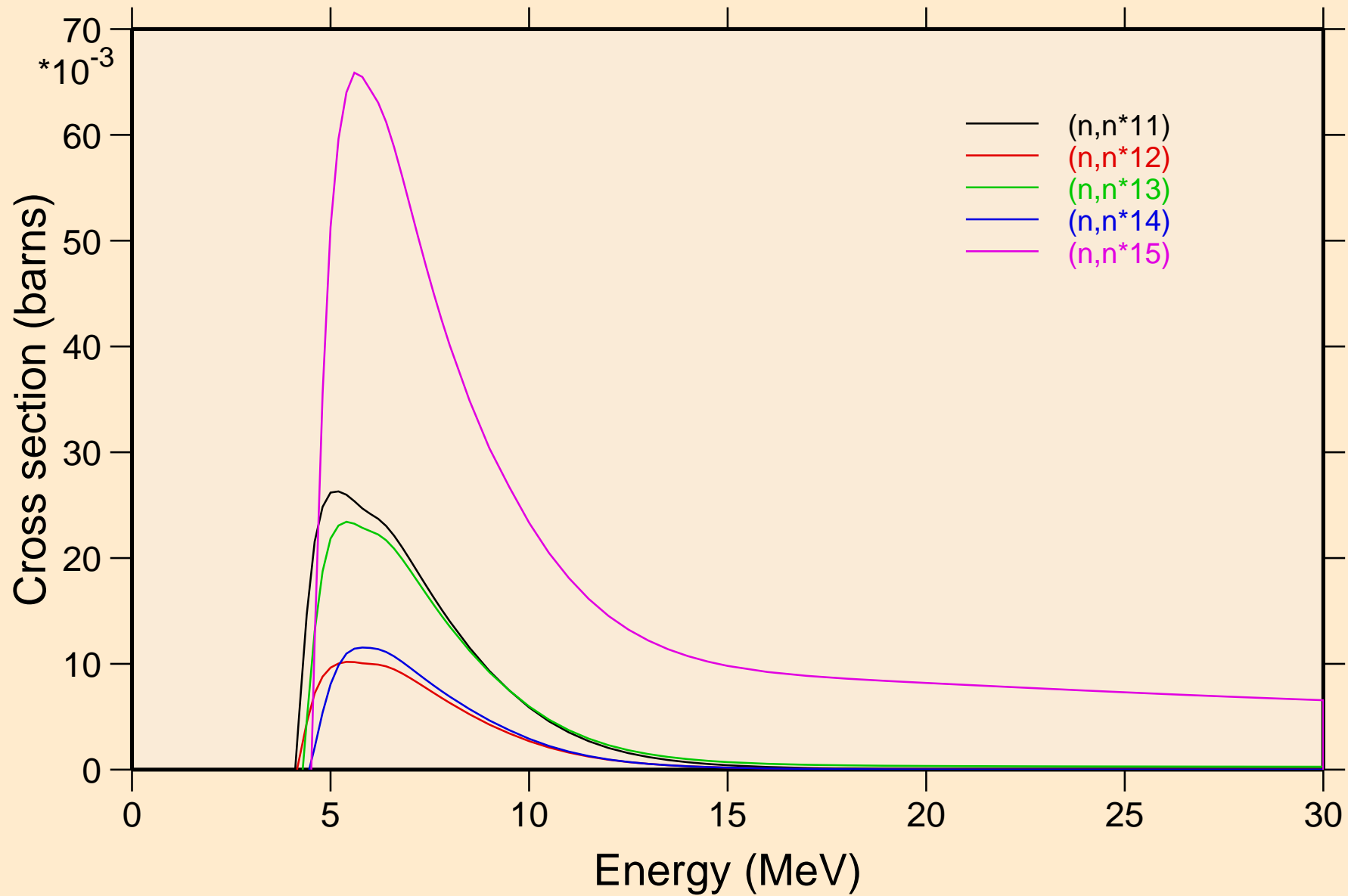

NA025 NEUTRON ACER TENDL-2024 LIBRARY; T=293.6K  
Inelastic levels

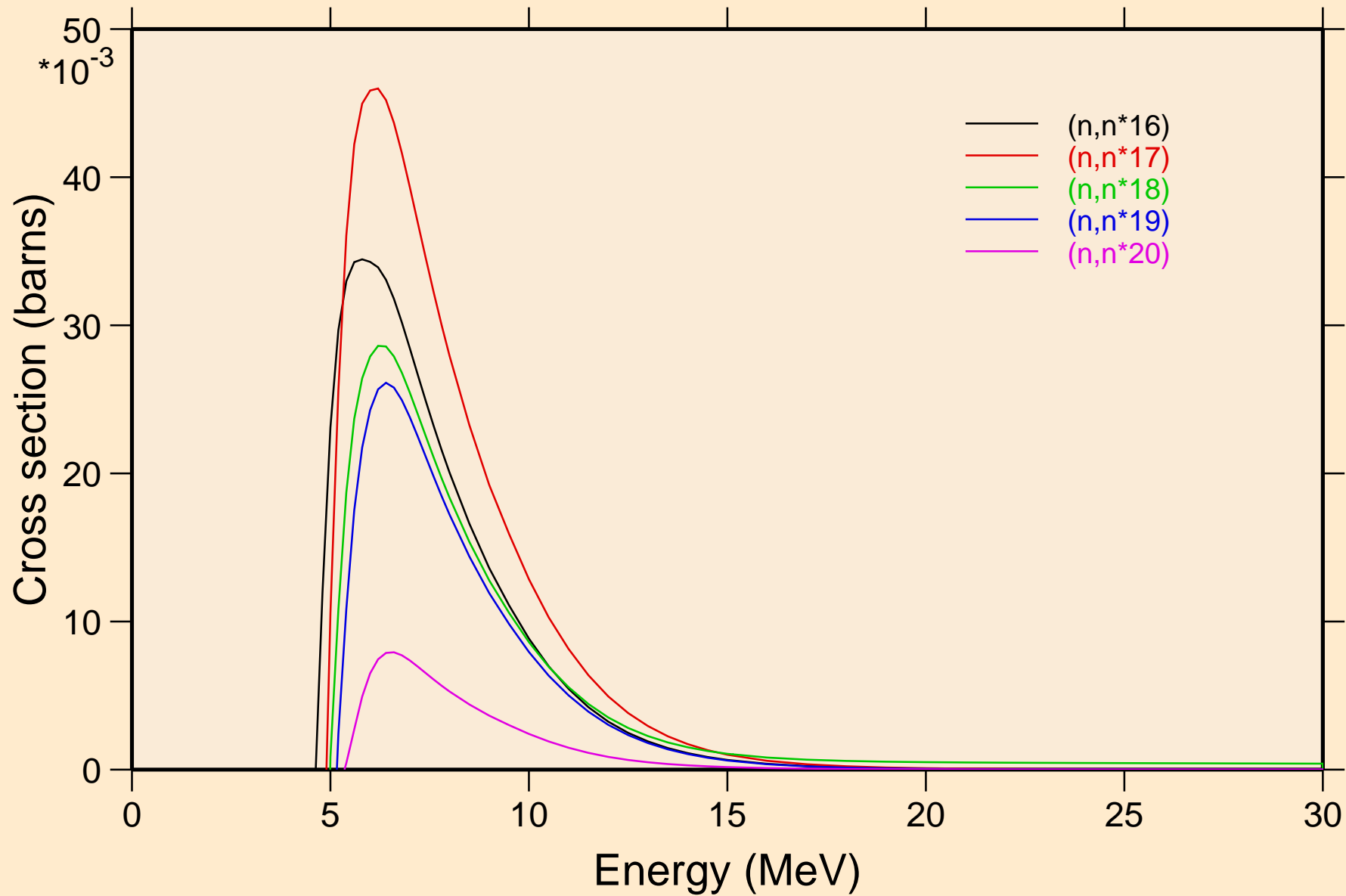

NA025 NEUTRON ACER TENDL-2024 LIBRARY; T=293.6K  
Inelastic levels

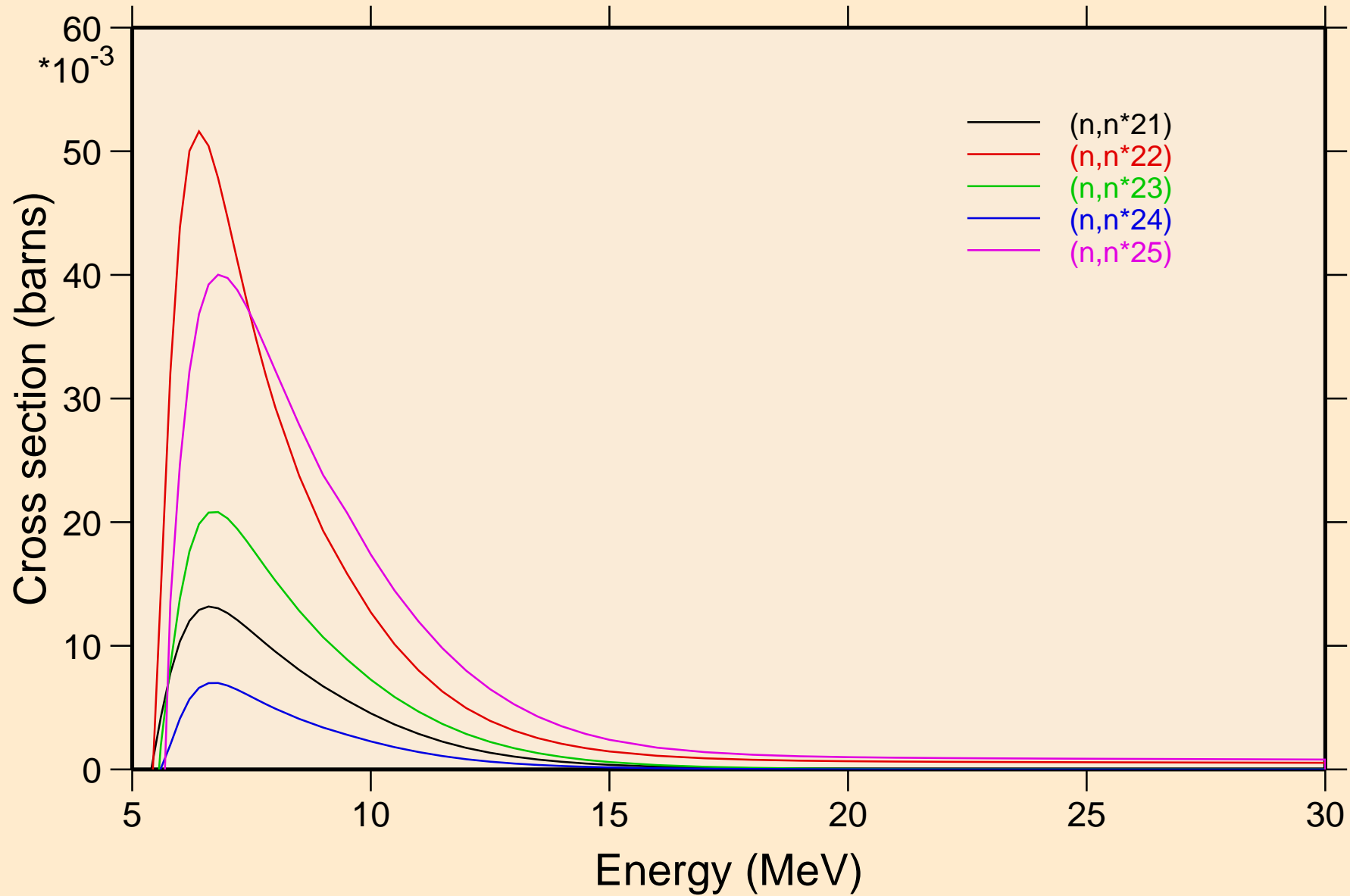

NA025 NEUTRON ACER TENDL-2024 LIBRARY; T=293.6K  
Inelastic levels

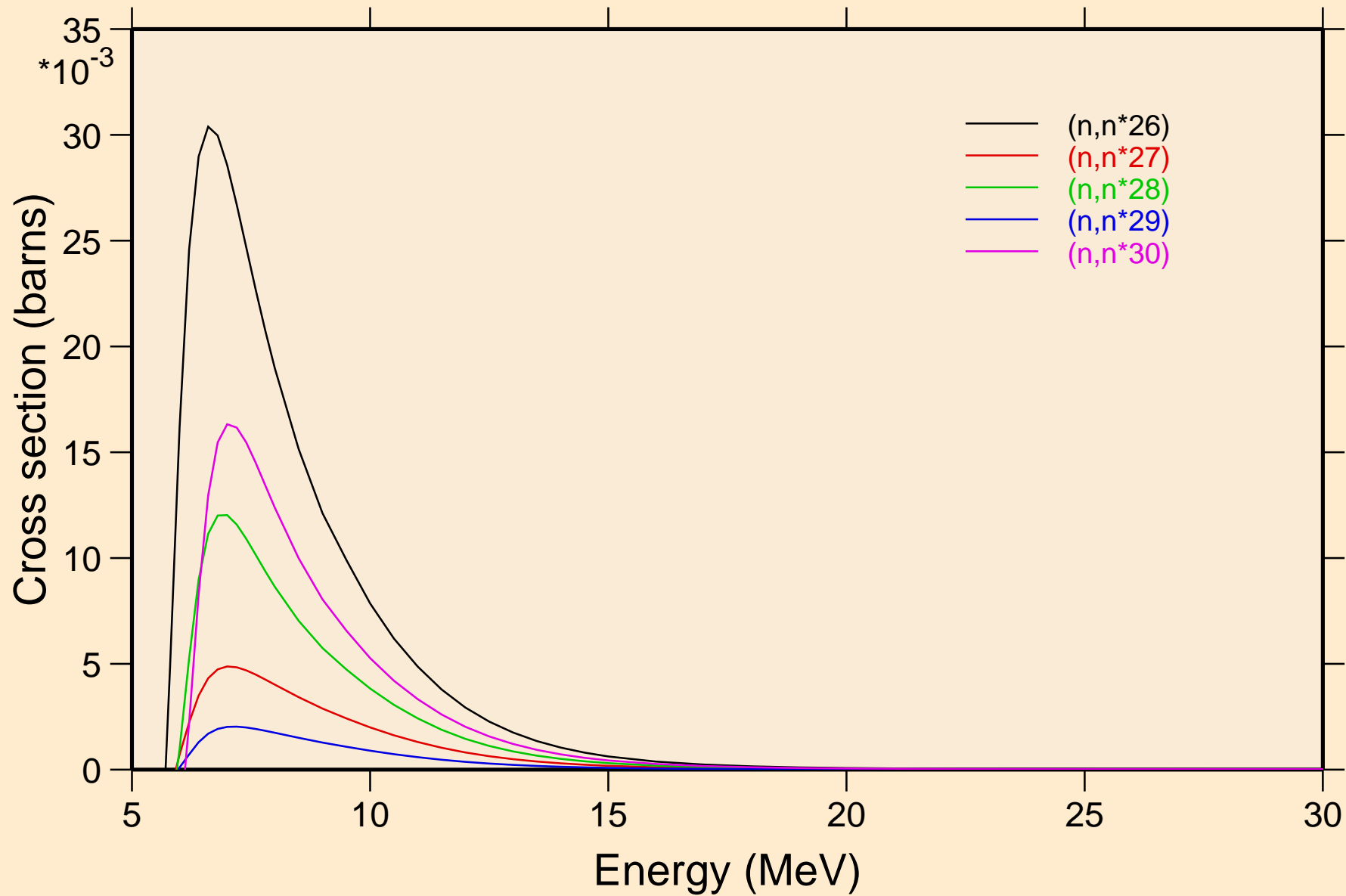

NA025 NEUTRON ACER TENDL-2024 LIBRARY; T=293.6K  
Threshold reactions

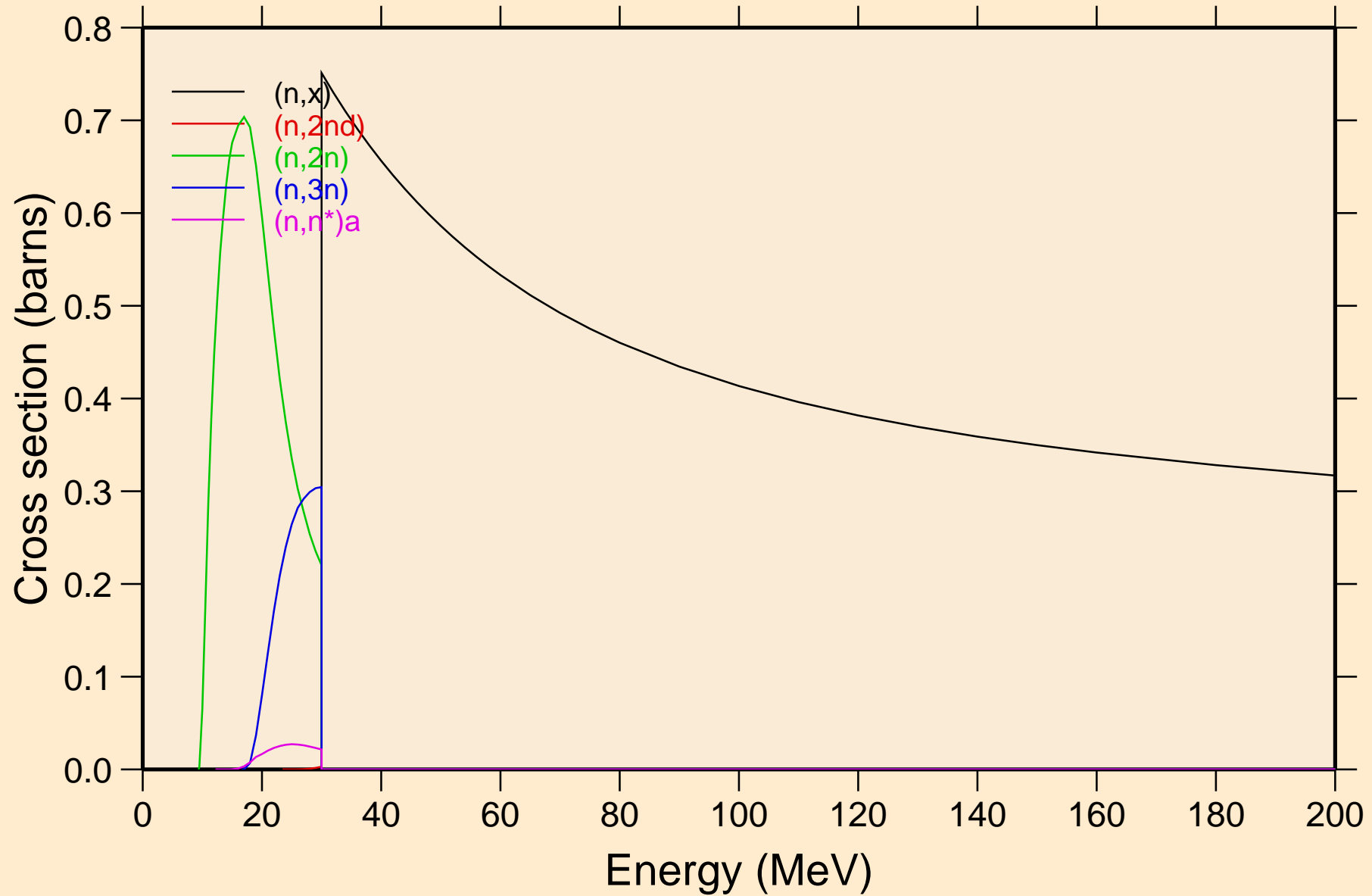

# NA025 NEUTRON ACER TENDL-2024 LIBRARY; T=293.6K

## Threshold reactions

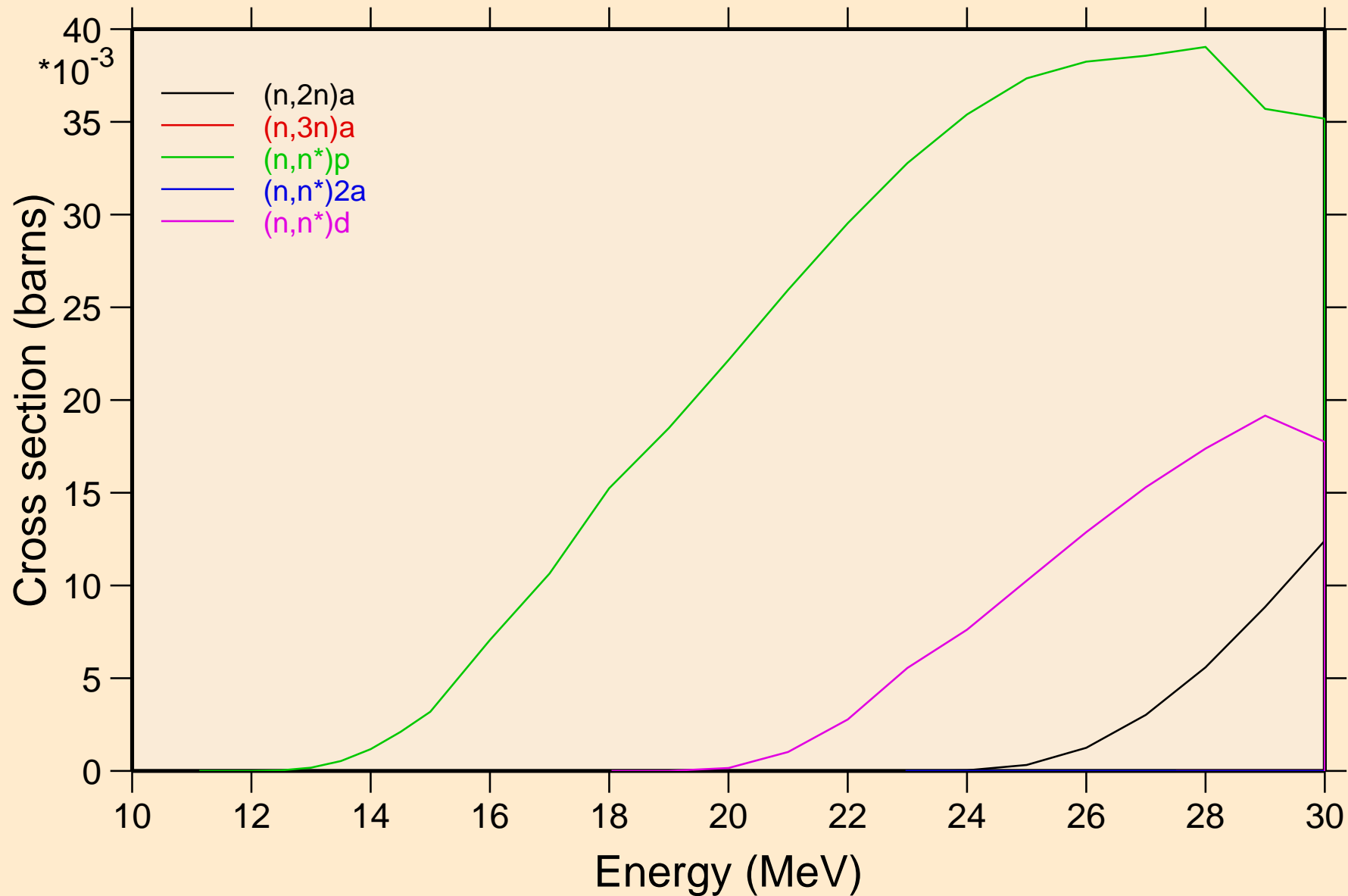

NA025 NEUTRON ACER TENDL-2024 LIBRARY; T=293.6K  
Threshold reactions

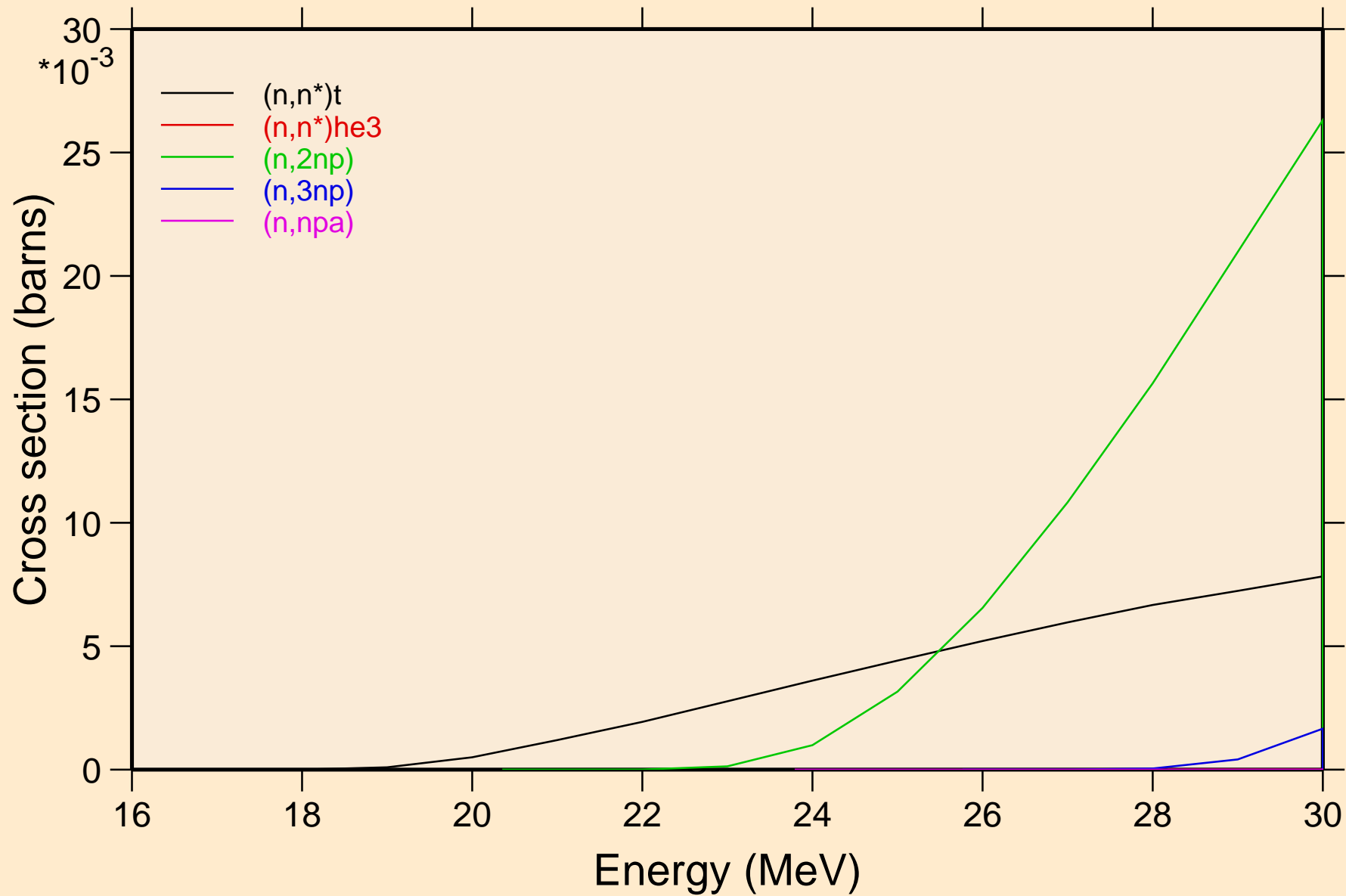

NA025 NEUTRON ACER TENDL-2024 LIBRARY; T=293.6K  
Threshold reactions

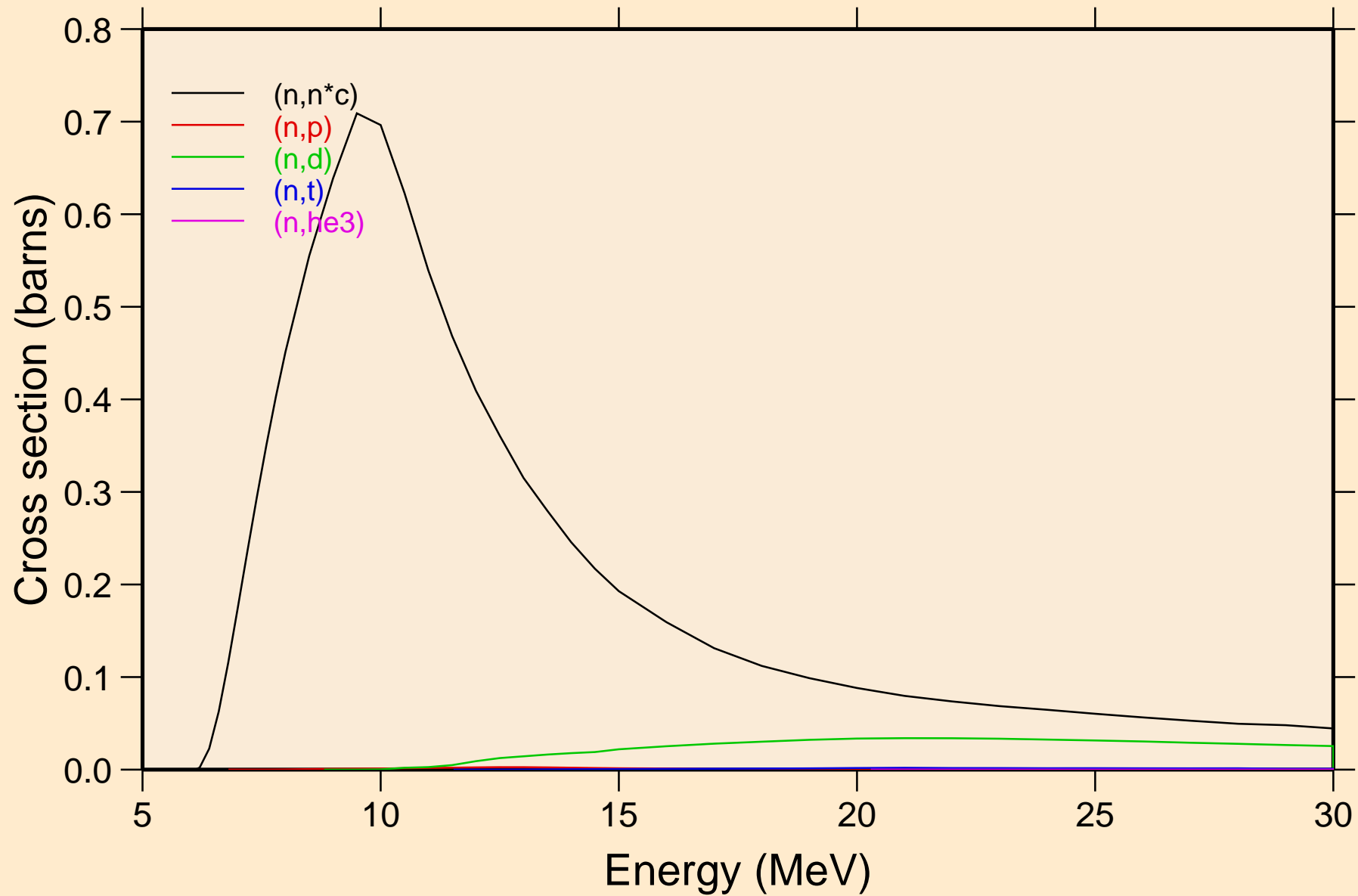

NA025 NEUTRON ACER TENDL-2024 LIBRARY; T=293.6K  
Threshold reactions

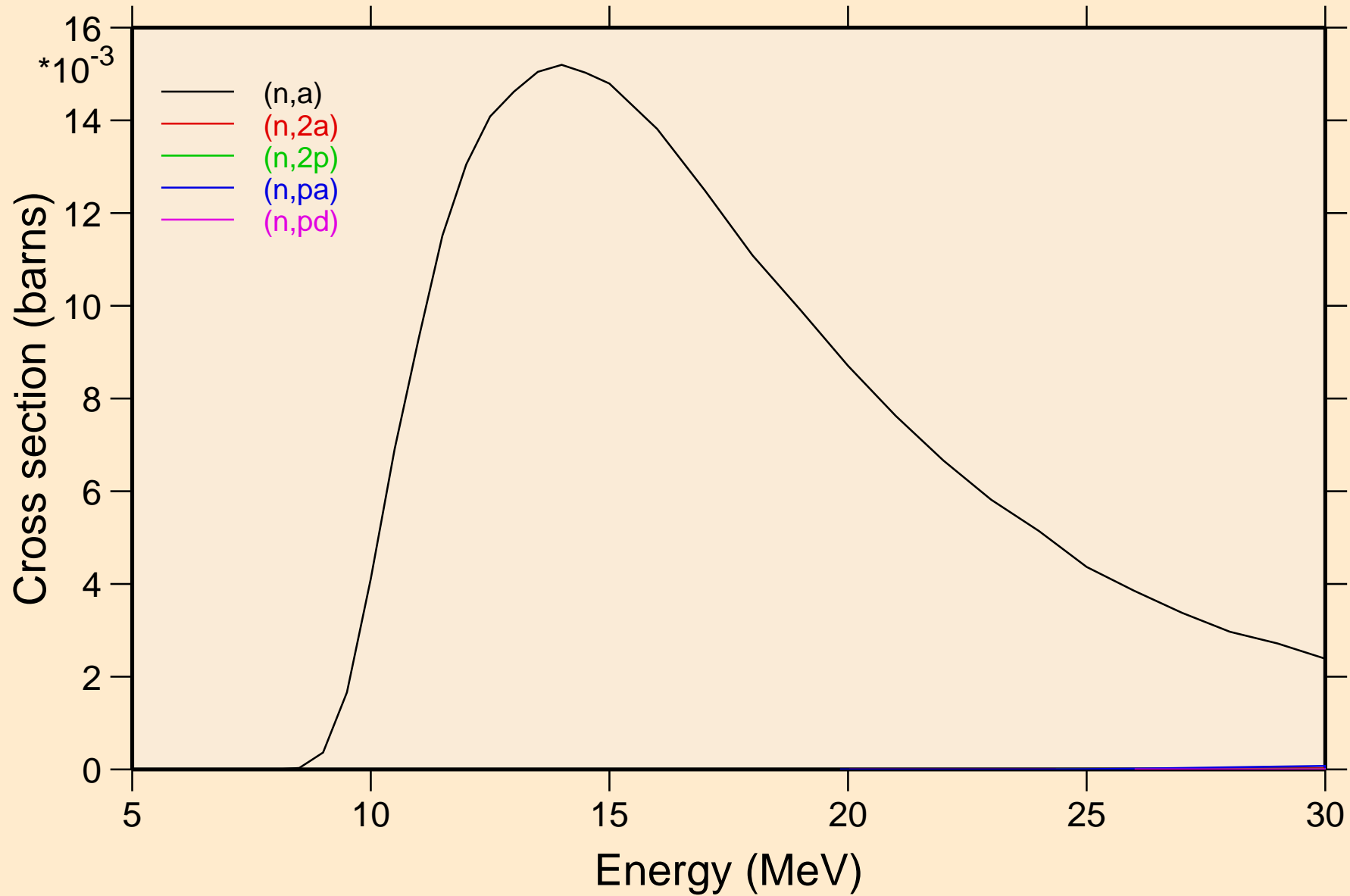

# NA025 NEUTRON ACER TENDL-2024 LIBRARY; T=293.6K

## Threshold reactions

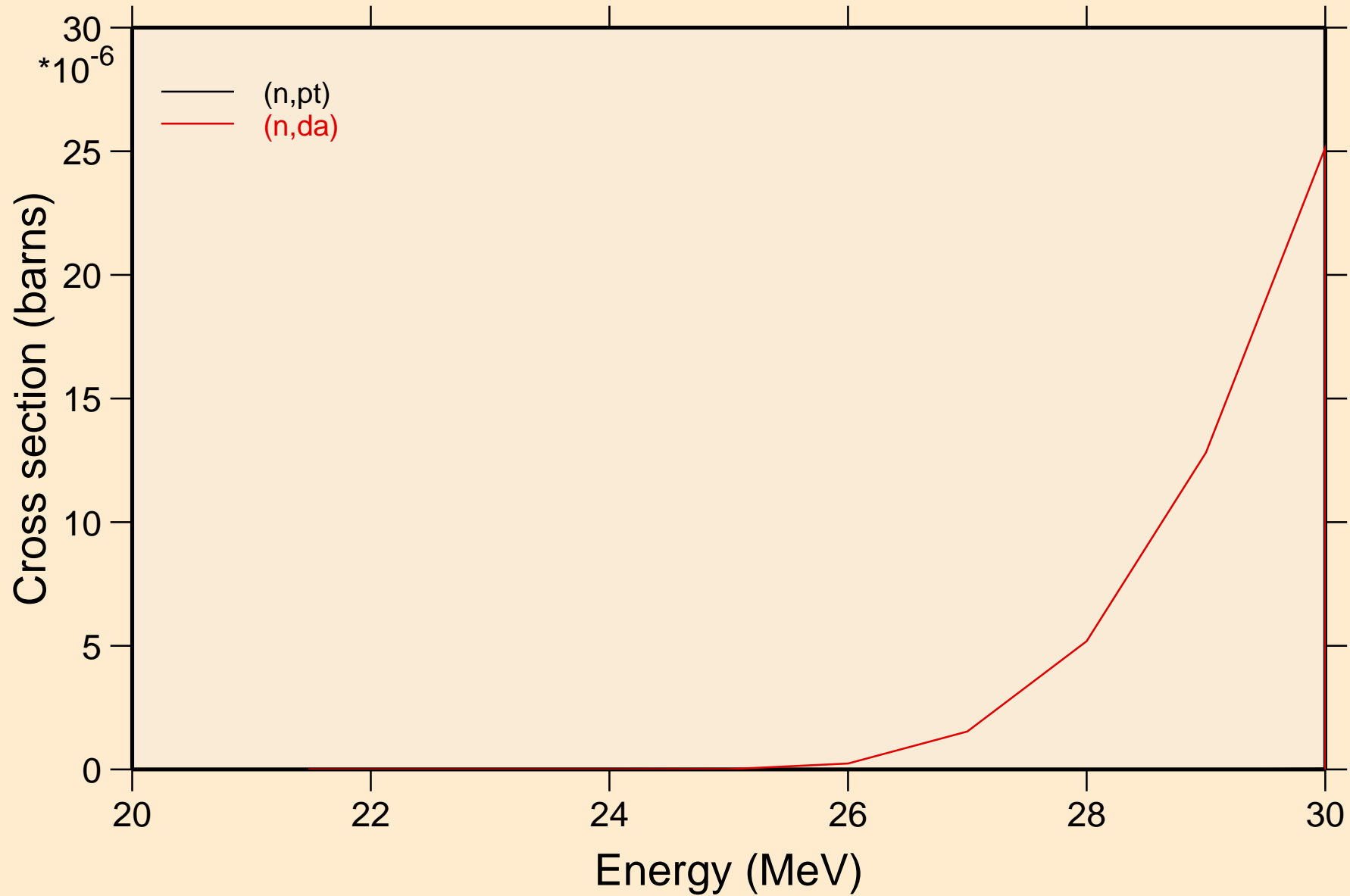

# NA025 NEUTRON ACER TENDL-2024 LIBRARY; T=293.6K

## Threshold reactions

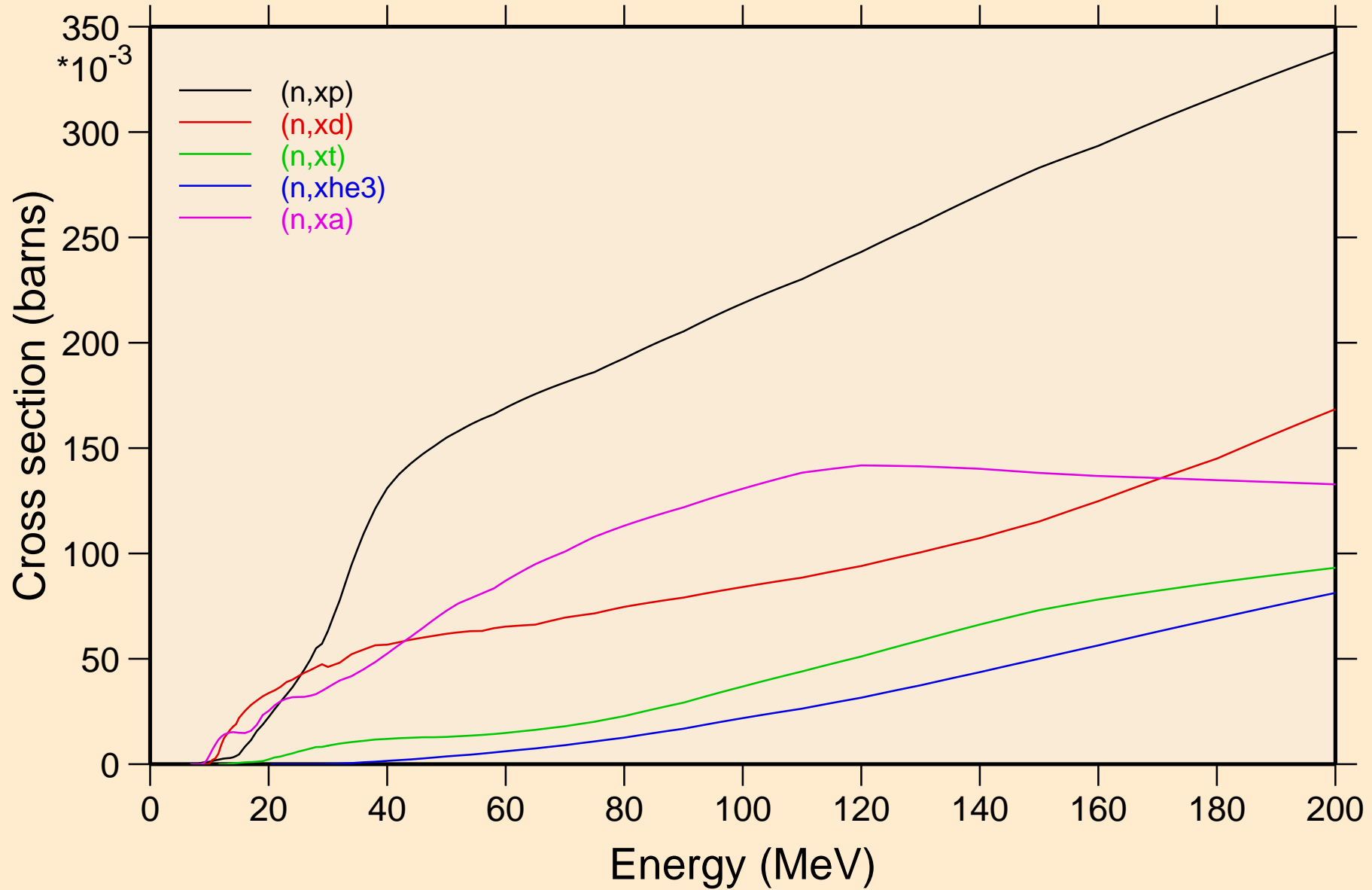

NA025 NEUTRON ACER TENDL-2024 LIBRARY; T=293.6K  
angular distribution for elastic

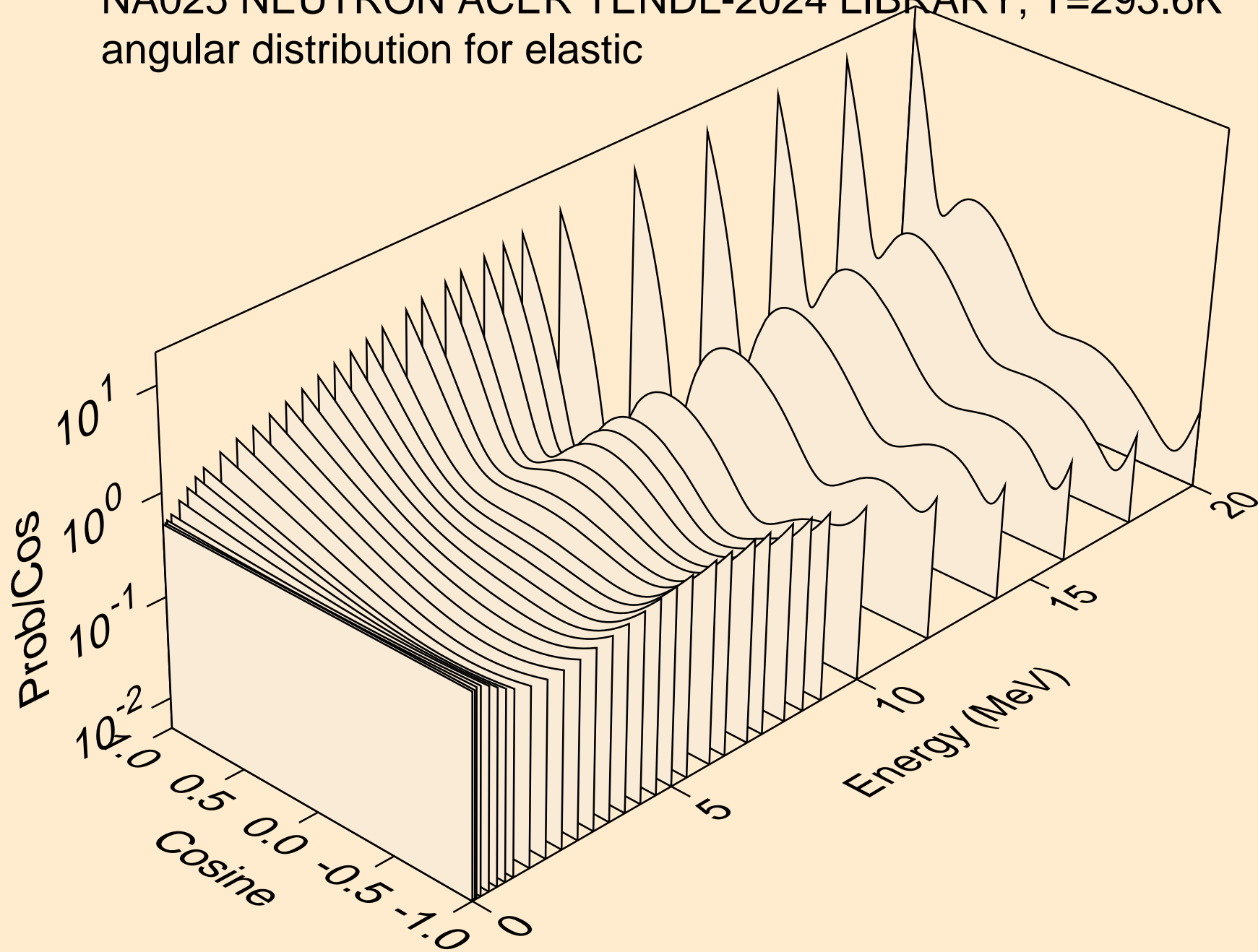

NA025 NEUTRON ACER TENDL-2024 LIBRARY; T=293.6K  
angular distribution for elastic

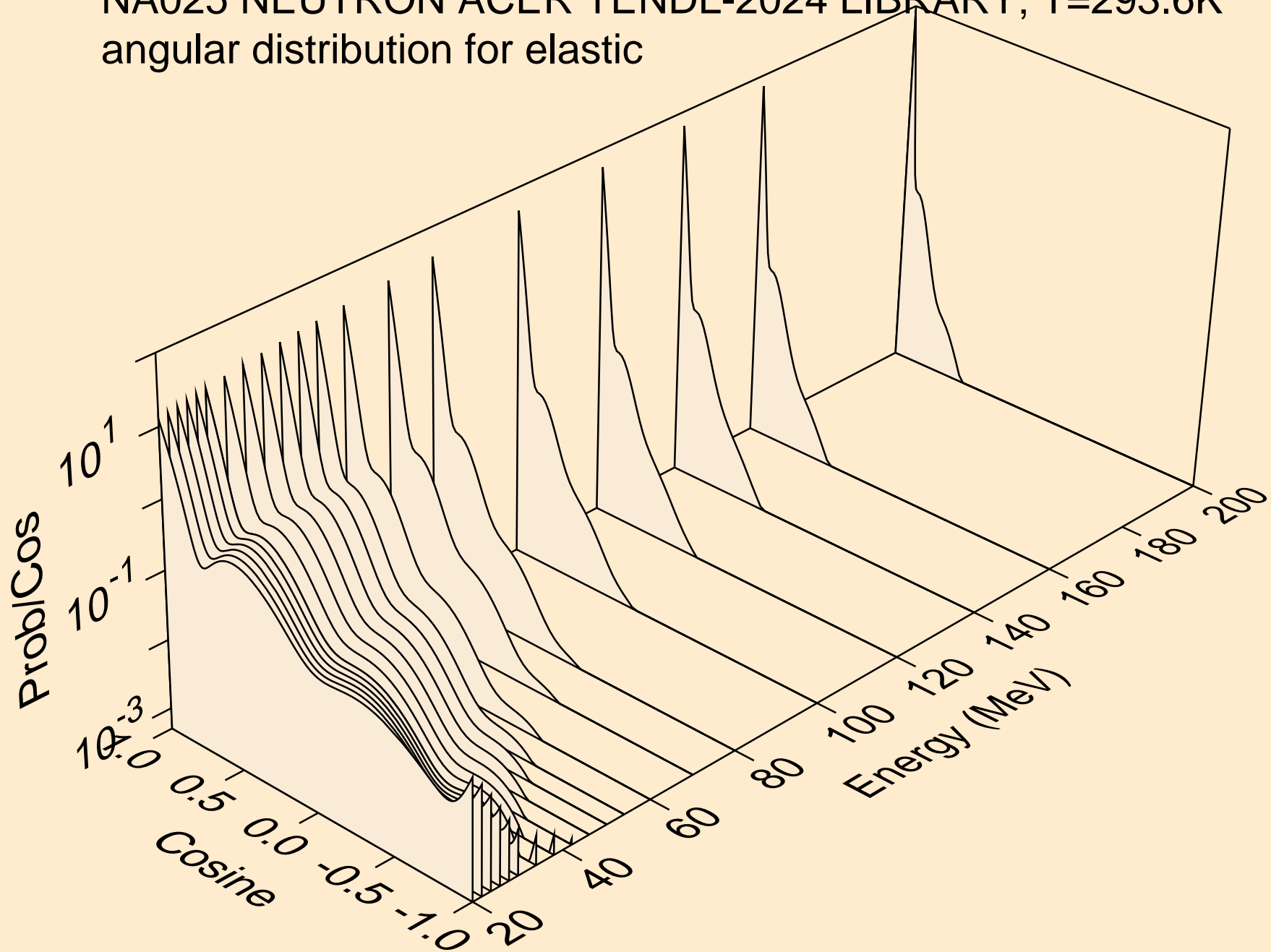

NA025 NEUTRON ACER TENDL-2024 LIBRARY; T=293.6K  
angular distribution for (n,n\*1)

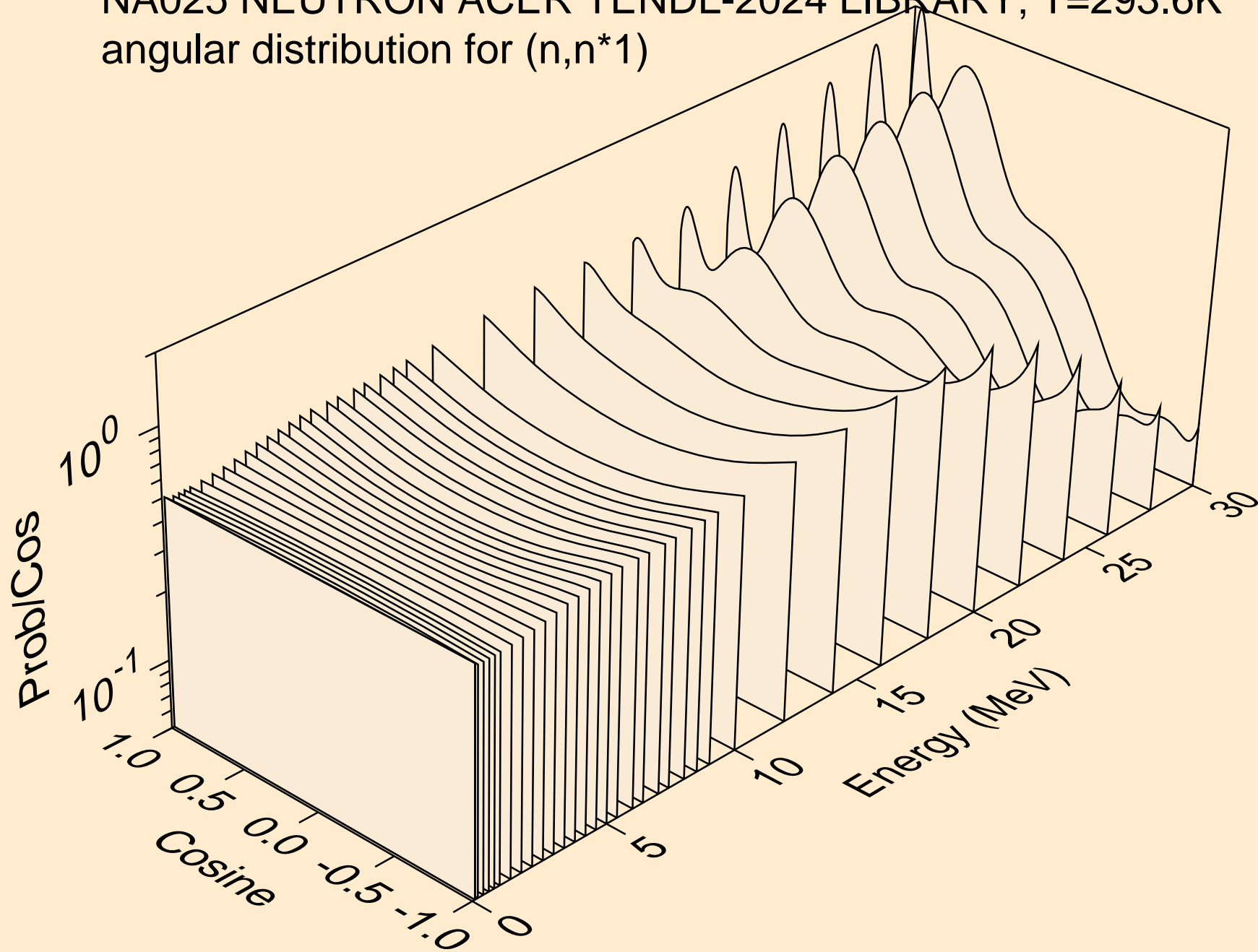

NA025 NEUTRON ACER TENDL-2024 LIBRARY; T=293.6K  
angular distribution for (n,n\*2)

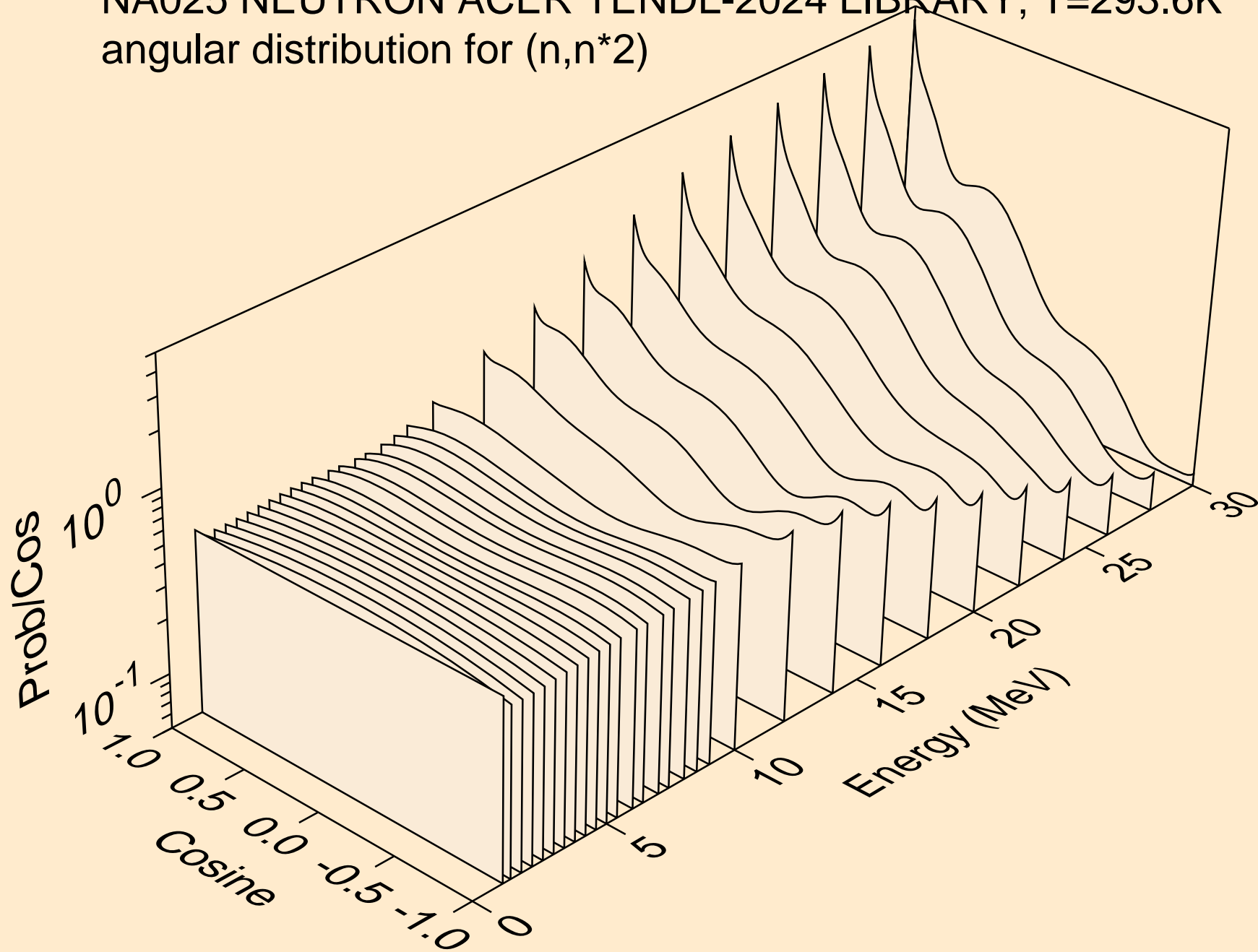

NA025 NEUTRON ACER TENDL-2024 LIBRARY; T=293.6K  
angular distribution for (n,n\*3)

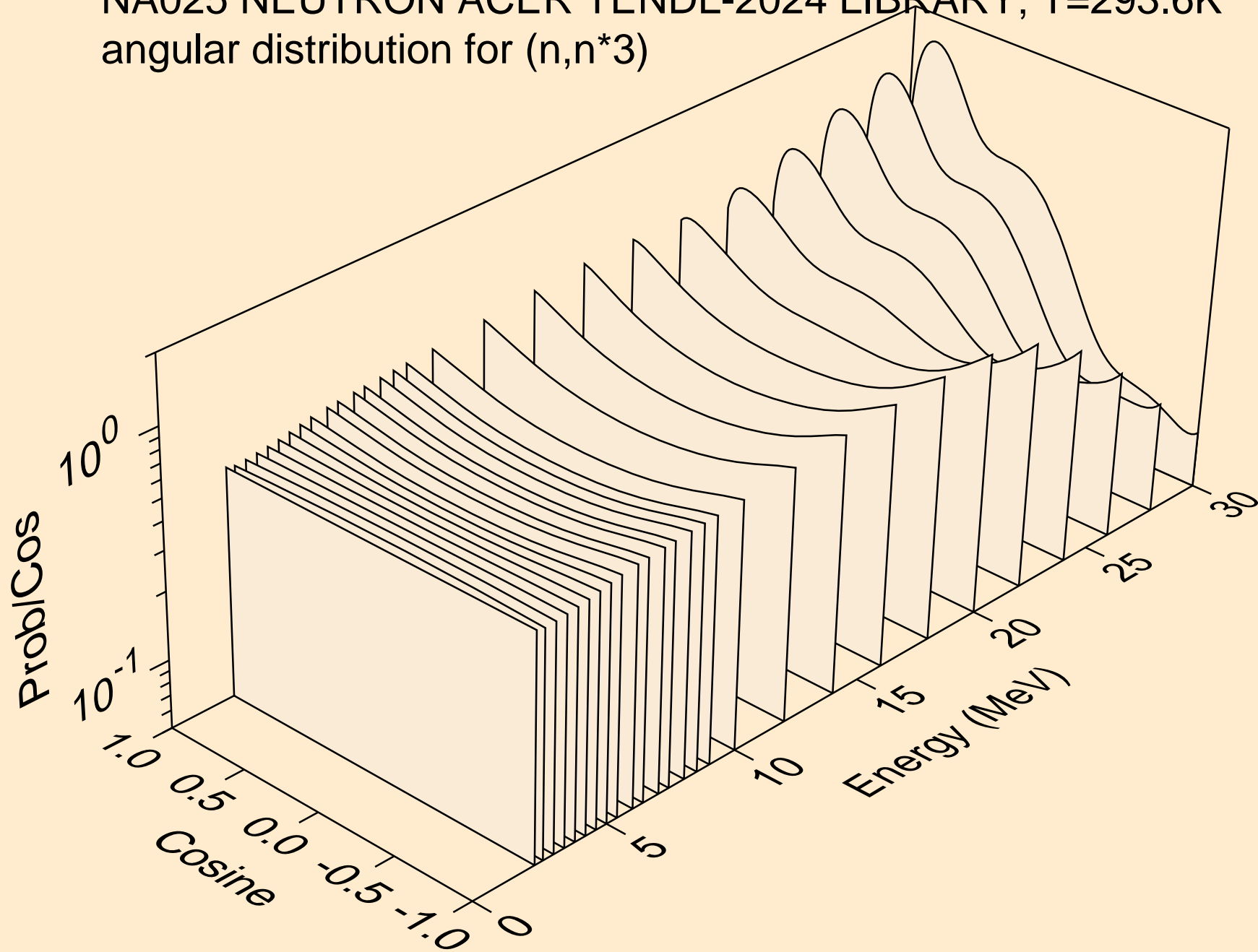

NA025 NEUTRON ACER TENDL-2024 LIBRARY; T=293.6K  
angular distribution for (n,n\*4)

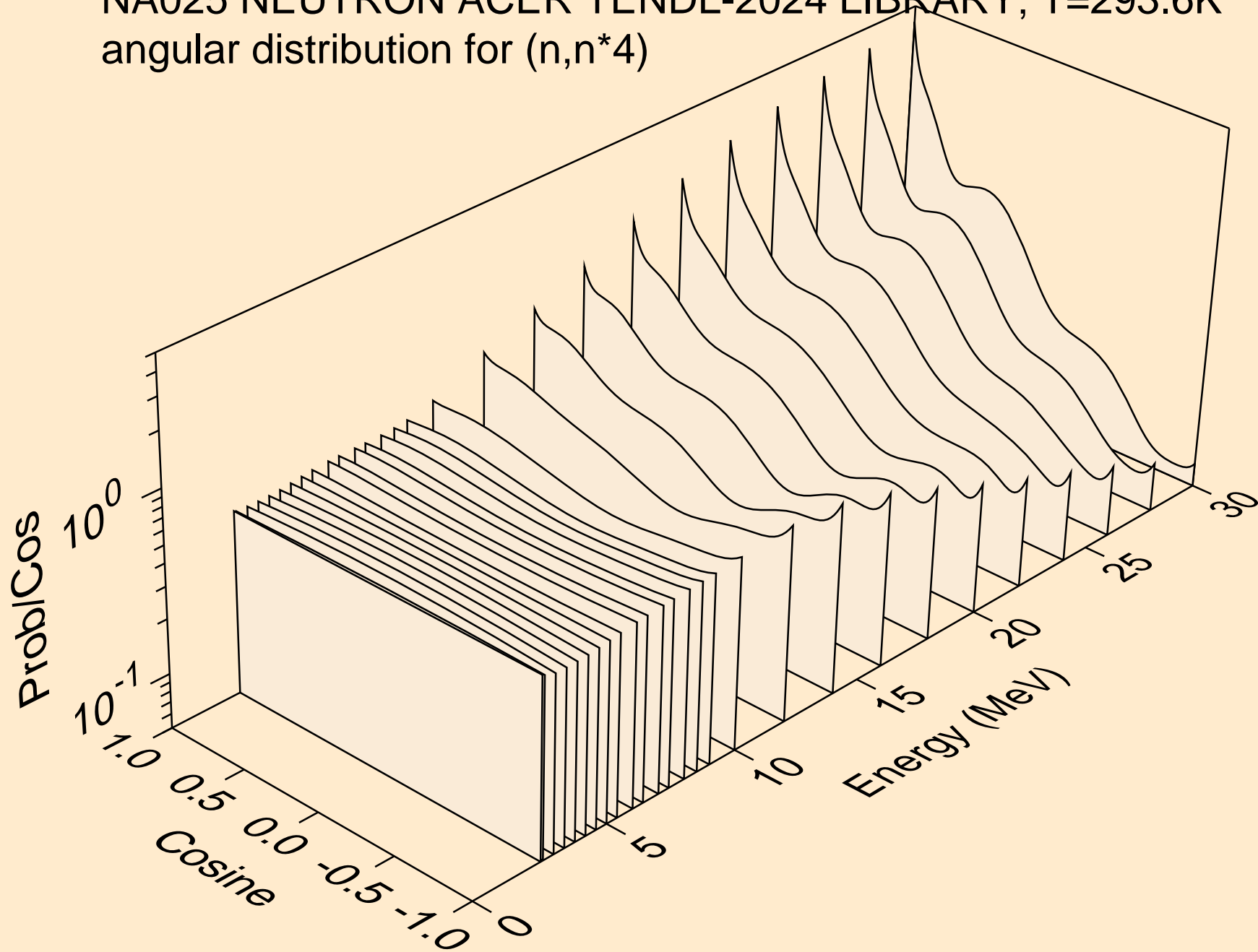

NA025 NEUTRON ACER TENDL-2024 LIBRARY; T=293.6K  
angular distribution for (n,n\*5)

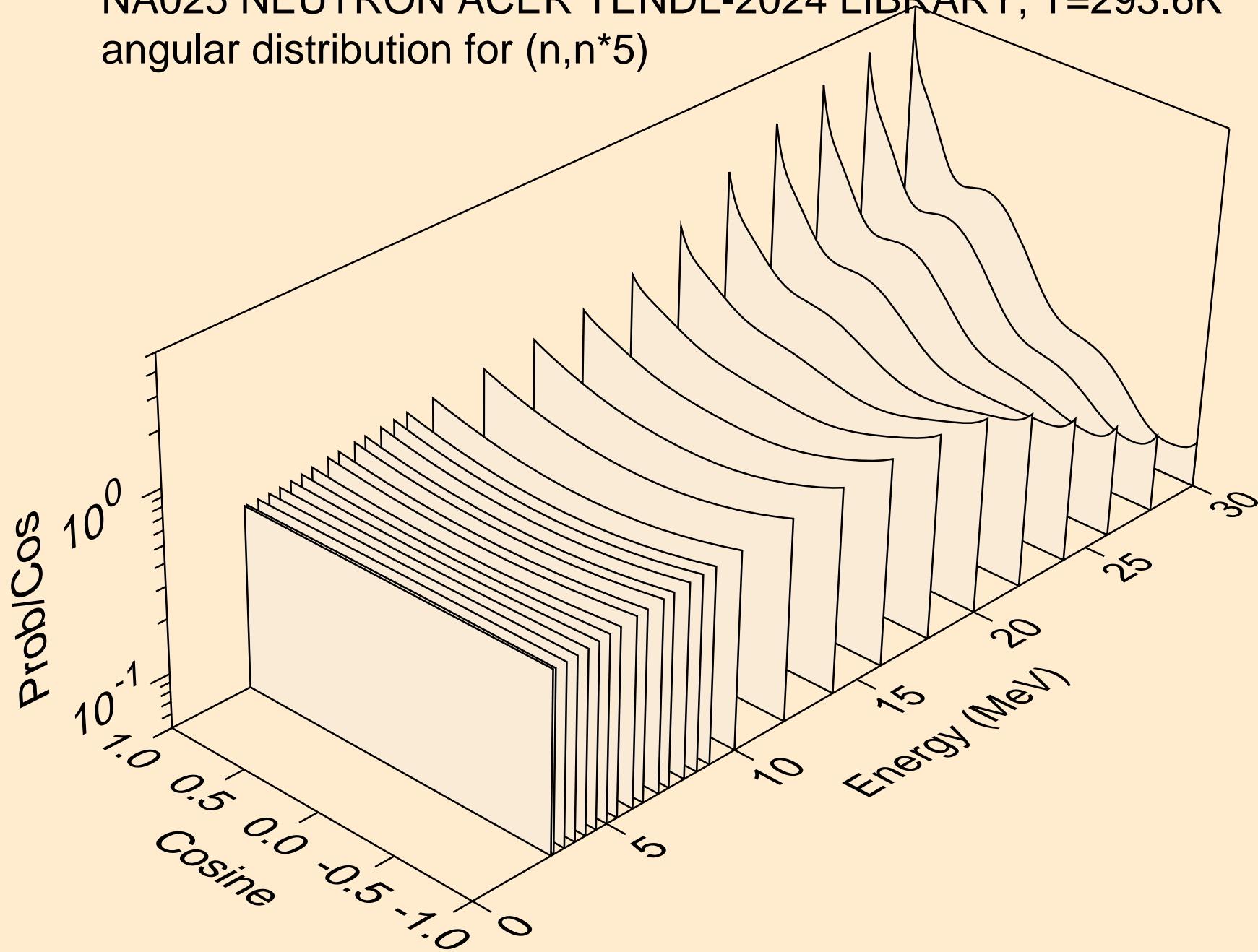

NA025 NEUTRON ACER TENDL-2024 LIBRARY; T=293.6K  
angular distribution for (n,n\*6)

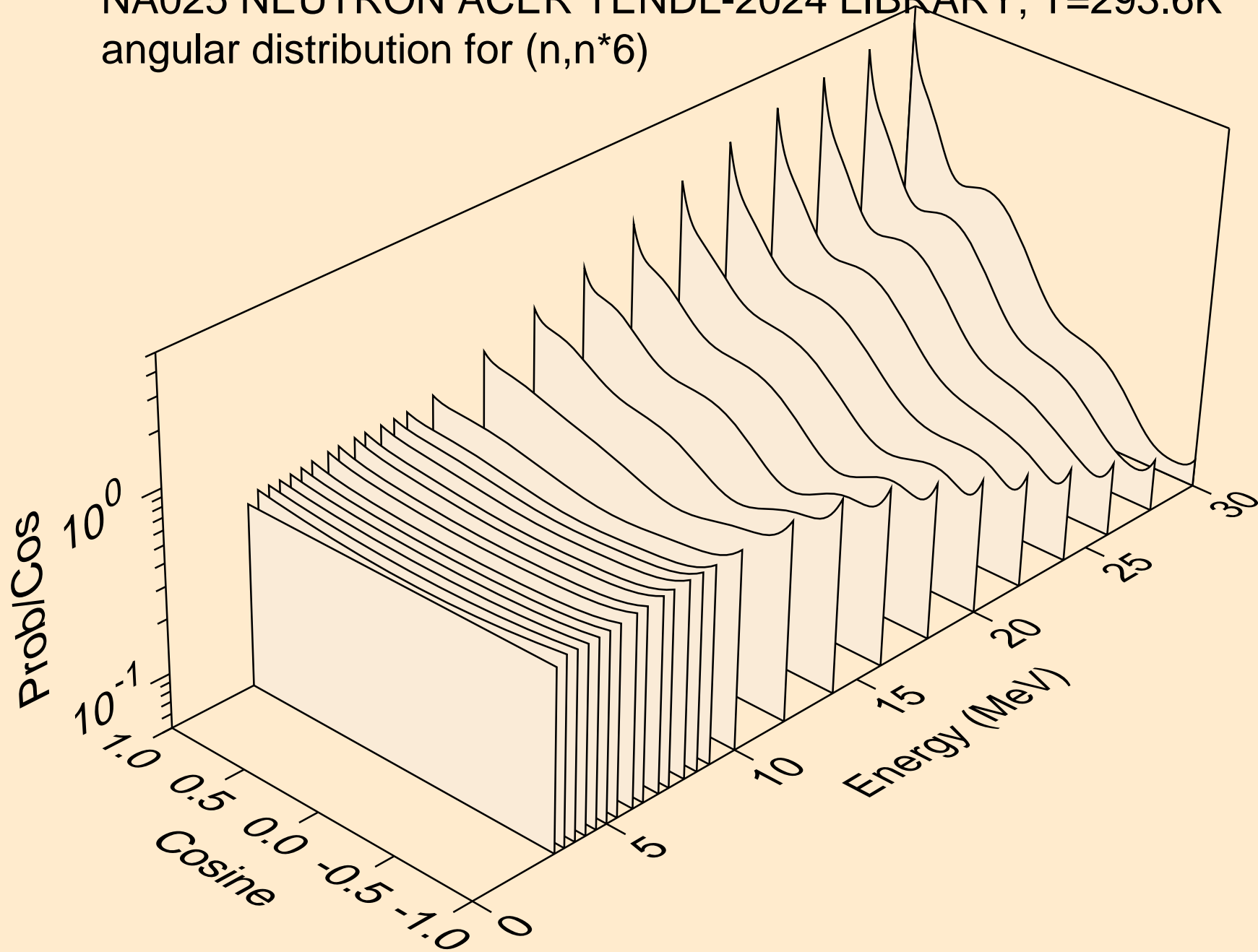

NA025 NEUTRON ACER TENDL-2024 LIBRARY; T=293.6K  
angular distribution for (n,n\*7)

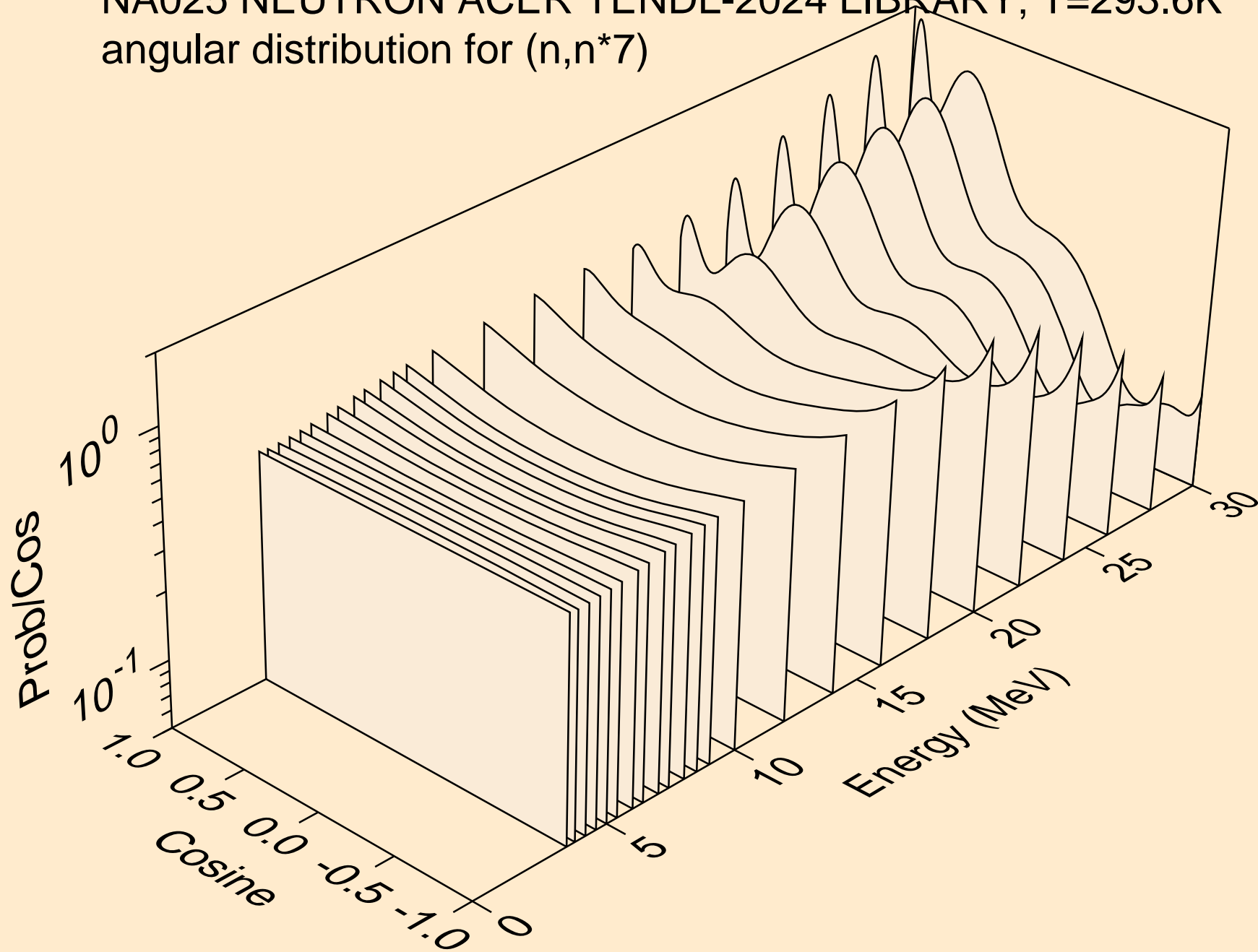

NA025 NEUTRON ACER TENDL-2024 LIBRARY; T=293.6K  
angular distribution for (n,n\*8)

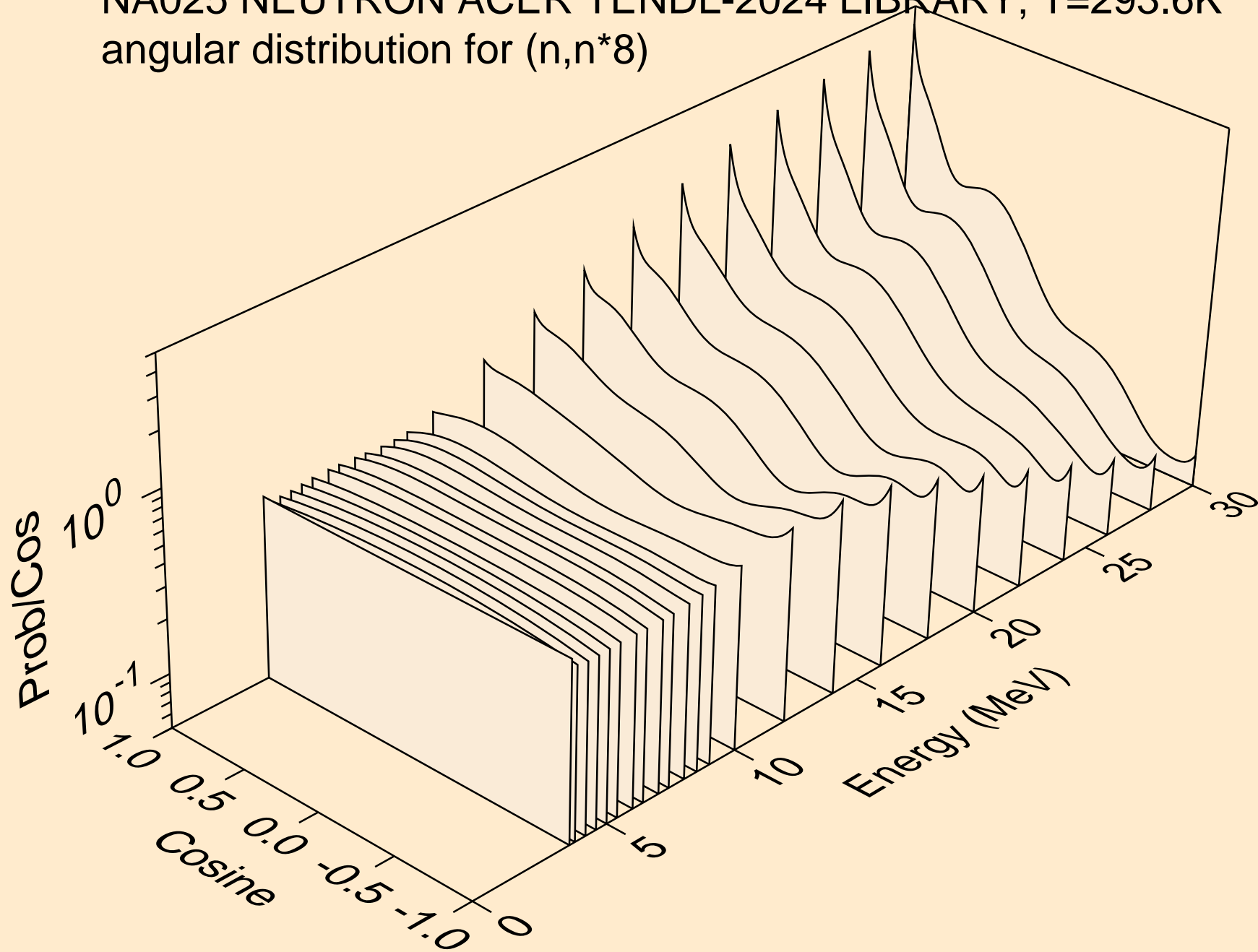

NA025 NEUTRON ACER TENDL-2024 LIBRARY; T=293.6K  
angular distribution for (n,n\*9)

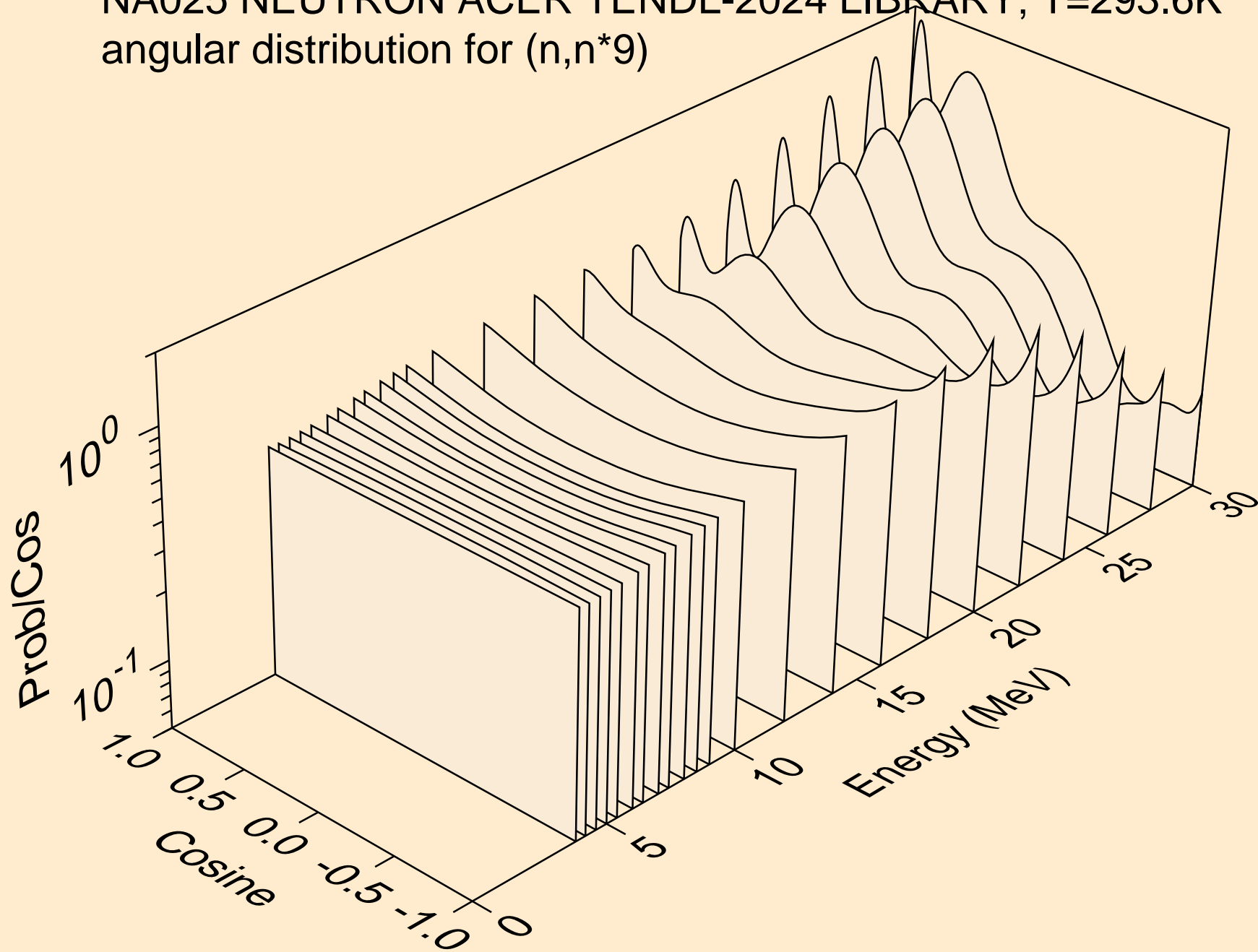

NA025 NEUTRON ACER TENDL-2024 LIBRARY; T=293.6K  
angular distribution for (n,n\*10)

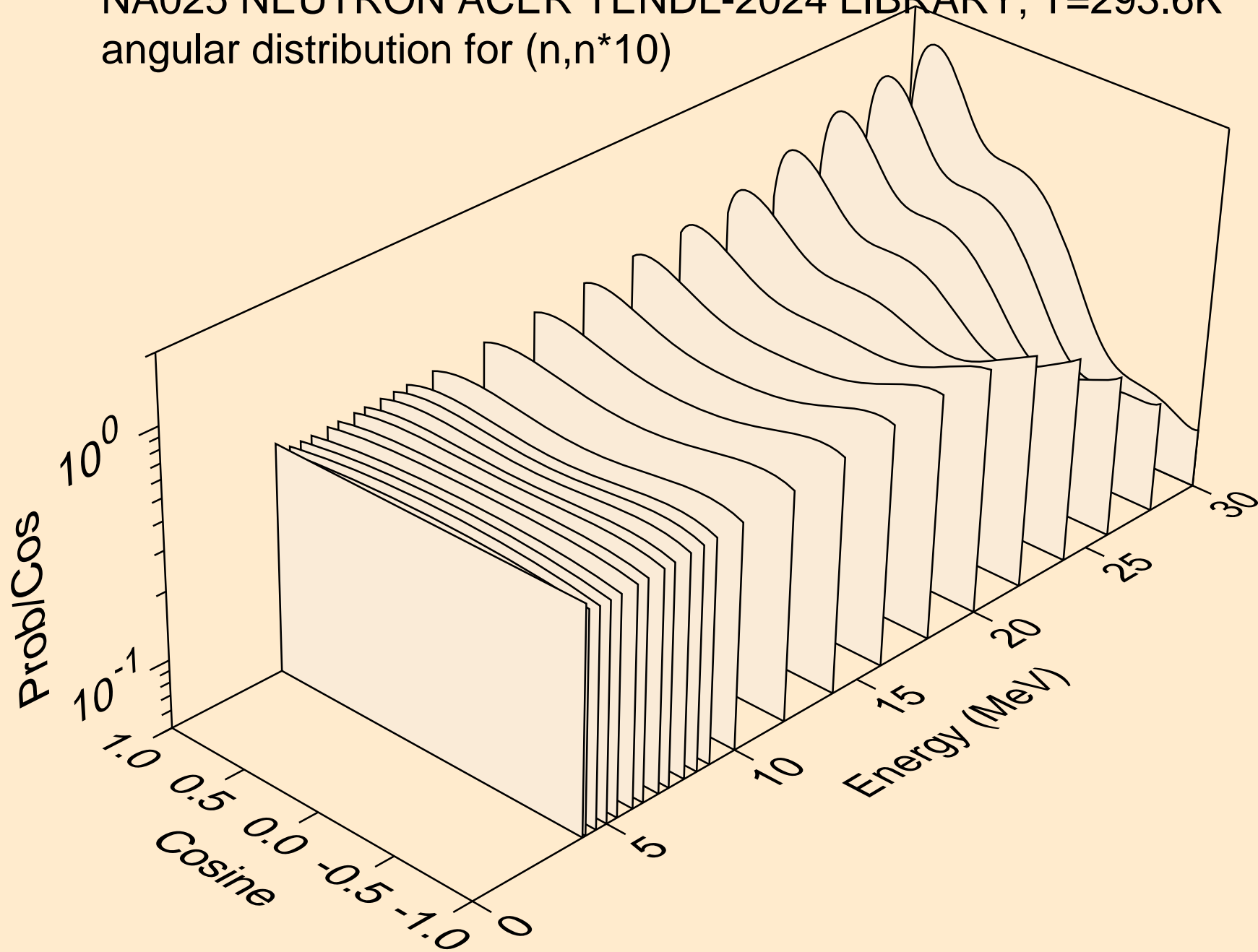

NA025 NEUTRON ACER TENDL-2024 LIBRARY; T=293.6K  
angular distribution for (n,n\*11)

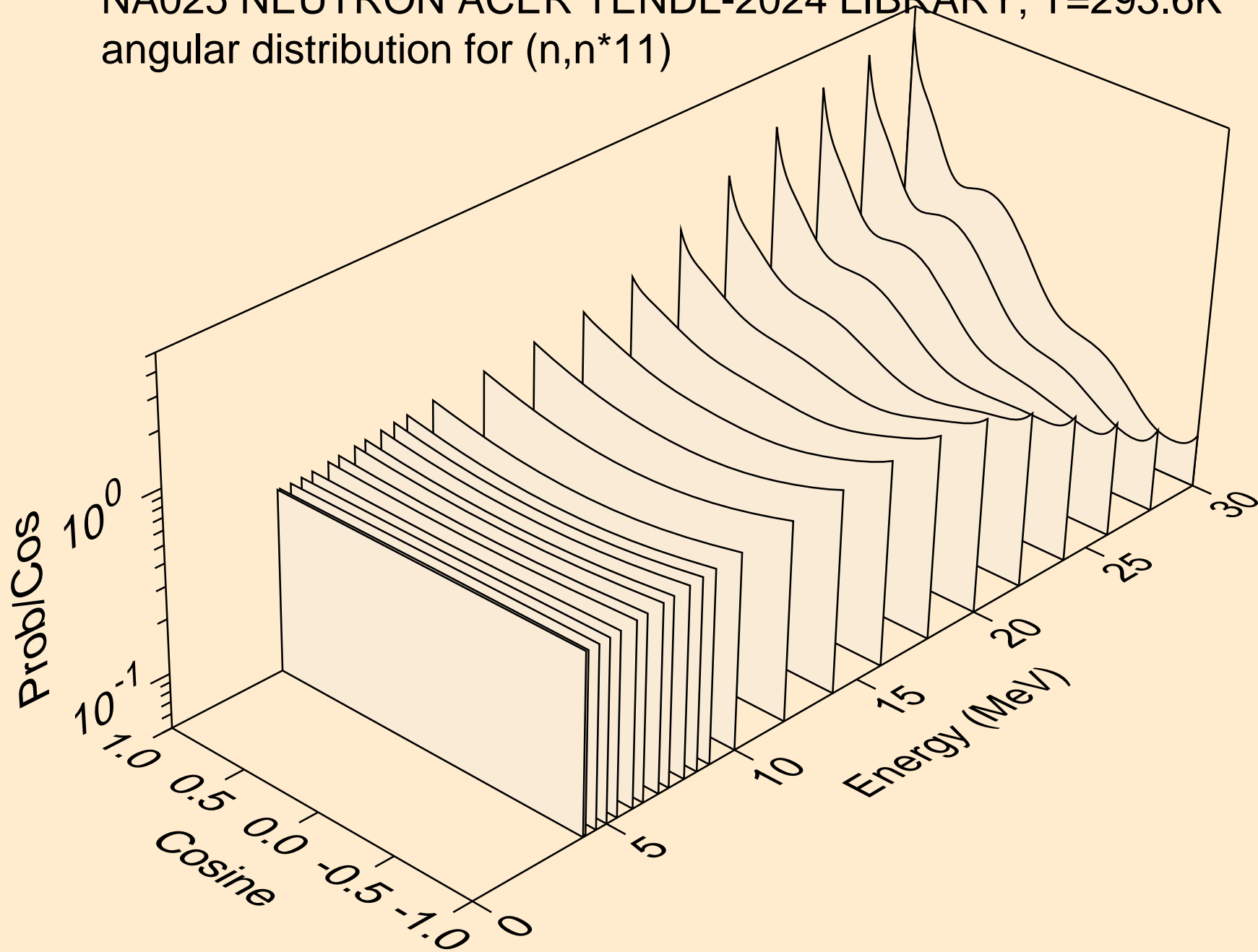

NA025 NEUTRON ACER TENDL-2024 LIBRARY; T=293.6K  
angular distribution for (n,n\*12)

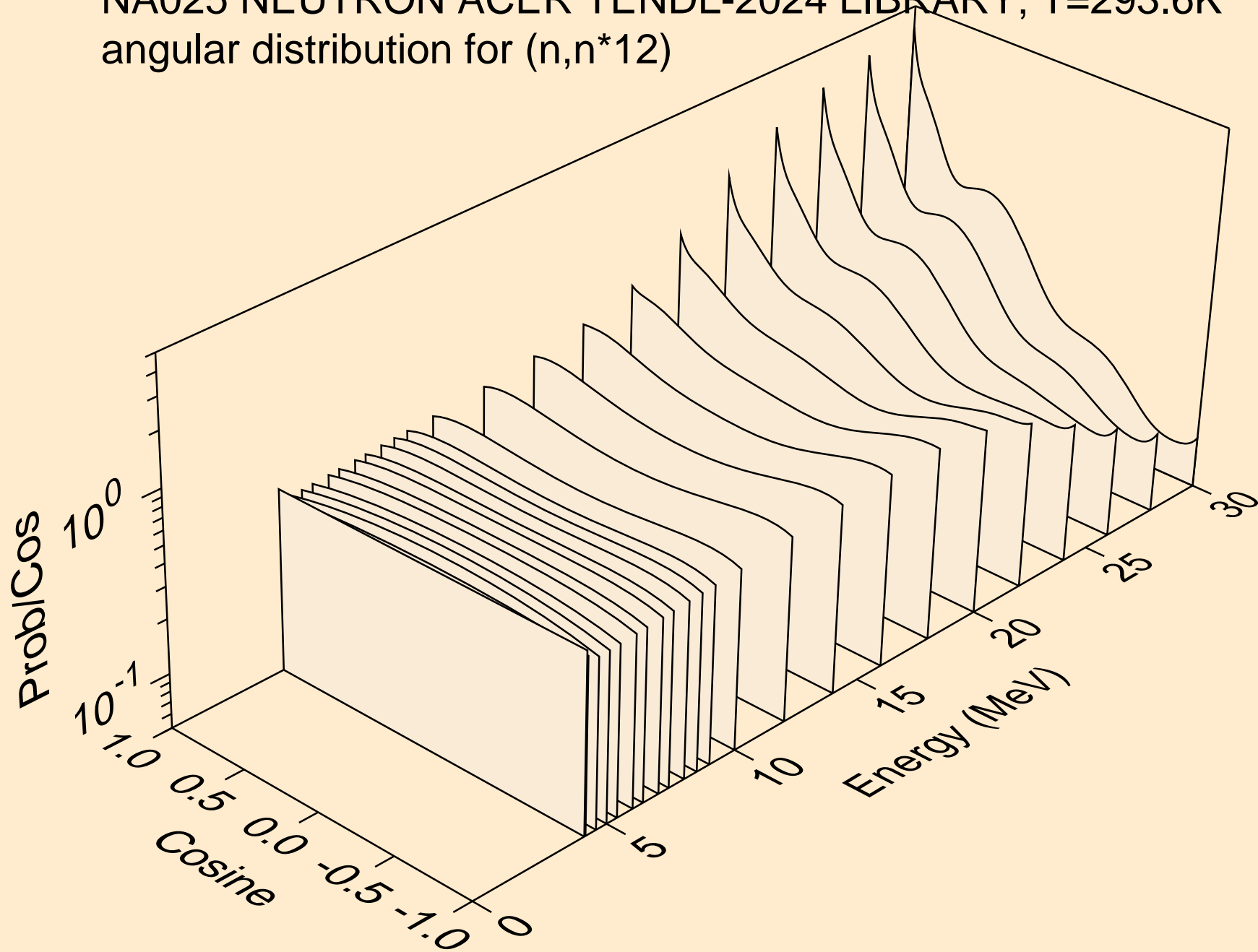

NA025 NEUTRON ACER TENDL-2024 LIBRARY; T=293.6K  
angular distribution for (n,n\*13)

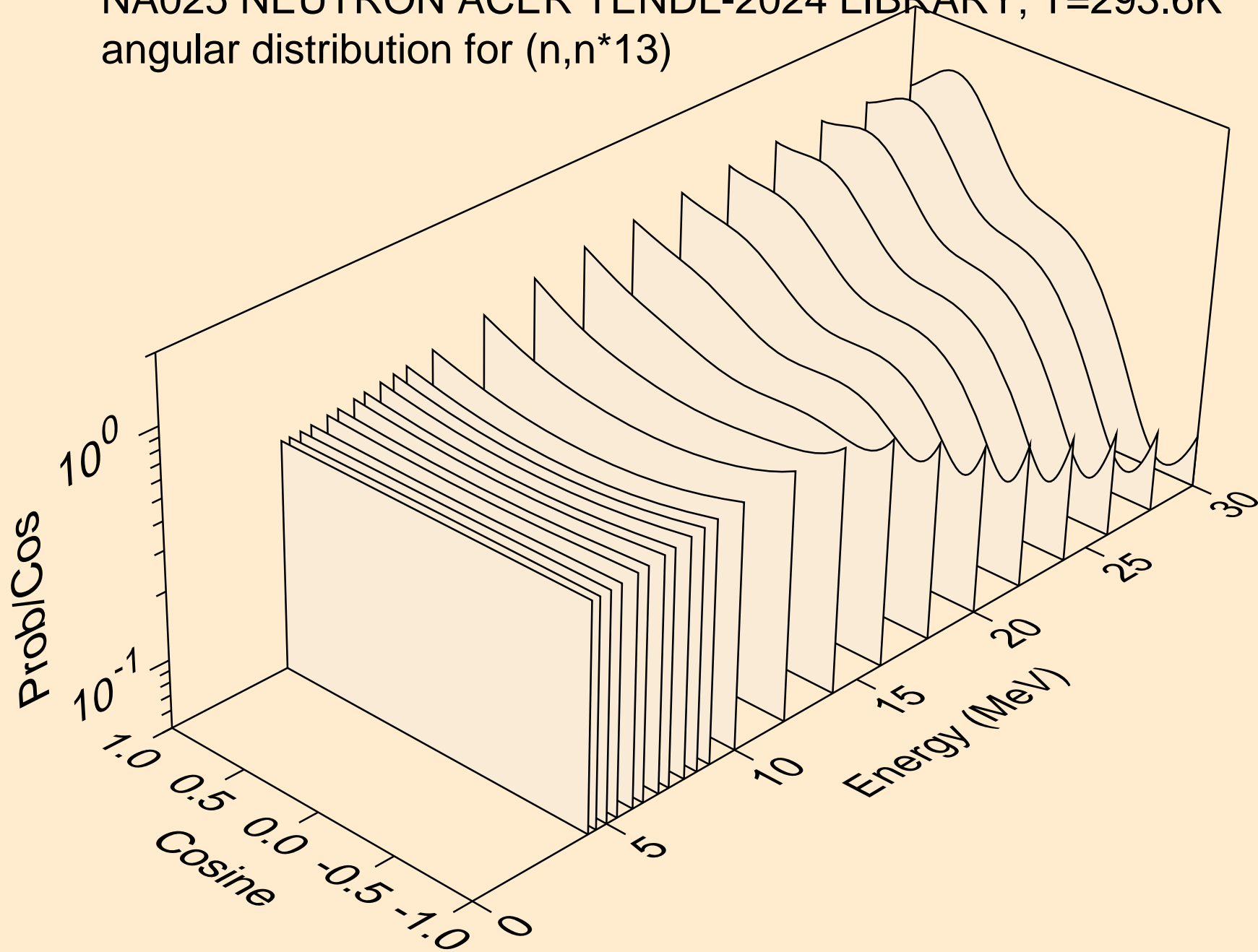

NA025 NEUTRON ACER TENDL-2024 LIBRARY; T=293.6K  
angular distribution for (n,n\*14)

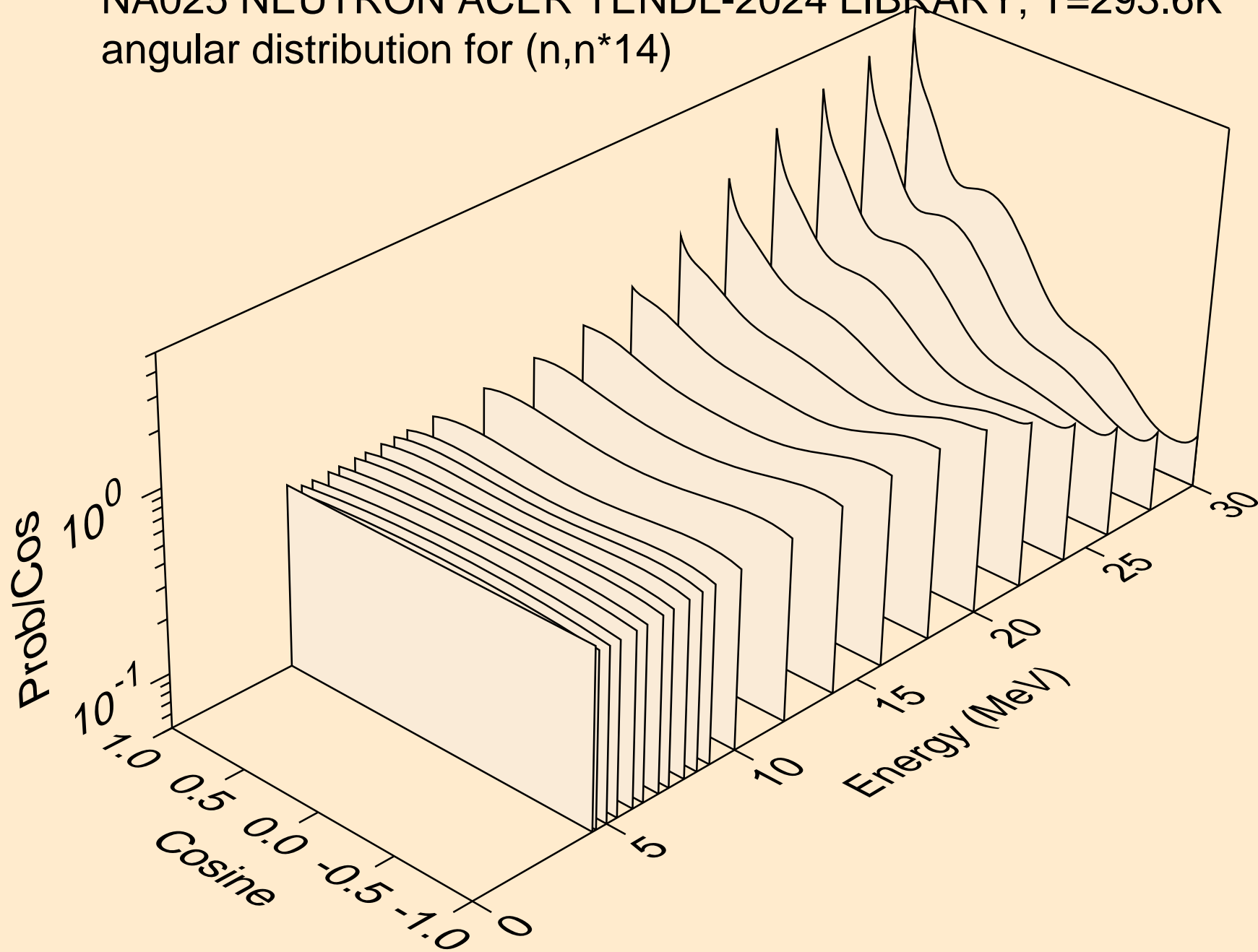

NA025 NEUTRON ACER TENDL-2024 LIBRARY; T=293.6K  
angular distribution for (n,n\*15)

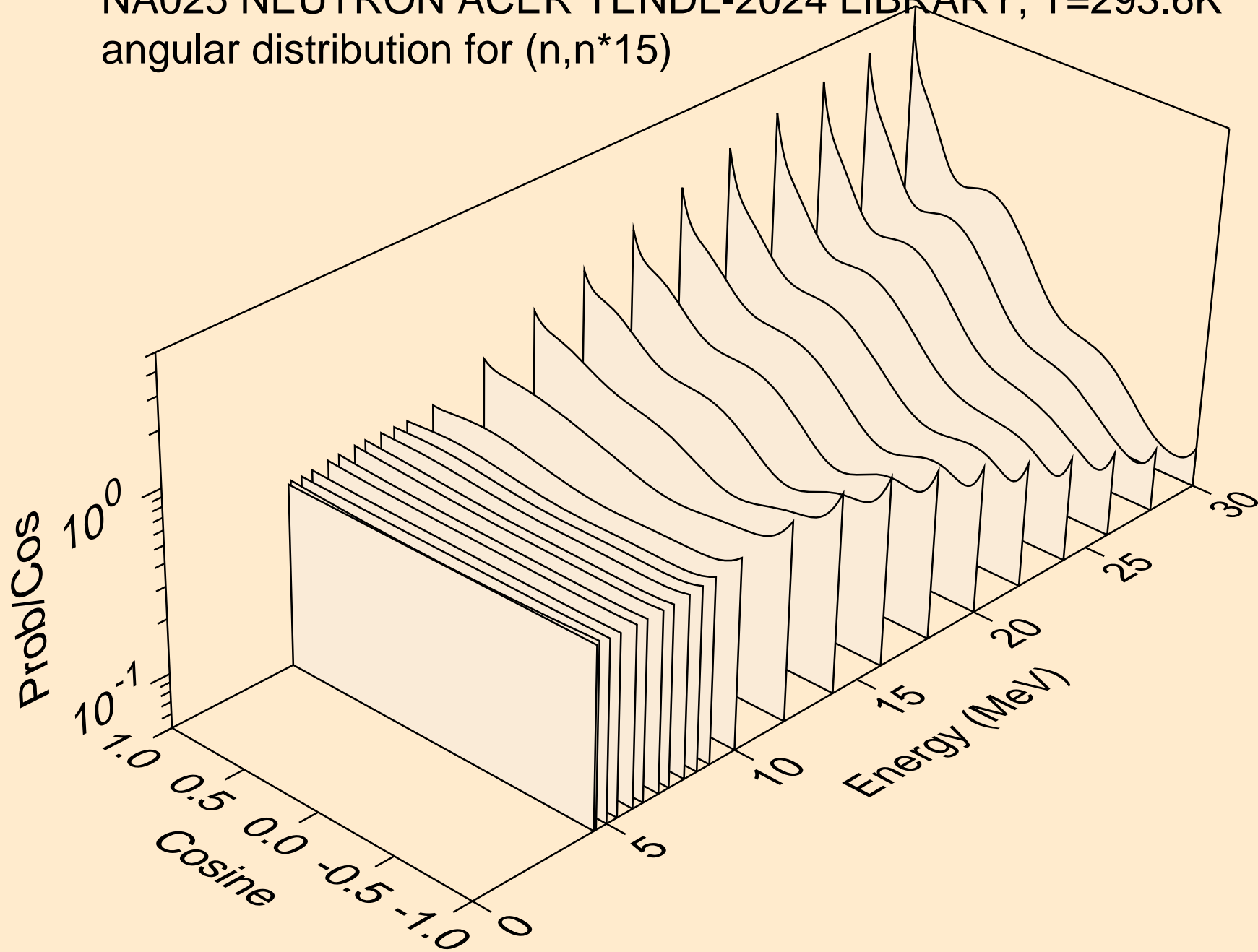

NA025 NEUTRON ACER TENDL-2024 LIBRARY; T=293.6K  
angular distribution for (n,n\*16)

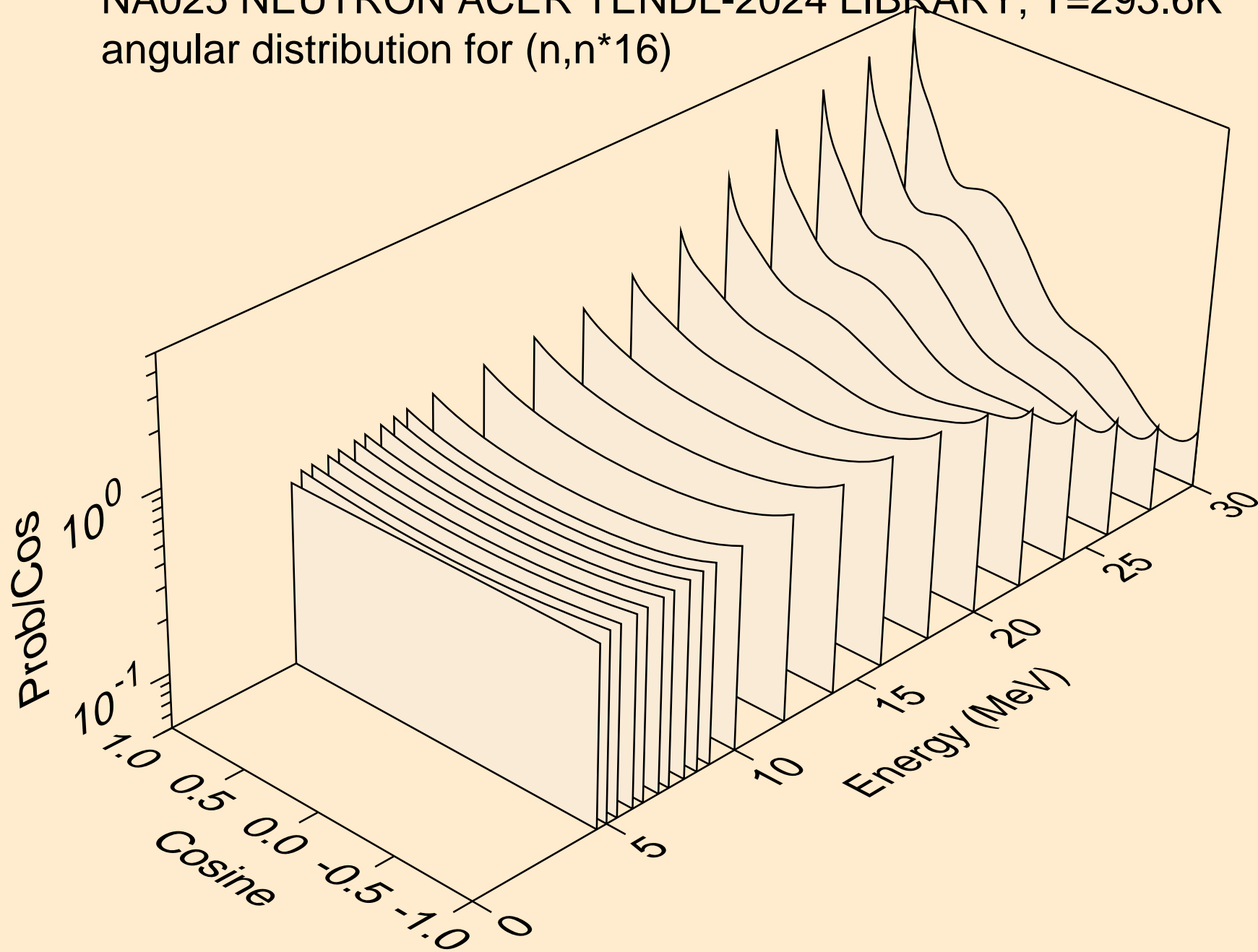

NA025 NEUTRON ACER TENDL-2024 LIBRARY; T=293.6K  
angular distribution for (n,n\*17)

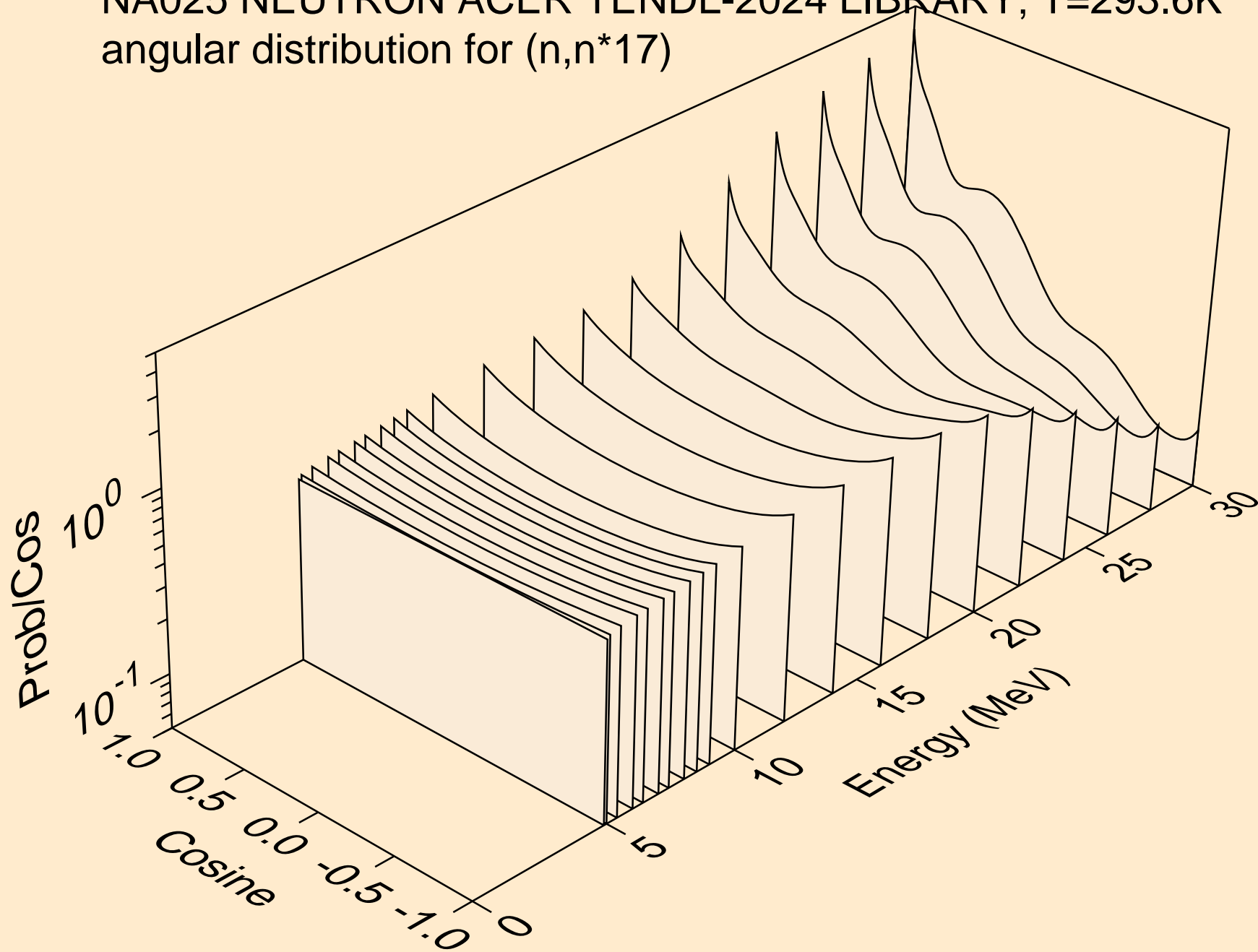

NA025 NEUTRON ACER TENDL-2024 LIBRARY; T=293.6K  
angular distribution for (n,n\*18)

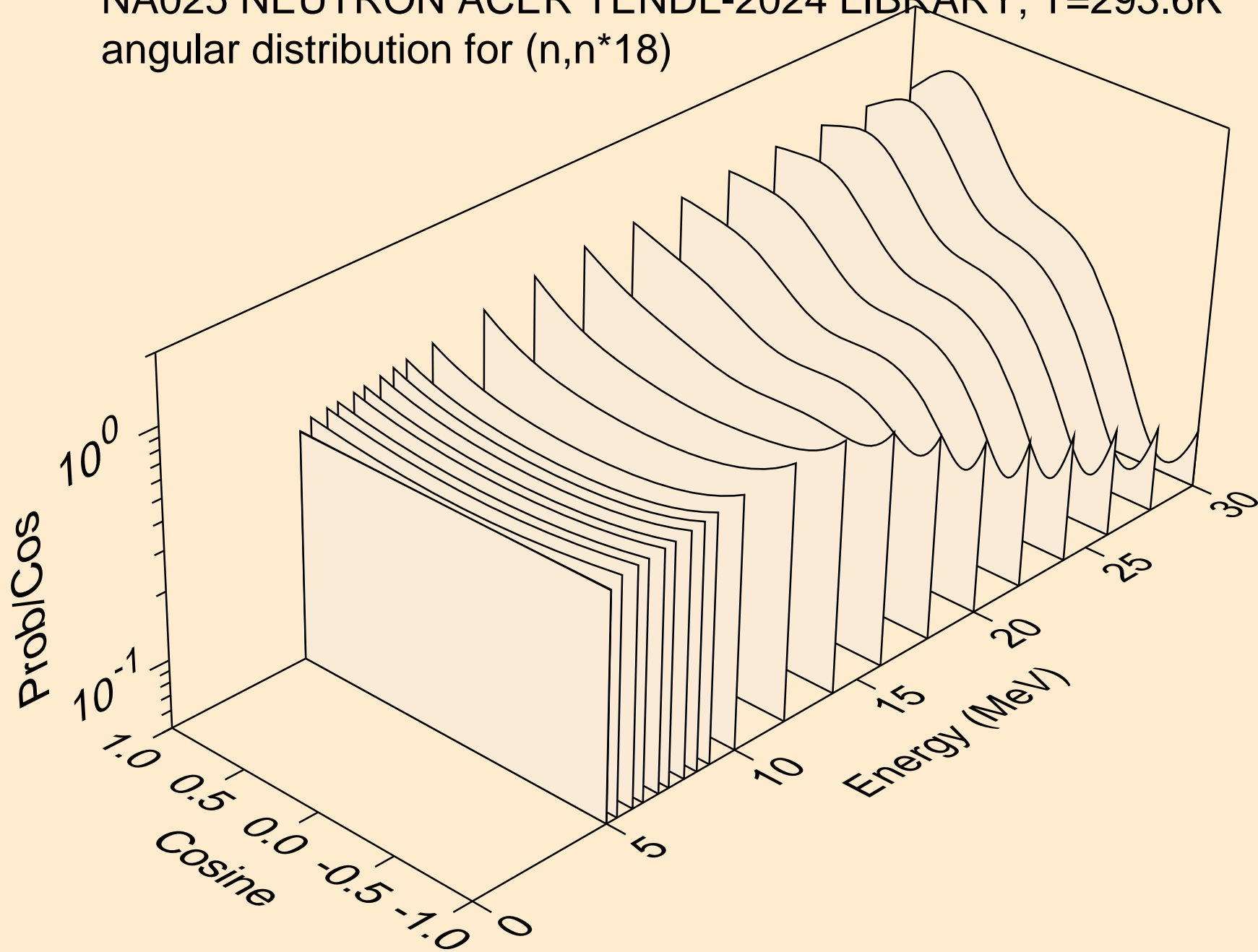

NA025 NEUTRON ACER TENDL-2024 LIBRARY; T=293.6K  
angular distribution for (n,n\*19)

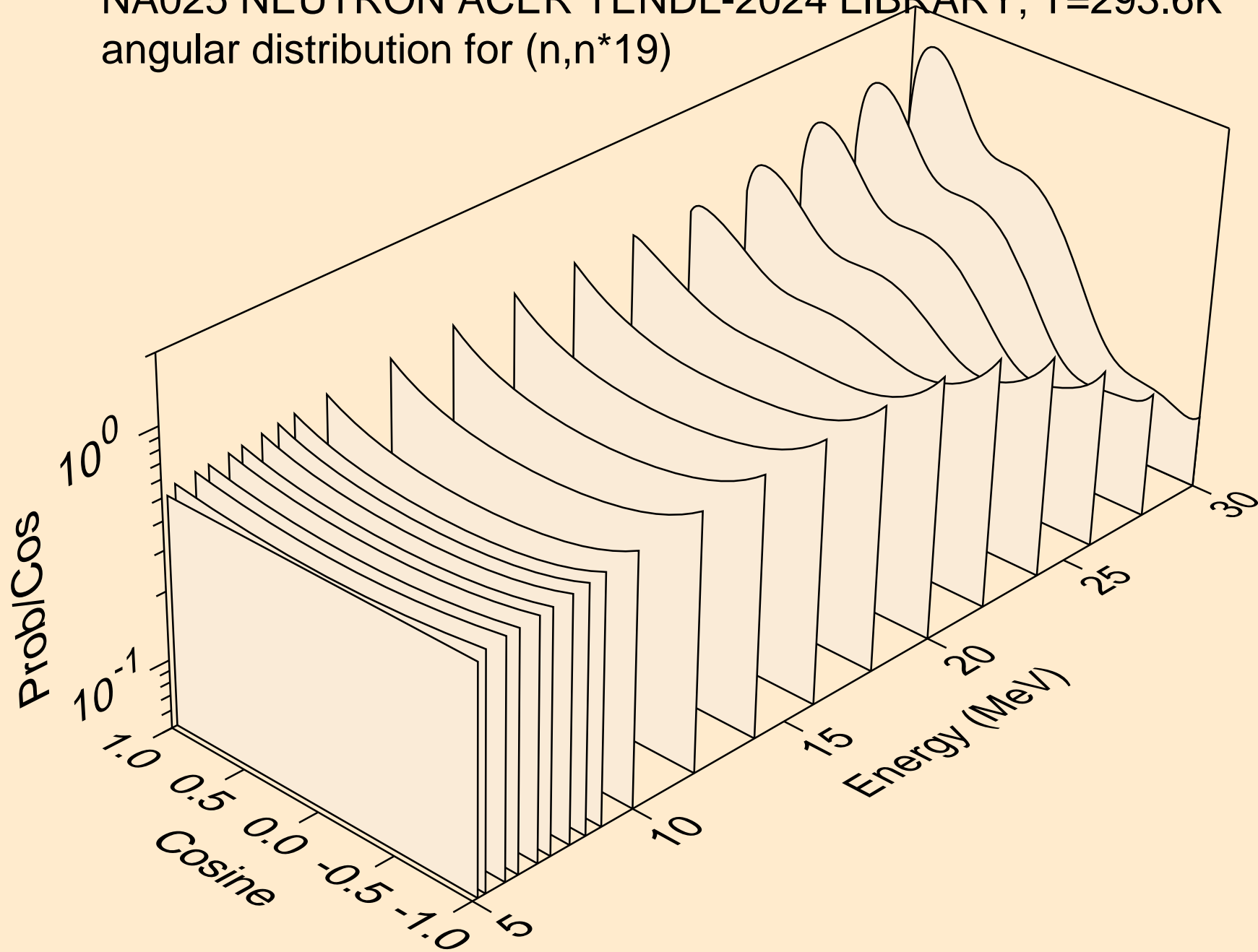

NA025 NEUTRON ACER TENDL-2024 LIBRARY; T=293.6K  
angular distribution for (n,n\*20)

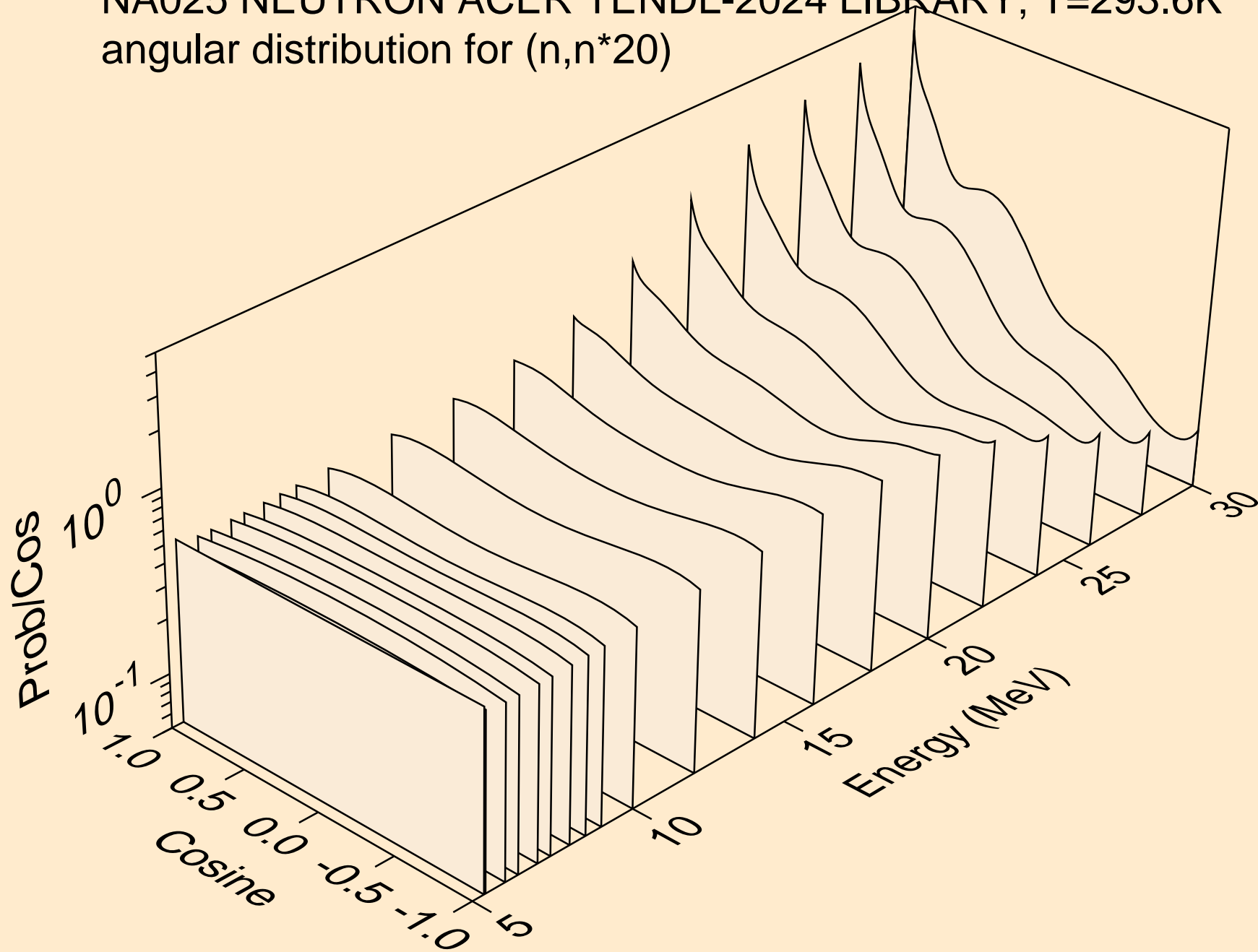

NA025 NEUTRON ACER TENDL-2024 LIBRARY; T=293.6K  
angular distribution for (n,n\*21)

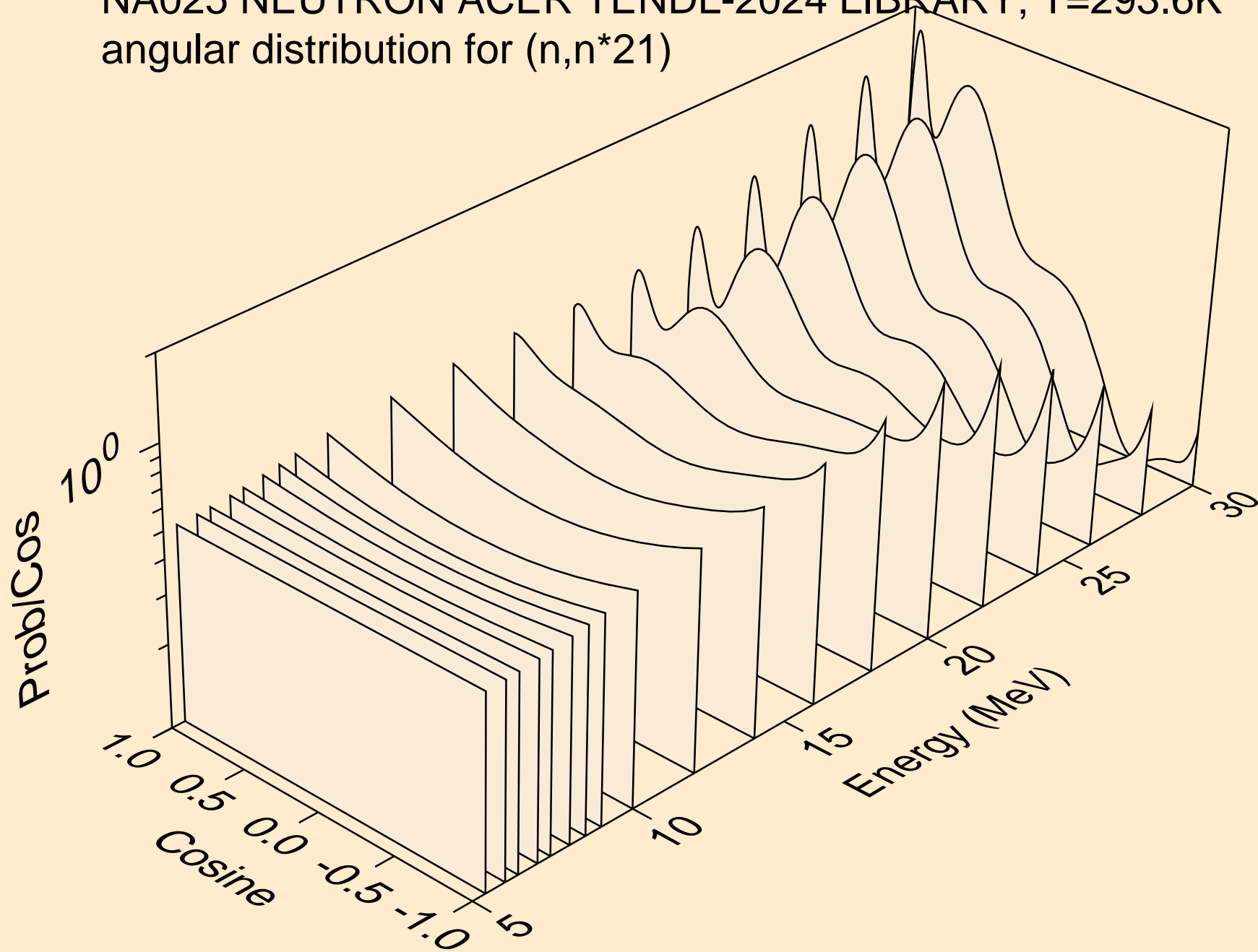

NA025 NEUTRON ACER TENDL-2024 LIBRARY; T=293.6K  
angular distribution for (n,n\*22)

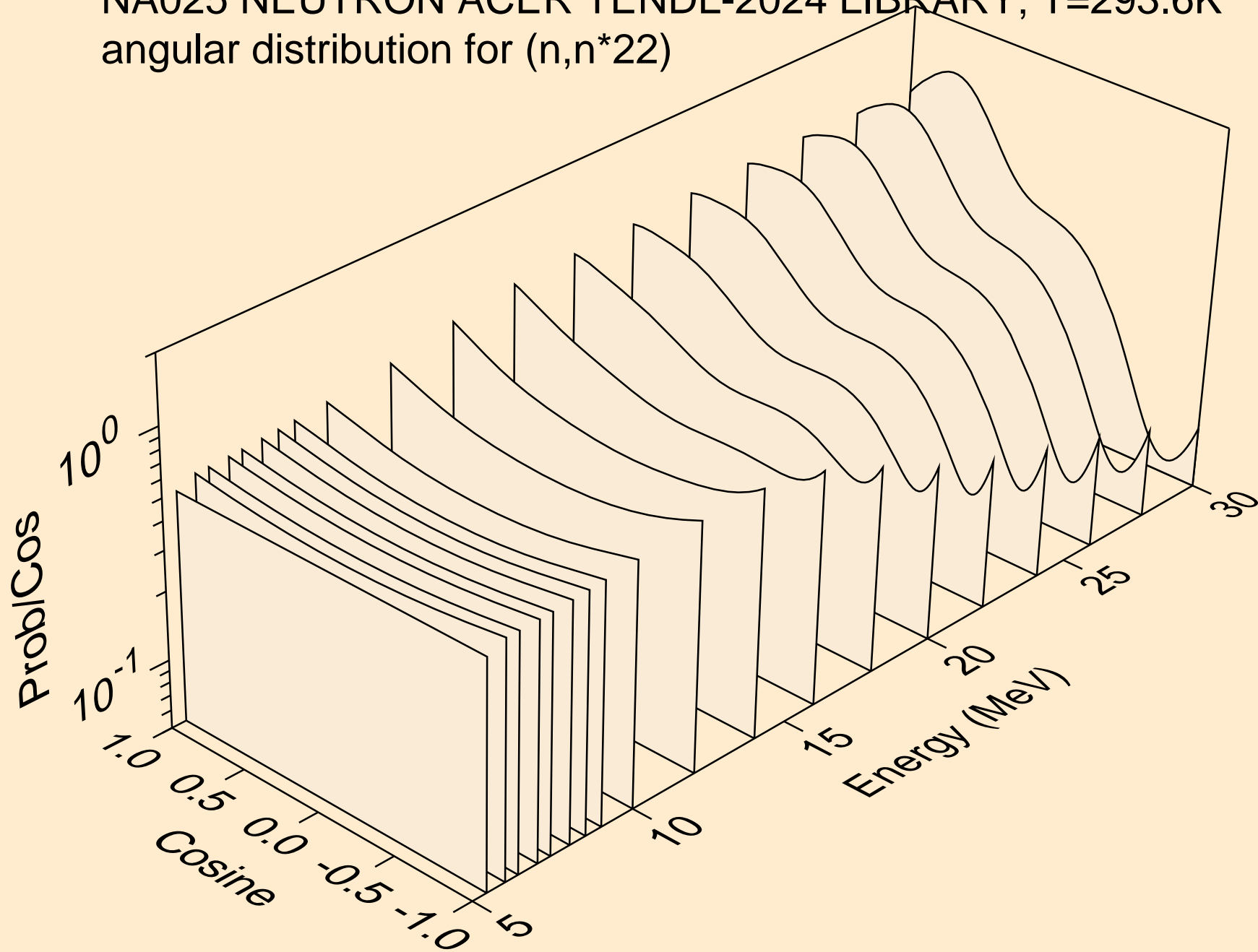

NA025 NEUTRON ACER TENDL-2024 LIBRARY; T=293.6K  
angular distribution for (n,n\*23)

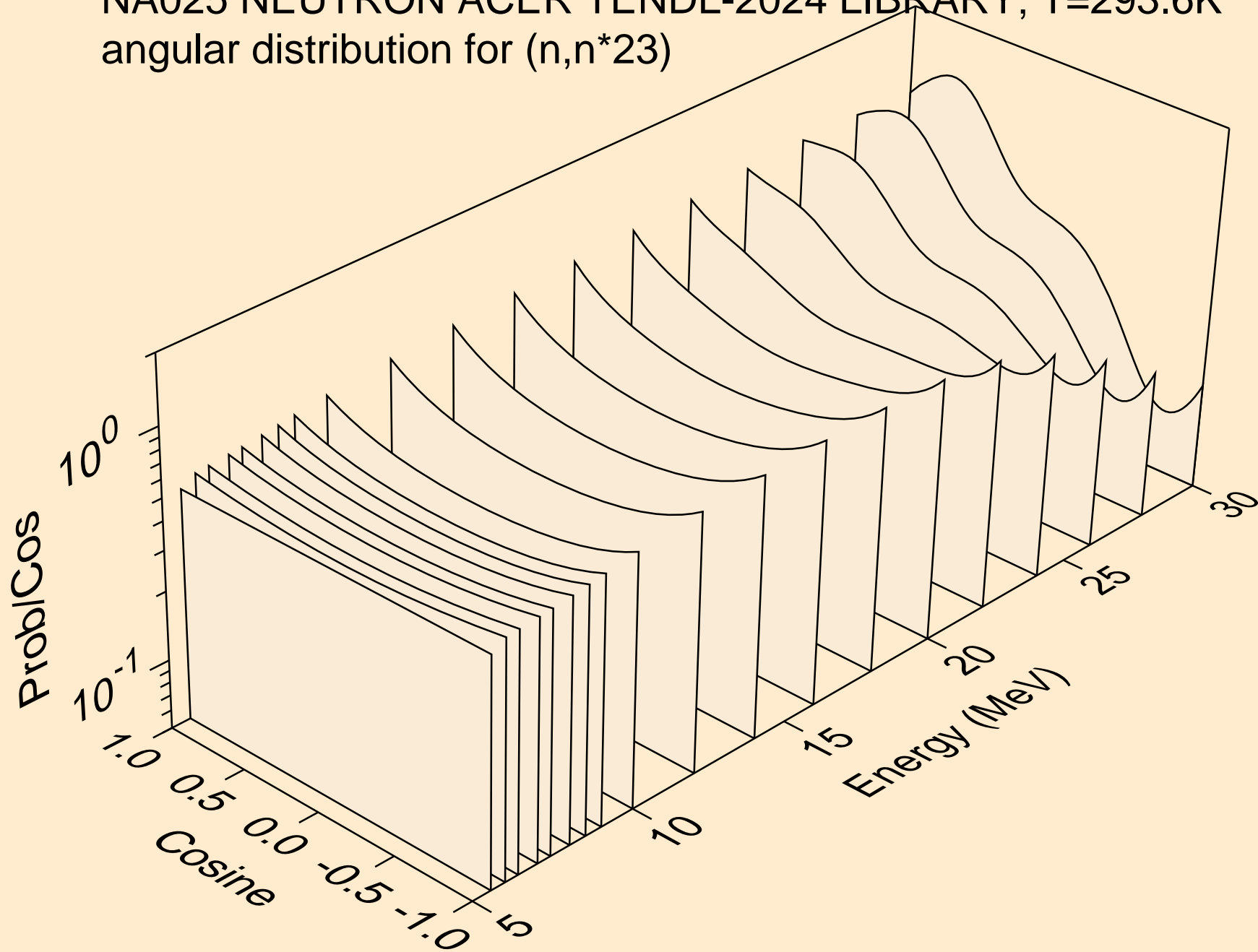

NA025 NEUTRON ACER TENDL-2024 LIBRARY; T=293.6K  
angular distribution for (n,n\*24)

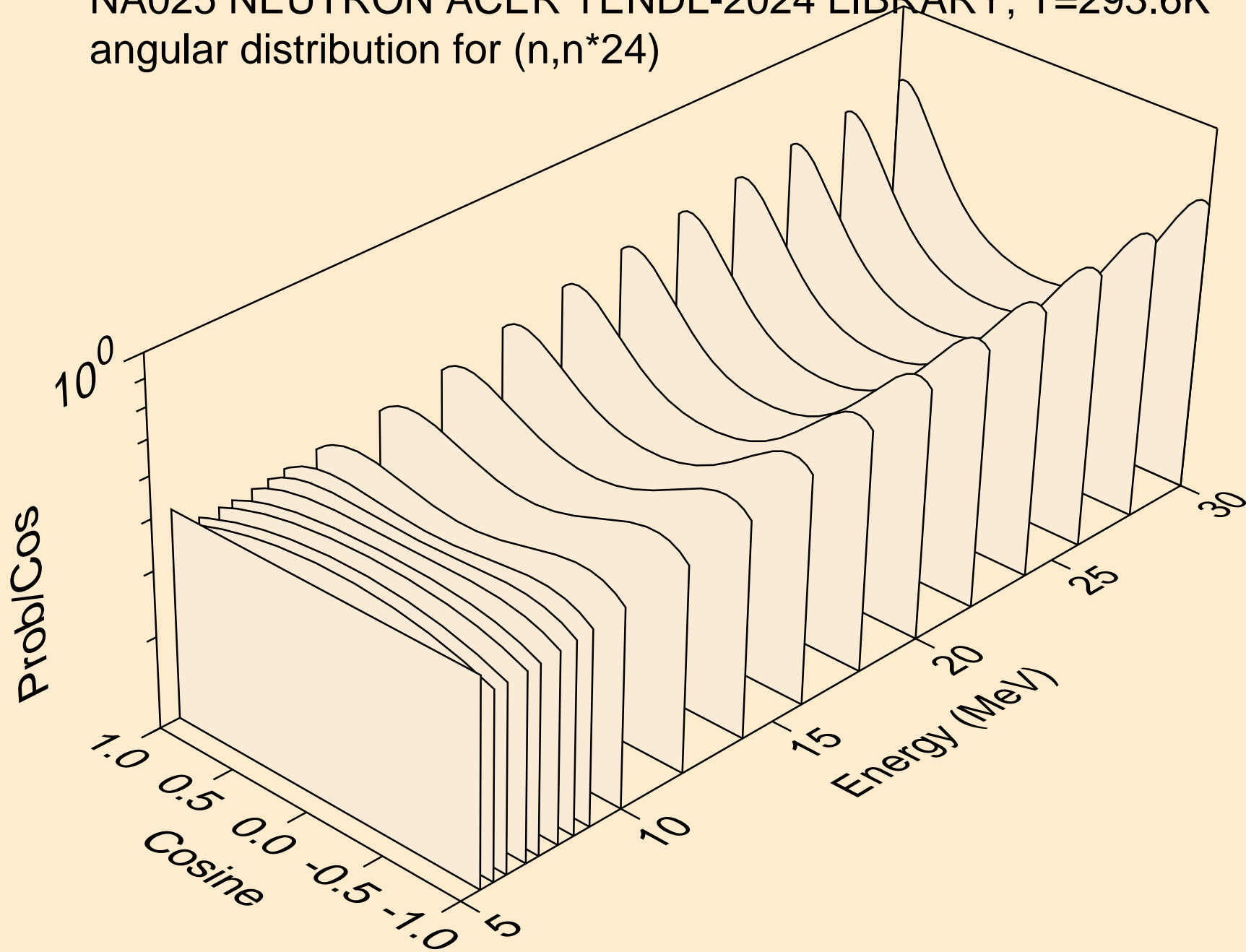

NA025 NEUTRON ACER TENDL-2024 LIBRARY; T=293.6K  
angular distribution for (n,n\*25)

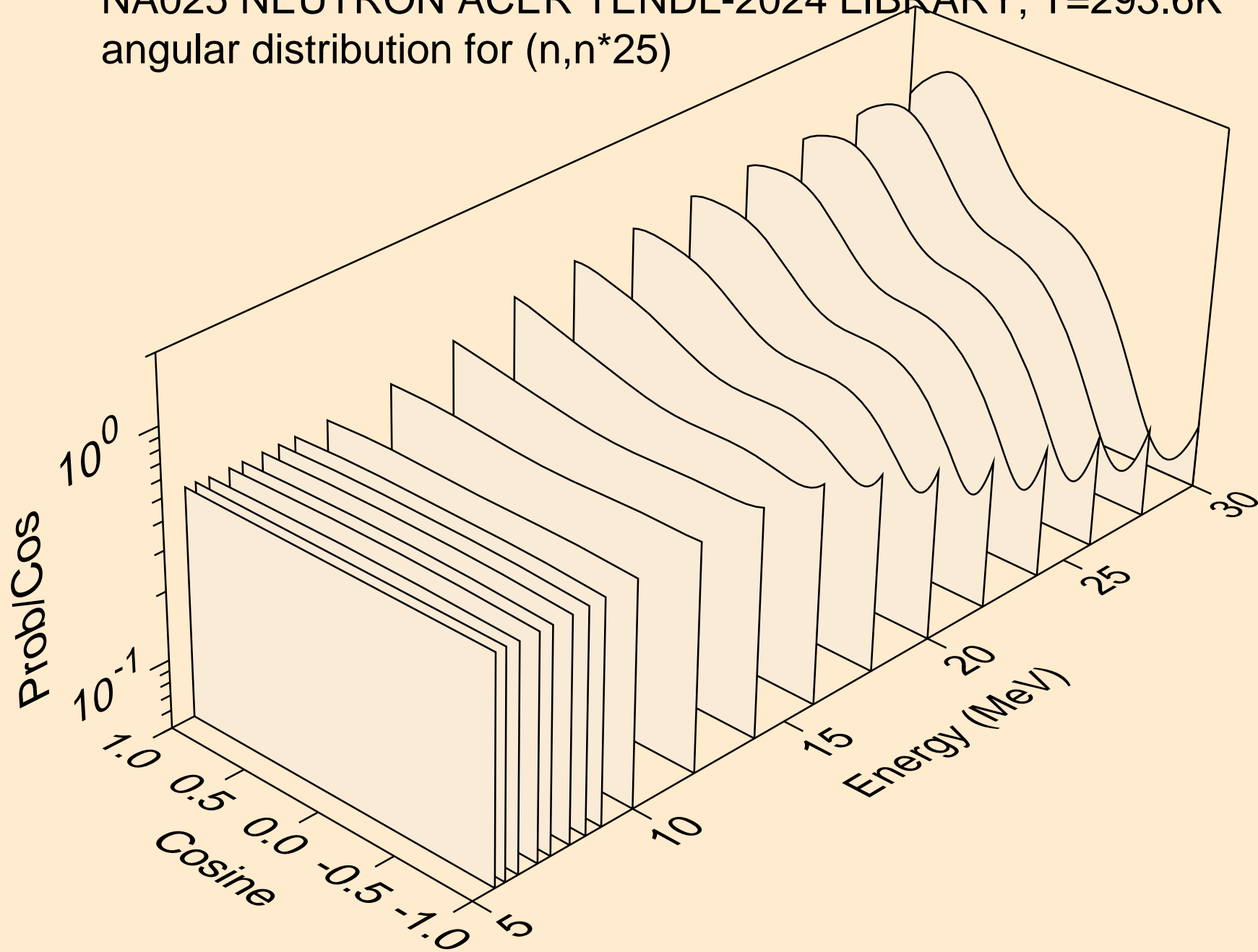

NA025 NEUTRON ACER TENDL-2024 LIBRARY; T=293.6K  
angular distribution for (n,n\*26)

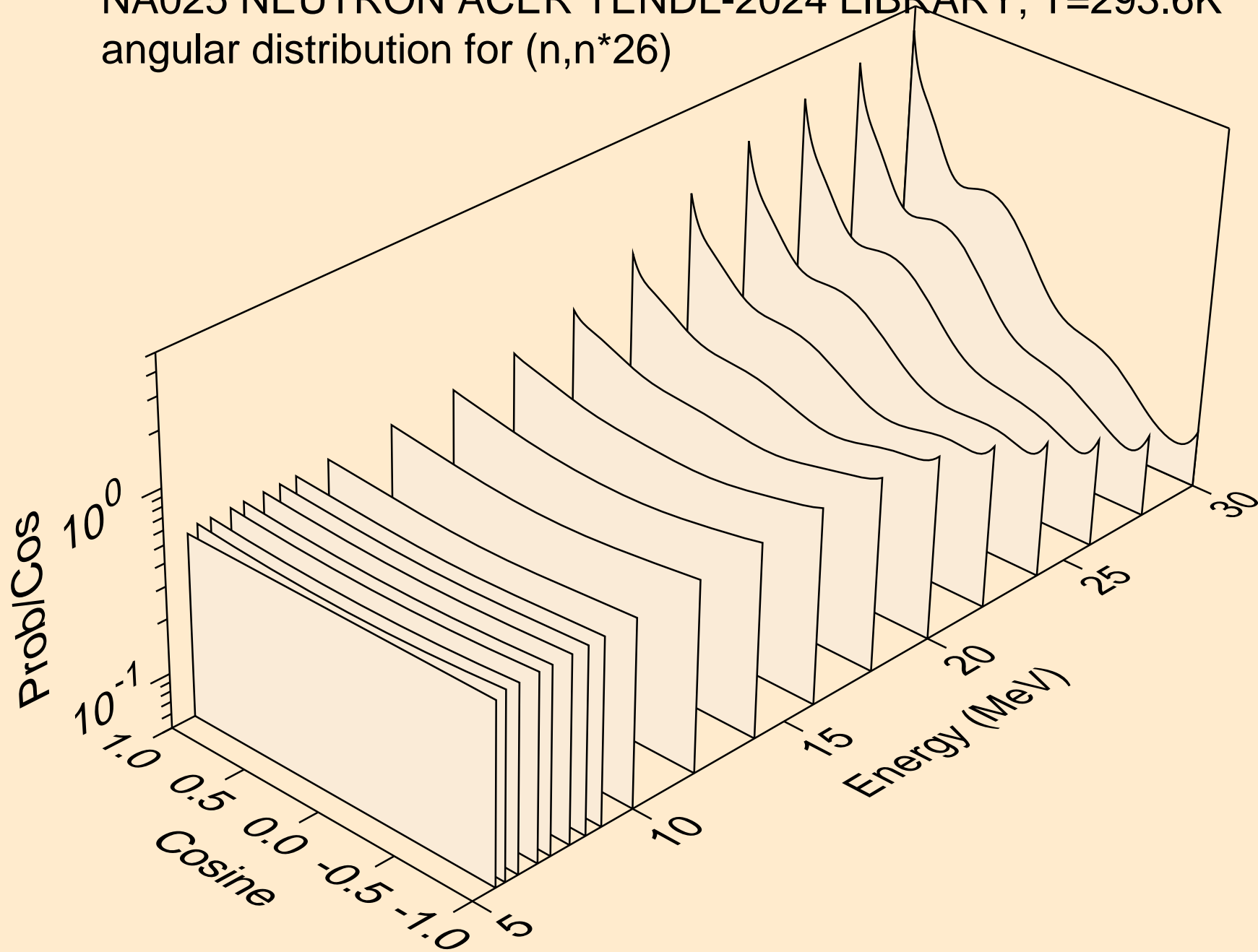

NA025 NEUTRON ACER TENDL-2024 LIBRARY; T=293.6K  
angular distribution for (n,n\*27)

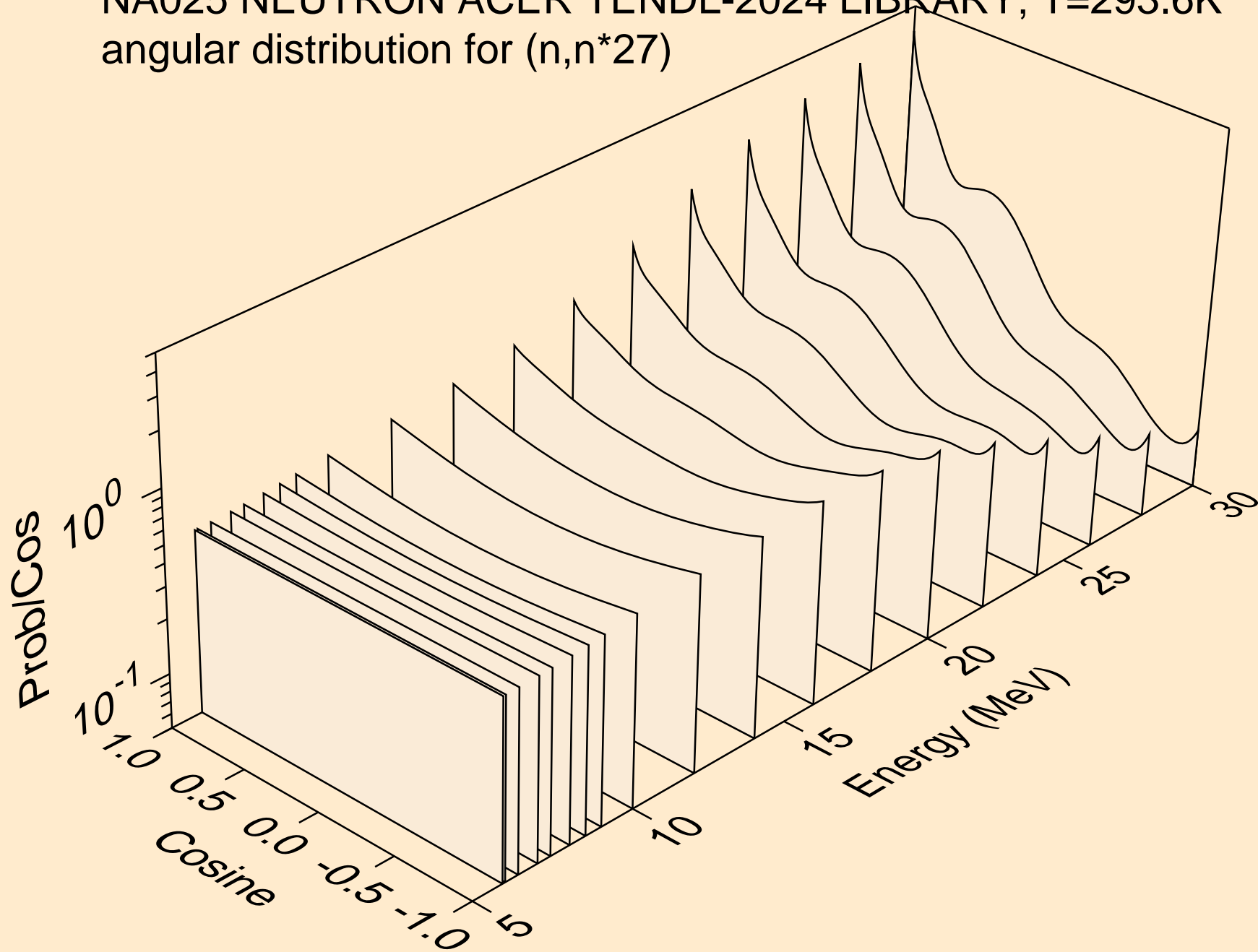

NA025 NEUTRON ACER TENDL-2024 LIBRARY; T=293.6K  
angular distribution for (n,n\*28)

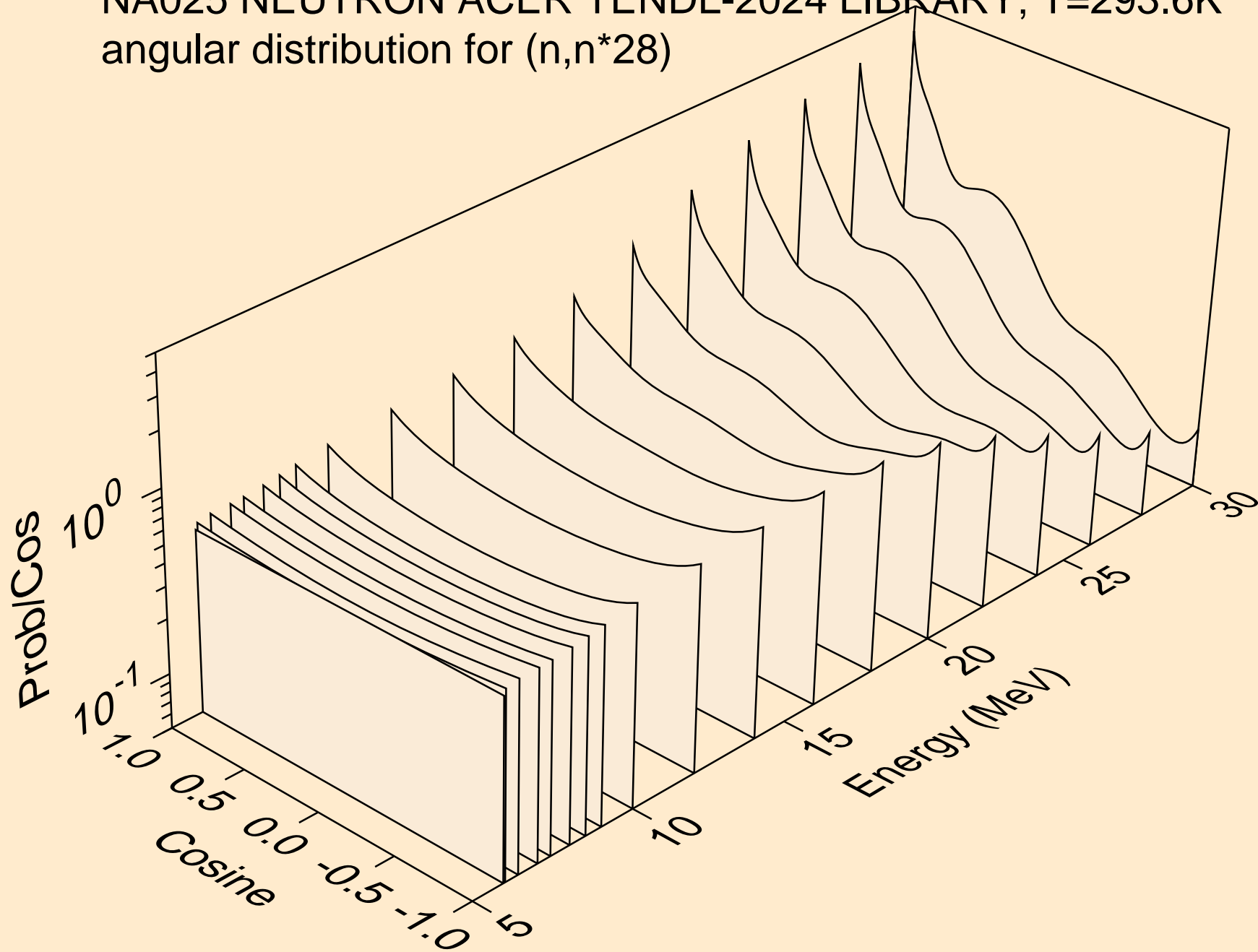

NA025 NEUTRON ACER TENDL-2024 LIBRARY; T=293.6K  
angular distribution for (n,n\*29)

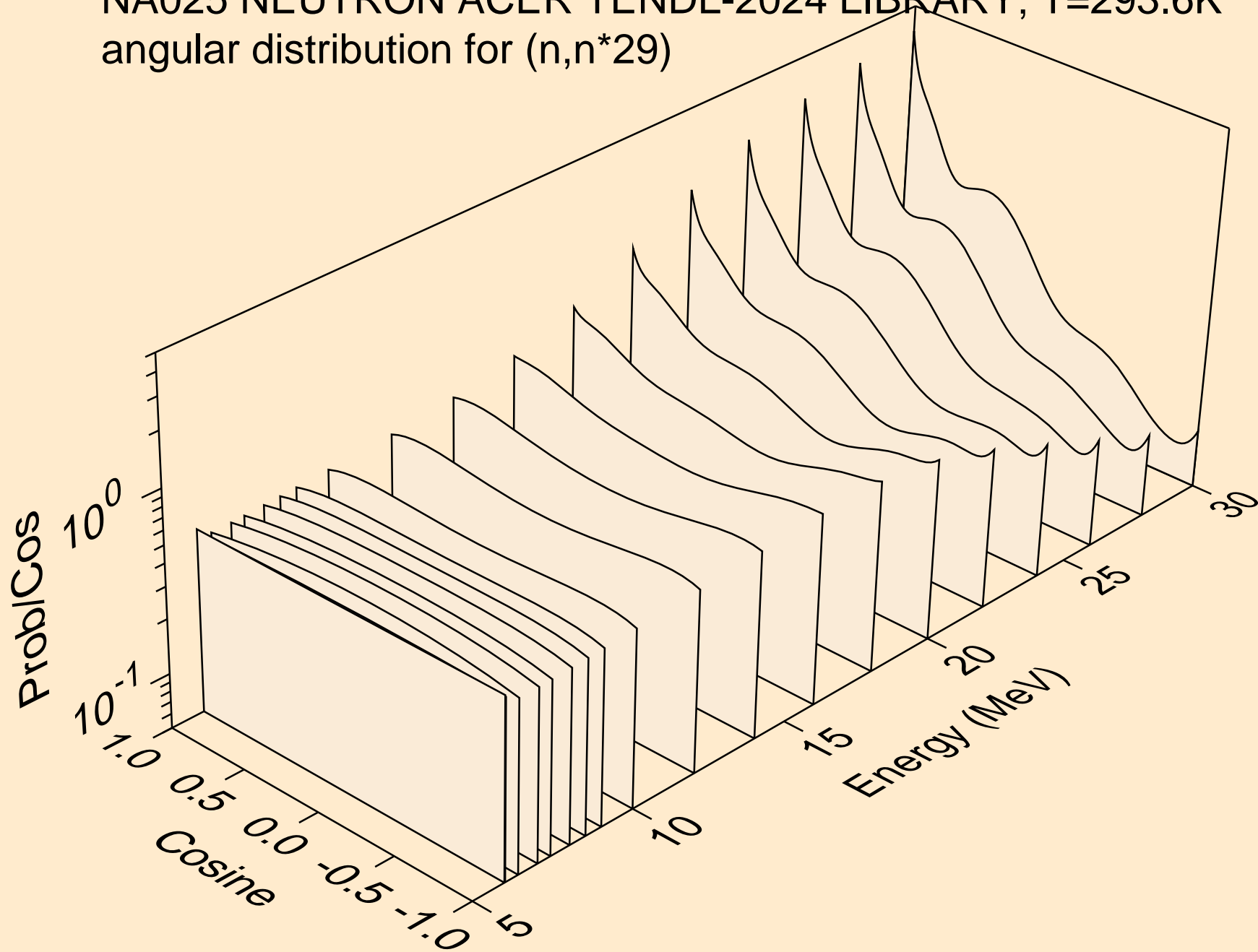

NA025 NEUTRON ACER TENDL-2024 LIBRARY; T=293.6K  
angular distribution for (n,n\*30)

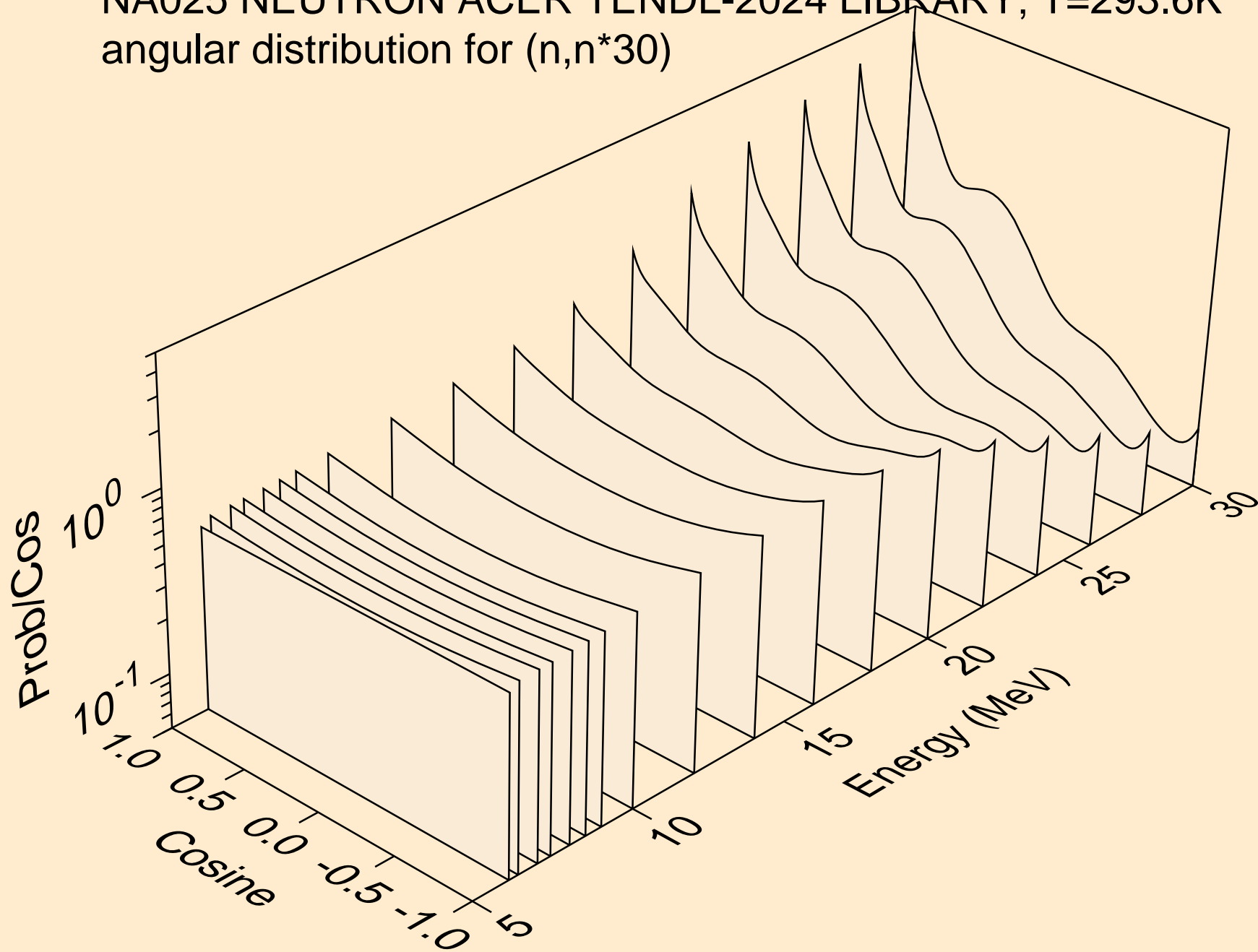

NA025 NEUTRON ACER TENDL-2024 LIBRARY; T=293.6K  
Neutron emission for (n,x)

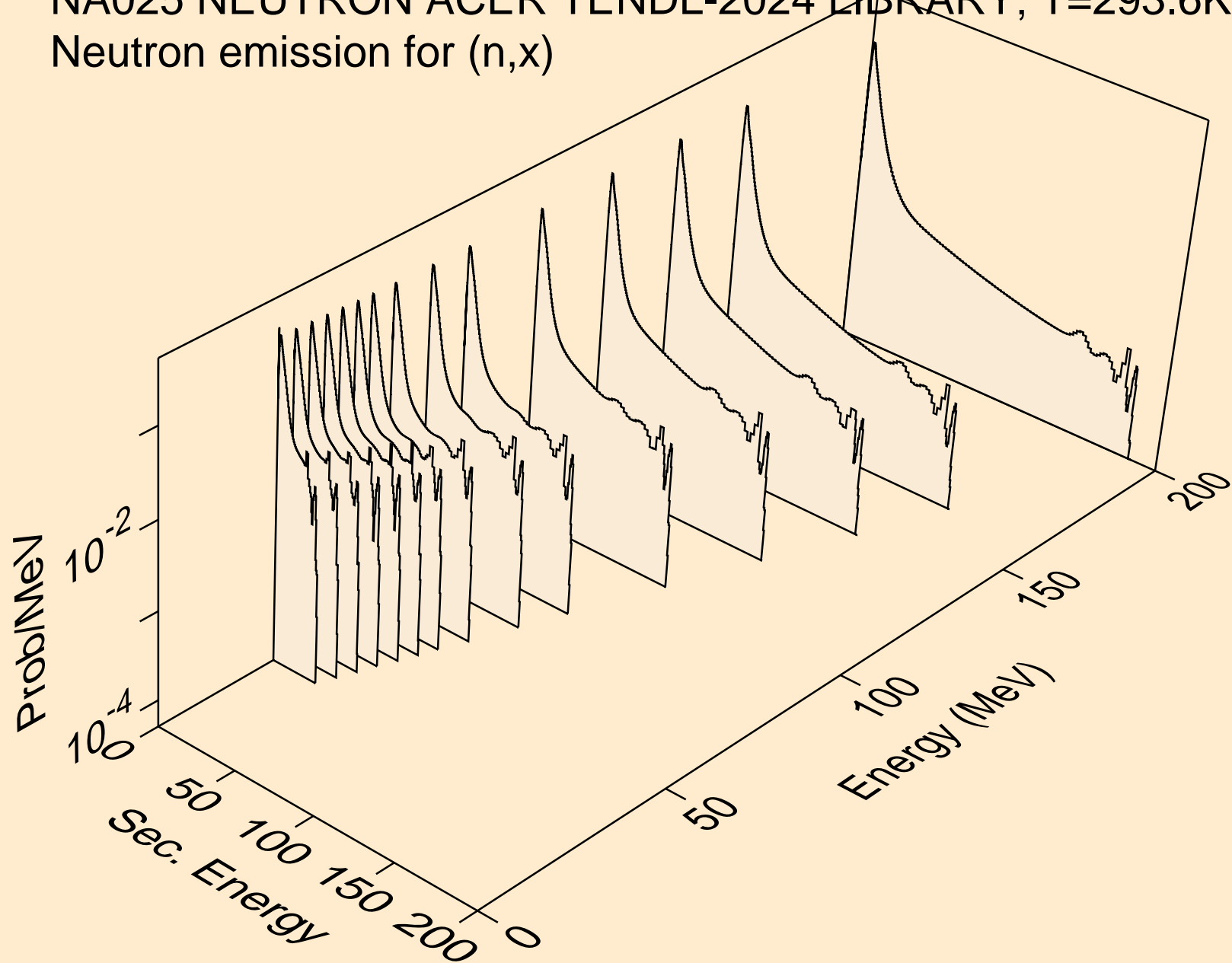

NA025 NEUTRON ACER TENDL-2024 LIBRARY; T=293.6K  
Neutron emission for (n,2nd)

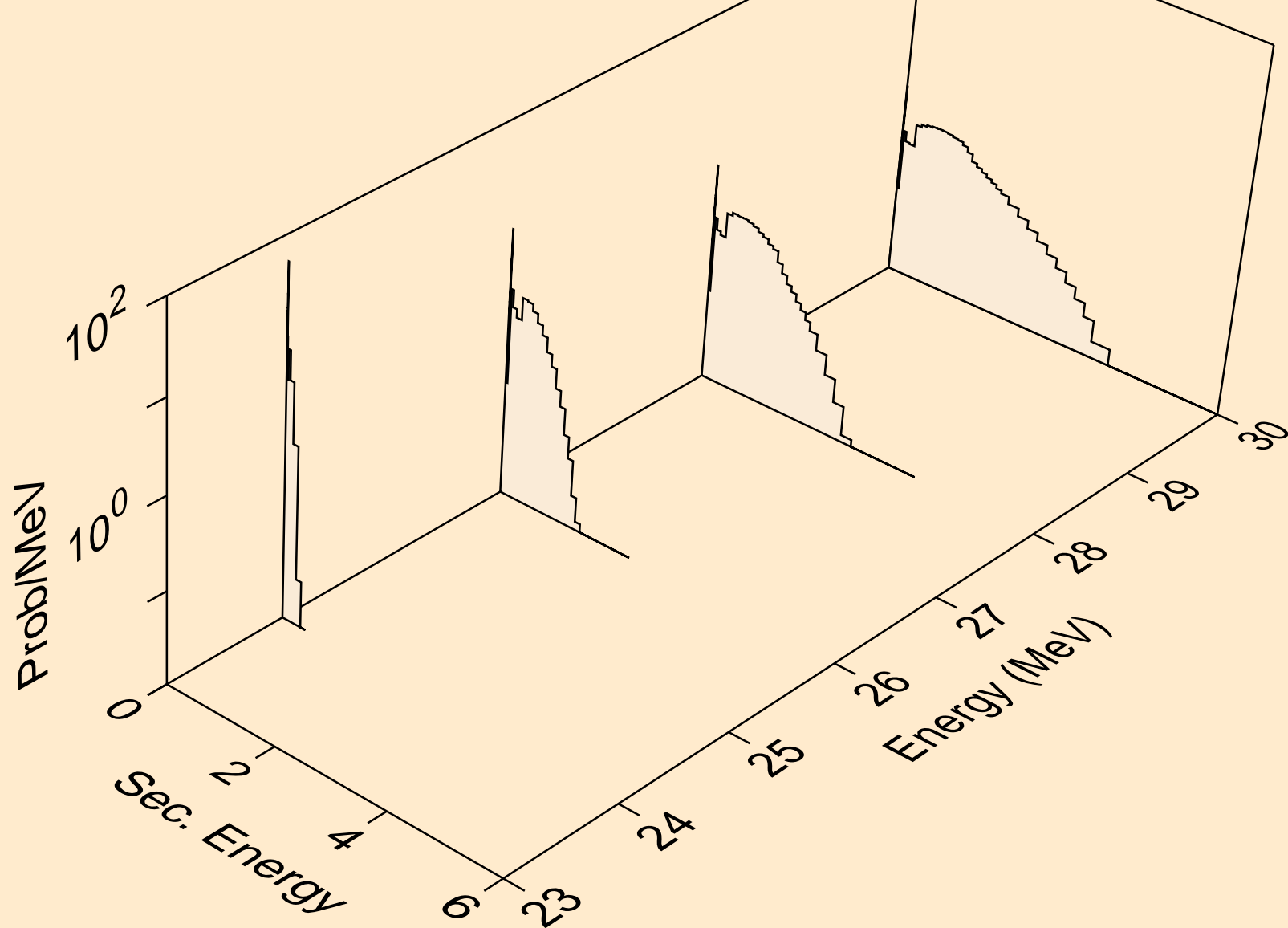

NA025 NEUTRON ACER TENDL-2024 LIBRARY; T=293.6K  
Neutron emission for (n,2n)

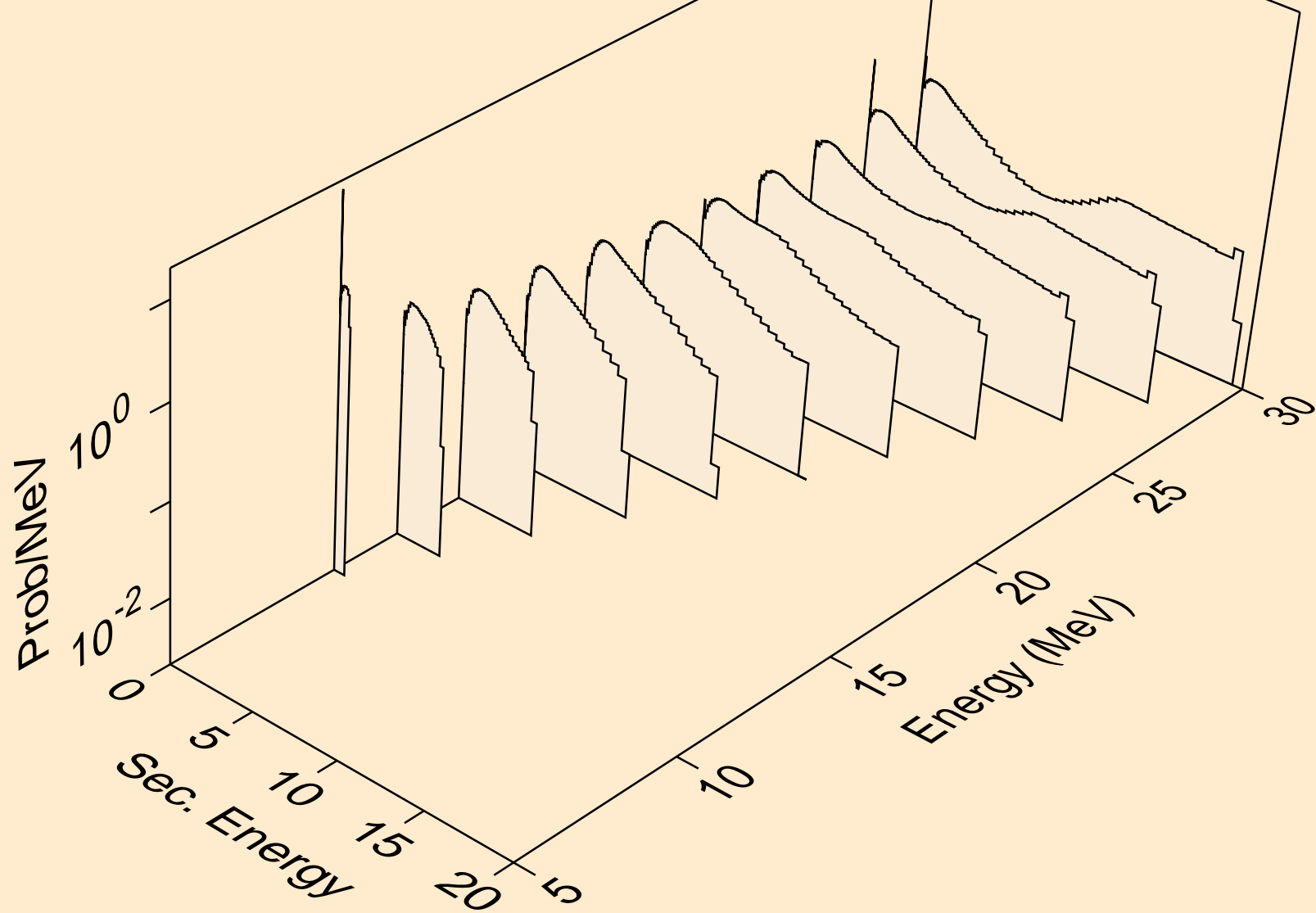

NA025 NEUTRON ACER TENDL-2024 LIBRARY; T=293.6K  
Neutron emission for (n,3n)

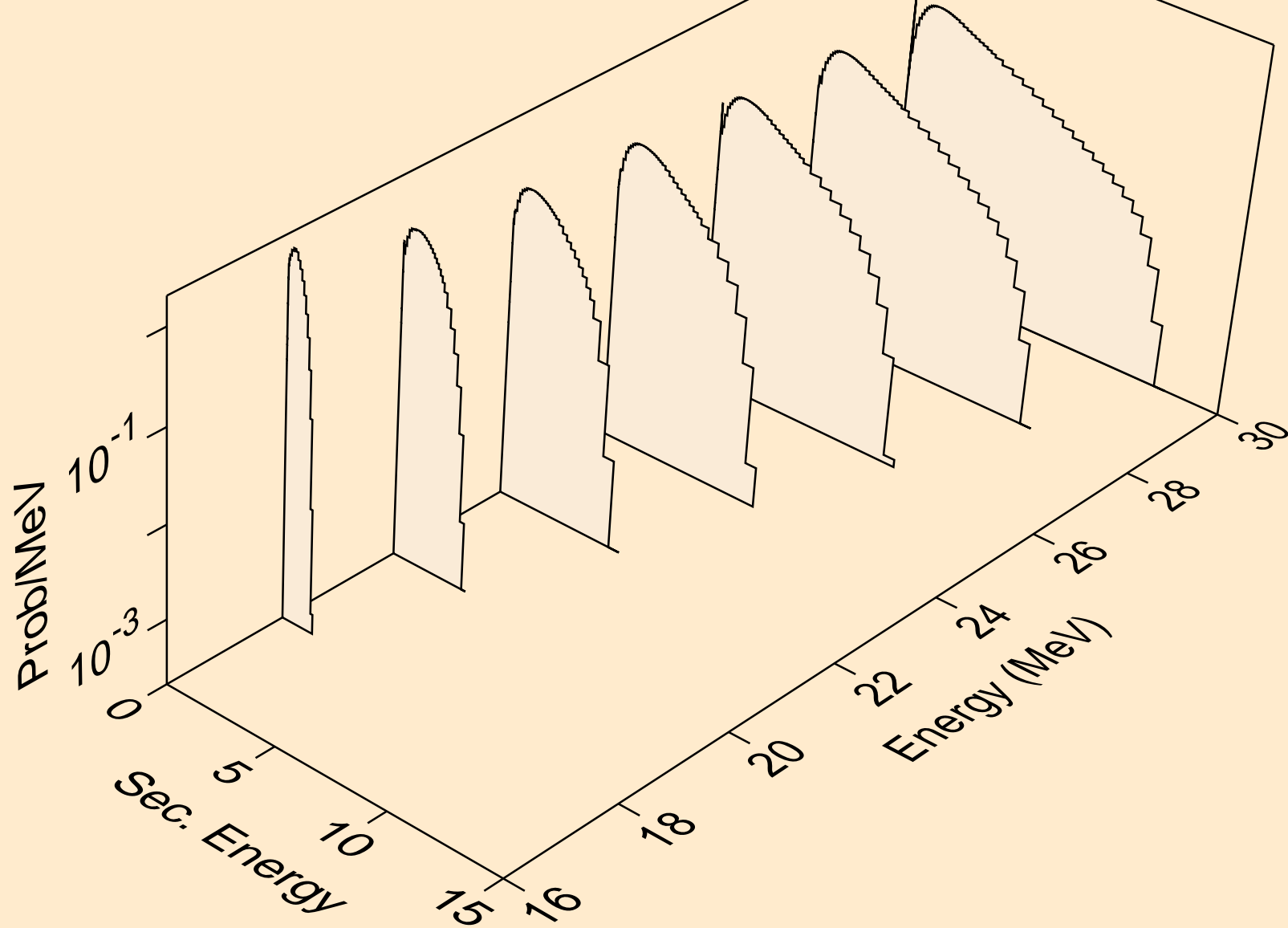

NA025 NEUTRON ACER TENDL-2024 LIBRARY; T=293.6K  
Neutron emission for (n,n\*)a

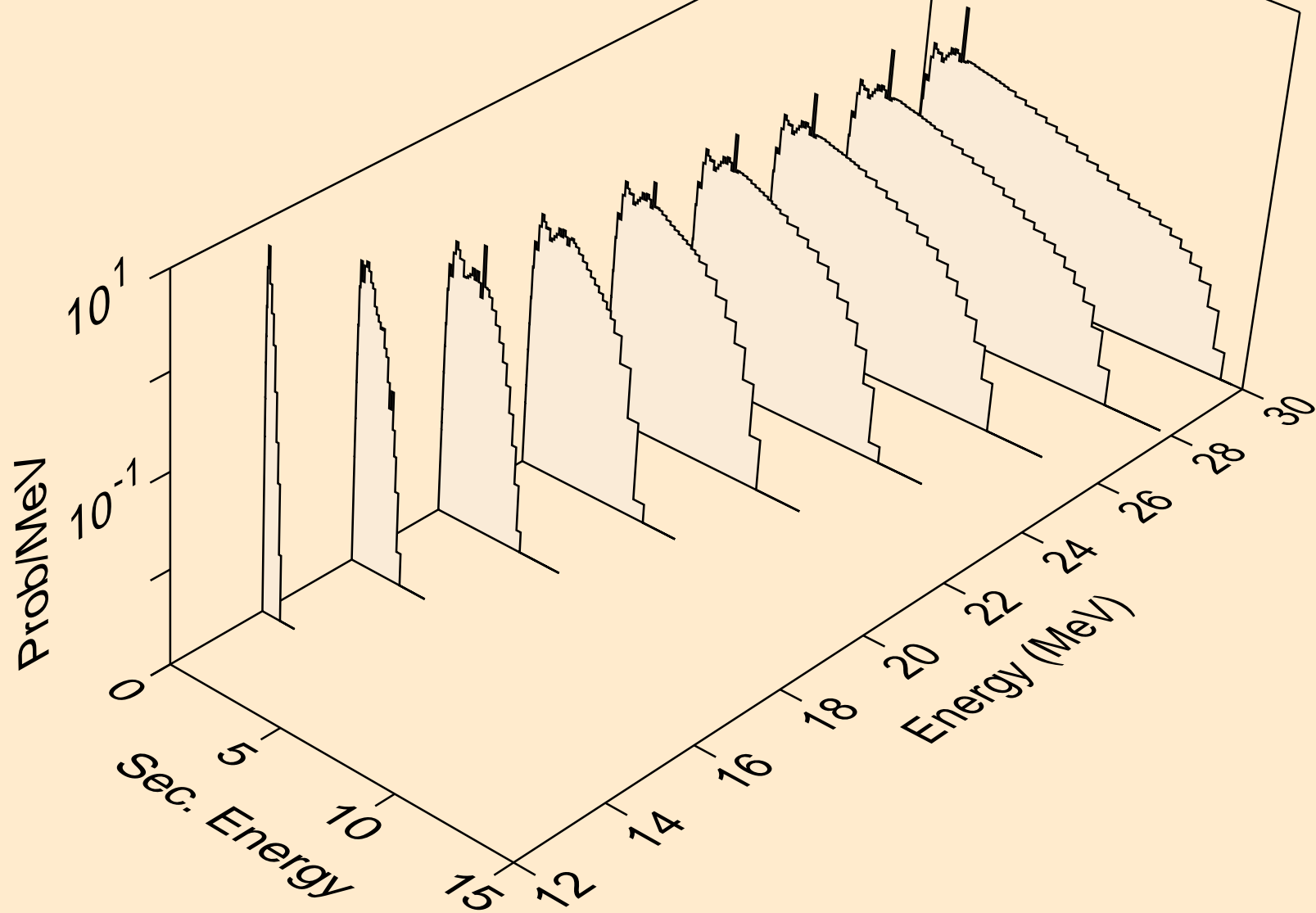

NA025 NEUTRON ACER TENDL-2024 LIBRARY; T=293.6K  
Neutron emission for (n,2n)<sub>a</sub>

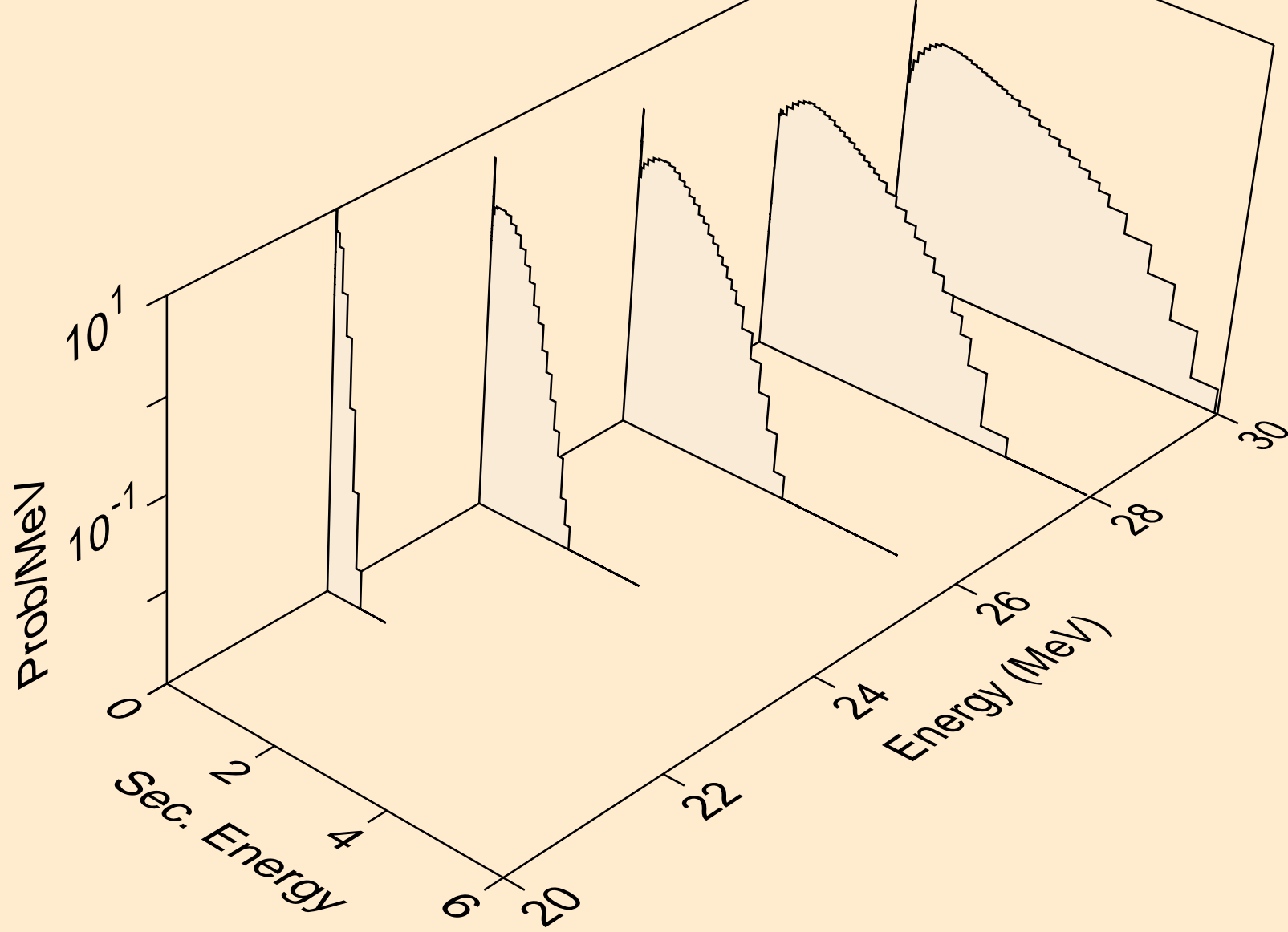

NA025 NEUTRON ACER TENDL-2024 LIBRARY; T=293.6K  
Neutron emission for (n,3n)a

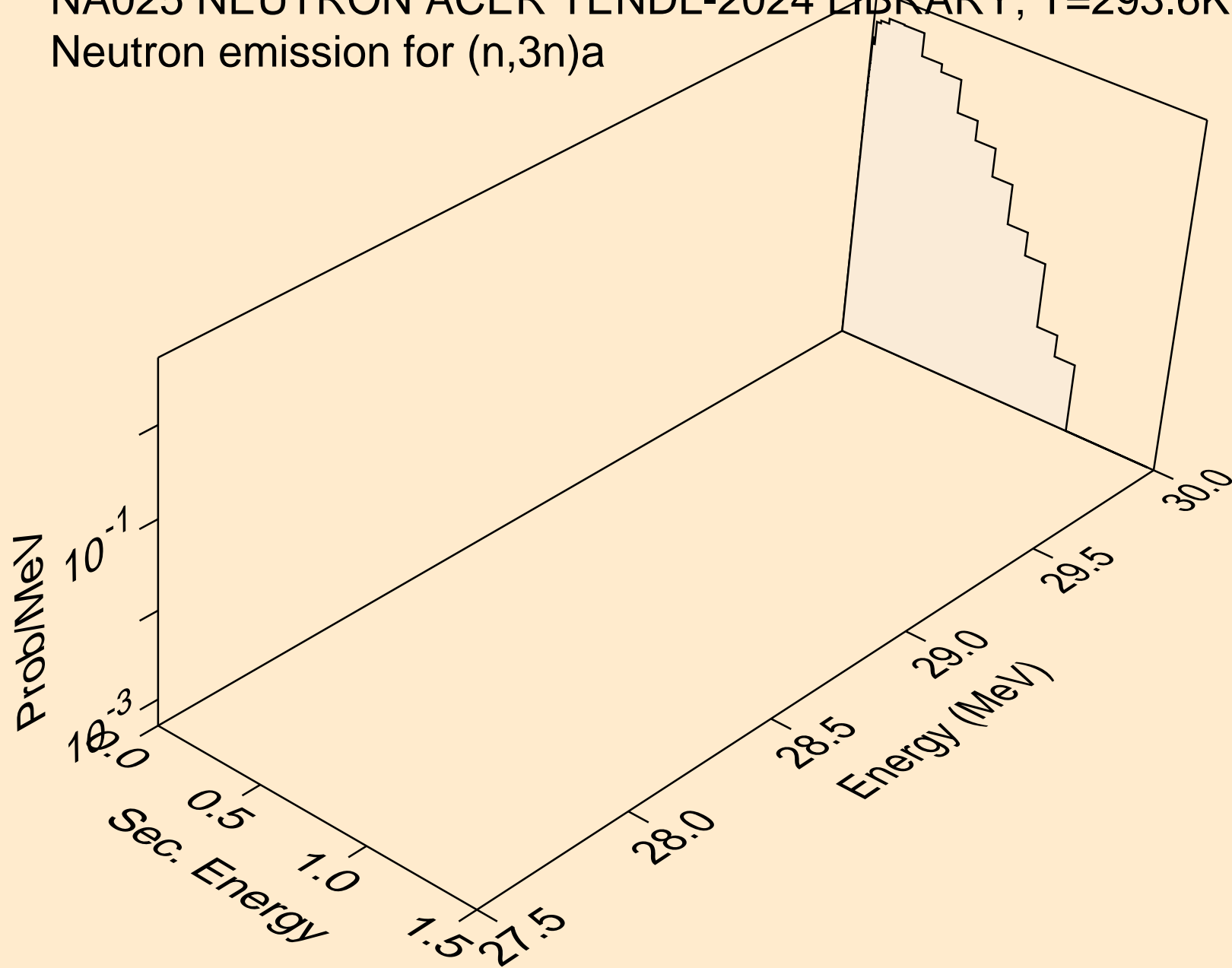

NA025 NEUTRON ACER TENDL-2024 LIBRARY; T=293.6K  
Neutron emission for (n,n\*)p

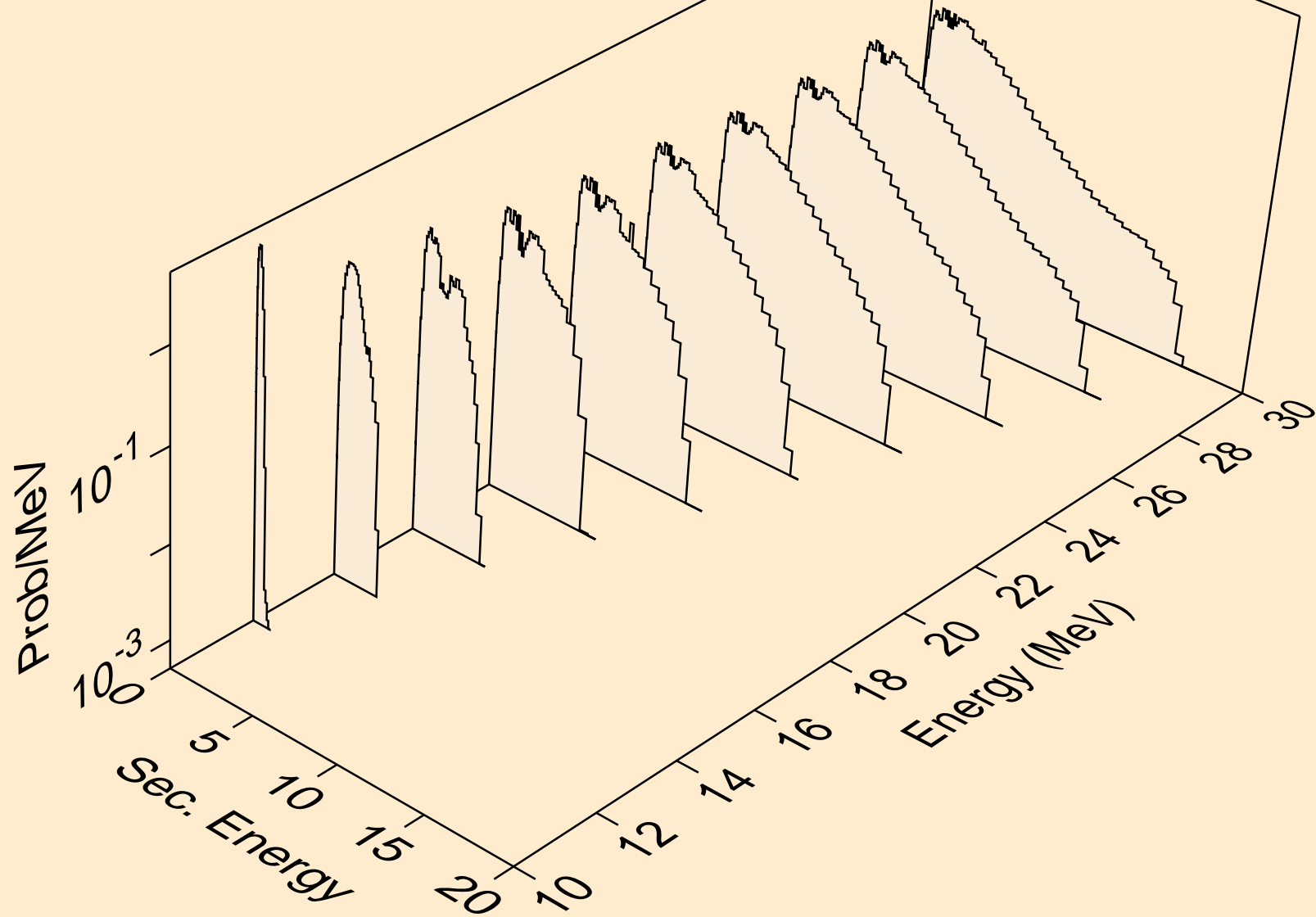

NA025 NEUTRON ACER TENDL-2024 LIBRARY; T=293.6K  
Neutron emission for (n,n\*)2a

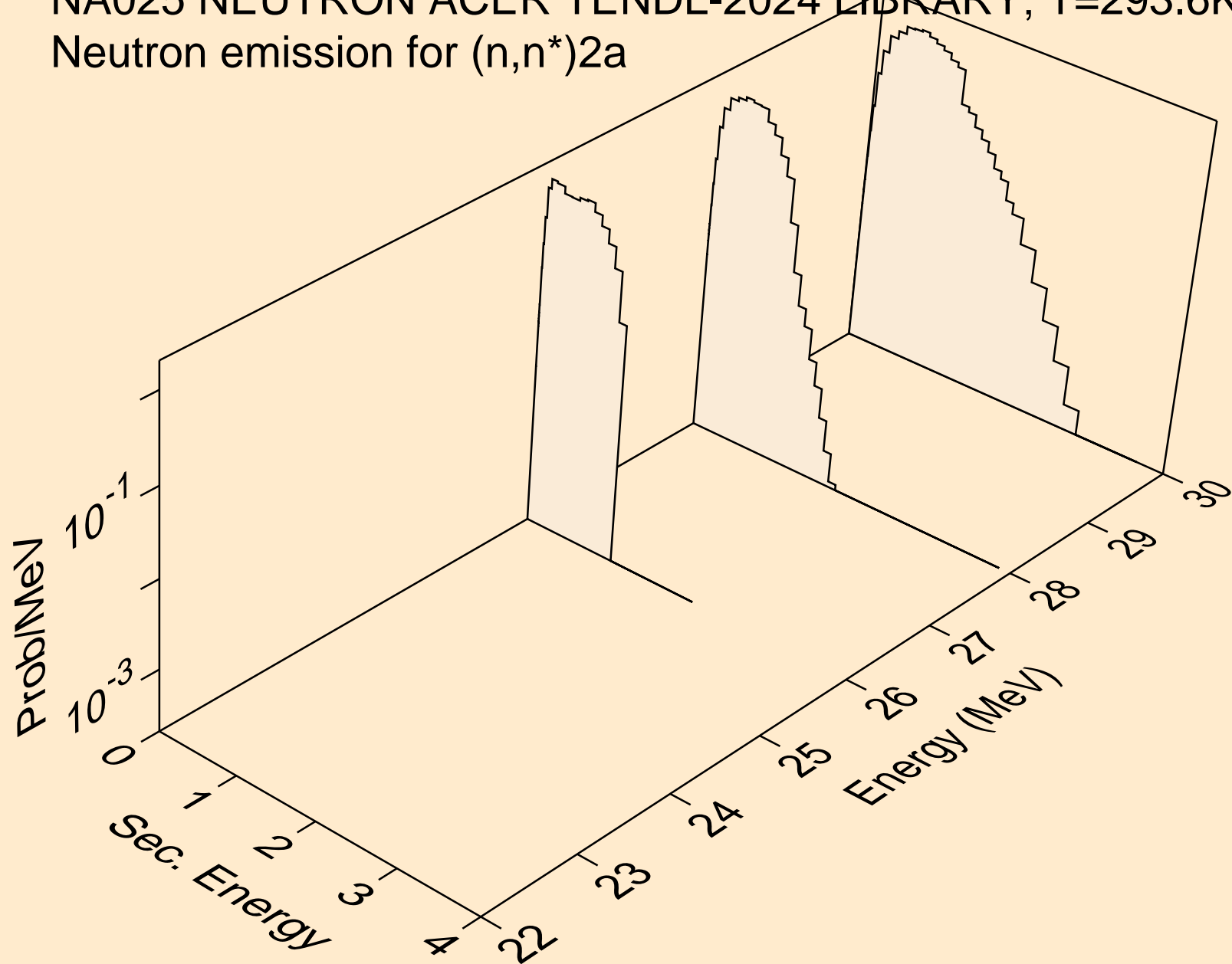

NA025 NEUTRON ACER TENDL-2024 LIBRARY; T=293.6K  
Neutron emission for (n,n\*)d

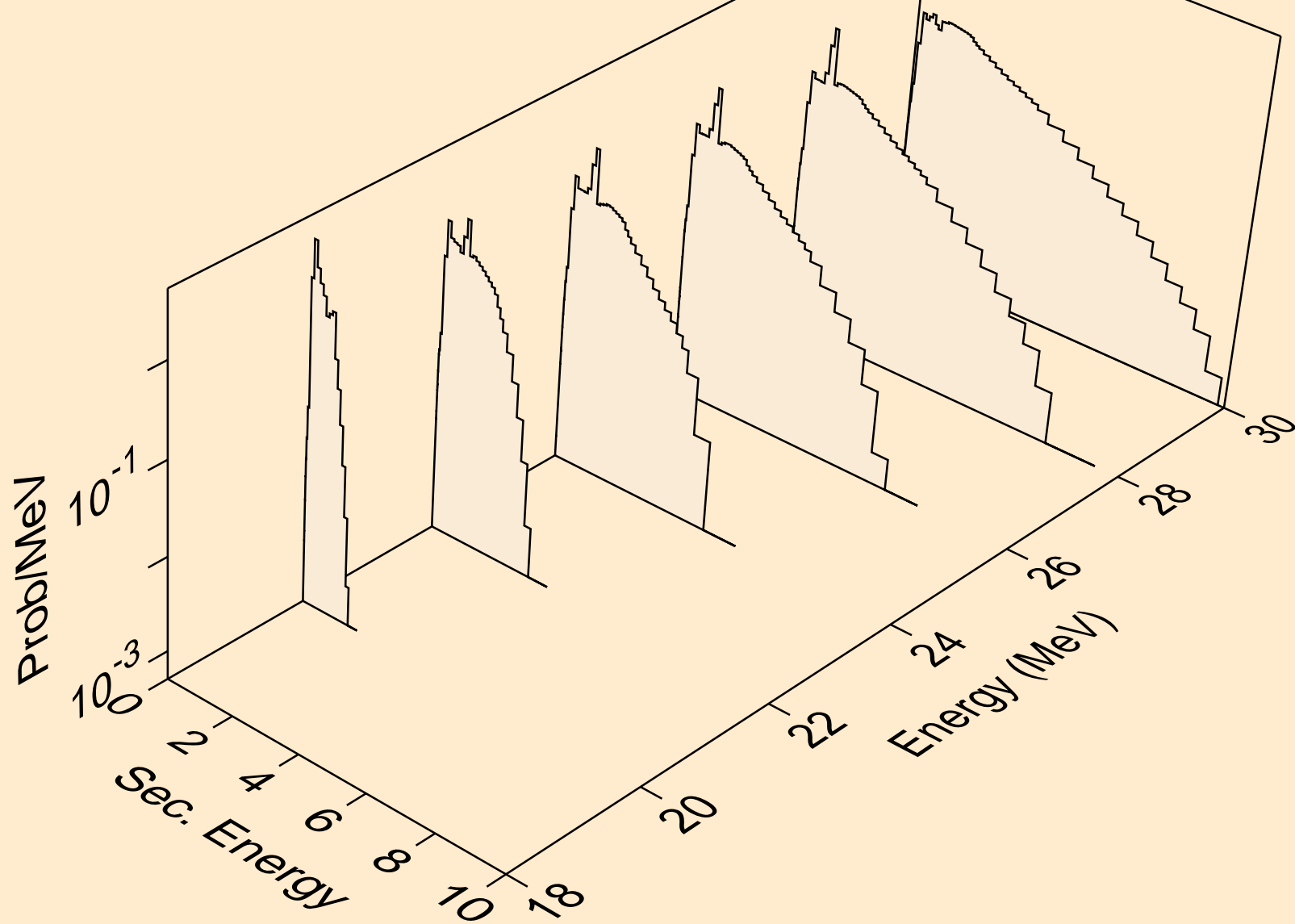

NA025 NEUTRON ACER TENDL-2024 LIBRARY; T=293.6K  
Neutron emission for (n,n\*)t

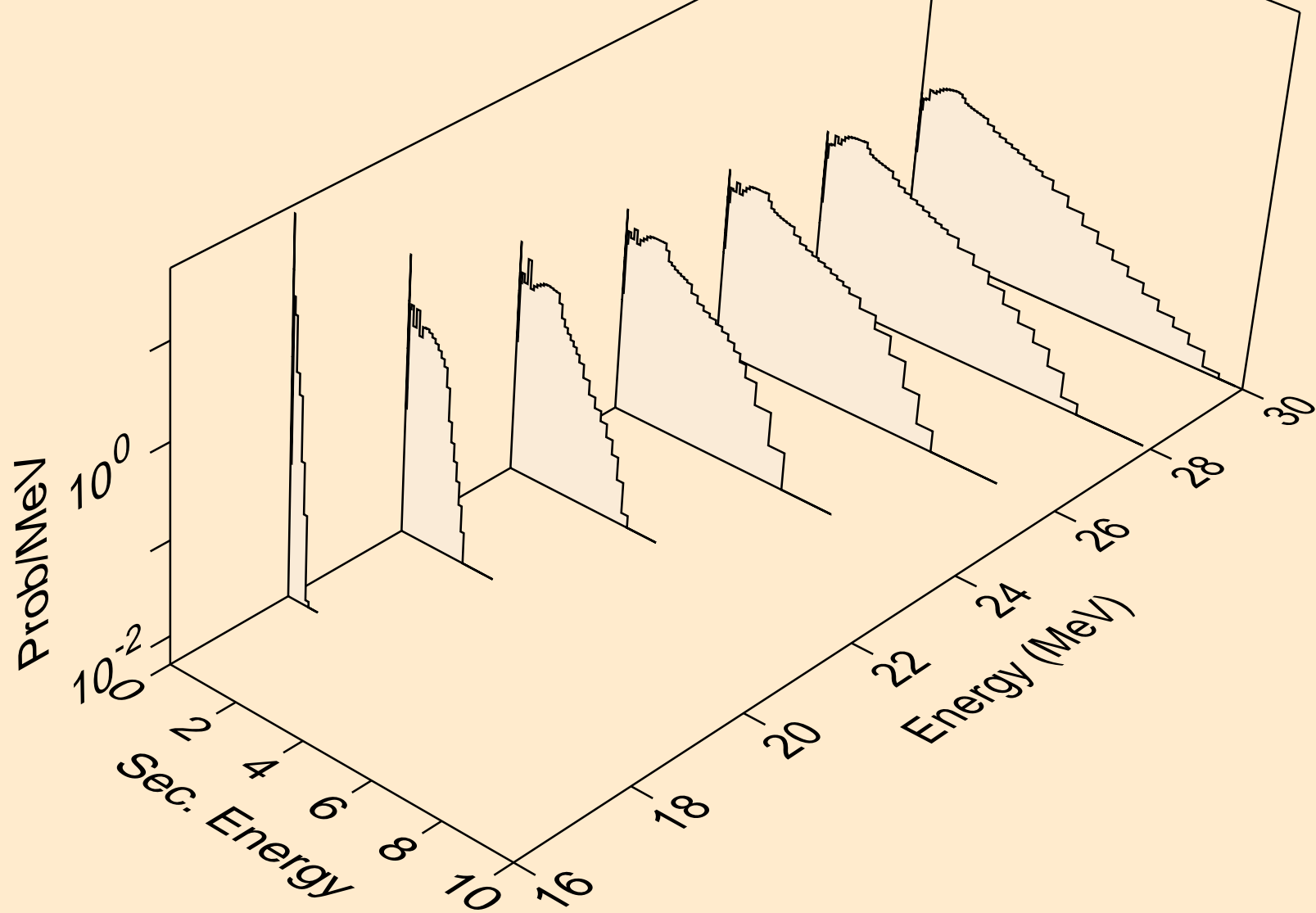

NA025 NEUTRON ACER TENDL-2024 LIBRARY; T=293.6K  
Neutron emission for (n,n\*)he3

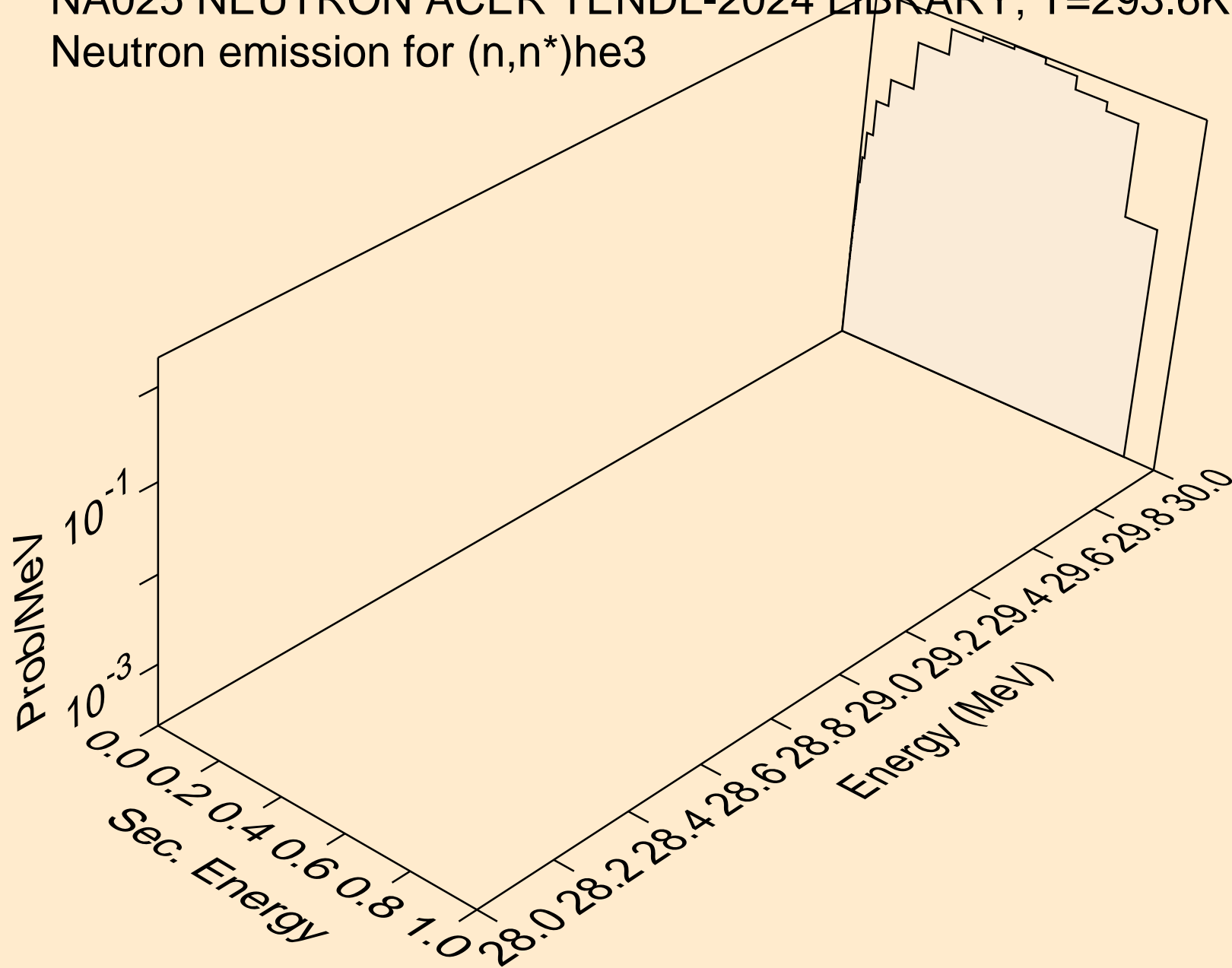

NA025 NEUTRON ACER TENDL-2024 LIBRARY; T=293.6K  
Neutron emission for (n,2np)

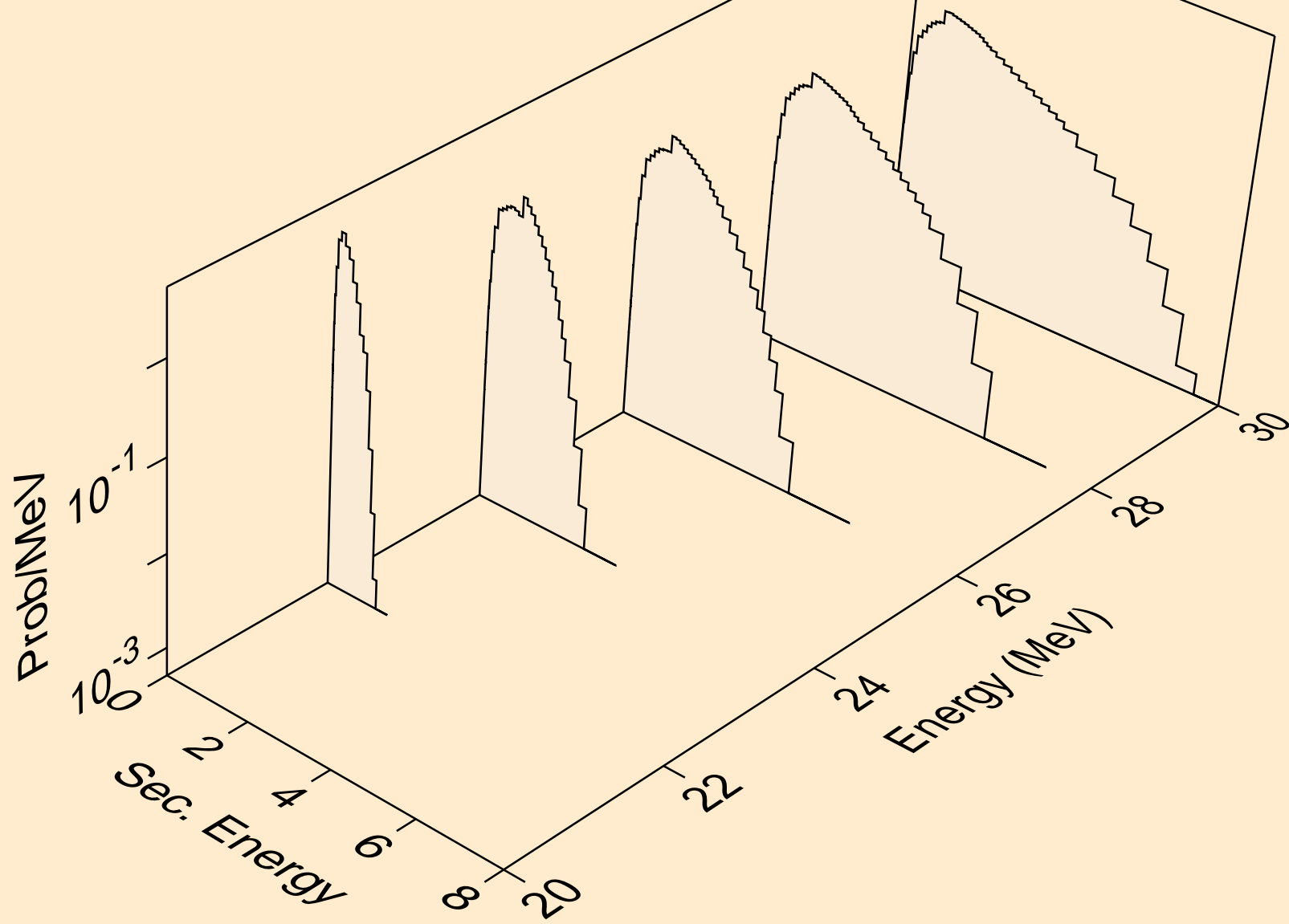

NA025 NEUTRON ACER TENDL-2024 LIBRARY; T=293.6K  
Neutron emission for (n,3np)

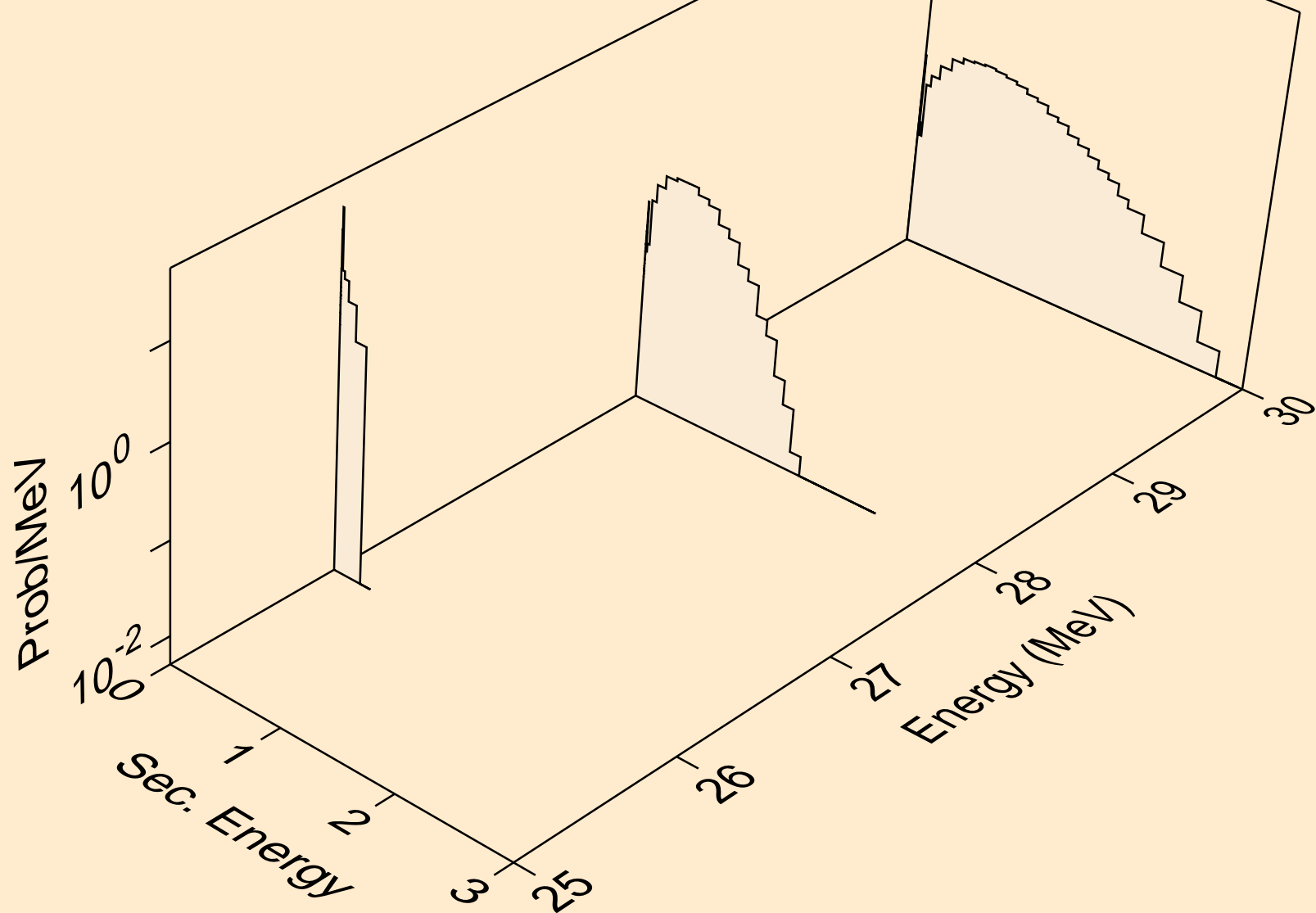

NA025 NEUTRON ACER TENDL-2024 LIBRARY; T=293.6K  
Neutron emission for (n,npa)

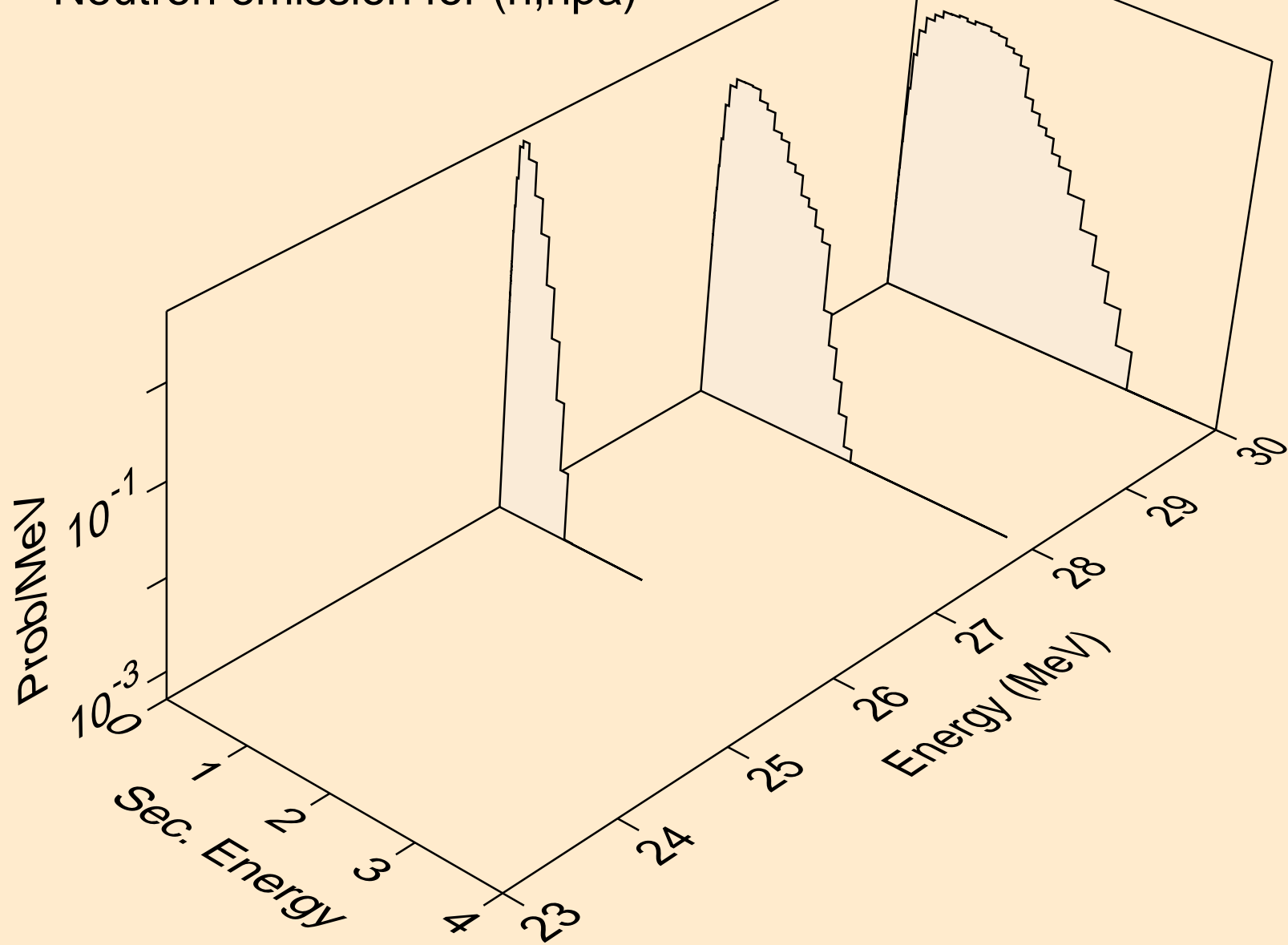

NA025 NEUTRON ACER TENDL-2024 LIBRARY; T=293.6K  
Neutron emission for (n,n\*c)

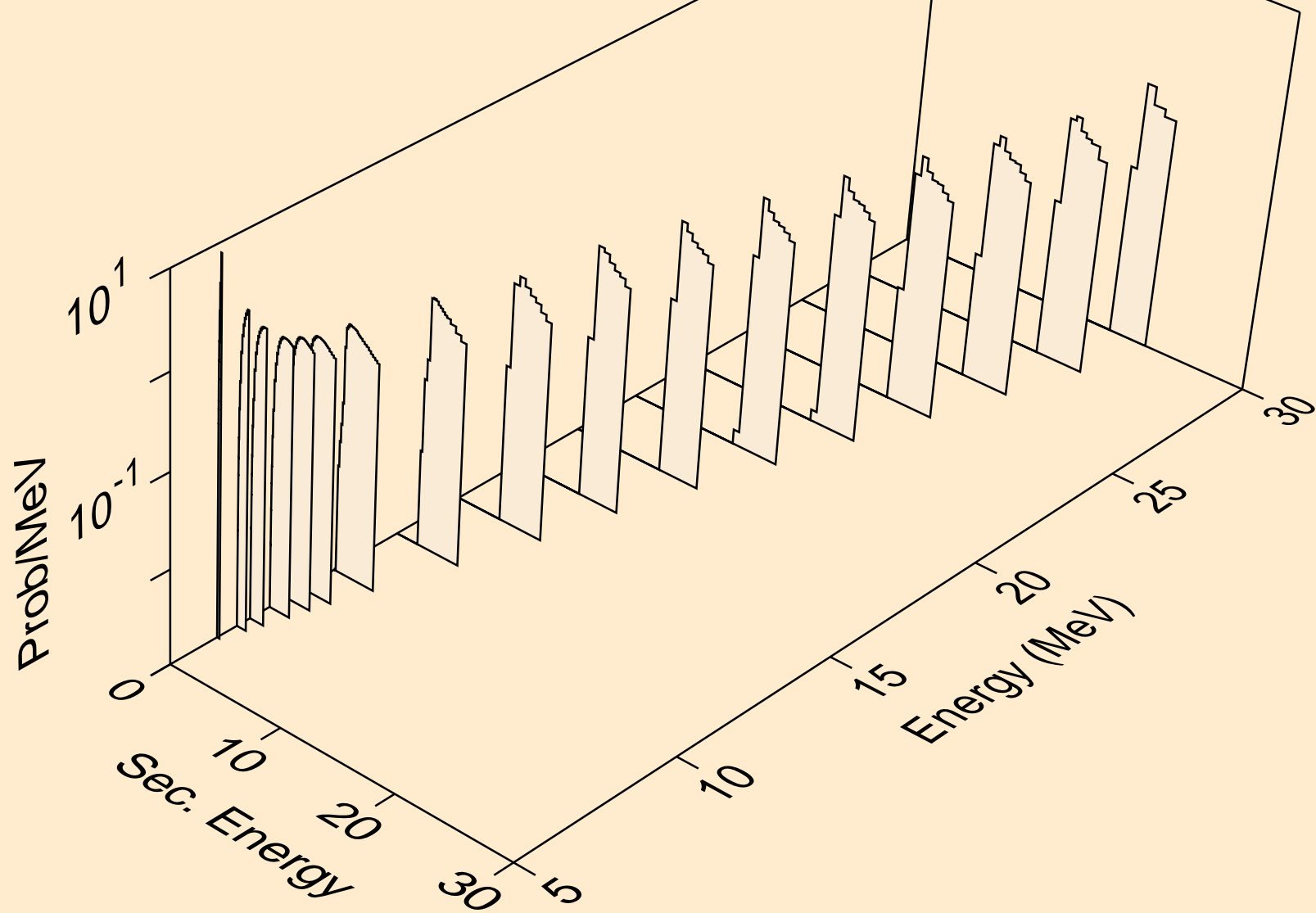

NA025 NEUTRON ACER TENDL-2024 LIBRARY; T=293.6K  
Photon emission for (n,x)

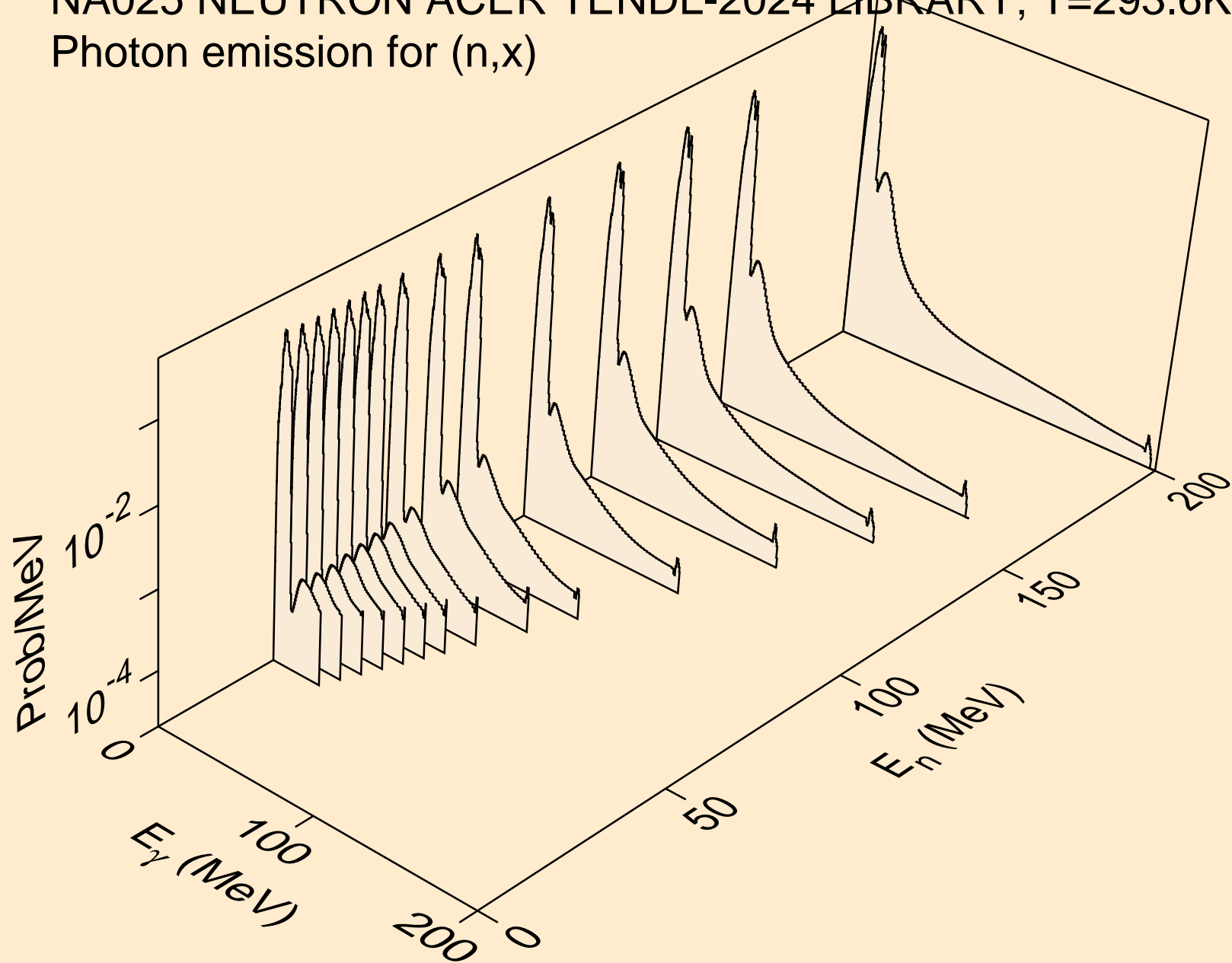

NA025 NEUTRON ACER TENDL-2024 LIBRARY; T=293.6K  
Photon emission for (n,2nd)

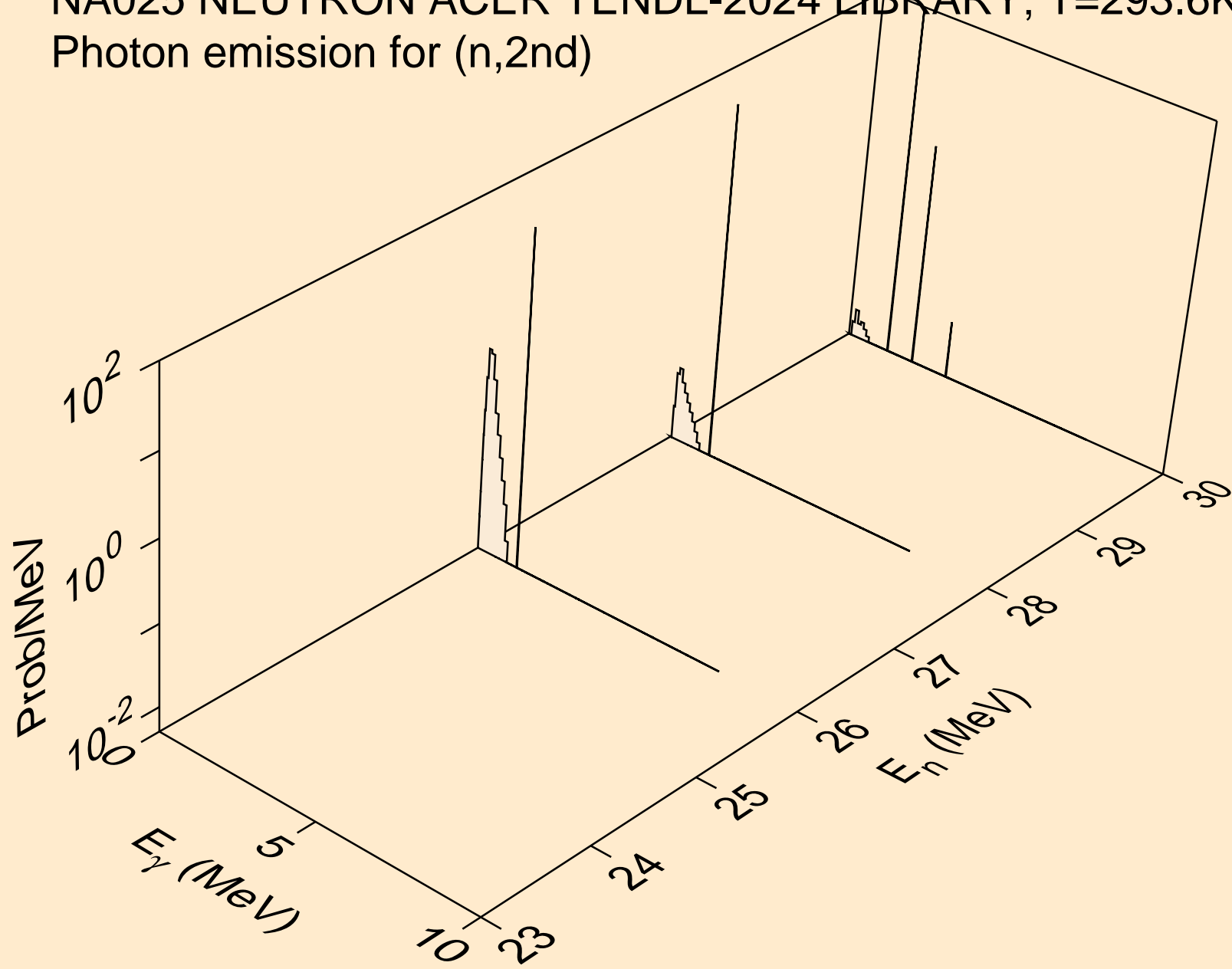

NA025 NEUTRON ACER TENDL-2024 LIBRARY; T=293.6K  
Photon emission for (n,2n)

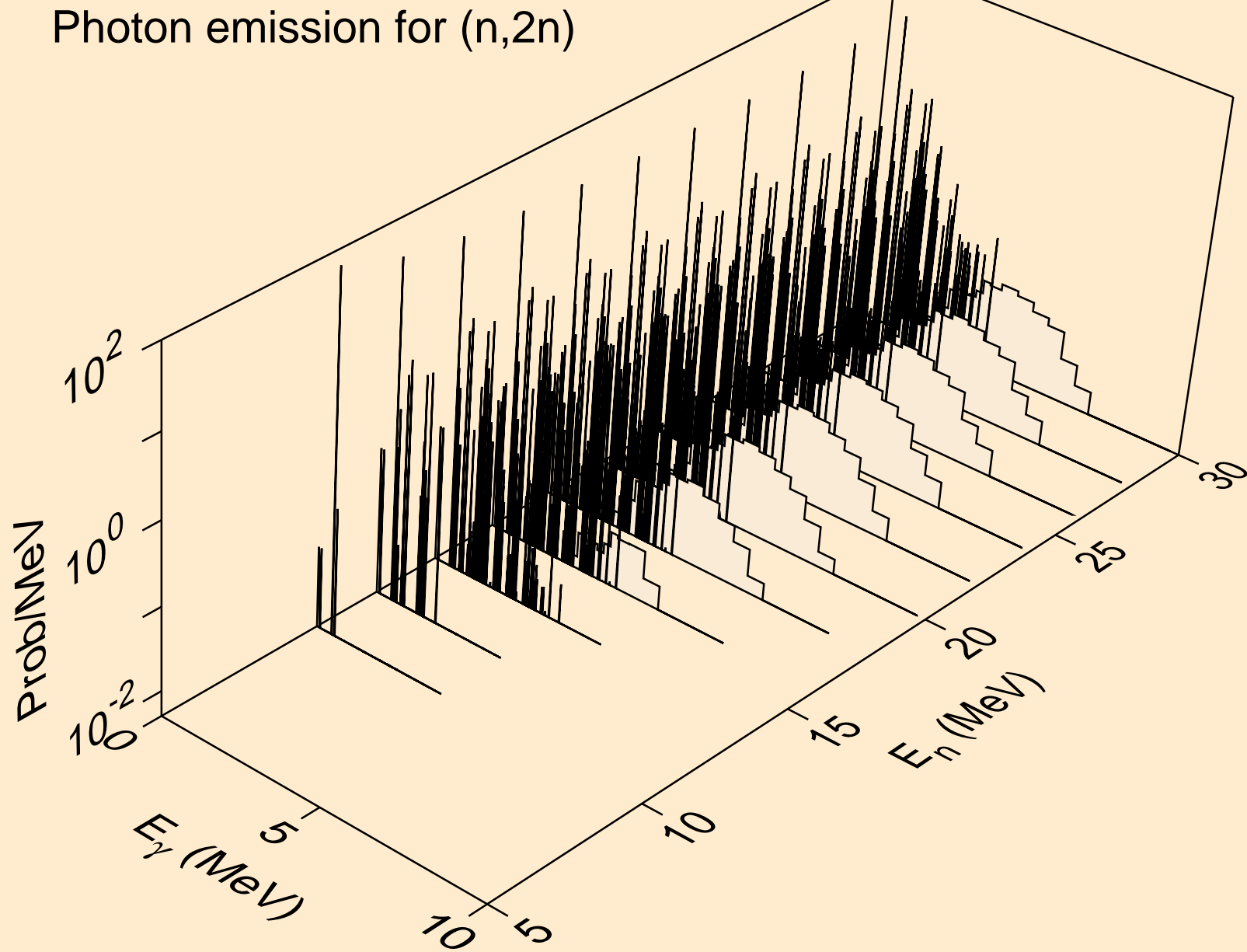

NA025 NEUTRON ACER TENDL-2024 LIBRARY; T=293.6K  
Photon emission for (n,3n)

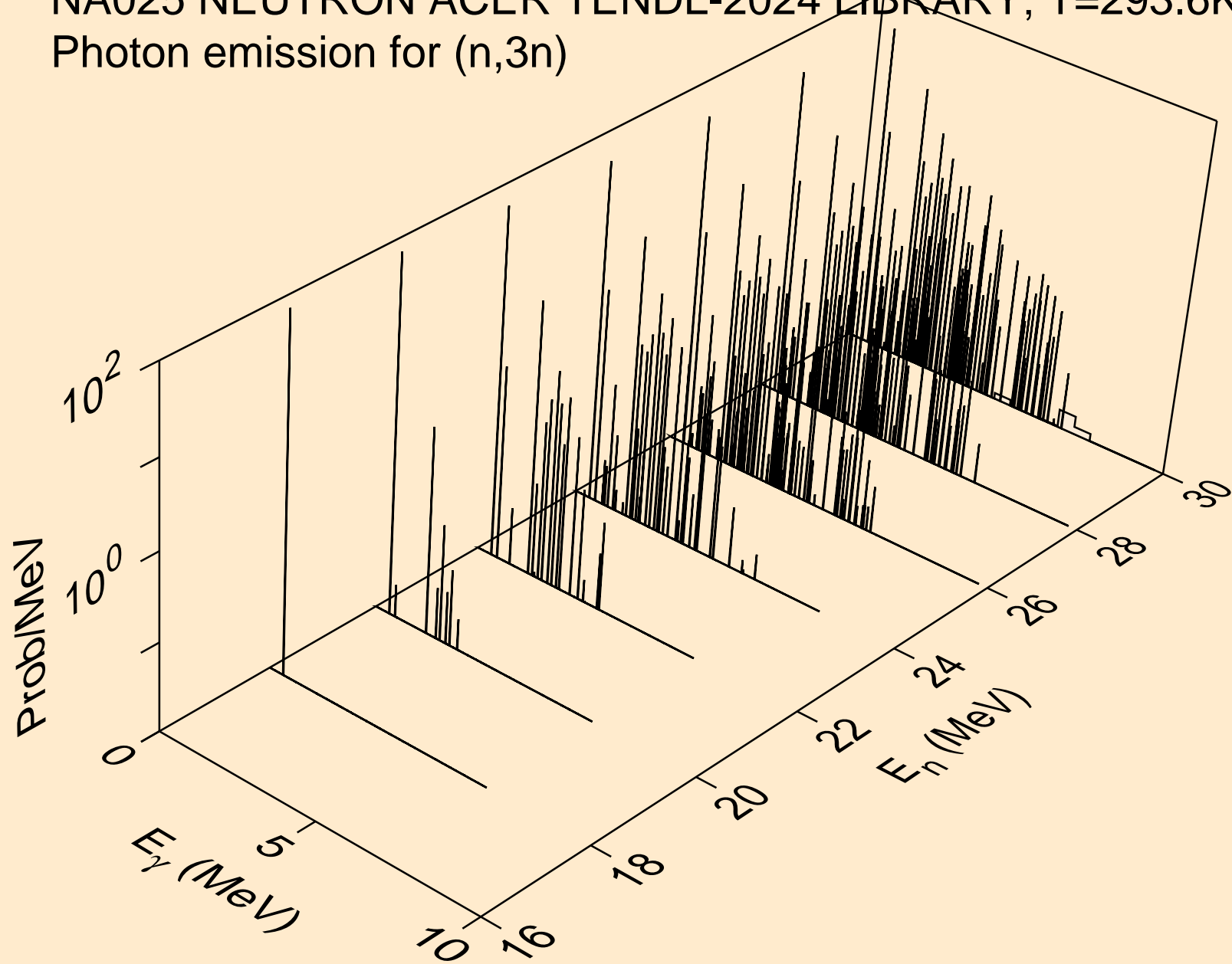

NA025 NEUTRON ACER TENDL-2024 LIBRARY; T=293.6K  
Photon emission for (n,n\*)a

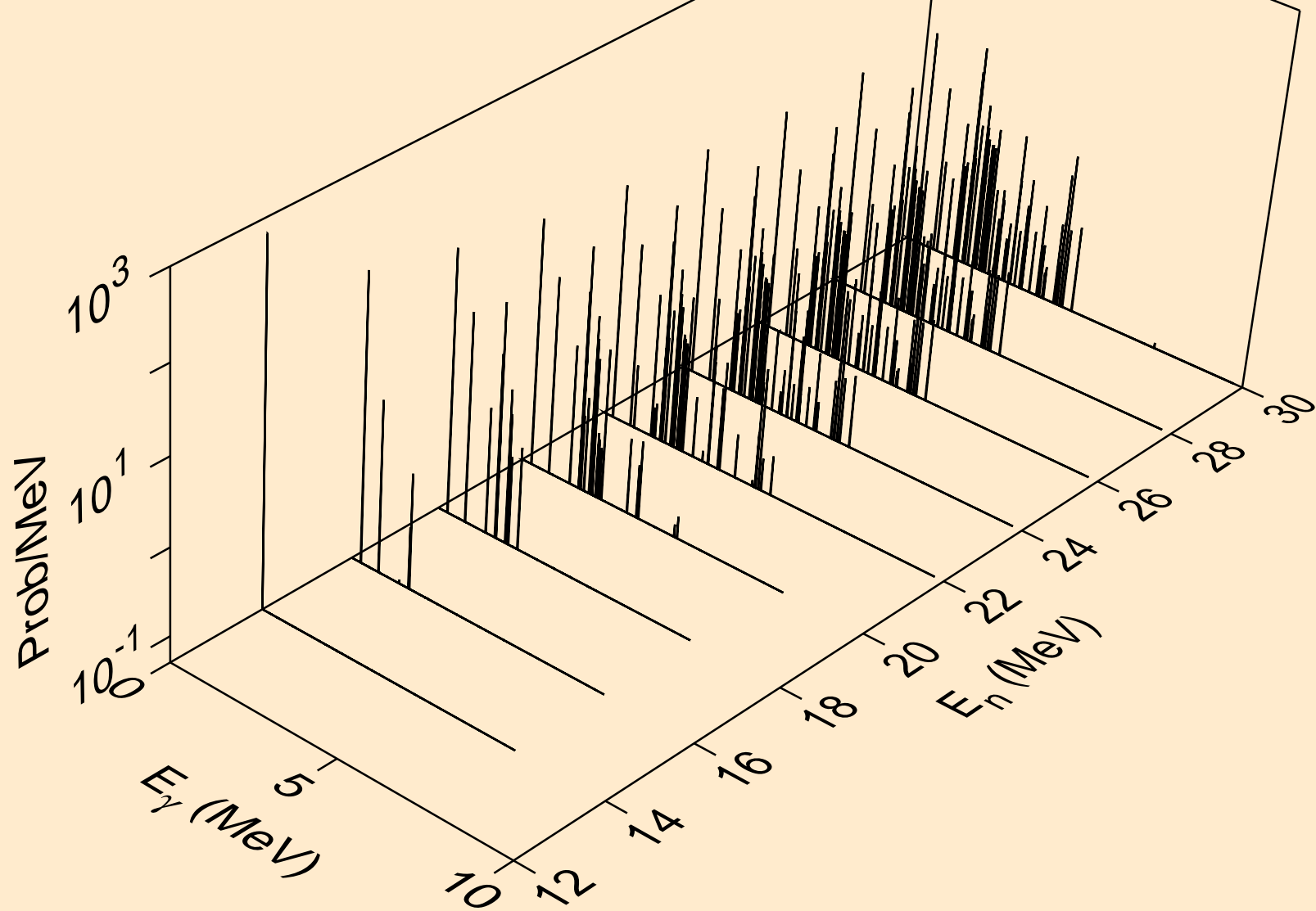

NA025 NEUTRON ACER TENDL-2024 LIBRARY; T=293.6K  
Photon emission for (n,2n)a

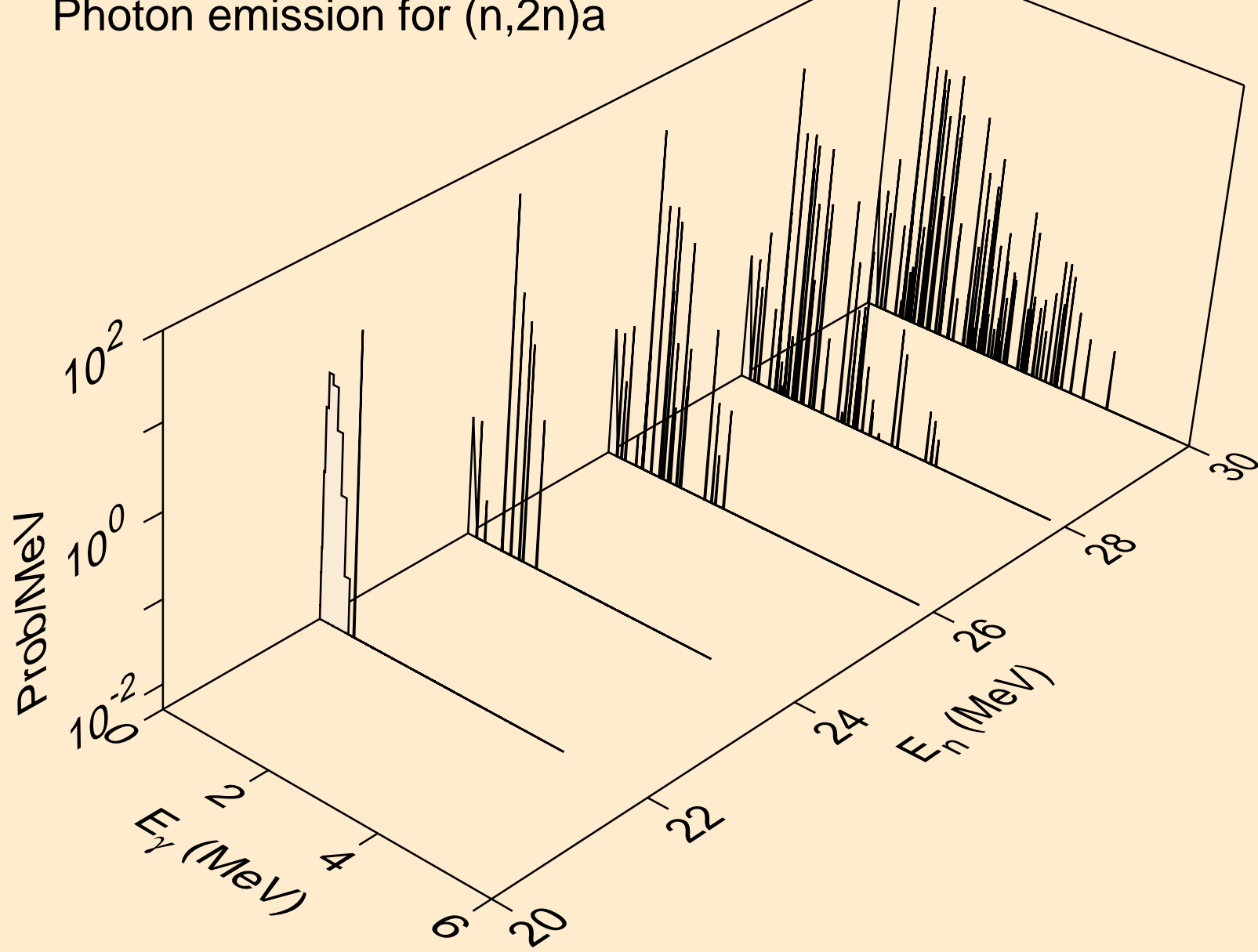

NA025 NEUTRON ACER TENDL-2024 LIBRARY; T=293.6K  
Photon emission for (n,3n)a

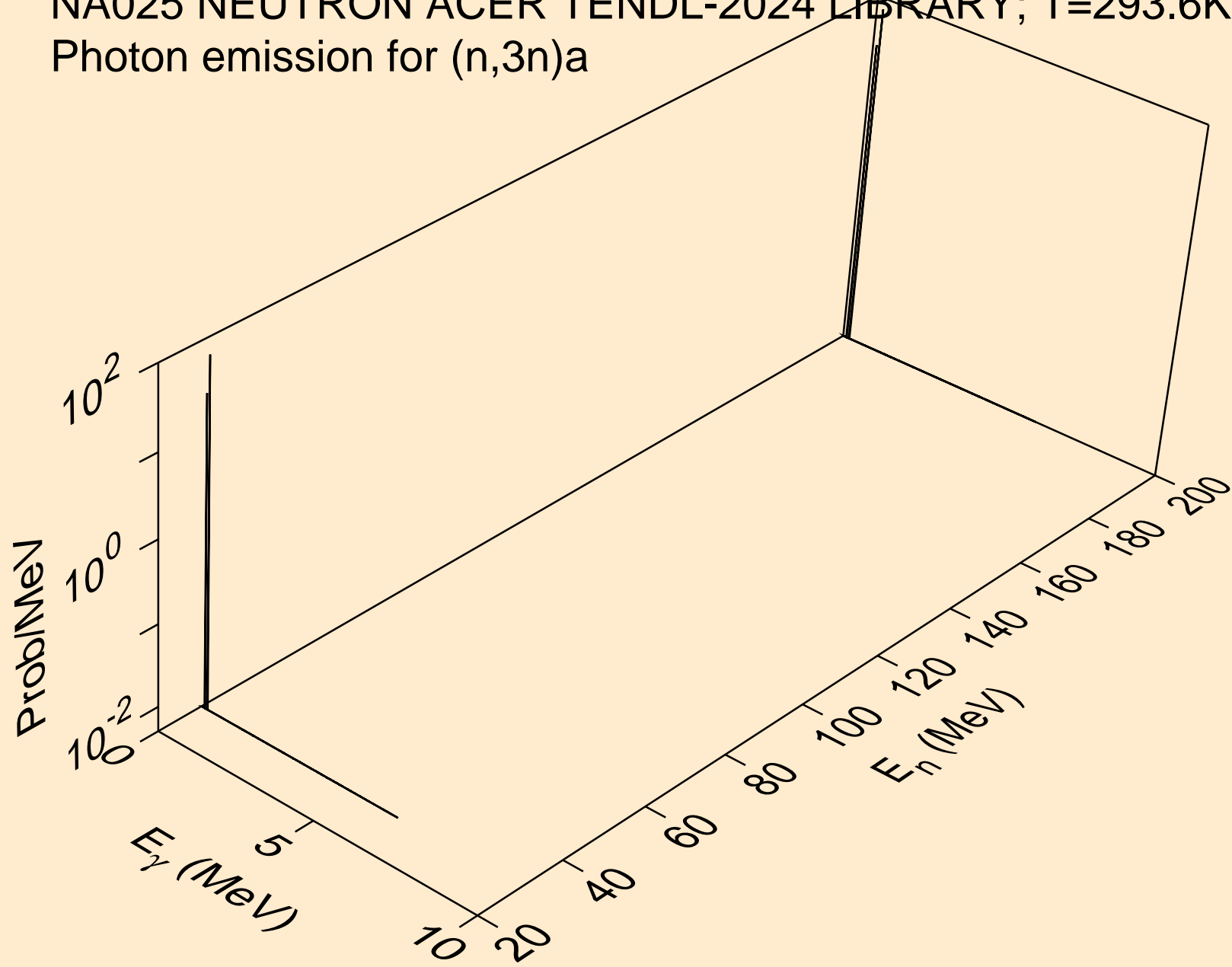

NA025 NEUTRON ACER TENDL-2024 LIBRARY; T=293.6K  
Photon emission for (n,n\*)p

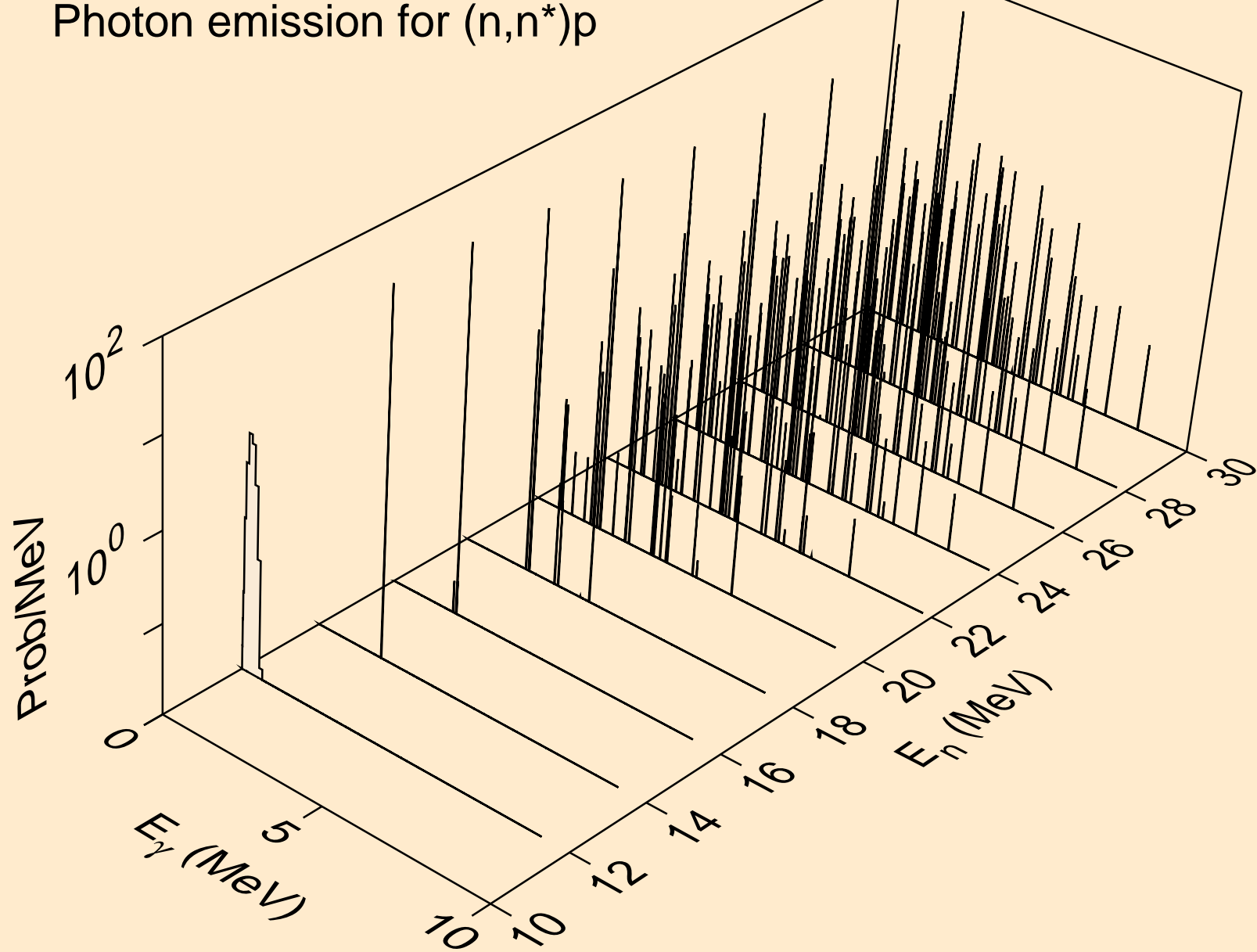

NA025 NEUTRON ACER TENDL-2024 LIBRARY; T=293.6K  
Photon emission for (n,n\*)2a

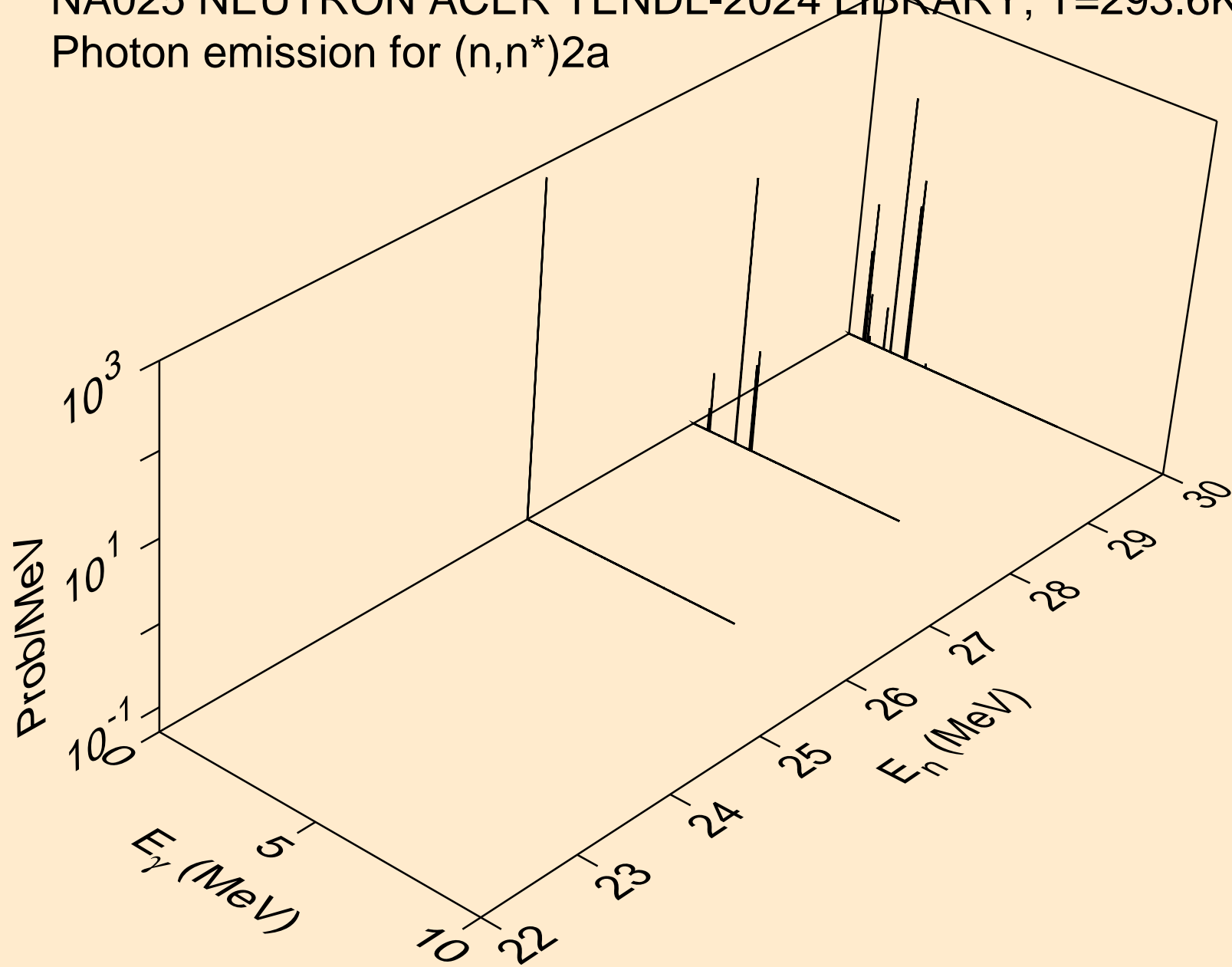

NA025 NEUTRON ACER TENDL-2024 LIBRARY; T=293.6K  
Photon emission for (n,n\*)d

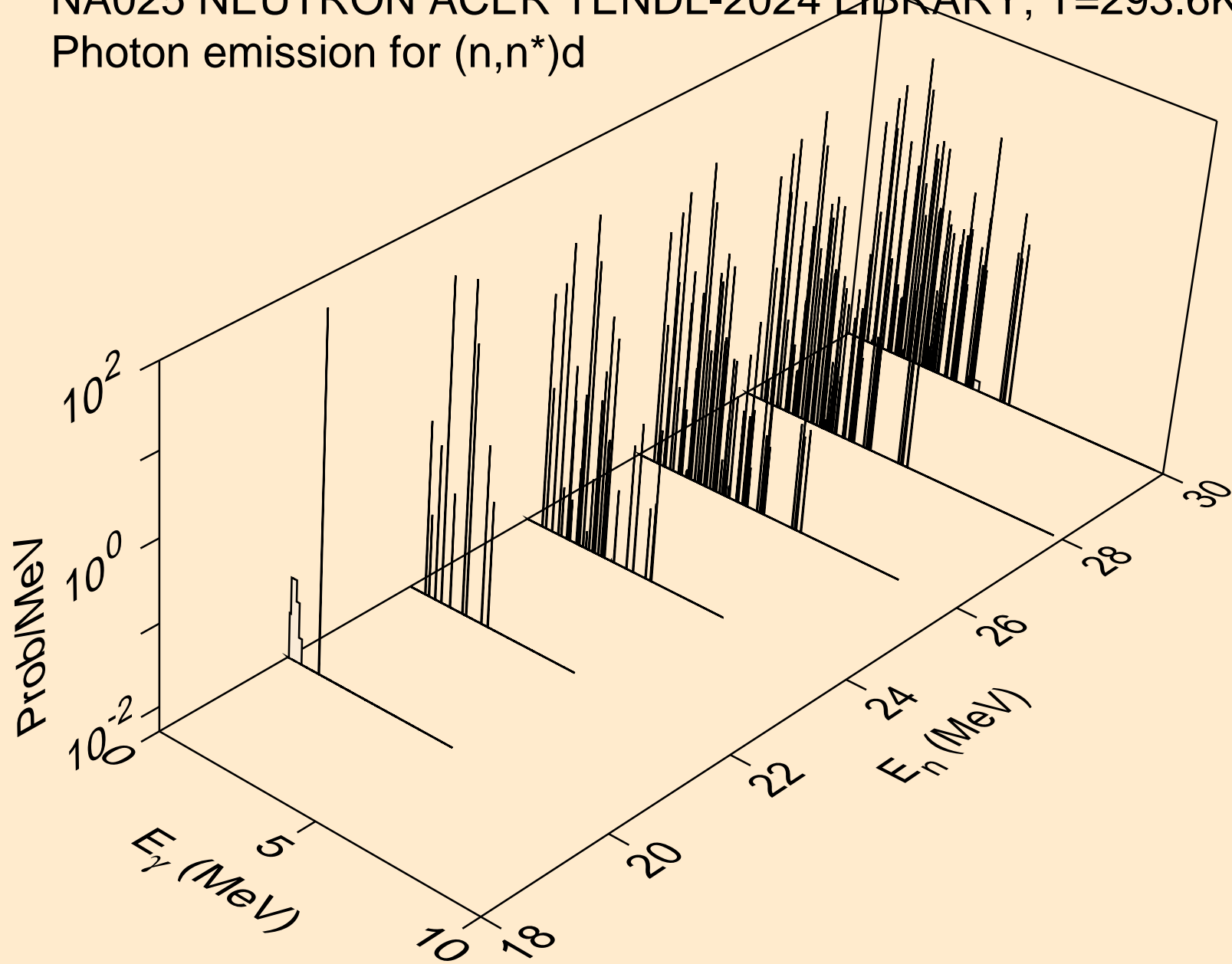

NA025 NEUTRON ACER TENDL-2024 LIBRARY; T=293.6K  
Photon emission for (n,n\*)t

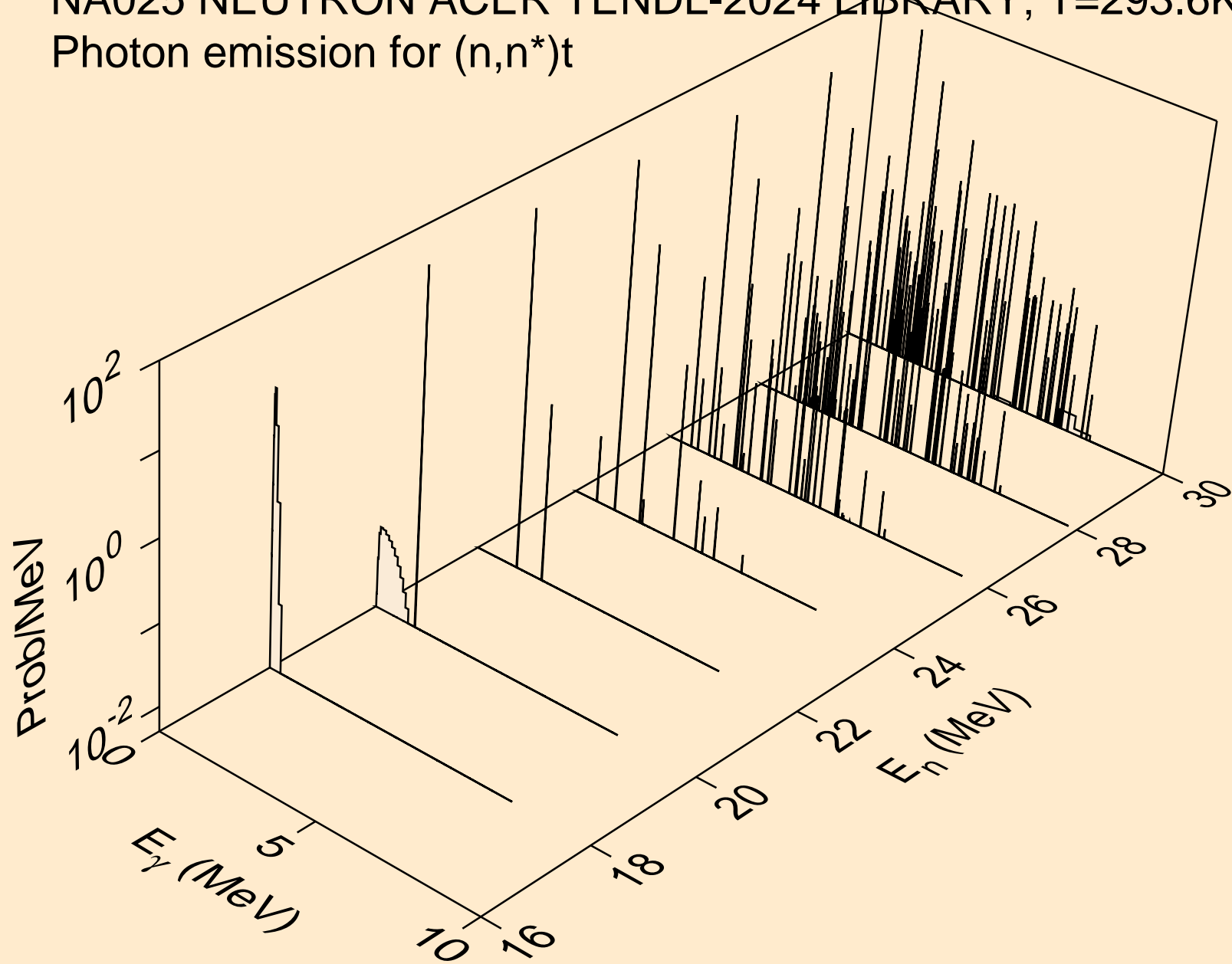

NA025 NEUTRON ACER TENDL-2024 LIBRARY; T=293.6K  
Photon emission for (n,n\*)he3

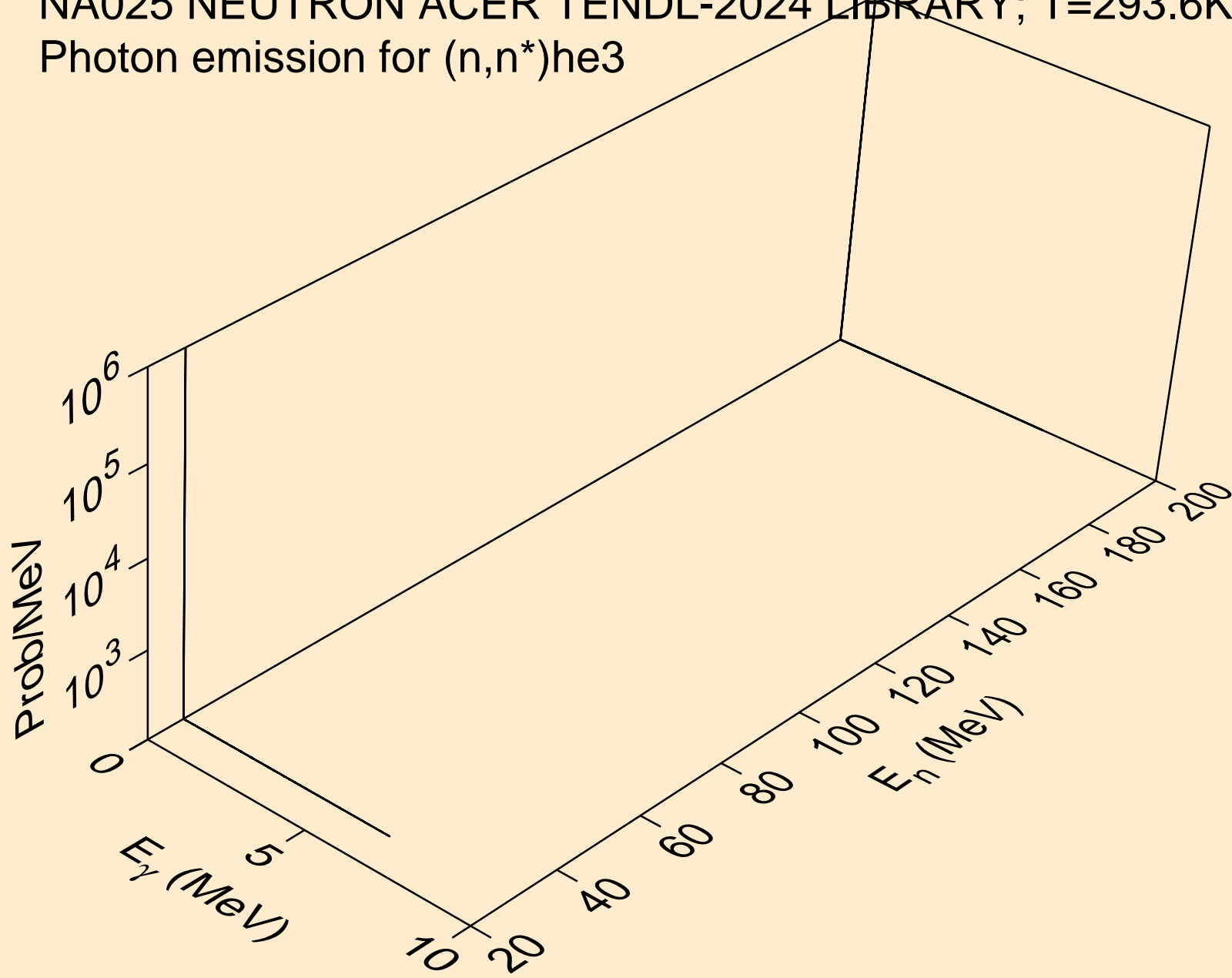

NA025 NEUTRON ACER TENDL-2024 LIBRARY; T=293.6K  
Photon emission for (n,2np)

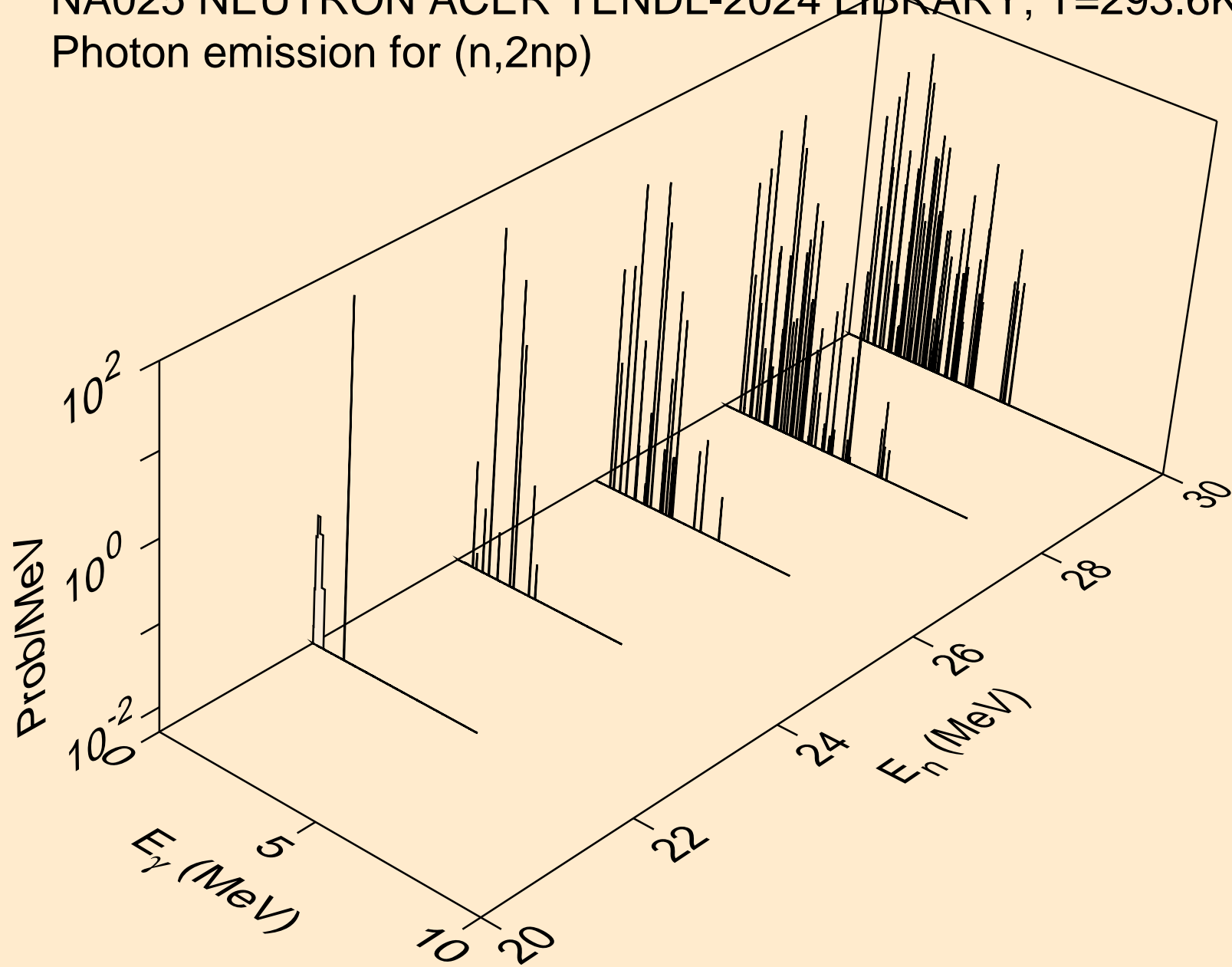

NA025 NEUTRON ACER TENDL-2024 LIBRARY; T=293.6K  
Photon emission for (n,3np)

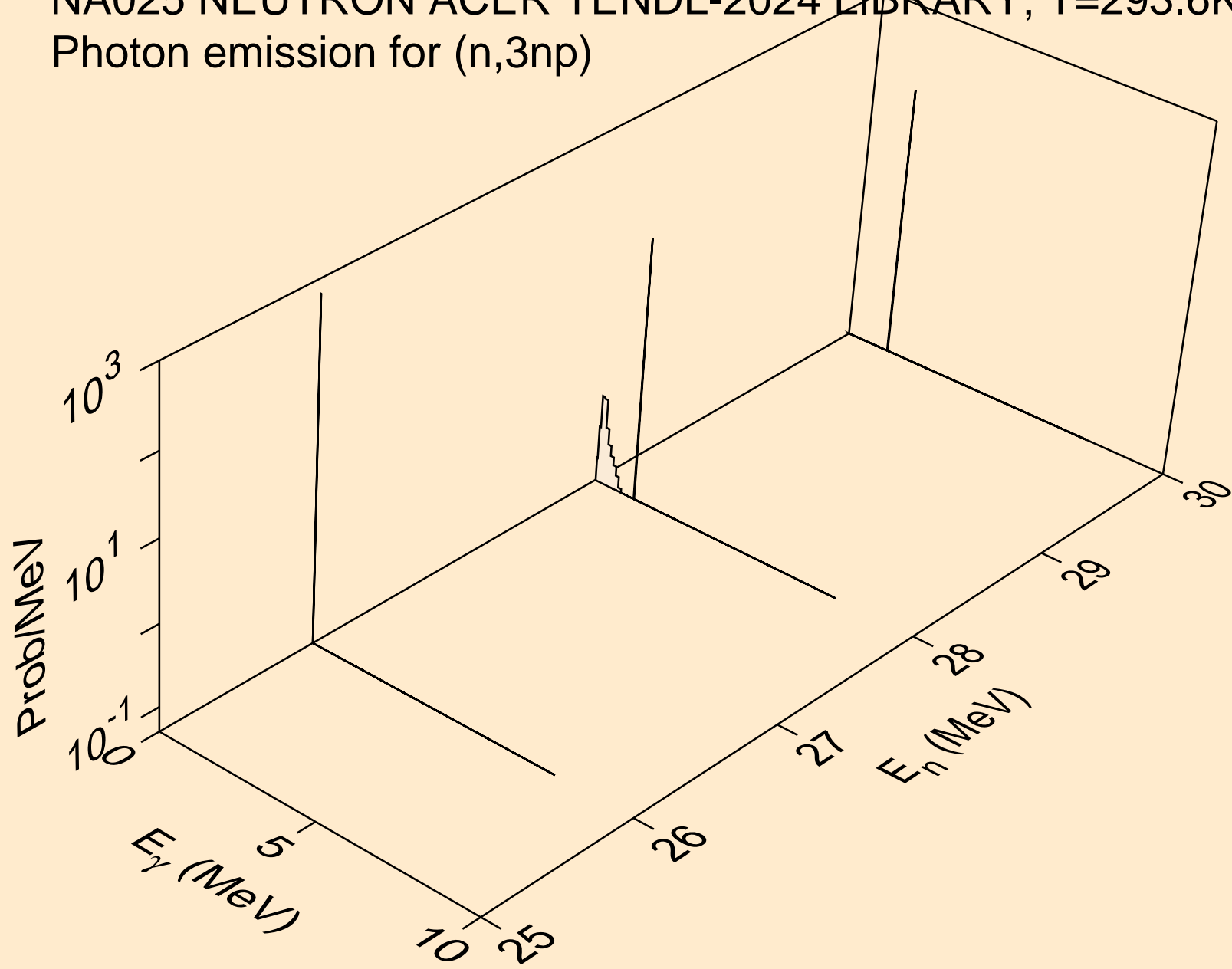

NA025 NEUTRON ACER TENDL-2024 LIBRARY; T=293.6K  
Photon emission for (n,npa)

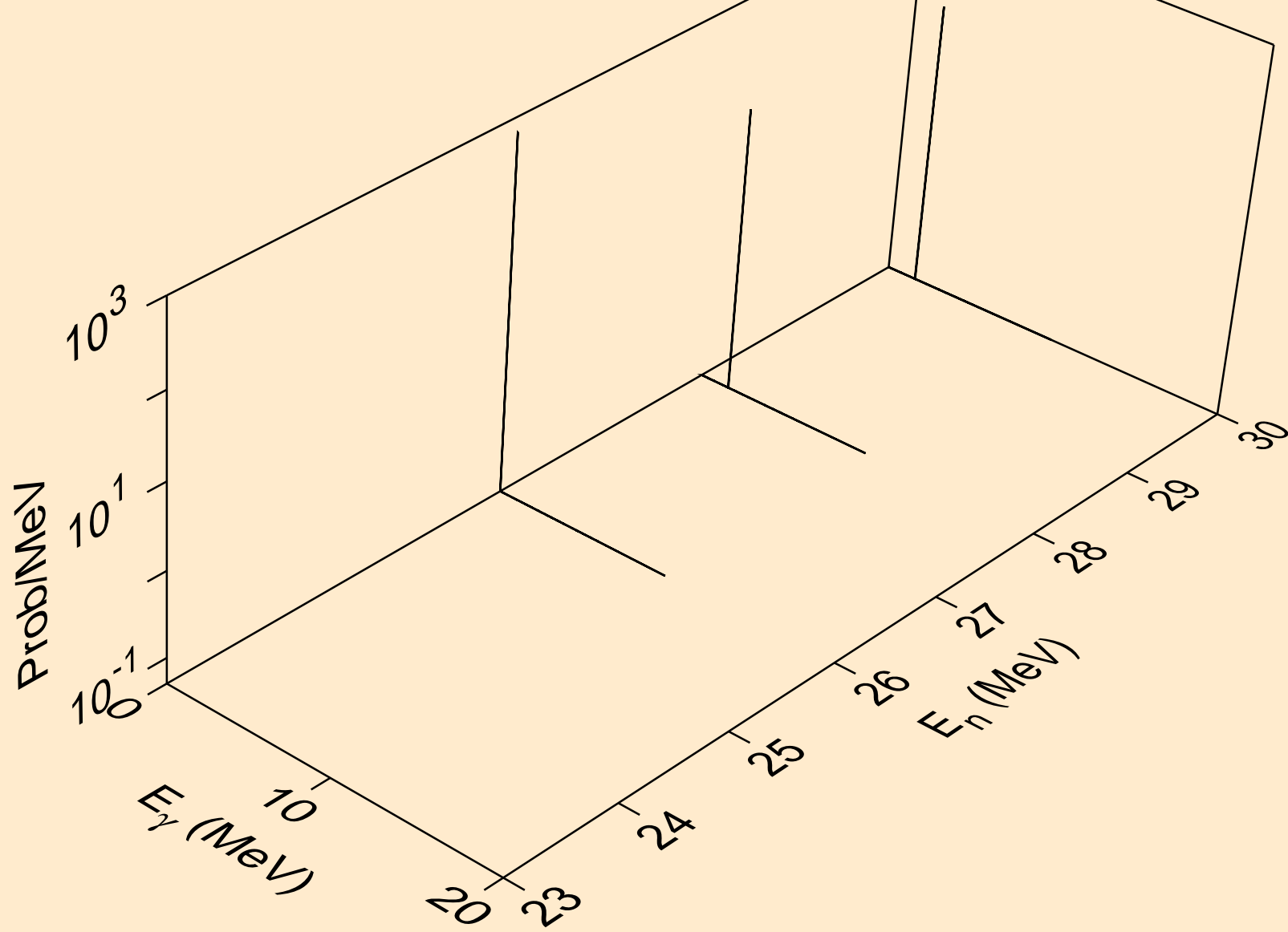

NA025 NEUTRON ACER TENDL-2024 LIBRARY; T=293.6K  
Photon emission for (n,n\*c)

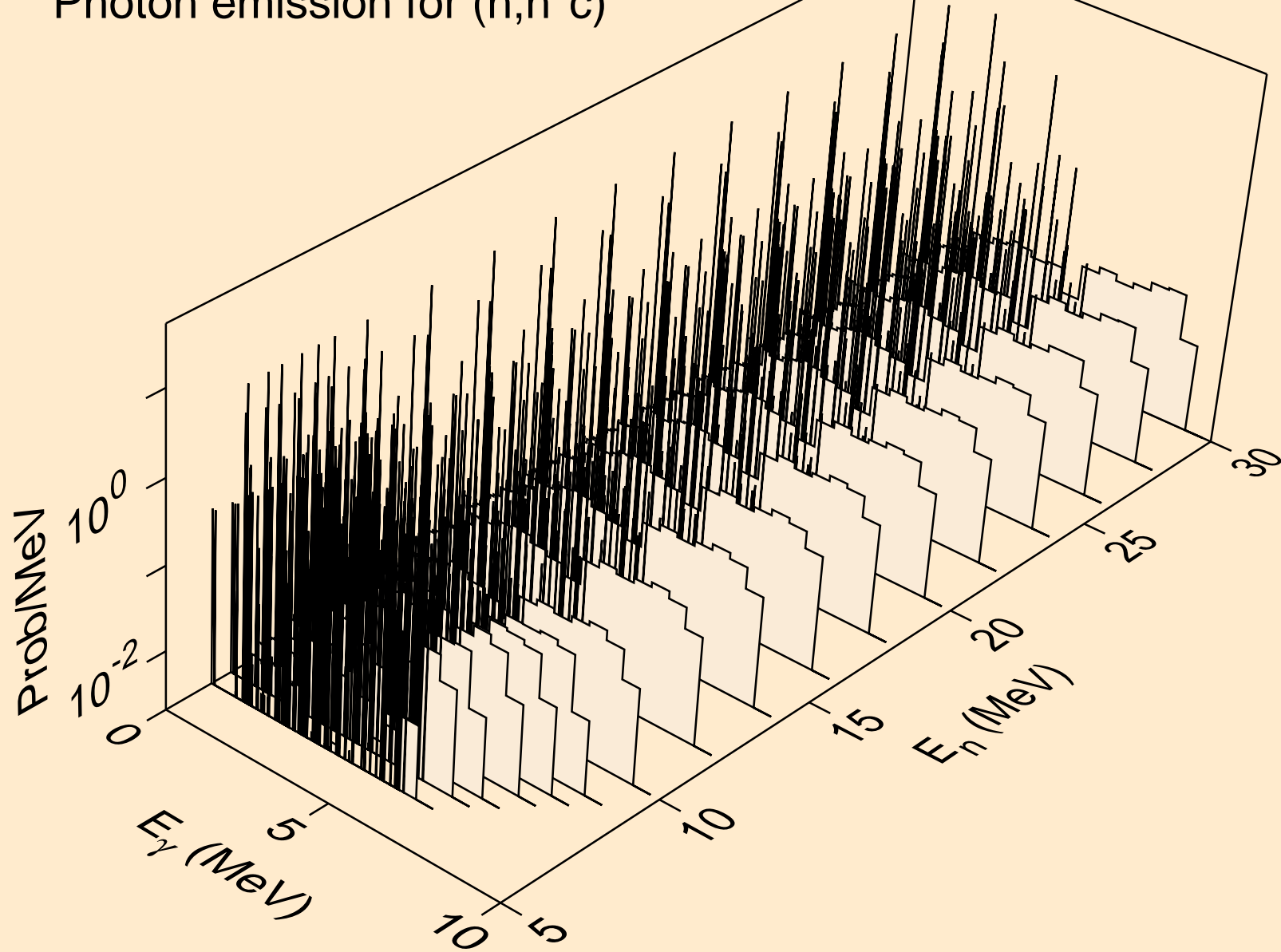

NA025 NEUTRON ACER TENDL-2024 LIBRARY; T=293.6K  
Photon emission for (n,gma)

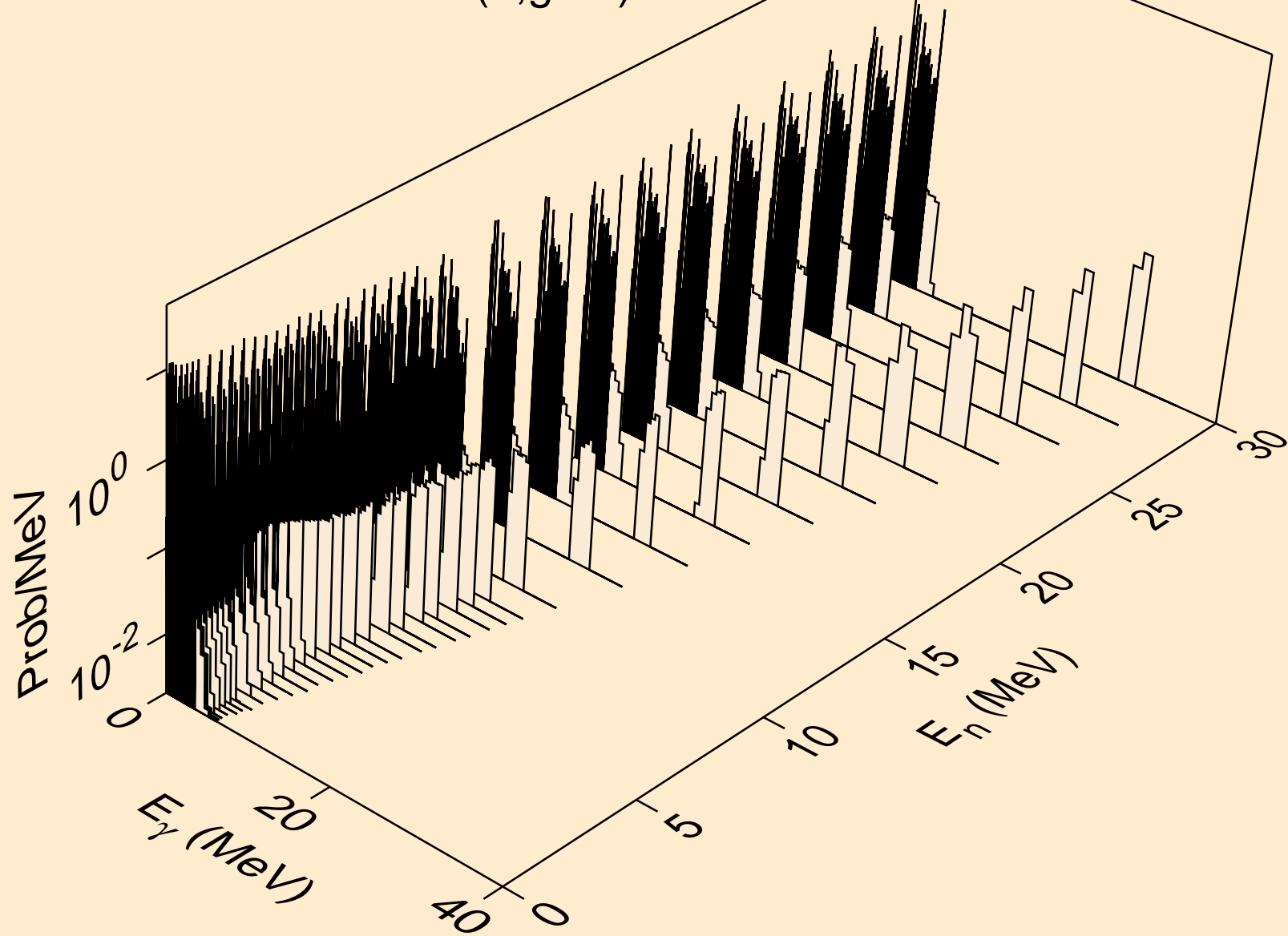

NA025 NEUTRON ACER TENDL-2024 LIBRARY; T=293.6K  
Photon emission for (n,p)

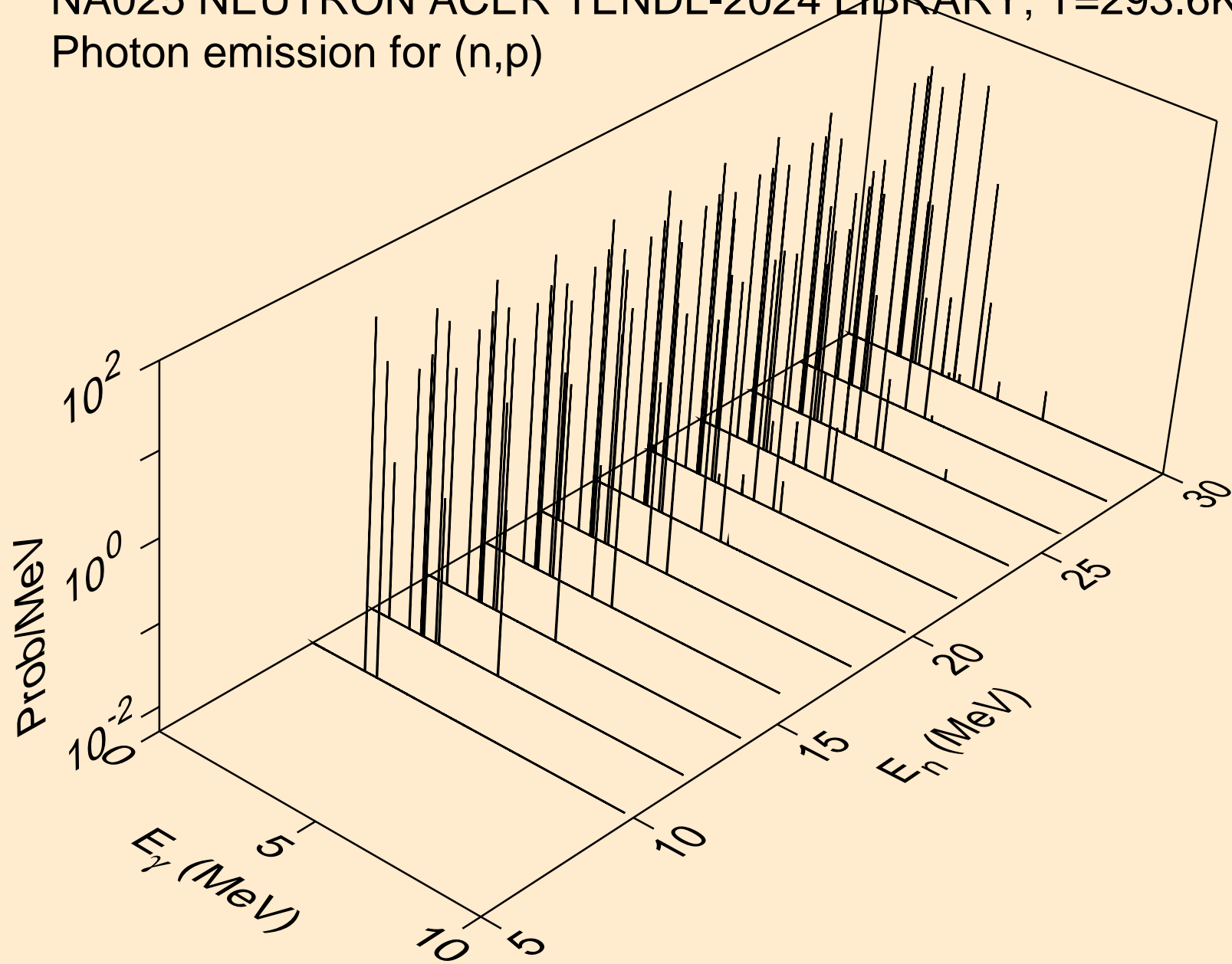

NA025 NEUTRON ACER TENDL-2024 LIBRARY; T=293.6K  
Photon emission for (n,d)

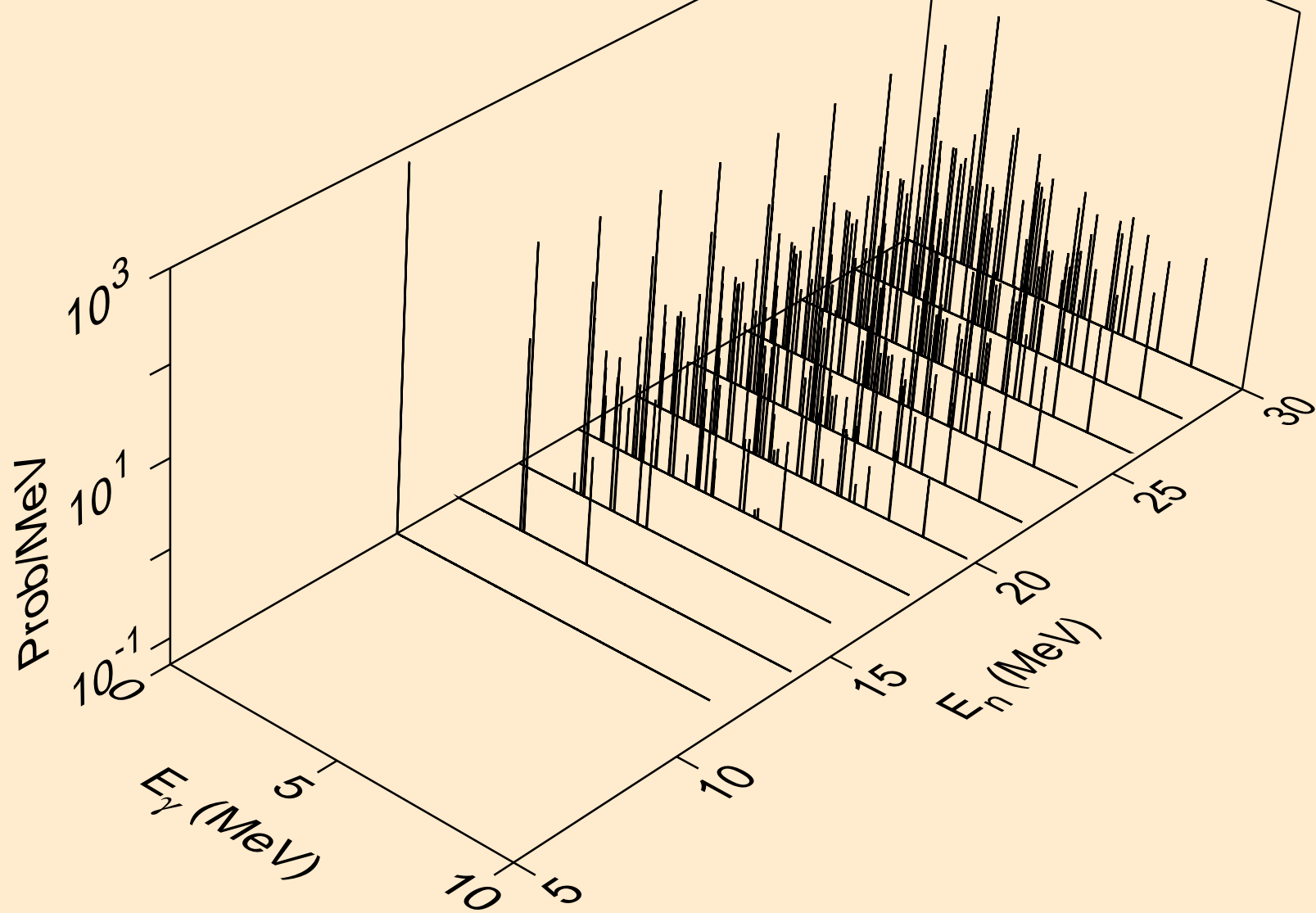

NA025 NEUTRON ACER TENDL-2024 LIBRARY; T=293.6K  
Photon emission for (n,t)

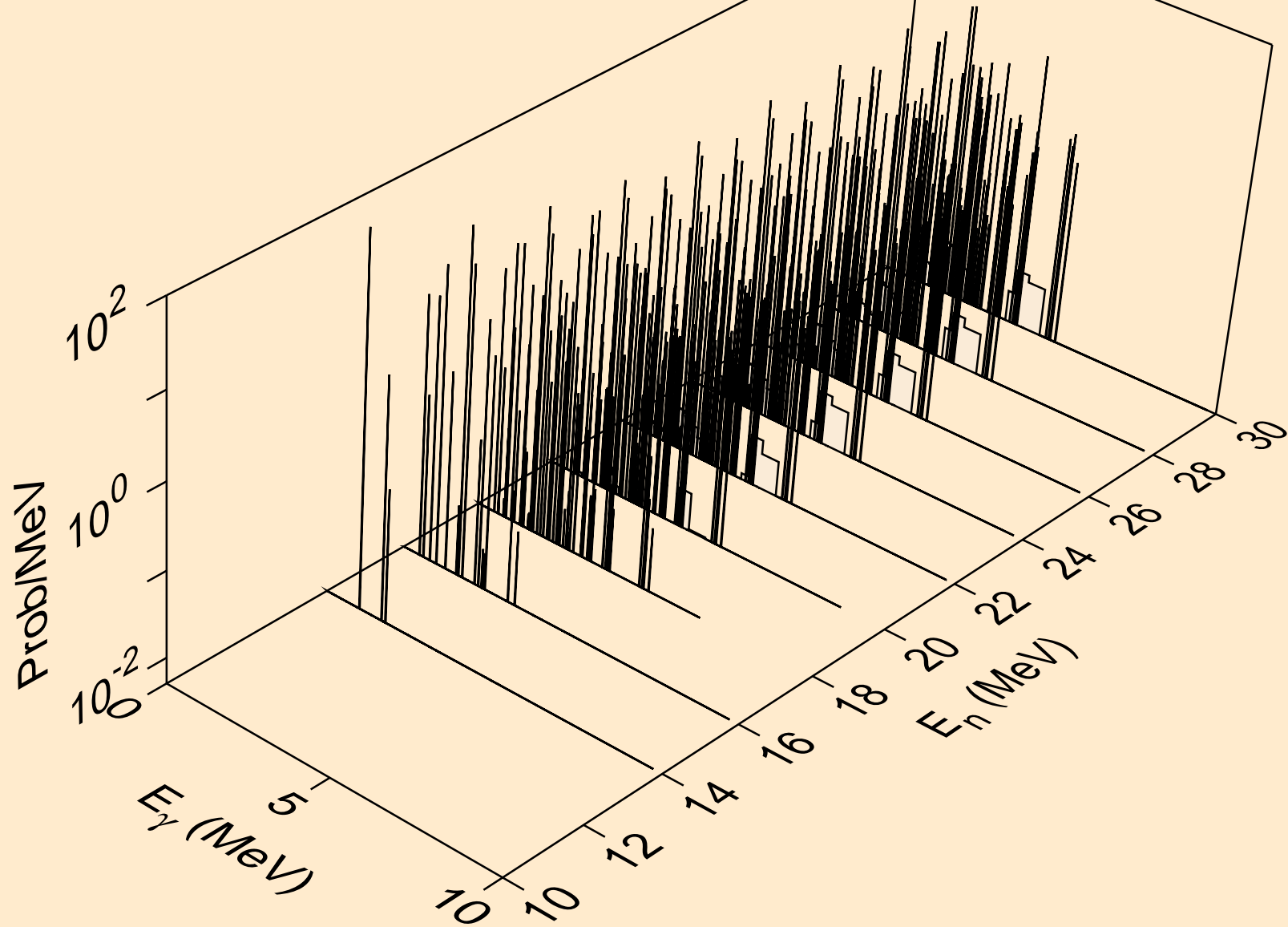

NA025 NEUTRON ACER TENDL-2024 LIBRARY; T=293.6K  
Photon emission for (n,he3)

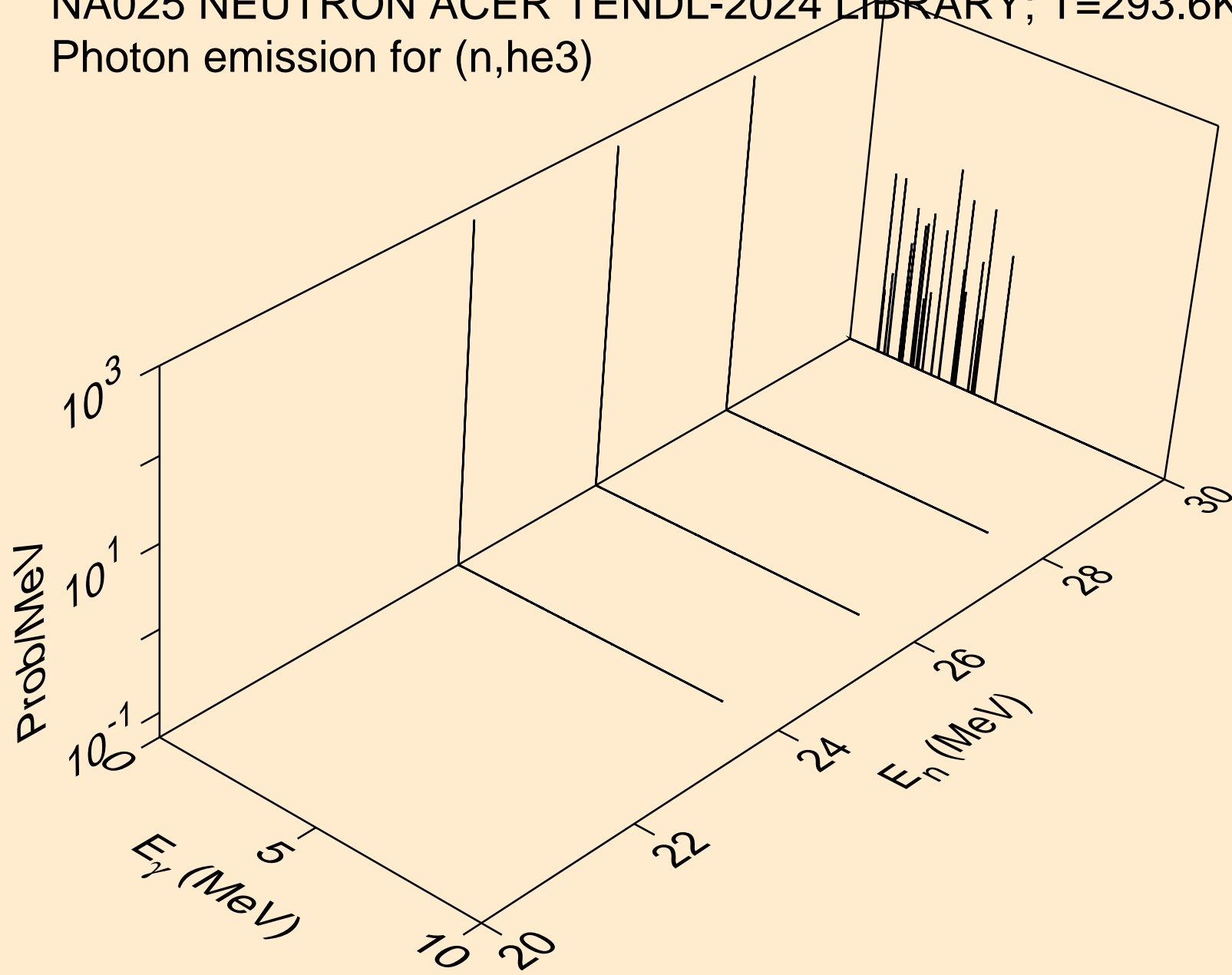

NA025 NEUTRON ACER TENDL-2024 LIBRARY; T=293.6K  
Photon emission for (n,a)

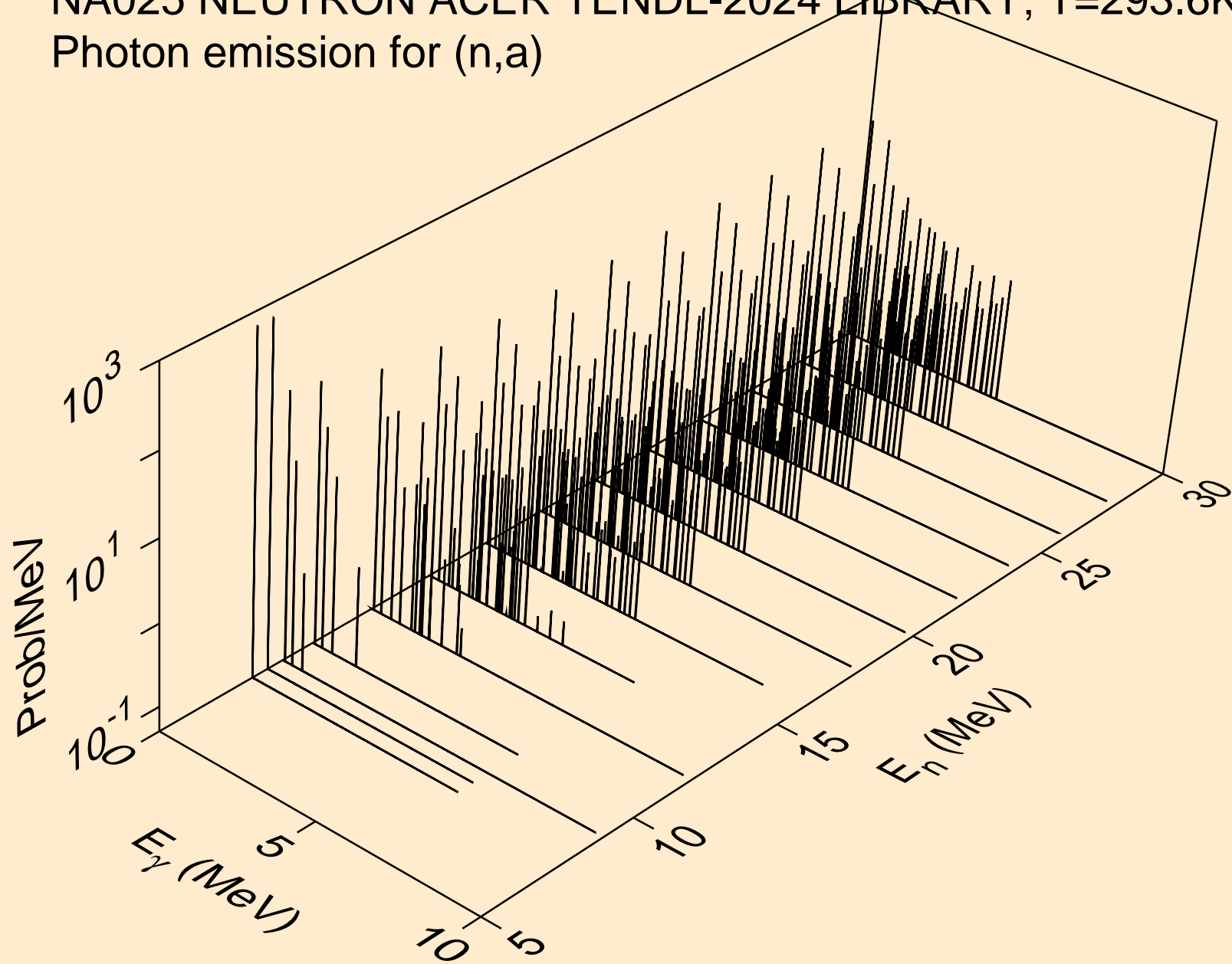

NA025 NEUTRON ACER TENDL-2024 LIBRARY; T=293.6K  
Photon emission for (n,2a)

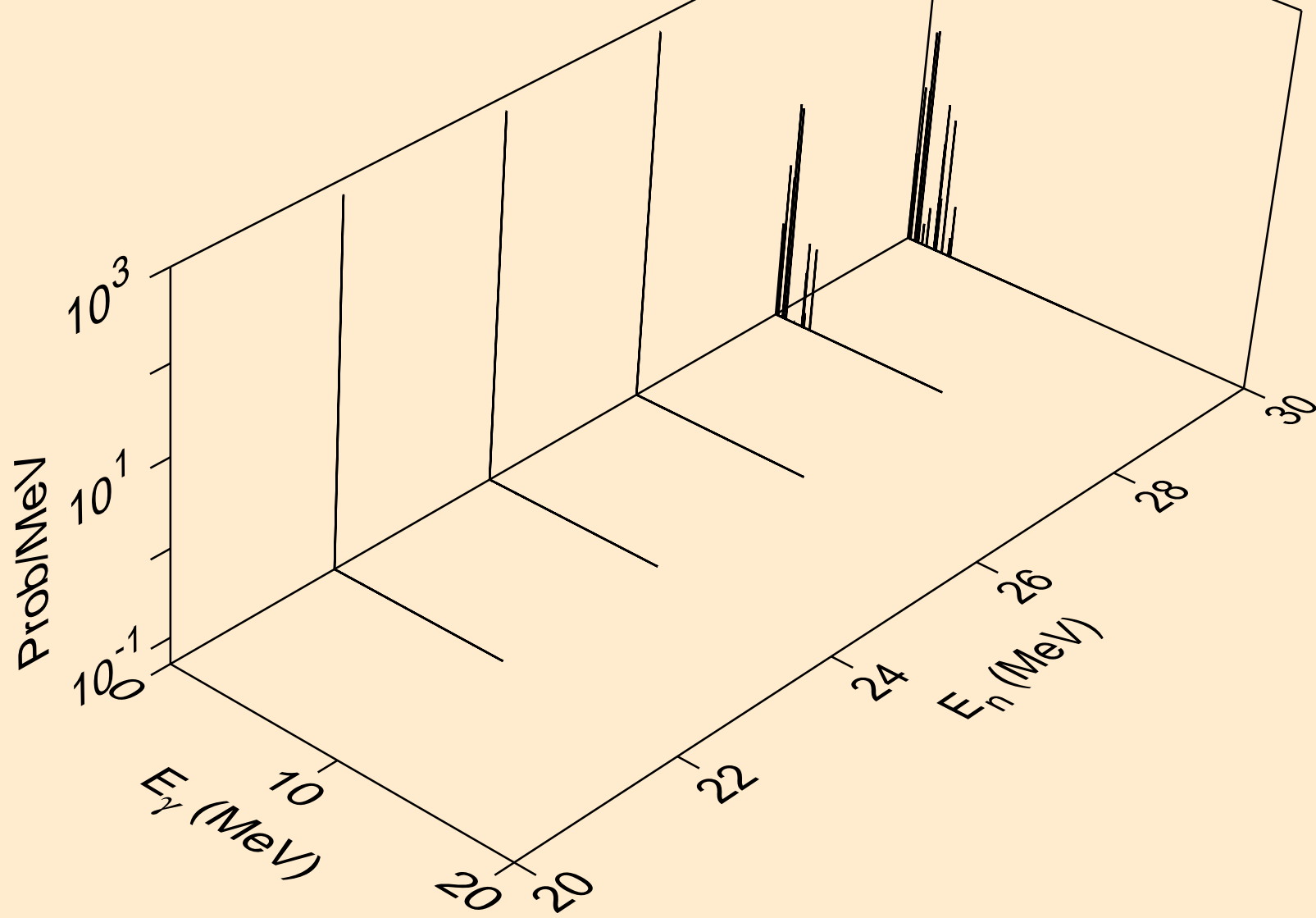

NA025 NEUTRON ACER TENDL-2024 LIBRARY; T=293.6K  
Photon emission for (n,2p)

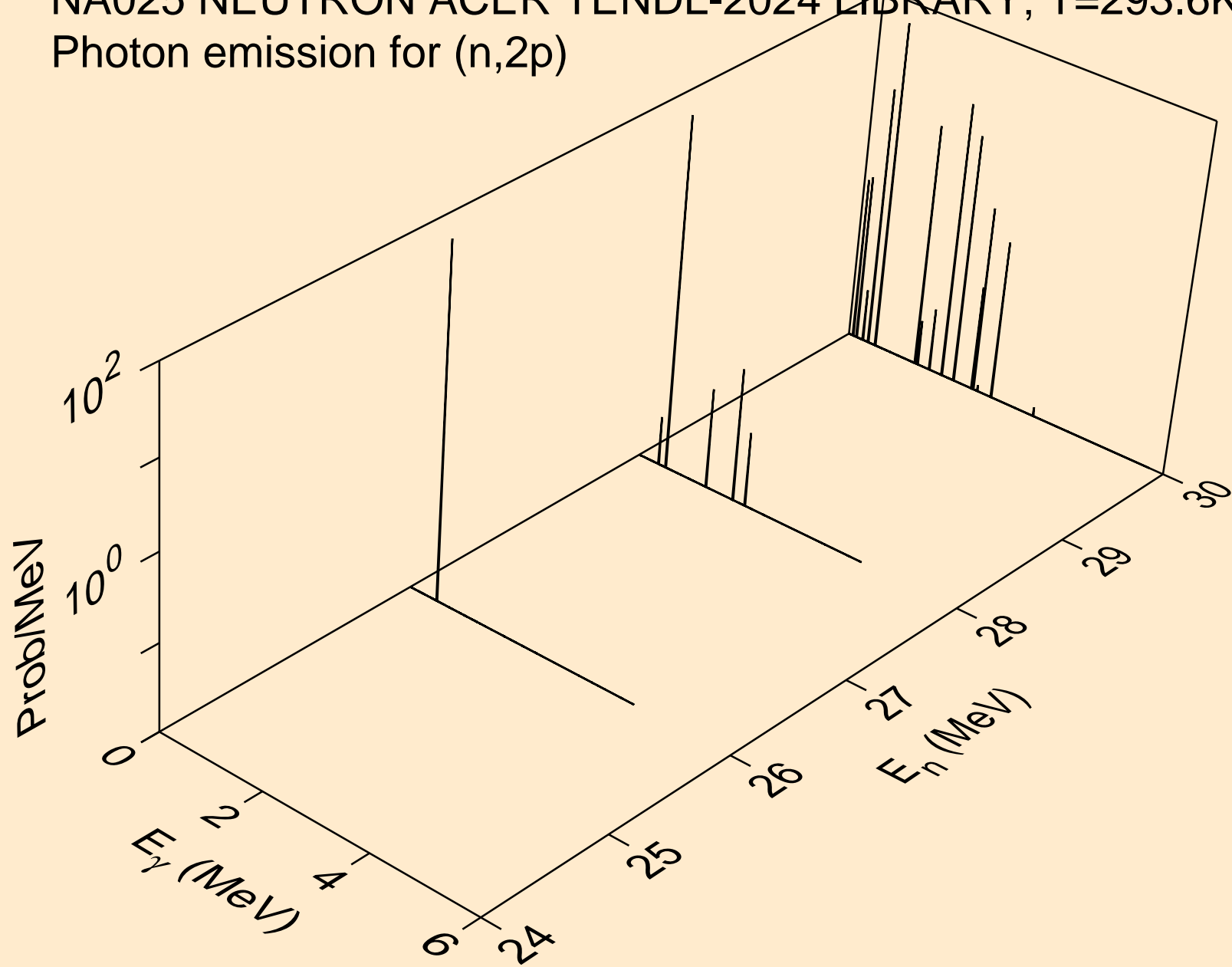

NA025 NEUTRON ACER TENDL-2024 LIBRARY; T=293.6K  
Photon emission for (n,p)

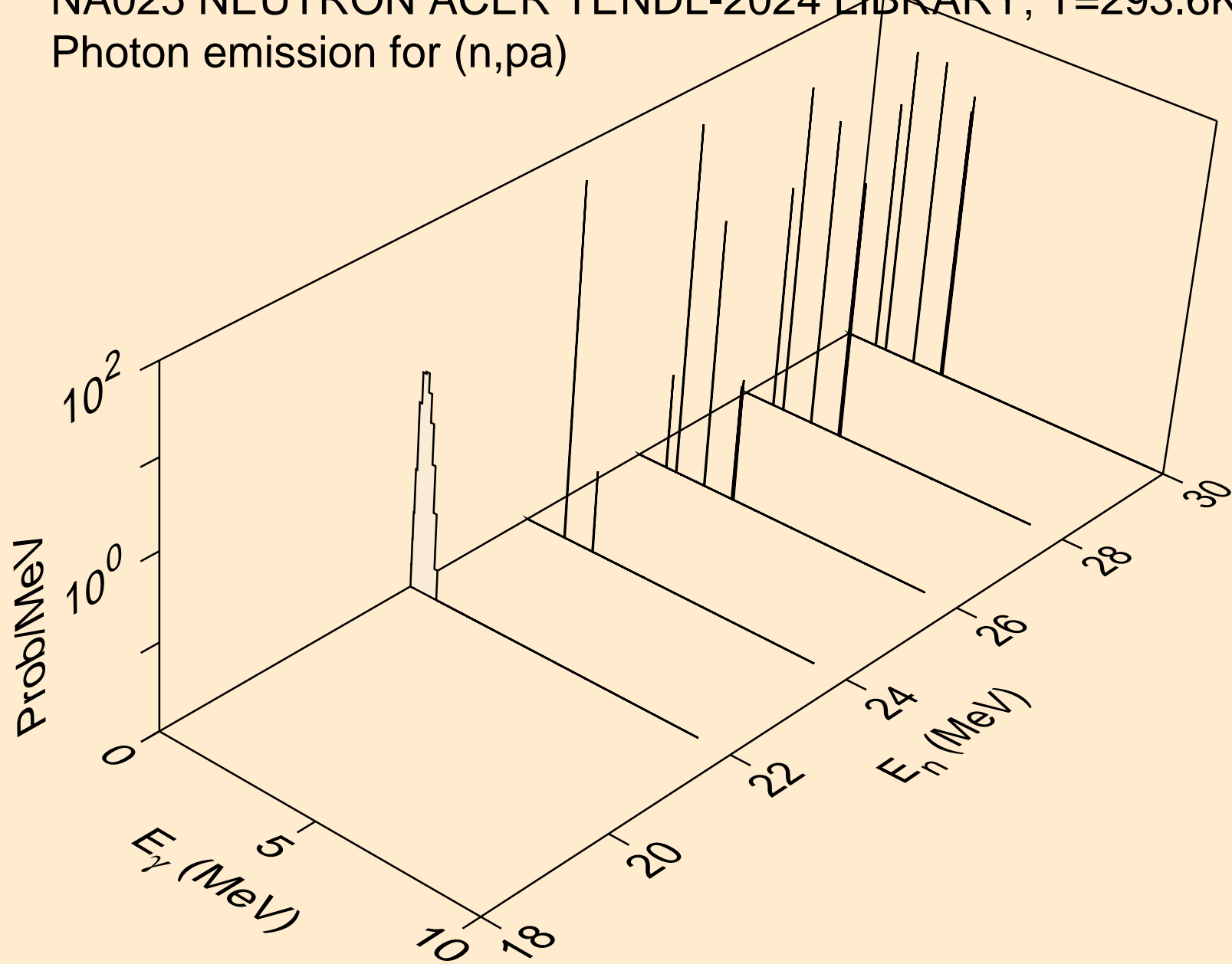

NA025 NEUTRON ACER TENDL-2024 LIBRARY; T=293.6K  
Photon emission for (n,pd)

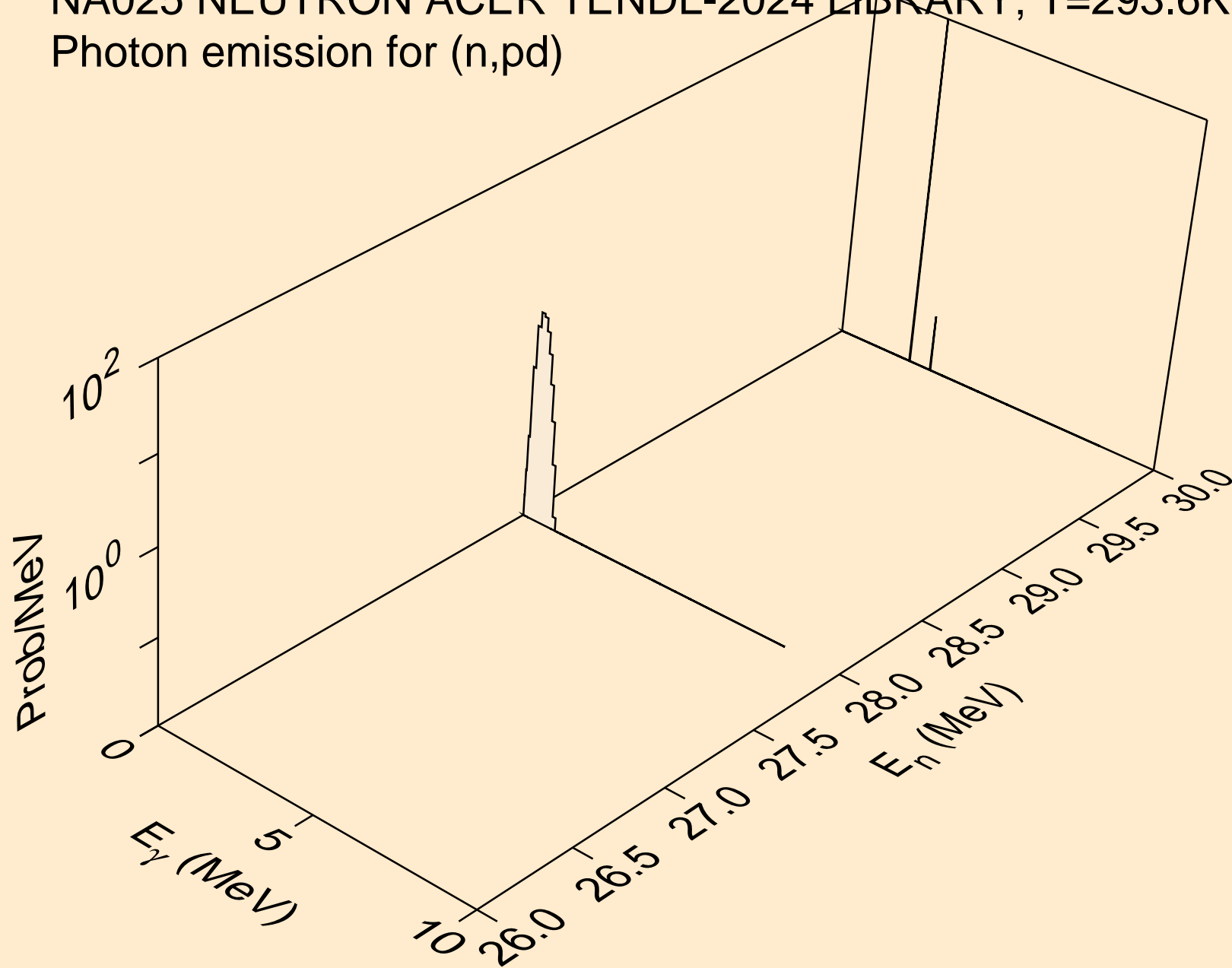

NA025 NEUTRON ACER TENDL-2024 LIBRARY; T=293.6K  
Photon emission for (n,pt)

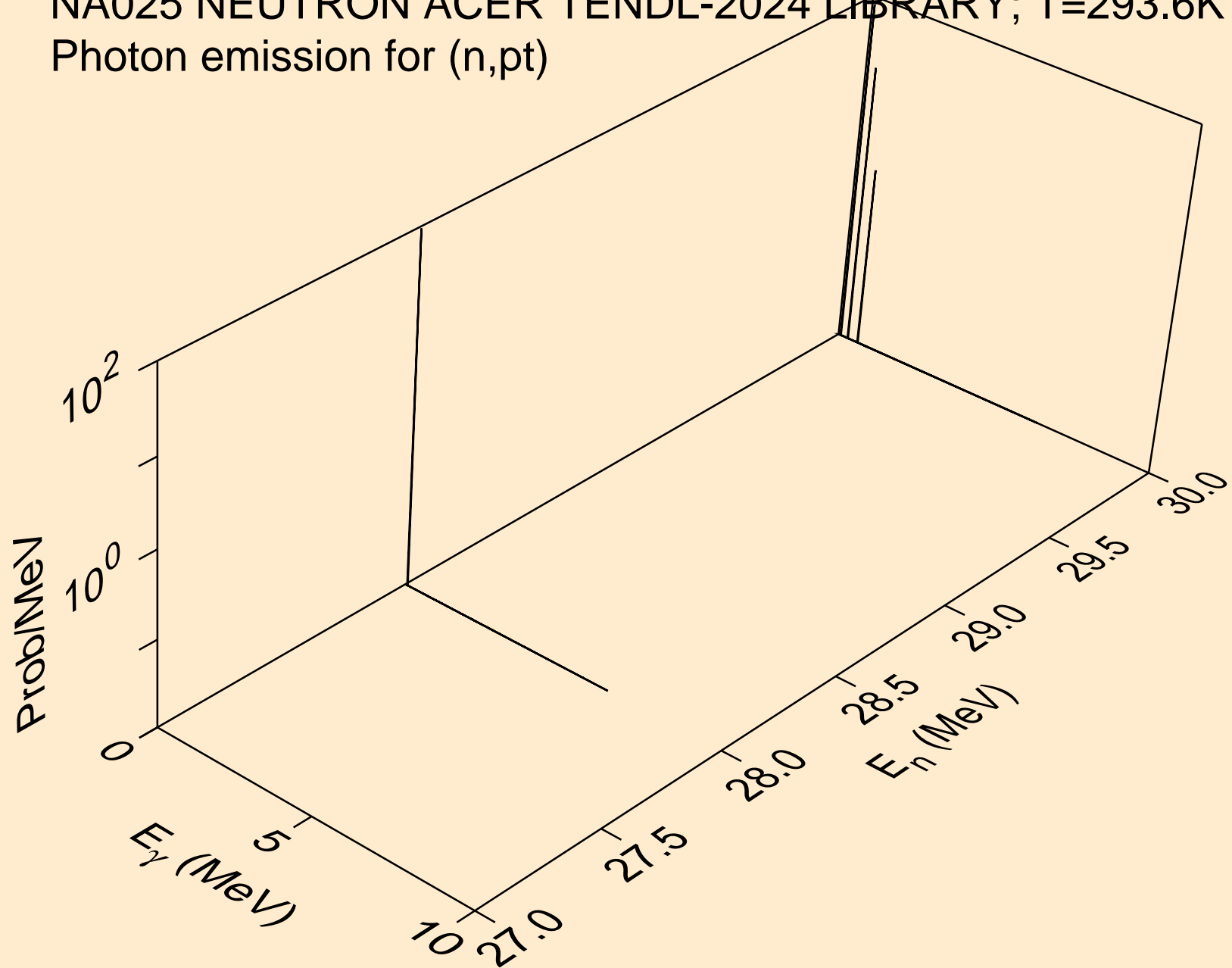

NA025 NEUTRON ACER TENDL-2024 LIBRARY; T=293.6K  
Photon emission for (n,da)

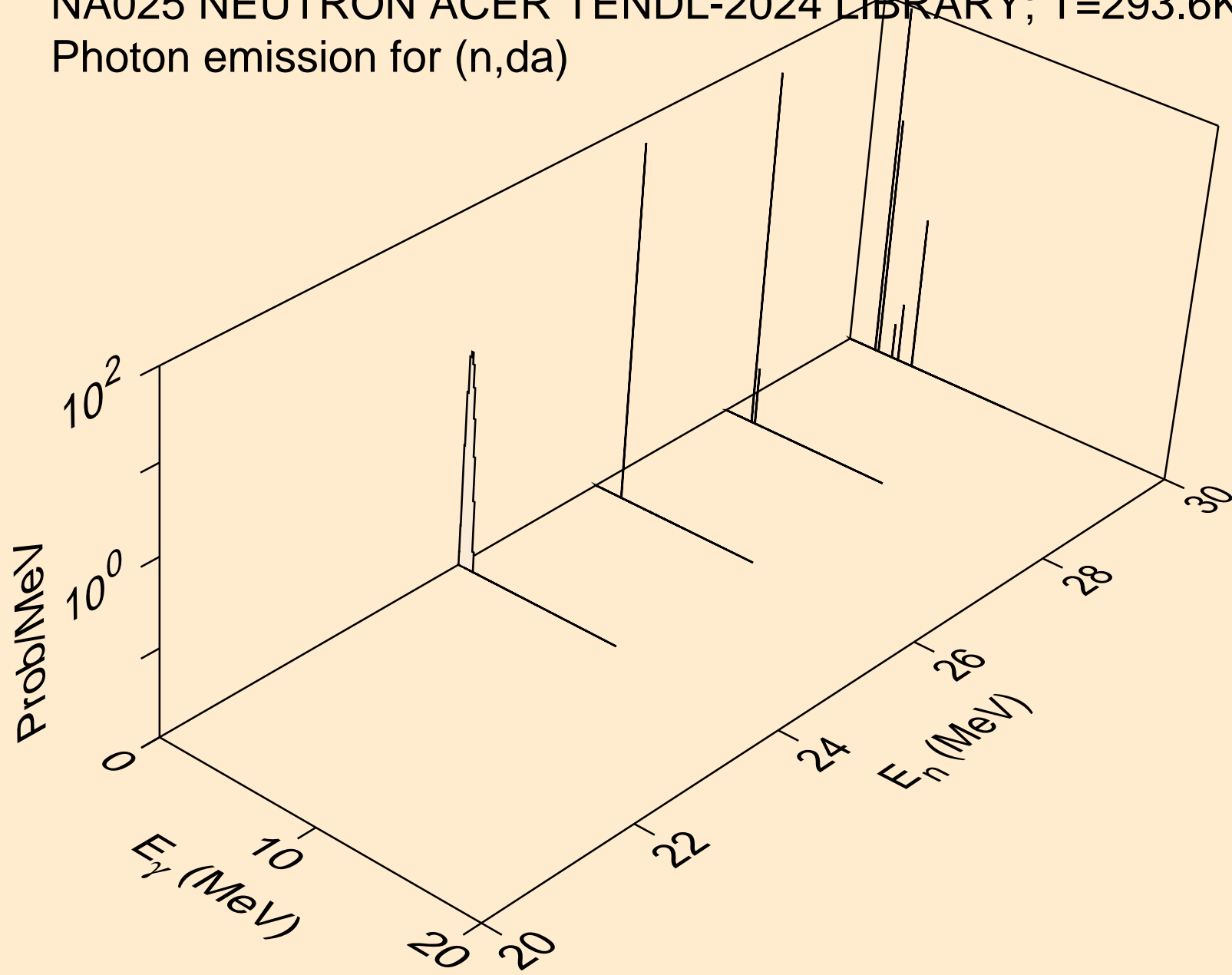

NA025 NEUTRON ACER TENDL-2024 LIBRARY; T=293.6K  
thermal capture photon spectrum

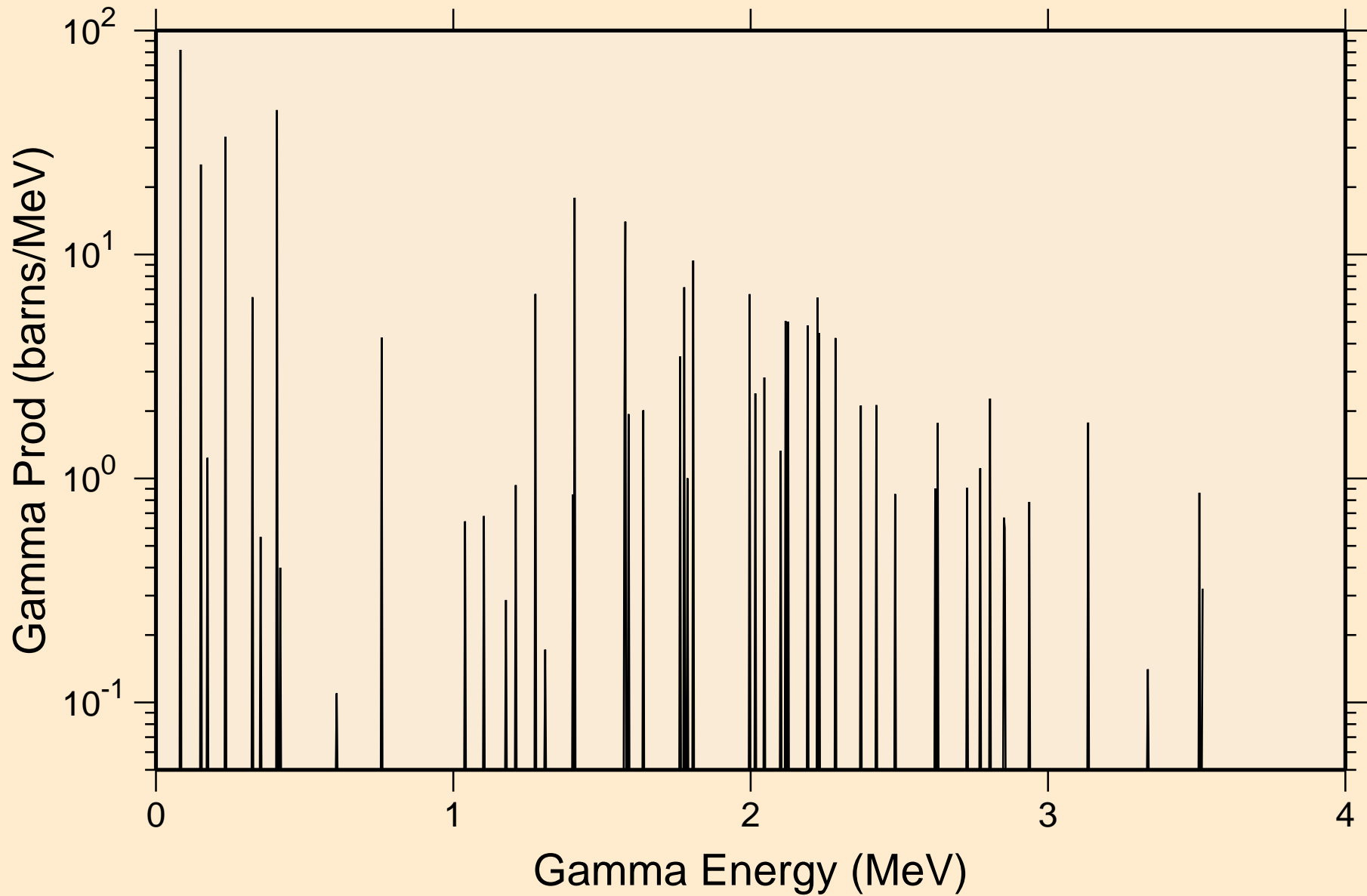

NA025 NEUTRON ACER TENDL-2024 LIBRARY; T=293.6K  
14 MeV photon spectrum

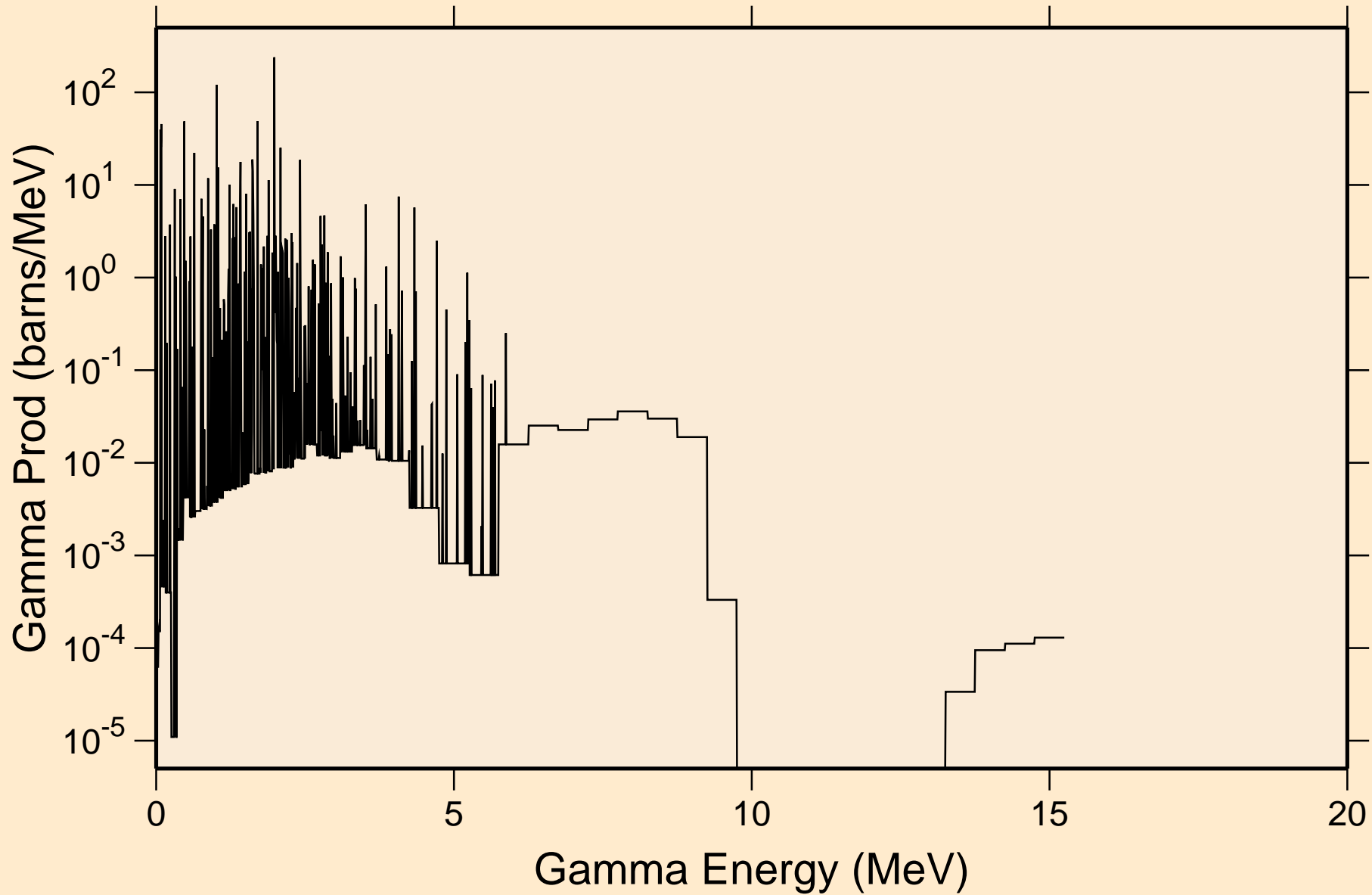

NA025 NEUTRON ACER TENDL-2024 LIBRARY; T=293.6K  
Particle heating contributions

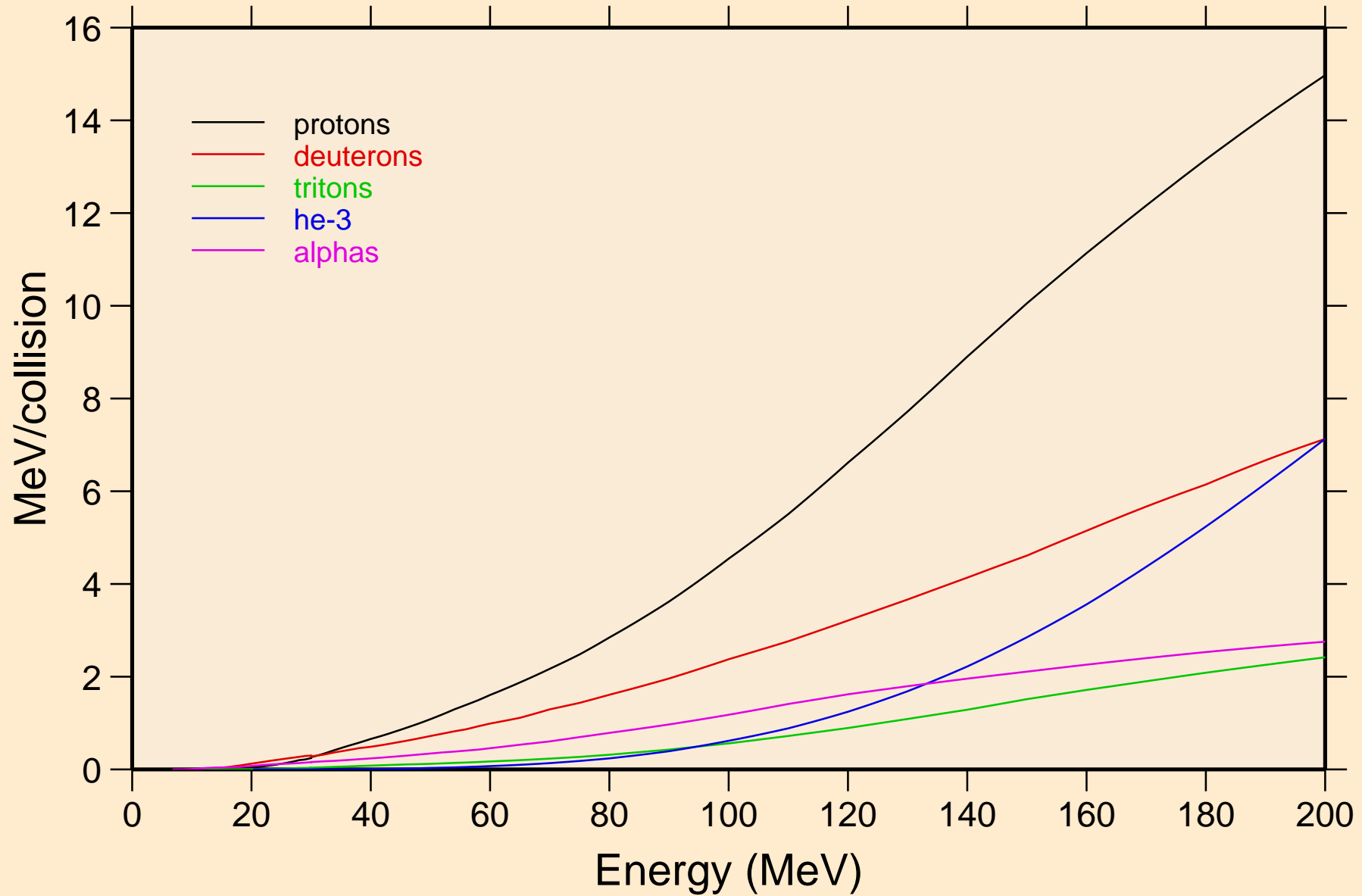

NA025 NEUTRON ACER TENDL-2024 LIBRARY; T=293.6K  
Recoil Heating

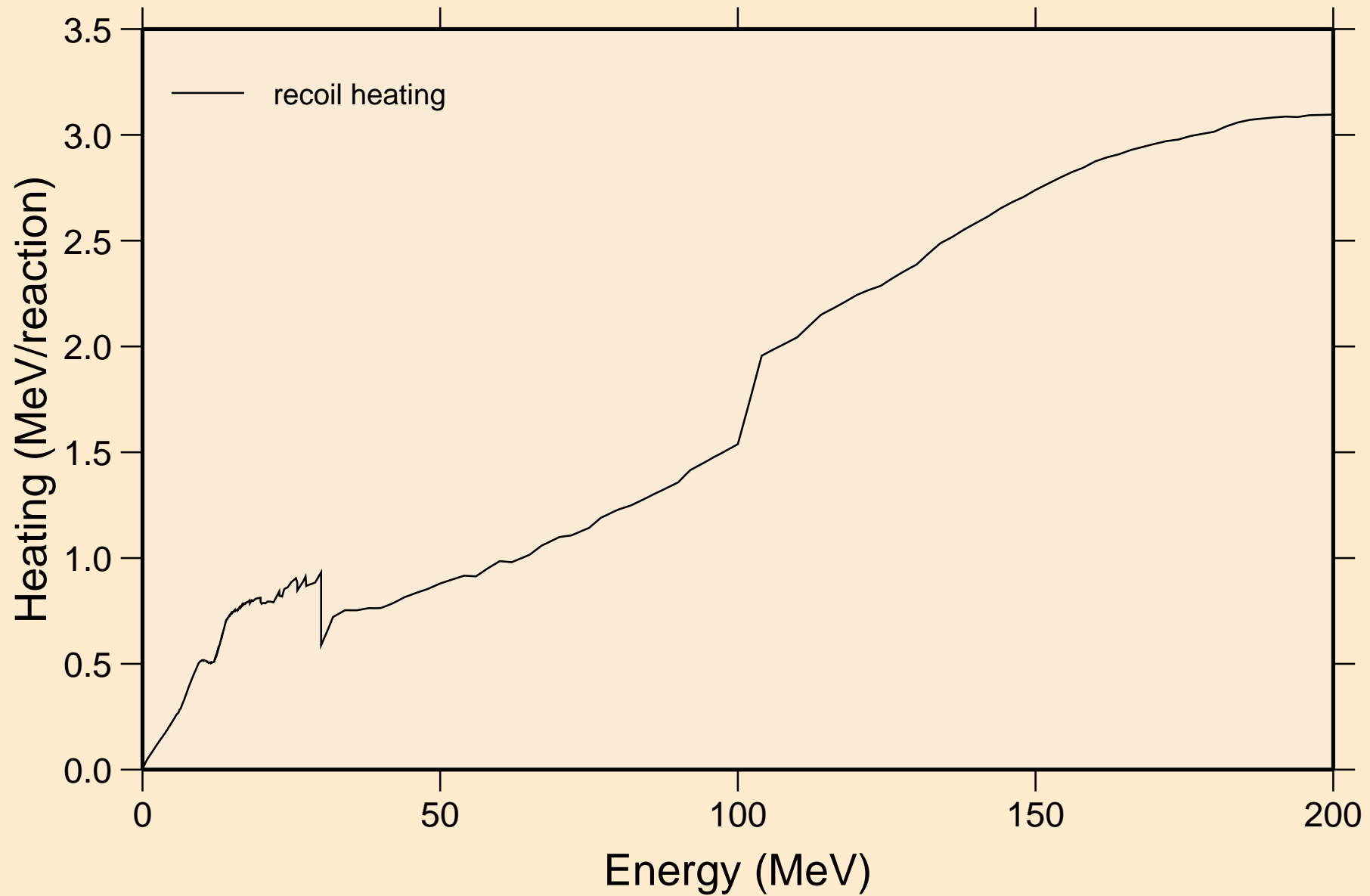

# NA025 NEUTRON ACER TENDL-2024 LIBRARY; T=293.6K

## Particle production cross sections

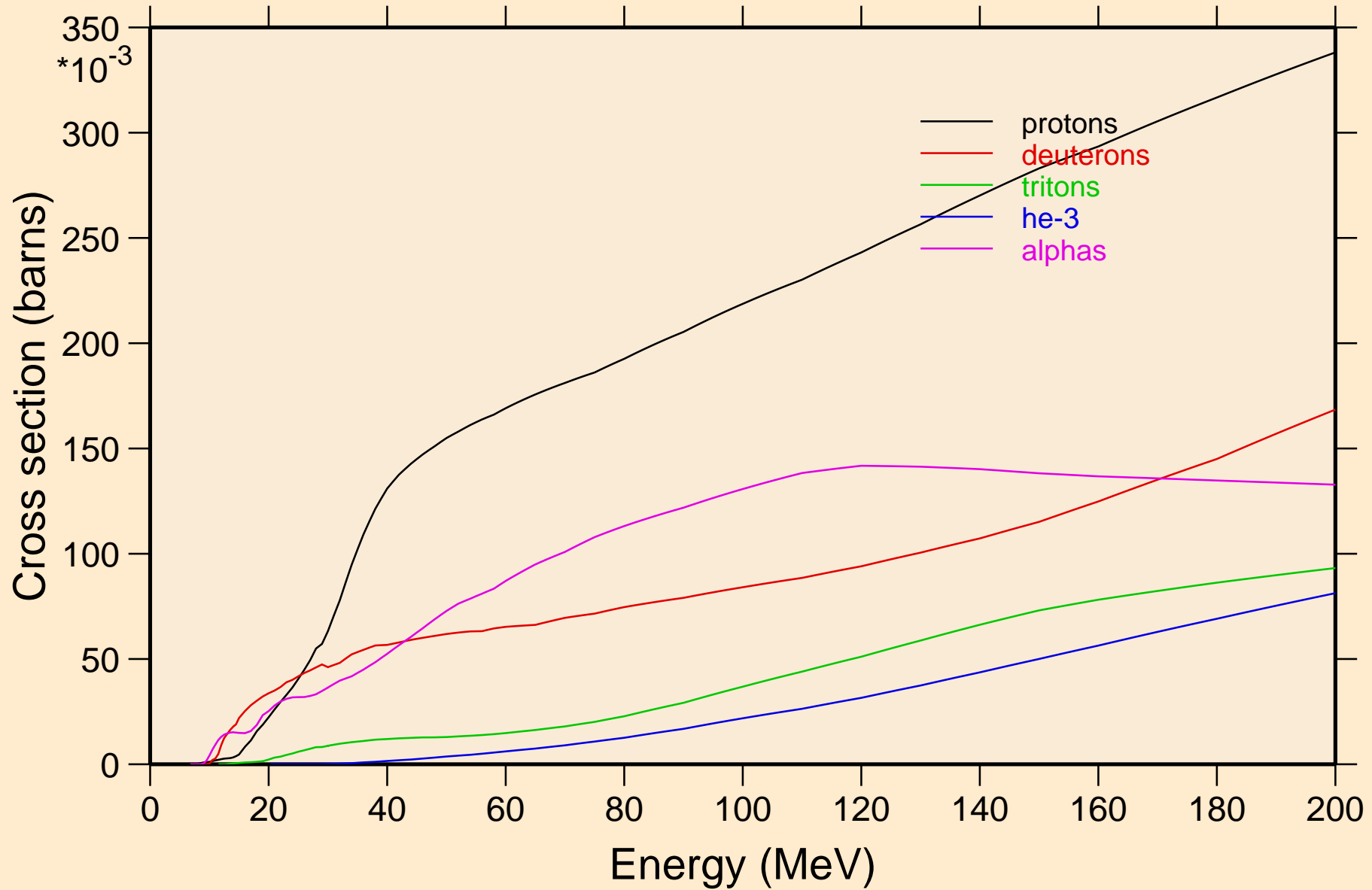

NA025 NEUTRON ACER TENDL-2024 LIBRARY; T=293.6K  
protons from (n,x)

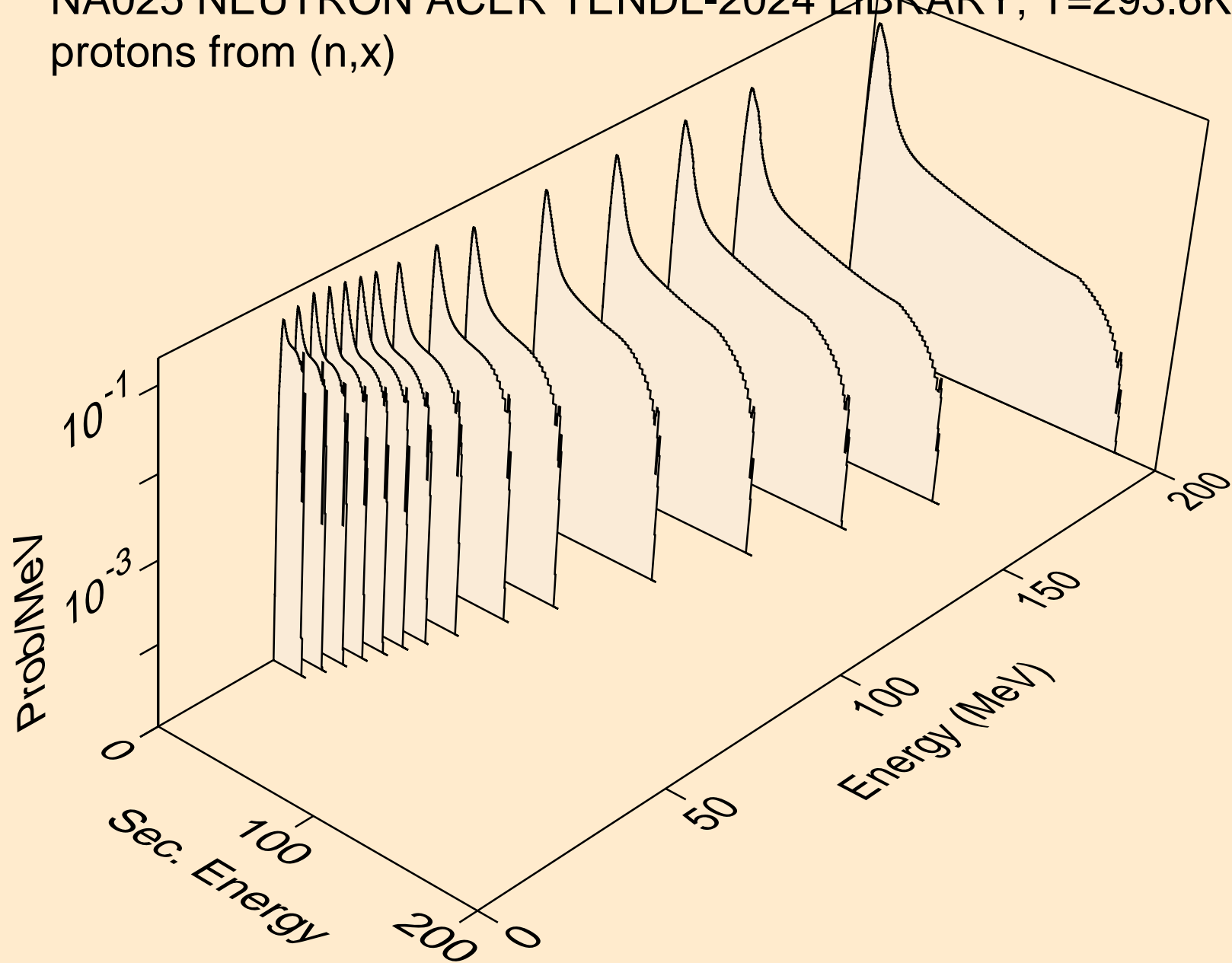

NA025 NEUTRON ACER TENDL-2024 LIBRARY; T=293.6K  
protons from (n,n\*)p

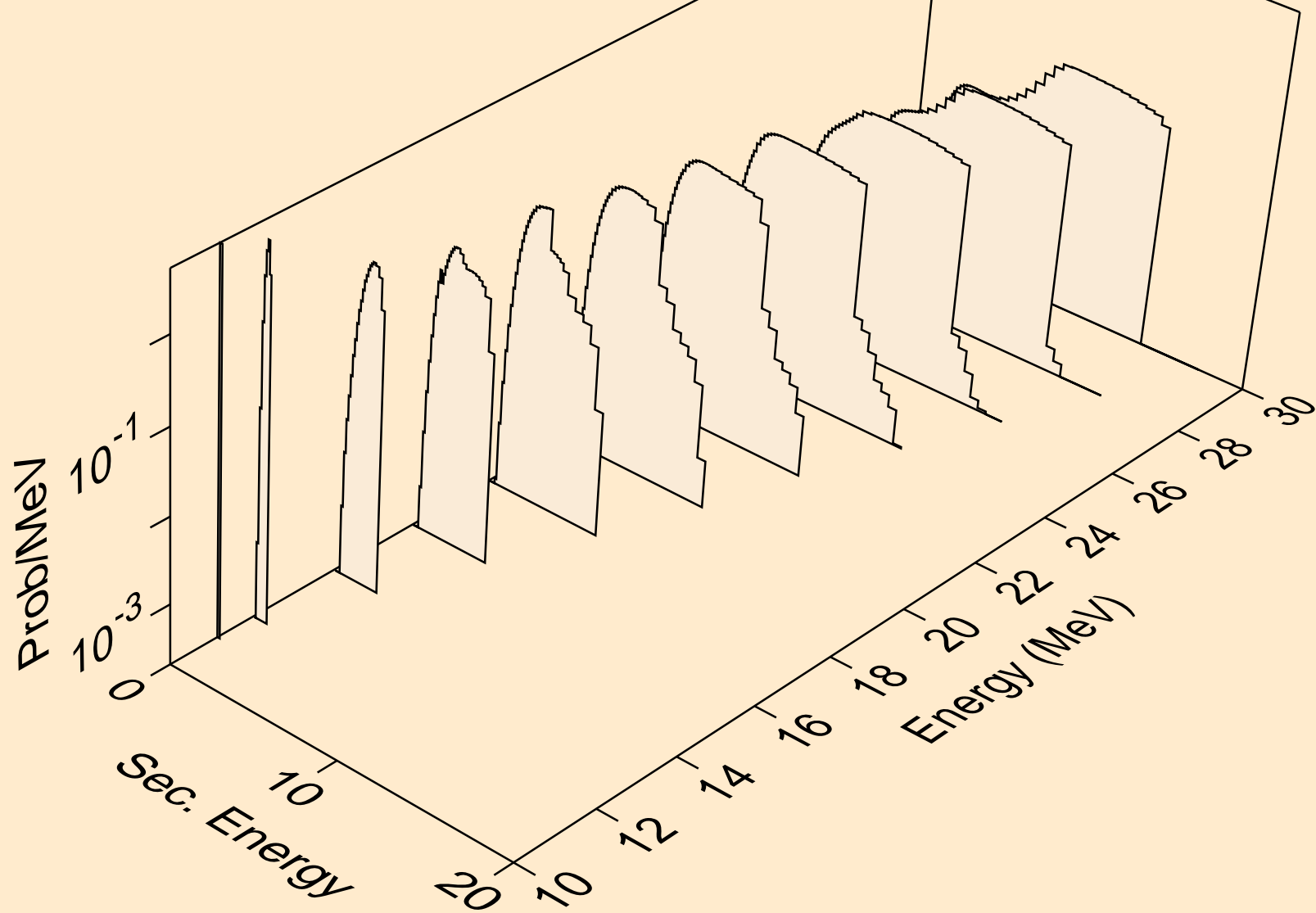

NA025 NEUTRON ACER TENDL-2024 LIBRARY; T=293.6K  
protons from (n,2np)

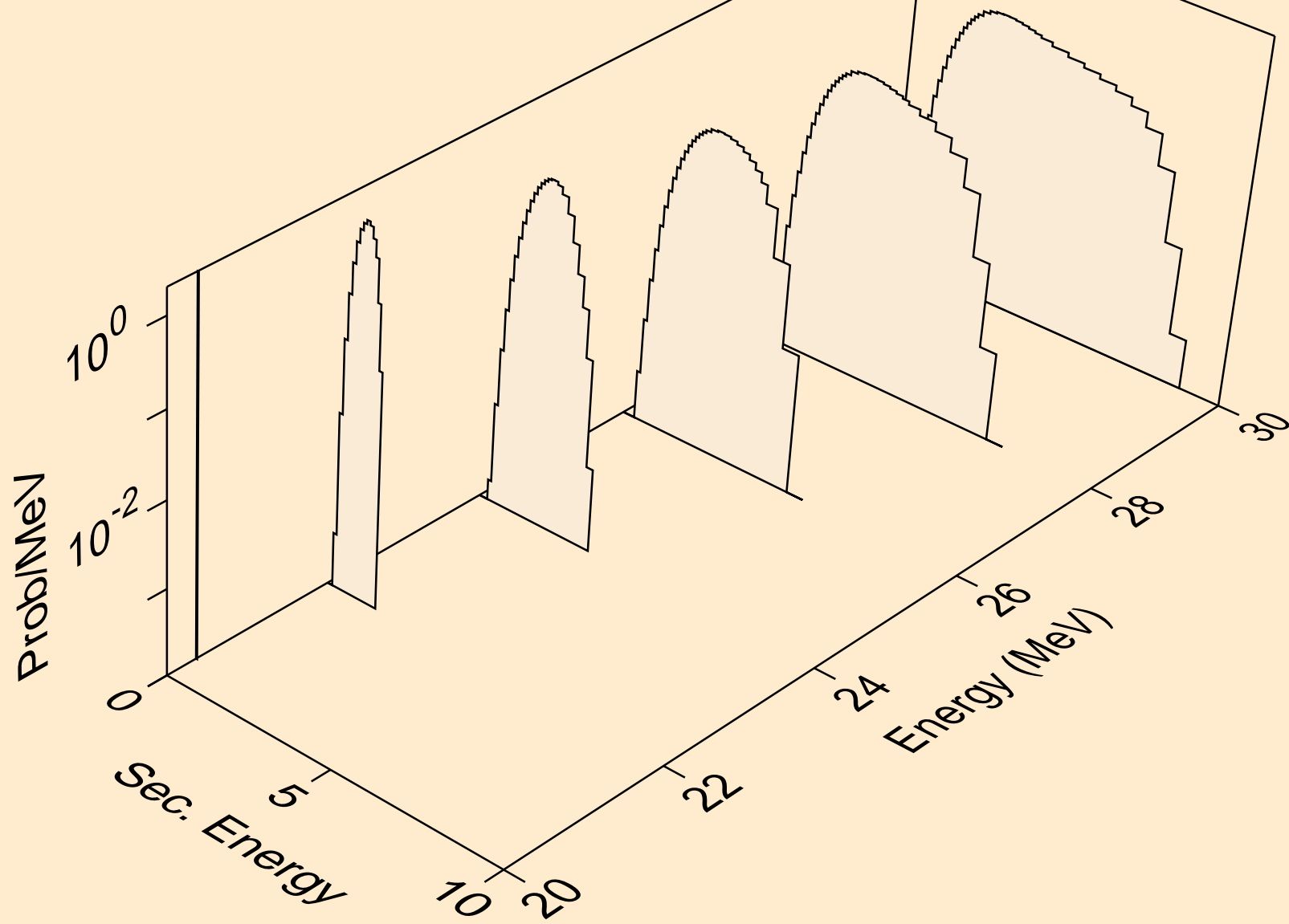

NA025 NEUTRON ACER TENDL-2024 LIBRARY; T=293.6K  
protons from (n,3np)

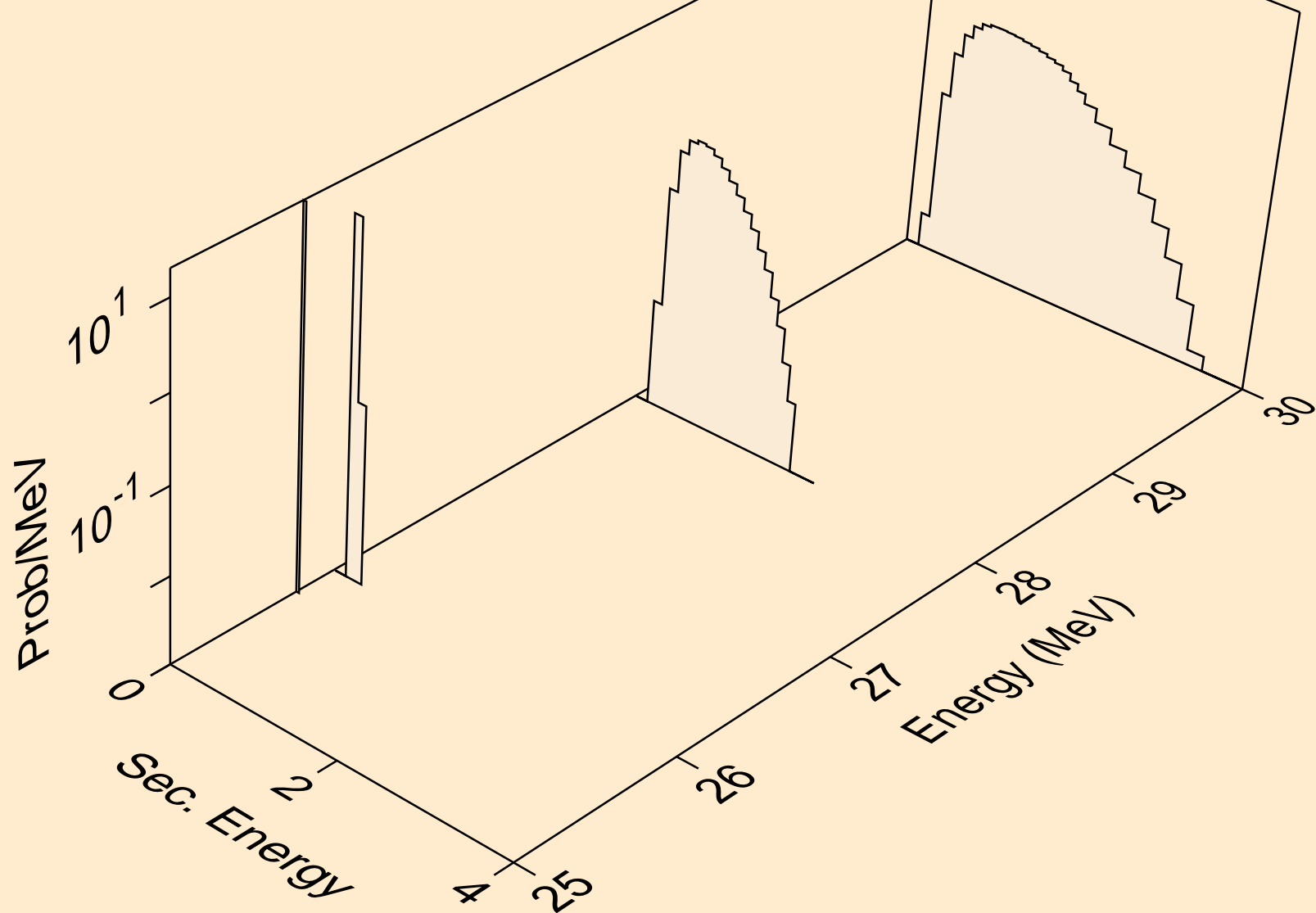

NA025 NEUTRON ACER TENDL-2024 LIBRARY; T=293.6K  
protons from (n,npa)

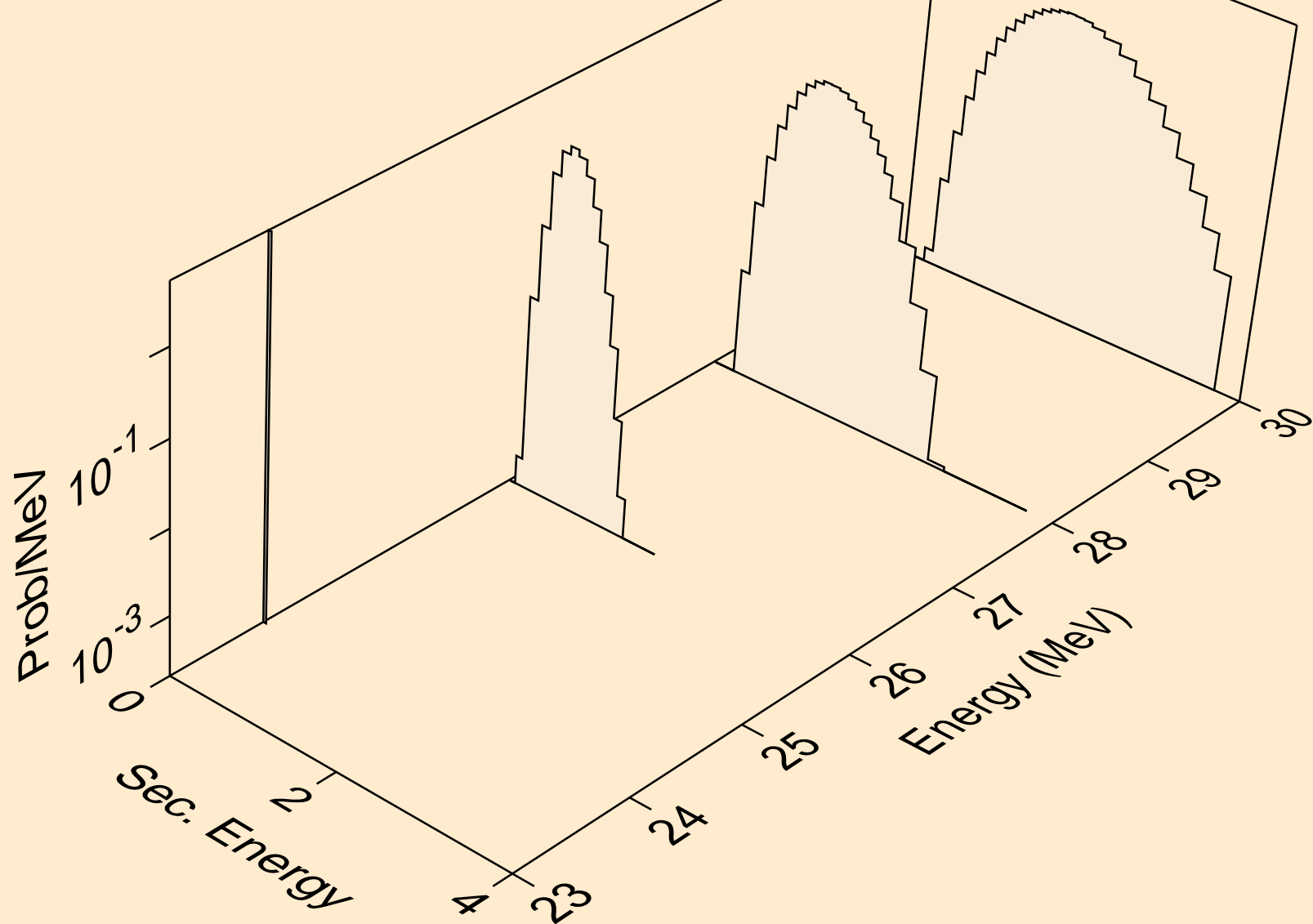

NA025 NEUTRON ACER TENDL-2024 LIBRARY; T=293.6K  
protons from (n,p)

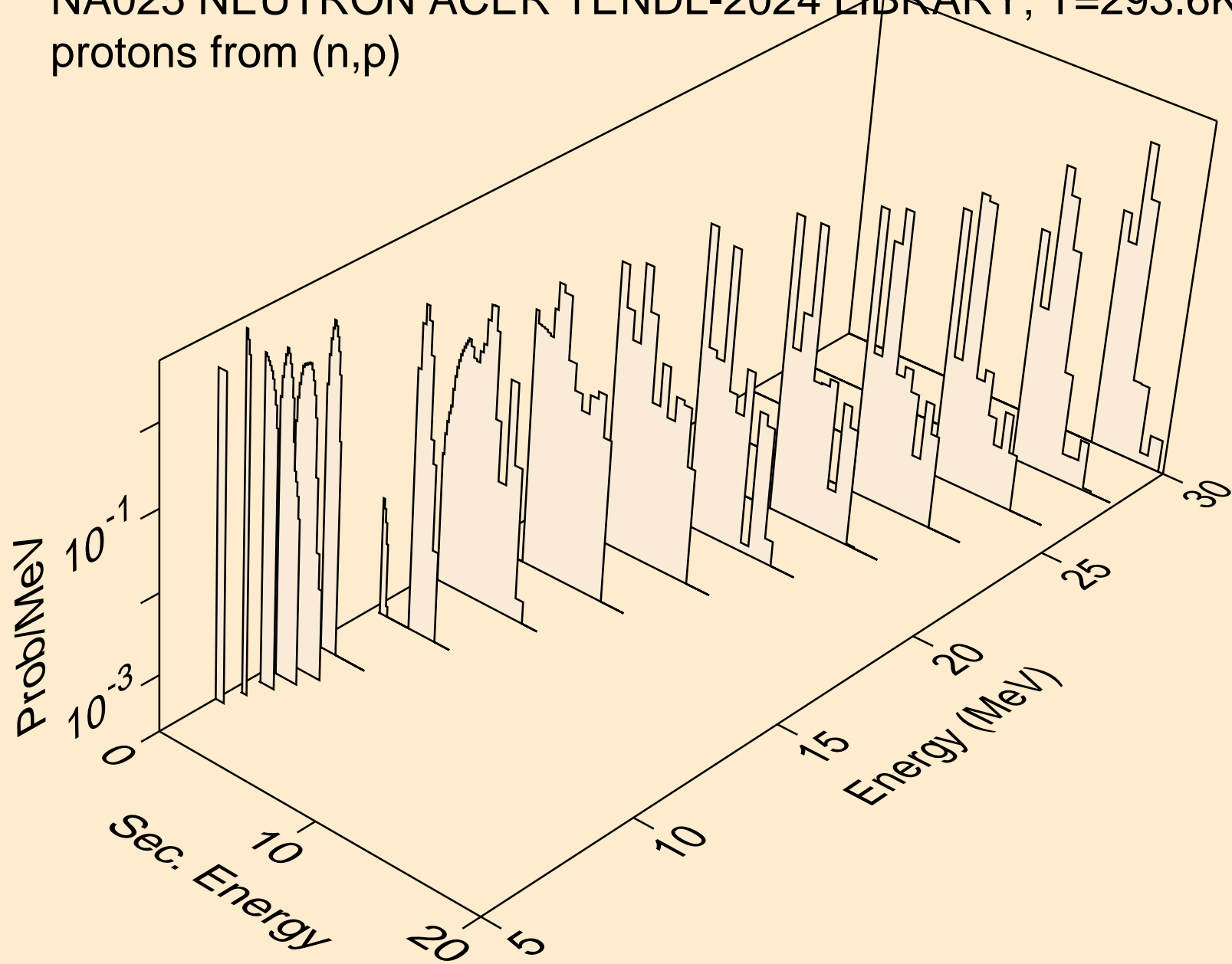

NA025 NEUTRON ACER TENDL-2024 LIBRARY; T=293.6K  
protons from (n,2p)

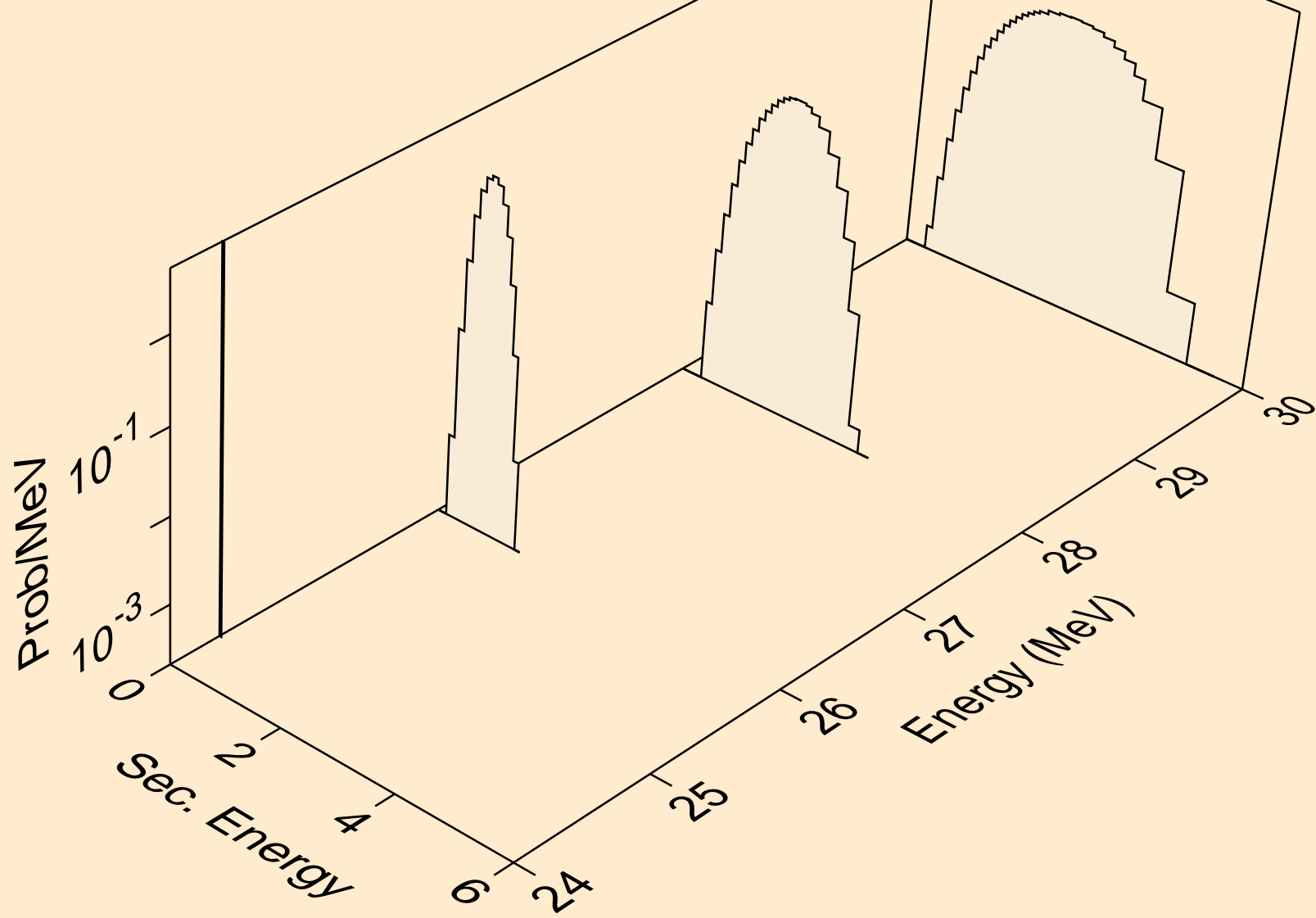

NA025 NEUTRON ACER TENDL-2024 LIBRARY; T=293.6K  
protons from (n,p)

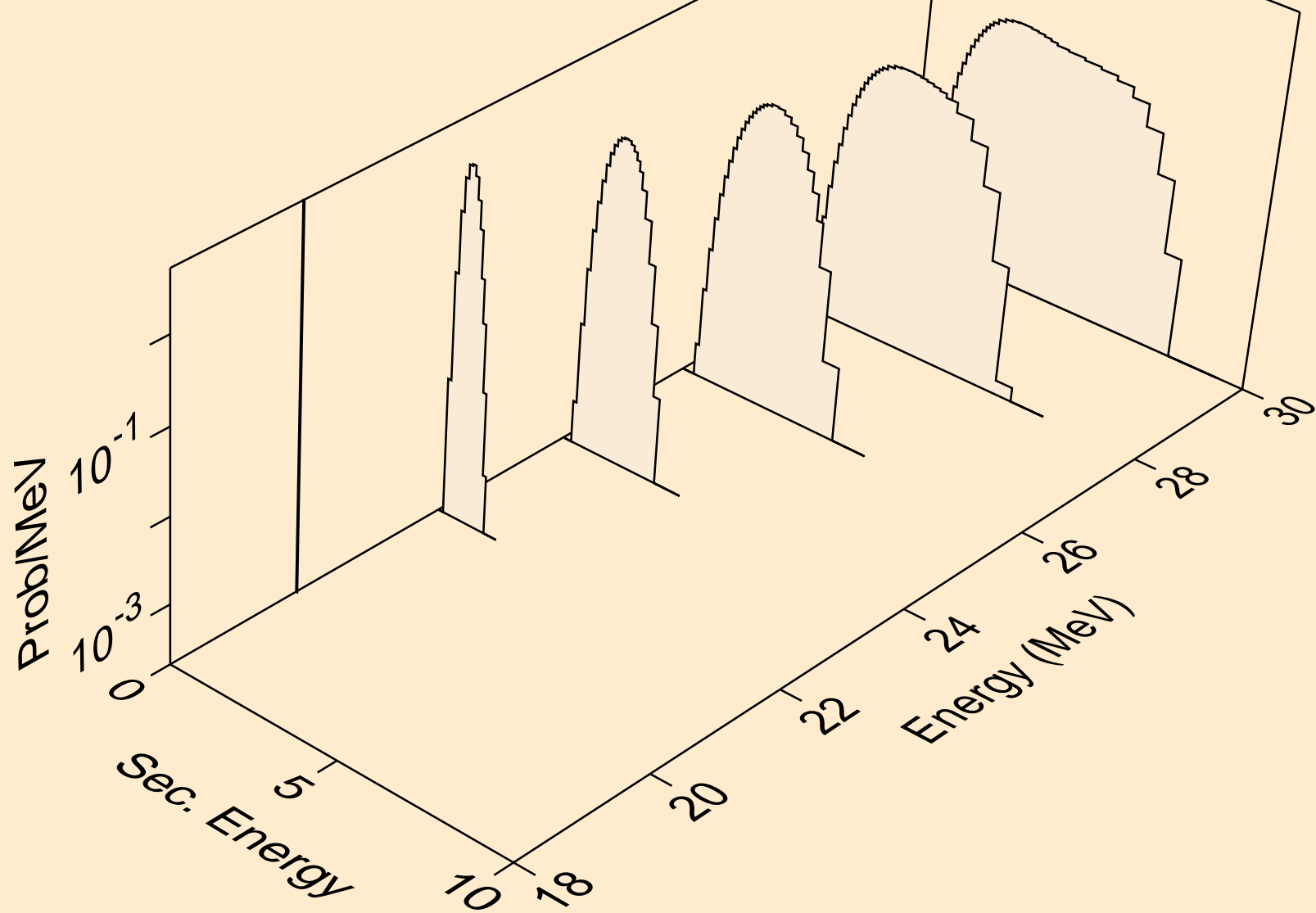

NA025 NEUTRON ACER TENDL-2024 LIBRARY; T=293.6K  
protons from (n,pd)

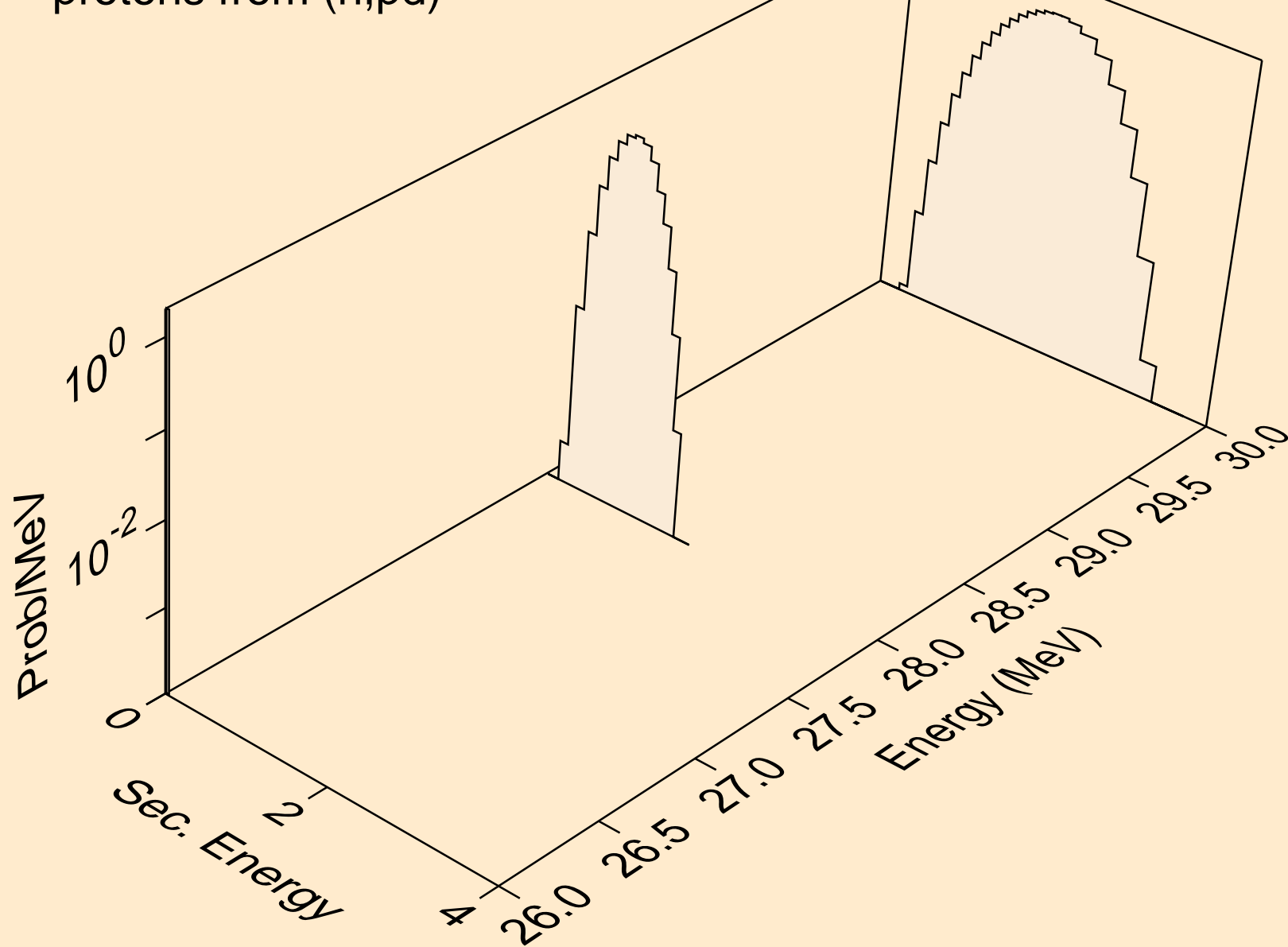

NA025 NEUTRON ACER TENDL-2024 LIBRARY; T=293.6K  
protons from (n,pt)

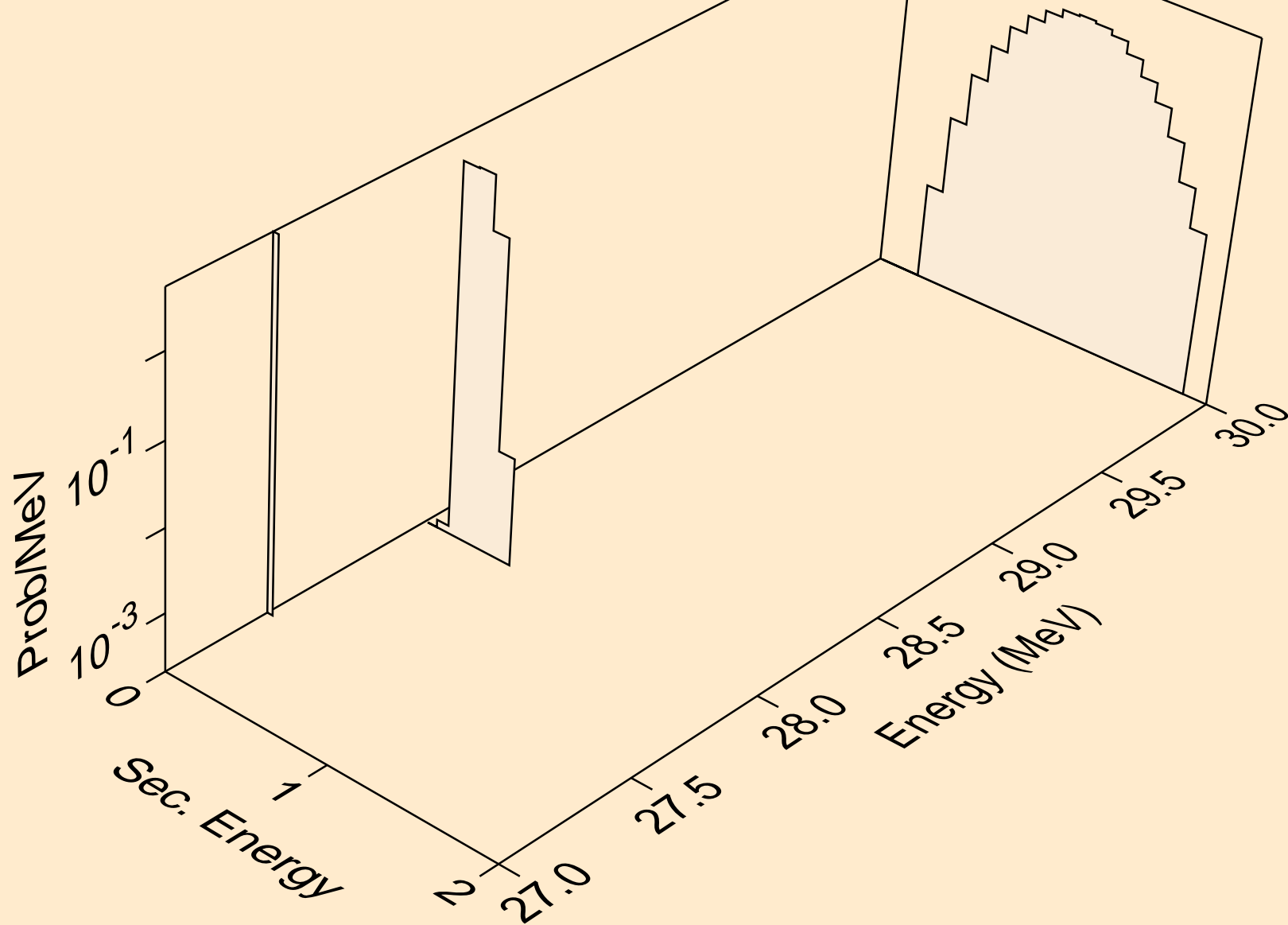

NA025 NEUTRON ACER TENDL-2024 LIBRARY; T=293.6K  
deuterons from (n,x)

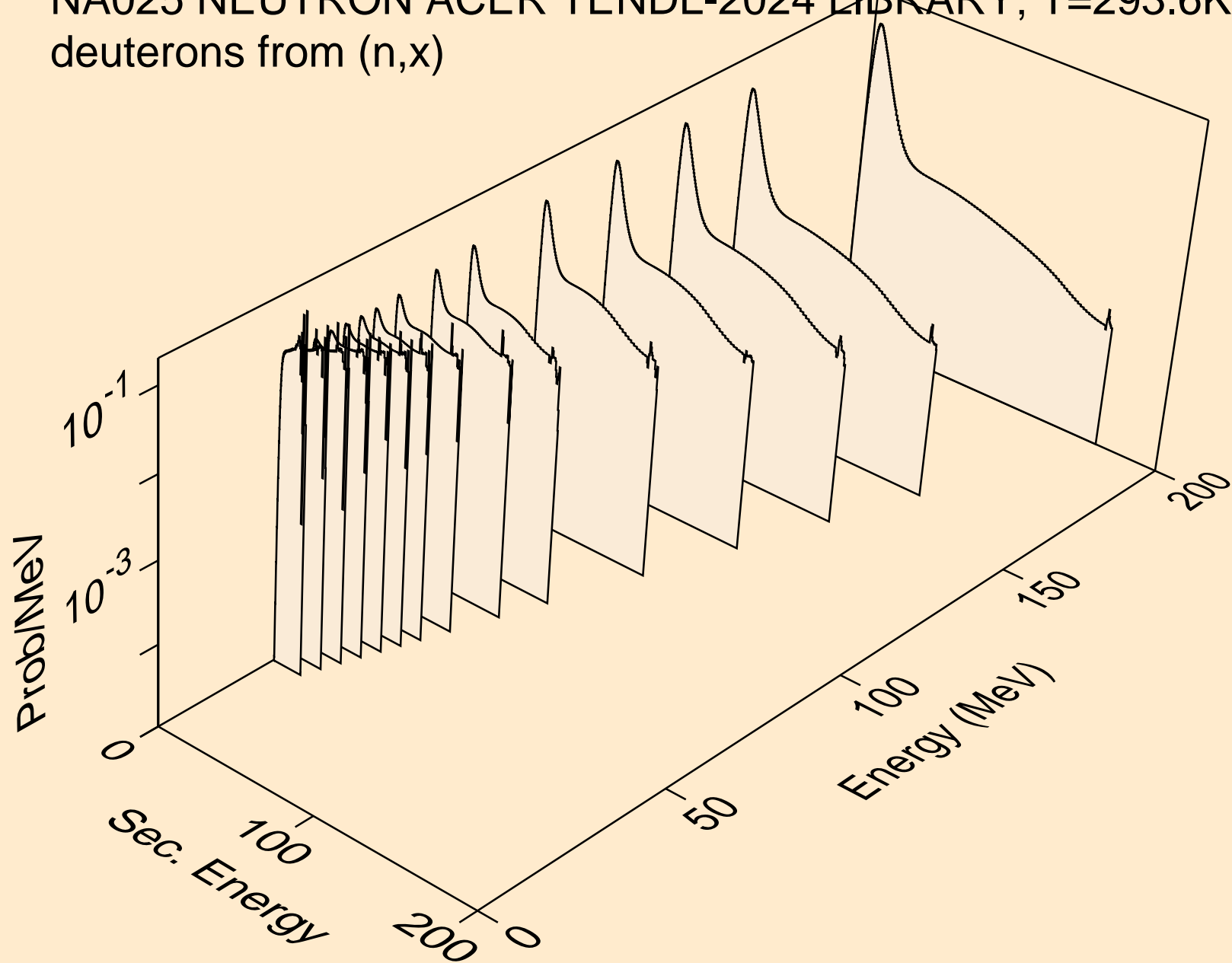

NA025 NEUTRON ACER TENDL-2024 LIBRARY; T=293.6K  
deuterons from (n,2nd)

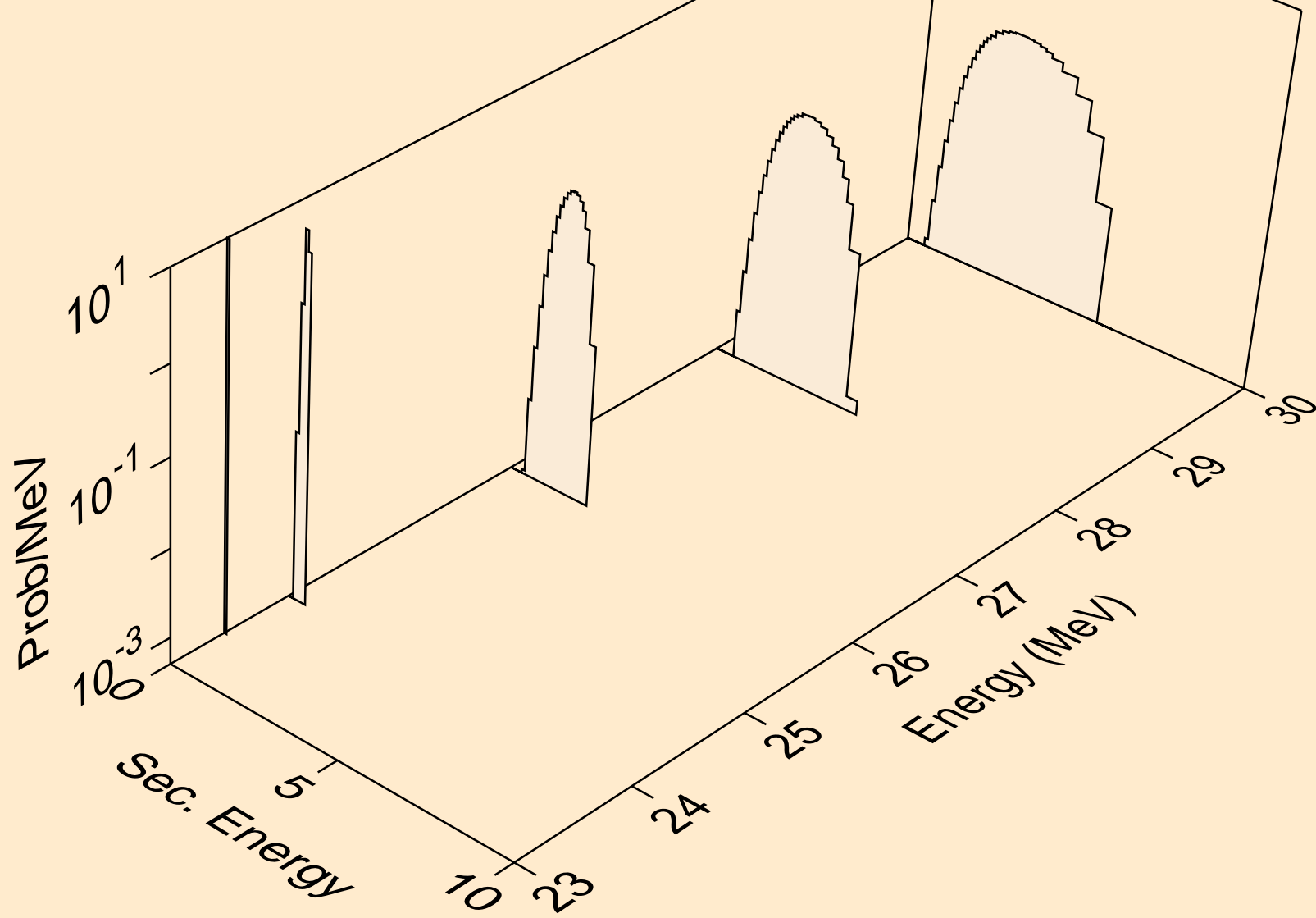

NA025 NEUTRON ACER TENDL-2024 LIBRARY; T=293.6K  
deuterons from (n,n\*)d

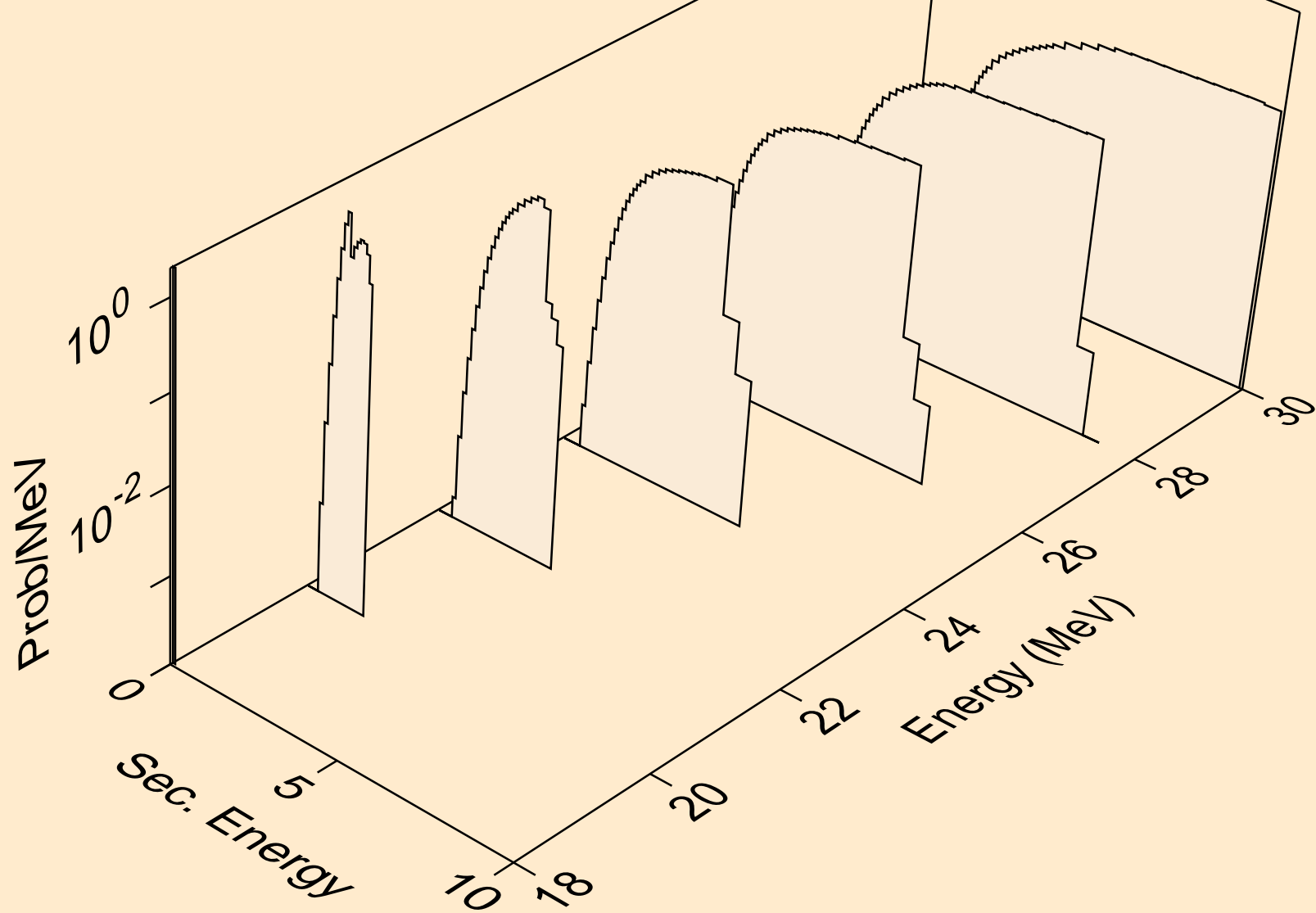

NA025 NEUTRON ACER TENDL-2024 LIBRARY; T=293.6K  
deuterons from (n,d)

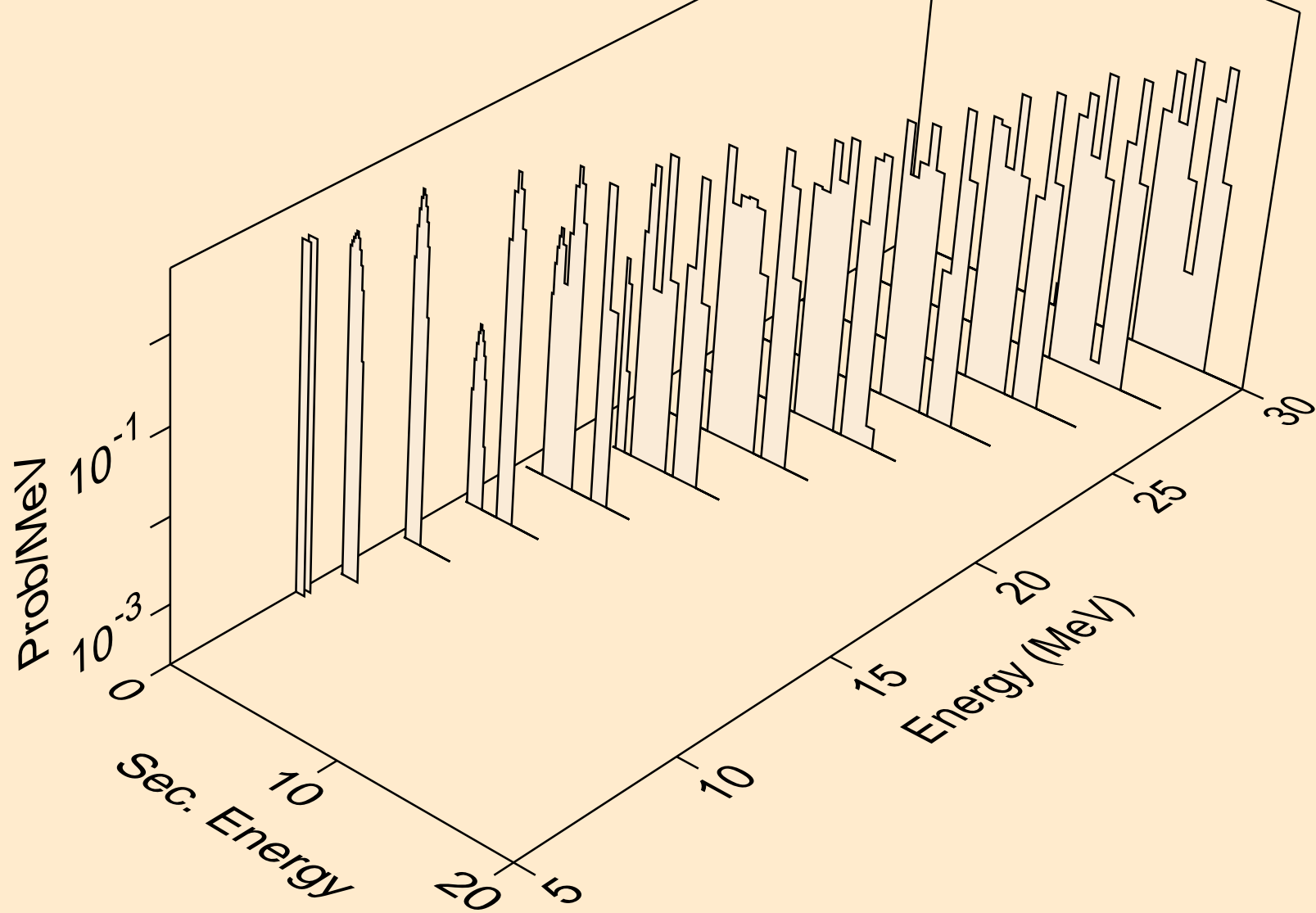

NA025 NEUTRON ACER TENDL-2024 LIBRARY; T=293.6K  
deuterons from (n,pd)

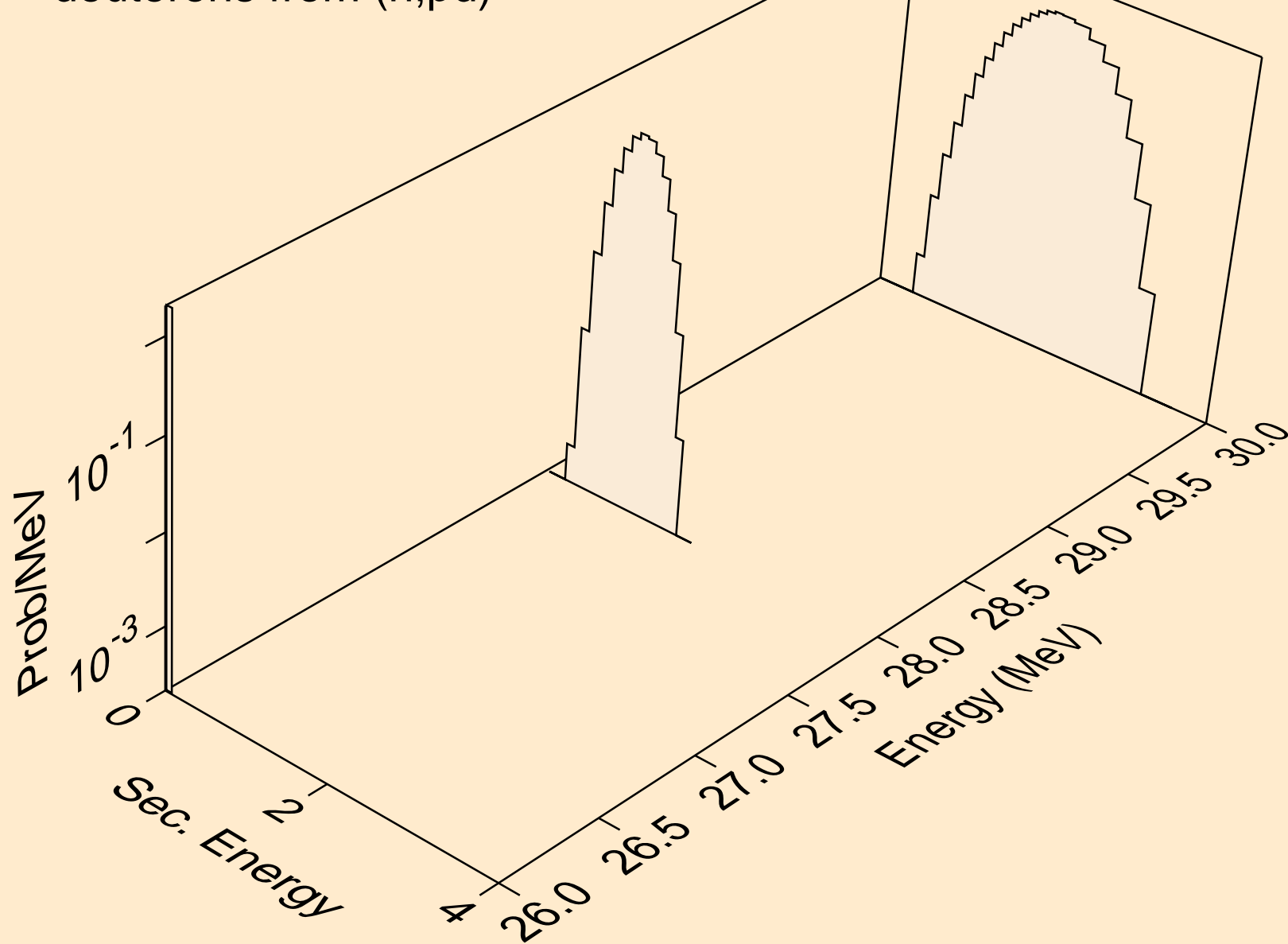

NA025 NEUTRON ACER TENDL-2024 LIBRARY; T=293.6K  
deuterons from (n,da)

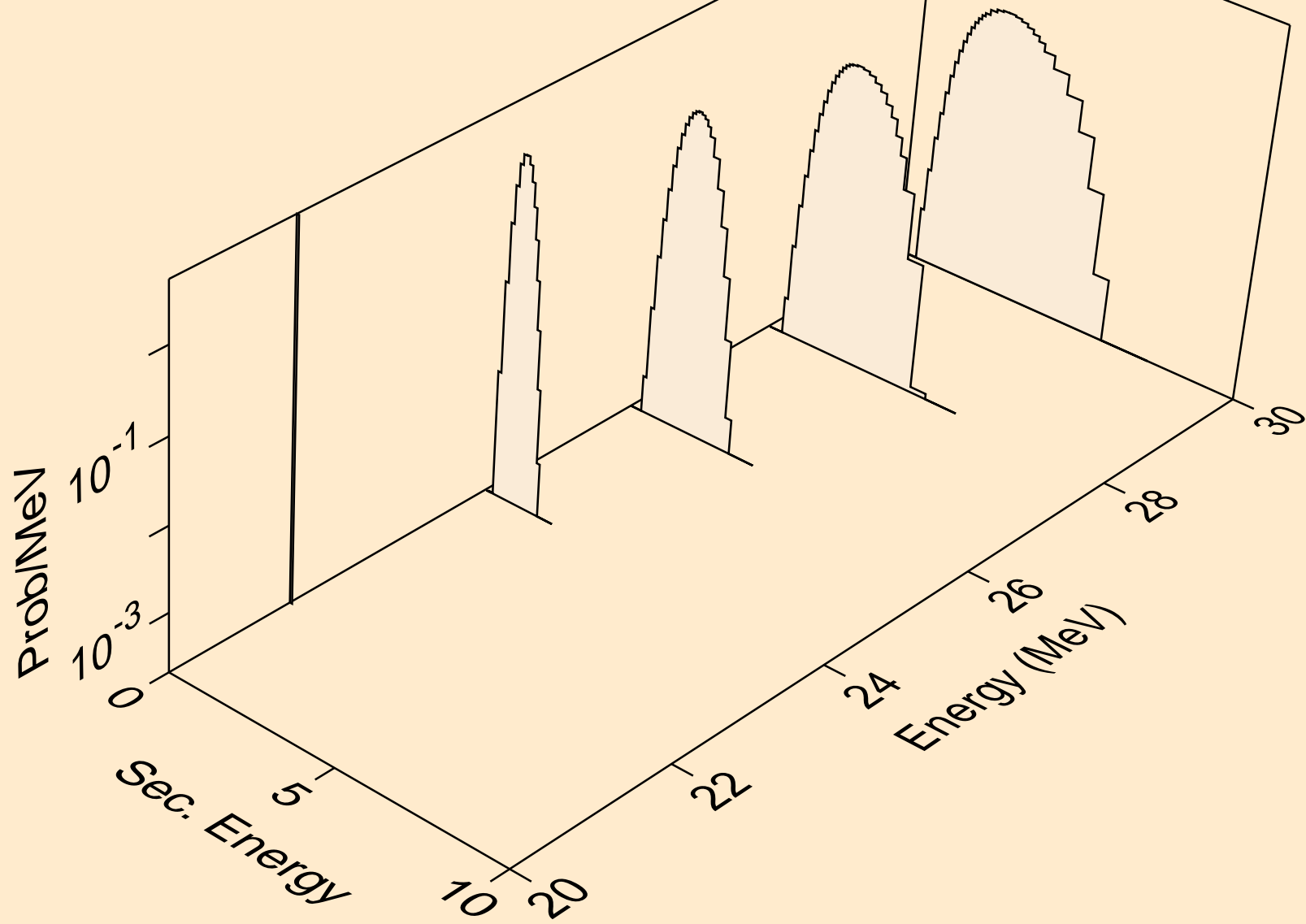

NA025 NEUTRON ACER TENDL-2024 LIBRARY; T=293.6K  
tritons from (n,x)

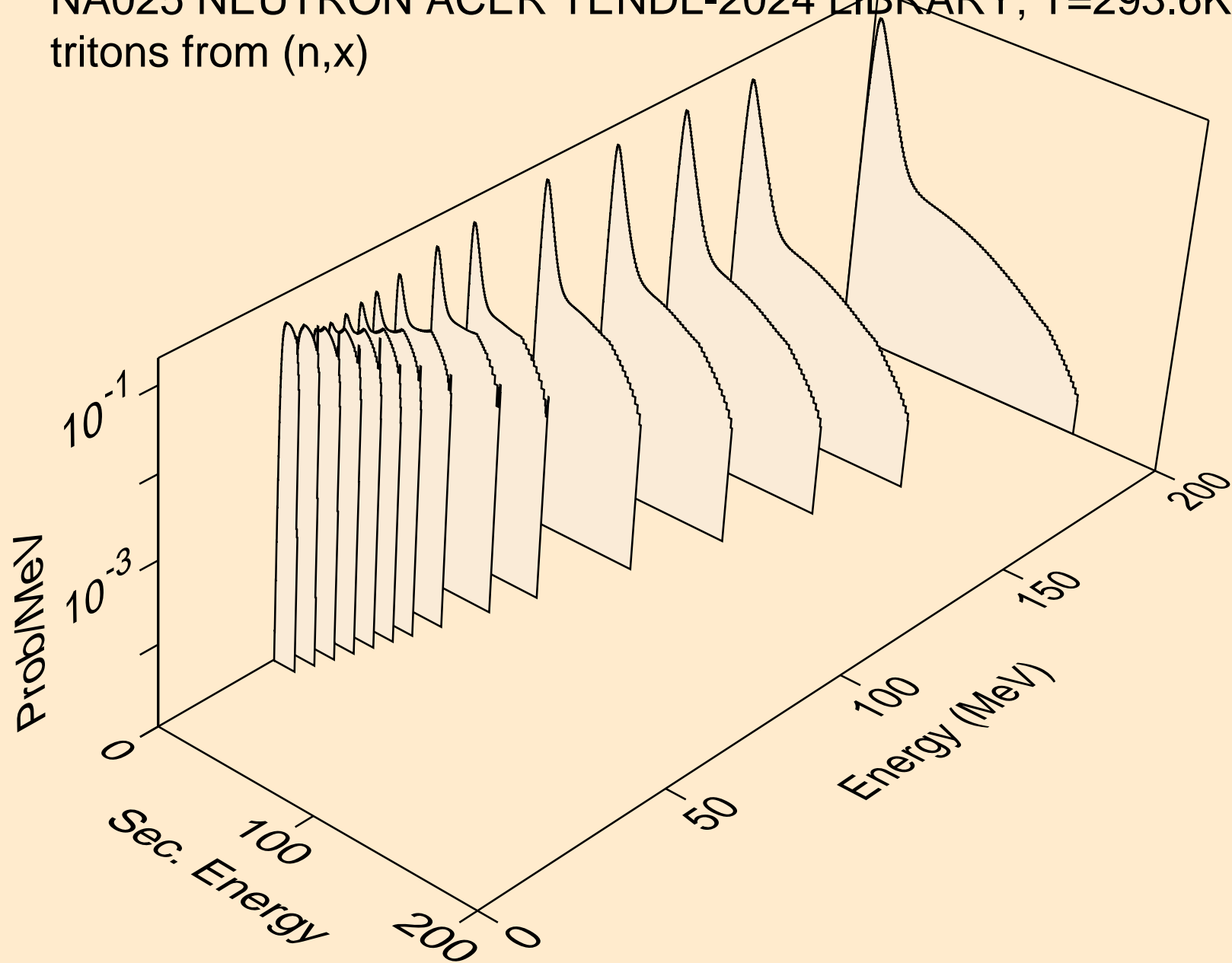

NA025 NEUTRON ACER TENDL-2024 LIBRARY; T=293.6K  
tritons from (n,n\*)t

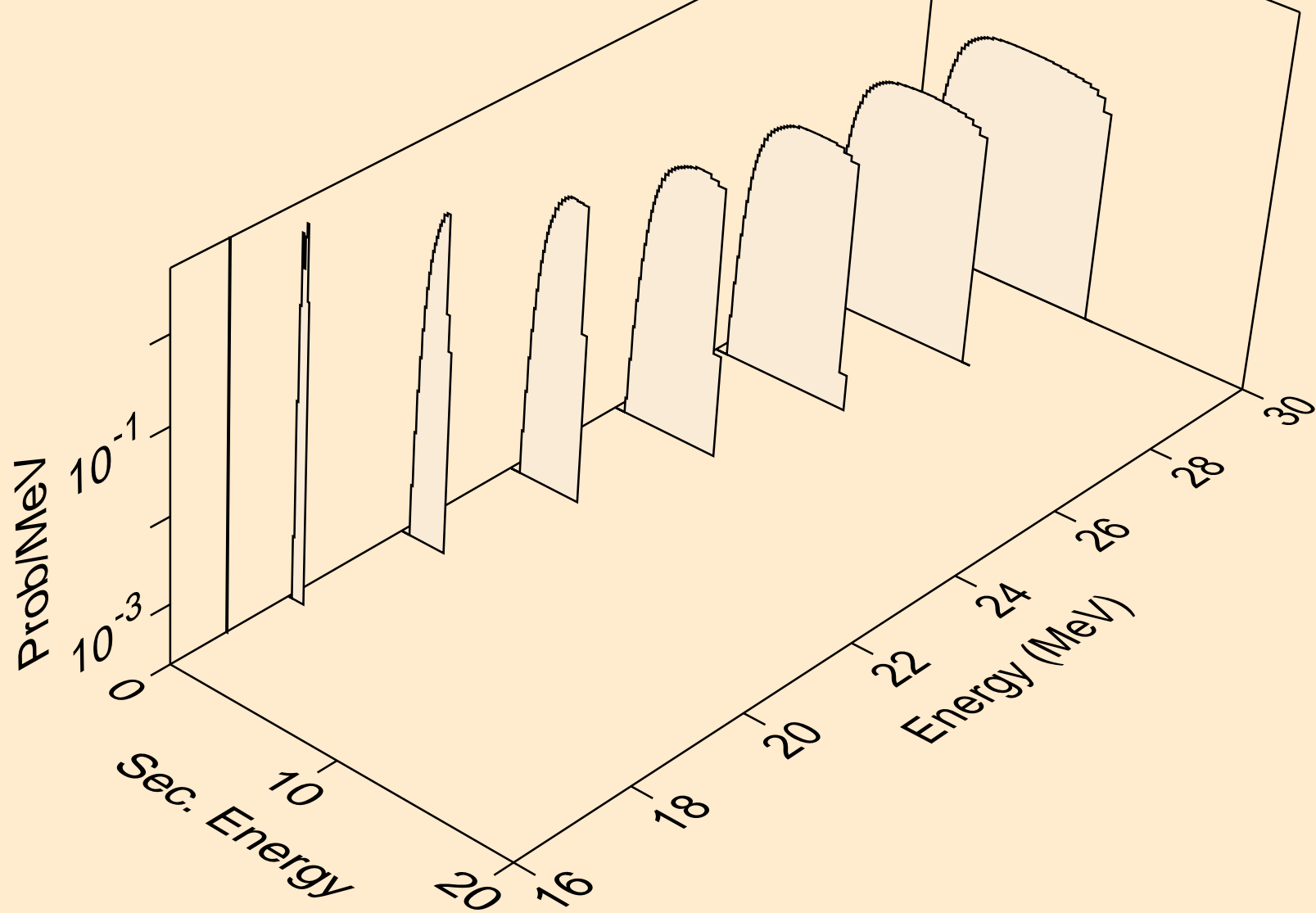

NA025 NEUTRON ACER TENDL-2024 LIBRARY; T=293.6K  
tritons from (n,t)

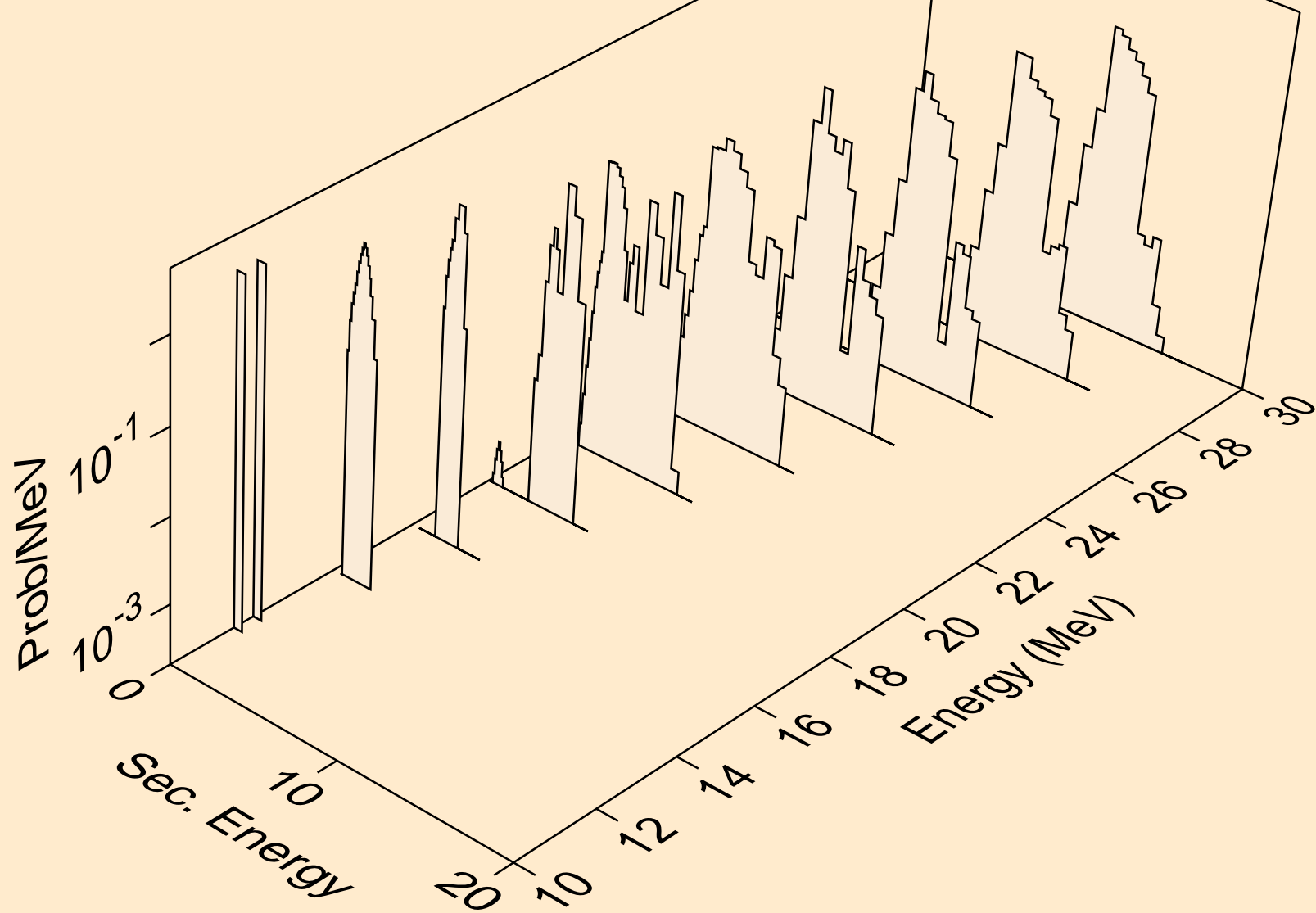

NA025 NEUTRON ACER TENDL-2024 LIBRARY; T=293.6K  
tritons from (n,pt)

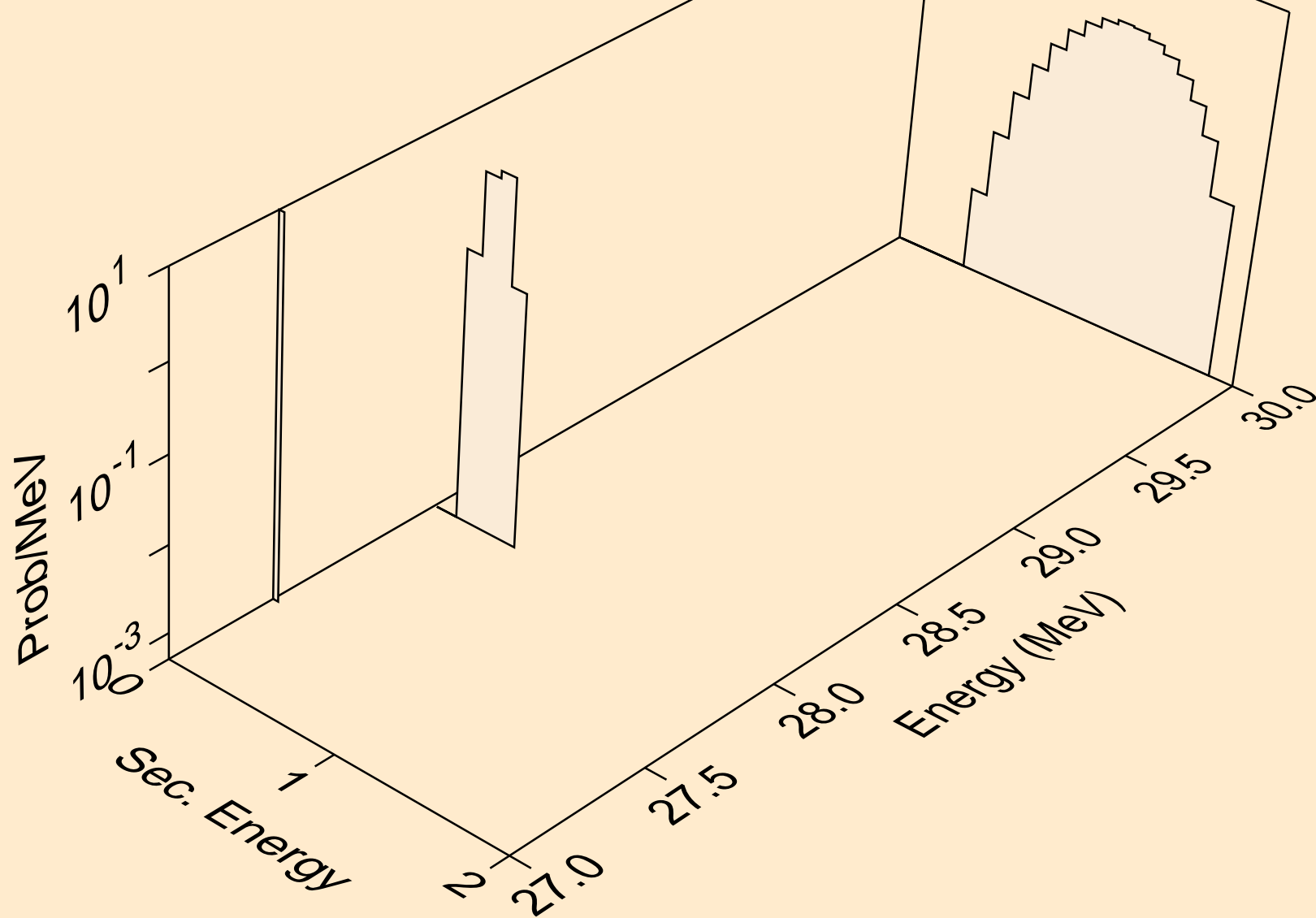

NA025 NEUTRON ACER TENDL-2024 LIBRARY; T=293.6K  
he3s from (n,x)

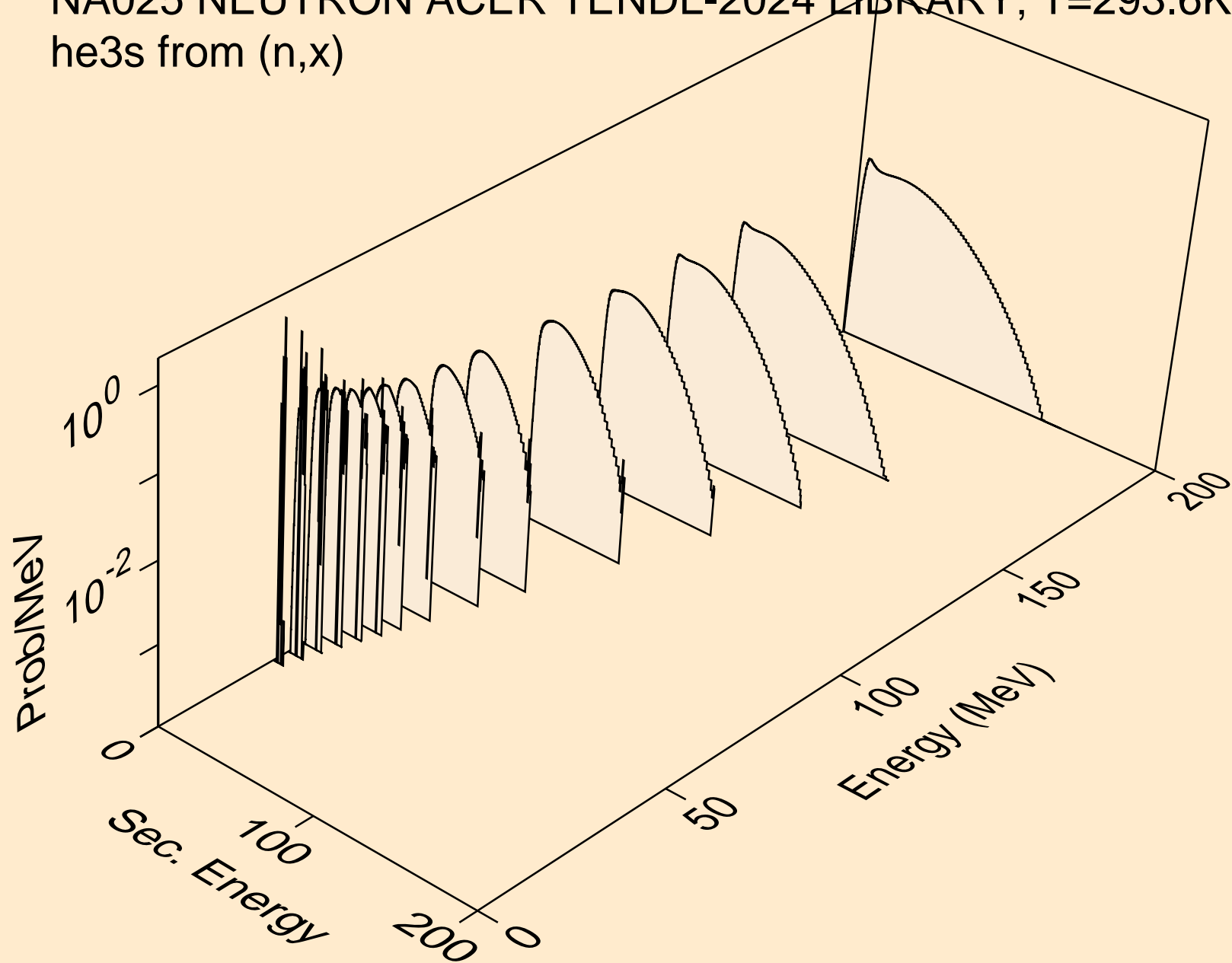

NA025 NEUTRON ACER TENDL-2024 LIBRARY; T=293.6K  
he3s from (n,n\*)he3

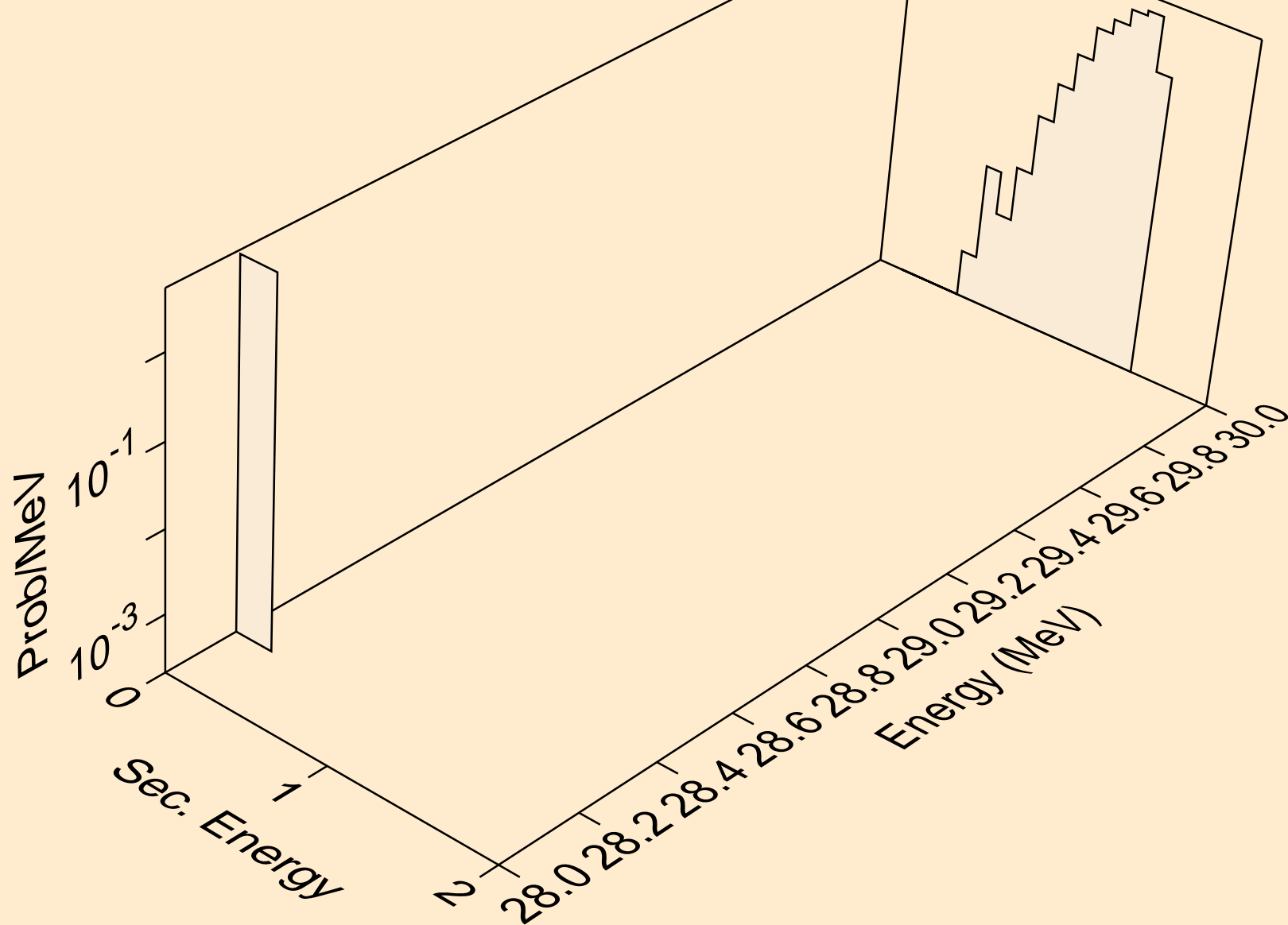

NA025 NEUTRON ACER TENDL-2024 LIBRARY; T=293.6K  
he3s from (n,he3)

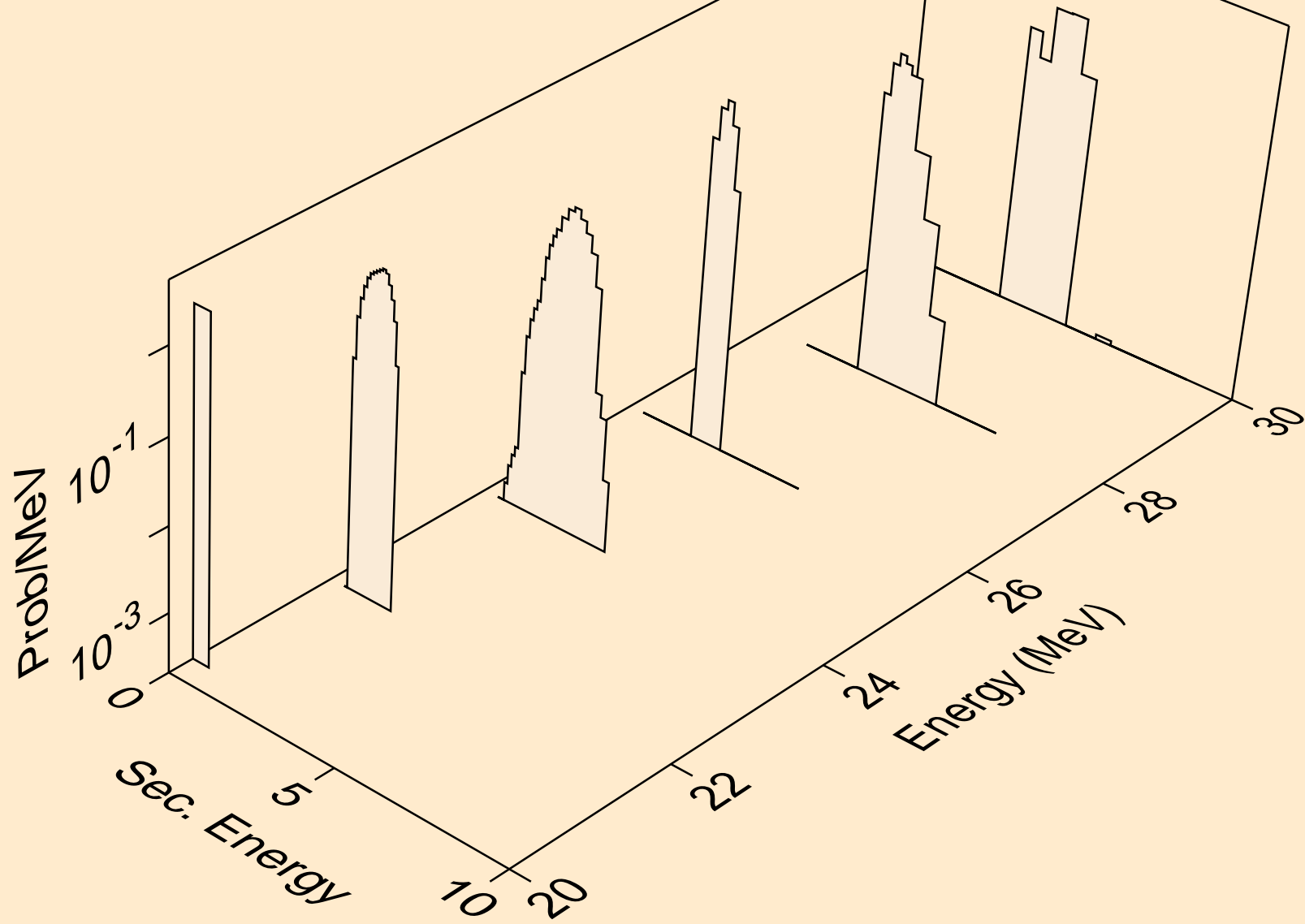

NA025 NEUTRON ACER TENDL-2024 LIBRARY; T=293.6K  
alphas from (n,x)

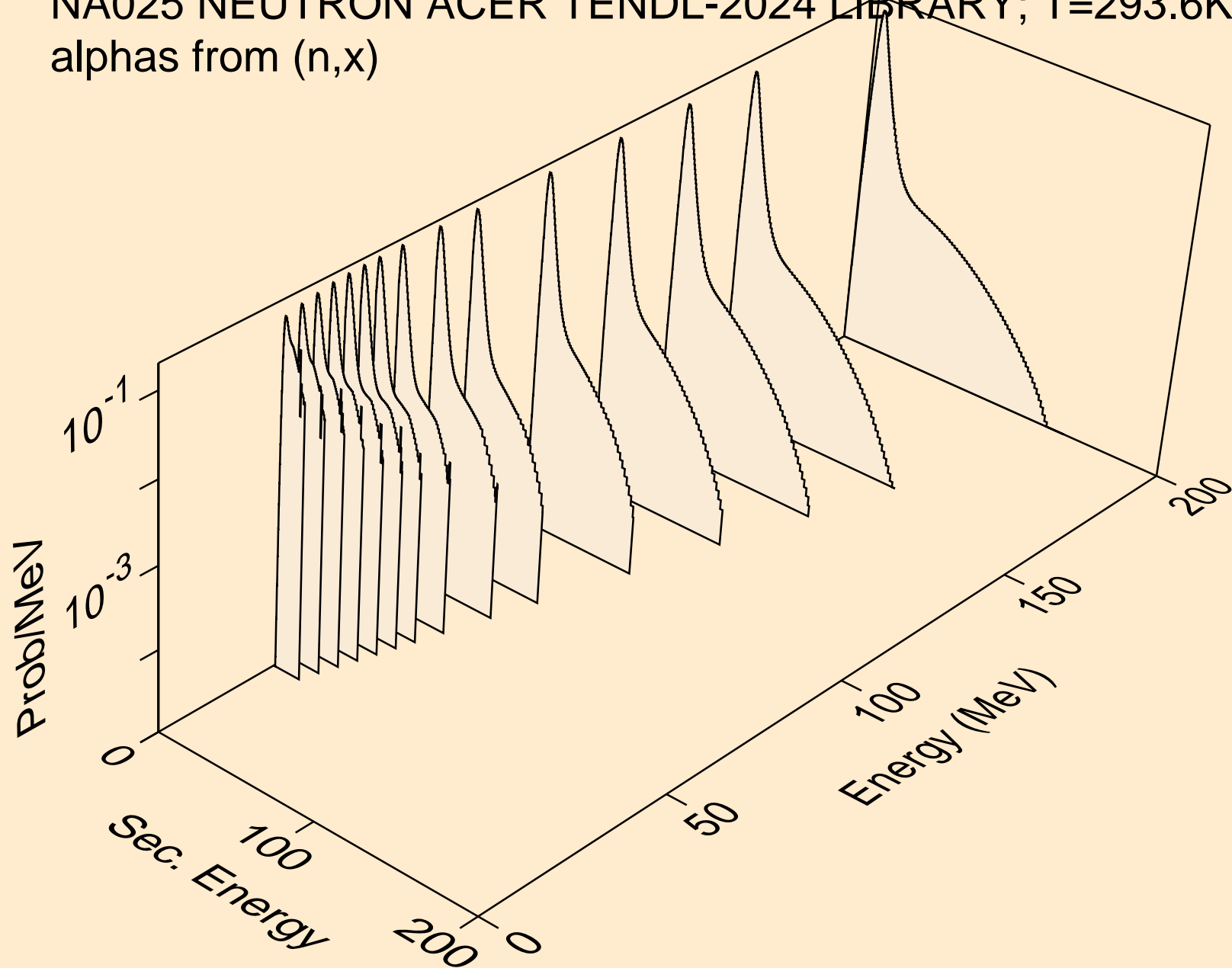

NA025 NEUTRON ACER TENDL-2024 LIBRARY; T=293.6K  
alphas from (n,n\*)a

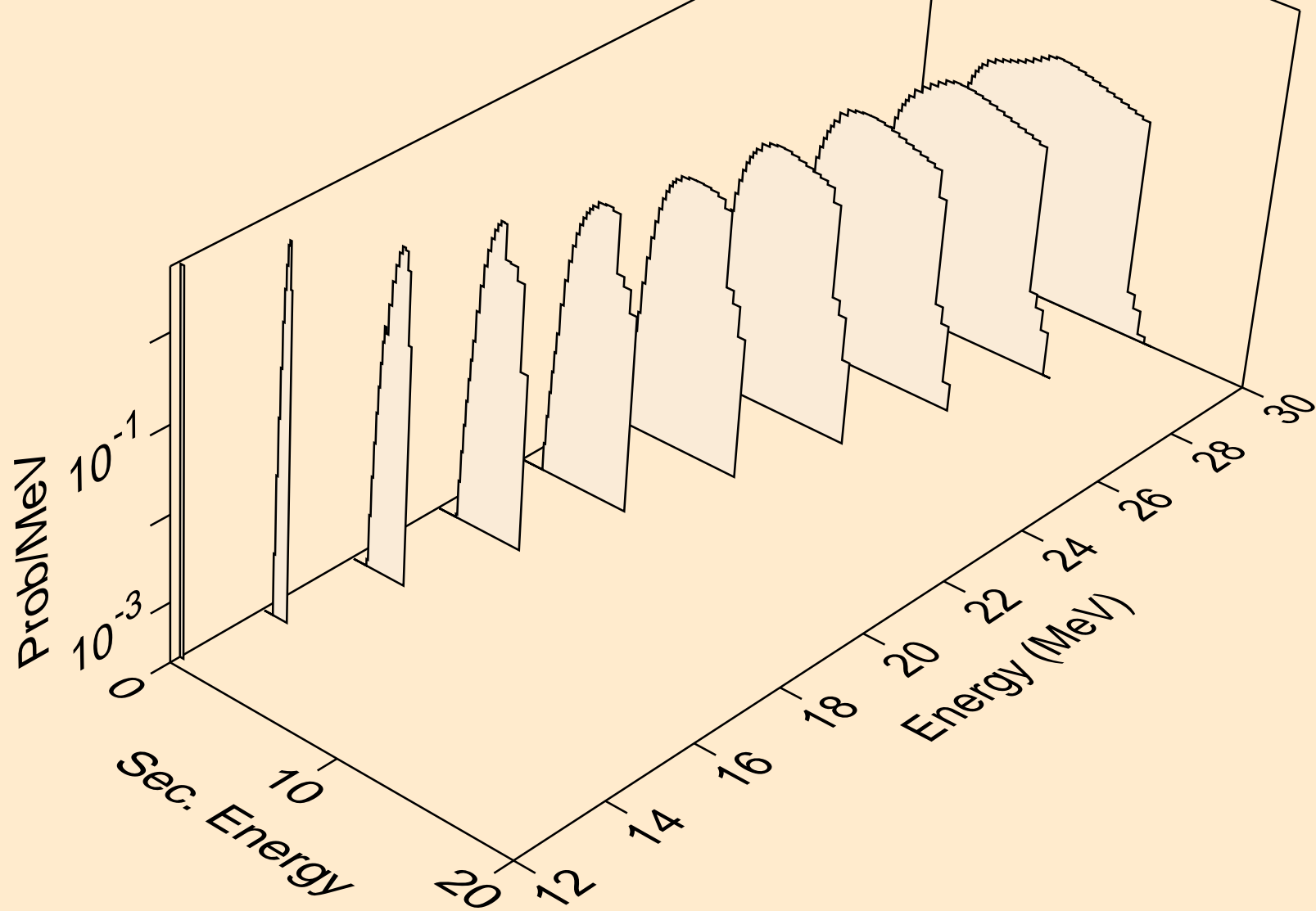

NA025 NEUTRON ACER TENDL-2024 LIBRARY; T=293.6K  
alphas from (n,2n)a

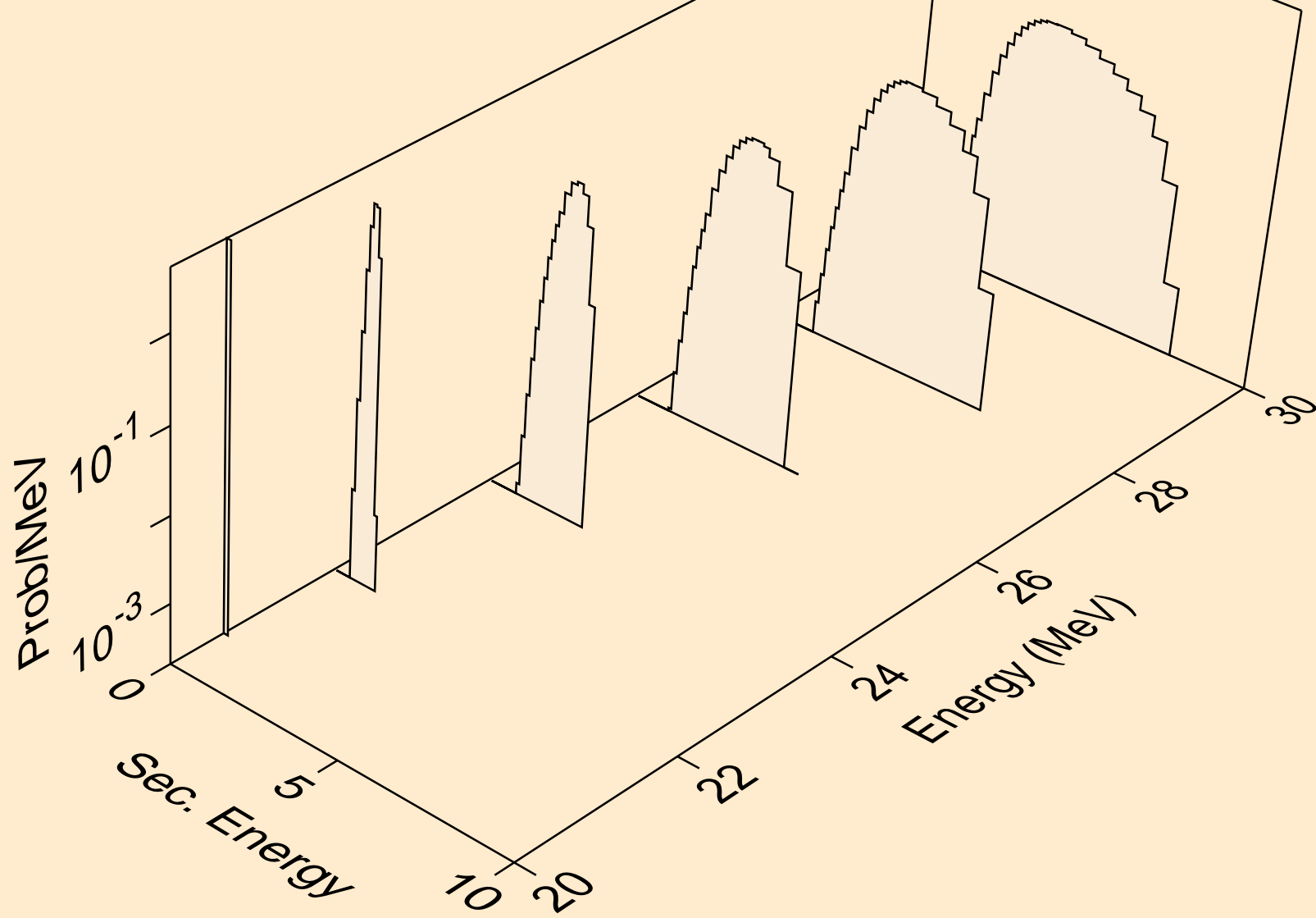

NA025 NEUTRON ACER TENDL-2024 LIBRARY; T=293.6K  
alphas from (n,3n)a

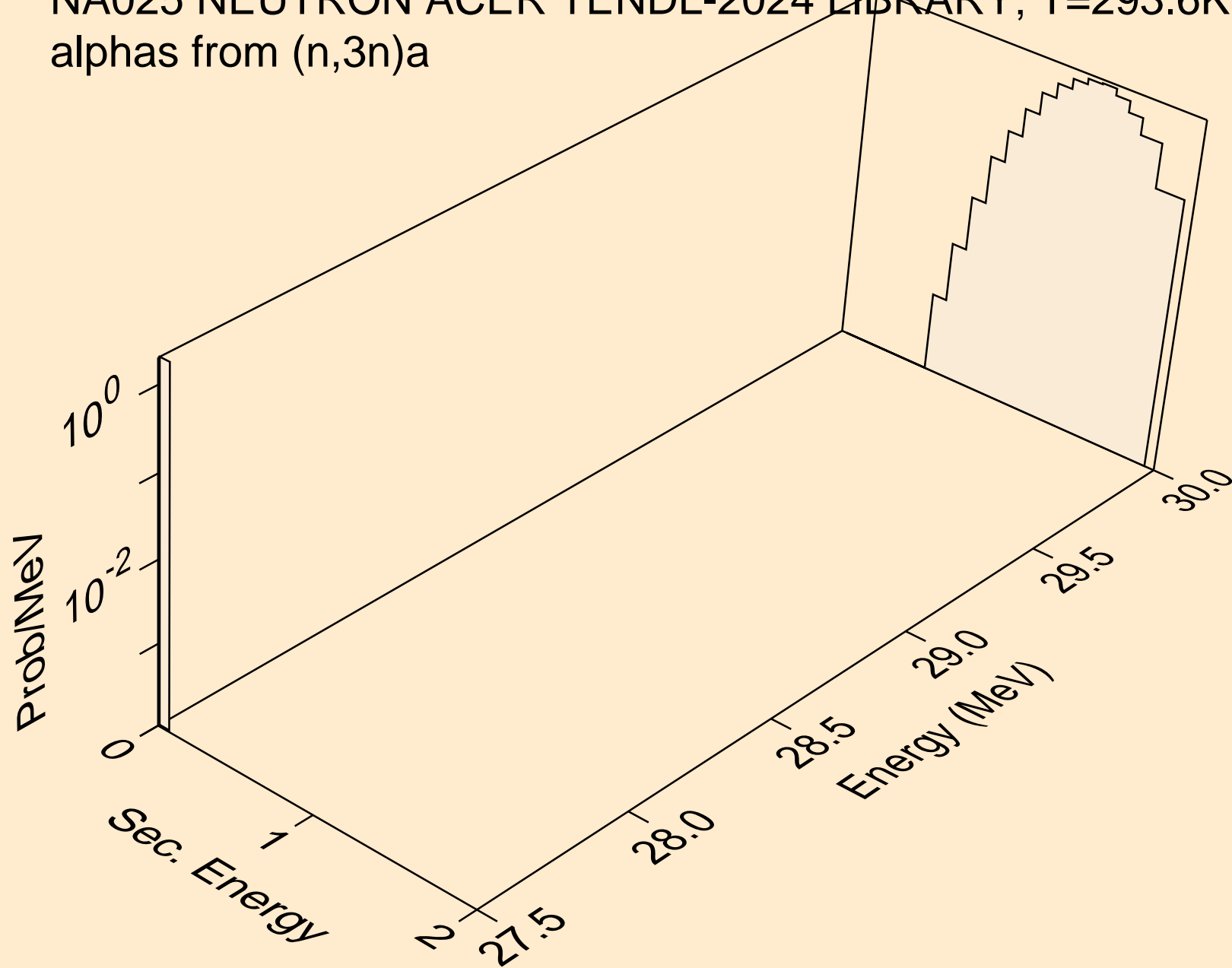

NA025 NEUTRON ACER TENDL-2024 LIBRARY; T=293.6K  
alphas from (n,n\*)2a

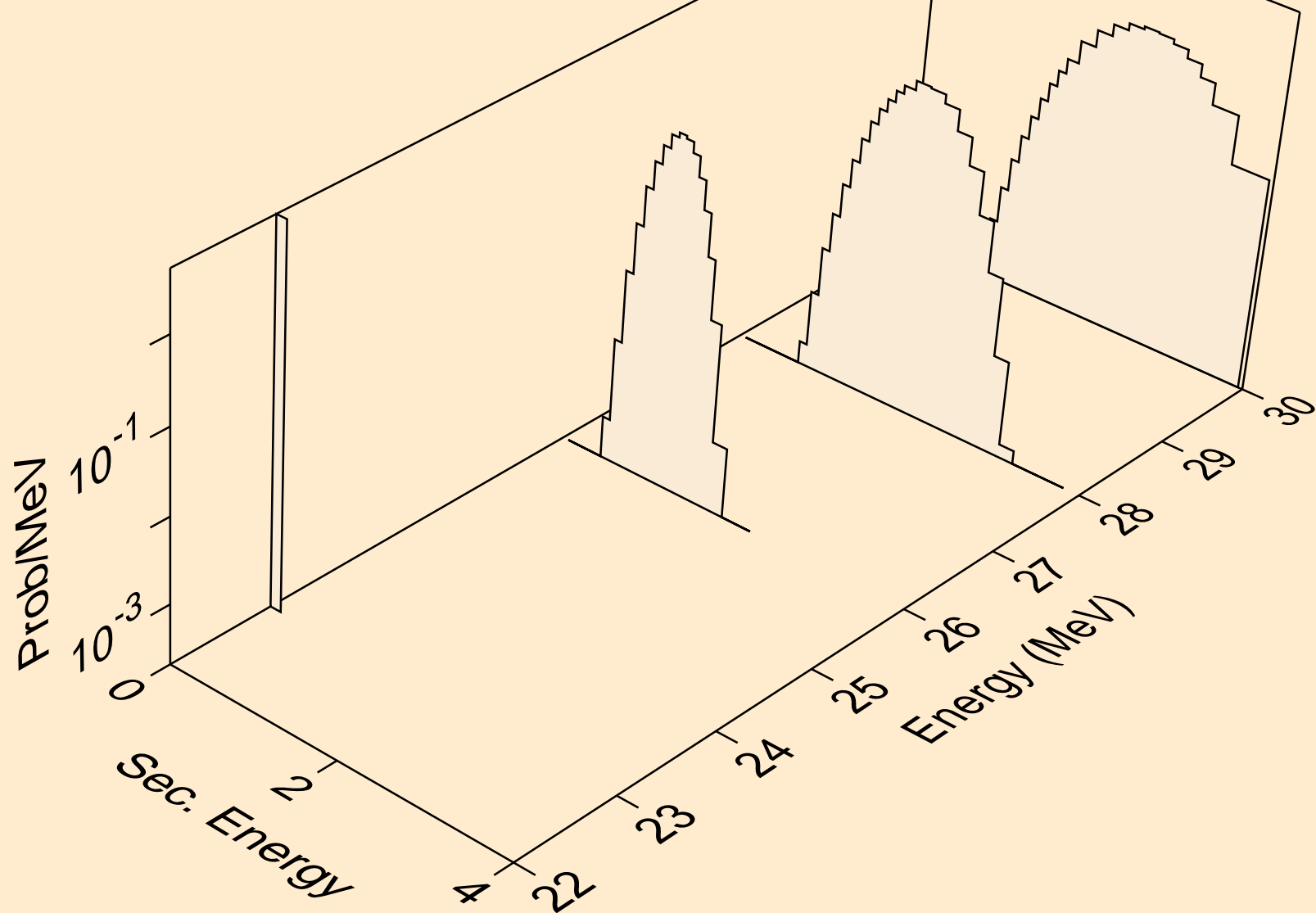

NA025 NEUTRON ACER TENDL-2024 LIBRARY; T=293.6K  
alphas from (n,npa)

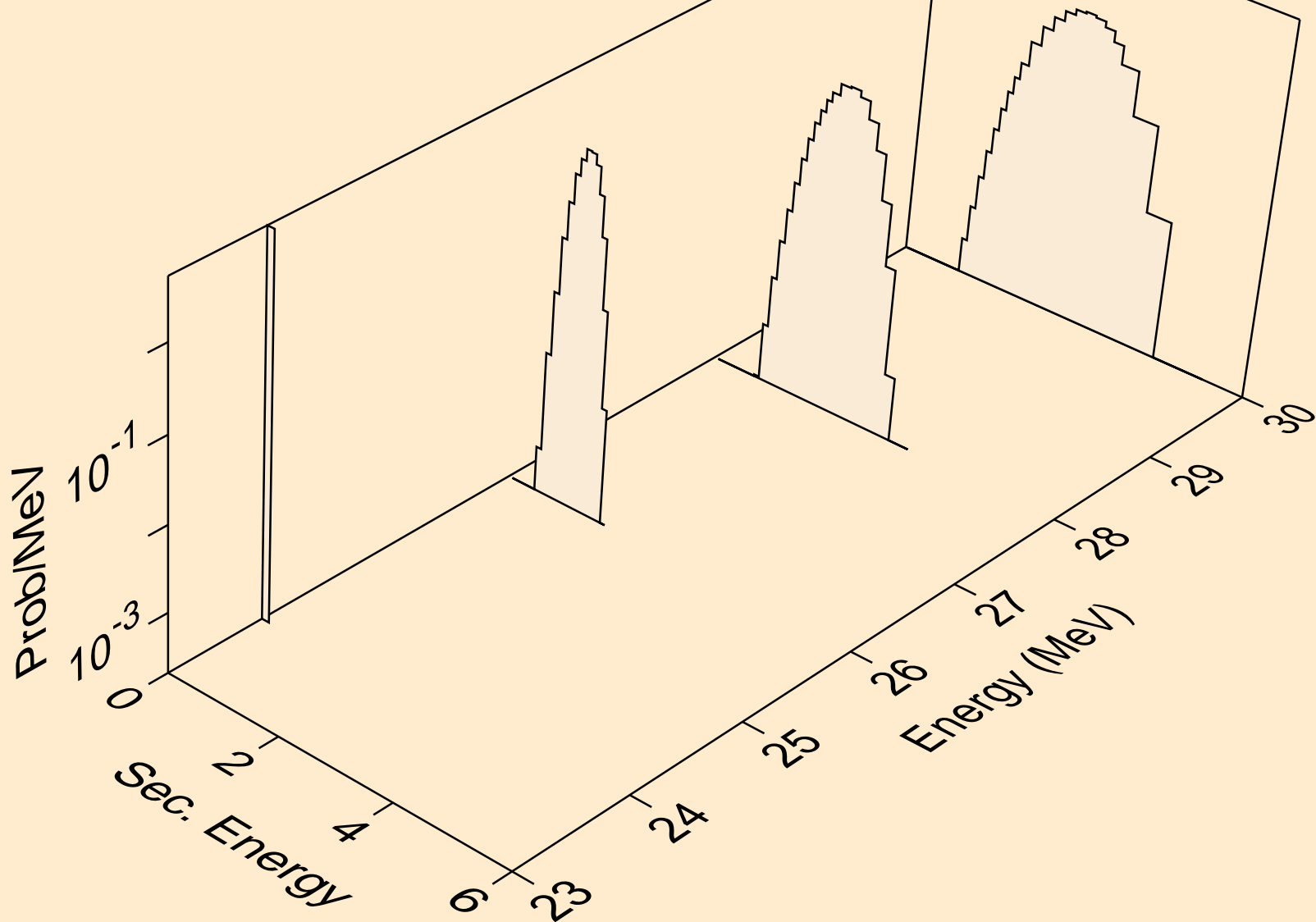

NA025 NEUTRON ACER TENDL-2024 LIBRARY; T=293.6K  
alphas from (n,a)

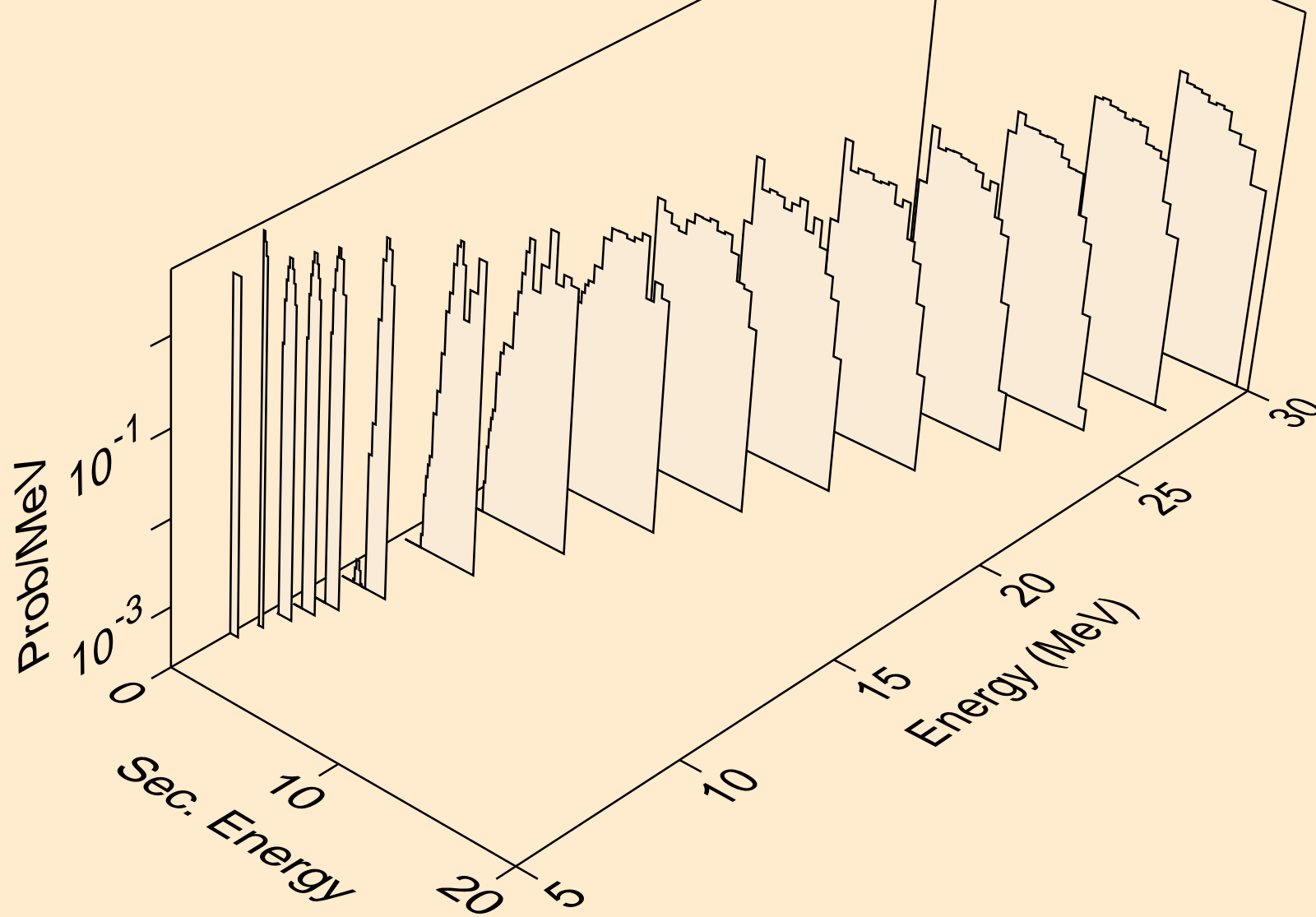

NA025 NEUTRON ACER TENDL-2024 LIBRARY; T=293.6K  
alphas from (n,2a)

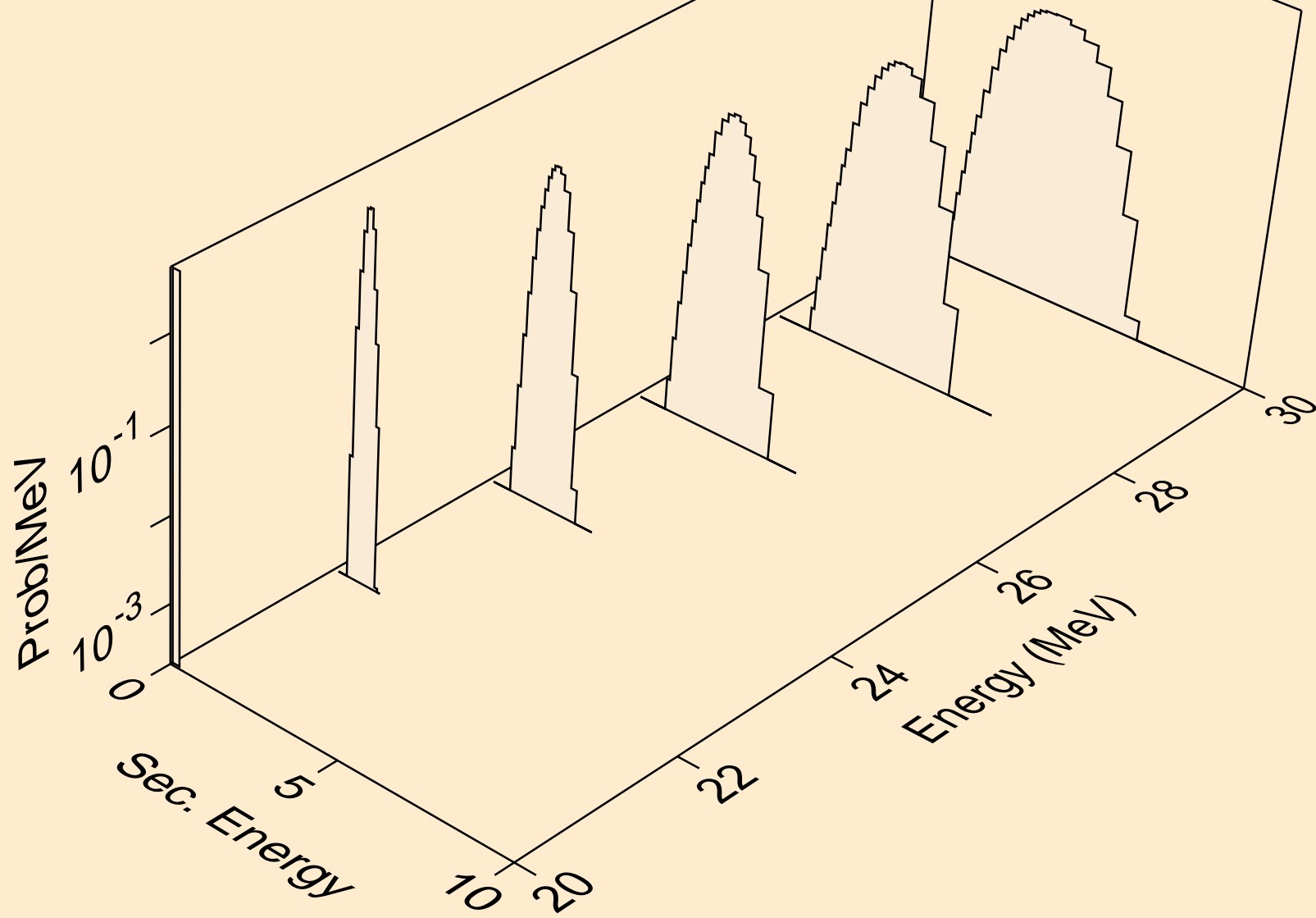

NA025 NEUTRON ACER TENDL-2024 LIBRARY; T=293.6K  
alphas from (n,pa)

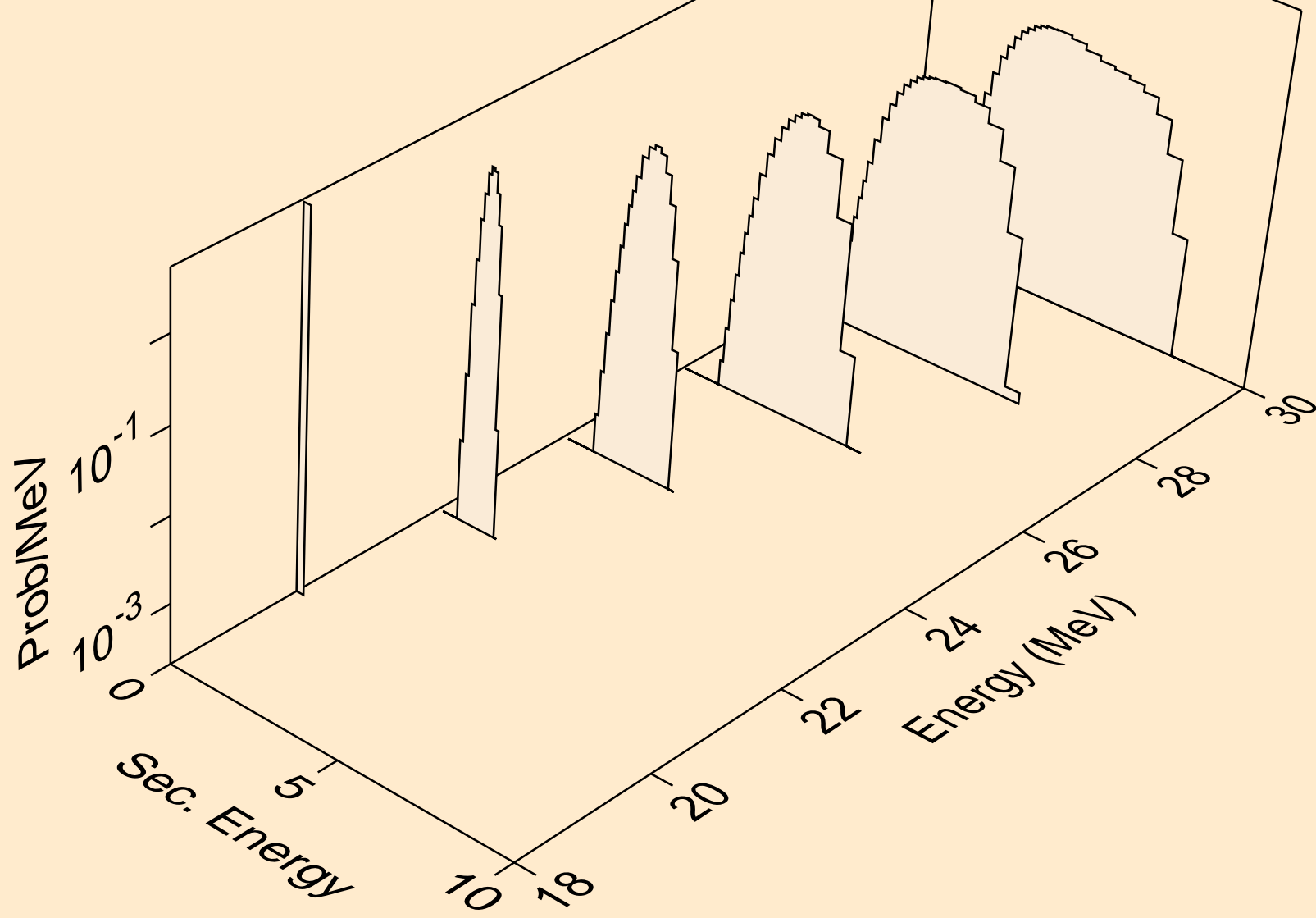

NA025 NEUTRON ACER TENDL-2024 LIBRARY; T=293.6K  
alphas from (n,da)

