

NB086 NEUTRON ACER TENDL-2024 LIBRARY; T=293.6K

Principal cross sections

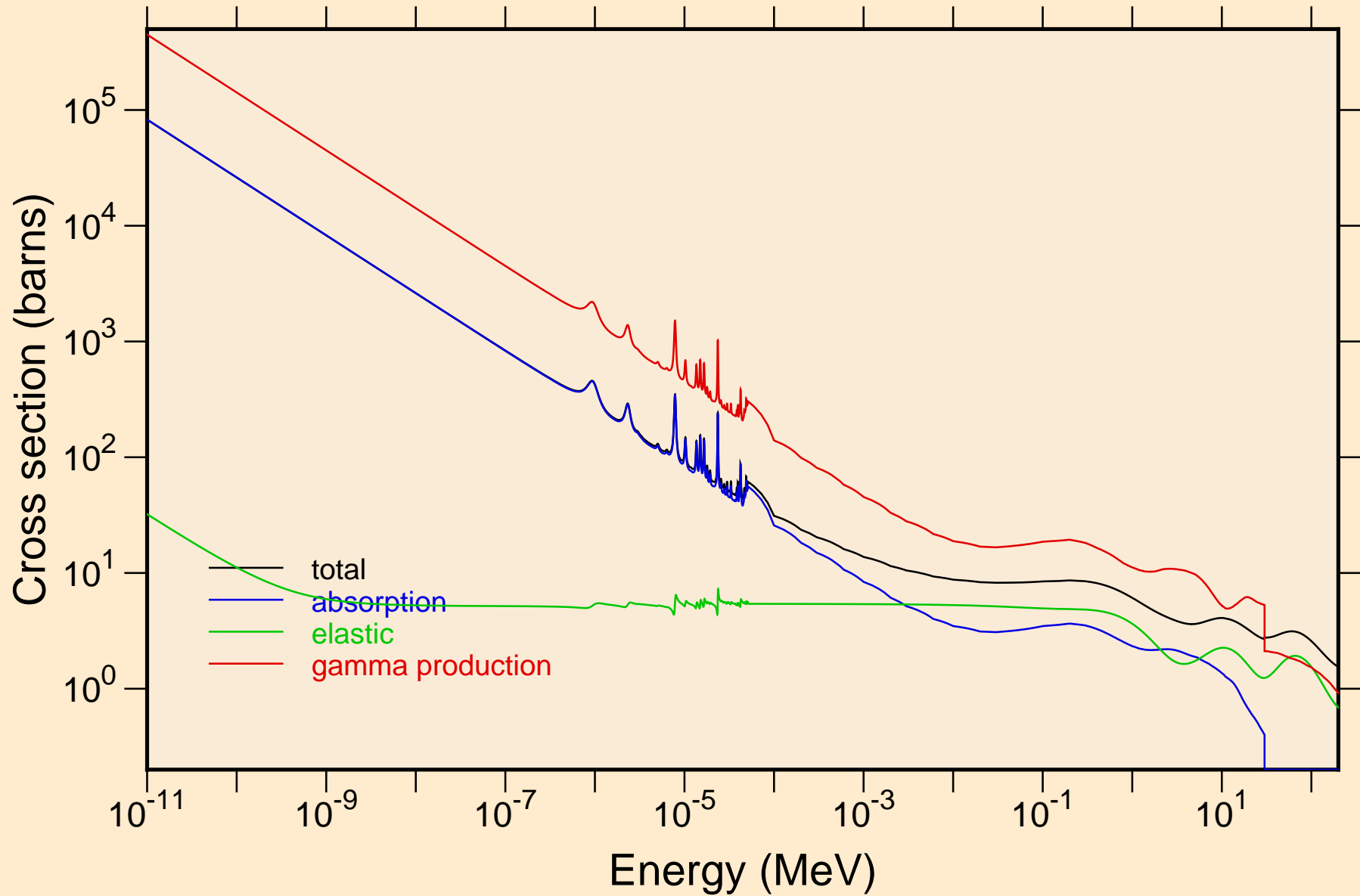

NB086 NEUTRON ACER TENDL-2024 LIBRARY; T=293.6K
resonance total cross section

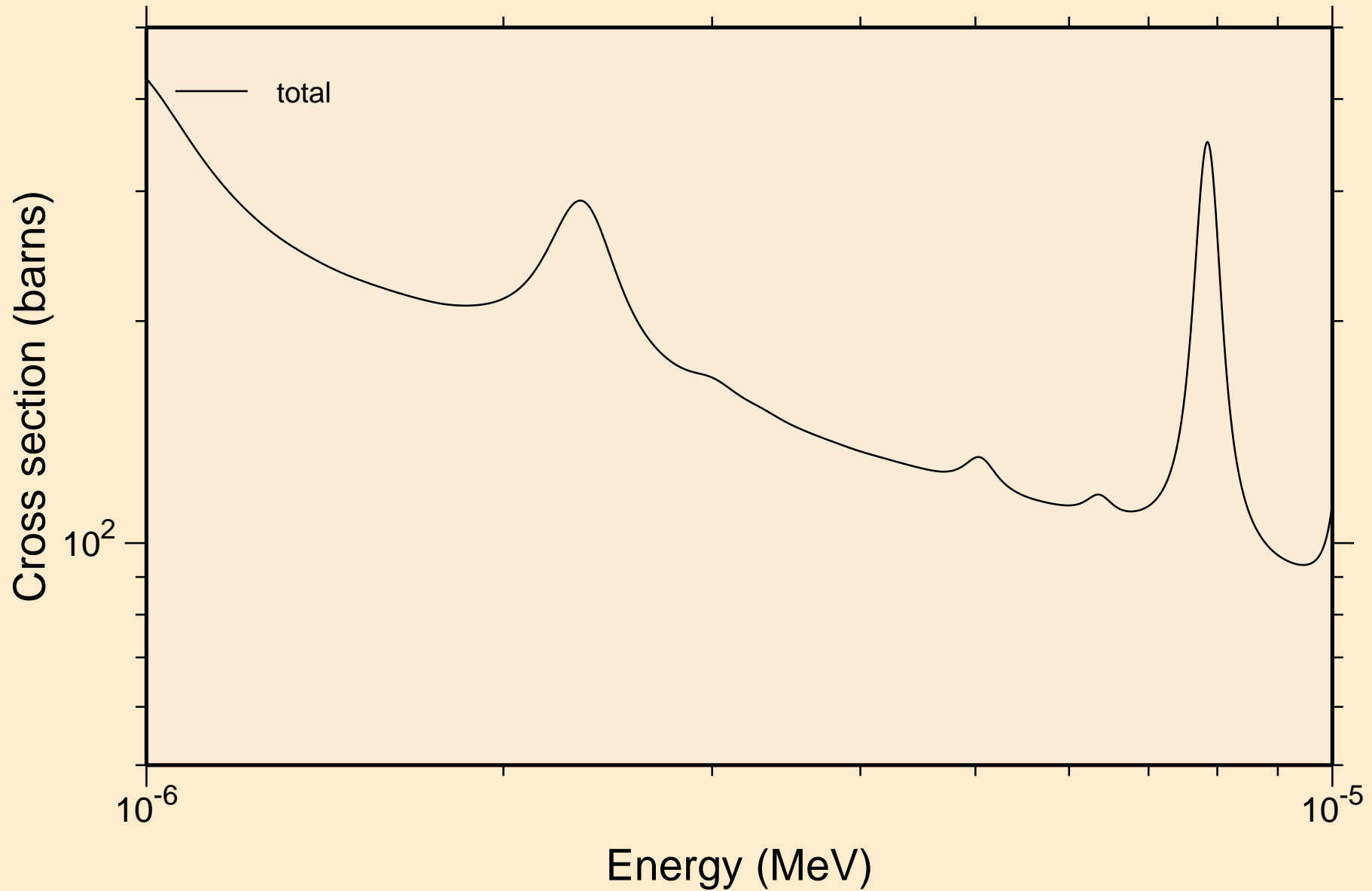

NB086 NEUTRON ACER TENDL-2024 LIBRARY; T=293.6K
resonance total cross section

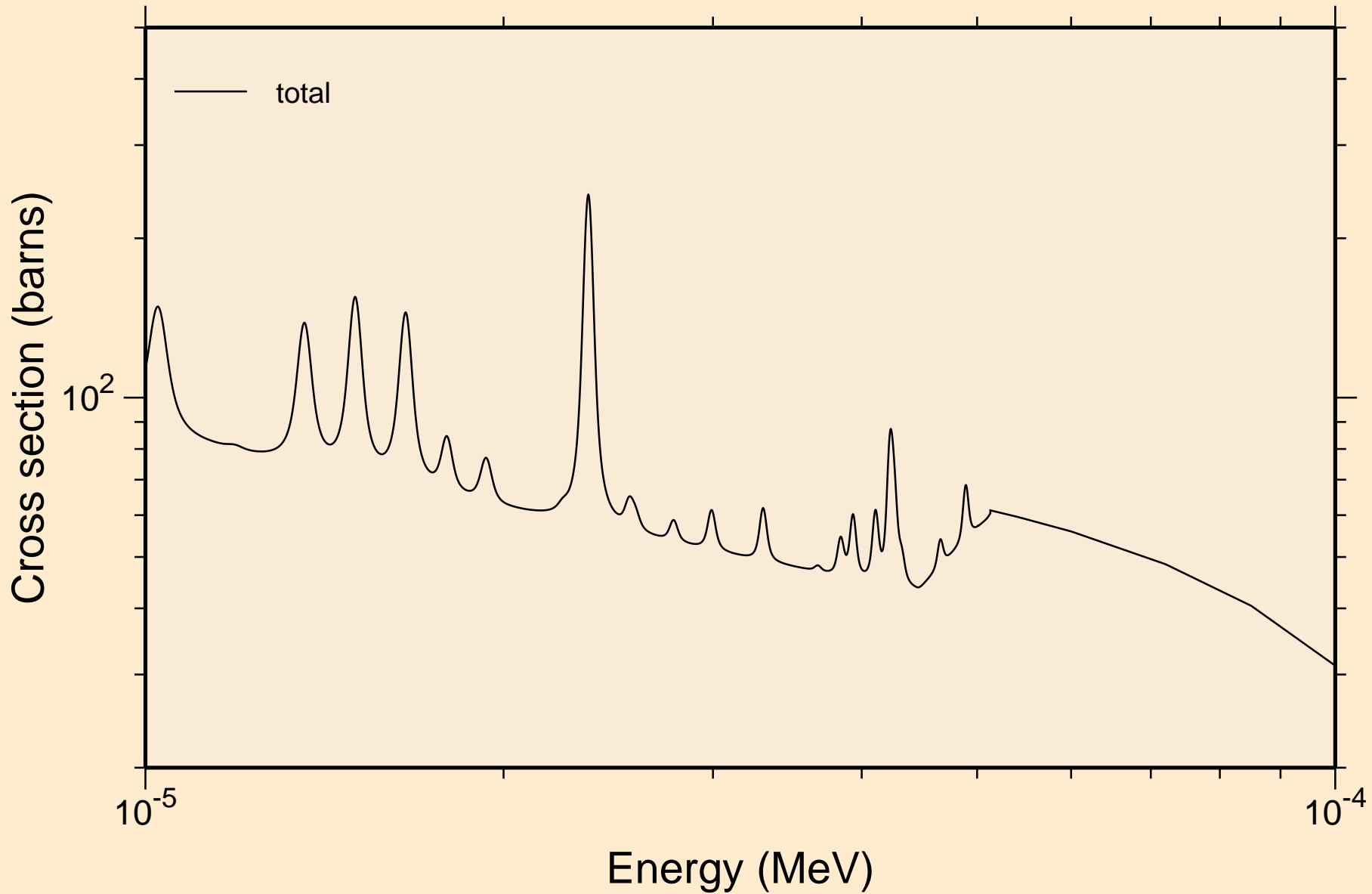

NB086 NEUTRON ACER TENDL-2024 LIBRARY; T=293.6K
resonance total cross section

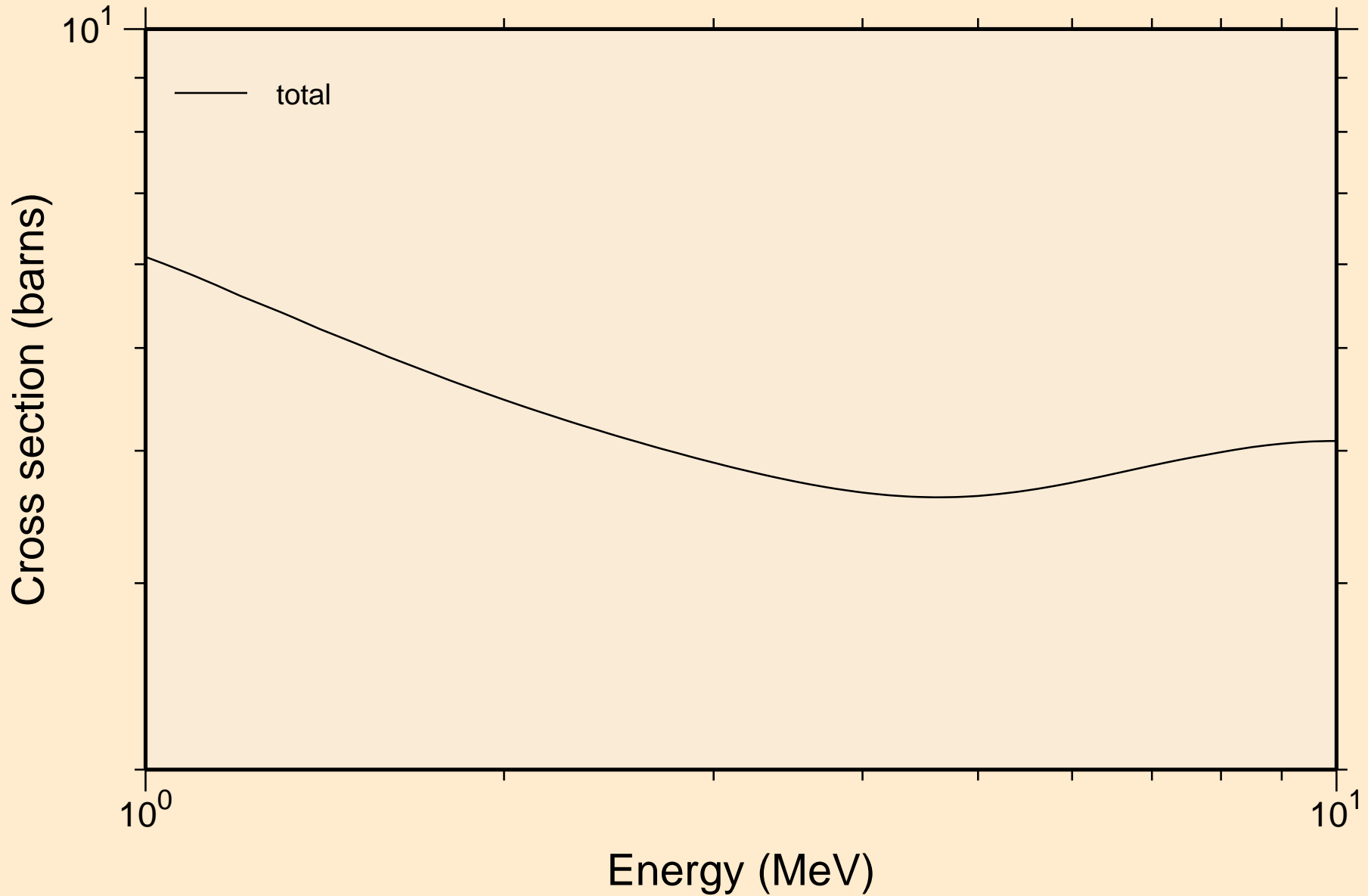

NB086 NEUTRON ACER TENDL-2024 LIBRARY; T=293.6K
resonance absorption cross sections

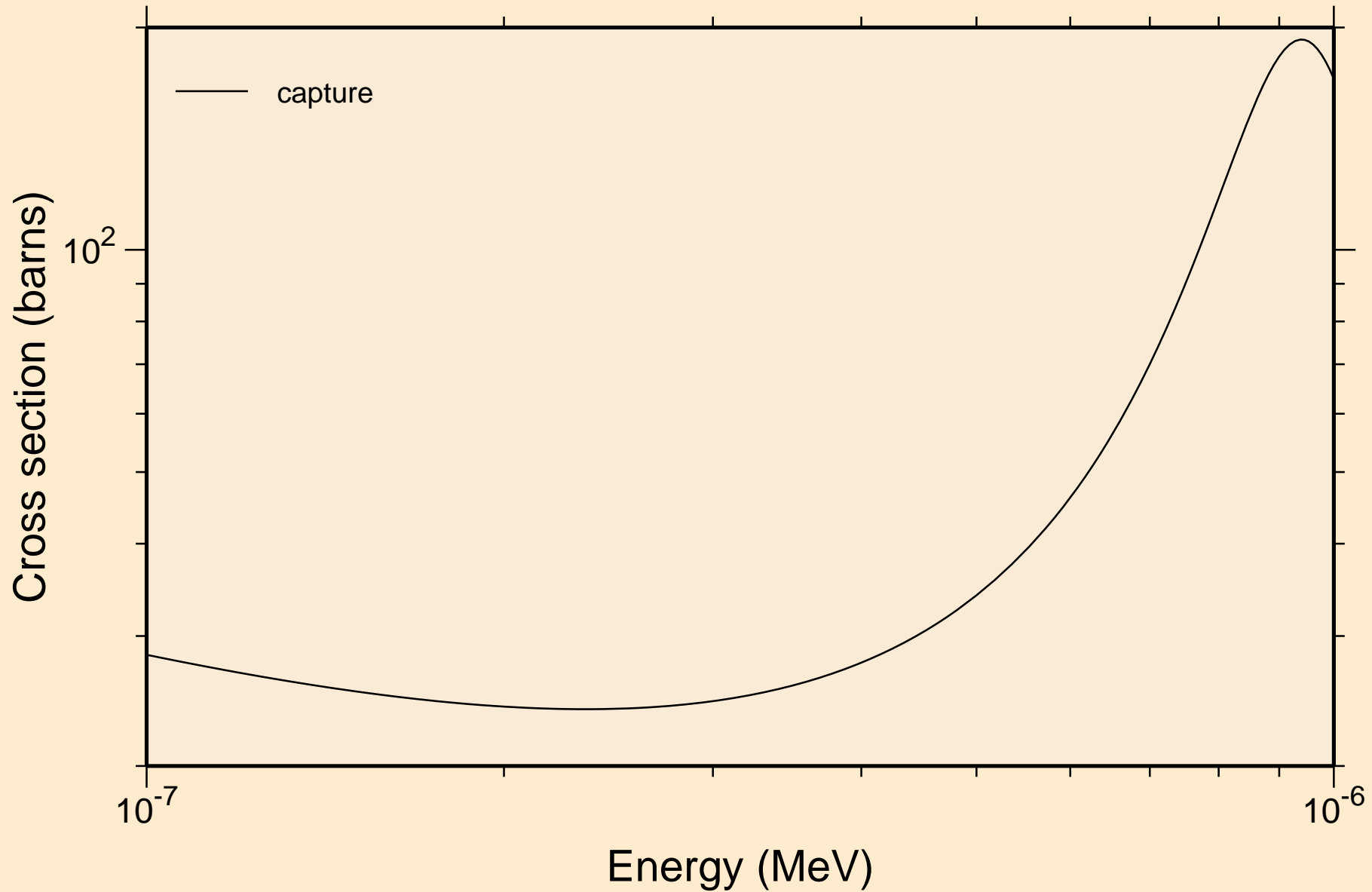

NB086 NEUTRON ACER TENDL-2024 LIBRARY; T=293.6K
resonance absorption cross sections

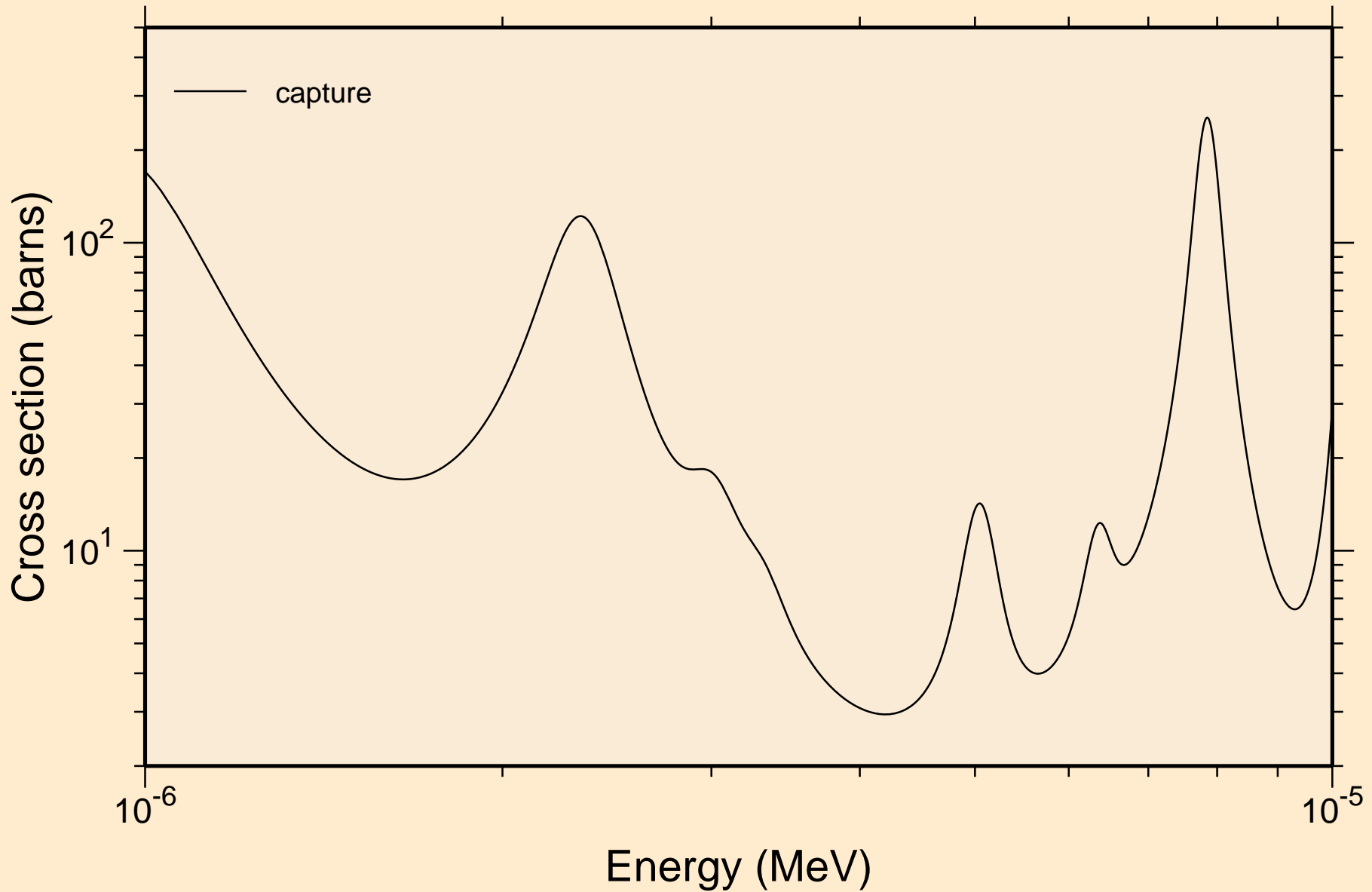

NB086 NEUTRON ACER TENDL-2024 LIBRARY; T=293.6K
resonance absorption cross sections

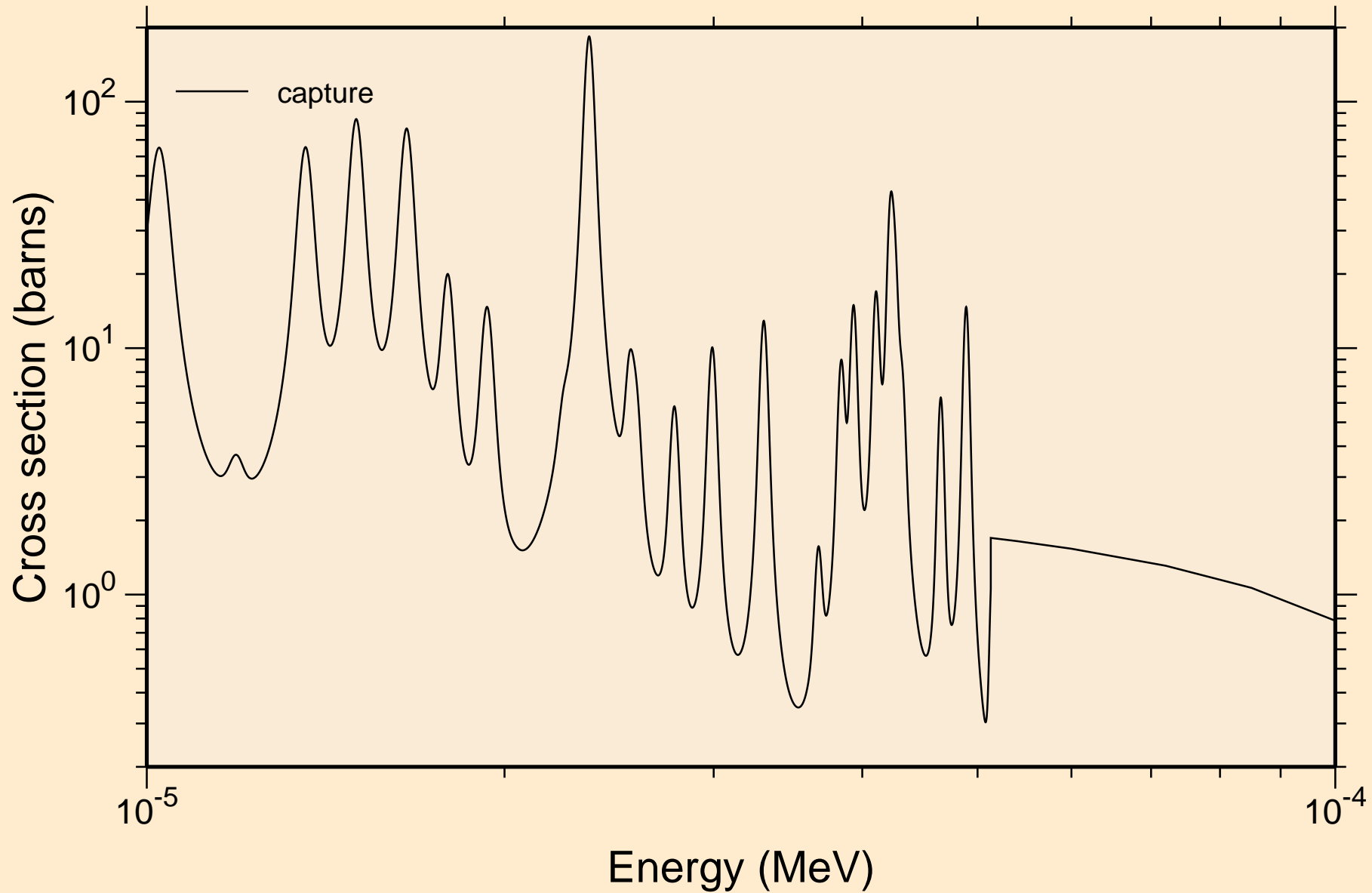

NB086 NEUTRON ACER TENDL-2024 LIBRARY; T=293.6K
resonance absorption cross sections

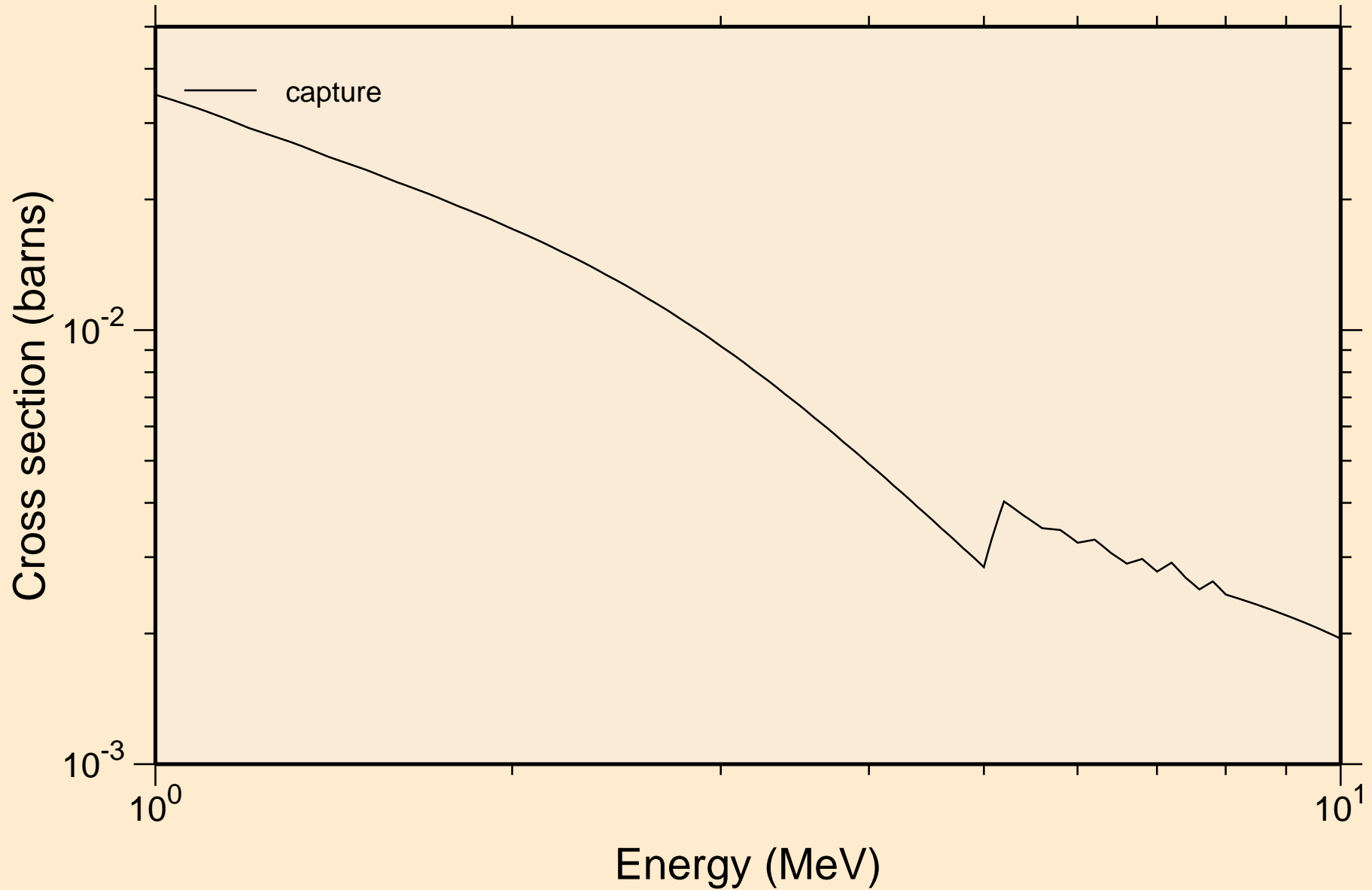

NB086 NEUTRON ACER TENDL-2024 LIBRARY; T=293.6K
Heating

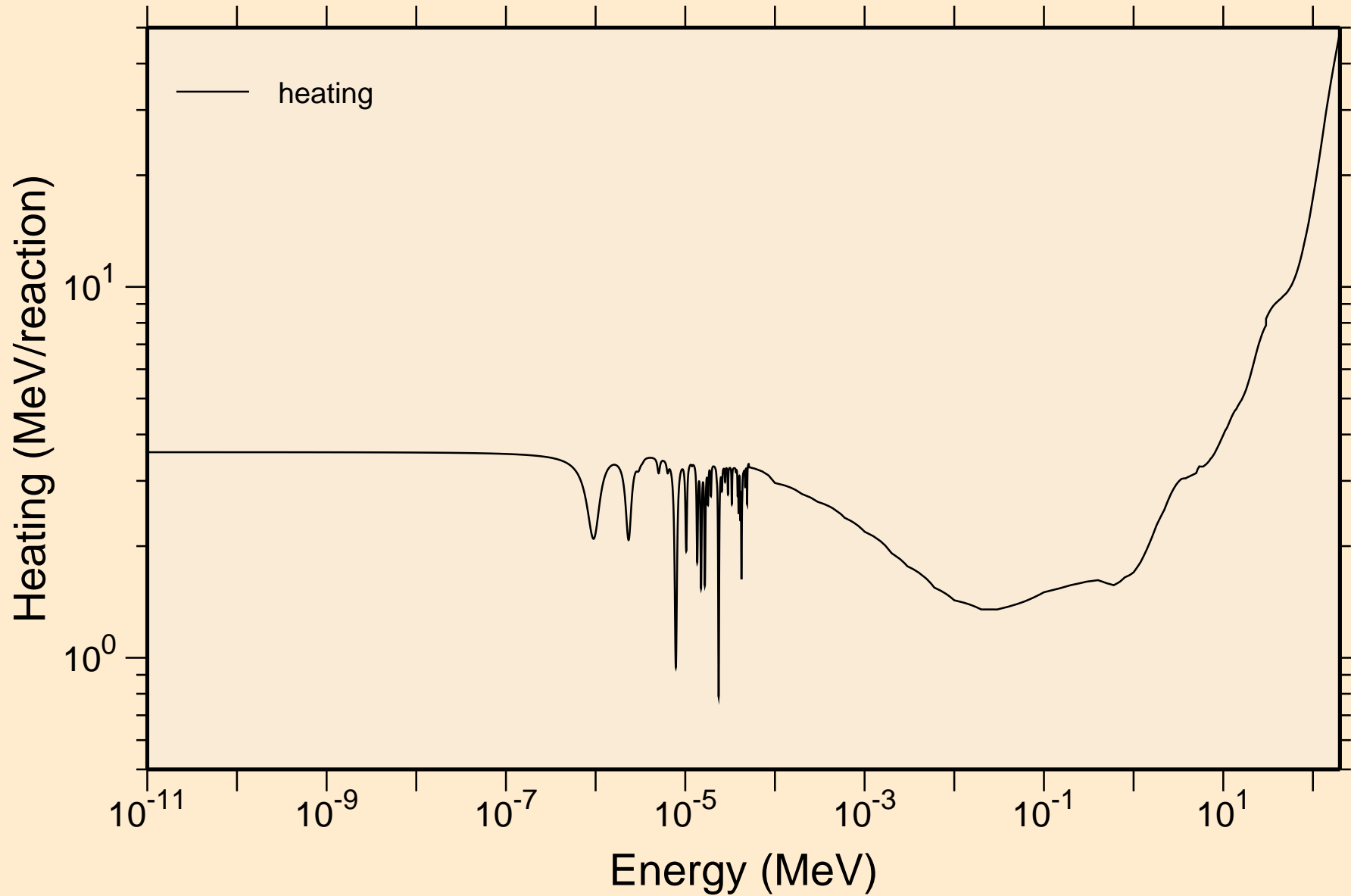

NB086 NEUTRON ACER TENDL-2024 LIBRARY; T=293.6K
Damage

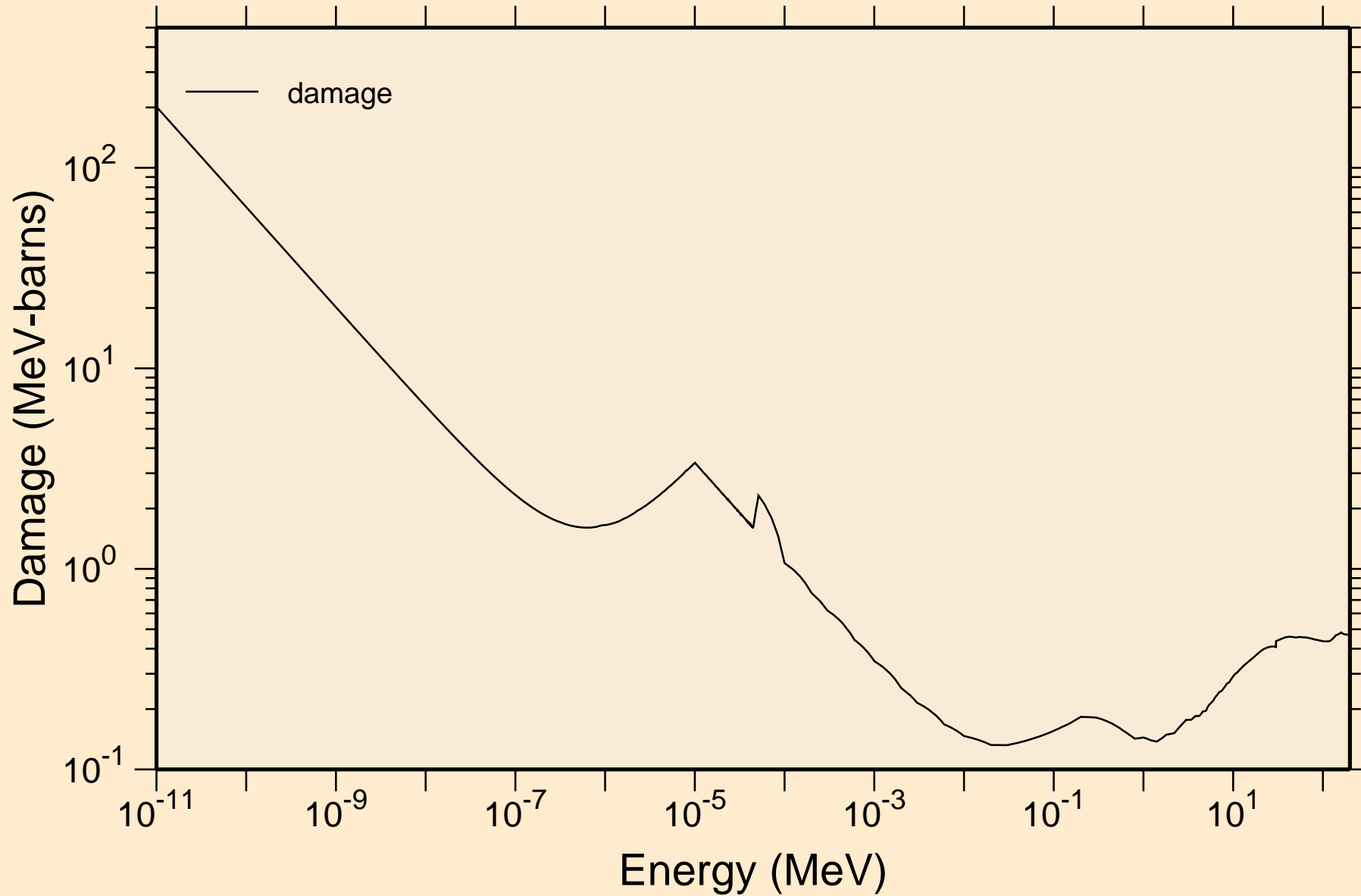

NB086 NEUTRON ACER TENDL-2024 LIBRARY; T=293.6K
Non-threshold reactions

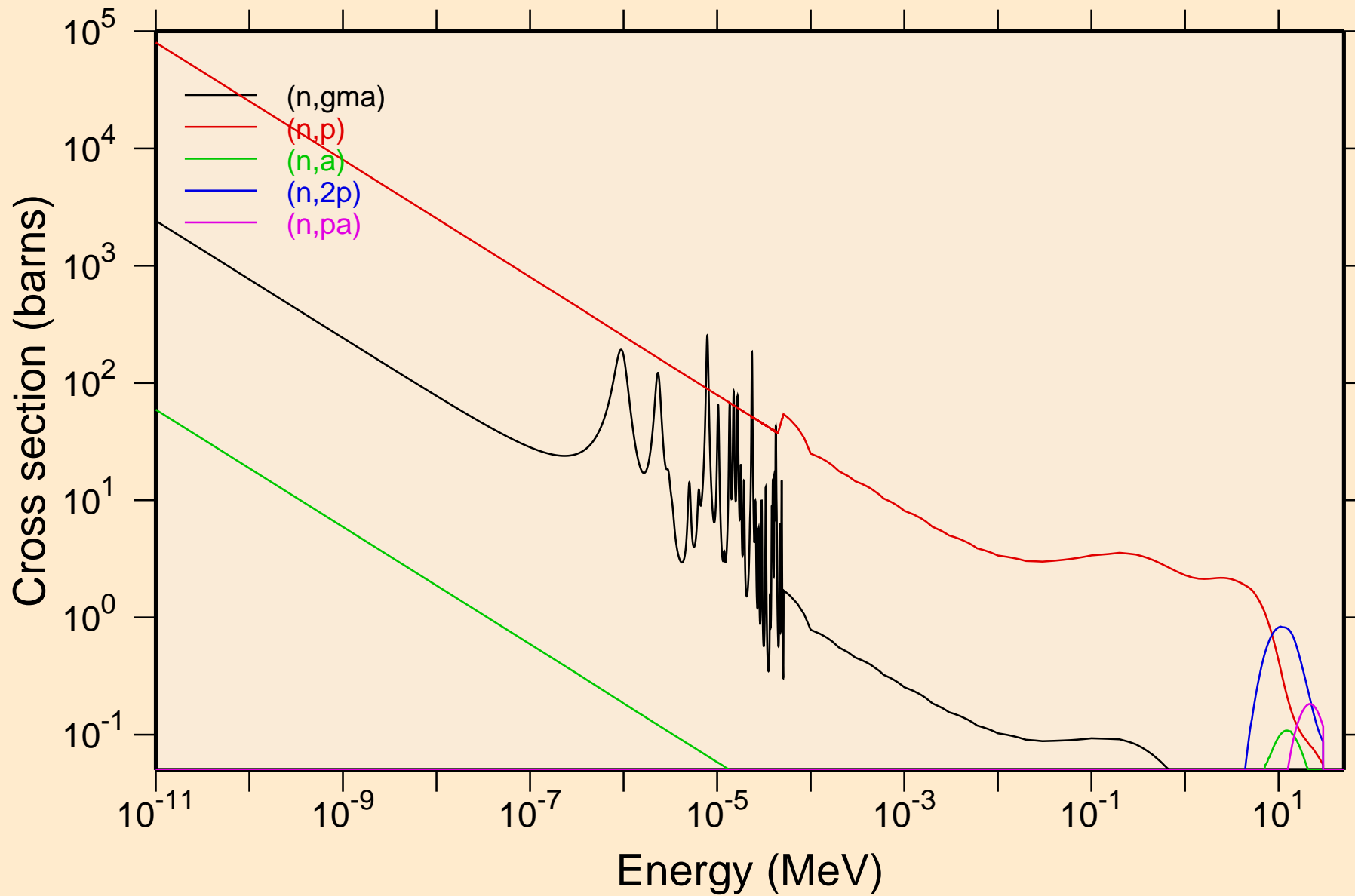

NB086 NEUTRON ACER TENDL-2024 LIBRARY; T=293.6K
Non-threshold reactions

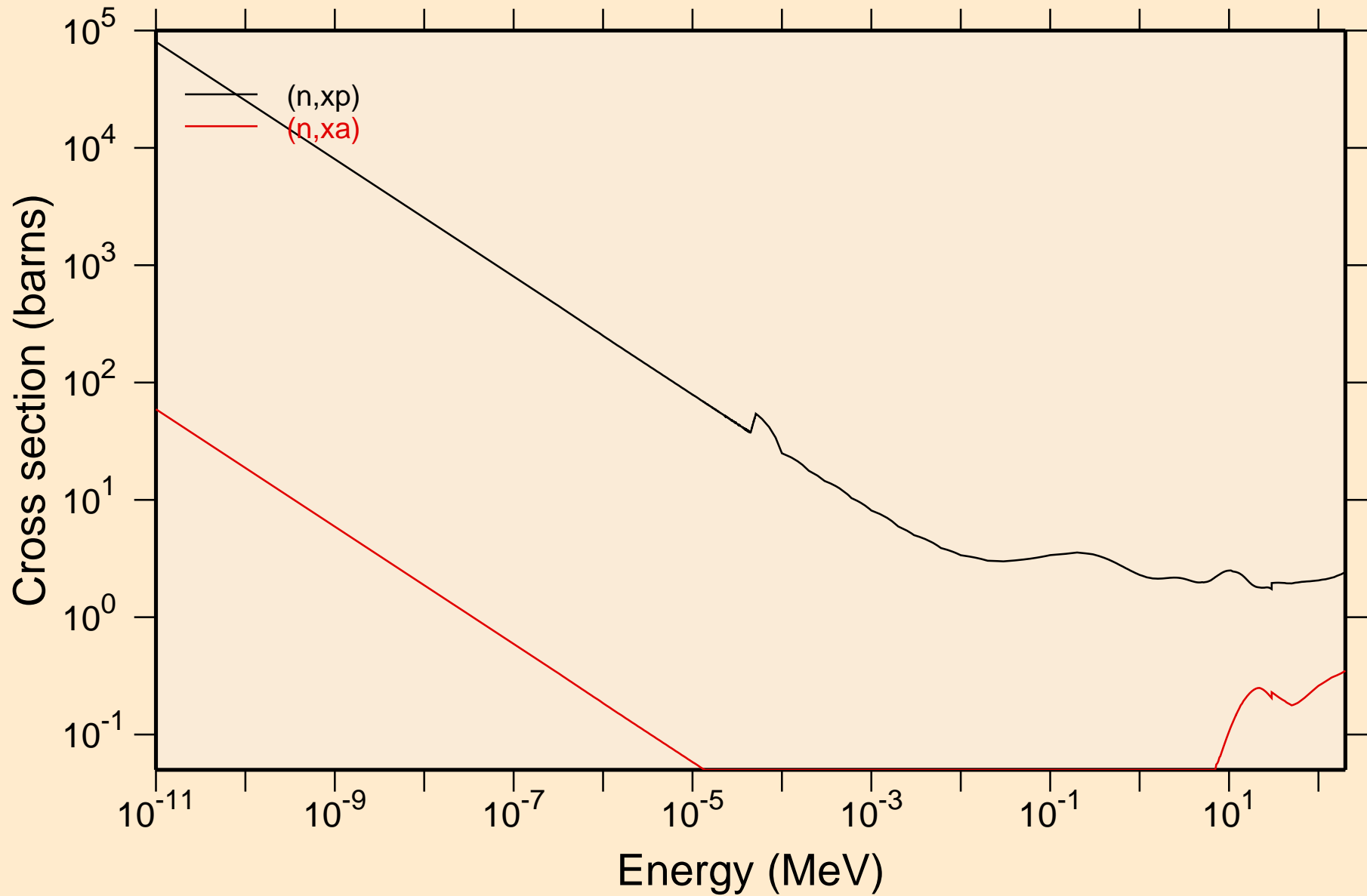

NB086 NEUTRON ACER TENDL-2024 LIBRARY; T=293.6K
Principal cross sections

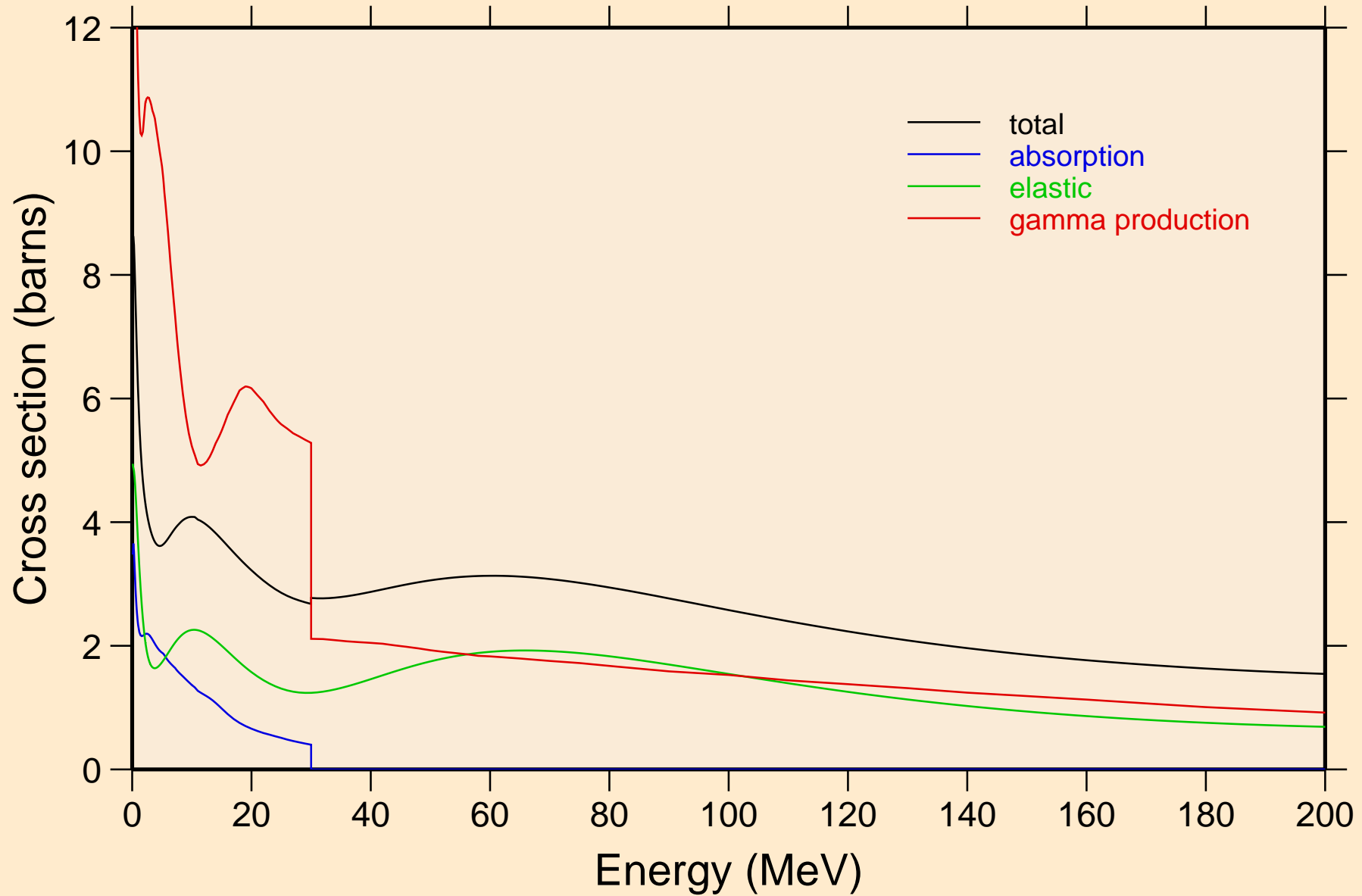

NB086 NEUTRON ACER TENDL-2024 LIBRARY; T=293.6K
Heating

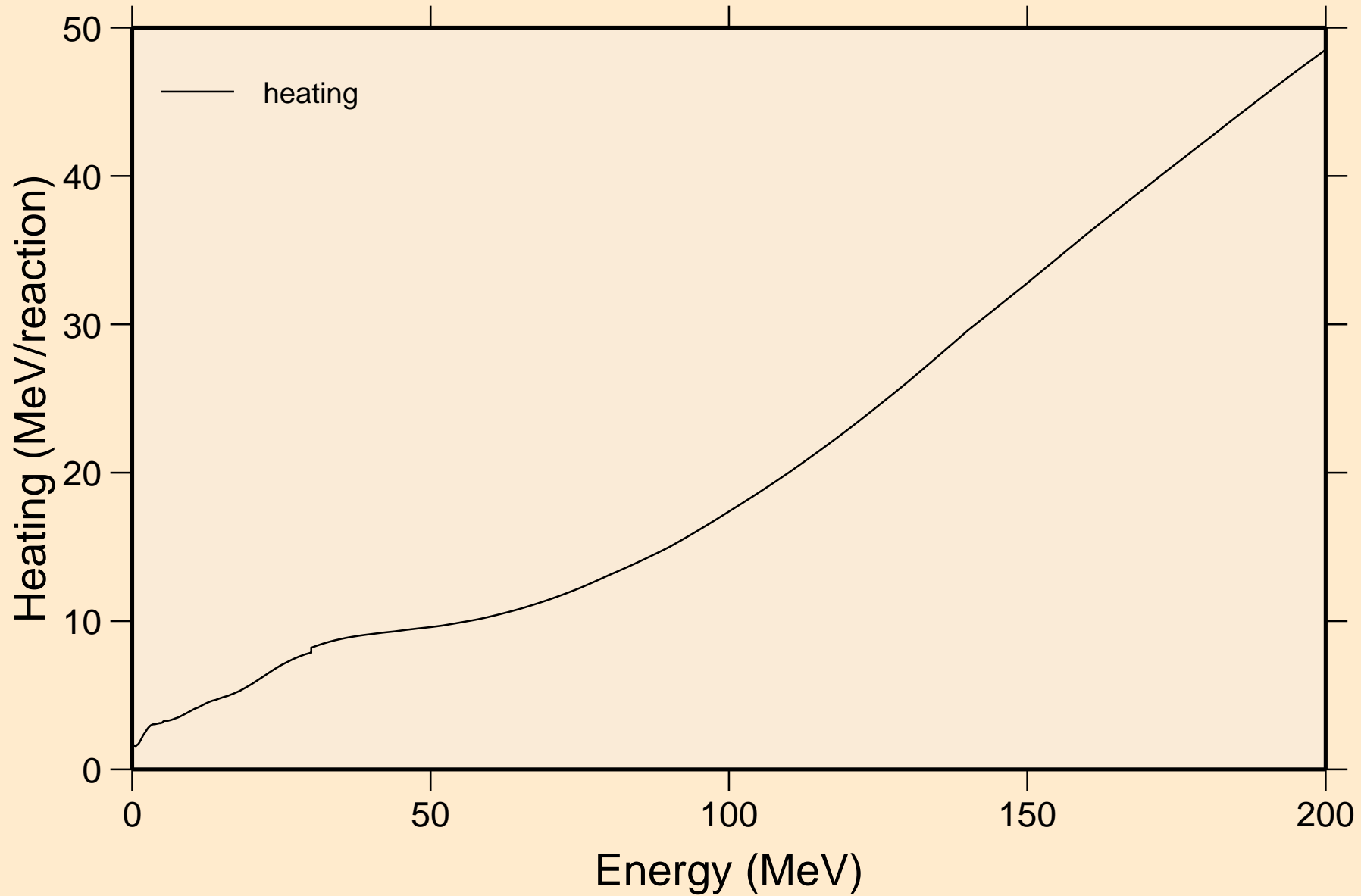

NB086 NEUTRON ACER TENDL-2024 LIBRARY; T=293.6K
Damage

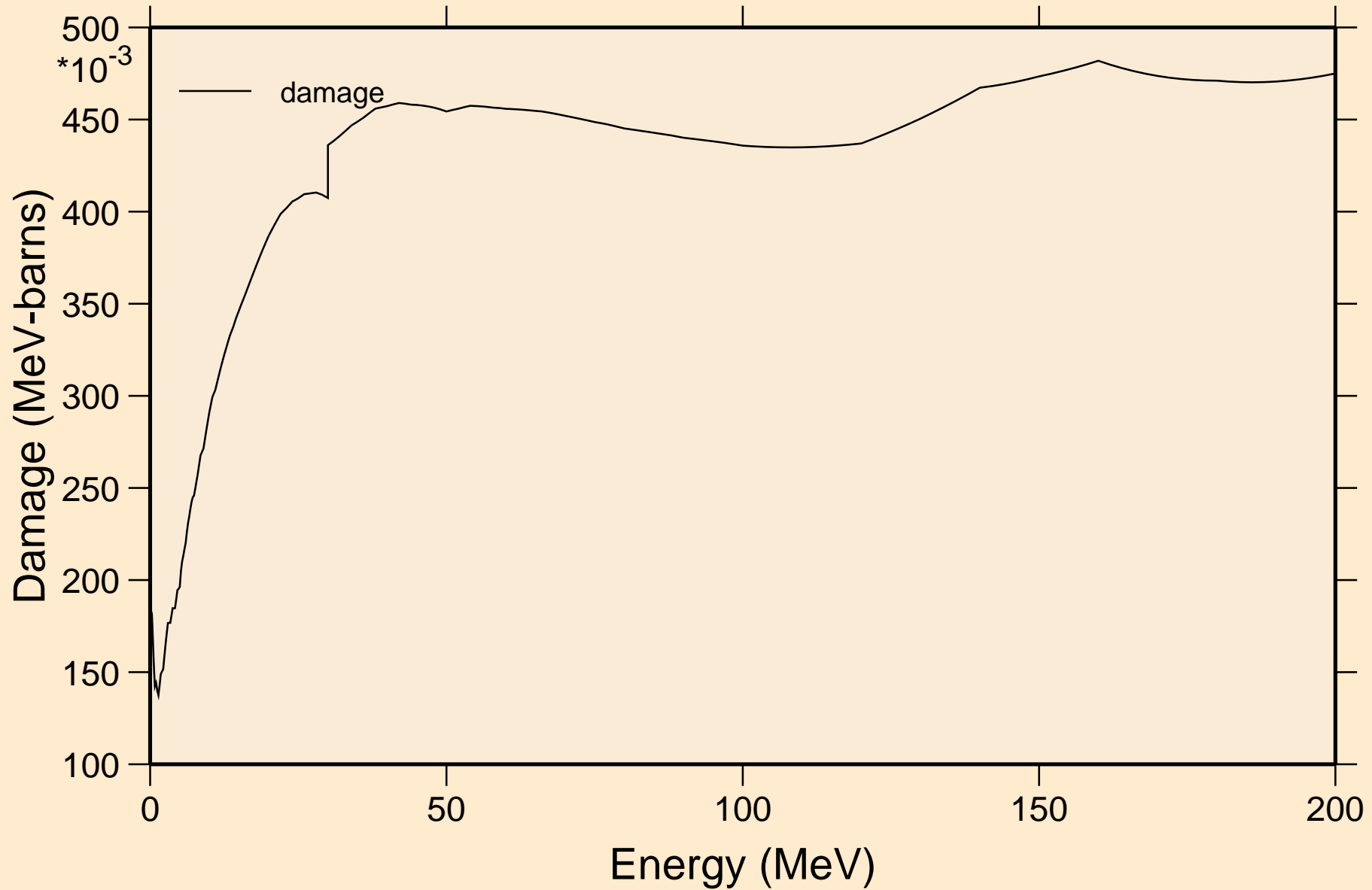

NB086 NEUTRON ACER TENDL-2024 LIBRARY; T=293.6K
Non-threshold reactions

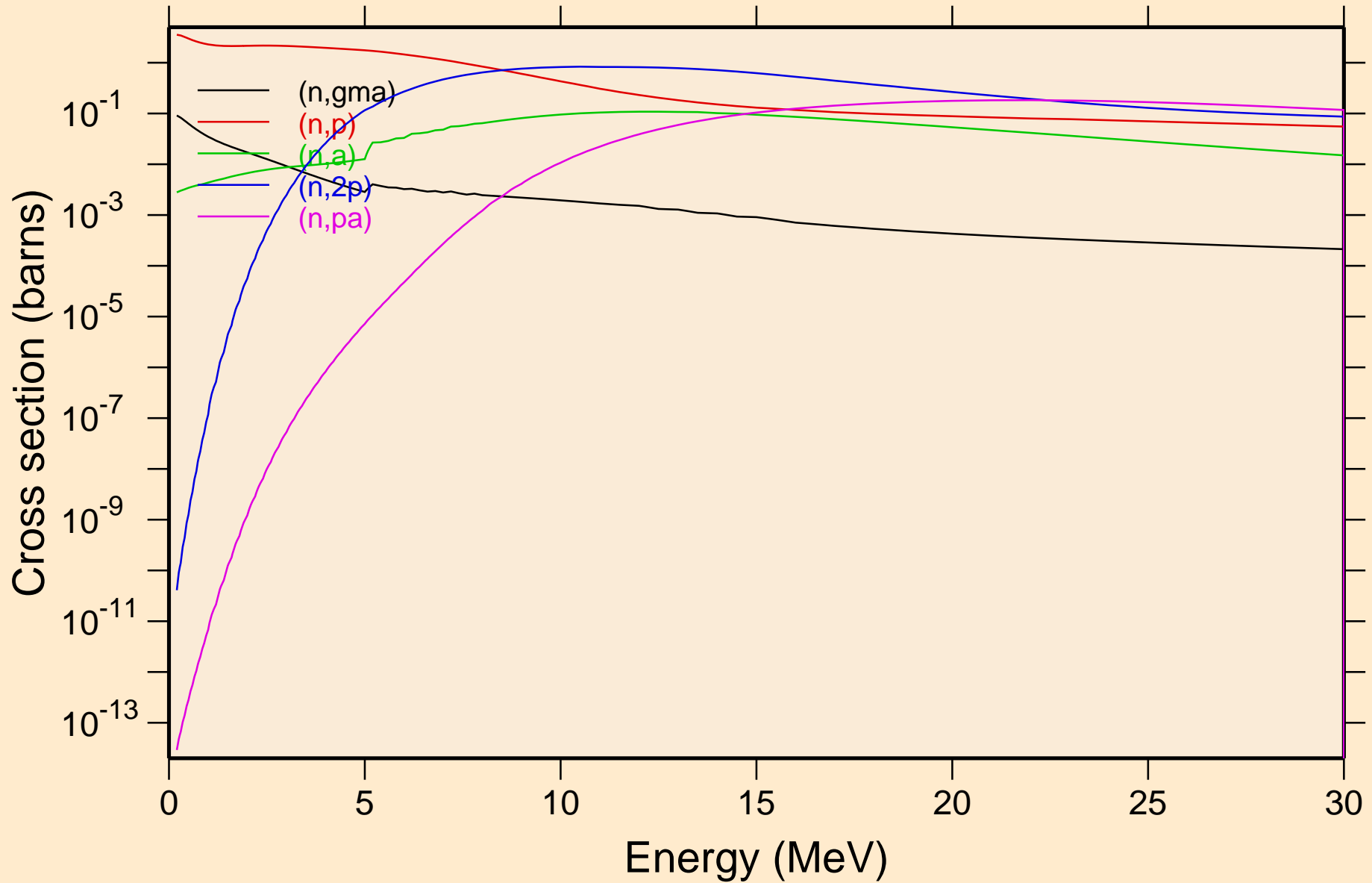

NB086 NEUTRON ACER TENDL-2024 LIBRARY; T=293.6K
Non-threshold reactions

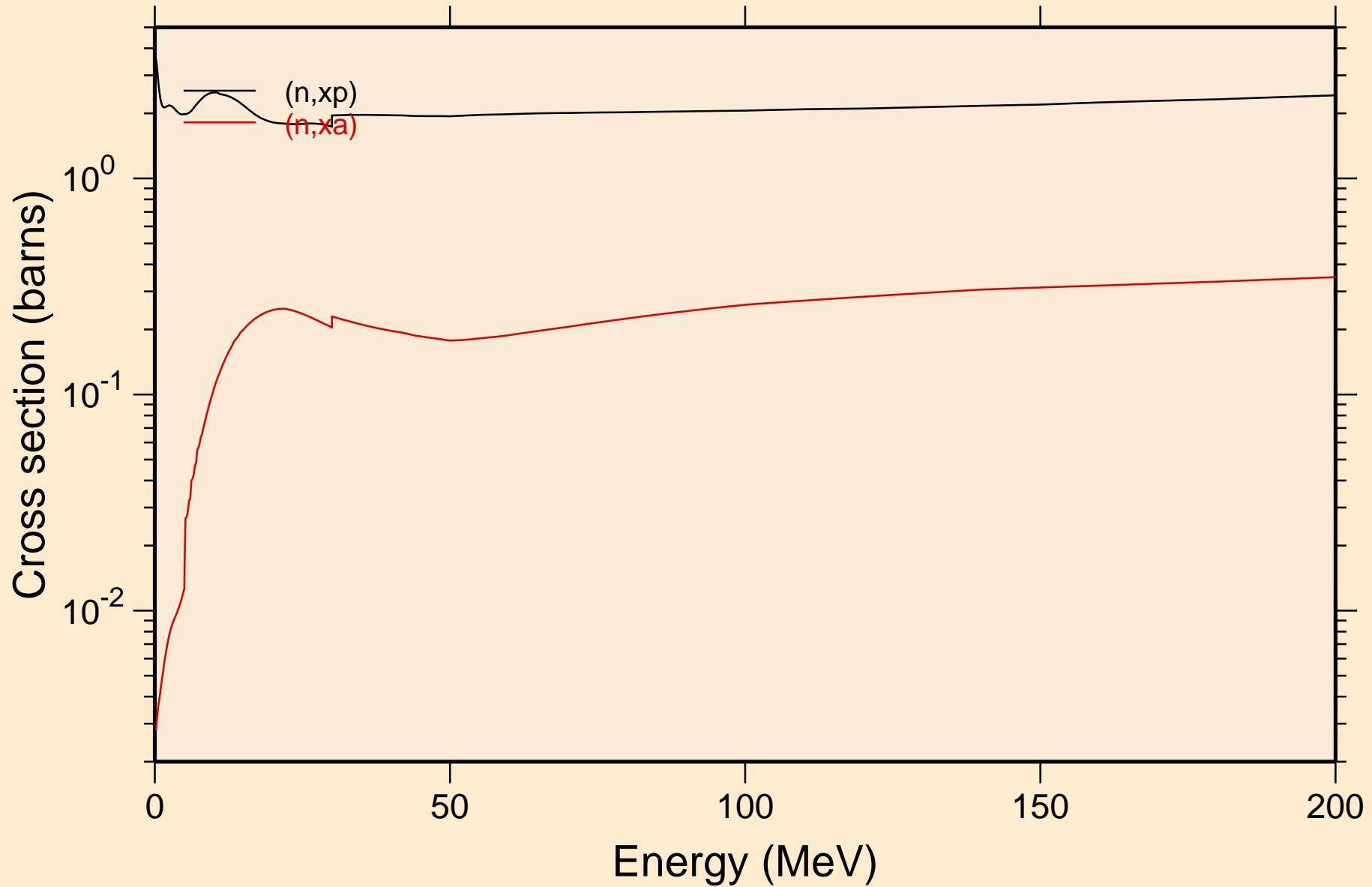

NB086 NEUTRON ACER TENDL-2024 LIBRARY; T=293.6K
Inelastic levels

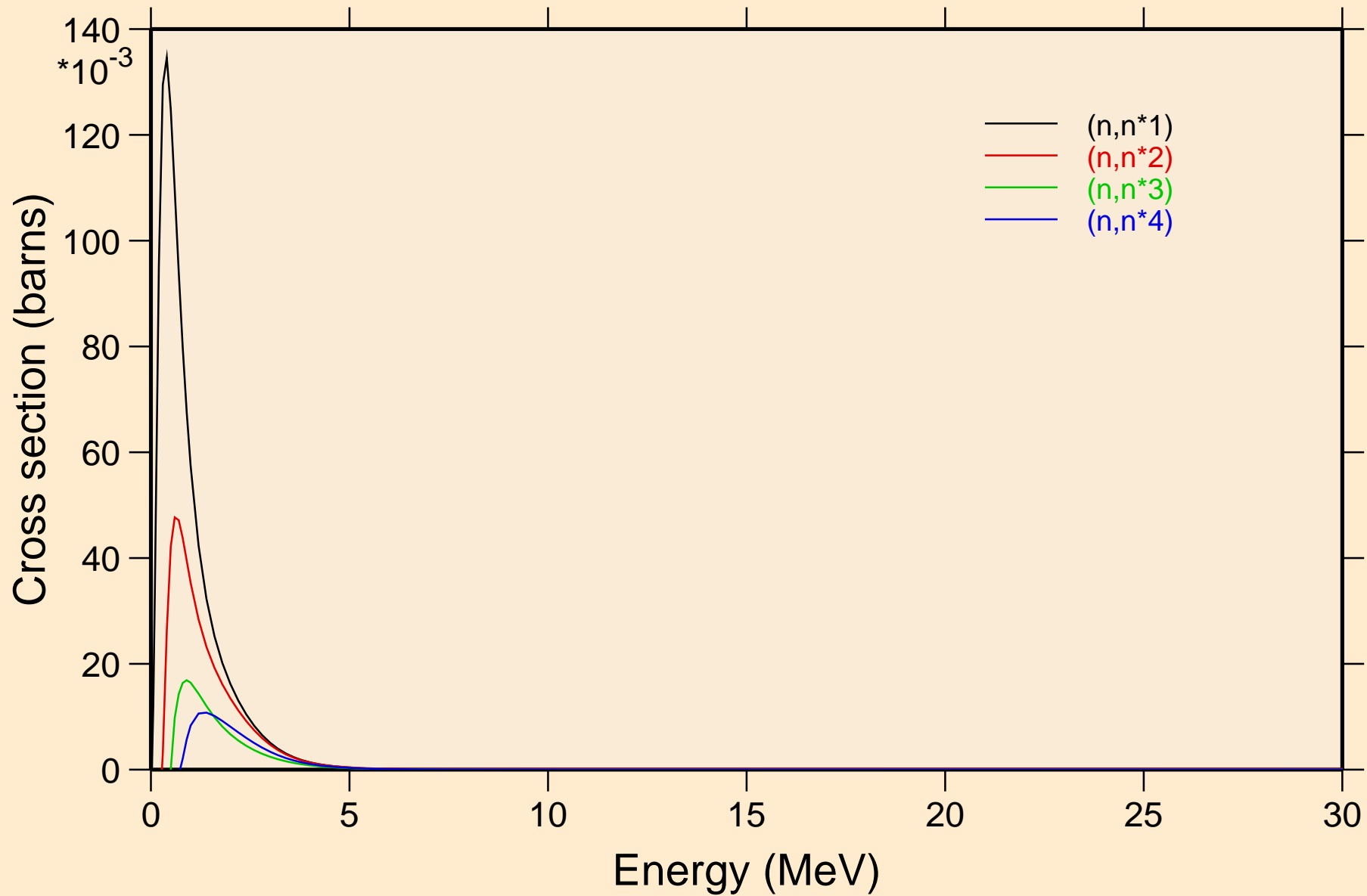

NB086 NEUTRON ACER TENDL-2024 LIBRARY; T=293.6K
Threshold reactions

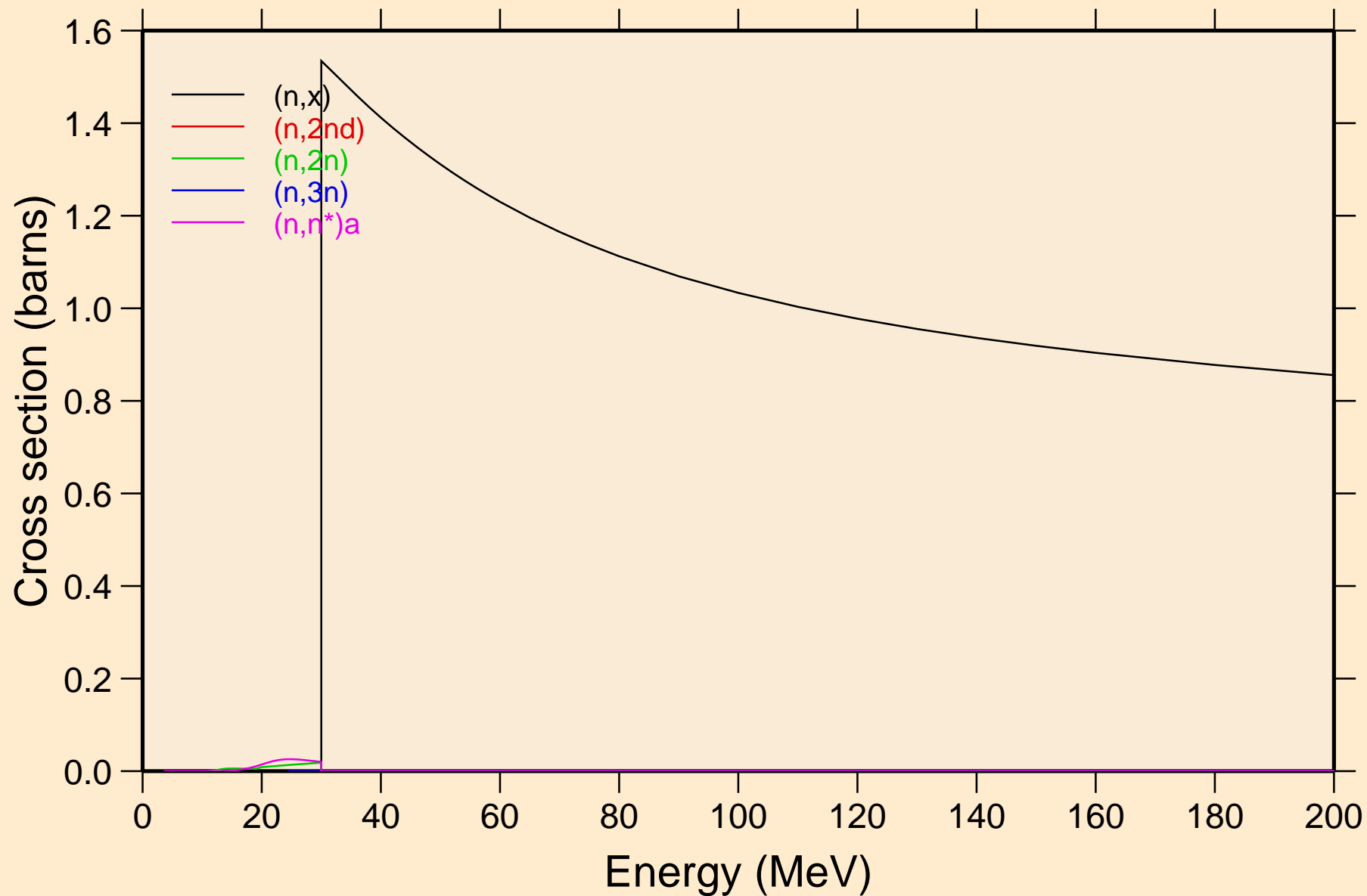

NB086 NEUTRON ACER TENDL-2024 LIBRARY; T=293.6K
Threshold reactions

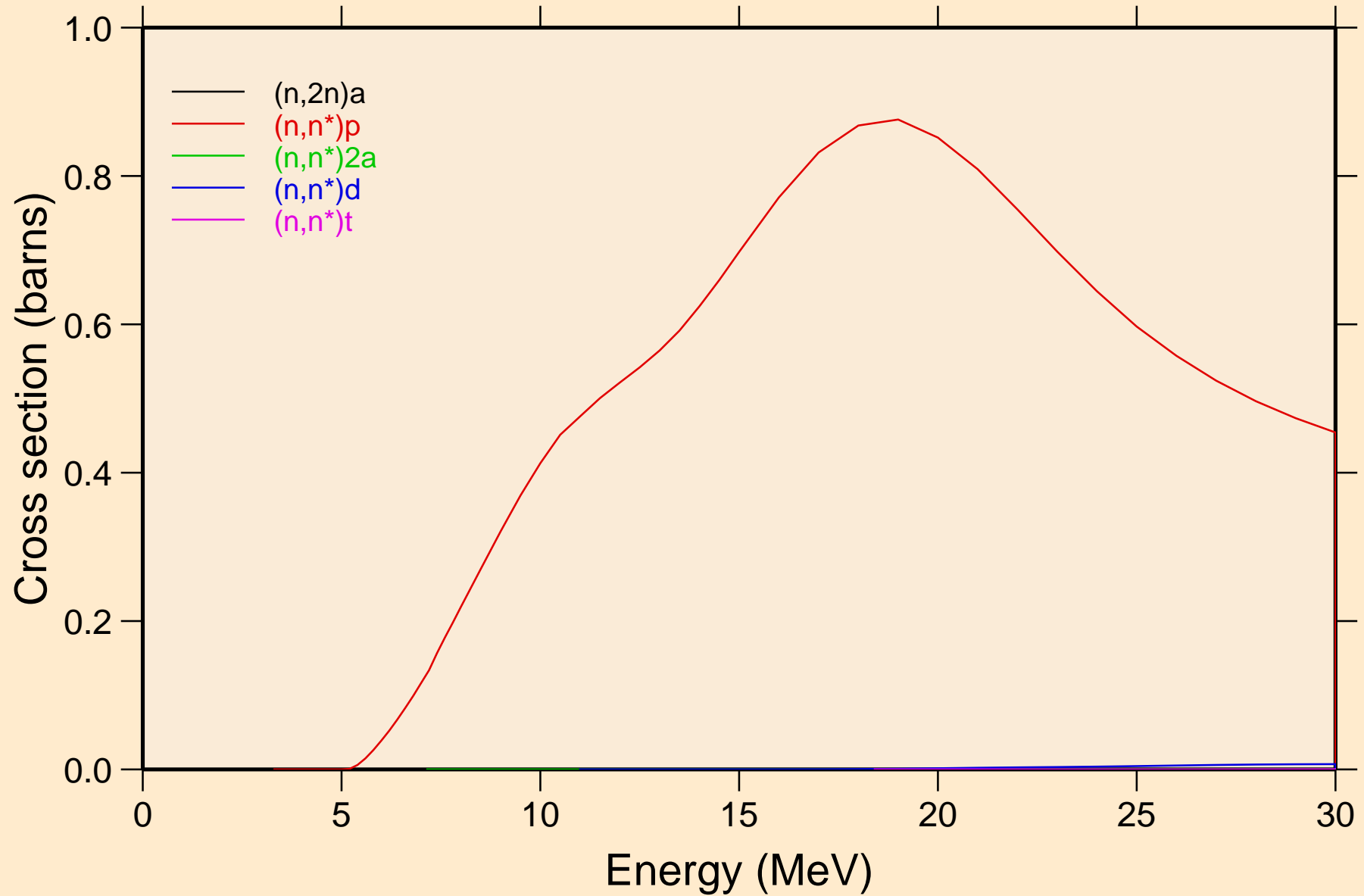

NB086 NEUTRON ACER TENDL-2024 LIBRARY; T=293.6K
Threshold reactions

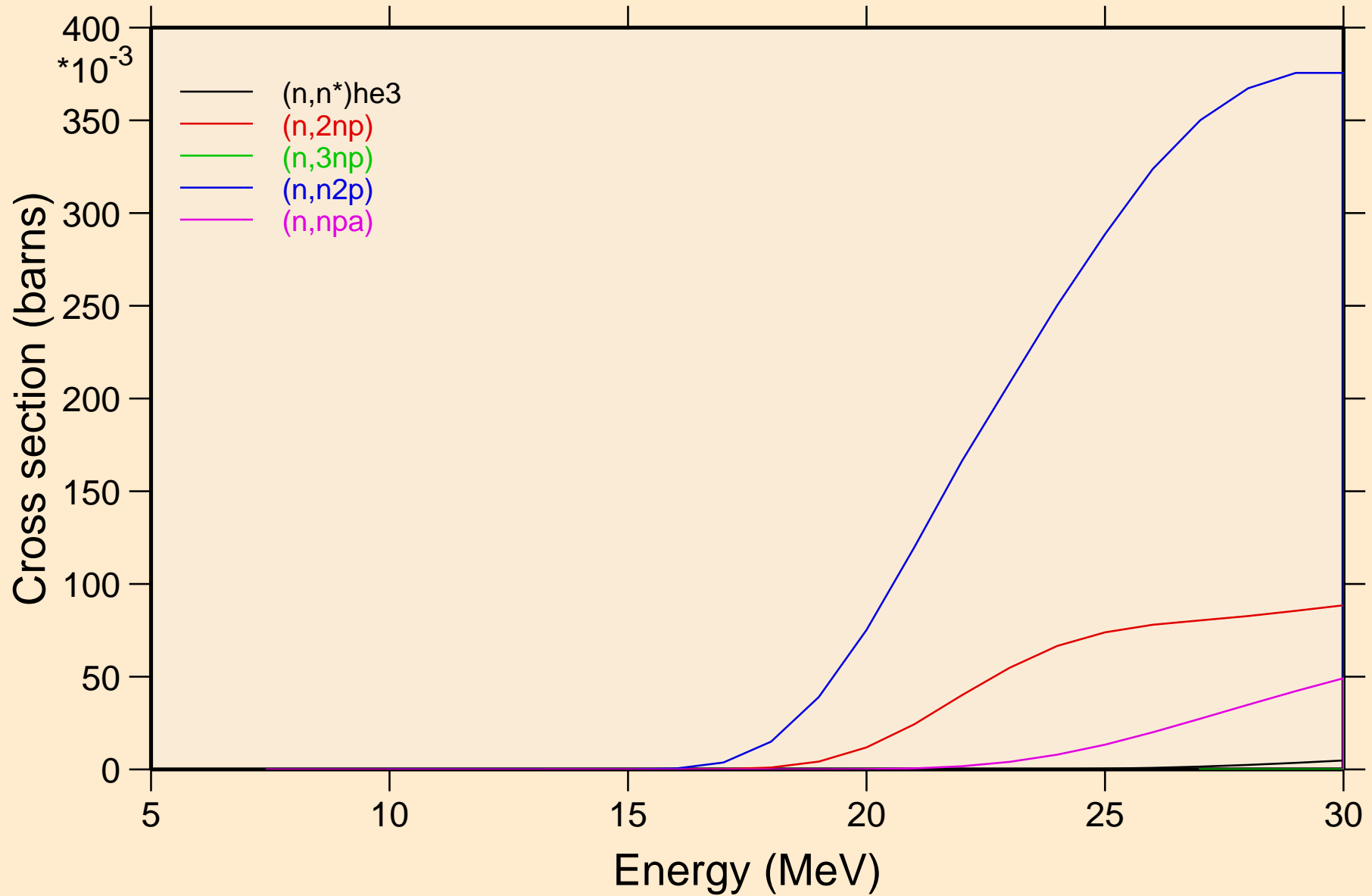

NB086 NEUTRON ACER TENDL-2024 LIBRARY; T=293.6K
Threshold reactions

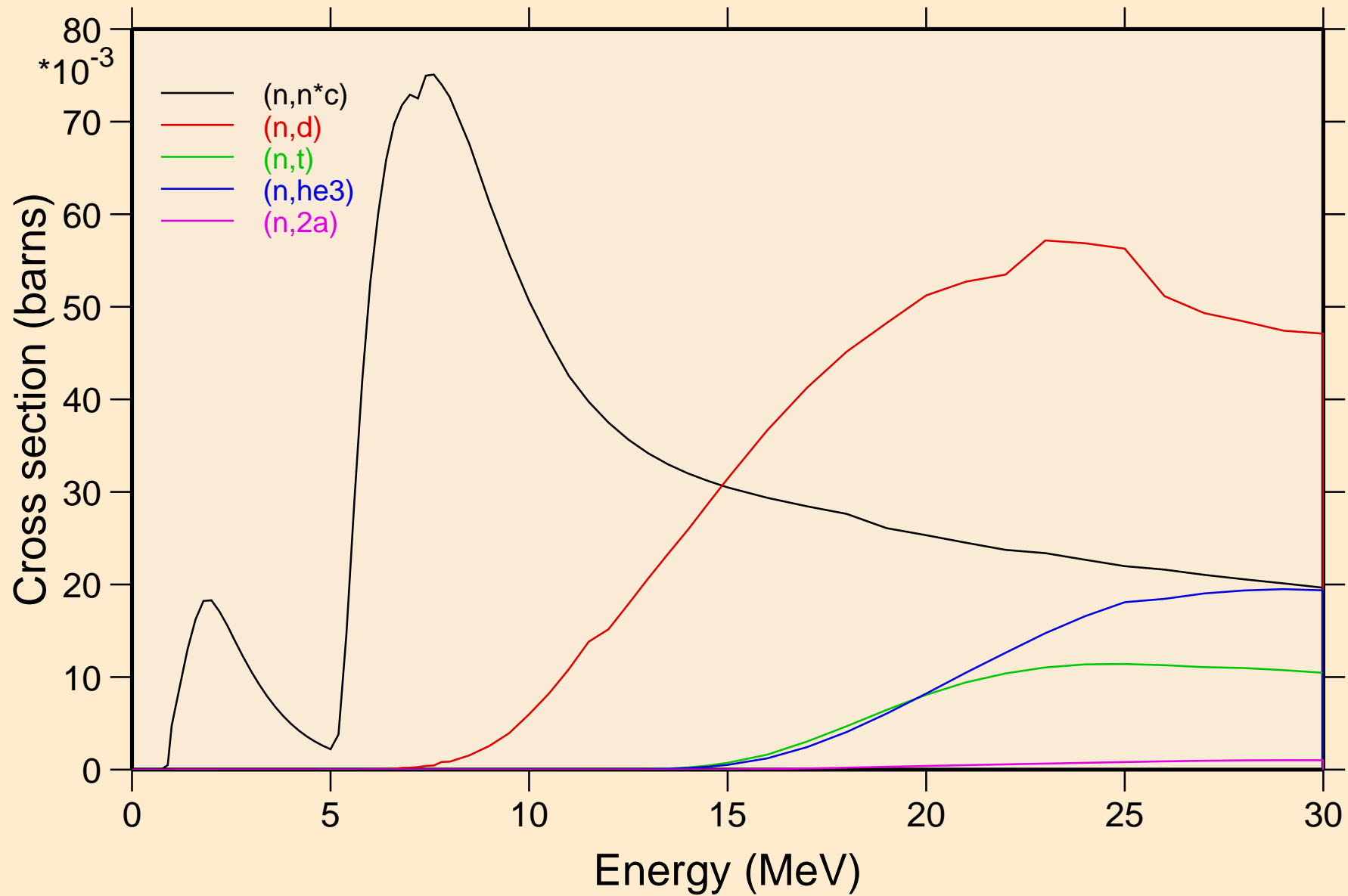

NB086 NEUTRON ACER TENDL-2024 LIBRARY; T=293.6K
Threshold reactions

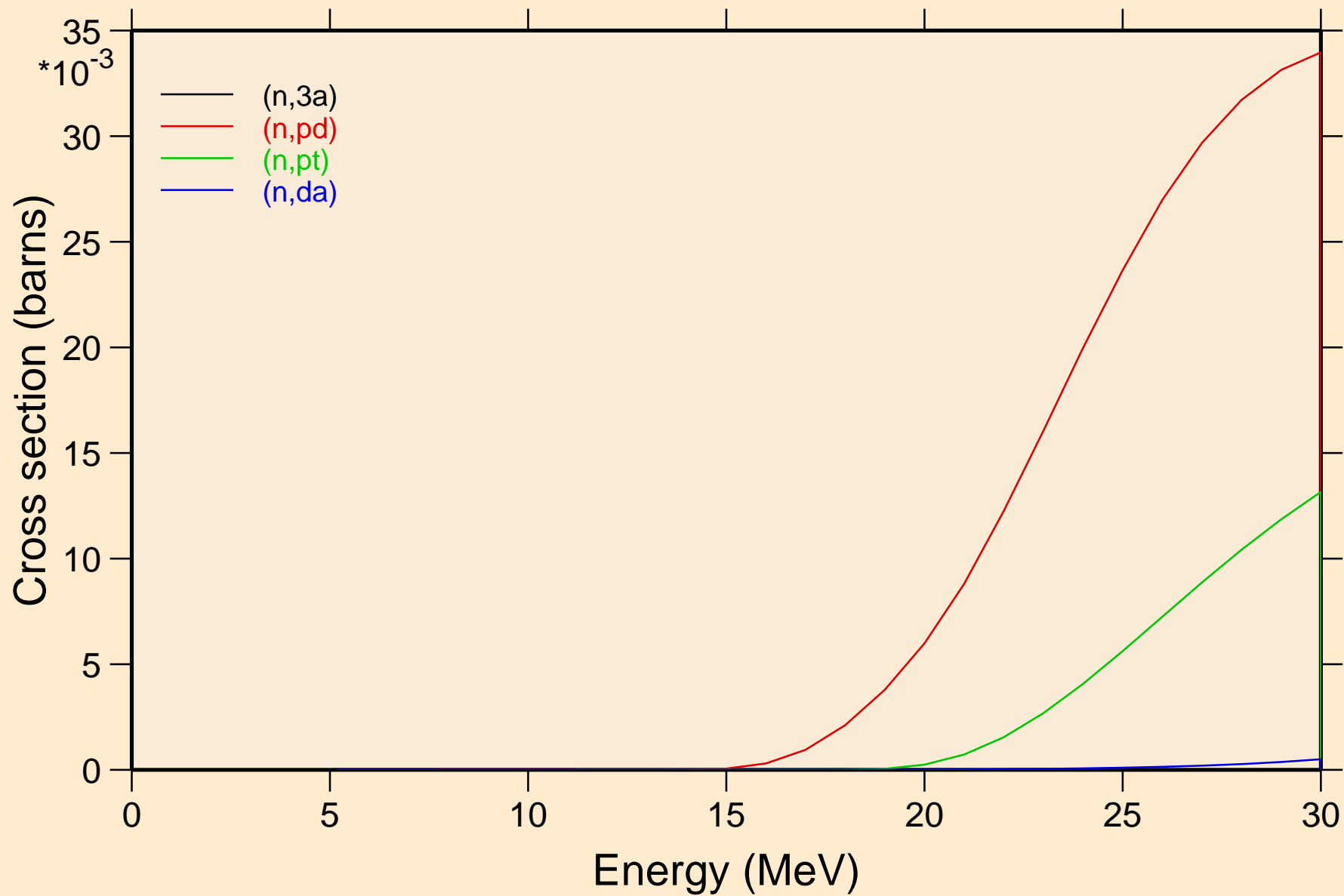

NB086 NEUTRON ACER TENDL-2024 LIBRARY; T=293.6K

Threshold reactions

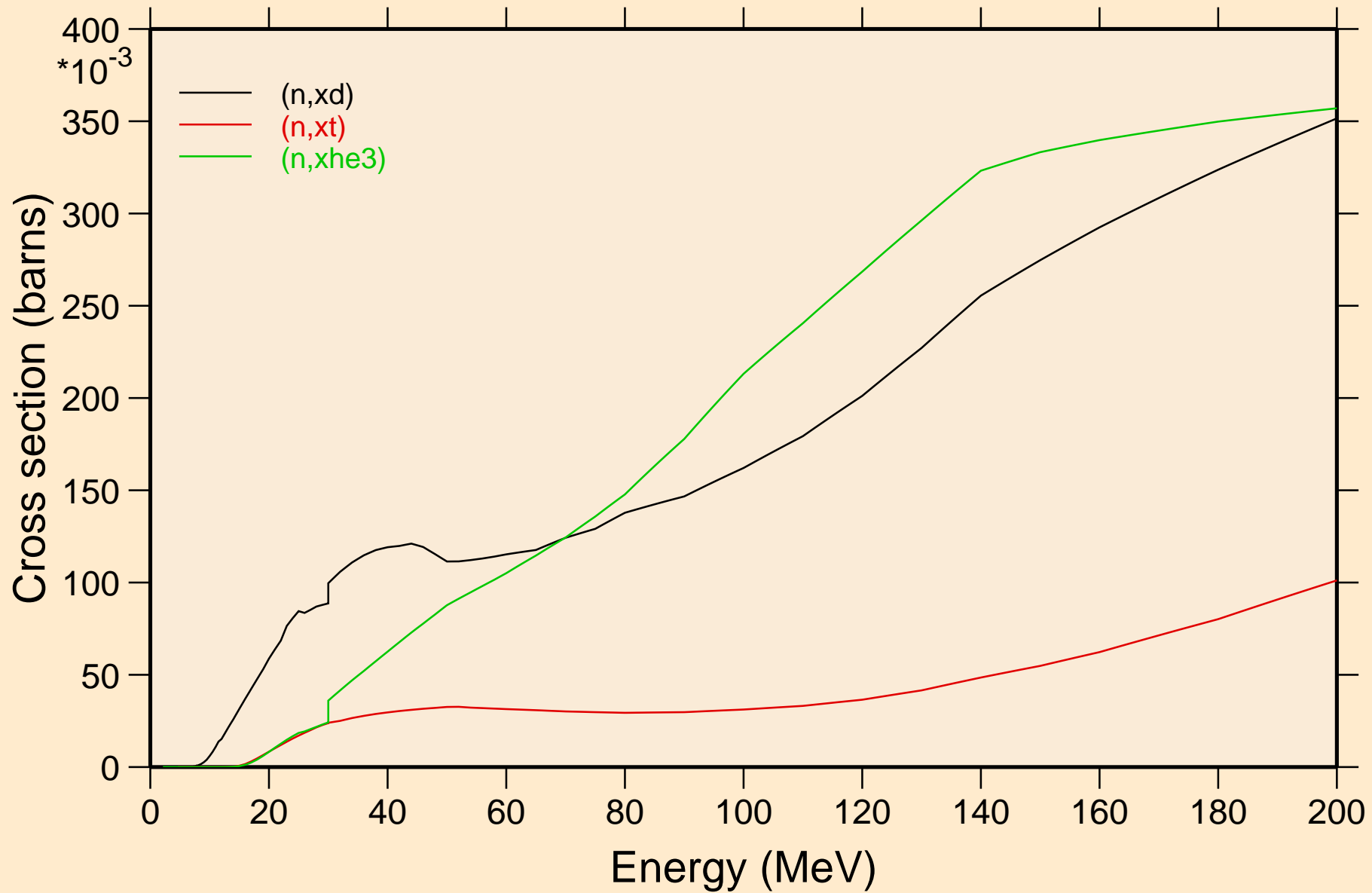

NB086 NEUTRON ACER TENDL-2024 LIBRARY; T=293.6K
angular distribution for elastic

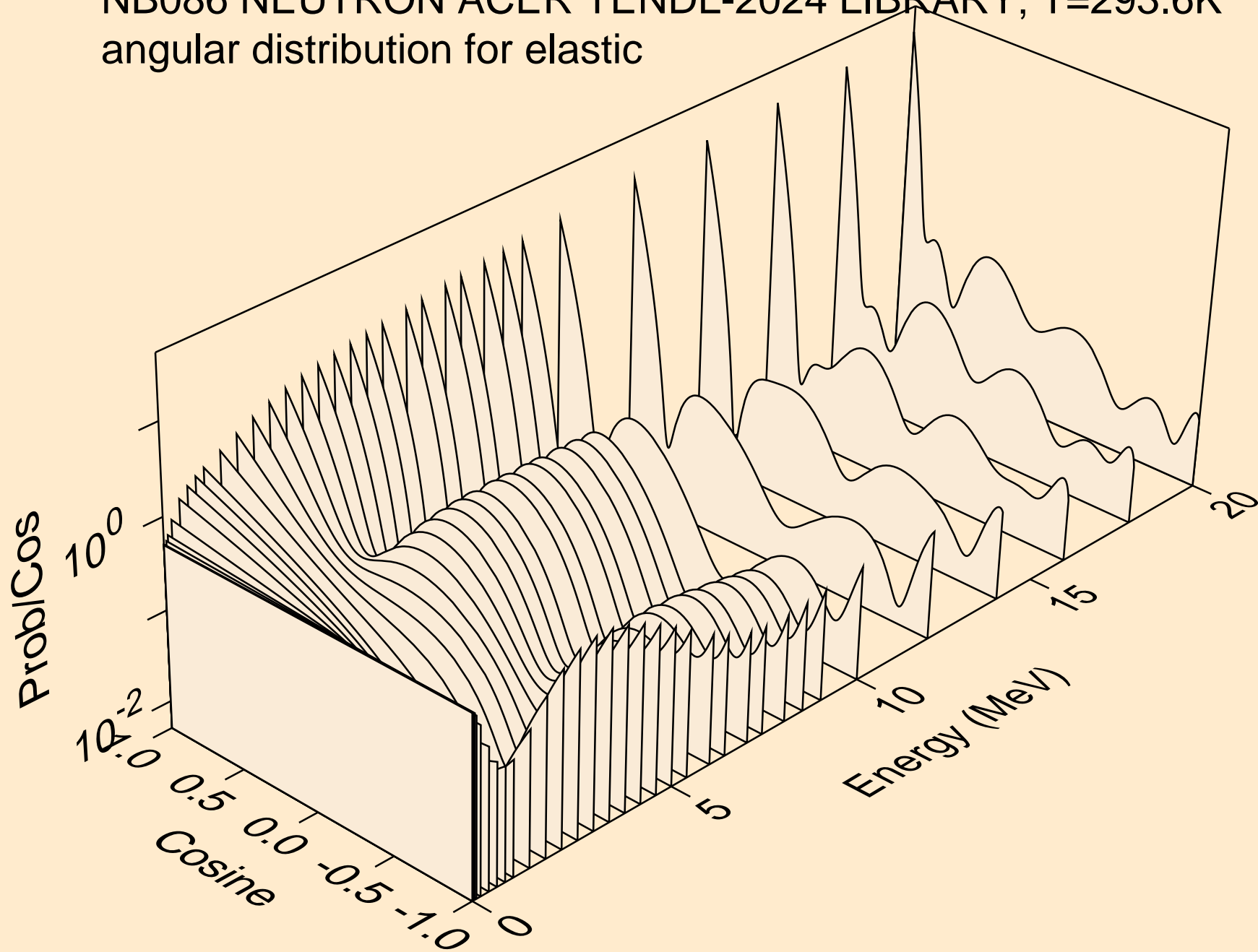

NB086 NEUTRON ACER TENDL-2024 LIBRARY; T=293.6K
angular distribution for elastic

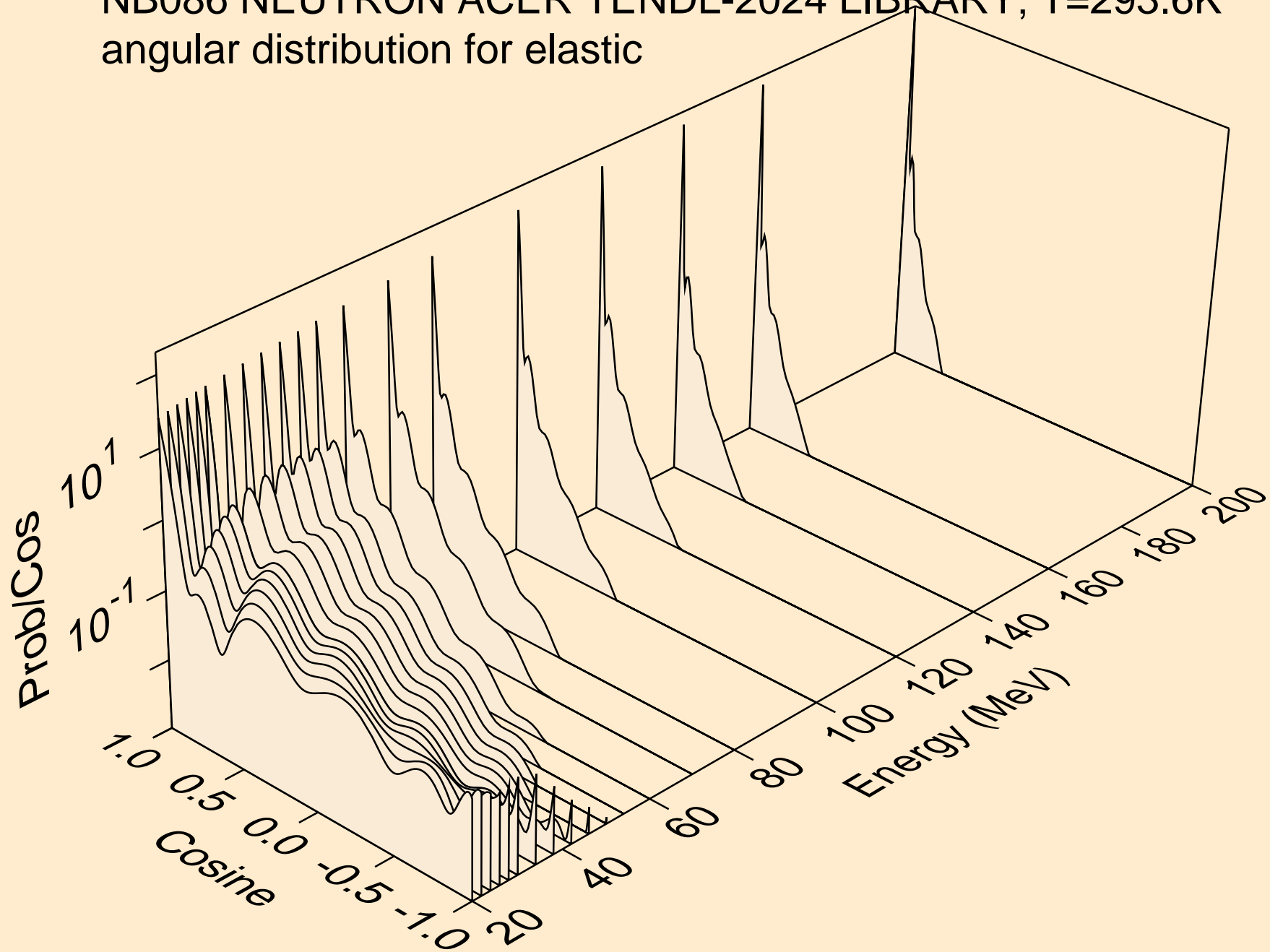

NB086 NEUTRON ACER TENDL-2024 LIBRARY; T=293.6K
angular distribution for (n,n*1)

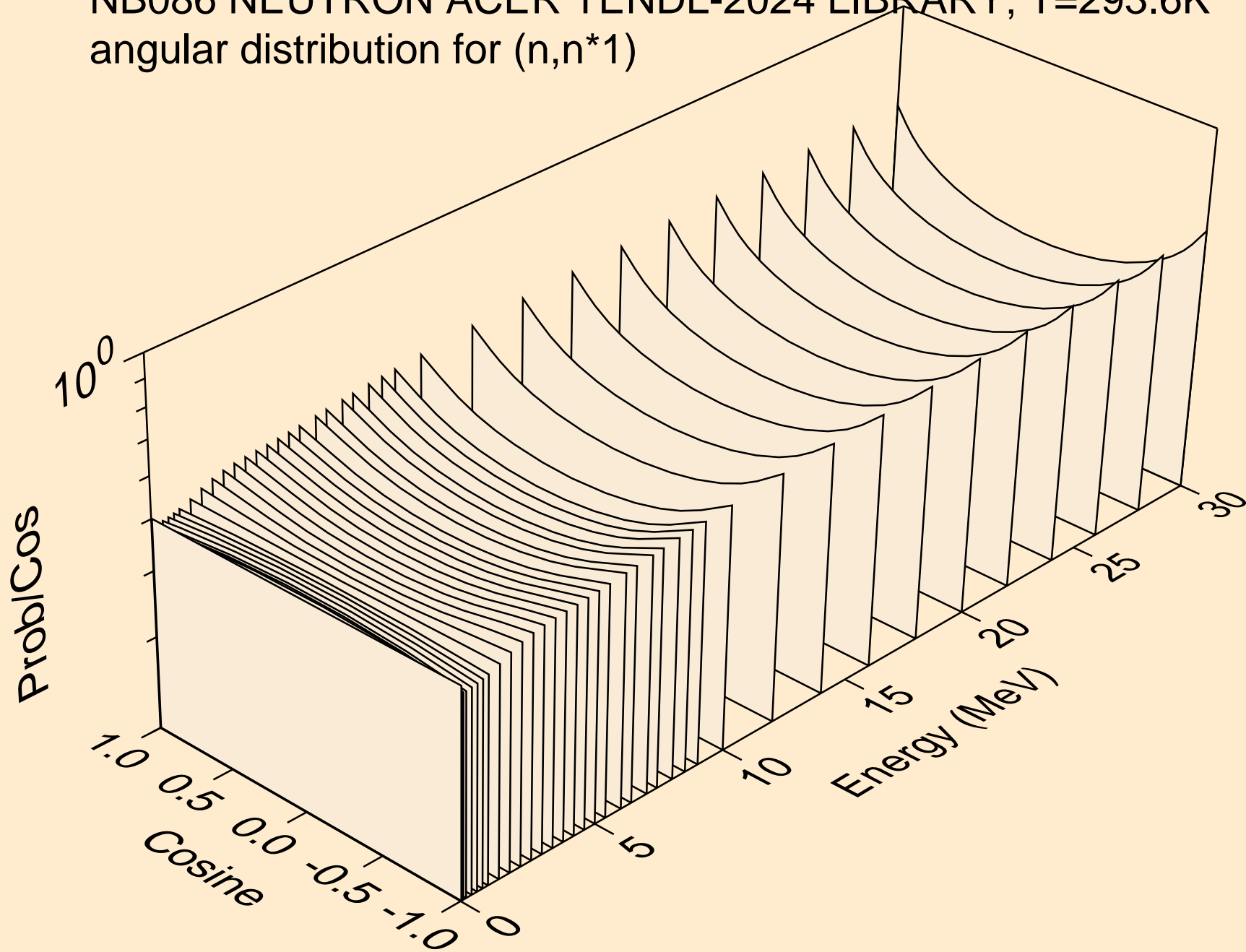

NB086 NEUTRON ACER TENDL-2024 LIBRARY; T=293.6K
angular distribution for (n,n*2)

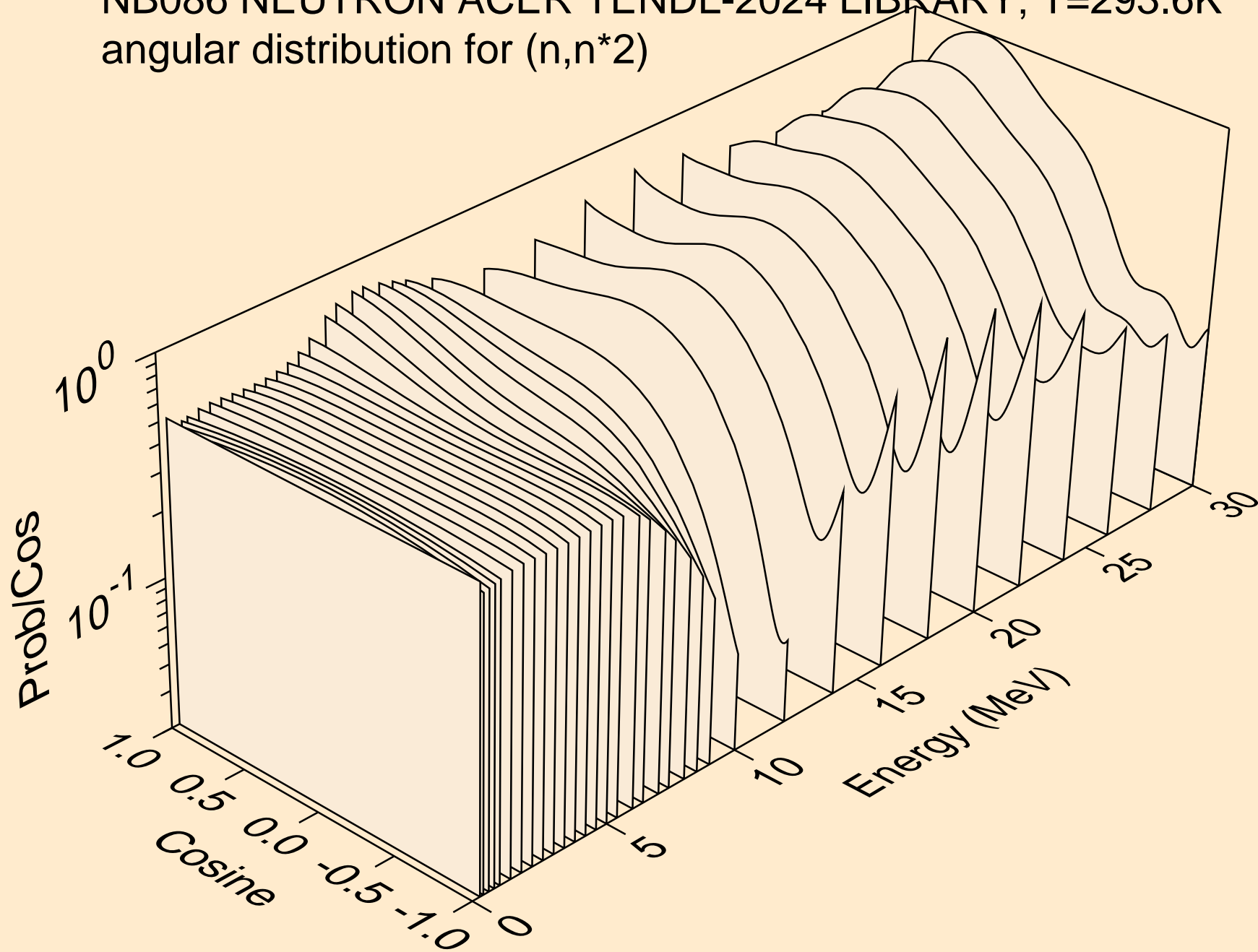

NB086 NEUTRON ACER TENDL-2024 LIBRARY; T=293.6K
angular distribution for (n,n*3)

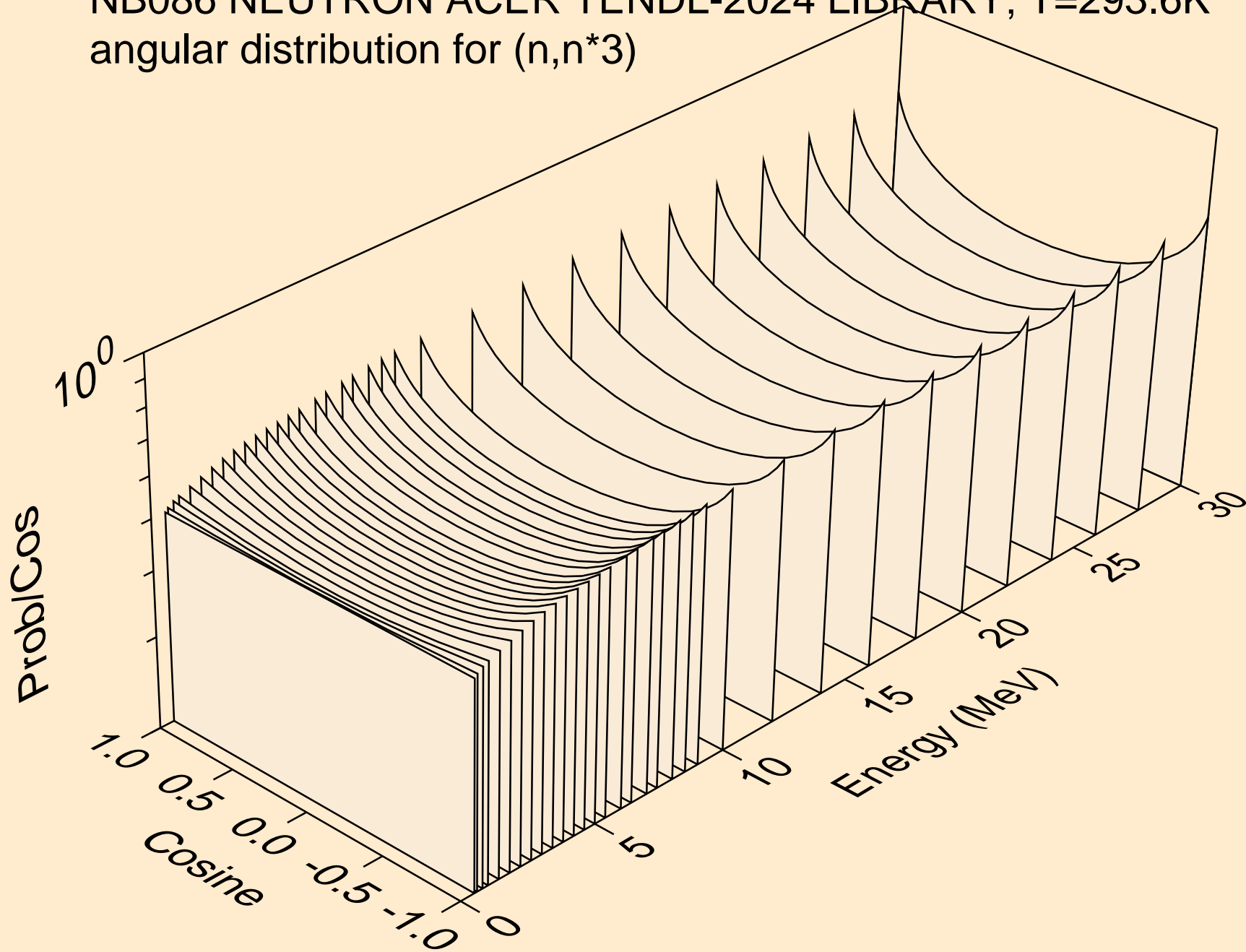

NB086 NEUTRON ACER TENDL-2024 LIBRARY; T=293.6K
angular distribution for (n,n*4)

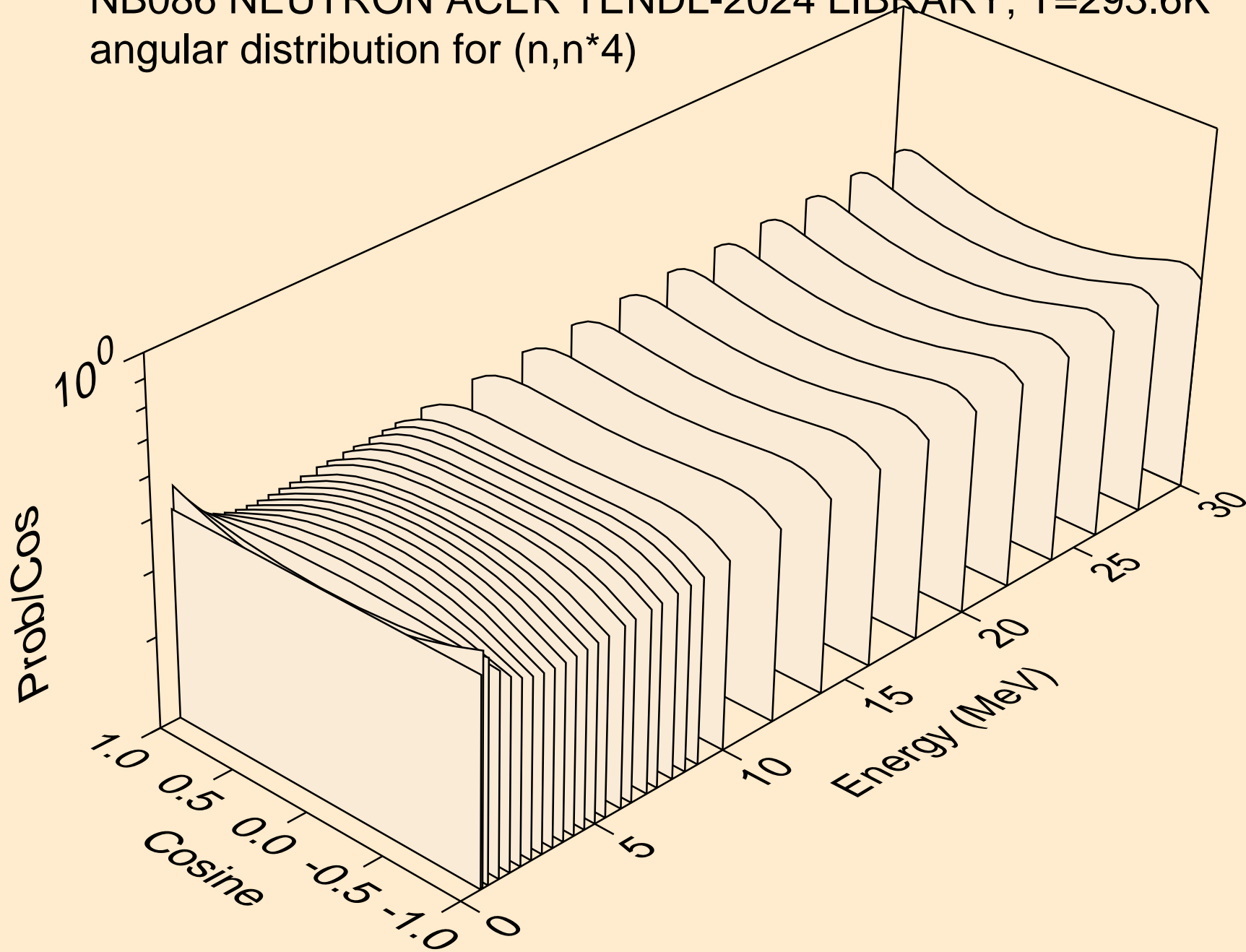

NB086 NEUTRON ACER TENDL-2024 LIBRARY; T=293.6K
Neutron emission for (n,x)

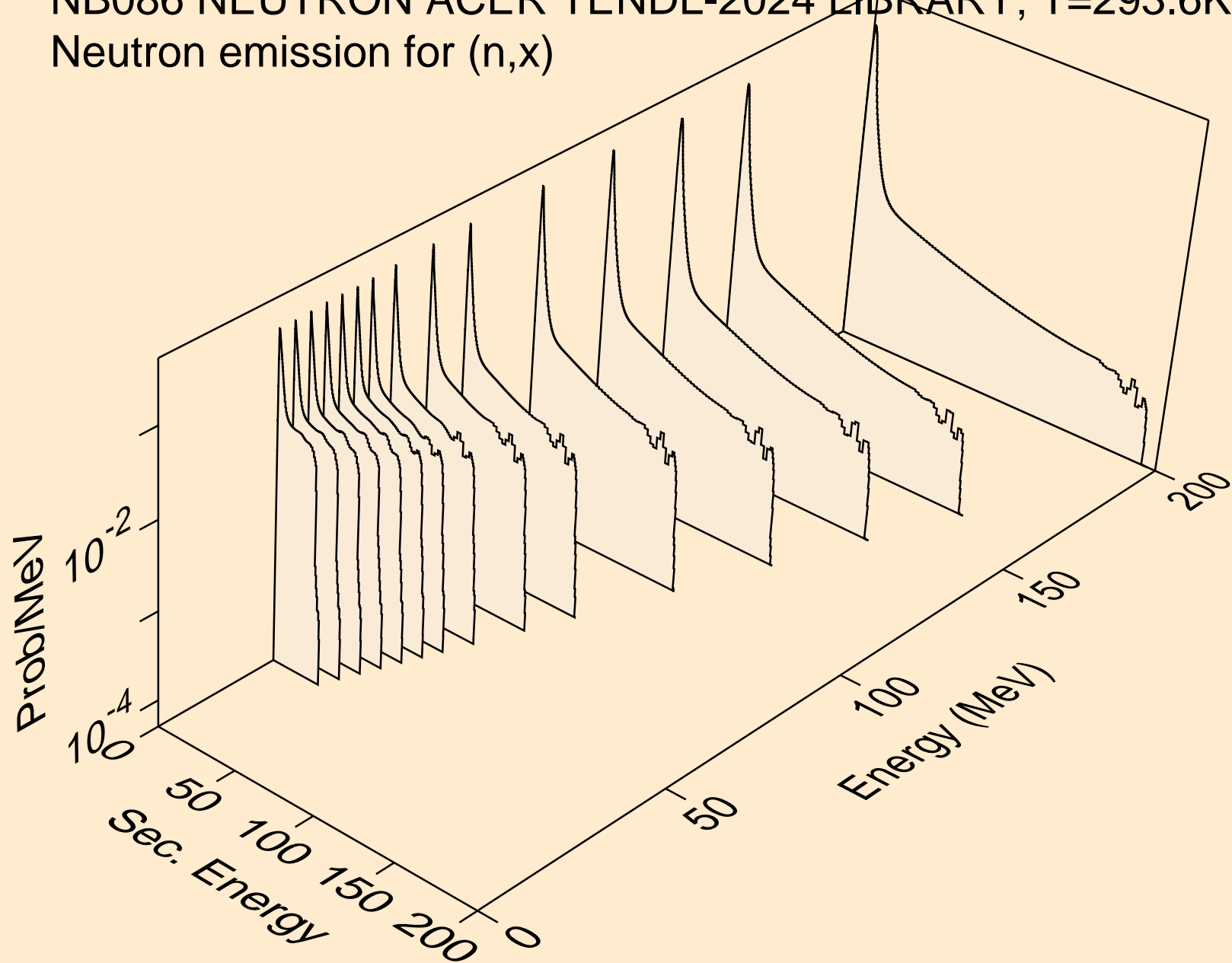

NB086 NEUTRON ACER TENDL-2024 LIBRARY; T=293.6K
Neutron emission for (n,2nd)

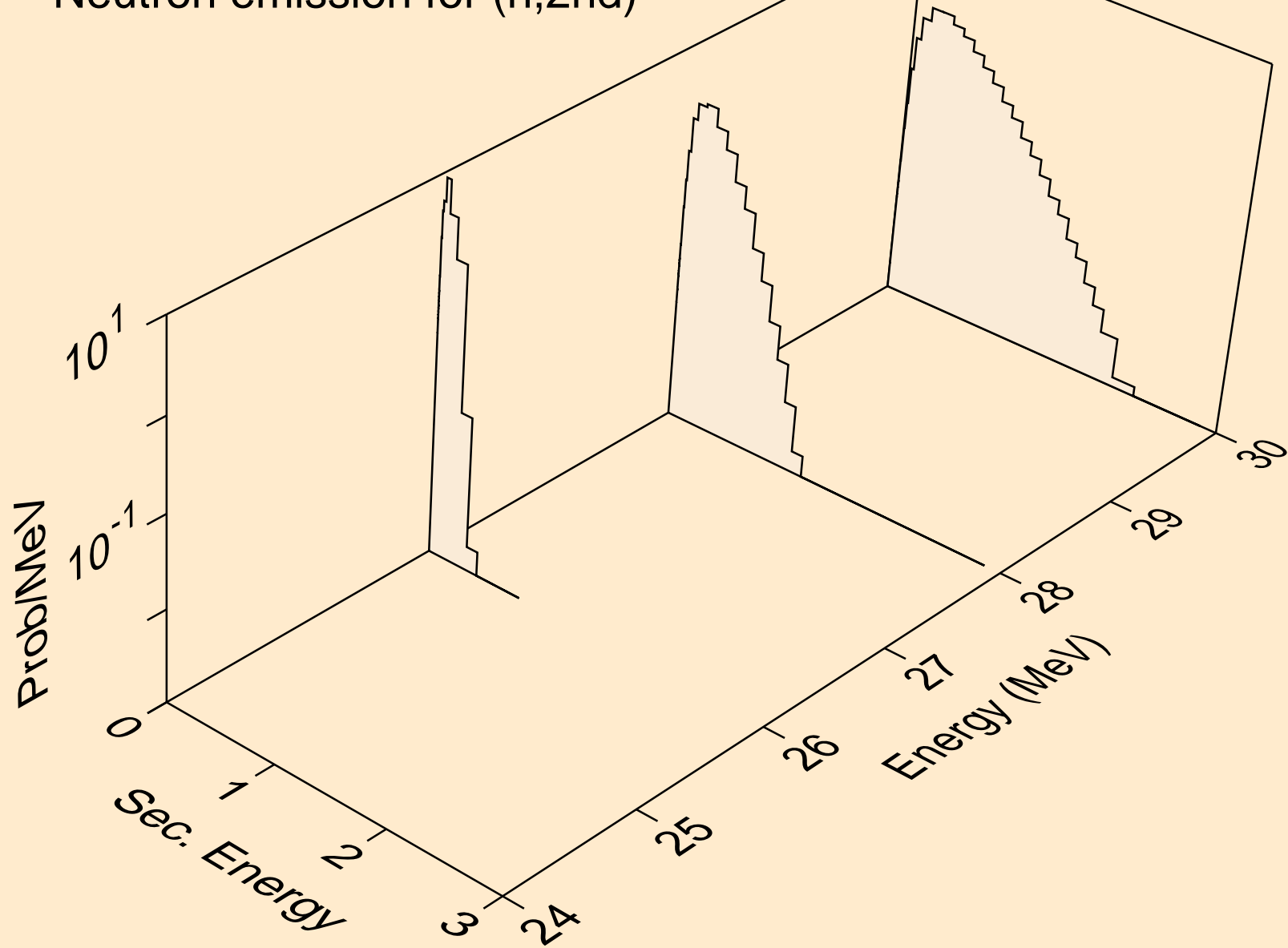

NB086 NEUTRON ACER TENDL-2024 LIBRARY; T=293.6K
Neutron emission for (n,2n)

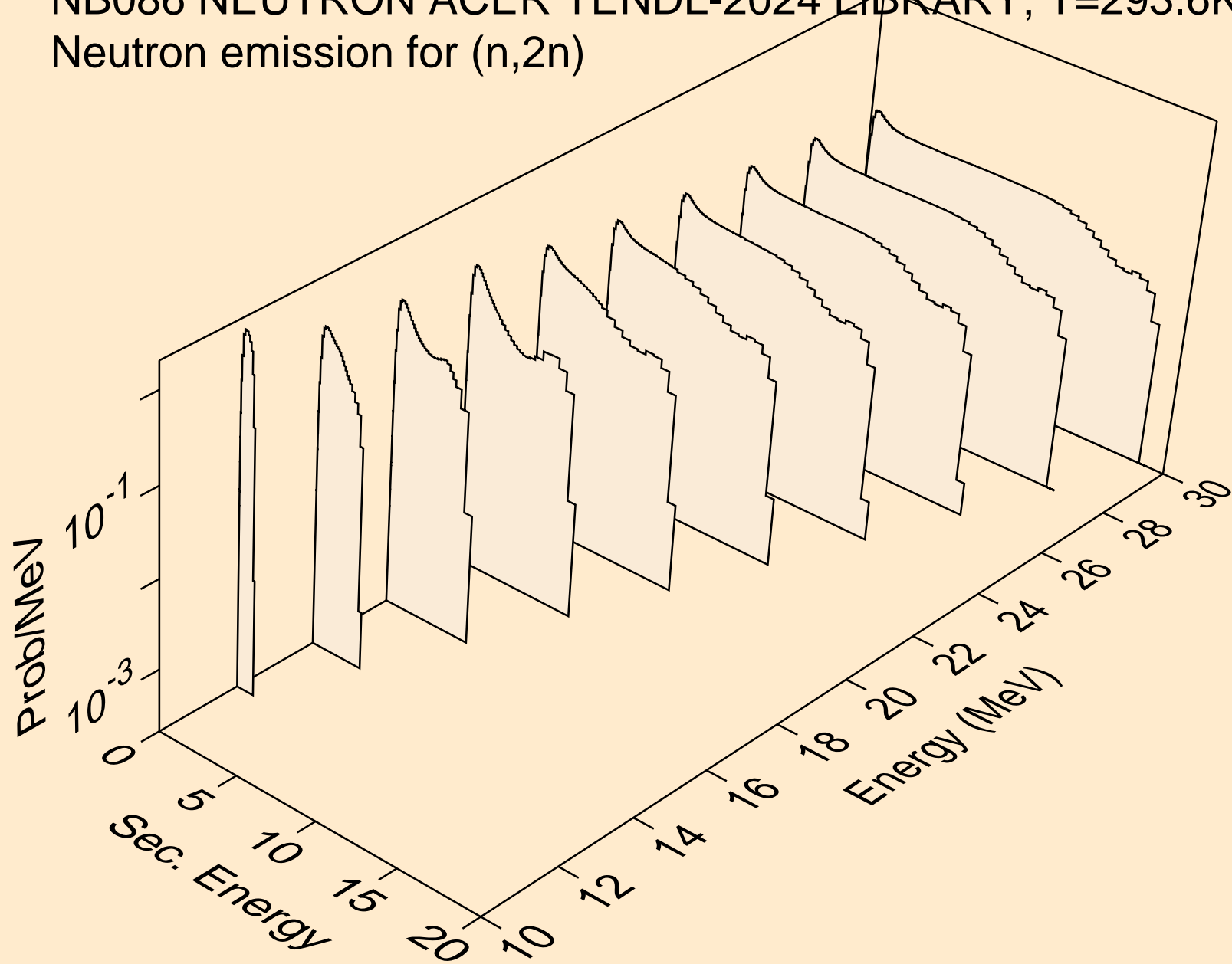

NB086 NEUTRON ACER TENDL-2024 LIBRARY; T=293.6K
Neutron emission for (n,3n)

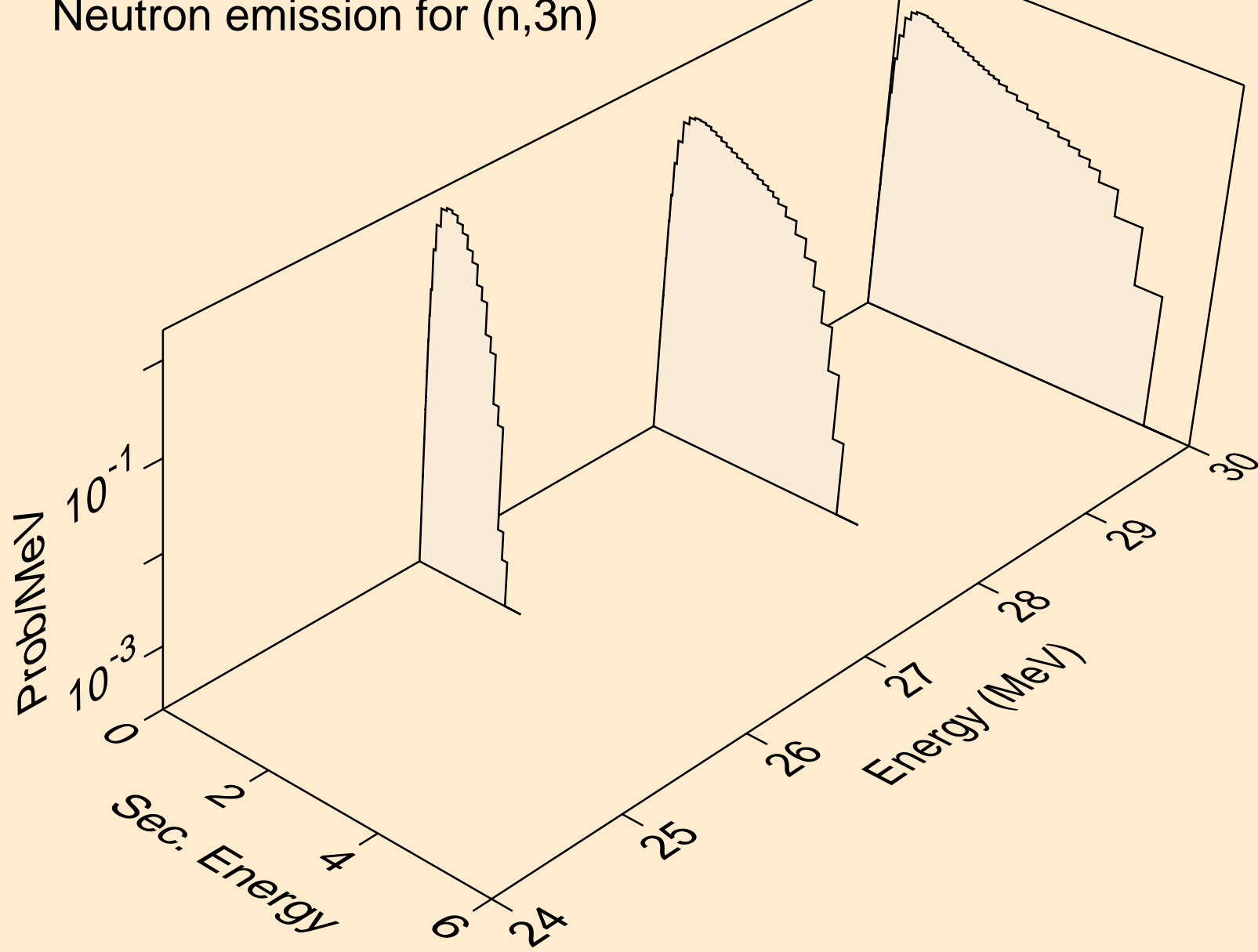

NB086 NEUTRON ACER TENDL-2024 LIBRARY; T=293.6K
Neutron emission for (n,n*)a

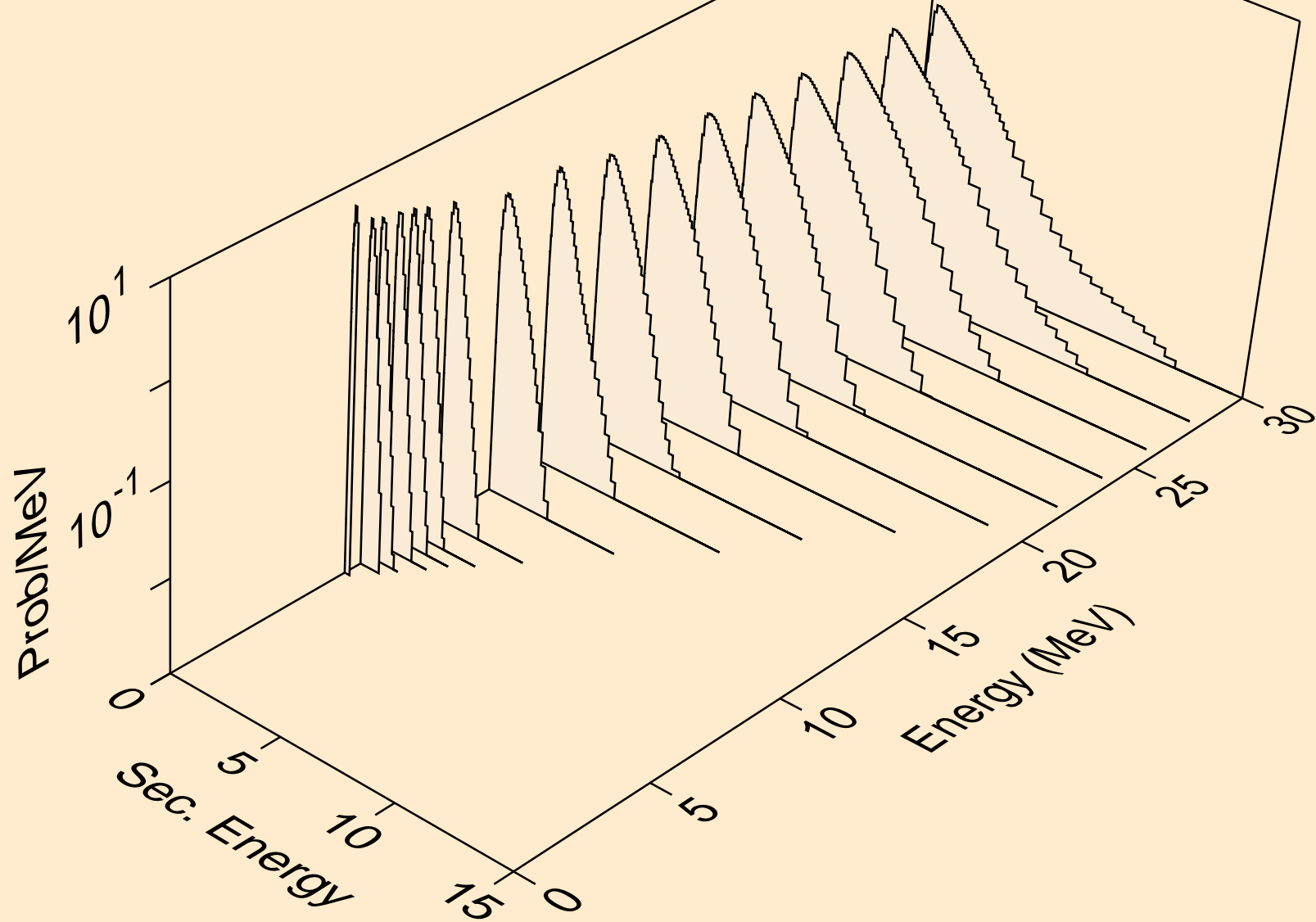

NB086 NEUTRON ACER TENDL-2024 LIBRARY; T=293.6K
Neutron emission for (n,2n)a

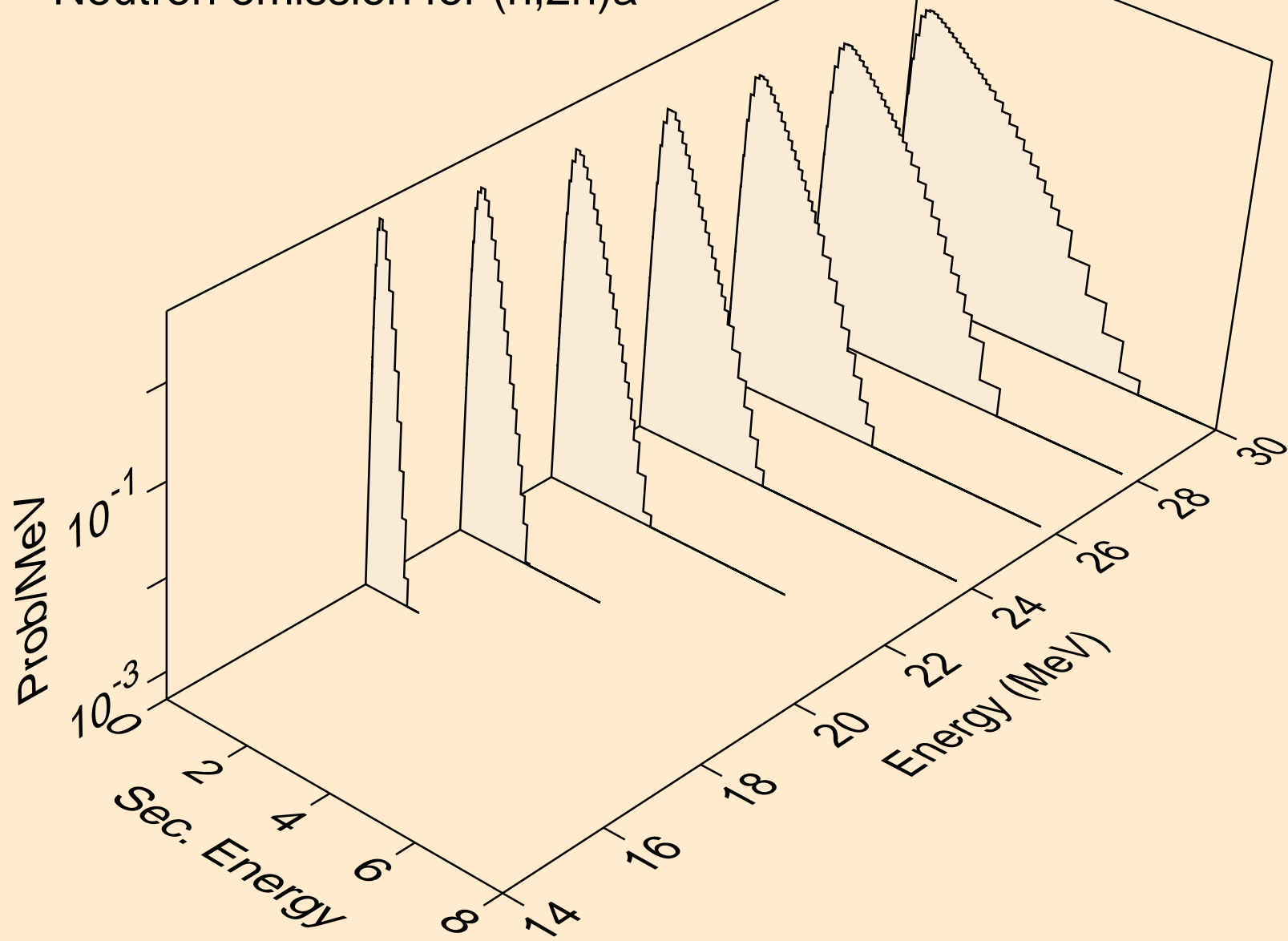

NB086 NEUTRON ACER TENDL-2024 LIBRARY; T=293.6K
Neutron emission for (n,n*)p

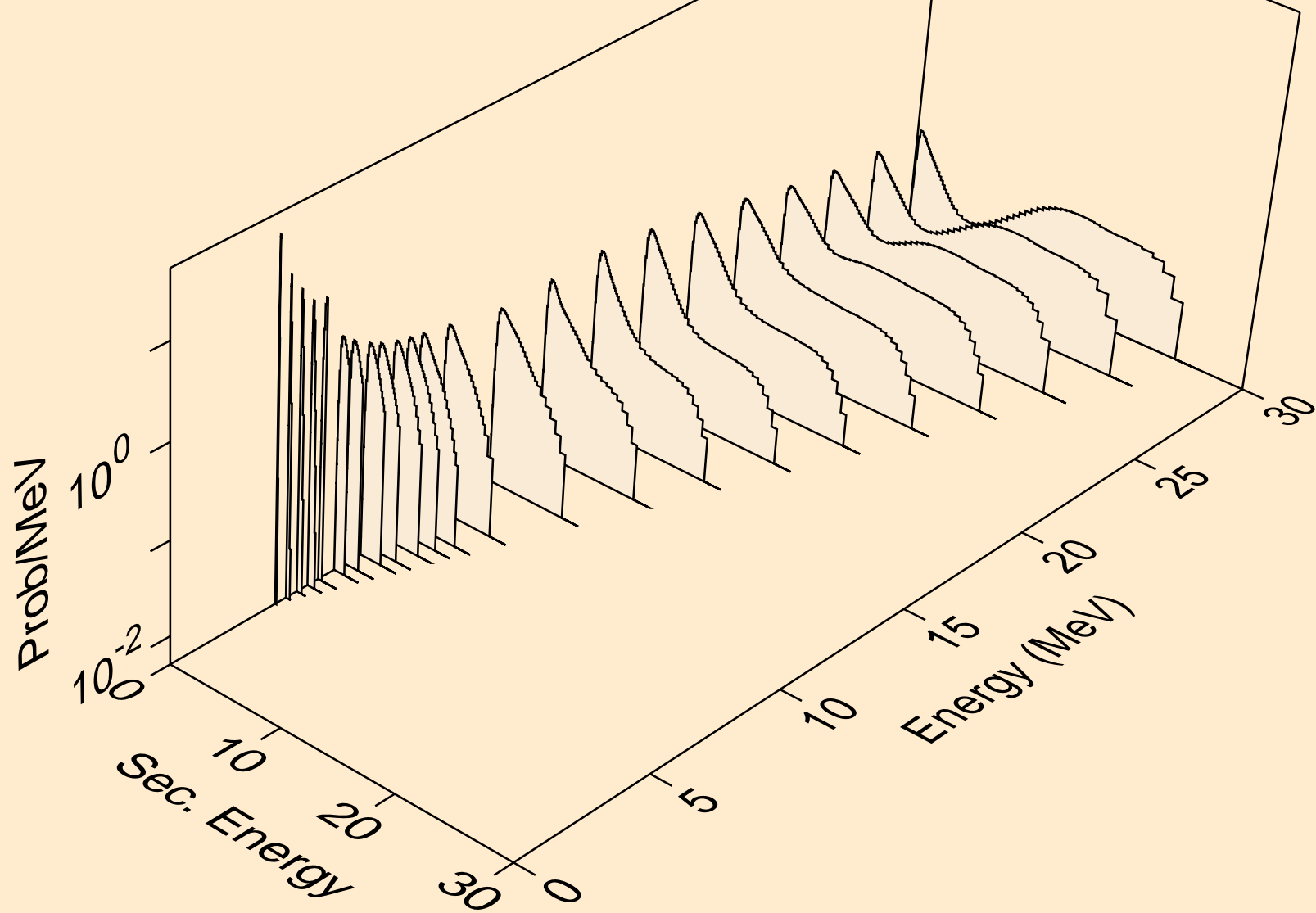

NB086 NEUTRON ACER TENDL-2024 LIBRARY; T=293.6K
Neutron emission for (n,n*)2a

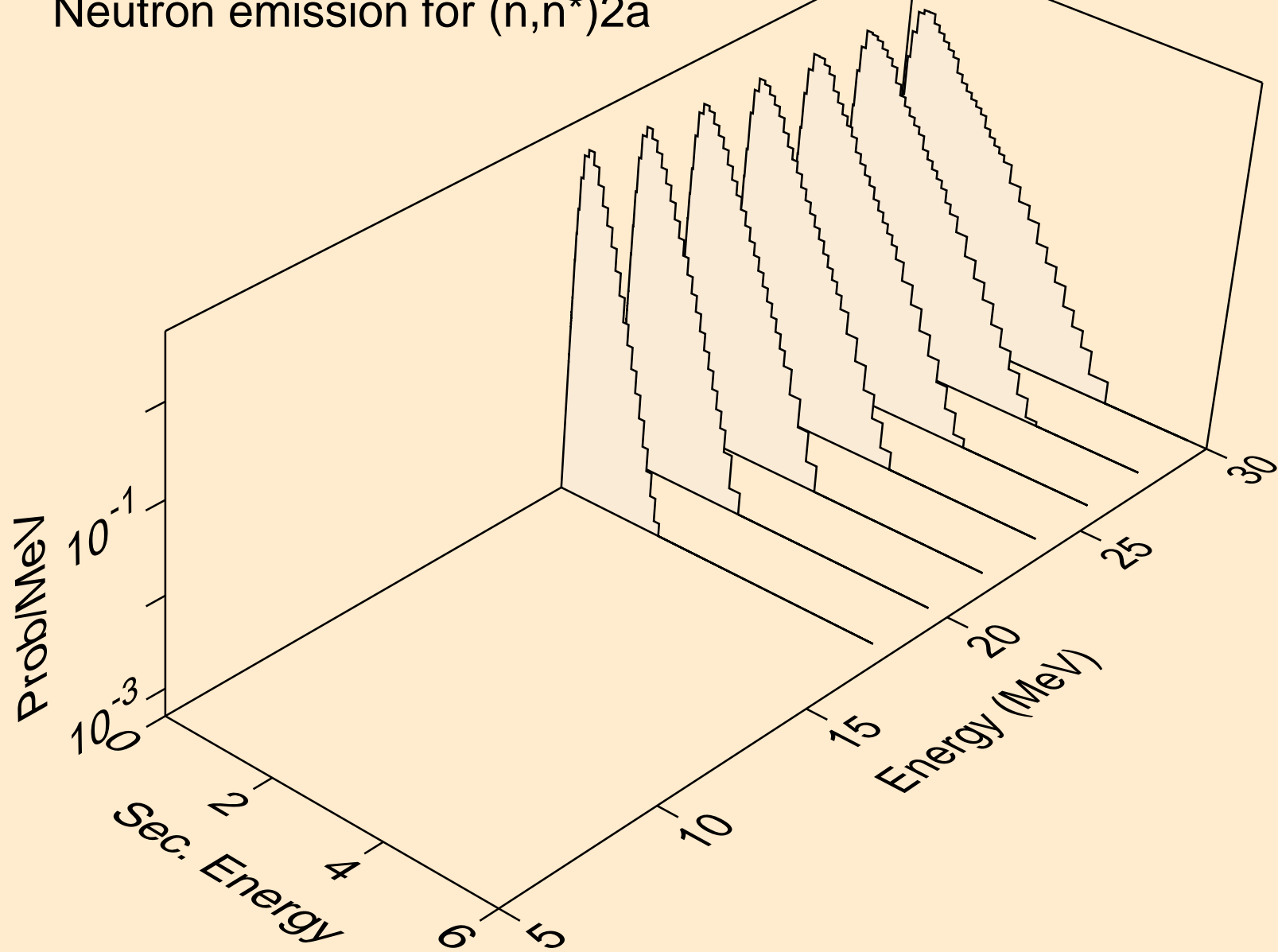

NB086 NEUTRON ACER TENDL-2024 LIBRARY; T=293.6K
Neutron emission for (n,n*)d

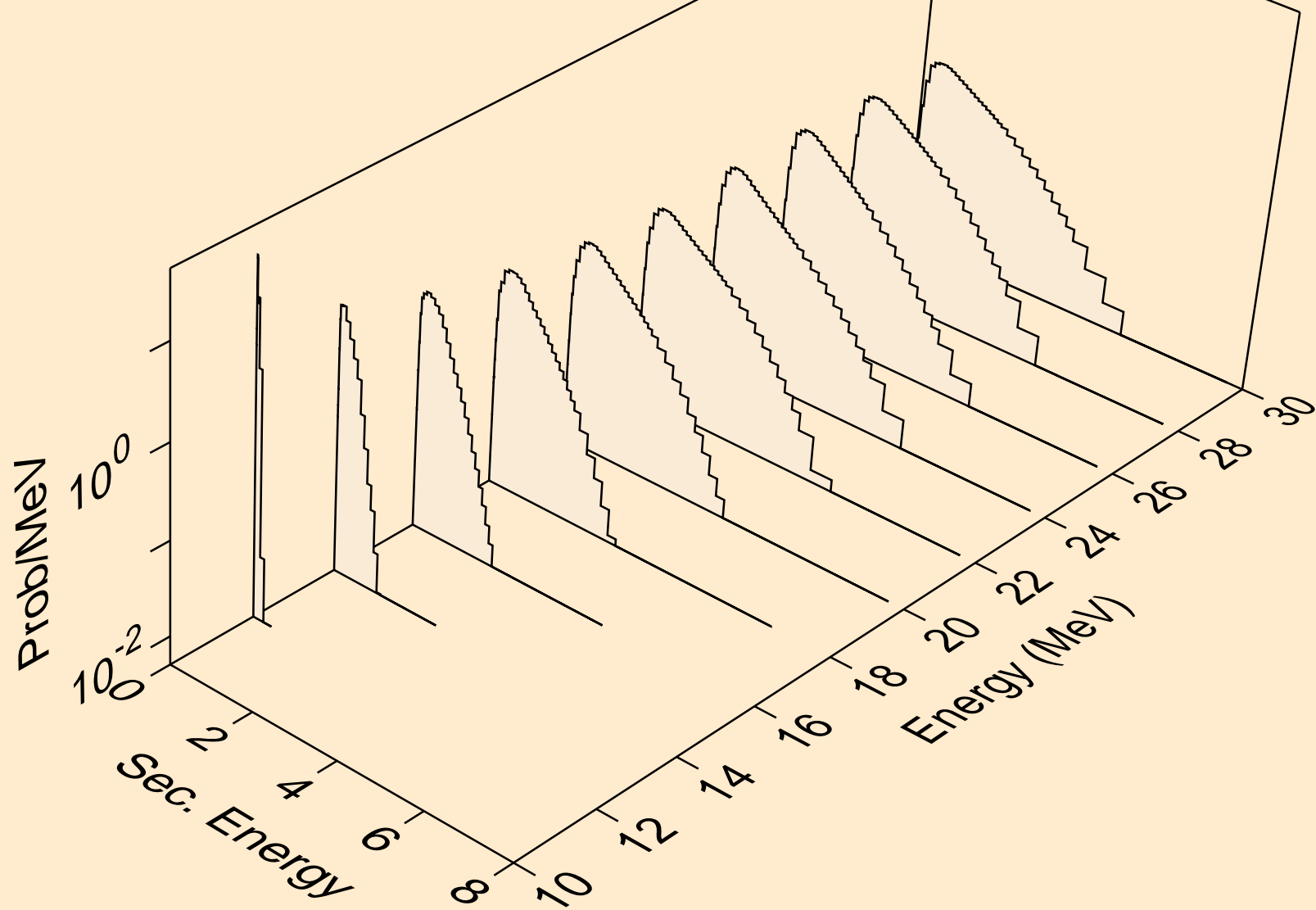

NB086 NEUTRON ACER TENDL-2024 LIBRARY; T=293.6K
Neutron emission for (n,n*)t

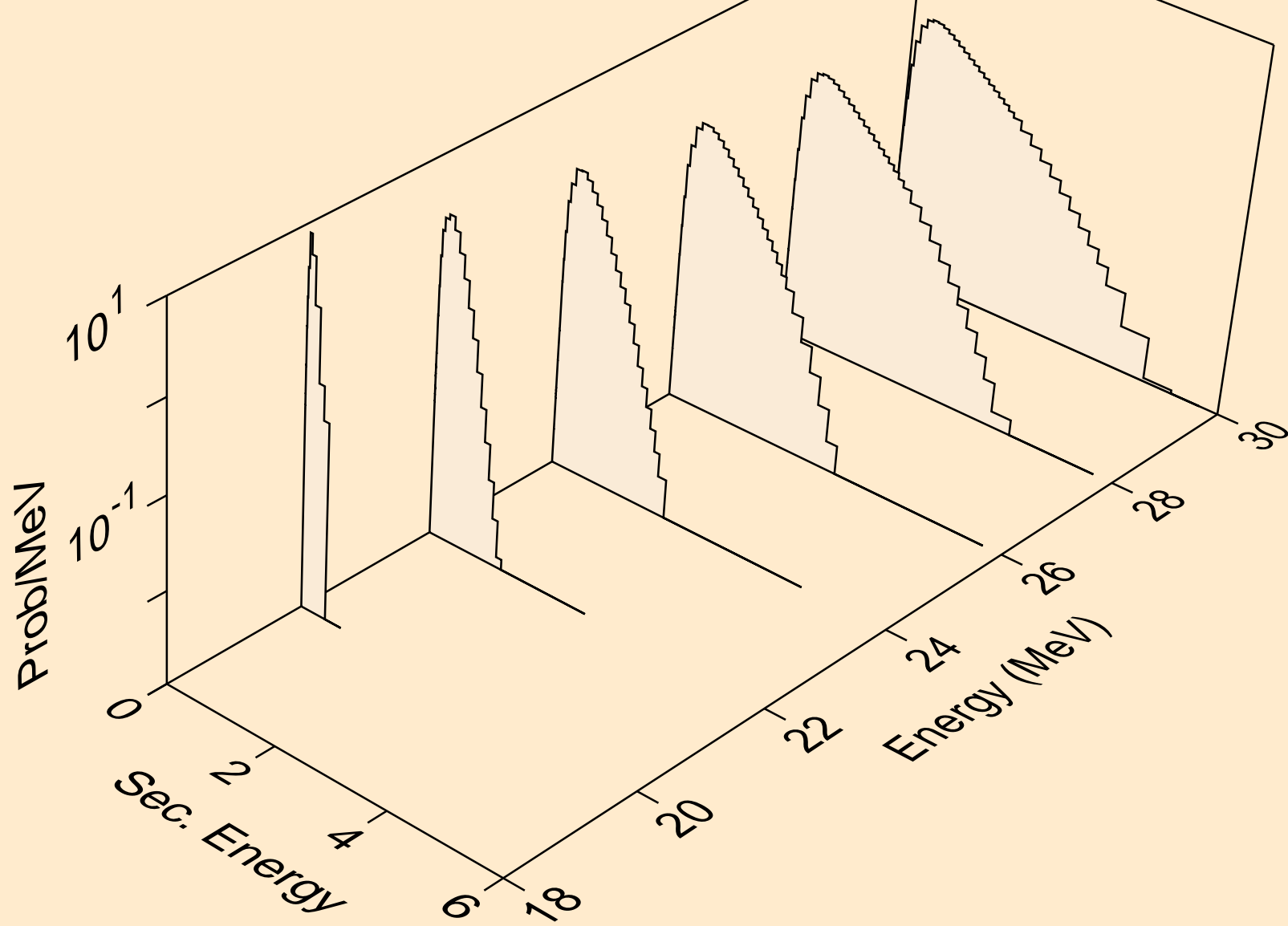

NB086 NEUTRON ACER TENDL-2024 LIBRARY; T=293.6K
Neutron emission for (n,n*)he3

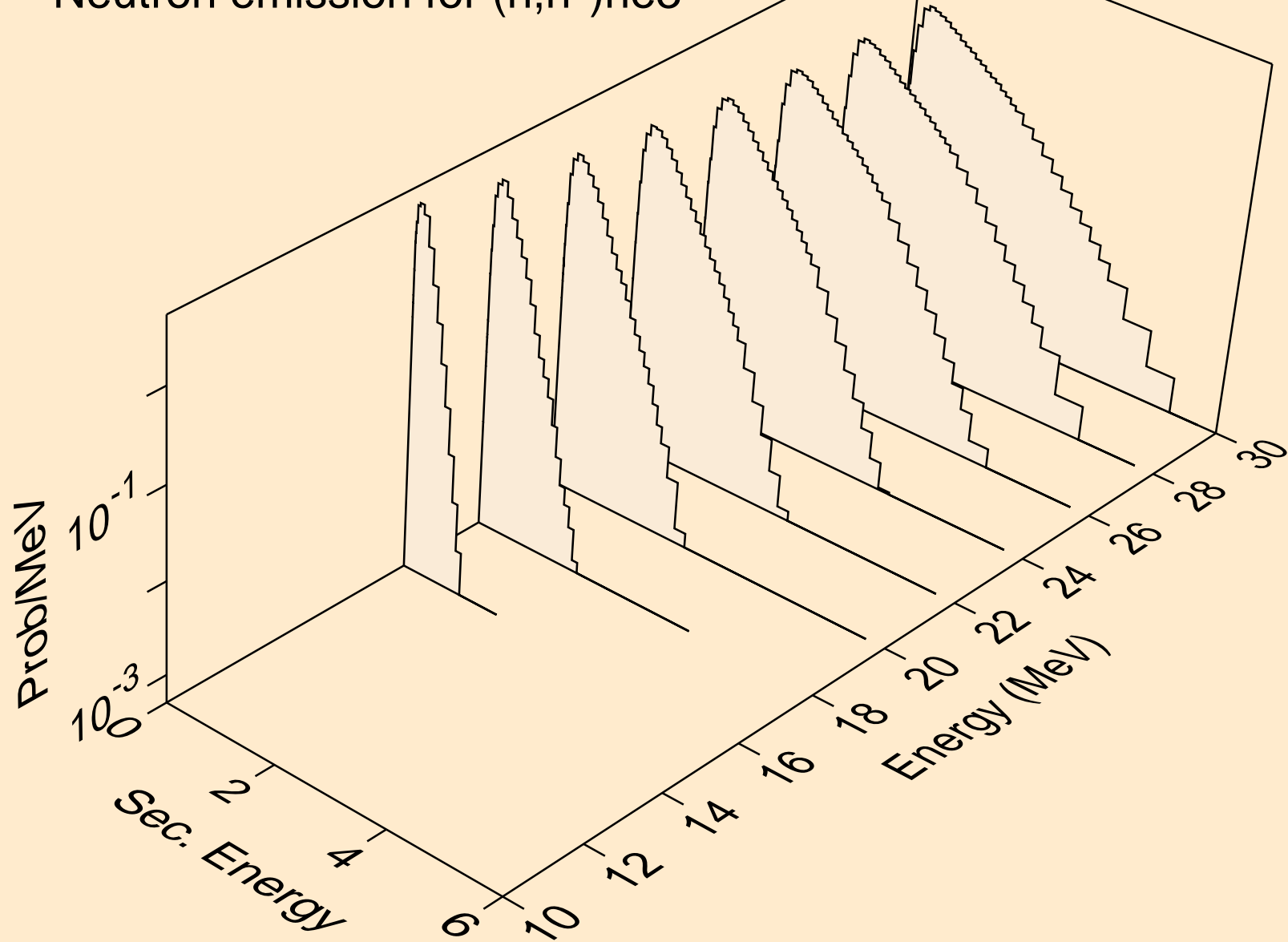

NB086 NEUTRON ACER TENDL-2024 LIBRARY; T=293.6K
Neutron emission for (n,2np)

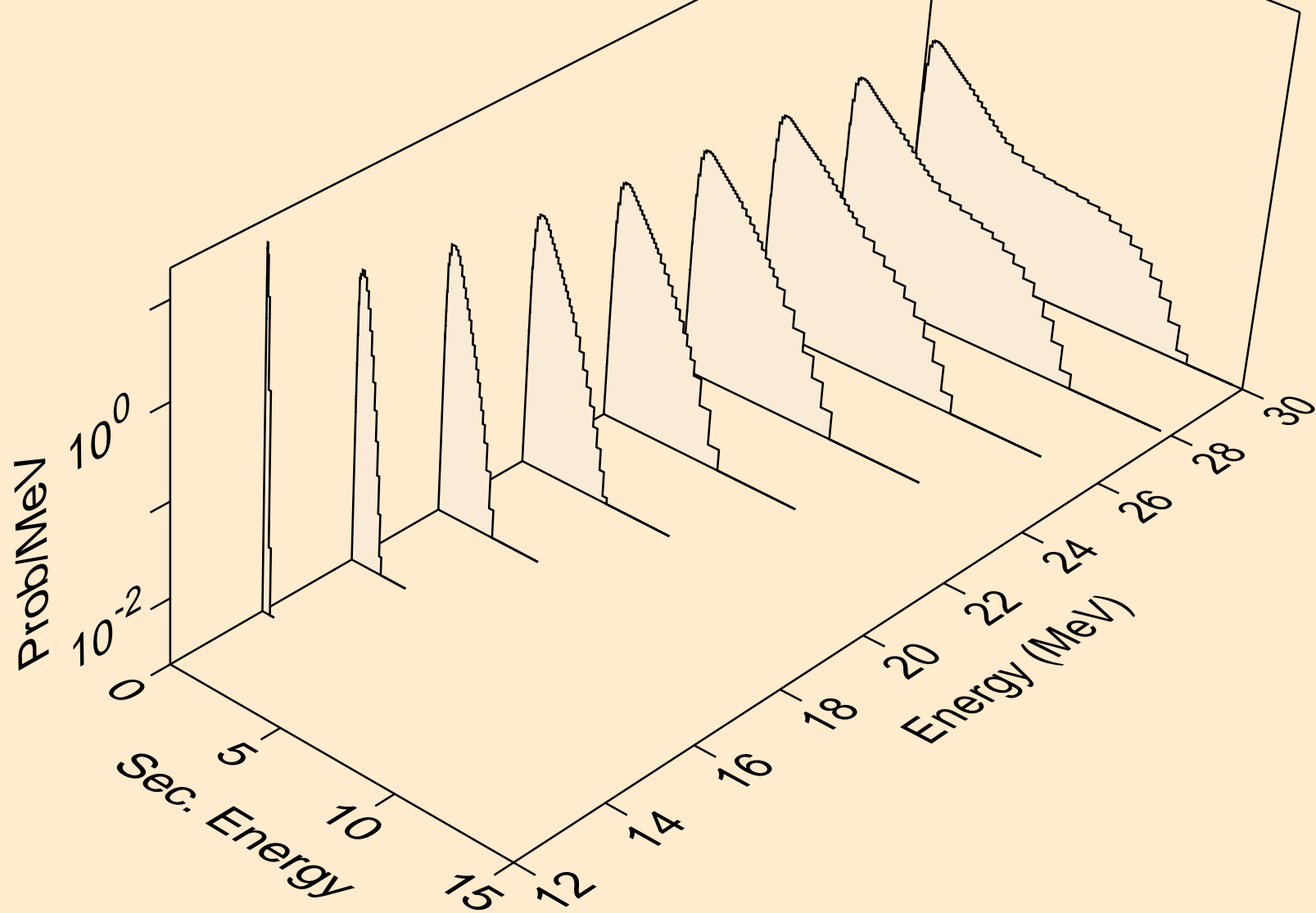

NB086 NEUTRON ACER TENDL-2024 LIBRARY; T=293.6K
Neutron emission for (n,3np)

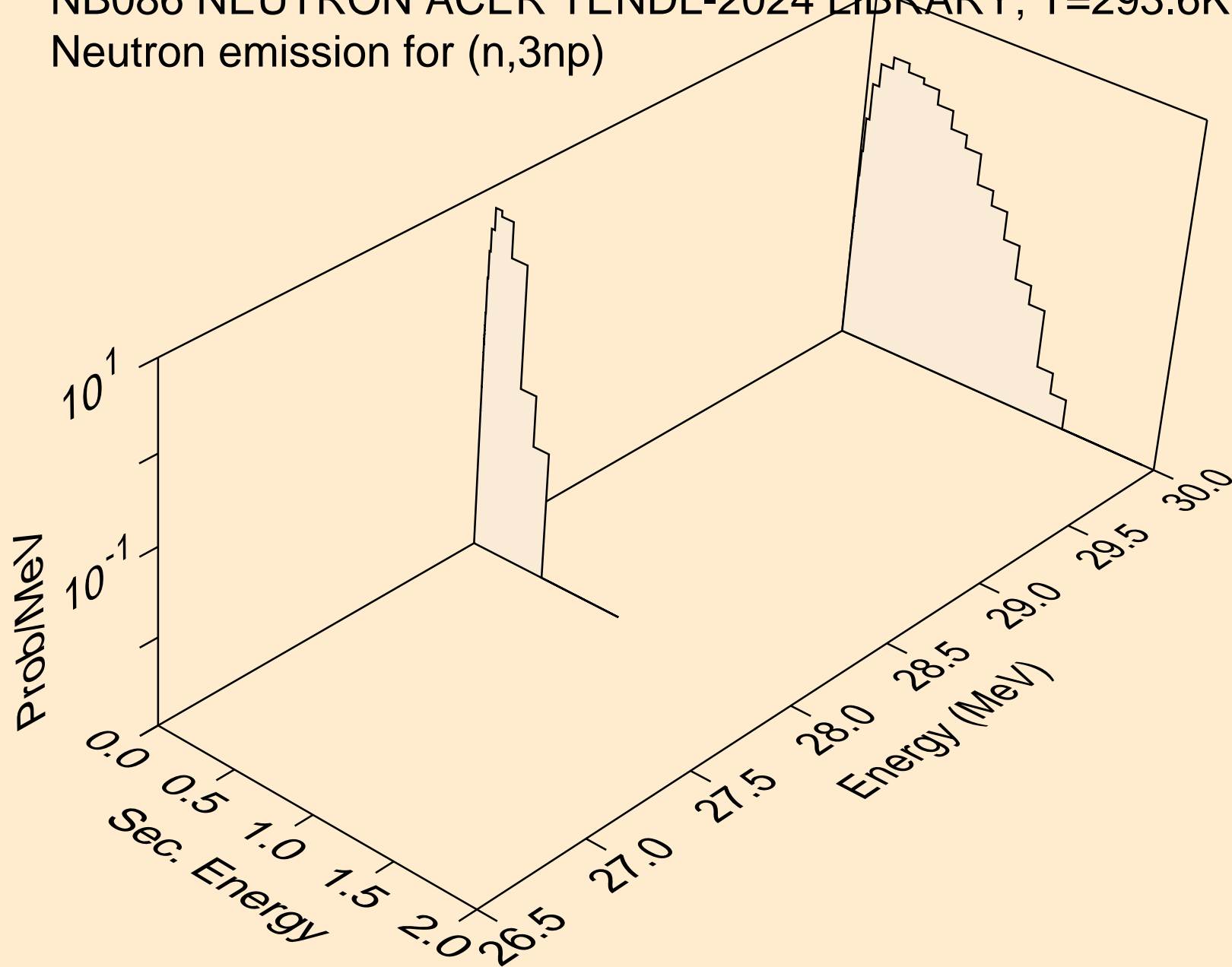

NB086 NEUTRON ACER TENDL-2024 LIBRARY; T=293.6K
Neutron emission for (n,n2p)

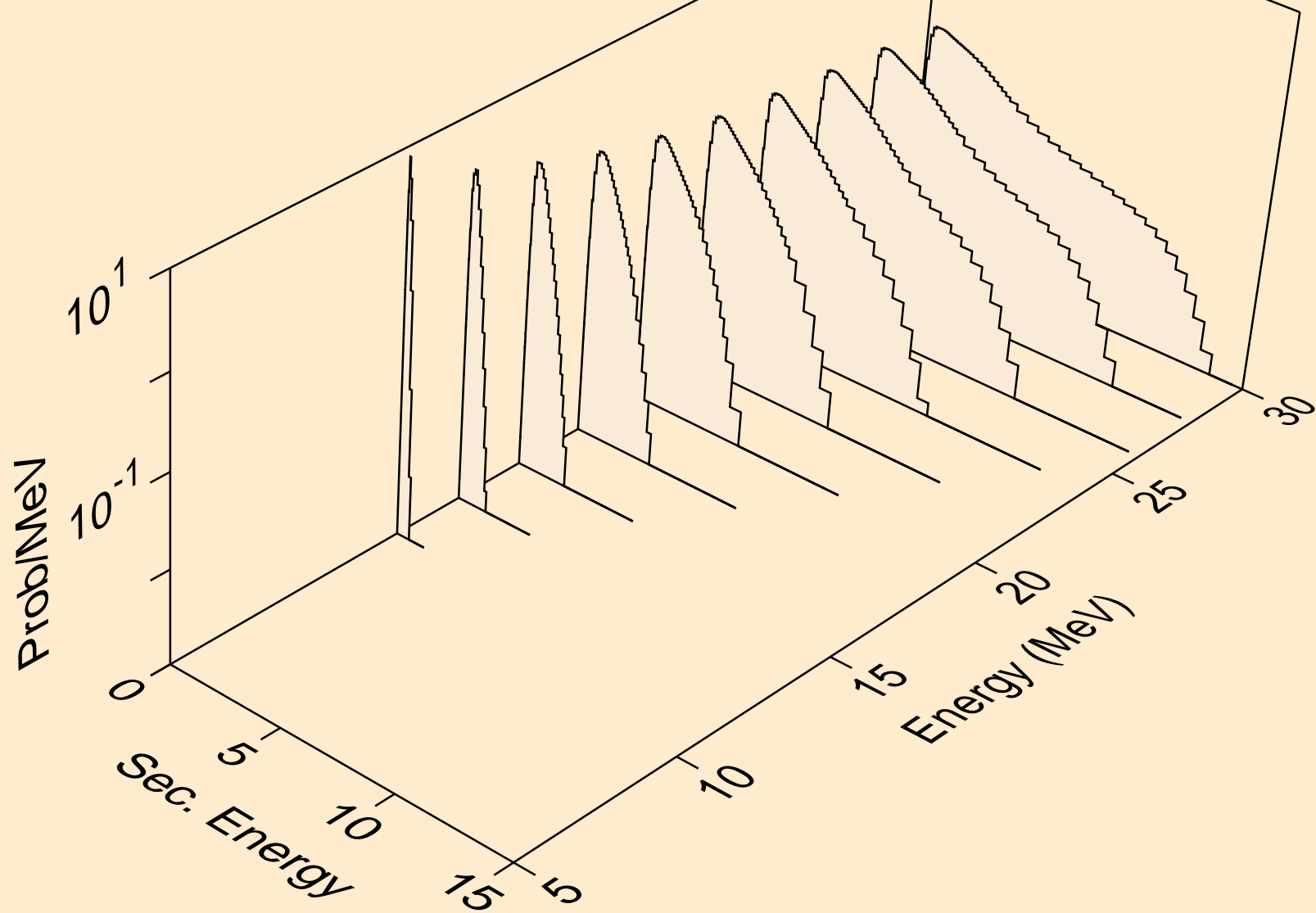

NB086 NEUTRON ACER TENDL-2024 LIBRARY; T=293.6K
Neutron emission for (n,npa)

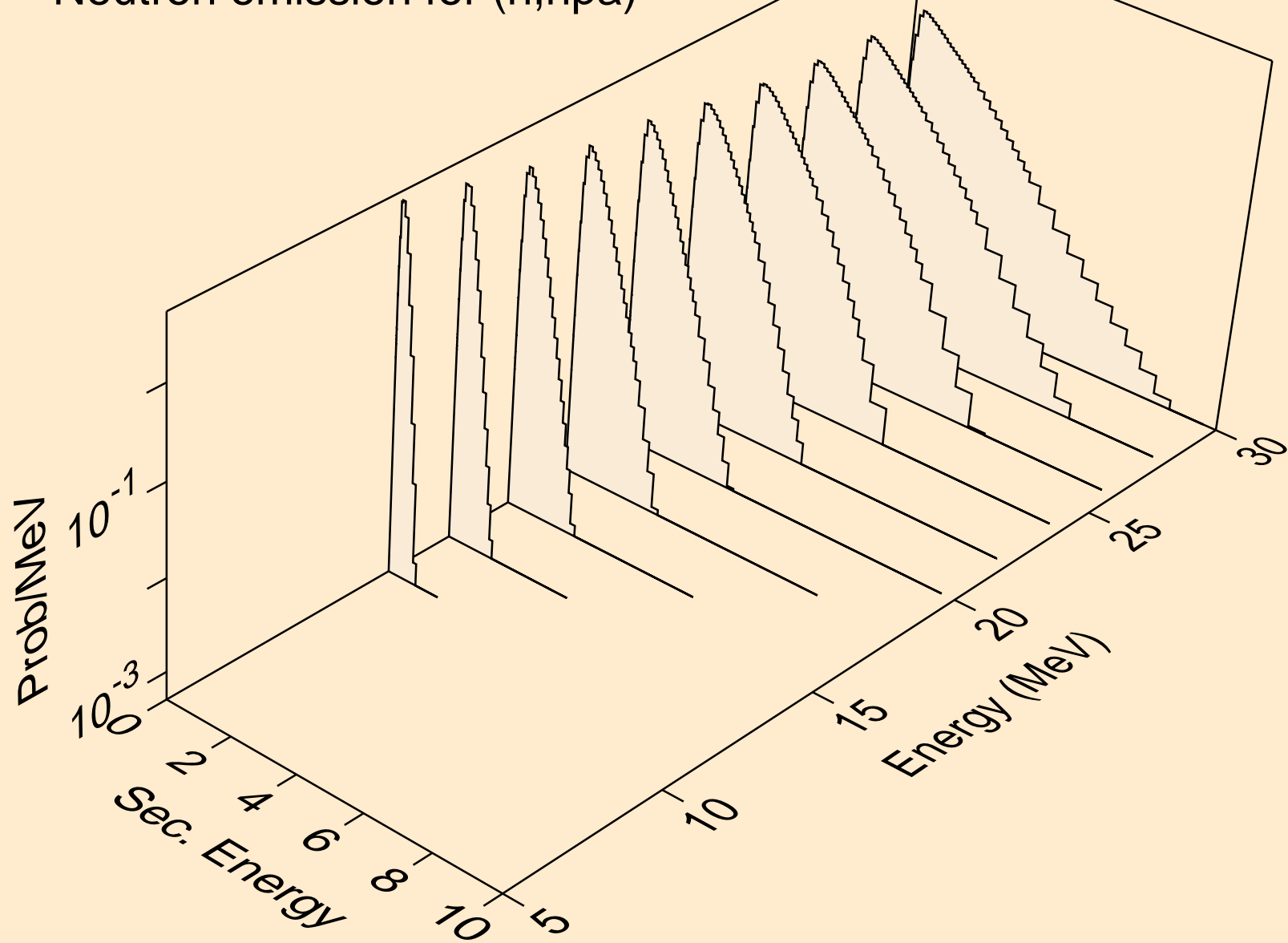

NB086 NEUTRON ACER TENDL-2024 LIBRARY; T=293.6K
Neutron emission for (n,n*c)

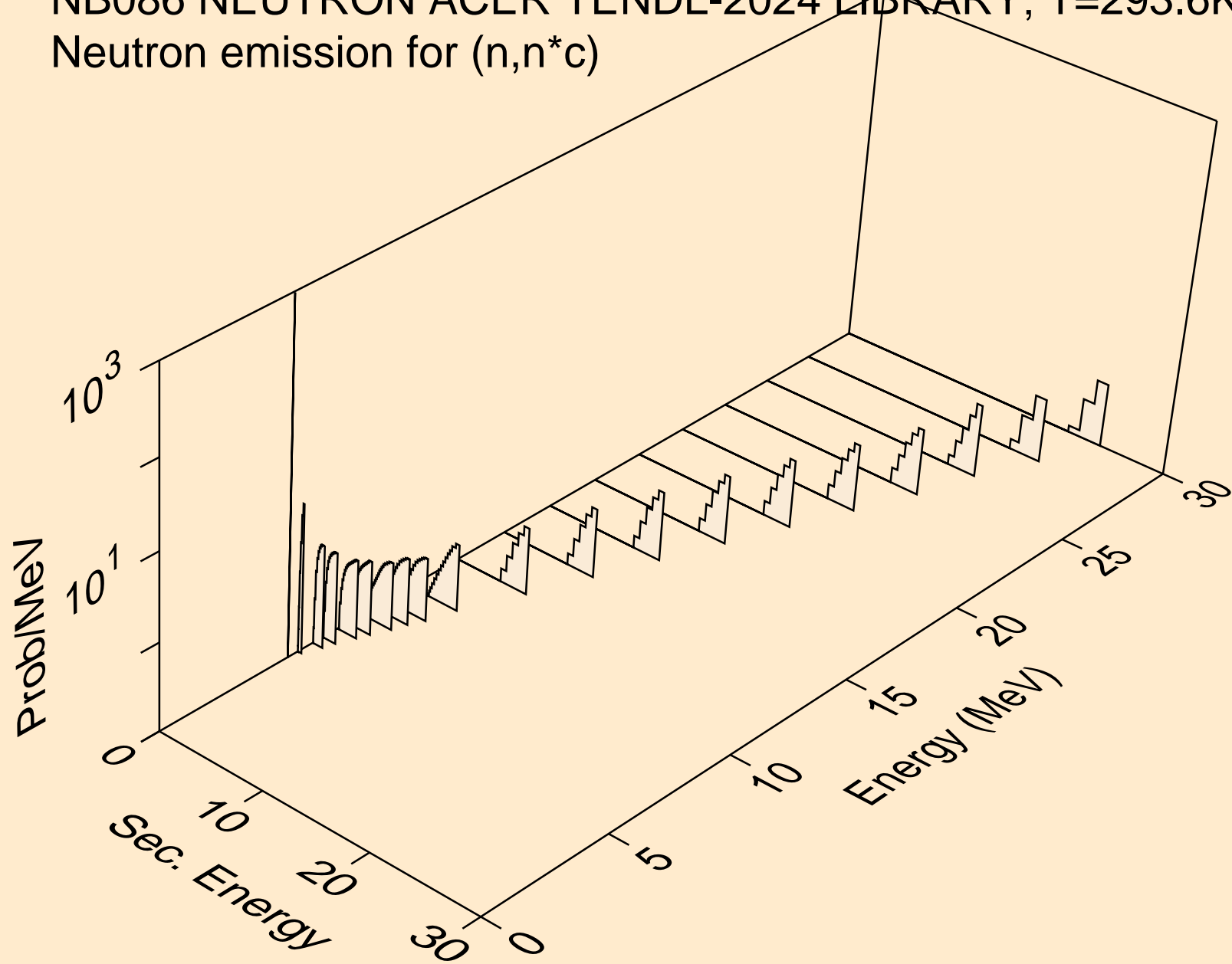

NB086 NEUTRON ACER TENDL-2024 LIBRARY; T=293.6K
Photon emission for (n,x)

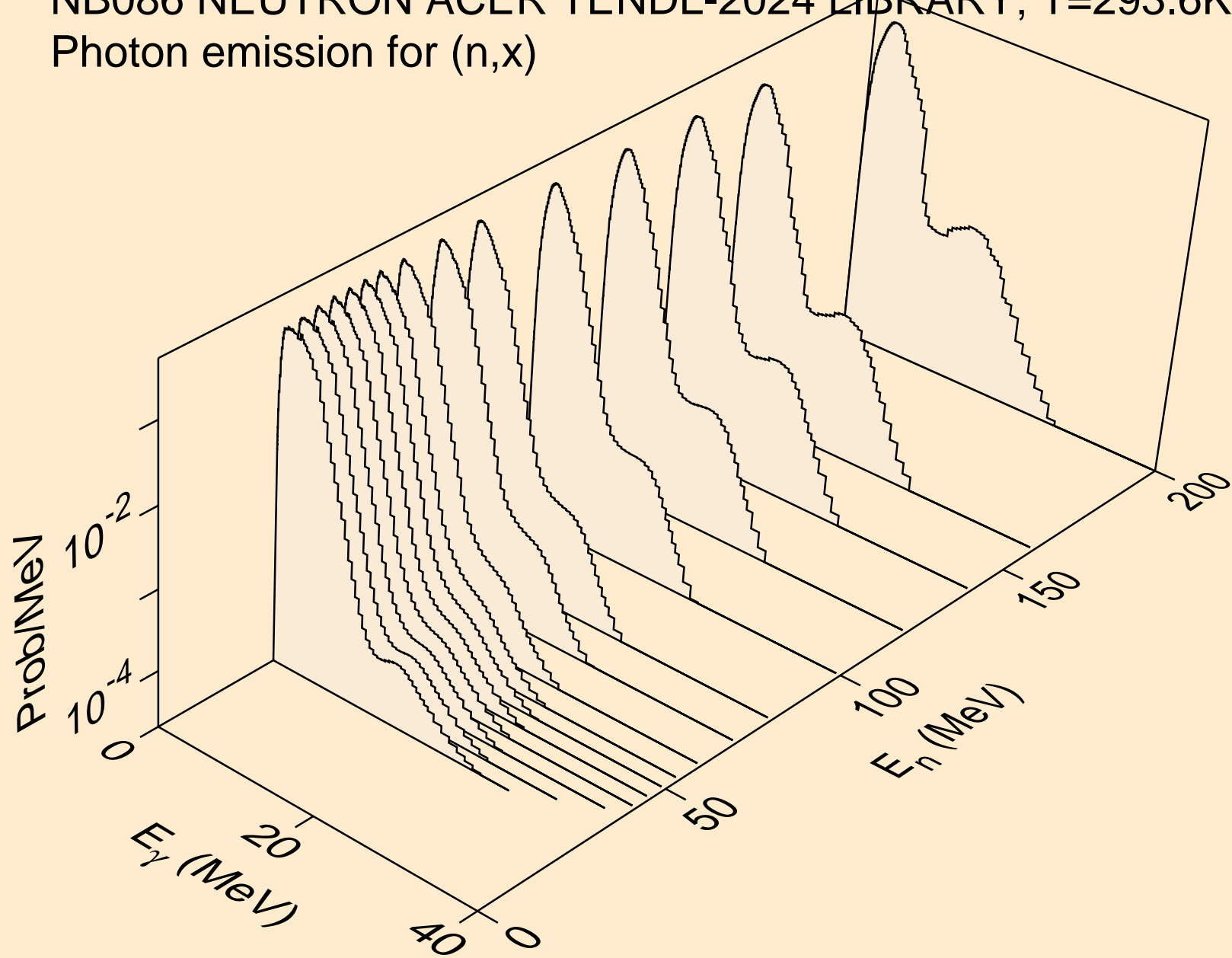

NB086 NEUTRON ACER TENDL-2024 LIBRARY; T=293.6K
Photon emission for (n,2nd)

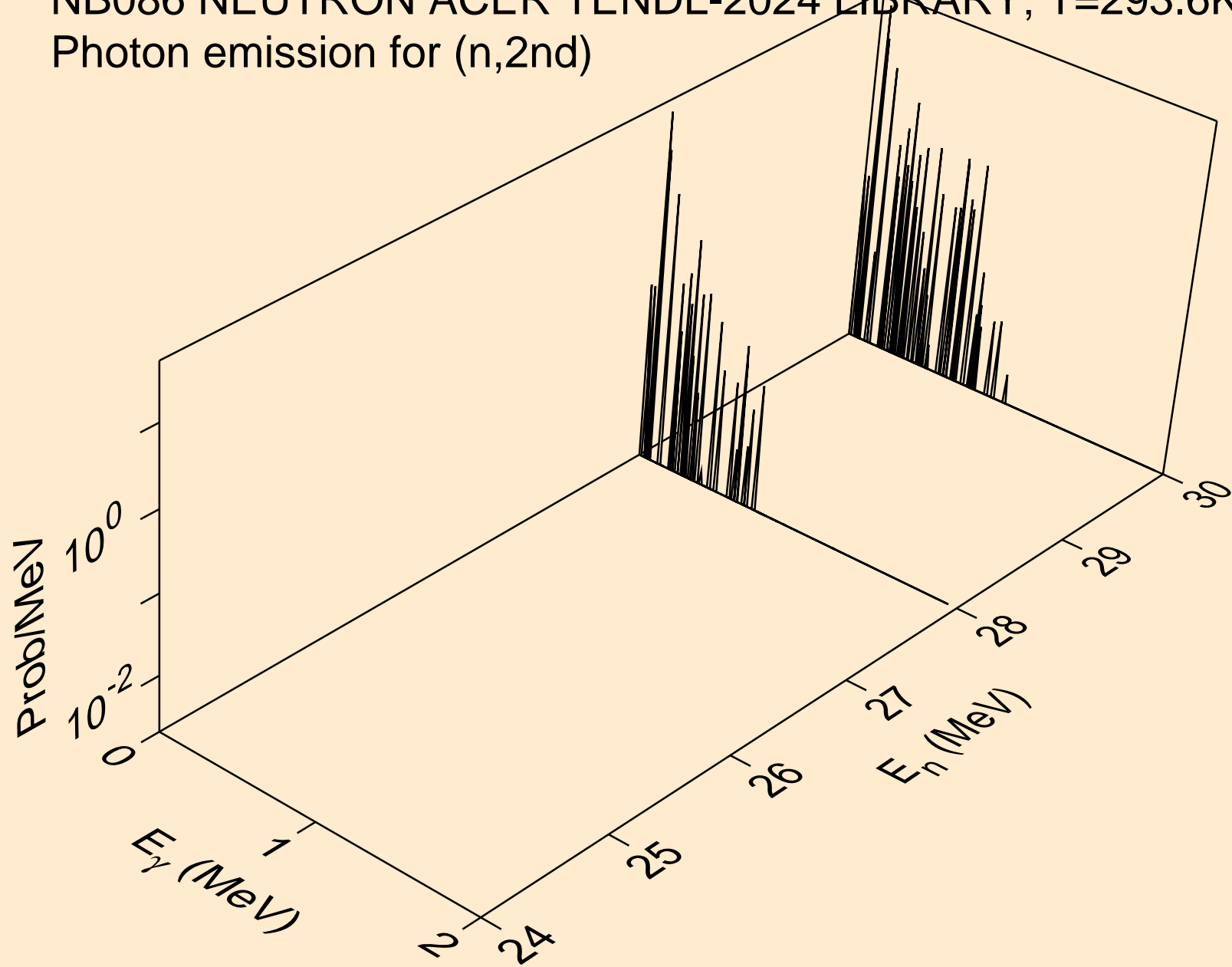

NB086 NEUTRON ACER TENDL-2024 LIBRARY; T=293.6K
Photon emission for (n,2n)

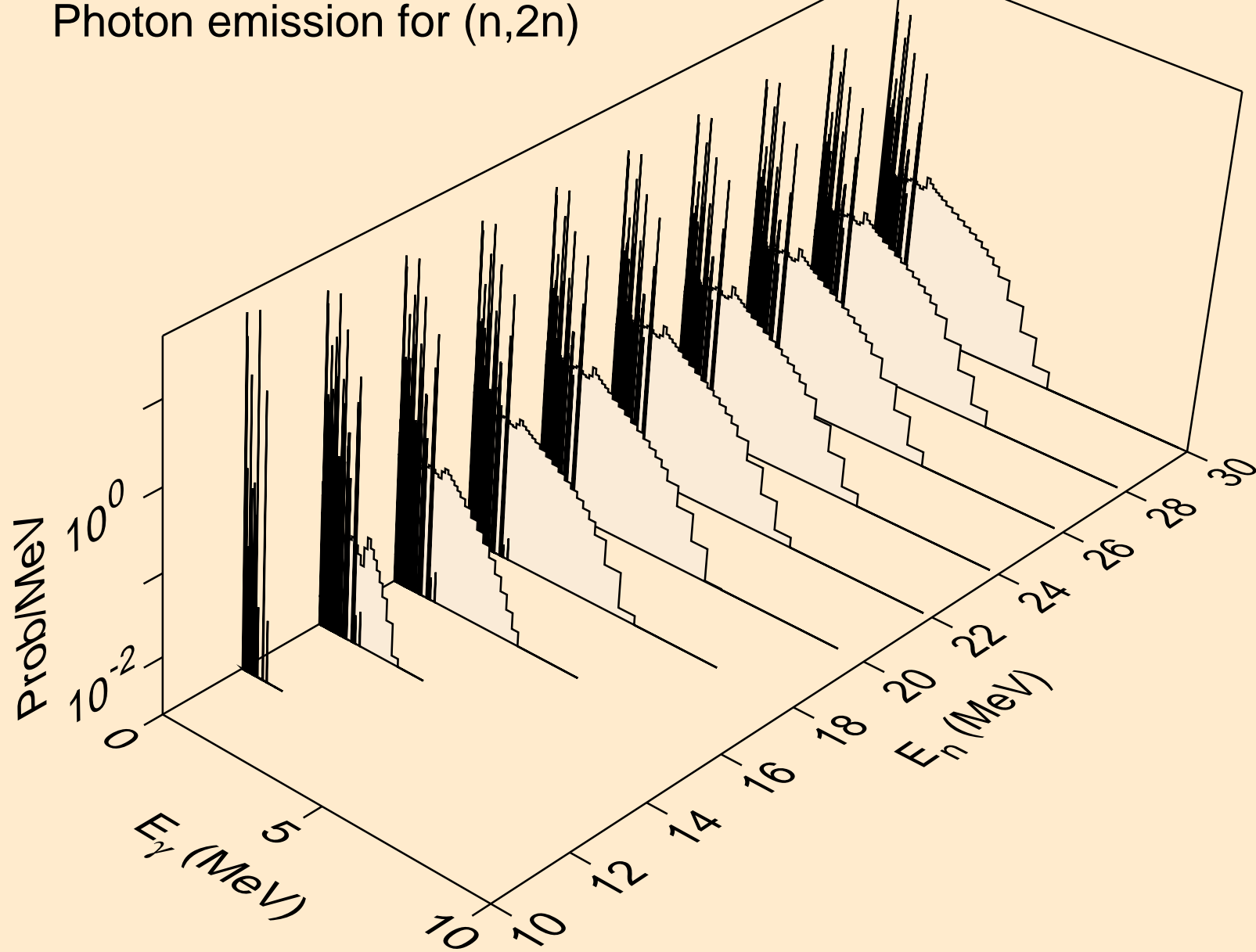

NB086 NEUTRON ACER TENDL-2024 LIBRARY; T=293.6K
Photon emission for (n,3n)

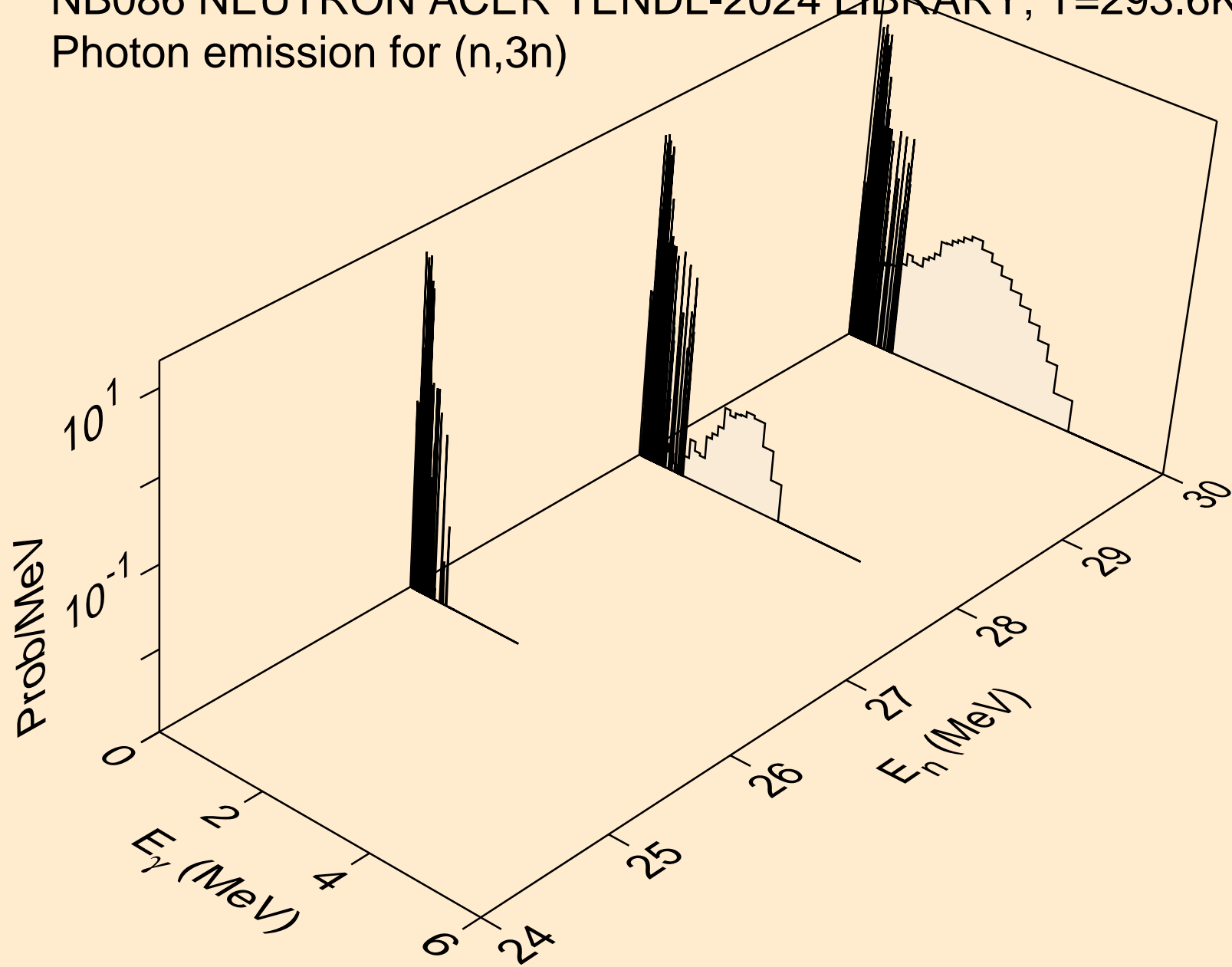

NB086 NEUTRON ACER TENDL-2024 LIBRARY; T=293.6K
Photon emission for (n,n*)a

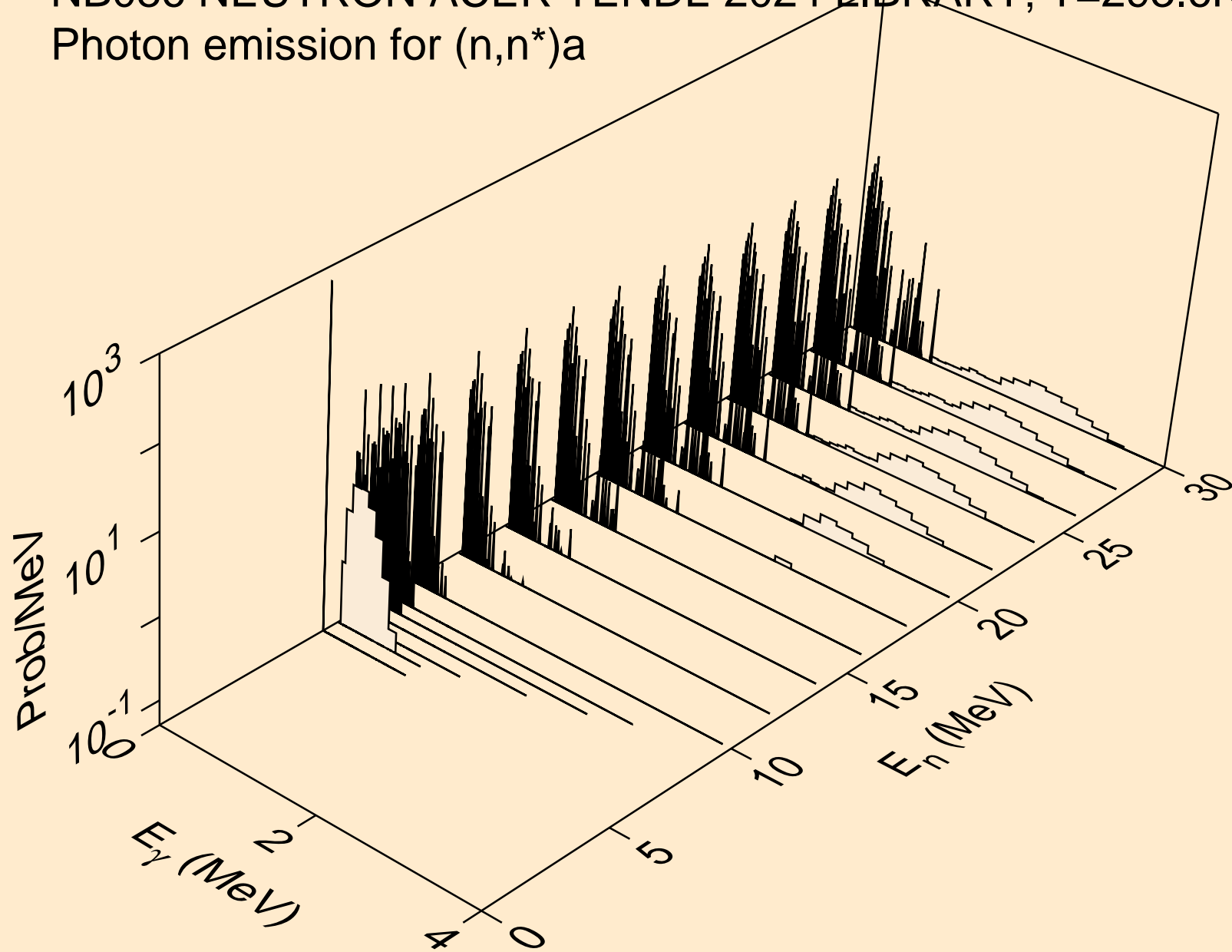

NB086 NEUTRON ACER TENDL-2024 LIBRARY; T=293.6K
Photon emission for (n,2n)a

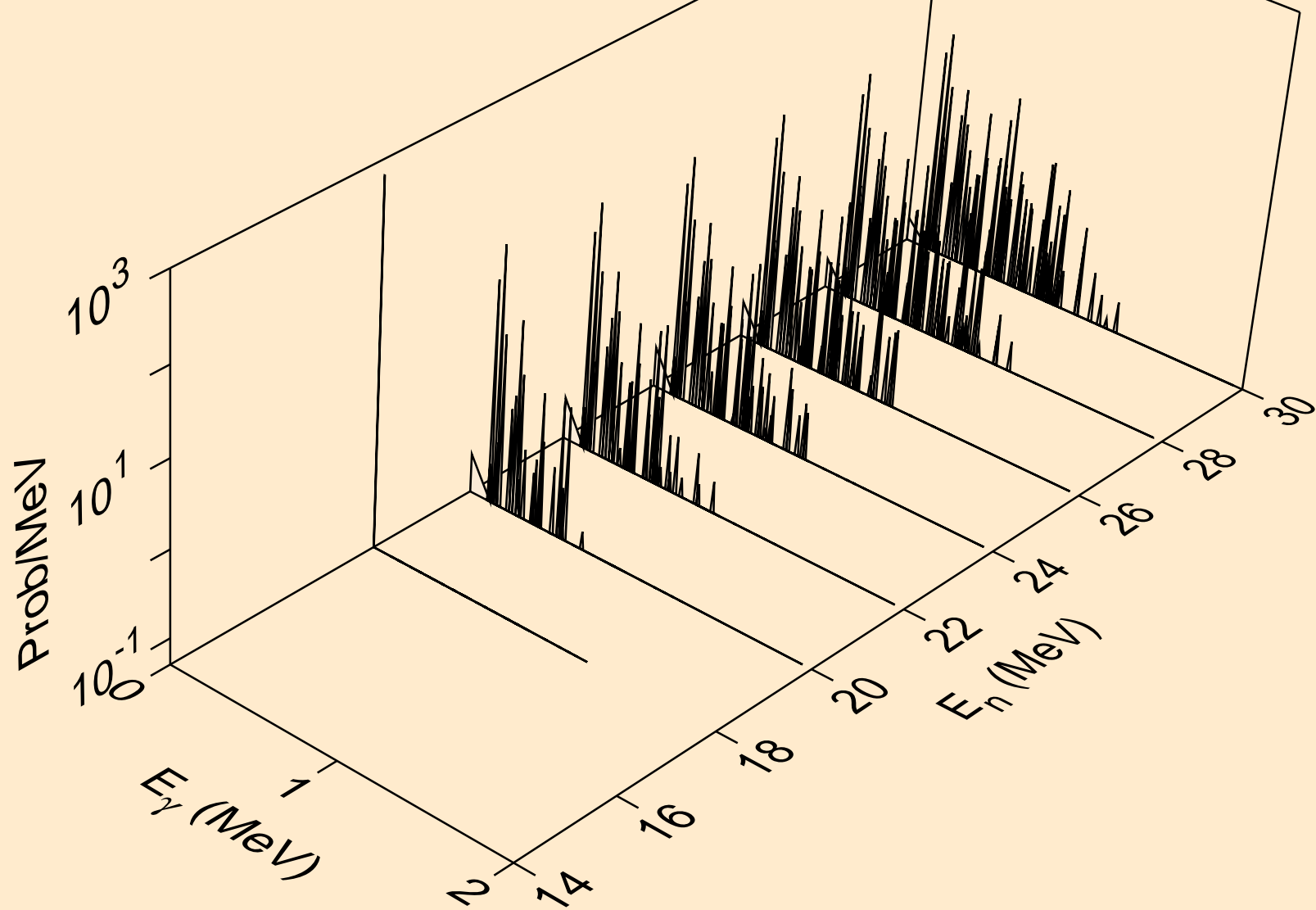

NB086 NEUTRON ACER TENDL-2024 LIBRARY; T=293.6K
Photon emission for (n,n*)p

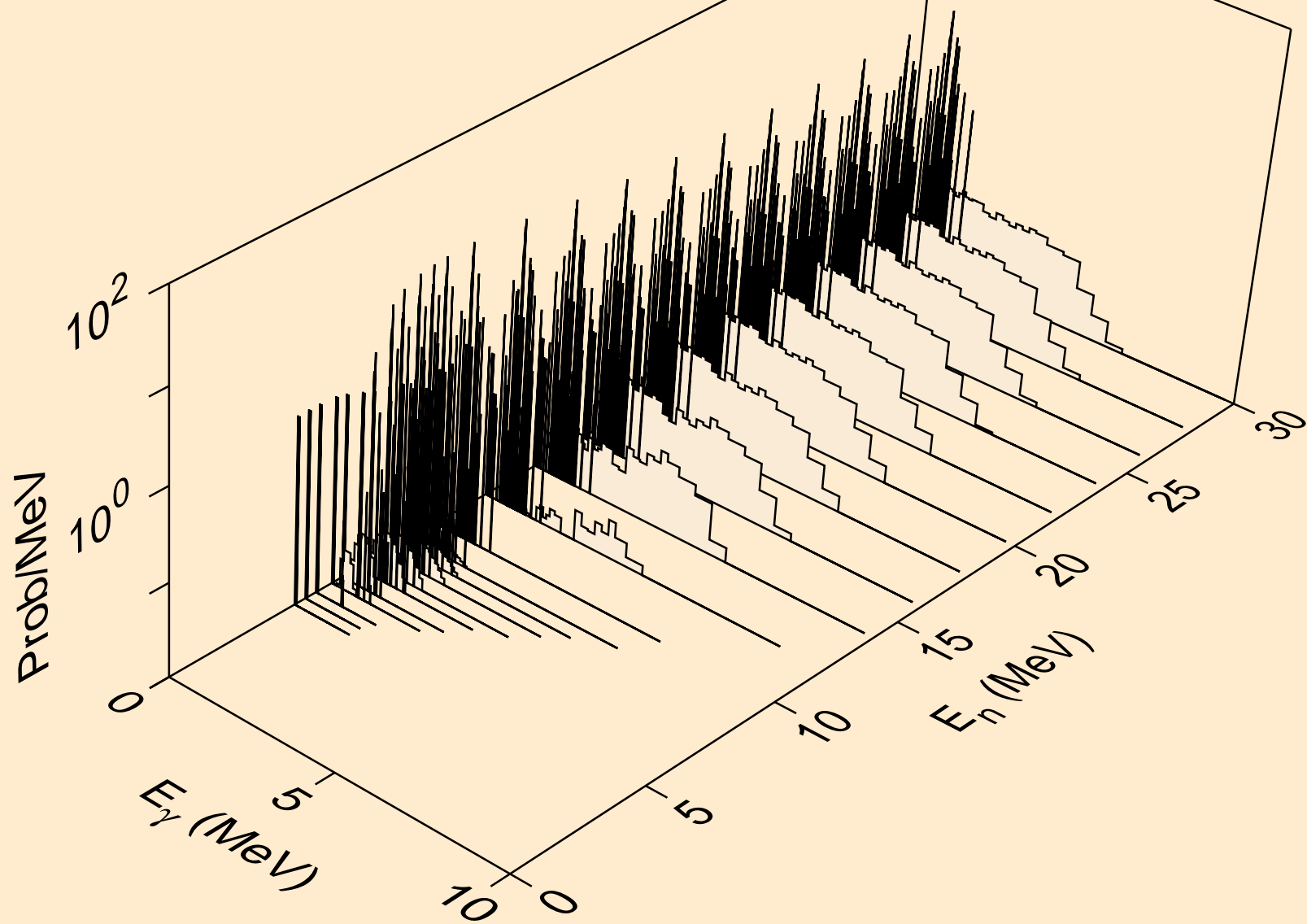

NB086 NEUTRON ACER TENDL-2024 LIBRARY; T=293.6K
Photon emission for (n,n*)2a

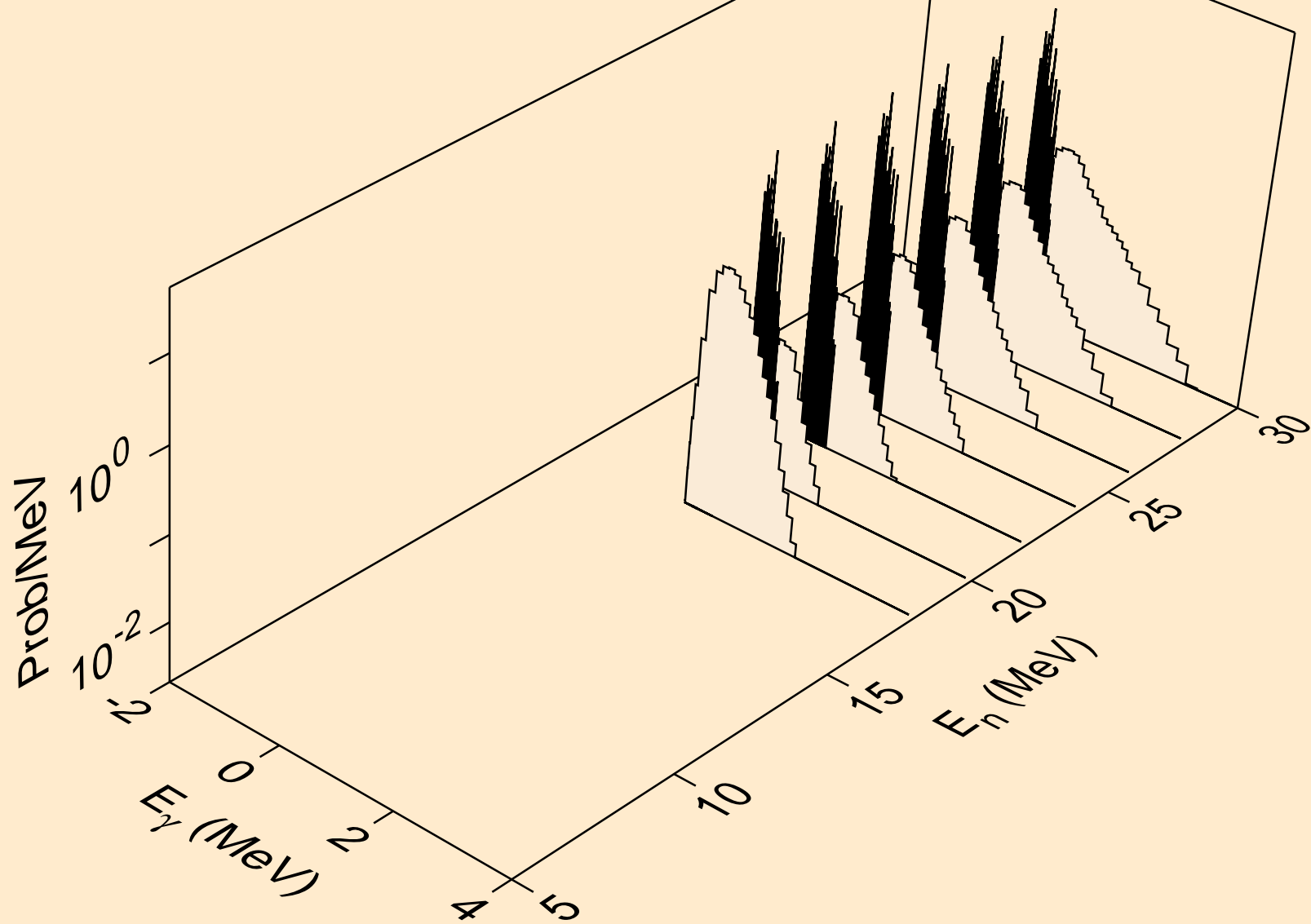

NB086 NEUTRON ACER TENDL-2024 LIBRARY; T=293.6K
Photon emission for (n,n*)d

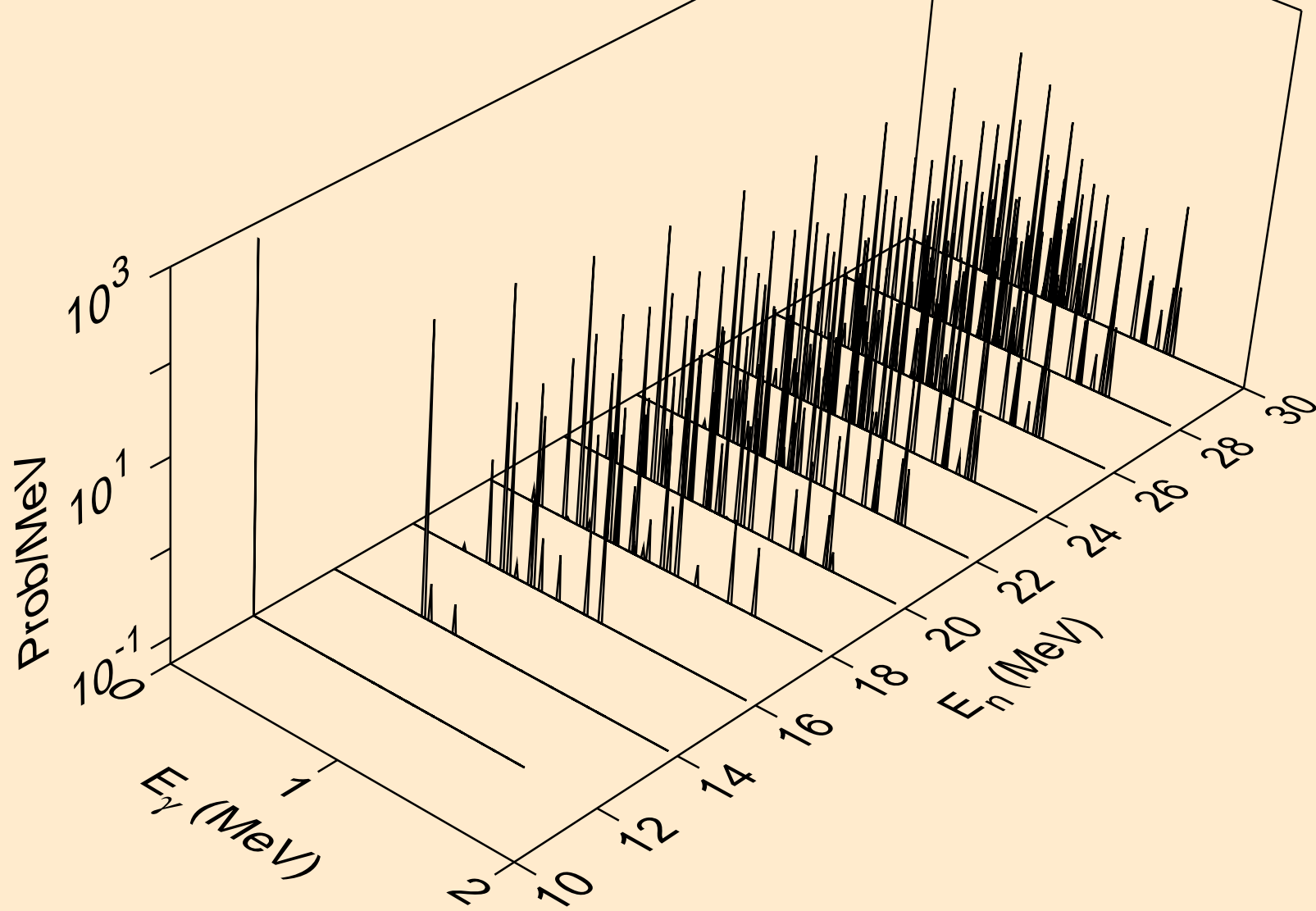

NB086 NEUTRON ACER TENDL-2024 LIBRARY; T=293.6K
Photon emission for (n,n*)t

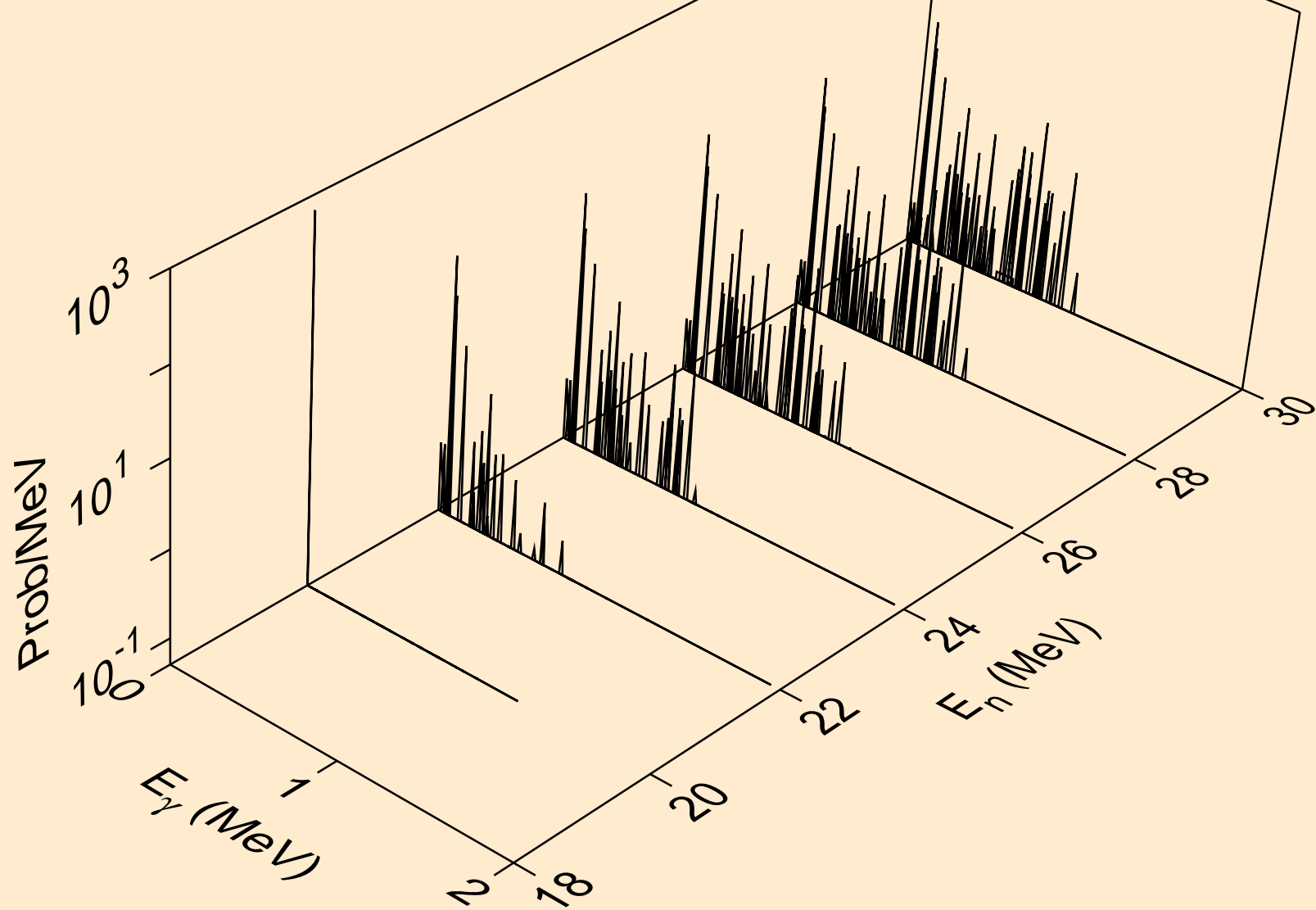

NB086 NEUTRON ACER TENDL-2024 LIBRARY; T=293.6K
Photon emission for (n,n*)he3

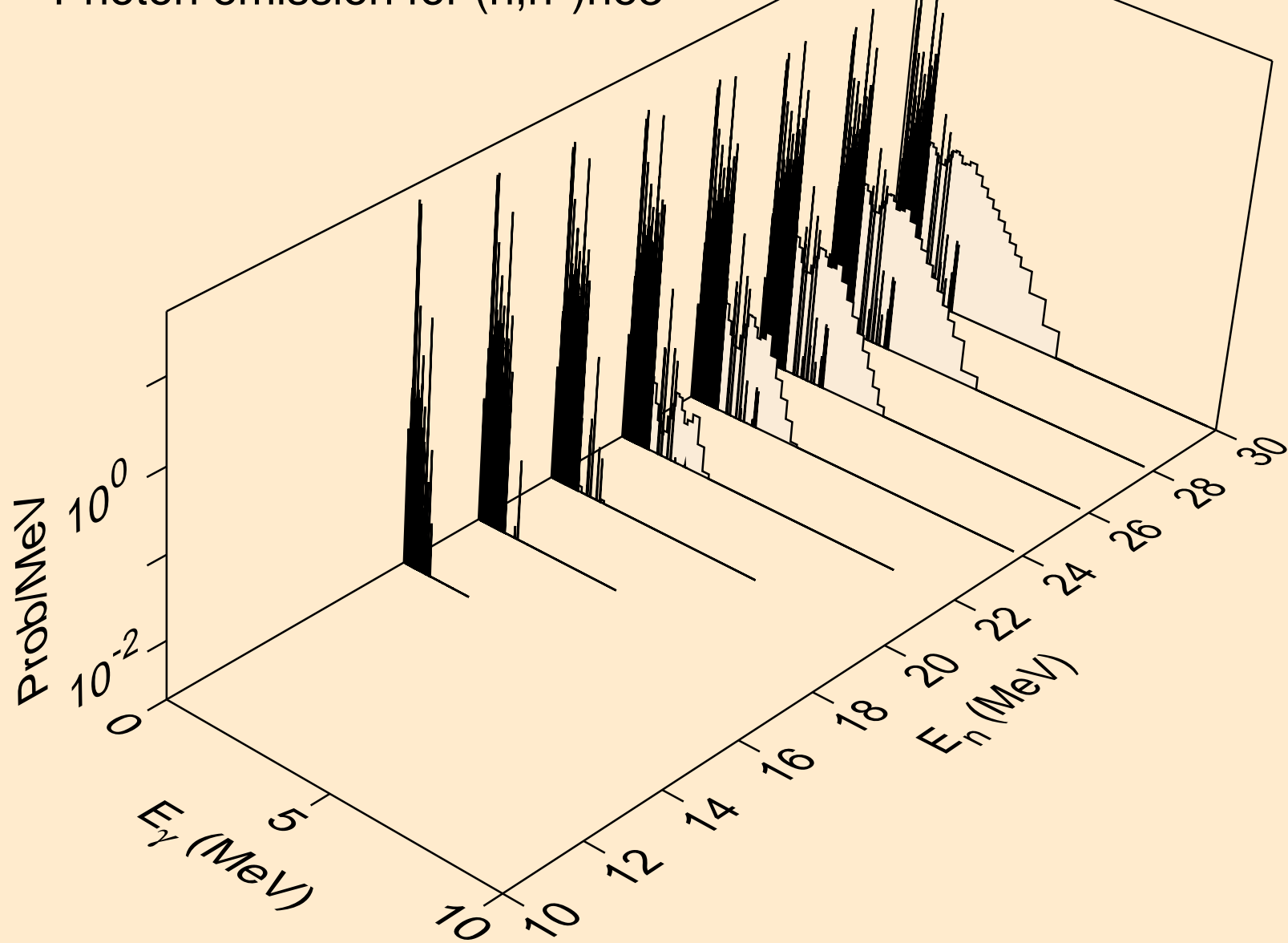

NB086 NEUTRON ACER TENDL-2024 LIBRARY; T=293.6K
Photon emission for (n,2np)

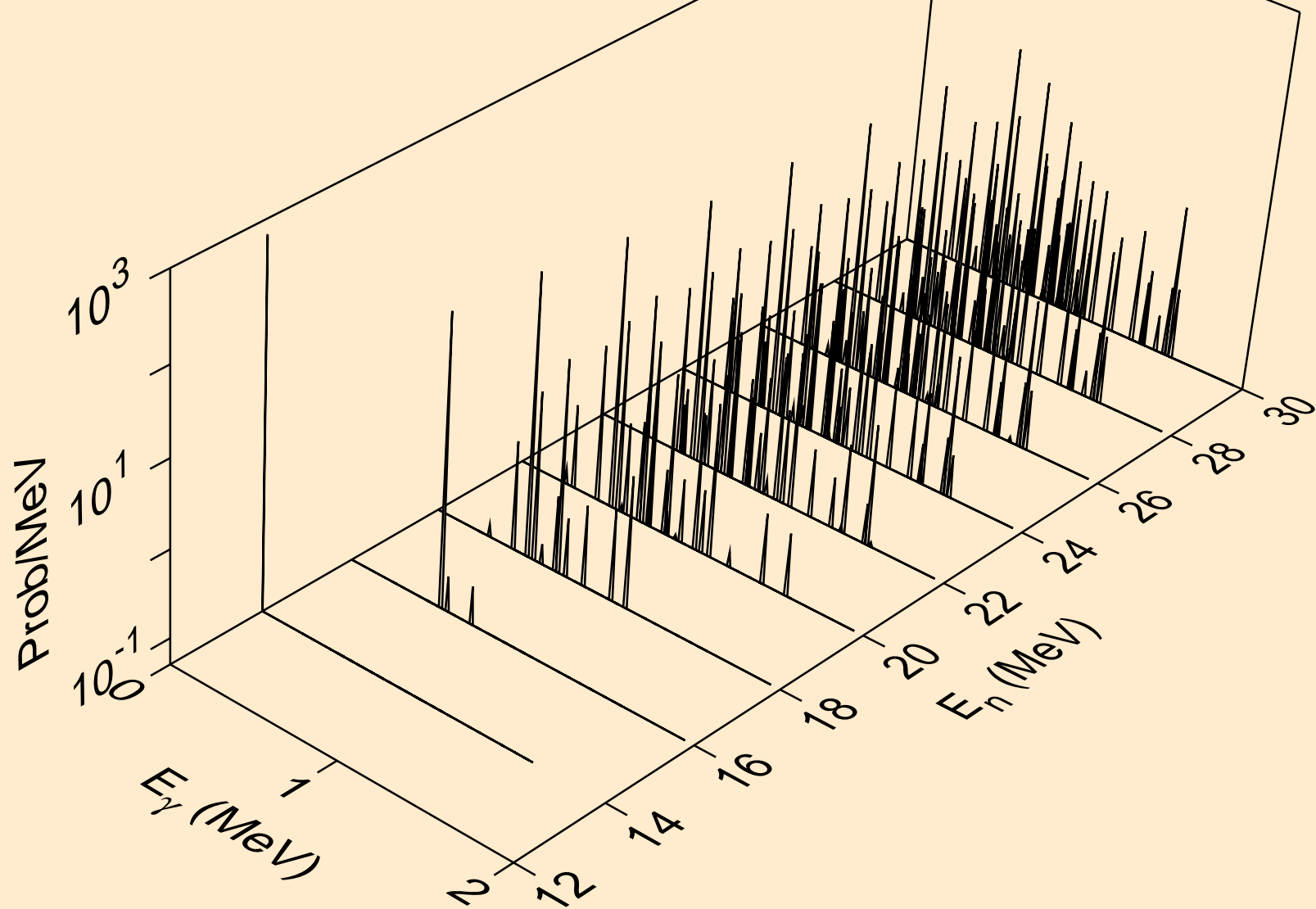

NB086 NEUTRON ACER TENDL-2024 LIBRARY; T=293.6K
Photon emission for (n,3np)

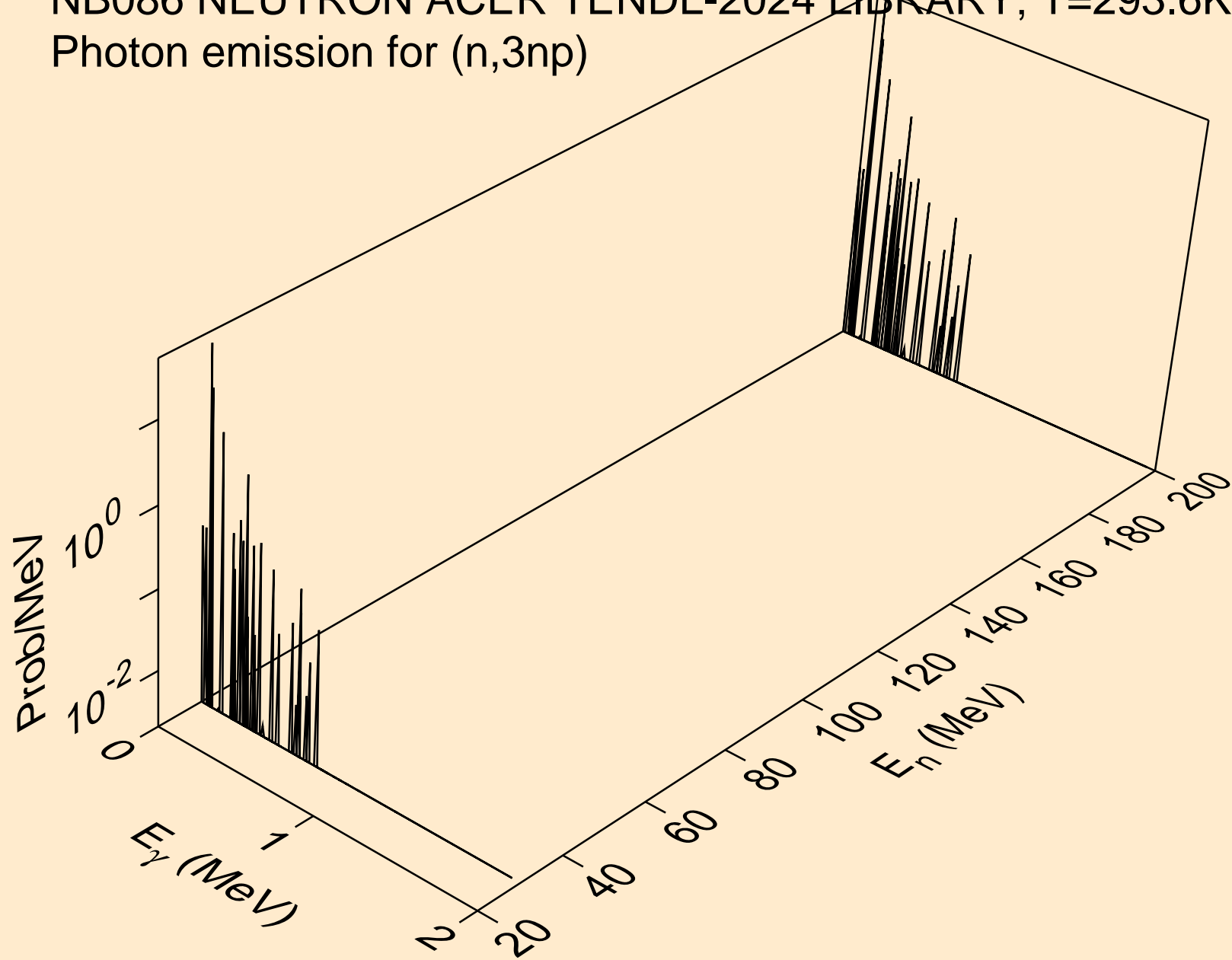

NB086 NEUTRON ACER TENDL-2024 LIBRARY; T=293.6K
Photon emission for (n,n2p)

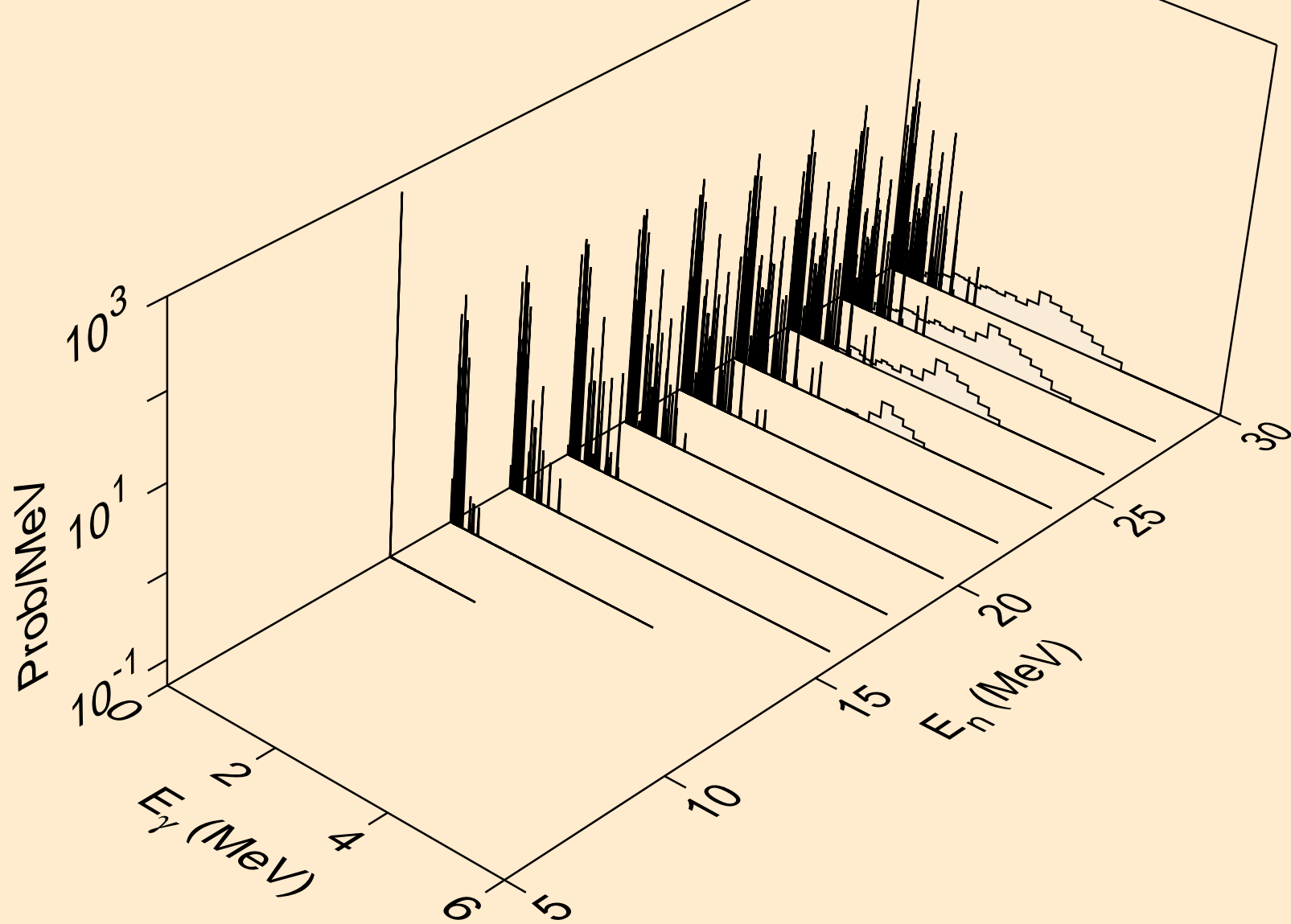

NB086 NEUTRON ACER TENDL-2024 LIBRARY; T=293.6K
Photon emission for (n,npa)

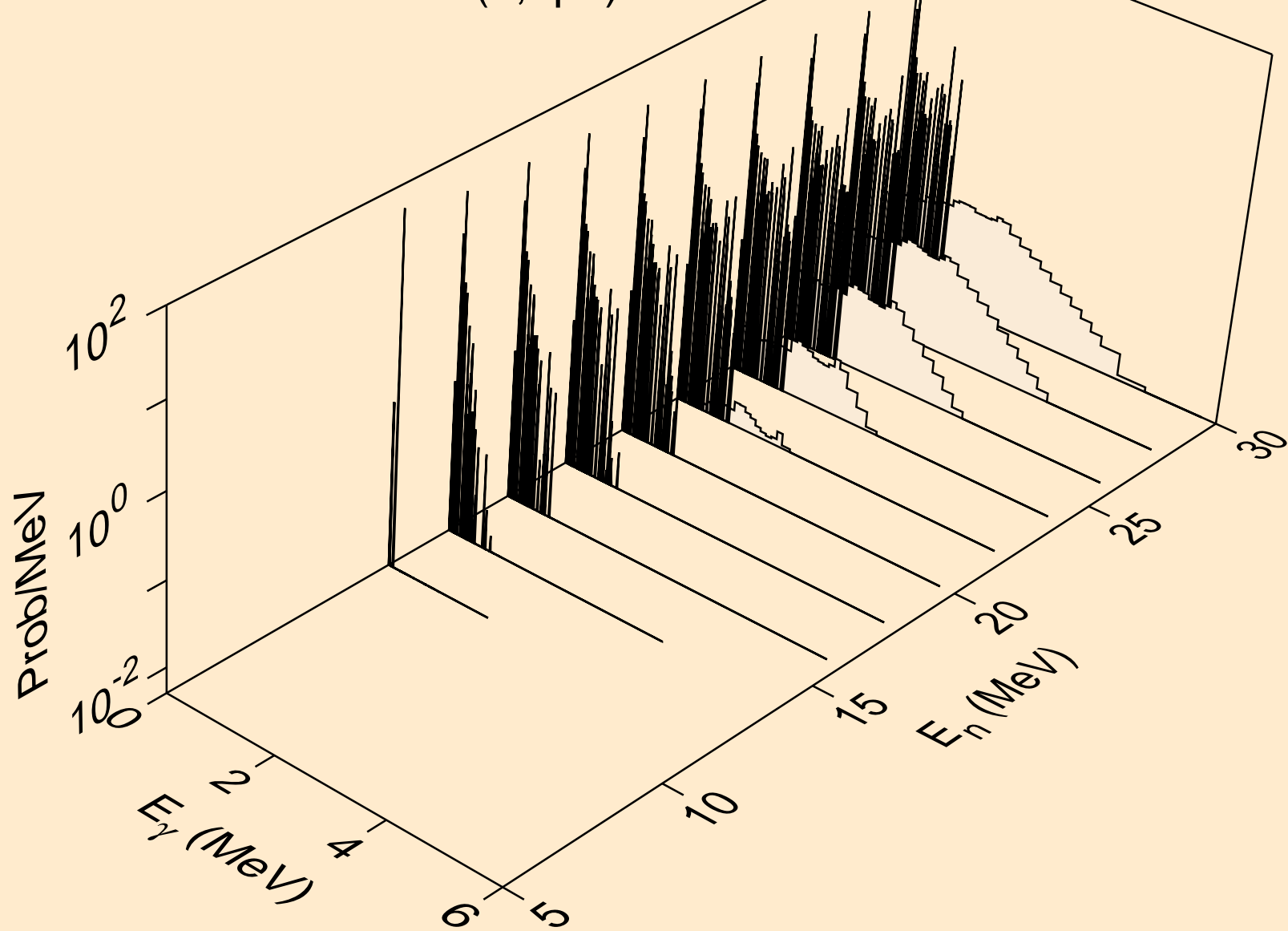

NB086 NEUTRON ACER TENDL-2024 LIBRARY; T=293.6K
Photon emission for (n,n*c)

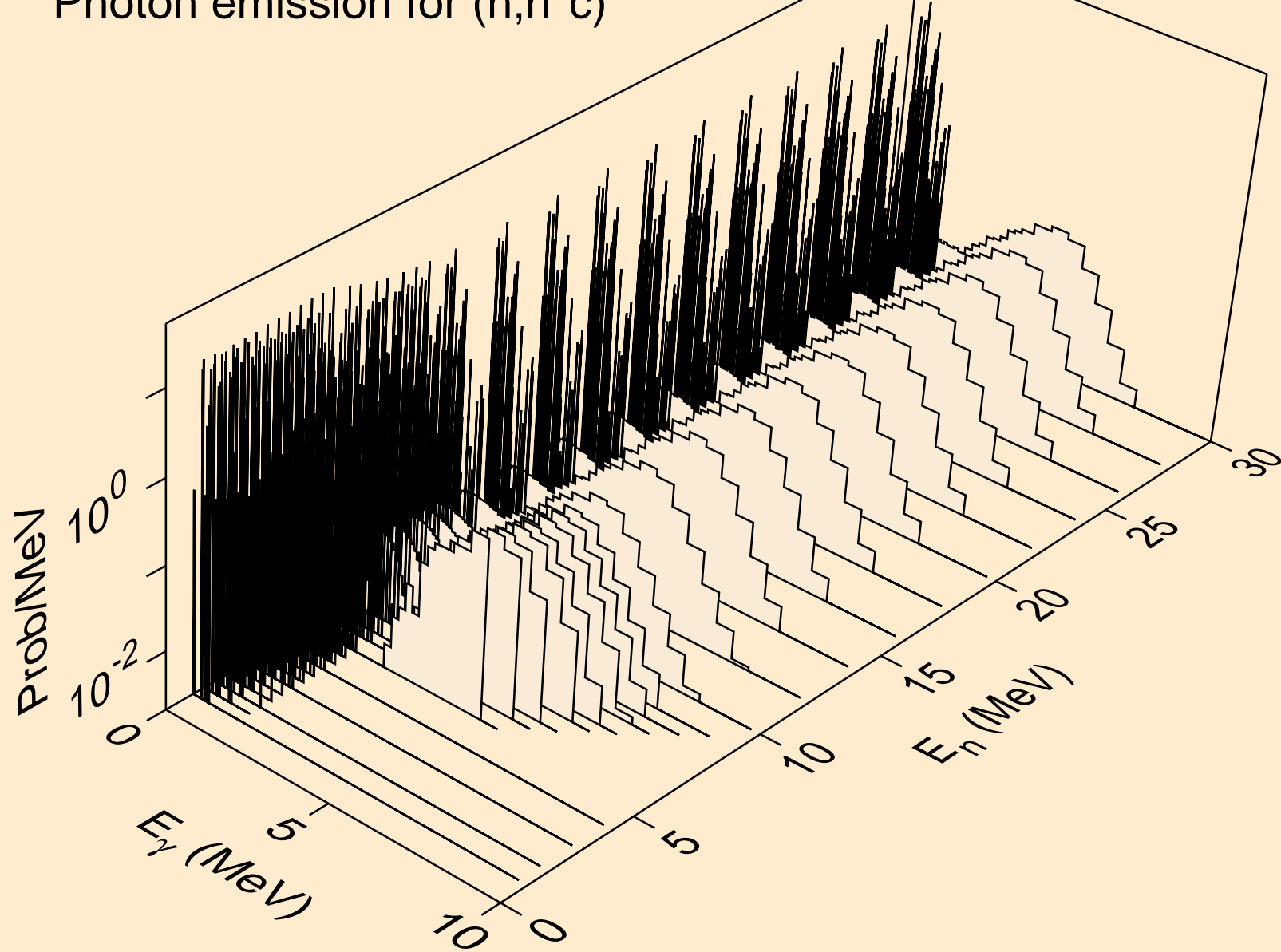

NB086 NEUTRON ACER TENDL-2024 LIBRARY; T=293.6K
Photon emission for (n,gma)

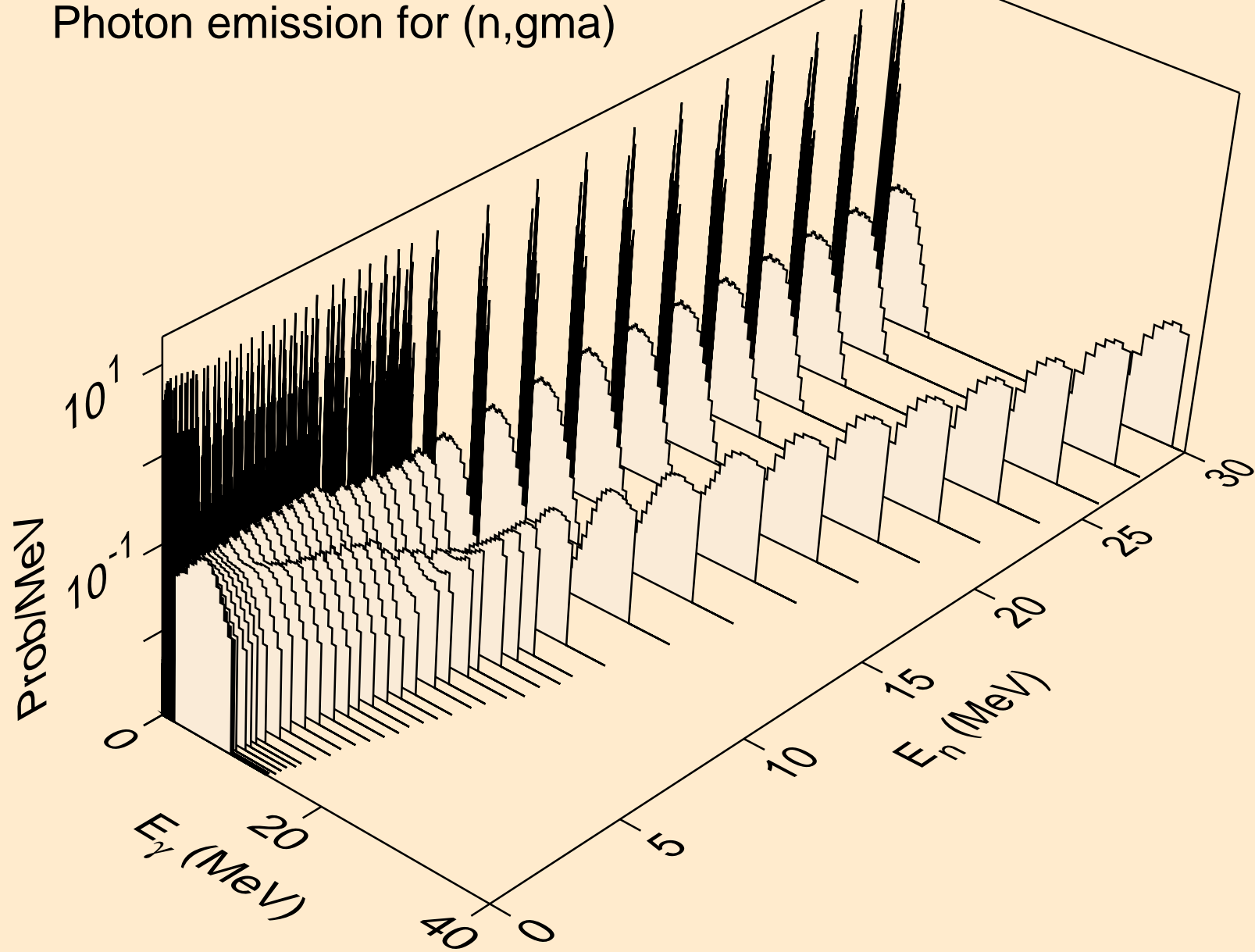

NB086 NEUTRON ACER TENDL-2024 LIBRARY; T=293.6K
Photon emission for (n,p)

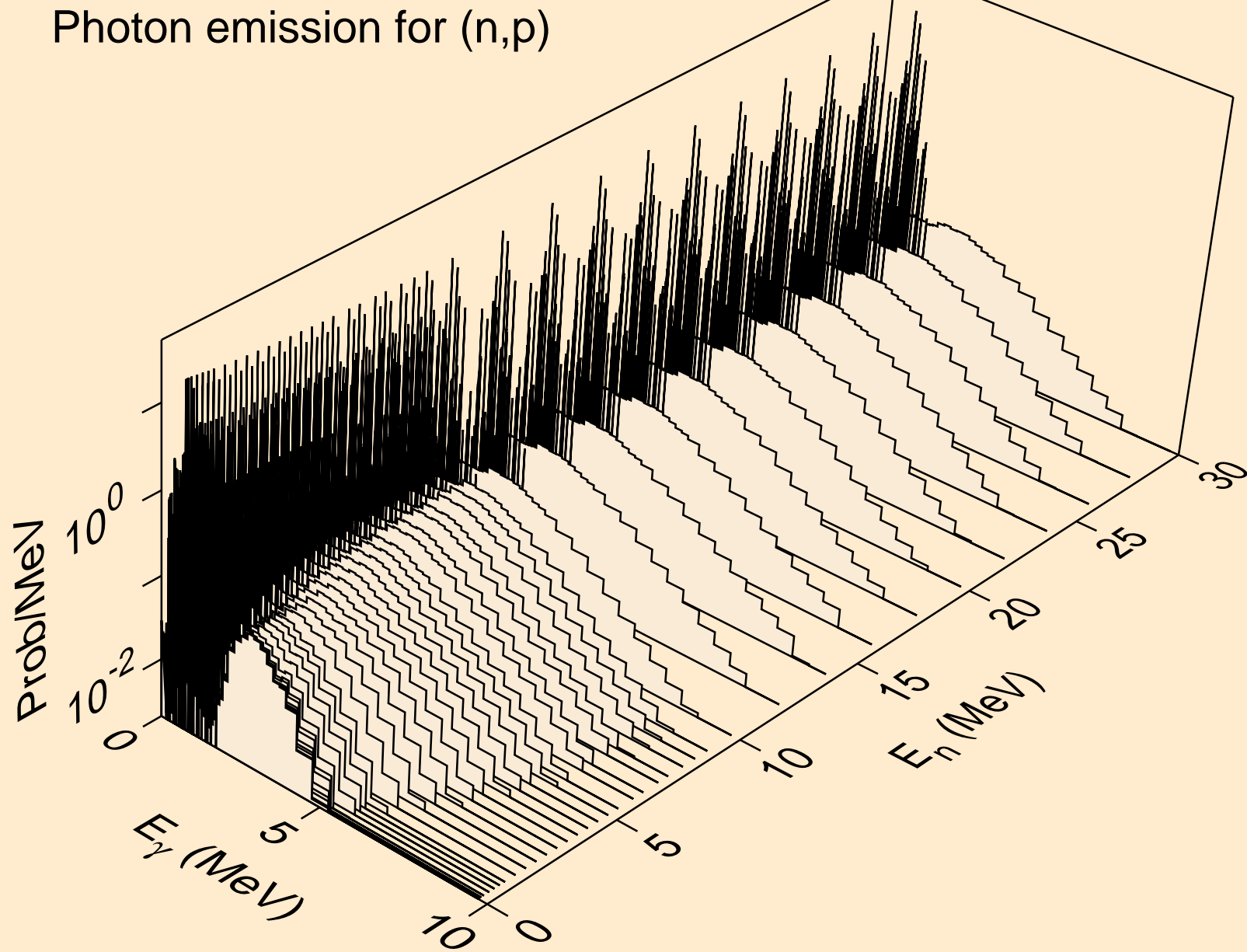

NB086 NEUTRON ACER TENDL-2024 LIBRARY; T=293.6K
Photon emission for (n,d)

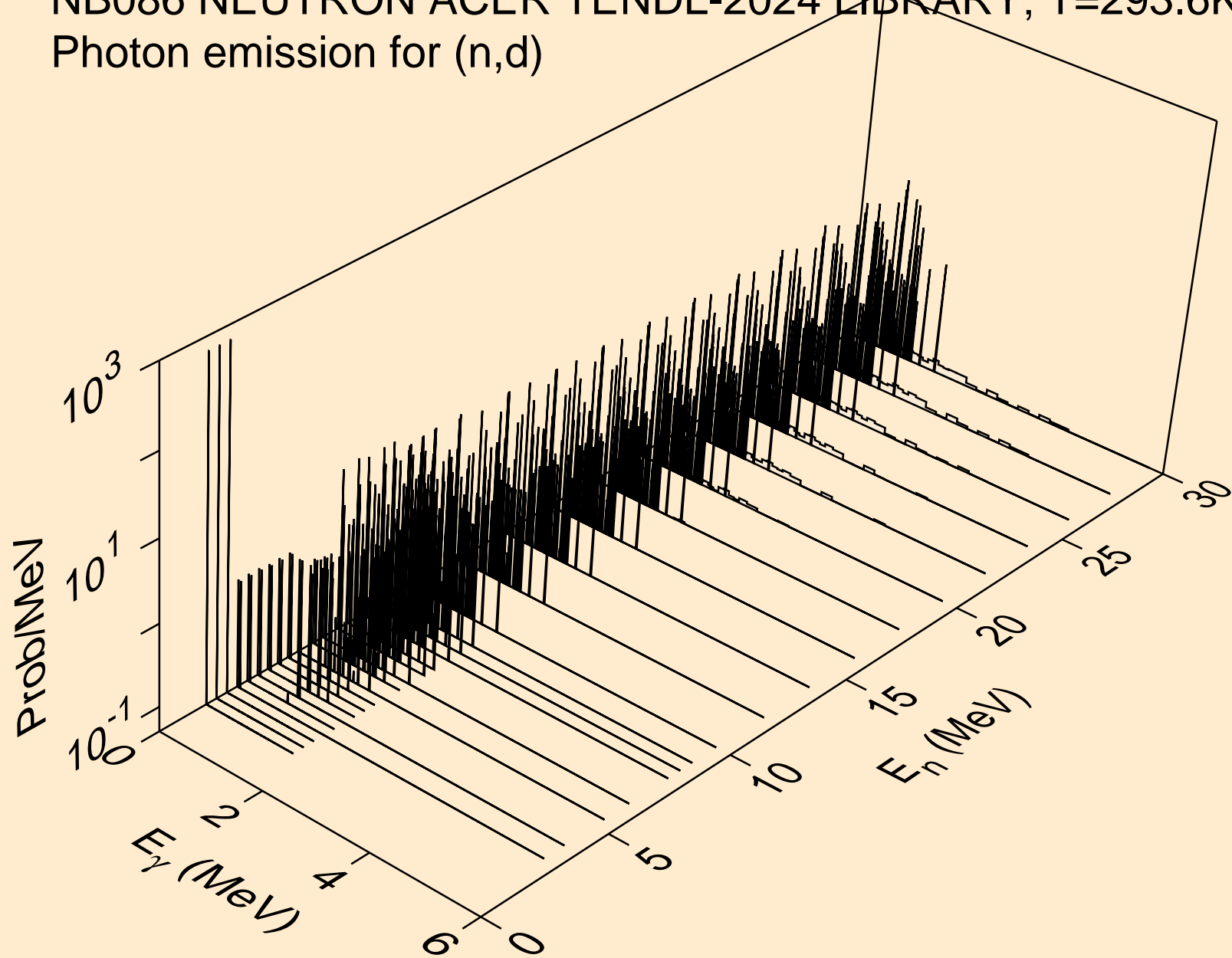

NB086 NEUTRON ACER TENDL-2024 LIBRARY; T=293.6K
Photon emission for (n,t)

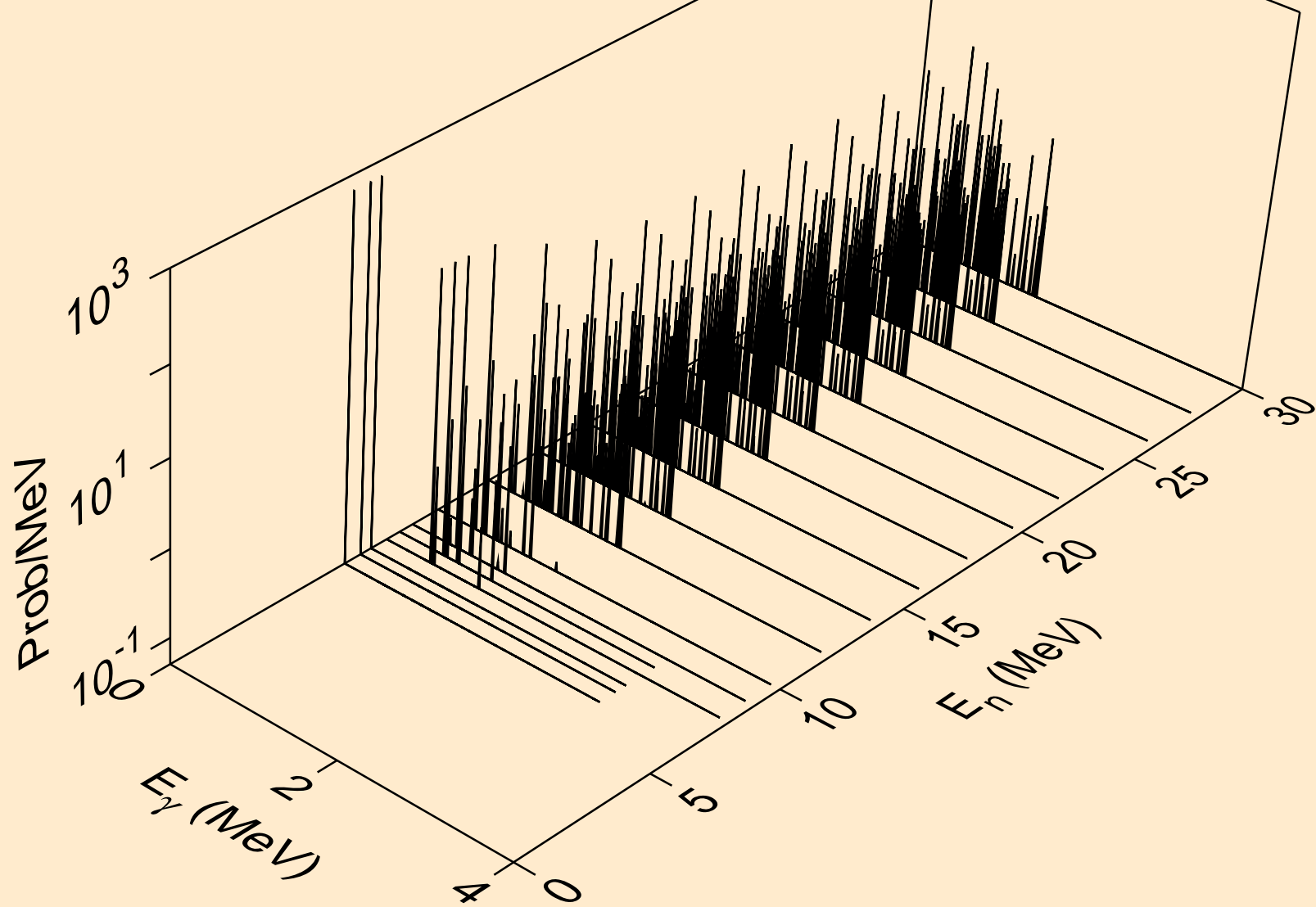

NB086 NEUTRON ACER TENDL-2024 LIBRARY; T=293.6K
Photon emission for (n,he3)

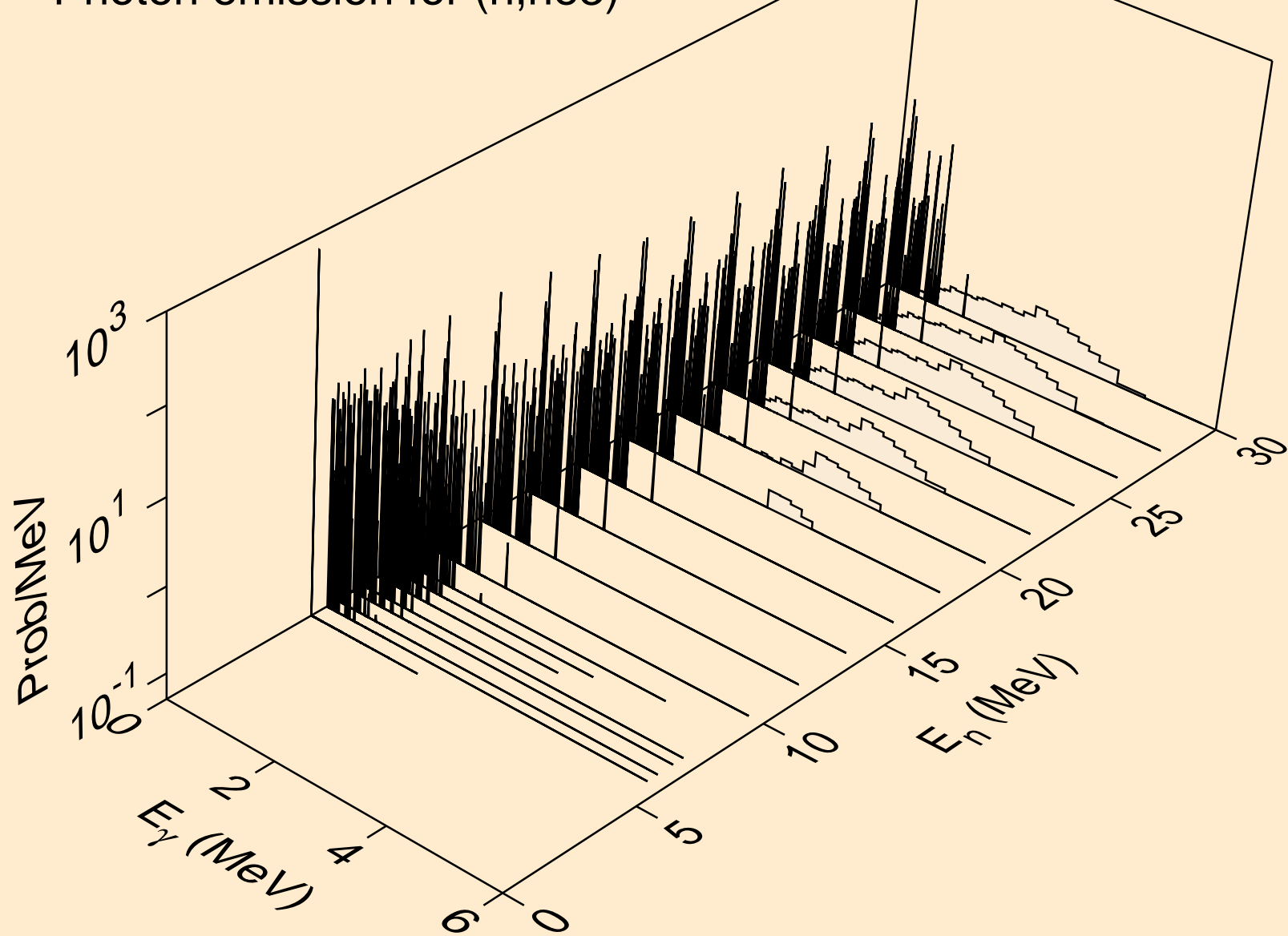

NB086 NEUTRON ACER TENDL-2024 LIBRARY; T=293.6K
Photon emission for (n,a)

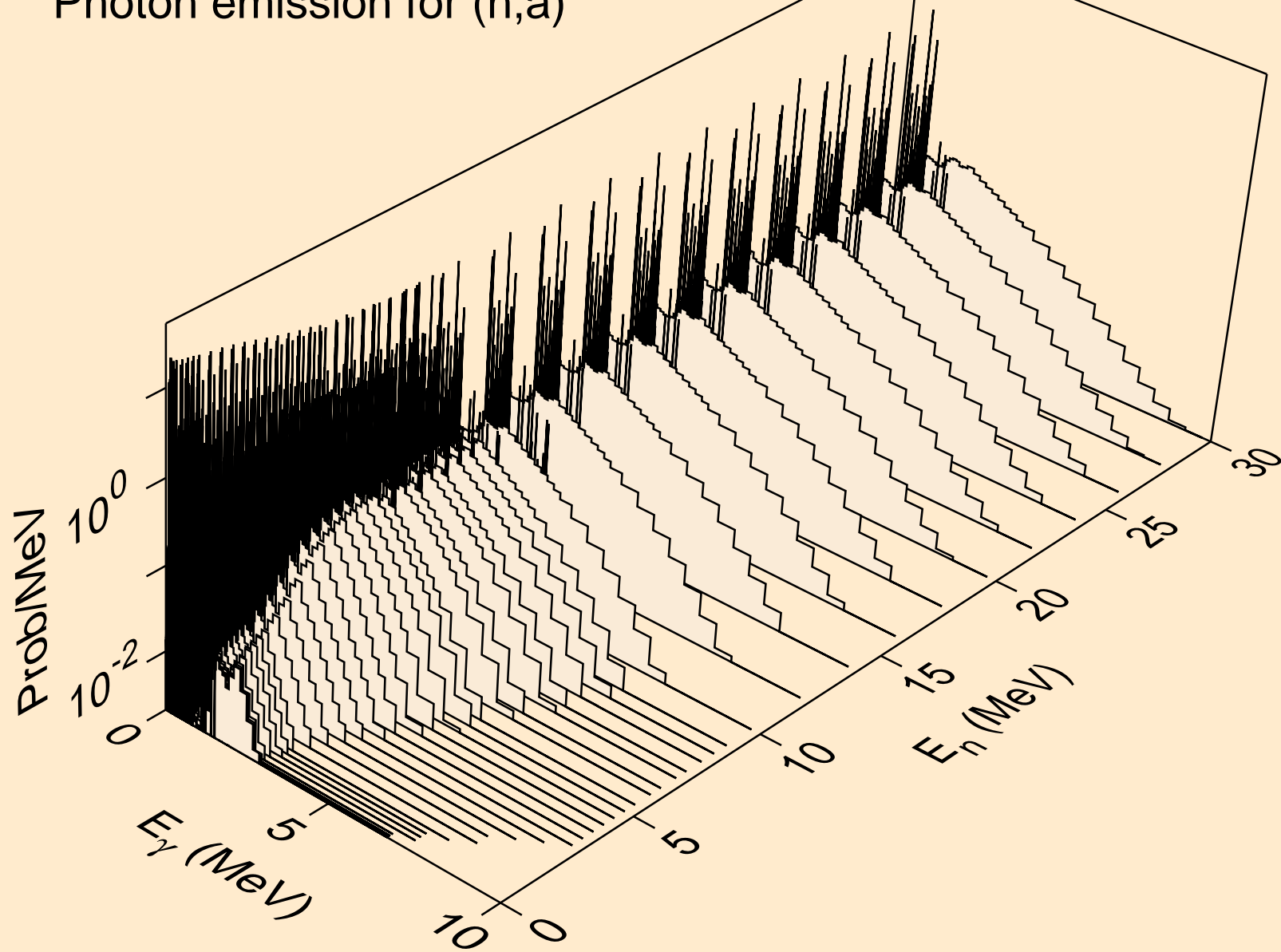

NB086 NEUTRON ACER TENDL-2024 LIBRARY; T=293.6K
Photon emission for (n,2a)

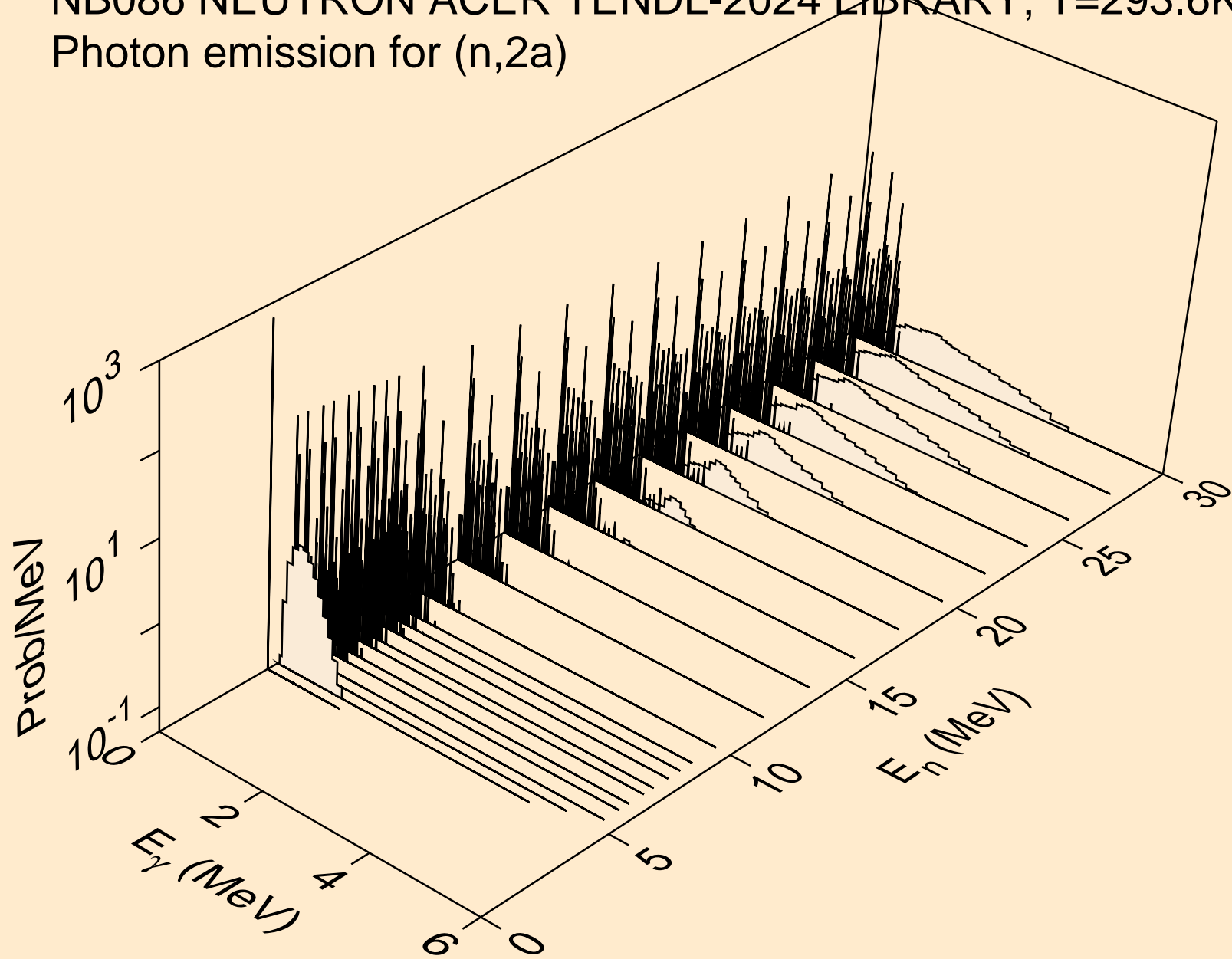

NB086 NEUTRON ACER TENDL-2024 LIBRARY; T=293.6K
Photon emission for (n,3a)

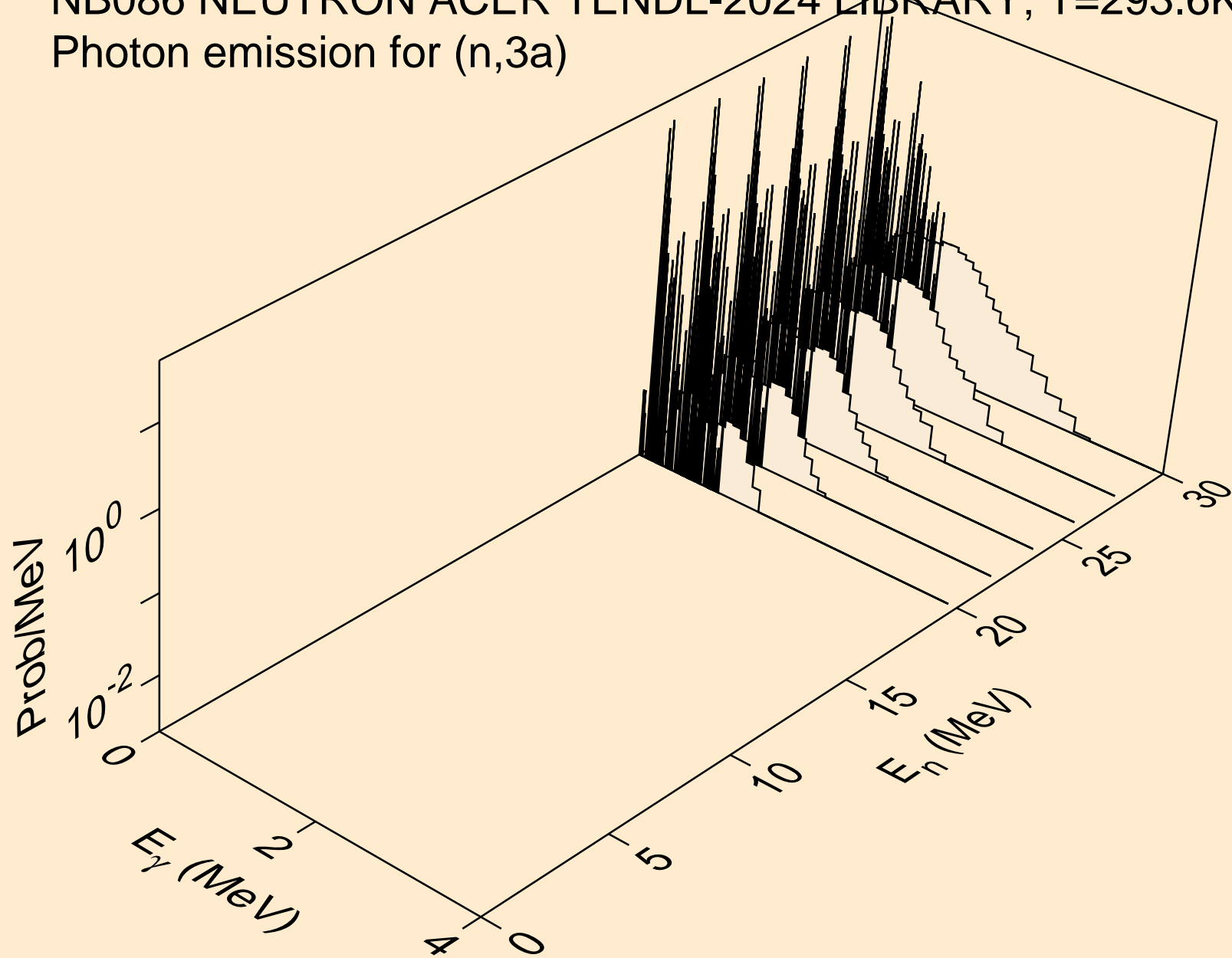

NB086 NEUTRON ACER TENDL-2024 LIBRARY; T=293.6K
Photon emission for (n,2p)

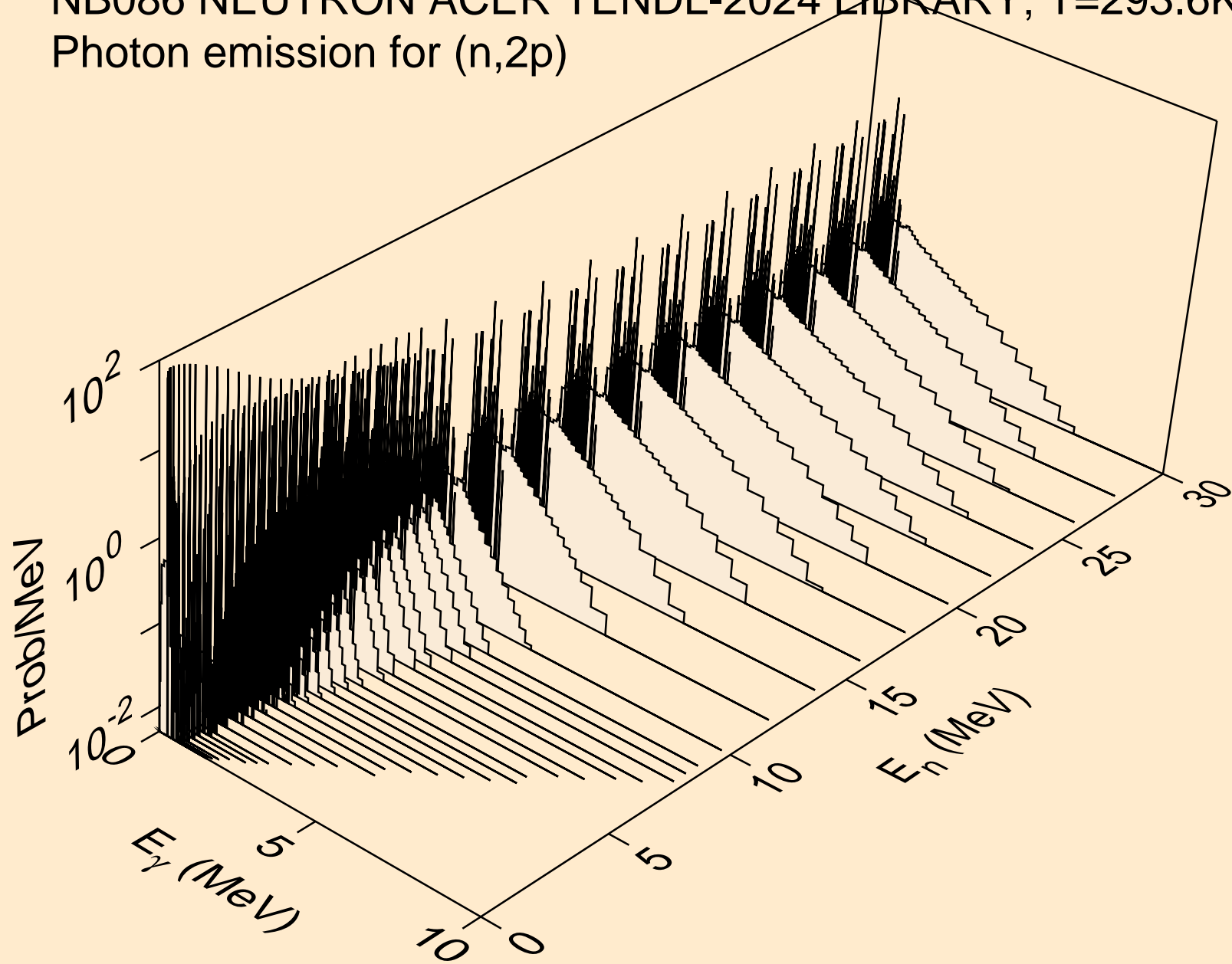

NB086 NEUTRON ACER TENDL-2024 LIBRARY; T=293.6K
Photon emission for (n,p α)

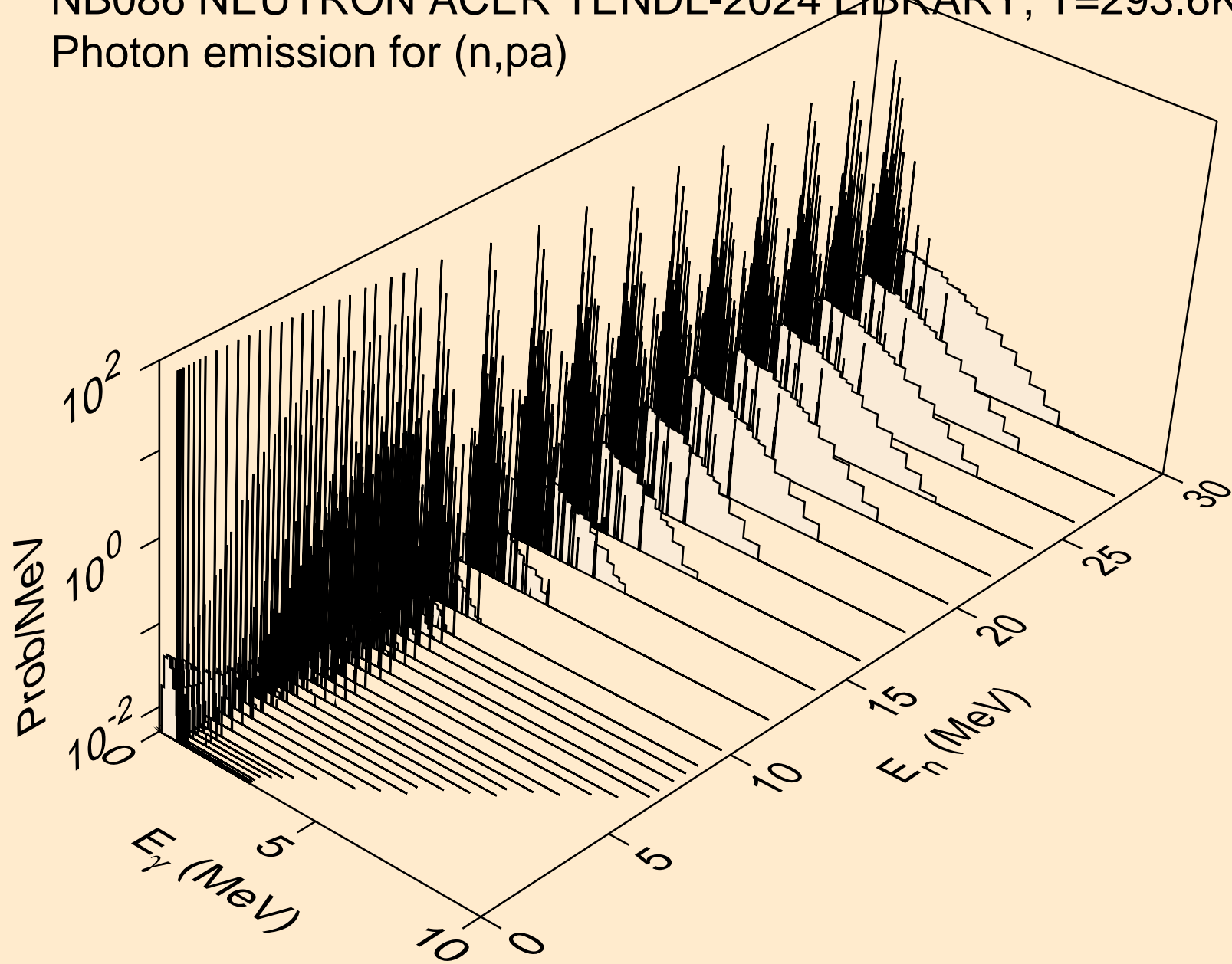

NB086 NEUTRON ACER TENDL-2024 LIBRARY; T=293.6K
Photon emission for (n,pd)

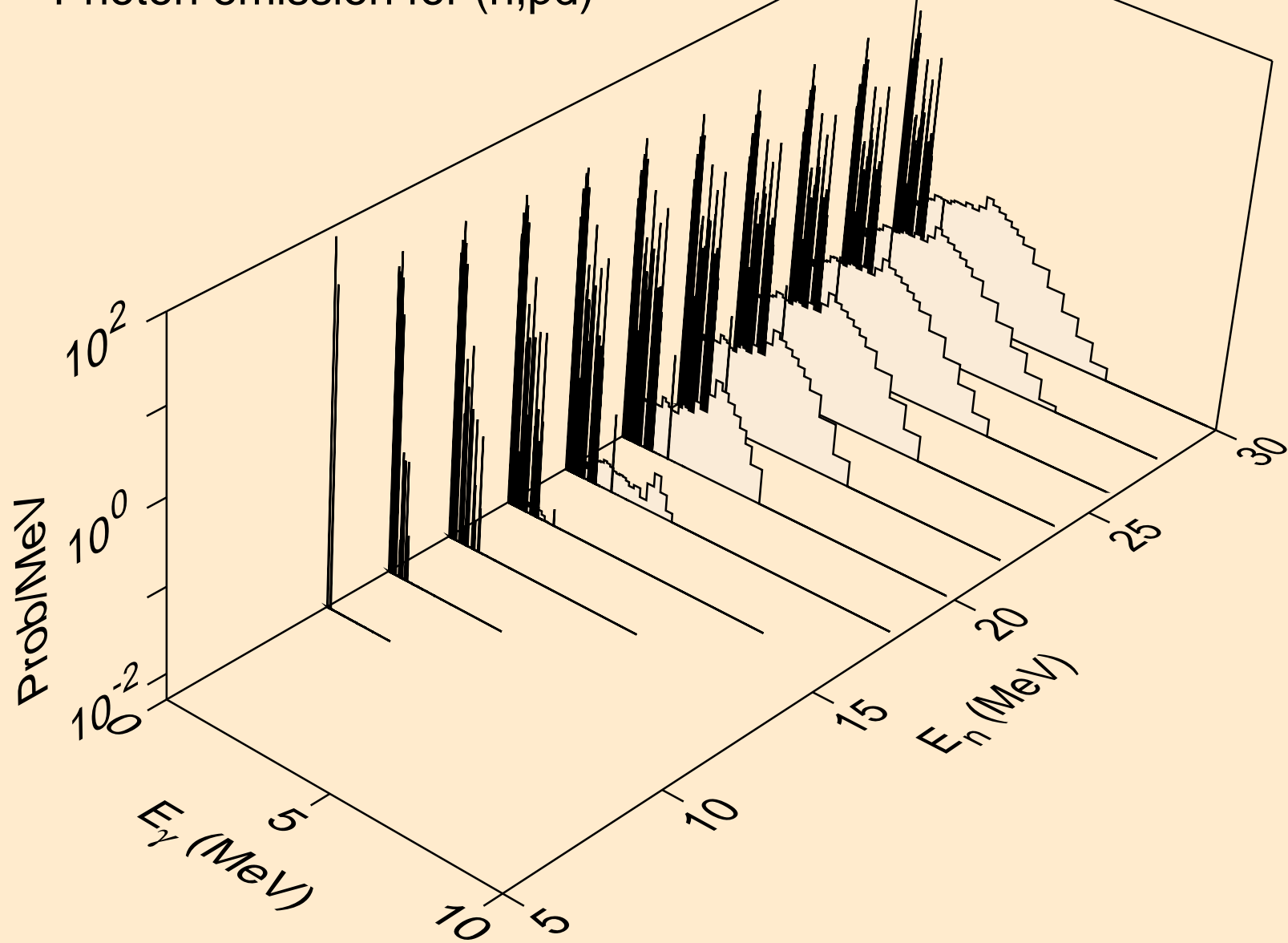

NB086 NEUTRON ACER TENDL-2024 LIBRARY; T=293.6K
Photon emission for (n,pt)

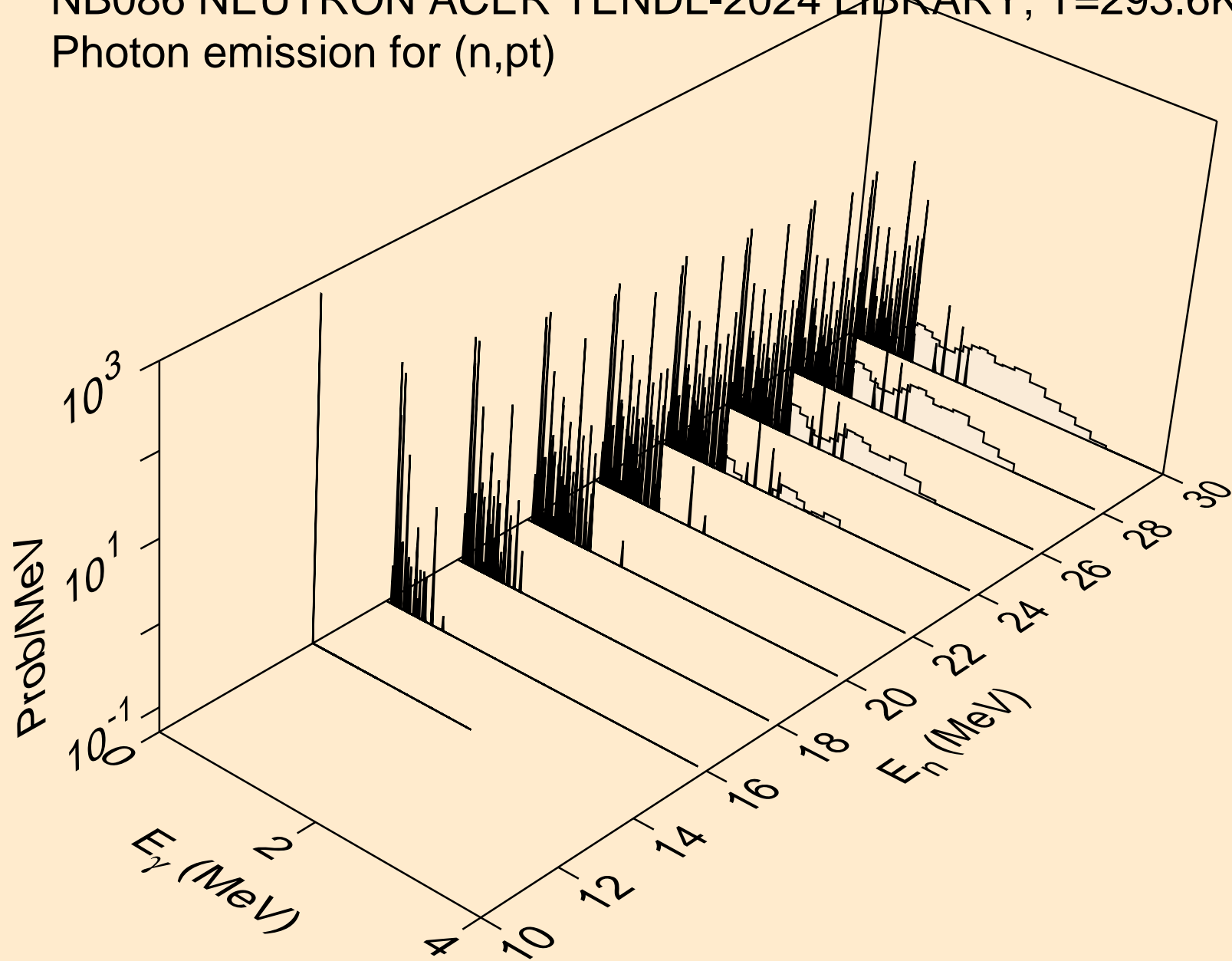

NB086 NEUTRON ACER TENDL-2024 LIBRARY; T=293.6K
Photon emission for (n,da)

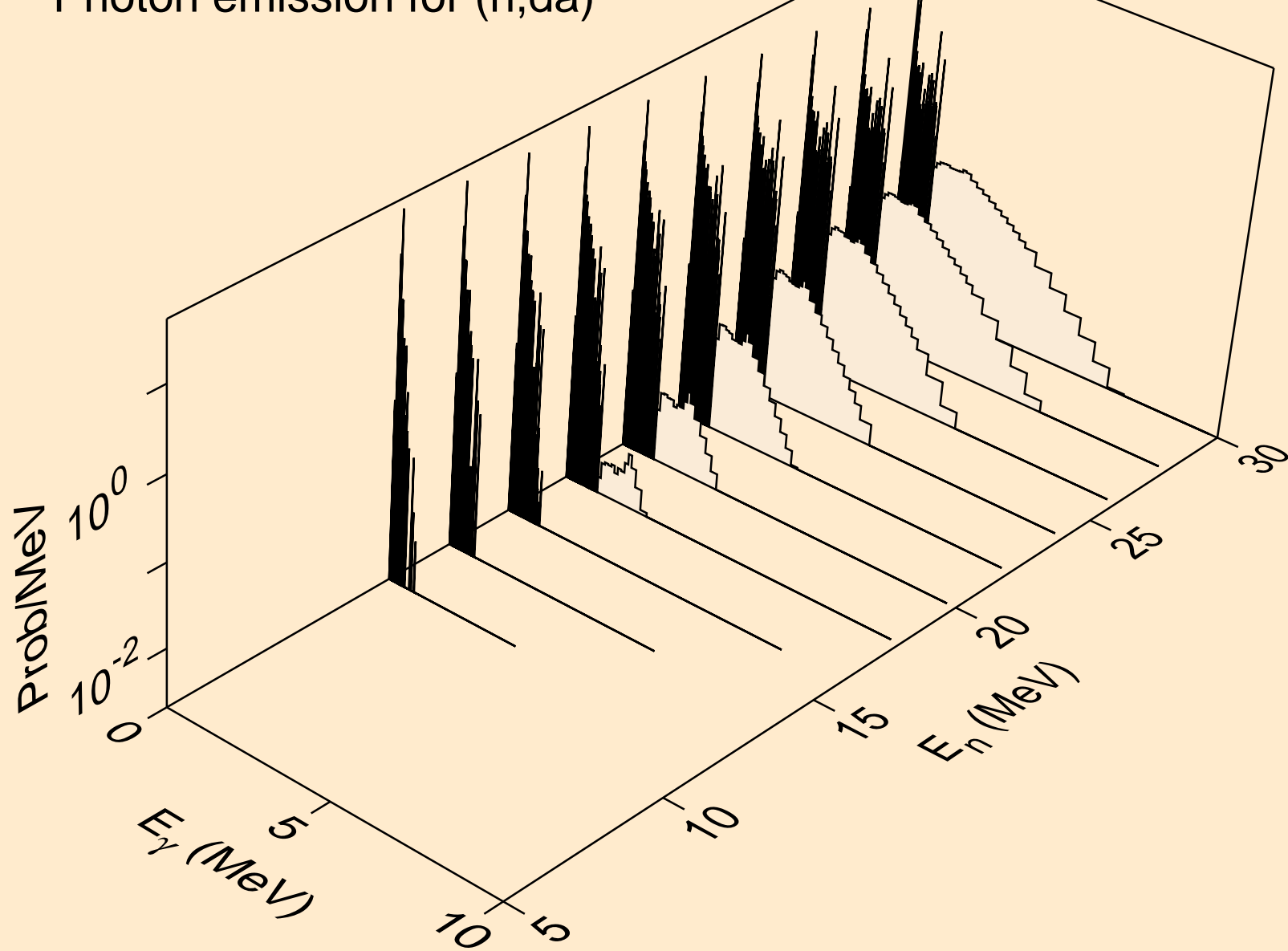

NB086 NEUTRON ACER TENDL-2024 LIBRARY; T=293.6K
thermal capture photon spectrum

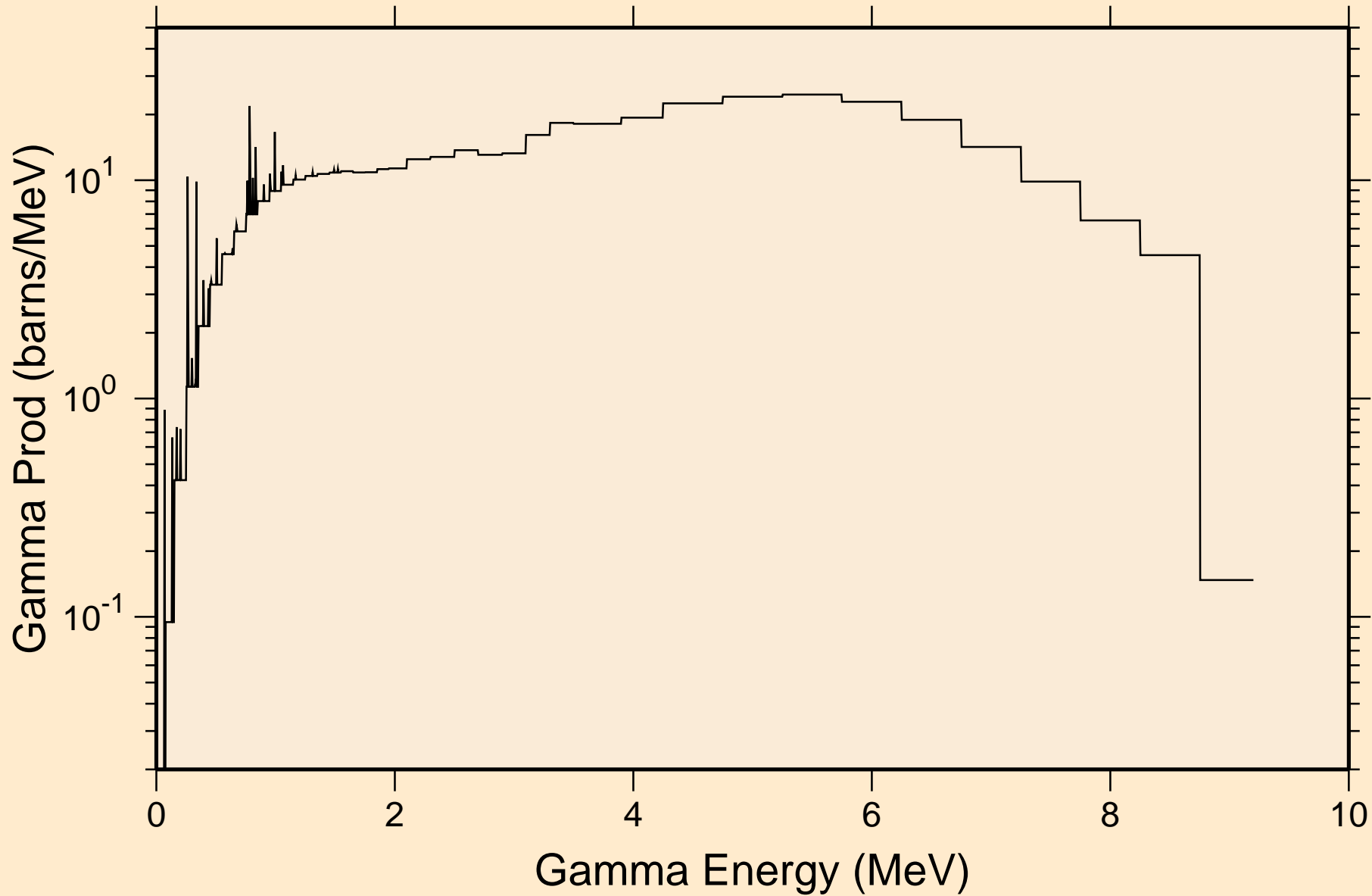

NB086 NEUTRON ACER TENDL-2024 LIBRARY; T=293.6K
14 MeV photon spectrum

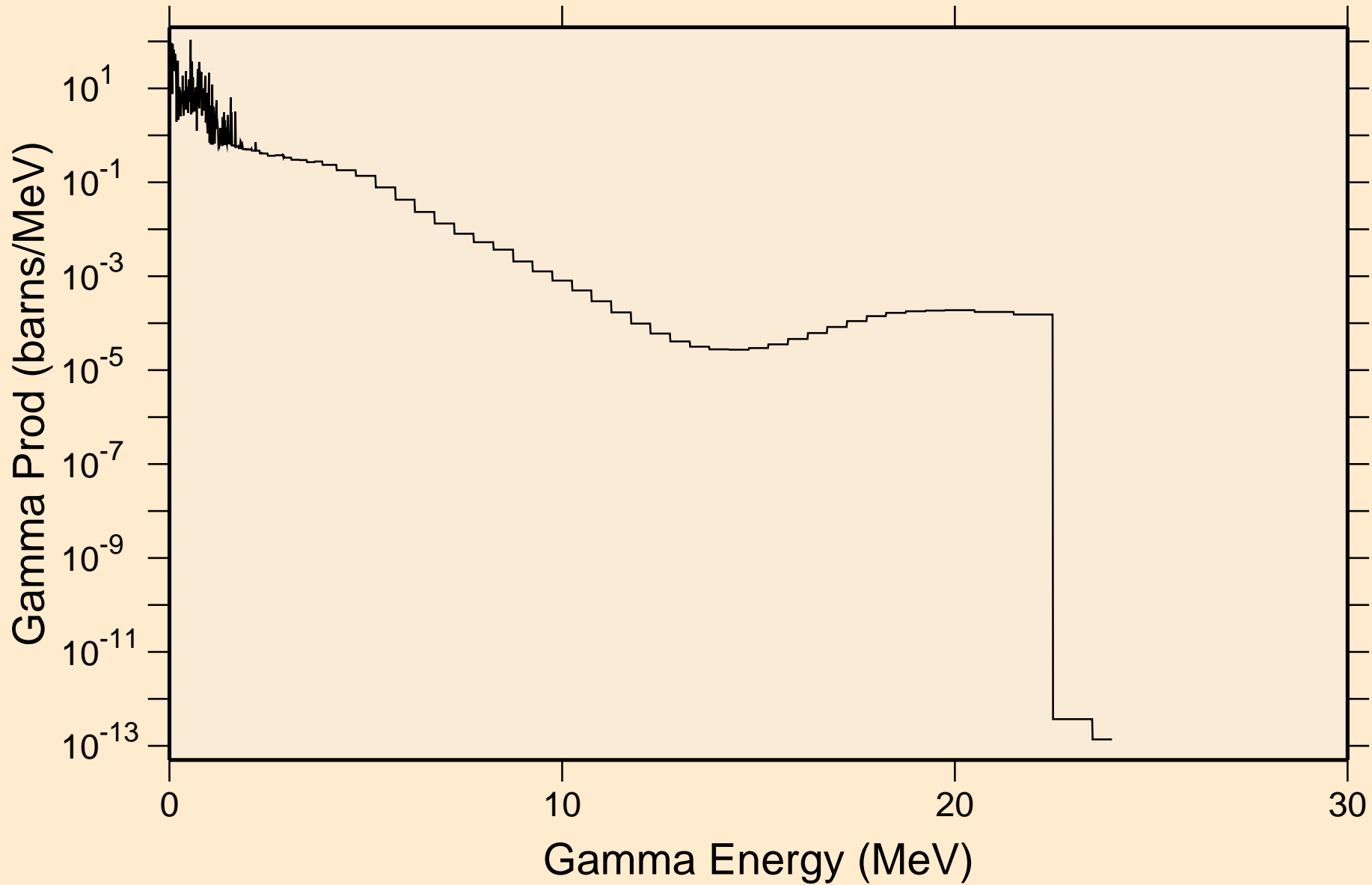

NB086 NEUTRON ACER TENDL-2024 LIBRARY; T=293.6K

Particle heating contributions

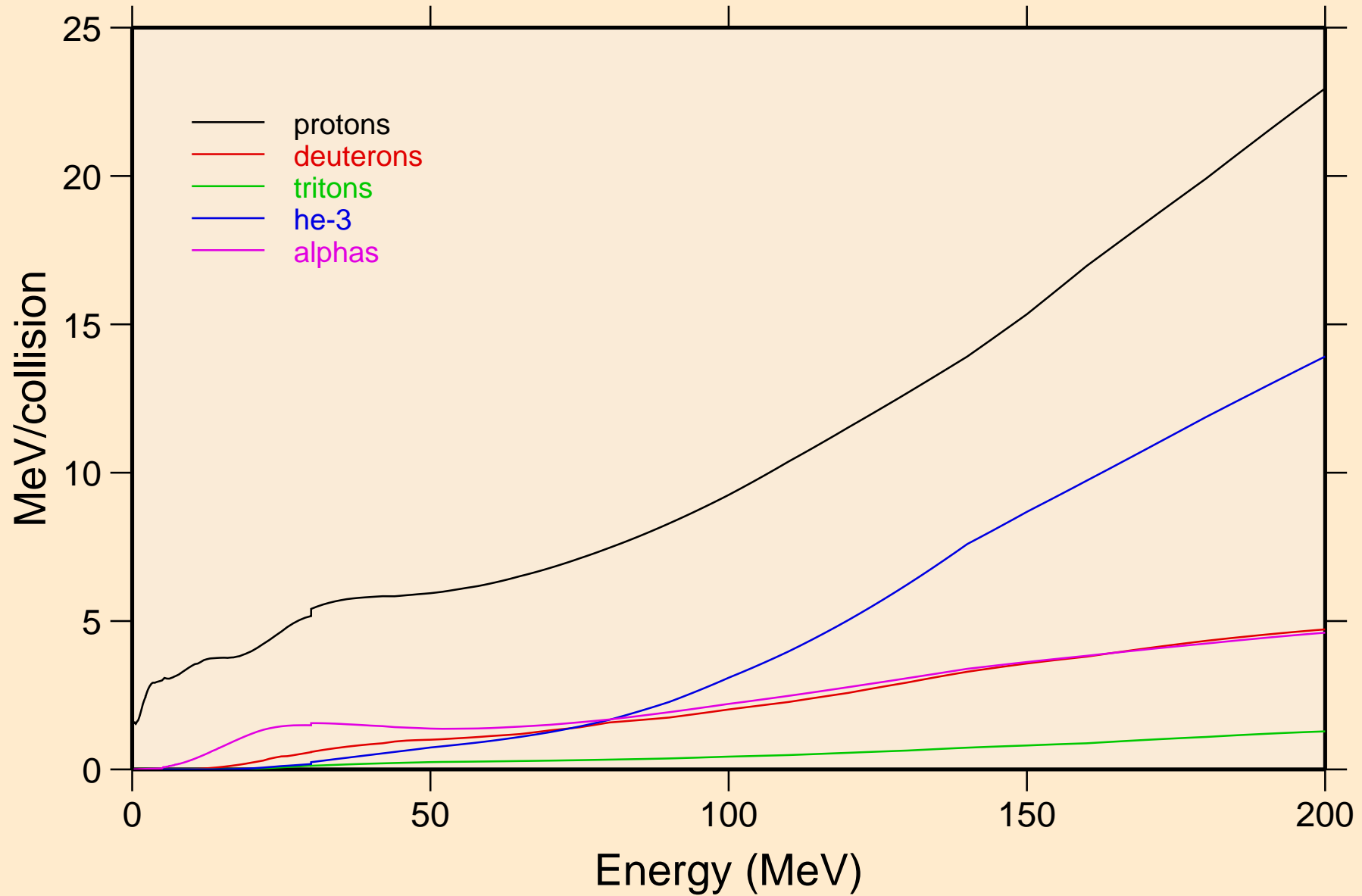

NB086 NEUTRON ACER TENDL-2024 LIBRARY; T=293.6K
Recoil Heating

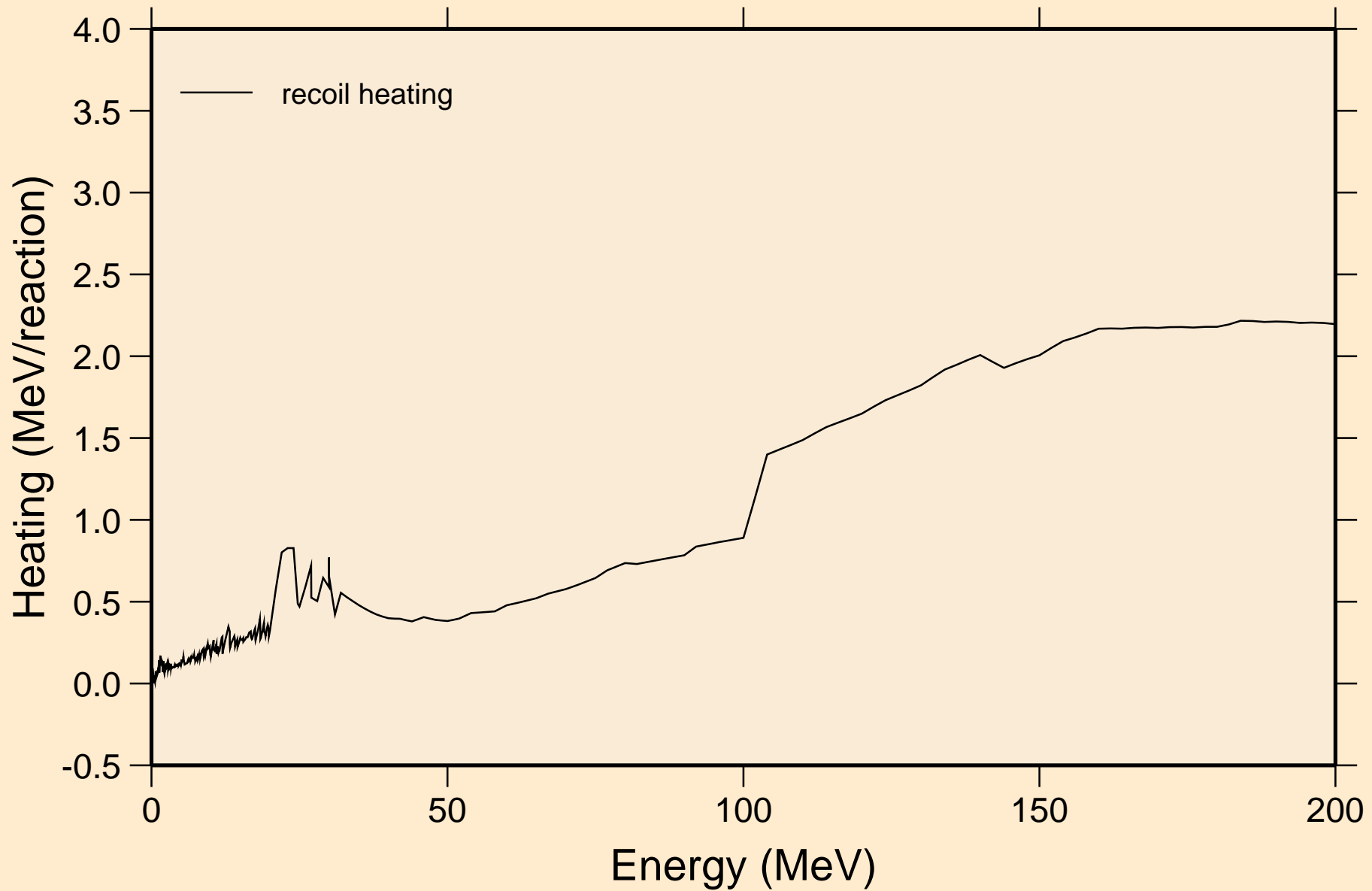

NB086 NEUTRON ACER TENDL-2024 LIBRARY; T=293.6K
Particle production cross sections

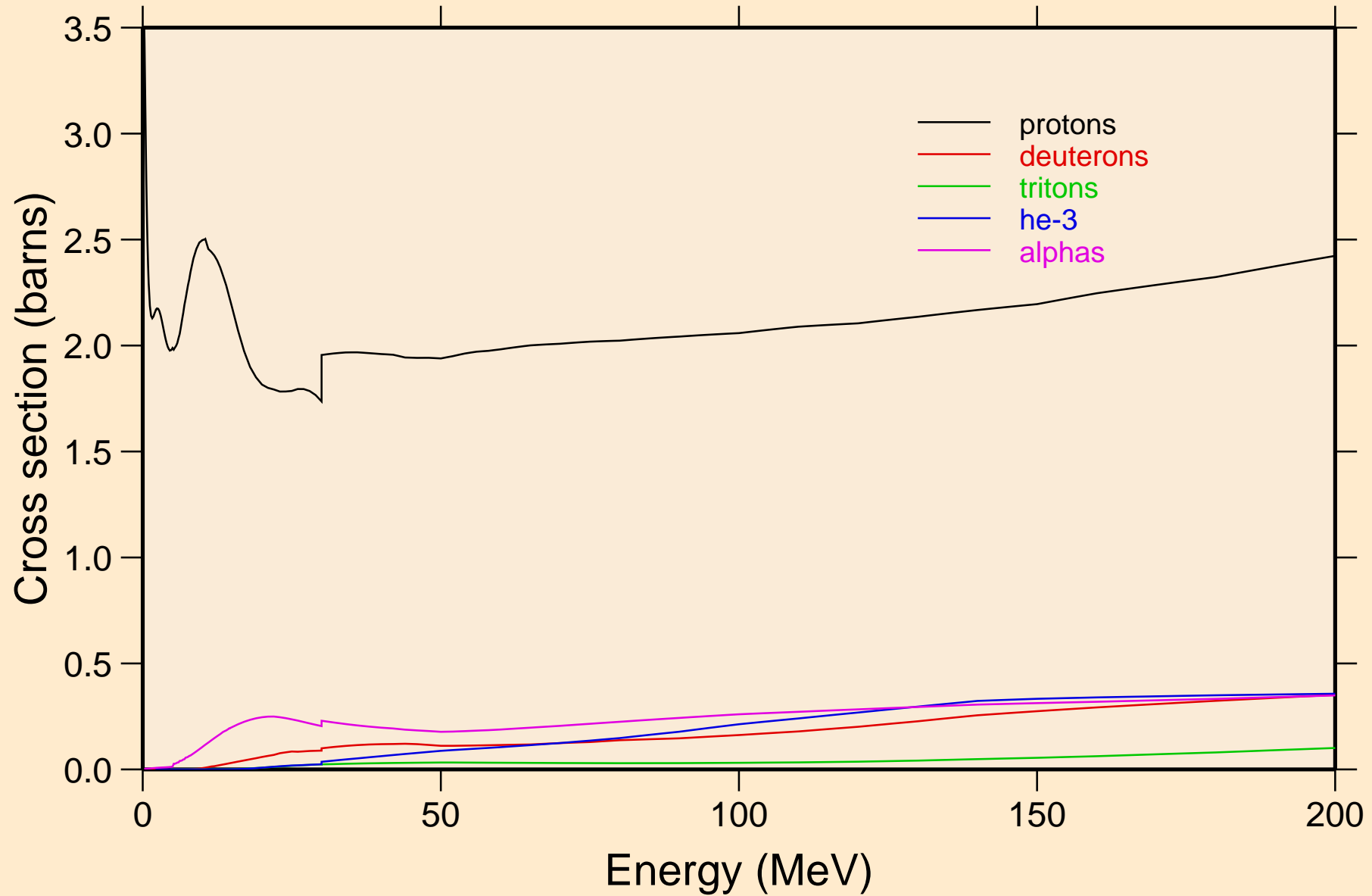

NB086 NEUTRON ACER TENDL-2024 LIBRARY; T=293.6K
protons from (n,x)

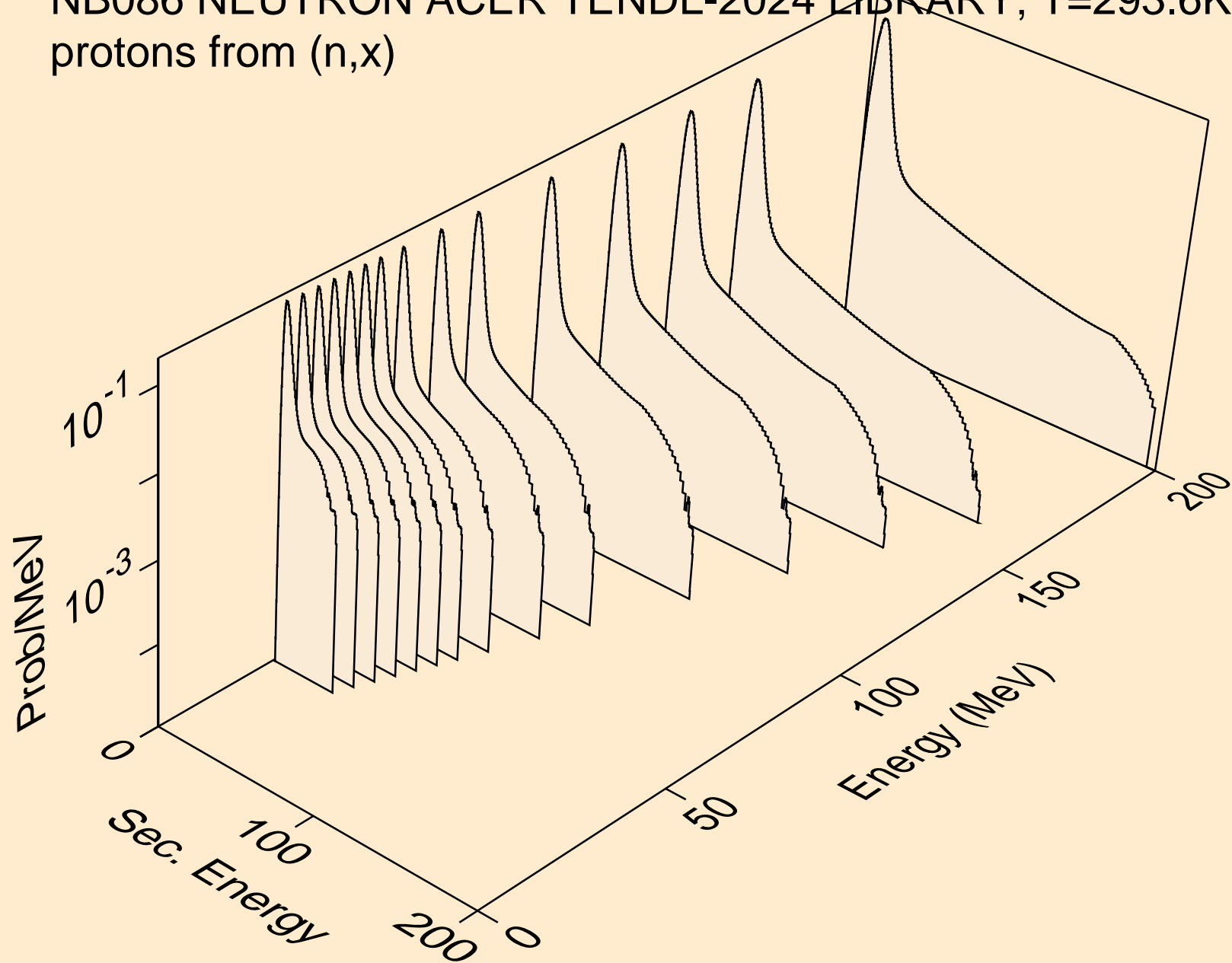

NB086 NEUTRON ACER TENDL-2024 LIBRARY; T=293.6K
protons from (n,n*)p

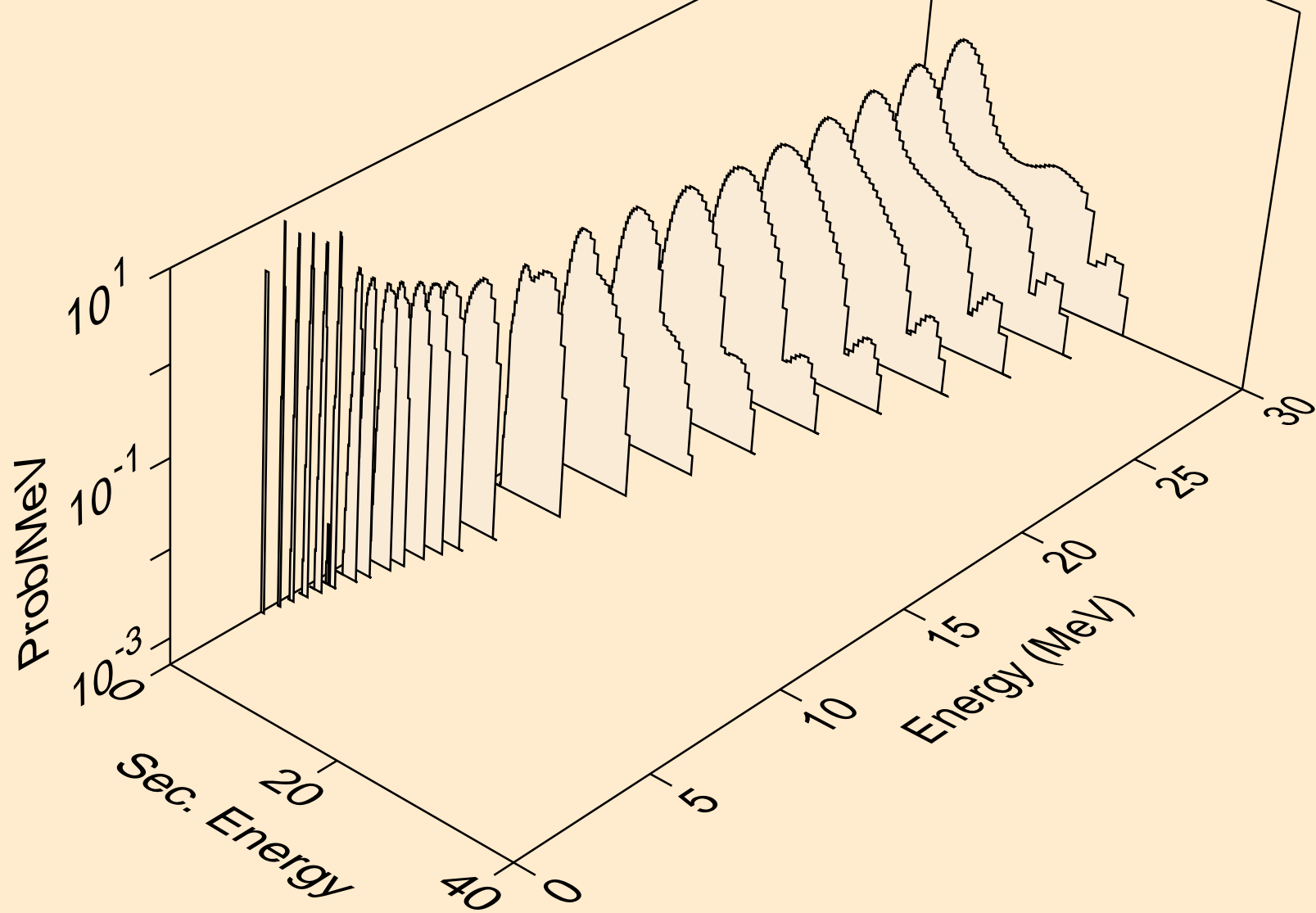

NB086 NEUTRON ACER TENDL-2024 LIBRARY; T=293.6K
protons from (n,2np)

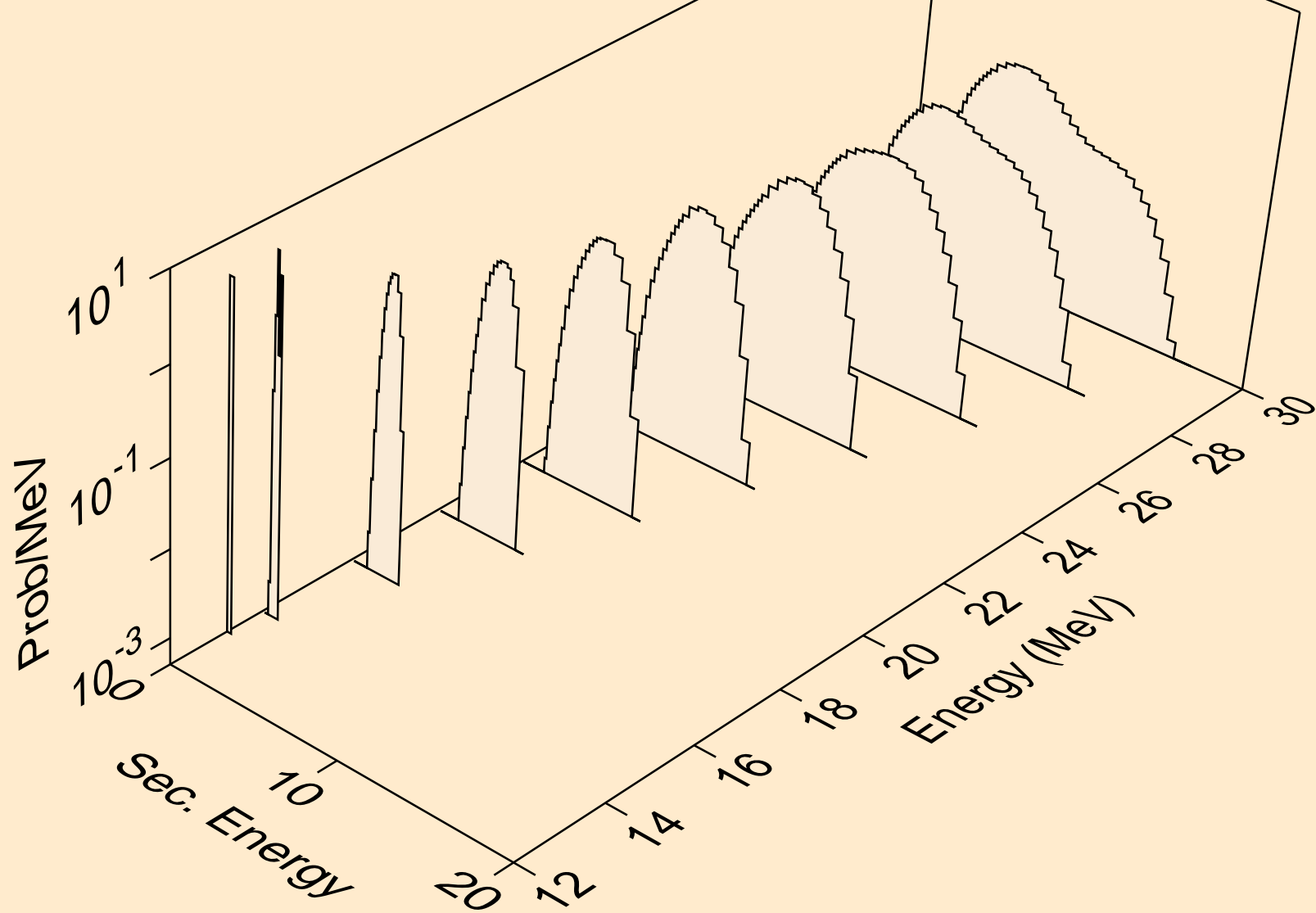

NB086 NEUTRON ACER TENDL-2024 LIBRARY; T=293.6K
protons from (n,3np)

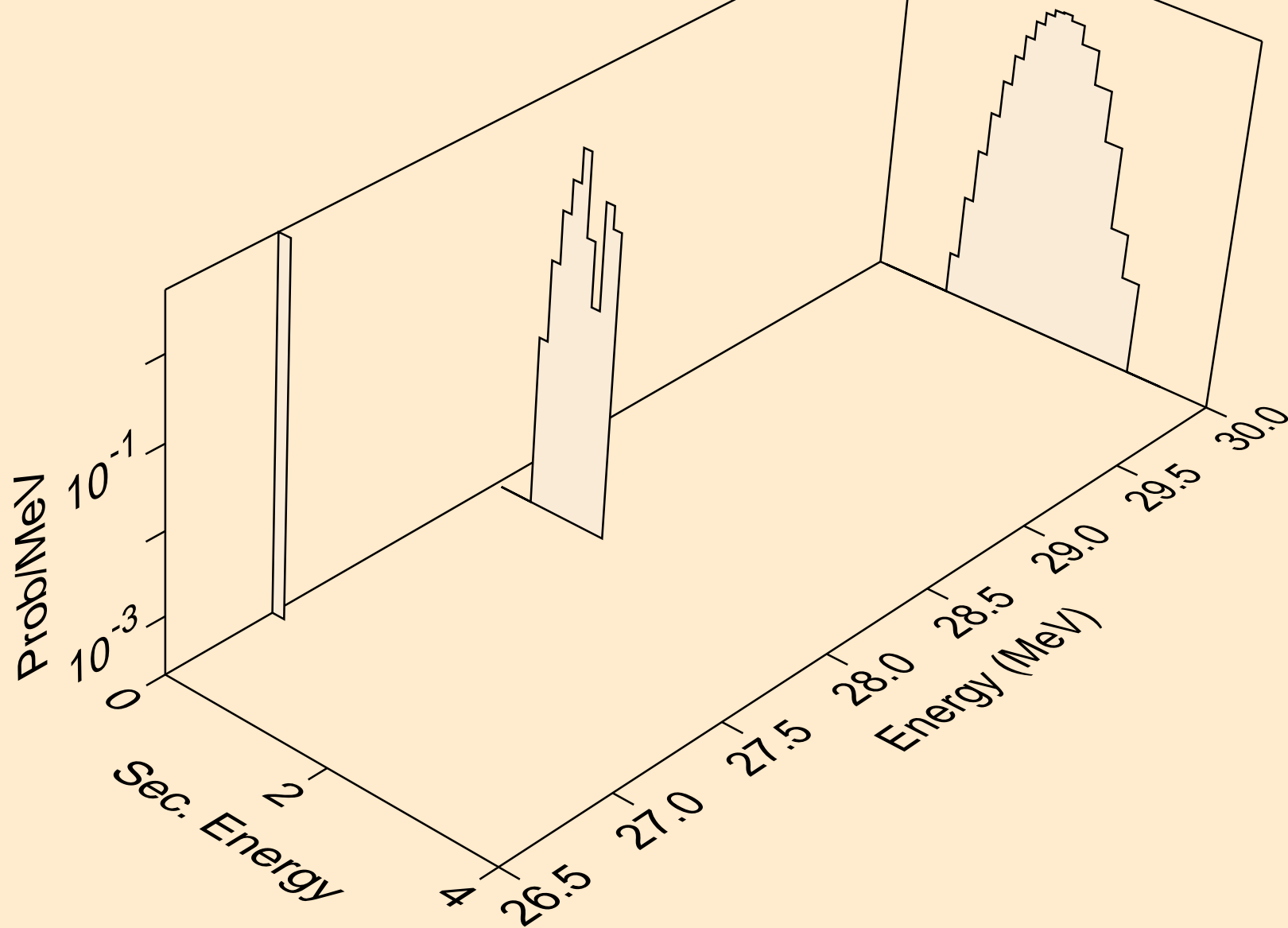

NB086 NEUTRON ACER TENDL-2024 LIBRARY; T=293.6K
protons from (n,n2p)

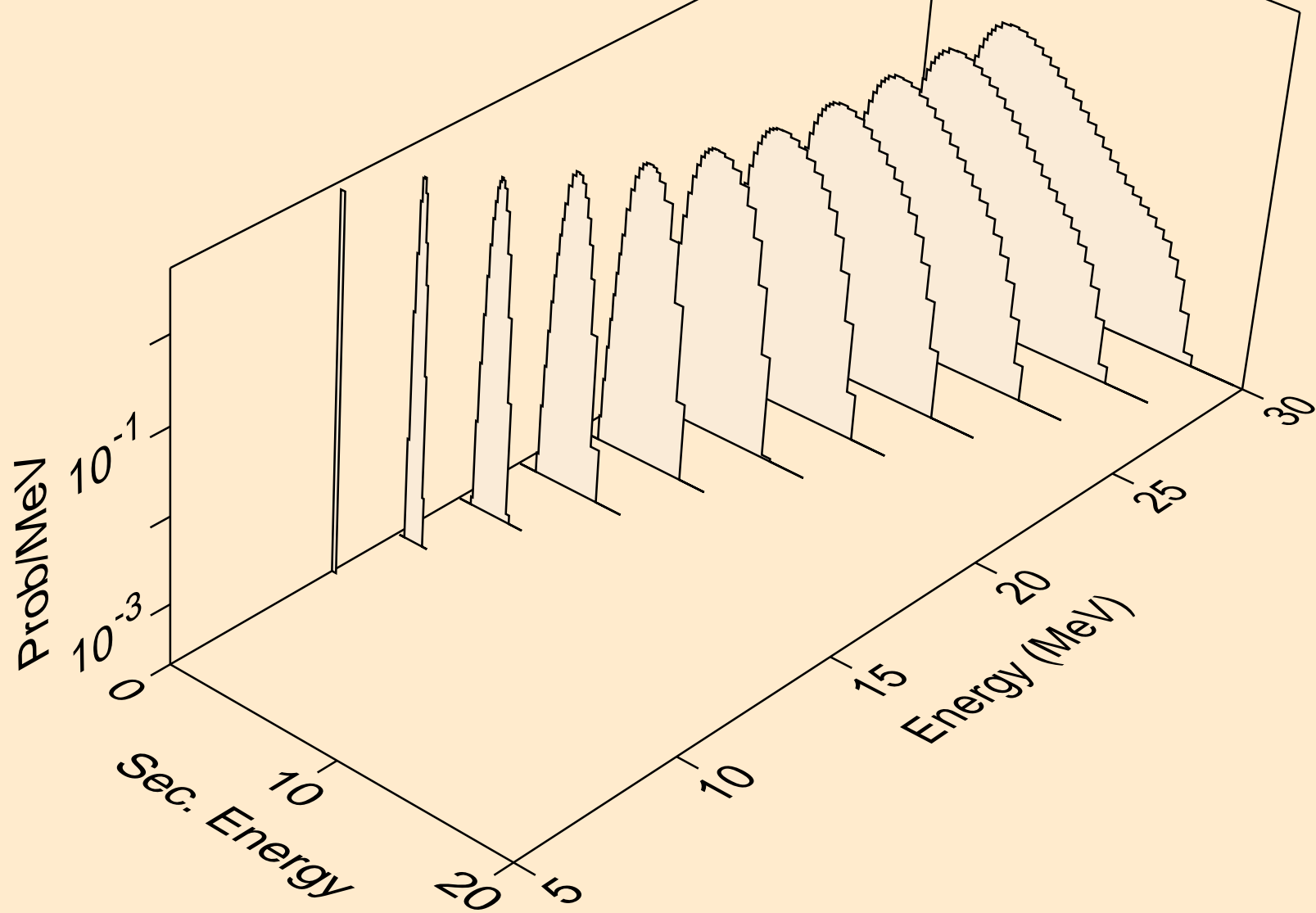

NB086 NEUTRON ACER TENDL-2024 LIBRARY; T=293.6K
protons from (n,npa)

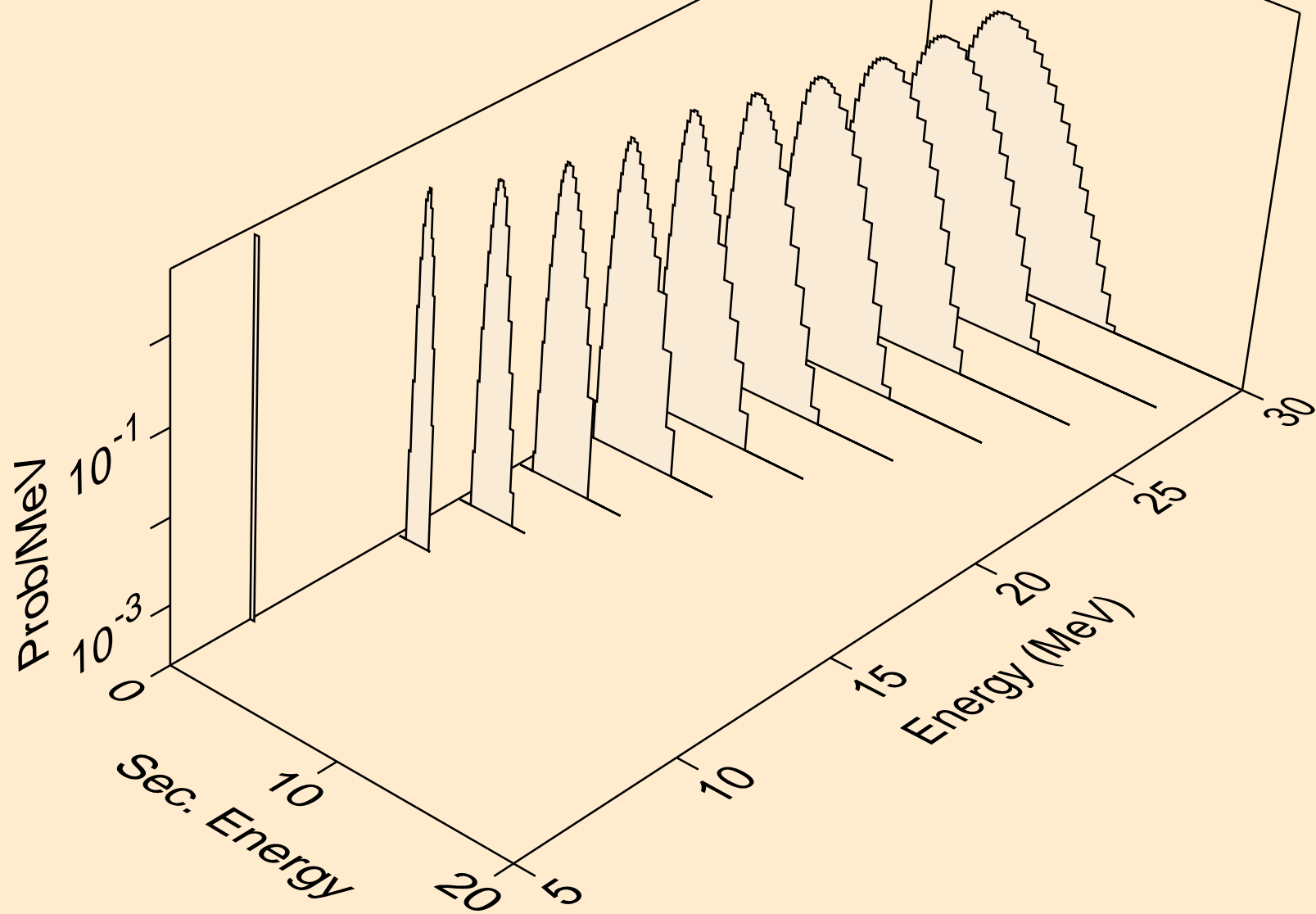

NB086 NEUTRON ACER TENDL-2024 LIBRARY; T=293.6K
protons from (n,p)

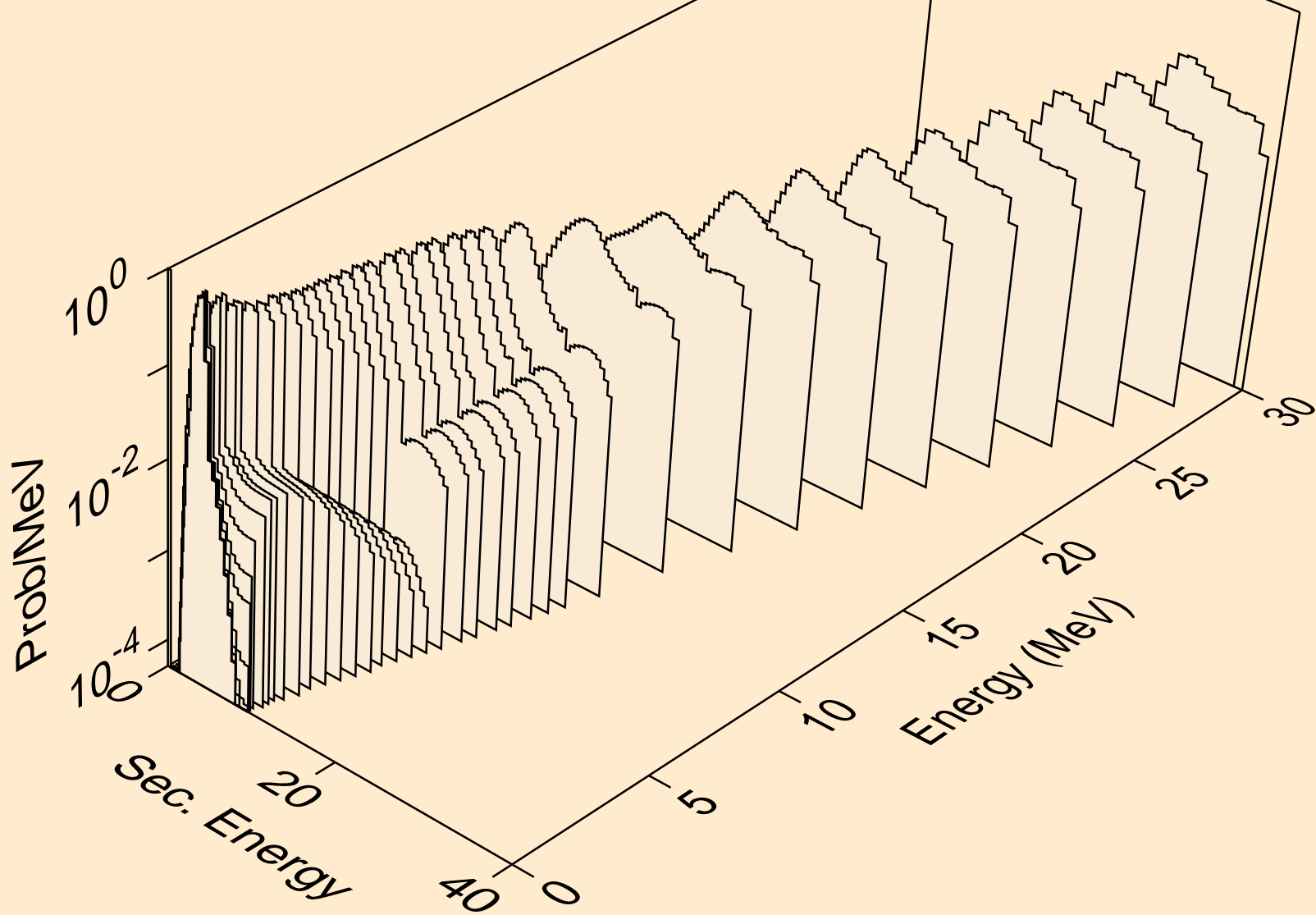

NB086 NEUTRON ACER TENDL-2024 LIBRARY; T=293.6K
protons from (n,2p)

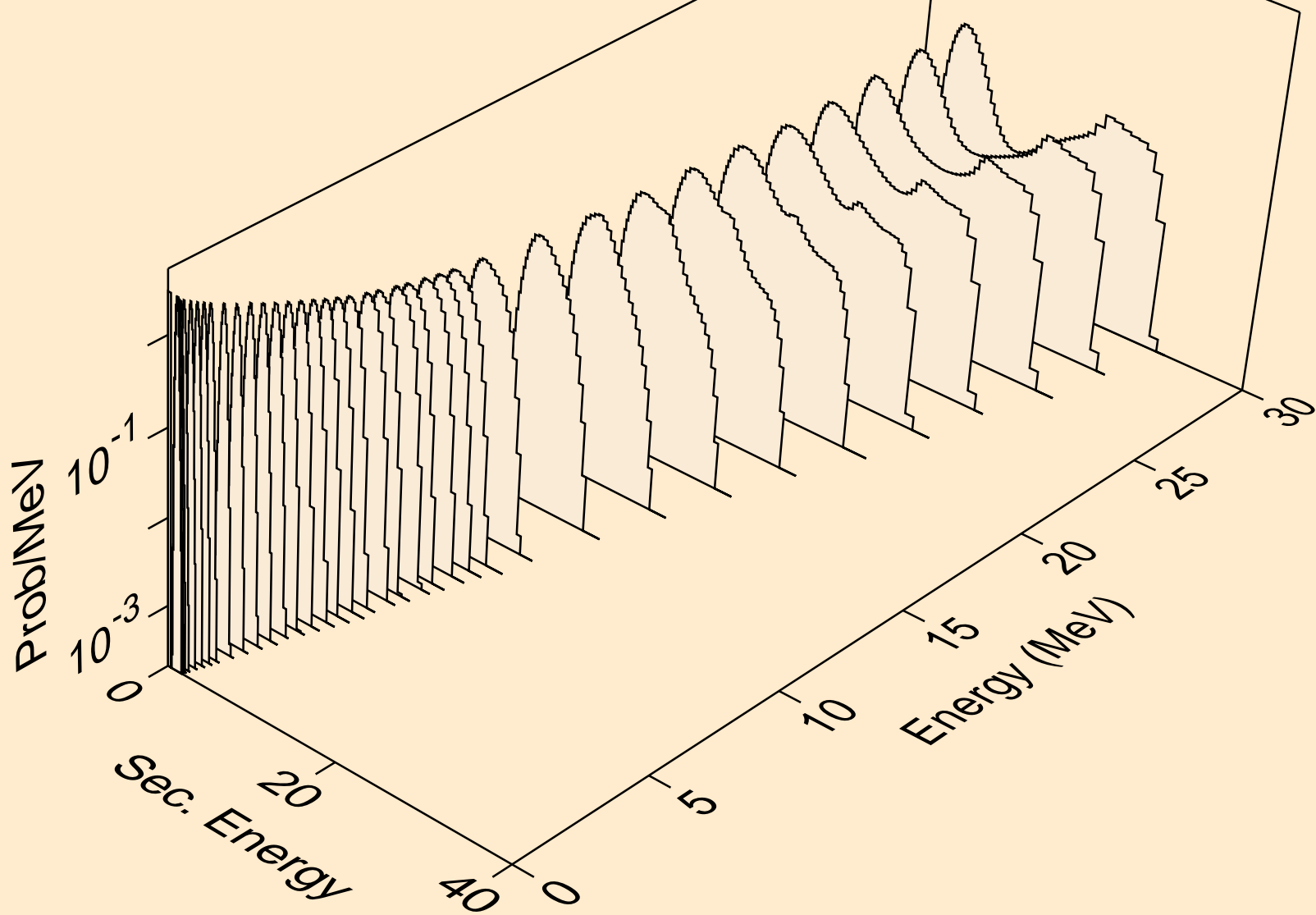

NB086 NEUTRON ACER TENDL-2024 LIBRARY; T=293.6K
protons from (n,p)

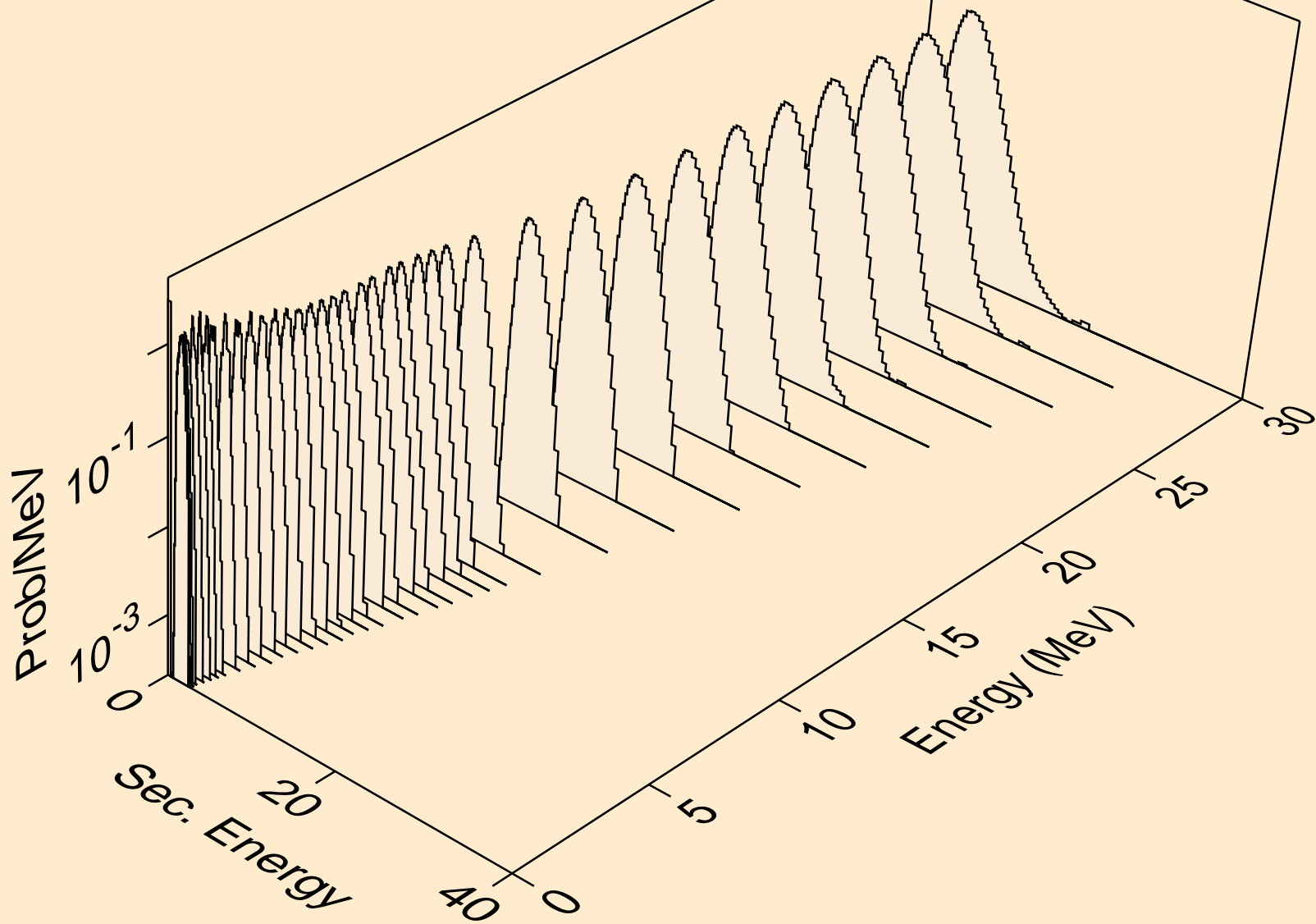

NB086 NEUTRON ACER TENDL-2024 LIBRARY; T=293.6K
protons from (n,pd)

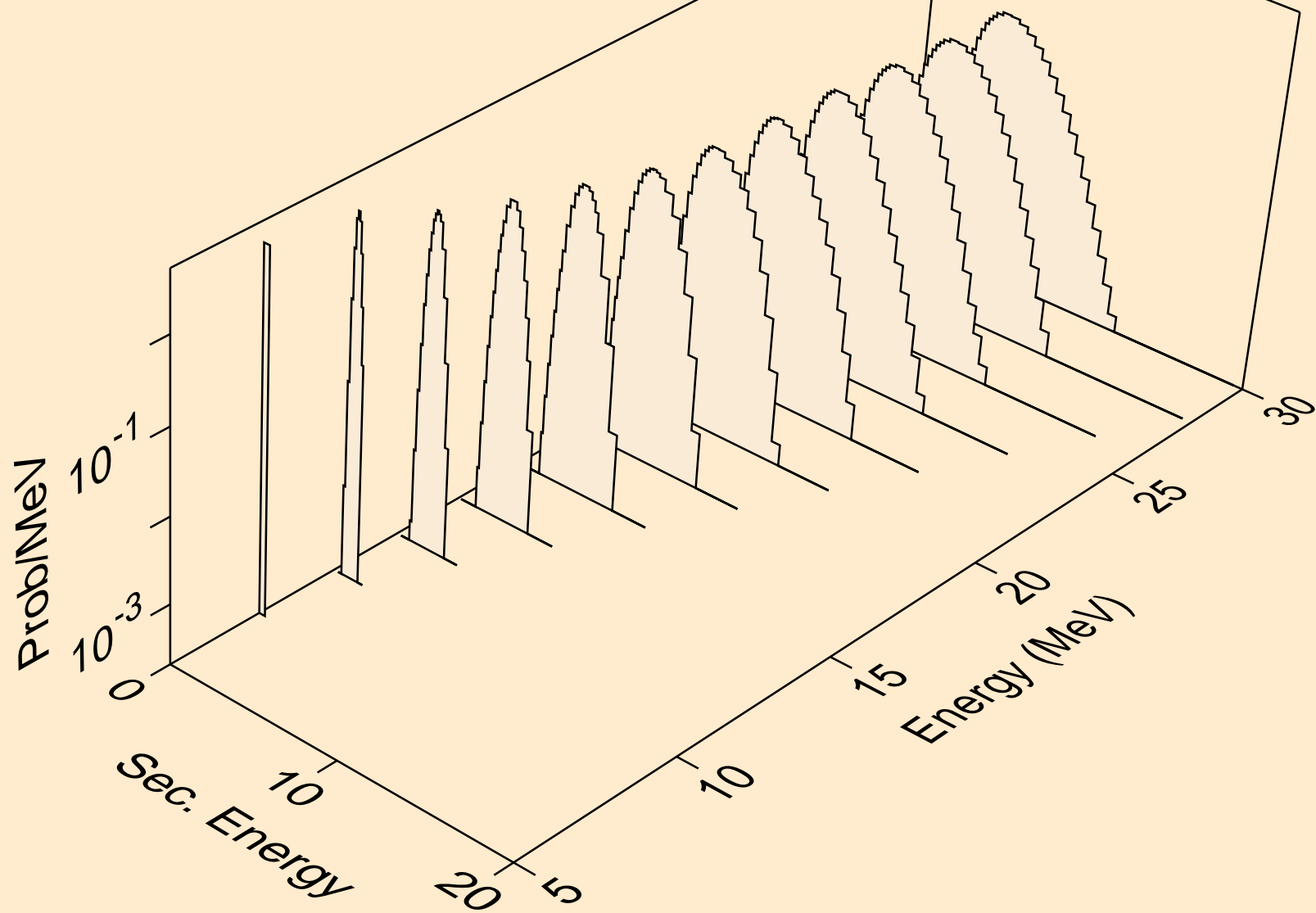

NB086 NEUTRON ACER TENDL-2024 LIBRARY; T=293.6K
protons from (n,pt)

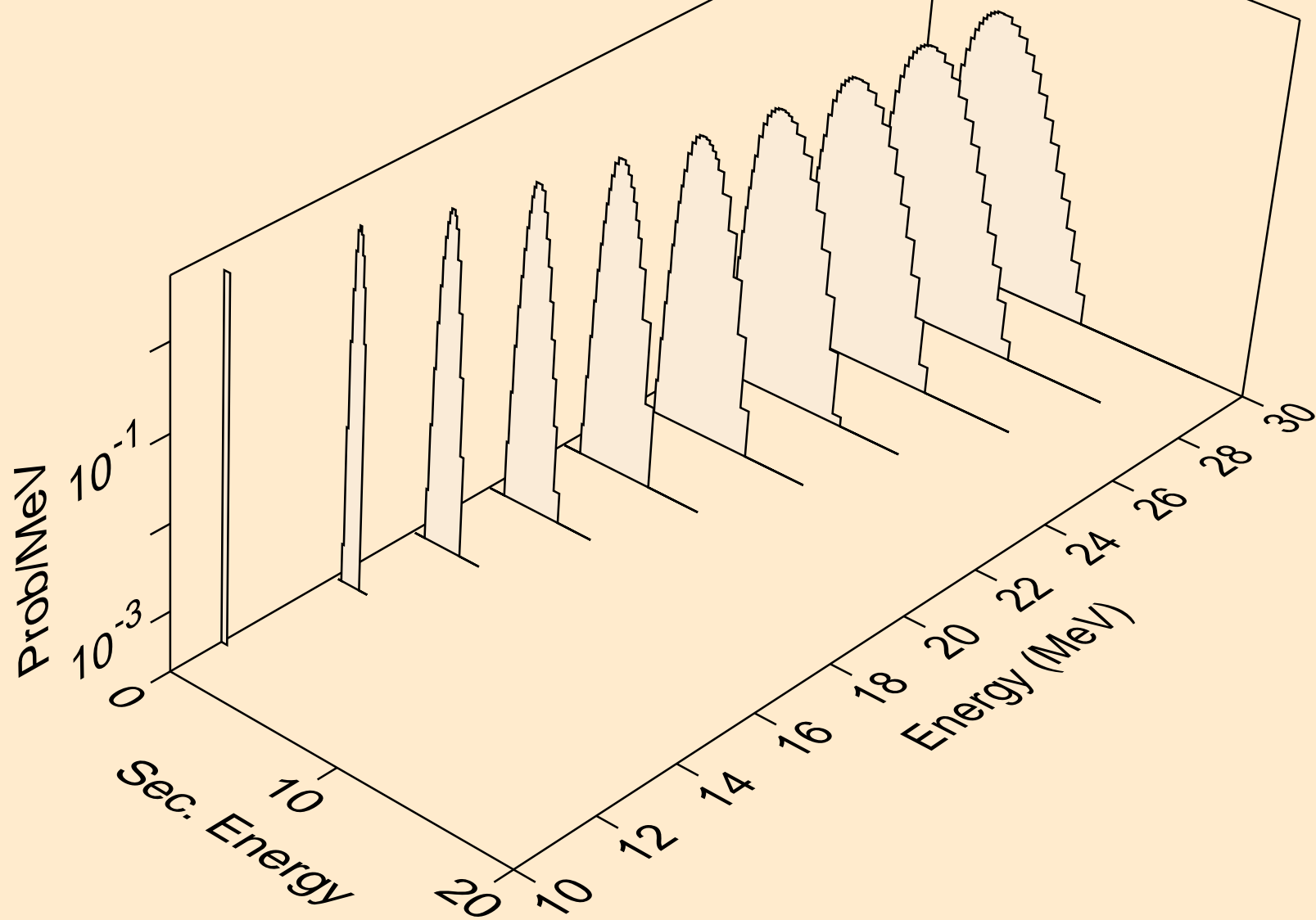

NB086 NEUTRON ACER TENDL-2024 LIBRARY; T=293.6K
deuterons from (n,x)

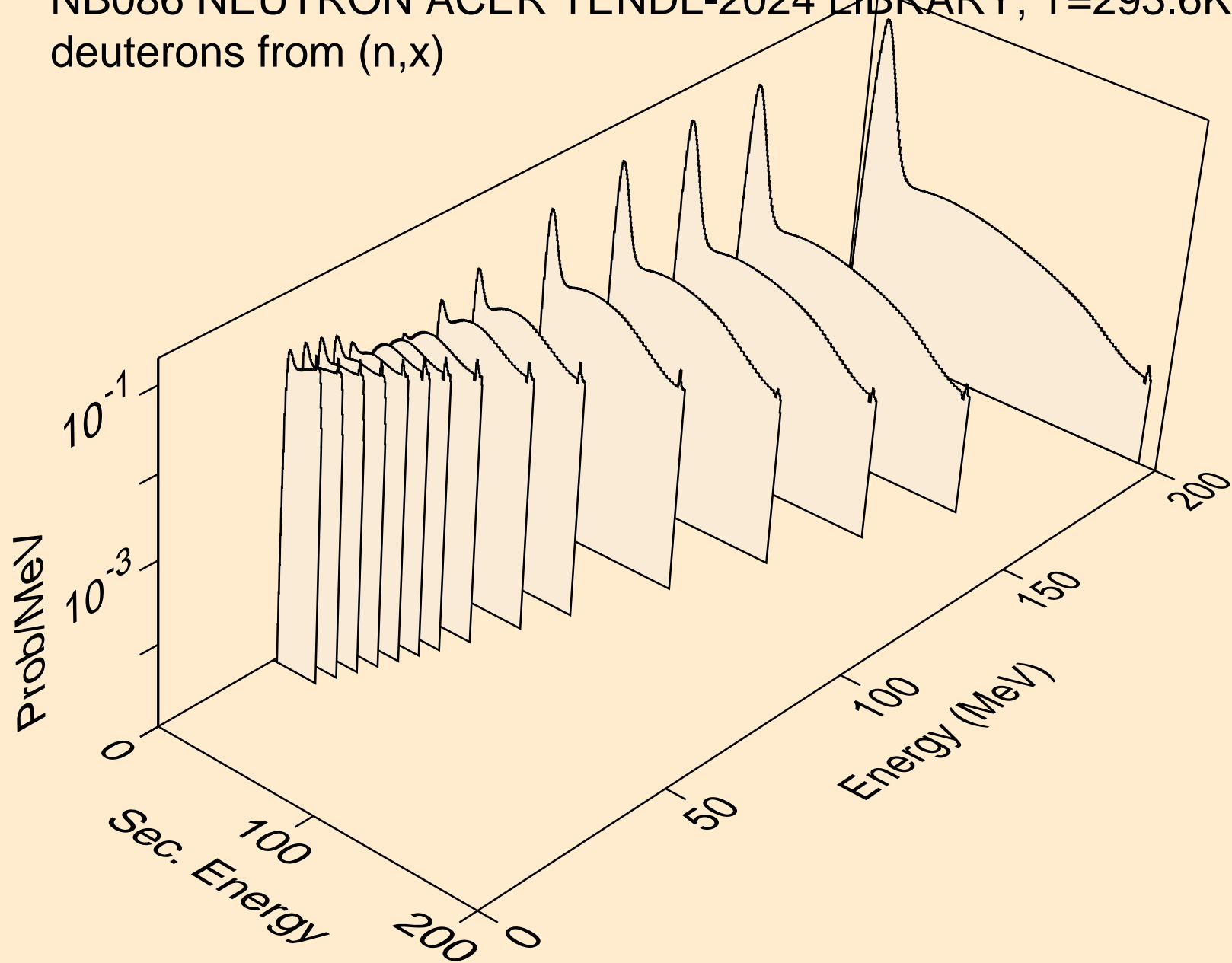

NB086 NEUTRON ACER TENDL-2024 LIBRARY; T=293.6K
deuterons from (n,2nd)

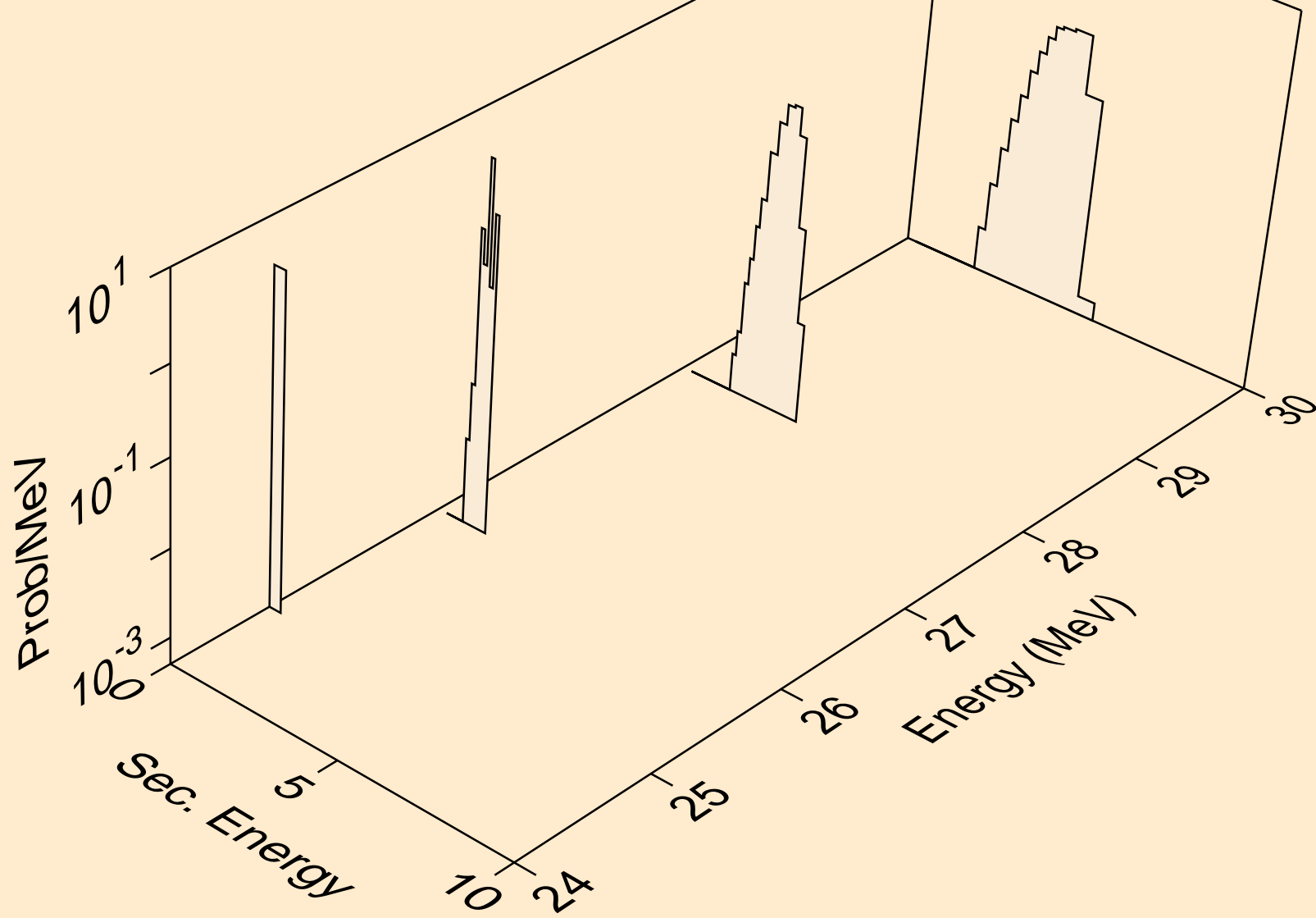

NB086 NEUTRON ACER TENDL-2024 LIBRARY; T=293.6K
deuterons from (n,n*)d

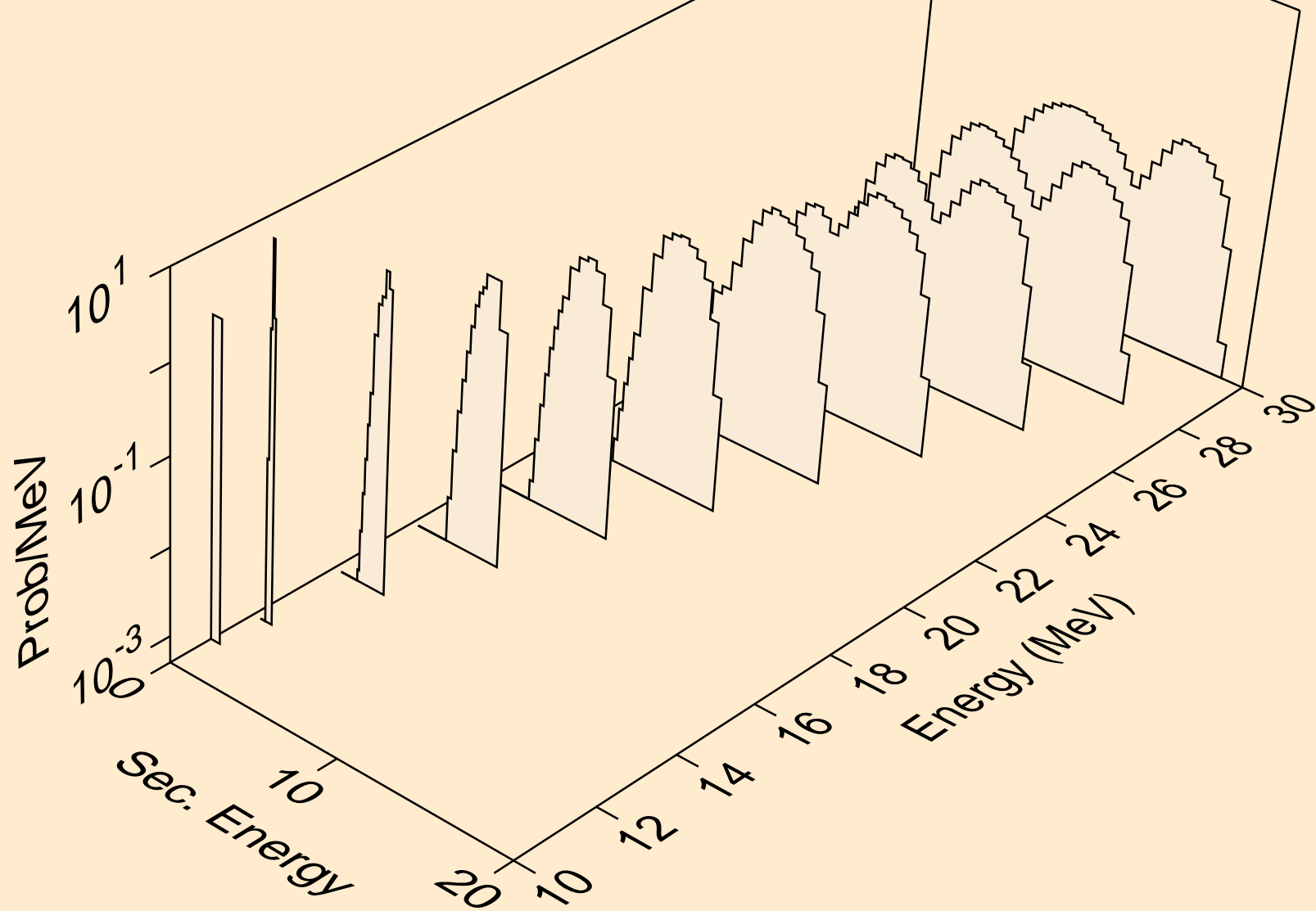

NB086 NEUTRON ACER TENDL-2024 LIBRARY; T=293.6K
deuterons from (n,d)

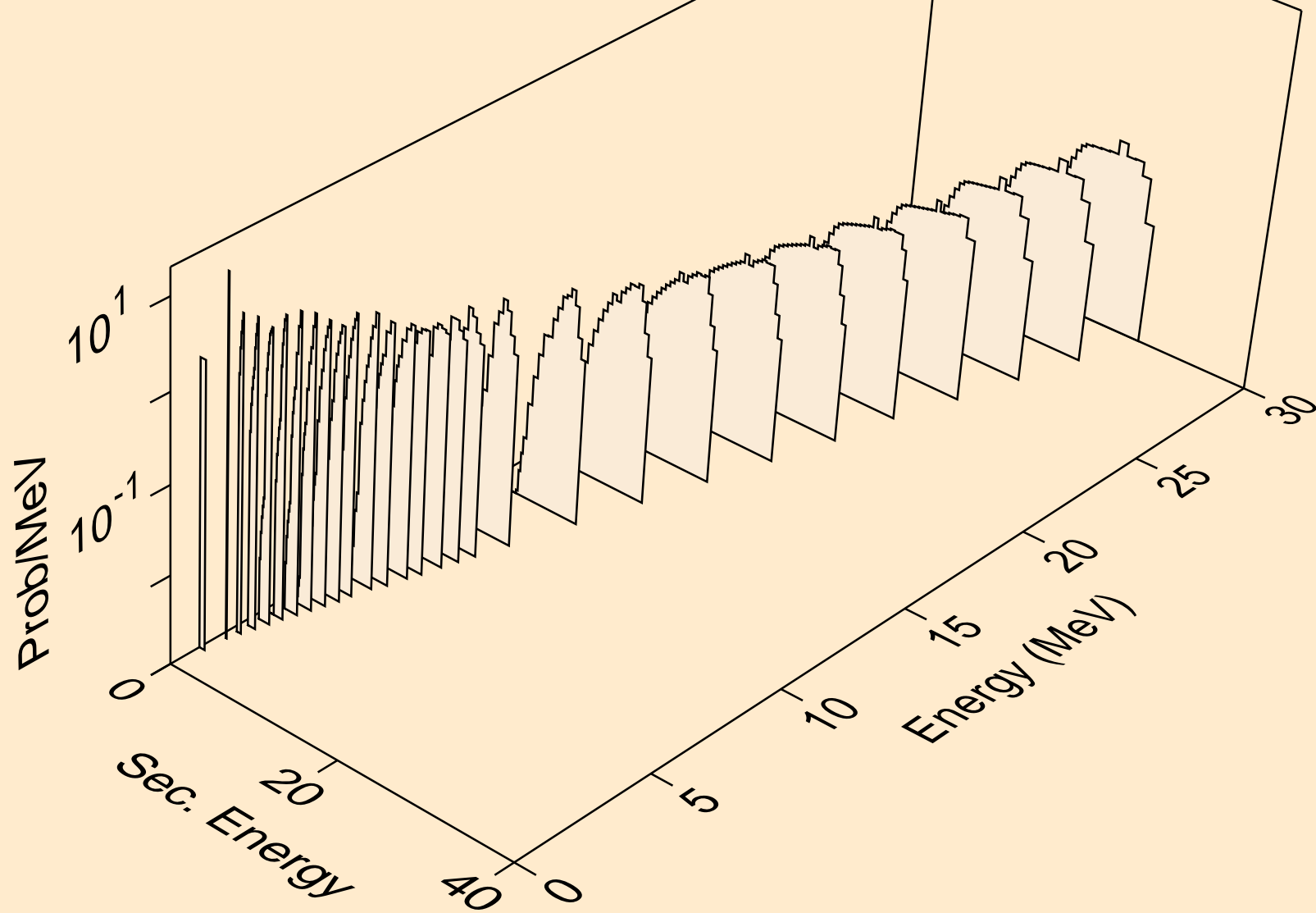

NB086 NEUTRON ACER TENDL-2024 LIBRARY; T=293.6K
deuterons from (n,pd)

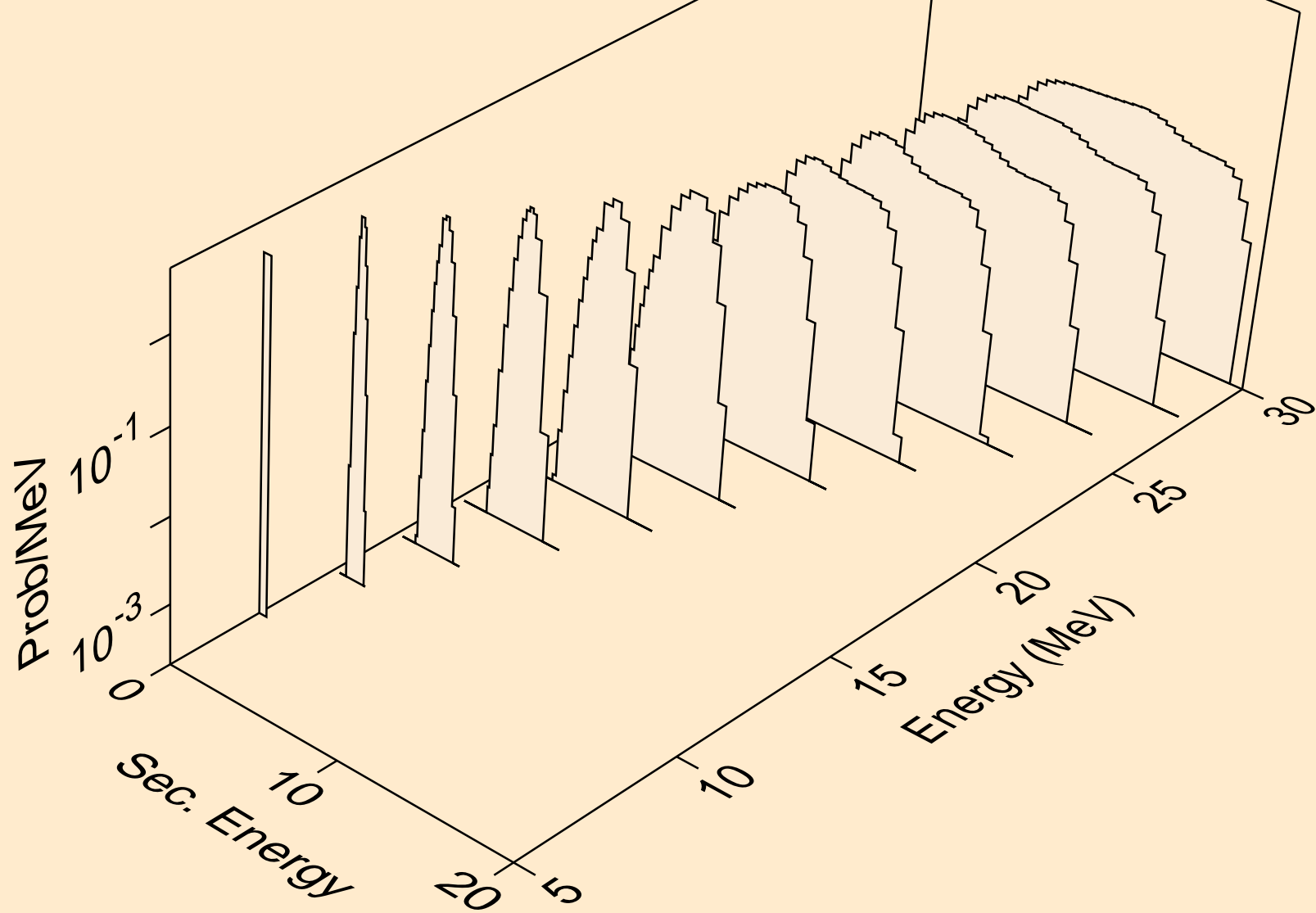

NB086 NEUTRON ACER TENDL-2024 LIBRARY; T=293.6K
deuterons from (n,da)

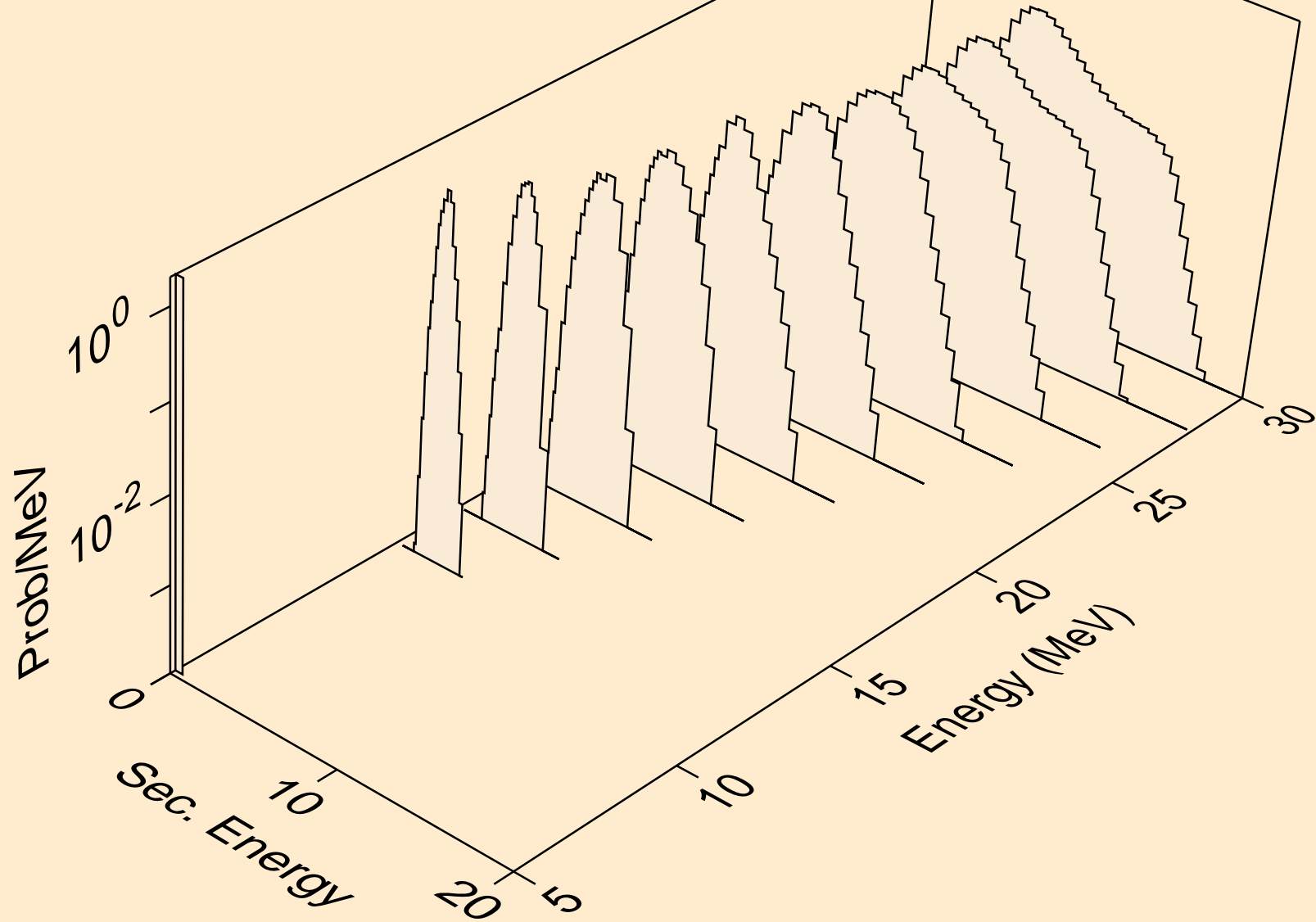

NB086 NEUTRON ACER TENDL-2024 LIBRARY; T=293.6K
tritons from (n,x)

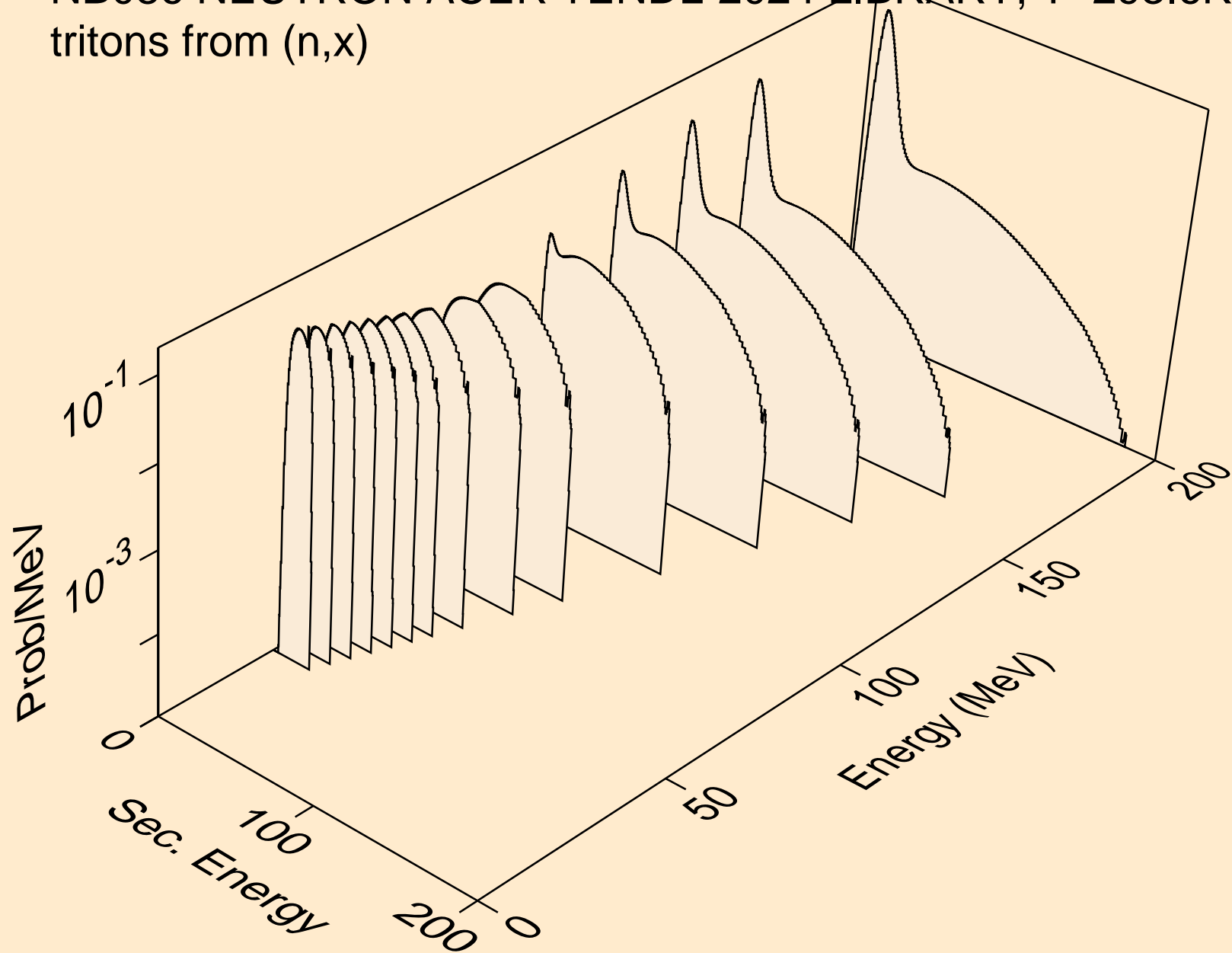

NB086 NEUTRON ACER TENDL-2024 LIBRARY; T=293.6K
tritons from (n,n*)t

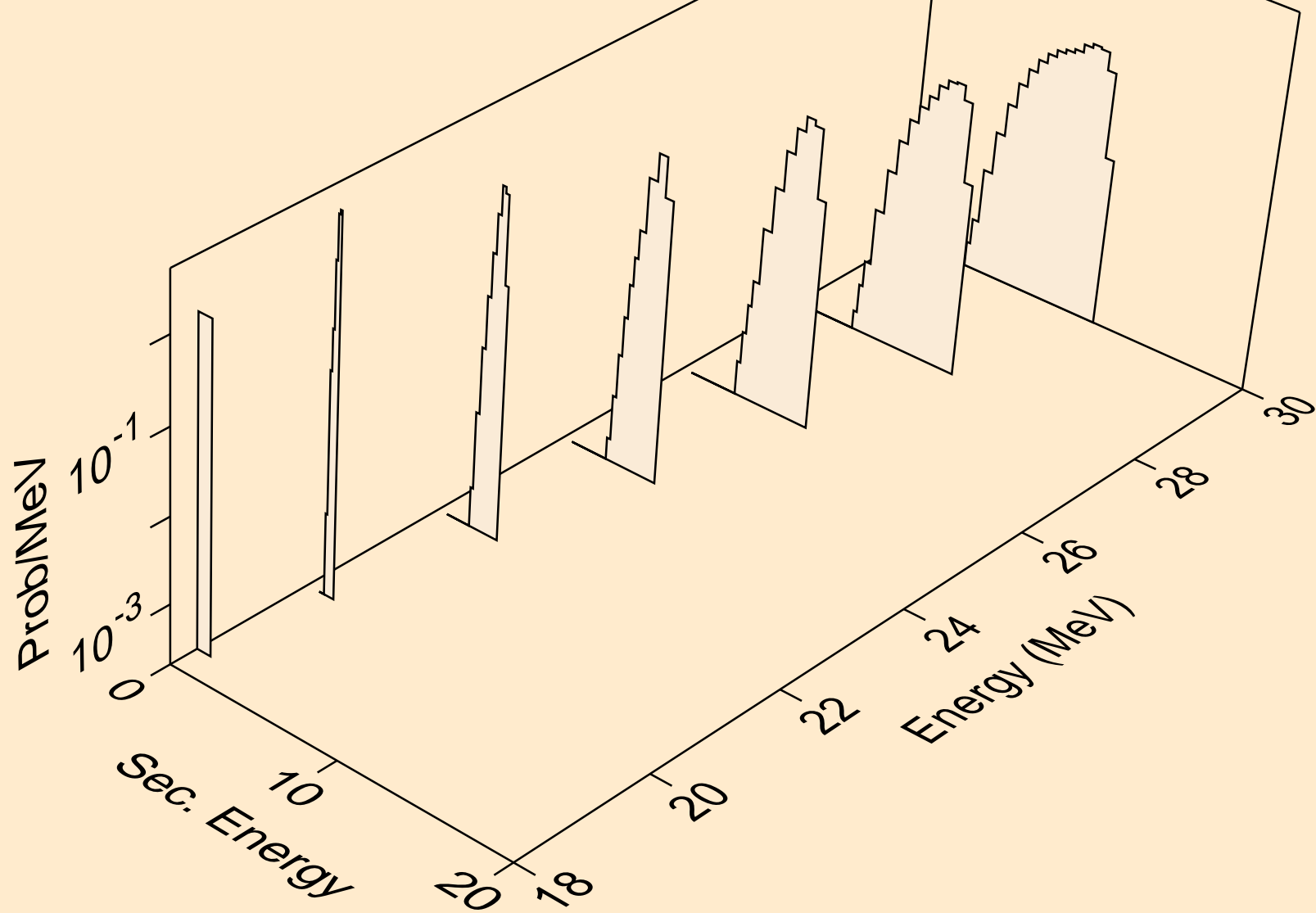

NB086 NEUTRON ACER TENDL-2024 LIBRARY; T=293.6K
tritons from (n,t)

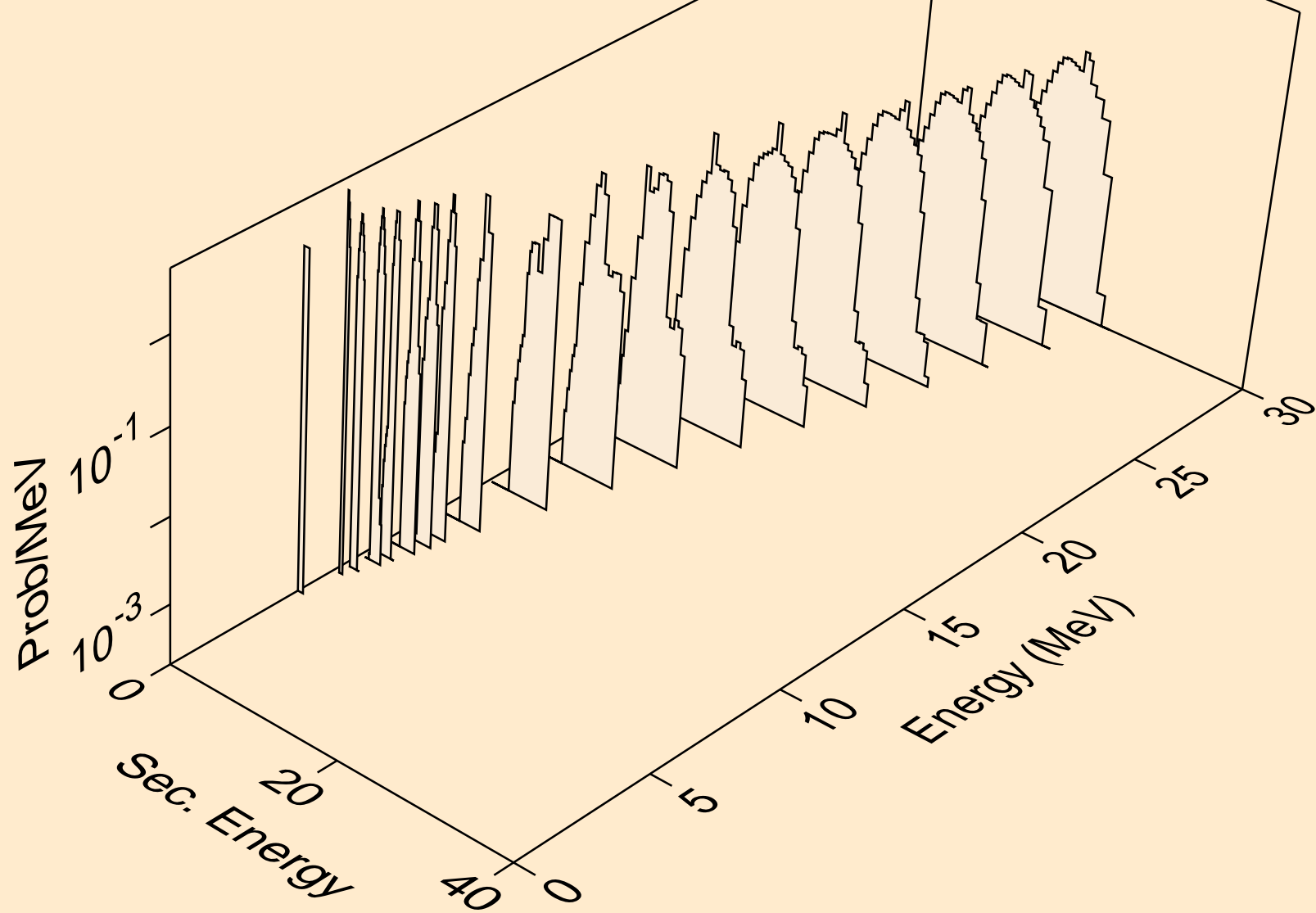

NB086 NEUTRON ACER TENDL-2024 LIBRARY; T=293.6K
tritons from (n,pt)

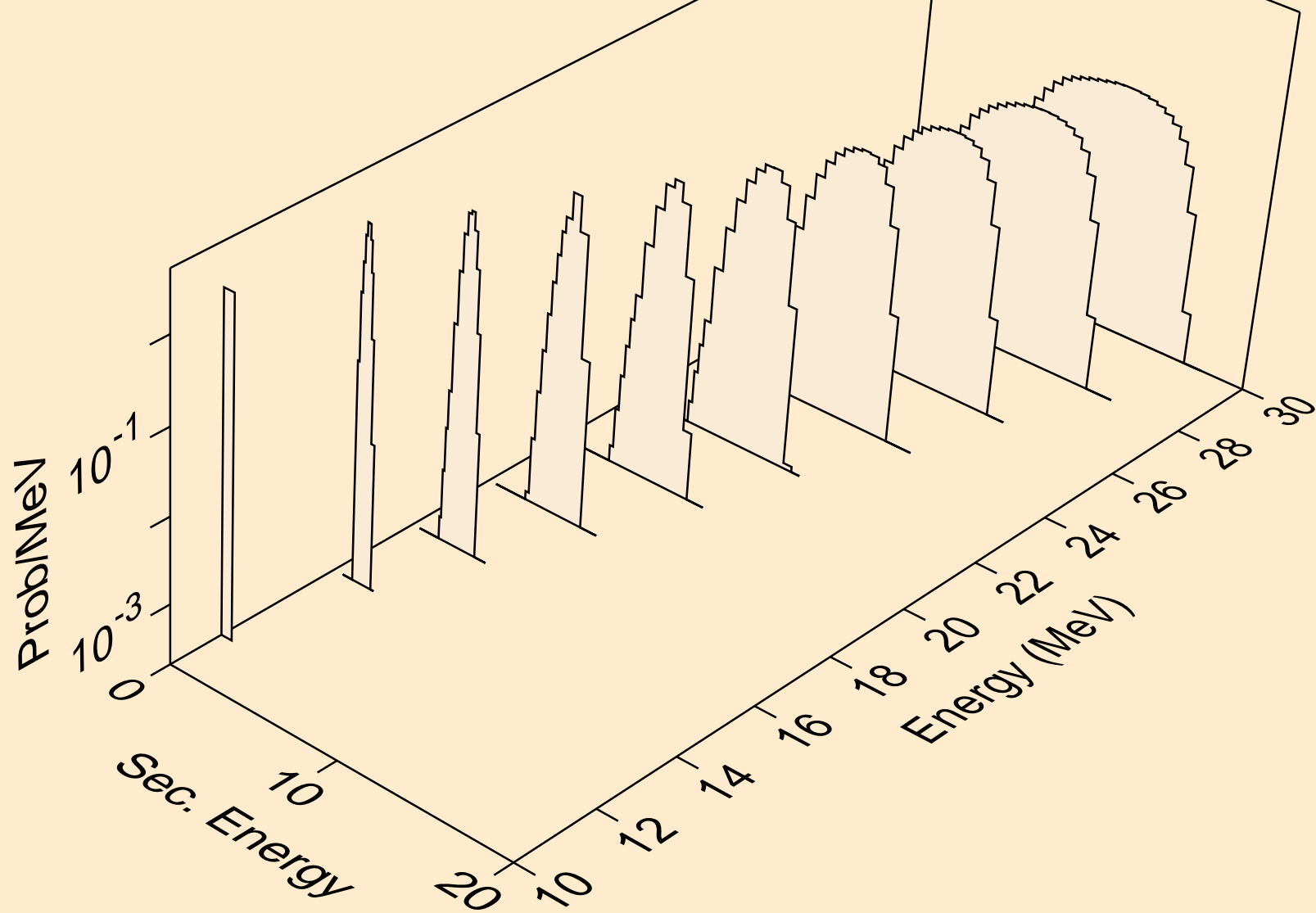

NB086 NEUTRON ACER TENDL-2024 LIBRARY; T=293.6K
he3s from (n,x)

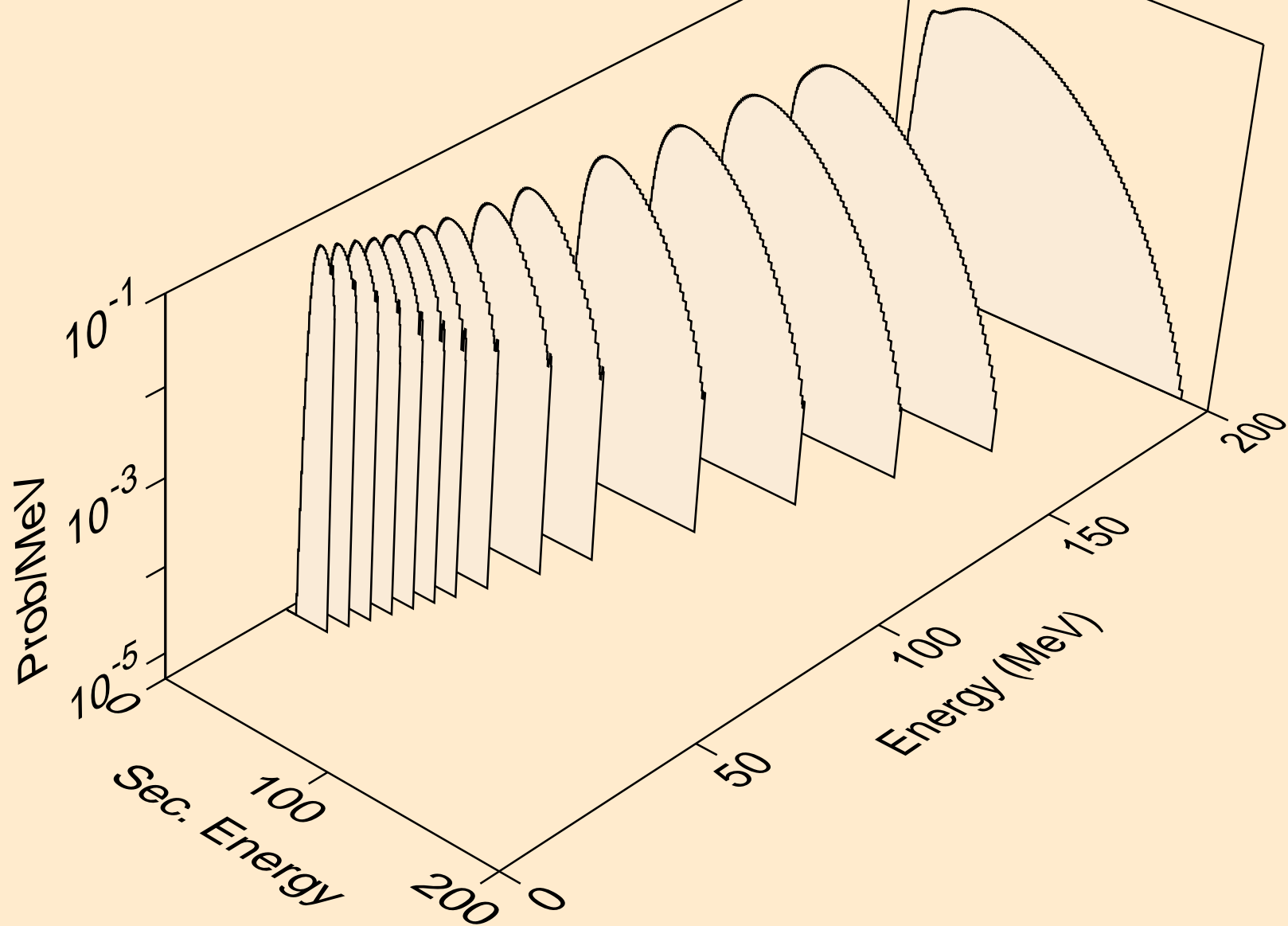

NB086 NEUTRON ACER TENDL-2024 LIBRARY; T=293.6K
he3s from (n,n*)he3

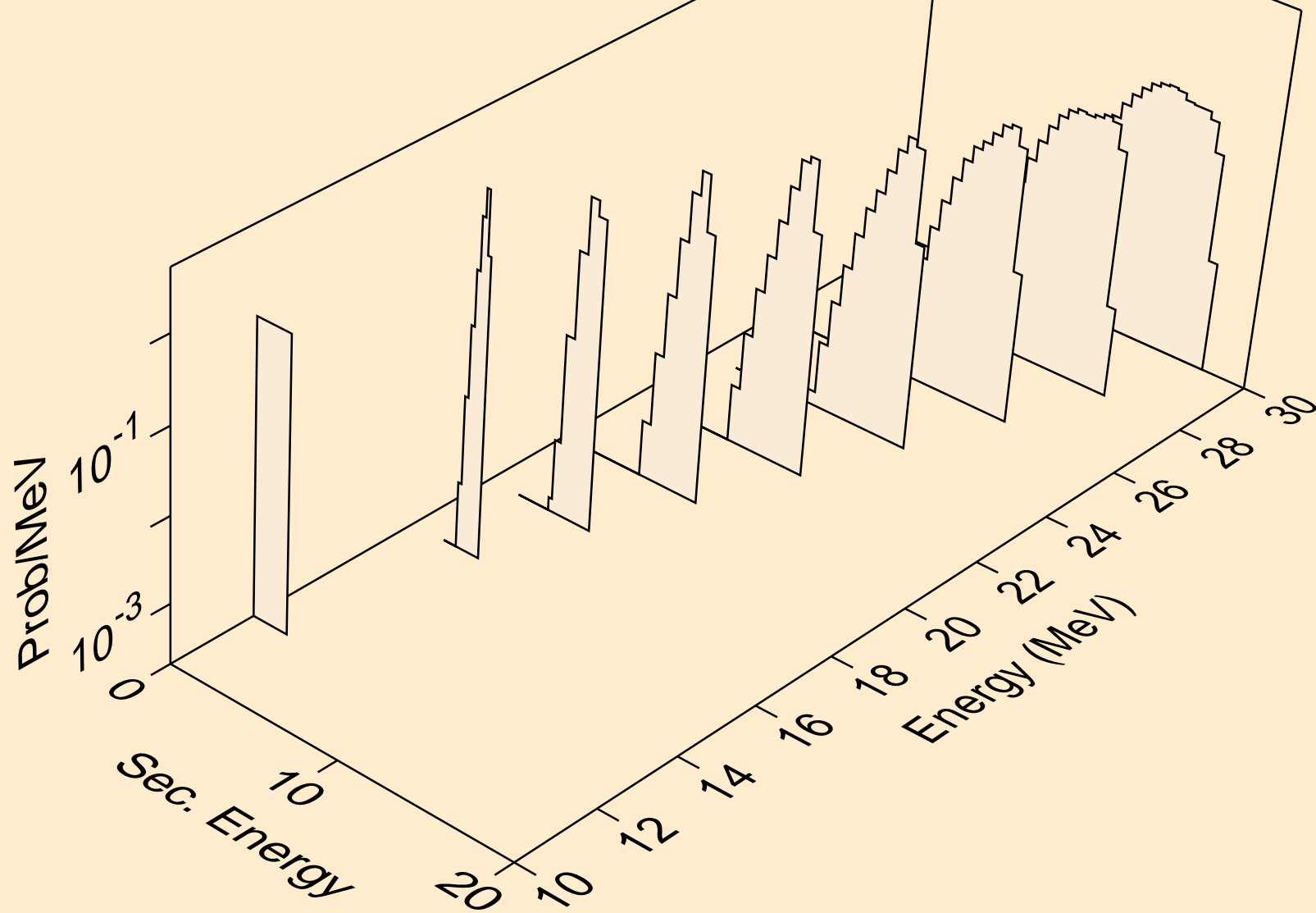

NB086 NEUTRON ACER TENDL-2024 LIBRARY; T=293.6K
he3s from (n,he3)

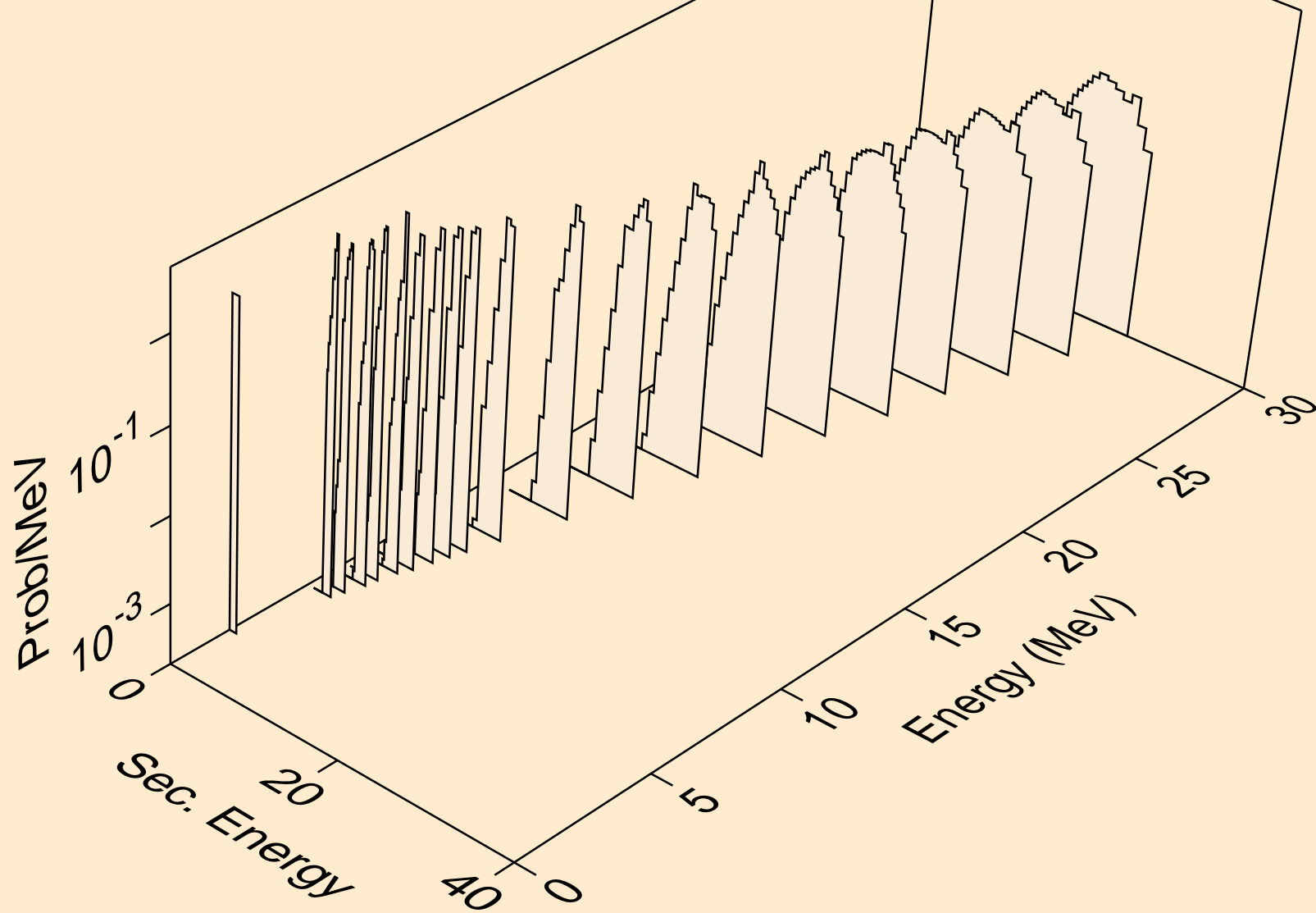

NB086 NEUTRON ACER TENDL-2024 LIBRARY; T=293.6K
alphas from (n,x)

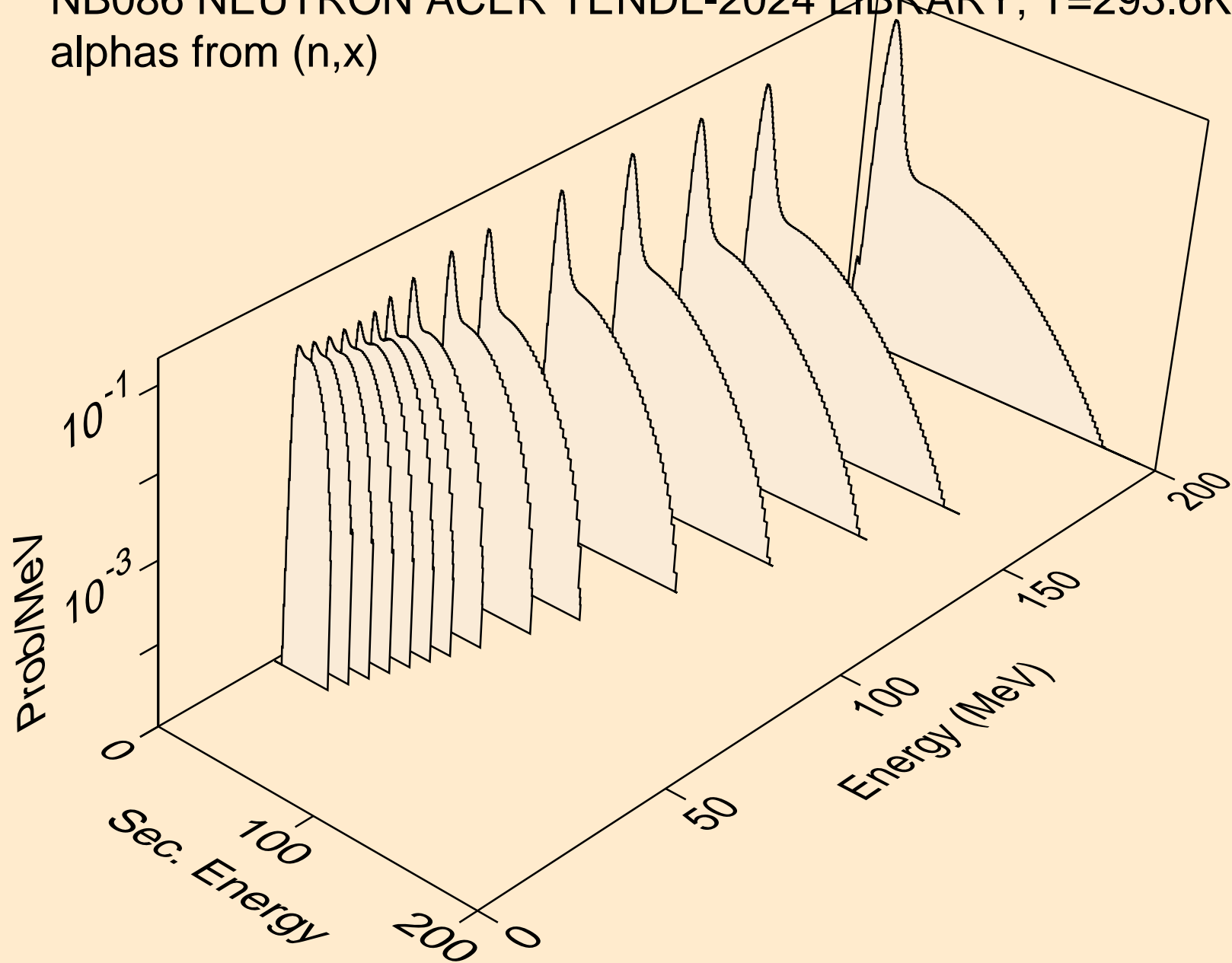

NB086 NEUTRON ACER TENDL-2024 LIBRARY; T=293.6K
alphas from (n,n*)a

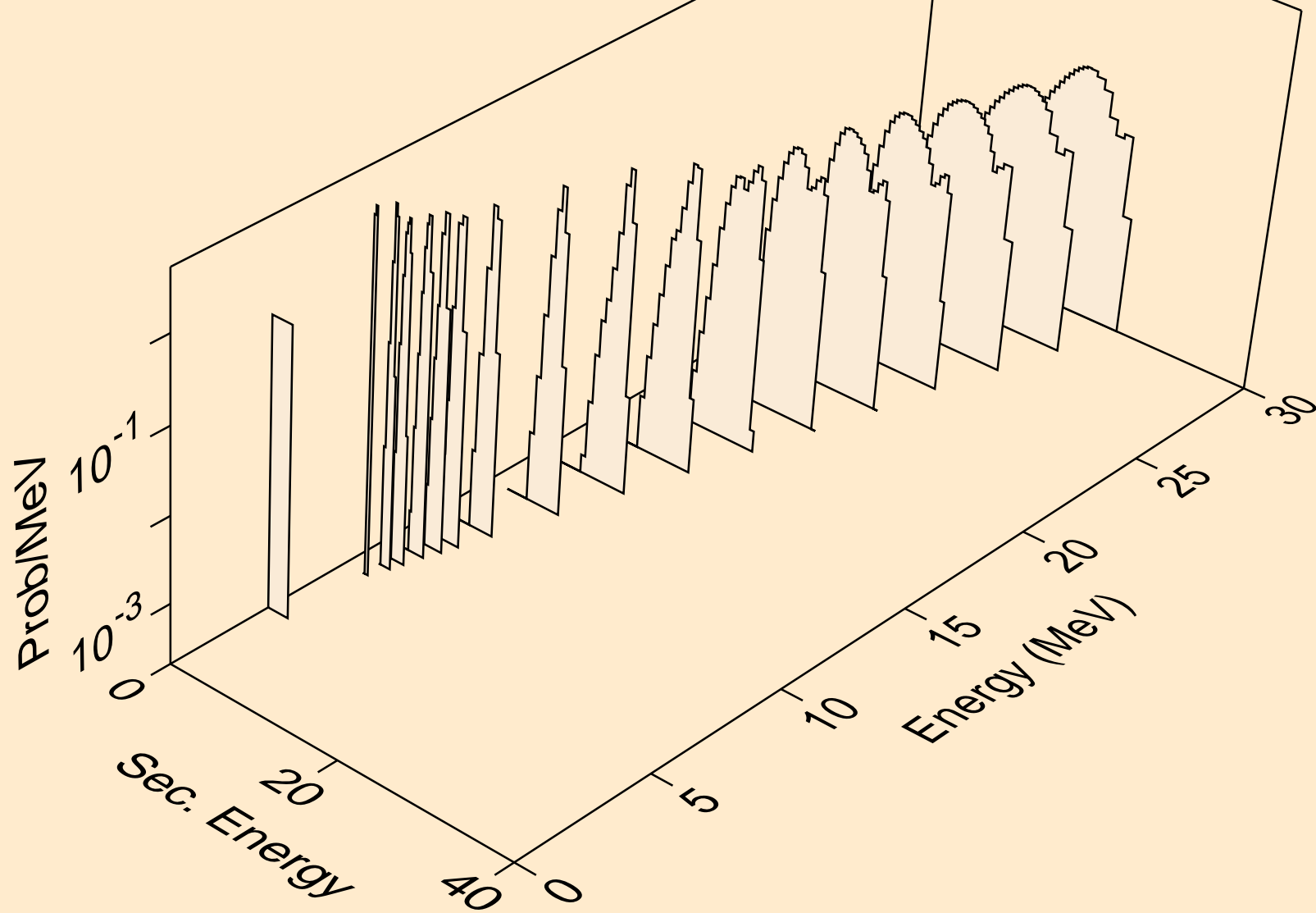

NB086 NEUTRON ACER TENDL-2024 LIBRARY; T=293.6K
alphas from (n,2n)a

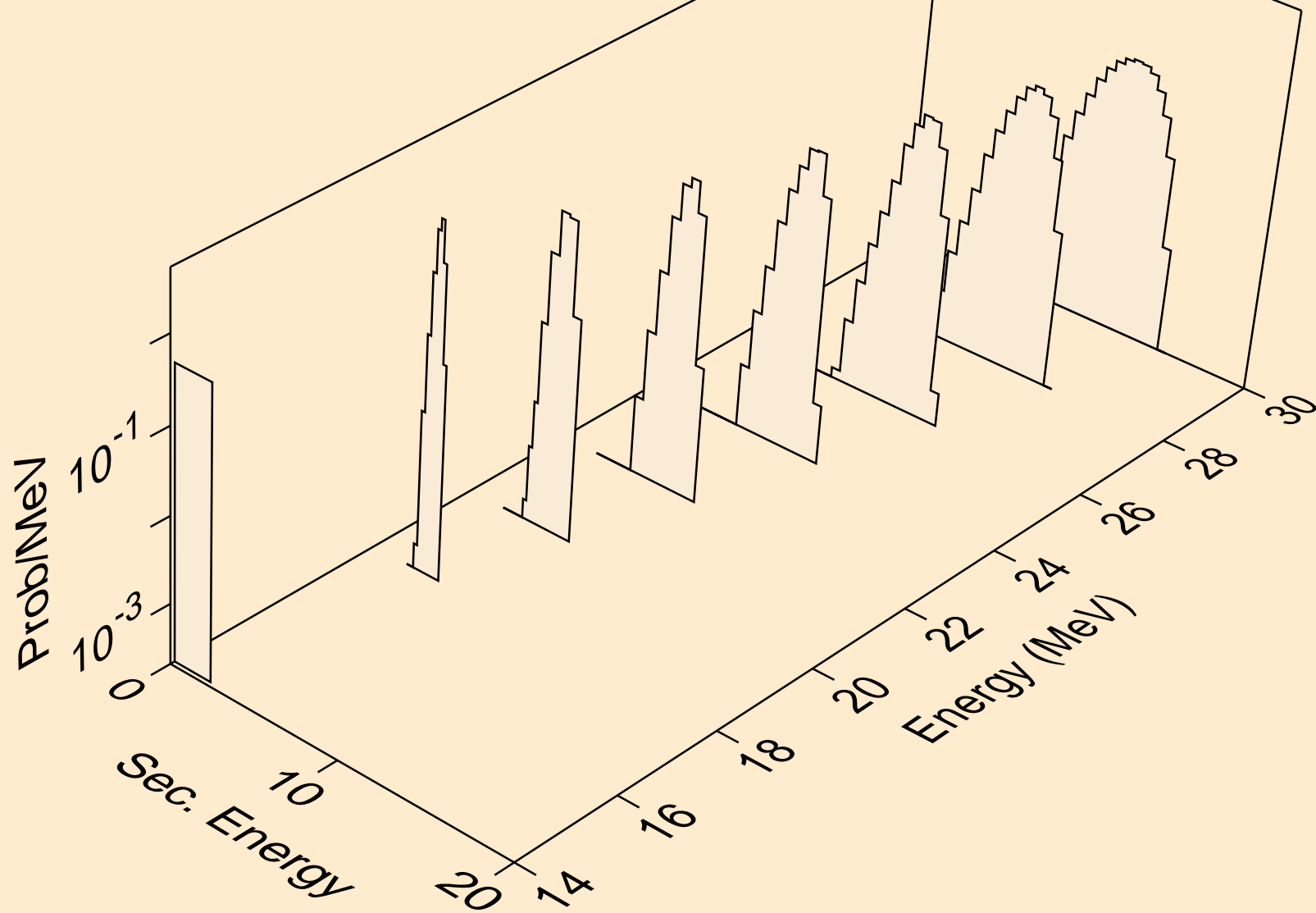

NB086 NEUTRON ACER TENDL-2024 LIBRARY; T=293.6K
alphas from (n,n*)2a

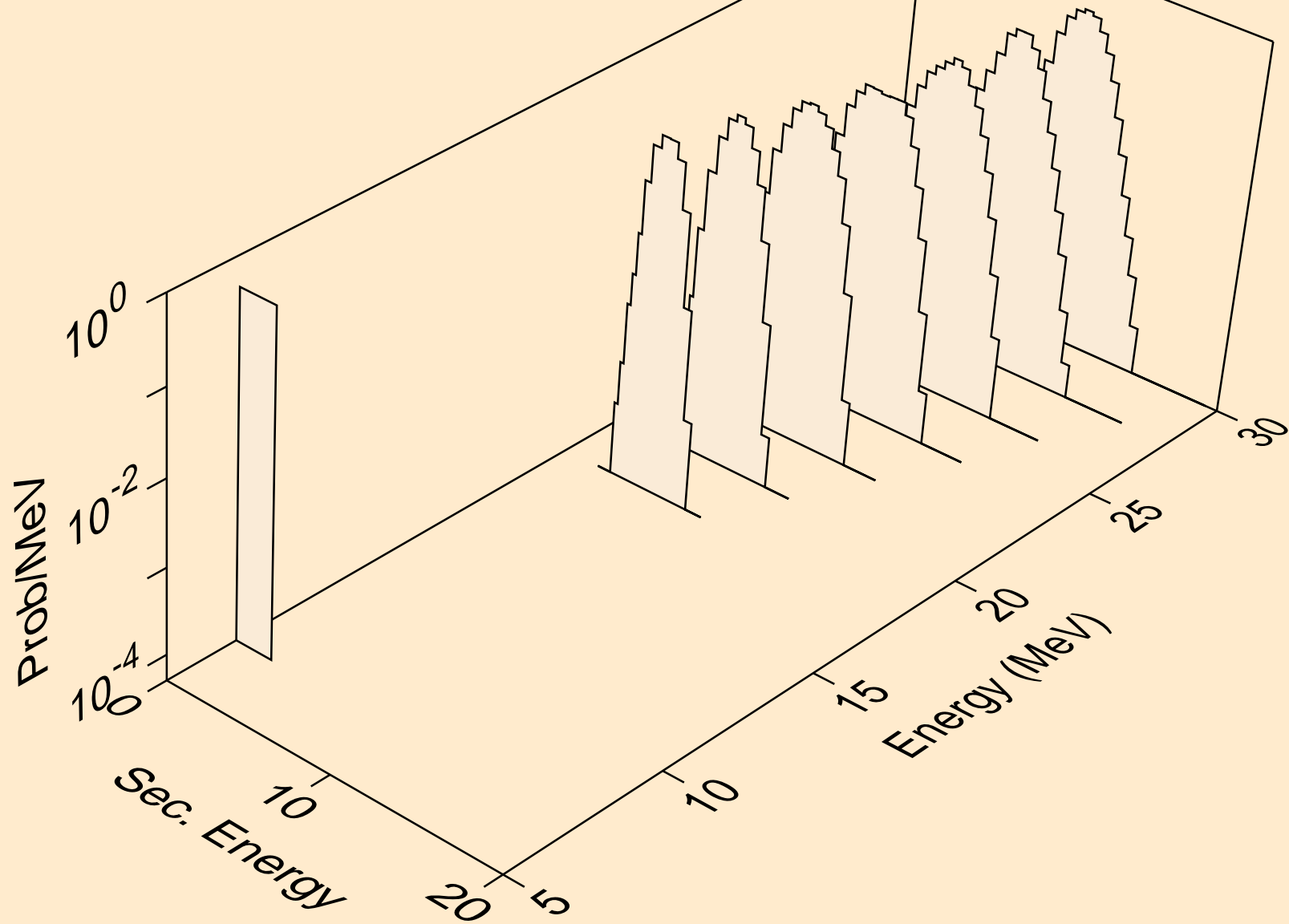

NB086 NEUTRON ACER TENDL-2024 LIBRARY; T=293.6K
alphas from (n,npa)

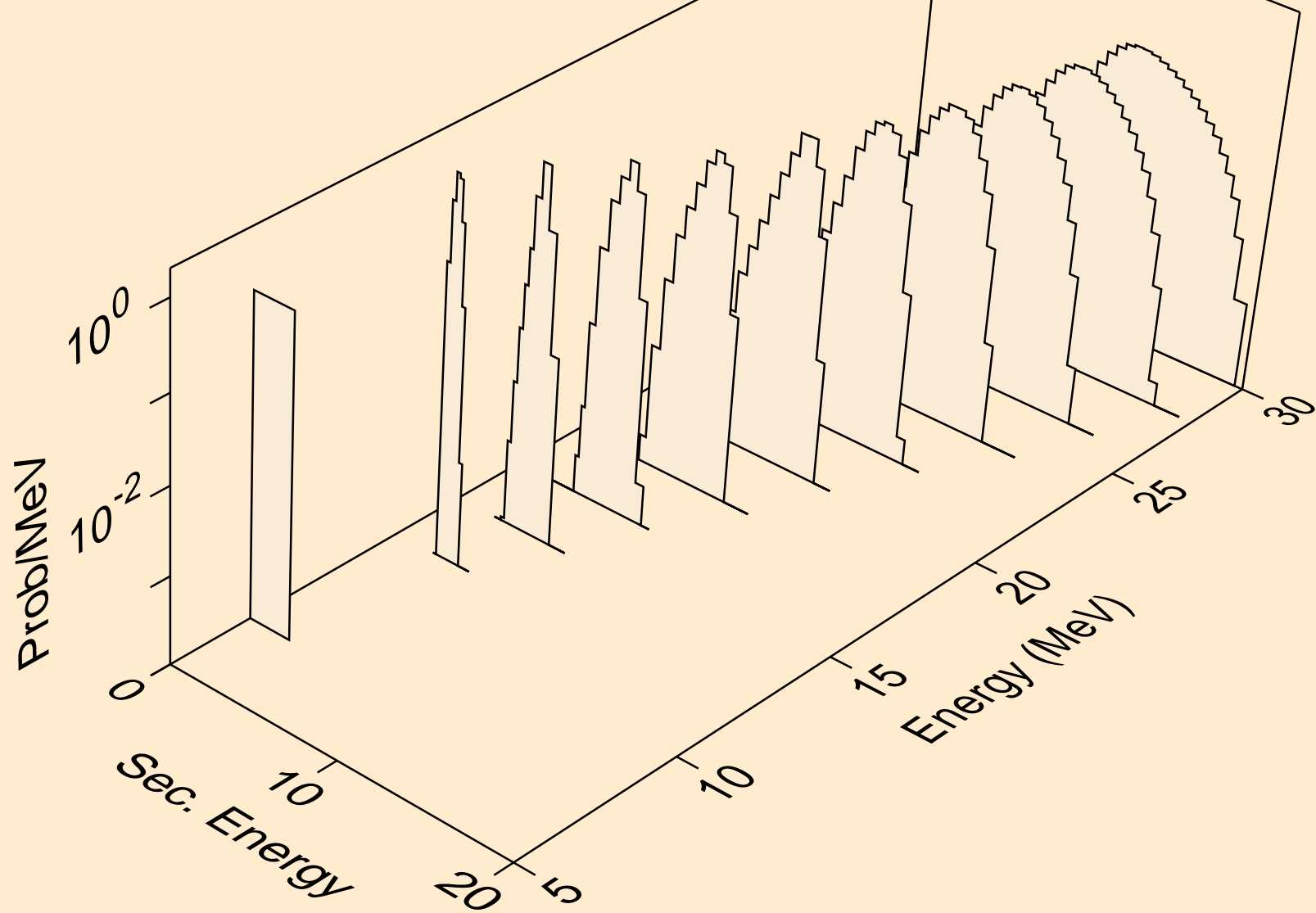

NB086 NEUTRON ACER TENDL-2024 LIBRARY; T=293.6K
alphas from (n,a)

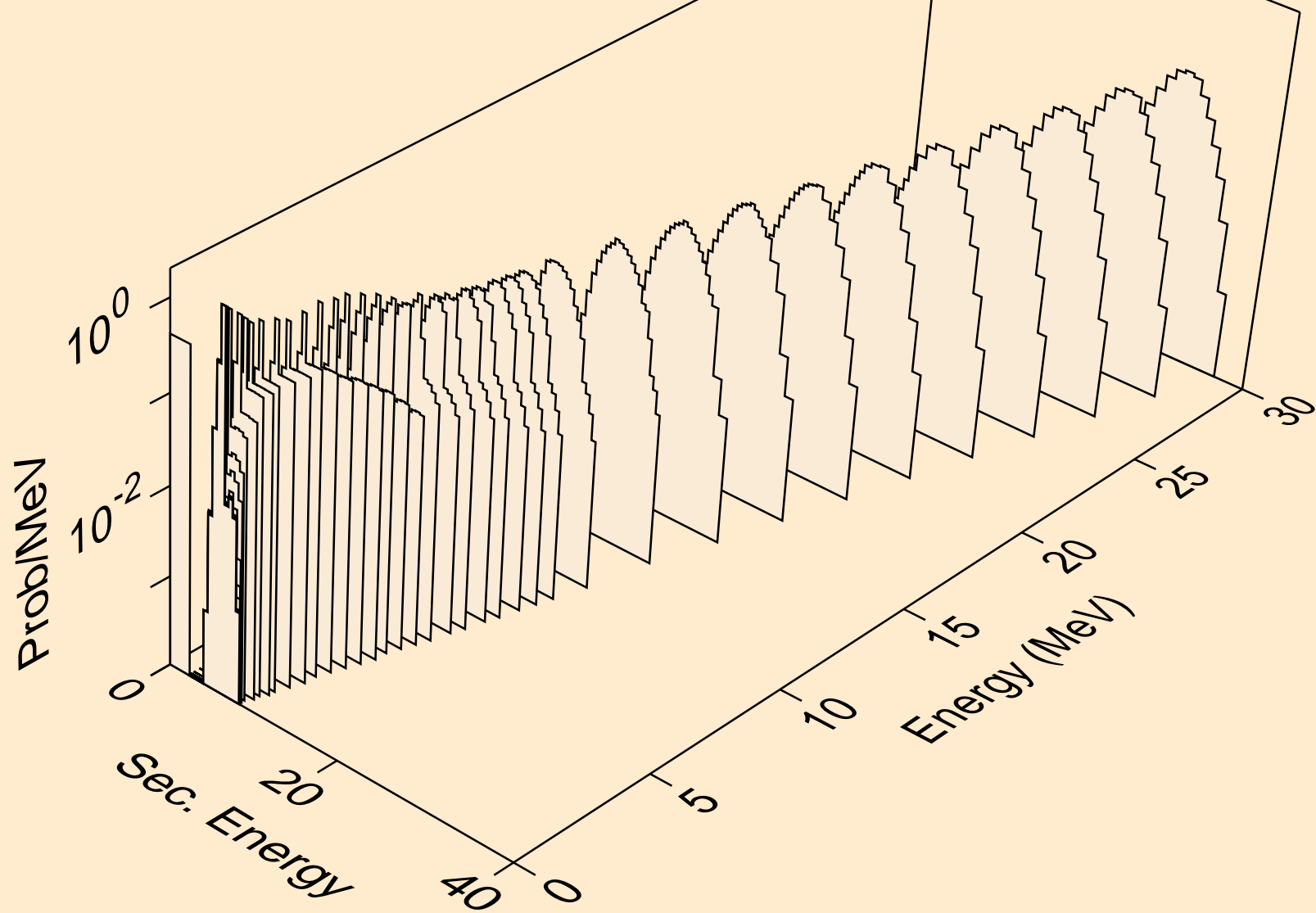

NB086 NEUTRON ACER TENDL-2024 LIBRARY; T=293.6K
alphas from (n,2a)

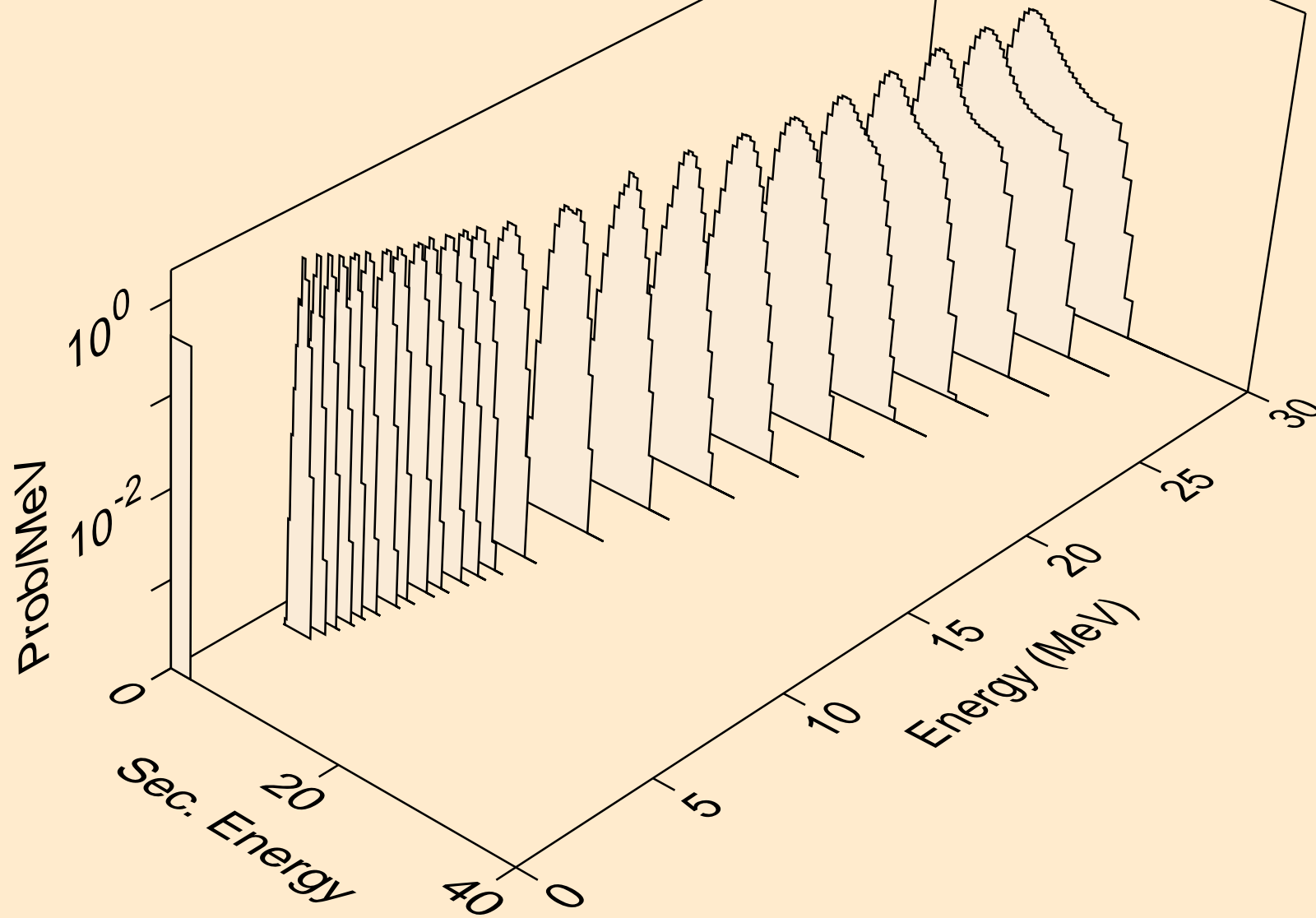

NB086 NEUTRON ACER TENDL-2024 LIBRARY; T=293.6K
alphas from (n,3a)

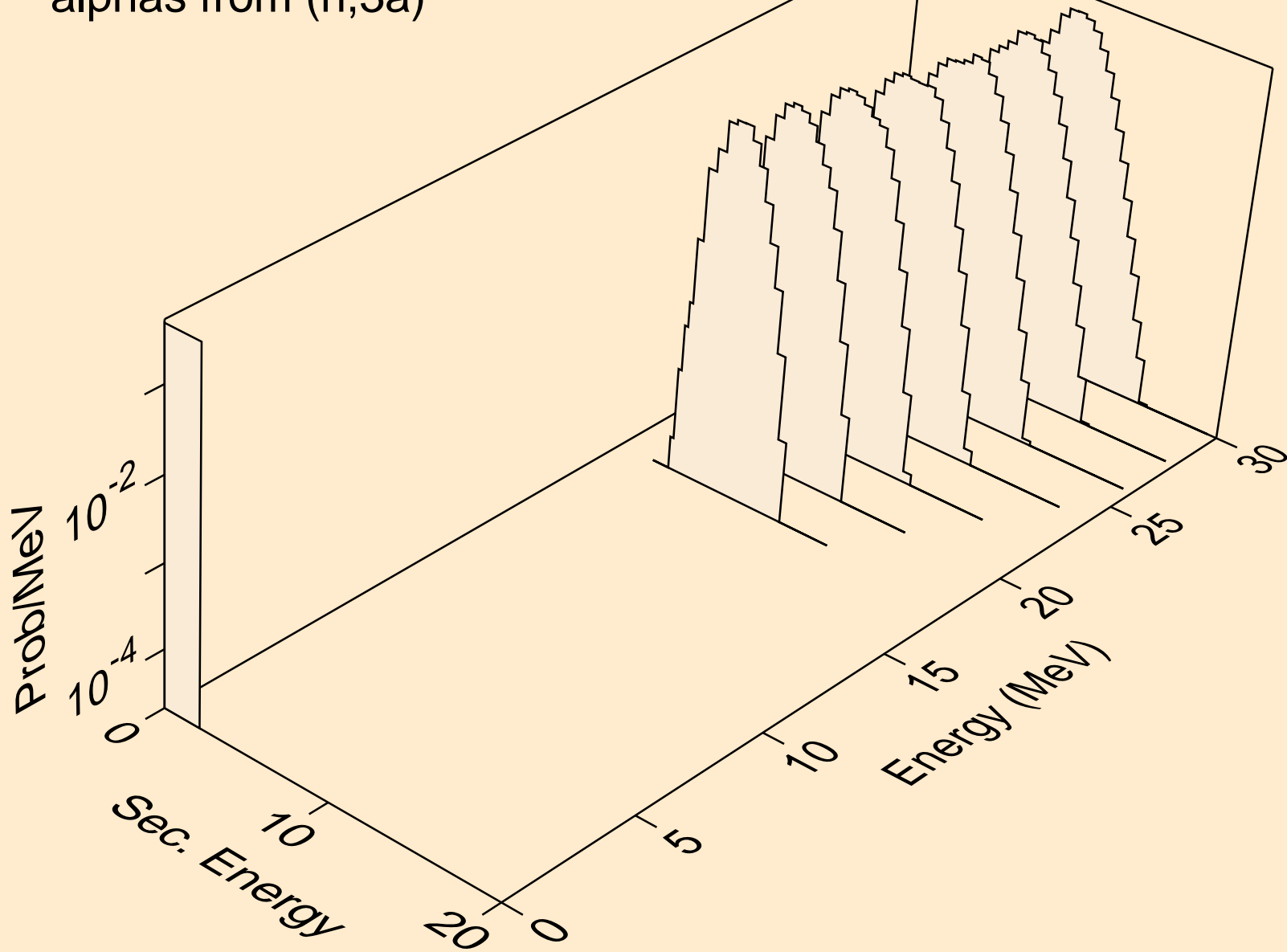

NB086 NEUTRON ACER TENDL-2024 LIBRARY; T=293.6K
alphas from (n,pa)

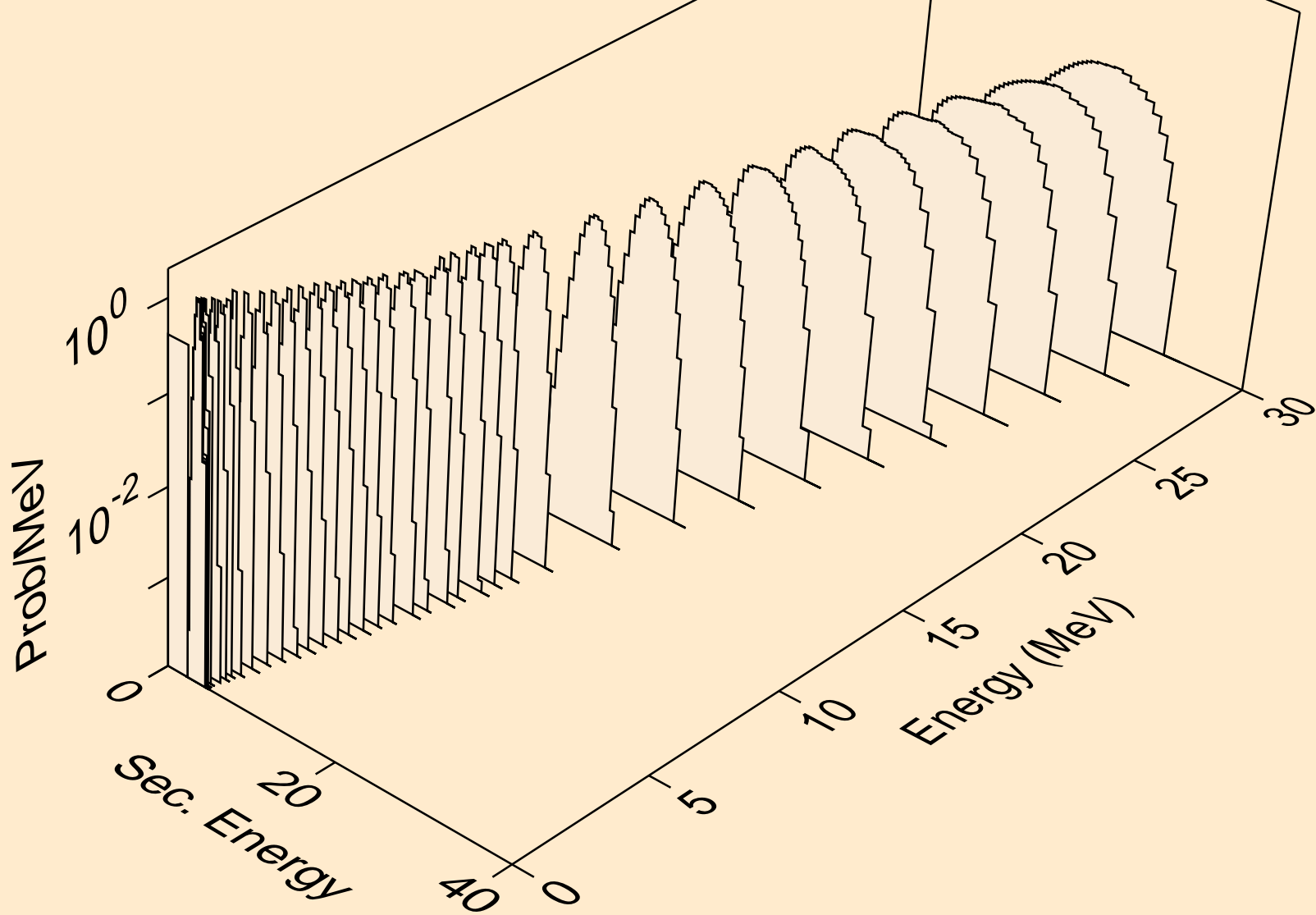

NB086 NEUTRON ACER TENDL-2024 LIBRARY; T=293.6K
alphas from (n,da)

