

# NB087 NEUTRON ACER TENDL-2024 LIBRARY; T=293.6K

## Principal cross sections

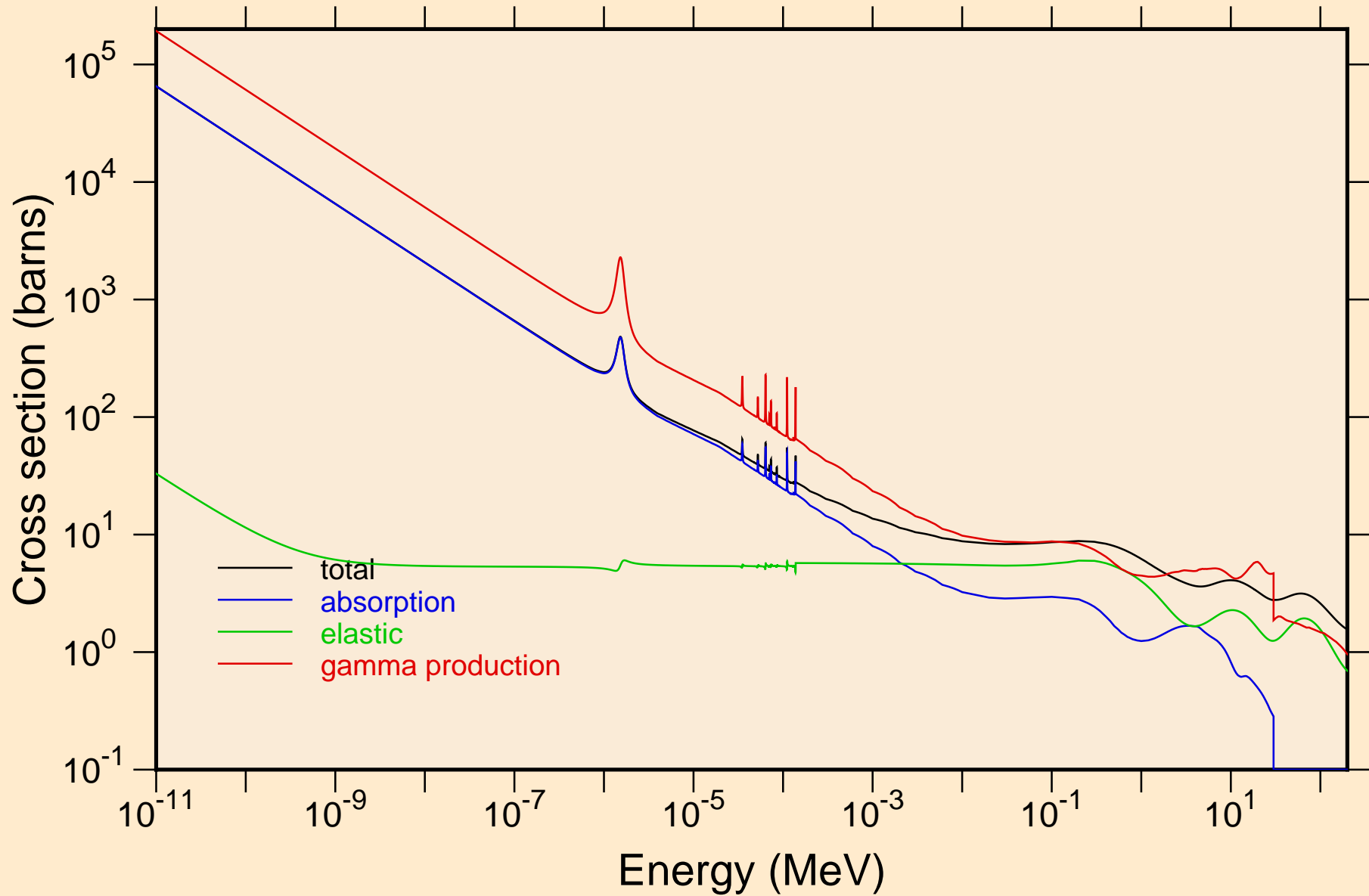

NB087 NEUTRON ACER TENDL-2024 LIBRARY; T=293.6K  
resonance total cross section

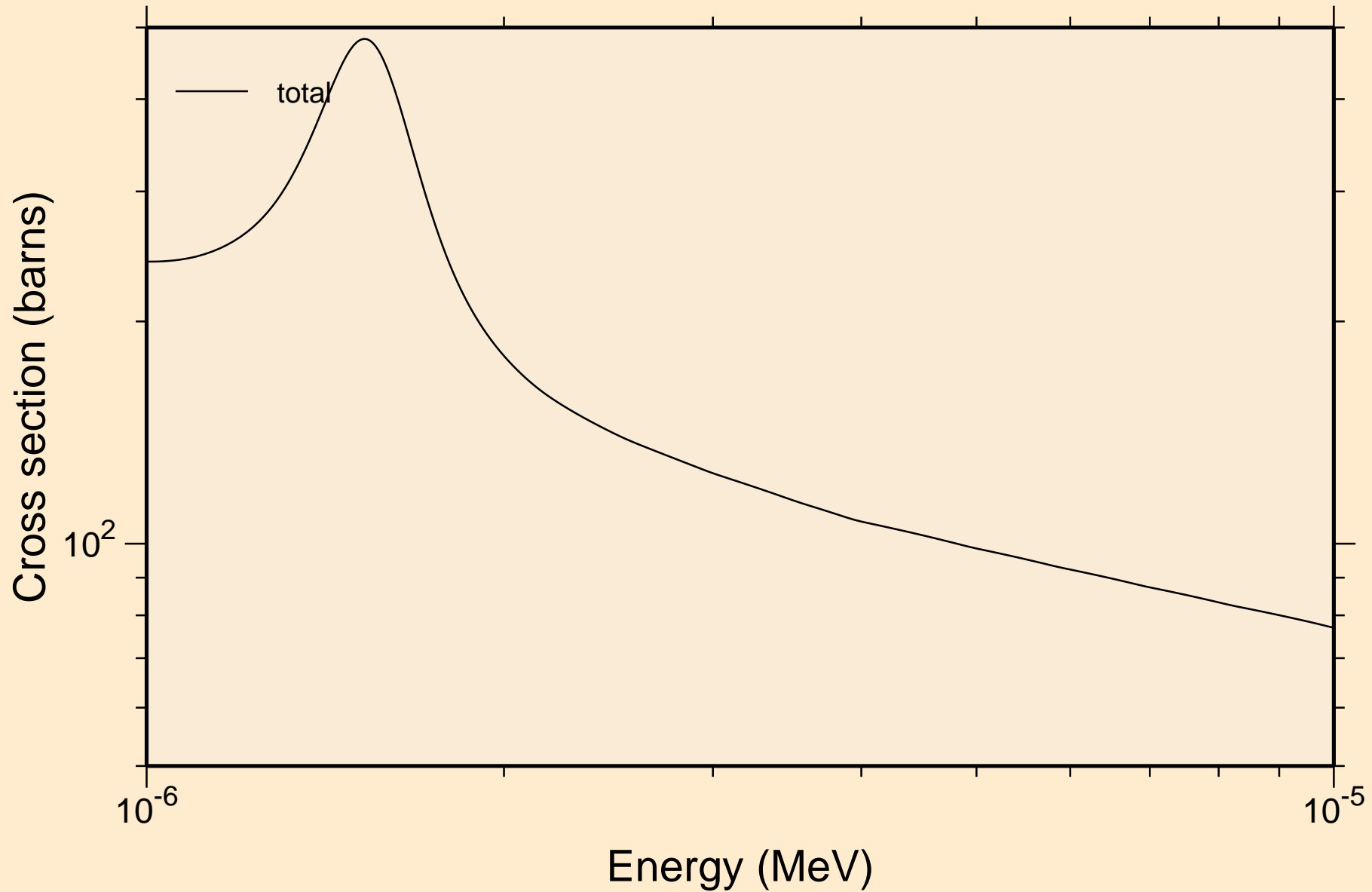

NB087 NEUTRON ACER TENDL-2024 LIBRARY; T=293.6K  
resonance total cross section

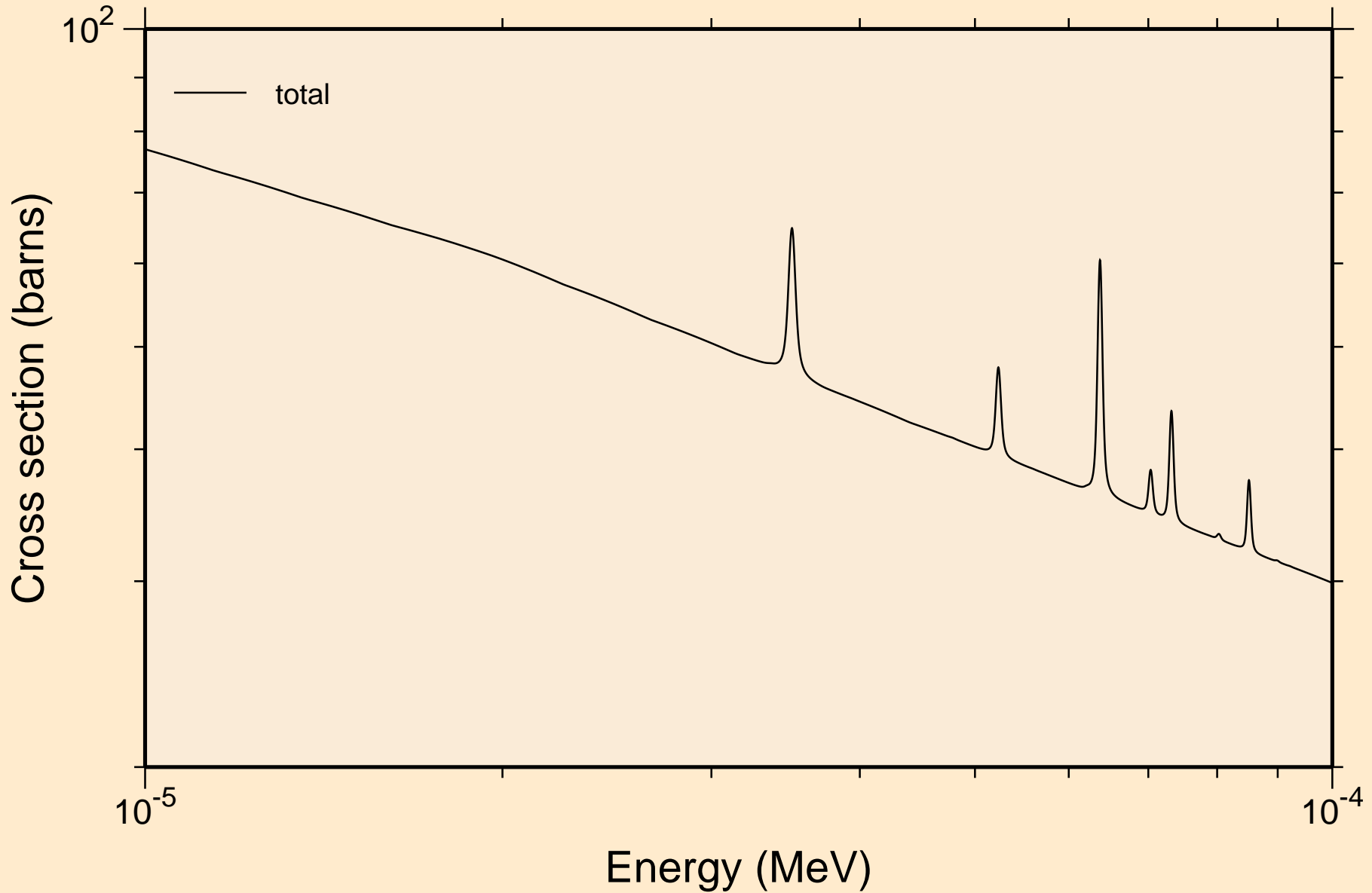

NB087 NEUTRON ACER TENDL-2024 LIBRARY; T=293.6K  
resonance total cross section

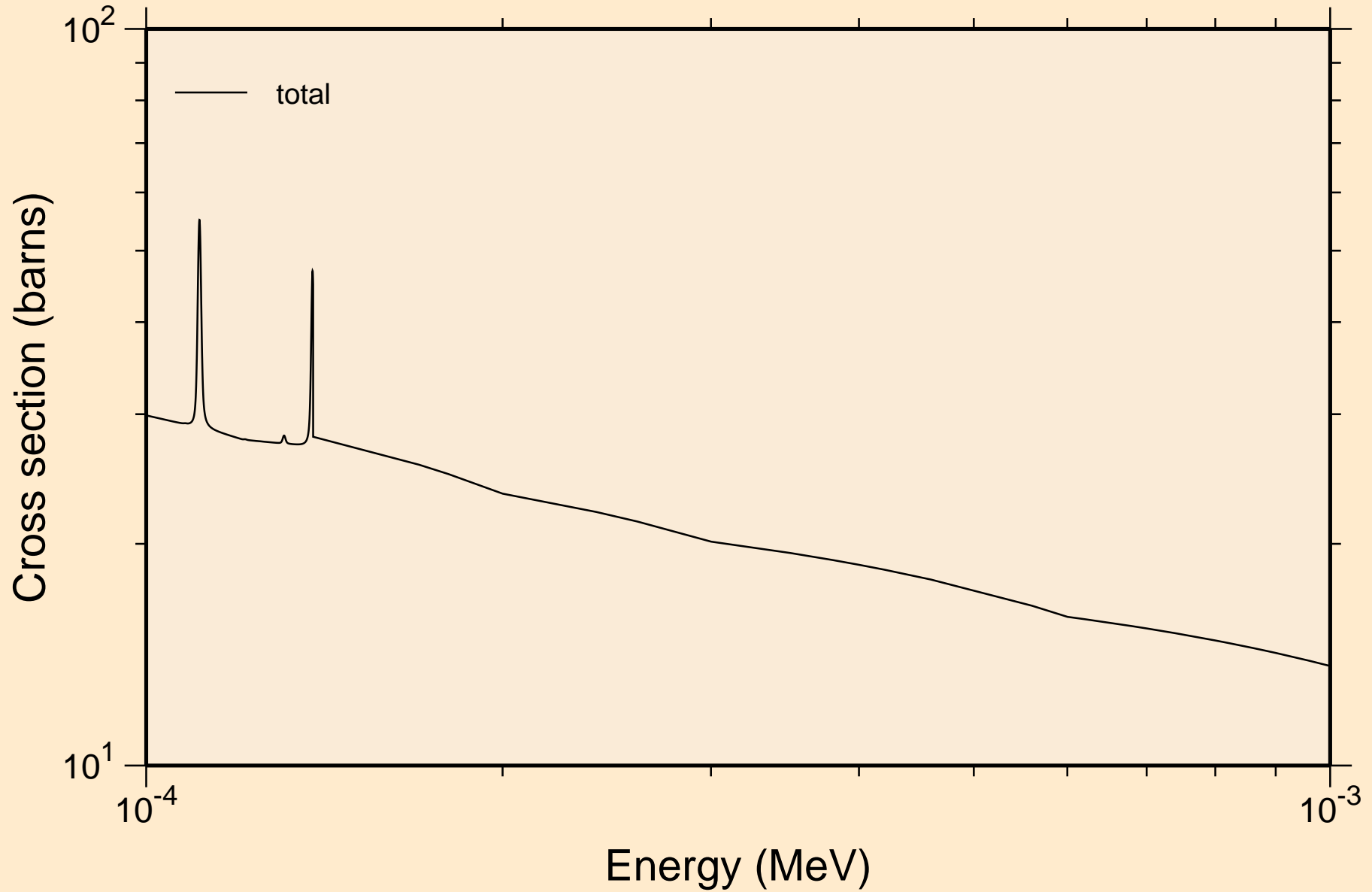

NB087 NEUTRON ACER TENDL-2024 LIBRARY; T=293.6K  
resonance total cross section

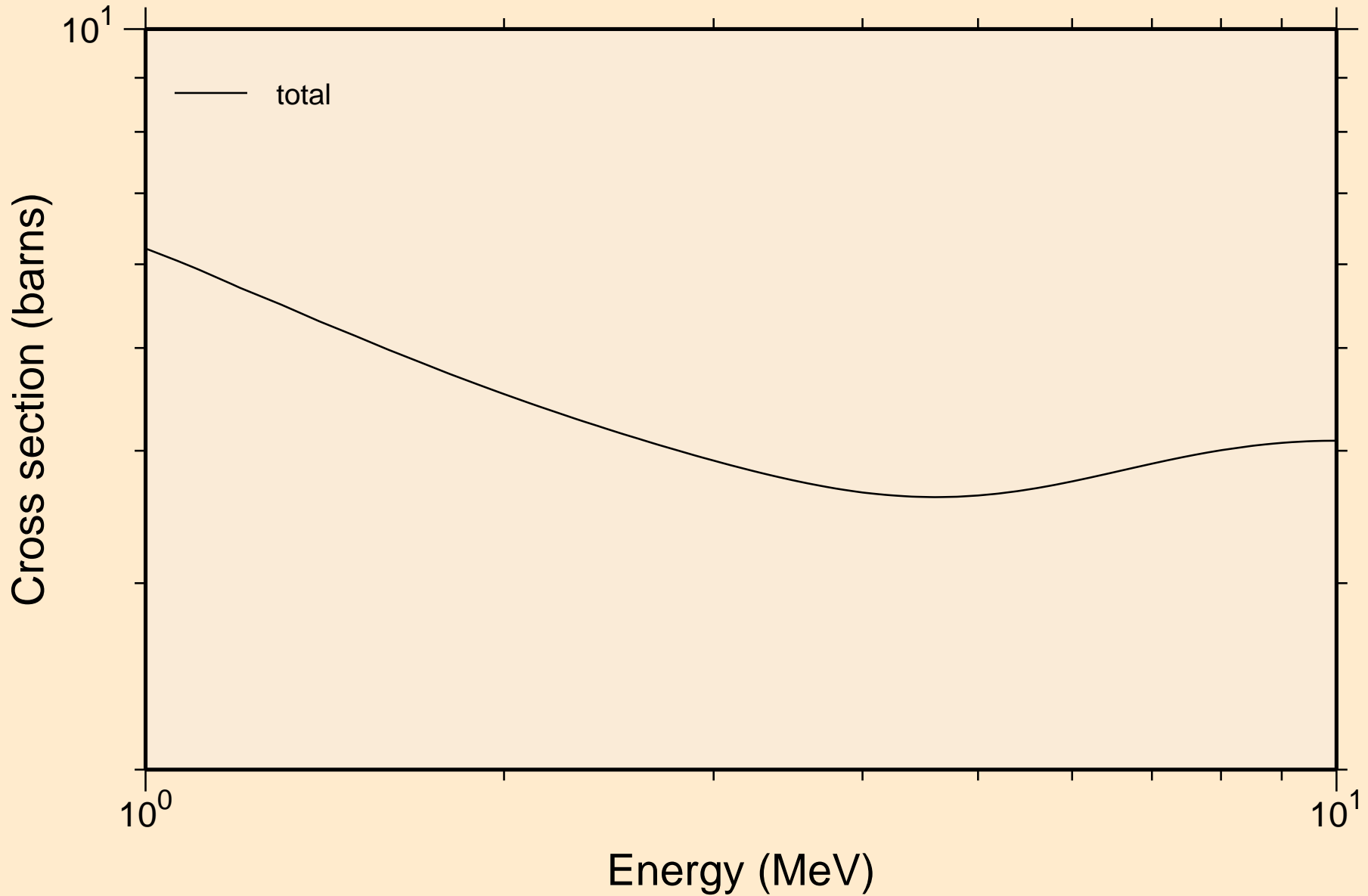

NB087 NEUTRON ACER TENDL-2024 LIBRARY; T=293.6K  
resonance absorption cross sections

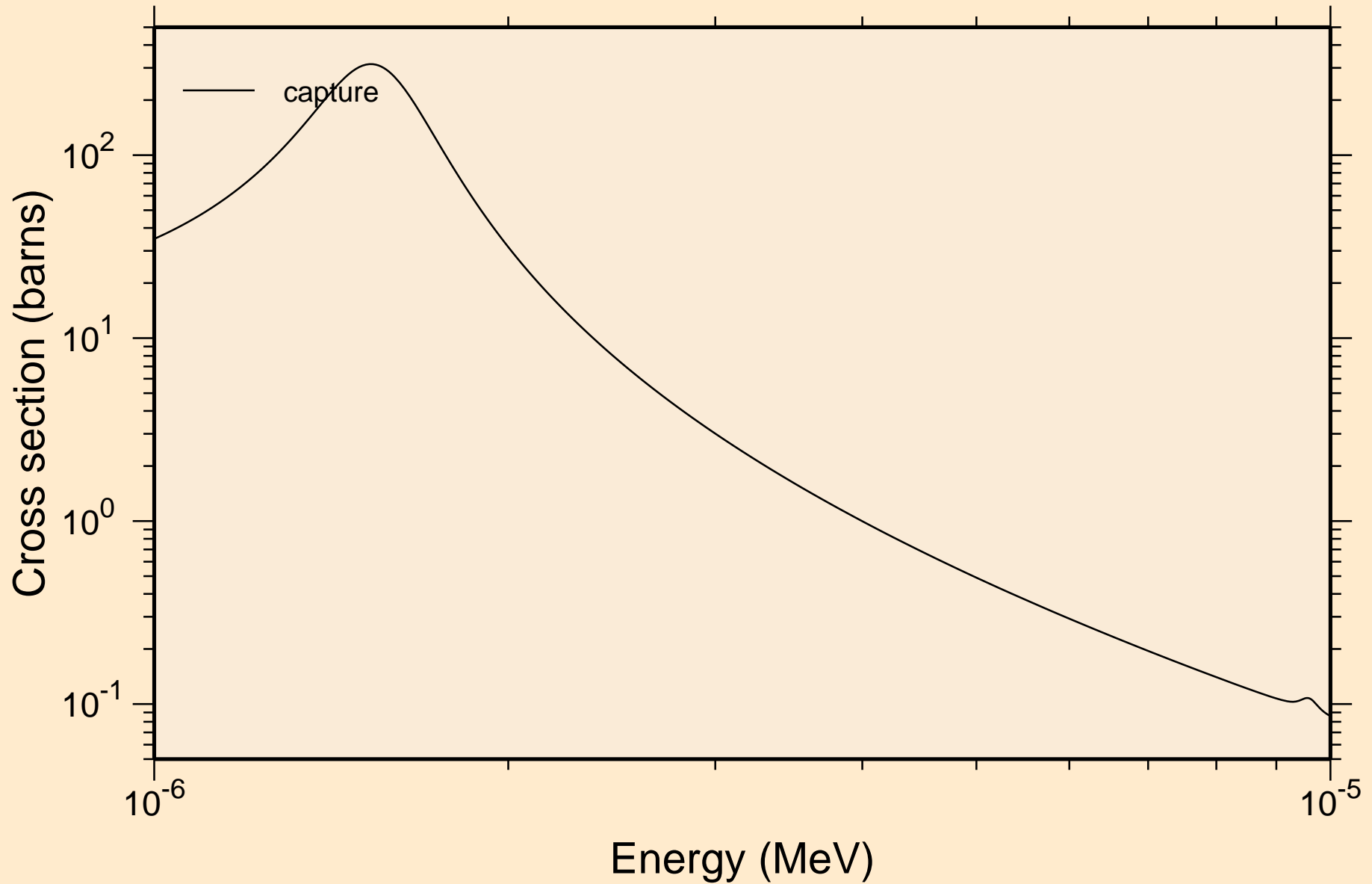

NB087 NEUTRON ACER TENDL-2024 LIBRARY; T=293.6K  
resonance absorption cross sections

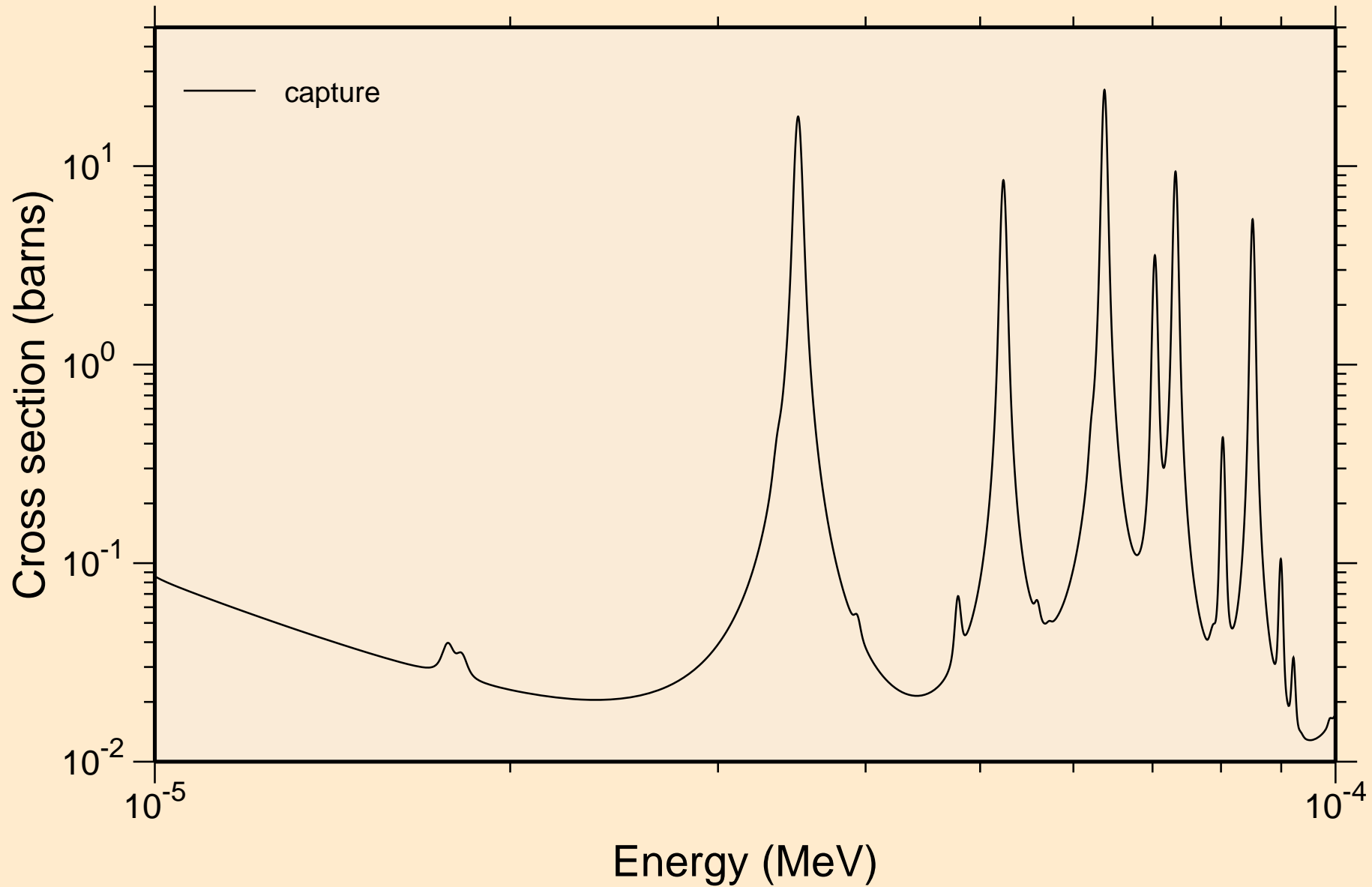

NB087 NEUTRON ACER TENDL-2024 LIBRARY; T=293.6K  
resonance absorption cross sections

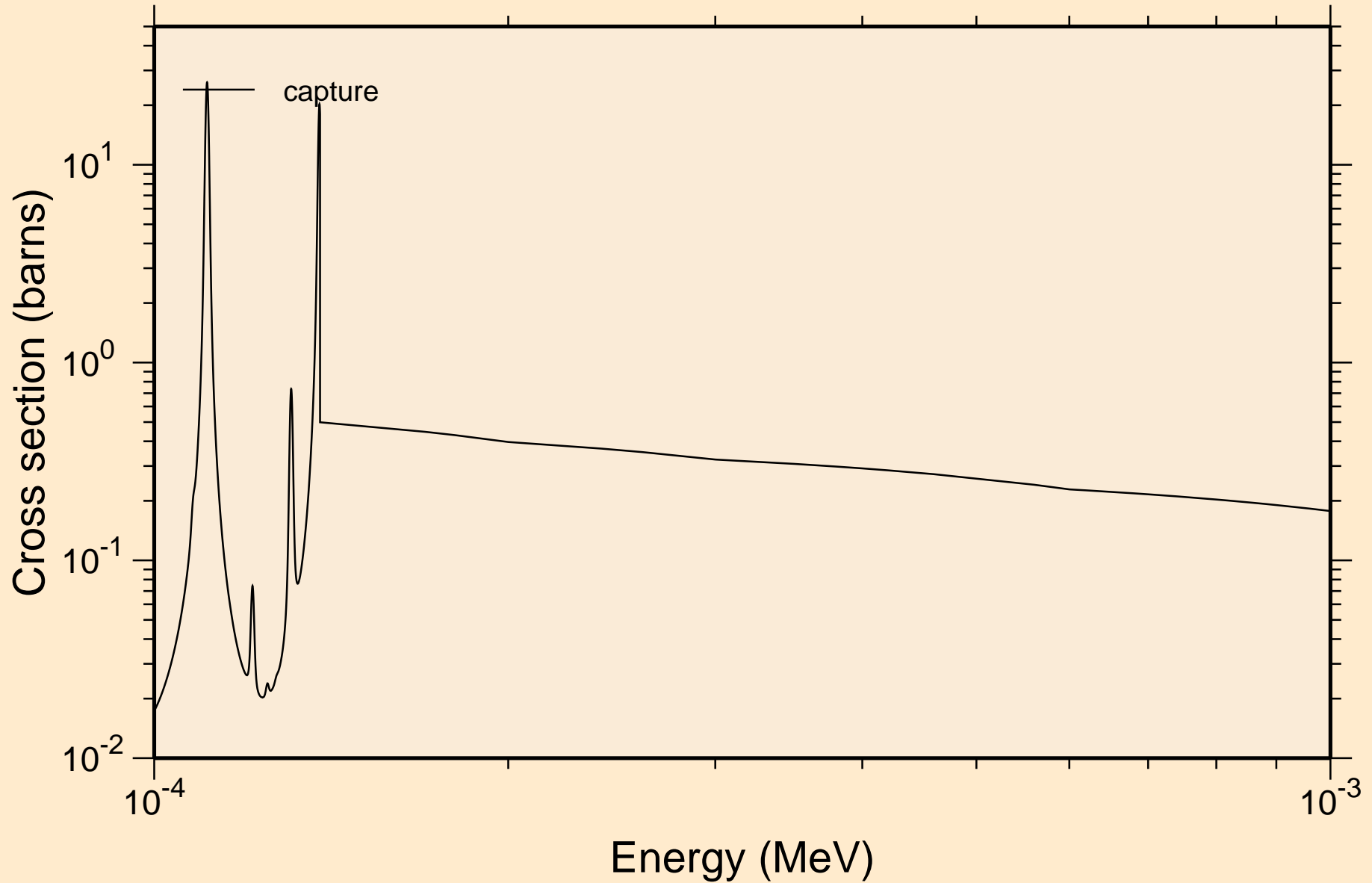

NB087 NEUTRON ACER TENDL-2024 LIBRARY; T=293.6K  
resonance absorption cross sections

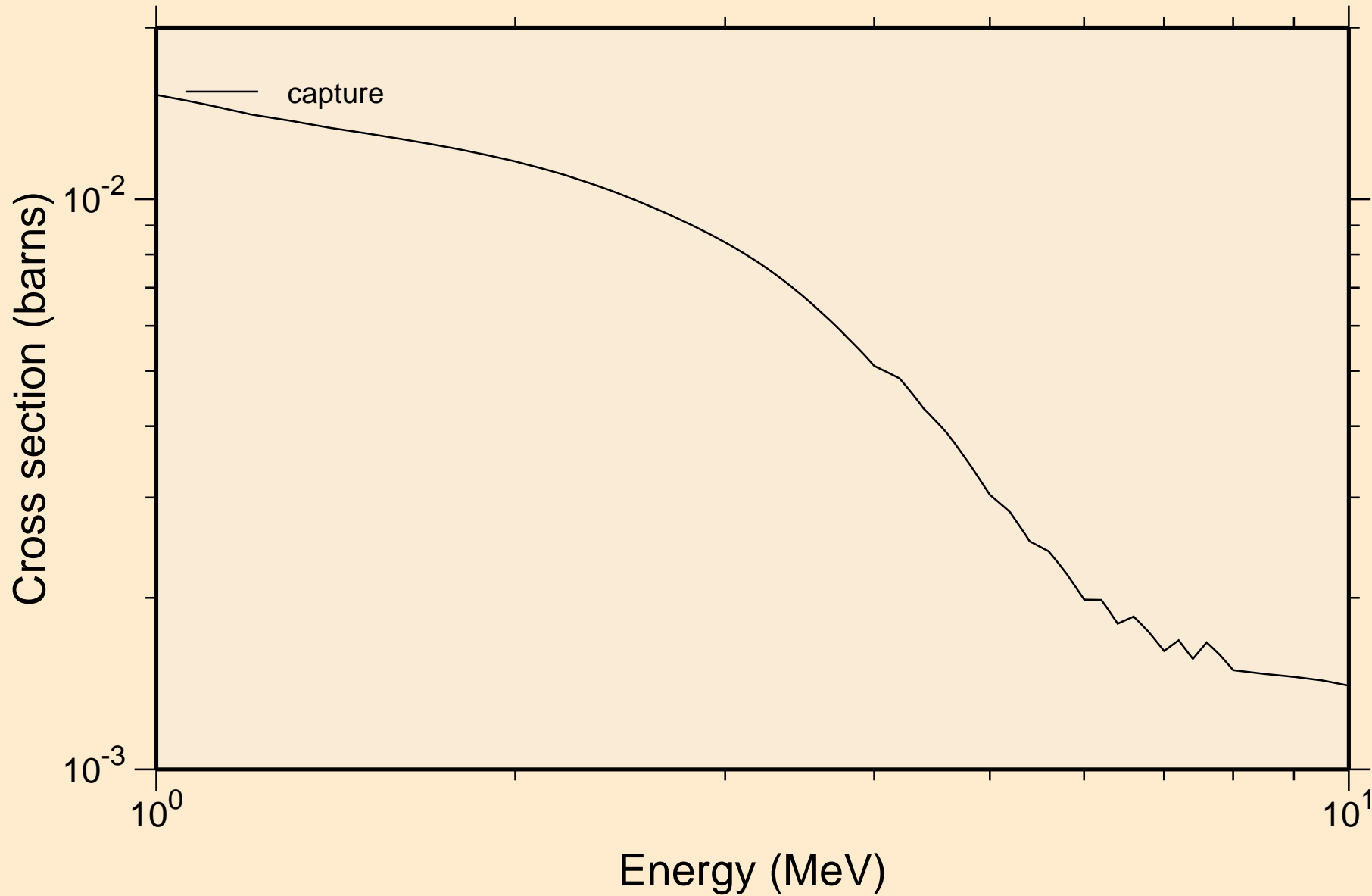

NB087 NEUTRON ACER TENDL-2024 LIBRARY; T=293.6K  
Heating

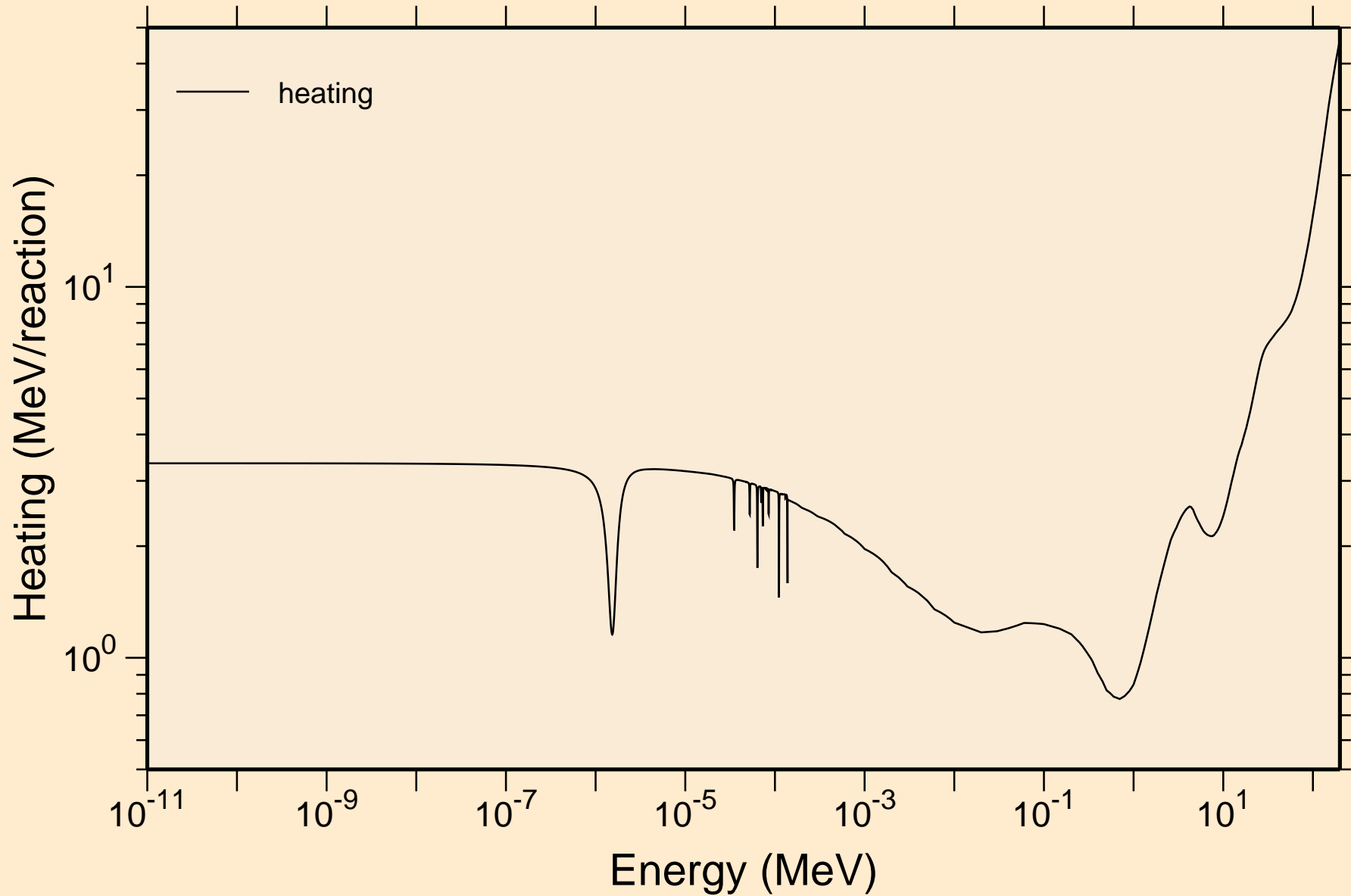

NB087 NEUTRON ACER TENDL-2024 LIBRARY; T=293.6K  
Damage

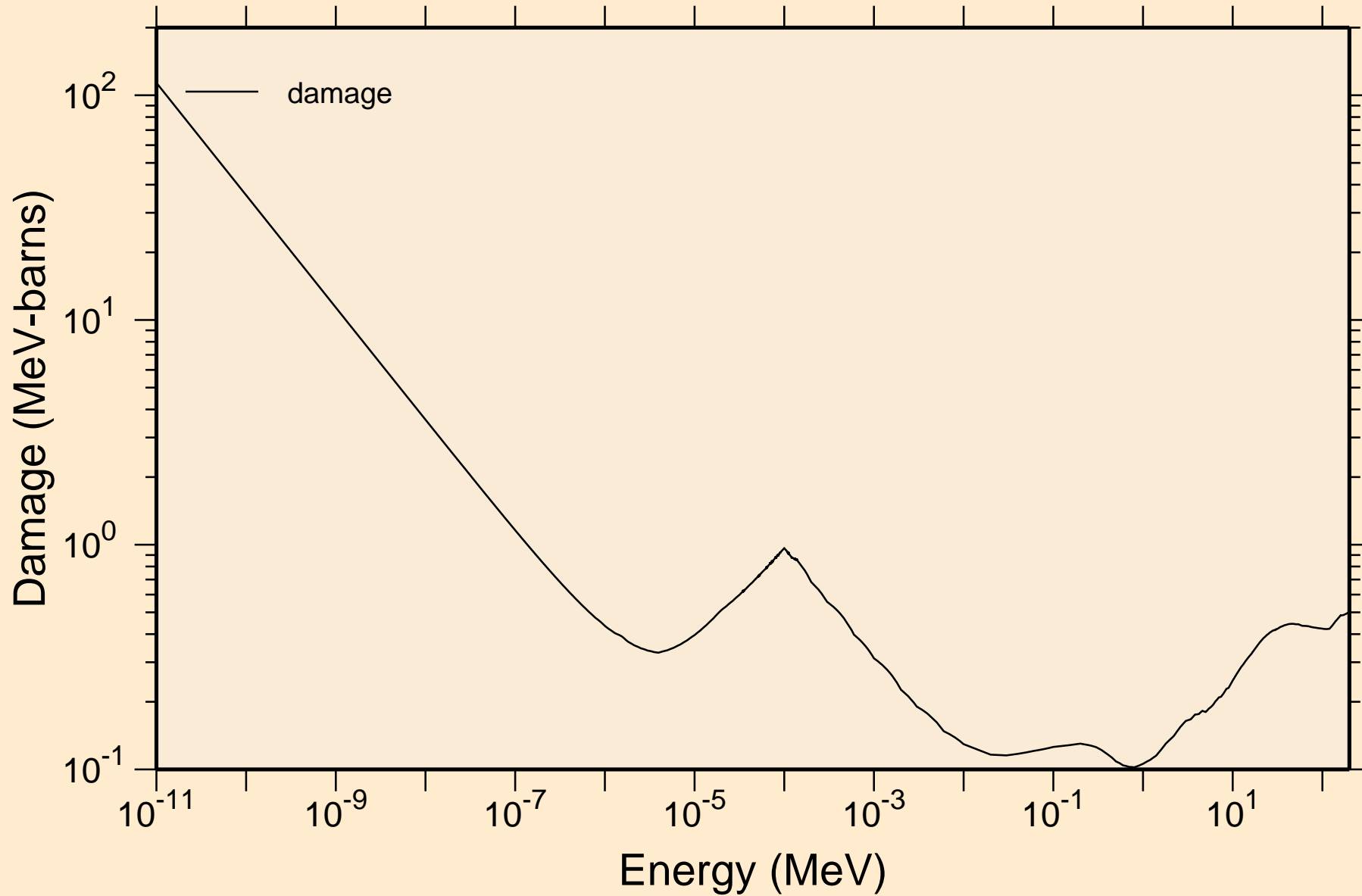

# NB087 NEUTRON ACER TENDL-2024 LIBRARY; T=293.6K

## Non-threshold reactions

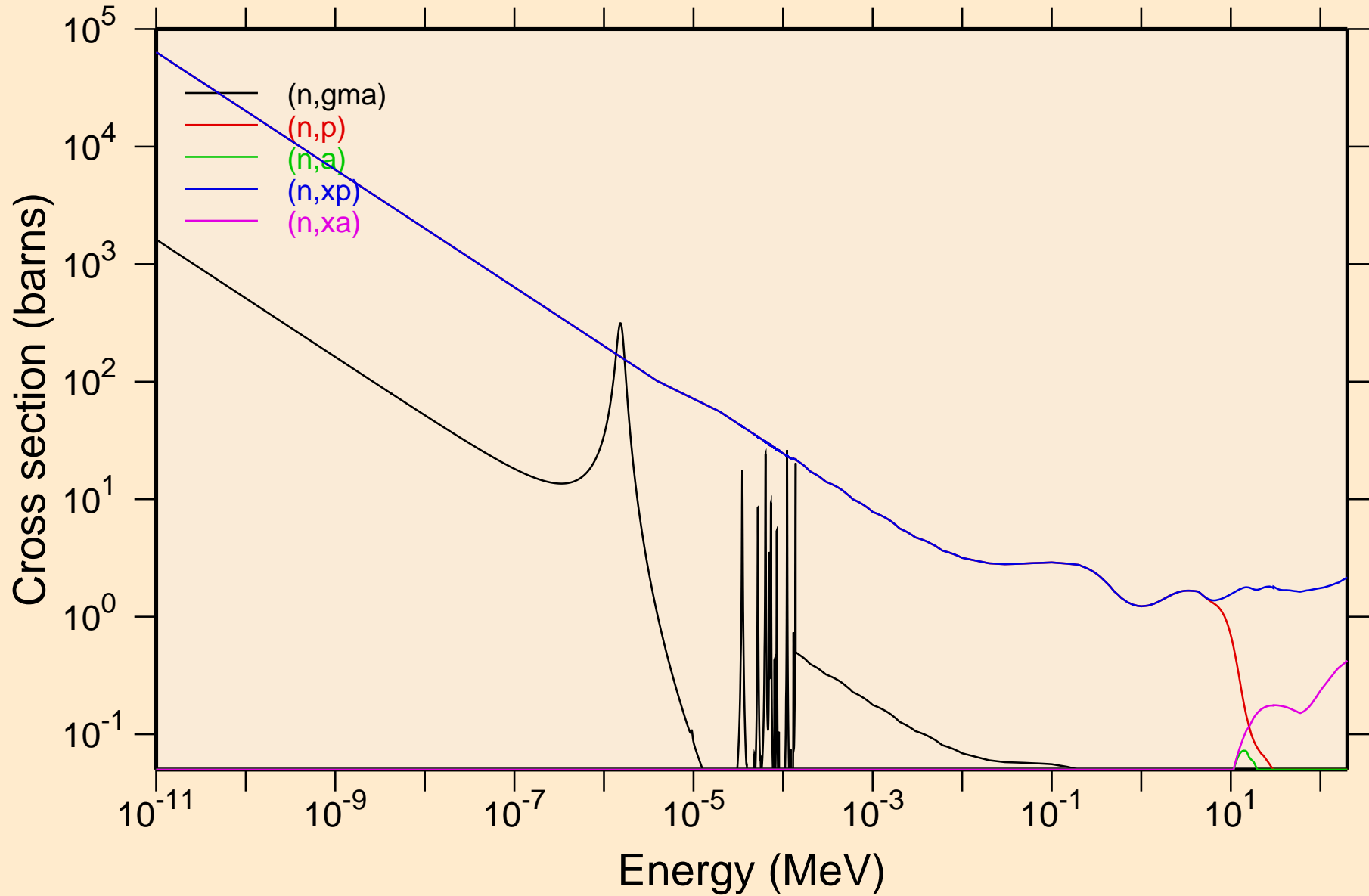

NB087 NEUTRON ACER TENDL-2024 LIBRARY; T=293.6K  
Principal cross sections

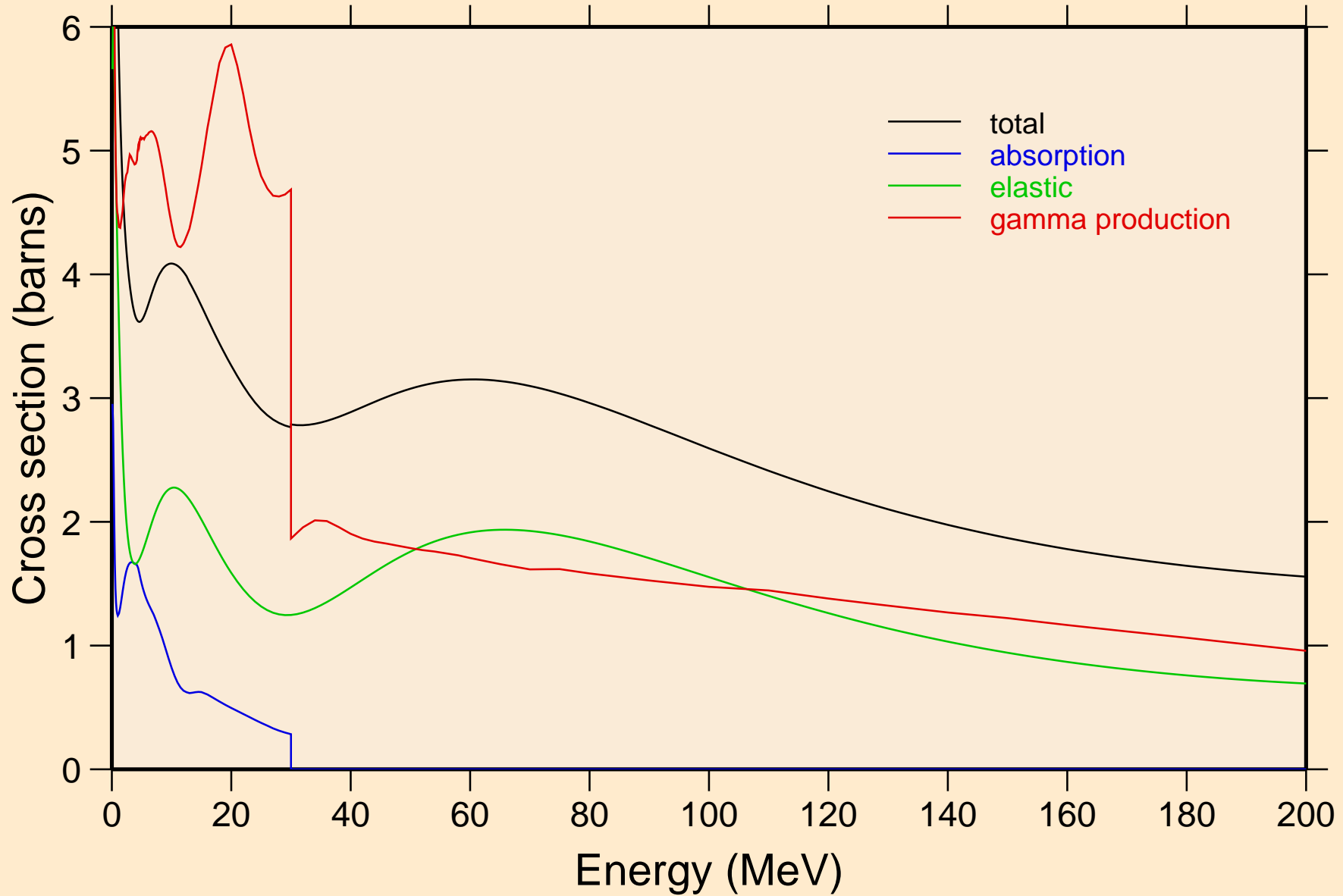

NB087 NEUTRON ACER TENDL-2024 LIBRARY; T=293.6K  
Heating

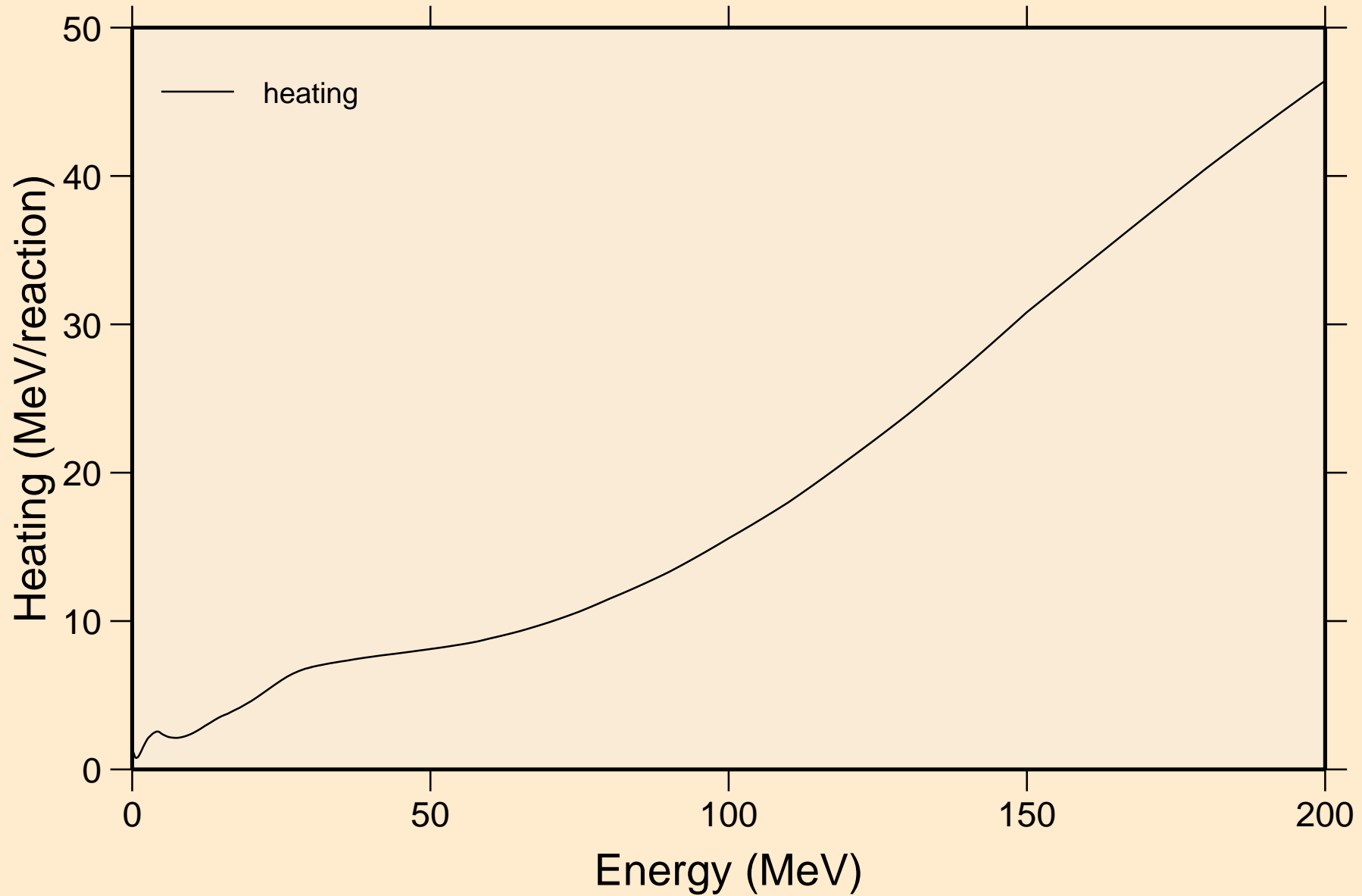

NB087 NEUTRON ACER TENDL-2024 LIBRARY; T=293.6K  
Damage

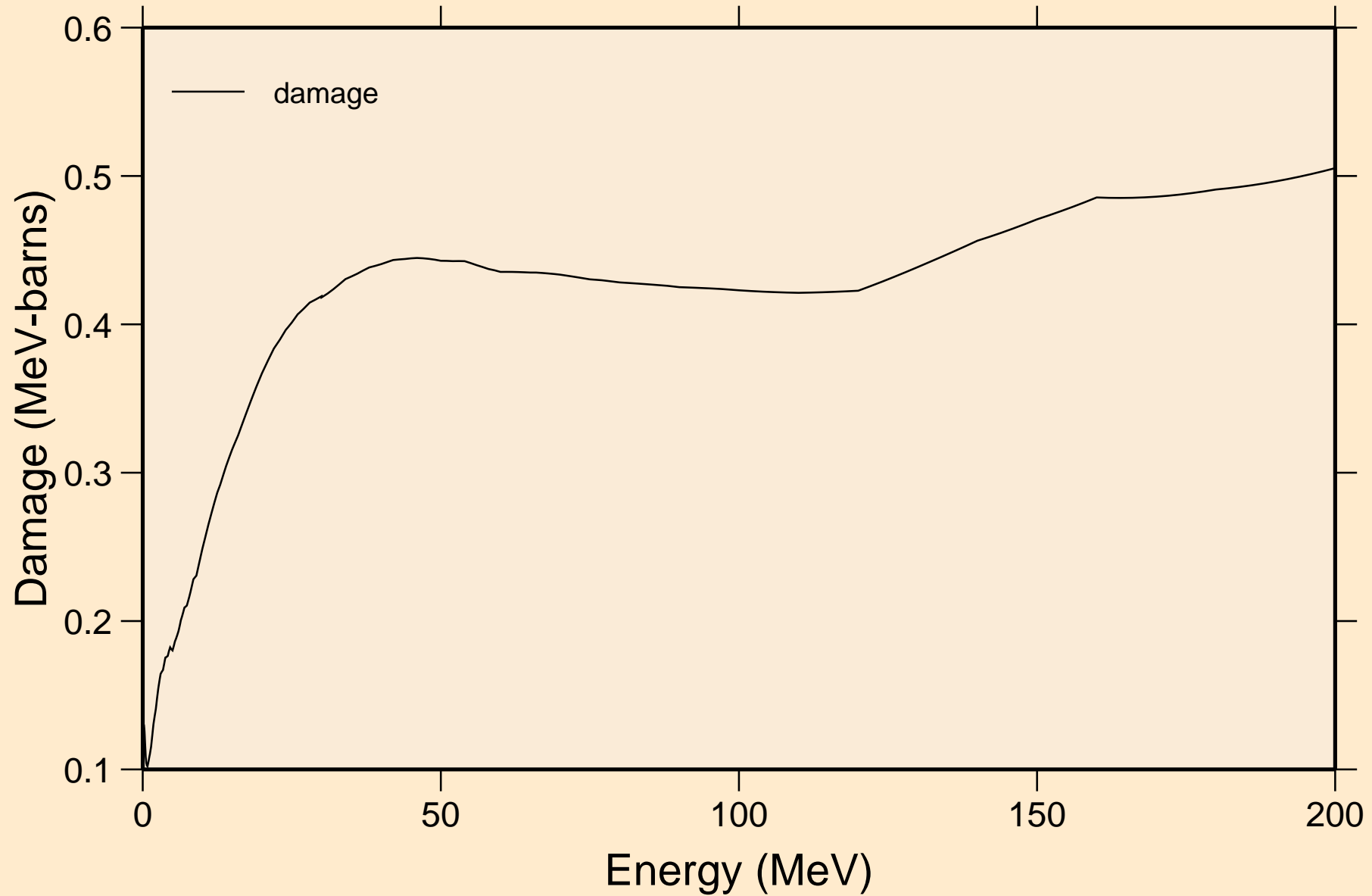

NB087 NEUTRON ACER TENDL-2024 LIBRARY; T=293.6K  
Non-threshold reactions

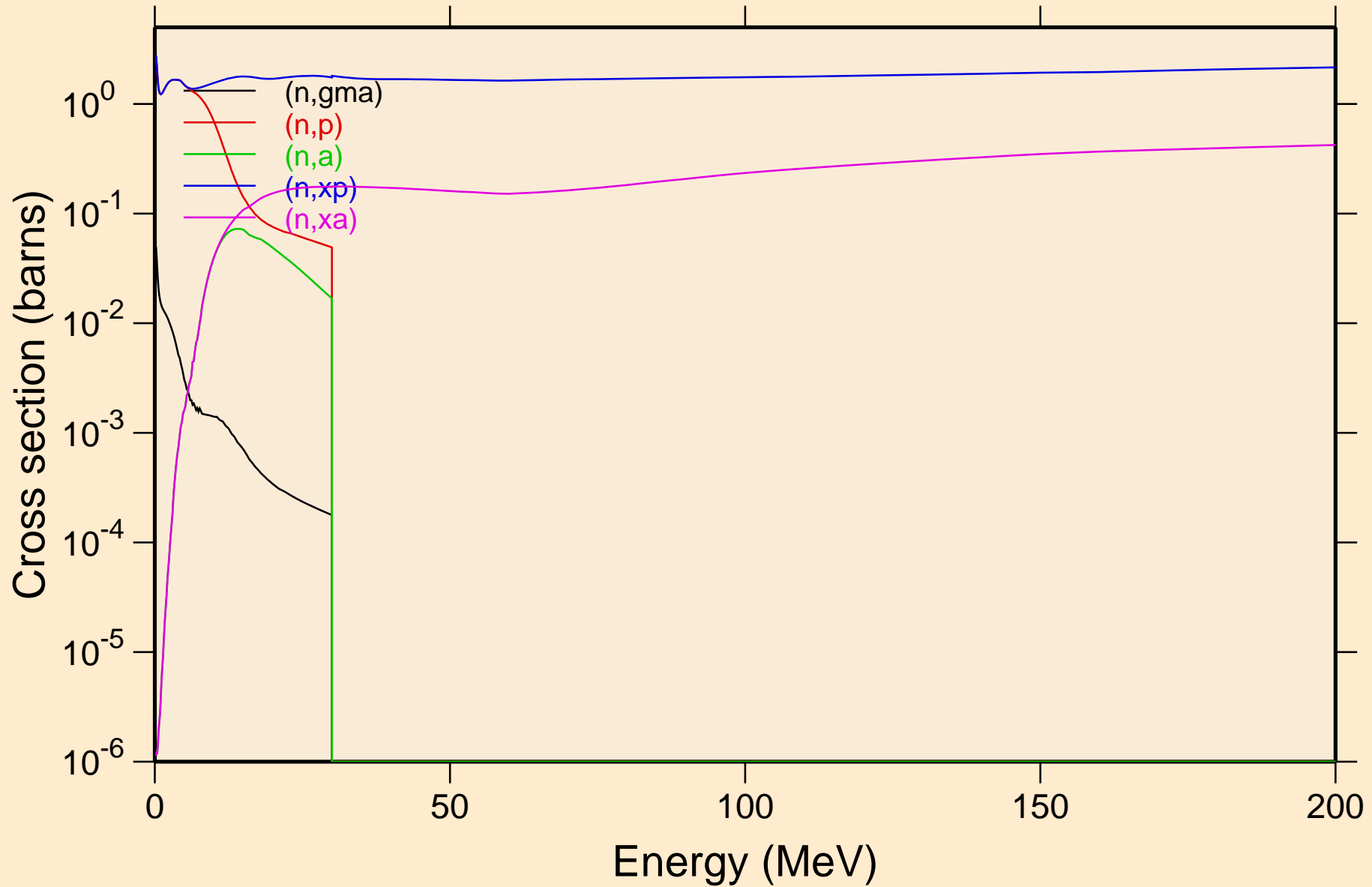

NB087 NEUTRON ACER TENDL-2024 LIBRARY; T=293.6K  
Inelastic levels

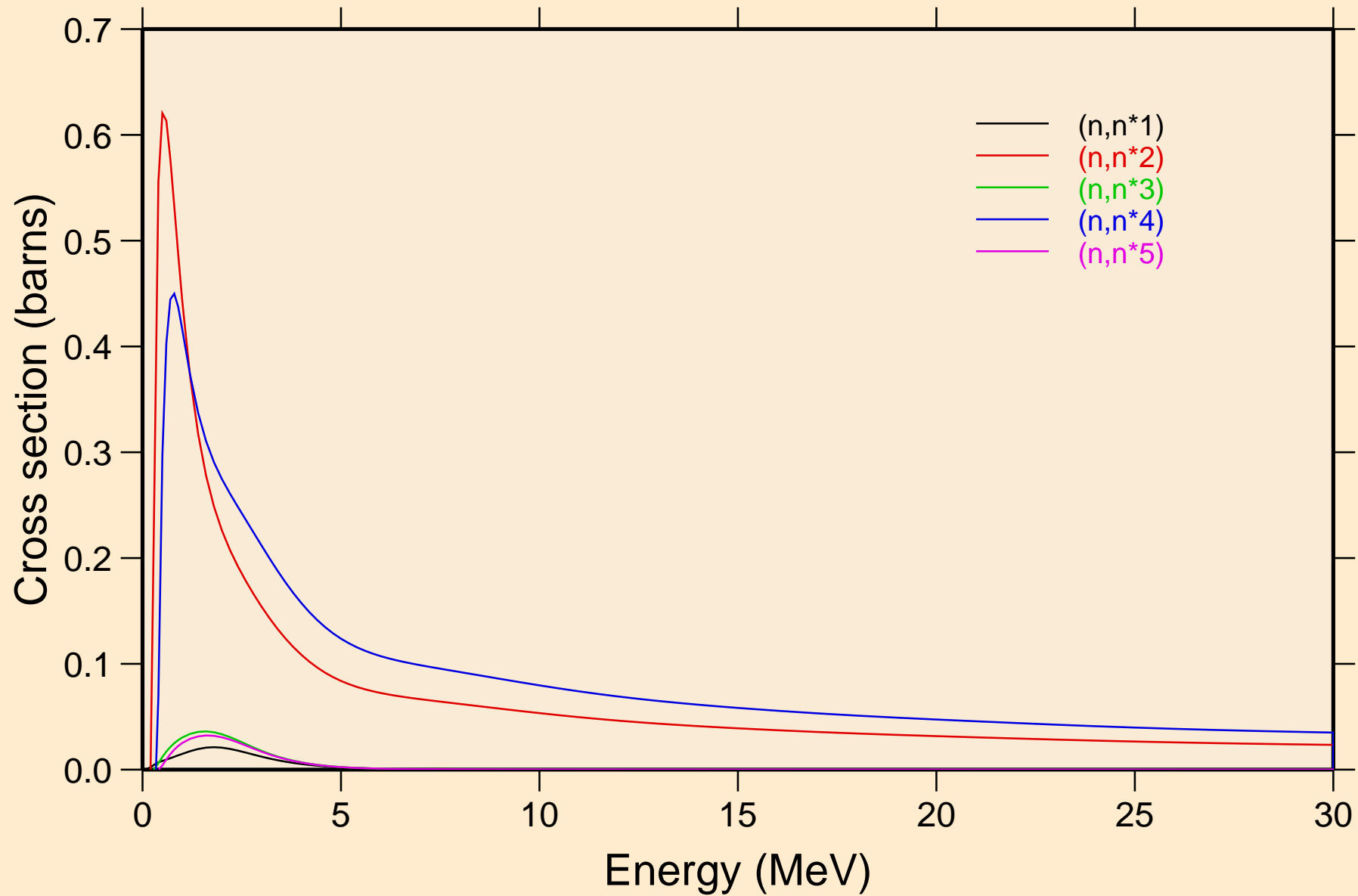

NB087 NEUTRON ACER TENDL-2024 LIBRARY; T=293.6K  
Inelastic levels

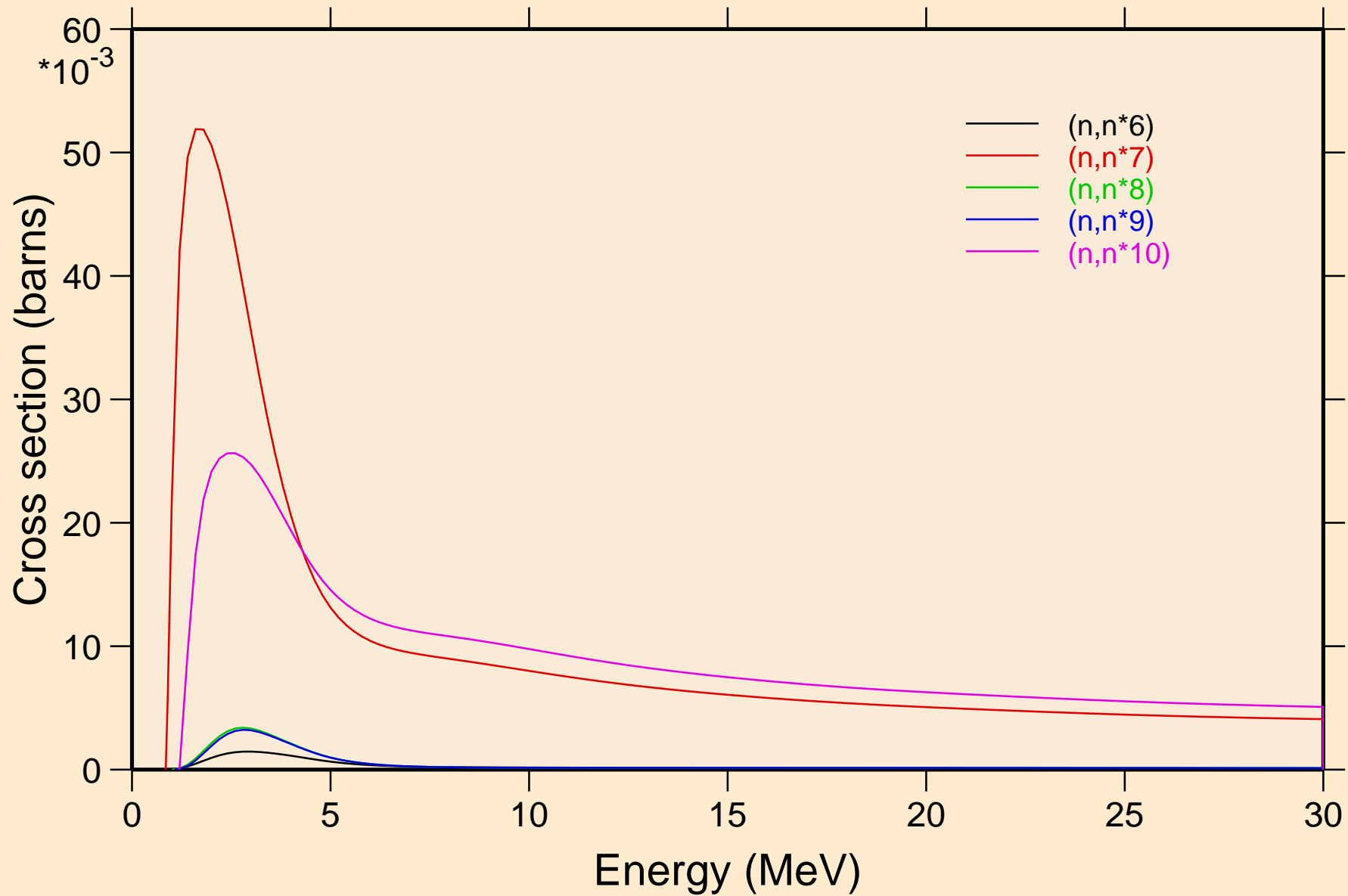

NB087 NEUTRON ACER TENDL-2024 LIBRARY; T=293.6K  
Threshold reactions

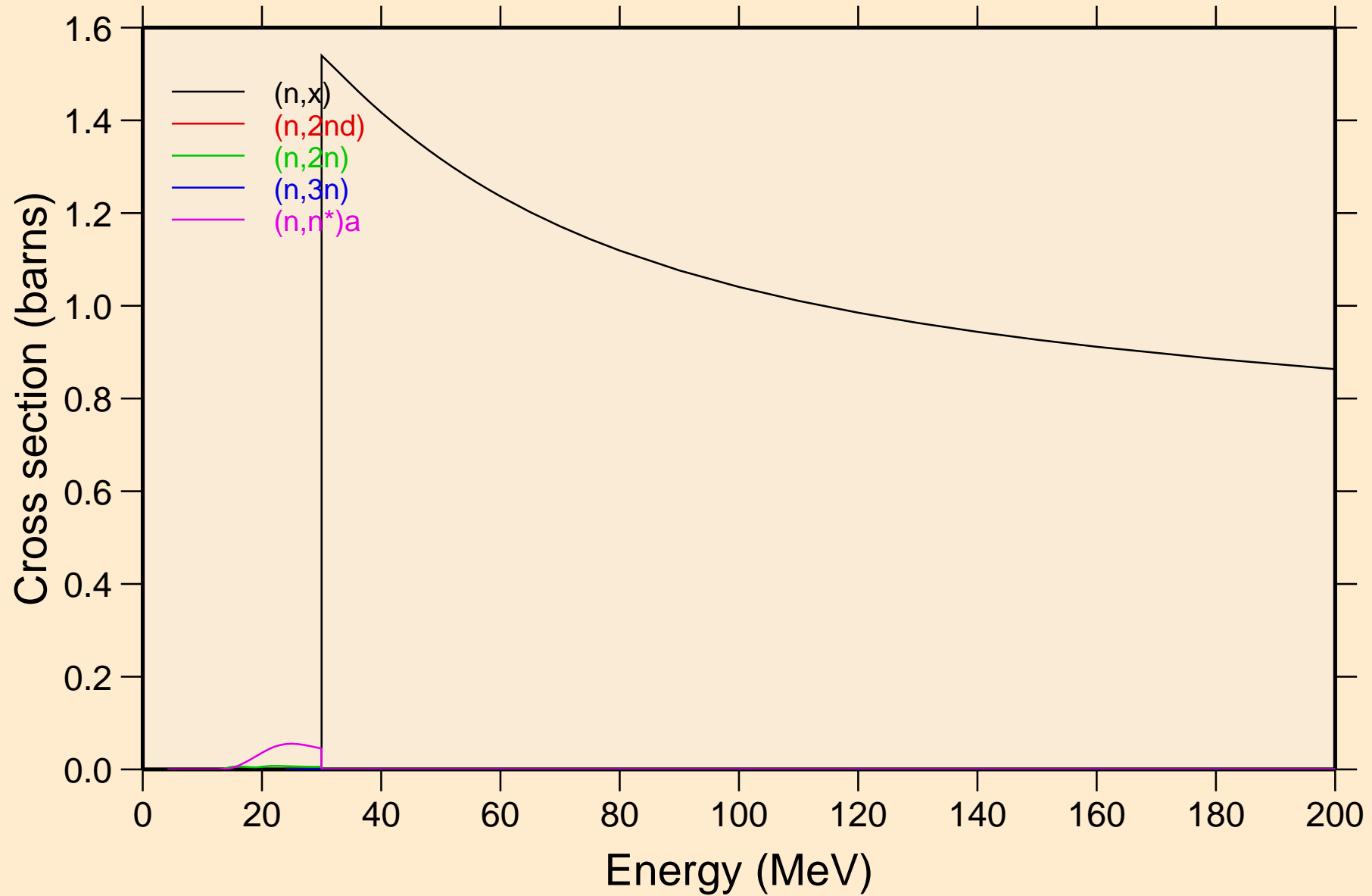

NB087 NEUTRON ACER TENDL-2024 LIBRARY; T=293.6K  
Threshold reactions

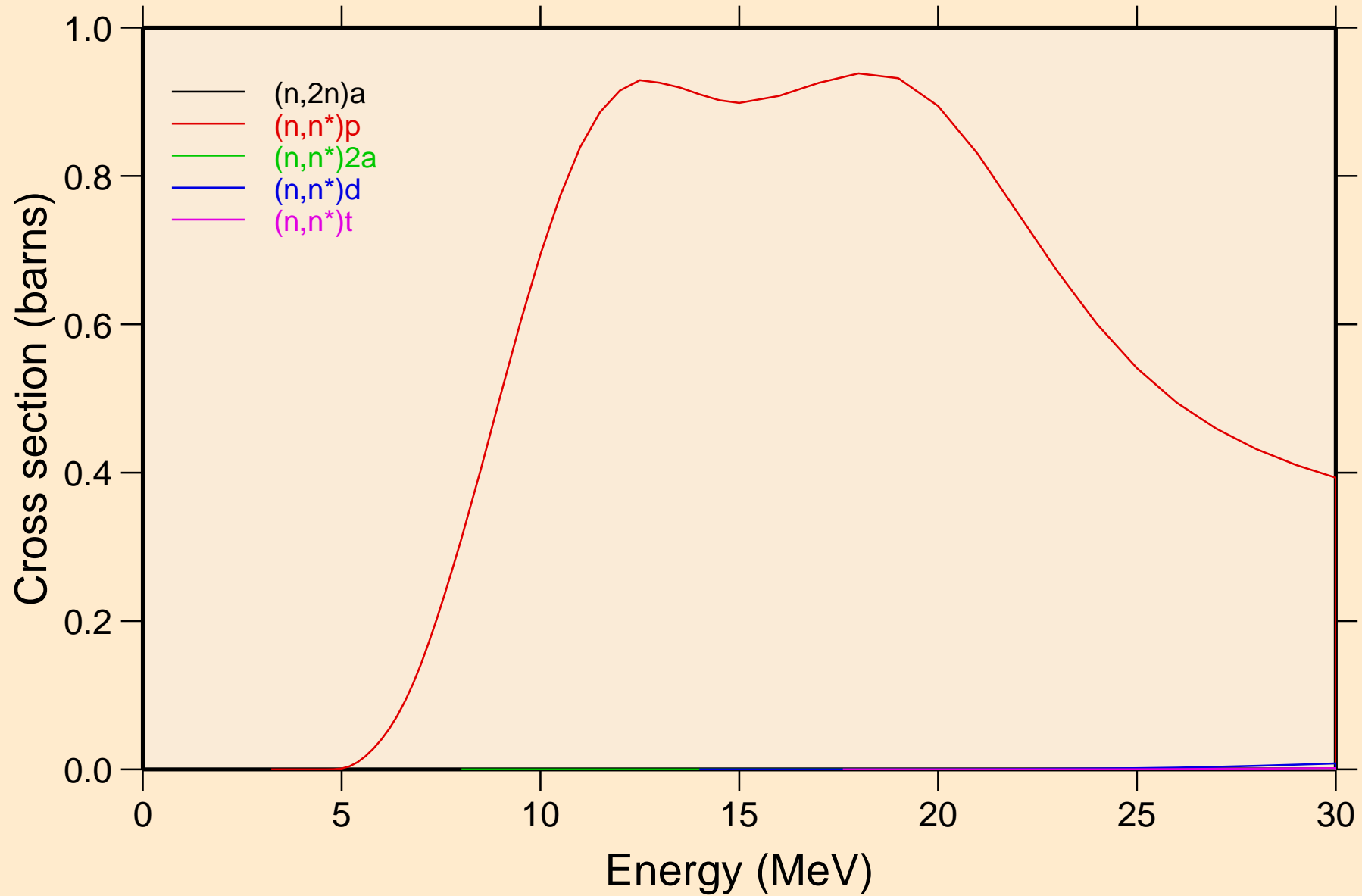

NB087 NEUTRON ACER TENDL-2024 LIBRARY; T=293.6K  
Threshold reactions

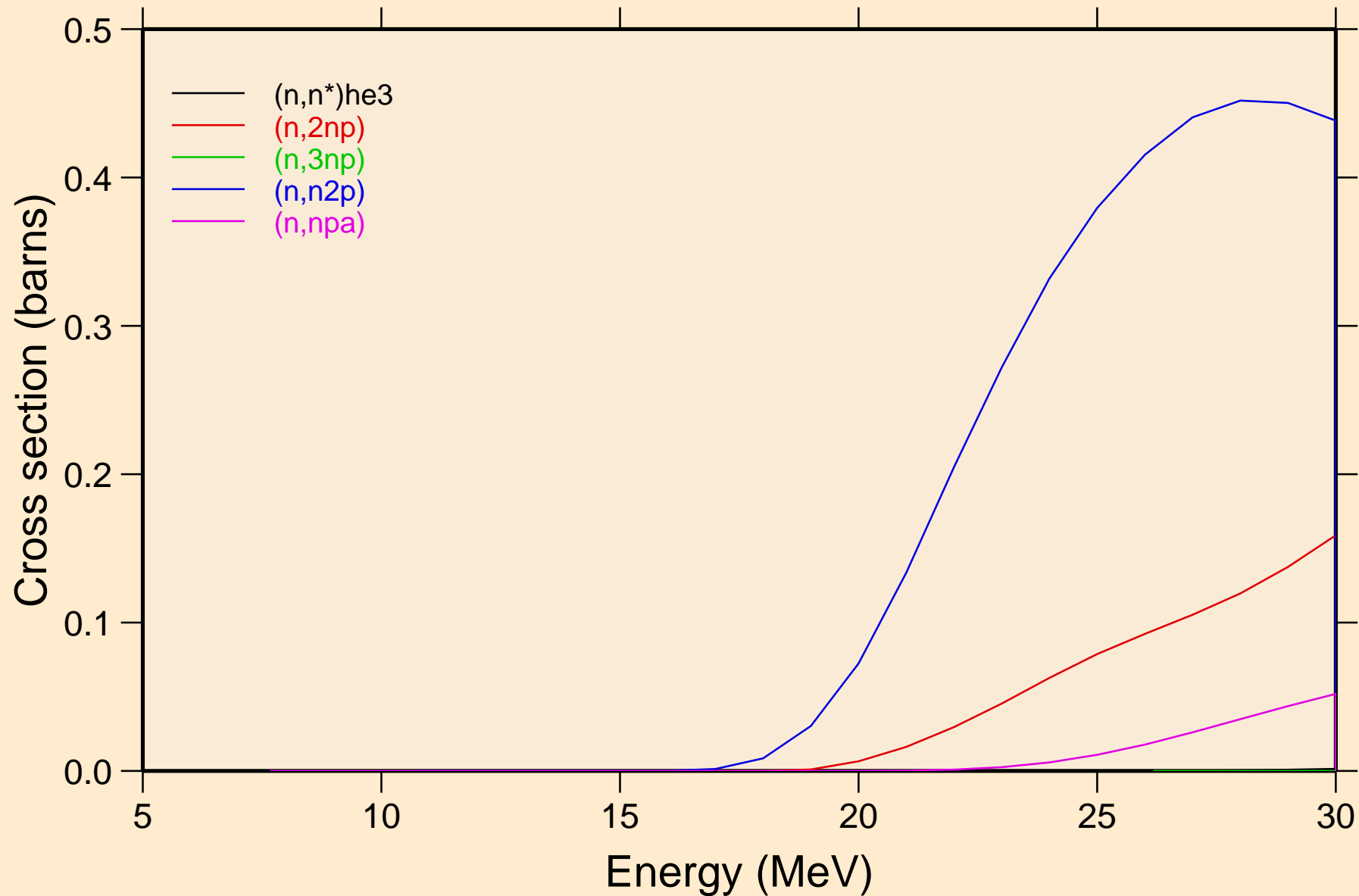

# NB087 NEUTRON ACER TENDL-2024 LIBRARY; T=293.6K

## Threshold reactions

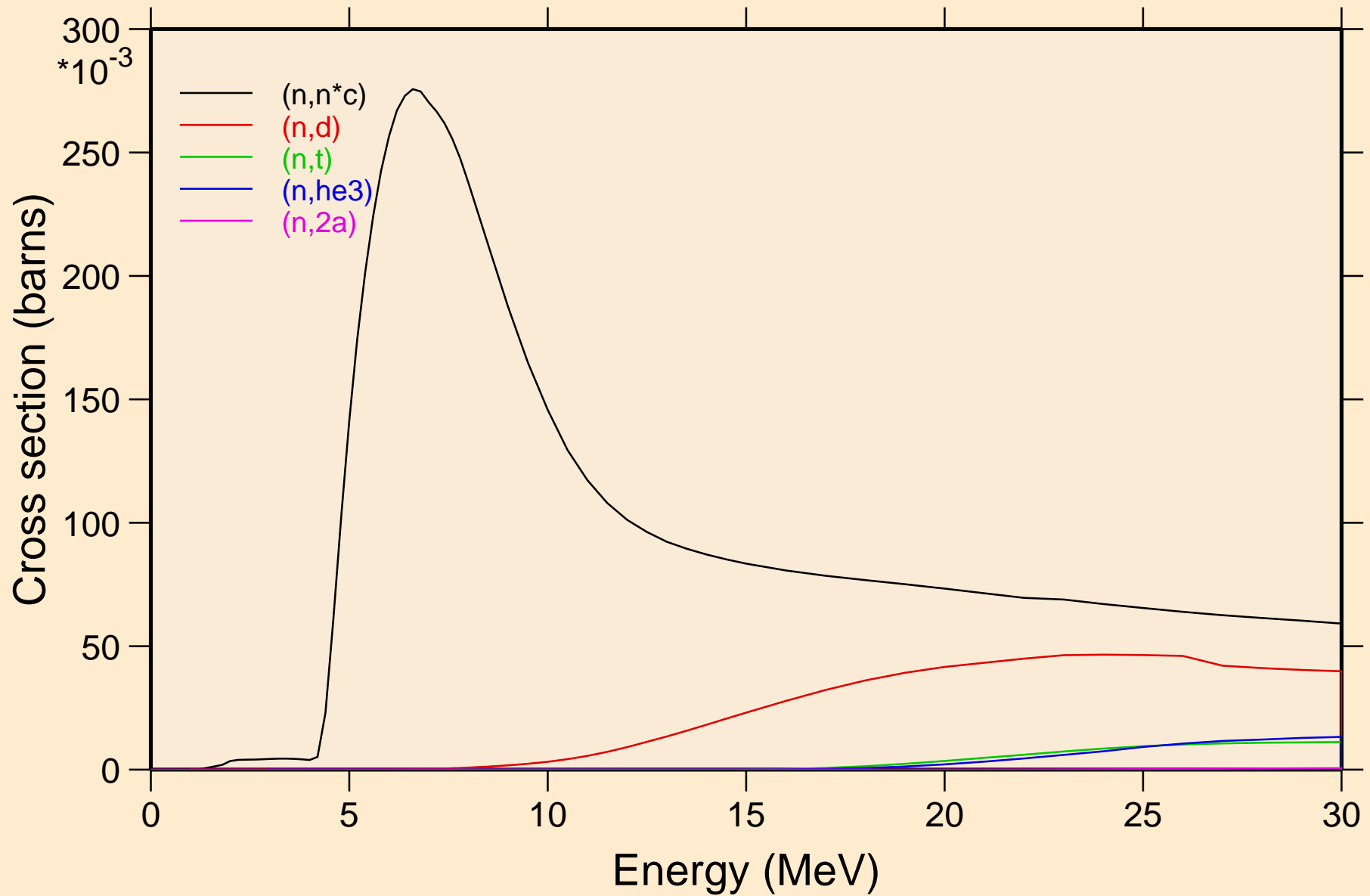

# NB087 NEUTRON ACER TENDL-2024 LIBRARY; T=293.6K

## Threshold reactions

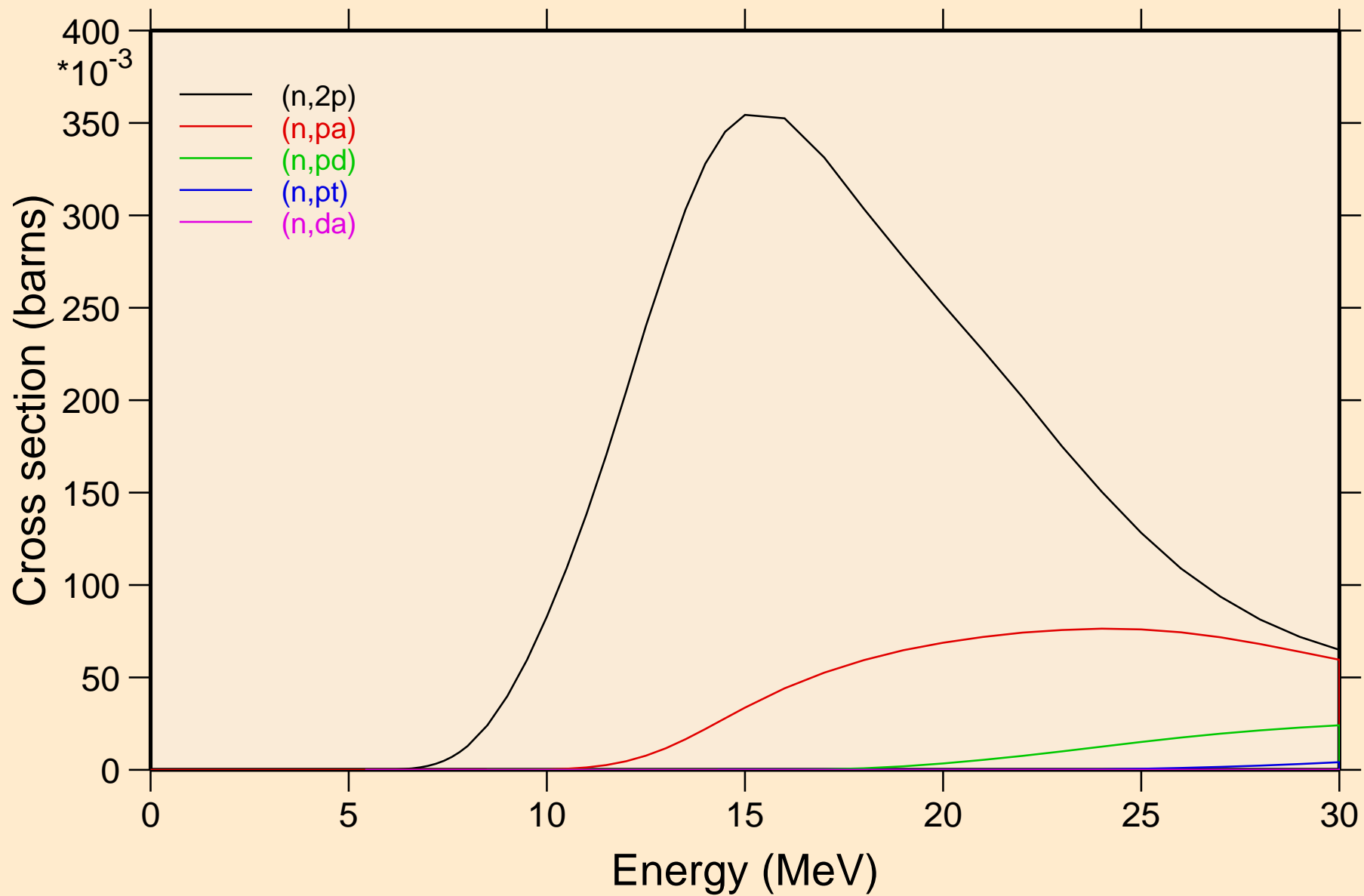

NB087 NEUTRON ACER TENDL-2024 LIBRARY; T=293.6K  
Threshold reactions

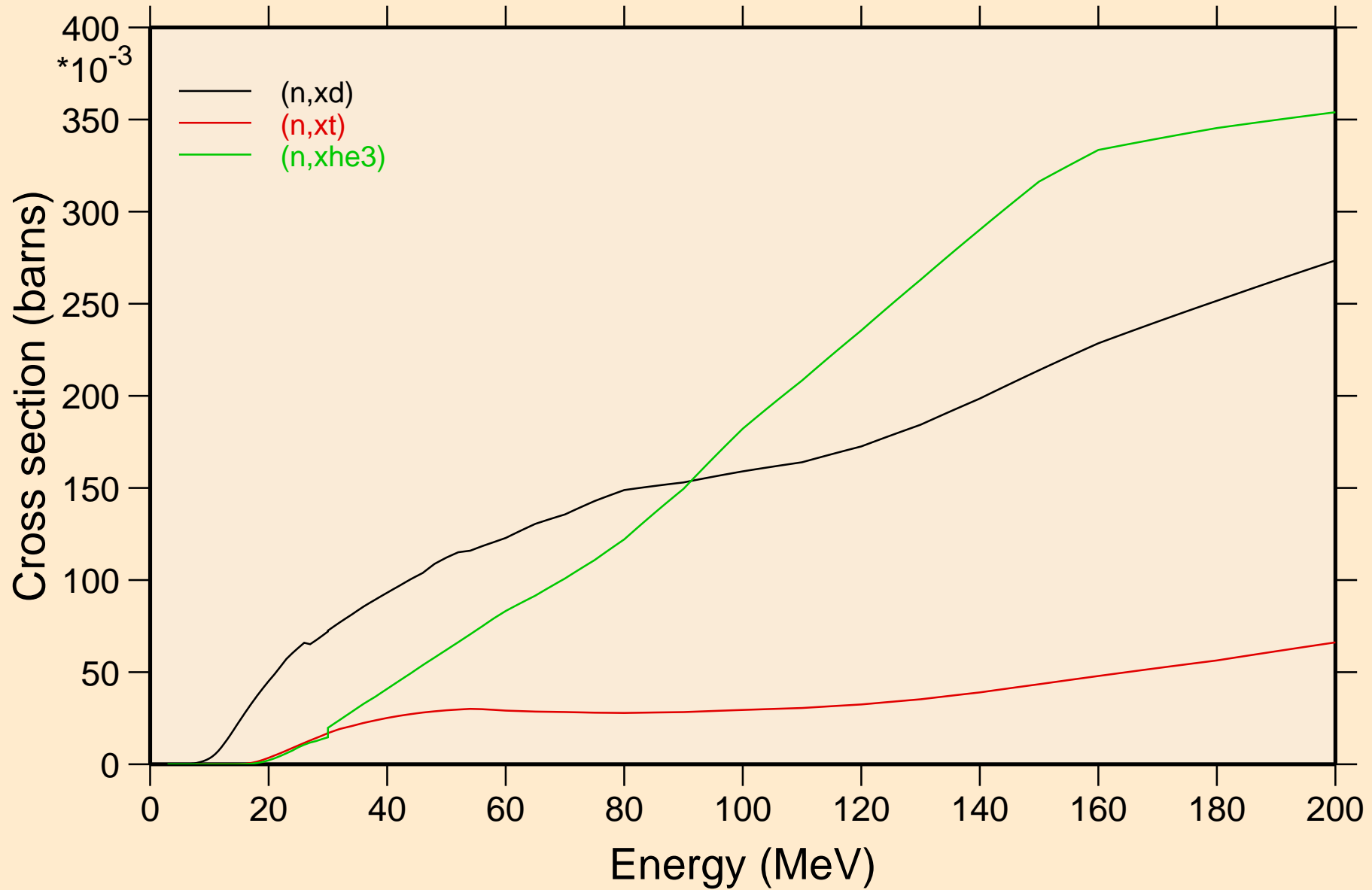

NB087 NEUTRON ACER TENDL-2024 LIBRARY; T=293.6K  
angular distribution for elastic

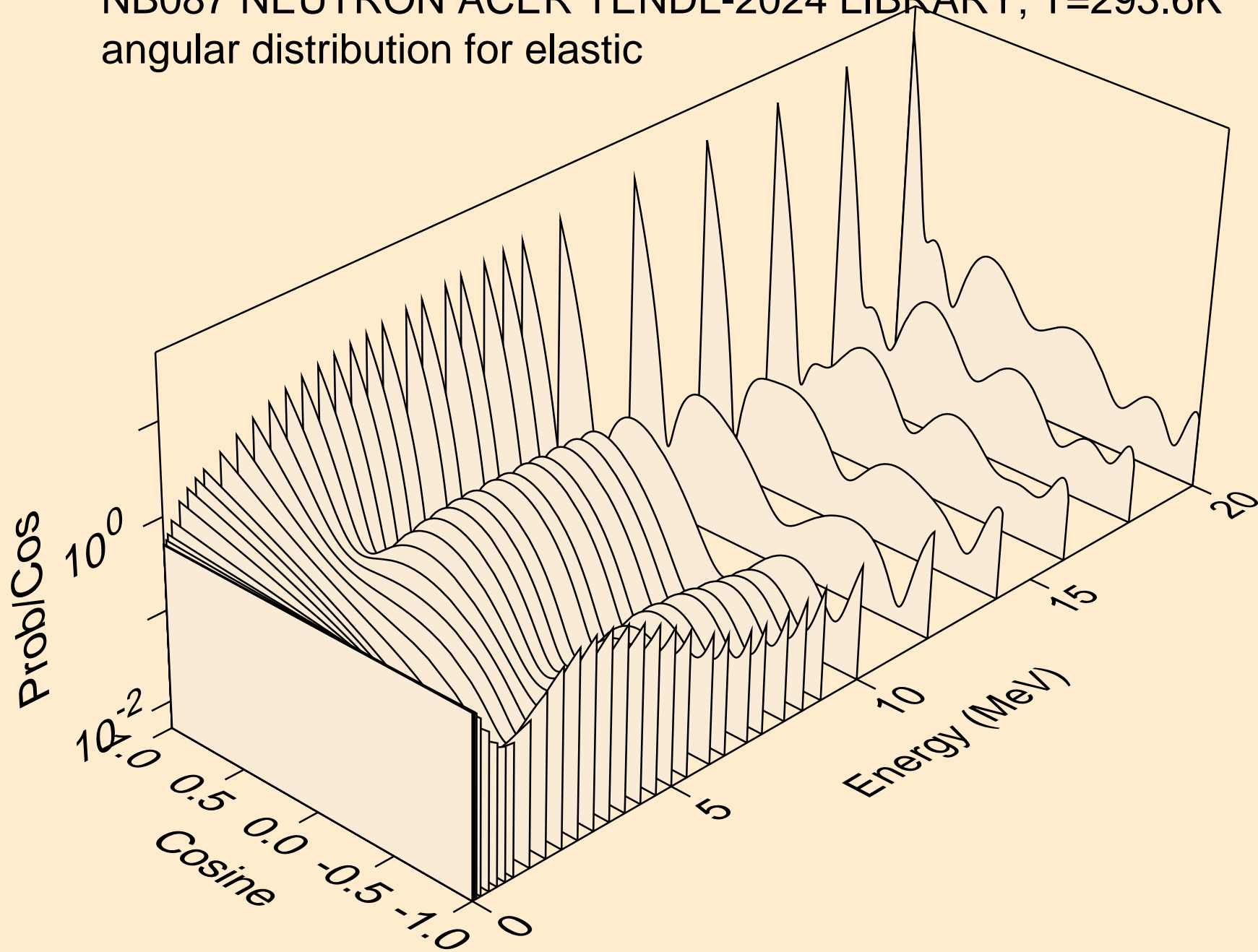

NB087 NEUTRON ACER TENDL-2024 LIBRARY; T=293.6K  
angular distribution for elastic

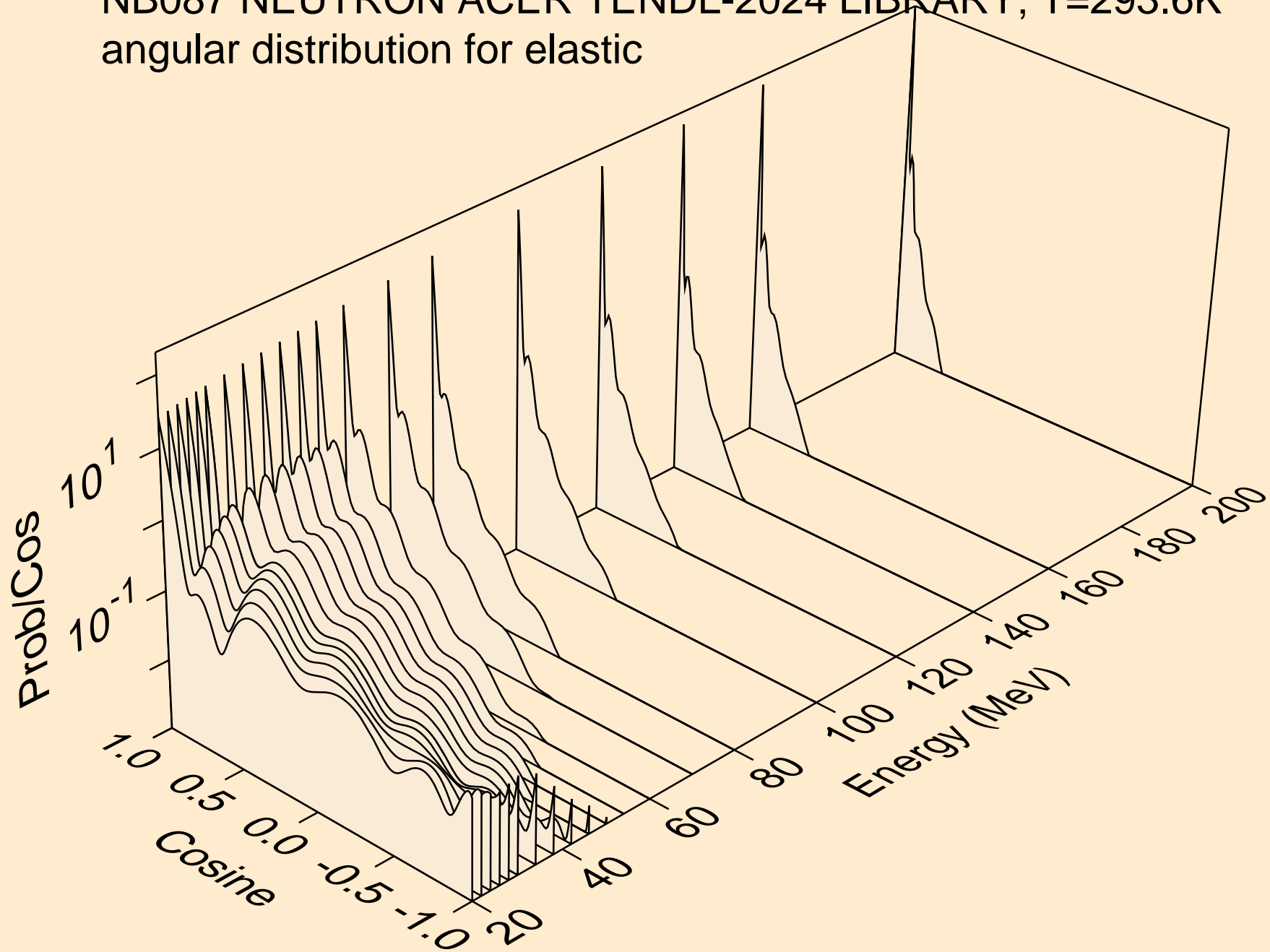

NB087 NEUTRON ACER TENDL-2024 LIBRARY; T=293.6K  
angular distribution for (n,n\*1)

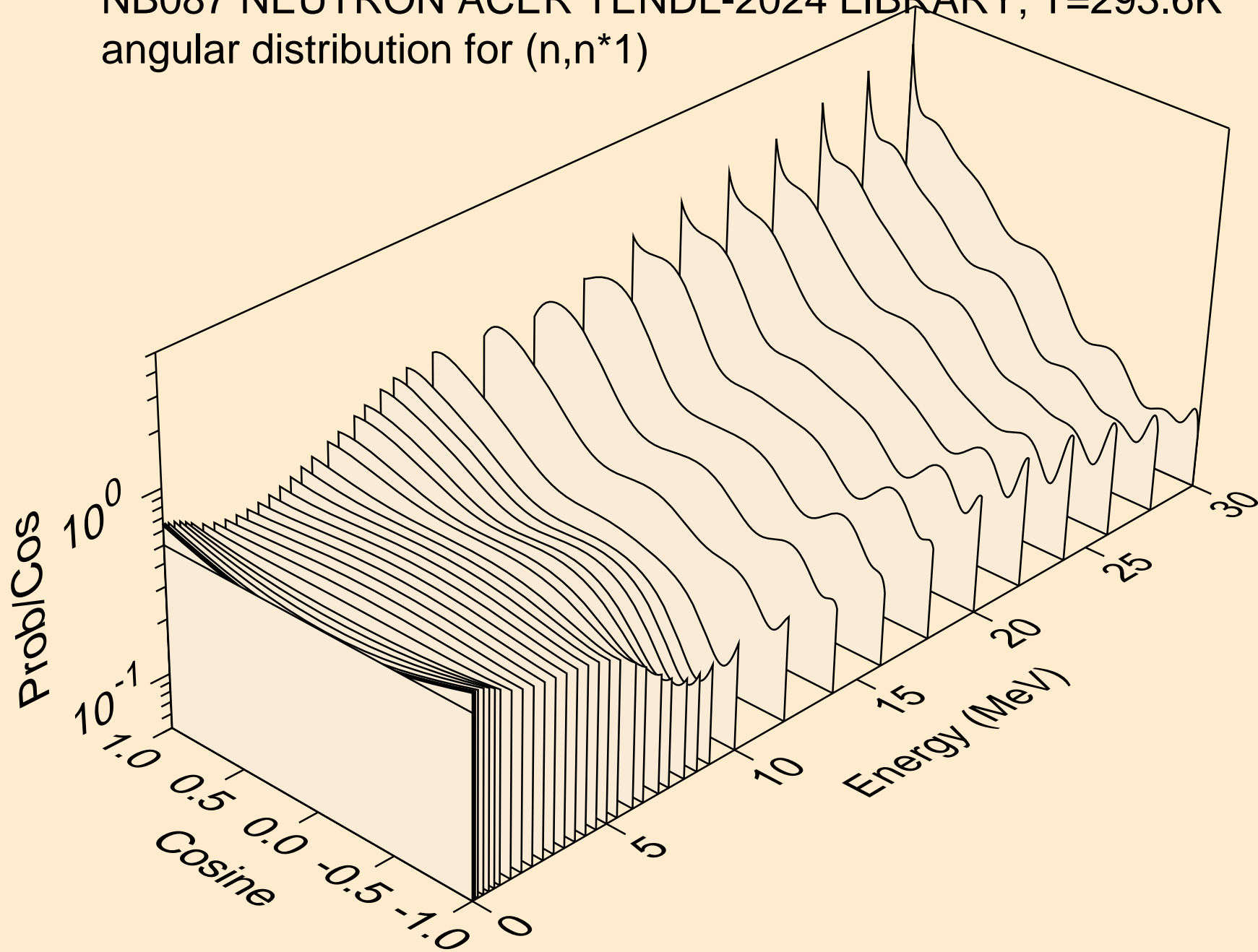

NB087 NEUTRON ACER TENDL-2024 LIBRARY; T=293.6K  
angular distribution for (n,n\*2)

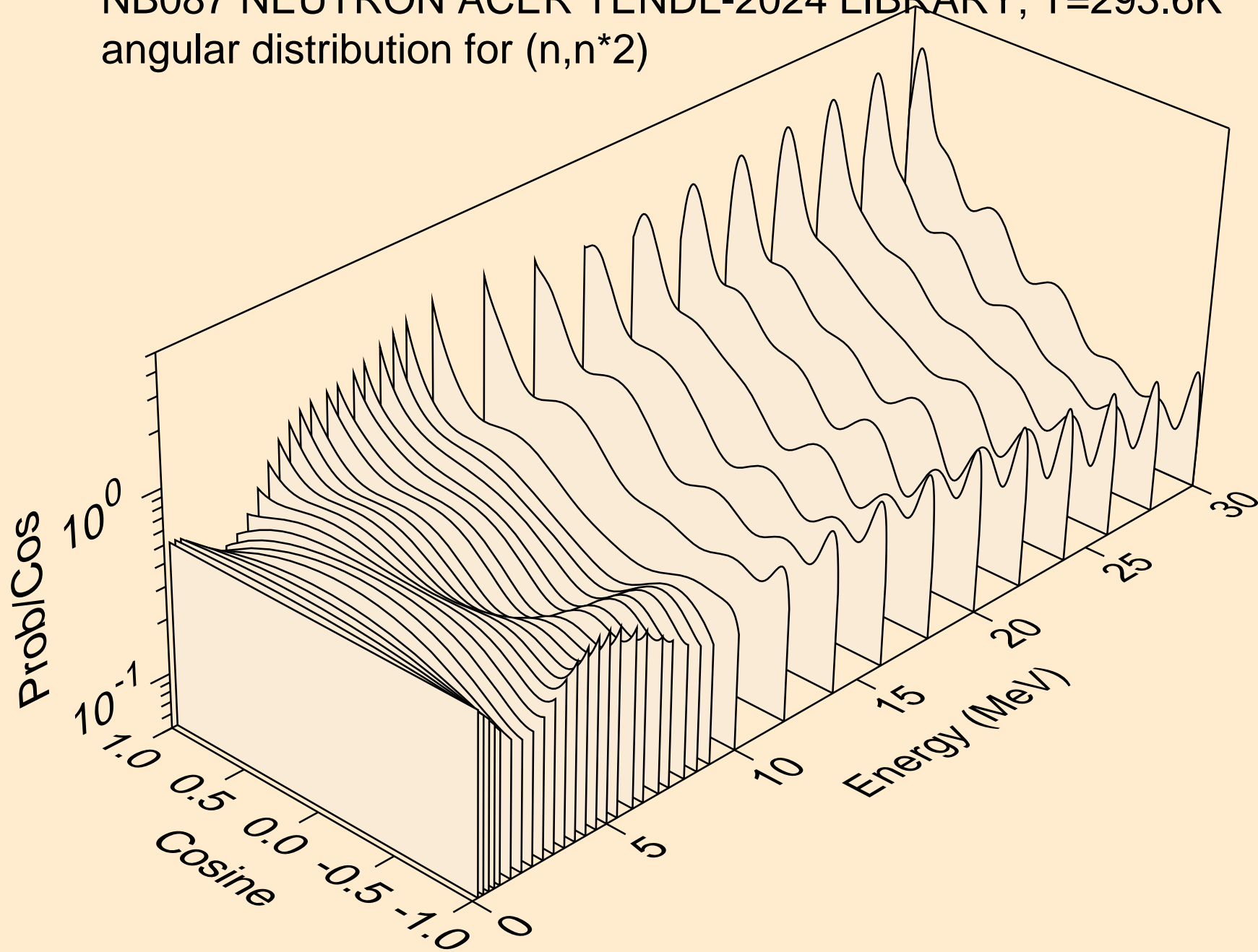

NB087 NEUTRON ACER TENDL-2024 LIBRARY; T=293.6K  
angular distribution for (n,n\*3)

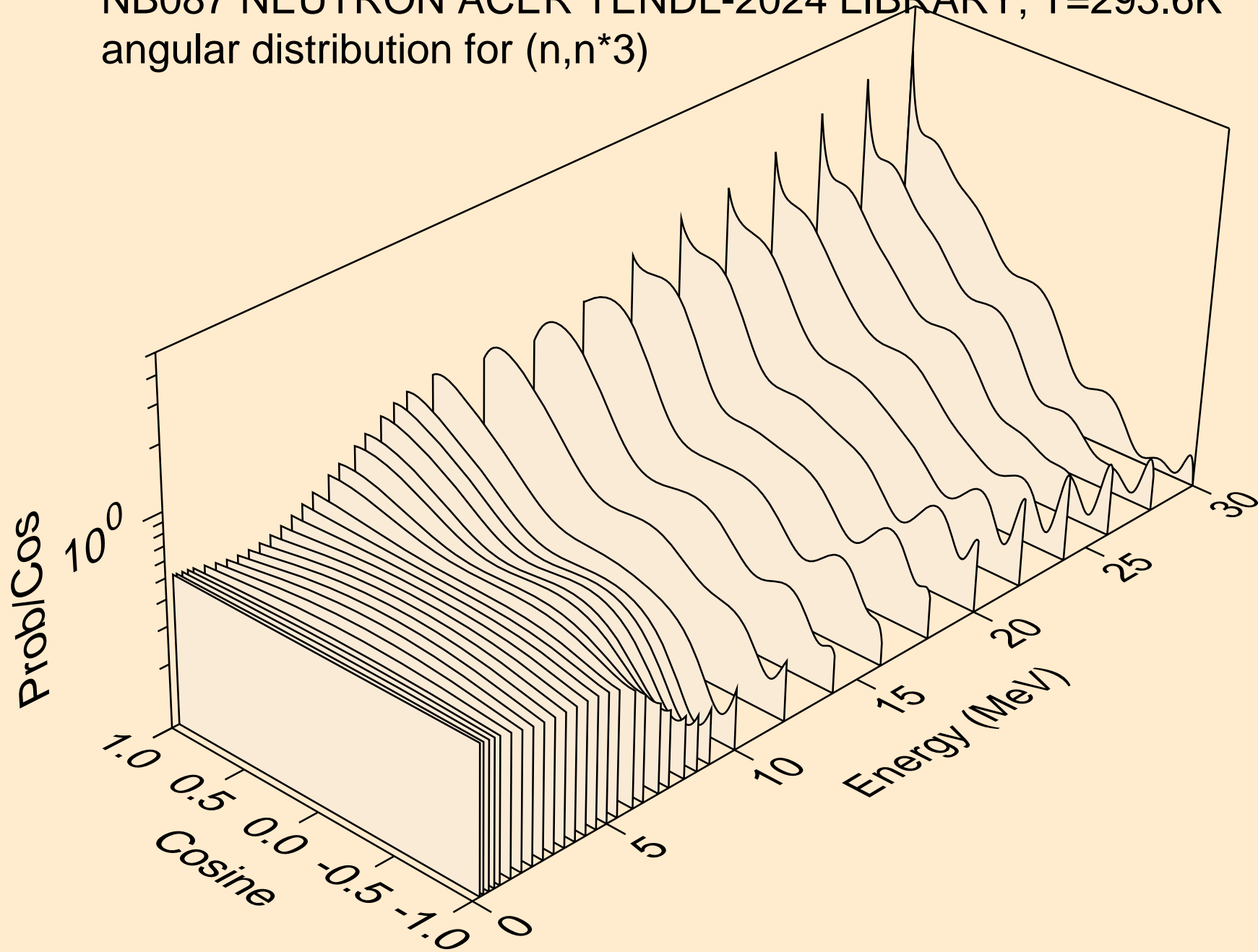

NB087 NEUTRON ACER TENDL-2024 LIBRARY; T=293.6K  
angular distribution for (n,n\*4)

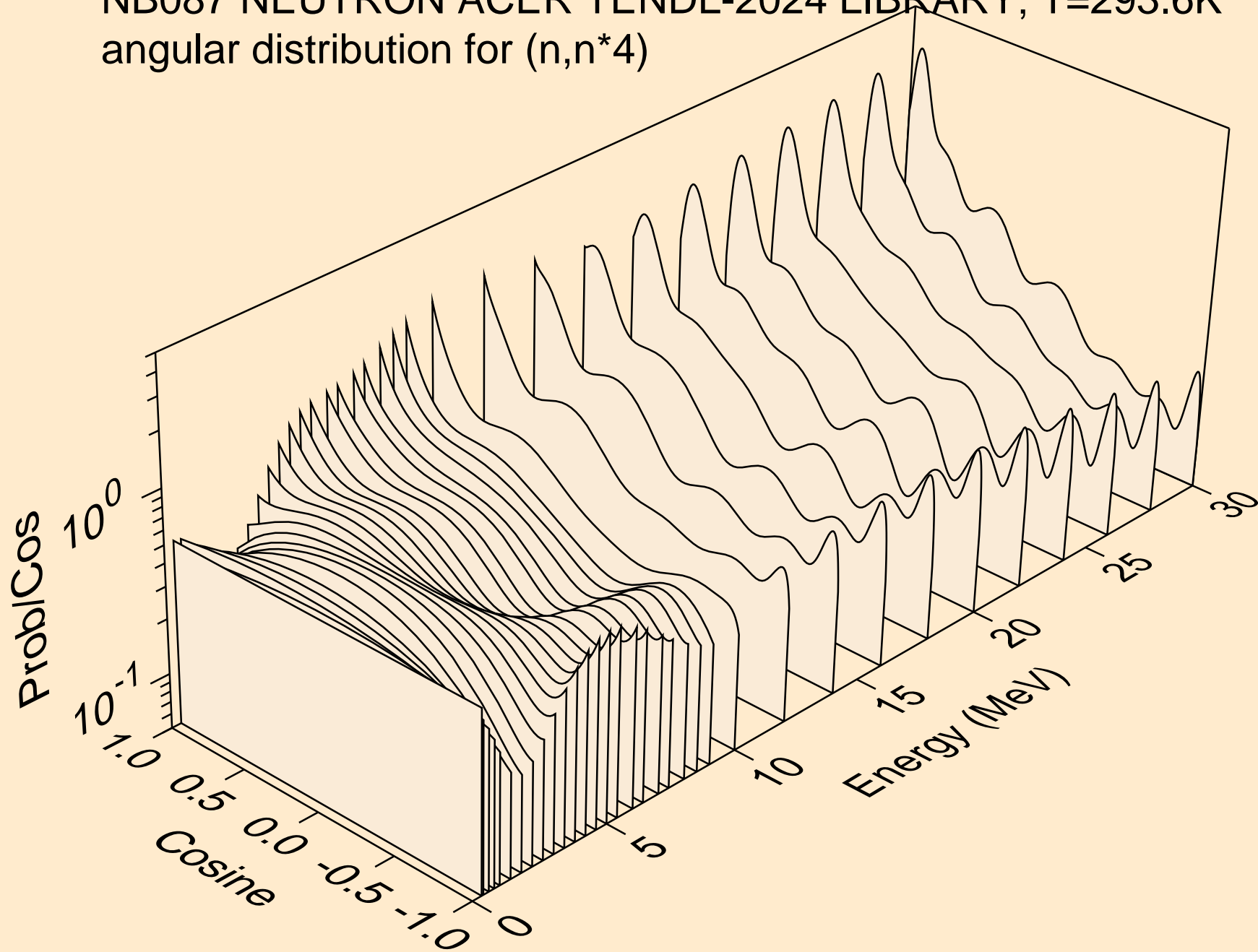

NB087 NEUTRON ACER TENDL-2024 LIBRARY; T=293.6K  
angular distribution for (n,n\*5)

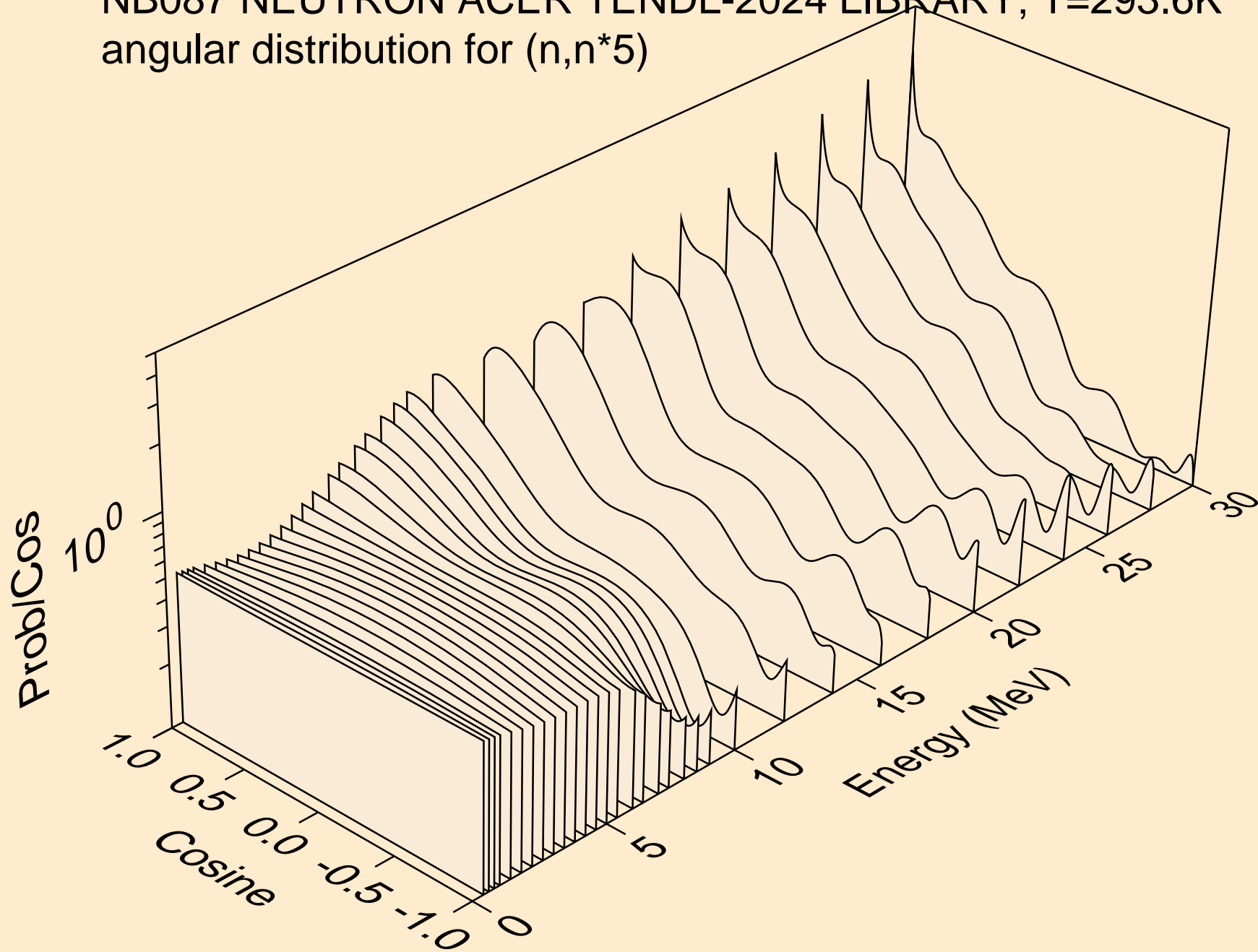

NB087 NEUTRON ACER TENDL-2024 LIBRARY; T=293.6K  
angular distribution for (n,n\*6)

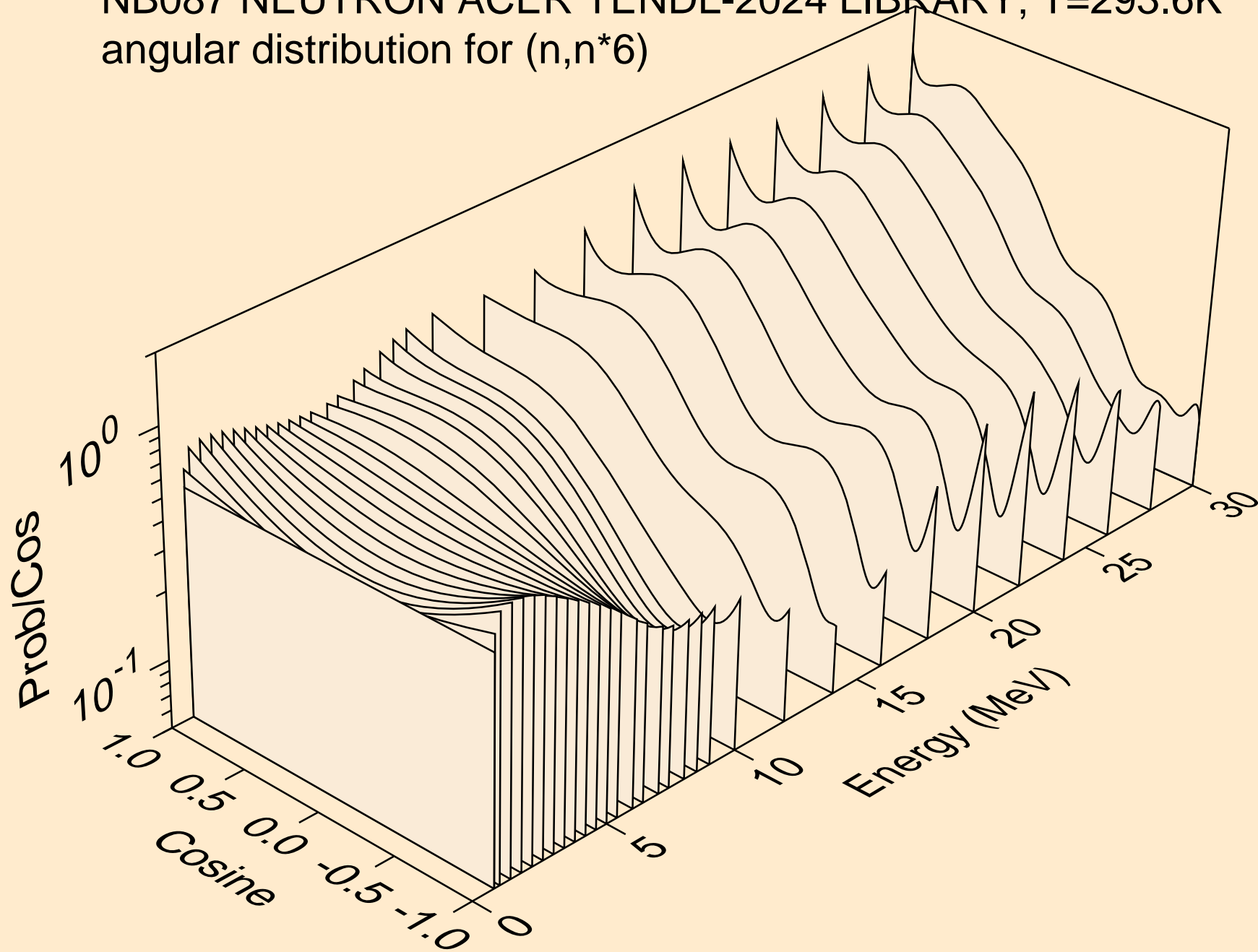

NB087 NEUTRON ACER TENDL-2024 LIBRARY; T=293.6K  
angular distribution for (n,n\*7)

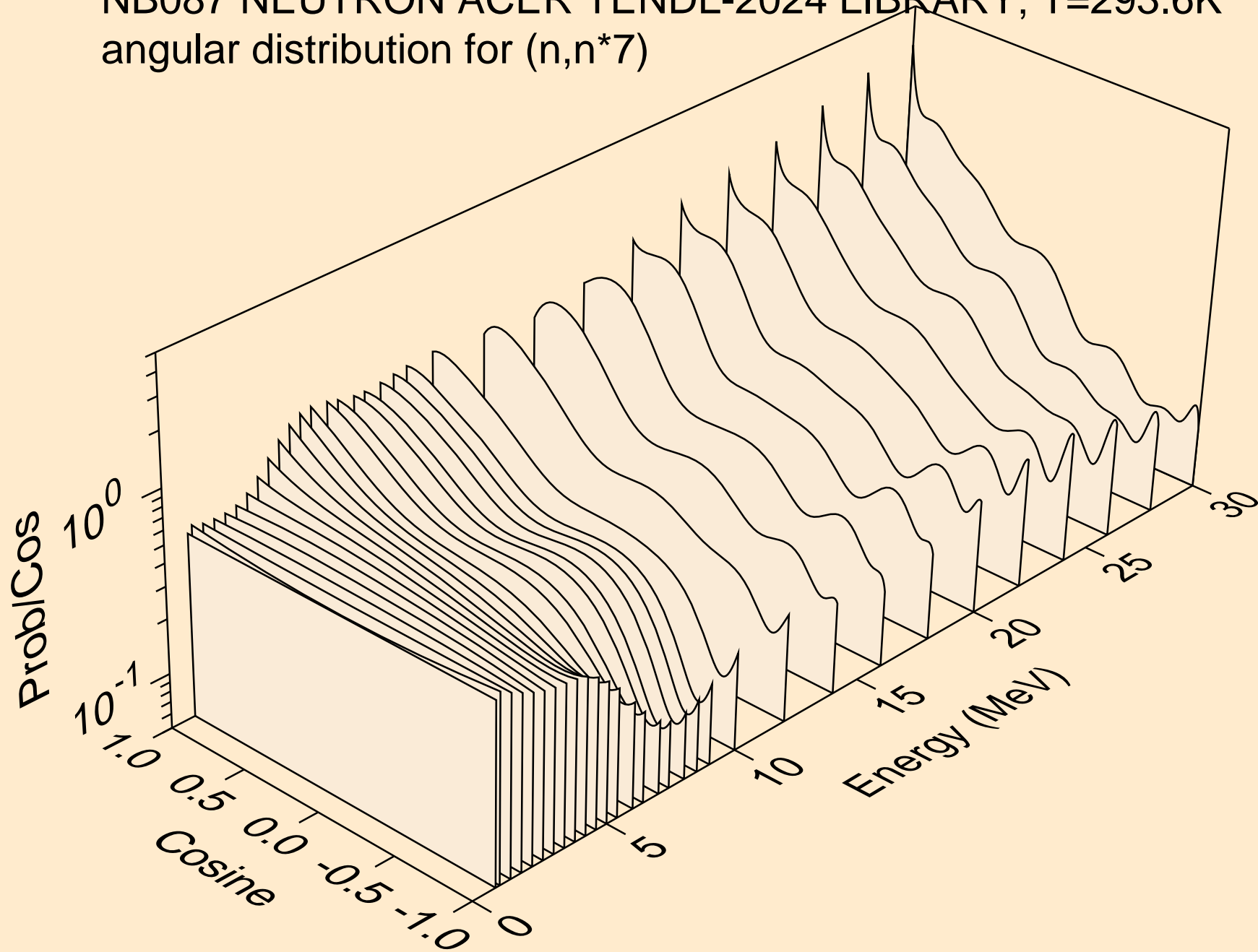

NB087 NEUTRON ACER TENDL-2024 LIBRARY; T=293.6K  
angular distribution for (n,n\*8)

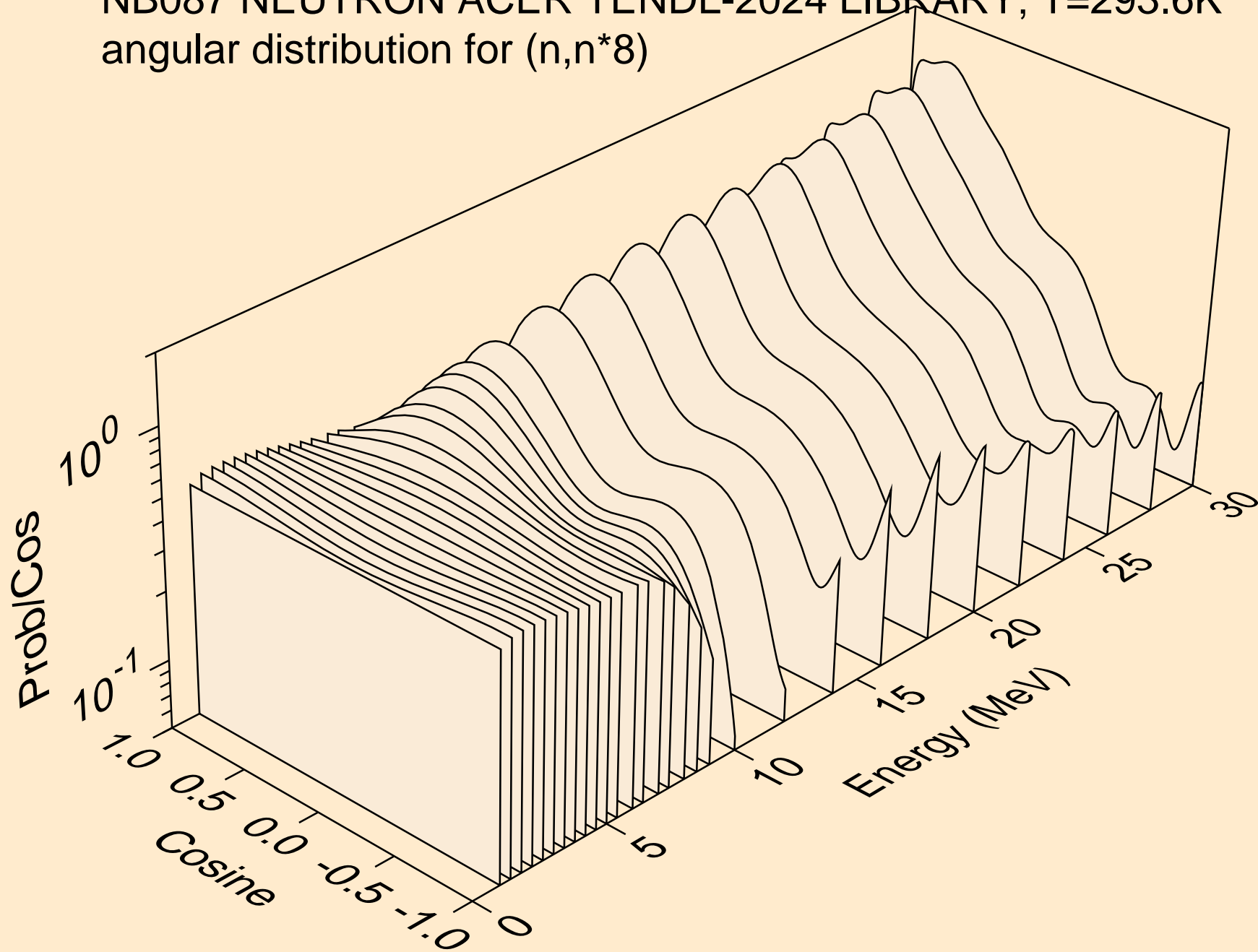

NB087 NEUTRON ACER TENDL-2024 LIBRARY; T=293.6K  
angular distribution for (n,n\*9)

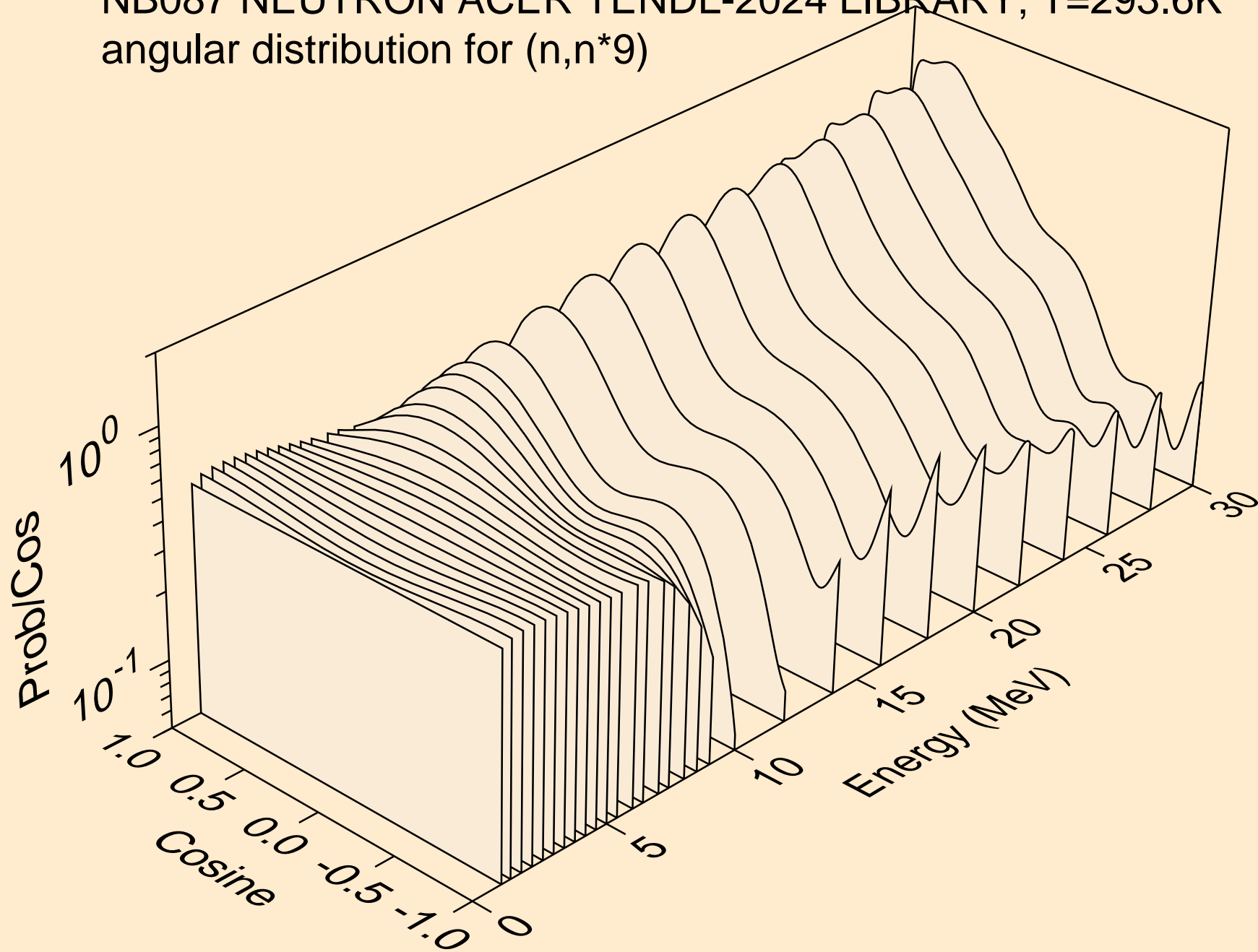

NB087 NEUTRON ACER TENDL-2024 LIBRARY; T=293.6K  
angular distribution for (n,n\*10)

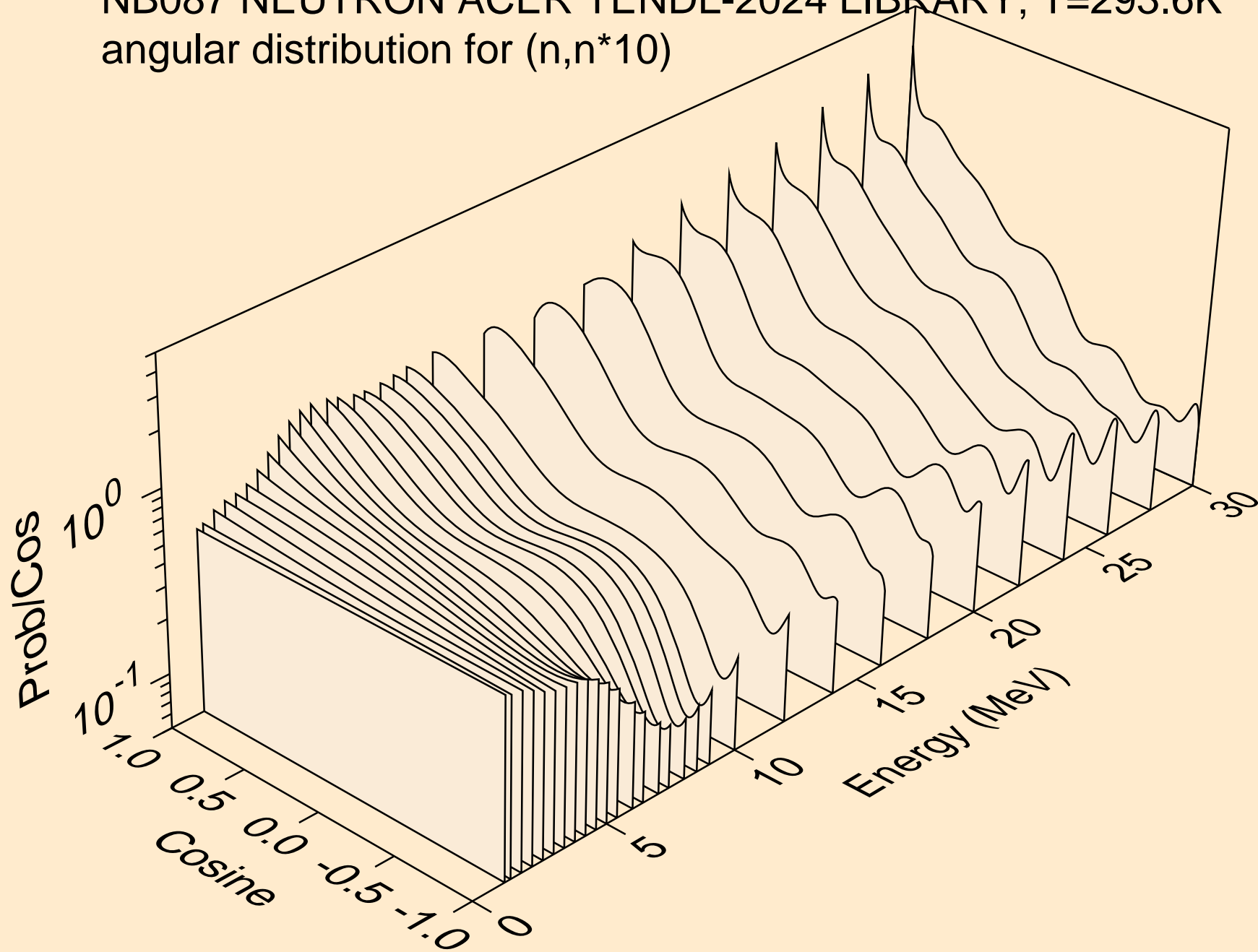

NB087 NEUTRON ACER TENDL-2024 LIBRARY; T=293.6K  
Neutron emission for (n,x)

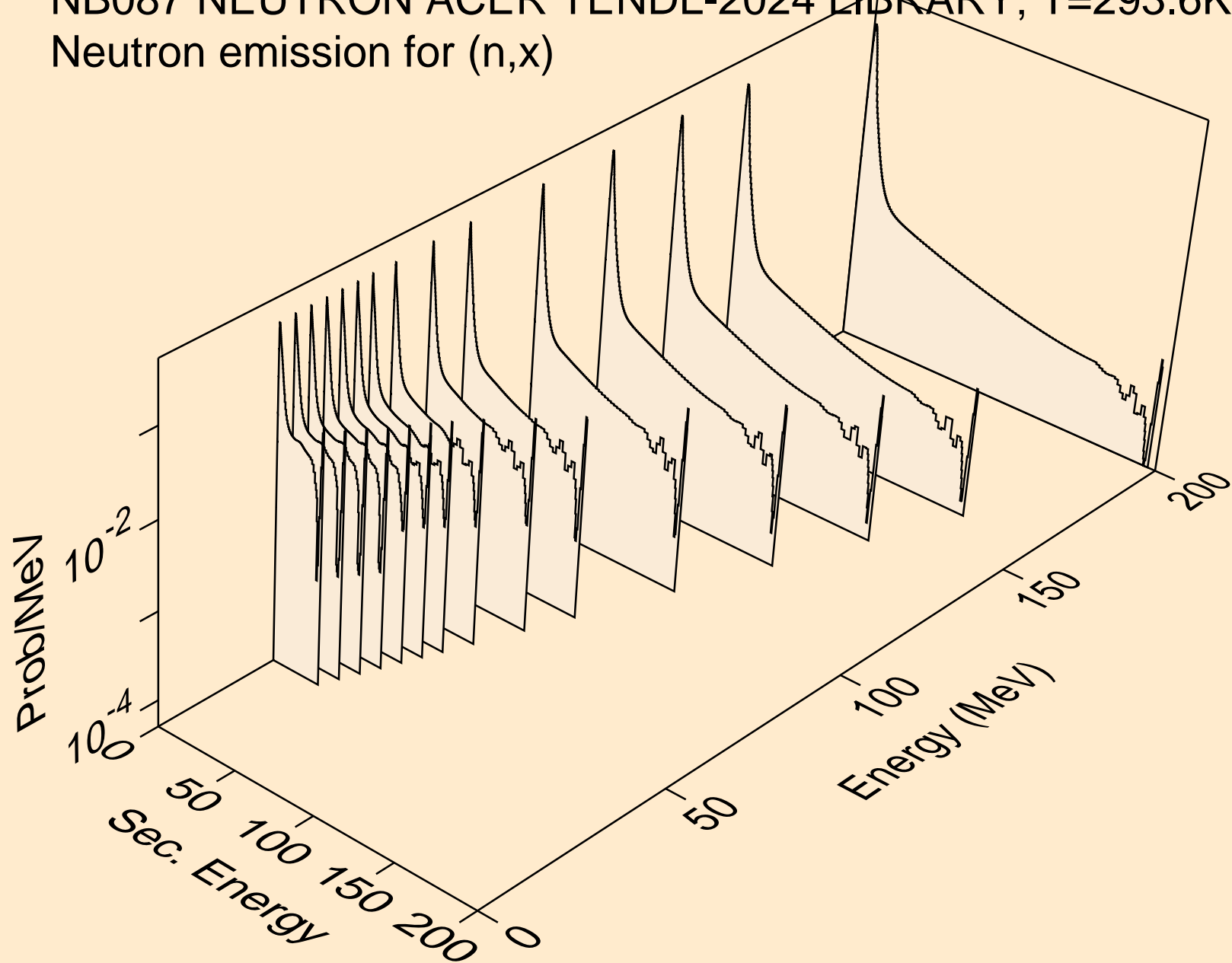

NB087 NEUTRON ACER TENDL-2024 LIBRARY; T=293.6K  
Neutron emission for (n,2nd)

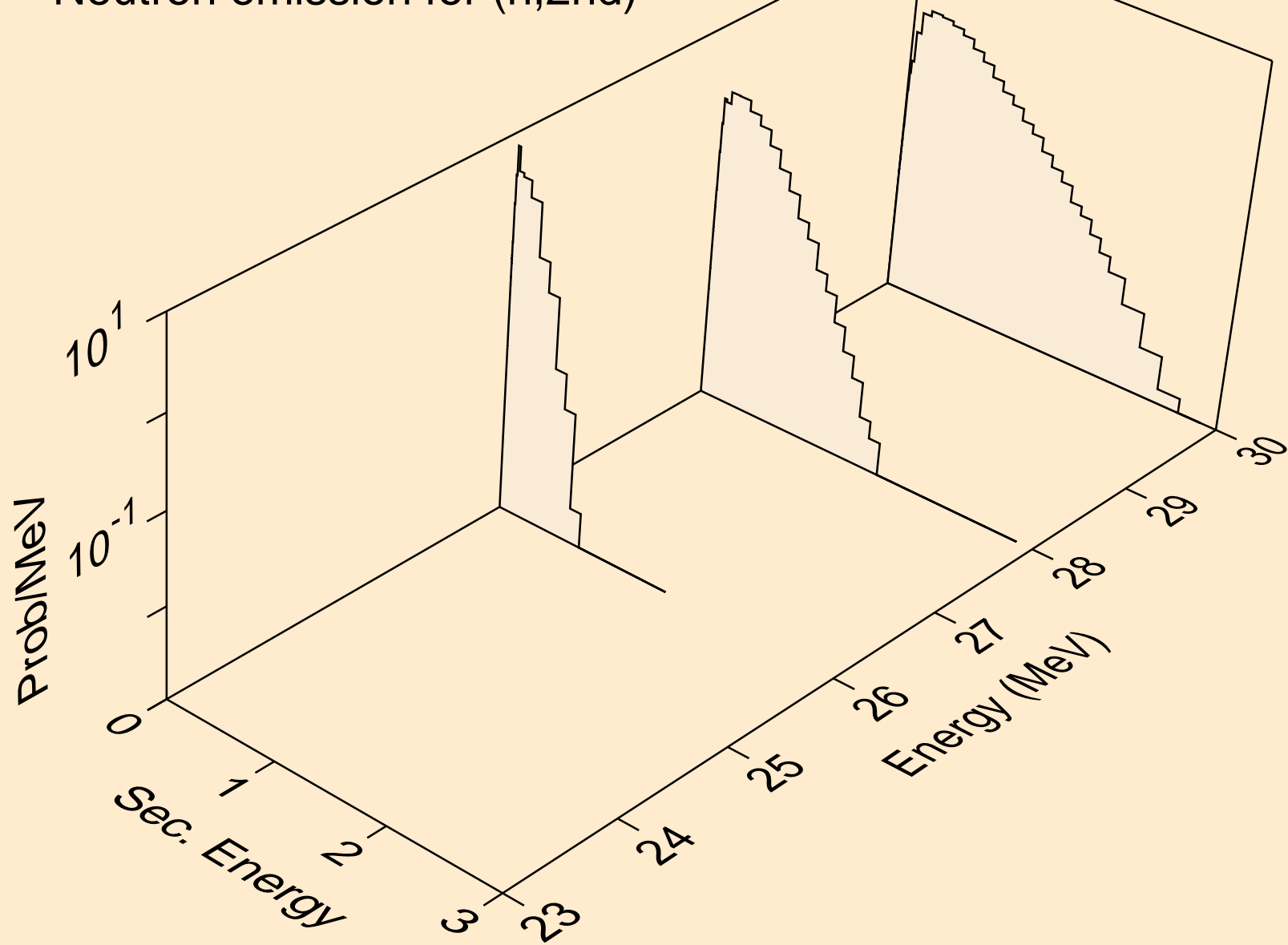

NB087 NEUTRON ACER TENDL-2024 LIBRARY; T=293.6K  
Neutron emission for (n,2n)

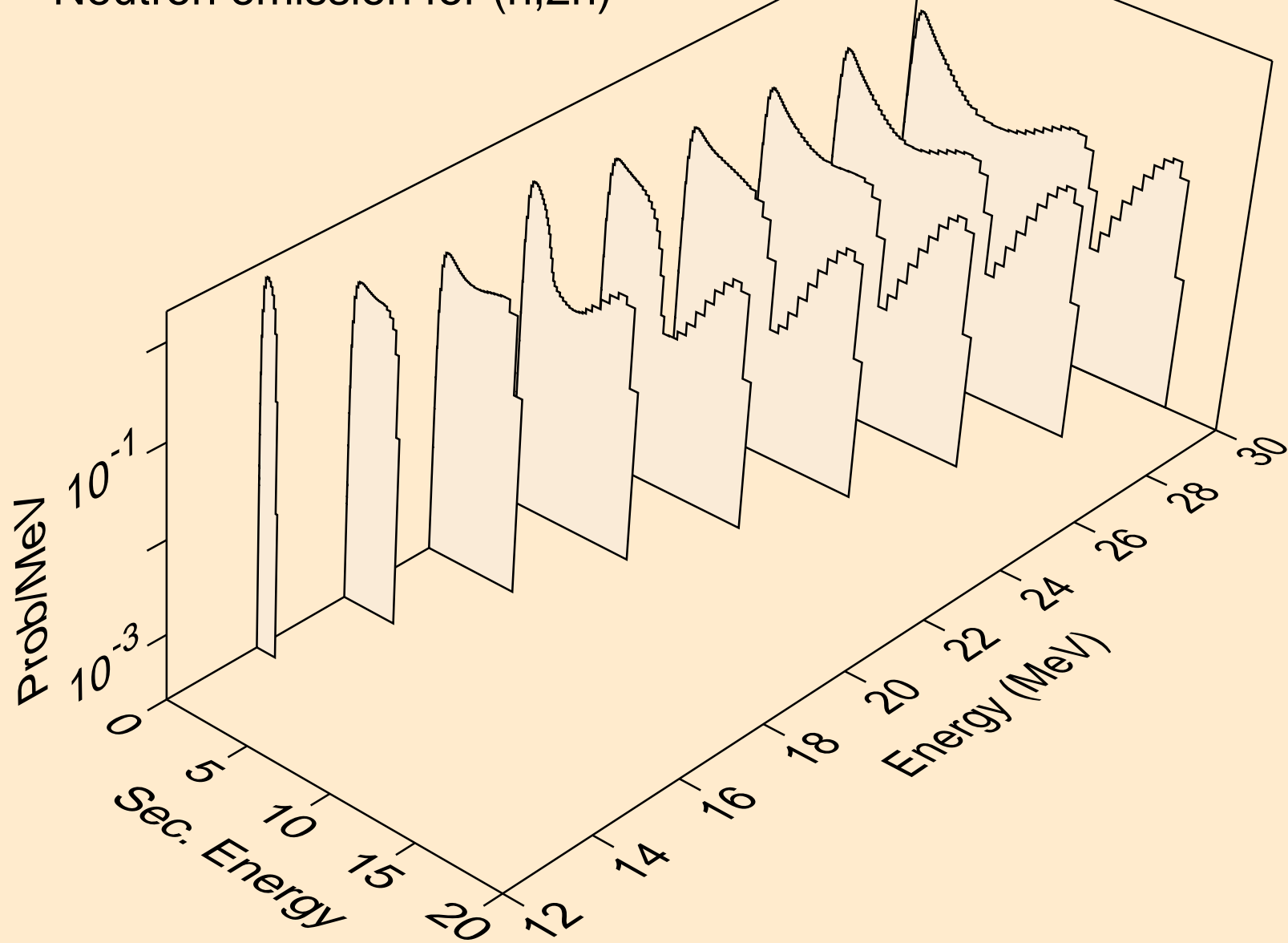

NB087 NEUTRON ACER TENDL-2024 LIBRARY; T=293.6K  
Neutron emission for (n,3n)

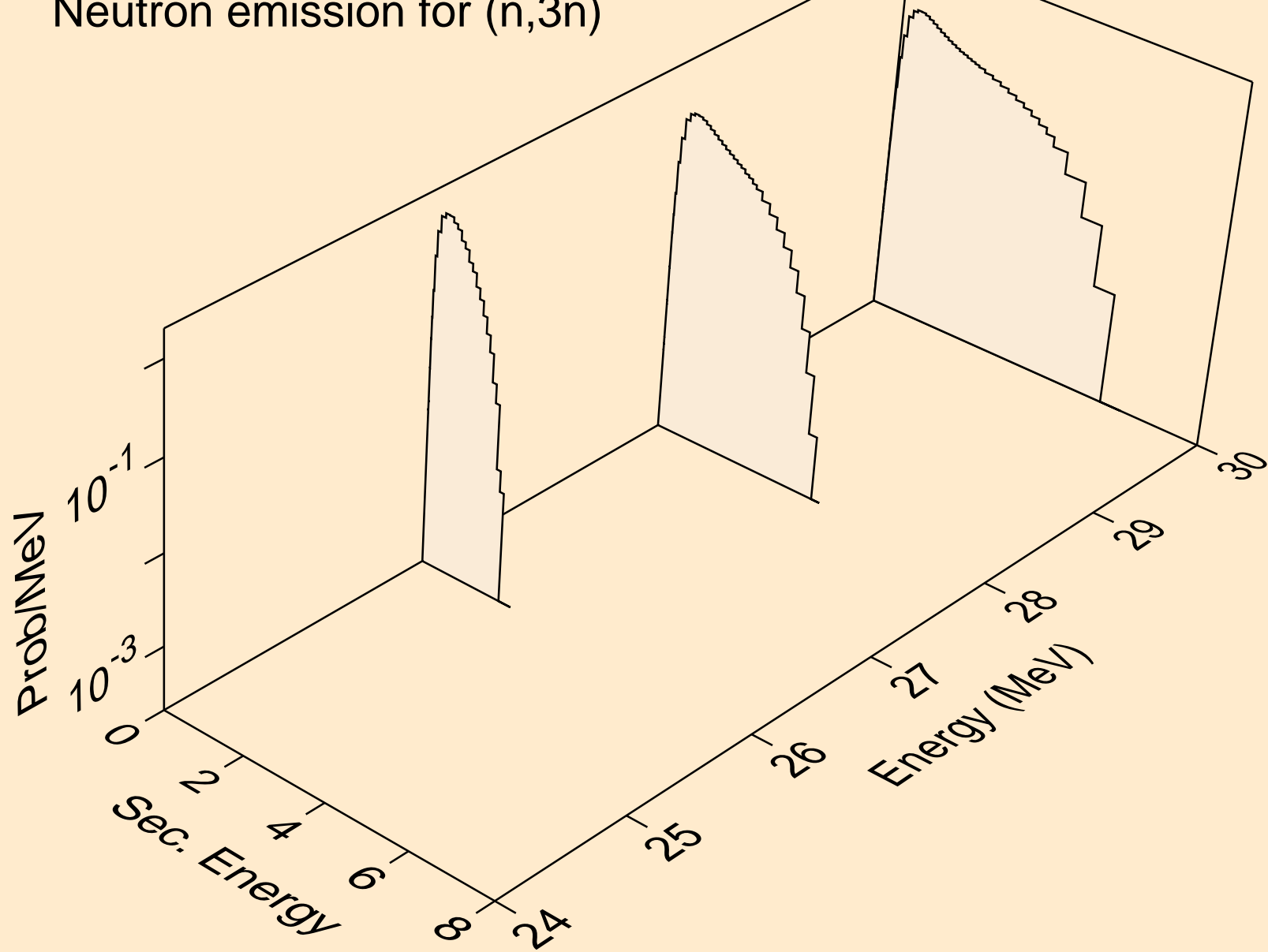

NB087 NEUTRON ACER TENDL-2024 LIBRARY; T=293.6K  
Neutron emission for (n,n\*)a

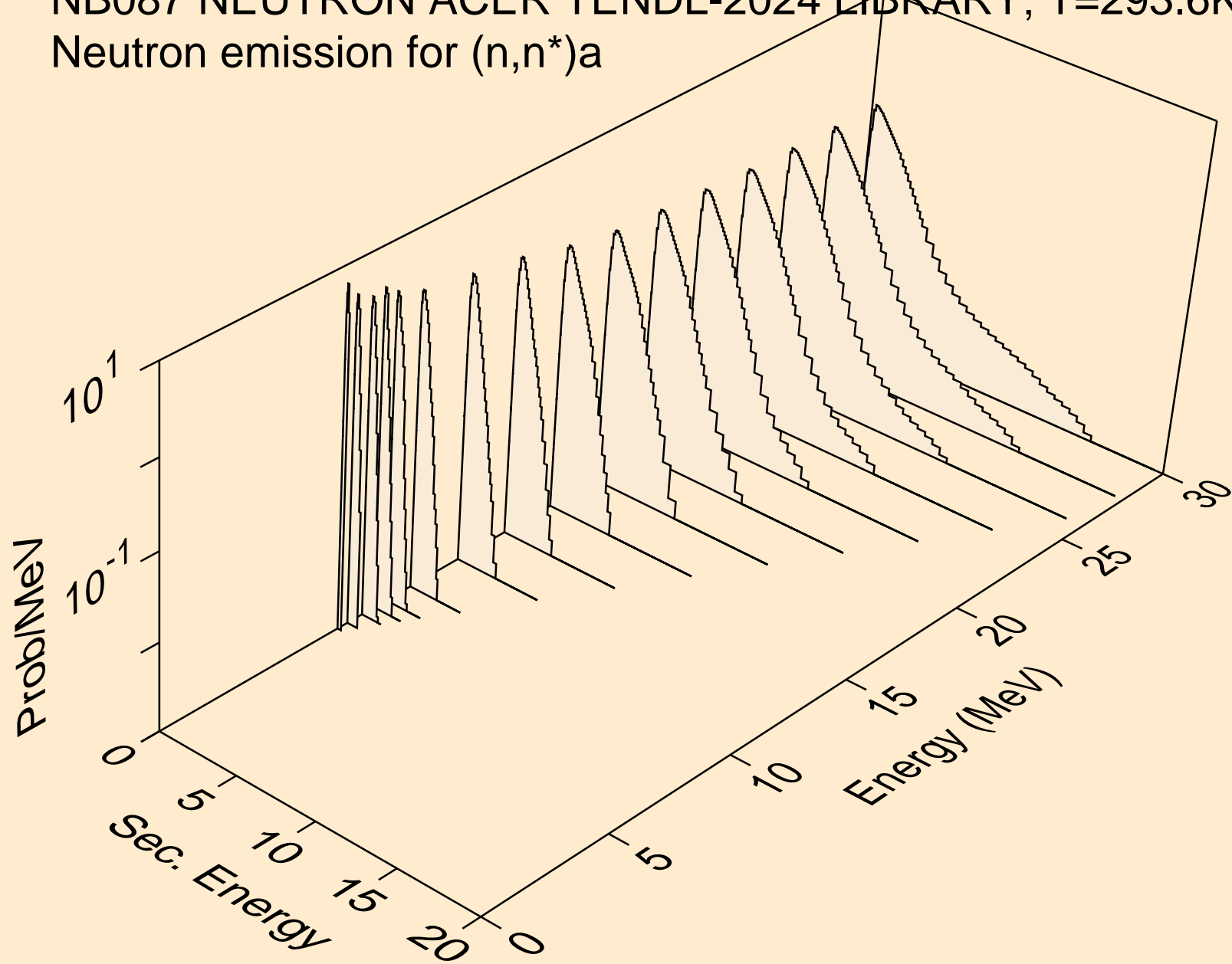

NB087 NEUTRON ACER TENDL-2024 LIBRARY; T=293.6K  
Neutron emission for (n,2n)a

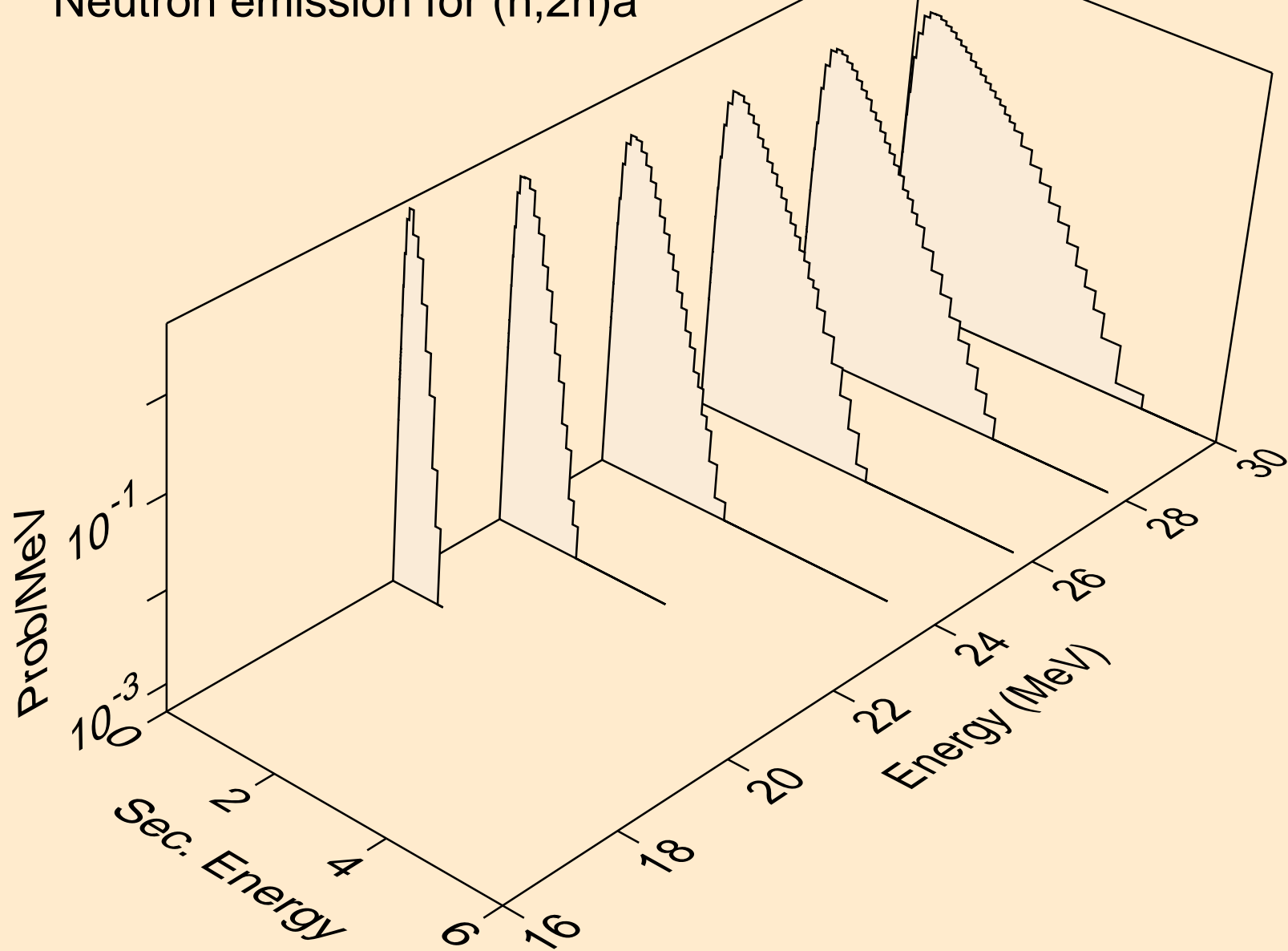

NB087 NEUTRON ACER TENDL-2024 LIBRARY; T=293.6K  
Neutron emission for (n,n\*)p

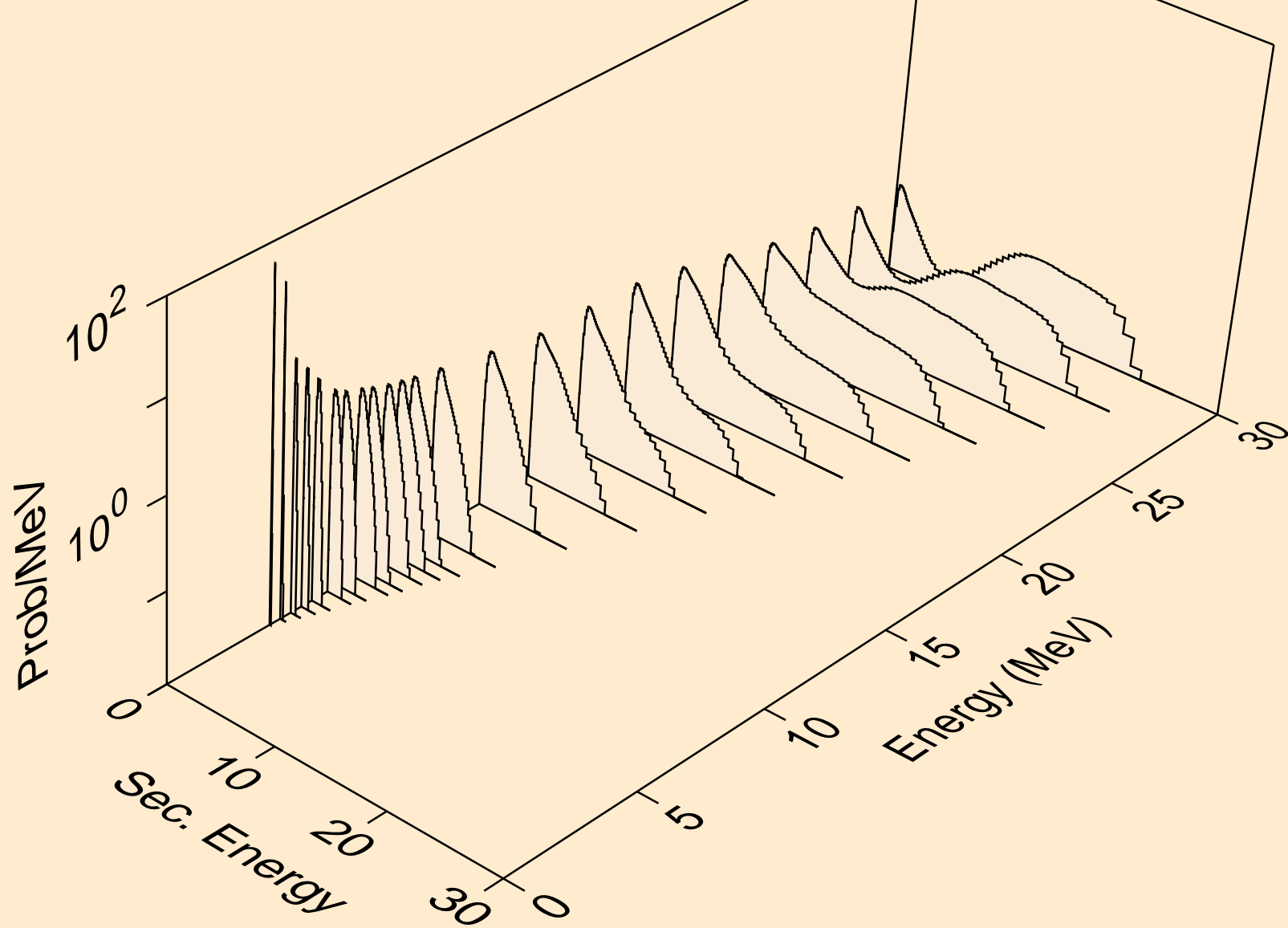

NB087 NEUTRON ACER TENDL-2024 LIBRARY; T=293.6K  
Neutron emission for (n,n\*)2a

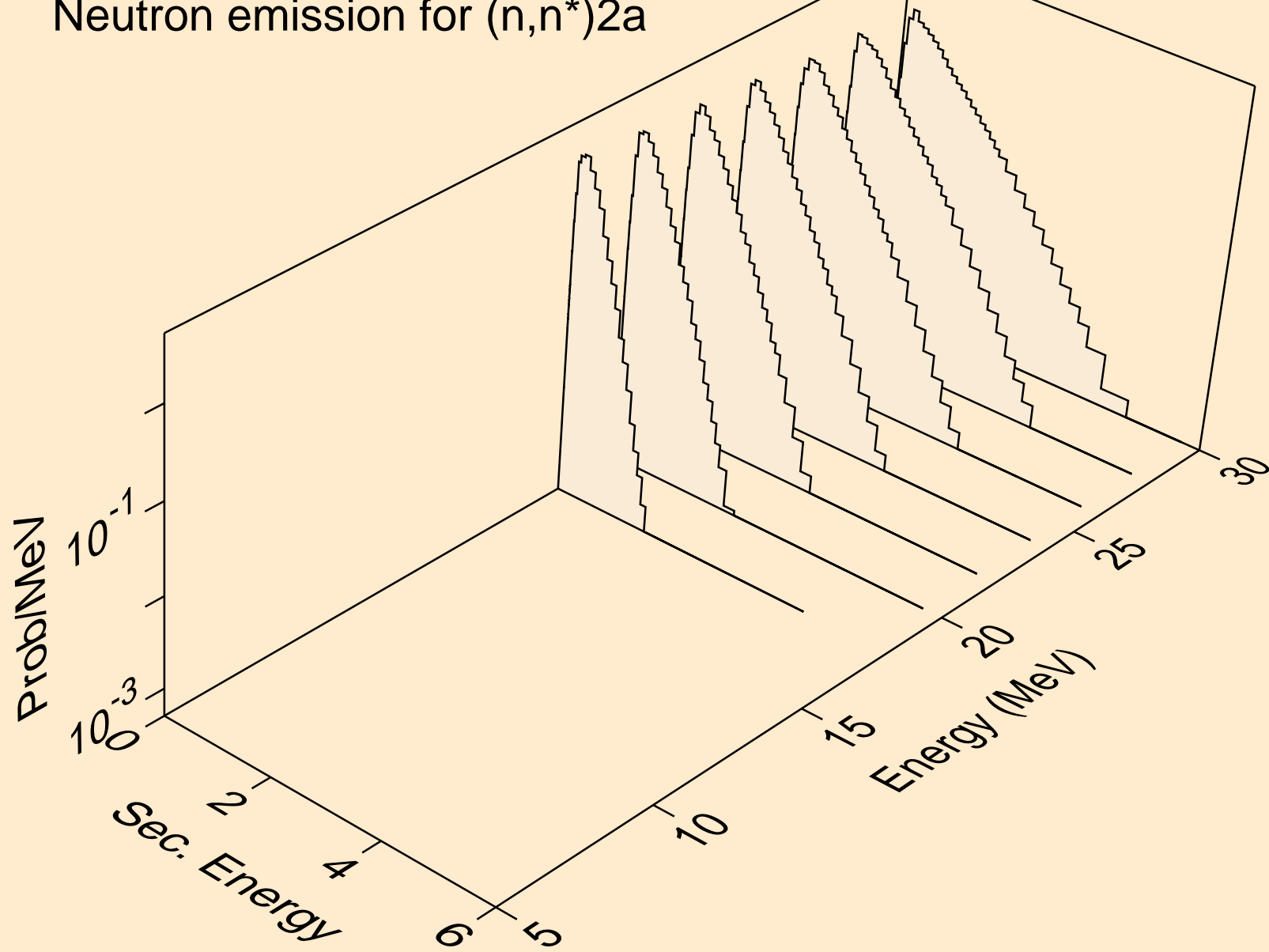

NB087 NEUTRON ACER TENDL-2024 LIBRARY; T=293.6K  
Neutron emission for (n,n\*)d

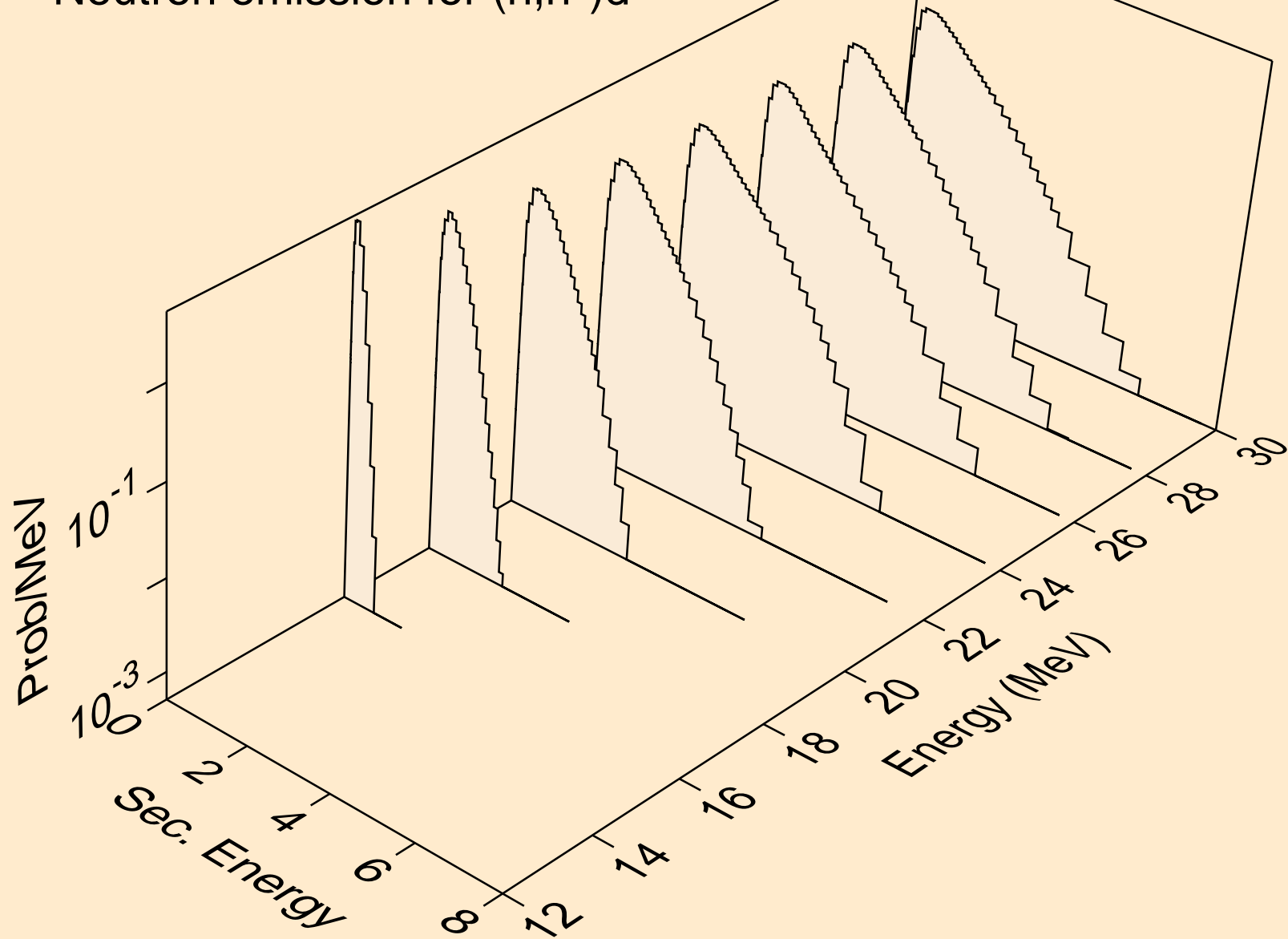

NB087 NEUTRON ACER TENDL-2024 LIBRARY; T=293.6K  
Neutron emission for (n,n\*)t

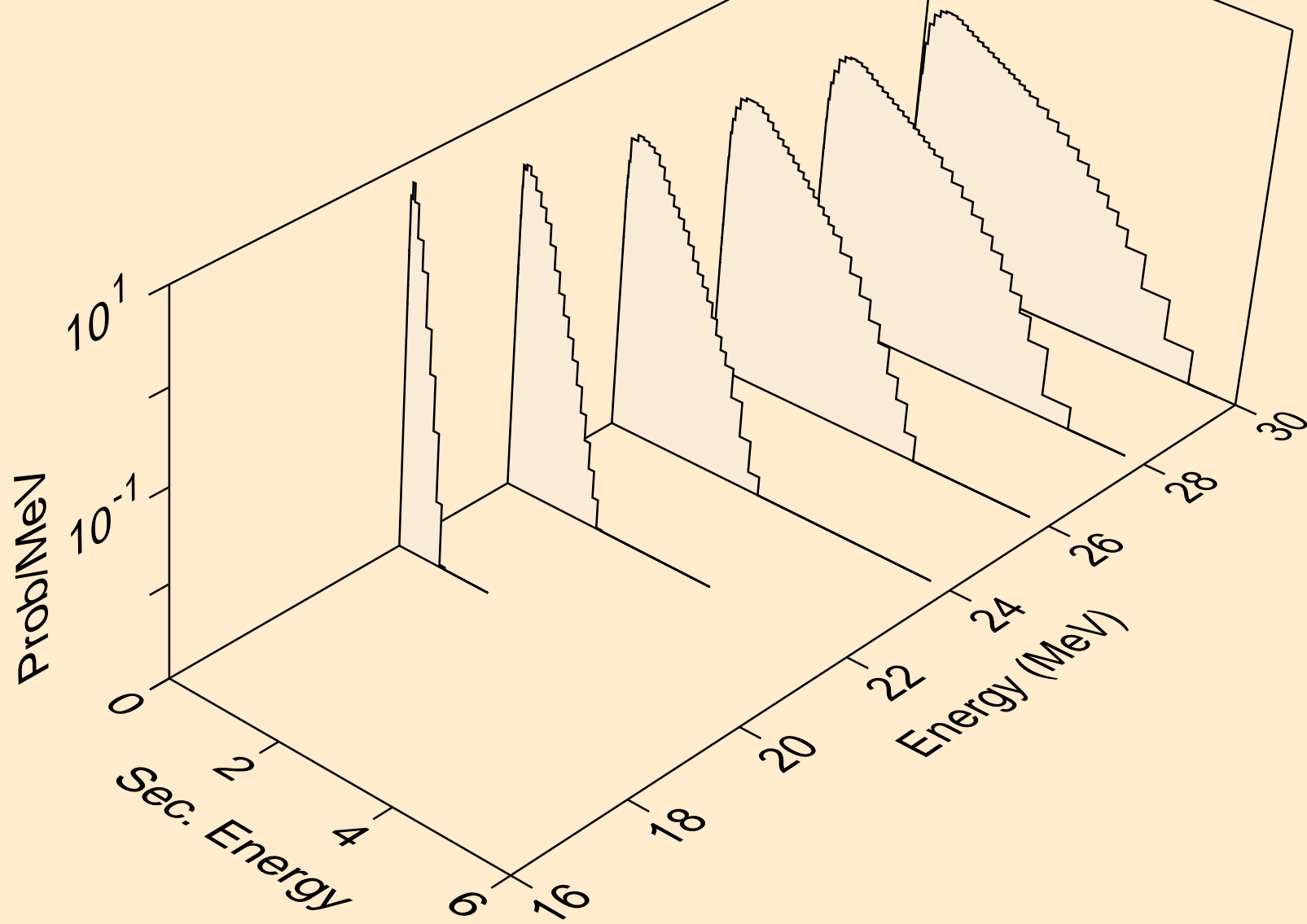

NB087 NEUTRON ACER TENDL-2024 LIBRARY; T=293.6K  
Neutron emission for (n,n\*)he3

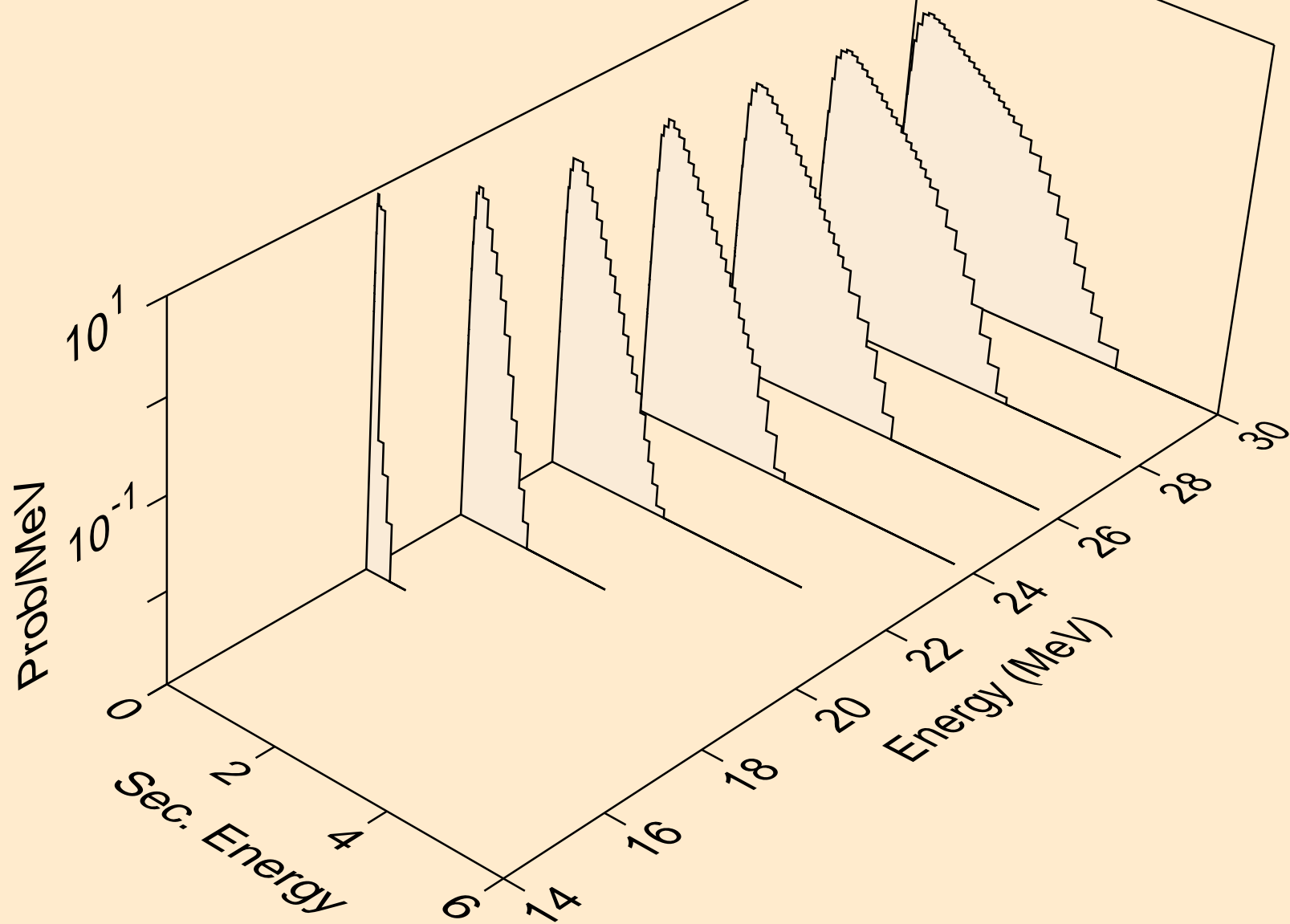

NB087 NEUTRON ACER TENDL-2024 LIBRARY; T=293.6K  
Neutron emission for (n,2np)

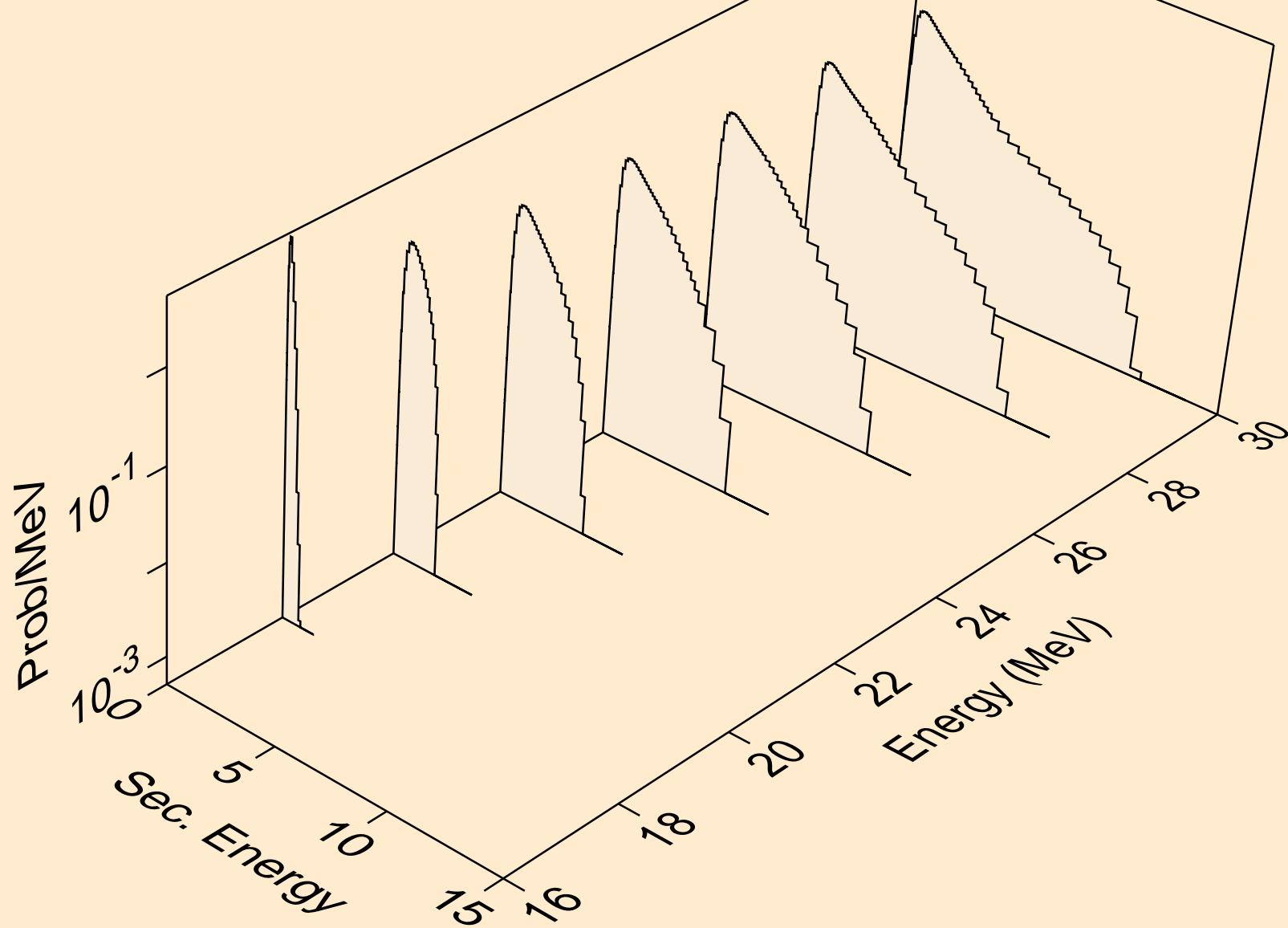

NB087 NEUTRON ACER TENDL-2024 LIBRARY; T=293.6K  
Neutron emission for (n,3np)

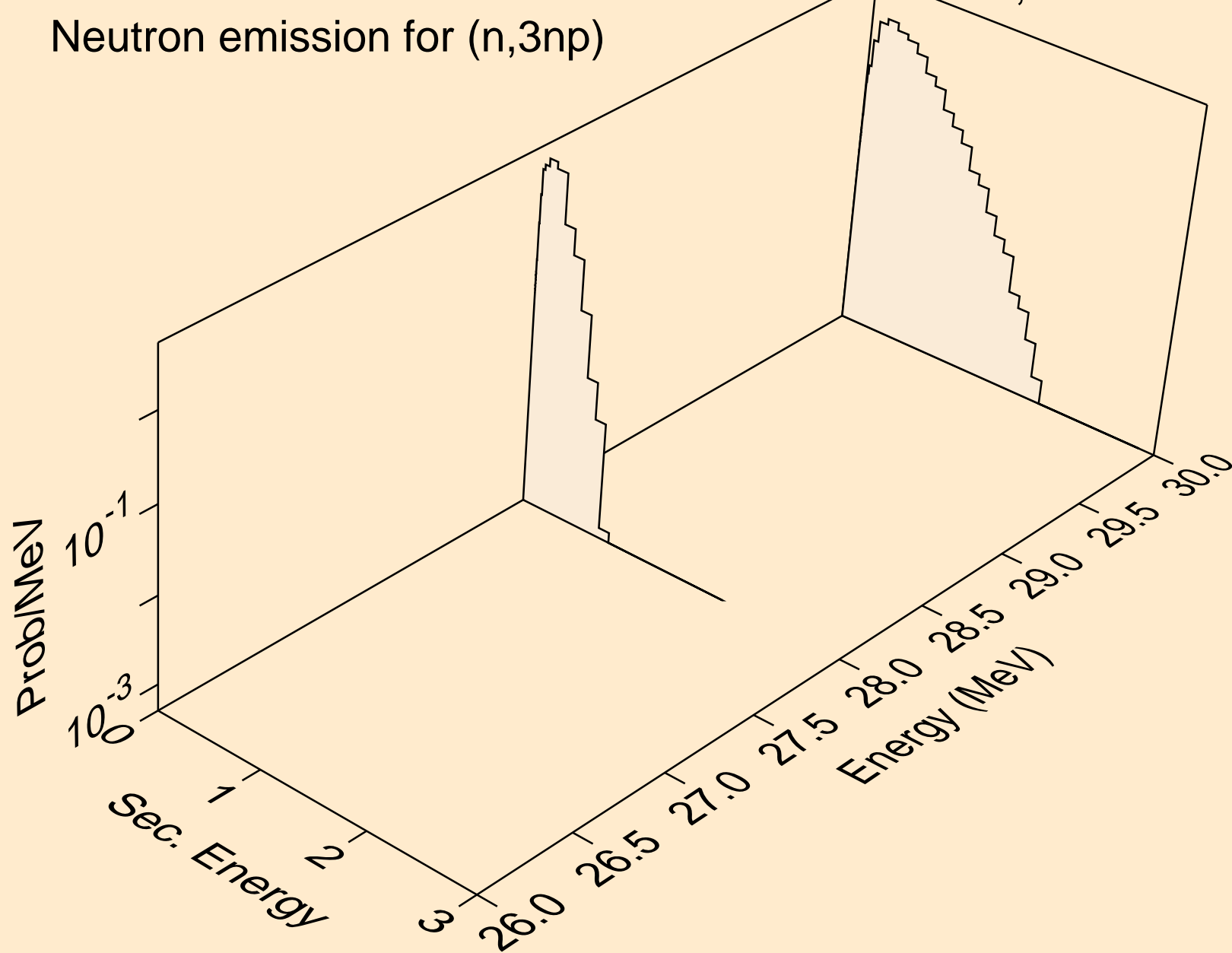

NB087 NEUTRON ACER TENDL-2024 LIBRARY; T=293.6K  
Neutron emission for (n,n2p)

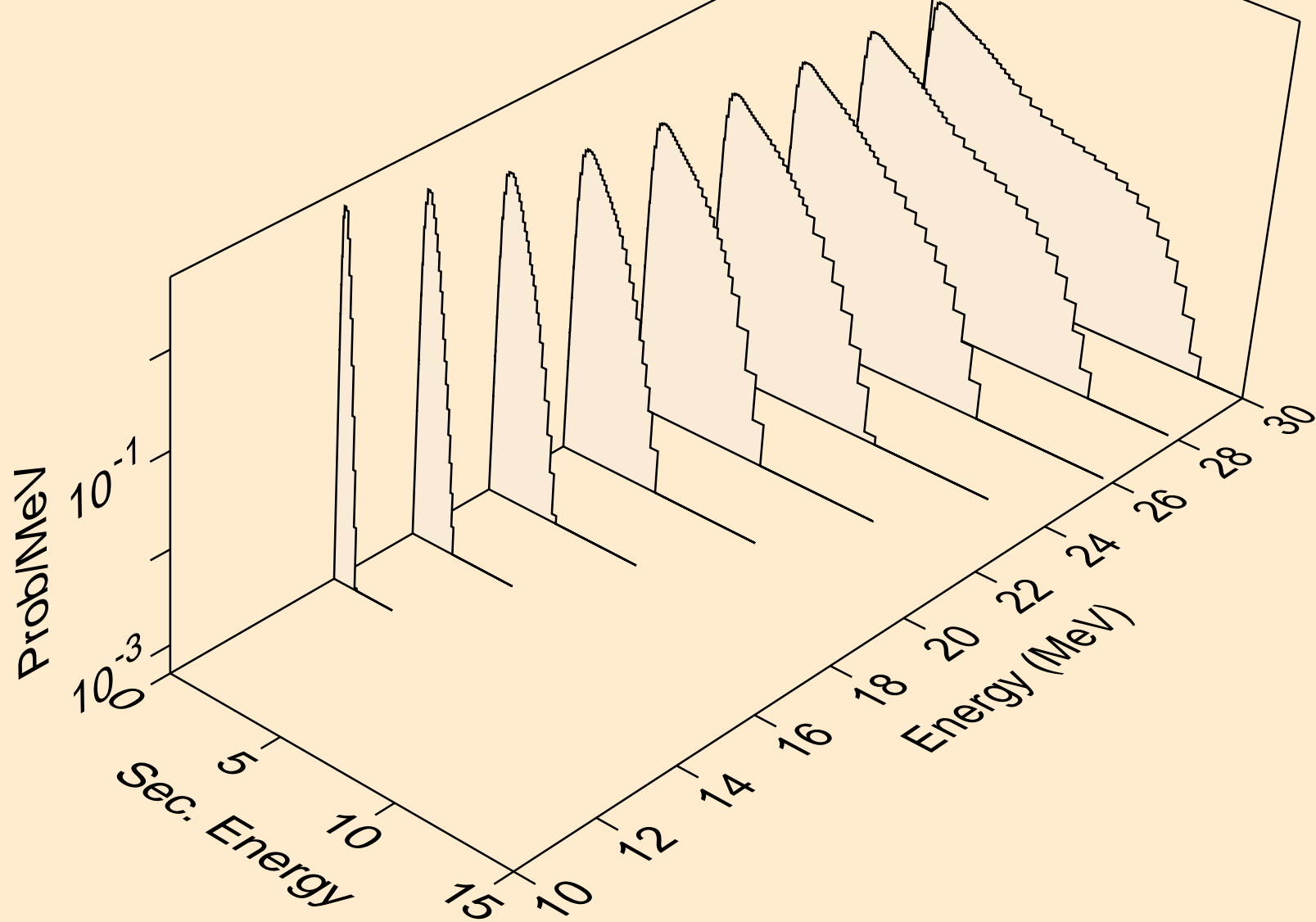

NB087 NEUTRON ACER TENDL-2024 LIBRARY; T=293.6K  
Neutron emission for (n,npa)

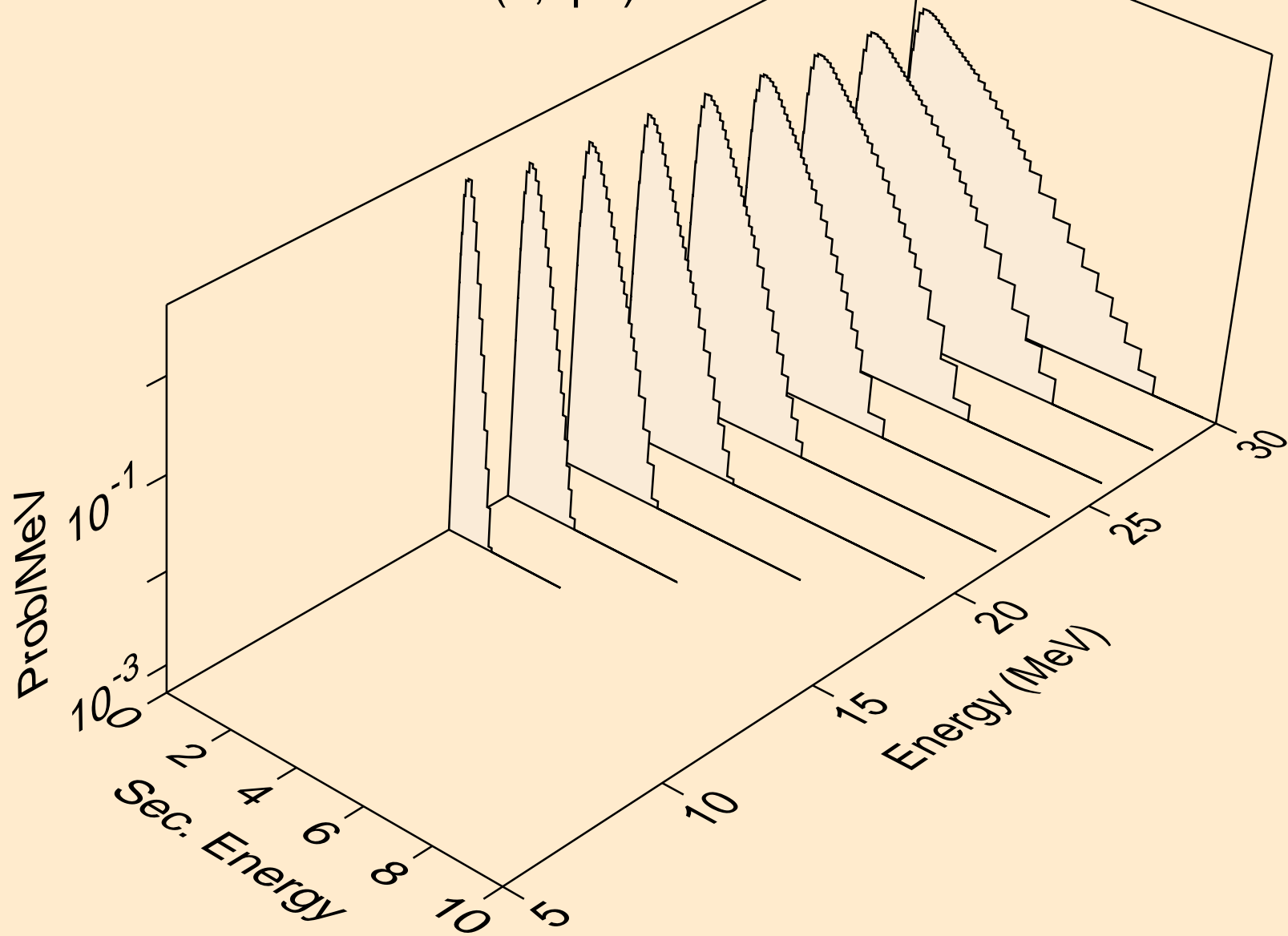

NB087 NEUTRON ACER TENDL-2024 LIBRARY; T=293.6K  
Neutron emission for (n,n\*c)

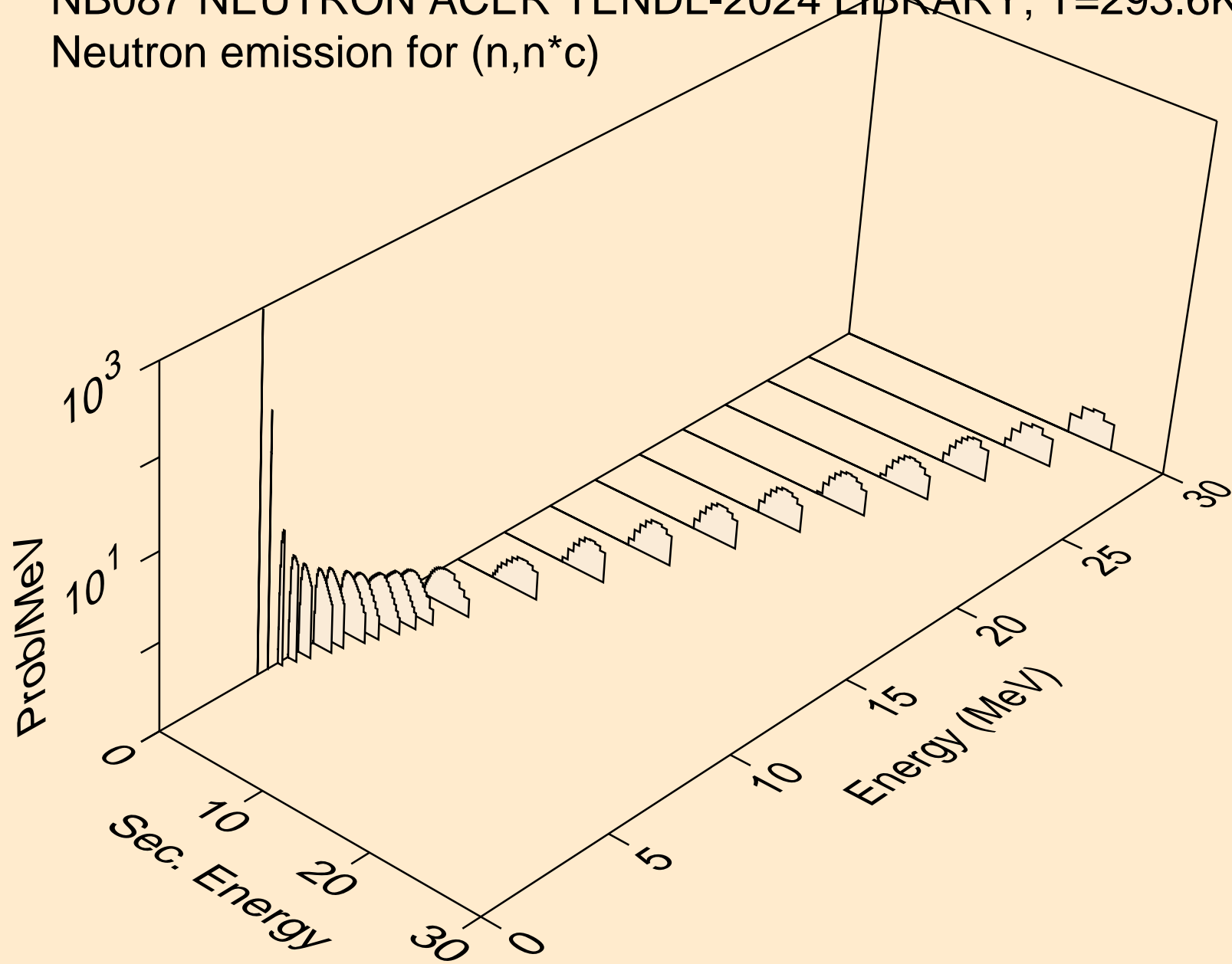

NB087 NEUTRON ACER TENDL-2024 LIBRARY; T=293.6K  
Photon emission for (n,x)

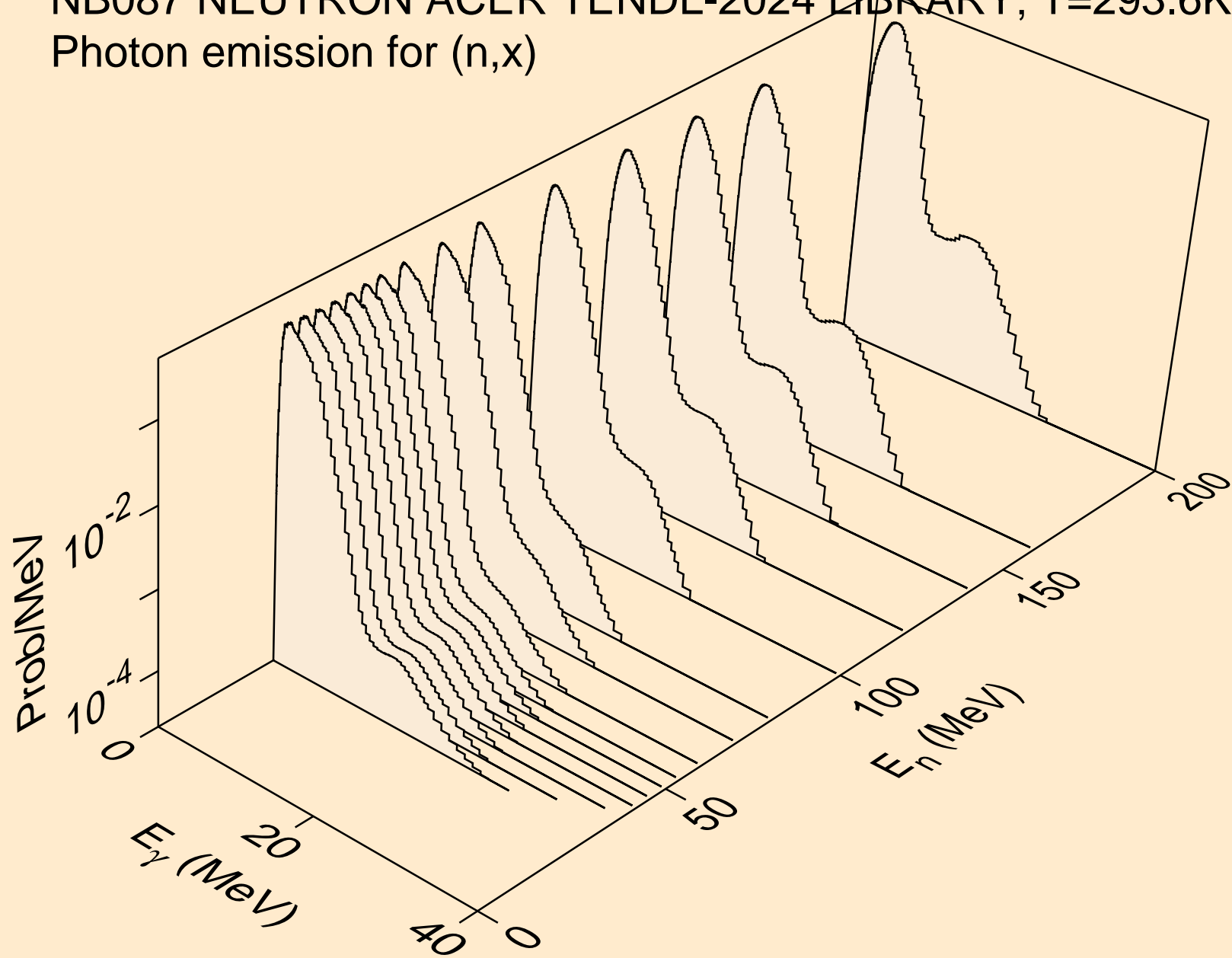

NB087 NEUTRON ACER TENDL-2024 LIBRARY; T=293.6K  
Photon emission for (n,2nd)

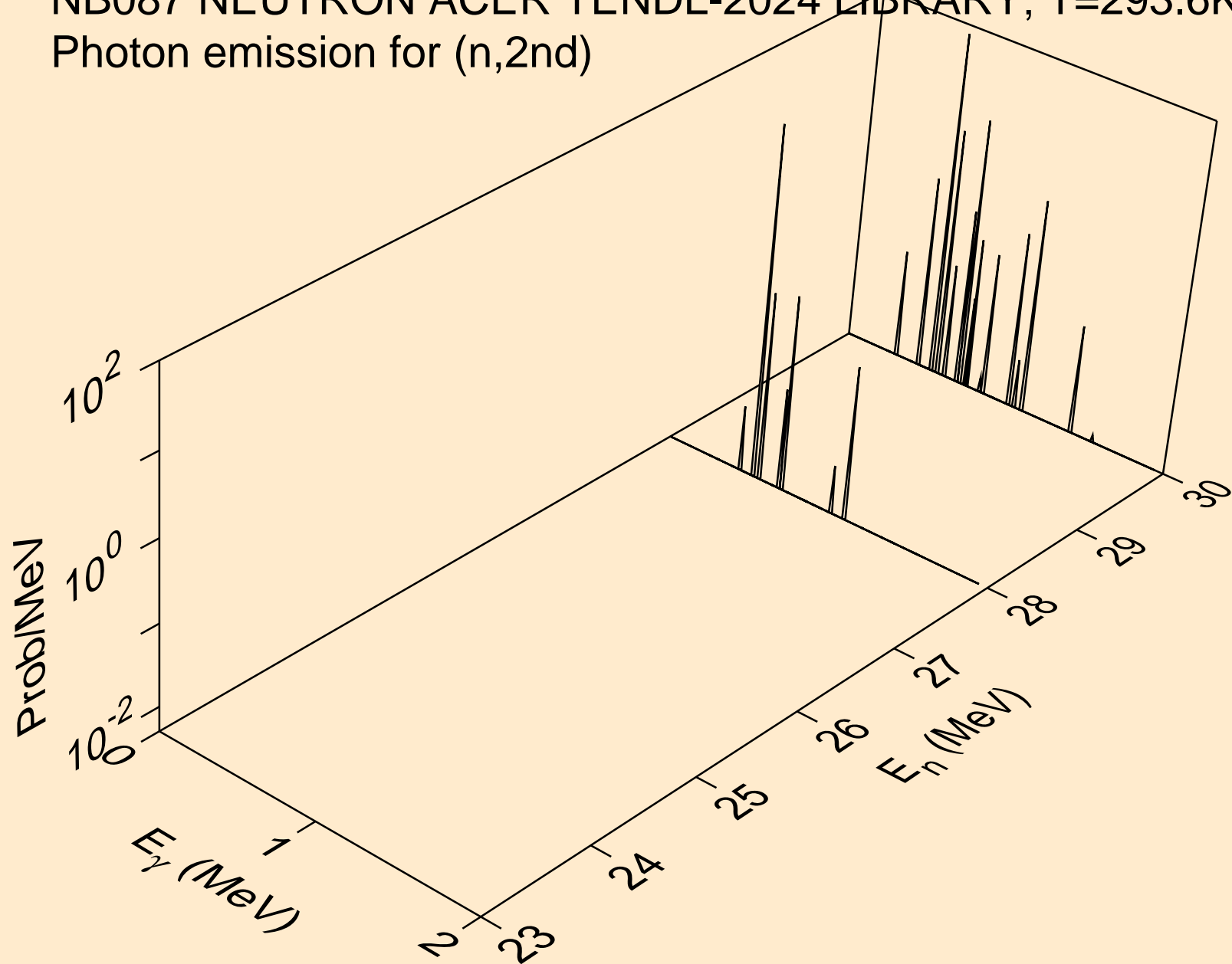

NB087 NEUTRON ACER TENDL-2024 LIBRARY; T=293.6K  
Photon emission for (n,2n)

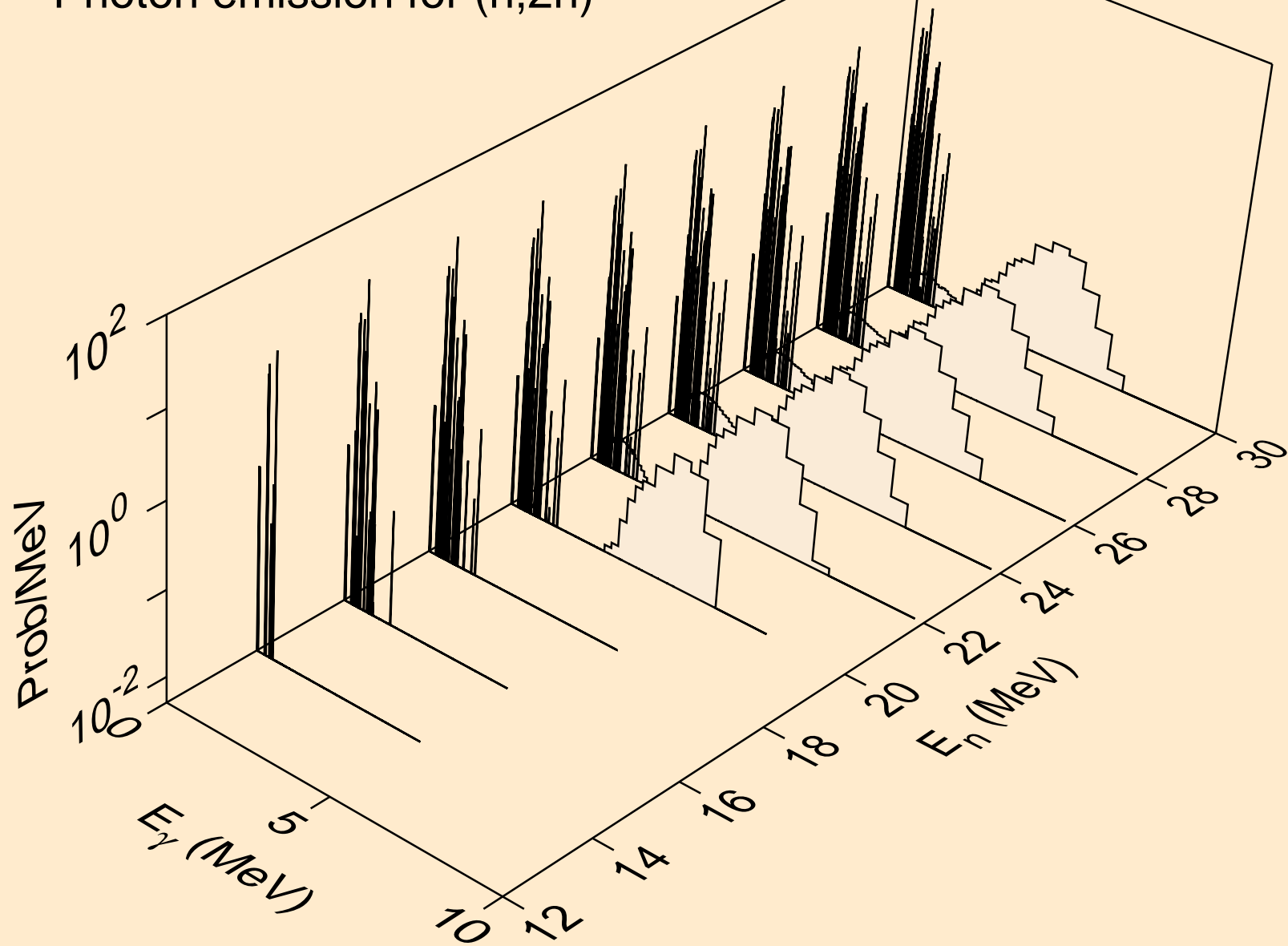

NB087 NEUTRON ACER TENDL-2024 LIBRARY; T=293.6K  
Photon emission for (n,3n)

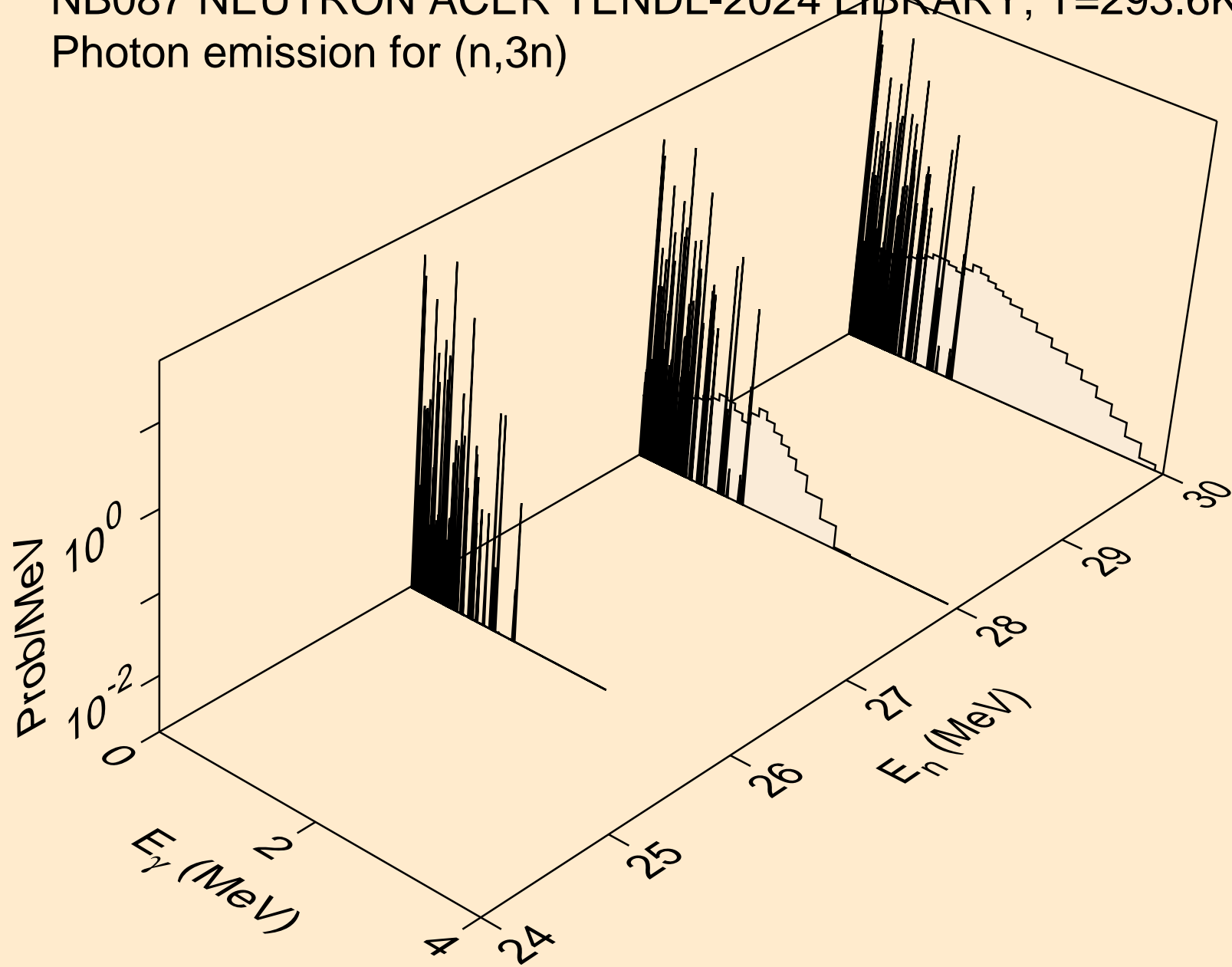

NB087 NEUTRON ACER TENDL-2024 LIBRARY; T=293.6K  
Photon emission for (n,n\*)a

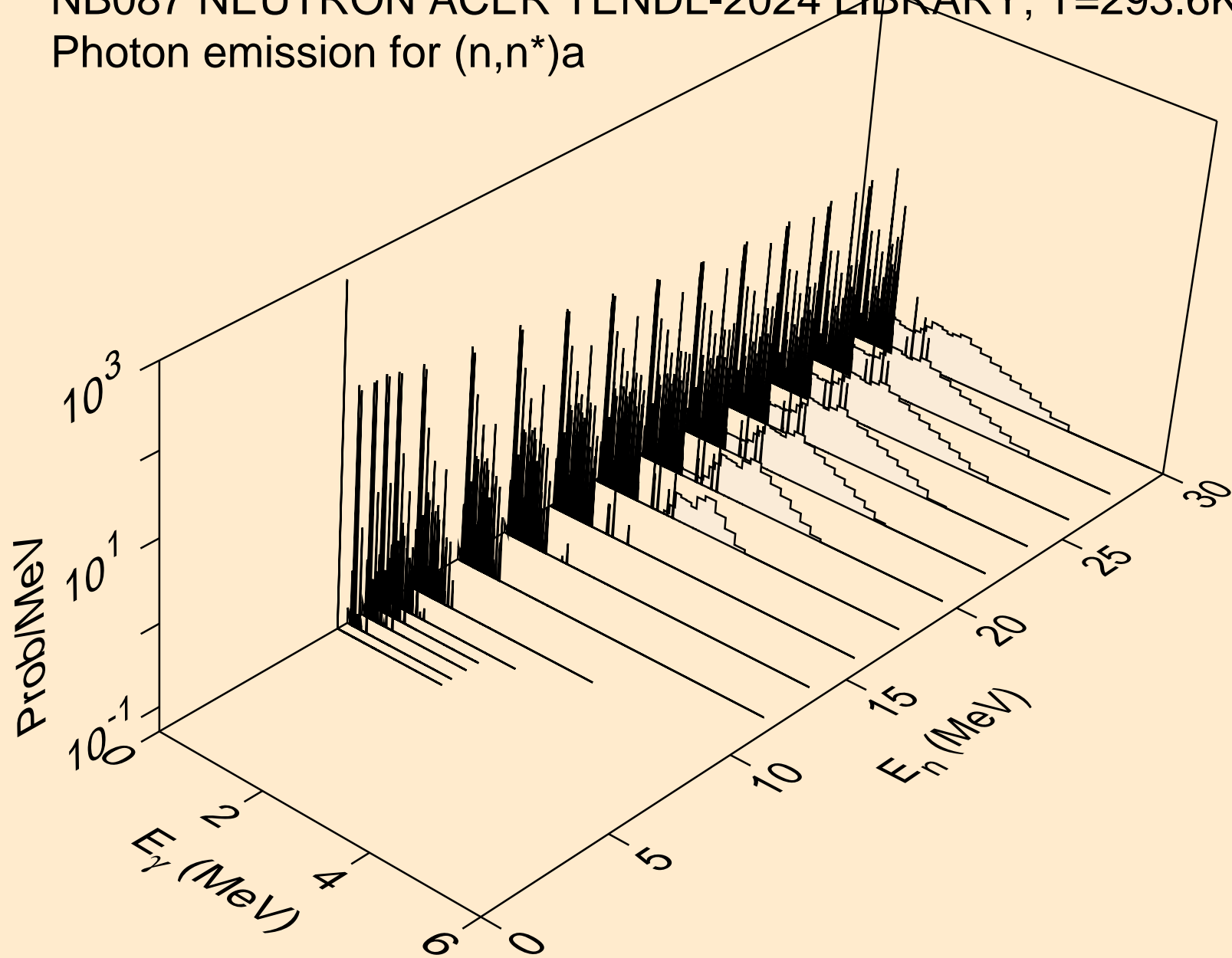

NB087 NEUTRON ACER TENDL-2024 LIBRARY; T=293.6K  
Photon emission for (n,2n)a

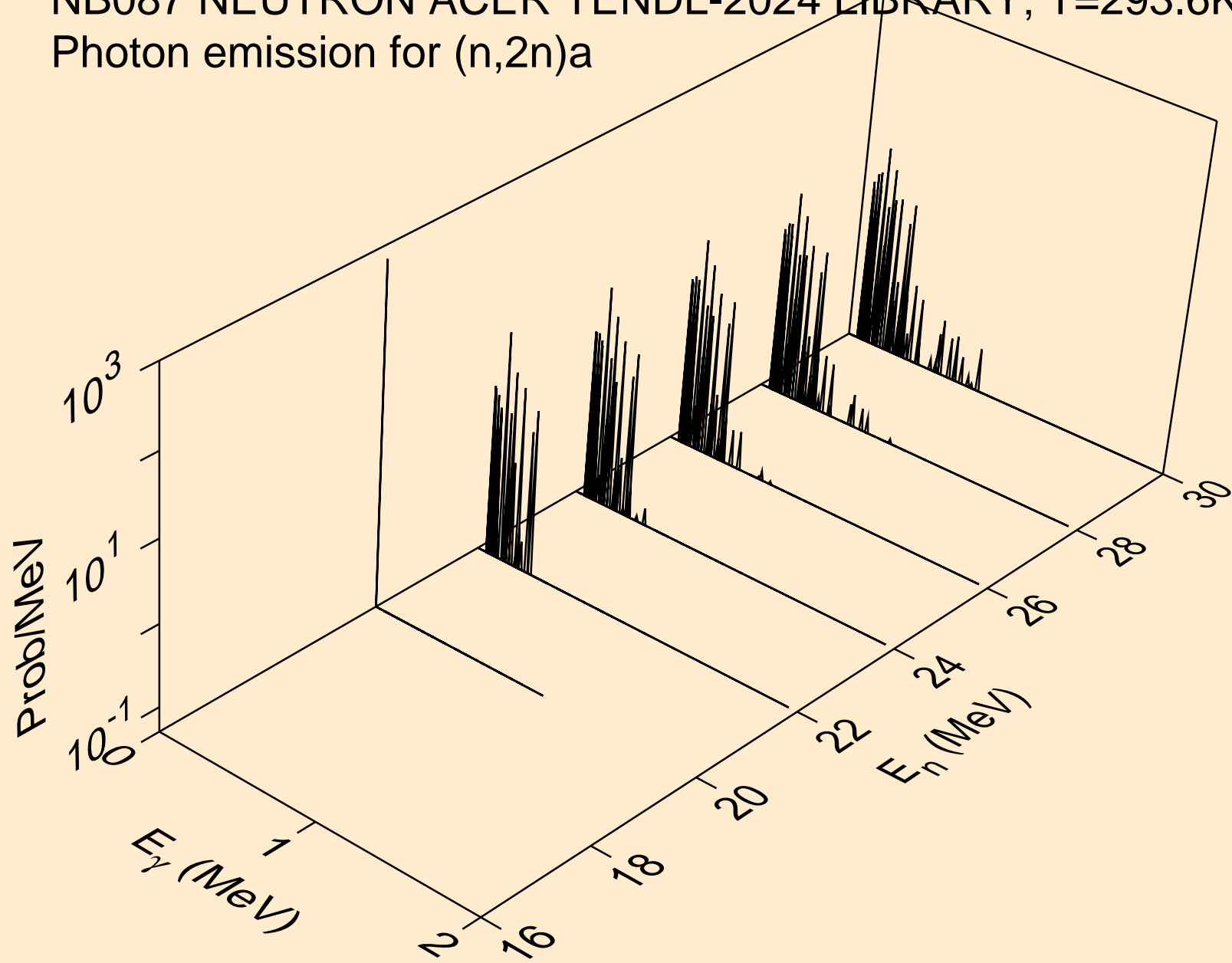

NB087 NEUTRON ACER TENDL-2024 LIBRARY; T=293.6K  
Photon emission for (n,n\*)p

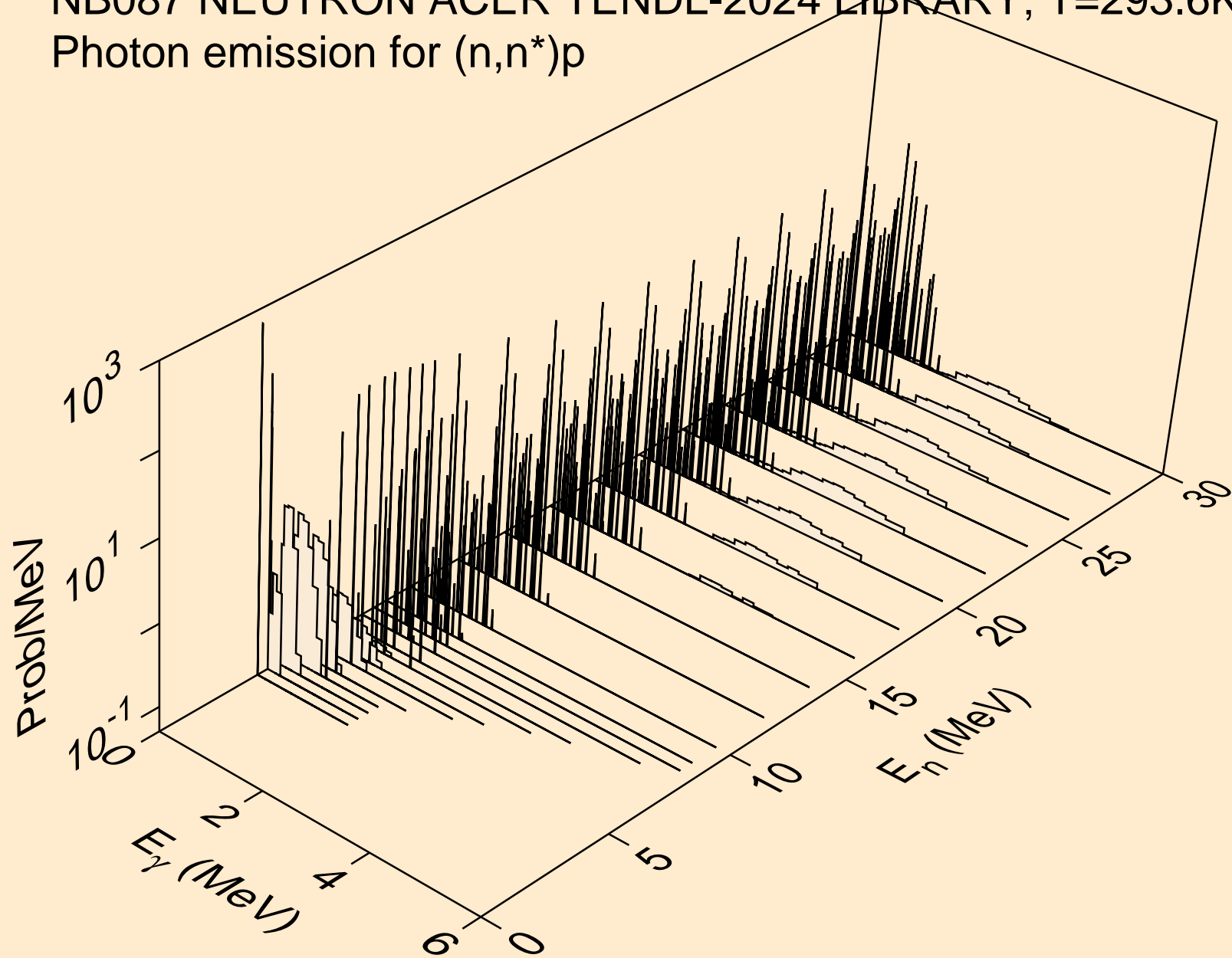

NB087 NEUTRON ACER TENDL-2024 LIBRARY; T=293.6K  
Photon emission for (n,n\*)2a

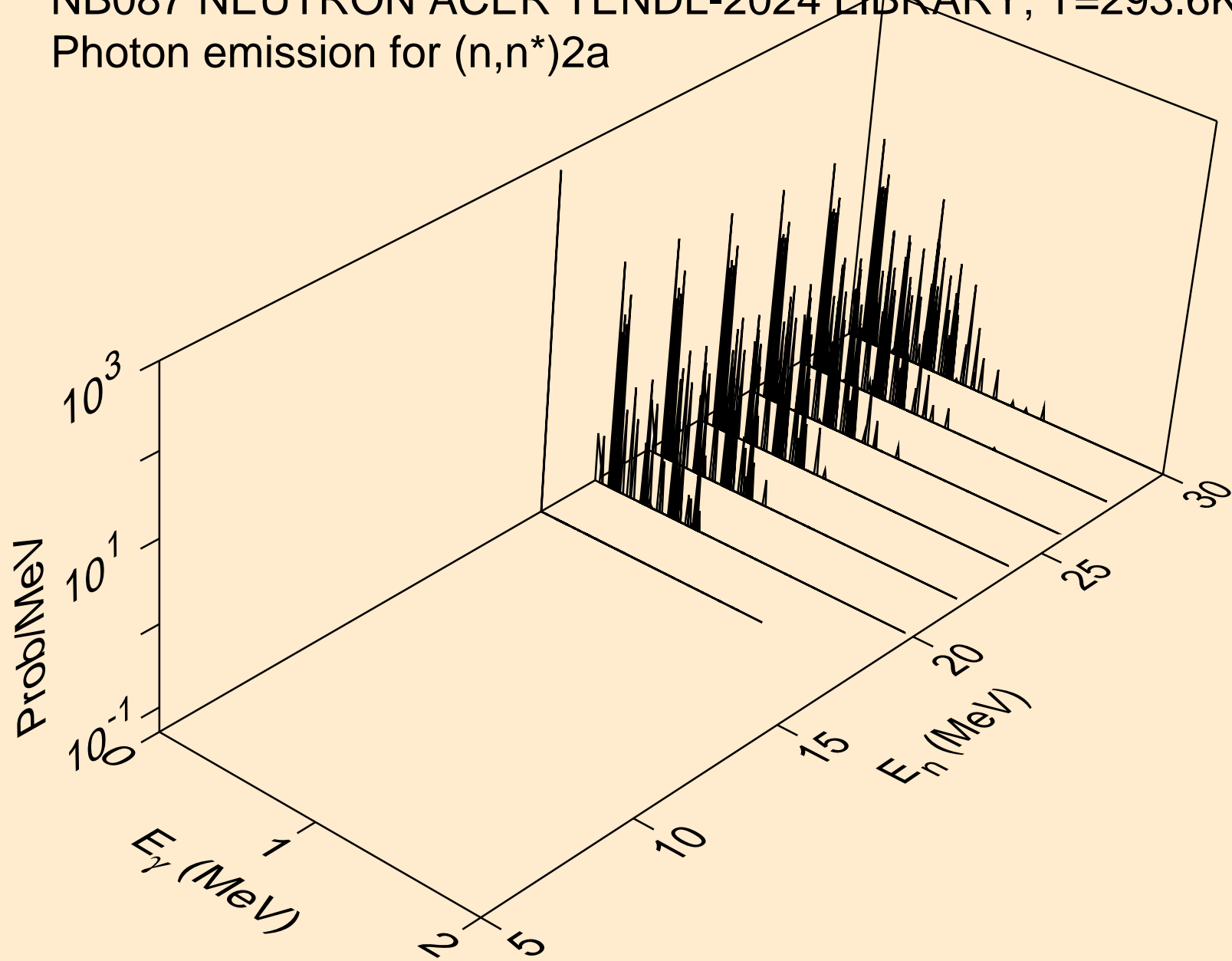

NB087 NEUTRON ACER TENDL-2024 LIBRARY; T=293.6K  
Photon emission for (n,n\*)d

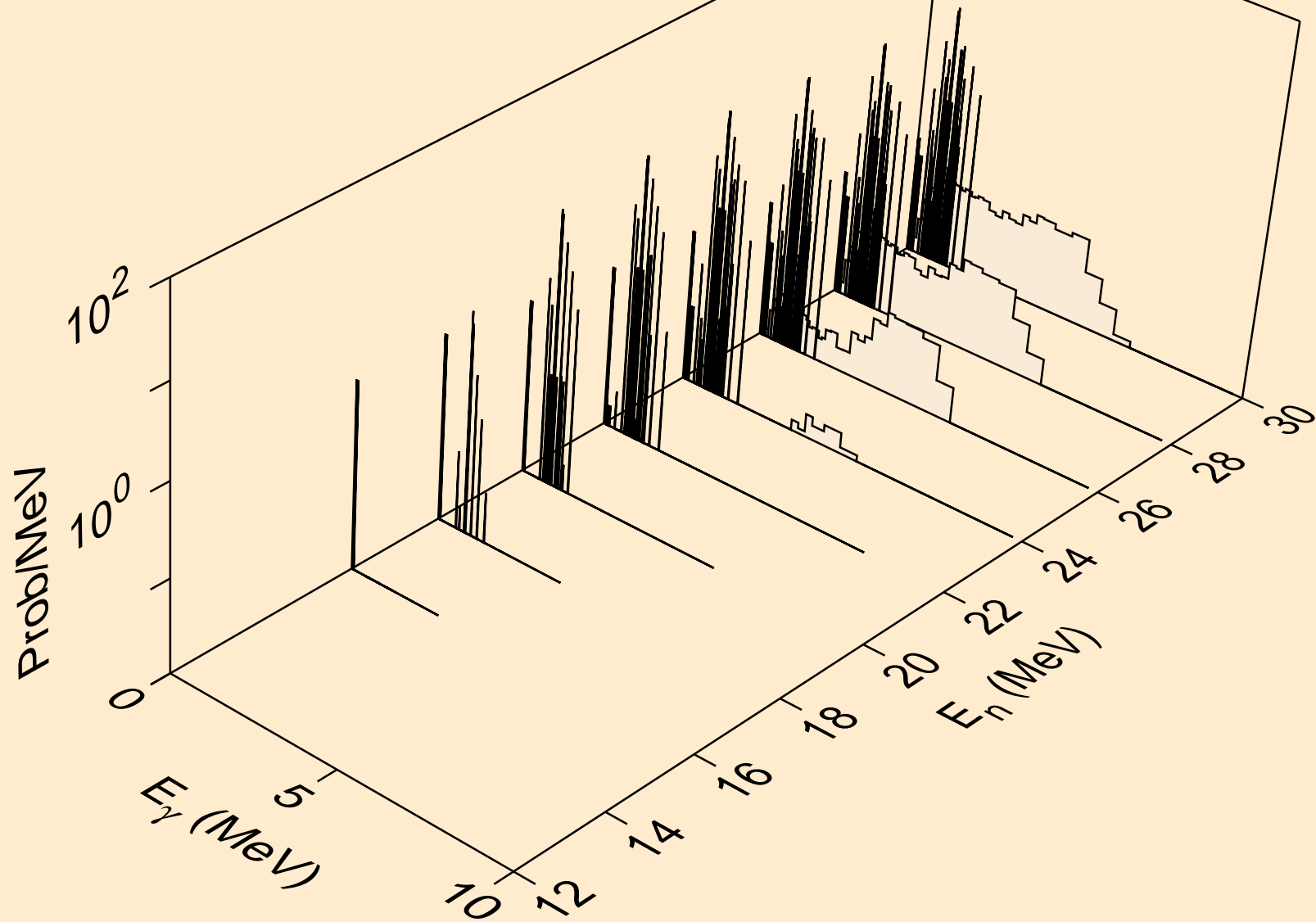

NB087 NEUTRON ACER TENDL-2024 LIBRARY; T=293.6K  
Photon emission for (n,n\*)t

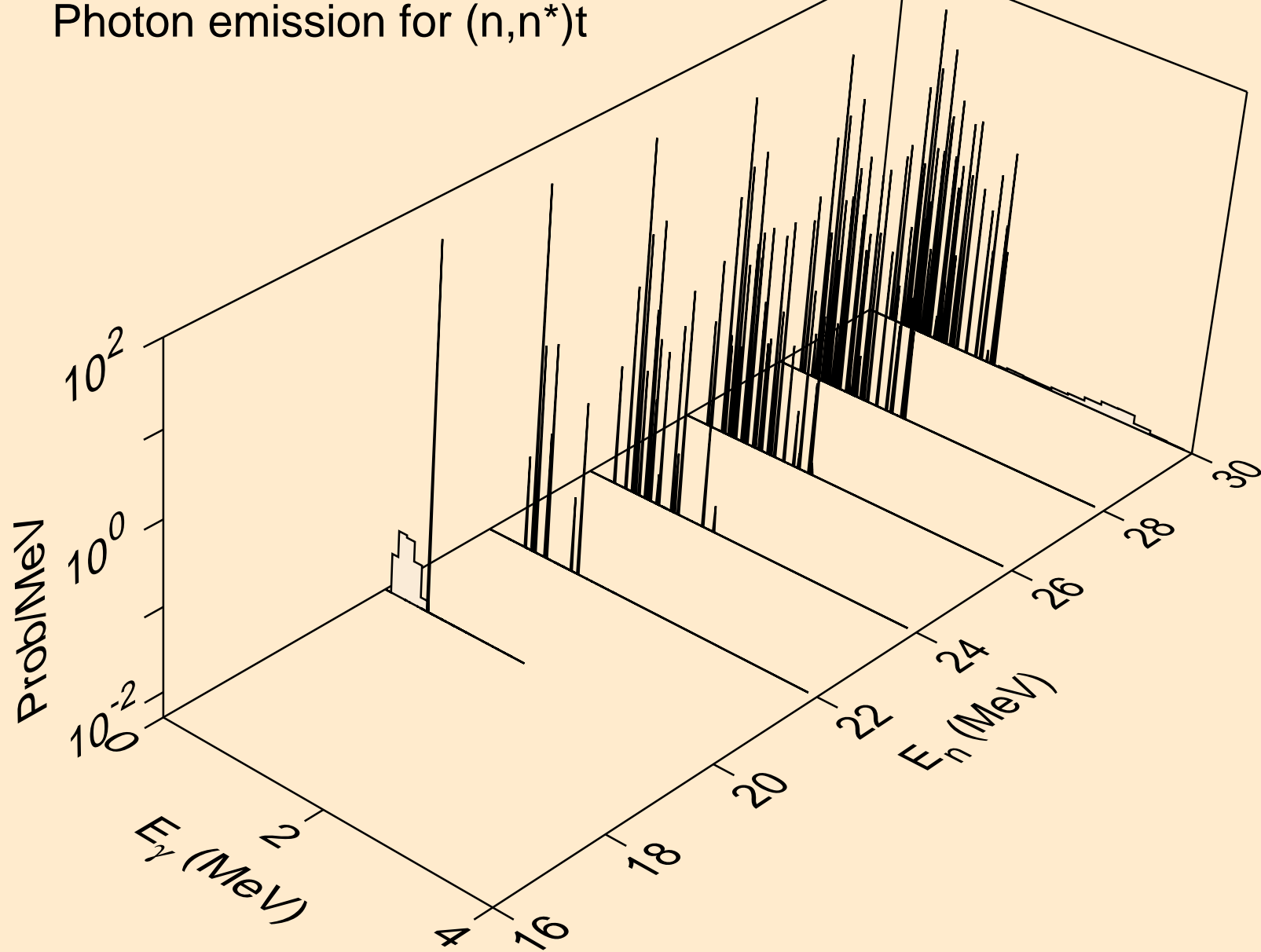

NB087 NEUTRON ACER TENDL-2024 LIBRARY; T=293.6K  
Photon emission for (n,n\*)he3

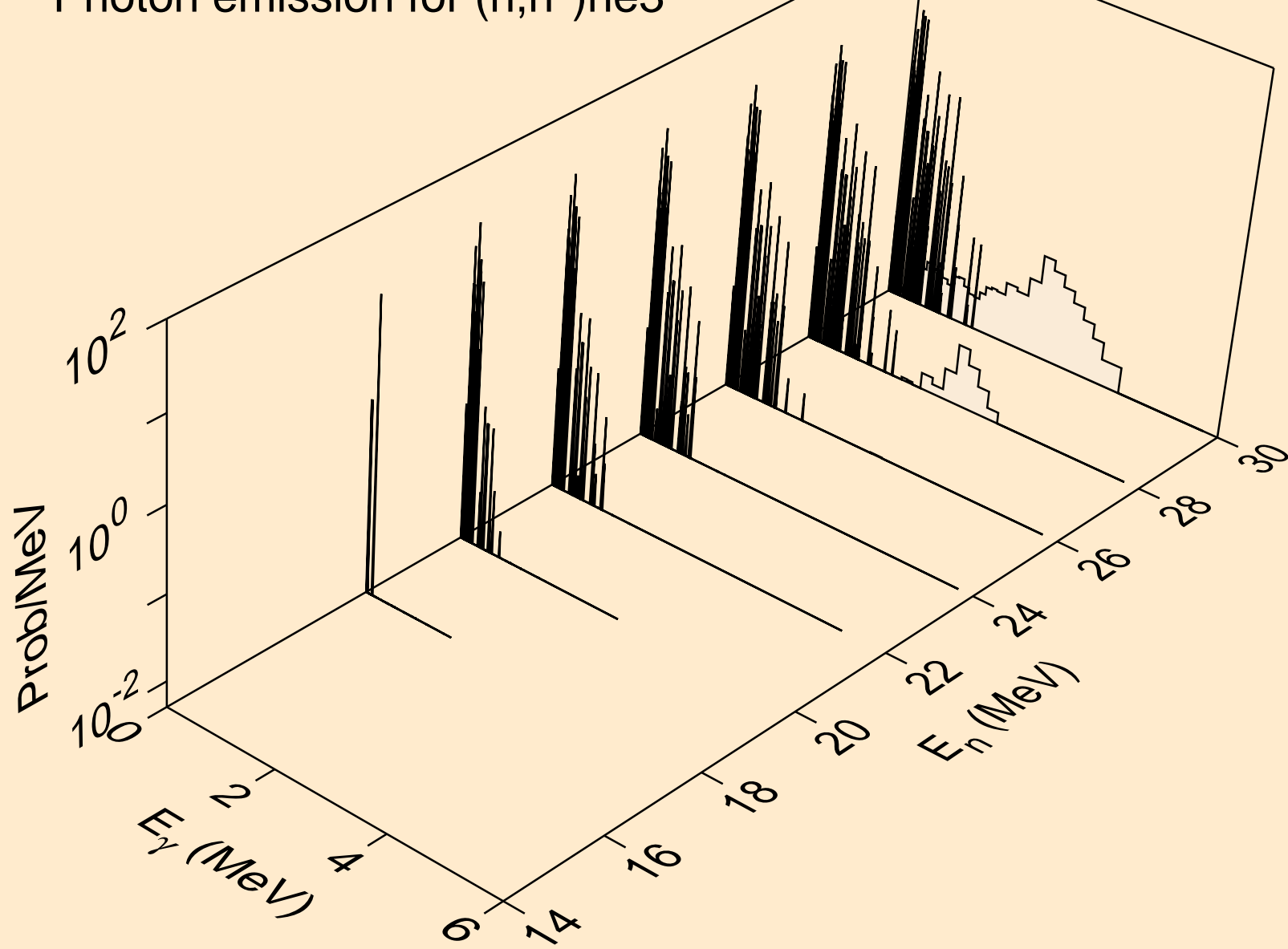

NB087 NEUTRON ACER TENDL-2024 LIBRARY; T=293.6K  
Photon emission for (n,2np)

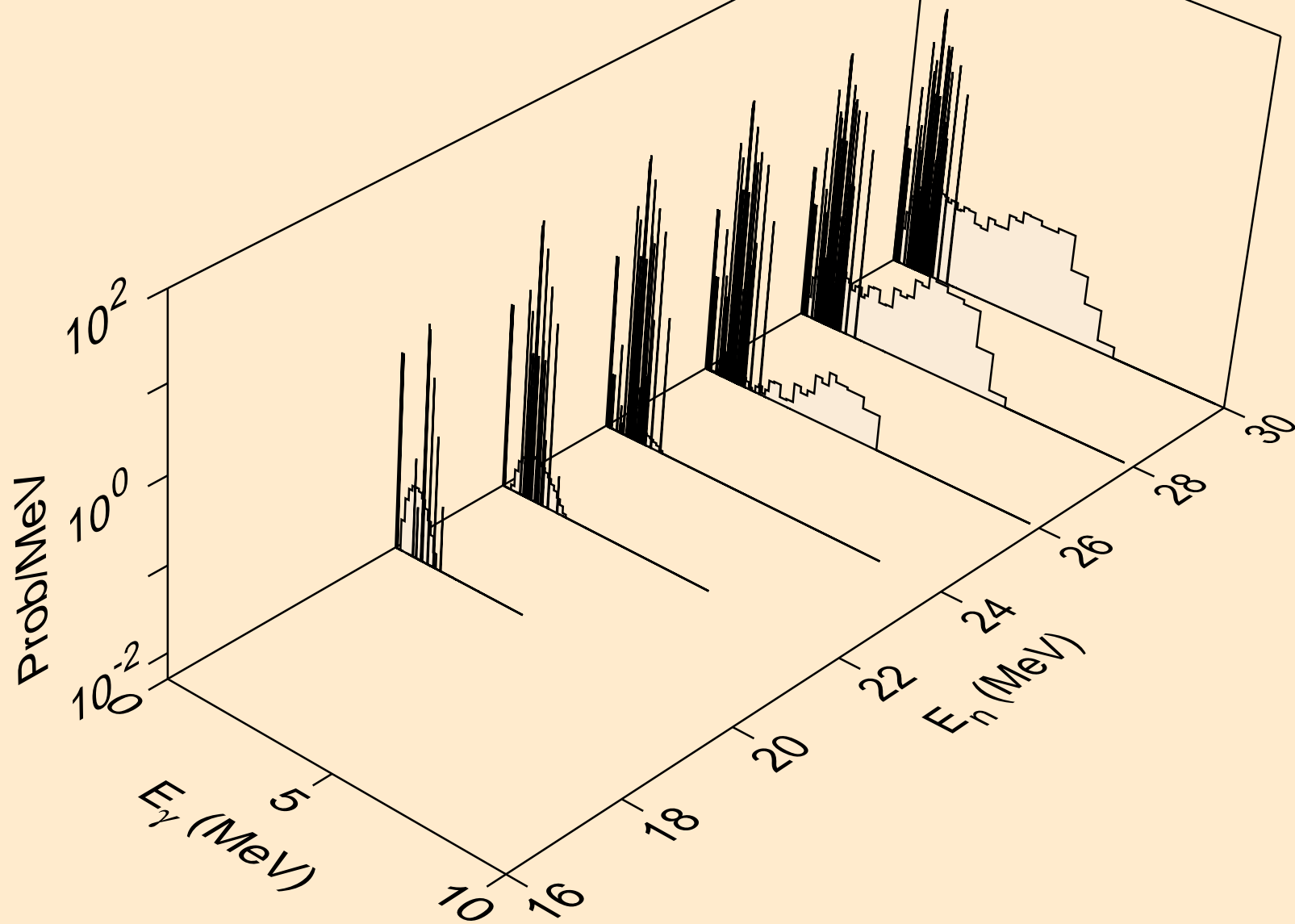

NB087 NEUTRON ACER TENDL-2024 LIBRARY; T=293.6K  
Photon emission for (n,3np)

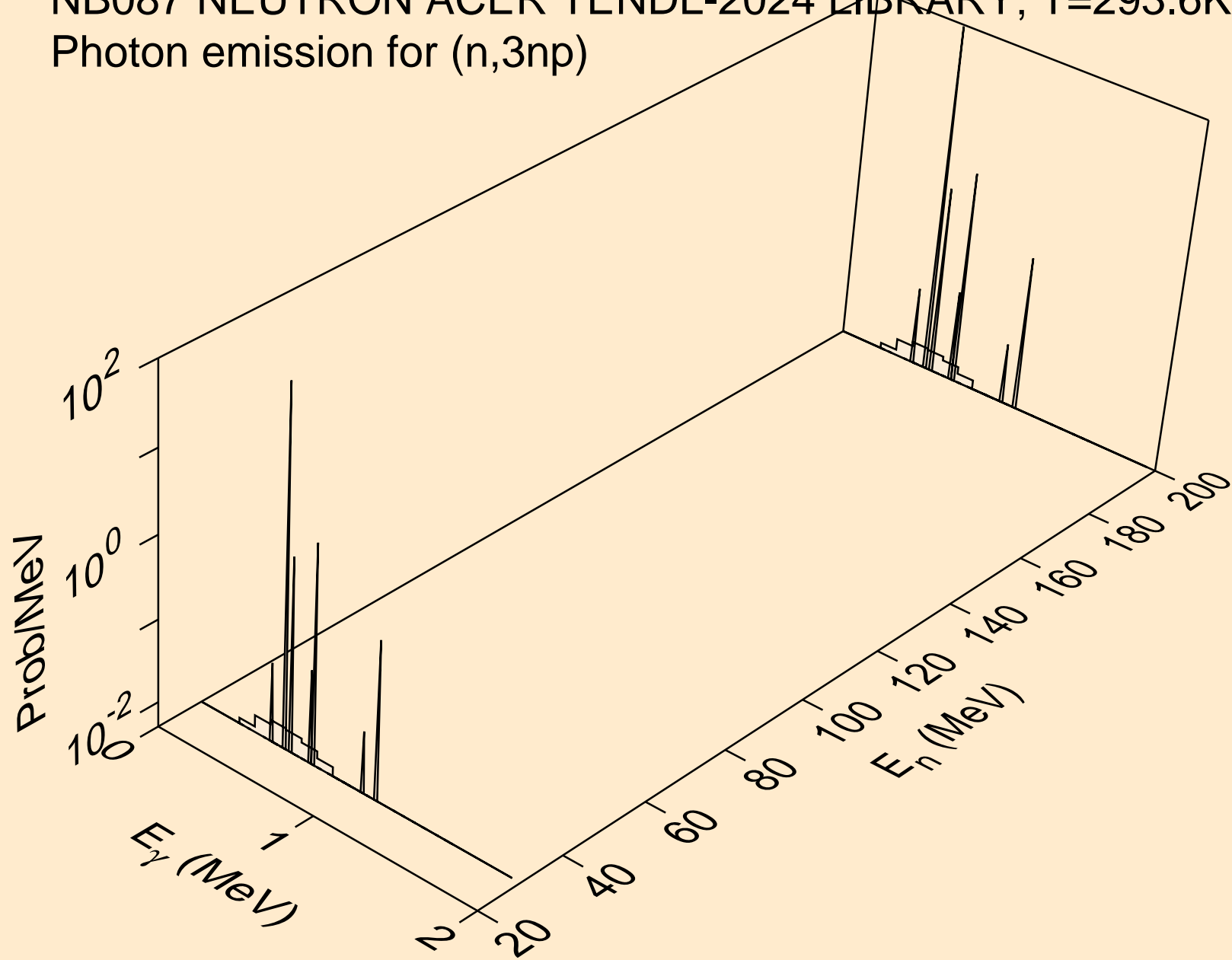

NB087 NEUTRON ACER TENDL-2024 LIBRARY; T=293.6K  
Photon emission for (n,n2p)

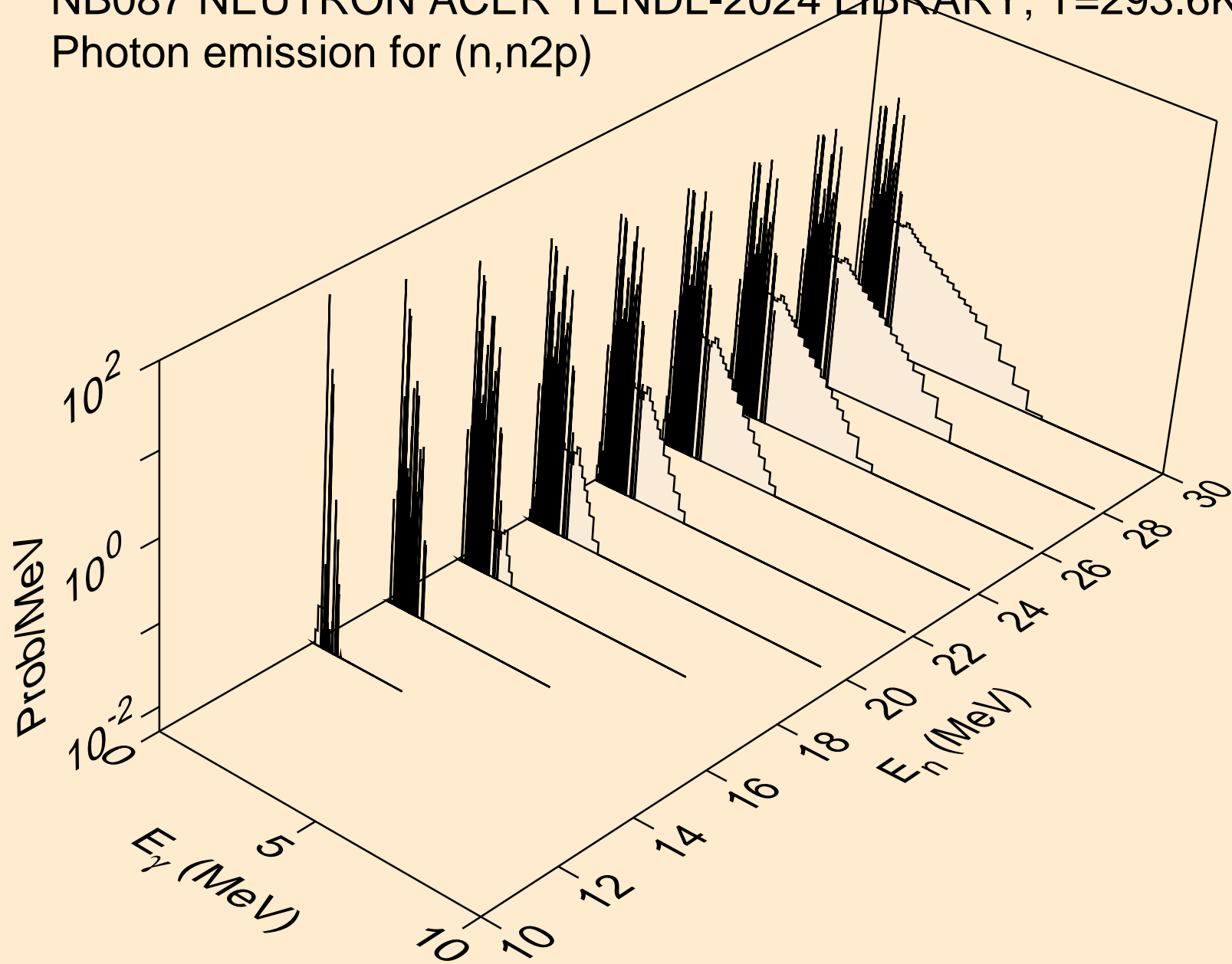

NB087 NEUTRON ACER TENDL-2024 LIBRARY; T=293.6K  
Photon emission for (n,npa)

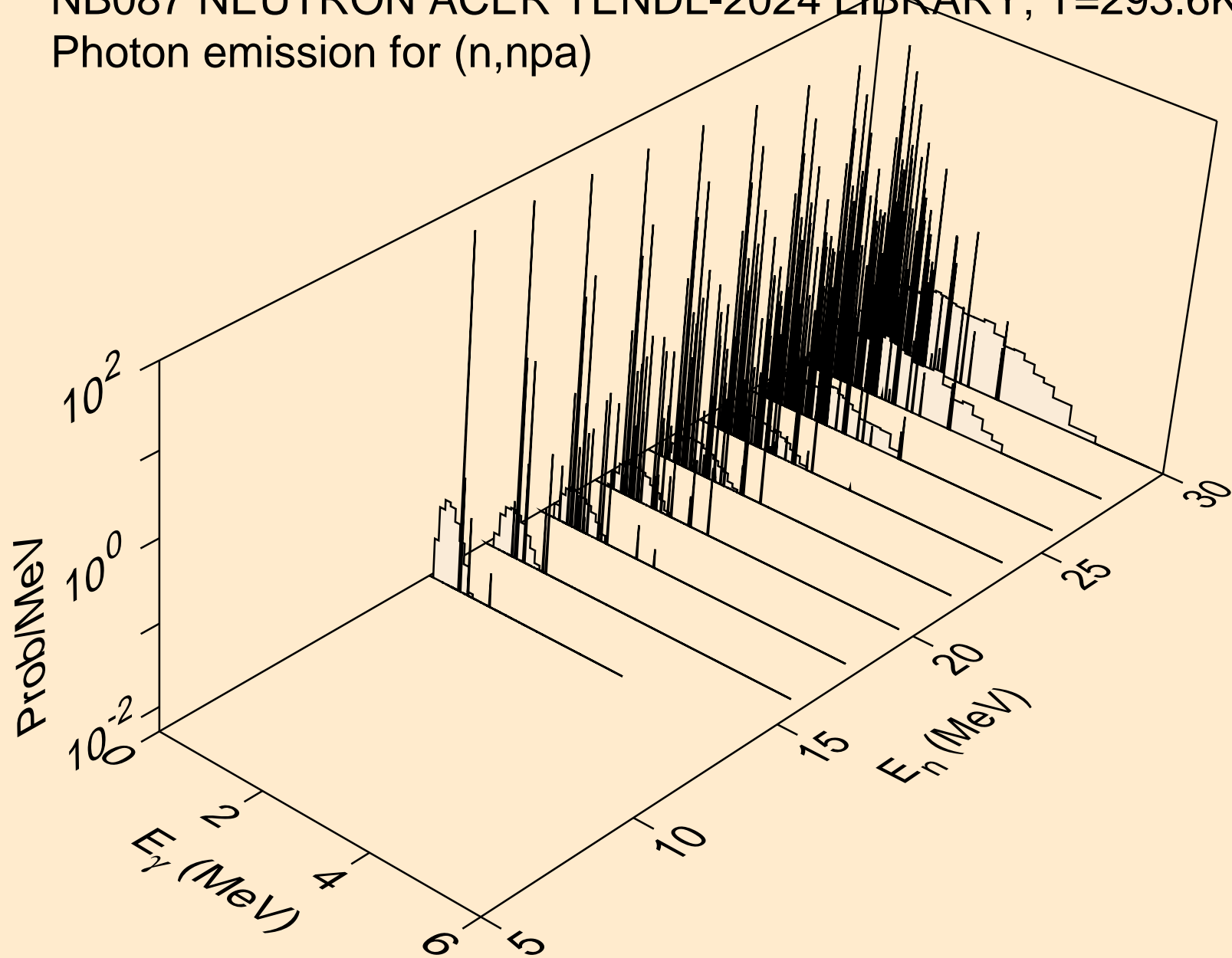

NB087 NEUTRON ACER TENDL-2024 LIBRARY; T=293.6K  
Photon emission for (n,n\*c)

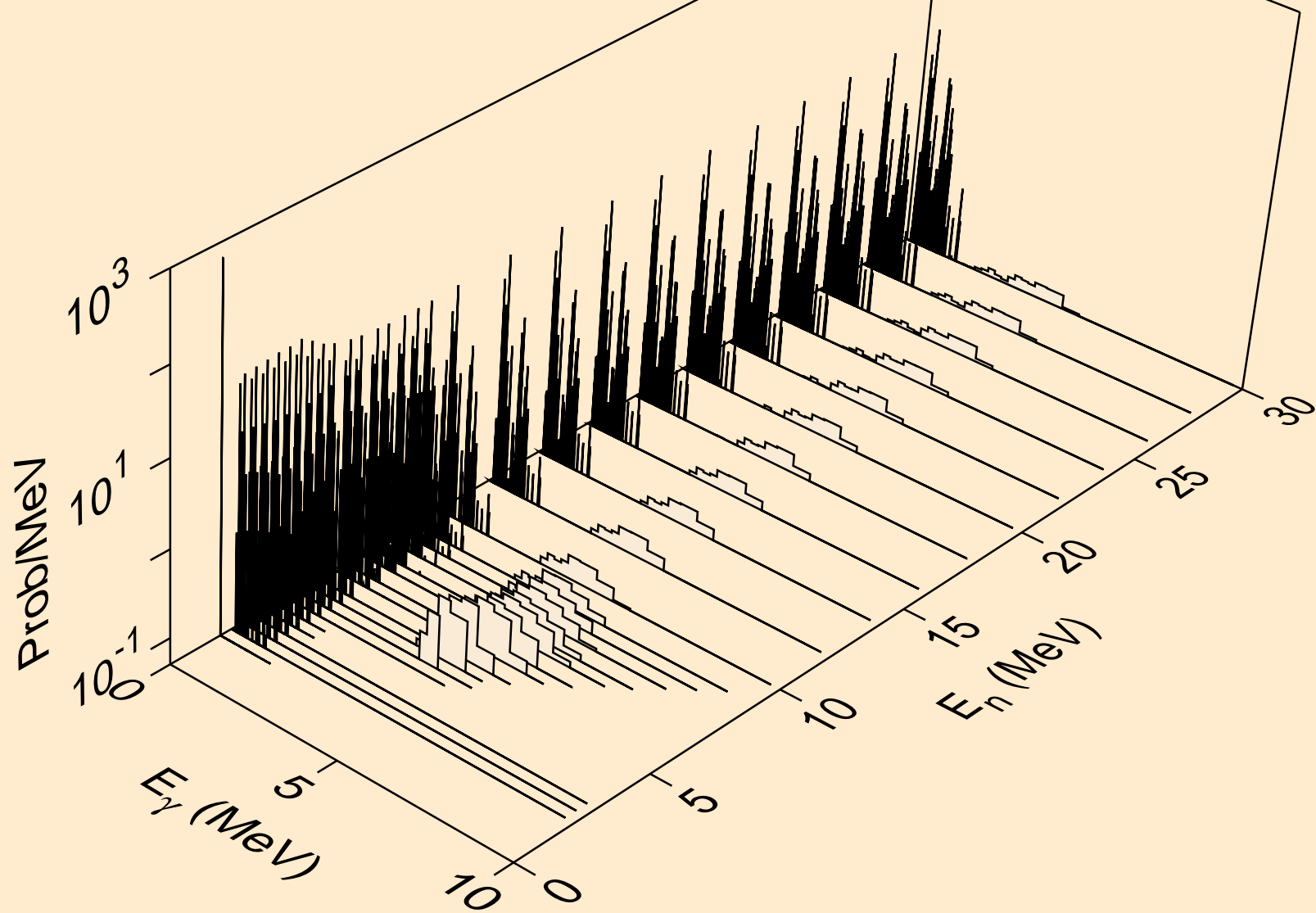

NB087 NEUTRON ACER TENDL-2024 LIBRARY; T=293.6K  
Photon emission for (n,gma)

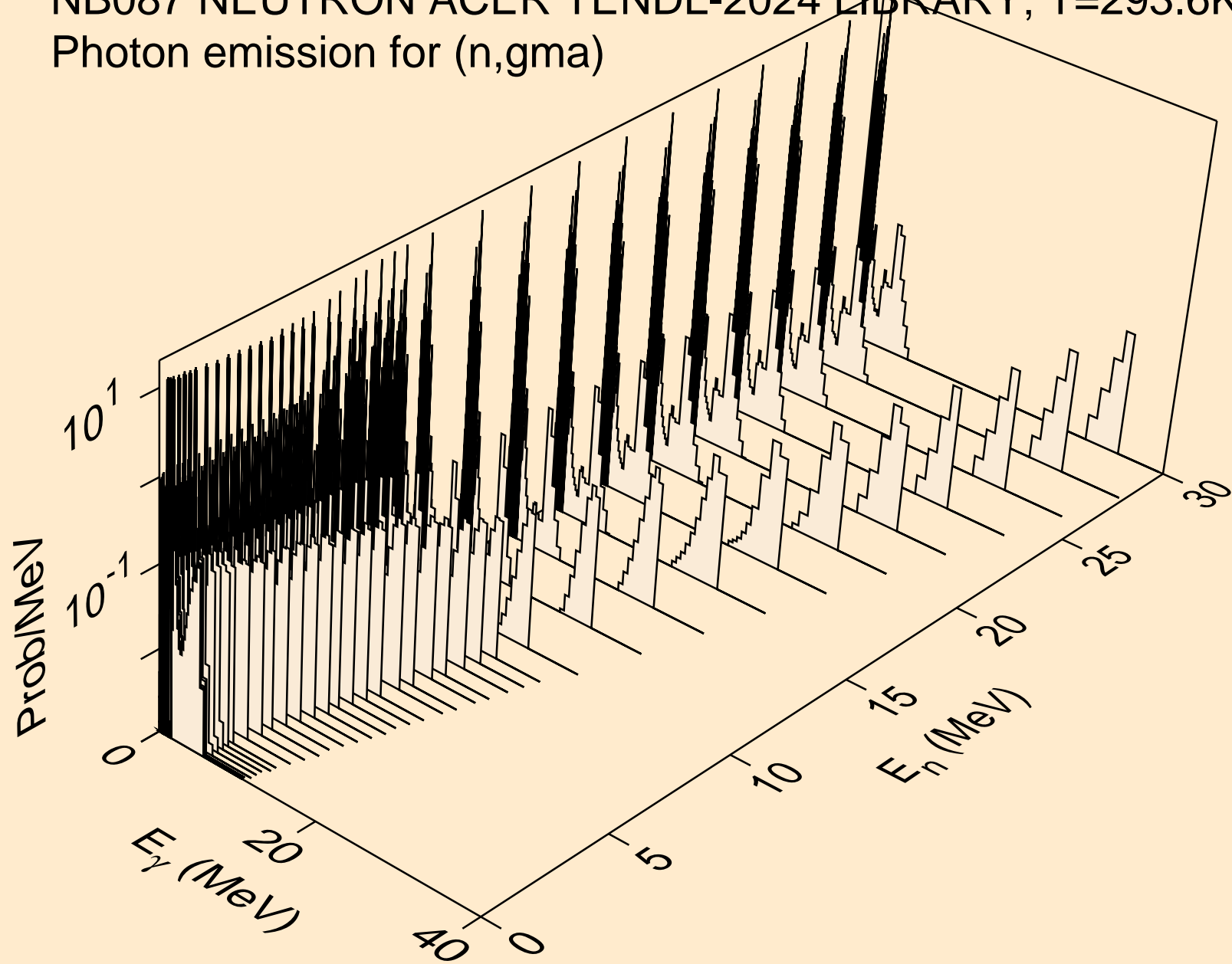

NB087 NEUTRON ACER TENDL-2024 LIBRARY; T=293.6K  
Photon emission for (n,p)

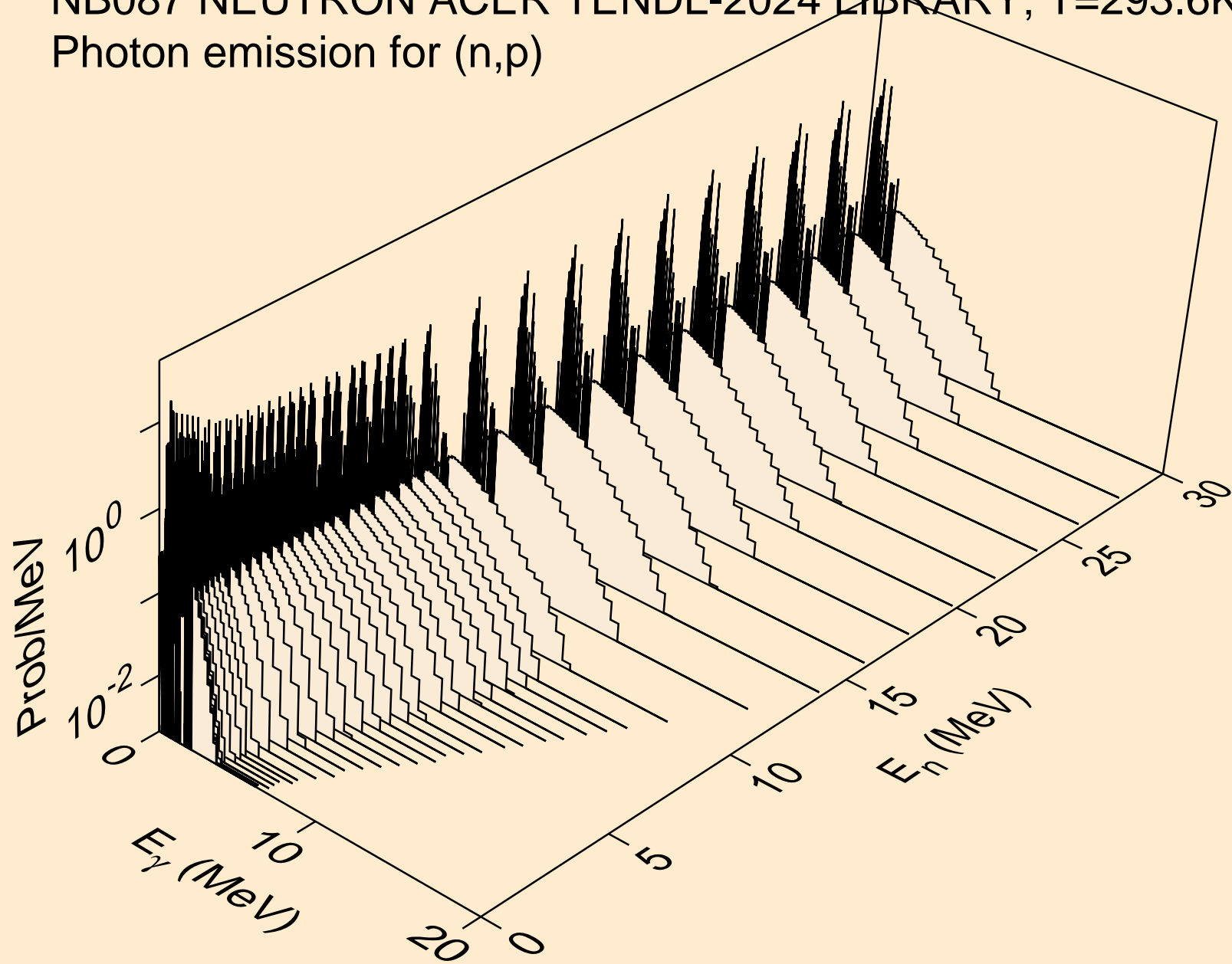

NB087 NEUTRON ACER TENDL-2024 LIBRARY; T=293.6K  
Photon emission for (n,d)

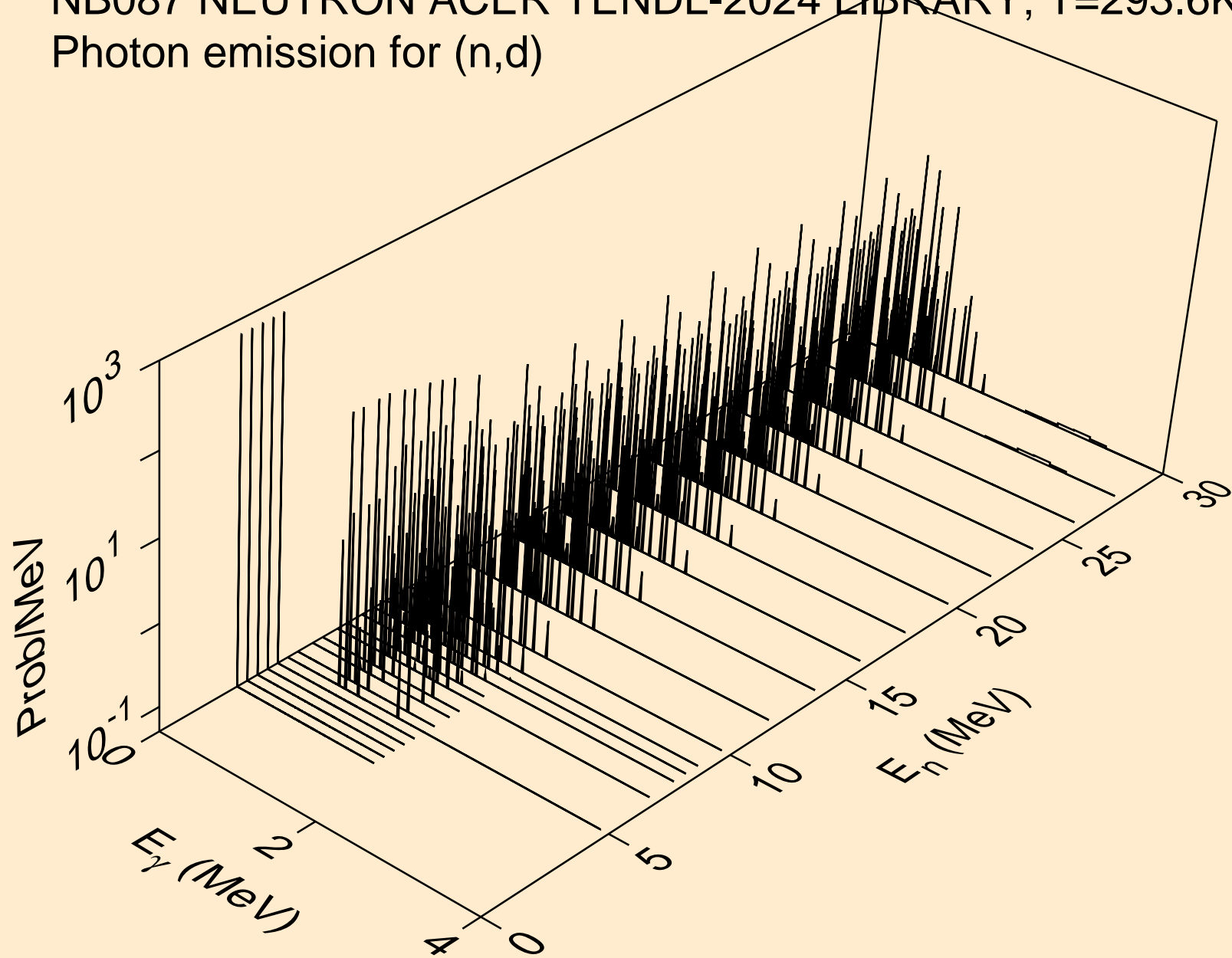

NB087 NEUTRON ACER TENDL-2024 LIBRARY; T=293.6K  
Photon emission for (n,t)

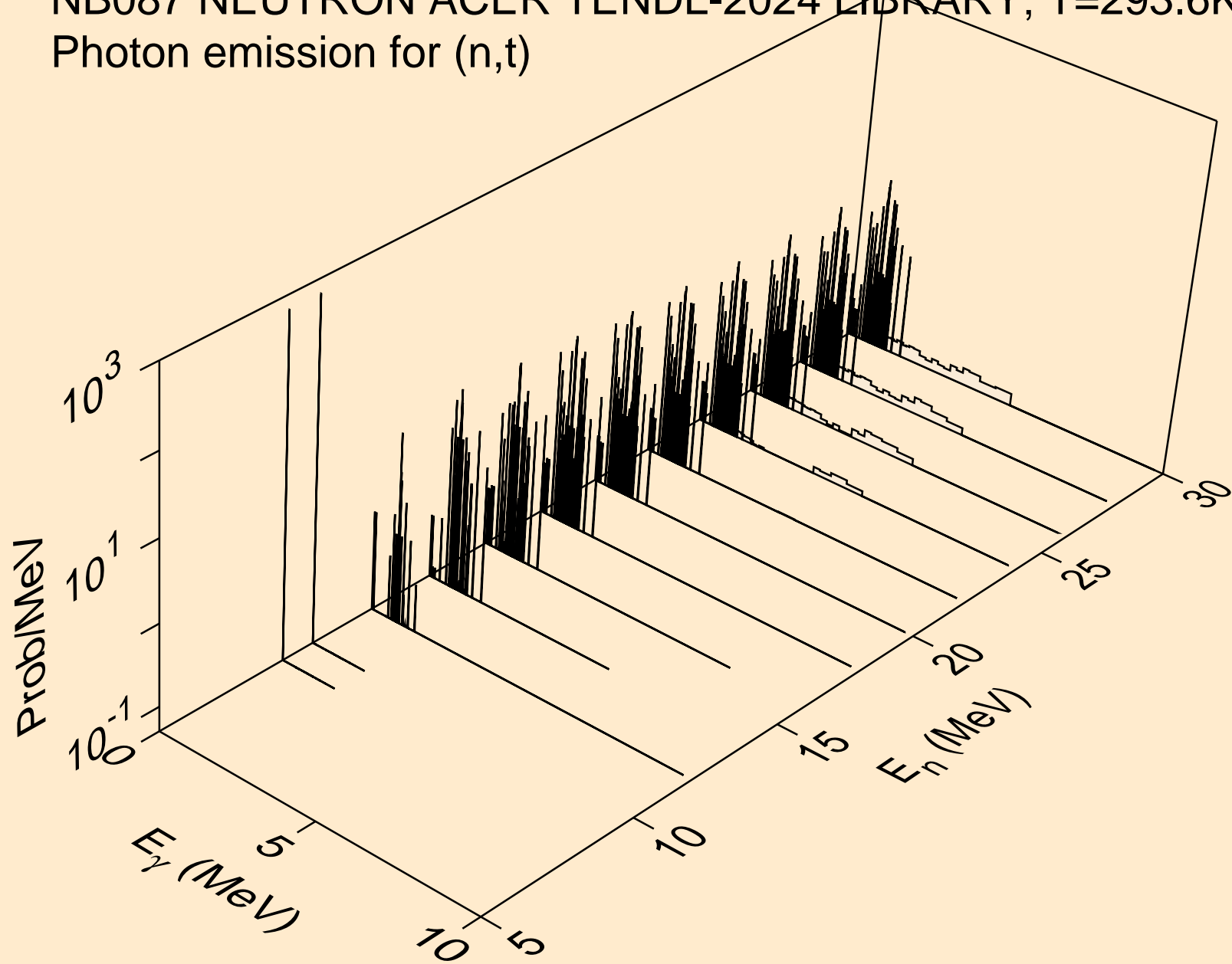

NB087 NEUTRON ACER TENDL-2024 LIBRARY; T=293.6K  
Photon emission for (n,he3)

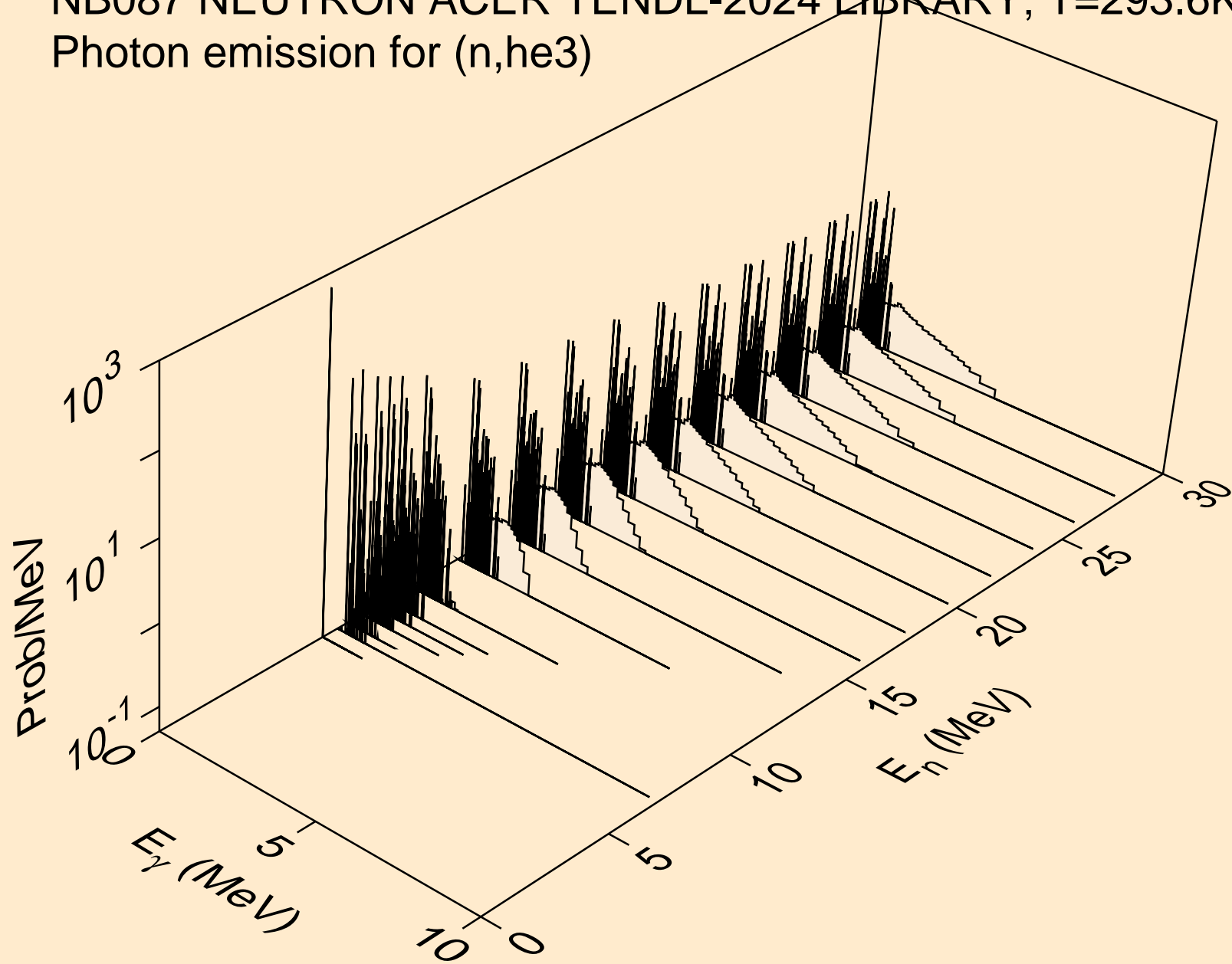

NB087 NEUTRON ACER TENDL-2024 LIBRARY; T=293.6K  
Photon emission for (n,a)

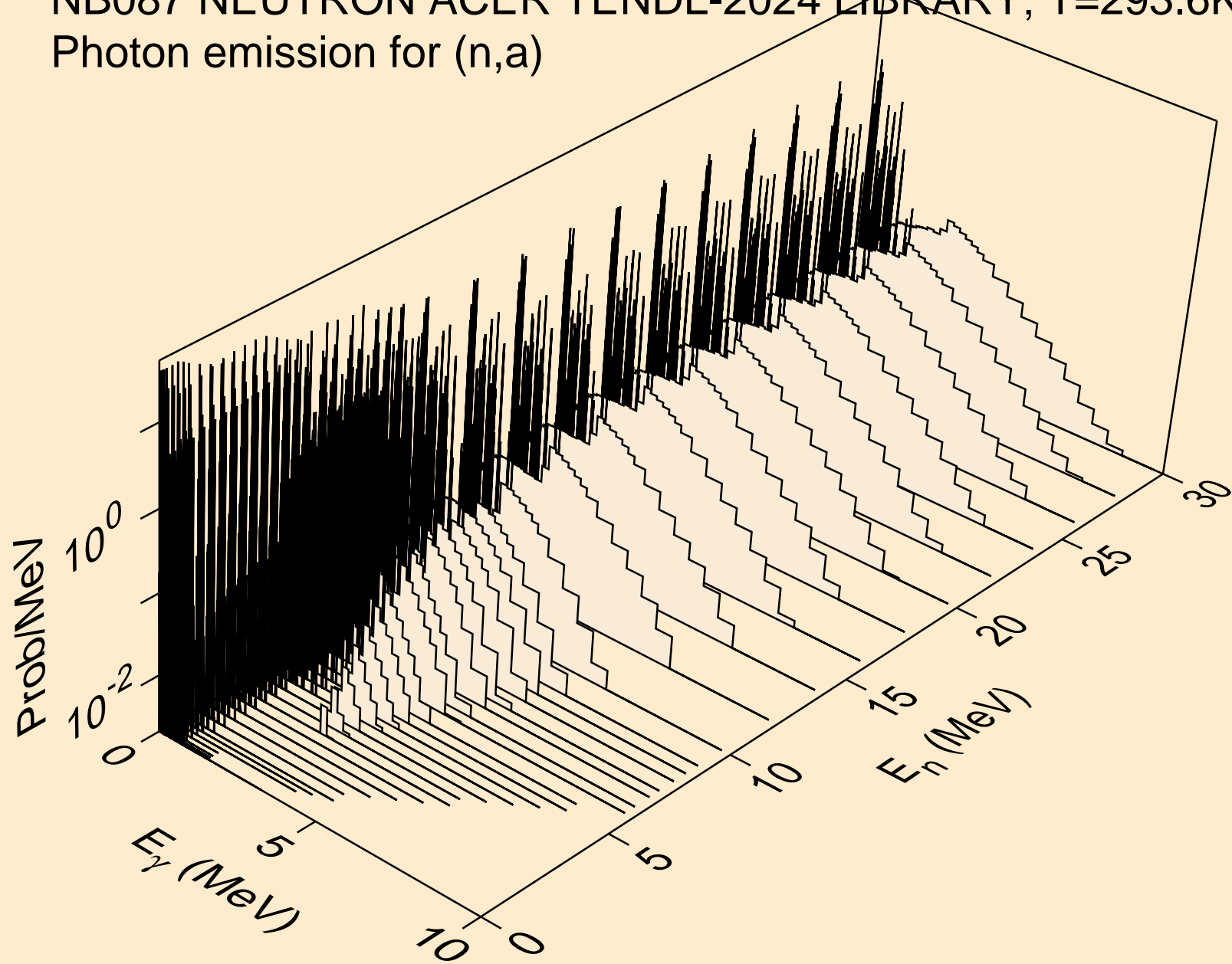

NB087 NEUTRON ACER TENDL-2024 LIBRARY; T=293.6K  
Photon emission for (n,2a)

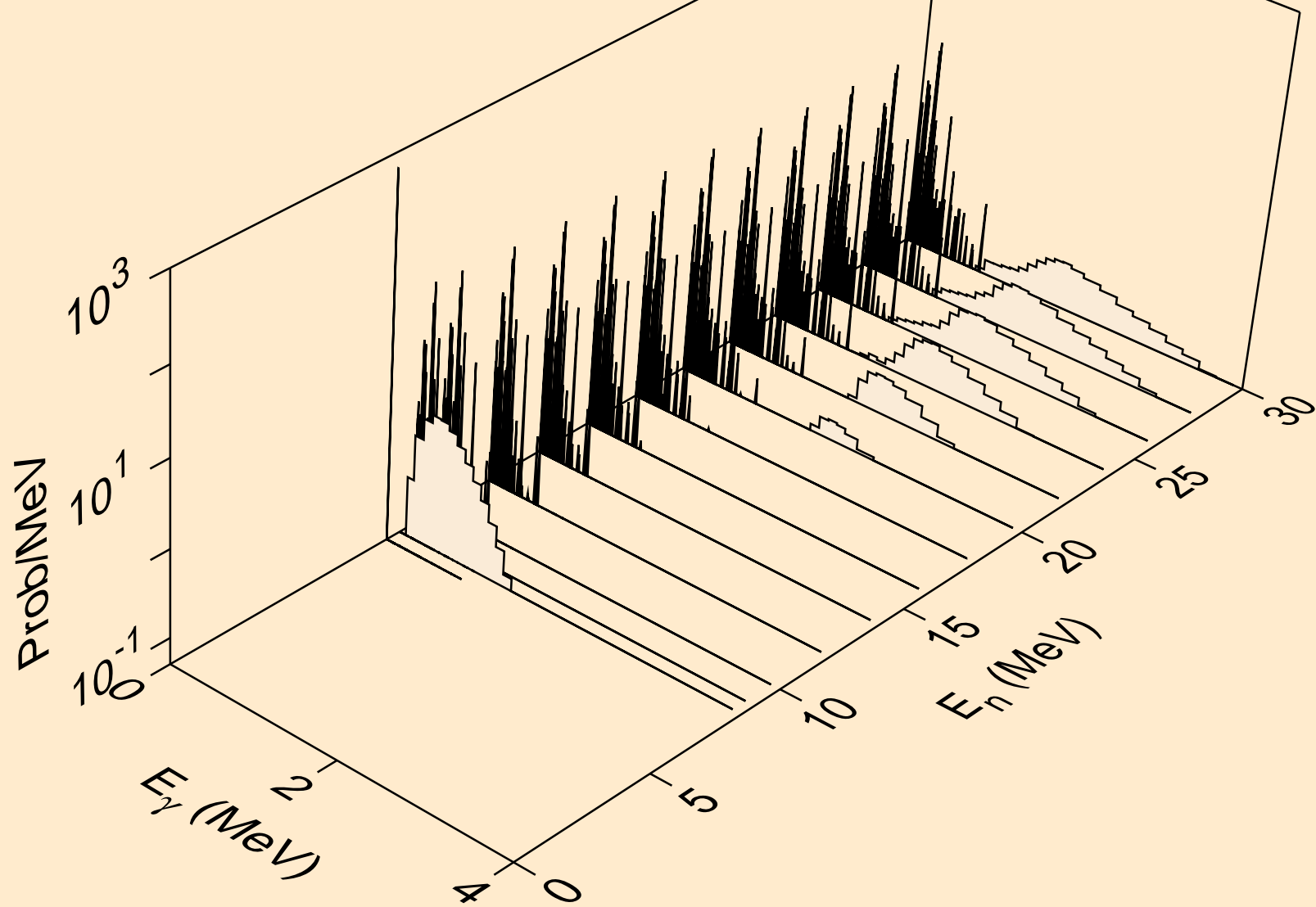

NB087 NEUTRON ACER TENDL-2024 LIBRARY; T=293.6K  
Photon emission for (n,2p)

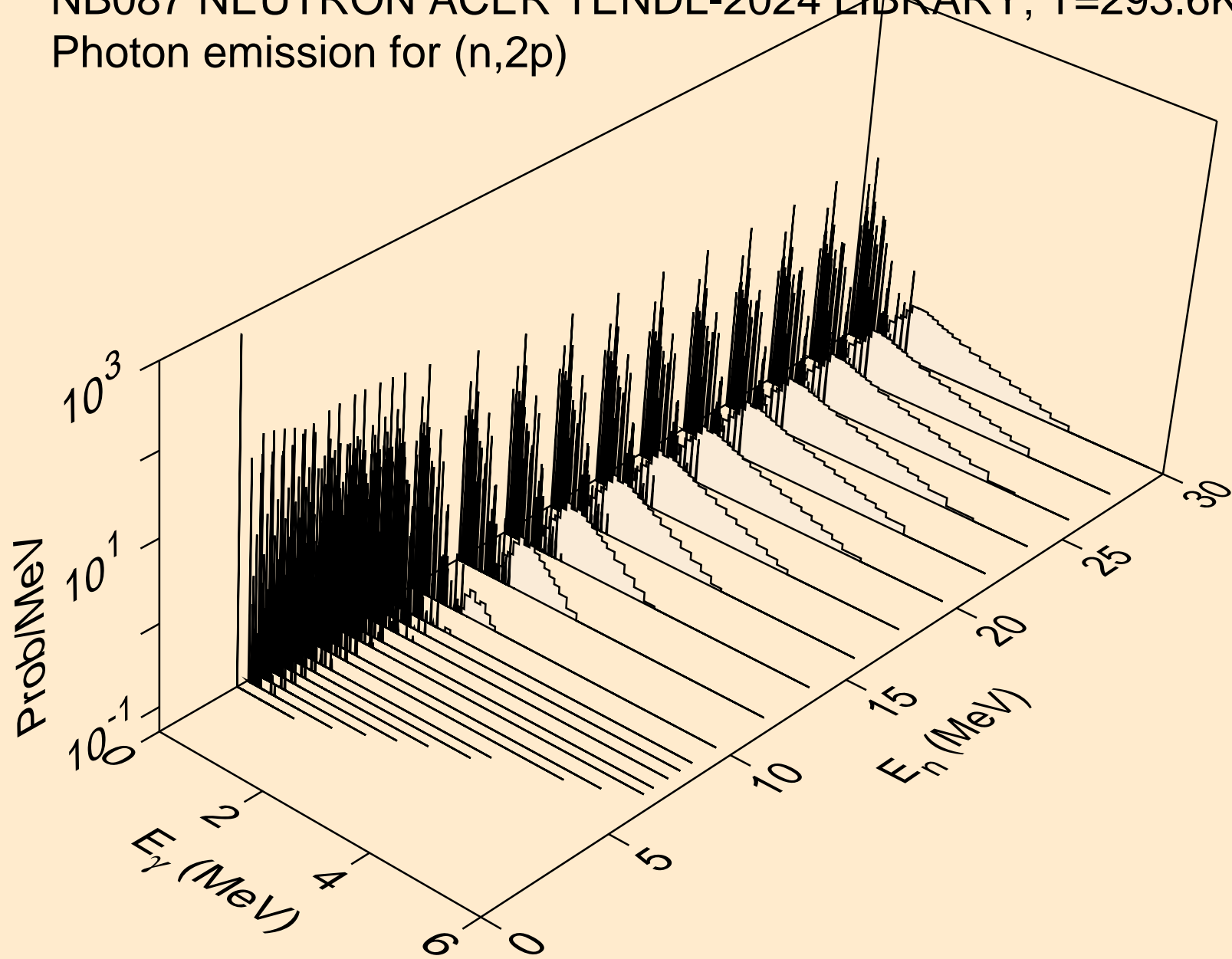

NB087 NEUTRON ACER TENDL-2024 LIBRARY; T=293.6K  
Photon emission for (n,p $\alpha$ )

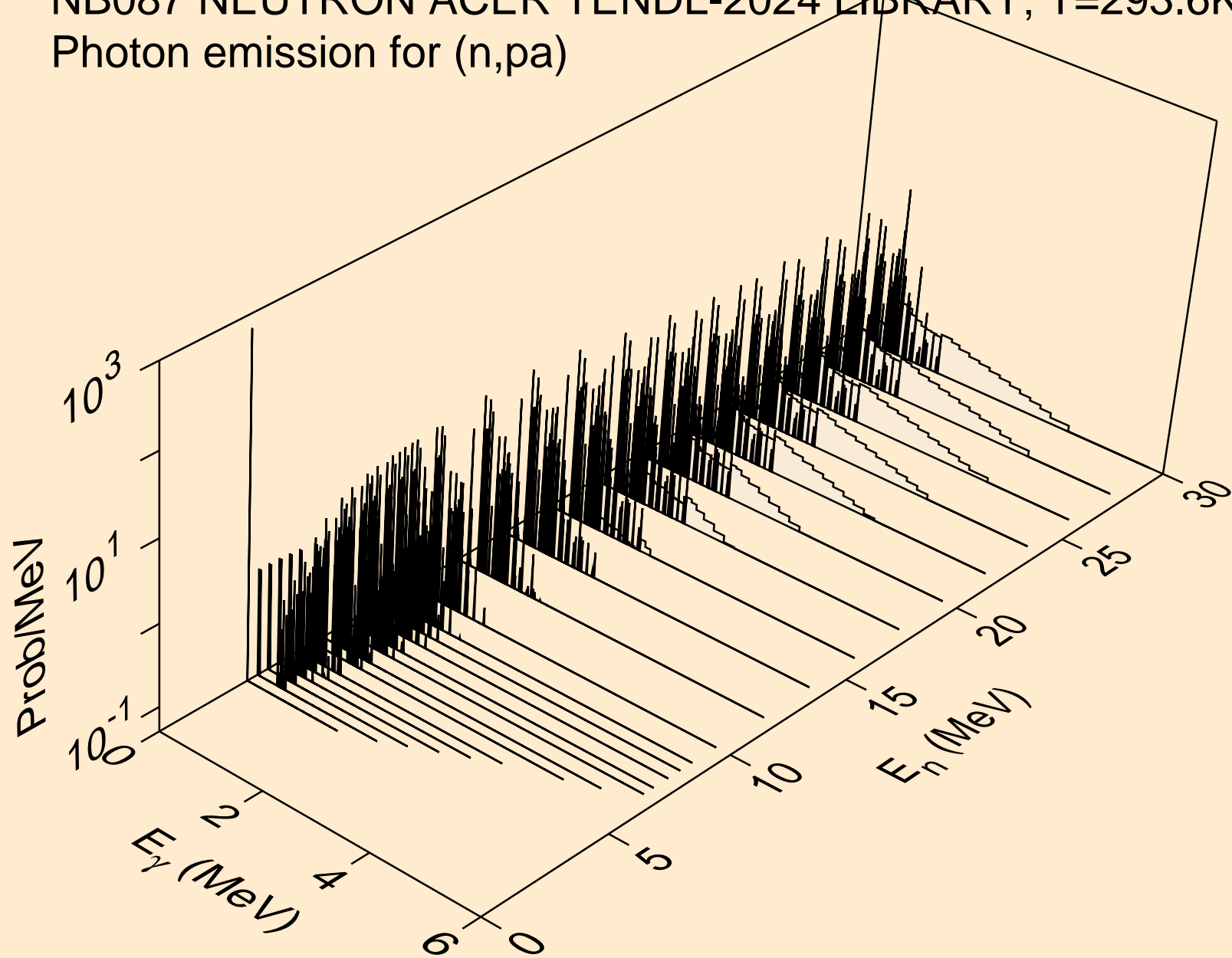

NB087 NEUTRON ACER TENDL-2024 LIBRARY; T=293.6K  
Photon emission for (n,pd)

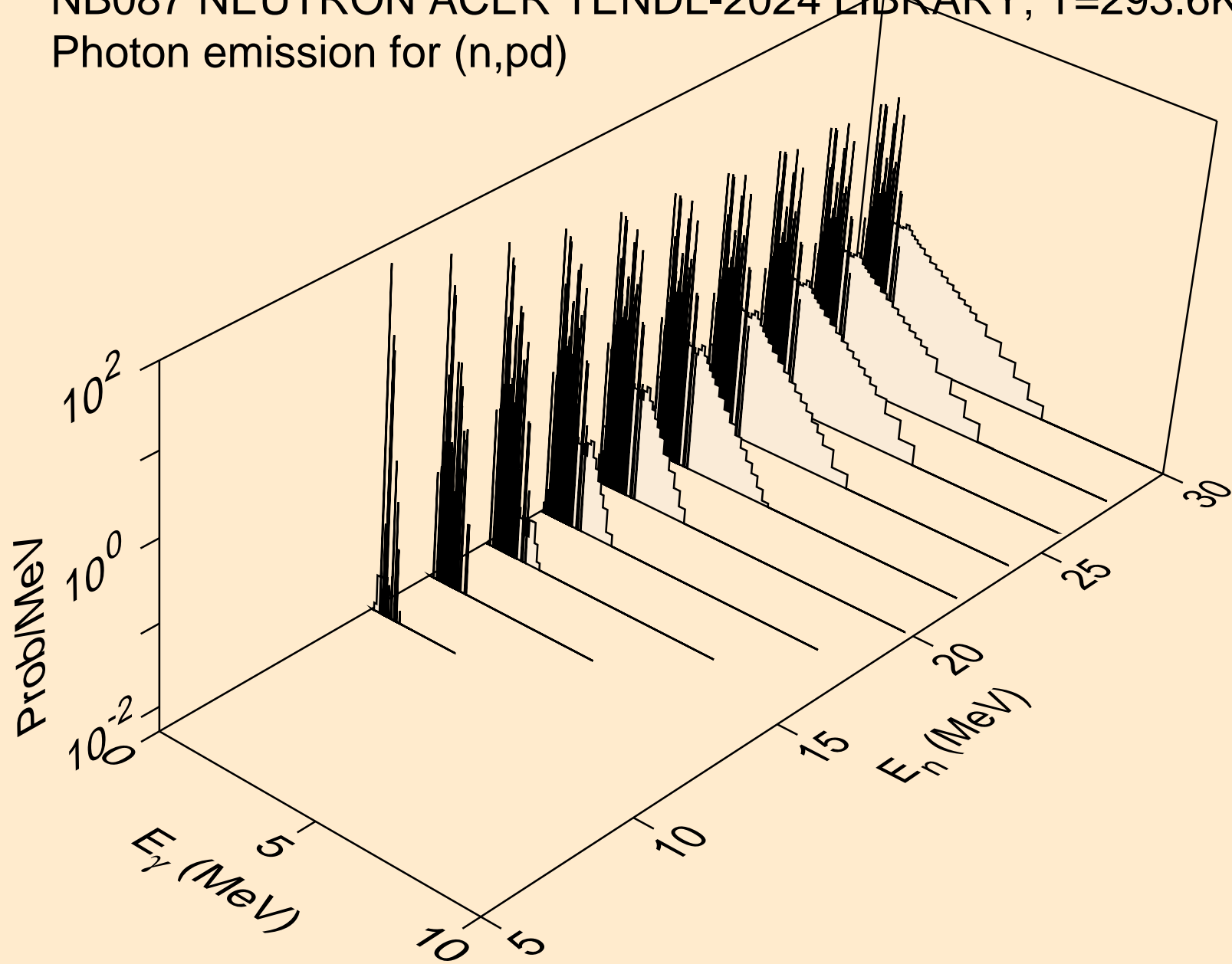

NB087 NEUTRON ACER TENDL-2024 LIBRARY; T=293.6K  
Photon emission for (n,pt)

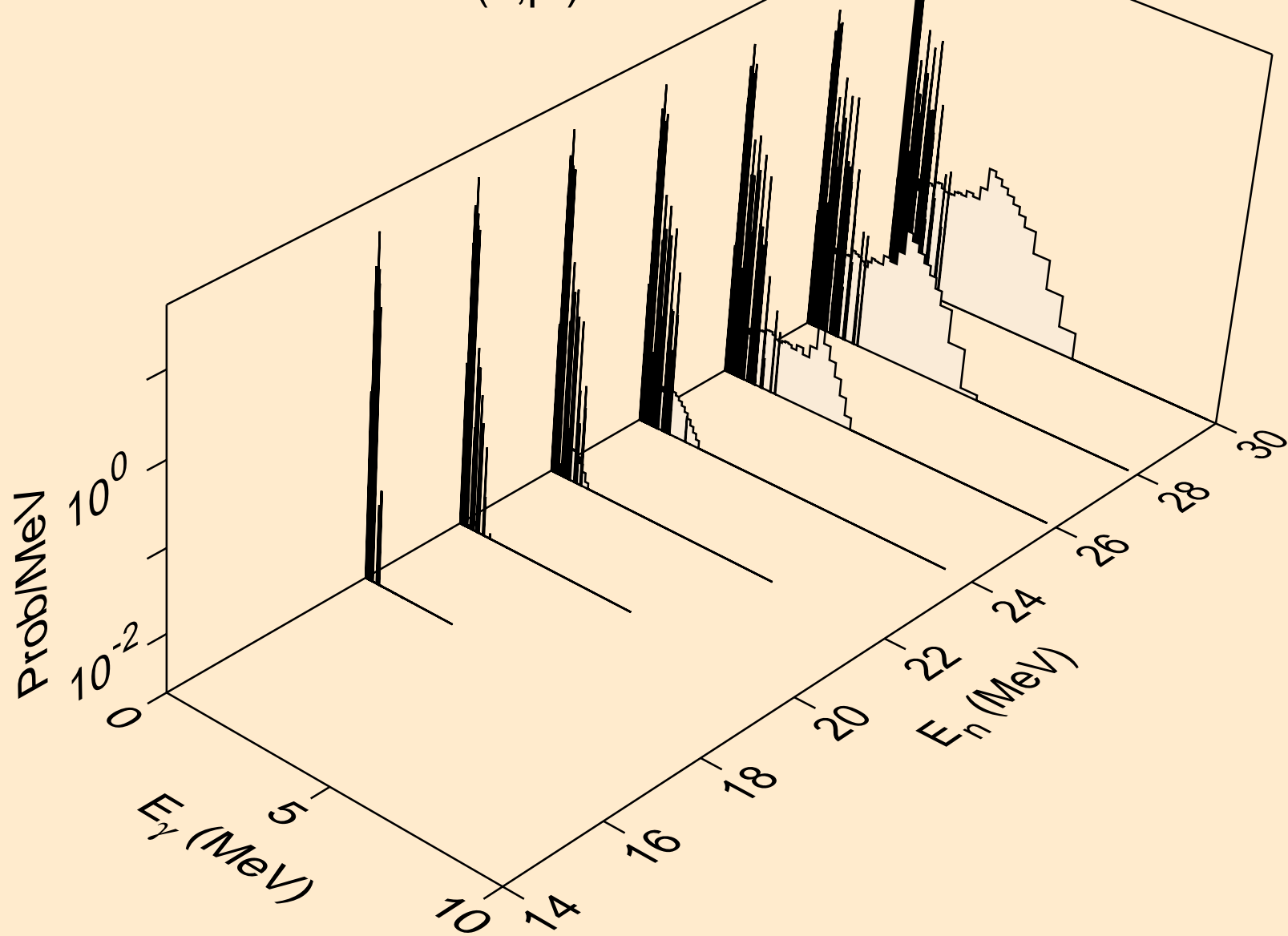

NB087 NEUTRON ACER TENDL-2024 LIBRARY; T=293.6K  
Photon emission for (n,da)

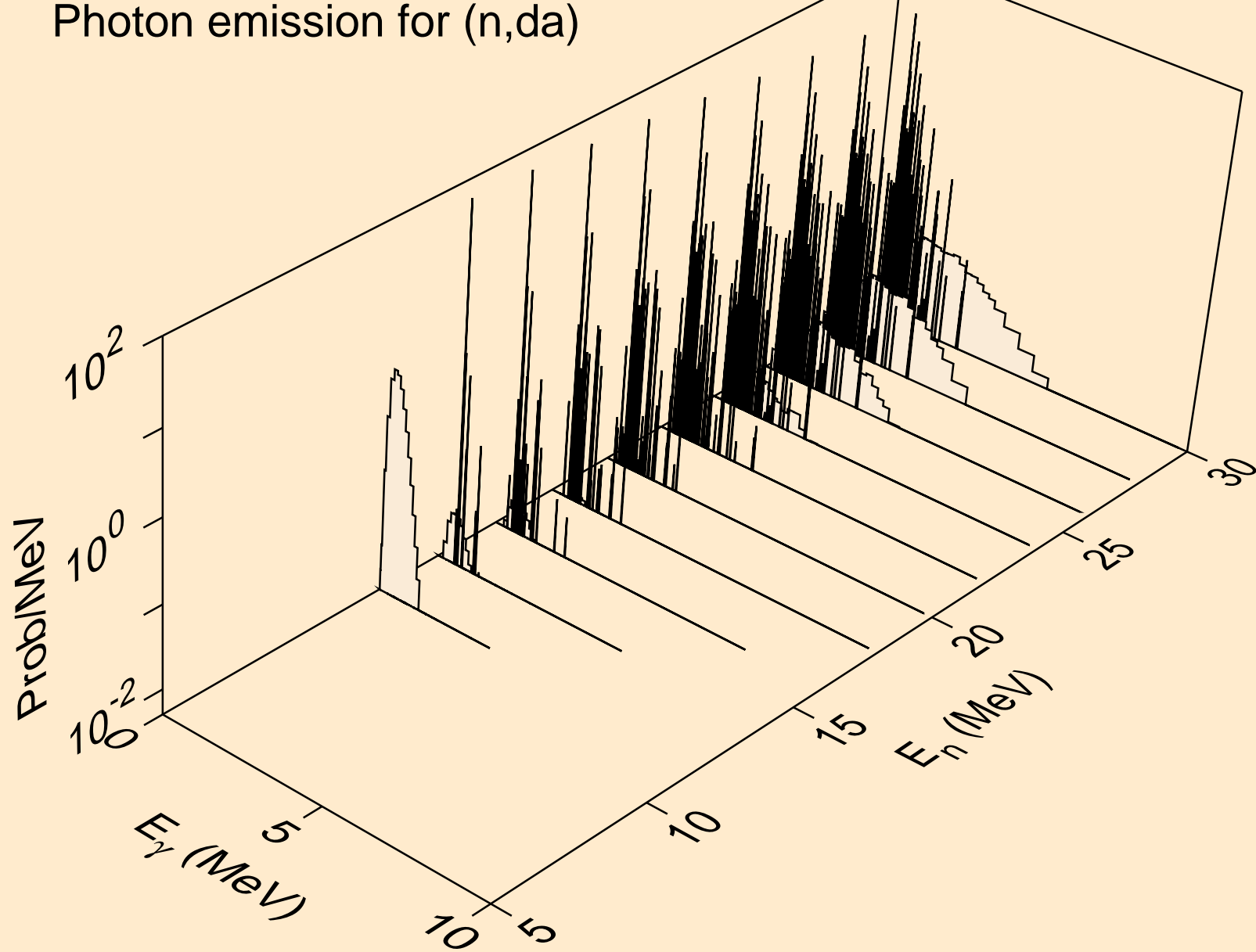

NB087 NEUTRON ACER TENDL-2024 LIBRARY; T=293.6K  
thermal capture photon spectrum

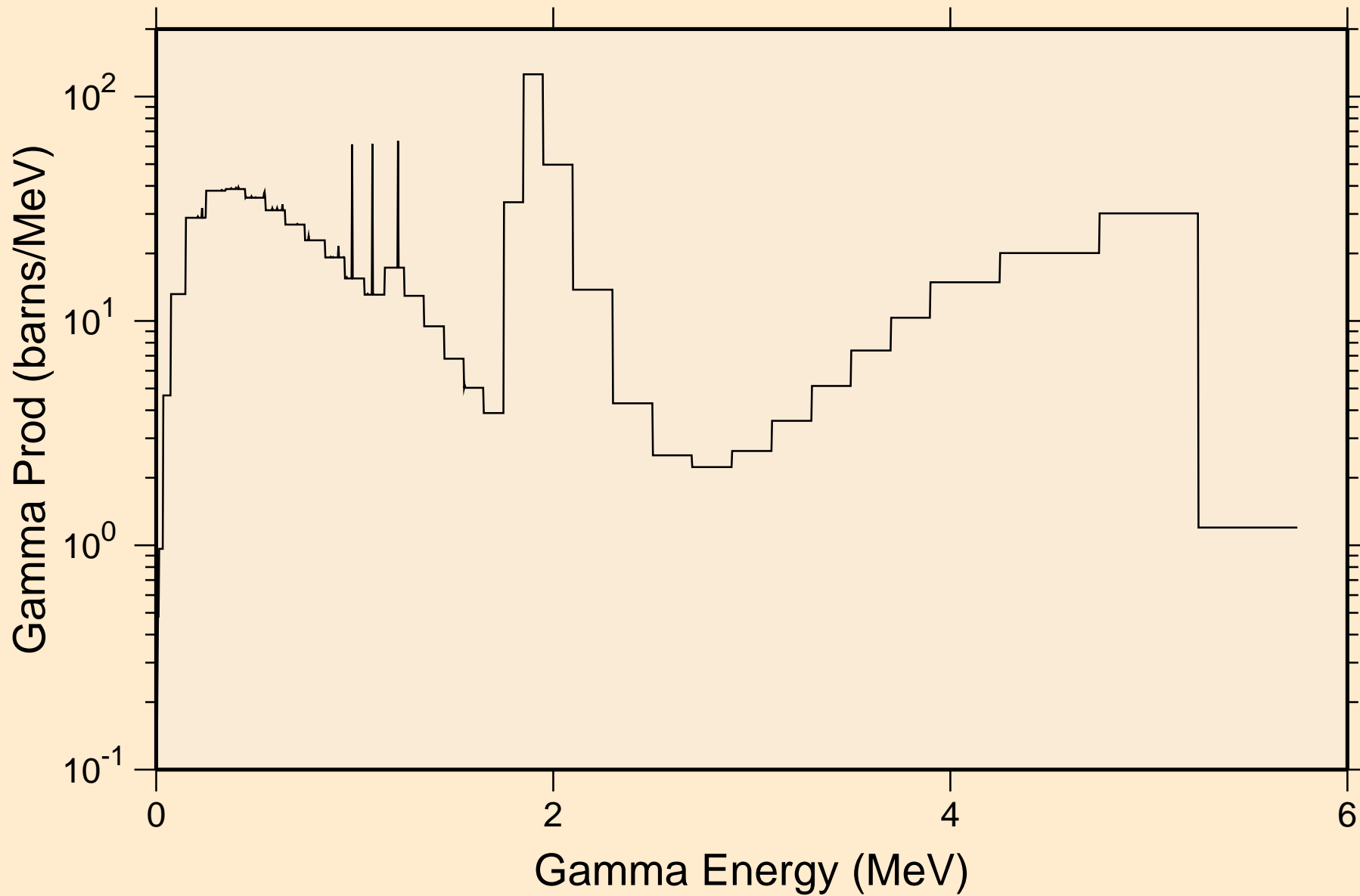

NB087 NEUTRON ACER TENDL-2024 LIBRARY; T=293.6K  
14 MeV photon spectrum

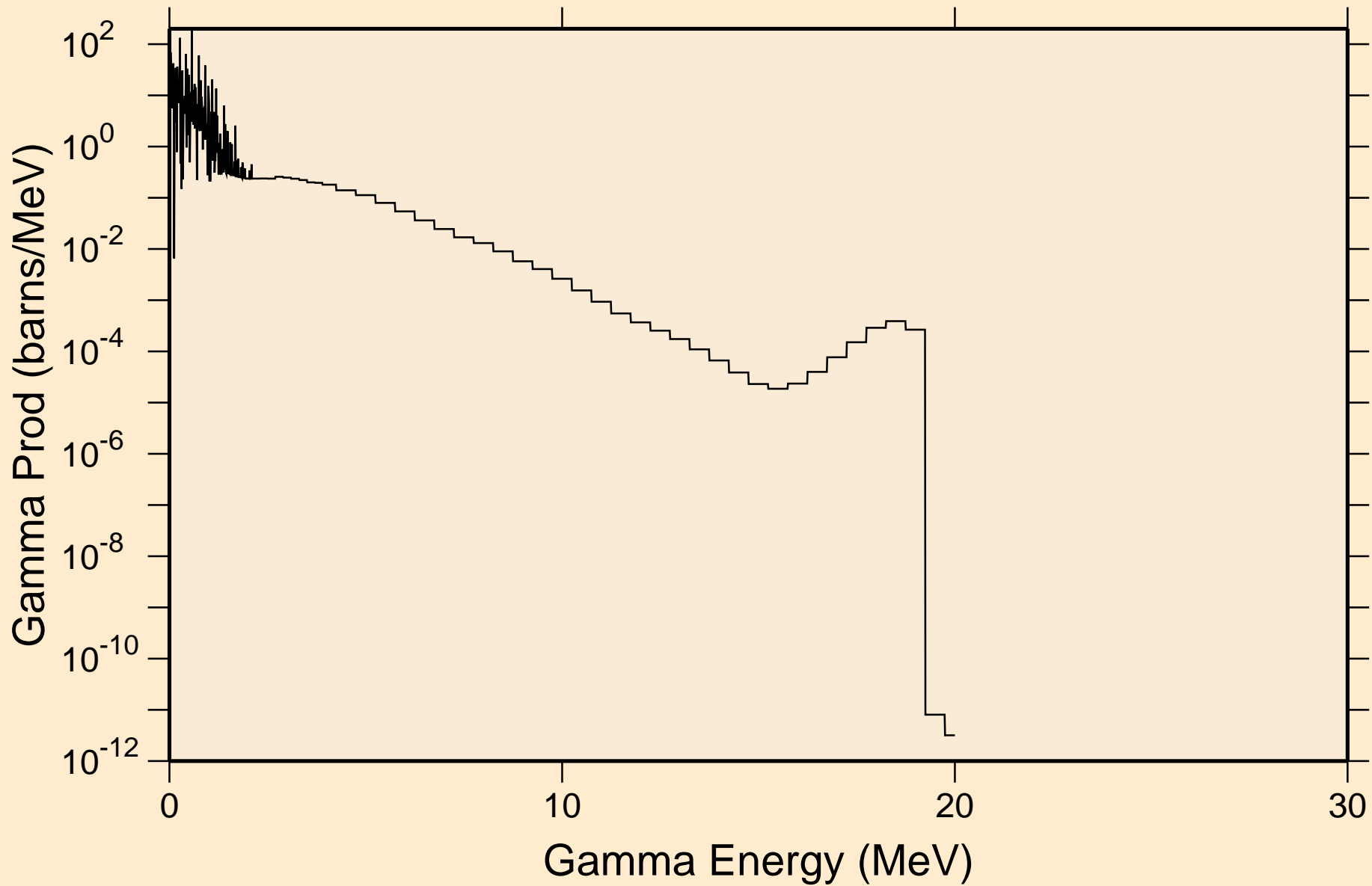

# NB087 NEUTRON ACER TENDL-2024 LIBRARY; T=293.6K

## Particle heating contributions

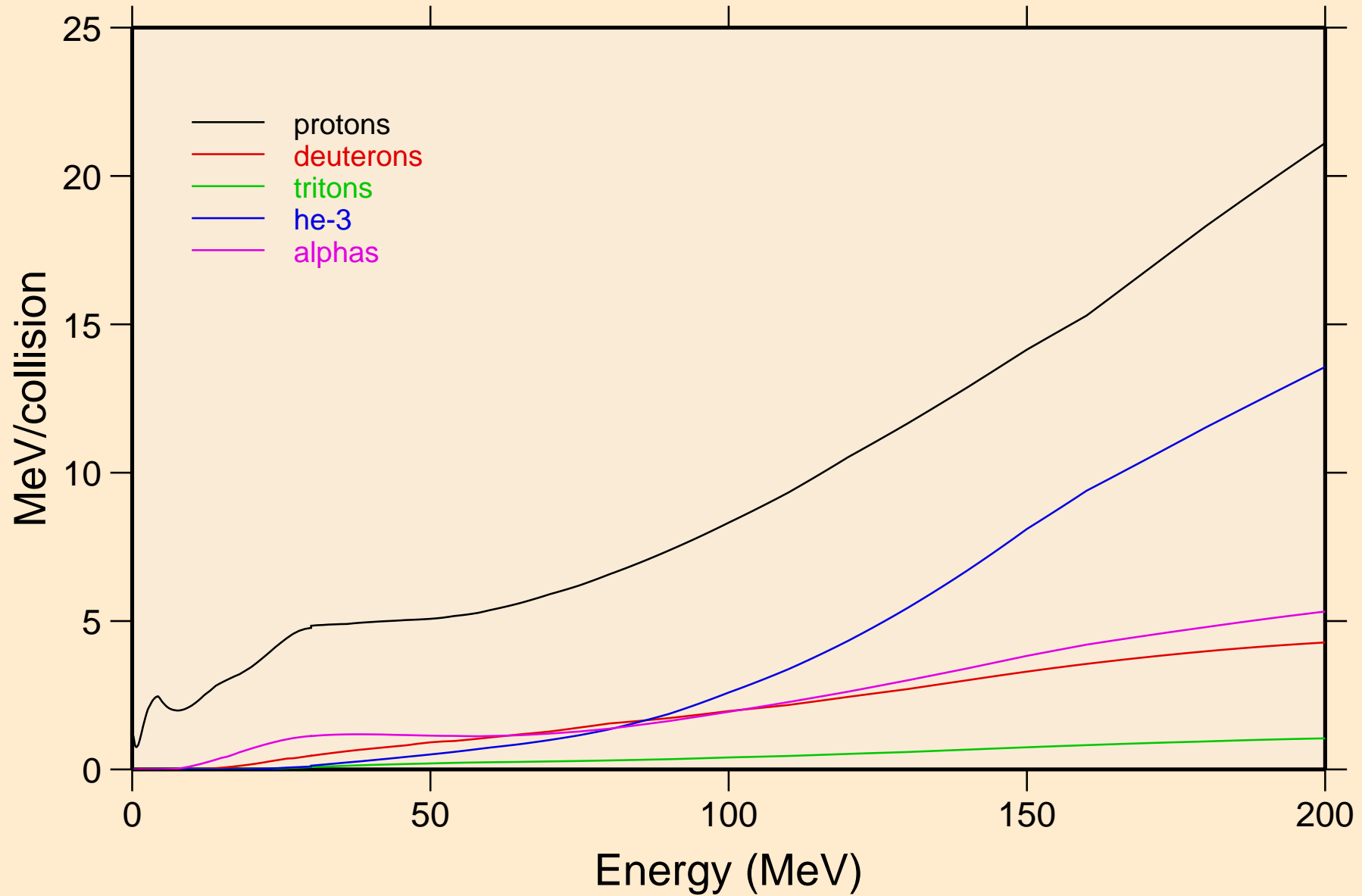

NB087 NEUTRON ACER TENDL-2024 LIBRARY; T=293.6K  
Recoil Heating

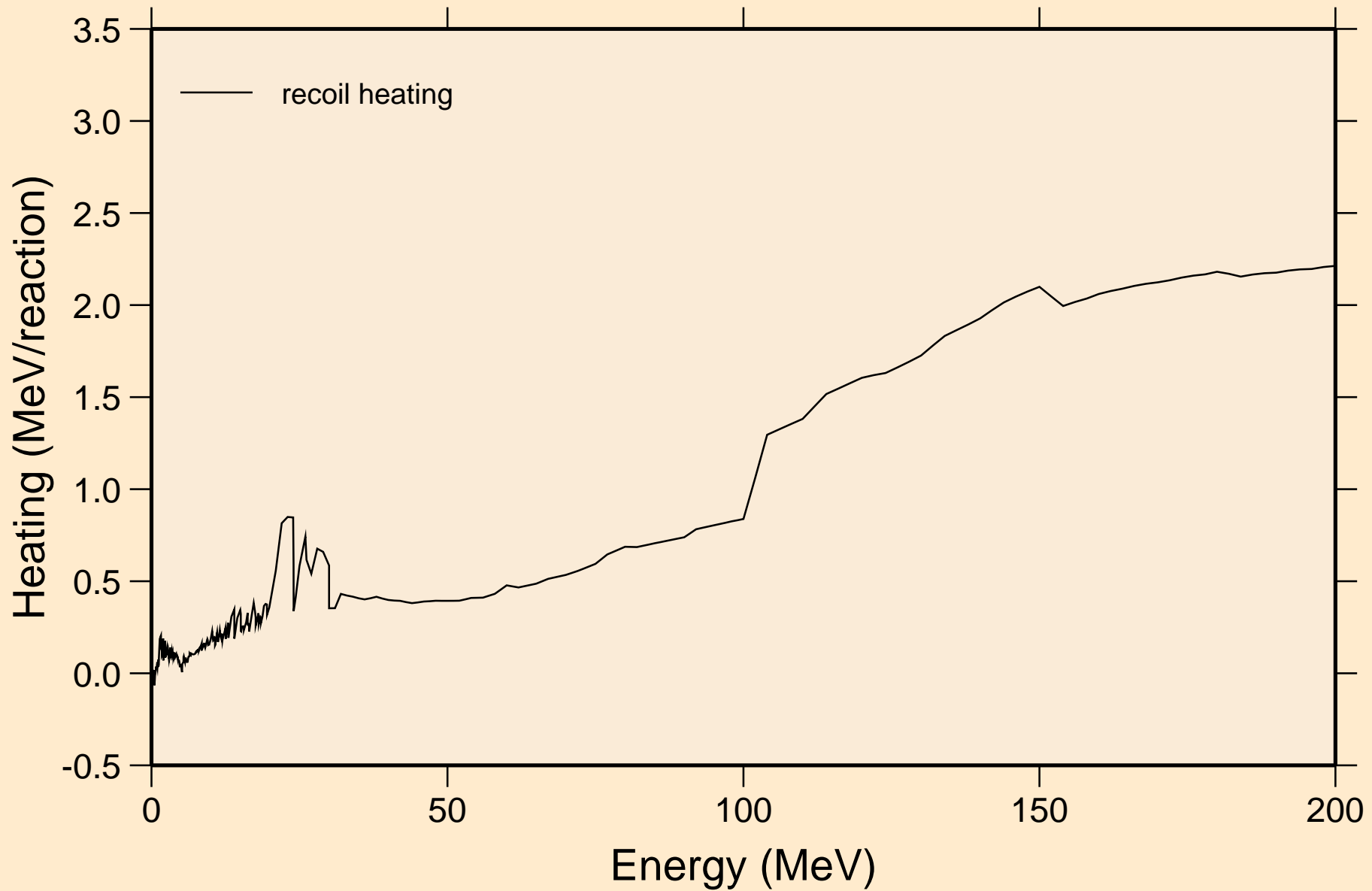

NB087 NEUTRON ACER TENDL-2024 LIBRARY; T=293.6K  
Particle production cross sections

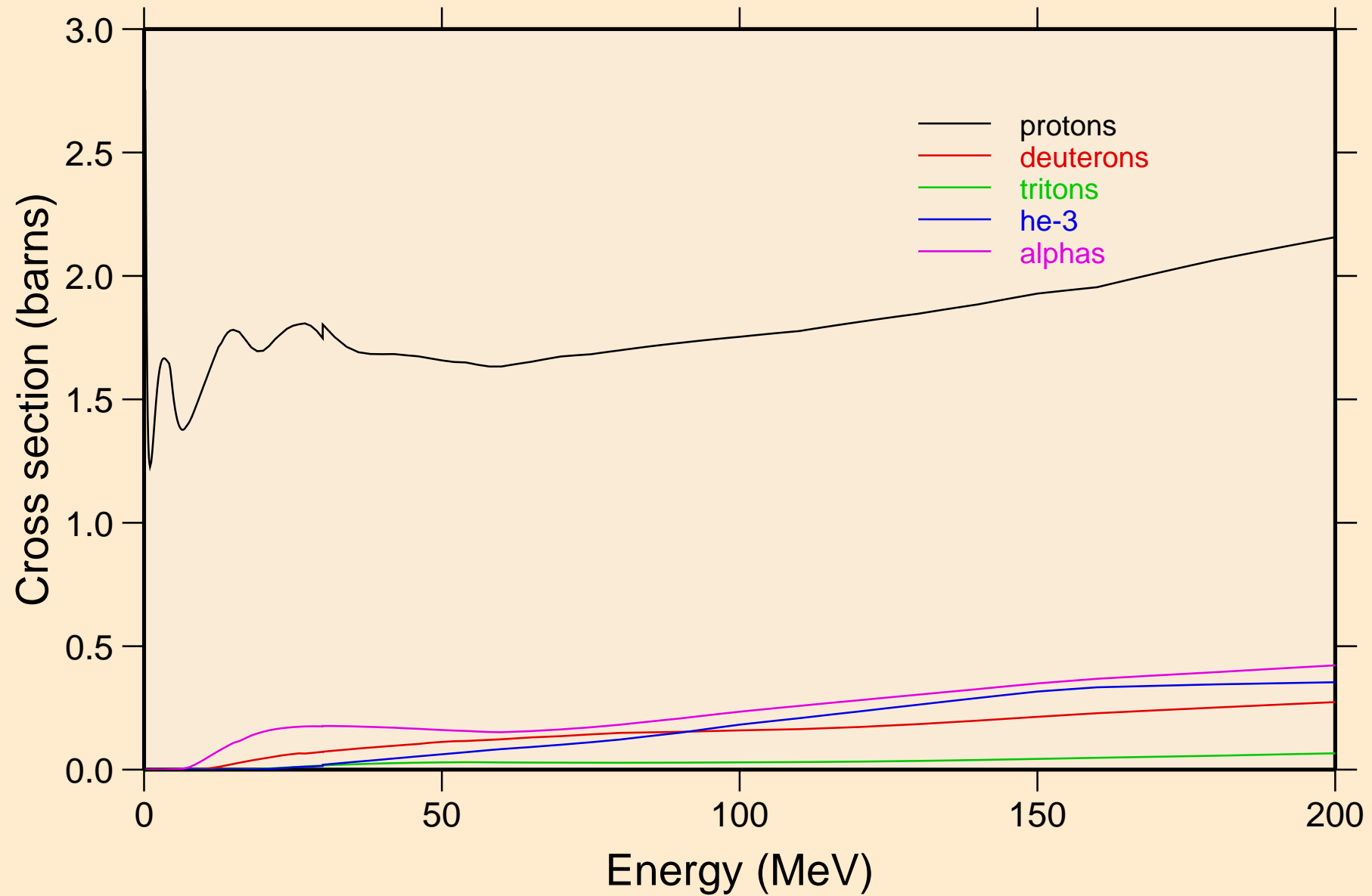

NB087 NEUTRON ACER TENDL-2024 LIBRARY; T=293.6K  
protons from (n,x)

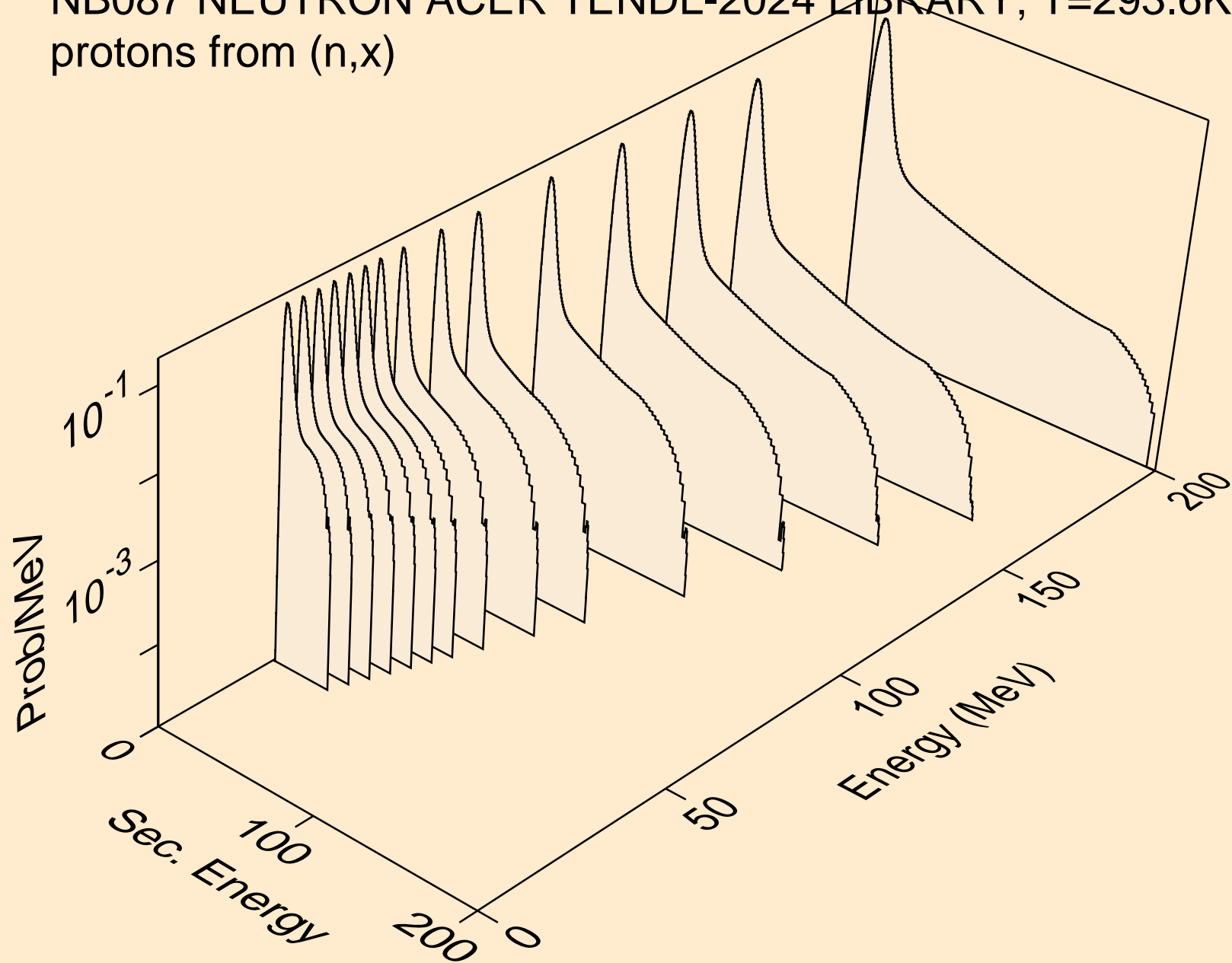

NB087 NEUTRON ACER TENDL-2024 LIBRARY; T=293.6K  
protons from (n,n\*)p

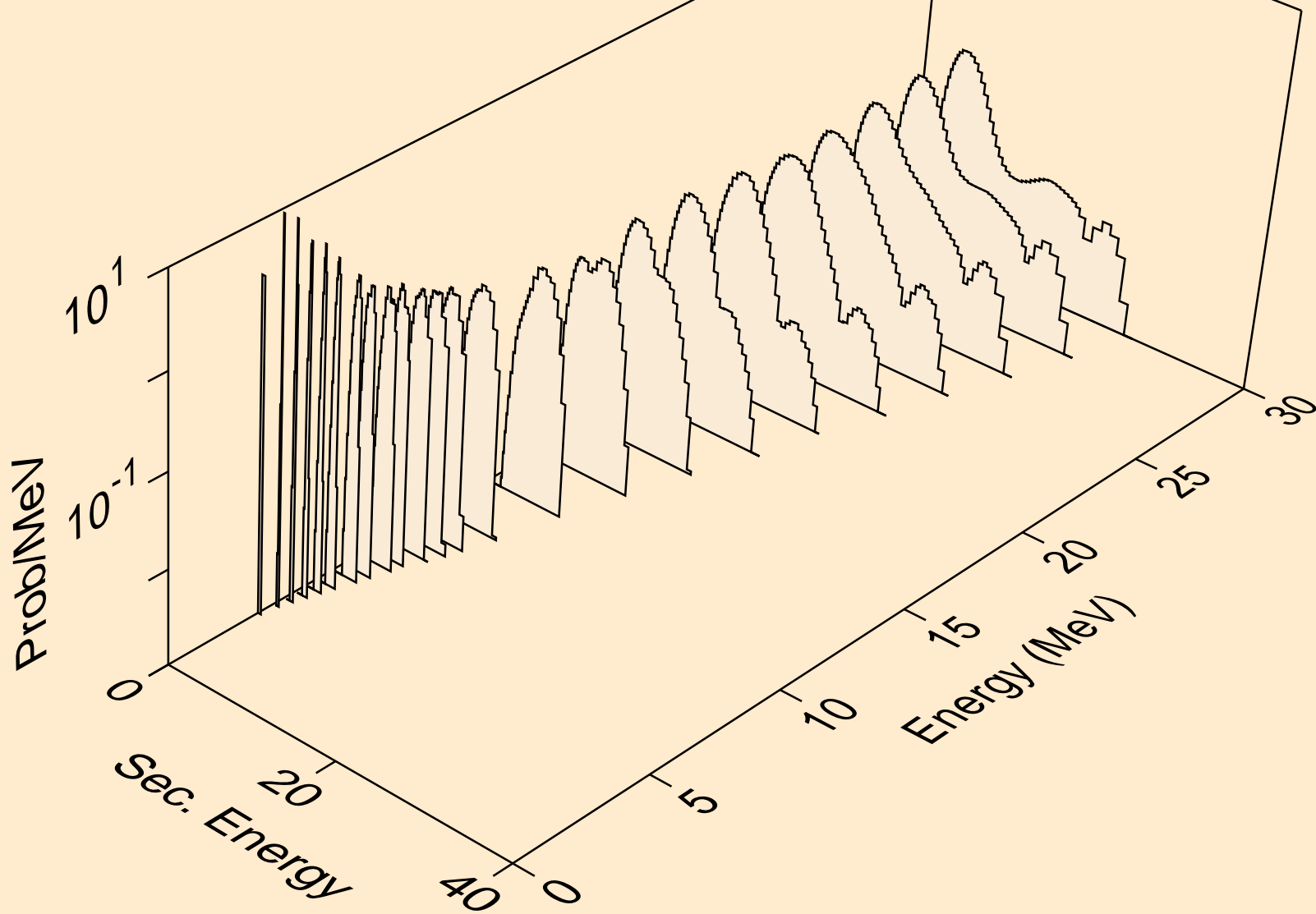

NB087 NEUTRON ACER TENDL-2024 LIBRARY; T=293.6K  
protons from (n,2np)

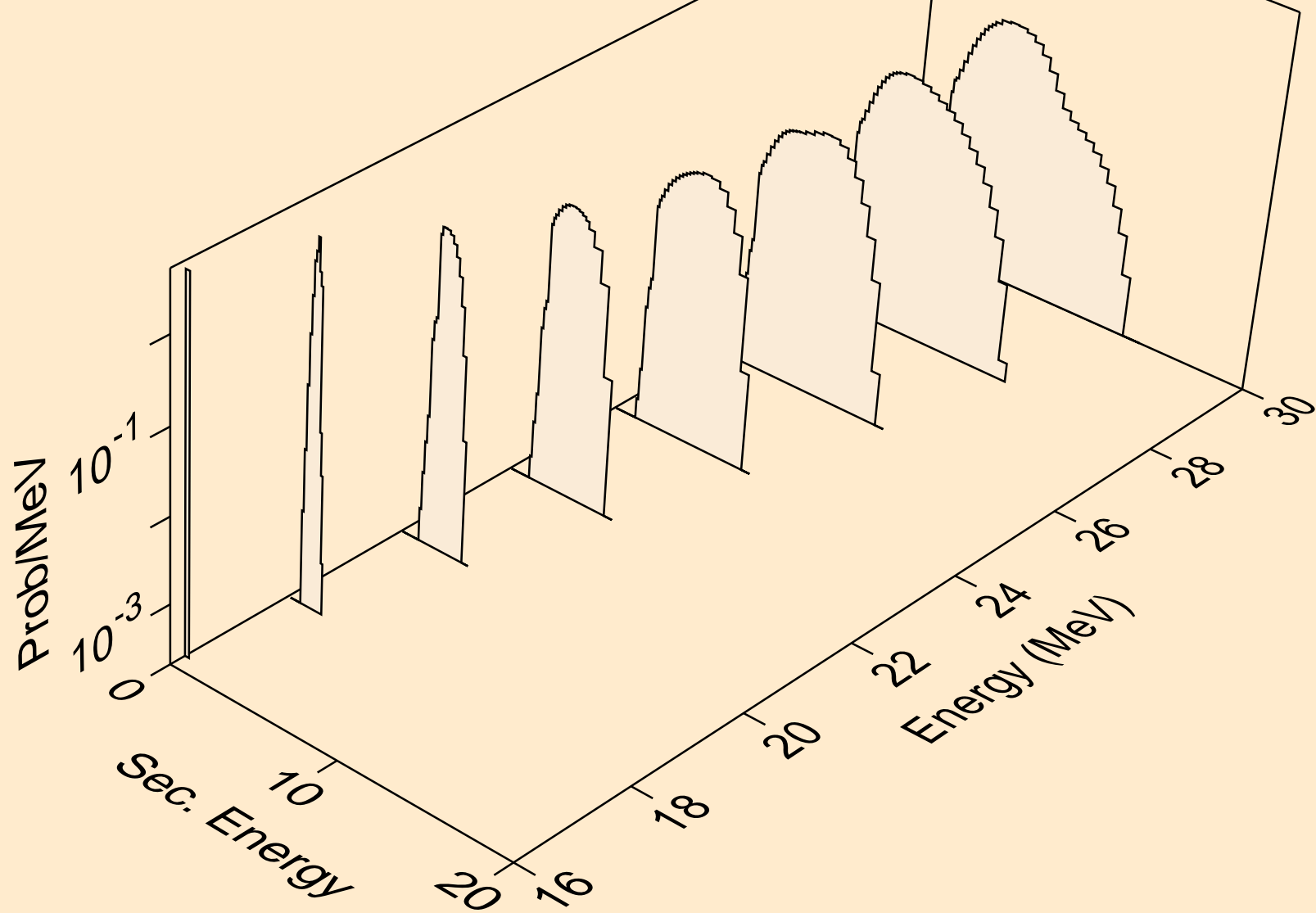

NB087 NEUTRON ACER TENDL-2024 LIBRARY; T=293.6K  
protons from (n,3np)

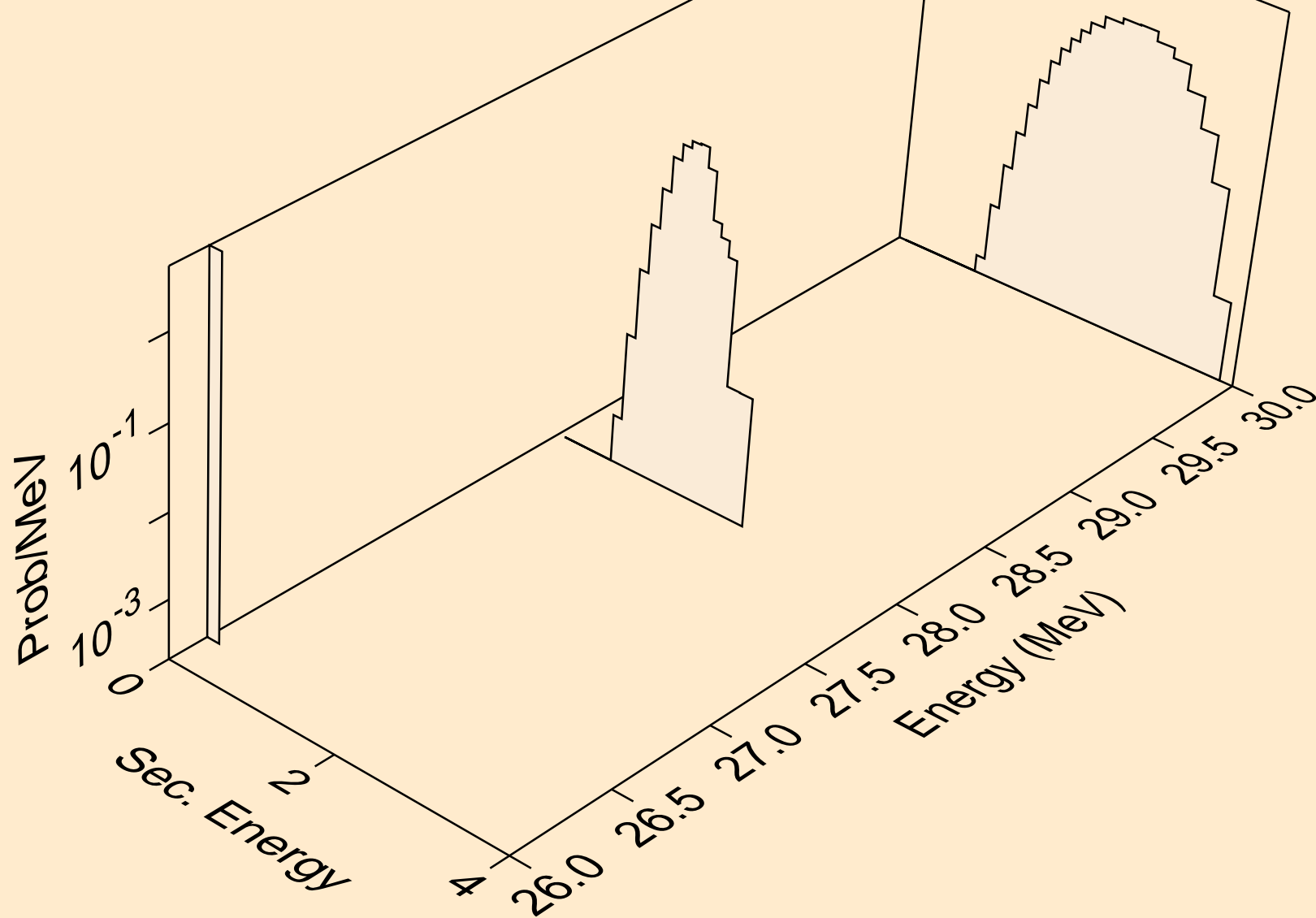

NB087 NEUTRON ACER TENDL-2024 LIBRARY; T=293.6K  
protons from (n,n2p)

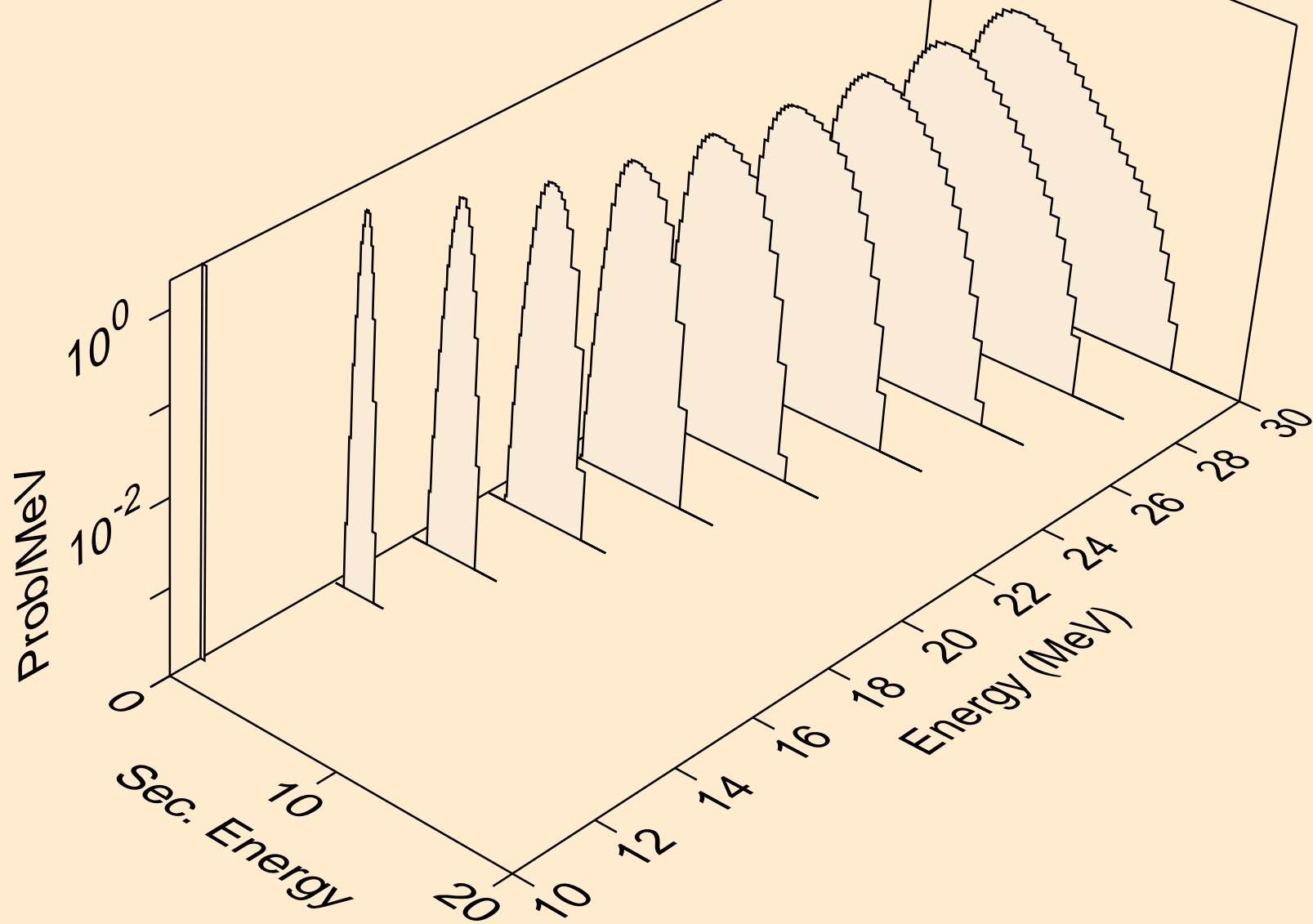

NB087 NEUTRON ACER TENDL-2024 LIBRARY; T=293.6K  
protons from (n,npa)

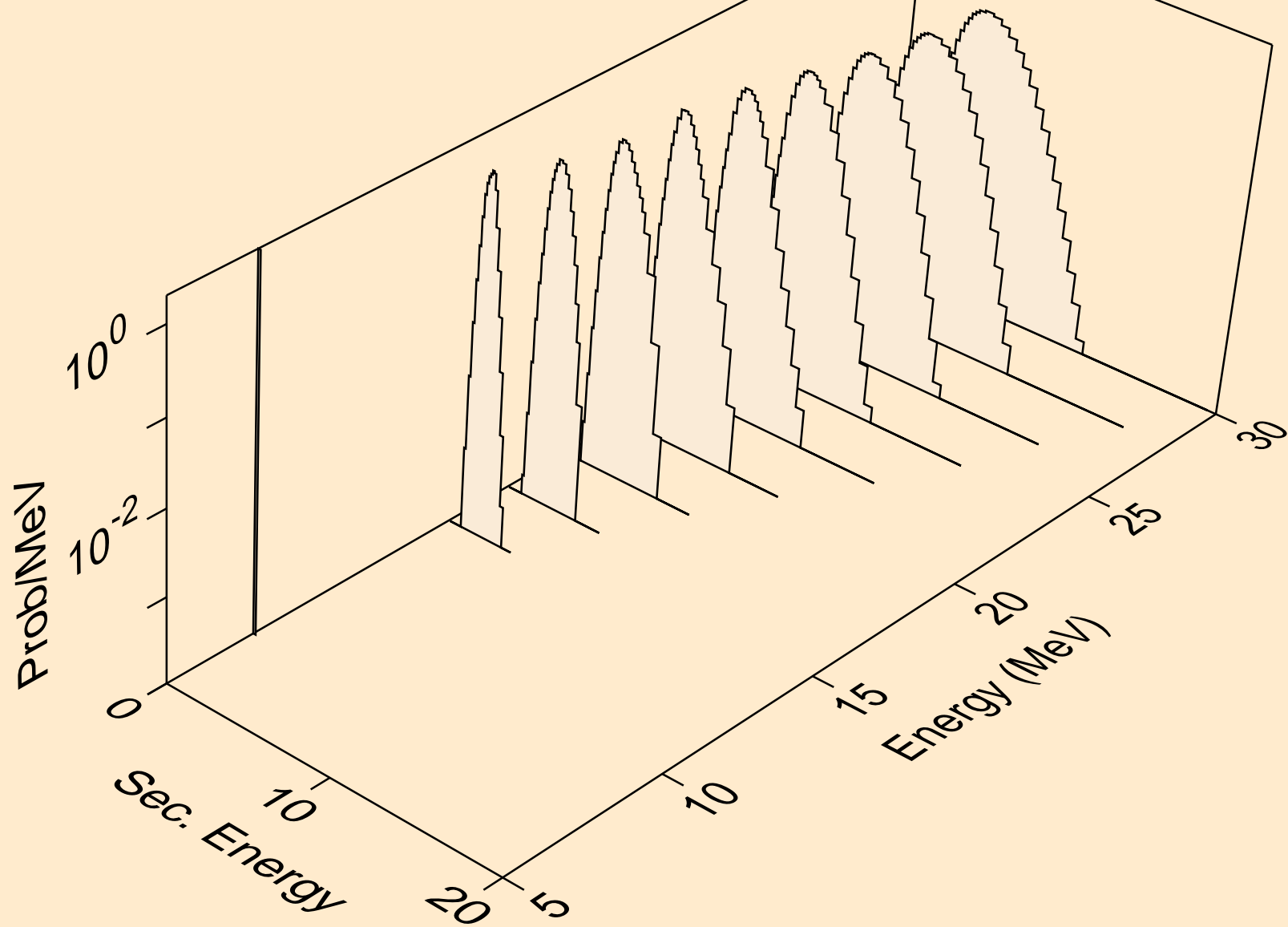

NB087 NEUTRON ACER TENDL-2024 LIBRARY; T=293.6K  
protons from (n,p)

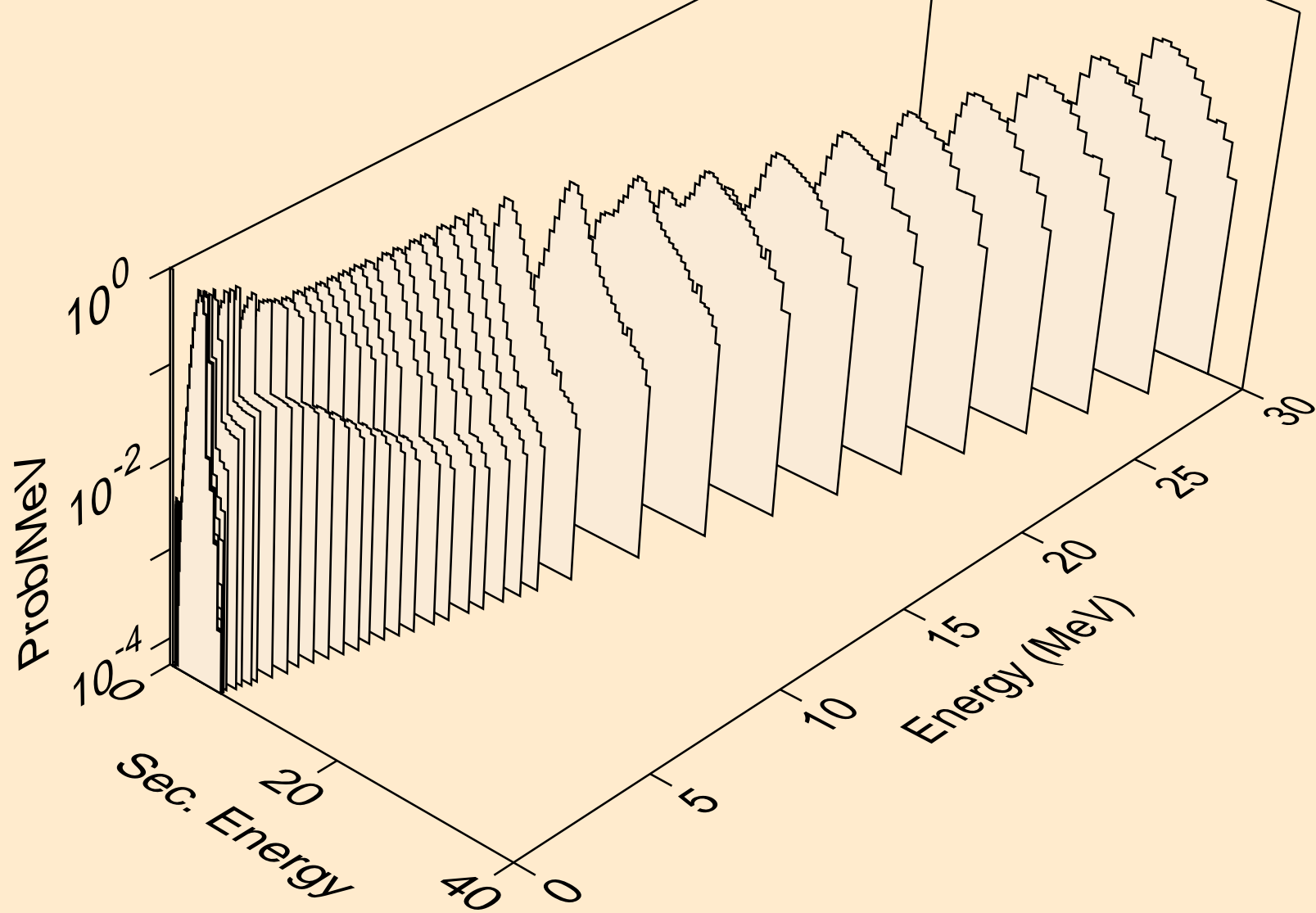

NB087 NEUTRON ACER TENDL-2024 LIBRARY; T=293.6K  
protons from (n,2p)

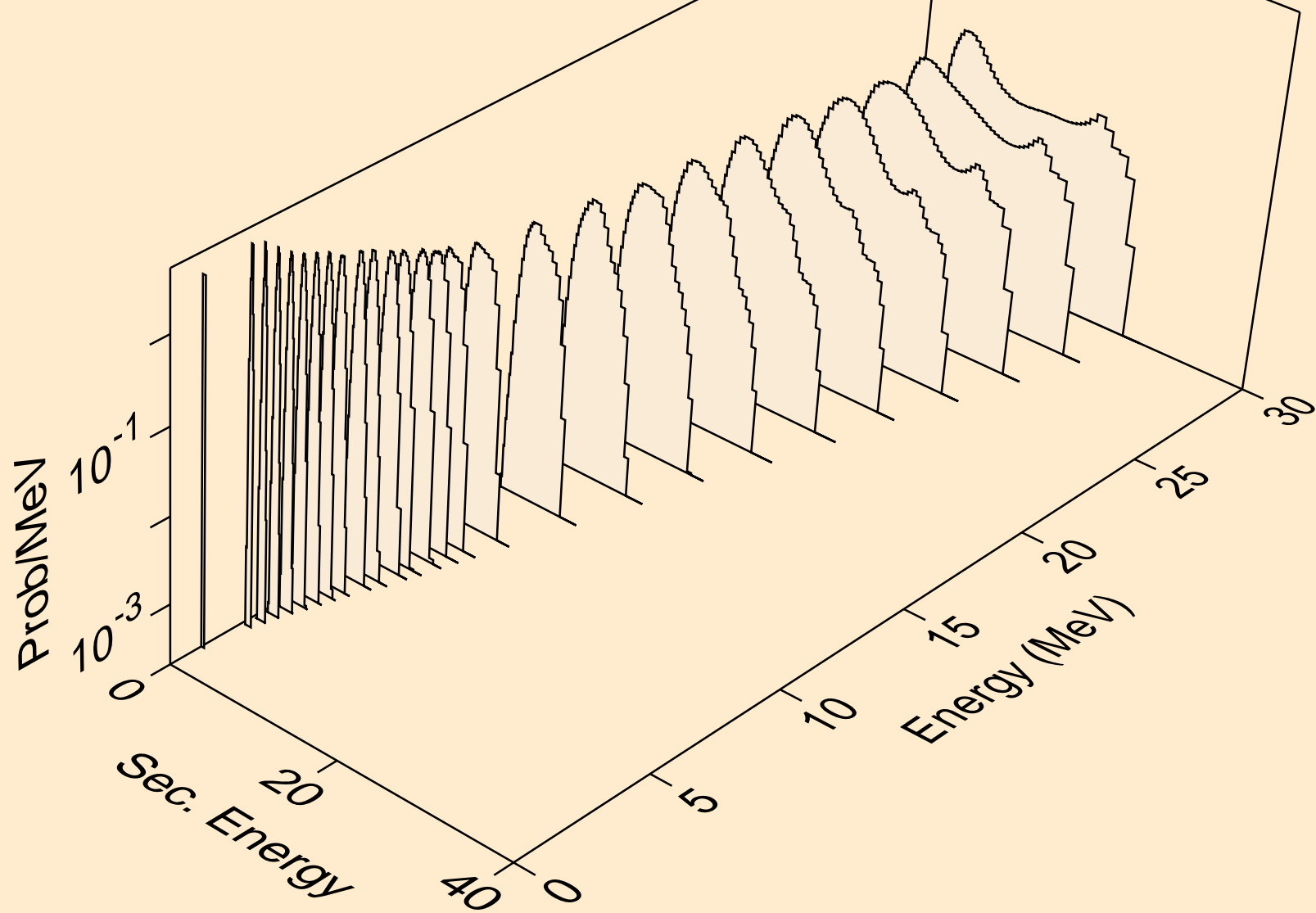

NB087 NEUTRON ACER TENDL-2024 LIBRARY; T=293.6K  
protons from (n,p)

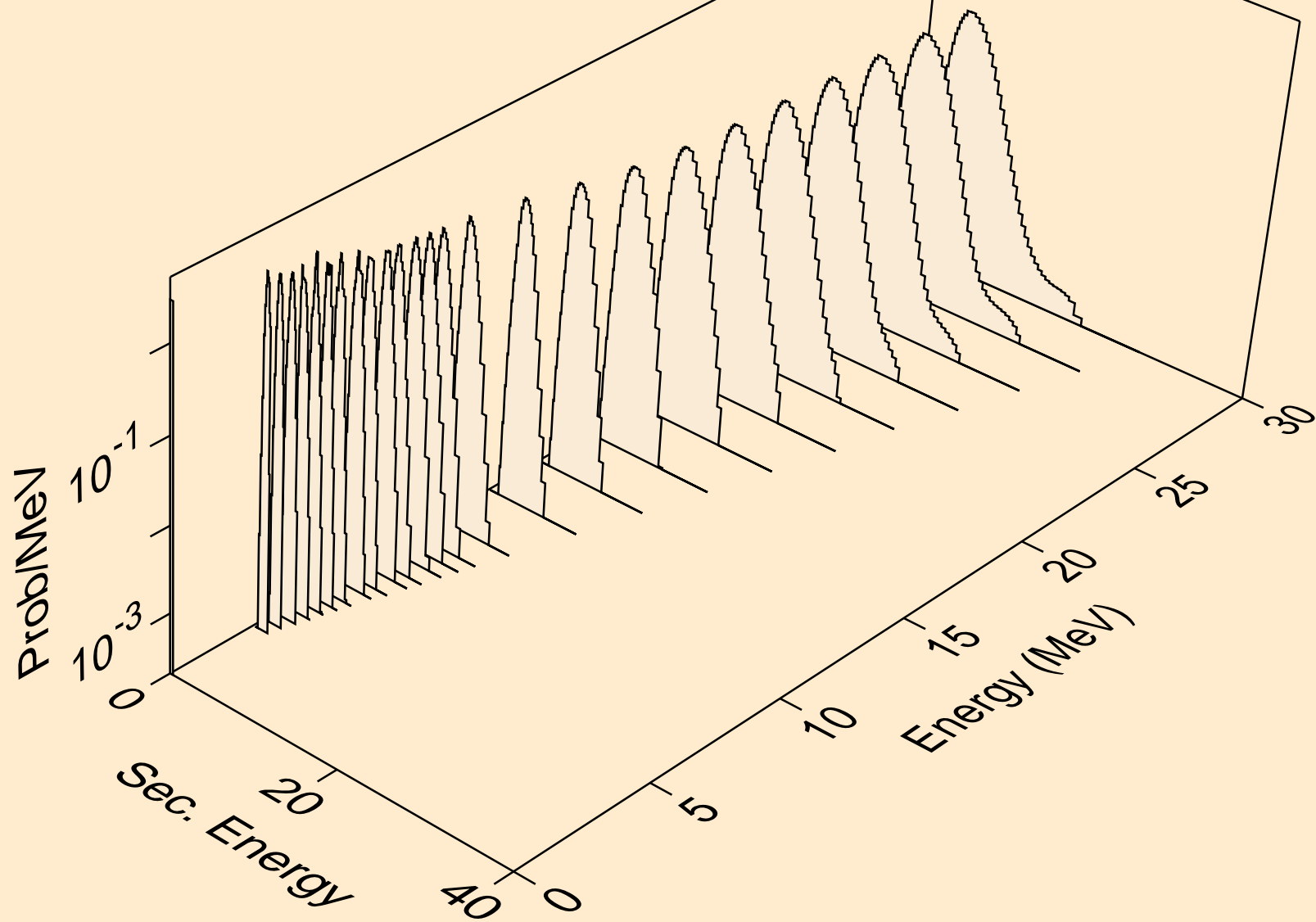

NB087 NEUTRON ACER TENDL-2024 LIBRARY; T=293.6K  
protons from (n,pd)

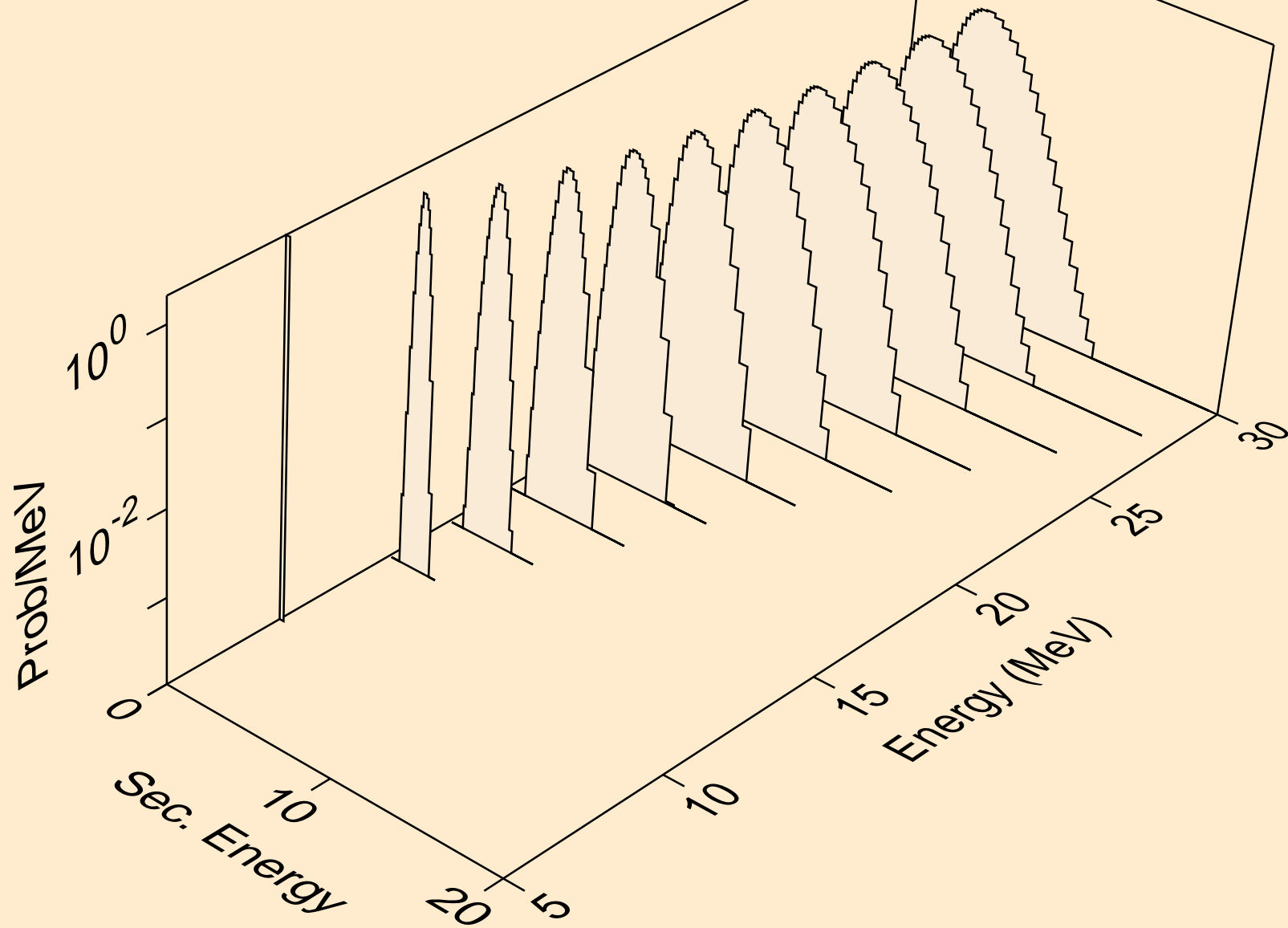

NB087 NEUTRON ACER TENDL-2024 LIBRARY; T=293.6K  
protons from (n,pt)

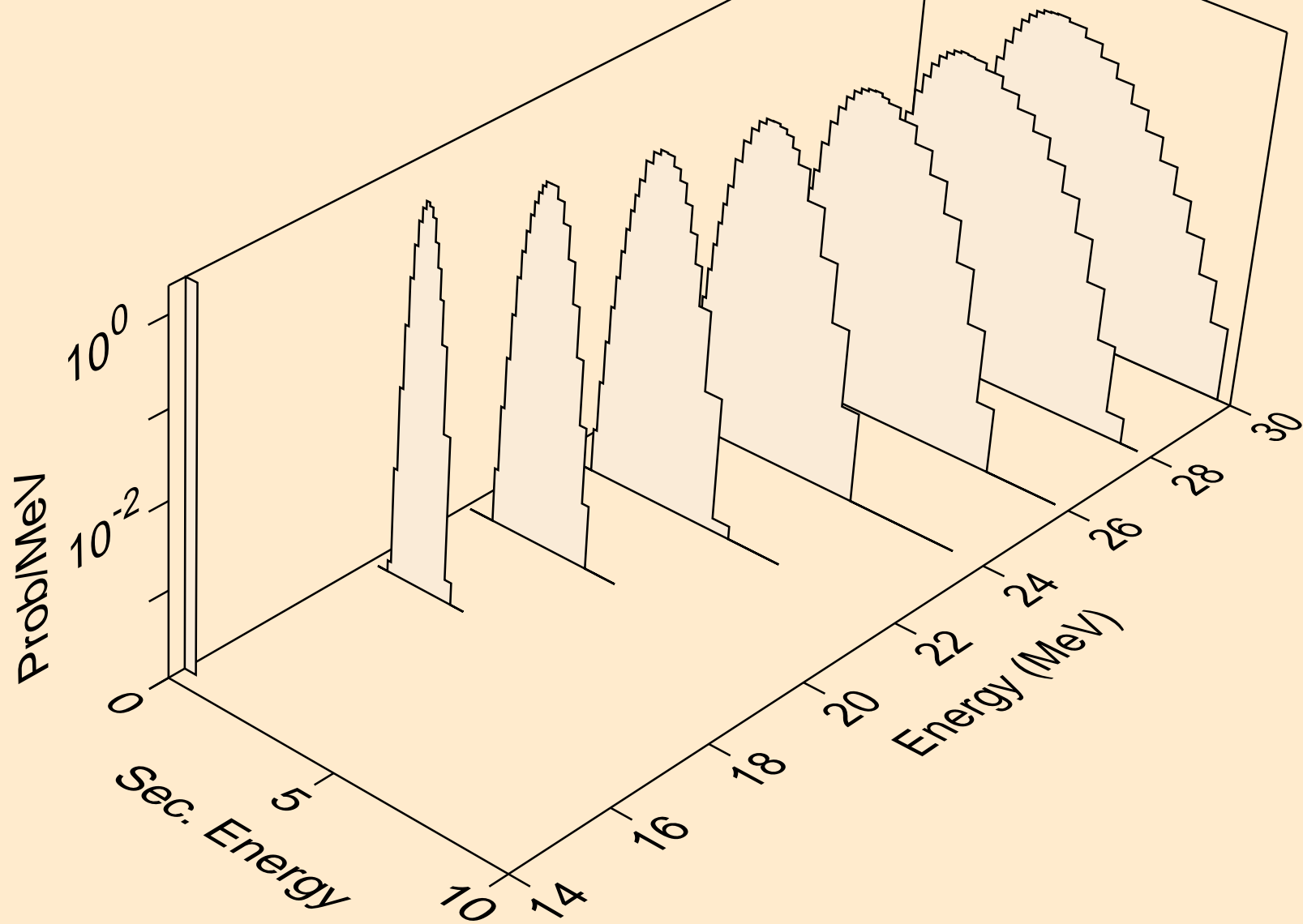

NB087 NEUTRON ACER TENDL-2024 LIBRARY; T=293.6K  
deuterons from (n,x)

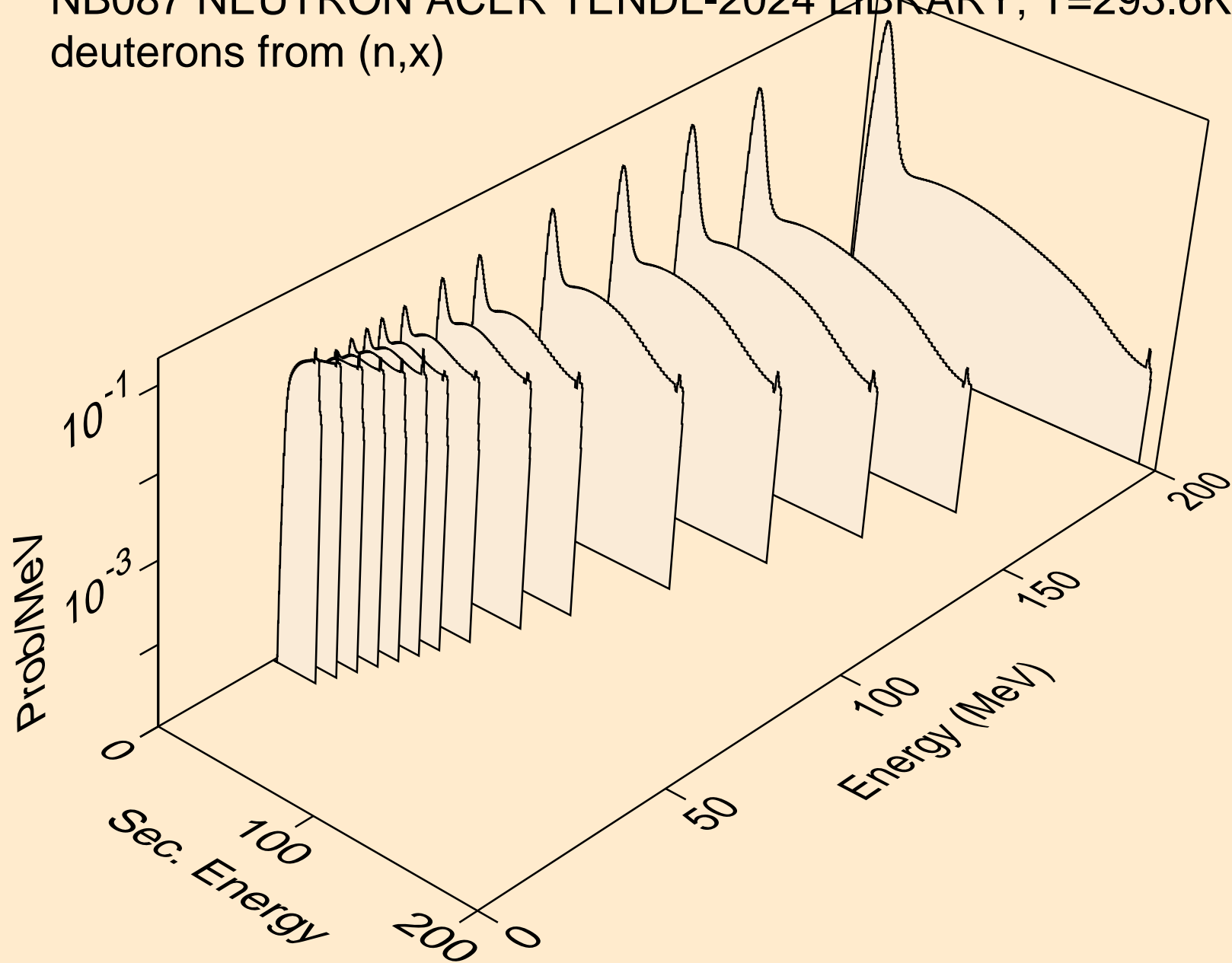

NB087 NEUTRON ACER TENDL-2024 LIBRARY; T=293.6K  
deuterons from (n,2nd)

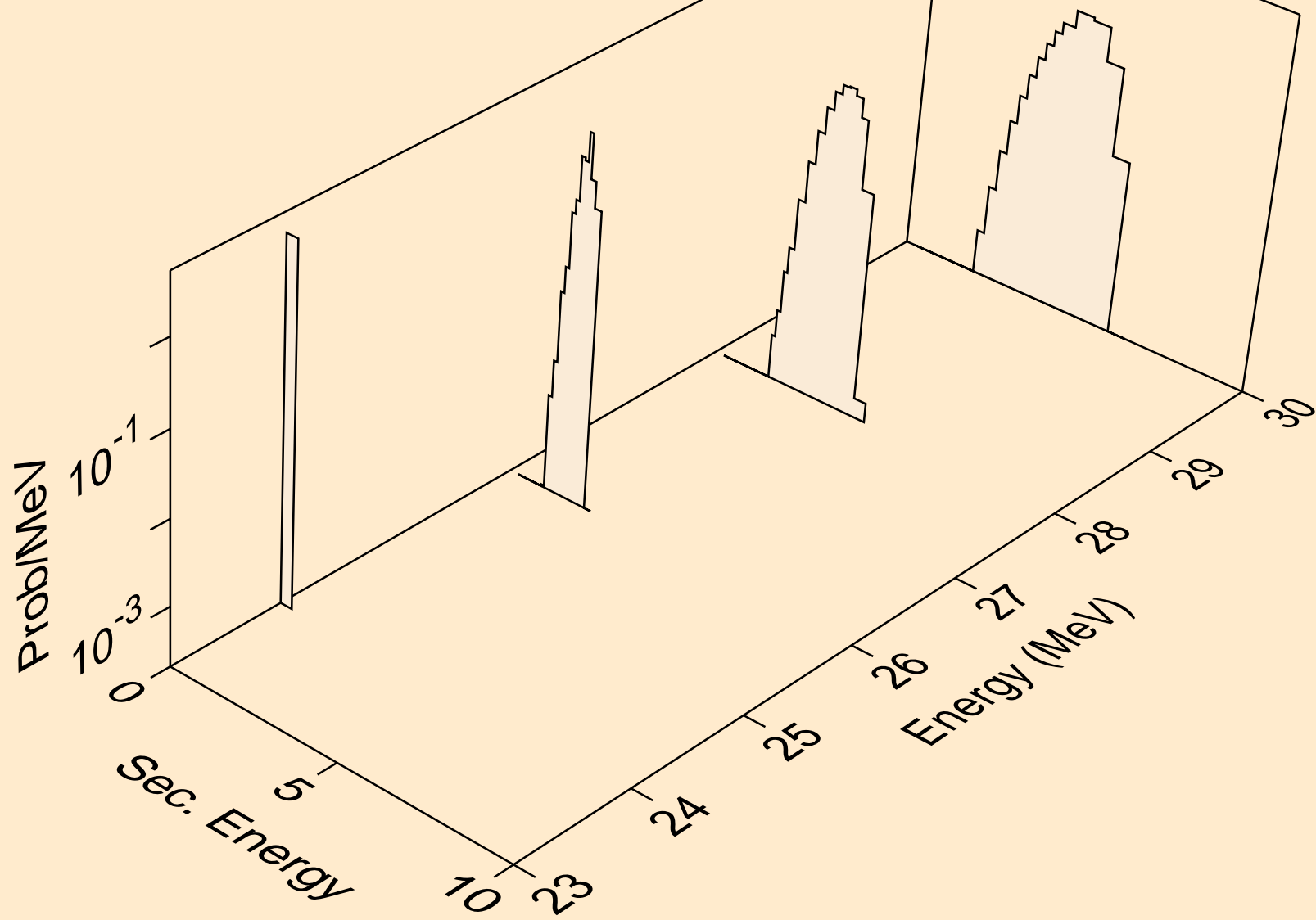

NB087 NEUTRON ACER TENDL-2024 LIBRARY; T=293.6K  
deuterons from (n,n\*)d

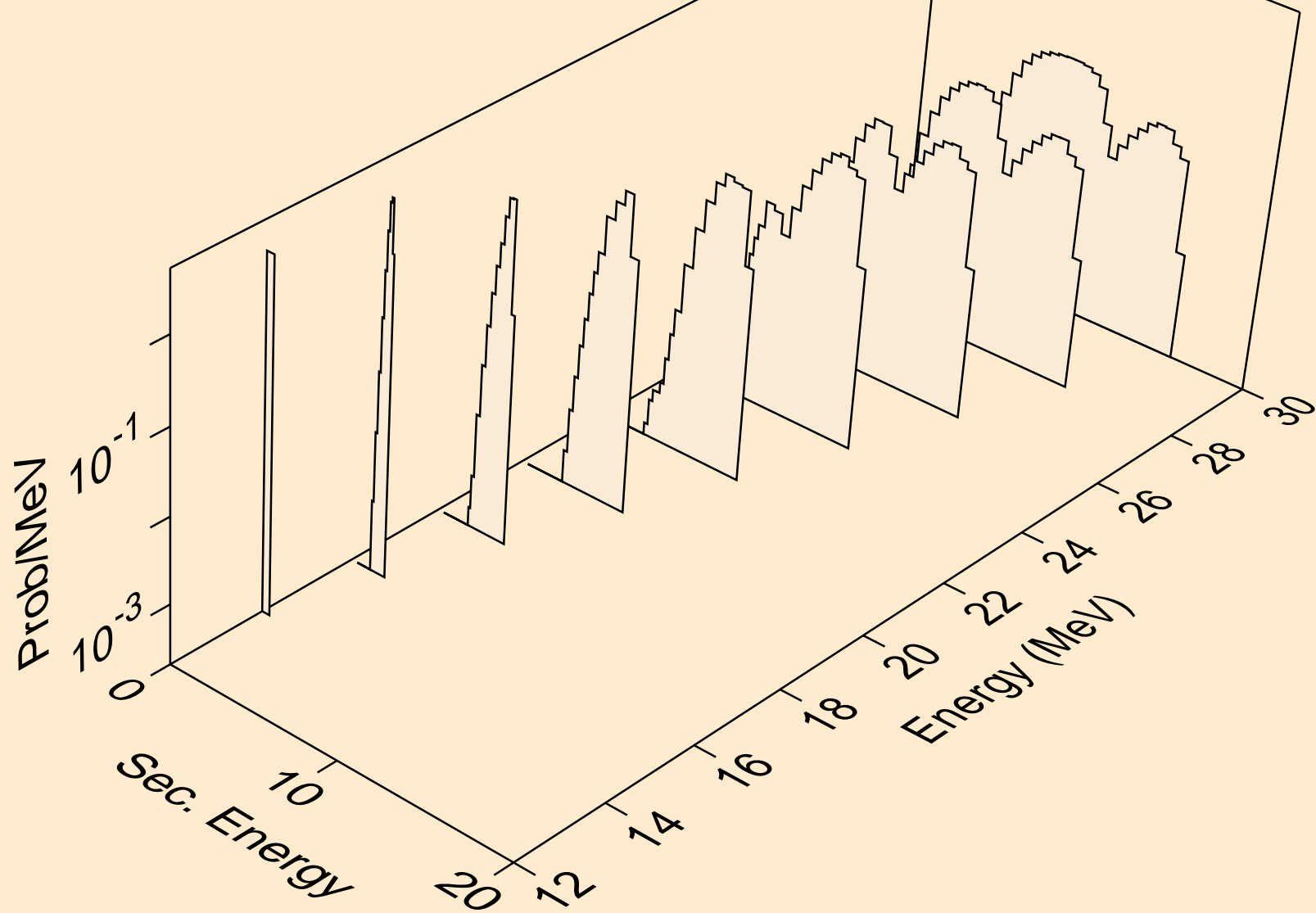

NB087 NEUTRON ACER TENDL-2024 LIBRARY; T=293.6K  
deuterons from (n,d)

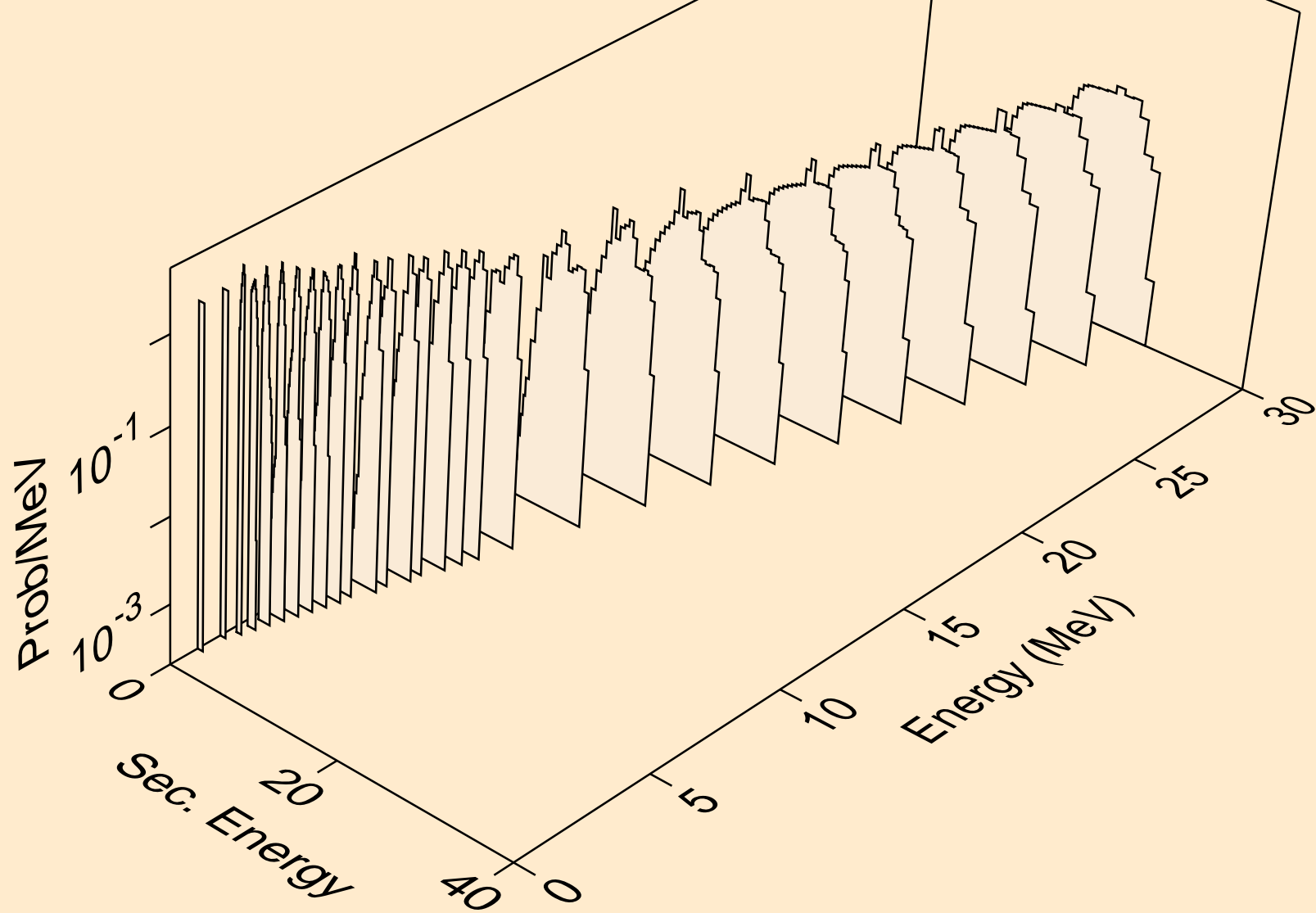

NB087 NEUTRON ACER TENDL-2024 LIBRARY; T=293.6K  
deuterons from (n,pd)

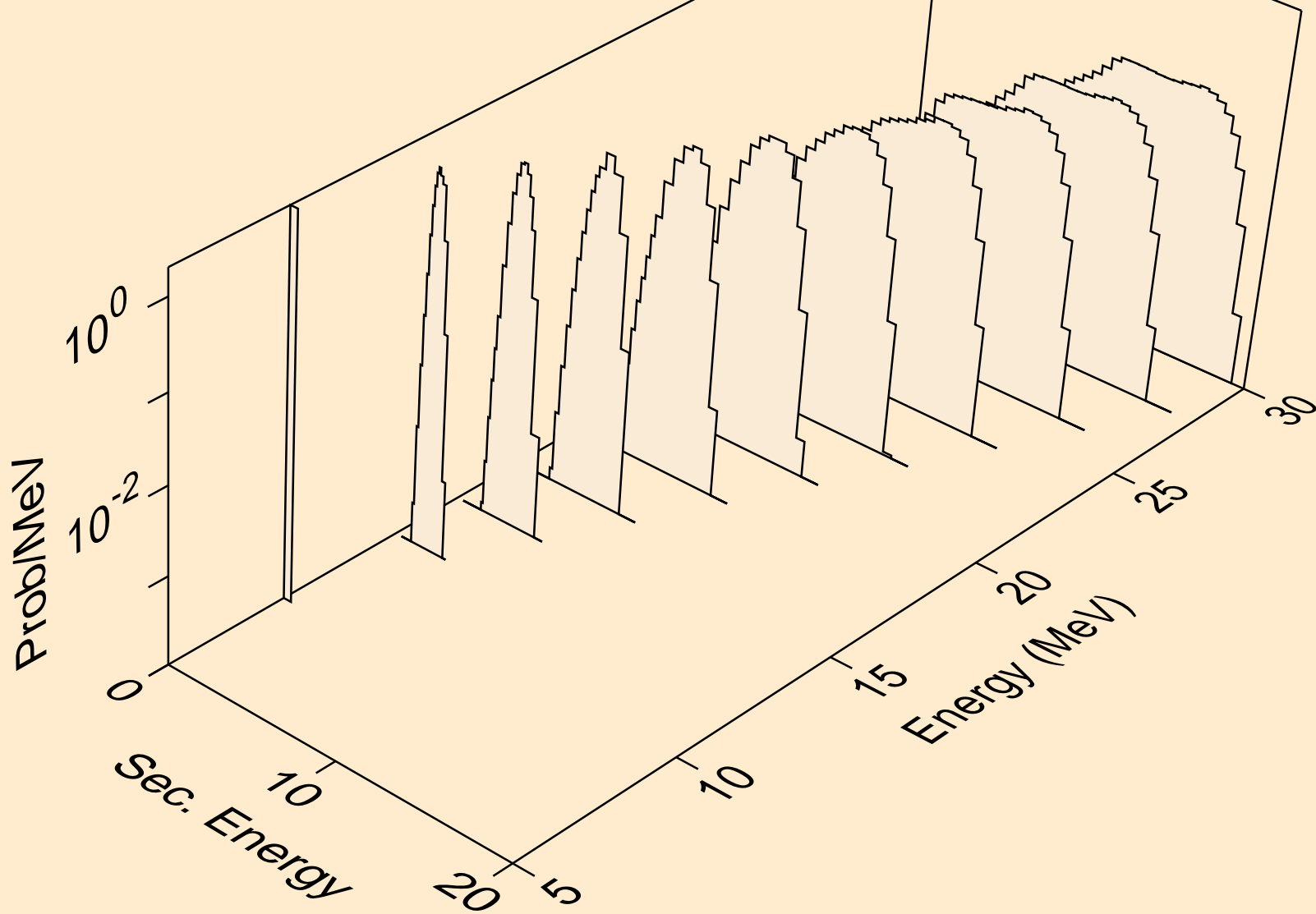

NB087 NEUTRON ACER TENDL-2024 LIBRARY; T=293.6K  
deuterons from (n,da)

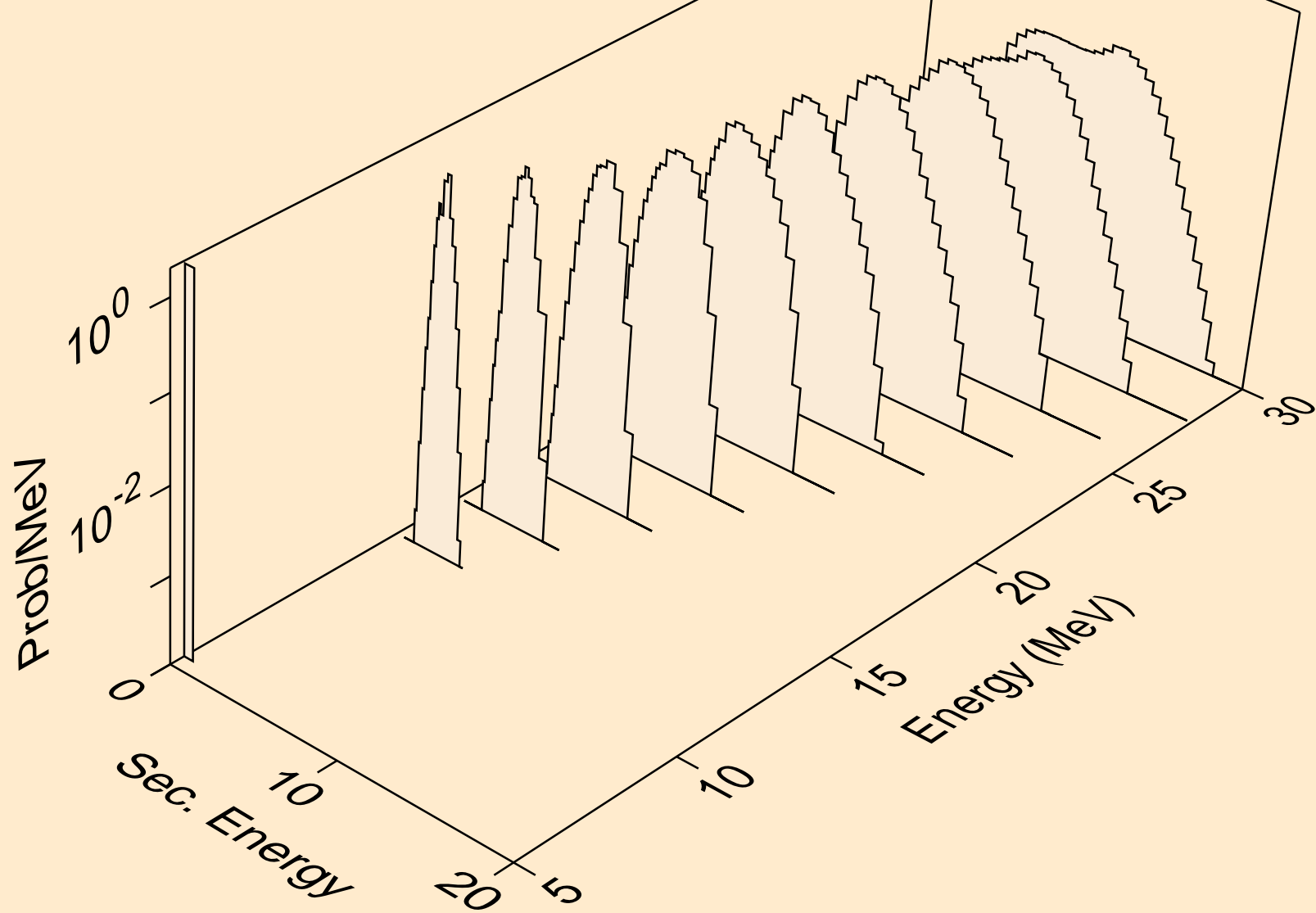

NB087 NEUTRON ACER TENDL-2024 LIBRARY; T=293.6K  
tritons from (n,x)

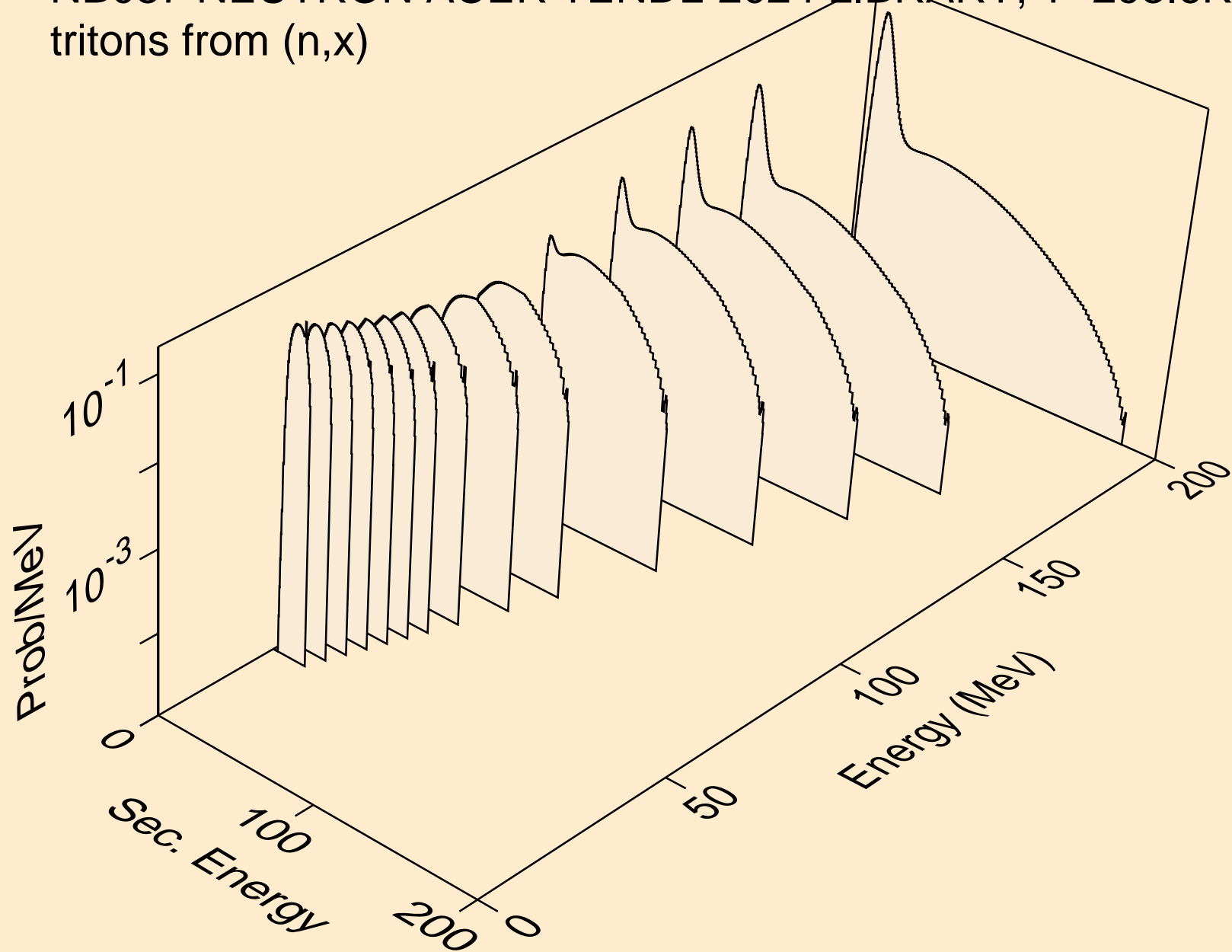

NB087 NEUTRON ACER TENDL-2024 LIBRARY; T=293.6K  
tritons from (n,n\*)t

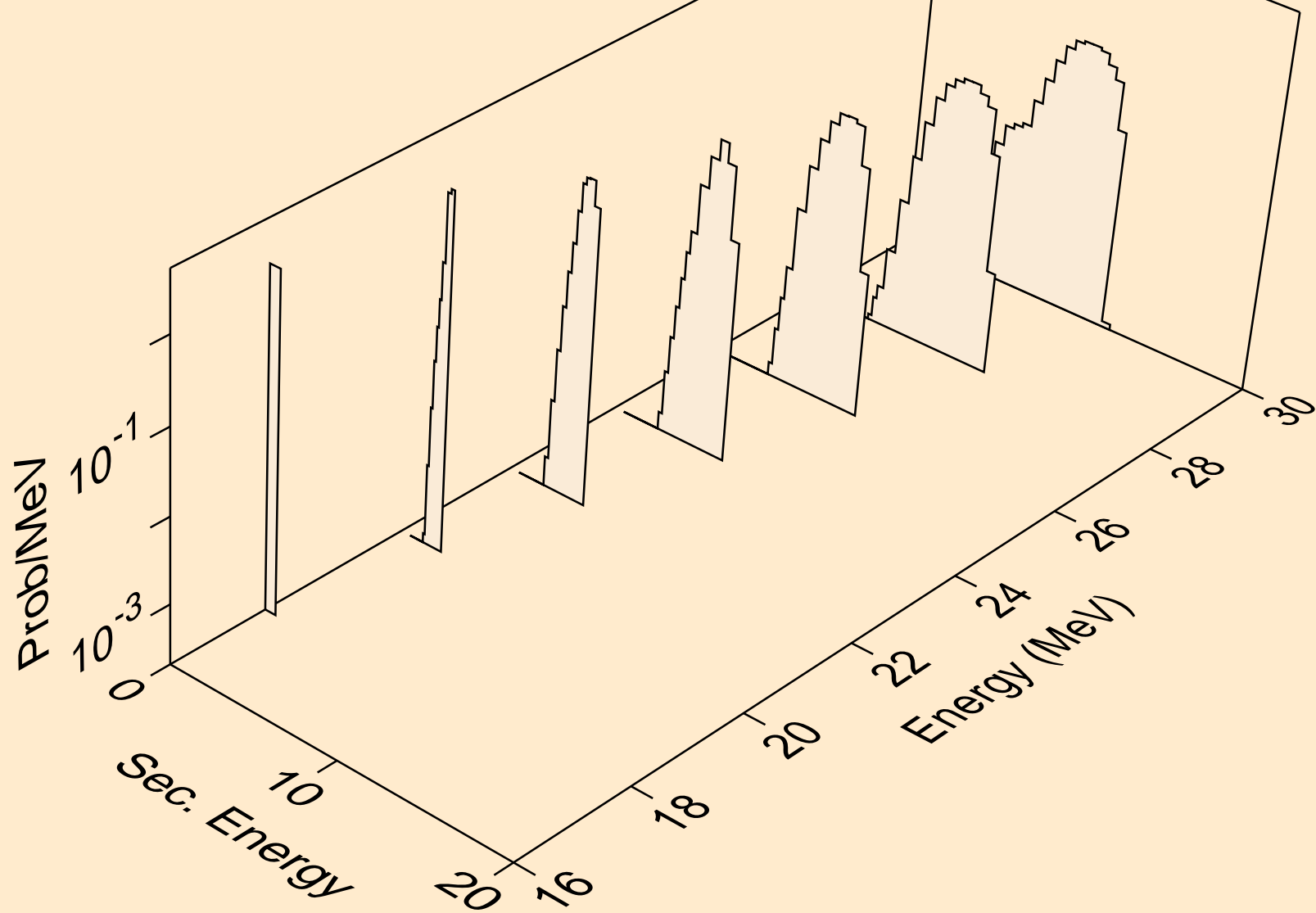

NB087 NEUTRON ACER TENDL-2024 LIBRARY; T=293.6K  
tritons from (n,t)

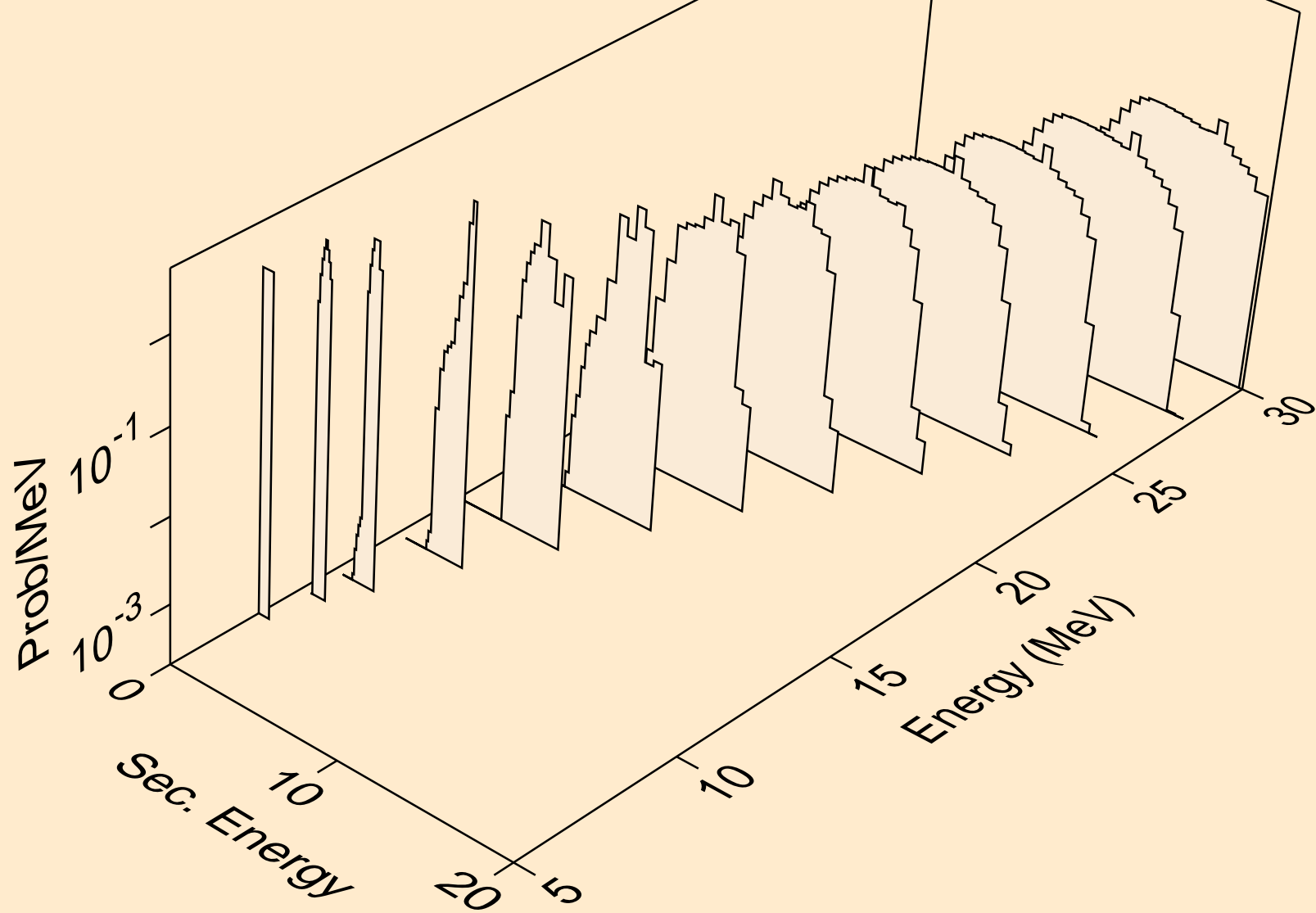

NB087 NEUTRON ACER TENDL-2024 LIBRARY; T=293.6K  
tritons from (n,pt)

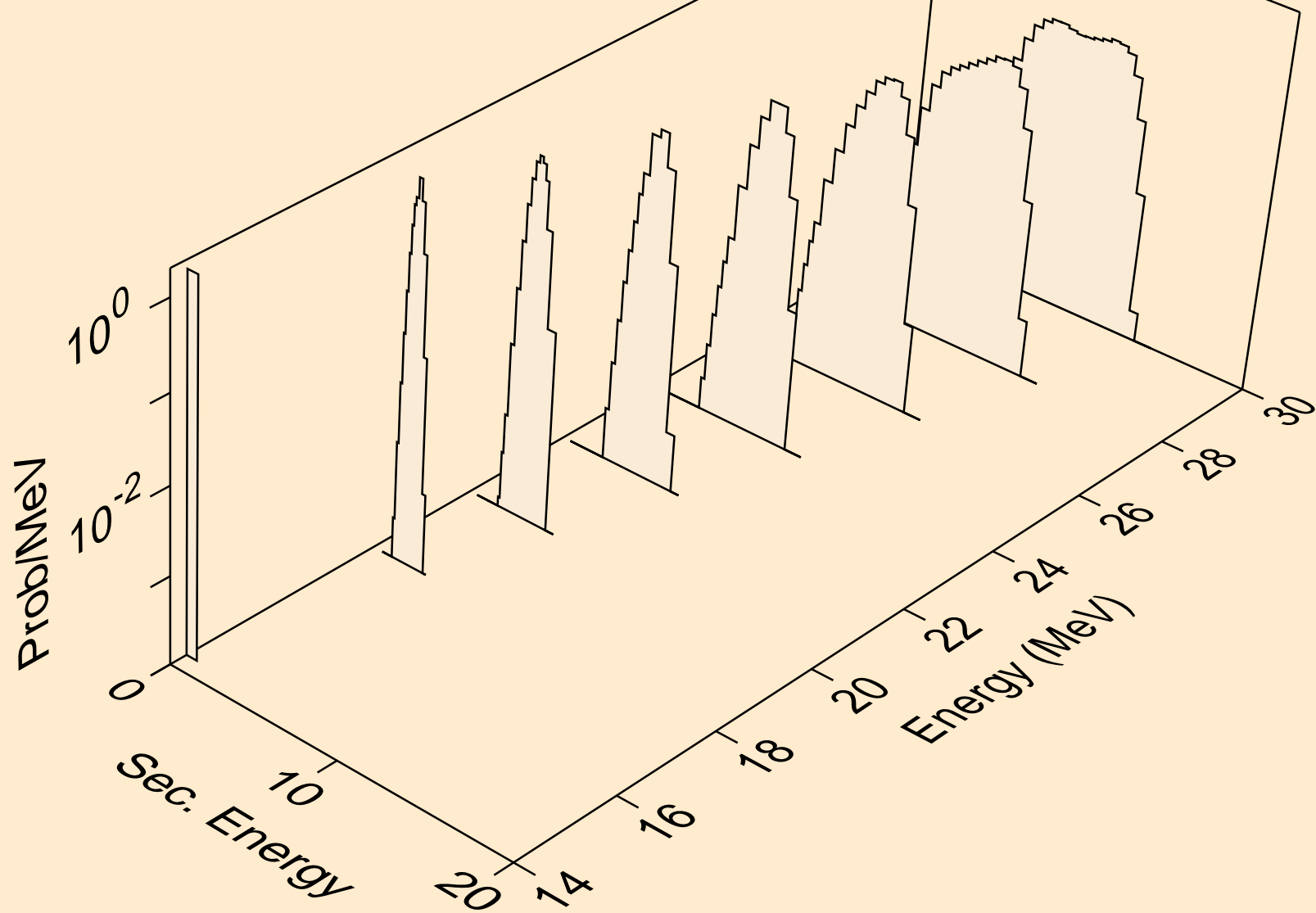

NB087 NEUTRON ACER TENDL-2024 LIBRARY; T=293.6K  
he3s from (n,x)

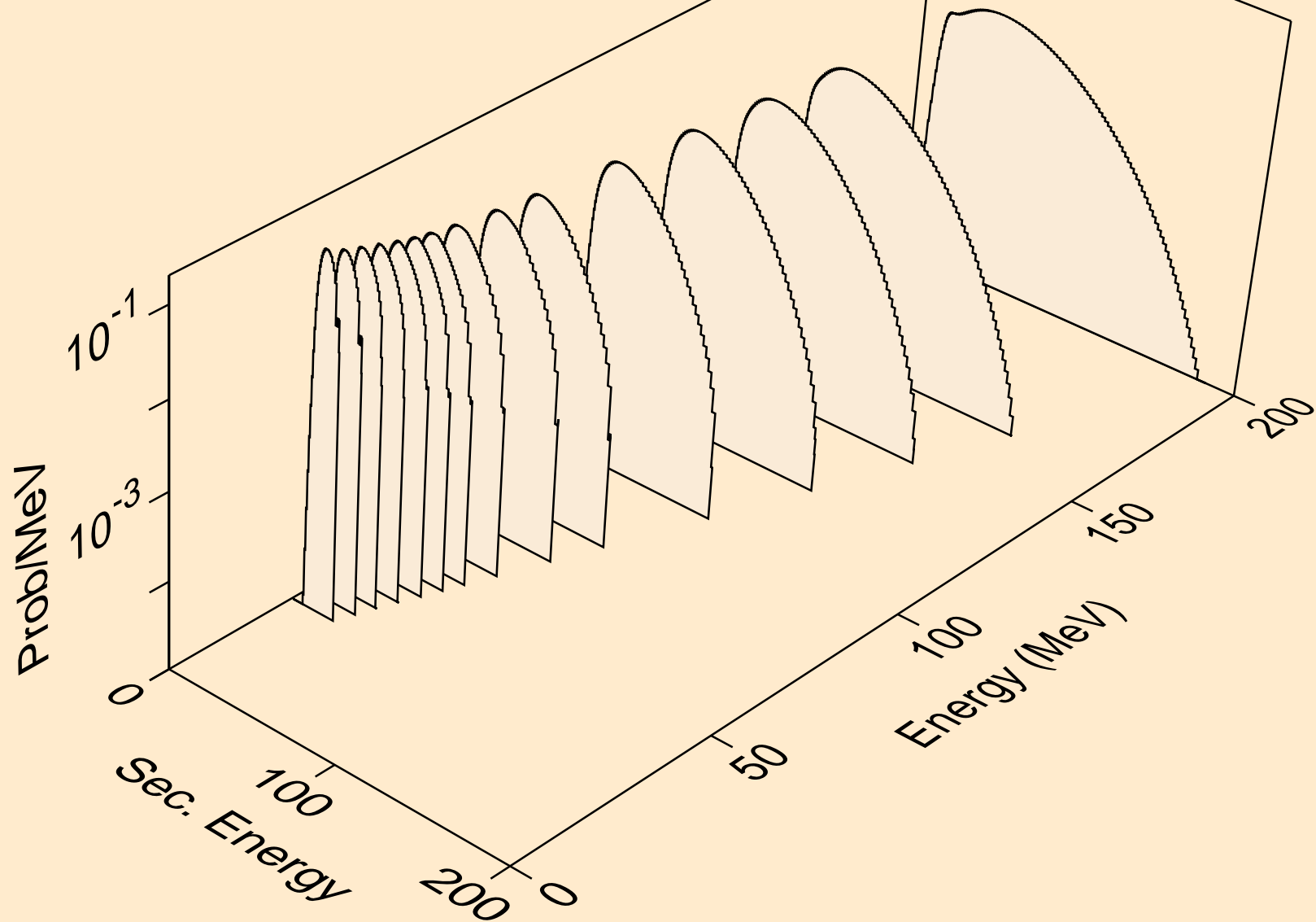

NB087 NEUTRON ACER TENDL-2024 LIBRARY; T=293.6K  
he3s from (n,n\*)he3

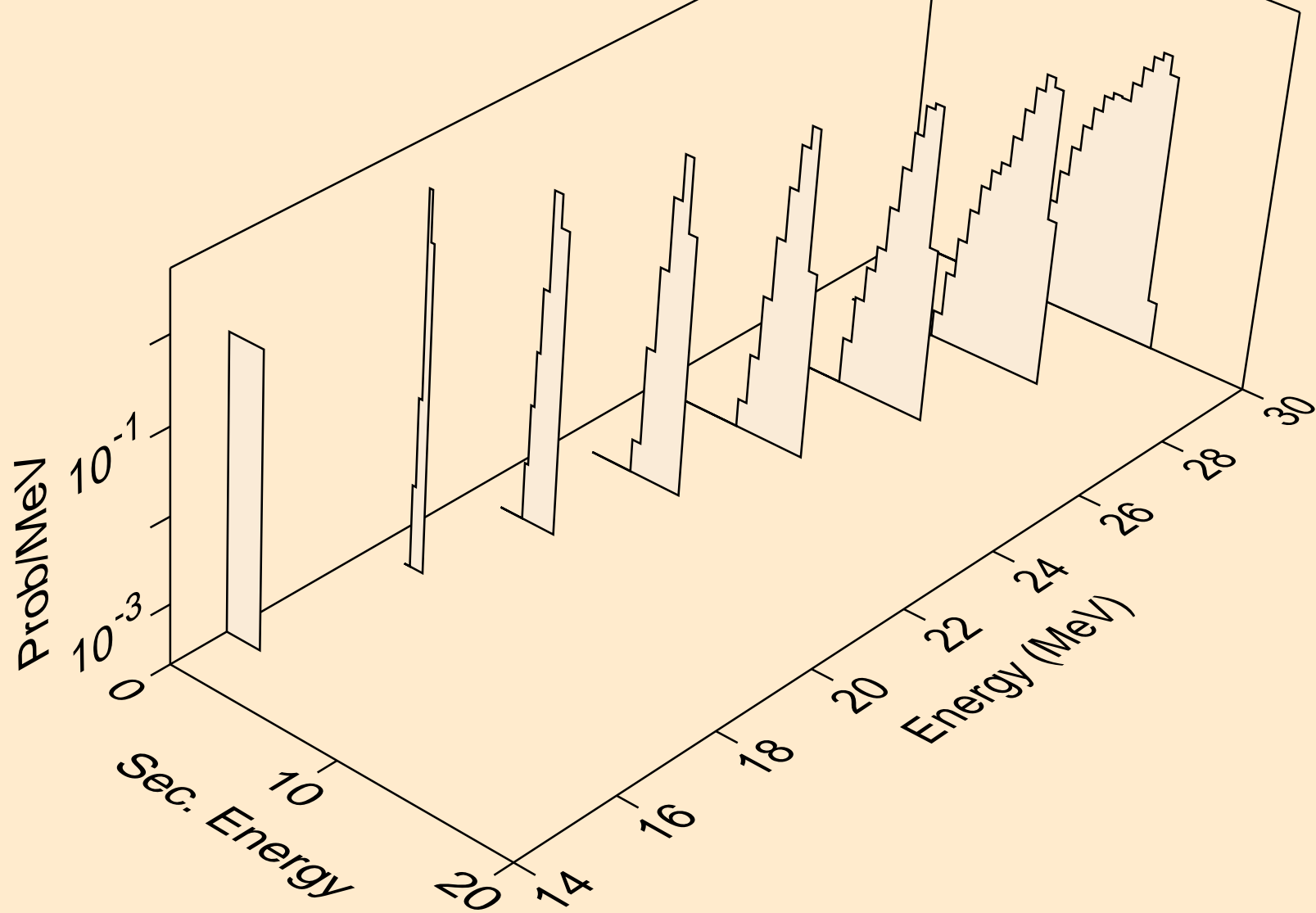

NB087 NEUTRON ACER TENDL-2024 LIBRARY; T=293.6K  
he3s from (n,he3)

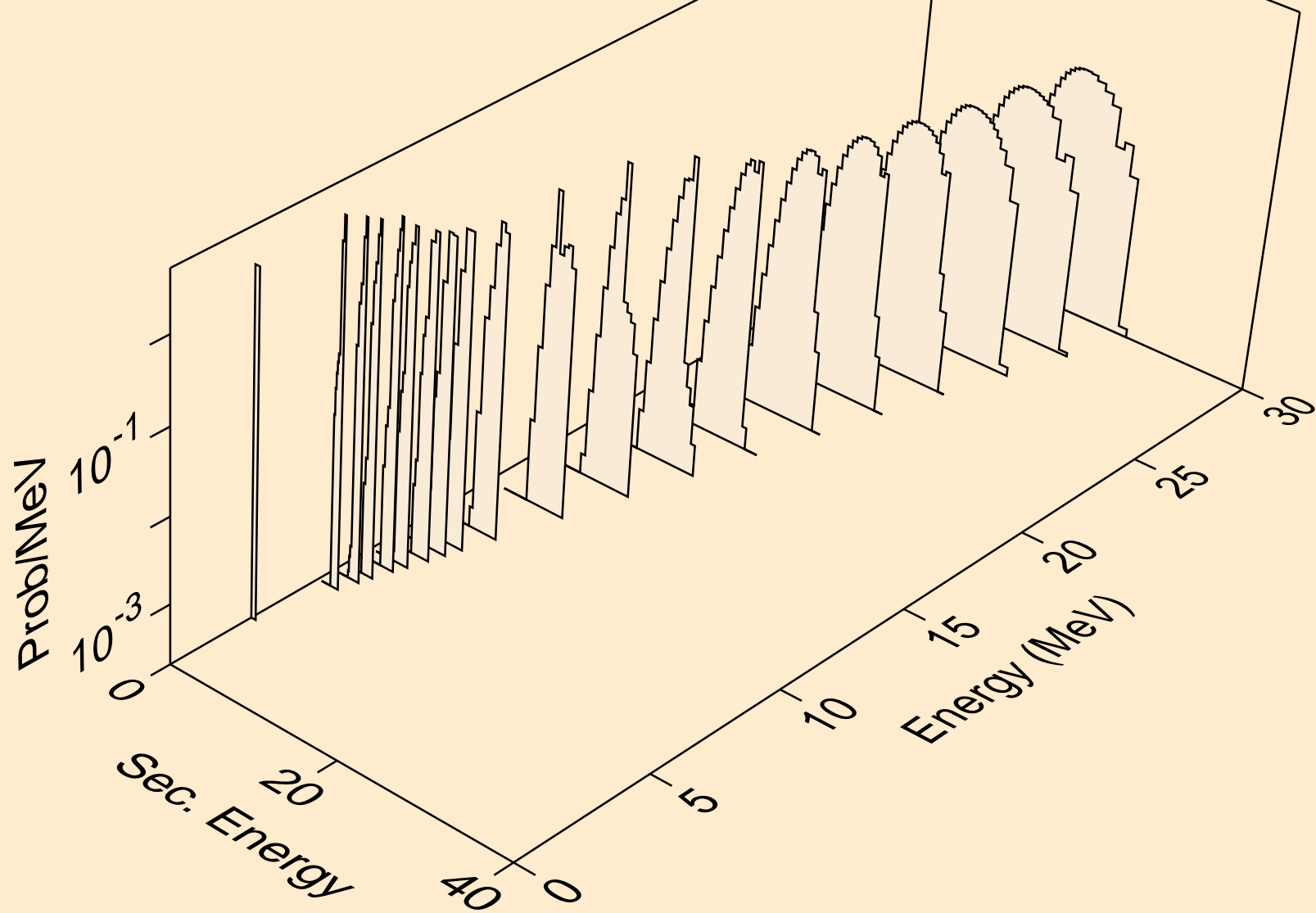

NB087 NEUTRON ACER TENDL-2024 LIBRARY; T=293.6K  
alphas from (n,x)

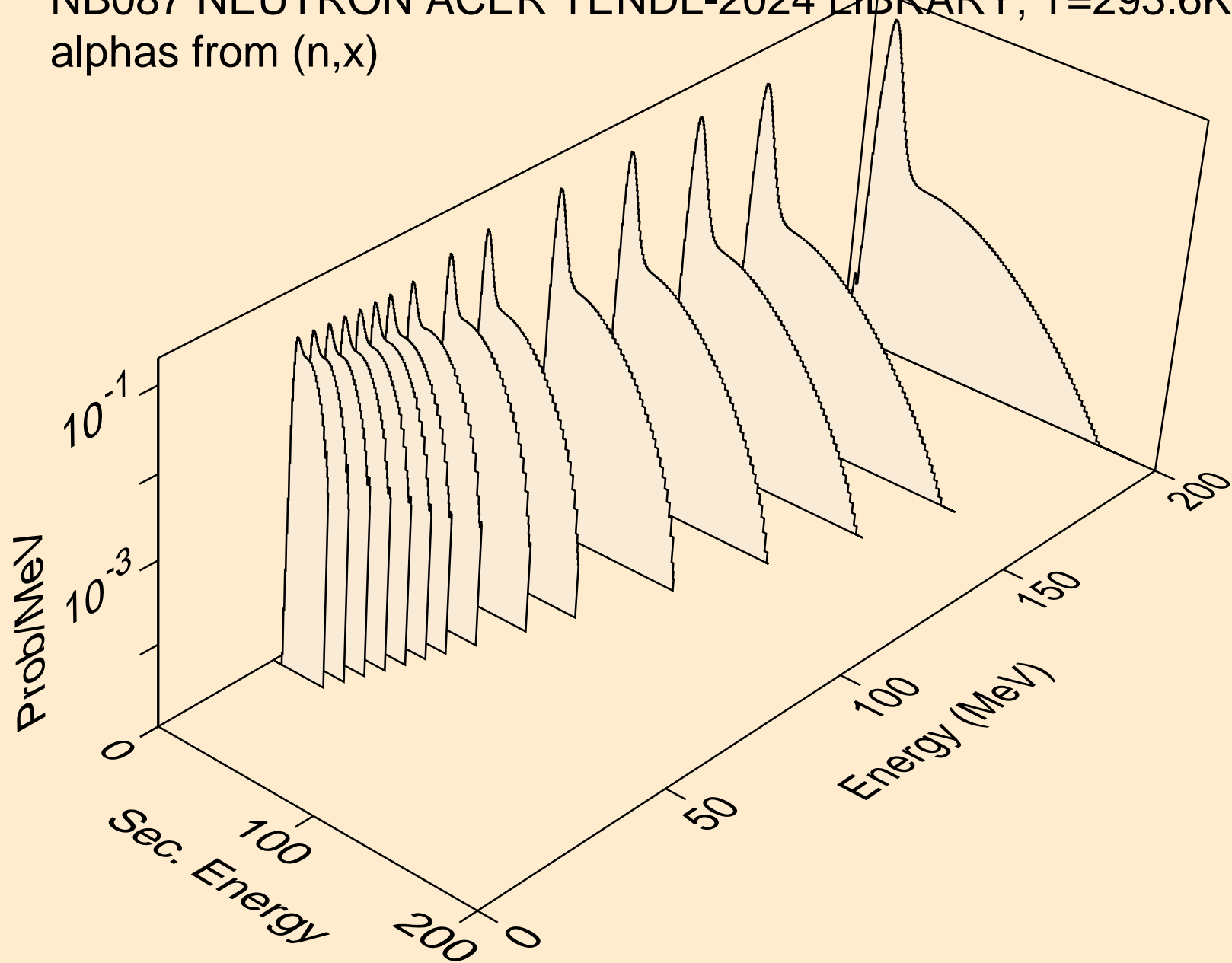

NB087 NEUTRON ACER TENDL-2024 LIBRARY; T=293.6K  
alphas from (n,n\*)a

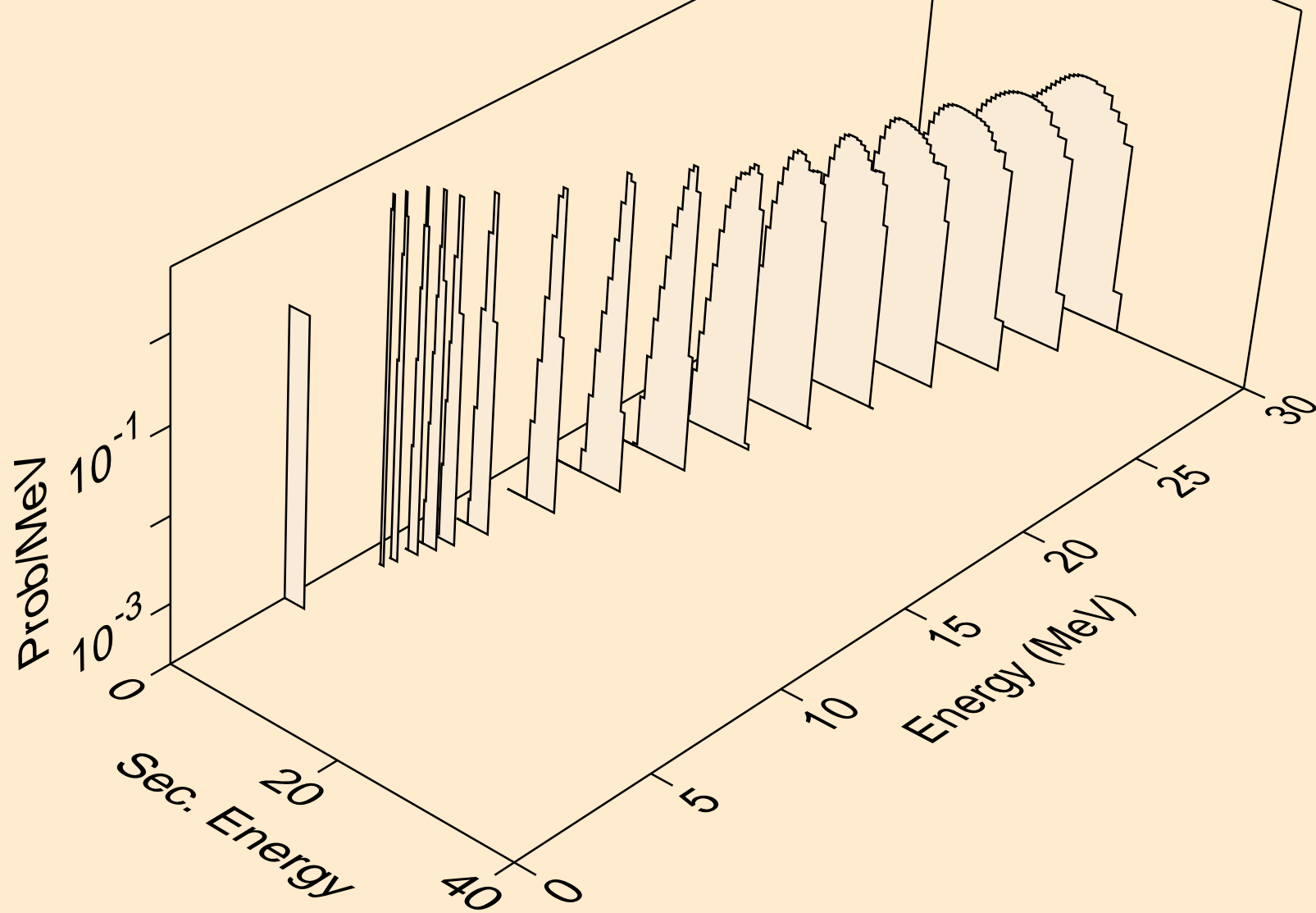

NB087 NEUTRON ACER TENDL-2024 LIBRARY; T=293.6K  
alphas from (n,2n)a

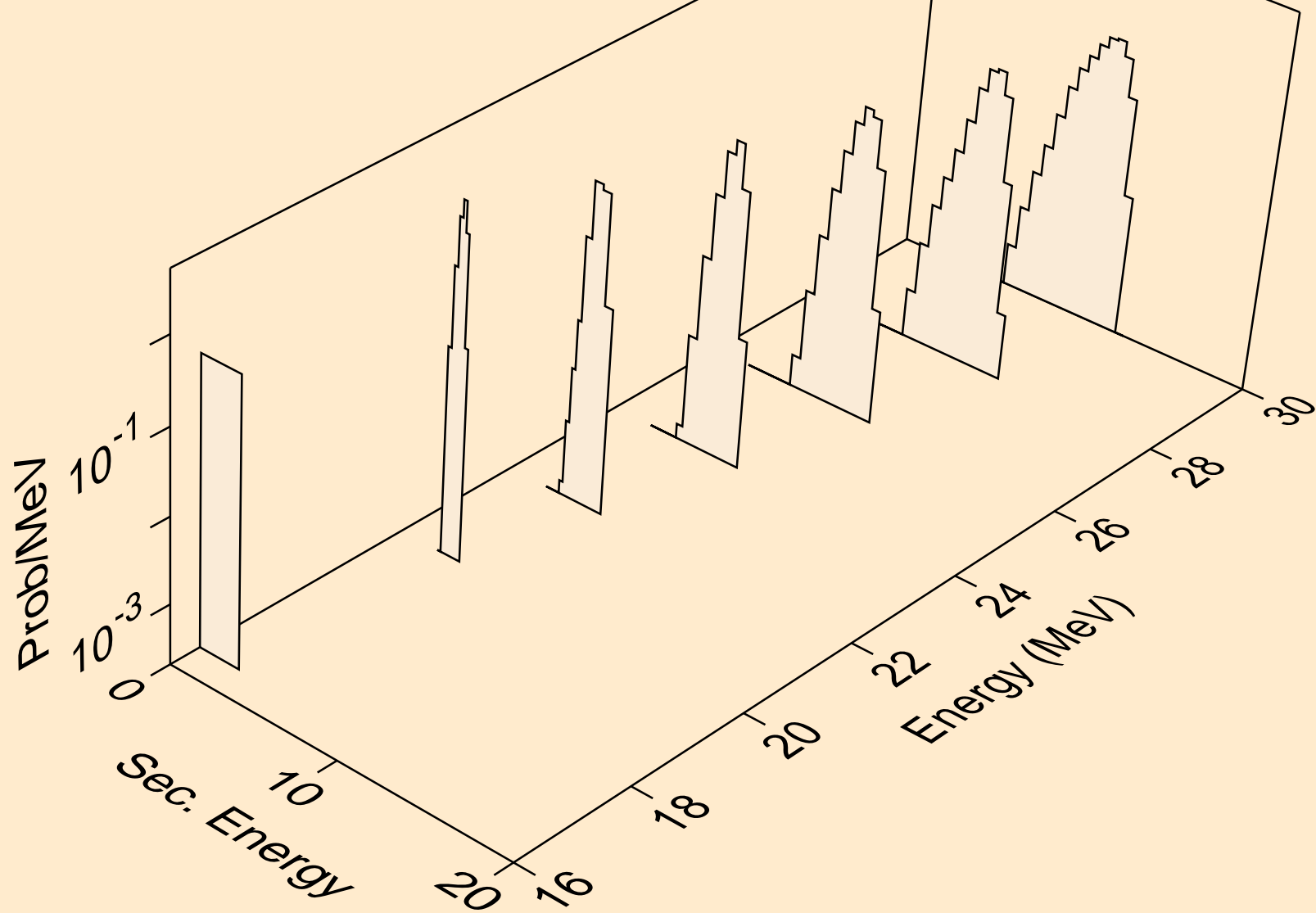

NB087 NEUTRON ACER TENDL-2024 LIBRARY; T=293.6K  
alphas from (n,n\*)2a

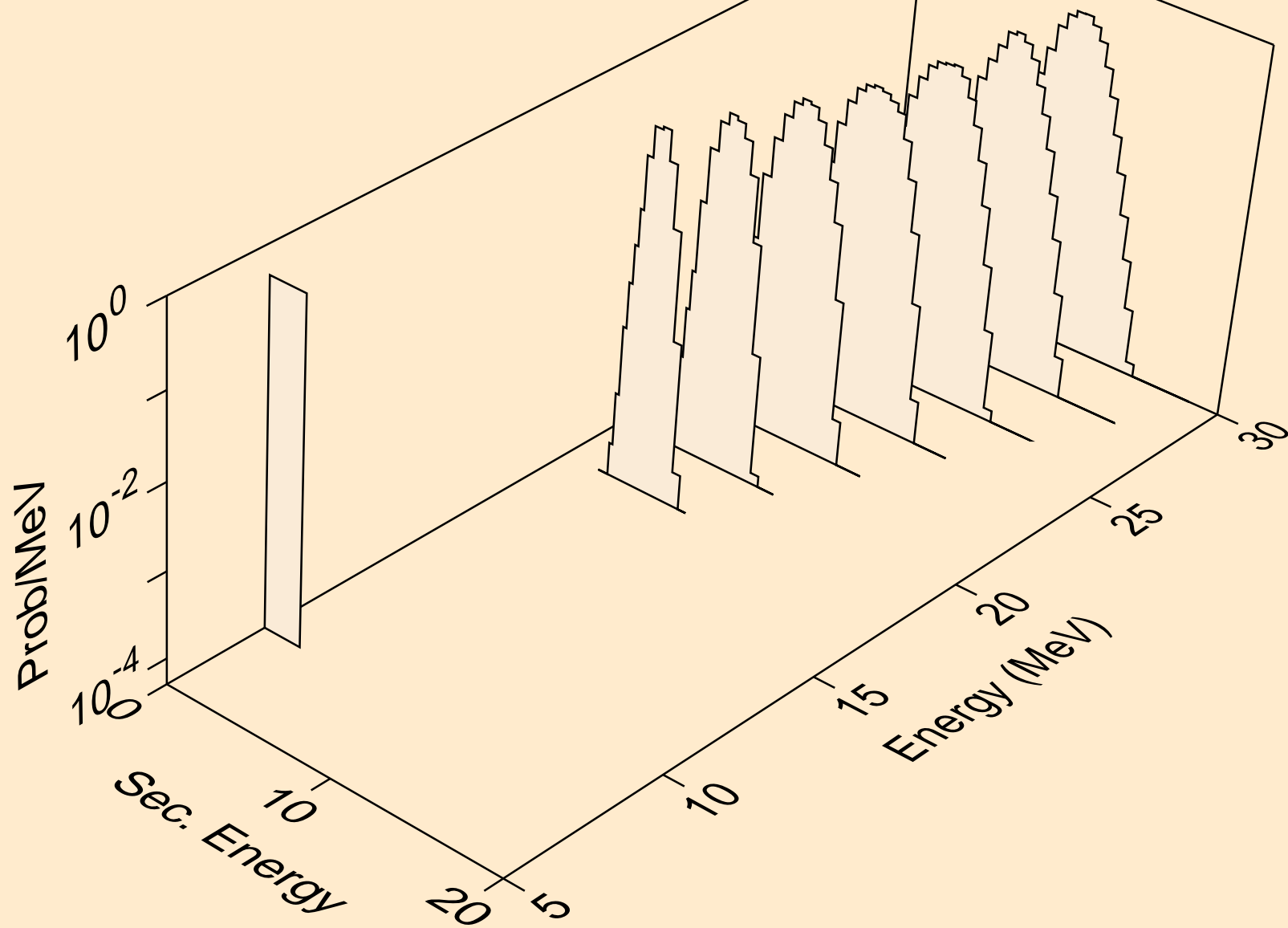

NB087 NEUTRON ACER TENDL-2024 LIBRARY; T=293.6K  
alphas from (n,npa)

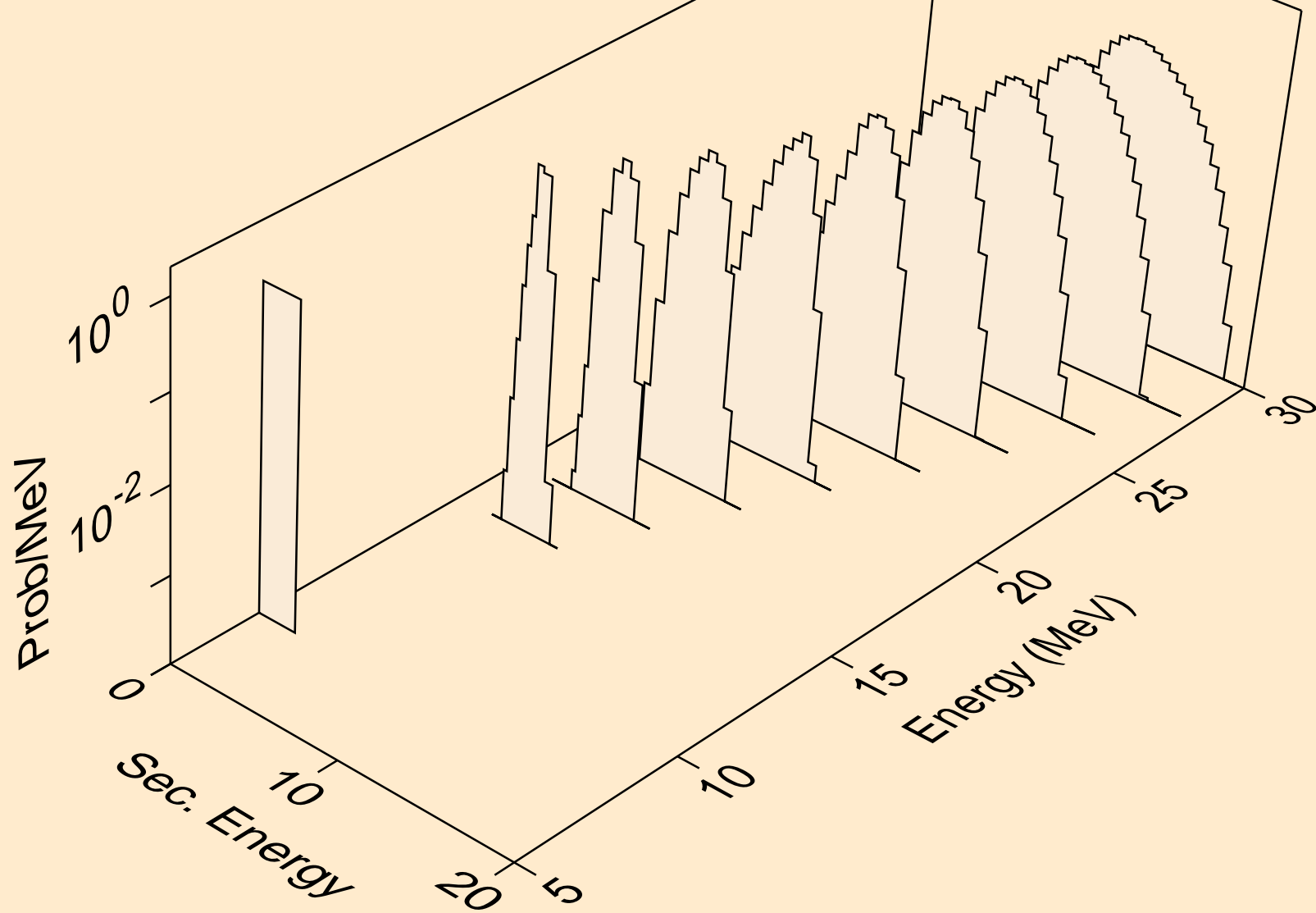

NB087 NEUTRON ACER TENDL-2024 LIBRARY; T=293.6K  
alphas from (n,a)

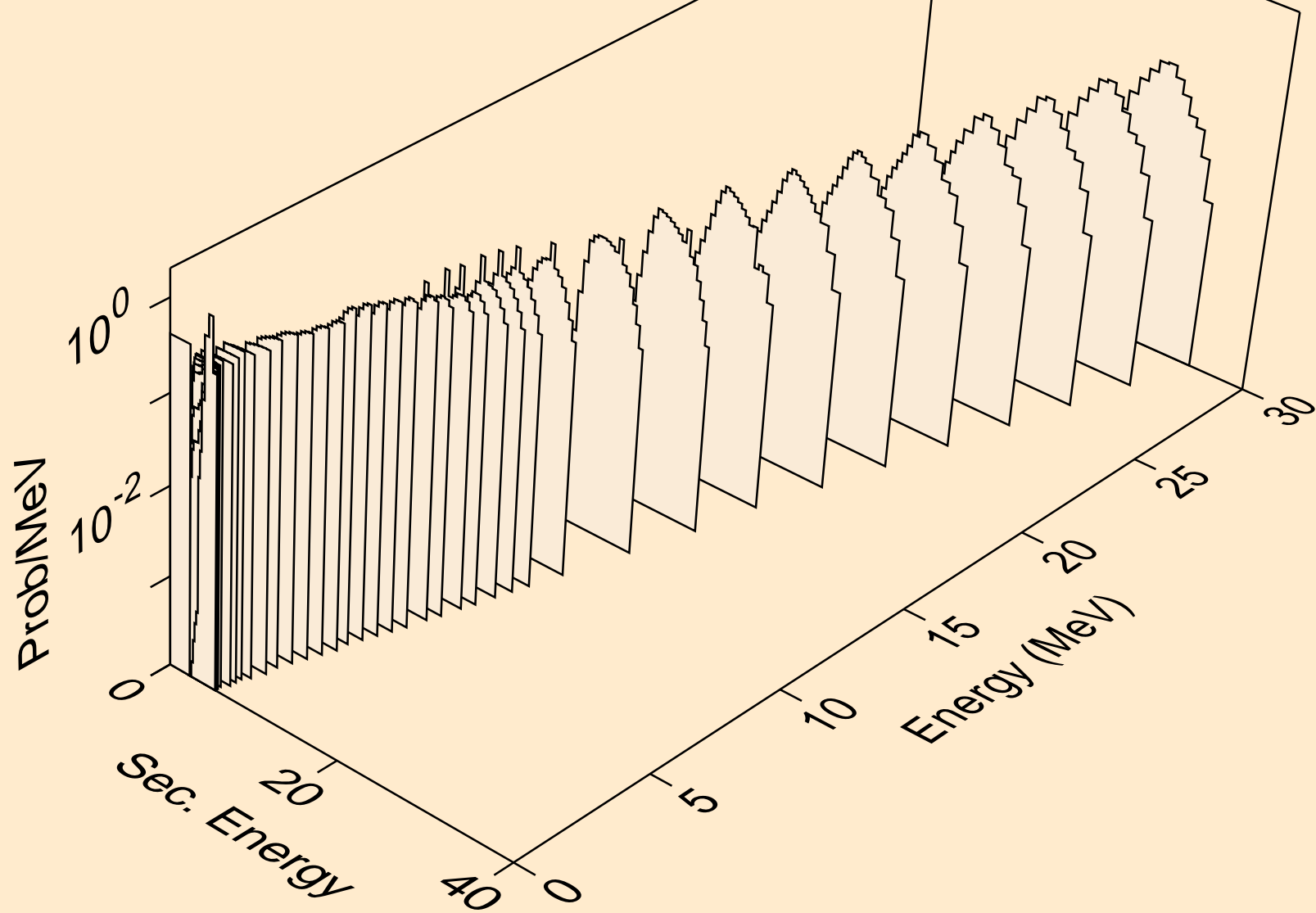

NB087 NEUTRON ACER TENDL-2024 LIBRARY; T=293.6K  
alphas from (n,2a)

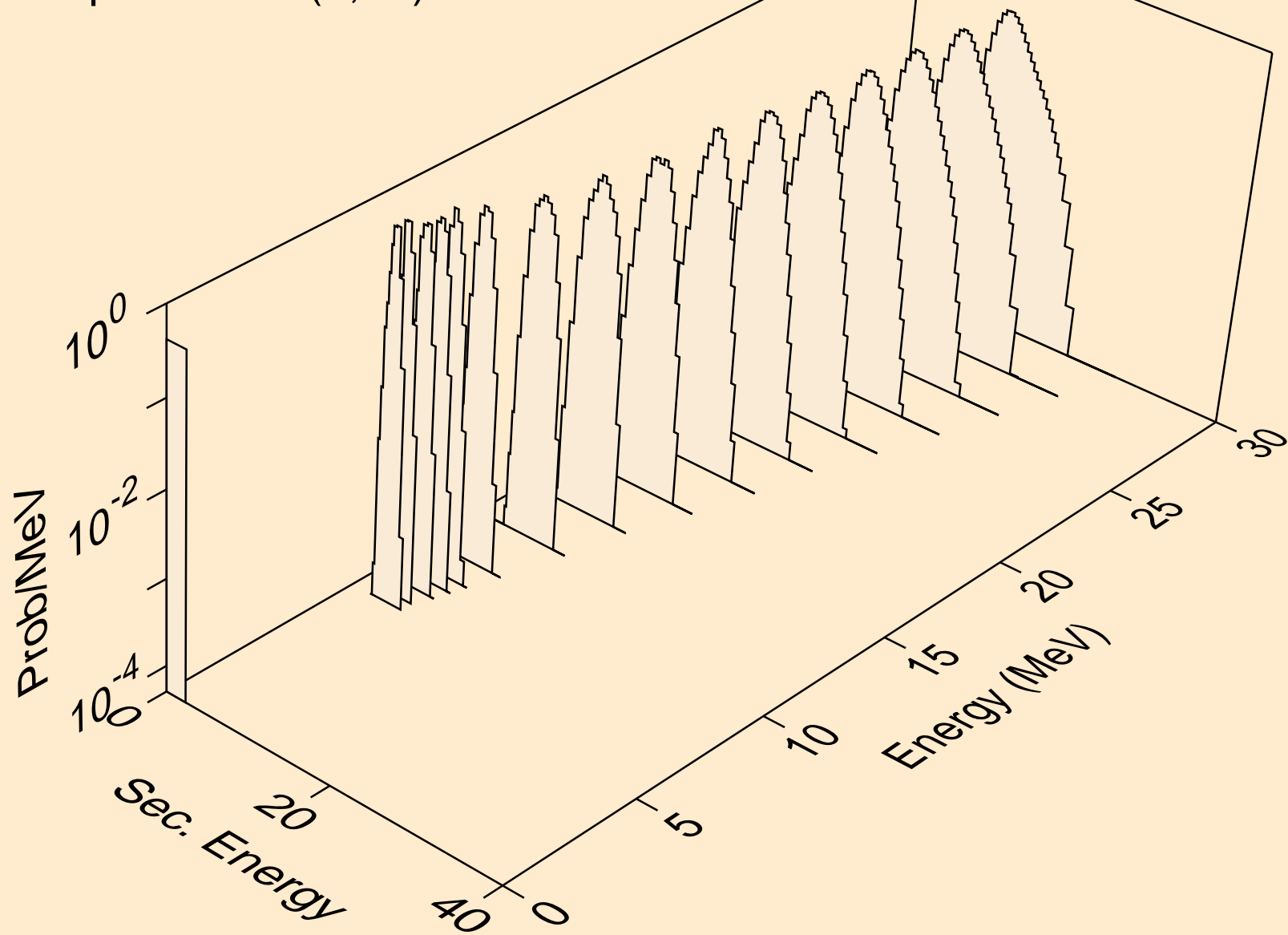

NB087 NEUTRON ACER TENDL-2024 LIBRARY; T=293.6K  
alphas from (n,pa)

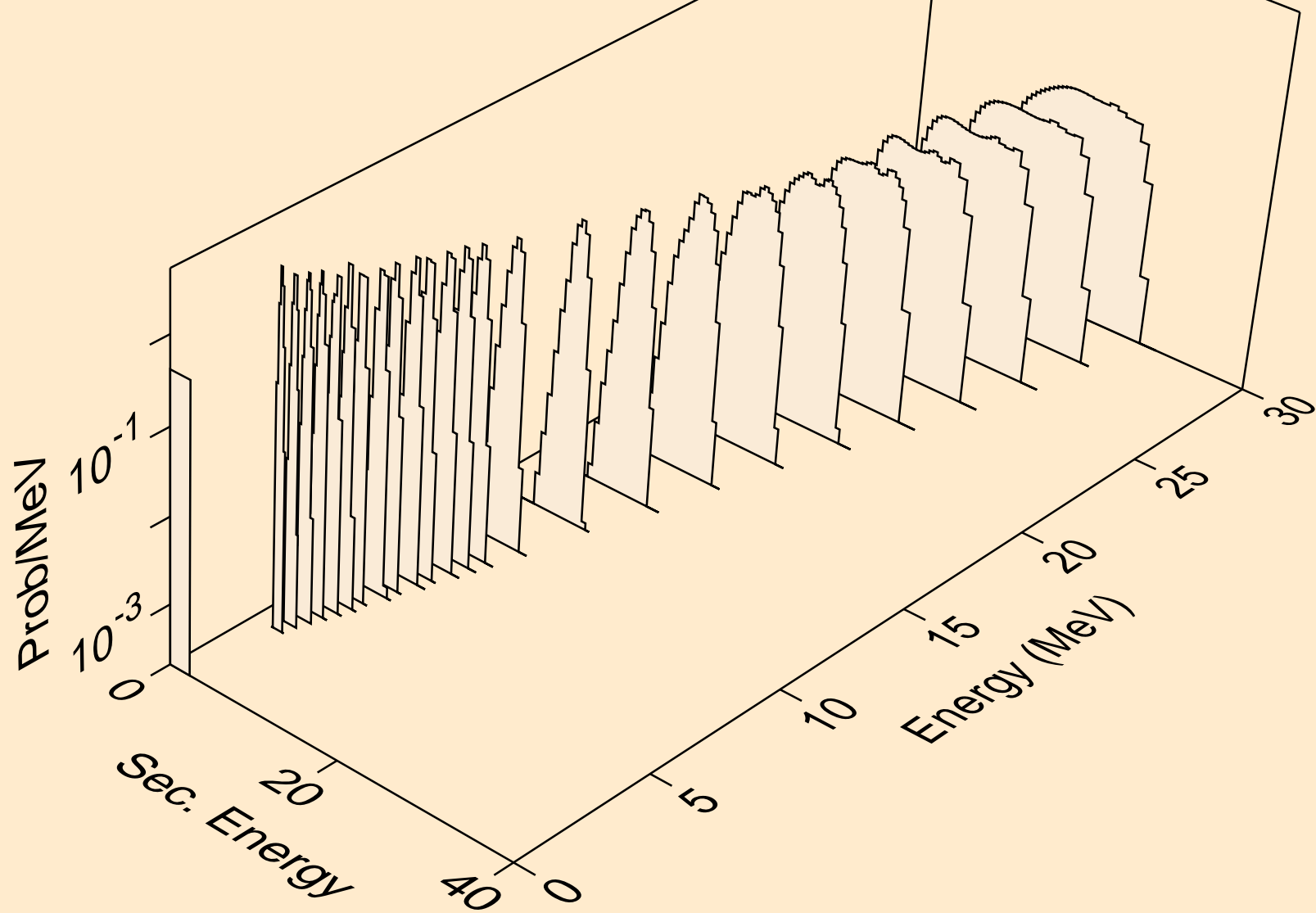

NB087 NEUTRON ACER TENDL-2024 LIBRARY; T=293.6K  
alphas from (n,da)

