

# NB102 NEUTRON ACER TENDL-2024 LIBRARY; T=293.6K

## Principal cross sections

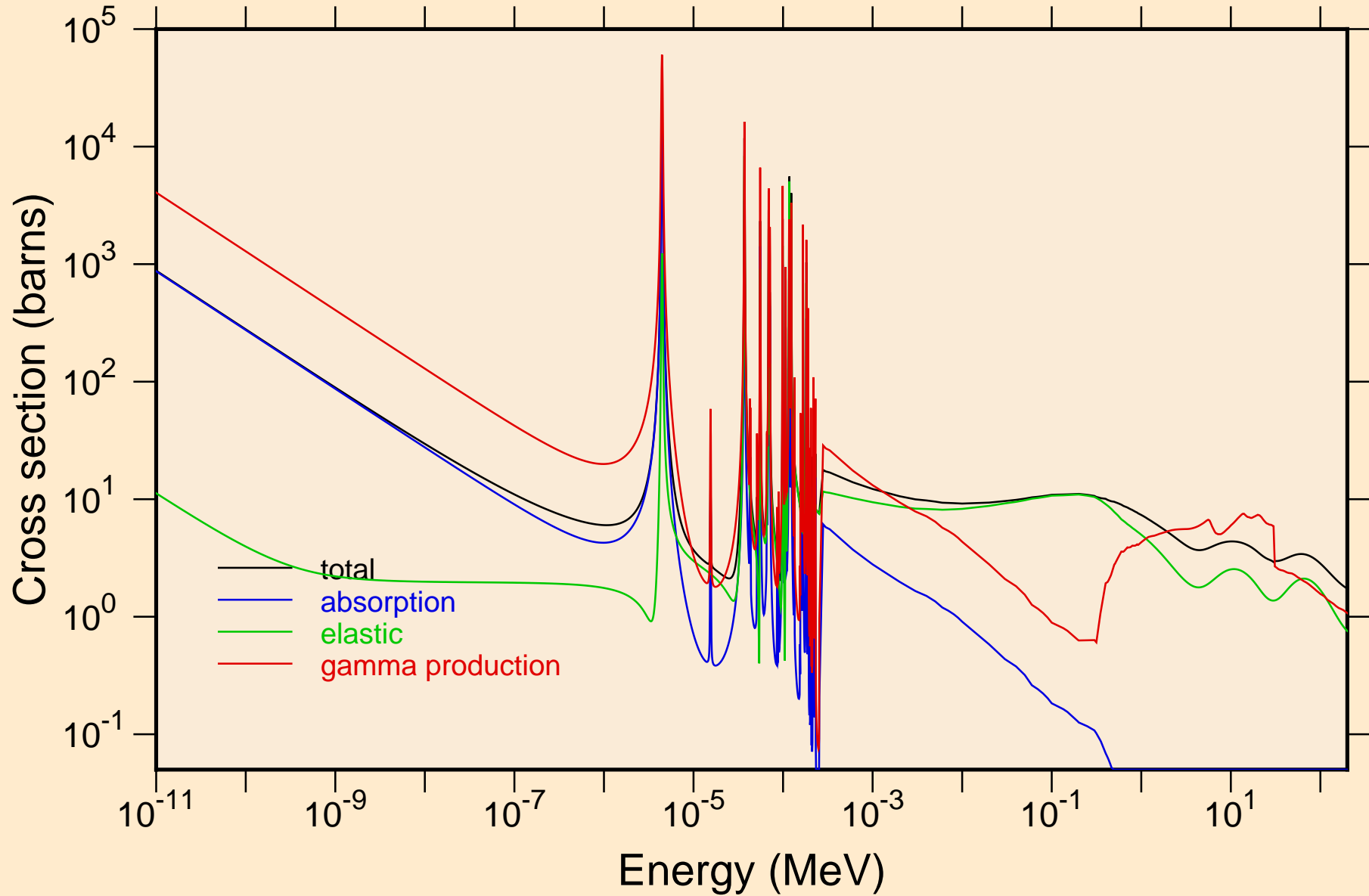

NB102 NEUTRON ACER TENDL-2024 LIBRARY; T=293.6K  
resonance total cross section

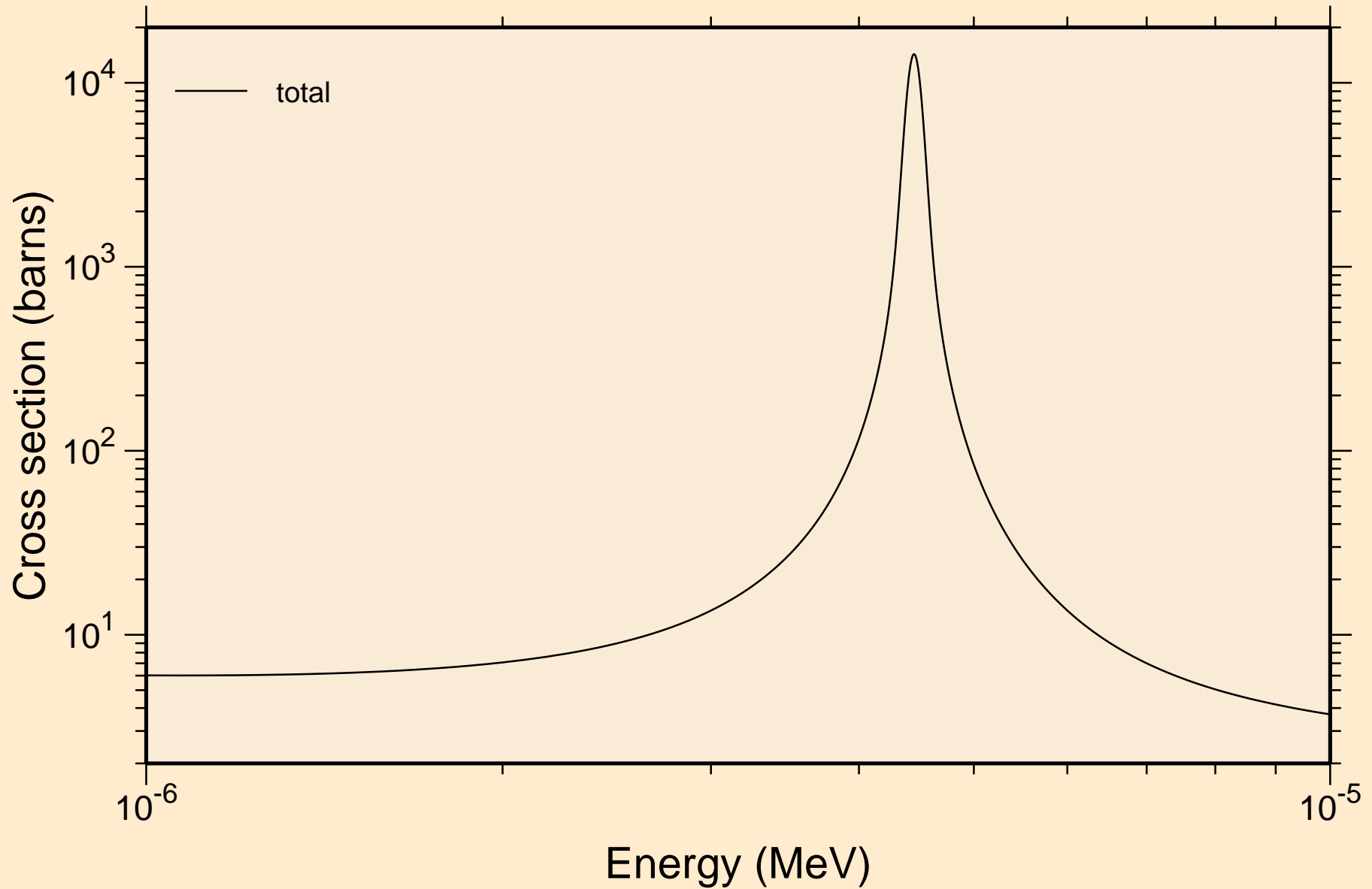

NB102 NEUTRON ACER TENDL-2024 LIBRARY; T=293.6K  
resonance total cross section

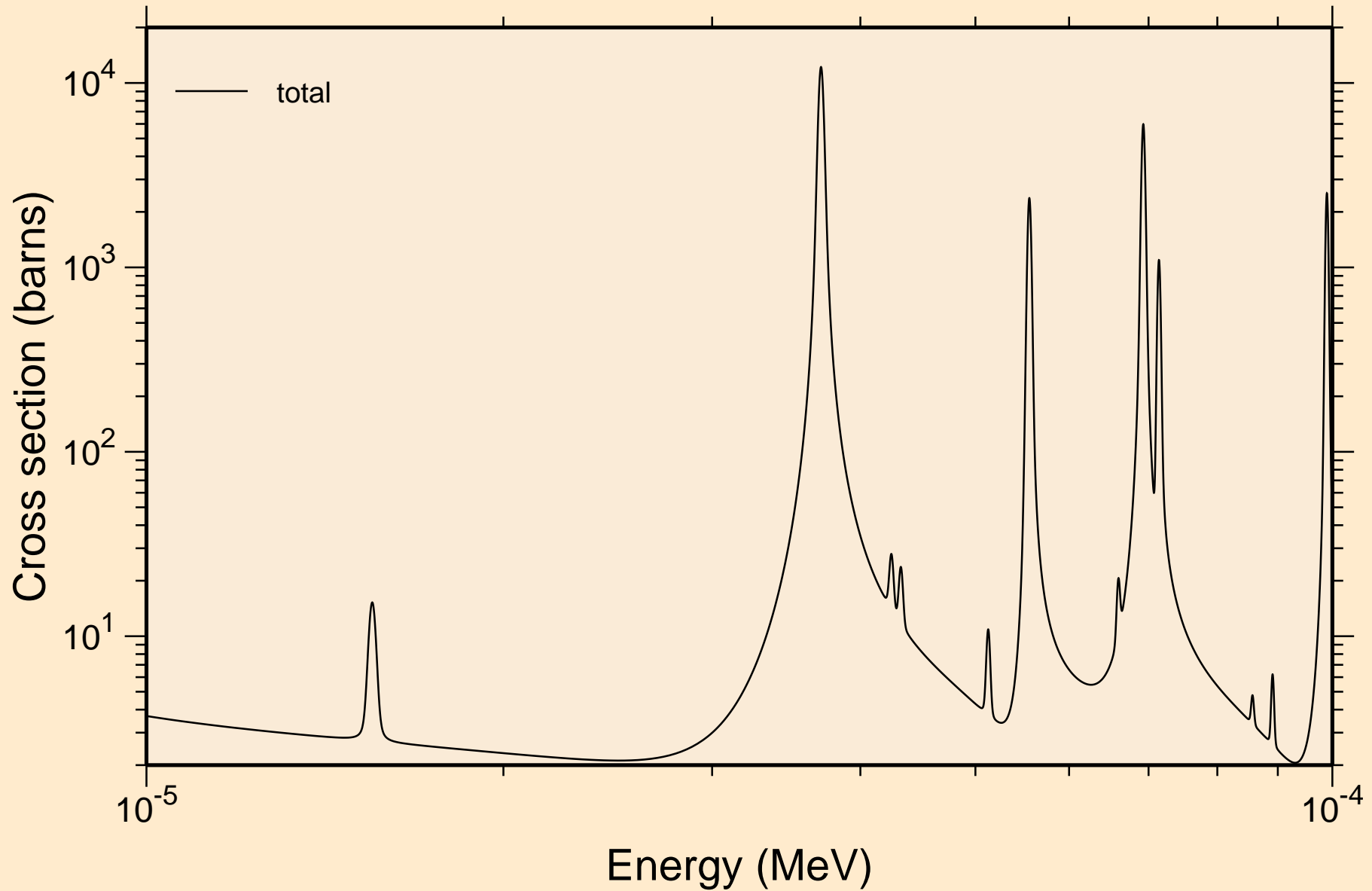

NB102 NEUTRON ACER TENDL-2024 LIBRARY; T=293.6K  
resonance total cross section

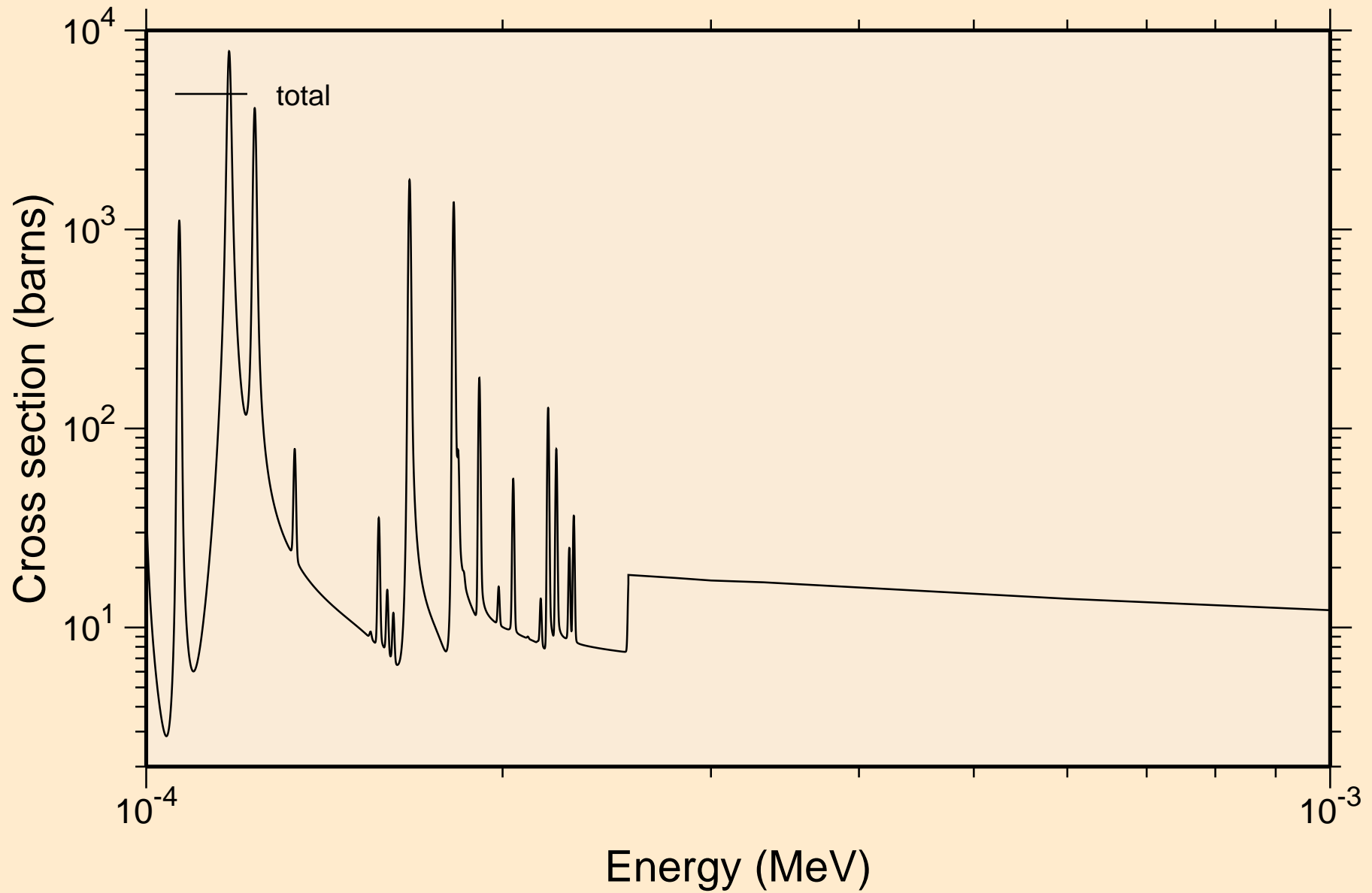

NB102 NEUTRON ACER TENDL-2024 LIBRARY; T=293.6K  
resonance total cross section

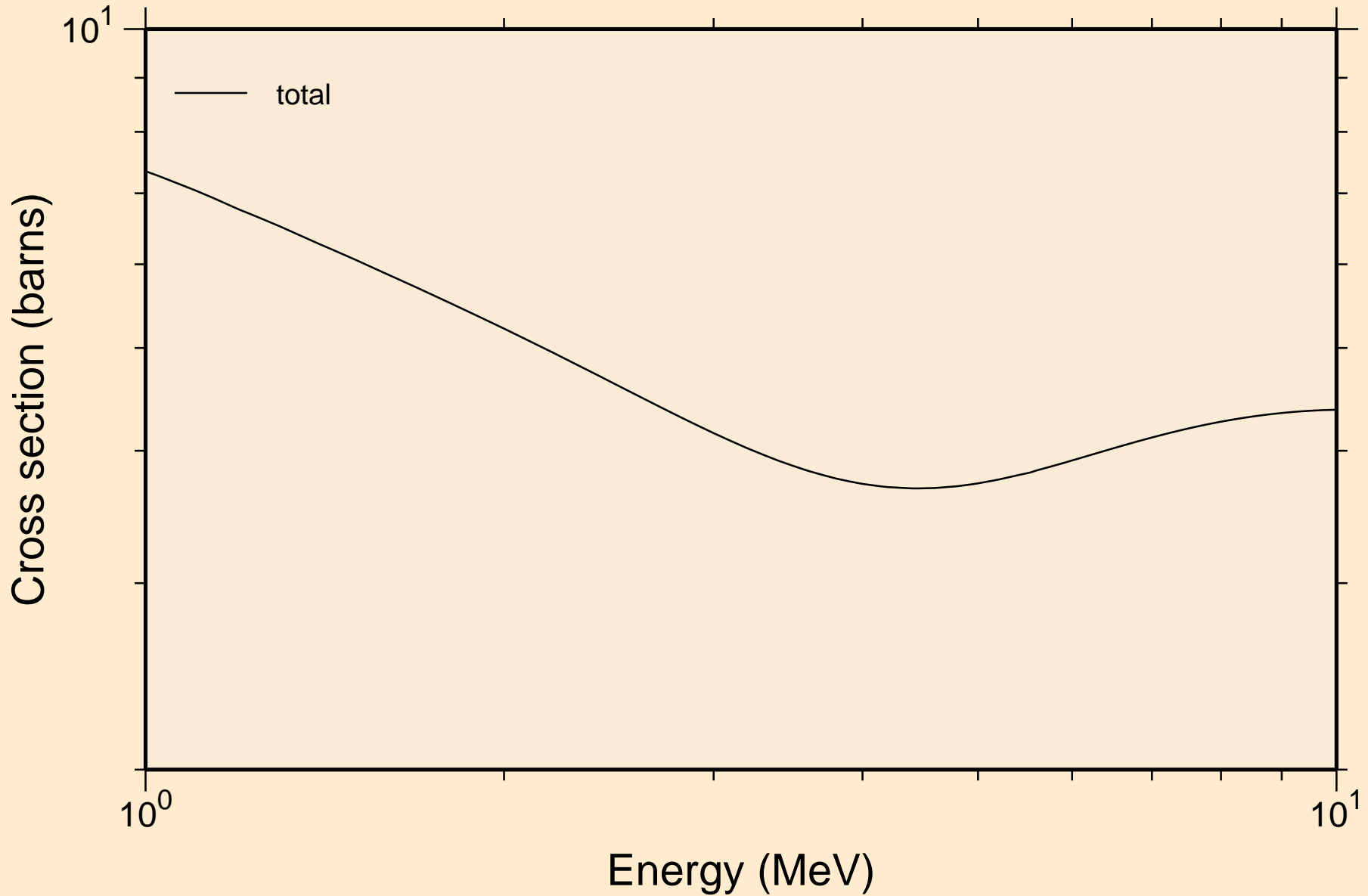

NB102 NEUTRON ACER TENDL-2024 LIBRARY; T=293.6K  
resonance absorption cross sections

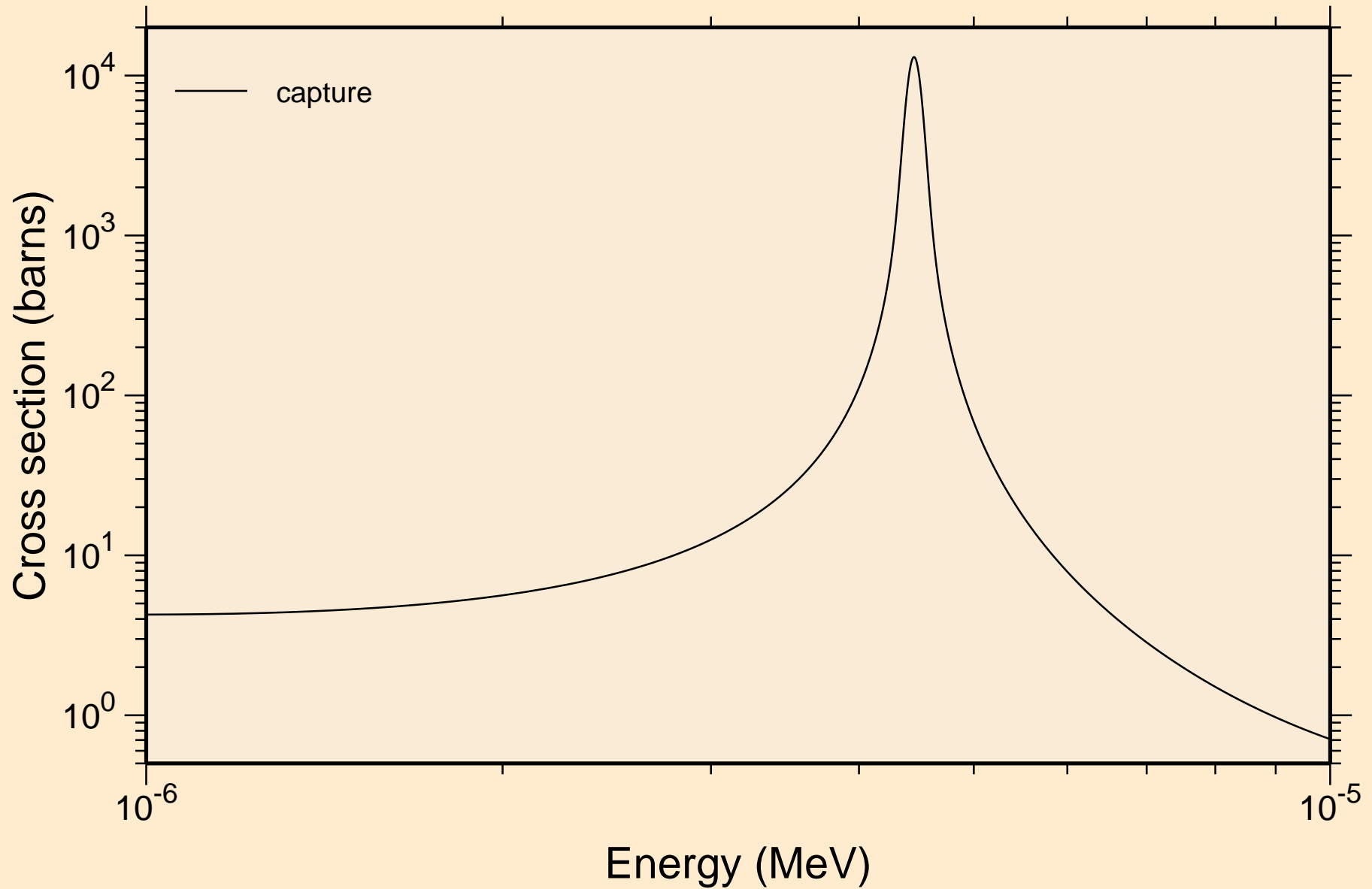

NB102 NEUTRON ACER TENDL-2024 LIBRARY; T=293.6K  
resonance absorption cross sections

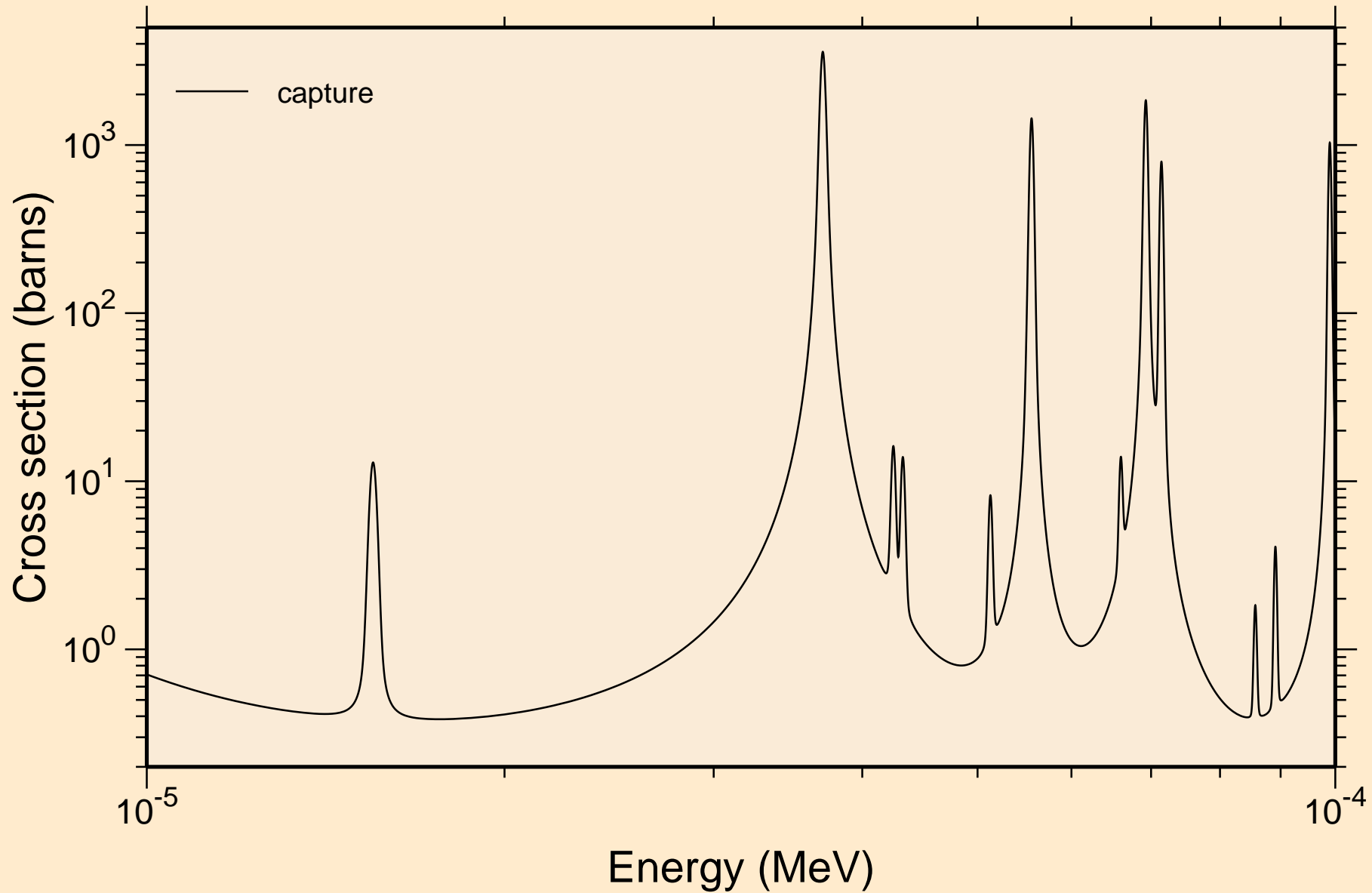

NB102 NEUTRON ACER TENDL-2024 LIBRARY; T=293.6K  
resonance absorption cross sections

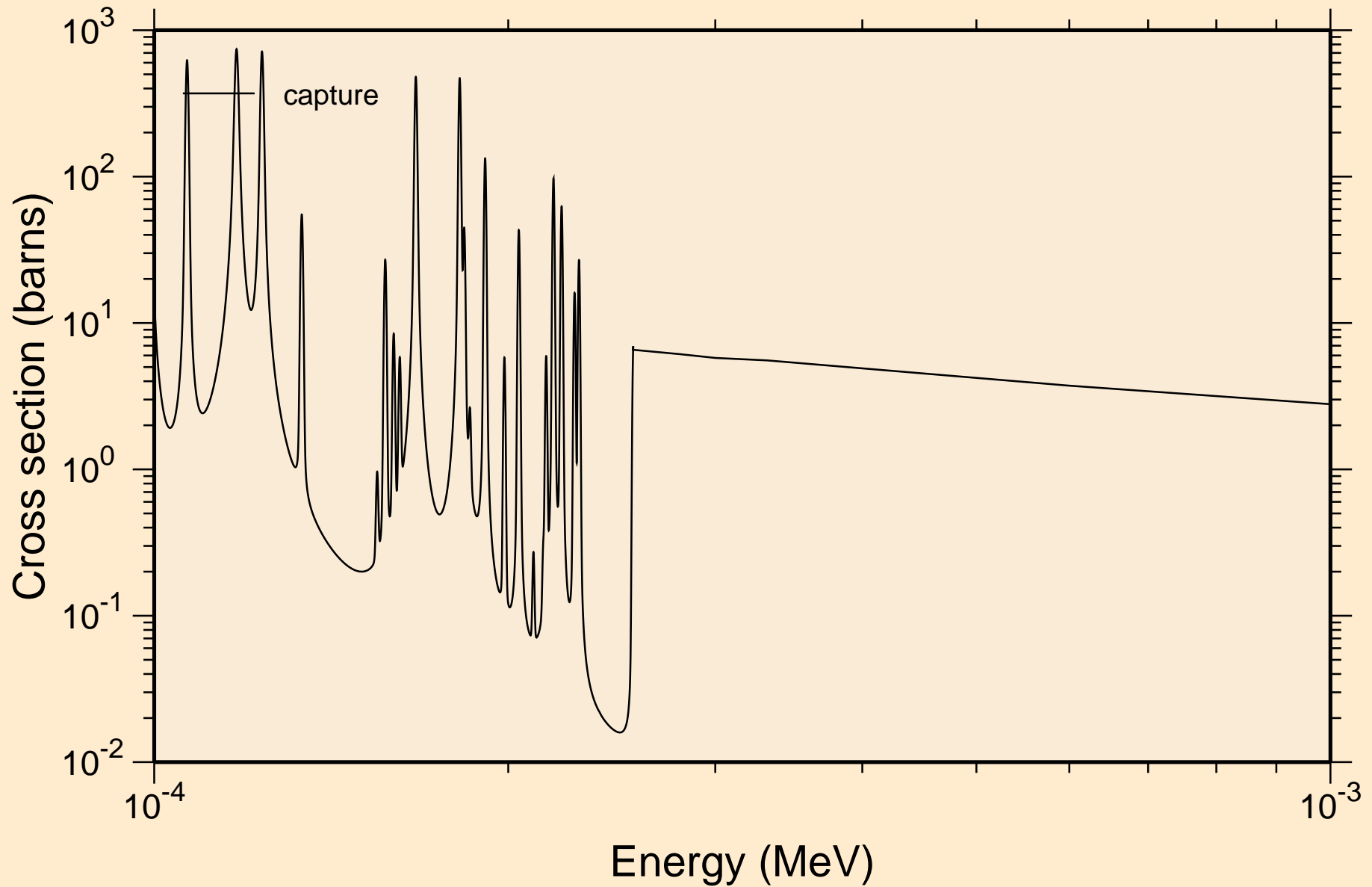

NB102 NEUTRON ACER TENDL-2024 LIBRARY; T=293.6K  
resonance absorption cross sections

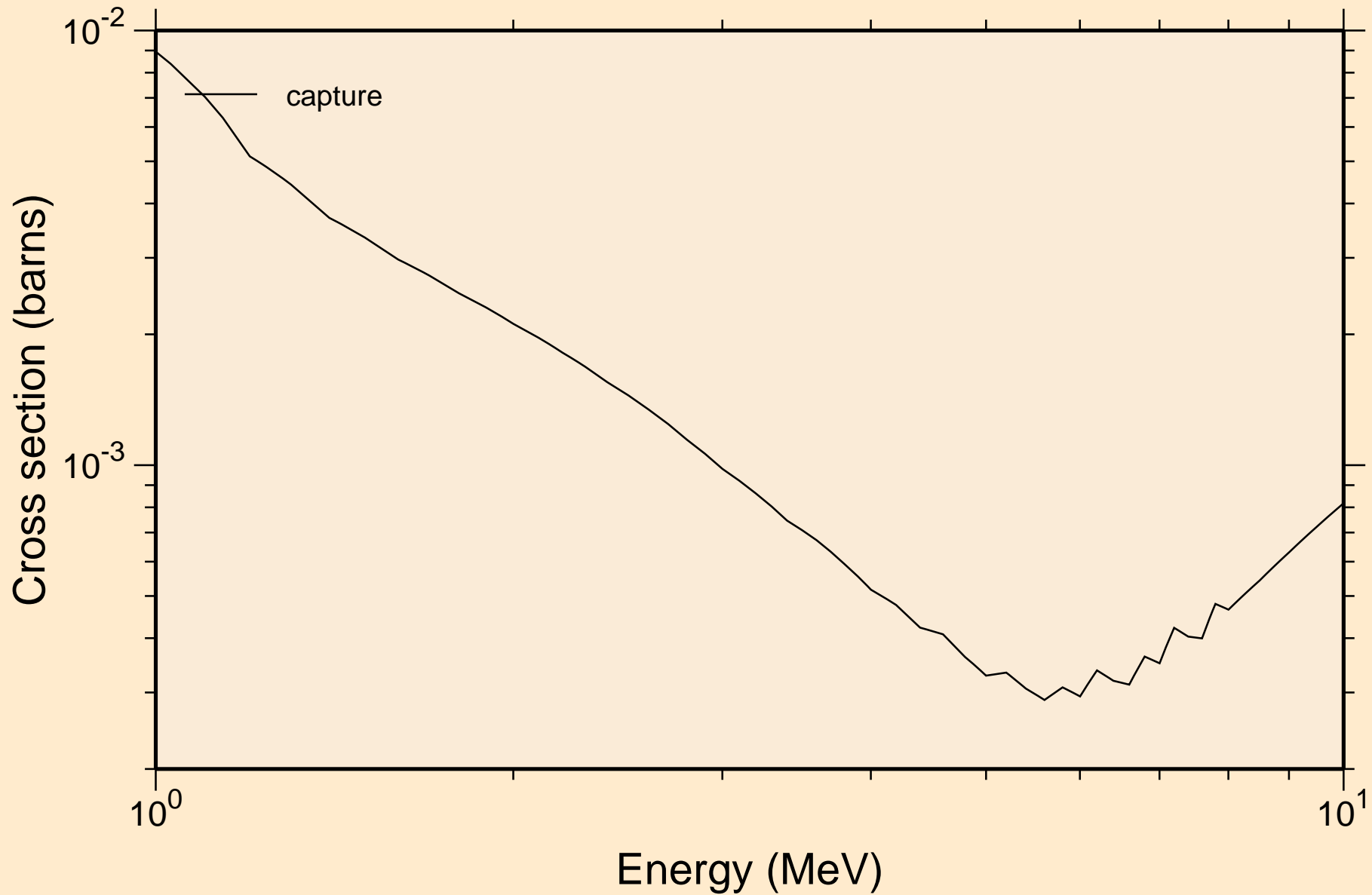

NB102 NEUTRON ACER TENDL-2024 LIBRARY; T=293.6K  
Heating

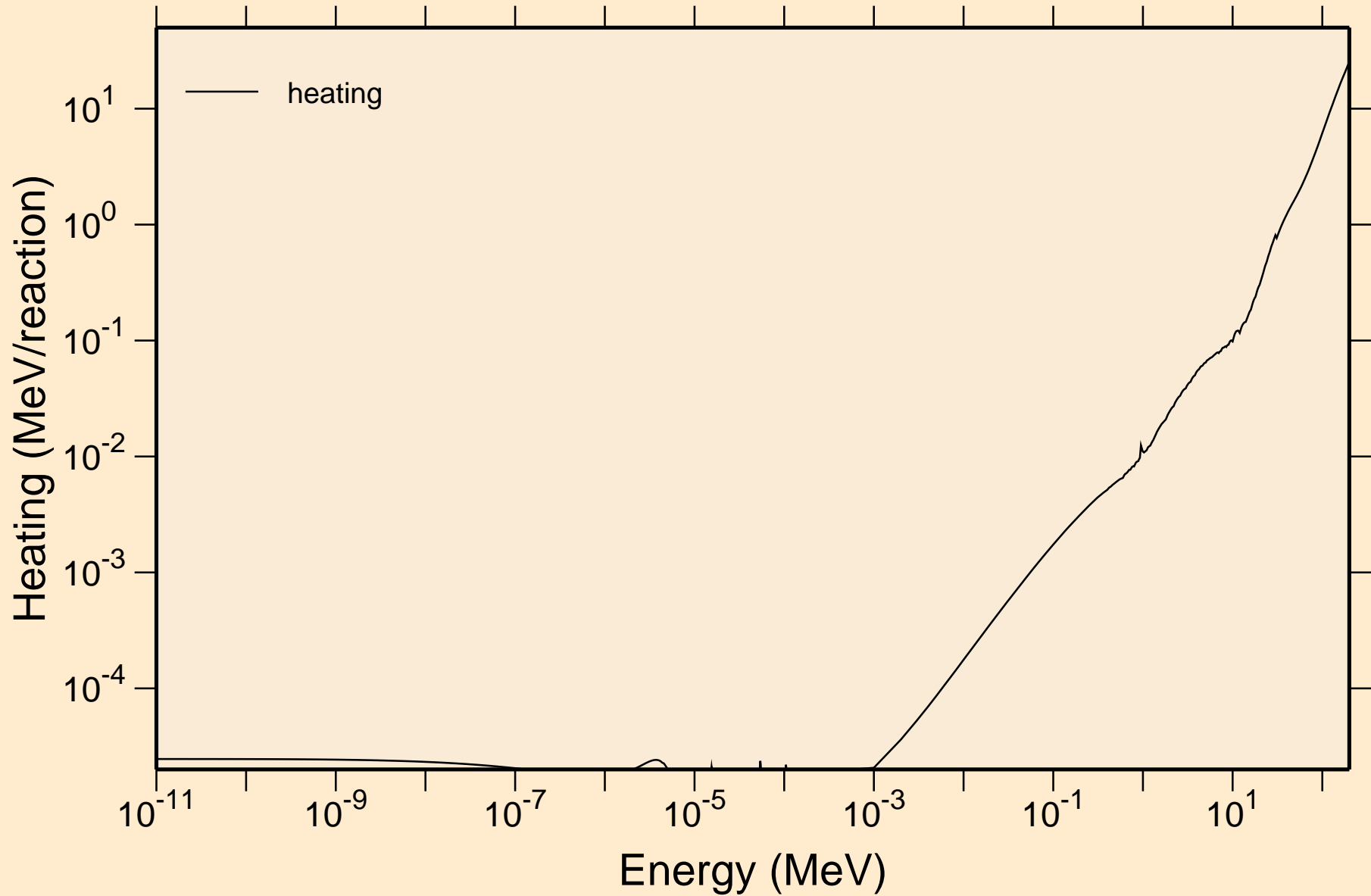

# NB102 NEUTRON ACER TENDL-2024 LIBRARY; T=293.6K

## Damage

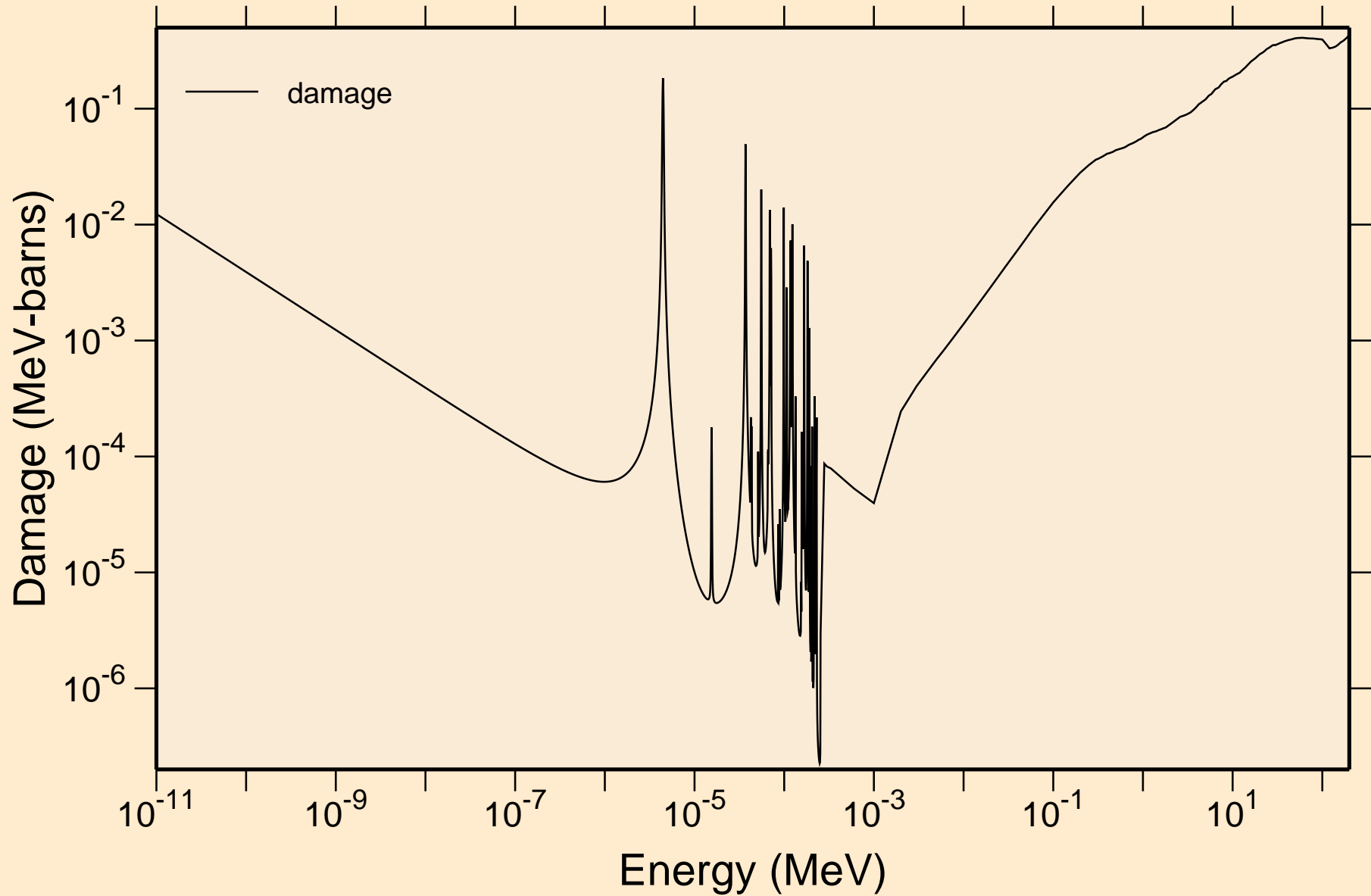

NB102 NEUTRON ACER TENDL-2024 LIBRARY; T=293.6K  
Non-threshold reactions

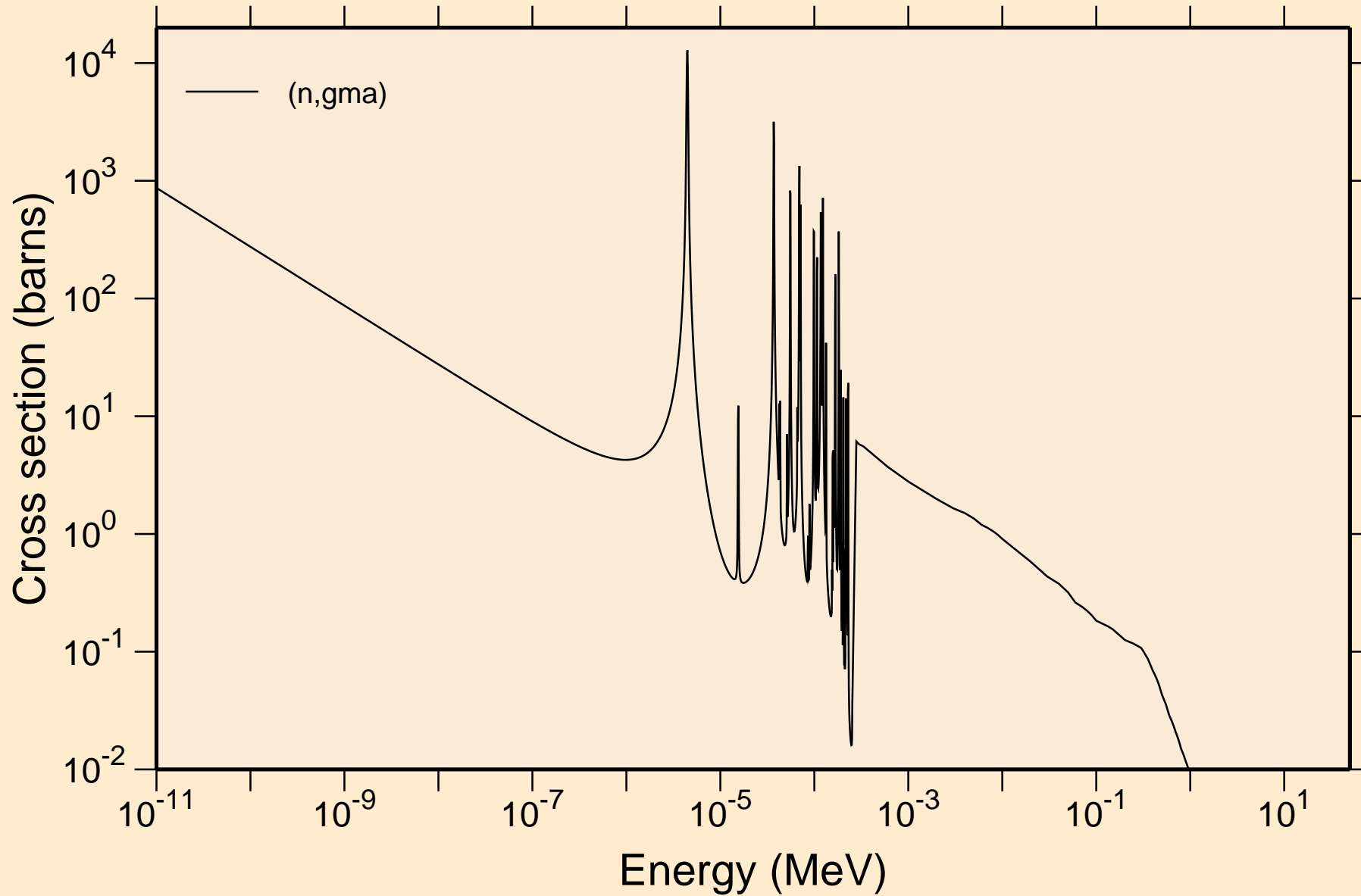

# NB102 NEUTRON ACER TENDL-2024 LIBRARY; T=293.6K

## Principal cross sections

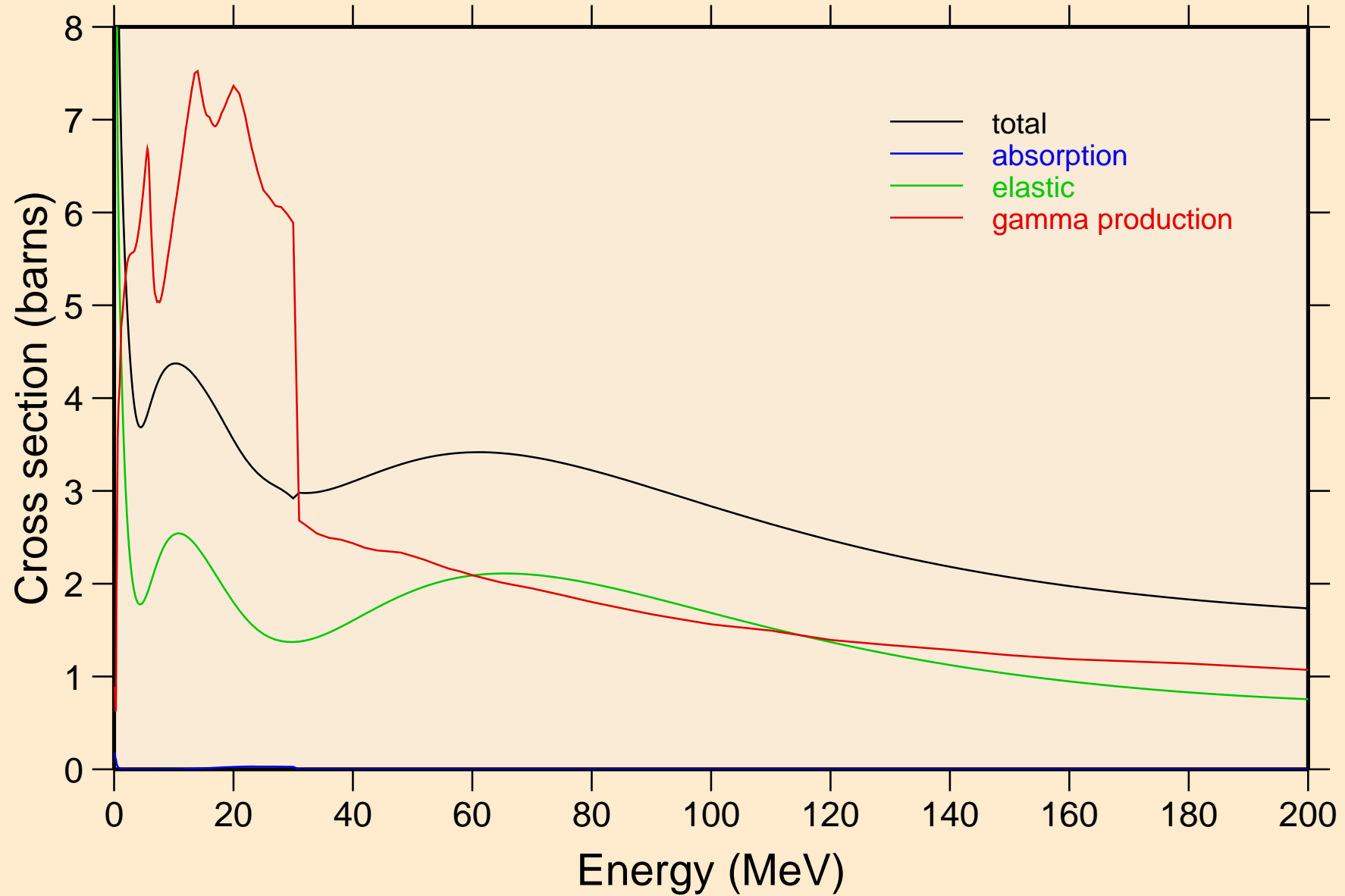

NB102 NEUTRON ACER TENDL-2024 LIBRARY; T=293.6K  
Heating

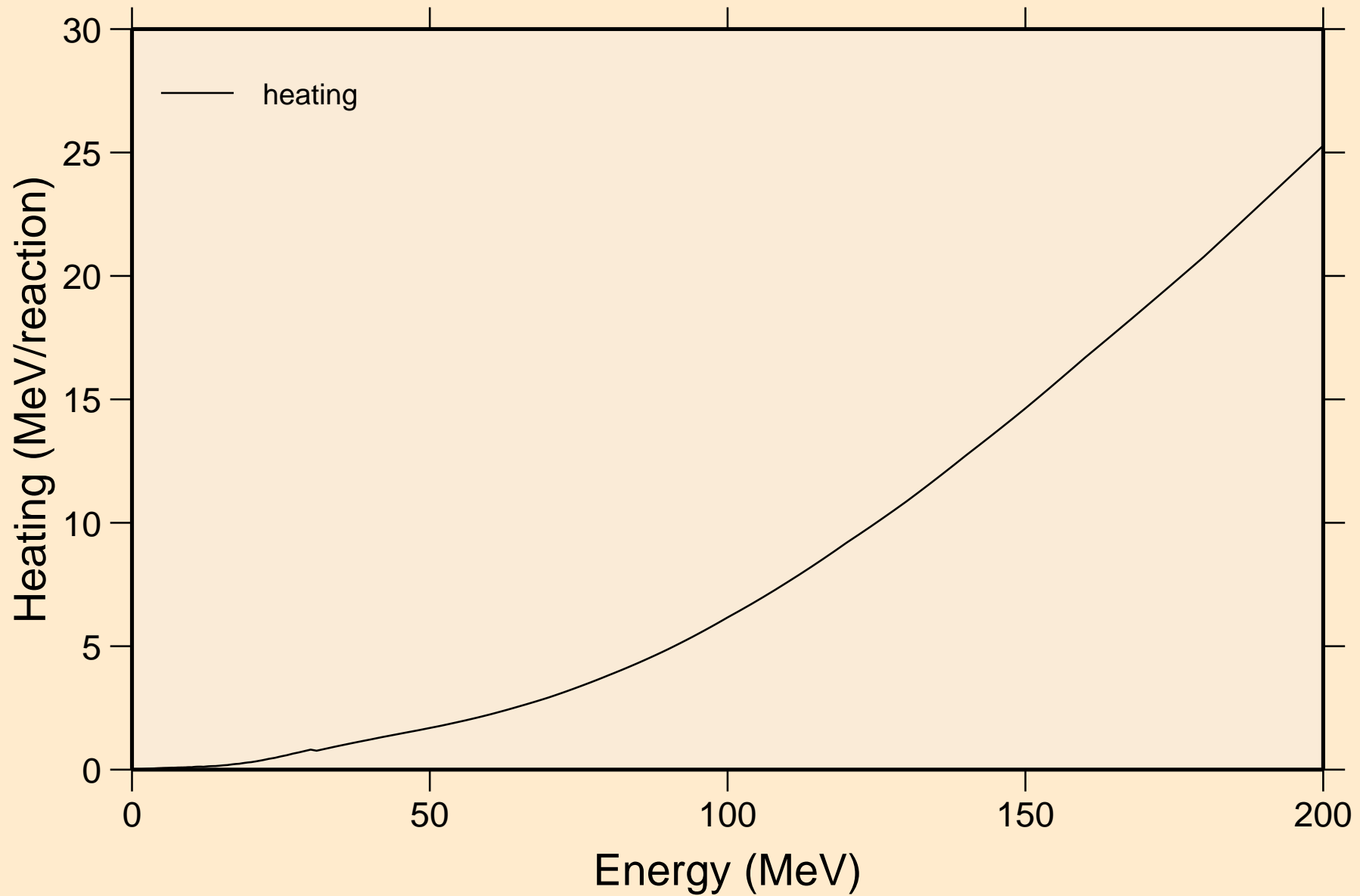

NB102 NEUTRON ACER TENDL-2024 LIBRARY; T=293.6K  
Damage

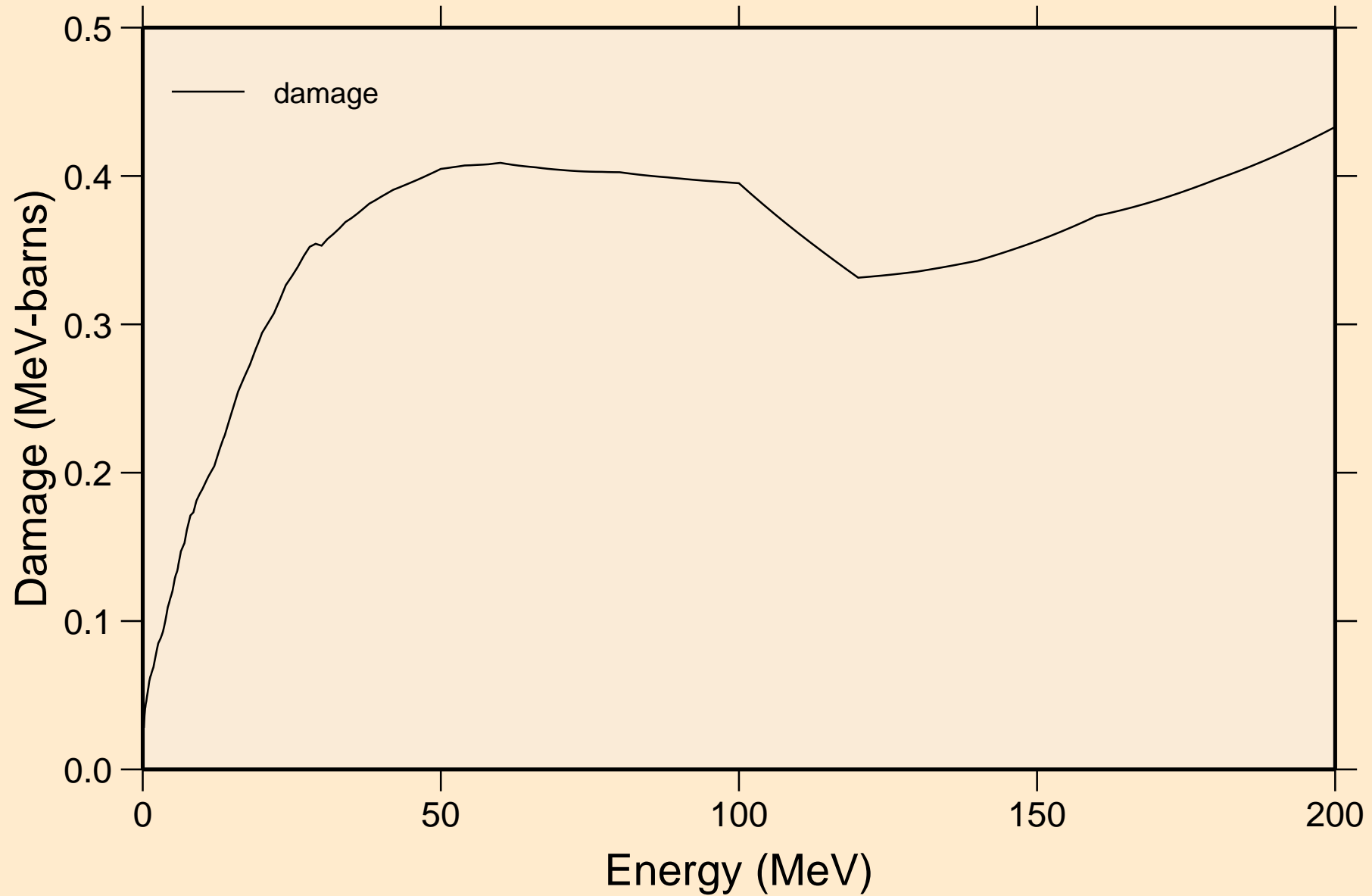

NB102 NEUTRON ACER TENDL-2024 LIBRARY; T=293.6K  
Non-threshold reactions

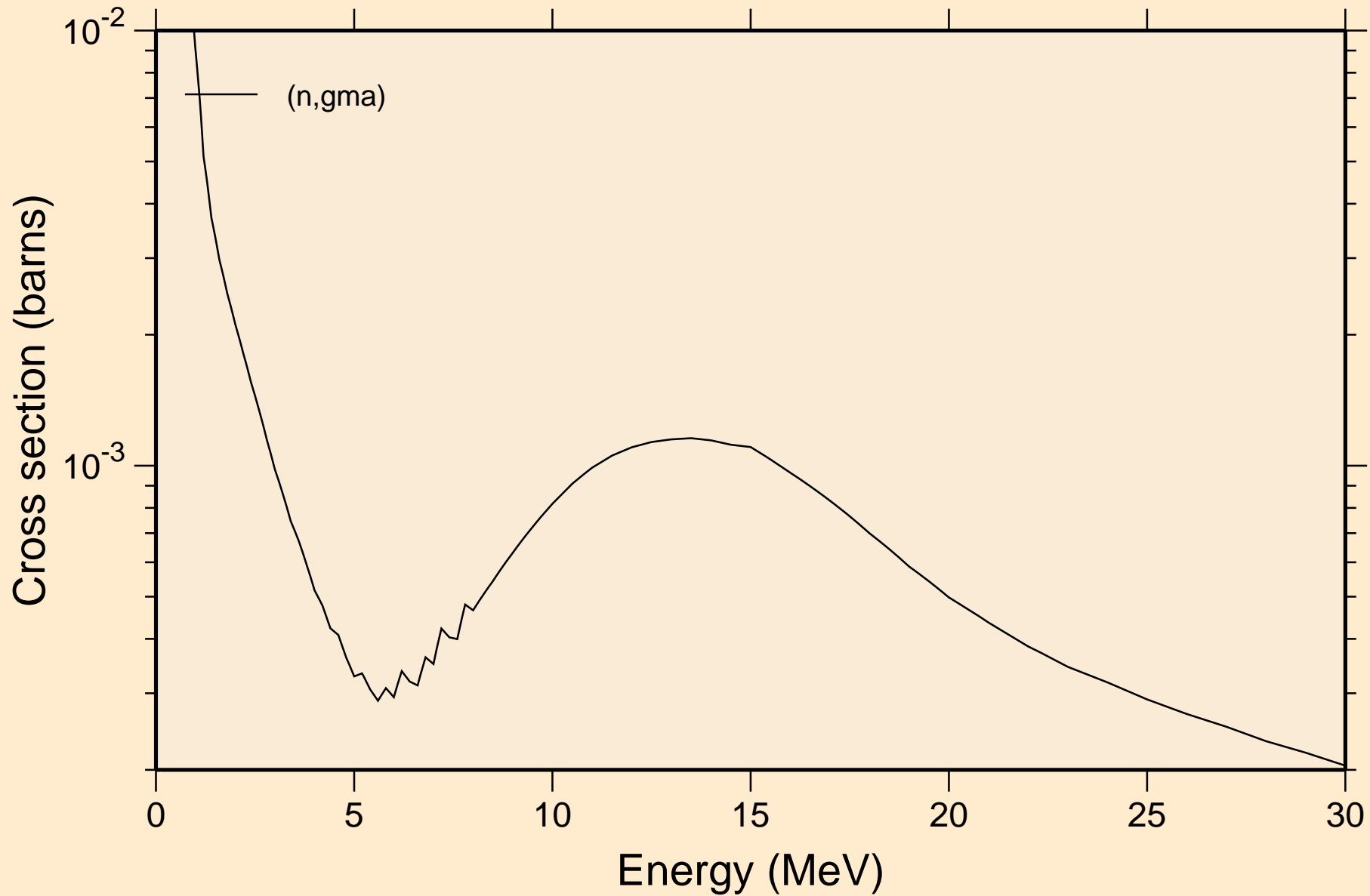

NB102 NEUTRON ACER TENDL-2024 LIBRARY; T=293.6K  
Inelastic levels

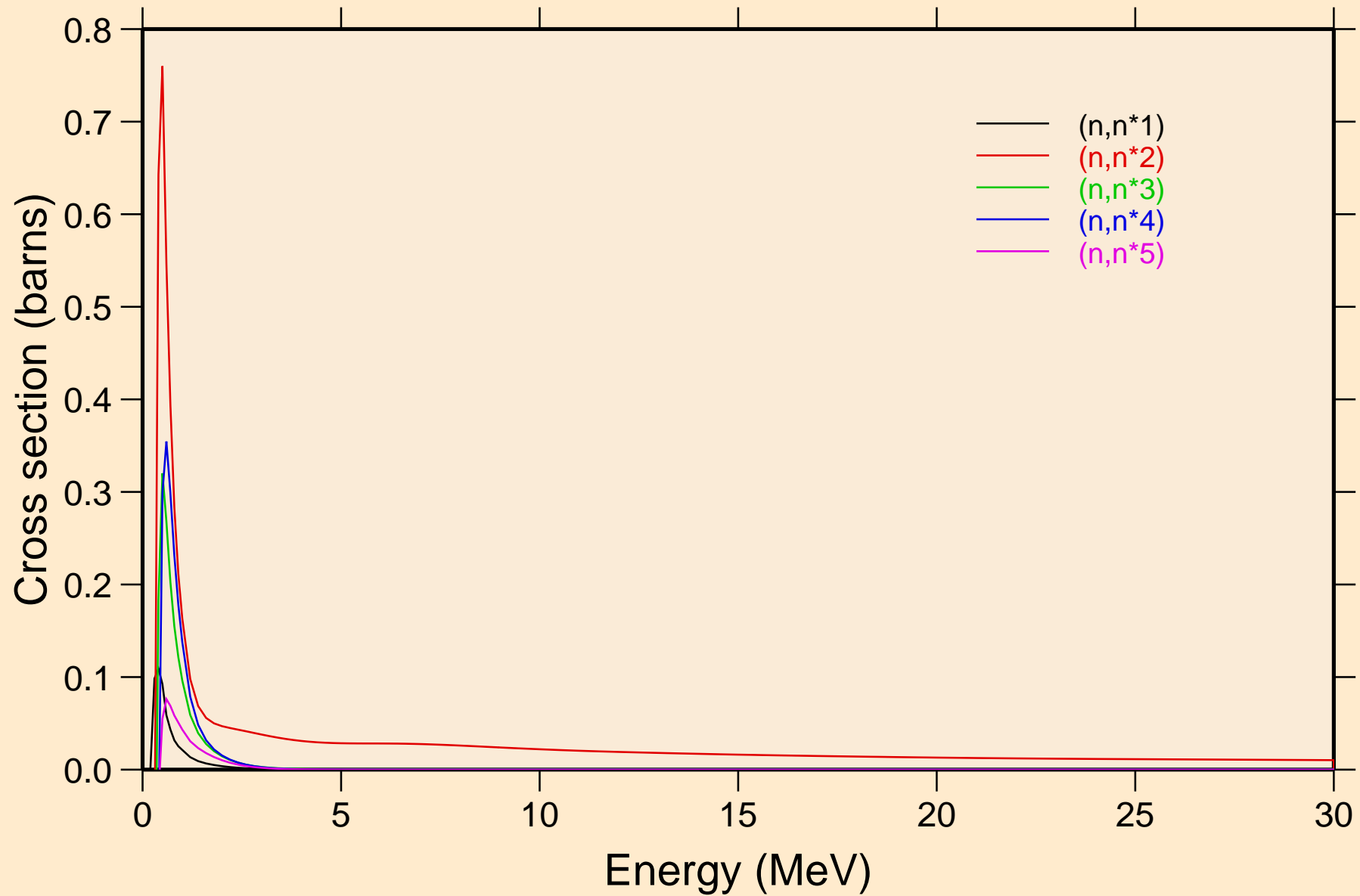

NB102 NEUTRON ACER TENDL-2024 LIBRARY; T=293.6K  
Inelastic levels

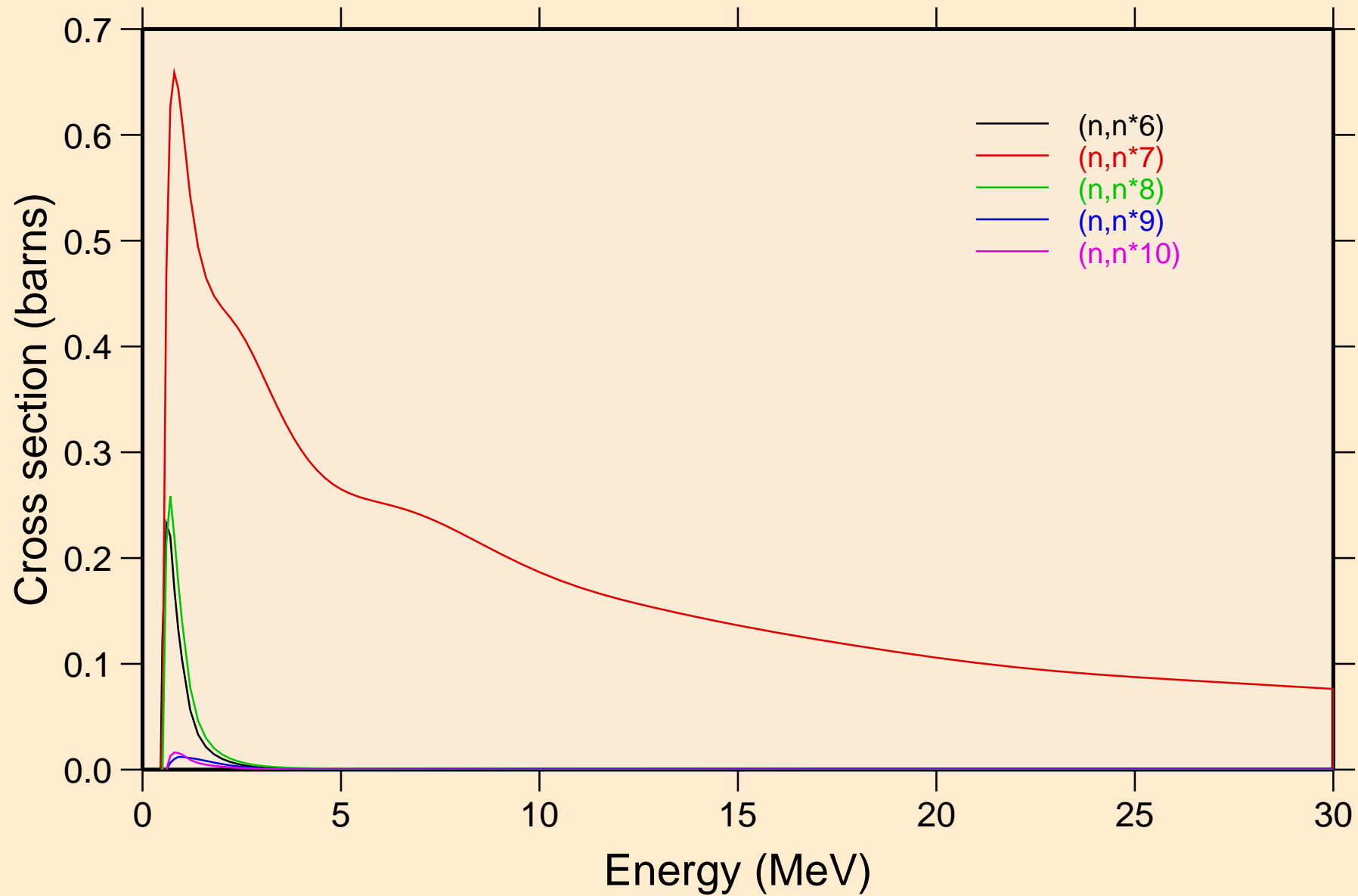

NB102 NEUTRON ACER TENDL-2024 LIBRARY; T=293.6K  
Inelastic levels

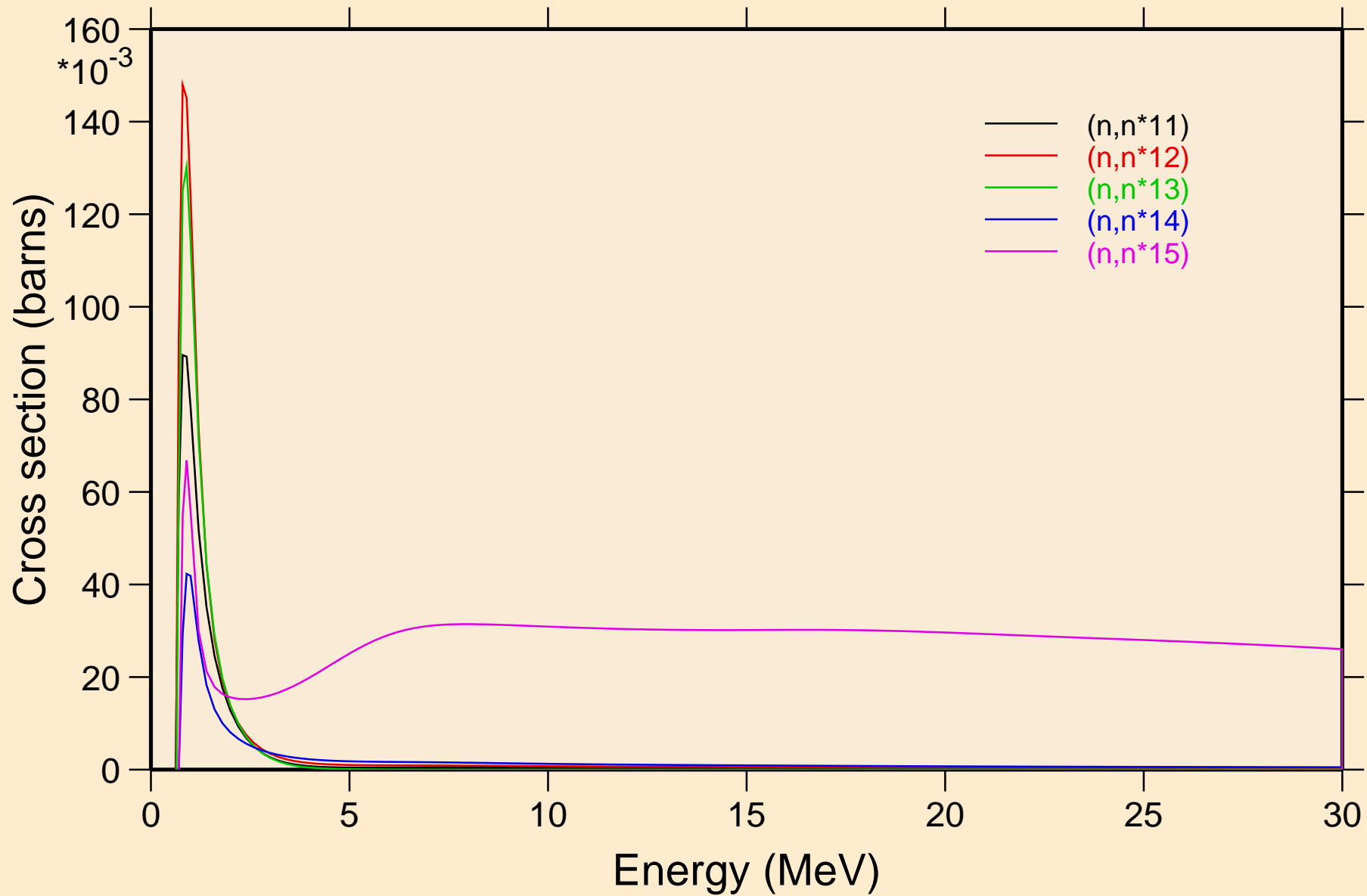

NB102 NEUTRON ACER TENDL-2024 LIBRARY; T=293.6K  
Inelastic levels

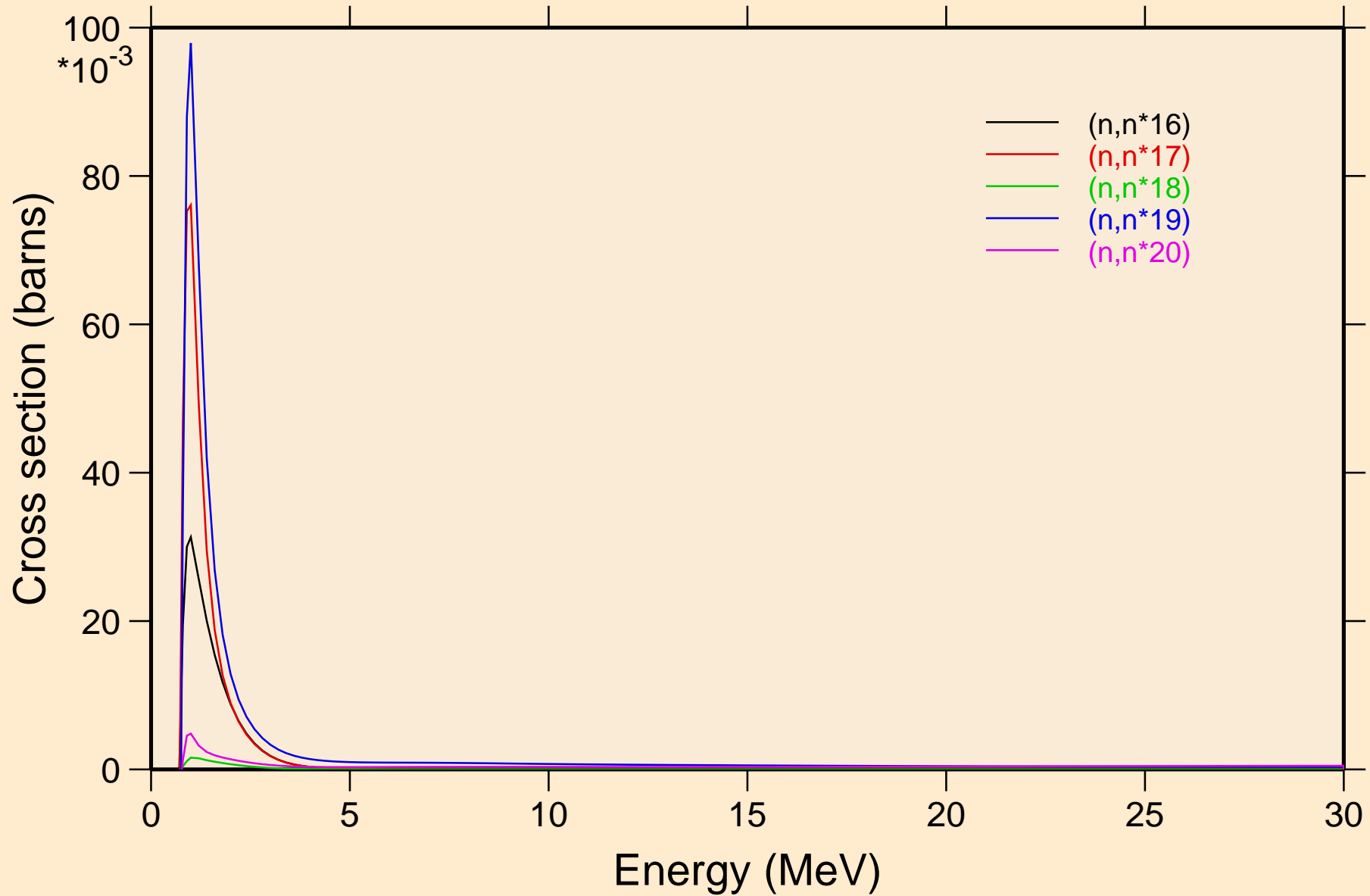

NB102 NEUTRON ACER TENDL-2024 LIBRARY; T=293.6K  
Inelastic levels

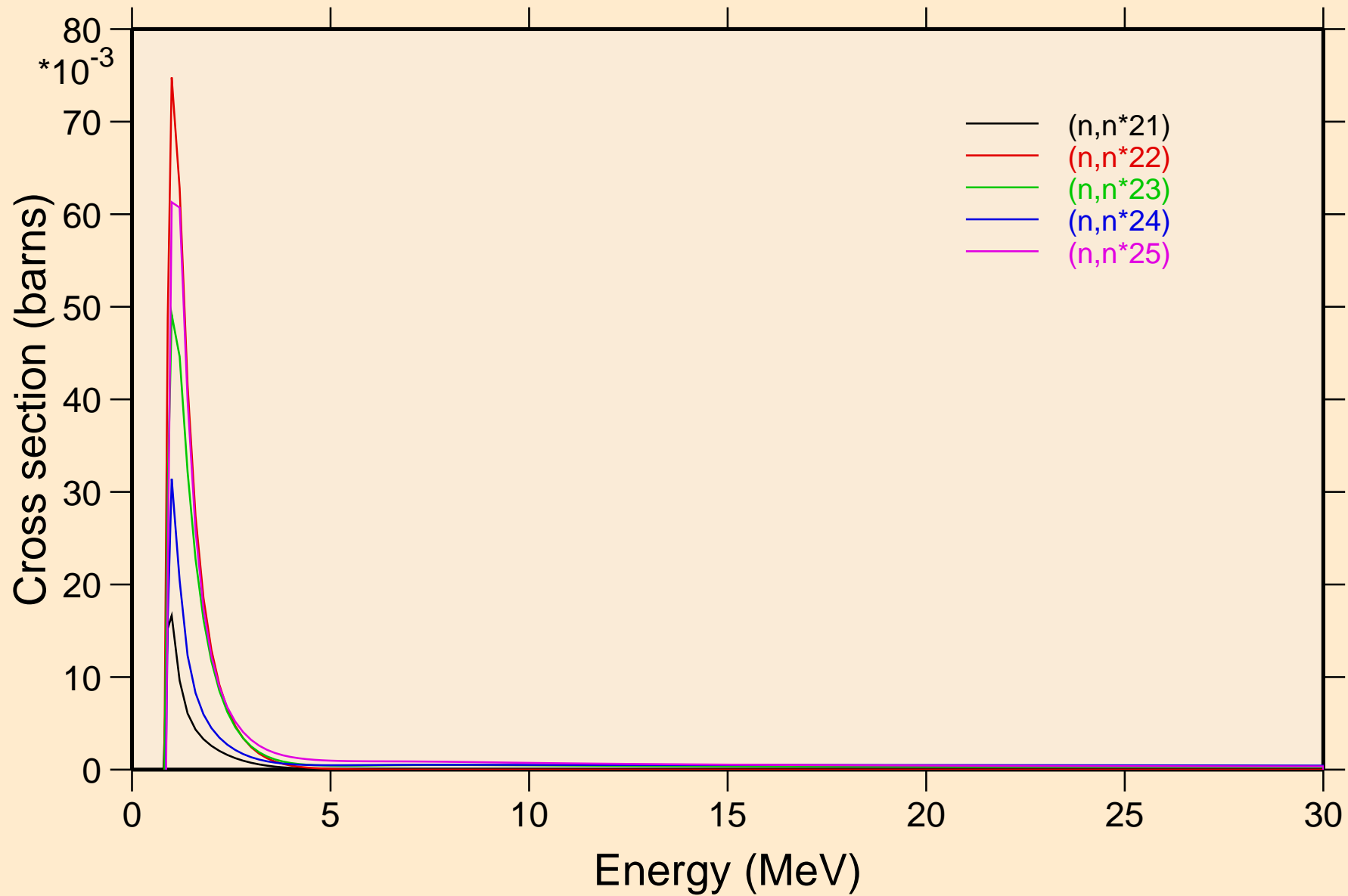

NB102 NEUTRON ACER TENDL-2024 LIBRARY; T=293.6K  
Inelastic levels

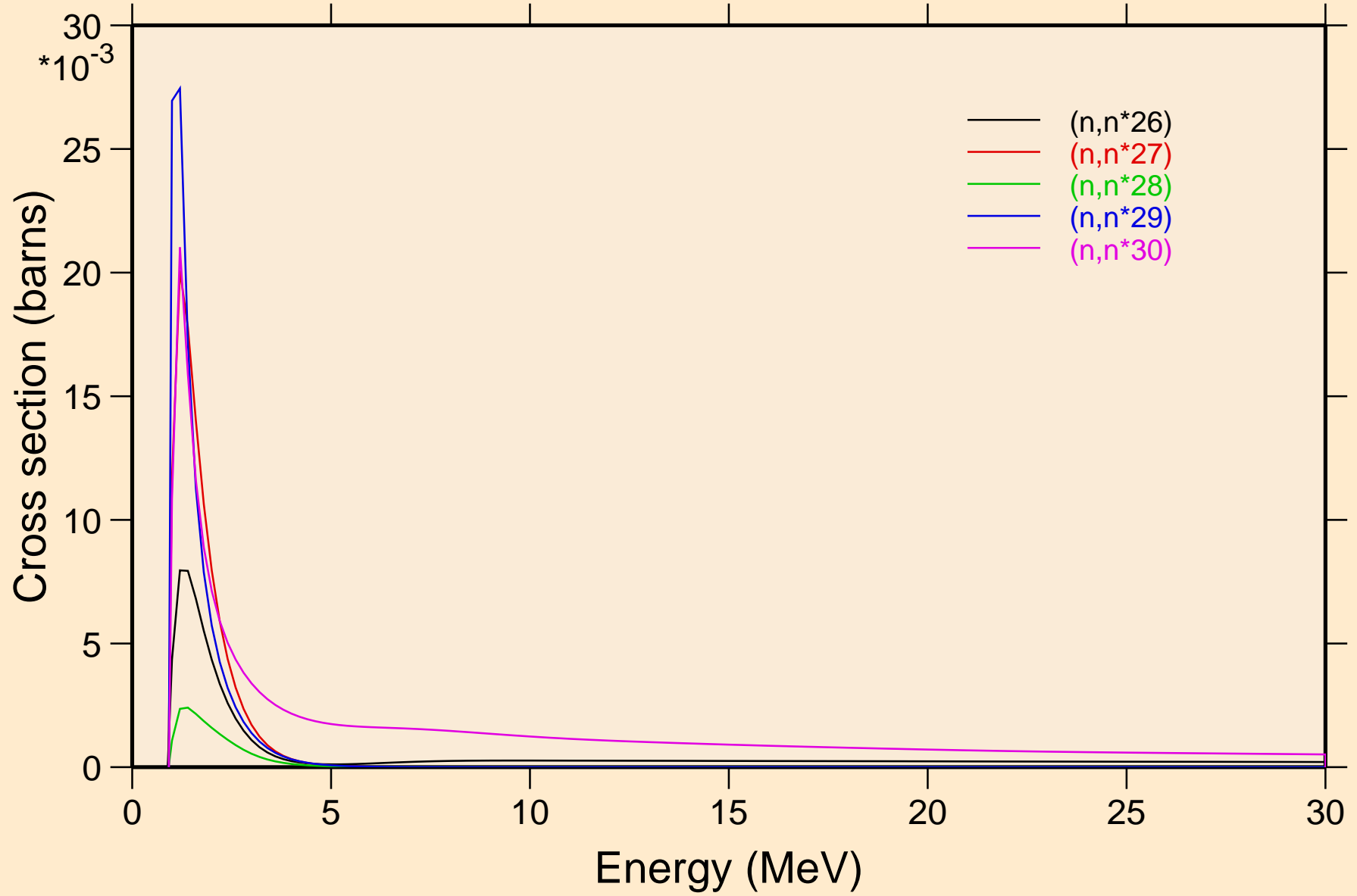

# NB102 NEUTRON ACER TENDL-2024 LIBRARY; T=293.6K

## Threshold reactions

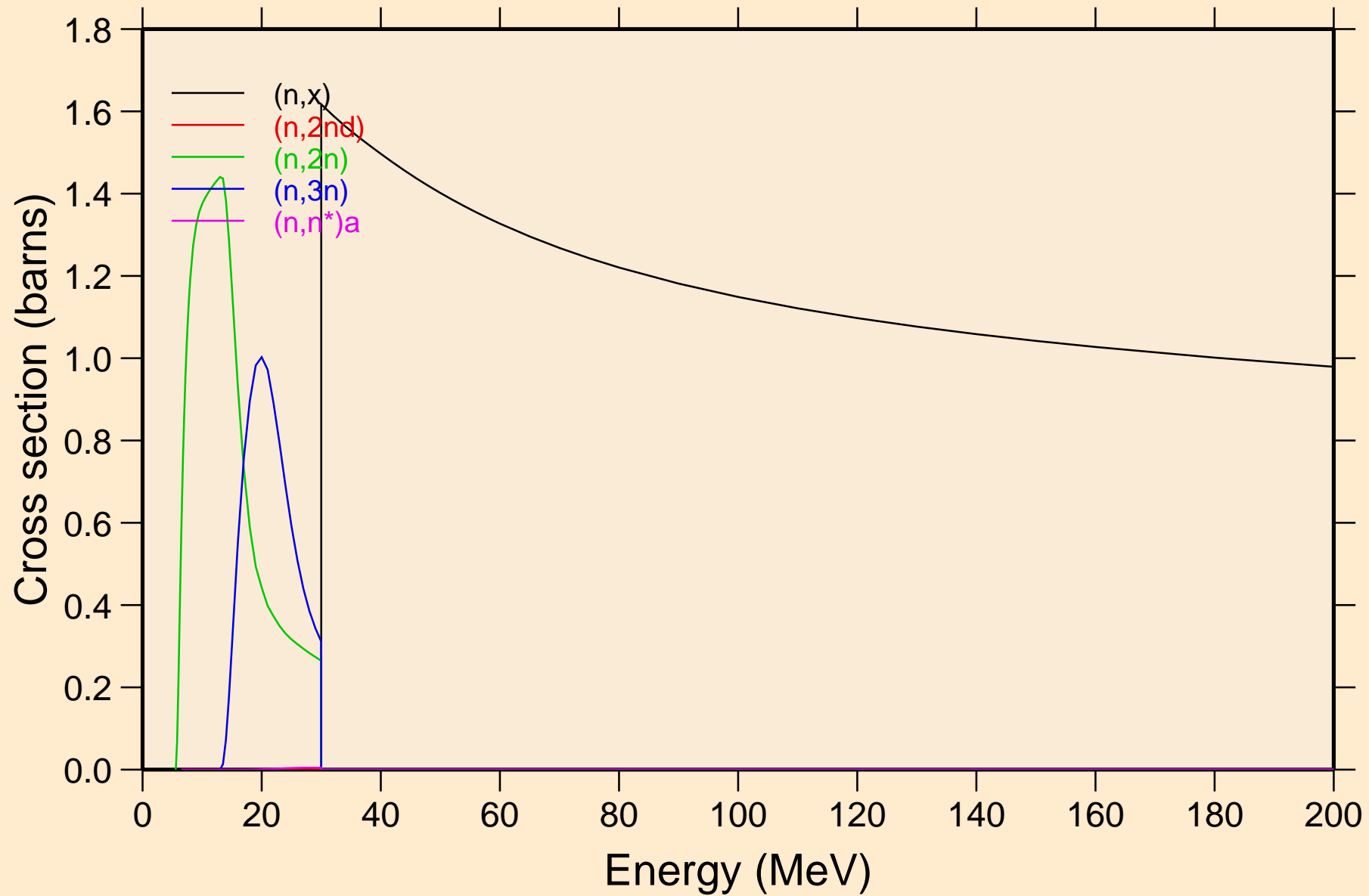

NB102 NEUTRON ACER TENDL-2024 LIBRARY; T=293.6K  
Threshold reactions

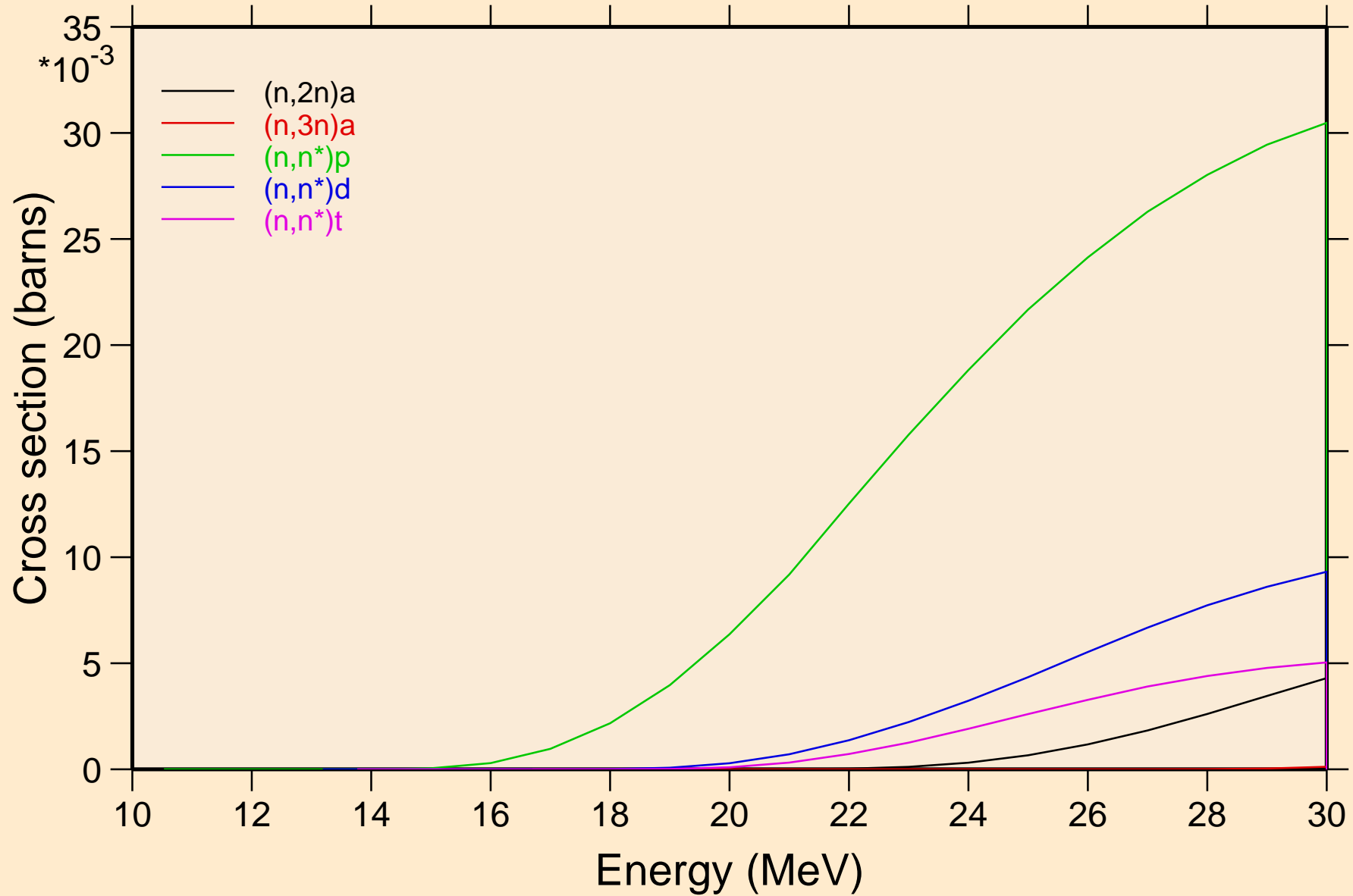

NB102 NEUTRON ACER TENDL-2024 LIBRARY; T=293.6K  
Threshold reactions

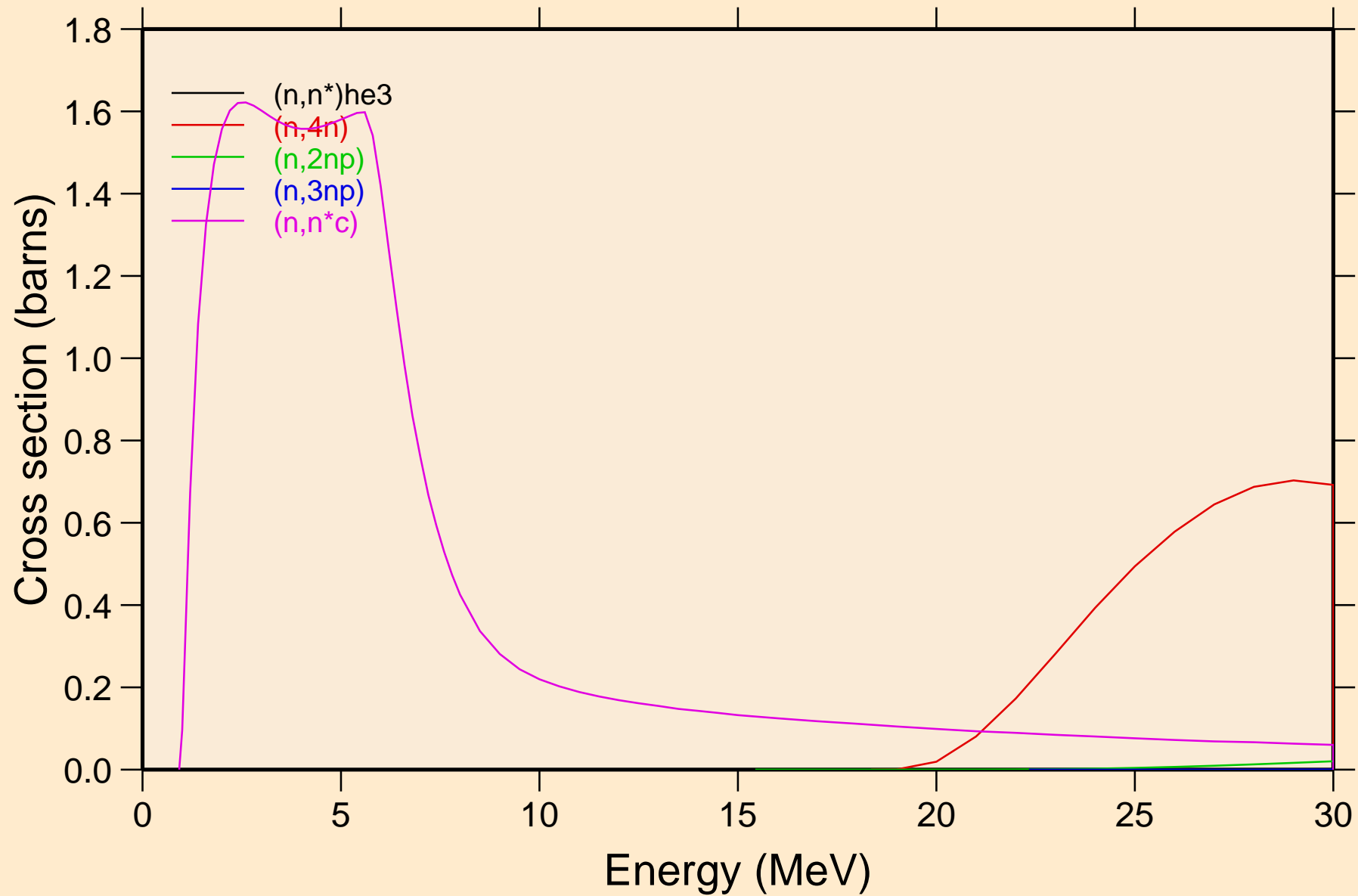

# NB102 NEUTRON ACER TENDL-2024 LIBRARY; T=293.6K

## Threshold reactions

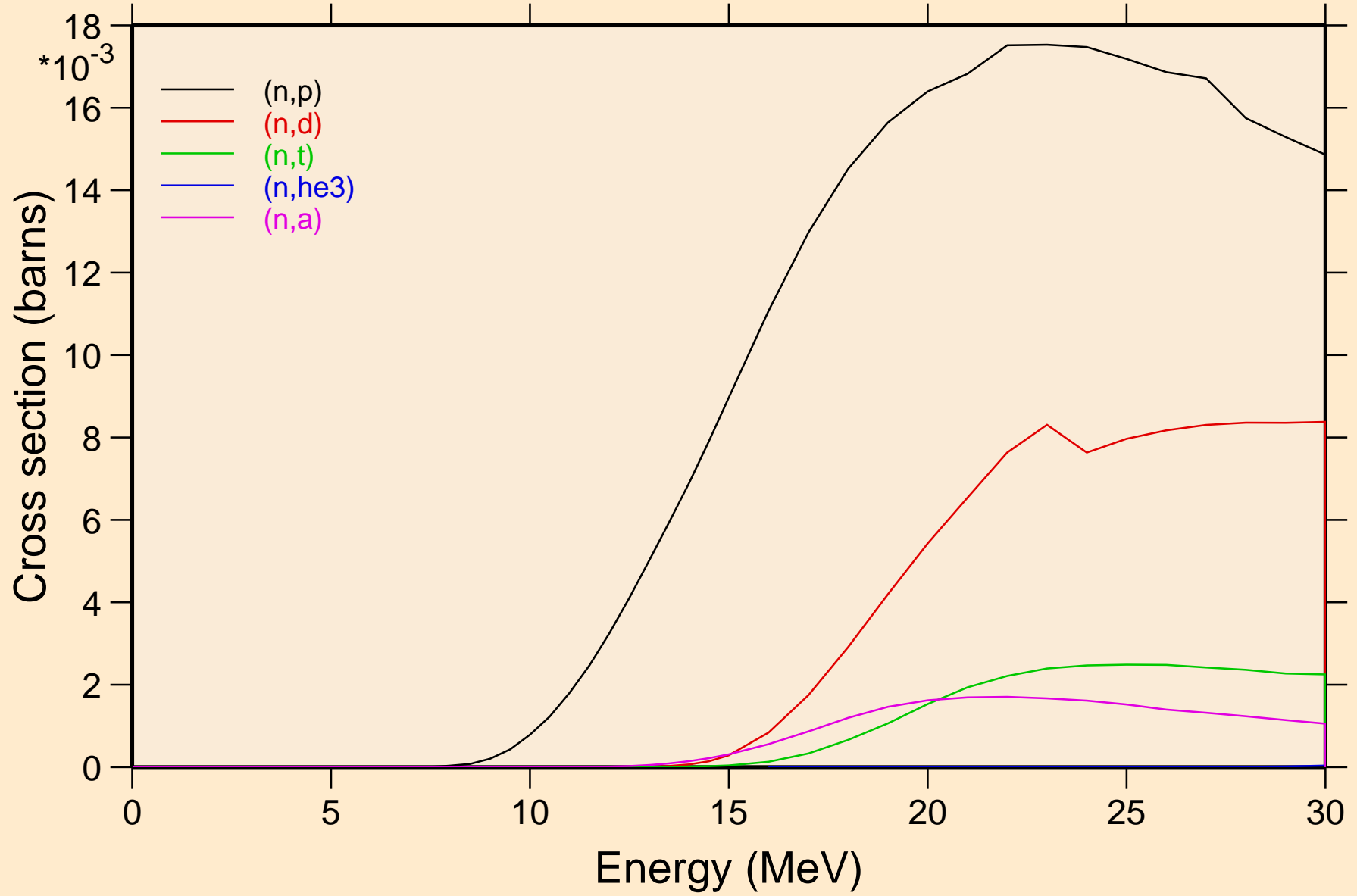

NB102 NEUTRON ACER TENDL-2024 LIBRARY; T=293.6K  
Threshold reactions

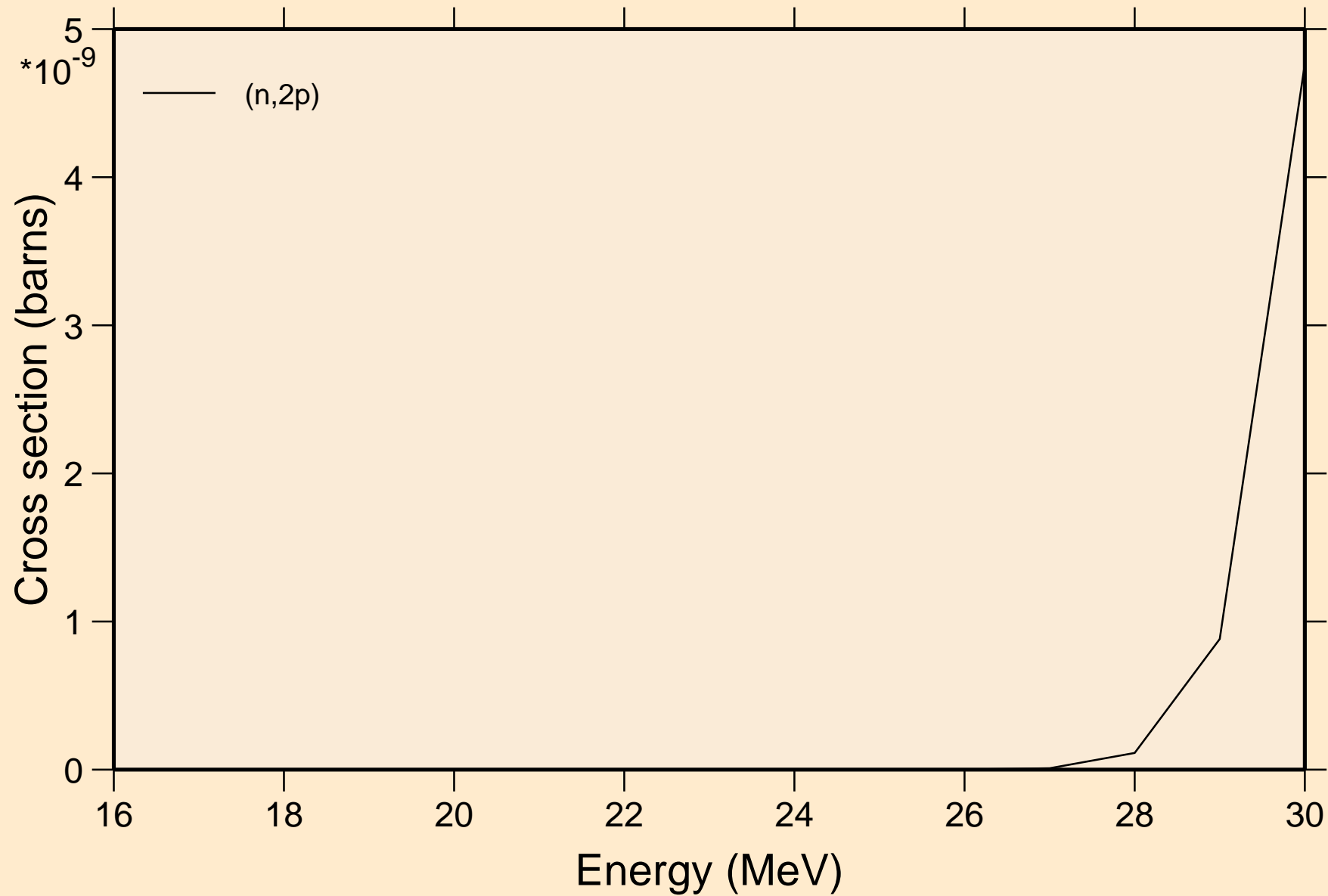

NB102 NEUTRON ACER TENDL-2024 LIBRARY; T=293.6K  
Threshold reactions

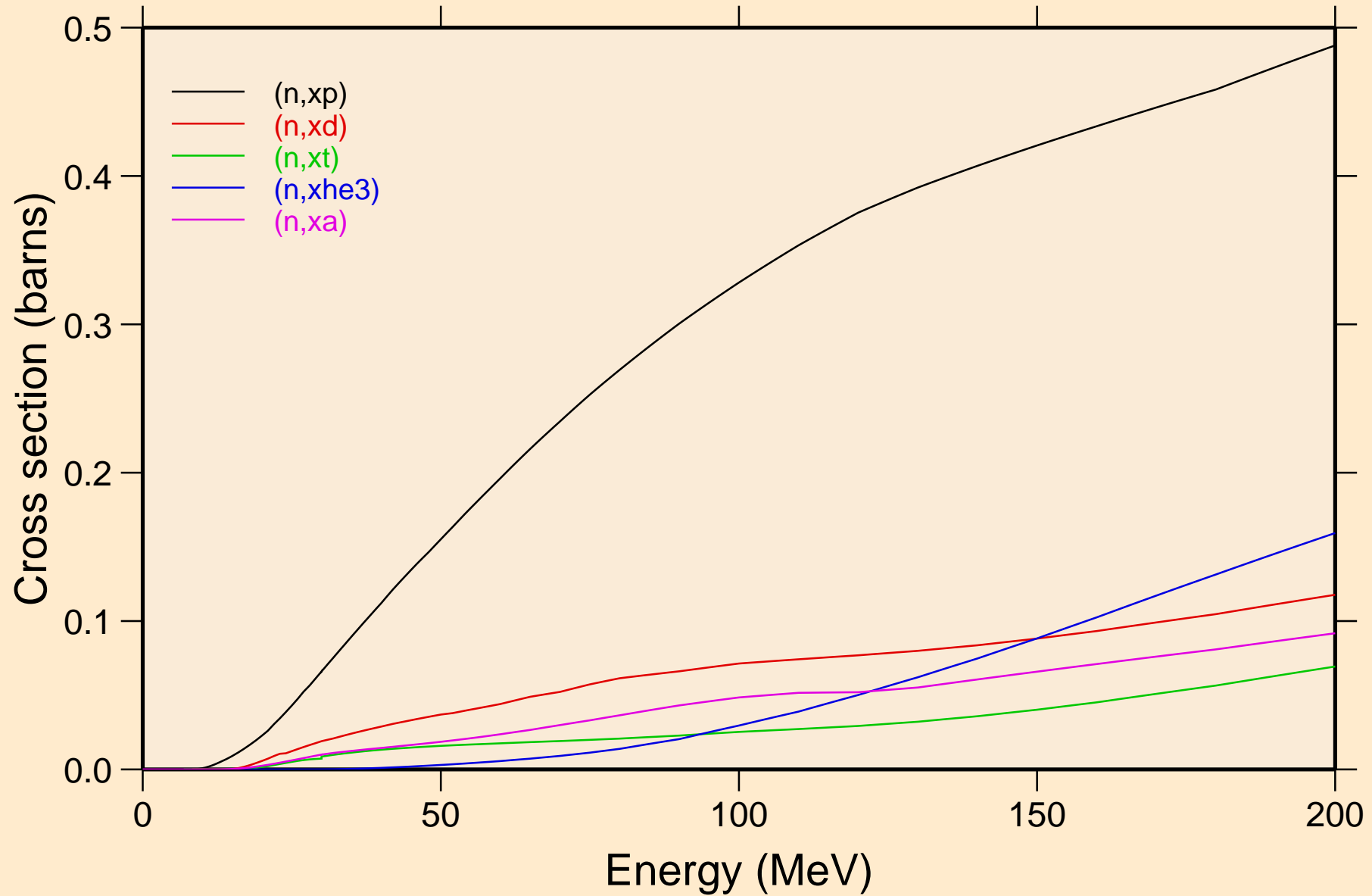

NB102 NEUTRON ACER TENDL-2024 LIBRARY; T=293.6K  
angular distribution for elastic

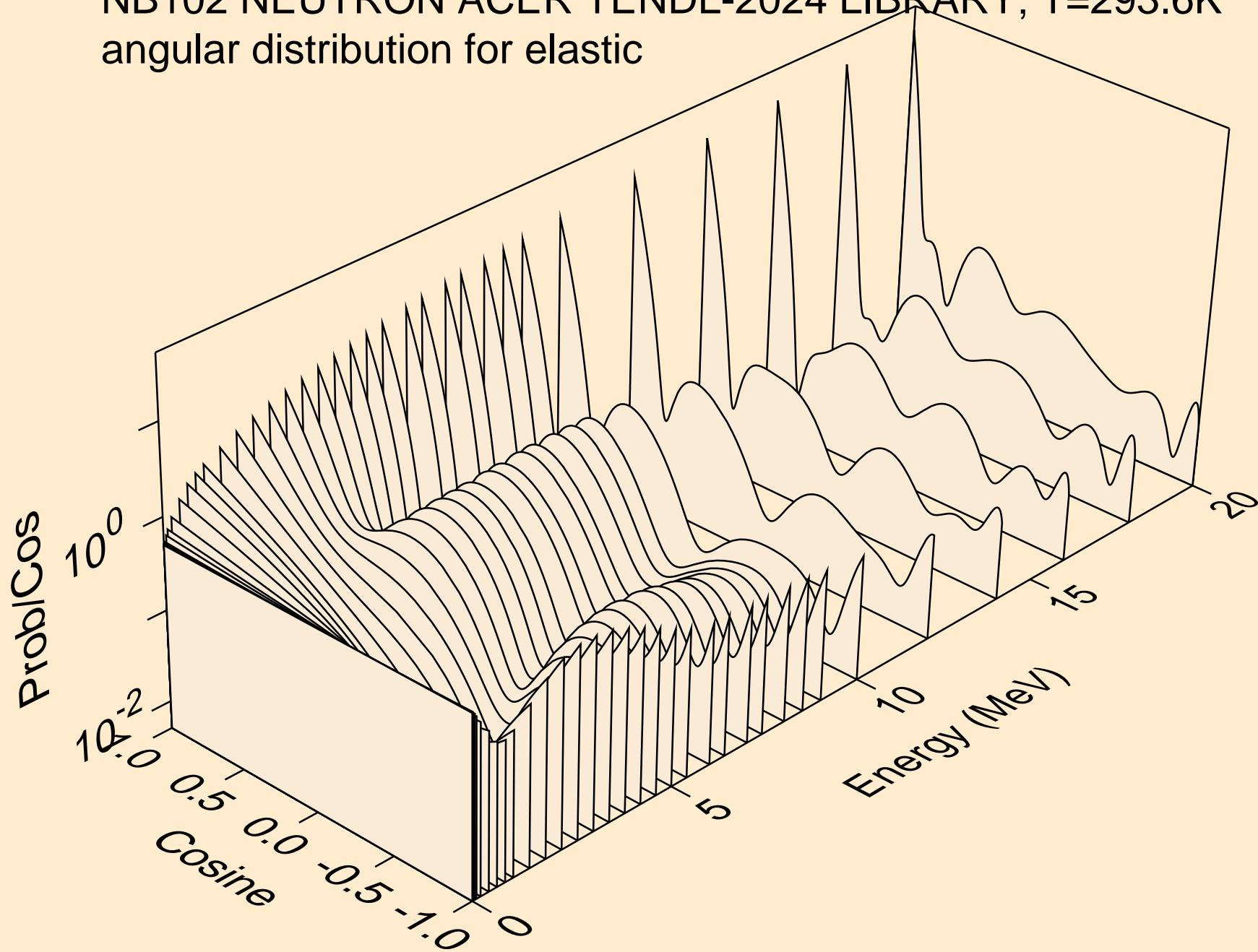

NB102 NEUTRON ACER TENDL-2024 LIBRARY; T=293.6K  
angular distribution for elastic

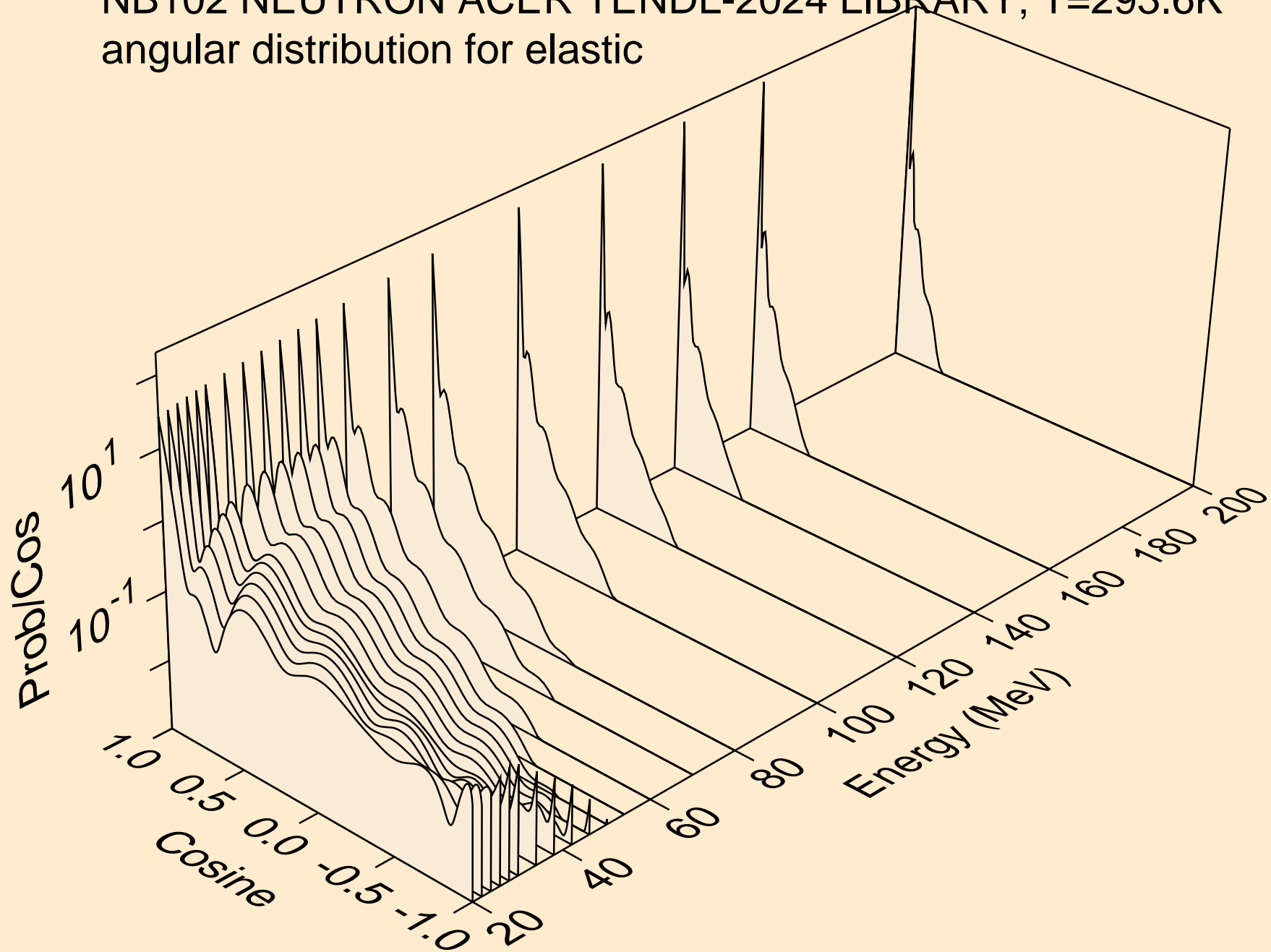

NB102 NEUTRON ACER TENDL-2024 LIBRARY; T=293.6K  
angular distribution for (n,n\*1)

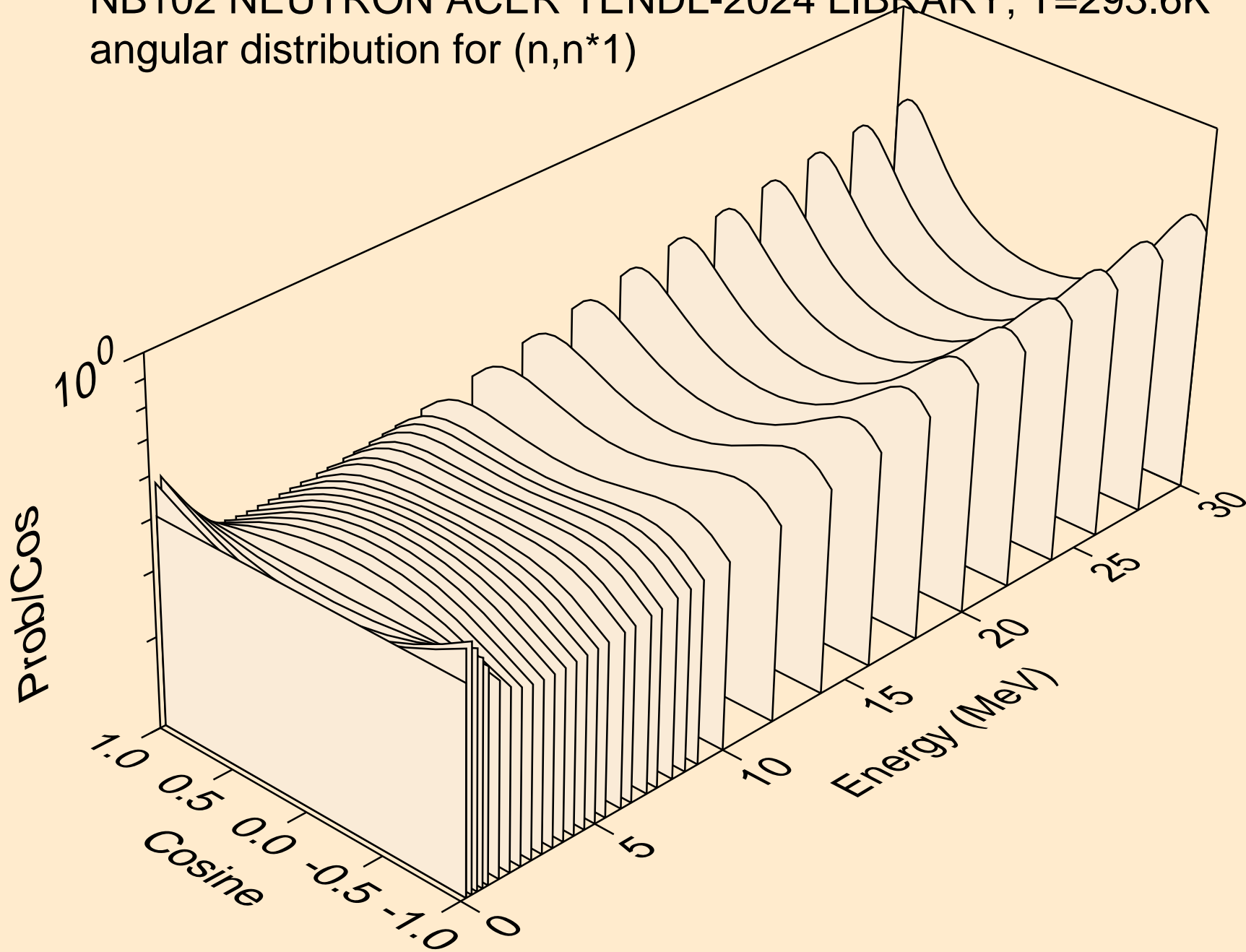

NB102 NEUTRON ACER TENDL-2024 LIBRARY; T=293.6K  
angular distribution for (n,n\*2)

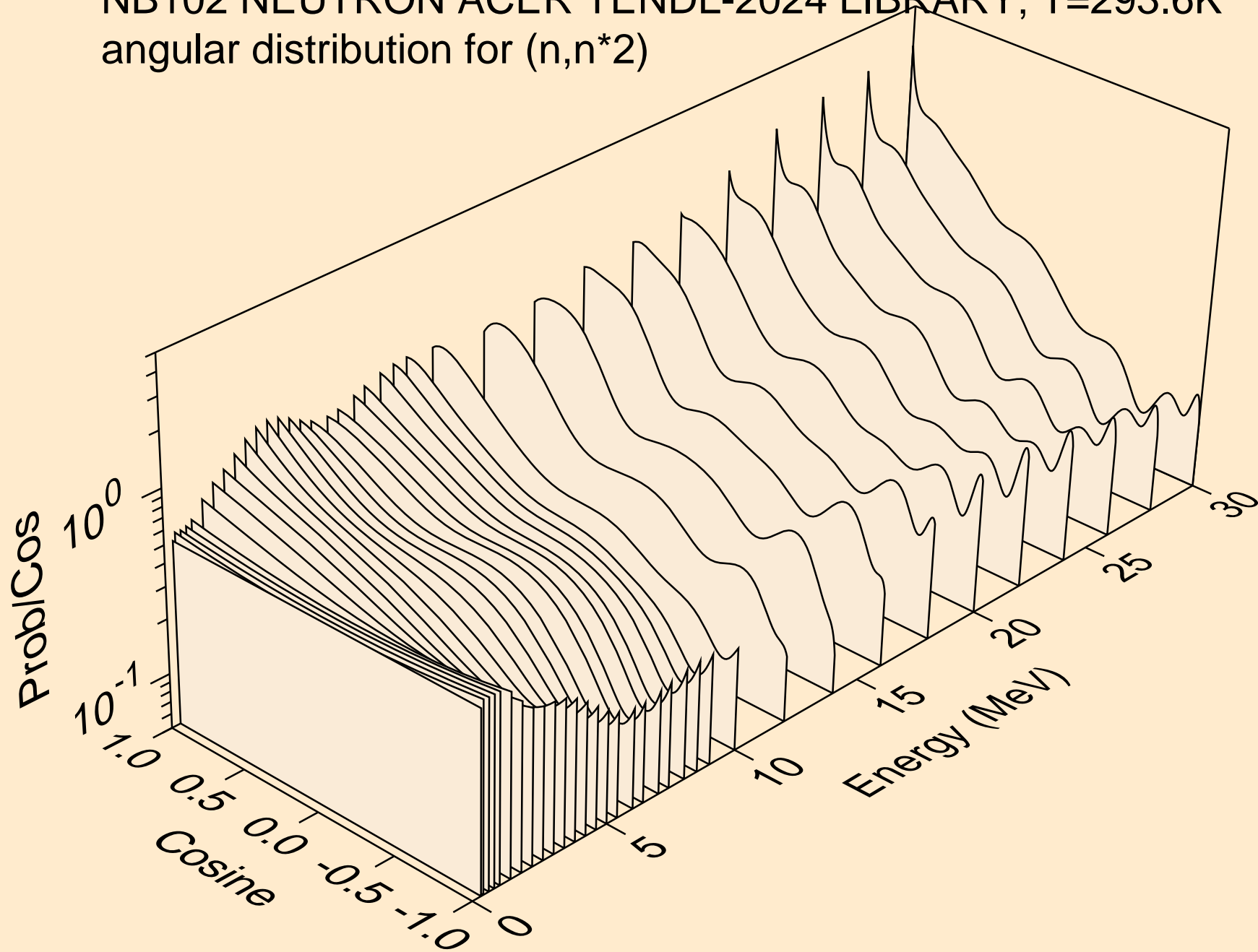

NB102 NEUTRON ACER TENDL-2024 LIBRARY; T=293.6K  
angular distribution for (n,n\*3)

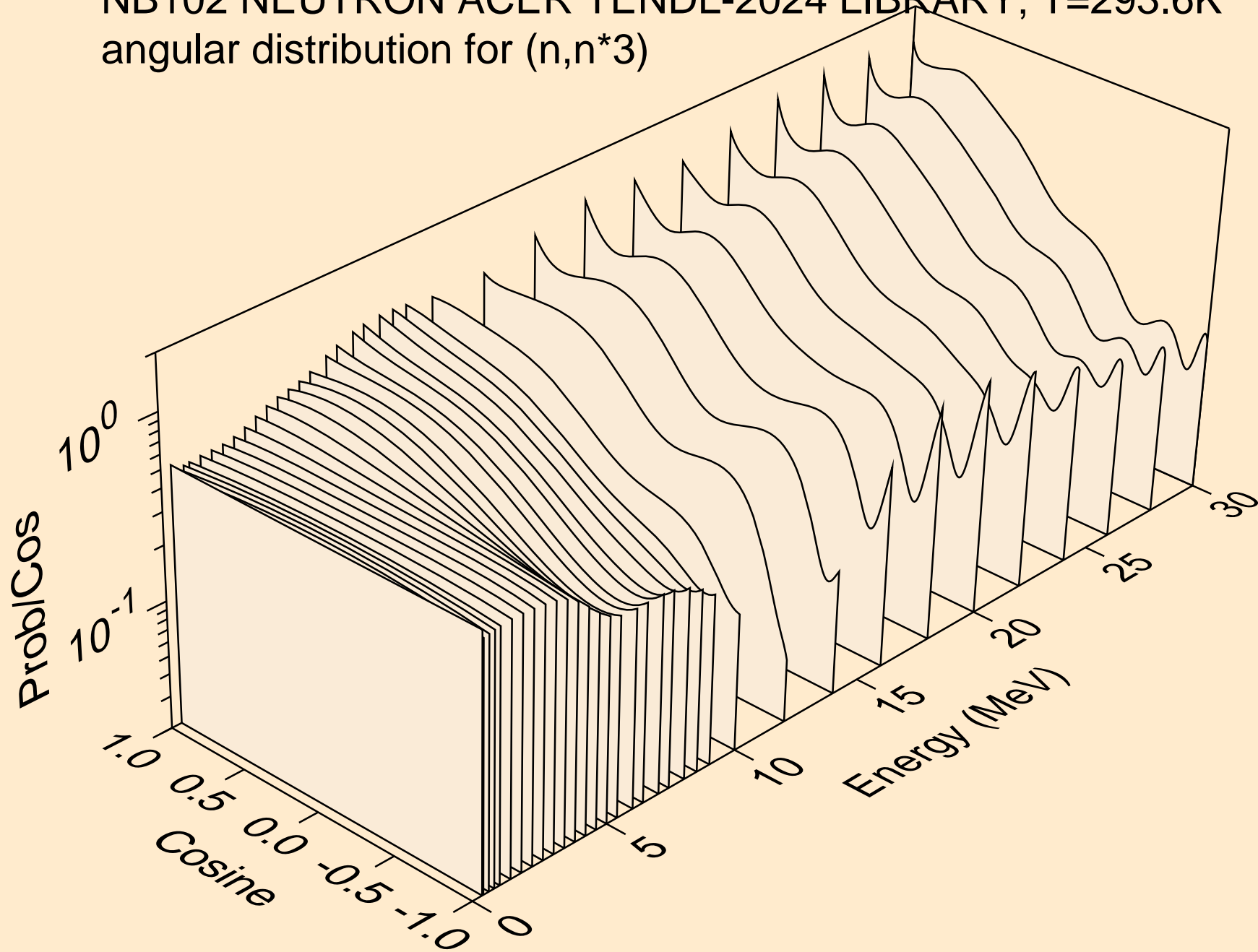

NB102 NEUTRON ACER TENDL-2024 LIBRARY; T=293.6K  
angular distribution for (n,n\*4)

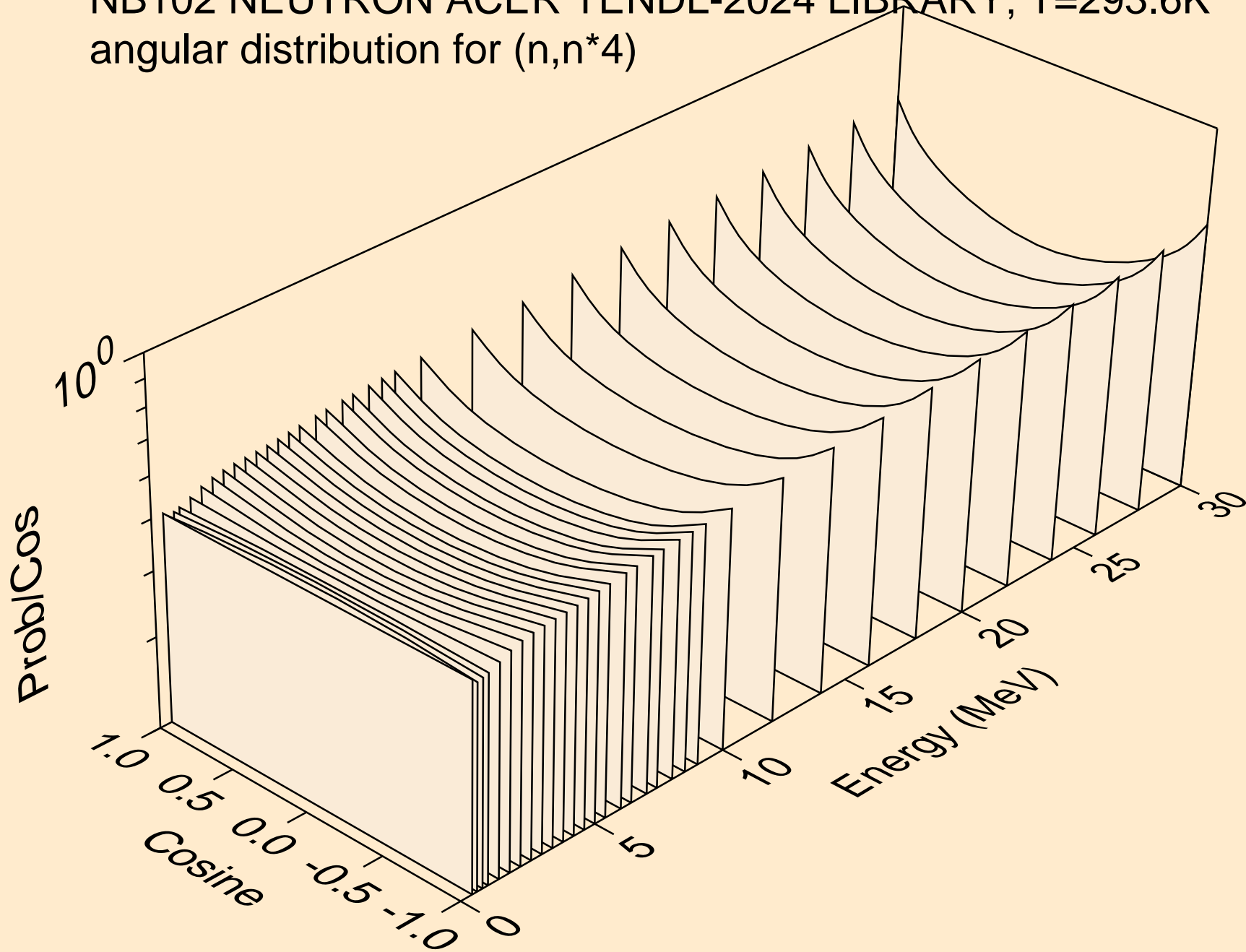

NB102 NEUTRON ACER TENDL-2024 LIBRARY; T=293.6K  
angular distribution for (n,n\*5)

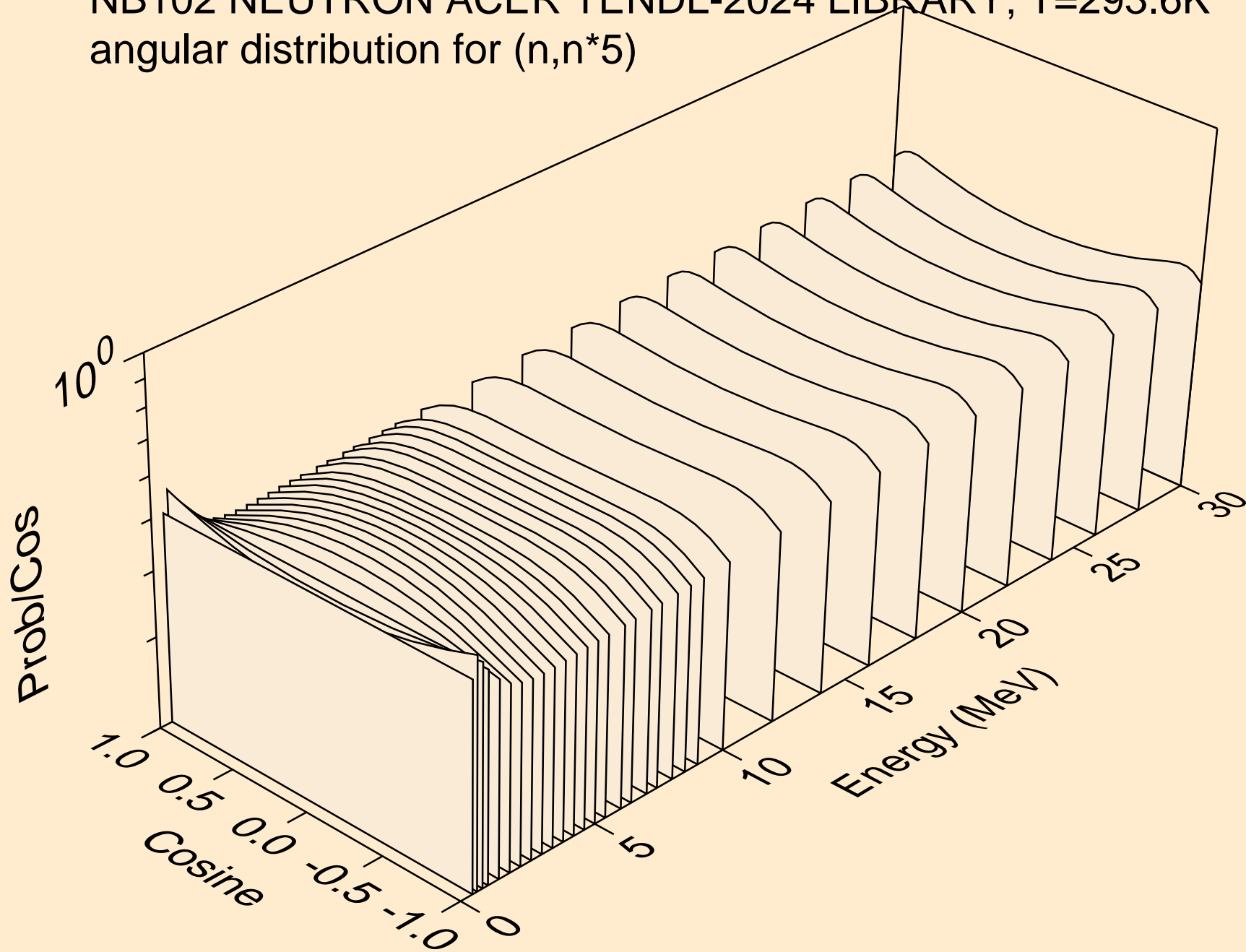

NB102 NEUTRON ACER TENDL-2024 LIBRARY; T=293.6K  
angular distribution for (n,n\*6)

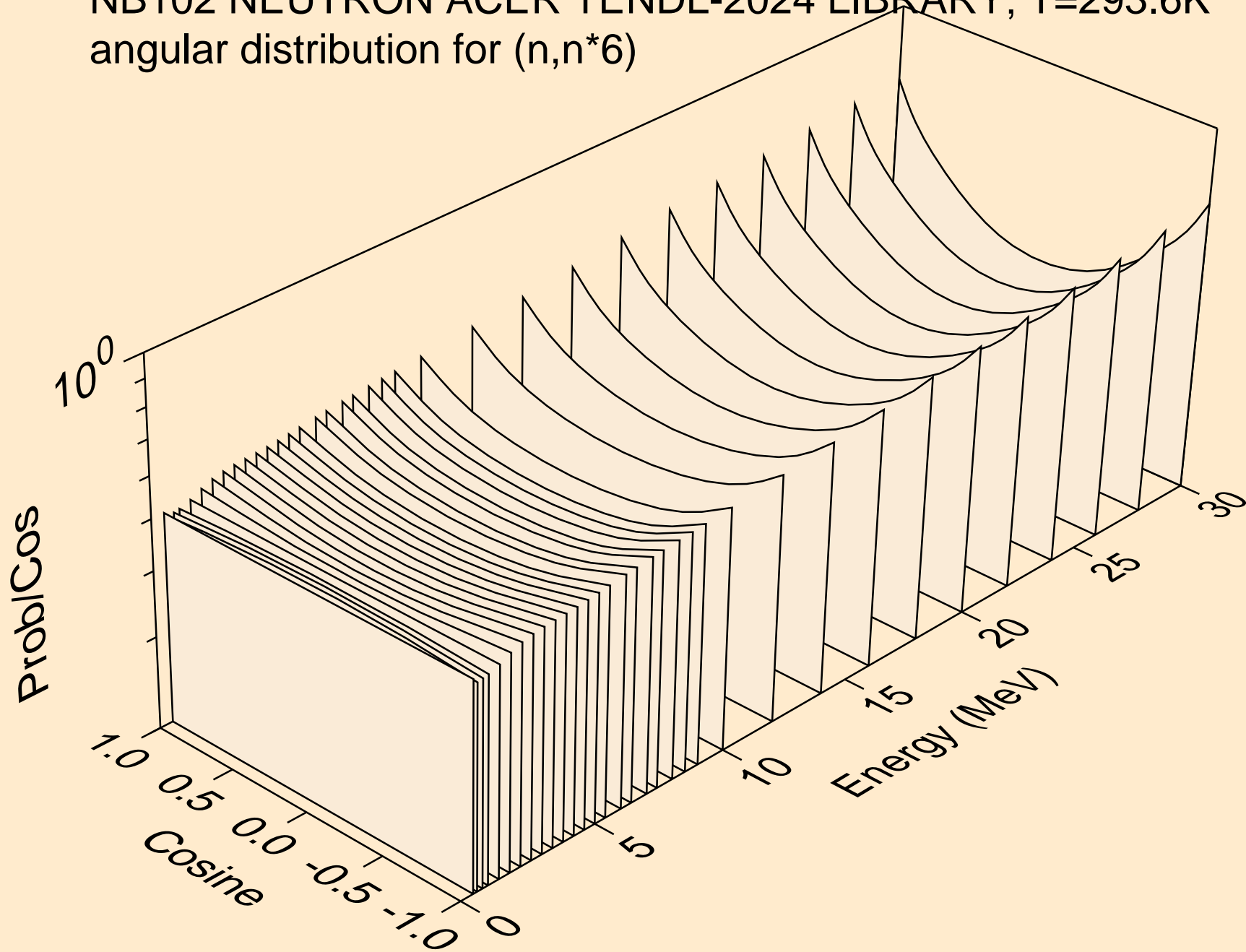

NB102 NEUTRON ACER TENDL-2024 LIBRARY; T=293.6K  
angular distribution for (n,n\*7)

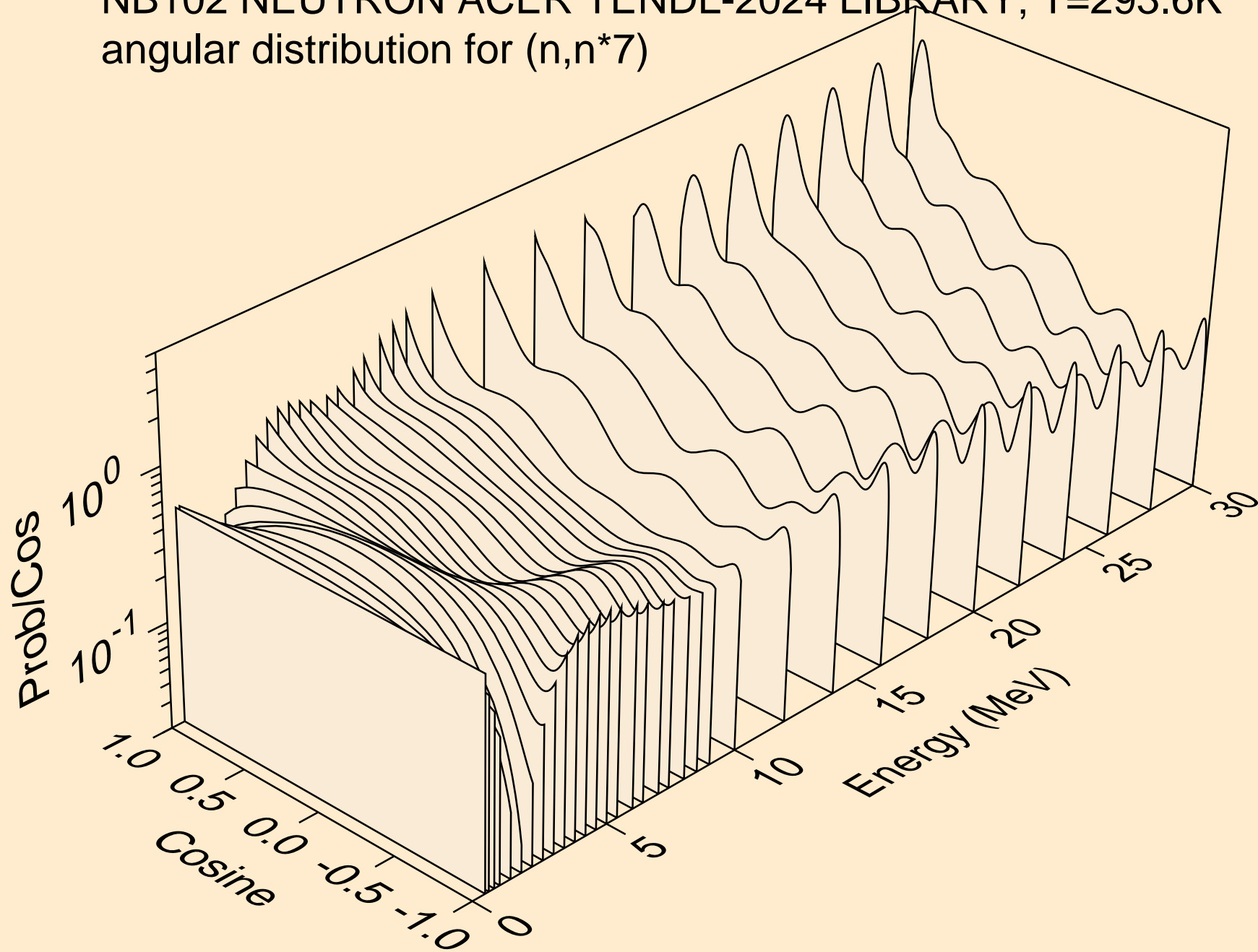

NB102 NEUTRON ACER TENDL-2024 LIBRARY; T=293.6K  
angular distribution for (n,n\*8)

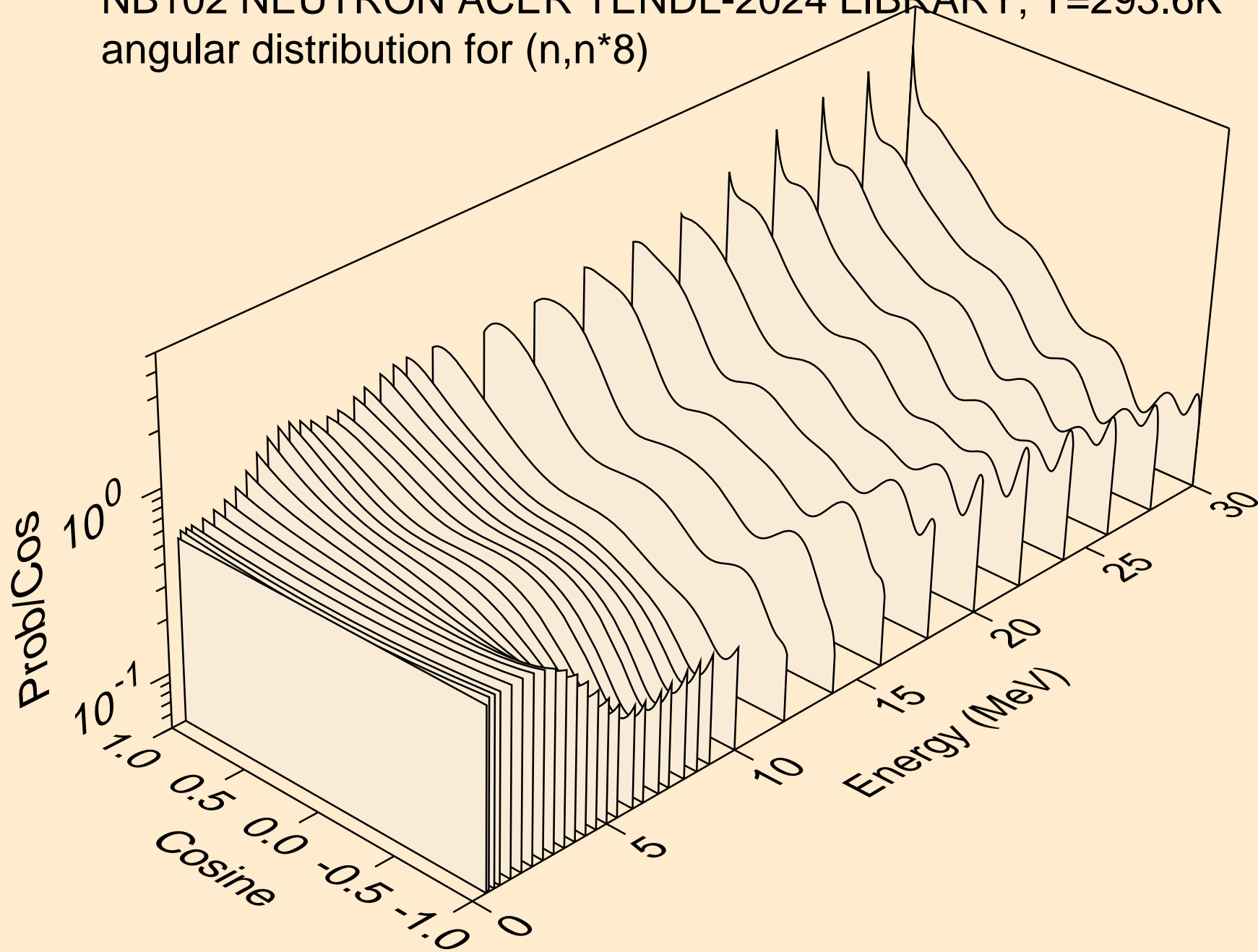

NB102 NEUTRON ACER TENDL-2024 LIBRARY; T=293.6K  
angular distribution for (n,n\*9)

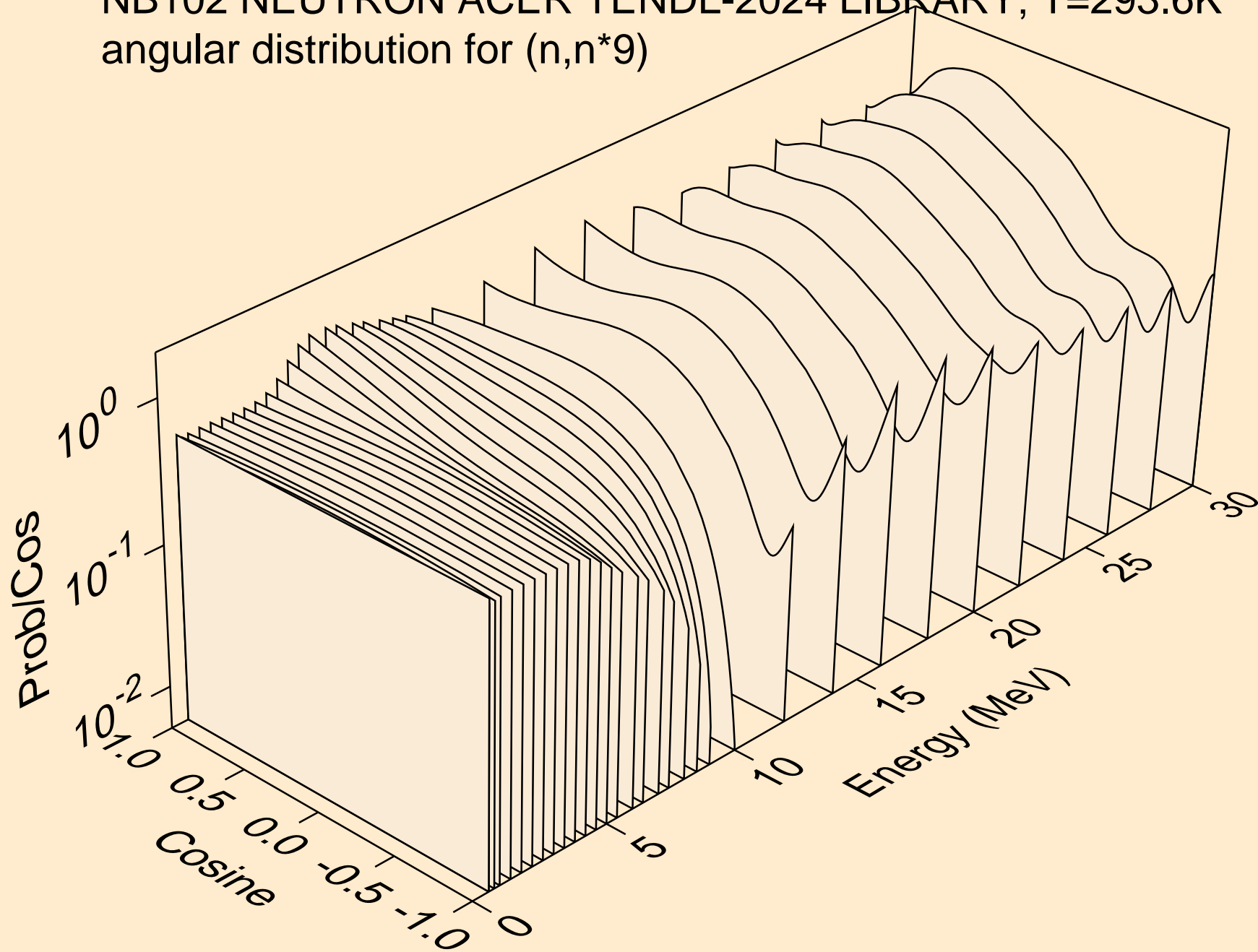

NB102 NEUTRON ACER TENDL-2024 LIBRARY; T=293.6K  
angular distribution for (n,n\*10)

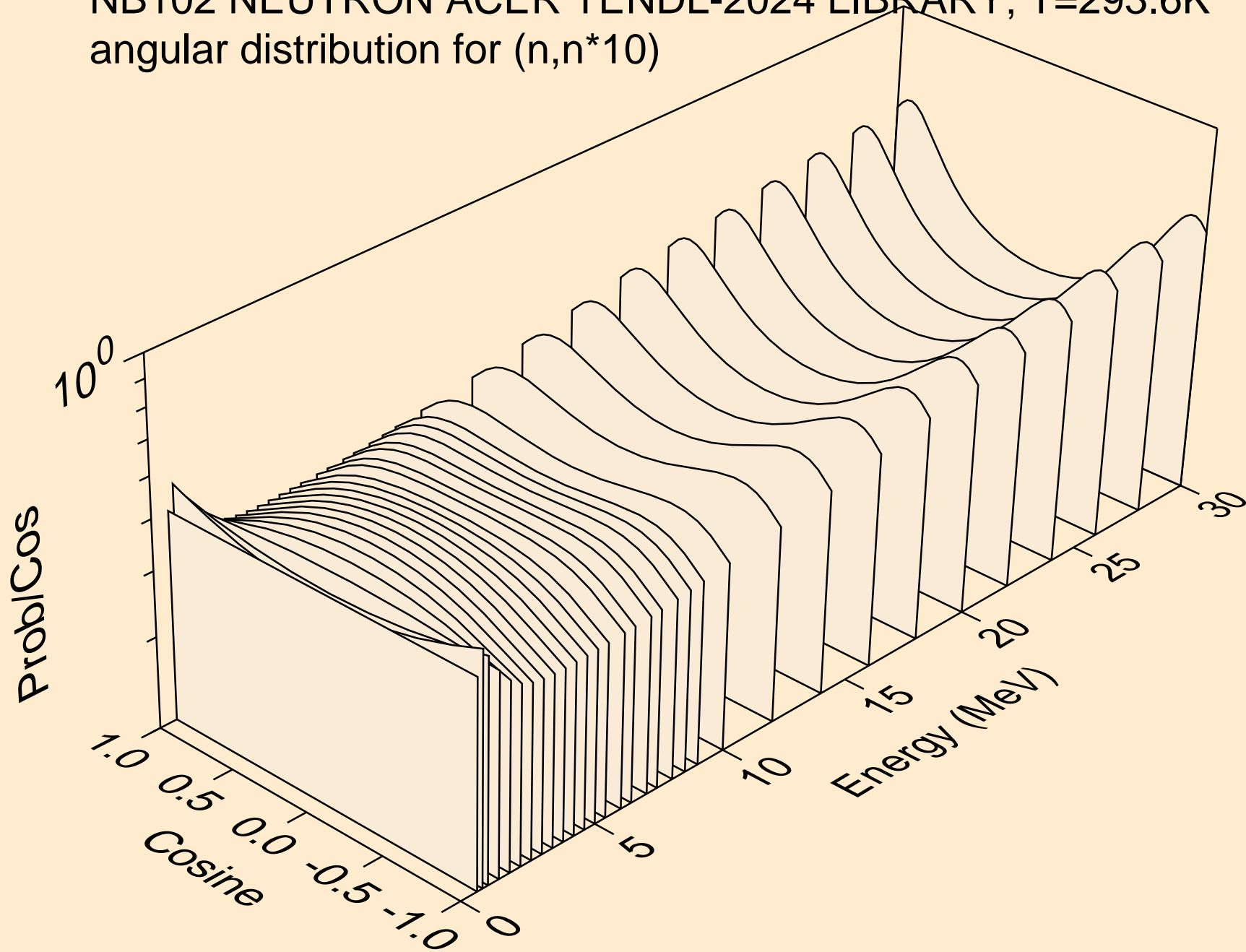

NB102 NEUTRON ACER TENDL-2024 LIBRARY; T=293.6K  
angular distribution for (n,n\*11)

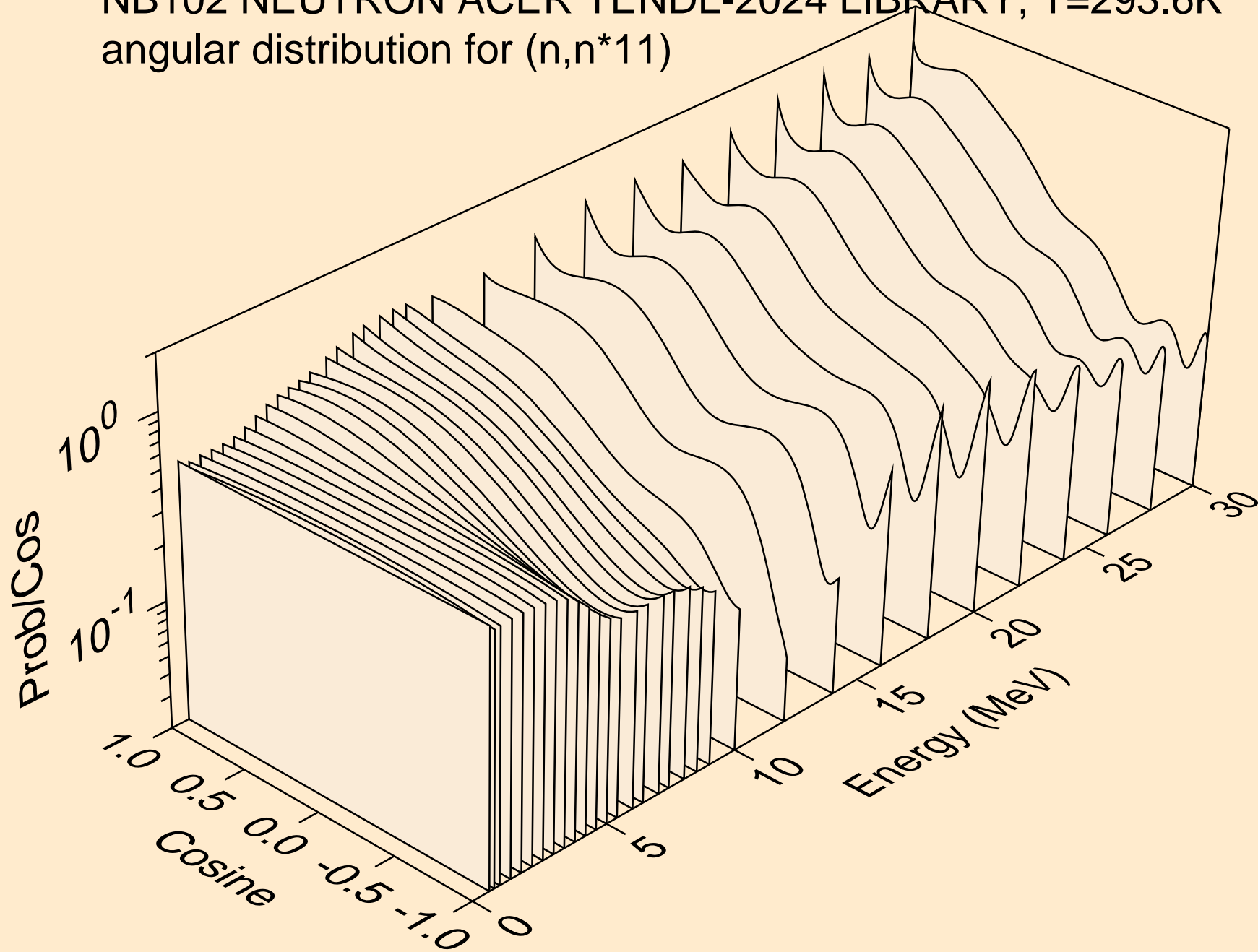

NB102 NEUTRON ACER TENDL-2024 LIBRARY; T=293.6K  
angular distribution for (n,n\*12)

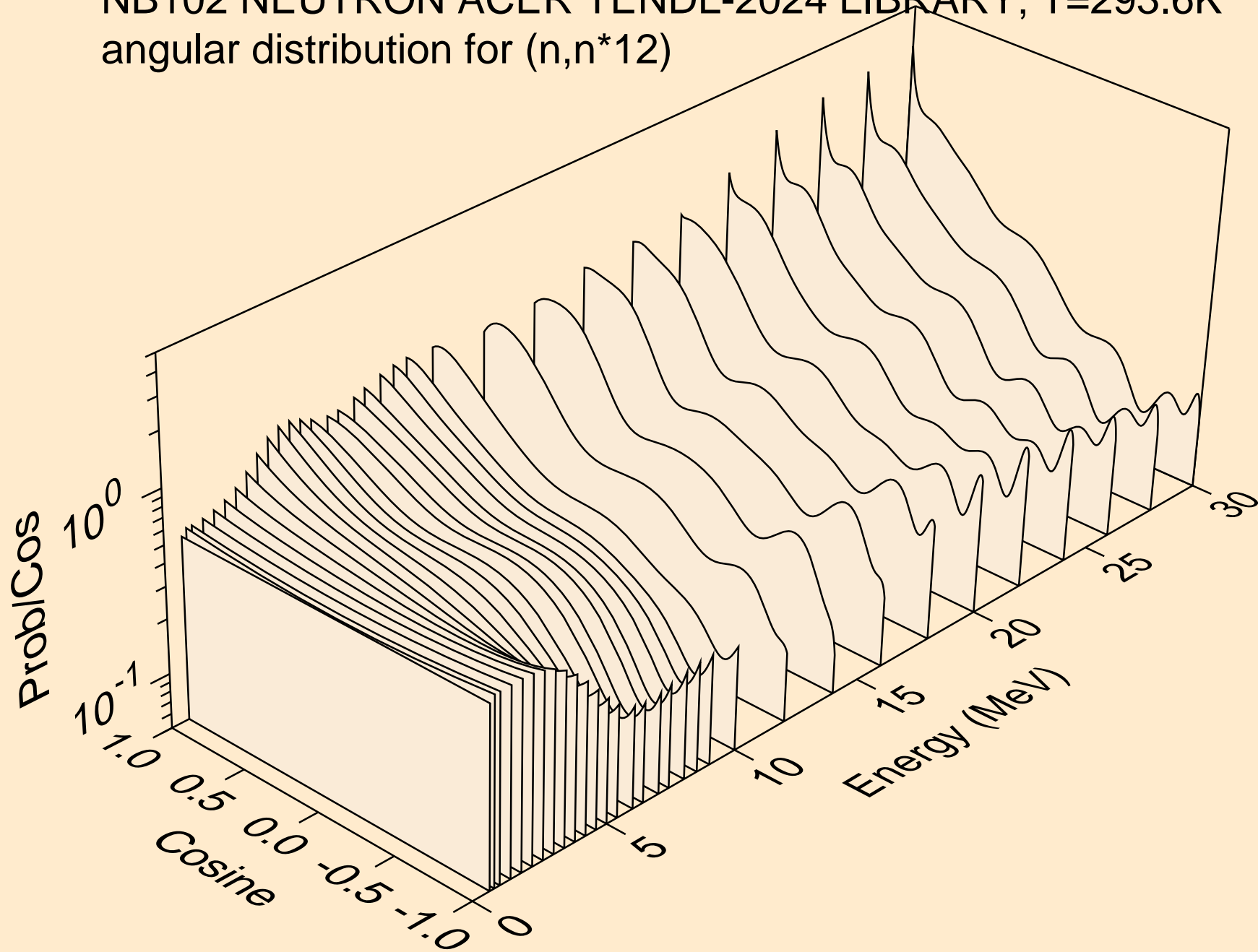

NB102 NEUTRON ACER TENDL-2024 LIBRARY; T=293.6K  
angular distribution for (n,n\*13)

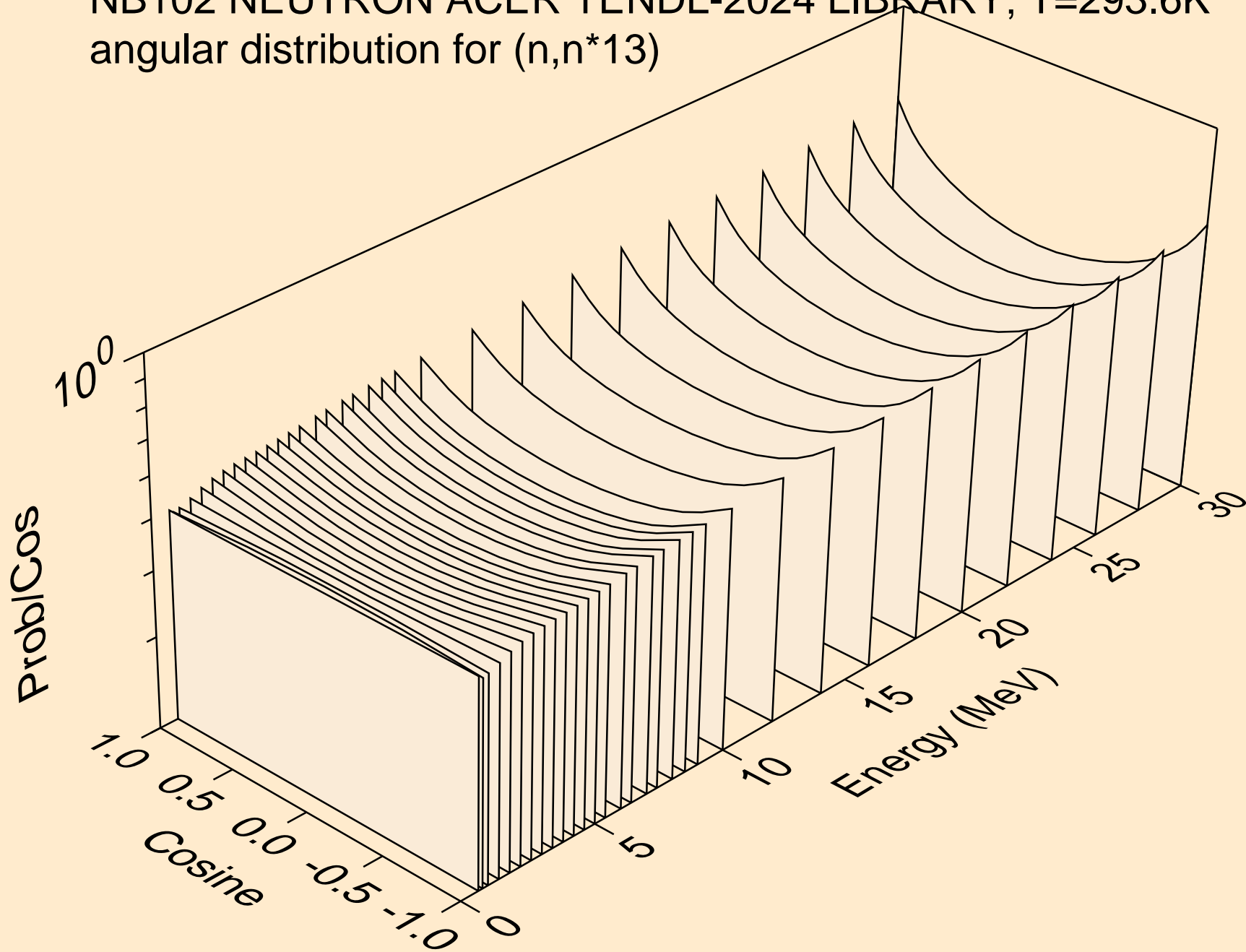

NB102 NEUTRON ACER TENDL-2024 LIBRARY; T=293.6K  
angular distribution for (n,n\*14)

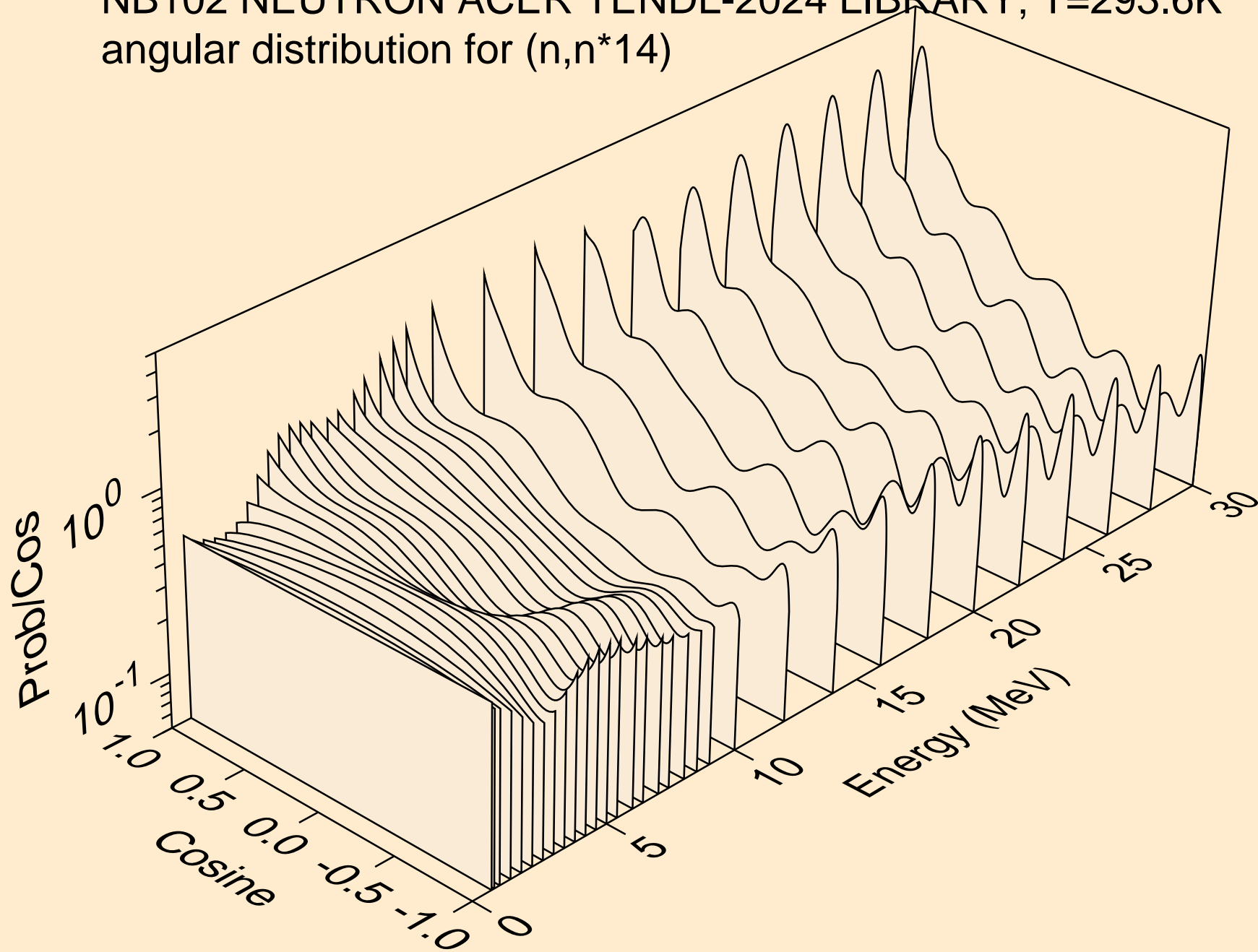

NB102 NEUTRON ACER TENDL-2024 LIBRARY; T=293.6K  
angular distribution for (n,n\*15)

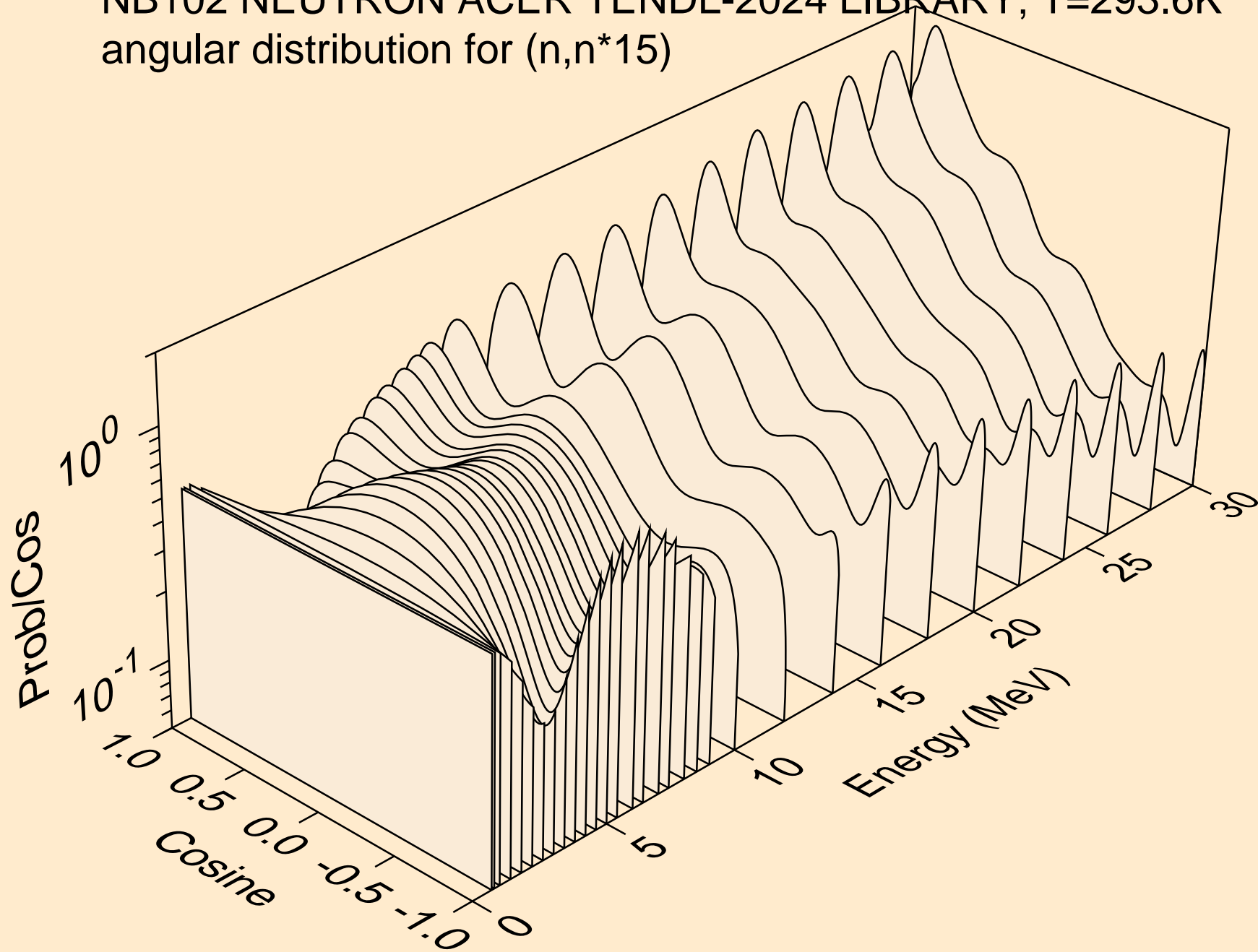

NB102 NEUTRON ACER TENDL-2024 LIBRARY; T=293.6K  
angular distribution for (n,n\*16)

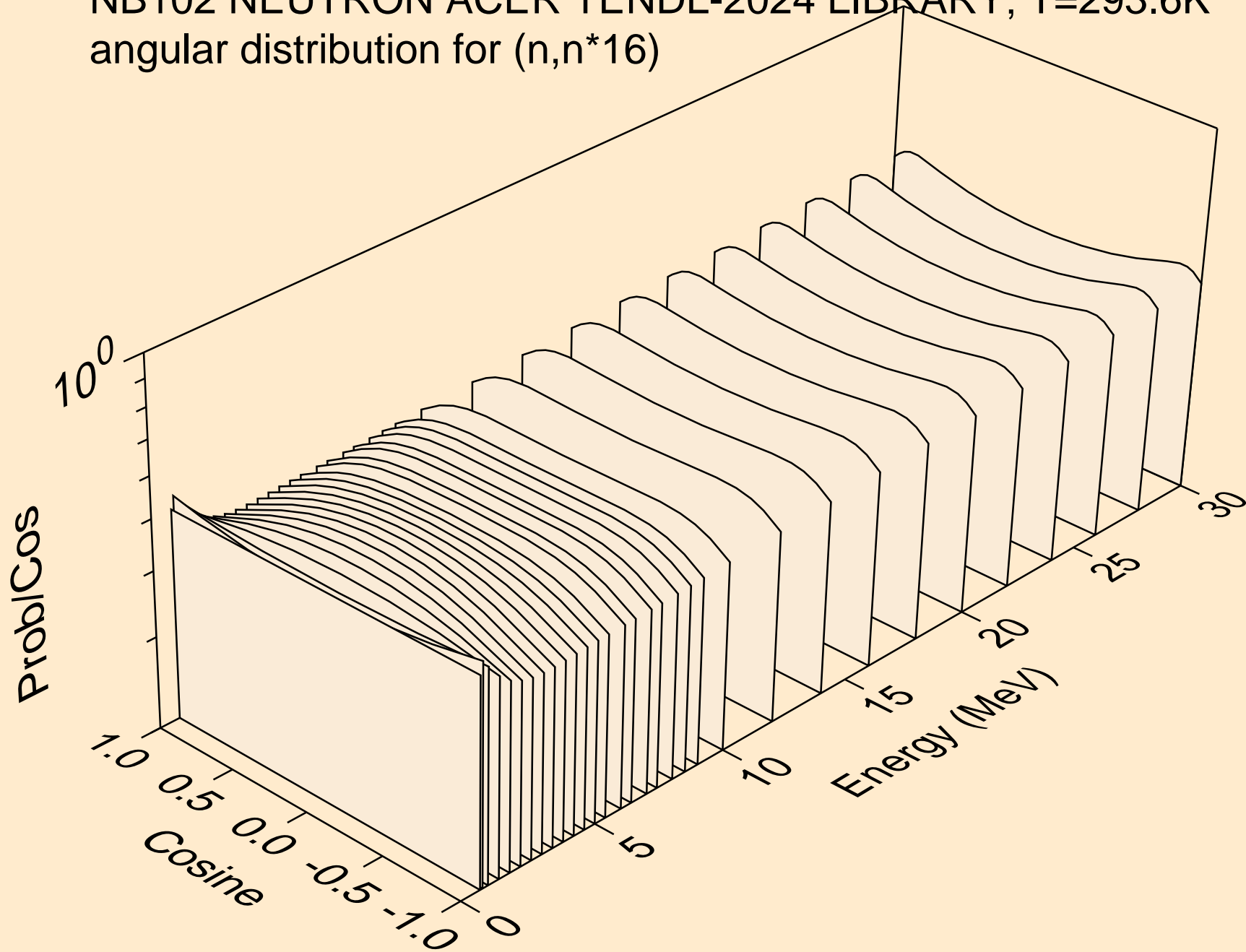

NB102 NEUTRON ACER TENDL-2024 LIBRARY; T=293.6K  
angular distribution for (n,n\*17)

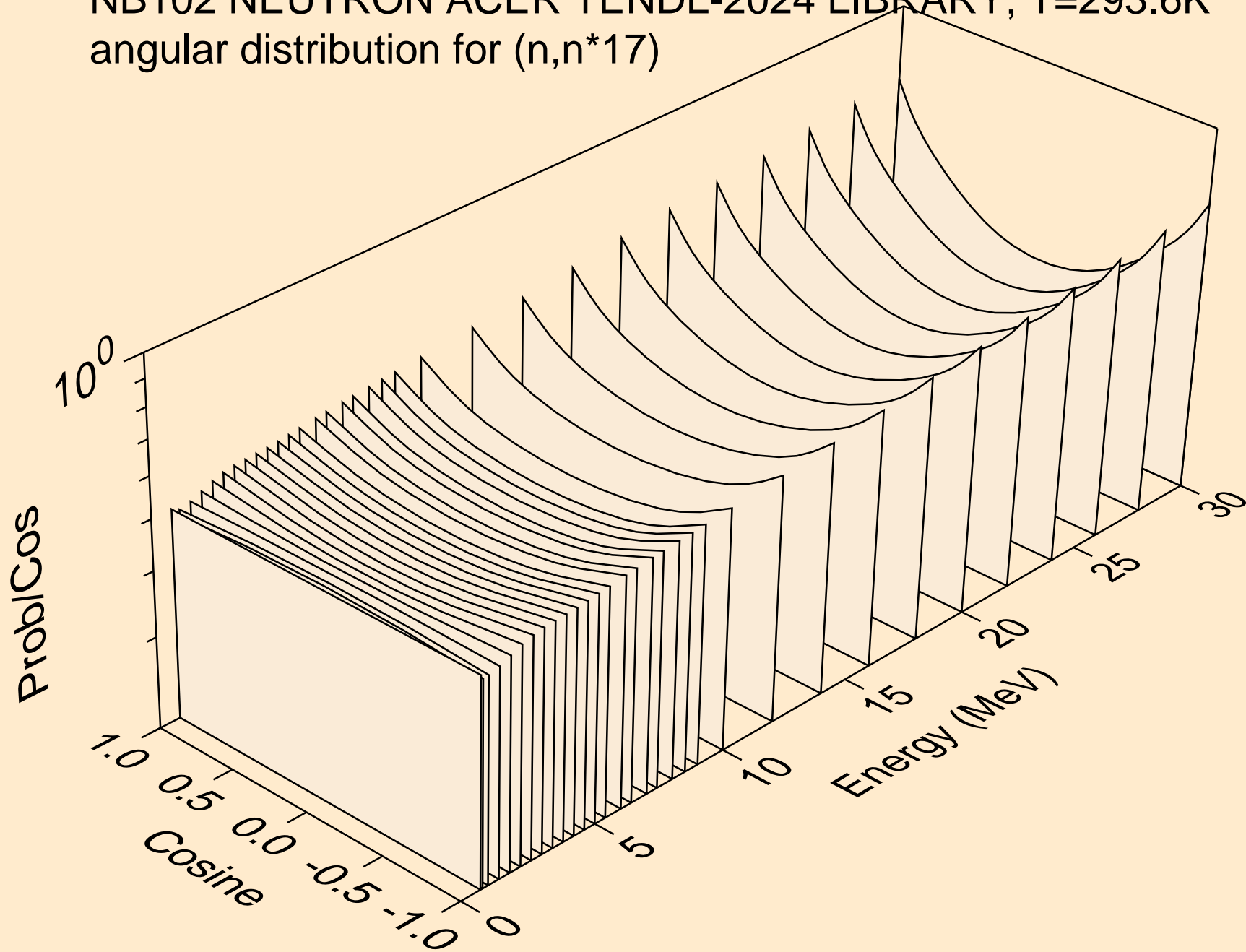

NB102 NEUTRON ACER TENDL-2024 LIBRARY; T=293.6K  
angular distribution for (n,n\*18)

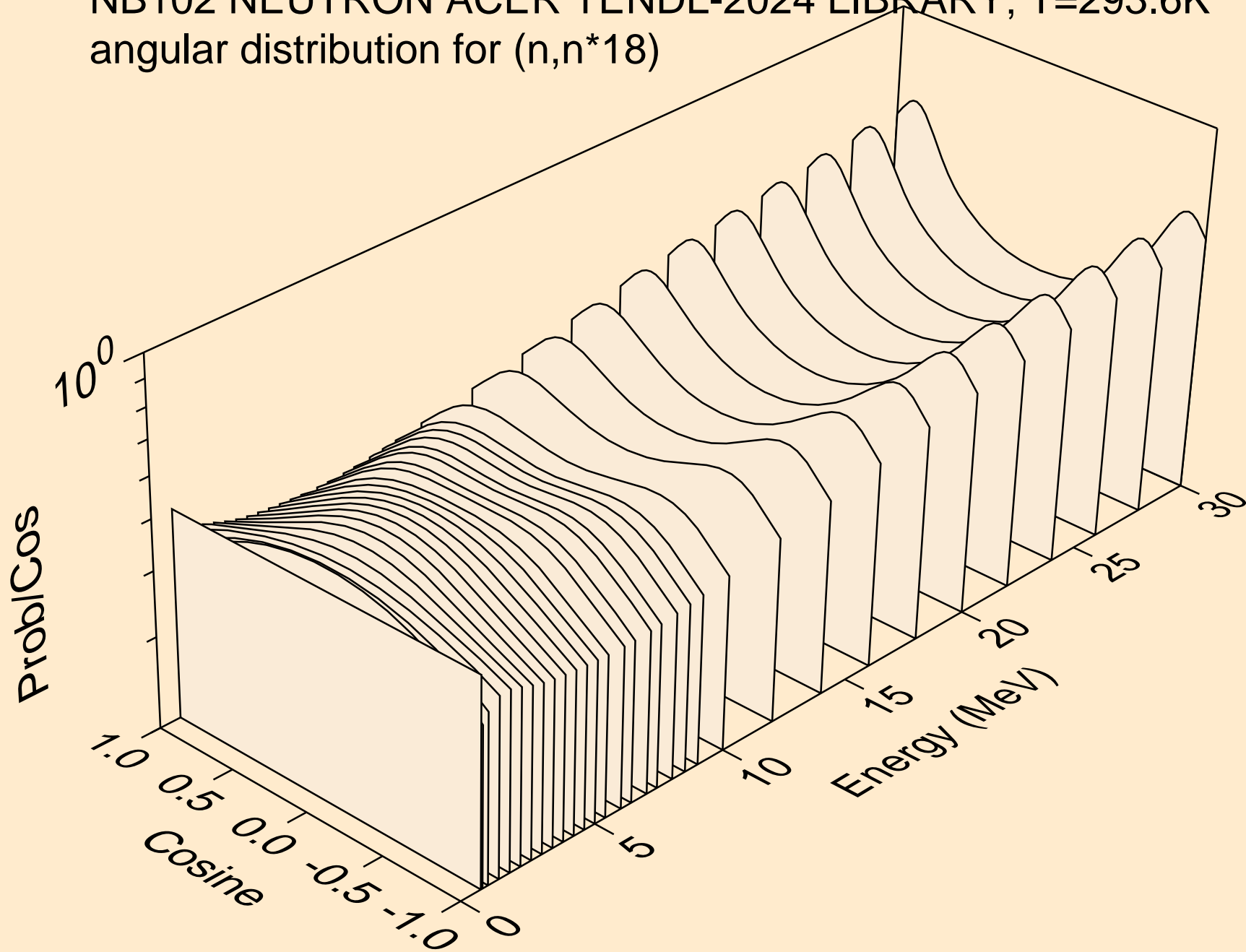

NB102 NEUTRON ACER TENDL-2024 LIBRARY; T=293.6K  
angular distribution for (n,n\*19)

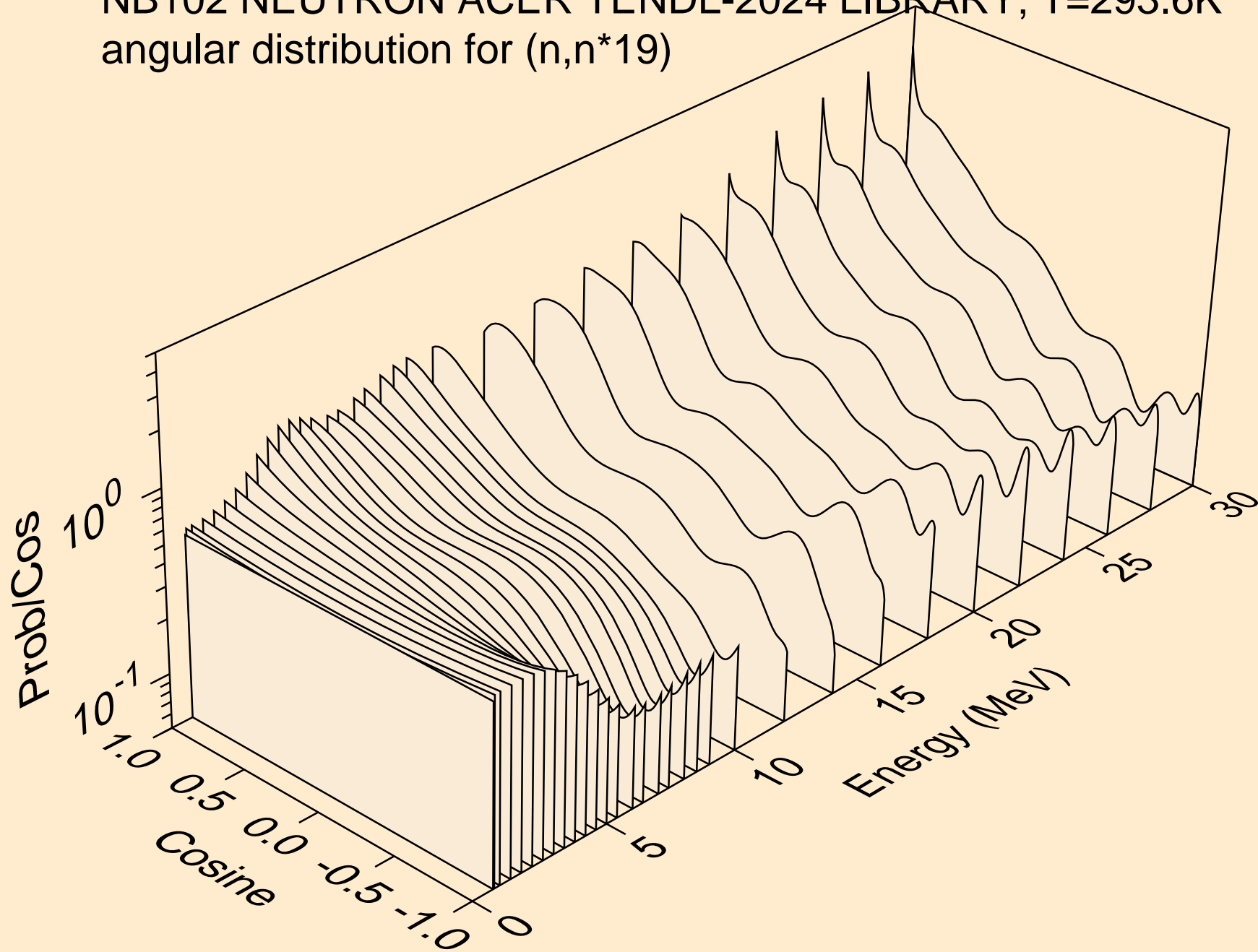

NB102 NEUTRON ACER TENDL-2024 LIBRARY; T=293.6K  
angular distribution for (n,n\*20)

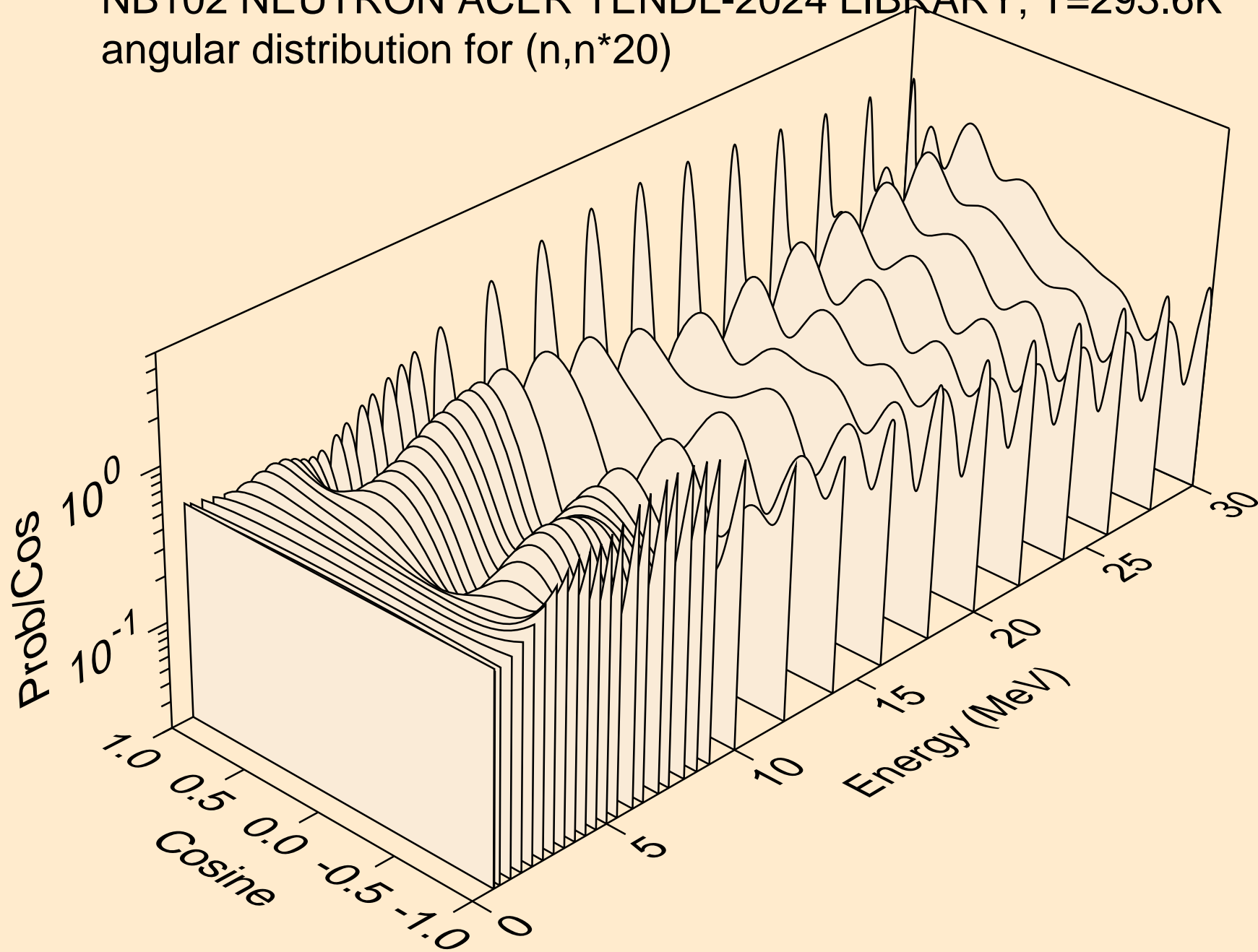

NB102 NEUTRON ACER TENDL-2024 LIBRARY; T=293.6K  
angular distribution for (n,n\*21)

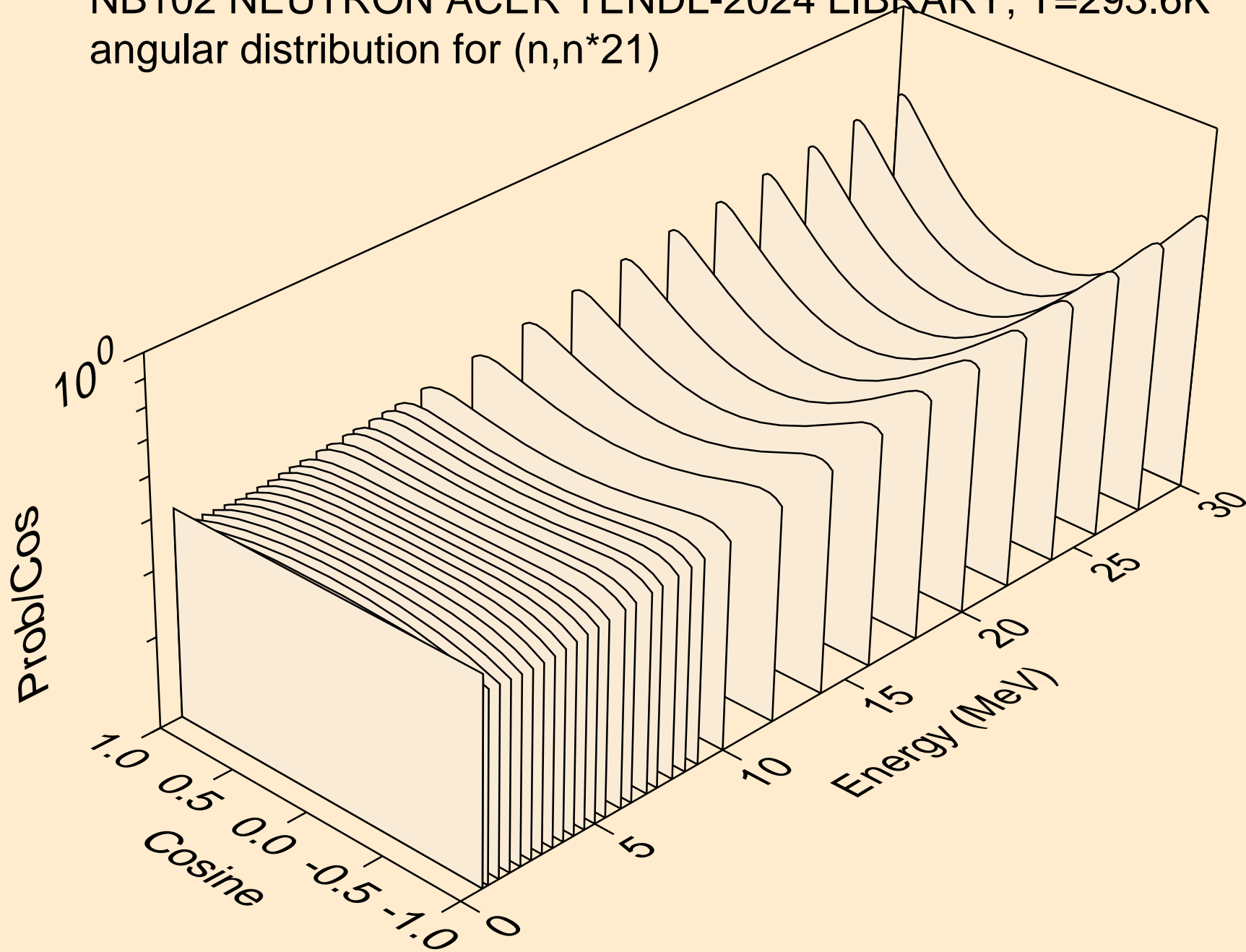

NB102 NEUTRON ACER TENDL-2024 LIBRARY; T=293.6K  
angular distribution for (n,n\*22)

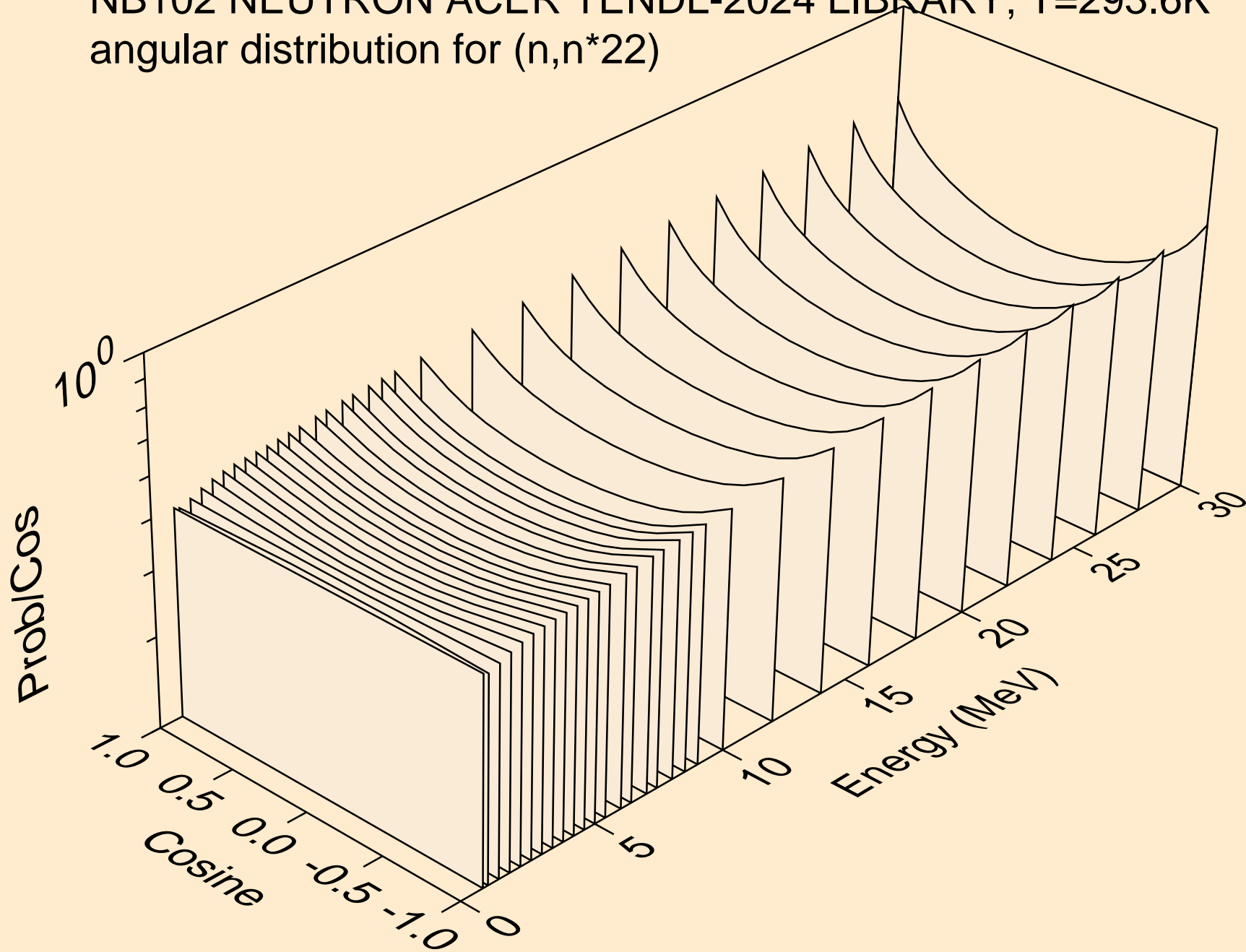

NB102 NEUTRON ACER TENDL-2024 LIBRARY; T=293.6K  
angular distribution for (n,n\*23)

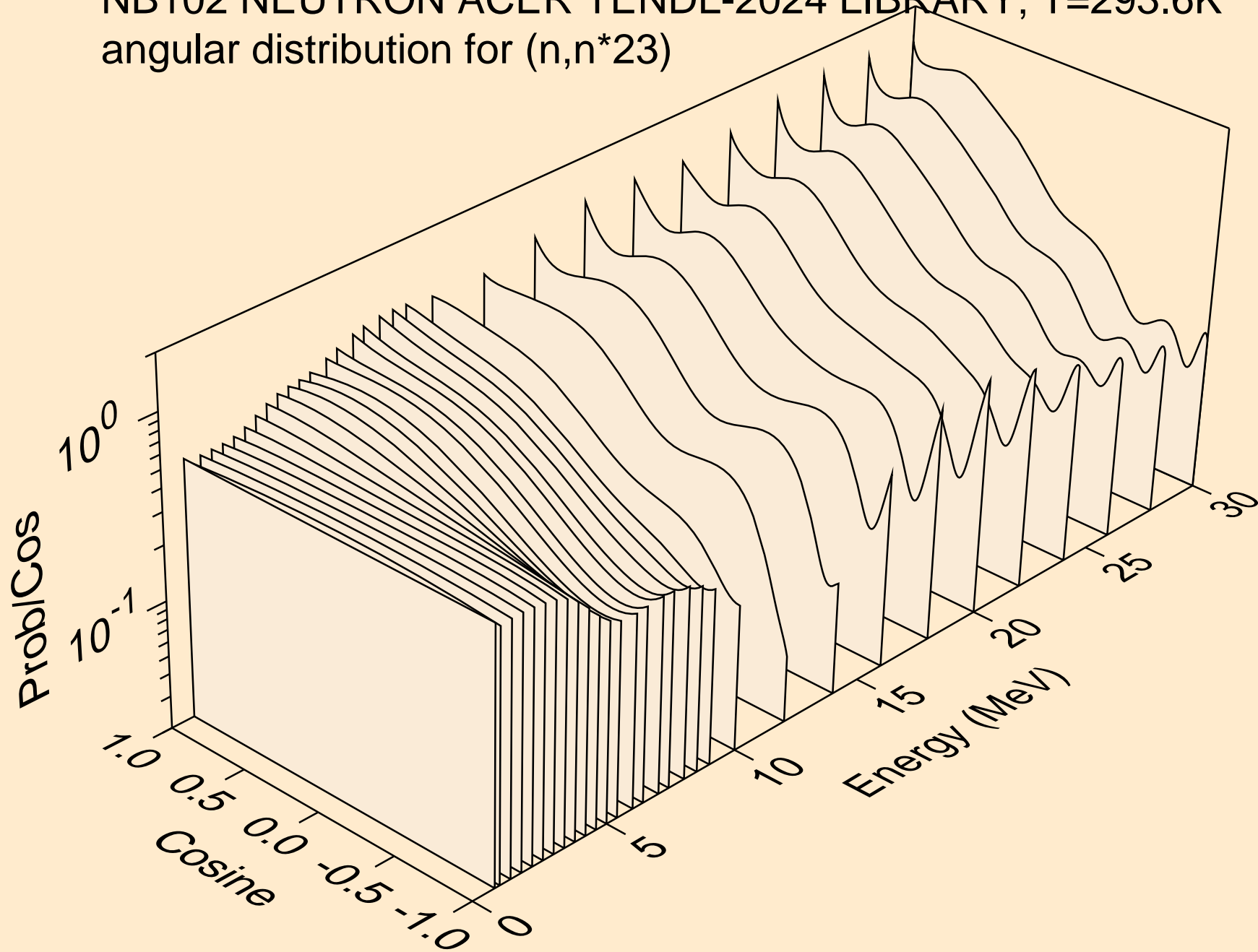

NB102 NEUTRON ACER TENDL-2024 LIBRARY; T=293.6K  
angular distribution for (n,n\*24)

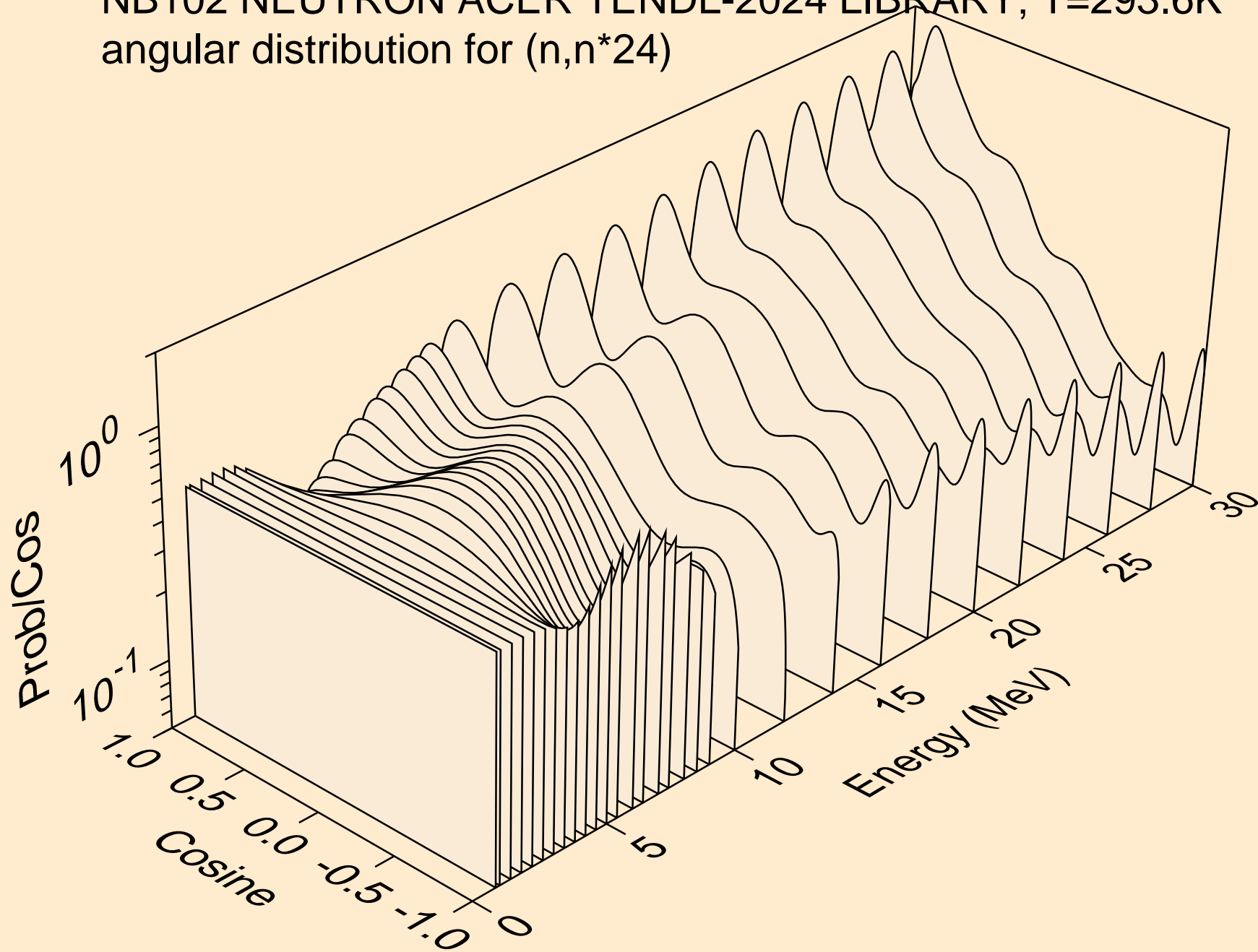

NB102 NEUTRON ACER TENDL-2024 LIBRARY; T=293.6K  
angular distribution for (n,n\*25)

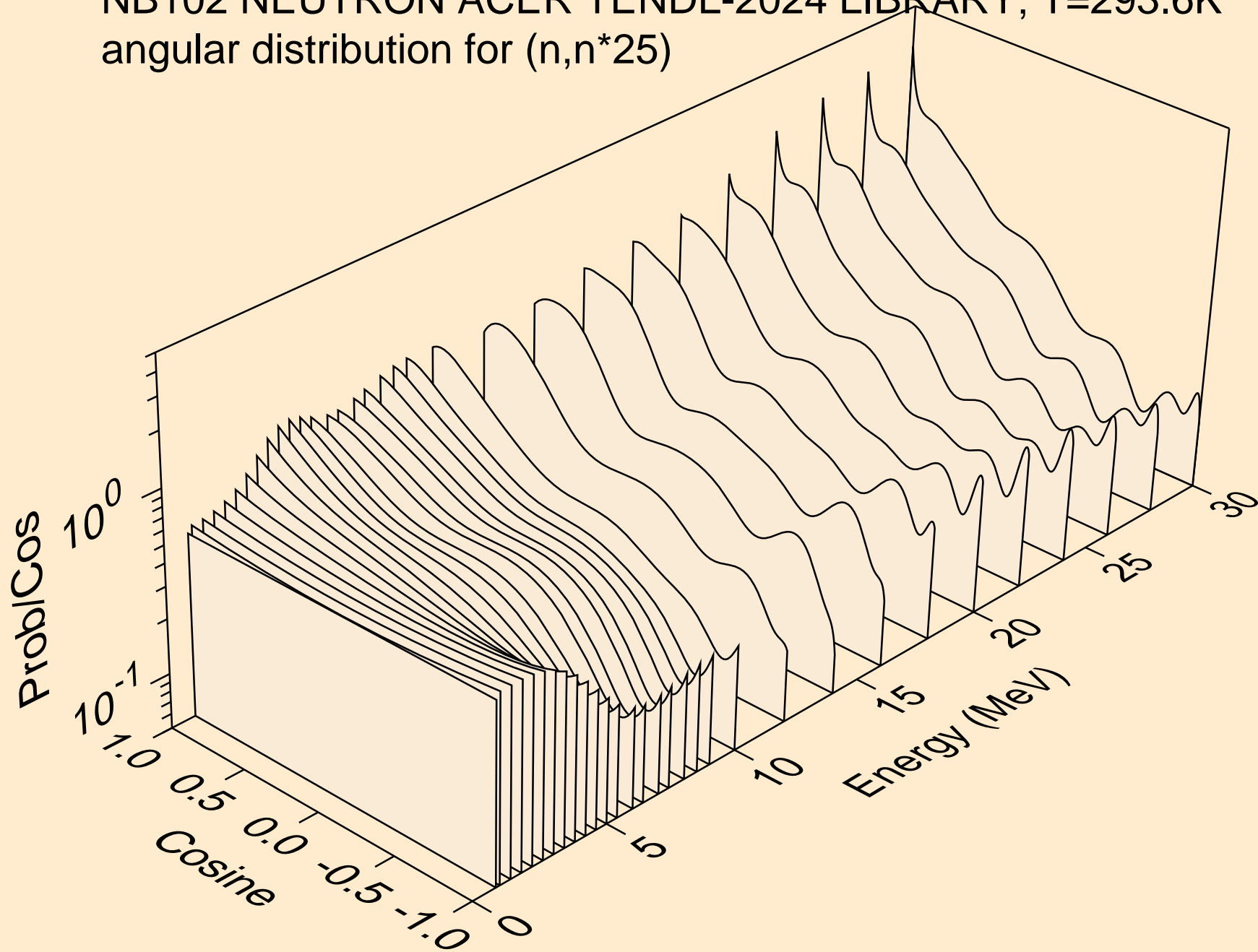

NB102 NEUTRON ACER TENDL-2024 LIBRARY; T=293.6K  
angular distribution for (n,n\*26)

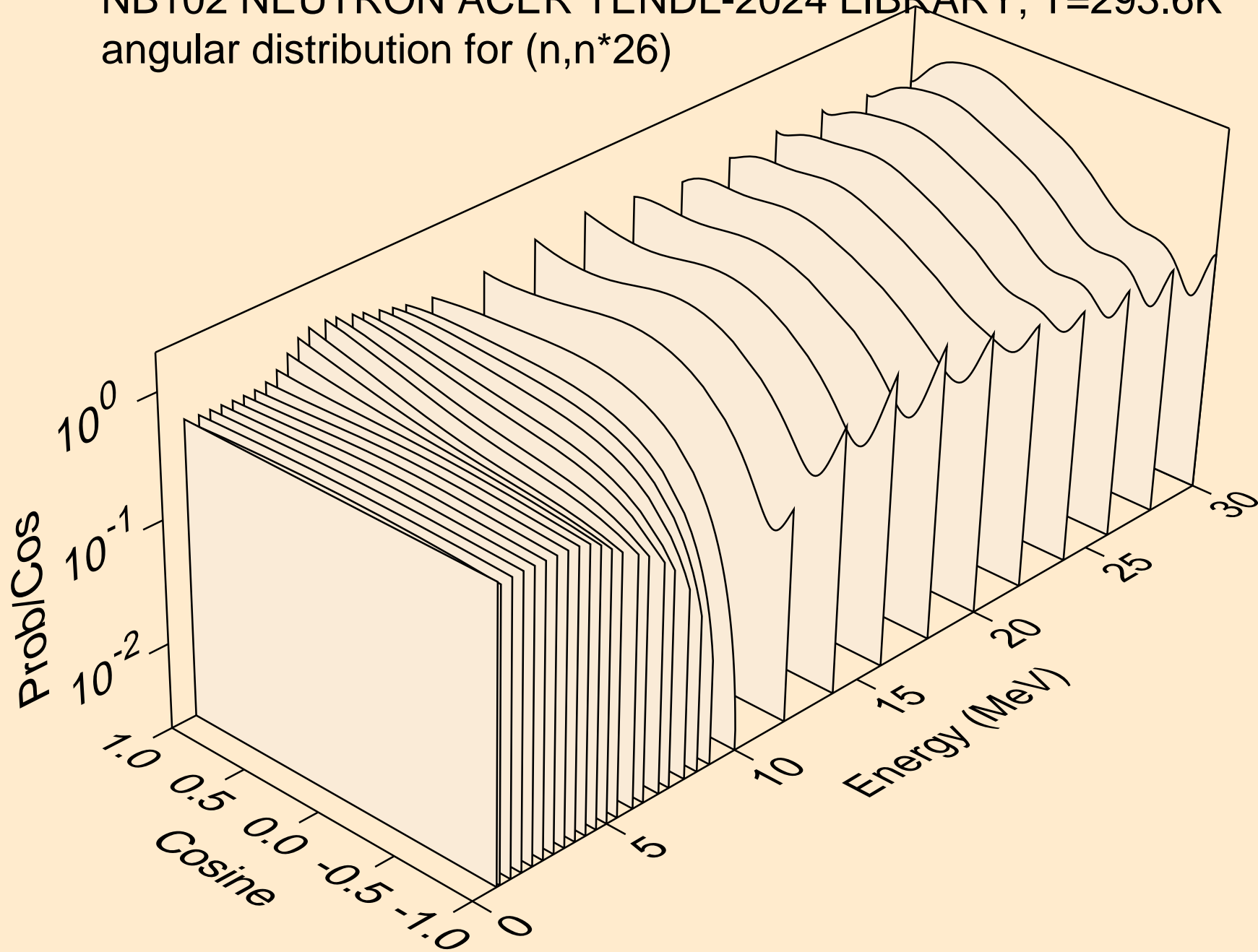

NB102 NEUTRON ACER TENDL-2024 LIBRARY; T=293.6K  
angular distribution for (n,n\*27)

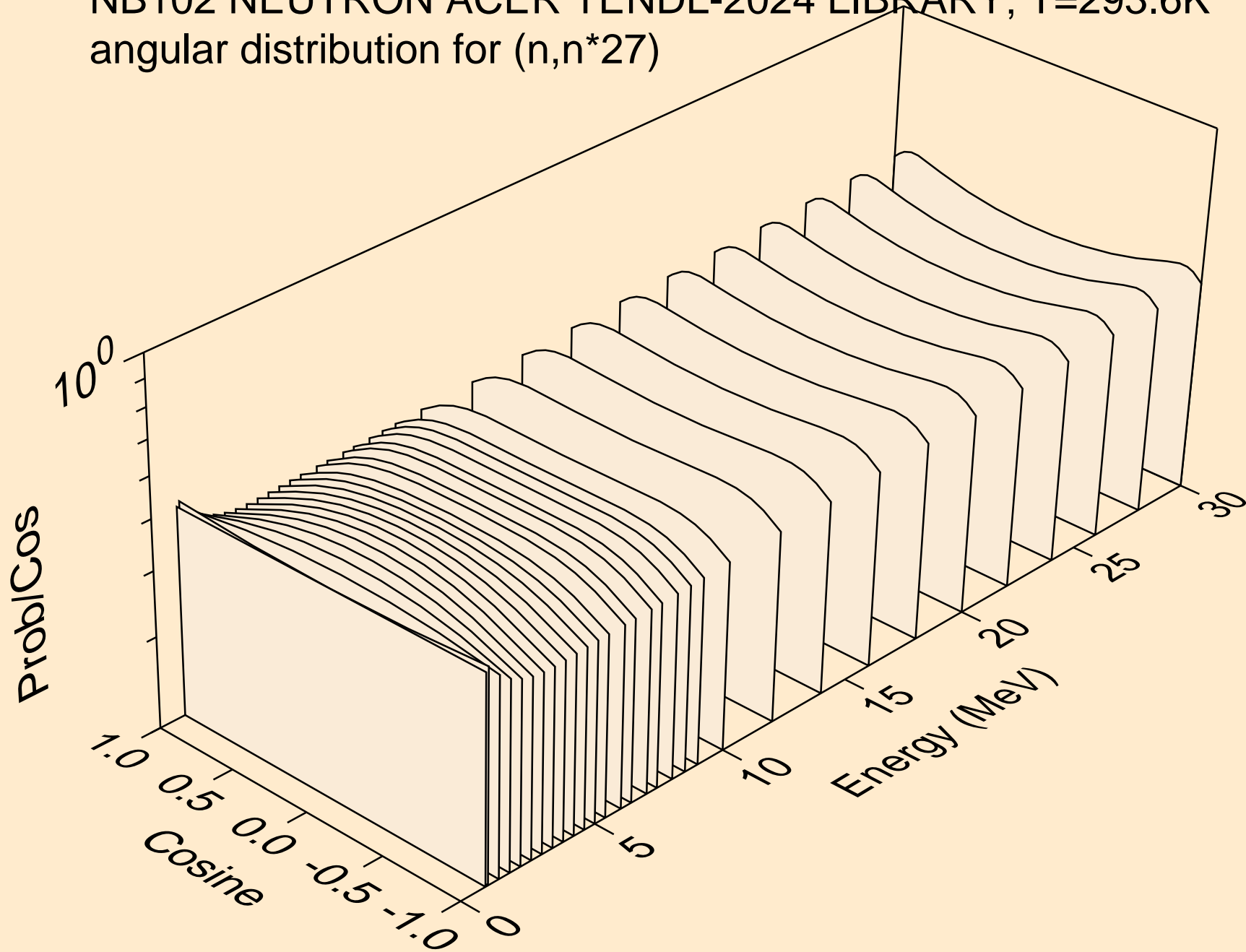

NB102 NEUTRON ACER TENDL-2024 LIBRARY; T=293.6K  
angular distribution for (n,n\*28)

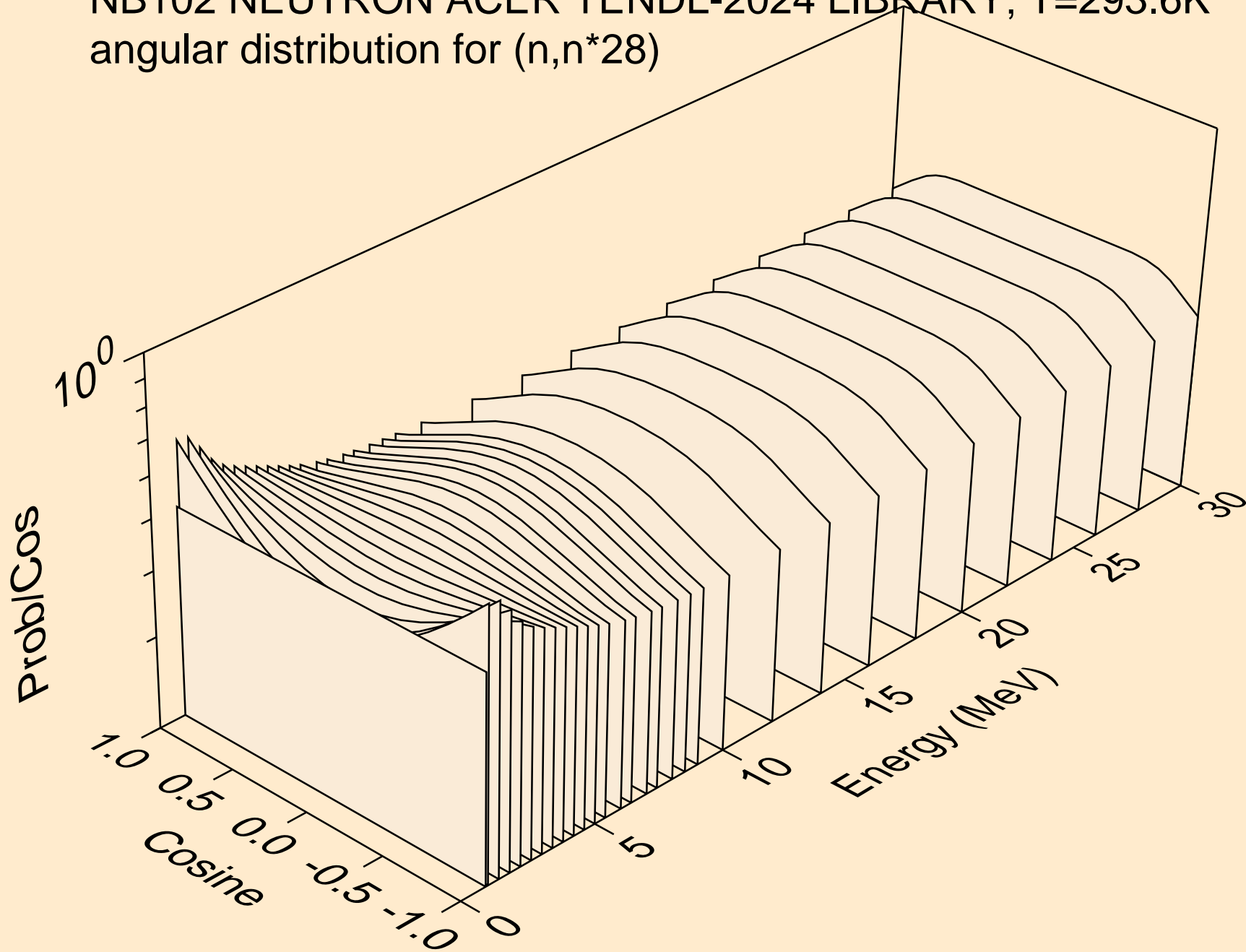

NB102 NEUTRON ACER TENDL-2024 LIBRARY; T=293.6K  
angular distribution for (n,n\*29)

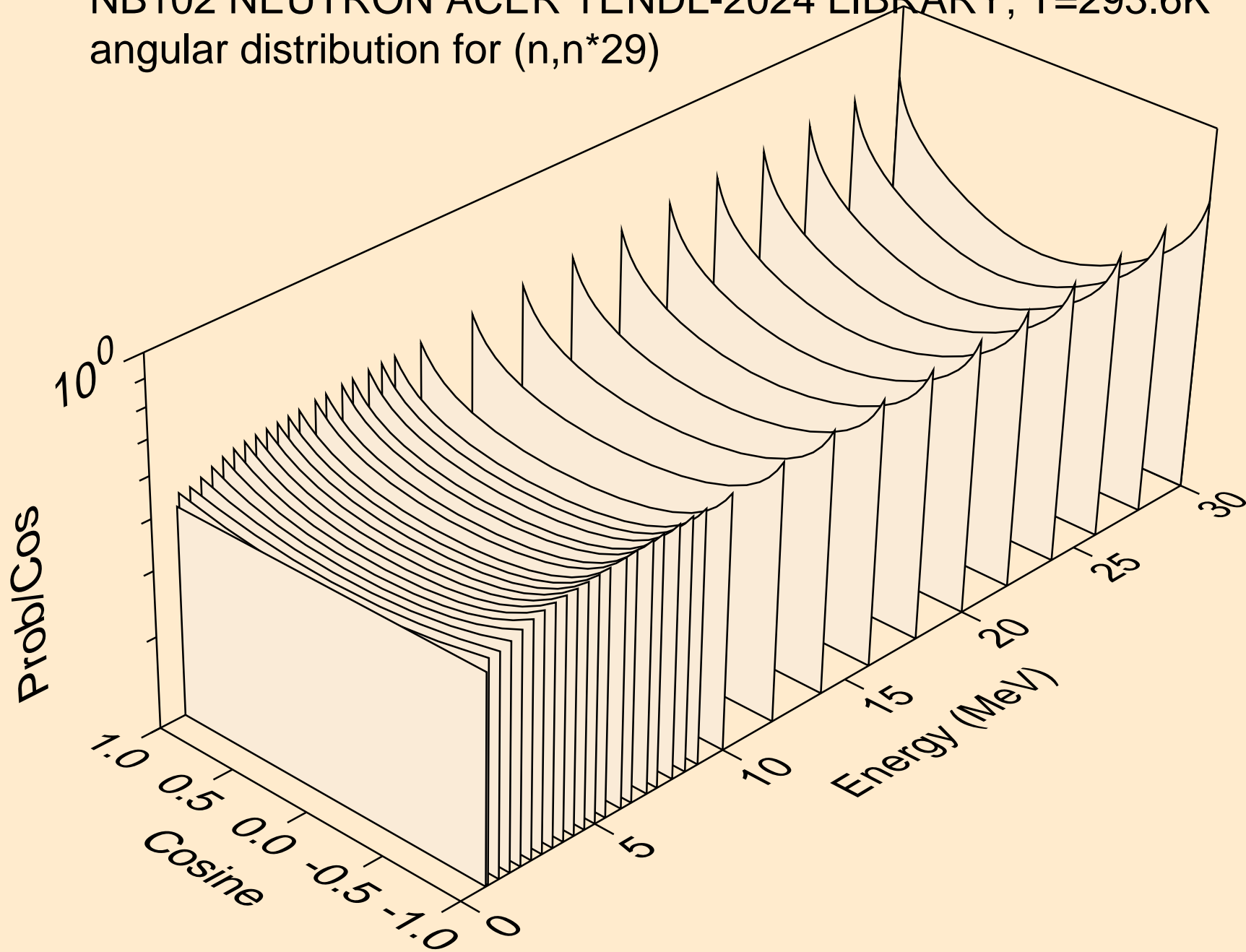

NB102 NEUTRON ACER TENDL-2024 LIBRARY; T=293.6K  
angular distribution for (n,n\*30)

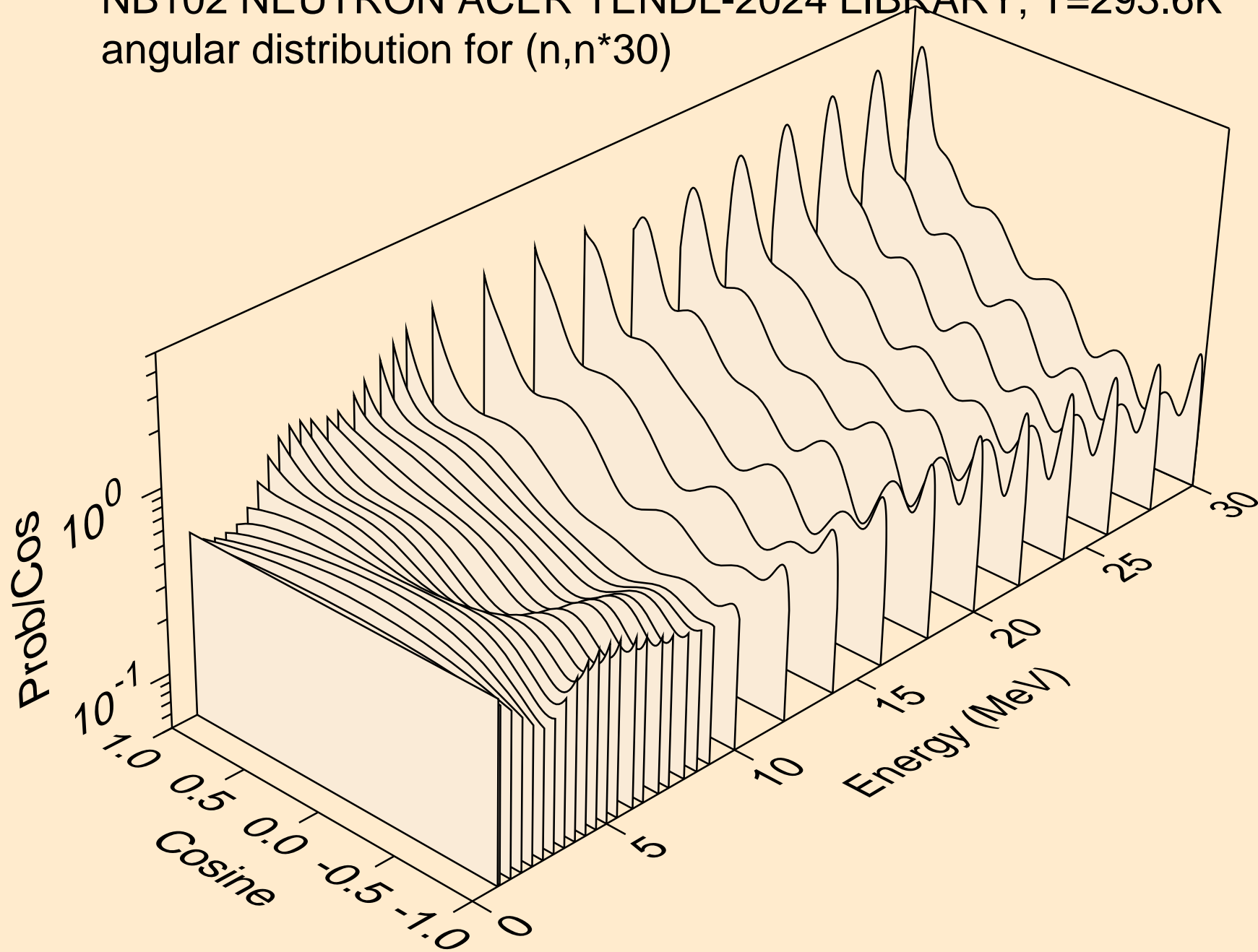

NB102 NEUTRON ACER TENDL-2024 LIBRARY; T=293.6K  
Neutron emission for (n,x)

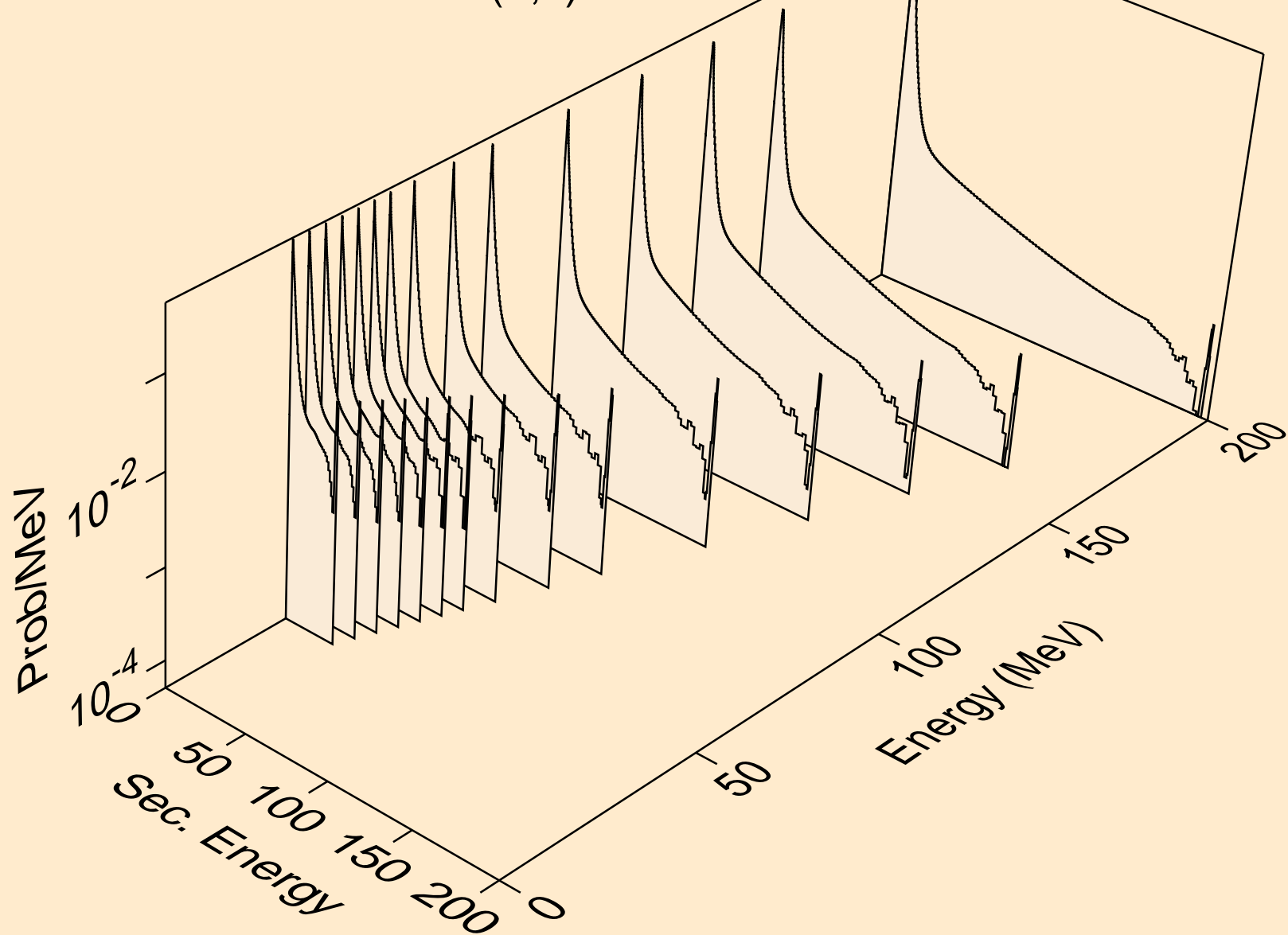

NB102 NEUTRON ACER TENDL-2024 LIBRARY; T=293.6K  
Neutron emission for (n,2nd)

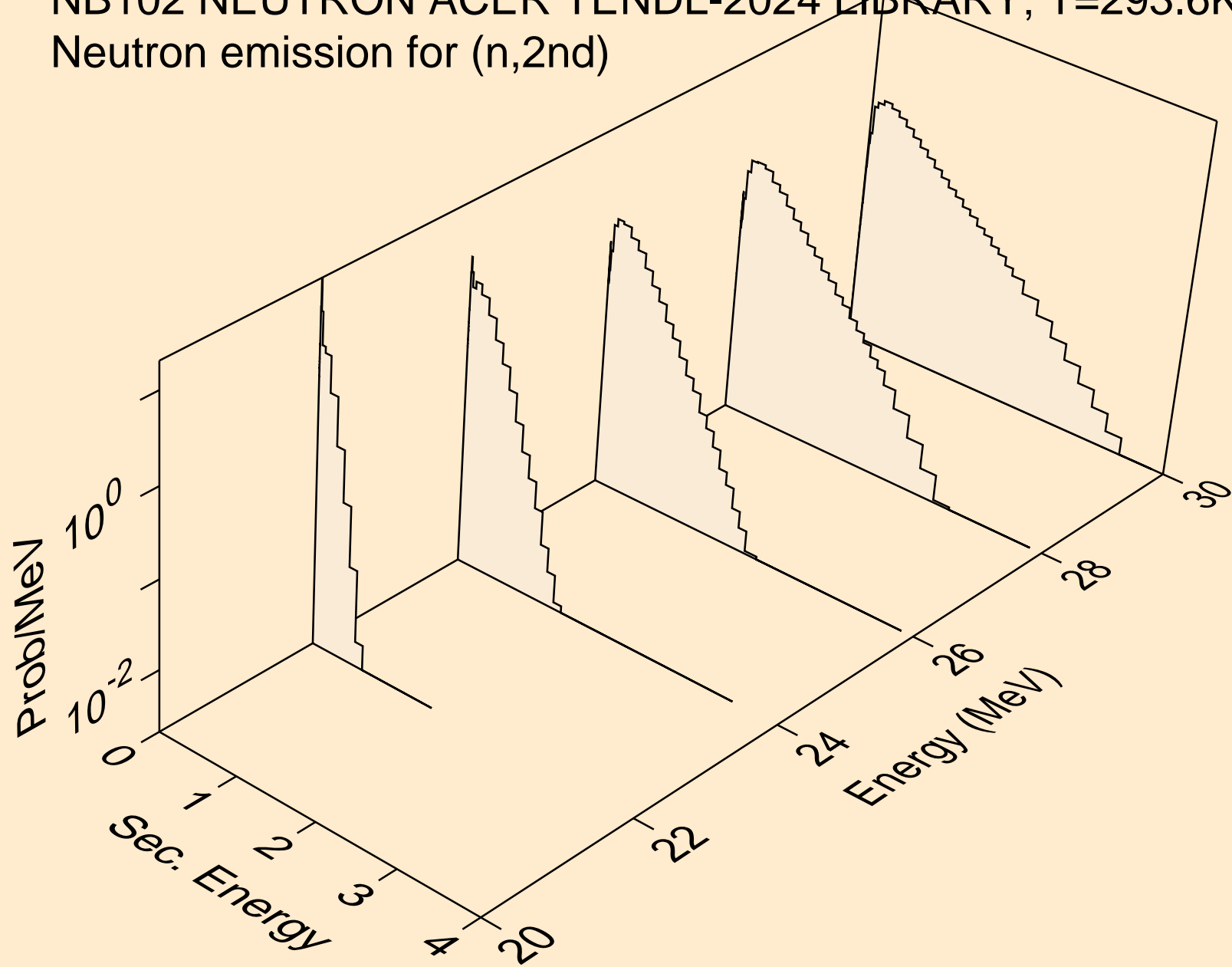

NB102 NEUTRON ACER TENDL-2024 LIBRARY; T=293.6K  
Neutron emission for (n,2n)

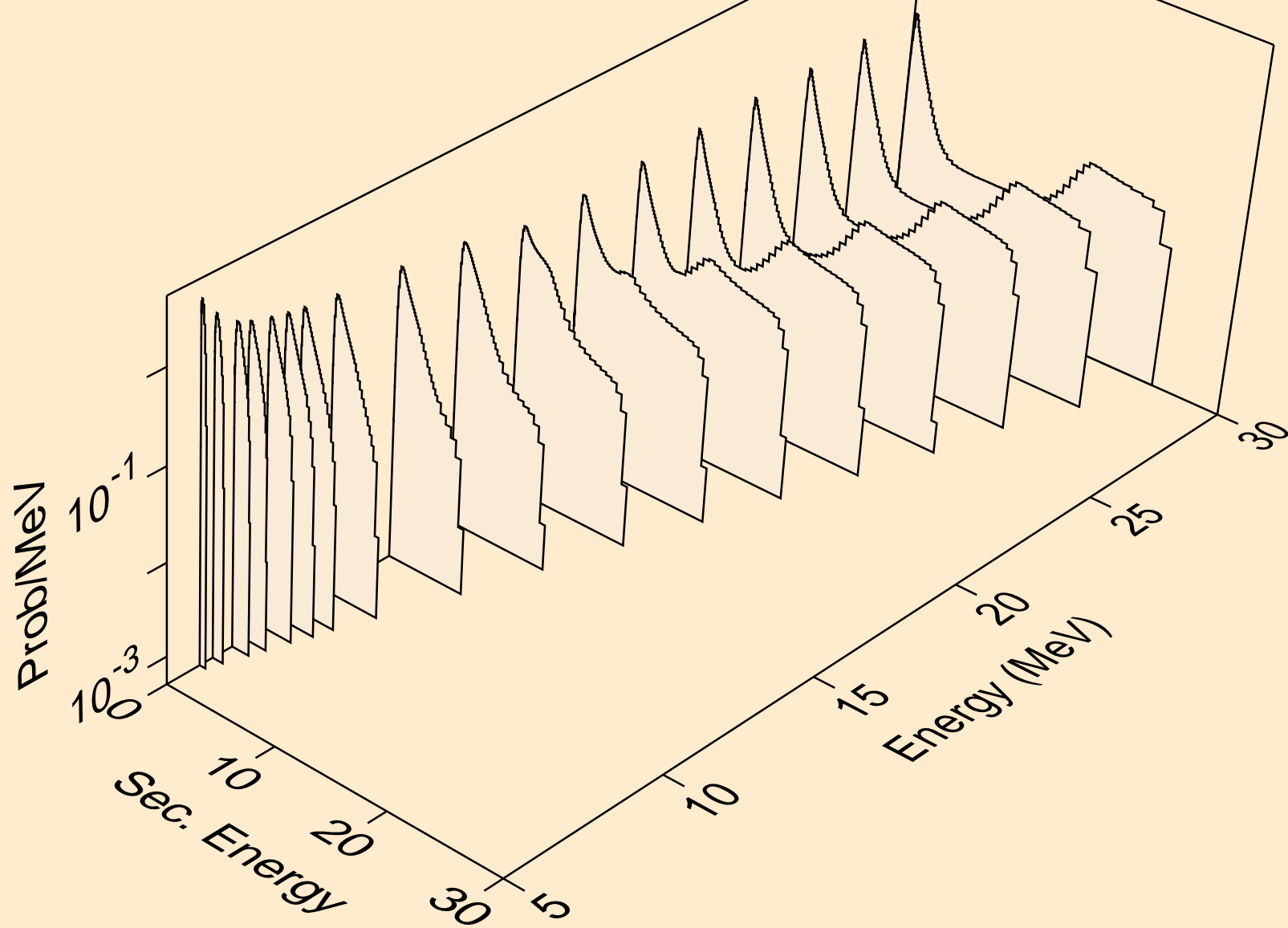

NB102 NEUTRON ACER TENDL-2024 LIBRARY; T=293.6K  
Neutron emission for (n,3n)

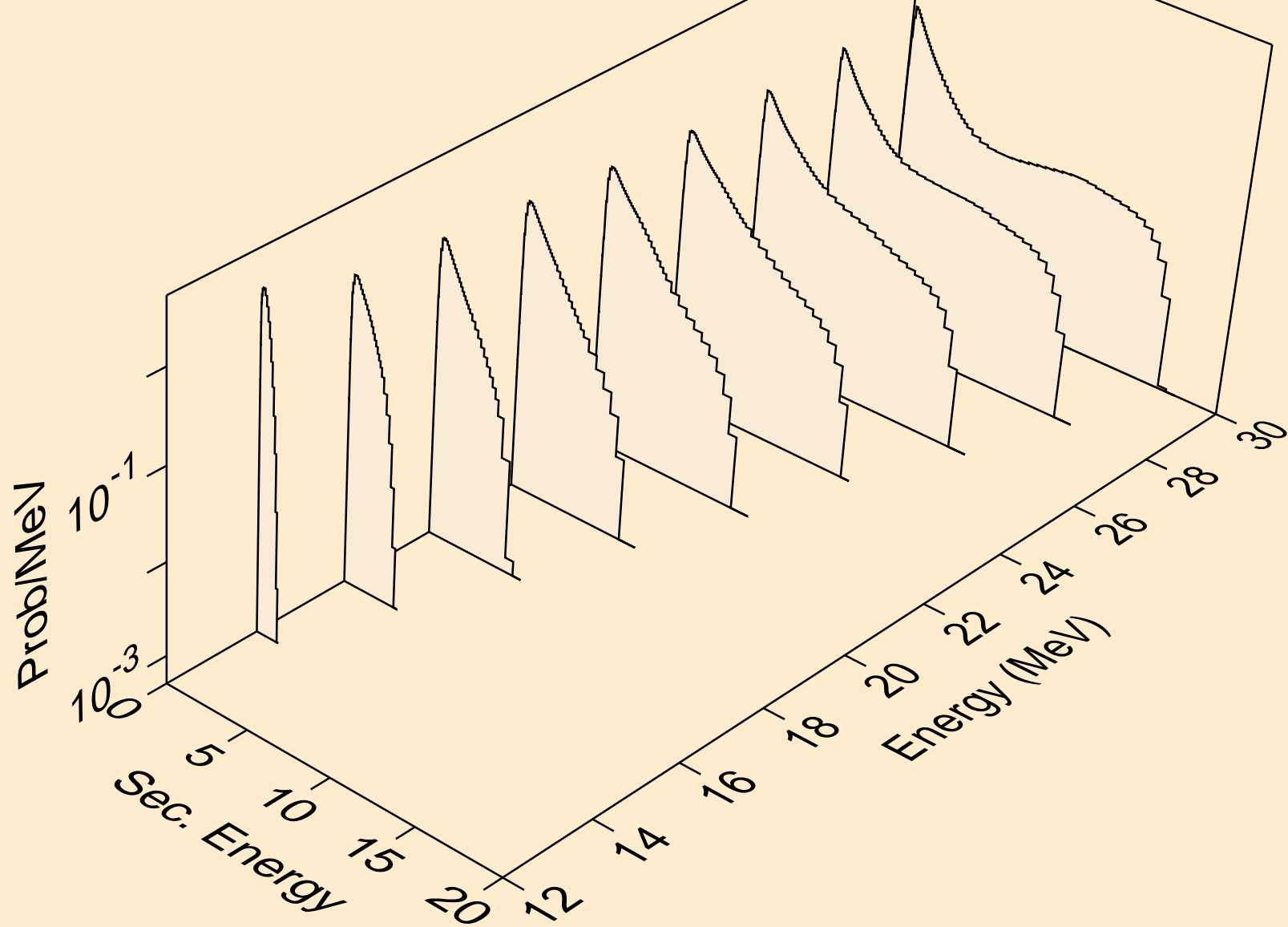

NB102 NEUTRON ACER TENDL-2024 LIBRARY; T=293.6K  
Neutron emission for (n,n\*)a

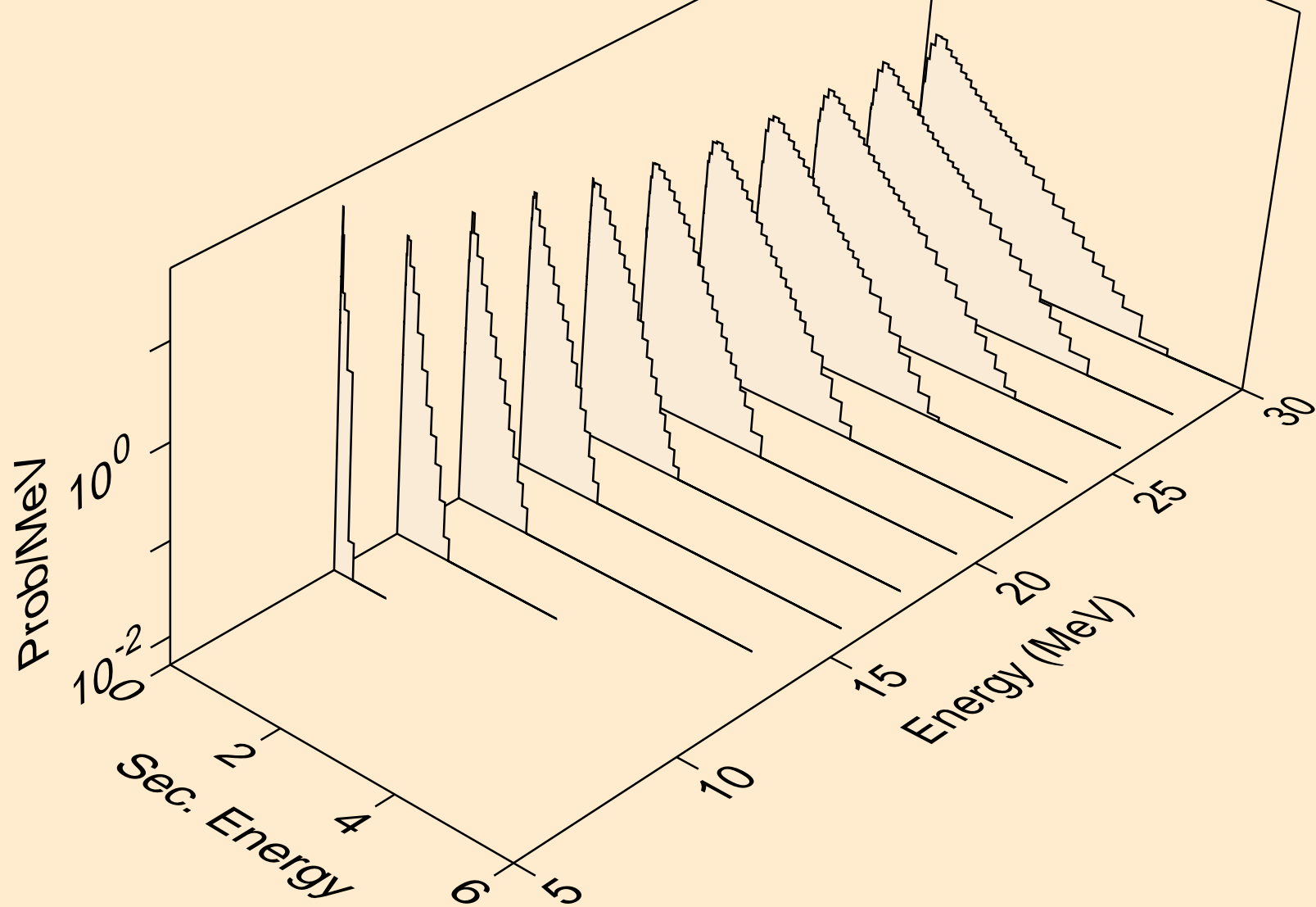

NB102 NEUTRON ACER TENDL-2024 LIBRARY; T=293.6K  
Neutron emission for (n,2n)<sub>a</sub>

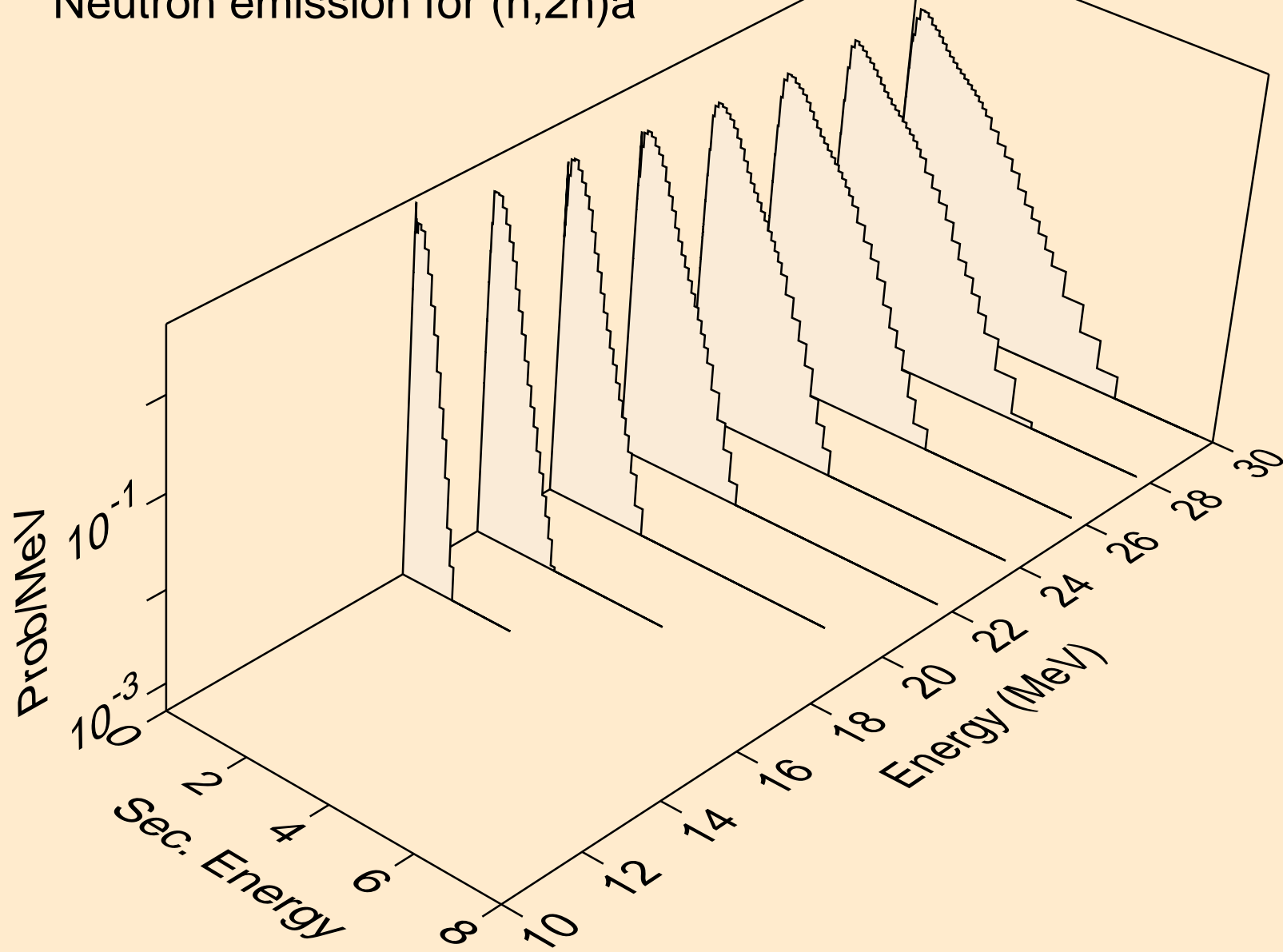

NB102 NEUTRON ACER TENDL-2024 LIBRARY; T=293.6K  
Neutron emission for (n,3n)a

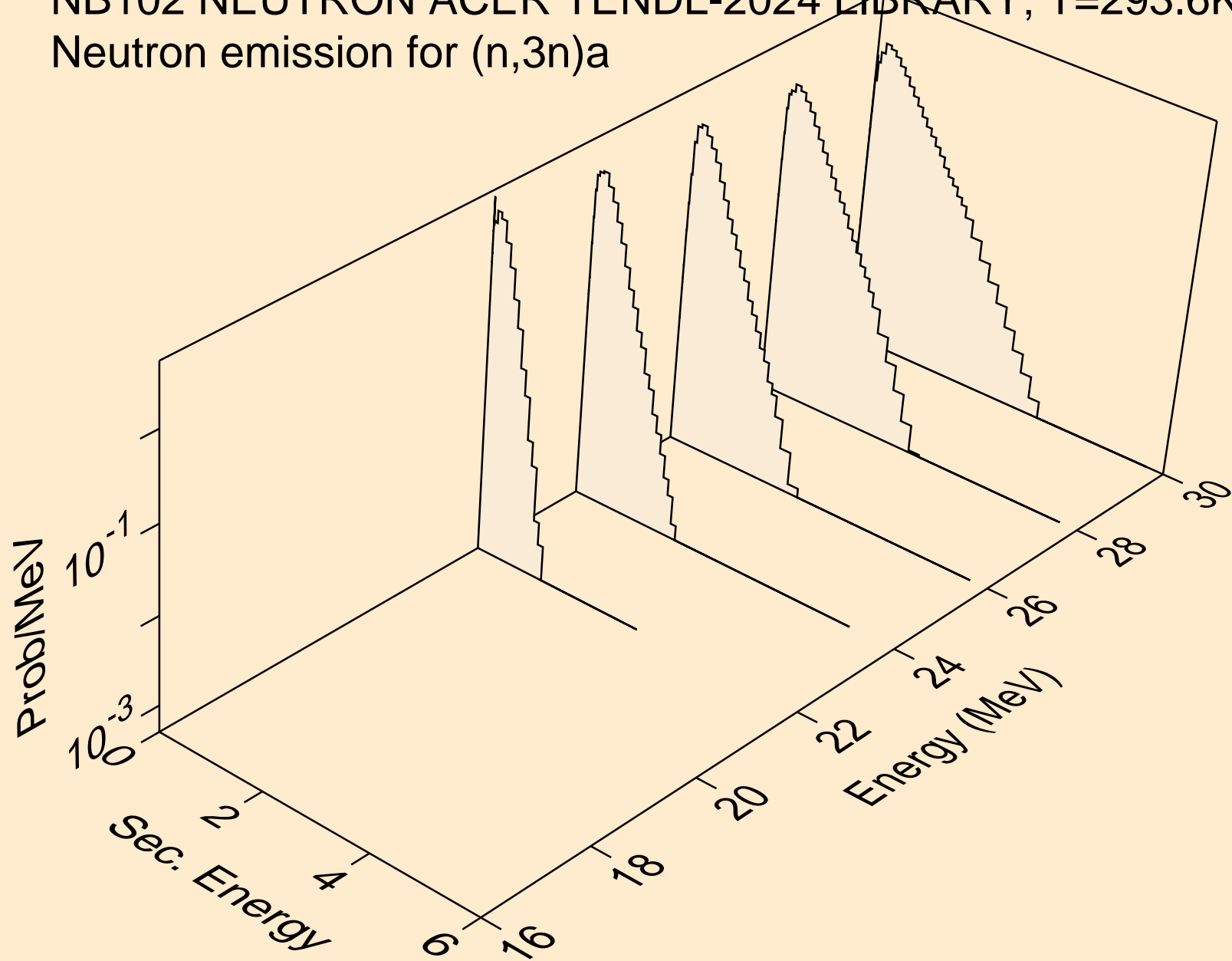

NB102 NEUTRON ACER TENDL-2024 LIBRARY; T=293.6K  
Neutron emission for (n,n\*)p

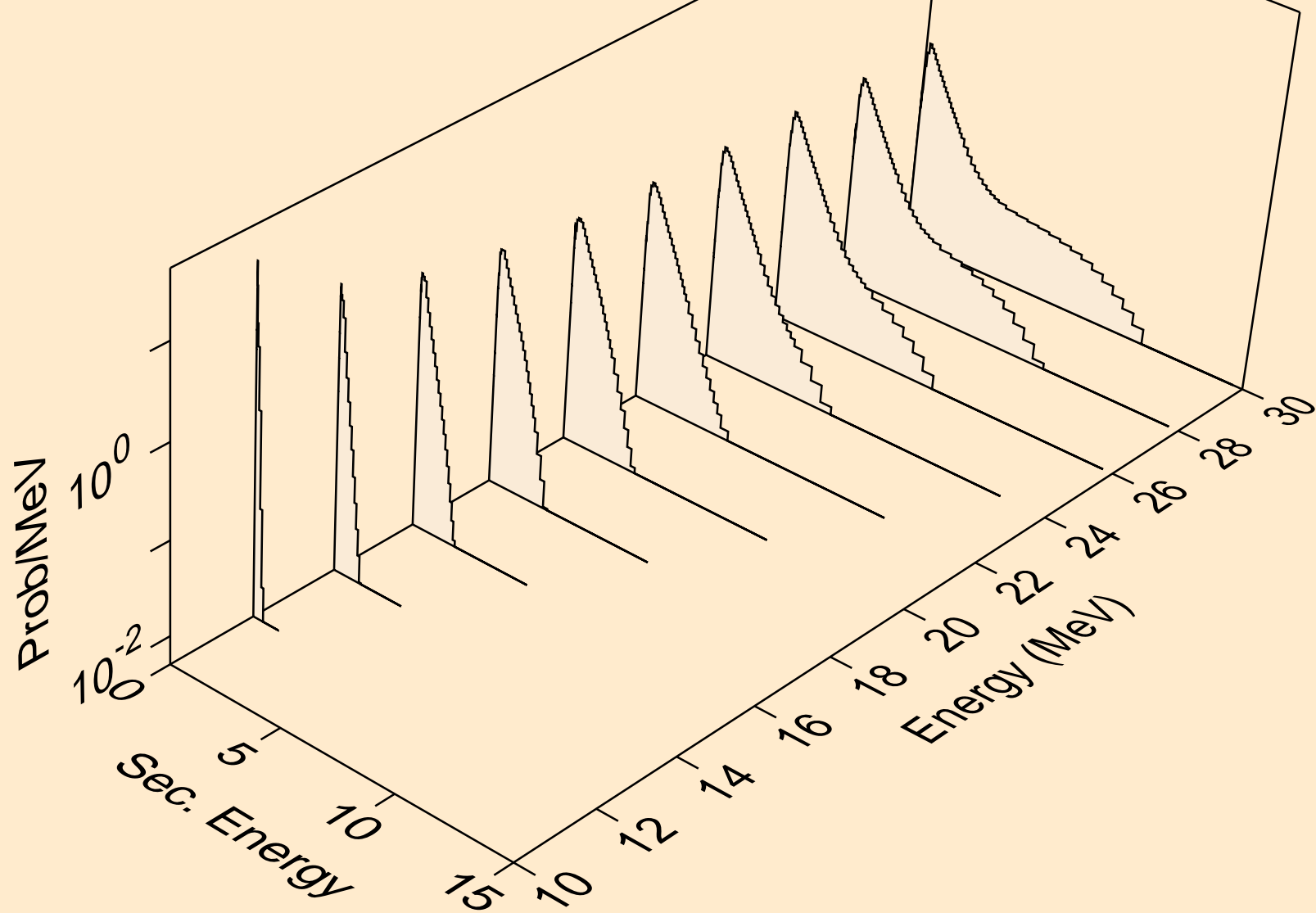

NB102 NEUTRON ACER TENDL-2024 LIBRARY; T=293.6K  
Neutron emission for (n,n\*)d

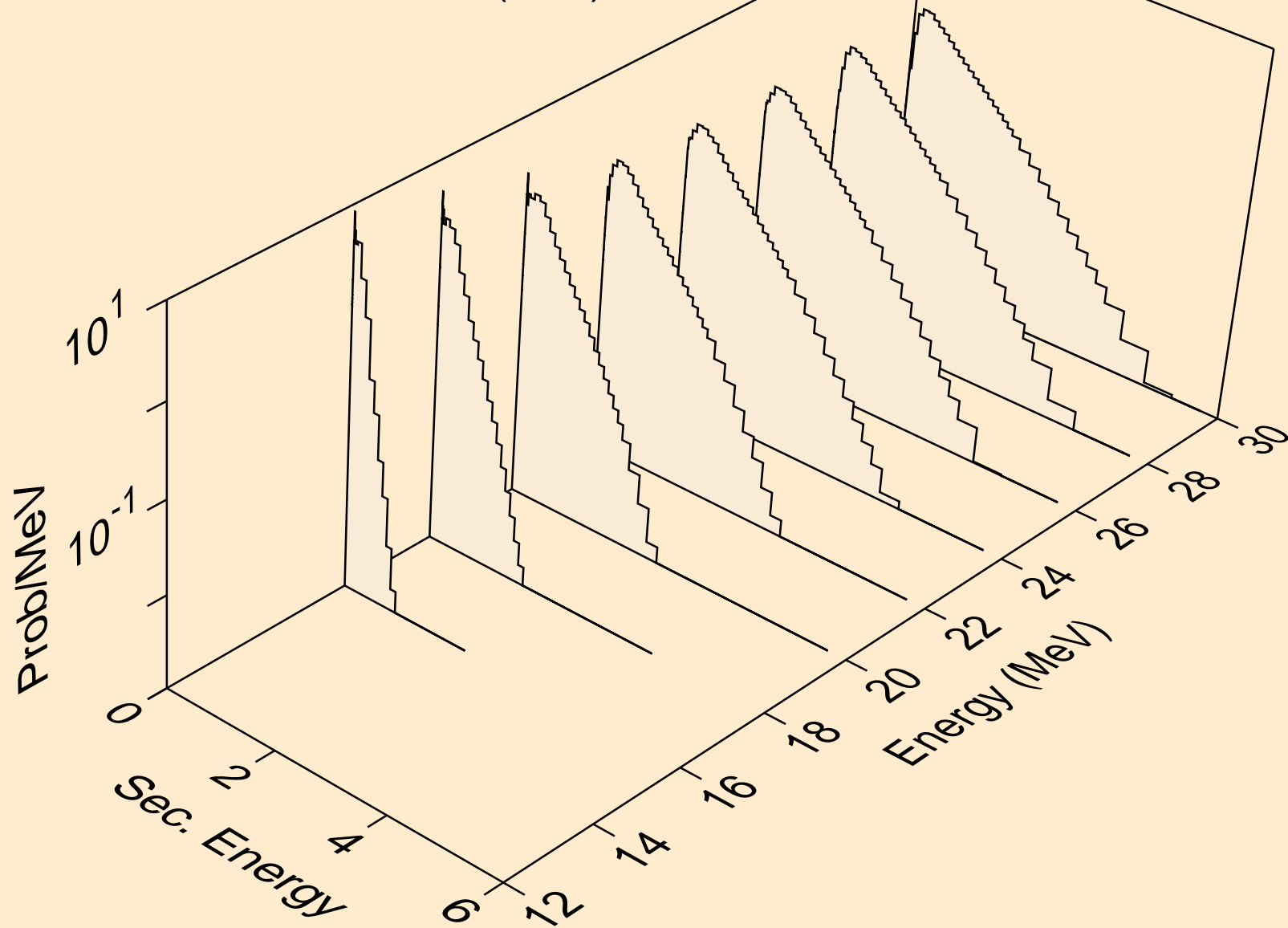

NB102 NEUTRON ACER TENDL-2024 LIBRARY; T=293.6K  
Neutron emission for (n,n\*)t

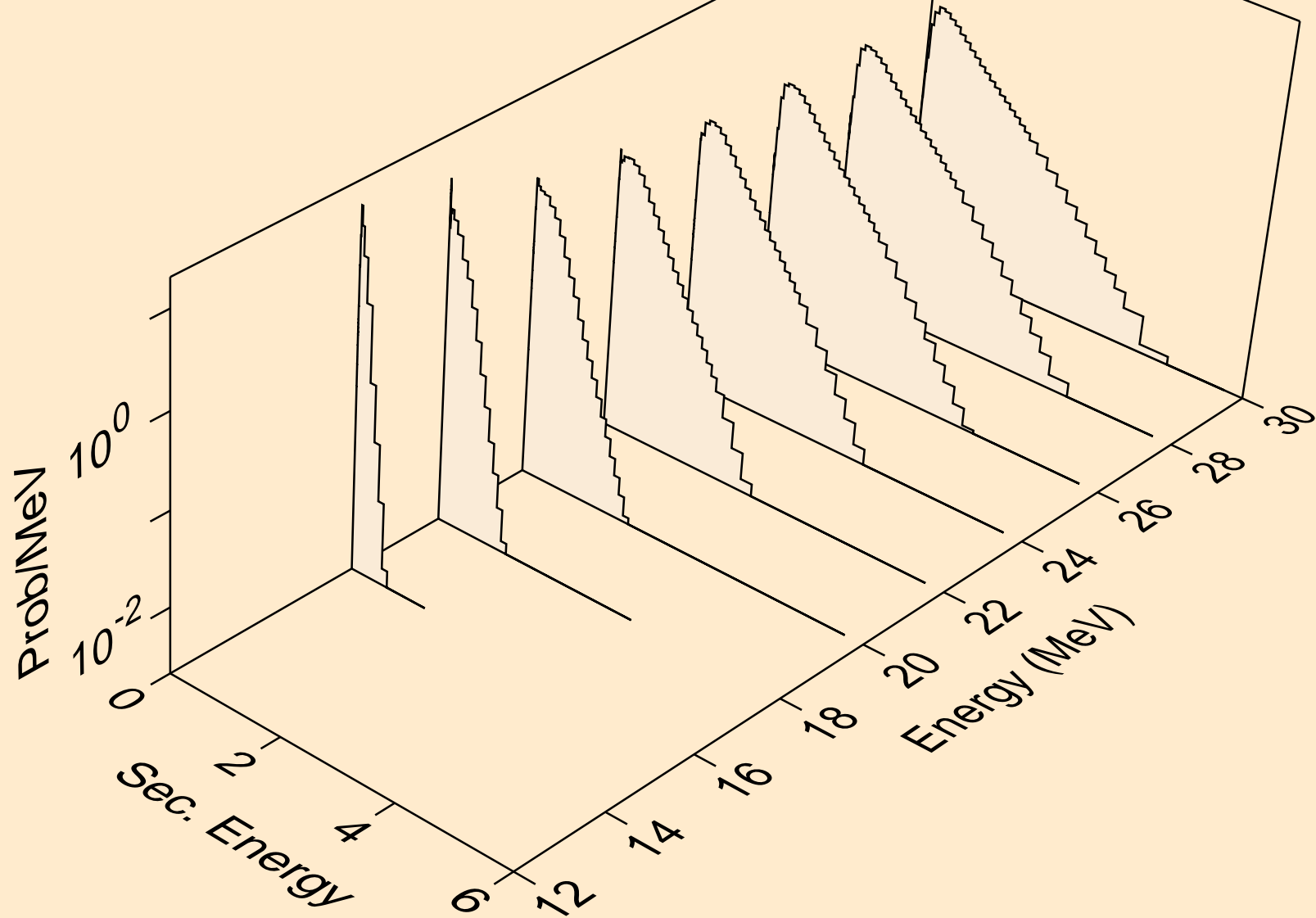

NB102 NEUTRON ACER TENDL-2024 LIBRARY; T=293.6K  
Neutron emission for (n,n\*)he3

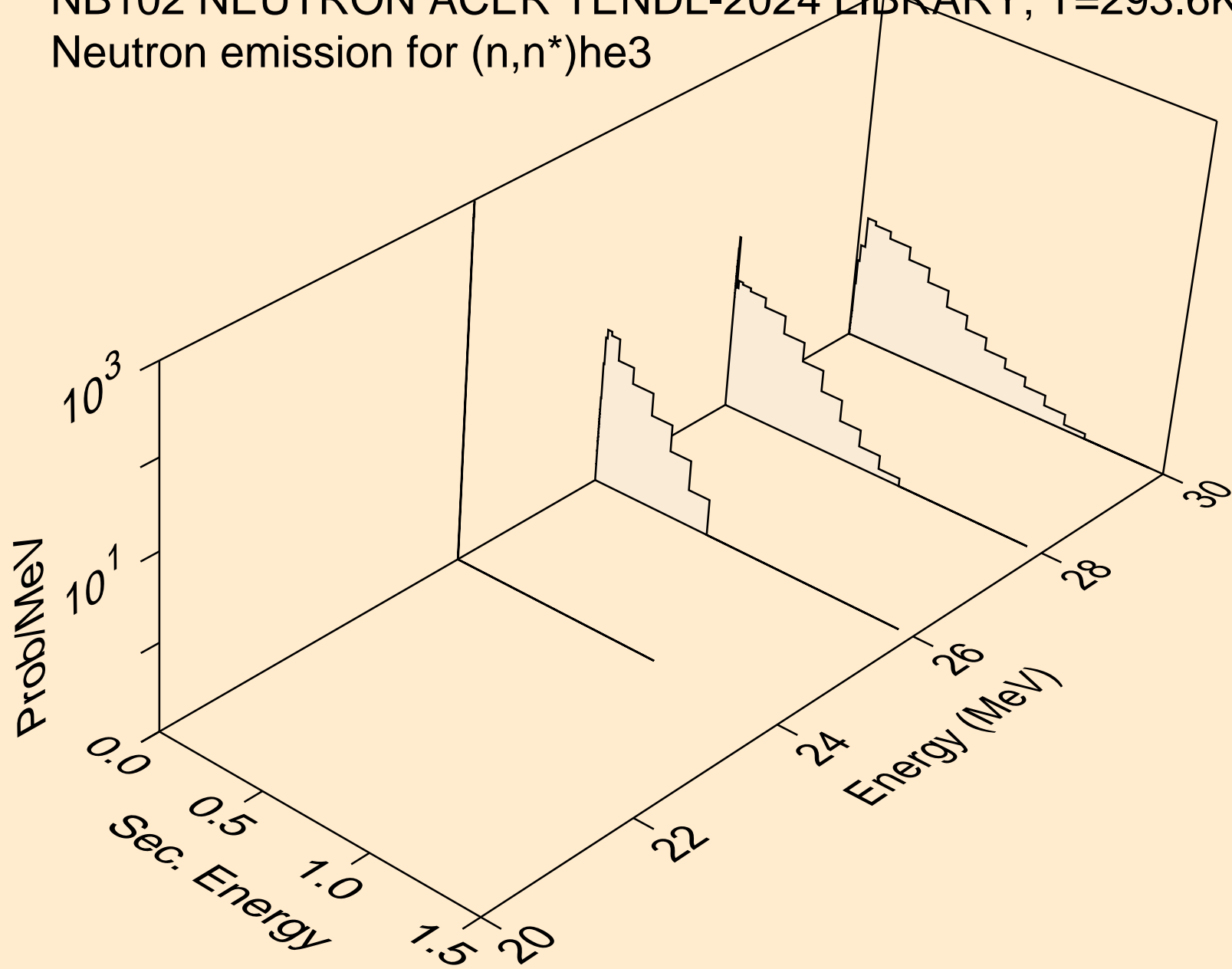

NB102 NEUTRON ACER TENDL-2024 LIBRARY; T=293.6K  
Neutron emission for (n,4n)

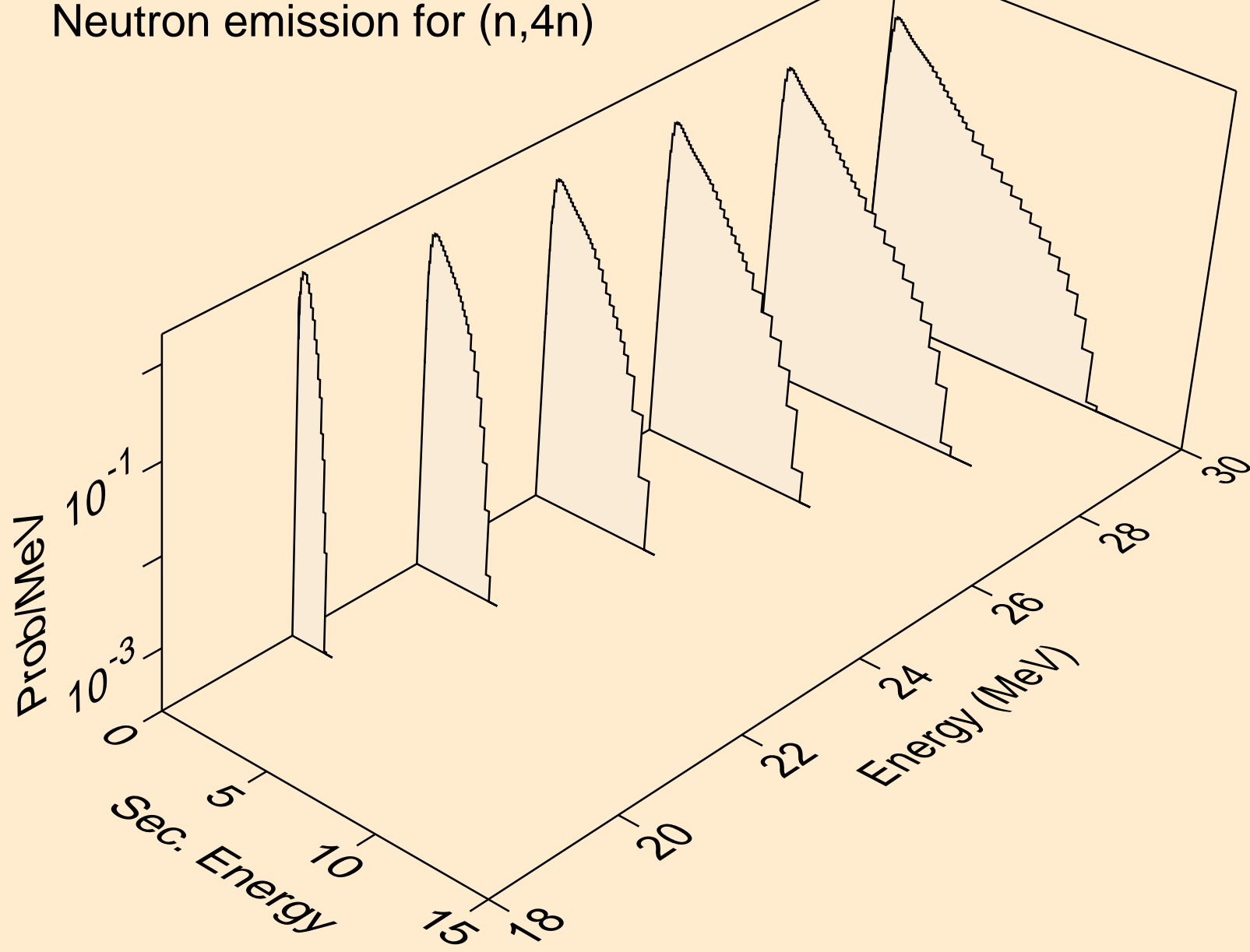

NB102 NEUTRON ACER TENDL-2024 LIBRARY; T=293.6K  
Neutron emission for (n,2np)

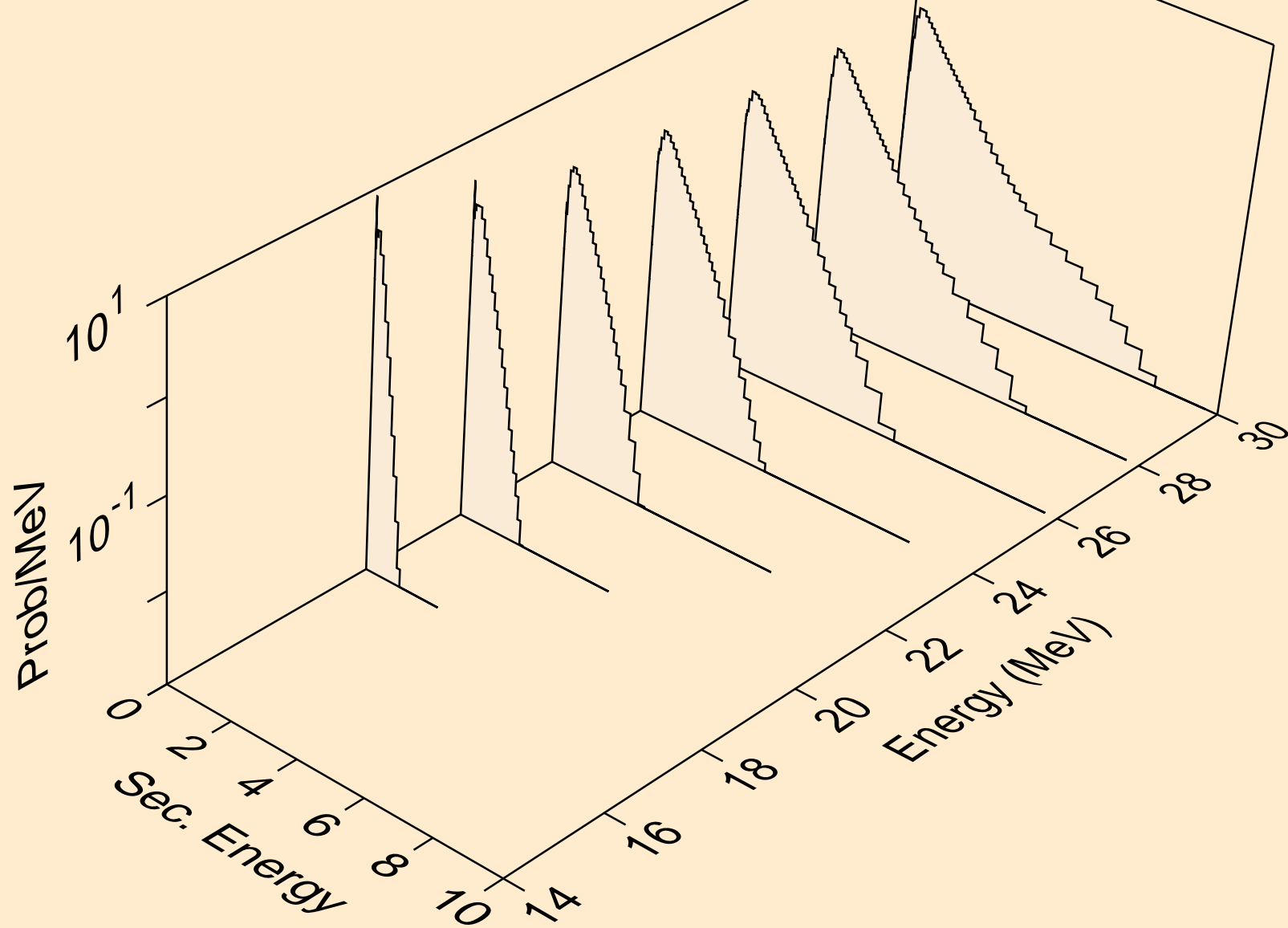

NB102 NEUTRON ACER TENDL-2024 LIBRARY; T=293.6K  
Neutron emission for (n,3np)

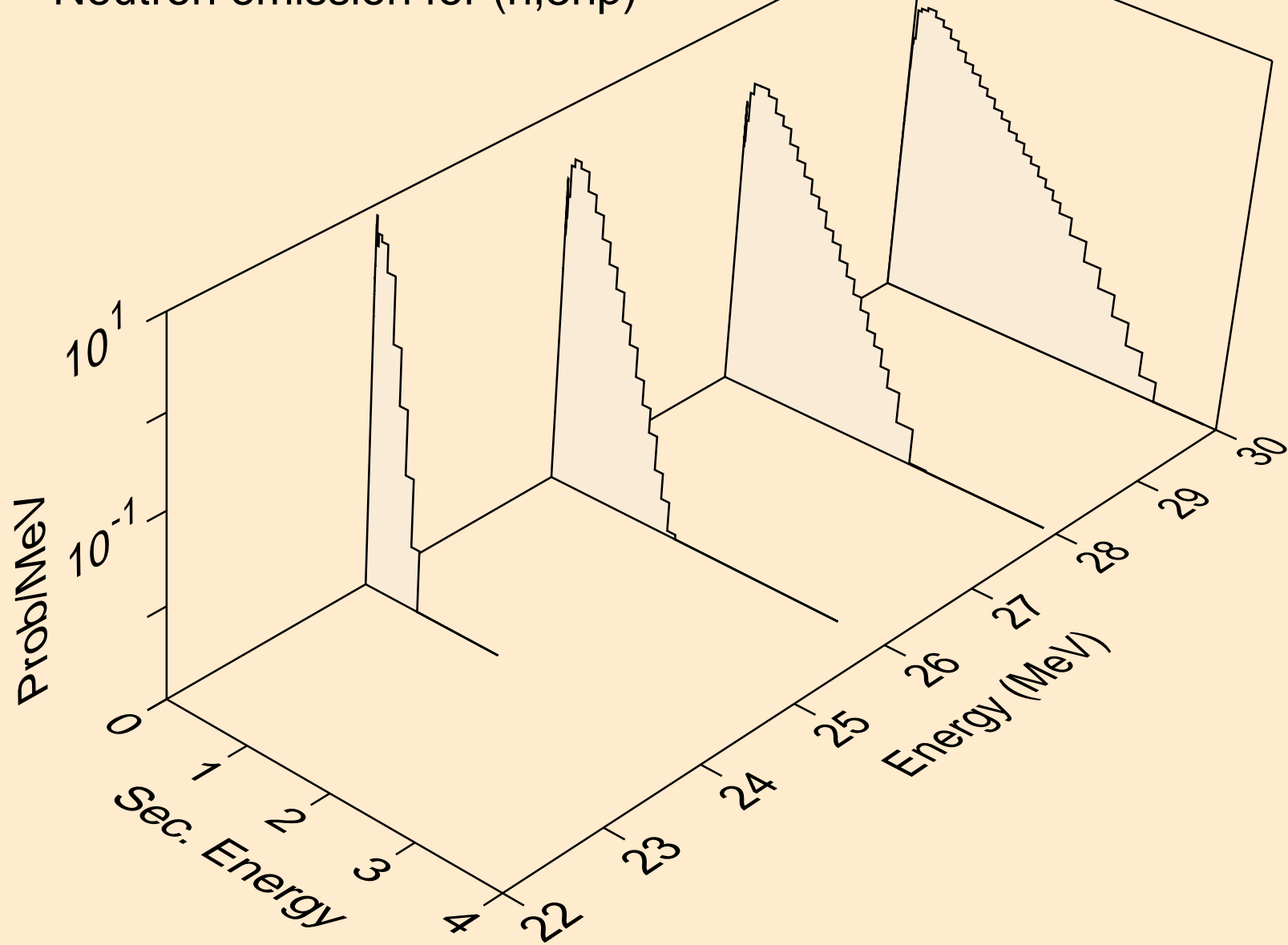

NB102 NEUTRON ACER TENDL-2024 LIBRARY; T=293.6K  
Neutron emission for (n,n\*c)

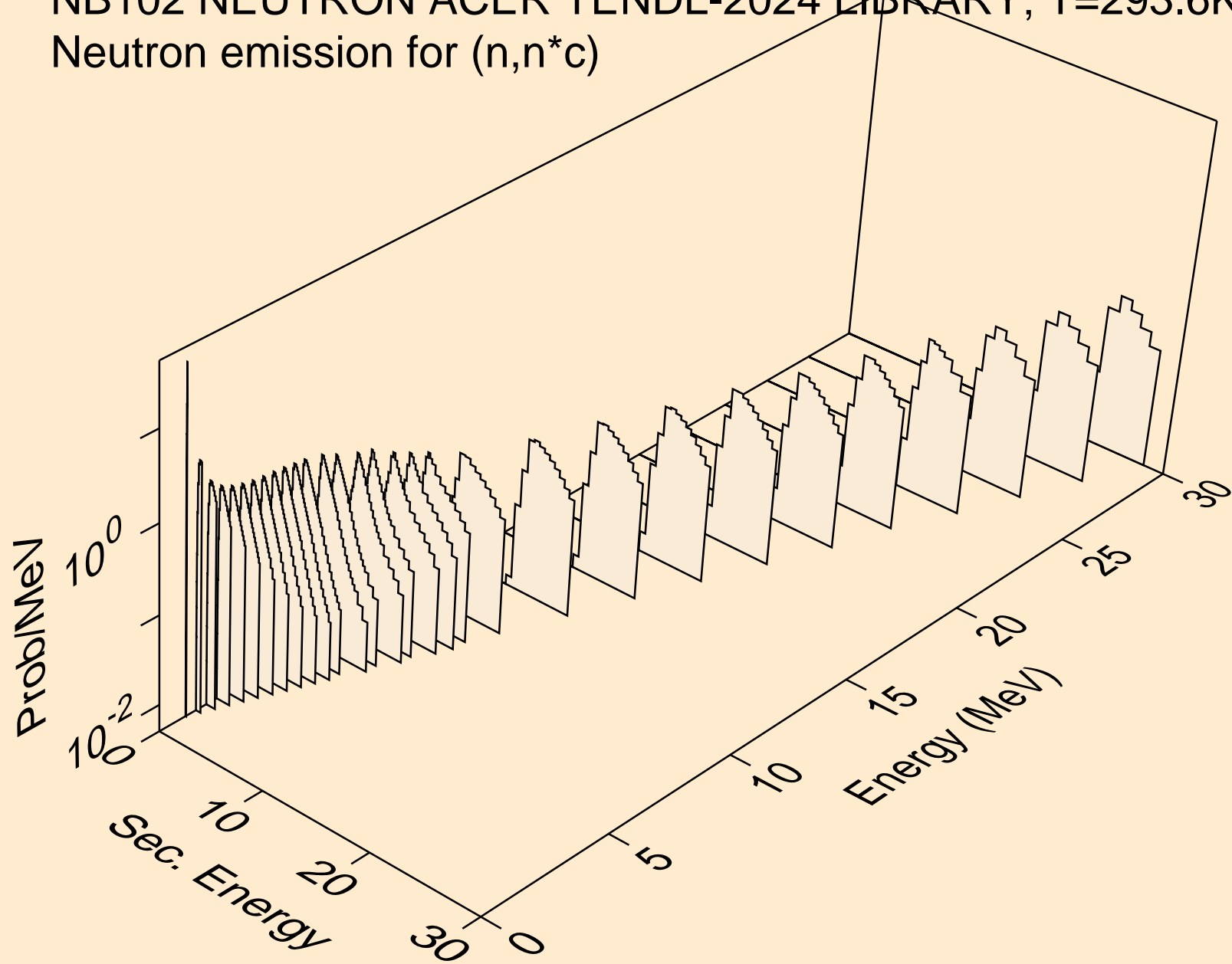

NB102 NEUTRON ACER TENDL-2024 LIBRARY; T=293.6K  
Photon emission for (n,x)

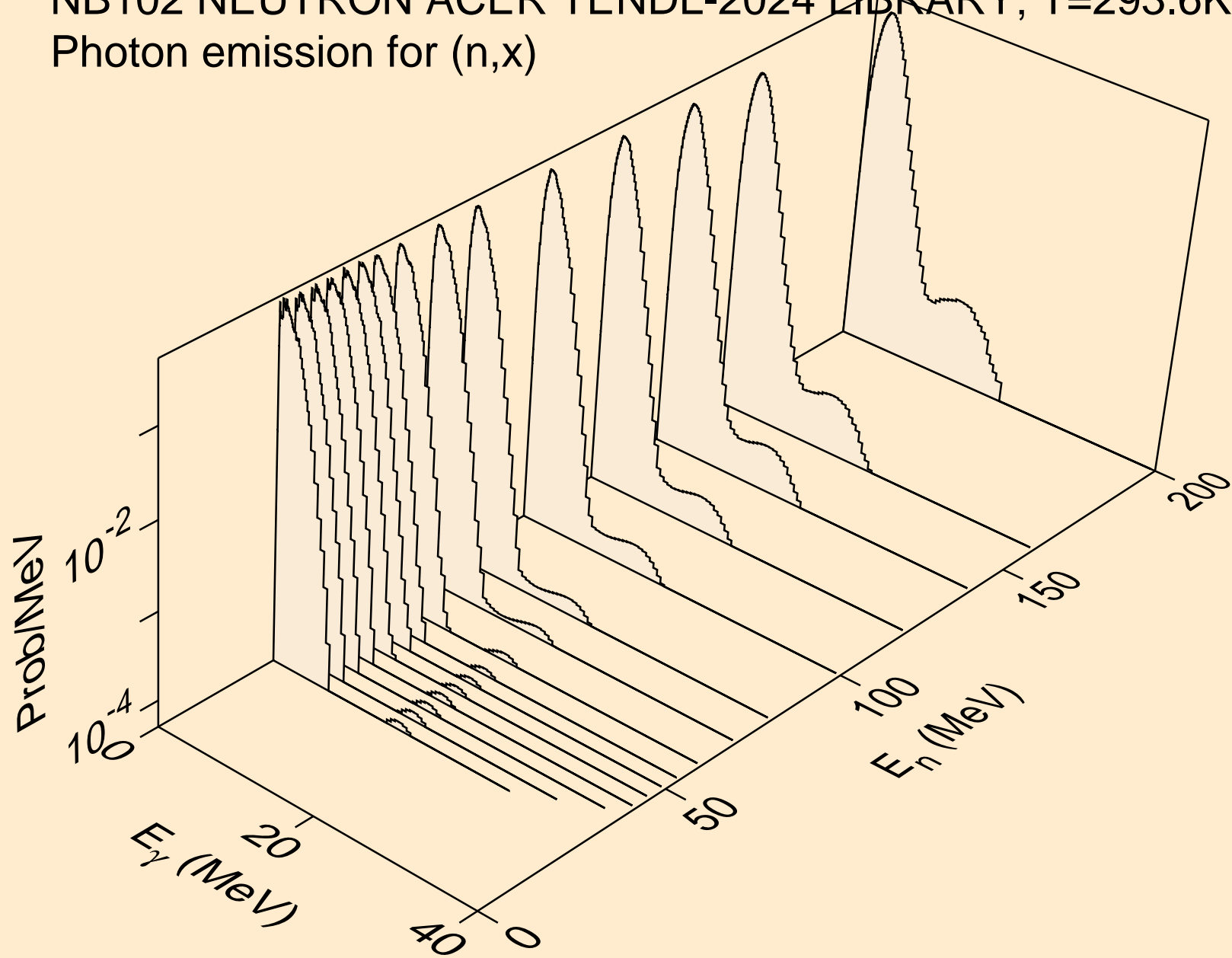

NB102 NEUTRON ACER TENDL-2024 LIBRARY; T=293.6K  
Photon emission for (n,2nd)

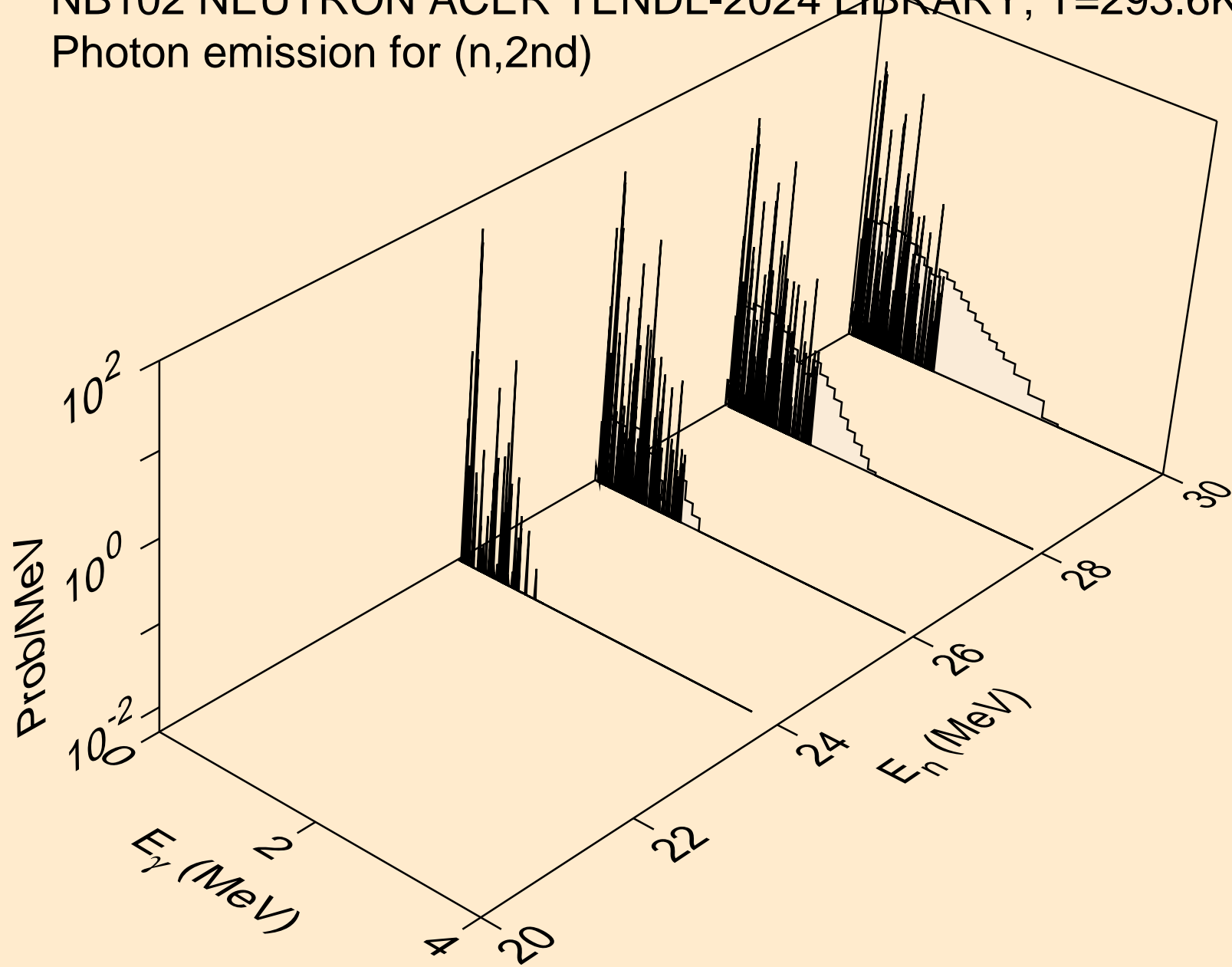

NB102 NEUTRON ACER TENDL-2024 LIBRARY; T=293.6K  
Photon emission for (n,2n)

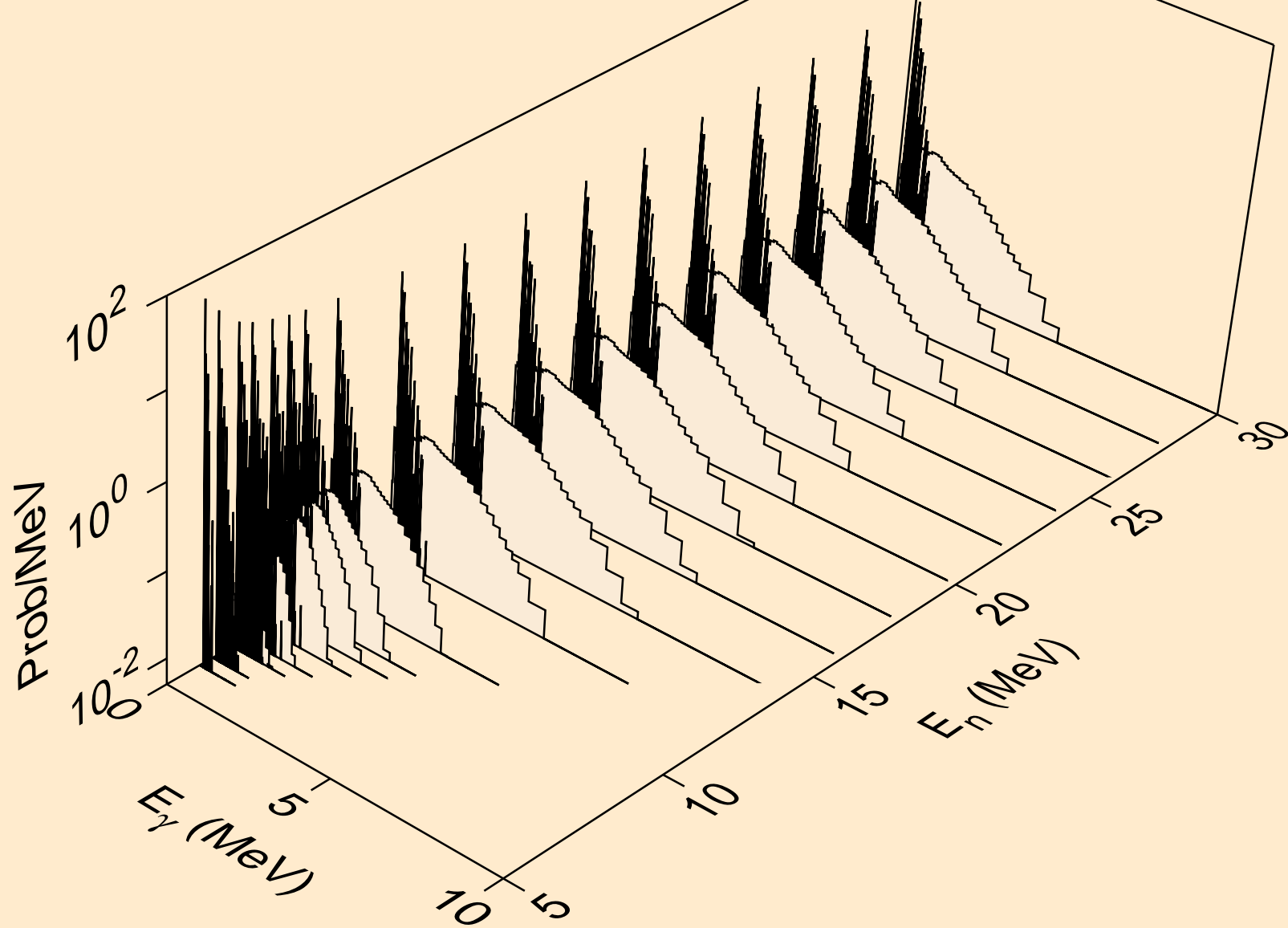

NB102 NEUTRON ACER TENDL-2024 LIBRARY; T=293.6K  
Photon emission for (n,3n)

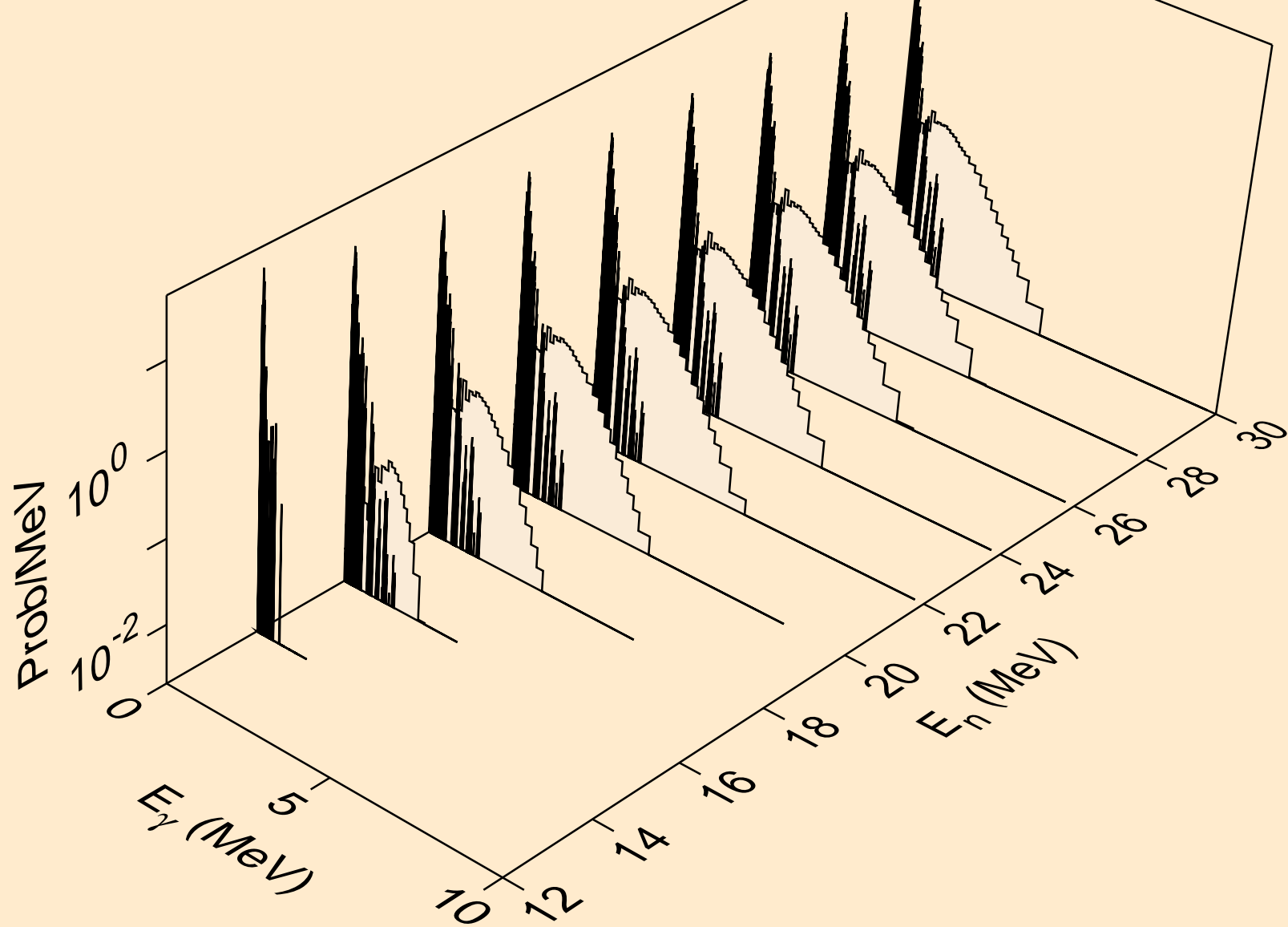

NB102 NEUTRON ACER TENDL-2024 LIBRARY; T=293.6K  
Photon emission for (n,n\*)a

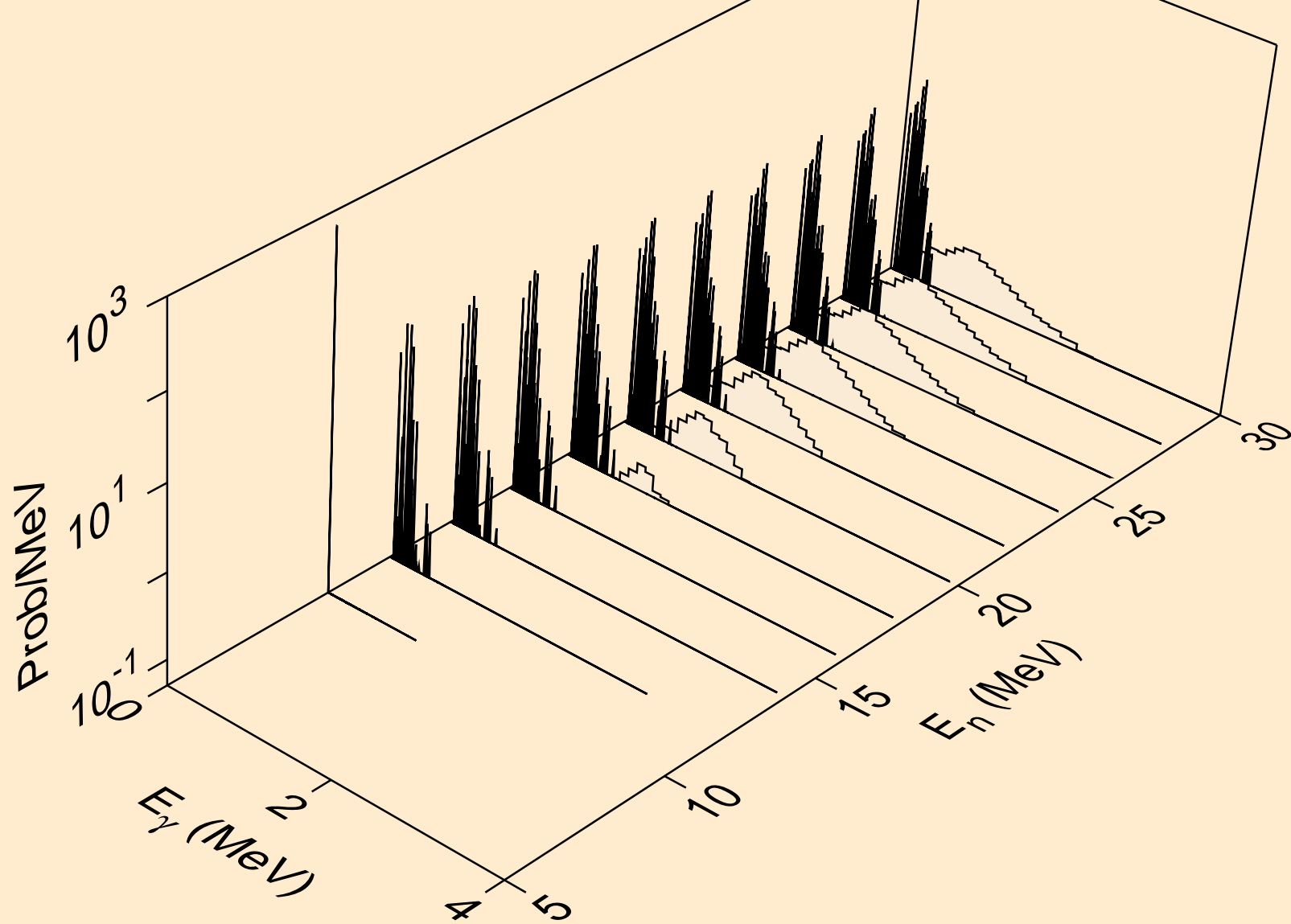

NB102 NEUTRON ACER TENDL-2024 LIBRARY; T=293.6K  
Photon emission for (n,2n)a

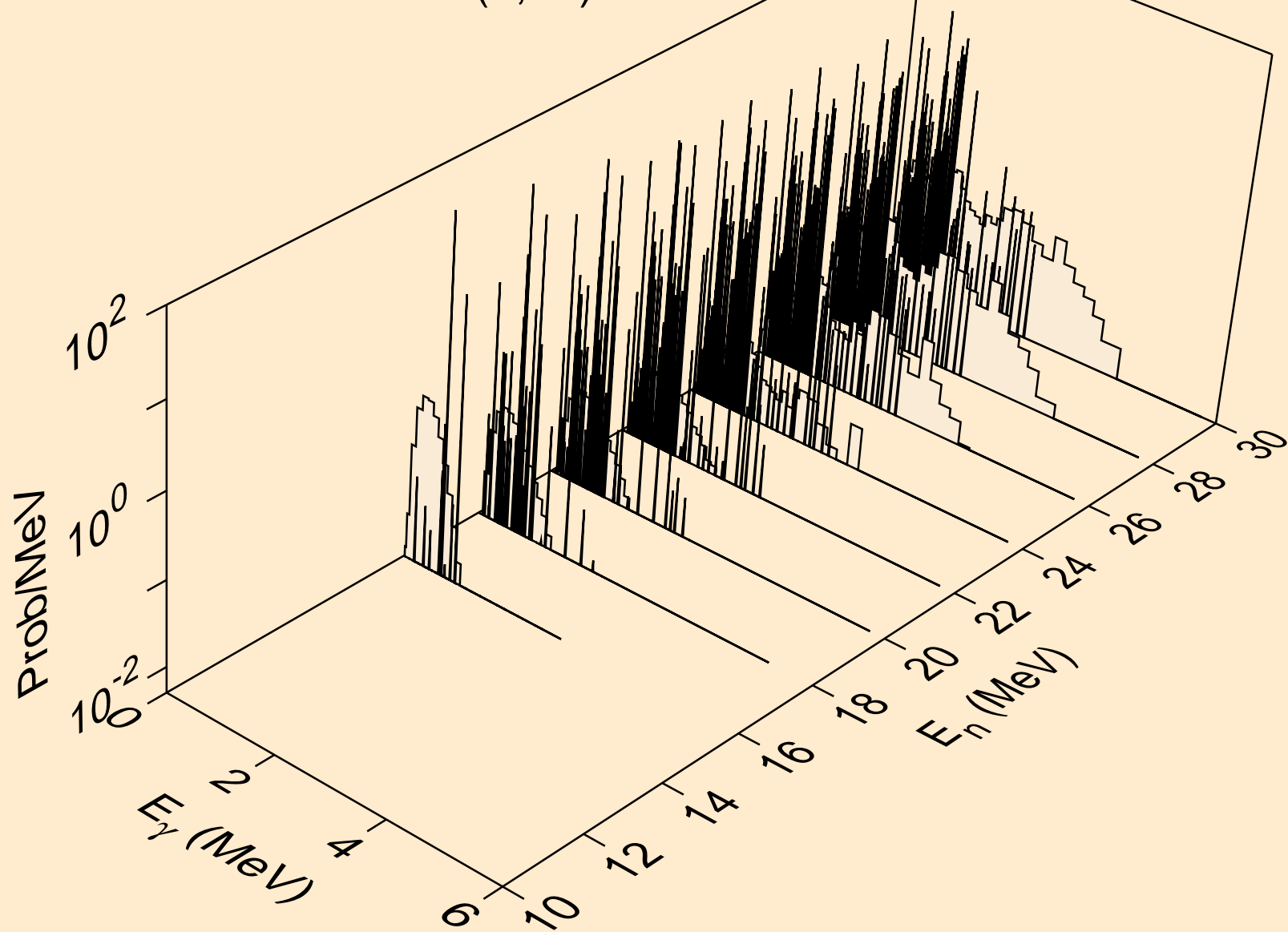

NB102 NEUTRON ACER TENDL-2024 LIBRARY; T=293.6K  
Photon emission for (n,3n)a

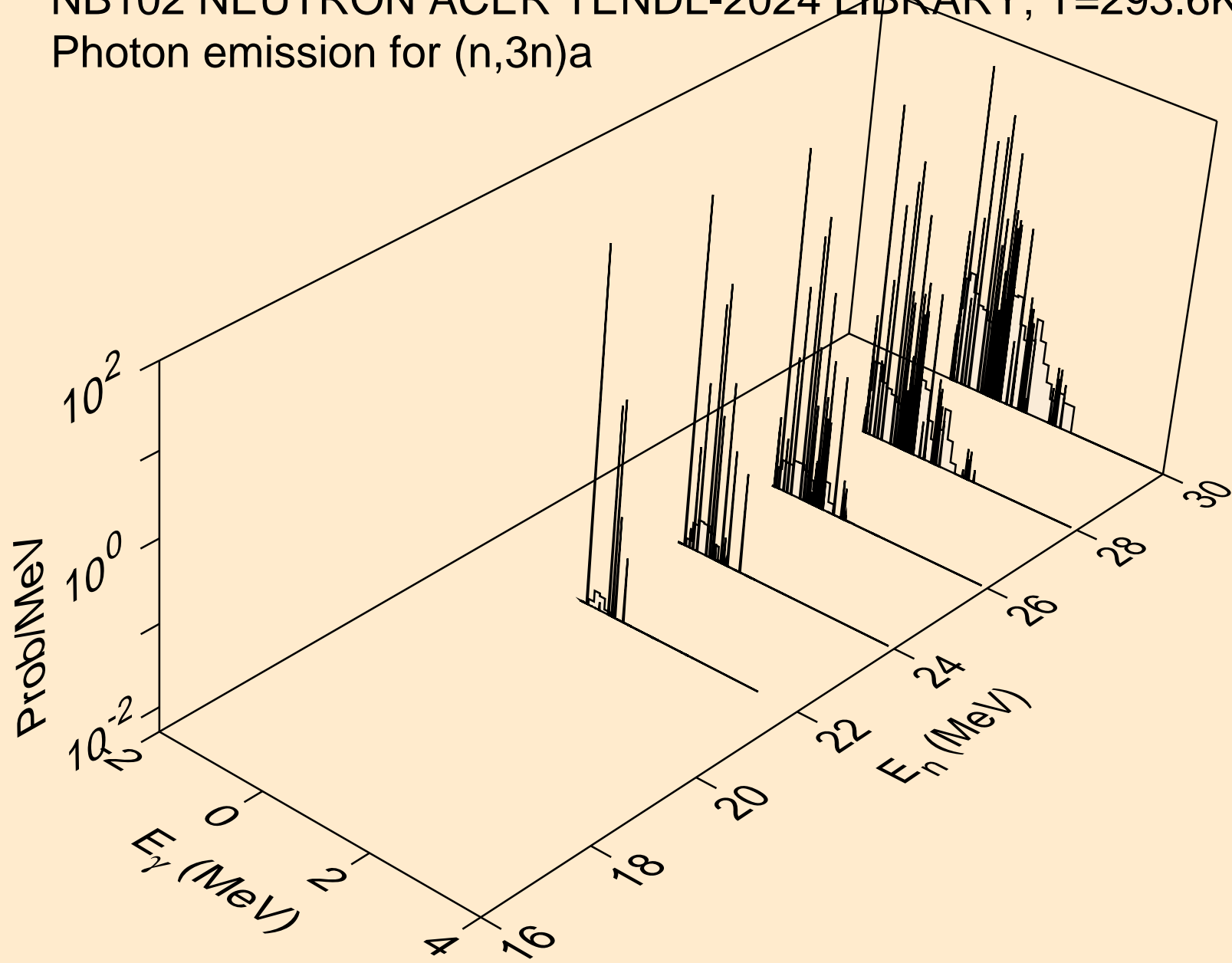

NB102 NEUTRON ACER TENDL-2024 LIBRARY; T=293.6K  
Photon emission for (n,n\*)p

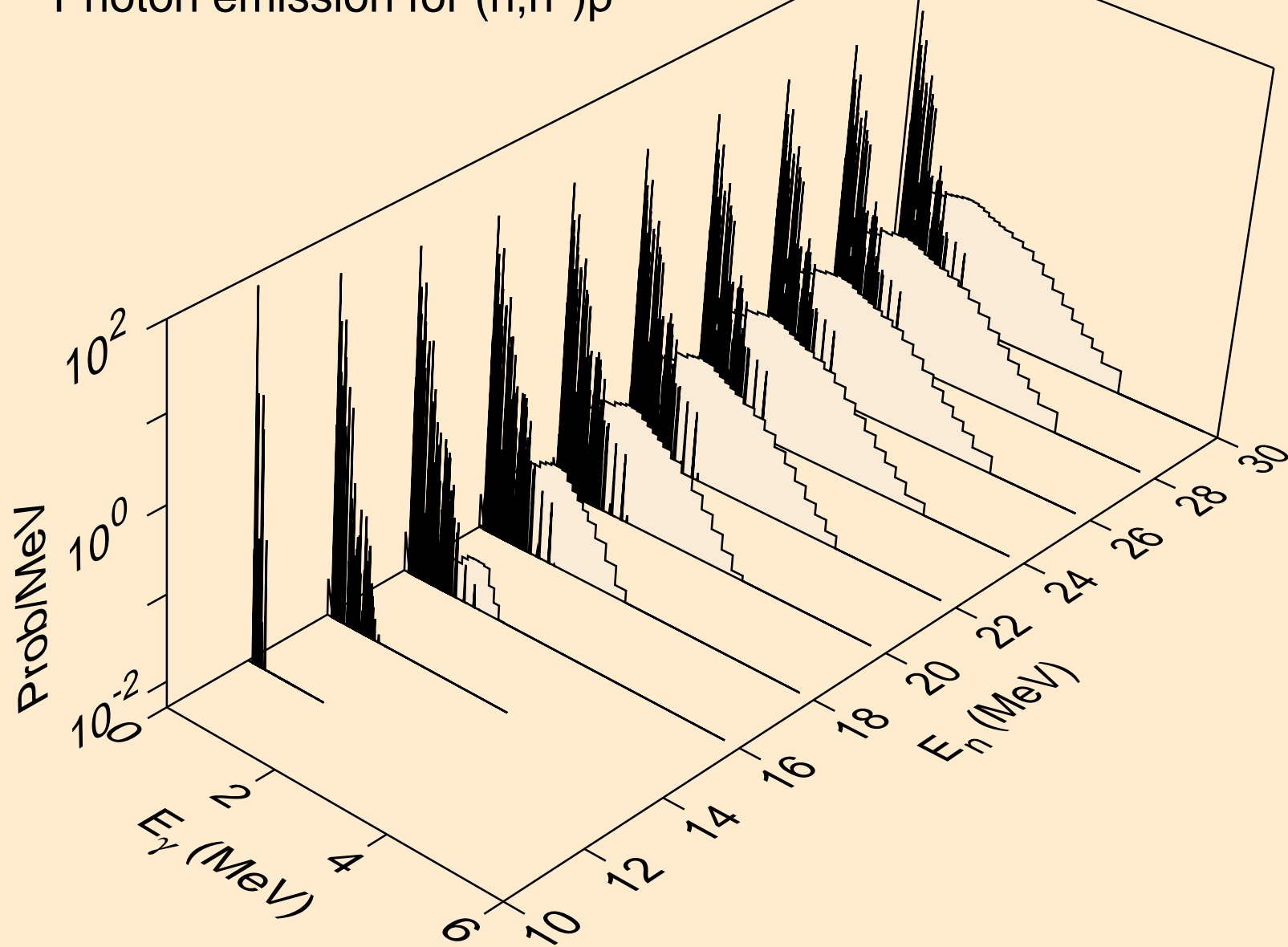

NB102 NEUTRON ACER TENDL-2024 LIBRARY; T=293.6K  
Photon emission for (n,n\*)d

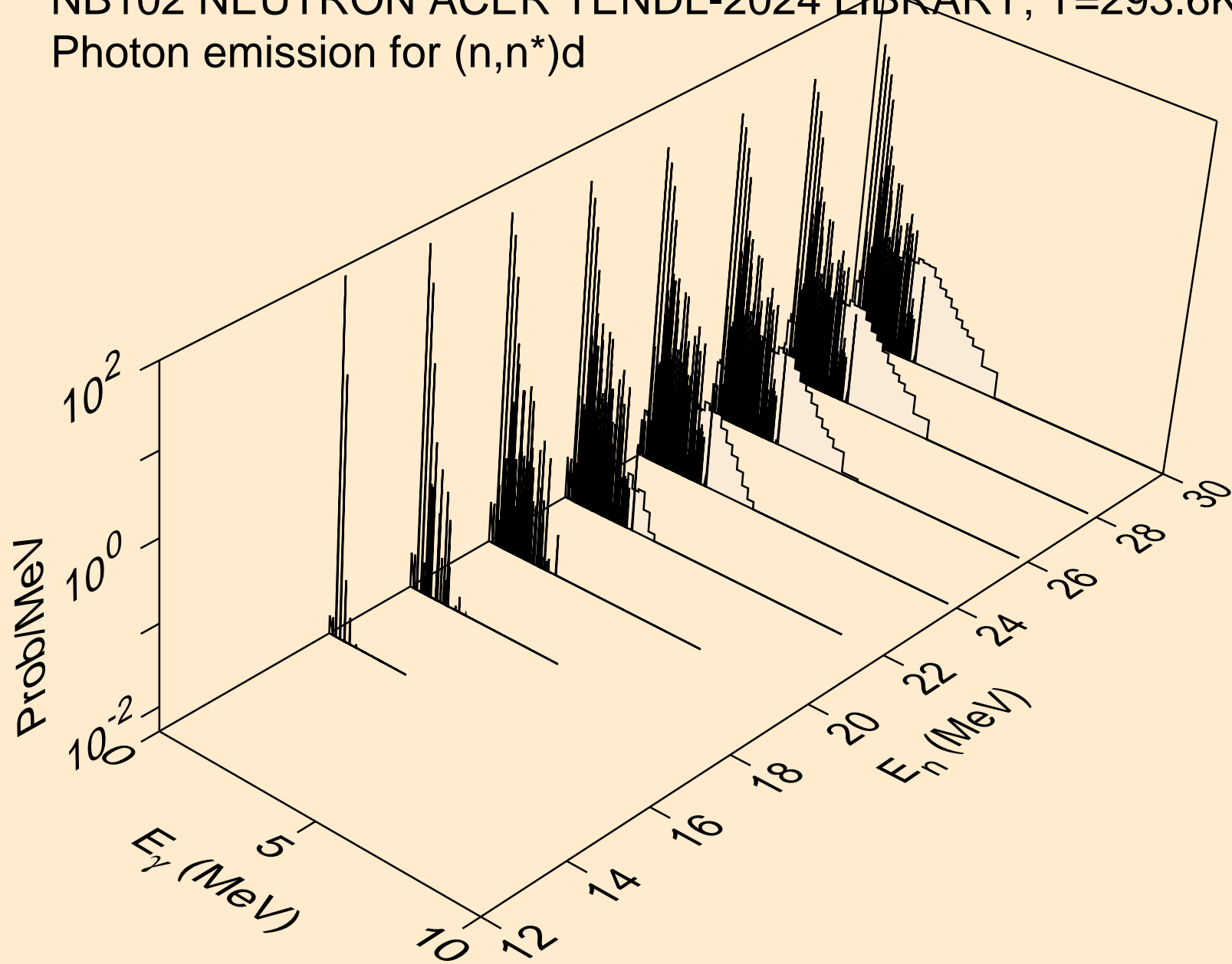

NB102 NEUTRON ACER TENDL-2024 LIBRARY; T=293.6K  
Photon emission for (n,n\*)t

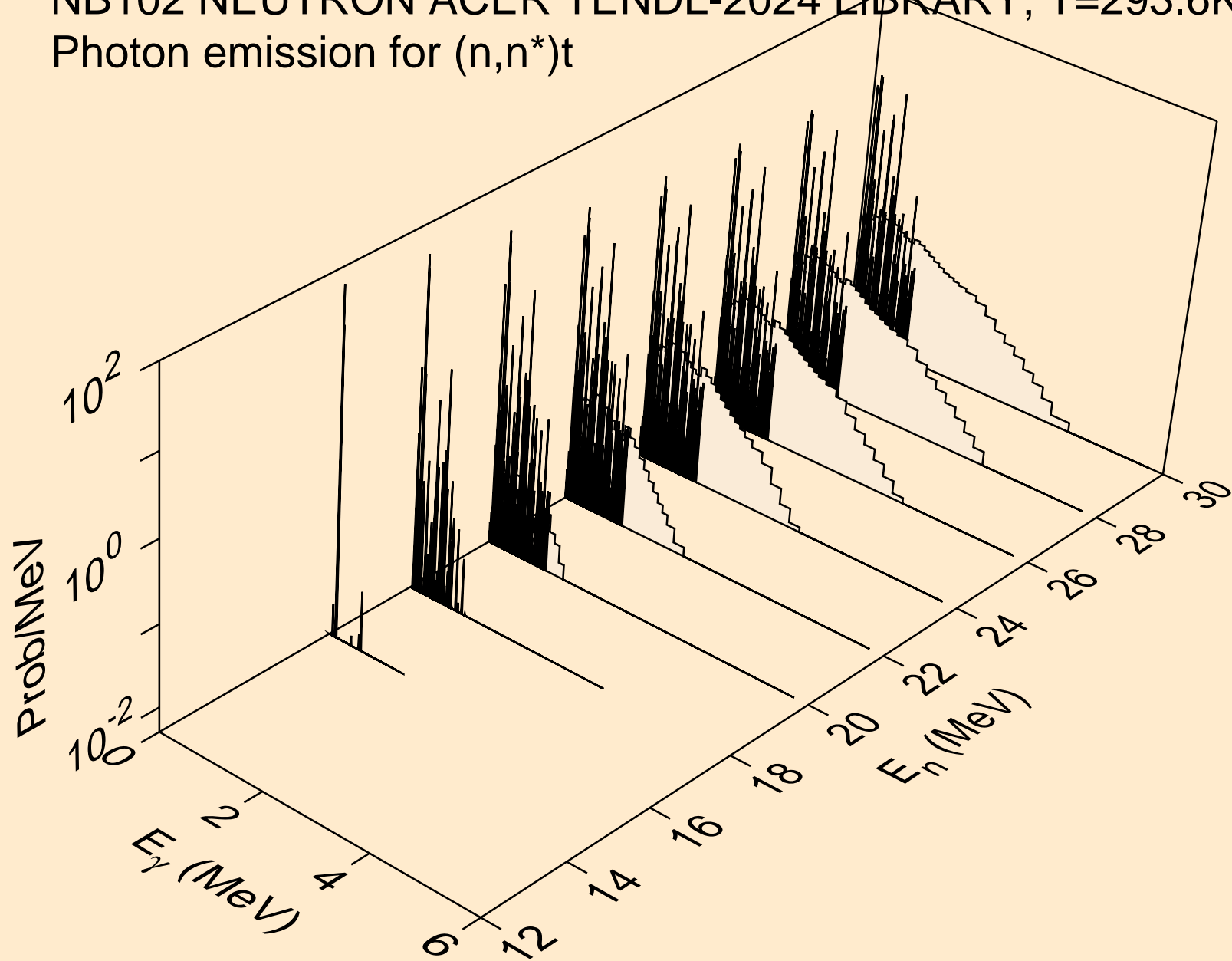

NB102 NEUTRON ACER TENDL-2024 LIBRARY; T=293.6K  
Photon emission for (n,n\*)he3

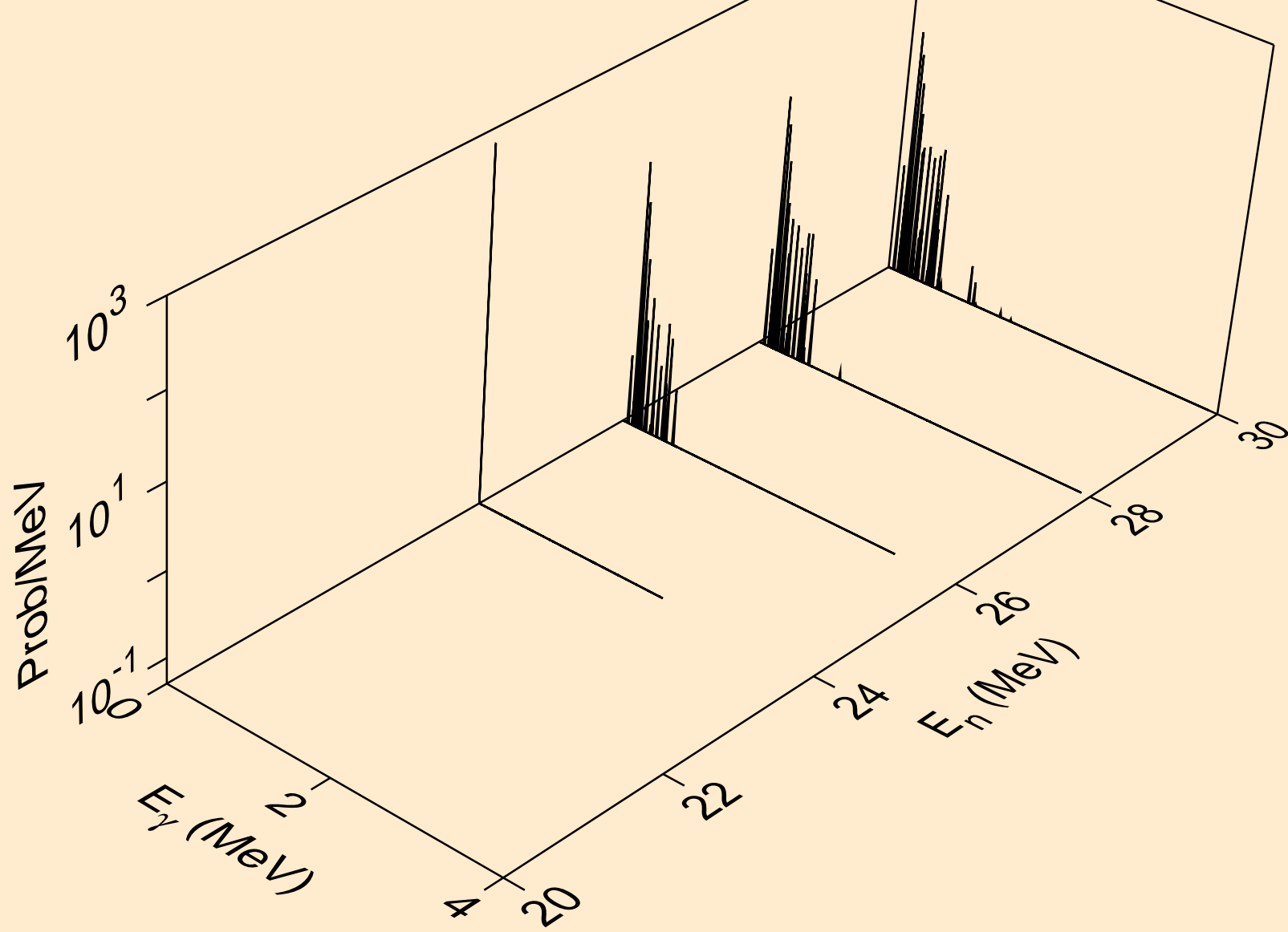

NB102 NEUTRON ACER TENDL-2024 LIBRARY; T=293.6K  
Photon emission for (n,4n)

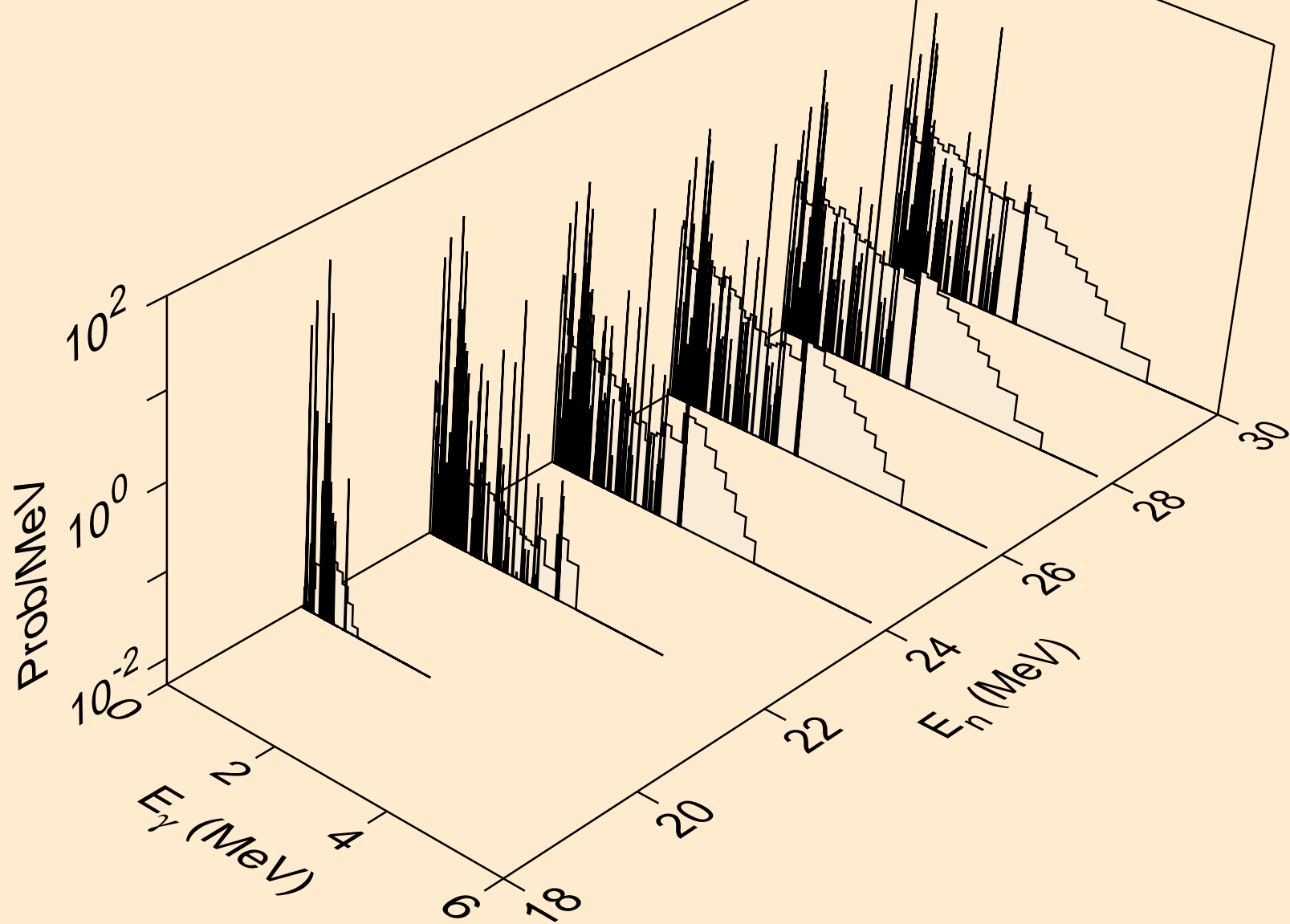

NB102 NEUTRON ACER TENDL-2024 LIBRARY; T=293.6K  
Photon emission for (n,2np)

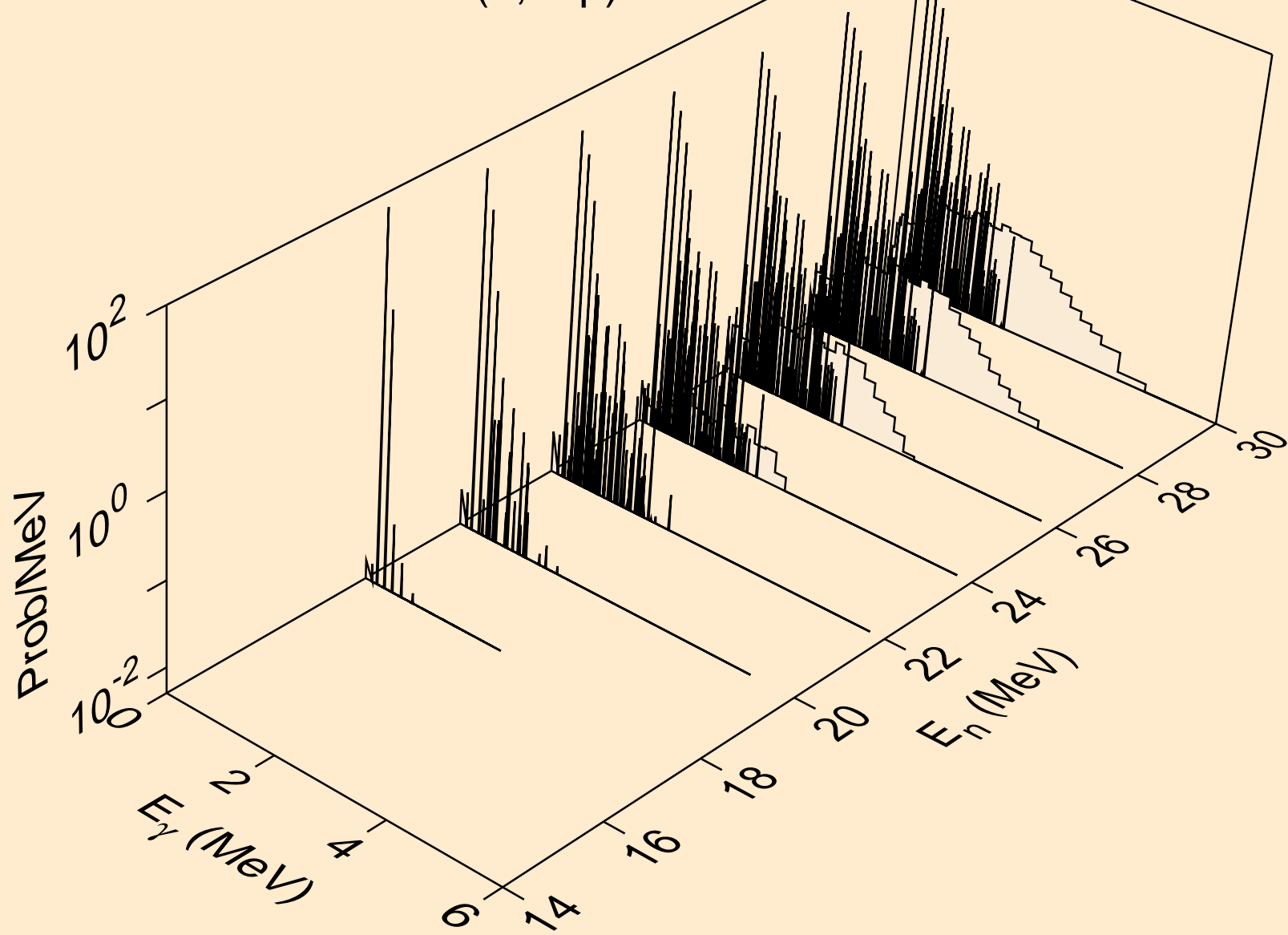

NB102 NEUTRON ACER TENDL-2024 LIBRARY; T=293.6K  
Photon emission for (n,3np)

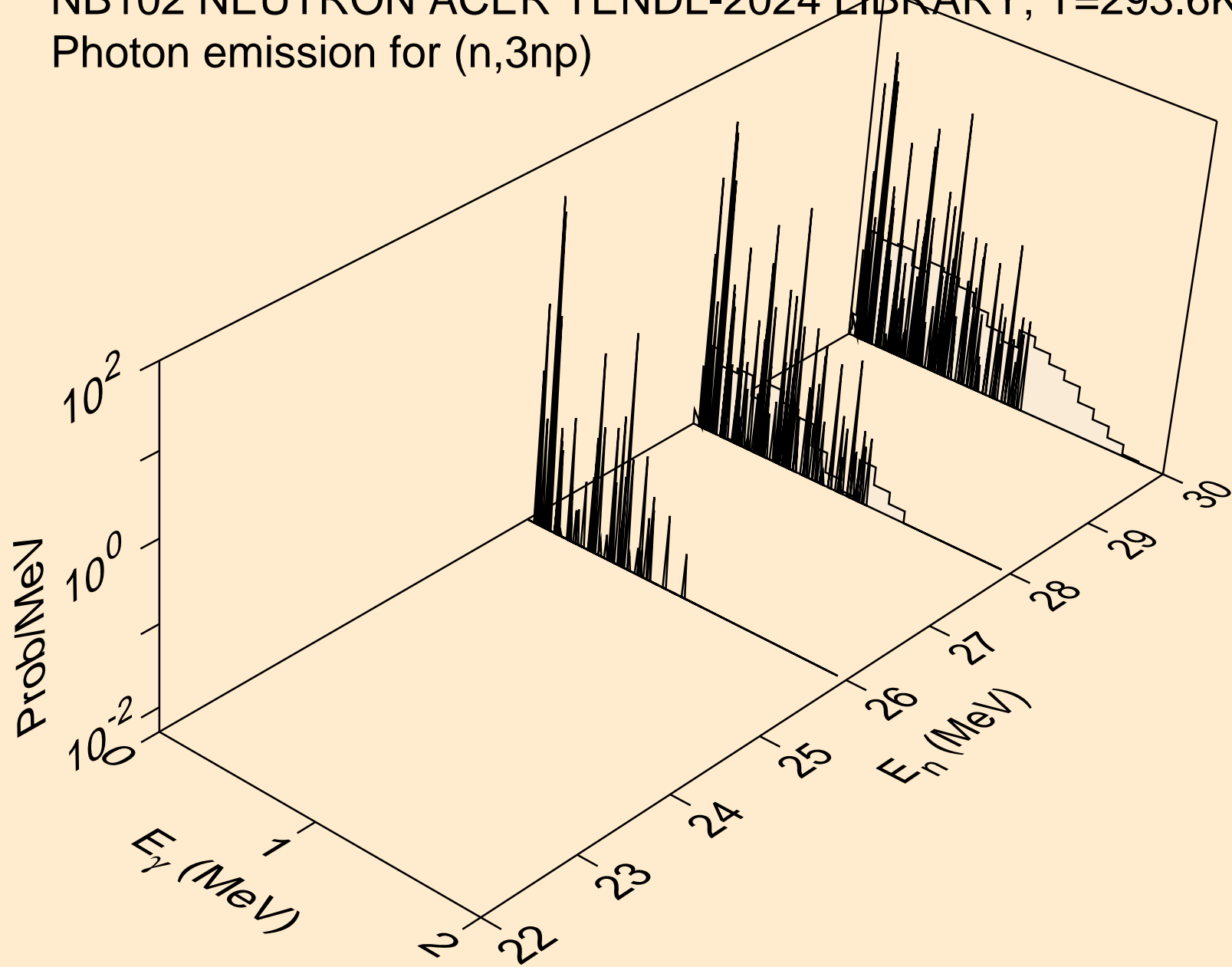

NB102 NEUTRON ACER TENDL-2024 LIBRARY; T=293.6K  
Photon emission for (n,n\*c)

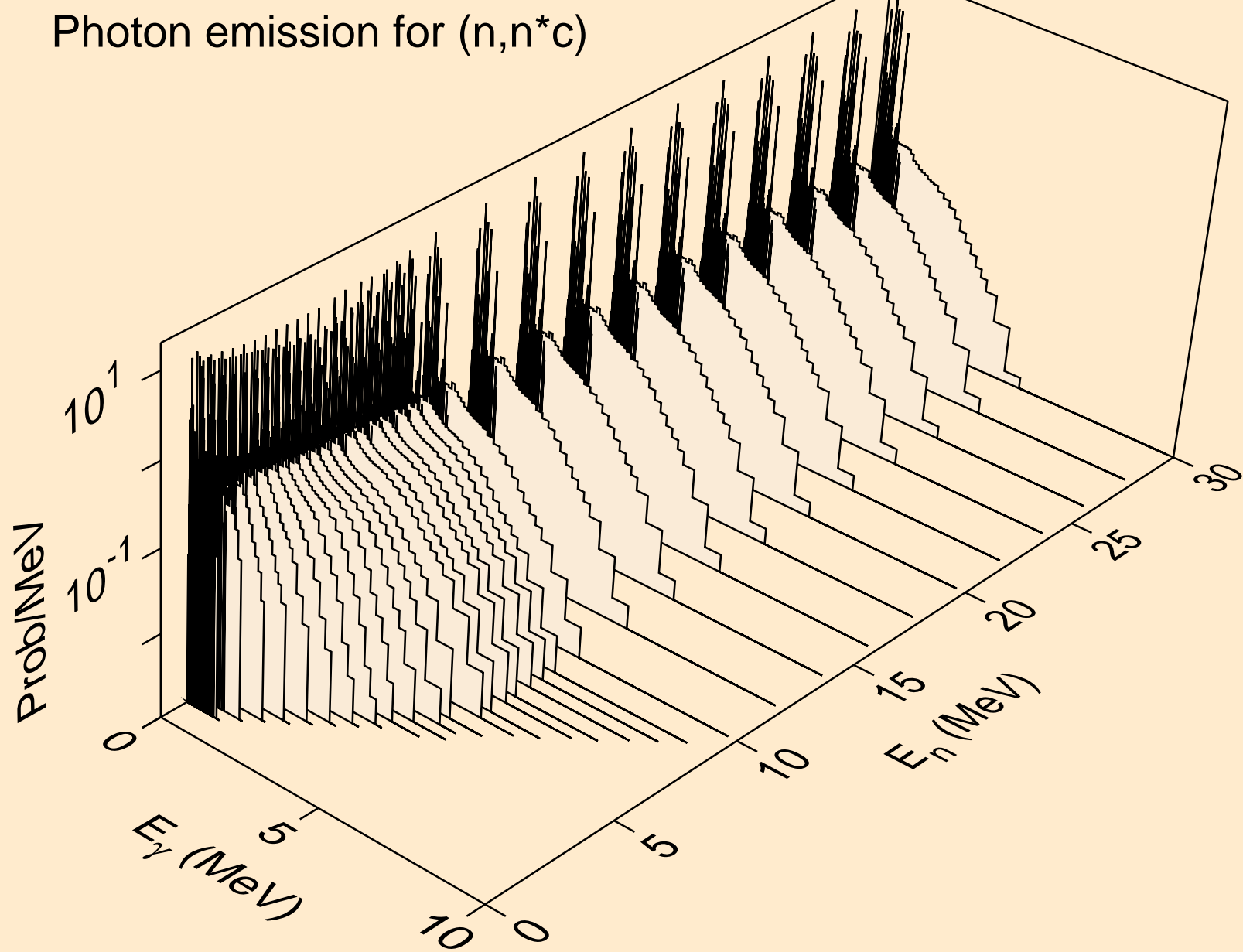

NB102 NEUTRON ACER TENDL-2024 LIBRARY; T=293.6K  
Photon emission for (n,gma)

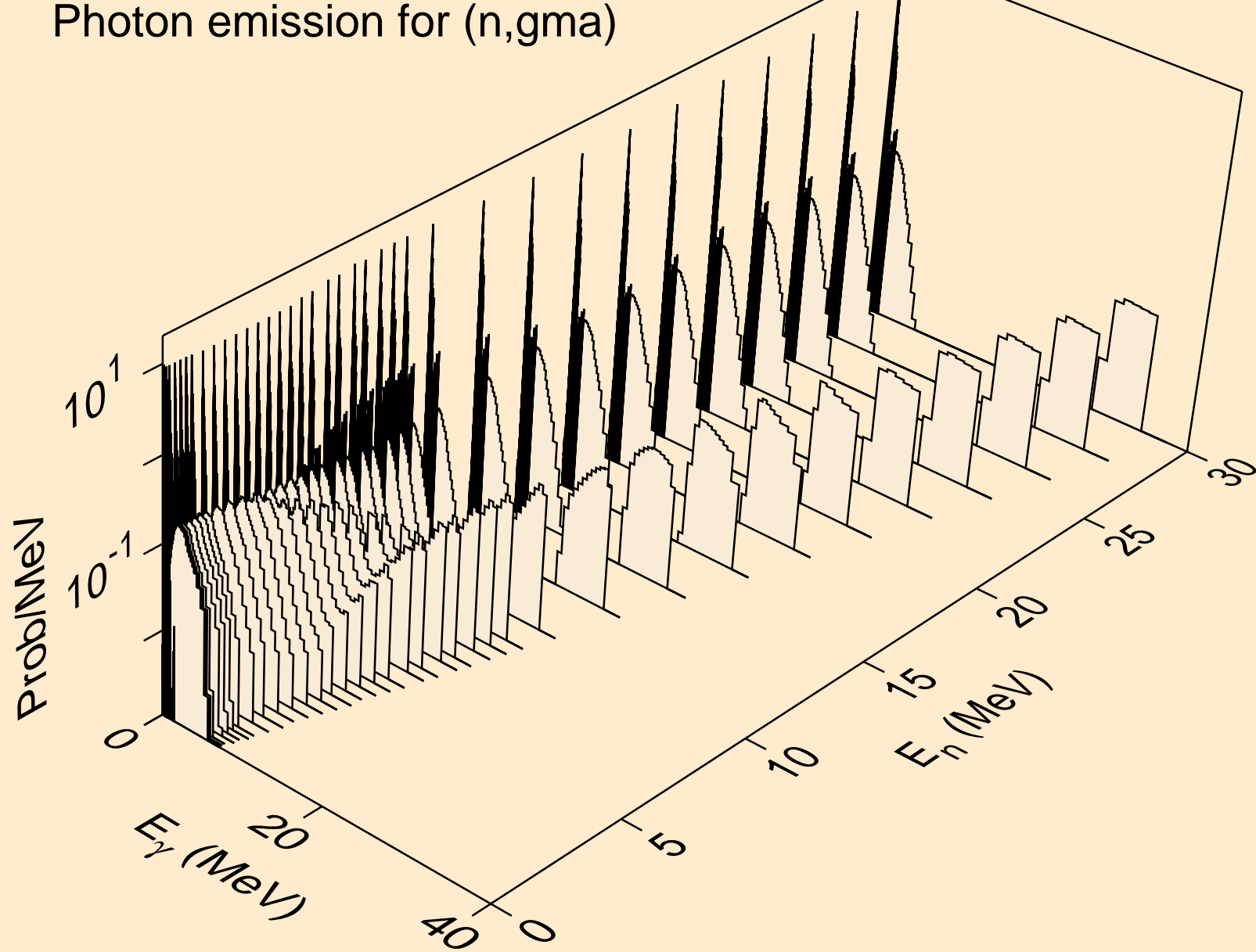

NB102 NEUTRON ACER TENDL-2024 LIBRARY; T=293.6K  
Photon emission for (n,p)

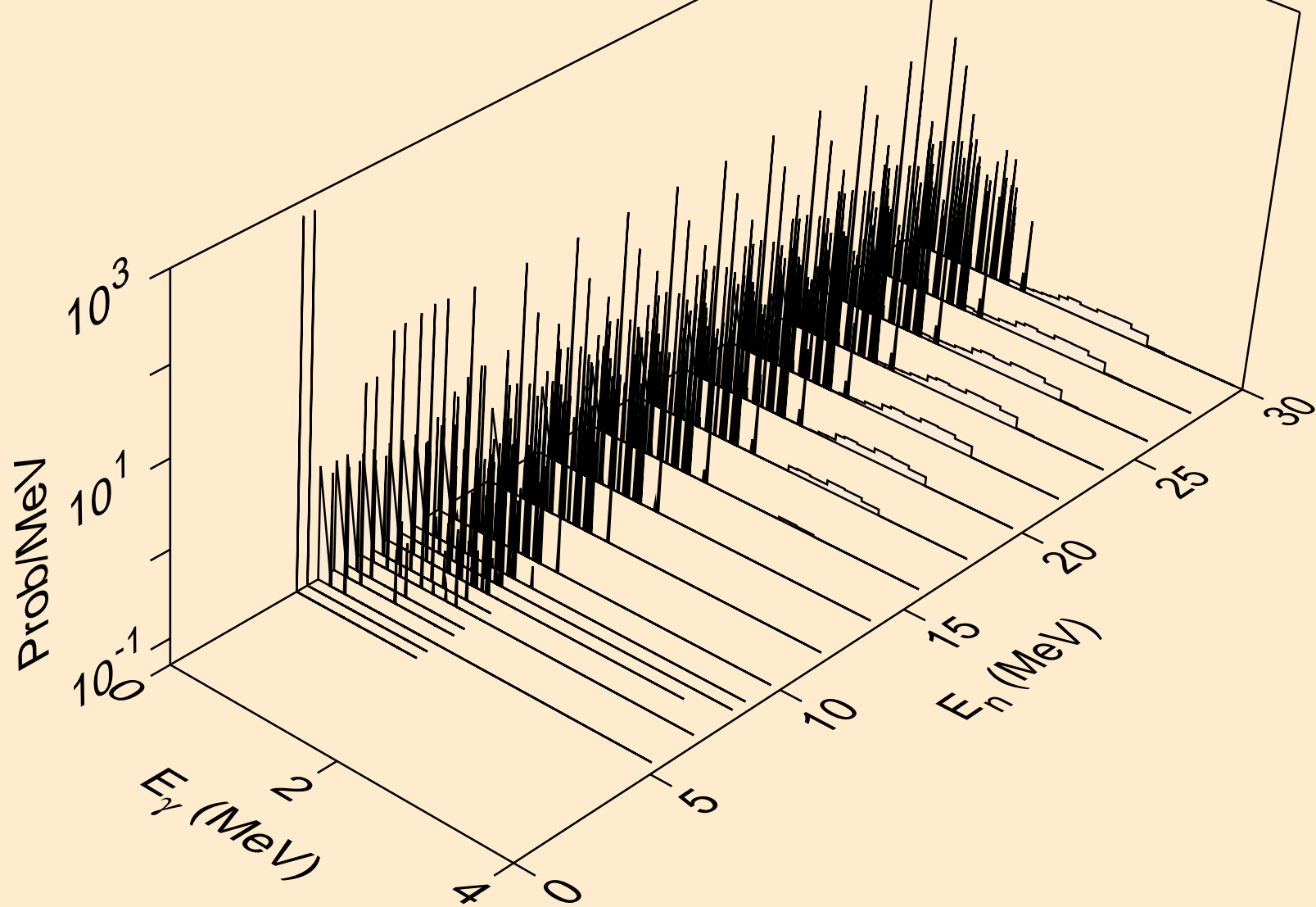

NB102 NEUTRON ACER TENDL-2024 LIBRARY; T=293.6K  
Photon emission for (n,d)

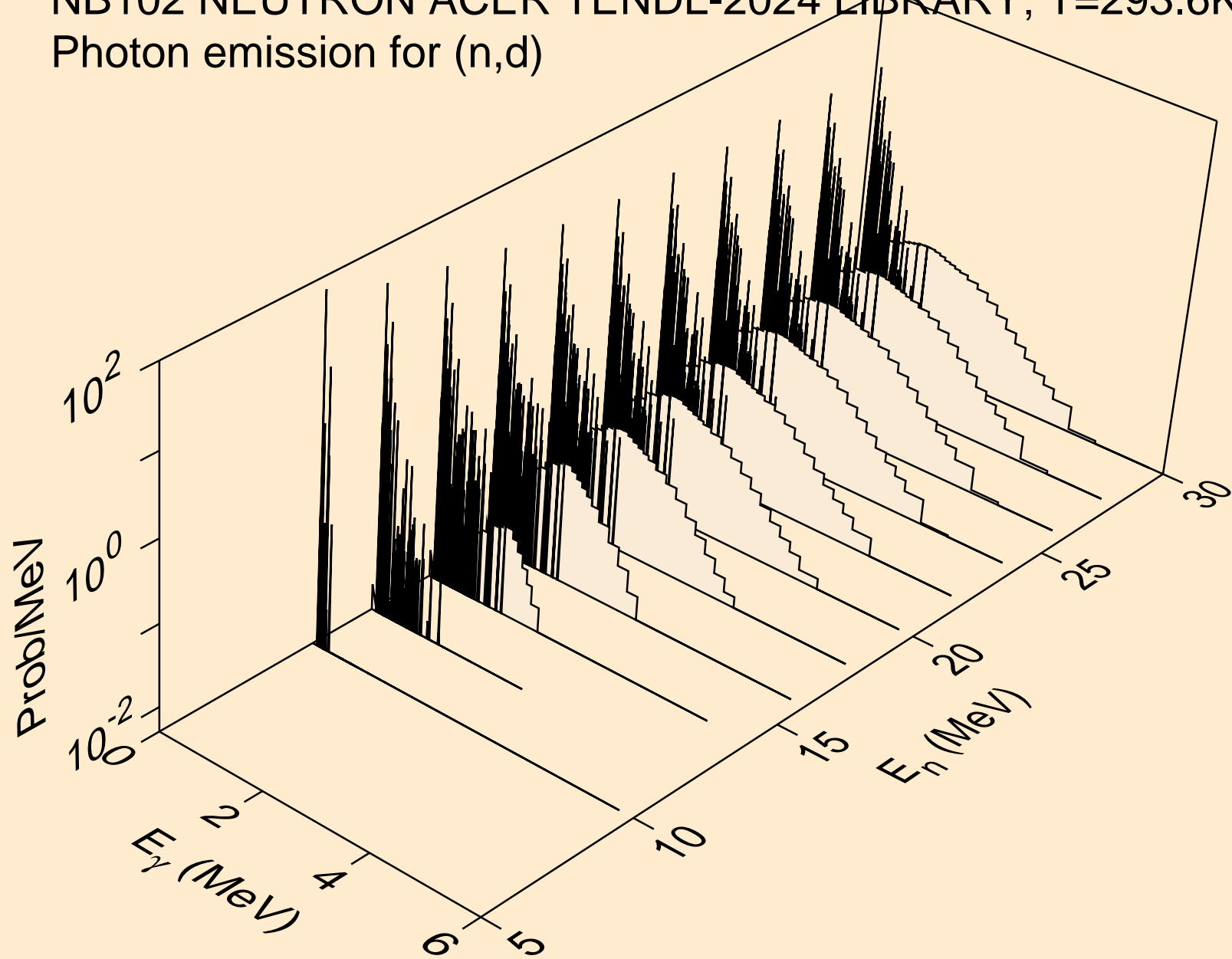

NB102 NEUTRON ACER TENDL-2024 LIBRARY; T=293.6K  
Photon emission for (n,t)

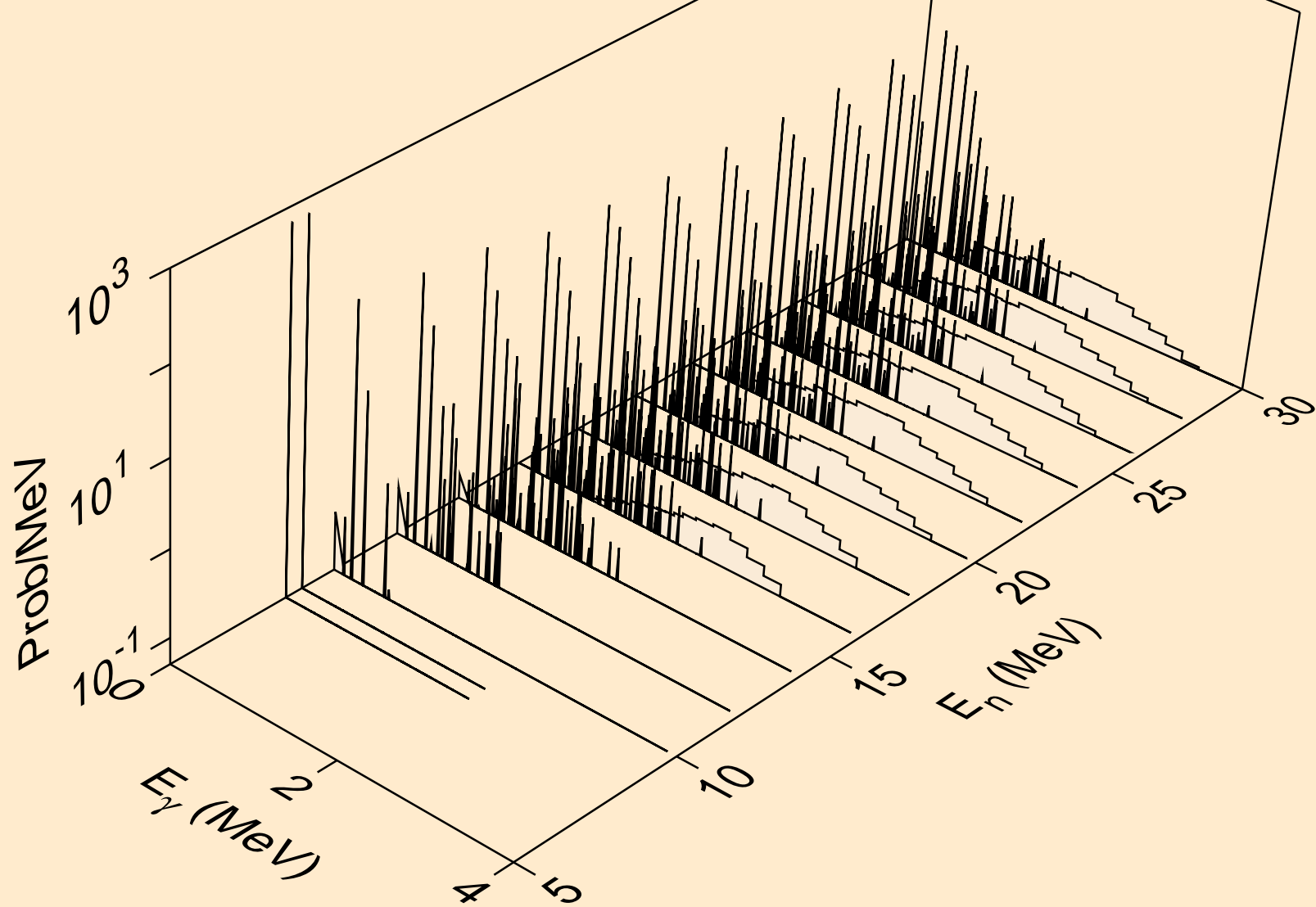

NB102 NEUTRON ACER TENDL-2024 LIBRARY; T=293.6K  
Photon emission for (n,he3)

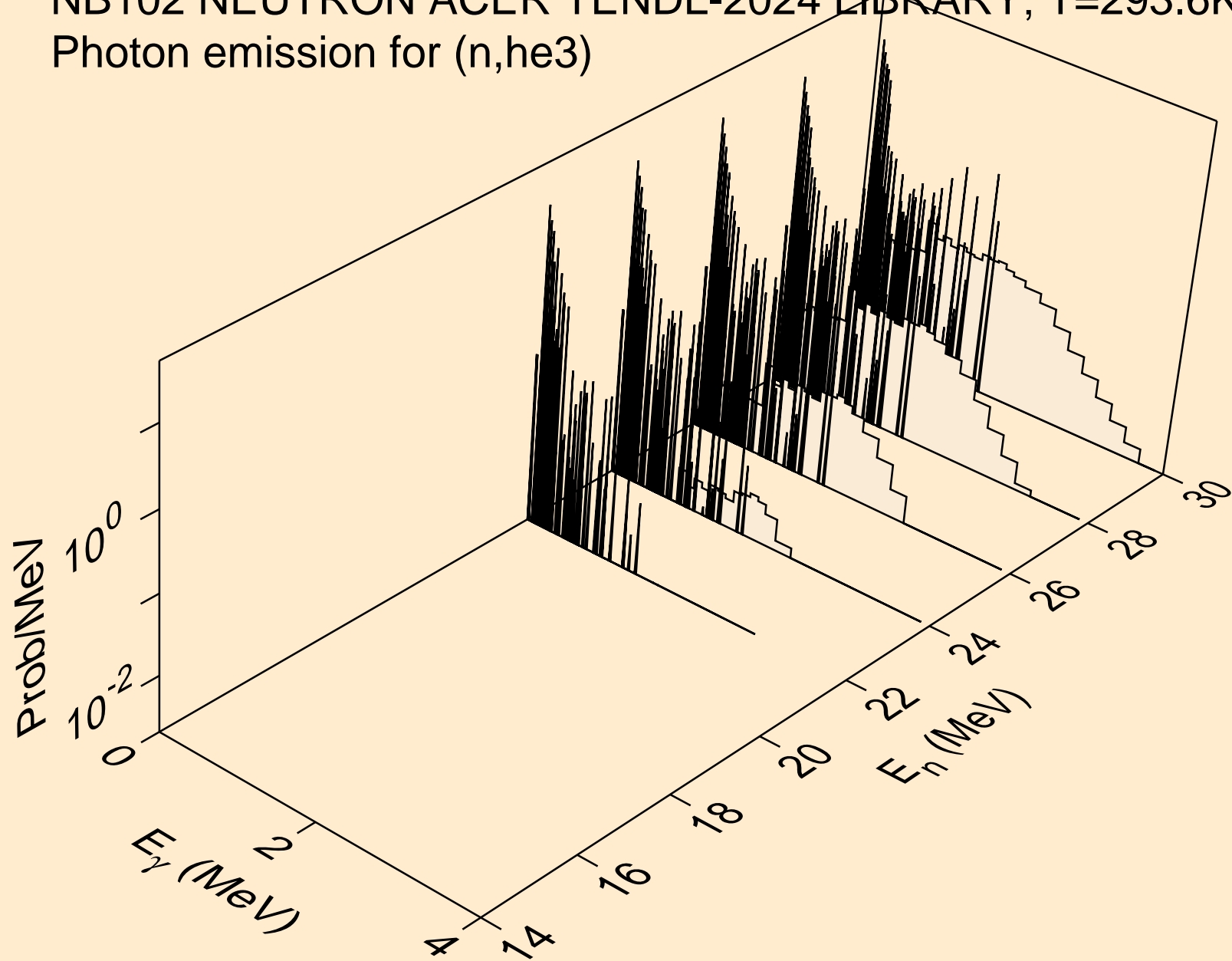

NB102 NEUTRON ACER TENDL-2024 LIBRARY; T=293.6K  
Photon emission for (n,a)

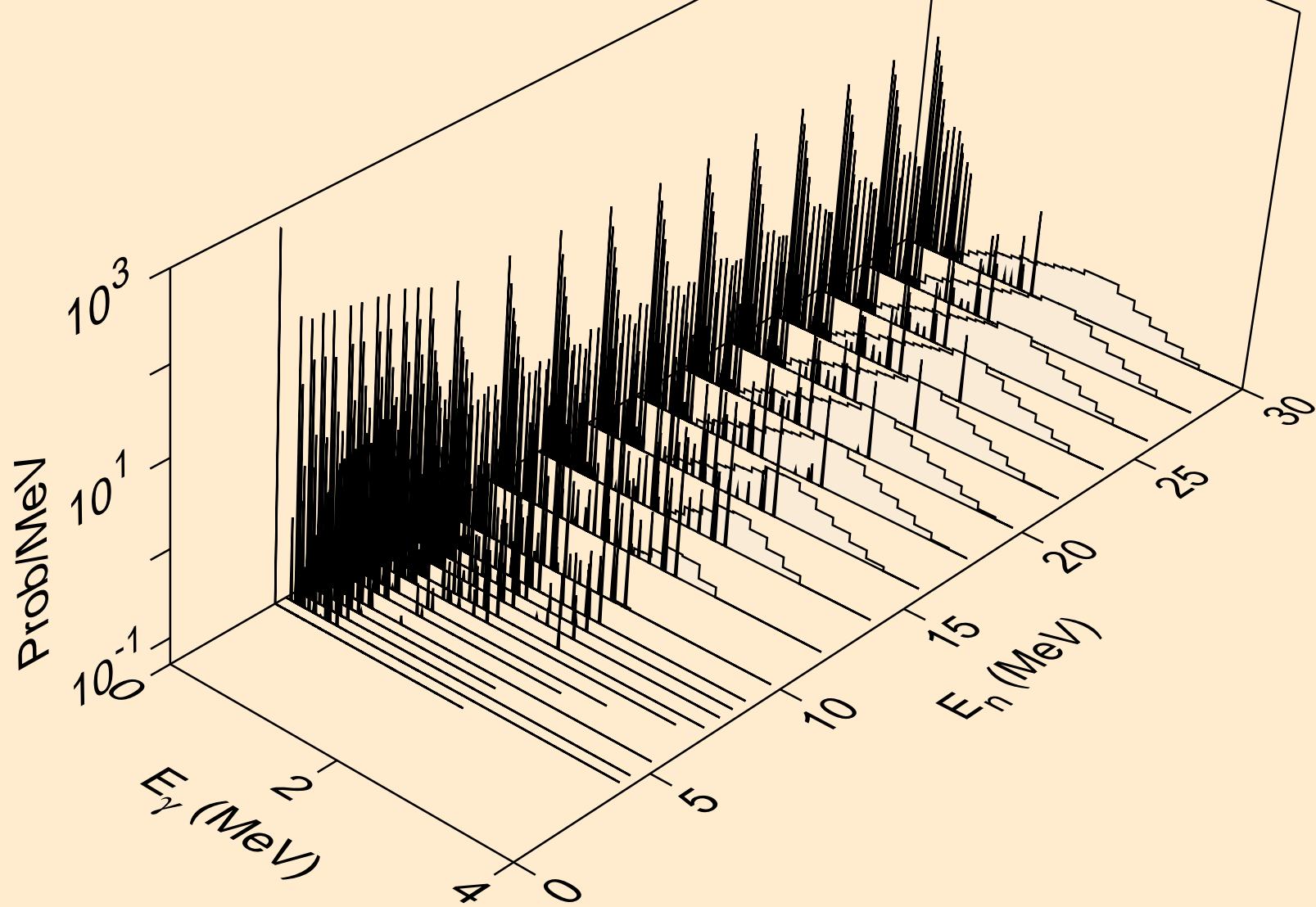

NB102 NEUTRON ACER TENDL-2024 LIBRARY; T=293.6K  
Photon emission for (n,2p)

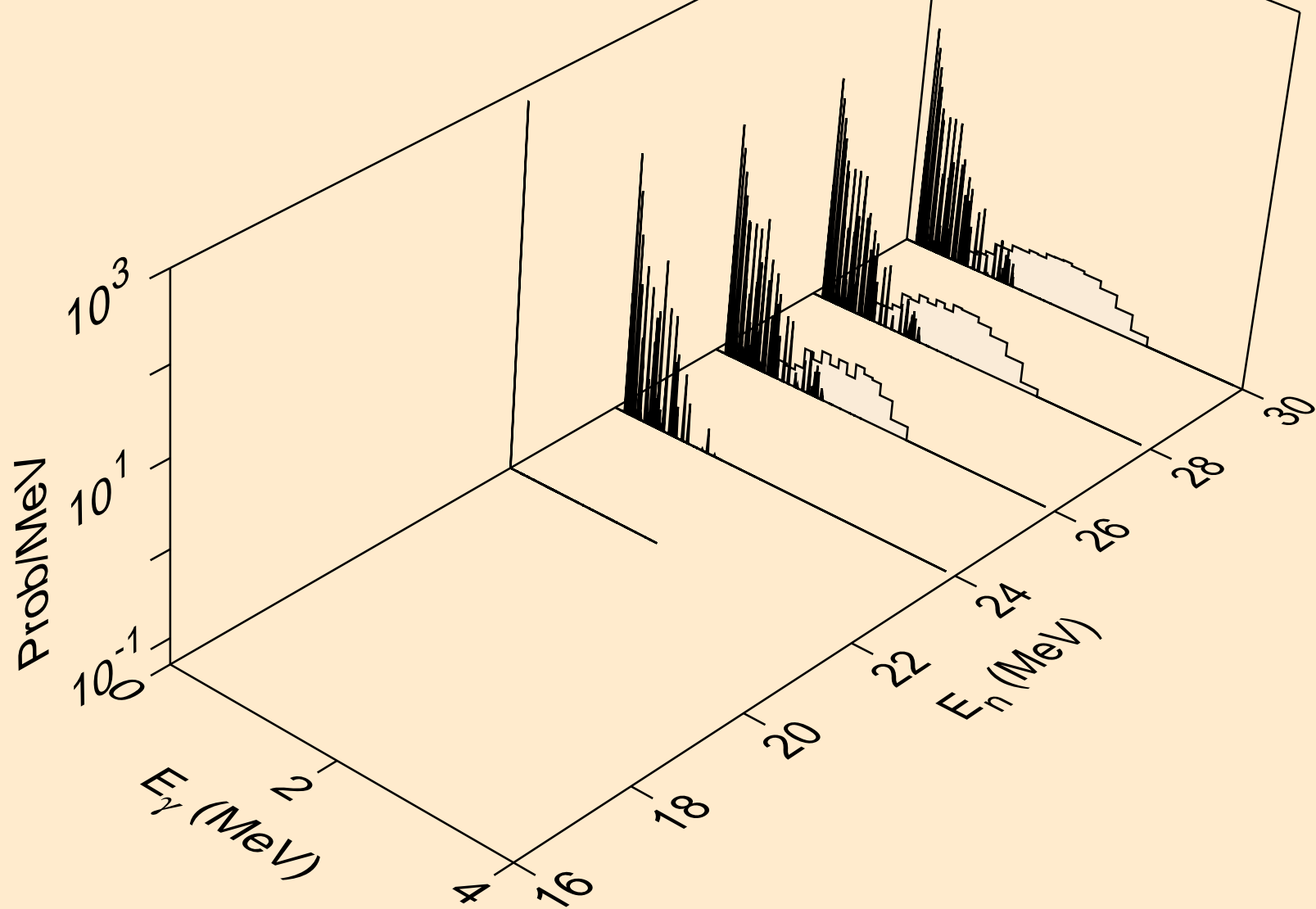

NB102 NEUTRON ACER TENDL-2024 LIBRARY; T=293.6K  
thermal capture photon spectrum

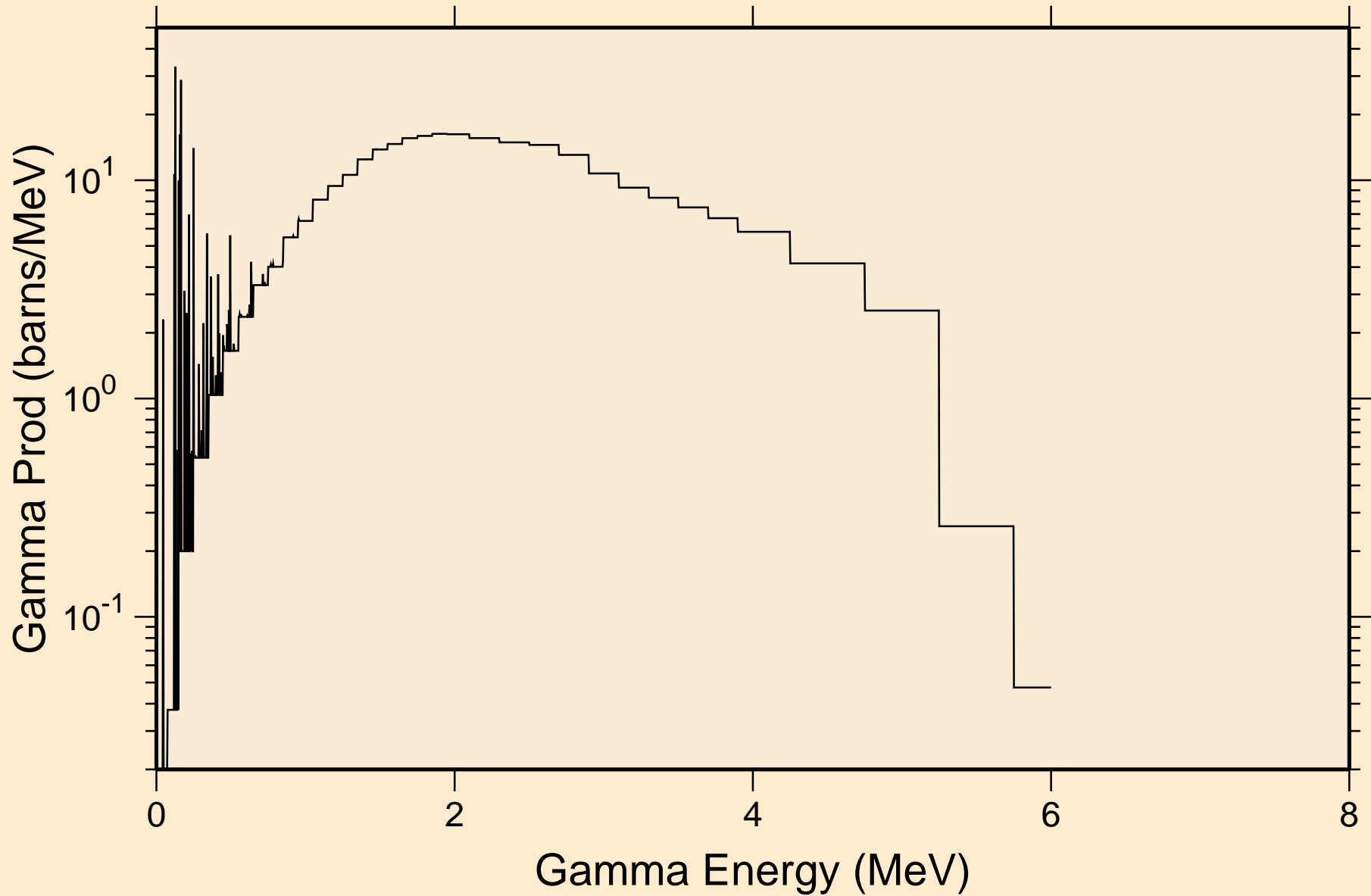

NB102 NEUTRON ACER TENDL-2024 LIBRARY; T=293.6K  
14 MeV photon spectrum

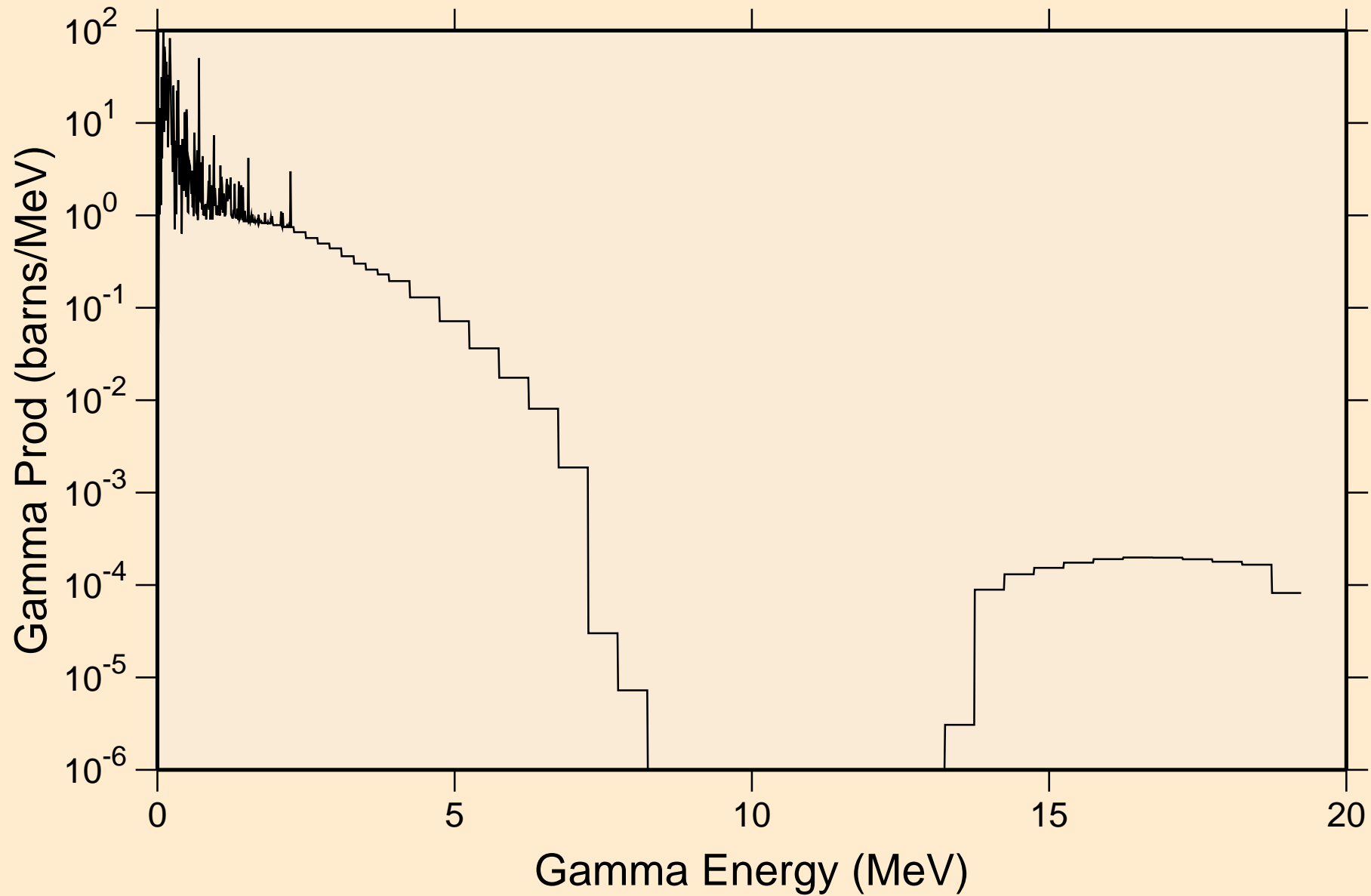

NB102 NEUTRON ACER TENDL-2024 LIBRARY; T=293.6K  
Particle heating contributions

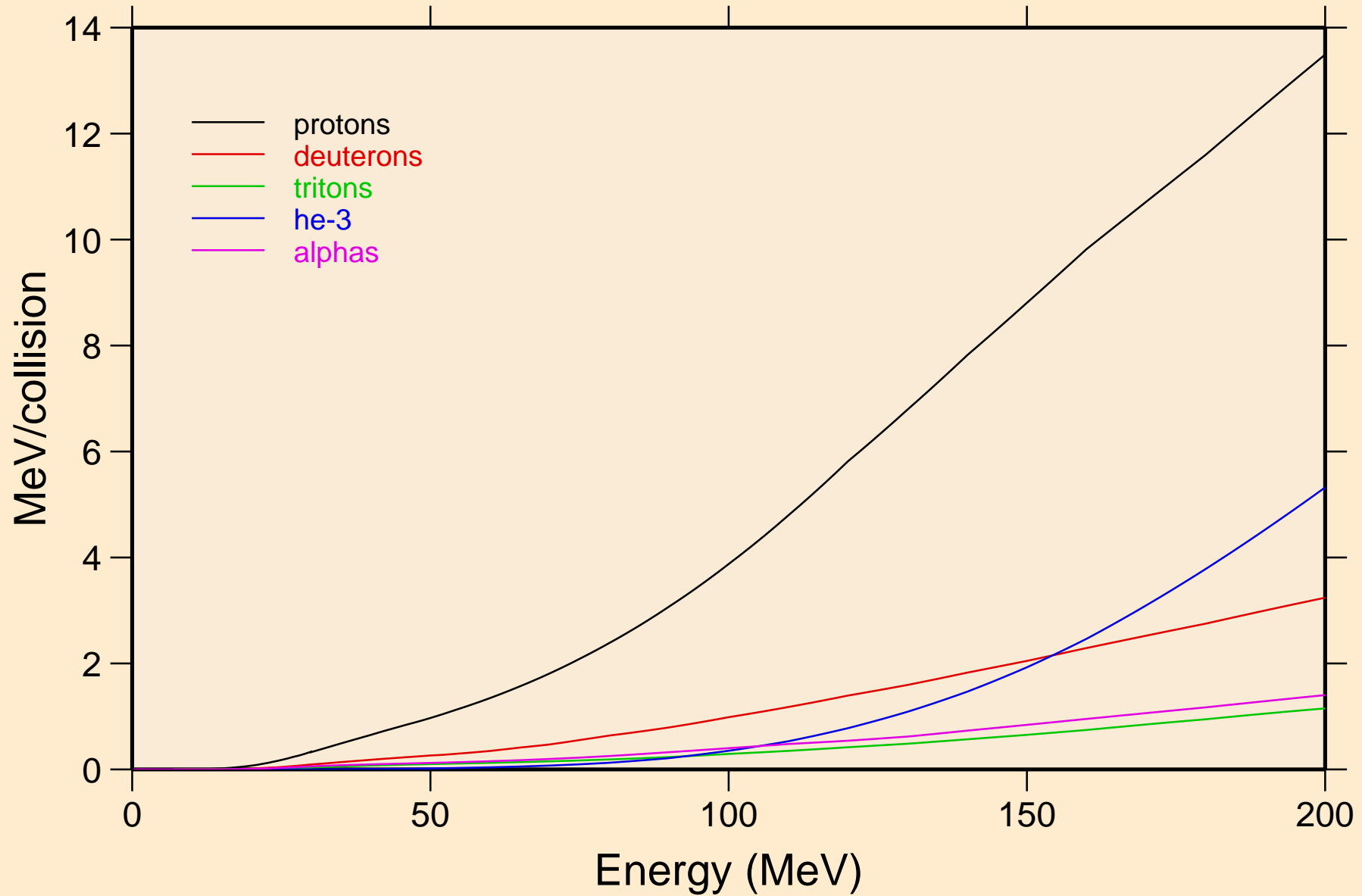

NB102 NEUTRON ACER TENDL-2024 LIBRARY; T=293.6K  
Recoil Heating

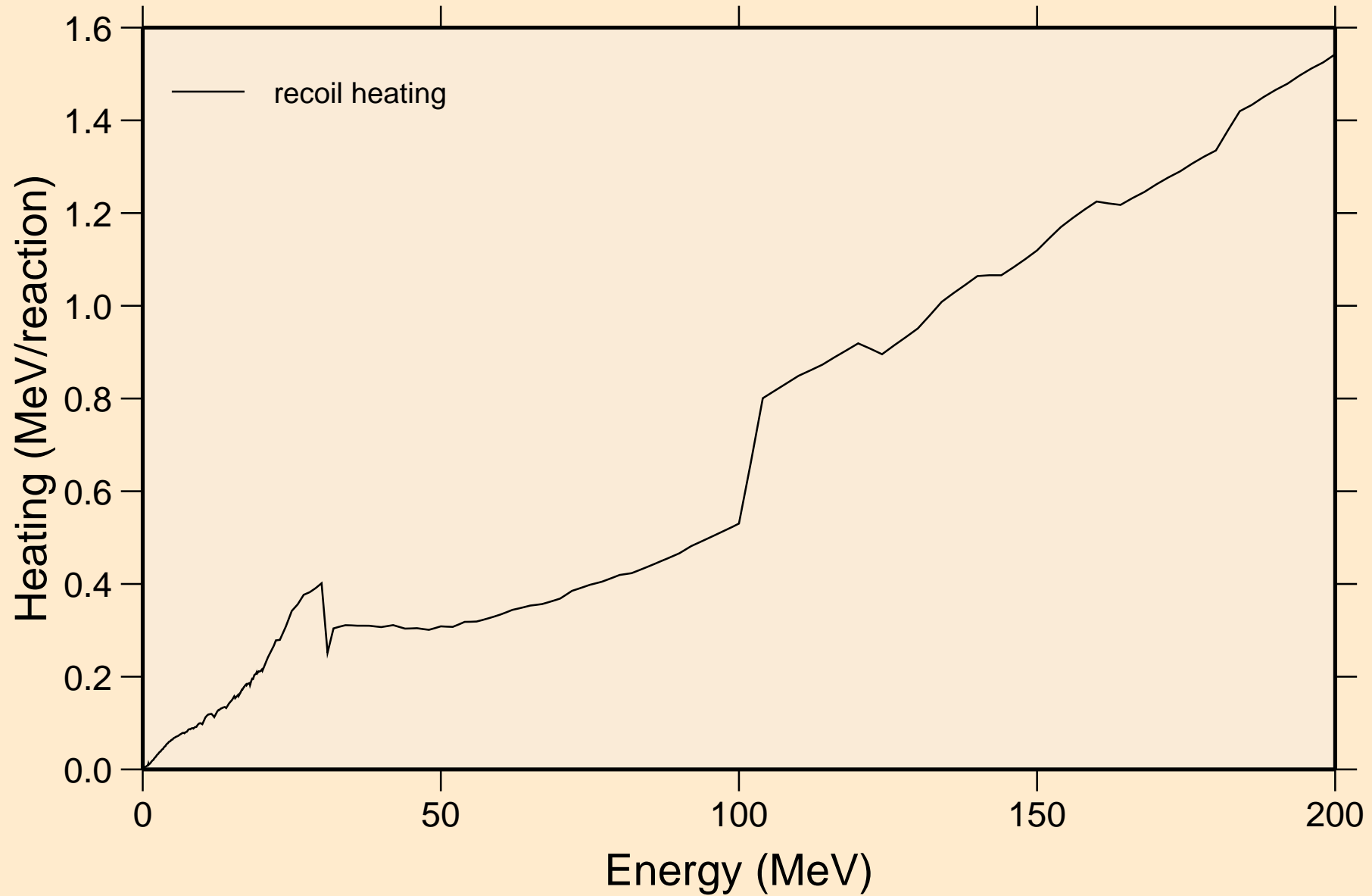

NB102 NEUTRON ACER TENDL-2024 LIBRARY; T=293.6K  
Particle production cross sections

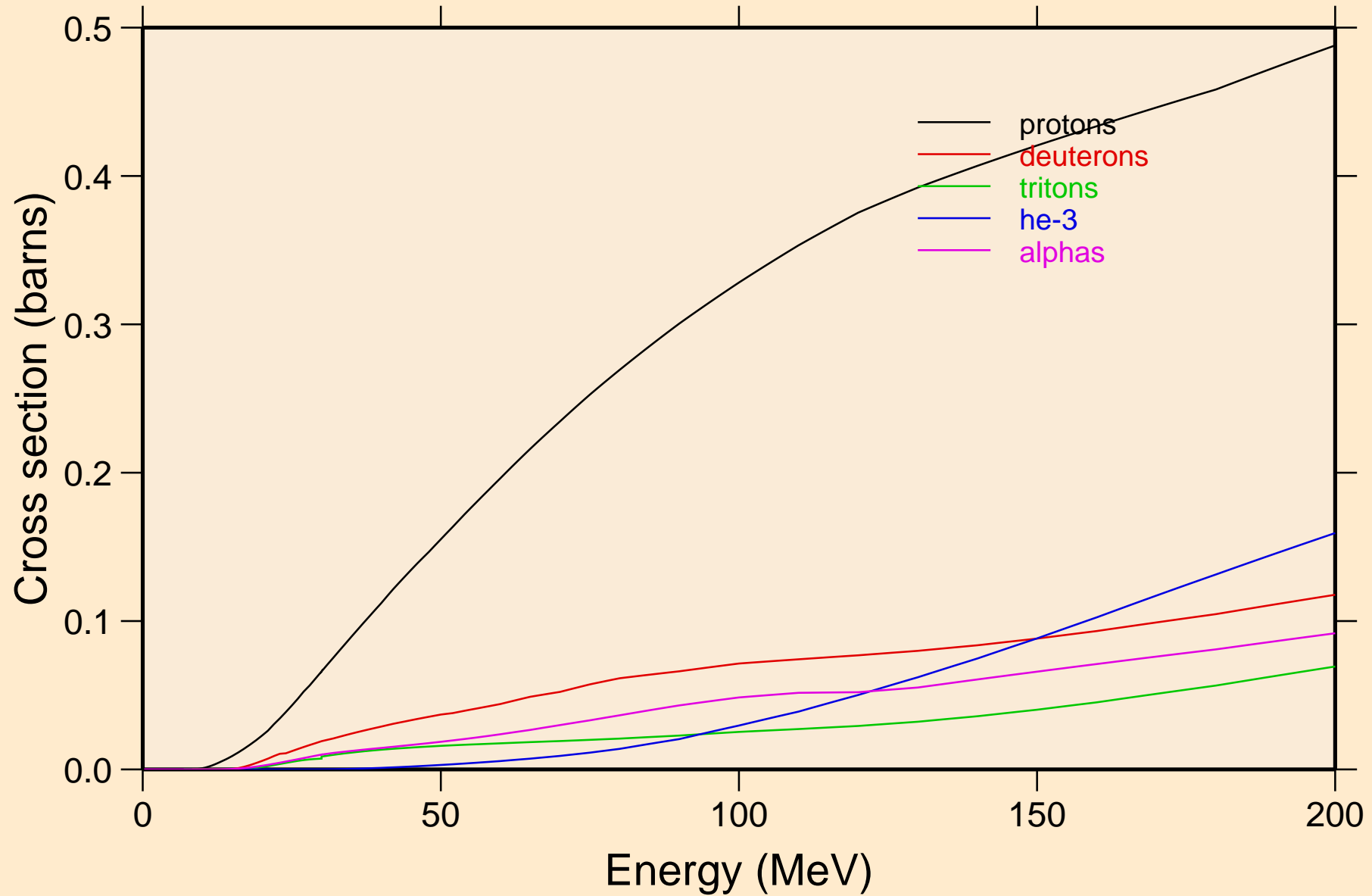

NB102 NEUTRON ACER TENDL-2024 LIBRARY; T=293.6K  
protons from (n,x)

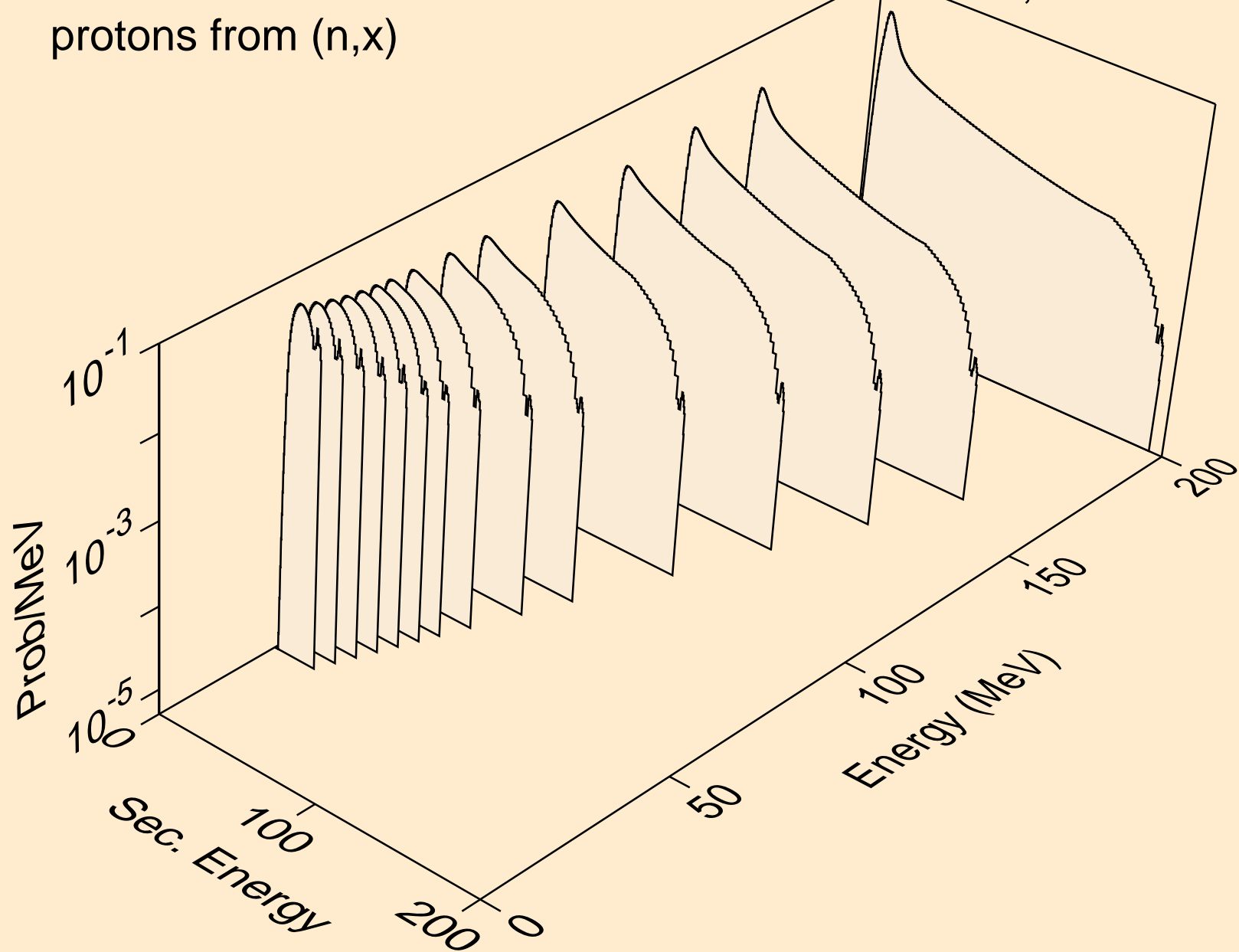

NB102 NEUTRON ACER TENDL-2024 LIBRARY; T=293.6K  
protons from (n,n\*)p

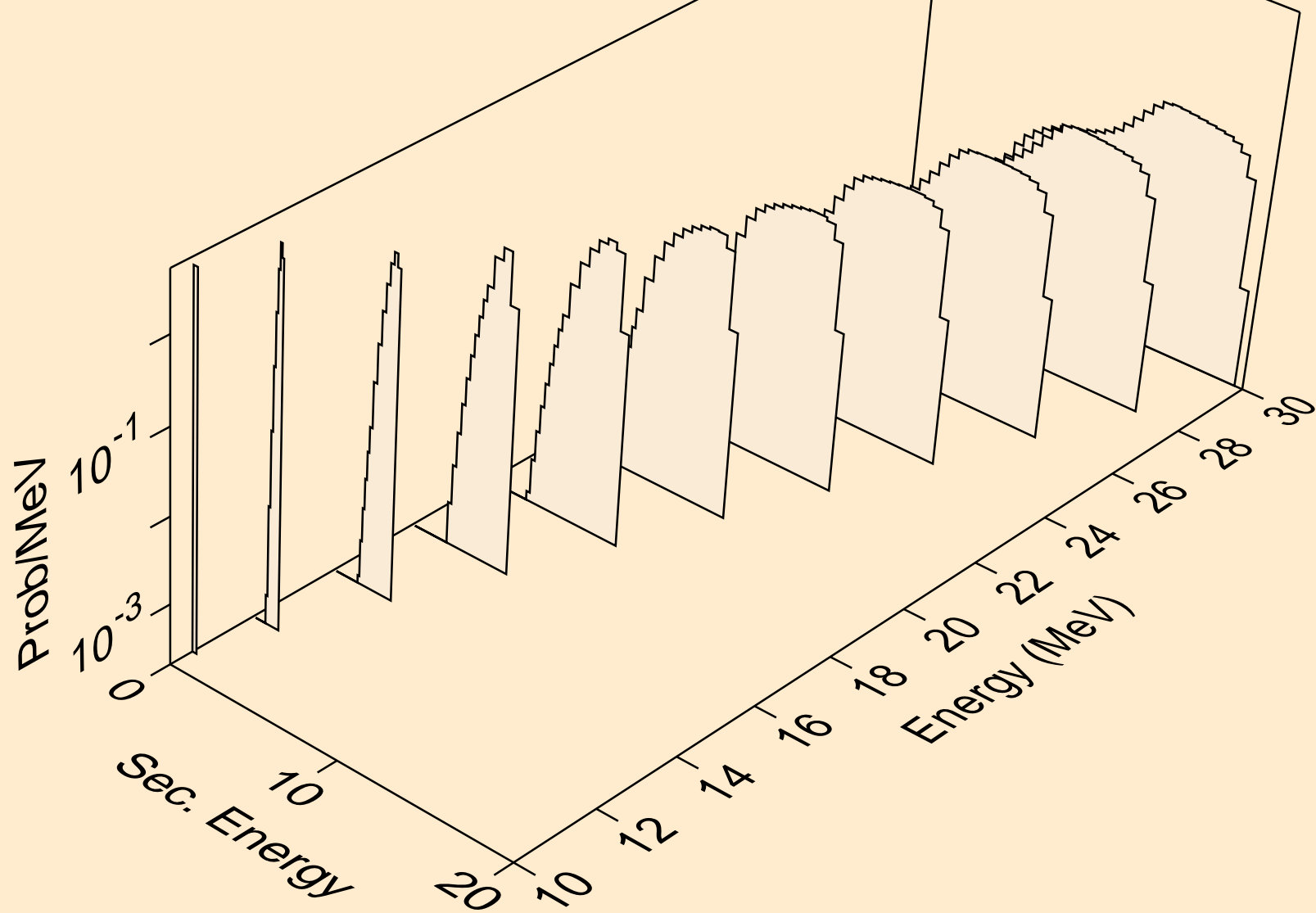

NB102 NEUTRON ACER TENDL-2024 LIBRARY; T=293.6K  
protons from (n,2np)

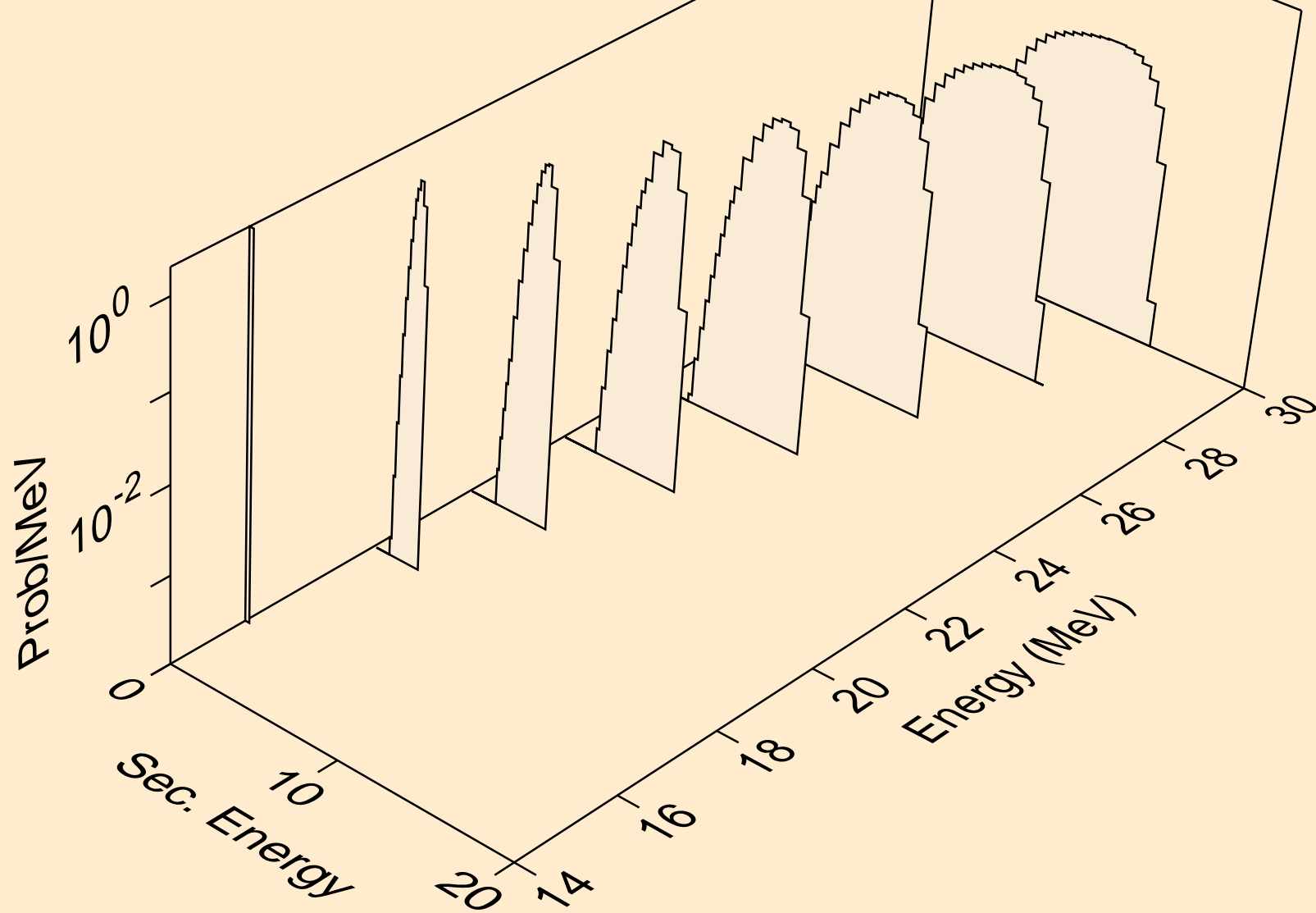

NB102 NEUTRON ACER TENDL-2024 LIBRARY; T=293.6K  
protons from (n,3np)

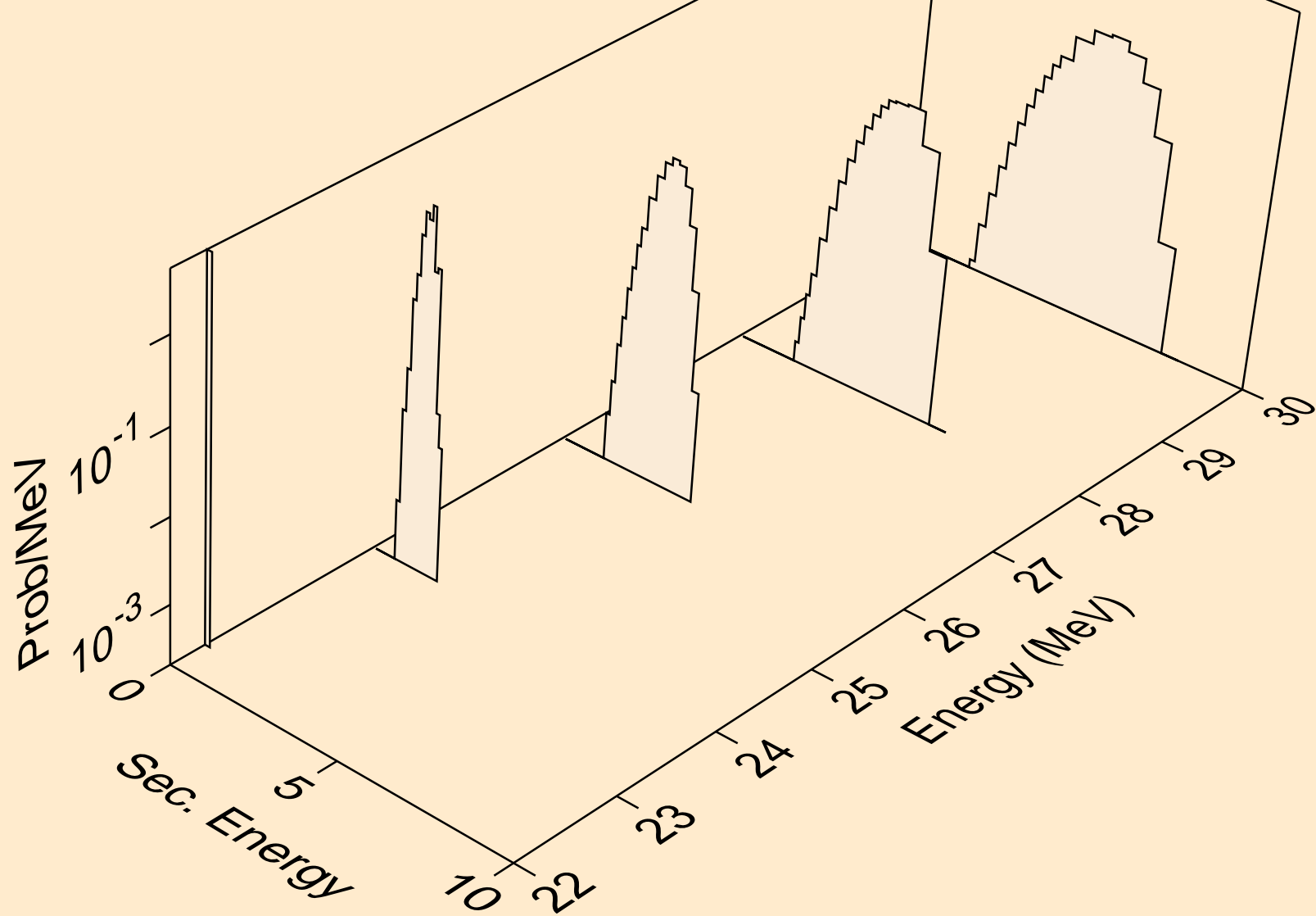

NB102 NEUTRON ACER TENDL-2024 LIBRARY; T=293.6K  
protons from (n,p)

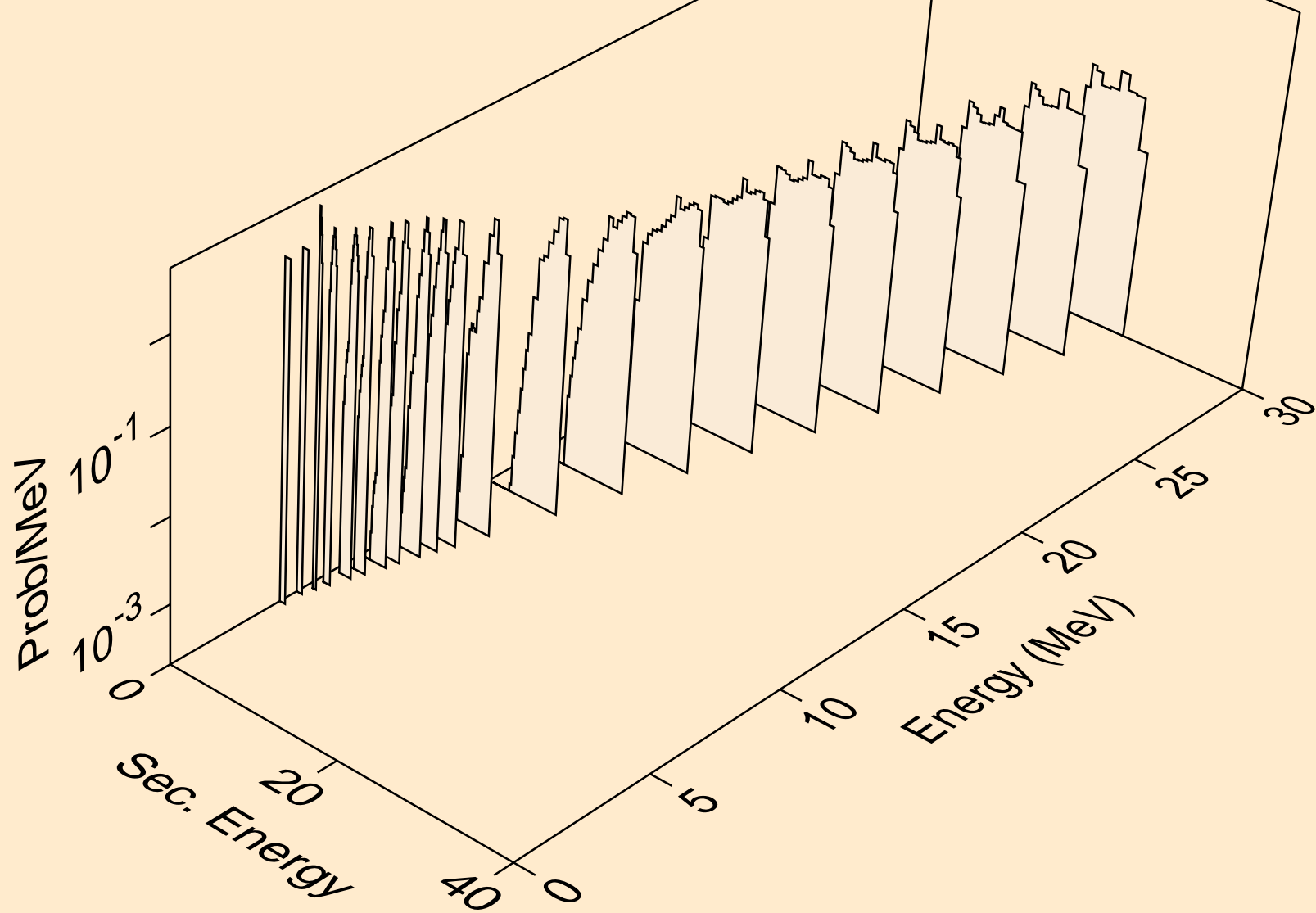

NB102 NEUTRON ACER TENDL-2024 LIBRARY; T=293.6K  
protons from (n,2p)

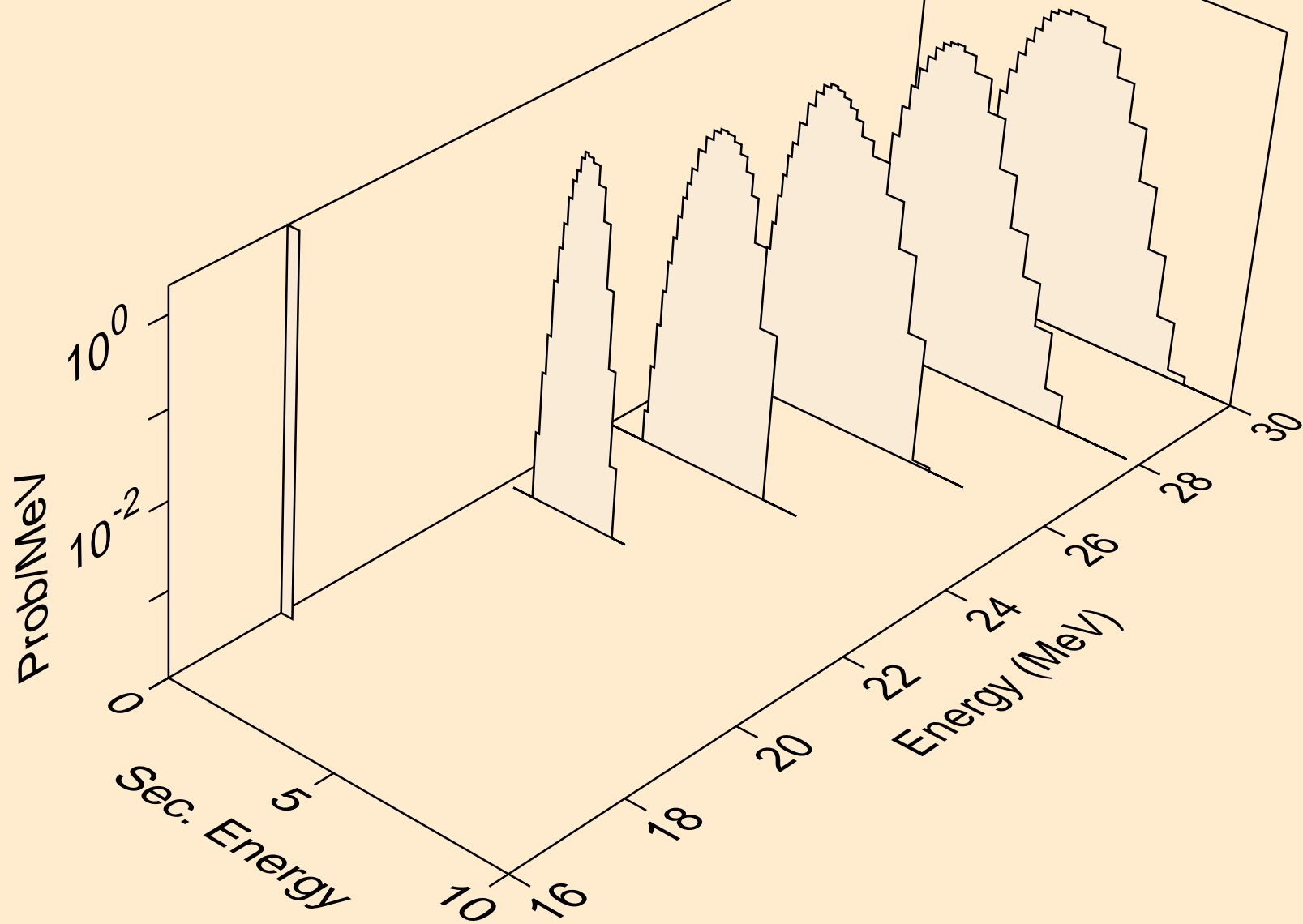

NB102 NEUTRON ACER TENDL-2024 LIBRARY; T=293.6K  
deuterons from (n,x)

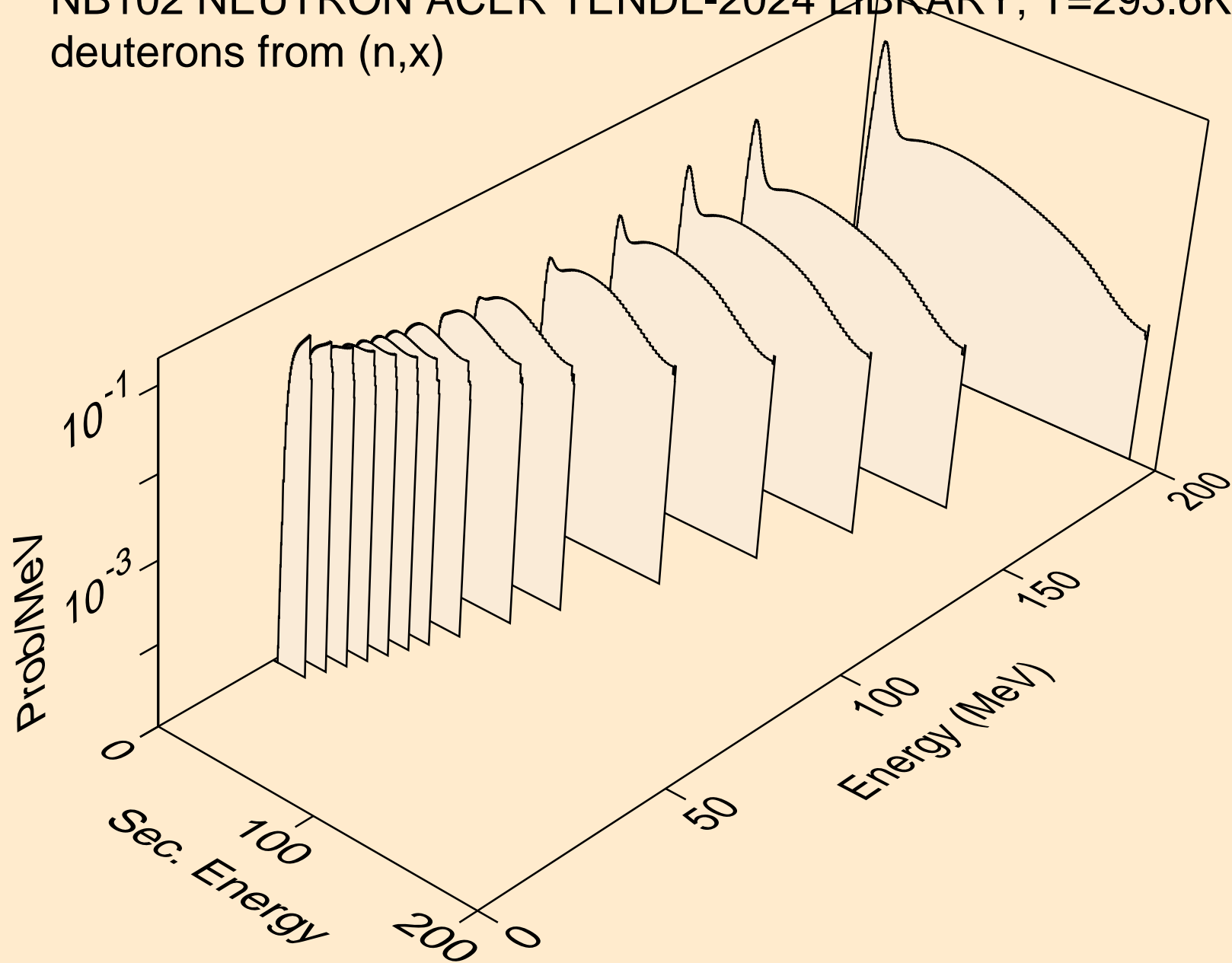

NB102 NEUTRON ACER TENDL-2024 LIBRARY; T=293.6K  
deuterons from (n,2nd)

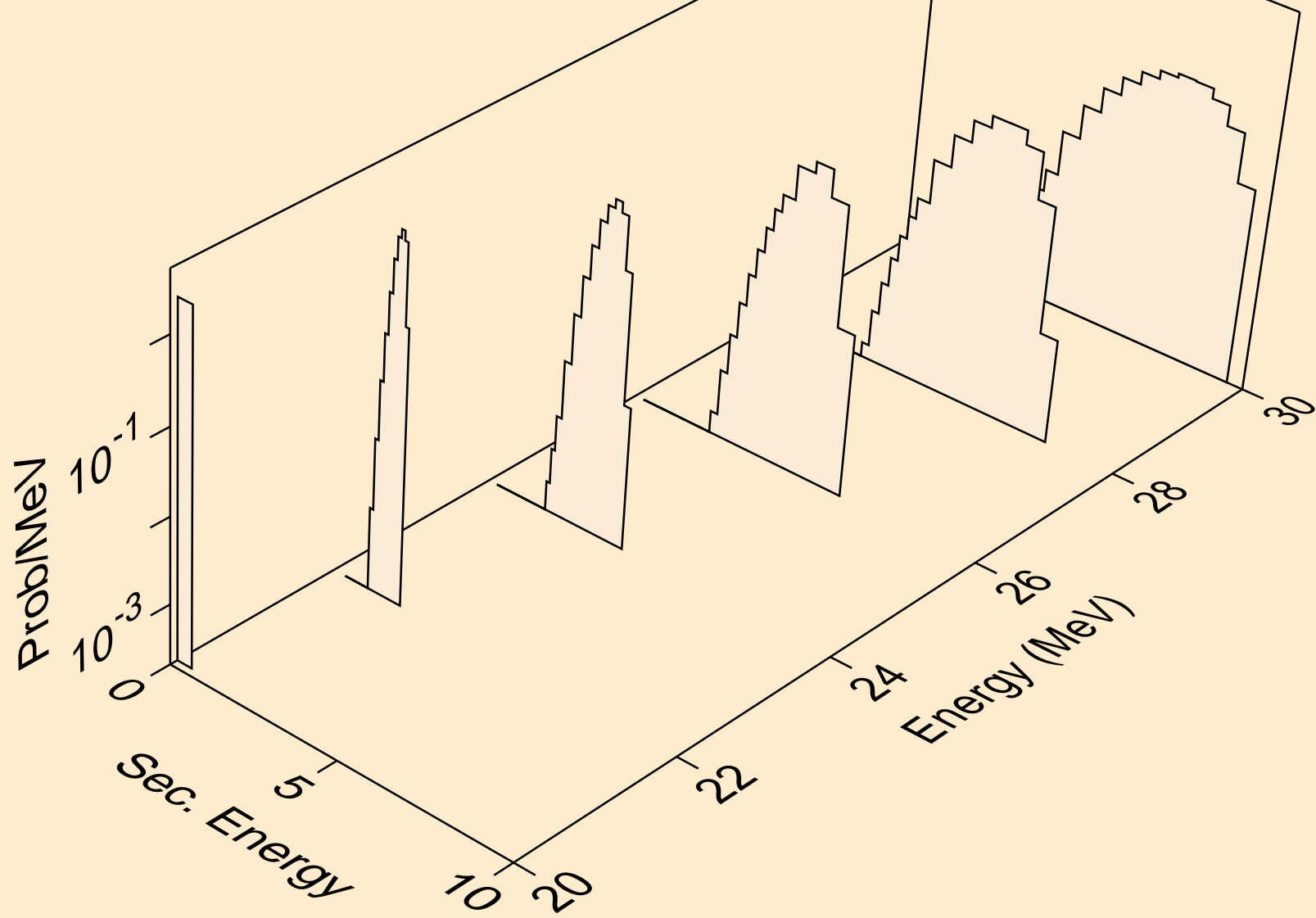

NB102 NEUTRON ACER TENDL-2024 LIBRARY; T=293.6K  
deuterons from (n,n\*)d

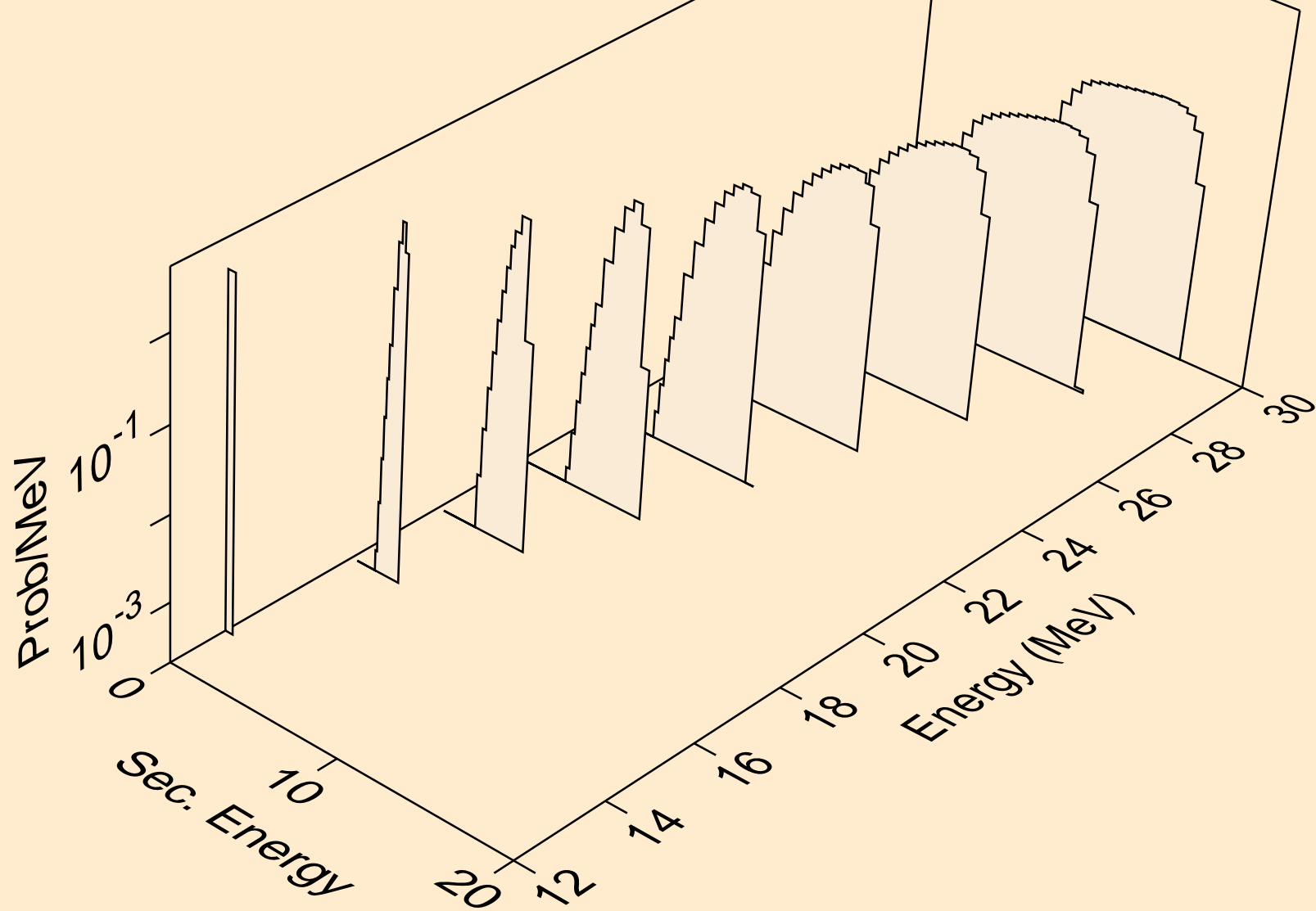

NB102 NEUTRON ACER TENDL-2024 LIBRARY; T=293.6K  
deuterons from (n,d)

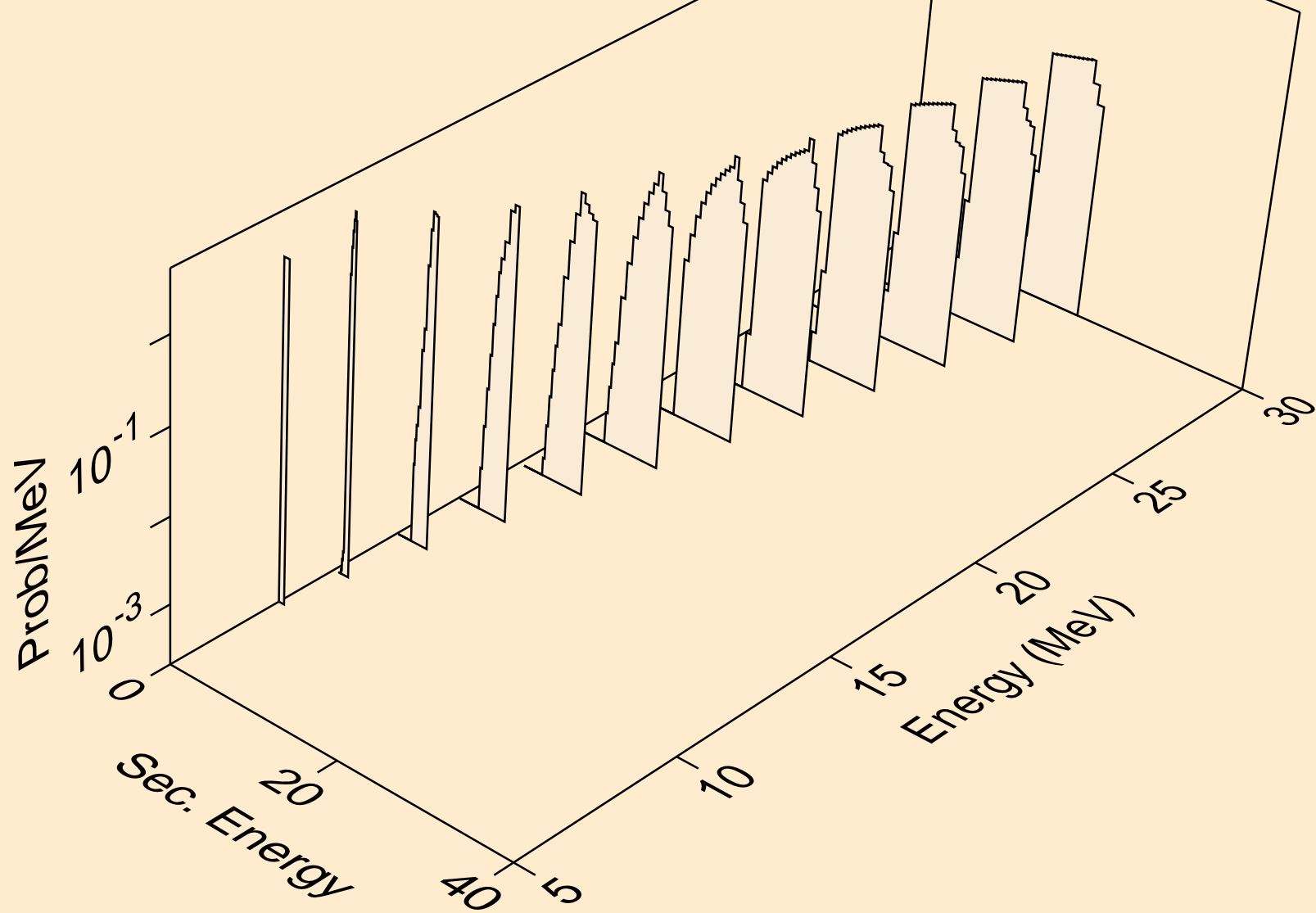

NB102 NEUTRON ACER TENDL-2024 LIBRARY; T=293.6K  
tritons from (n,x)

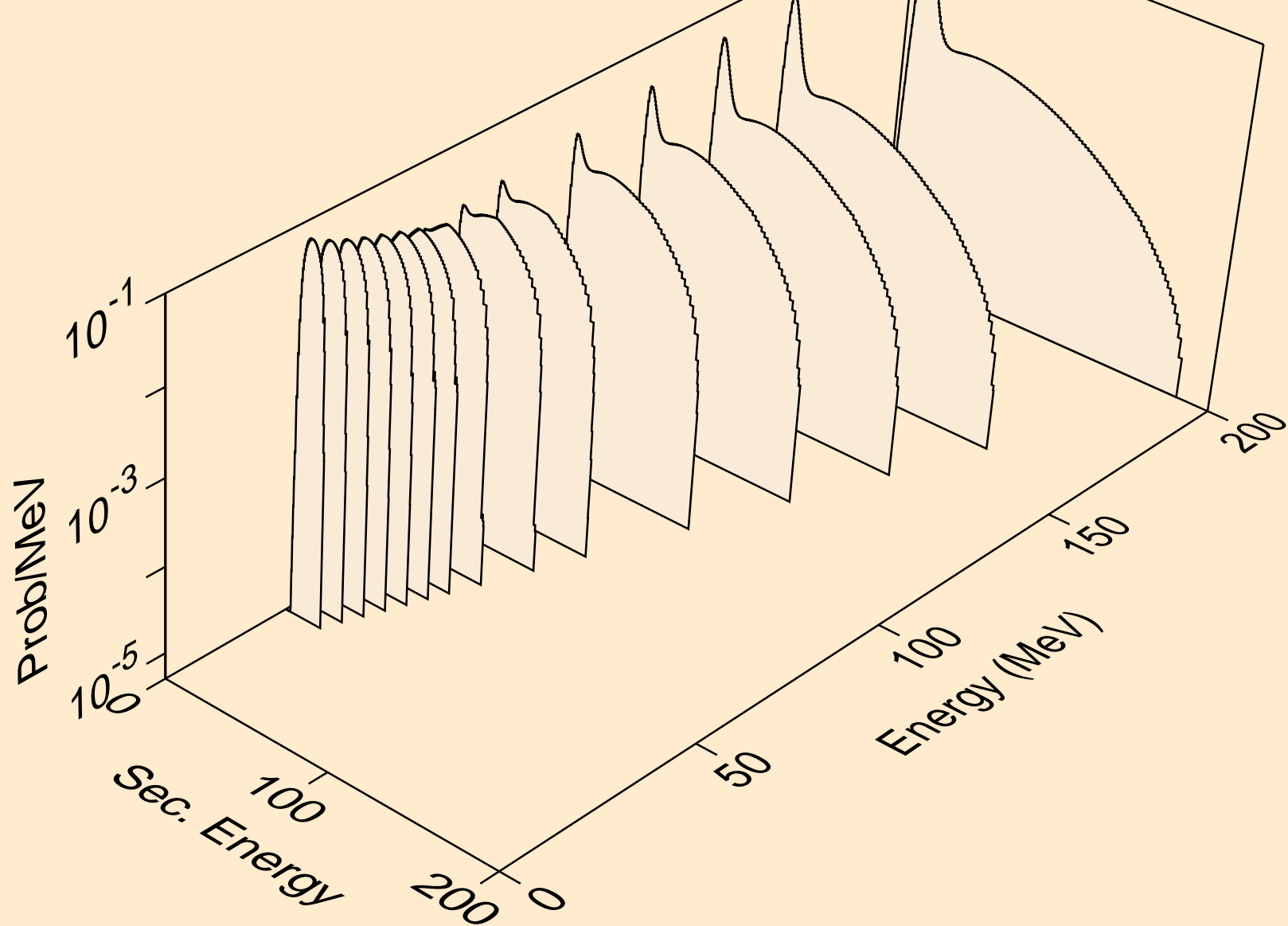

NB102 NEUTRON ACER TENDL-2024 LIBRARY; T=293.6K  
tritons from (n,n\*)t

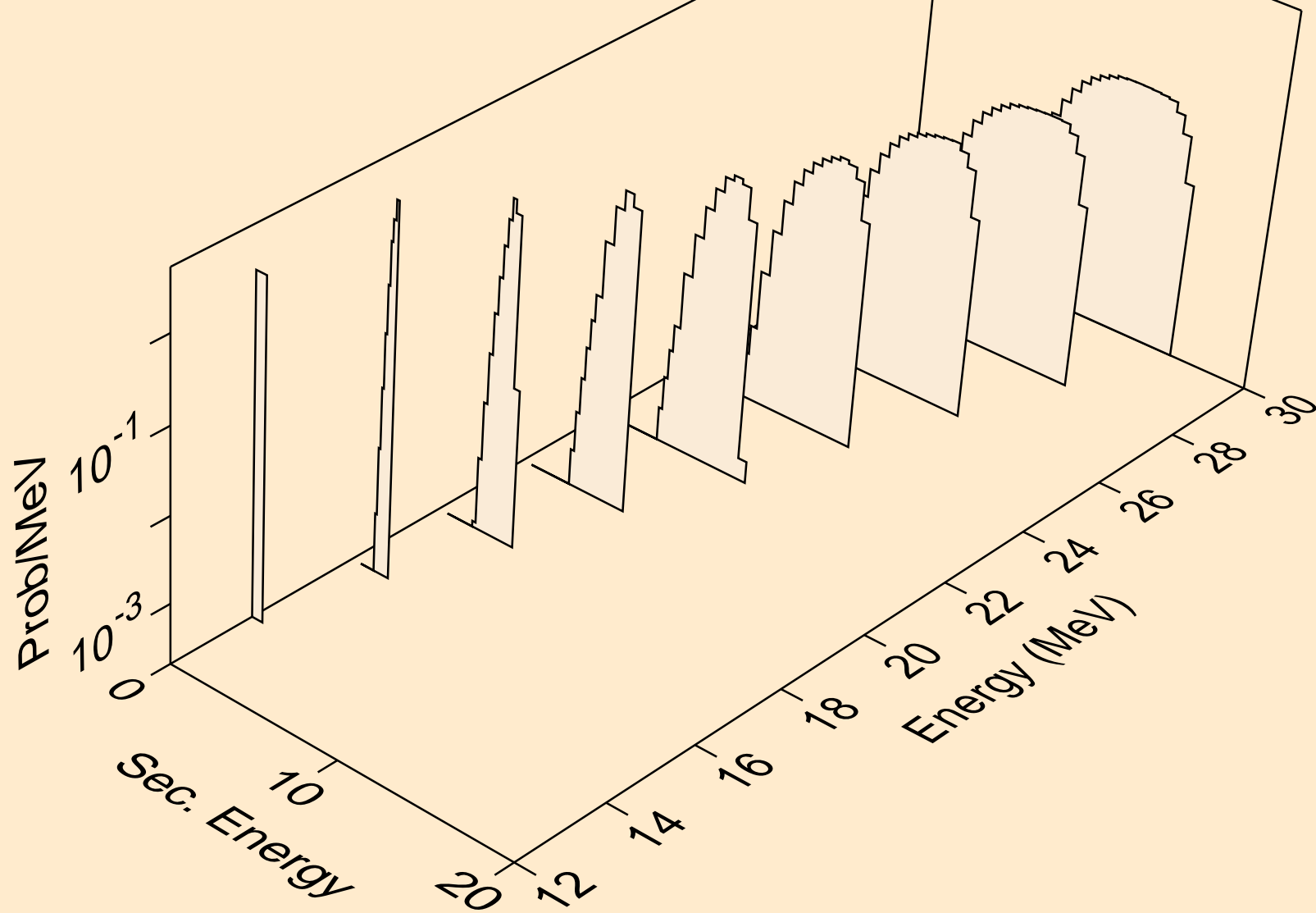

NB102 NEUTRON ACER TENDL-2024 LIBRARY; T=293.6K  
tritons from (n,t)

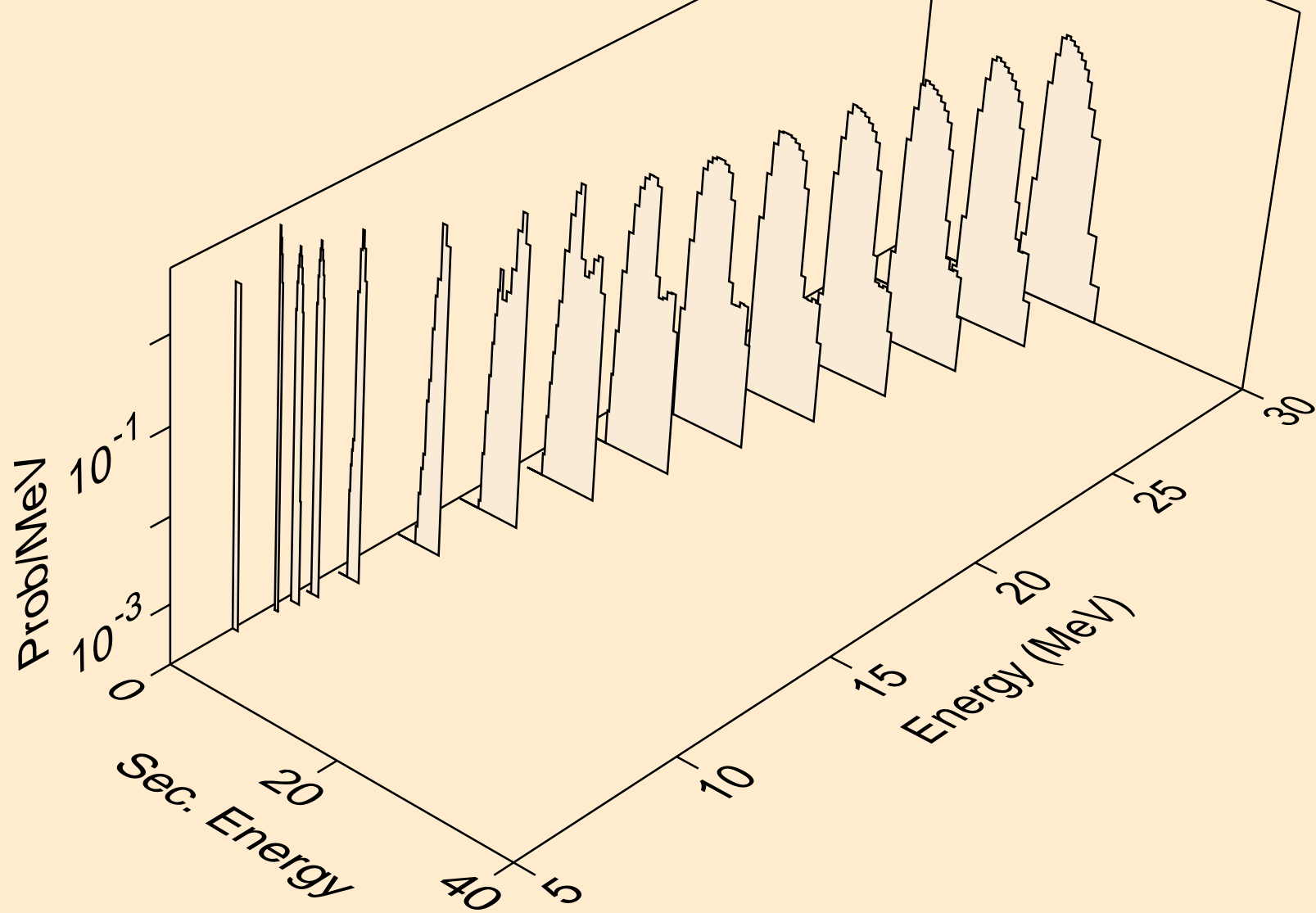

NB102 NEUTRON ACER TENDL-2024 LIBRARY; T=293.6K  
he3s from (n,x)

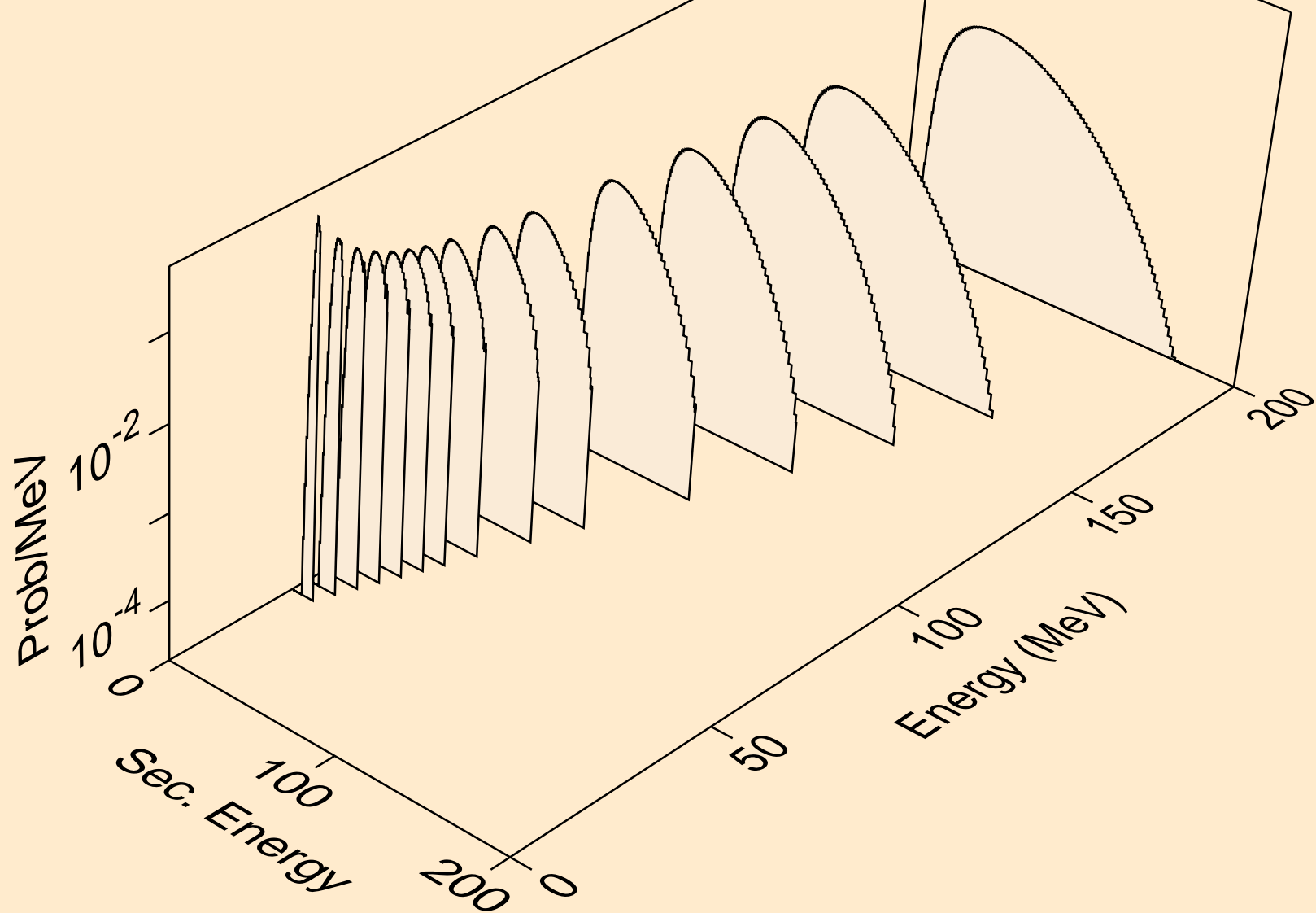

NB102 NEUTRON ACER TENDL-2024 LIBRARY; T=293.6K  
he3s from (n,n\*)he3

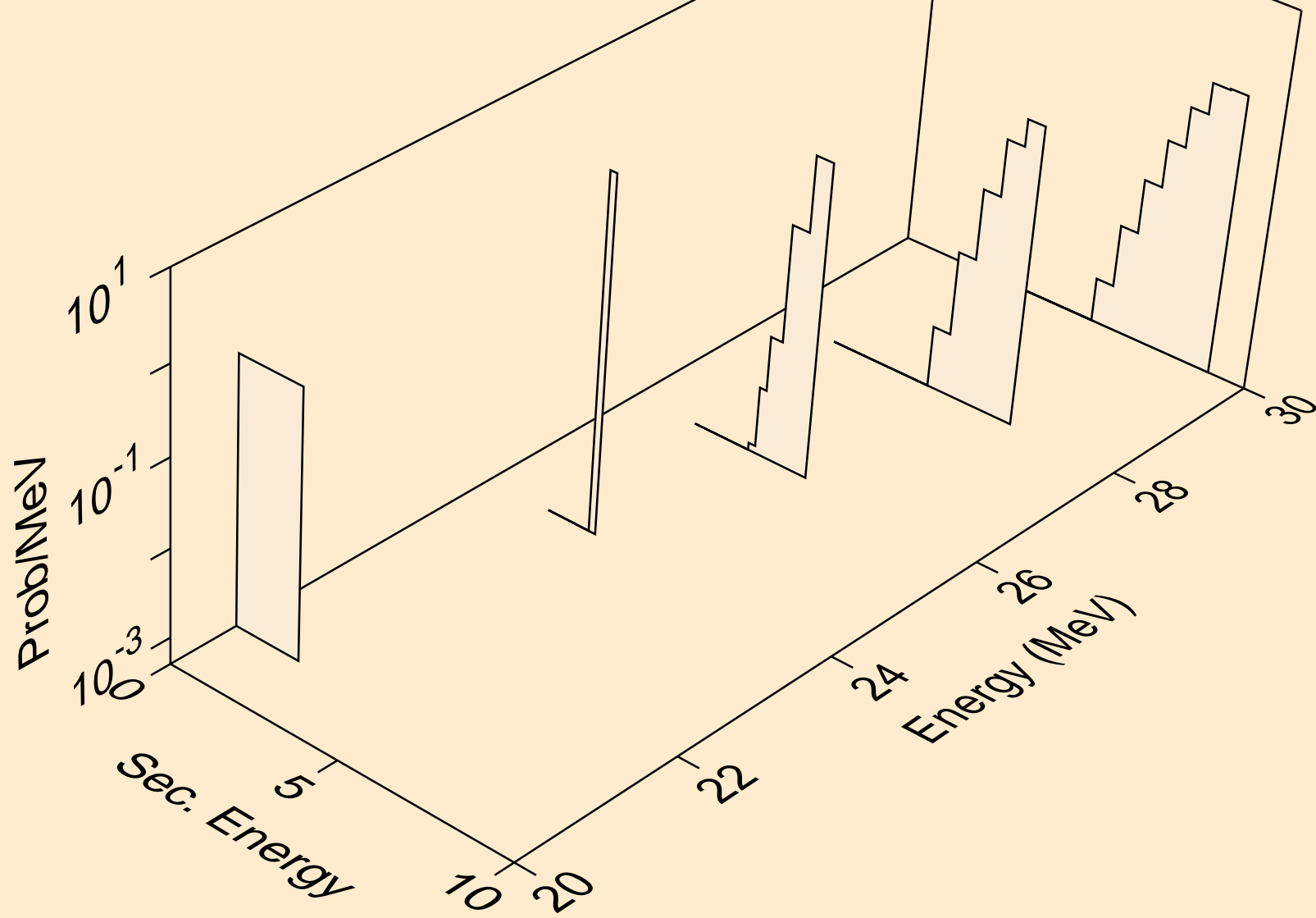

NB102 NEUTRON ACER TENDL-2024 LIBRARY; T=293.6K  
he3s from (n,he3)

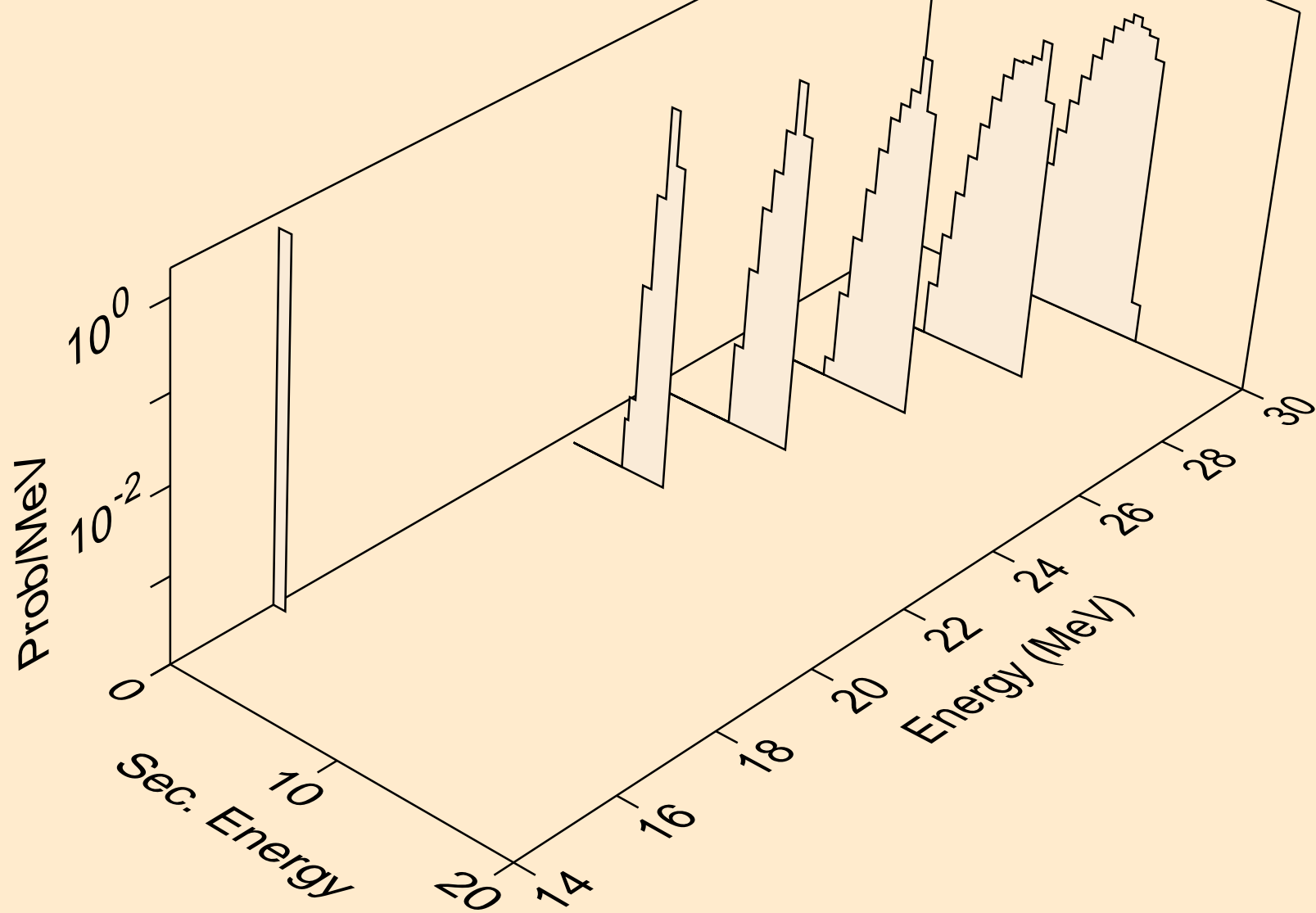

NB102 NEUTRON ACER TENDL-2024 LIBRARY; T=293.6K  
alphas from (n,x)

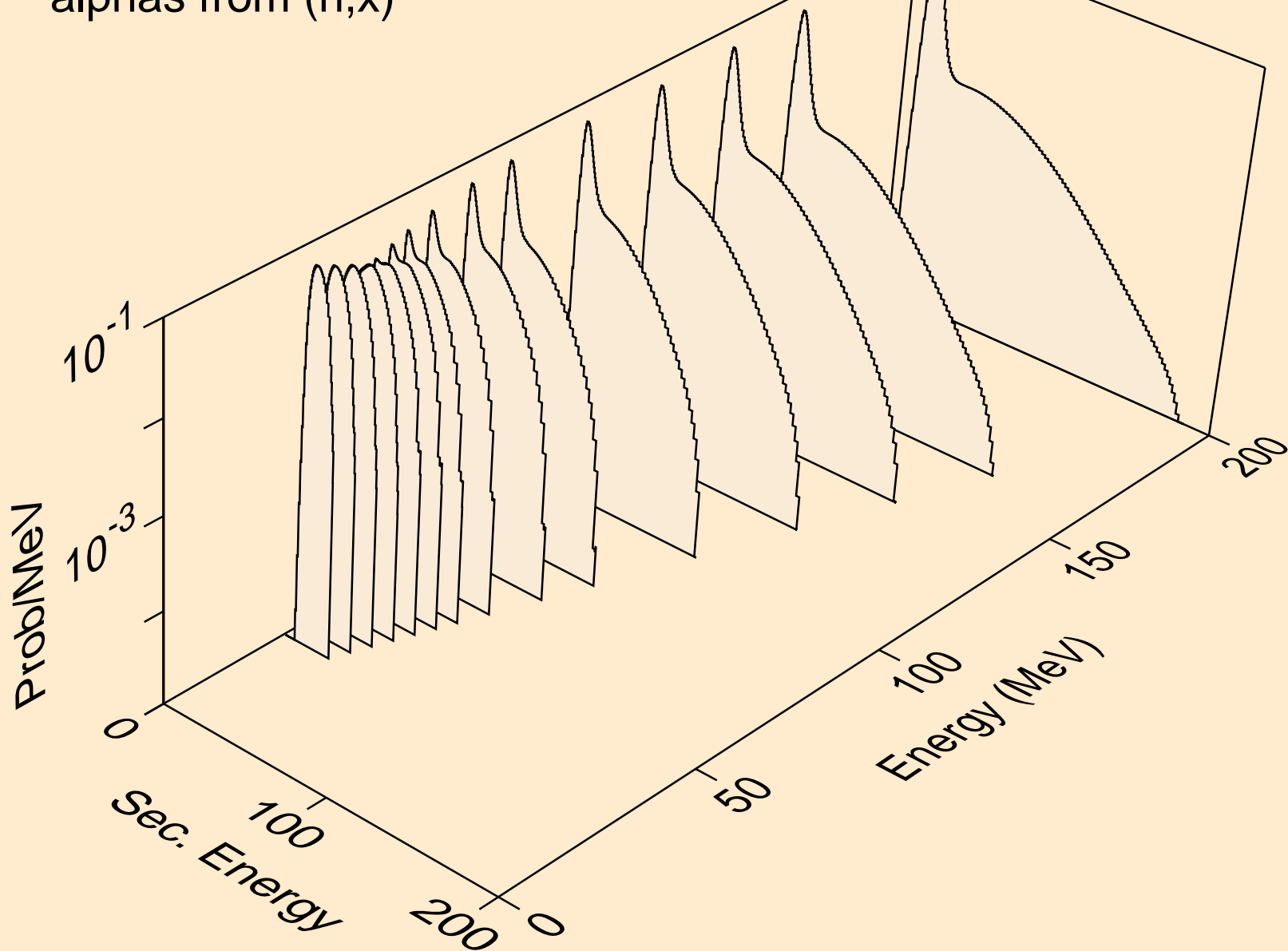

NB102 NEUTRON ACER TENDL-2024 LIBRARY; T=293.6K  
alphas from (n,n\*)a

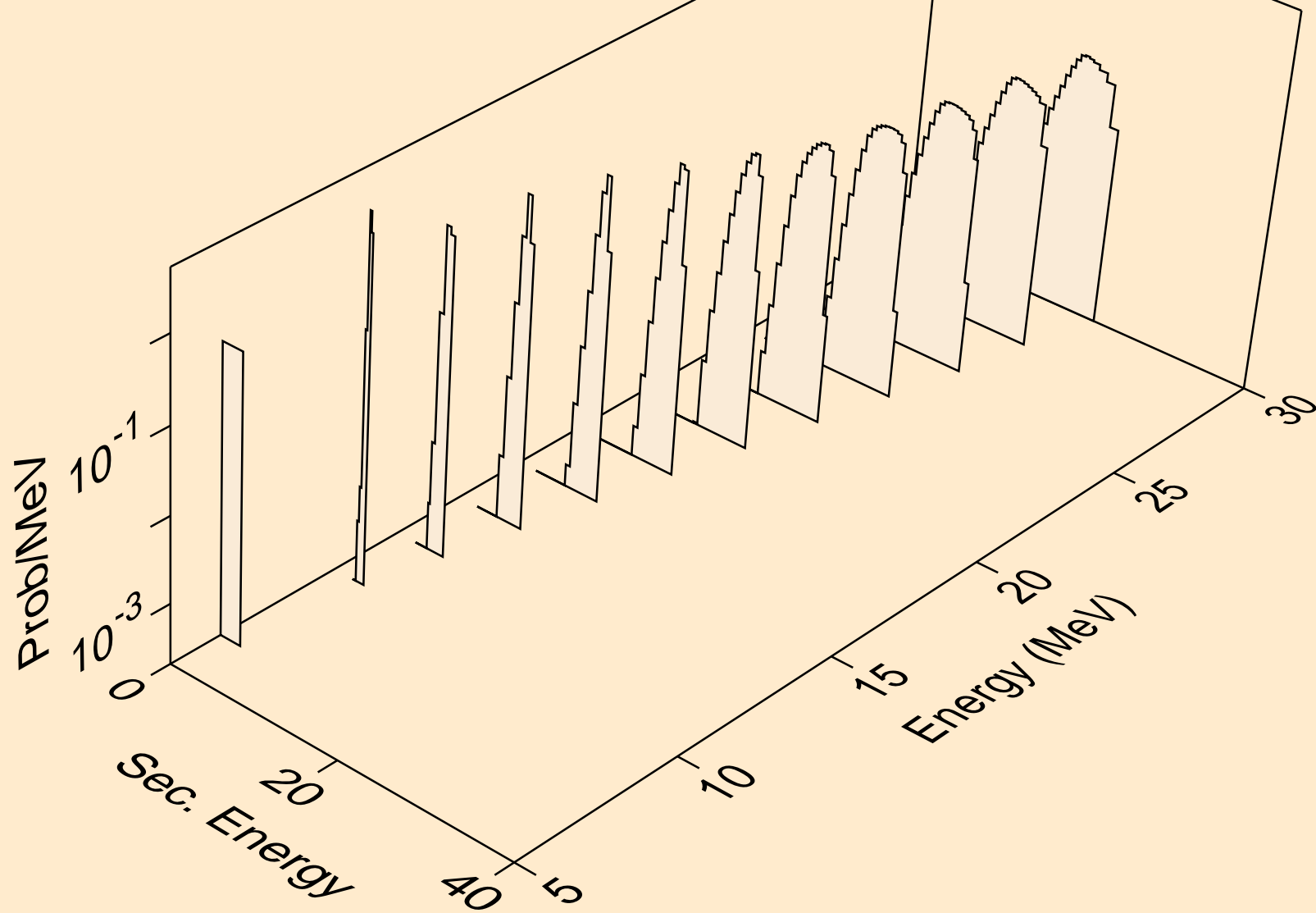

NB102 NEUTRON ACER TENDL-2024 LIBRARY; T=293.6K  
alphas from (n,2n)a

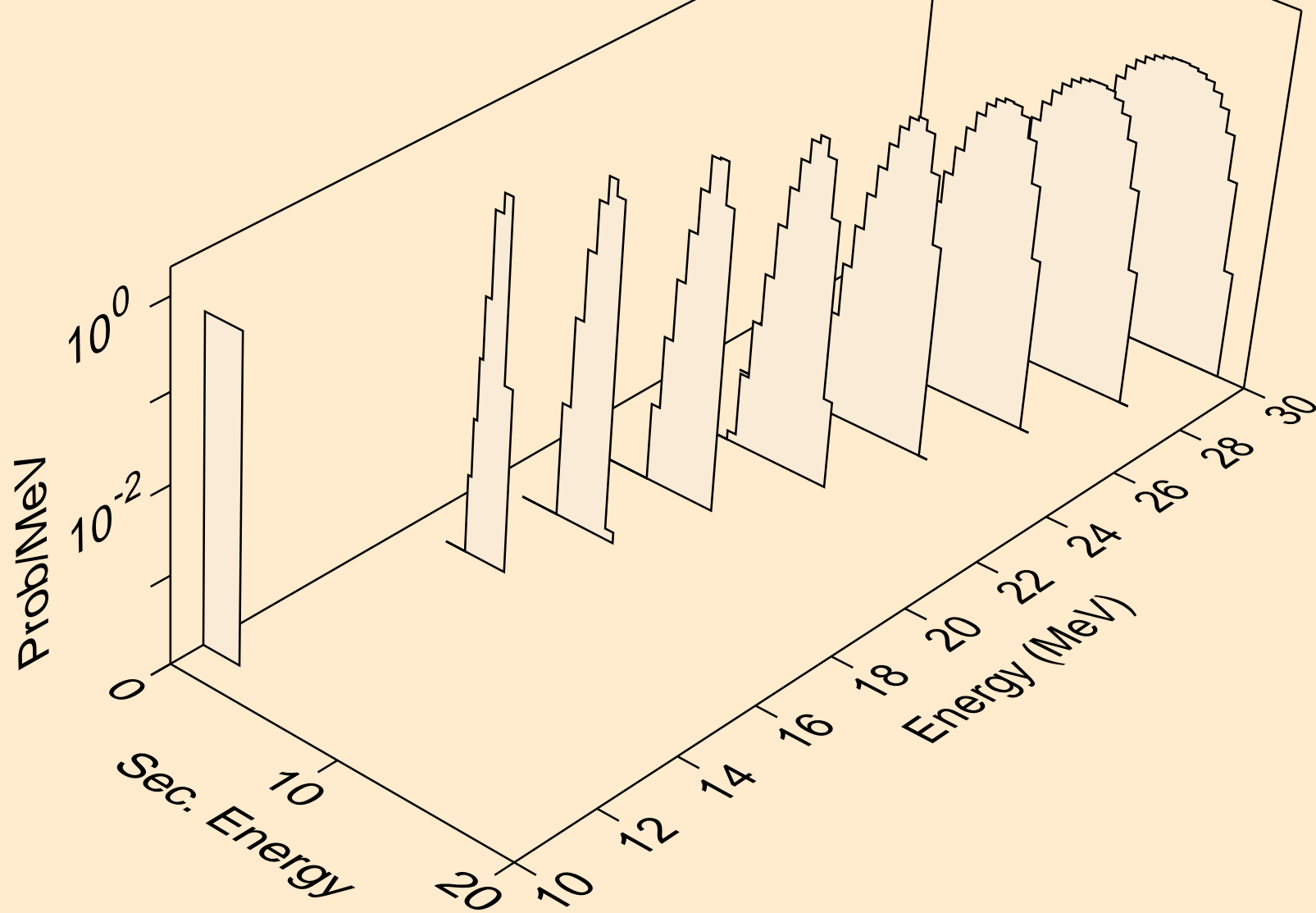

NB102 NEUTRON ACER TENDL-2024 LIBRARY; T=293.6K  
alphas from (n,3n)a

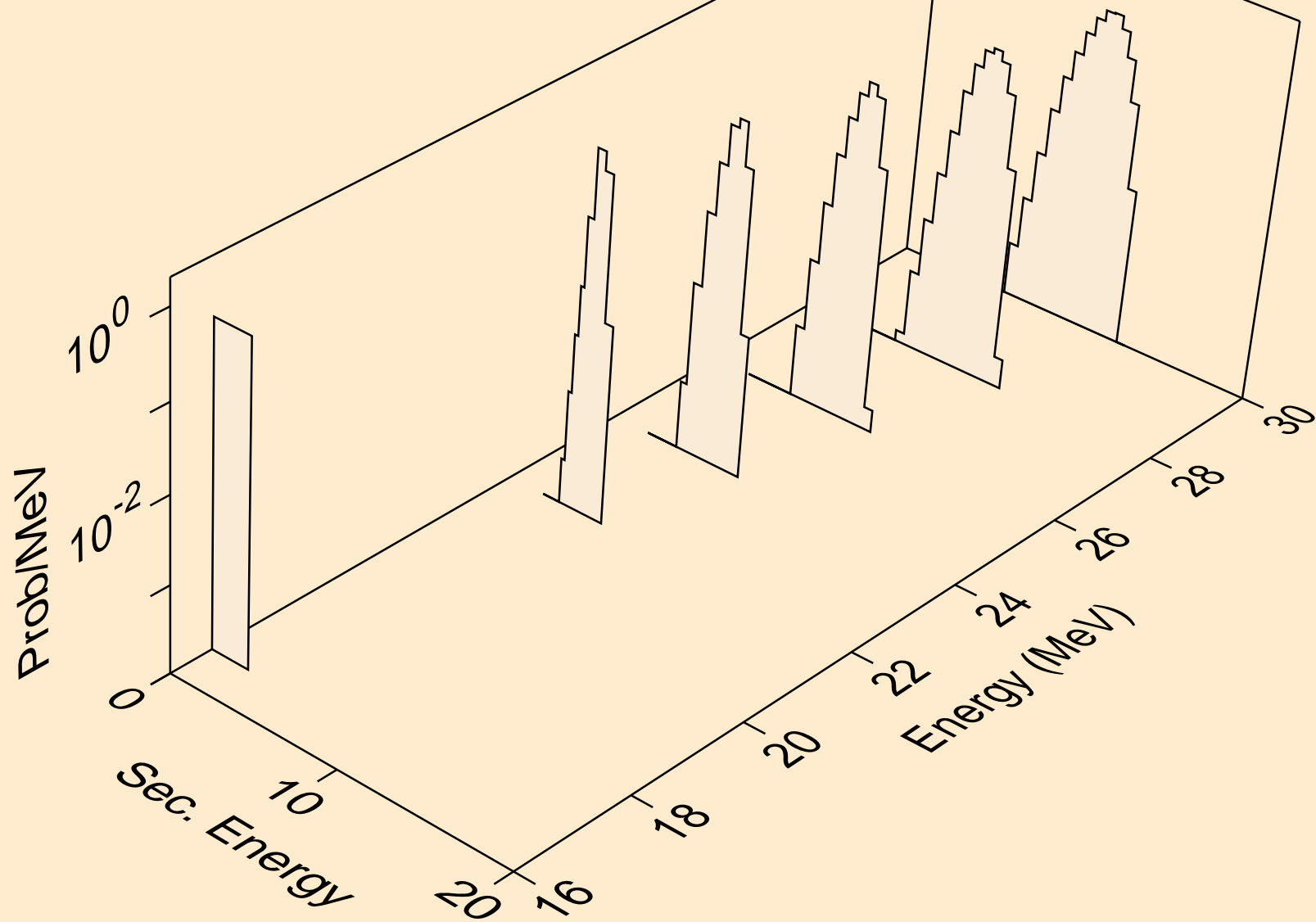

NB102 NEUTRON ACER TENDL-2024 LIBRARY; T=293.6K  
alphas from (n,a)

