

NE020 NEUTRON ACER TENDL-2024 LIBRARY; T=293.6K

Principal cross sections

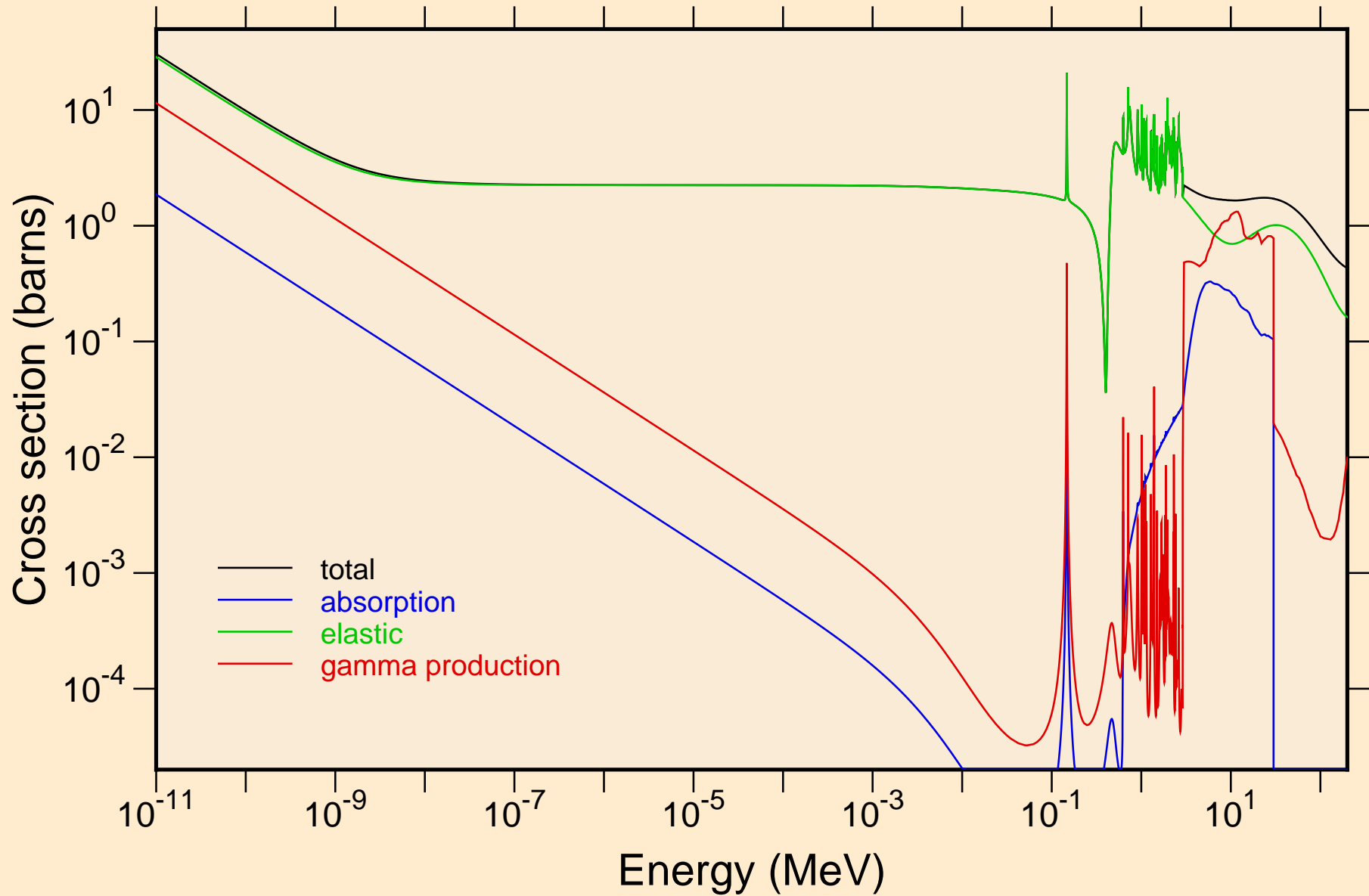

NE020 NEUTRON ACER TENDL-2024 LIBRARY; T=293.6K
resonance total cross section

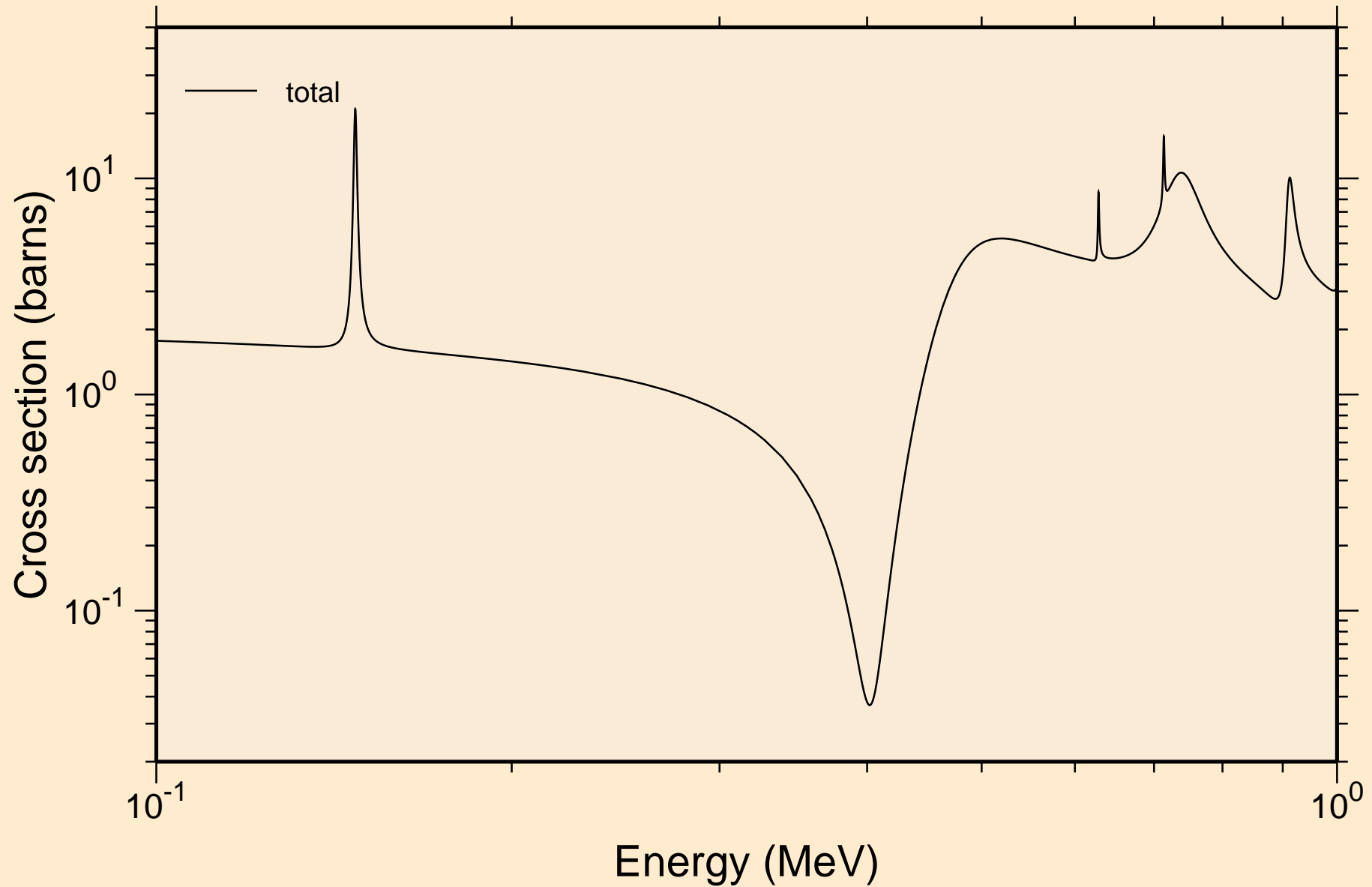

NE020 NEUTRON ACER TENDL-2024 LIBRARY; T=293.6K
resonance total cross section

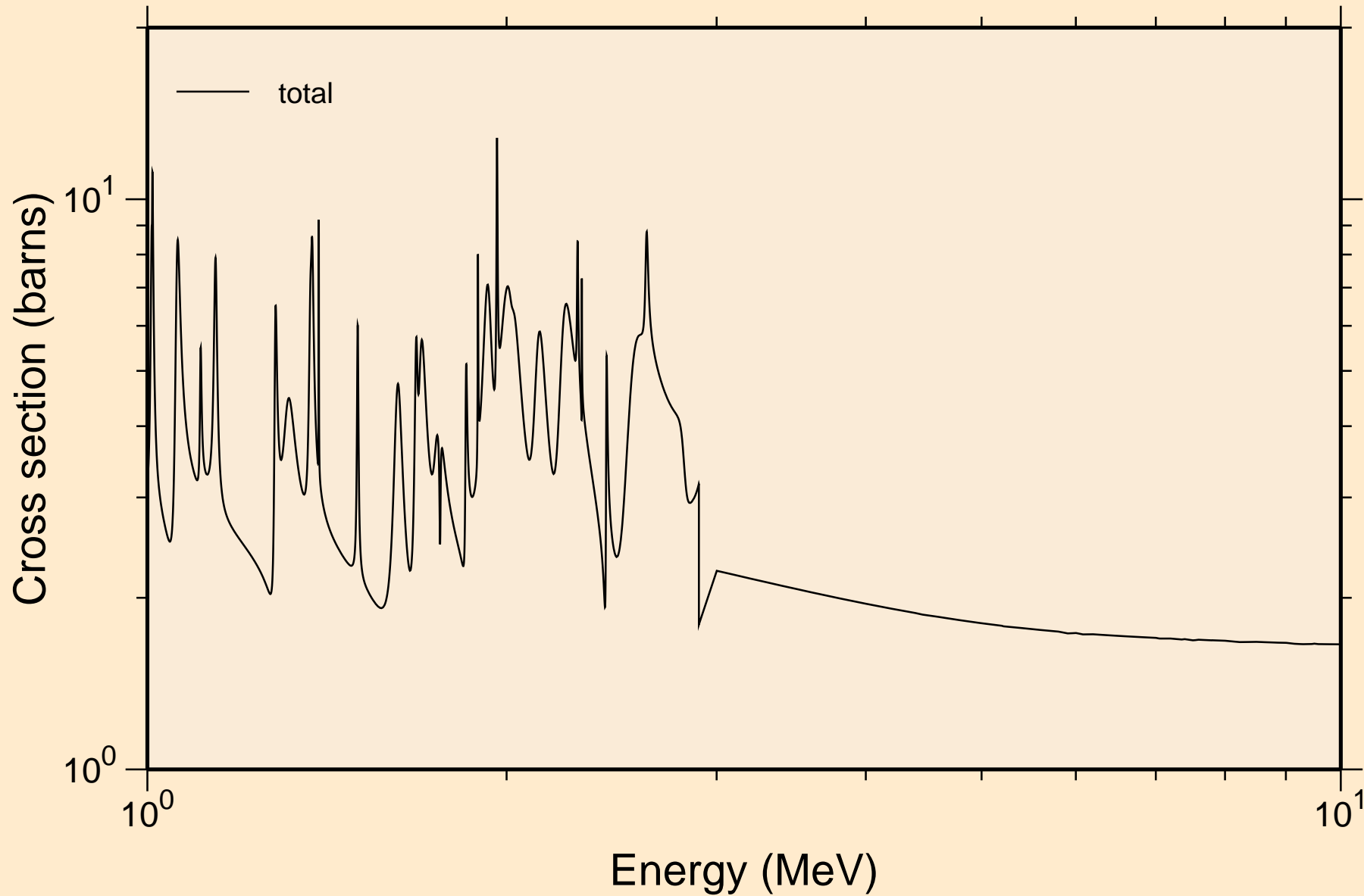

NE020 NEUTRON ACER TENDL-2024 LIBRARY; T=293.6K
resonance absorption cross sections

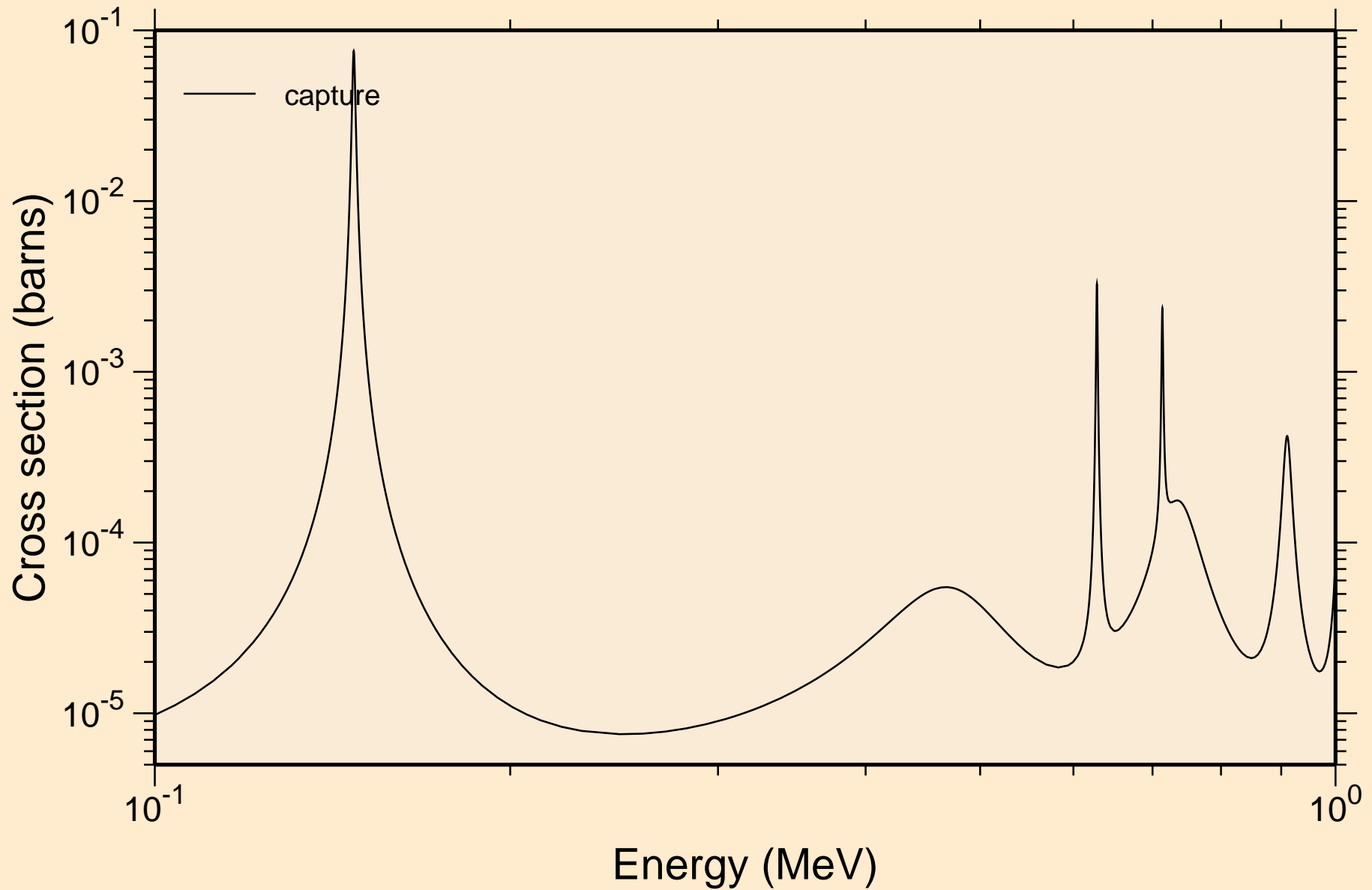

NE020 NEUTRON ACER TENDL-2024 LIBRARY; T=293.6K
resonance absorption cross sections

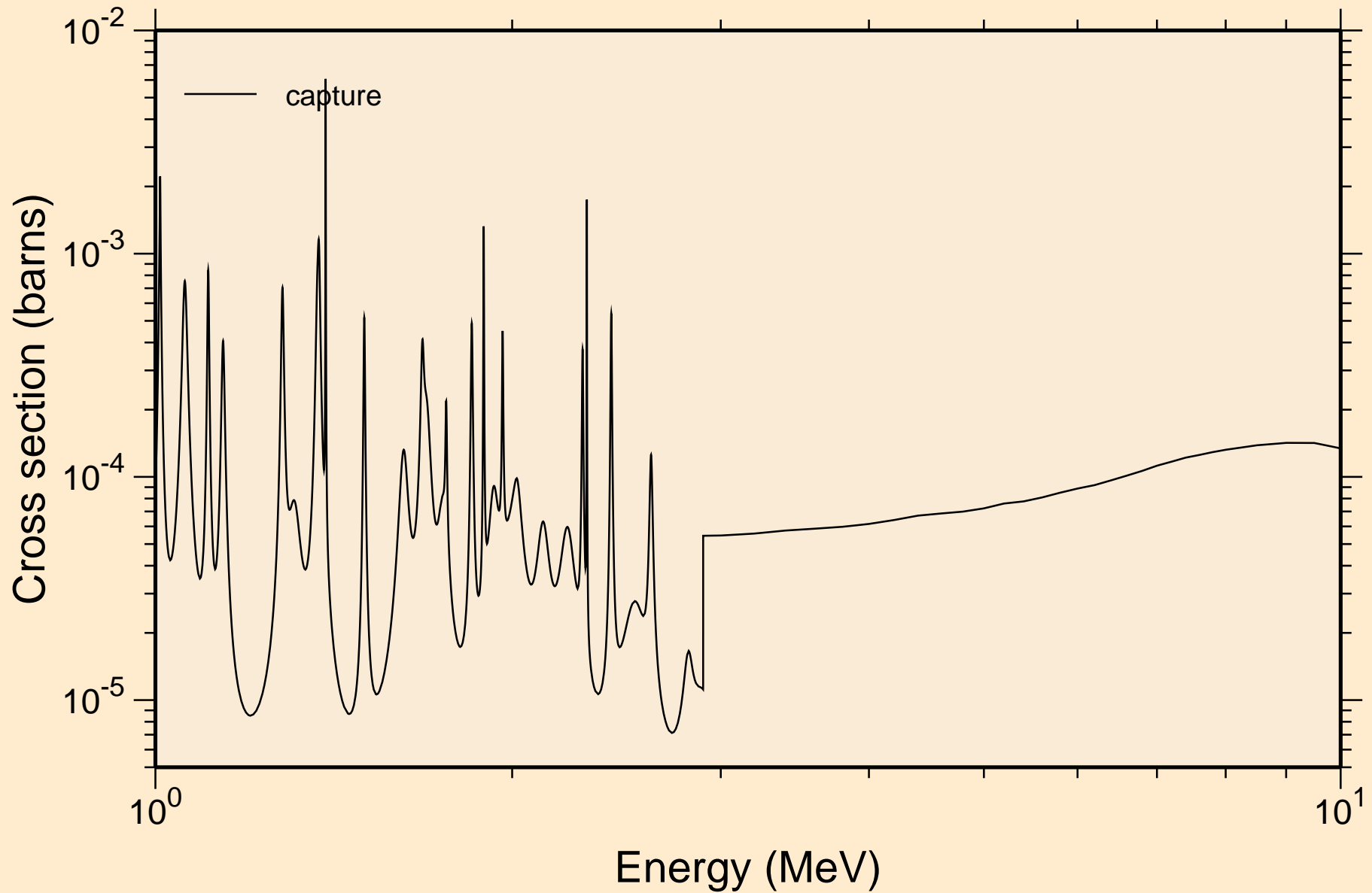

NE020 NEUTRON ACER TENDL-2024 LIBRARY; T=293.6K
Heating

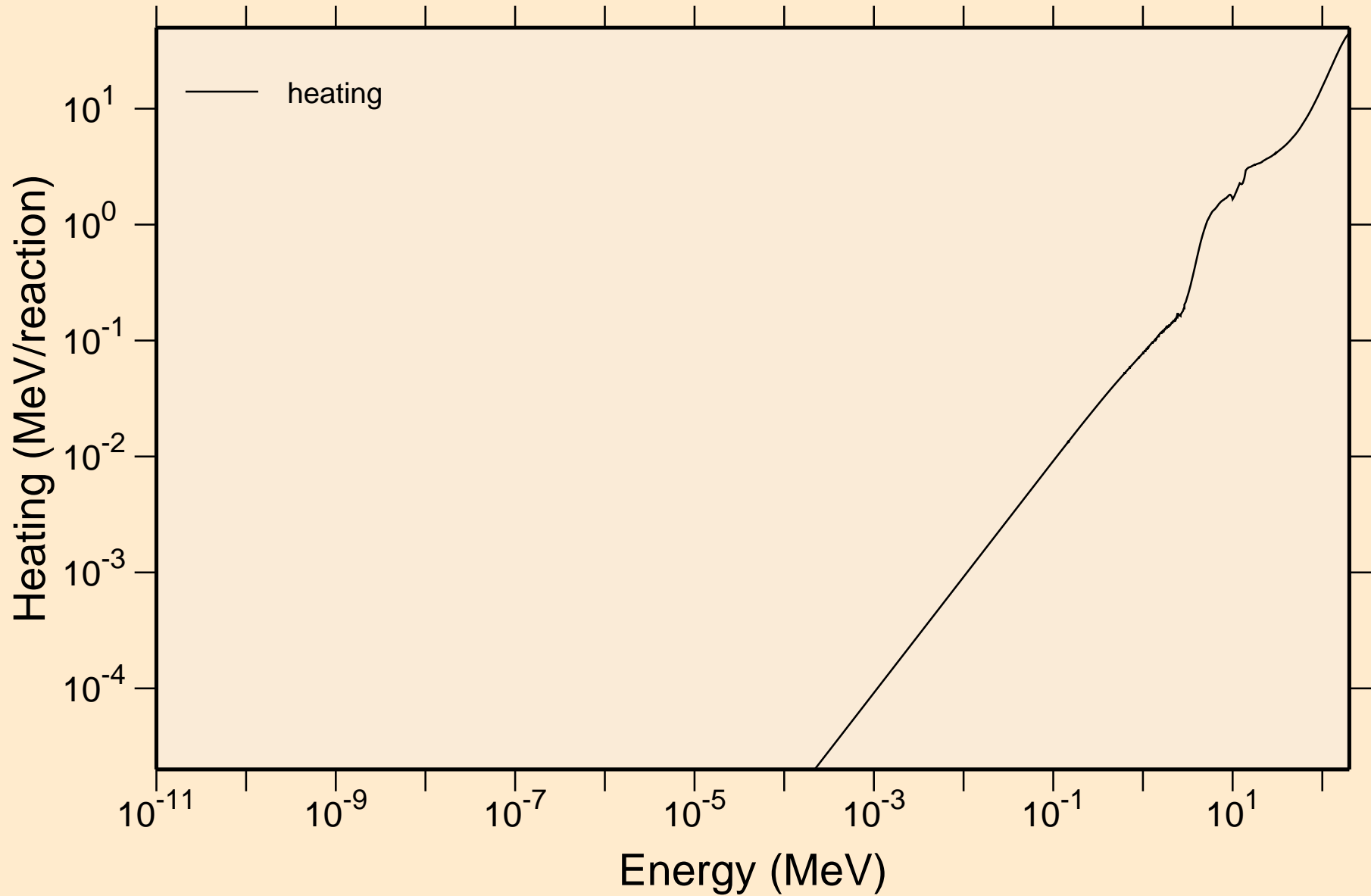

NE020 NEUTRON ACER TENDL-2024 LIBRARY; T=293.6K
Damage

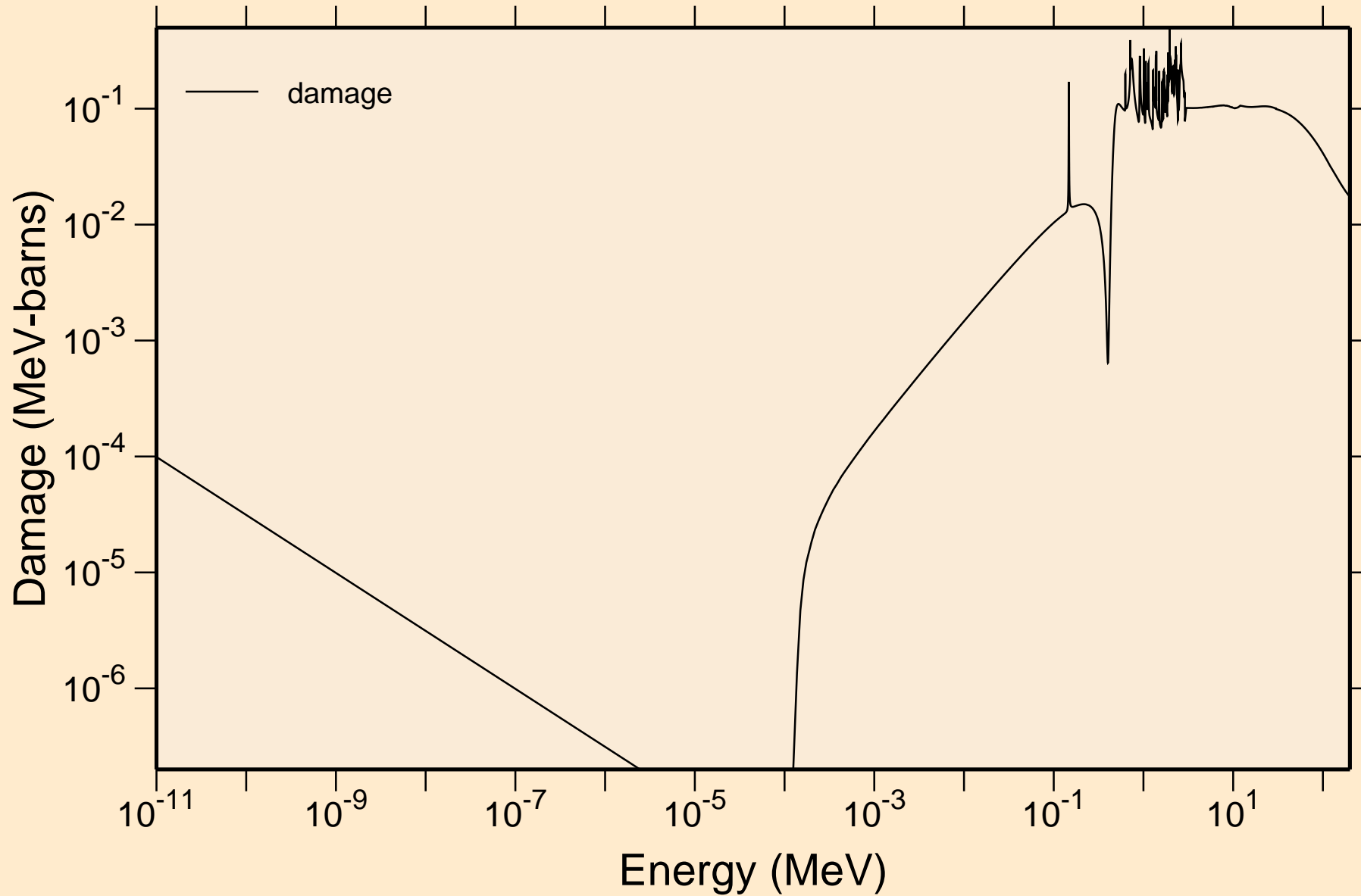

NE020 NEUTRON ACER TENDL-2024 LIBRARY; T=293.6K
Non-threshold reactions

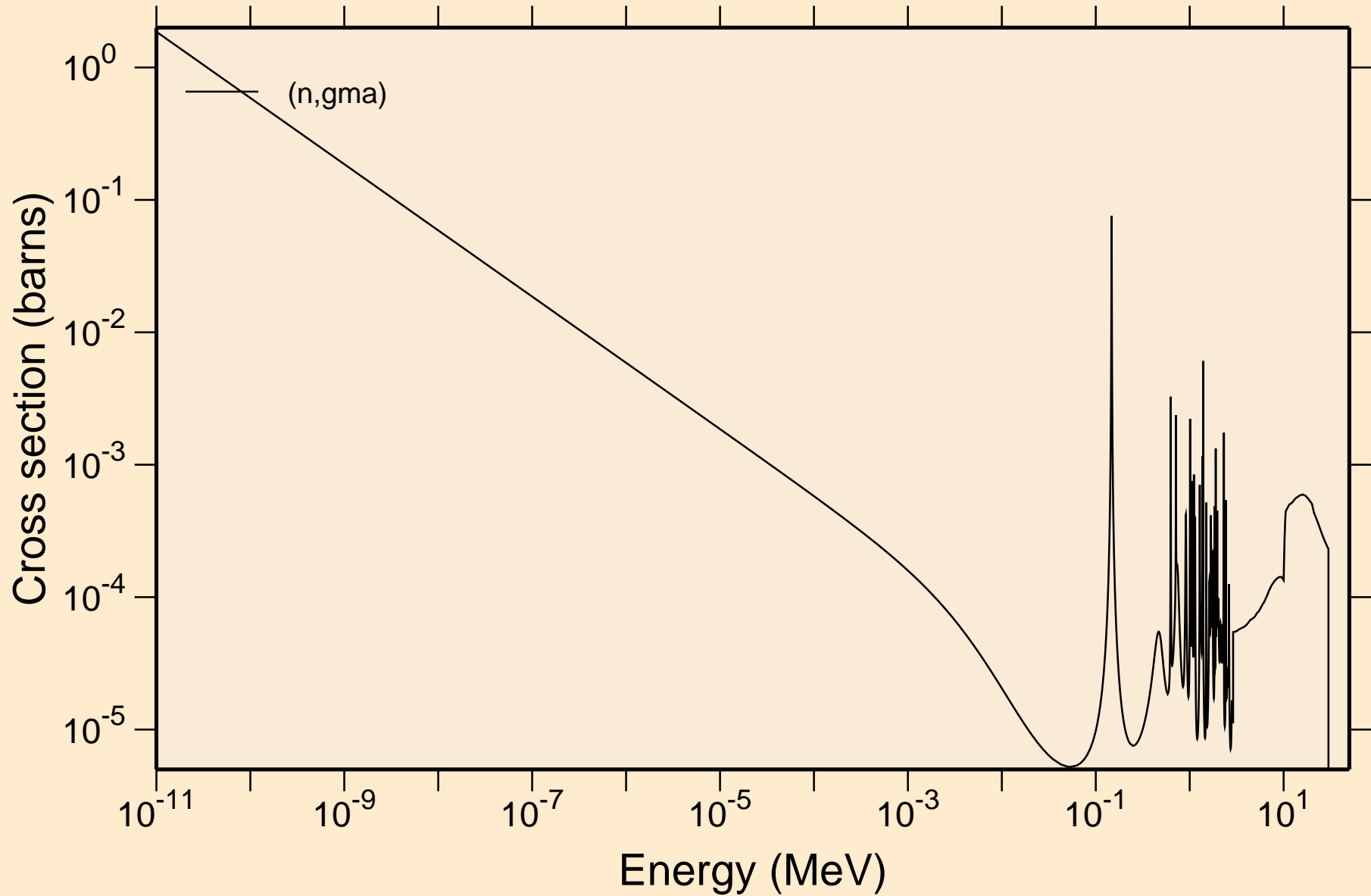

NE020 NEUTRON ACER TENDL-2024 LIBRARY; T=293.6K
Principal cross sections

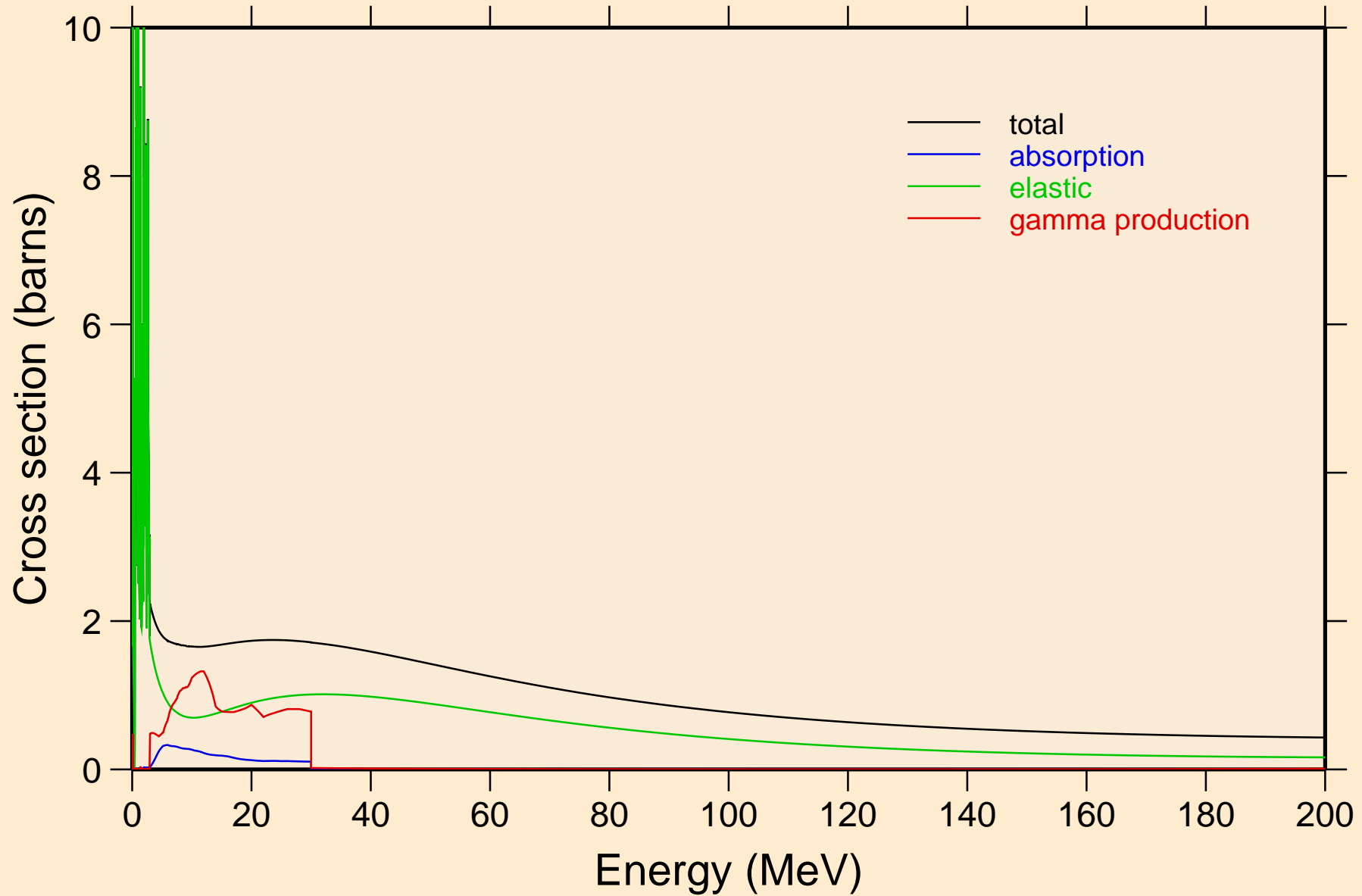

NE020 NEUTRON ACER TENDL-2024 LIBRARY; T=293.6K
Heating

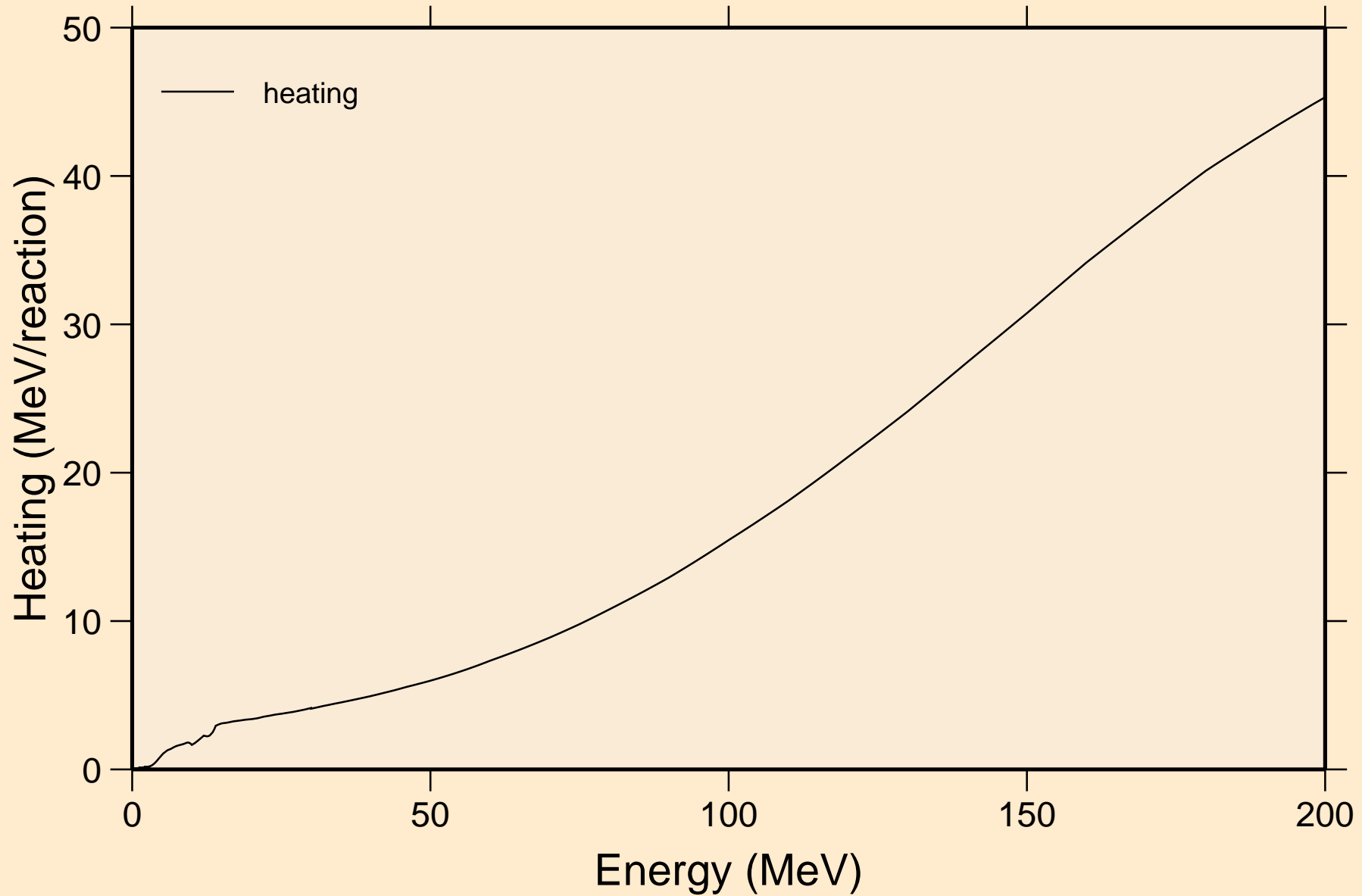

NE020 NEUTRON ACER TENDL-2024 LIBRARY; T=293.6K
Damage

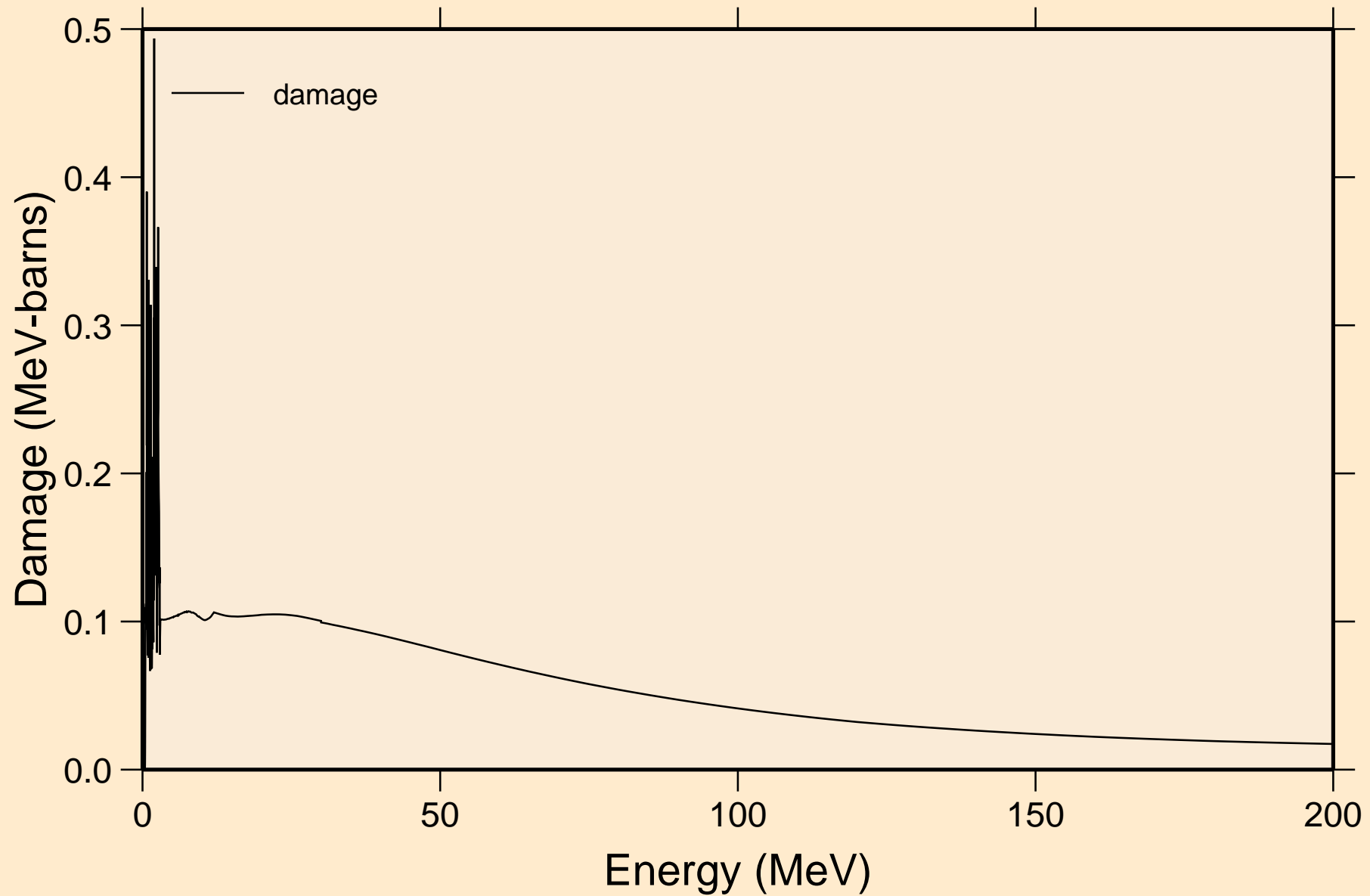

NE020 NEUTRON ACER TENDL-2024 LIBRARY; T=293.6K
Non-threshold reactions

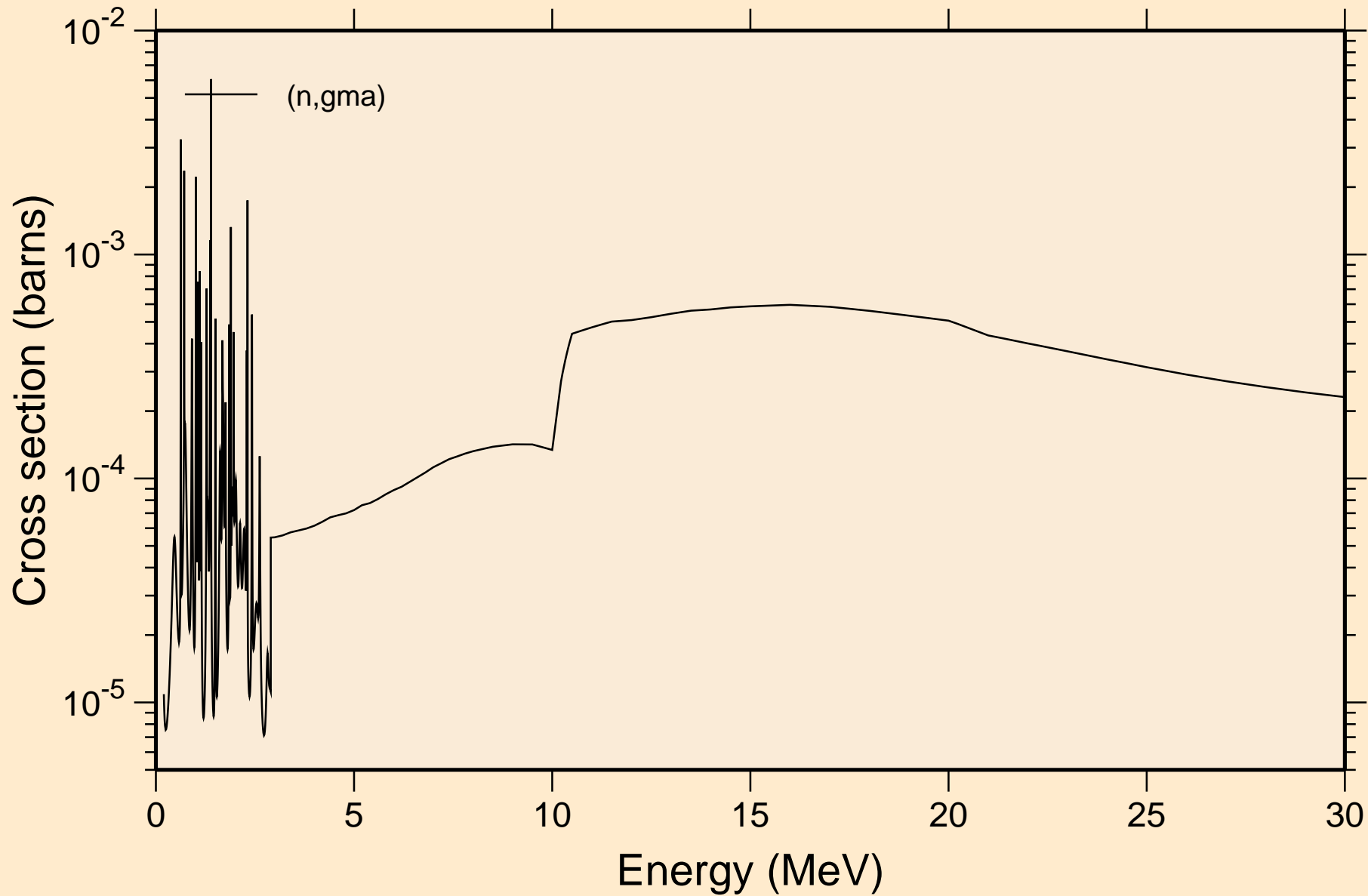

NE020 NEUTRON ACER TENDL-2024 LIBRARY; T=293.6K
Inelastic levels

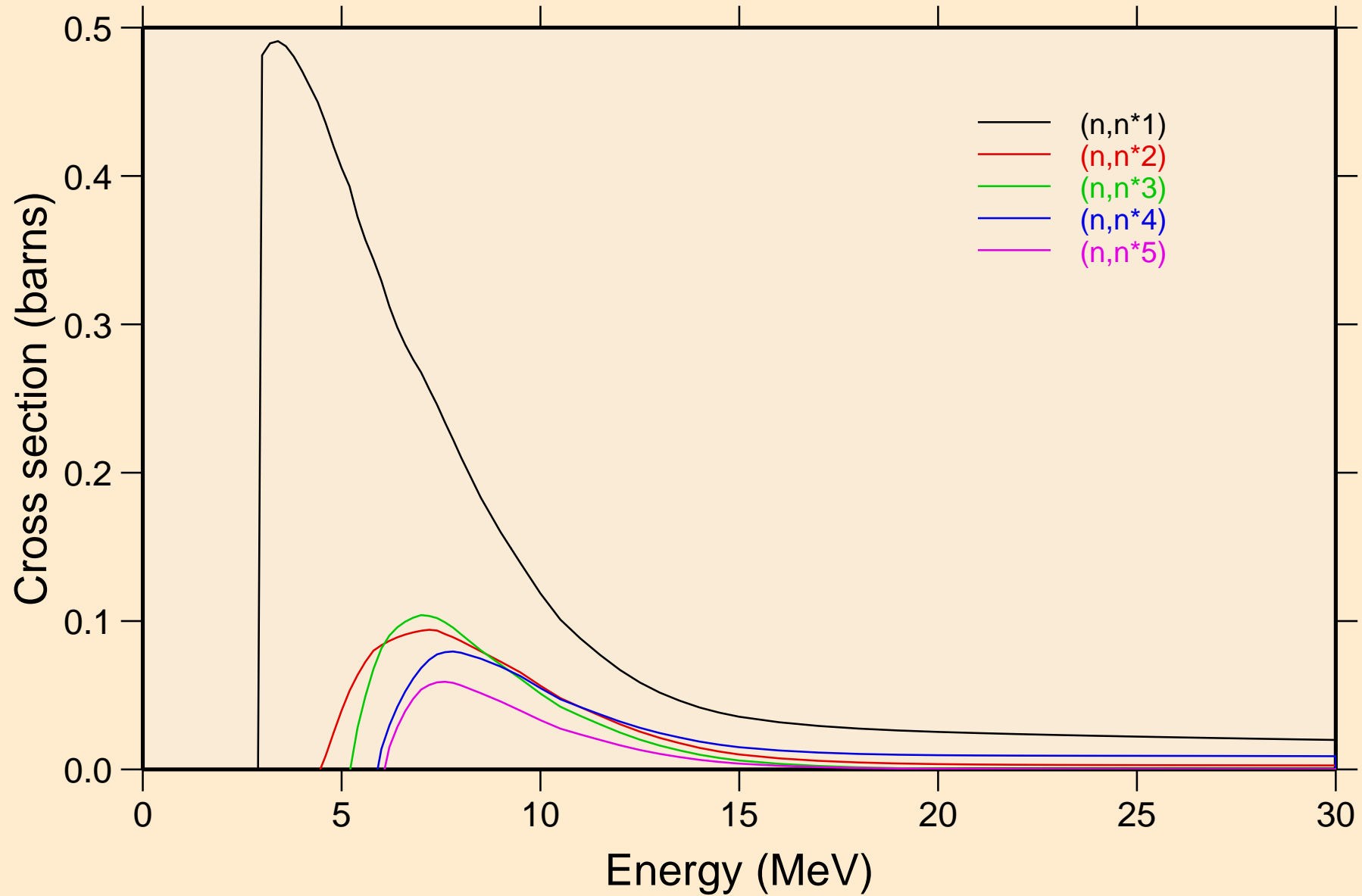

NE020 NEUTRON ACER TENDL-2024 LIBRARY; T=293.6K
Inelastic levels

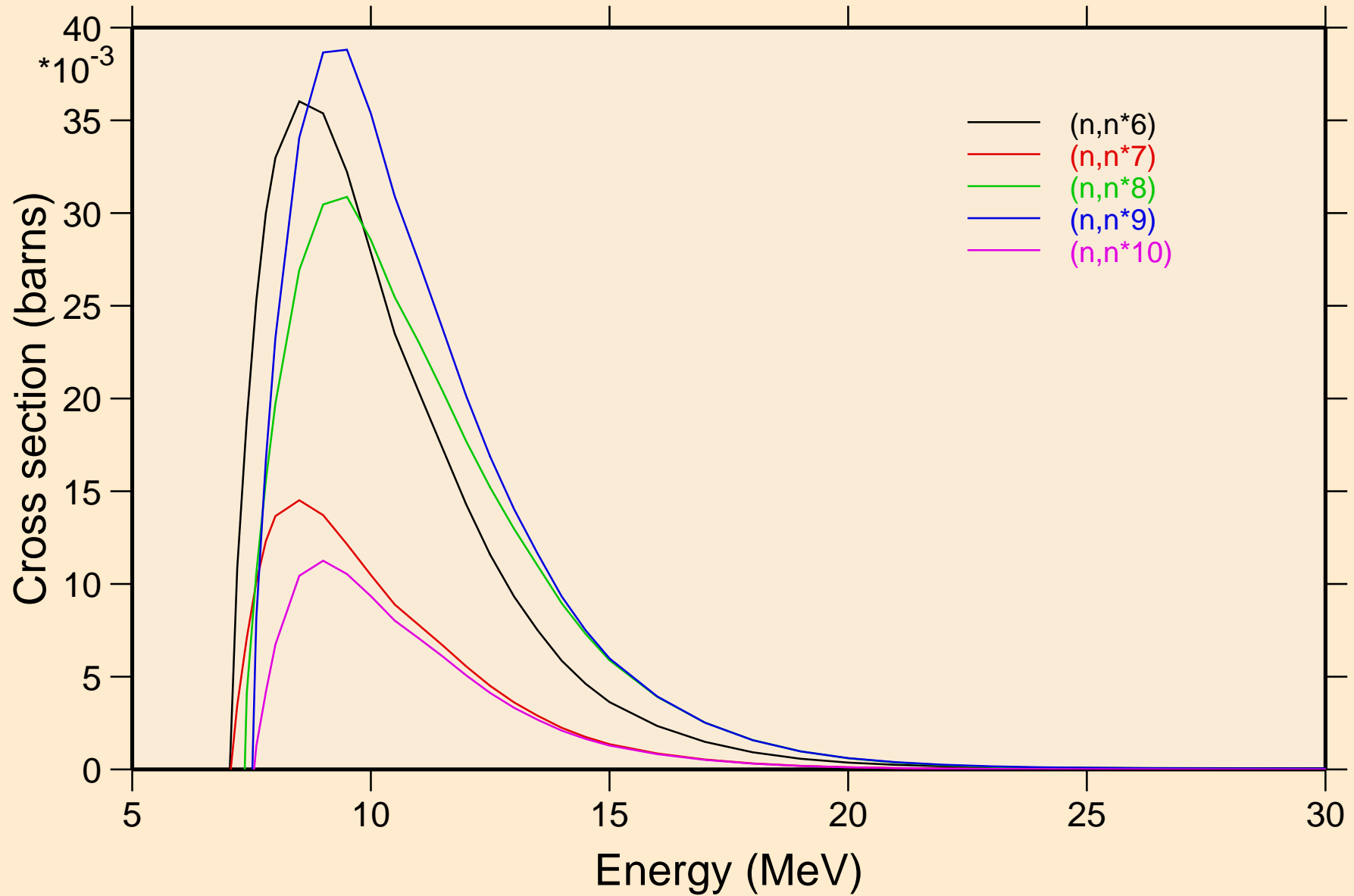

NE020 NEUTRON ACER TENDL-2024 LIBRARY; T=293.6K
Inelastic levels

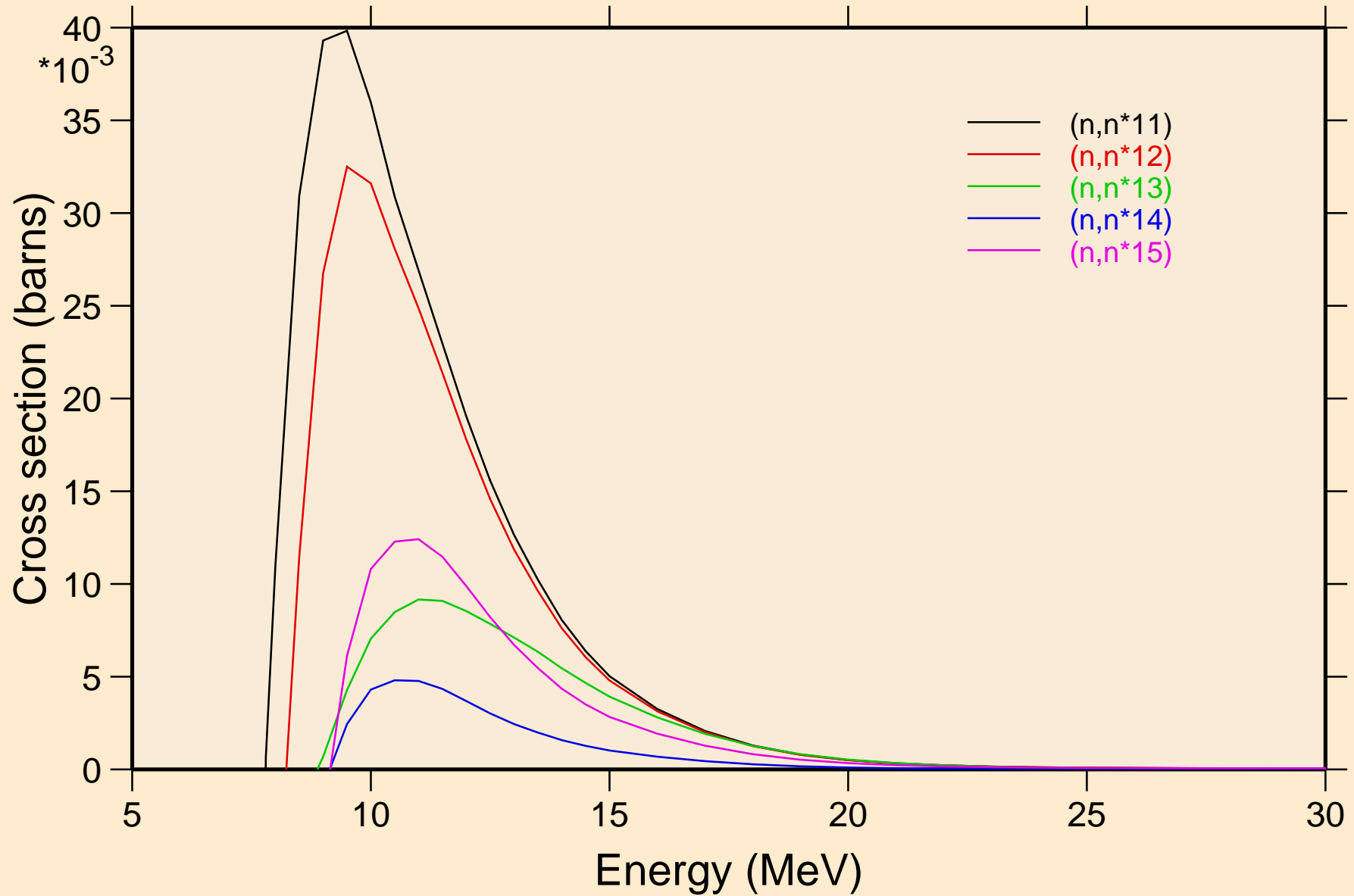

NE020 NEUTRON ACER TENDL-2024 LIBRARY; T=293.6K
Inelastic levels

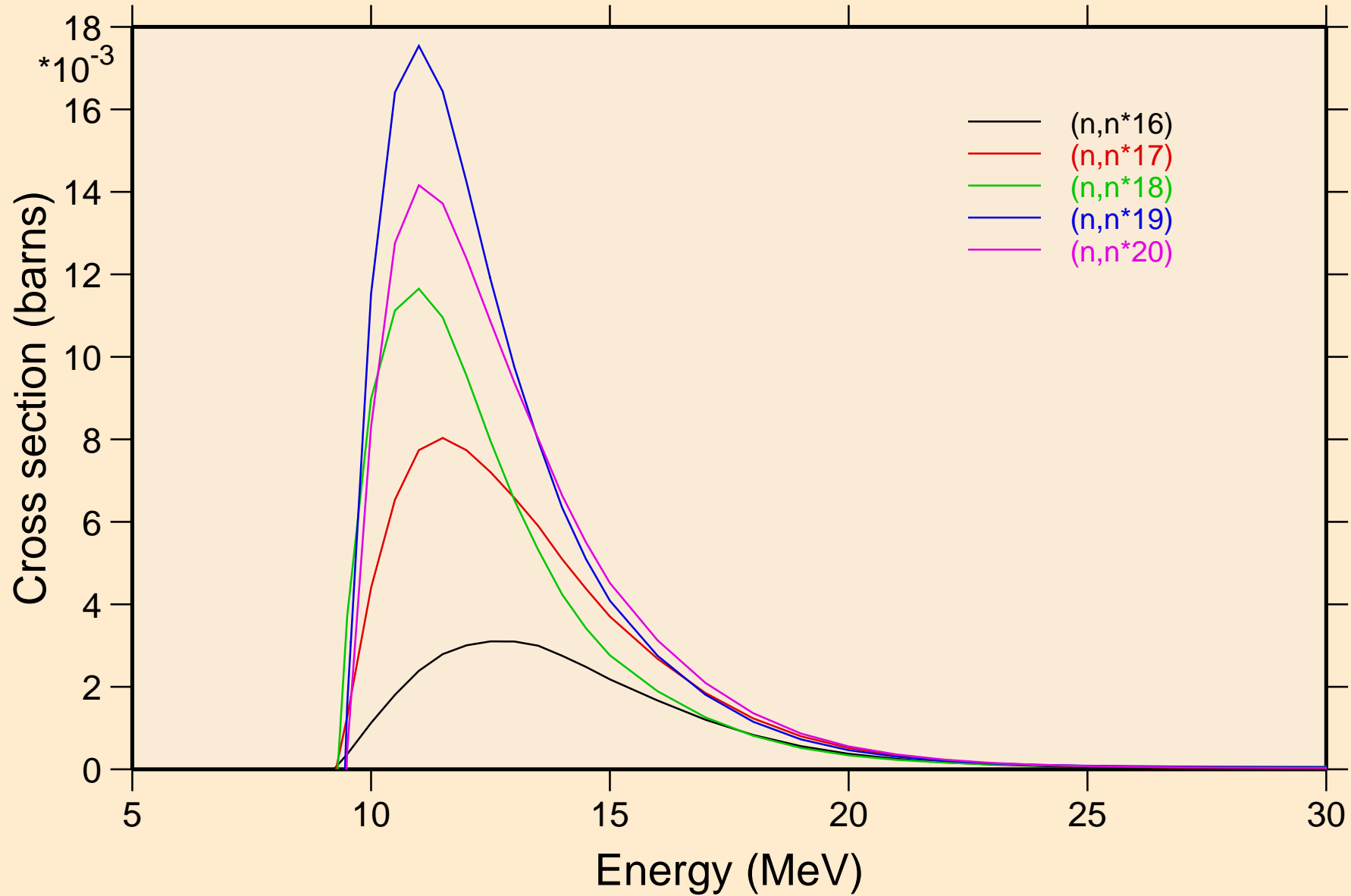

NE020 NEUTRON ACER TENDL-2024 LIBRARY; T=293.6K
Inelastic levels

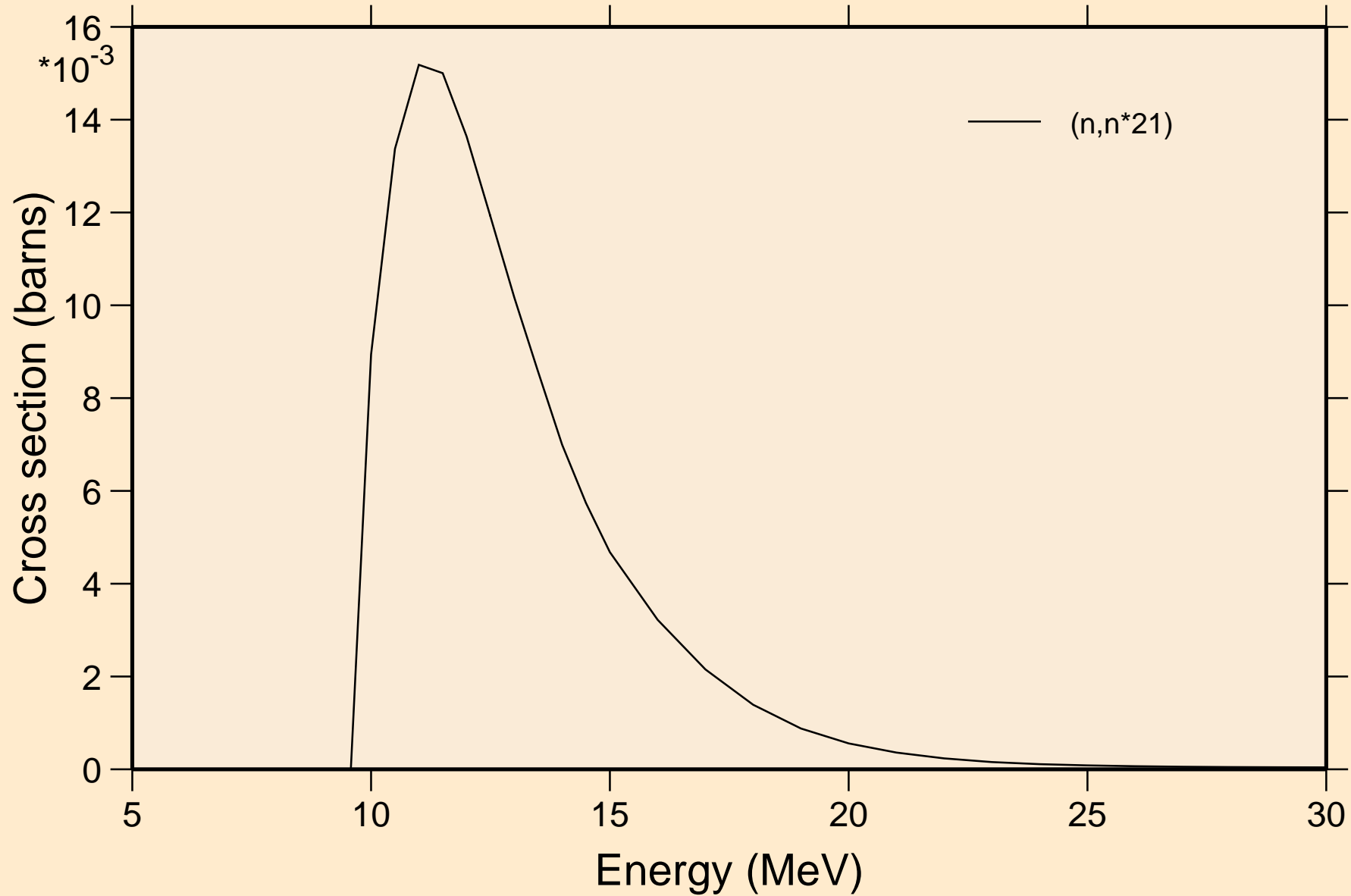

NE020 NEUTRON ACER TENDL-2024 LIBRARY; T=293.6K
Threshold reactions

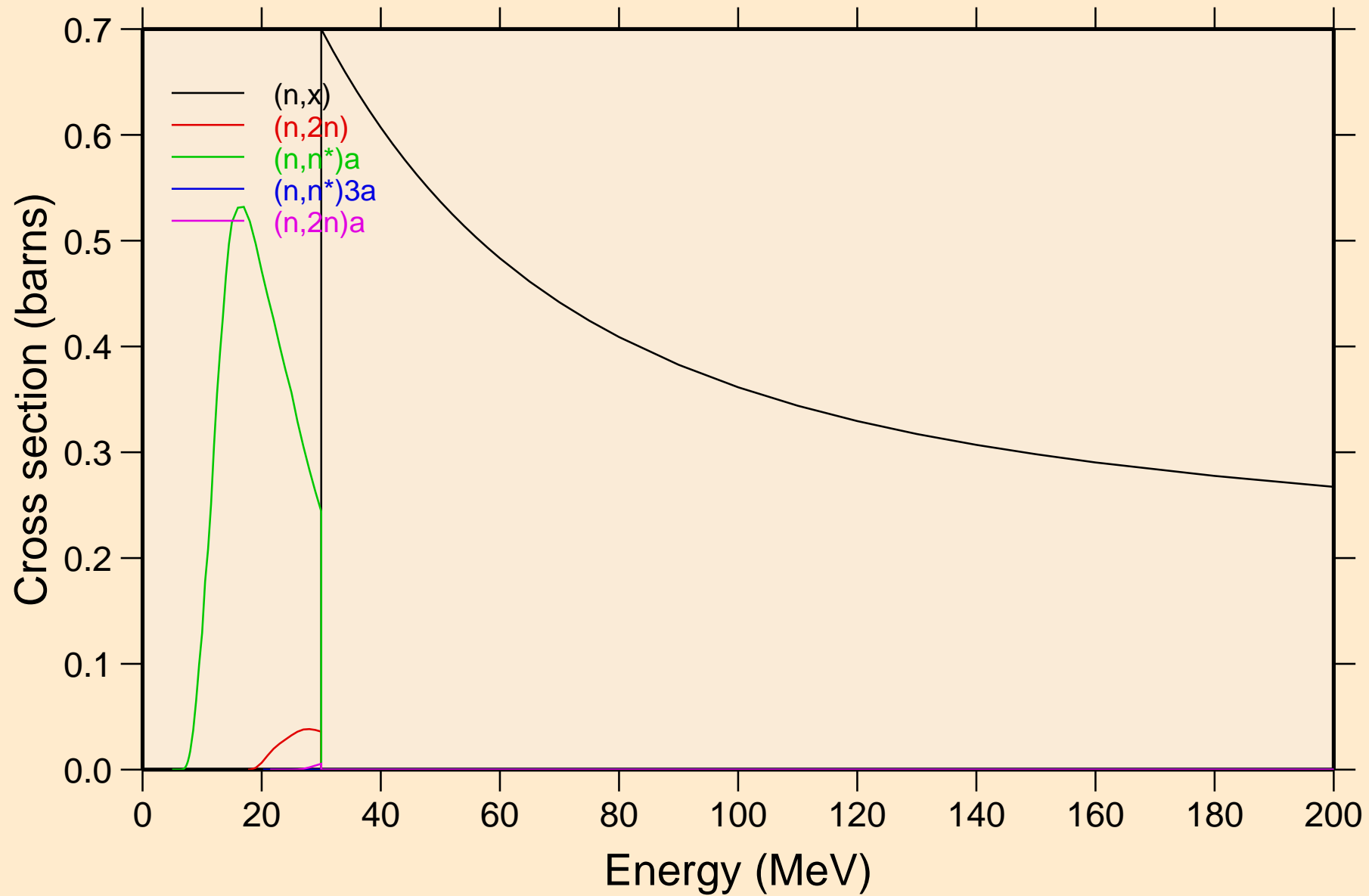

NE020 NEUTRON ACER TENDL-2024 LIBRARY; T=293.6K
Threshold reactions

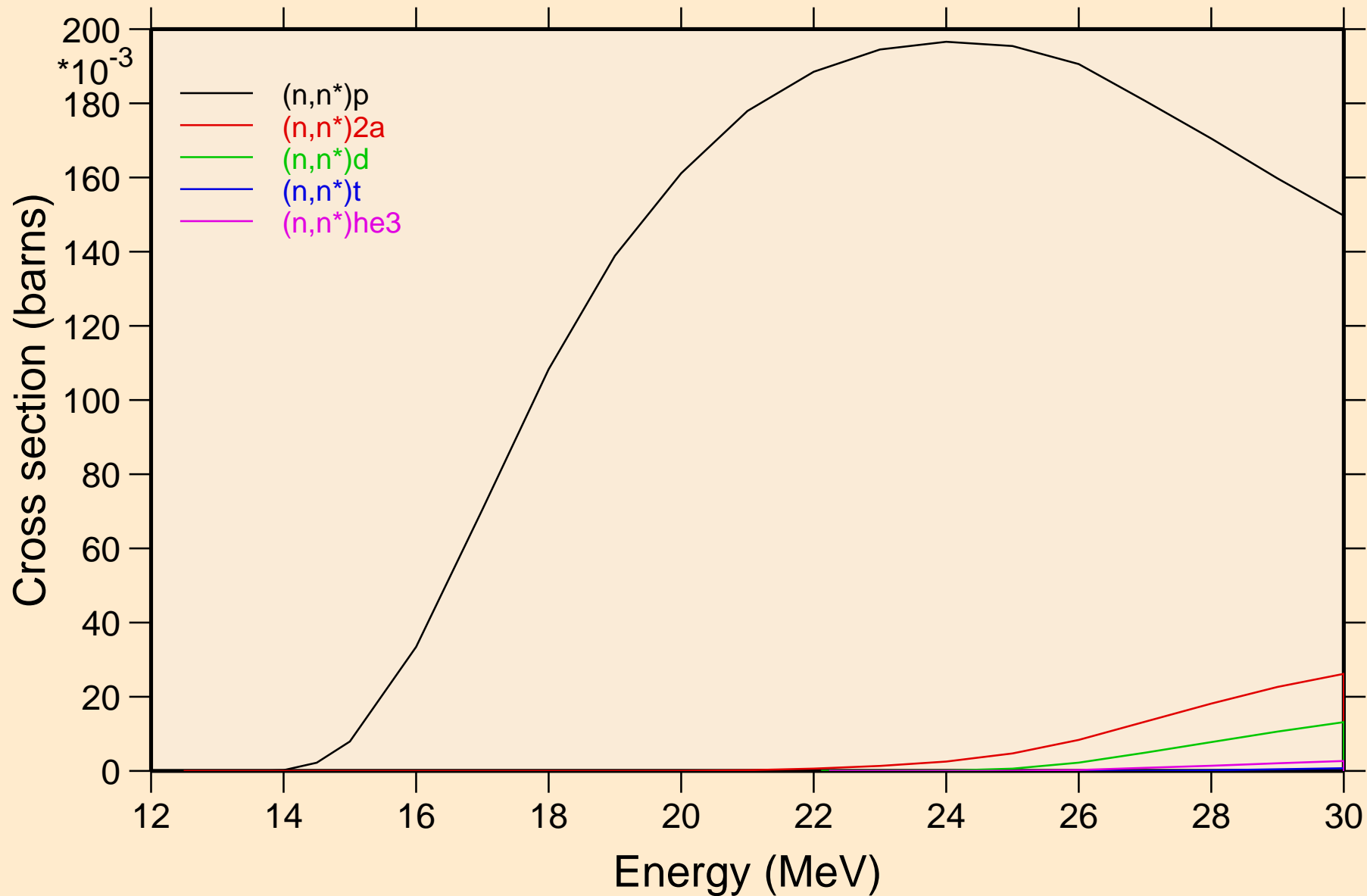

NE020 NEUTRON ACER TENDL-2024 LIBRARY; T=293.6K
Threshold reactions

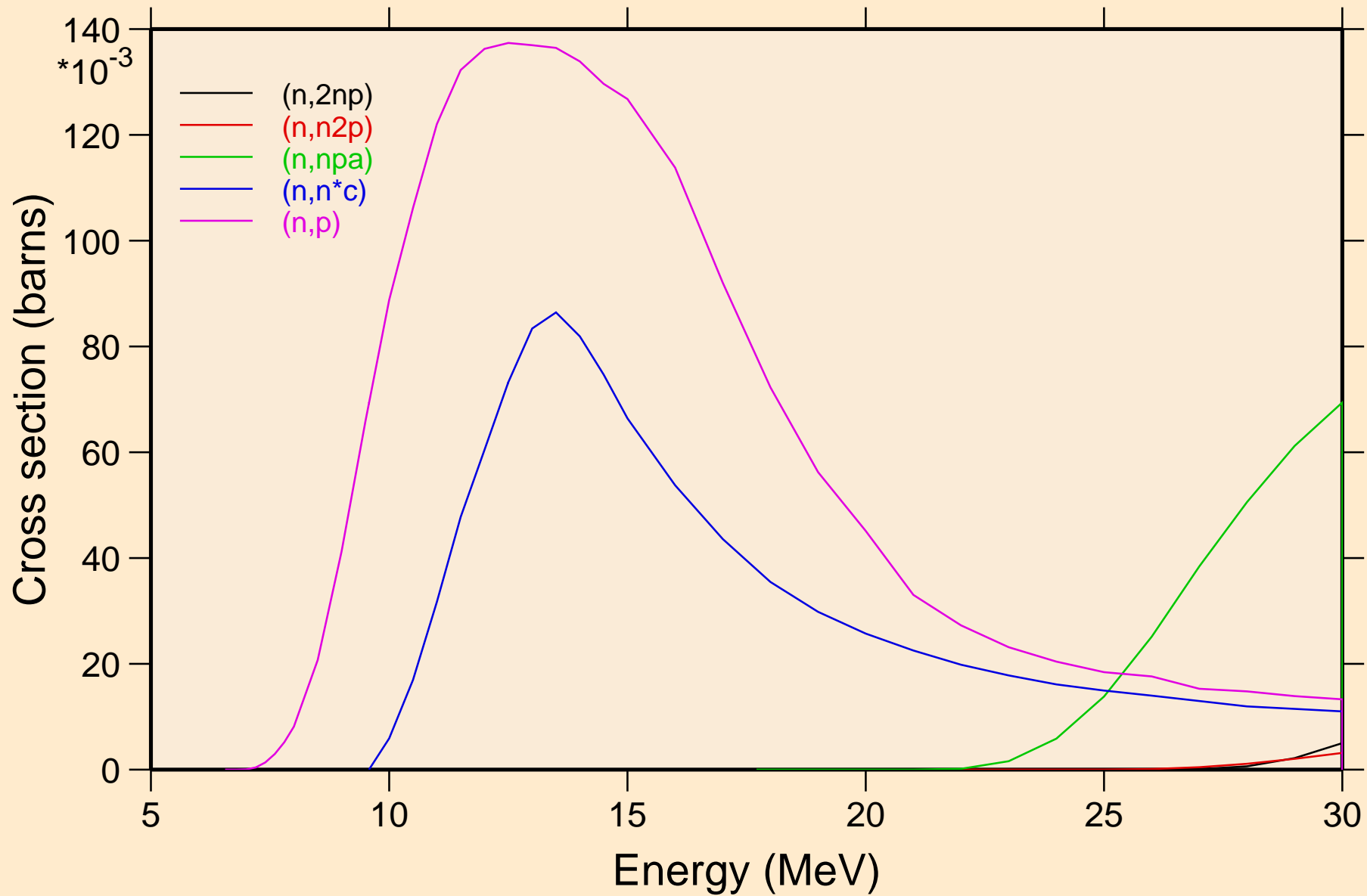

NE020 NEUTRON ACER TENDL-2024 LIBRARY; T=293.6K
Threshold reactions

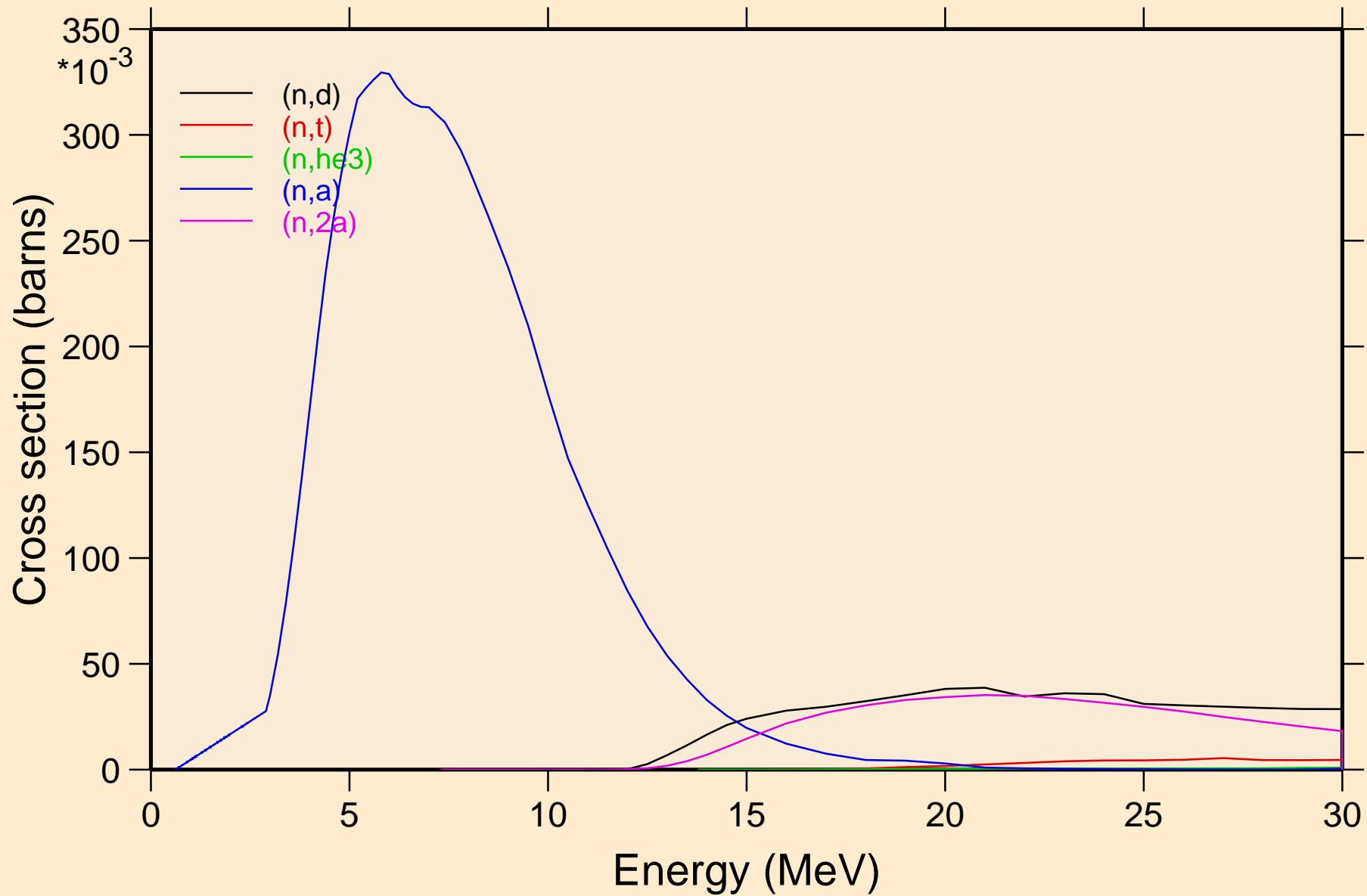

NE020 NEUTRON ACER TENDL-2024 LIBRARY; T=293.6K

Threshold reactions

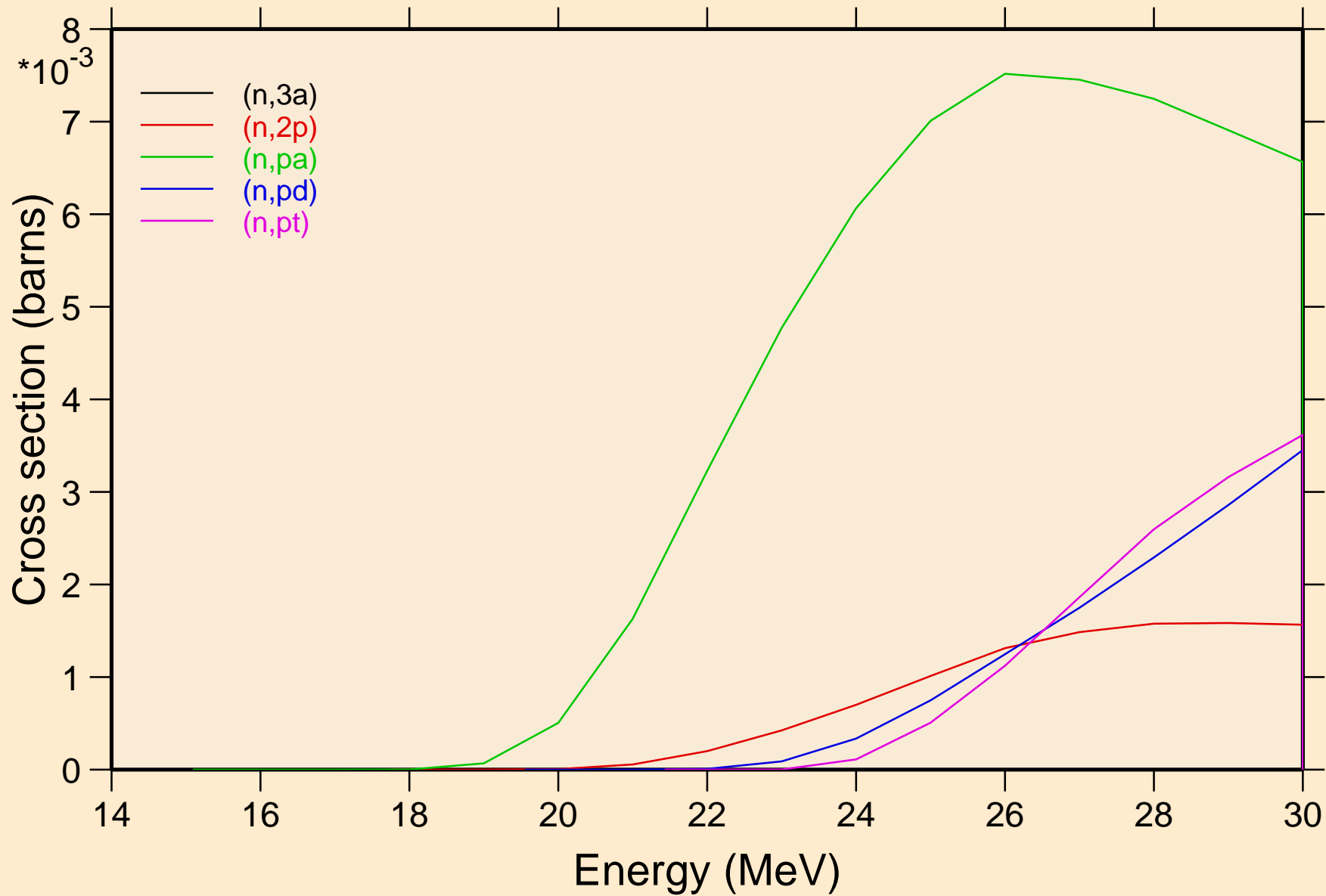

NE020 NEUTRON ACER TENDL-2024 LIBRARY; T=293.6K
Threshold reactions

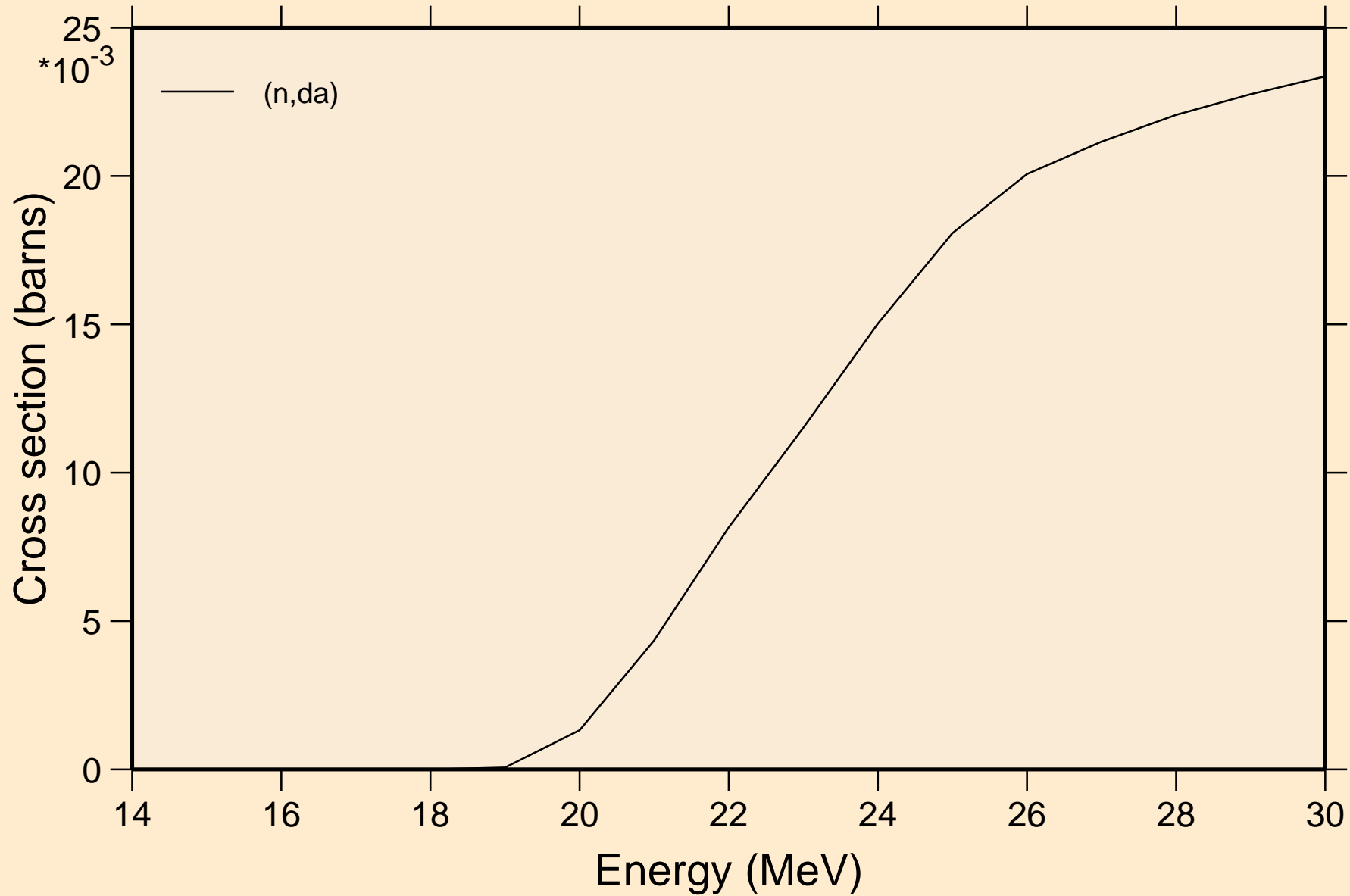

NE020 NEUTRON ACER TENDL-2024 LIBRARY; T=293.6K

Threshold reactions

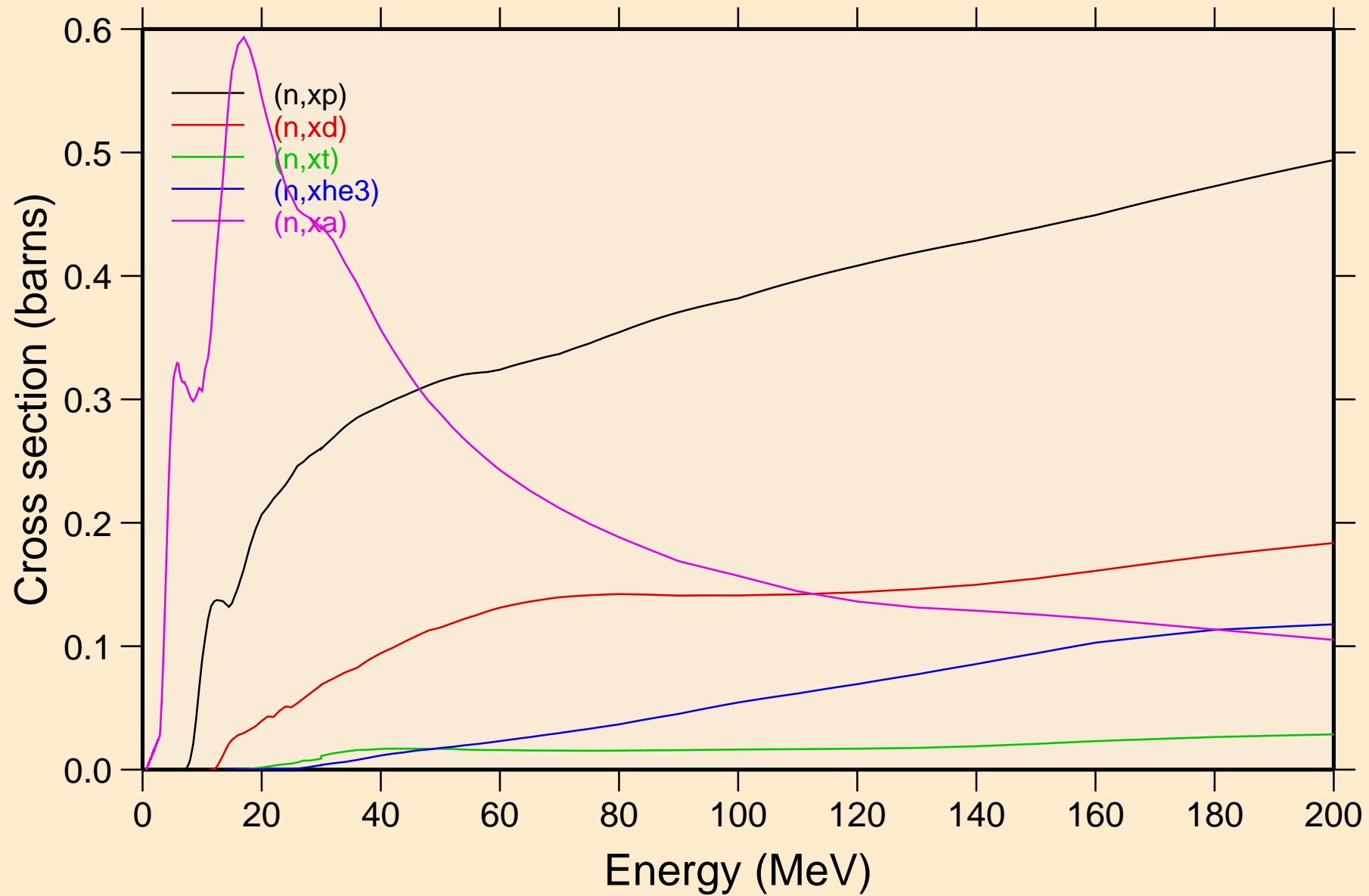

NE020 NEUTRON ACER TENDL-2024 LIBRARY; T=293.6K
angular distribution for elastic

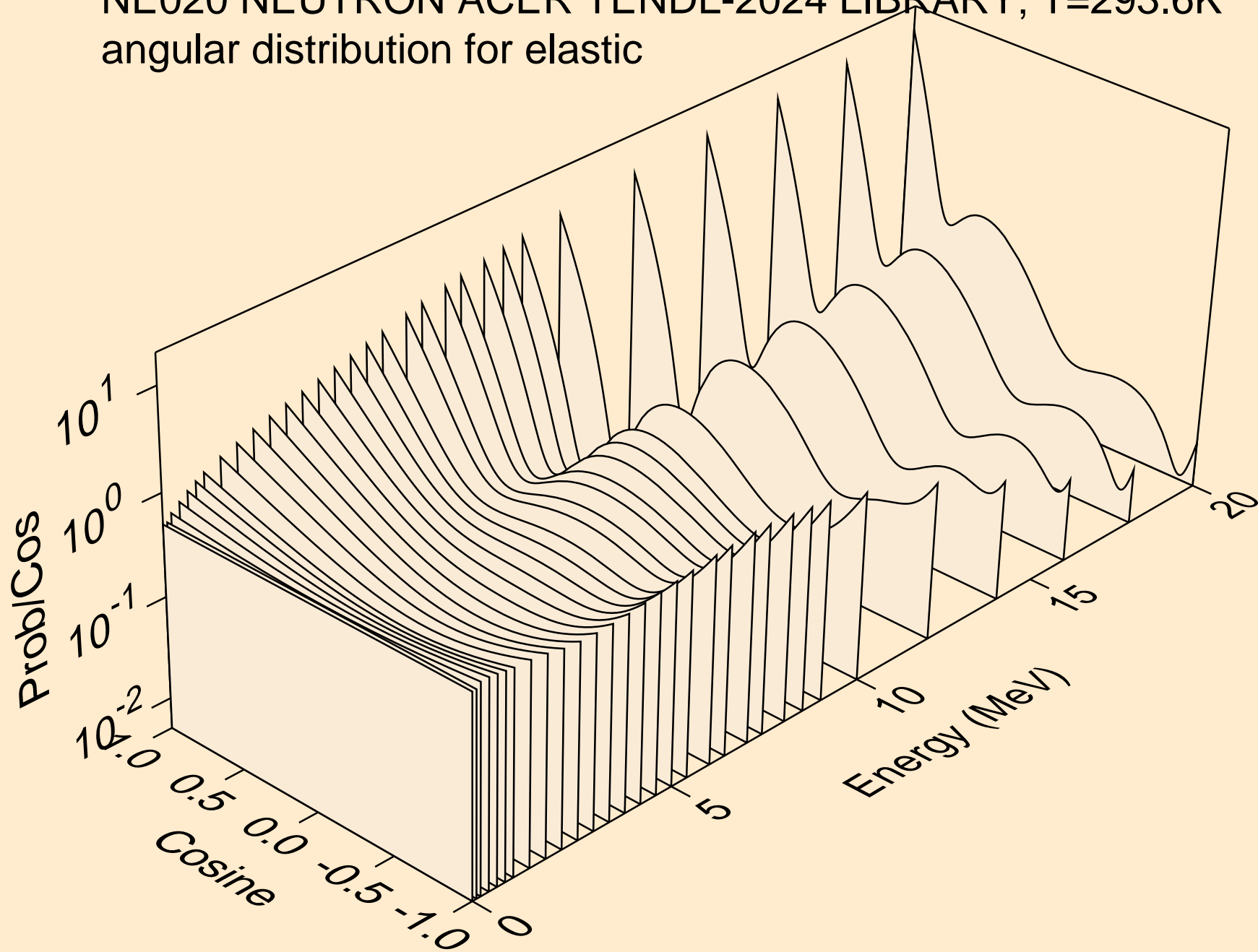

NE020 NEUTRON ACER TENDL-2024 LIBRARY; T=293.6K
angular distribution for elastic

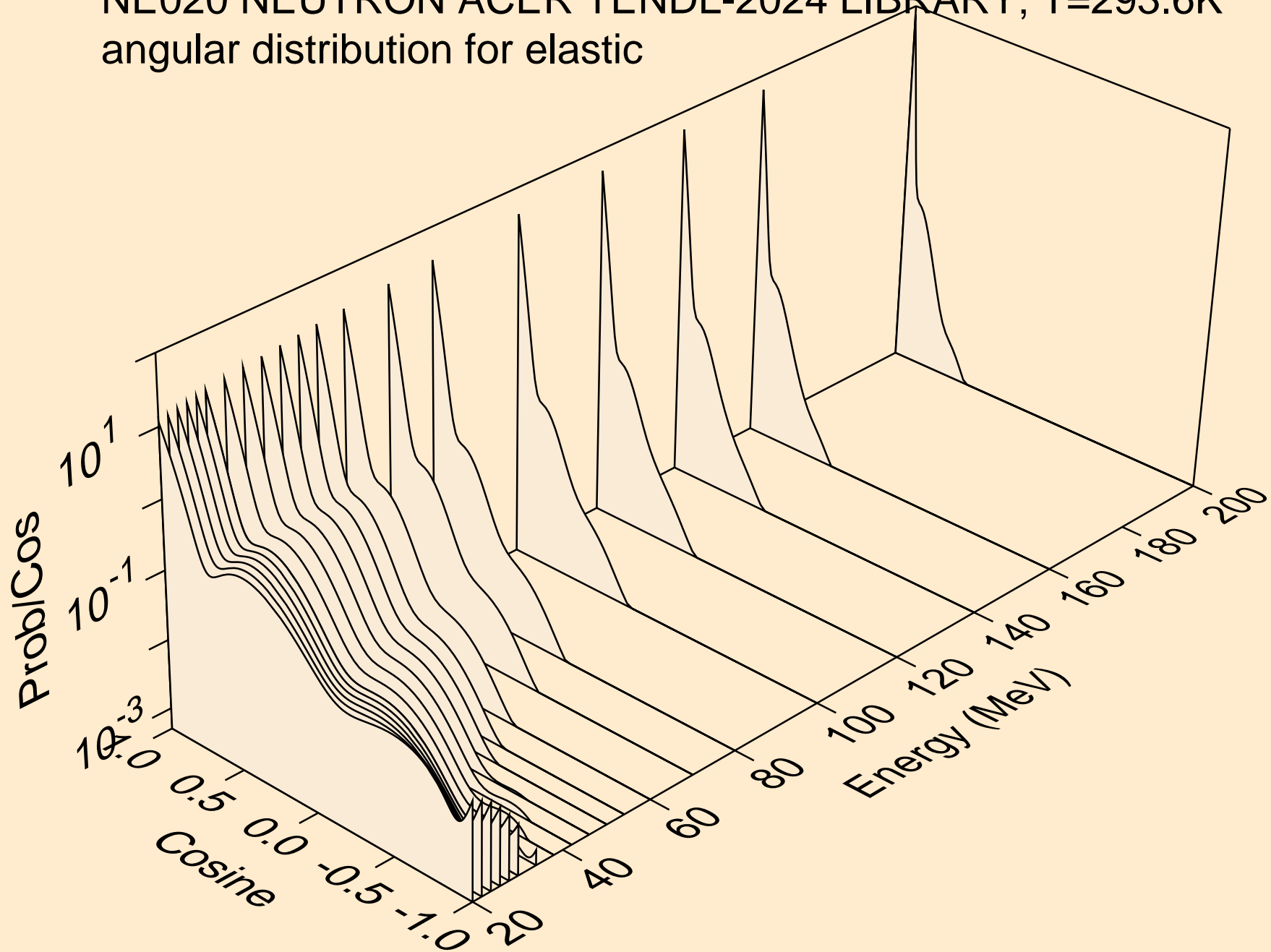

NE020 NEUTRON ACER TENDL-2024 LIBRARY; T=293.6K
angular distribution for (n,n*1)

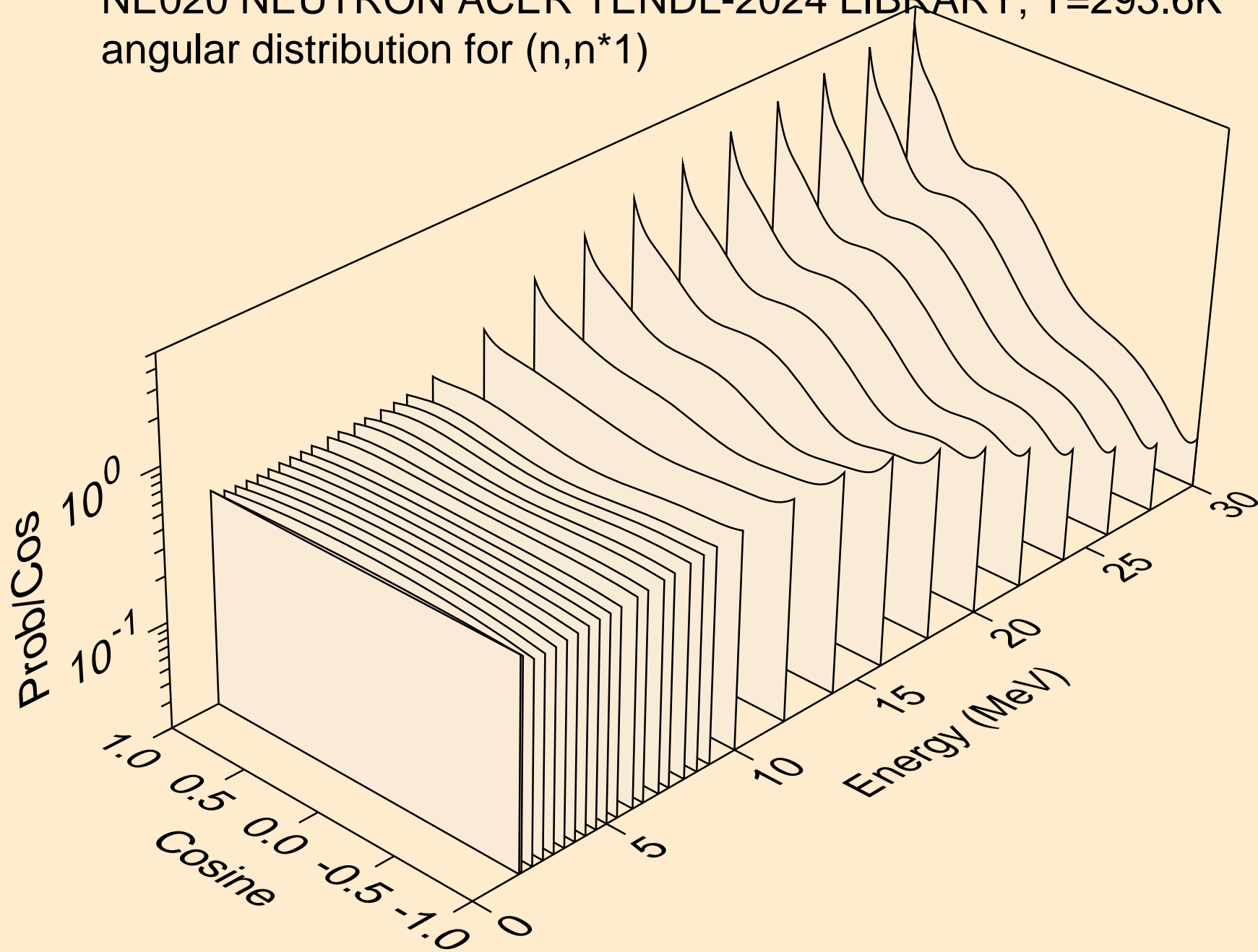

NE020 NEUTRON ACER TENDL-2024 LIBRARY; T=293.6K
angular distribution for (n,n*2)

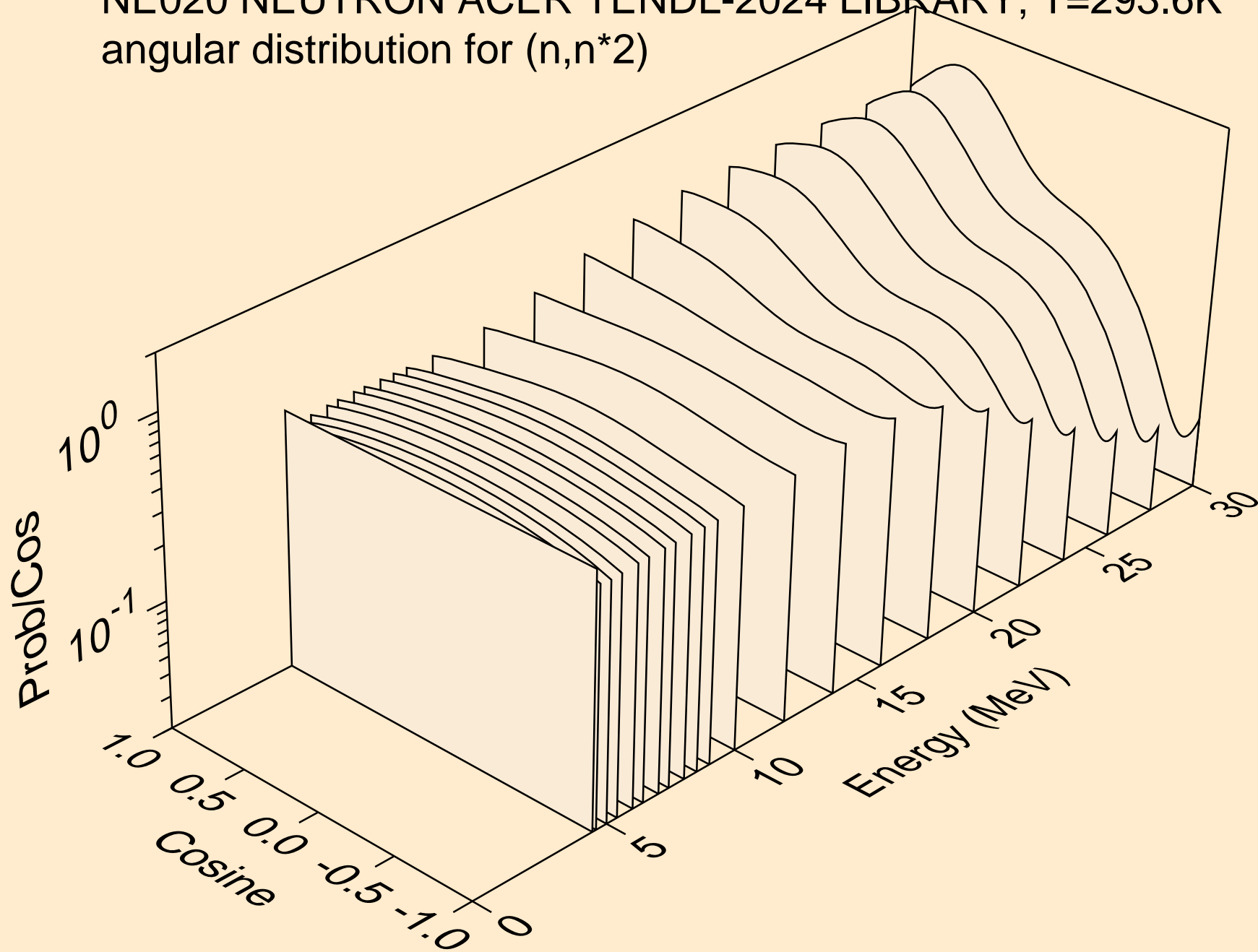

NE020 NEUTRON ACER TENDL-2024 LIBRARY; T=293.6K
angular distribution for (n,n*3)

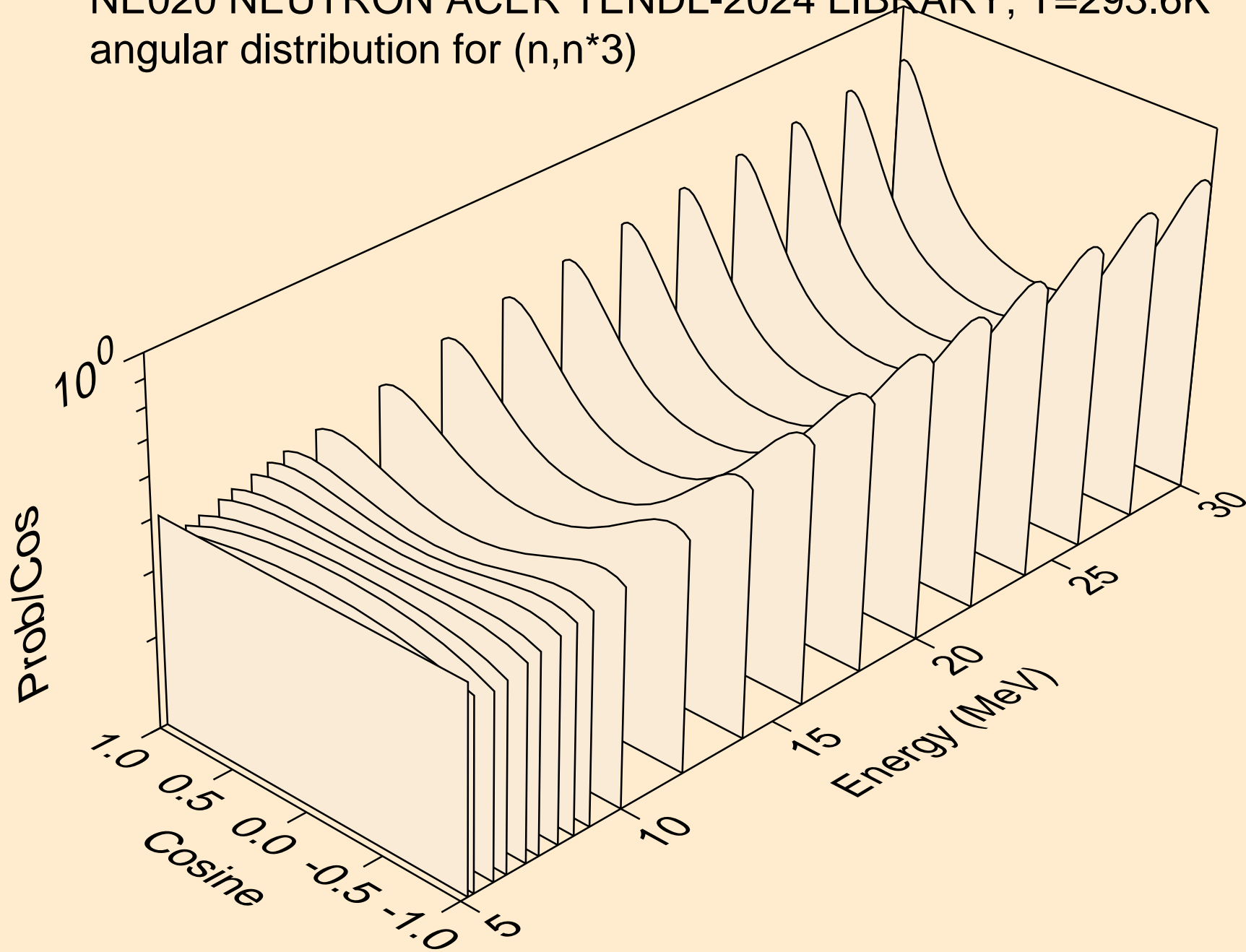

NE020 NEUTRON ACER TENDL-2024 LIBRARY; T=293.6K
angular distribution for (n,n*4)

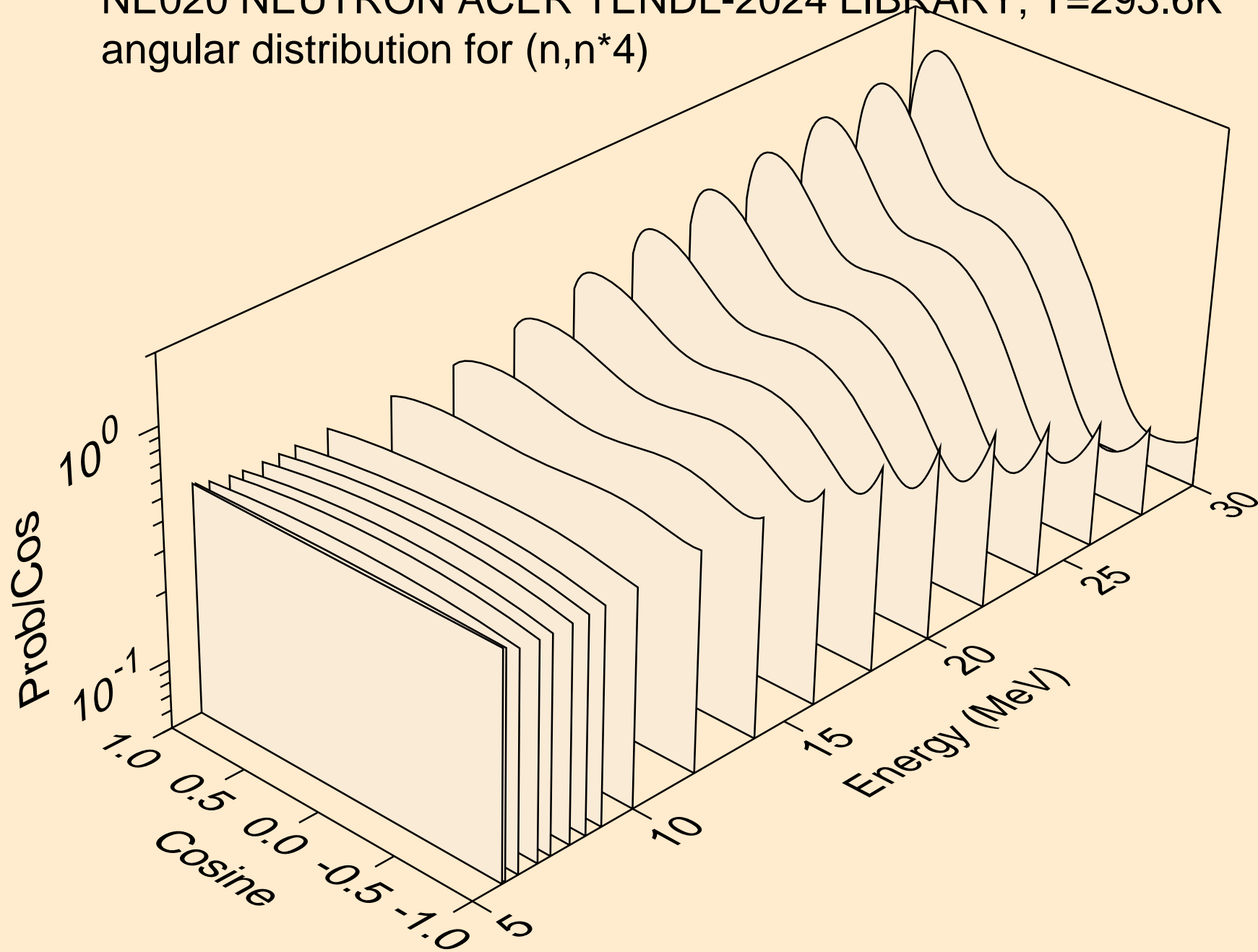

NE020 NEUTRON ACER TENDL-2024 LIBRARY; T=293.6K
angular distribution for (n,n*5)

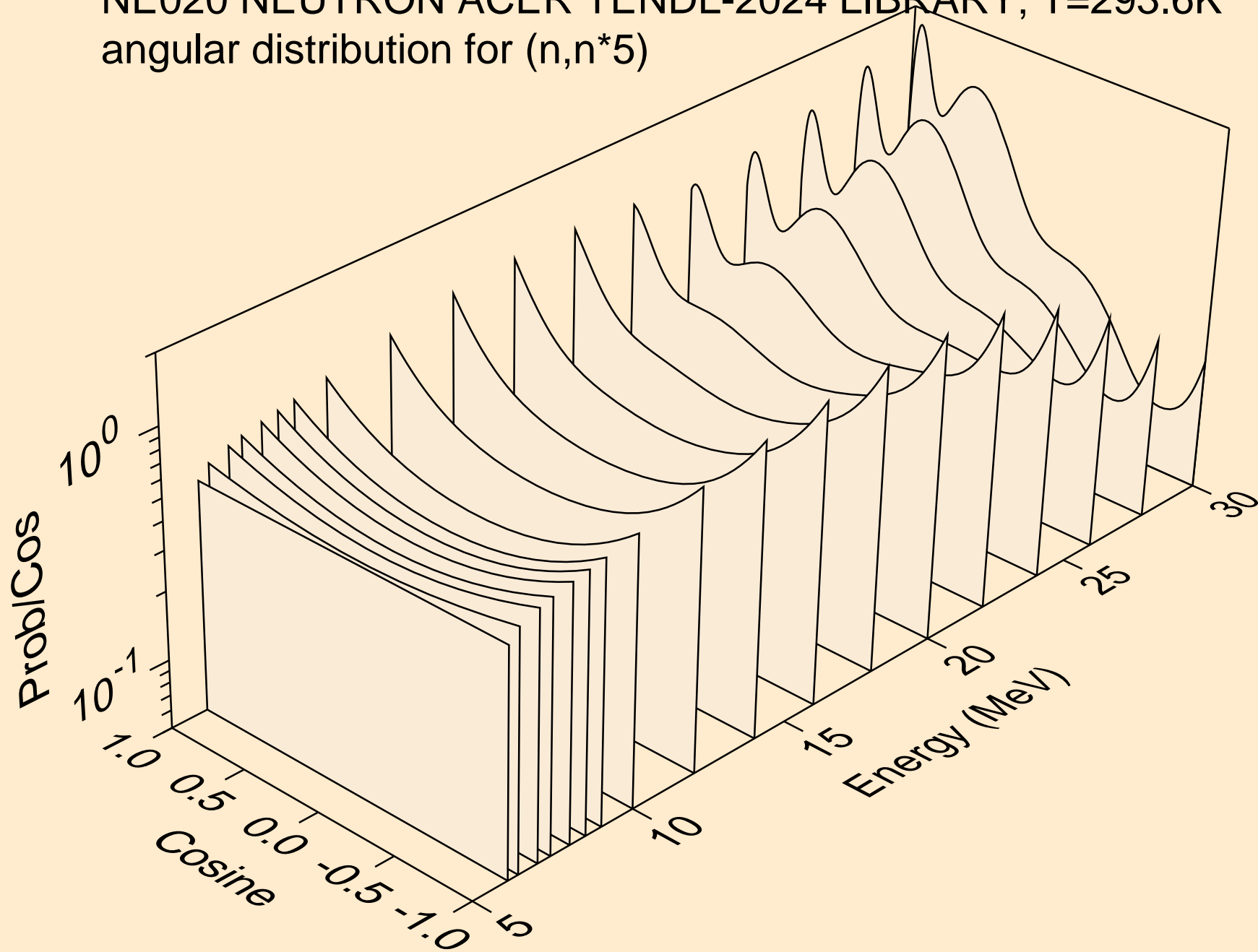

NE020 NEUTRON ACER TENDL-2024 LIBRARY; T=293.6K
angular distribution for (n,n*6)

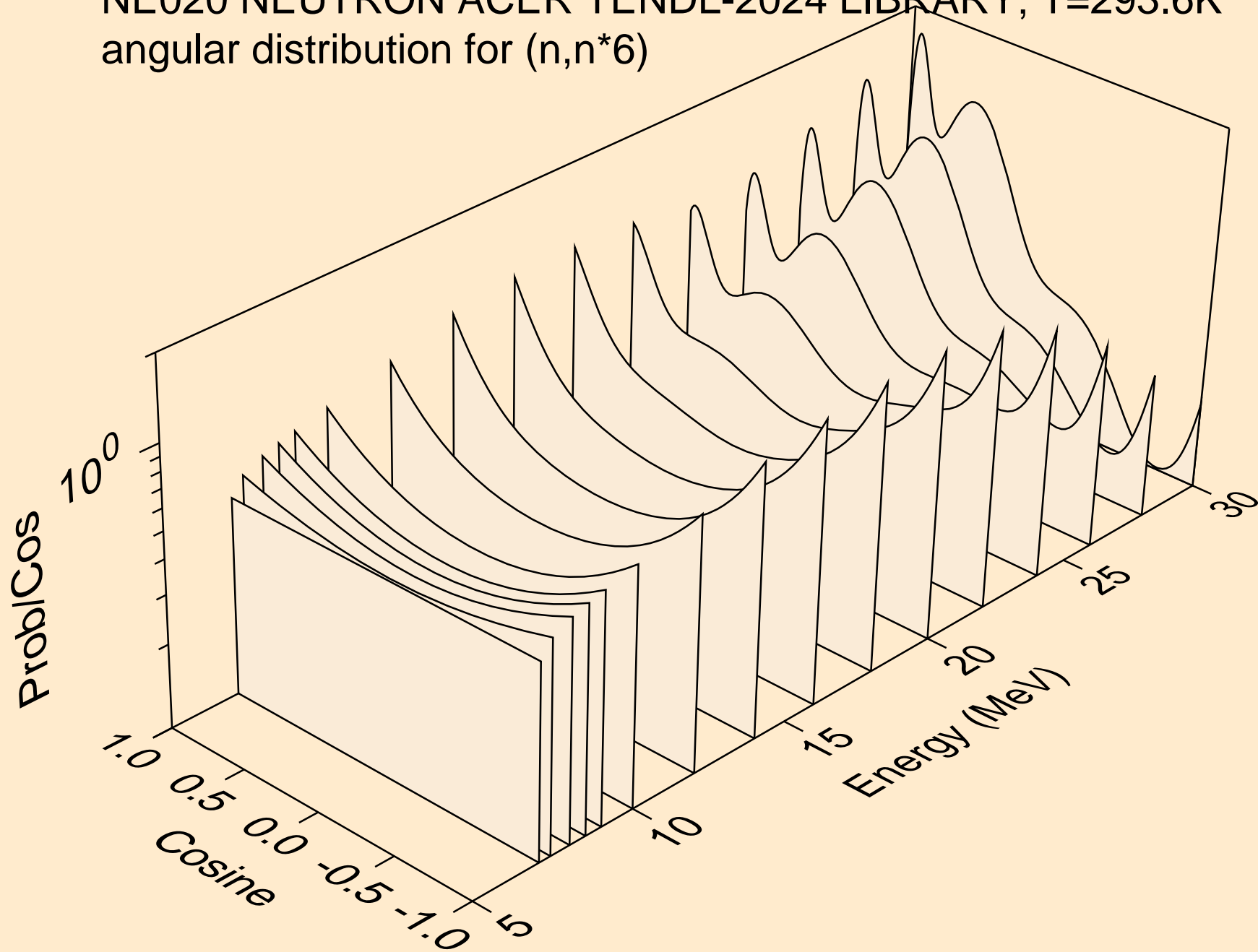

NE020 NEUTRON ACER TENDL-2024 LIBRARY; T=293.6K
angular distribution for (n,n*7)

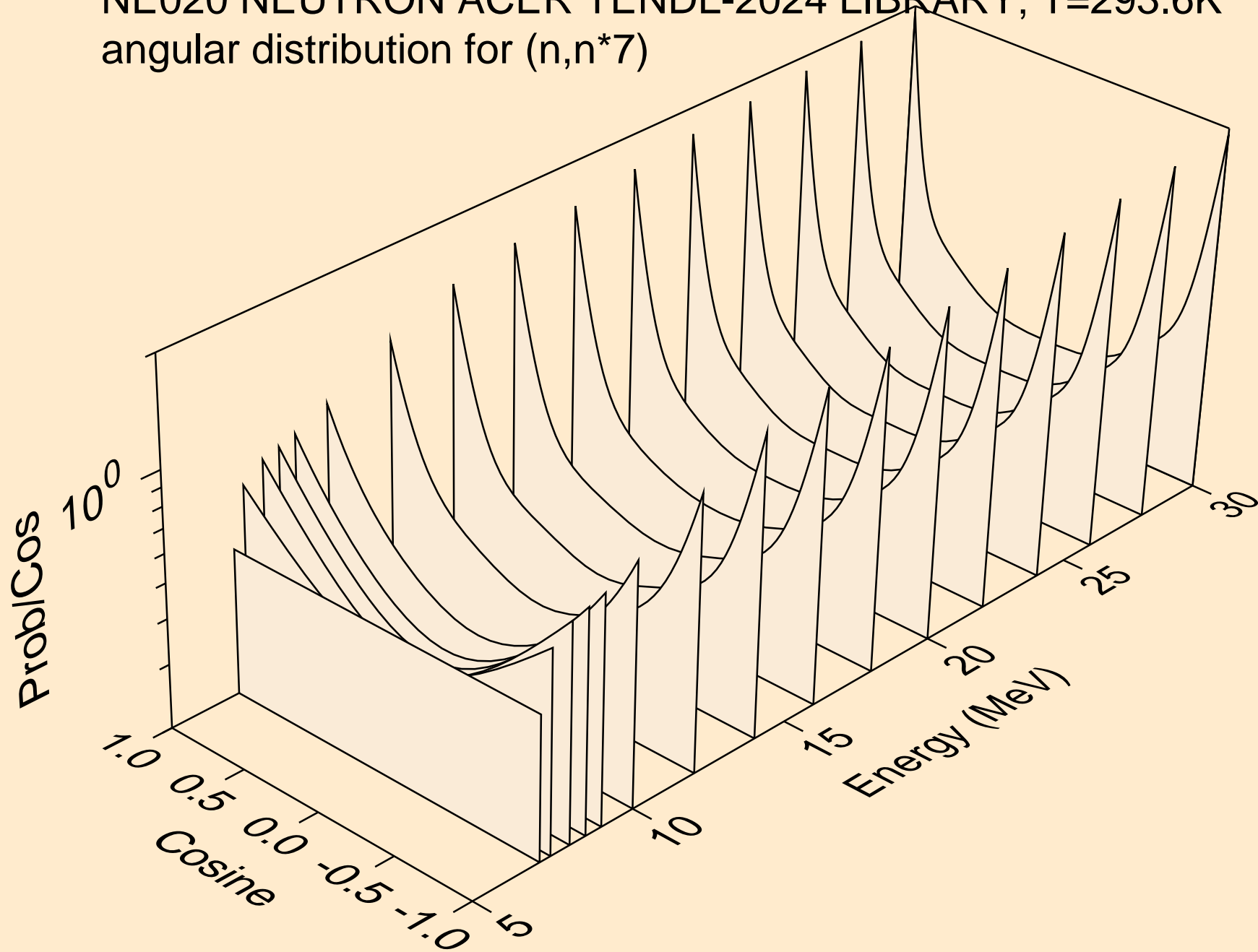

NE020 NEUTRON ACER TENDL-2024 LIBRARY; T=293.6K
angular distribution for (n,n*8)

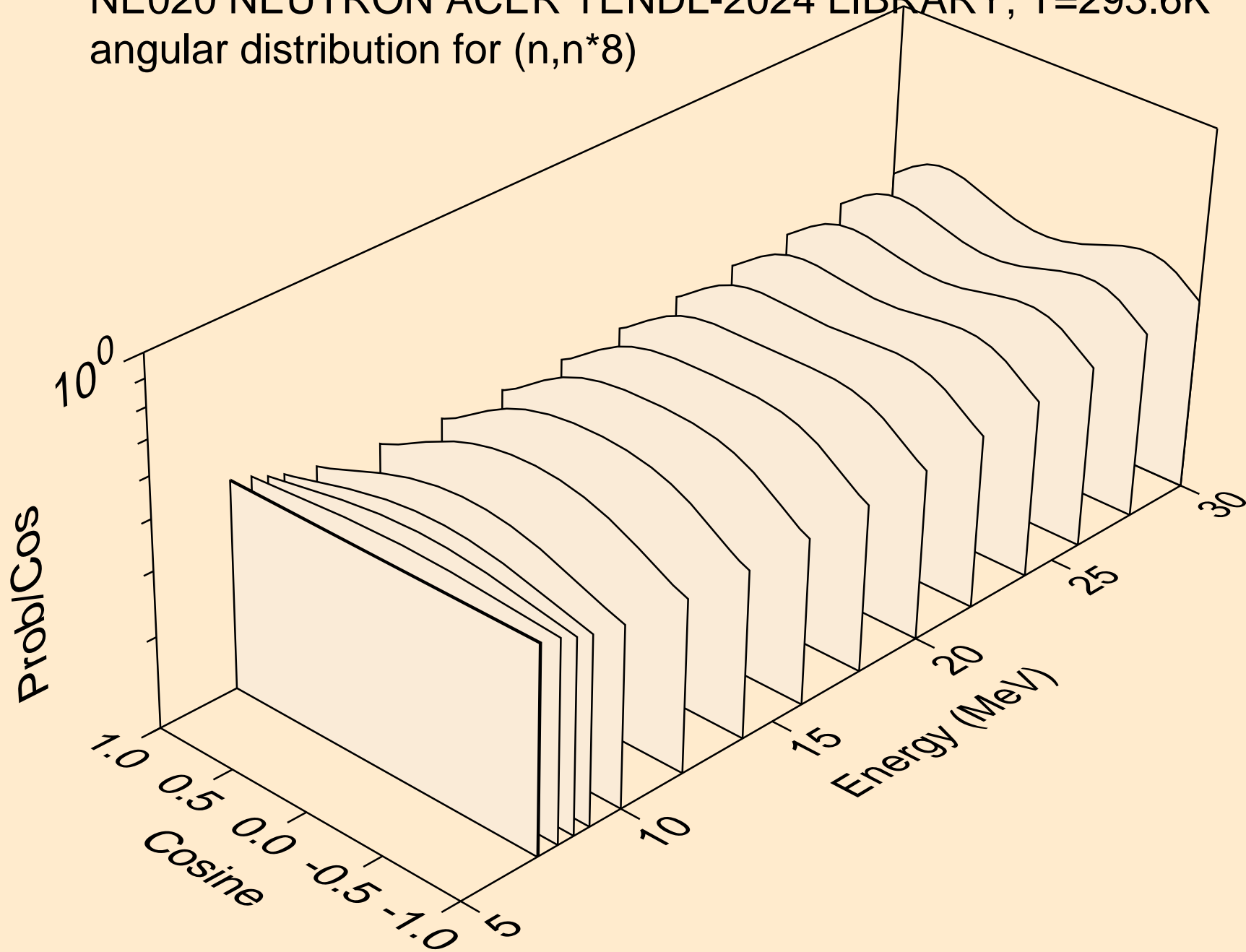

NE020 NEUTRON ACER TENDL-2024 LIBRARY; T=293.6K
angular distribution for (n,n*9)

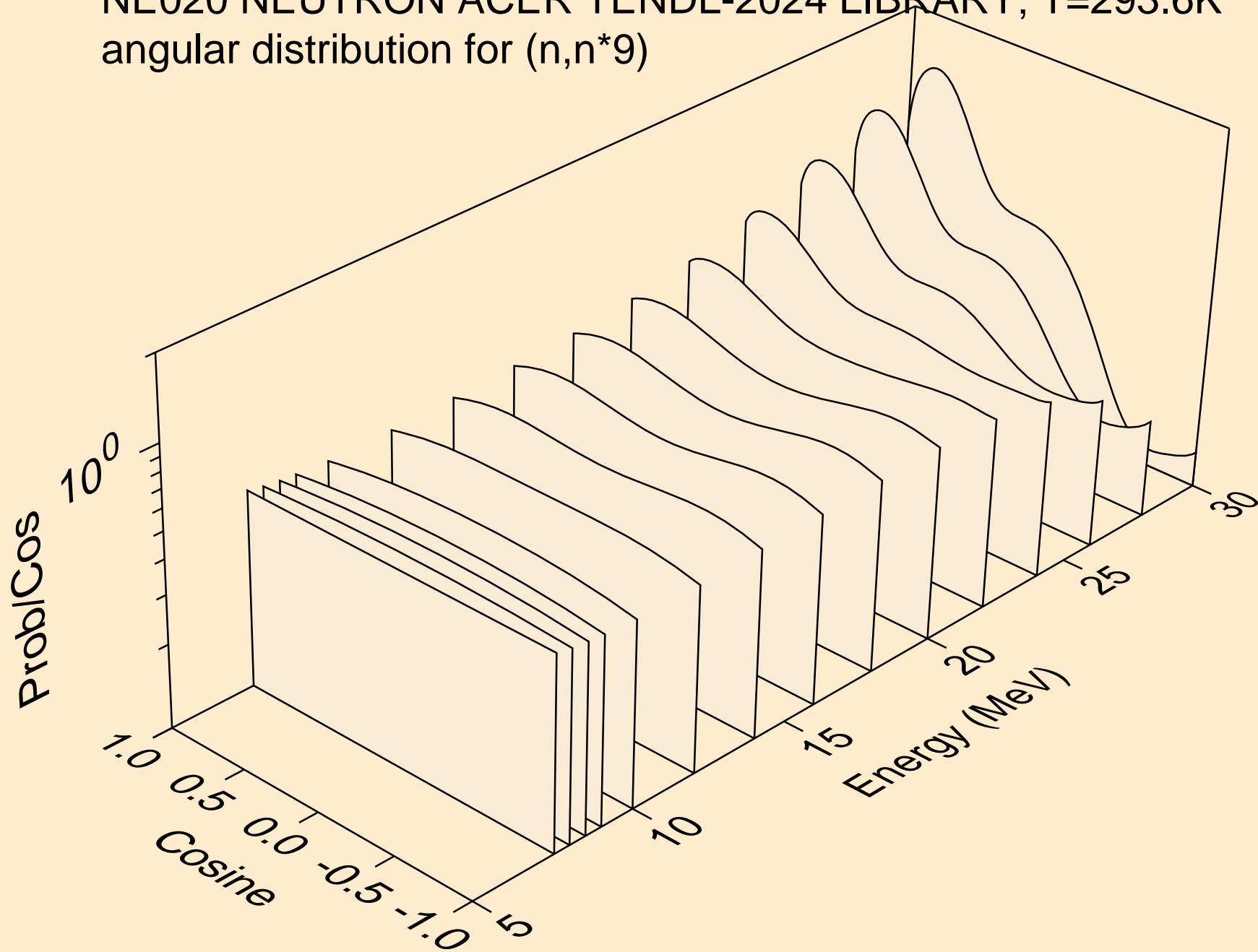

NE020 NEUTRON ACER TENDL-2024 LIBRARY; T=293.6K
angular distribution for (n,n*10)

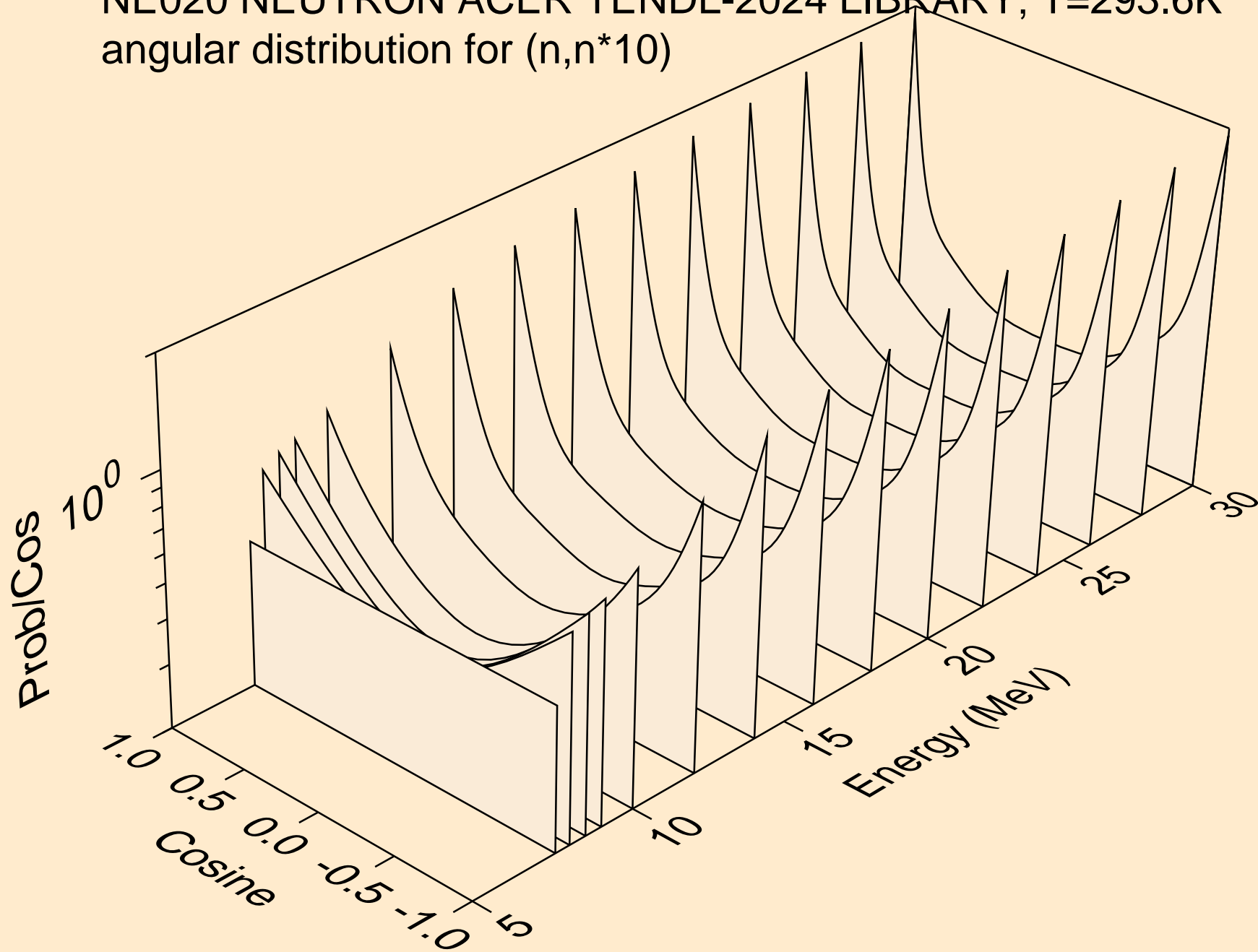

NE020 NEUTRON ACER TENDL-2024 LIBRARY; T=293.6K
angular distribution for (n,n*11)

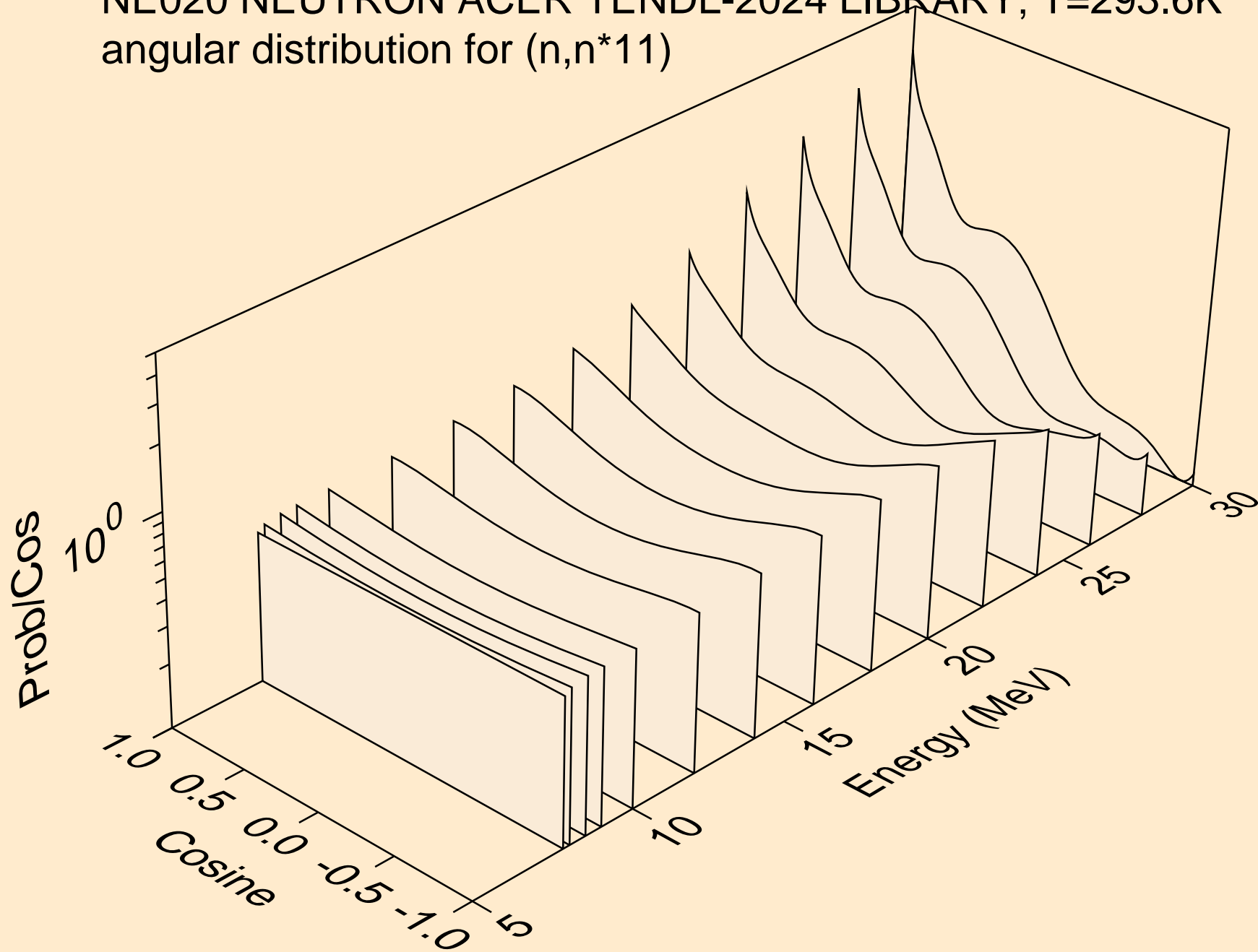

NE020 NEUTRON ACER TENDL-2024 LIBRARY; T=293.6K
angular distribution for (n,n*12)

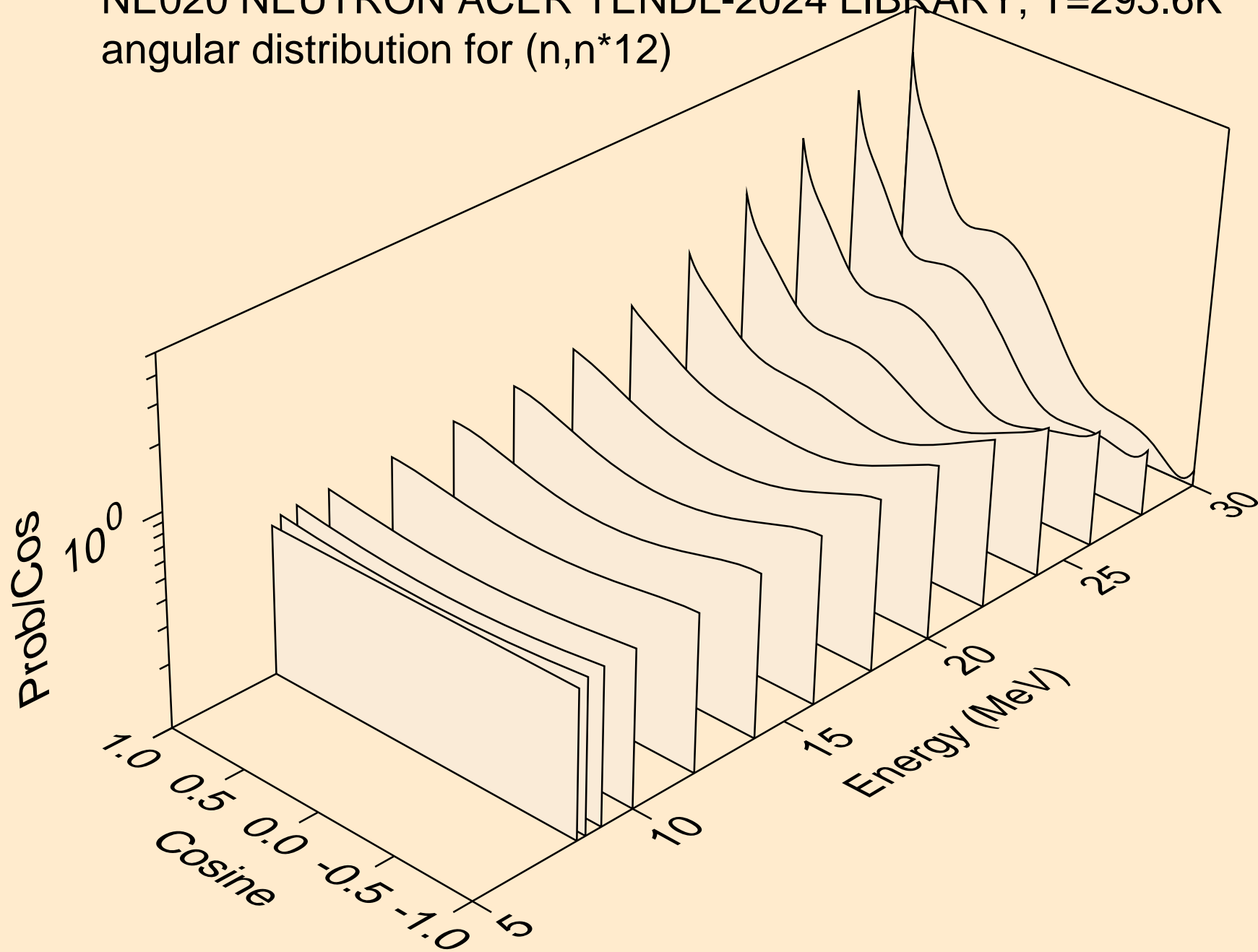

NE020 NEUTRON ACER TENDL-2024 LIBRARY; T=293.6K
angular distribution for (n,n*13)

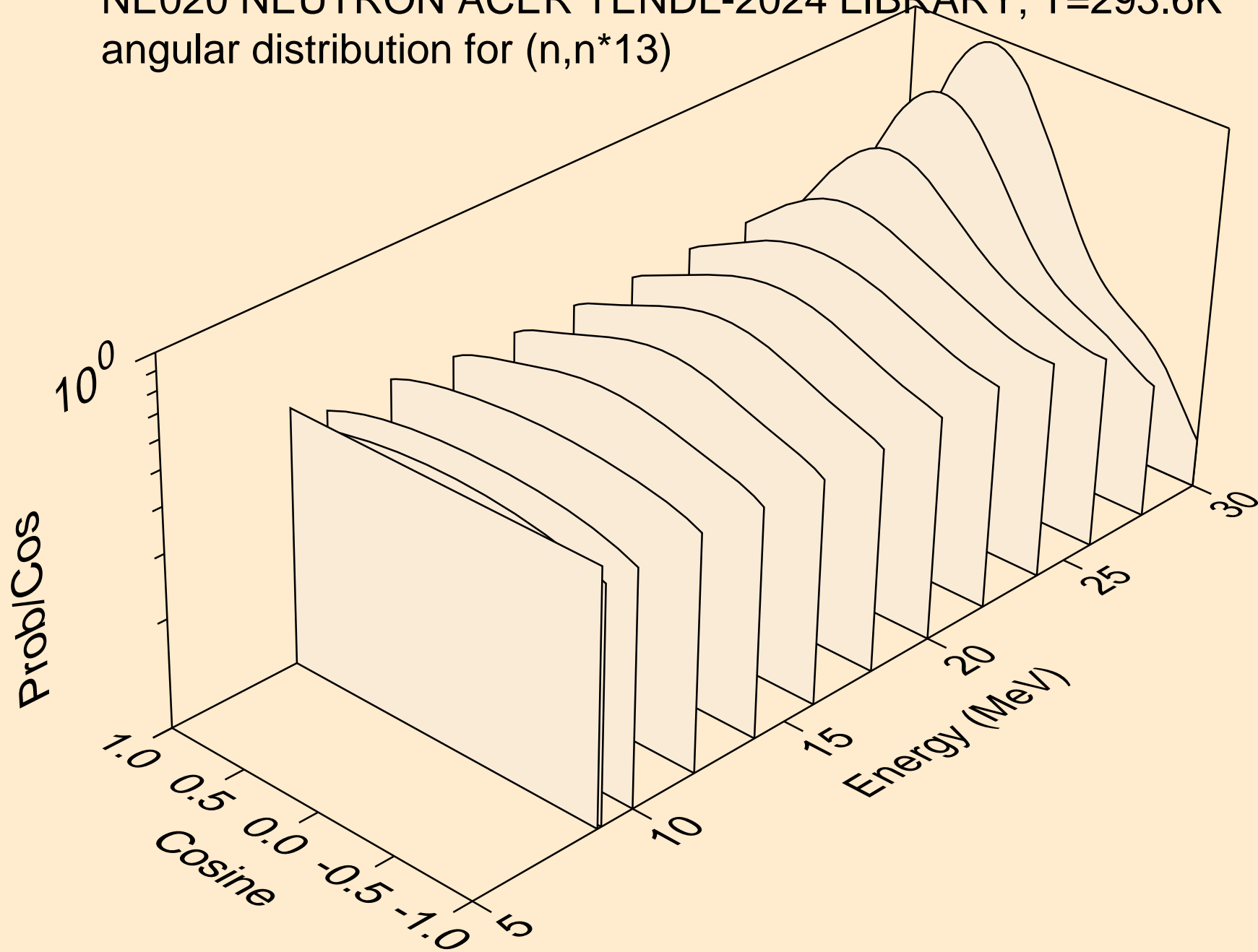

NE020 NEUTRON ACER TENDL-2024 LIBRARY; T=293.6K
angular distribution for (n,n*14)

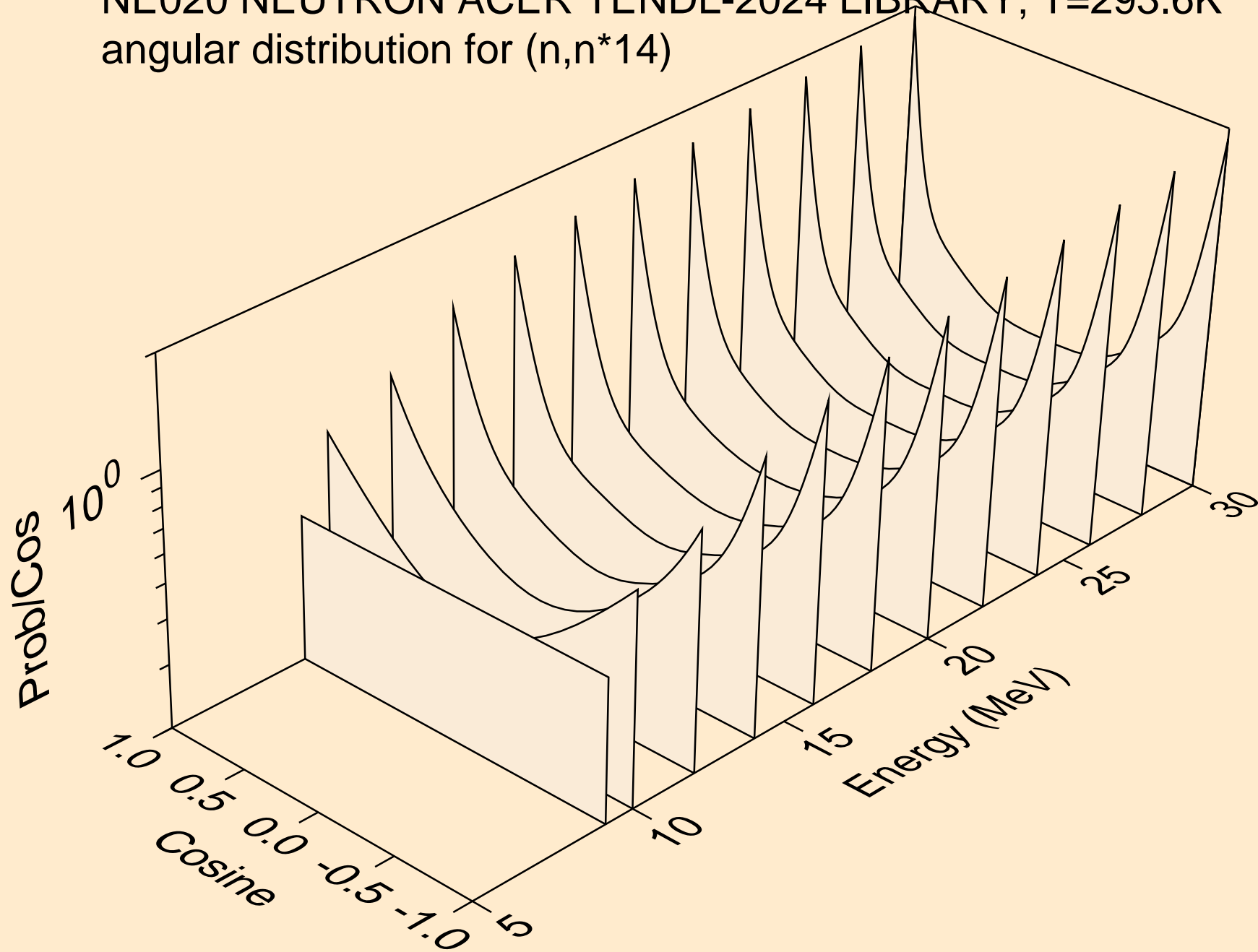

NE020 NEUTRON ACER TENDL-2024 LIBRARY; T=293.6K
angular distribution for (n,n*15)

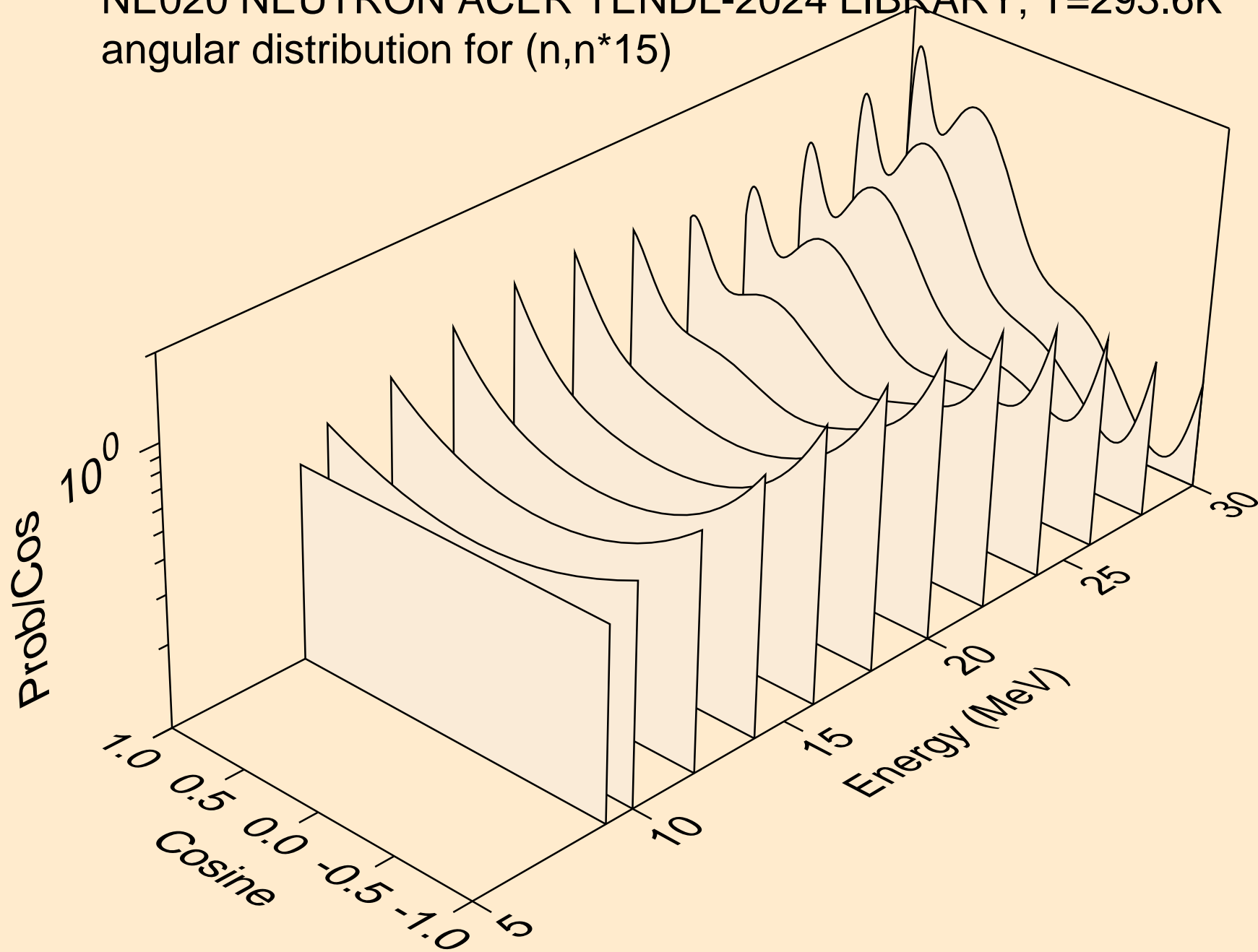

NE020 NEUTRON ACER TENDL-2024 LIBRARY; T=293.6K
angular distribution for (n,n*16)

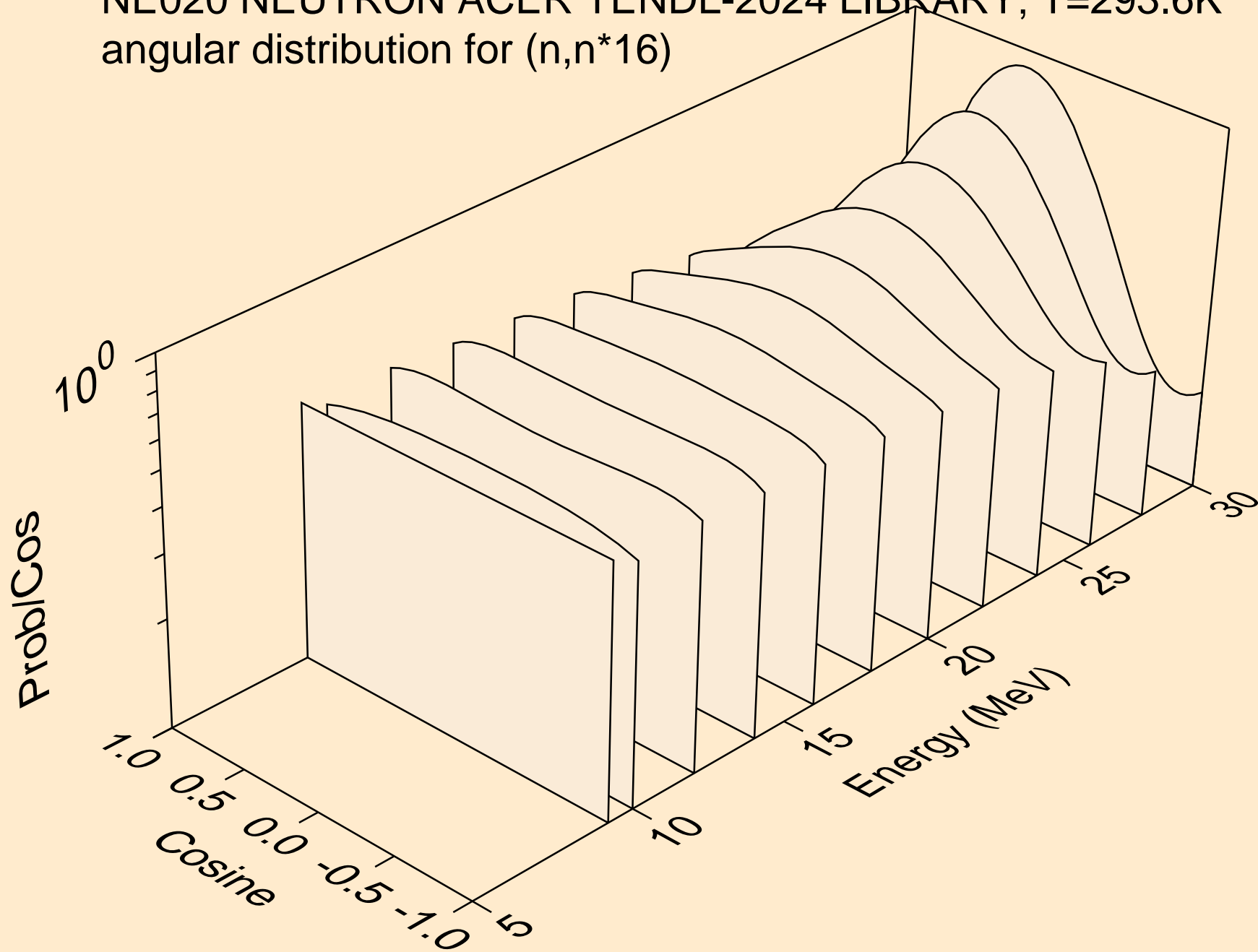

NE020 NEUTRON ACER TENDL-2024 LIBRARY; T=293.6K
angular distribution for (n,n*17)

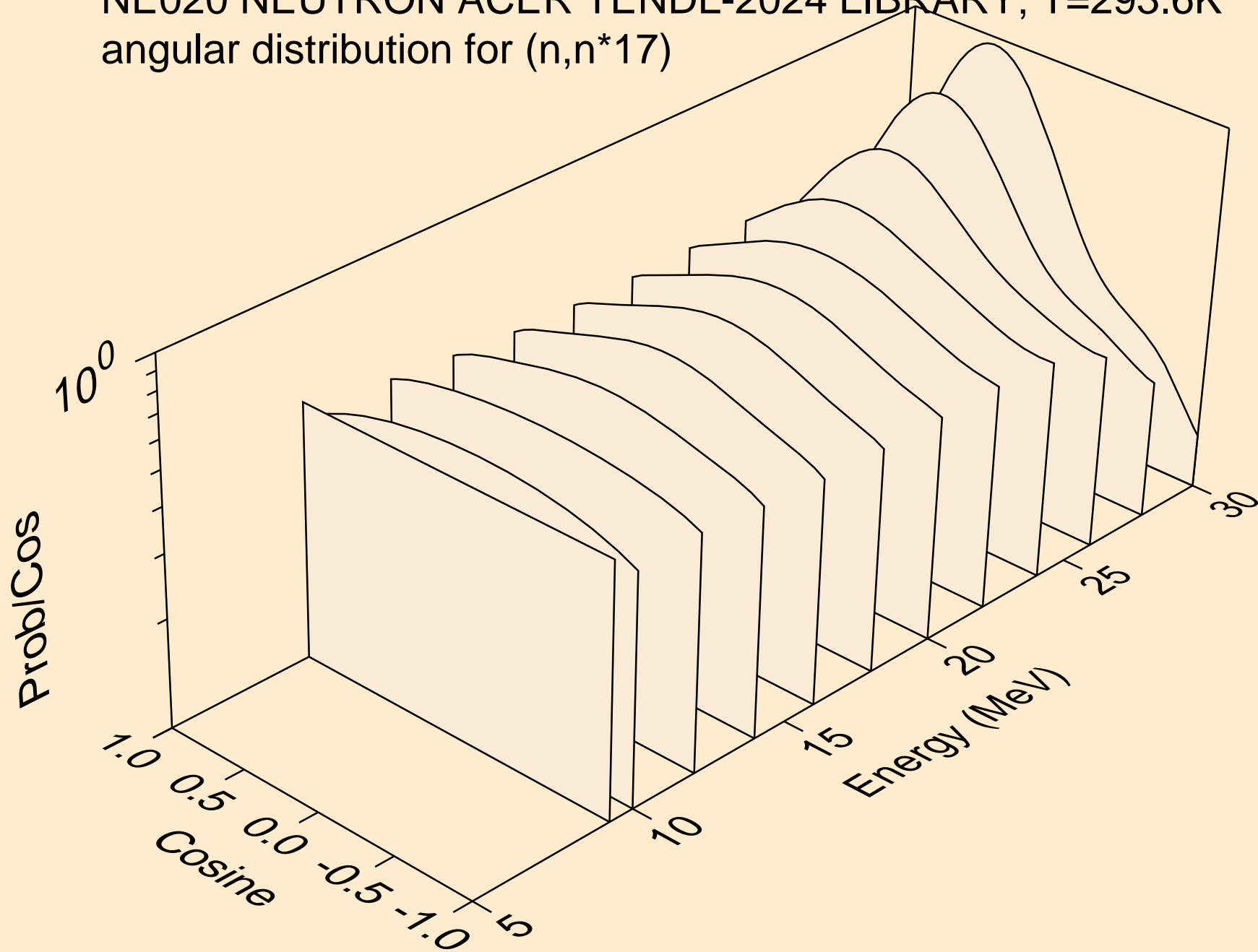

NE020 NEUTRON ACER TENDL-2024 LIBRARY; T=293.6K
angular distribution for (n,n*18)

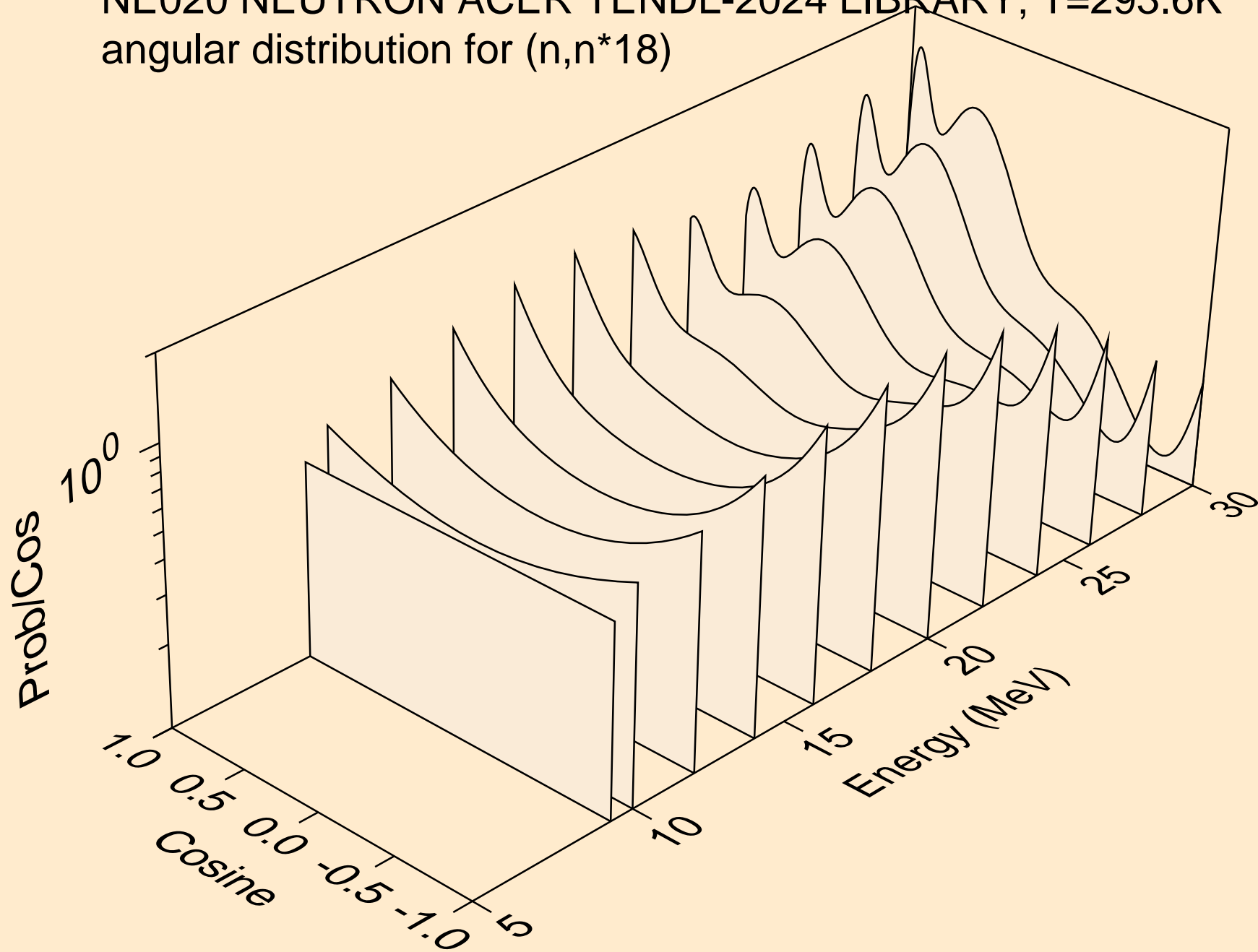

NE020 NEUTRON ACER TENDL-2024 LIBRARY; T=293.6K
angular distribution for (n,n*19)

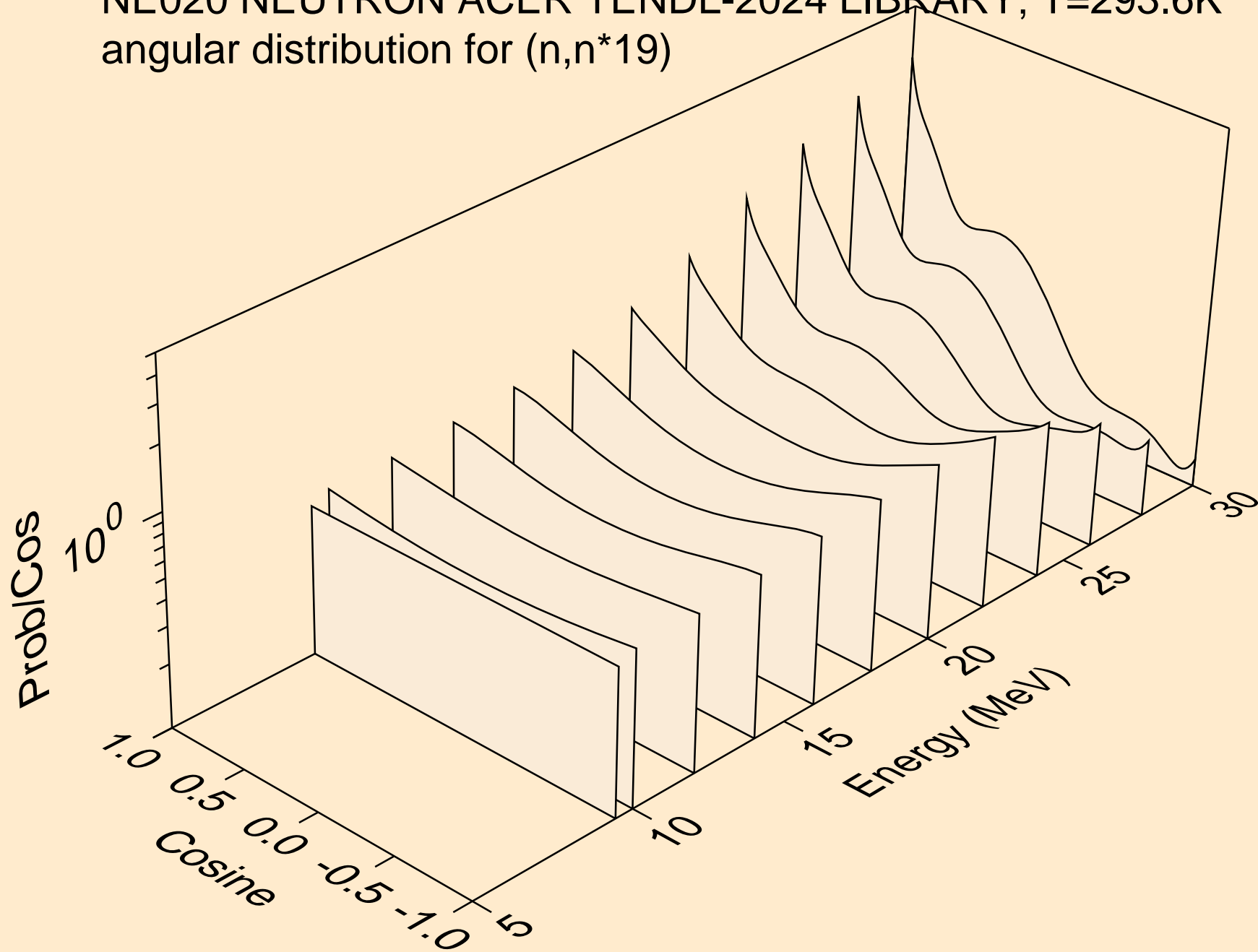

NE020 NEUTRON ACER TENDL-2024 LIBRARY; T=293.6K
angular distribution for (n,n*20)

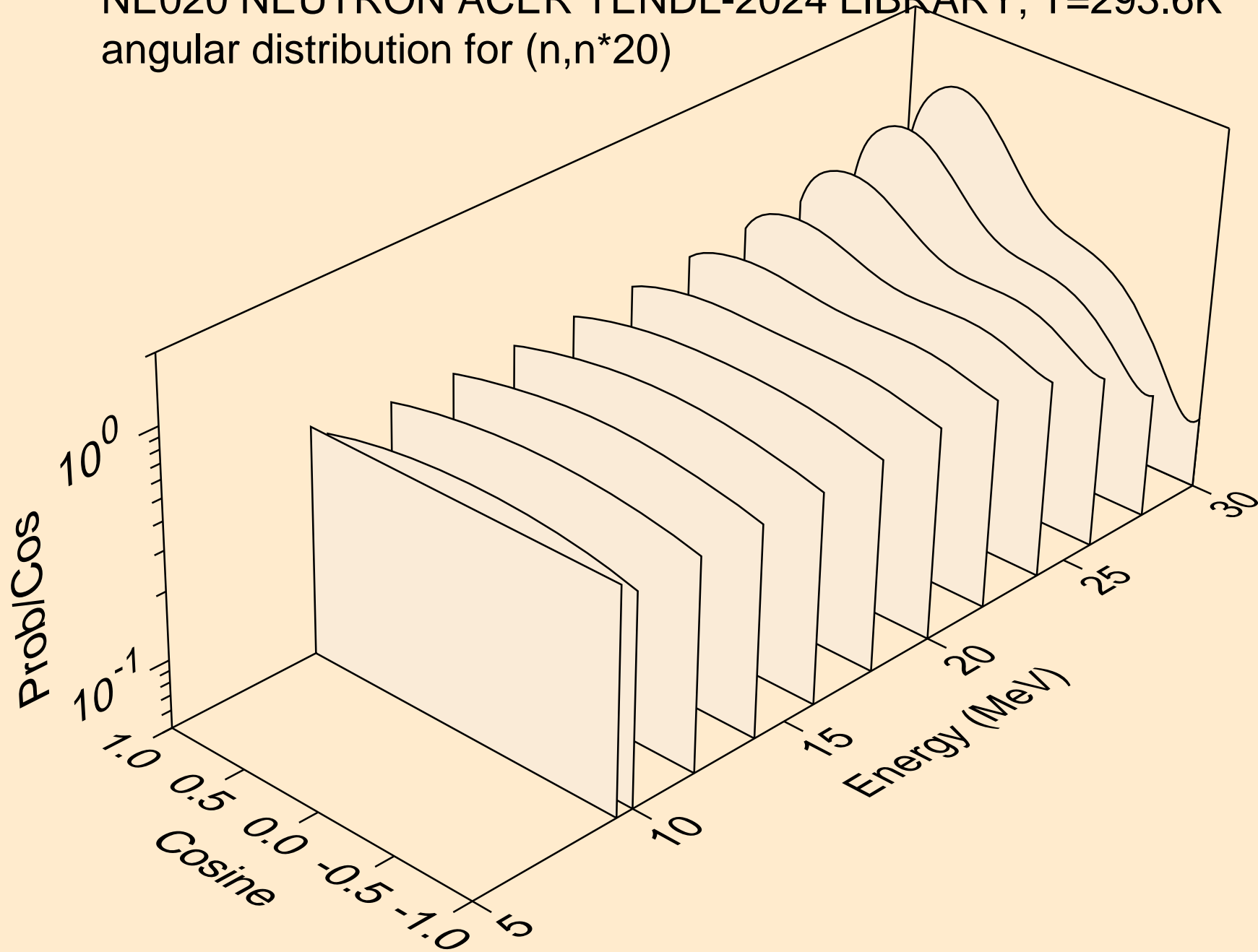

NE020 NEUTRON ACER TENDL-2024 LIBRARY; T=293.6K
angular distribution for (n,n*21)

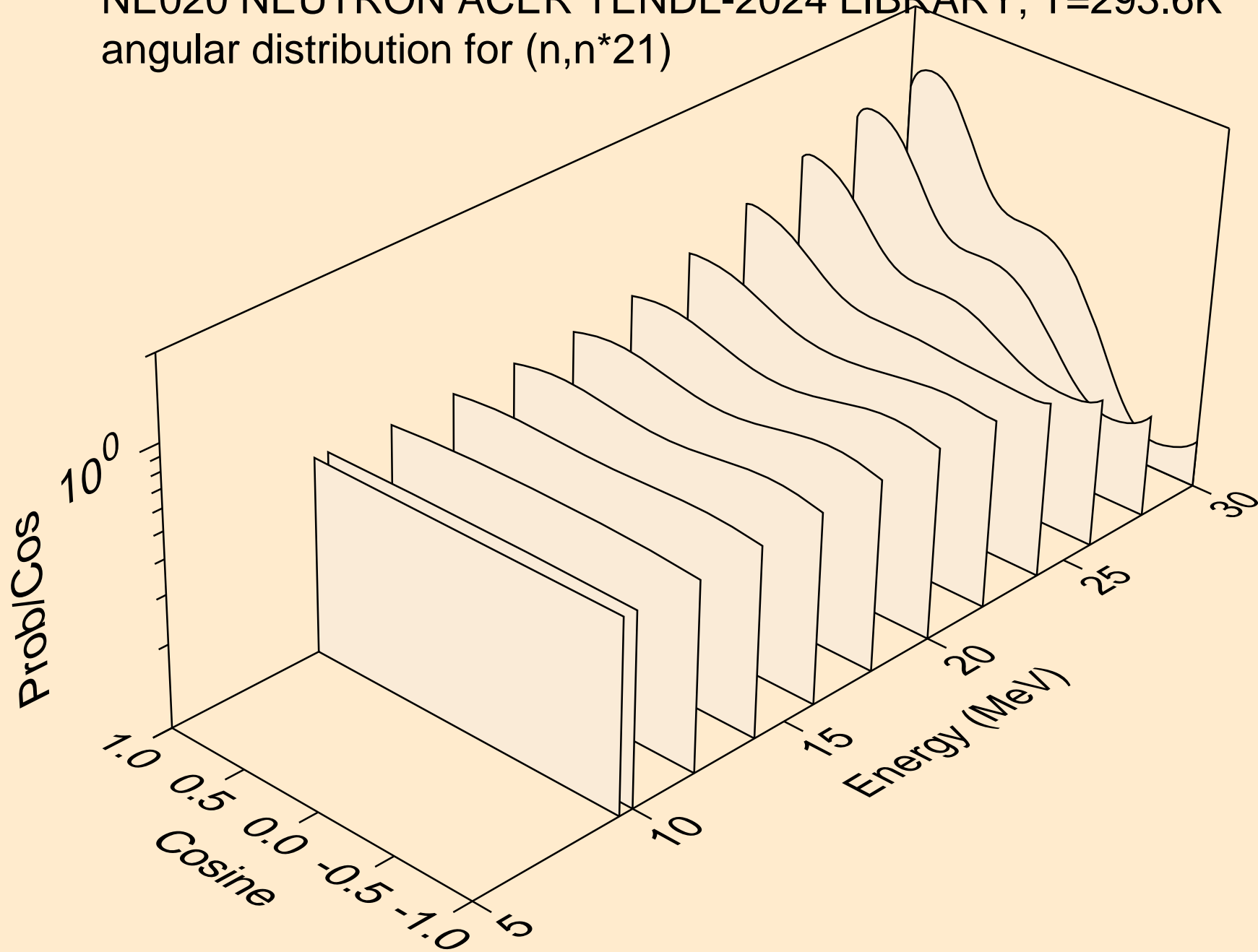

NE020 NEUTRON ACER TENDL-2024 LIBRARY; T=293.6K
Neutron emission for (n,x)

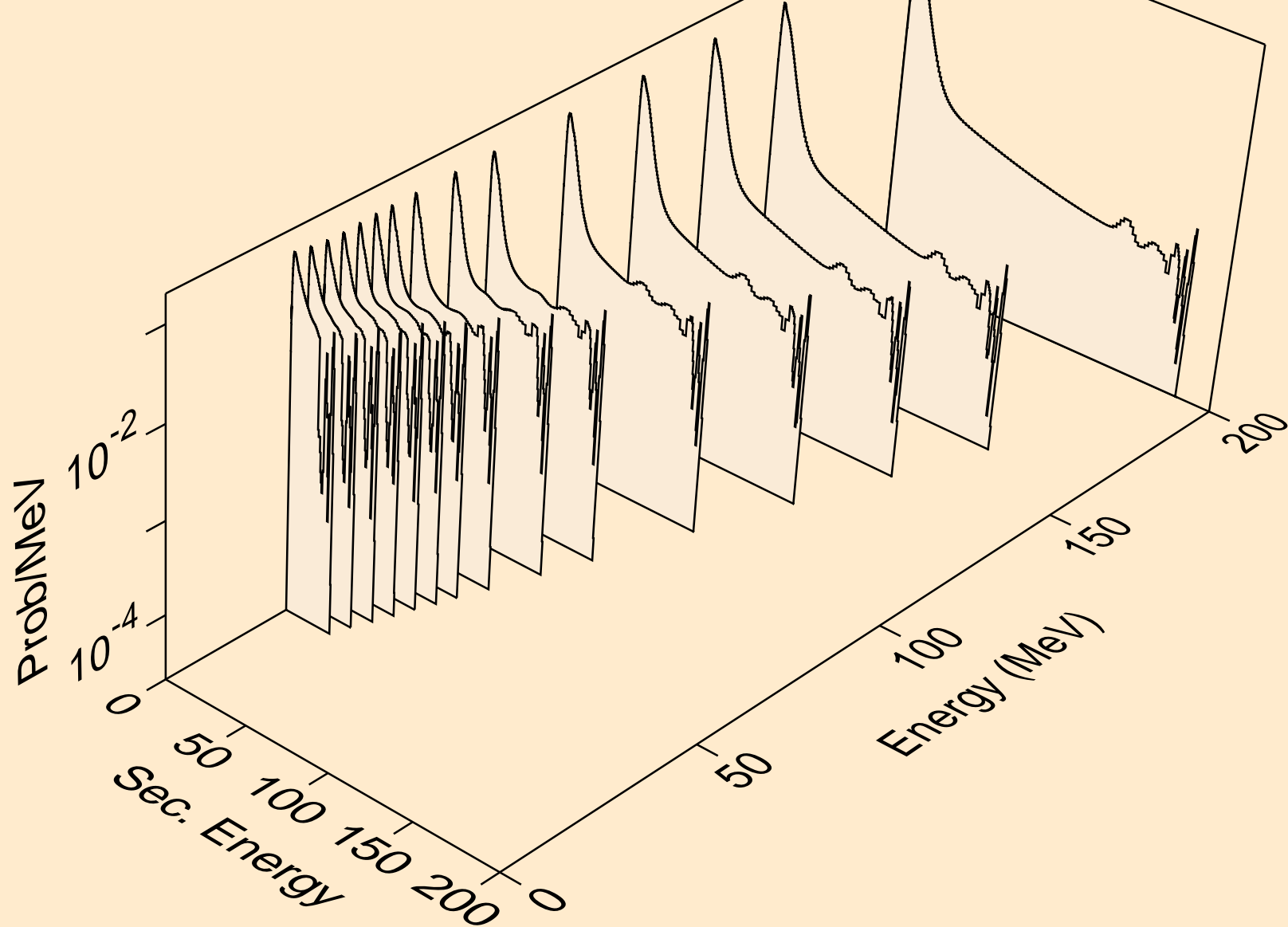

NE020 NEUTRON ACER TENDL-2024 LIBRARY; T=293.6K
Neutron emission for (n,2n)

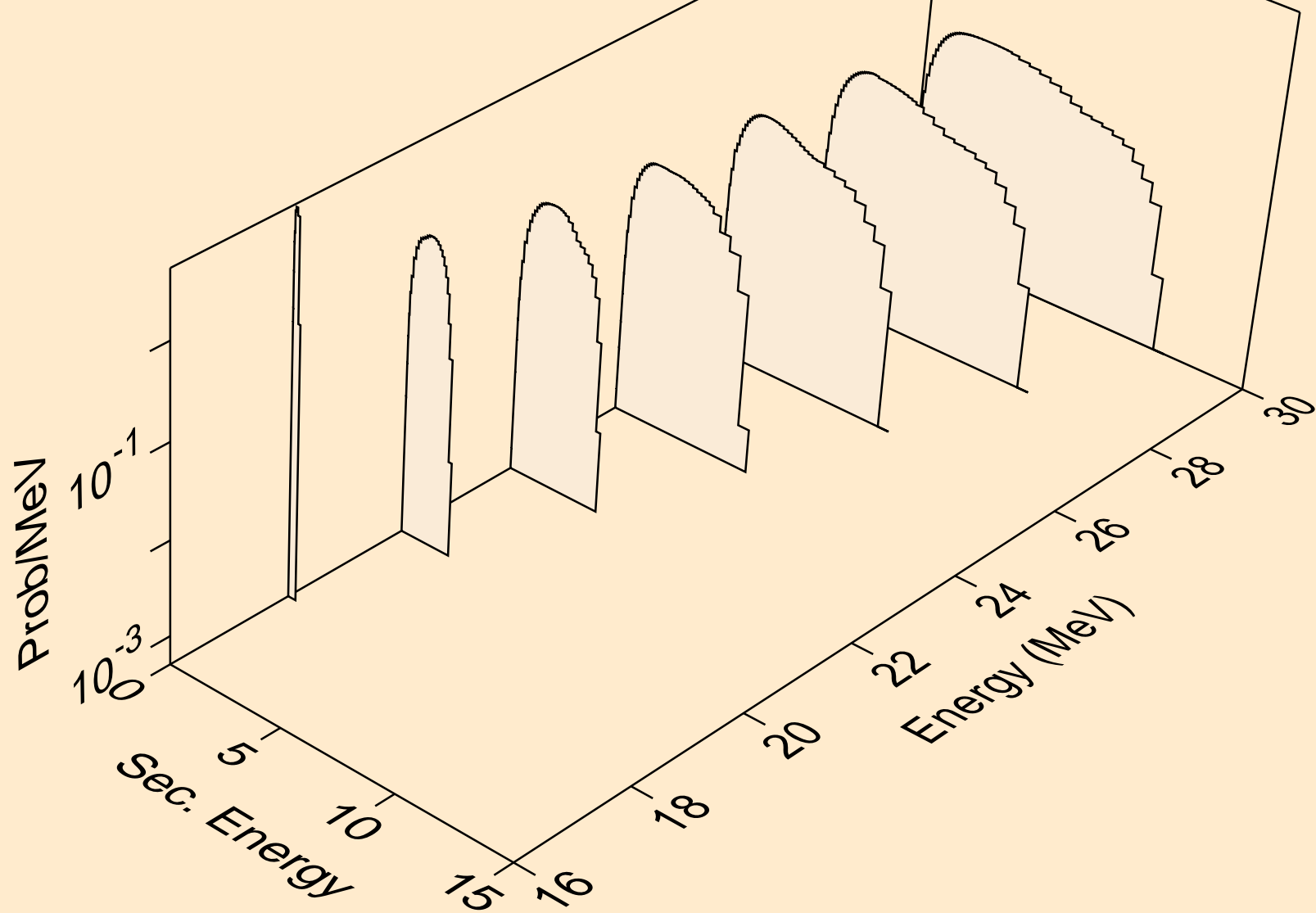

NE020 NEUTRON ACER TENDL-2024 LIBRARY; T=293.6K
Neutron emission for (n,n*)a

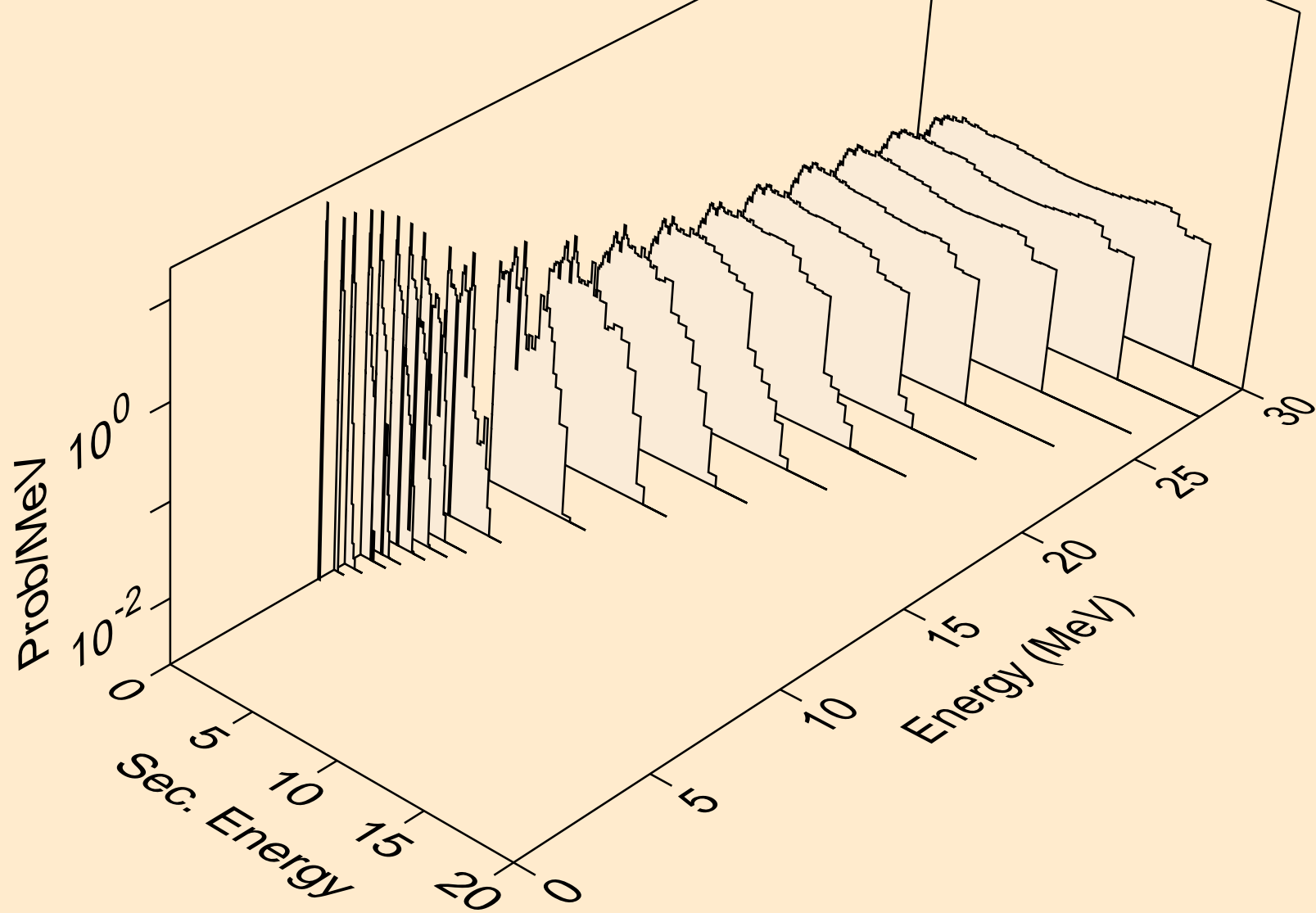

NE020 NEUTRON ACER TENDL-2024 LIBRARY; T=293.6K
Neutron emission for (n,n*)3a

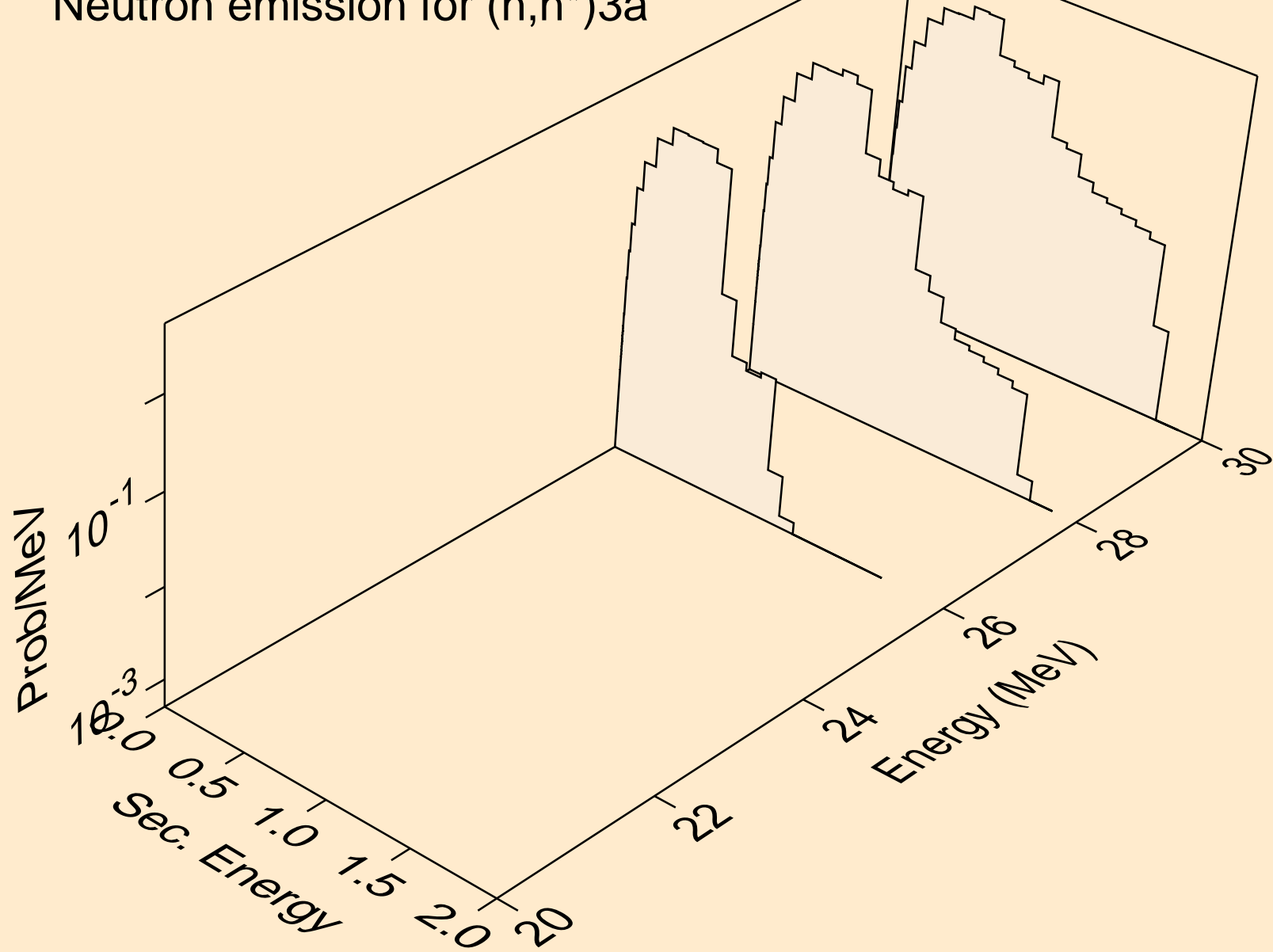

NE020 NEUTRON ACER TENDL-2024 LIBRARY; T=293.6K
Neutron emission for (n,2n)a

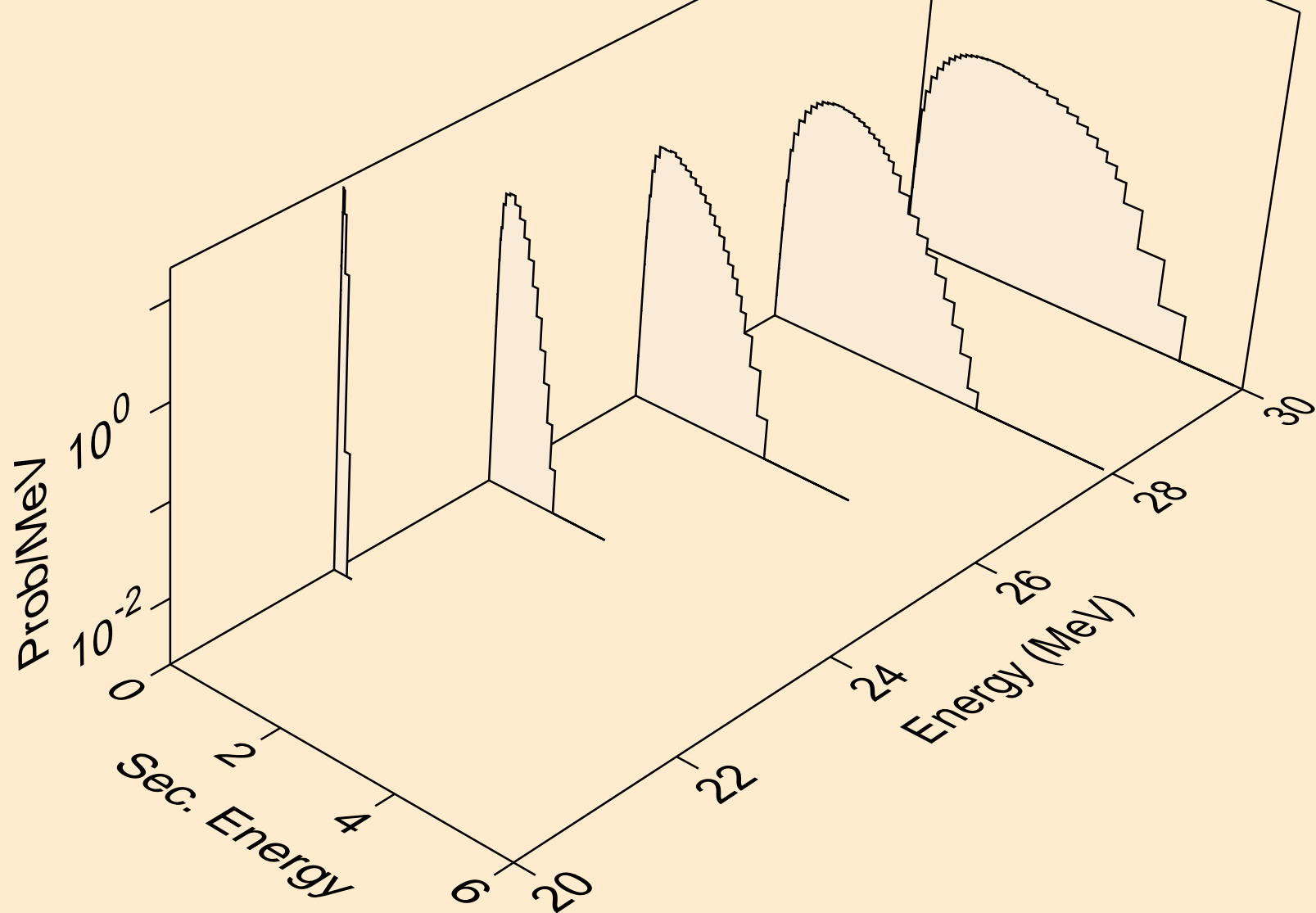

NE020 NEUTRON ACER TENDL-2024 LIBRARY; T=293.6K
Neutron emission for (n,n*)p

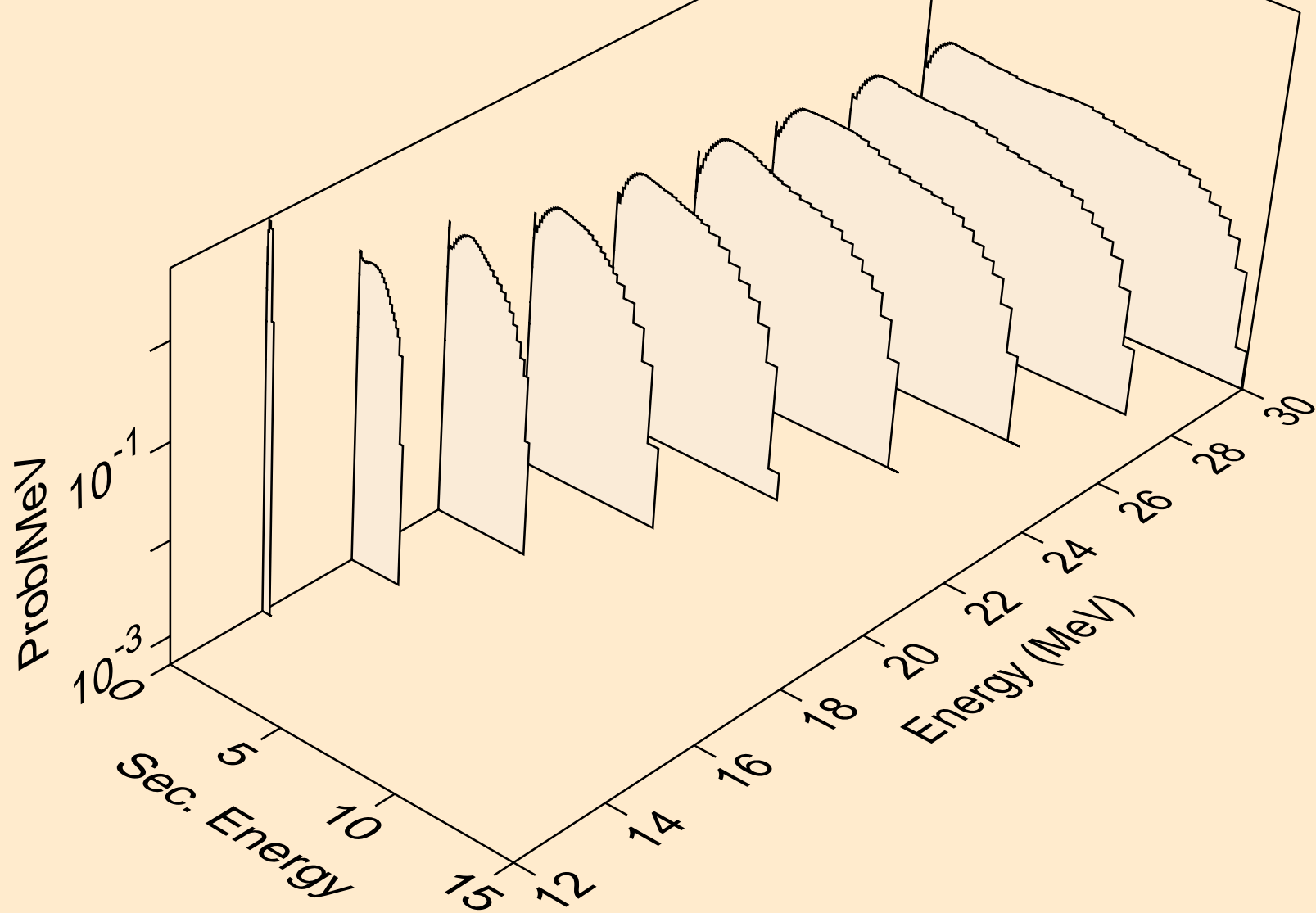

NE020 NEUTRON ACER TENDL-2024 LIBRARY; T=293.6K
Neutron emission for (n,n*)2a

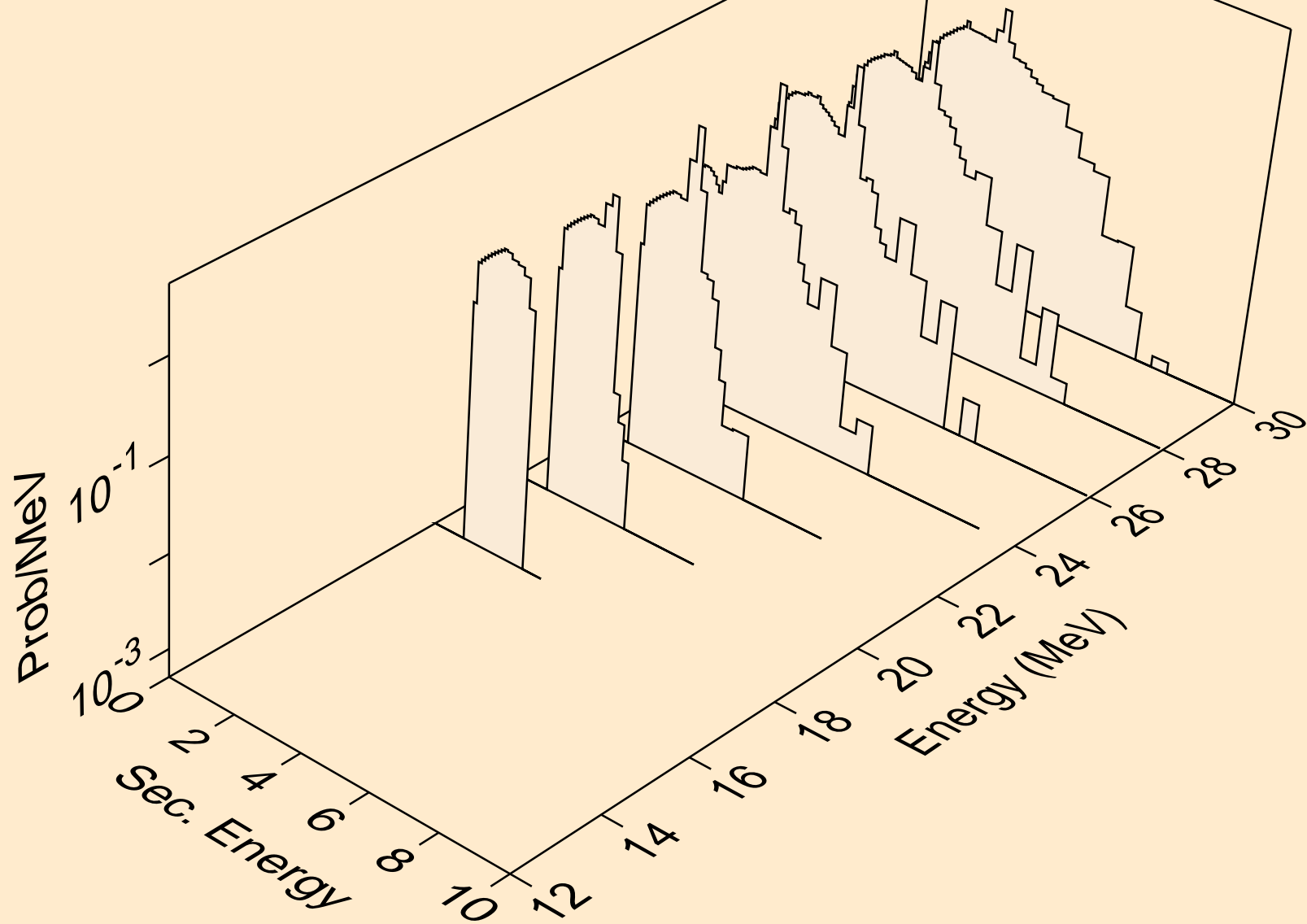

NE020 NEUTRON ACER TENDL-2024 LIBRARY; T=293.6K
Neutron emission for (n,n*)d

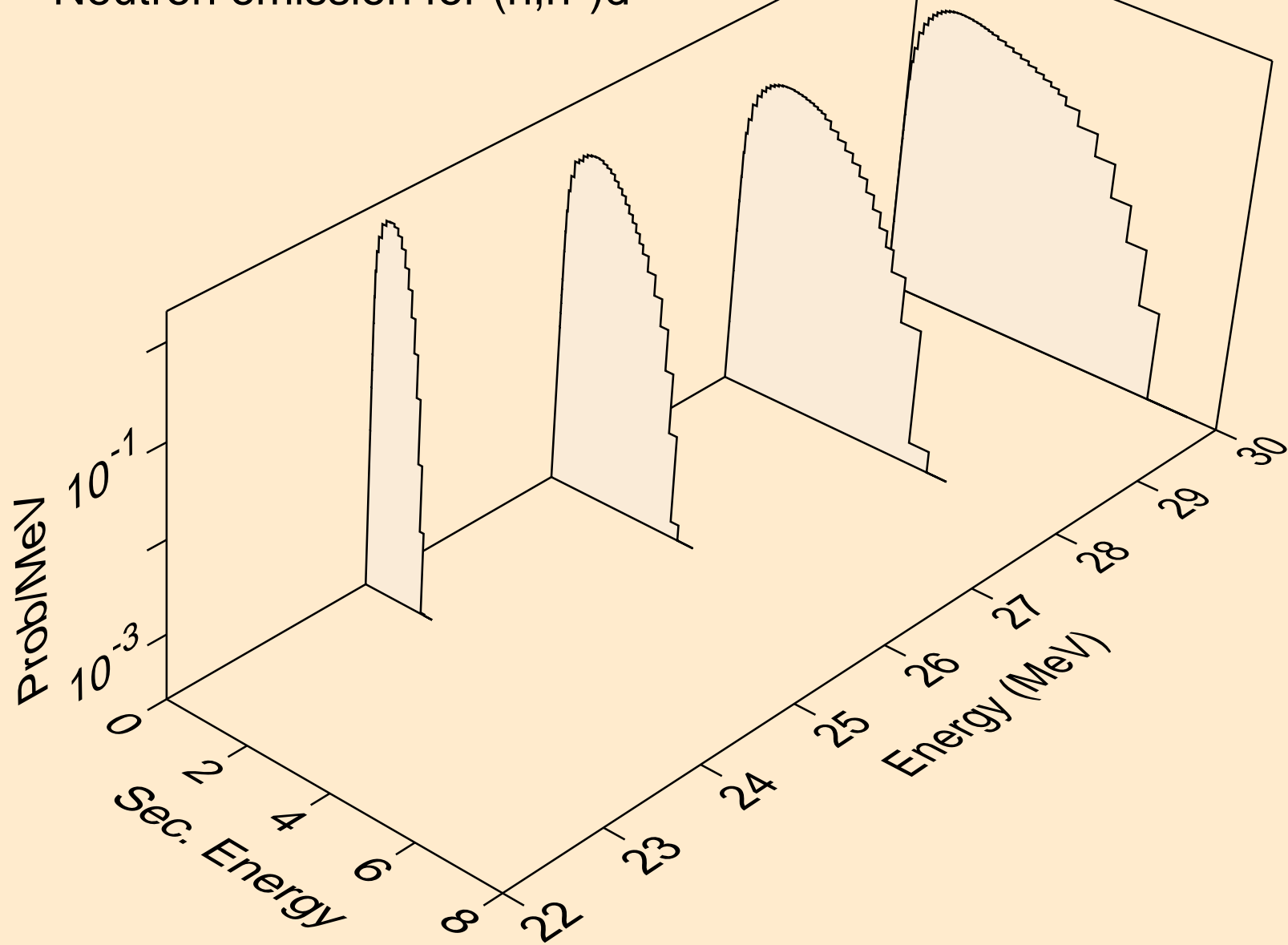

NE020 NEUTRON ACER TENDL-2024 LIBRARY; T=293.6K
Neutron emission for (n,n*)t

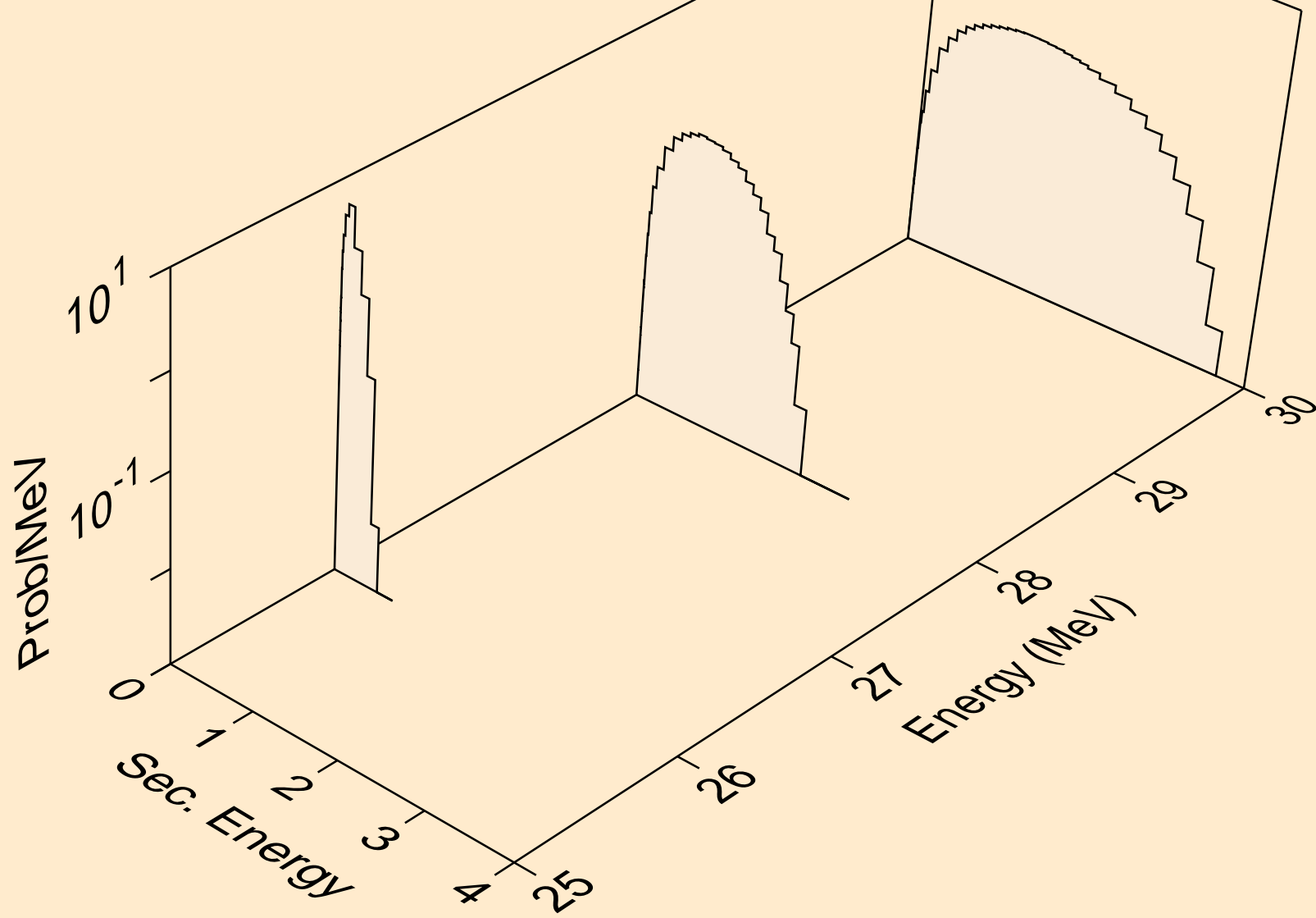

NE020 NEUTRON ACER TENDL-2024 LIBRARY; T=293.6K
Neutron emission for (n,n*)he3

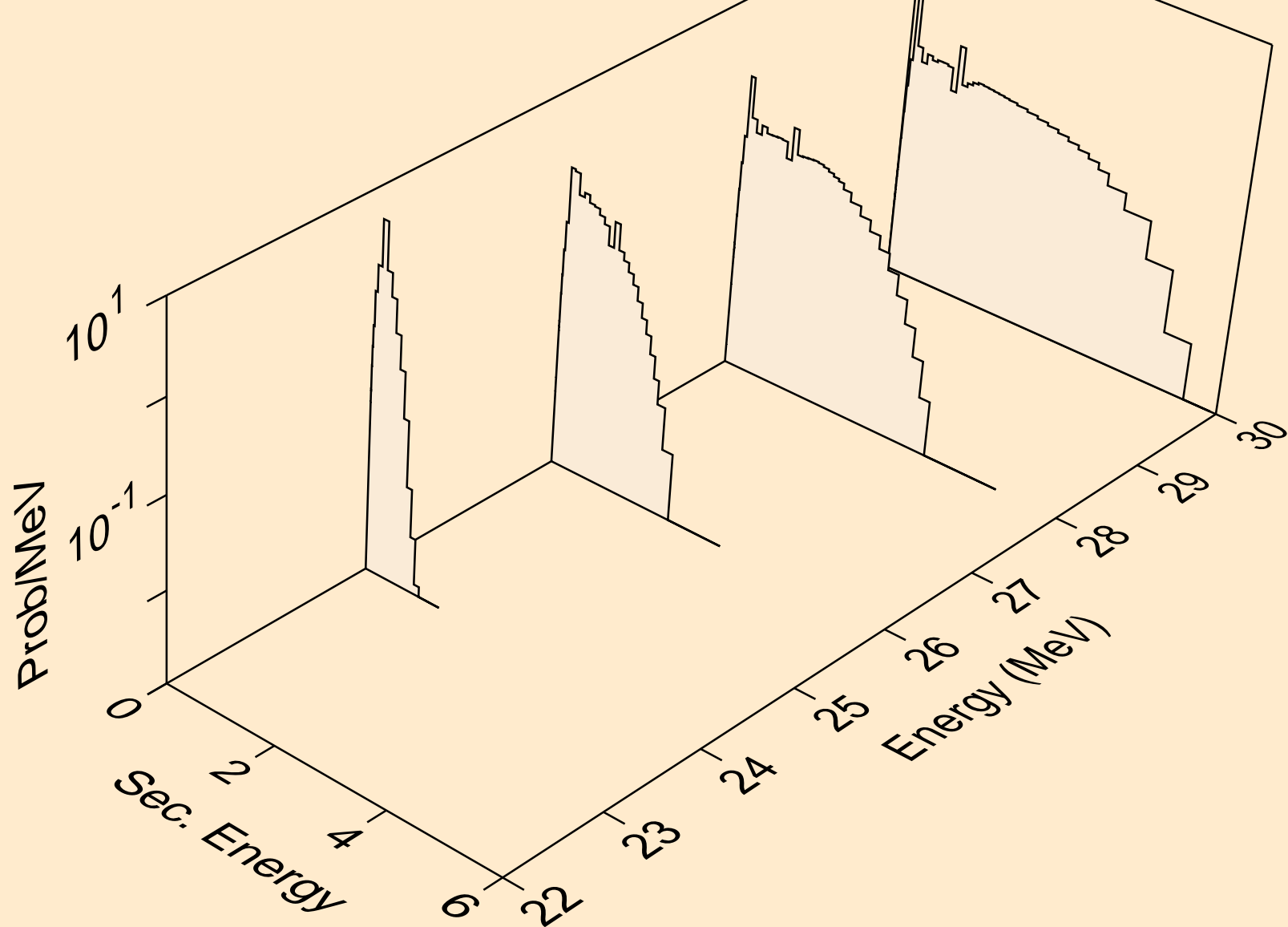

NE020 NEUTRON ACER TENDL-2024 LIBRARY; T=293.6K
Neutron emission for (n,2np)

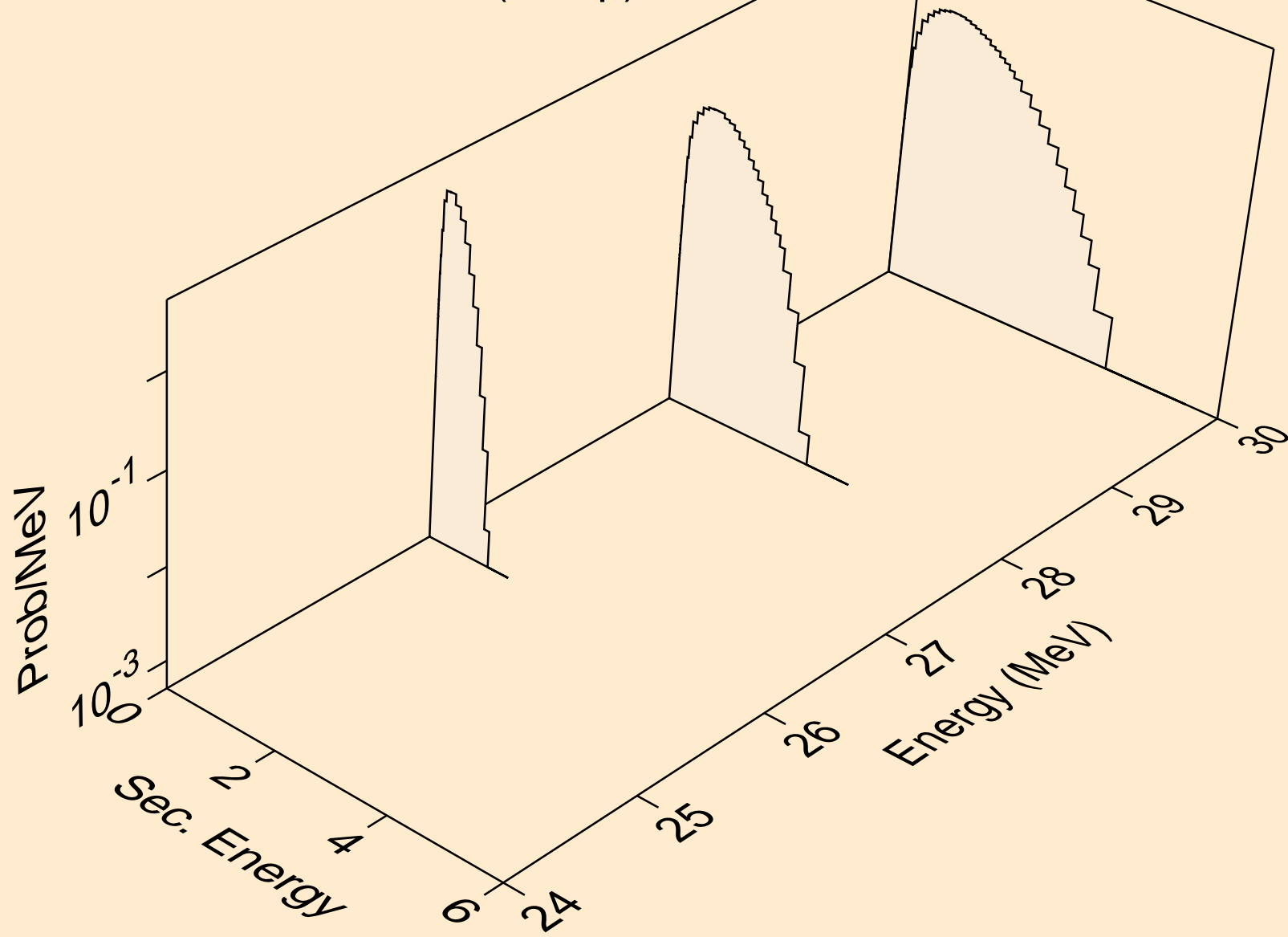

NE020 NEUTRON ACER TENDL-2024 LIBRARY; T=293.6K
Neutron emission for (n,n2p)

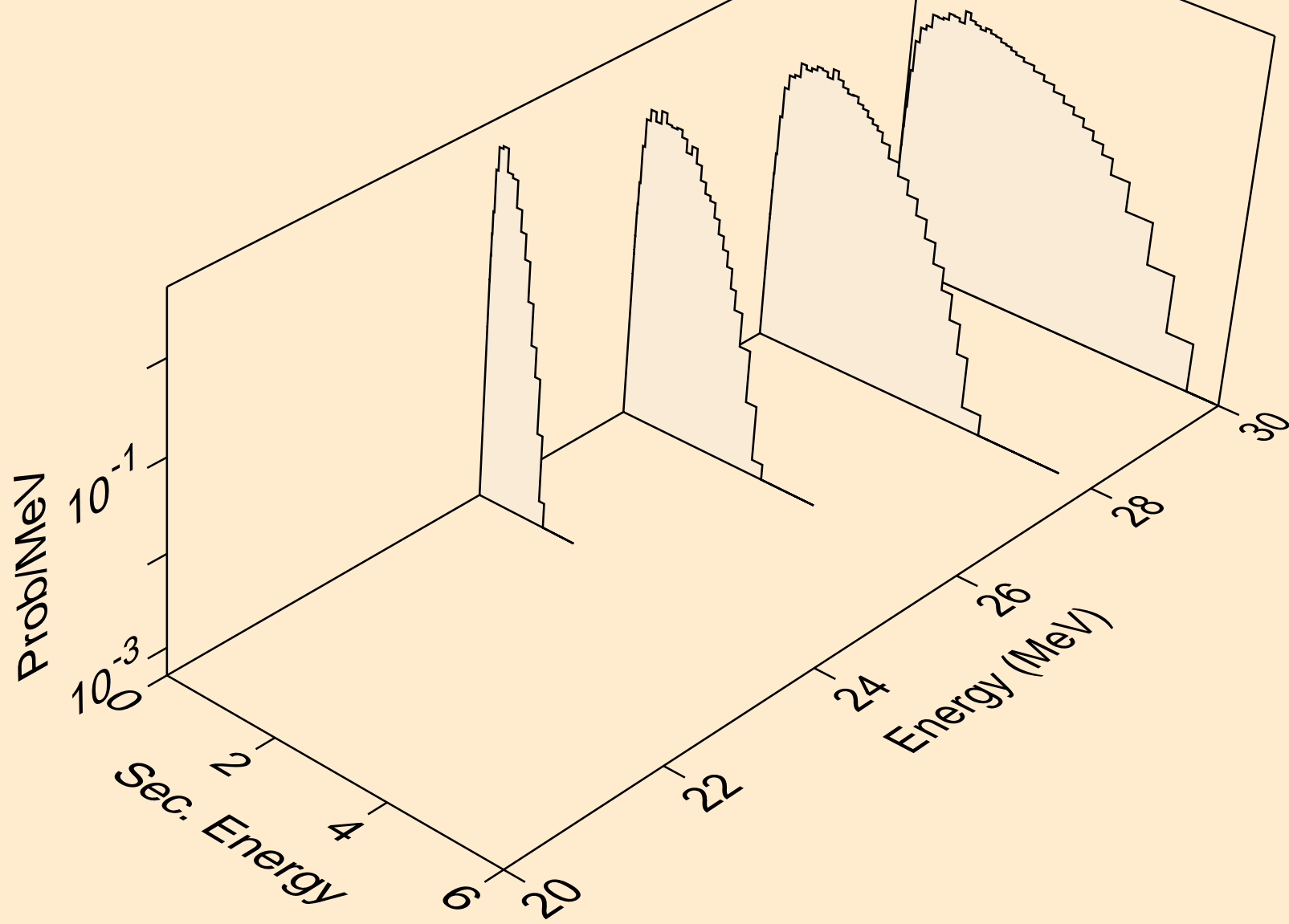

NE020 NEUTRON ACER TENDL-2024 LIBRARY; T=293.6K
Neutron emission for (n,npa)

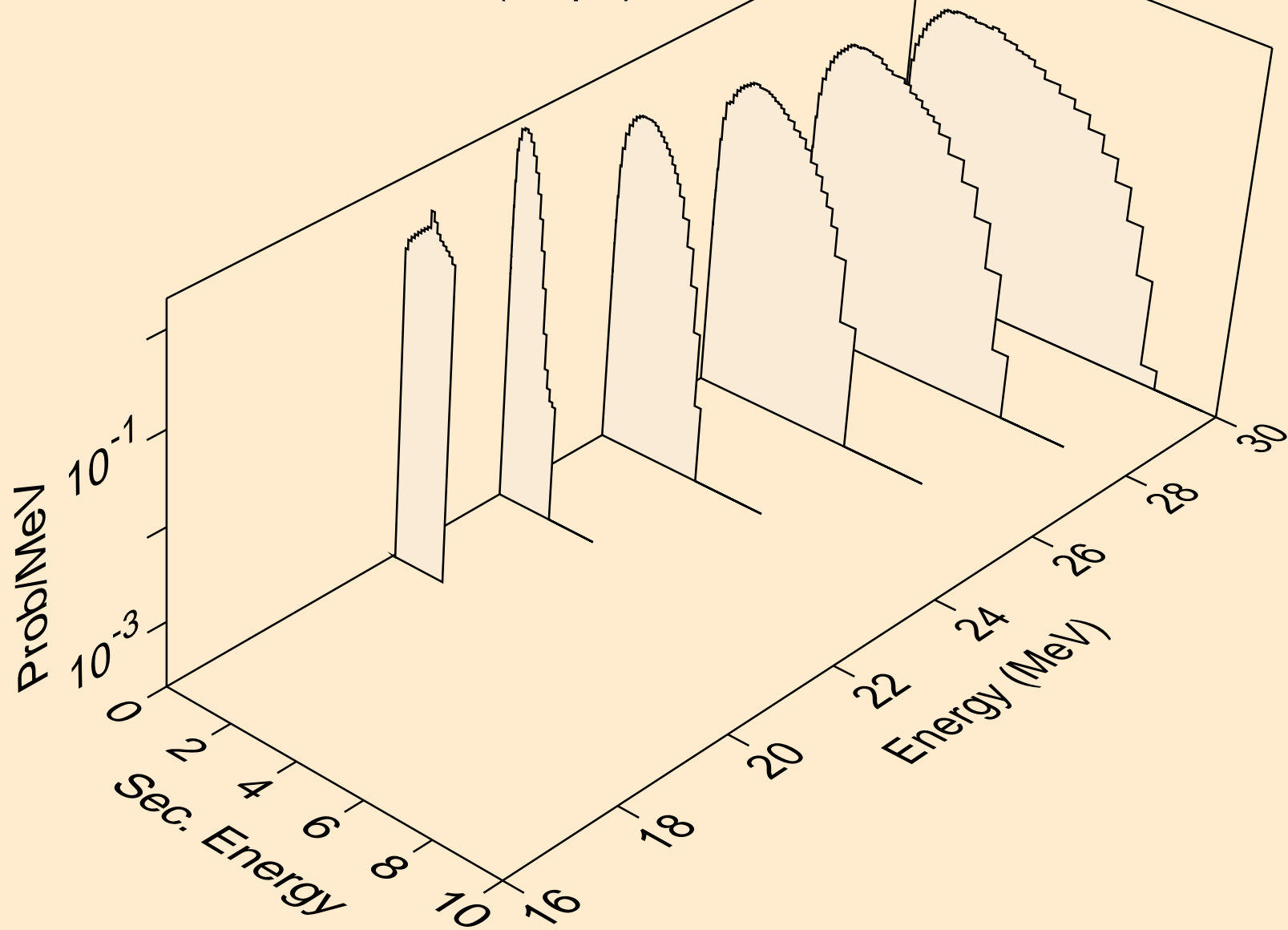

NE020 NEUTRON ACER TENDL-2024 LIBRARY; T=293.6K
Neutron emission for (n,n*c)

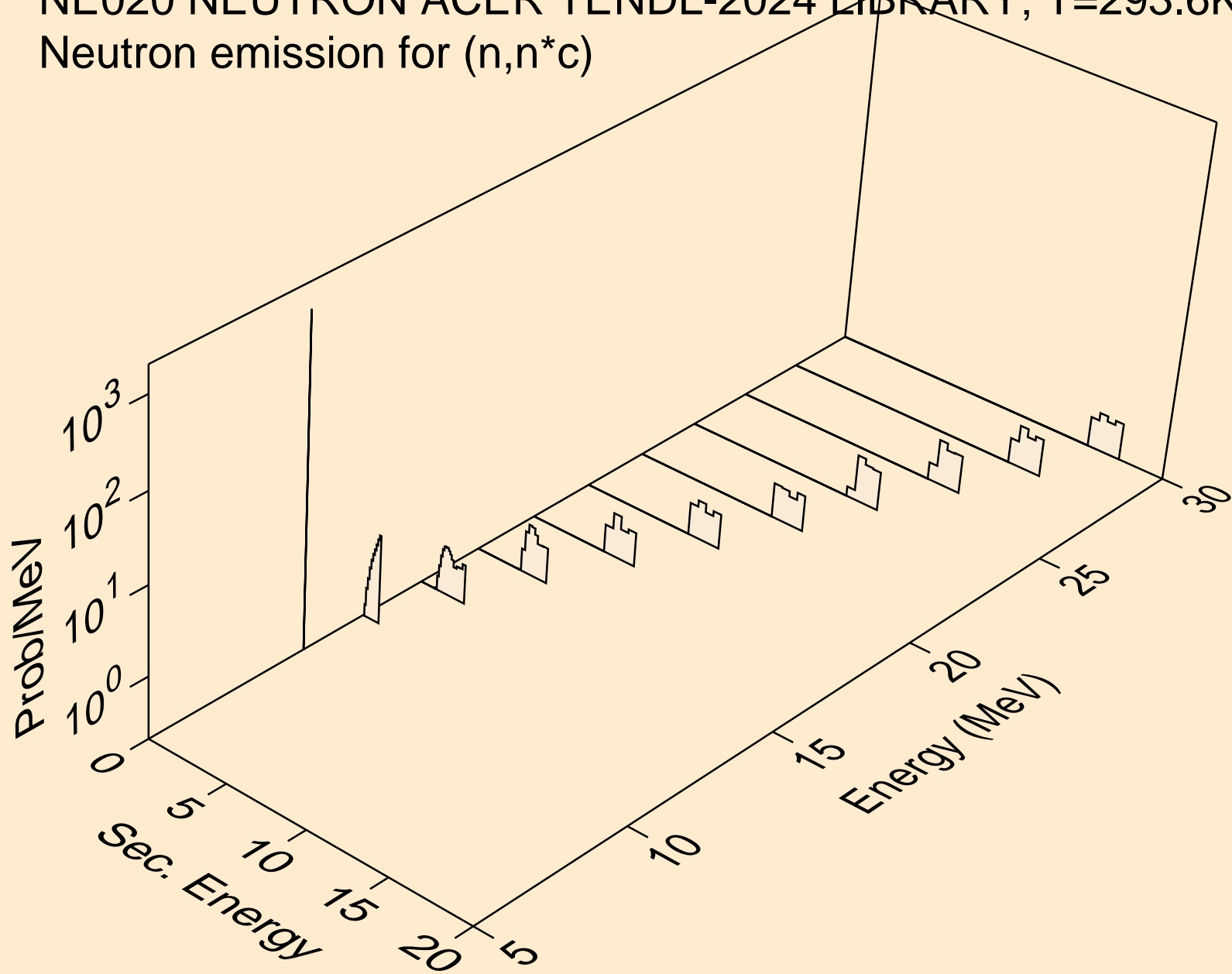

NE020 NEUTRON ACER TENDL-2024 LIBRARY; T=293.6K
Photon emission for (n,x)

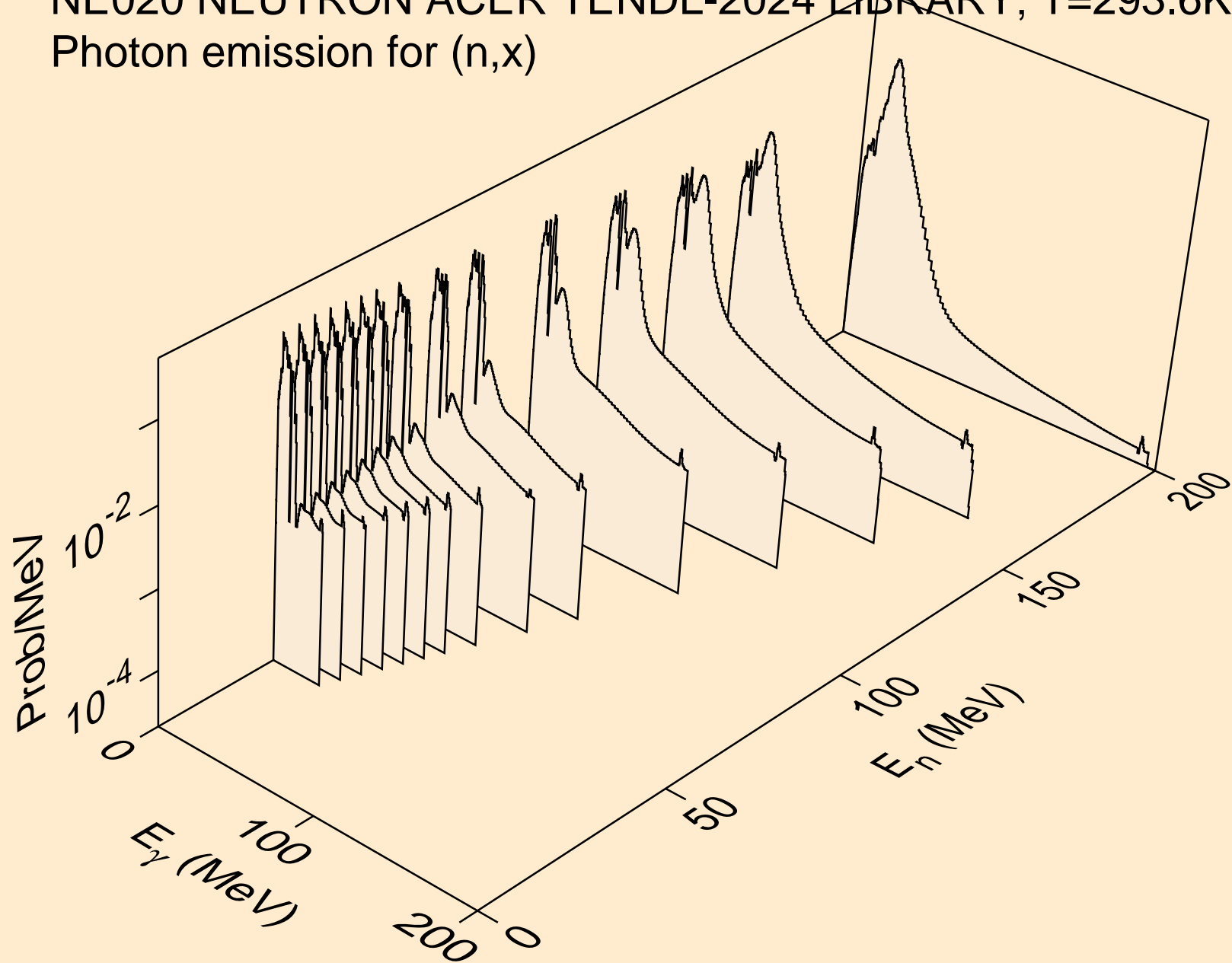

NE020 NEUTRON ACER TENDL-2024 LIBRARY; T=293.6K
Photon emission for (n,2n)

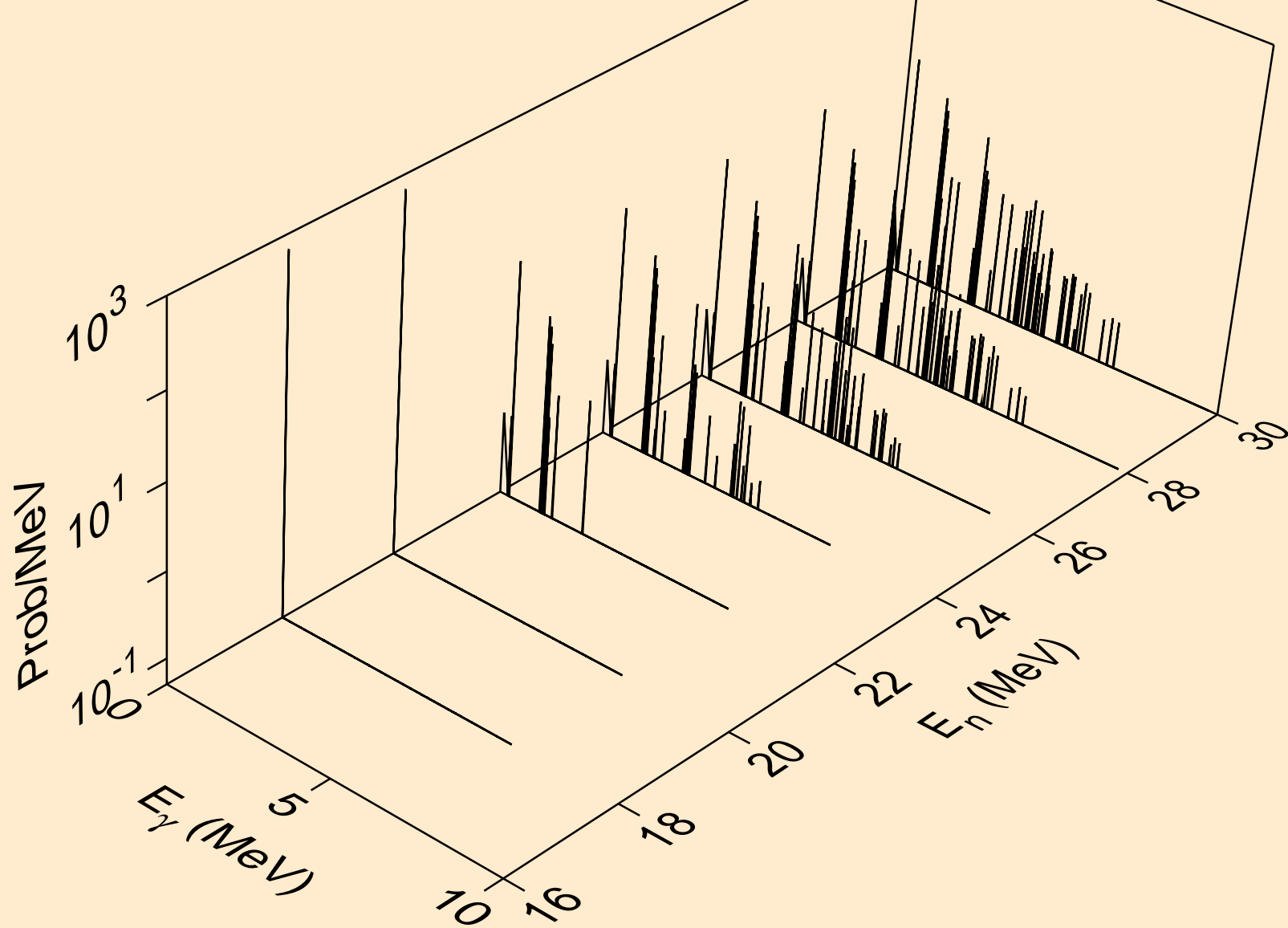

NE020 NEUTRON ACER TENDL-2024 LIBRARY; T=293.6K
Photon emission for (n,n*)a

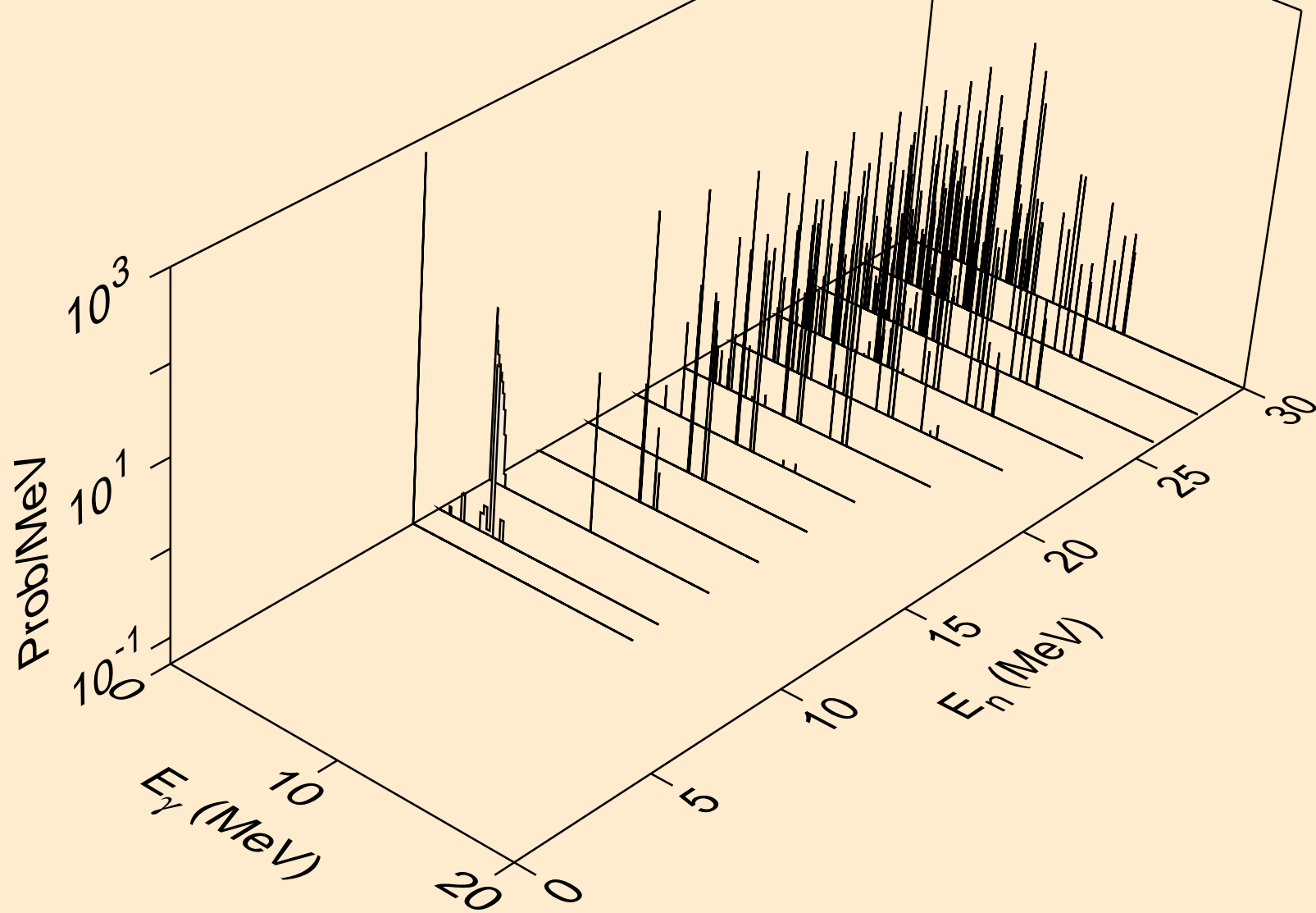

NE020 NEUTRON ACER TENDL-2024 LIBRARY; T=293.6K
Photon emission for (n,n*)3a

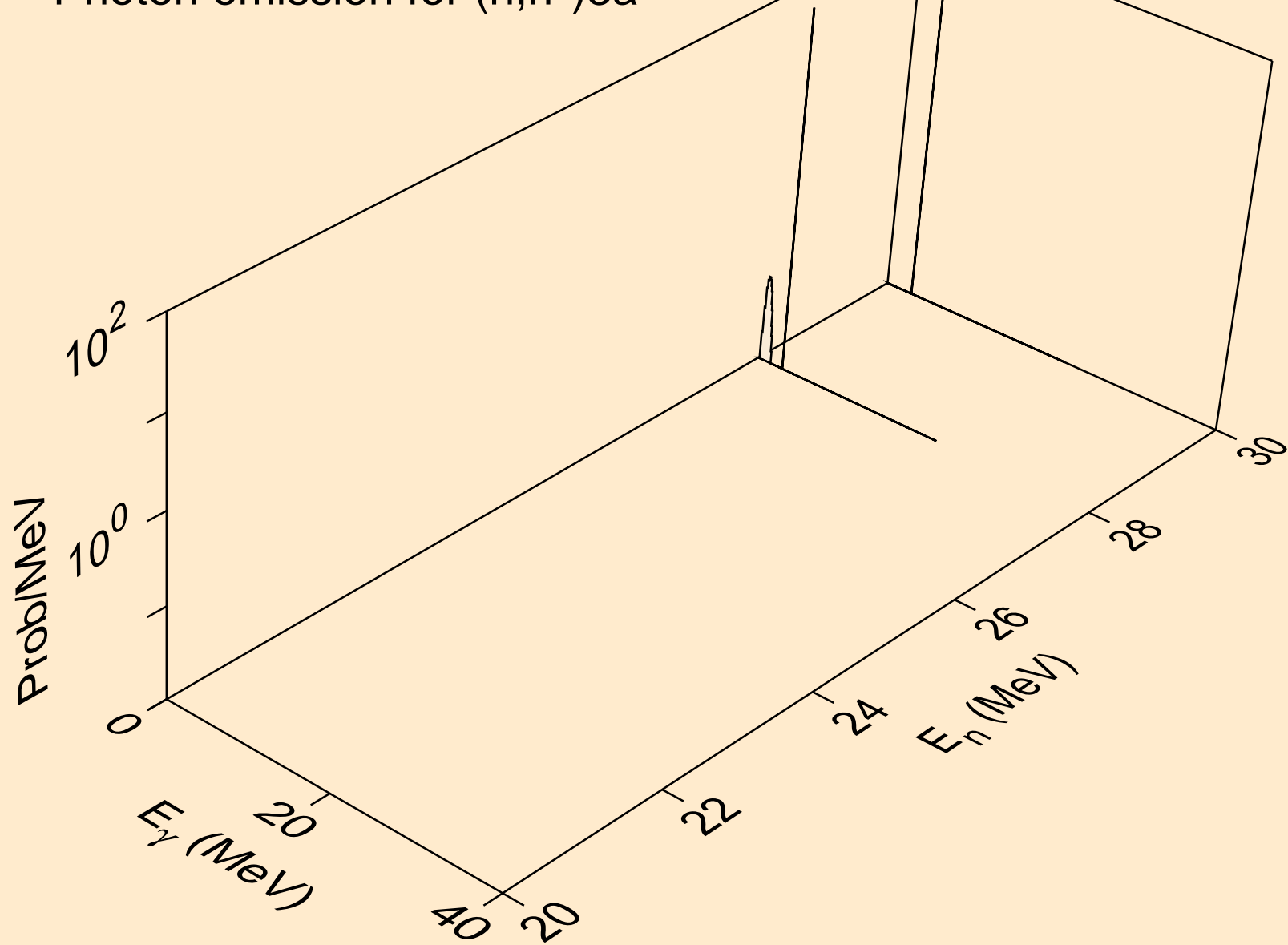

NE020 NEUTRON ACER TENDL-2024 LIBRARY; T=293.6K
Photon emission for (n,2n)a

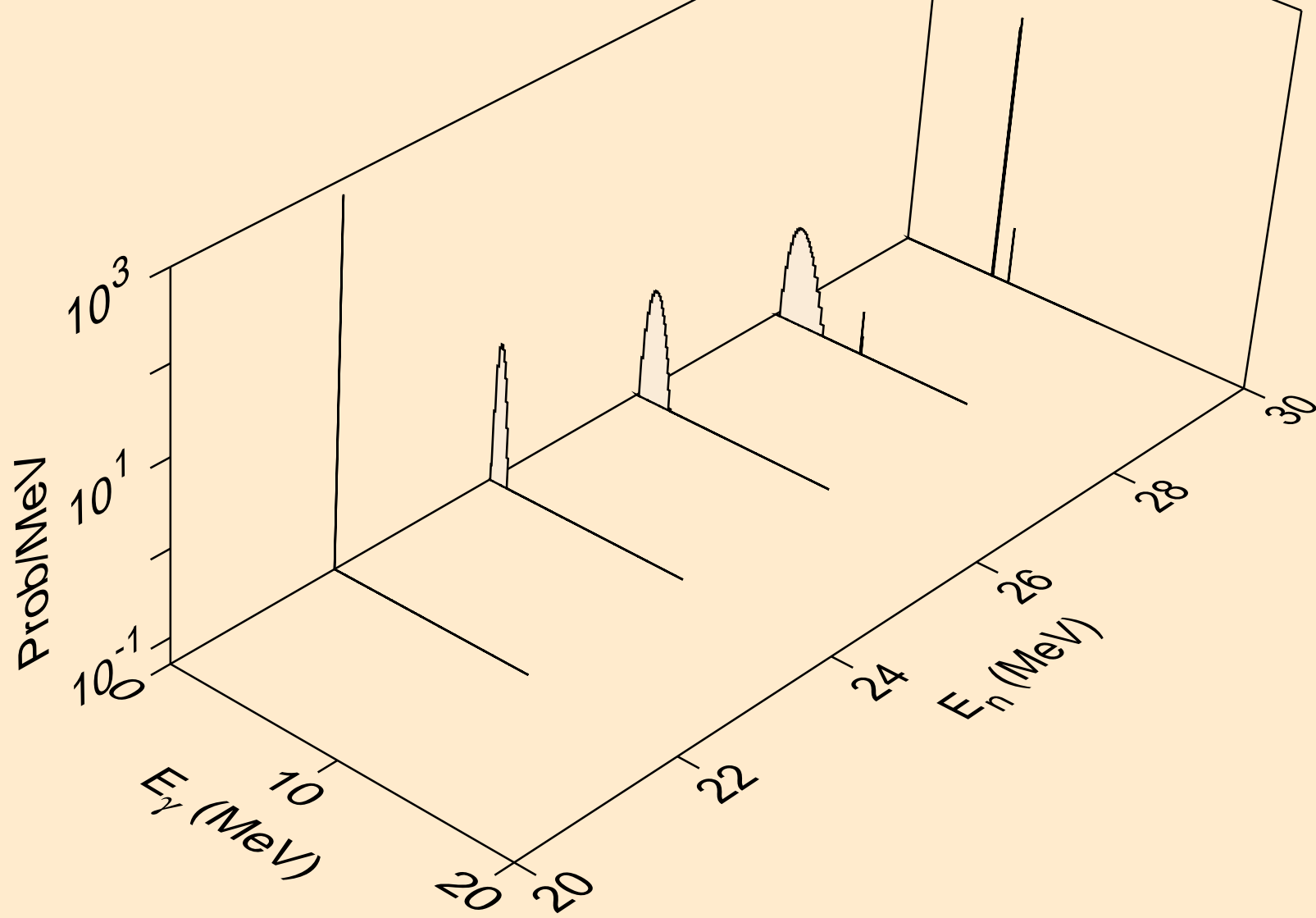

NE020 NEUTRON ACER TENDL-2024 LIBRARY; T=293.6K
Photon emission for (n,n*)p

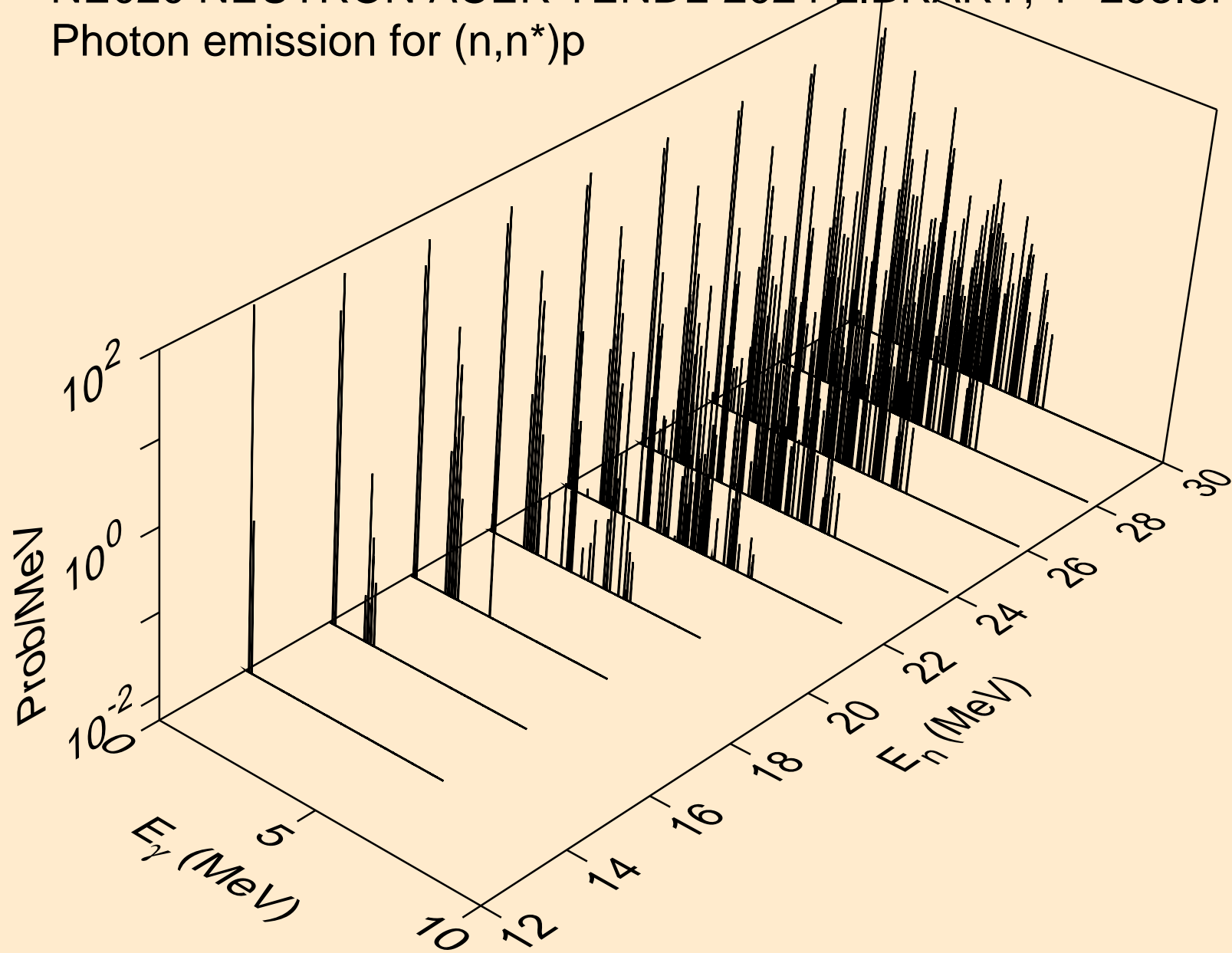

NE020 NEUTRON ACER TENDL-2024 LIBRARY; T=293.6K
Photon emission for (n,n*)2a

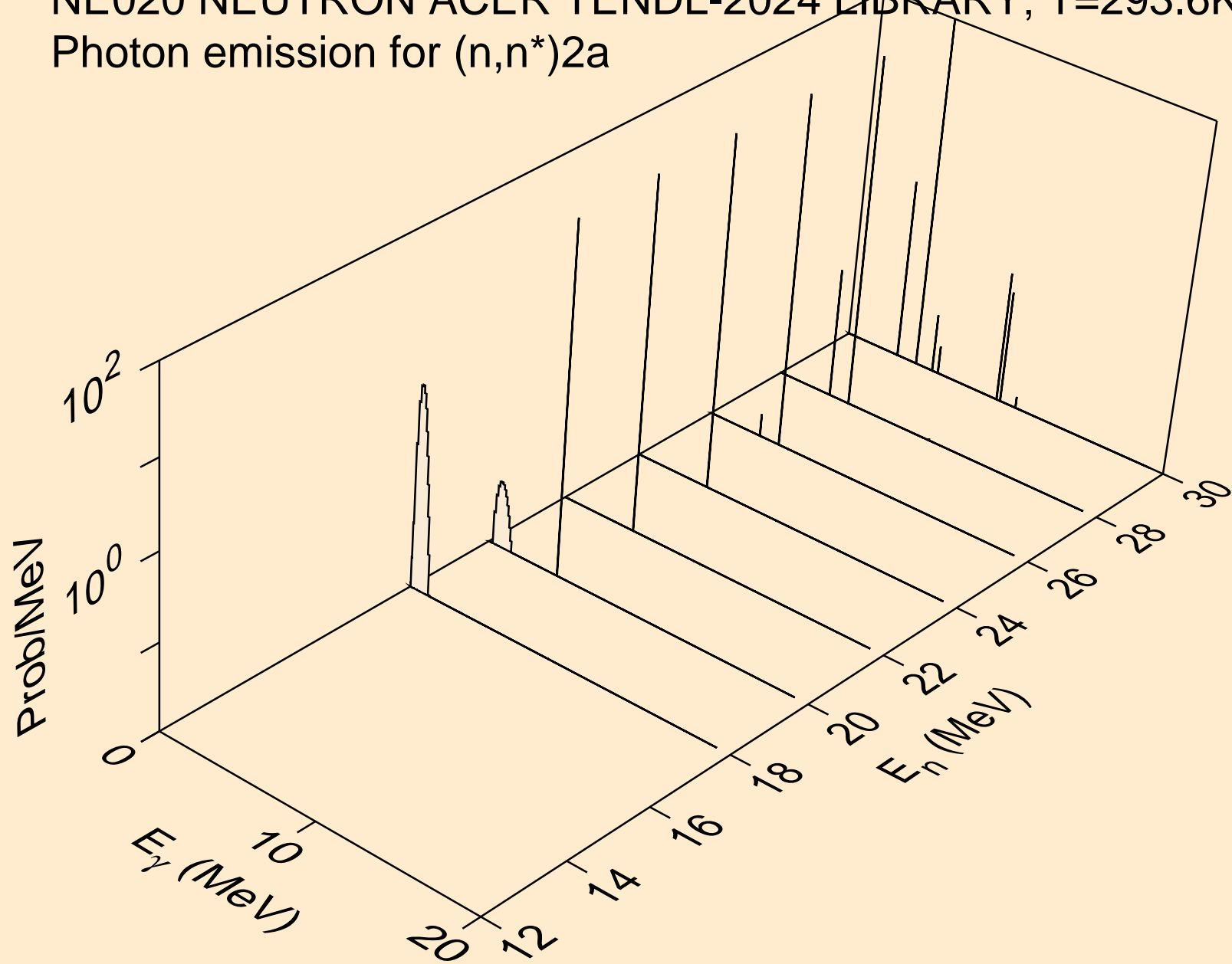

NE020 NEUTRON ACER TENDL-2024 LIBRARY; T=293.6K
Photon emission for (n,n*)d

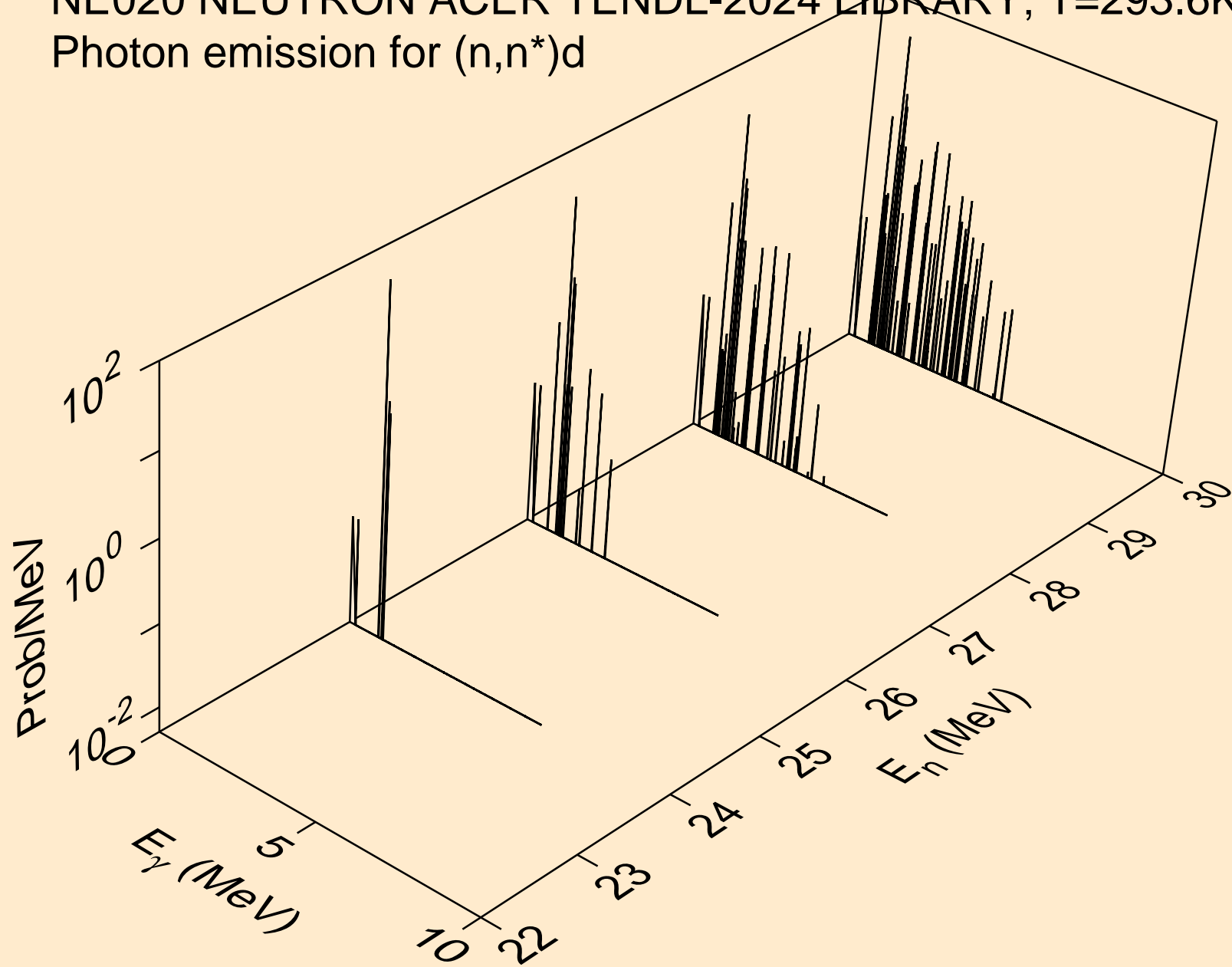

NE020 NEUTRON ACER TENDL-2024 LIBRARY; T=293.6K
Photon emission for (n,n*)t

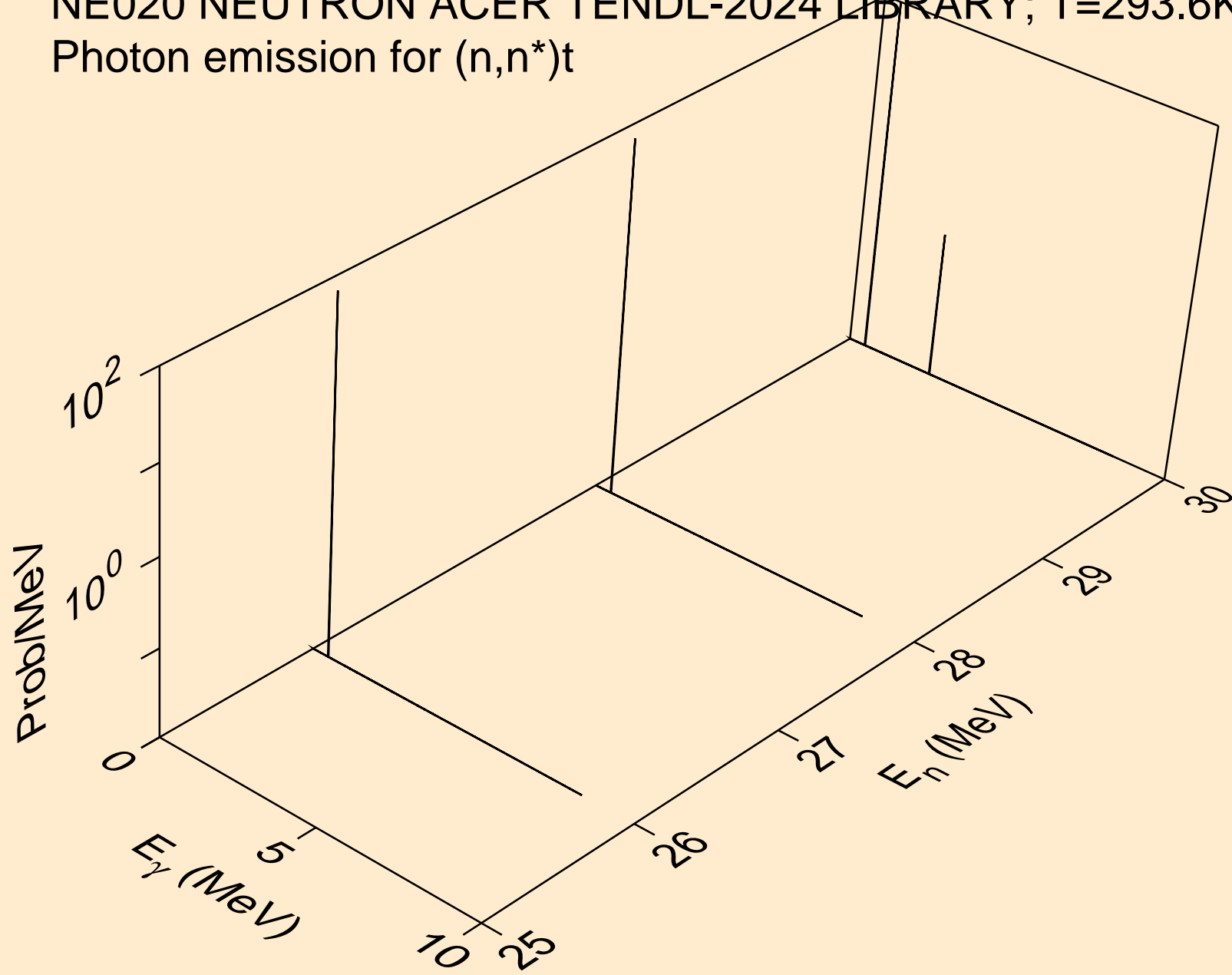

NE020 NEUTRON ACER TENDL-2024 LIBRARY; T=293.6K
Photon emission for (n,n*)he3

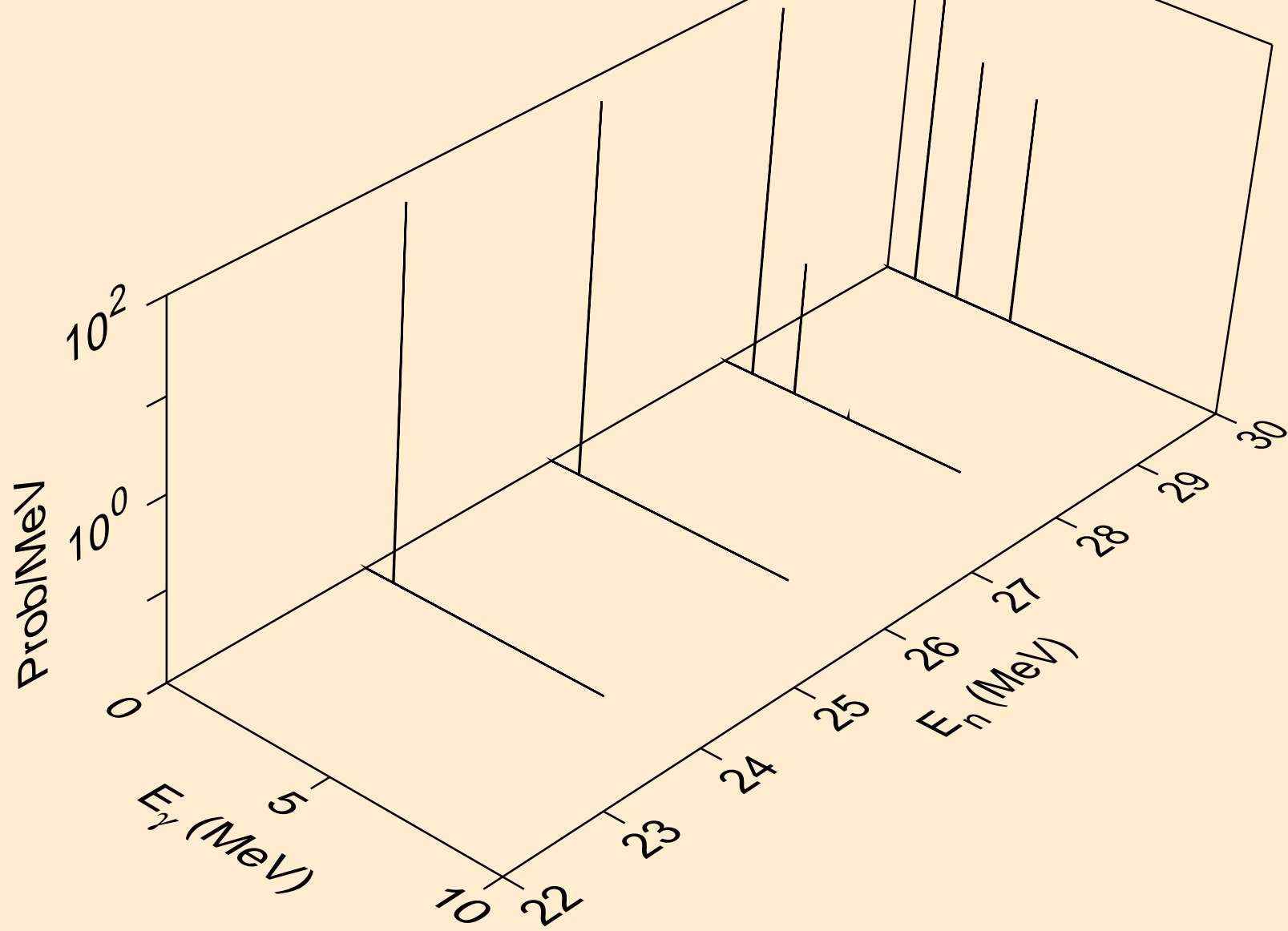

NE020 NEUTRON ACER TENDL-2024 LIBRARY; T=293.6K
Photon emission for (n,2np)

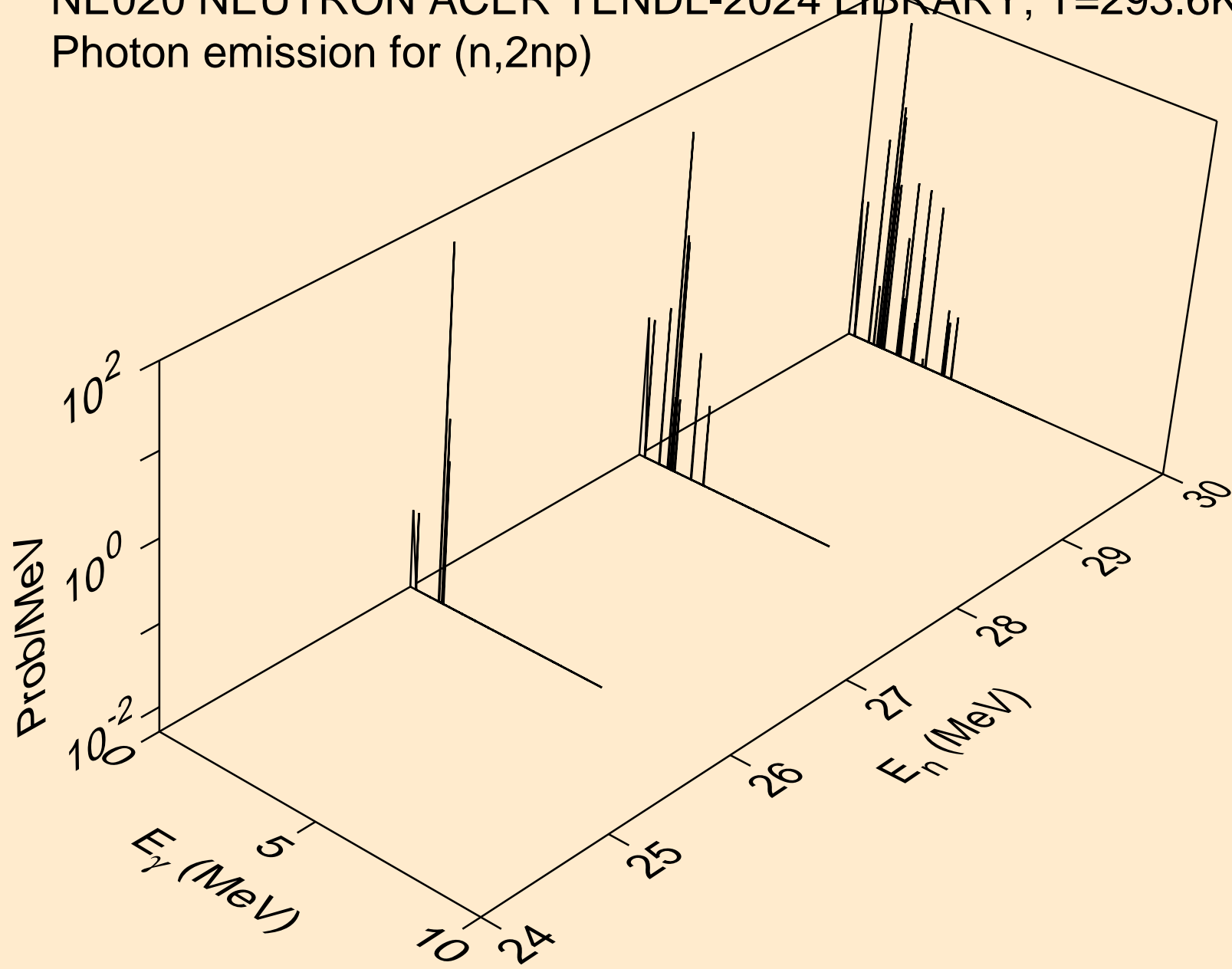

NE020 NEUTRON ACER TENDL-2024 LIBRARY; T=293.6K
Photon emission for (n,n2p)

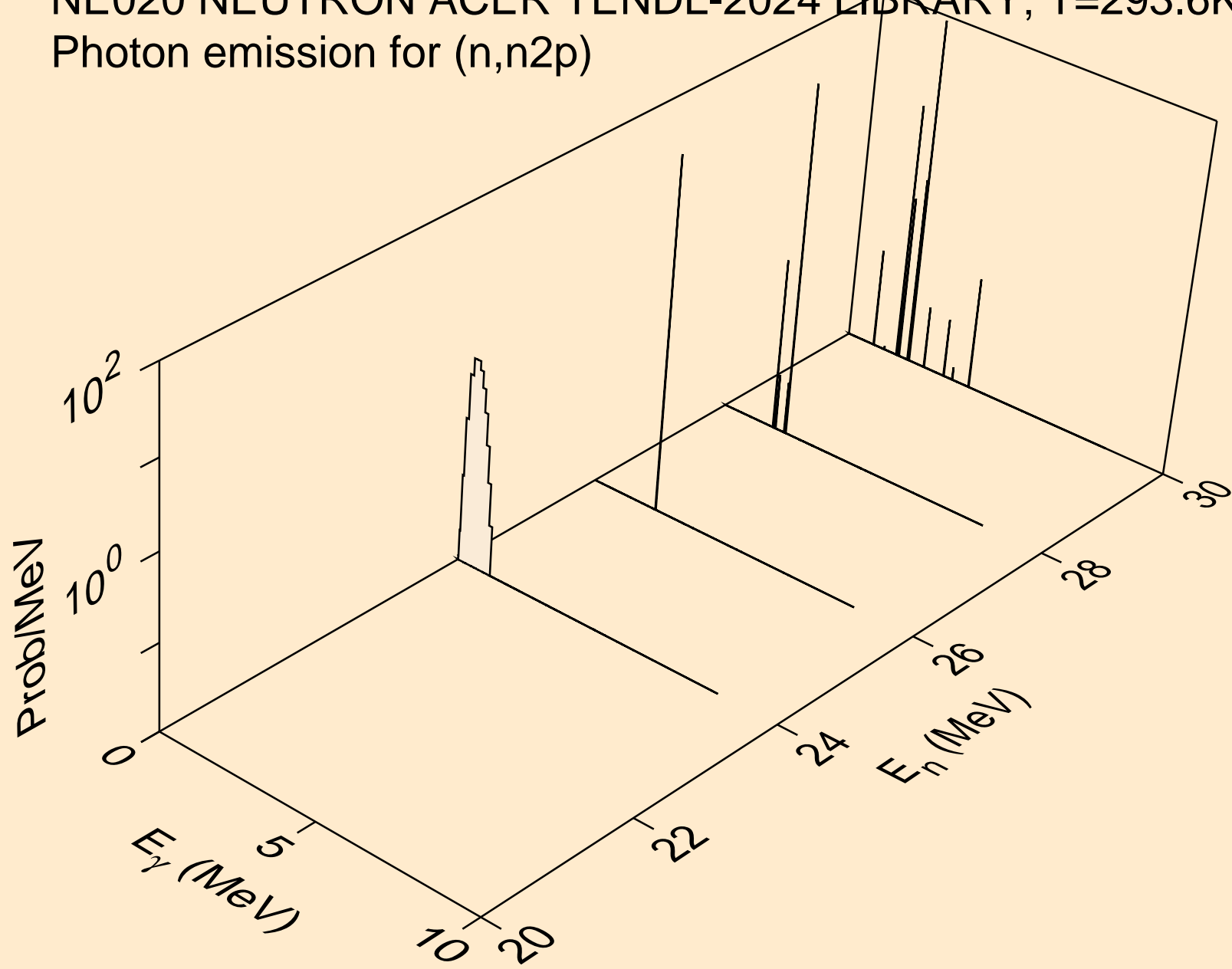

NE020 NEUTRON ACER TENDL-2024 LIBRARY; T=293.6K
Photon emission for (n,npa)

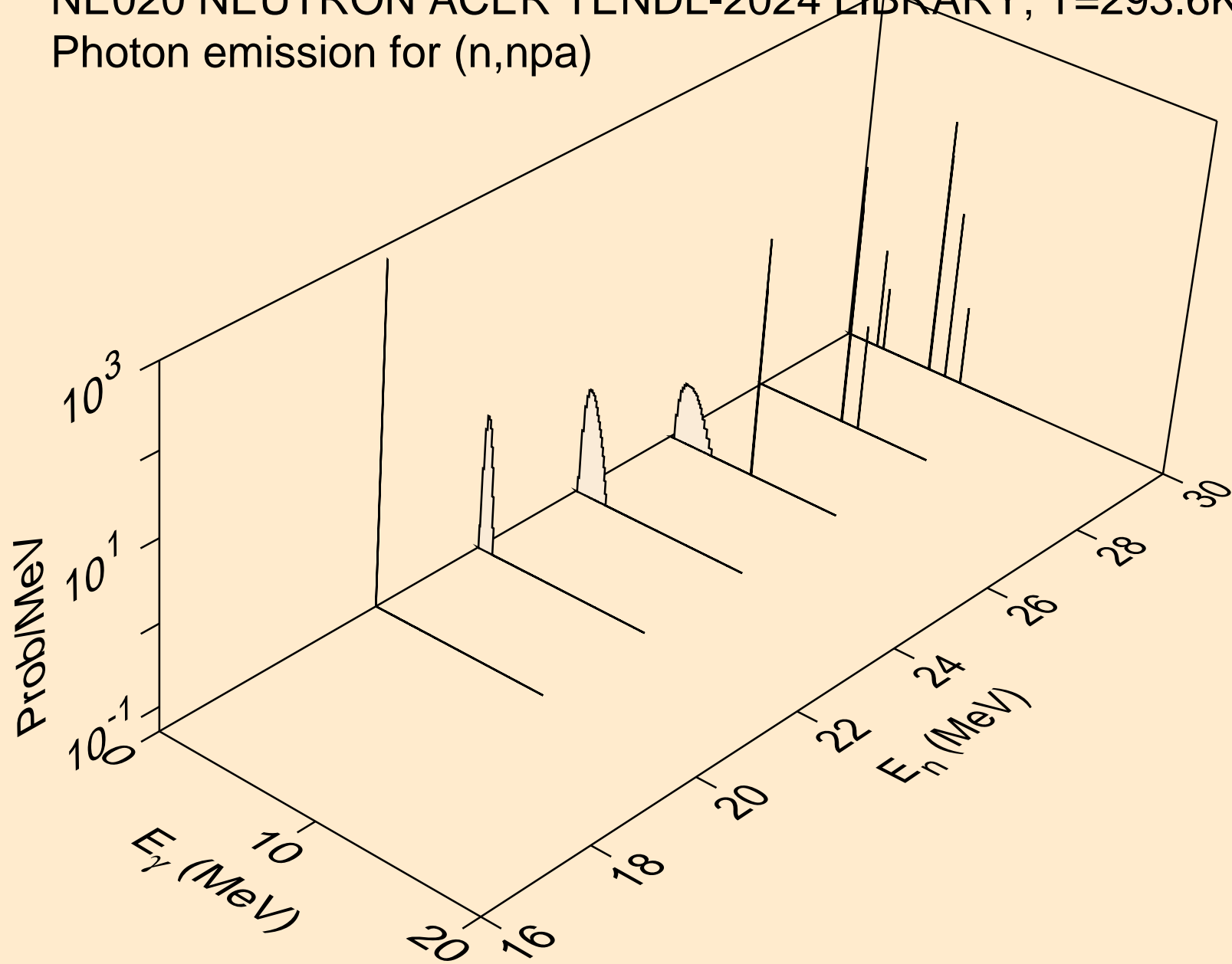

NE020 NEUTRON ACER TENDL-2024 LIBRARY; T=293.6K
Photon emission for (n,n*c)

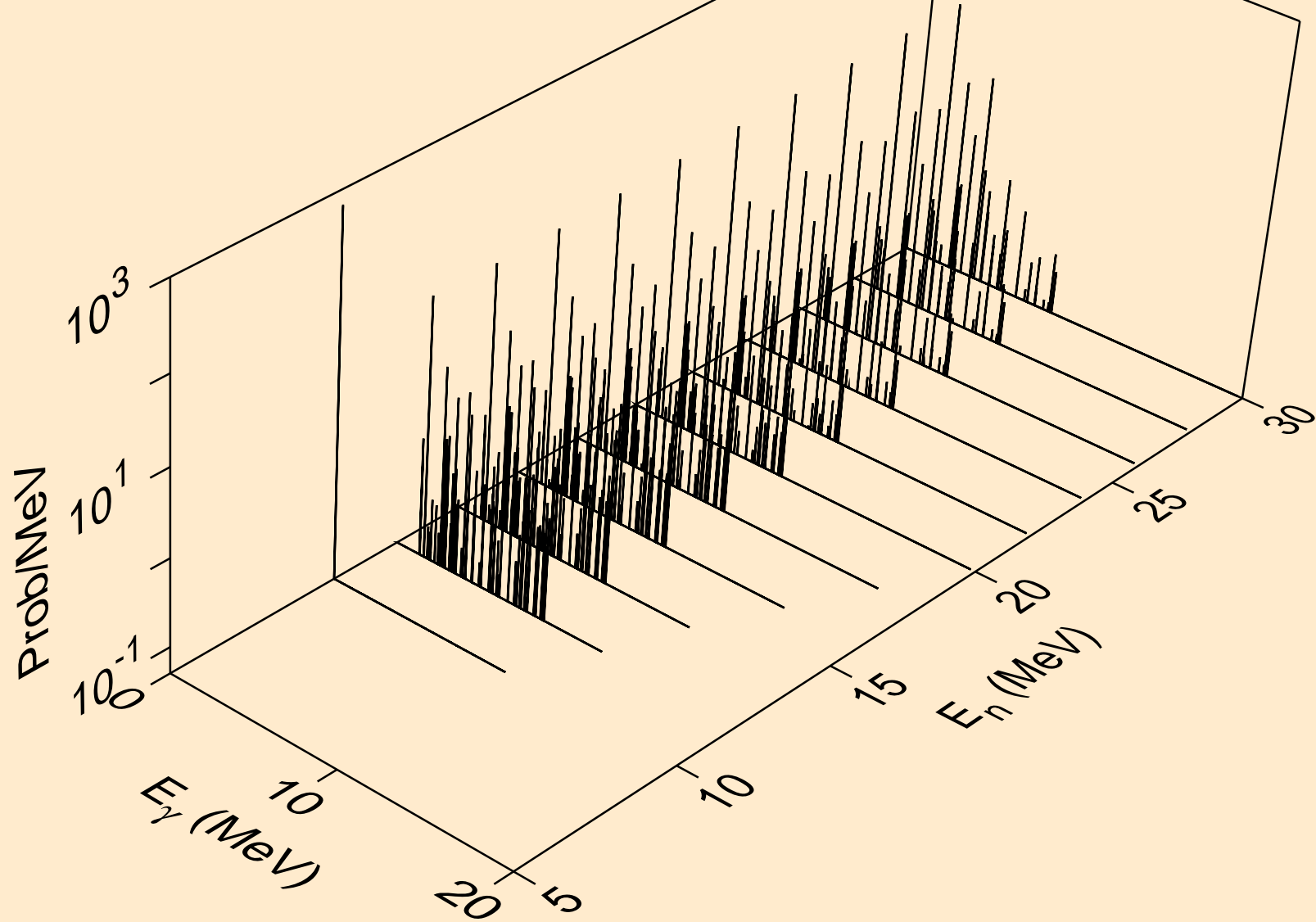

NE020 NEUTRON ACER TENDL-2024 LIBRARY; T=293.6K
Photon emission for (n,gma)

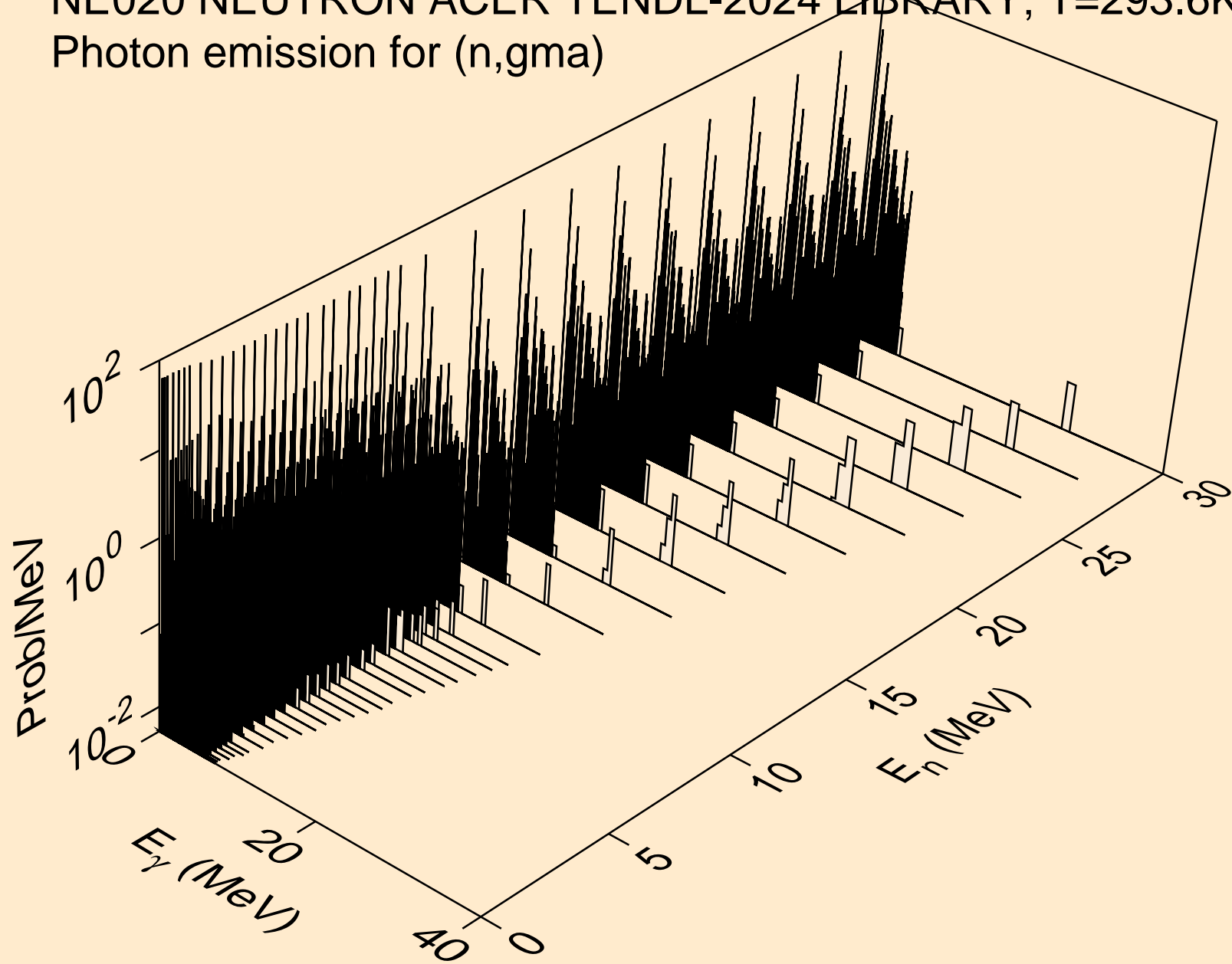

NE020 NEUTRON ACER TENDL-2024 LIBRARY; T=293.6K
Photon emission for (n,p)

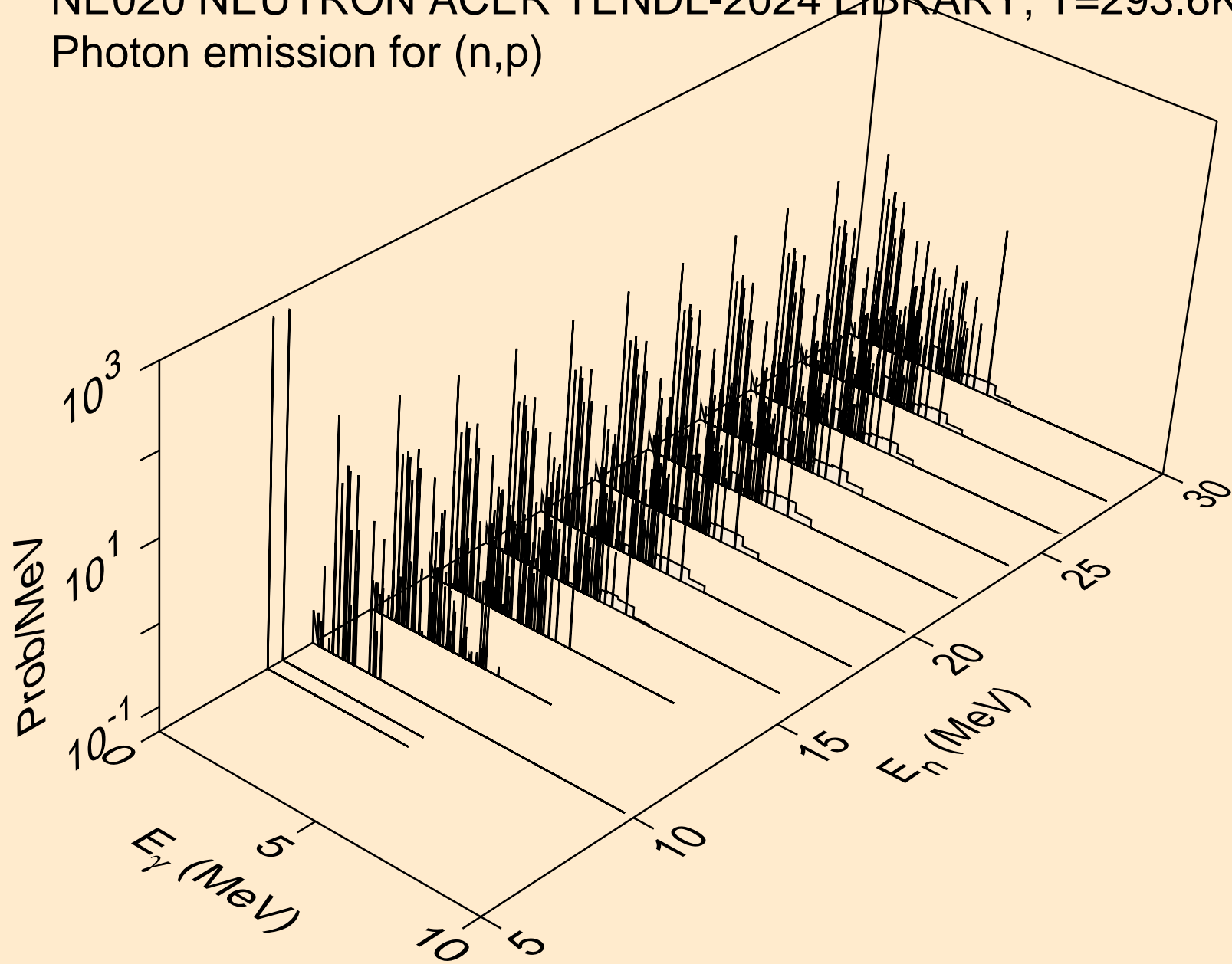

NE020 NEUTRON ACER TENDL-2024 LIBRARY; T=293.6K
Photon emission for (n,d)

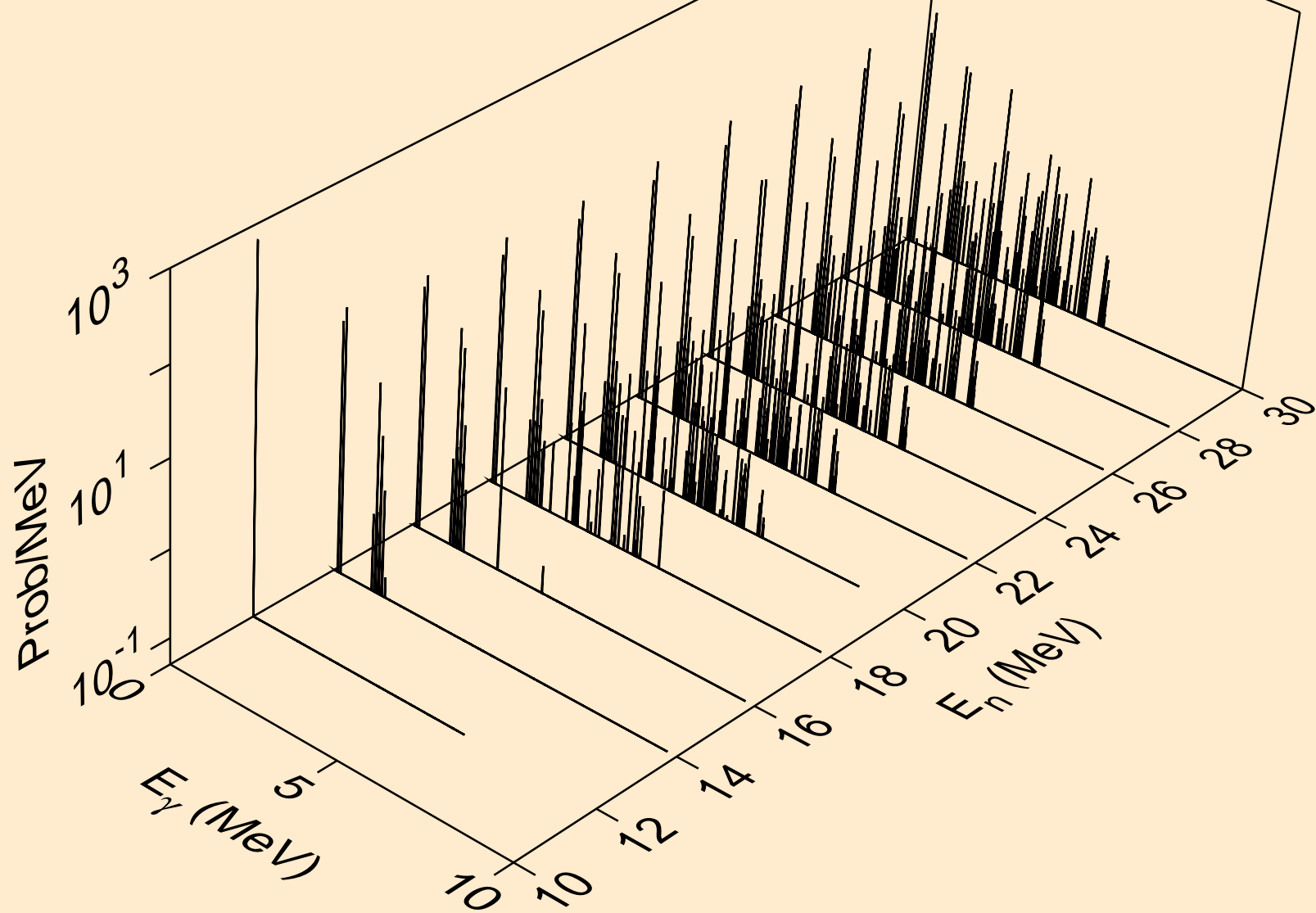

NE020 NEUTRON ACER TENDL-2024 LIBRARY; T=293.6K
Photon emission for (n,t)

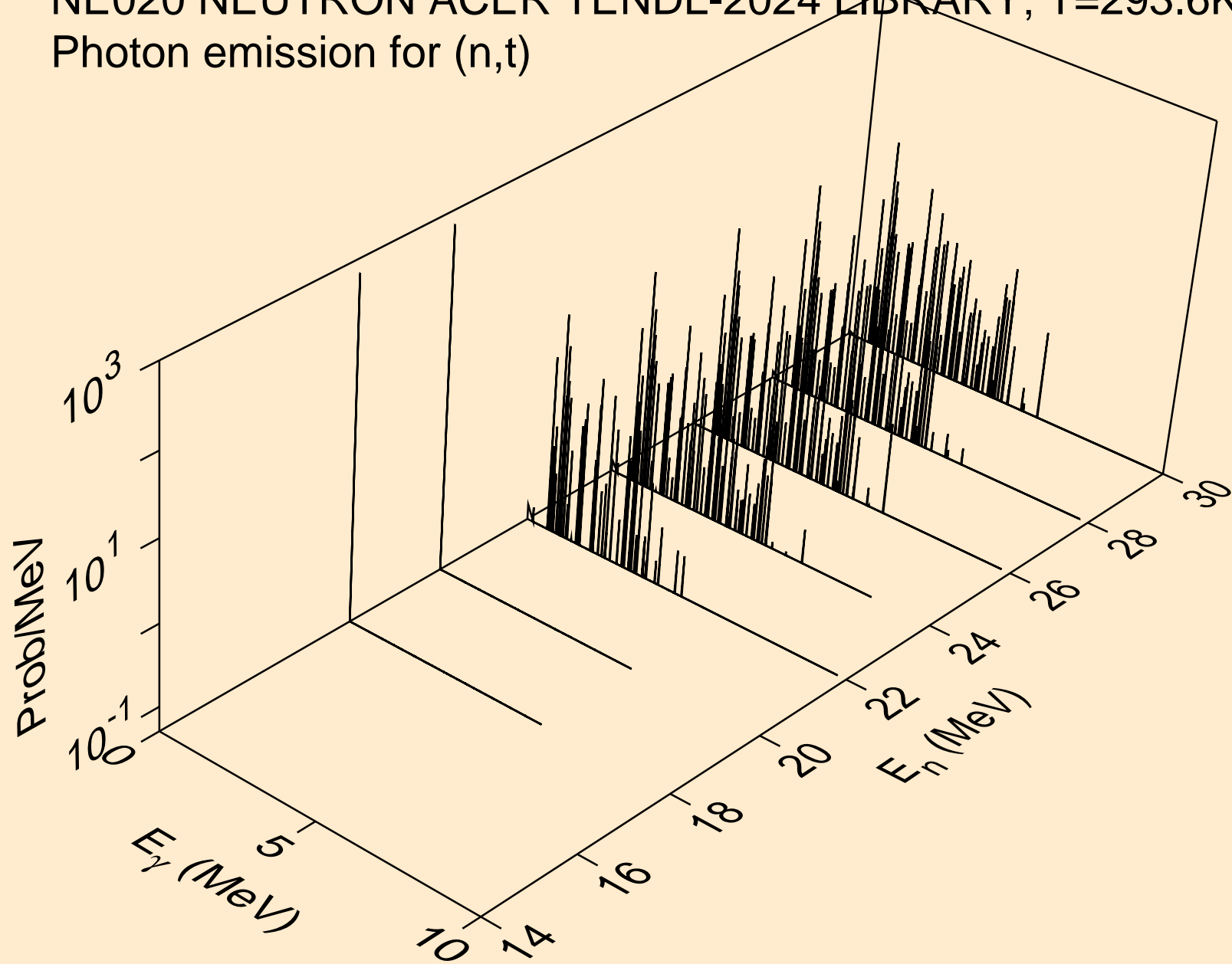

NE020 NEUTRON ACER TENDL-2024 LIBRARY; T=293.6K
Photon emission for (n,he3)

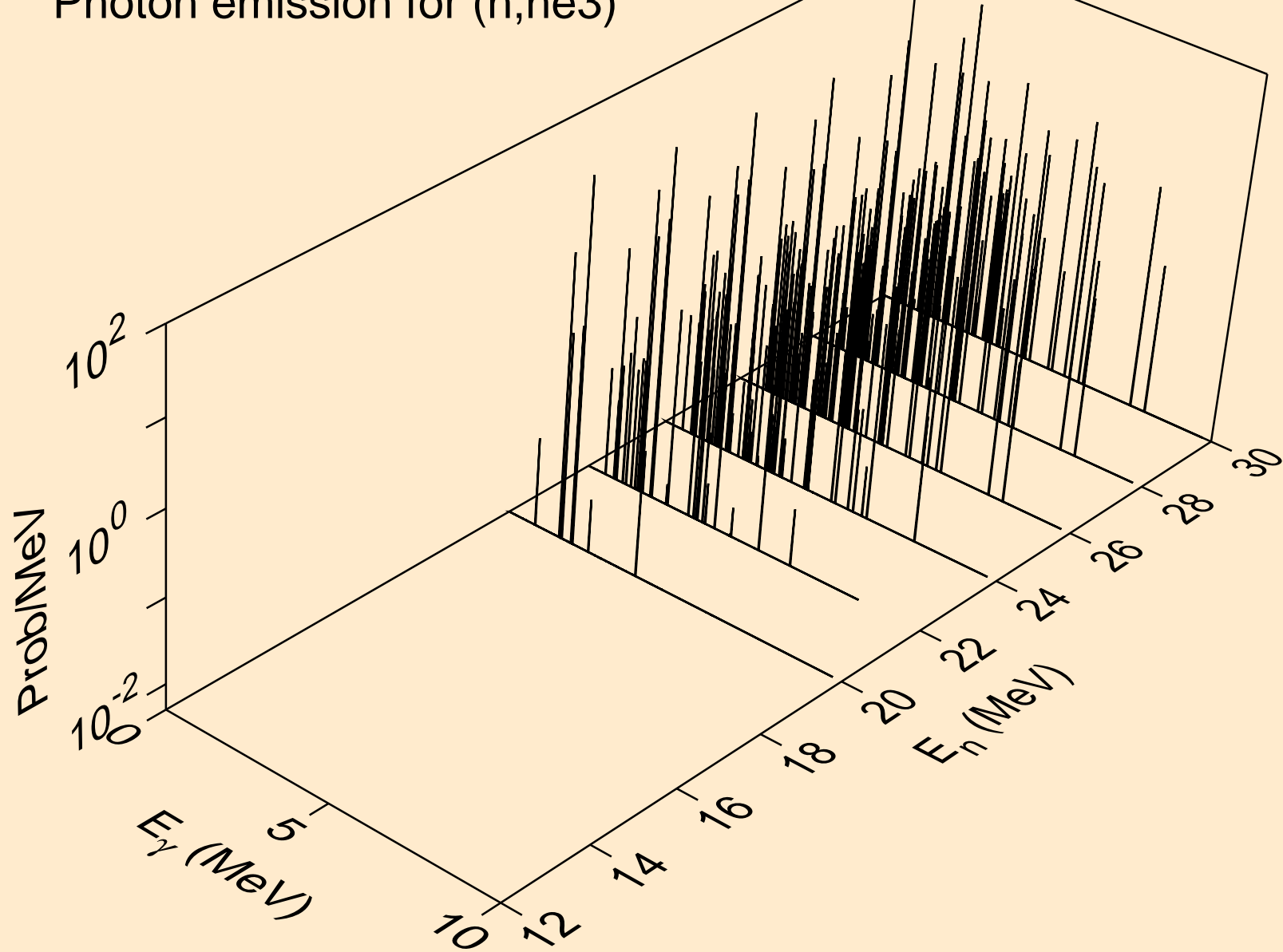

NE020 NEUTRON ACER TENDL-2024 LIBRARY; T=293.6K
Photon emission for (n,a)

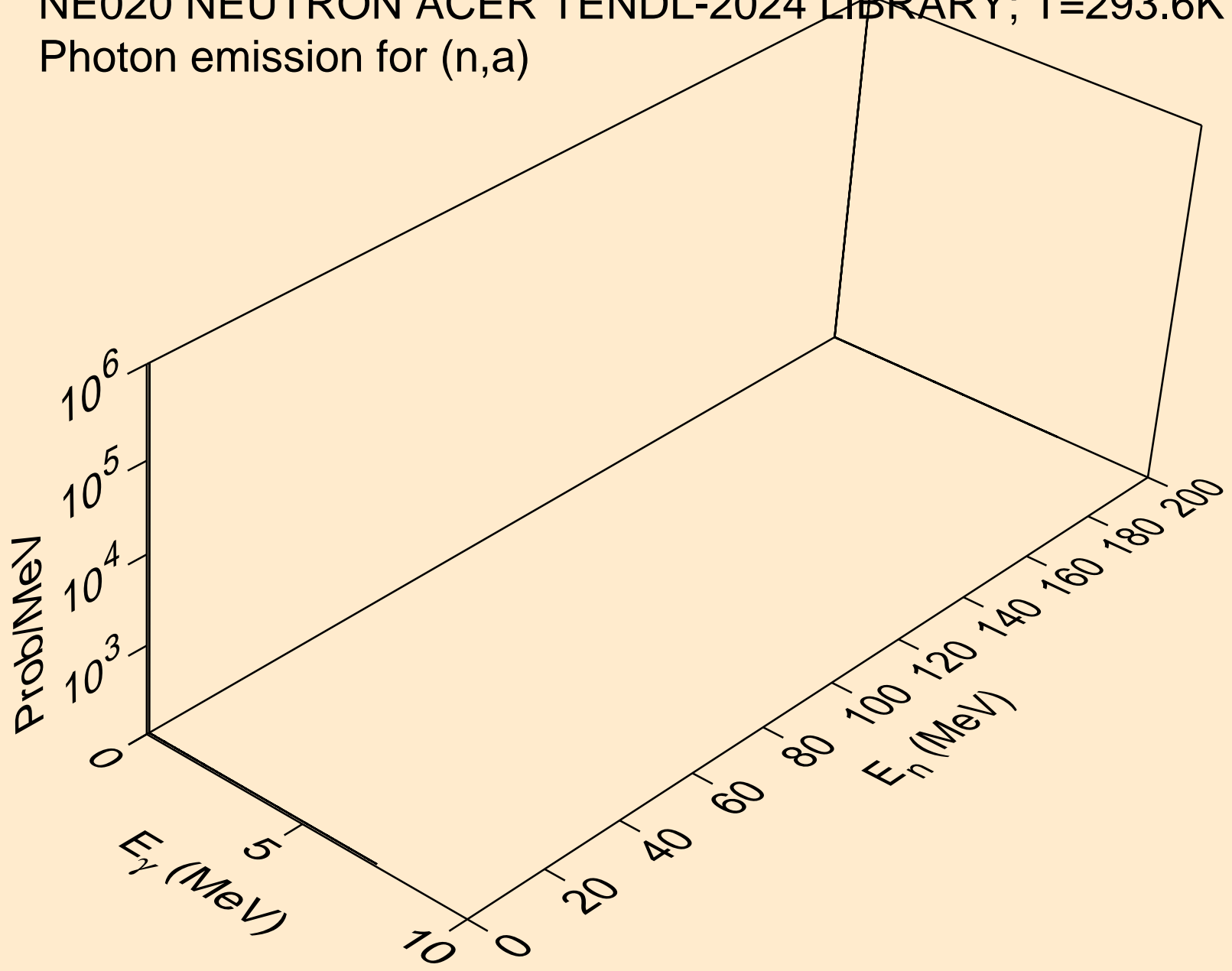

NE020 NEUTRON ACER TENDL-2024 LIBRARY; T=293.6K
Photon emission for (n,2a)

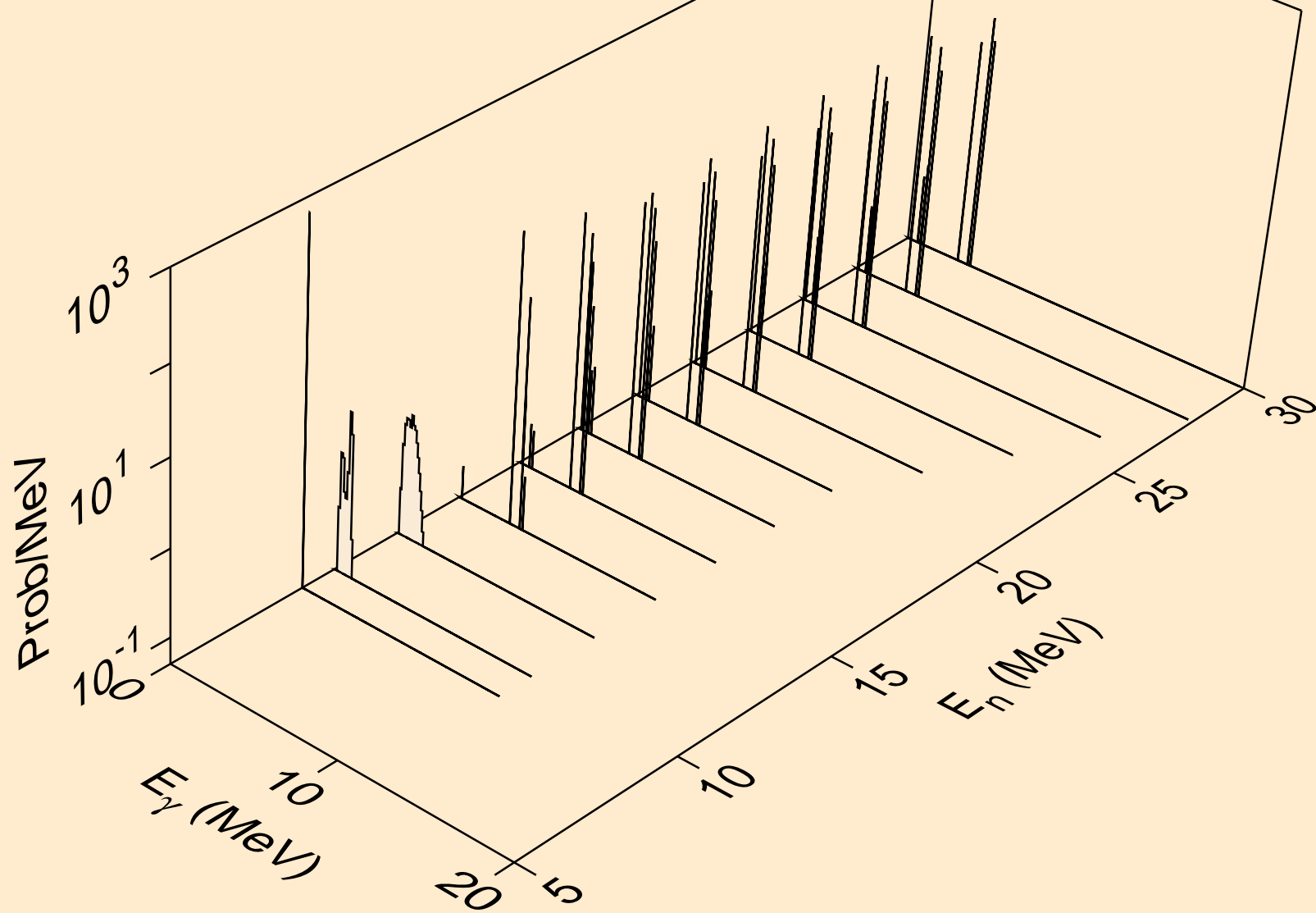

NE020 NEUTRON ACER TENDL-2024 LIBRARY; T=293.6K
Photon emission for (n,3a)

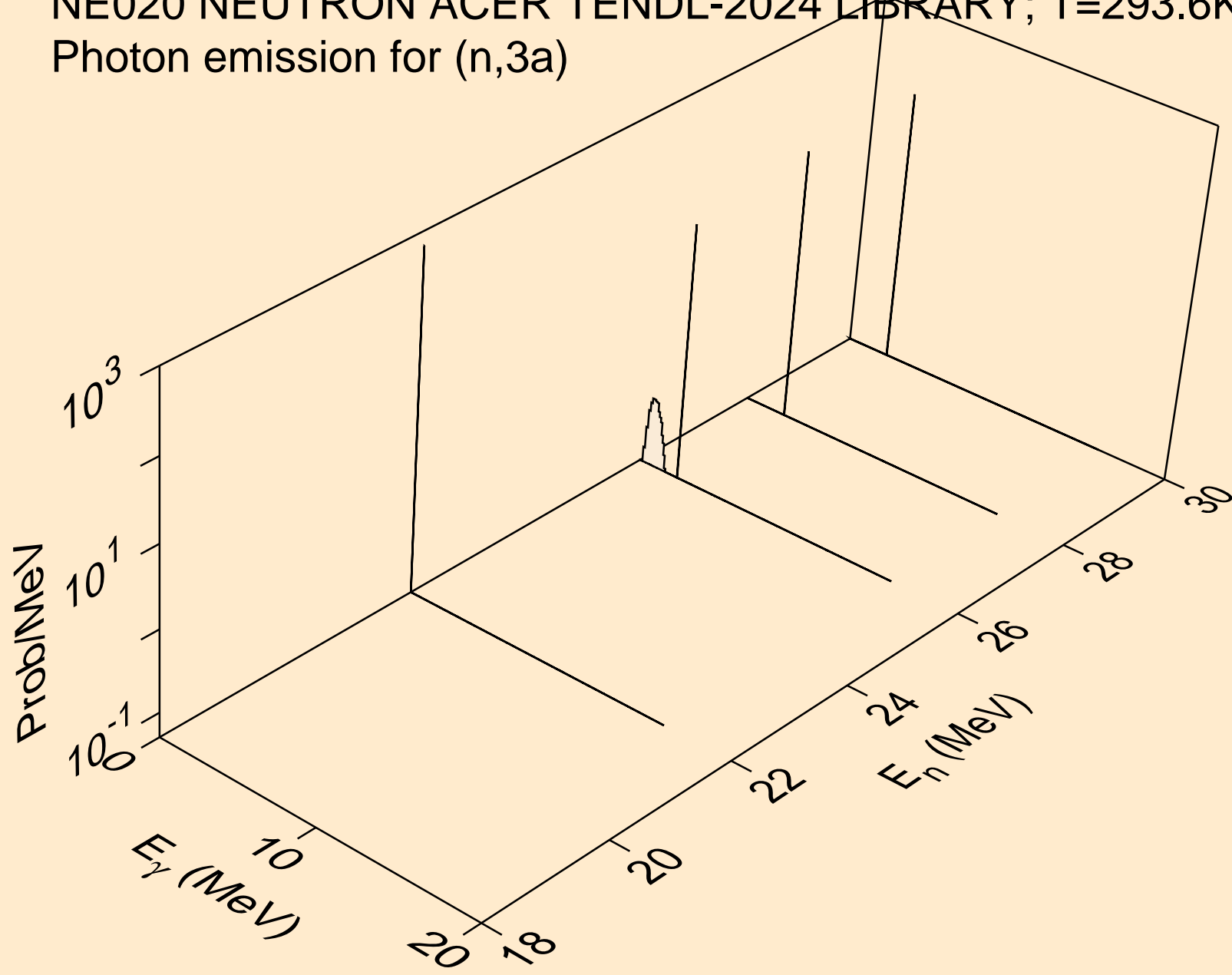

NE020 NEUTRON ACER TENDL-2024 LIBRARY; T=293.6K
Photon emission for (n,2p)

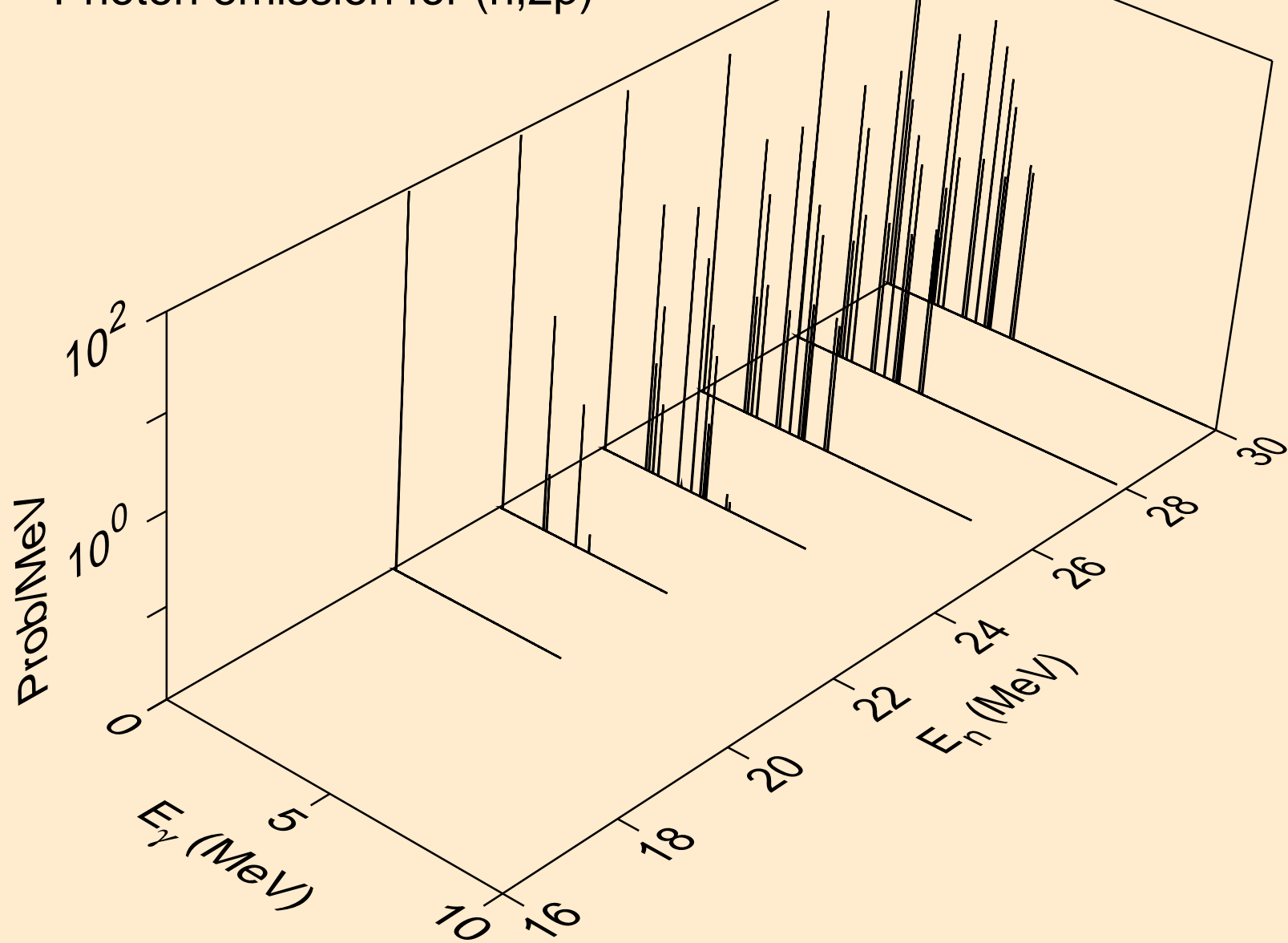

NE020 NEUTRON ACER TENDL-2024 LIBRARY; T=293.6K
Photon emission for (n,p α)

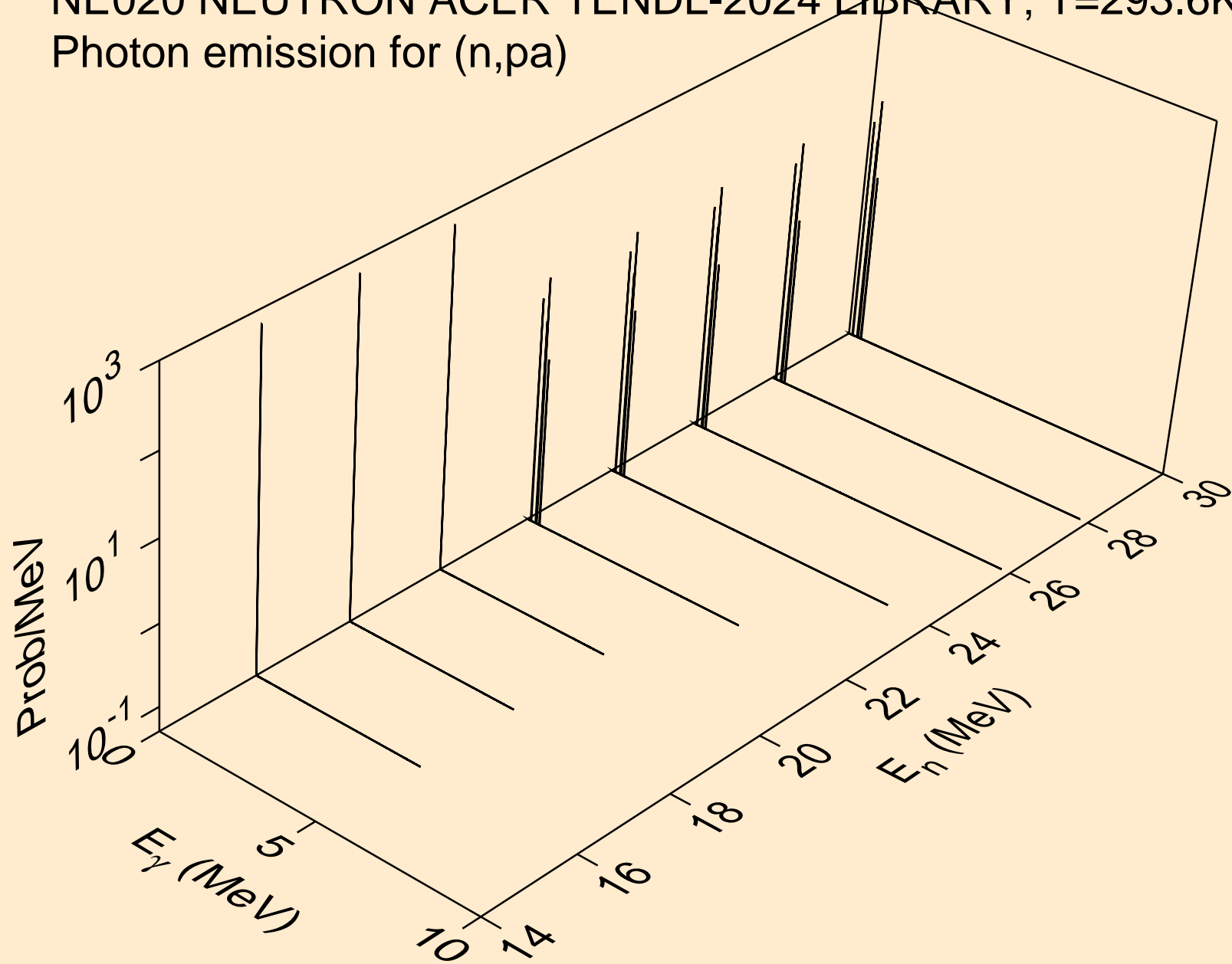

NE020 NEUTRON ACER TENDL-2024 LIBRARY; T=293.6K
Photon emission for (n,pd)

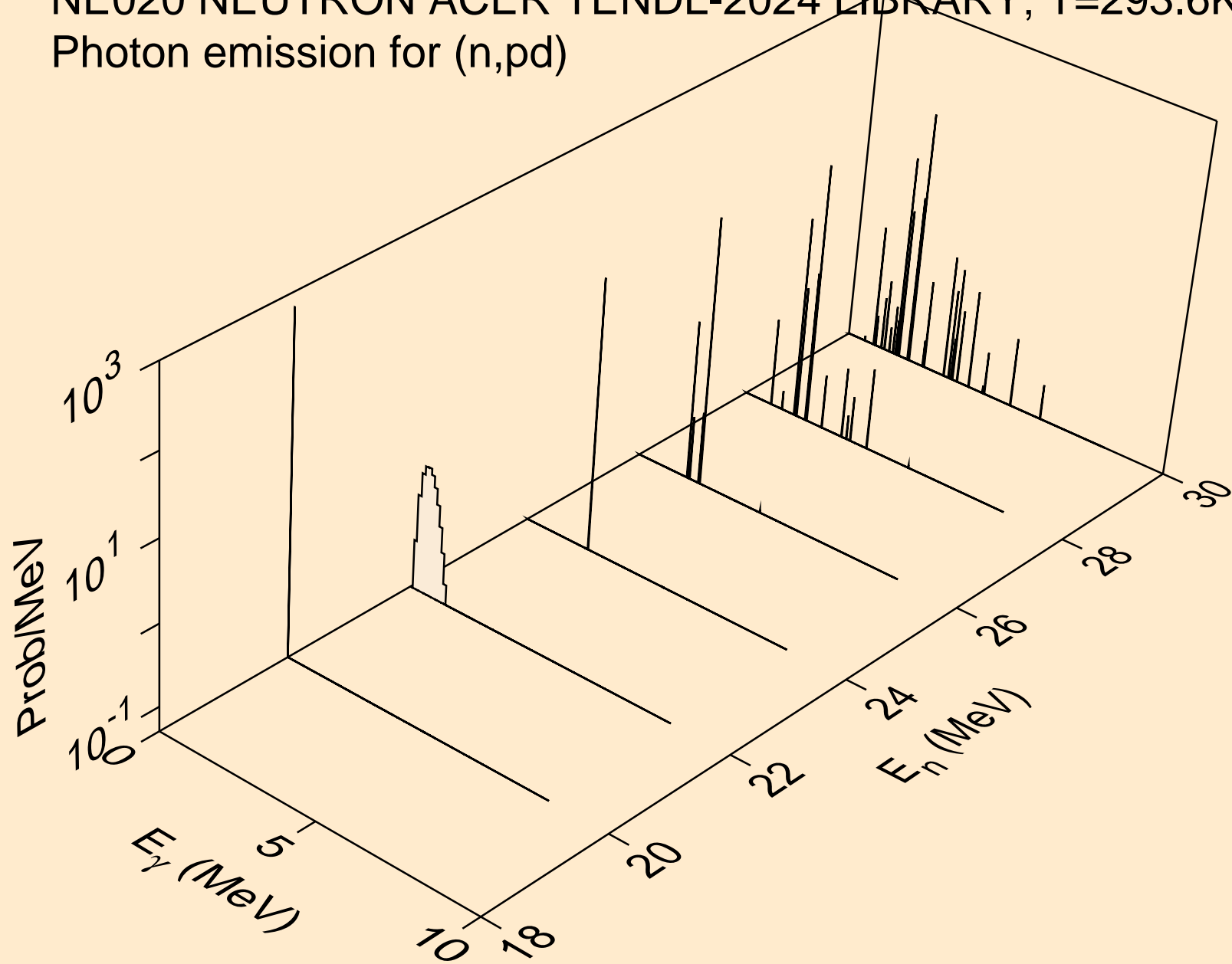

NE020 NEUTRON ACER TENDL-2024 LIBRARY; T=293.6K
Photon emission for (n,pt)

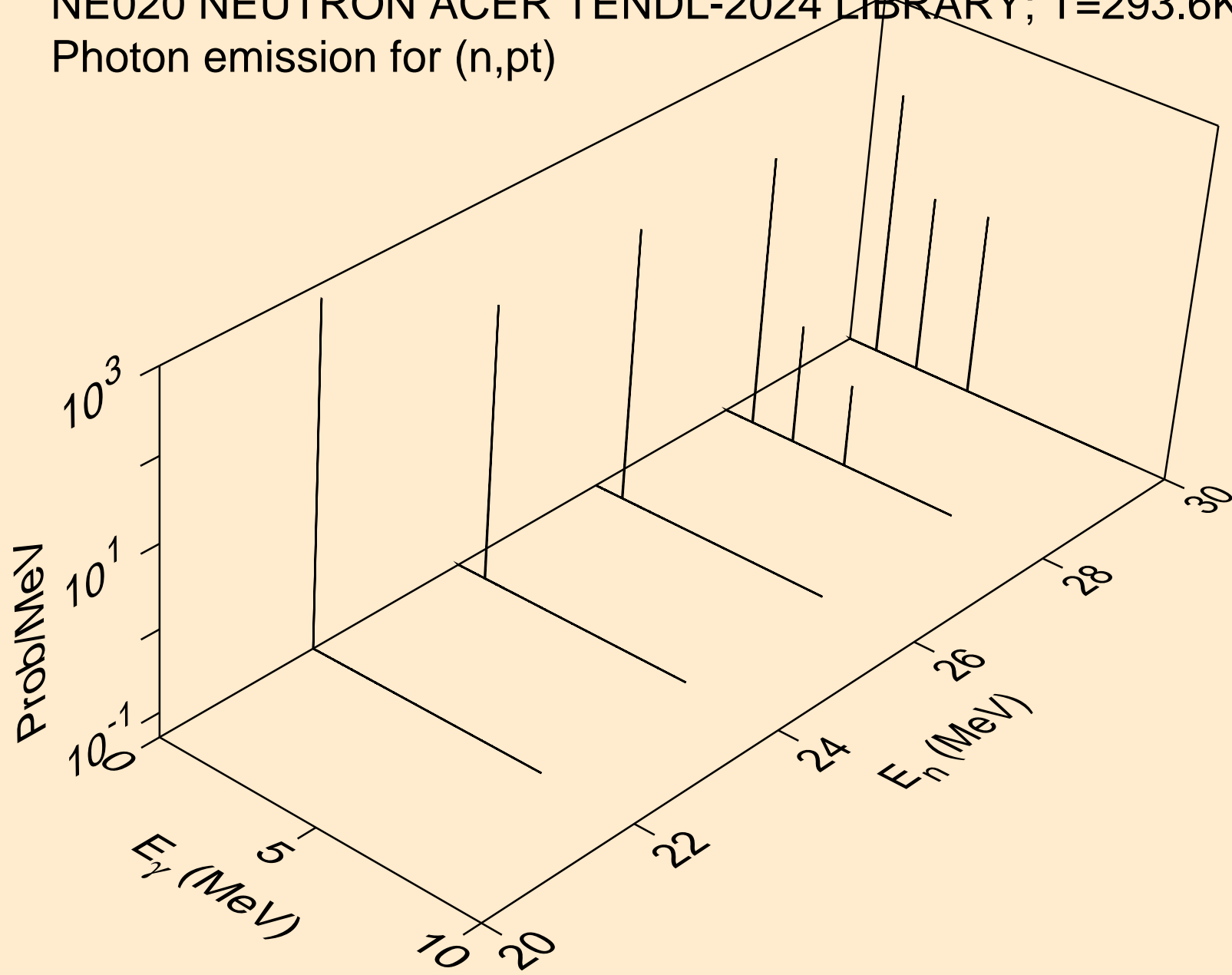

NE020 NEUTRON ACER TENDL-2024 LIBRARY; T=293.6K
Photon emission for (n,da)

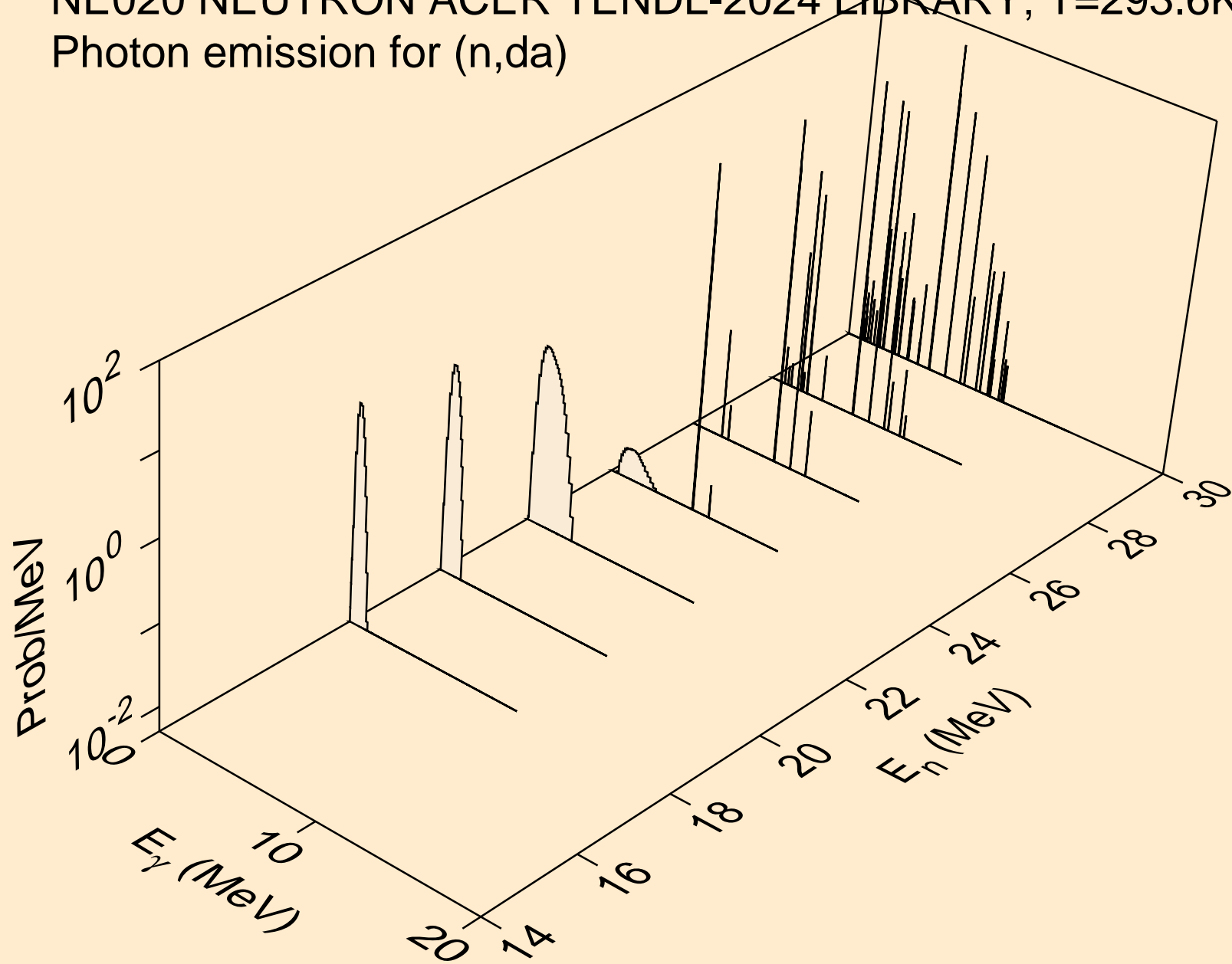

NE020 NEUTRON ACER TENDL-2024 LIBRARY; T=293.6K
thermal capture photon spectrum

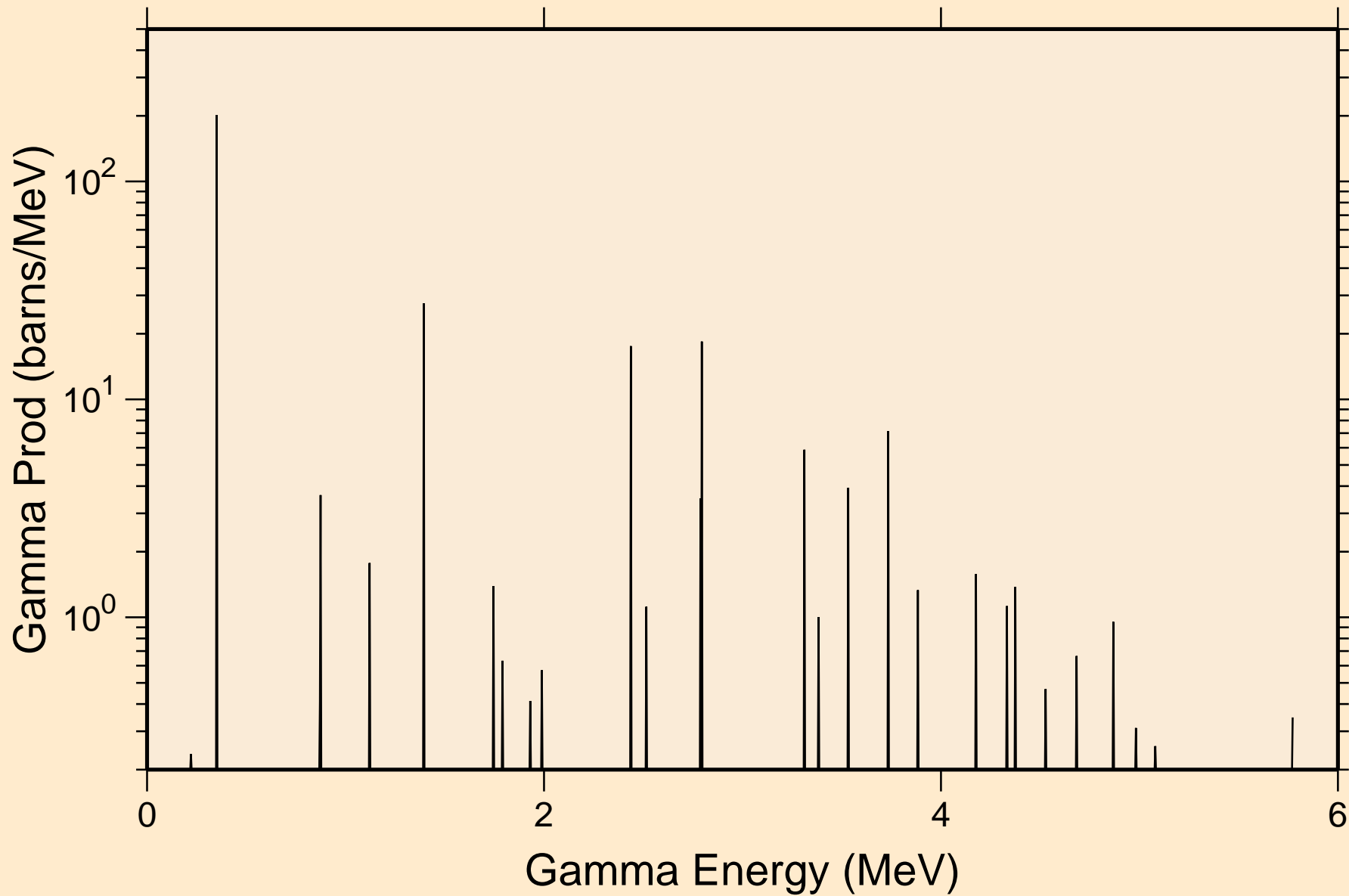

NE020 NEUTRON ACER TENDL-2024 LIBRARY; T=293.6K
14 MeV photon spectrum

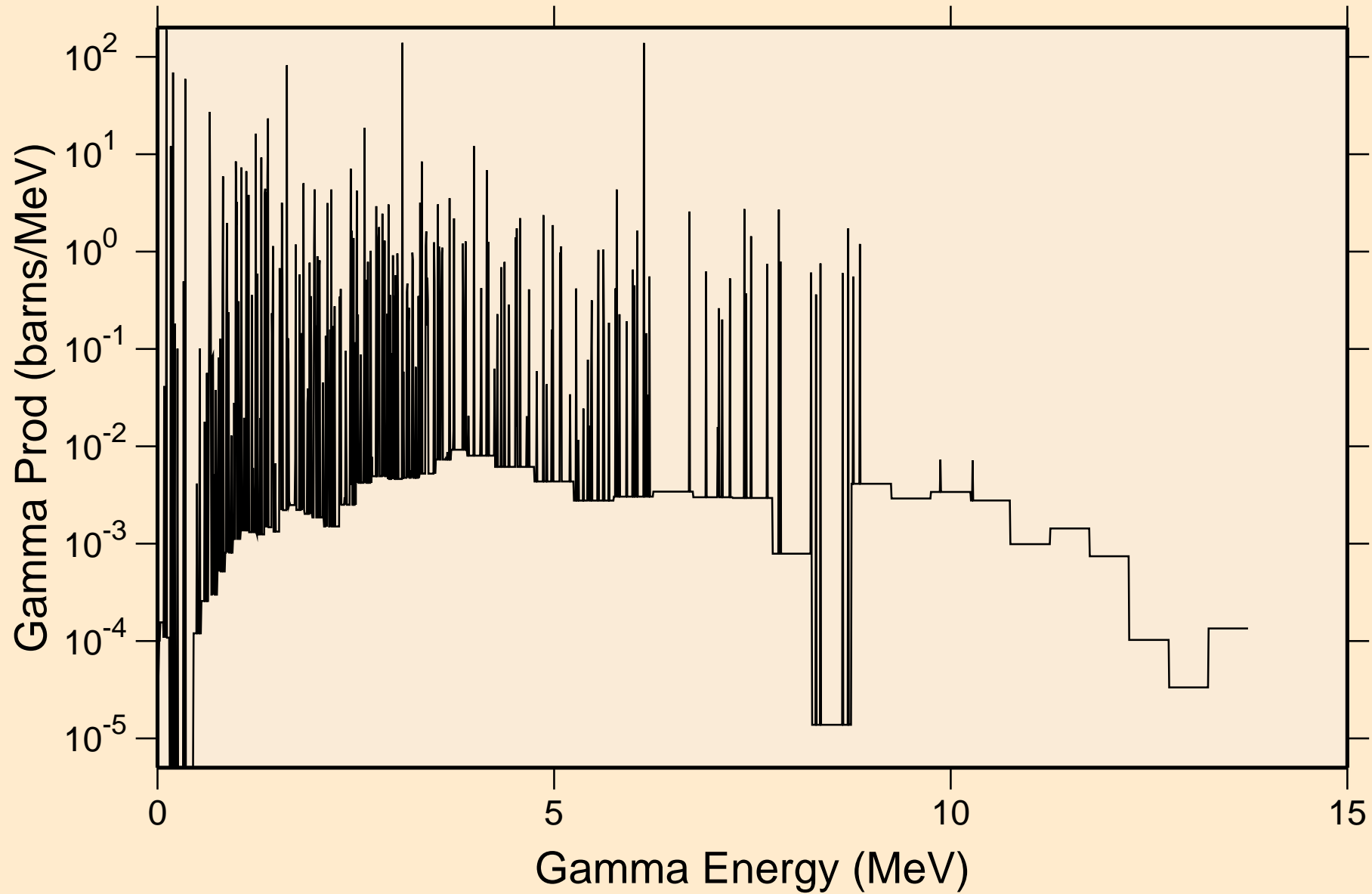

NE020 NEUTRON ACER TENDL-2024 LIBRARY; T=293.6K
Particle heating contributions

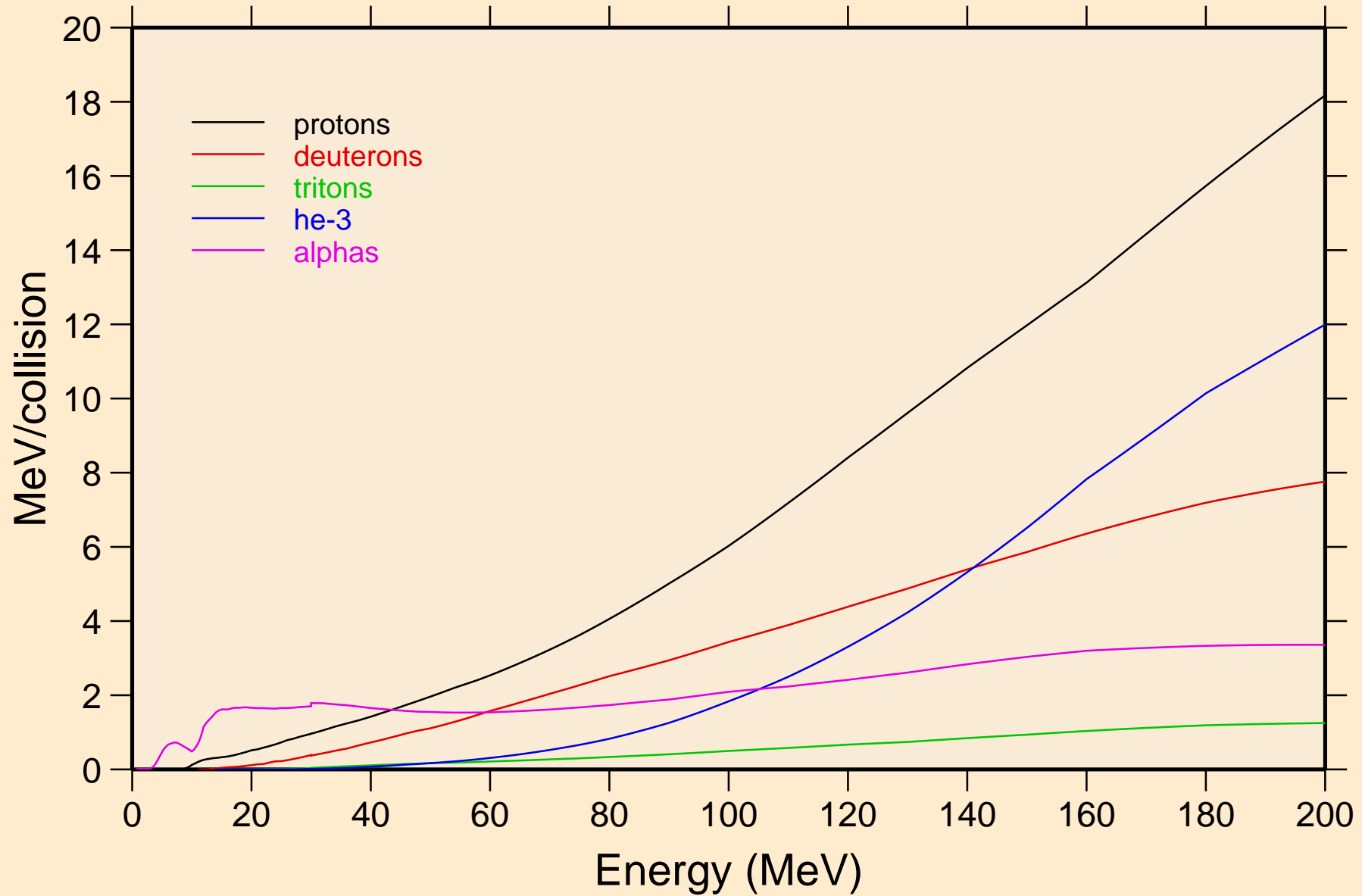

NE020 NEUTRON ACER TENDL-2024 LIBRARY; T=293.6K
Recoil Heating

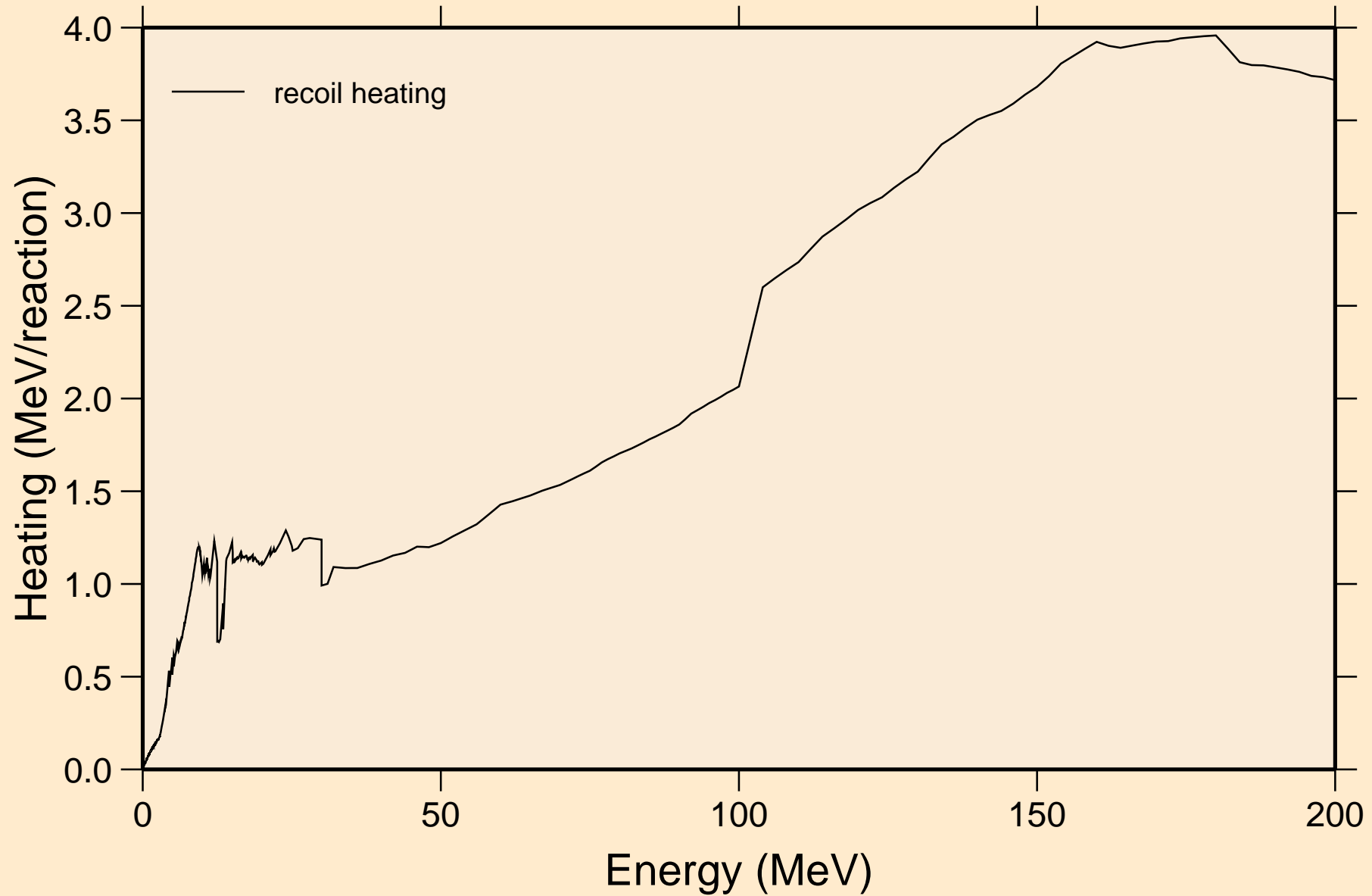

NE020 NEUTRON ACER TENDL-2024 LIBRARY; T=293.6K
Particle production cross sections

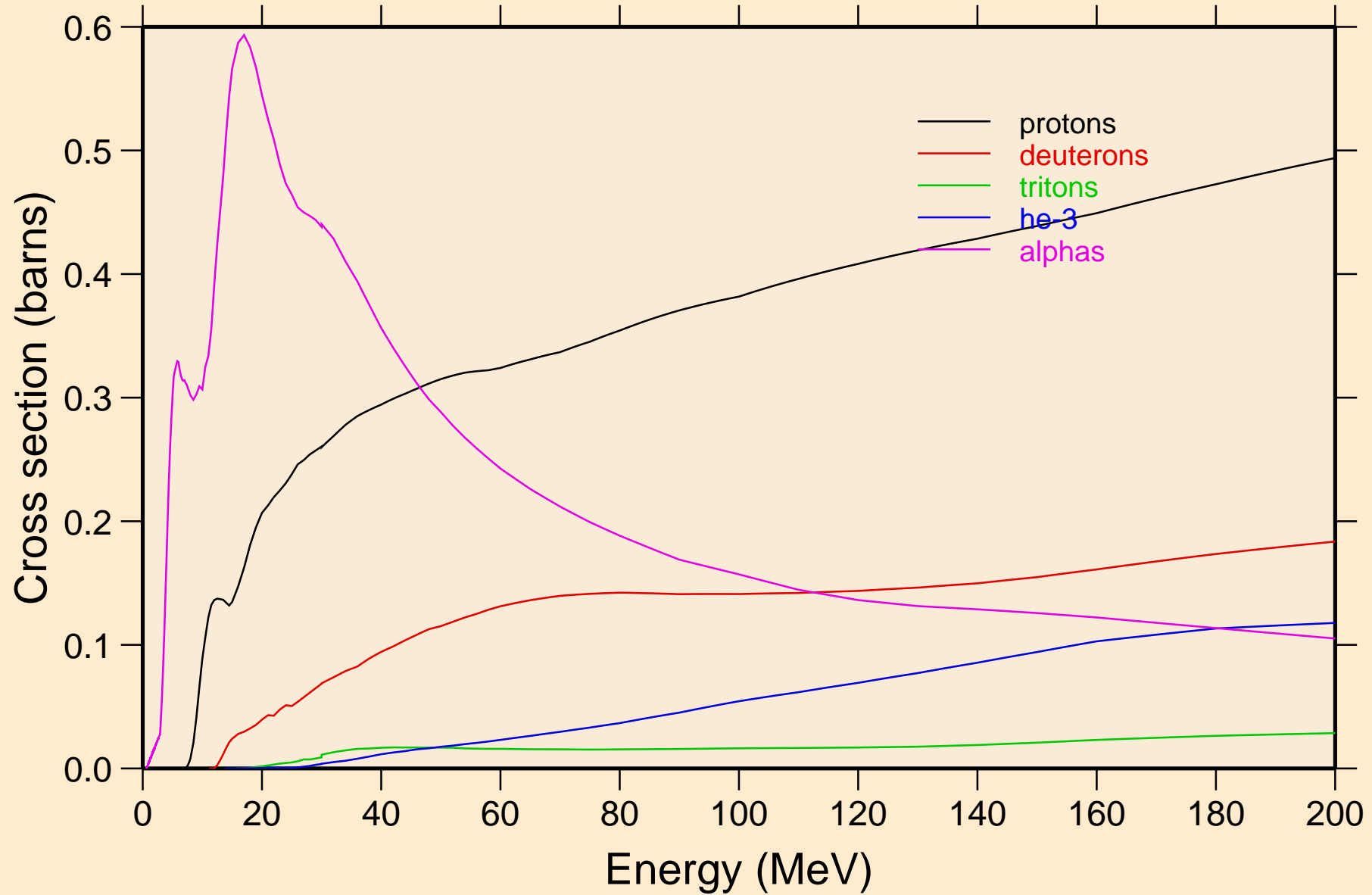

NE020 NEUTRON ACER TENDL-2024 LIBRARY; T=293.6K
protons from (n,x)

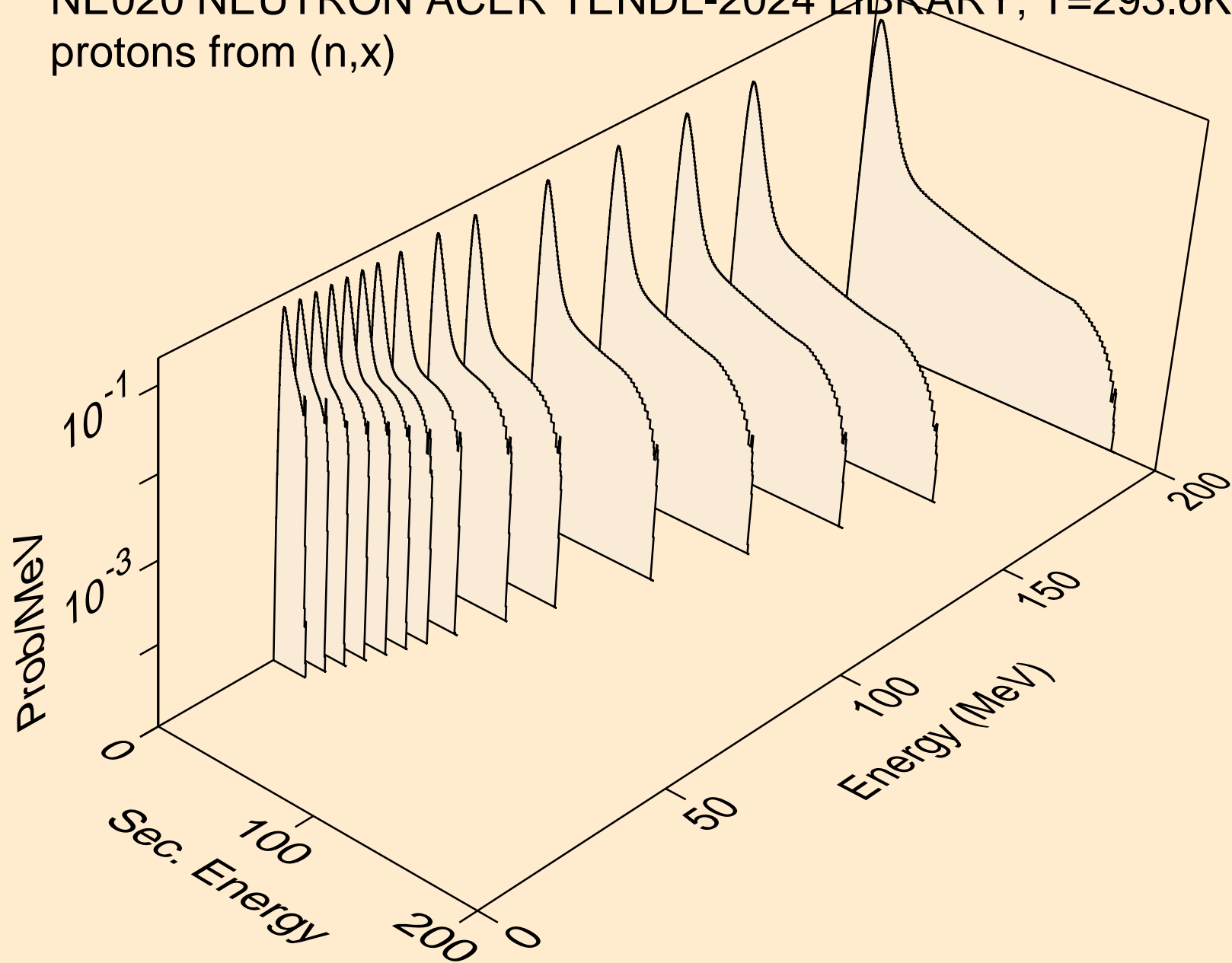

NE020 NEUTRON ACER TENDL-2024 LIBRARY; T=293.6K
protons from (n,n*)p

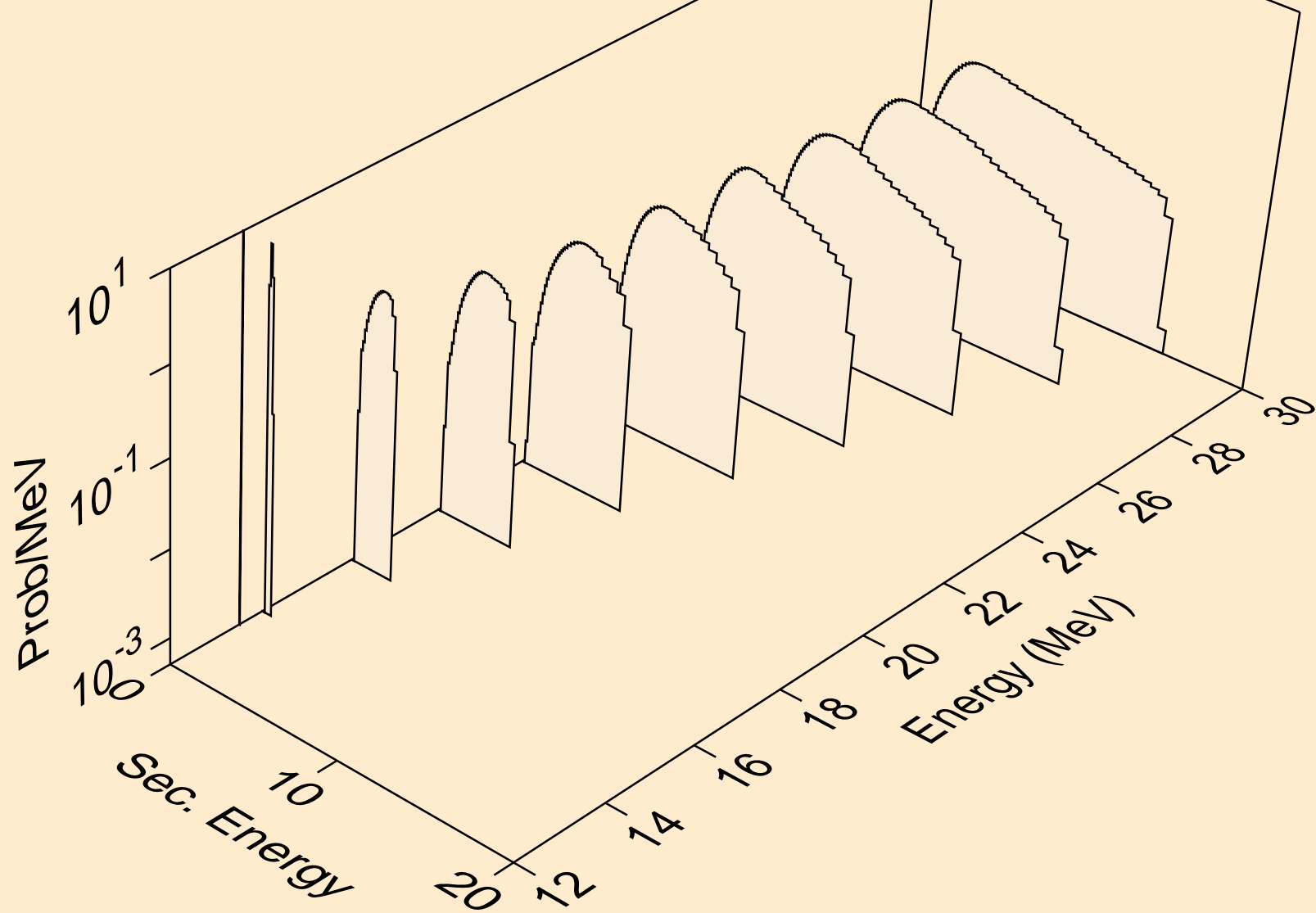

NE020 NEUTRON ACER TENDL-2024 LIBRARY; T=293.6K
protons from (n,2np)

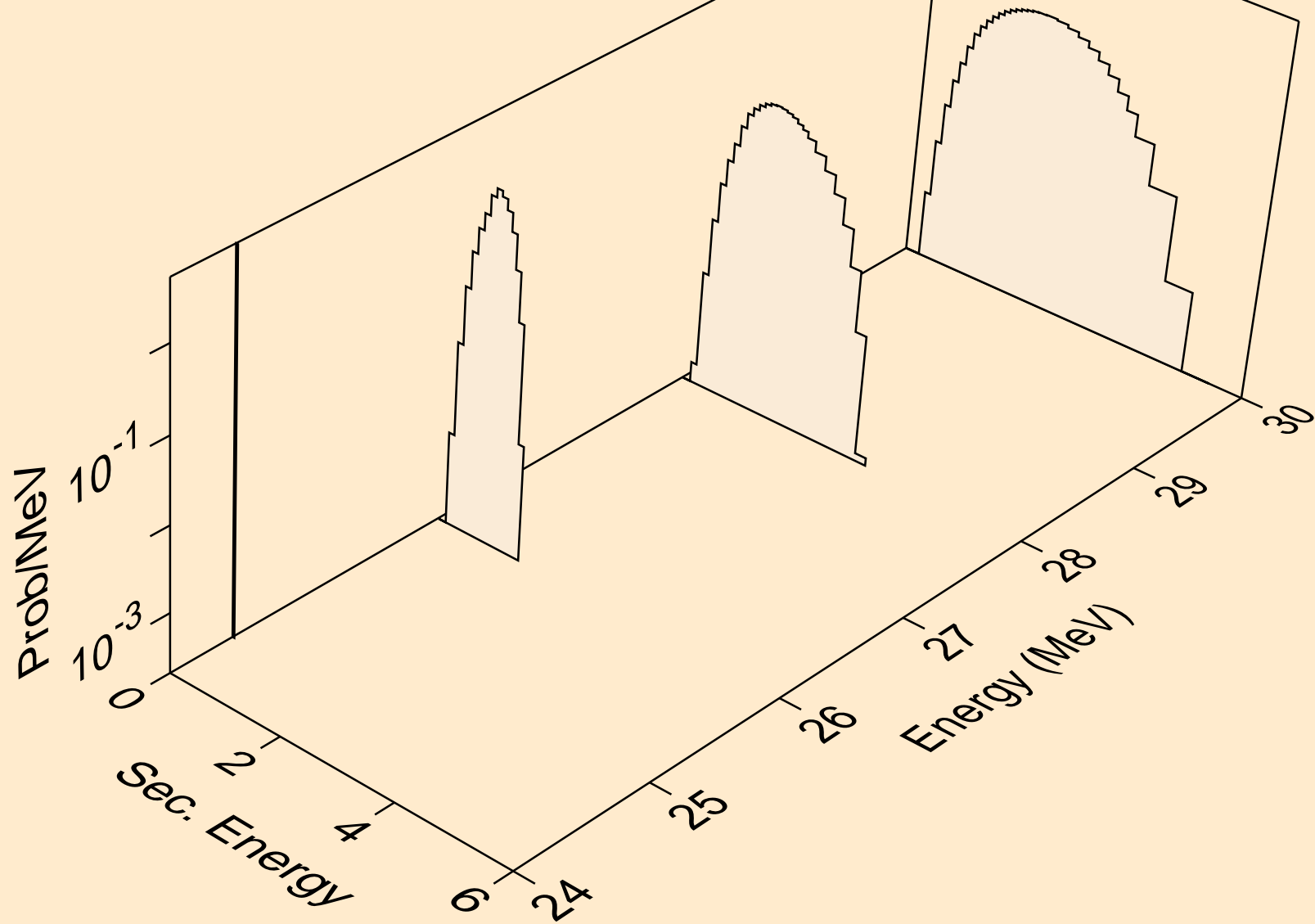

NE020 NEUTRON ACER TENDL-2024 LIBRARY; T=293.6K
protons from (n,n2p)

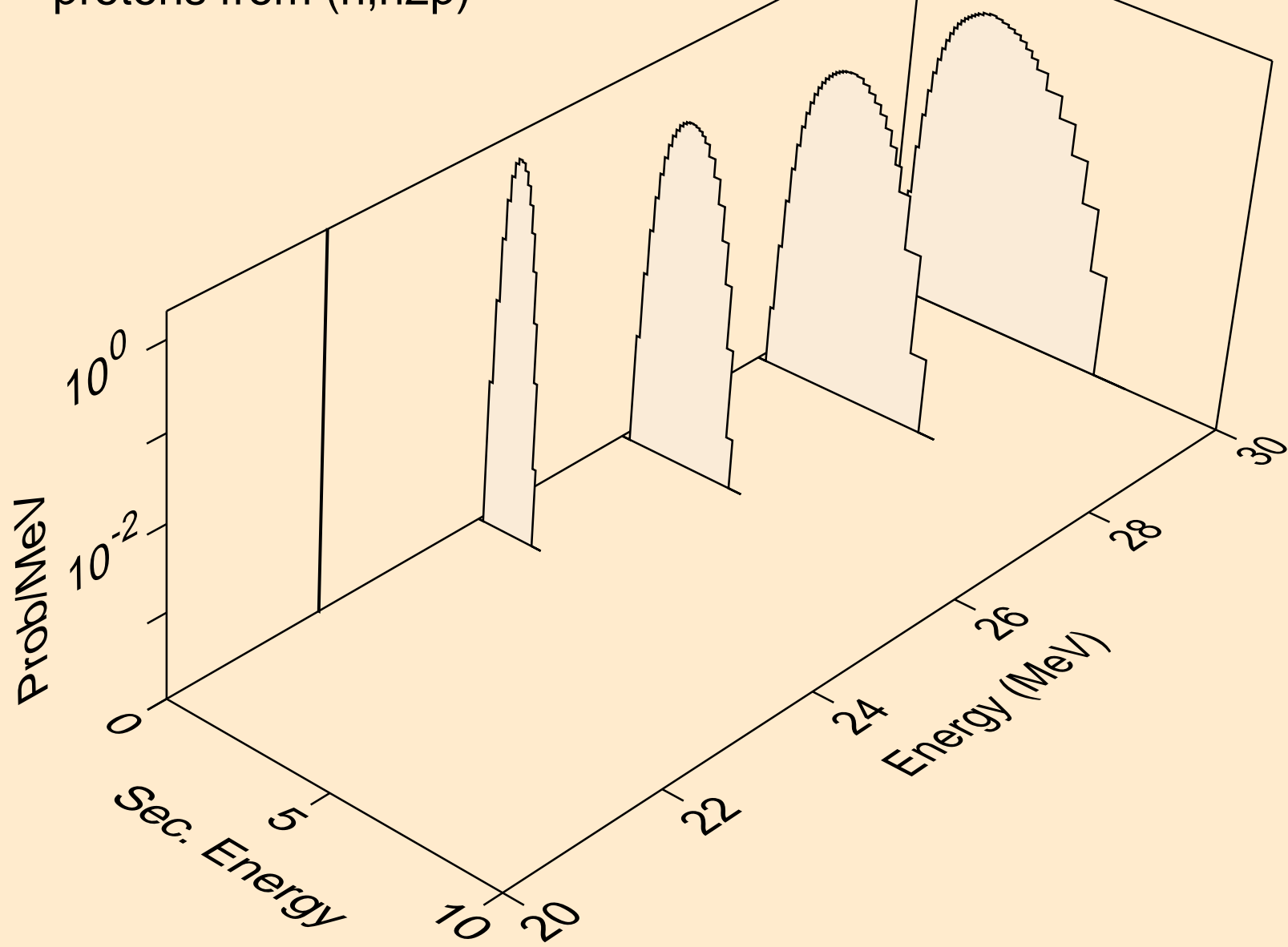

NE020 NEUTRON ACER TENDL-2024 LIBRARY; T=293.6K
protons from (n,npa)

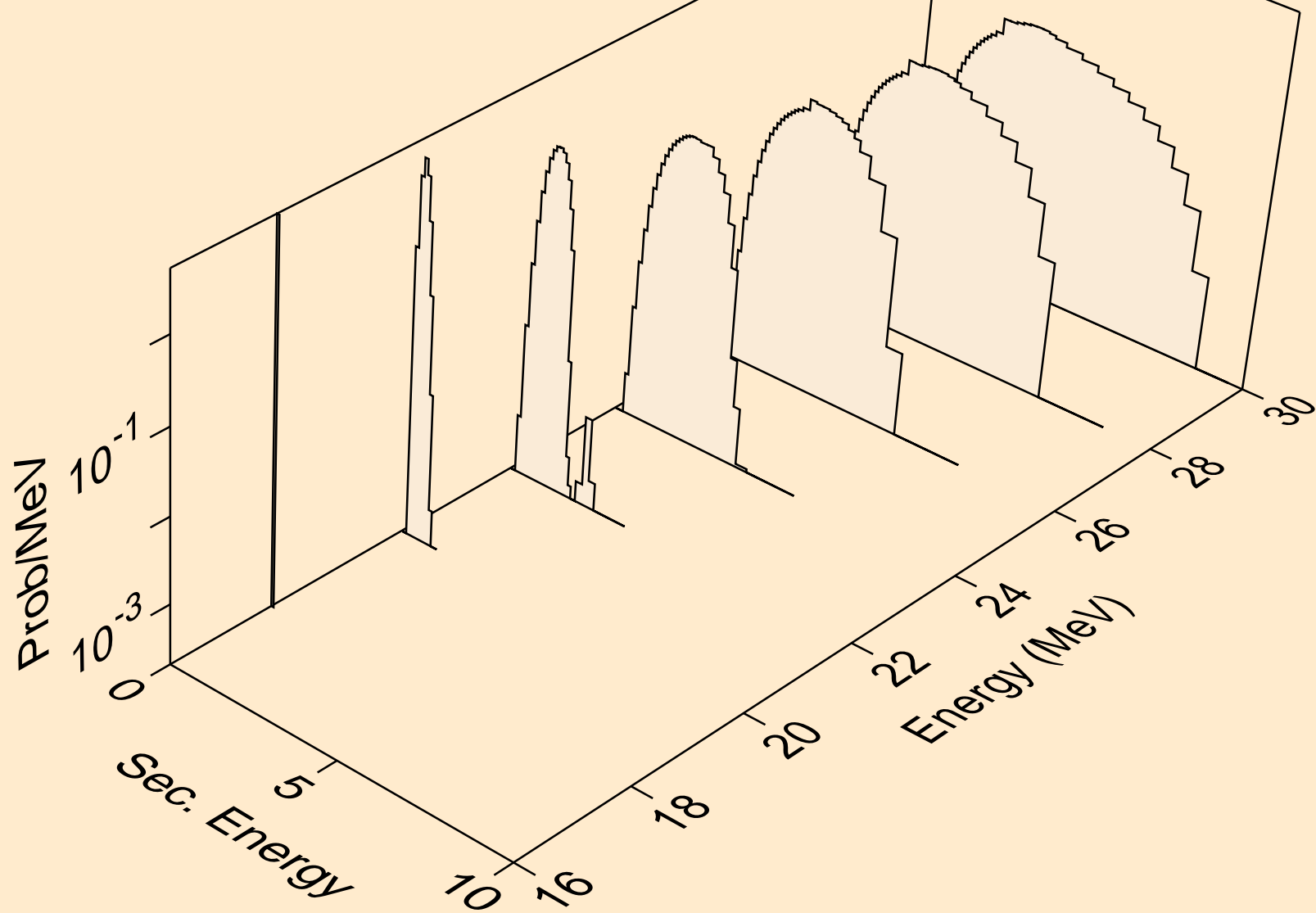

NE020 NEUTRON ACER TENDL-2024 LIBRARY; T=293.6K
protons from (n,p)

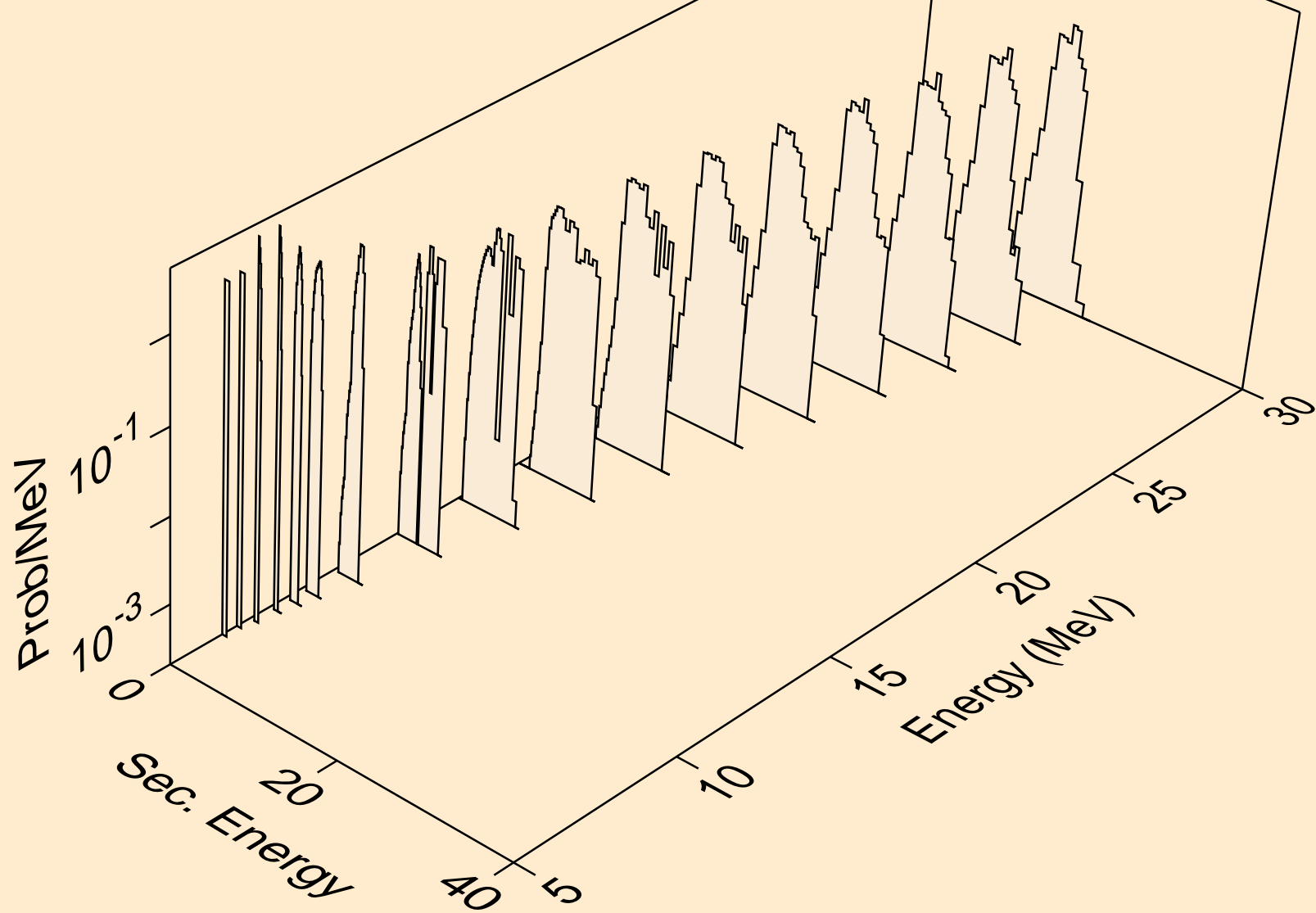

NE020 NEUTRON ACER TENDL-2024 LIBRARY; T=293.6K
protons from (n,2p)

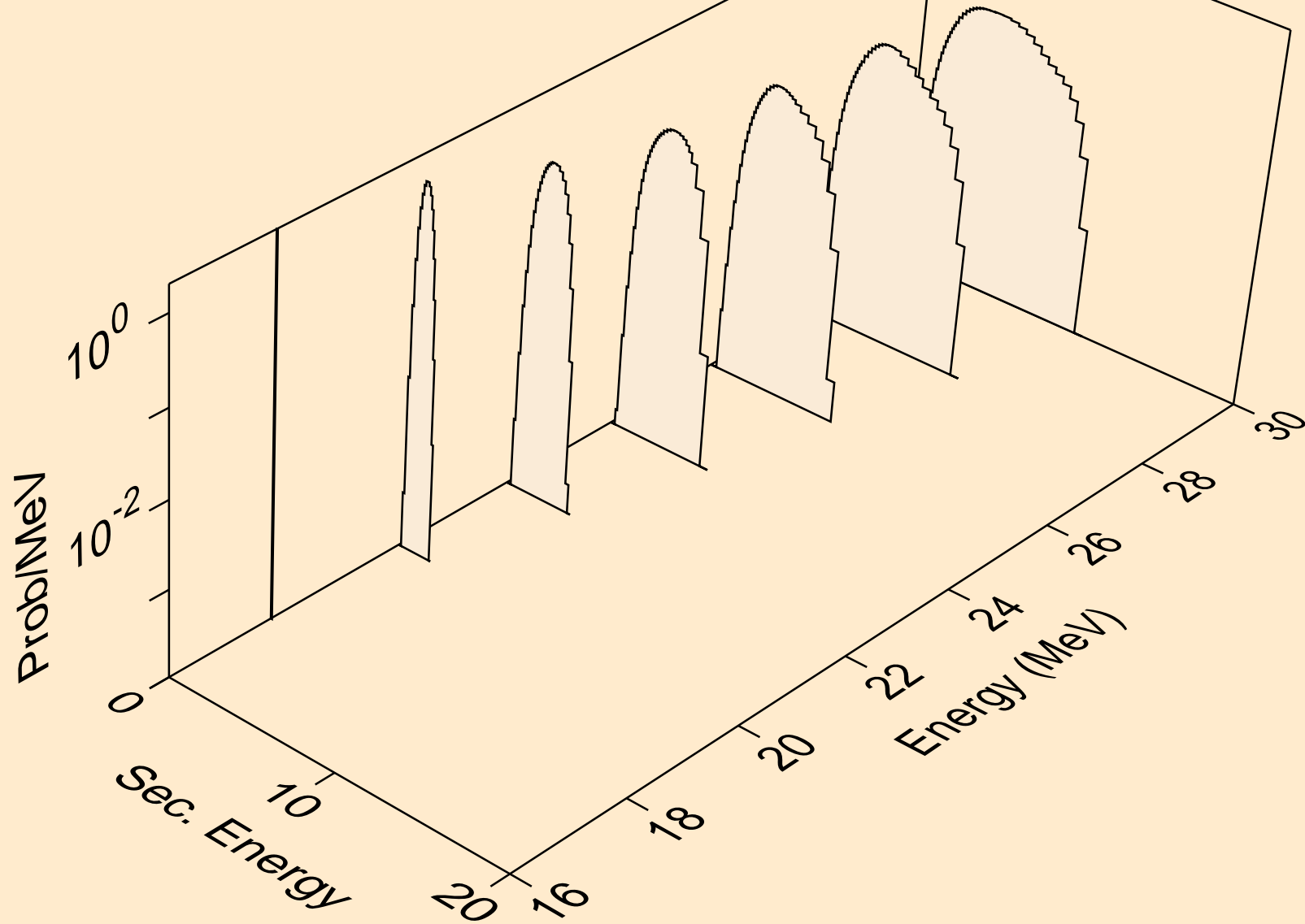

NE020 NEUTRON ACER TENDL-2024 LIBRARY; T=293.6K
protons from (n,p)

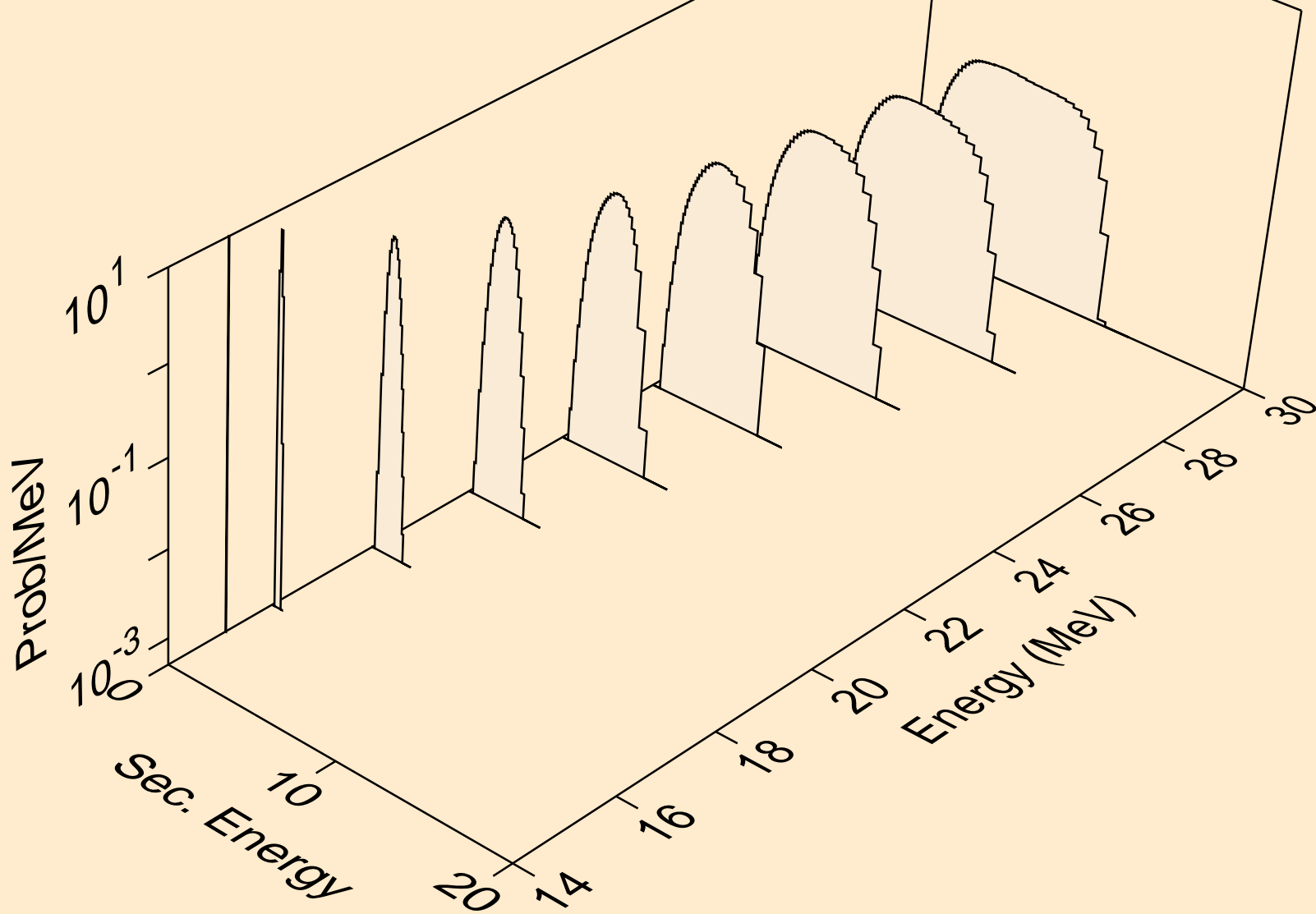

NE020 NEUTRON ACER TENDL-2024 LIBRARY; T=293.6K
protons from (n,pd)

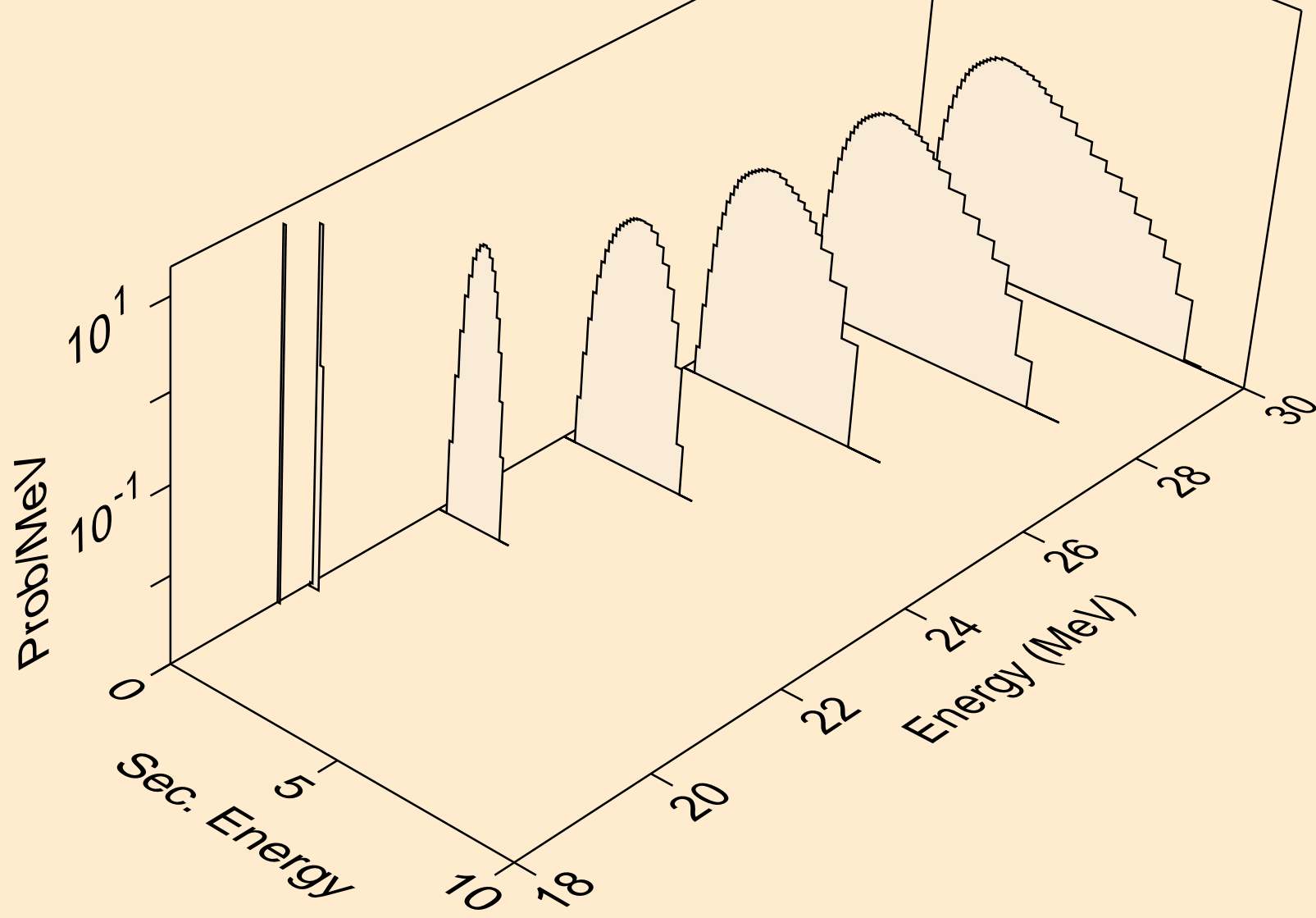

NE020 NEUTRON ACER TENDL-2024 LIBRARY; T=293.6K
protons from (n,pt)

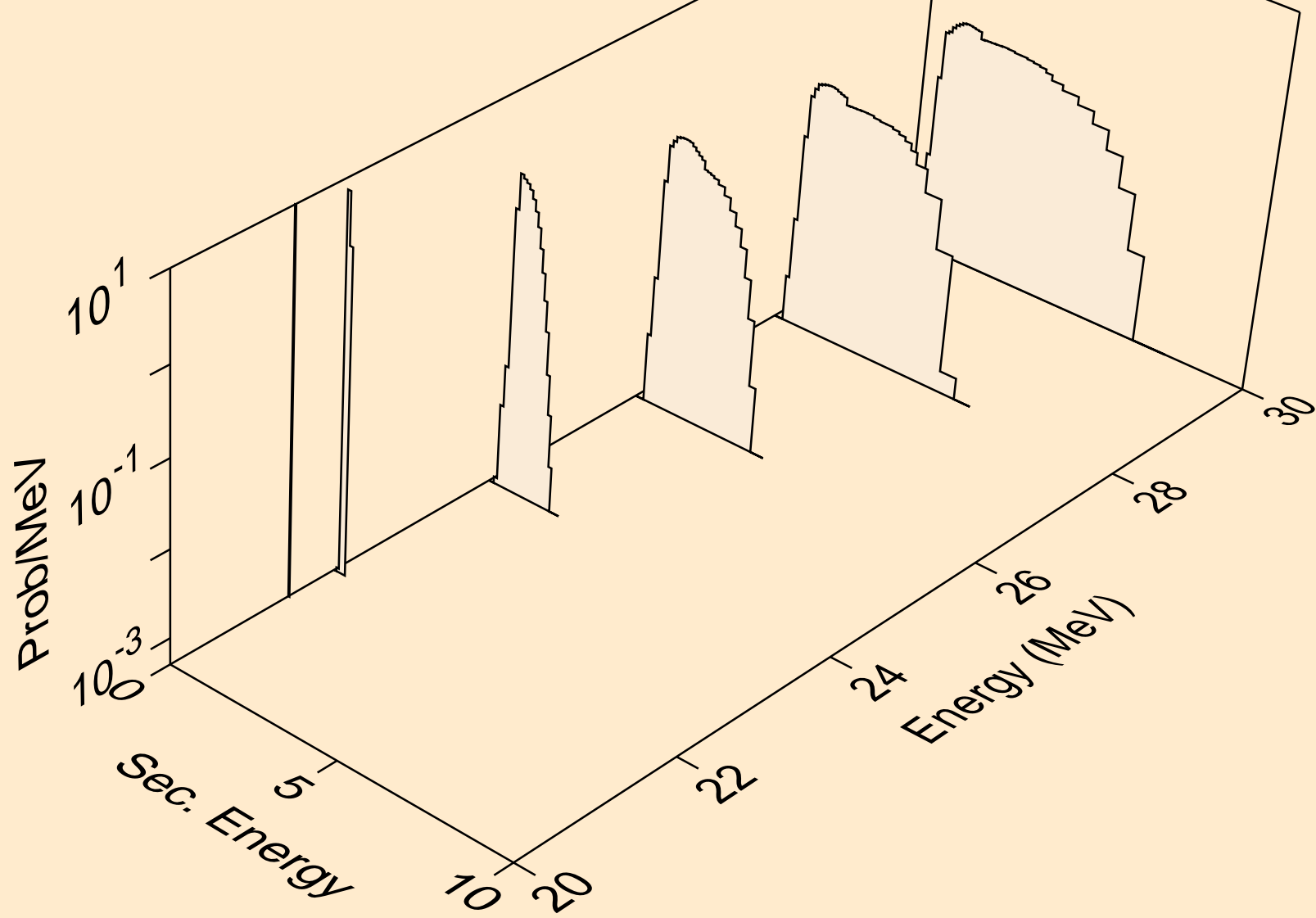

NE020 NEUTRON ACER TENDL-2024 LIBRARY; T=293.6K
deuterons from (n,x)

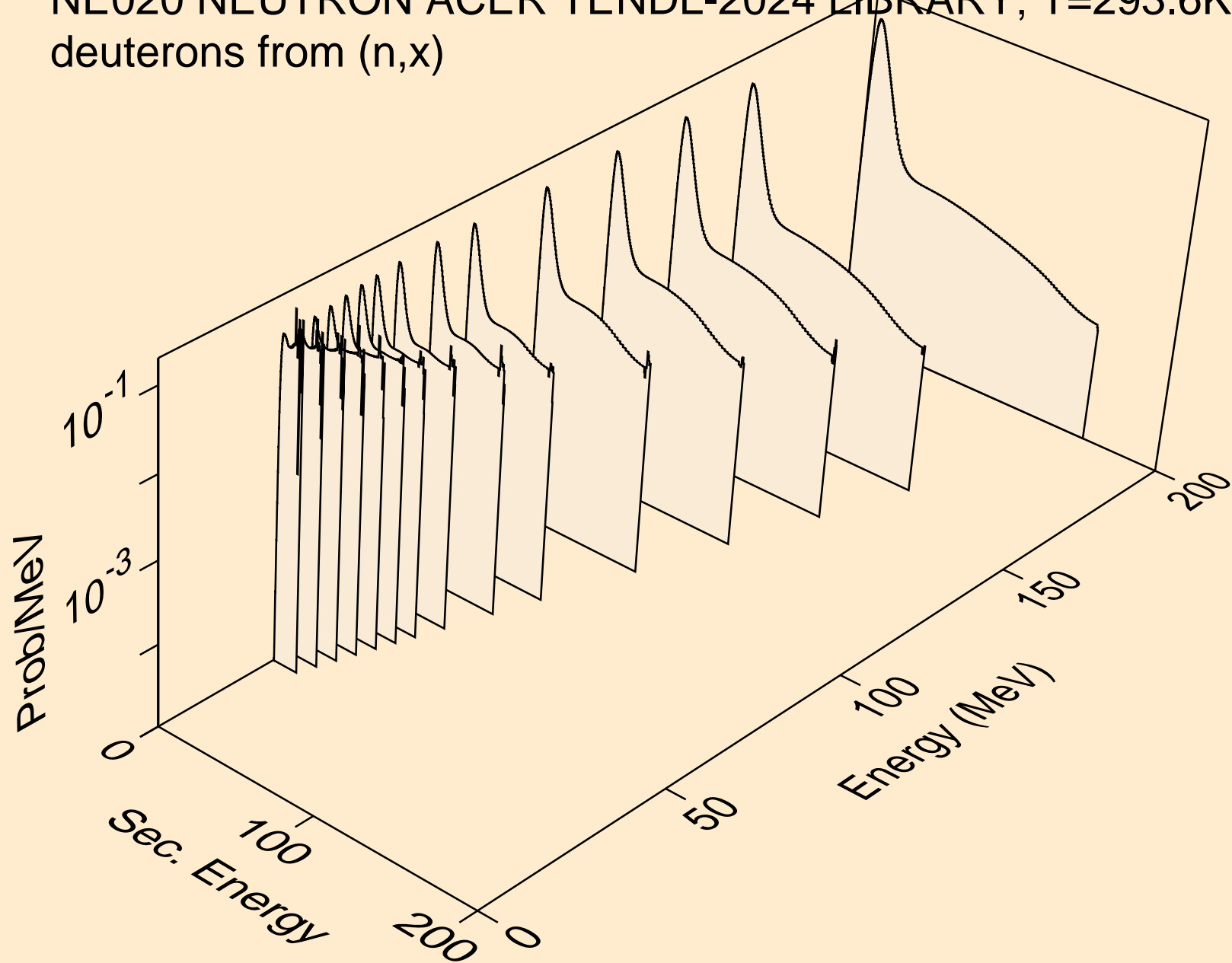

NE020 NEUTRON ACER TENDL-2024 LIBRARY; T=293.6K
deuterons from (n,n*)d

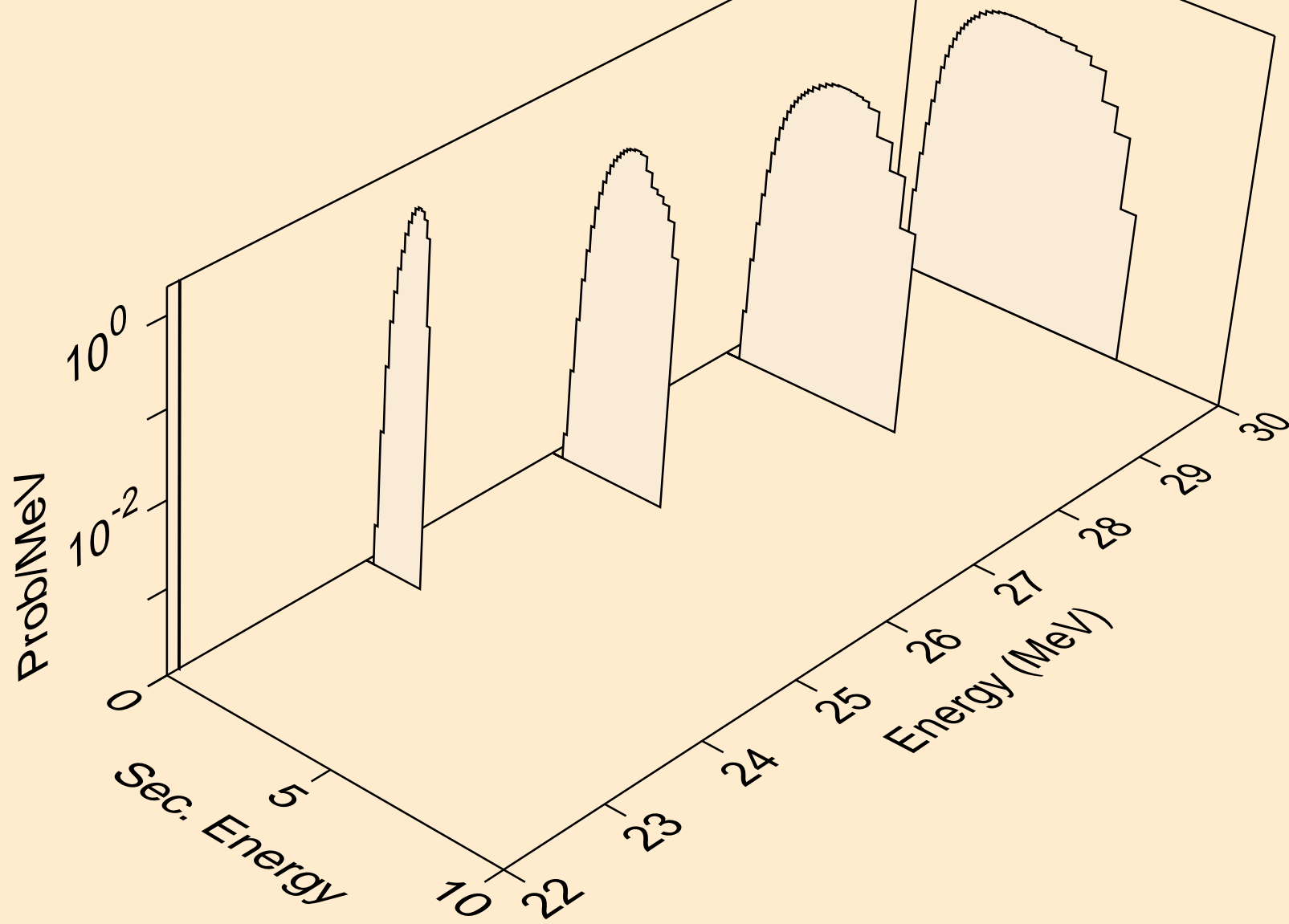

NE020 NEUTRON ACER TENDL-2024 LIBRARY; T=293.6K
deuterons from (n,d)

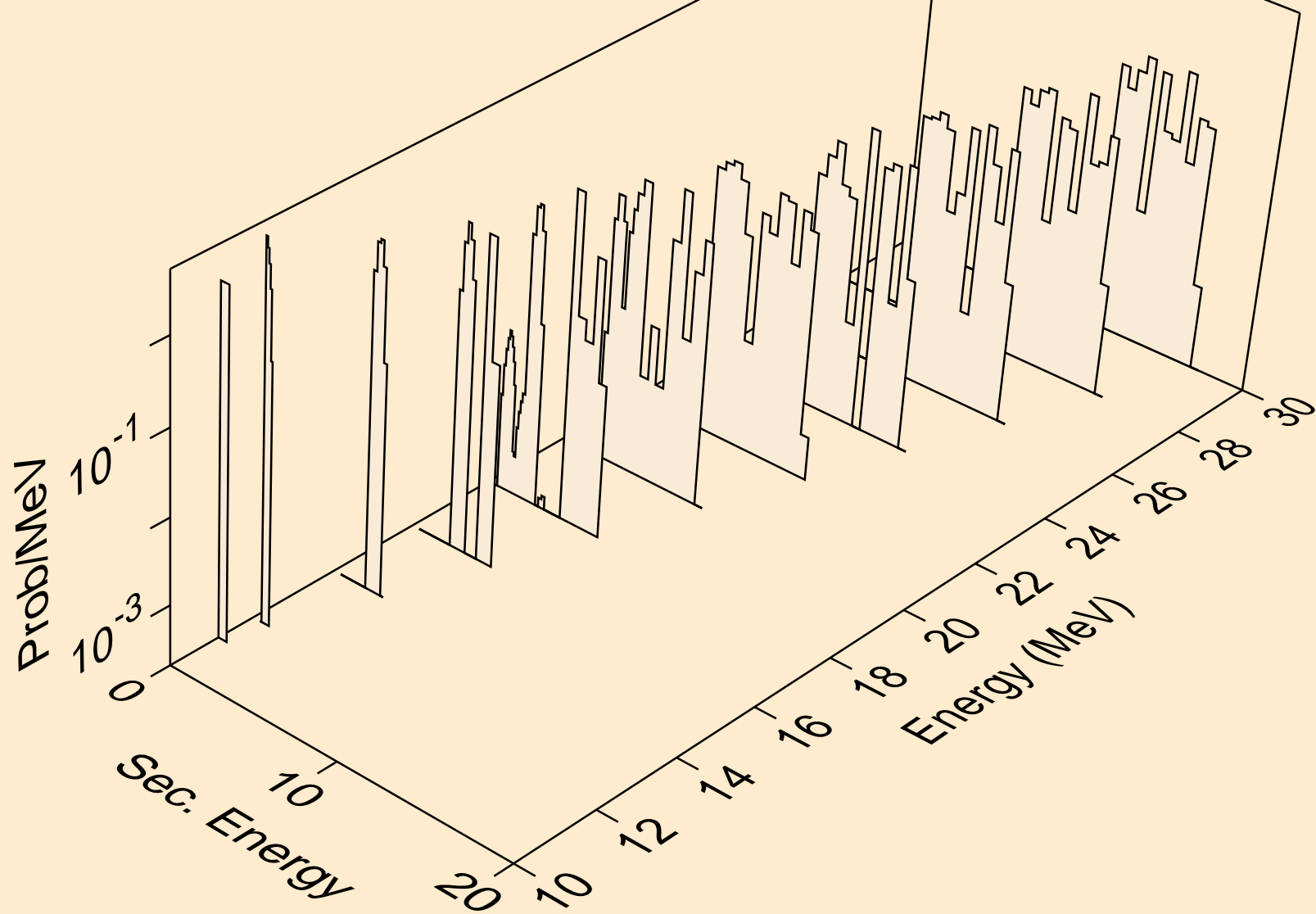

NE020 NEUTRON ACER TENDL-2024 LIBRARY; T=293.6K
deuterons from (n,pd)

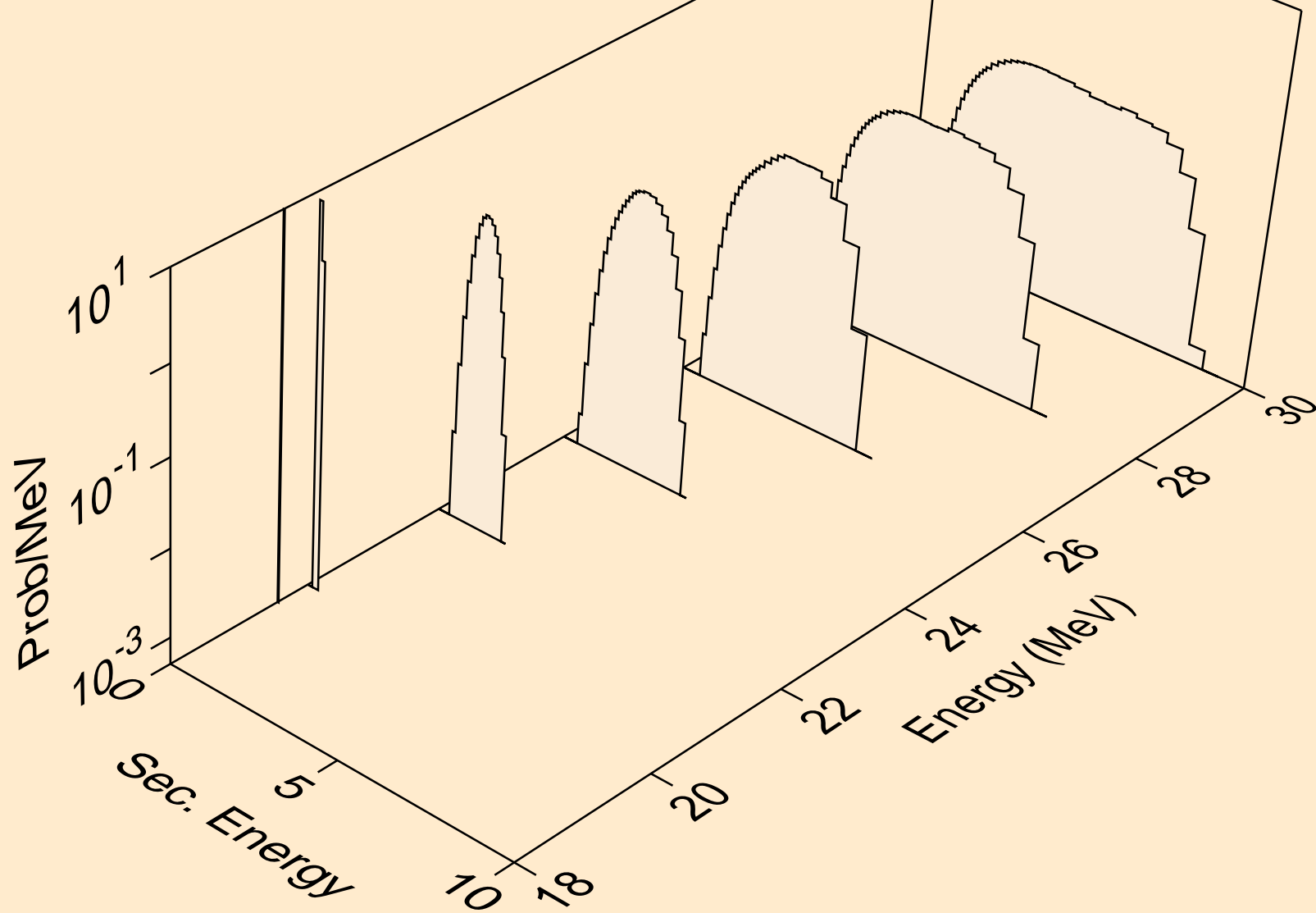

NE020 NEUTRON ACER TENDL-2024 LIBRARY; T=293.6K
deuterons from (n,da)

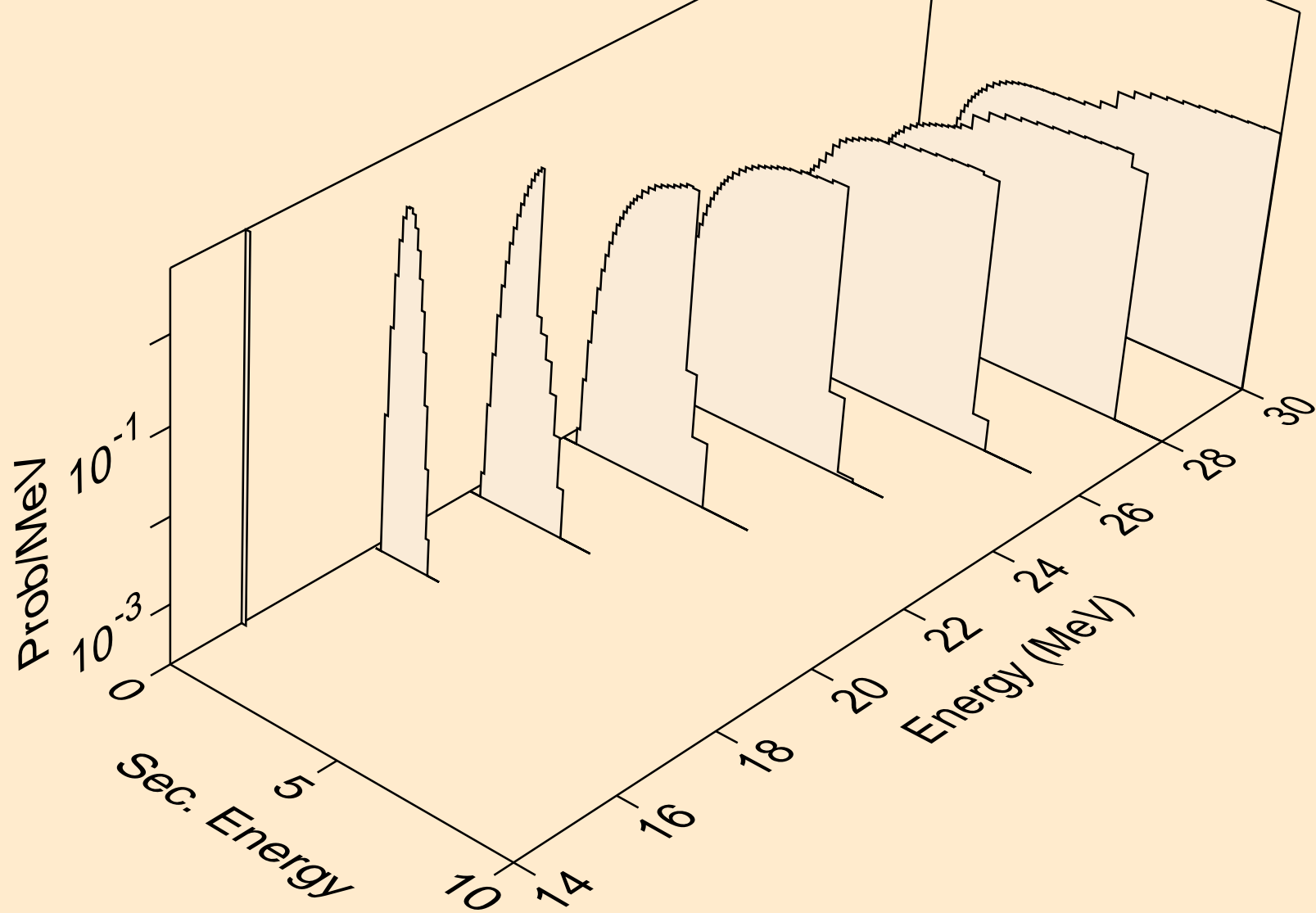

NE020 NEUTRON ACER TENDL-2024 LIBRARY; T=293.6K
tritons from (n,x)

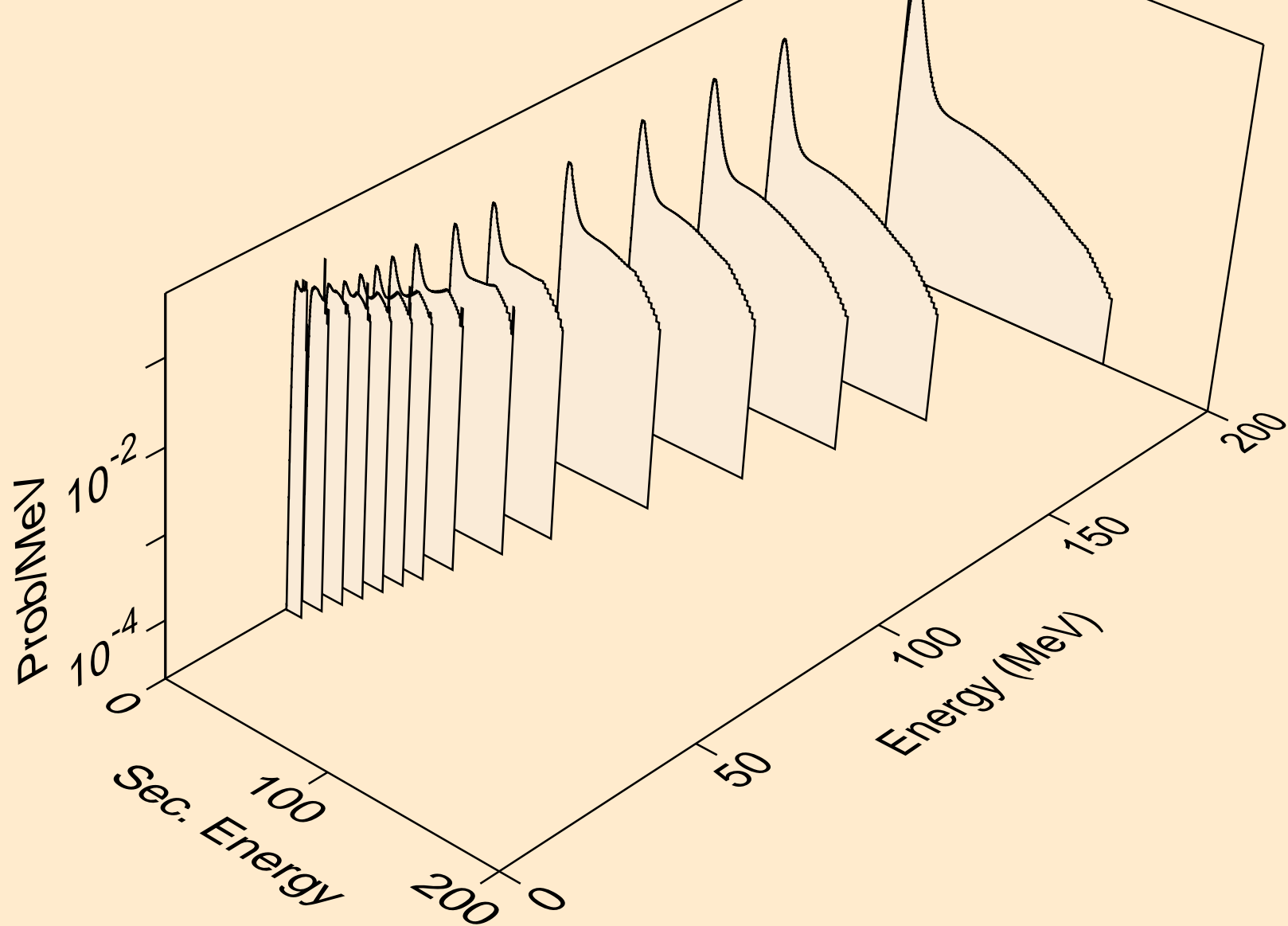

NE020 NEUTRON ACER TENDL-2024 LIBRARY; T=293.6K
tritons from (n,n*)t

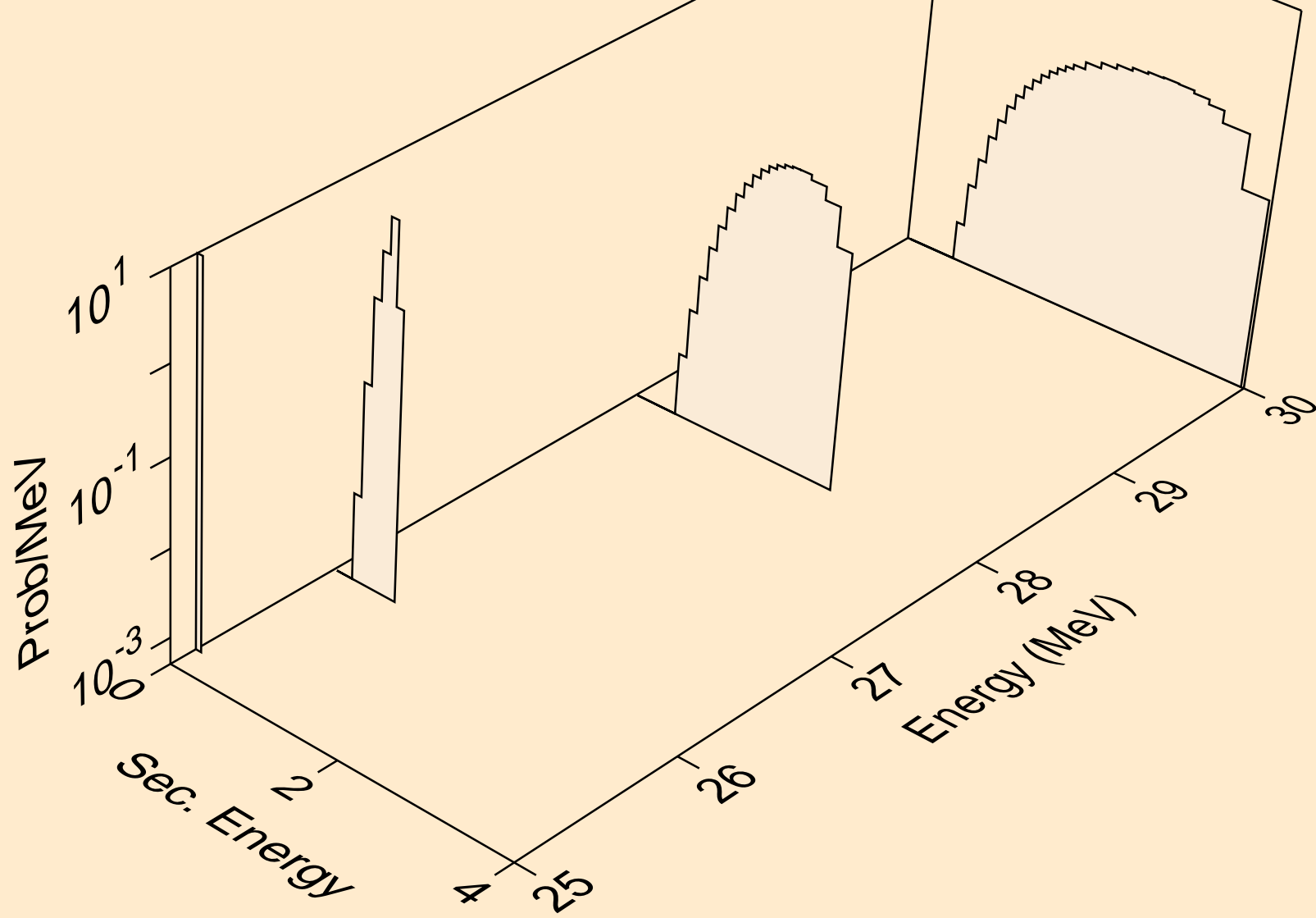

NE020 NEUTRON ACER TENDL-2024 LIBRARY; T=293.6K
tritons from (n,t)

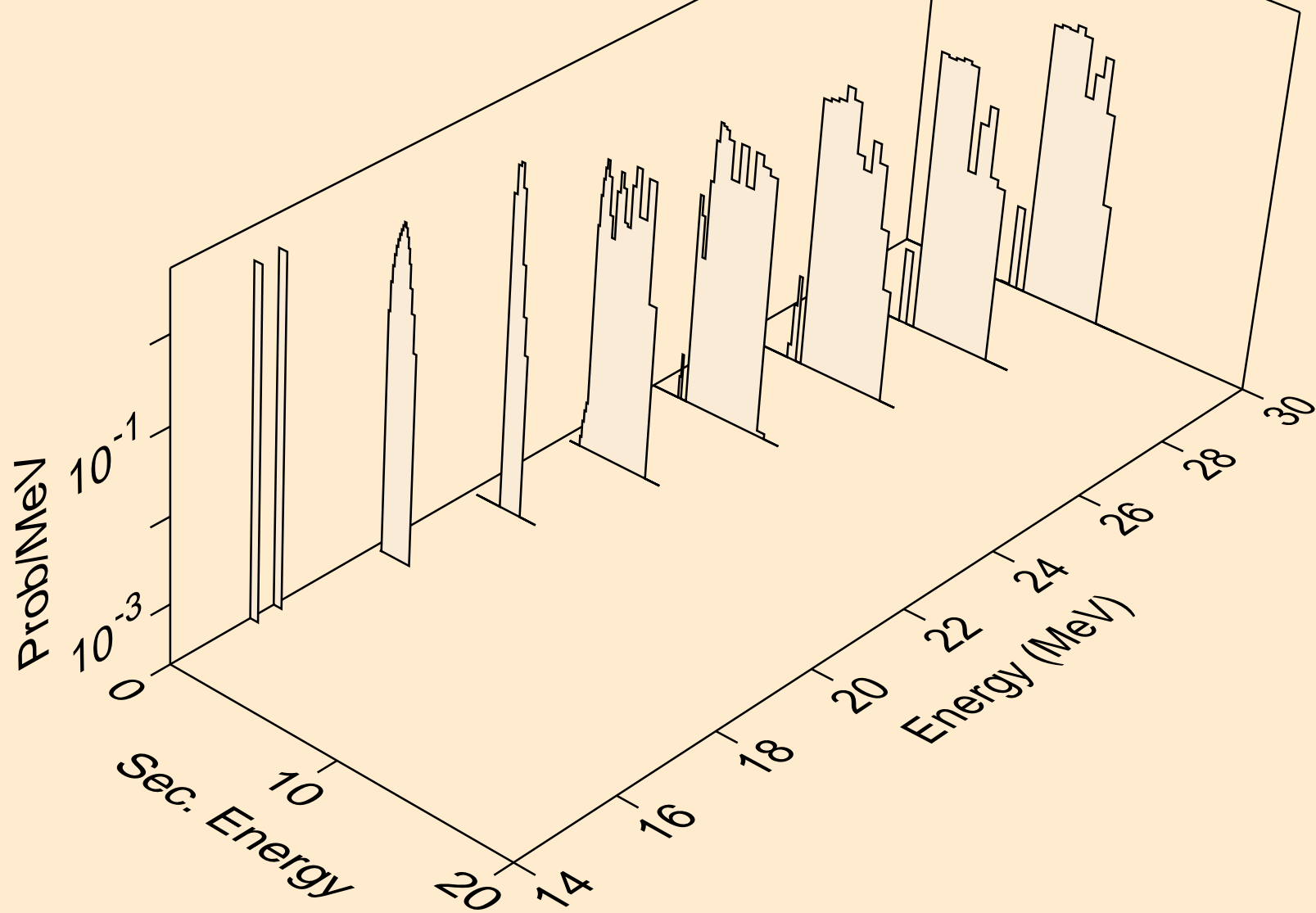

NE020 NEUTRON ACER TENDL-2024 LIBRARY; T=293.6K
tritons from (n,pt)

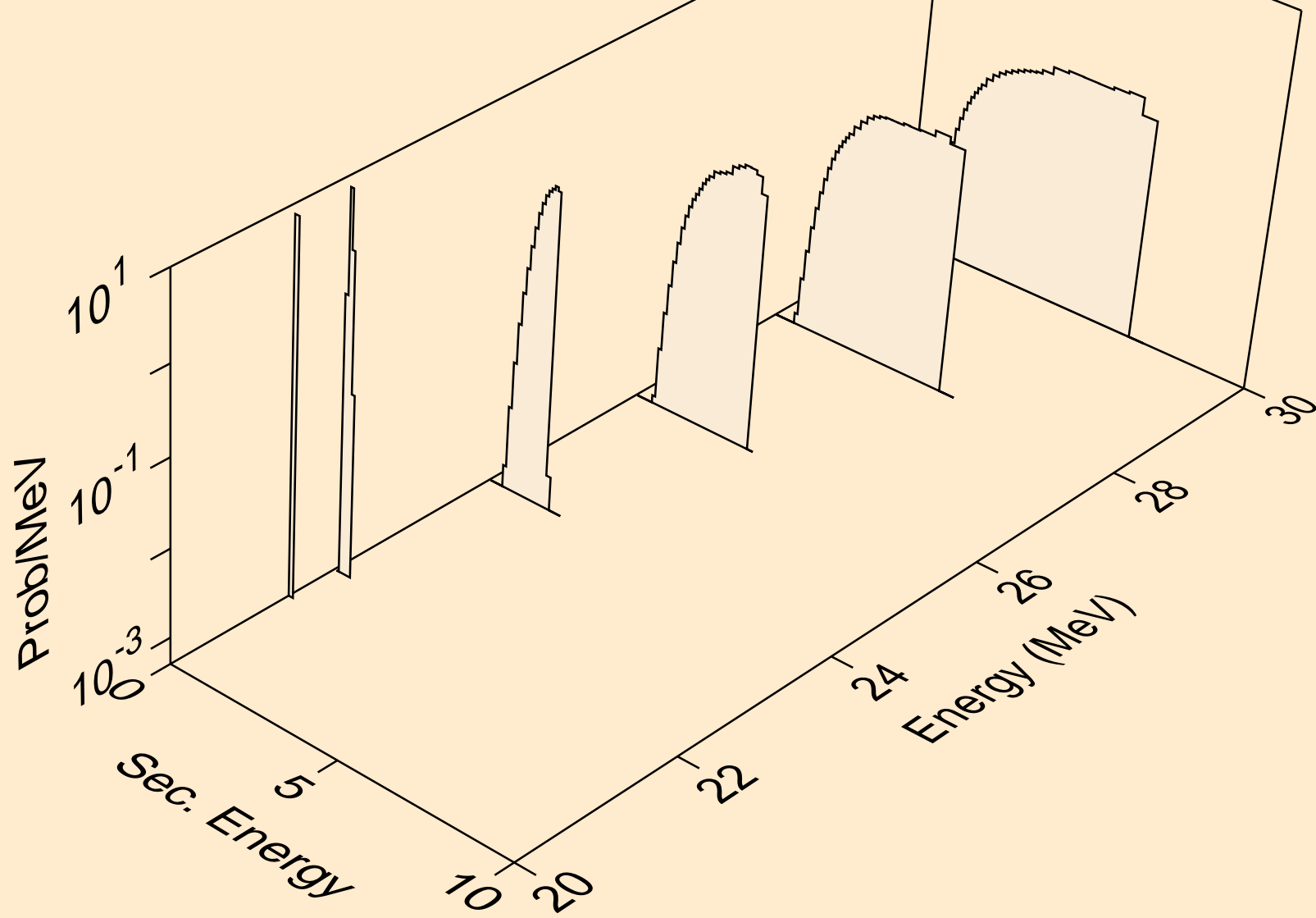

NE020 NEUTRON ACER TENDL-2024 LIBRARY; T=293.6K
he3s from (n,x)

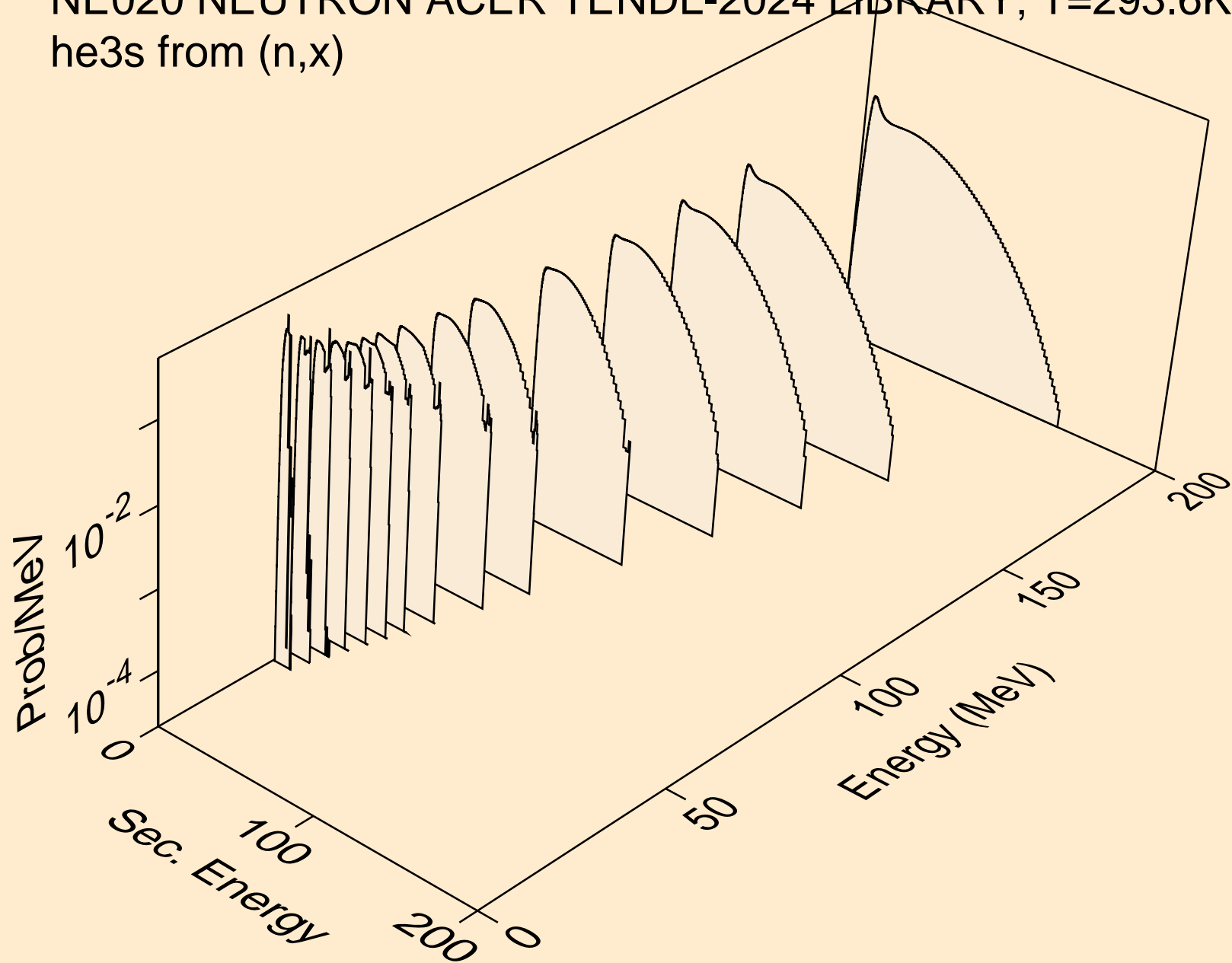

NE020 NEUTRON ACER TENDL-2024 LIBRARY; T=293.6K
he3s from (n,n*)he3

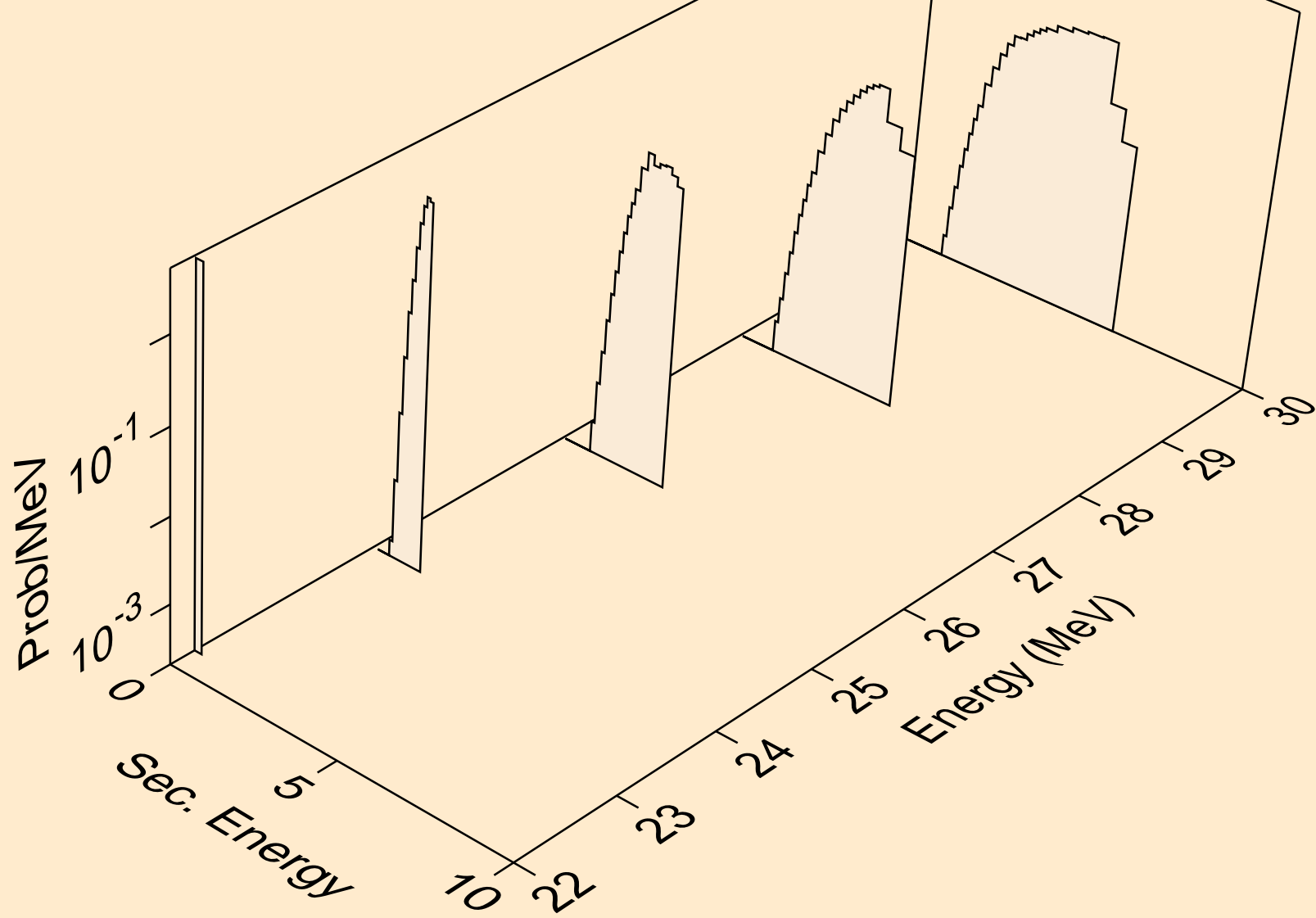

NE020 NEUTRON ACER TENDL-2024 LIBRARY; T=293.6K
he3s from (n,he3)

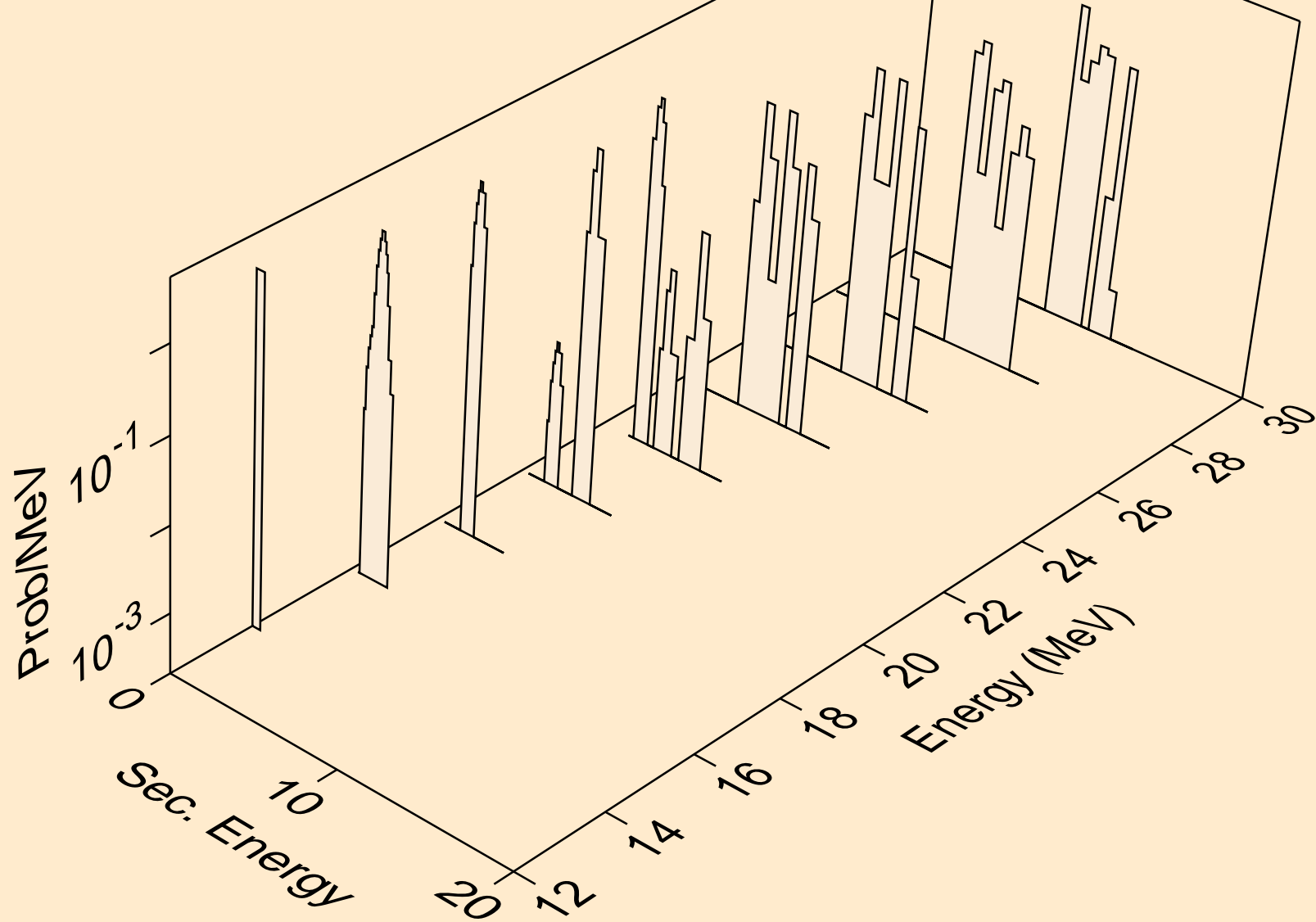

NE020 NEUTRON ACER TENDL-2024 LIBRARY; T=293.6K
alphas from (n,x)

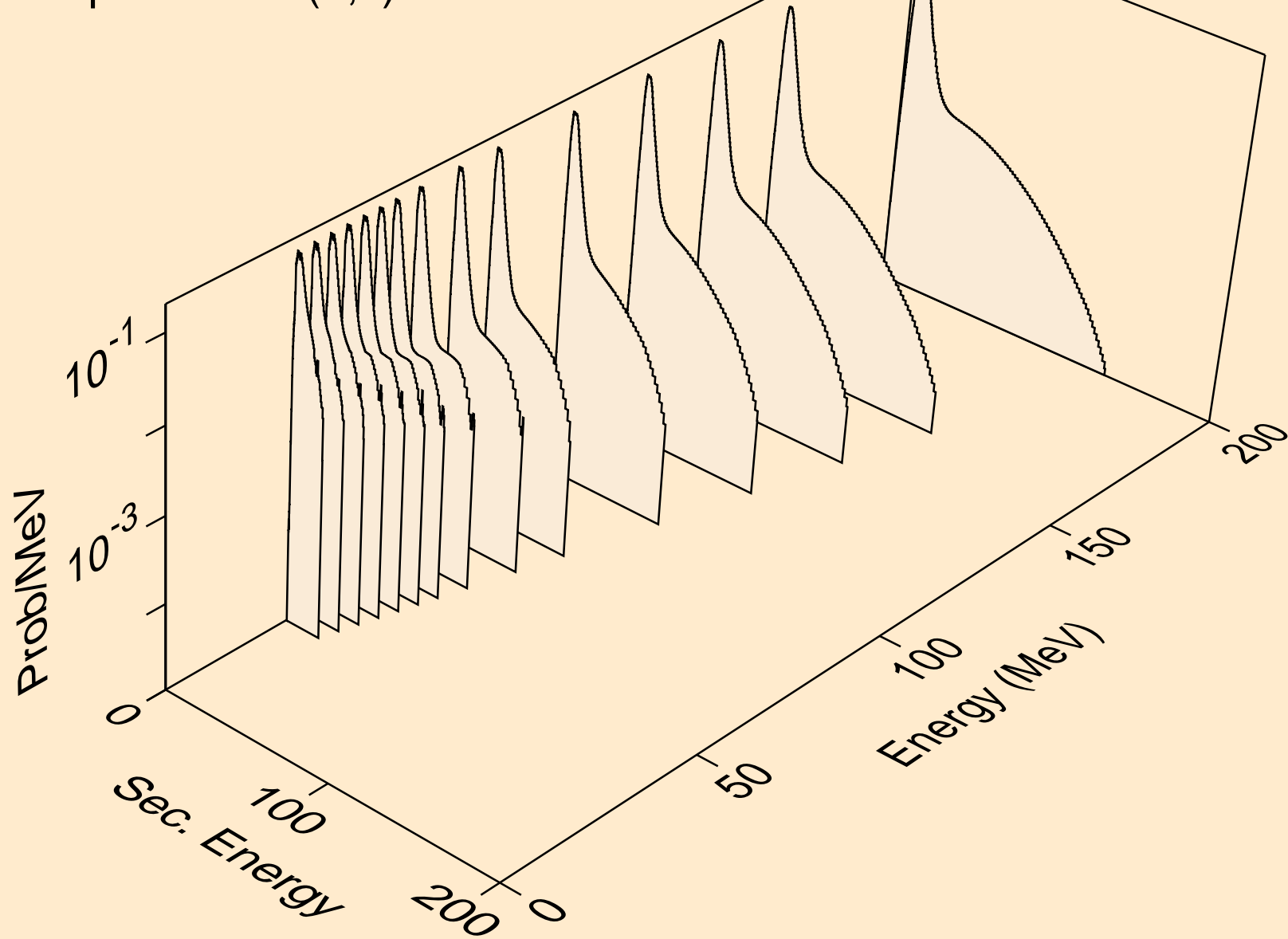

NE020 NEUTRON ACER TENDL-2024 LIBRARY; T=293.6K
alphas from (n,n*)a

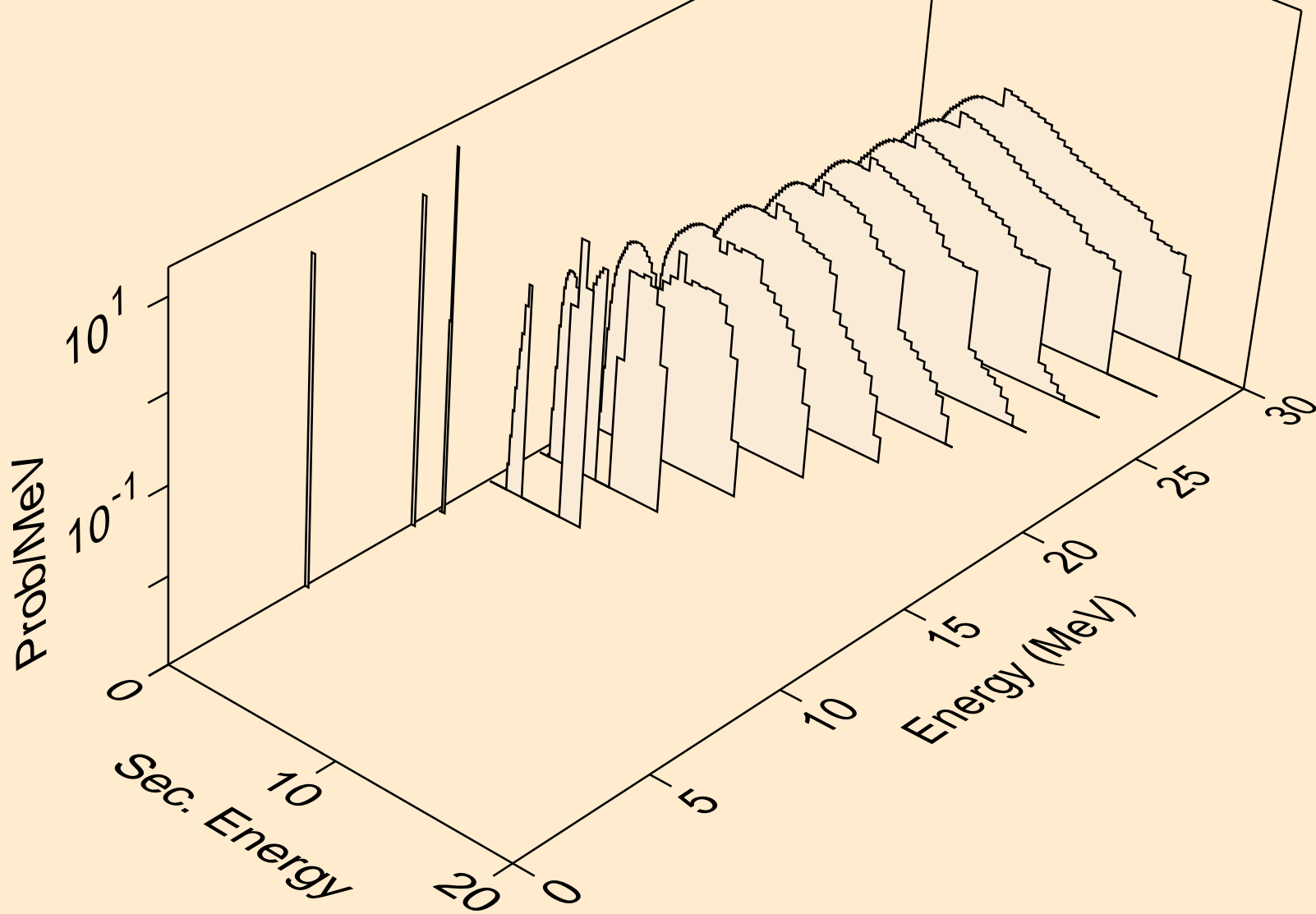

NE020 NEUTRON ACER TENDL-2024 LIBRARY; T=293.6K
alphas from (n,n*)3a

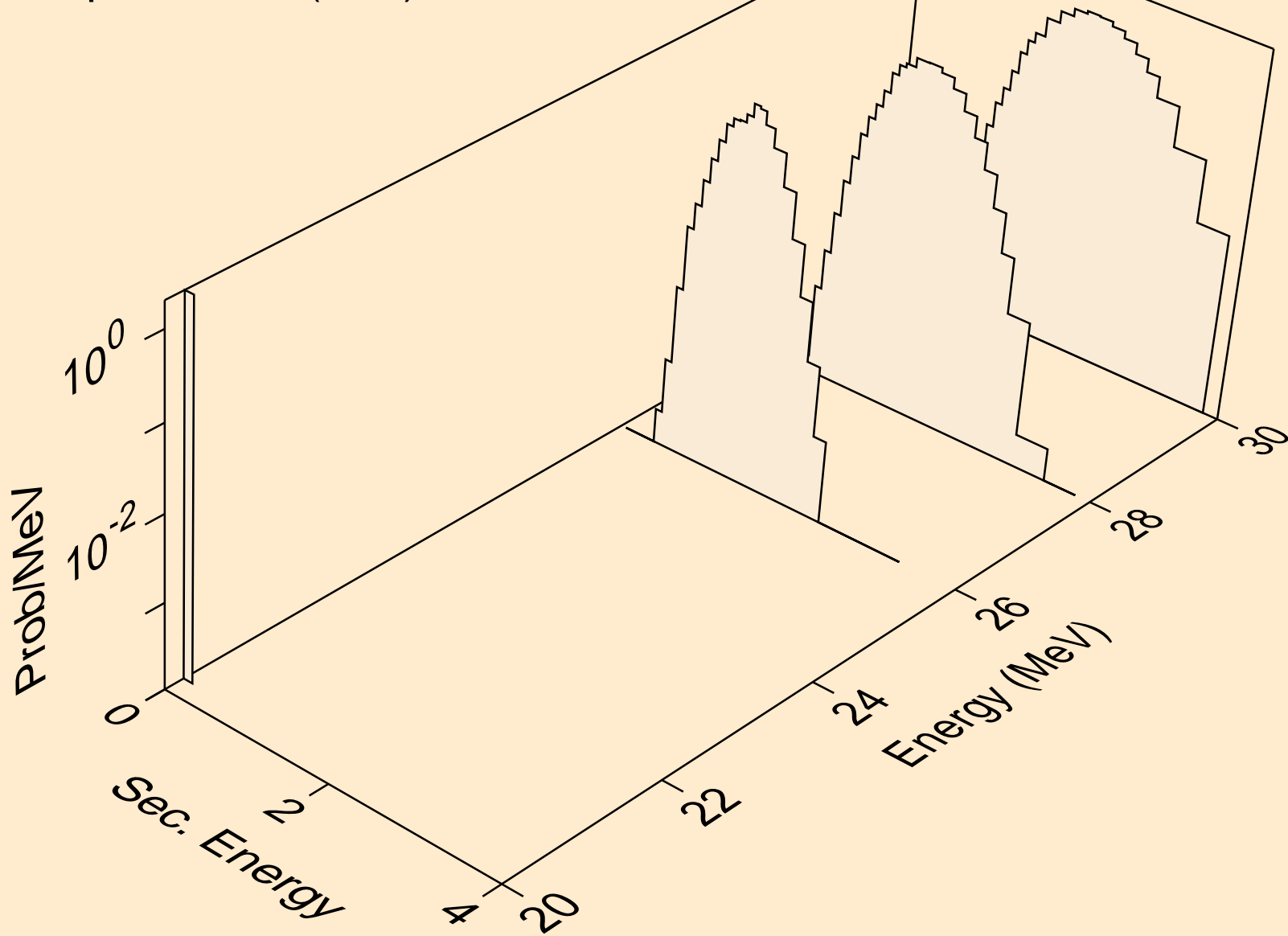

NE020 NEUTRON ACER TENDL-2024 LIBRARY; T=293.6K
alphas from (n,2n)a

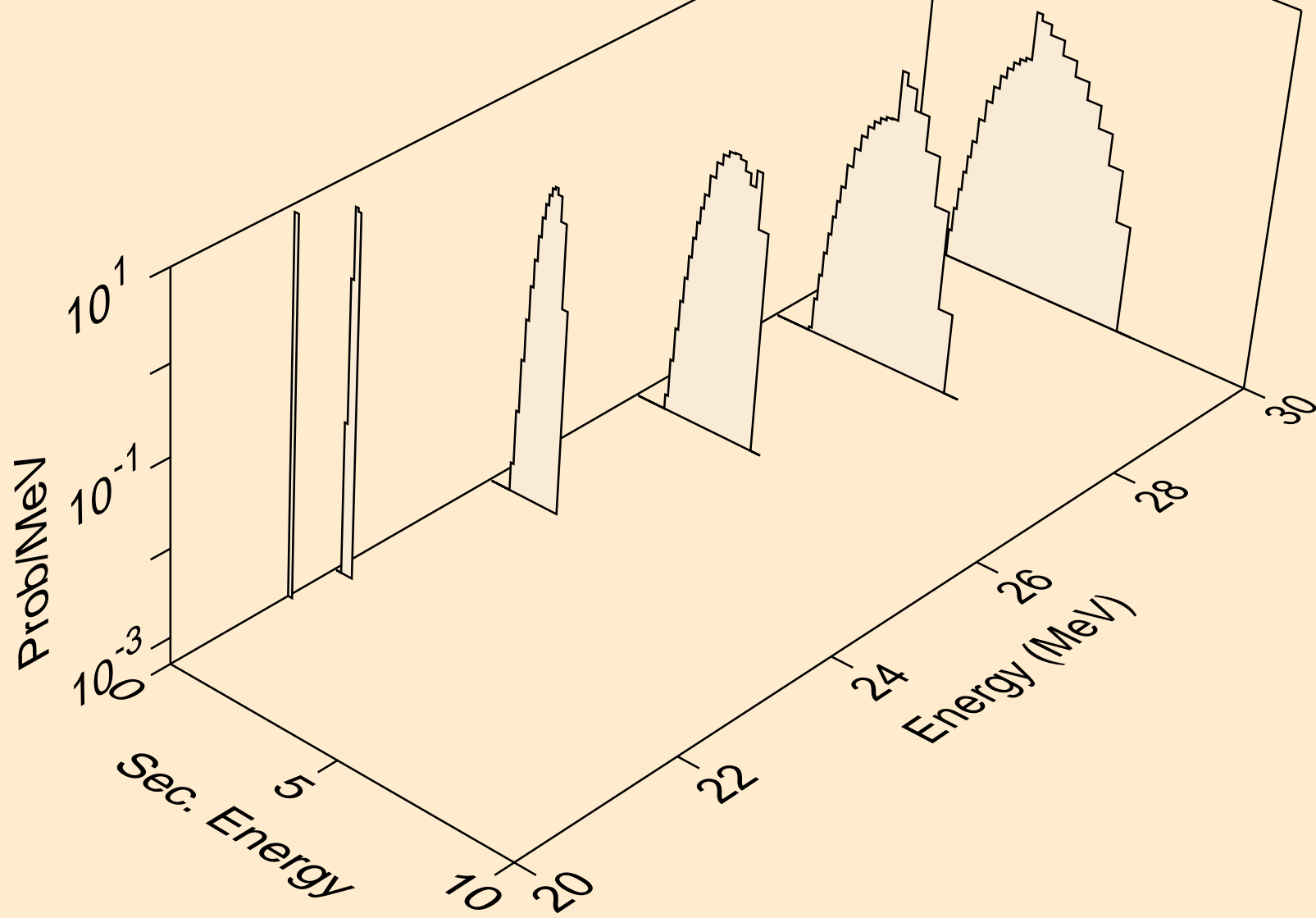

NE020 NEUTRON ACER TENDL-2024 LIBRARY; T=293.6K
alphas from (n,n*)2a

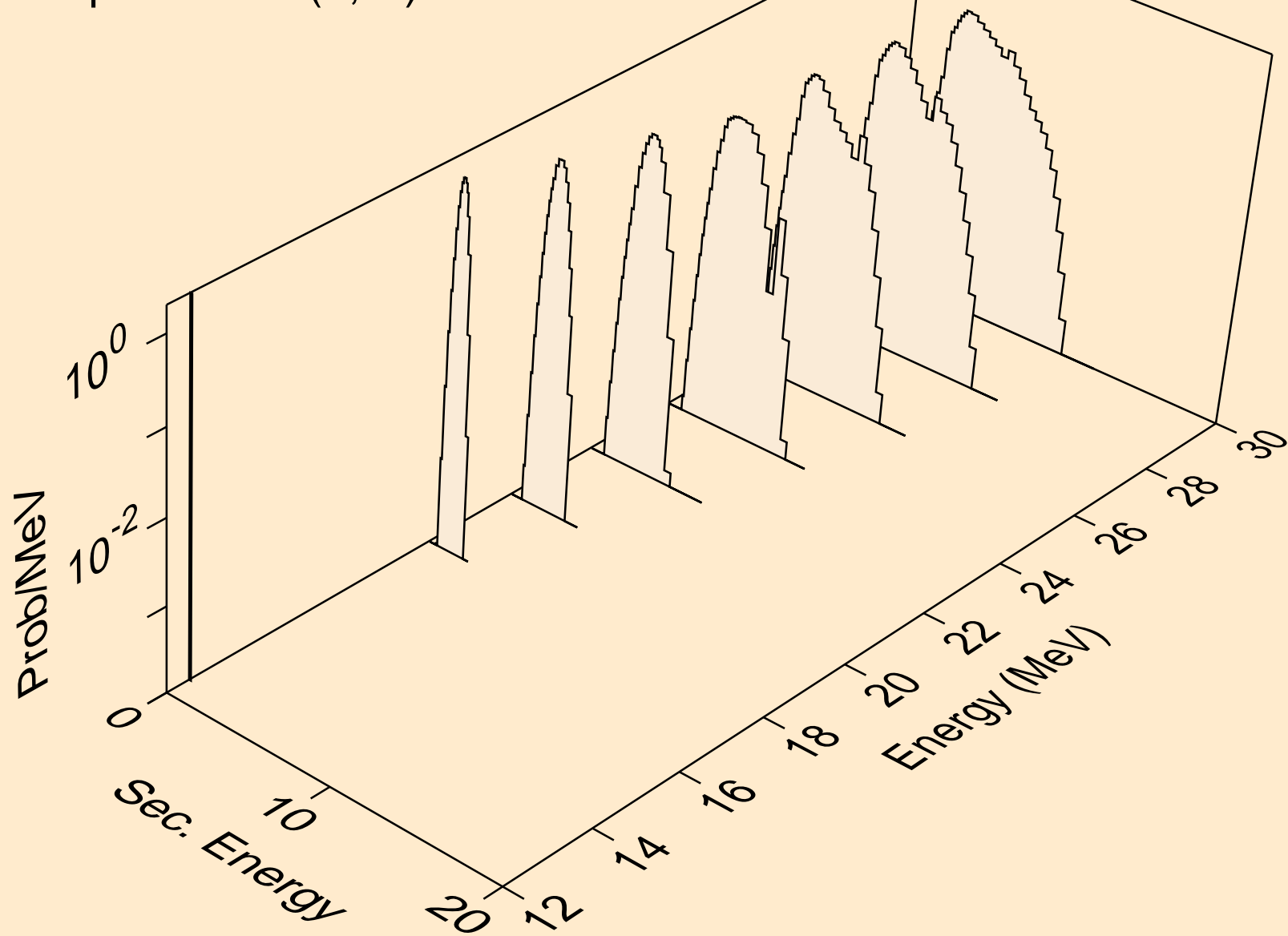

NE020 NEUTRON ACER TENDL-2024 LIBRARY; T=293.6K
alphas from (n,npa)

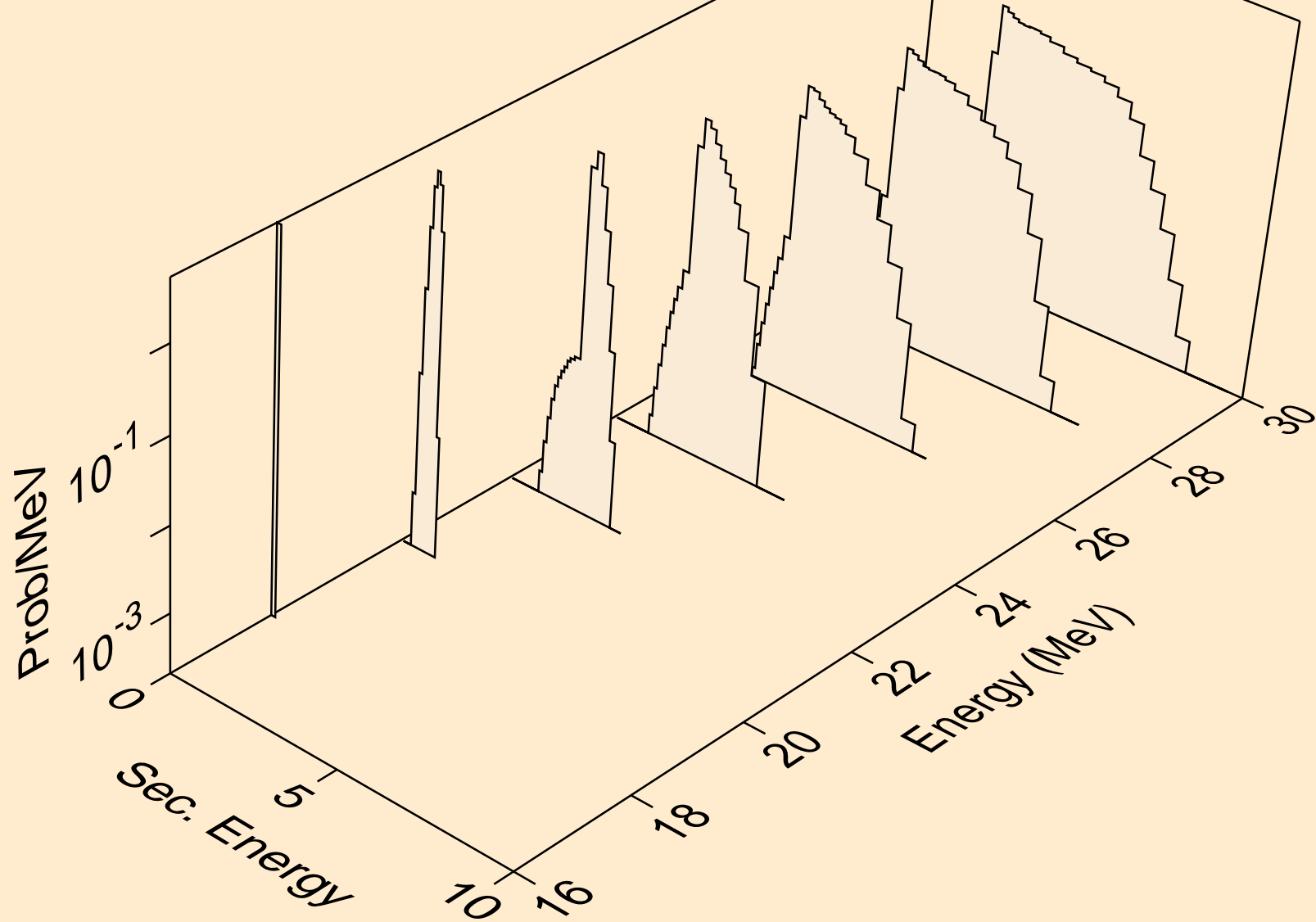

NE020 NEUTRON ACER TENDL-2024 LIBRARY; T=293.6K
alphas from (n,a)

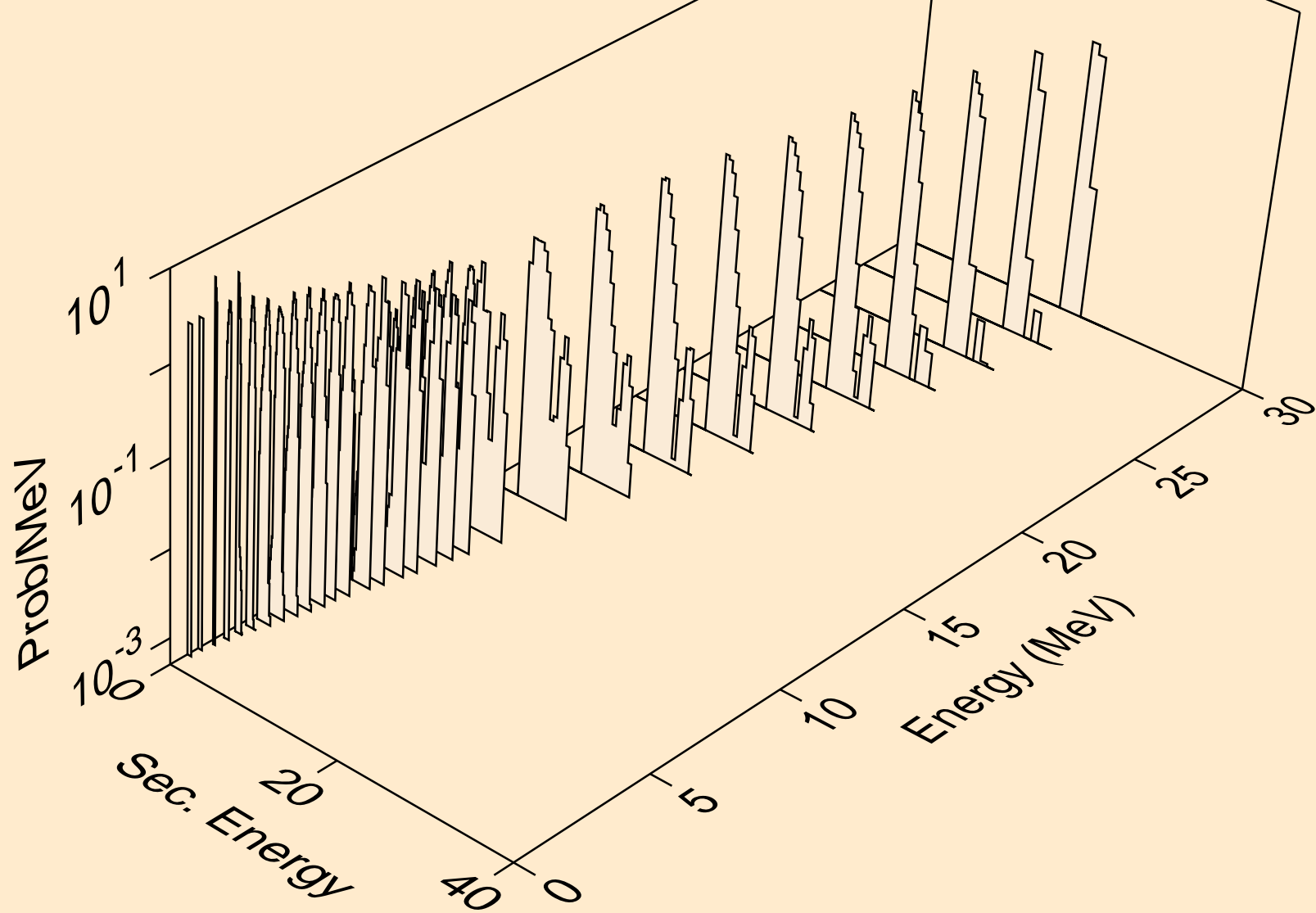

NE020 NEUTRON ACER TENDL-2024 LIBRARY; T=293.6K
alphas from (n,2a)

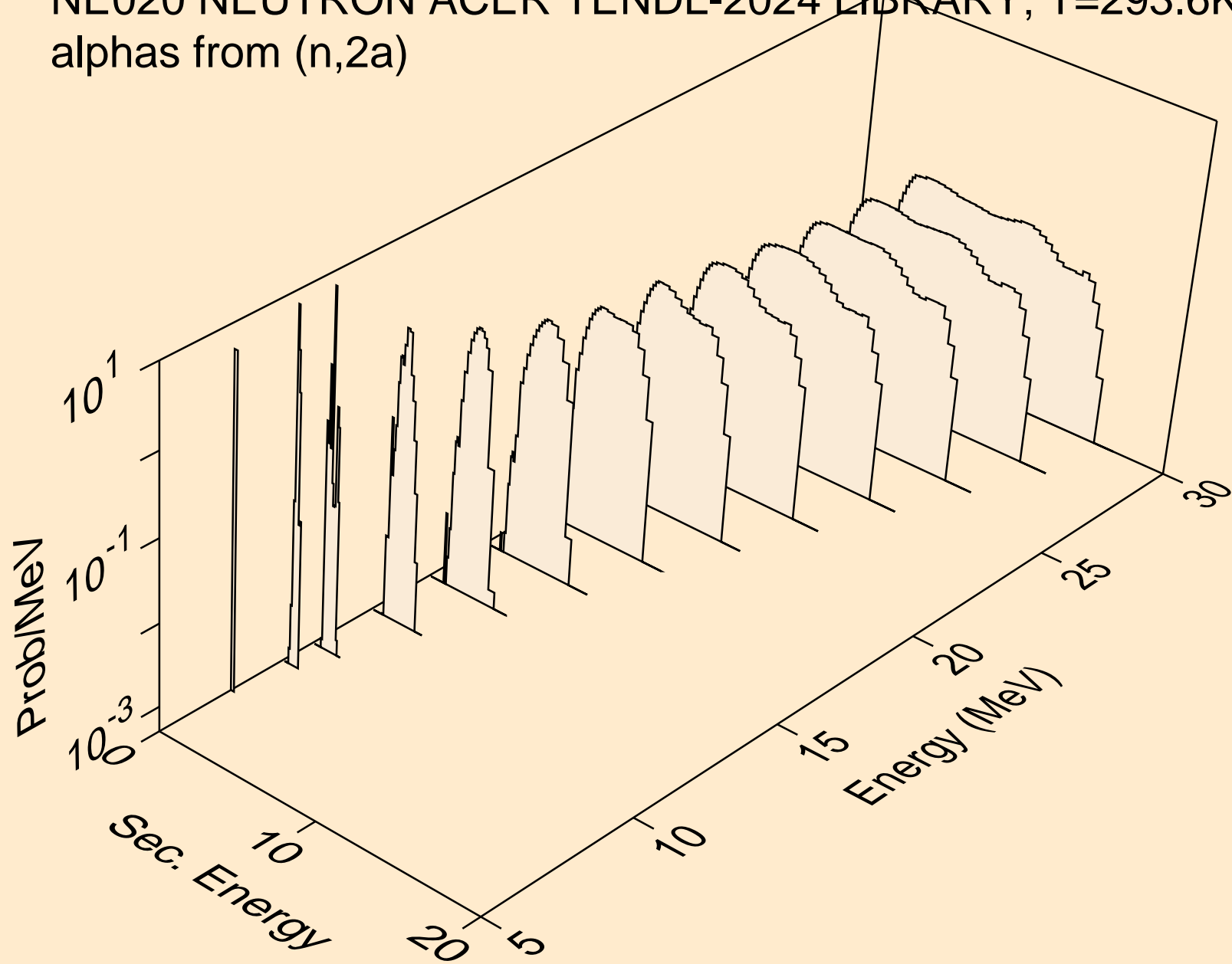

NE020 NEUTRON ACER TENDL-2024 LIBRARY; T=293.6K
alphas from (n,3a)

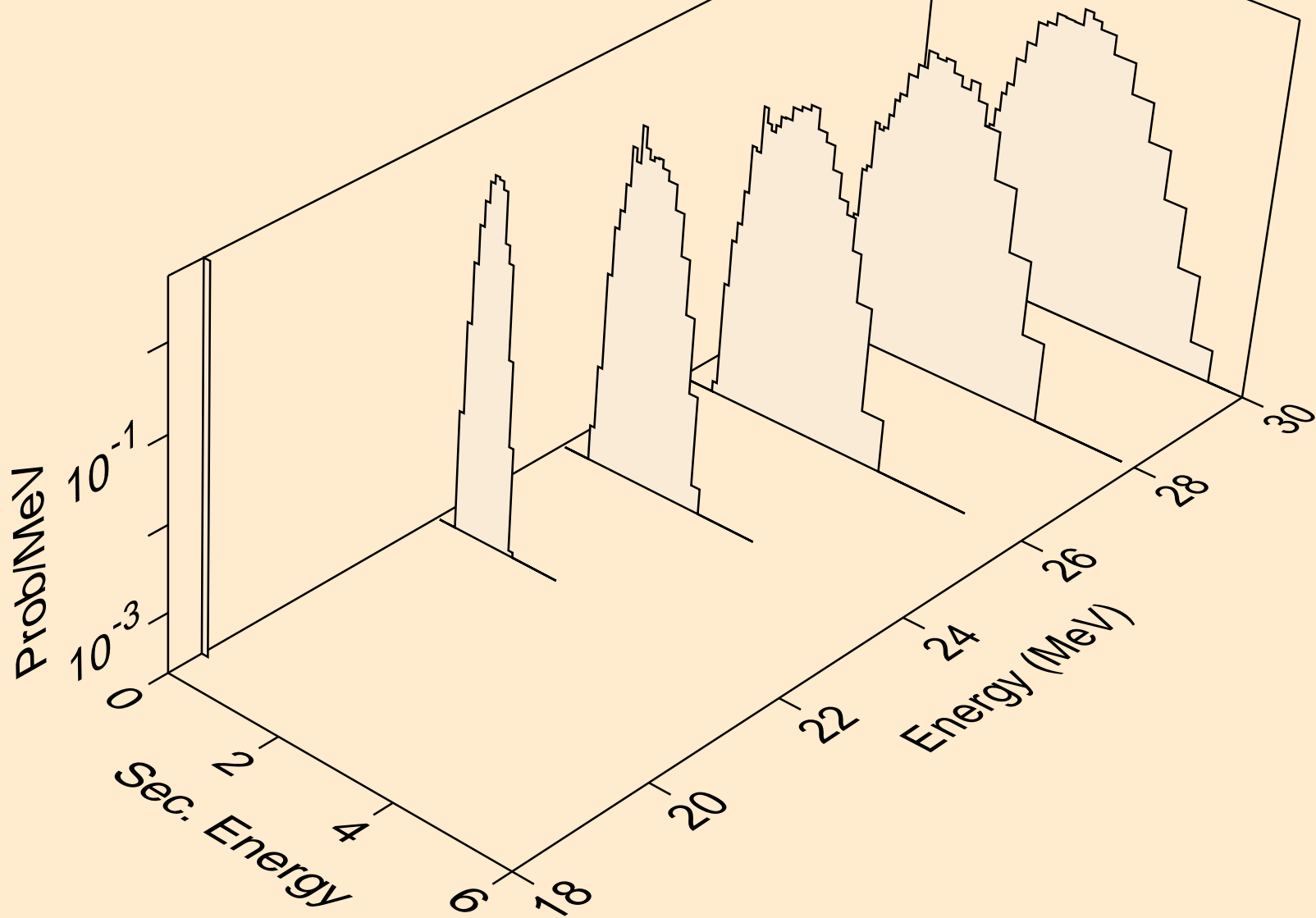

NE020 NEUTRON ACER TENDL-2024 LIBRARY; T=293.6K
alphas from (n,pa)

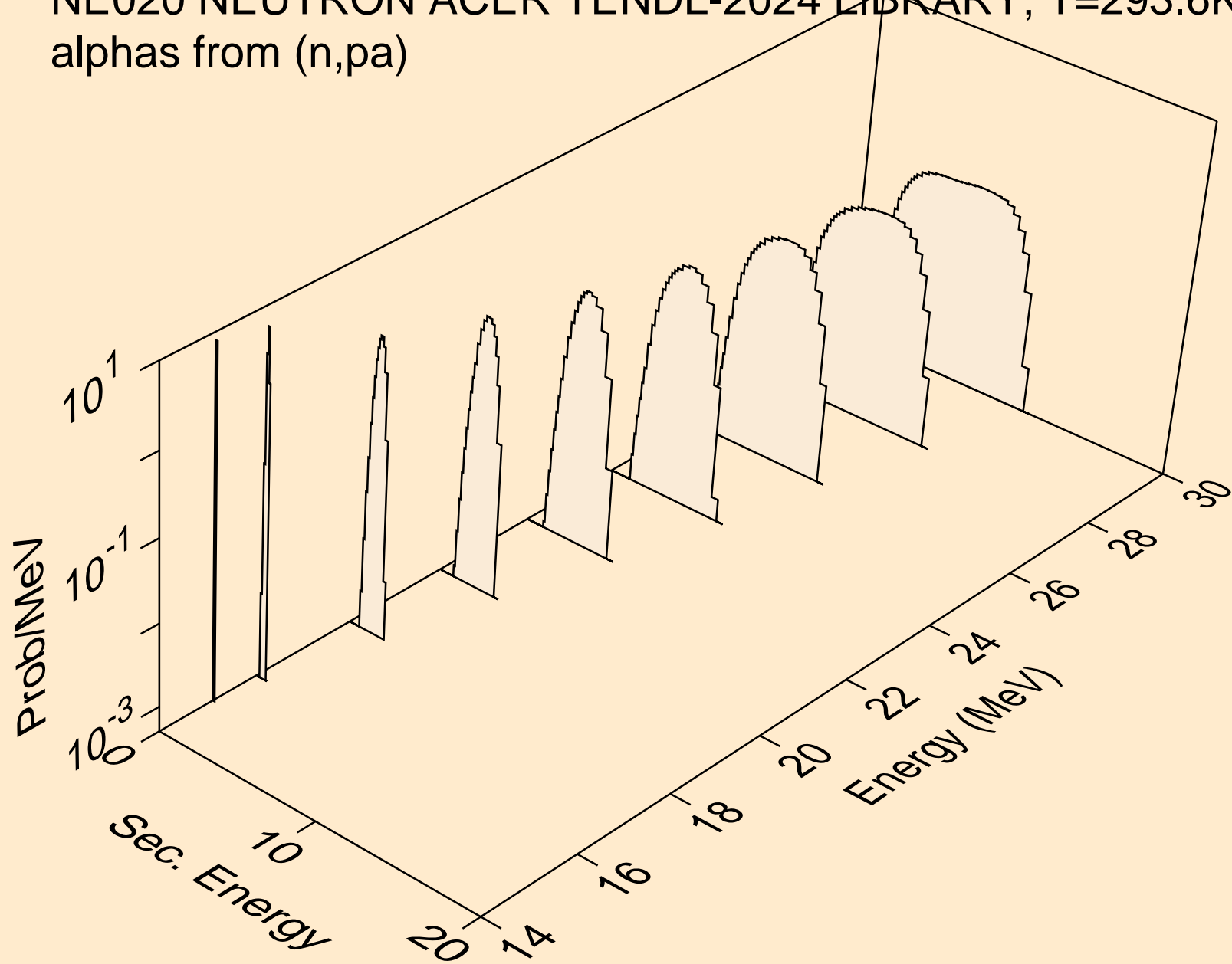

NE020 NEUTRON ACER TENDL-2024 LIBRARY; T=293.6K
alphas from (n,da)

