

O014 NEUTRON ACER TENDL-2024 LIBRARY; T=293.6K  
Principal cross sections

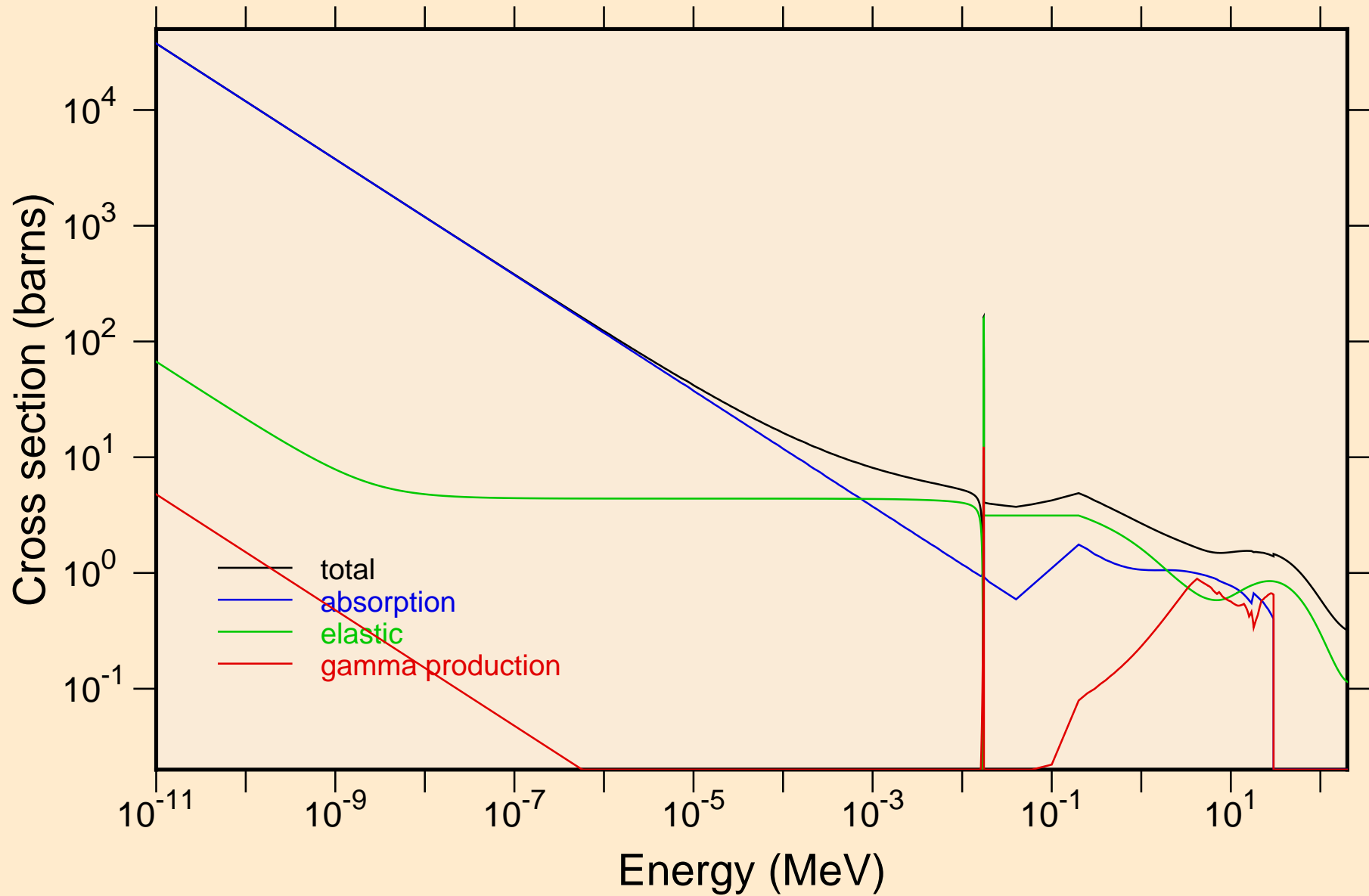

O014 NEUTRON ACER TENDL-2024 LIBRARY; T=293.6K  
Heating

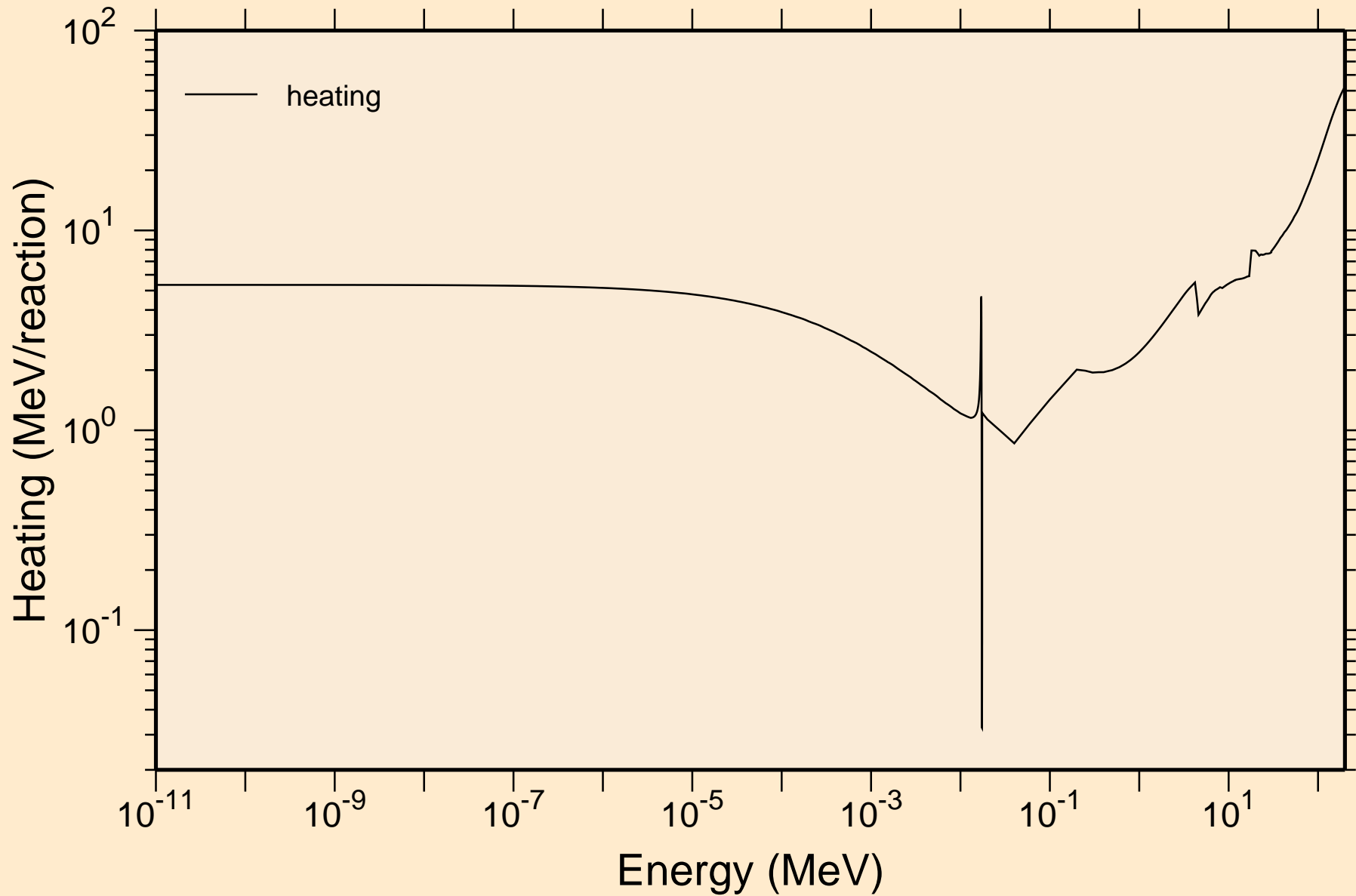

O014 NEUTRON ACER TENDL-2024 LIBRARY; T=293.6K  
Damage

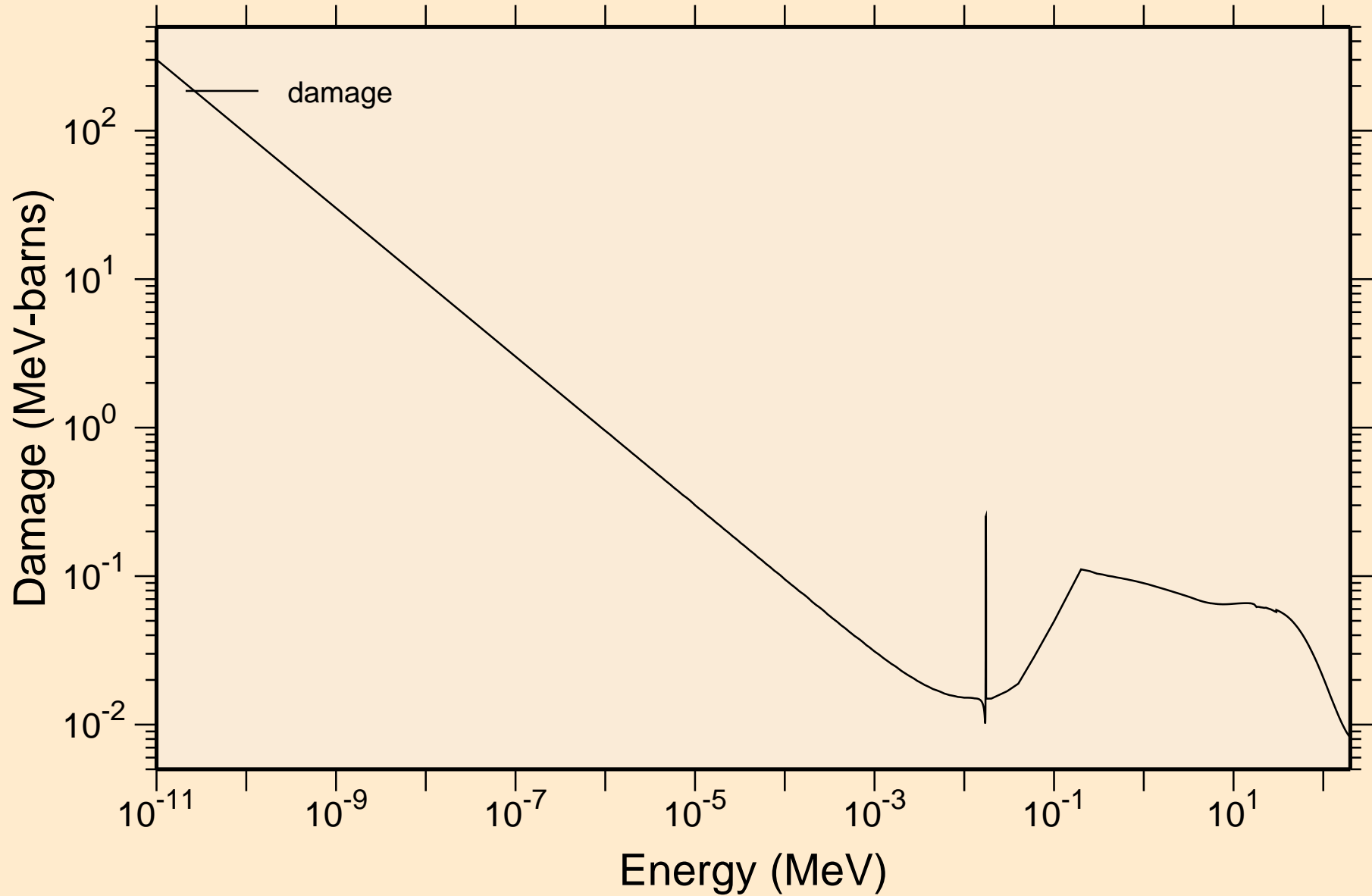

O014 NEUTRON ACER TENDL-2024 LIBRARY; T=293.6K  
Non-threshold reactions

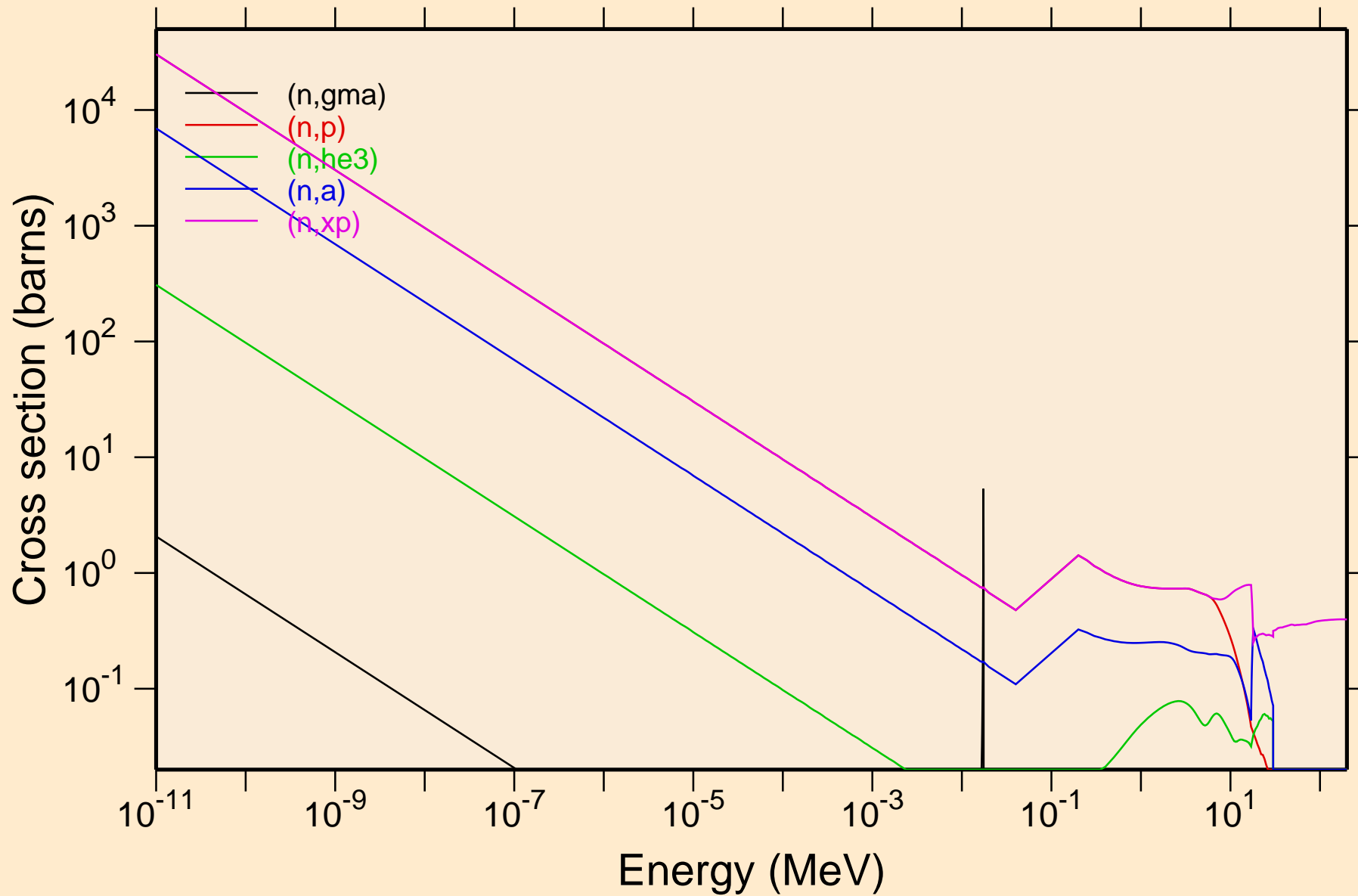

O014 NEUTRON ACER TENDL-2024 LIBRARY; T=293.6K  
Non-threshold reactions

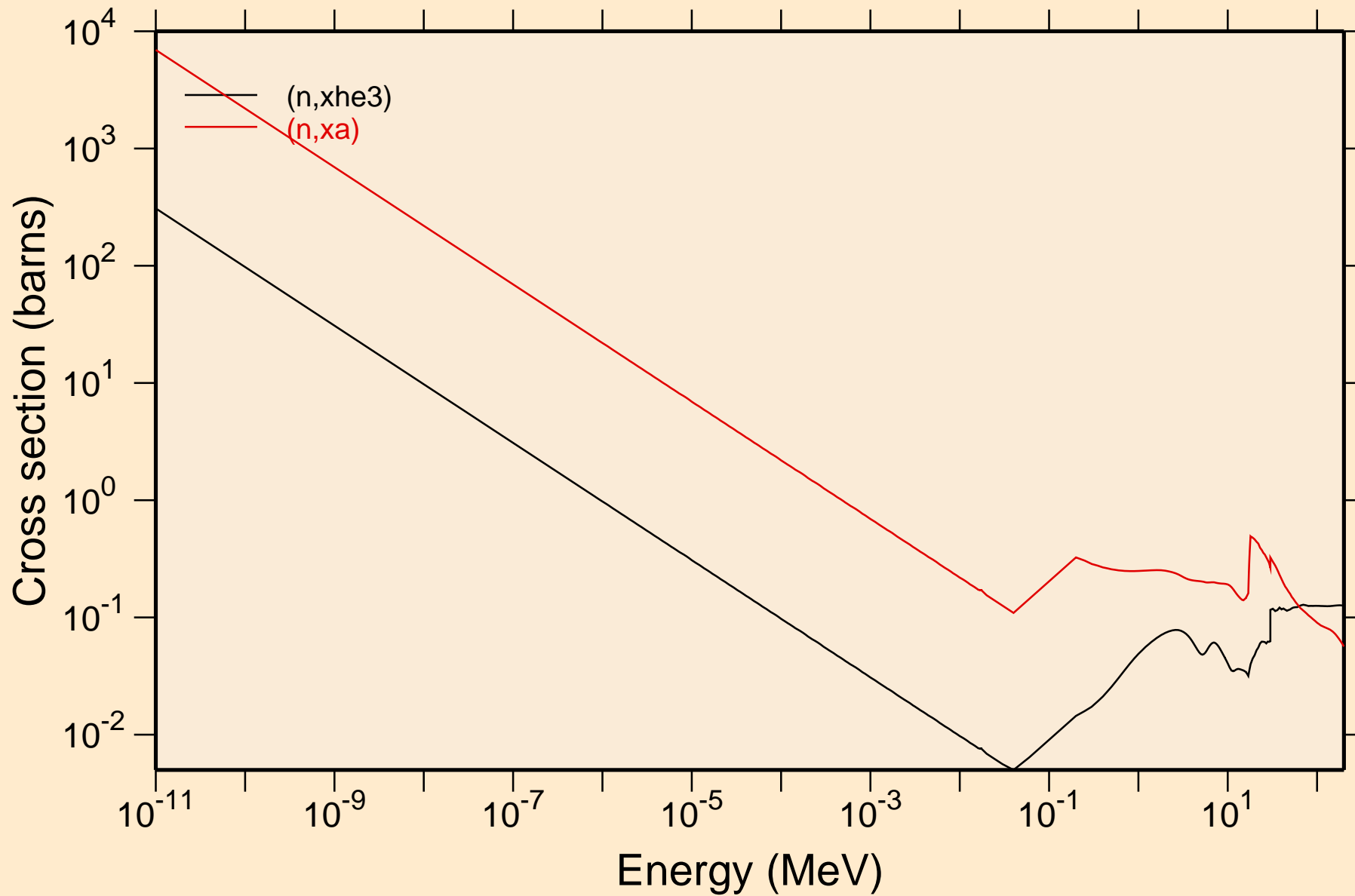

O014 NEUTRON ACER TENDL-2024 LIBRARY; T=293.6K  
Principal cross sections

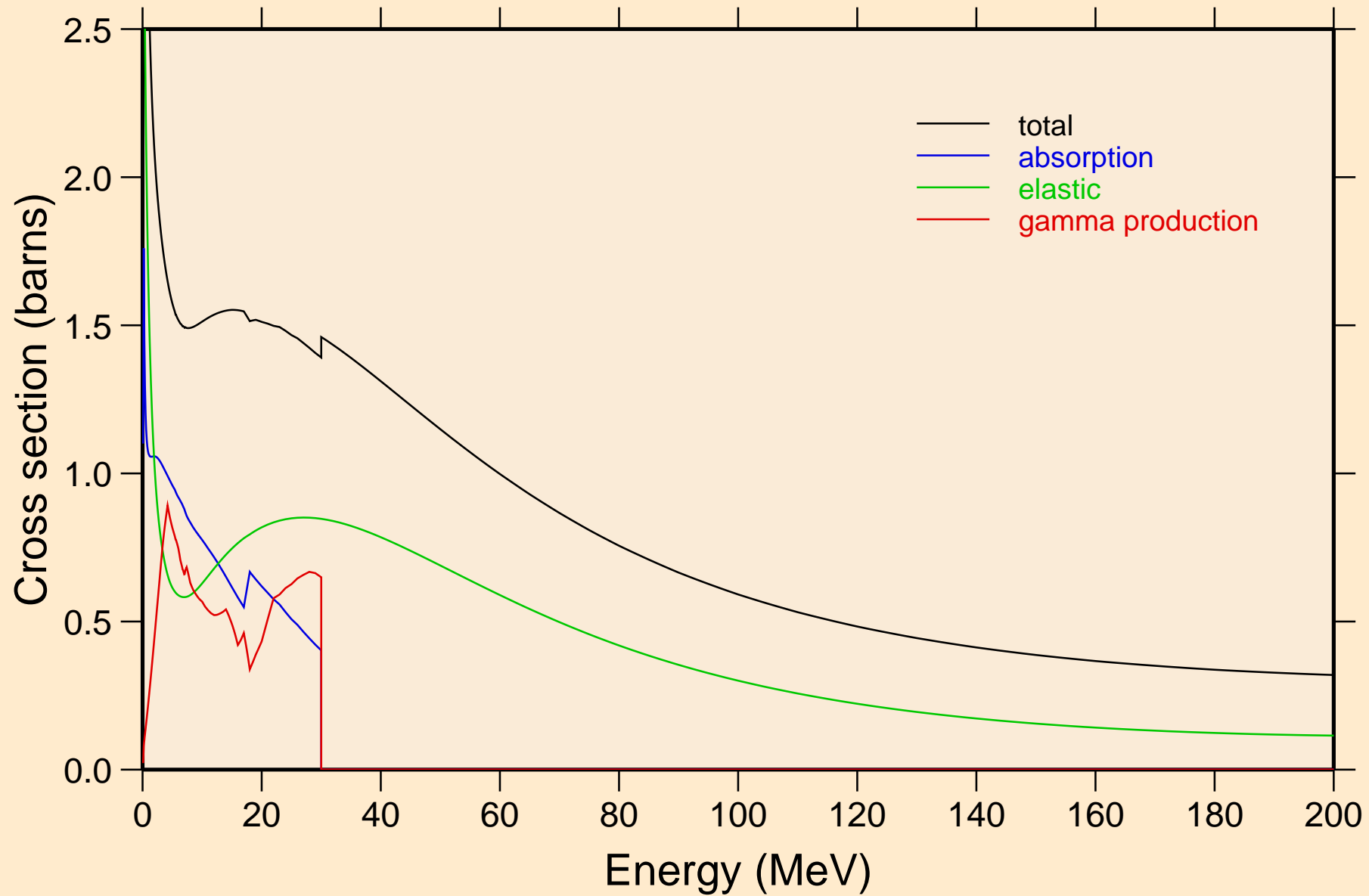

O014 NEUTRON ACER TENDL-2024 LIBRARY; T=293.6K  
Heating

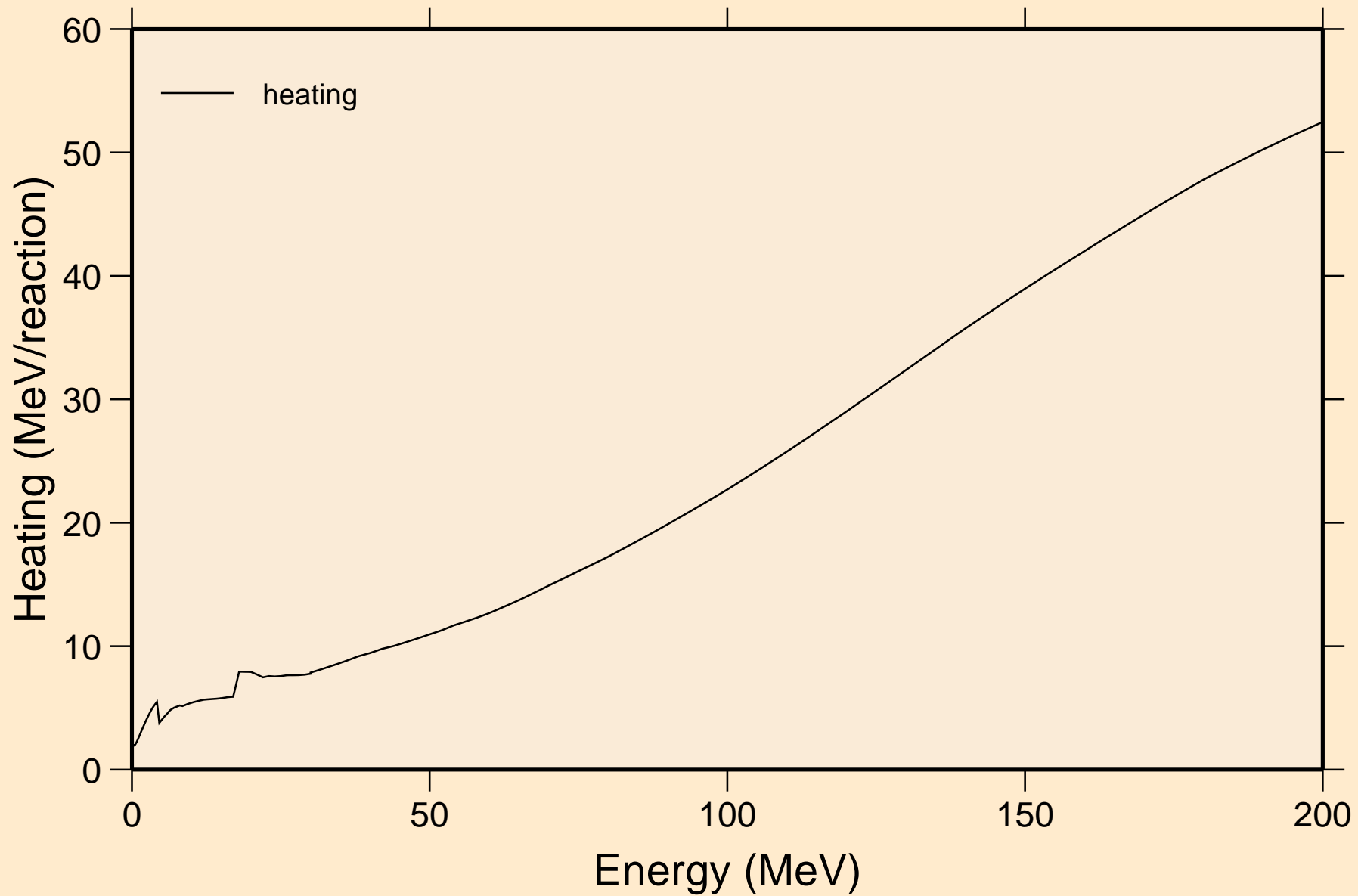

O014 NEUTRON ACER TENDL-2024 LIBRARY; T=293.6K  
Damage

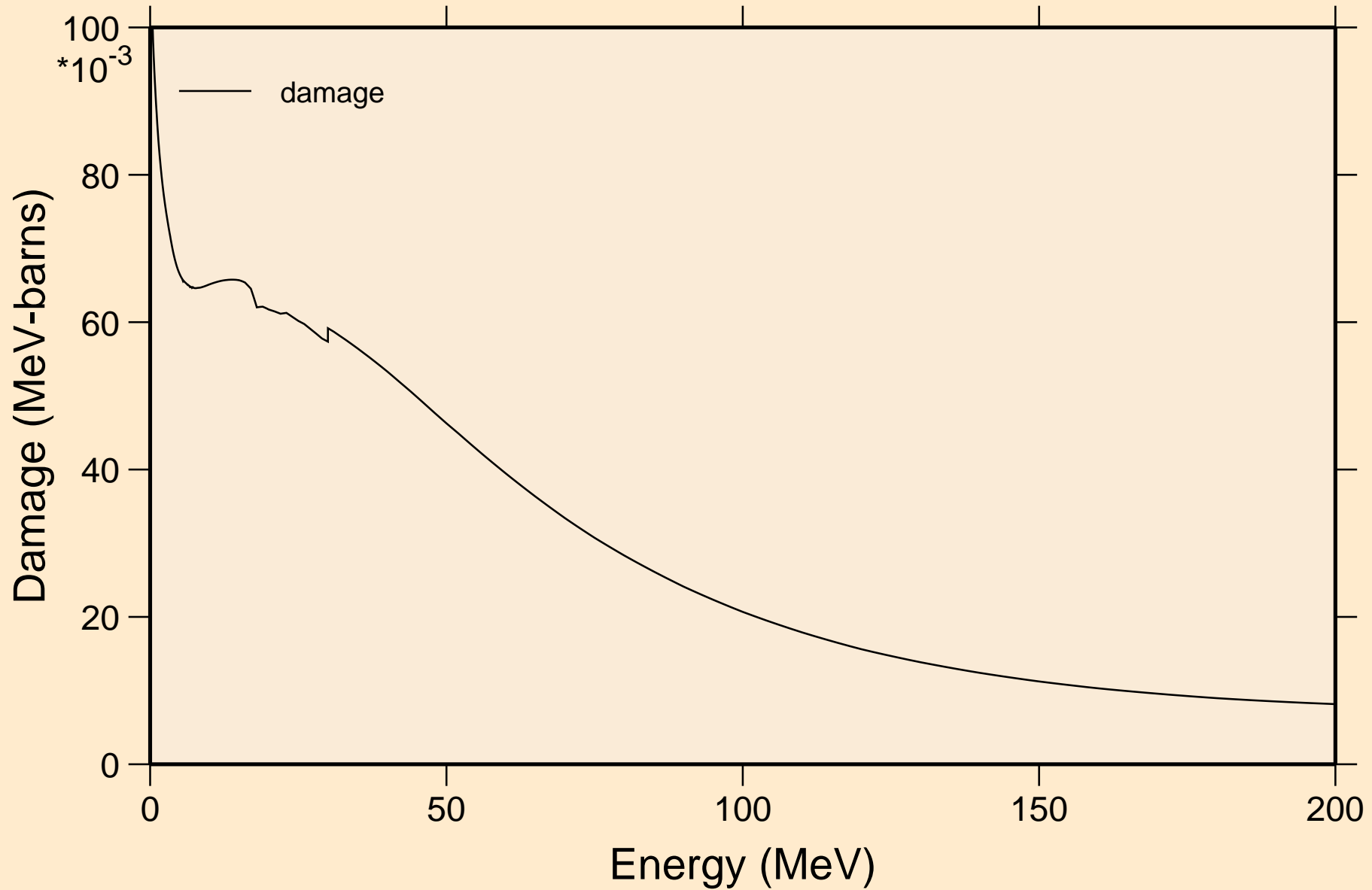

# O014 NEUTRON ACER TENDL-2024 LIBRARY; T=293.6K

## Non-threshold reactions

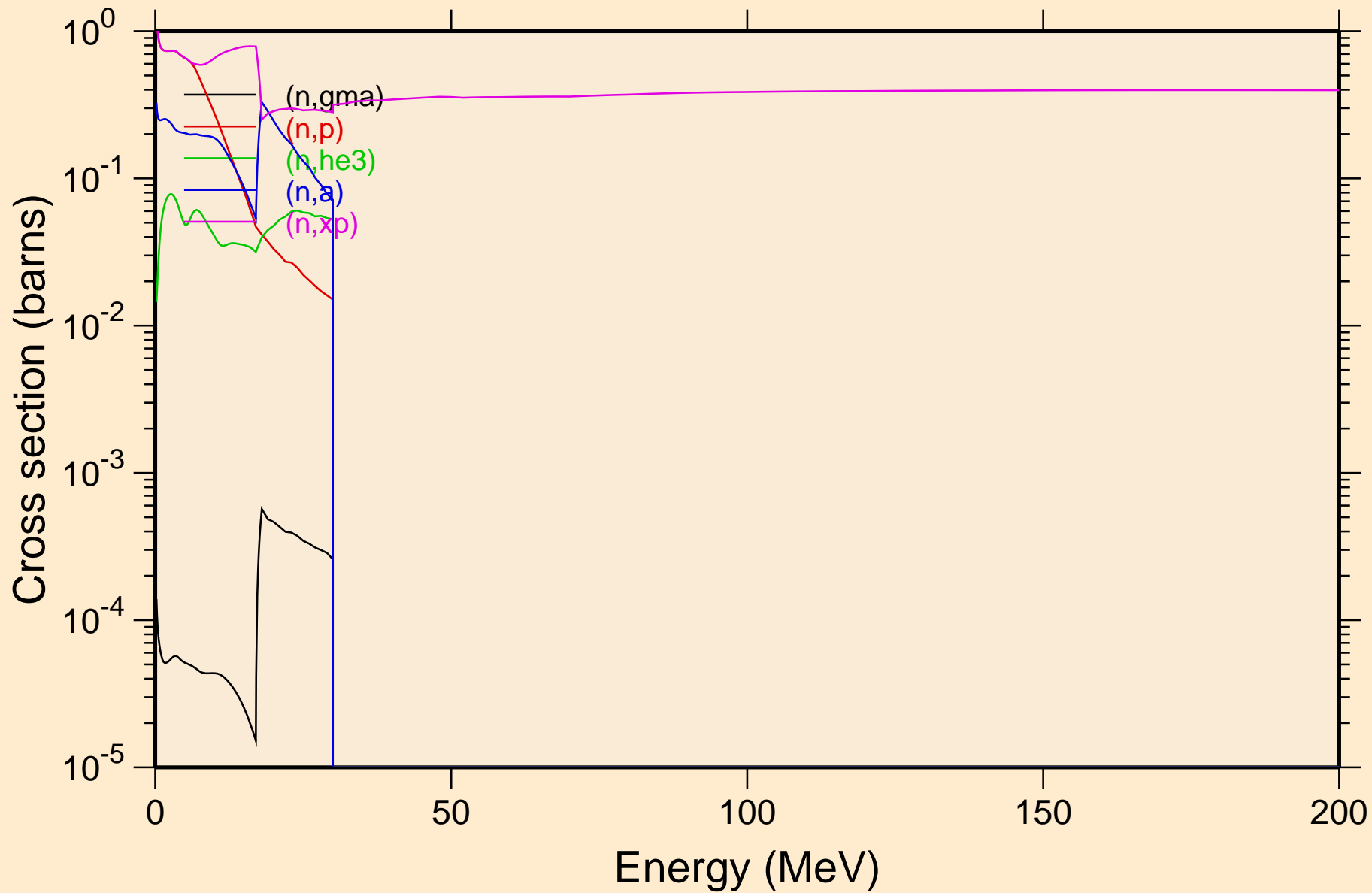

O014 NEUTRON ACER TENDL-2024 LIBRARY; T=293.6K  
Non-threshold reactions

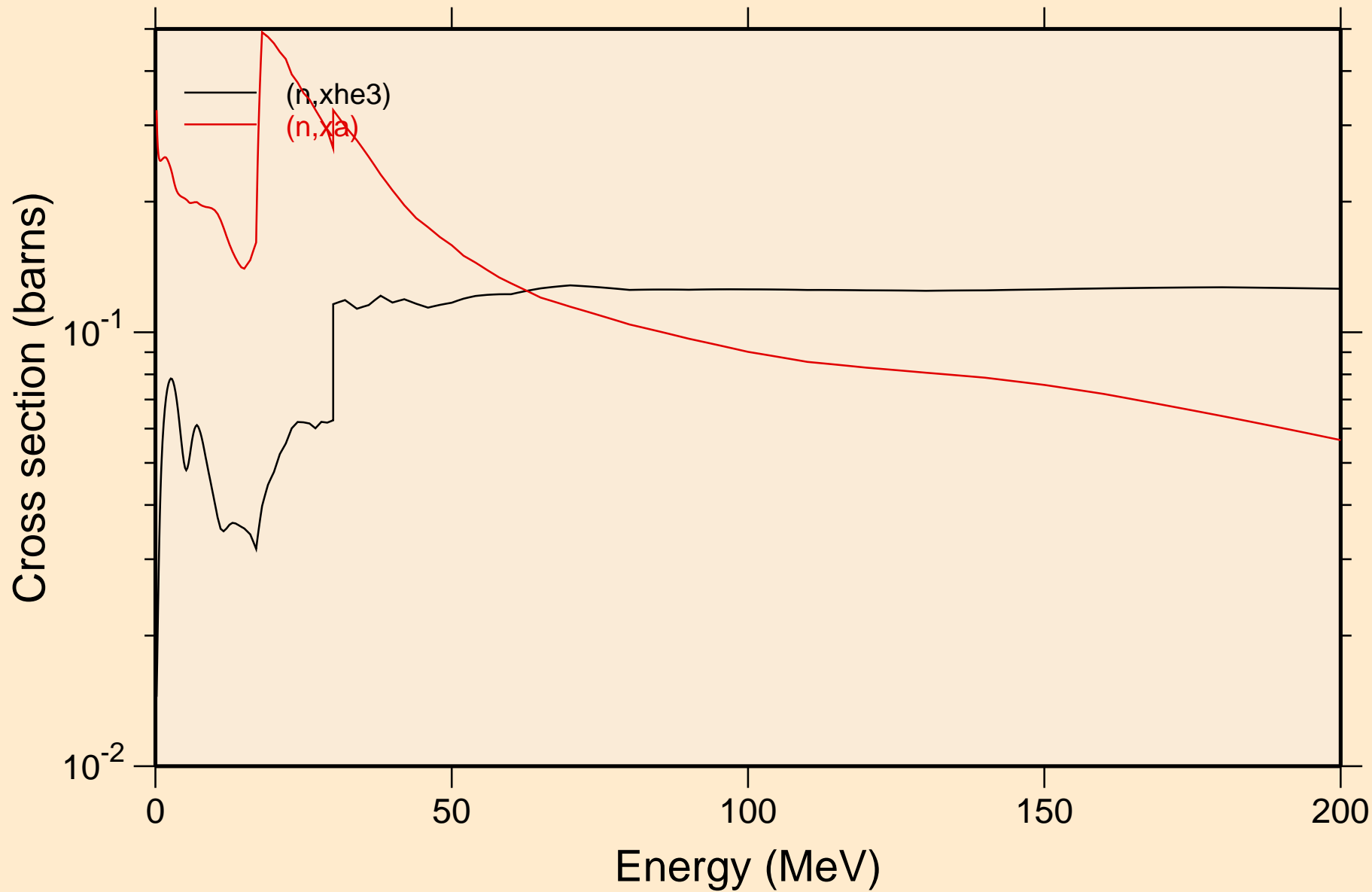

O014 NEUTRON ACER TENDL-2024 LIBRARY; T=293.6K  
Inelastic levels

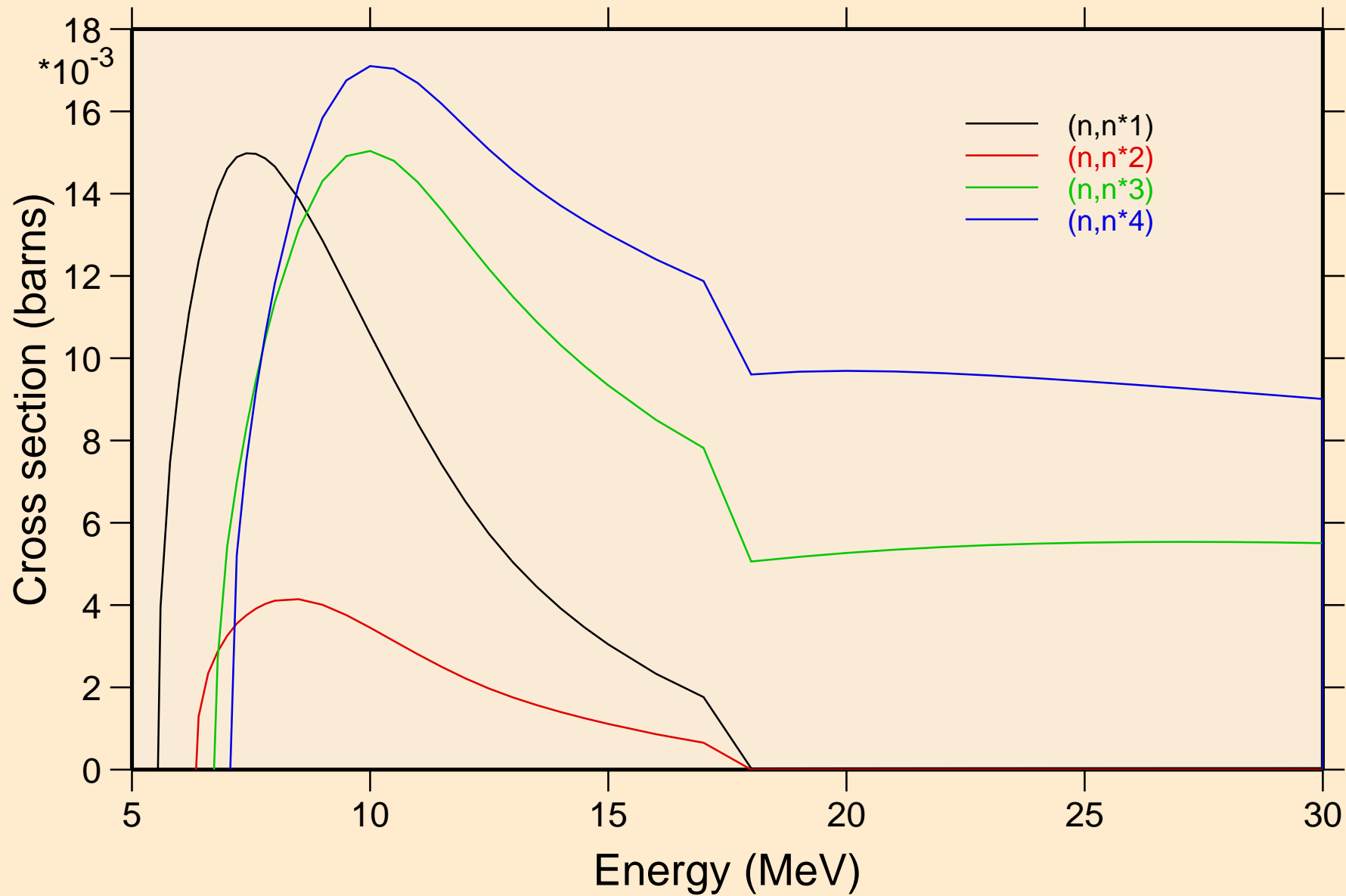

O014 NEUTRON ACER TENDL-2024 LIBRARY; T=293.6K  
Threshold reactions

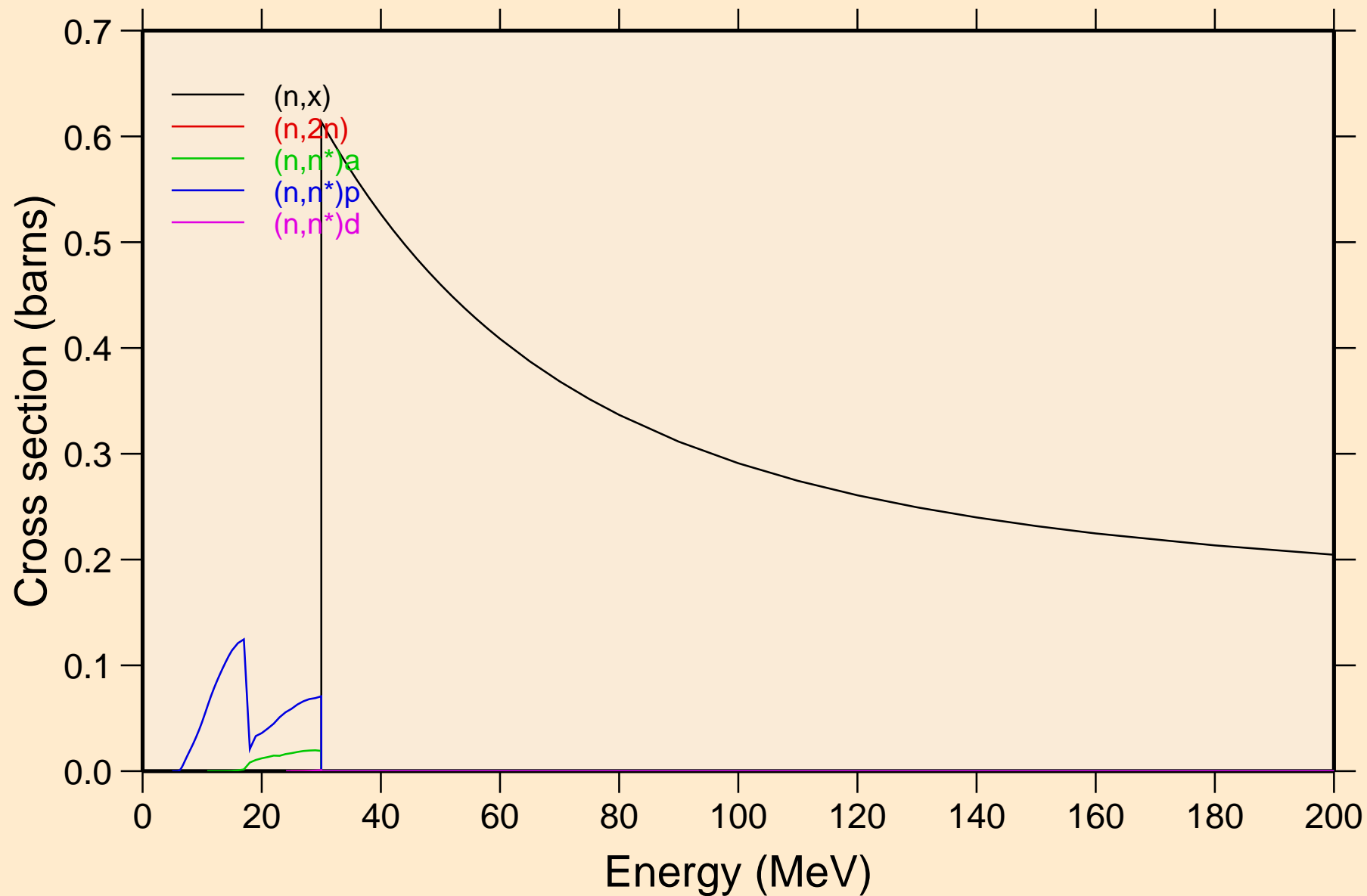

# O014 NEUTRON ACER TENDL-2024 LIBRARY; T=293.6K

## Threshold reactions

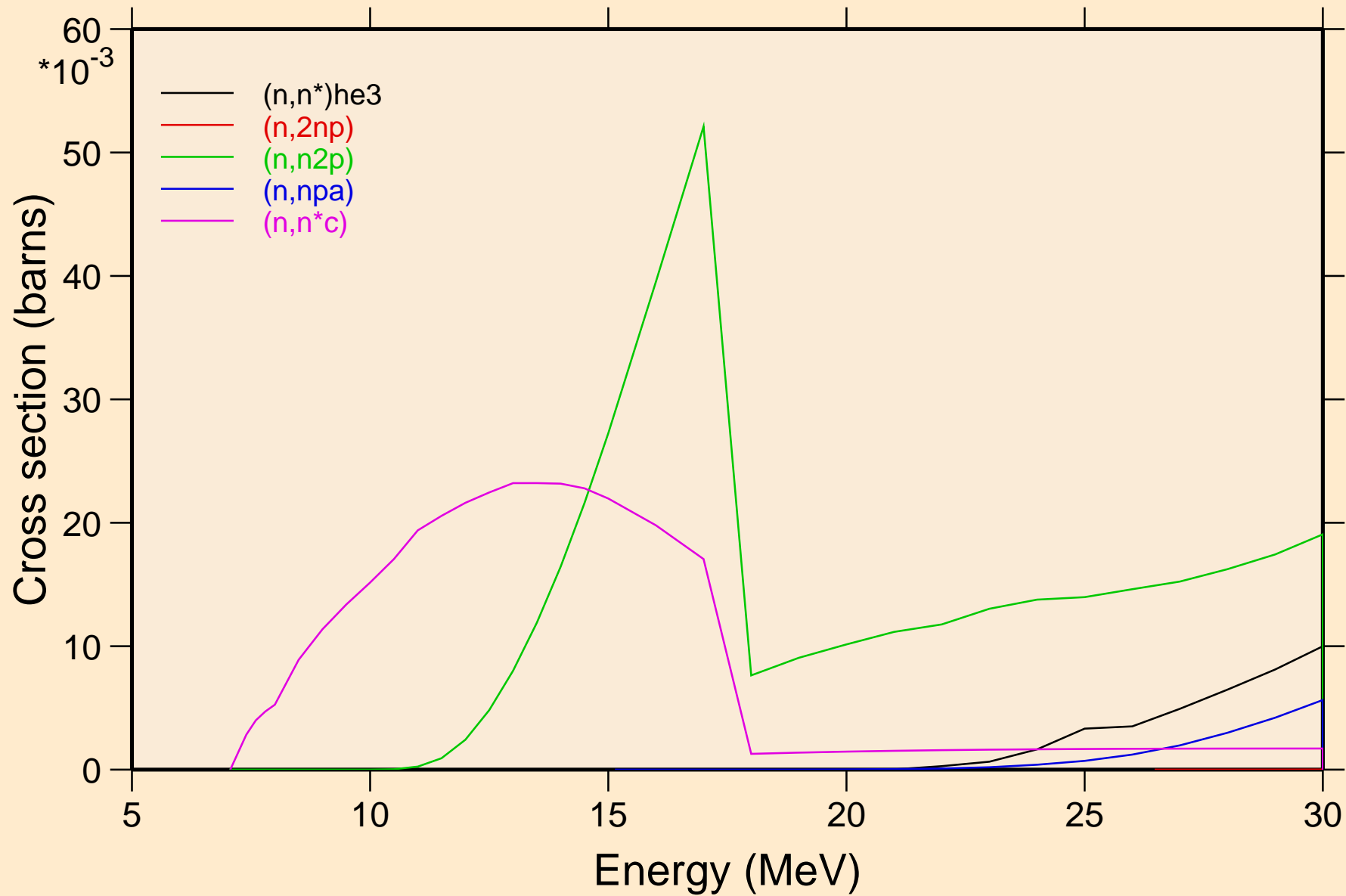

# O014 NEUTRON ACER TENDL-2024 LIBRARY; T=293.6K

## Threshold reactions

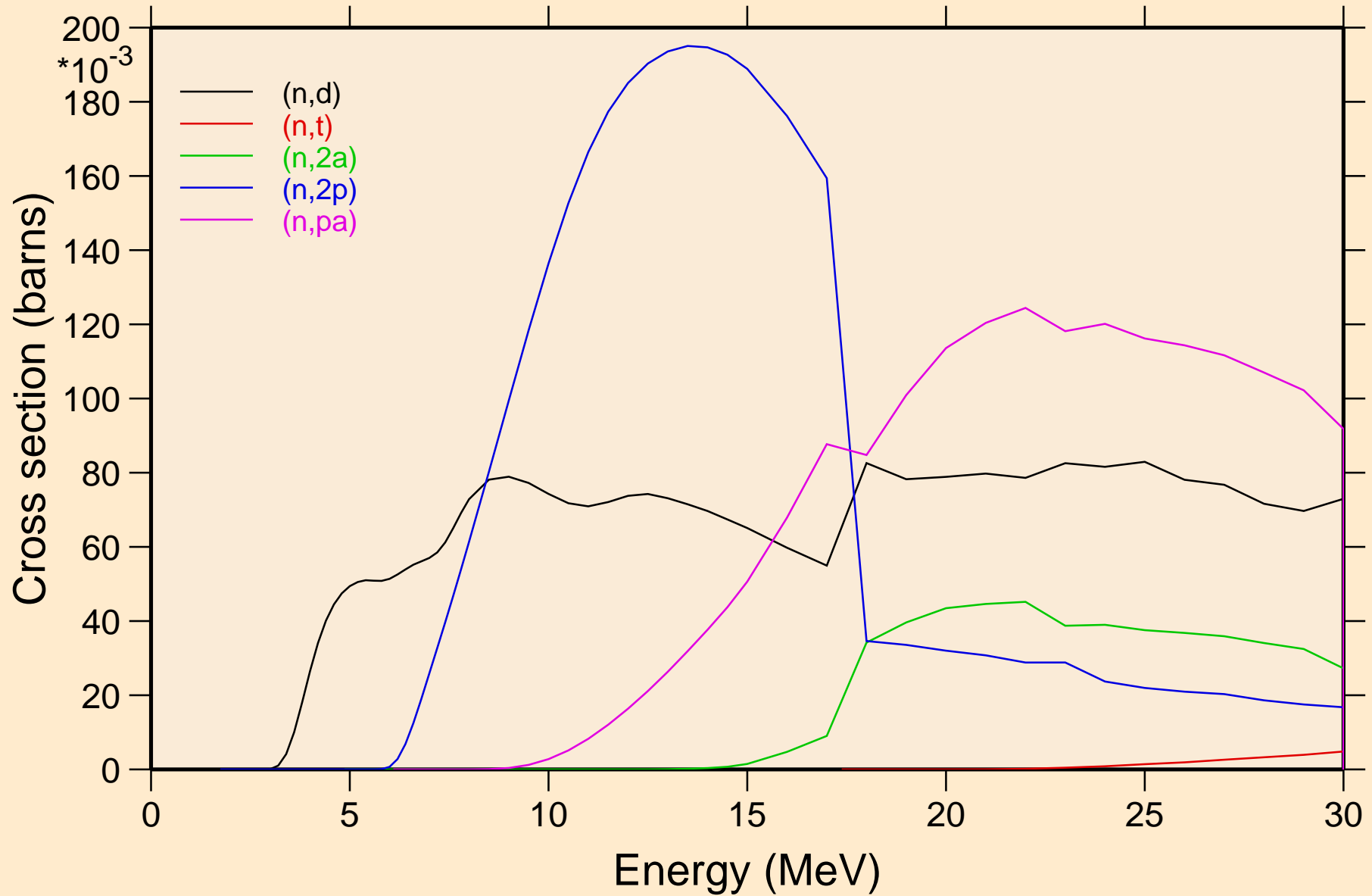

O014 NEUTRON ACER TENDL-2024 LIBRARY; T=293.6K  
Threshold reactions

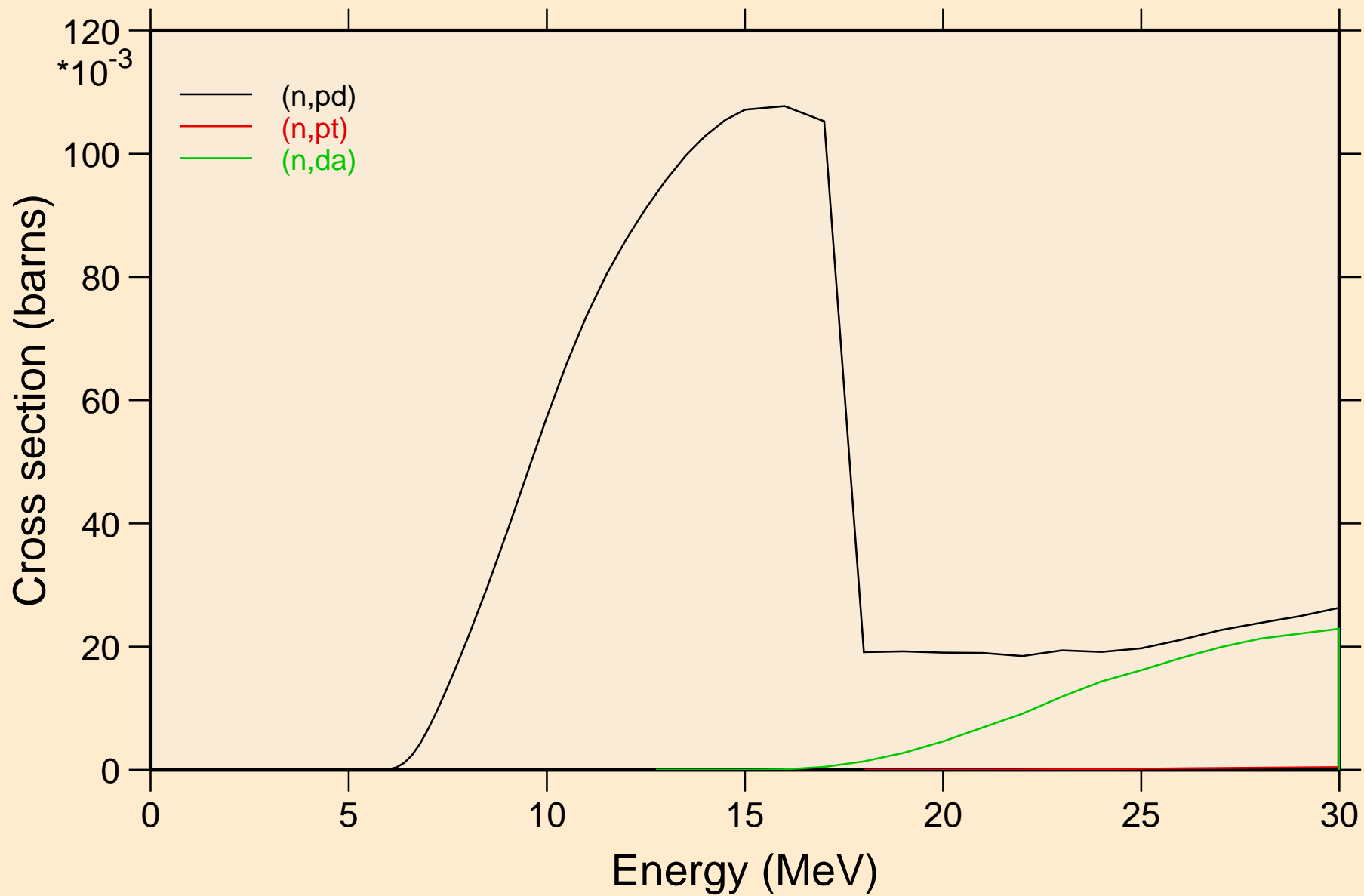

# O014 NEUTRON ACER TENDL-2024 LIBRARY; T=293.6K

## Threshold reactions

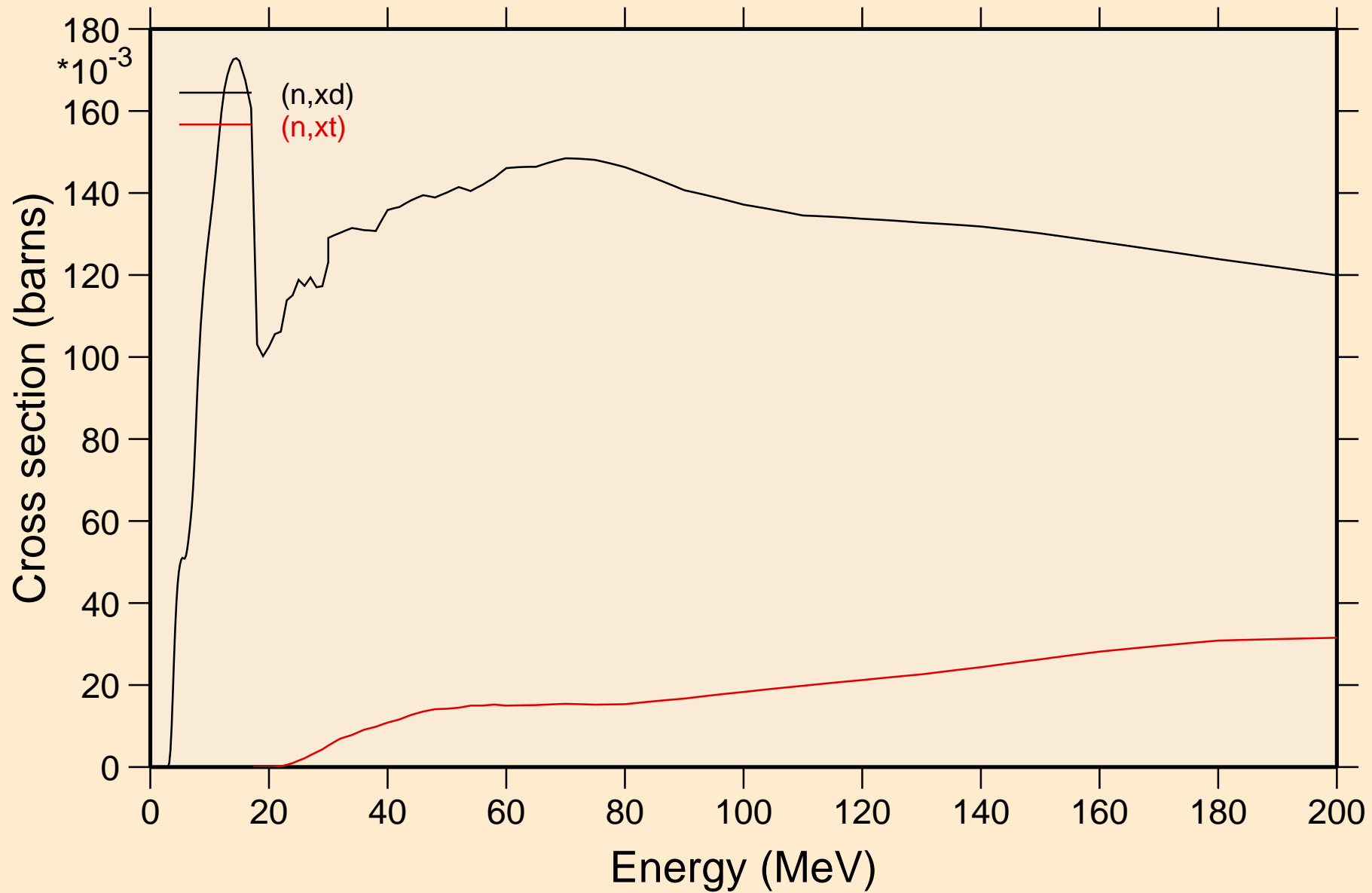

O014 NEUTRON ACER TENDL-2024 LIBRARY; T=293.6K  
angular distribution for elastic

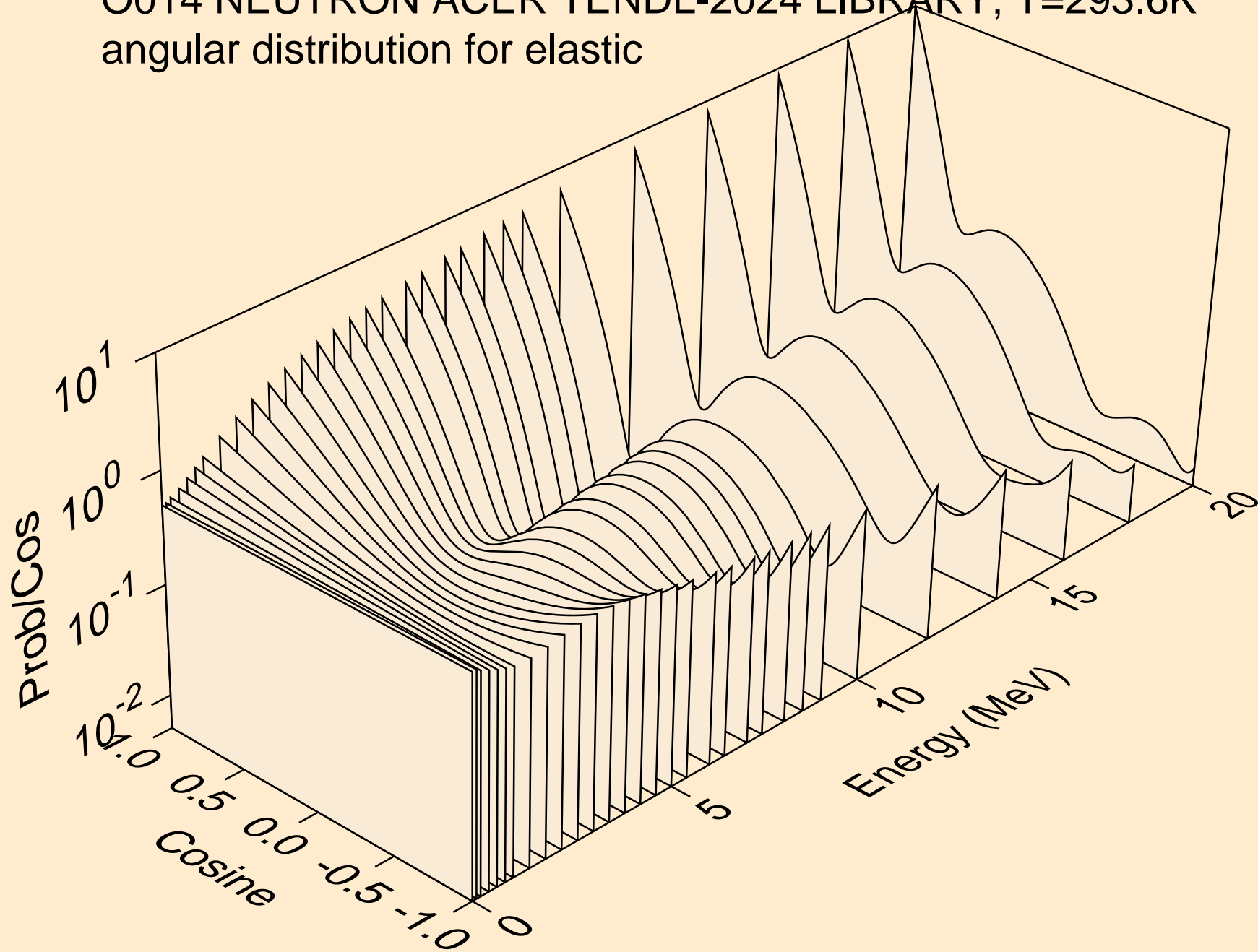

O014 NEUTRON ACER TENDL-2024 LIBRARY; T=293.6K  
angular distribution for elastic

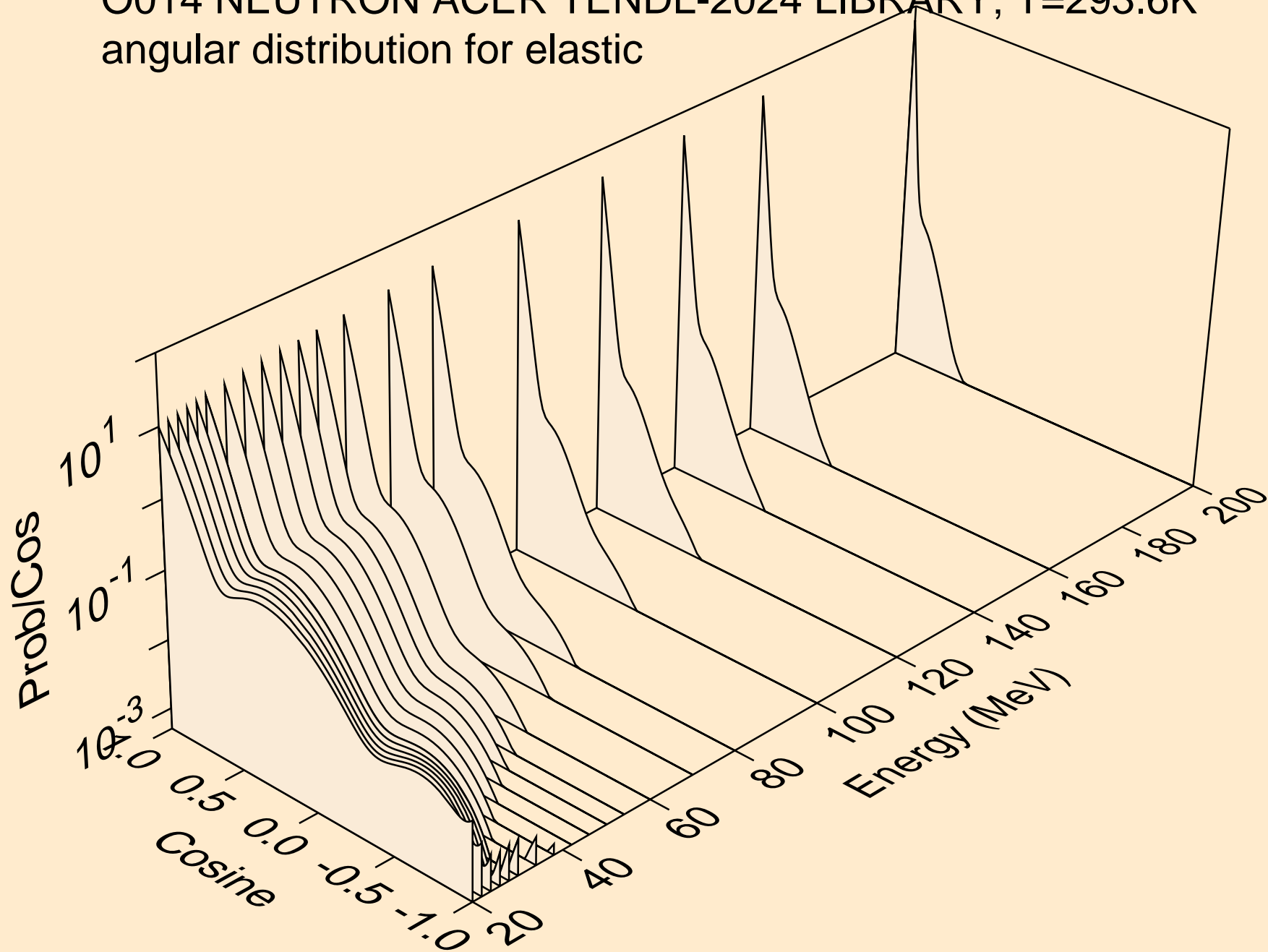

O014 NEUTRON ACER TENDL-2024 LIBRARY; T=293.6K  
angular distribution for (n,n\*1)

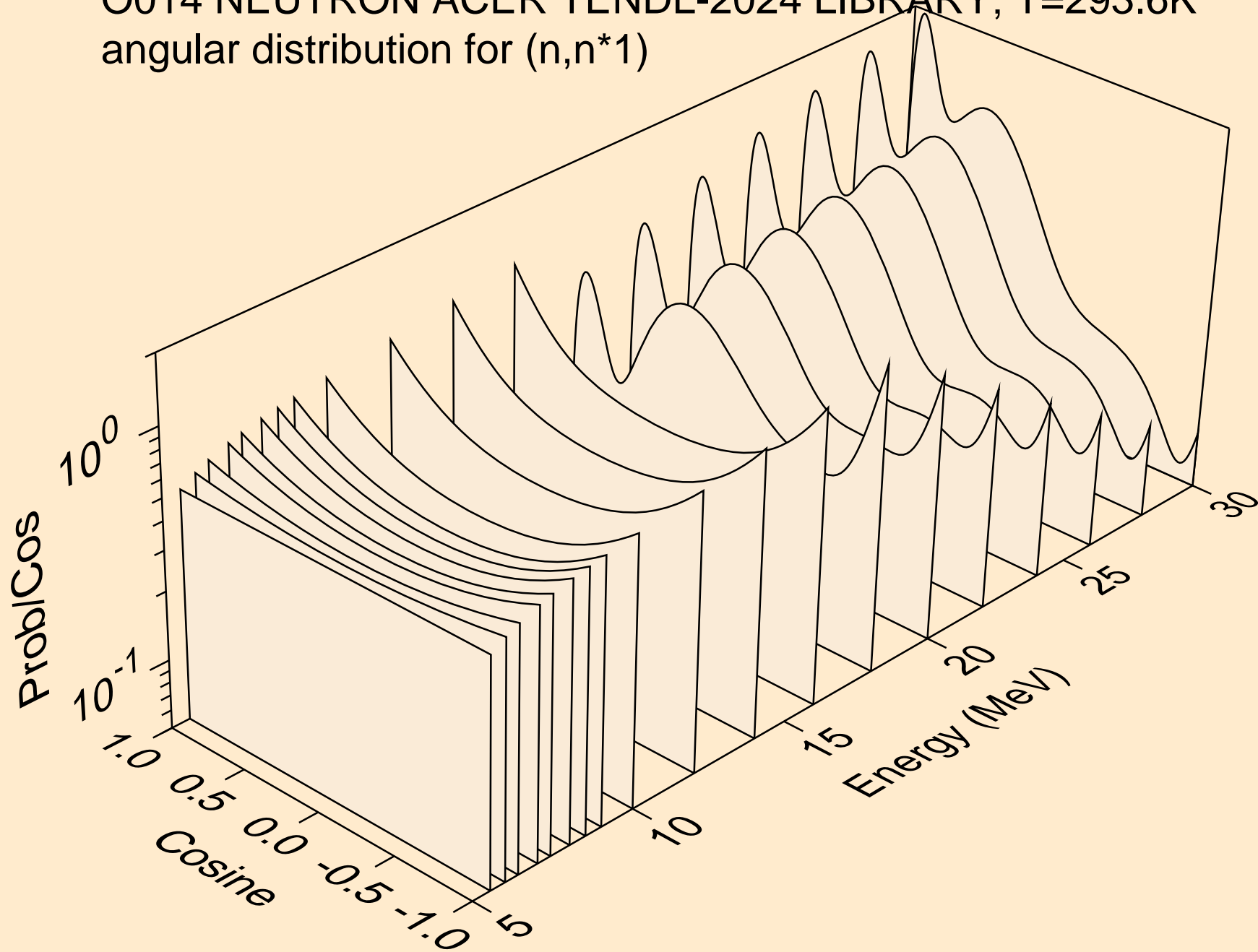

O014 NEUTRON ACER TENDL-2024 LIBRARY; T=293.6K  
angular distribution for (n,n\*2)

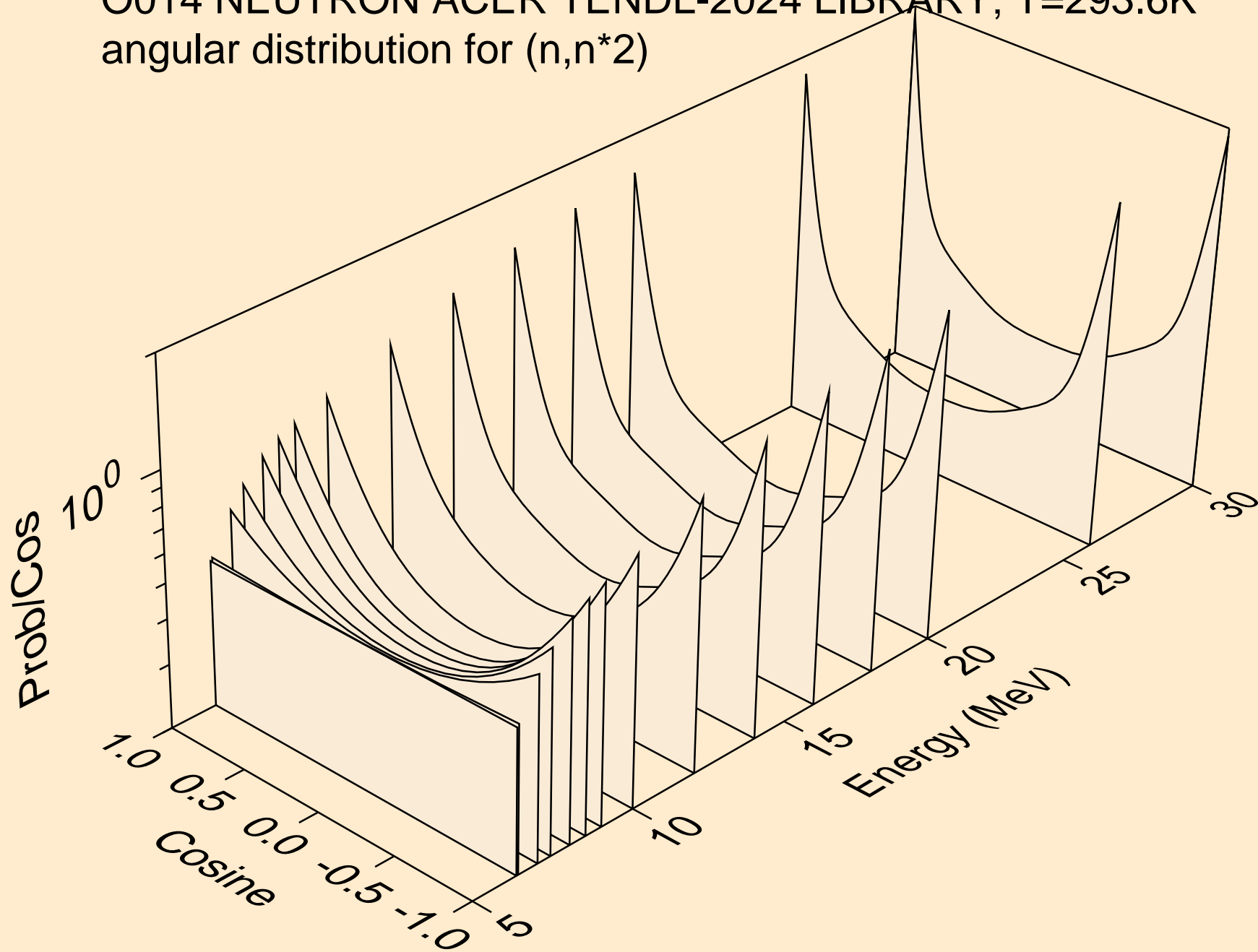

O014 NEUTRON ACER TENDL-2024 LIBRARY; T=293.6K  
angular distribution for (n,n\*3)

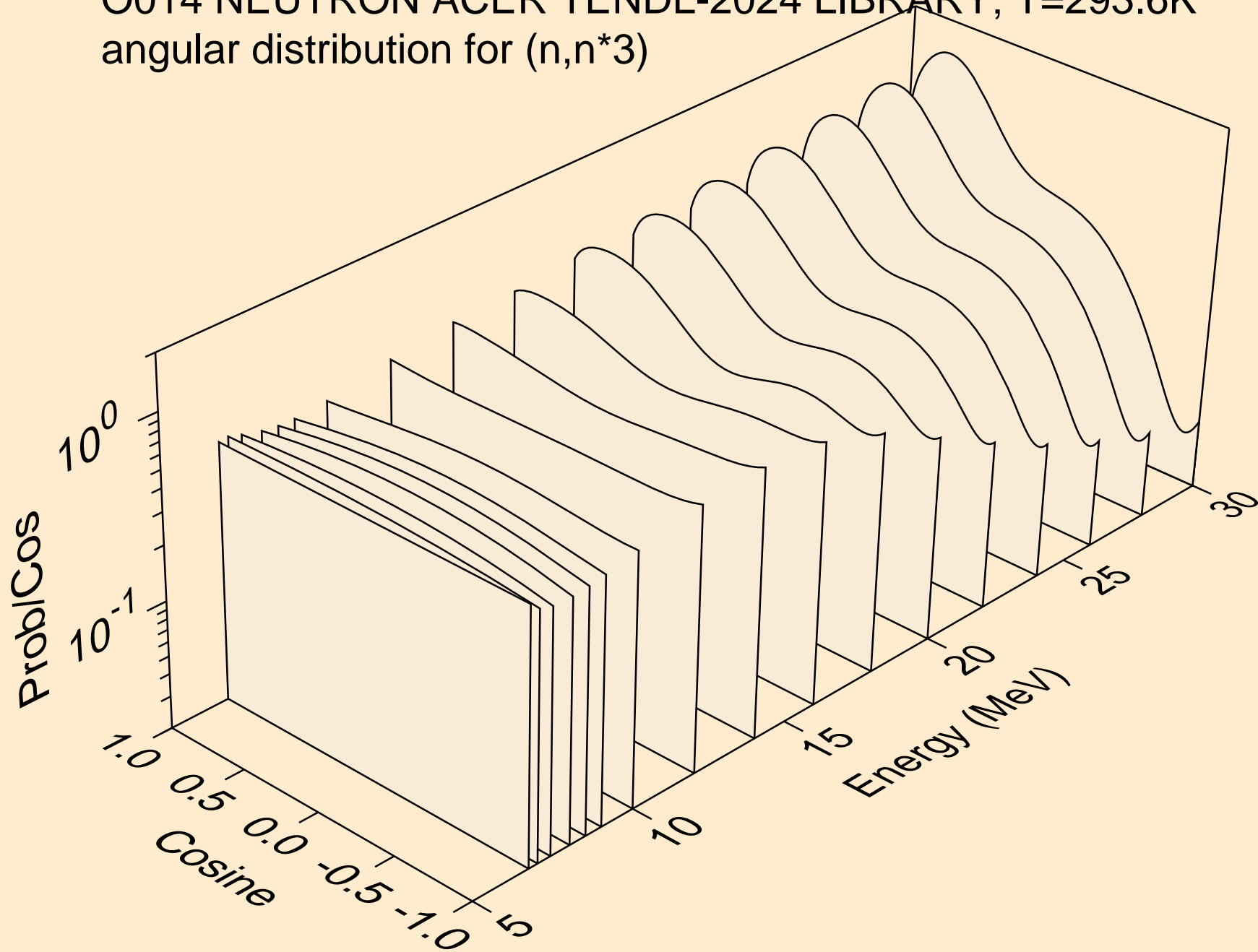

O014 NEUTRON ACER TENDL-2024 LIBRARY; T=293.6K  
angular distribution for (n,n\*4)

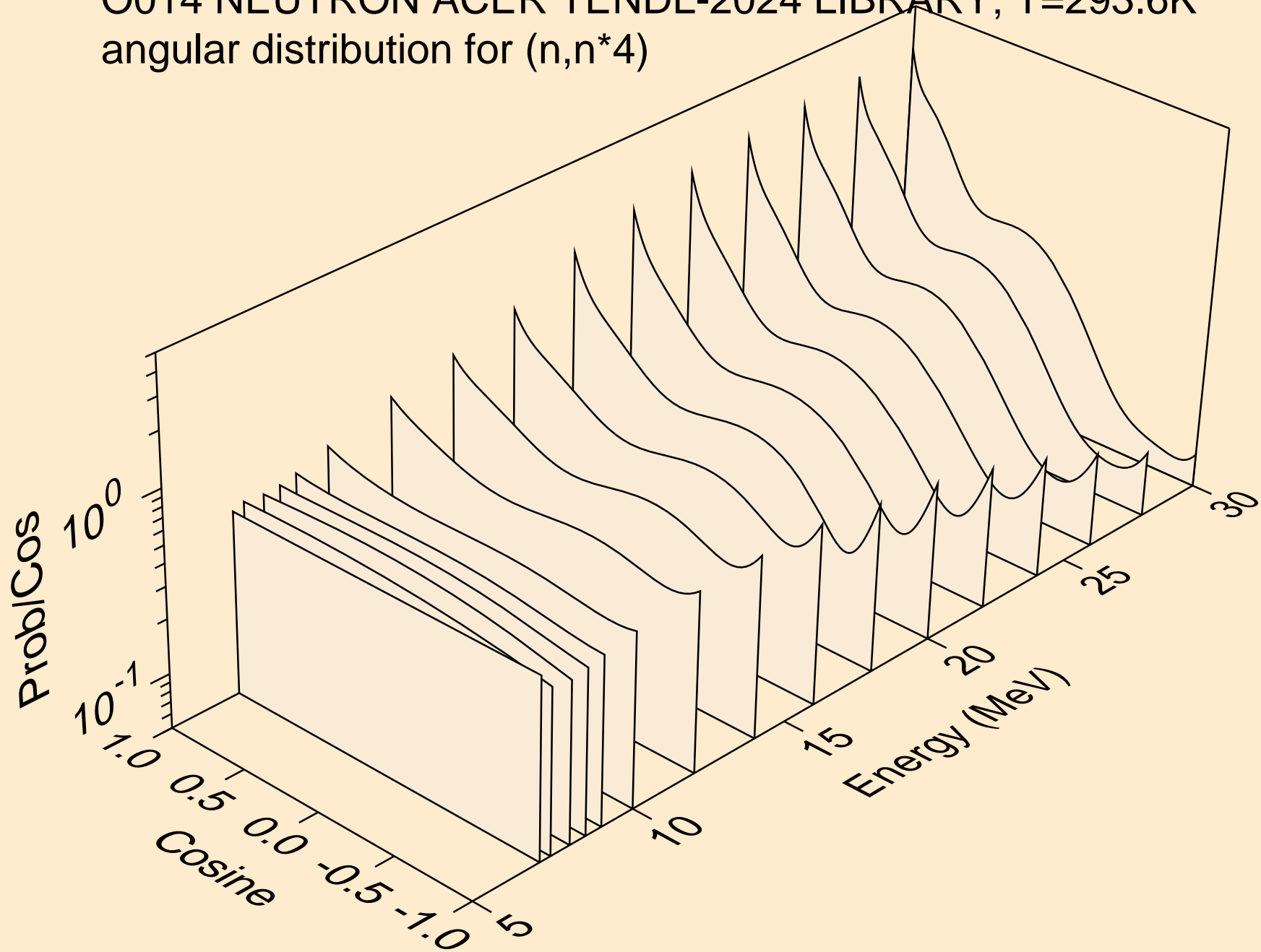

O014 NEUTRON ACER TENDL-2024 LIBRARY; T=293.6K  
Neutron emission for (n,x)

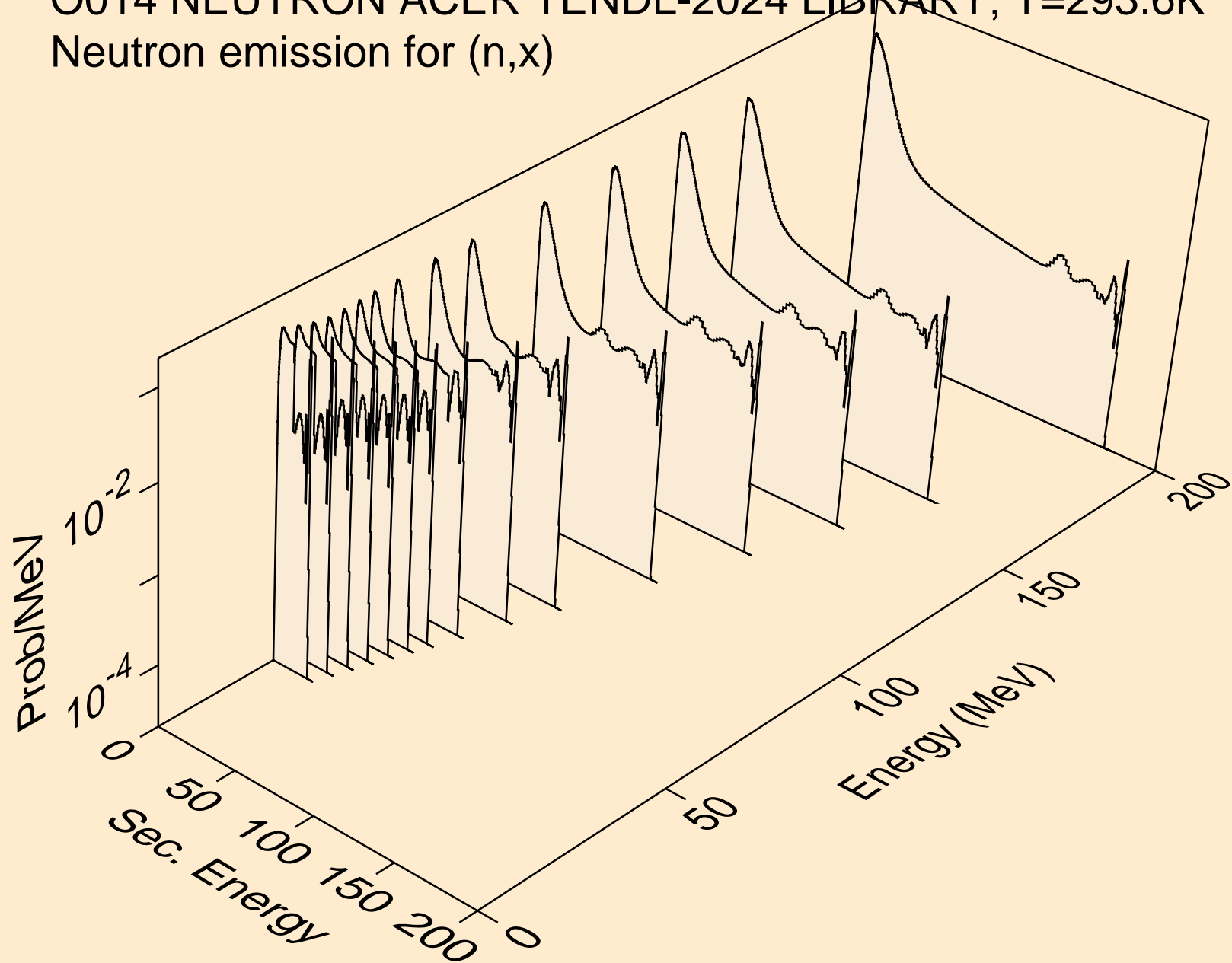

O014 NEUTRON ACER TENDL-2024 LIBRARY; T=293.6K  
Neutron emission for (n,2n)

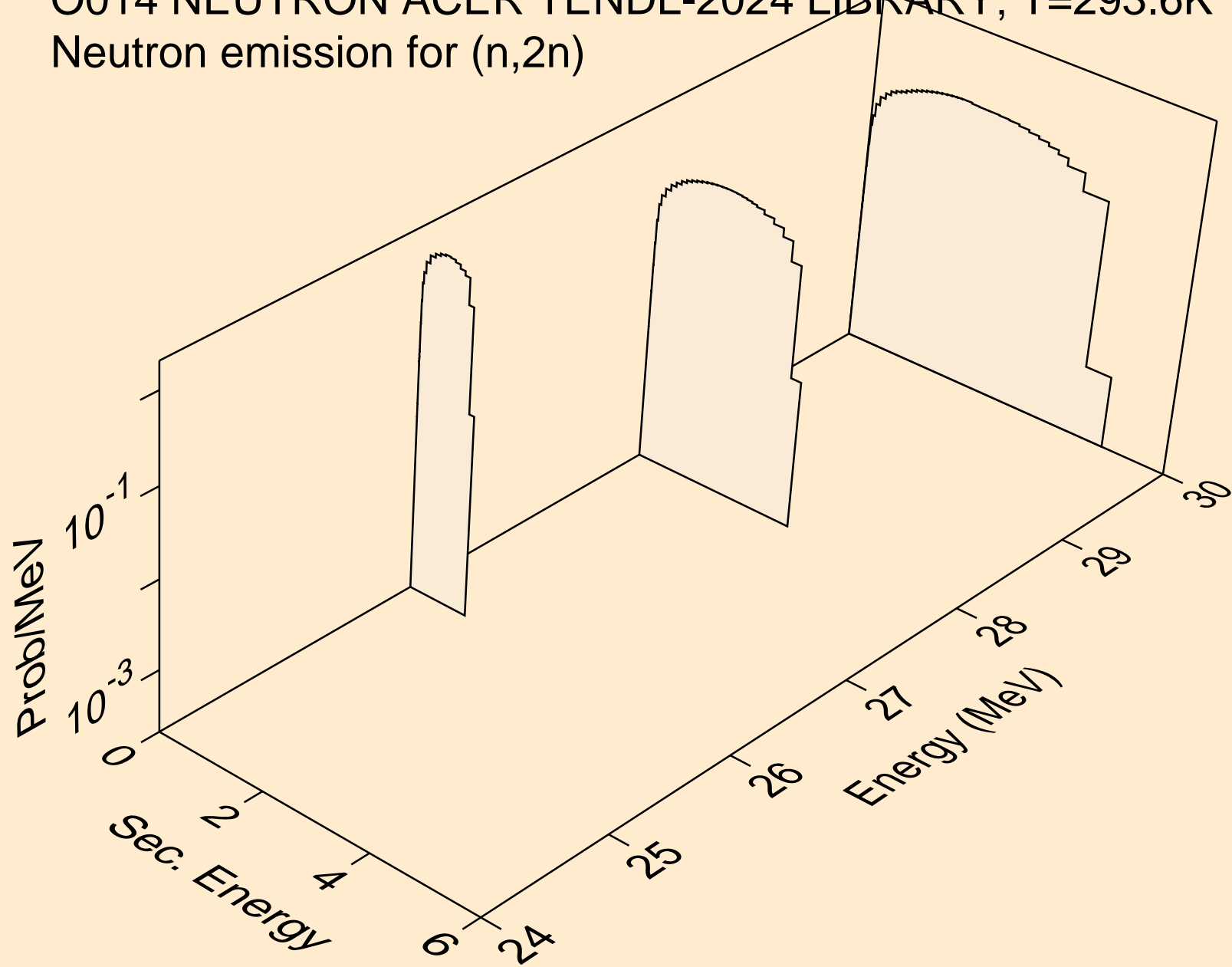

O014 NEUTRON ACER TENDL-2024 LIBRARY; T=293.6K  
Neutron emission for (n,n\*)a

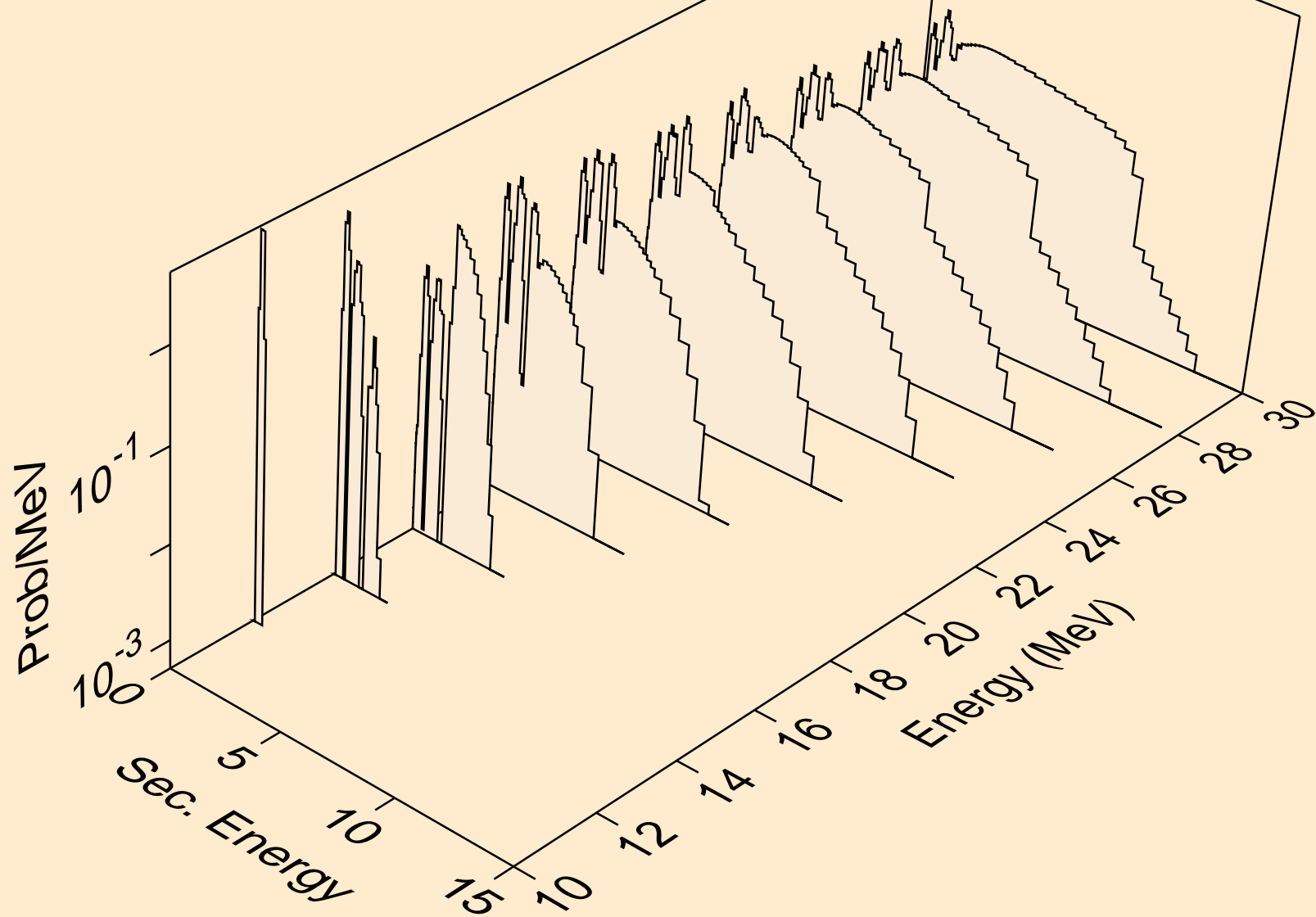

O014 NEUTRON ACER TENDL-2024 LIBRARY; T=293.6K  
Neutron emission for (n,n\*)p

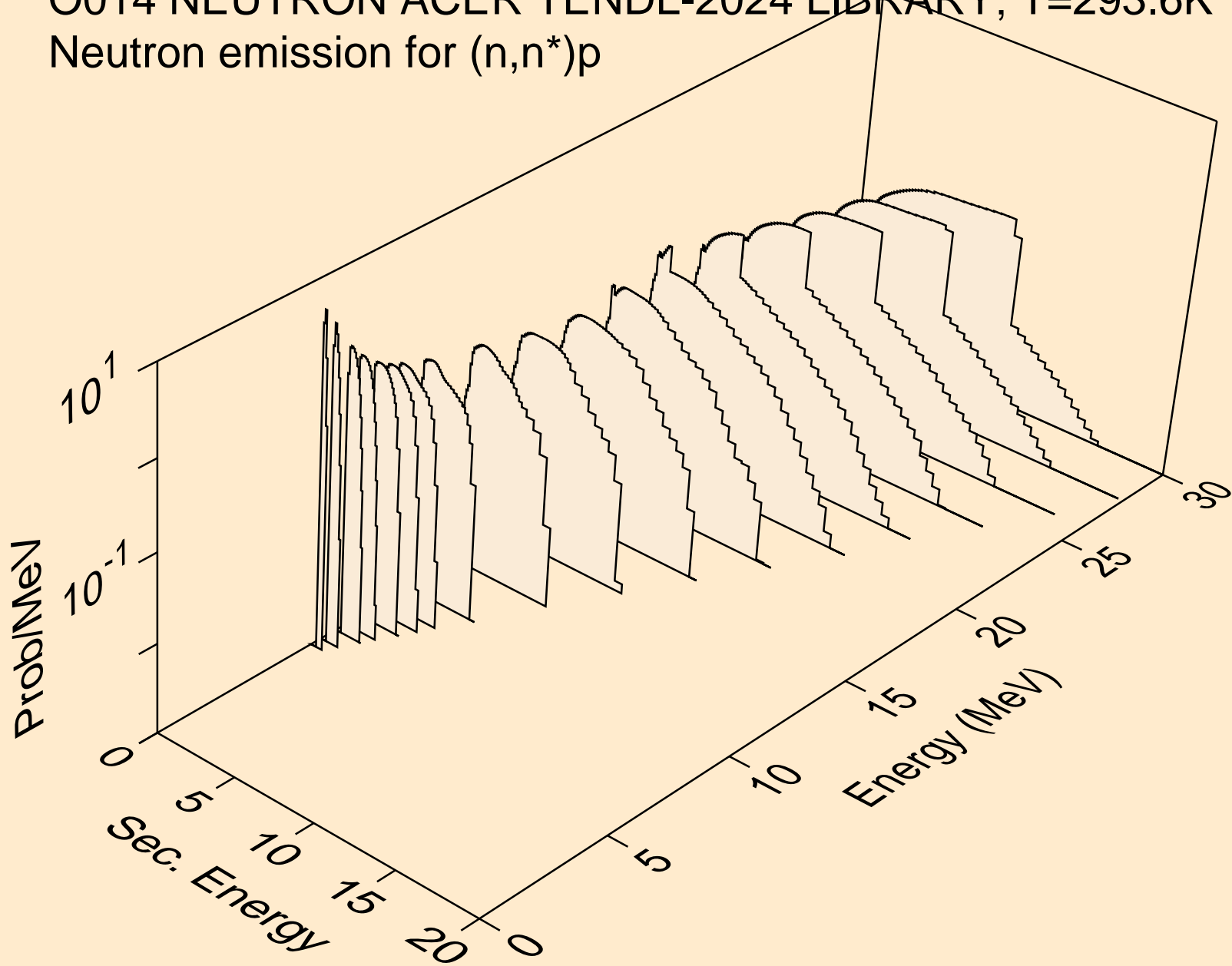

O014 NEUTRON ACER TENDL-2024 LIBRARY; T=293.6K  
Neutron emission for (n,n\*)d

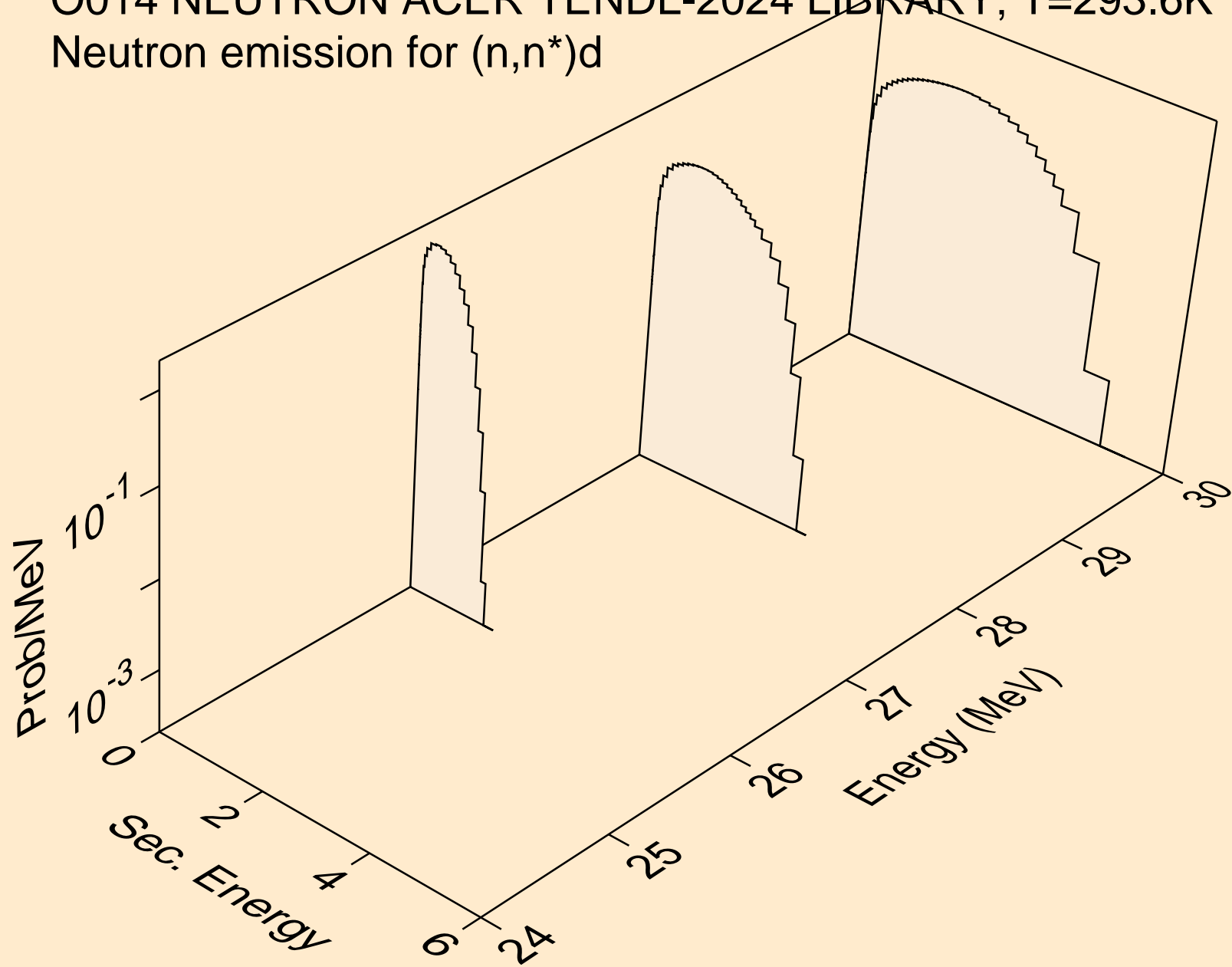

O014 NEUTRON ACER TENDL-2024 LIBRARY; T=293.6K  
Neutron emission for (n,n\*)he3

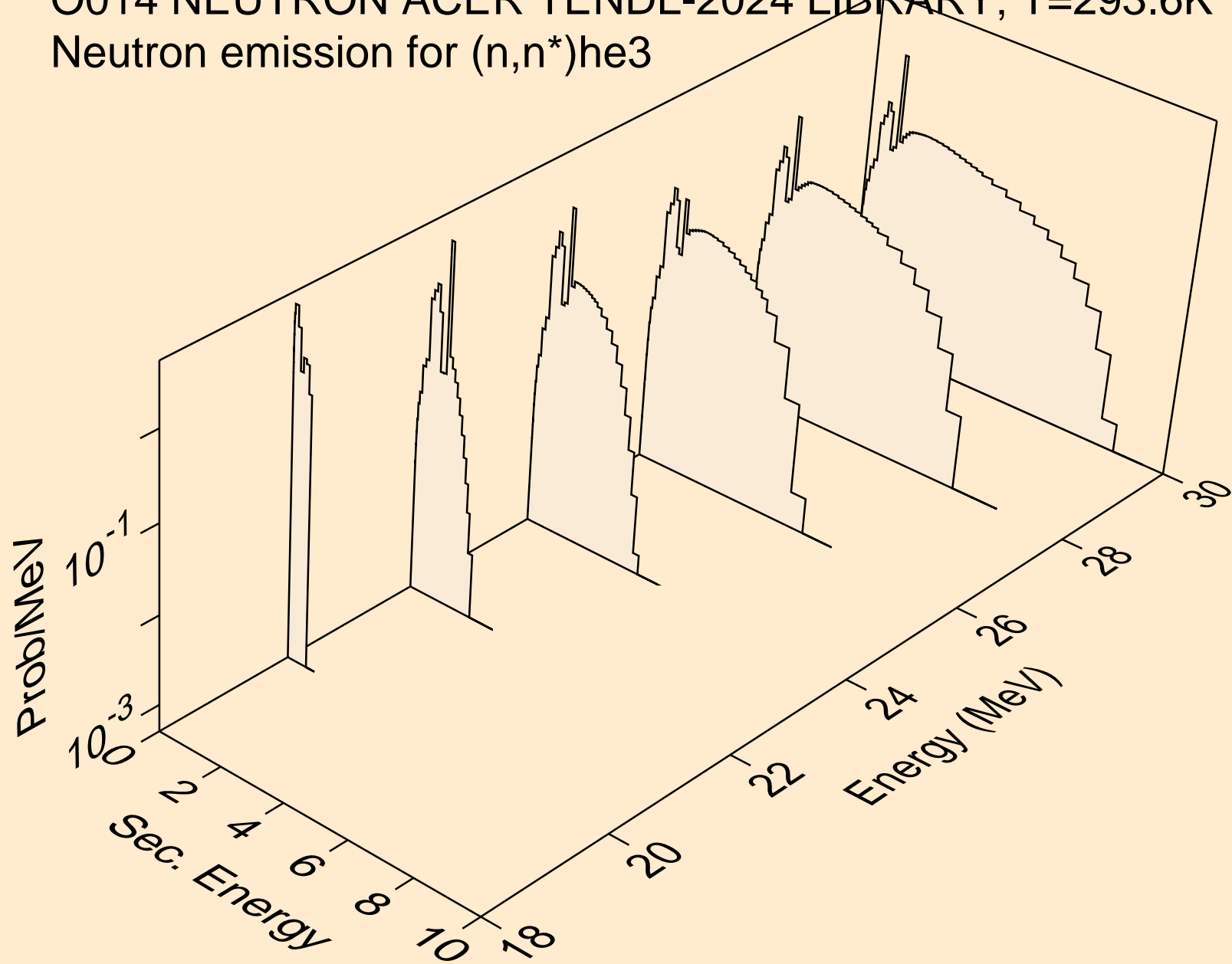

O014 NEUTRON ACER TENDL-2024 LIBRARY; T=293.6K  
Neutron emission for (n,2np)

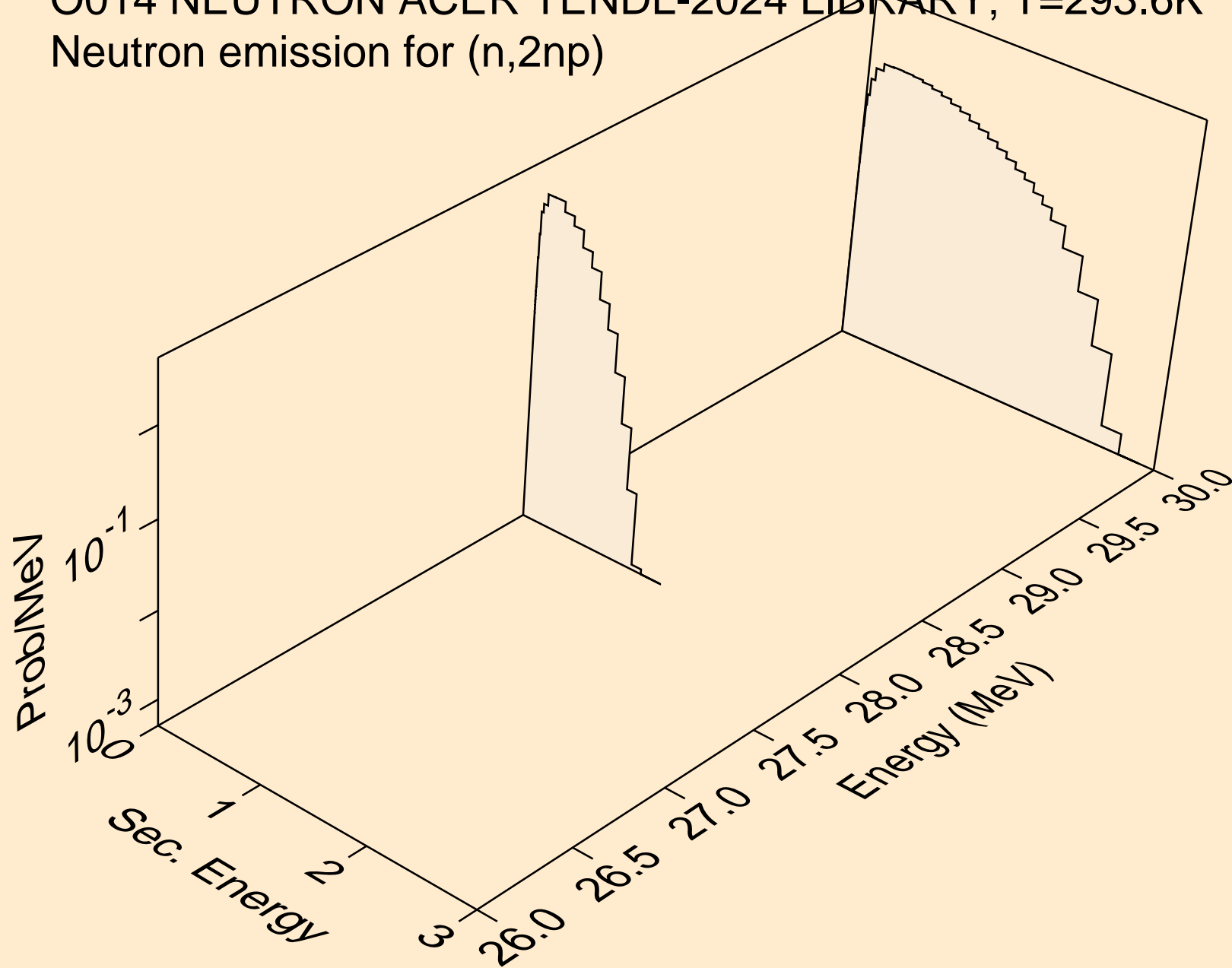

O014 NEUTRON ACER TENDL-2024 LIBRARY; T=293.6K  
Neutron emission for (n,n2p)

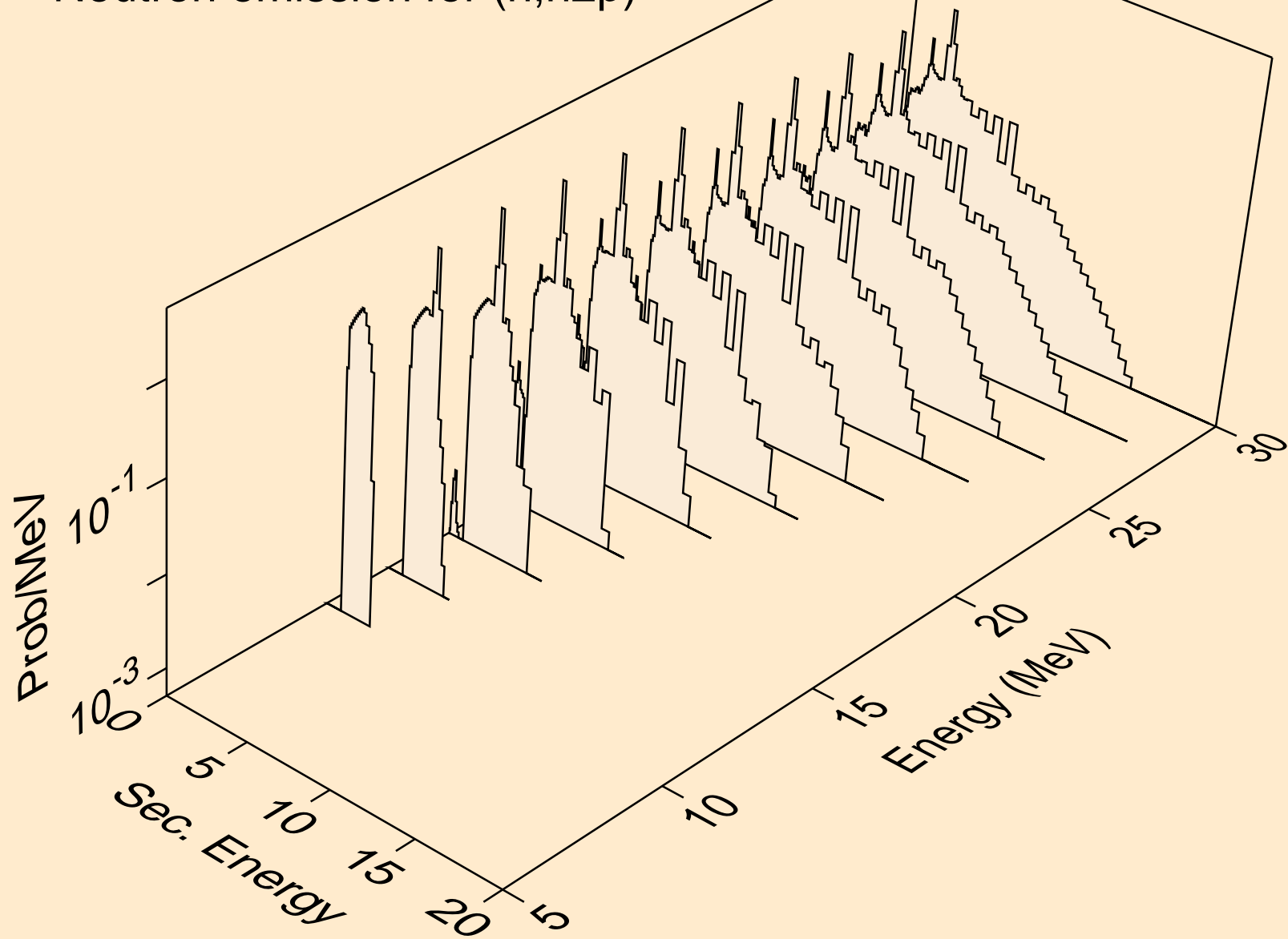

O014 NEUTRON ACER TENDL-2024 LIBRARY; T=293.6K  
Neutron emission for (n,npa)

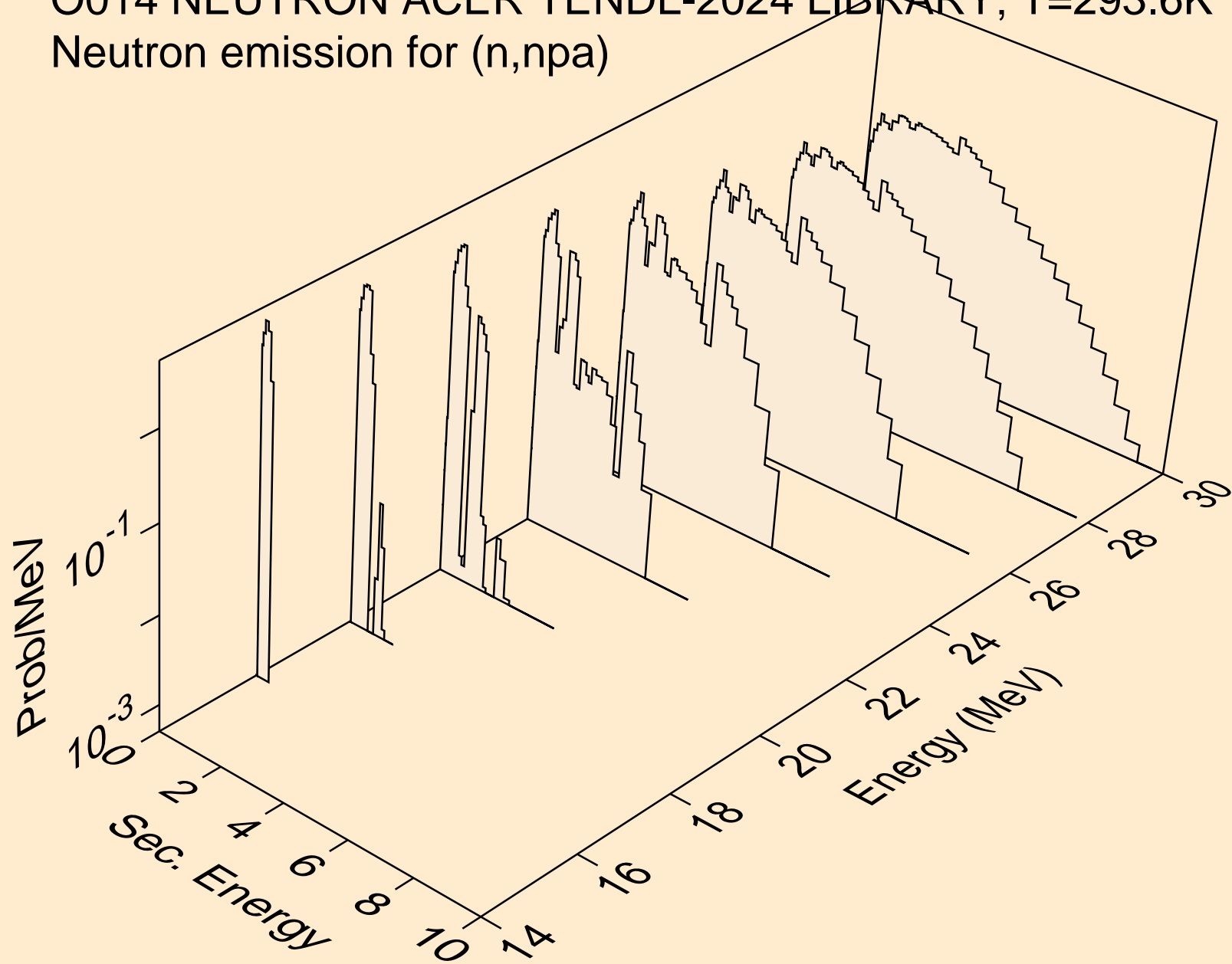

O014 NEUTRON ACER TENDL-2024 LIBRARY; T=293.6K  
Neutron emission for (n,n\*c)

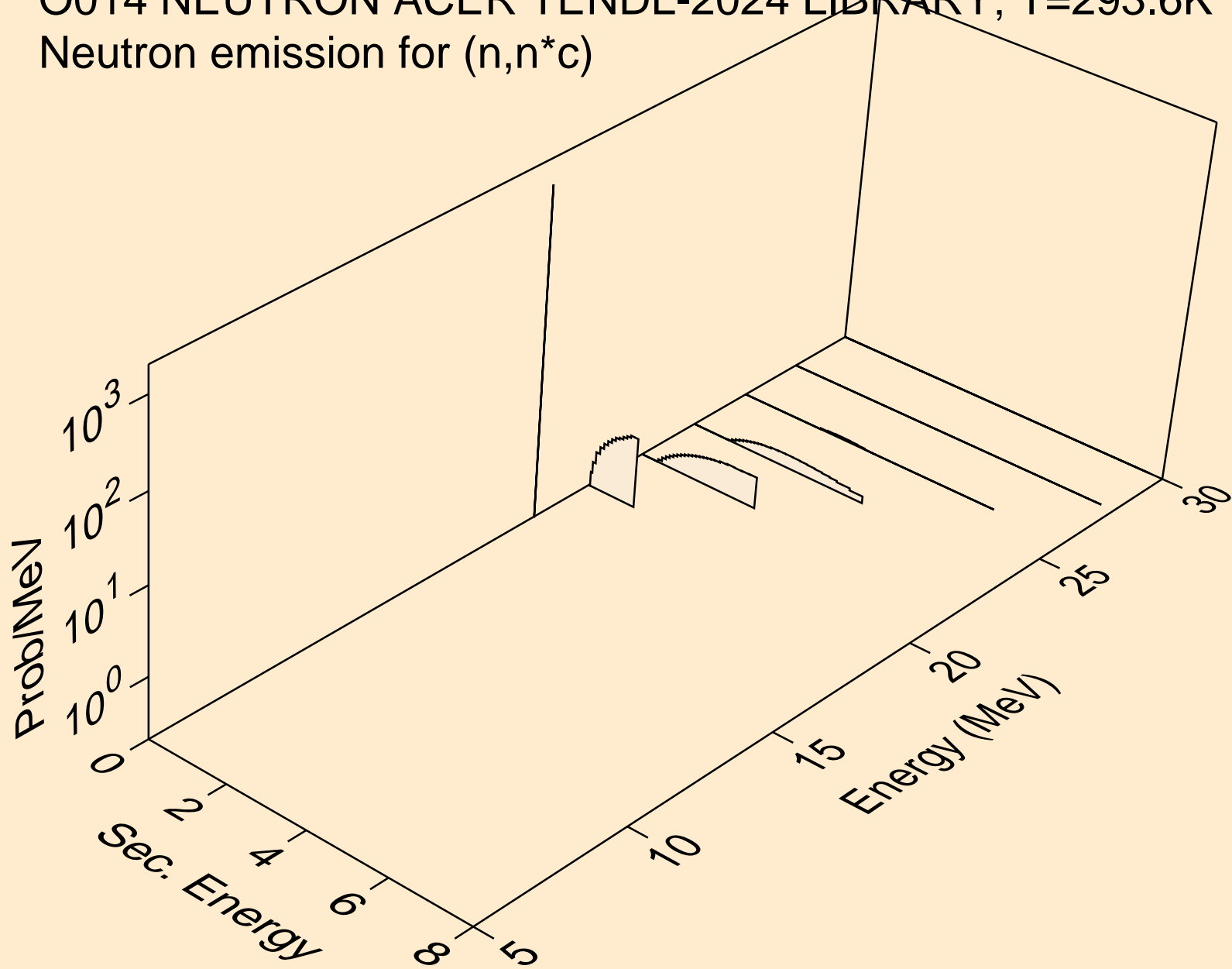

O014 NEUTRON ACER TENDL-2024 LIBRARY; T=293.6K  
Photon emission for (n,x)

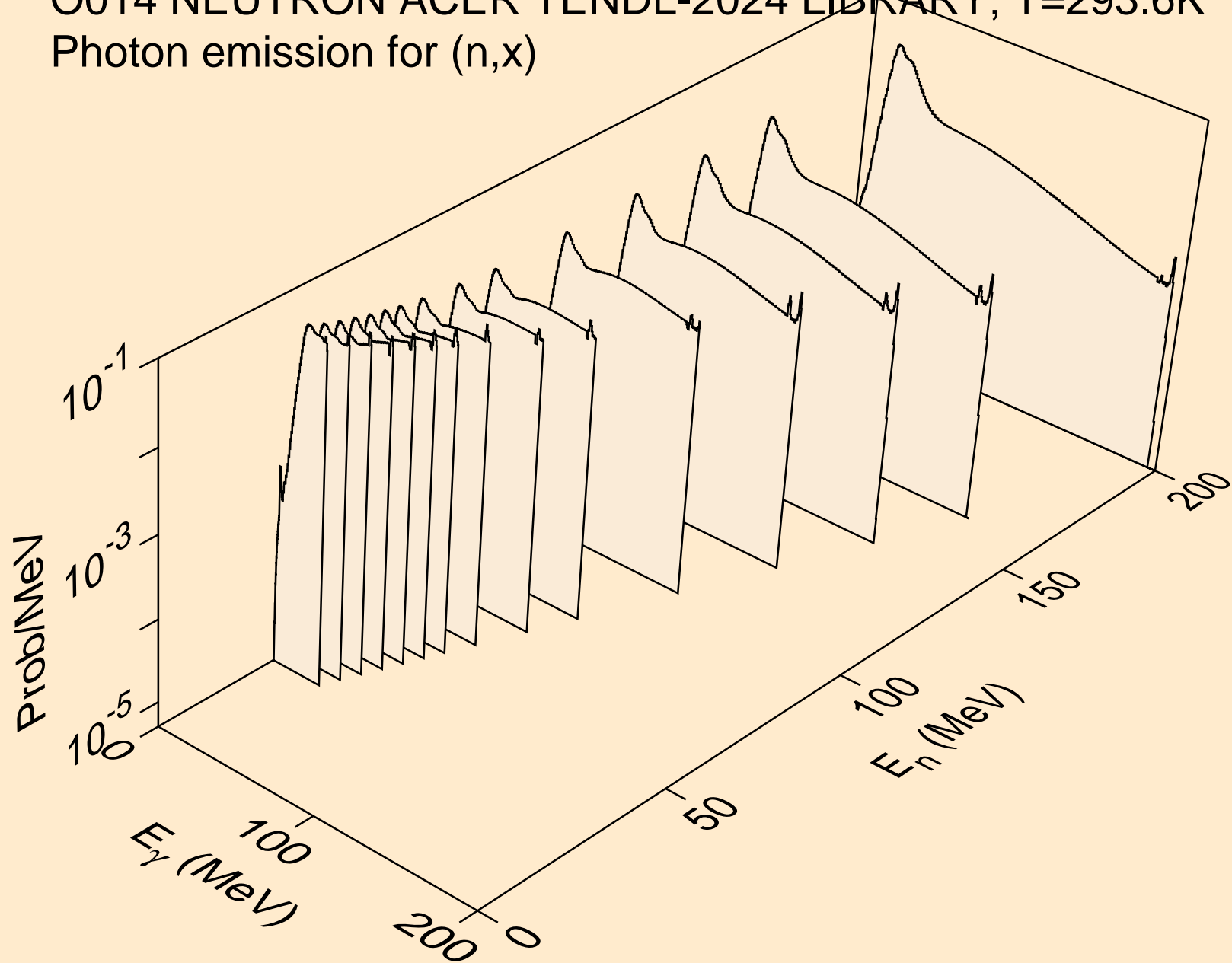

O014 NEUTRON ACER TENDL-2024 LIBRARY; T=293.6K  
Photon emission for (n,2n)

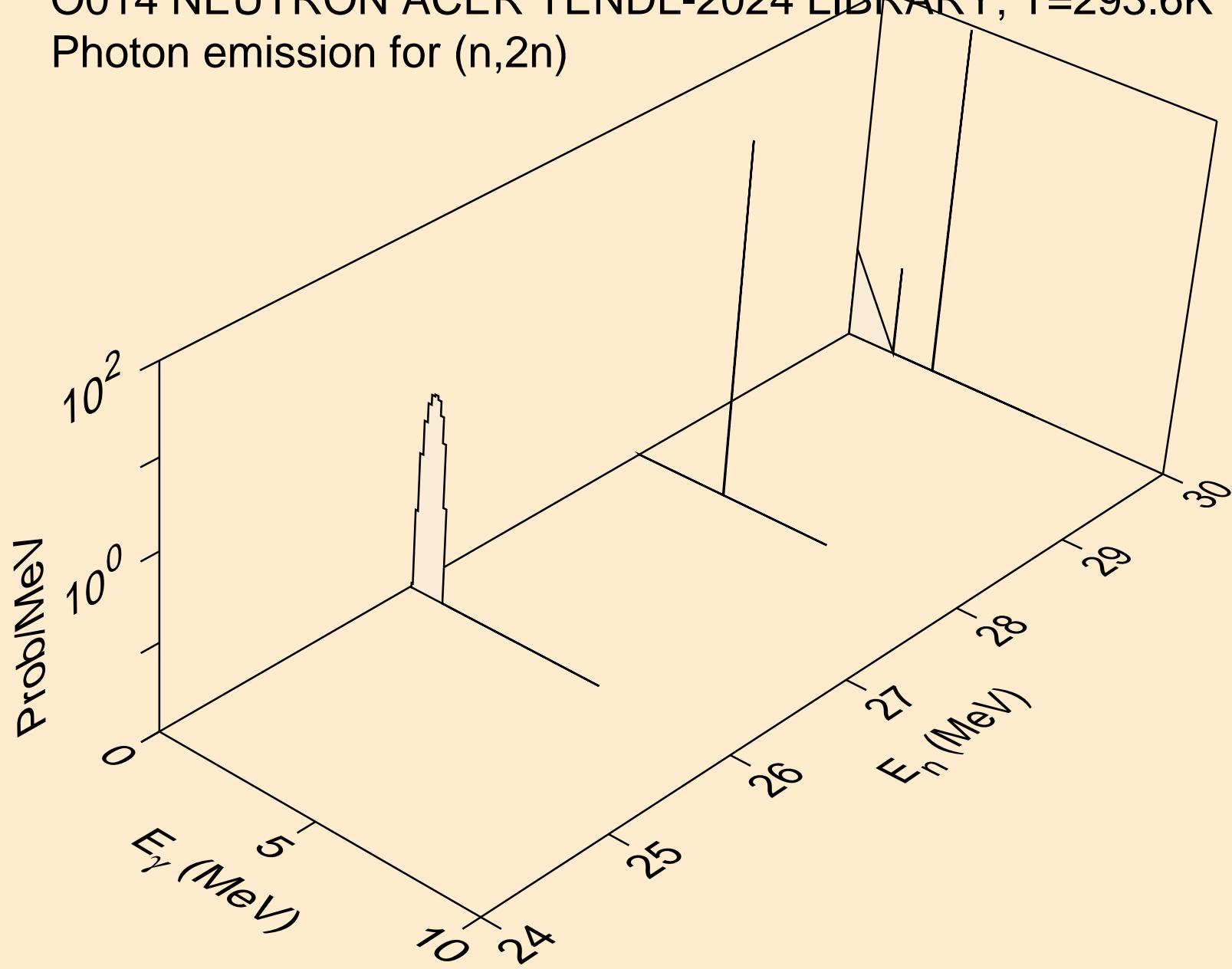

O014 NEUTRON ACER TENDL-2024 LIBRARY; T=293.6K  
Photon emission for (n,n\*)a

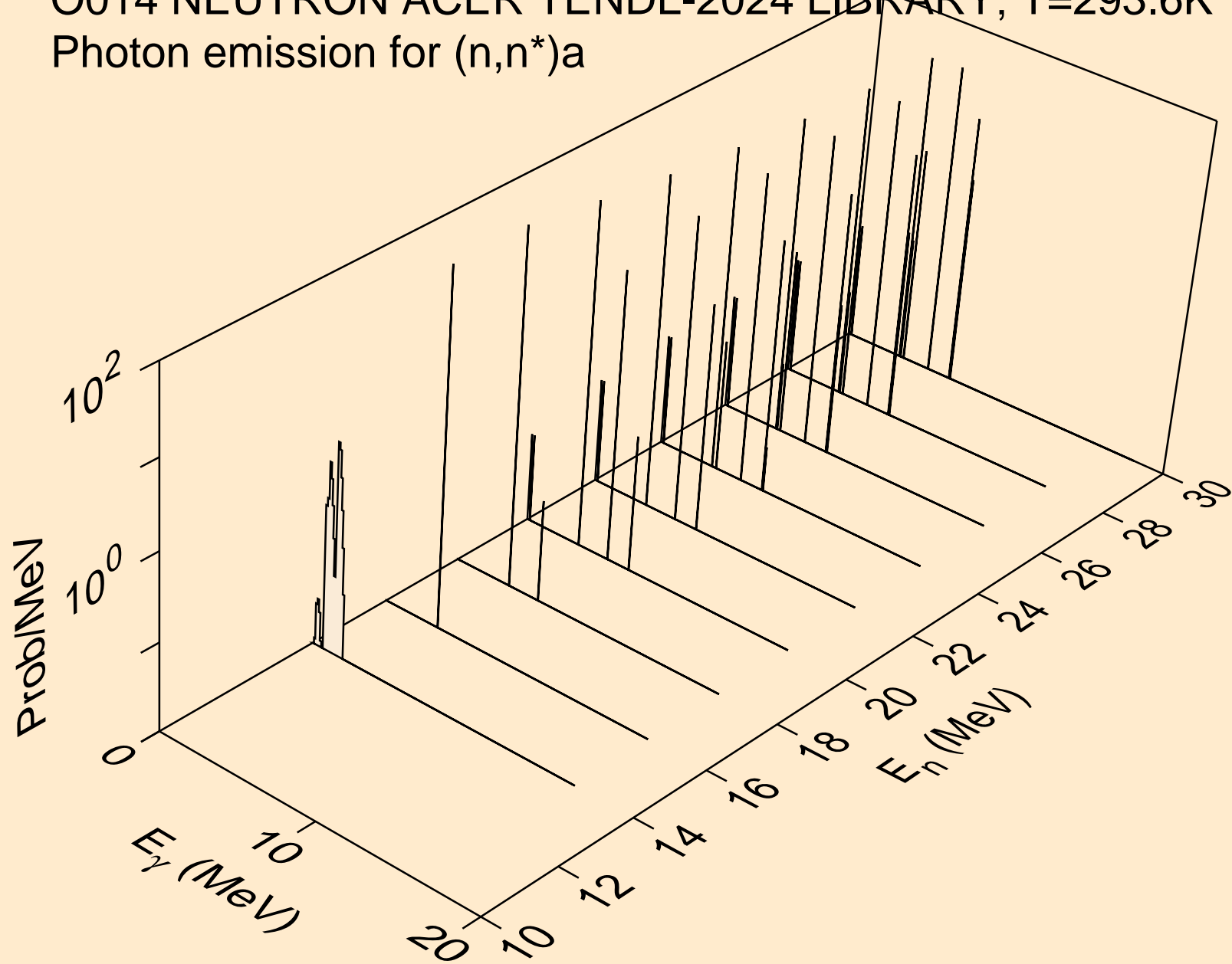

O014 NEUTRON ACER TENDL-2024 LIBRARY; T=293.6K  
Photon emission for (n,n\*)p

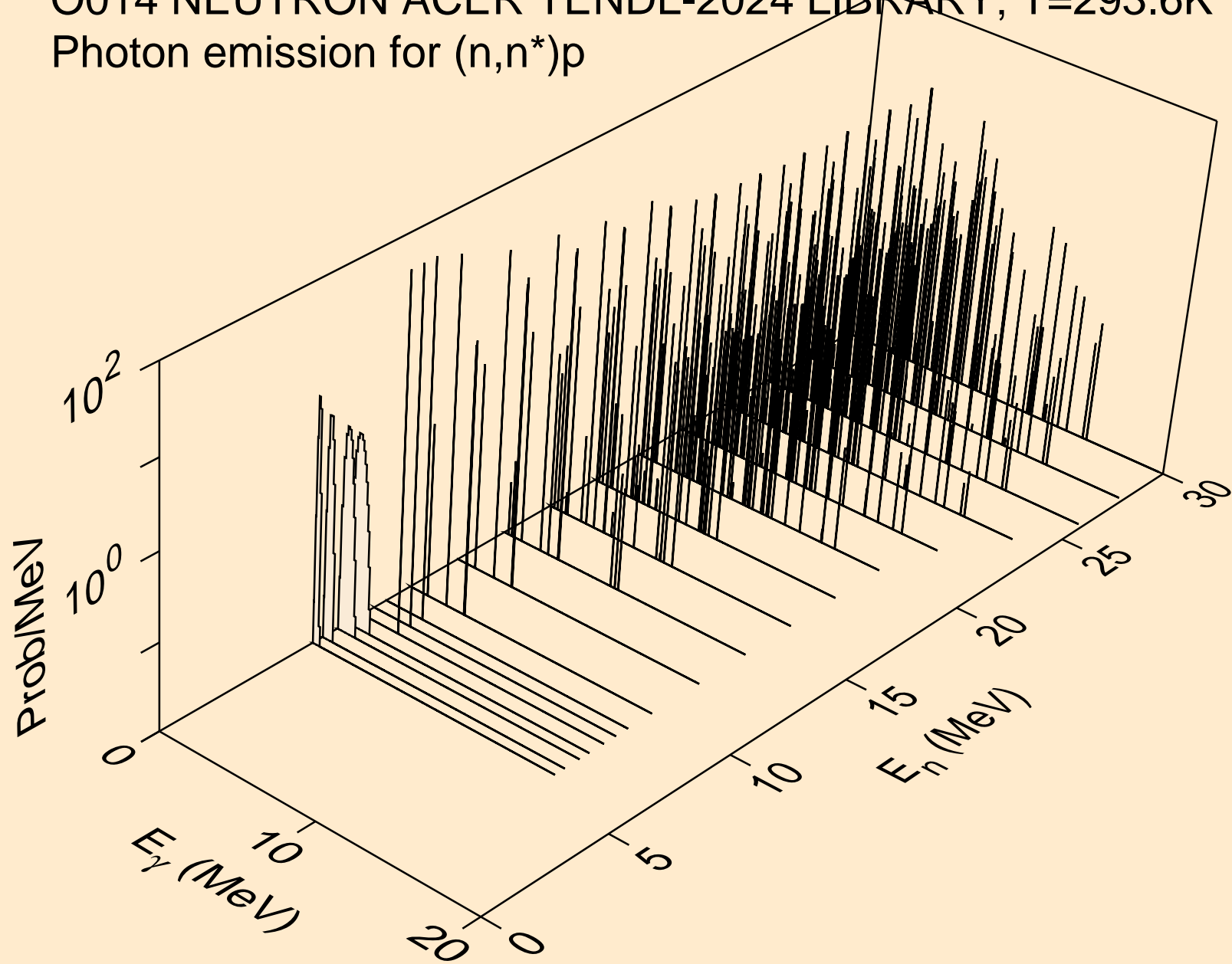

O014 NEUTRON ACER TENDL-2024 LIBRARY; T=293.6K  
Photon emission for (n,n\*)d

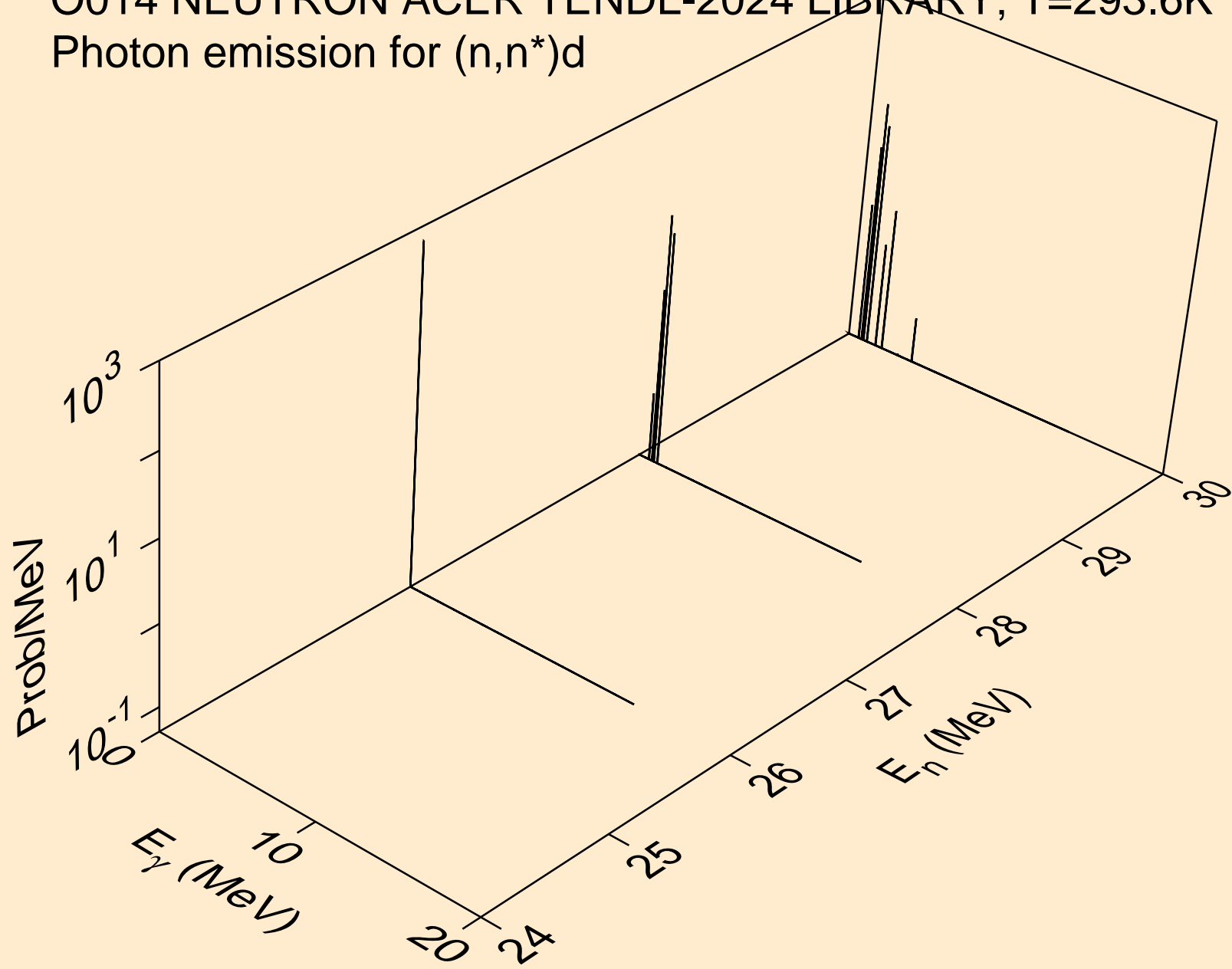

O014 NEUTRON ACER TENDL-2024 LIBRARY; T=293.6K  
Photon emission for (n,n\*)he3

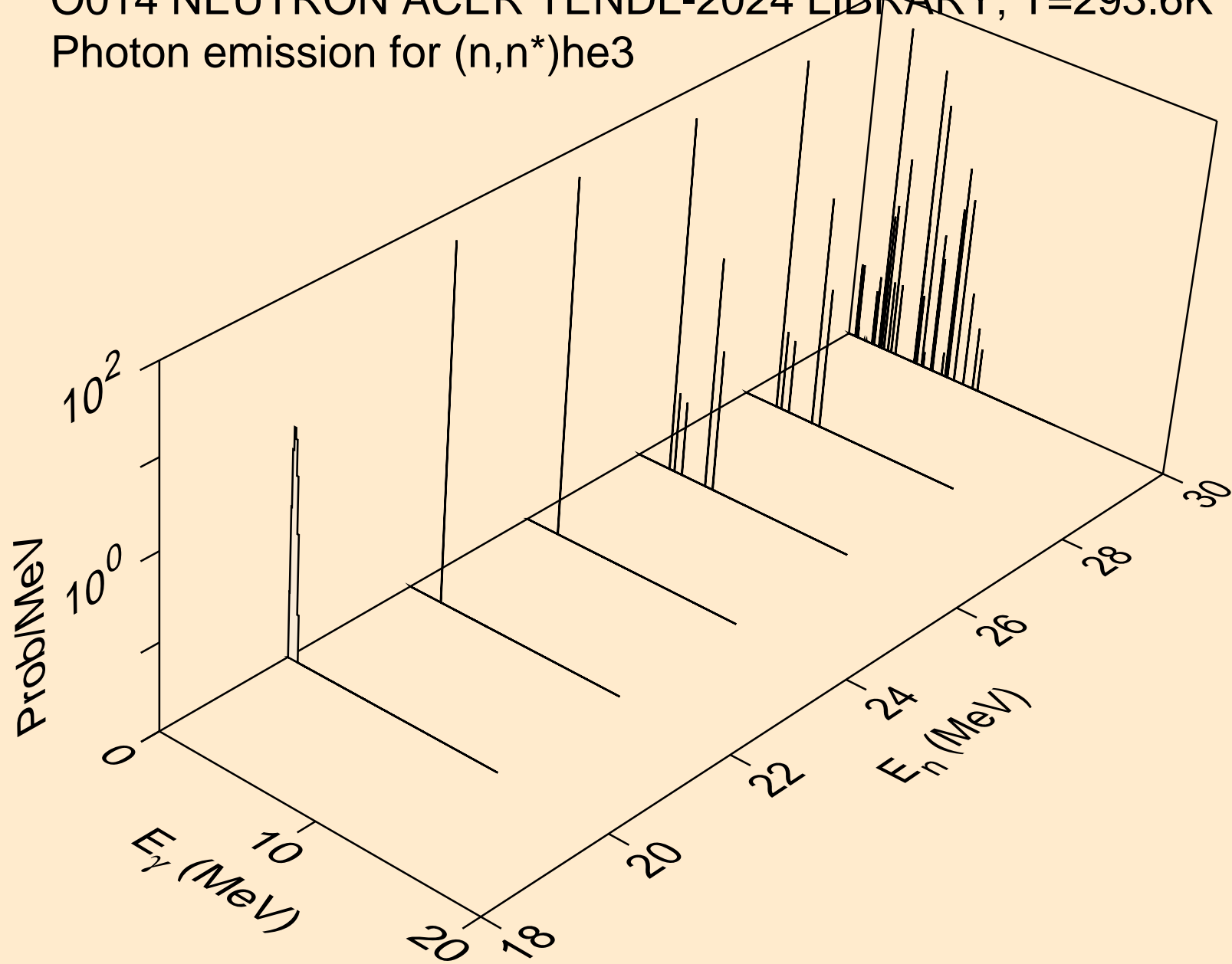

O014 NEUTRON ACER TENDL-2024 LIBRARY; T=293.6K  
Photon emission for (n,2np)

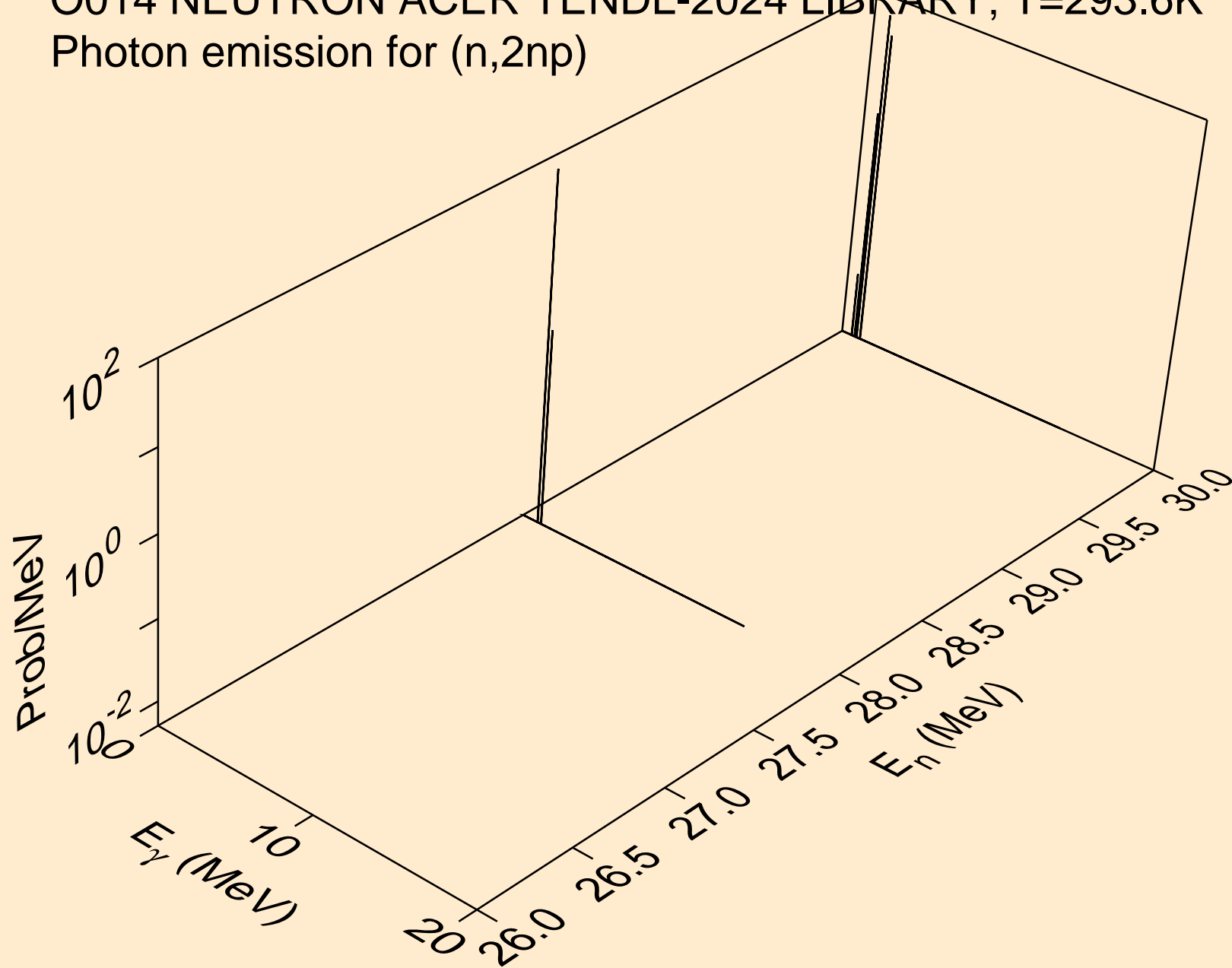

O014 NEUTRON ACER TENDL-2024 LIBRARY; T=293.6K  
Photon emission for (n,n2p)

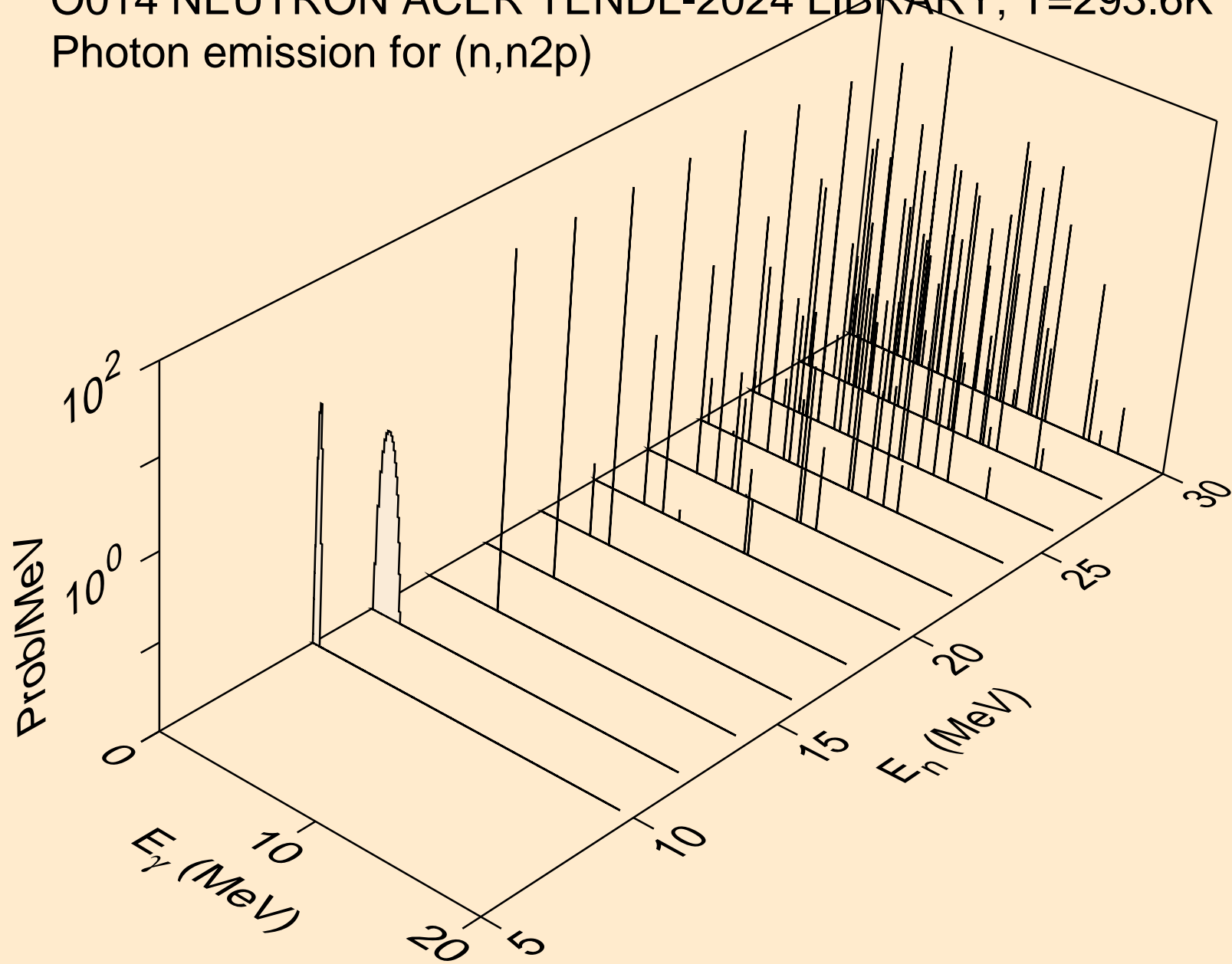

O014 NEUTRON ACER TENDL-2024 LIBRARY; T=293.6K  
Photon emission for (n,npa)

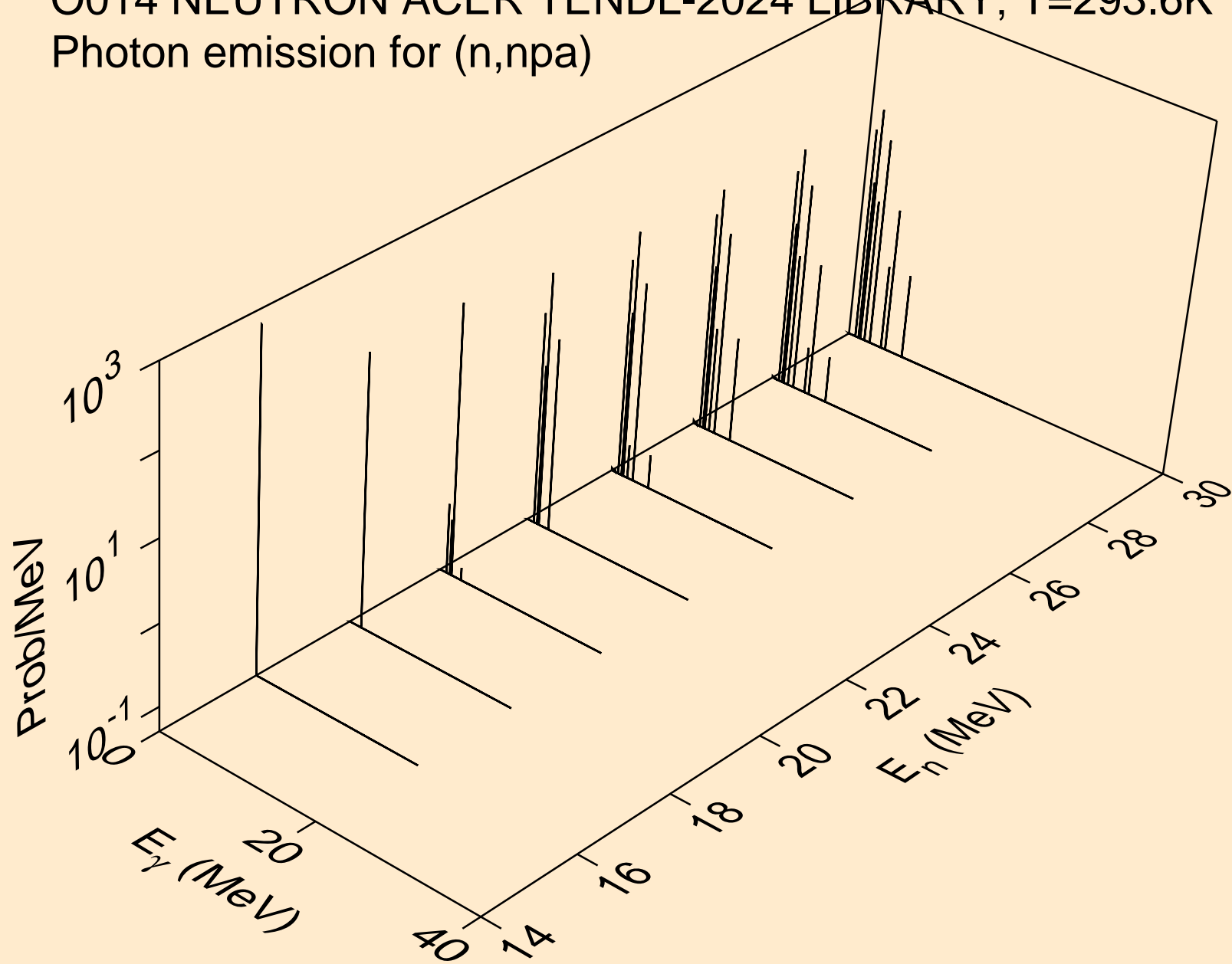

O014 NEUTRON ACER TENDL-2024 LIBRARY; T=293.6K  
Photon emission for (n,n\*c)

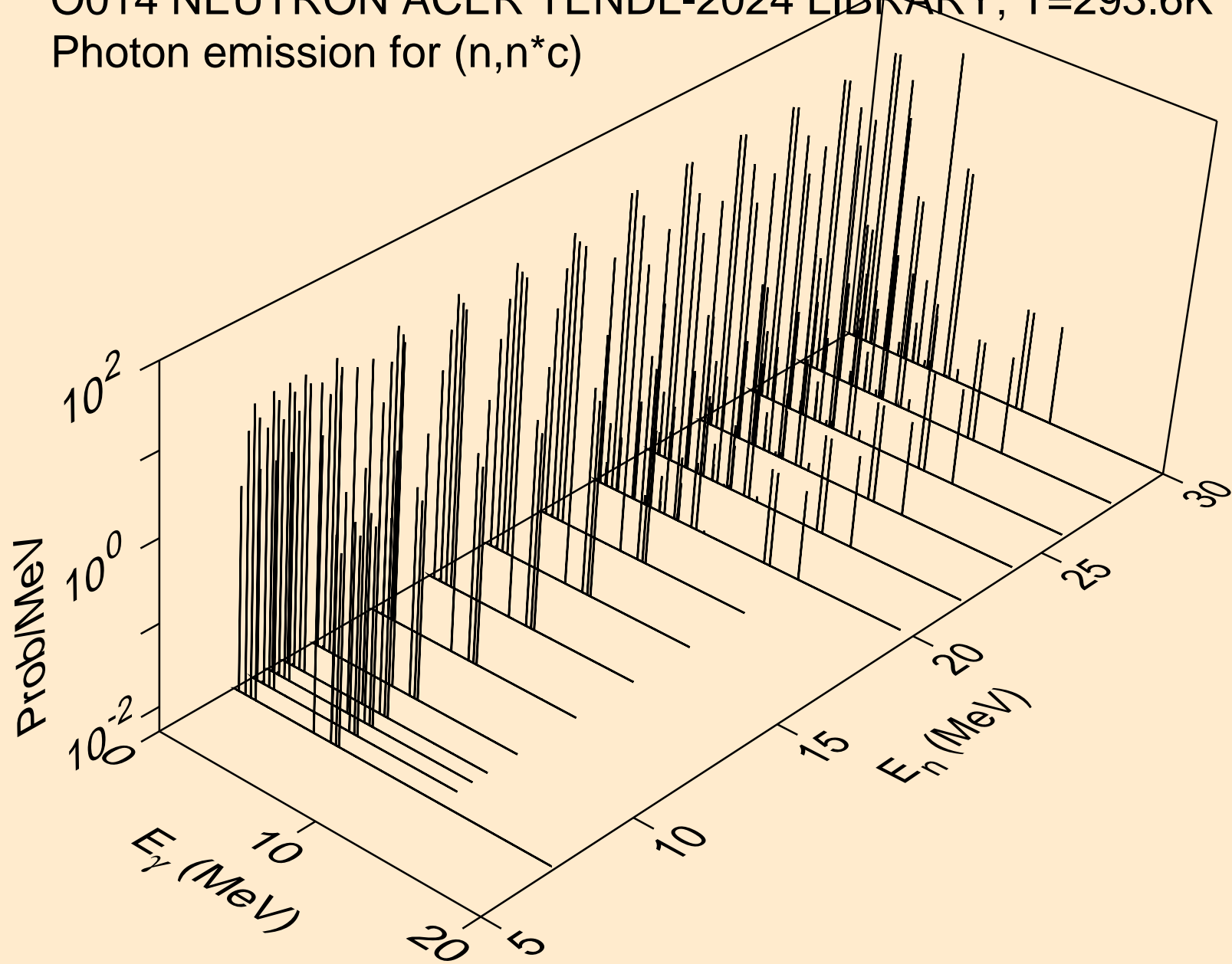

O014 NEUTRON ACER TENDL-2024 LIBRARY; T=293.6K  
Photon emission for (n,gma)

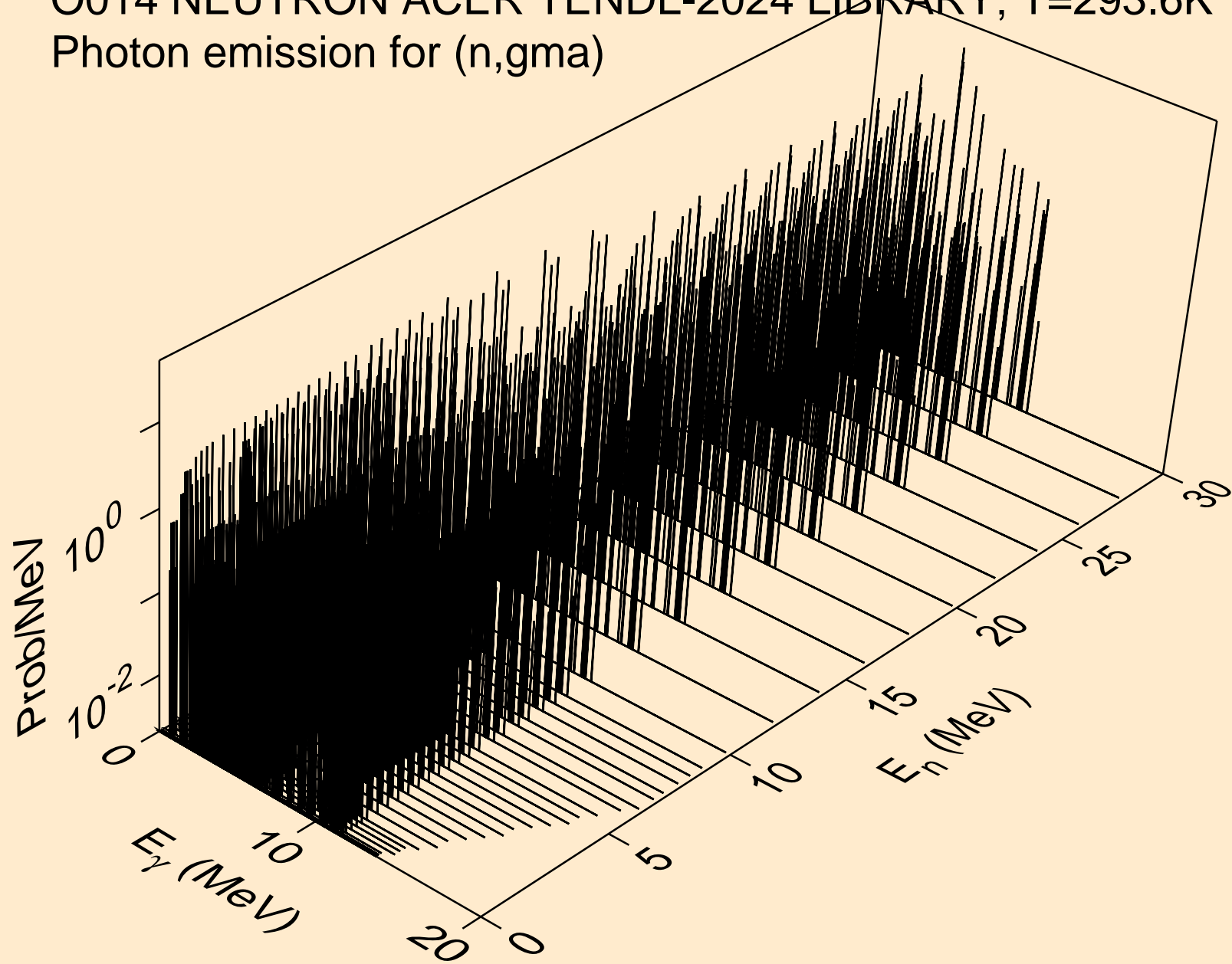

O014 NEUTRON ACER TENDL-2024 LIBRARY; T=293.6K  
Photon emission for (n,p)

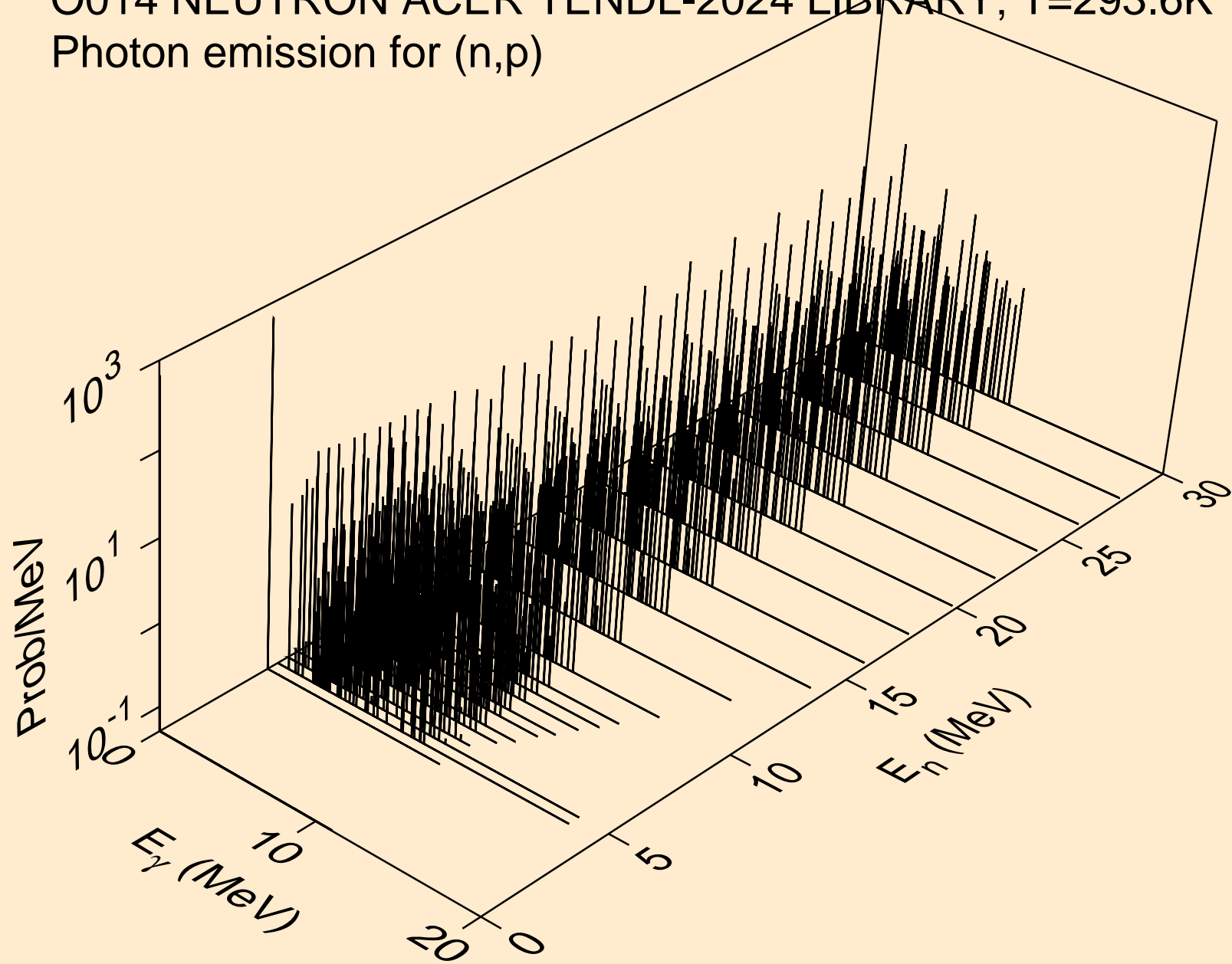

O014 NEUTRON ACER TENDL-2024 LIBRARY; T=293.6K  
Photon emission for (n,d)

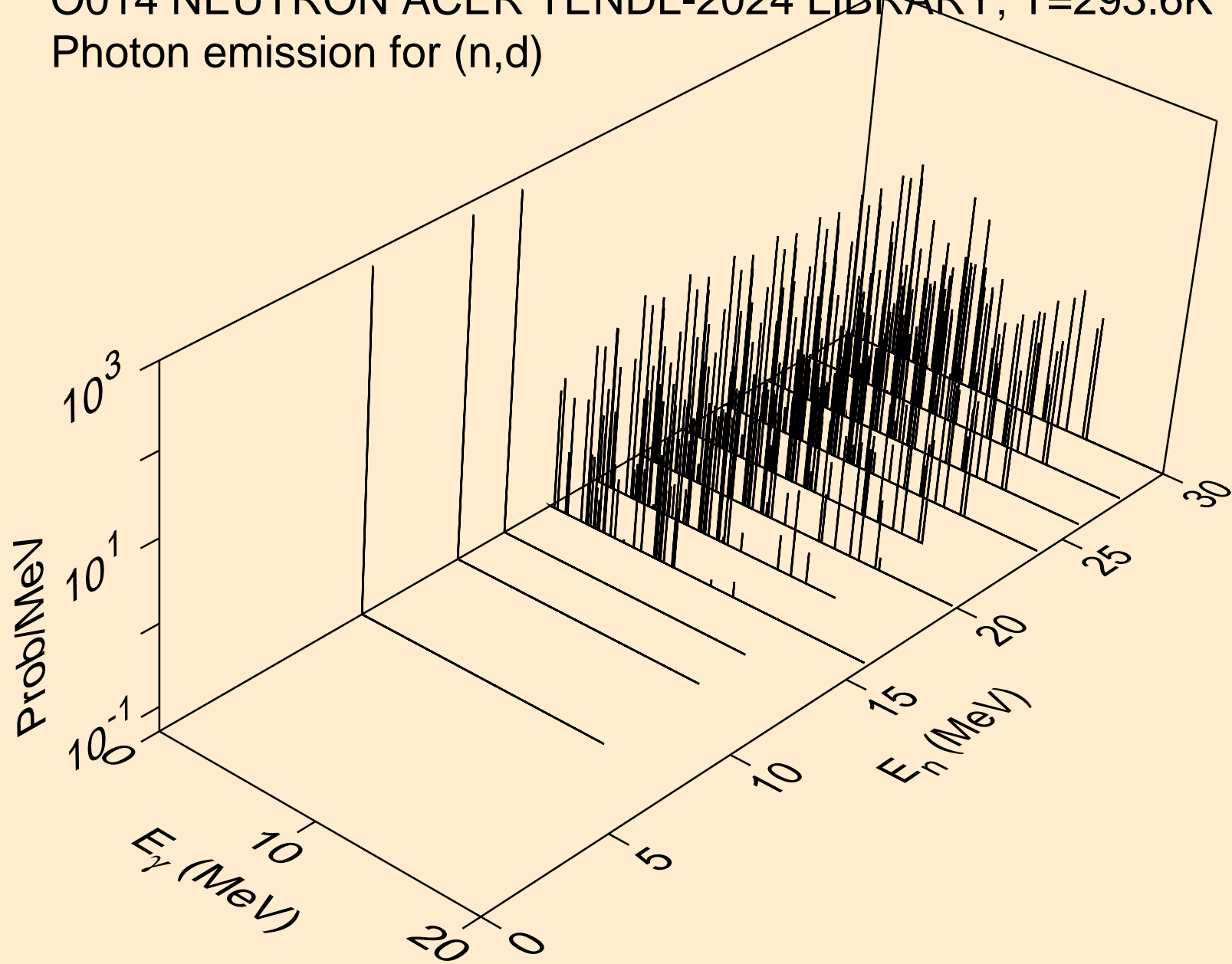

O014 NEUTRON ACER TENDL-2024 LIBRARY; T=293.6K  
Photon emission for (n,t)

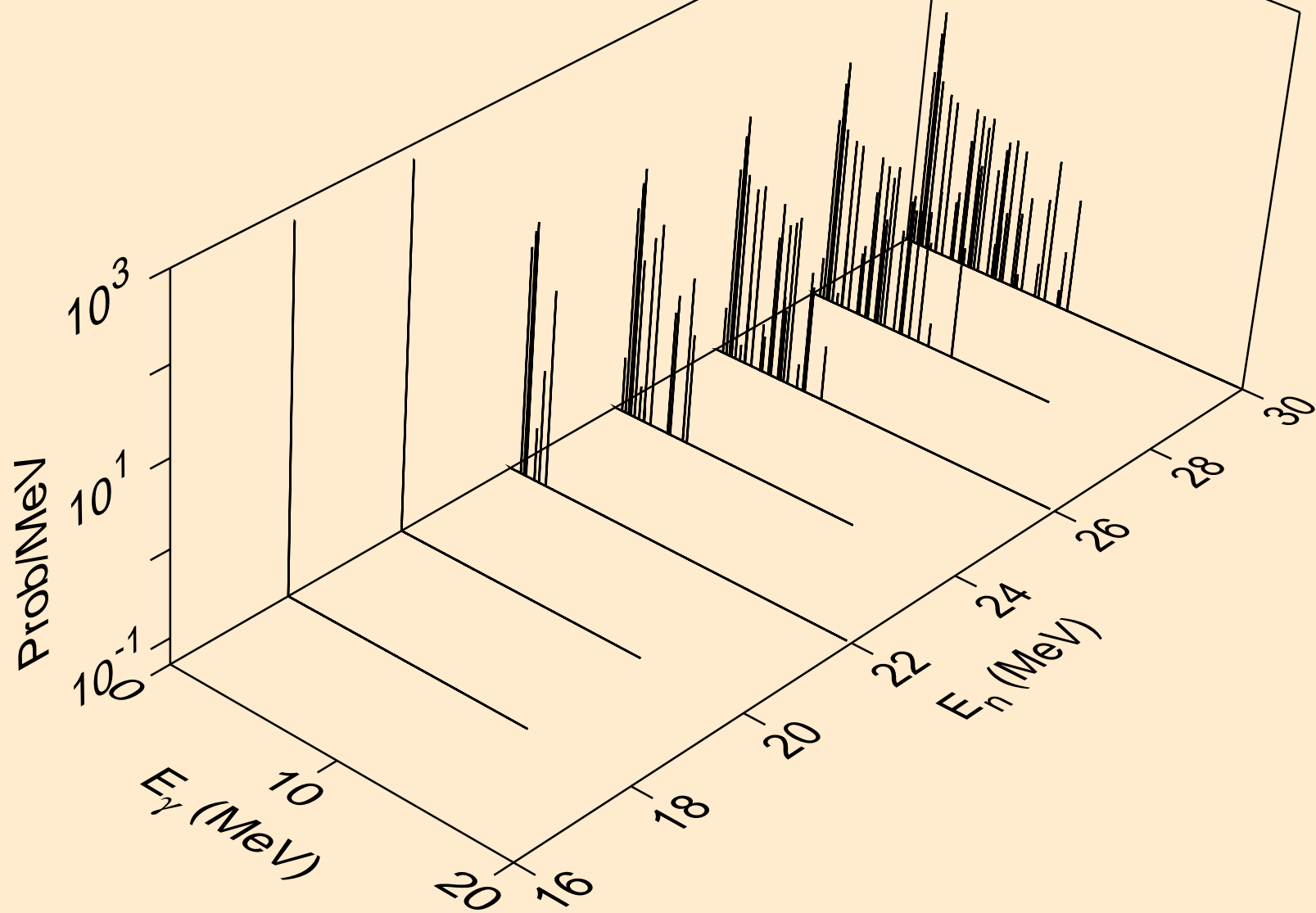

O014 NEUTRON ACER TENDL-2024 LIBRARY; T=293.6K  
Photon emission for (n,he3)

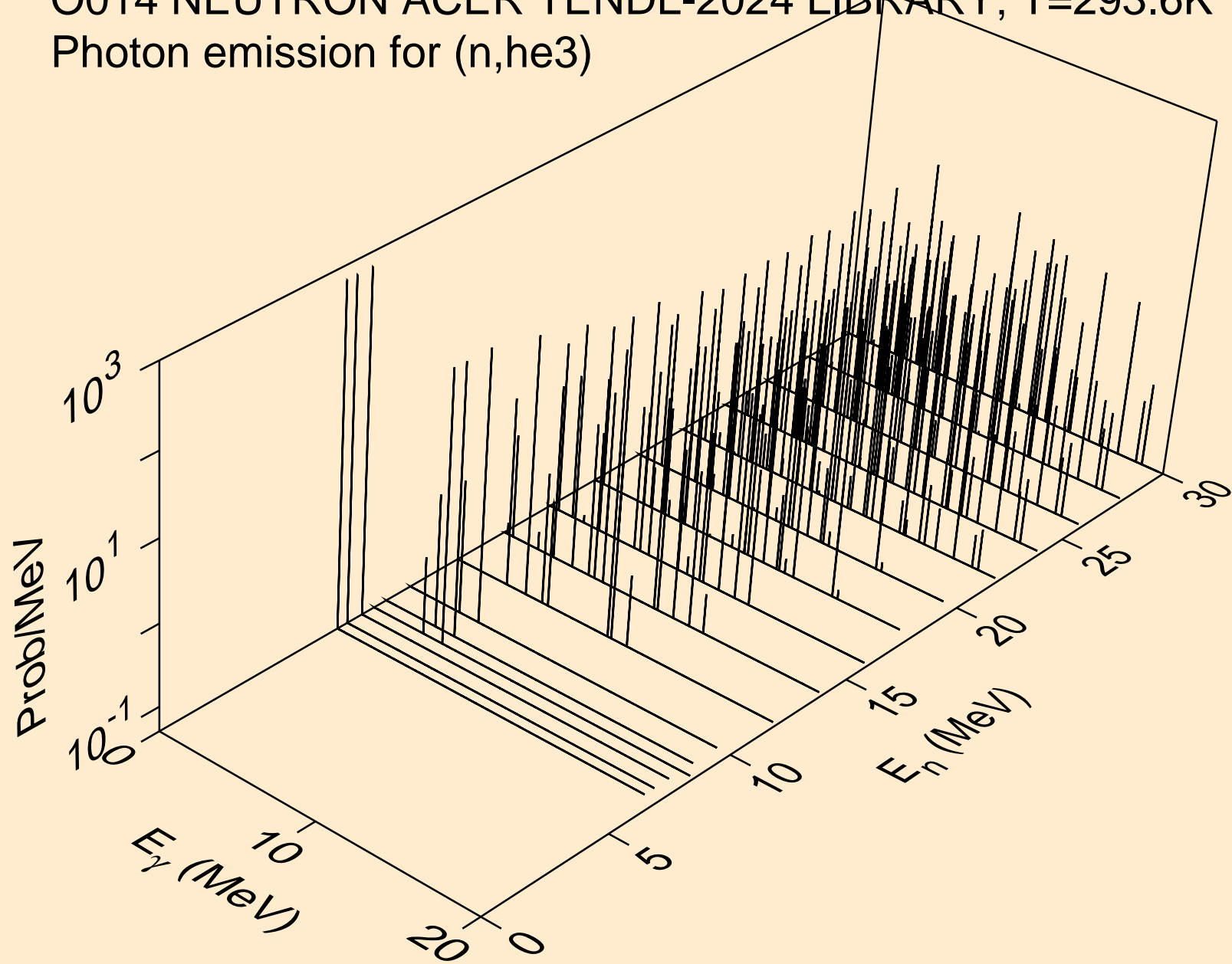

O014 NEUTRON ACER TENDL-2024 LIBRARY; T=293.6K  
Photon emission for (n,a)

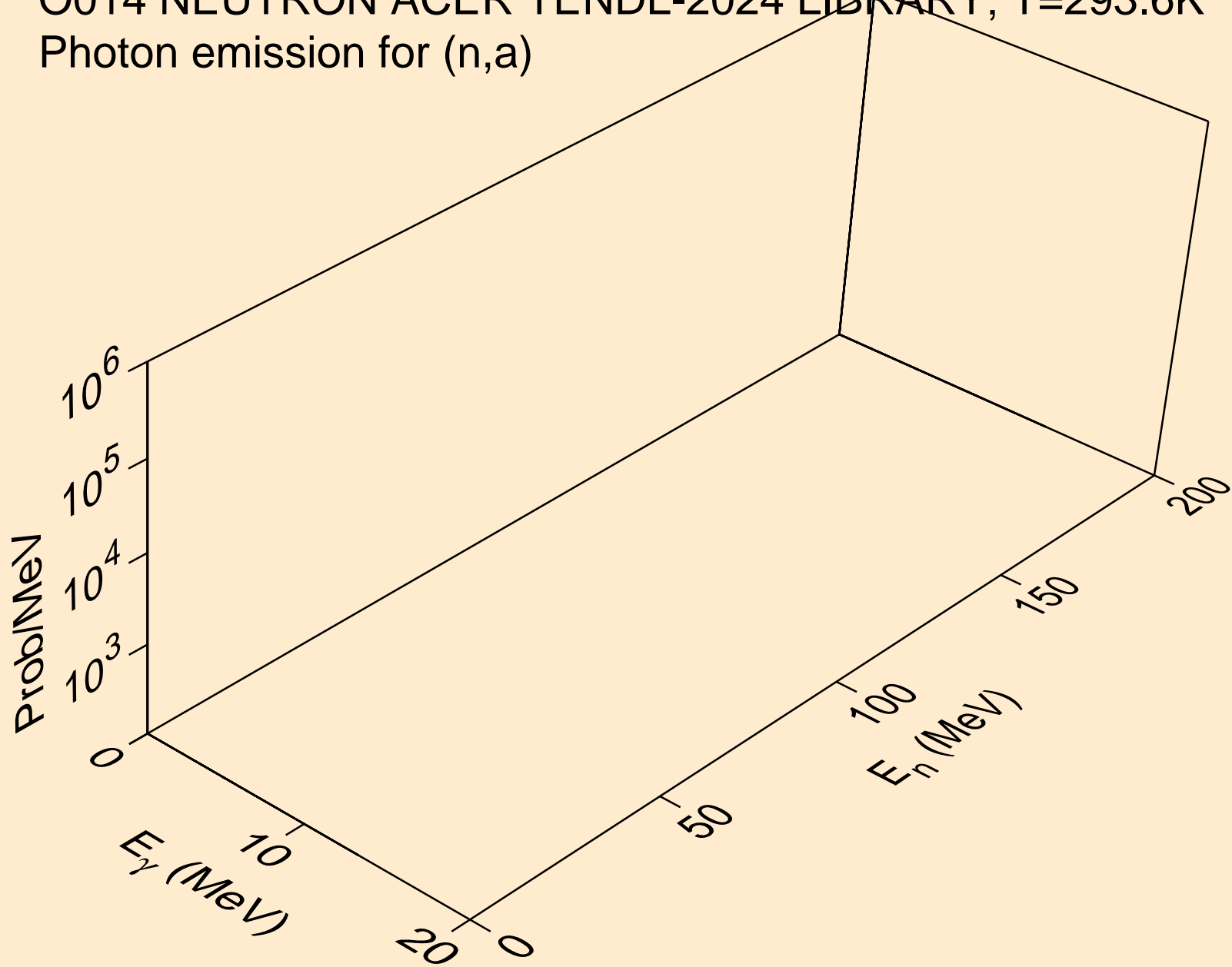

O014 NEUTRON ACER TENDL-2024 LIBRARY; T=293.6K  
Photon emission for (n,2a)

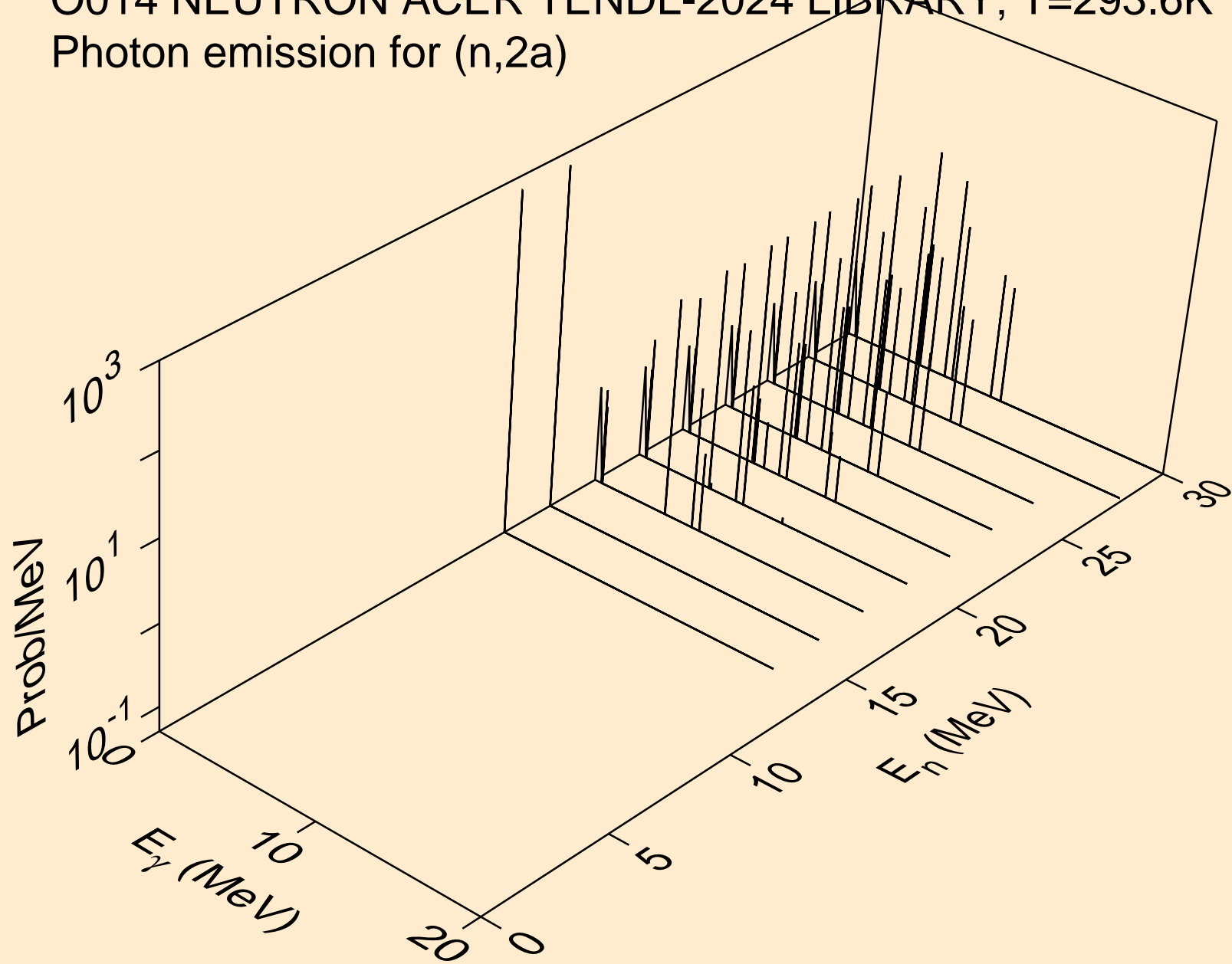

O014 NEUTRON ACER TENDL-2024 LIBRARY; T=293.6K  
Photon emission for (n,2p)

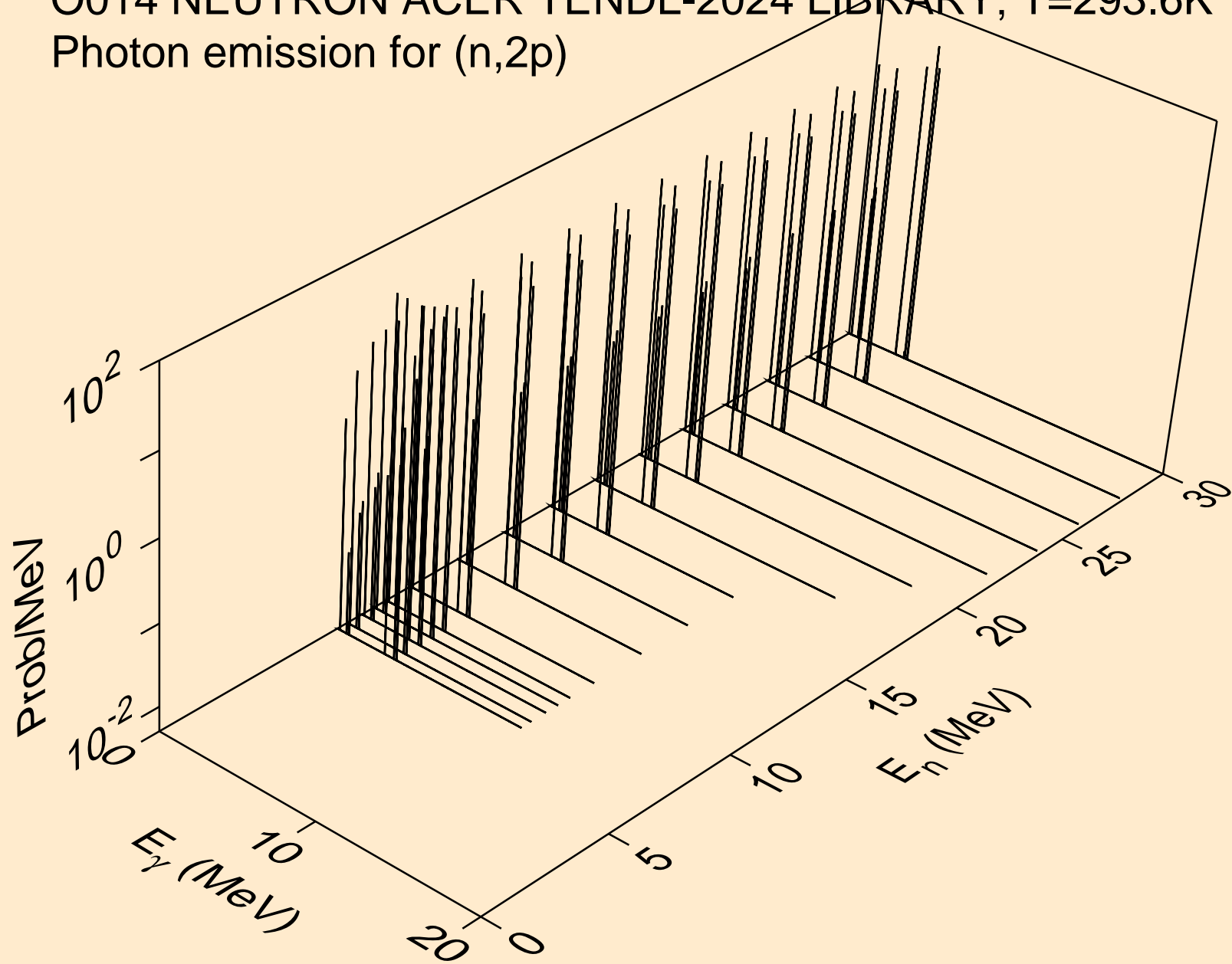

O014 NEUTRON ACER TENDL-2024 LIBRARY; T=293.6K  
Photon emission for (n,p $\alpha$ )

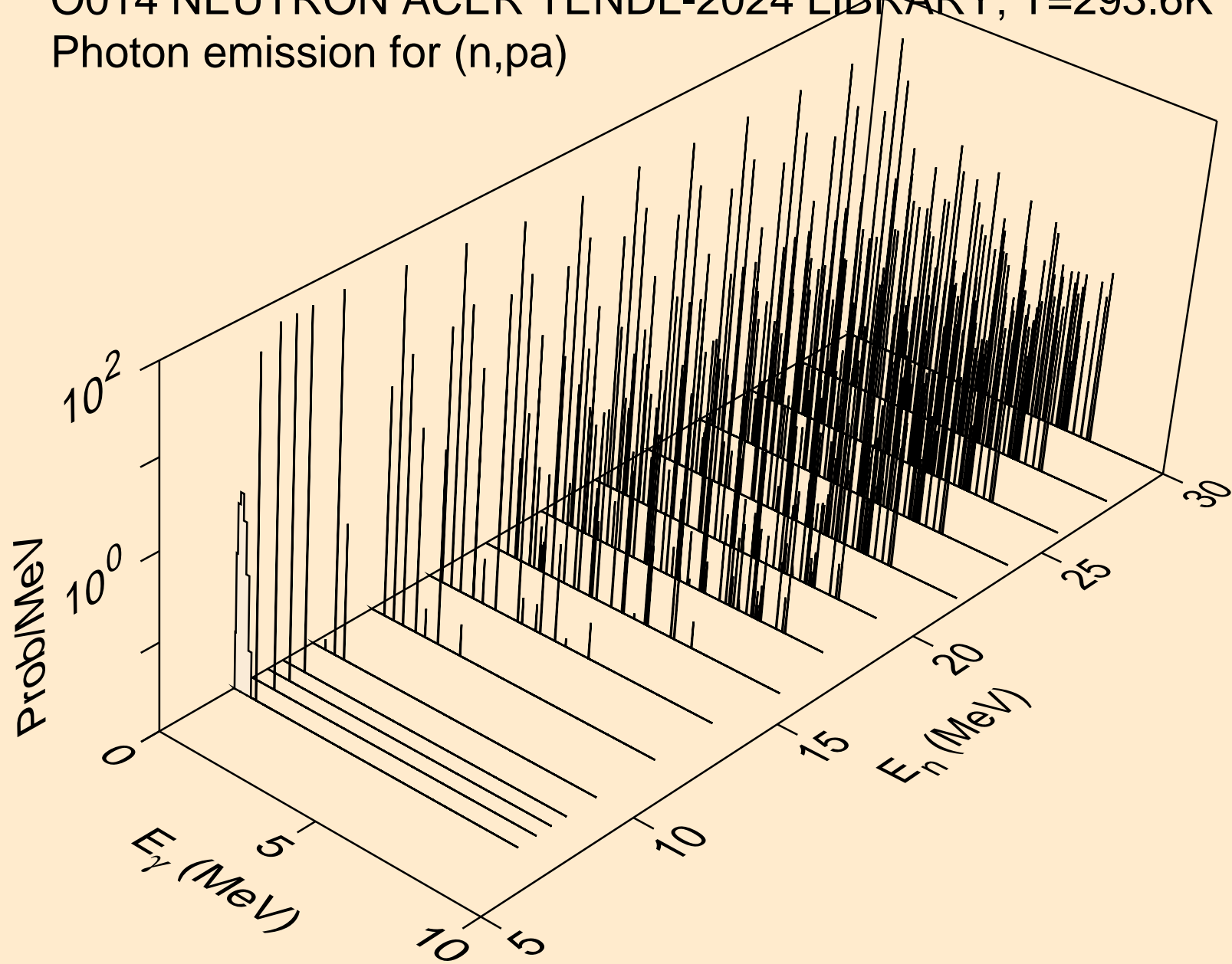

O014 NEUTRON ACER TENDL-2024 LIBRARY; T=293.6K  
Photon emission for (n,pd)

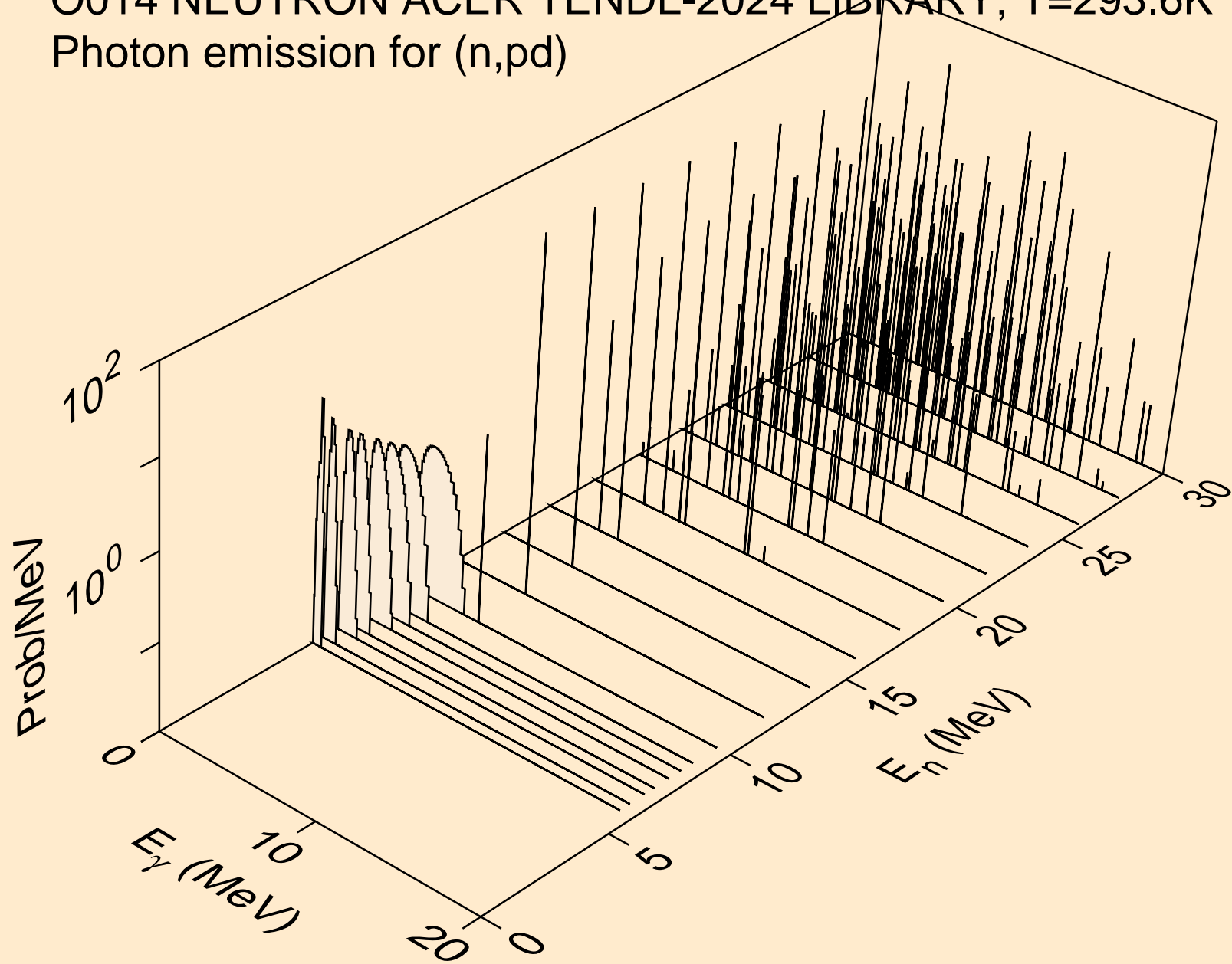

O014 NEUTRON ACER TENDL-2024 LIBRARY; T=293.6K  
Photon emission for (n,pt)

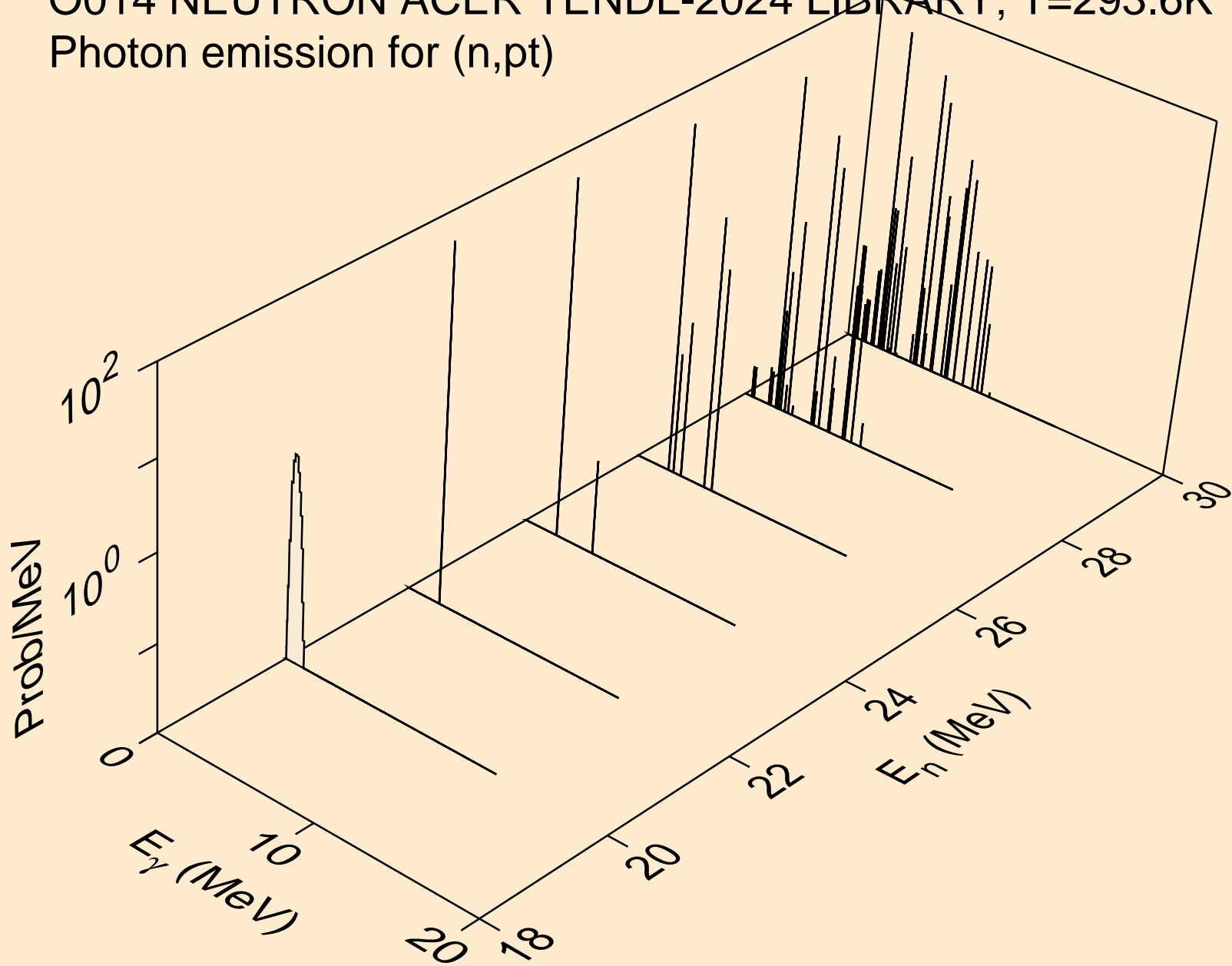

O014 NEUTRON ACER TENDL-2024 LIBRARY; T=293.6K  
Photon emission for (n,da)

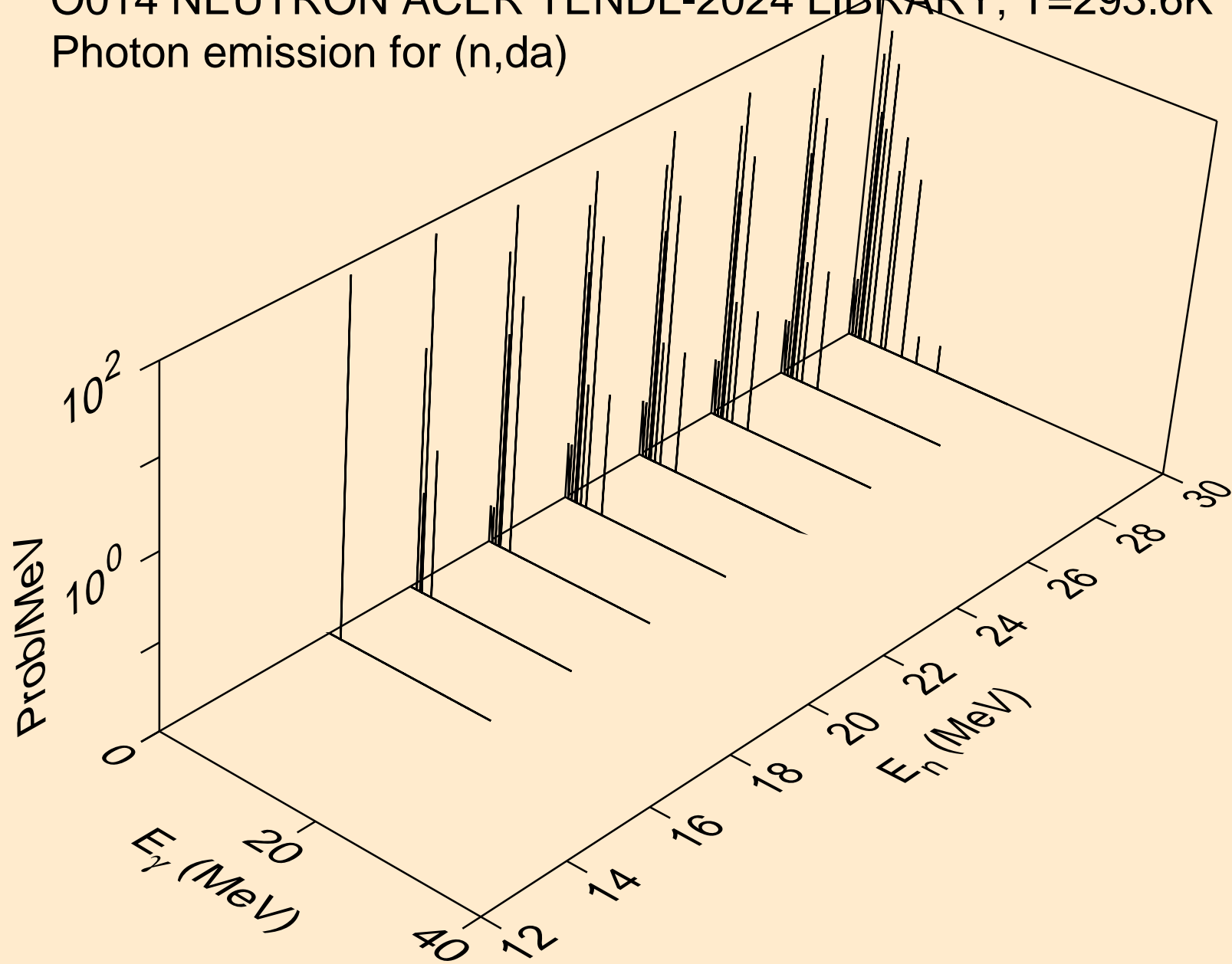

O014 NEUTRON ACER TENDL-2024 LIBRARY; T=293.6K  
thermal capture photon spectrum

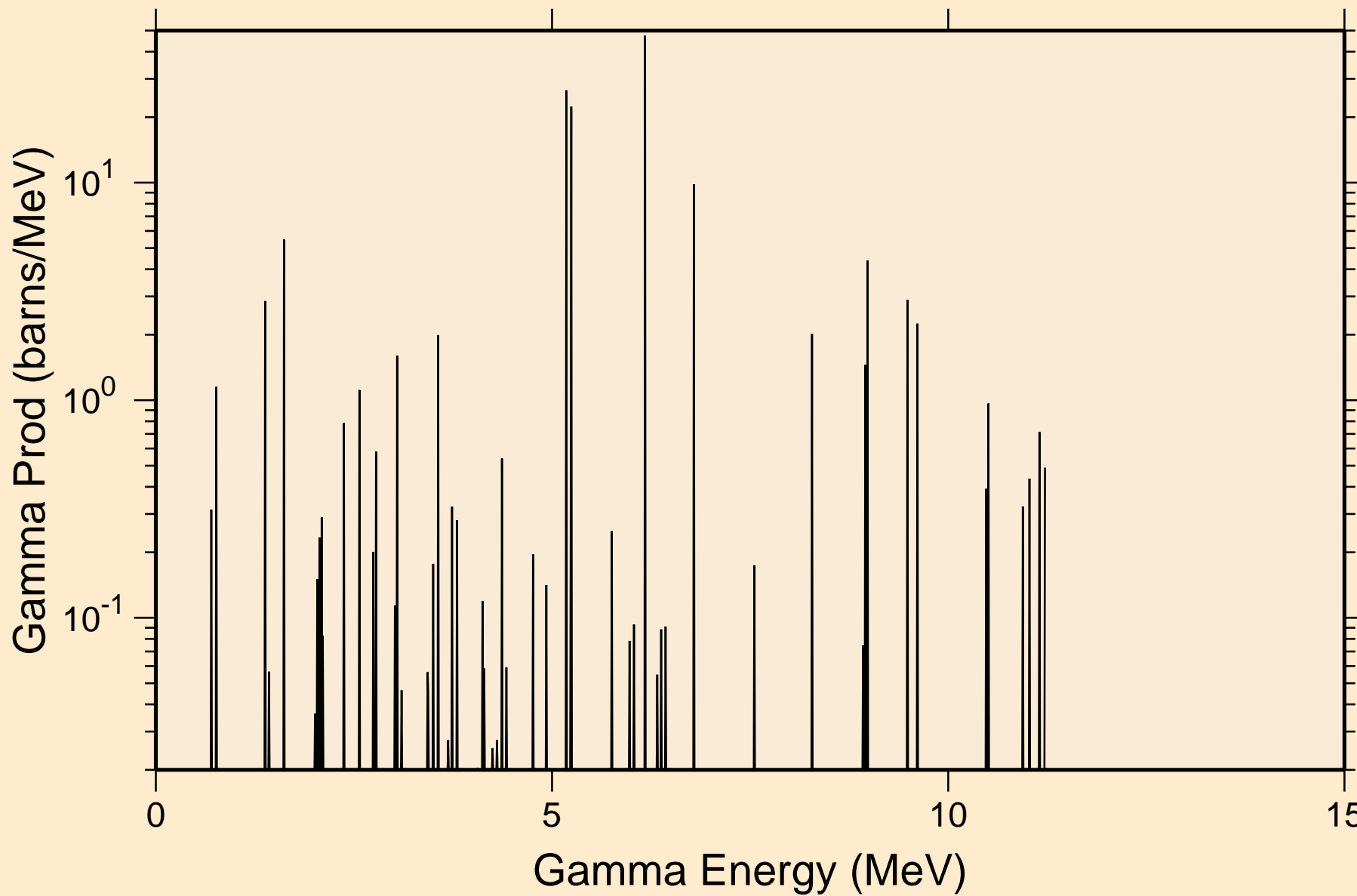

O014 NEUTRON ACER TENDL-2024 LIBRARY; T=293.6K  
14 MeV photon spectrum

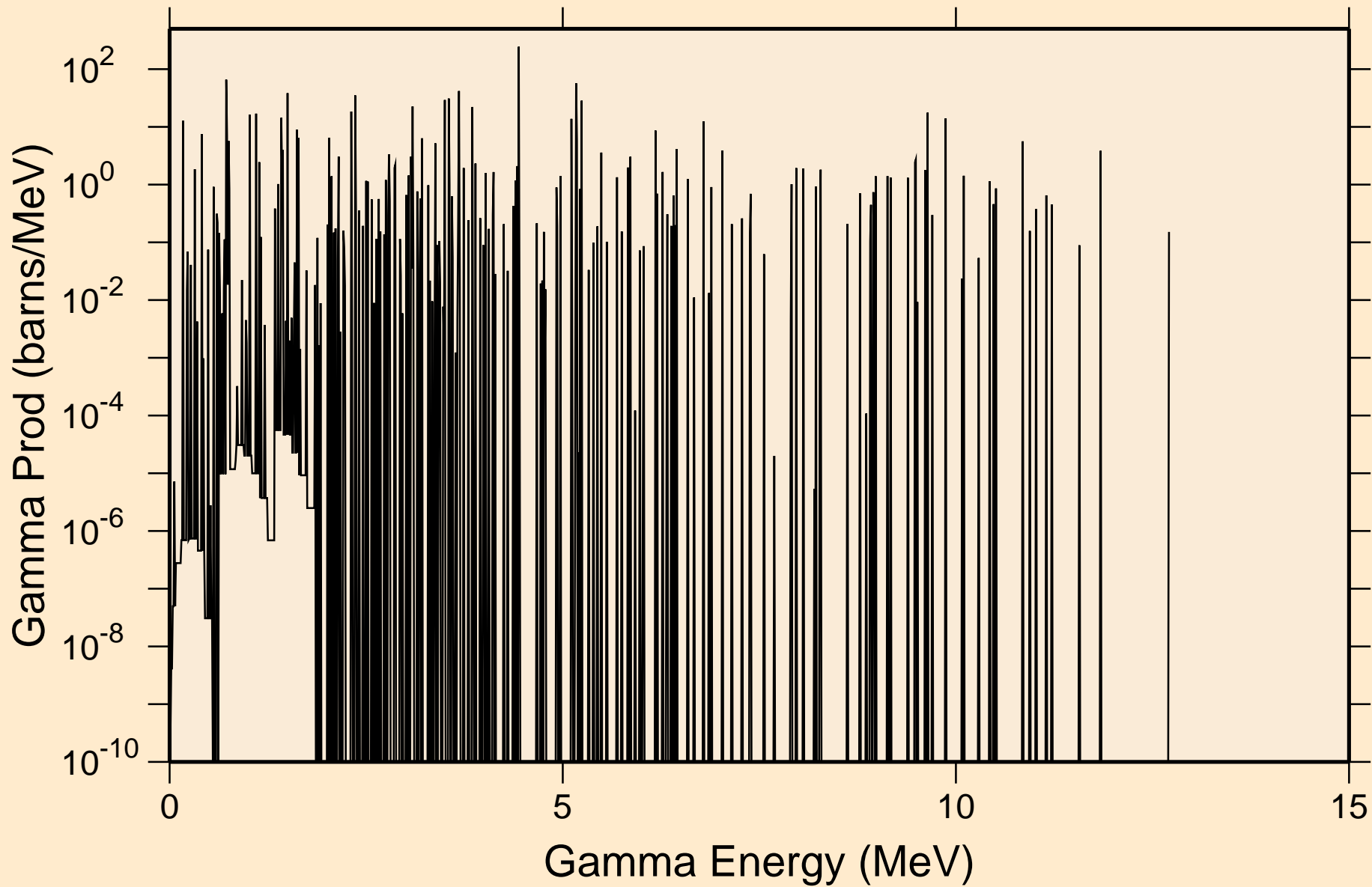

# O014 NEUTRON ACER TENDL-2024 LIBRARY; T=293.6K

## Particle heating contributions

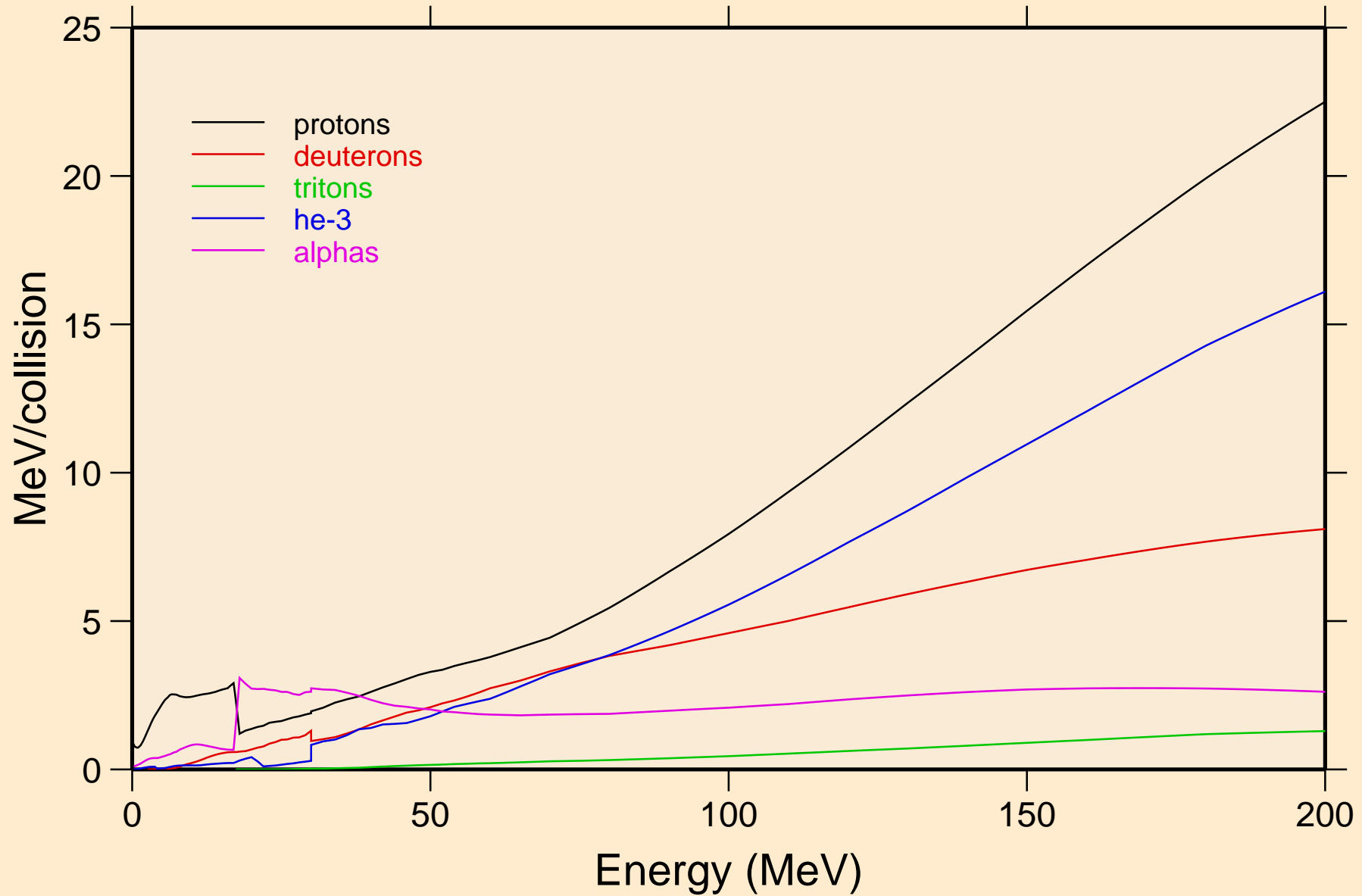

O014 NEUTRON ACER TENDL-2024 LIBRARY; T=293.6K  
Recoil Heating

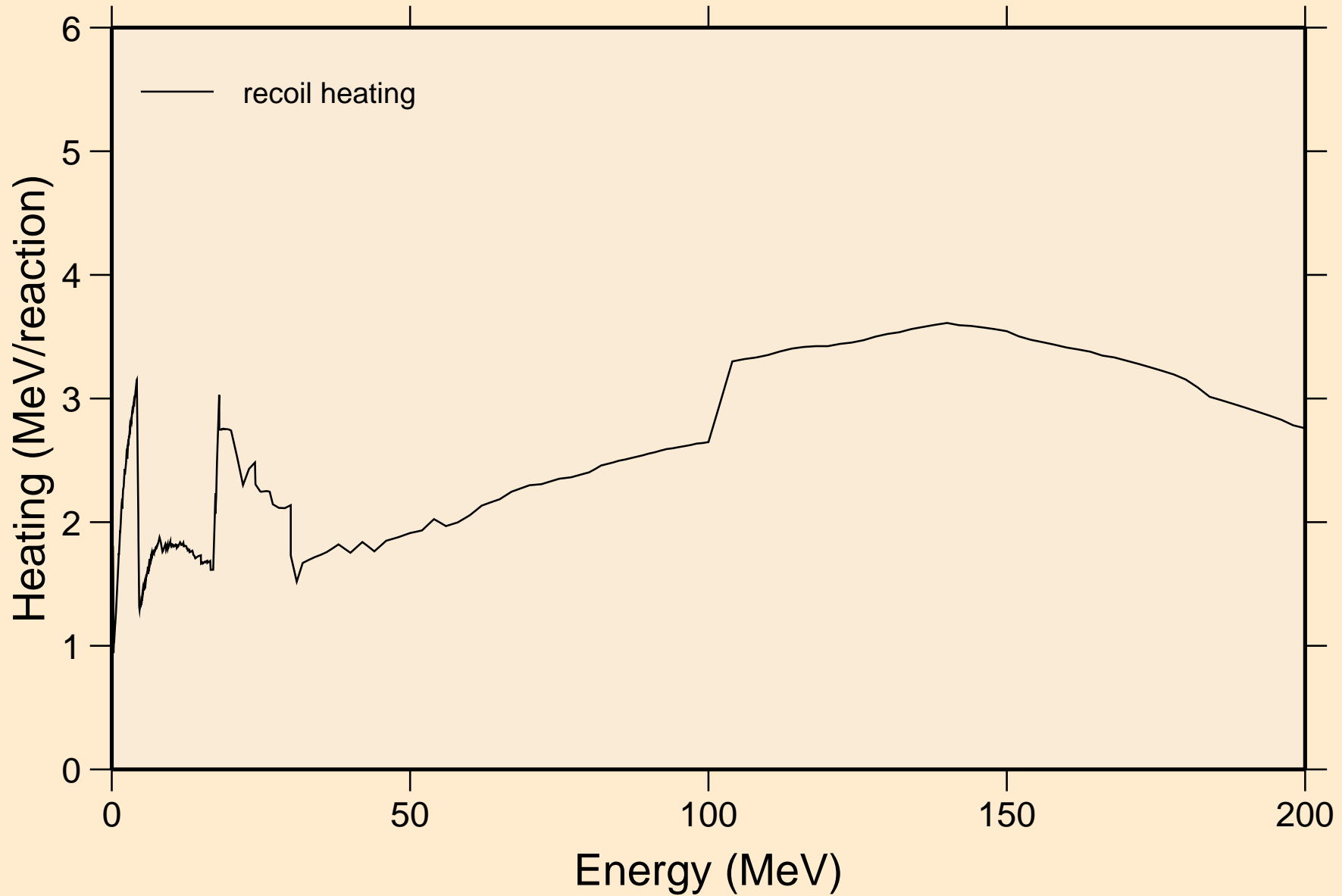

O014 NEUTRON ACER TENDL-2024 LIBRARY; T=293.6K  
Particle production cross sections

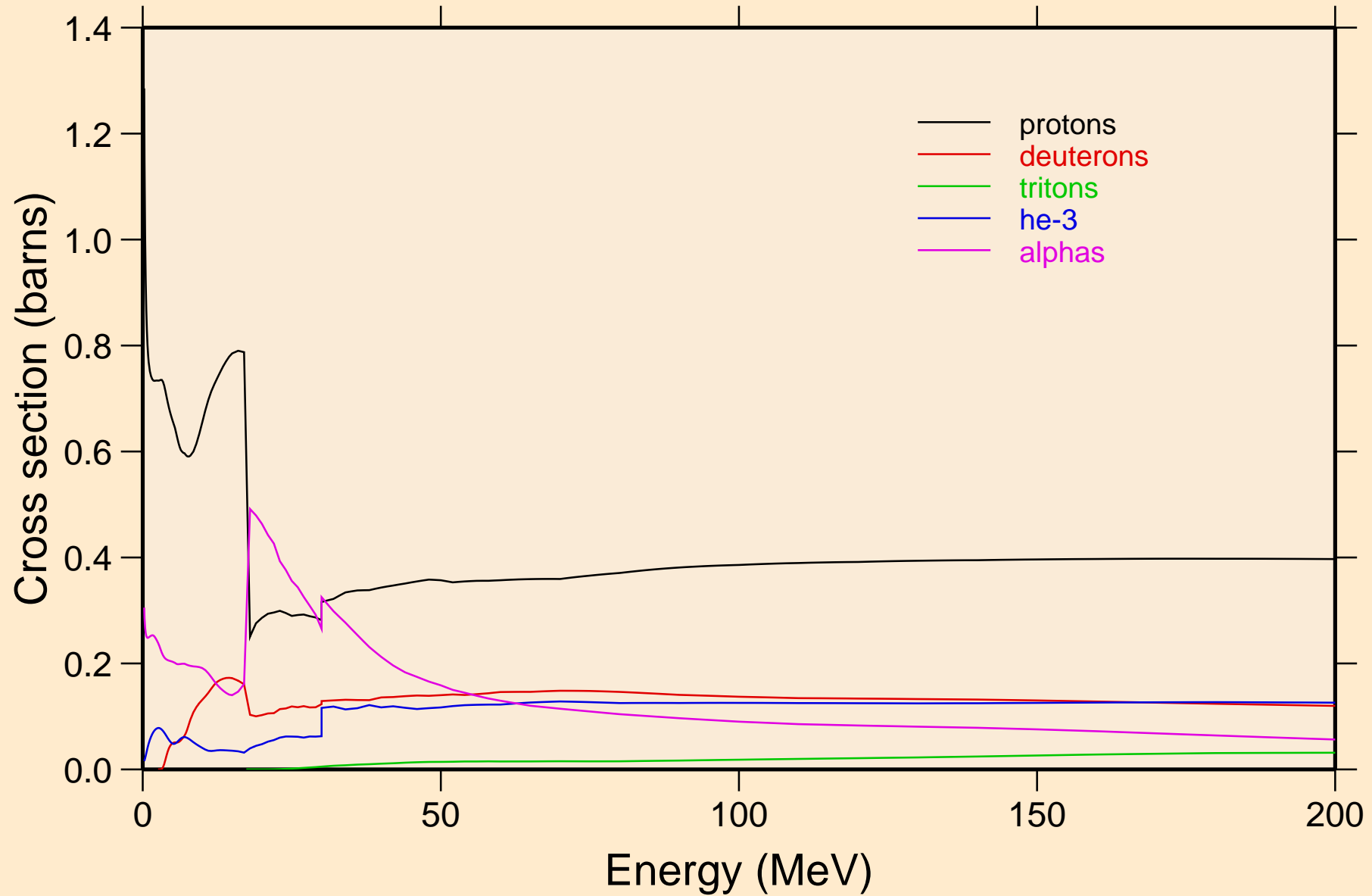

O014 NEUTRON ACER TENDL-2024 LIBRARY; T=293.6K  
protons from (n,x)

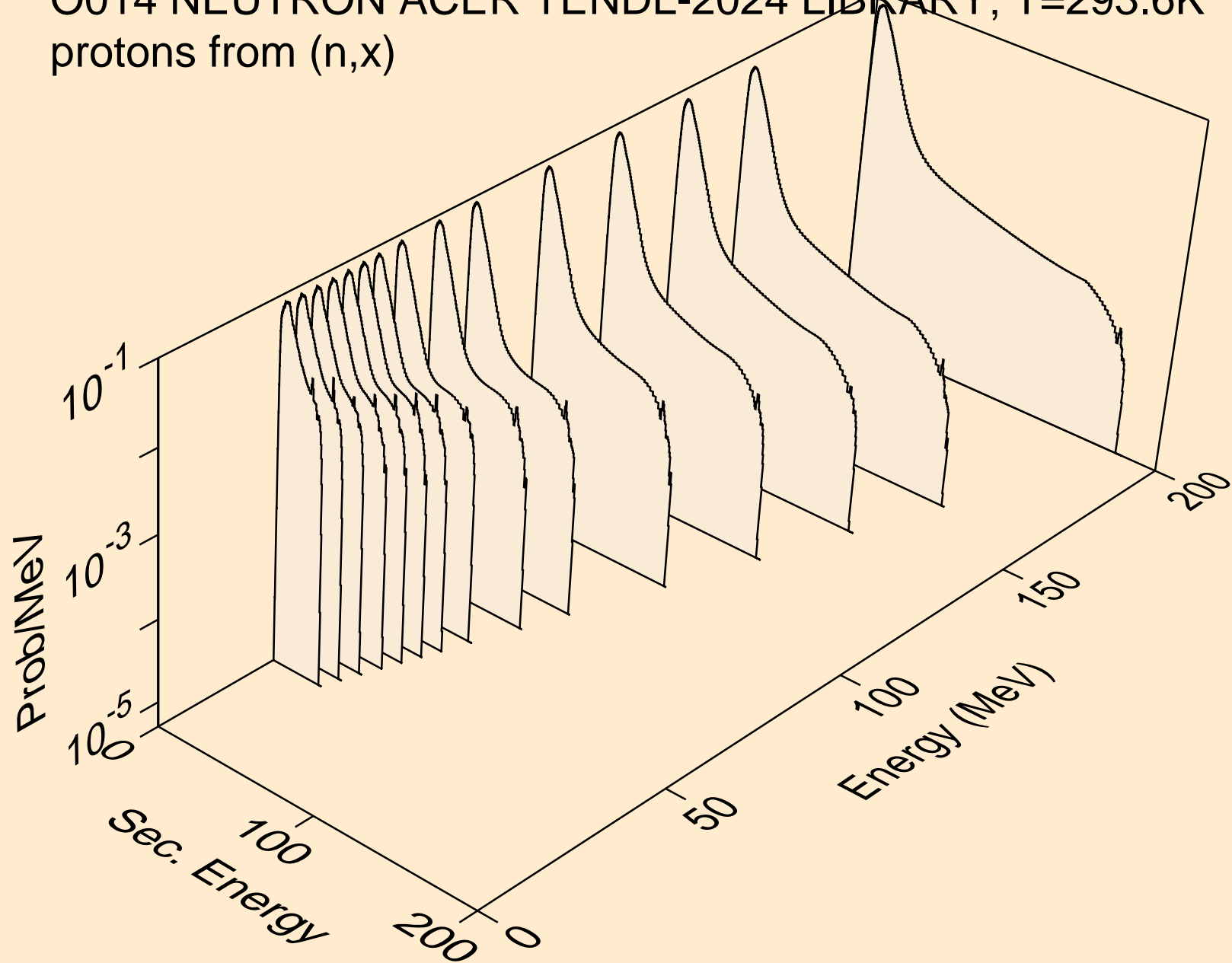

O014 NEUTRON ACER TENDL-2024 LIBRARY; T=293.6K  
protons from (n,n\*)p

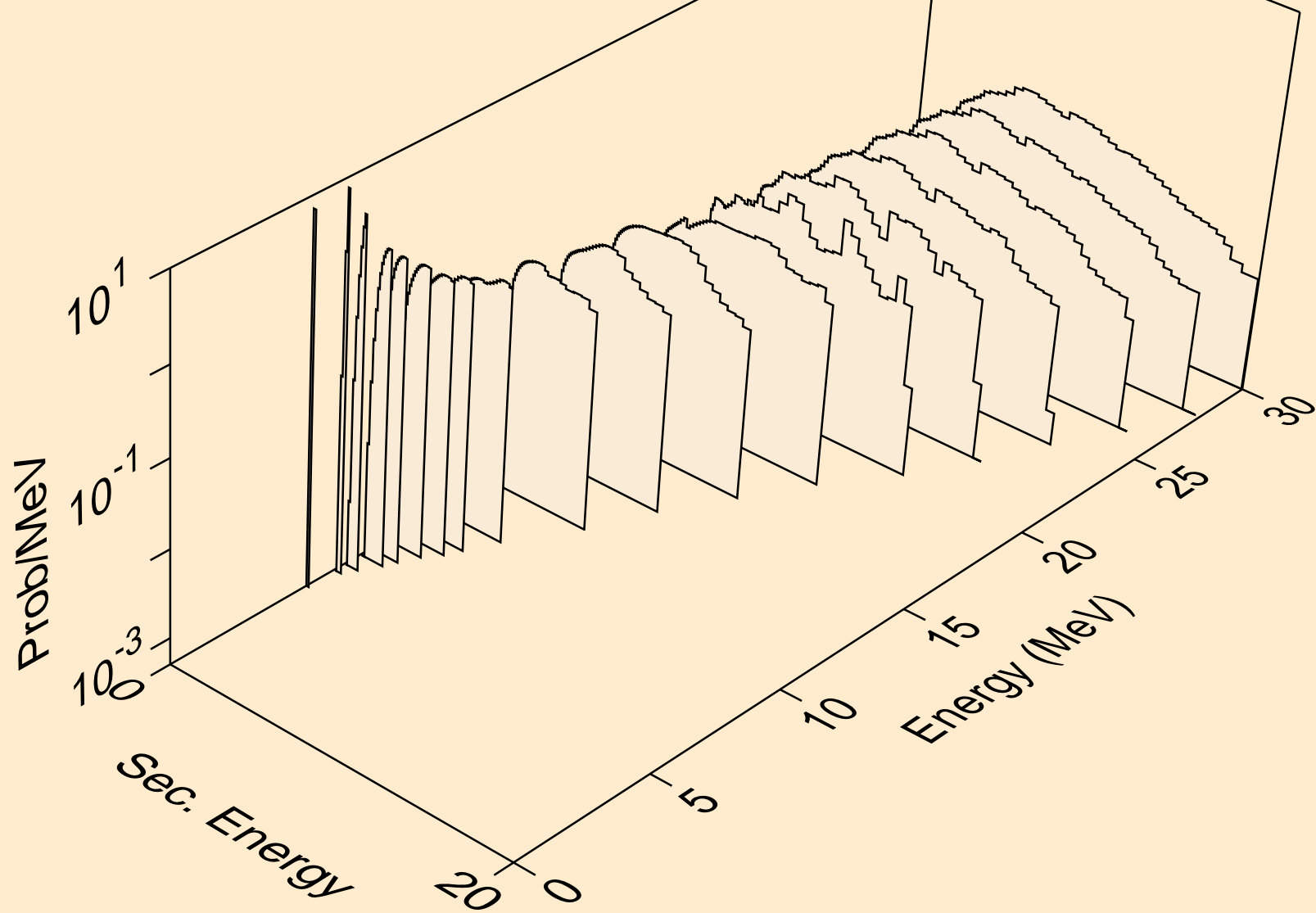

O014 NEUTRON ACER TENDL-2024 LIBRARY; T=293.6K  
protons from (n,2np)

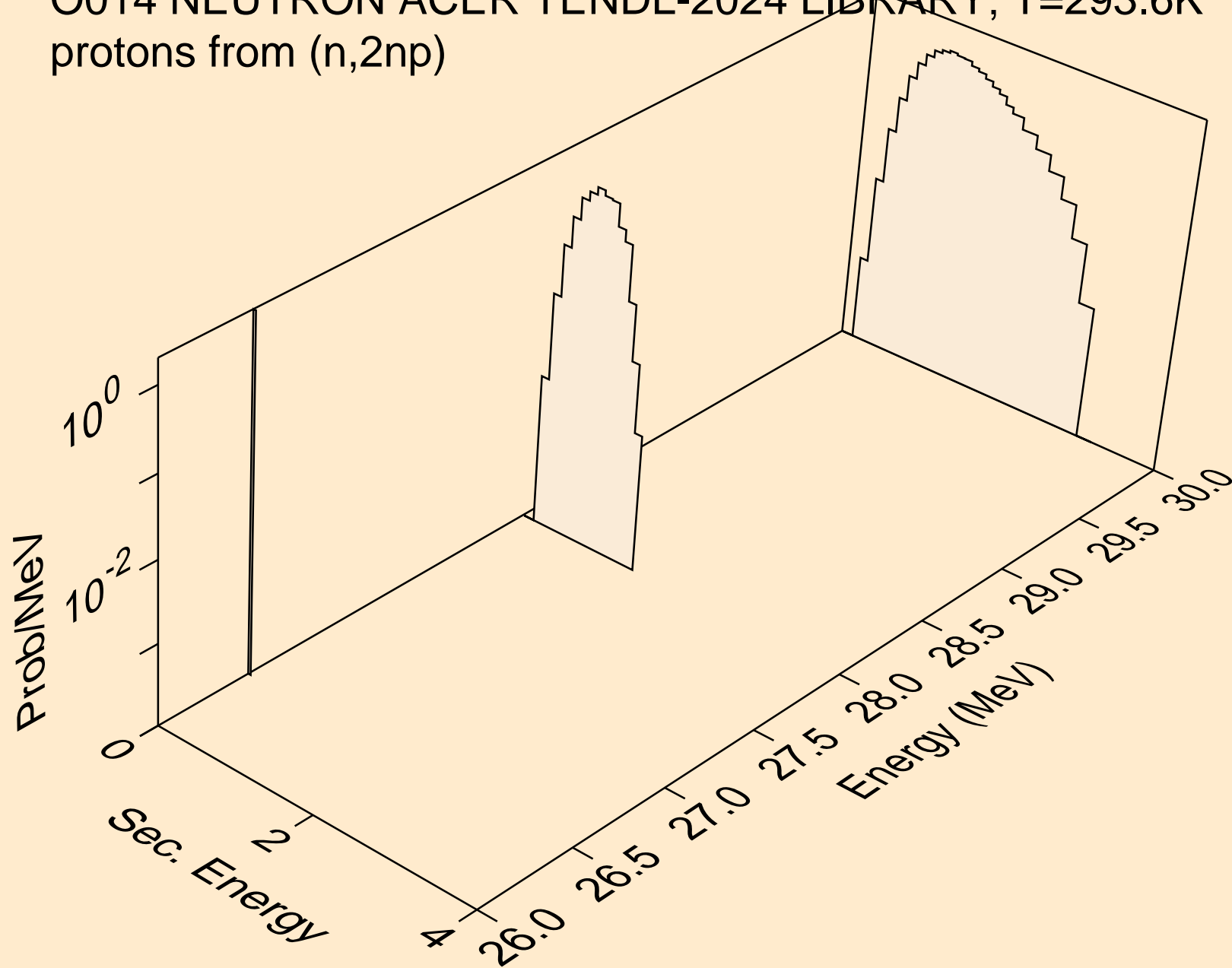

O014 NEUTRON ACER TENDL-2024 LIBRARY; T=293.6K  
protons from (n,n2p)

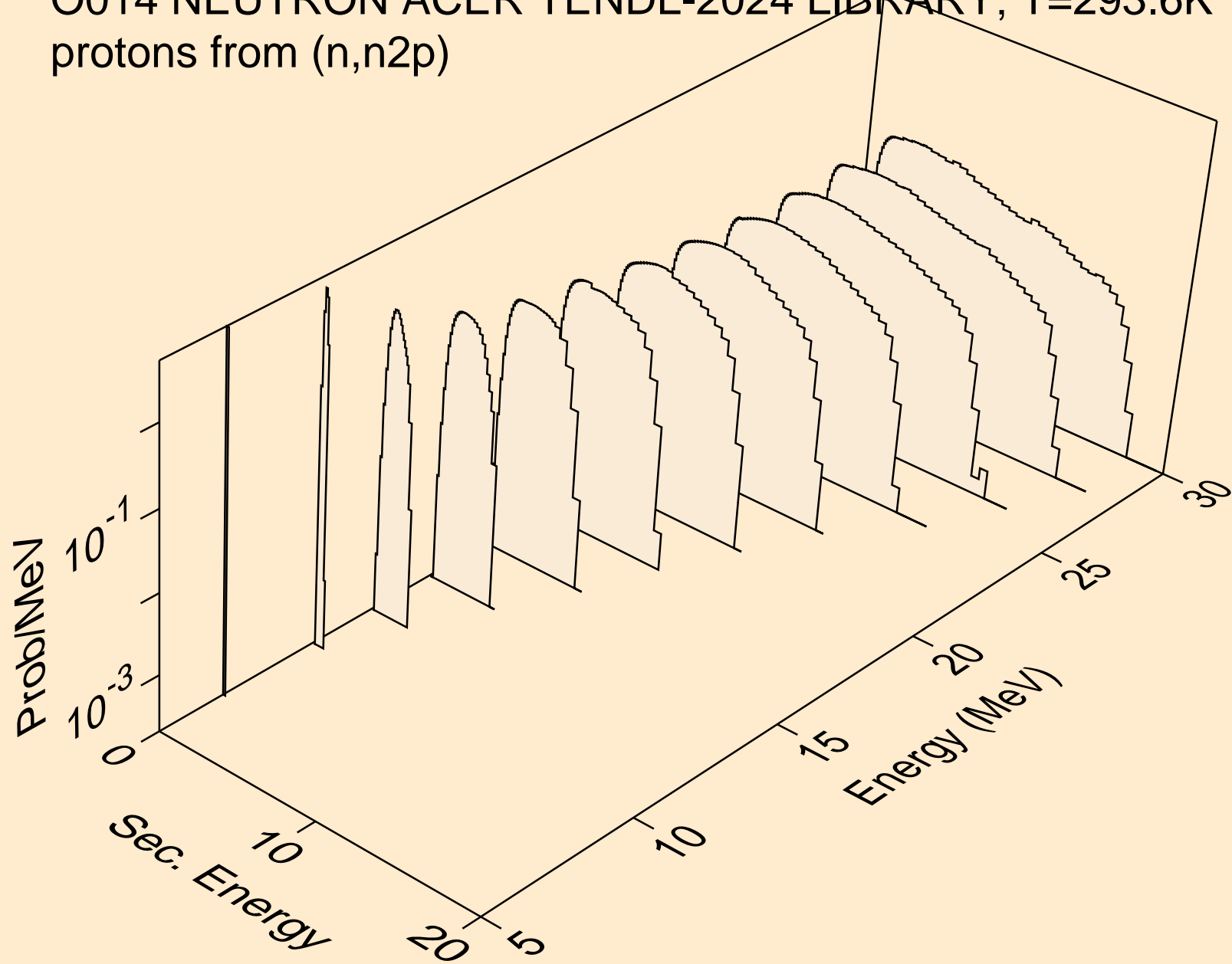

O014 NEUTRON ACER TENDL-2024 LIBRARY; T=293.6K  
protons from (n,npa)

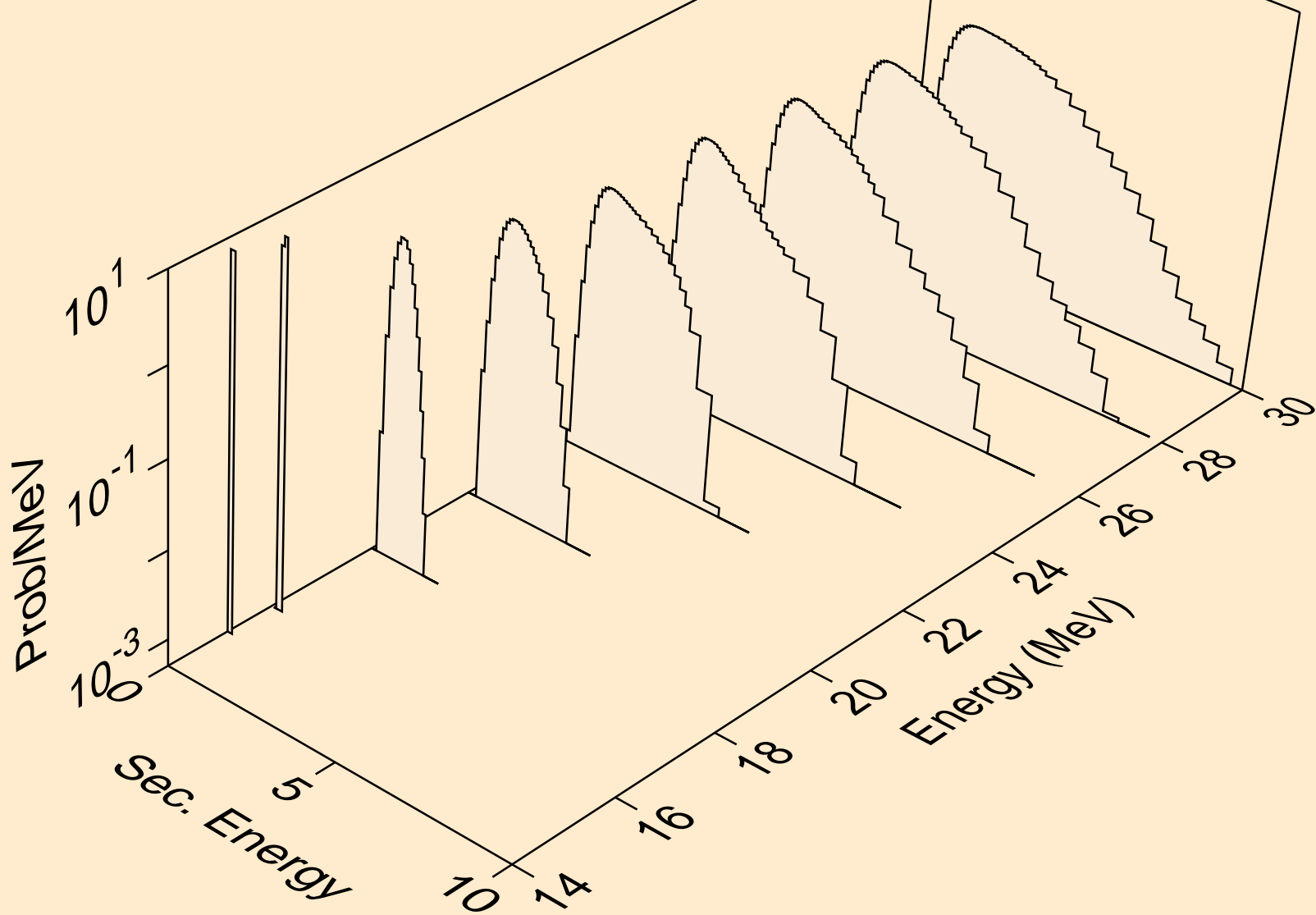

O014 NEUTRON ACER TENDL-2024 LIBRARY; T=293.6K  
protons from (n,p)

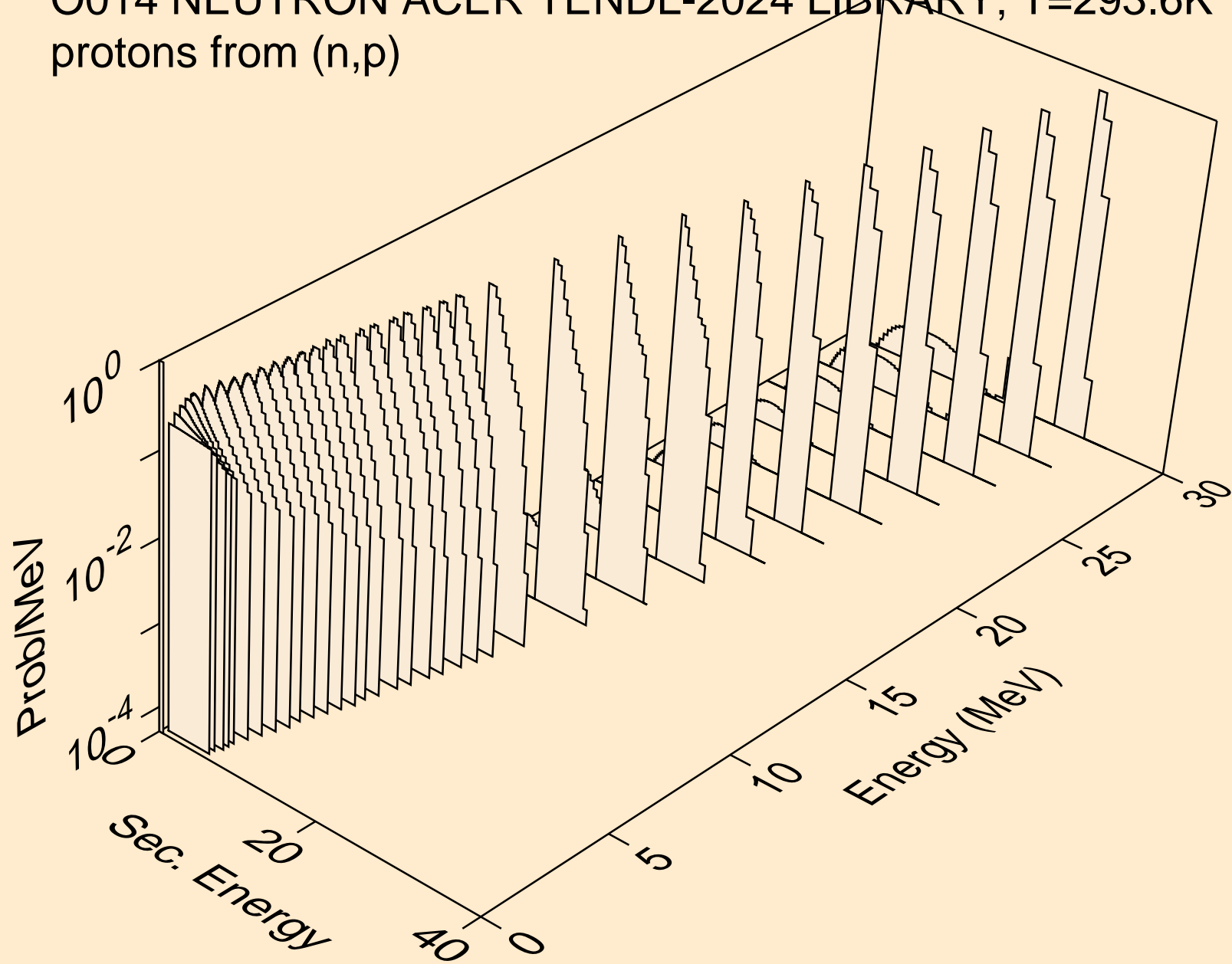

O014 NEUTRON ACER TENDL-2024 LIBRARY; T=293.6K  
protons from (n,2p)

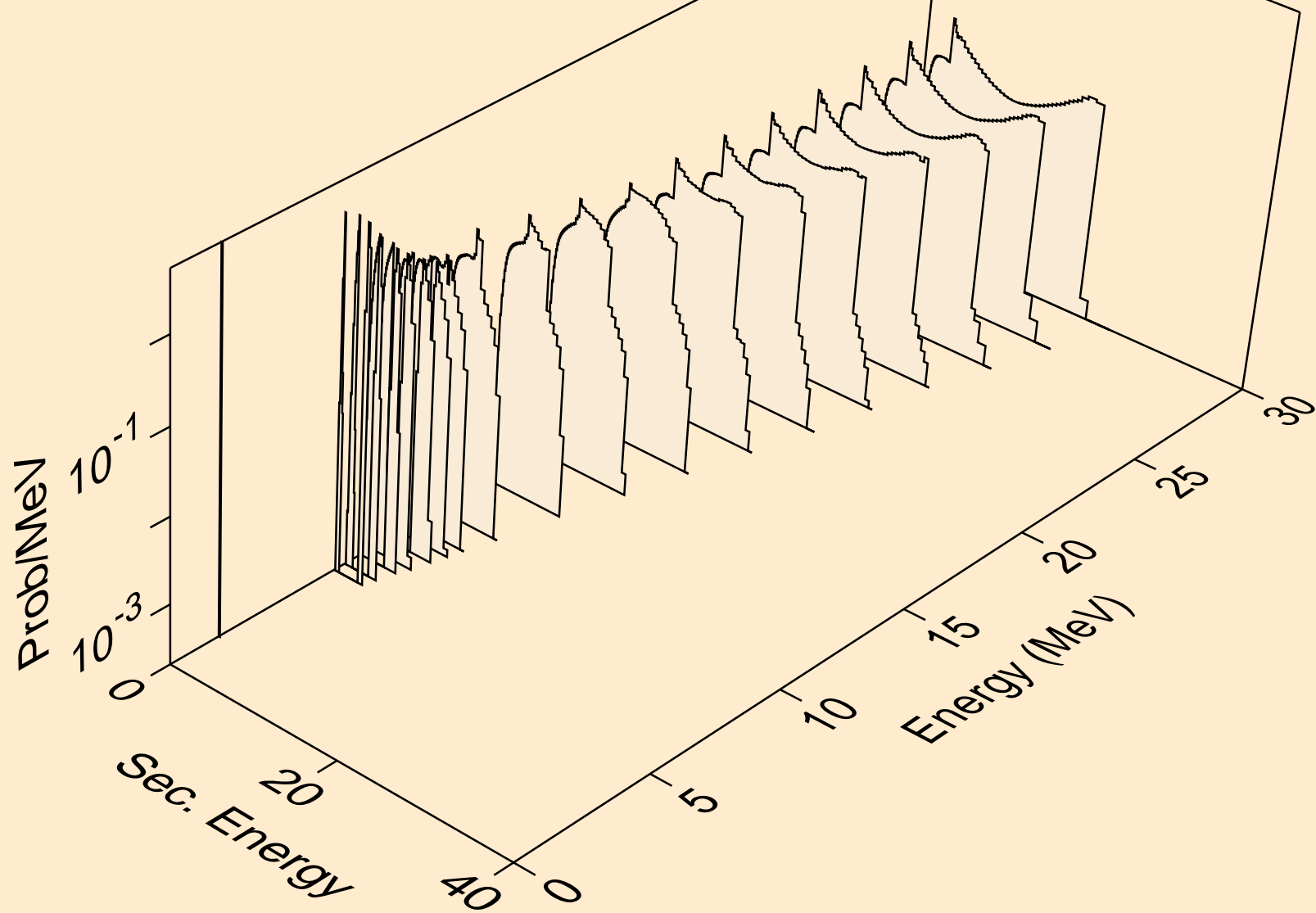

O014 NEUTRON ACER TENDL-2024 LIBRARY; T=293.6K  
protons from (n,p)

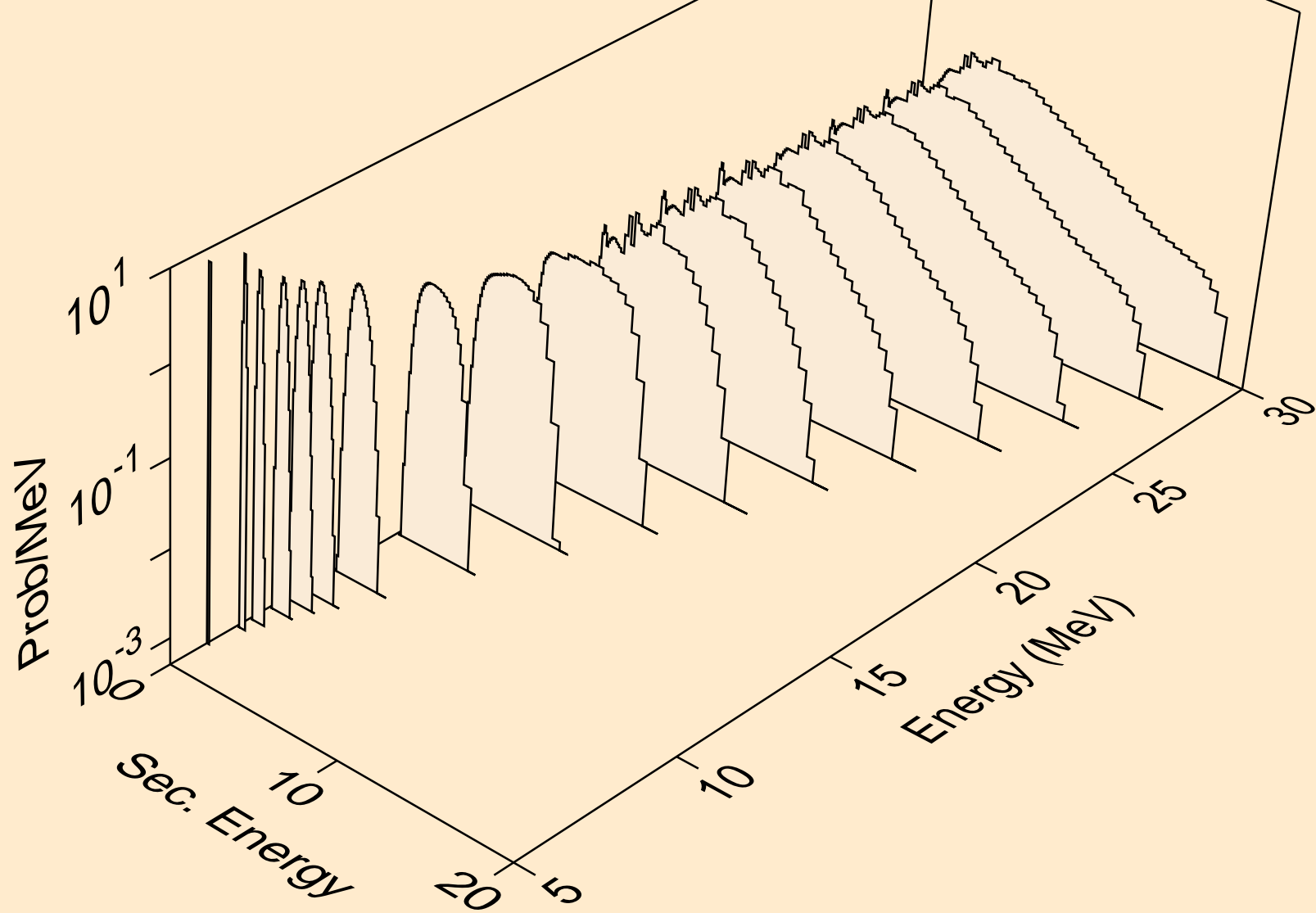

O014 NEUTRON ACER TENDL-2024 LIBRARY; T=293.6K  
protons from (n,pd)

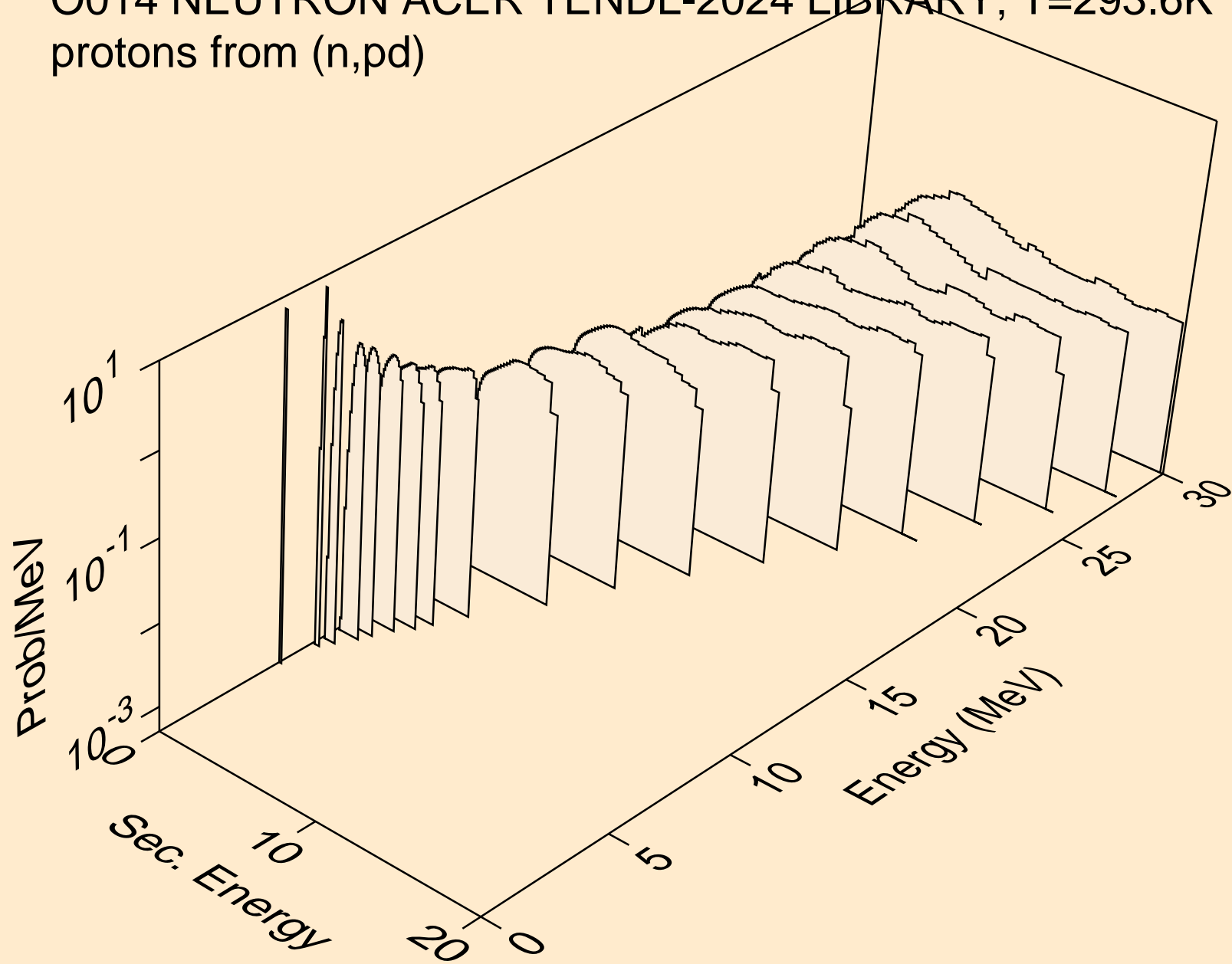

O014 NEUTRON ACER TENDL-2024 LIBRARY; T=293.6K  
protons from (n,pt)

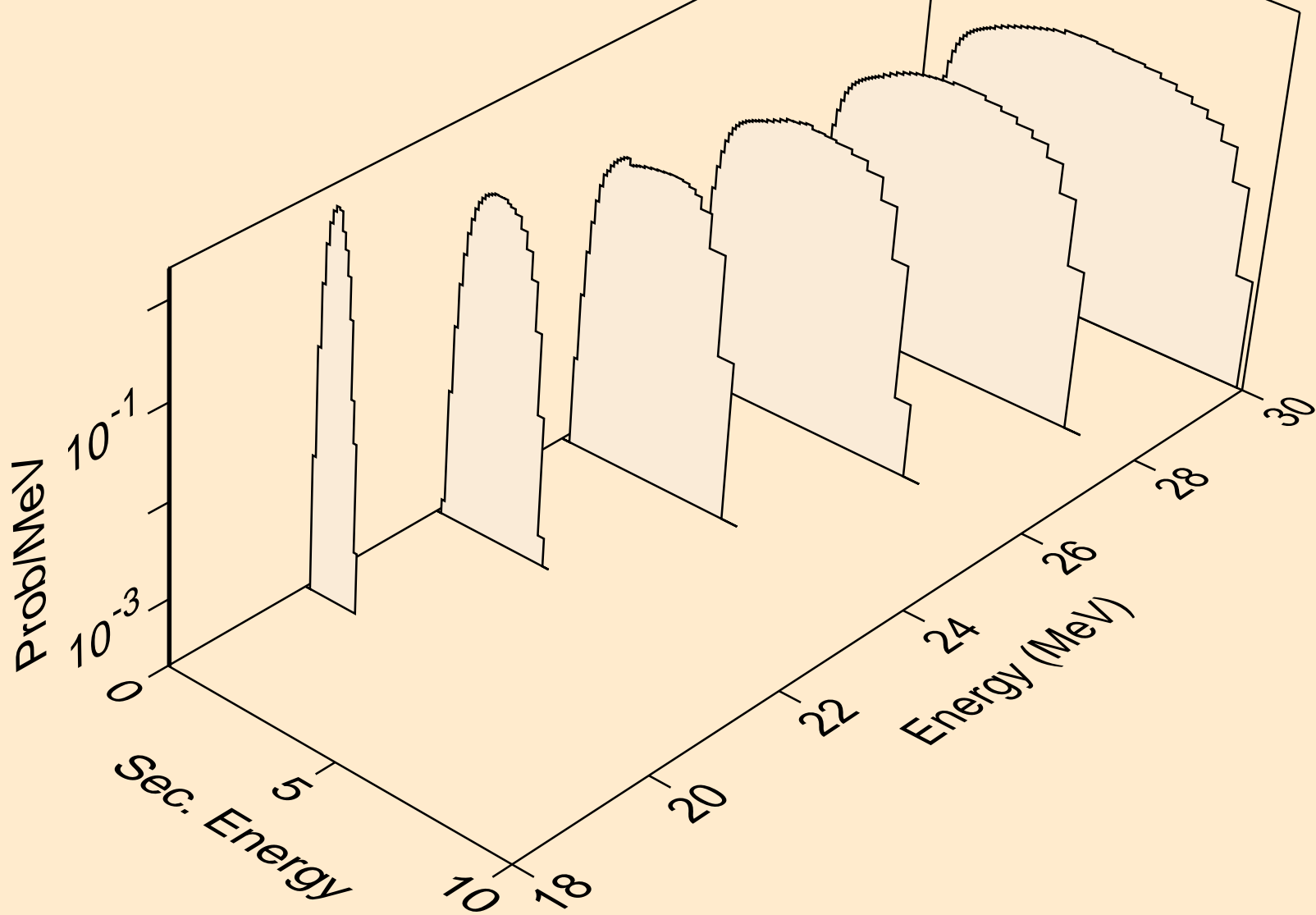

O014 NEUTRON ACER TENDL-2024 LIBRARY; T=293.6K  
deuterons from (n,x)

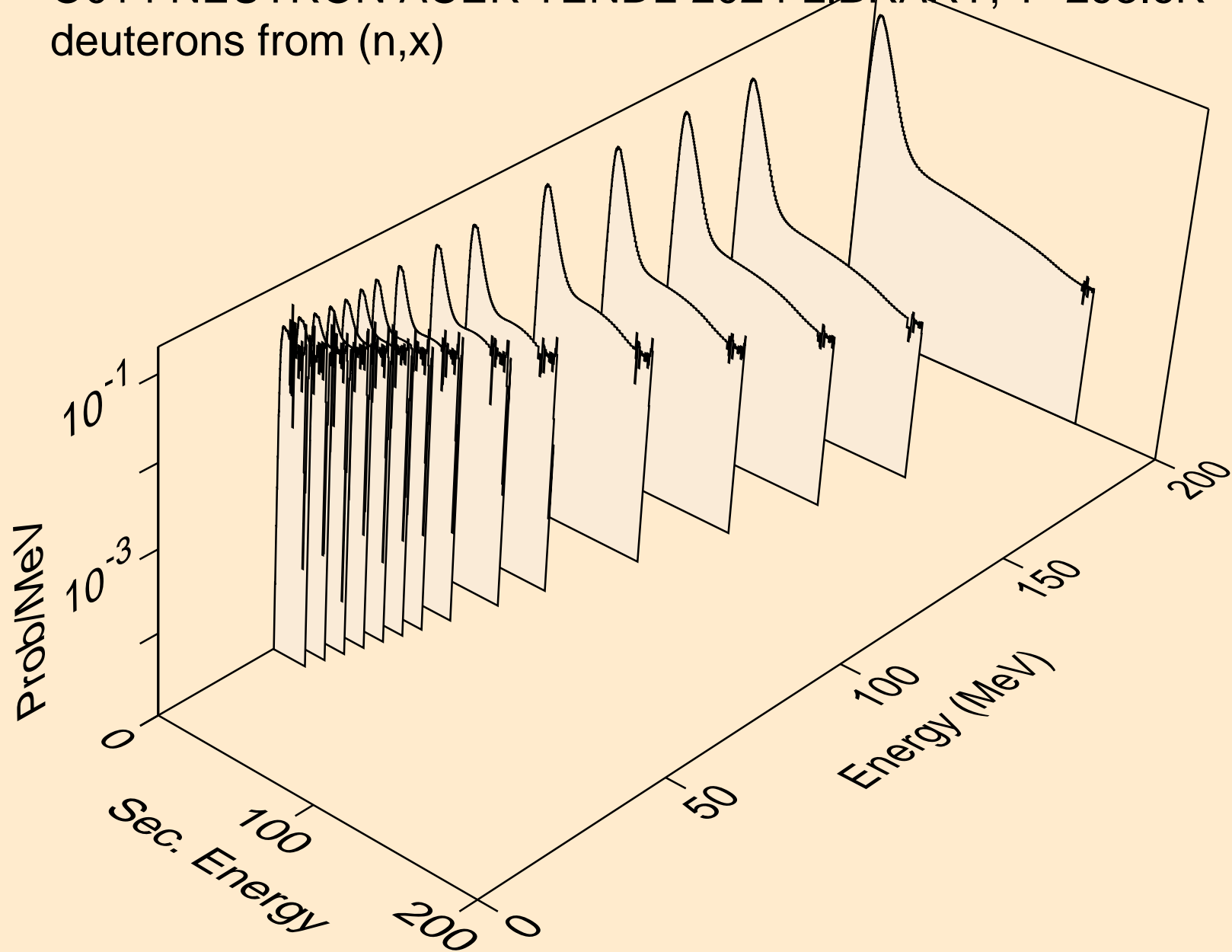

O014 NEUTRON ACER TENDL-2024 LIBRARY; T=293.6K  
deuterons from (n,n\*)d

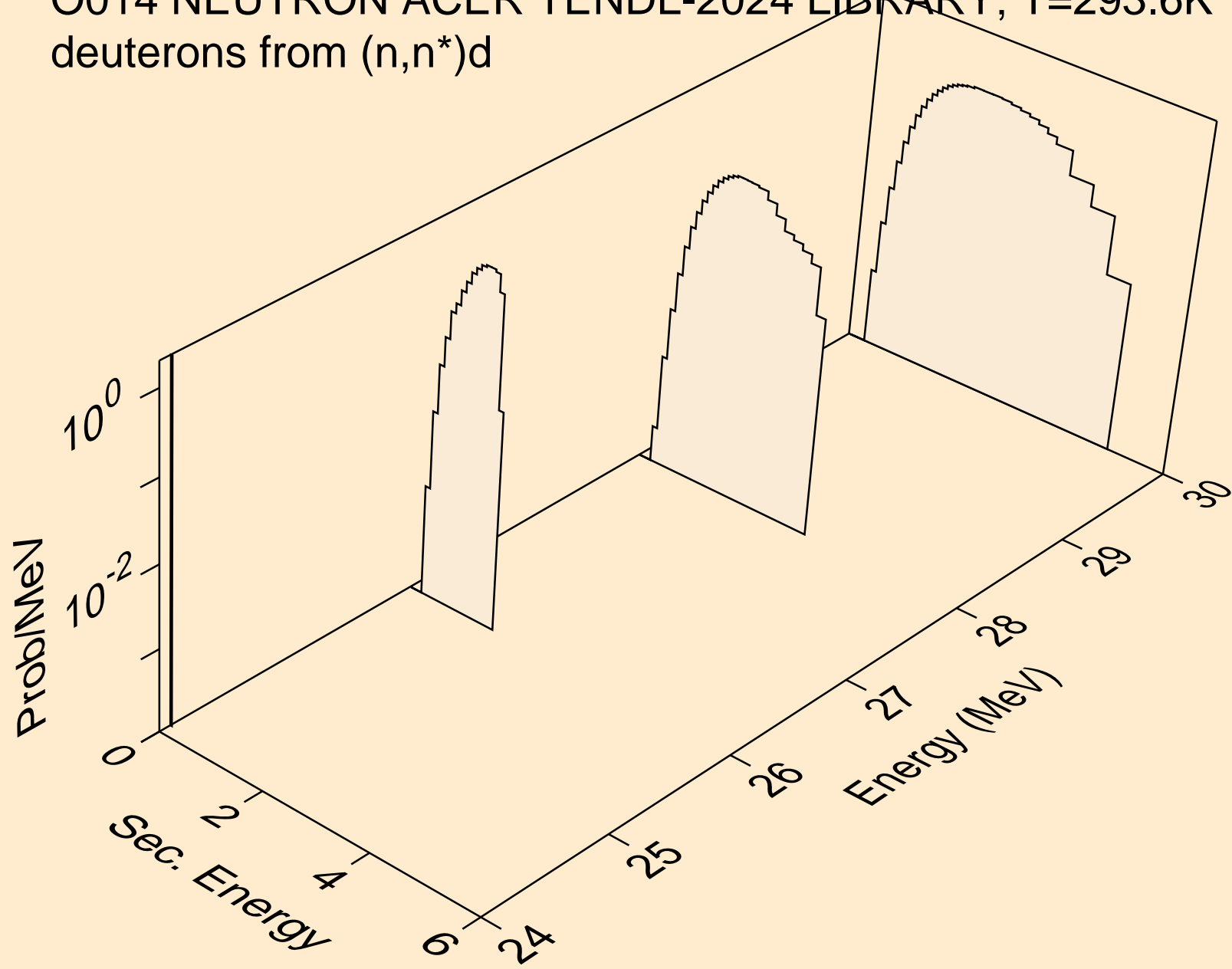

O014 NEUTRON ACER TENDL-2024 LIBRARY; T=293.6K  
deuterons from (n,d)

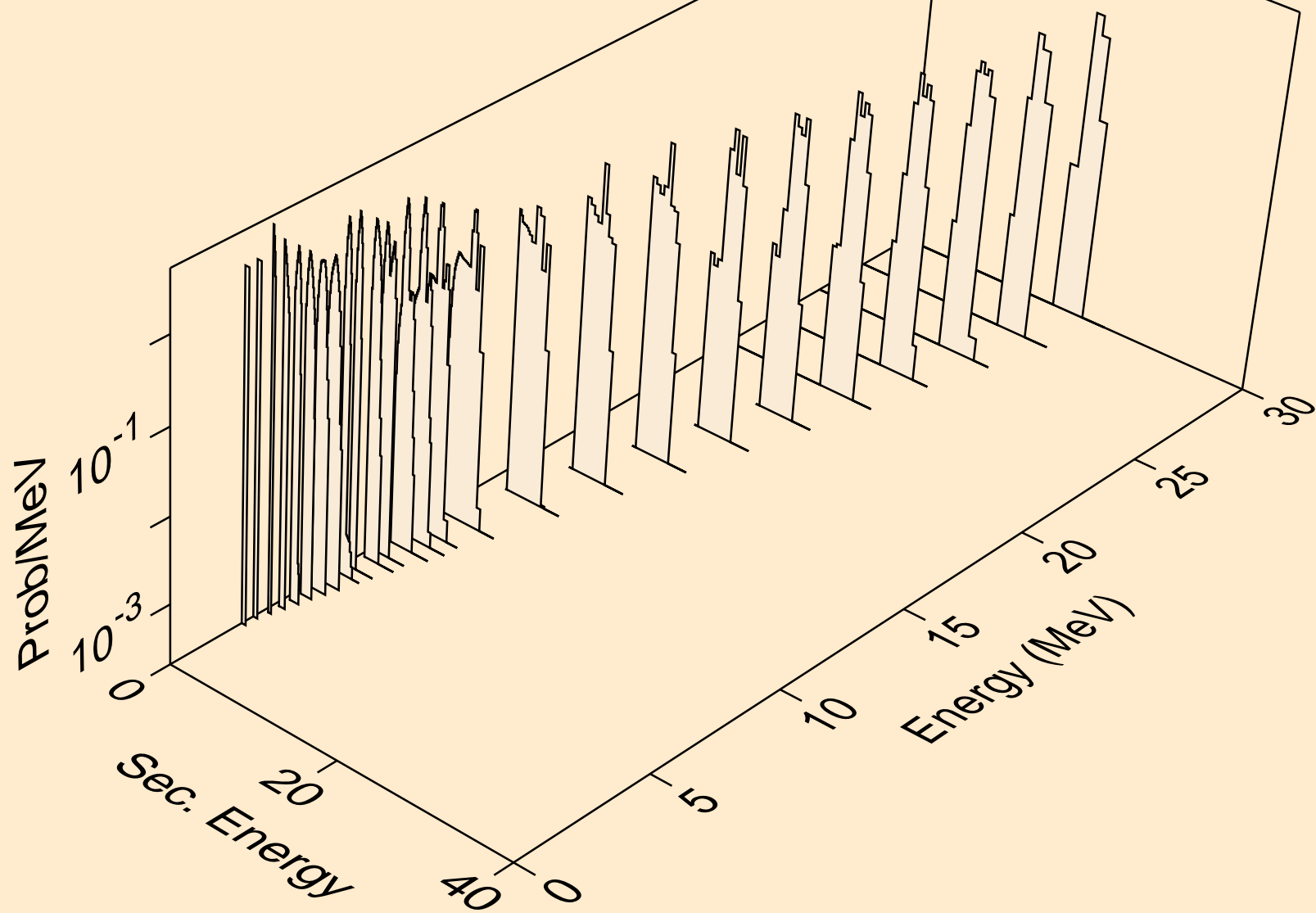

O014 NEUTRON ACER TENDL-2024 LIBRARY; T=293.6K  
deuterons from (n,pd)

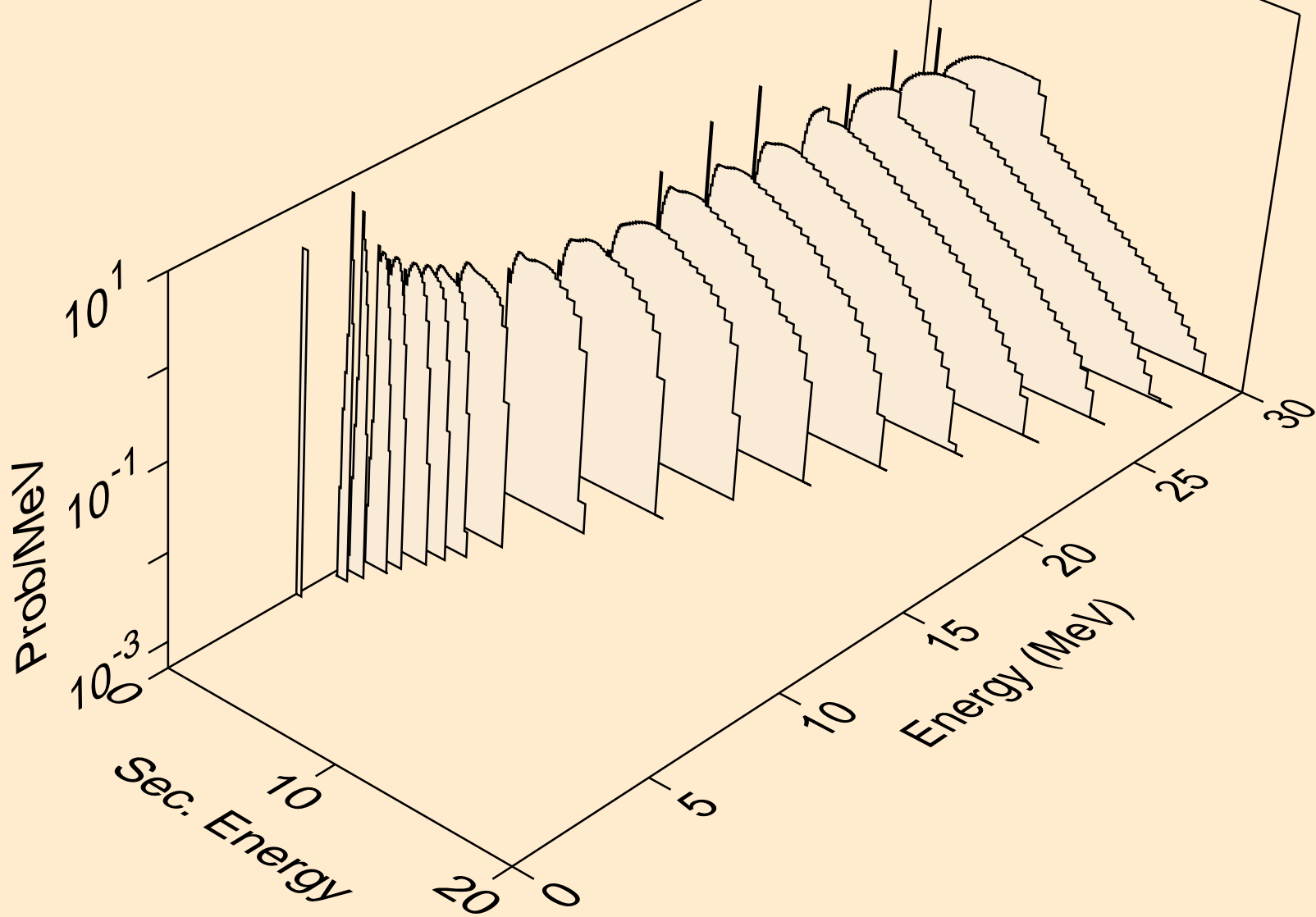

O014 NEUTRON ACER TENDL-2024 LIBRARY; T=293.6K  
deuterons from (n,da)

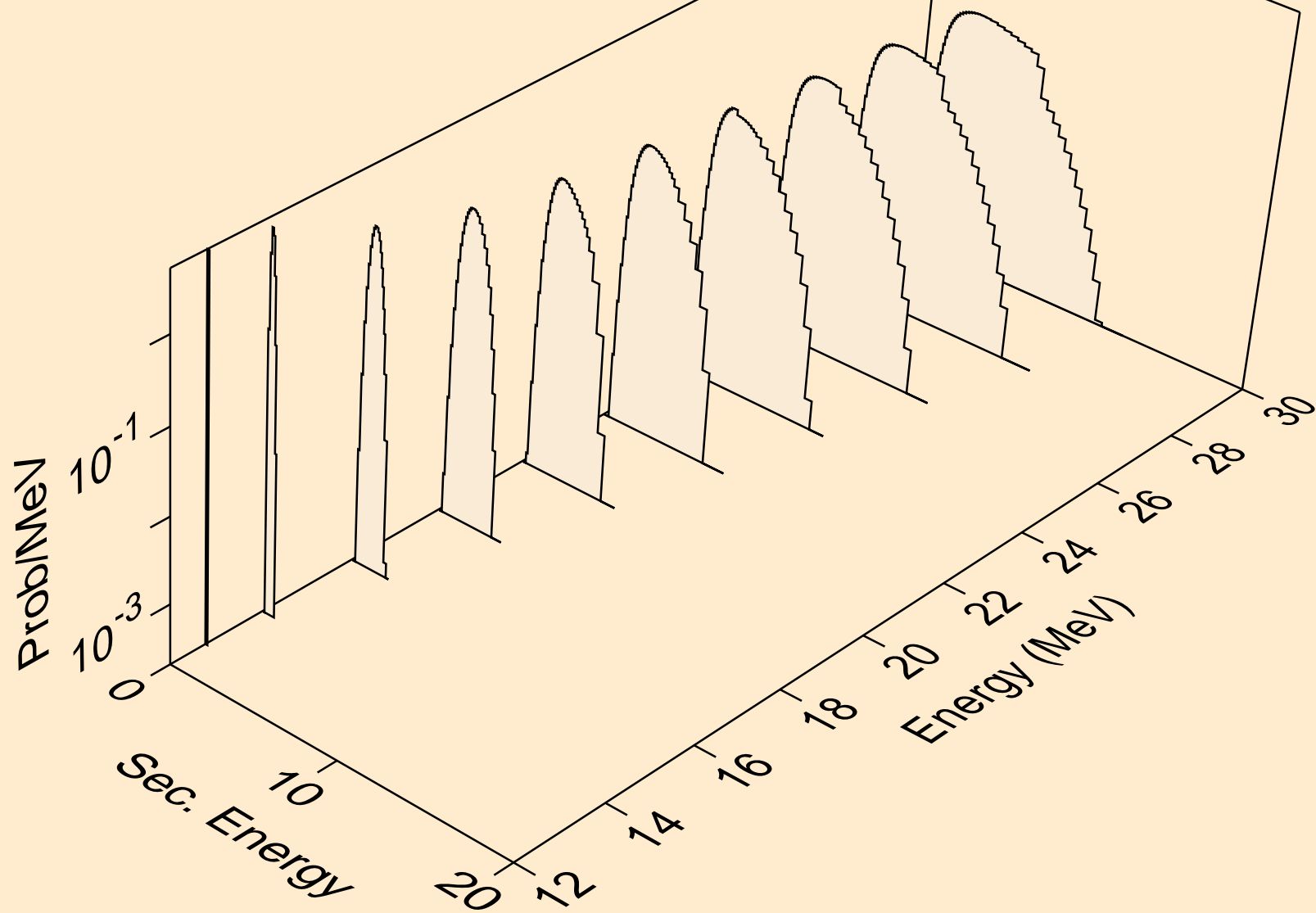

O014 NEUTRON ACER TENDL-2024 LIBRARY; T=293.6K  
tritons from (n,x)

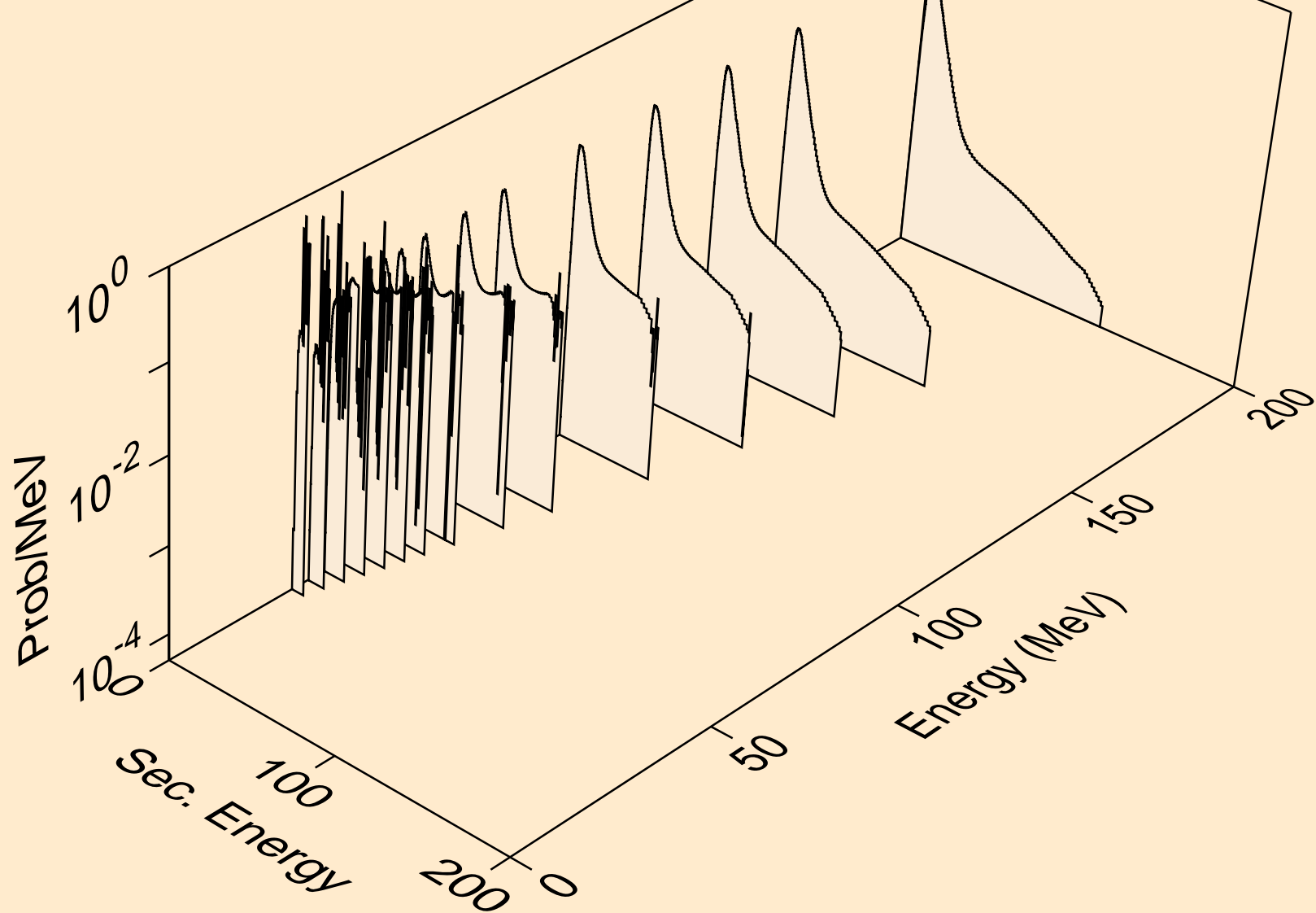

O014 NEUTRON ACER TENDL-2024 LIBRARY; T=293.6K  
tritons from (n,t)

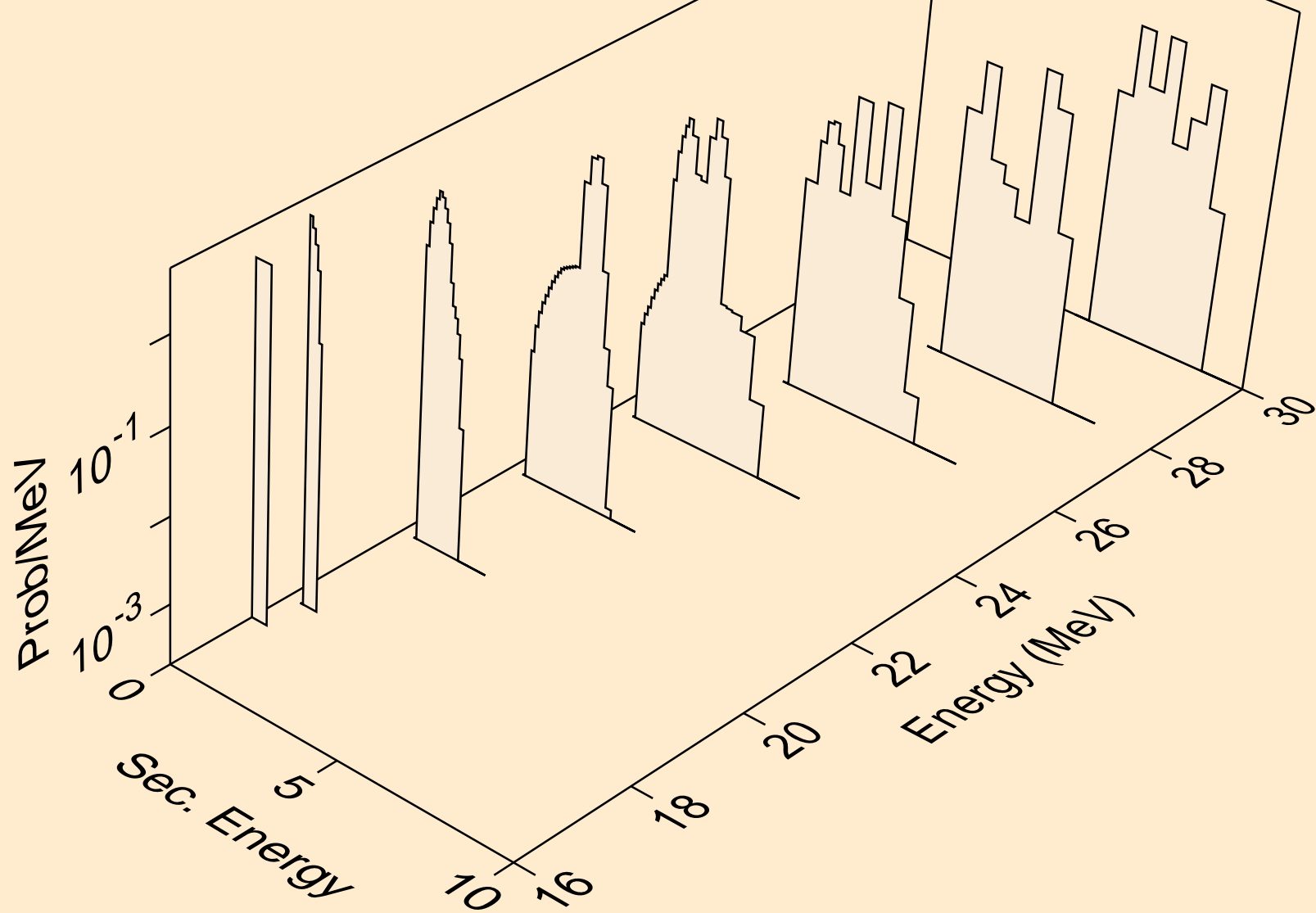

O014 NEUTRON ACER TENDL-2024 LIBRARY; T=293.6K  
tritons from (n,pt)

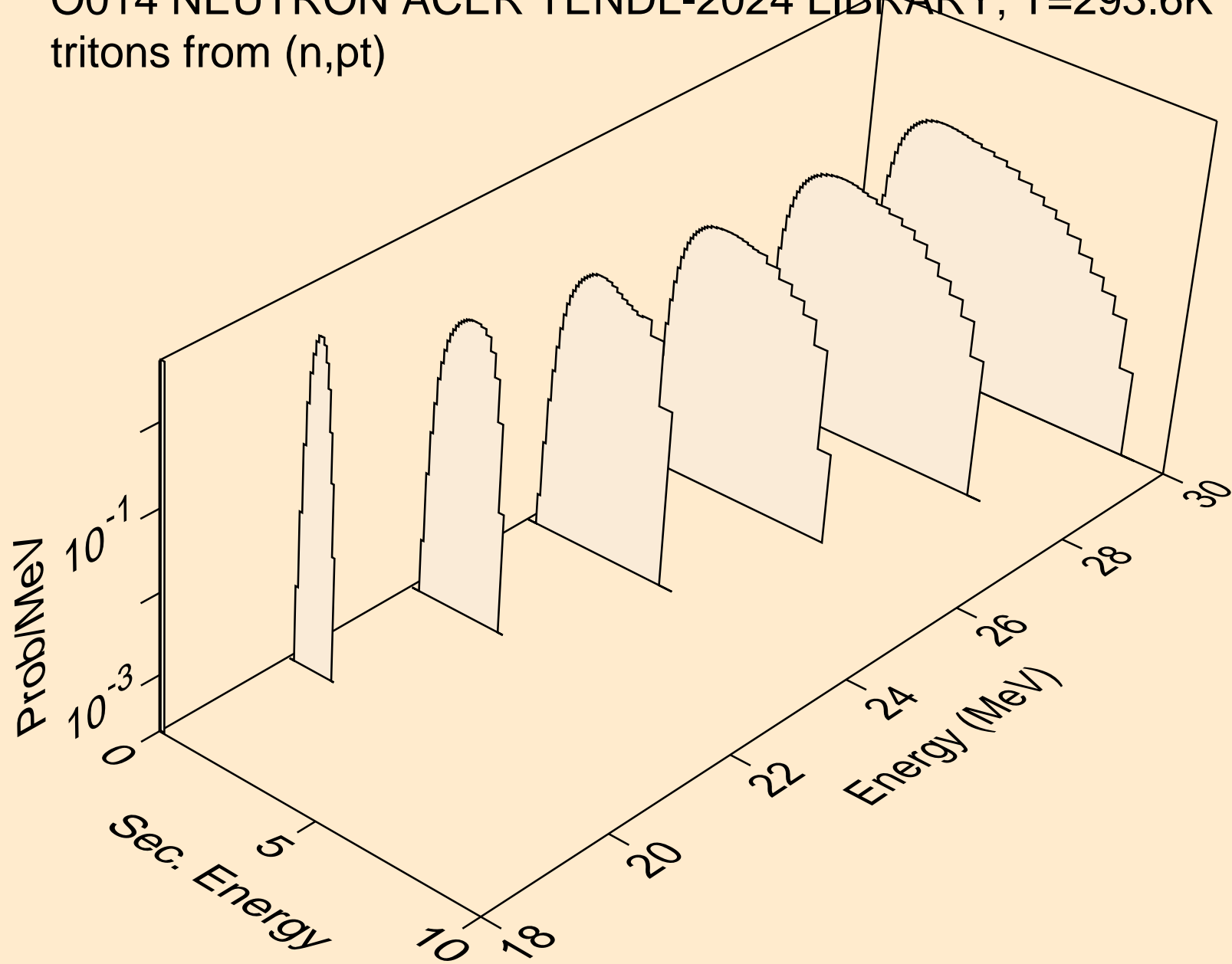

O014 NEUTRON ACER TENDL-2024 LIBRARY; T=293.6K  
he3s from (n,x)

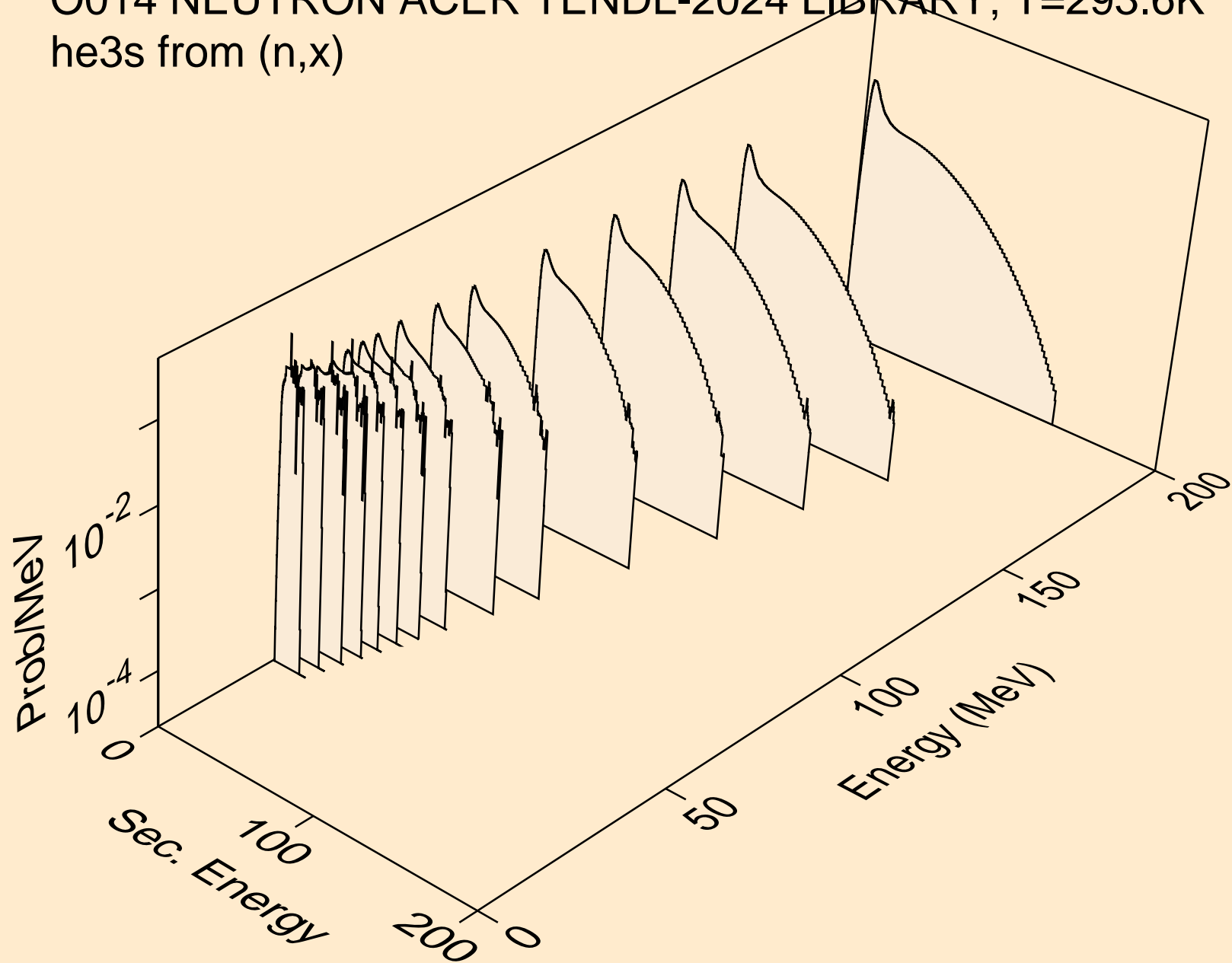

O014 NEUTRON ACER TENDL-2024 LIBRARY; T=293.6K  
he3s from (n,n\*)he3

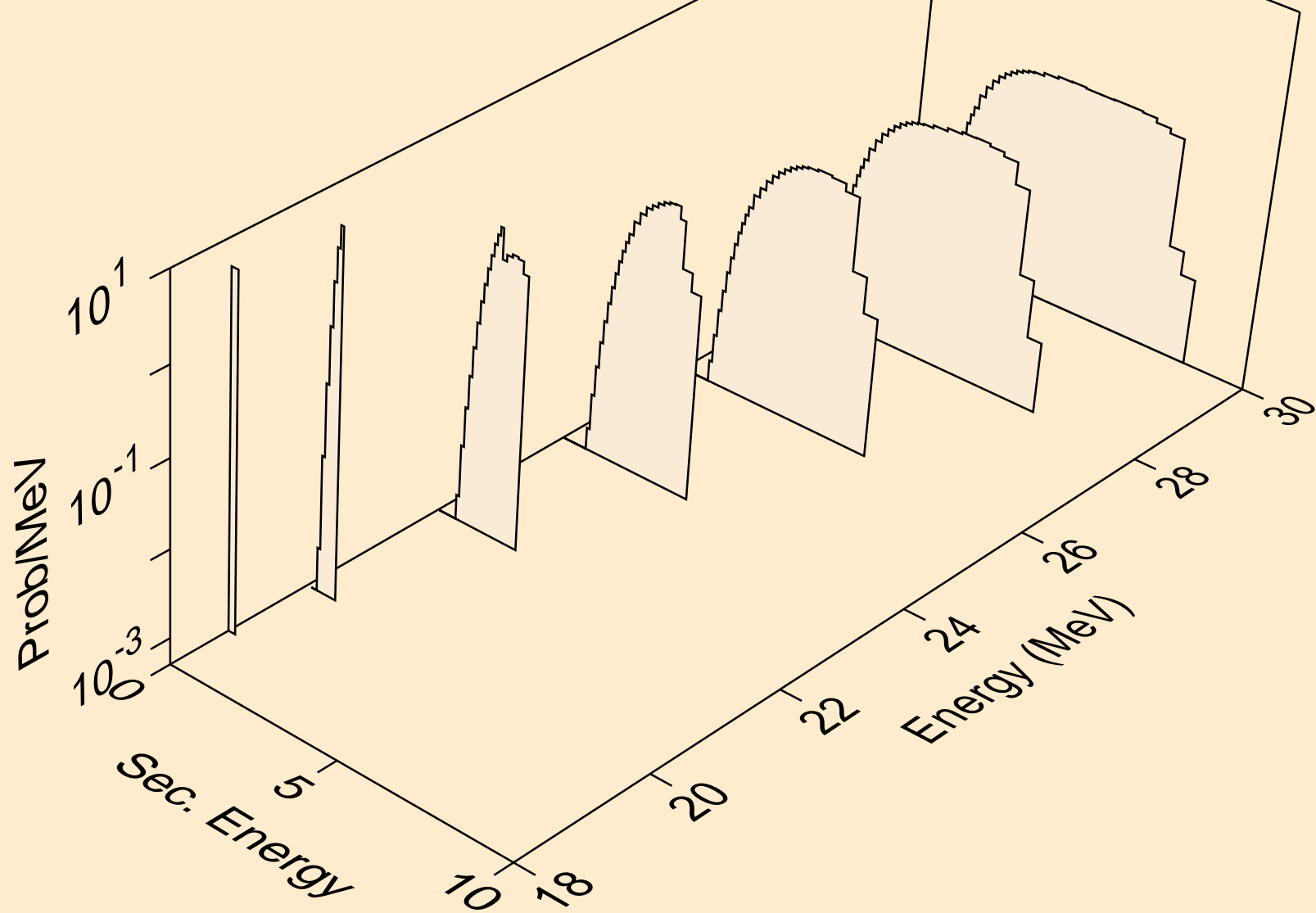

O014 NEUTRON ACER TENDL-2024 LIBRARY; T=293.6K  
he3s from (n,he3)

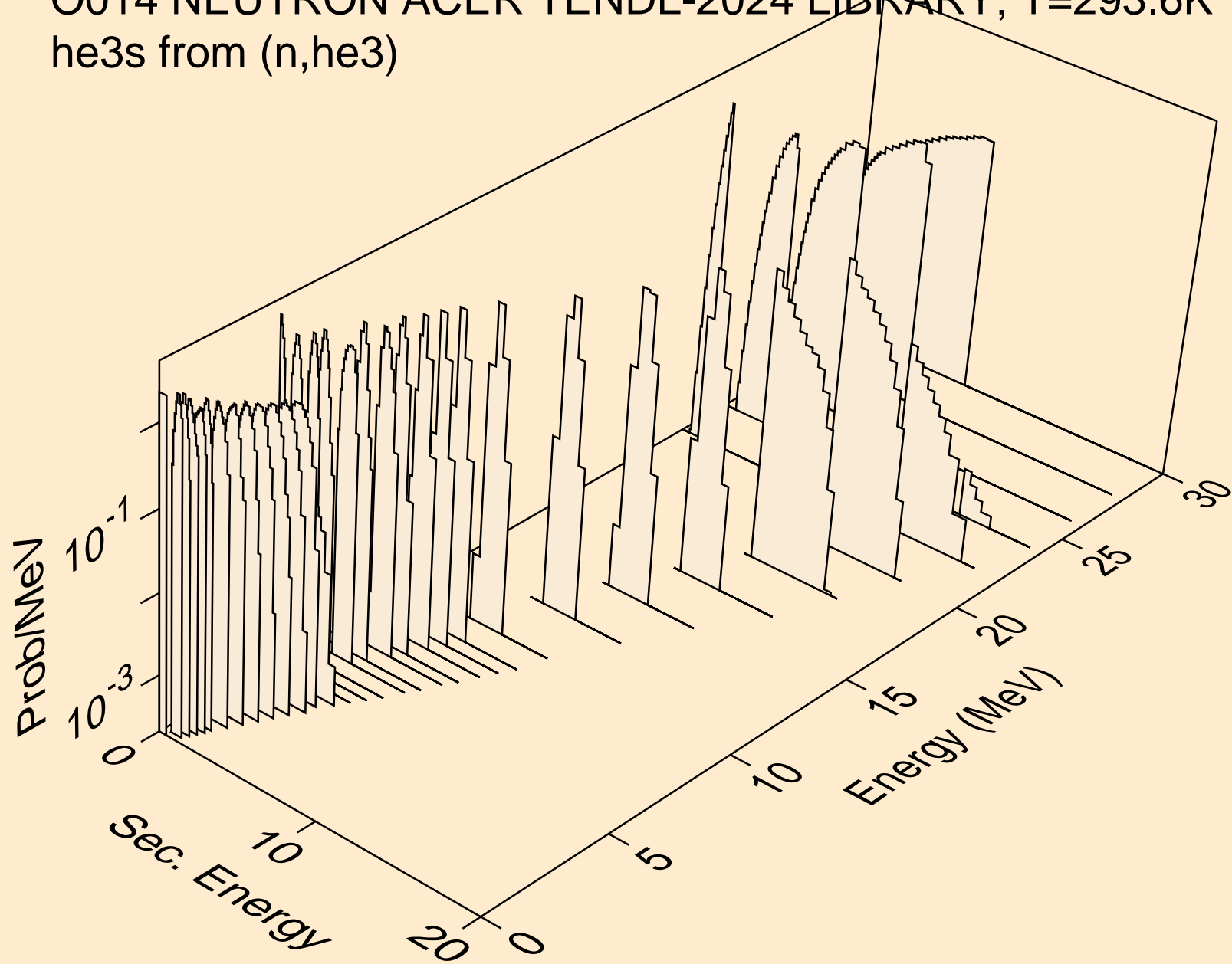

O014 NEUTRON ACER TENDL-2024 LIBRARY; T=293.6K  
alphas from (n,x)

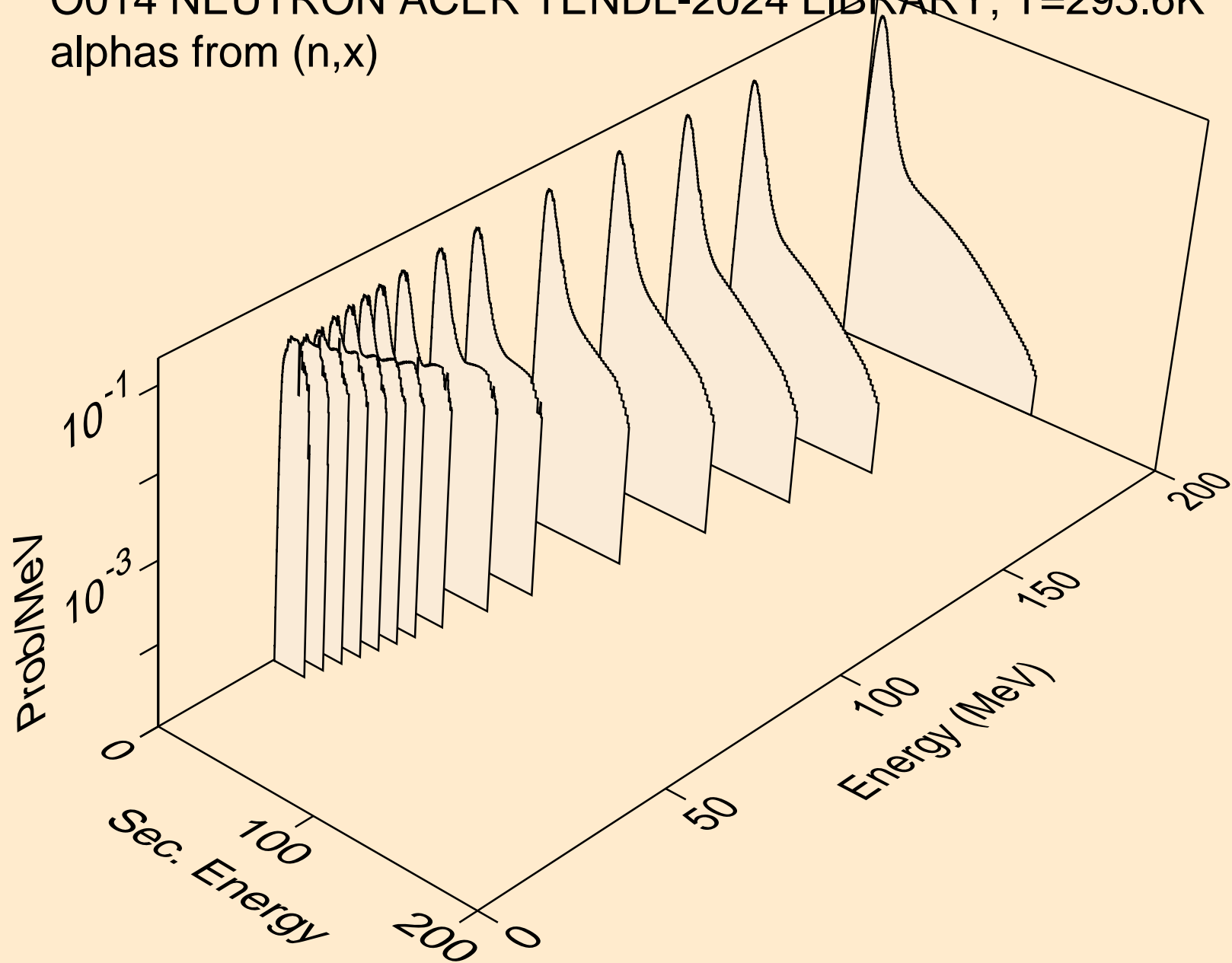

O014 NEUTRON ACER TENDL-2024 LIBRARY; T=293.6K  
alphas from (n,n\*)a

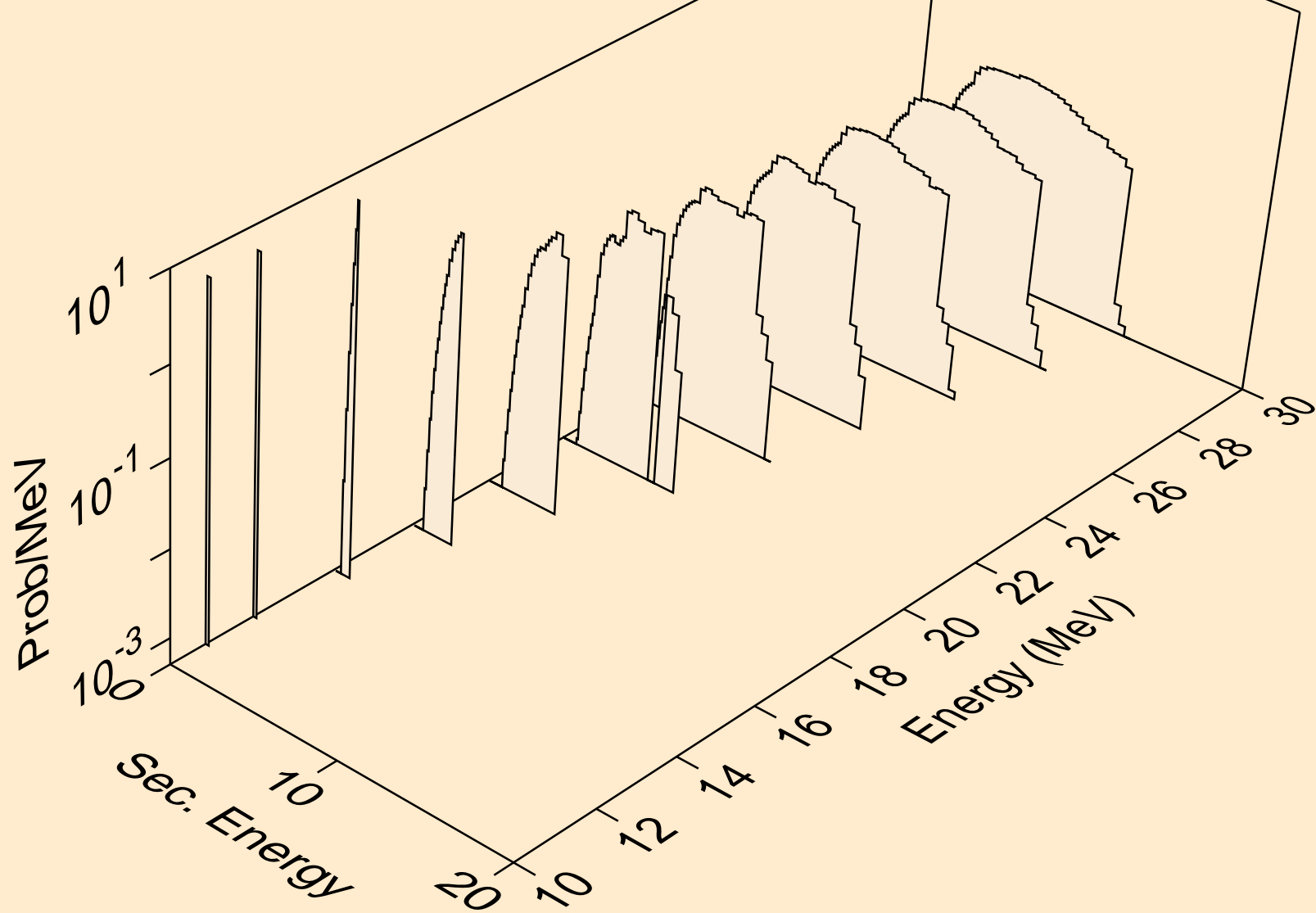

O014 NEUTRON ACER TENDL-2024 LIBRARY; T=293.6K  
alphas from (n,npa)

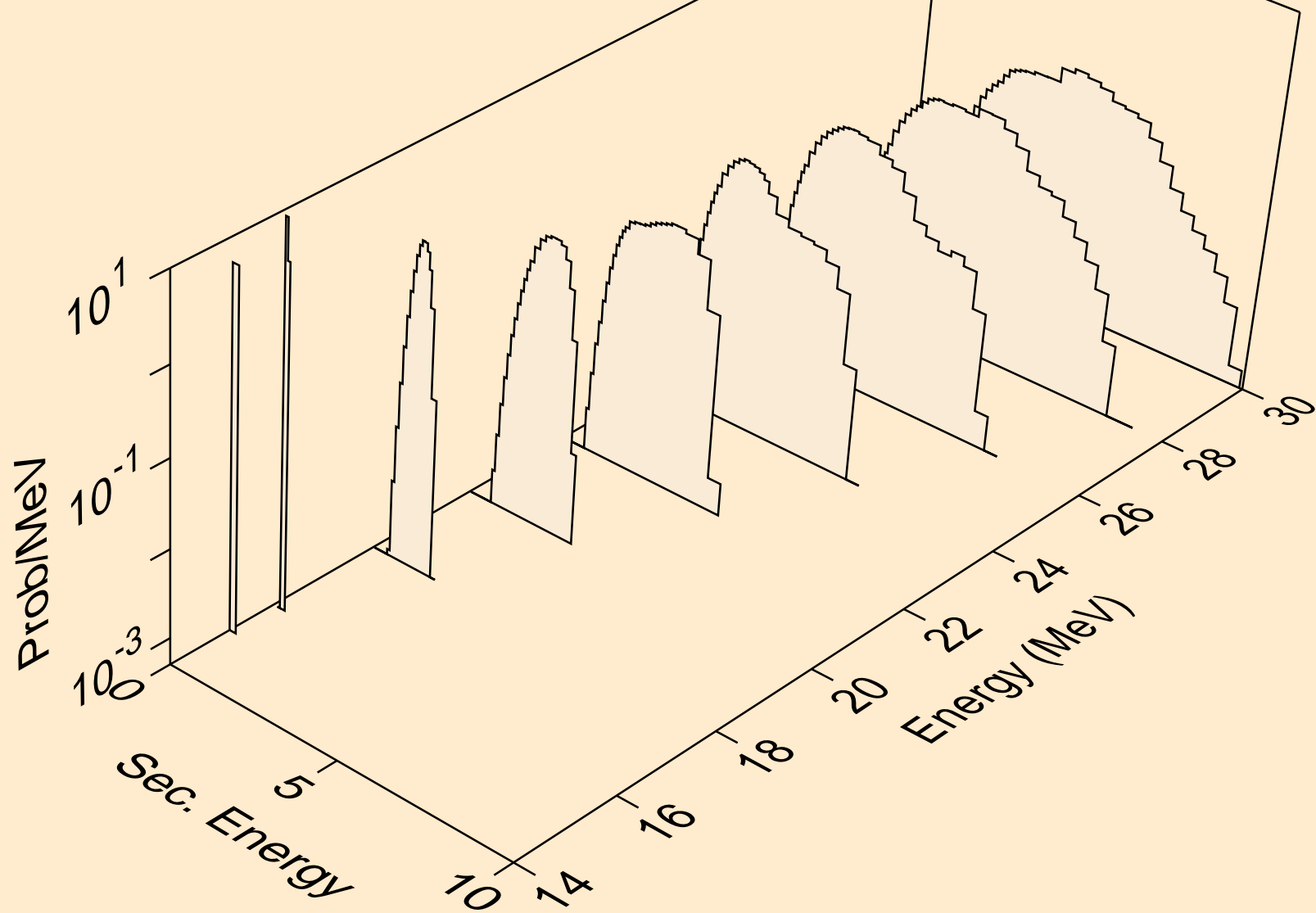

O014 NEUTRON ACER TENDL-2024 LIBRARY; T=293.6K  
alphas from (n,a)

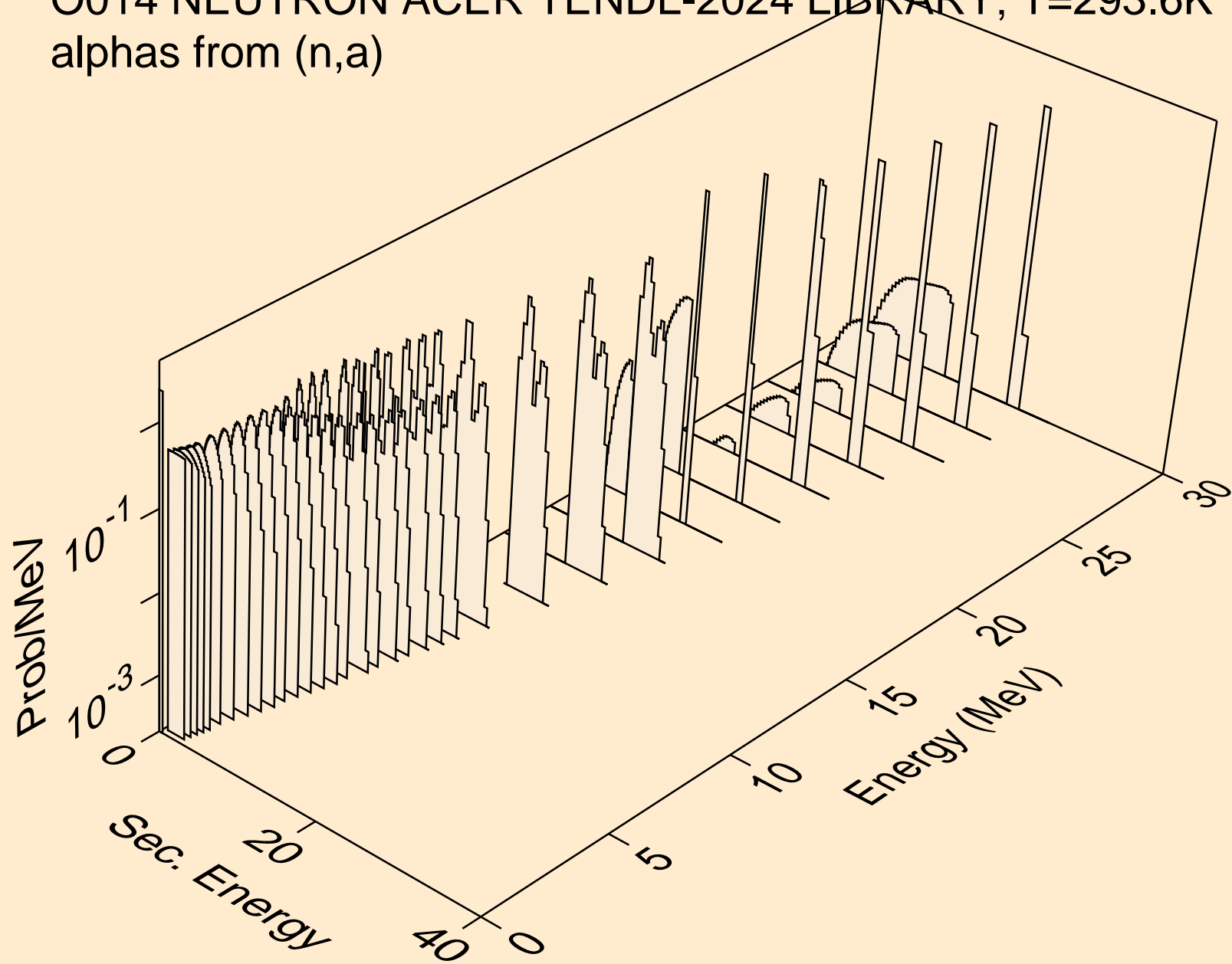

O014 NEUTRON ACER TENDL-2024 LIBRARY; T=293.6K  
alphas from (n,2a)

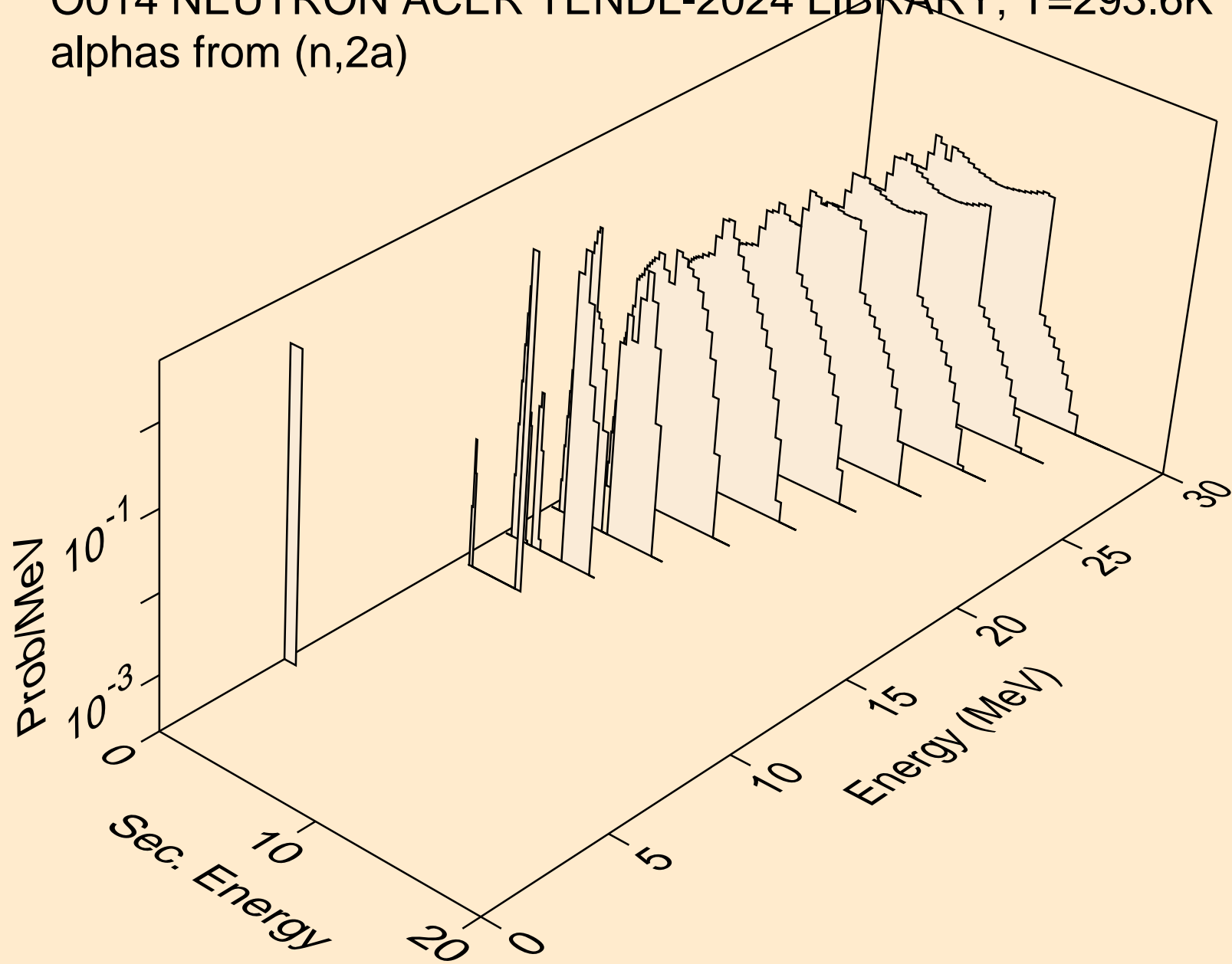

O014 NEUTRON ACER TENDL-2024 LIBRARY; T=293.6K  
alphas from (n,pa)

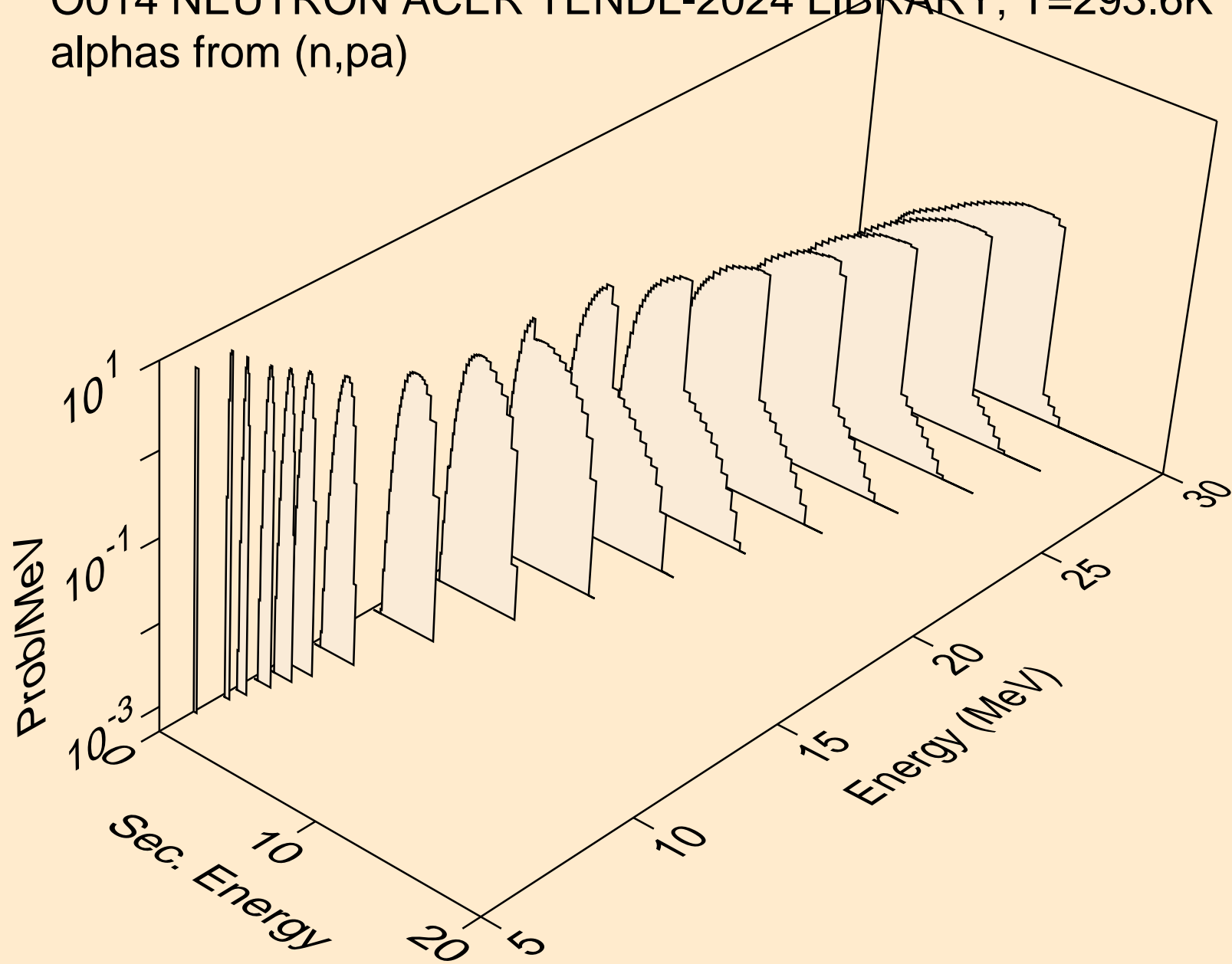

O014 NEUTRON ACER TENDL-2024 LIBRARY; T=293.6K  
alphas from (n,da)

