

# OS191M NEUTRON ACER TENDL-2024 LIBRARY; T=293.6K

## Principal cross sections

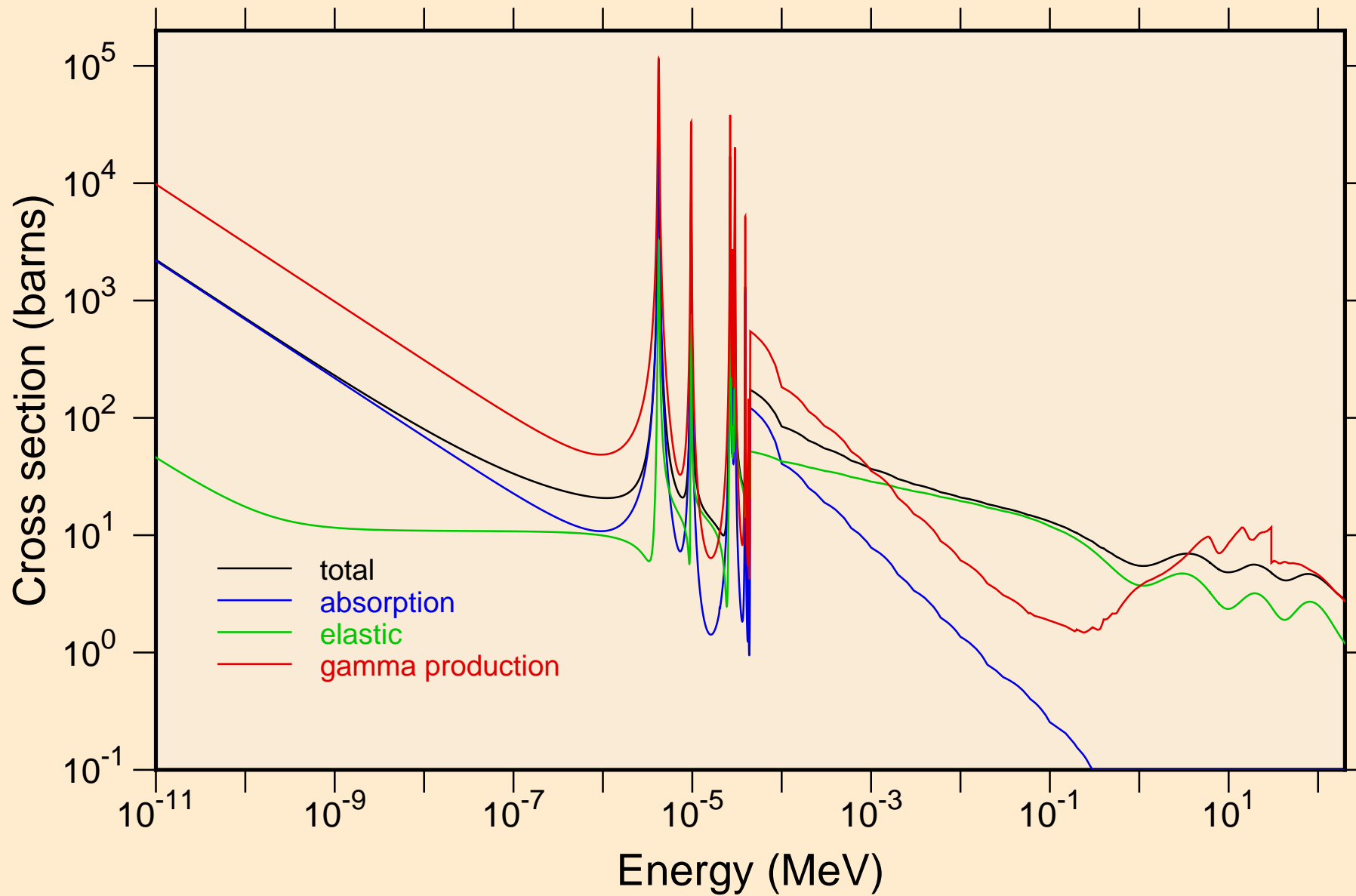

OS191M NEUTRON ACER TENDL-2024 LIBRARY; T=293.6K  
resonance total cross section

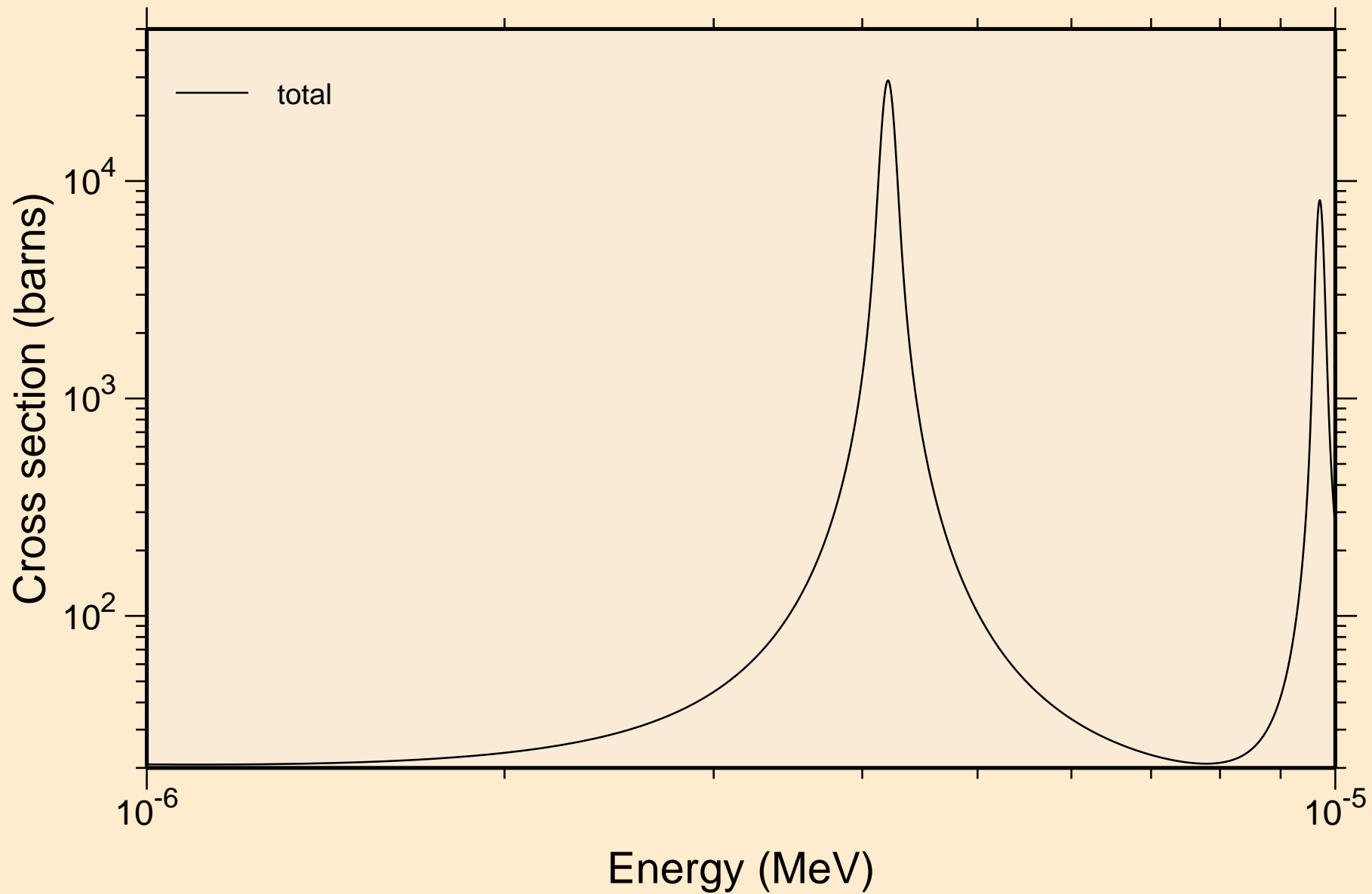

OS191M NEUTRON ACER TENDL-2024 LIBRARY; T=293.6K  
resonance total cross section

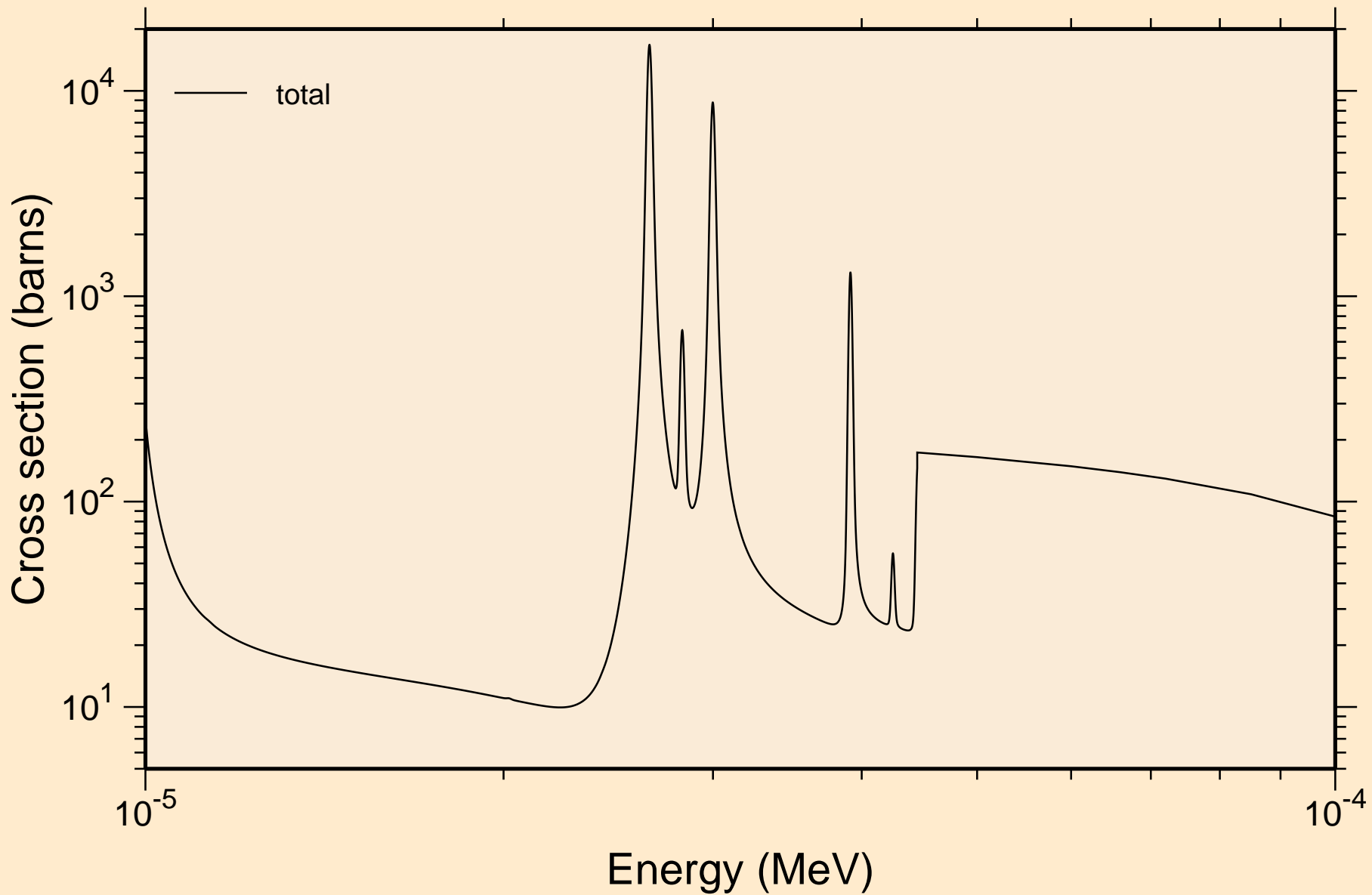

OS191M NEUTRON ACER TENDL-2024 LIBRARY; T=293.6K  
resonance total cross section

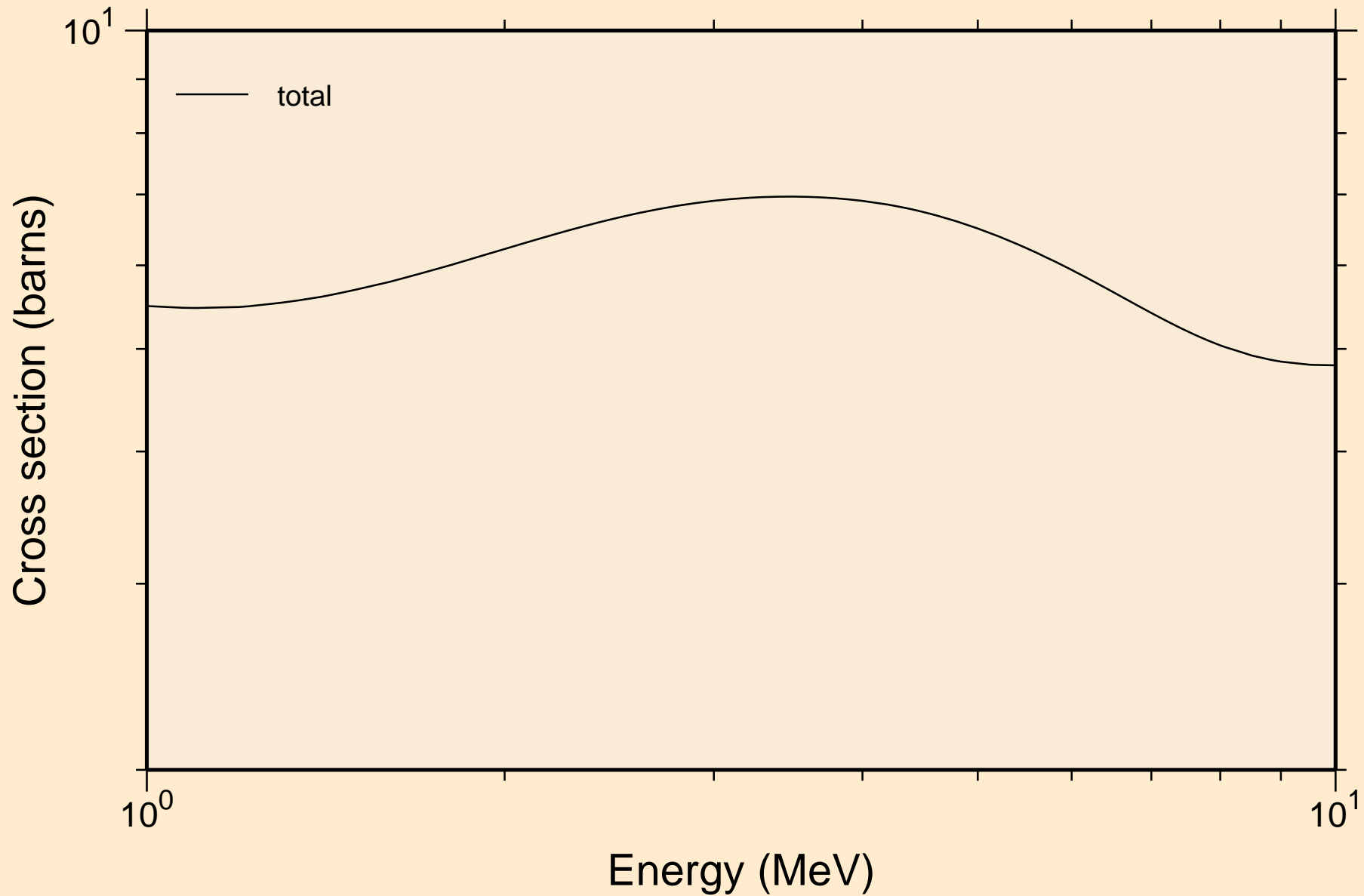

OS191M NEUTRON ACER TENDL-2024 LIBRARY; T=293.6K  
resonance absorption cross sections

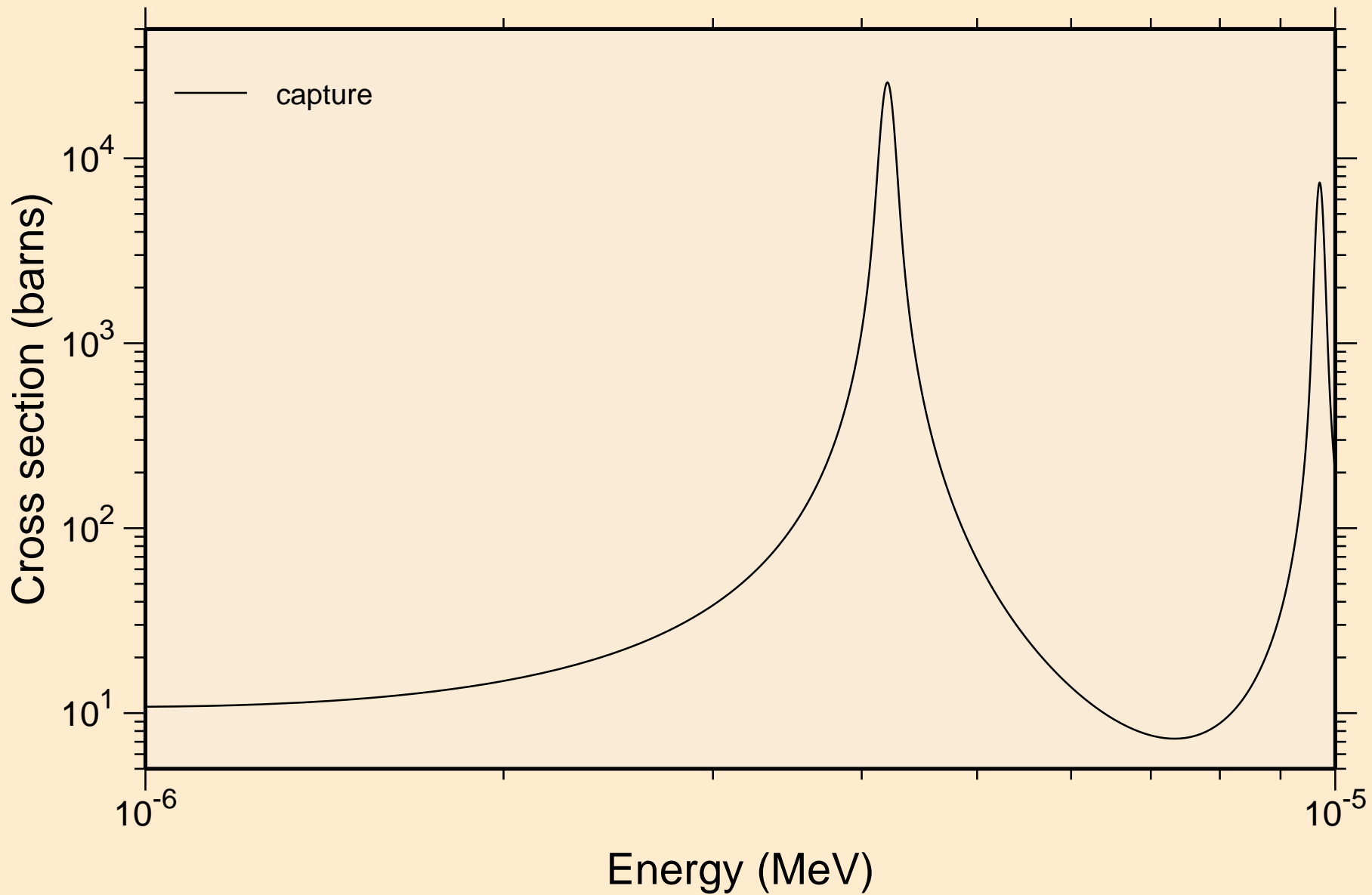

OS191M NEUTRON ACER TENDL-2024 LIBRARY; T=293.6K  
resonance absorption cross sections

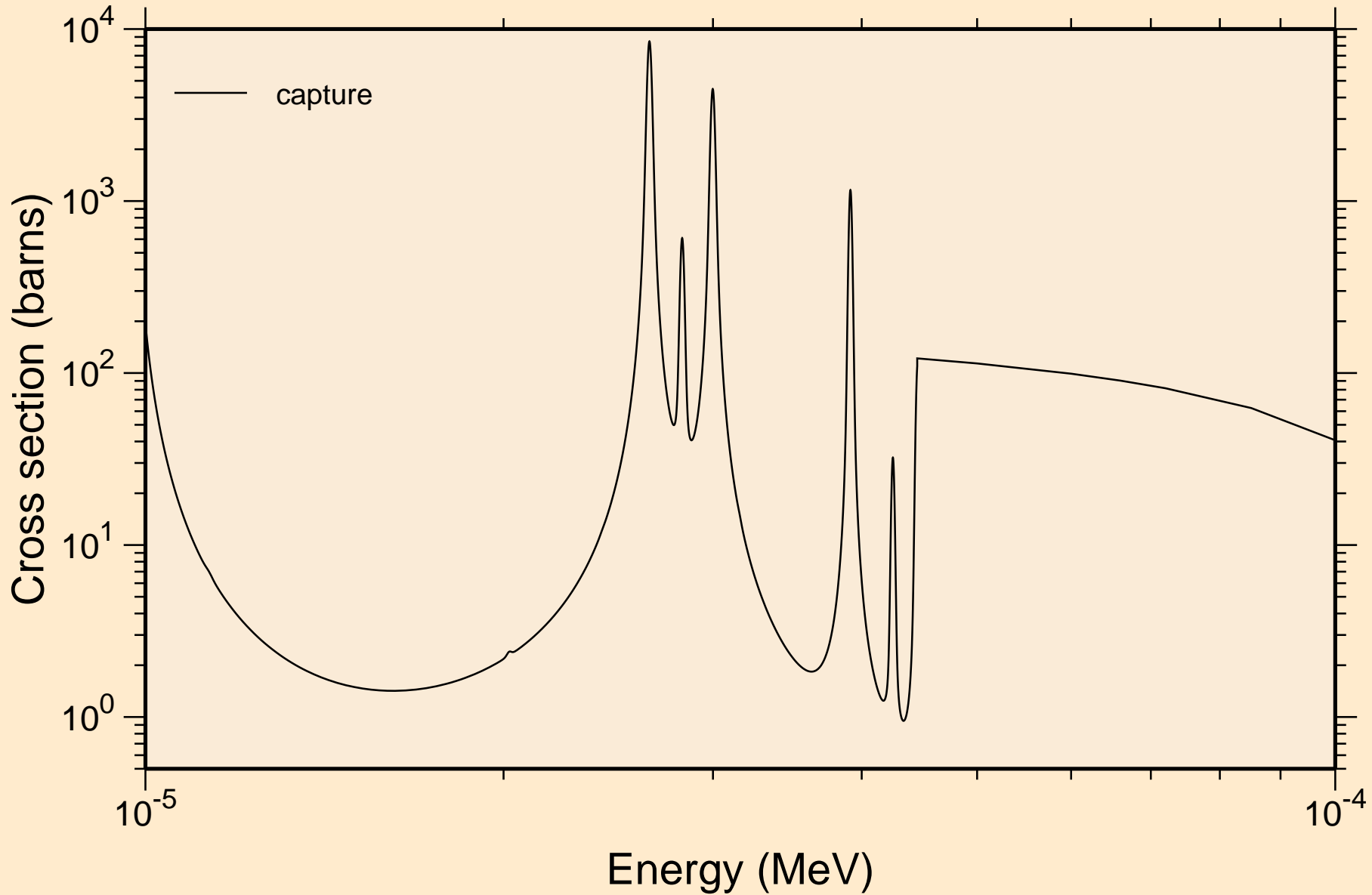

OS191M NEUTRON ACER TENDL-2024 LIBRARY; T=293.6K  
resonance absorption cross sections

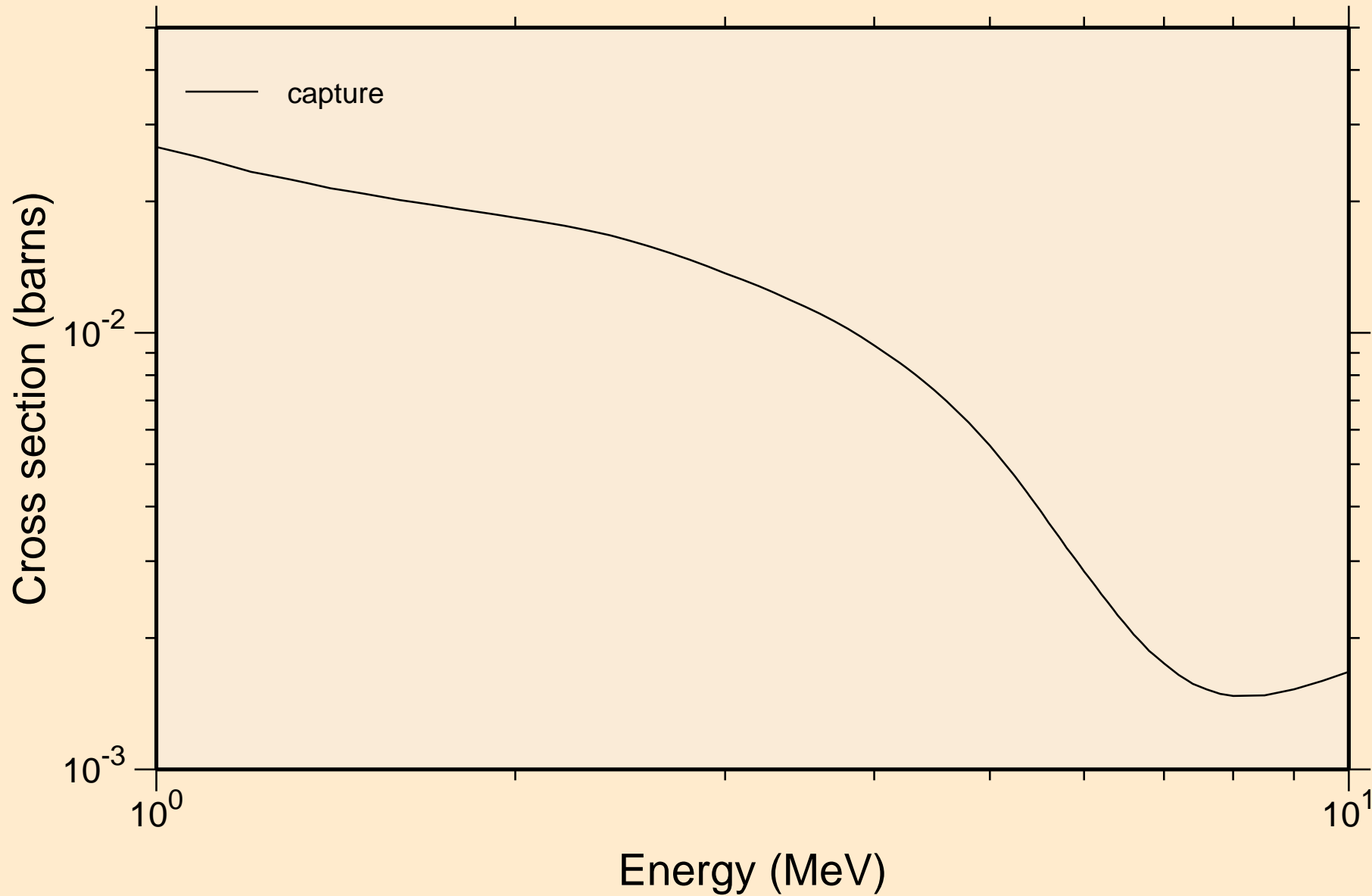

OS191M NEUTRON ACER TENDL-2024 LIBRARY; T=293.6K  
Heating

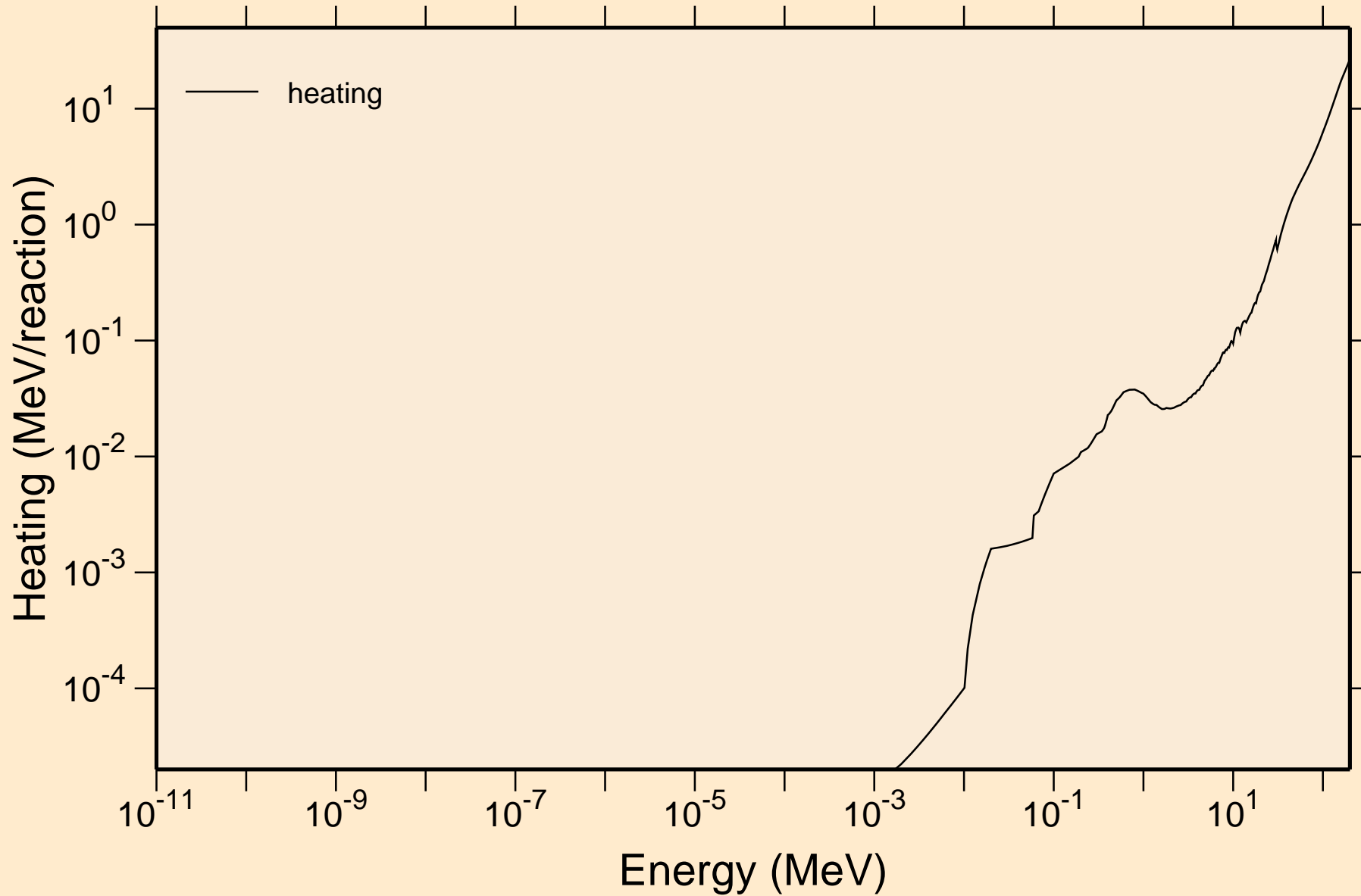

OS191M NEUTRON ACER TENDL-2024 LIBRARY; T=293.6K  
Damage

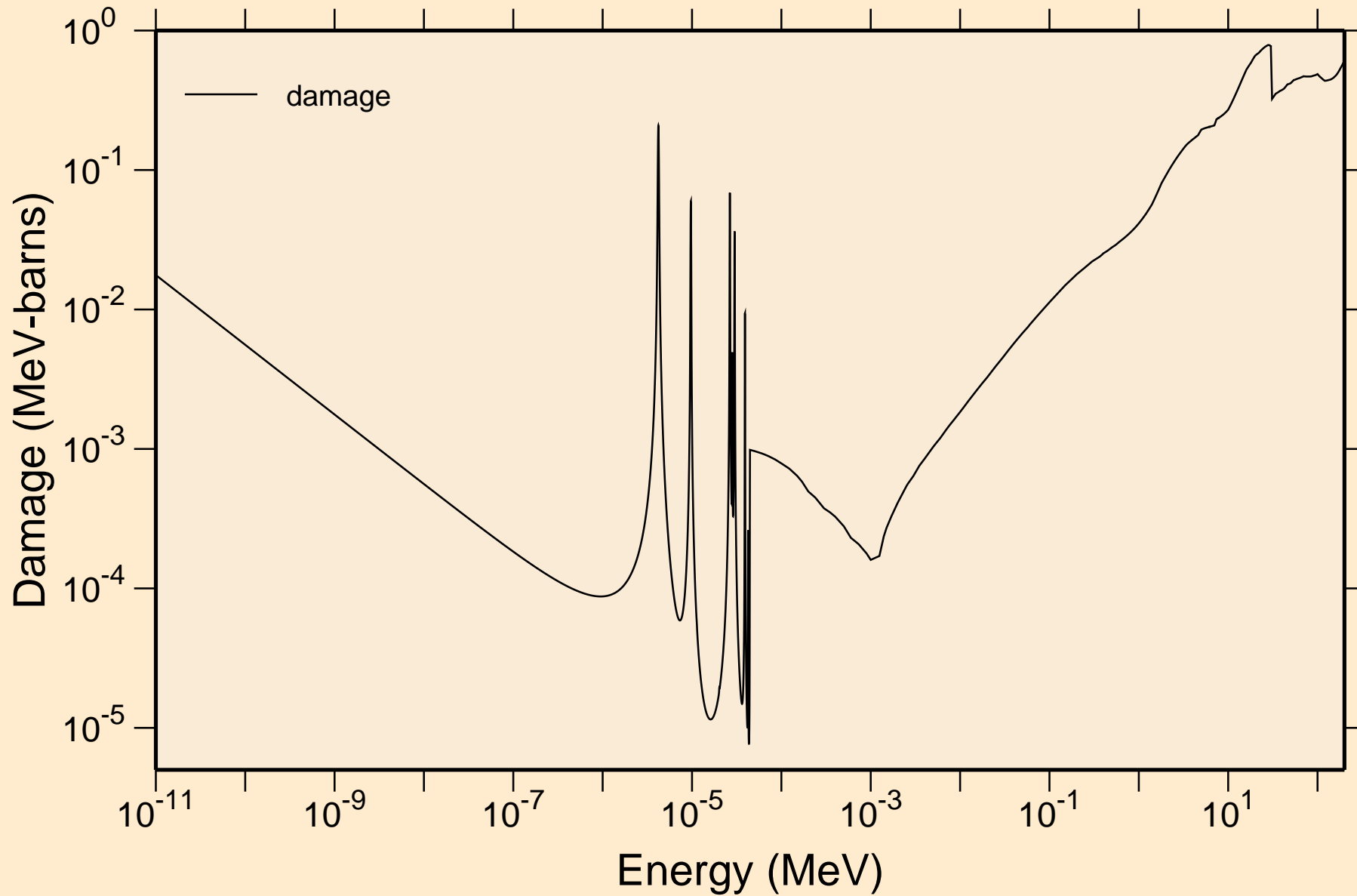

OS191M NEUTRON ACER TENDL-2024 LIBRARY; T=293.6K  
Non-threshold reactions

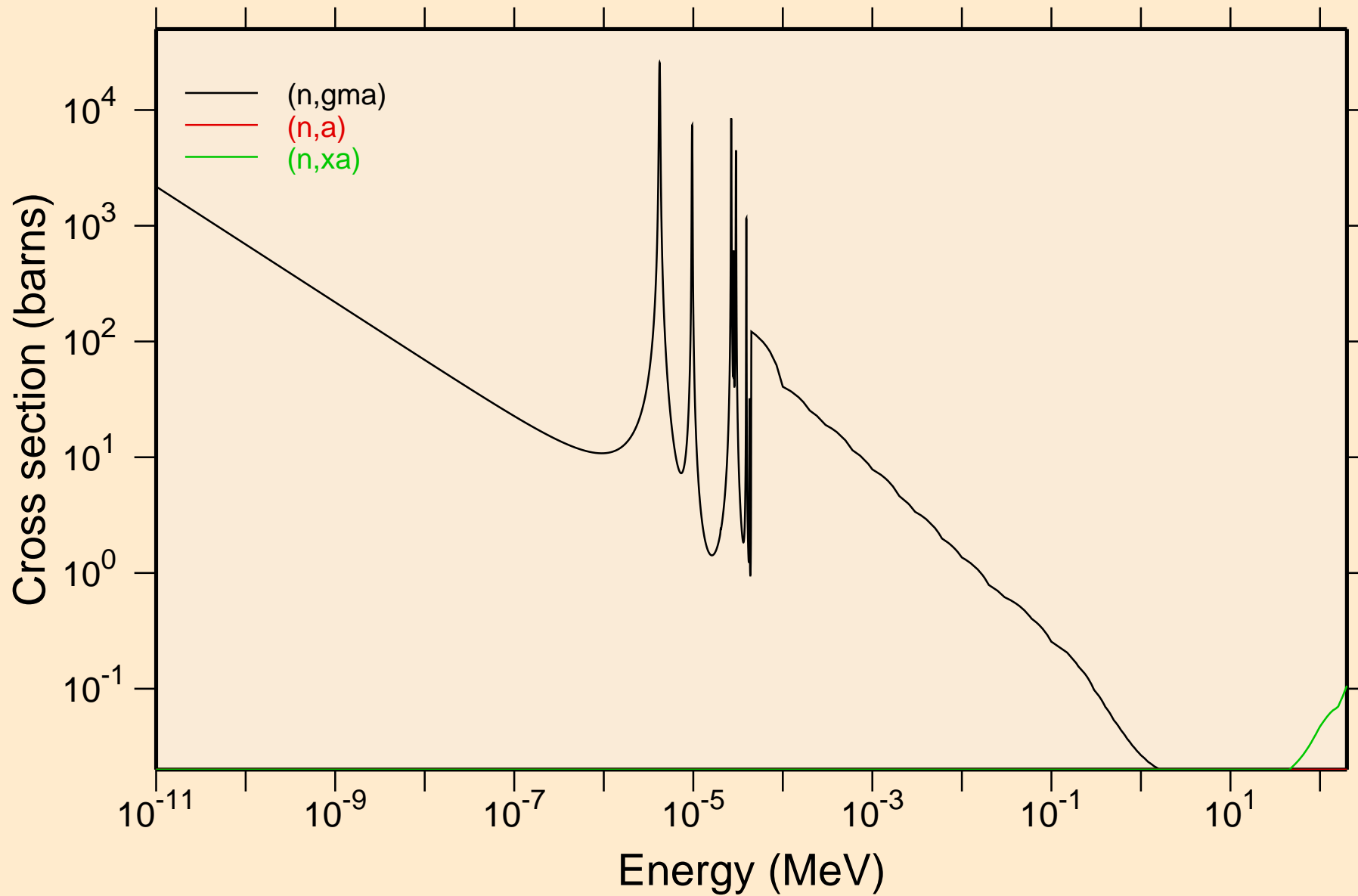

OS191M NEUTRON ACER TENDL-2024 LIBRARY; T=293.6K  
Principal cross sections

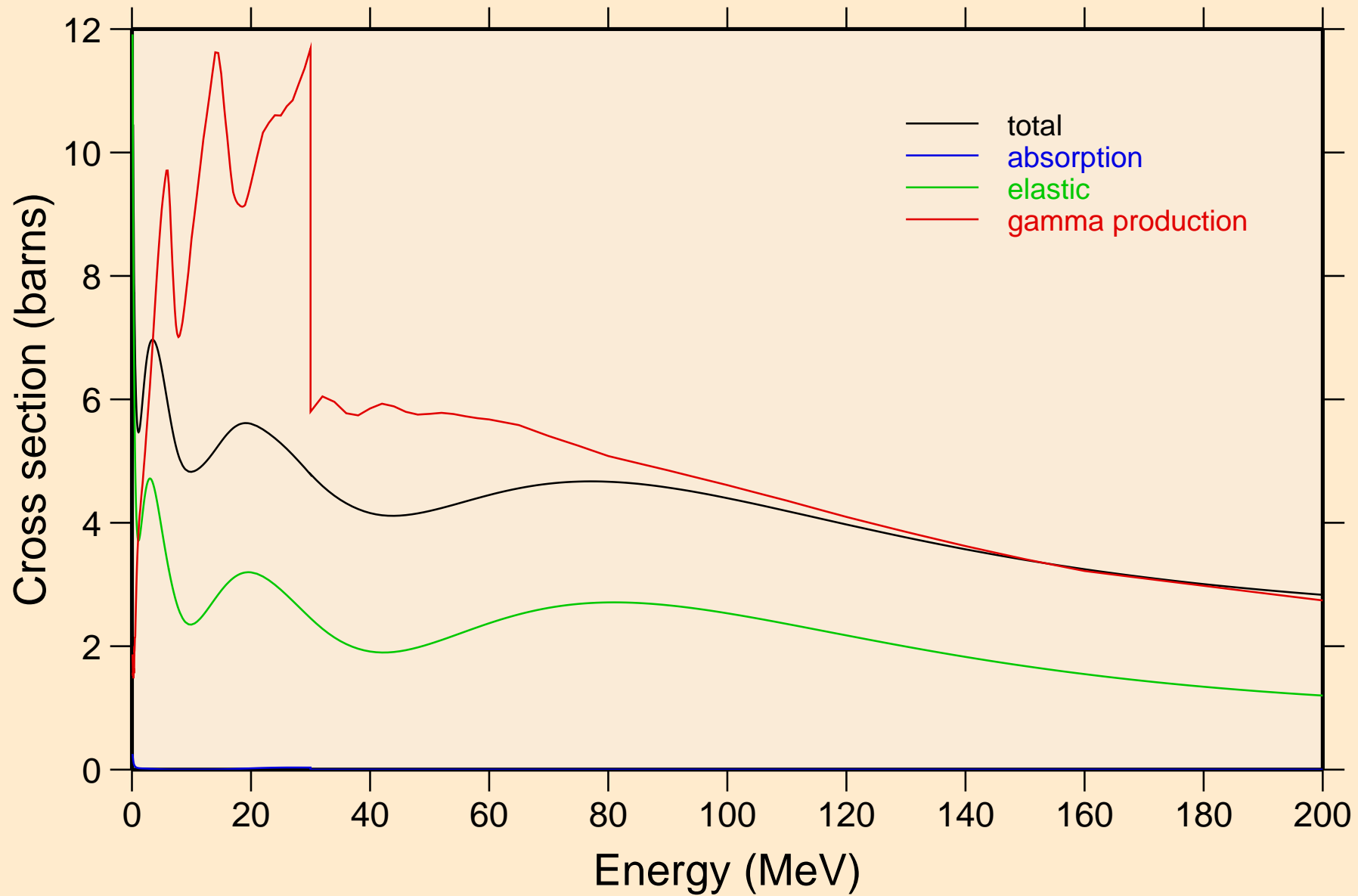

OS191M NEUTRON ACER TENDL-2024 LIBRARY; T=293.6K  
Heating

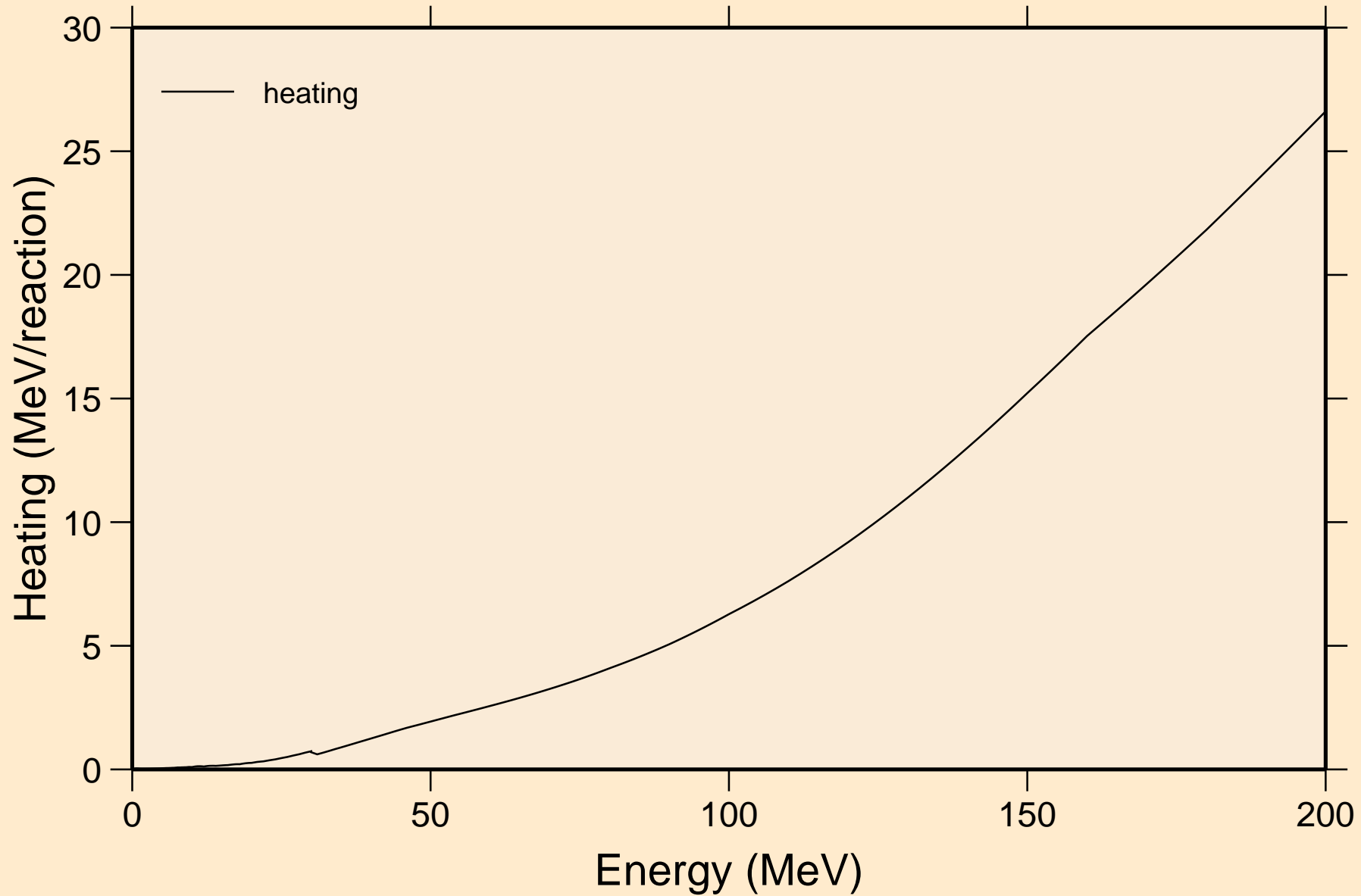

OS191M NEUTRON ACER TENDL-2024 LIBRARY; T=293.6K  
Damage

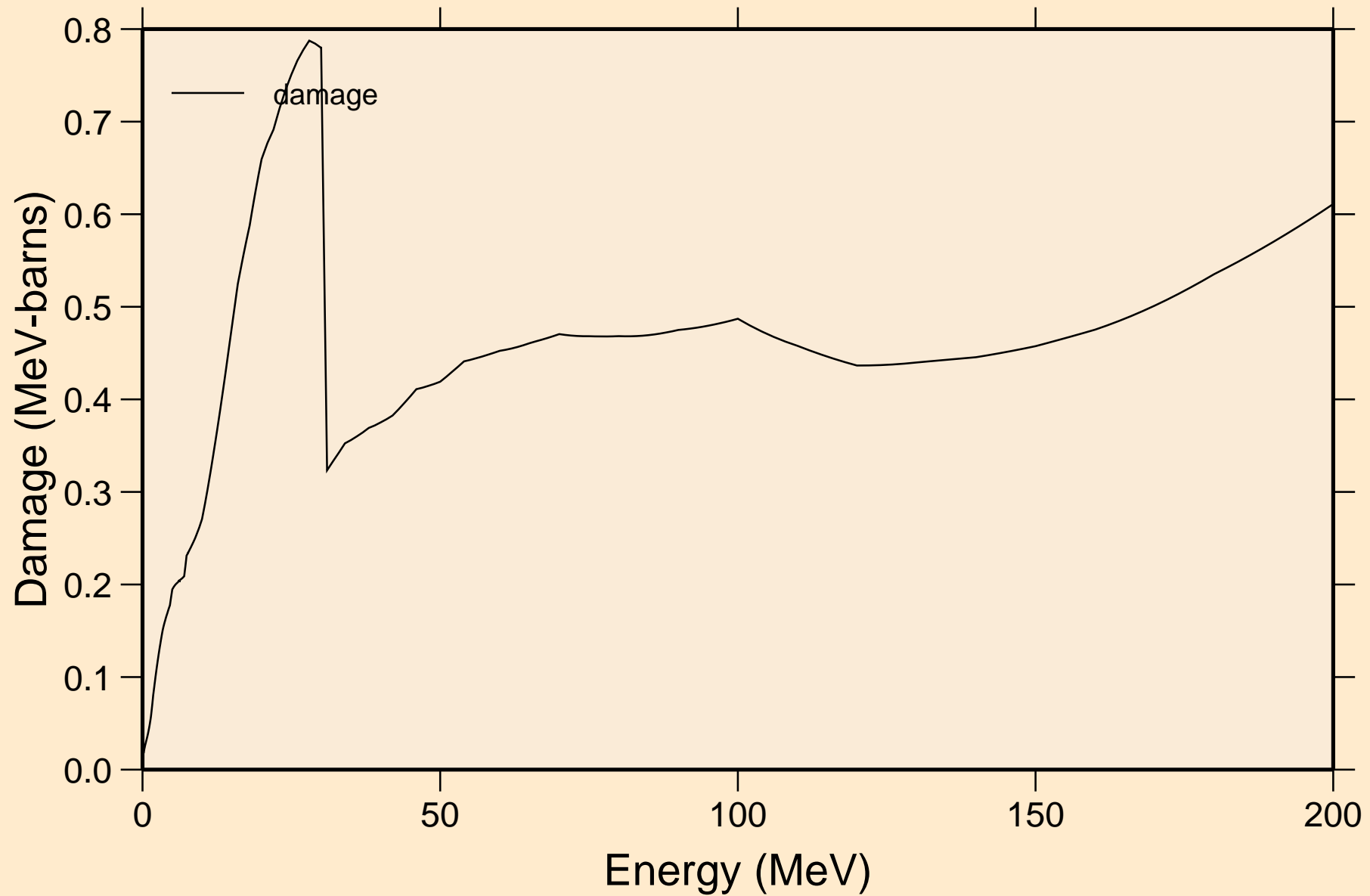

OS191M NEUTRON ACER TENDL-2024 LIBRARY; T=293.6K  
Non-threshold reactions

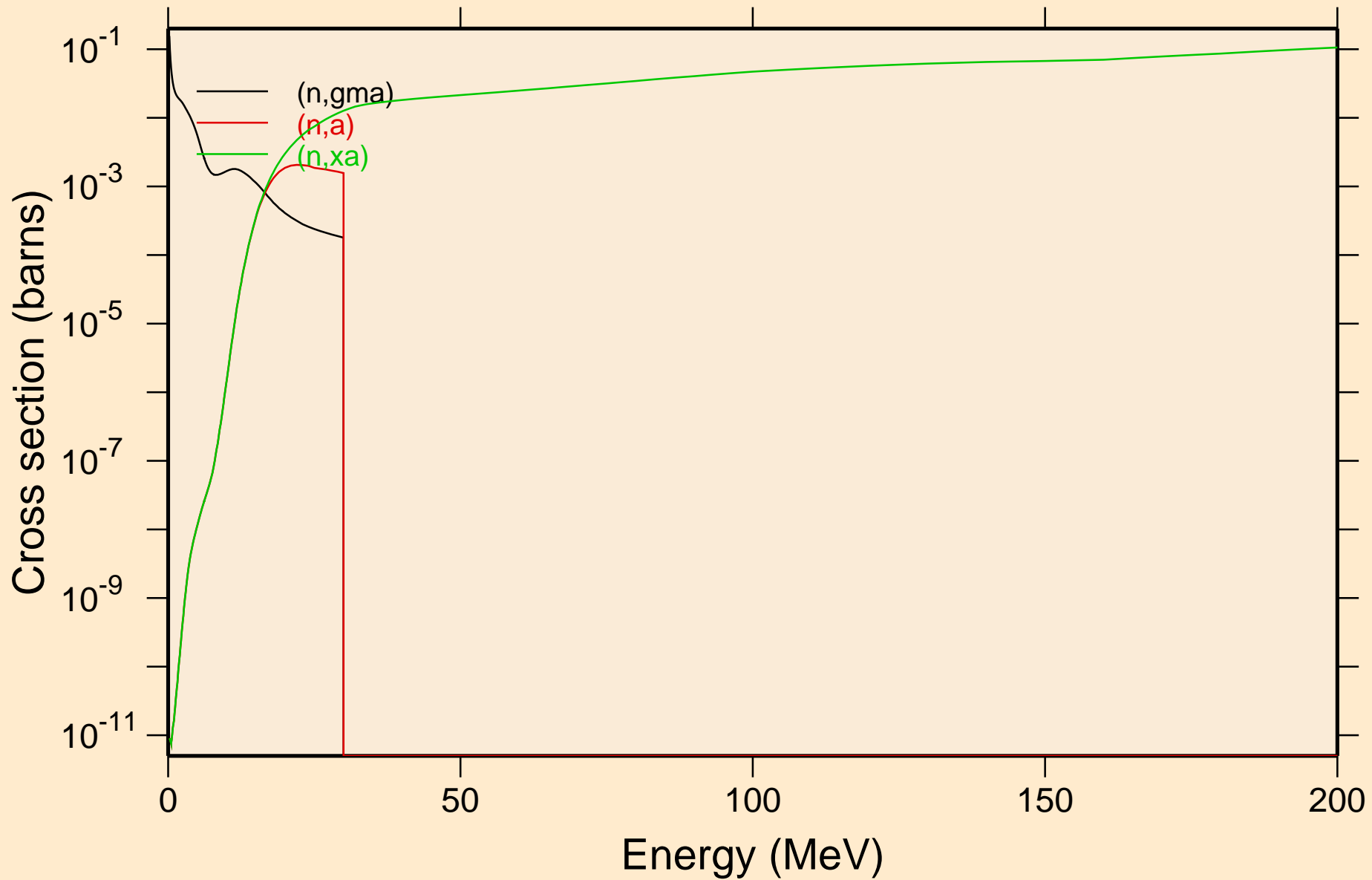

OS191M NEUTRON ACER TENDL-2024 LIBRARY; T=293.6K  
Inelastic levels

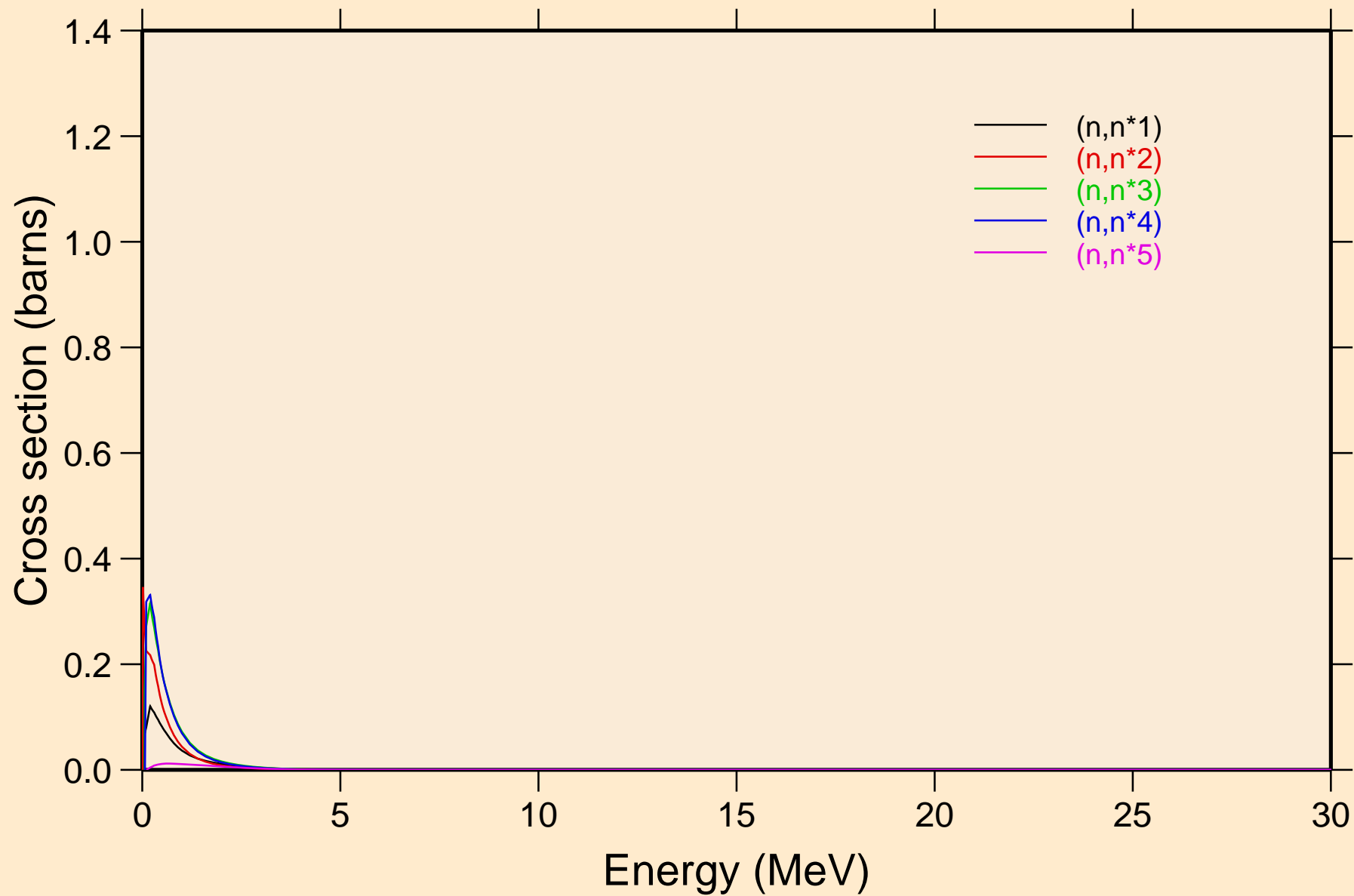

OS191M NEUTRON ACER TENDL-2024 LIBRARY; T=293.6K  
Inelastic levels

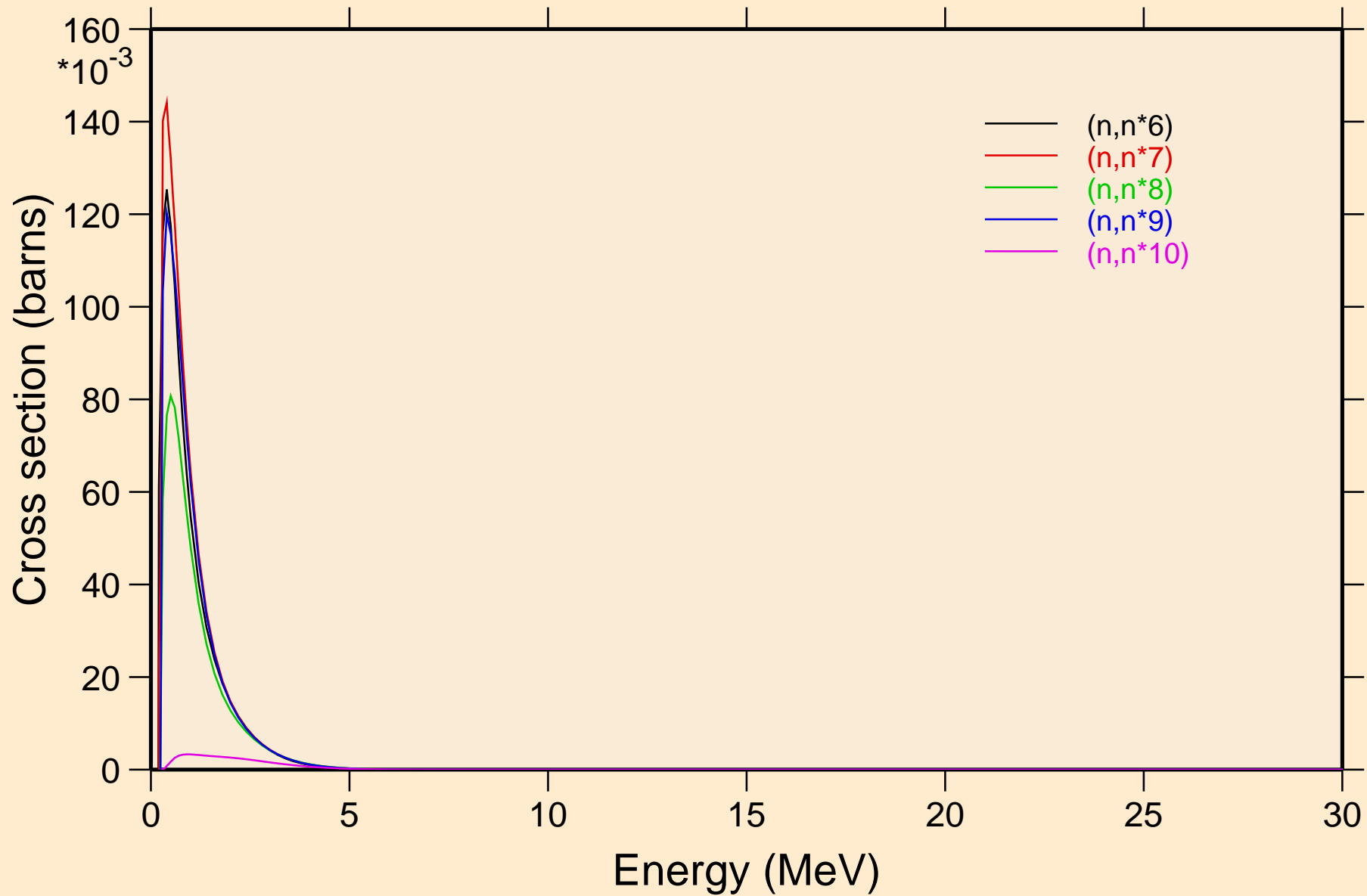

OS191M NEUTRON ACER TENDL-2024 LIBRARY; T=293.6K  
Inelastic levels

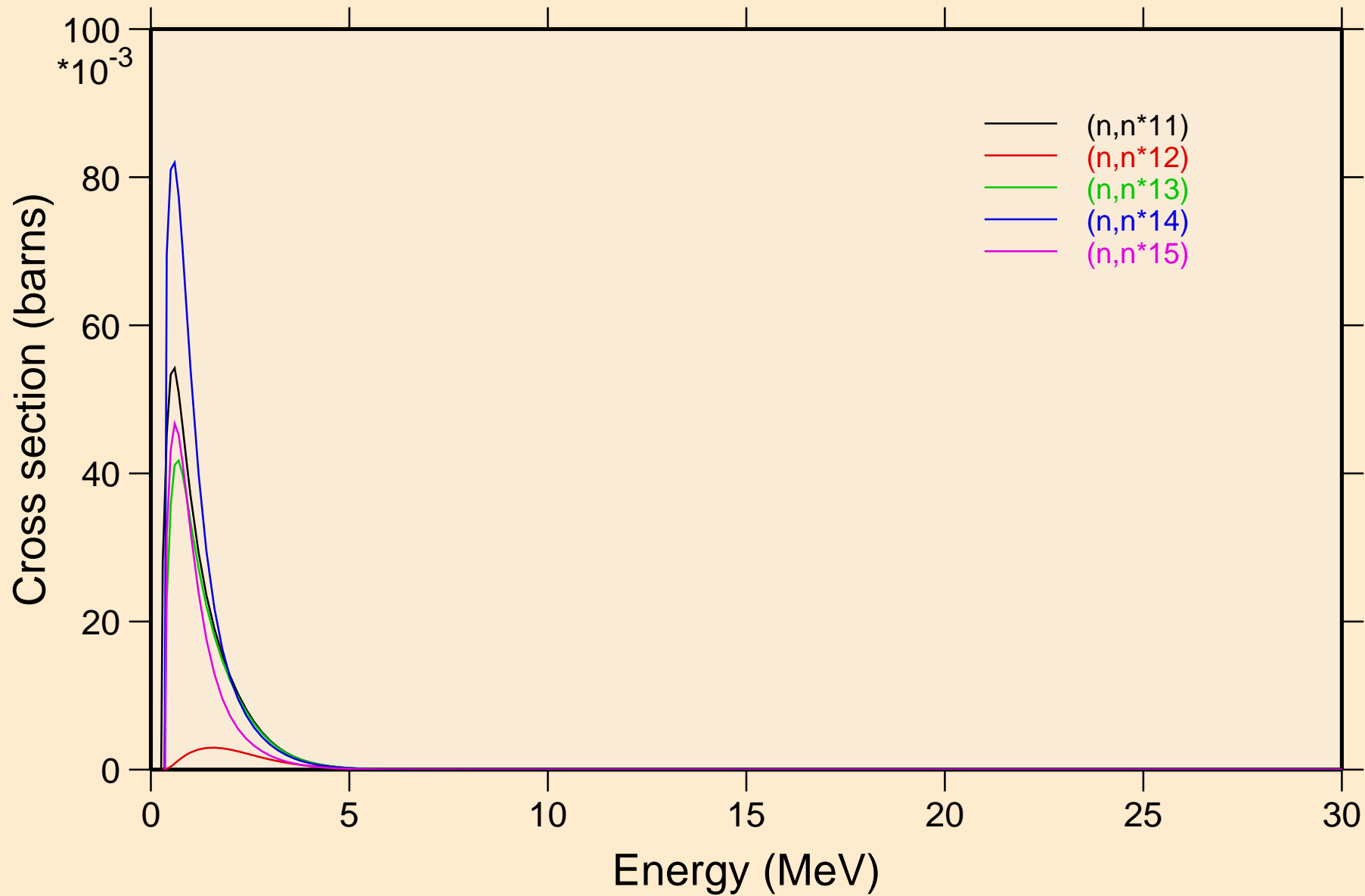

OS191M NEUTRON ACER TENDL-2024 LIBRARY; T=293.6K  
Inelastic levels

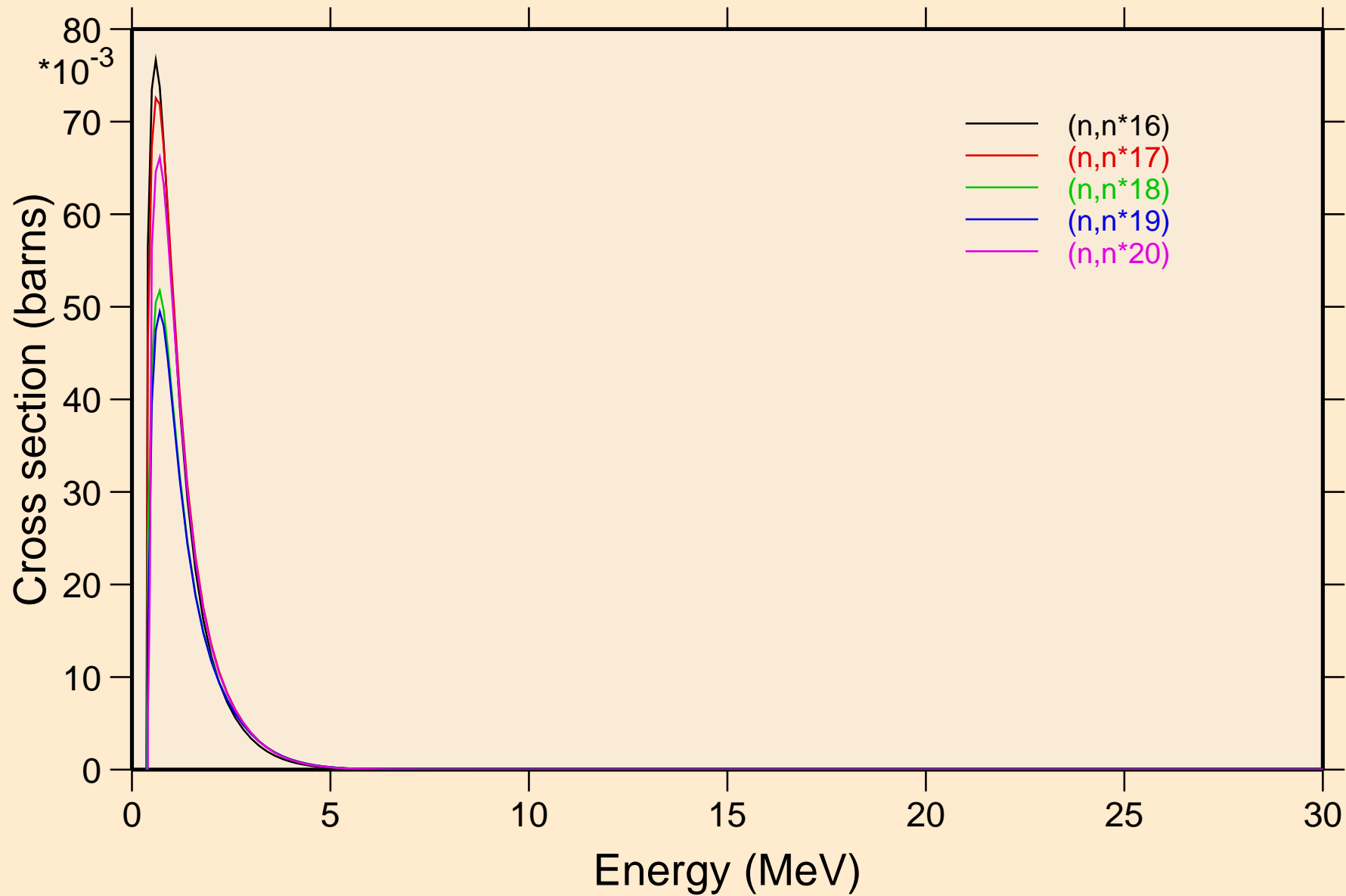

OS191M NEUTRON ACER TENDL-2024 LIBRARY; T=293.6K  
Inelastic levels

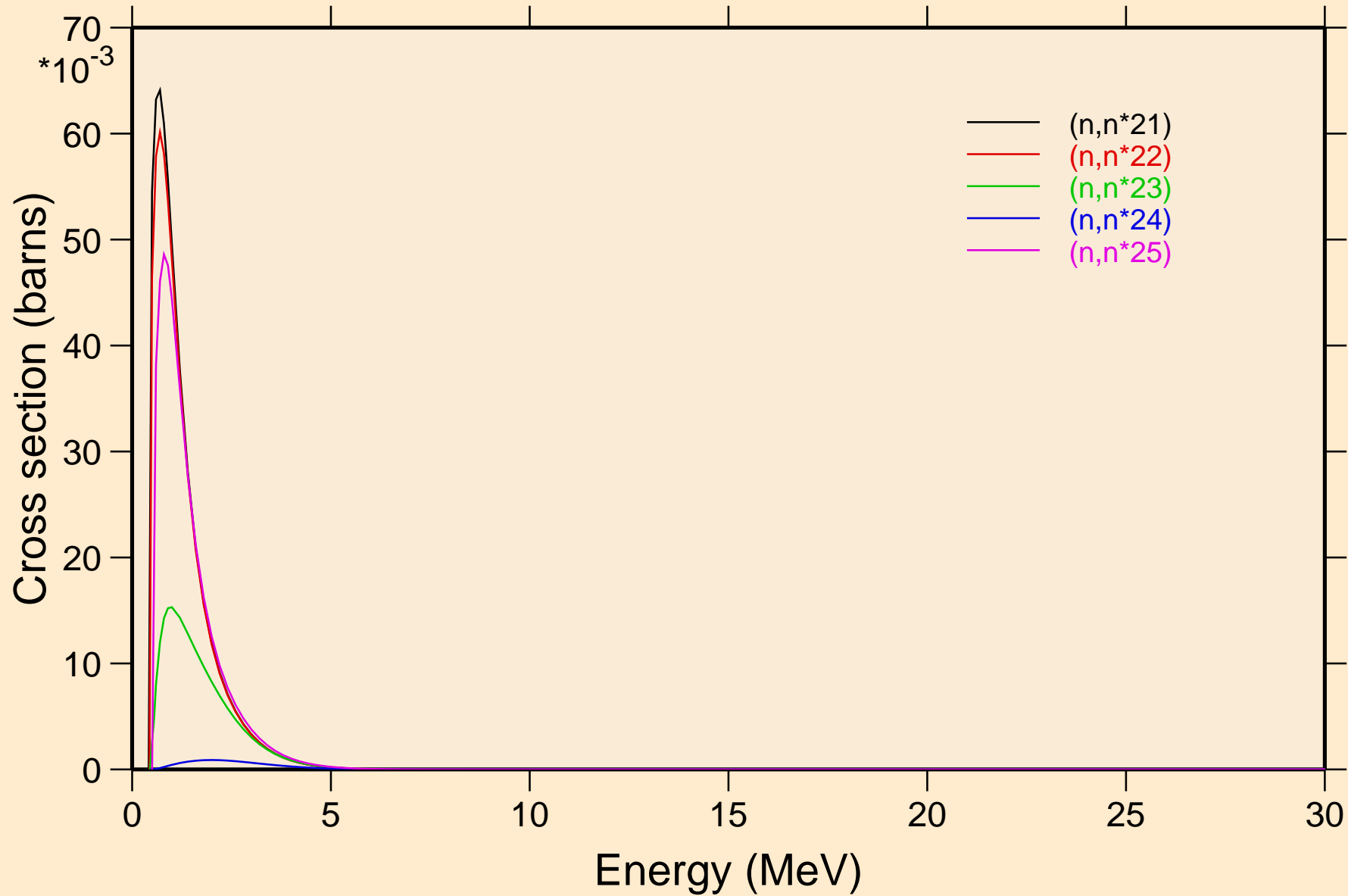

OS191M NEUTRON ACER TENDL-2024 LIBRARY; T=293.6K  
Inelastic levels

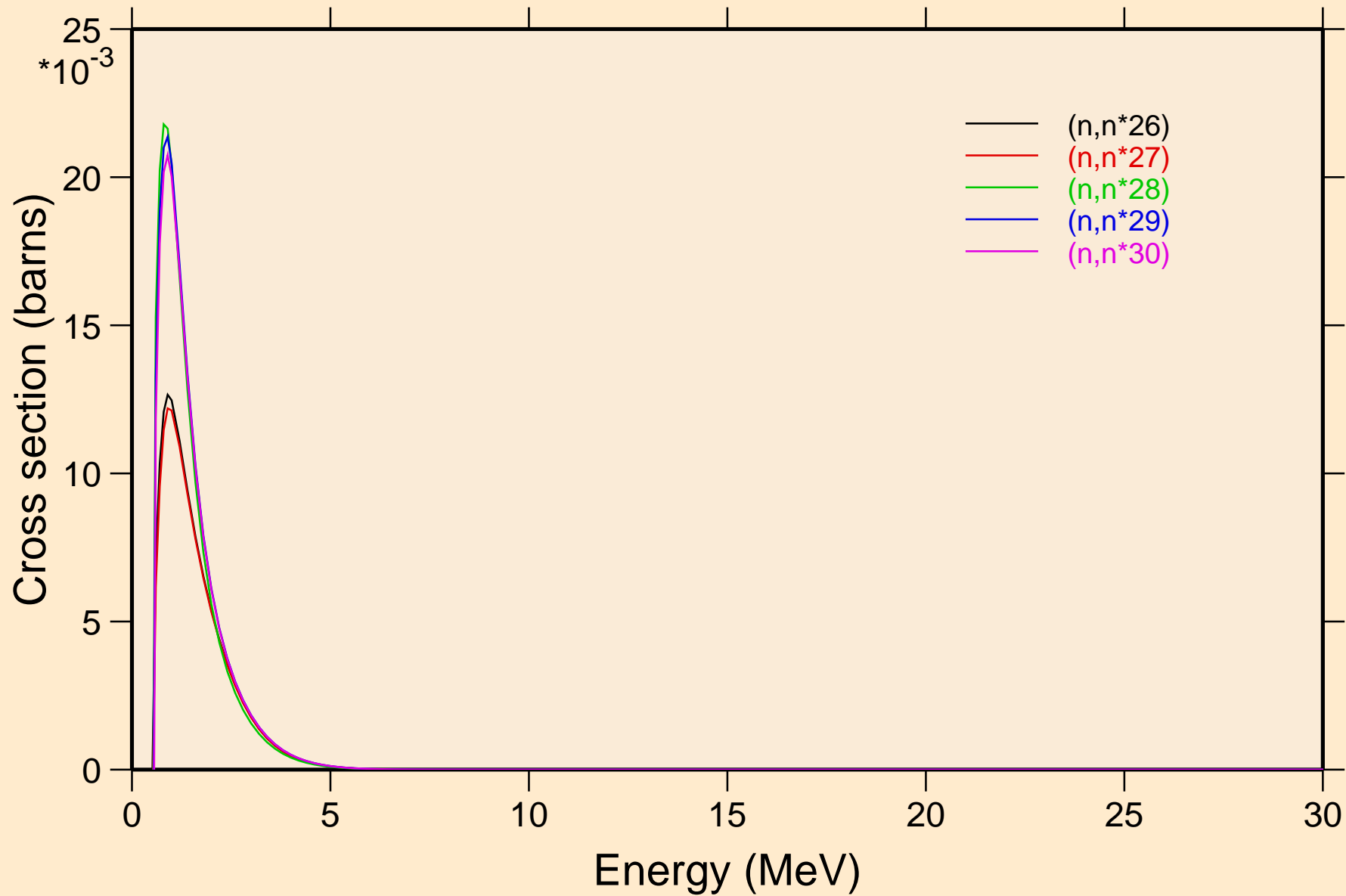

OS191M NEUTRON ACER TENDL-2024 LIBRARY; T=293.6K  
Threshold reactions

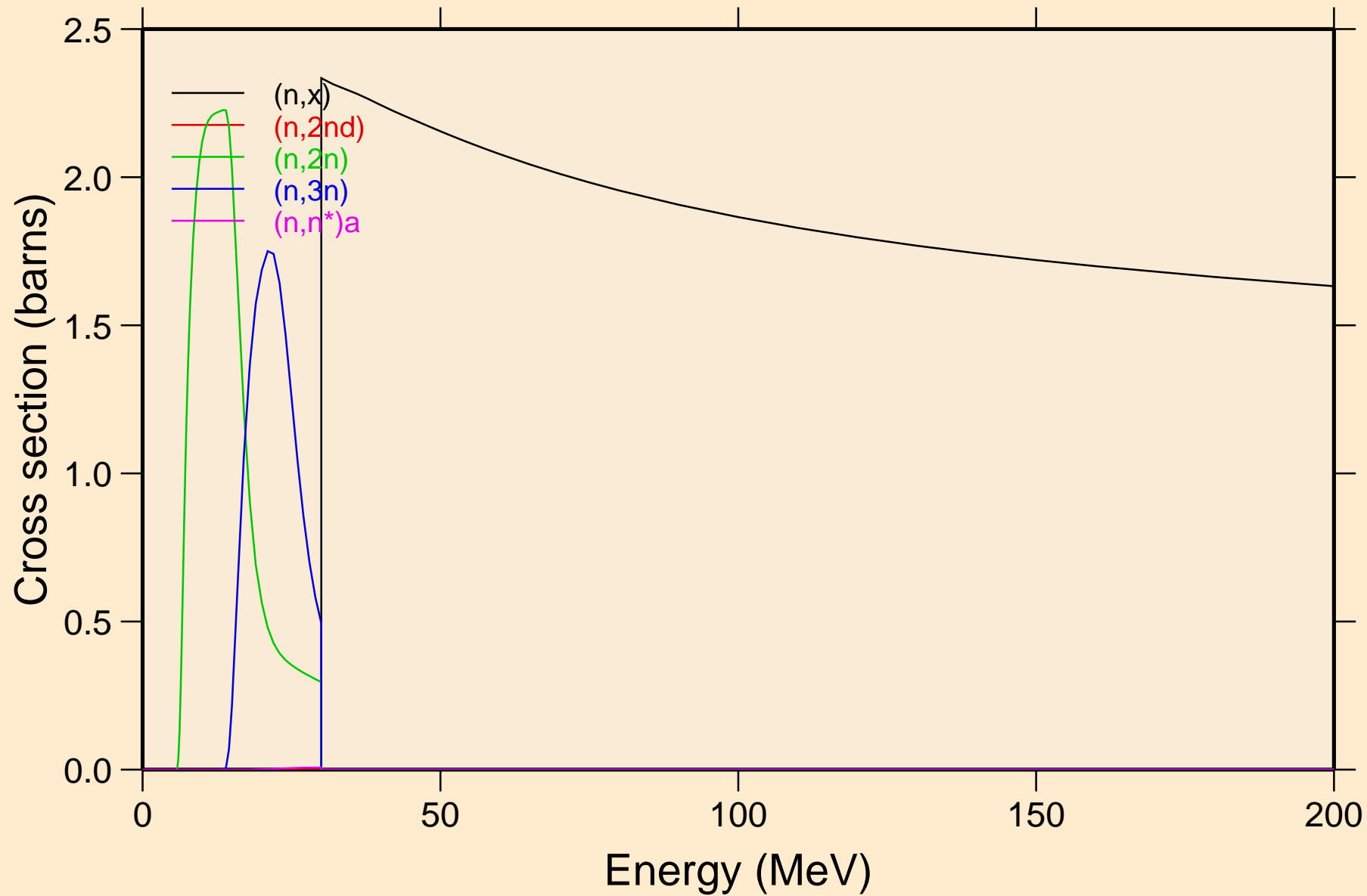

OS191M NEUTRON ACER TENDL-2024 LIBRARY; T=293.6K  
Threshold reactions

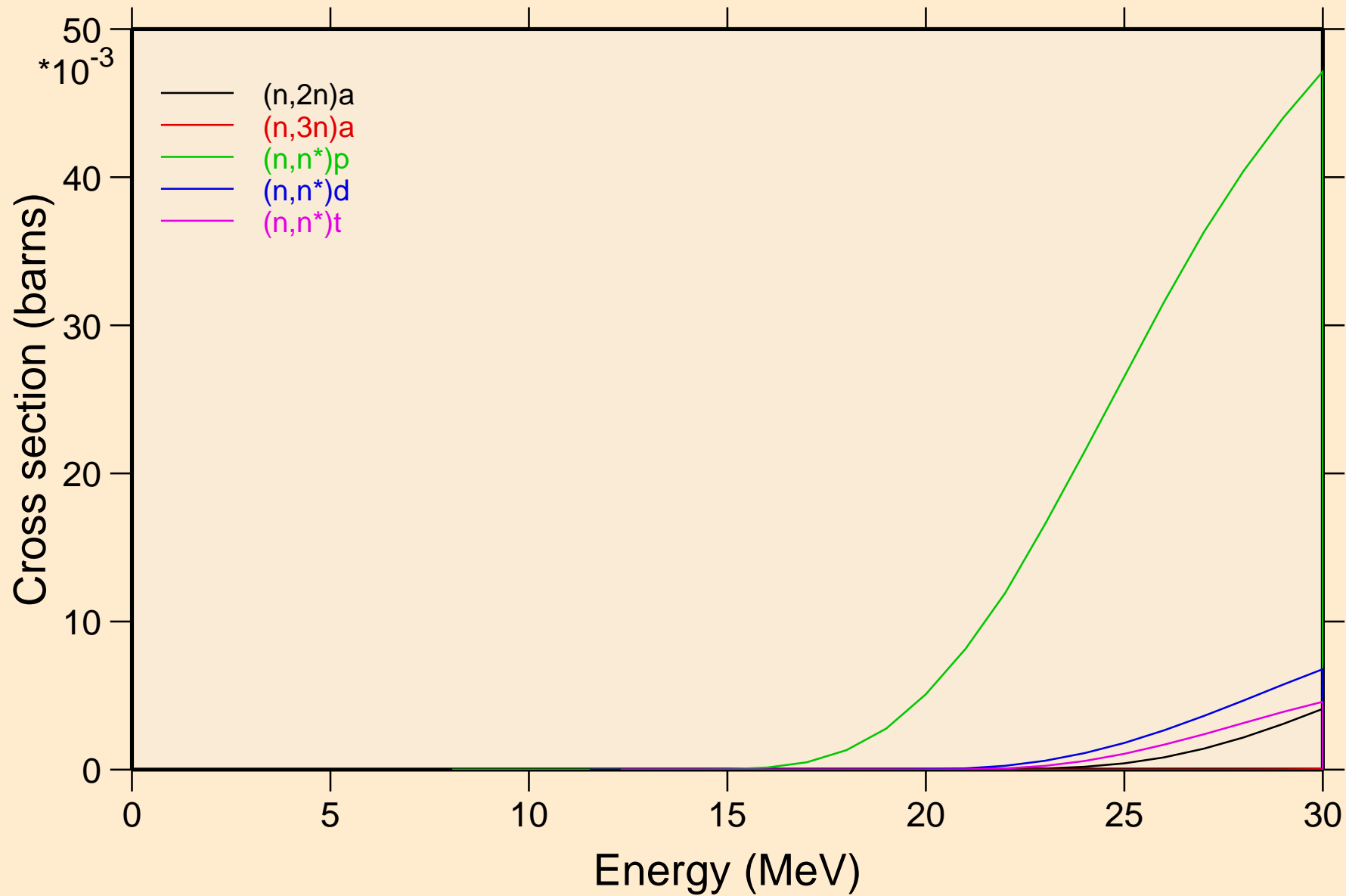

OS191M NEUTRON ACER TENDL-2024 LIBRARY; T=293.6K  
Threshold reactions

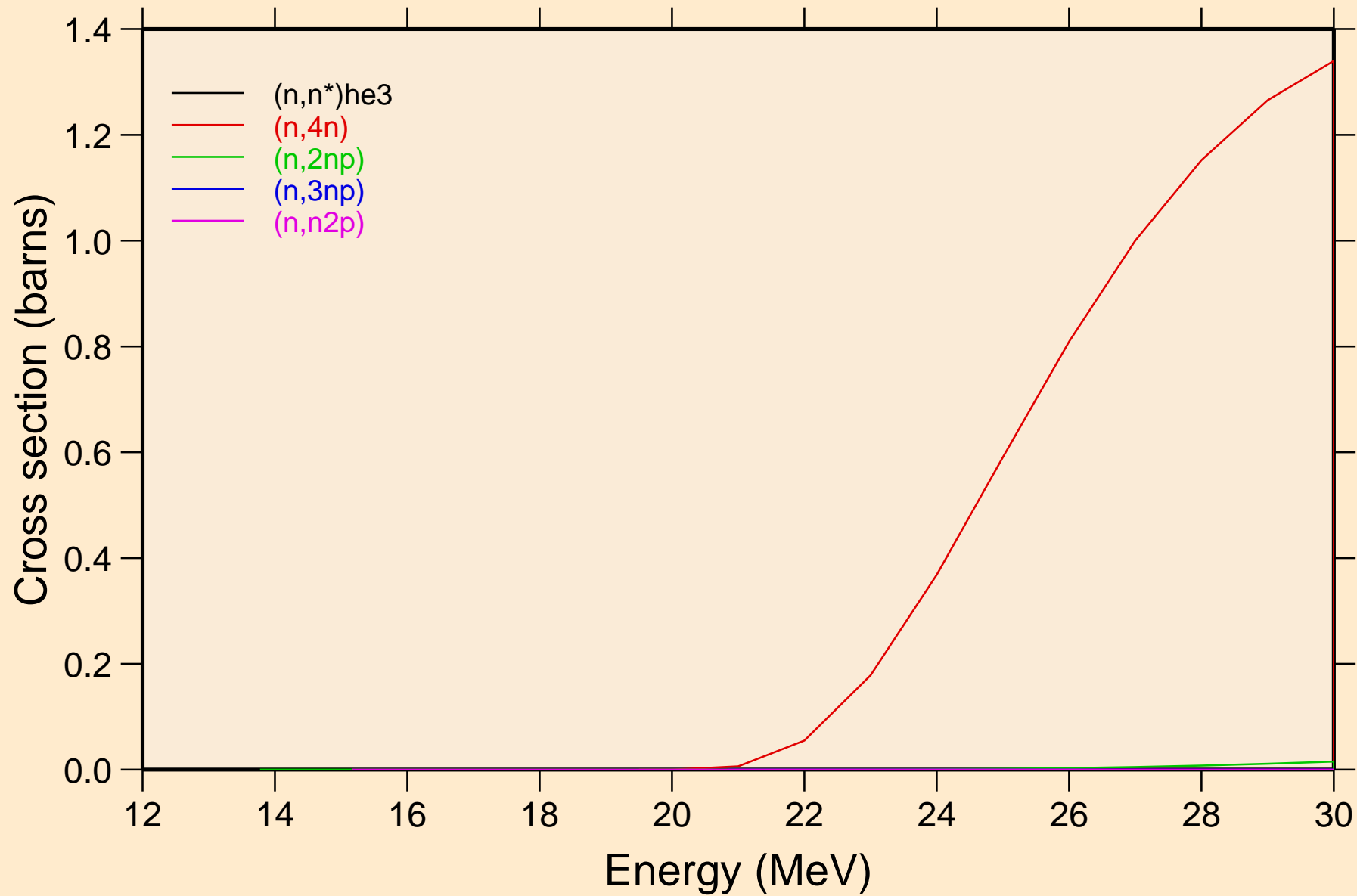

OS191M NEUTRON ACER TENDL-2024 LIBRARY; T=293.6K  
Threshold reactions

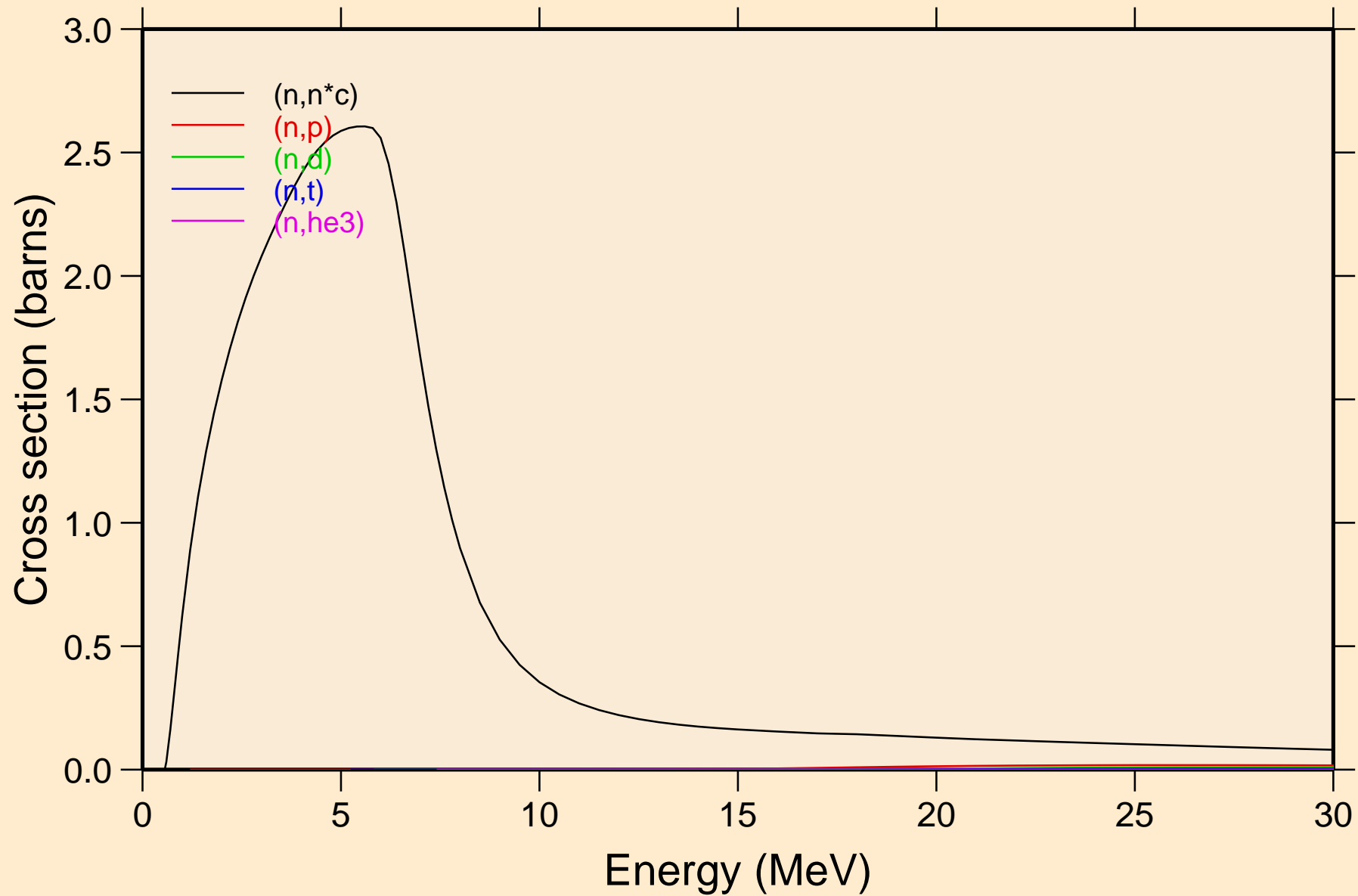

OS191M NEUTRON ACER TENDL-2024 LIBRARY; T=293.6K  
Threshold reactions

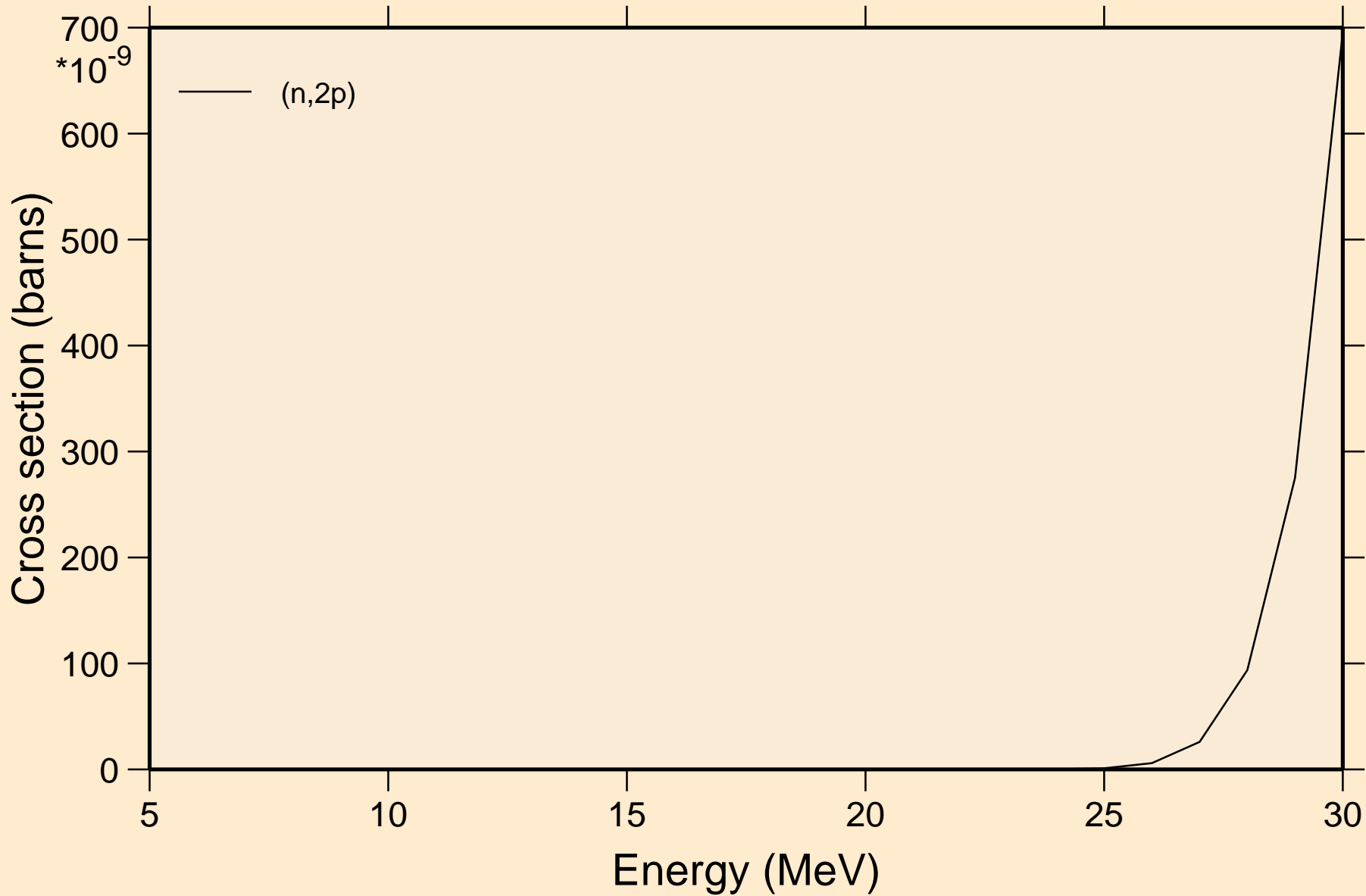

OS191M NEUTRON ACER TENDL-2024 LIBRARY; T=293.6K  
Threshold reactions

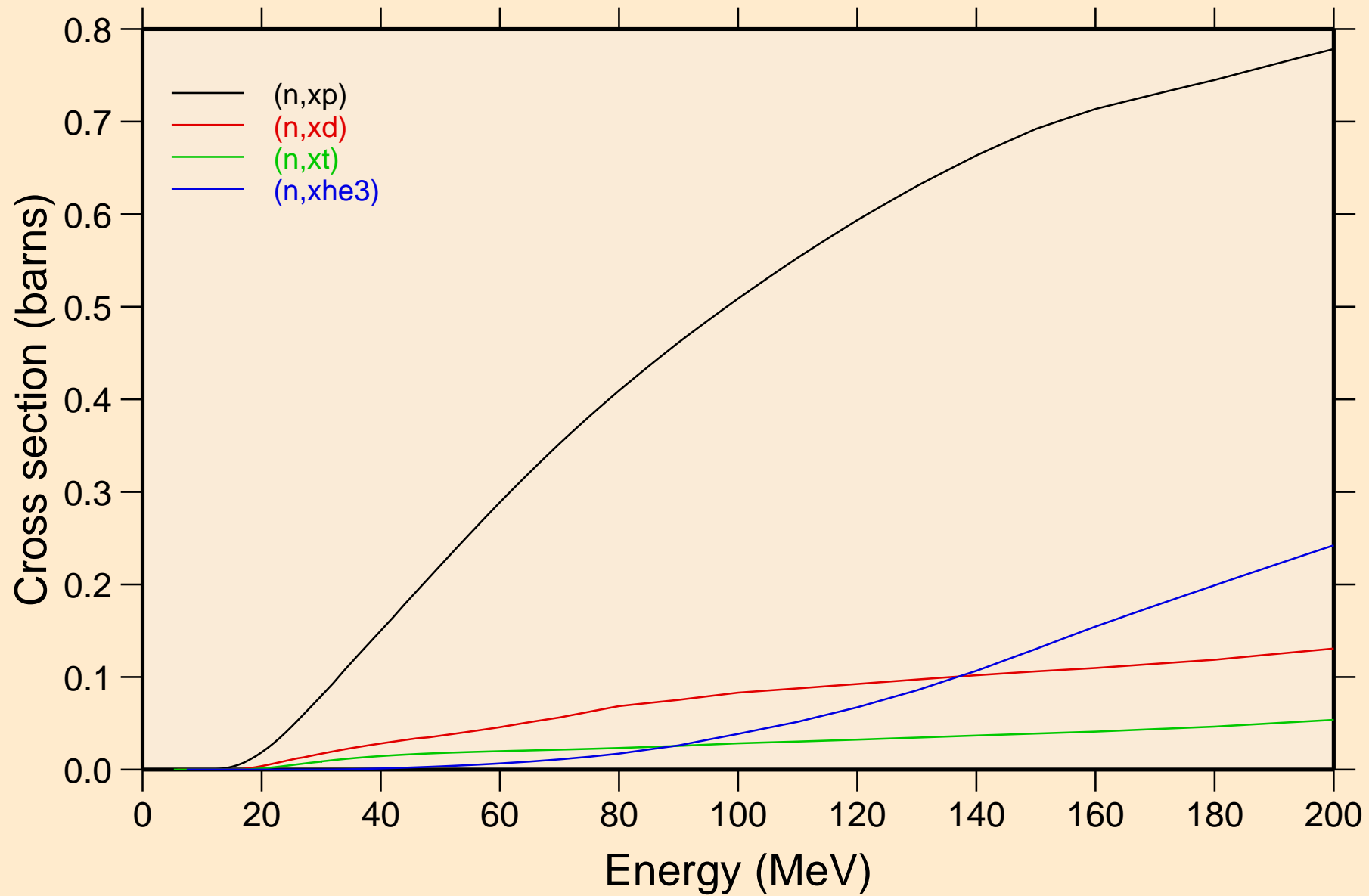

OS191M NEUTRON ACER TENDL-2024 LIBRARY; T=293.6K  
angular distribution for elastic

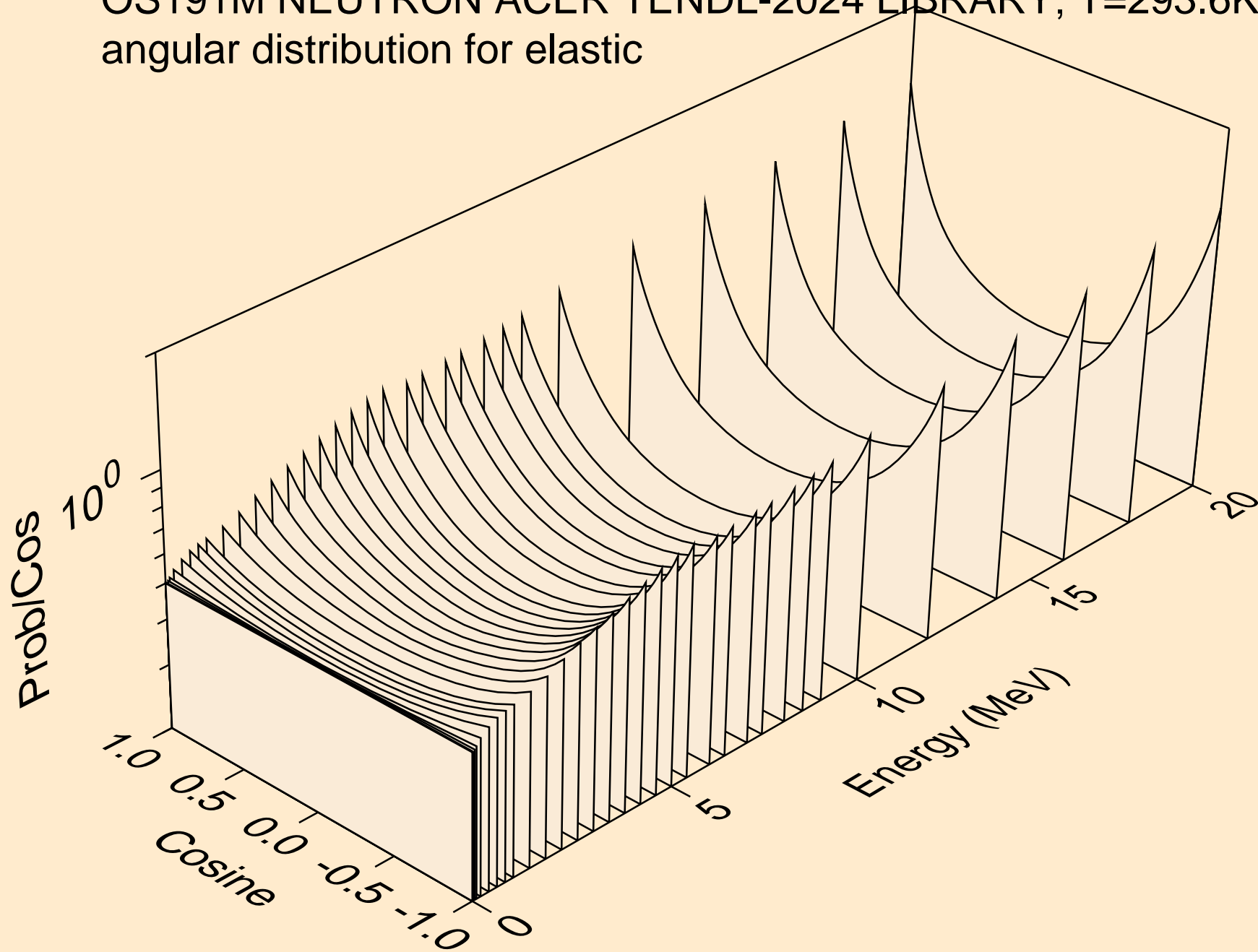

OS191M NEUTRON ACER TENDL-2024 LIBRARY; T=293.6K  
angular distribution for elastic

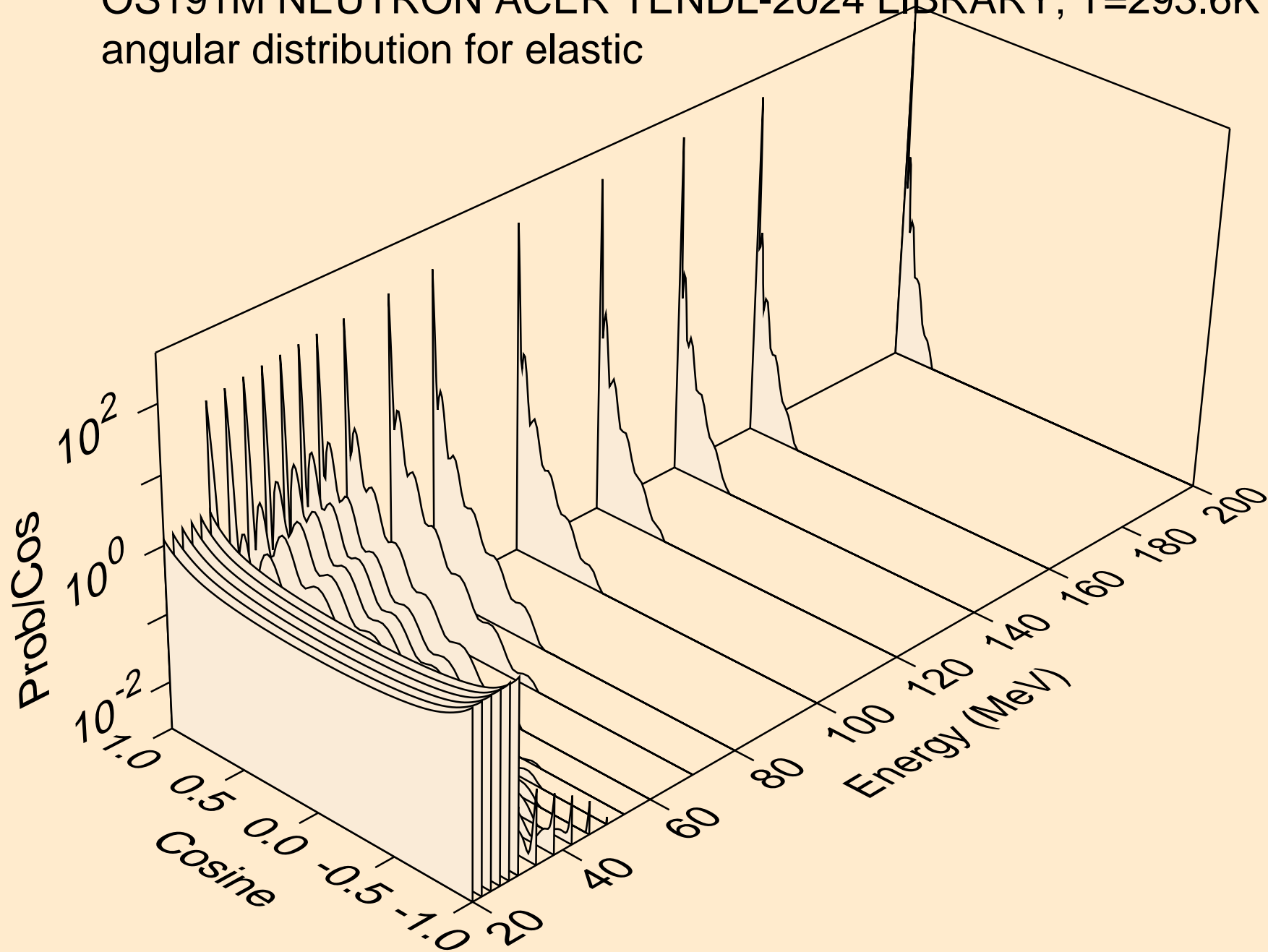

OS191M NEUTRON ACER TENDL-2024 LIBRARY; T=293.6K  
angular distribution for (n,n\*1)

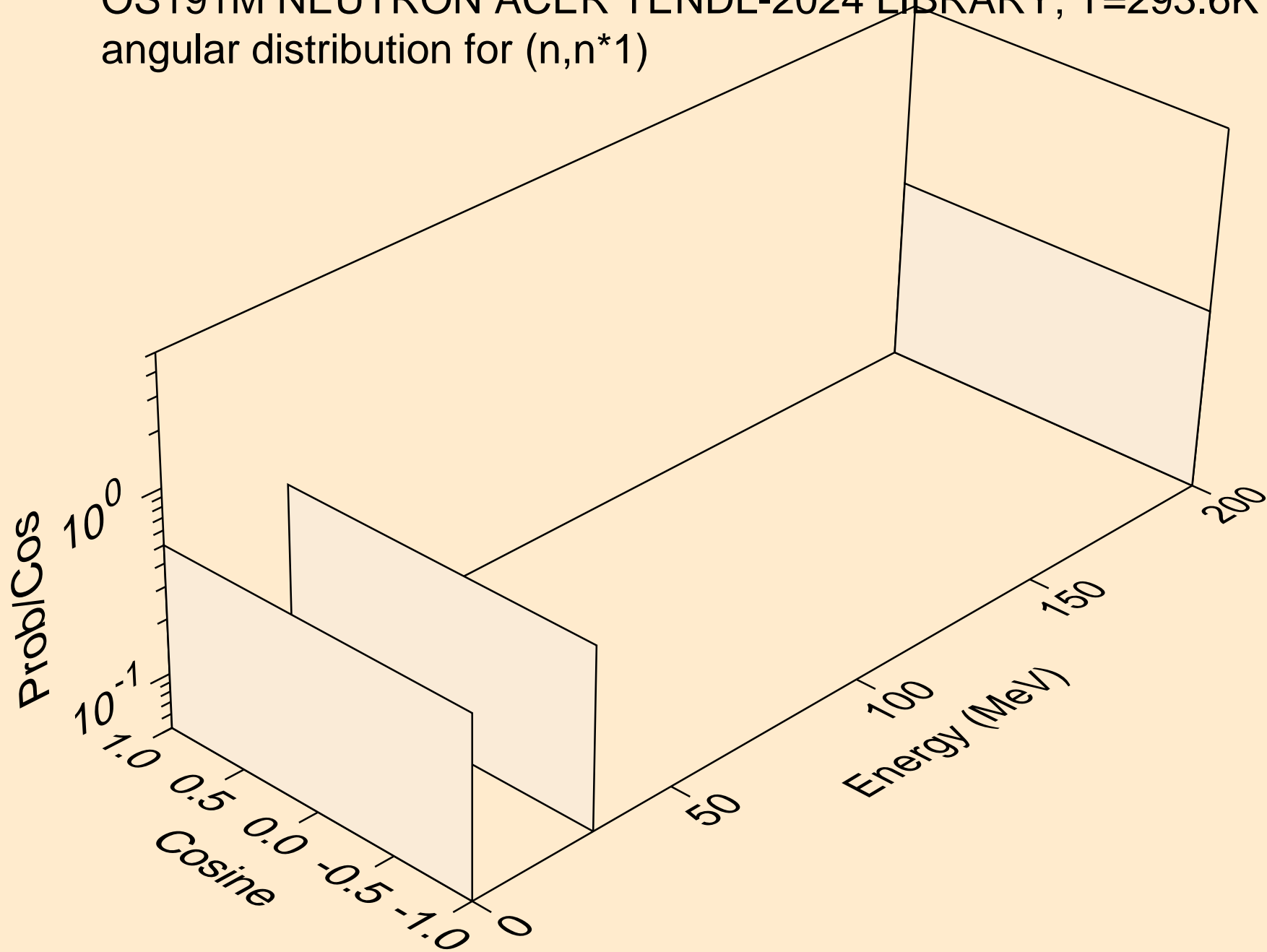

OS191M NEUTRON ACER TENDL-2024 LIBRARY; T=293.6K  
angular distribution for (n,n\*2)

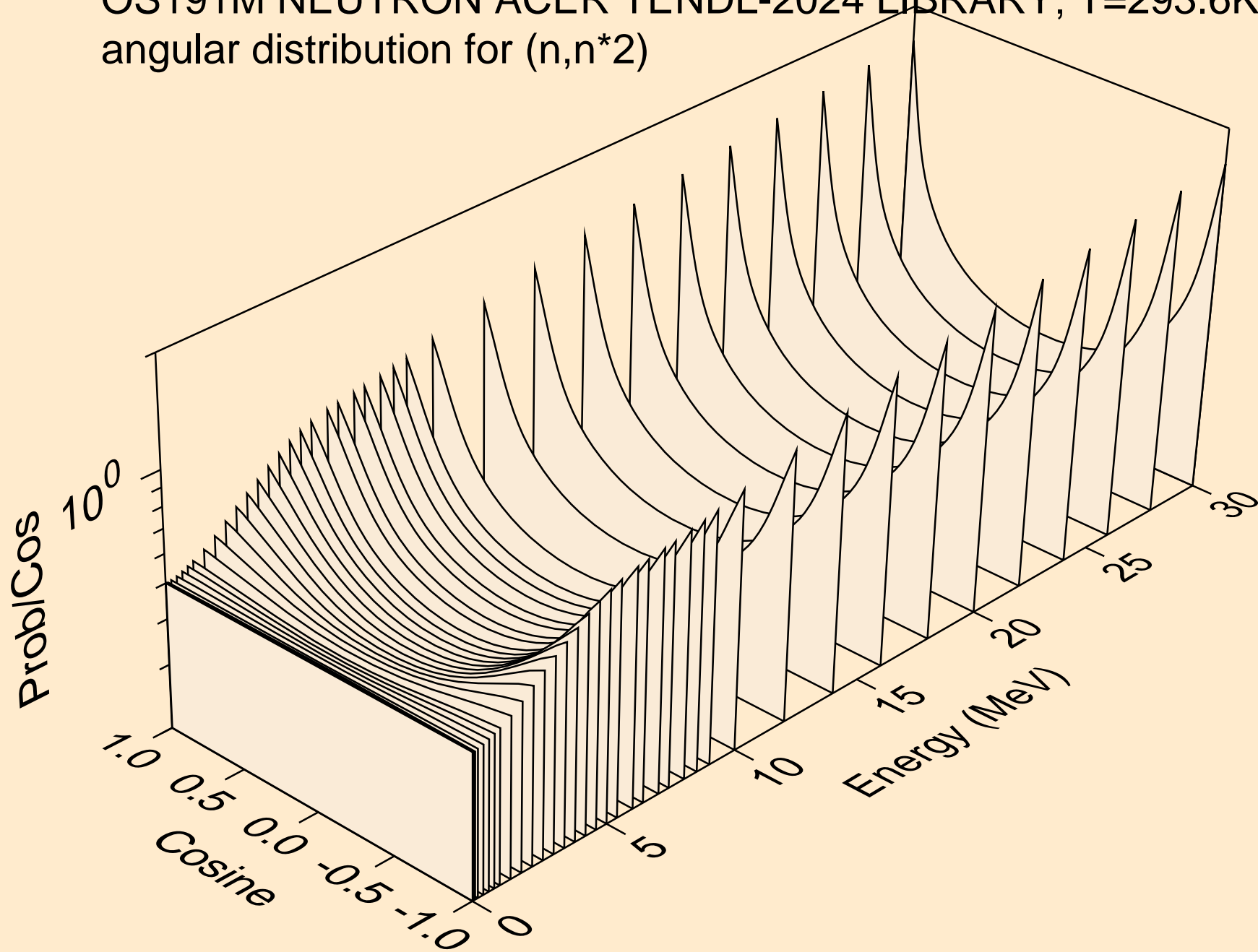

OS191M NEUTRON ACER TENDL-2024 LIBRARY; T=293.6K  
angular distribution for (n,n\*3)

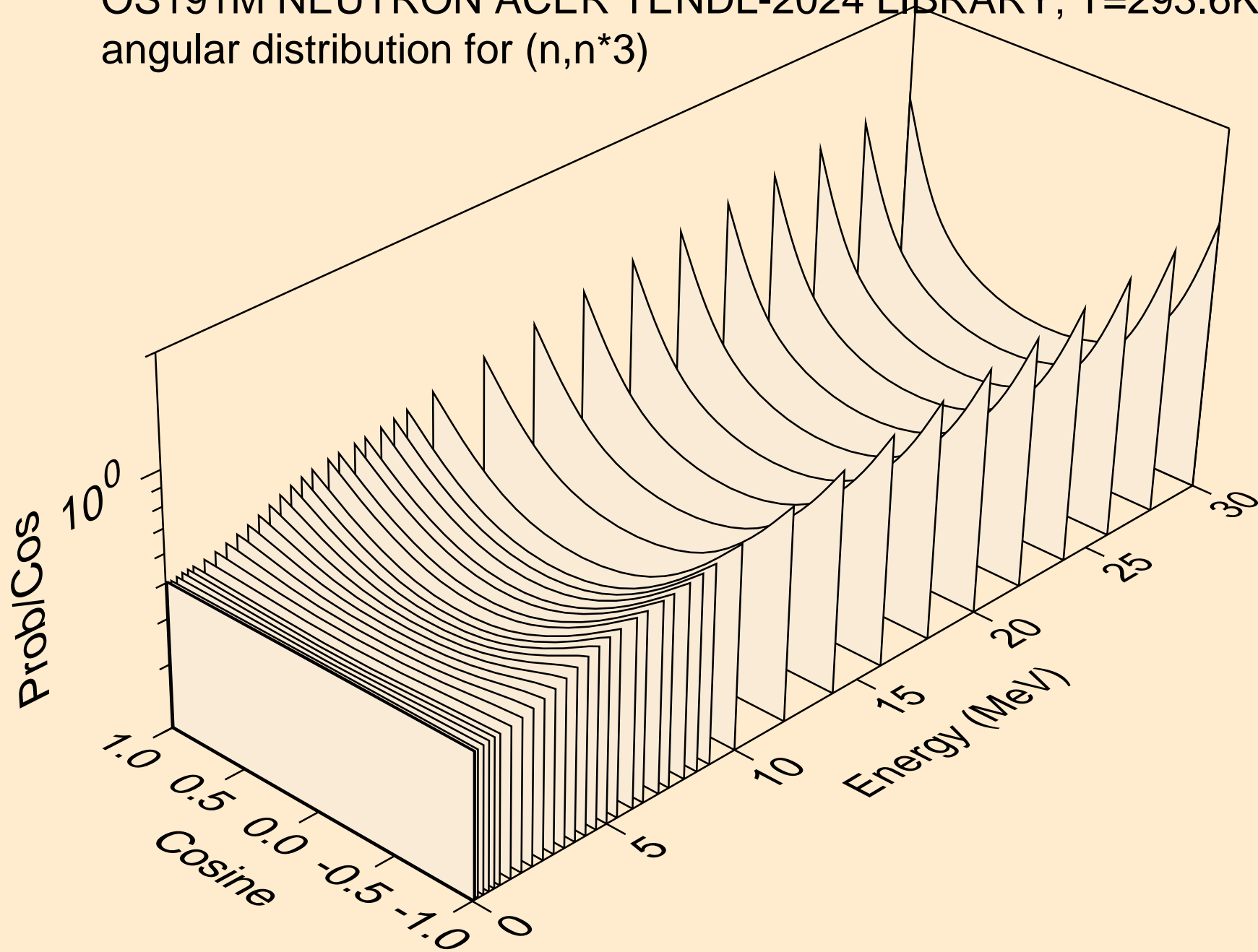

OS191M NEUTRON ACER TENDL-2024 LIBRARY; T=293.6K  
angular distribution for (n,n\*4)

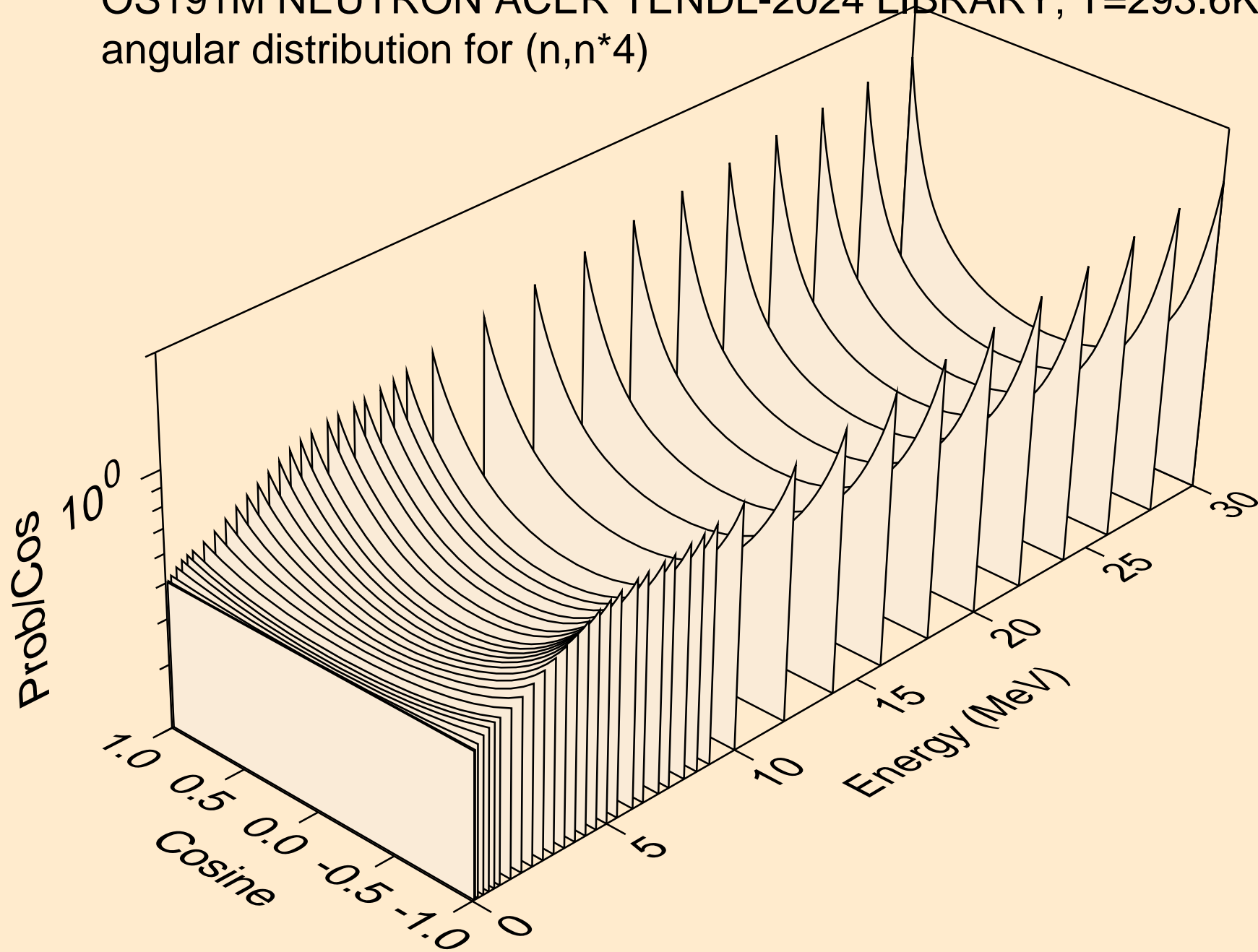

OS191M NEUTRON ACER TENDL-2024 LIBRARY; T=293.6K  
angular distribution for (n,n\*5)

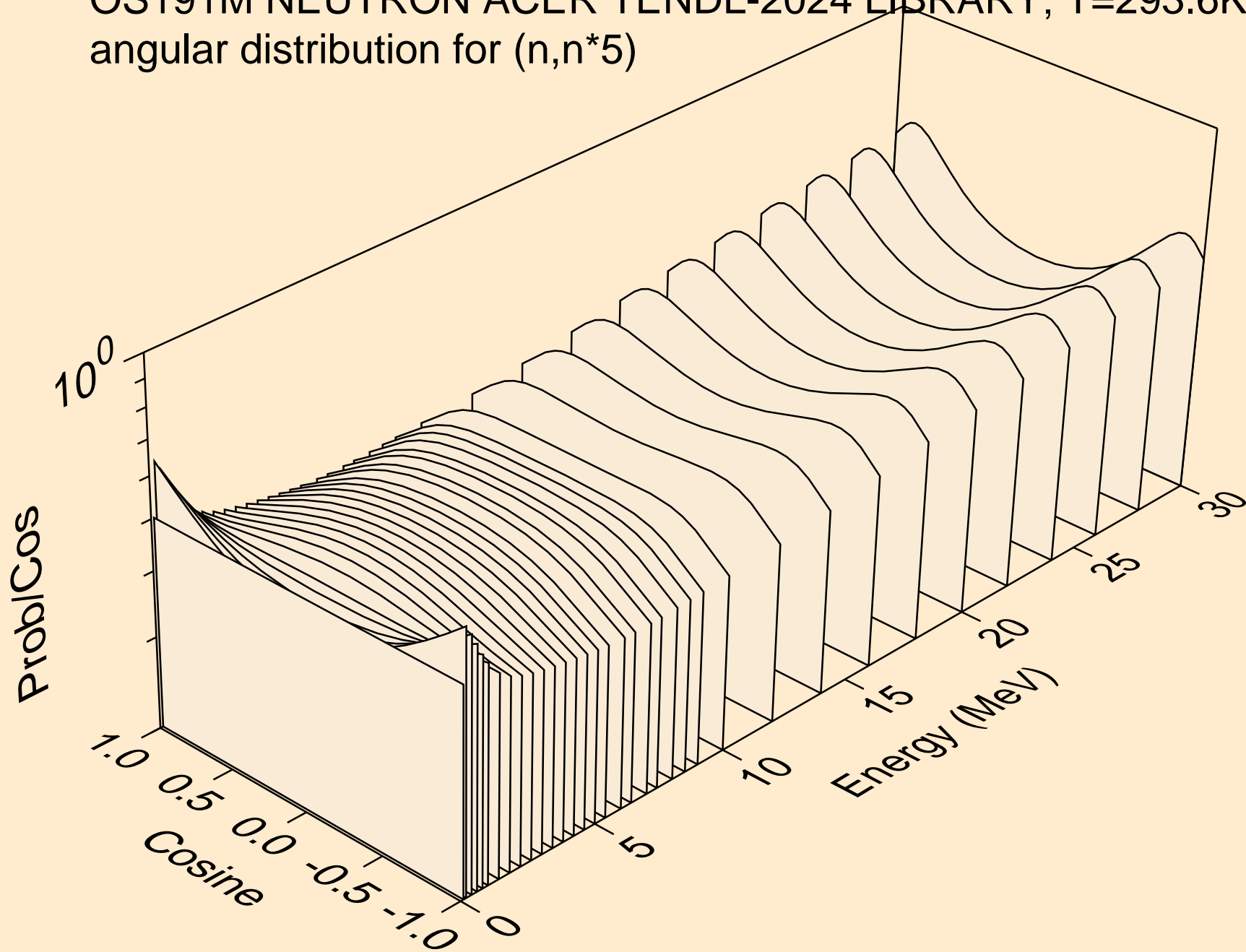

OS191M NEUTRON ACER TENDL-2024 LIBRARY; T=293.6K  
angular distribution for (n,n\*6)

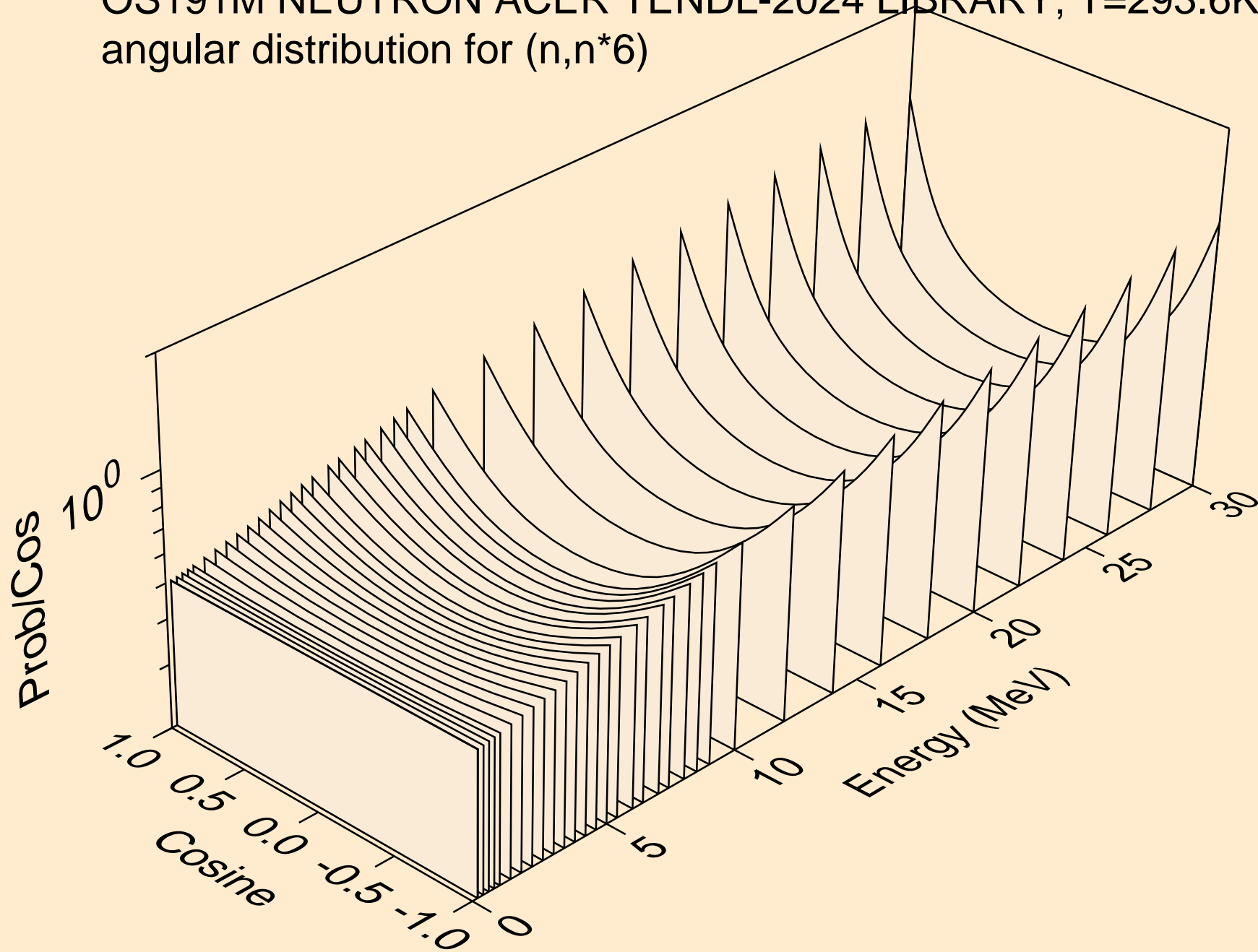

OS191M NEUTRON ACER TENDL-2024 LIBRARY; T=293.6K  
angular distribution for (n,n\*7)

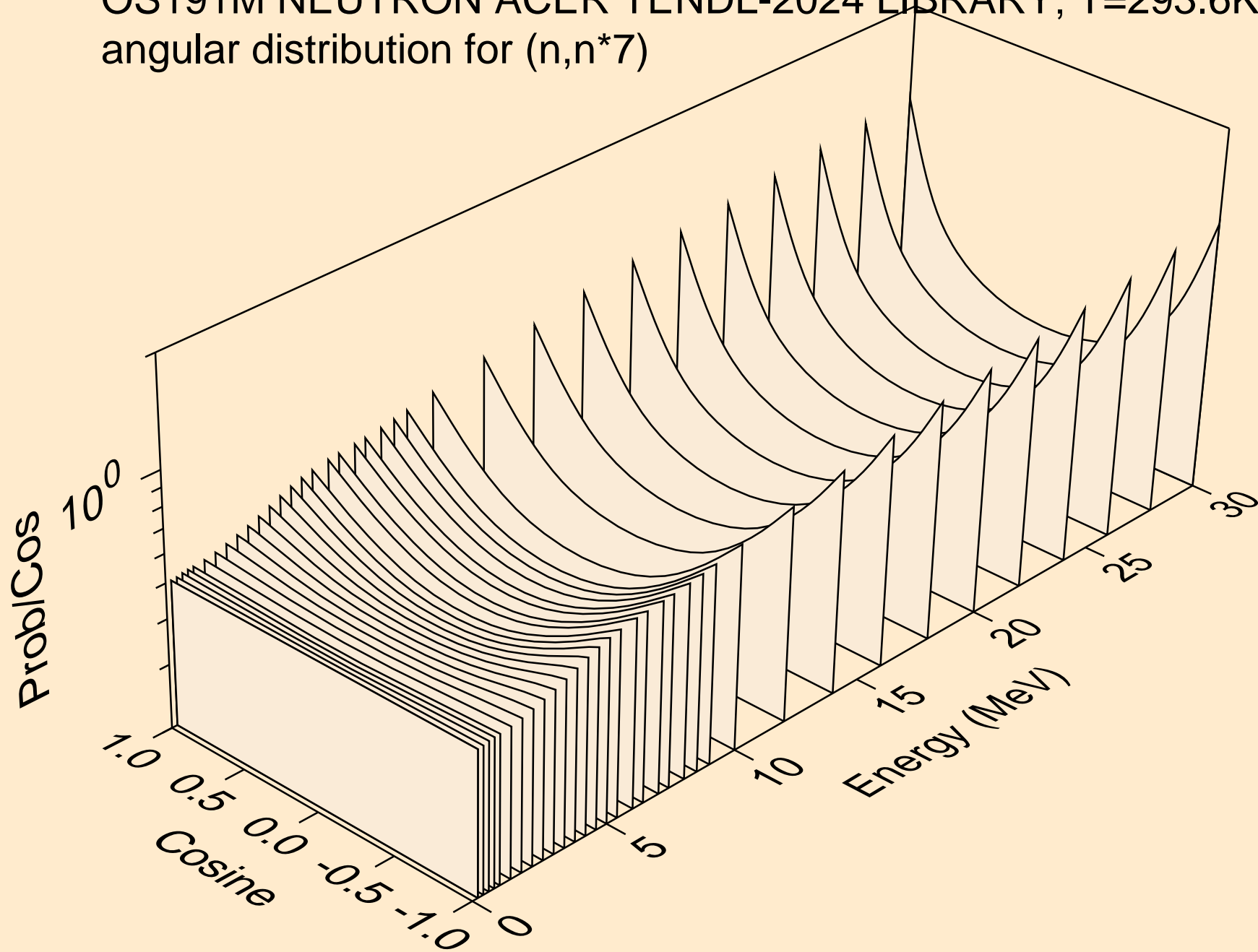

OS191M NEUTRON ACER TENDL-2024 LIBRARY; T=293.6K  
angular distribution for (n,n\*8)

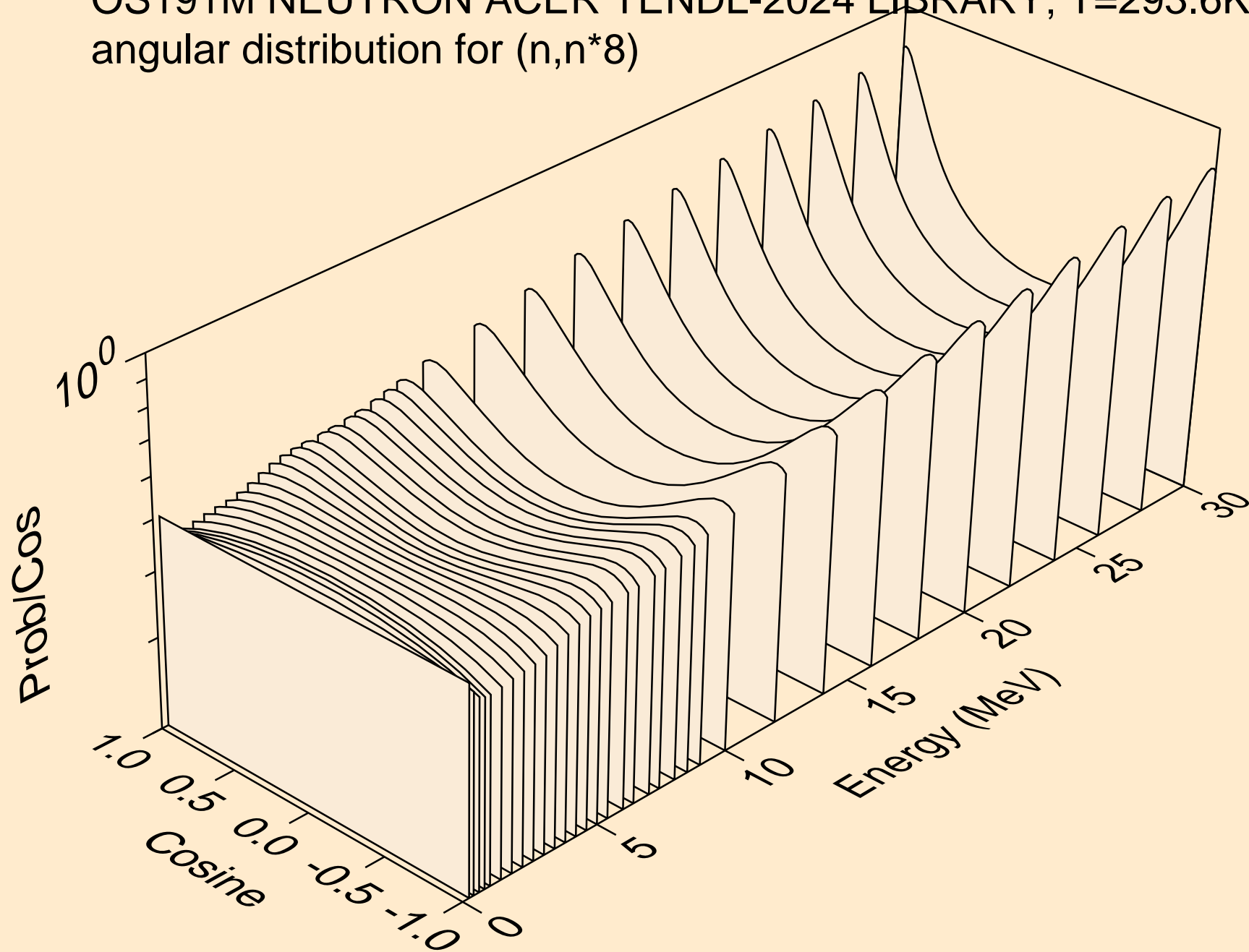

OS191M NEUTRON ACER TENDL-2024 LIBRARY; T=293.6K  
angular distribution for (n,n\*9)

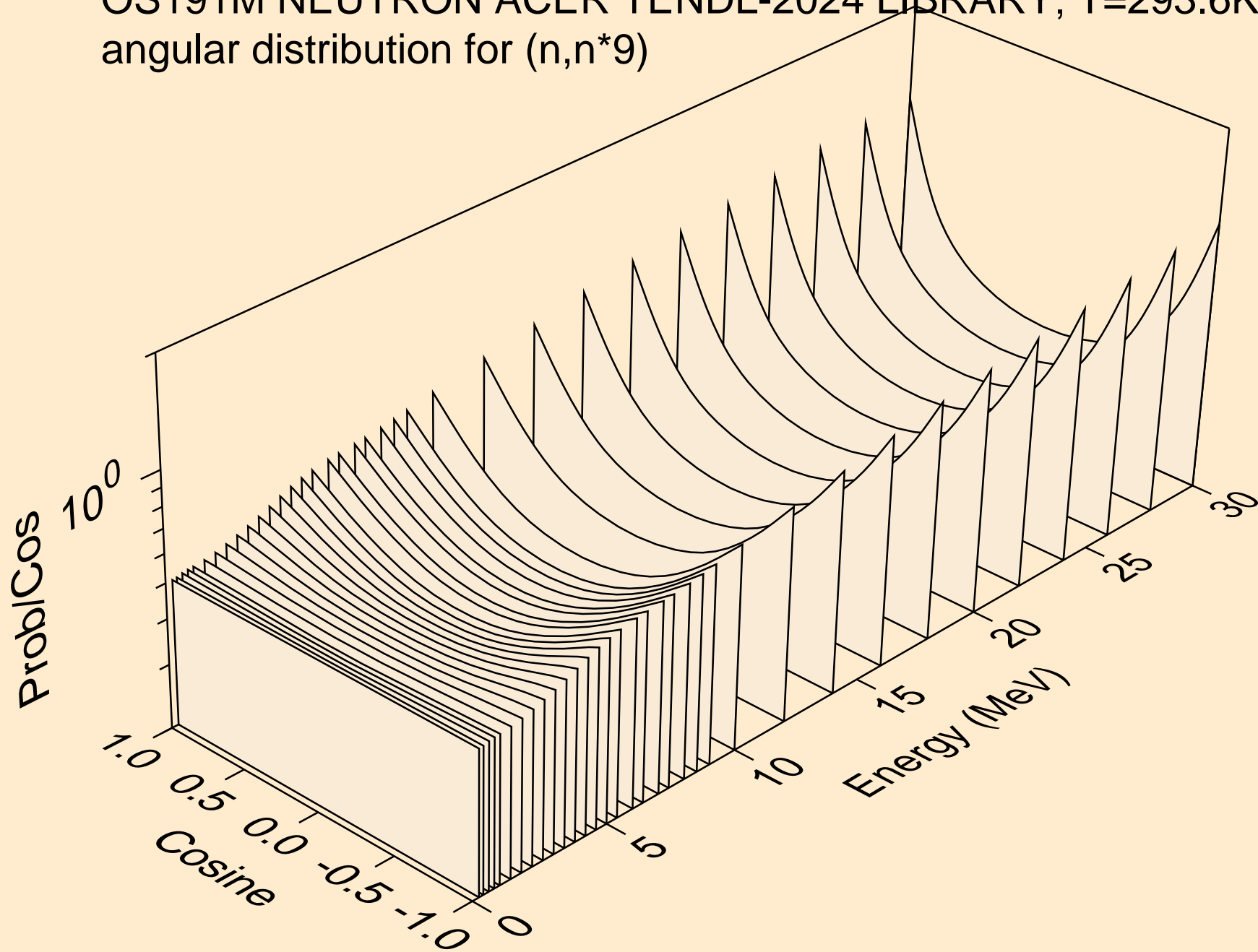

OS191M NEUTRON ACER TENDL-2024 LIBRARY; T=293.6K  
angular distribution for (n,n\*10)

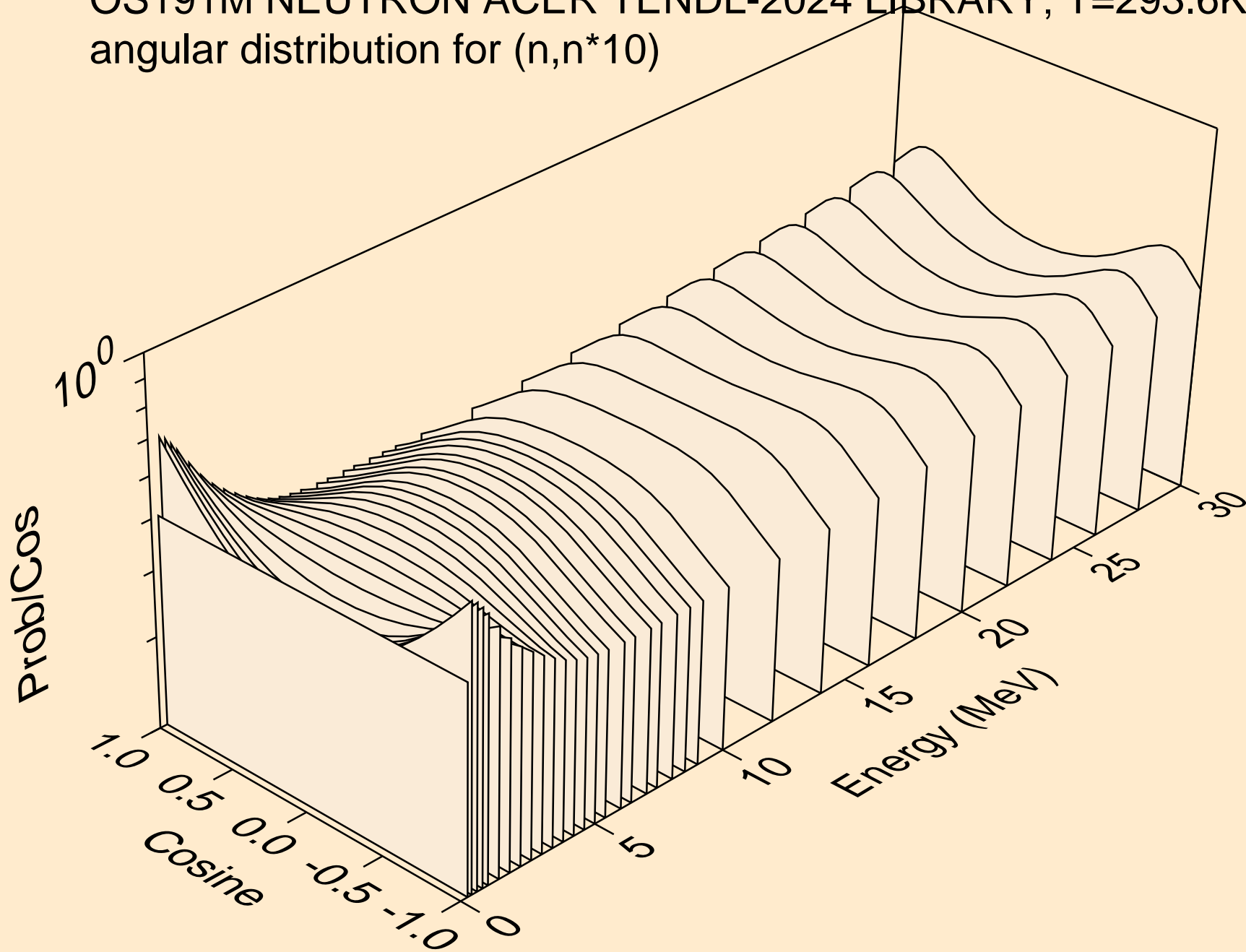

OS191M NEUTRON ACER TENDL-2024 LIBRARY; T=293.6K  
angular distribution for (n,n\*11)

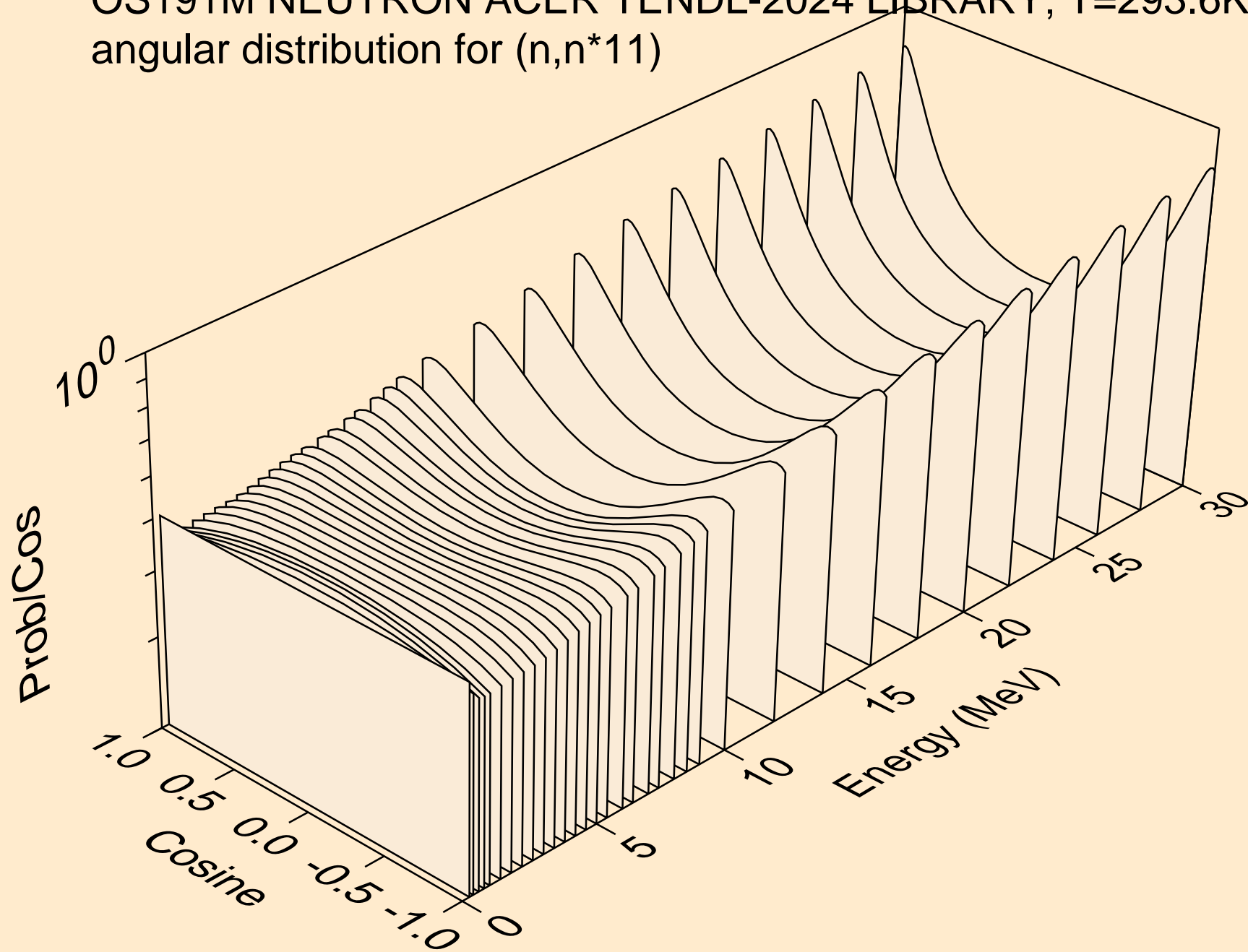

OS191M NEUTRON ACER TENDL-2024 LIBRARY; T=293.6K  
angular distribution for (n,n\*12)

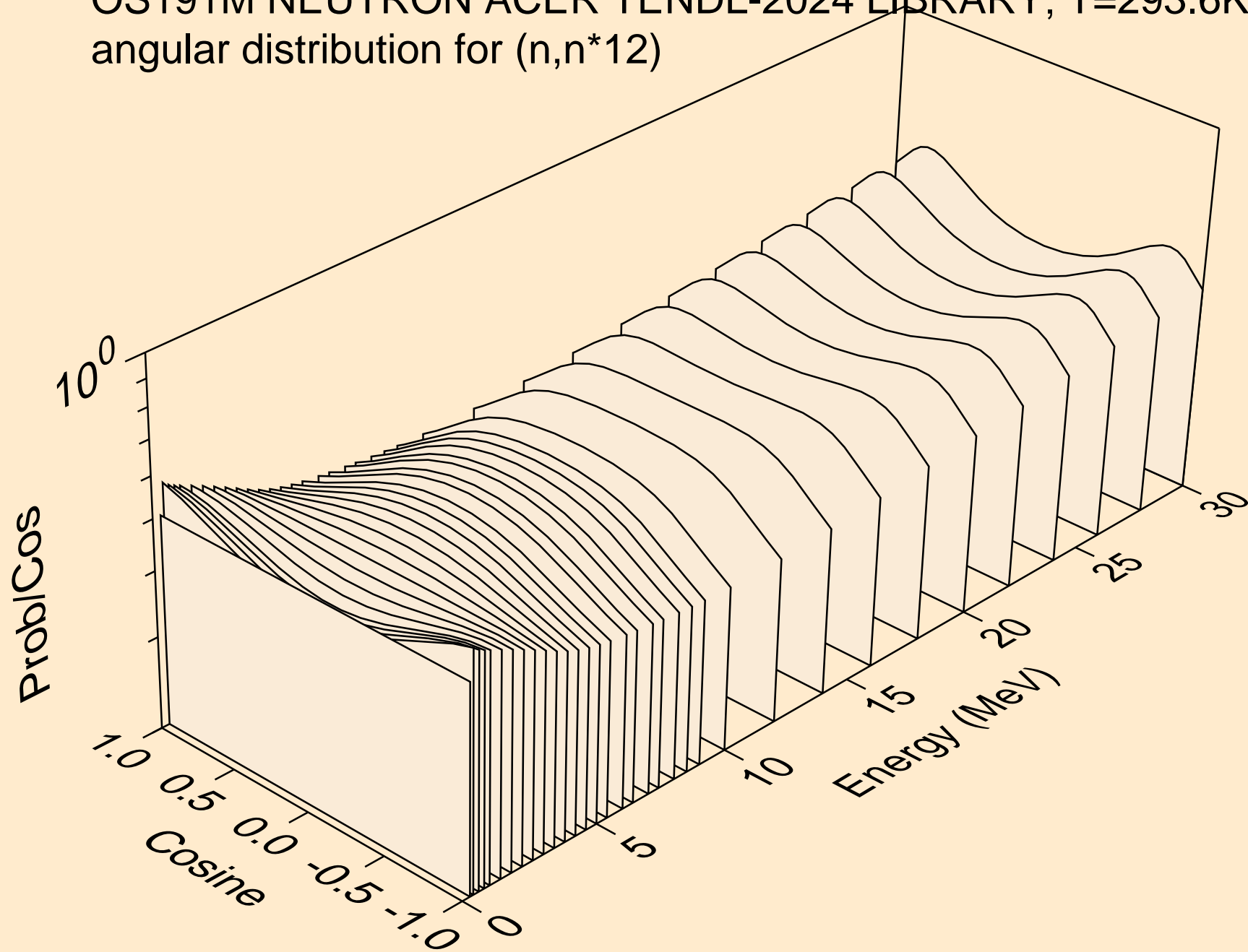

OS191M NEUTRON ACER TENDL-2024 LIBRARY; T=293.6K  
angular distribution for (n,n\*13)

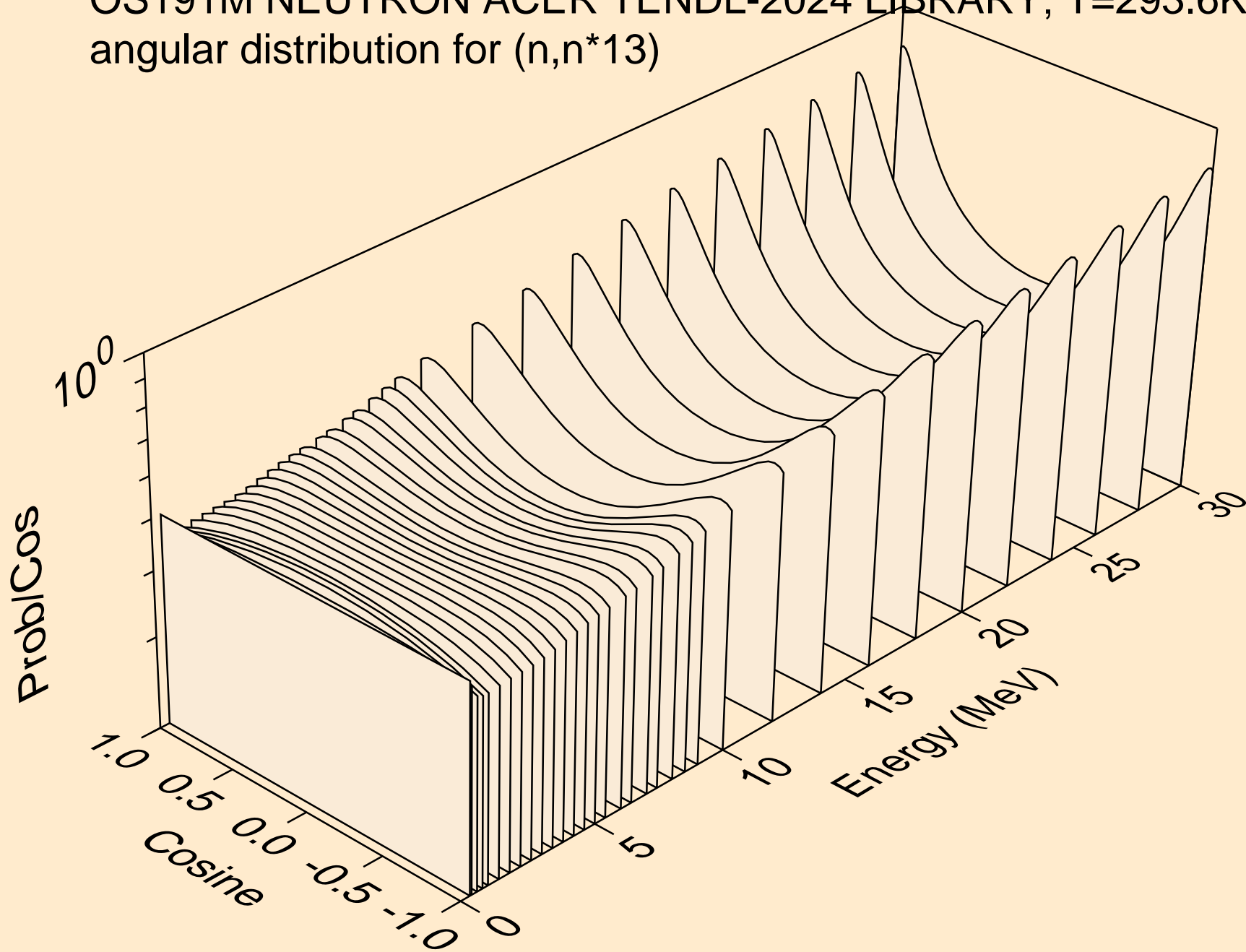

OS191M NEUTRON ACER TENDL-2024 LIBRARY; T=293.6K  
angular distribution for (n,n\*14)

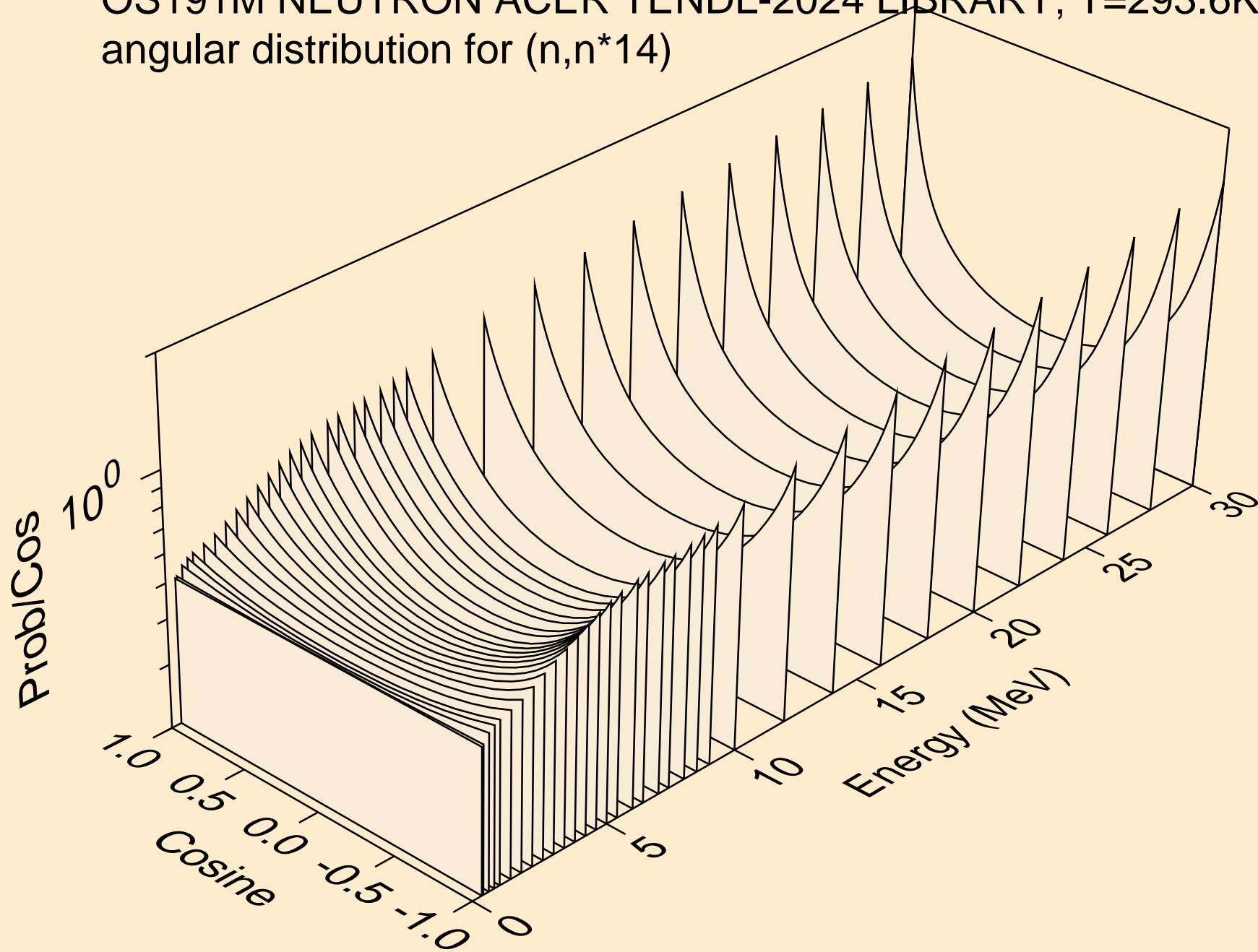

OS191M NEUTRON ACER TENDL-2024 LIBRARY; T=293.6K  
angular distribution for (n,n\*15)

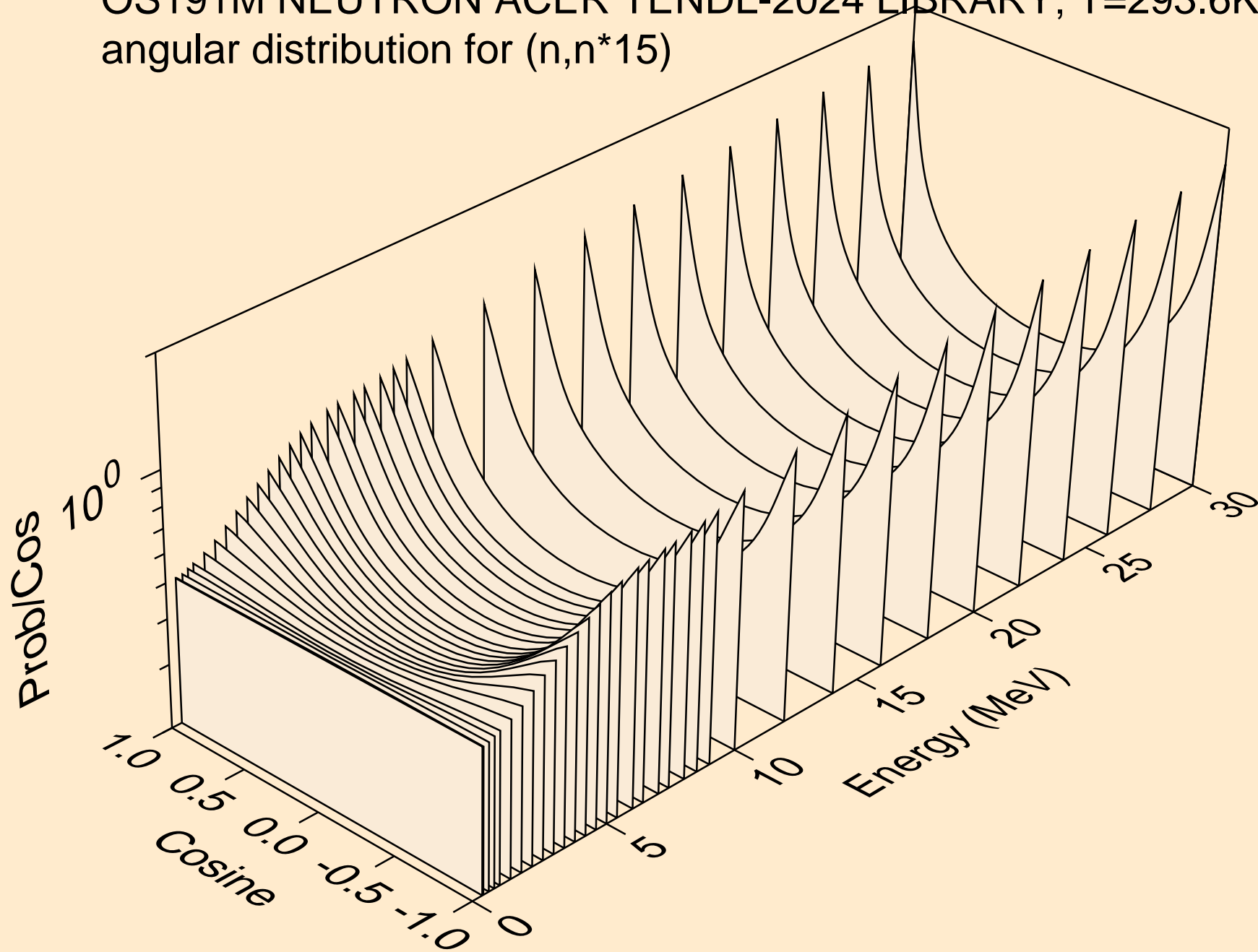

OS191M NEUTRON ACER TENDL-2024 LIBRARY; T=293.6K  
angular distribution for (n,n\*16)

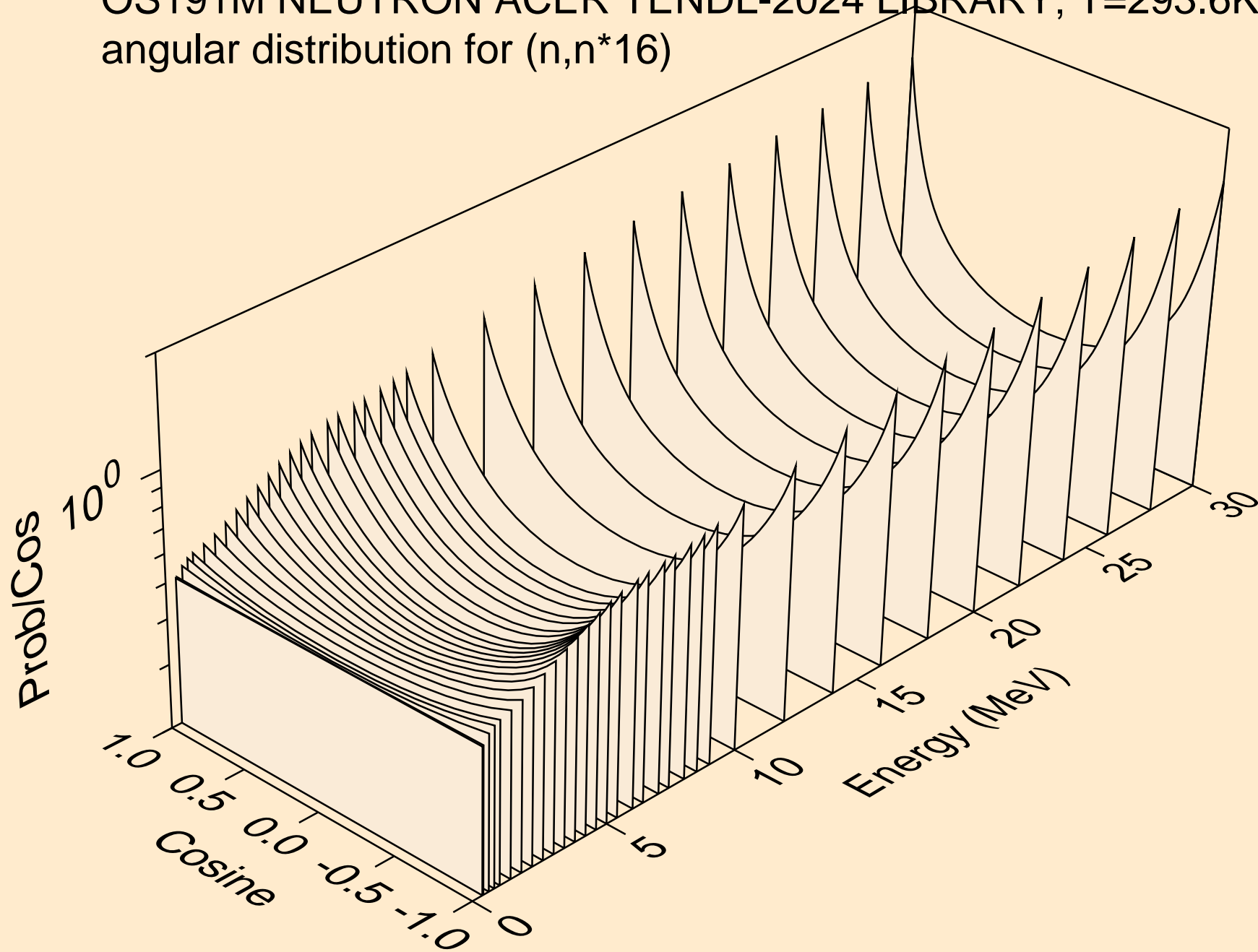

OS191M NEUTRON ACER TENDL-2024 LIBRARY; T=293.6K  
angular distribution for (n,n\*17)

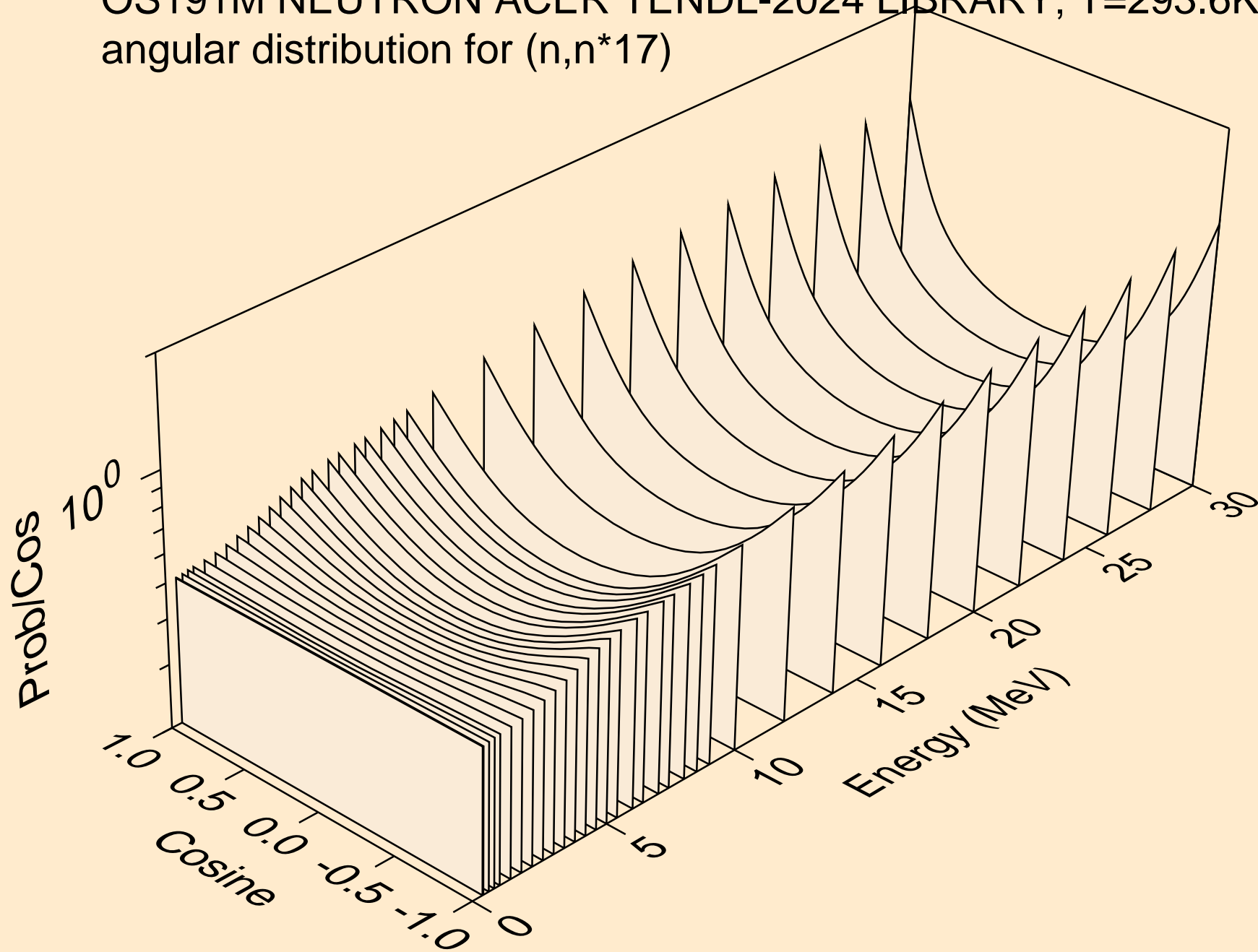

OS191M NEUTRON ACER TENDL-2024 LIBRARY; T=293.6K  
angular distribution for (n,n\*18)

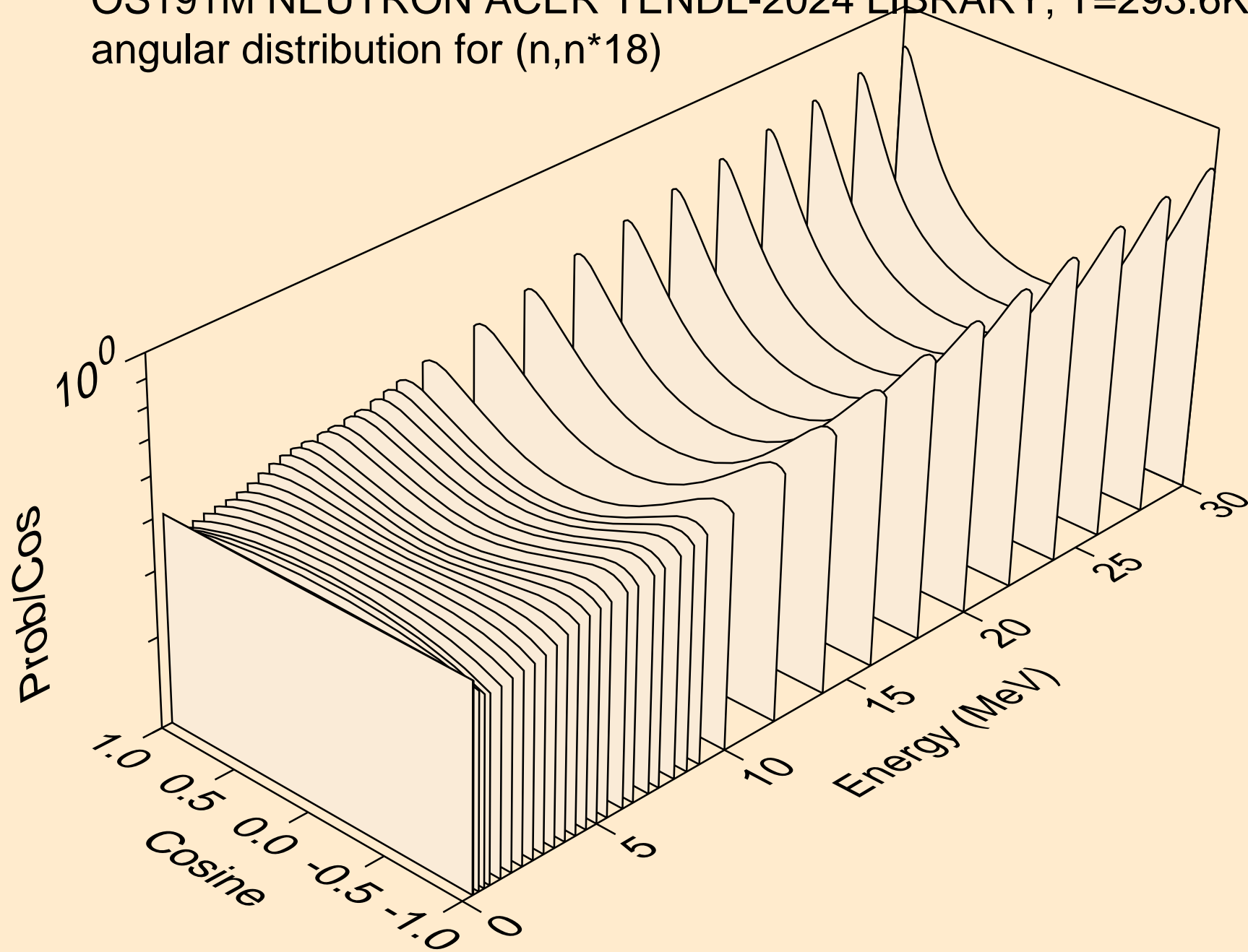

OS191M NEUTRON ACER TENDL-2024 LIBRARY; T=293.6K  
angular distribution for (n,n\*19)

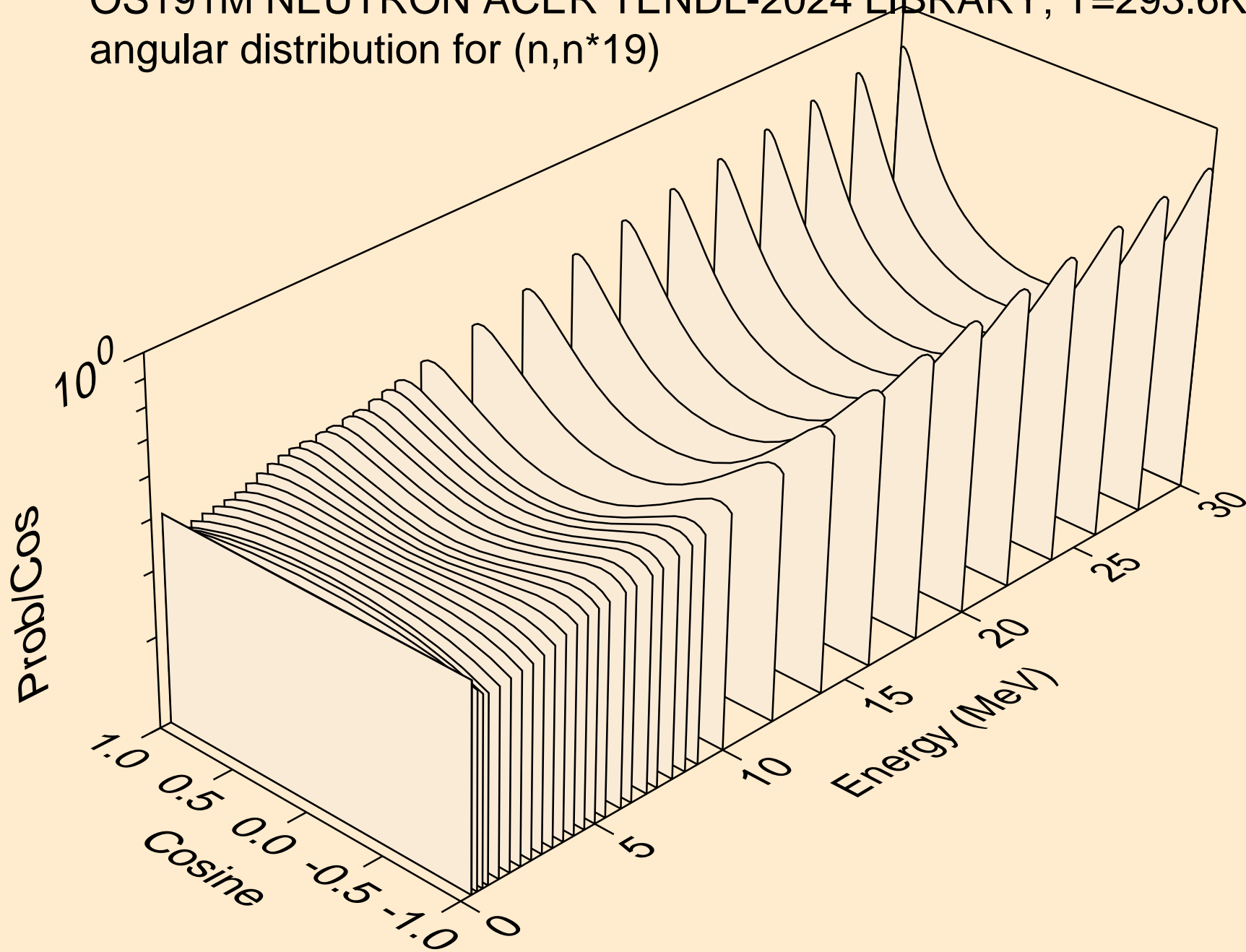

OS191M NEUTRON ACER TENDL-2024 LIBRARY; T=293.6K  
angular distribution for (n,n\*20)

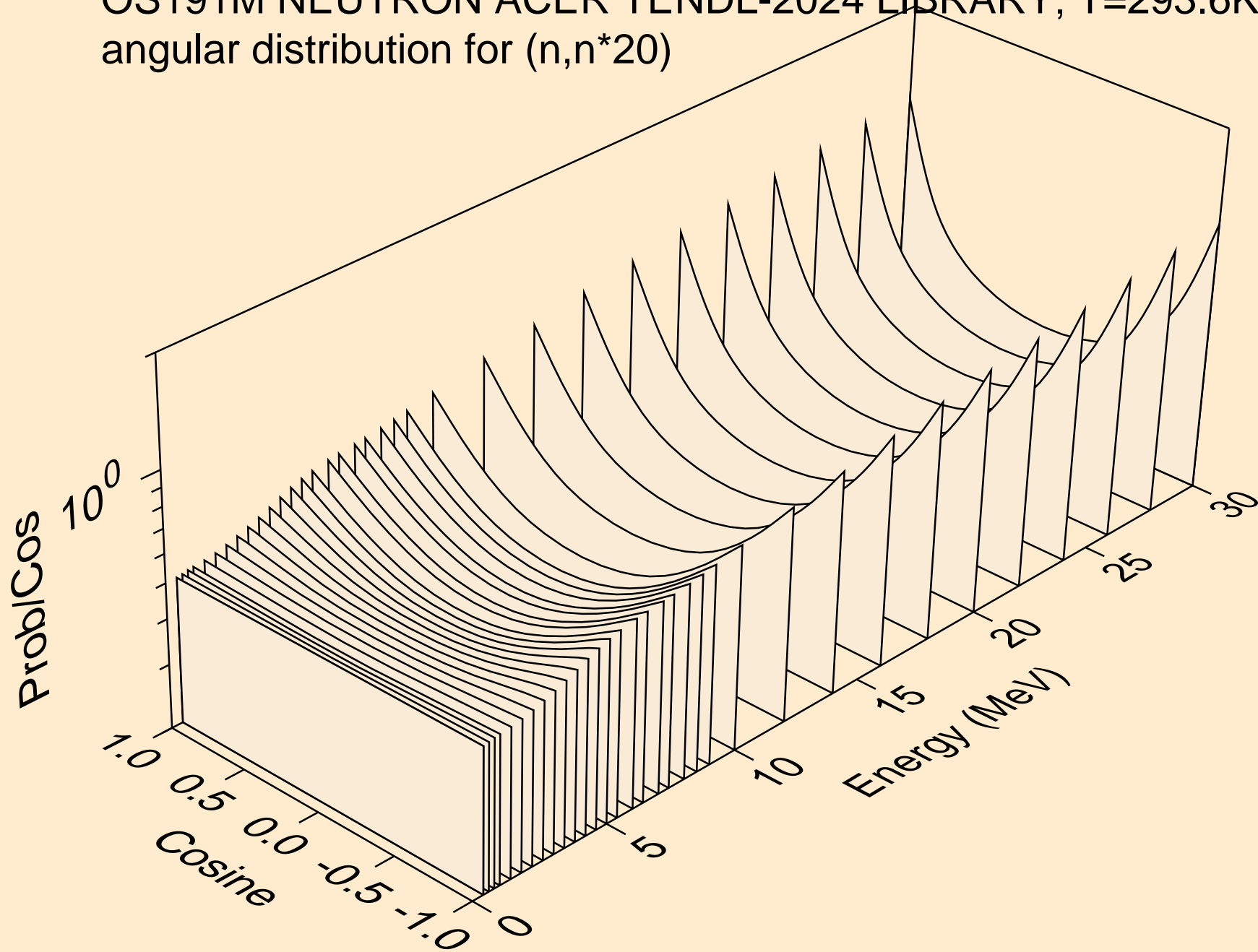

OS191M NEUTRON ACER TENDL-2024 LIBRARY; T=293.6K  
angular distribution for (n,n\*21)

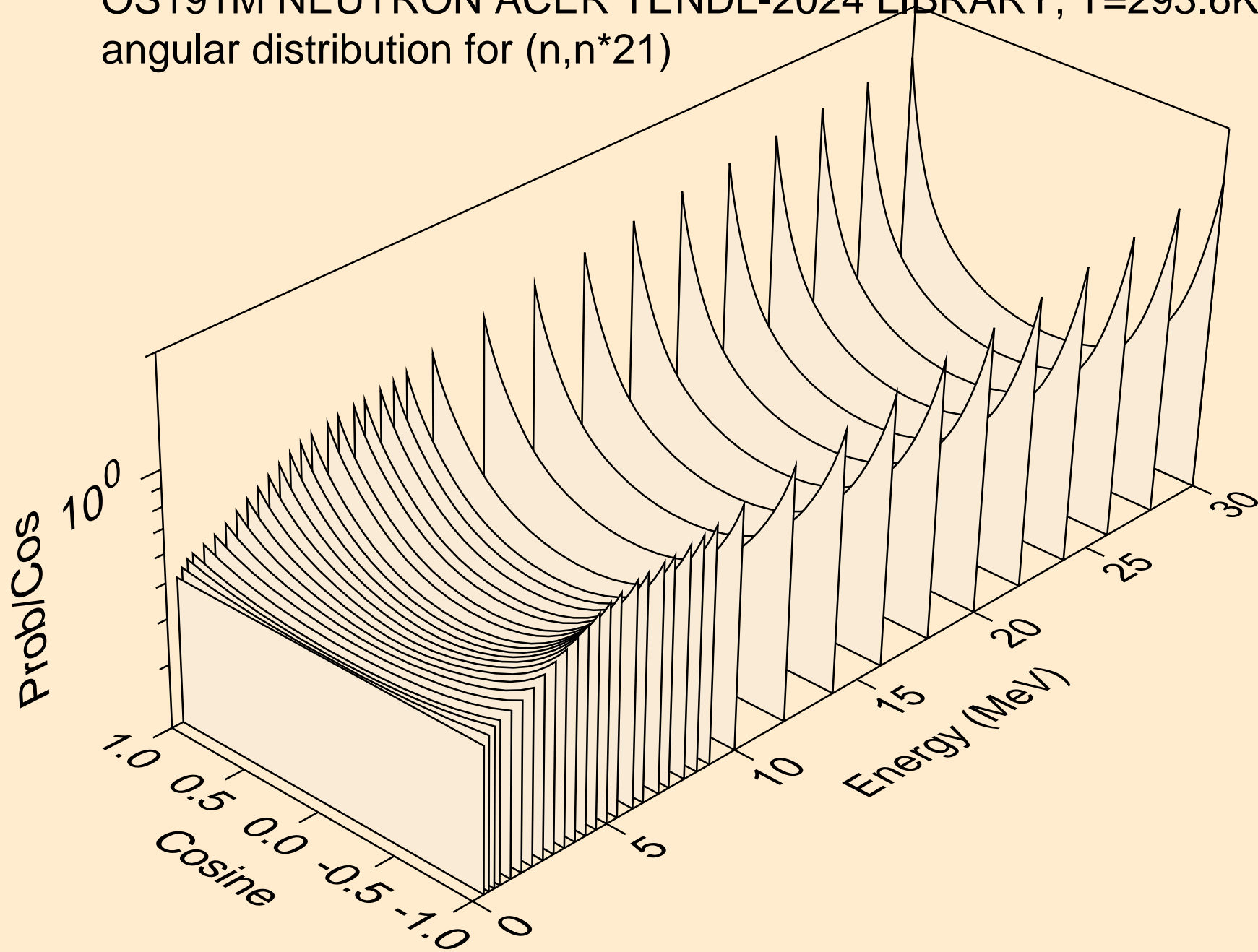

OS191M NEUTRON ACER TENDL-2024 LIBRARY; T=293.6K  
angular distribution for (n,n\*22)

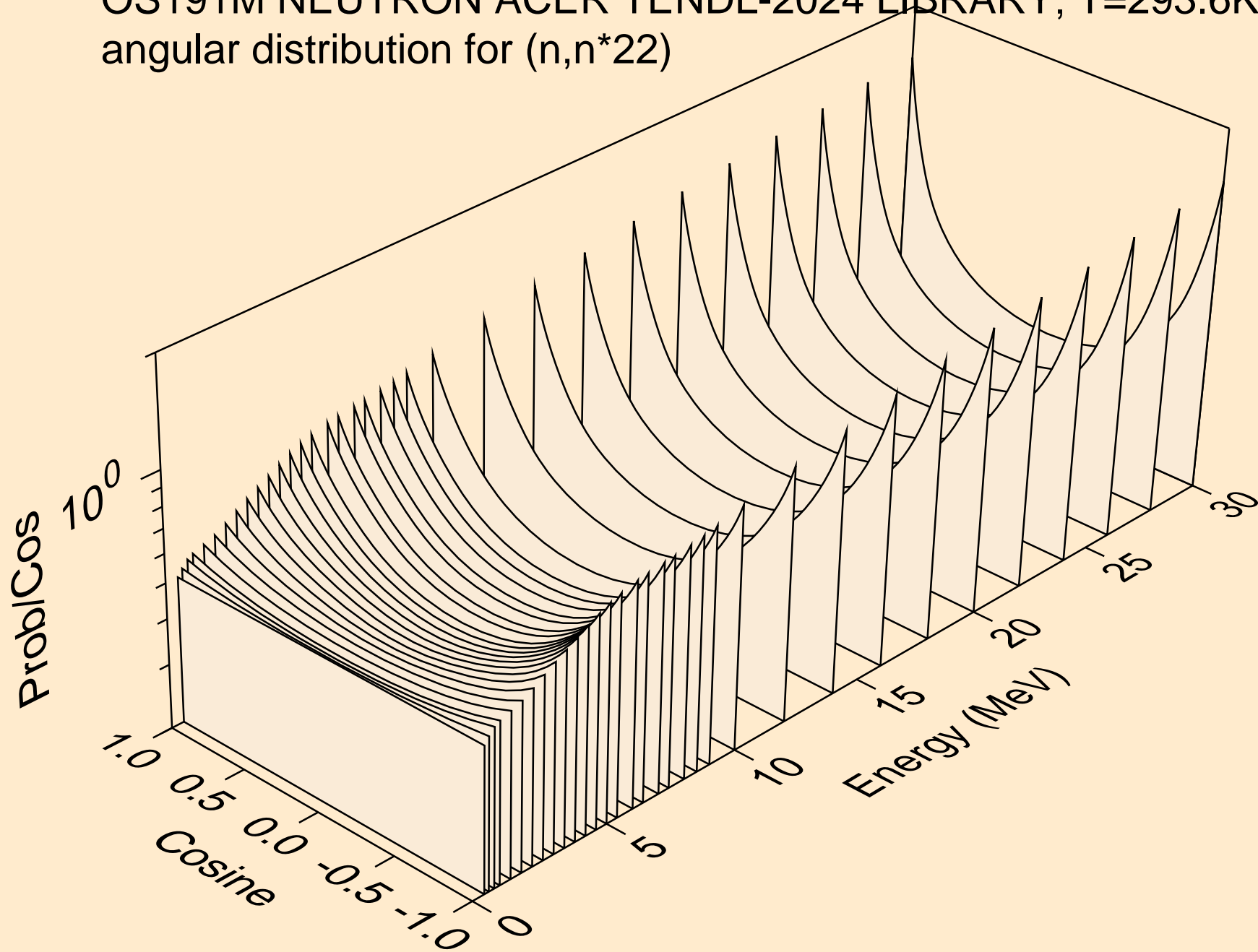

OS191M NEUTRON ACER TENDL-2024 LIBRARY; T=293.6K  
angular distribution for (n,n\*23)

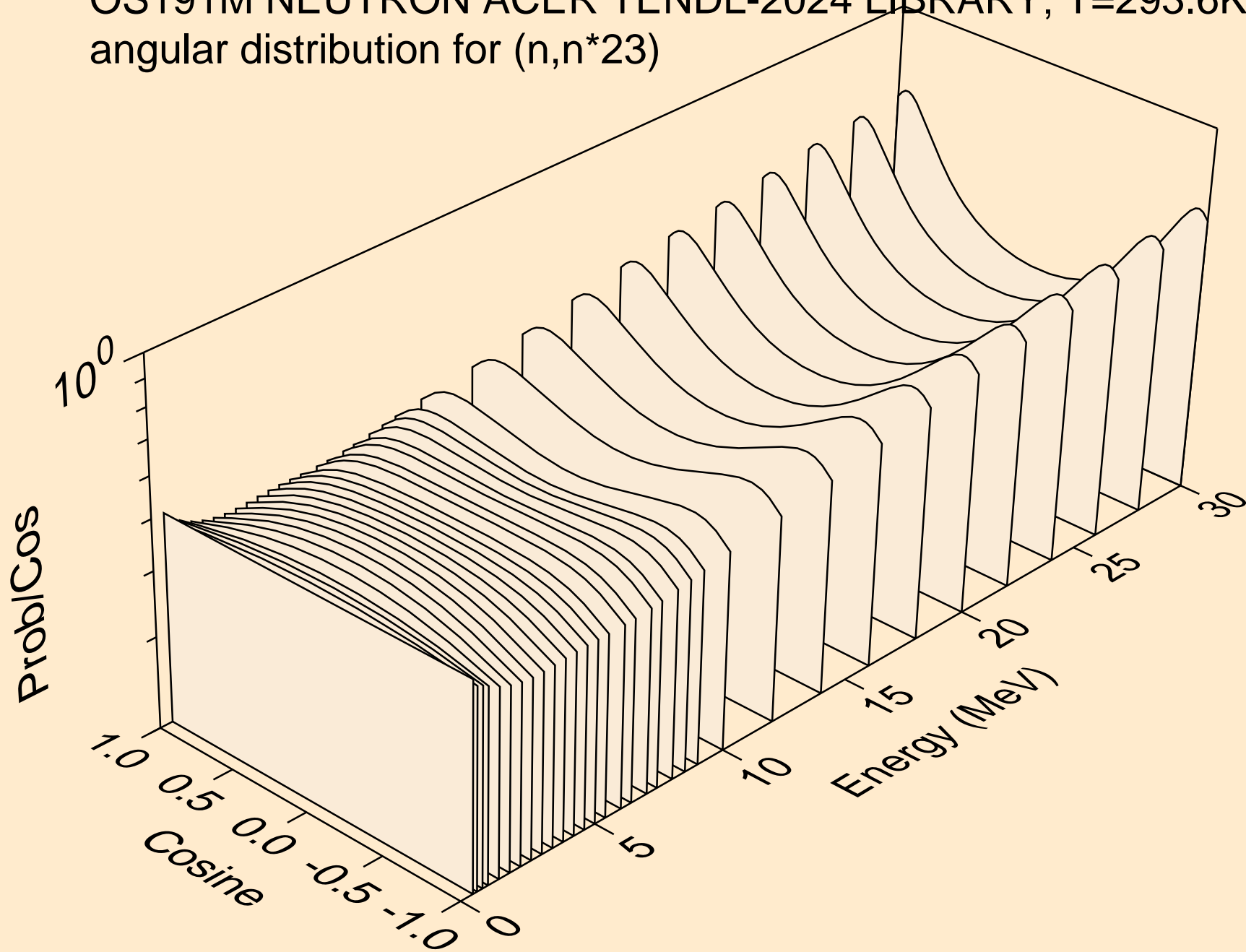

OS191M NEUTRON ACER TENDL-2024 LIBRARY; T=293.6K  
angular distribution for (n,n\*24)

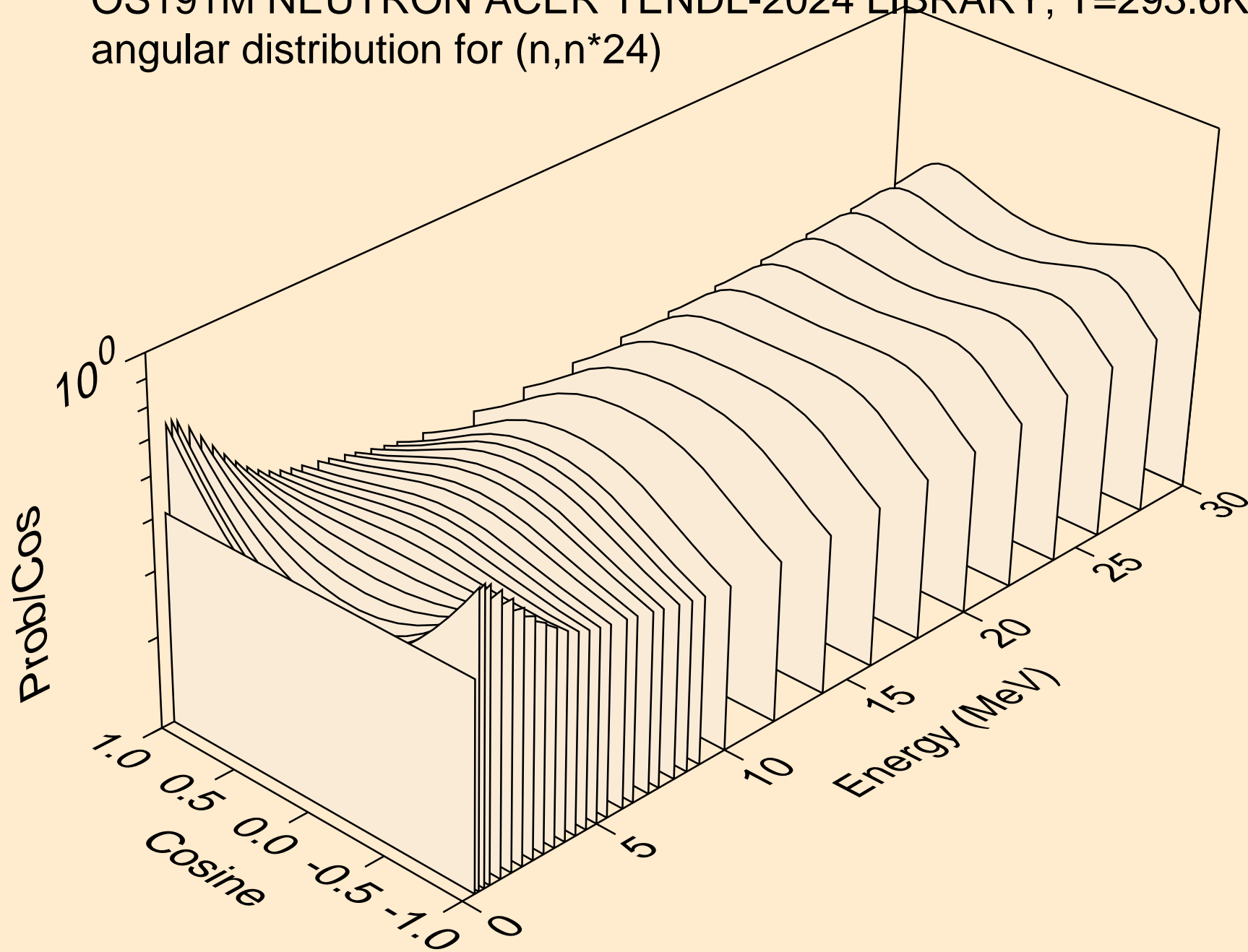

OS191M NEUTRON ACER TENDL-2024 LIBRARY; T=293.6K  
angular distribution for (n,n\*25)

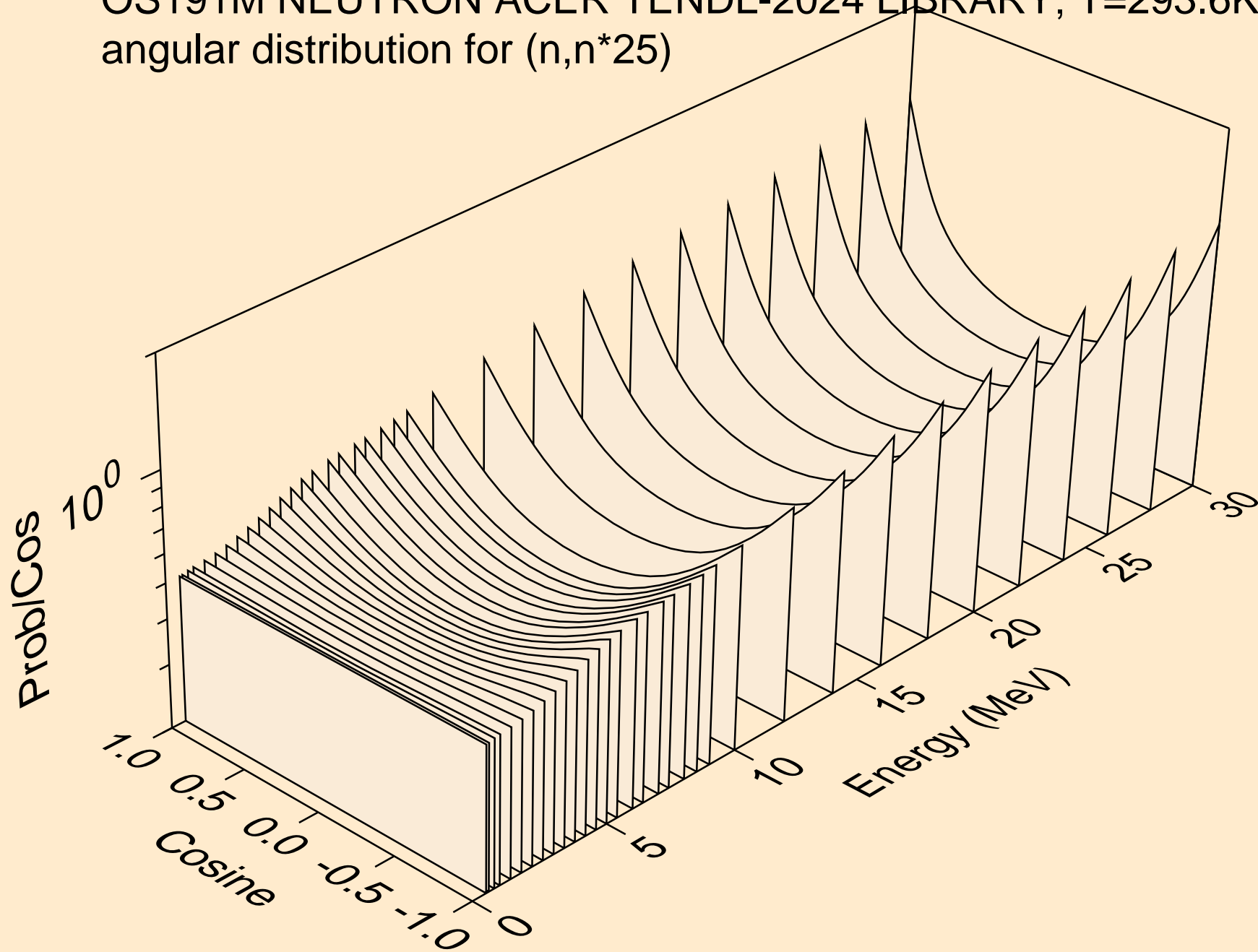

OS191M NEUTRON ACER TENDL-2024 LIBRARY; T=293.6K  
angular distribution for (n,n\*26)

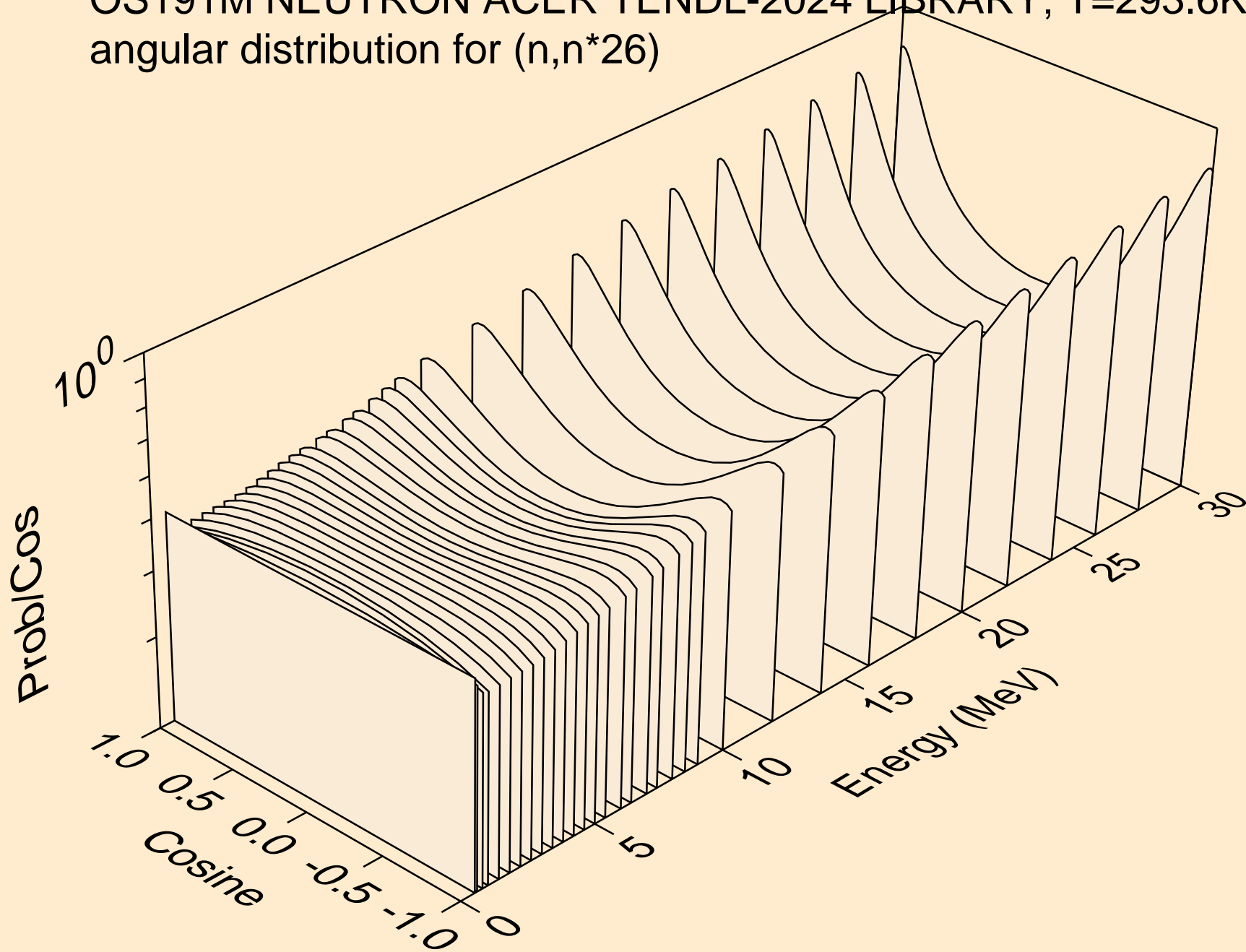

OS191M NEUTRON ACER TENDL-2024 LIBRARY; T=293.6K  
angular distribution for (n,n\*27)

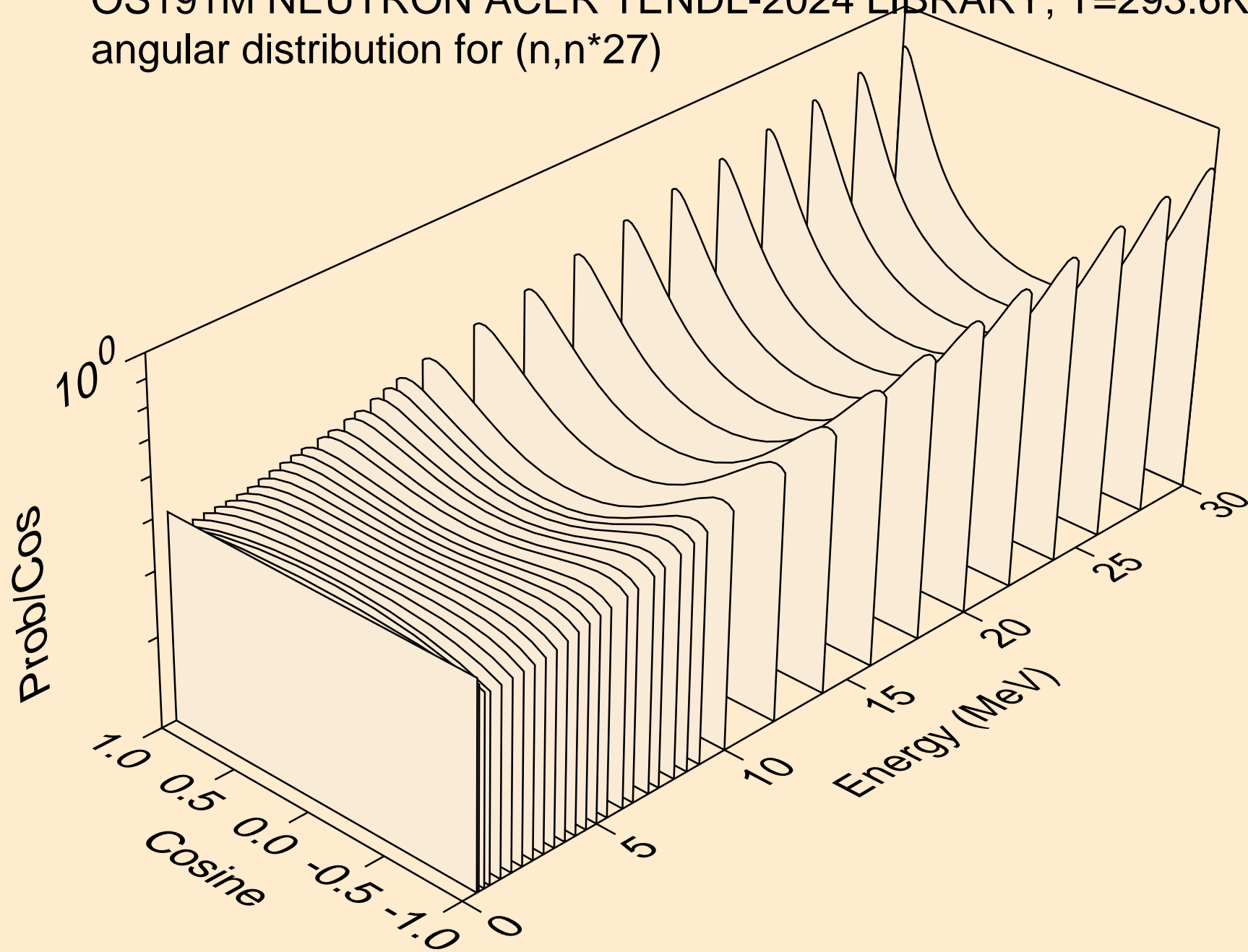

OS191M NEUTRON ACER TENDL-2024 LIBRARY; T=293.6K  
angular distribution for (n,n\*28)

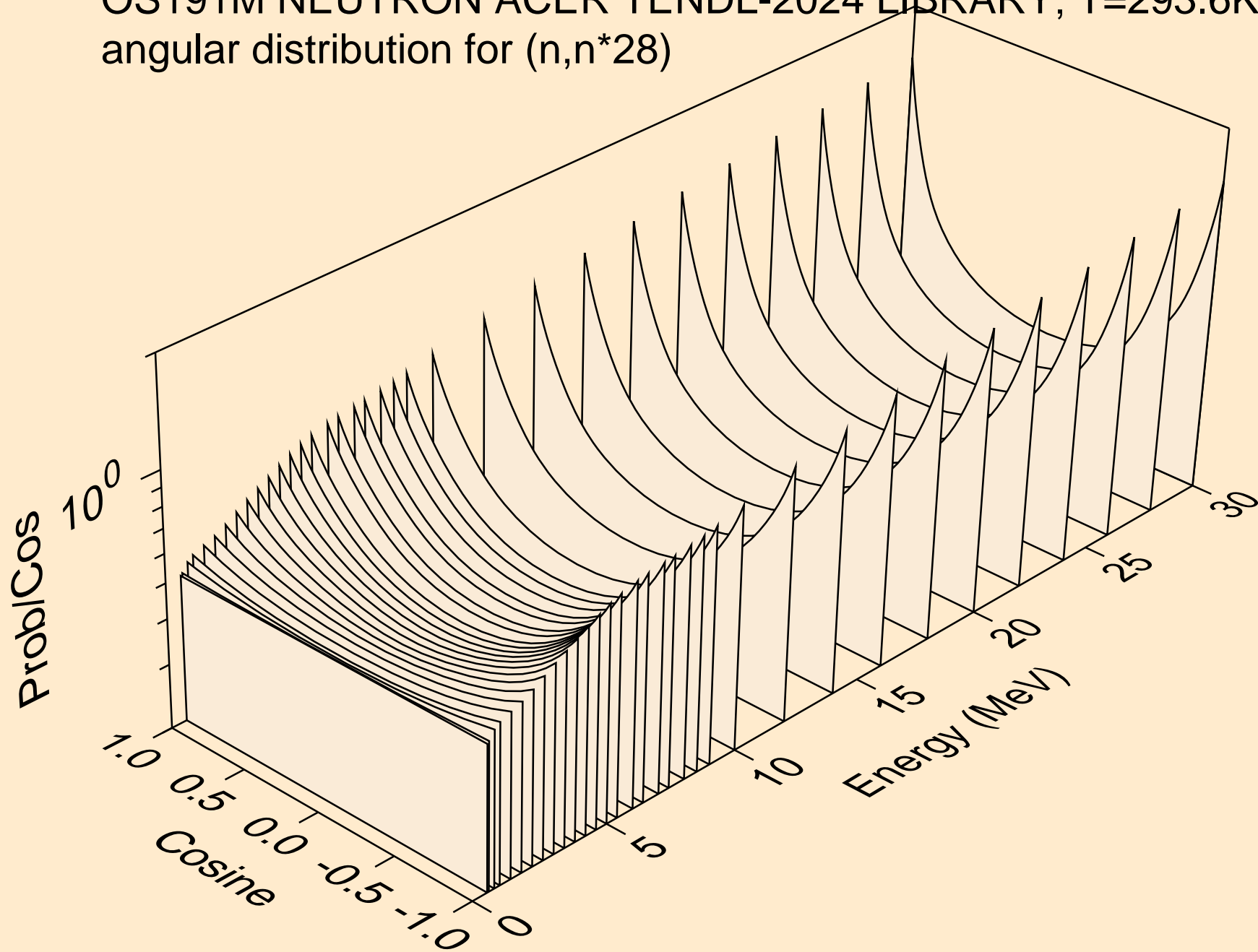

OS191M NEUTRON ACER TENDL-2024 LIBRARY; T=293.6K  
angular distribution for (n,n\*29)

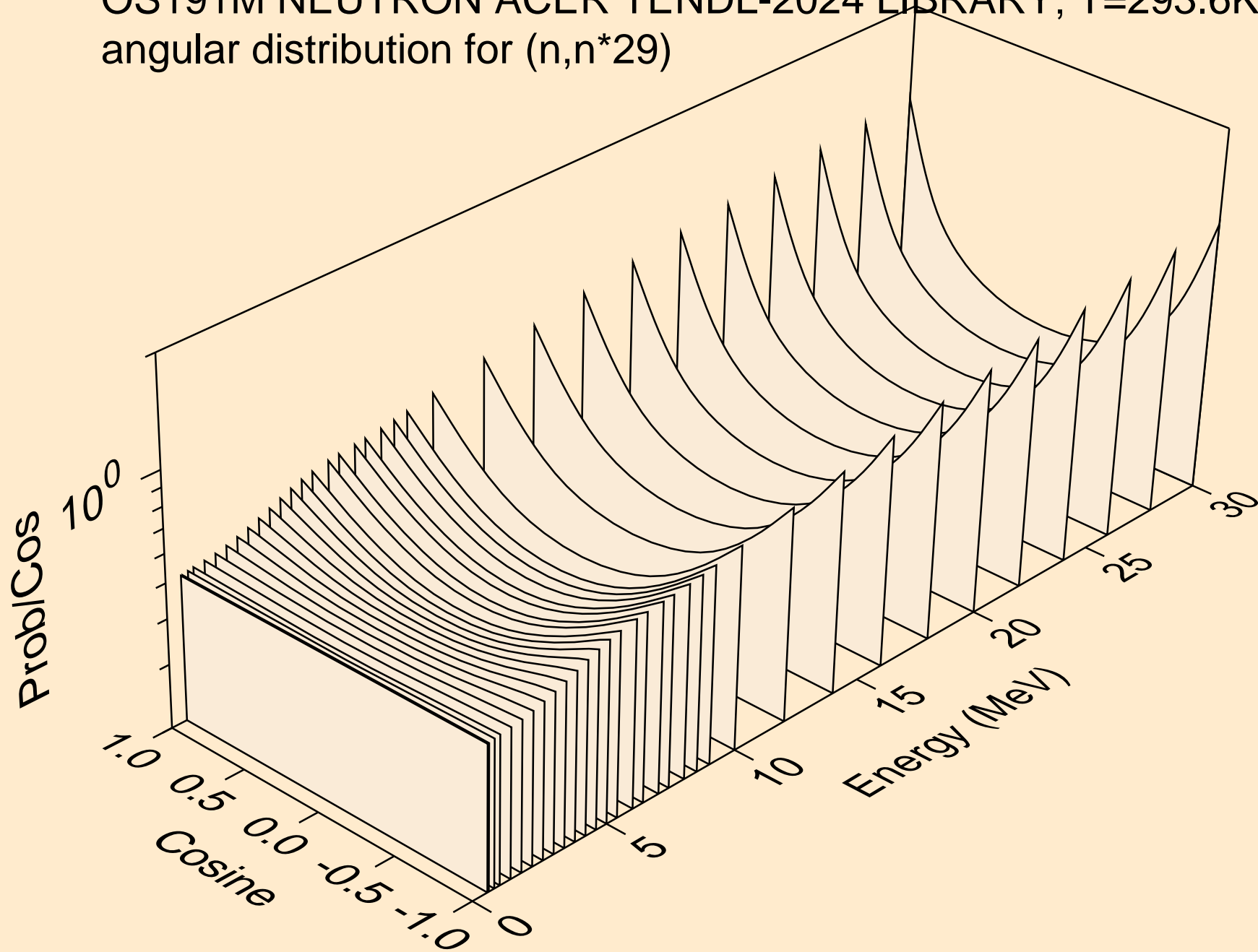

OS191M NEUTRON ACER TENDL-2024 LIBRARY; T=293.6K  
angular distribution for (n,n\*30)

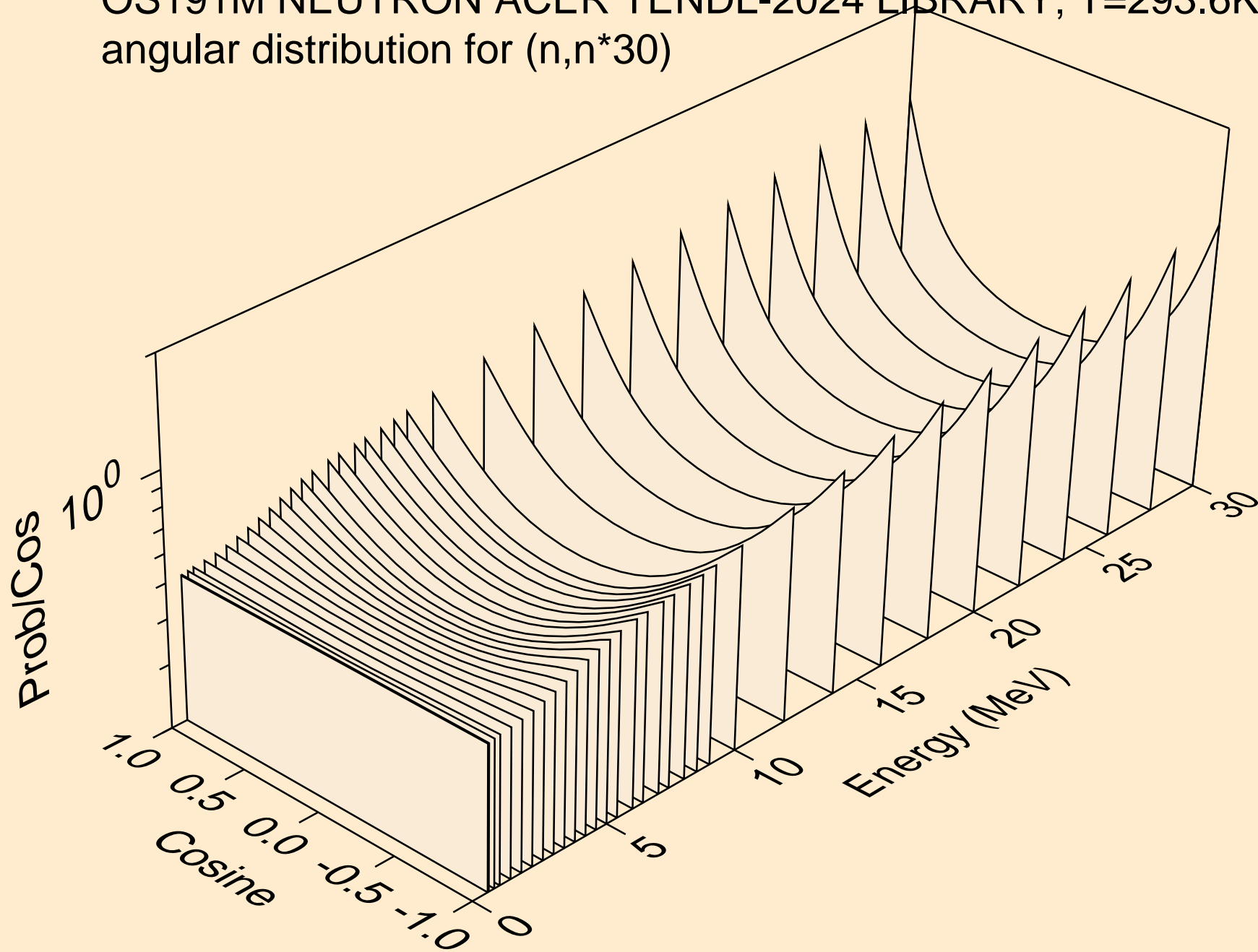

OS191M NEUTRON ACER TENDL-2024 LIBRARY; T=293.6K  
Neutron emission for (n,x)

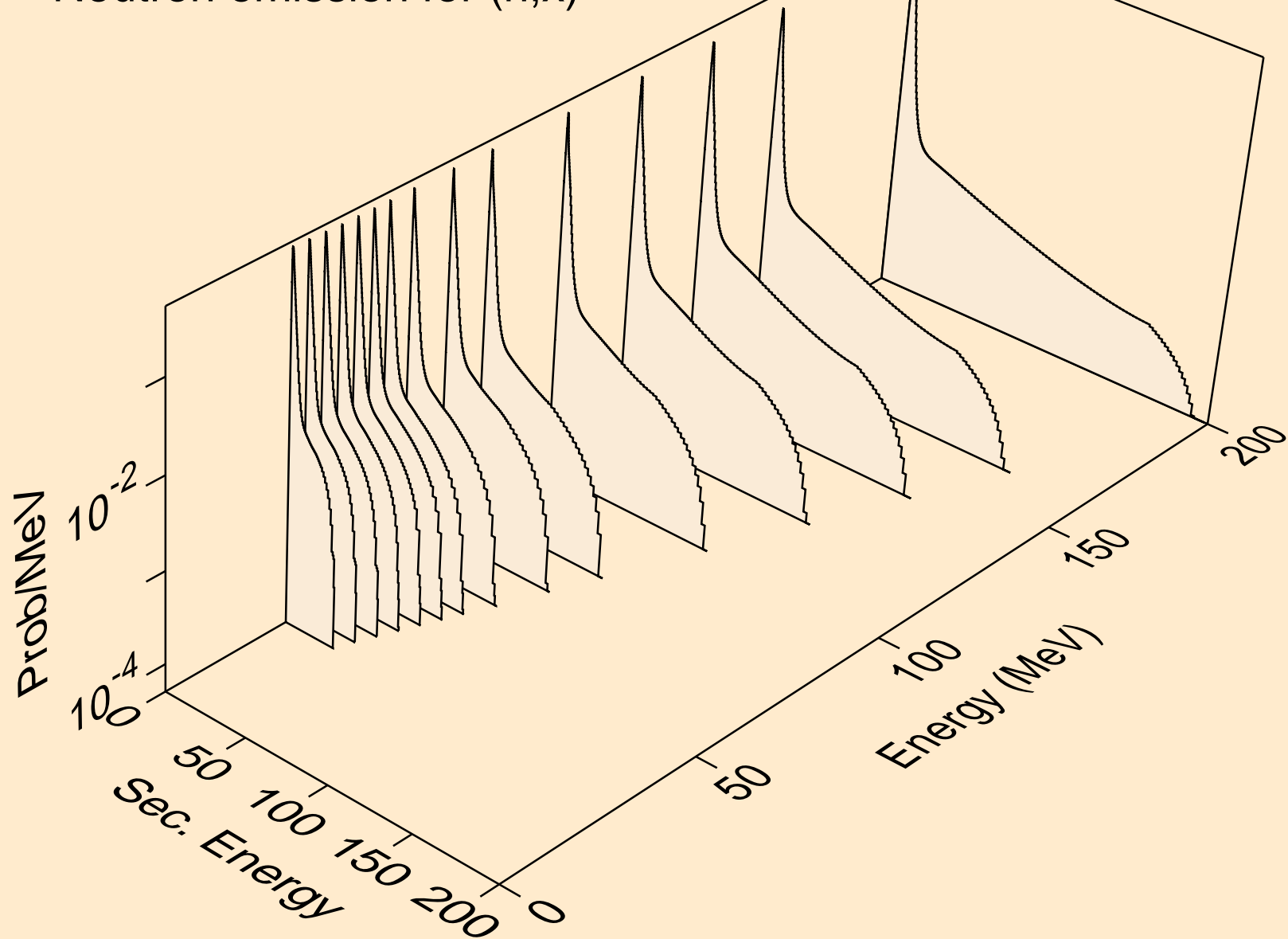

OS191M NEUTRON ACER TENDL-2024 LIBRARY; T=293.6K  
Neutron emission for (n,2nd)

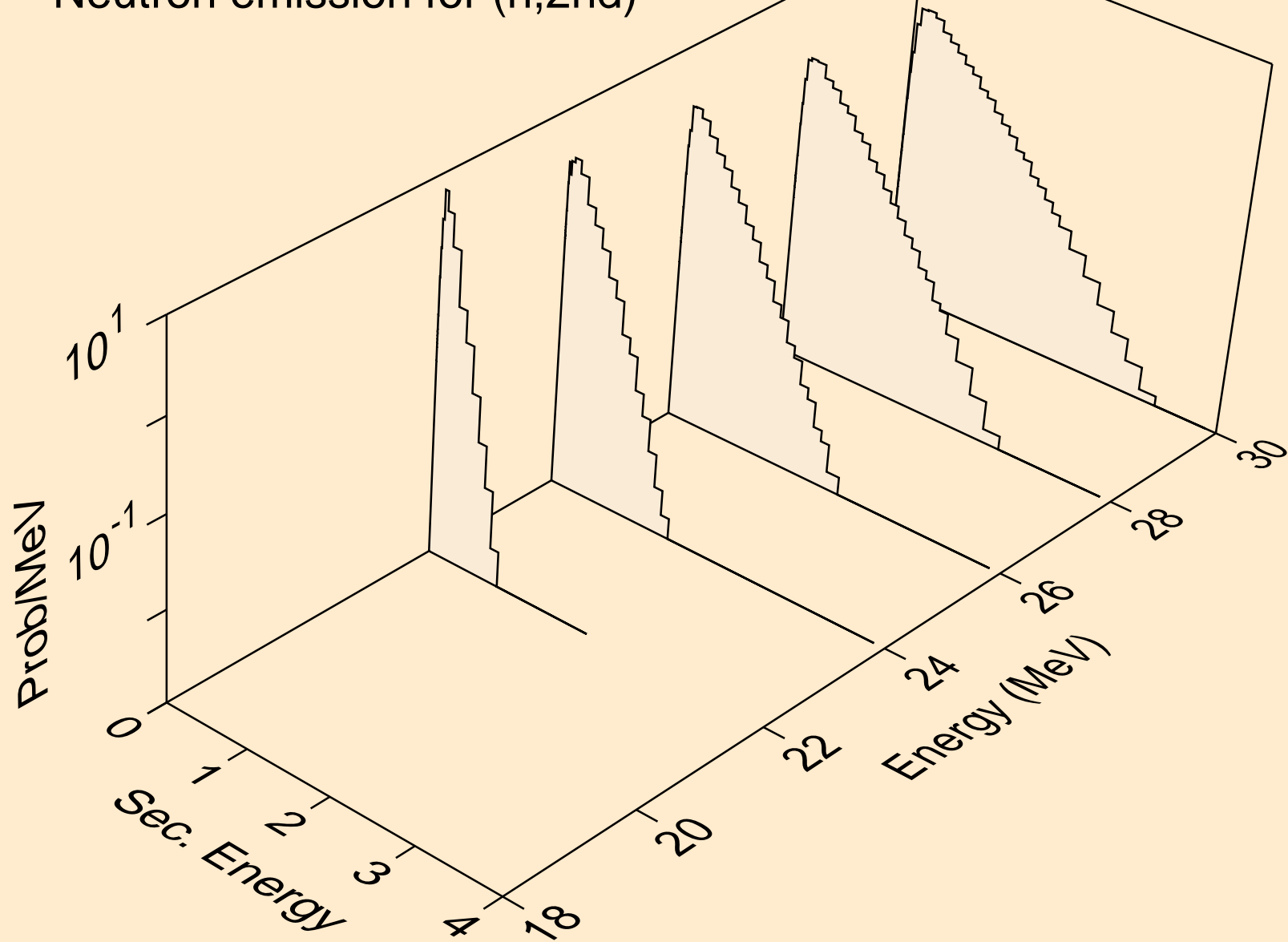

OS191M NEUTRON ACER TENDL-2024 LIBRARY; T=293.6K  
Neutron emission for (n,2n)

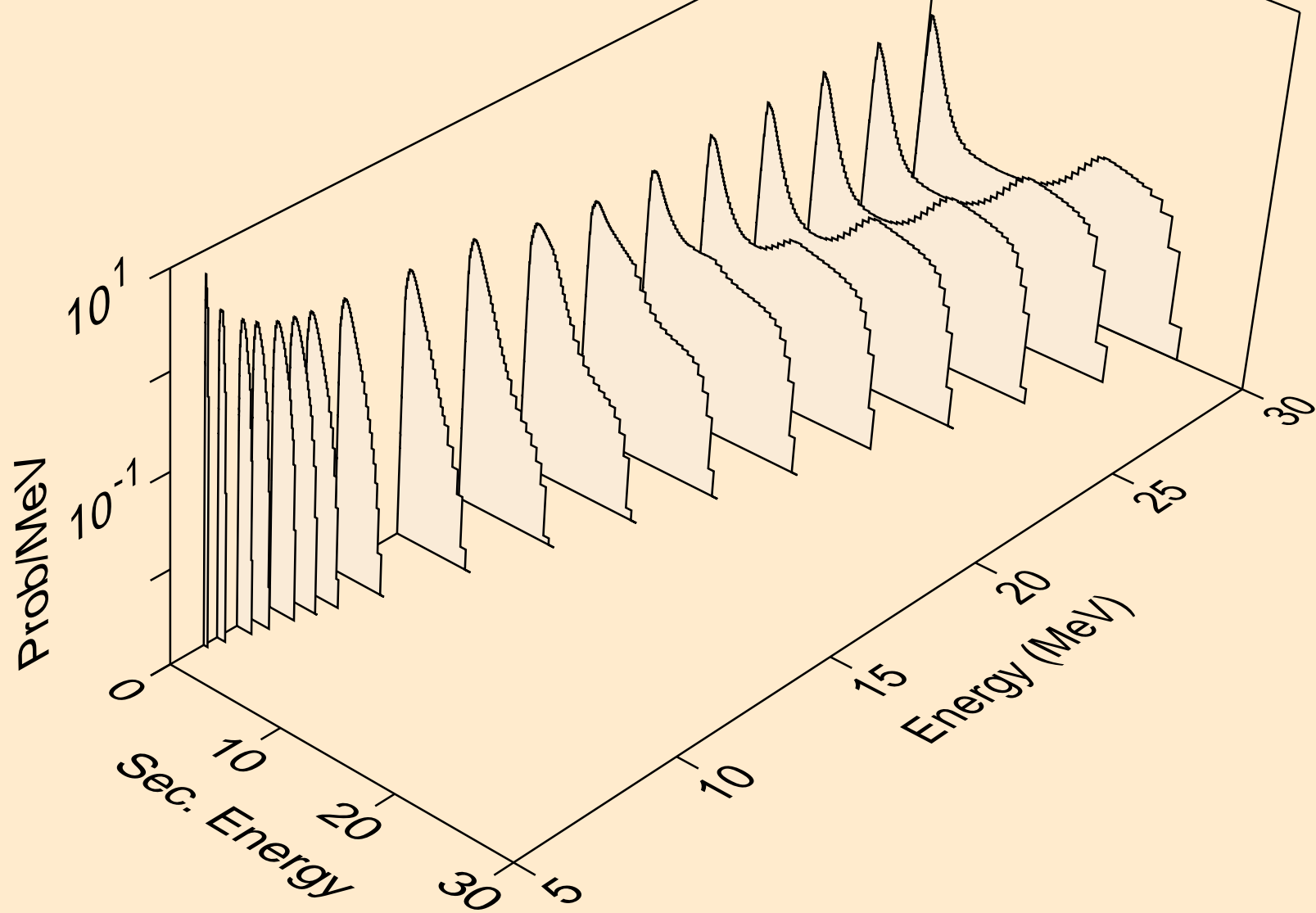

OS191M NEUTRON ACER TENDL-2024 LIBRARY; T=293.6K  
Neutron emission for (n,3n)

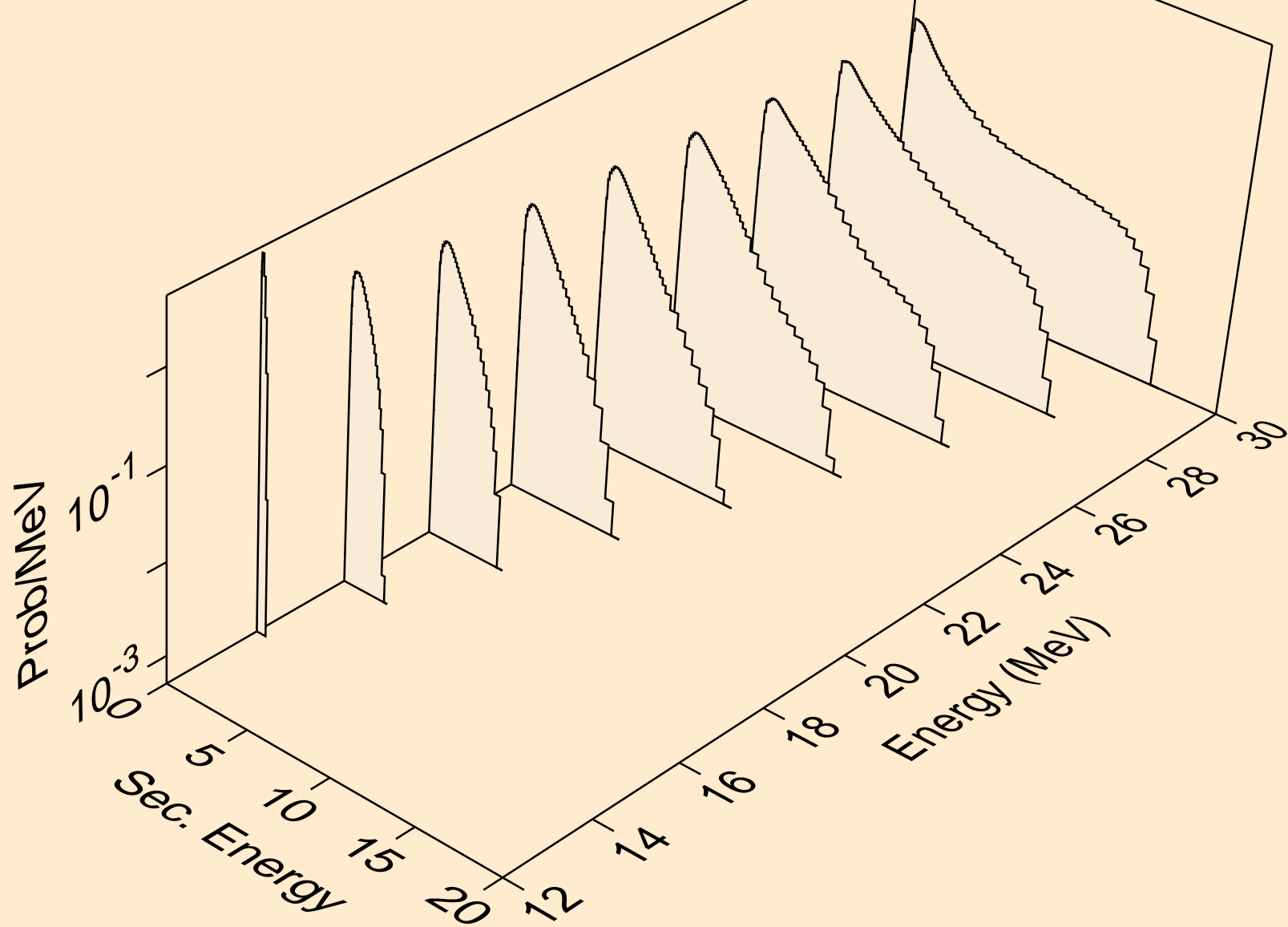

OS191M NEUTRON ACER TENDL-2024 LIBRARY; T=293.6K  
Neutron emission for (n,n\*)a

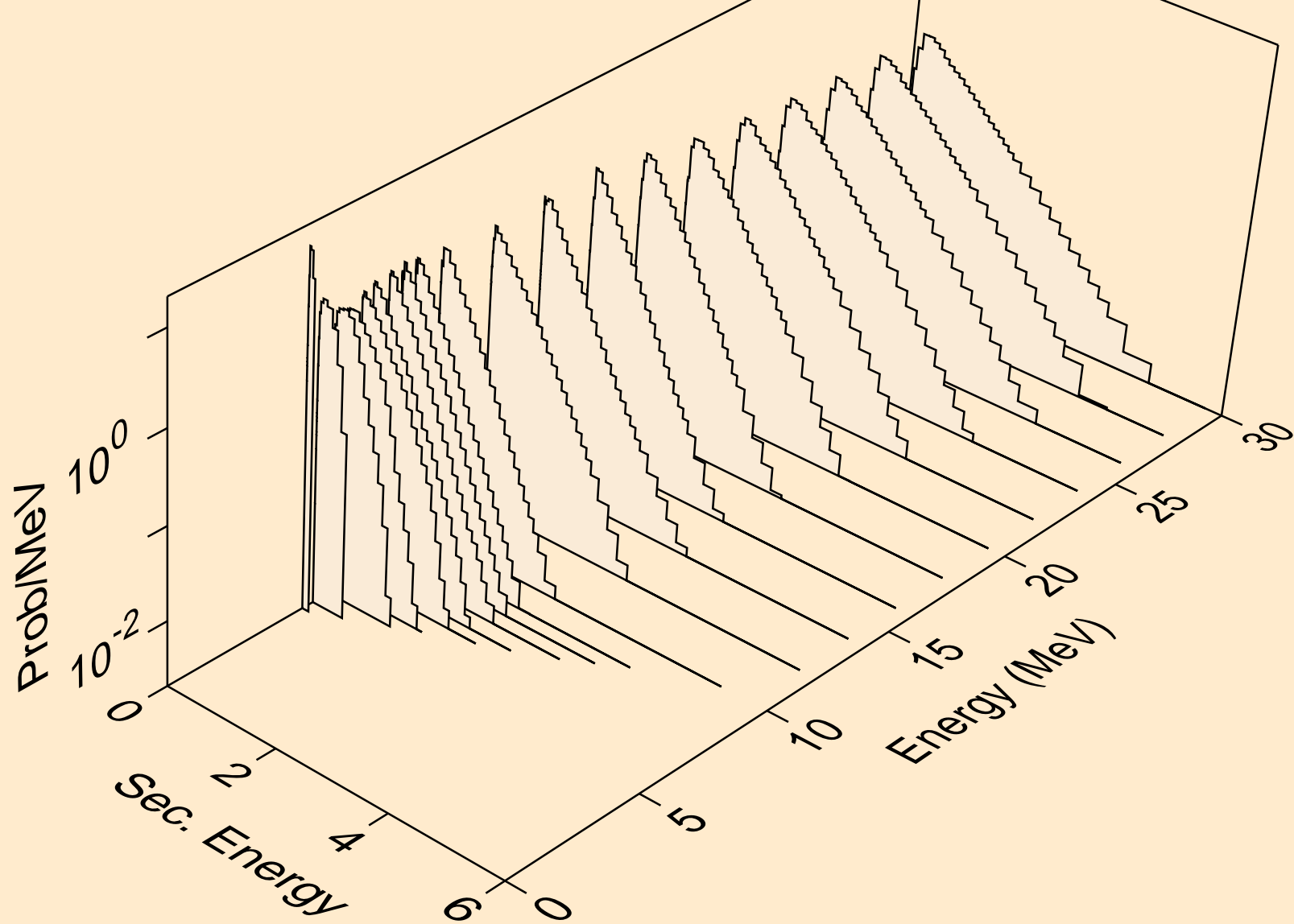

OS191M NEUTRON ACER TENDL-2024 LIBRARY; T=293.6K  
Neutron emission for (n,2n)<sub>a</sub>

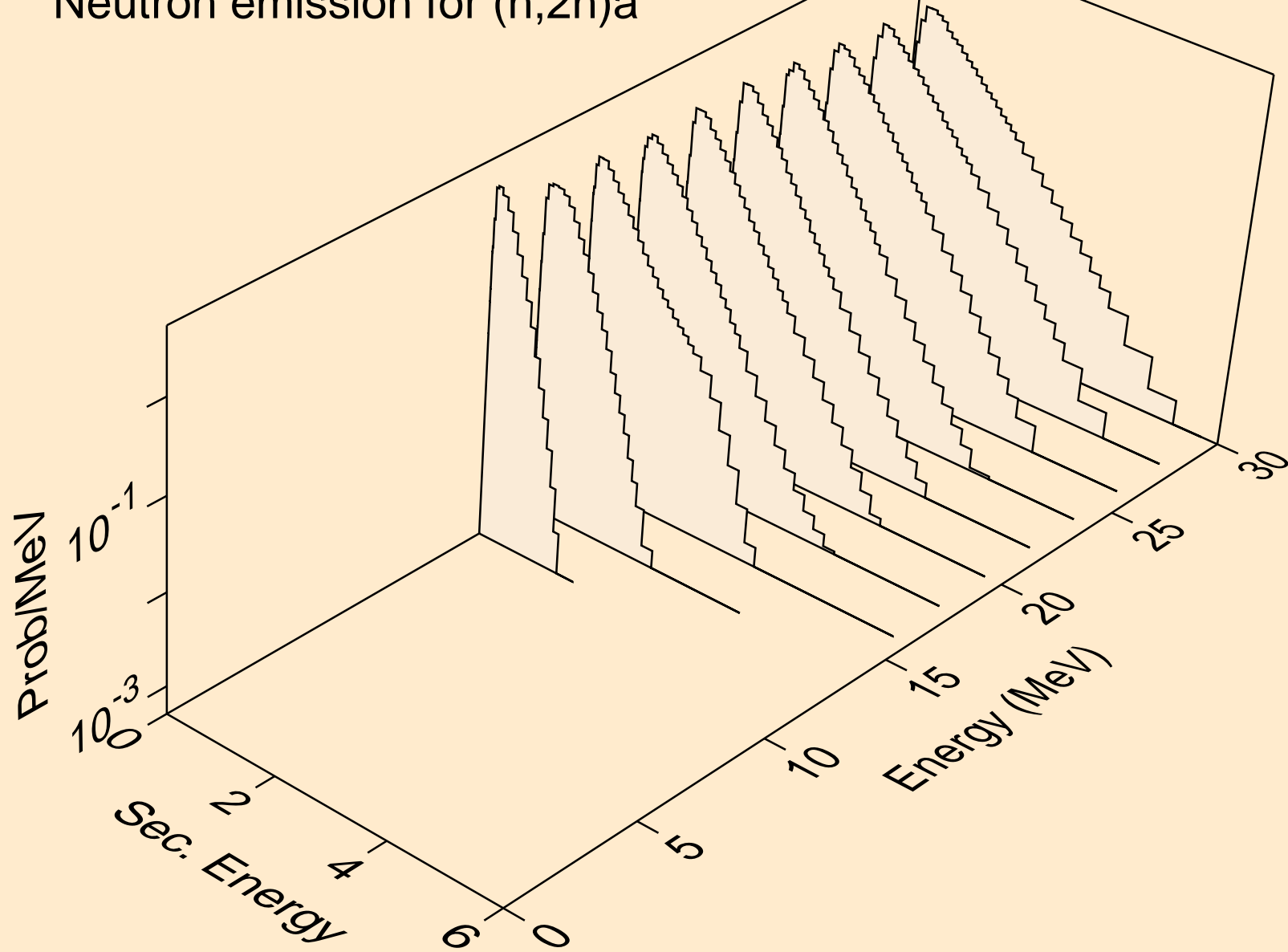

OS191M NEUTRON ACER TENDL-2024 LIBRARY; T=293.6K  
Neutron emission for (n,3n)a

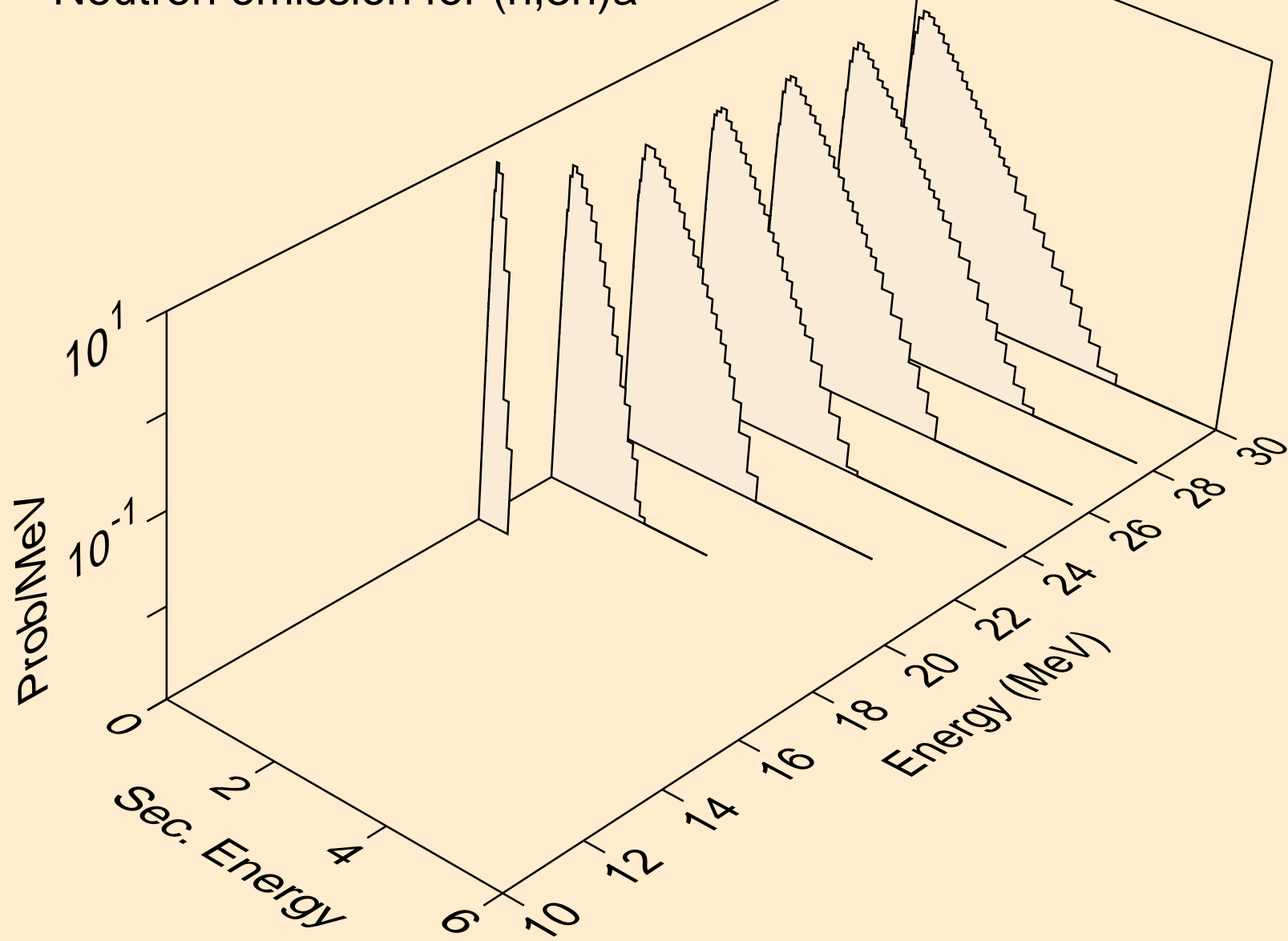

OS191M NEUTRON ACER TENDL-2024 LIBRARY; T=293.6K  
Neutron emission for (n,n\*)p

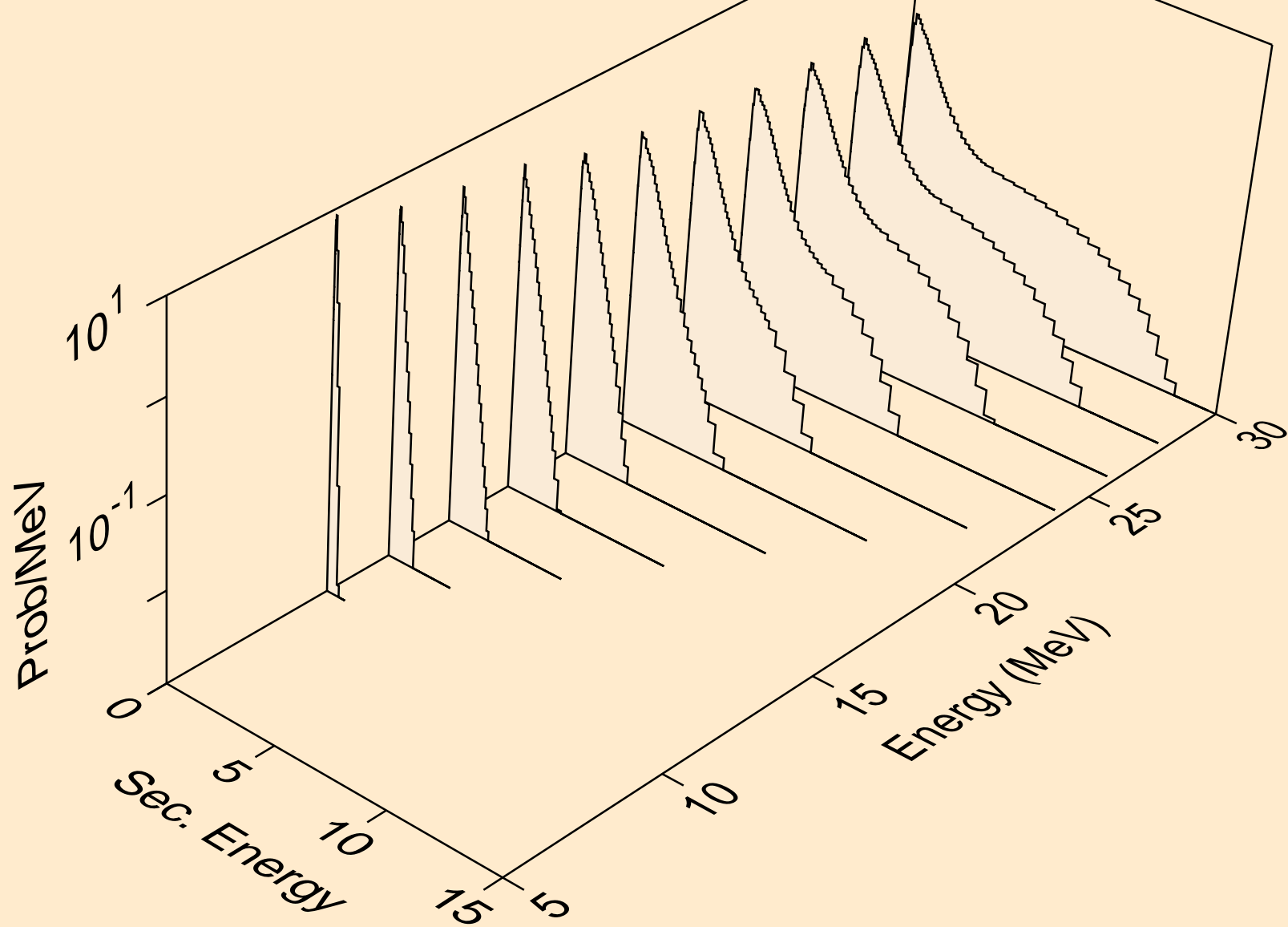

OS191M NEUTRON ACER TENDL-2024 LIBRARY; T=293.6K  
Neutron emission for (n,n\*)d

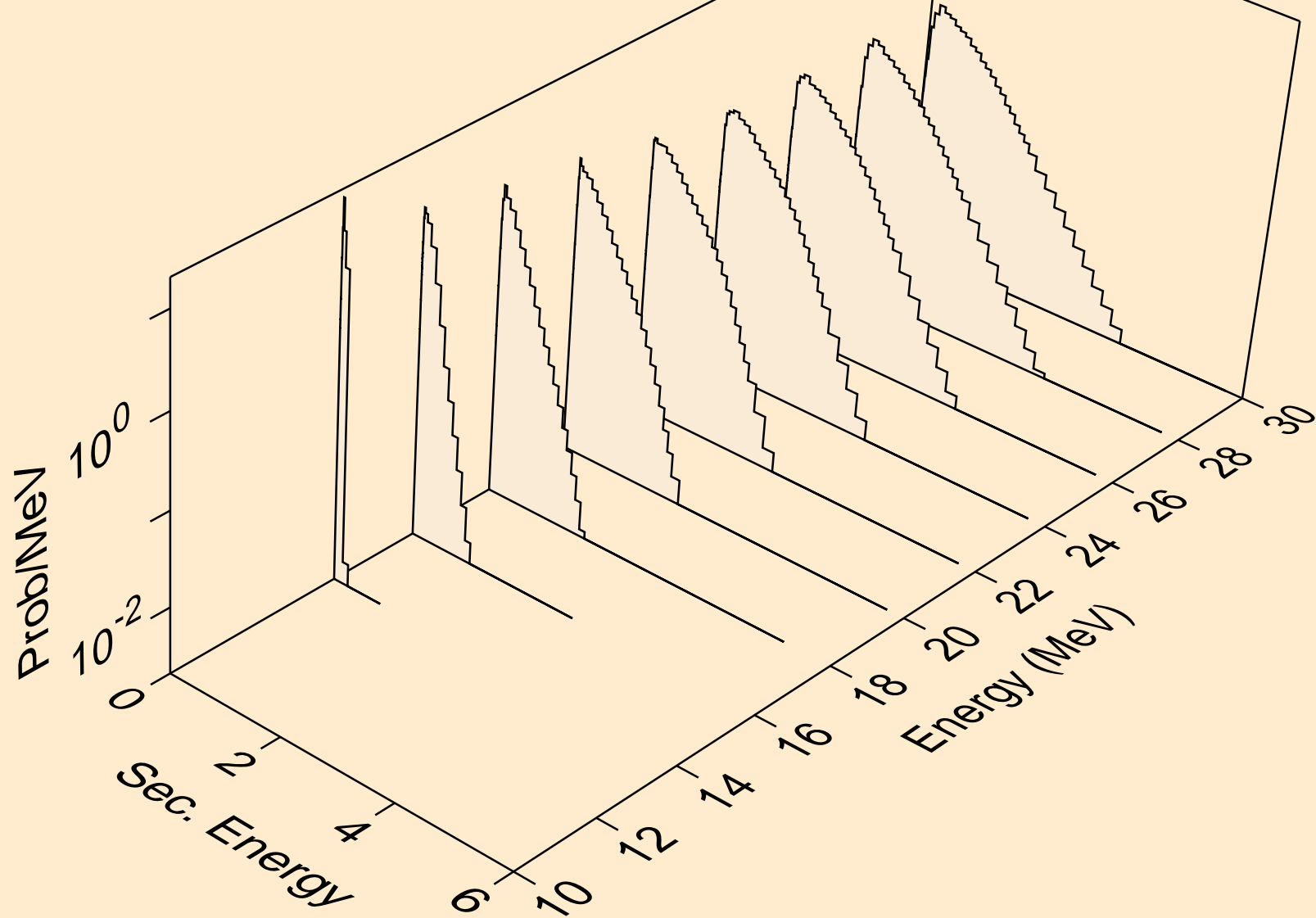

OS191M NEUTRON ACER TENDL-2024 LIBRARY; T=293.6K  
Neutron emission for (n,n\*)t

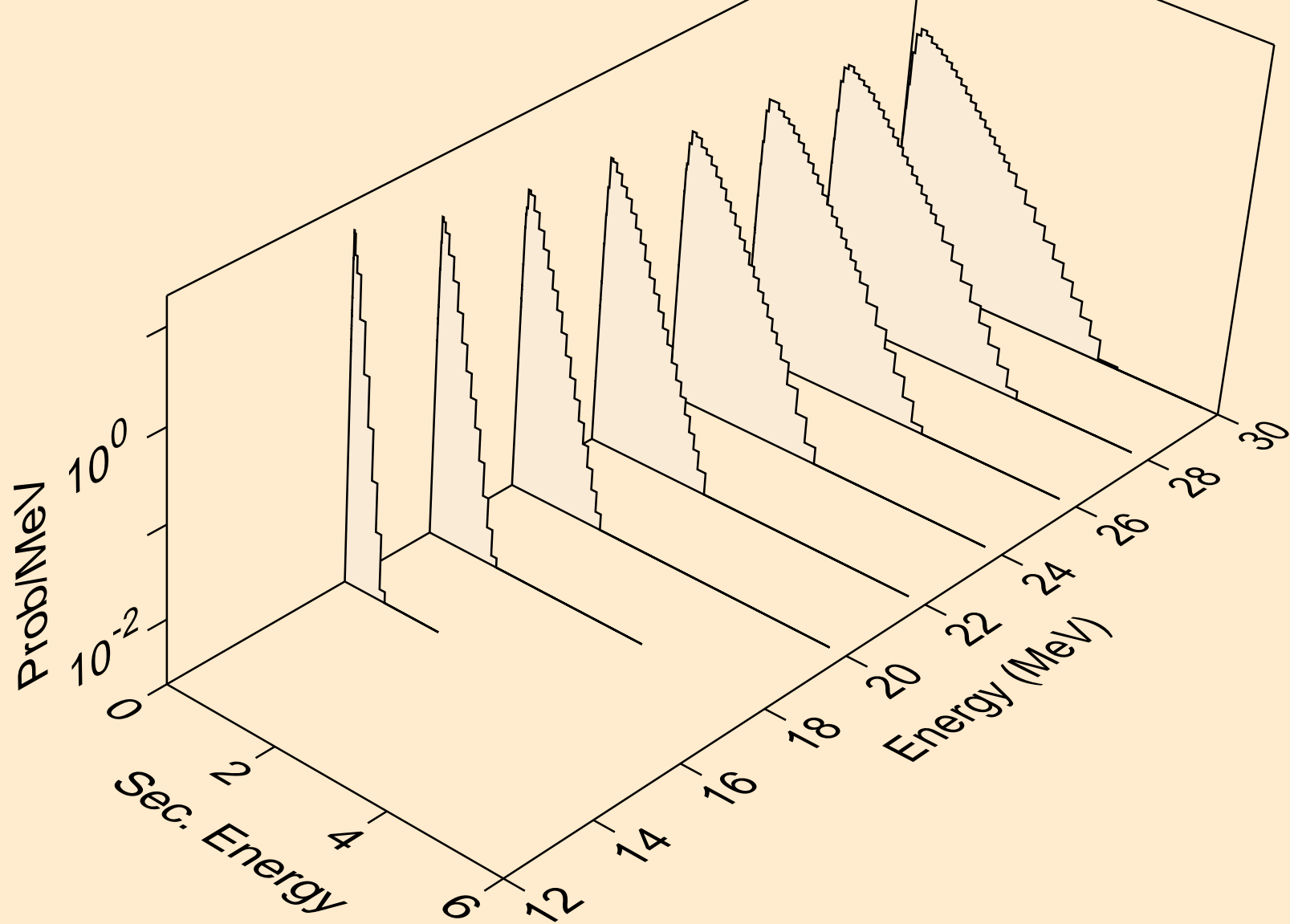

OS191M NEUTRON ACER TENDL-2024 LIBRARY; T=293.6K  
Neutron emission for (n,n\*)he3

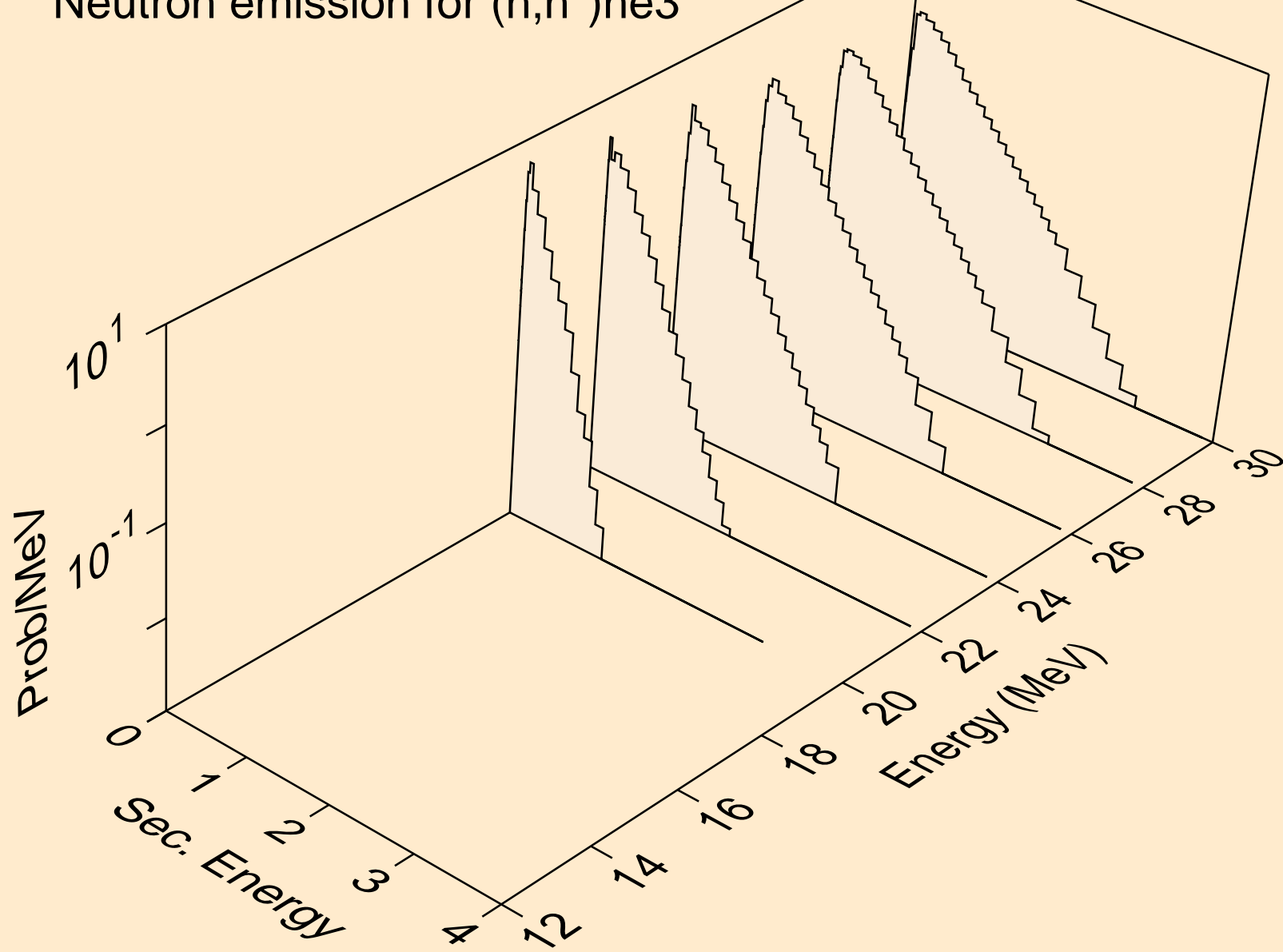

OS191M NEUTRON ACER TENDL-2024 LIBRARY; T=293.6K  
Neutron emission for (n,4n)

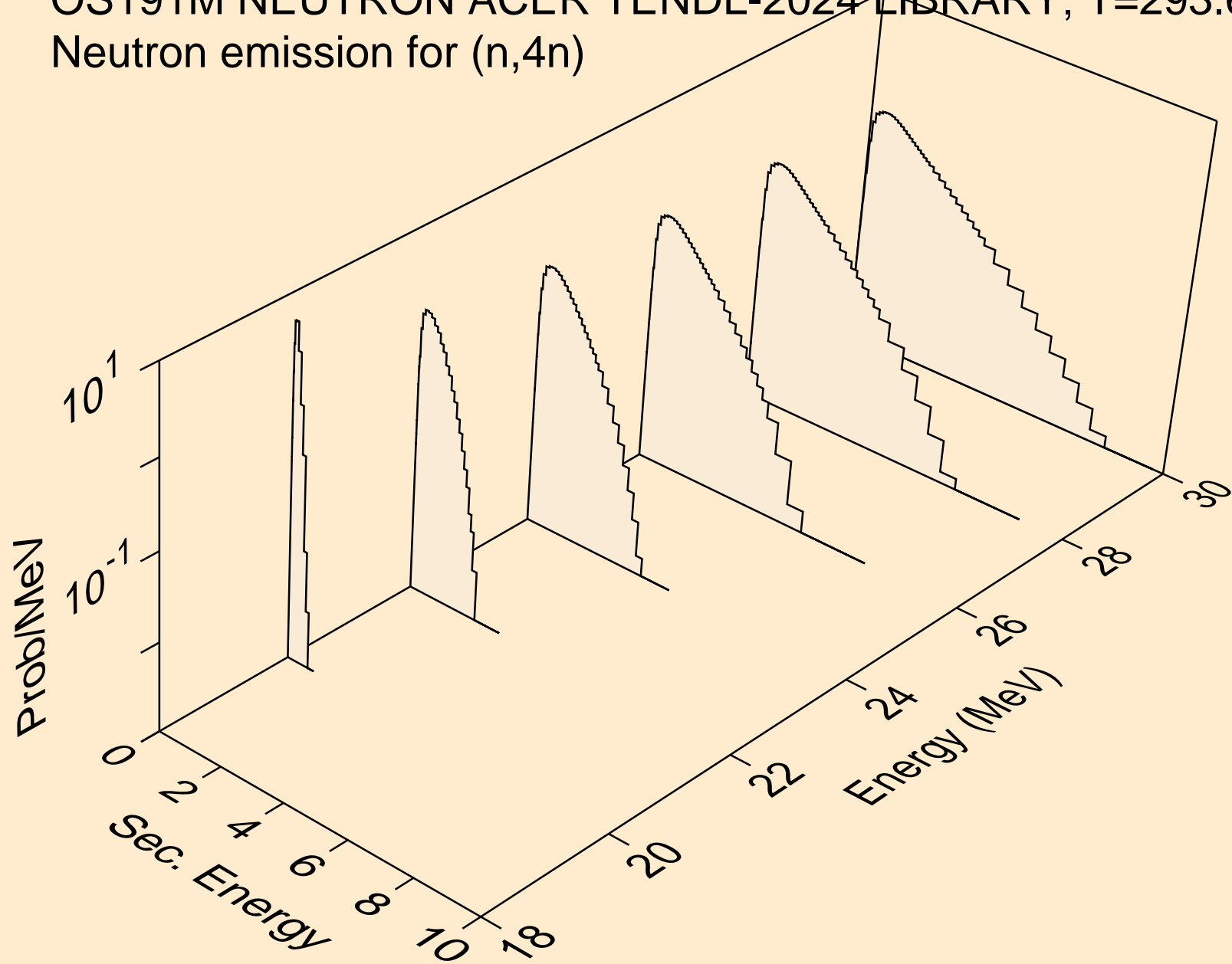

OS191M NEUTRON ACER TENDL-2024 LIBRARY; T=293.6K  
Neutron emission for (n,2np)

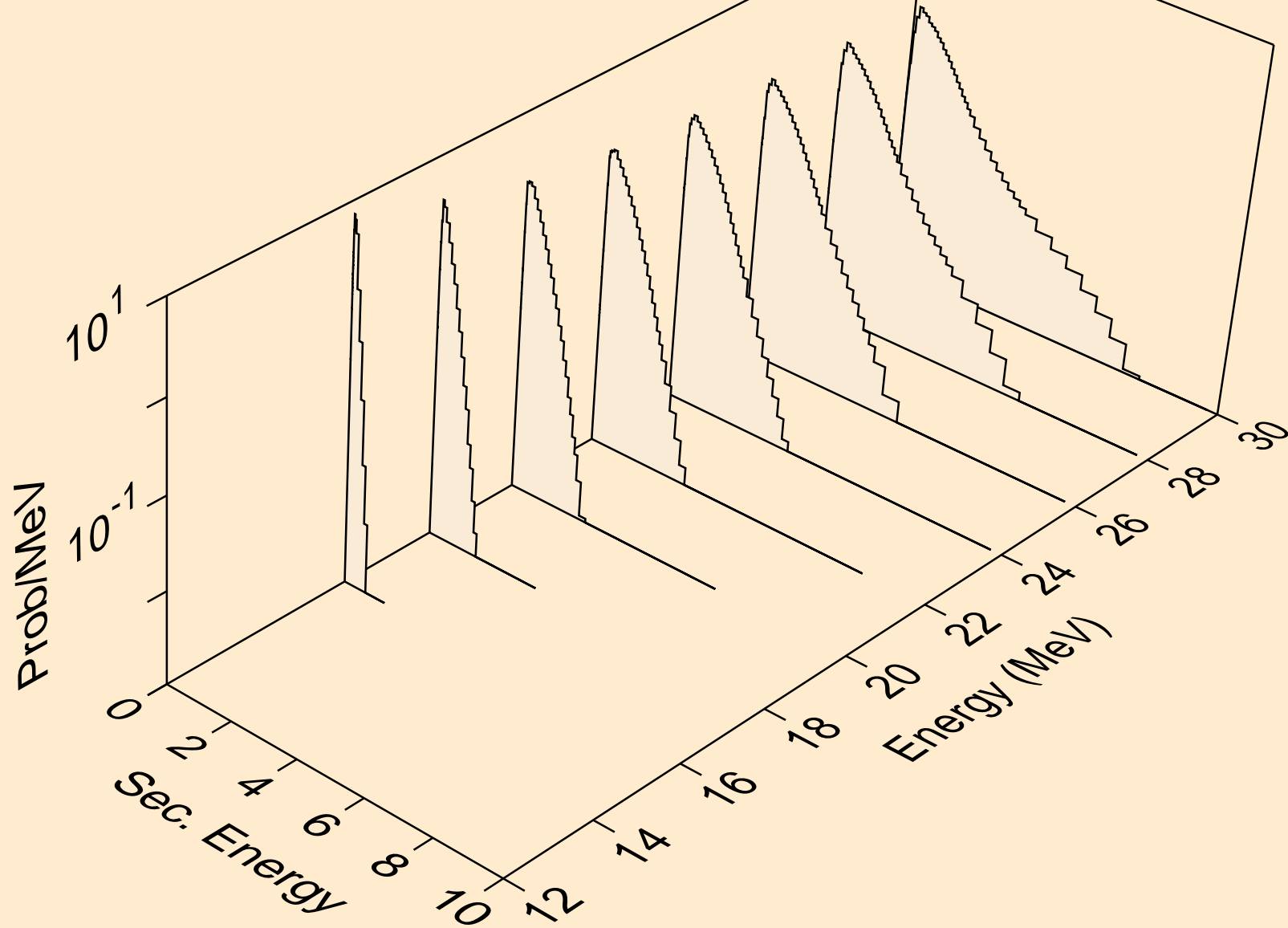

OS191M NEUTRON ACER TENDL-2024 LIBRARY; T=293.6K  
Neutron emission for (n,3np)

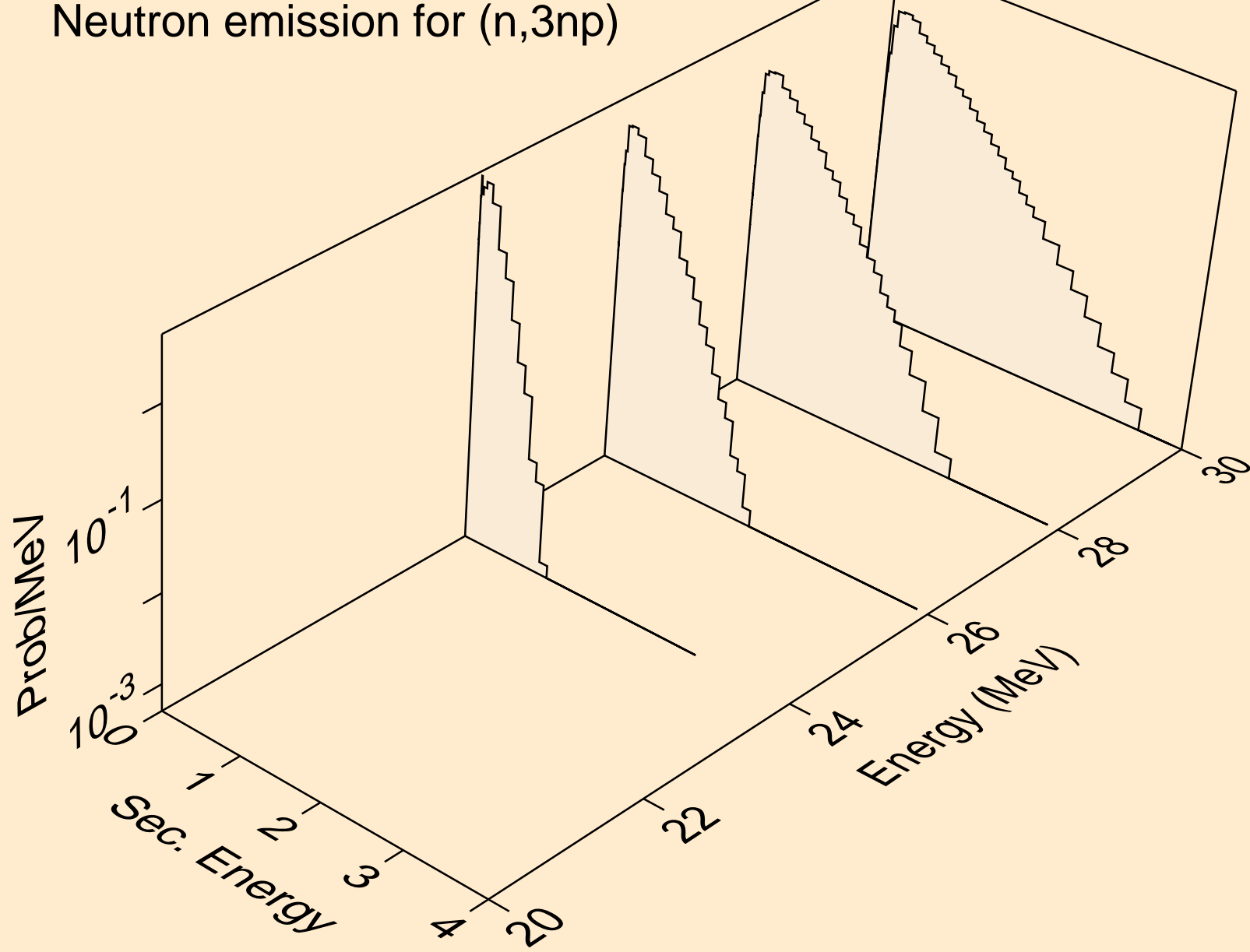

OS191M NEUTRON ACER TENDL-2024 LIBRARY; T=293.6K  
Neutron emission for (n,n2p)

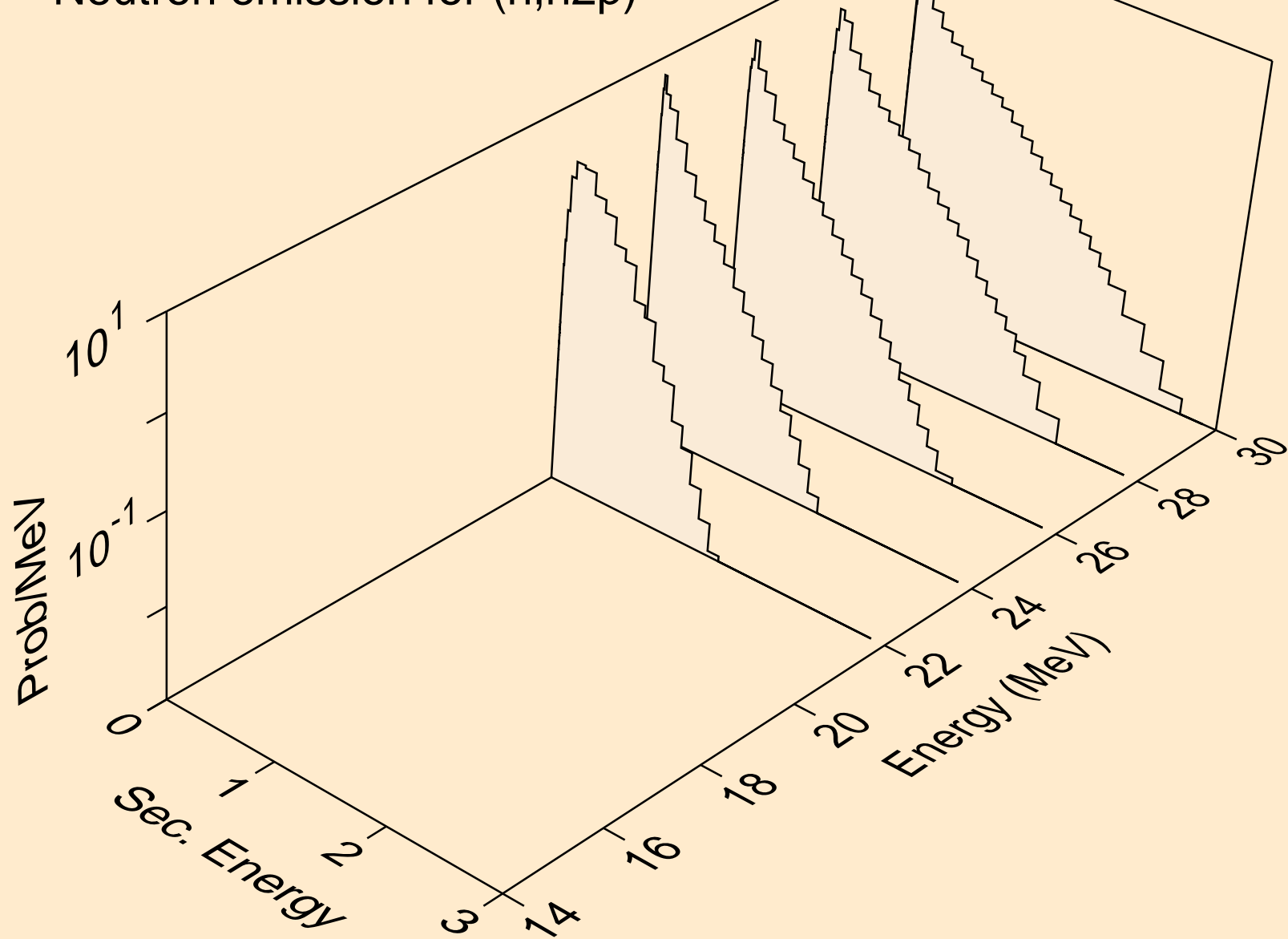

OS191M NEUTRON ACER TENDL-2024 LIBRARY; T=293.6K  
Neutron emission for (n,n\*c)

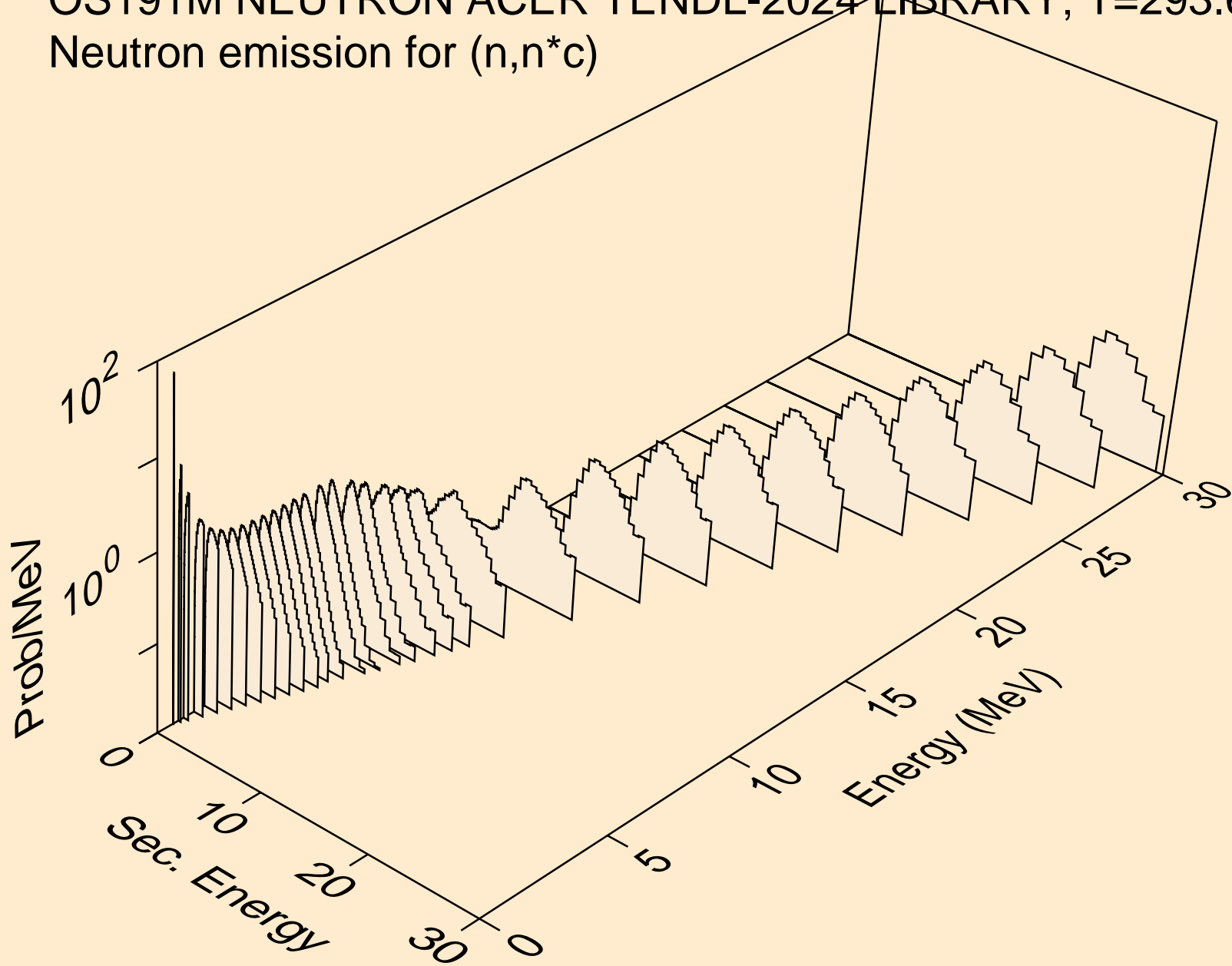

OS191M NEUTRON ACER TENDL-2024 LIBRARY; T=293.6K  
Photon emission for (n,x)

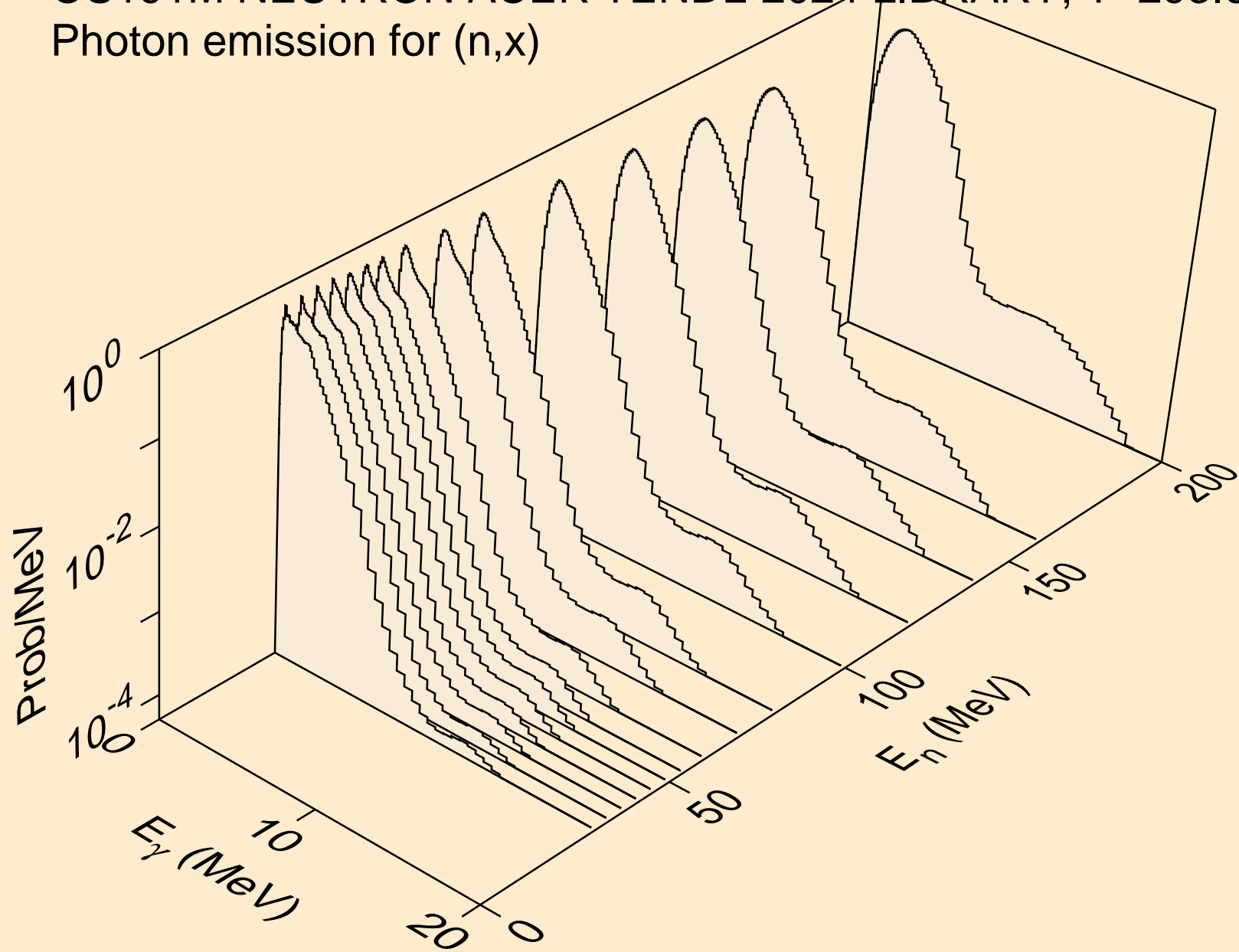

OS191M NEUTRON ACER TENDL-2024 LIBRARY; T=293.6K  
Photon emission for (n,2nd)

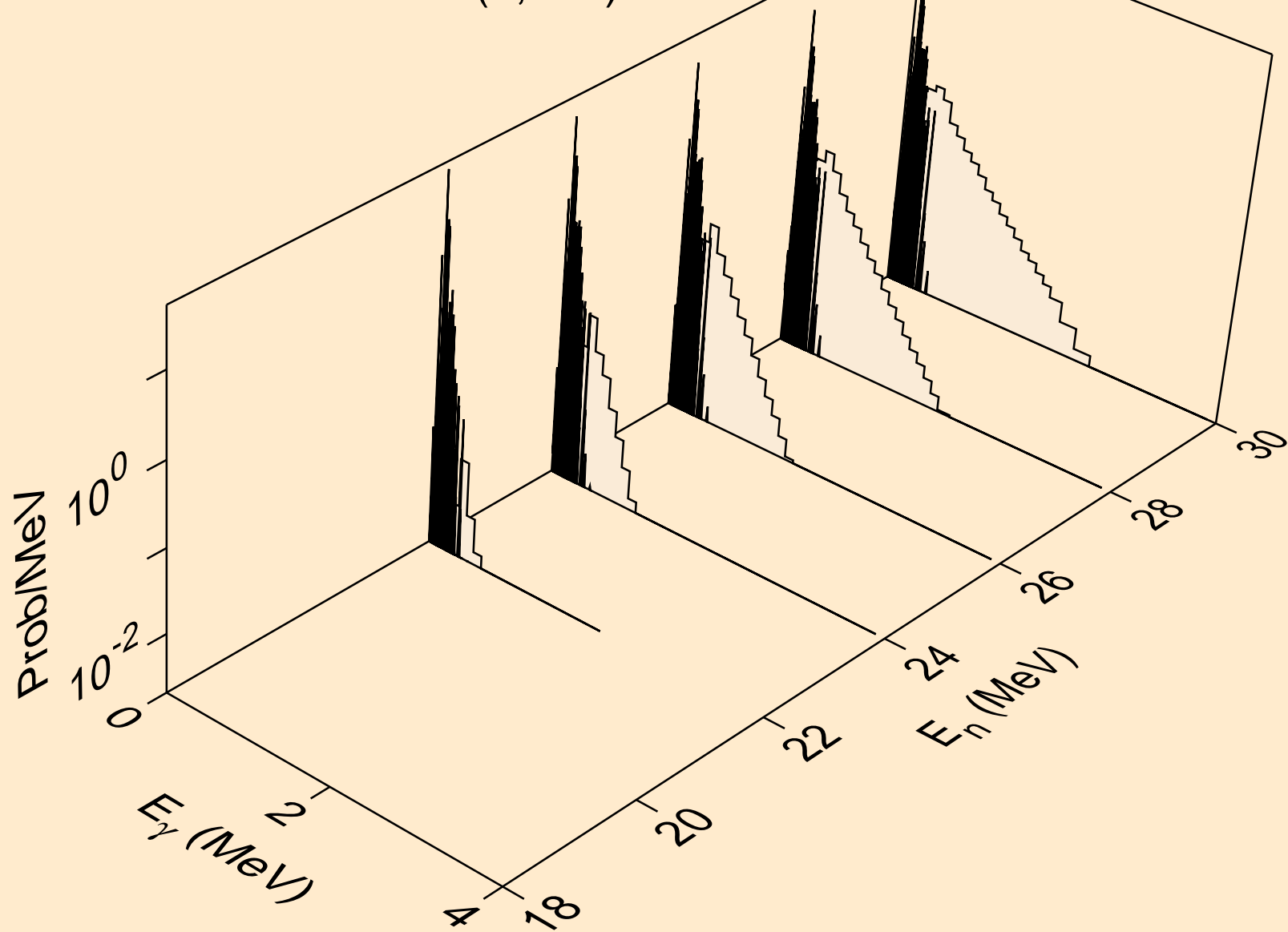

OS191M NEUTRON ACER TENDL-2024 LIBRARY; T=293.6K  
Photon emission for (n,2n)

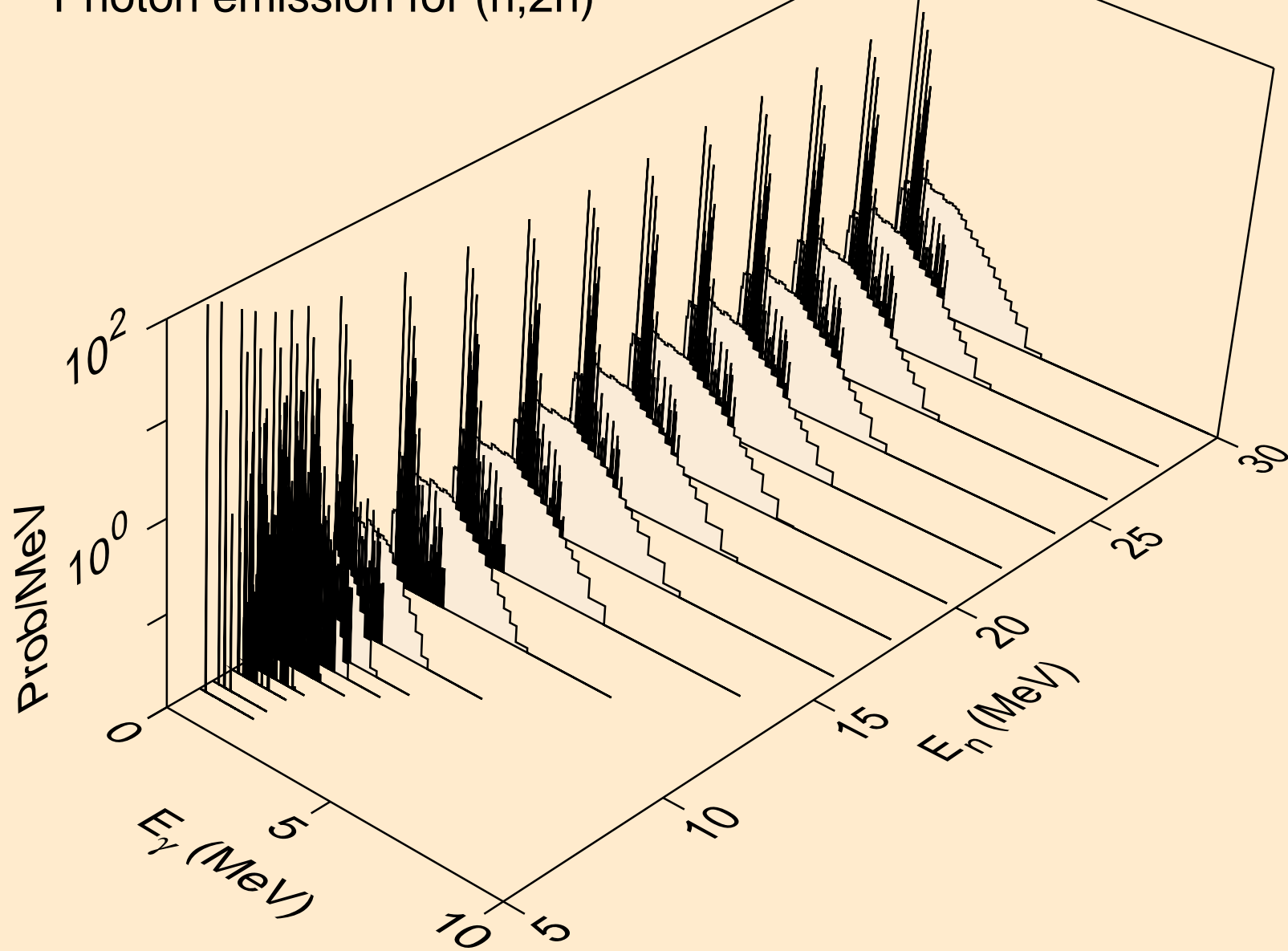

OS191M NEUTRON ACER TENDL-2024 LIBRARY; T=293.6K  
Photon emission for (n,3n)

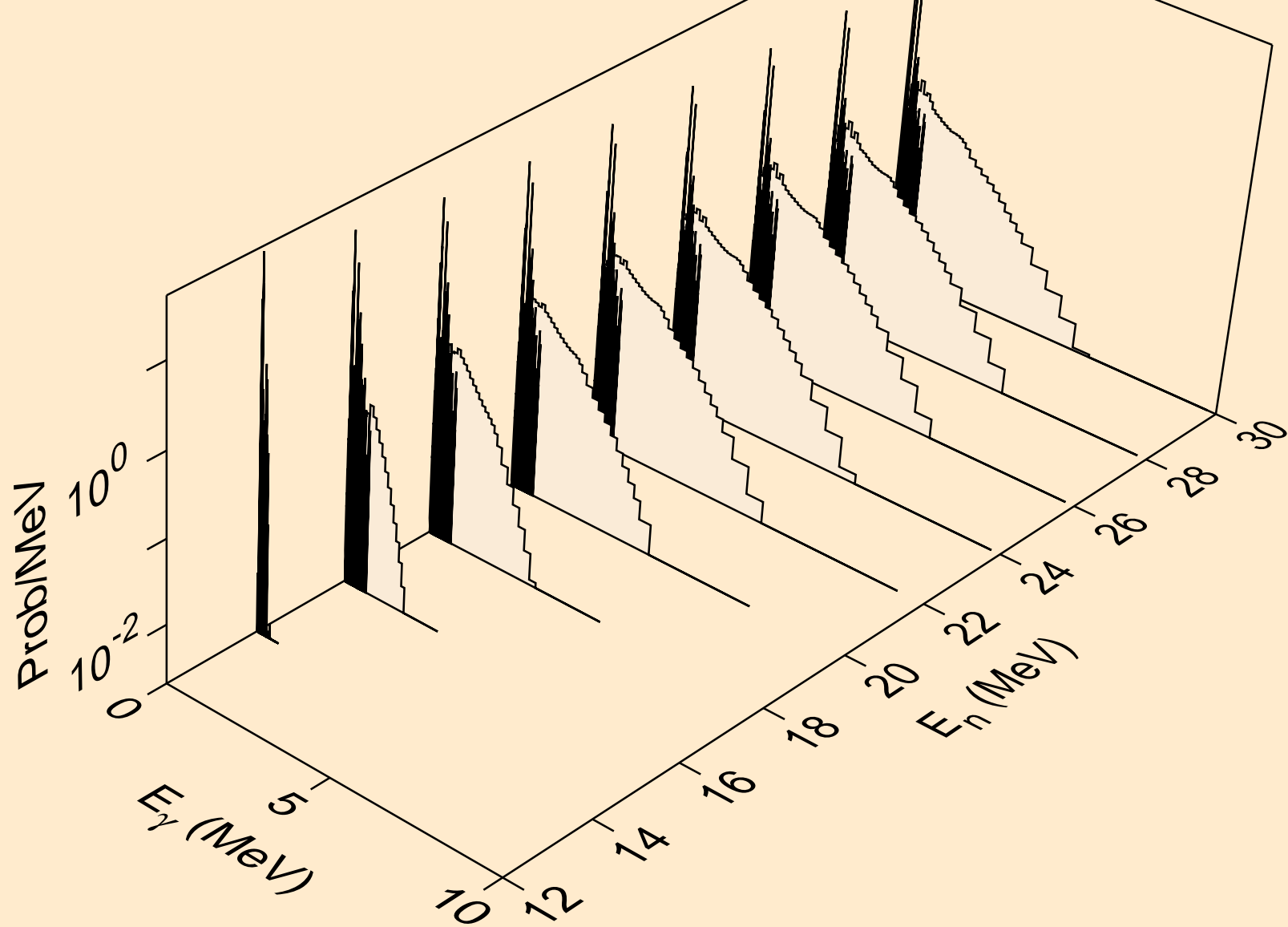

OS191M NEUTRON ACER TENDL-2024 LIBRARY; T=293.6K  
Photon emission for (n,n\*)a

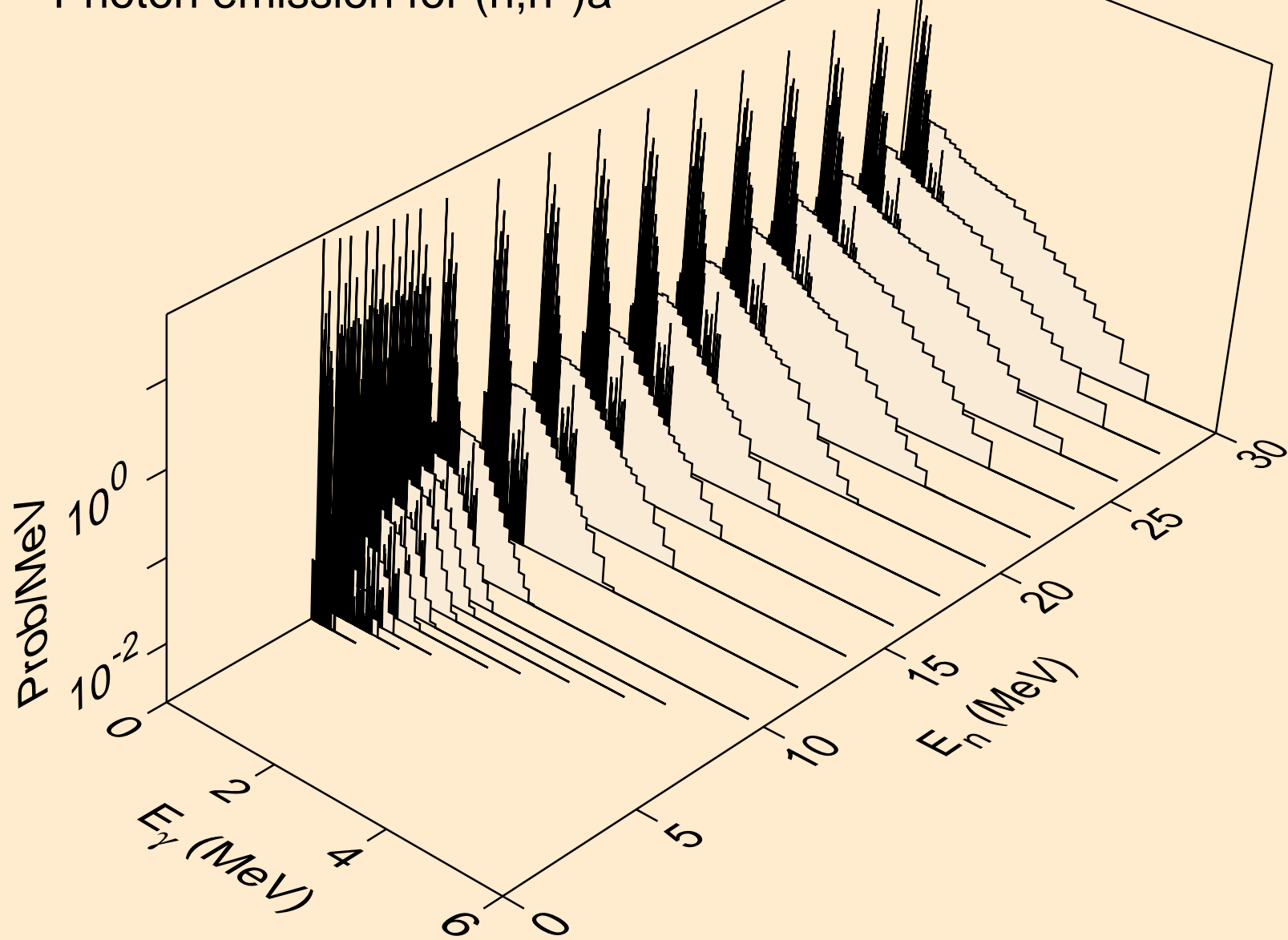

OS191M NEUTRON ACER TENDL-2024 LIBRARY; T=293.6K  
Photon emission for (n,2n)a

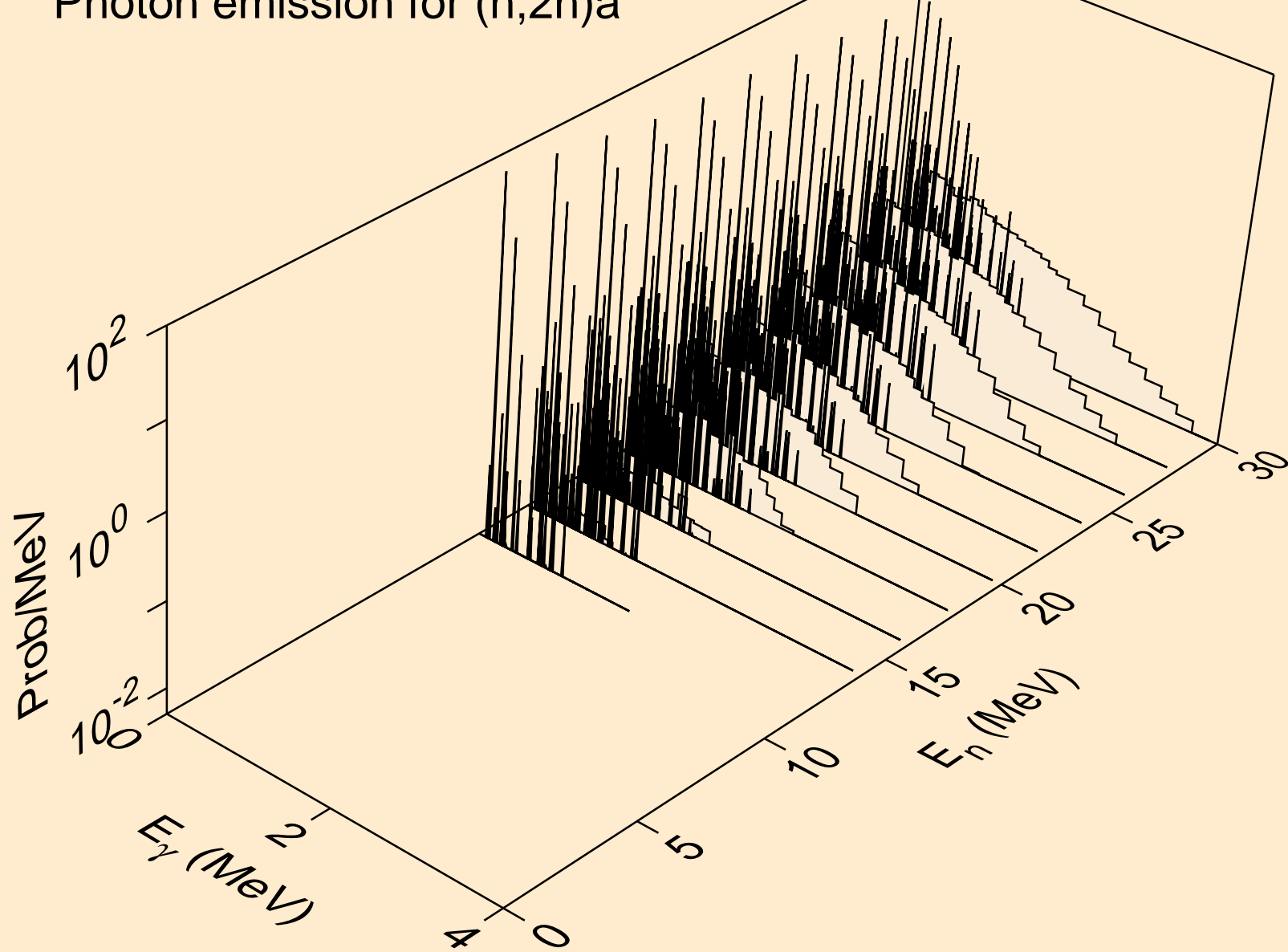

OS191M NEUTRON ACER TENDL-2024 LIBRARY; T=293.6K  
Photon emission for (n,3n)a

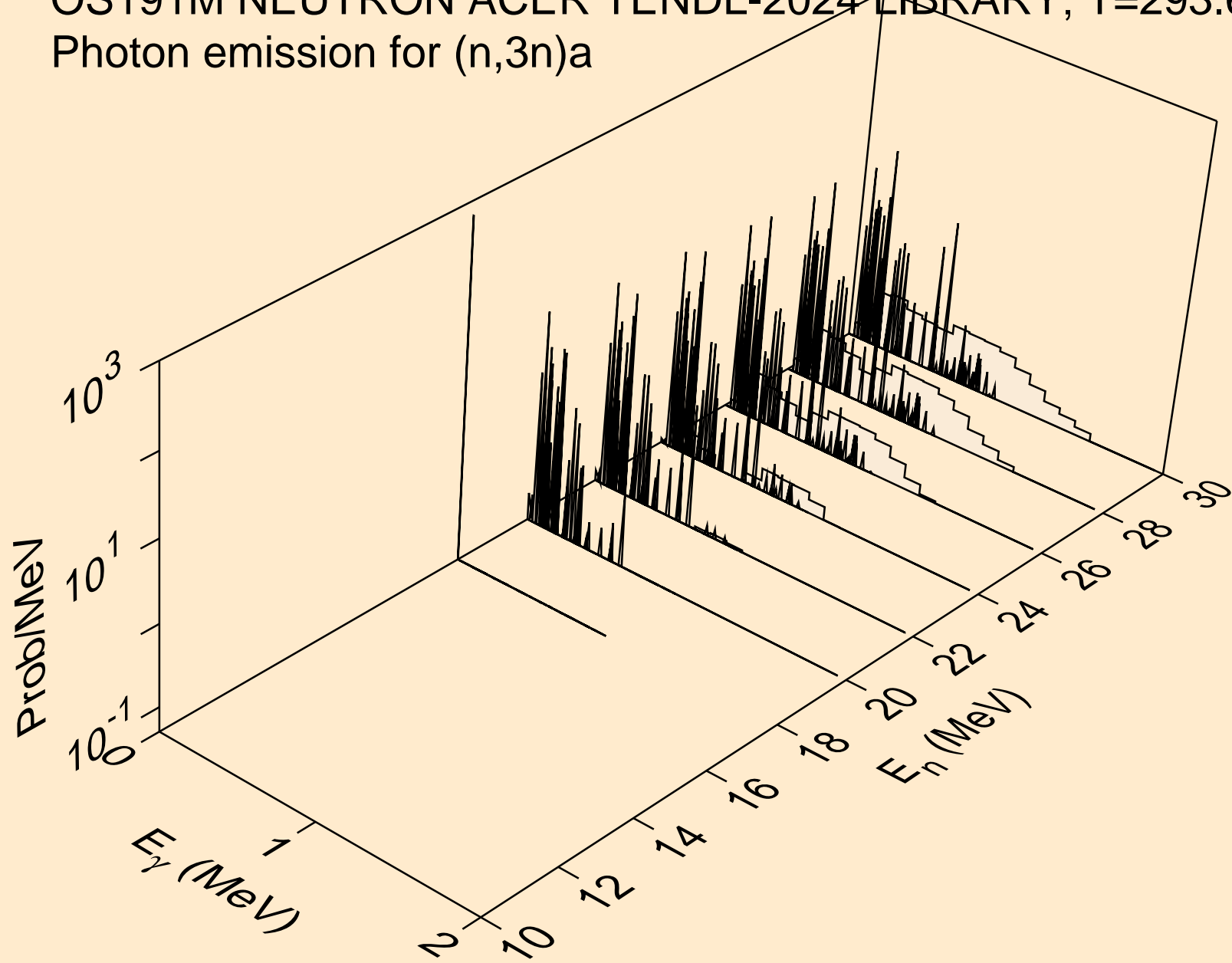

OS191M NEUTRON ACER TENDL-2024 LIBRARY; T=293.6K  
Photon emission for (n,n\*)p

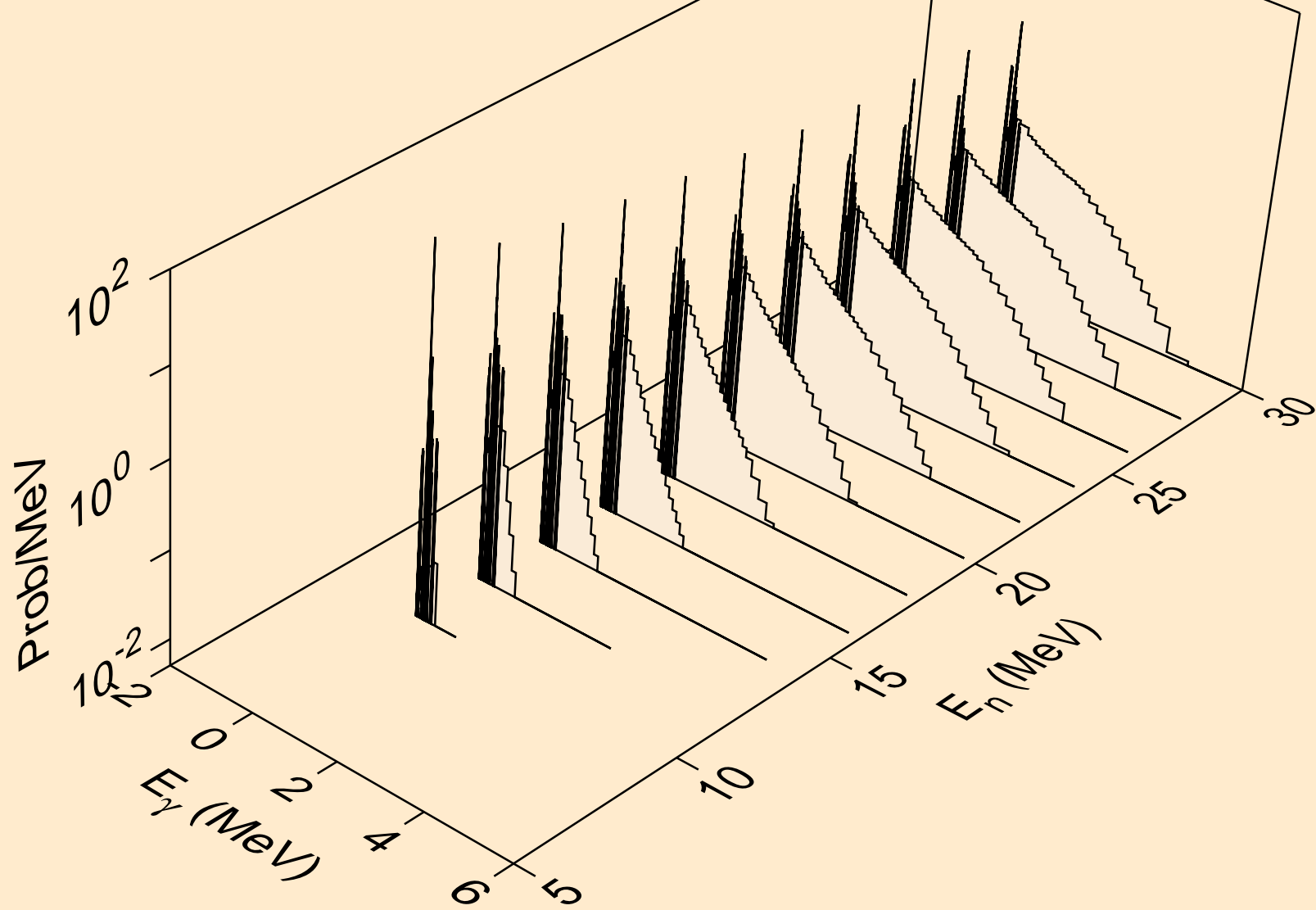

OS191M NEUTRON ACER TENDL-2024 LIBRARY; T=293.6K  
Photon emission for (n,n\*)d

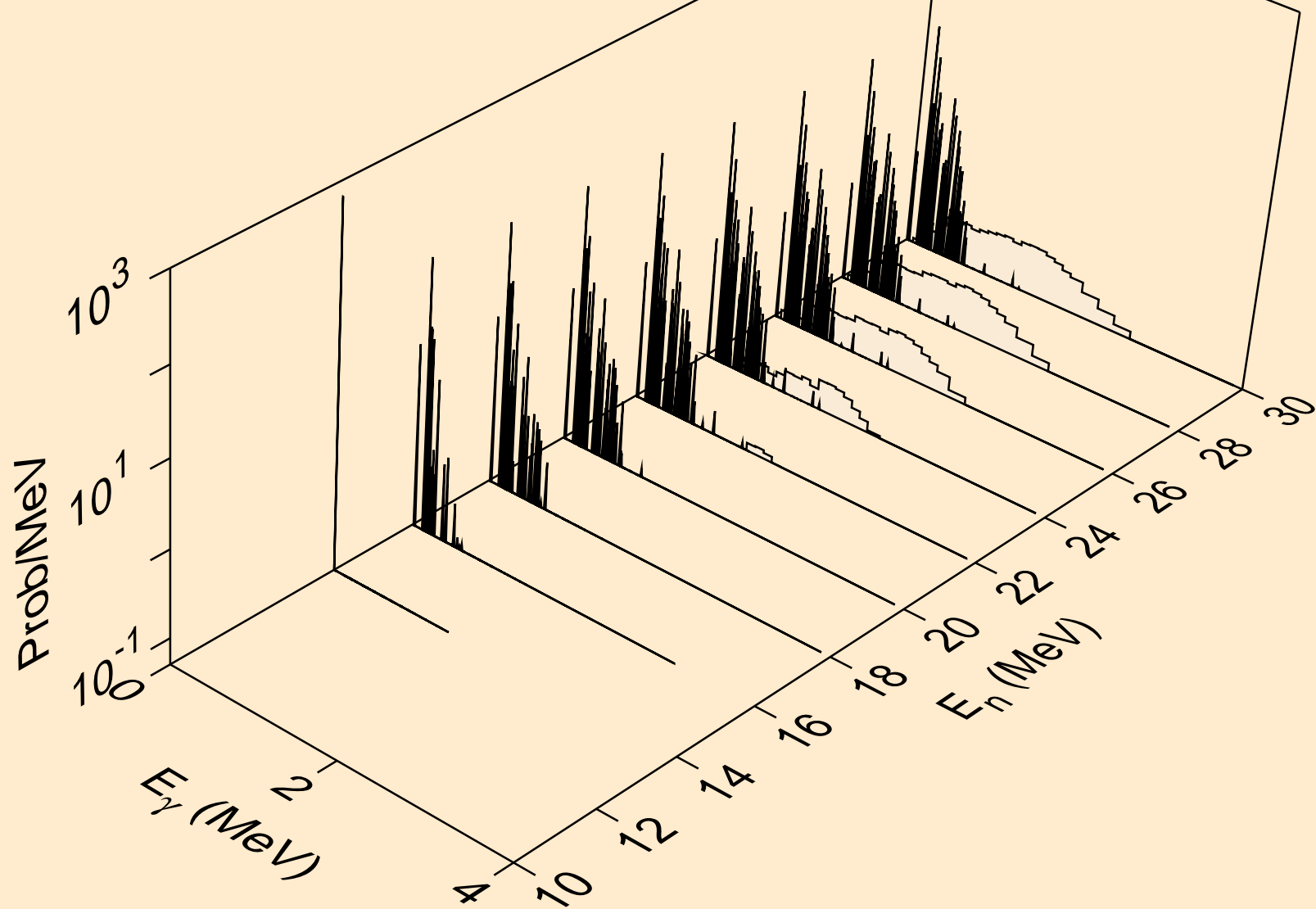

OS191M NEUTRON ACER TENDL-2024 LIBRARY; T=293.6K  
Photon emission for (n,n\*)t

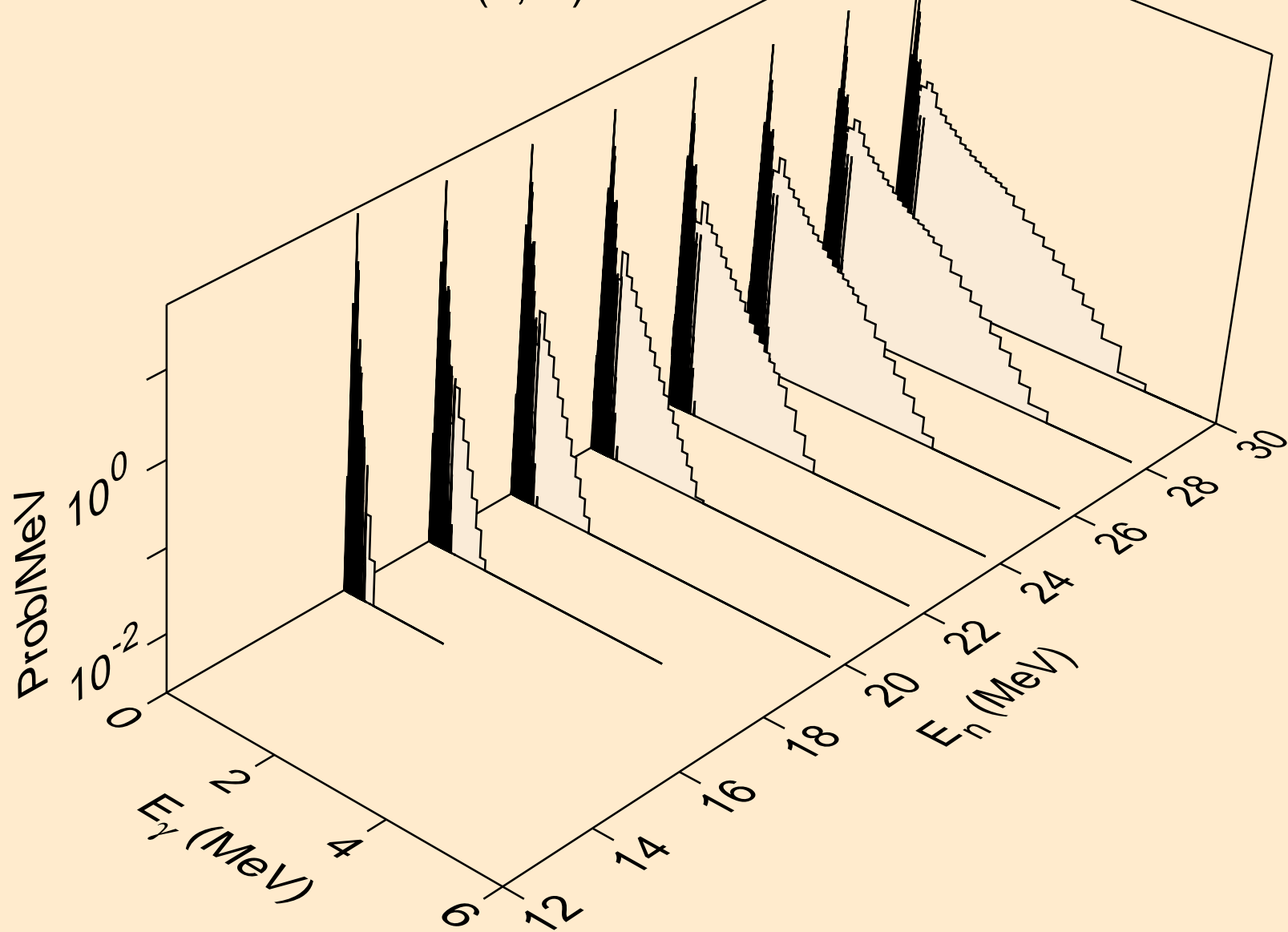

OS191M NEUTRON ACER TENDL-2024 LIBRARY; T=293.6K  
Photon emission for (n,n\*)he3

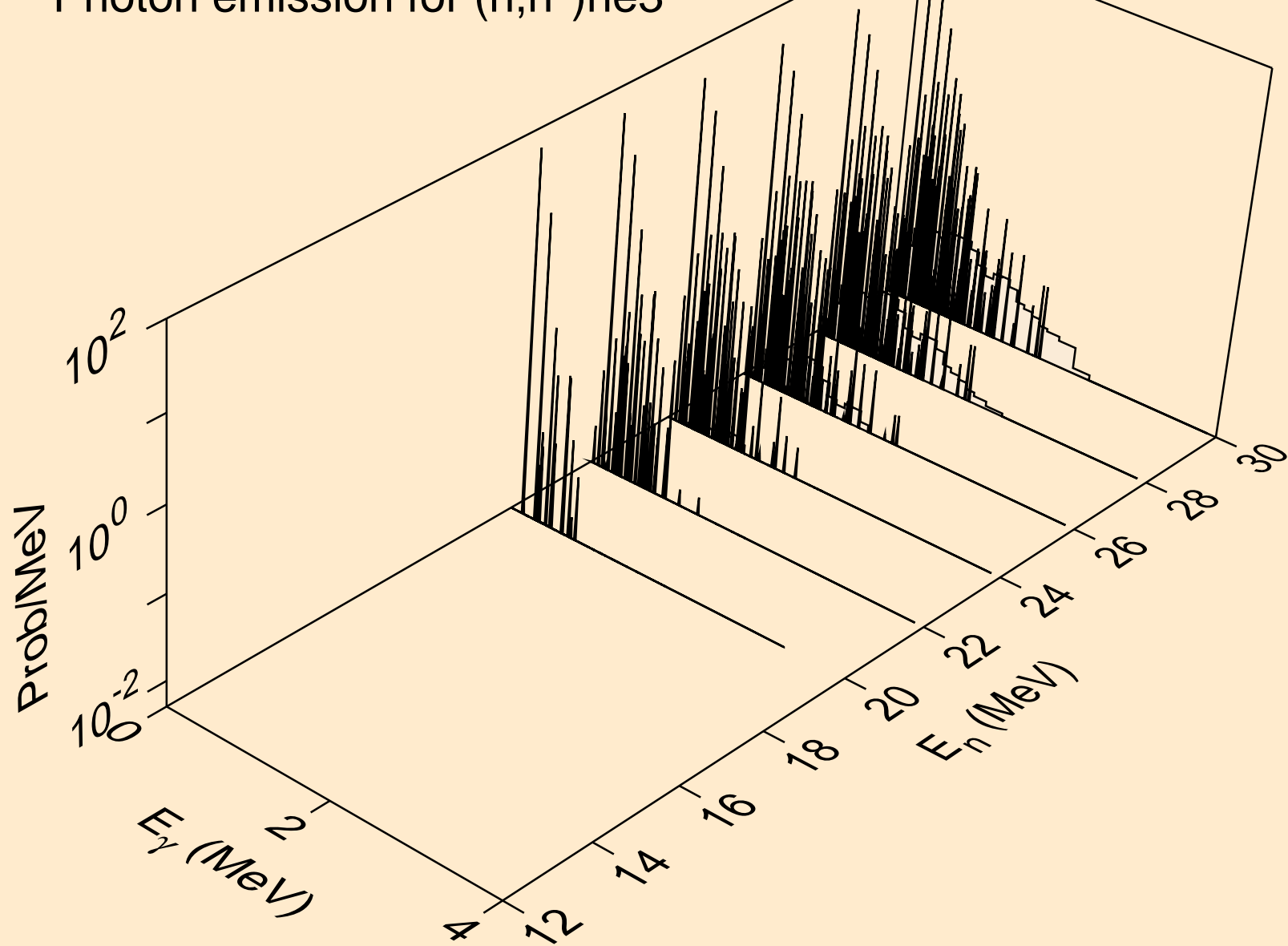

OS191M NEUTRON ACER TENDL-2024 LIBRARY; T=293.6K  
Photon emission for (n,4n)

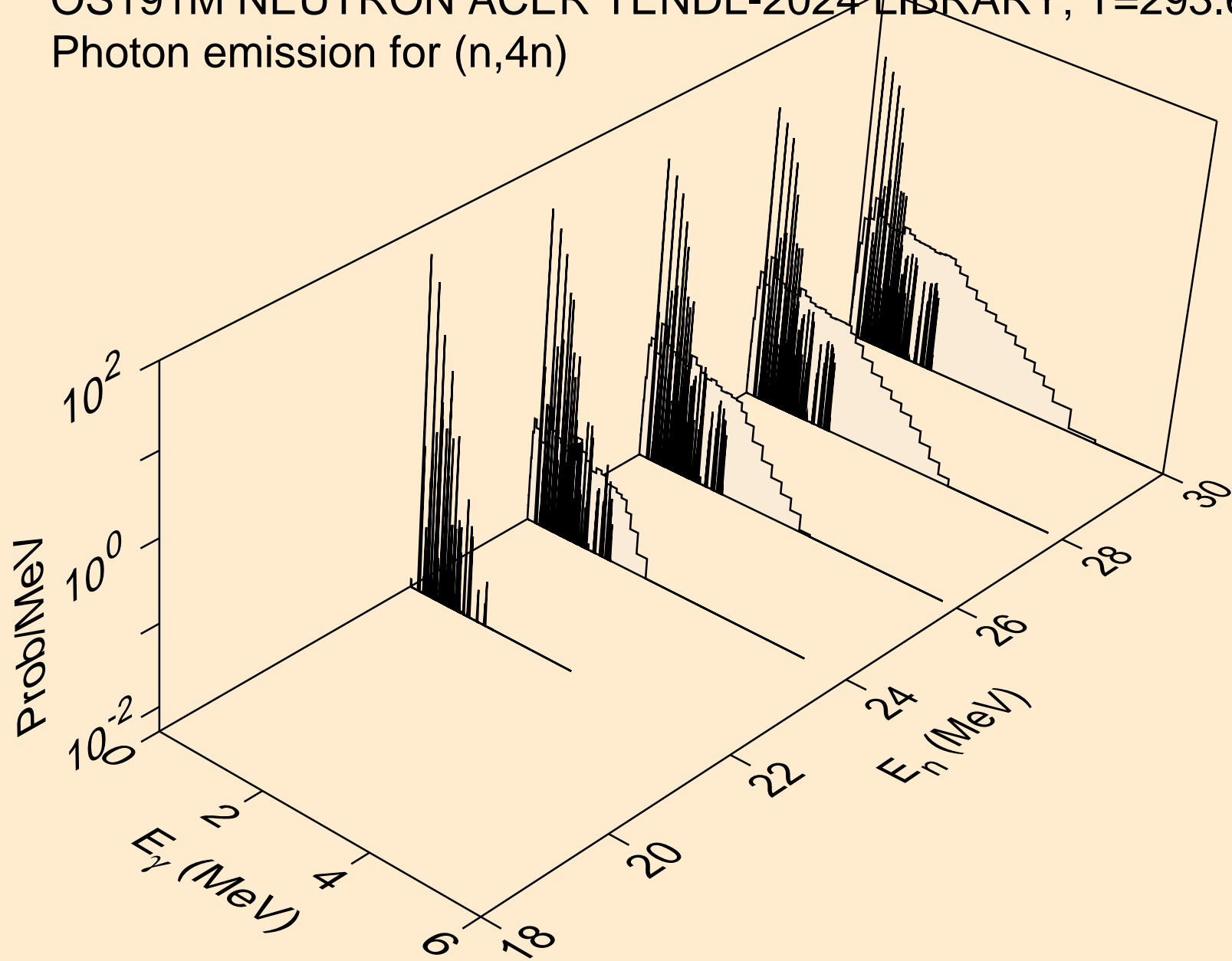

OS191M NEUTRON ACER TENDL-2024 LIBRARY; T=293.6K  
Photon emission for (n,2np)

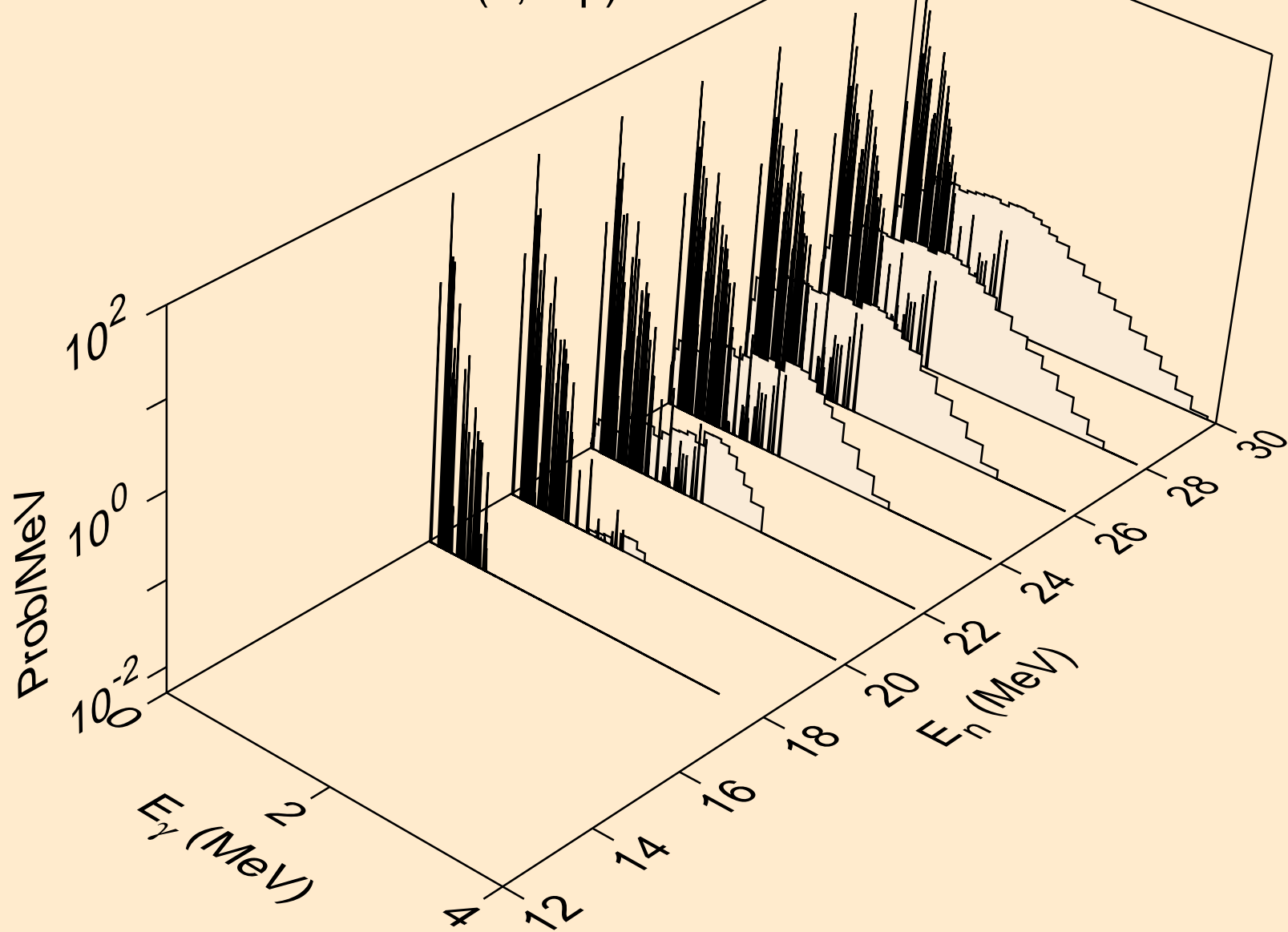

OS191M NEUTRON ACER TENDL-2024 LIBRARY; T=293.6K  
Photon emission for (n,3np)

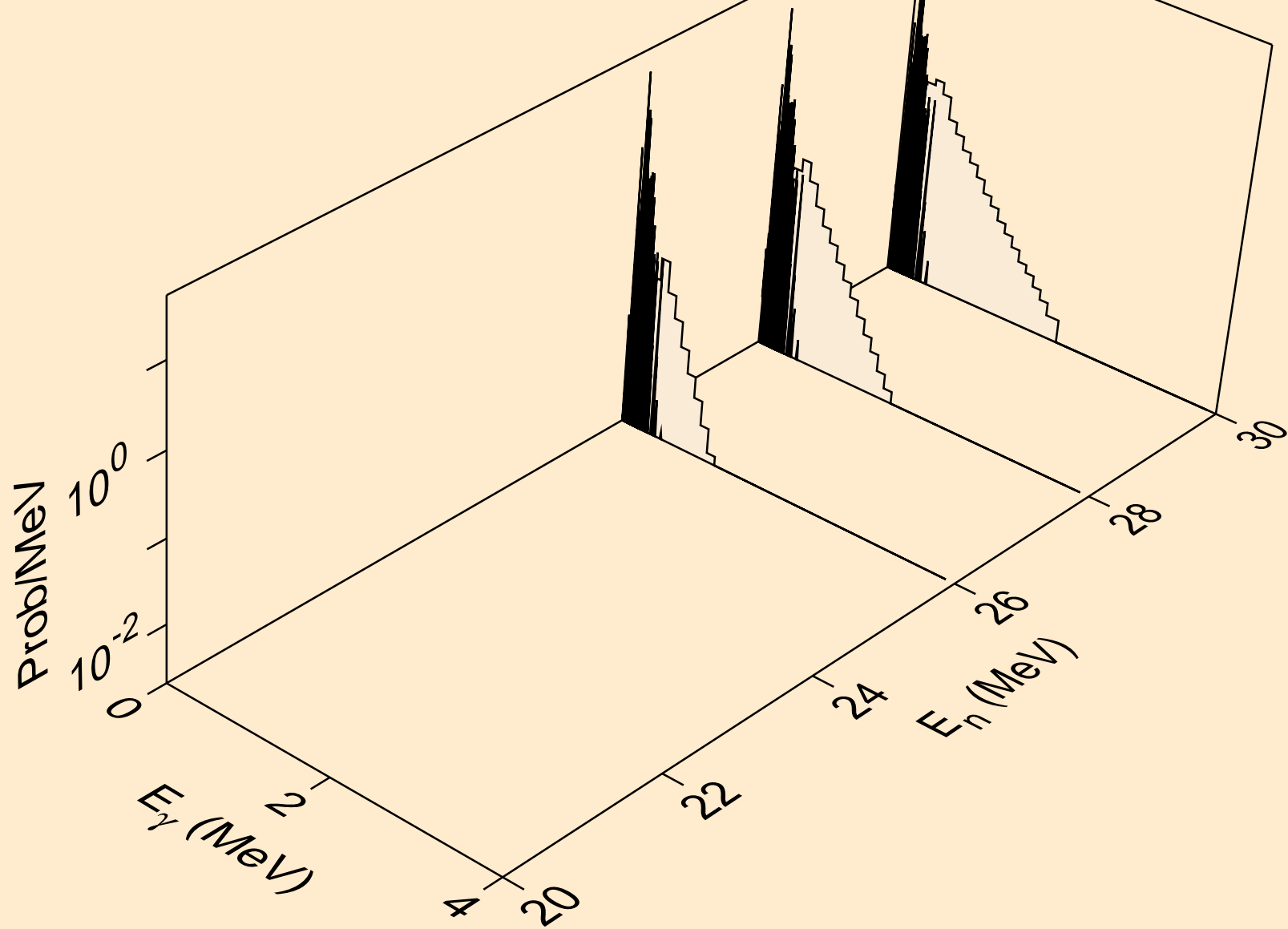

OS191M NEUTRON ACER TENDL-2024 LIBRARY; T=293.6K  
Photon emission for (n,n2p)

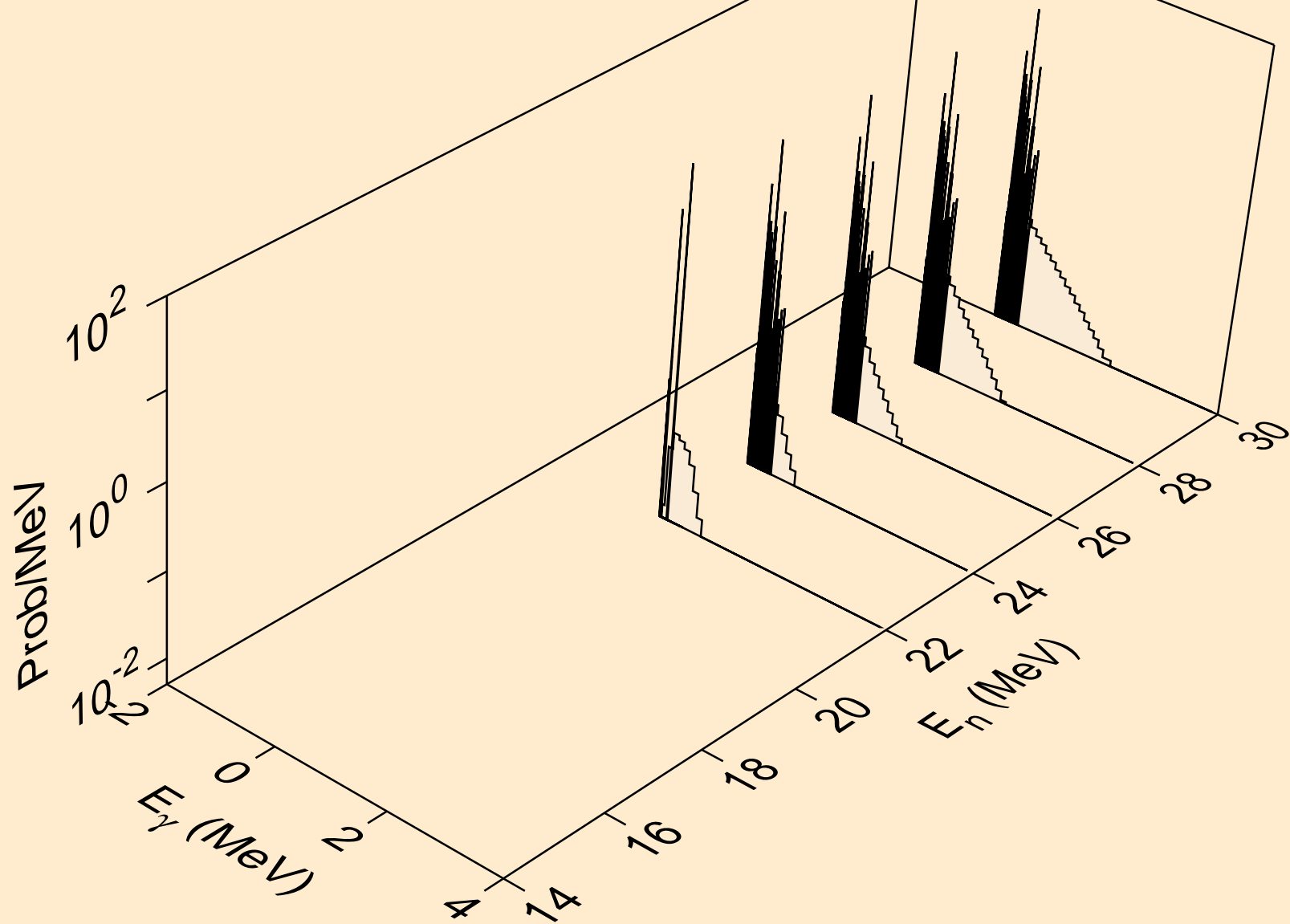

OS191M NEUTRON ACER TENDL-2024 LIBRARY; T=293.6K  
Photon emission for (n,n\*2)

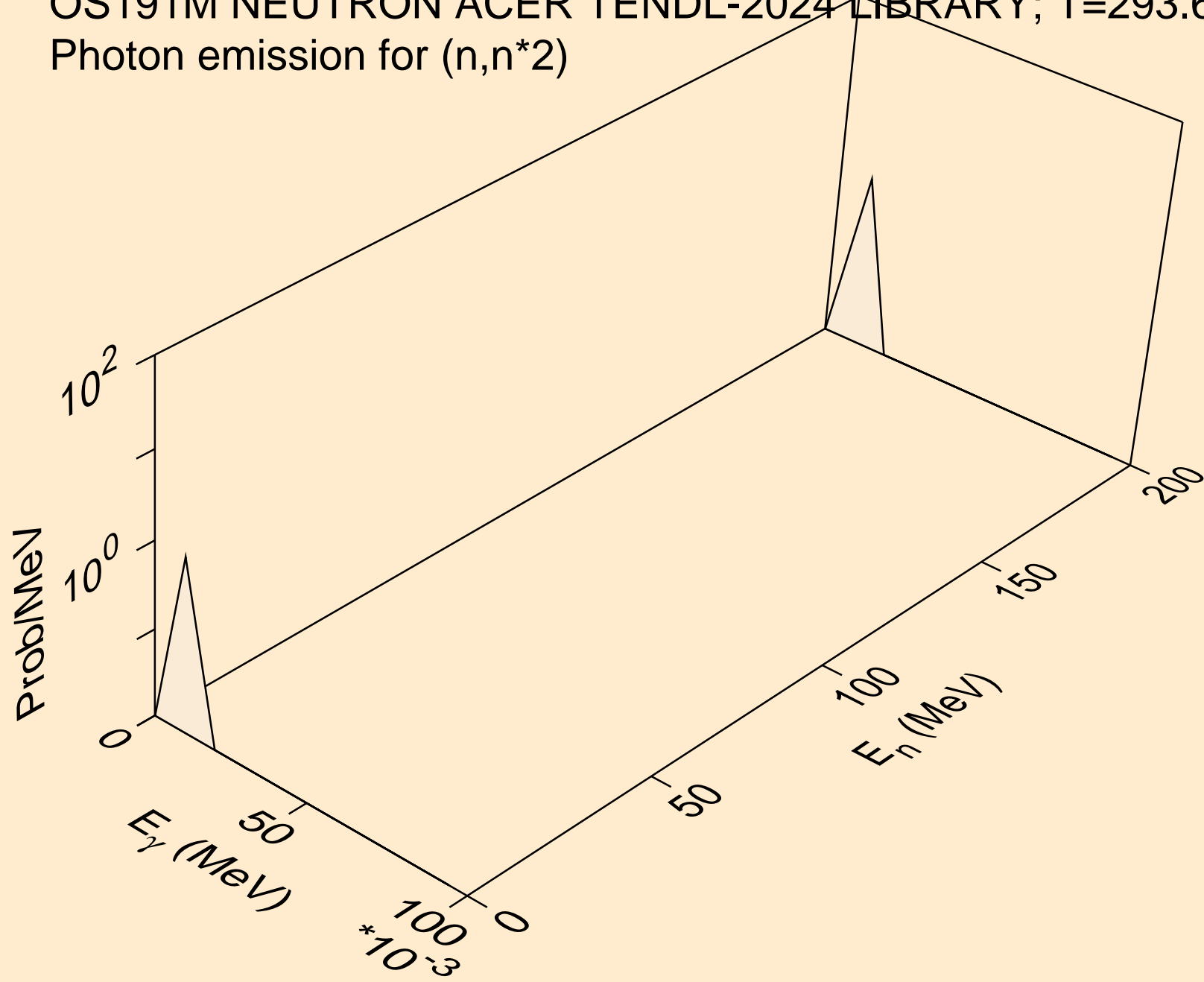

OS191M NEUTRON ACER TENDL-2024 LIBRARY; T=293.6K  
Photon emission for (n,n\*3)

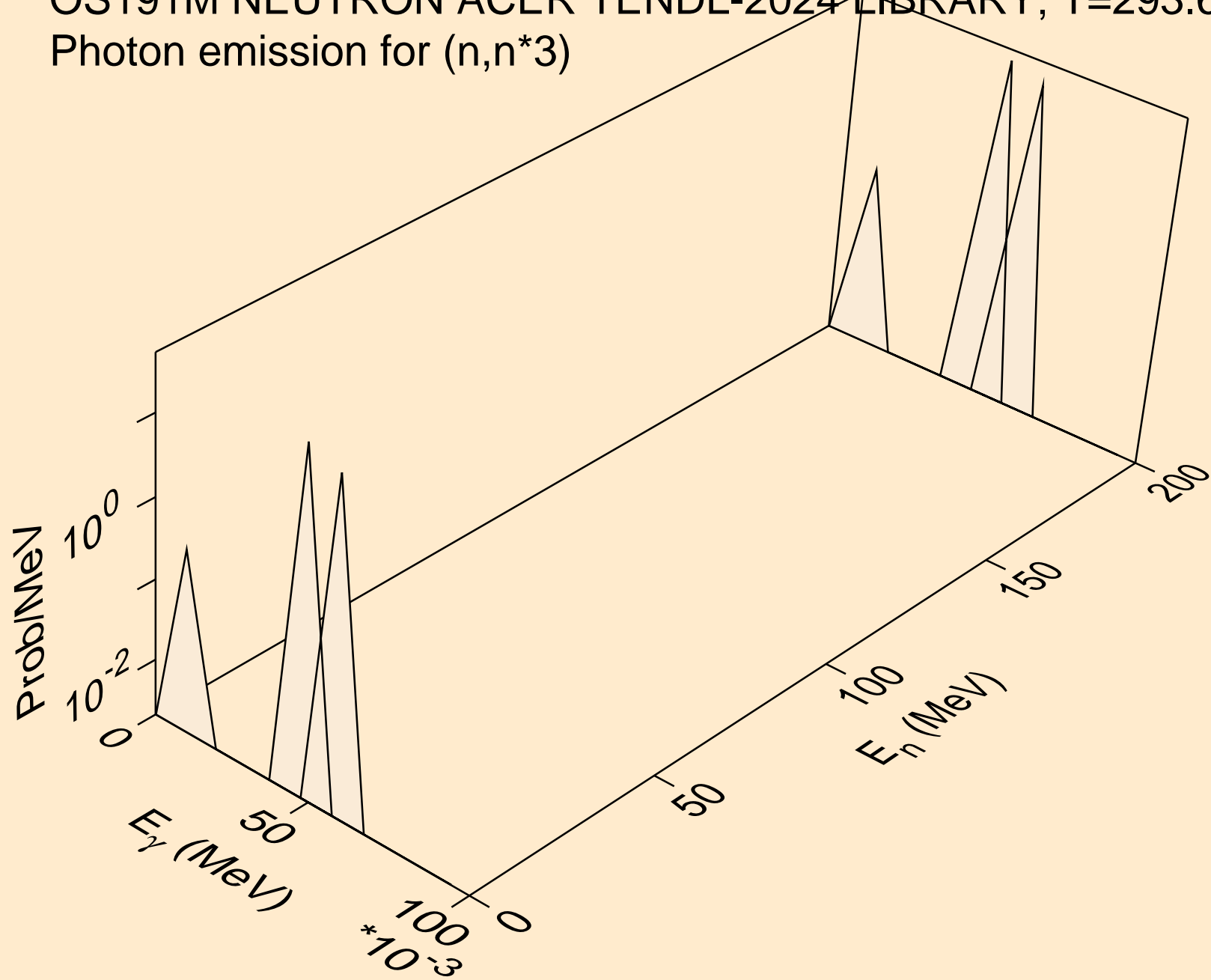

OS191M NEUTRON ACER TENDL-2024 LIBRARY; T=293.6K  
Photon emission for (n,n\*4)

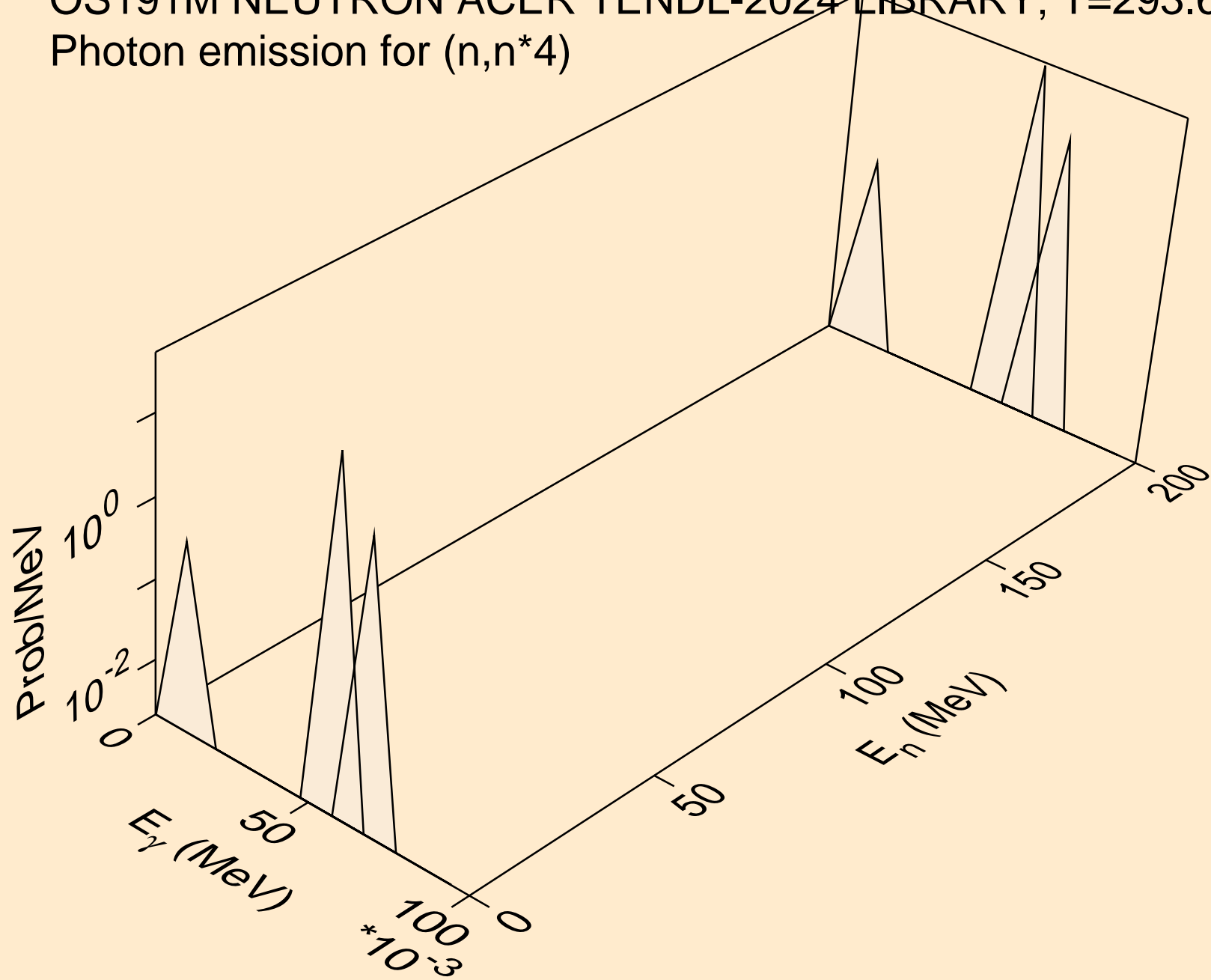

OS191M NEUTRON ACER TENDL-2024 LIBRARY; T=293.6K  
Photon emission for (n,n\*5)

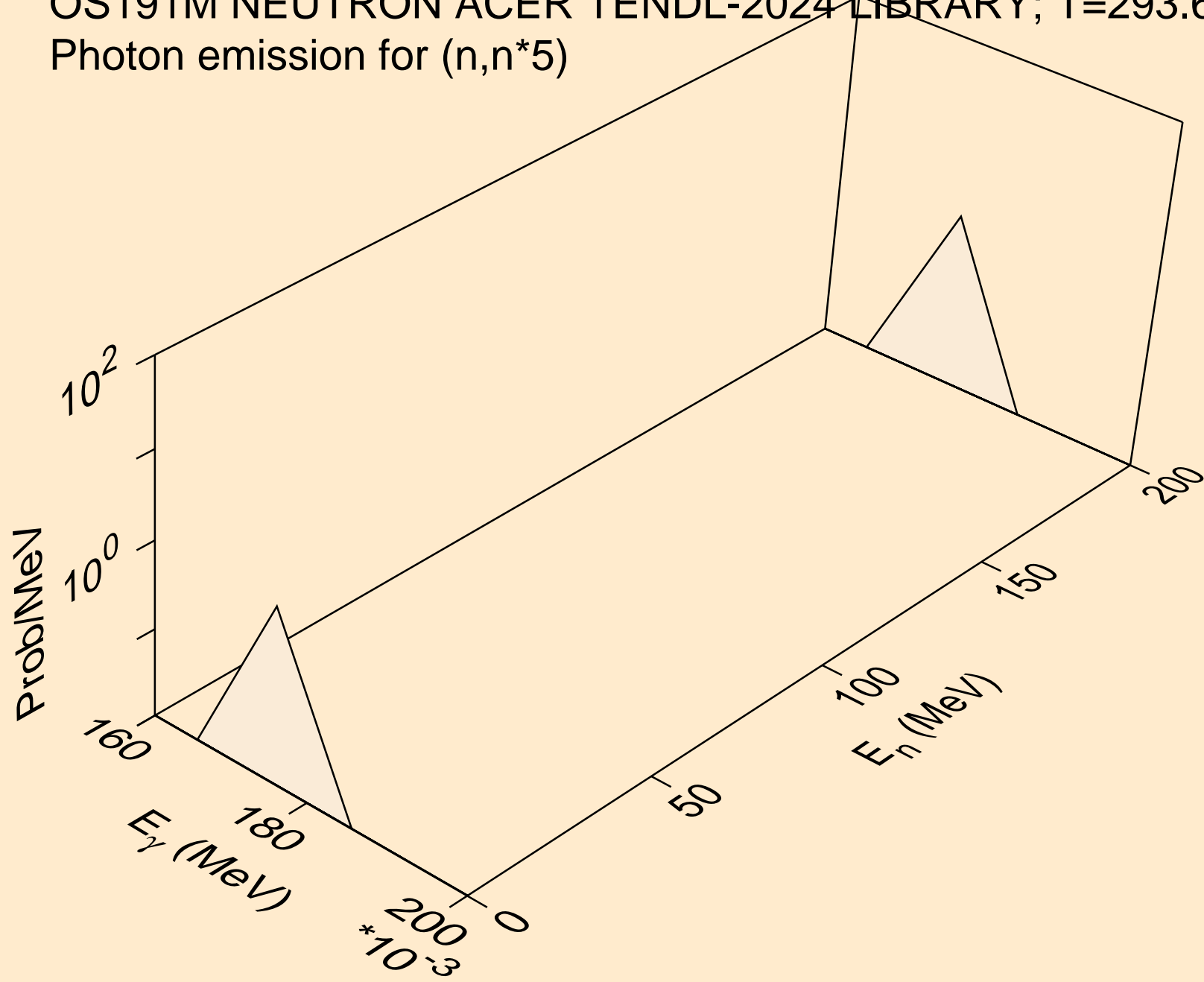

OS191M NEUTRON ACER TENDL-2024 LIBRARY; T=293.6K  
Photon emission for (n,n\*6)

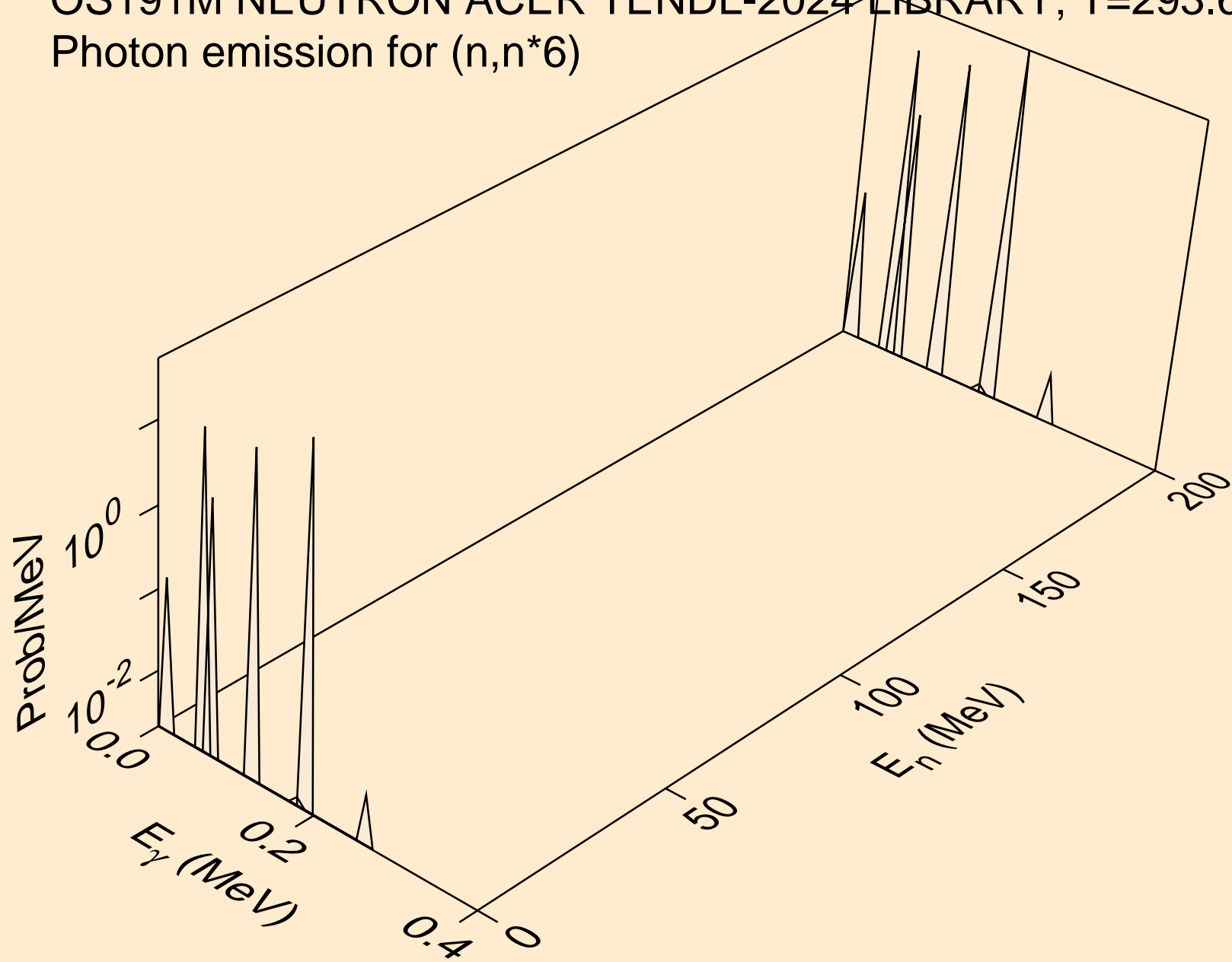

OS191M NEUTRON ACER TENDL-2024 LIBRARY; T=293.6K  
Photon emission for (n,n\*7)

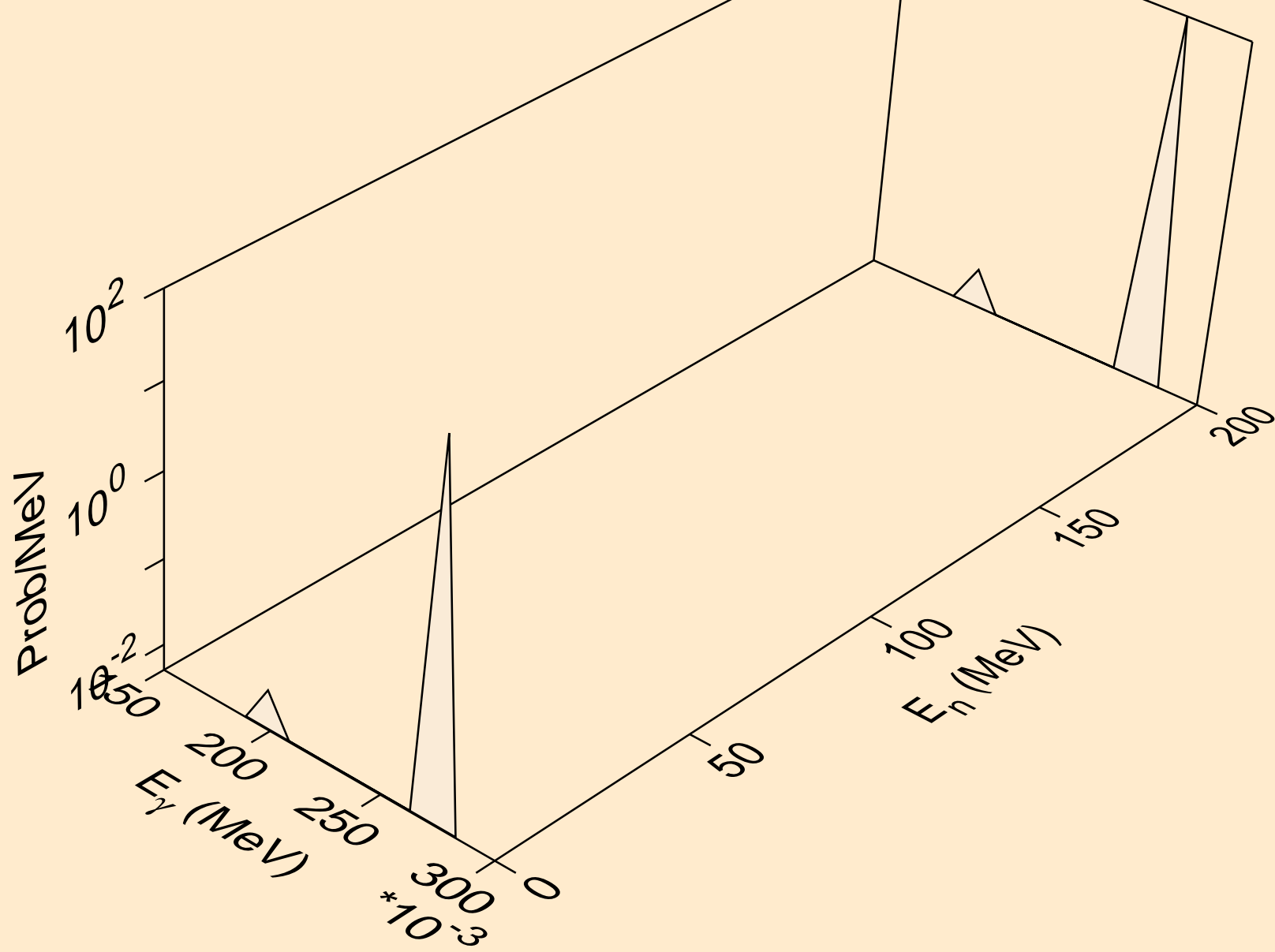

OS191M NEUTRON ACER TENDL-2024 LIBRARY; T=293.6K  
Photon emission for (n,n\*8)

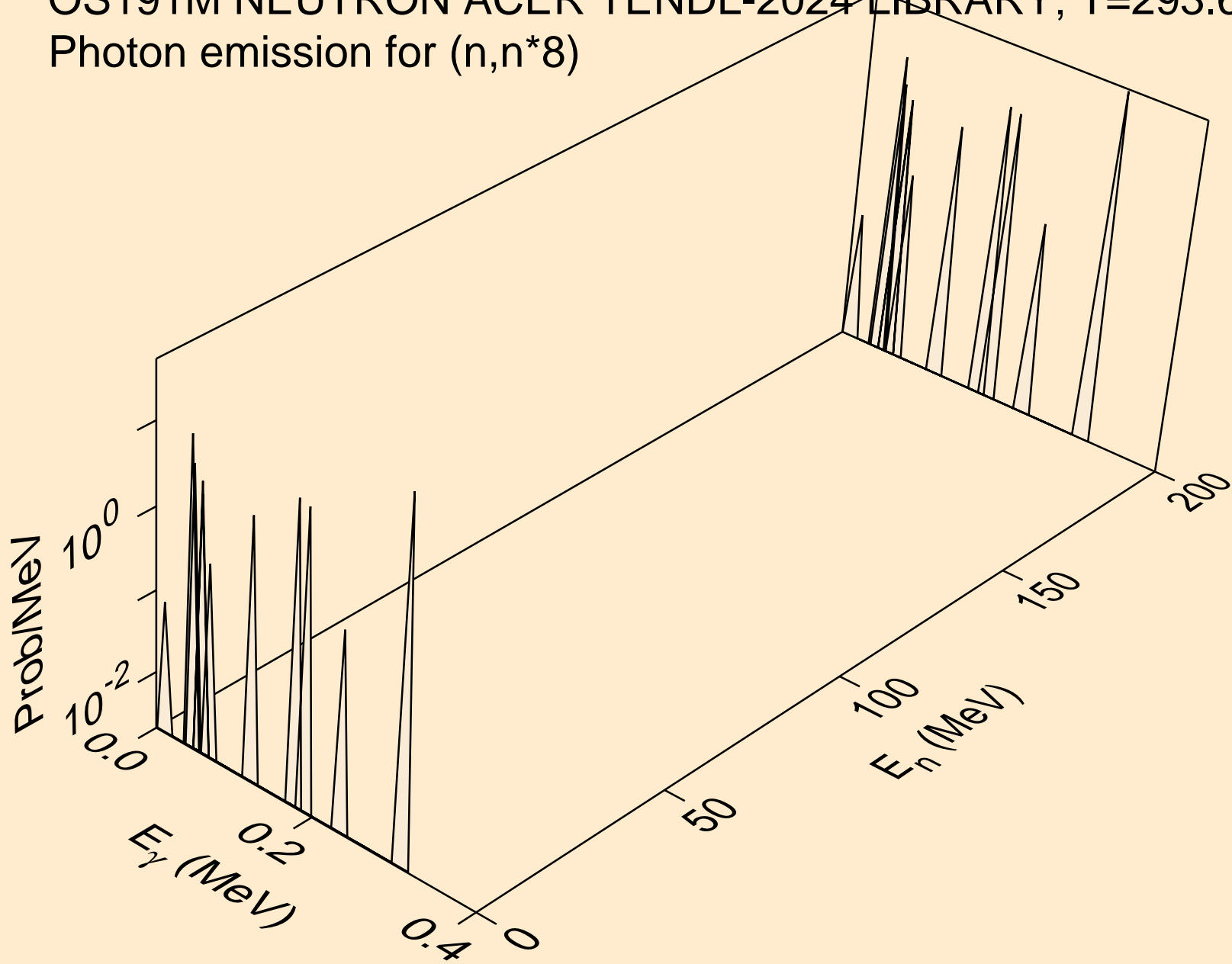

OS191M NEUTRON ACER TENDL-2024 LIBRARY; T=293.6K  
Photon emission for (n,n\*9)

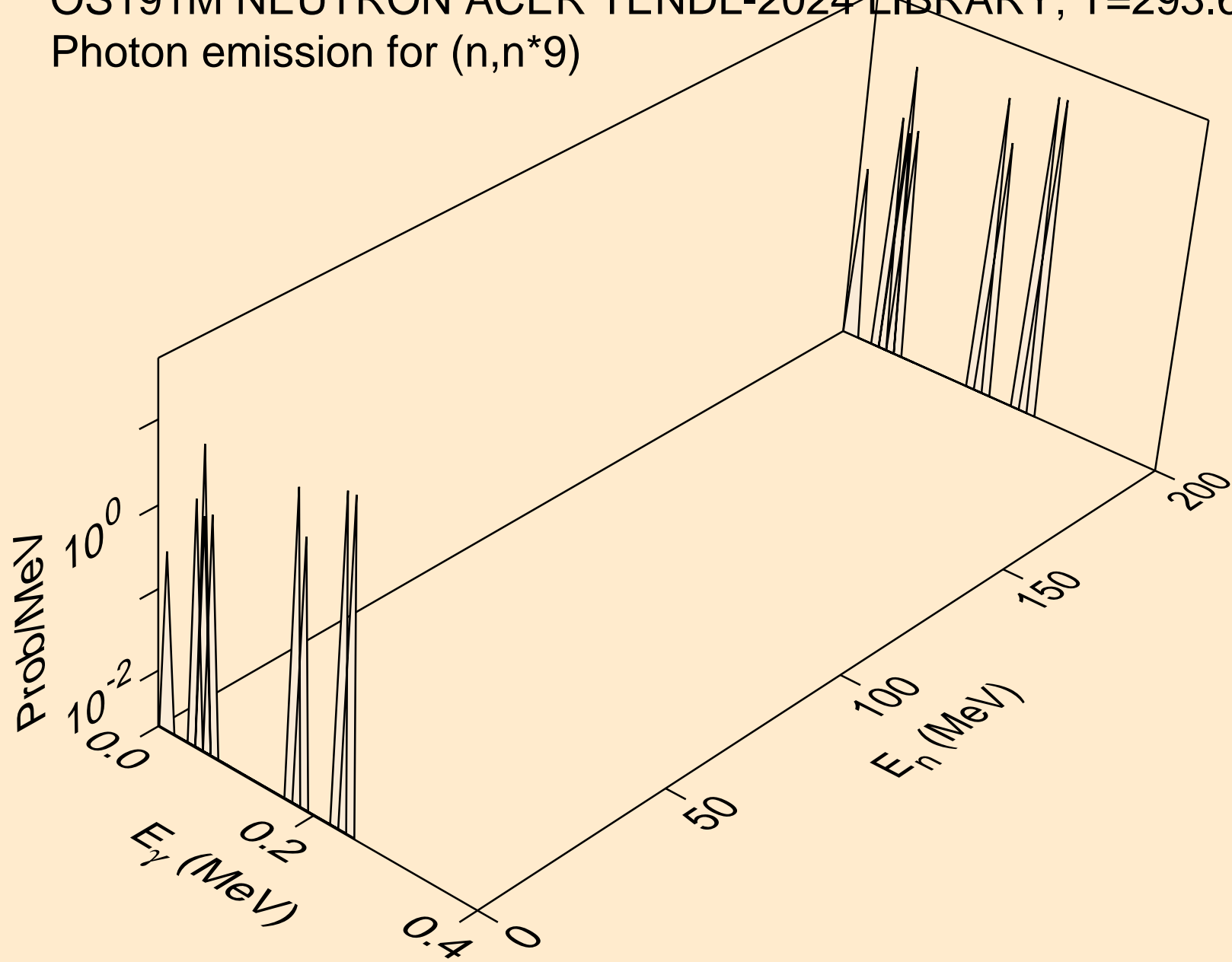

OS191M NEUTRON ACER TENDL-2024 LIBRARY; T=293.6K  
Photon emission for (n,n\*10)

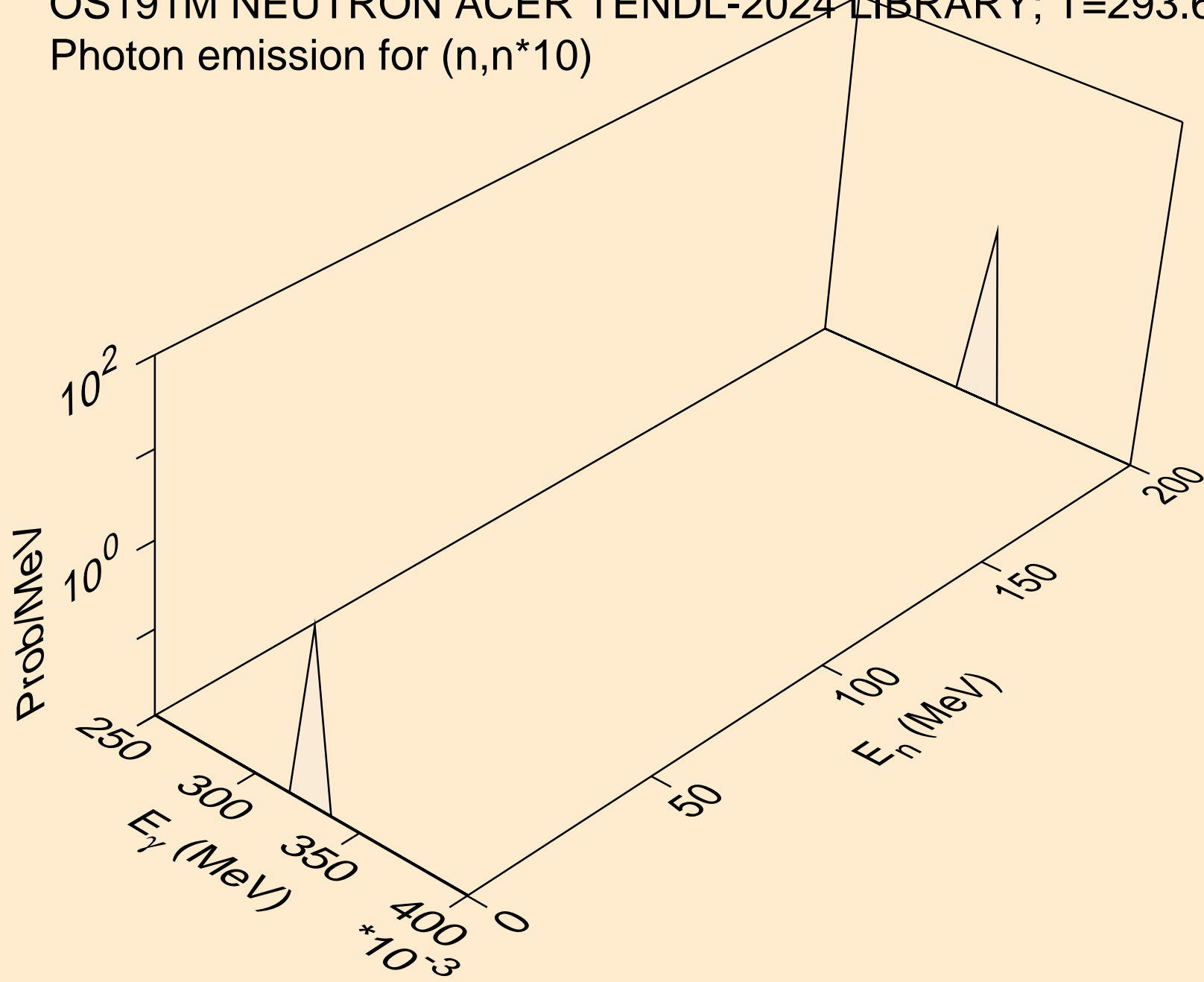

OS191M NEUTRON ACER TENDL-2024 LIBRARY; T=293.6K  
Photon emission for (n,n\*11)

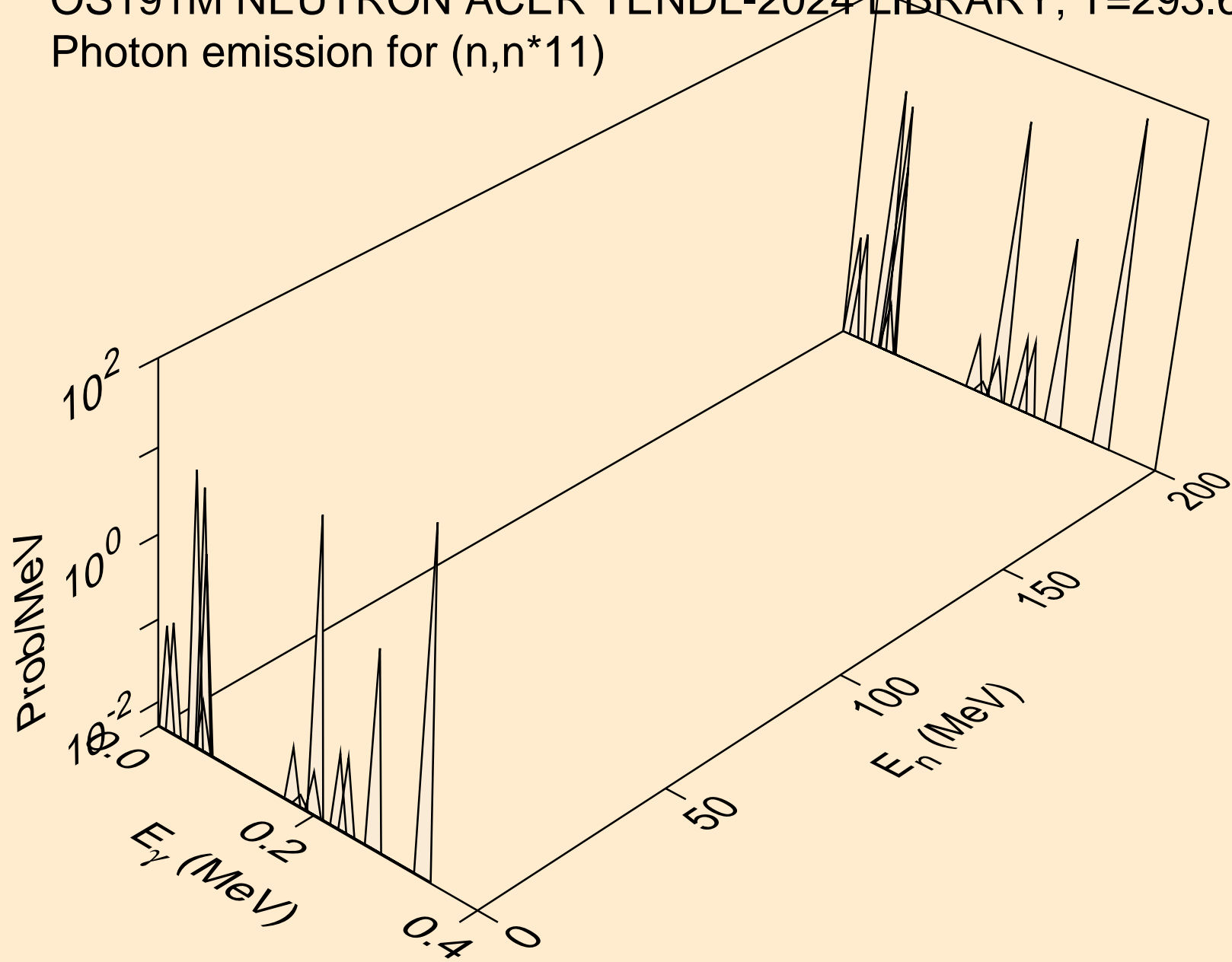

OS191M NEUTRON ACER TENDL-2024 LIBRARY; T=293.6K  
Photon emission for (n,n\*12)

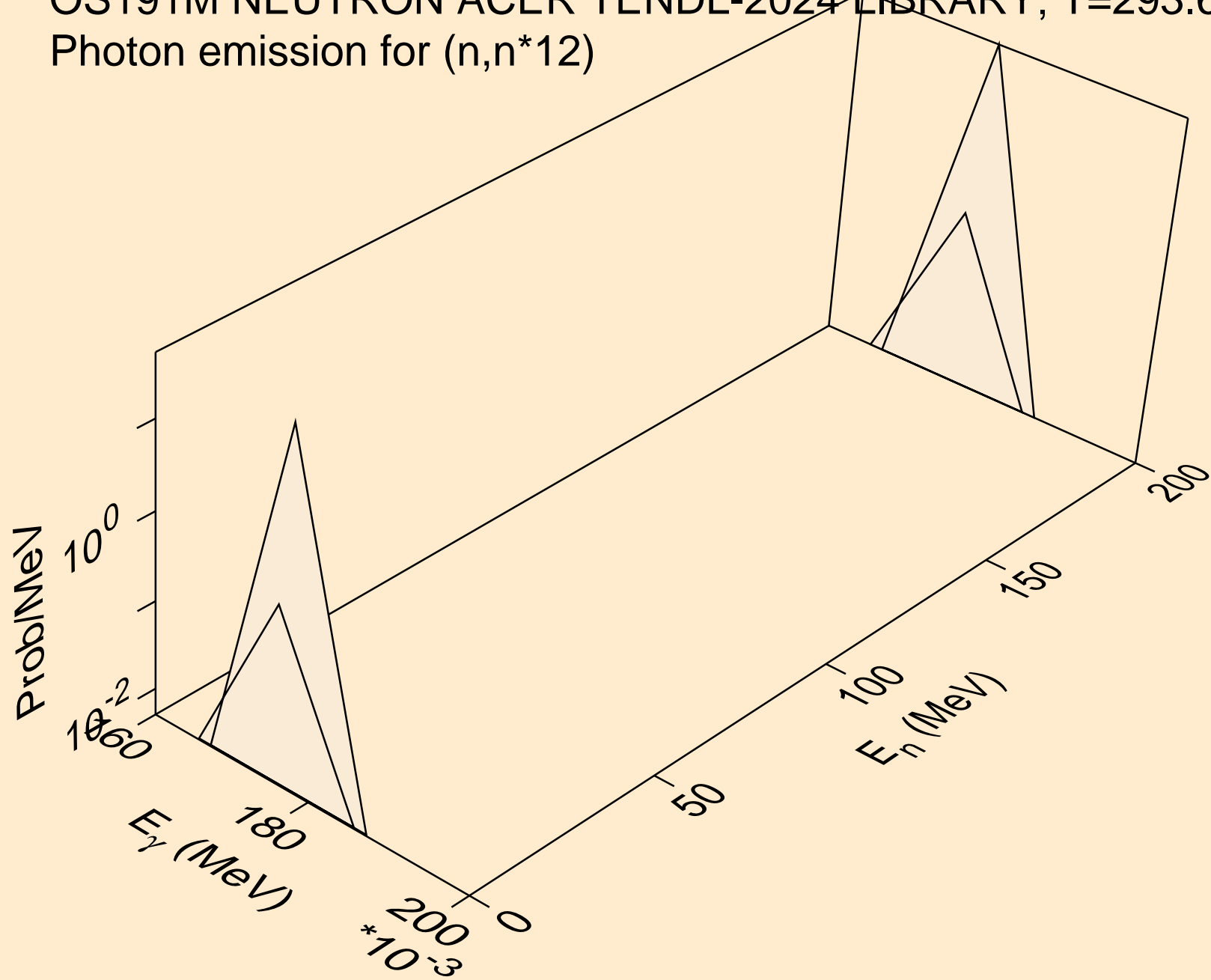

OS191M NEUTRON ACER TENDL-2024 LIBRARY; T=293.6K  
Photon emission for (n,n\*13)

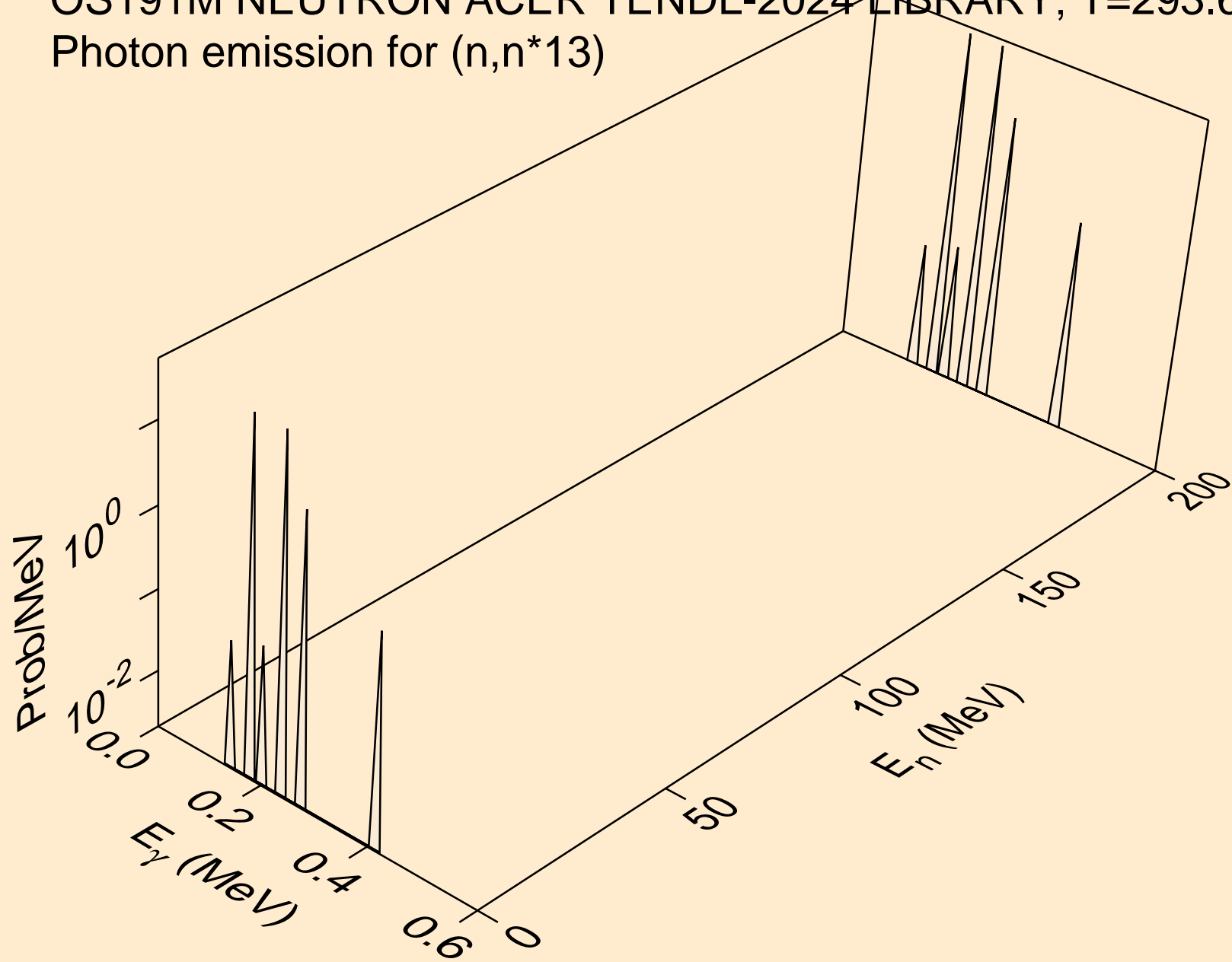

OS191M NEUTRON ACER TENDL-2024 LIBRARY; T=293.6K  
Photon emission for (n,n\*14)

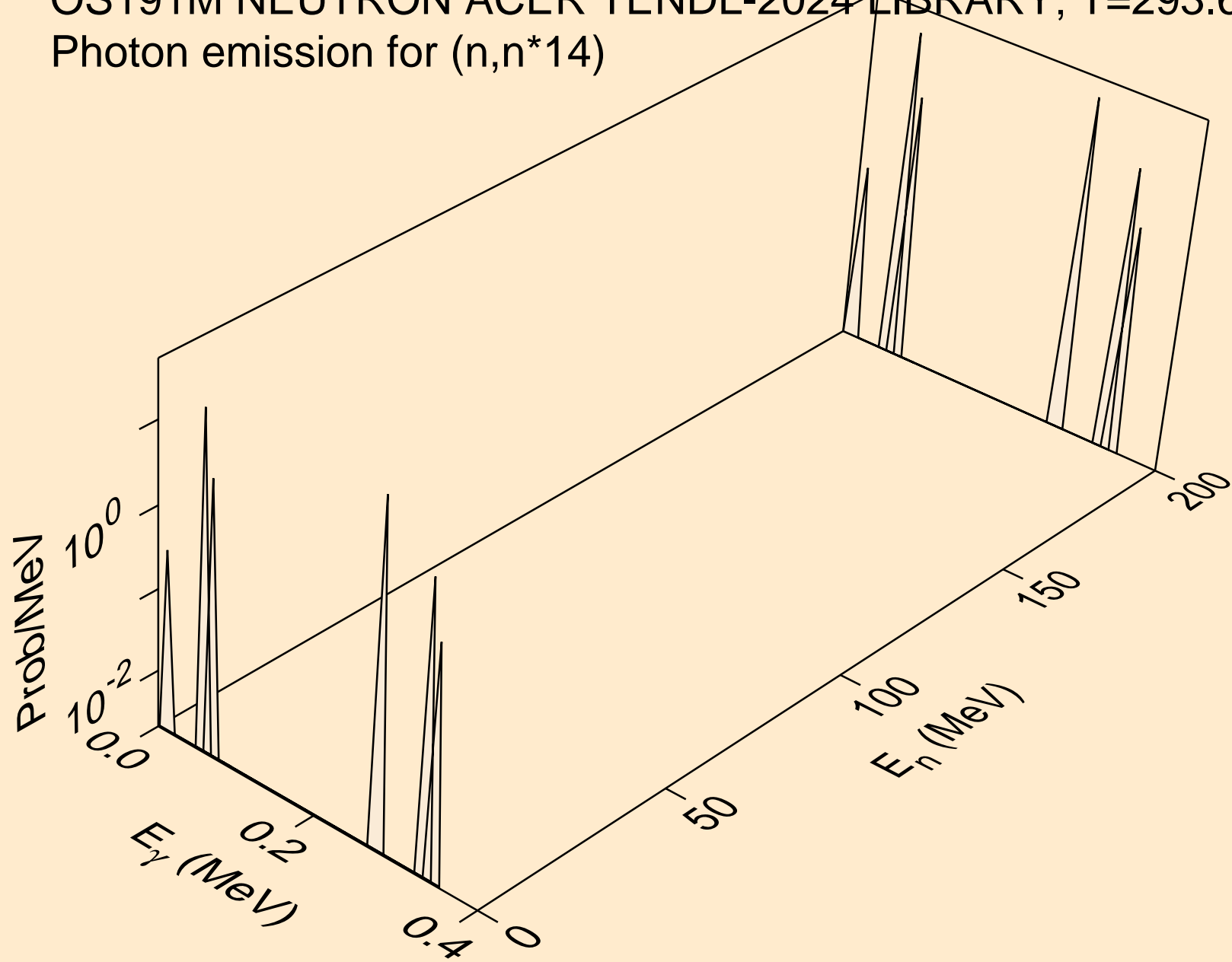

OS191M NEUTRON ACER TENDL-2024 LIBRARY; T=293.6K  
Photon emission for (n,n\*15)

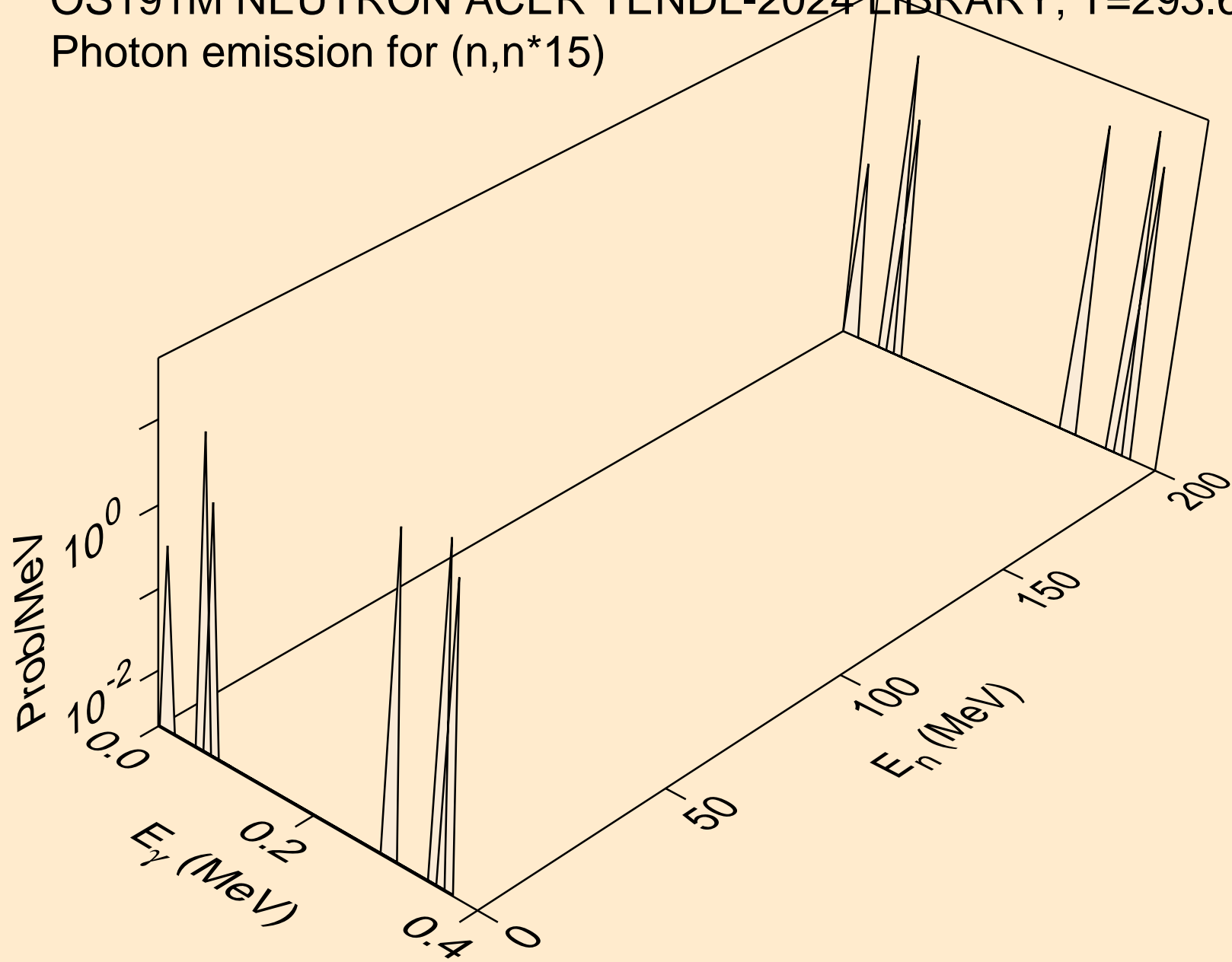

OS191M NEUTRON ACER TENDL-2024 LIBRARY; T=293.6K  
Photon emission for (n,n\*16)

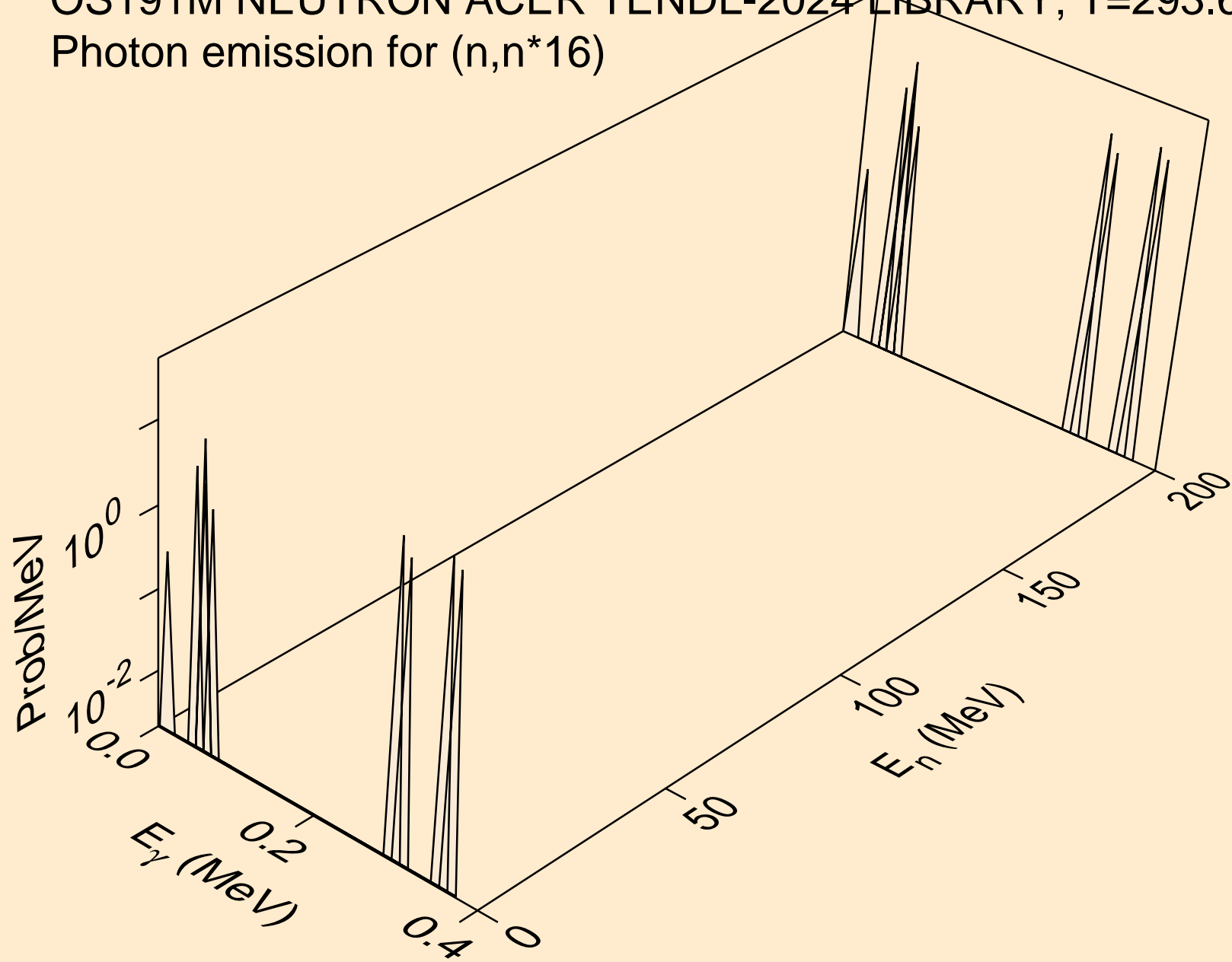

OS191M NEUTRON ACER TENDL-2024 LIBRARY; T=293.6K  
Photon emission for (n,n\*17)

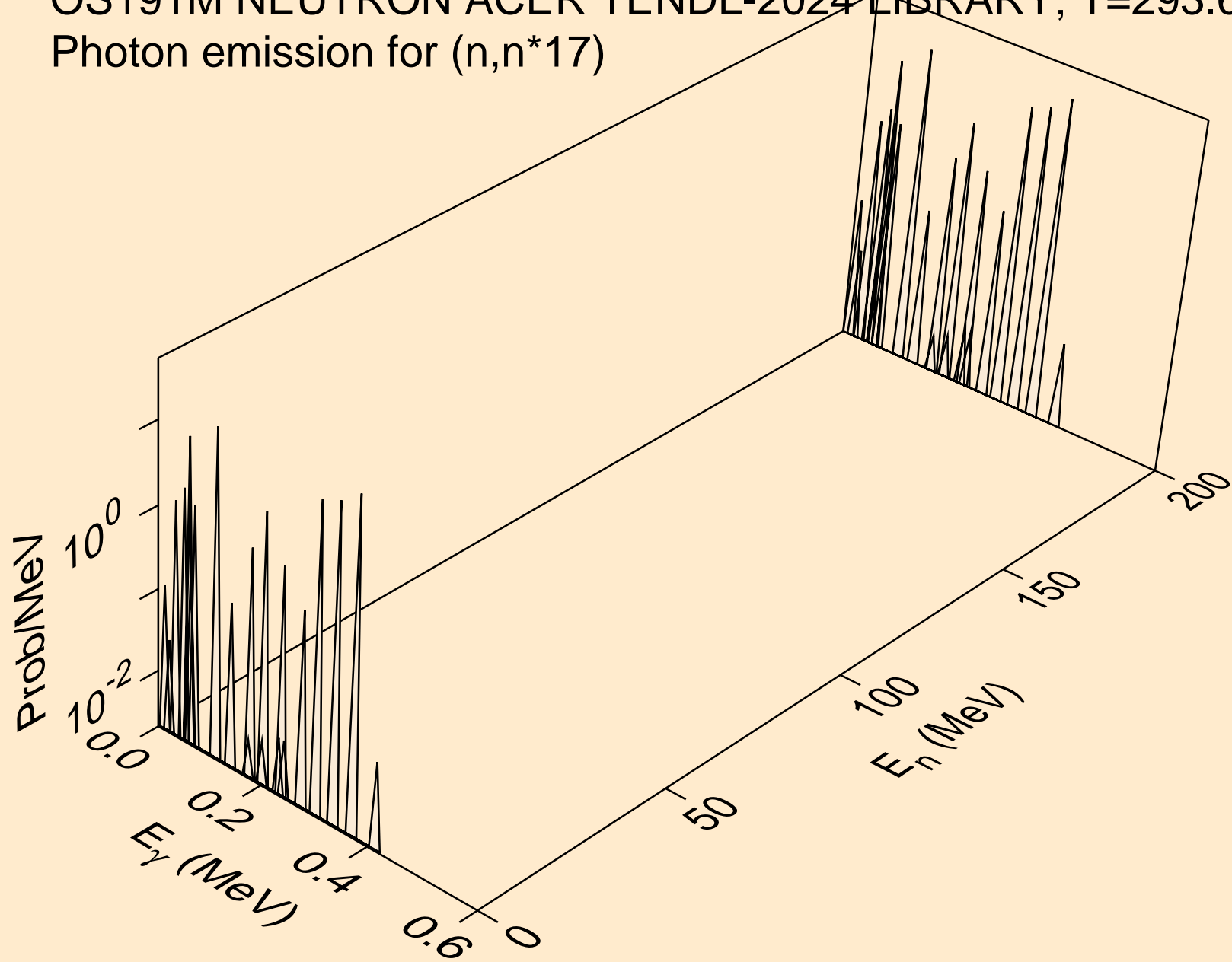

OS191M NEUTRON ACER TENDL-2024 LIBRARY; T=293.6K  
Photon emission for (n,n\*18)

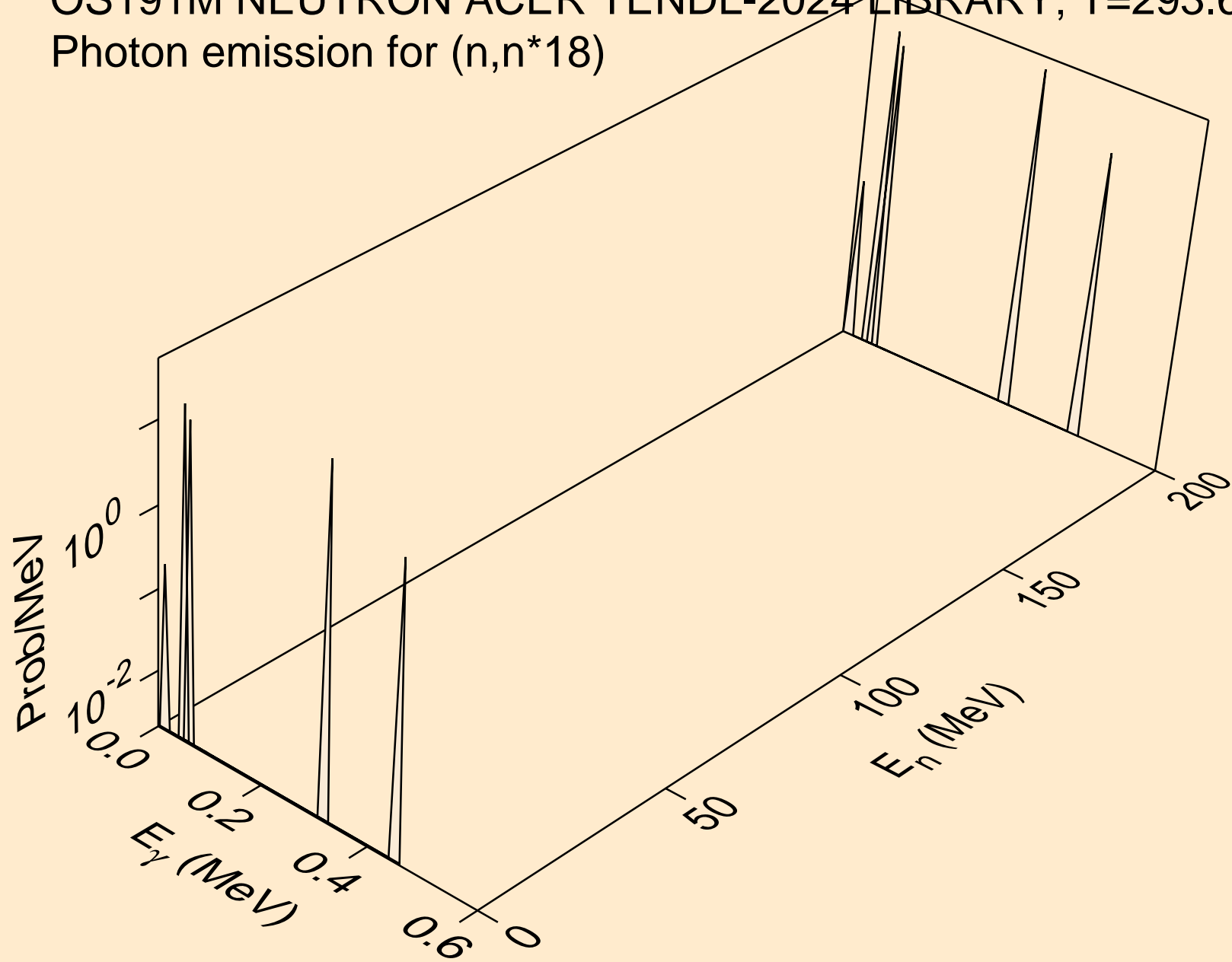

OS191M NEUTRON ACER TENDL-2024 LIBRARY; T=293.6K  
Photon emission for (n,n\*19)

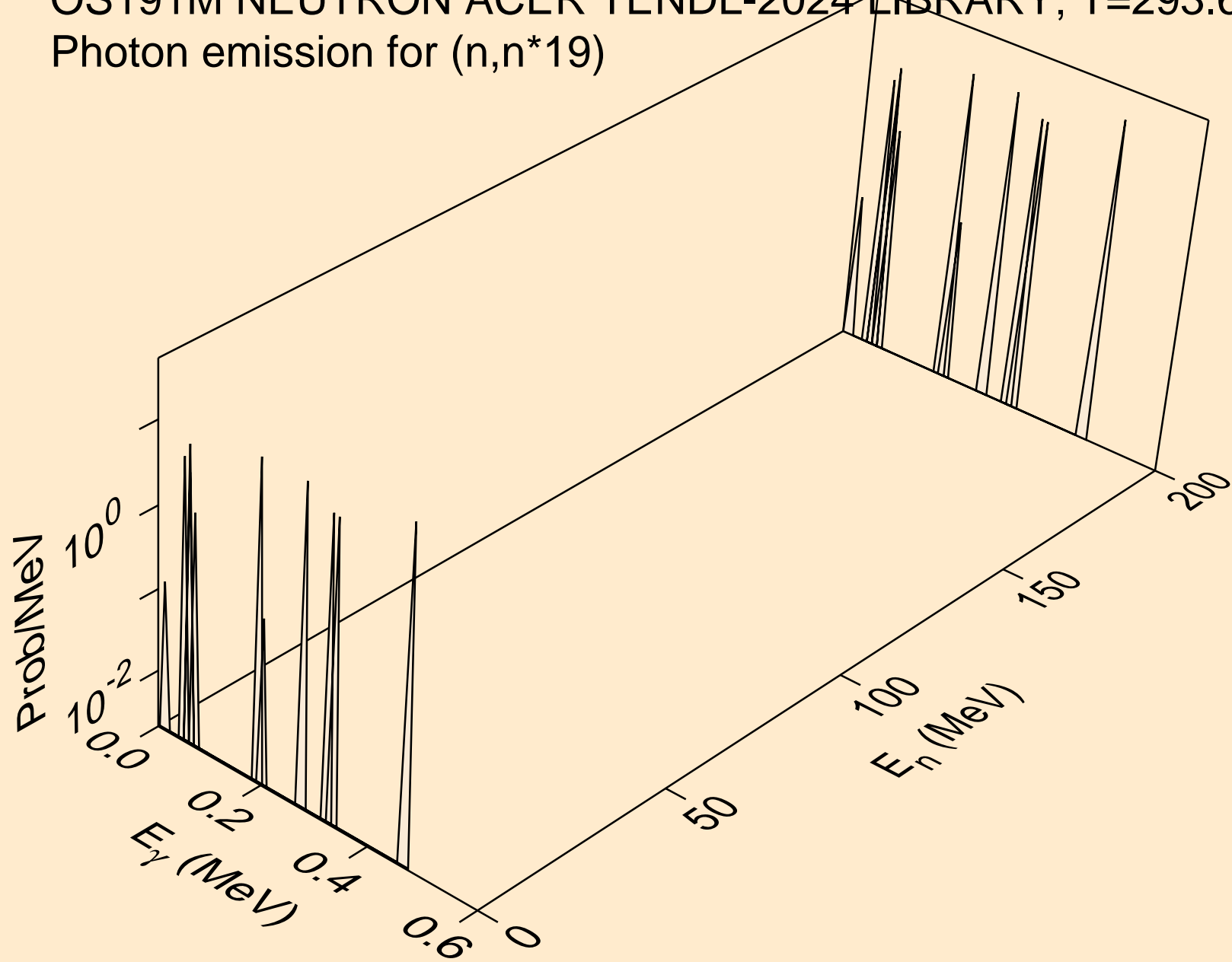

OS191M NEUTRON ACER TENDL-2024 LIBRARY; T=293.6K  
Photon emission for (n,n\*20)

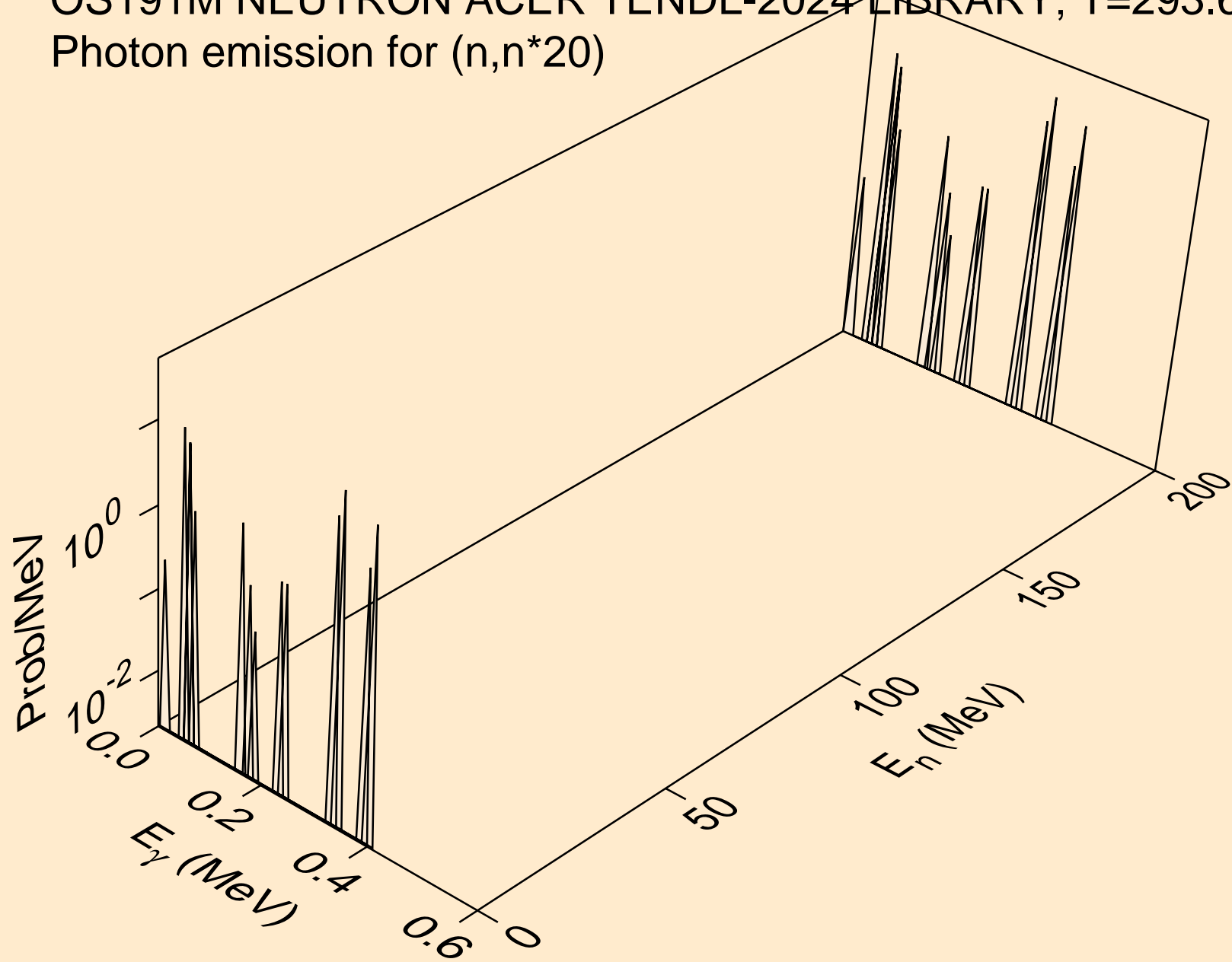

OS191M NEUTRON ACER TENDL-2024 LIBRARY; T=293.6K  
Photon emission for (n,n\*21)

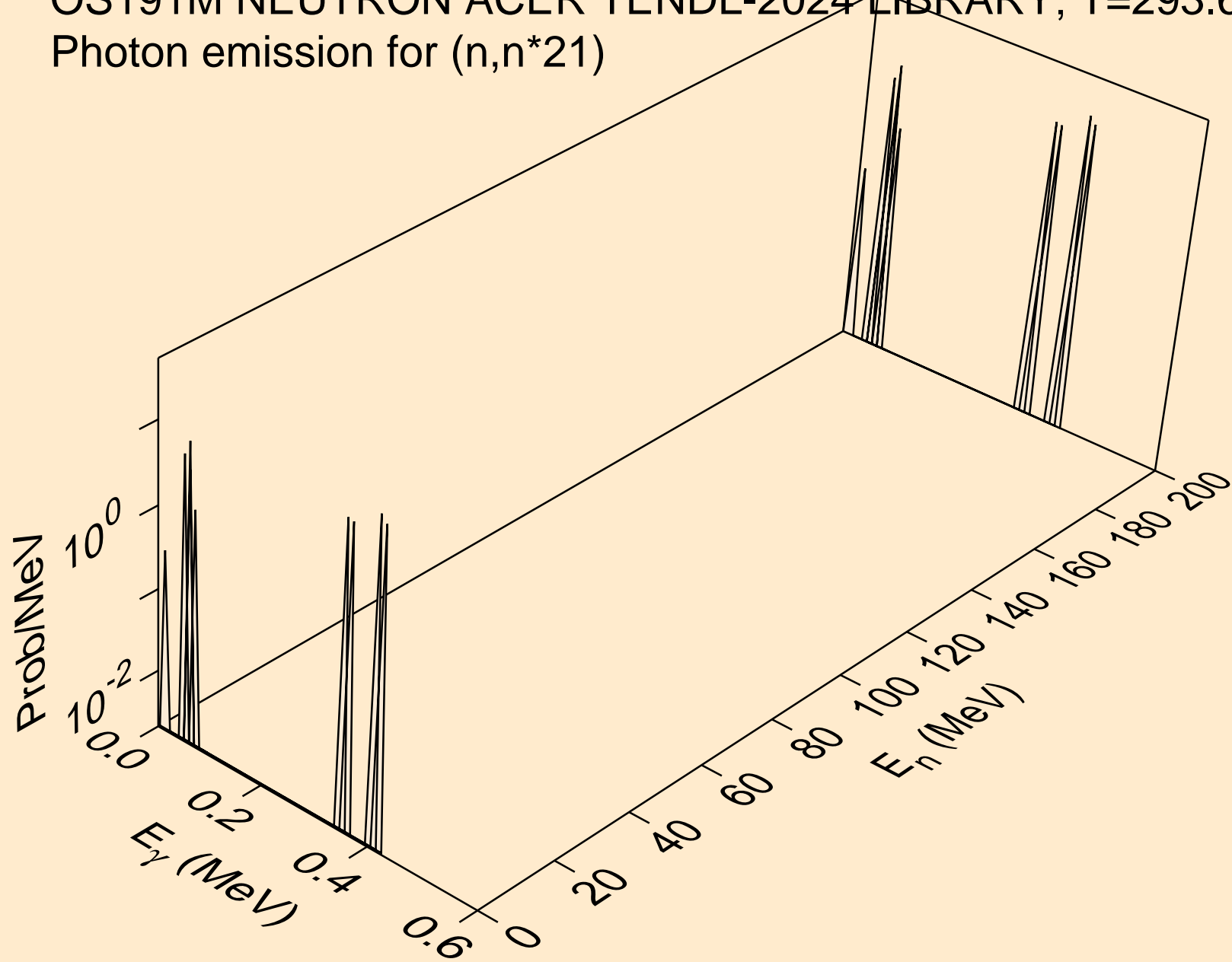

OS191M NEUTRON ACER TENDL-2024 LIBRARY; T=293.6K  
Photon emission for (n,n\*22)

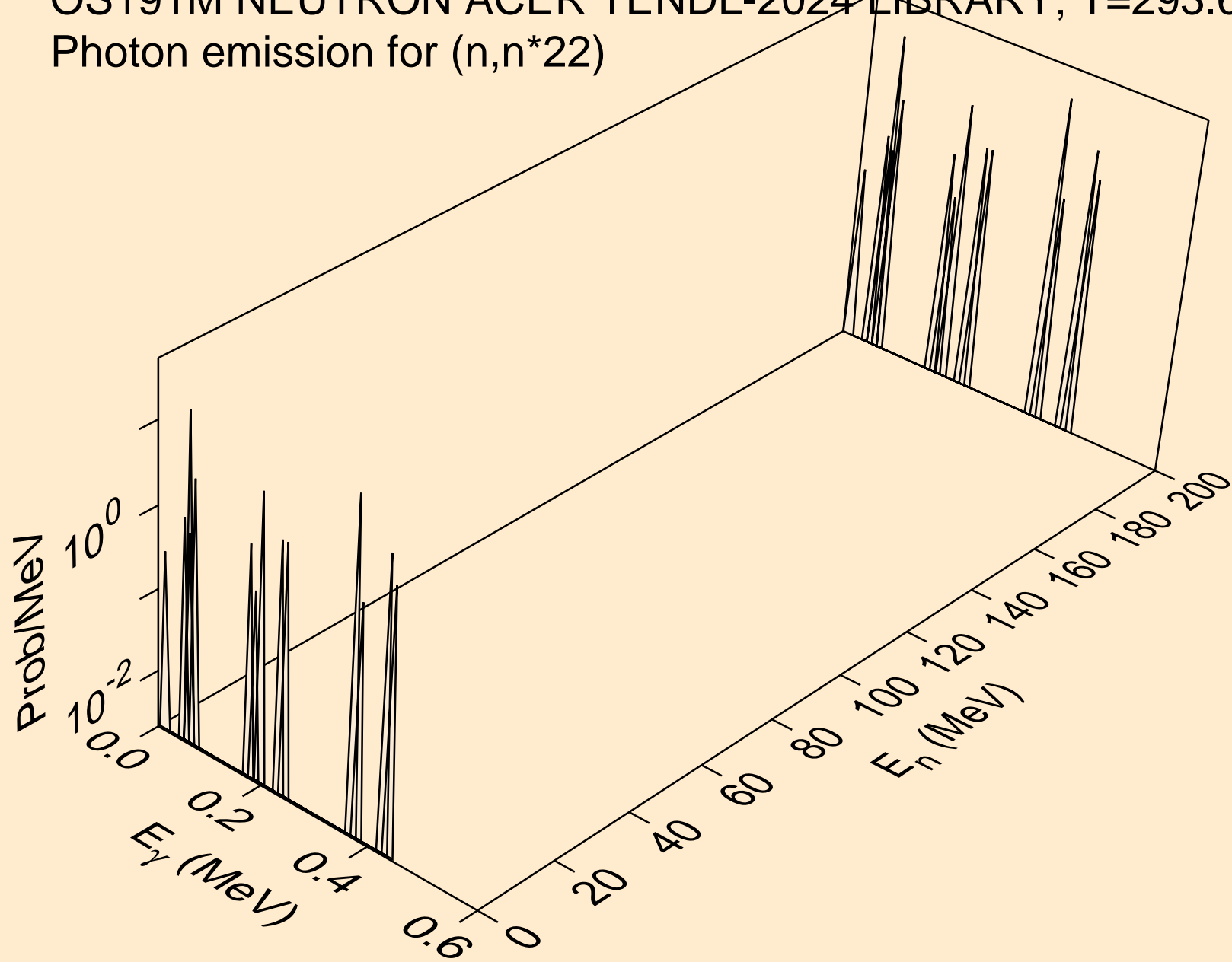

OS191M NEUTRON ACER TENDL-2024 LIBRARY; T=293.6K  
Photon emission for (n,n\*23)

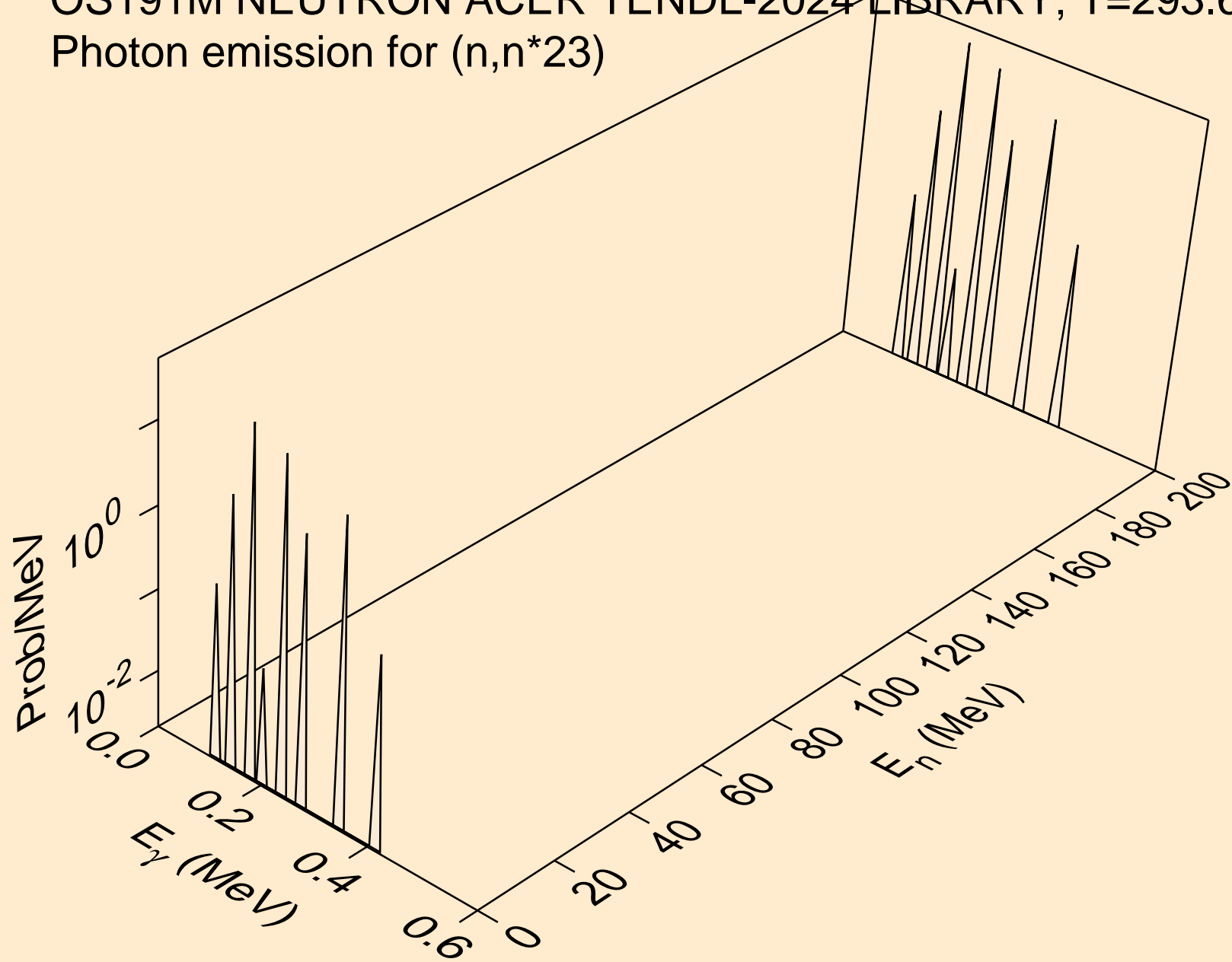

OS191M NEUTRON ACER TENDL-2024 LIBRARY; T=293.6K  
Photon emission for (n,n\*24)

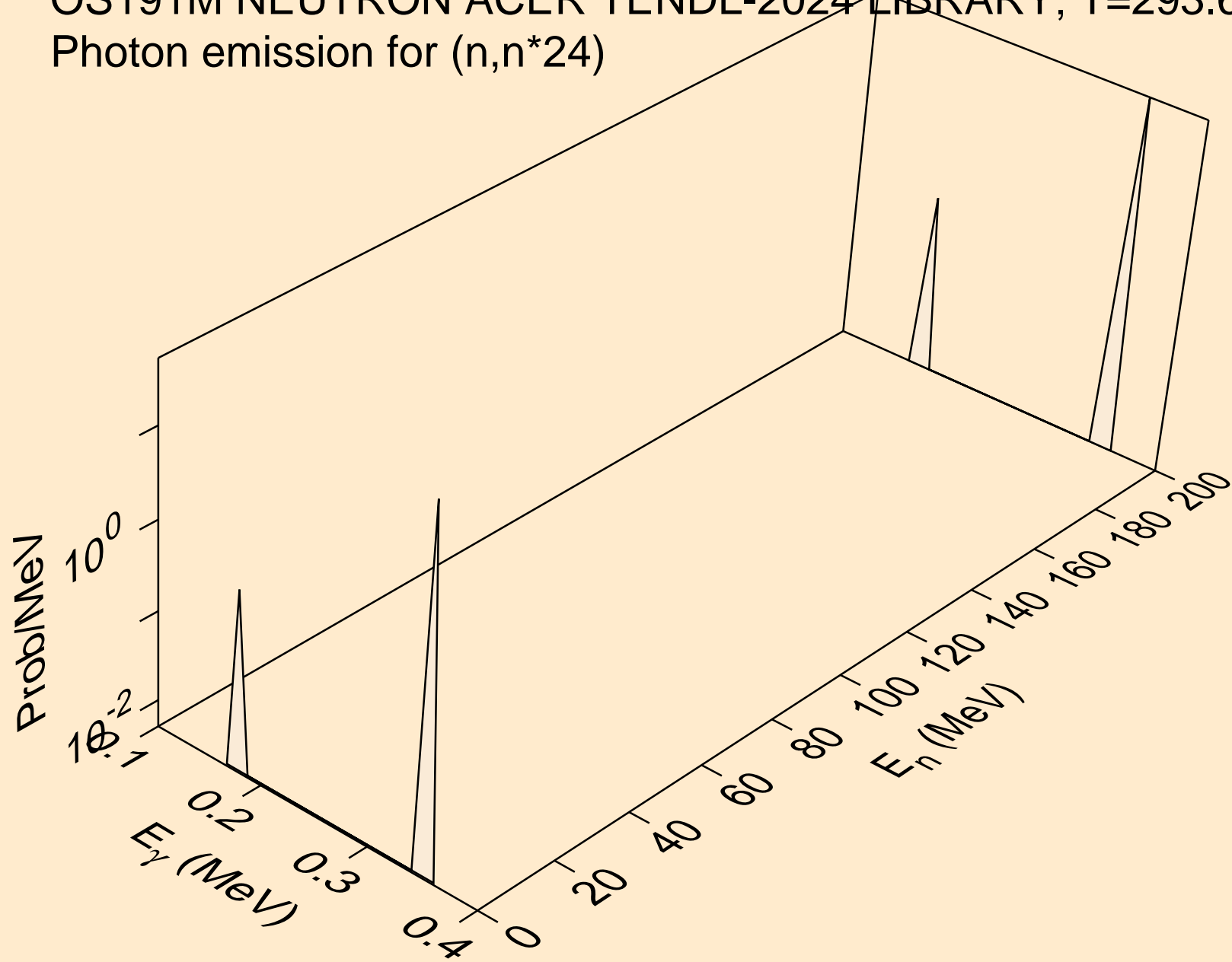

OS191M NEUTRON ACER TENDL-2024 LIBRARY; T=293.6K  
Photon emission for (n,n\*25)

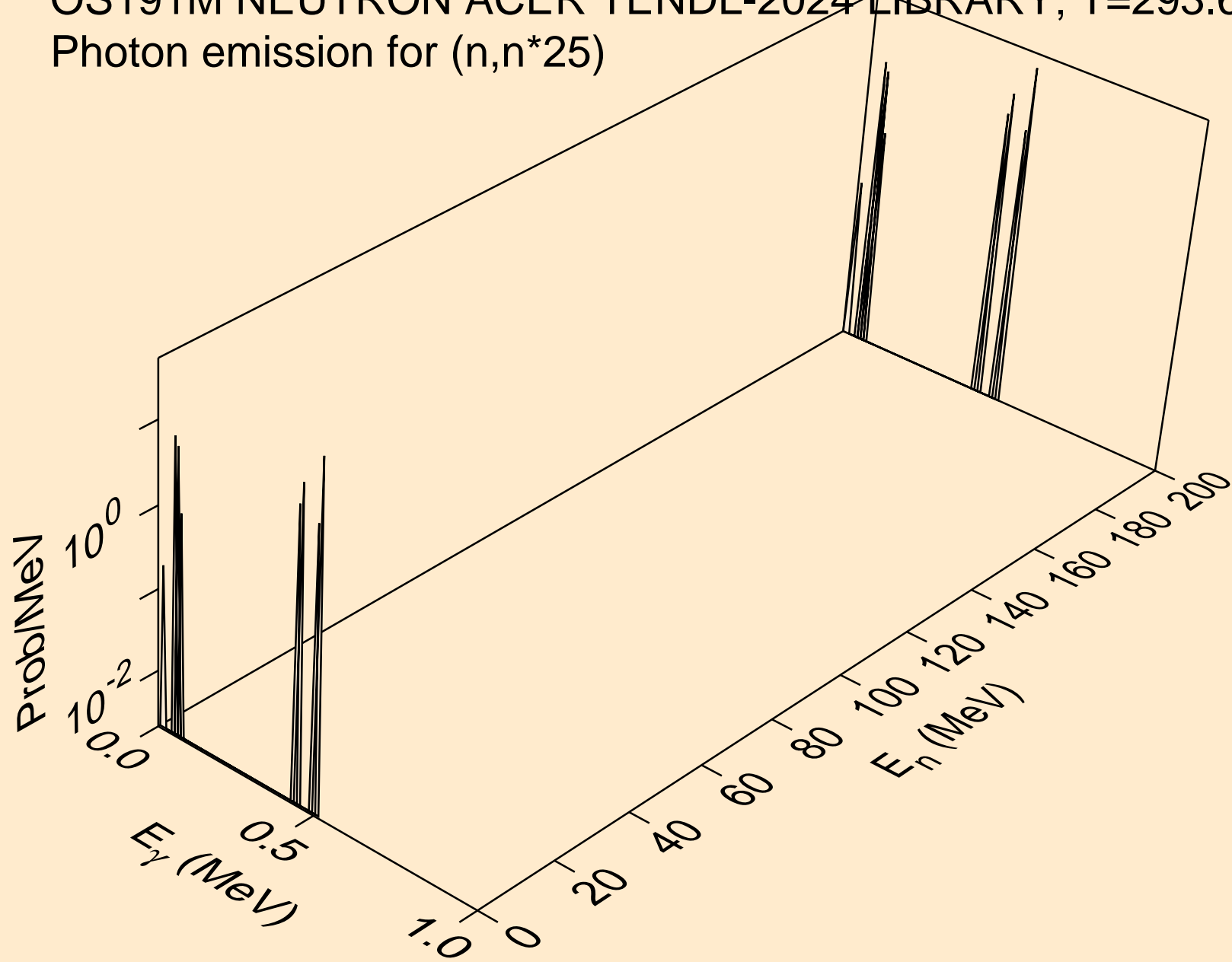

OS191M NEUTRON ACER TENDL-2024 LIBRARY; T=293.6K  
Photon emission for (n,n\*26)

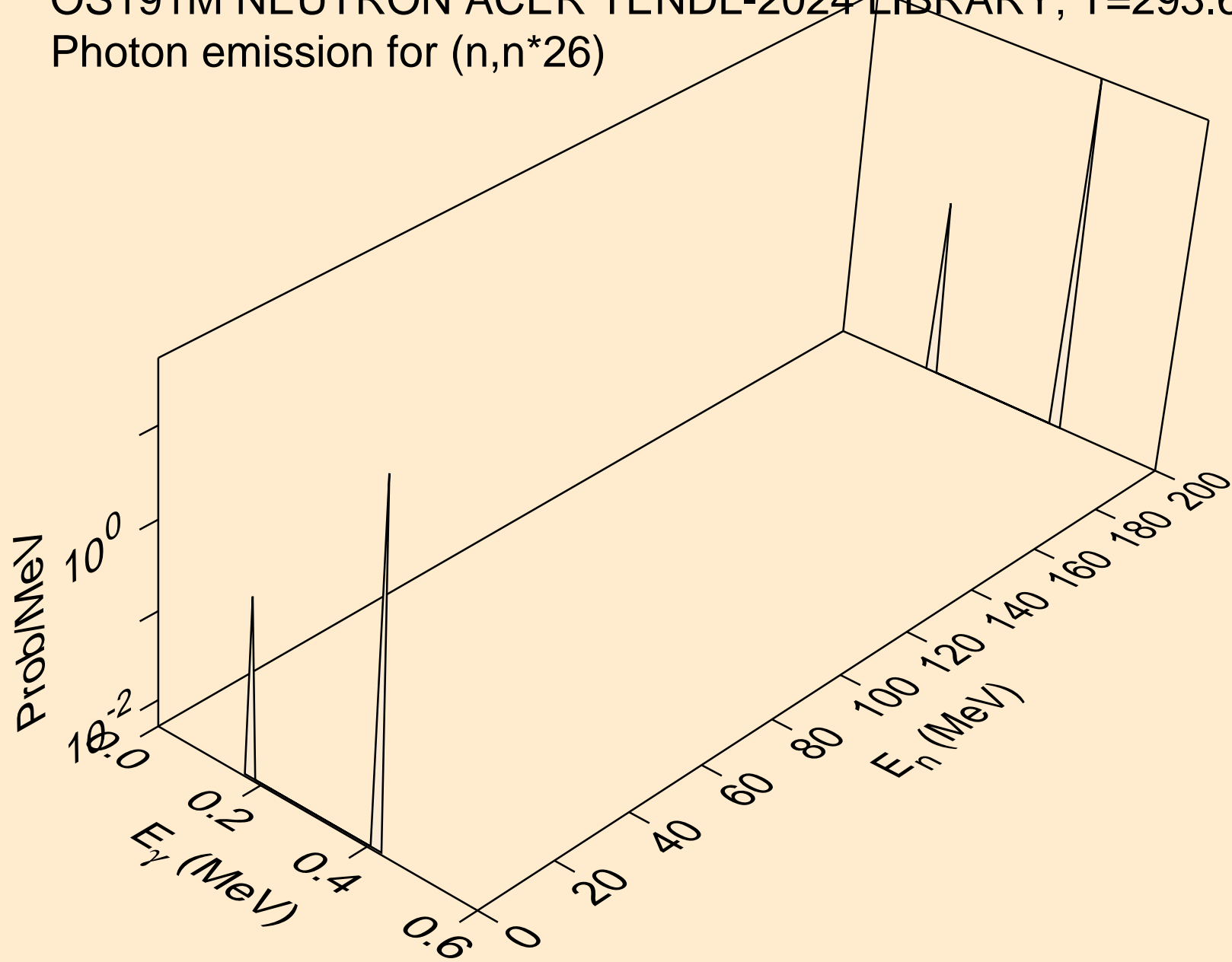

OS191M NEUTRON ACER TENDL-2024 LIBRARY; T=293.6K  
Photon emission for (n,n\*27)

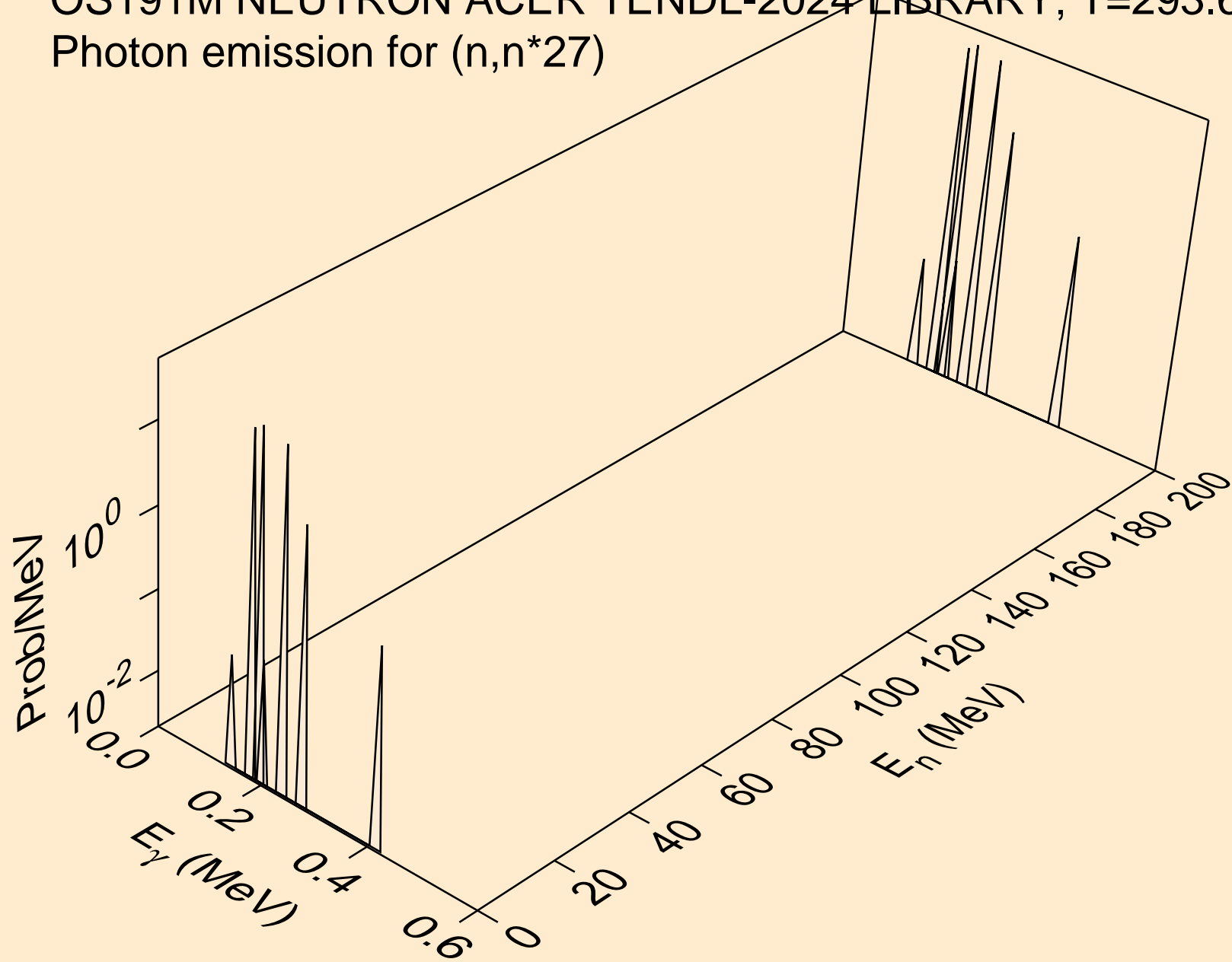

OS191M NEUTRON ACER TENDL-2024 LIBRARY; T=293.6K  
Photon emission for (n,n\*28)

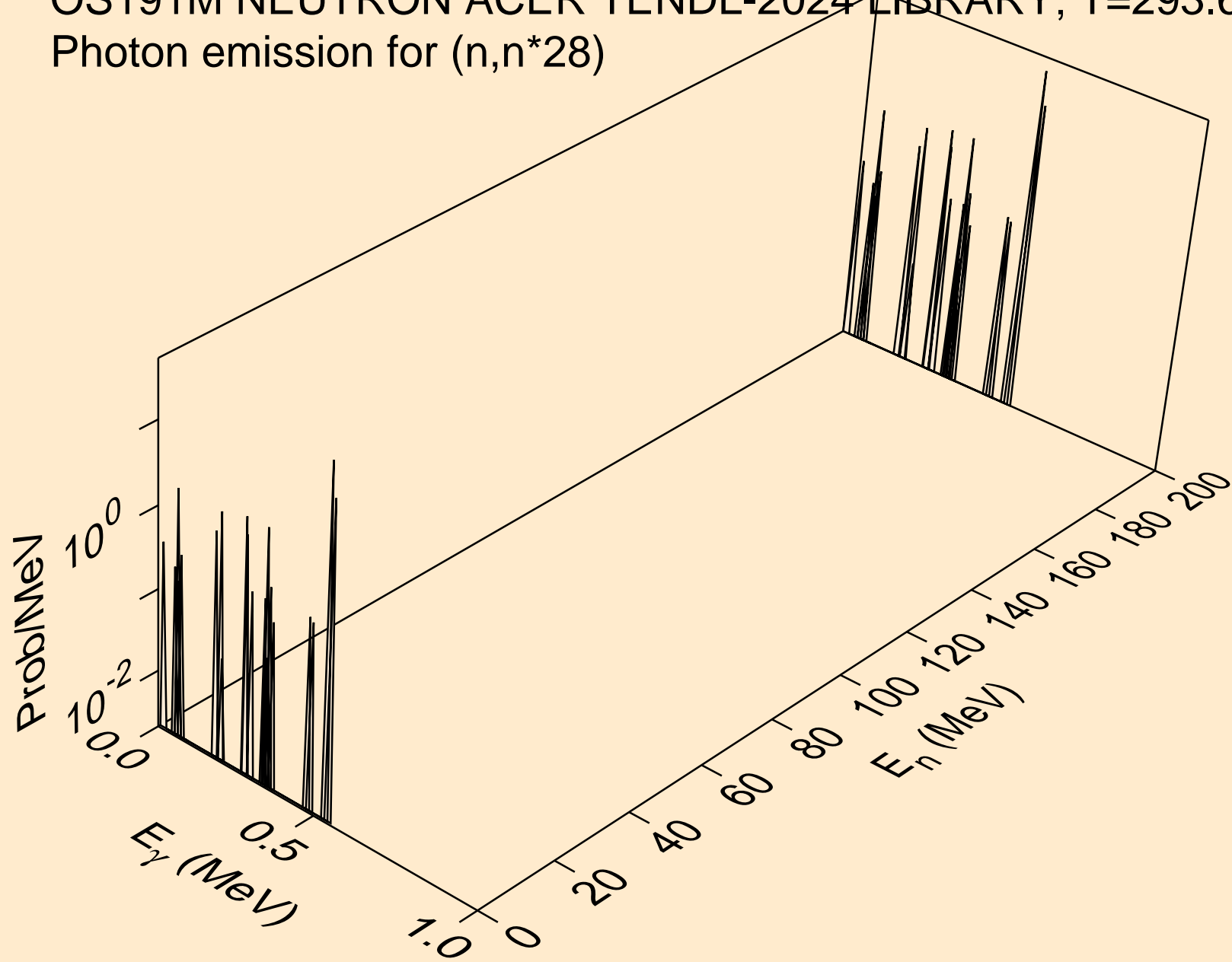

OS191M NEUTRON ACER TENDL-2024 LIBRARY; T=293.6K  
Photon emission for (n,n\*29)

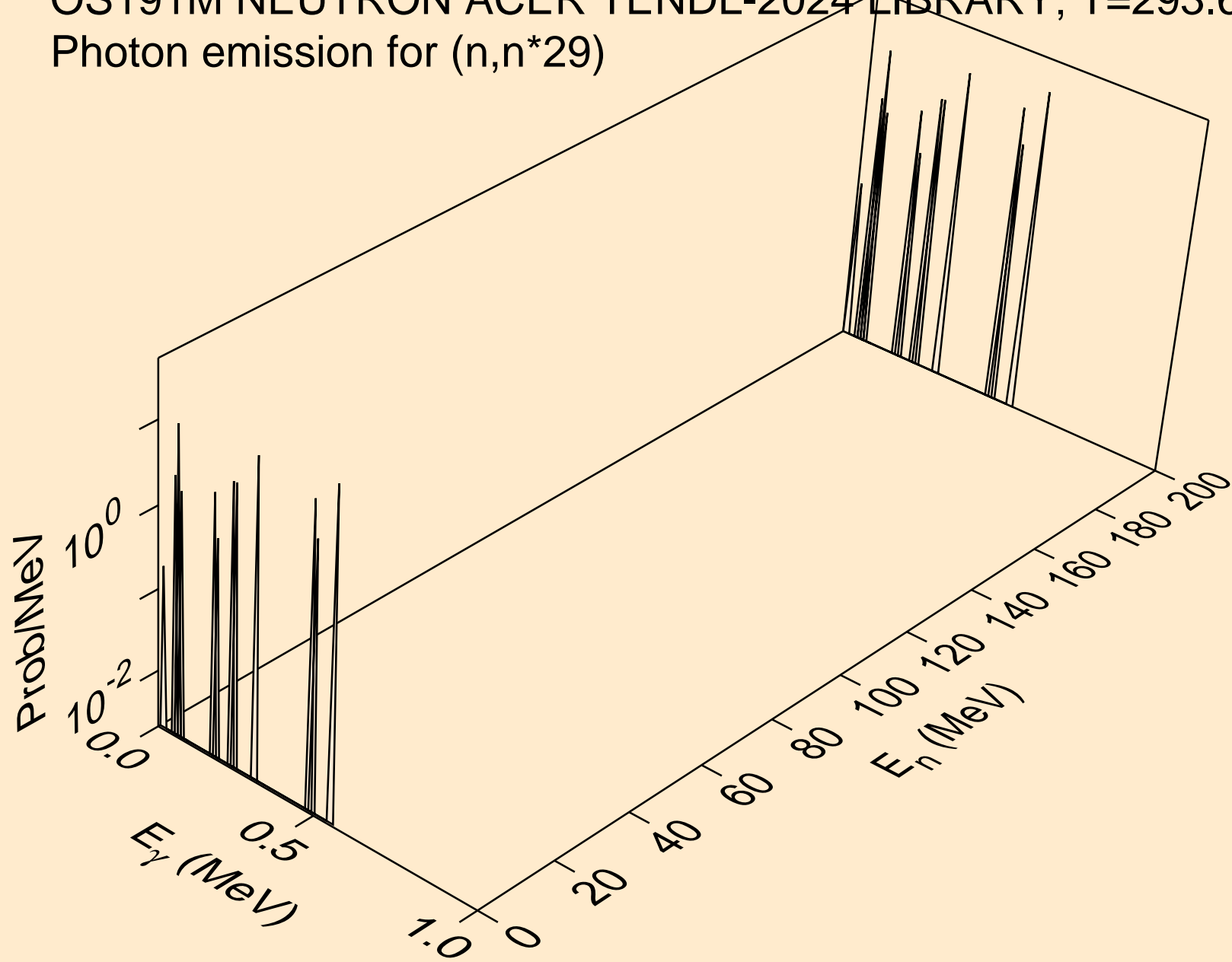

OS191M NEUTRON ACER TENDL-2024 LIBRARY; T=293.6K  
Photon emission for (n,n\*30)

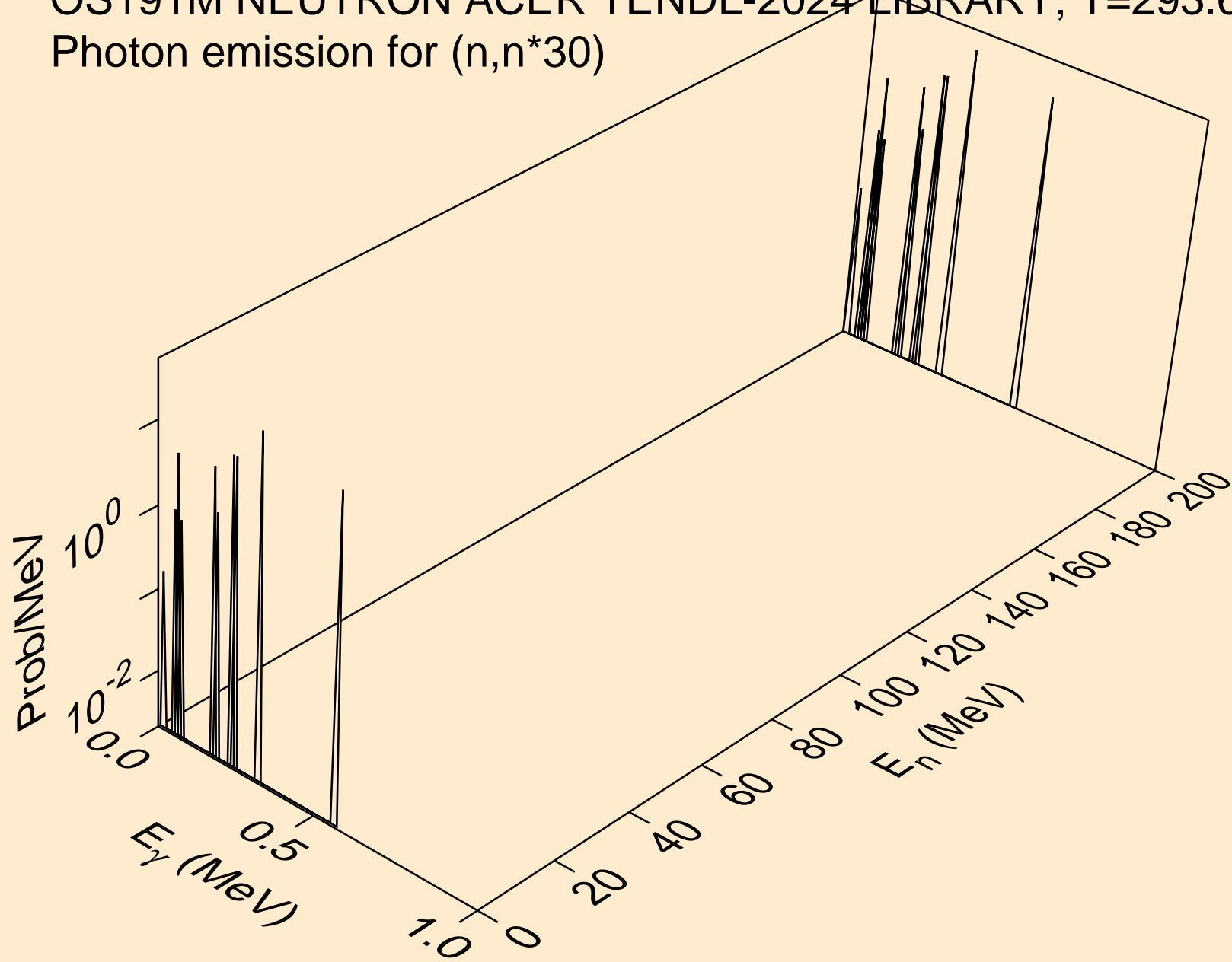

OS191M NEUTRON ACER TENDL-2024 LIBRARY; T=293.6K  
Photon emission for (n,n\*c)

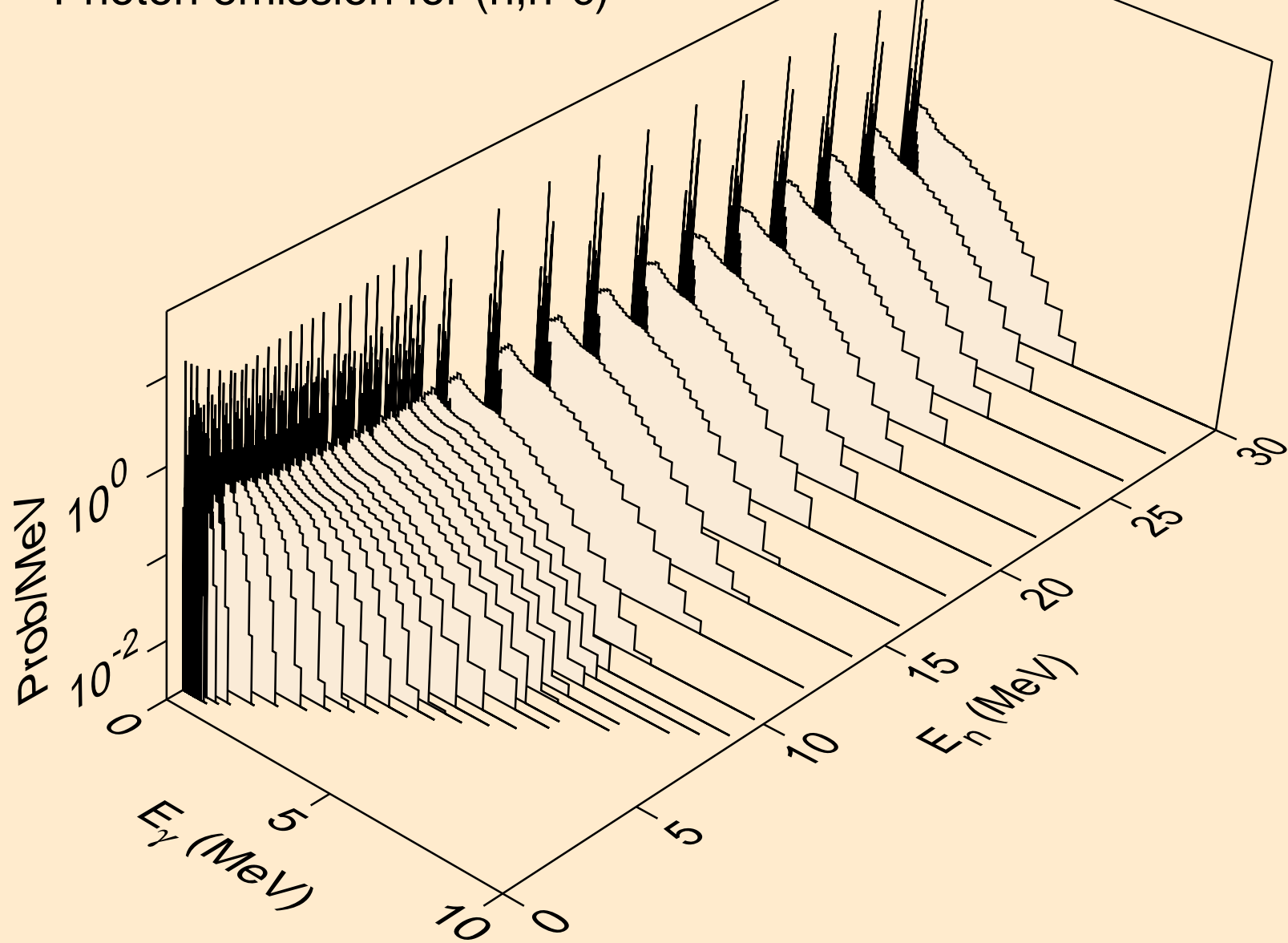

OS191M NEUTRON ACER TENDL-2024 LIBRARY; T=293.6K  
Photon emission for (n,gma)

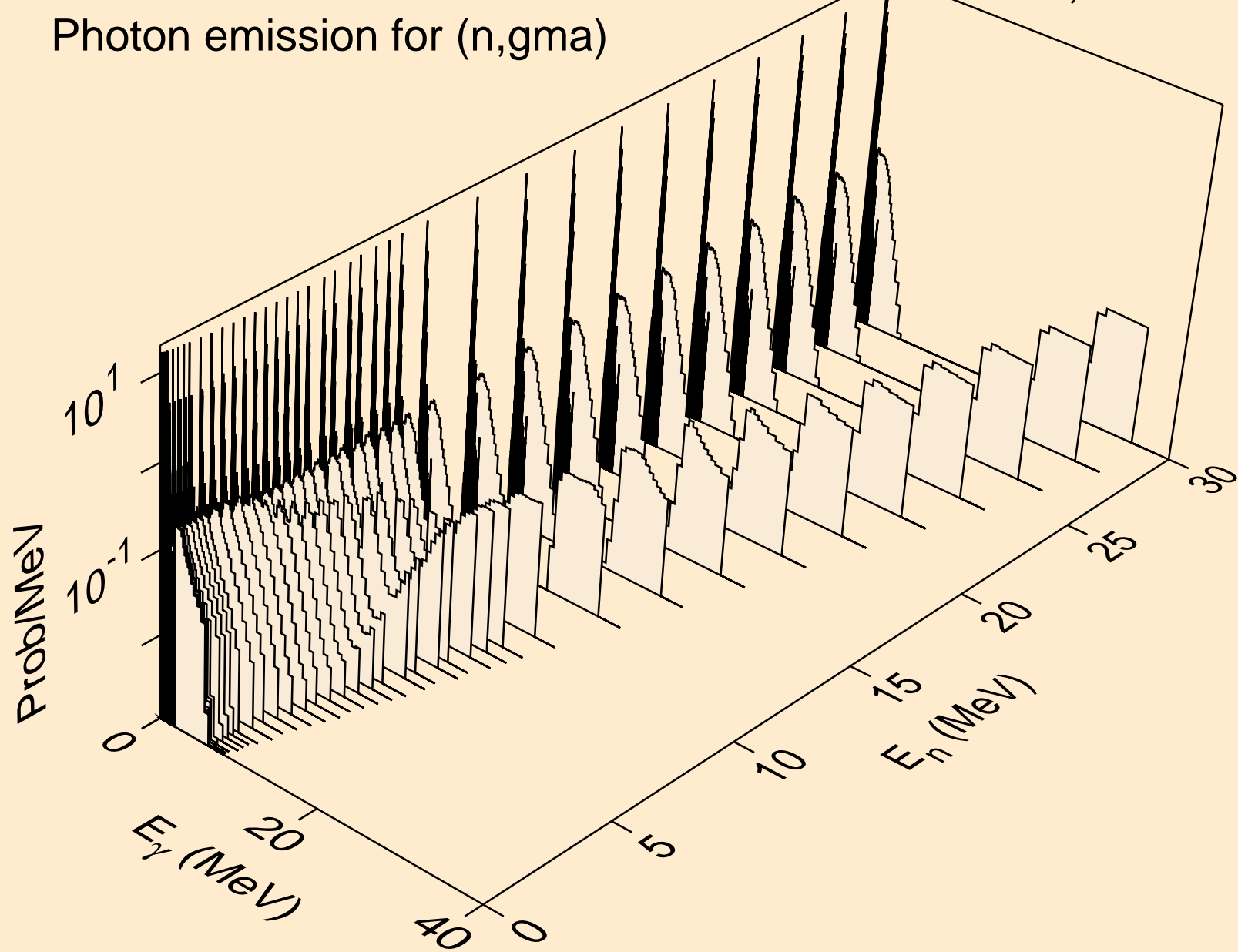

OS191M NEUTRON ACER TENDL-2024 LIBRARY; T=293.6K  
Photon emission for (n,p)

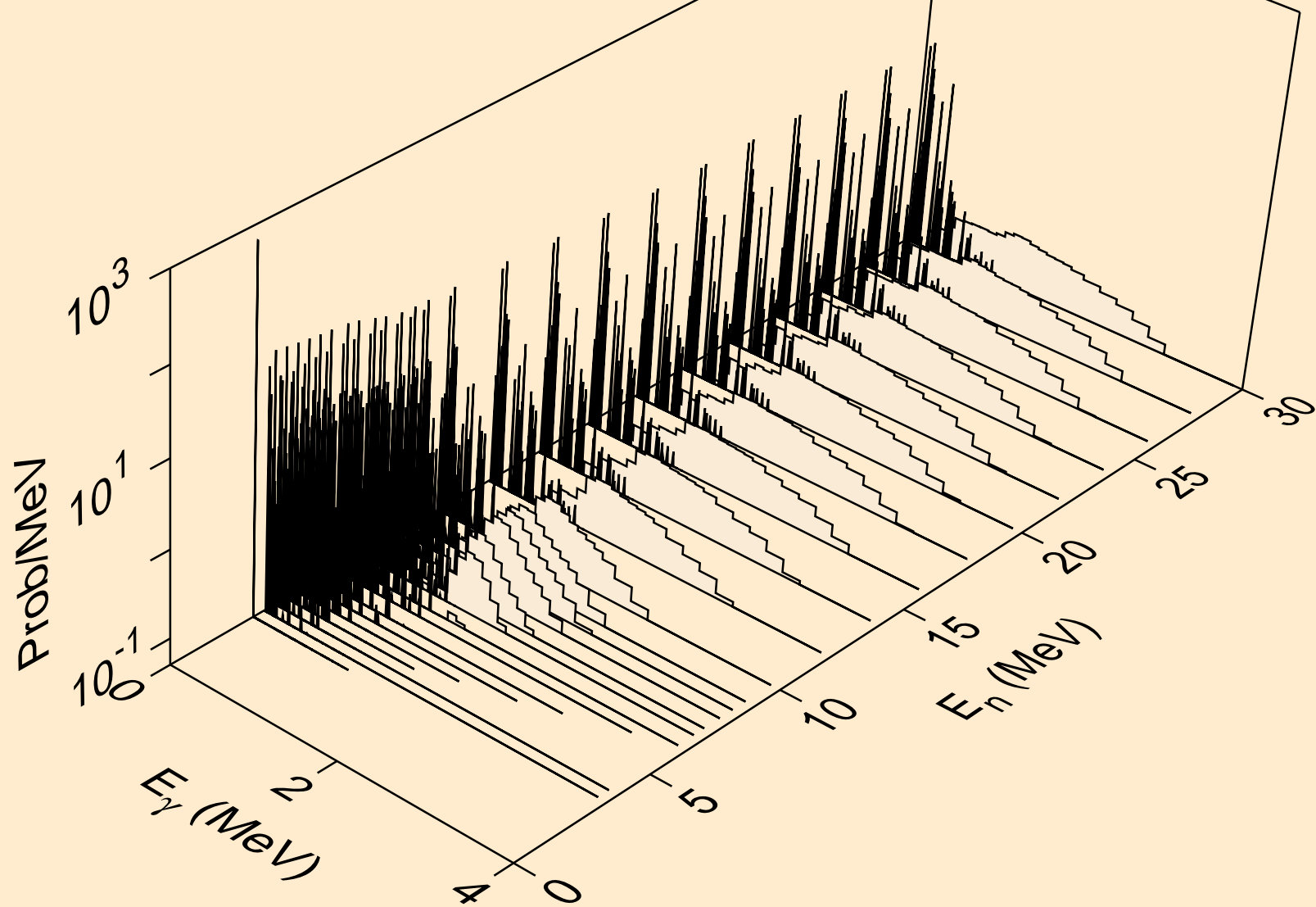

OS191M NEUTRON ACER TENDL-2024 LIBRARY; T=293.6K  
Photon emission for (n,d)

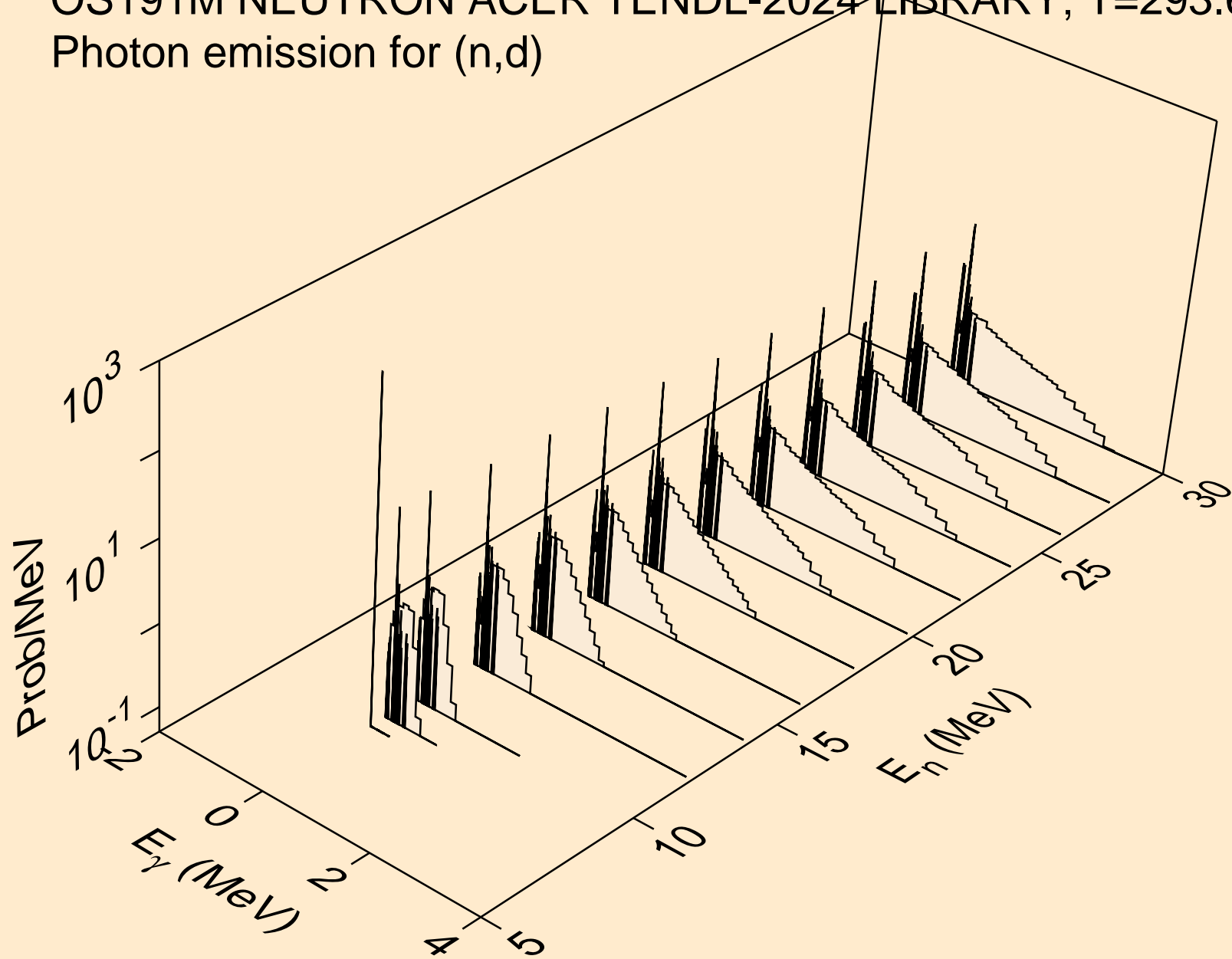

OS191M NEUTRON ACER TENDL-2024 LIBRARY; T=293.6K  
Photon emission for (n,t)

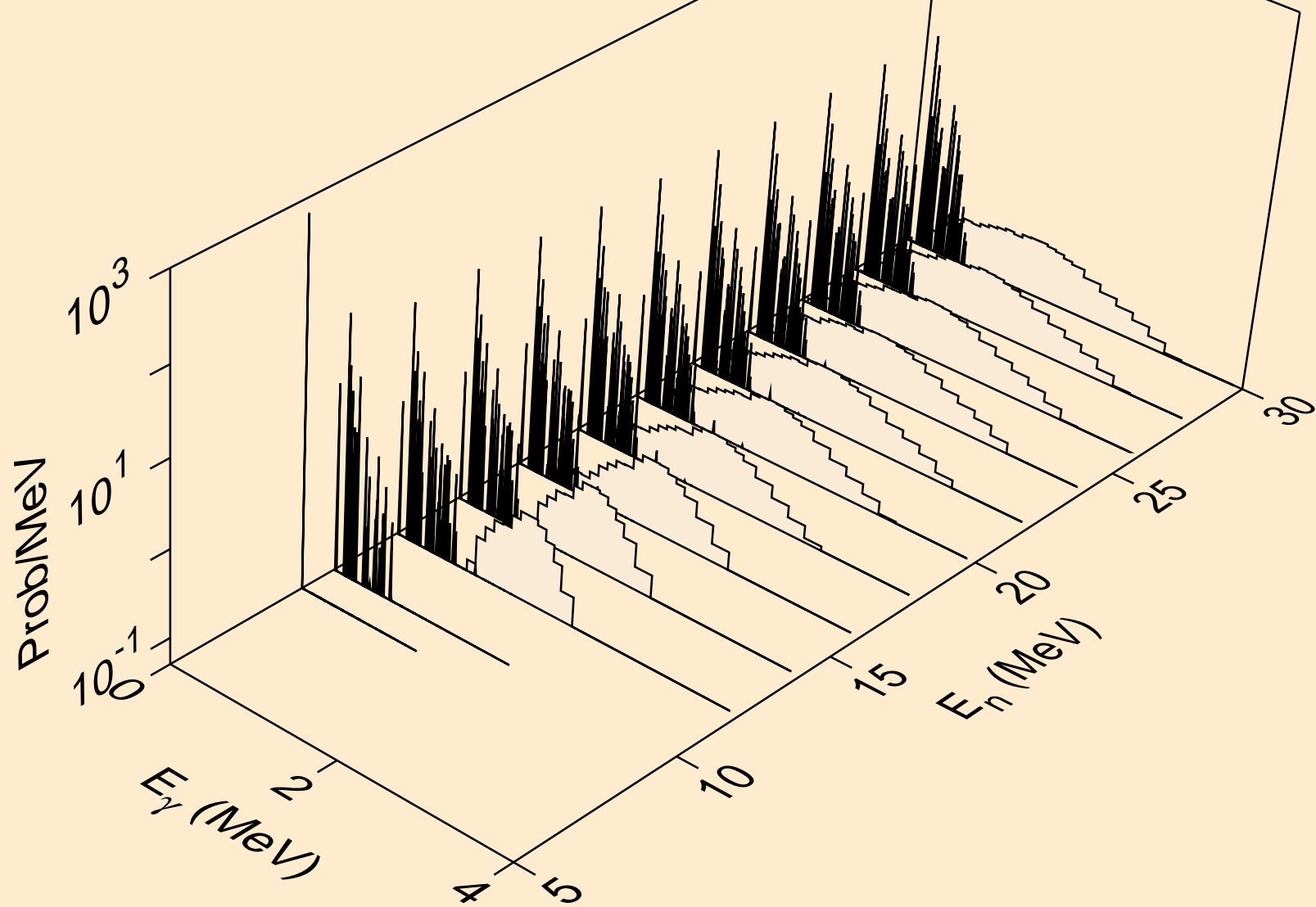

OS191M NEUTRON ACER TENDL-2024 LIBRARY; T=293.6K  
Photon emission for (n,he3)

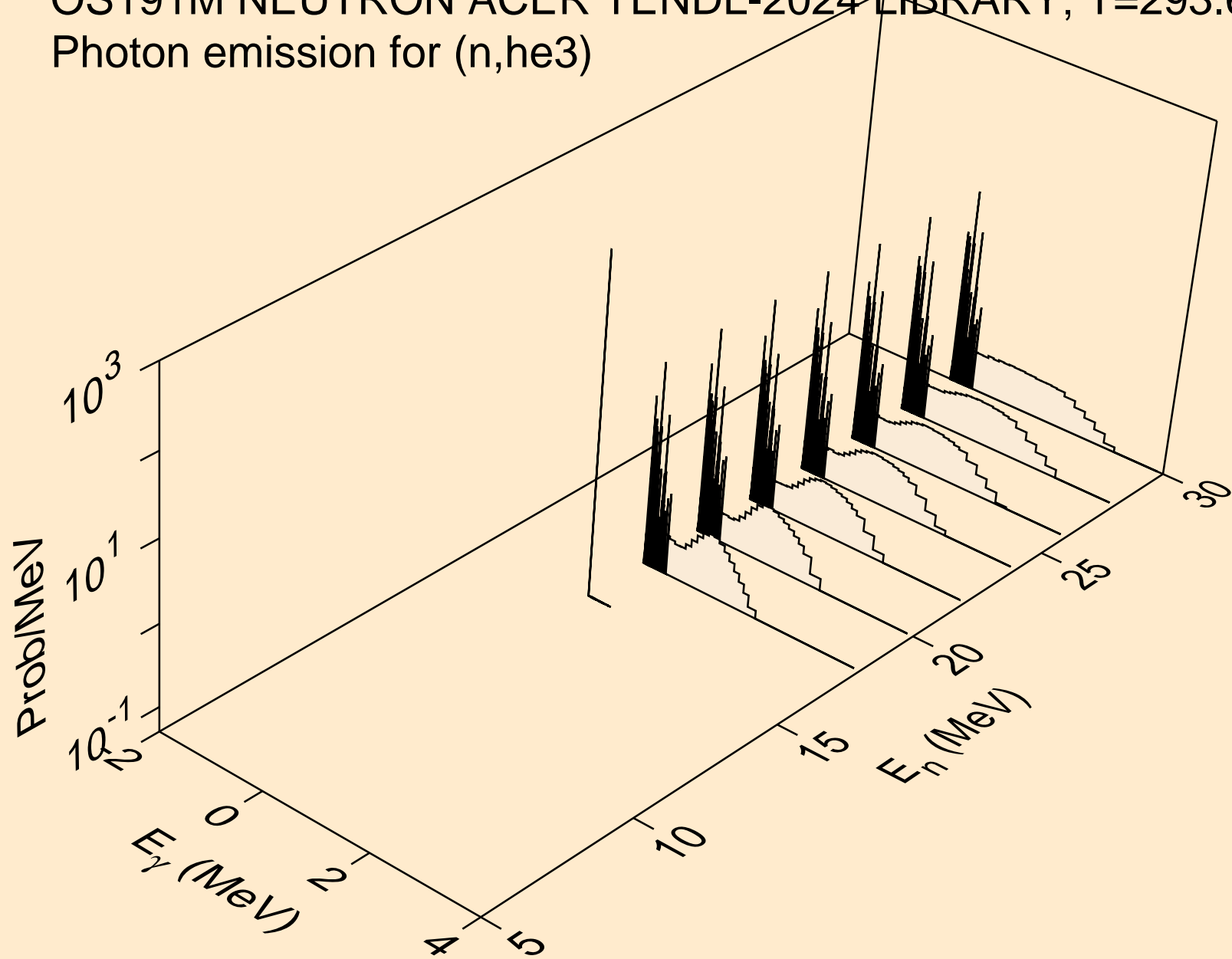

OS191M NEUTRON ACER TENDL-2024 LIBRARY; T=293.6K  
Photon emission for (n,a)

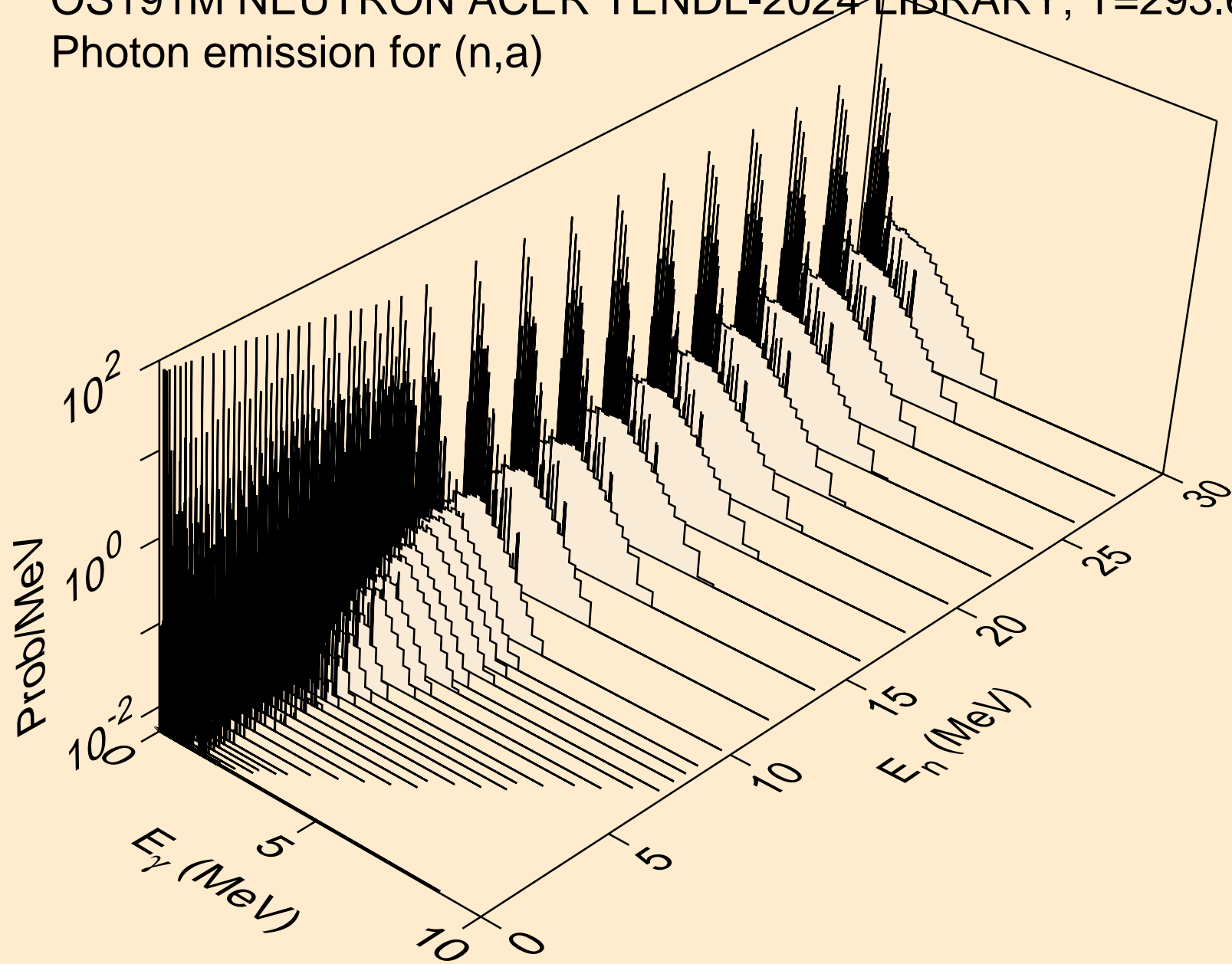

OS191M NEUTRON ACER TENDL-2024 LIBRARY; T=293.6K  
Photon emission for (n,2p)

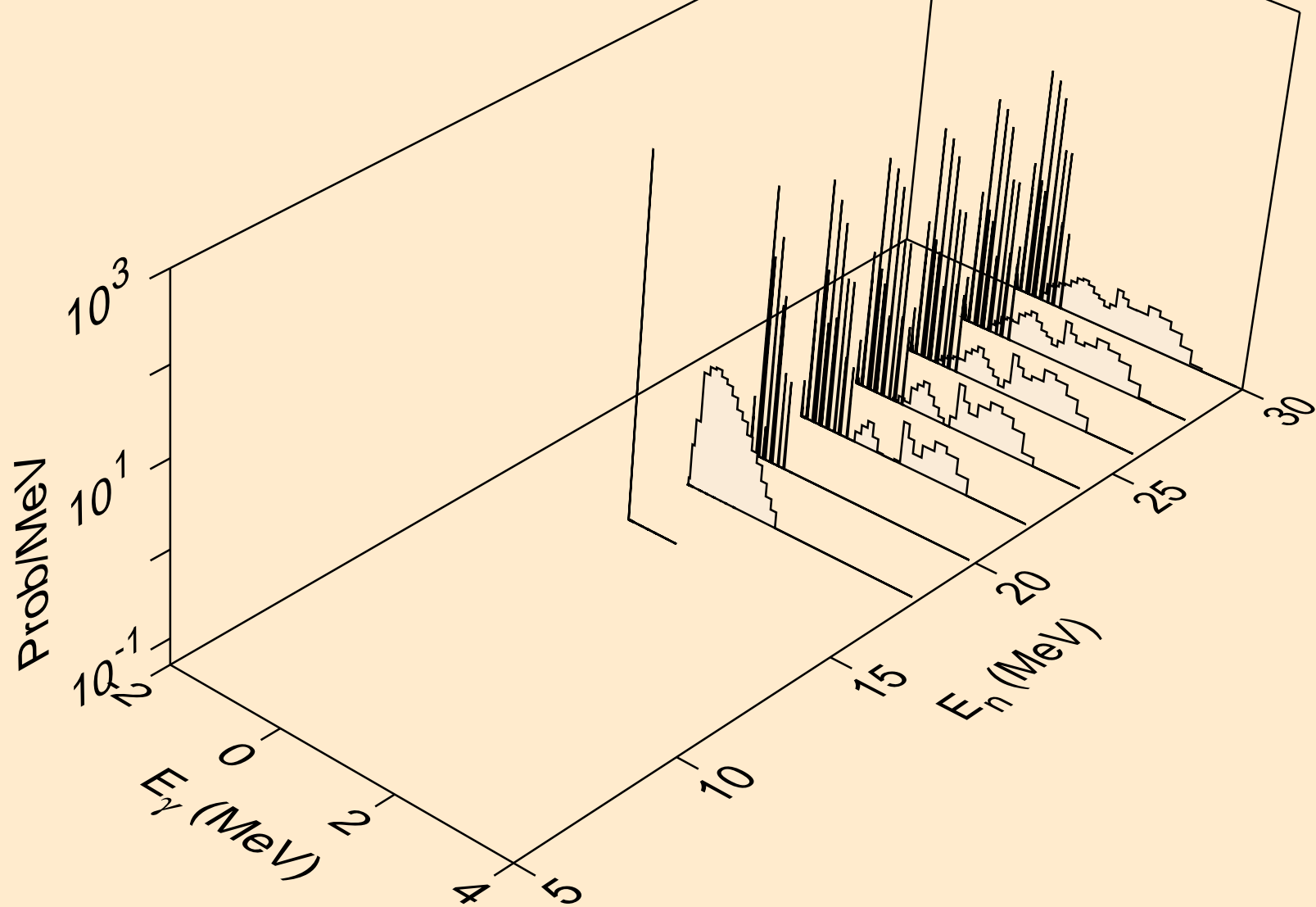

OS191M NEUTRON ACER TENDL-2024 LIBRARY; T=293.6K  
thermal capture photon spectrum

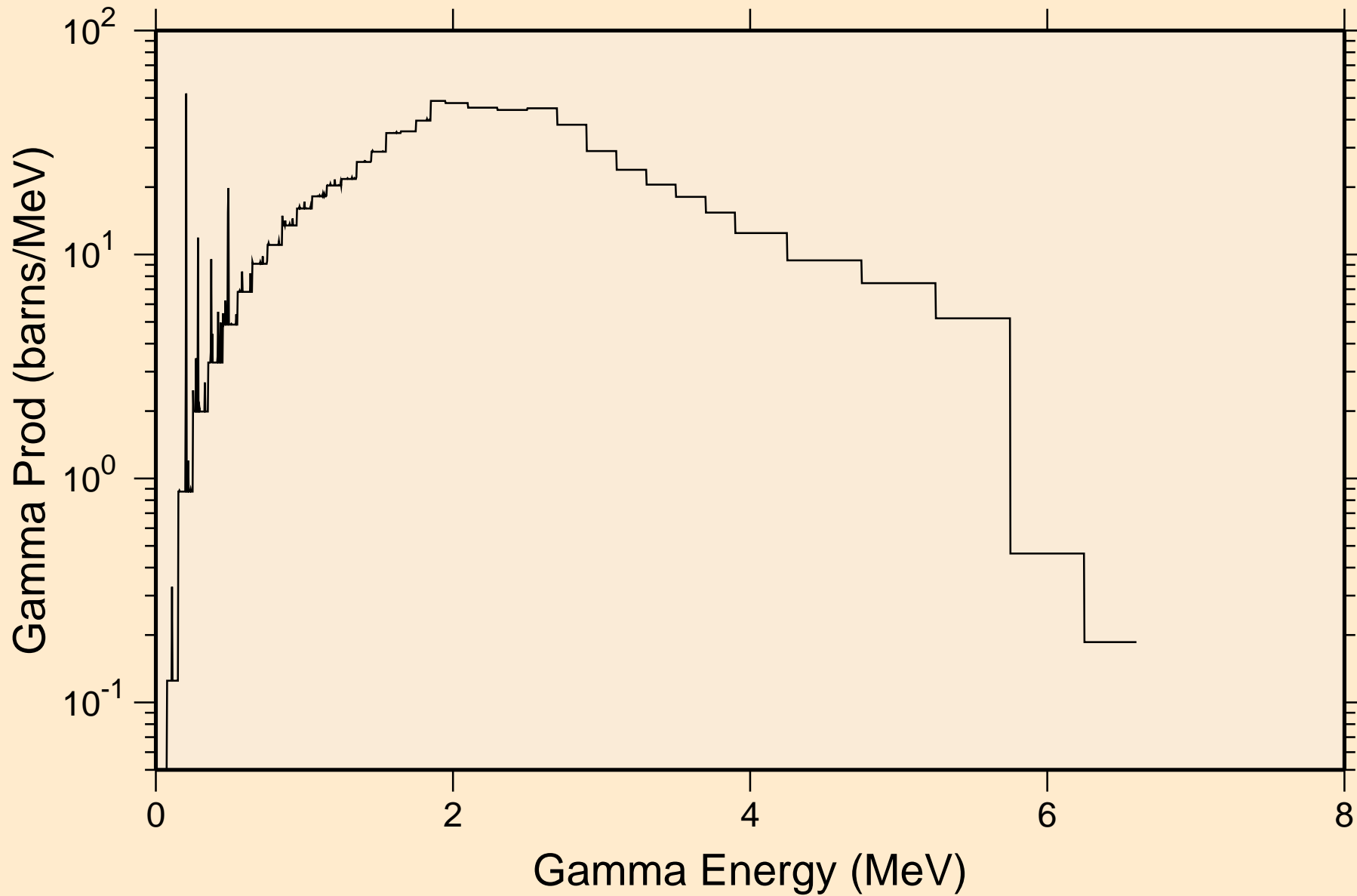

OS191M NEUTRON ACER TENDL-2024 LIBRARY; T=293.6K  
14 MeV photon spectrum

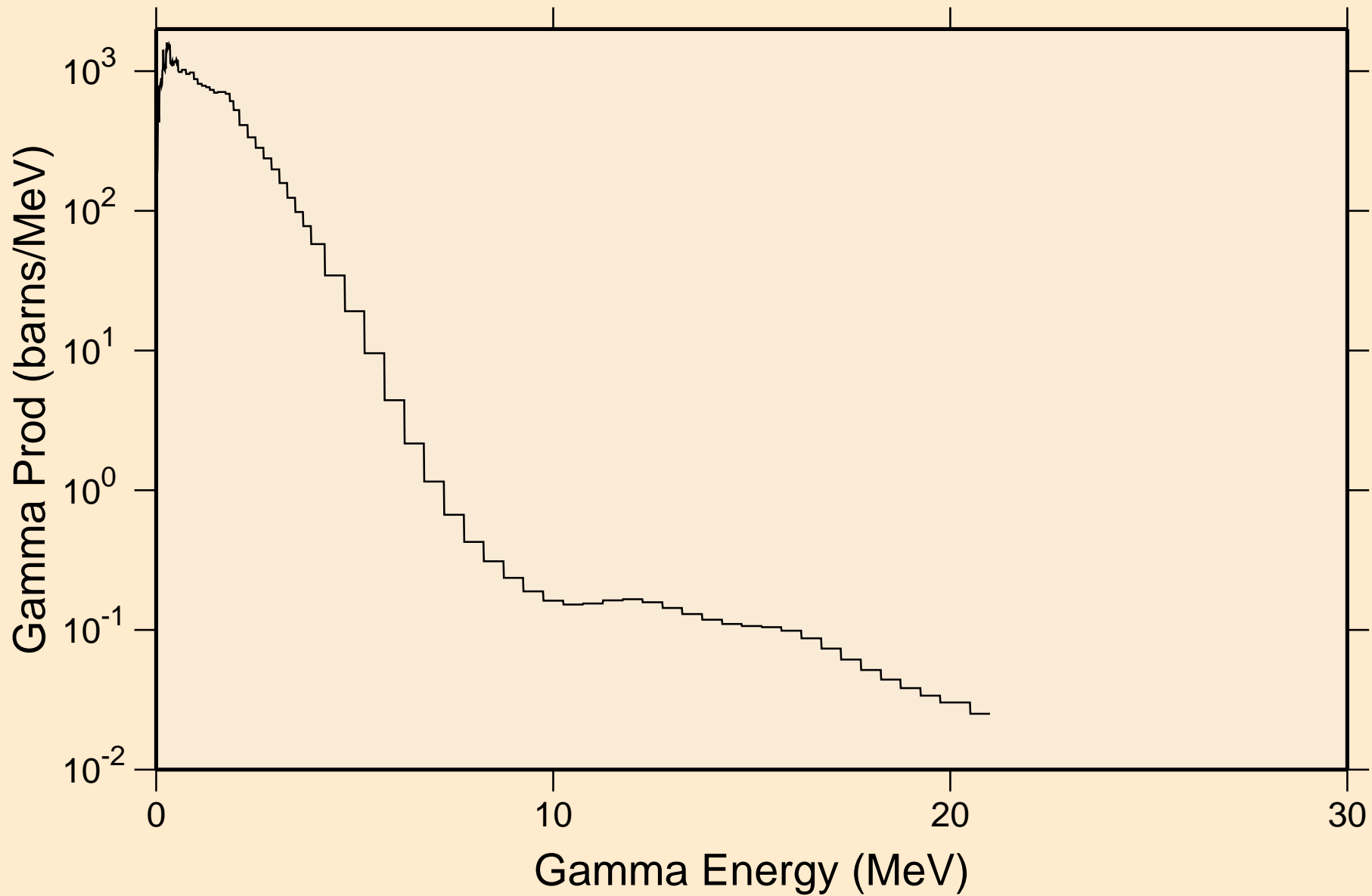

OS191M NEUTRON ACER TENDL-2024 LIBRARY; T=293.6K  
Particle heating contributions

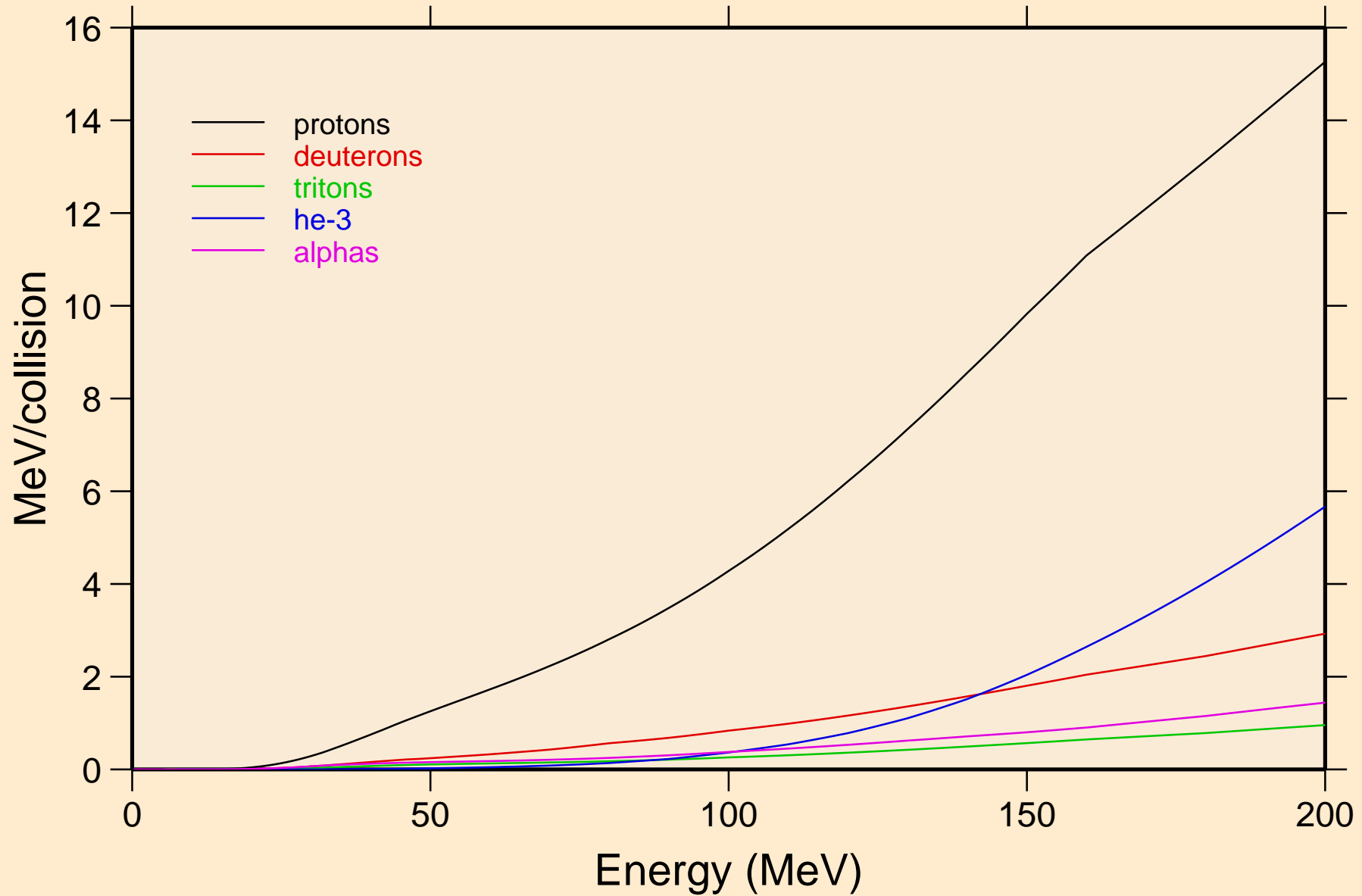

OS191M NEUTRON ACER TENDL-2024 LIBRARY; T=293.6K  
Recoil Heating

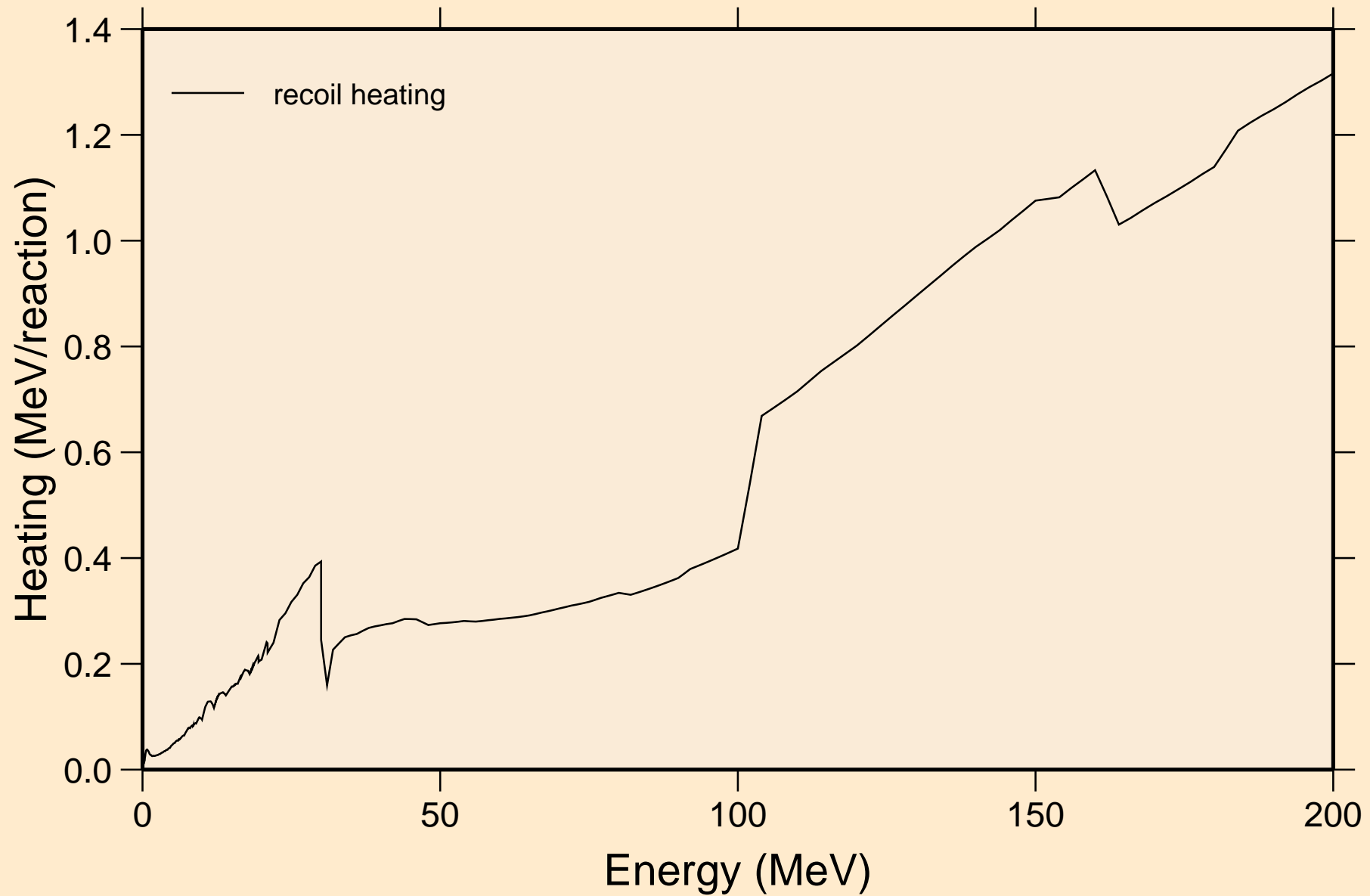

OS191M NEUTRON ACER TENDL-2024 LIBRARY; T=293.6K  
Particle production cross sections

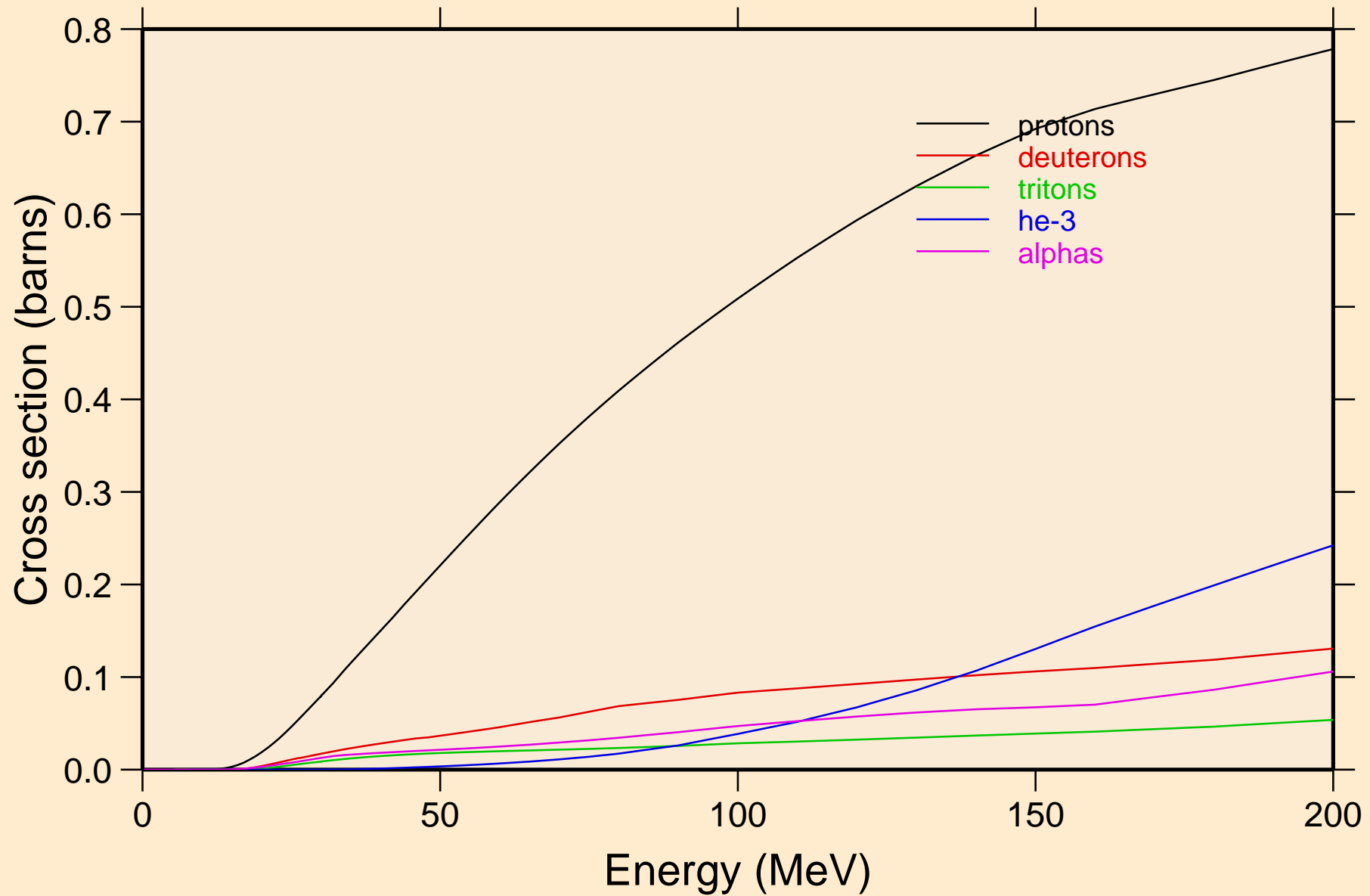

OS191M NEUTRON ACER TENDL-2024 LIBRARY; T=293.6K  
protons from (n,x)

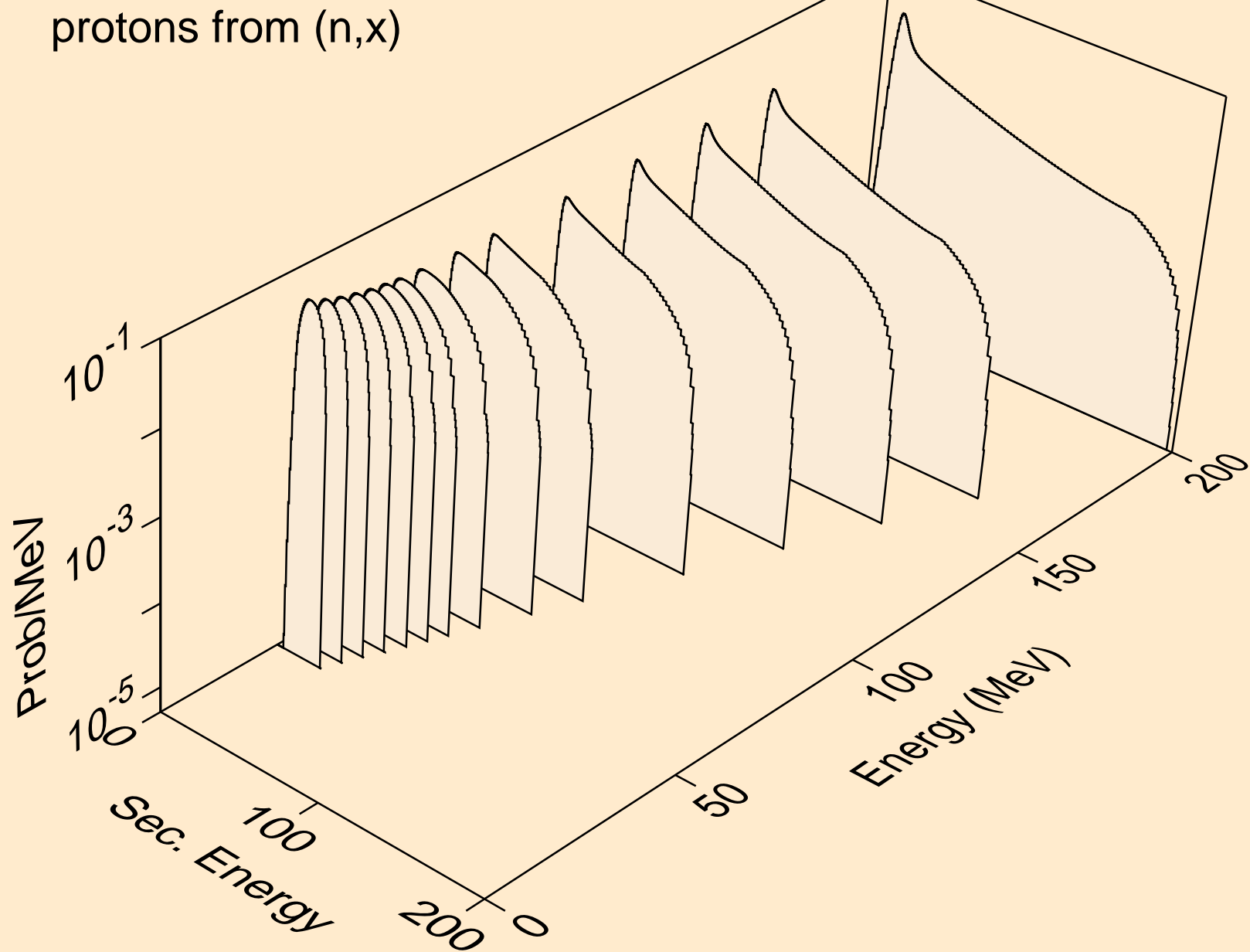

OS191M NEUTRON ACER TENDL-2024 LIBRARY; T=293.6K  
protons from (n,n\*)p

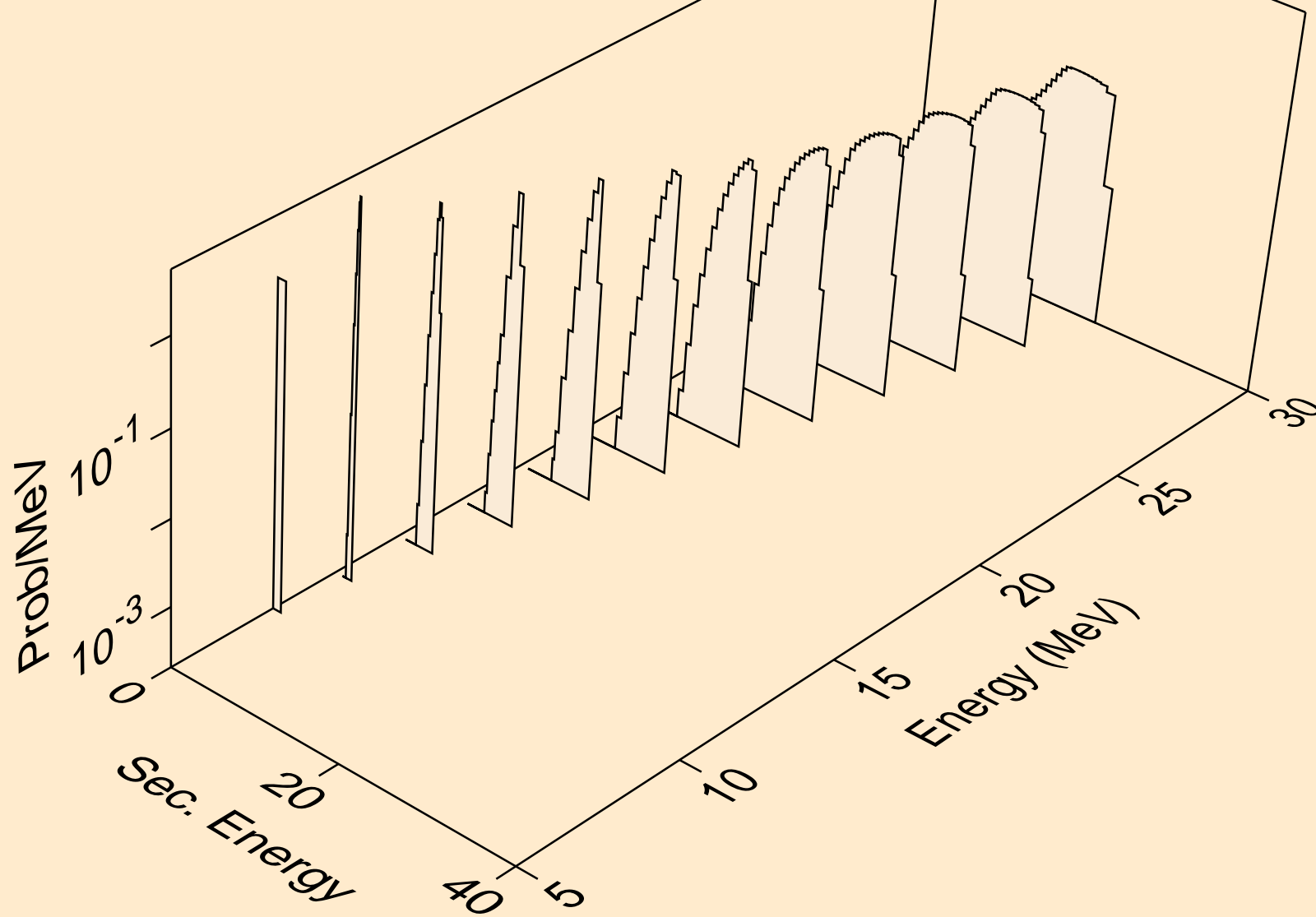

OS191M NEUTRON ACER TENDL-2024 LIBRARY; T=293.6K  
protons from (n,2np)

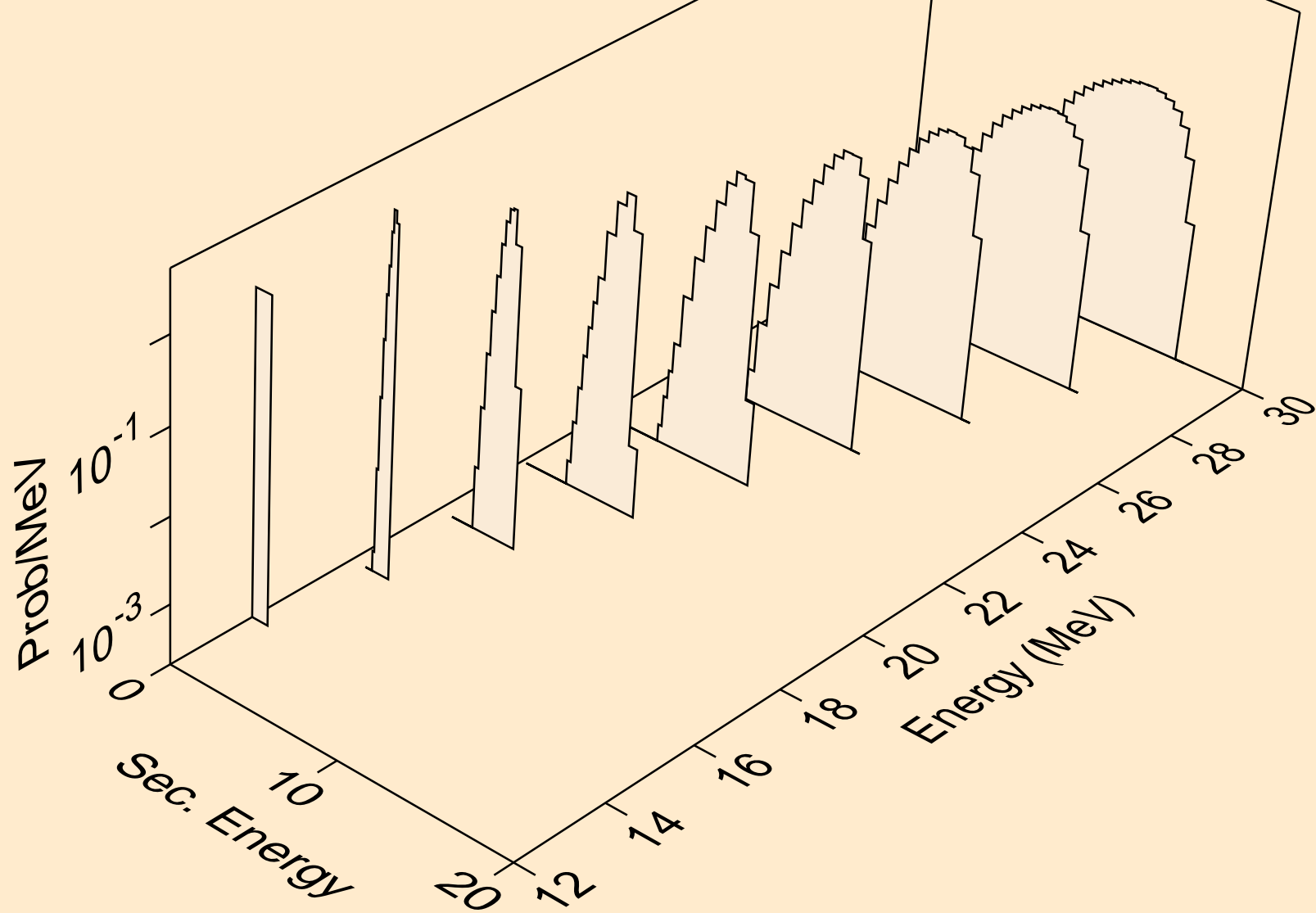

OS191M NEUTRON ACER TENDL-2024 LIBRARY; T=293.6K  
protons from (n,3np)

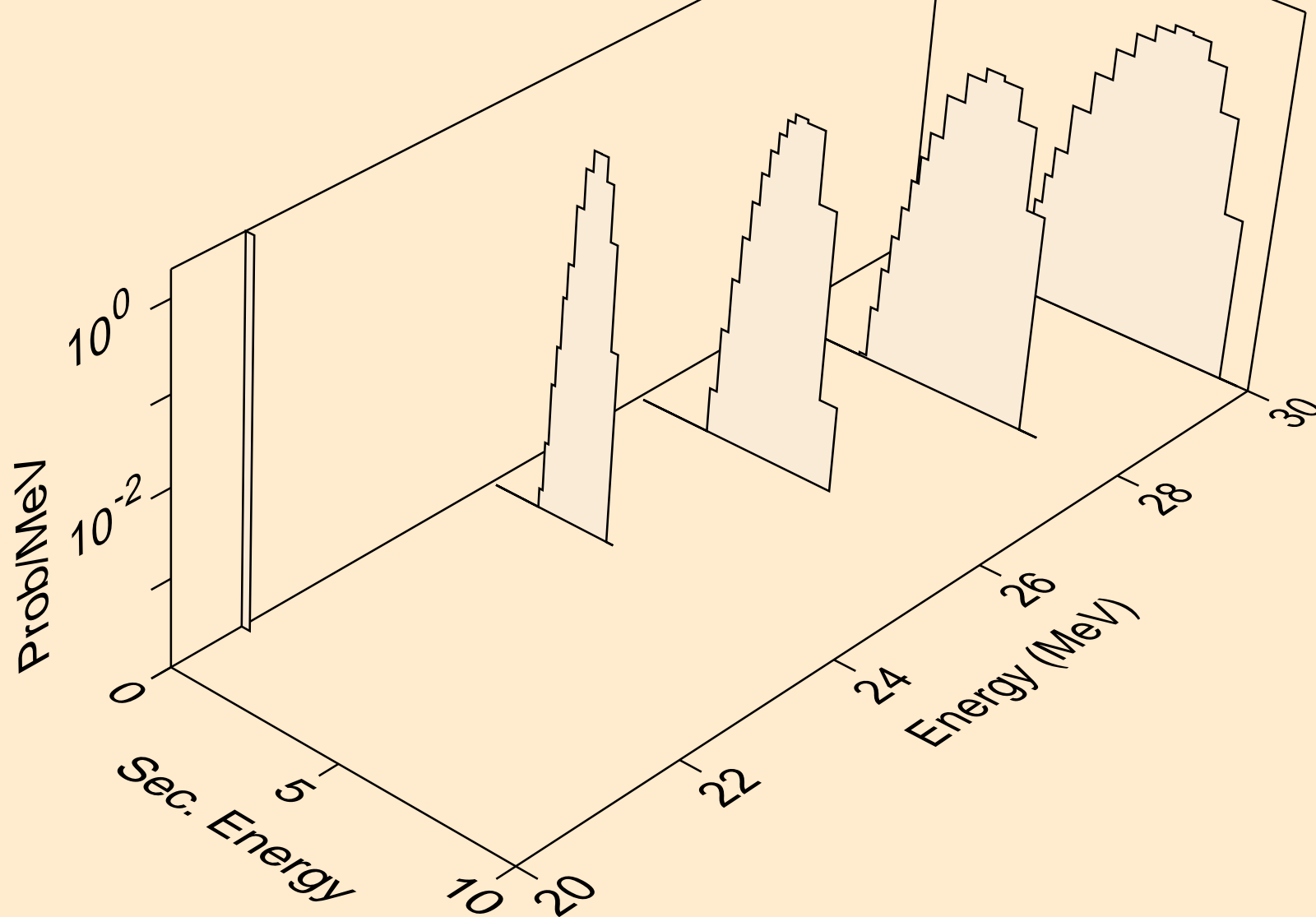

OS191M NEUTRON ACER TENDL-2024 LIBRARY; T=293.6K  
protons from (n,n2p)

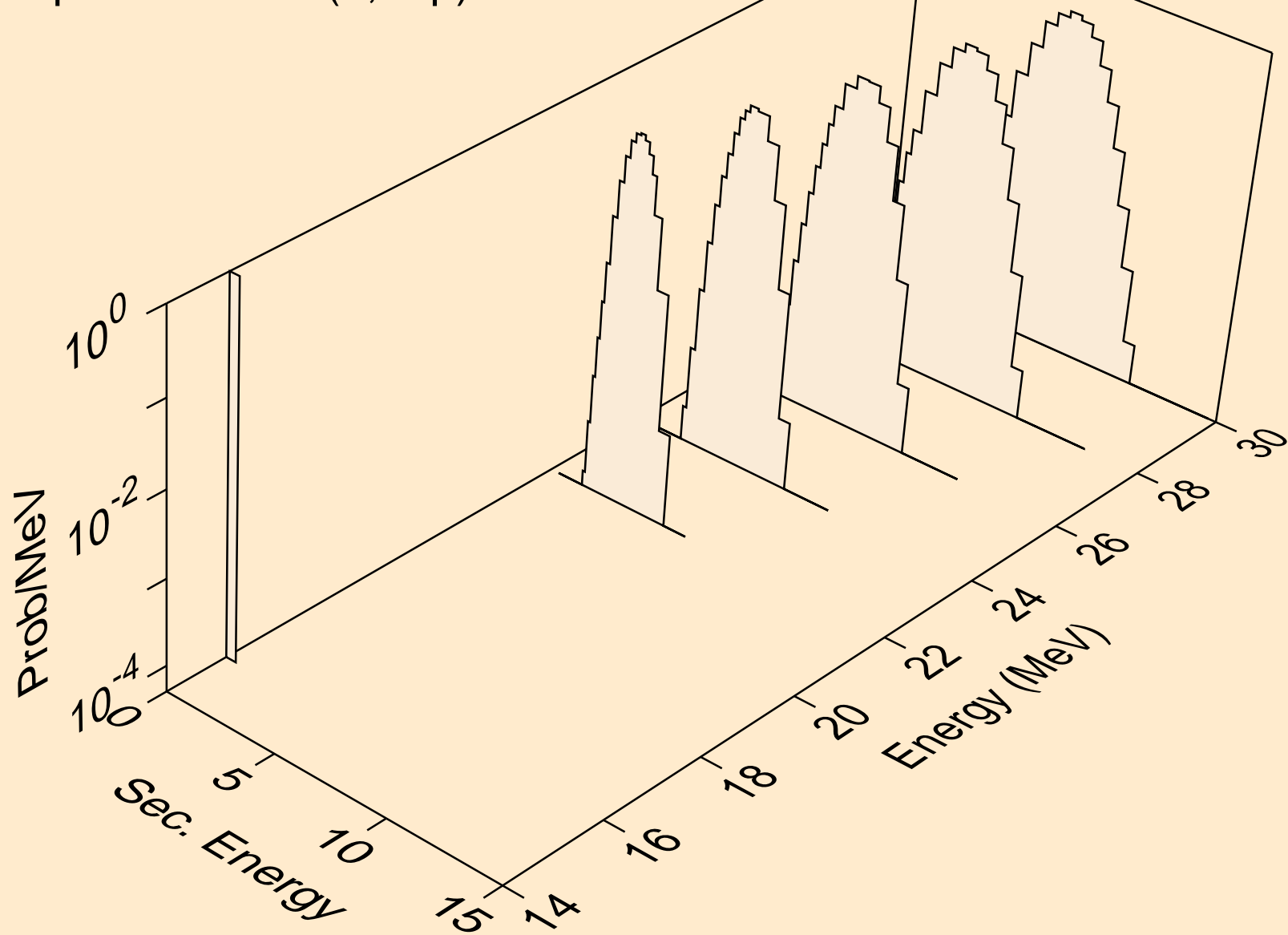

OS191M NEUTRON ACER TENDL-2024 LIBRARY; T=293.6K  
protons from (n,p)

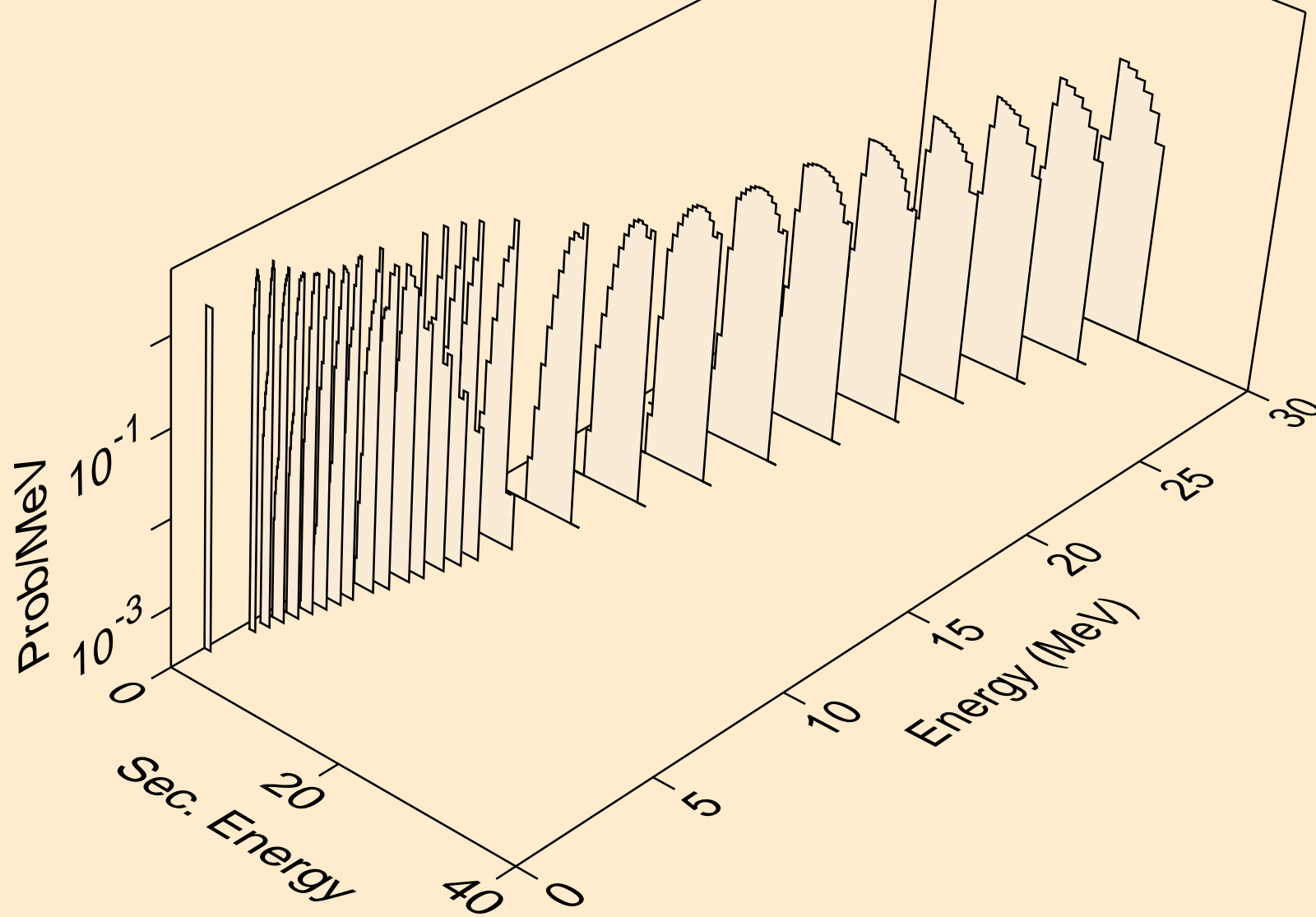

OS191M NEUTRON ACER TENDL-2024 LIBRARY; T=293.6K  
protons from (n,2p)

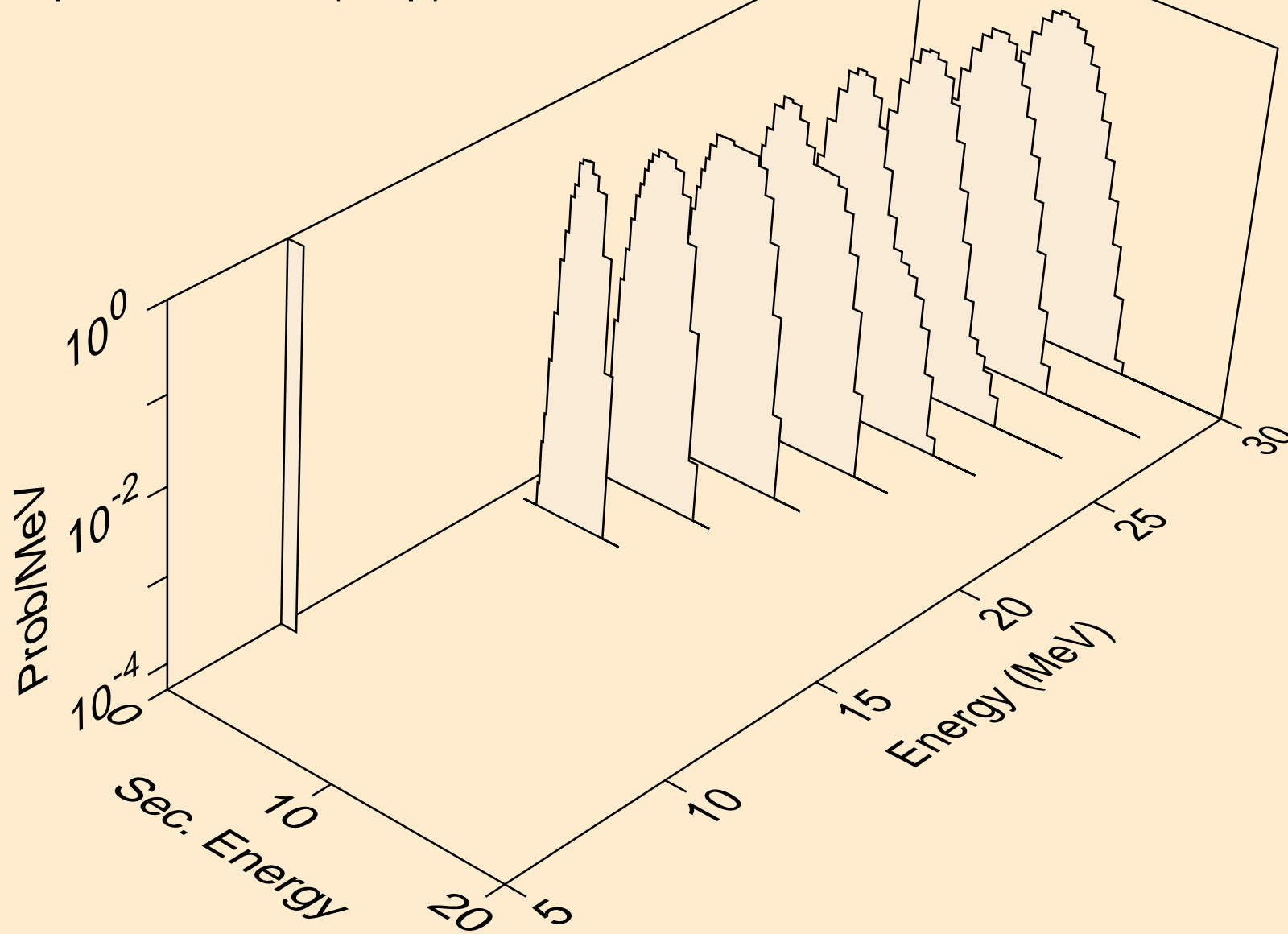

OS191M NEUTRON ACER TENDL-2024 LIBRARY; T=293.6K  
deuterons from (n,x)

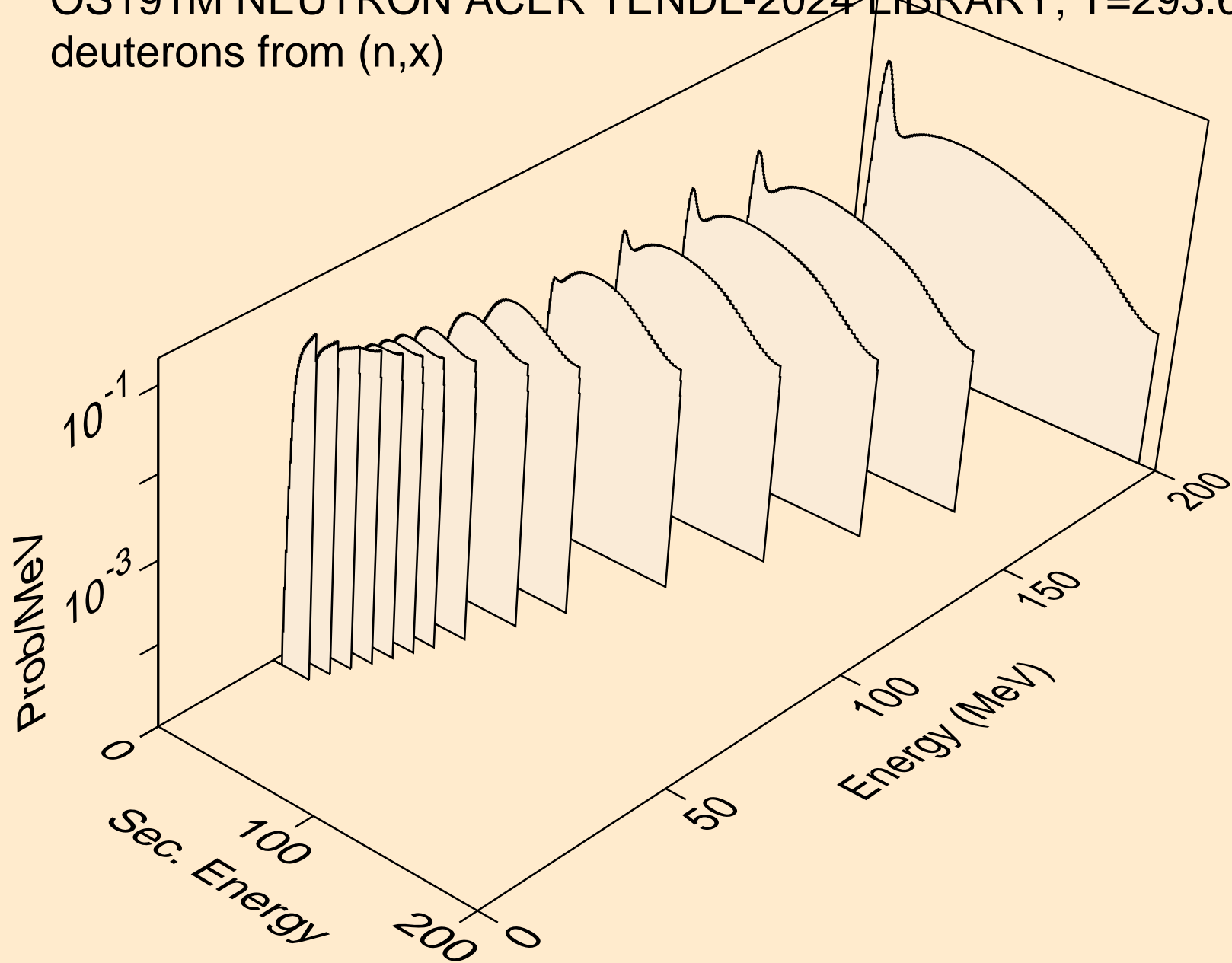

OS191M NEUTRON ACER TENDL-2024 LIBRARY; T=293.6K  
deuterons from (n,2nd)

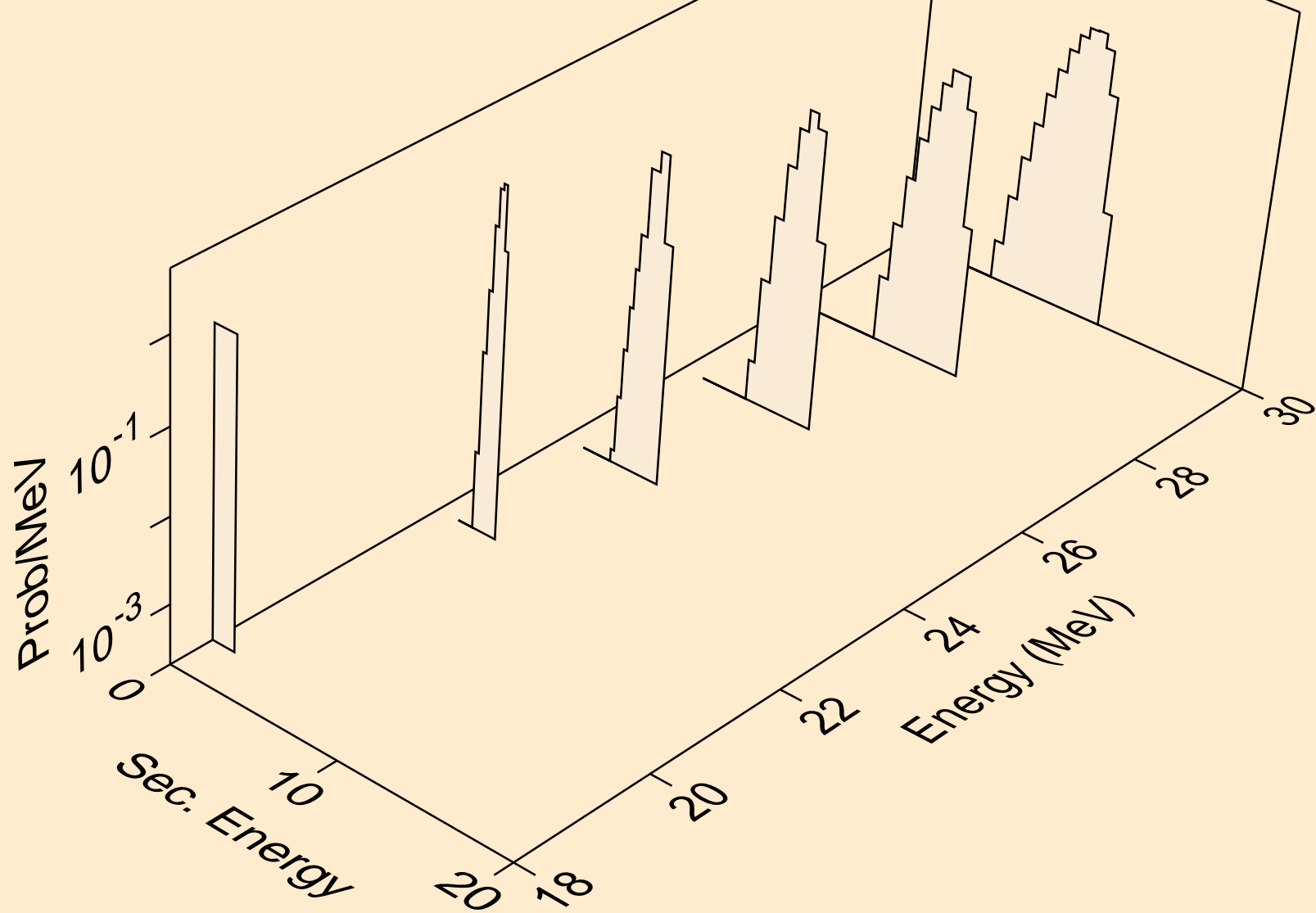

OS191M NEUTRON ACER TENDL-2024 LIBRARY; T=293.6K  
deuterons from (n,n\*)d

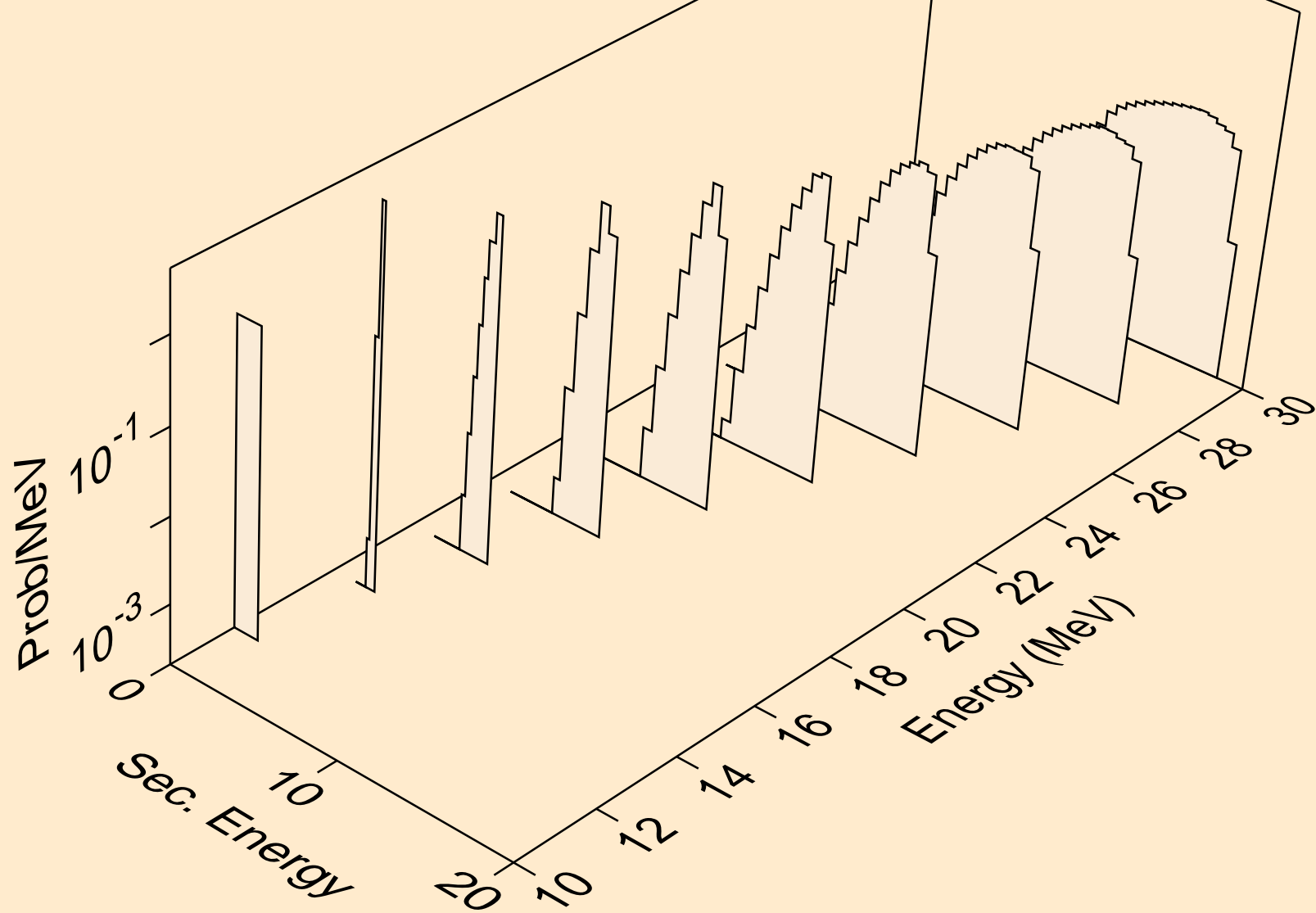

OS191M NEUTRON ACER TENDL-2024 LIBRARY; T=293.6K  
deuterons from (n,d)

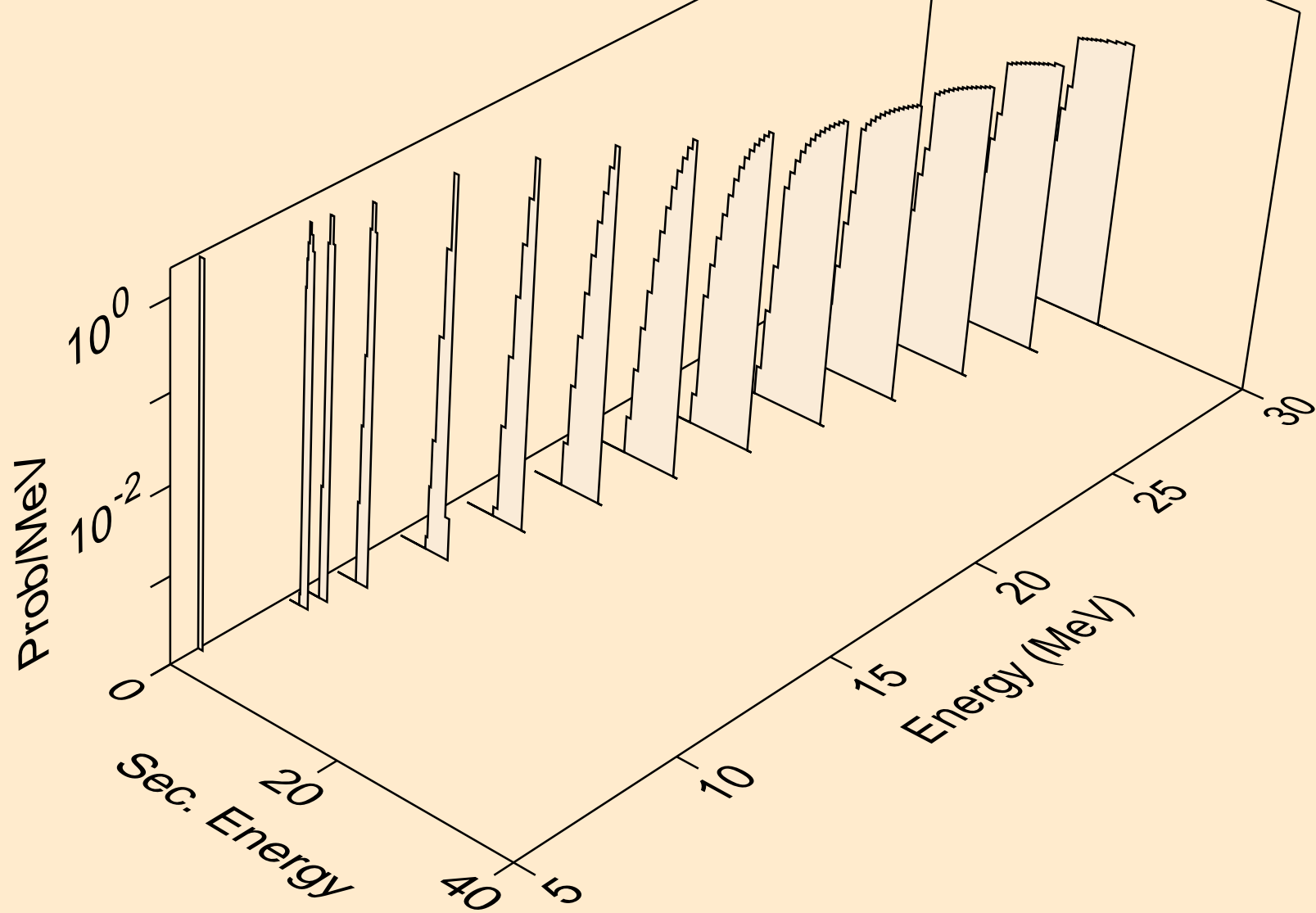

OS191M NEUTRON ACER TENDL-2024 LIBRARY; T=293.6K  
tritons from (n,x)

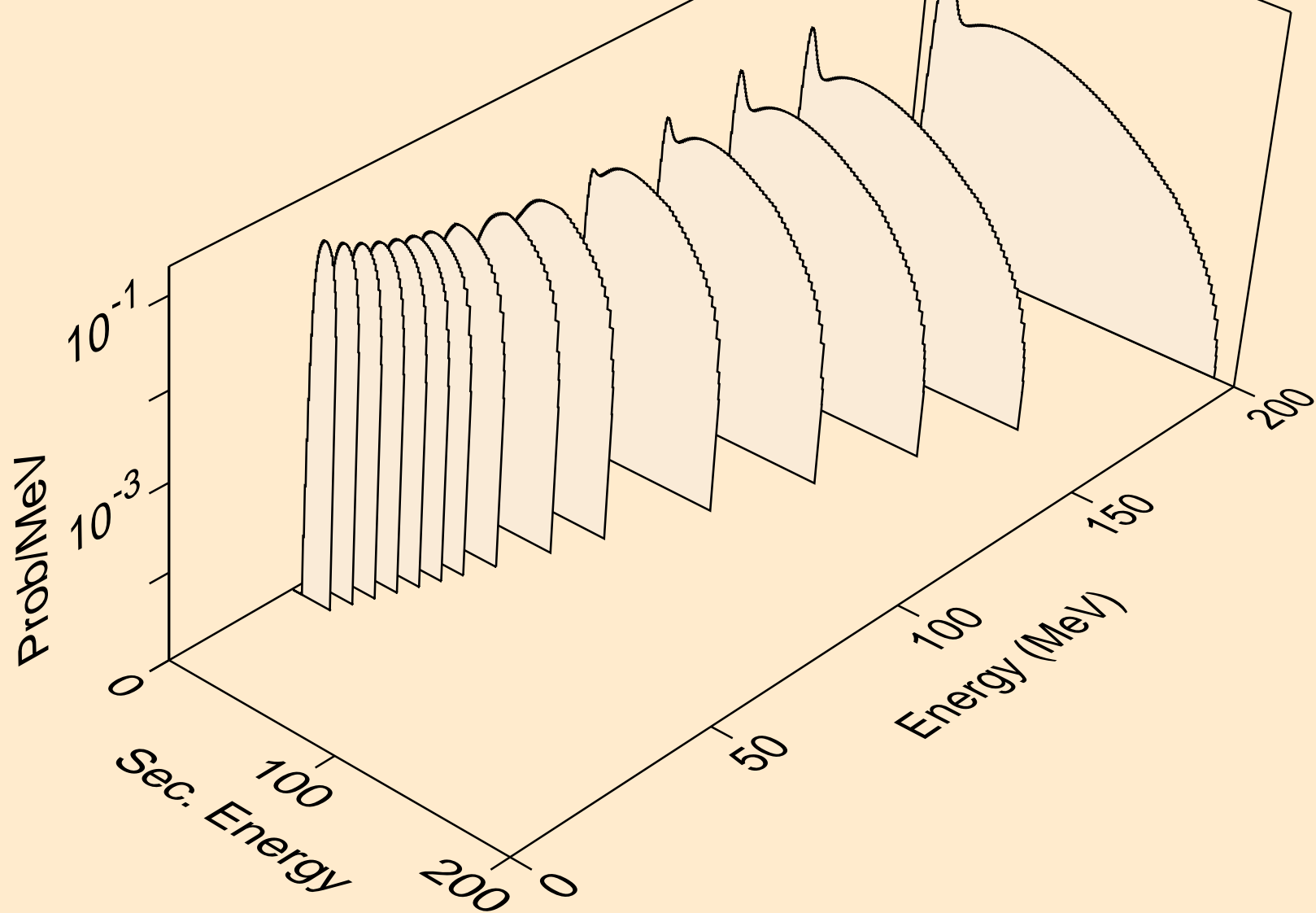

OS191M NEUTRON ACER TENDL-2024 LIBRARY; T=293.6K  
tritons from (n,n\*)t

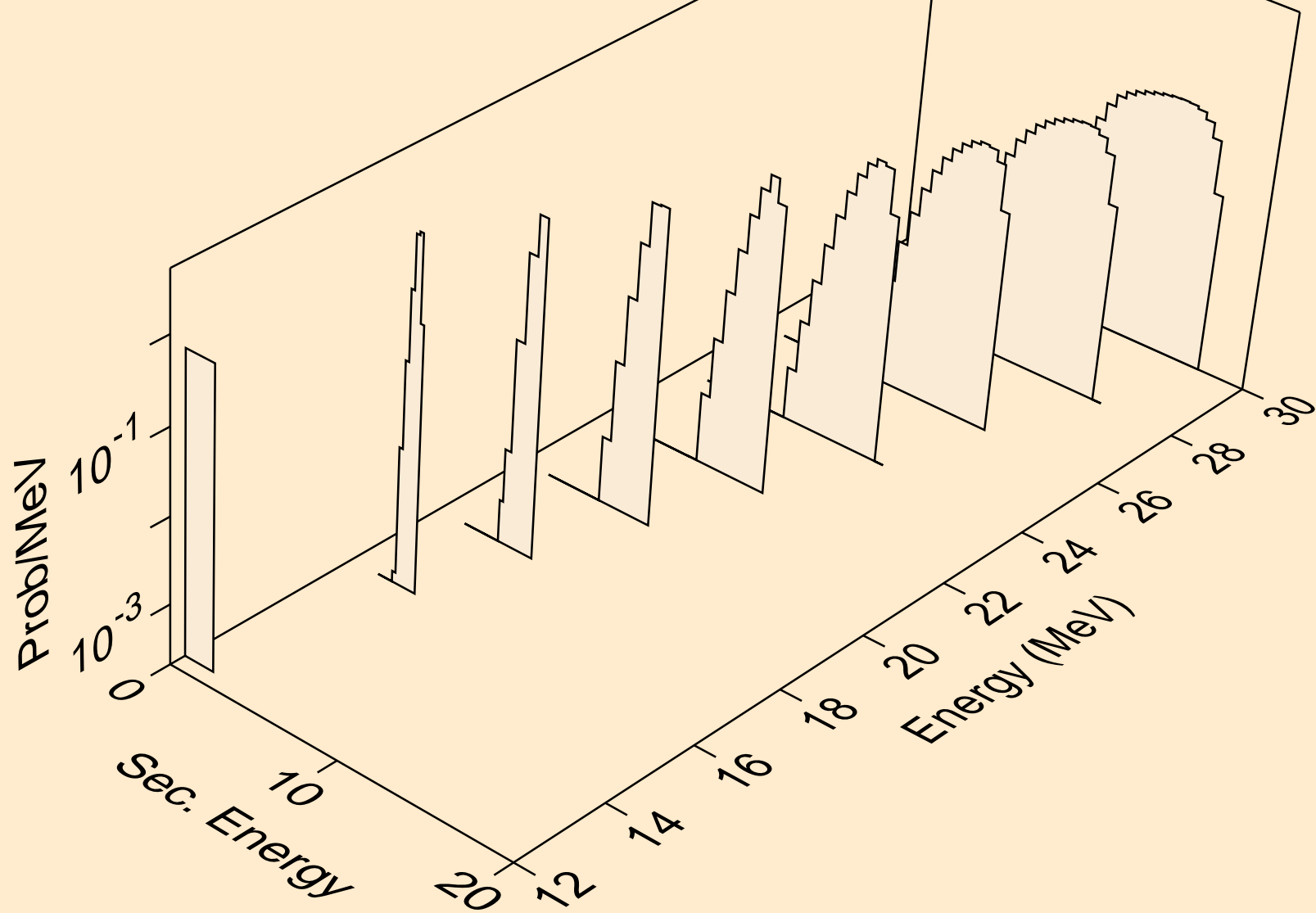

OS191M NEUTRON ACER TENDL-2024 LIBRARY; T=293.6K  
tritons from (n,t)

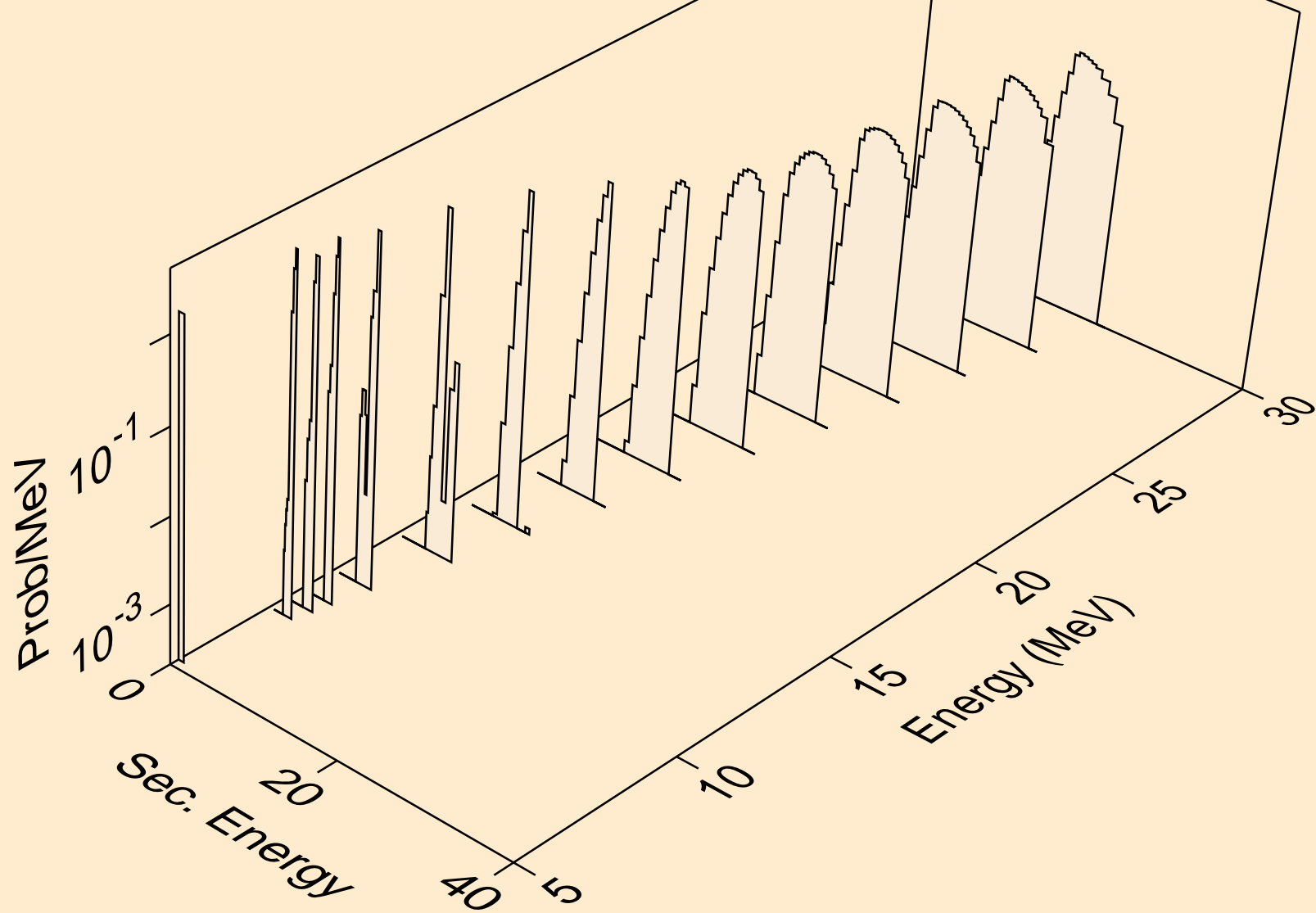

OS191M NEUTRON ACER TENDL-2024 LIBRARY; T=293.6K  
he3s from (n,x)

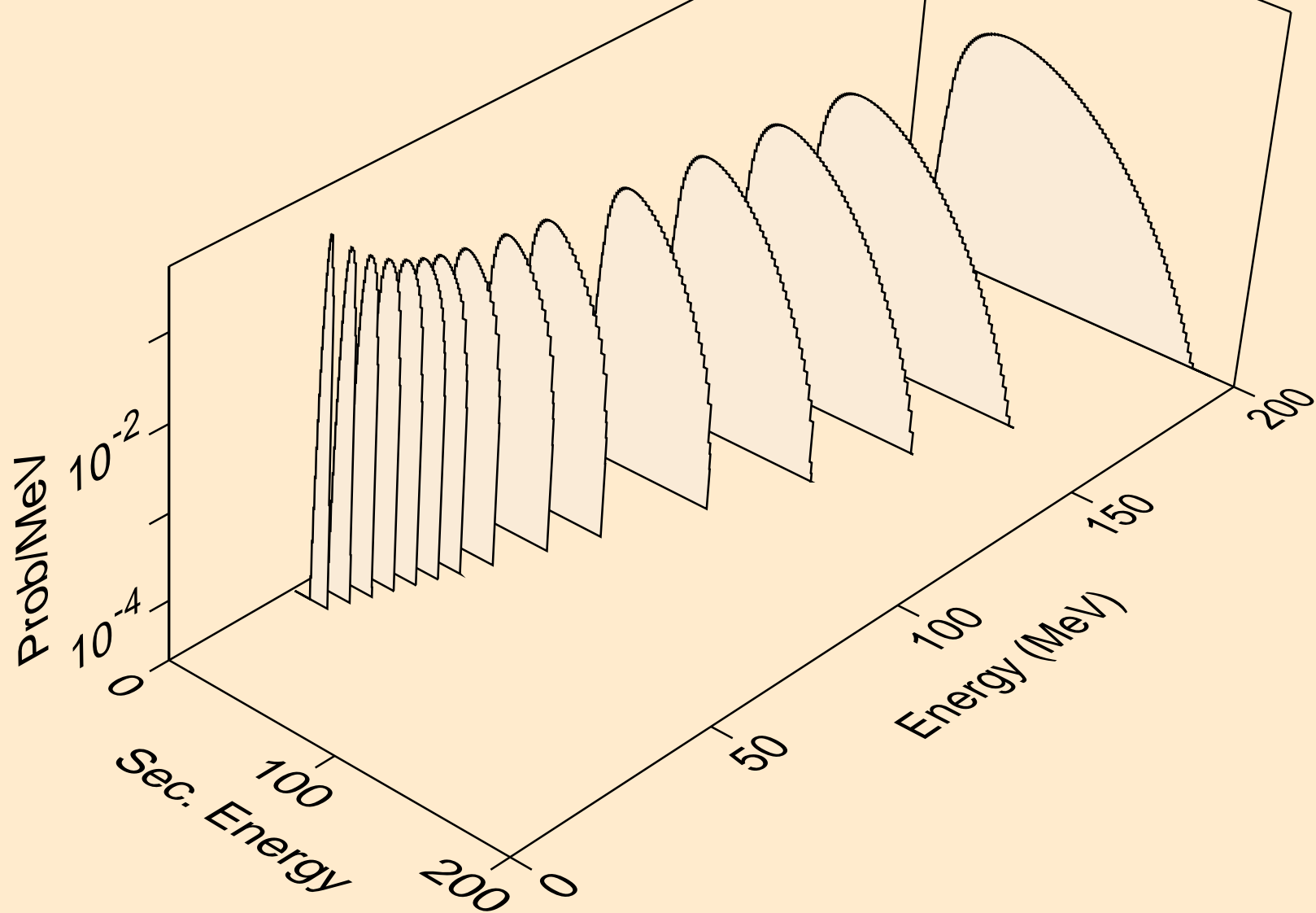

OS191M NEUTRON ACER TENDL-2024 LIBRARY; T=293.6K  
he3s from (n,n\*)he3

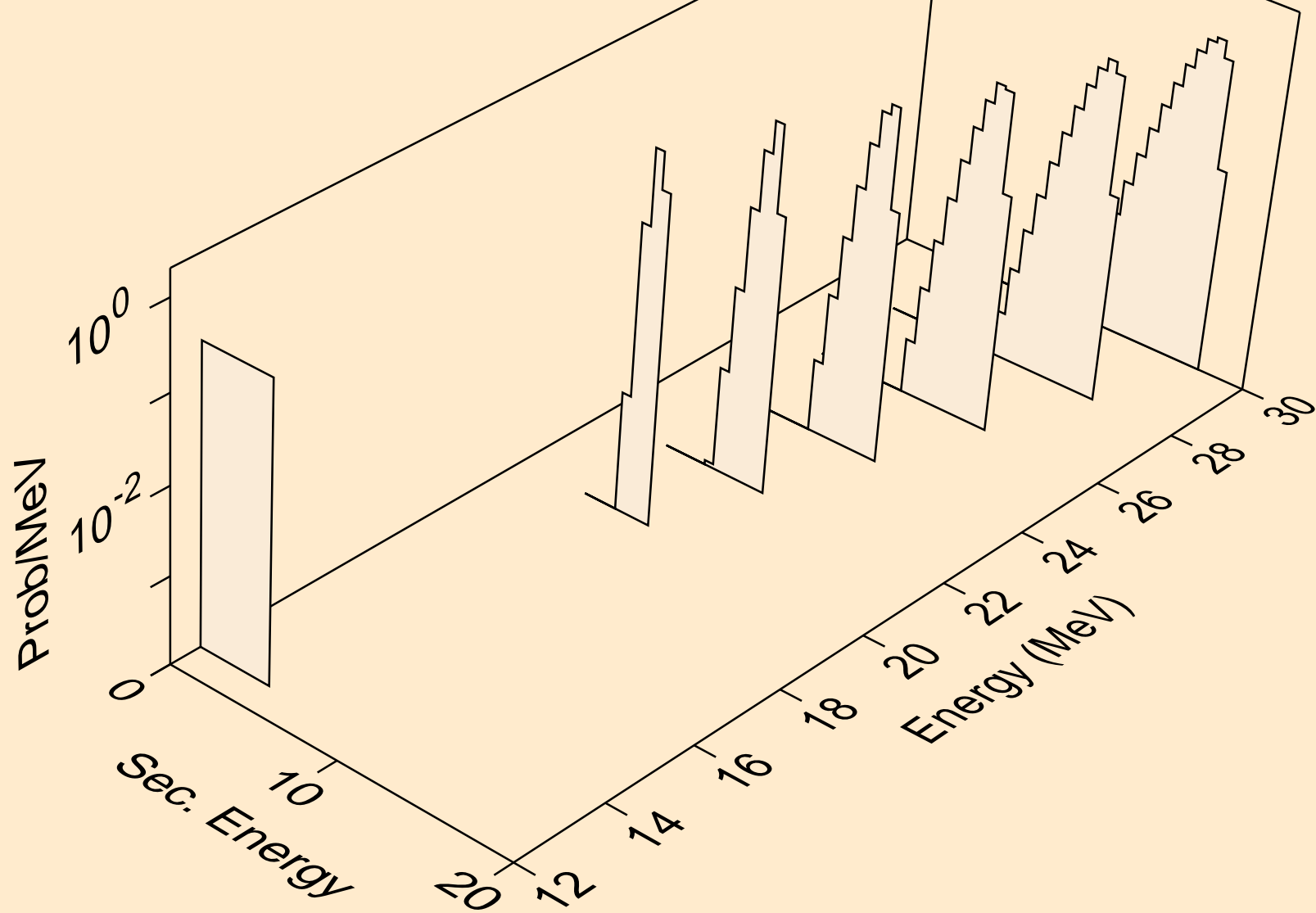

OS191M NEUTRON ACER TENDL-2024 LIBRARY; T=293.6K  
he3s from (n,he3)

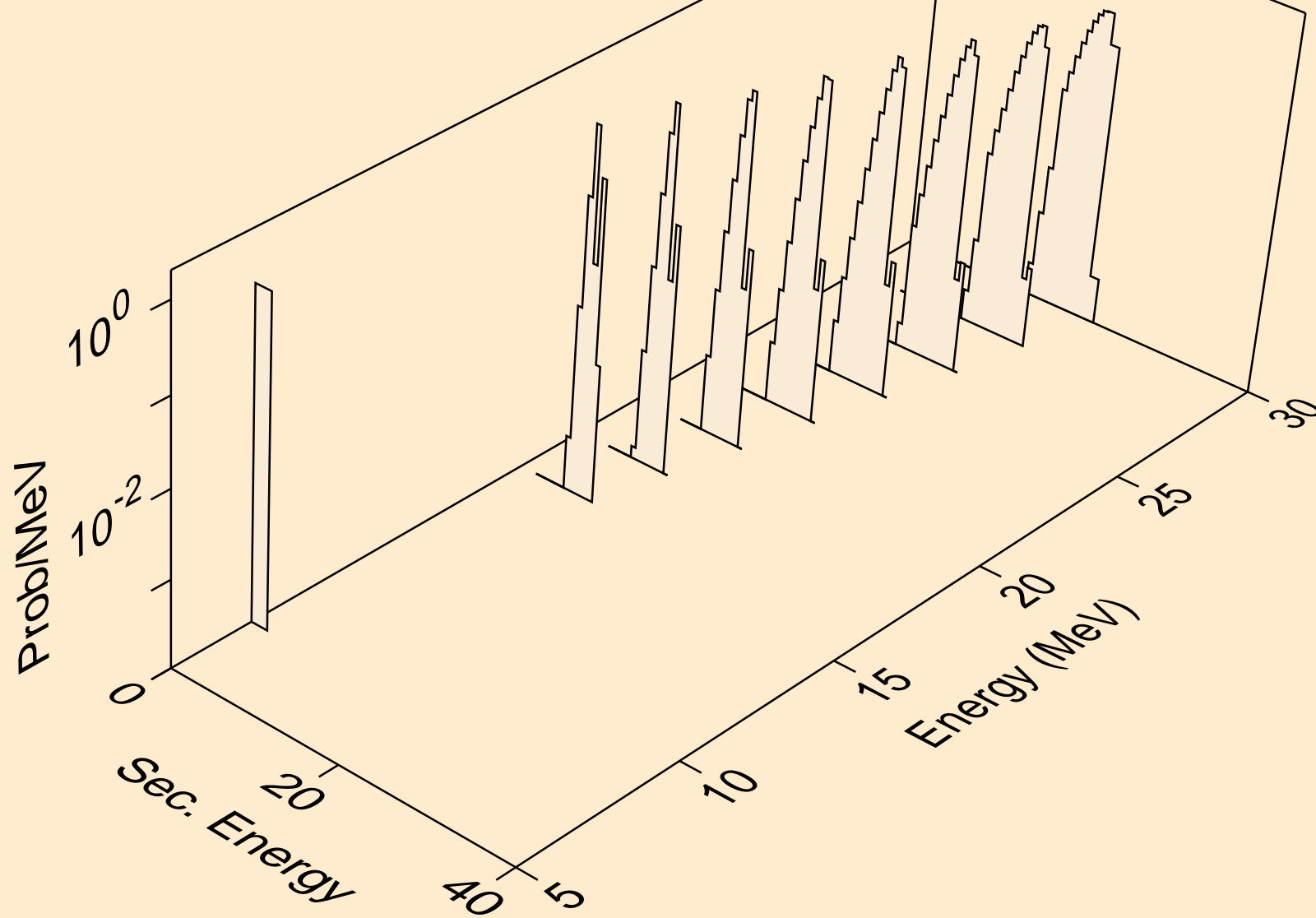

OS191M NEUTRON ACER TENDL-2024 LIBRARY; T=293.6K  
alphas from (n,x)

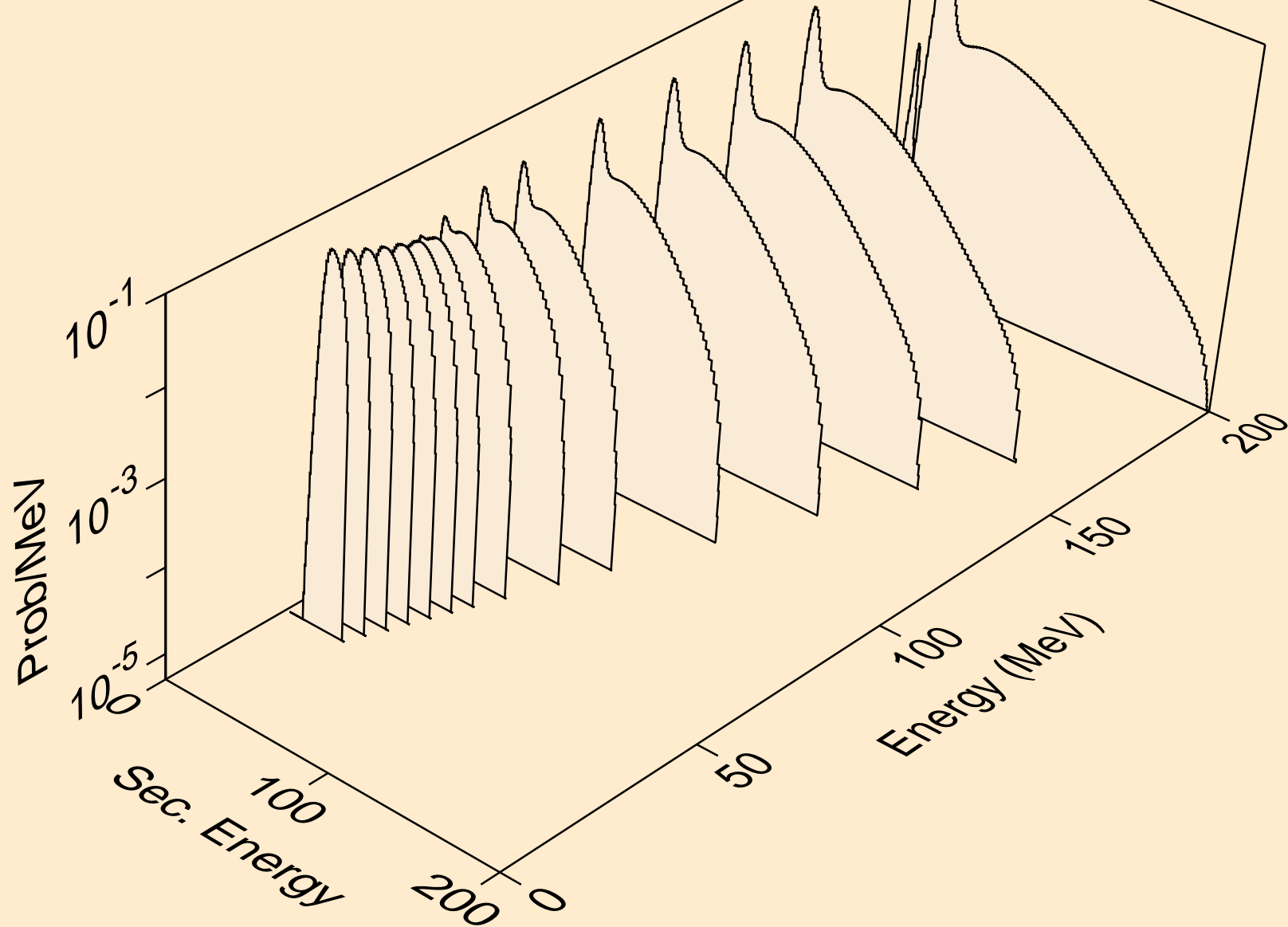

OS191M NEUTRON ACER TENDL-2024 LIBRARY; T=293.6K  
alphas from (n,n\*)a

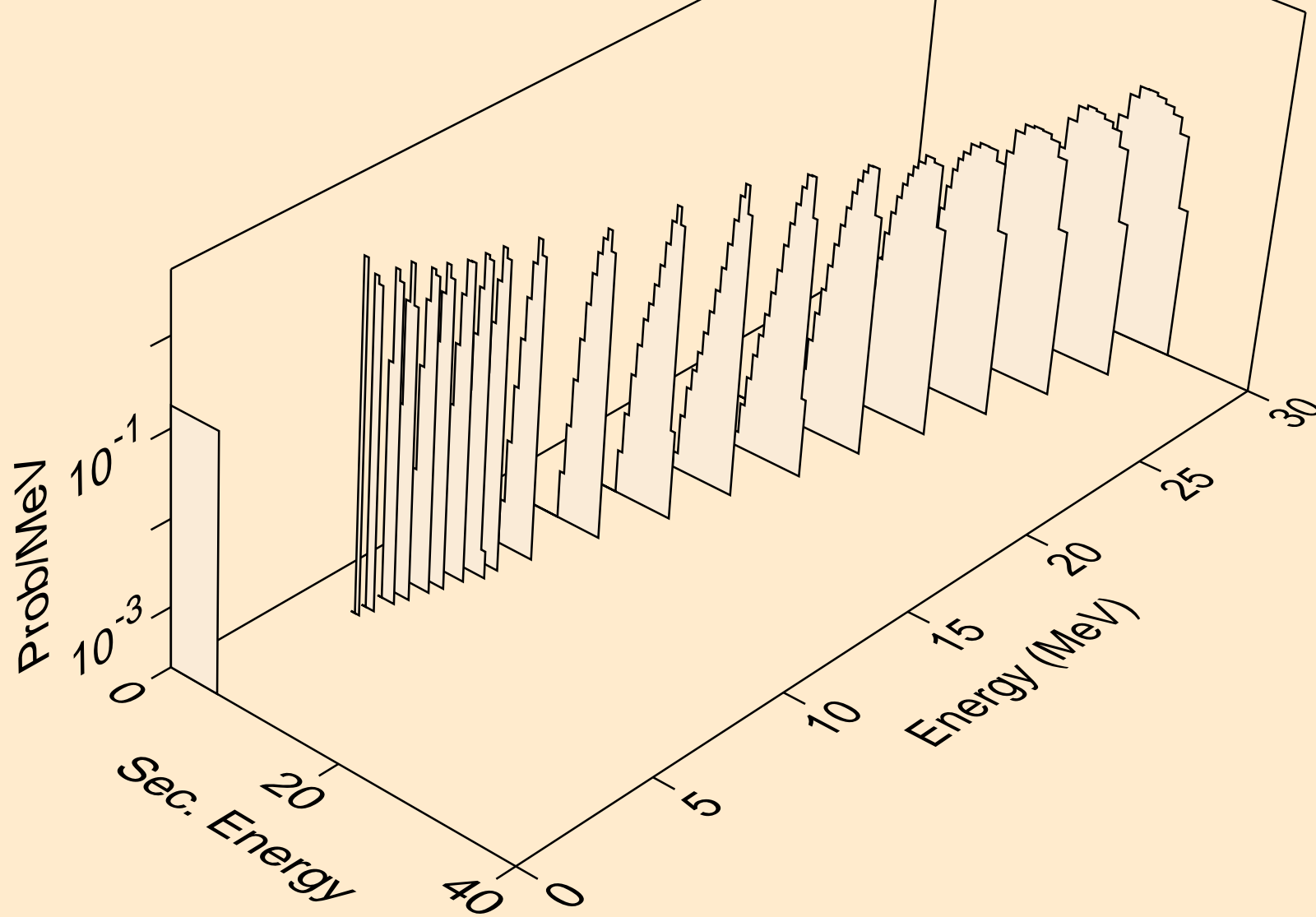

OS191M NEUTRON ACER TENDL-2024 LIBRARY; T=293.6K  
alphas from (n,2n)a

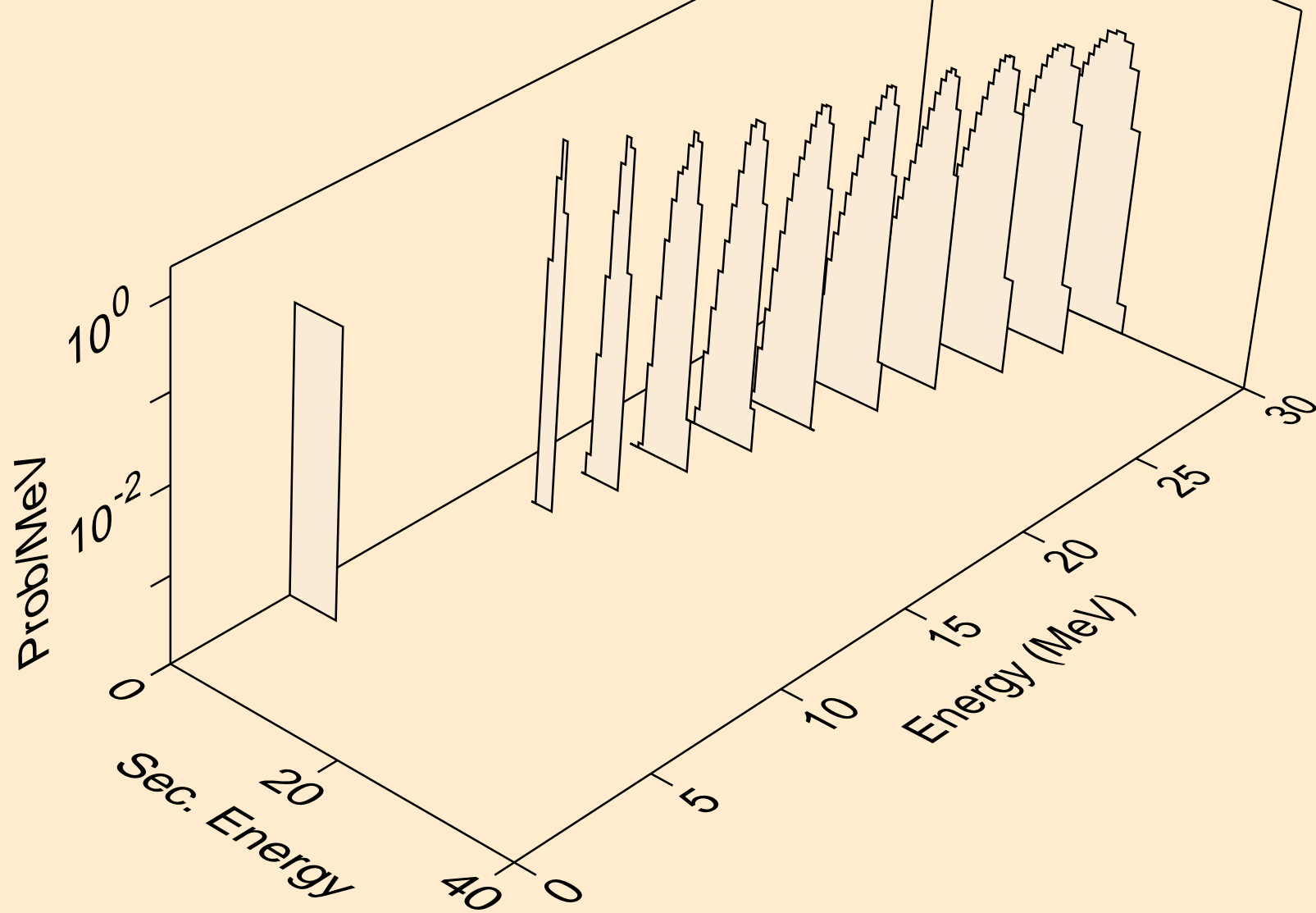

OS191M NEUTRON ACER TENDL-2024 LIBRARY; T=293.6K  
alphas from (n,3n)a

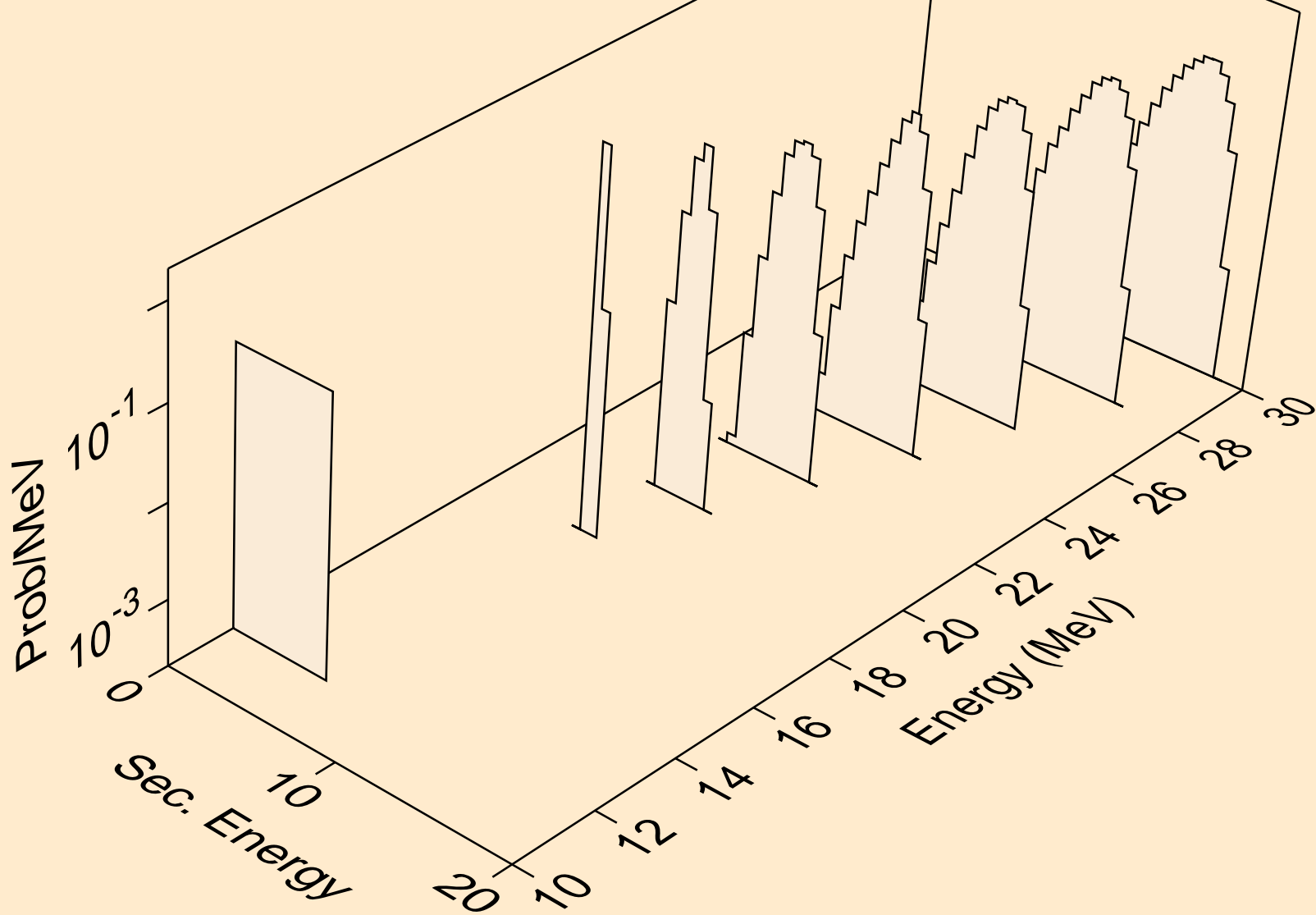

OS191M NEUTRON ACER TENDL-2024 LIBRARY; T=293.6K  
alphas from (n,a)

