

# P029 NEUTRON ACER TENDL-2024 LIBRARY; T=293.6K

## Principal cross sections

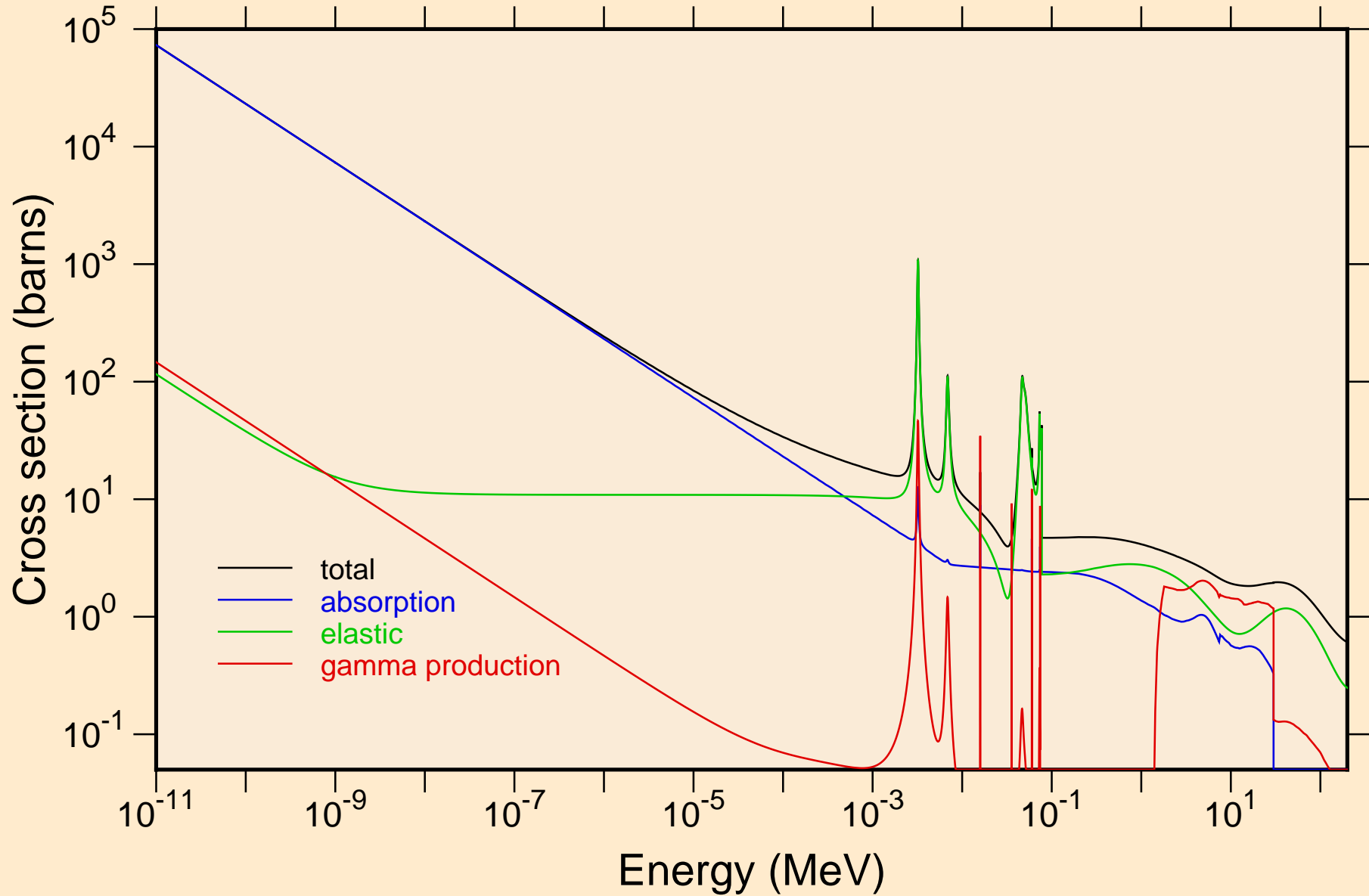

P029 NEUTRON ACER TENDL-2024 LIBRARY; T=293.6K  
resonance total cross section

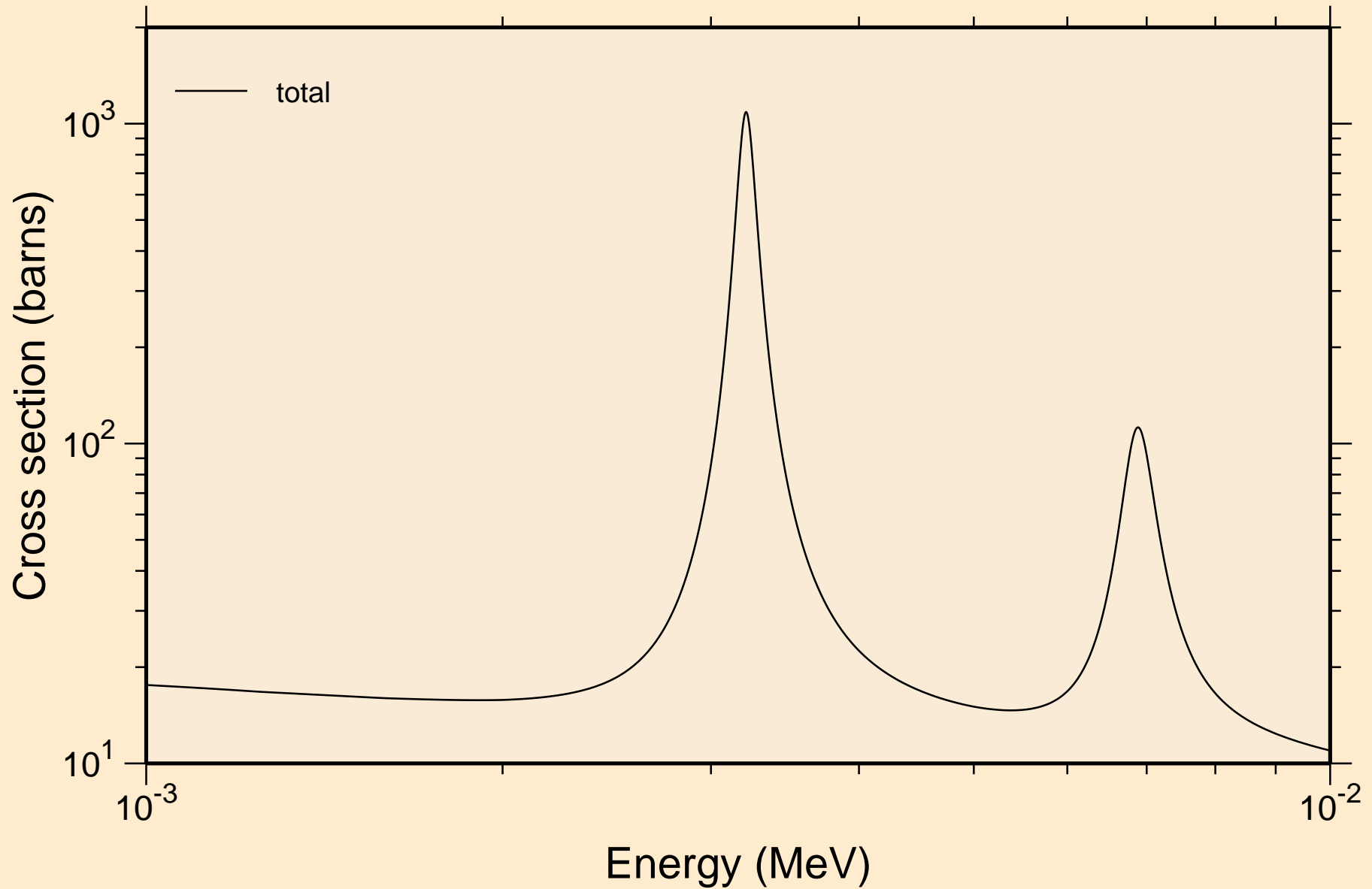

P029 NEUTRON ACER TENDL-2024 LIBRARY; T=293.6K  
resonance total cross section

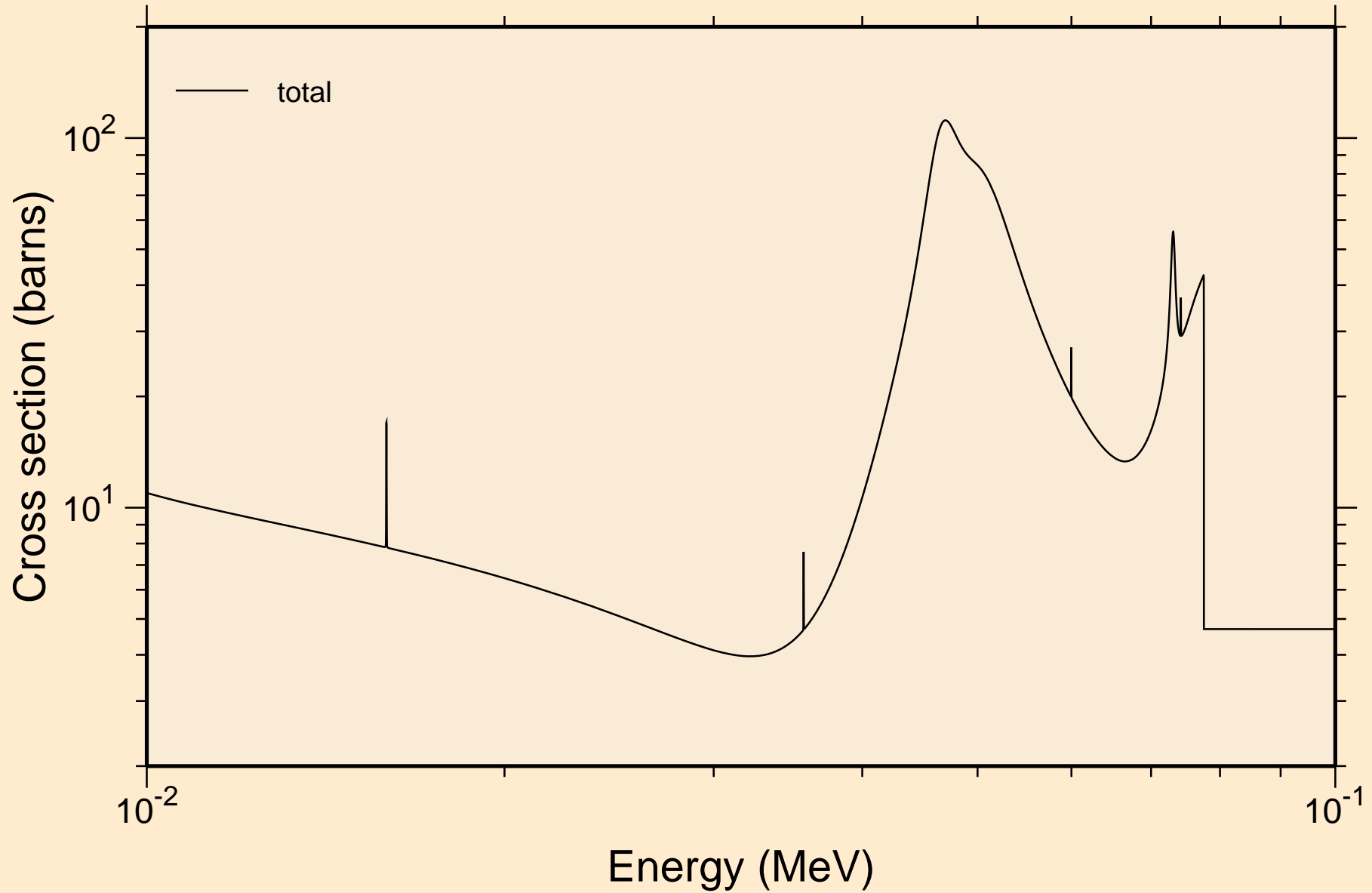

P029 NEUTRON ACER TENDL-2024 LIBRARY; T=293.6K  
resonance total cross section

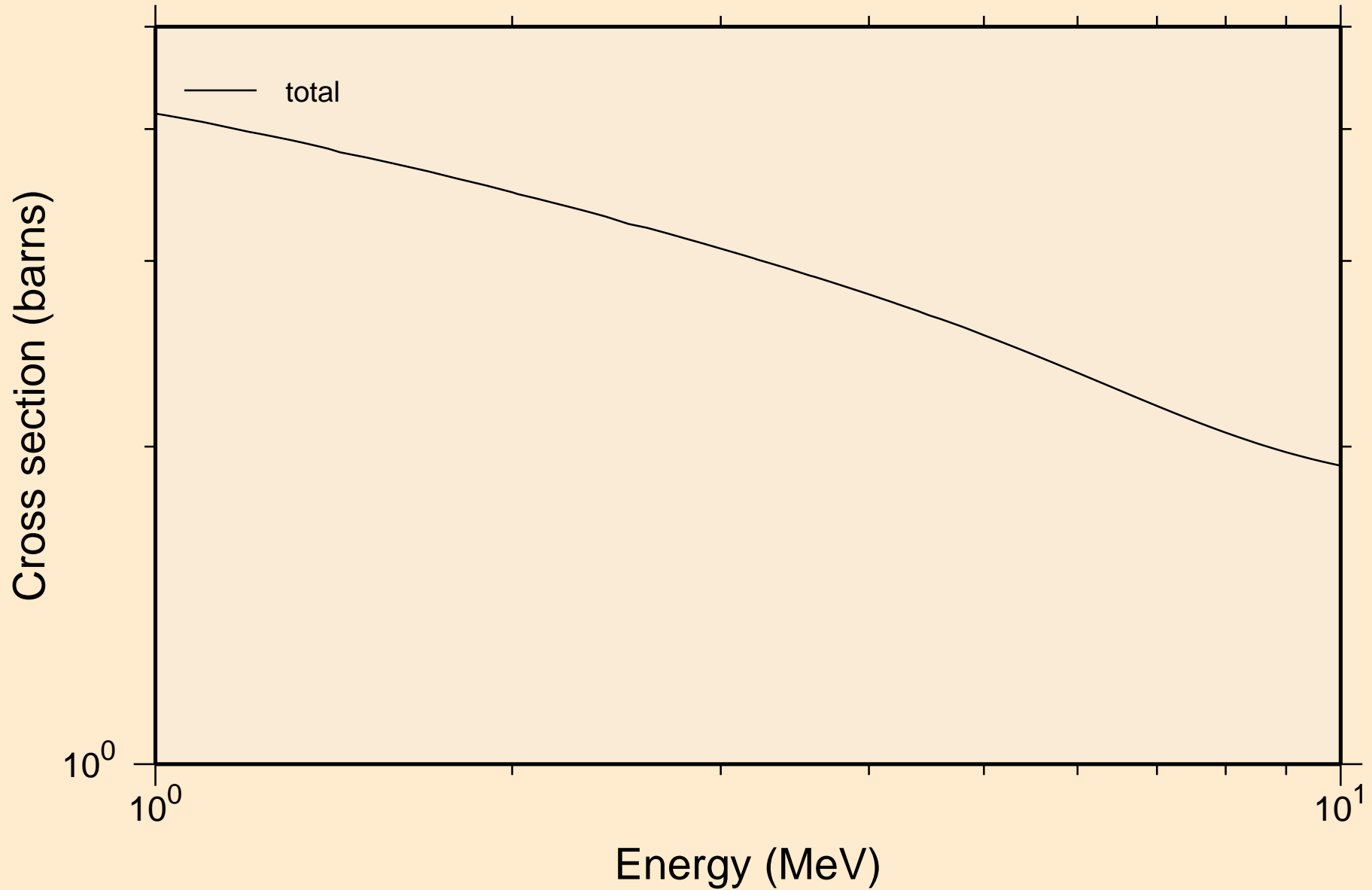

P029 NEUTRON ACER TENDL-2024 LIBRARY; T=293.6K  
resonance absorption cross sections

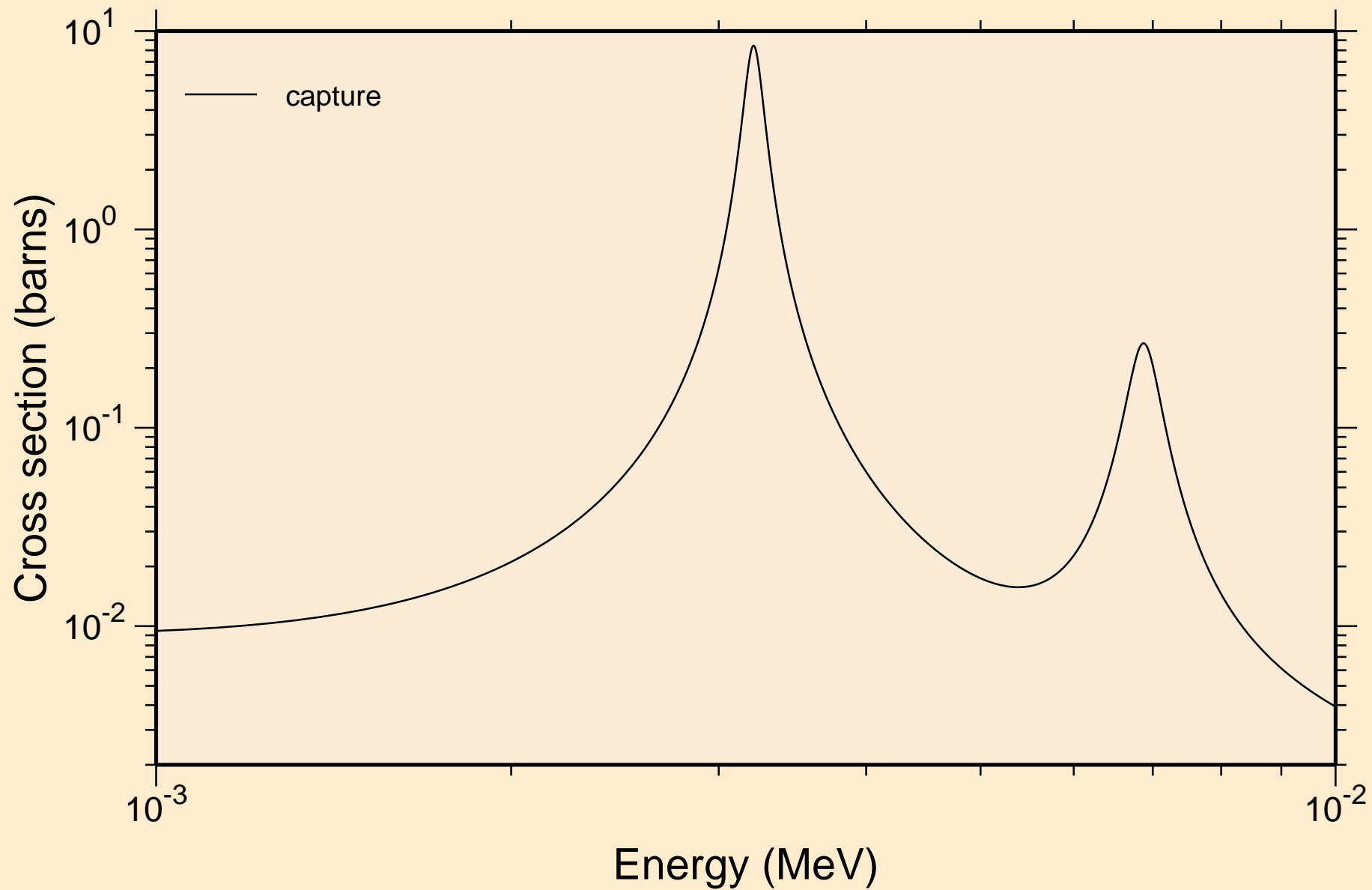

P029 NEUTRON ACER TENDL-2024 LIBRARY; T=293.6K  
resonance absorption cross sections

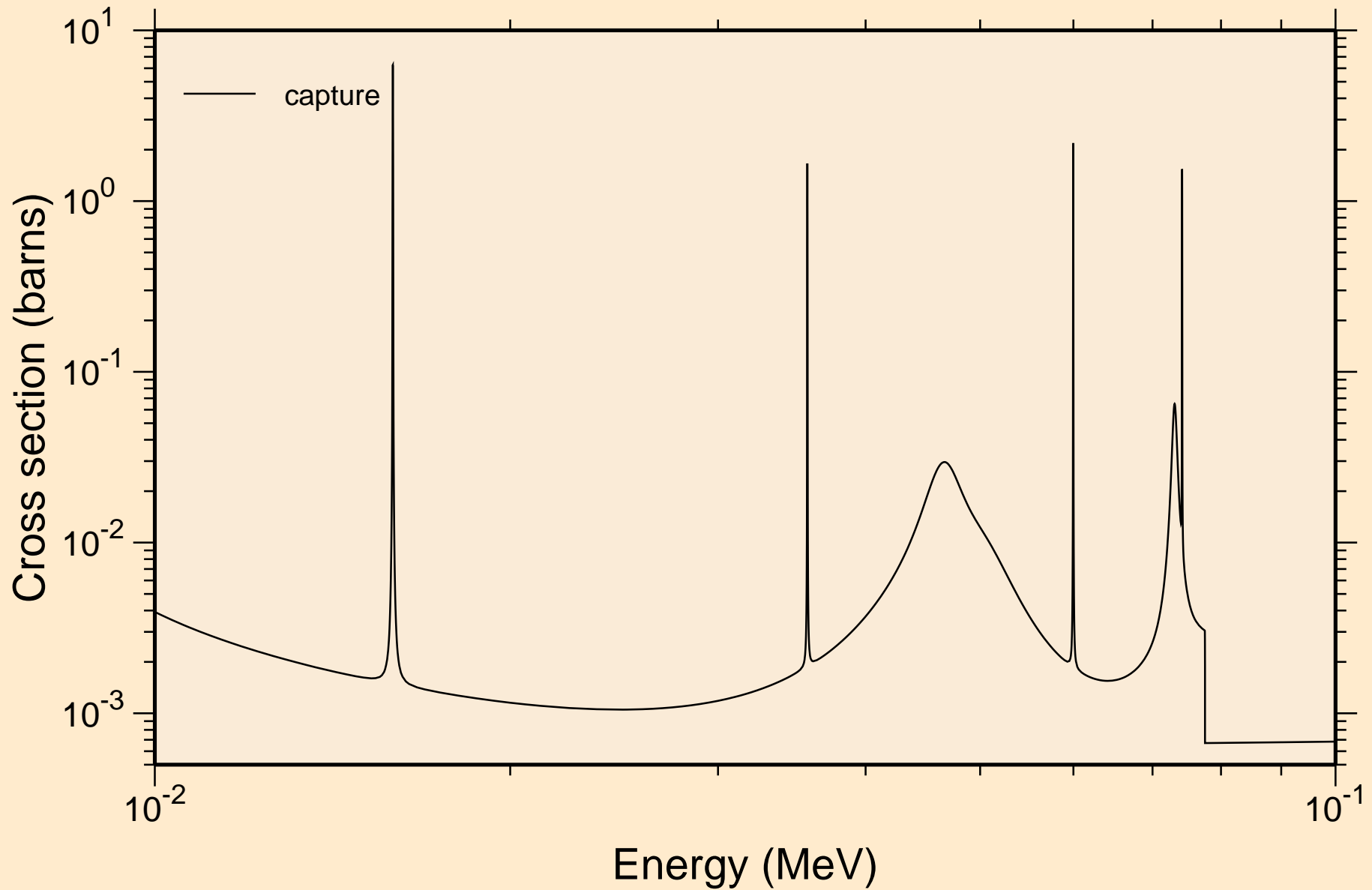

P029 NEUTRON ACER TENDL-2024 LIBRARY; T=293.6K  
resonance absorption cross sections

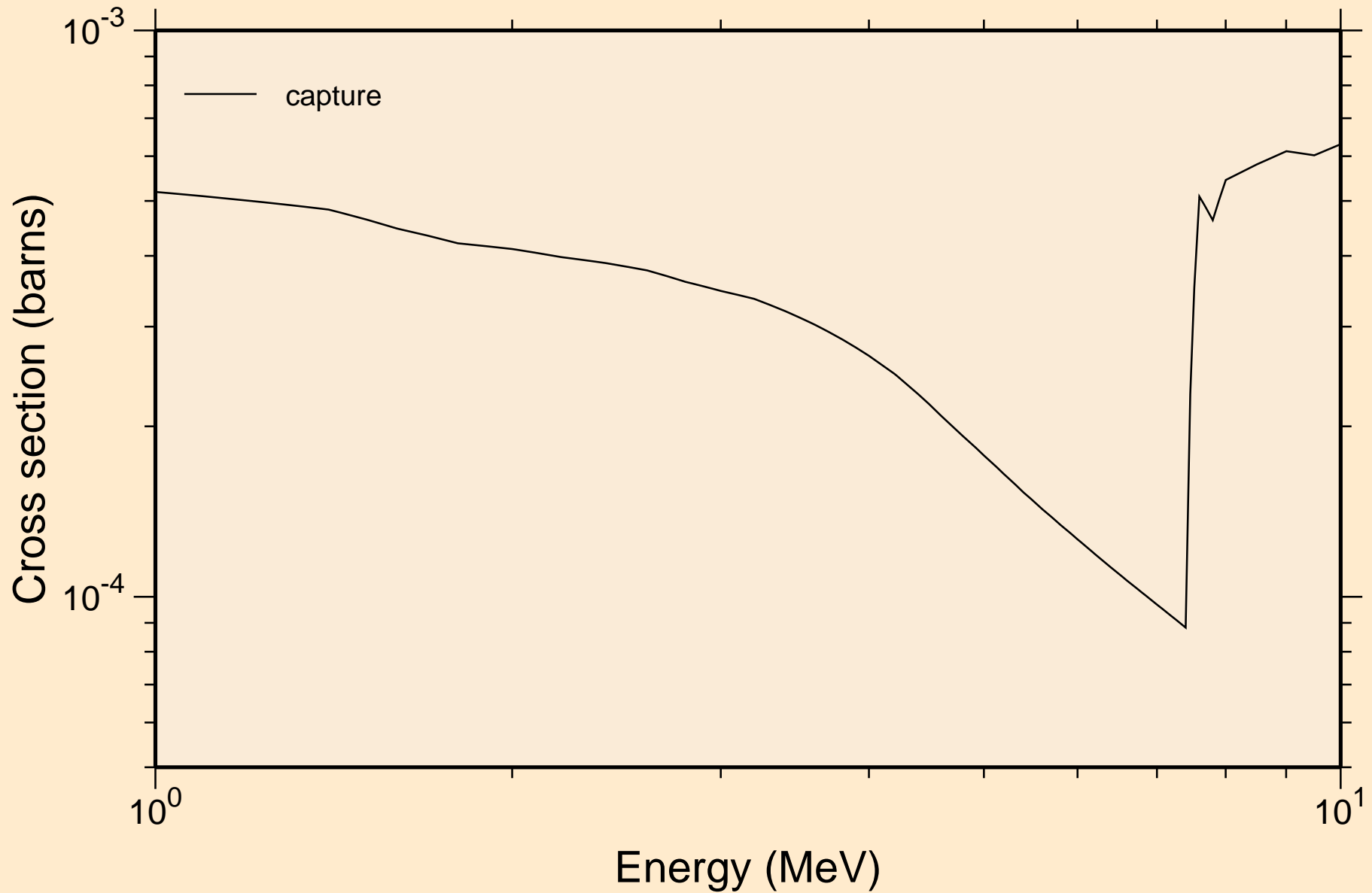

P029 NEUTRON ACER TENDL-2024 LIBRARY; T=293.6K  
Heating

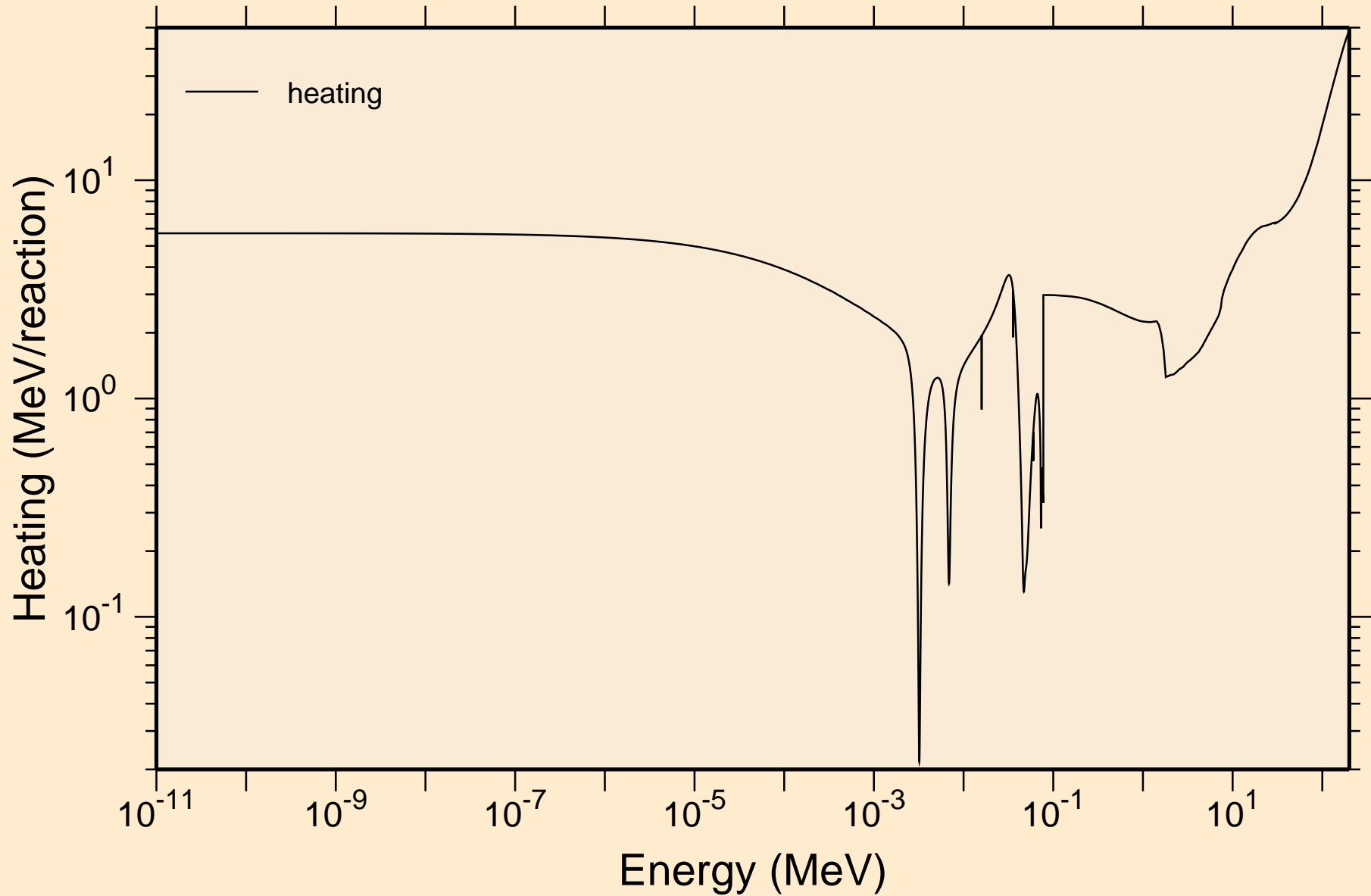

P029 NEUTRON ACER TENDL-2024 LIBRARY; T=293.6K  
Damage

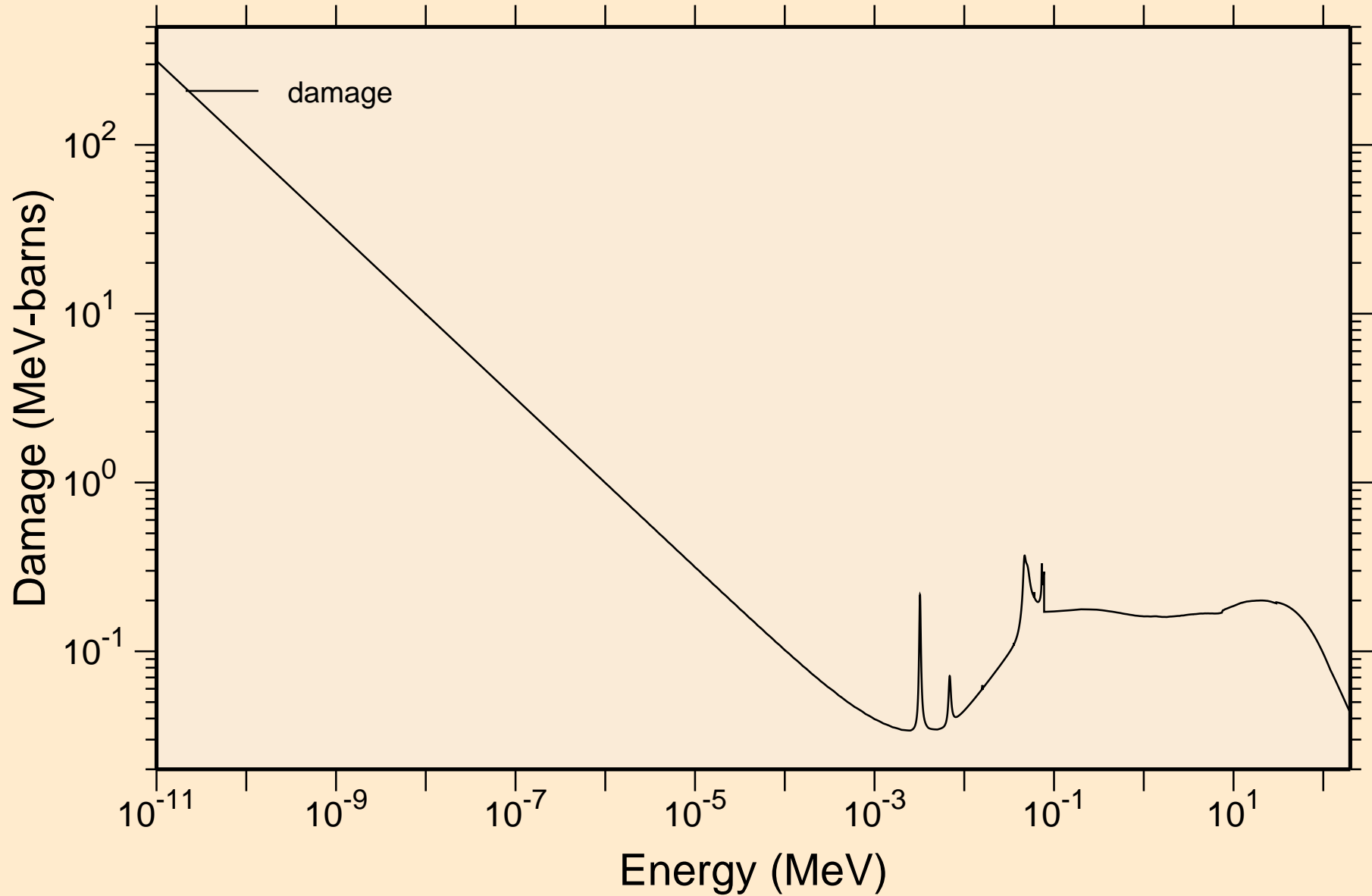

P029 NEUTRON ACER TENDL-2024 LIBRARY; T=293.6K  
Non-threshold reactions

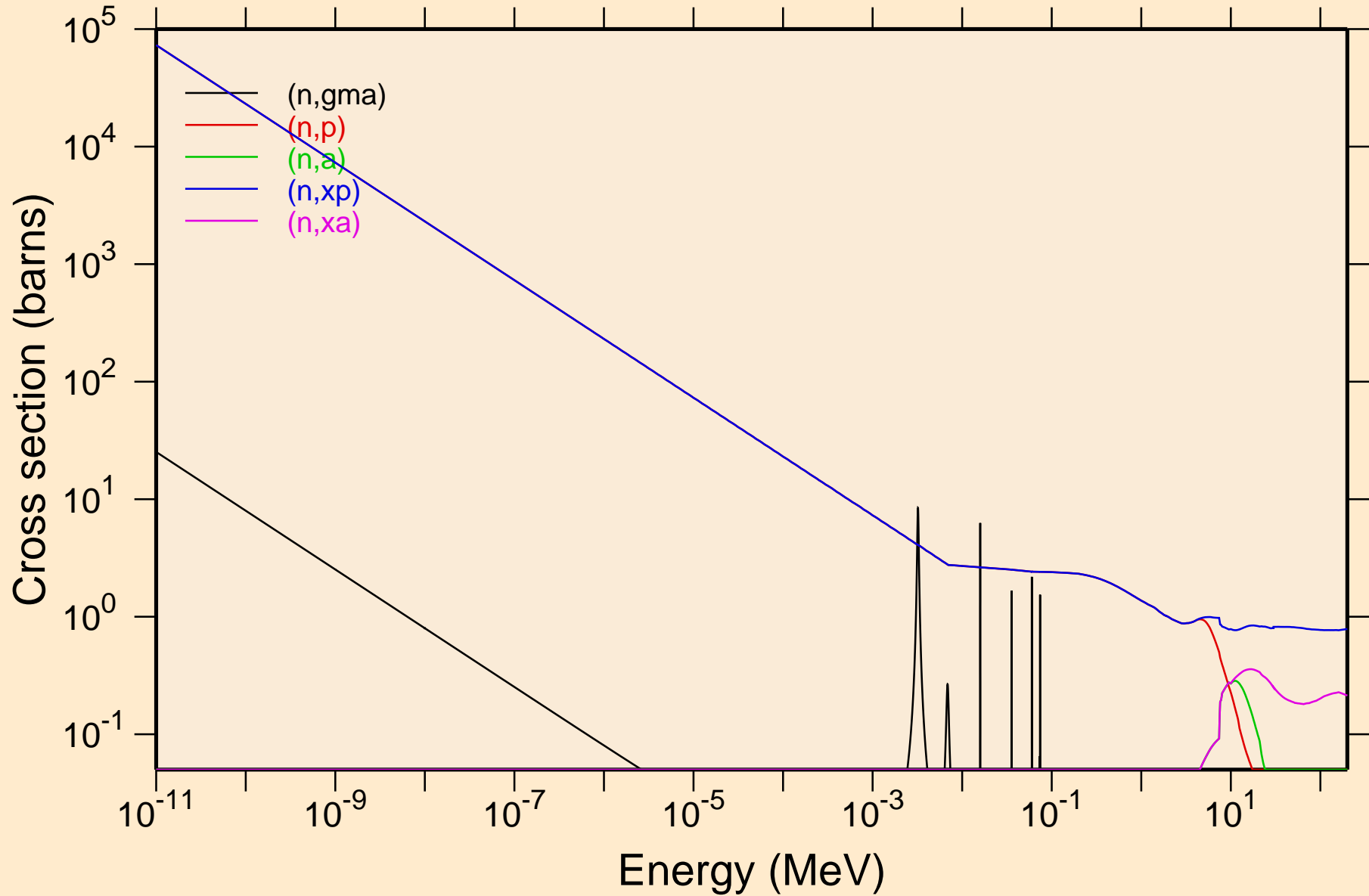

P029 NEUTRON ACER TENDL-2024 LIBRARY; T=293.6K  
Principal cross sections

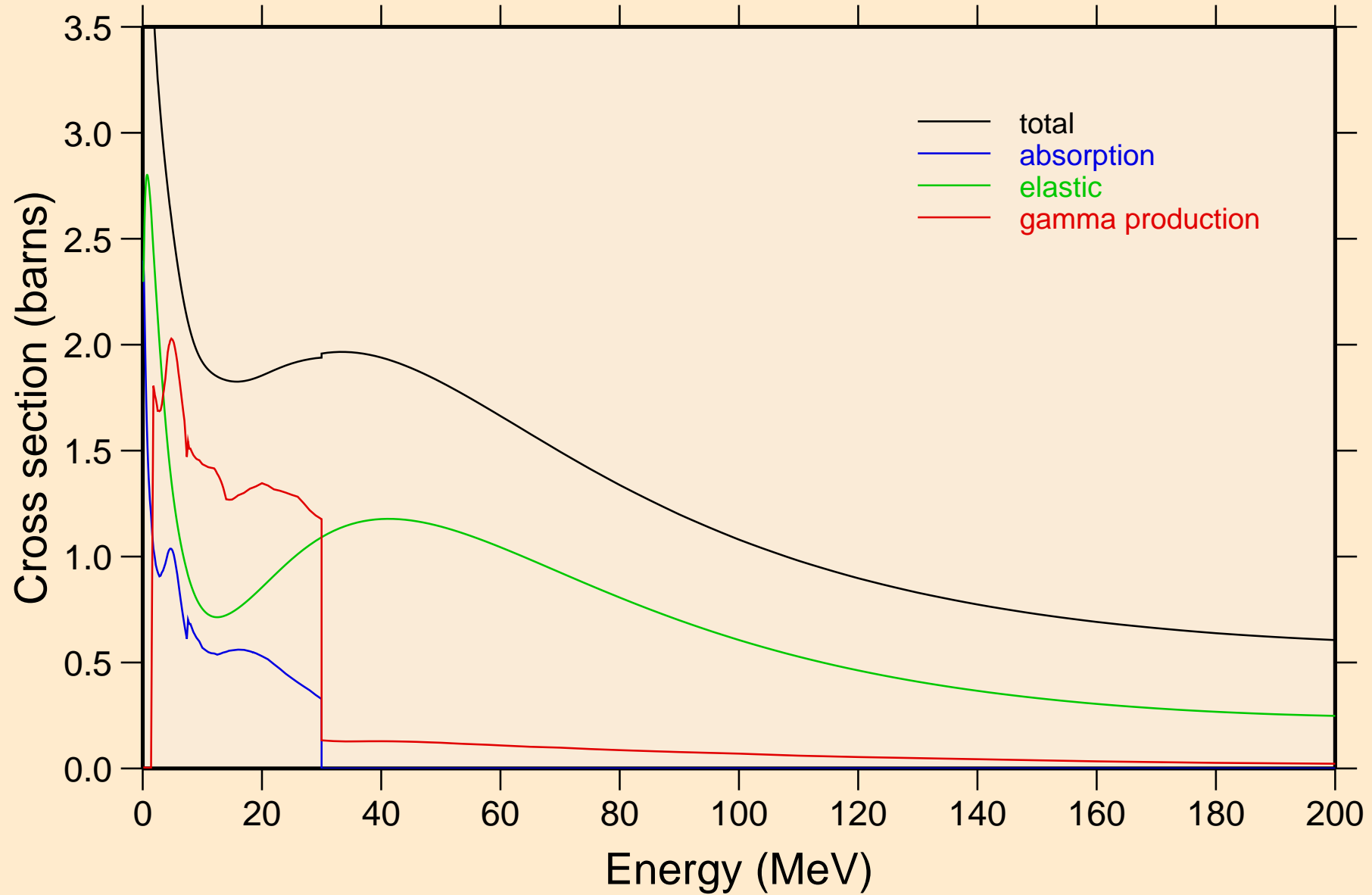

P029 NEUTRON ACER TENDL-2024 LIBRARY; T=293.6K

Heating

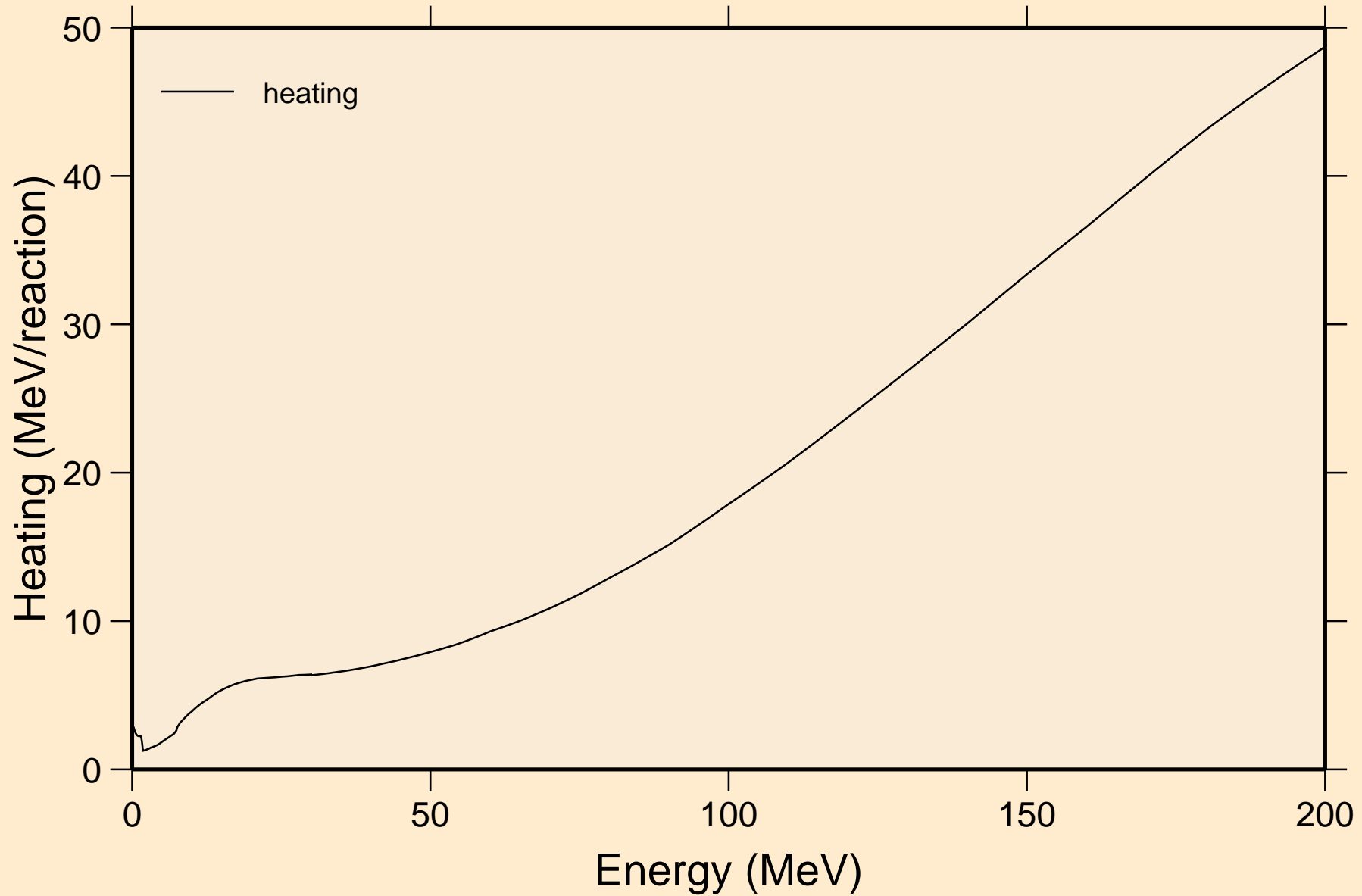

P029 NEUTRON ACER TENDL-2024 LIBRARY; T=293.6K  
Damage

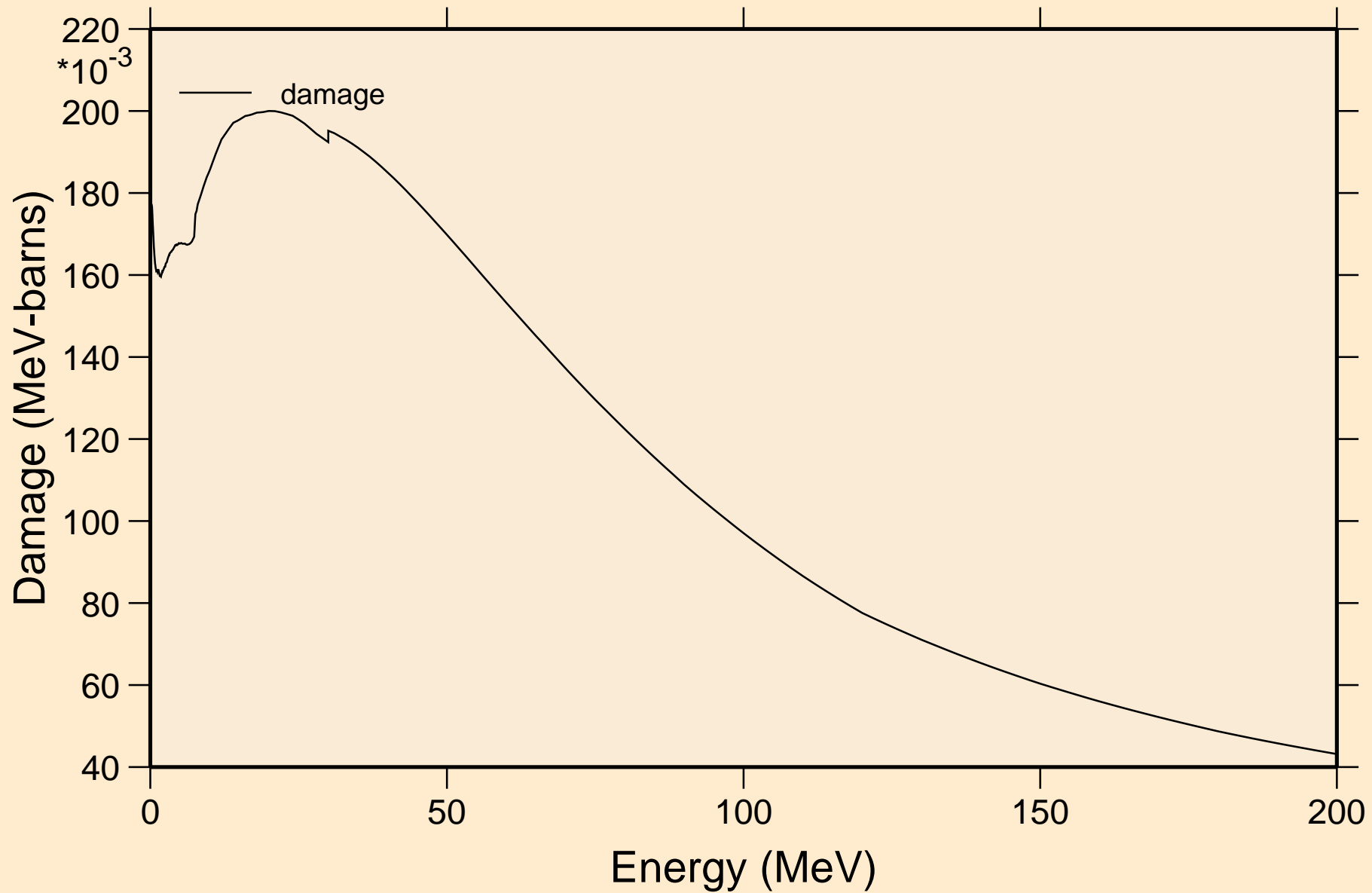

P029 NEUTRON ACER TENDL-2024 LIBRARY; T=293.6K  
Non-threshold reactions

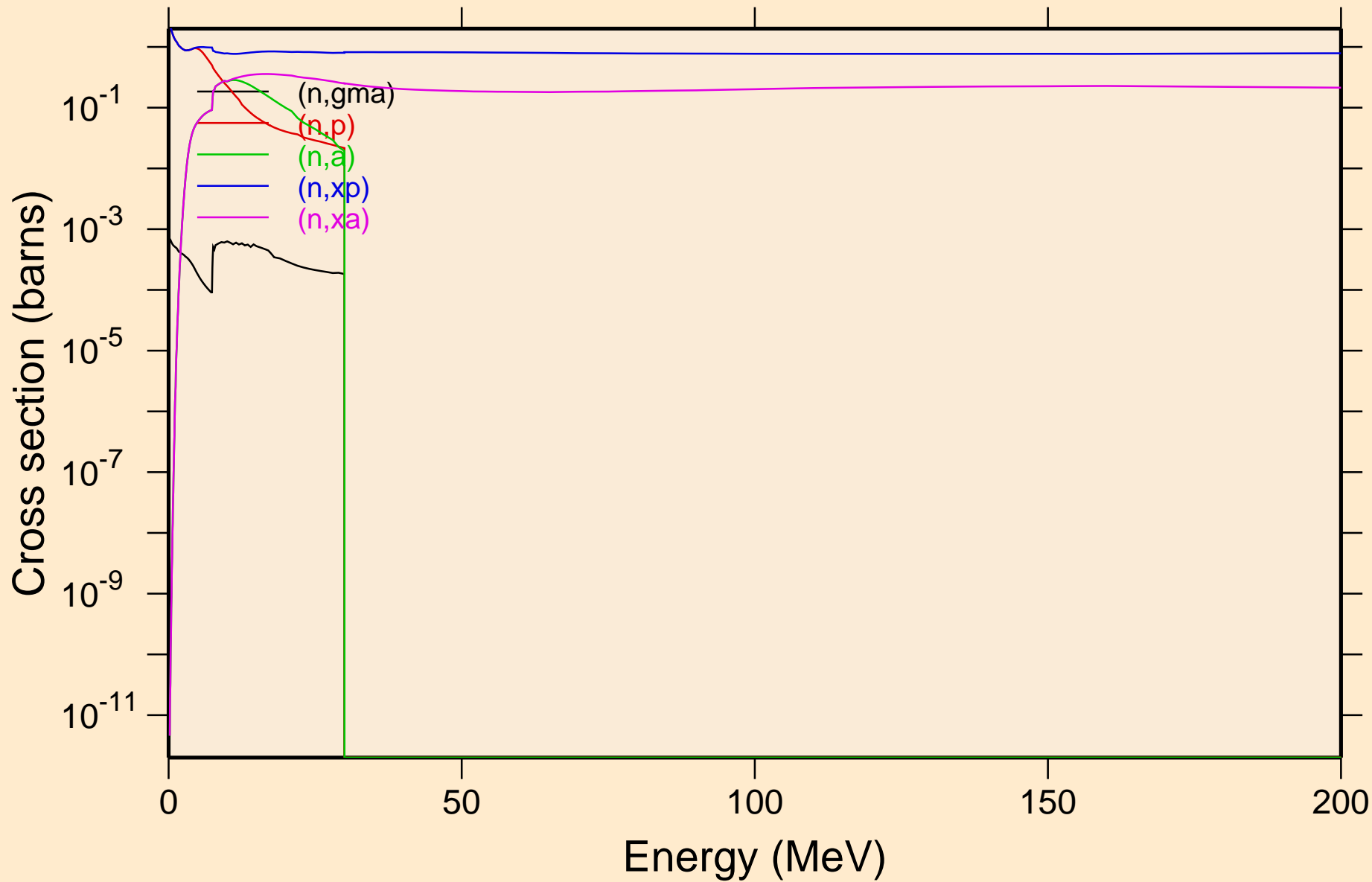

P029 NEUTRON ACER TENDL-2024 LIBRARY; T=293.6K  
Inelastic levels

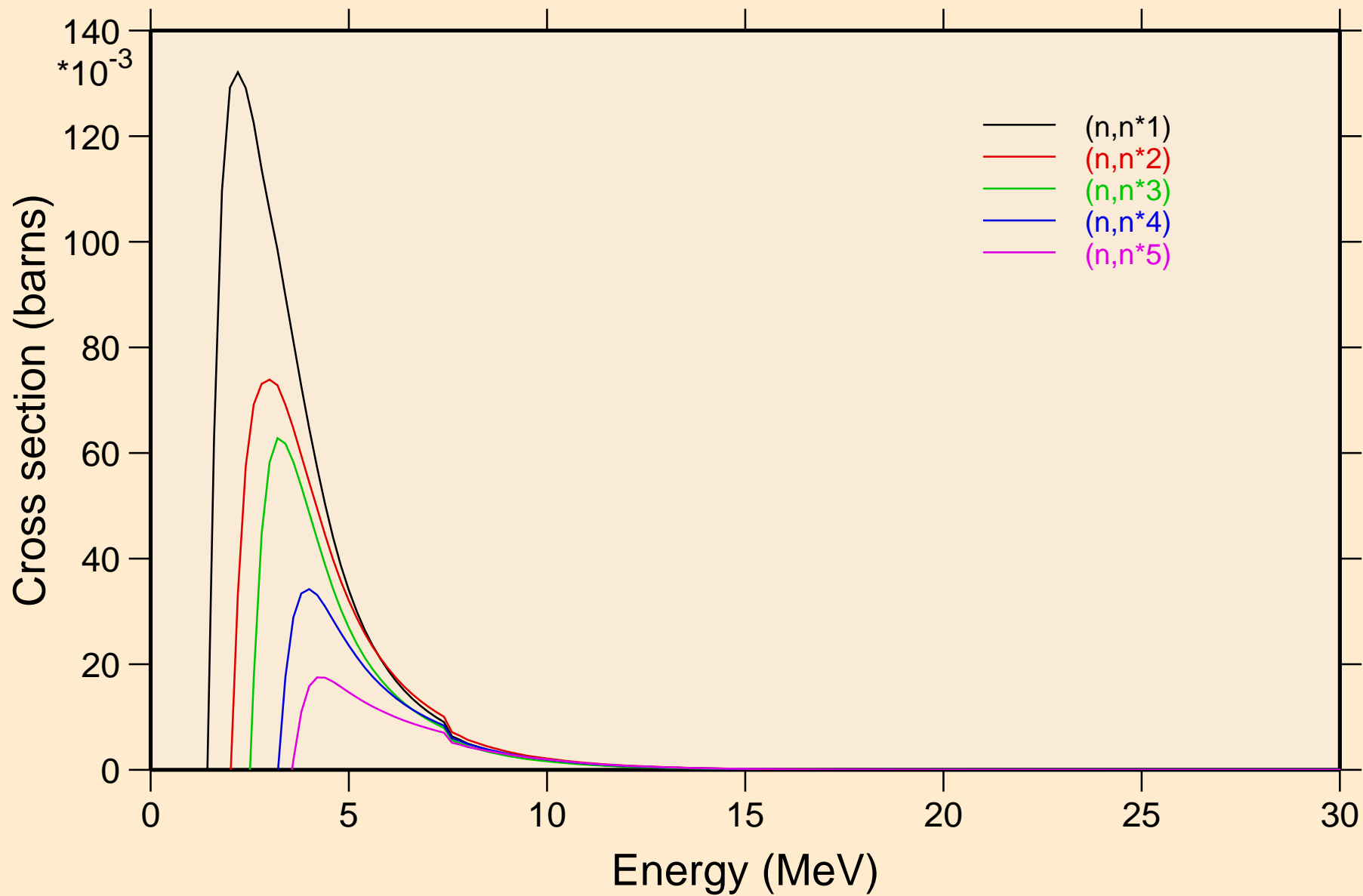

P029 NEUTRON ACER TENDL-2024 LIBRARY; T=293.6K  
Inelastic levels

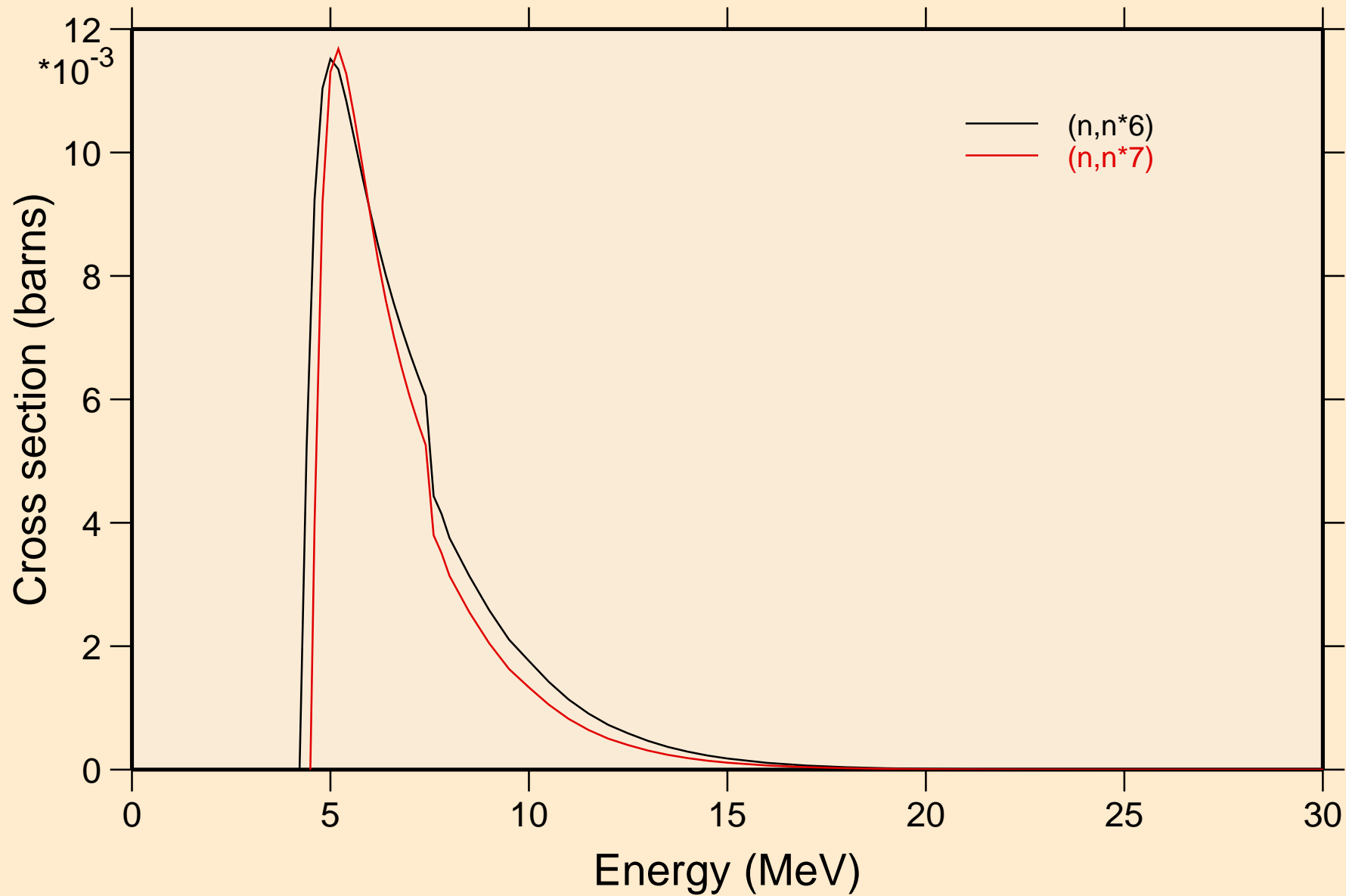

P029 NEUTRON ACER TENDL-2024 LIBRARY; T=293.6K  
Threshold reactions

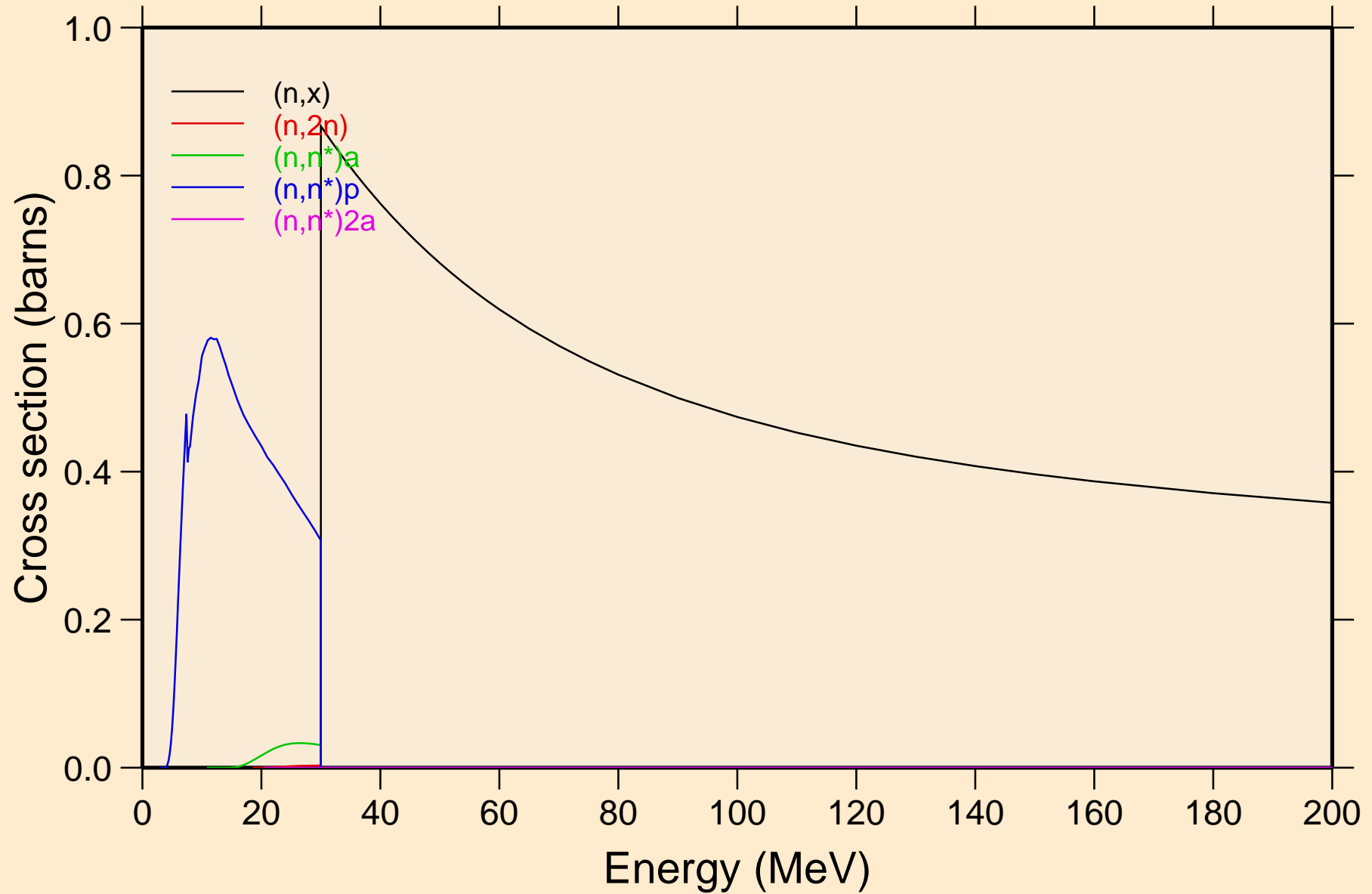

P029 NEUTRON ACER TENDL-2024 LIBRARY; T=293.6K  
Threshold reactions

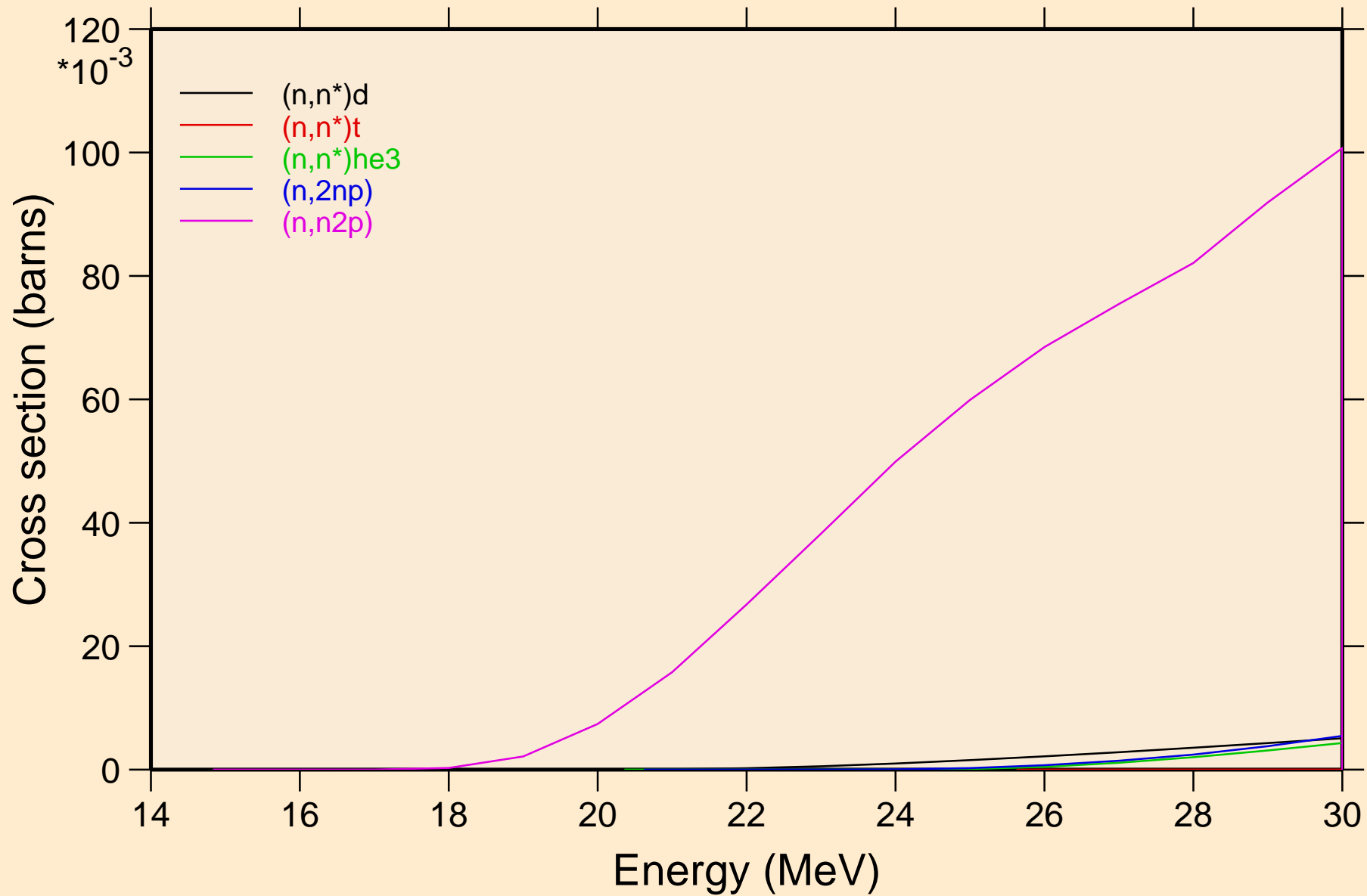

P029 NEUTRON ACER TENDL-2024 LIBRARY; T=293.6K  
Threshold reactions

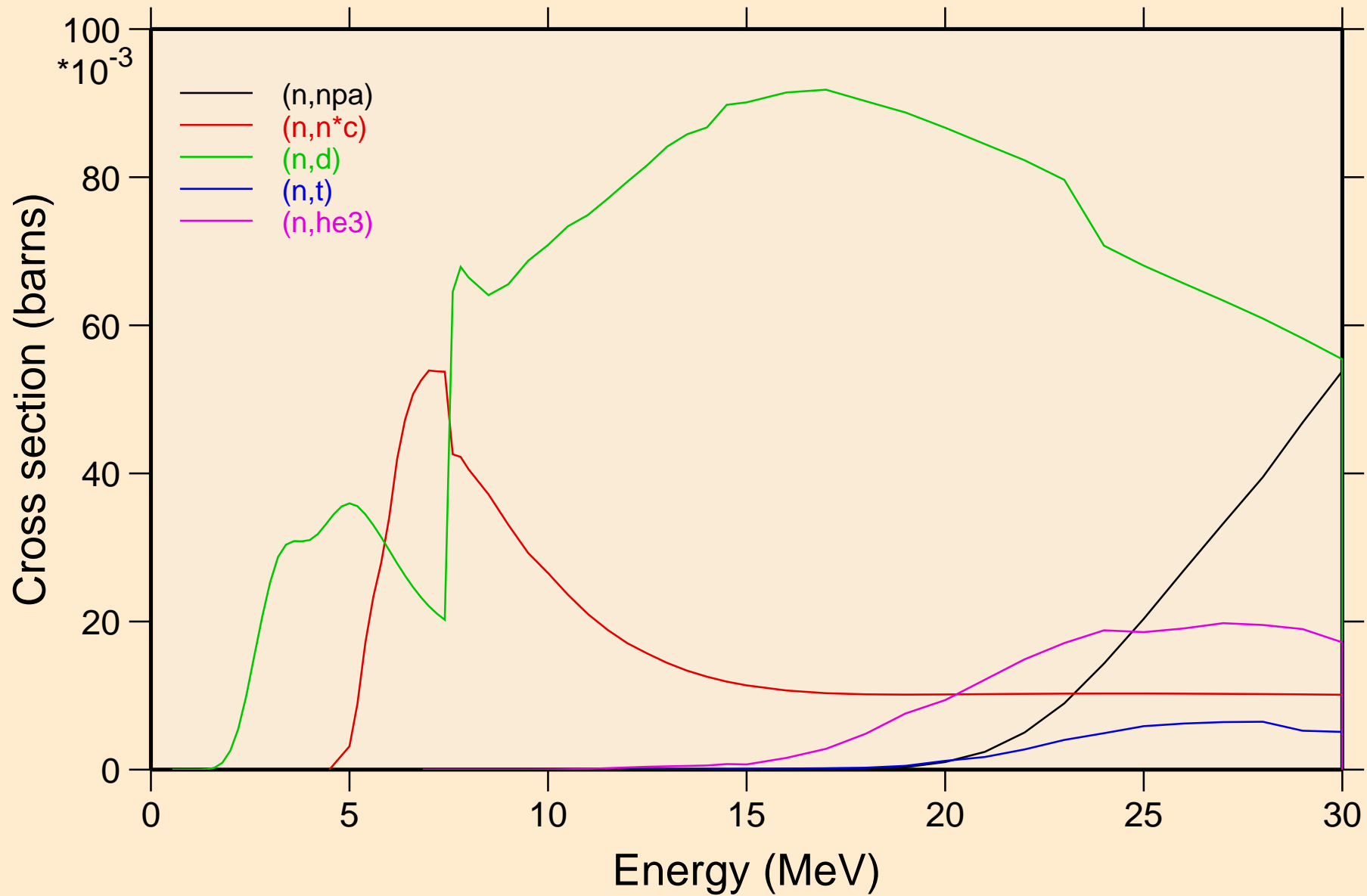

P029 NEUTRON ACER TENDL-2024 LIBRARY; T=293.6K  
Threshold reactions

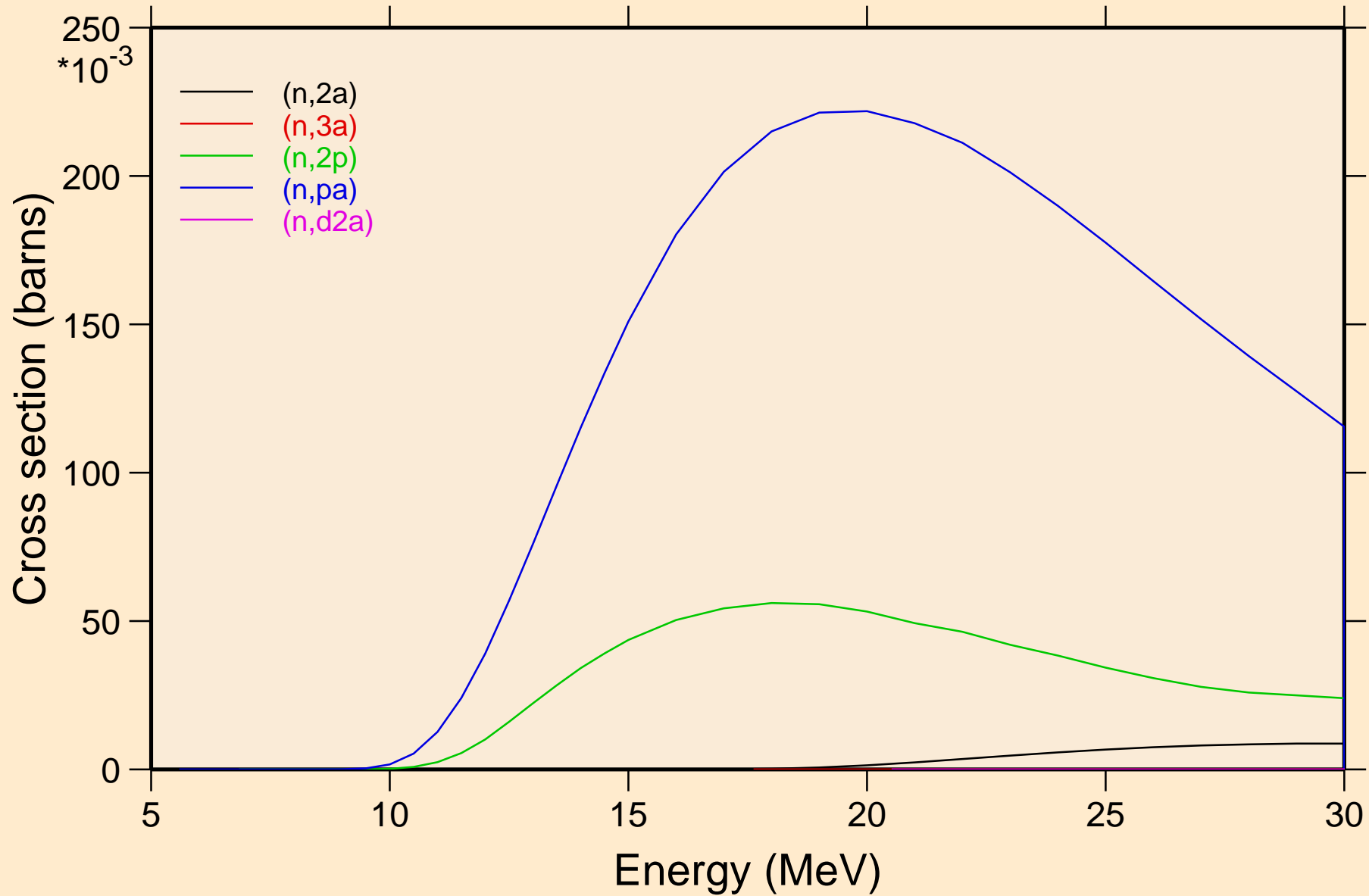

P029 NEUTRON ACER TENDL-2024 LIBRARY; T=293.6K  
Threshold reactions

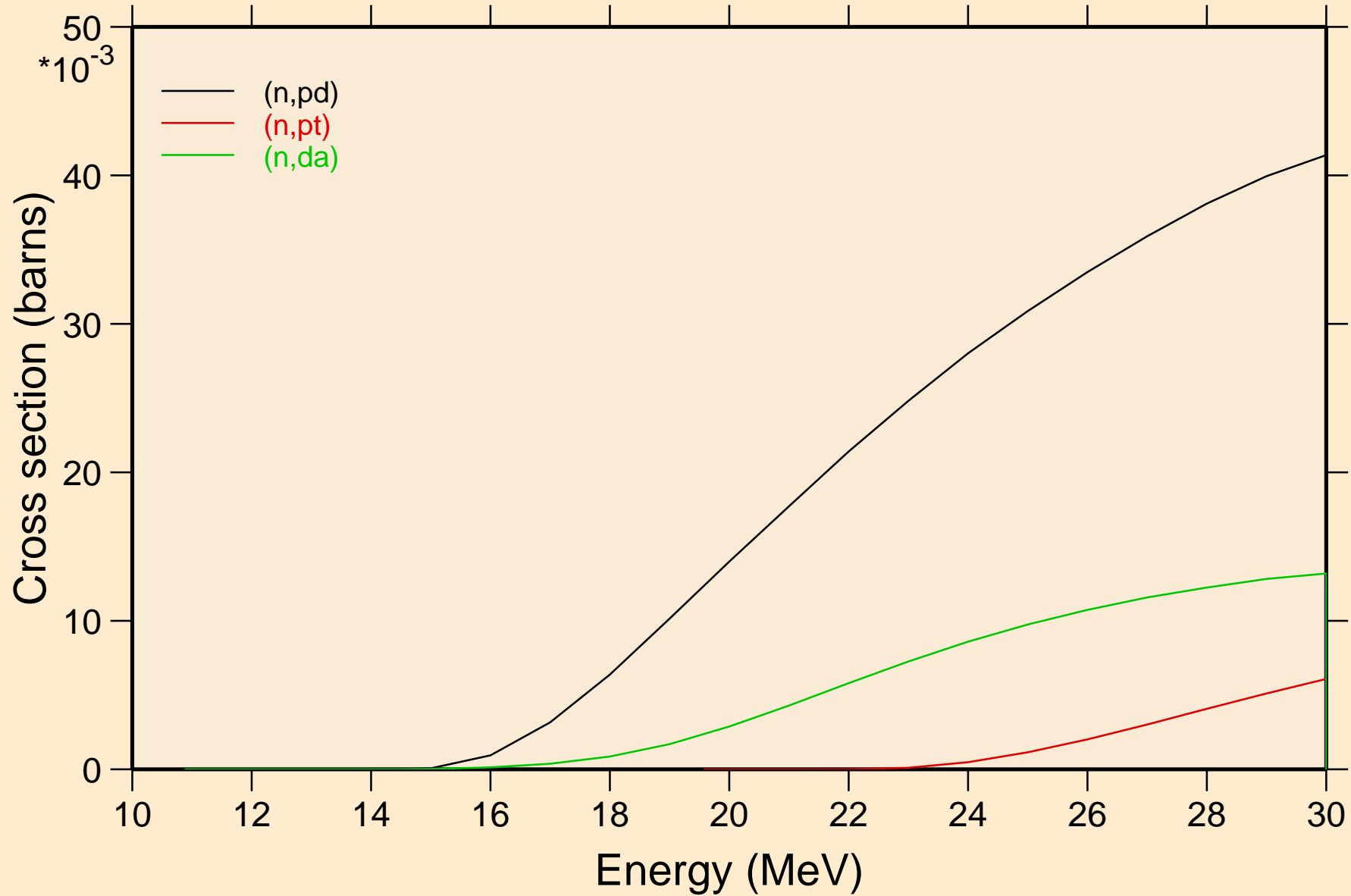

P029 NEUTRON ACER TENDL-2024 LIBRARY; T=293.6K  
Threshold reactions

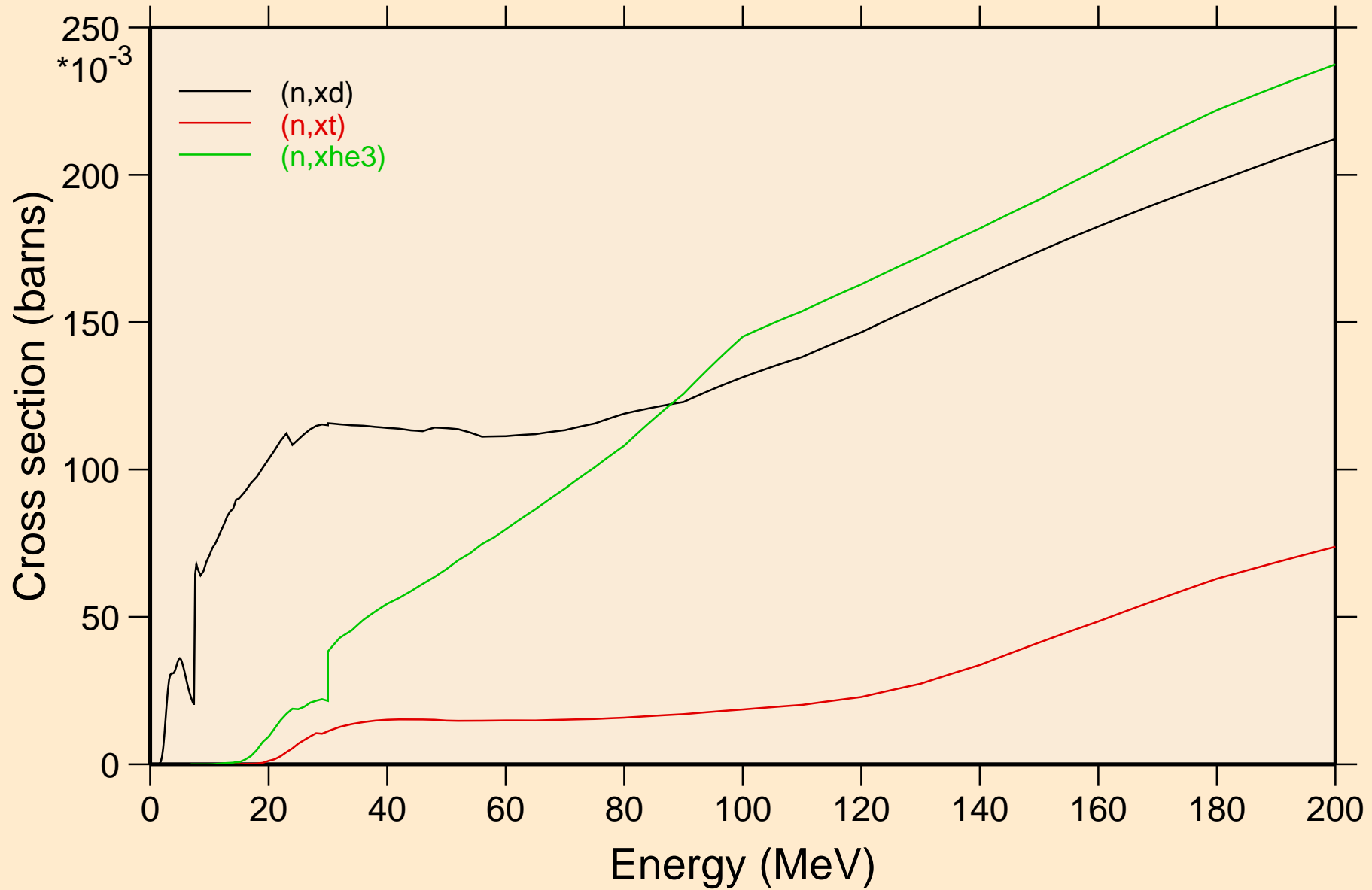

P029 NEUTRON ACER TENDL-2024 LIBRARY; T=293.6K  
angular distribution for elastic

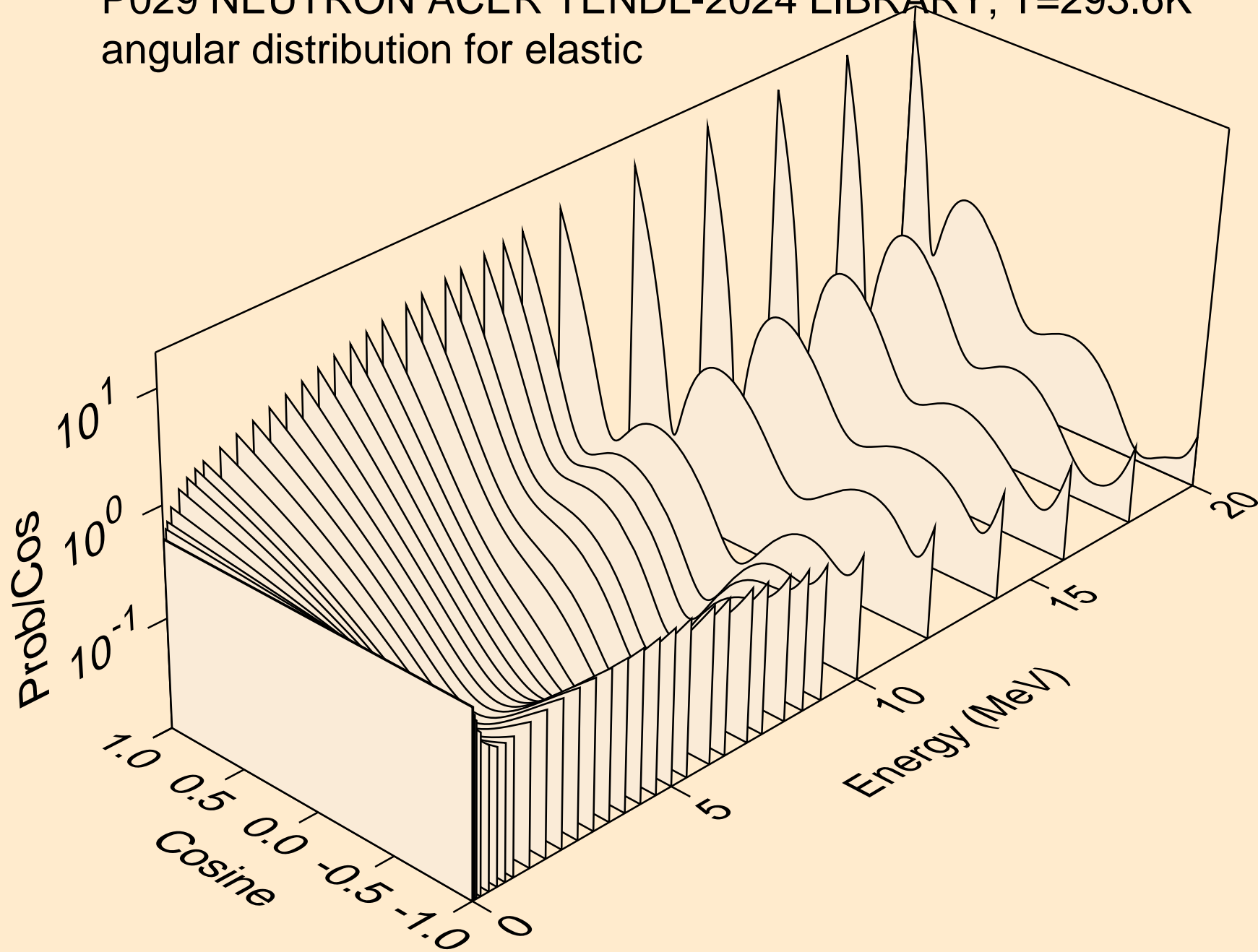

P029 NEUTRON ACER TENDL-2024 LIBRARY; T=293.6K  
angular distribution for elastic

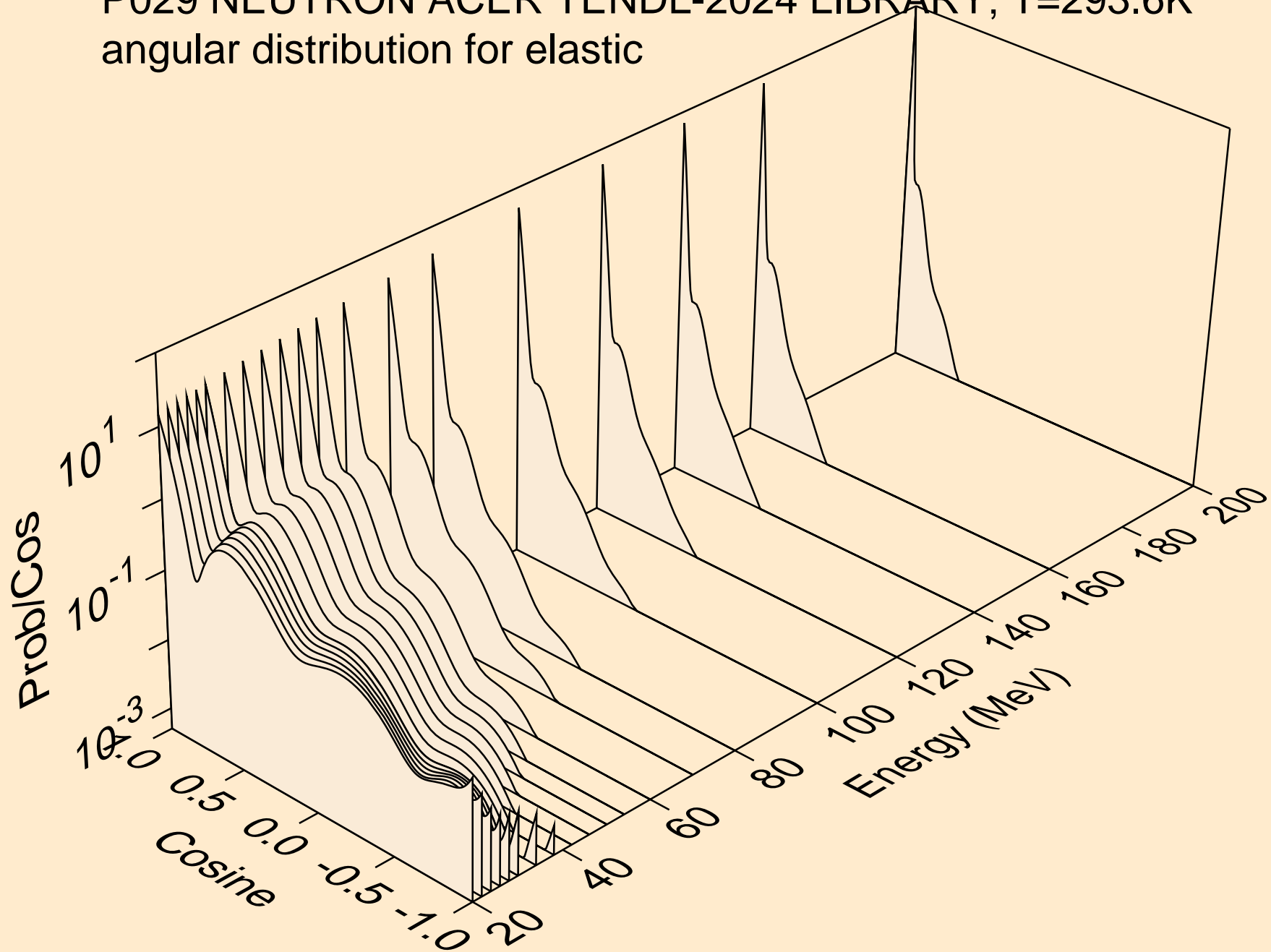

P029 NEUTRON ACER TENDL-2024 LIBRARY; T=293.6K  
angular distribution for (n,n\*1)

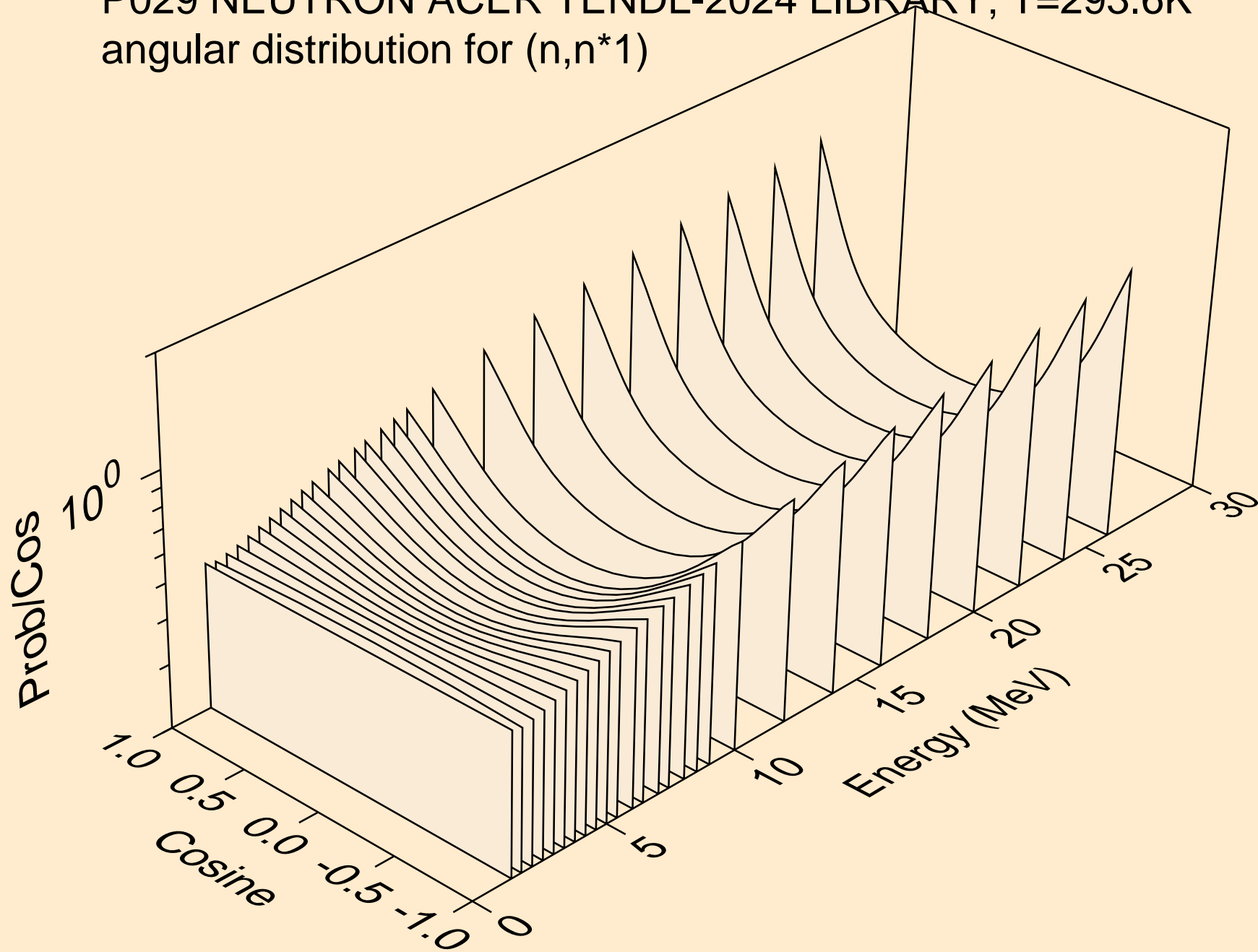

P029 NEUTRON ACER TENDL-2024 LIBRARY; T=293.6K  
angular distribution for (n,n\*2)

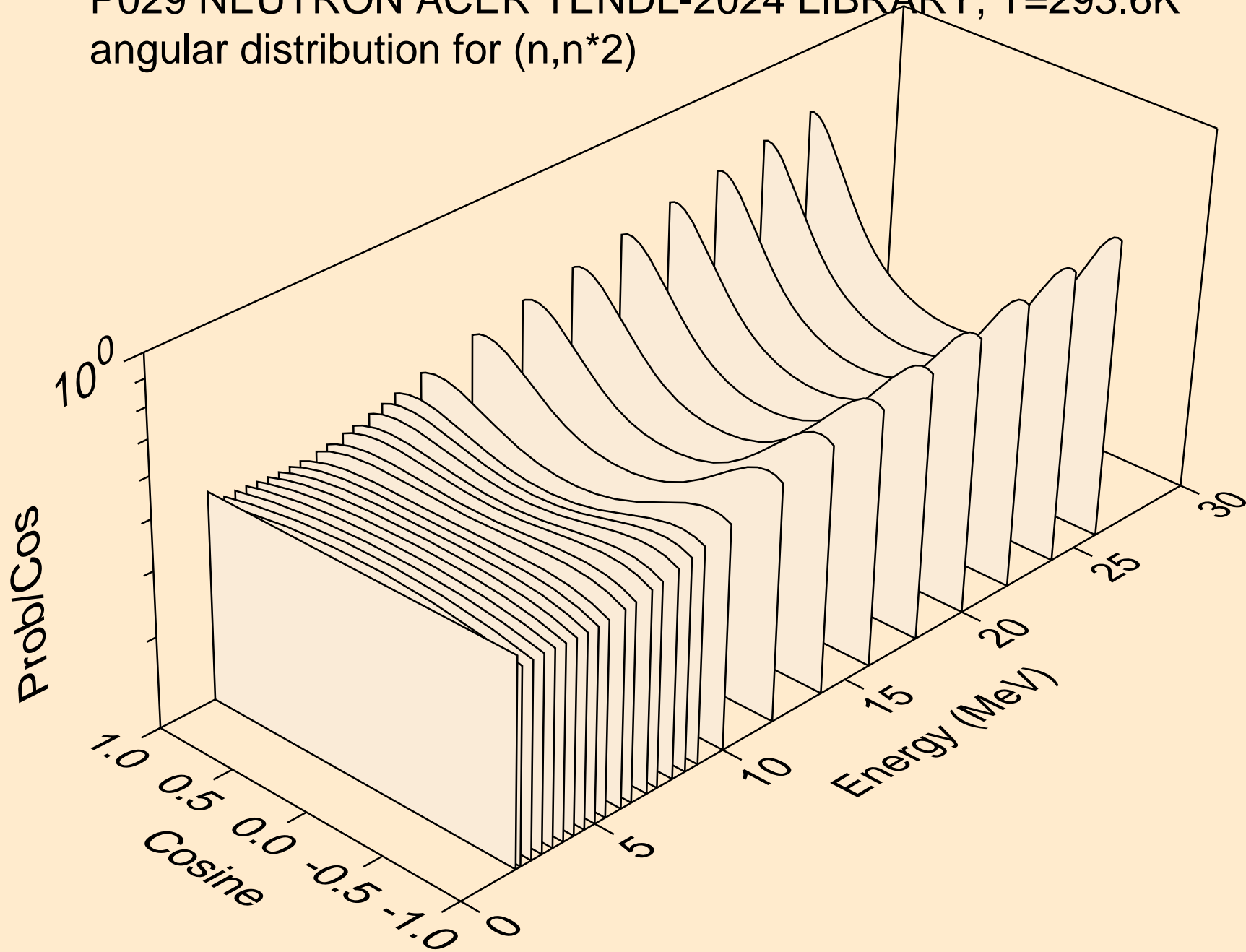

P029 NEUTRON ACER TENDL-2024 LIBRARY; T=293.6K  
angular distribution for (n,n\*3)

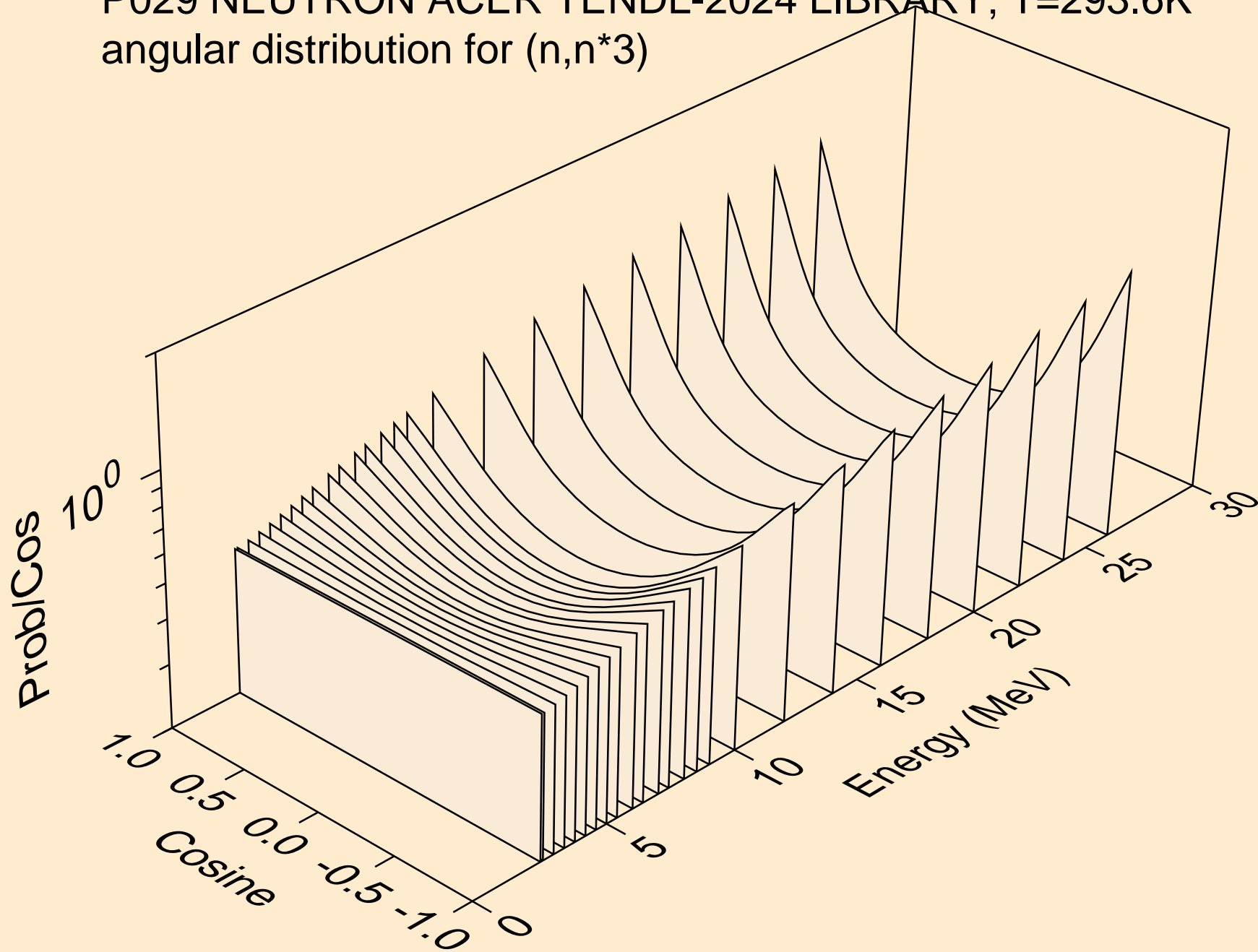

P029 NEUTRON ACER TENDL-2024 LIBRARY; T=293.6K  
angular distribution for (n,n\*4)

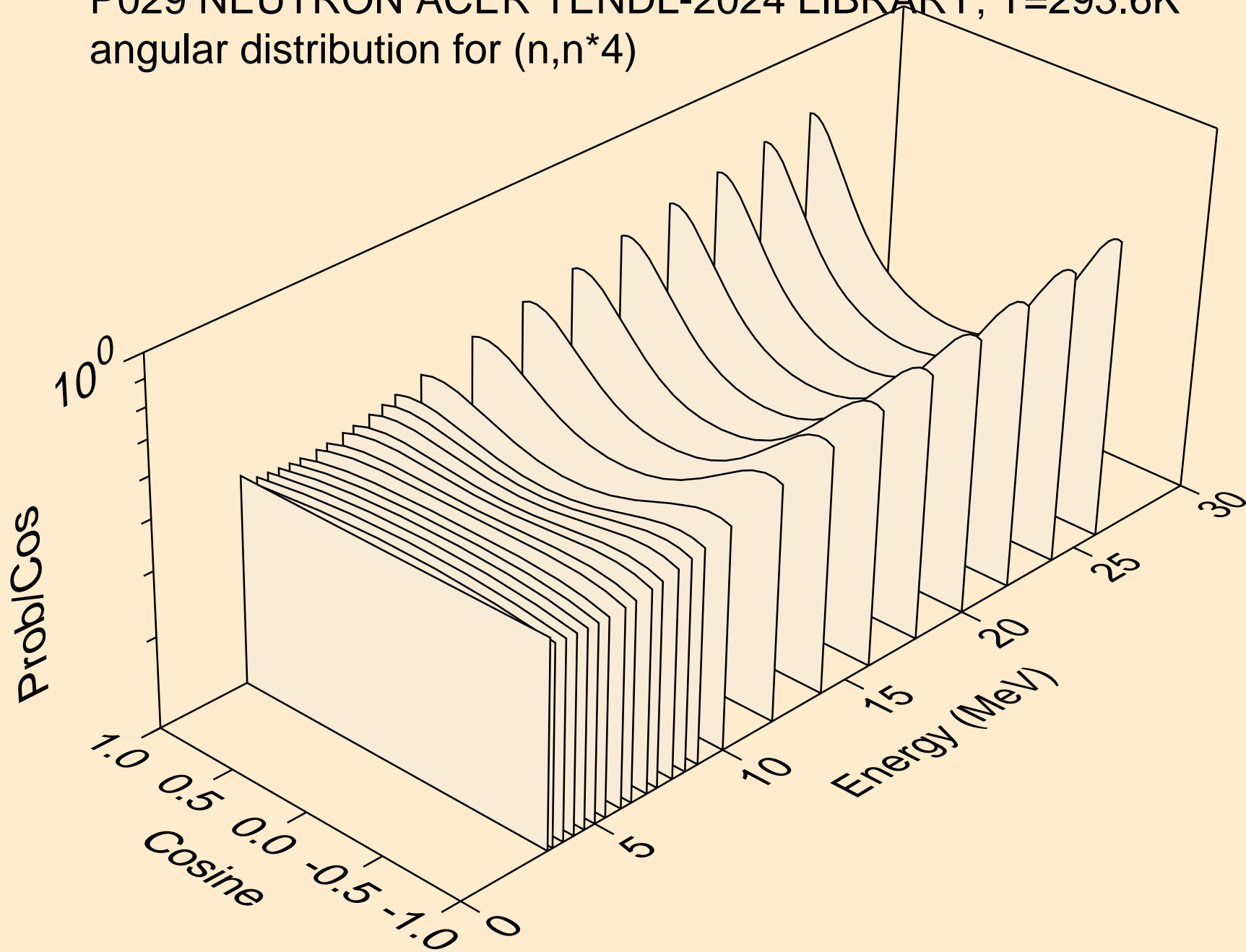

P029 NEUTRON ACER TENDL-2024 LIBRARY; T=293.6K  
angular distribution for (n,n\*5)

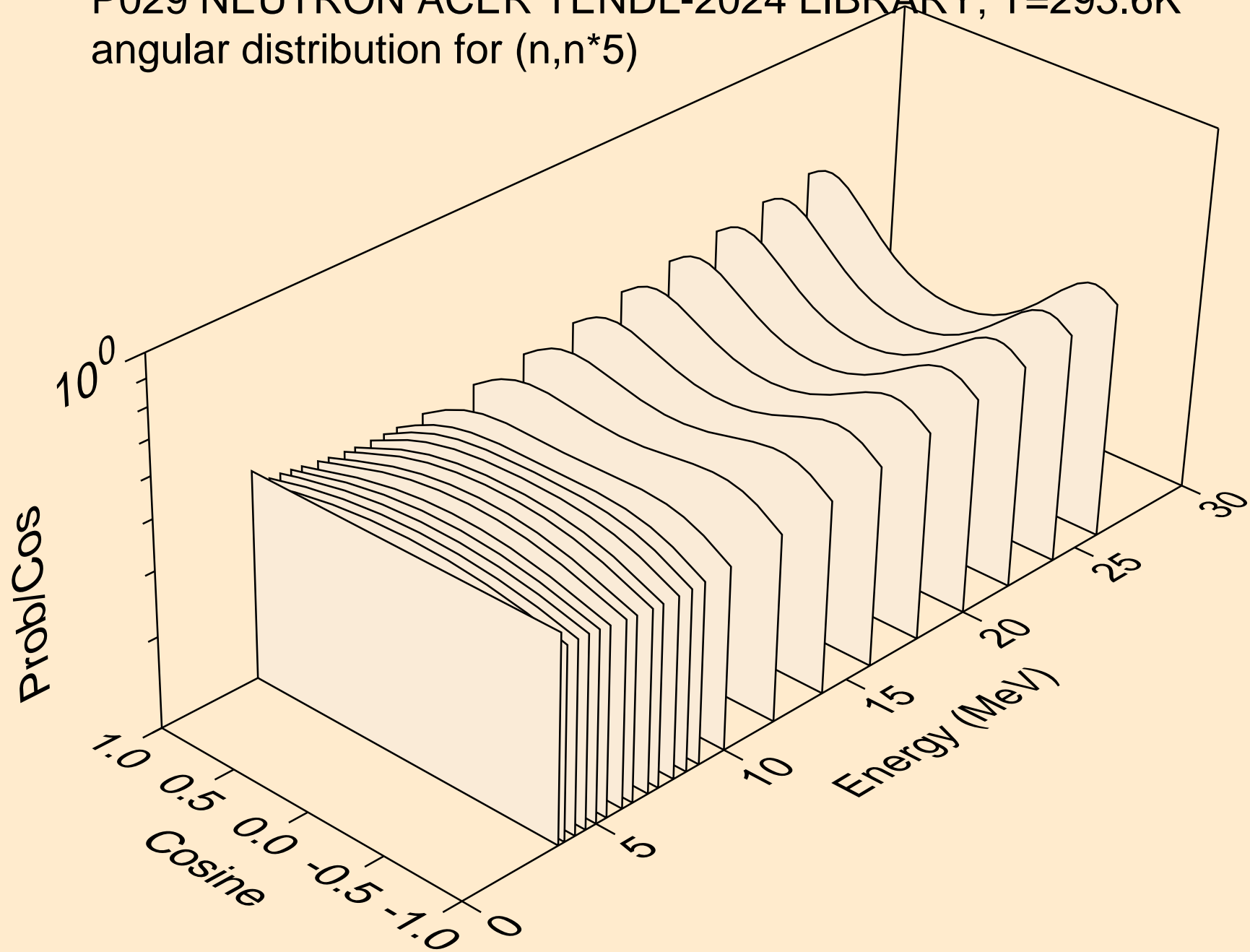

P029 NEUTRON ACER TENDL-2024 LIBRARY; T=293.6K  
angular distribution for (n,n\*6)

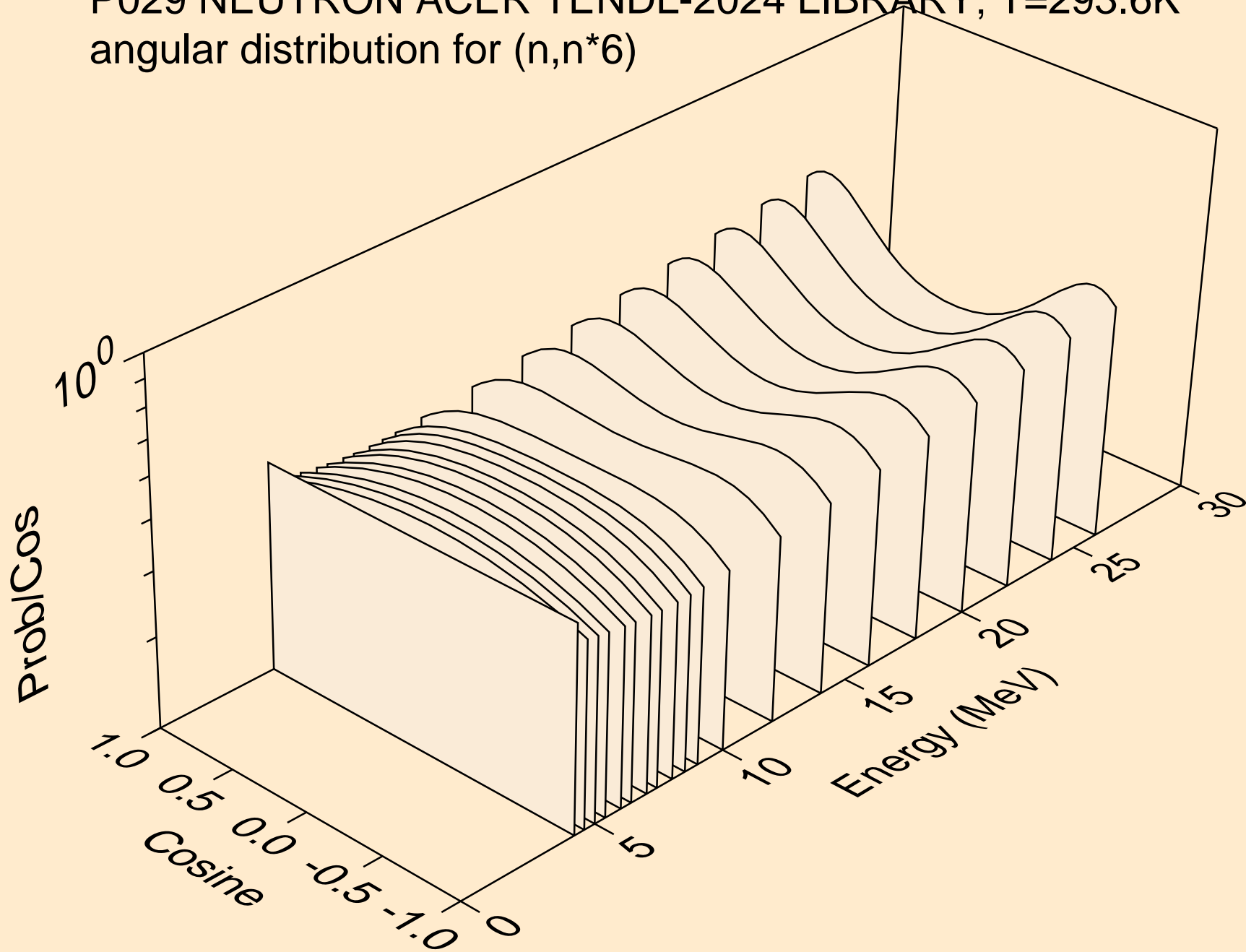

P029 NEUTRON ACER TENDL-2024 LIBRARY; T=293.6K  
angular distribution for (n,n\*7)

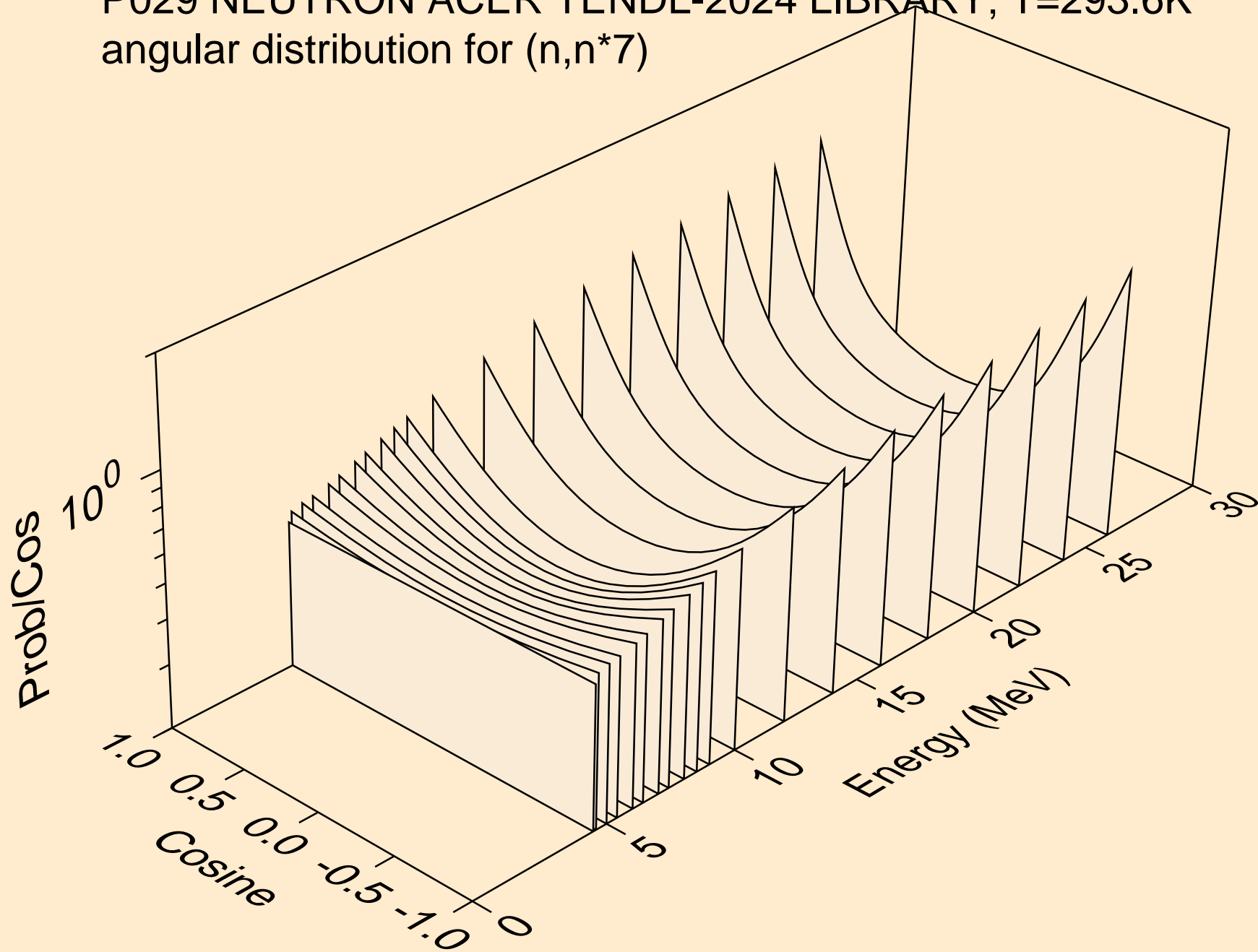

P029 NEUTRON ACER TENDL-2024 LIBRARY; T=293.6K  
Neutron emission for (n,x)

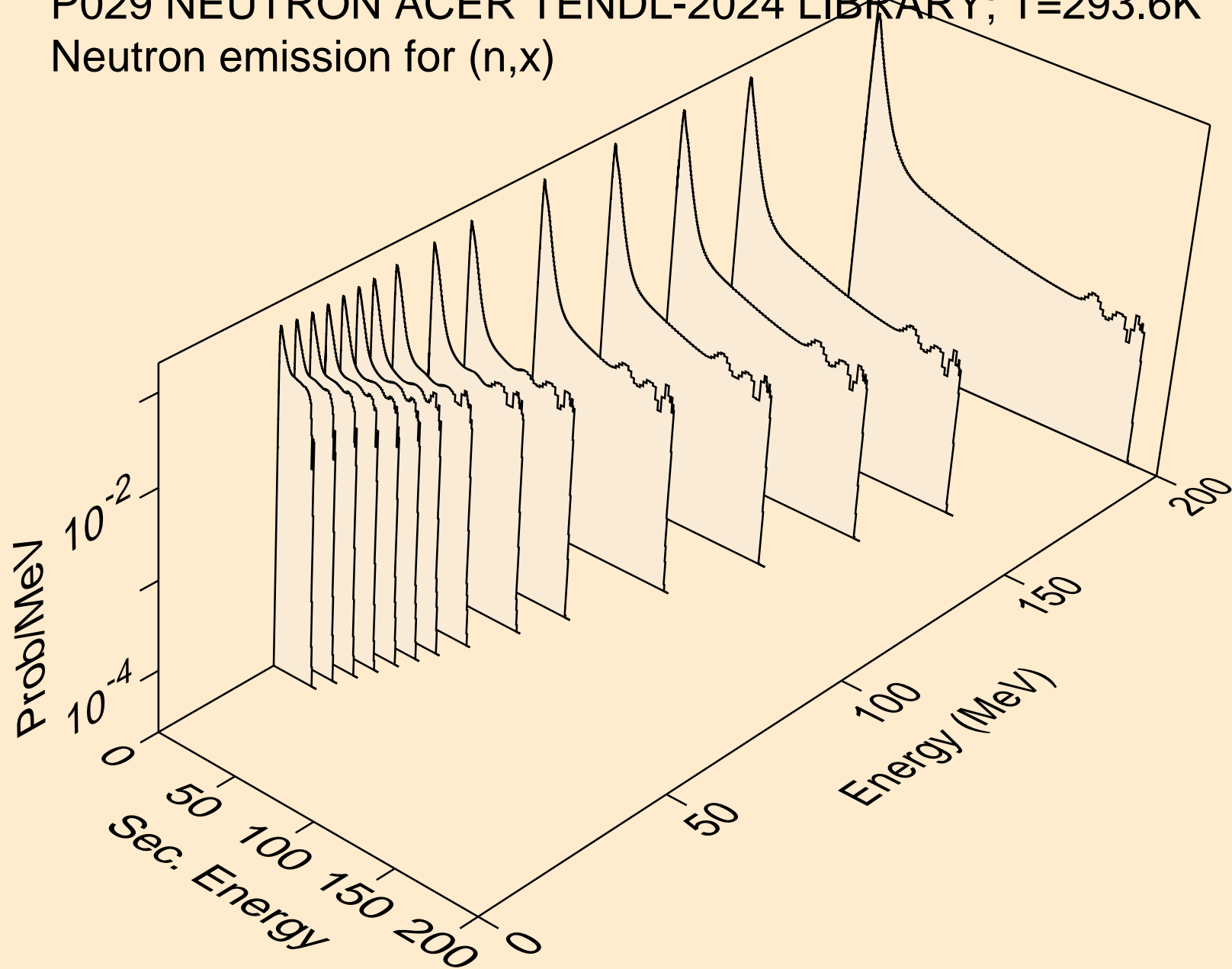

P029 NEUTRON ACER TENDL-2024 LIBRARY; T=293.6K  
Neutron emission for (n,2n)

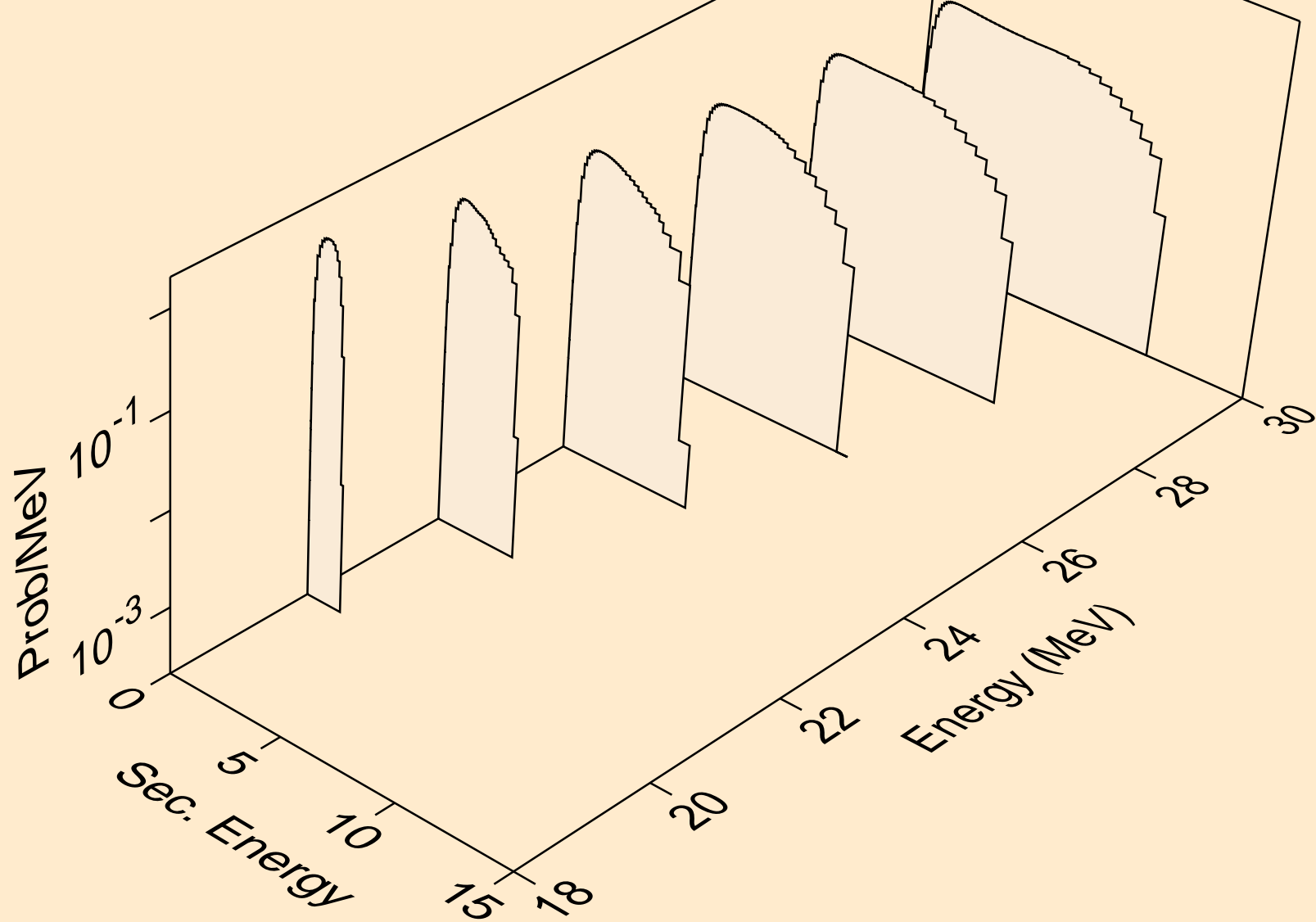

P029 NEUTRON ACER TENDL-2024 LIBRARY; T=293.6K  
Neutron emission for (n,n\*)a

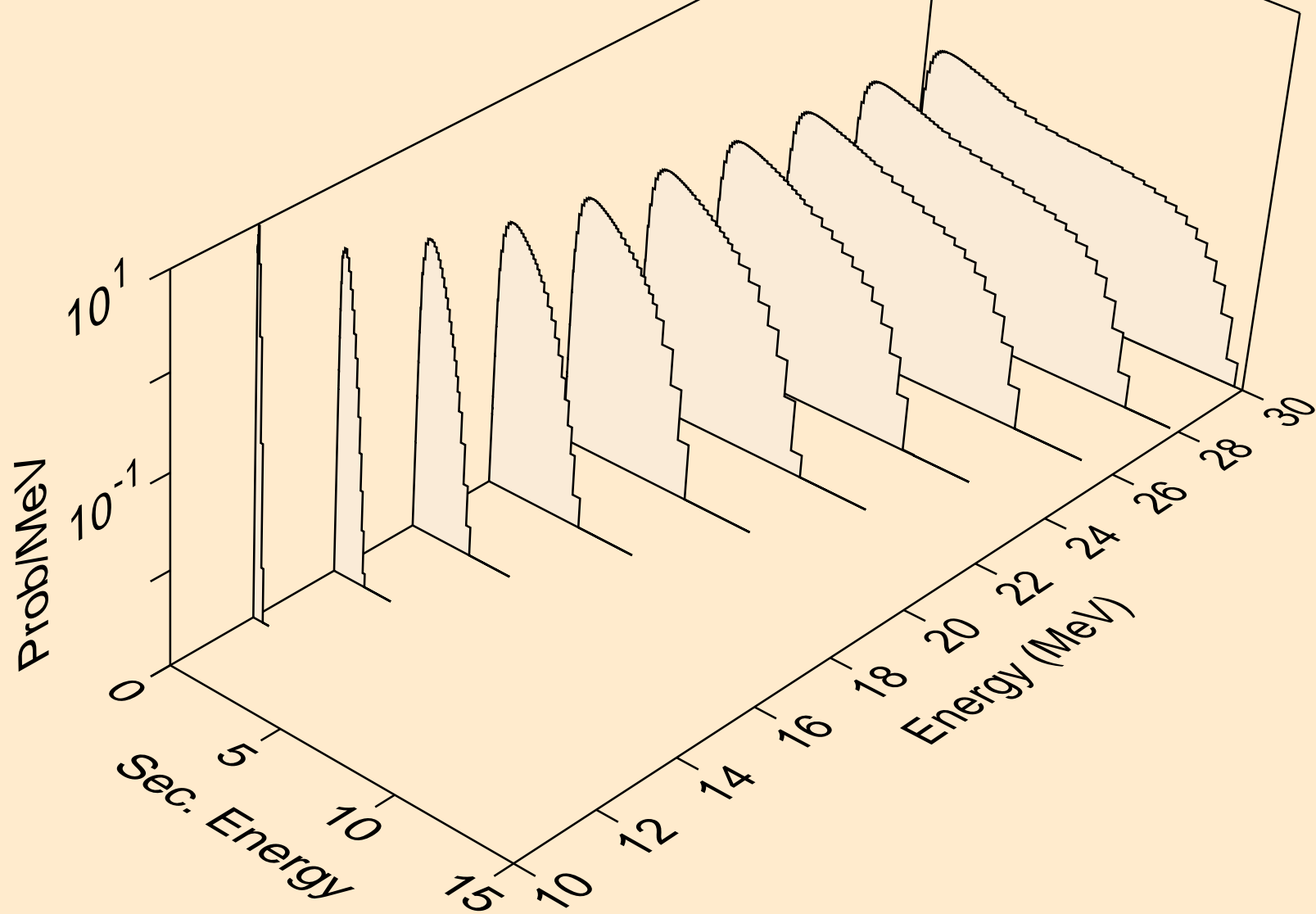

P029 NEUTRON ACER TENDL-2024 LIBRARY; T=293.6K  
Neutron emission for (n,n\*)p

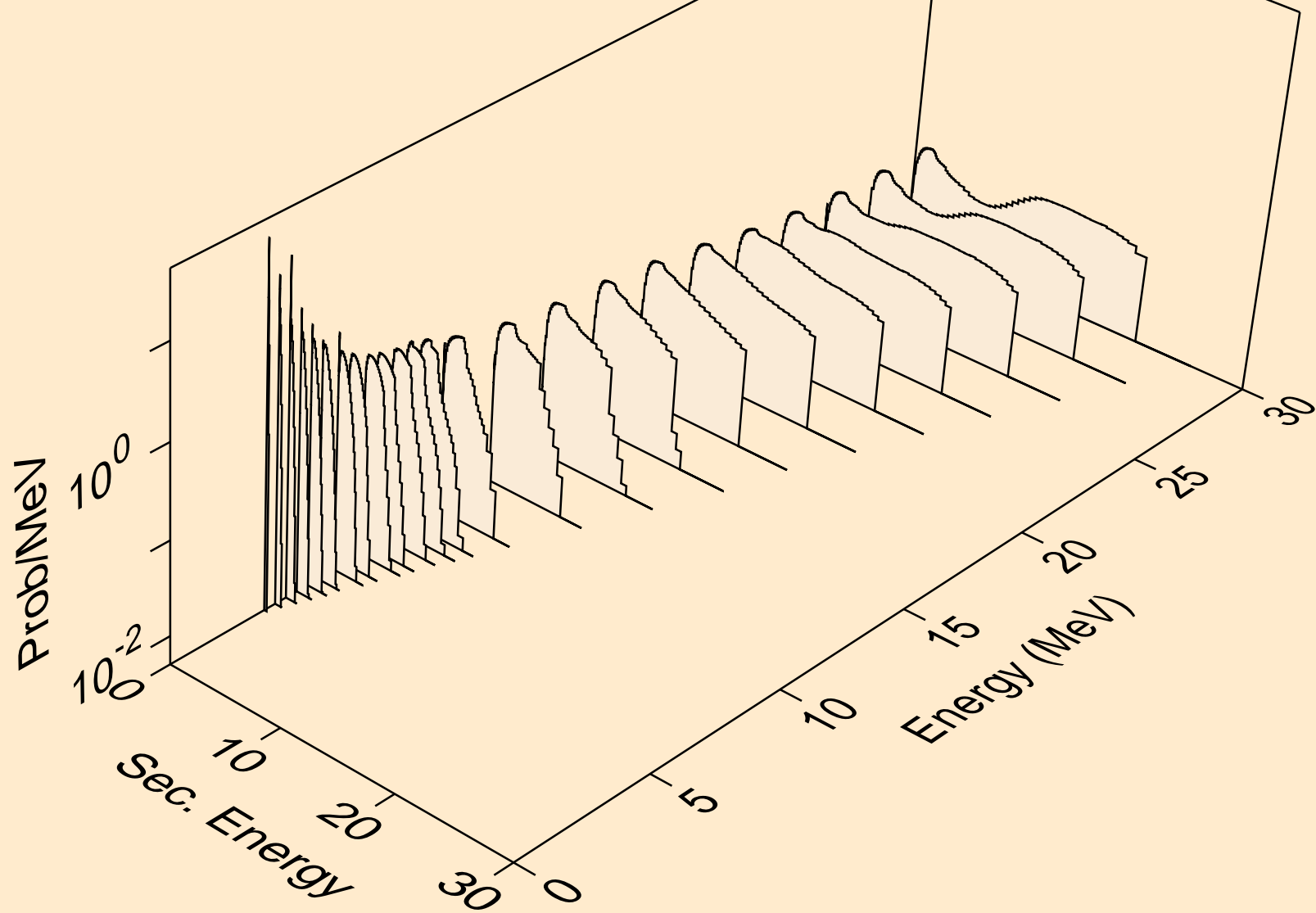

P029 NEUTRON ACER TENDL-2024 LIBRARY; T=293.6K  
Neutron emission for (n,n\*)2a

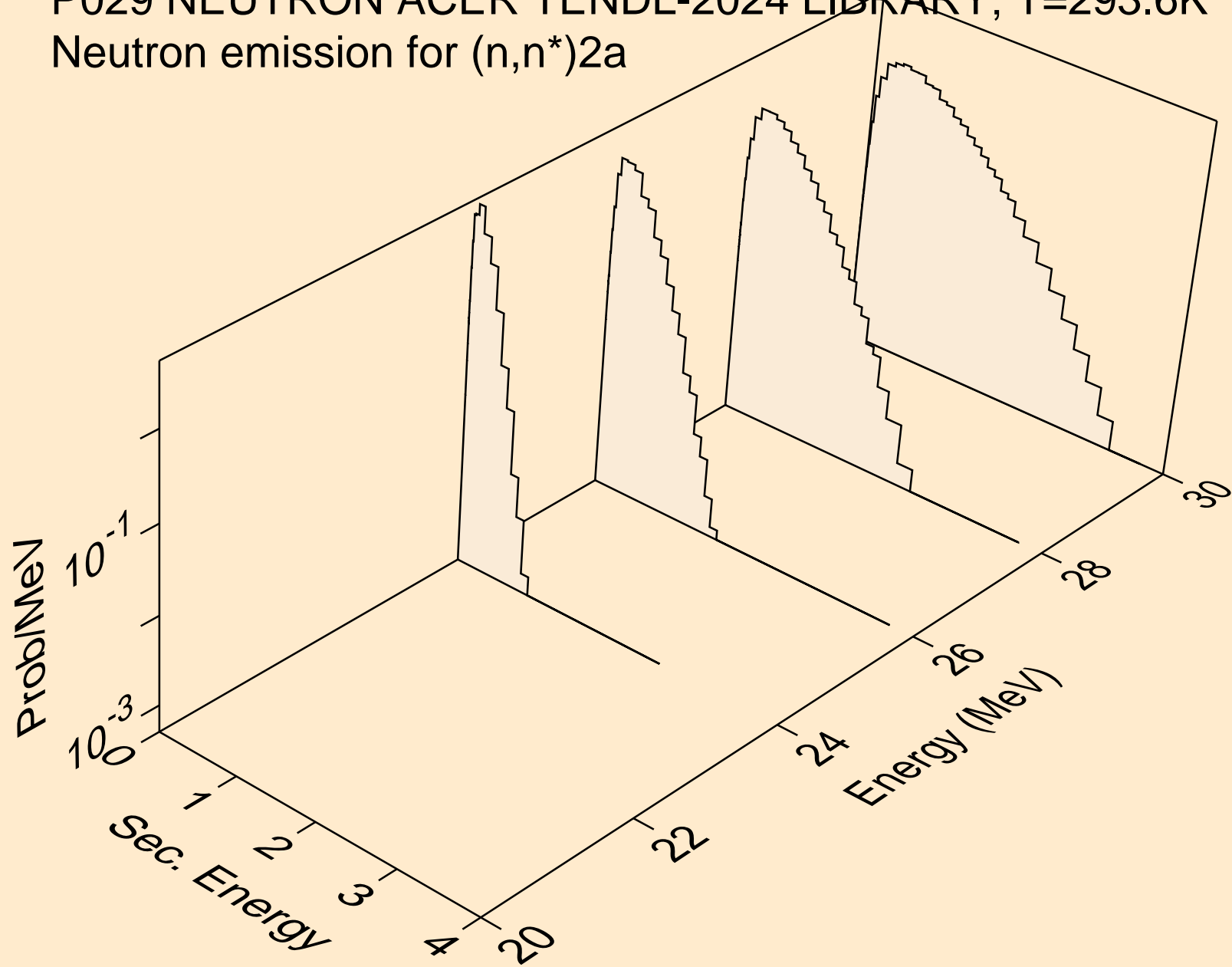

P029 NEUTRON ACER TENDL-2024 LIBRARY; T=293.6K  
Neutron emission for (n,n\*)d

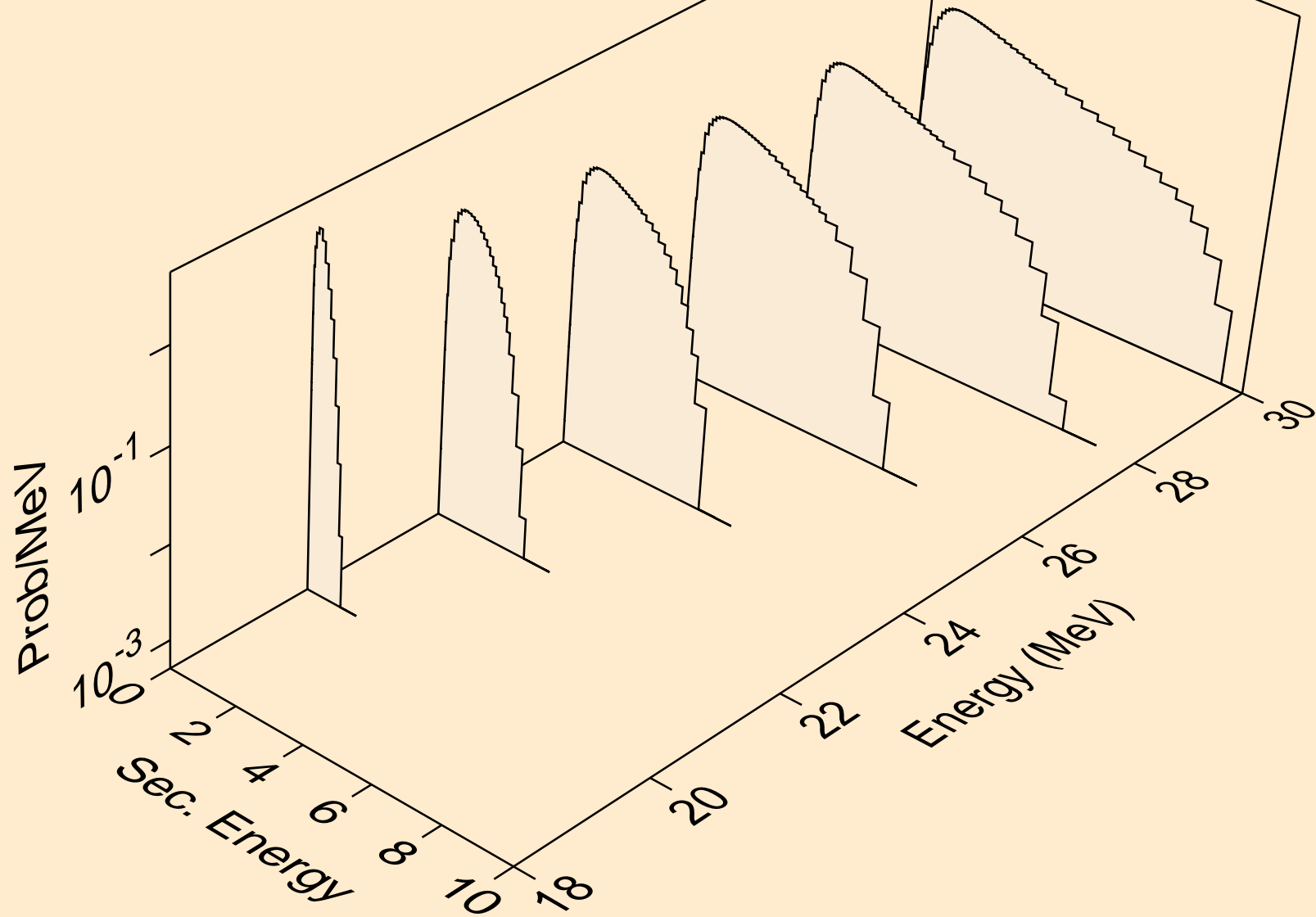

P029 NEUTRON ACER TENDL-2024 LIBRARY; T=293.6K  
Neutron emission for (n,n\*)t

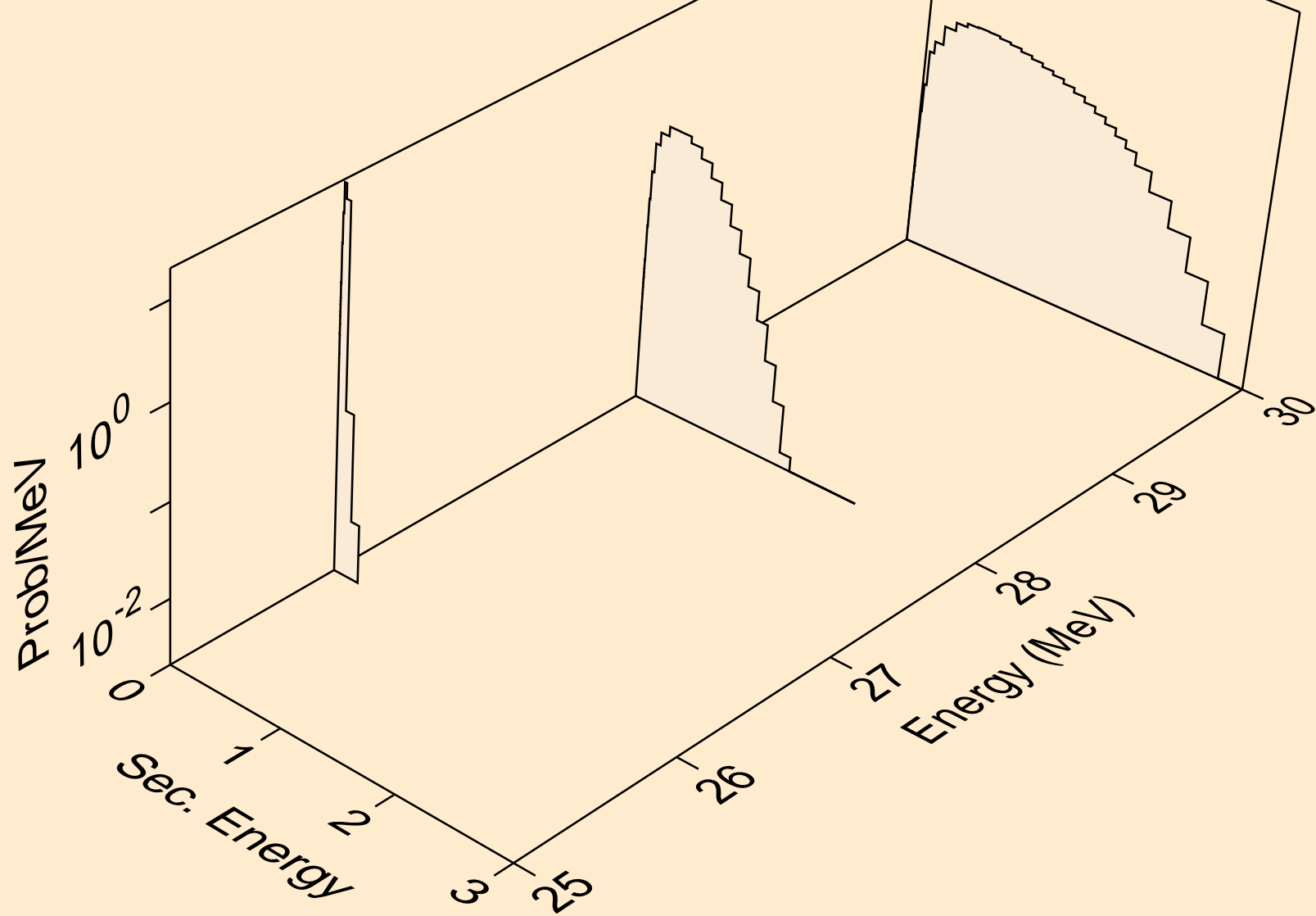

P029 NEUTRON ACER TENDL-2024 LIBRARY; T=293.6K  
Neutron emission for (n,n\*)he3

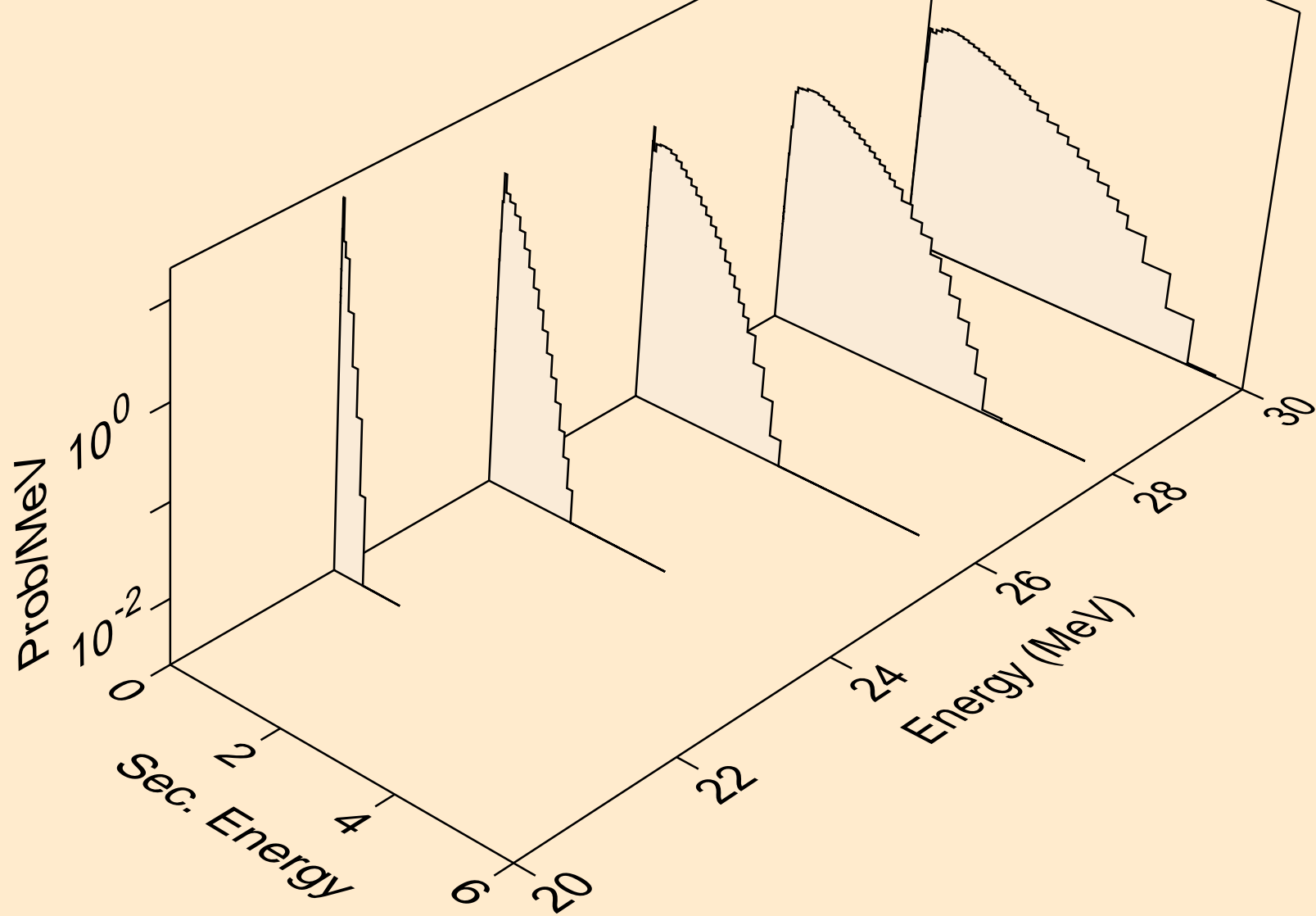

P029 NEUTRON ACER TENDL-2024 LIBRARY; T=293.6K  
Neutron emission for (n,2np)

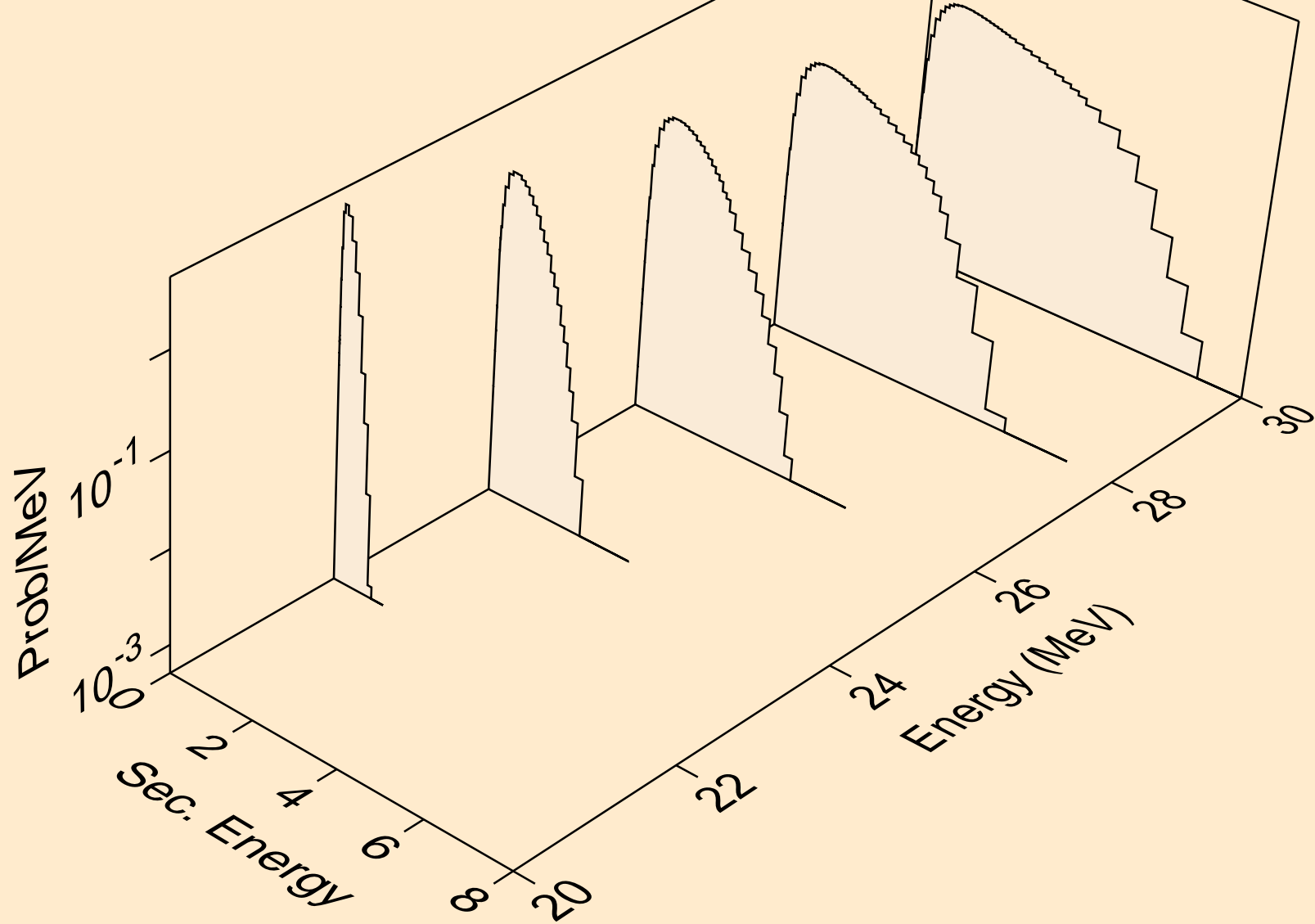

P029 NEUTRON ACER TENDL-2024 LIBRARY; T=293.6K  
Neutron emission for (n,n2p)

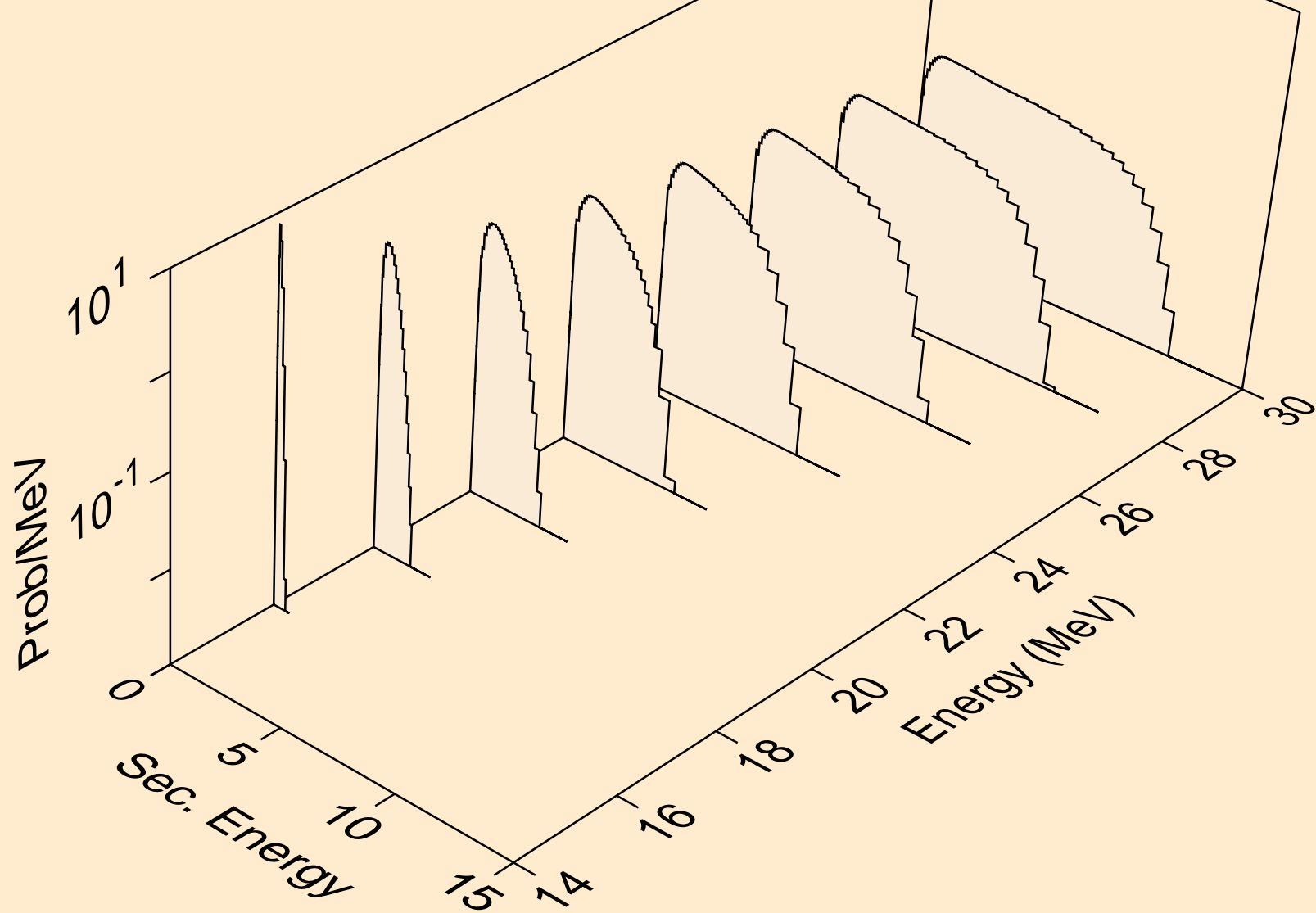

P029 NEUTRON ACER TENDL-2024 LIBRARY; T=293.6K  
Neutron emission for (n,npa)

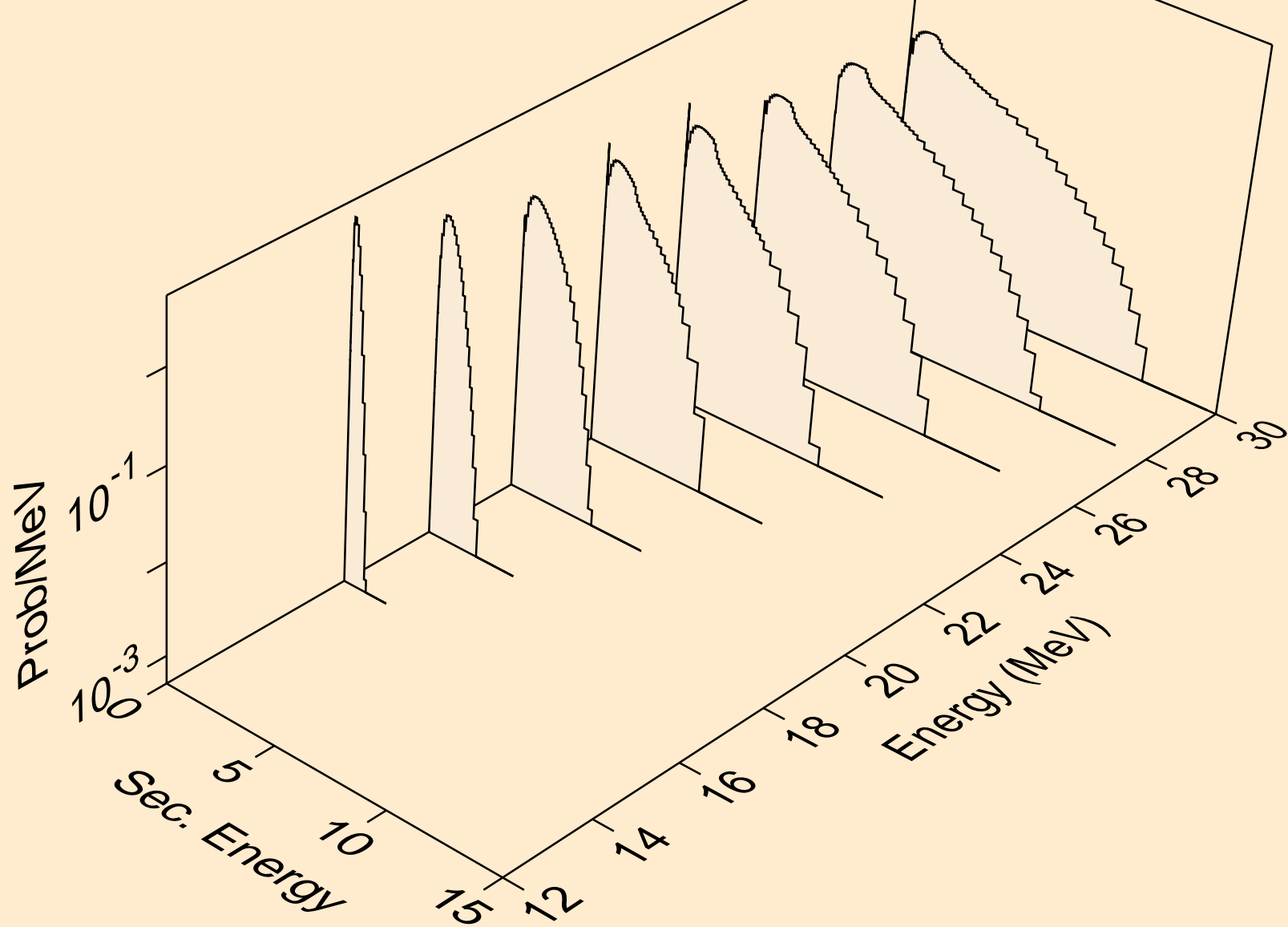

P029 NEUTRON ACER TENDL-2024 LIBRARY; T=293.6K  
Neutron emission for (n,n\*c)

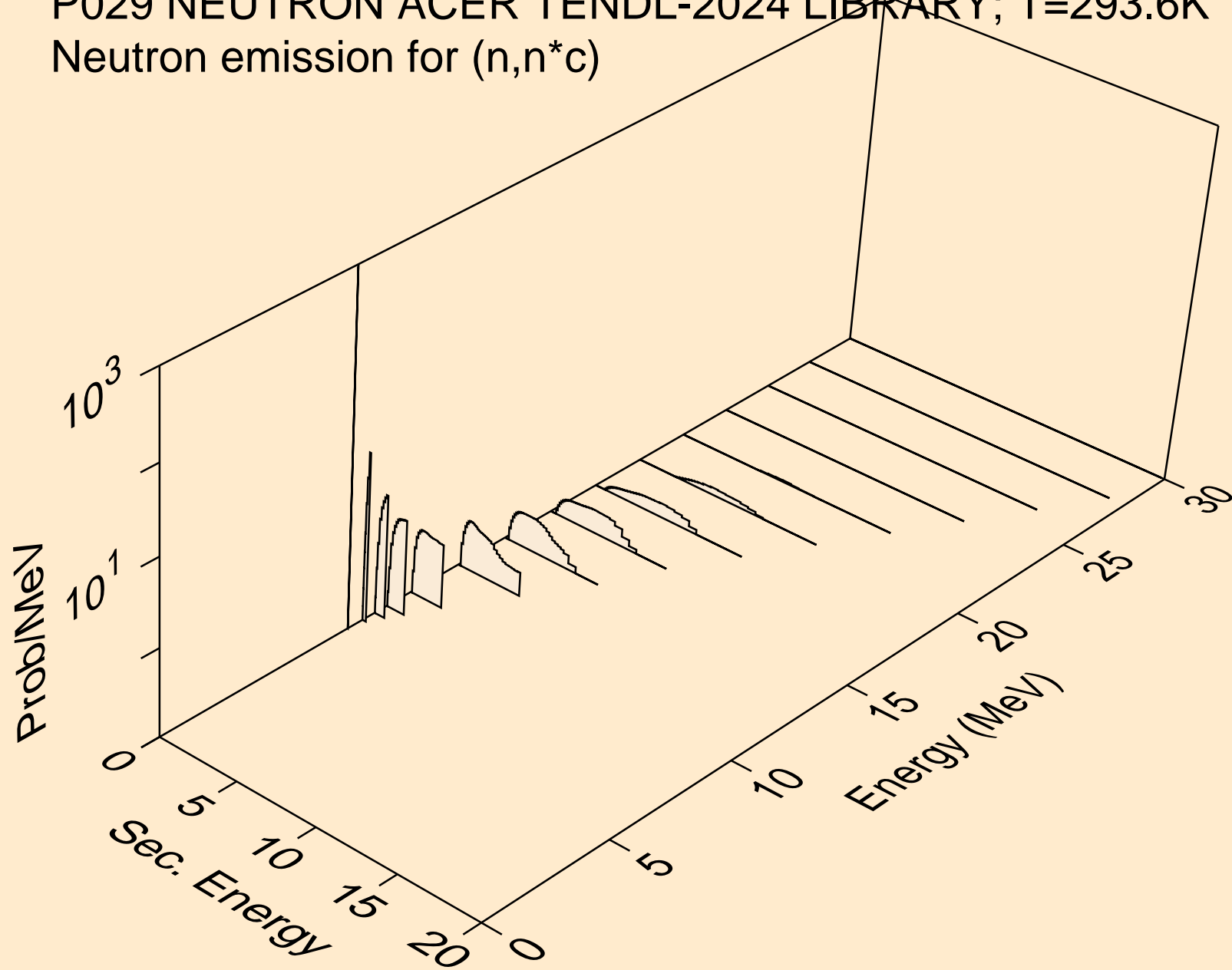

P029 NEUTRON ACER TENDL-2024 LIBRARY; T=293.6K  
Photon emission for (n,x)

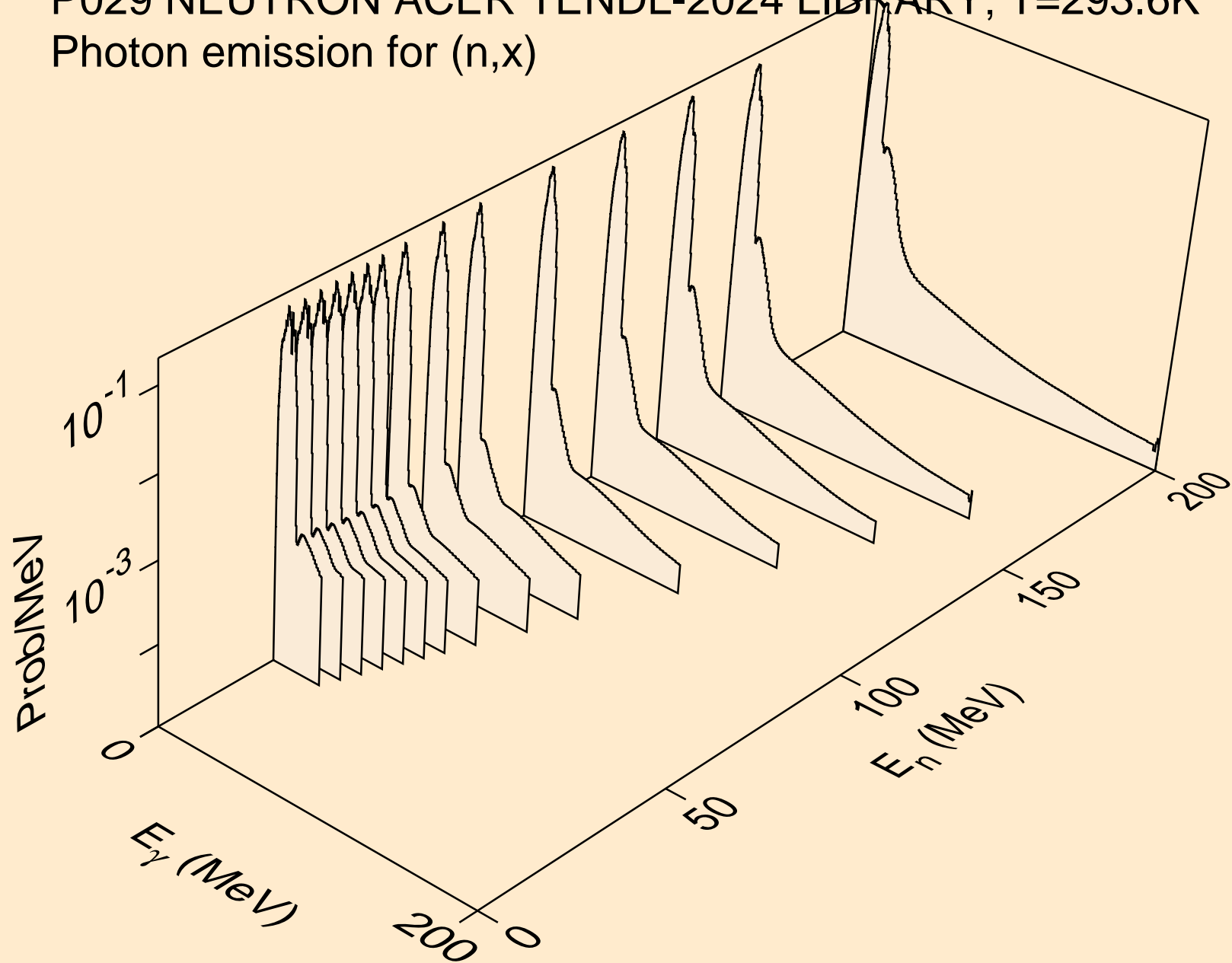

P029 NEUTRON ACER TENDL-2024 LIBRARY; T=293.6K  
Photon emission for (n,2n)

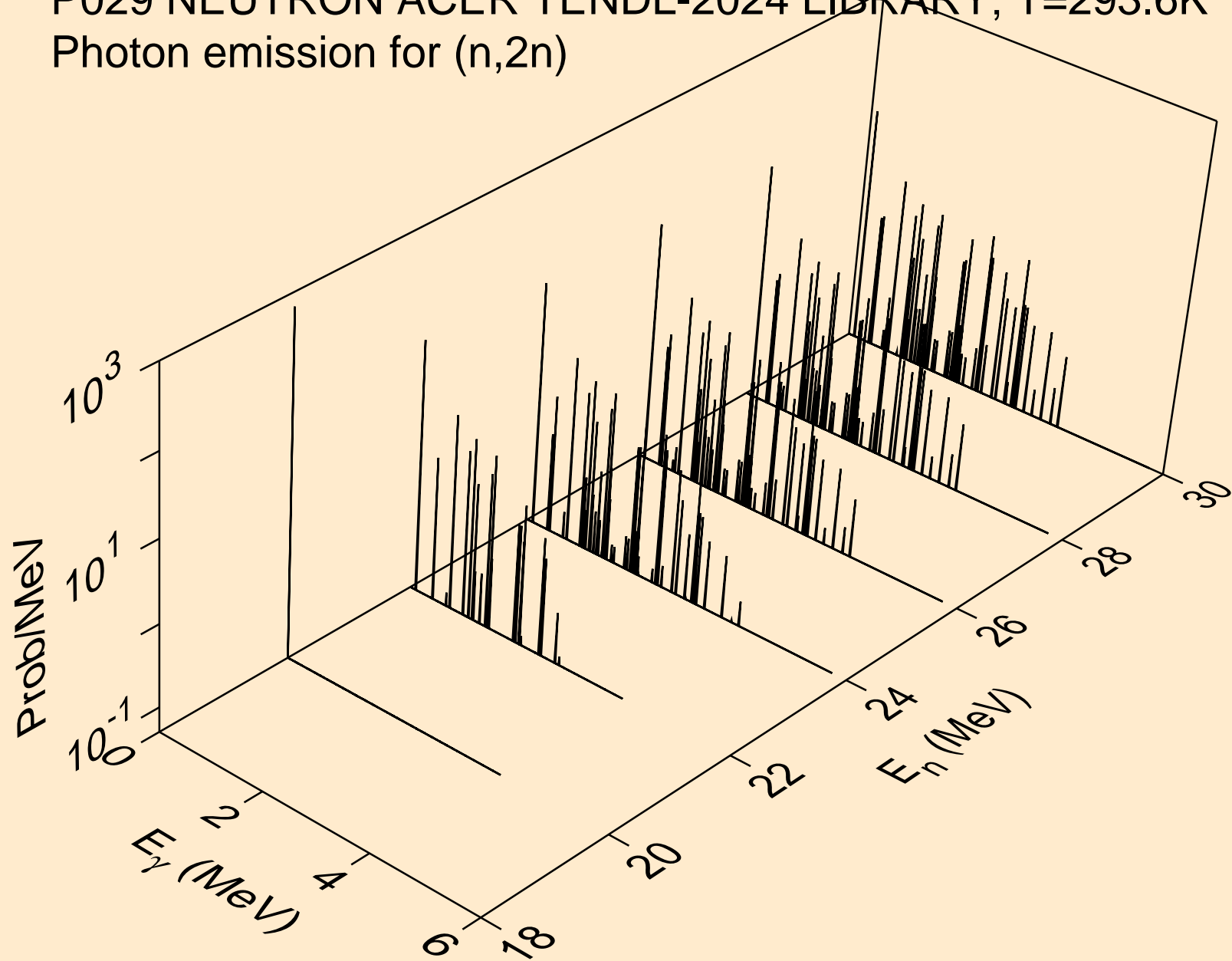

P029 NEUTRON ACER TENDL-2024 LIBRARY; T=293.6K  
Photon emission for (n,n\*)a

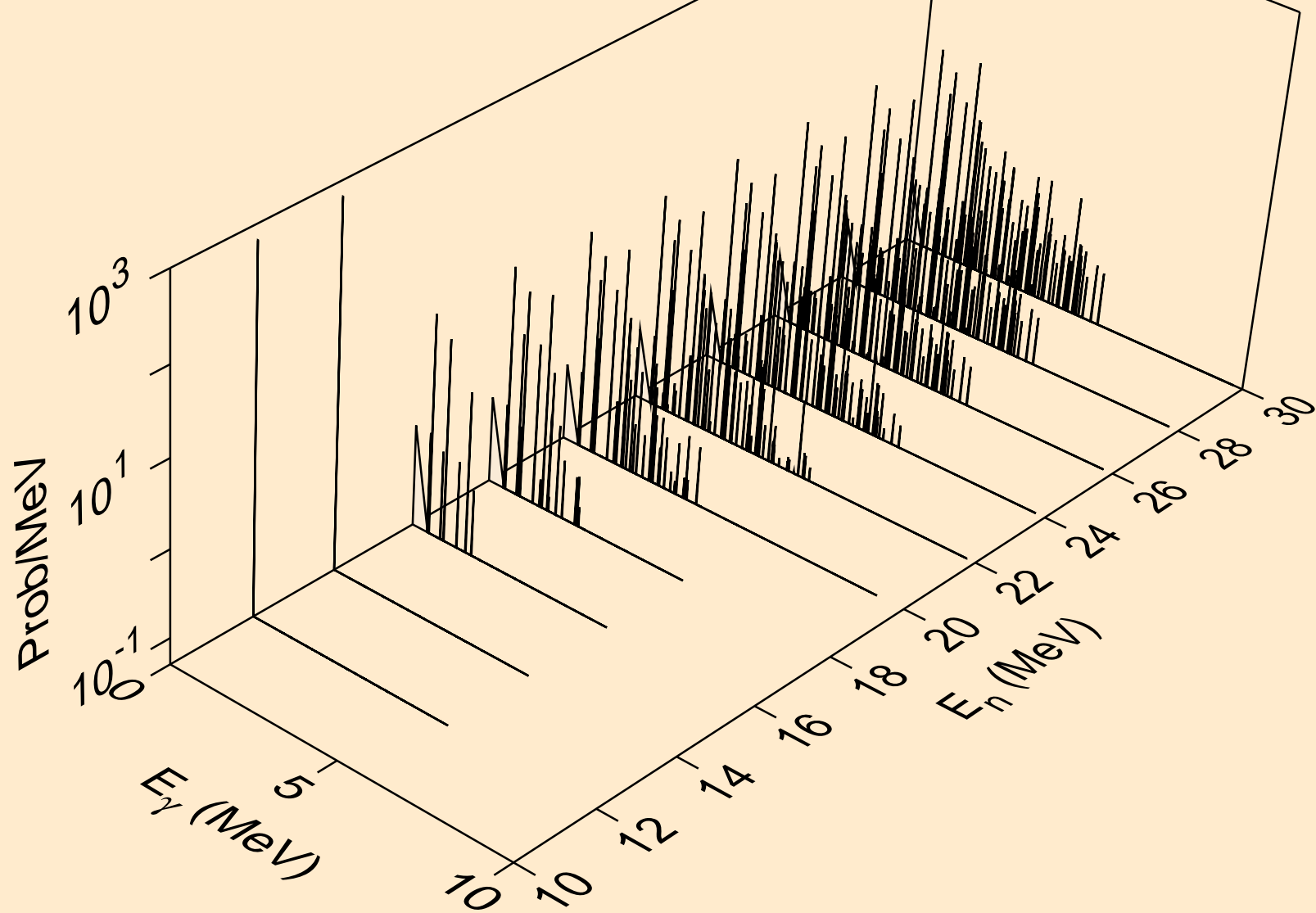

P029 NEUTRON ACER TENDL-2024 LIBRARY; T=293.6K  
Photon emission for (n,n\*)p

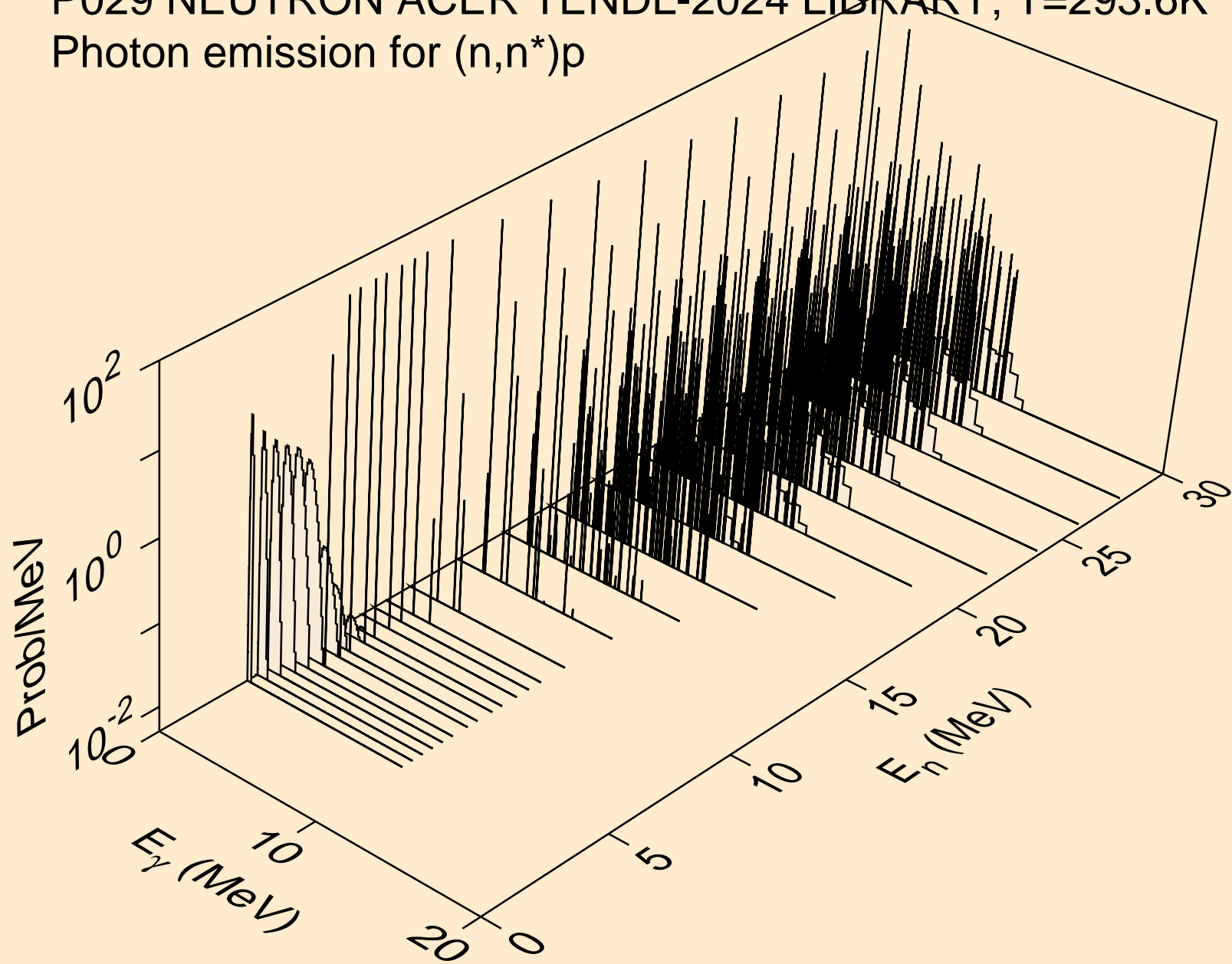

P029 NEUTRON ACER TENDL-2024 LIBRARY; T=293.6K  
Photon emission for (n,n\*)2a

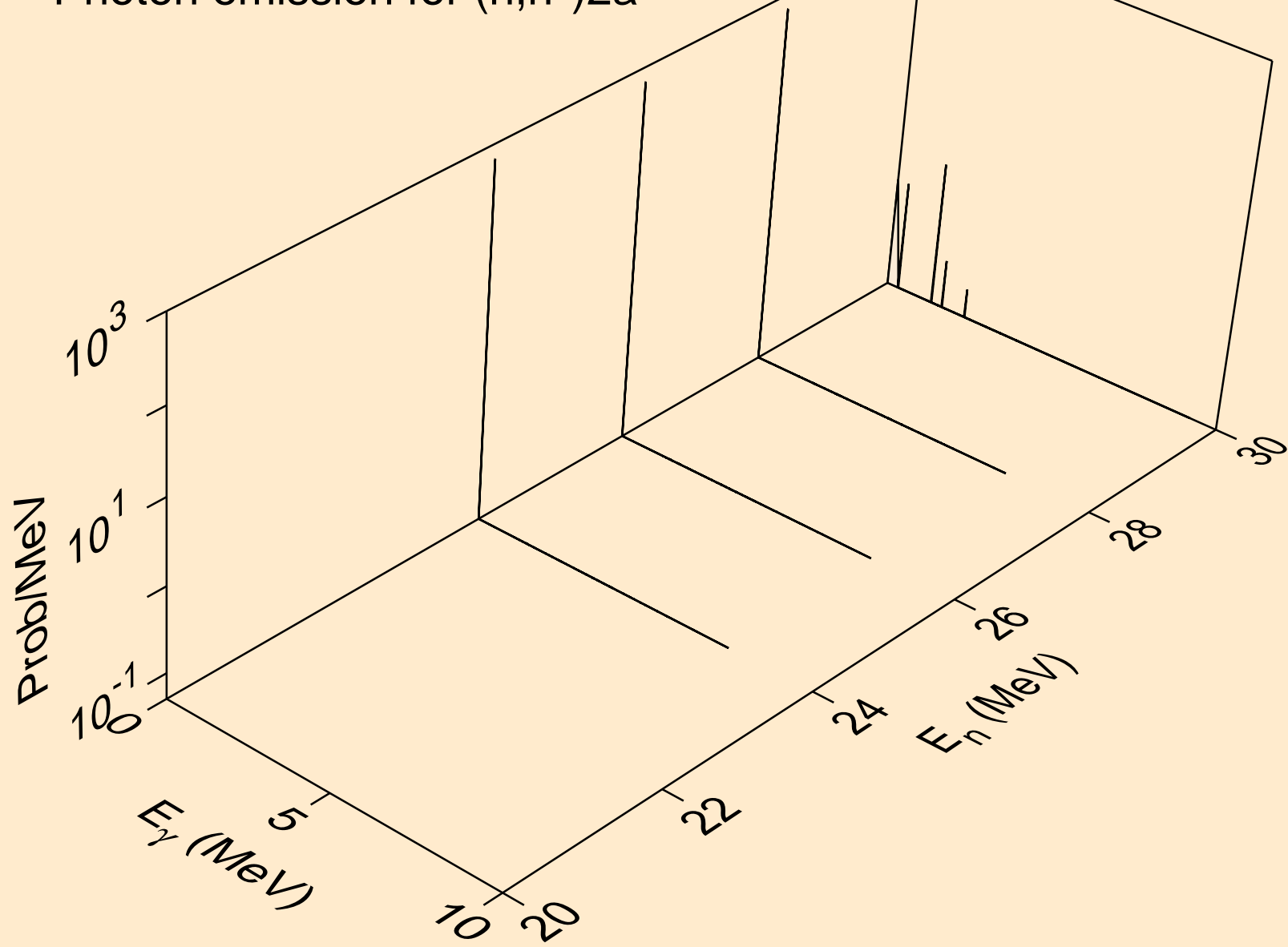

P029 NEUTRON ACER TENDL-2024 LIBRARY; T=293.6K  
Photon emission for (n,n\*)d

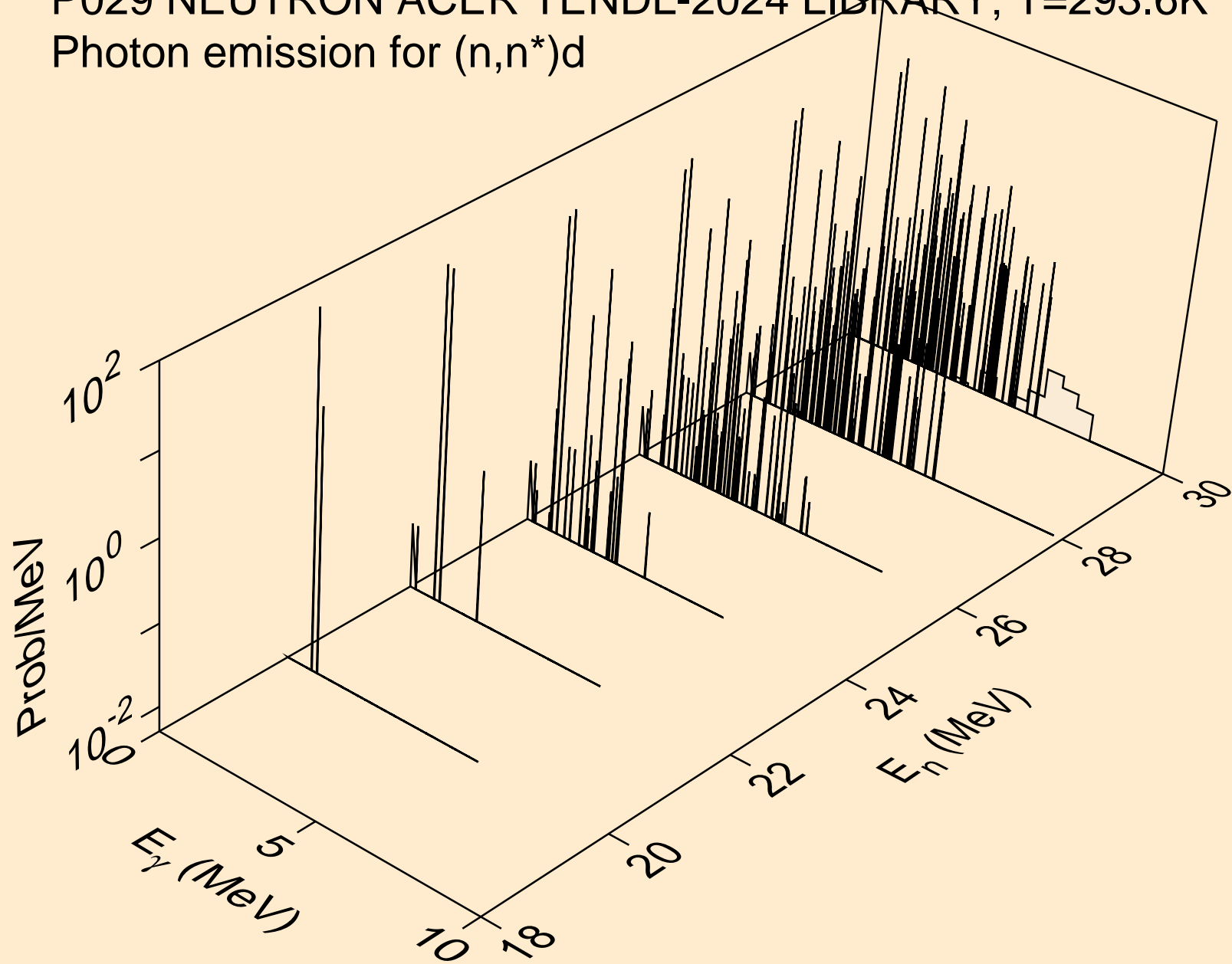

P029 NEUTRON ACER TENDL-2024 LIBRARY; T=293.6K  
Photon emission for (n,n\*)t

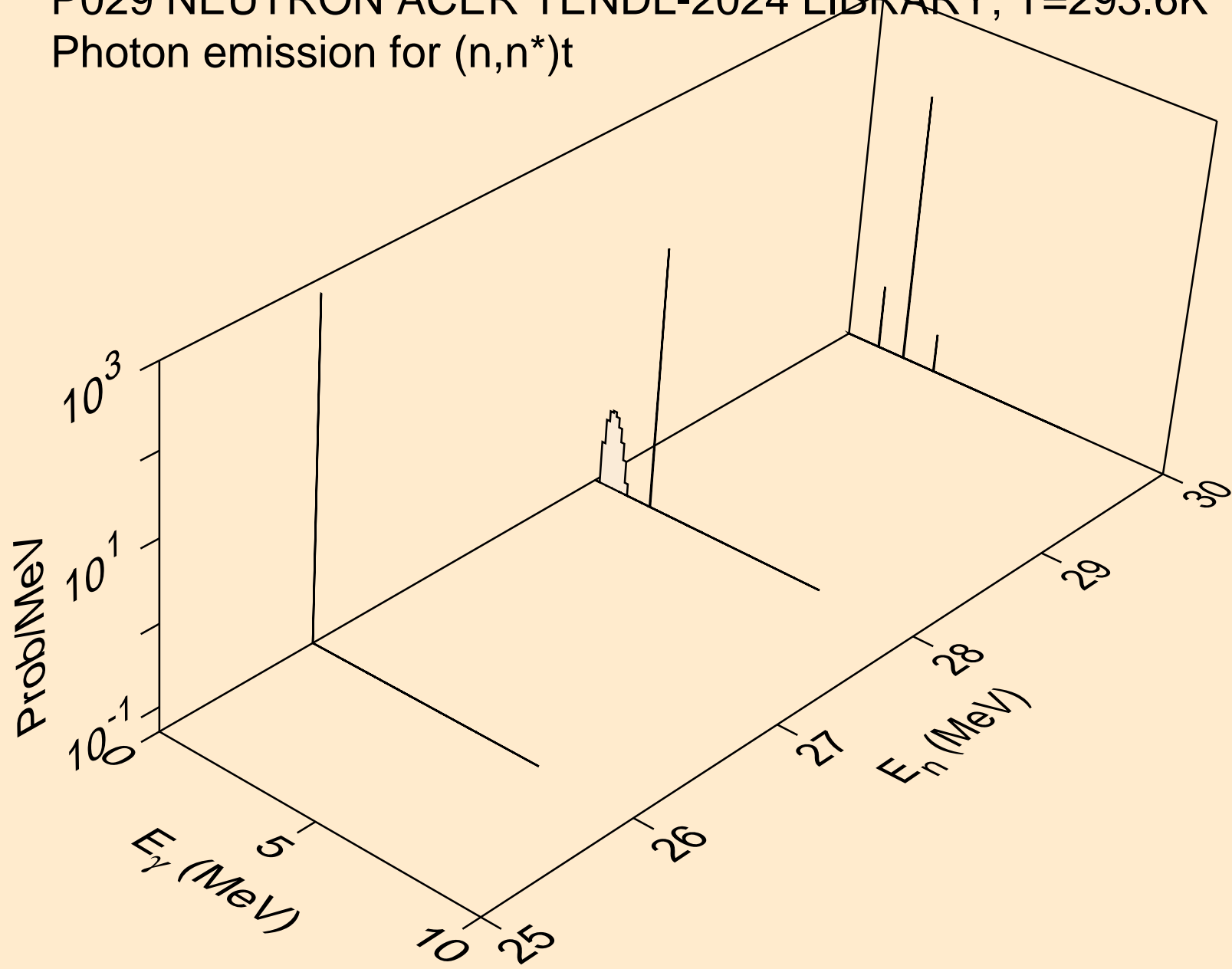

P029 NEUTRON ACER TENDL-2024 LIBRARY; T=293.6K  
Photon emission for (n,n\*)he3

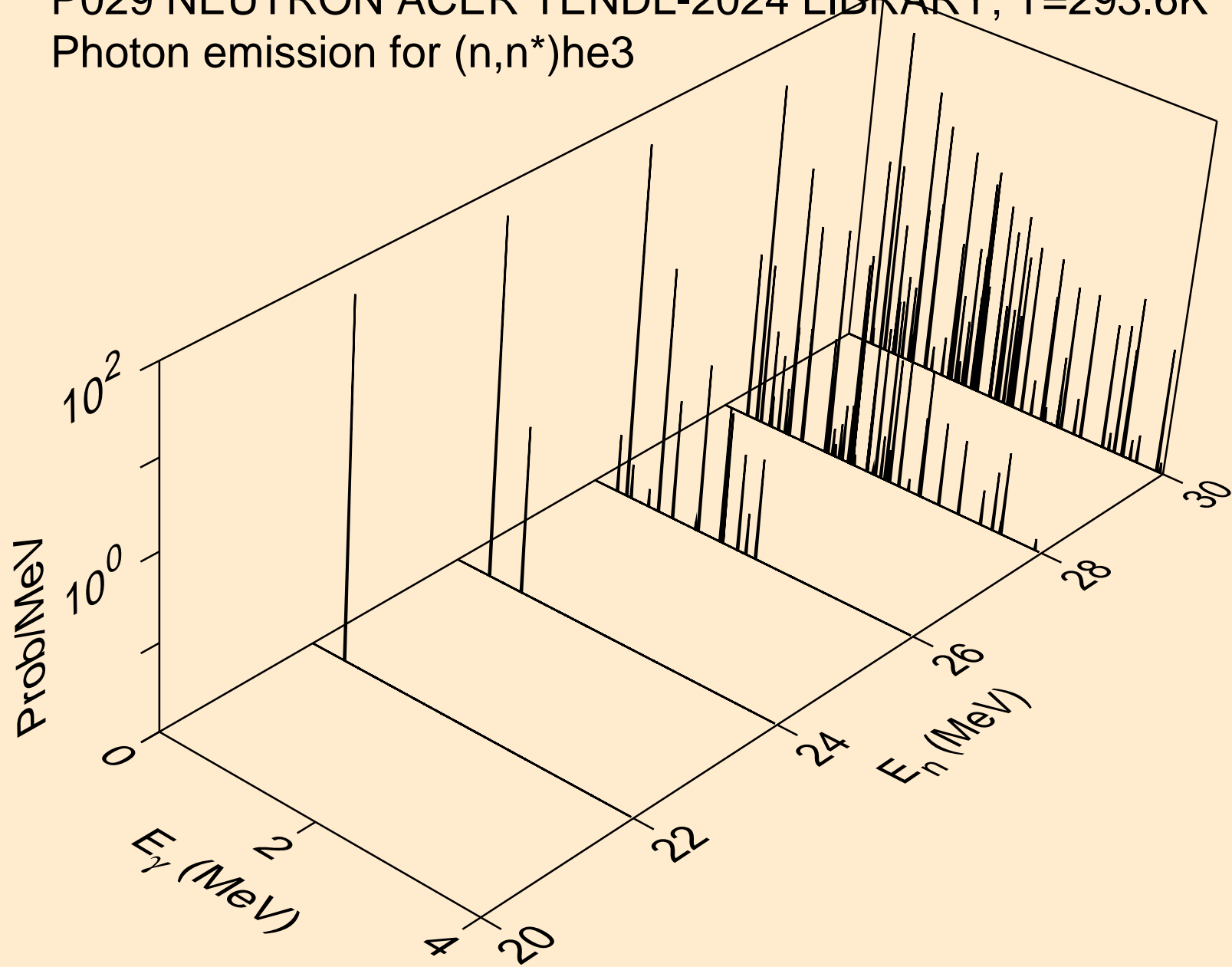

P029 NEUTRON ACER TENDL-2024 LIBRARY; T=293.6K  
Photon emission for (n,2np)

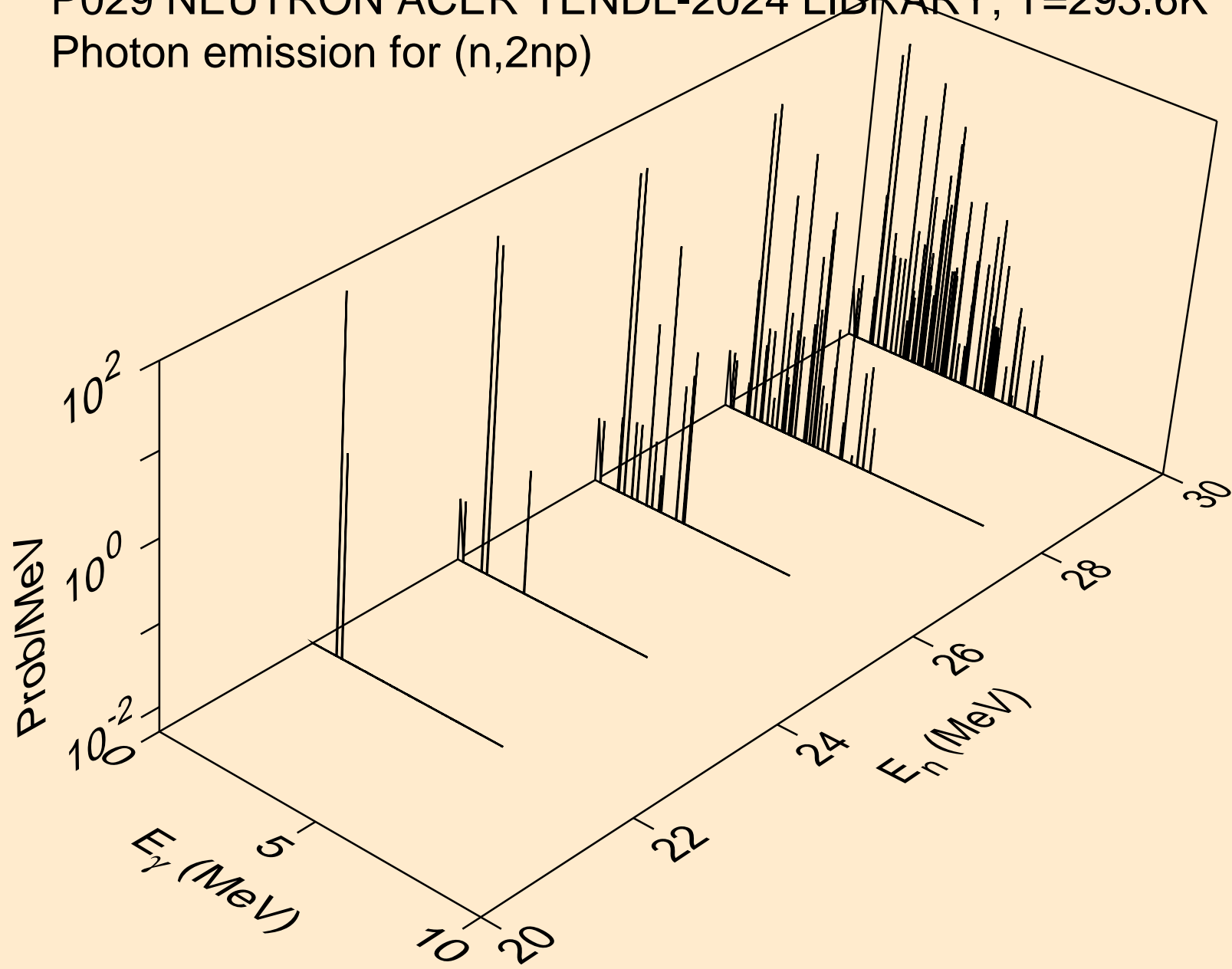

P029 NEUTRON ACER TENDL-2024 LIBRARY; T=293.6K  
Photon emission for (n,n2p)

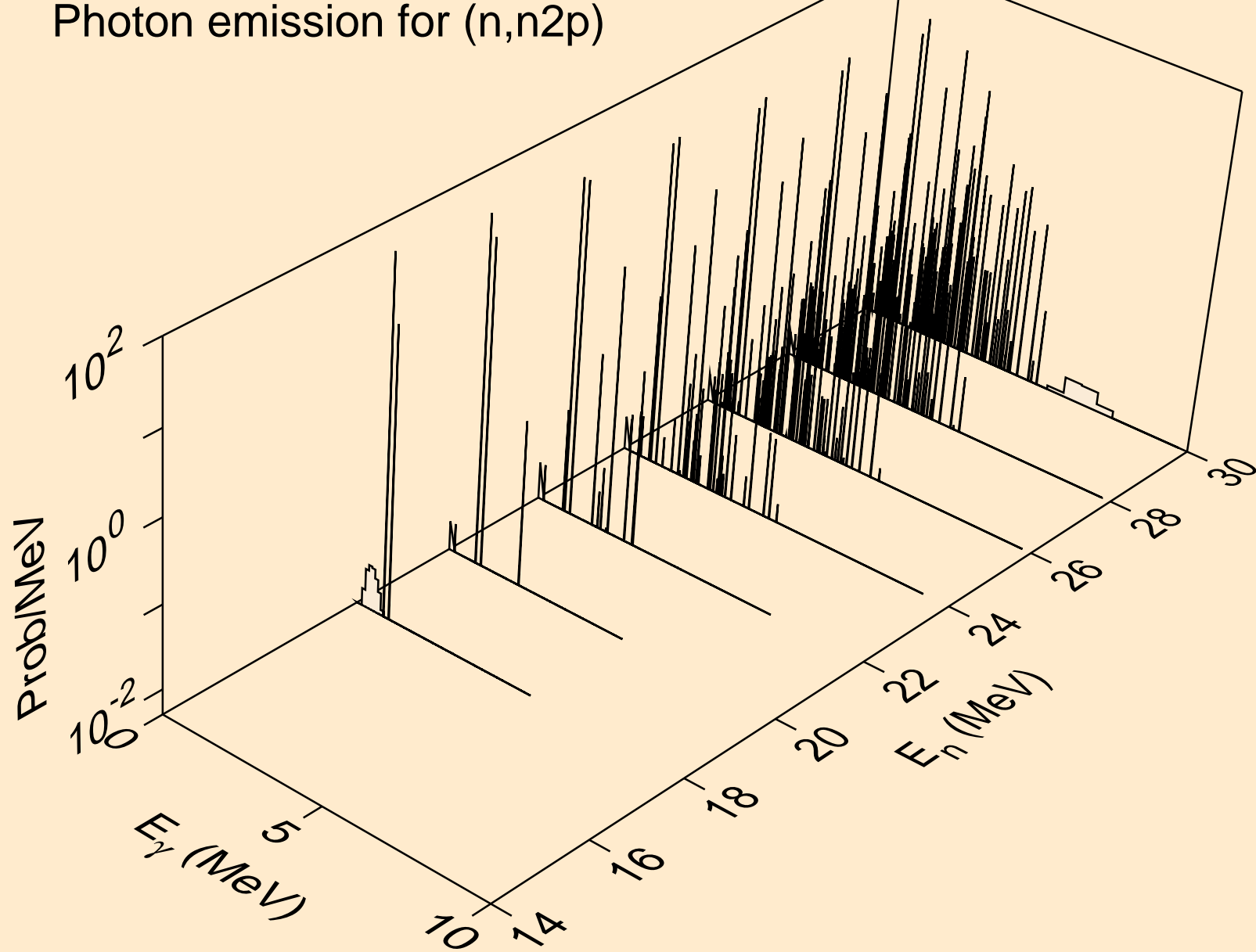

P029 NEUTRON ACER TENDL-2024 LIBRARY; T=293.6K  
Photon emission for (n,npa)

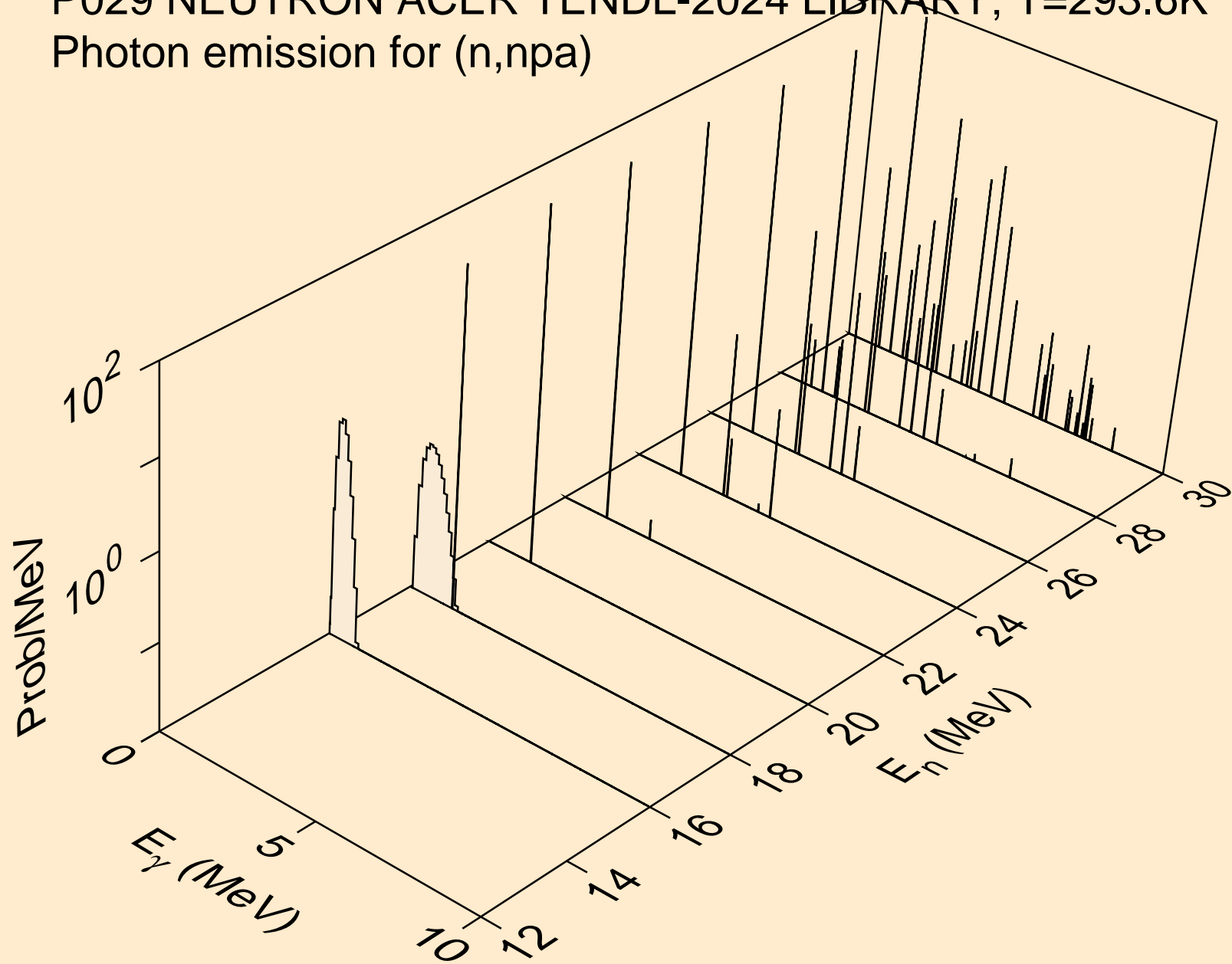

P029 NEUTRON ACER TENDL-2024 LIBRARY; T=293.6K  
Photon emission for (n,n\*c)

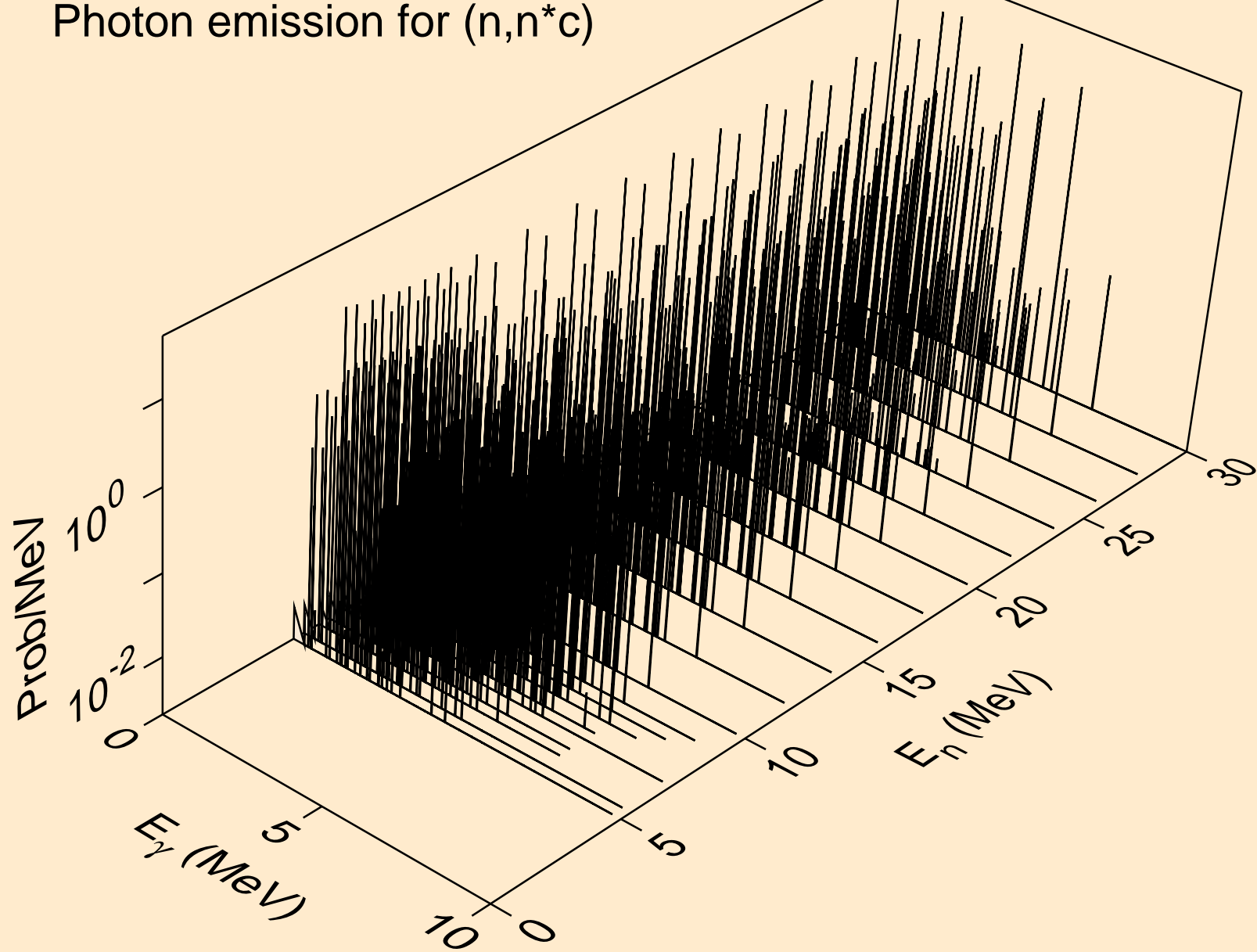

P029 NEUTRON ACER TENDL-2024 LIBRARY; T=293.6K  
Photon emission for (n,gma)

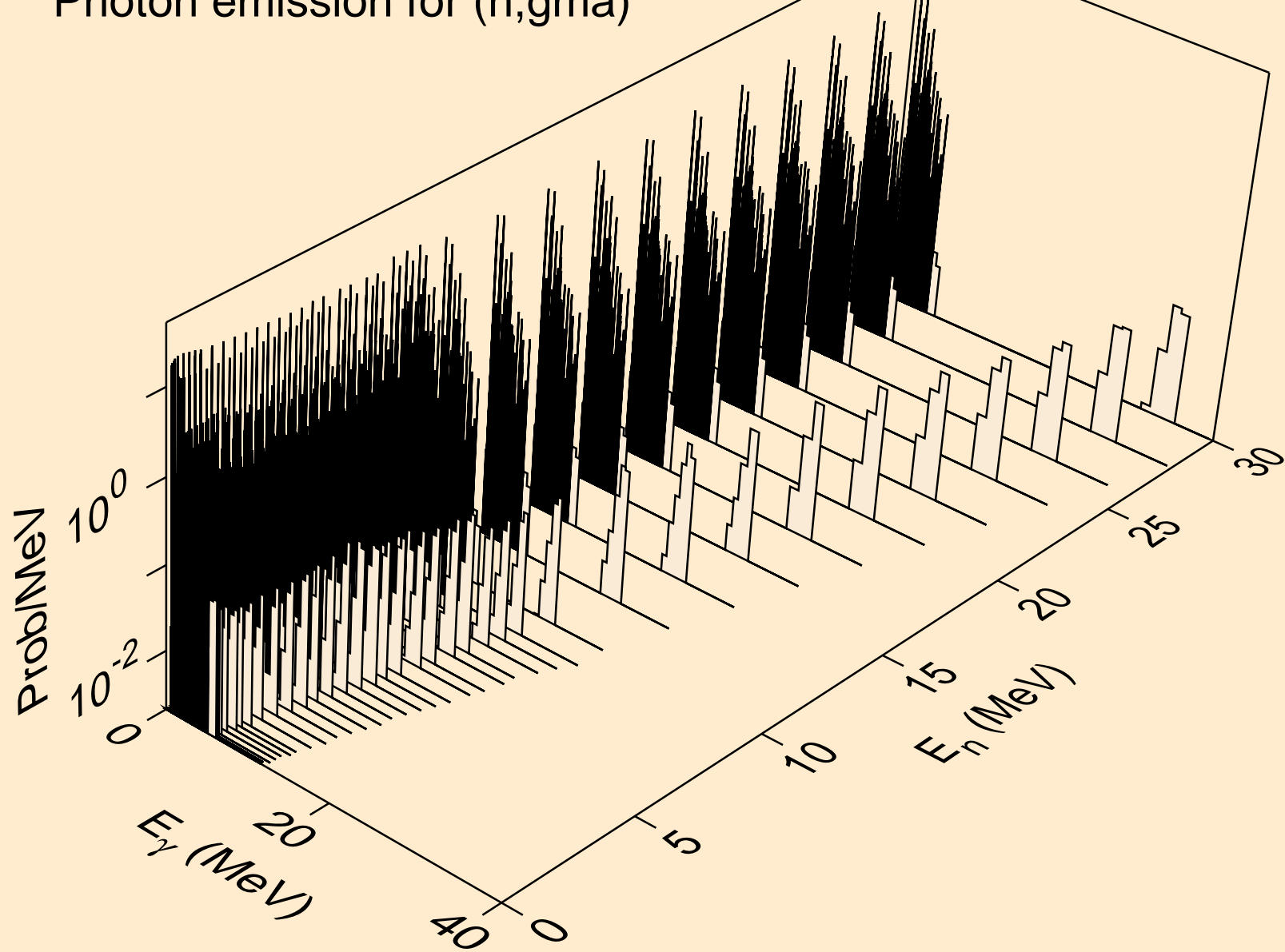

P029 NEUTRON ACER TENDL-2024 LIBRARY; T=293.6K  
Photon emission for (n,p)

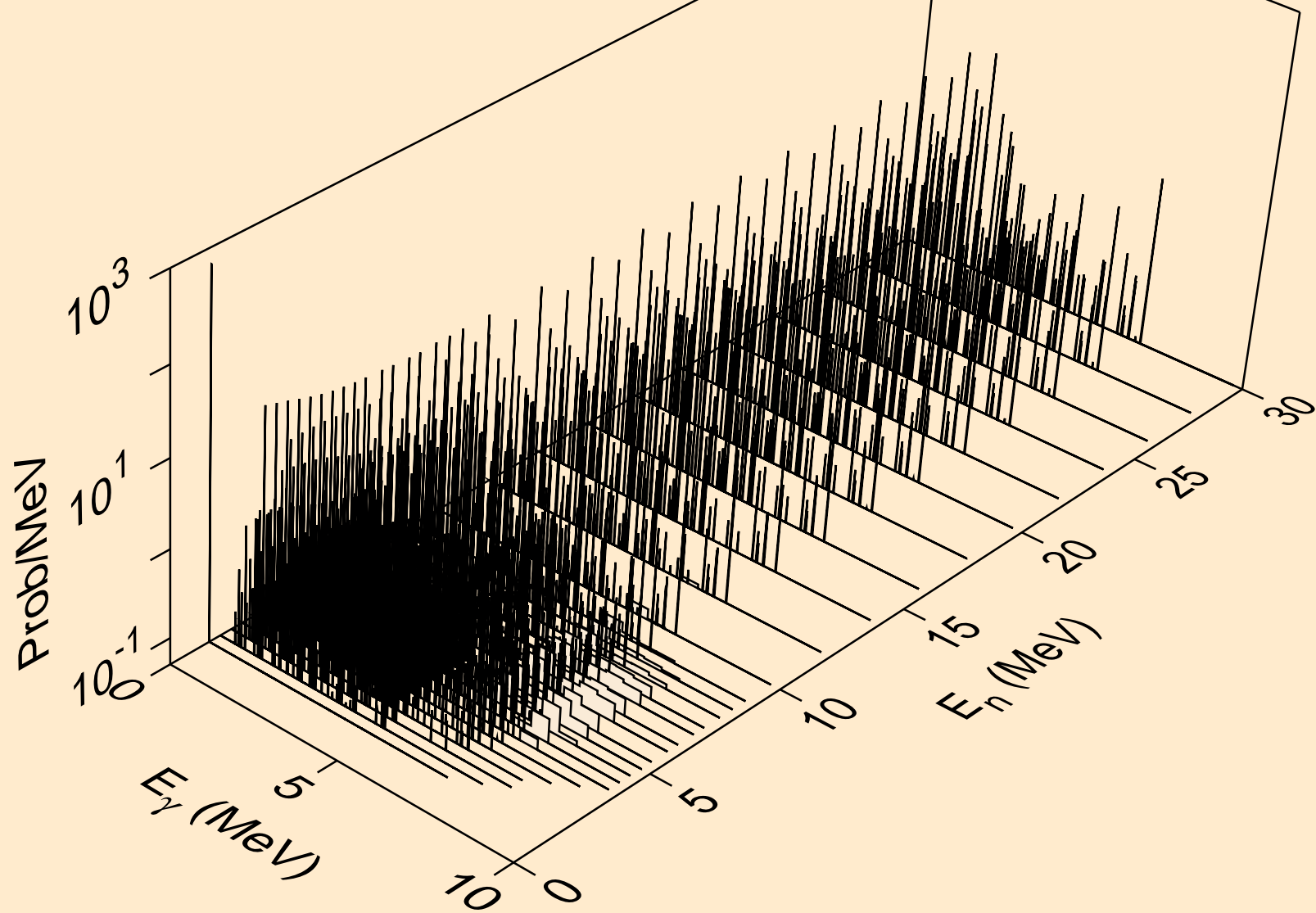

P029 NEUTRON ACER TENDL-2024 LIBRARY; T=293.6K  
Photon emission for (n,d)

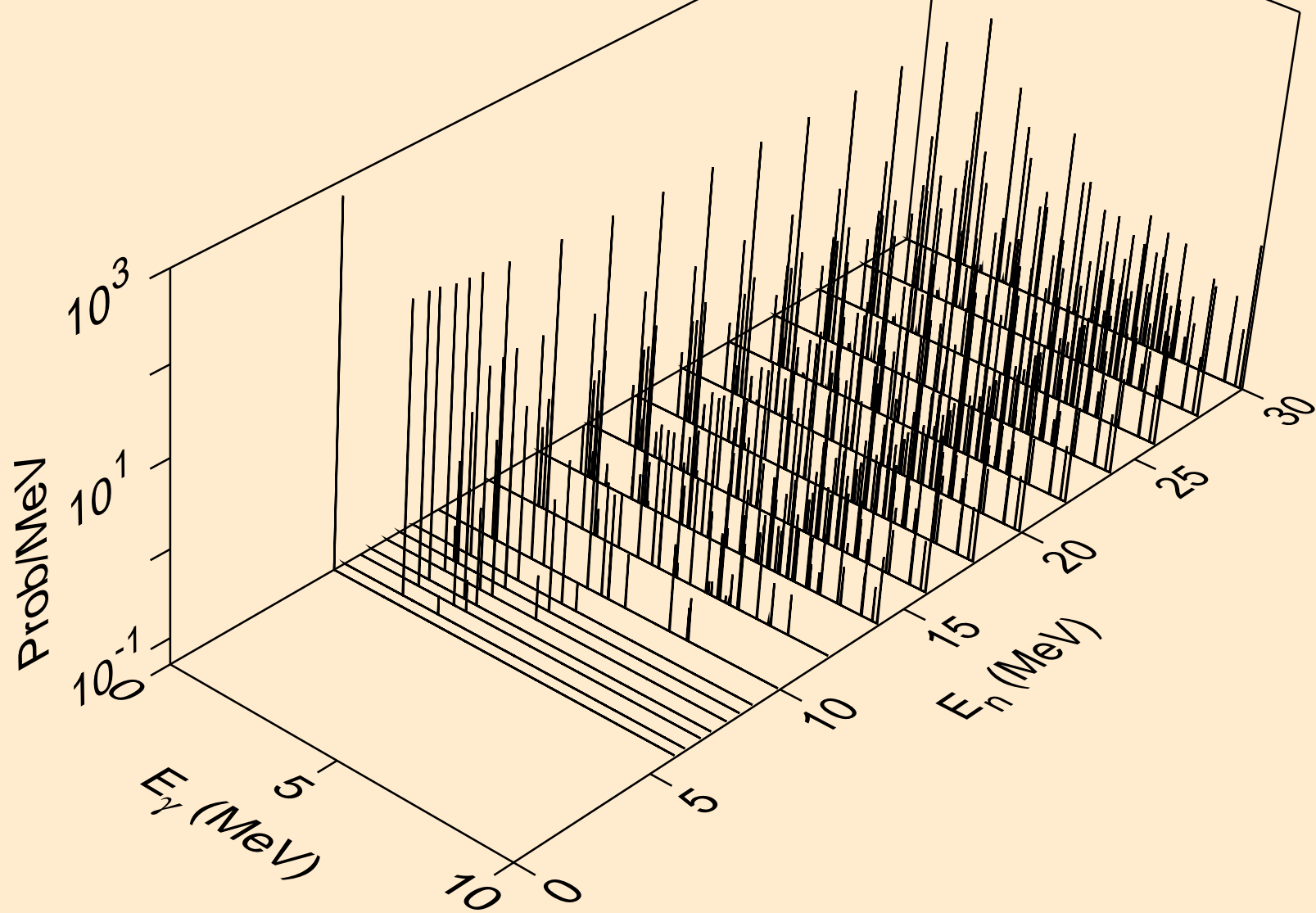

P029 NEUTRON ACER TENDL-2024 LIBRARY; T=293.6K  
Photon emission for (n,t)

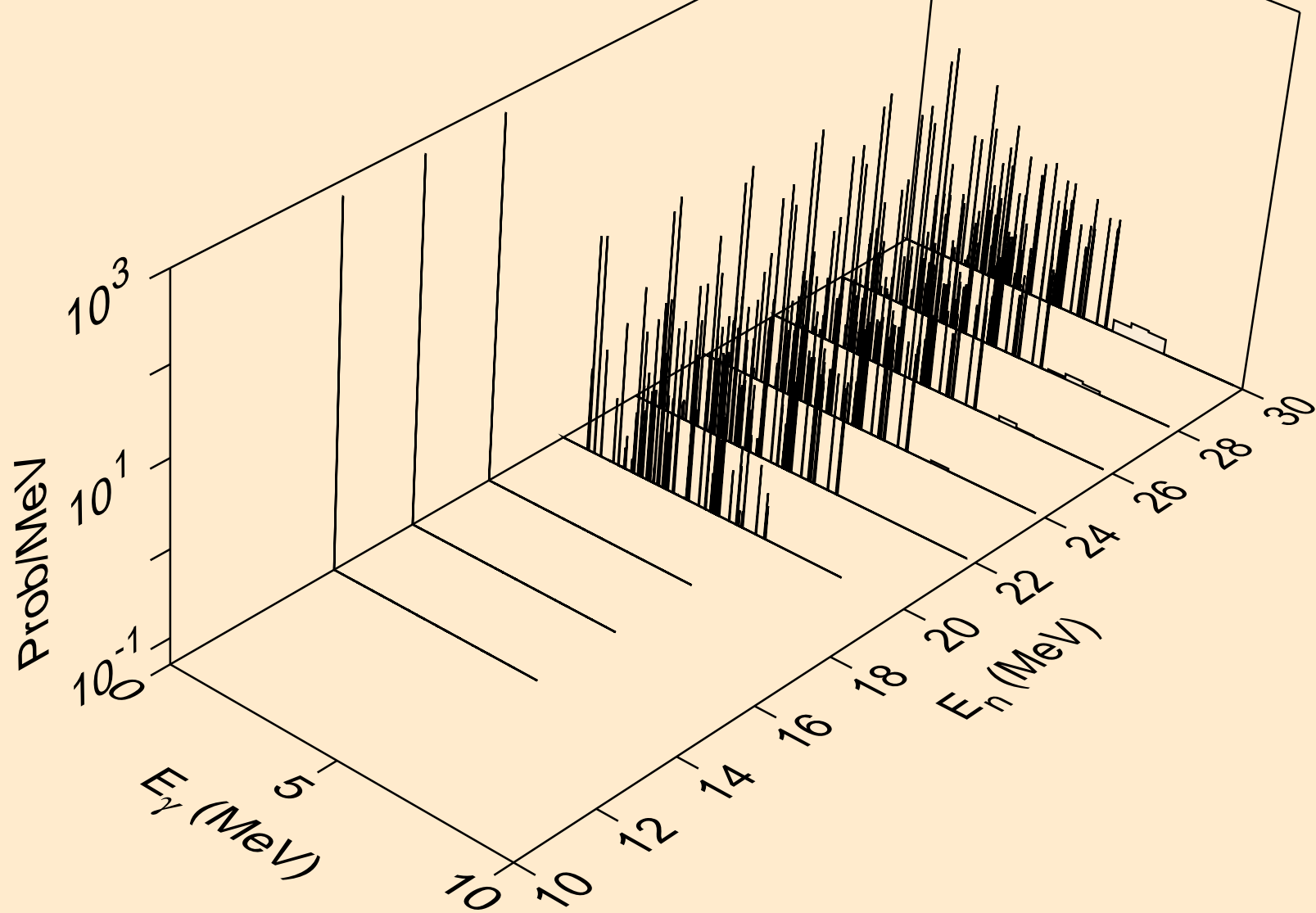

P029 NEUTRON ACER TENDL-2024 LIBRARY; T=293.6K  
Photon emission for (n,he3)

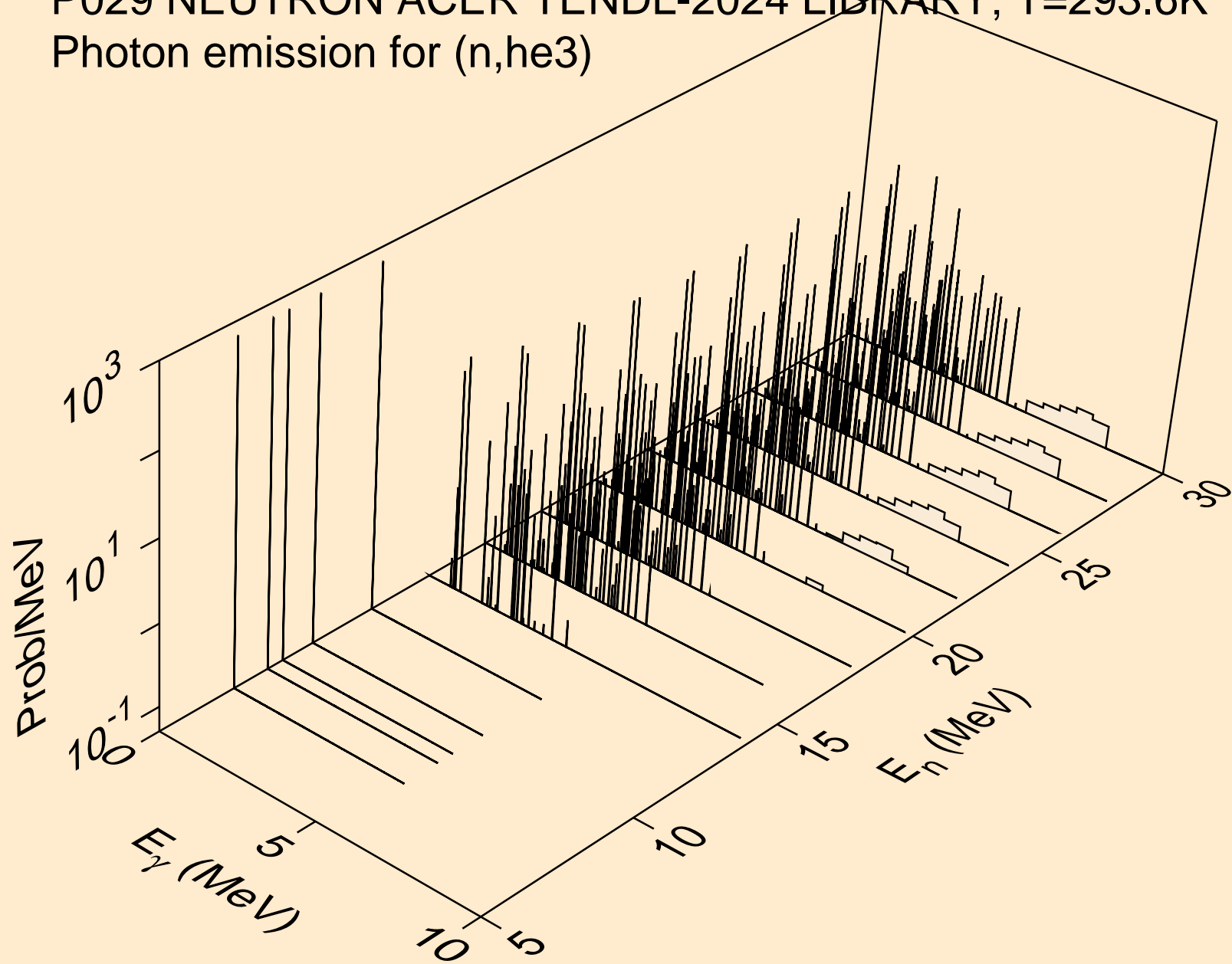

P029 NEUTRON ACER TENDL-2024 LIBRARY; T=293.6K  
Photon emission for (n,a)

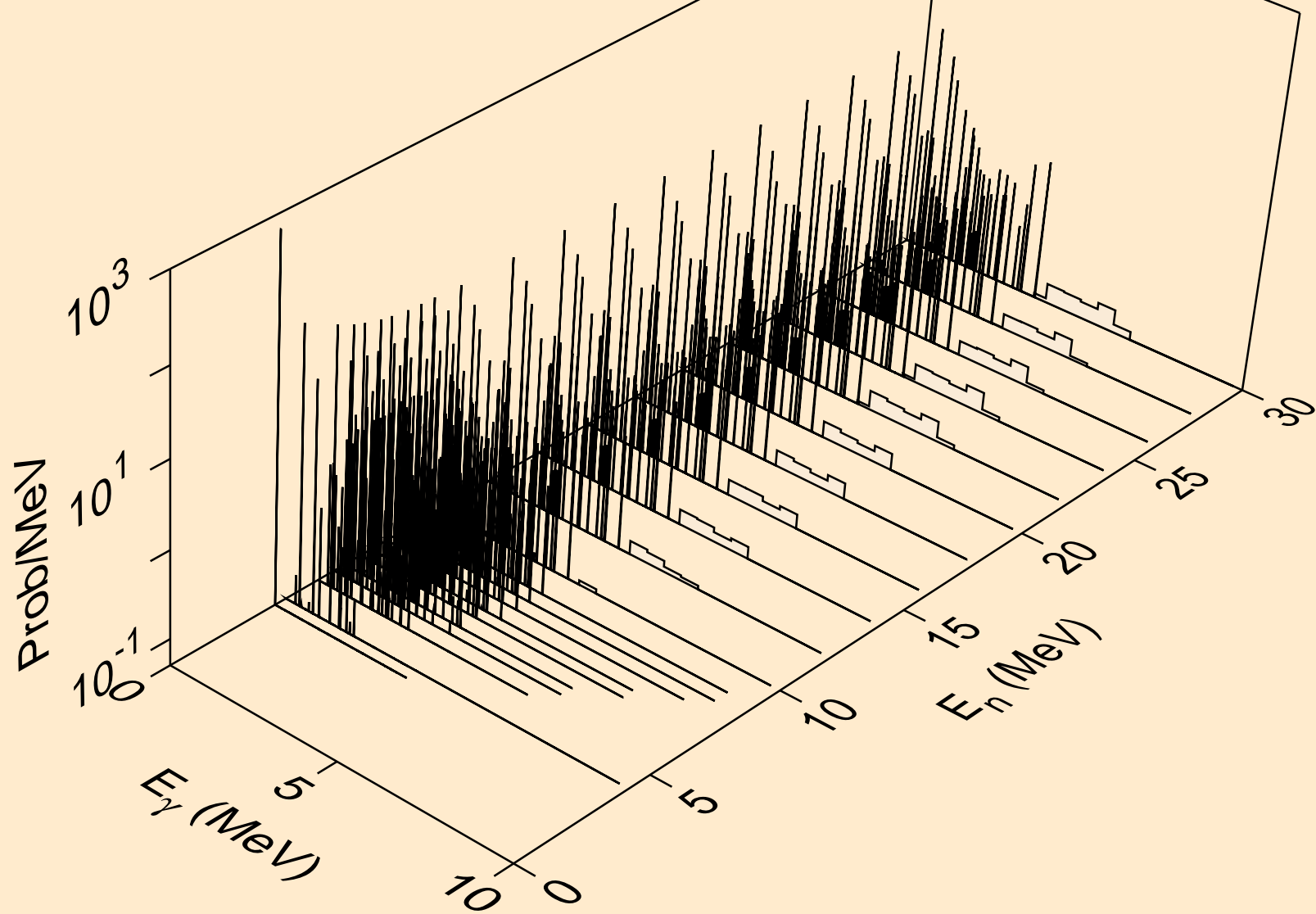

P029 NEUTRON ACER TENDL-2024 LIBRARY; T=293.6K  
Photon emission for (n,2a)

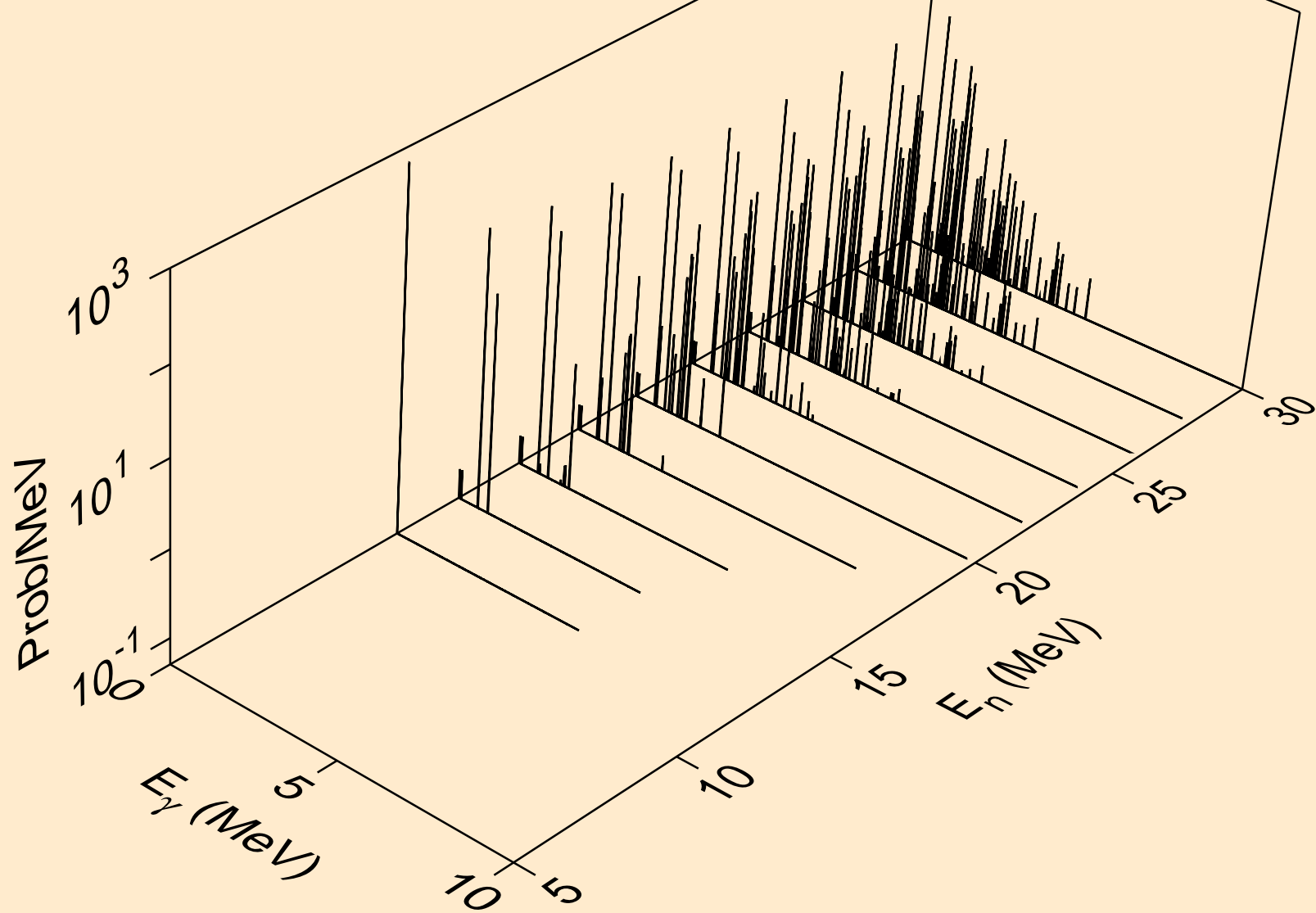

P029 NEUTRON ACER TENDL-2024 LIBRARY; T=293.6K  
Photon emission for (n,3a)

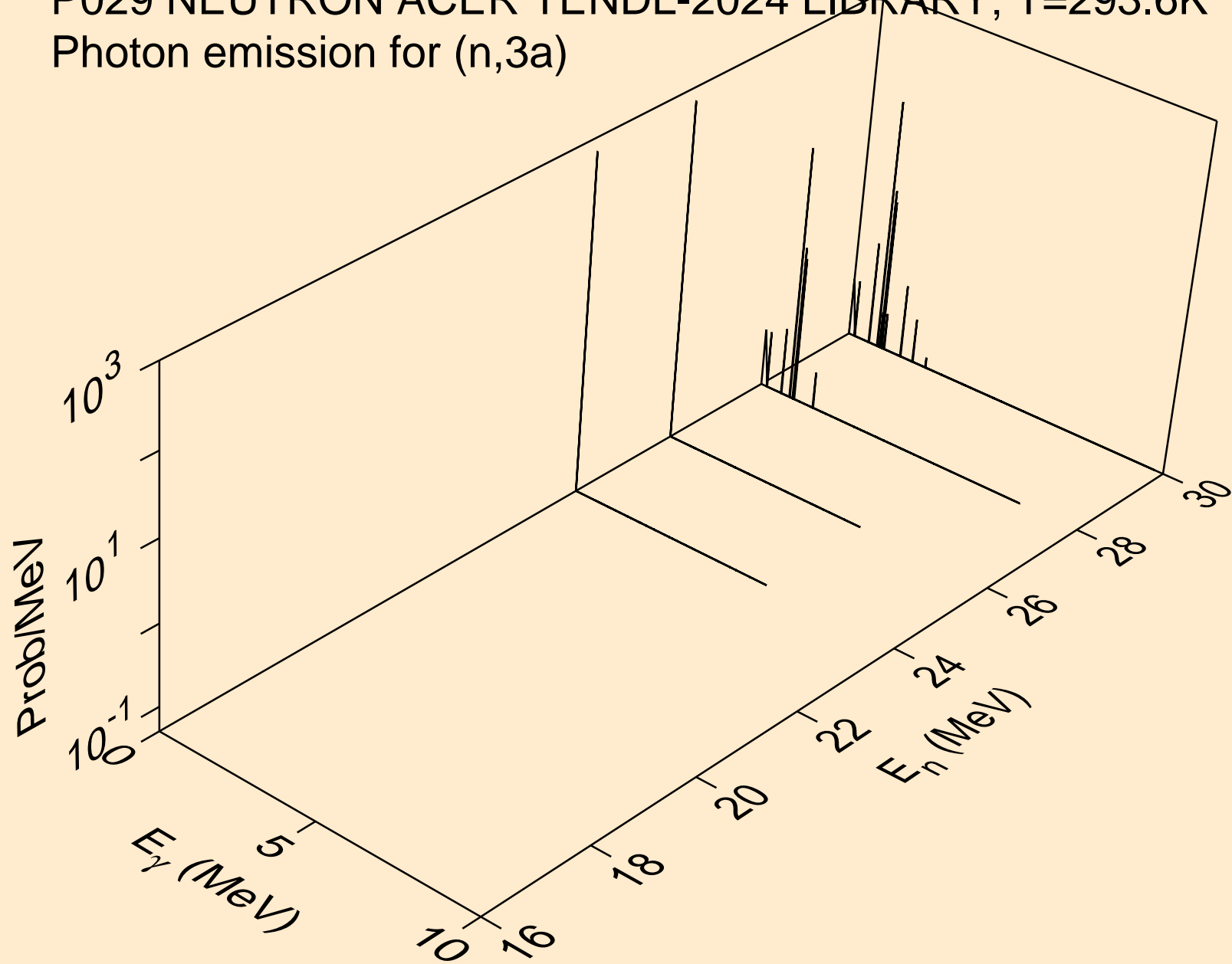

P029 NEUTRON ACER TENDL-2024 LIBRARY; T=293.6K  
Photon emission for (n,2p)

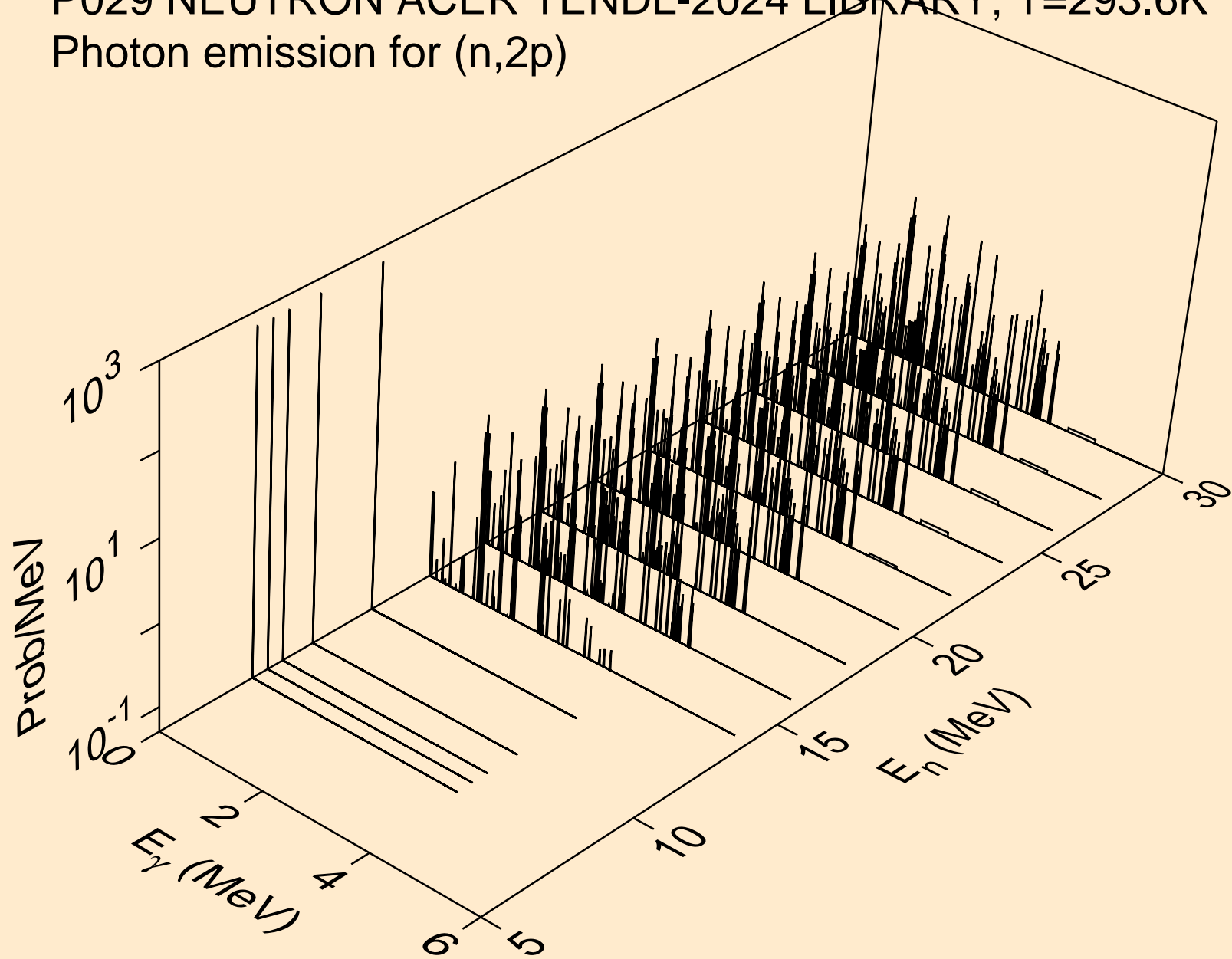

P029 NEUTRON ACER TENDL-2024 LIBRARY; T=293.6K  
Photon emission for (n,p $\alpha$ )

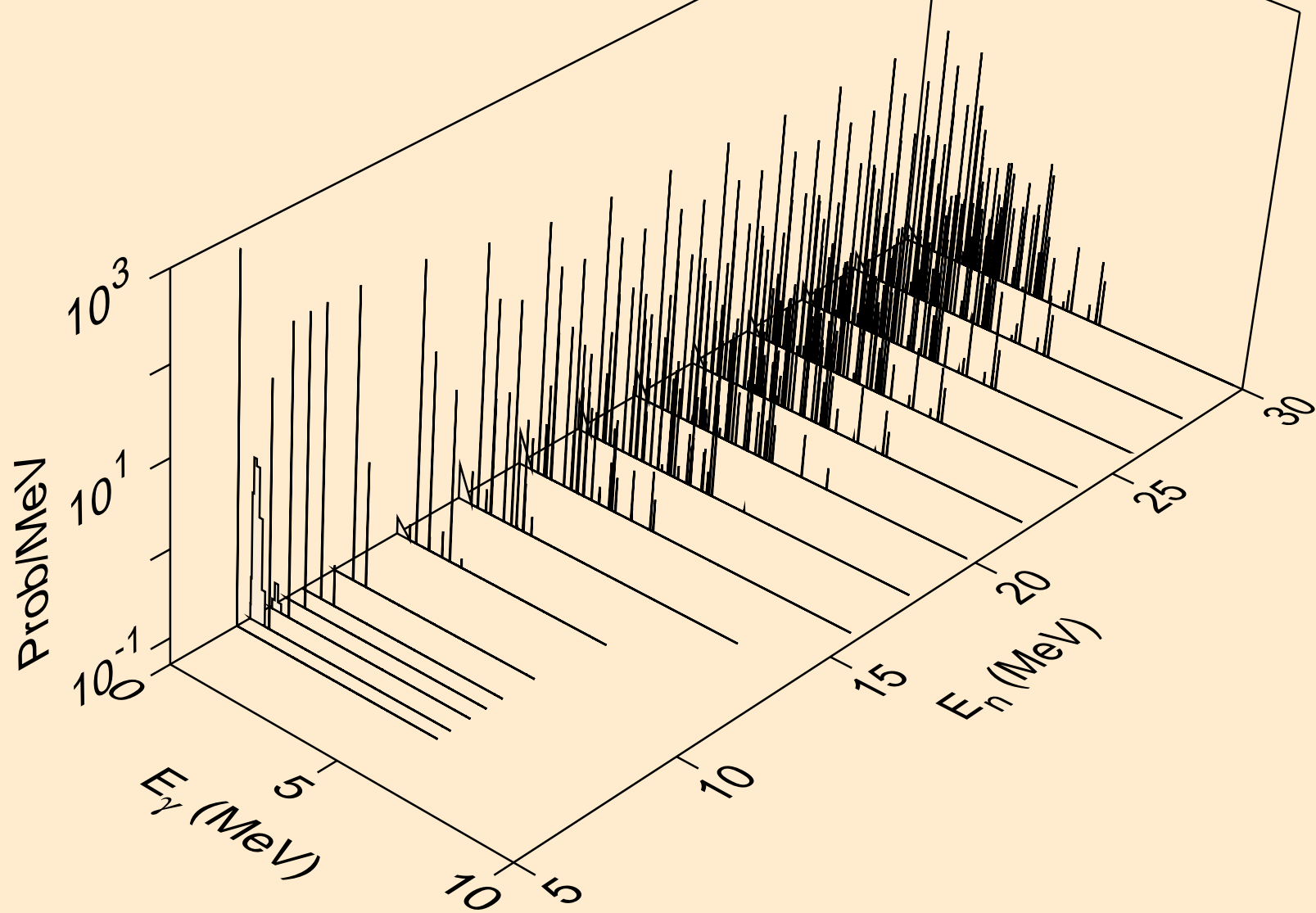

P029 NEUTRON ACER TENDL-2024 LIBRARY; T=293.6K  
Photon emission for (n,d2a)

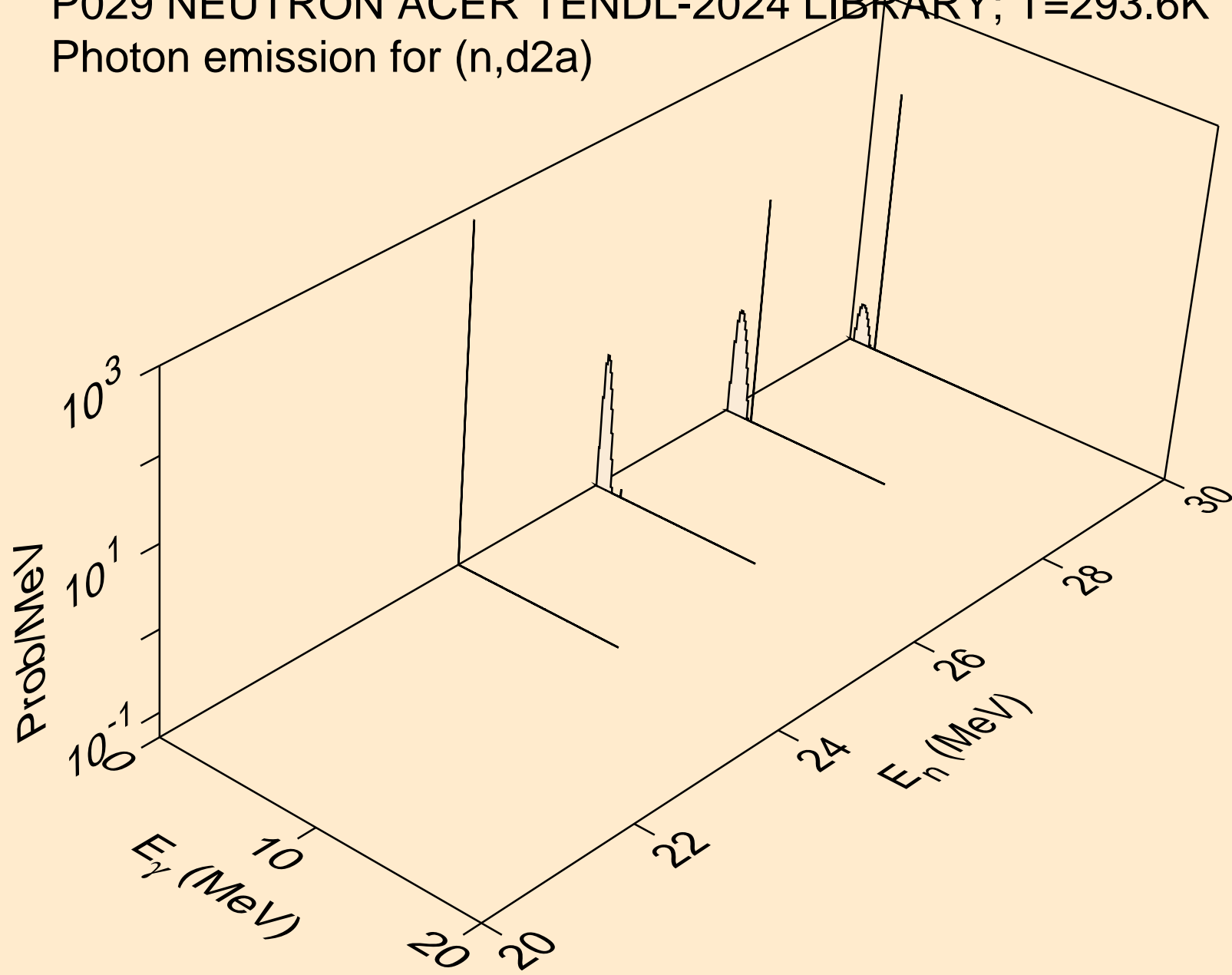

P029 NEUTRON ACER TENDL-2024 LIBRARY; T=293.6K  
Photon emission for (n,pd)

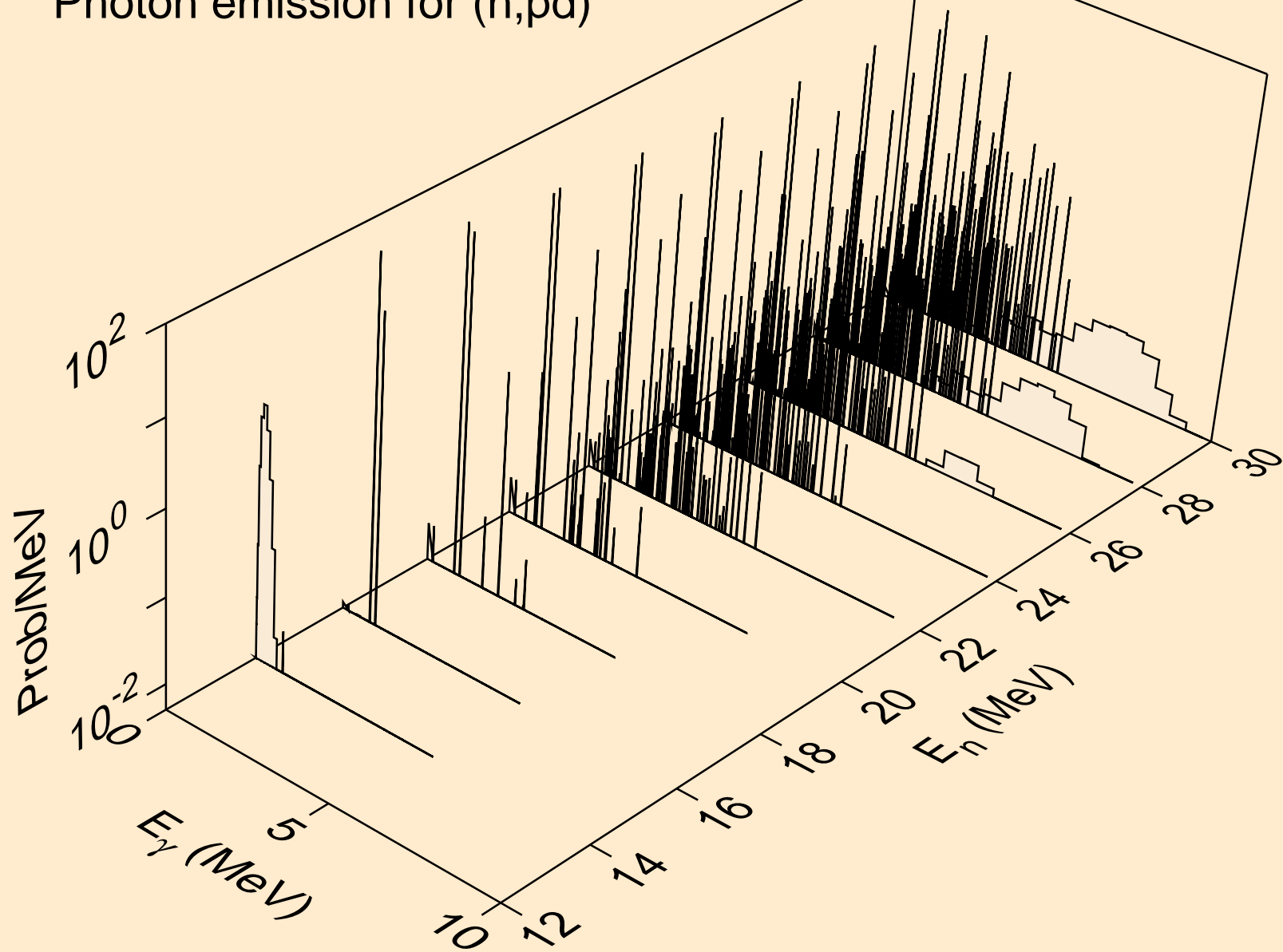

P029 NEUTRON ACER TENDL-2024 LIBRARY; T=293.6K  
Photon emission for (n,pt)

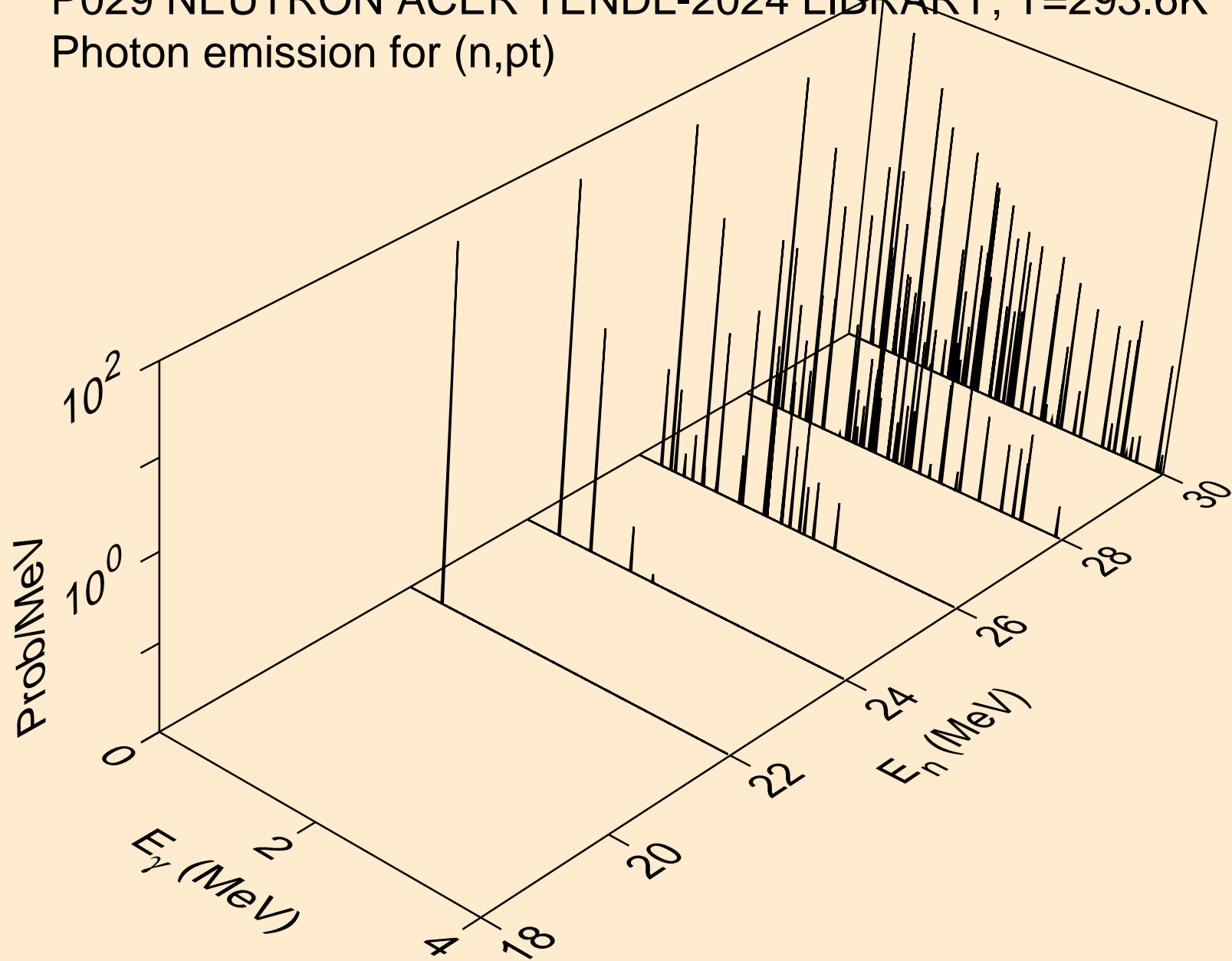

P029 NEUTRON ACER TENDL-2024 LIBRARY; T=293.6K  
Photon emission for (n,da)

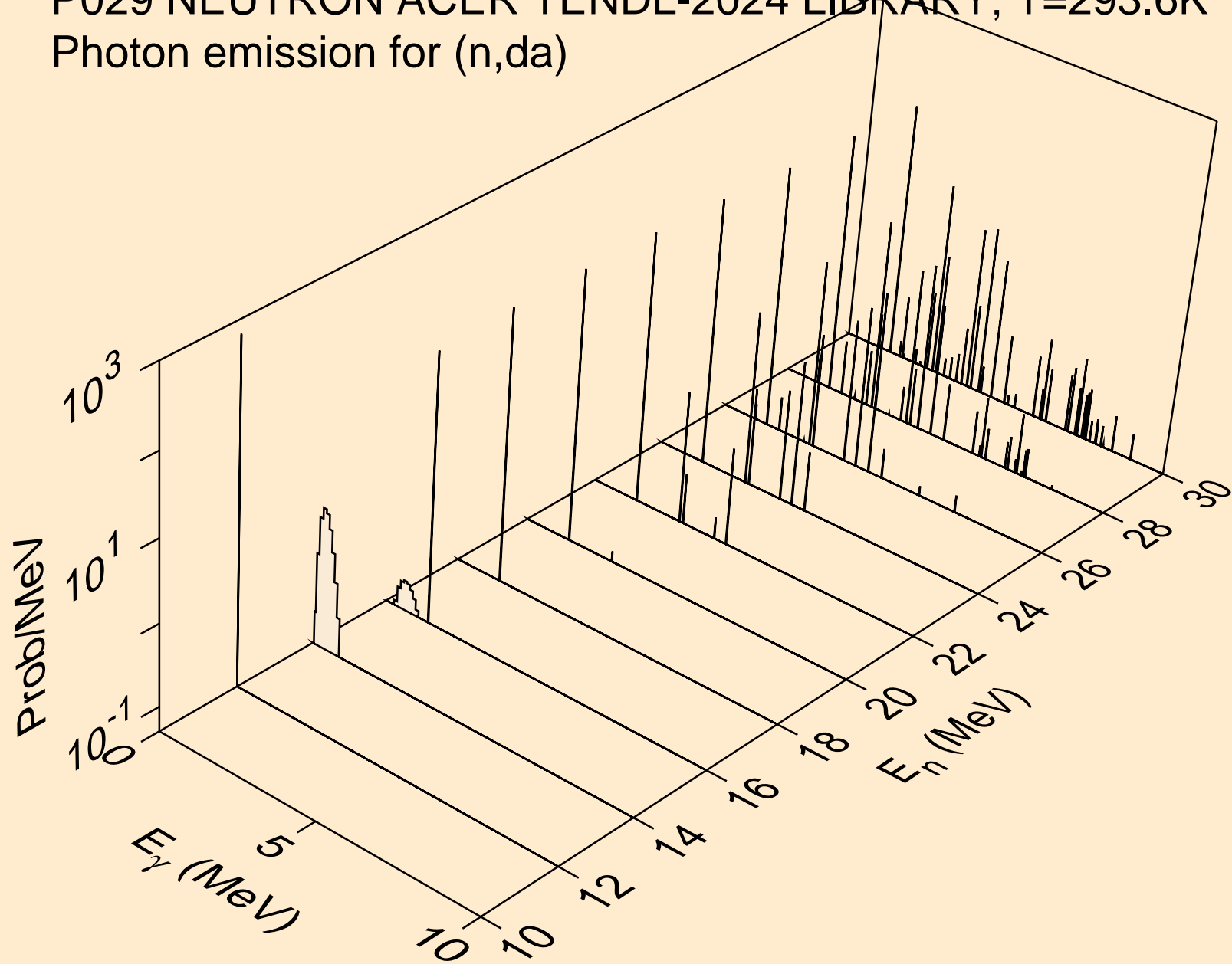

P029 NEUTRON ACER TENDL-2024 LIBRARY; T=293.6K  
thermal capture photon spectrum

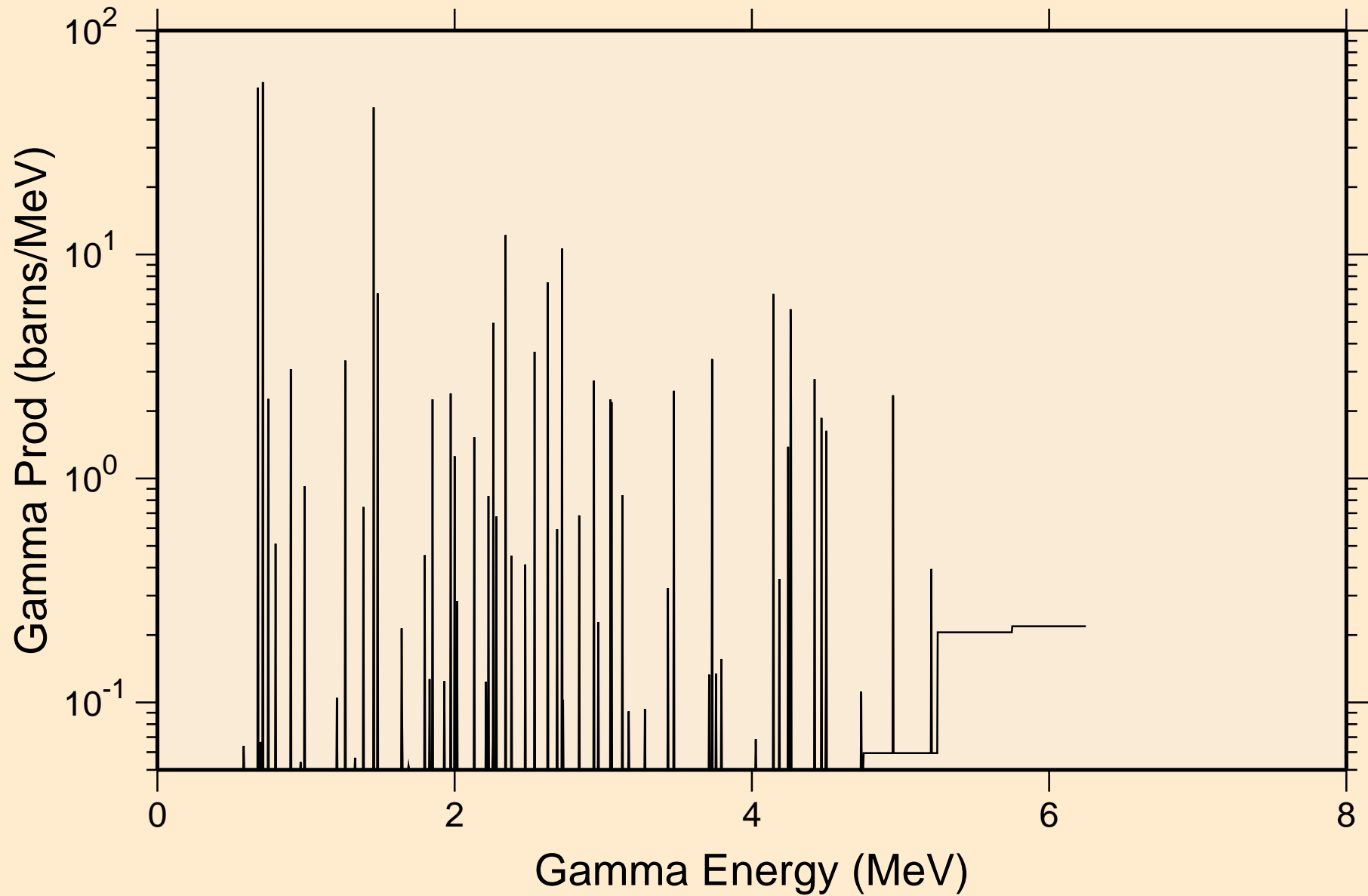

P029 NEUTRON ACER TENDL-2024 LIBRARY; T=293.6K  
14 MeV photon spectrum

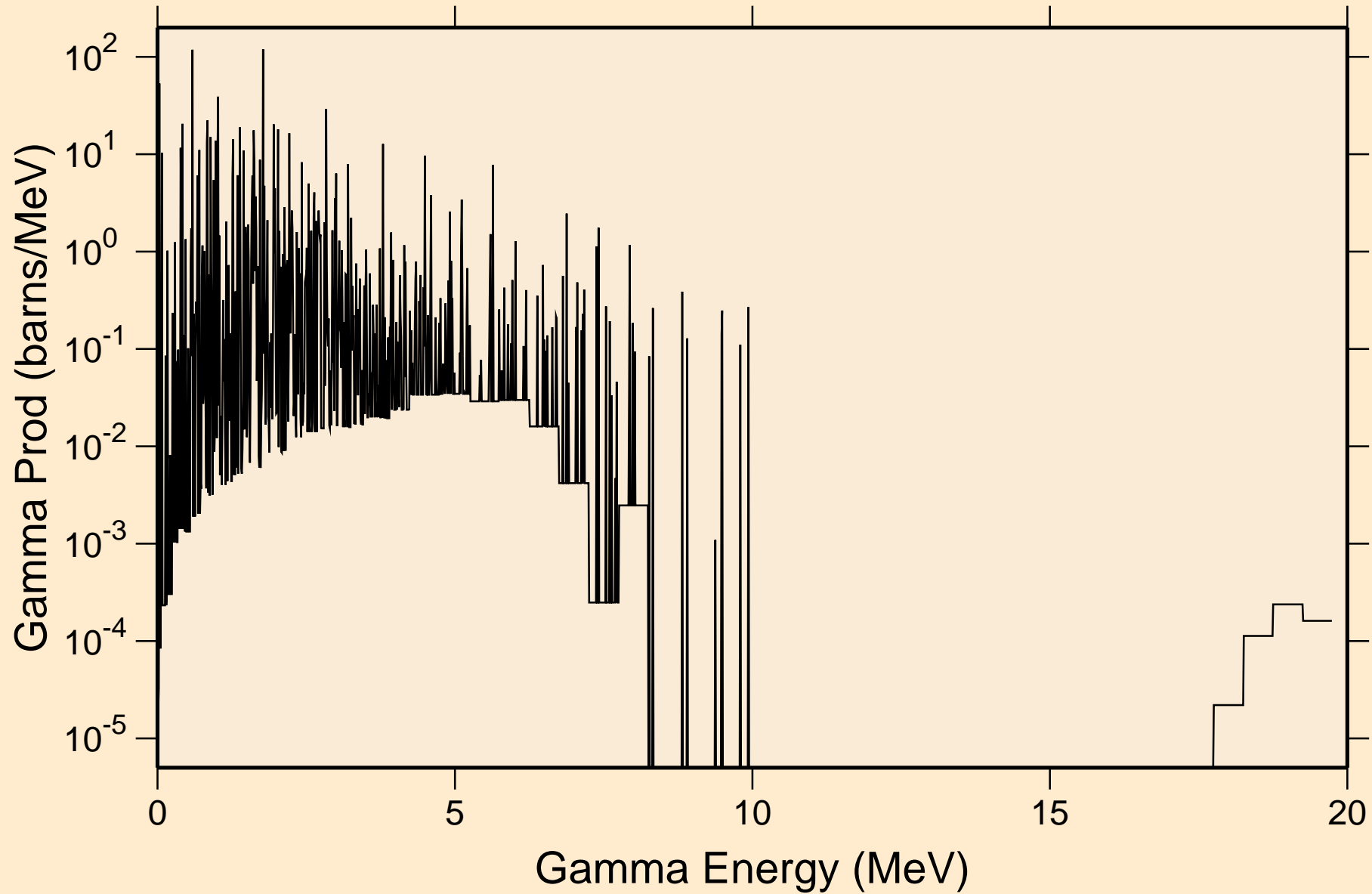

P029 NEUTRON ACER TENDL-2024 LIBRARY; T=293.6K  
Particle heating contributions

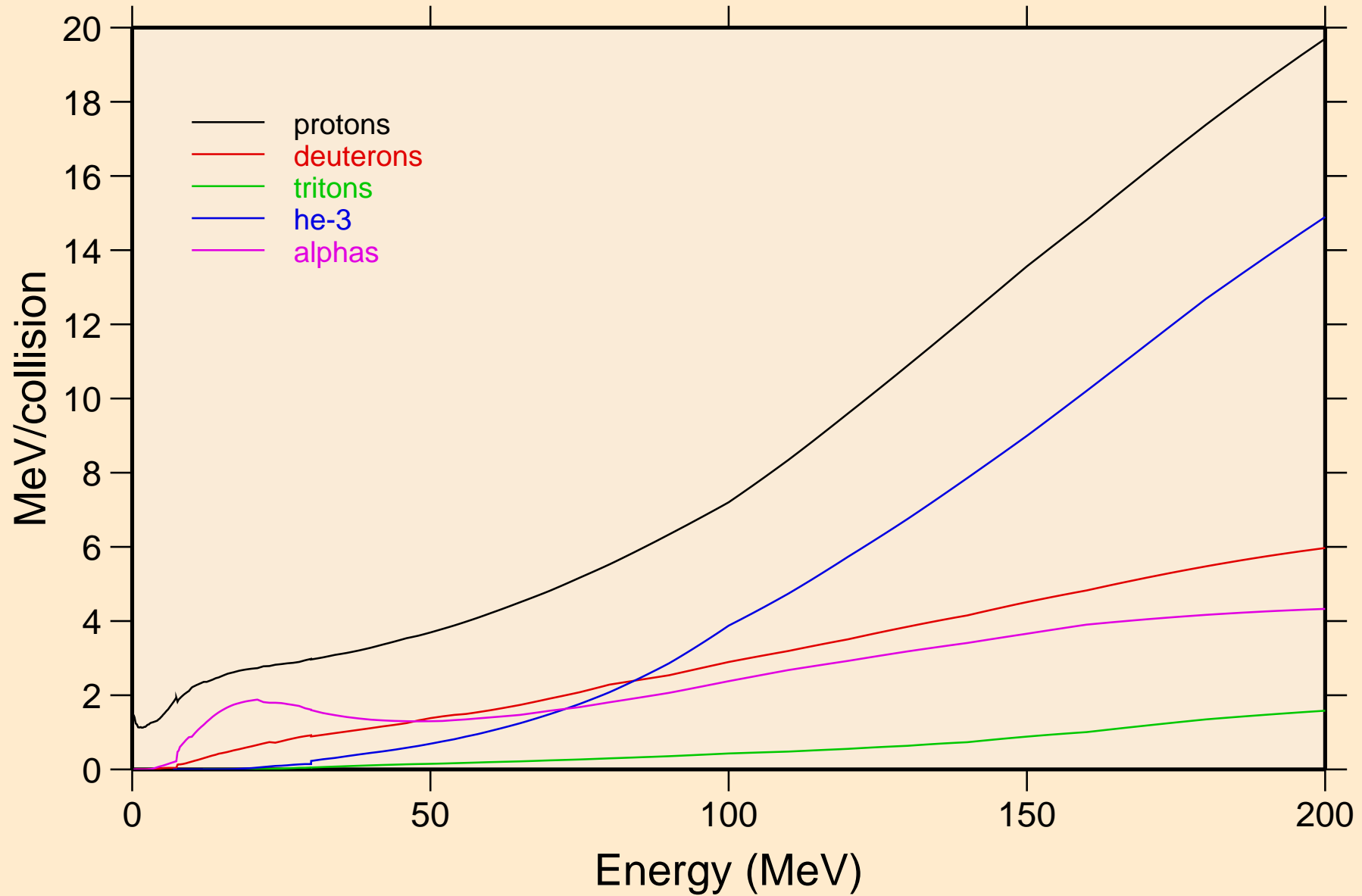

P029 NEUTRON ACER TENDL-2024 LIBRARY; T=293.6K  
Recoil Heating

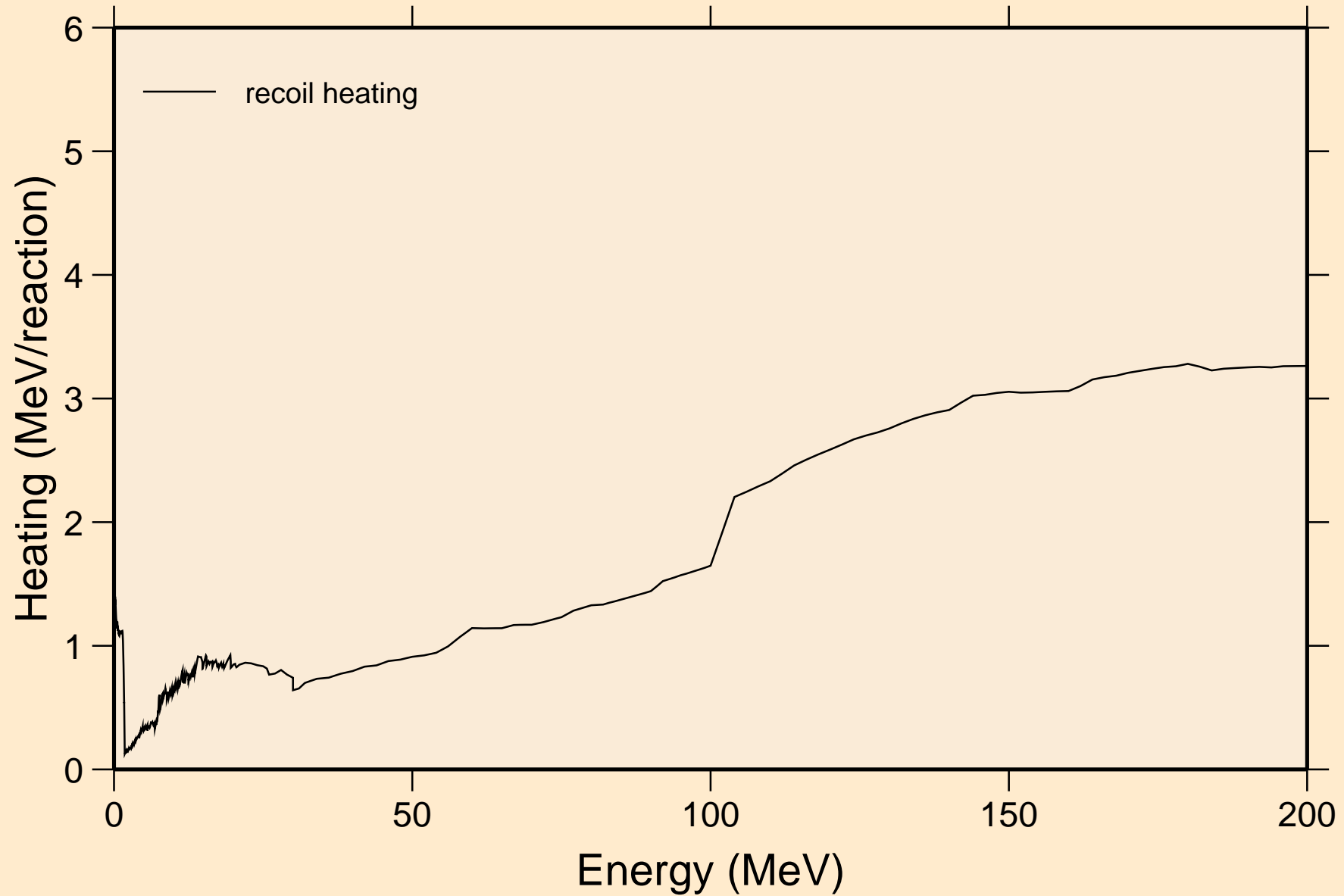

P029 NEUTRON ACER TENDL-2024 LIBRARY; T=293.6K  
Particle production cross sections

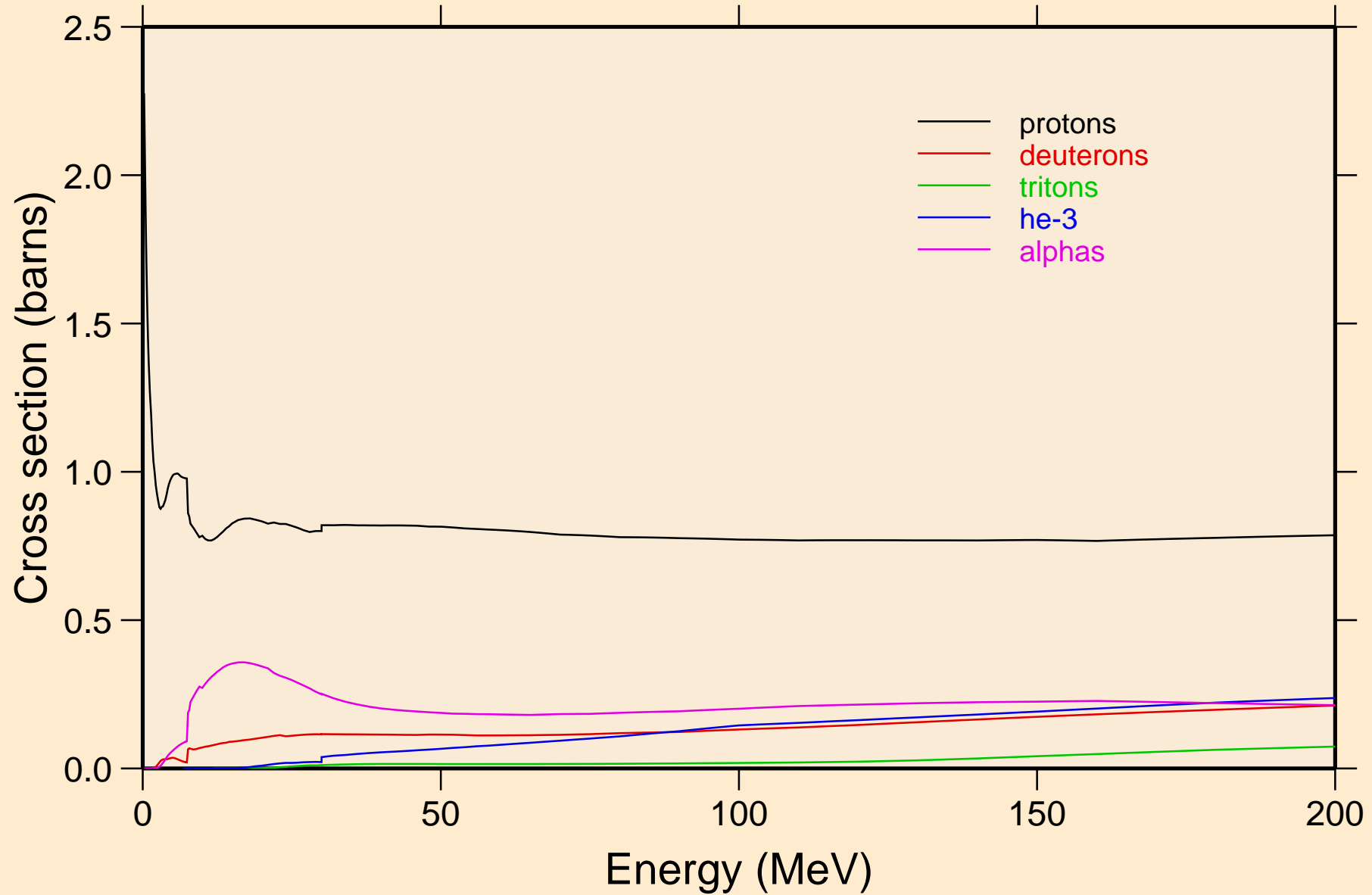

P029 NEUTRON ACER TENDL-2024 LIBRARY; T=293.6K  
protons from (n,x)

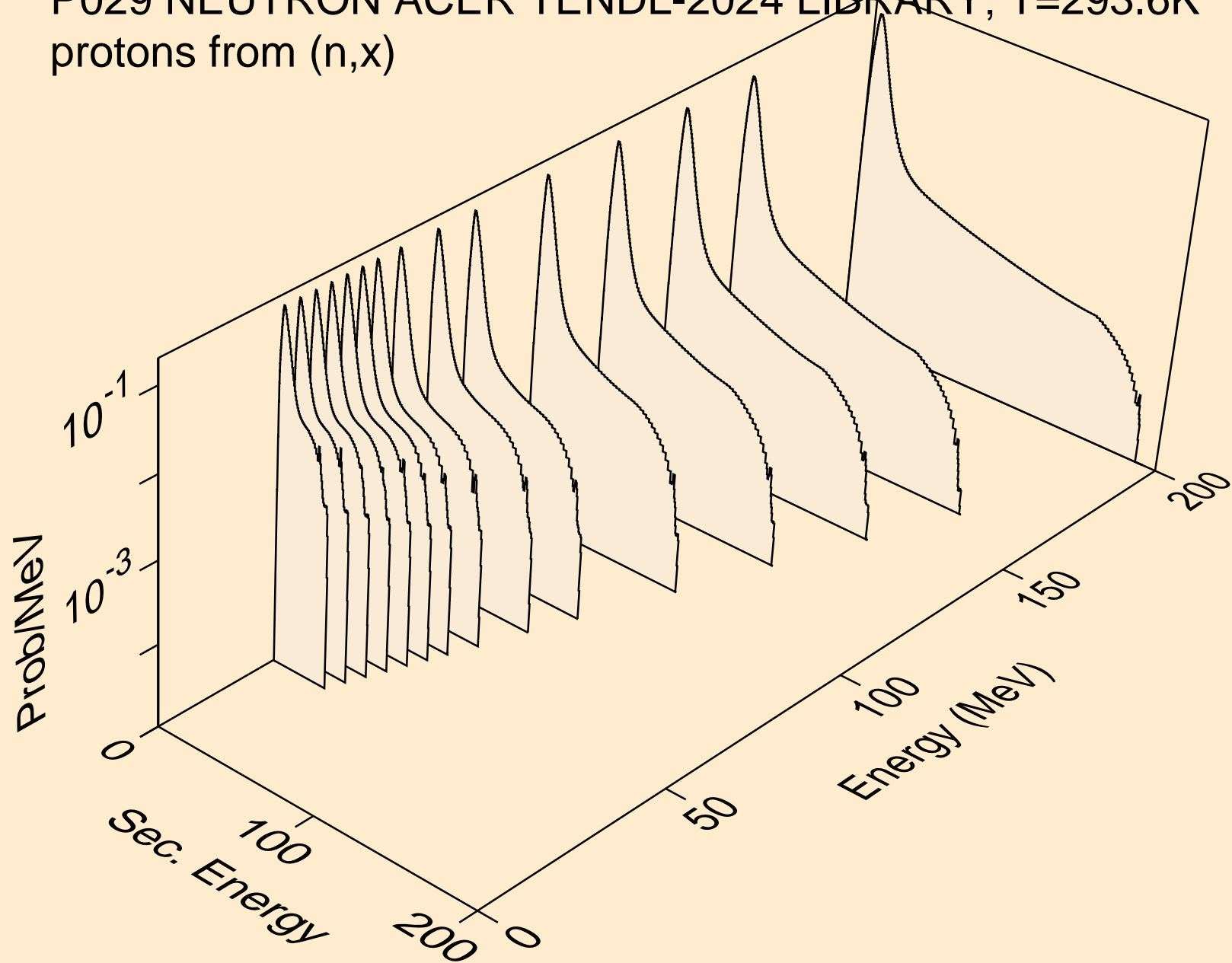

P029 NEUTRON ACER TENDL-2024 LIBRARY; T=293.6K  
protons from (n,n\*)p

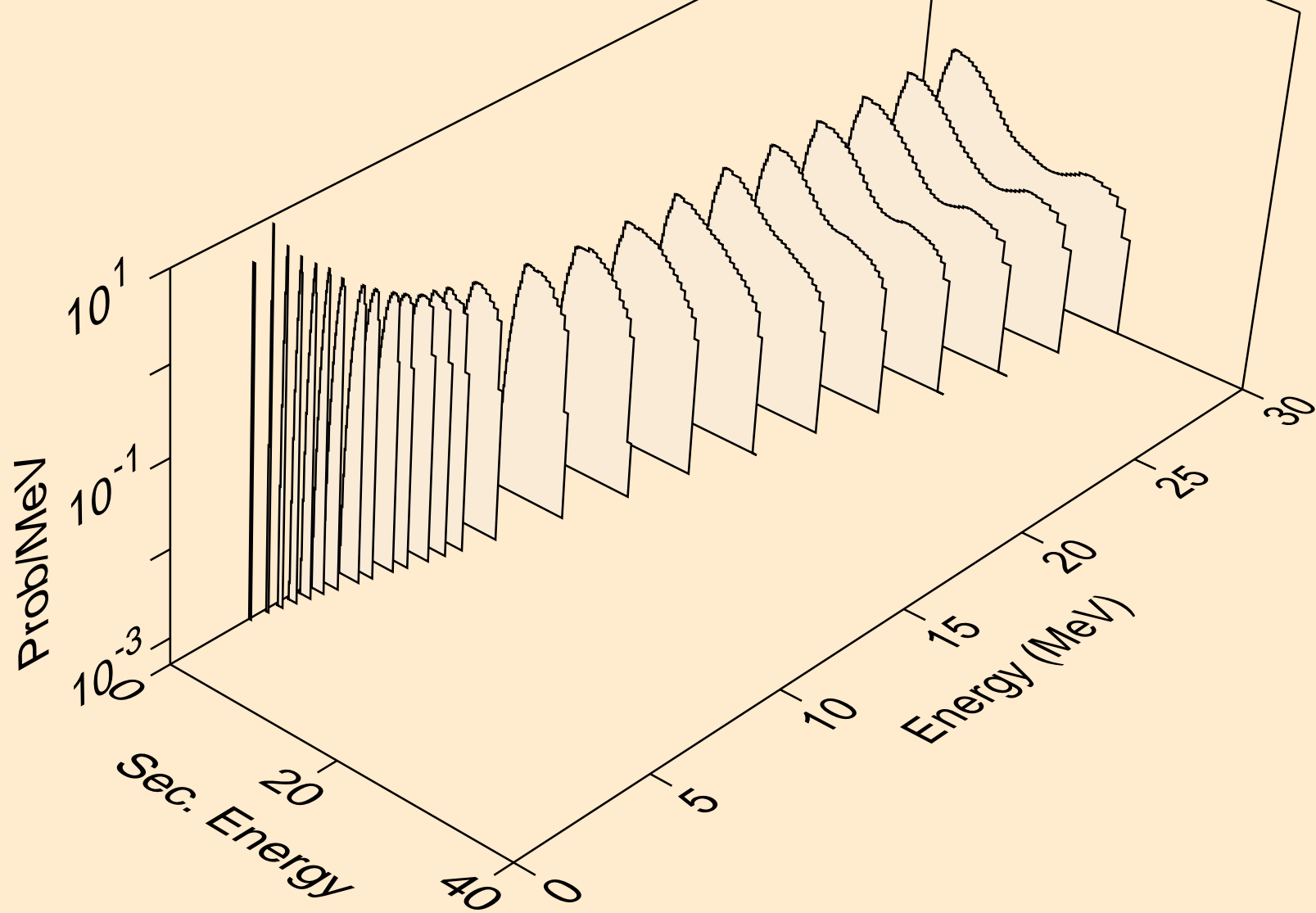

P029 NEUTRON ACER TENDL-2024 LIBRARY; T=293.6K  
protons from (n,2np)

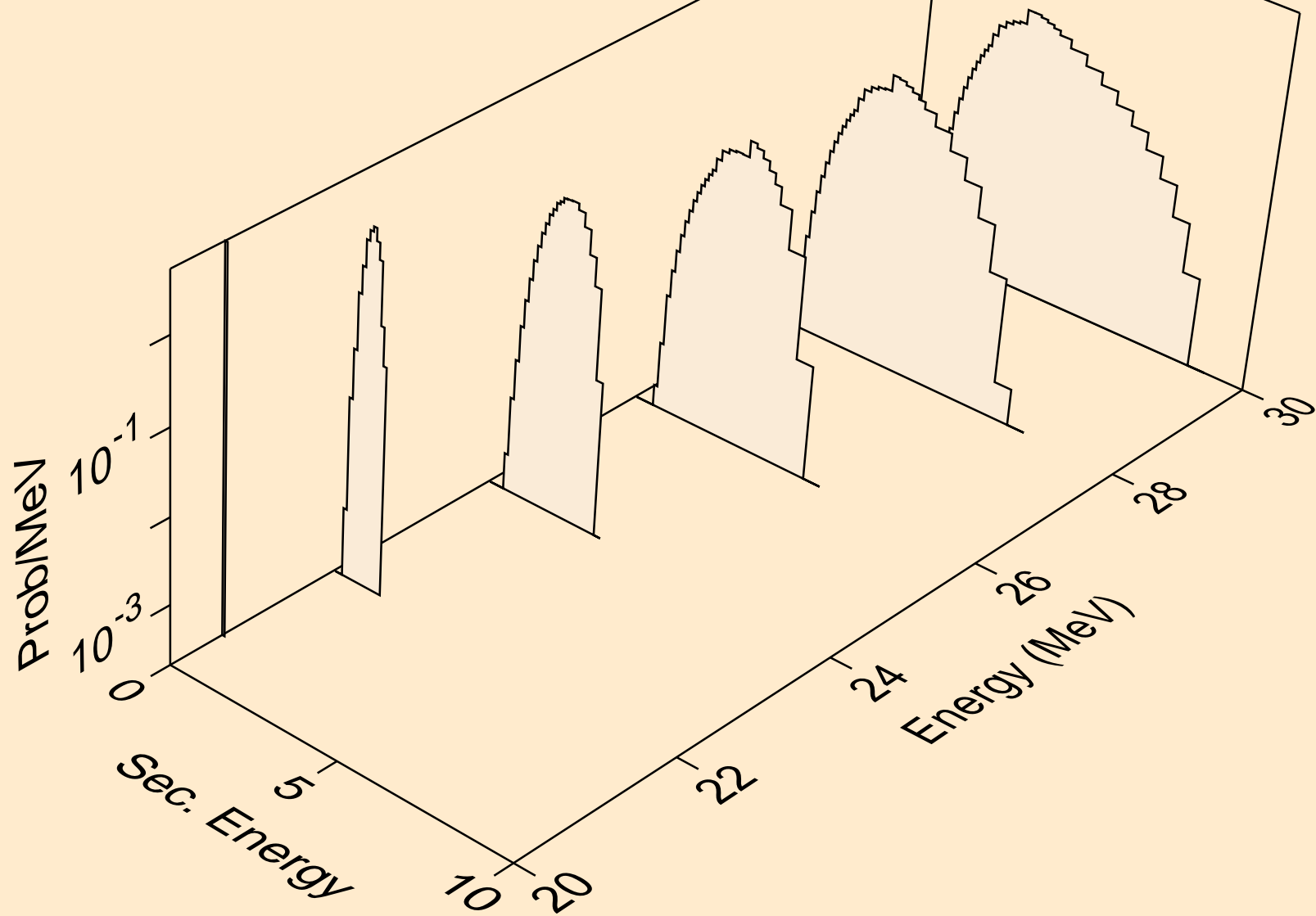

P029 NEUTRON ACER TENDL-2024 LIBRARY; T=293.6K  
protons from (n,n2p)

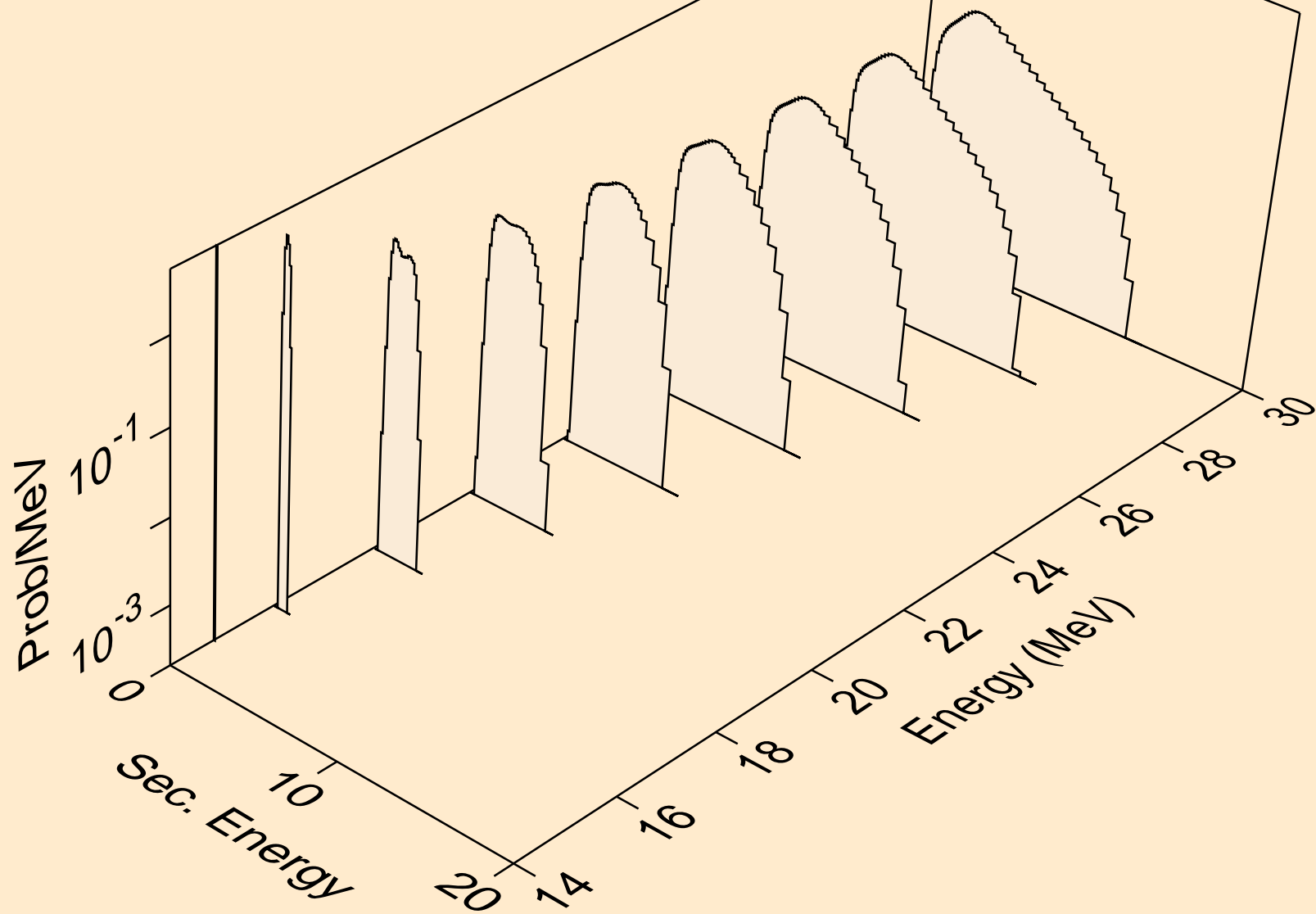

P029 NEUTRON ACER TENDL-2024 LIBRARY; T=293.6K  
protons from (n,npa)

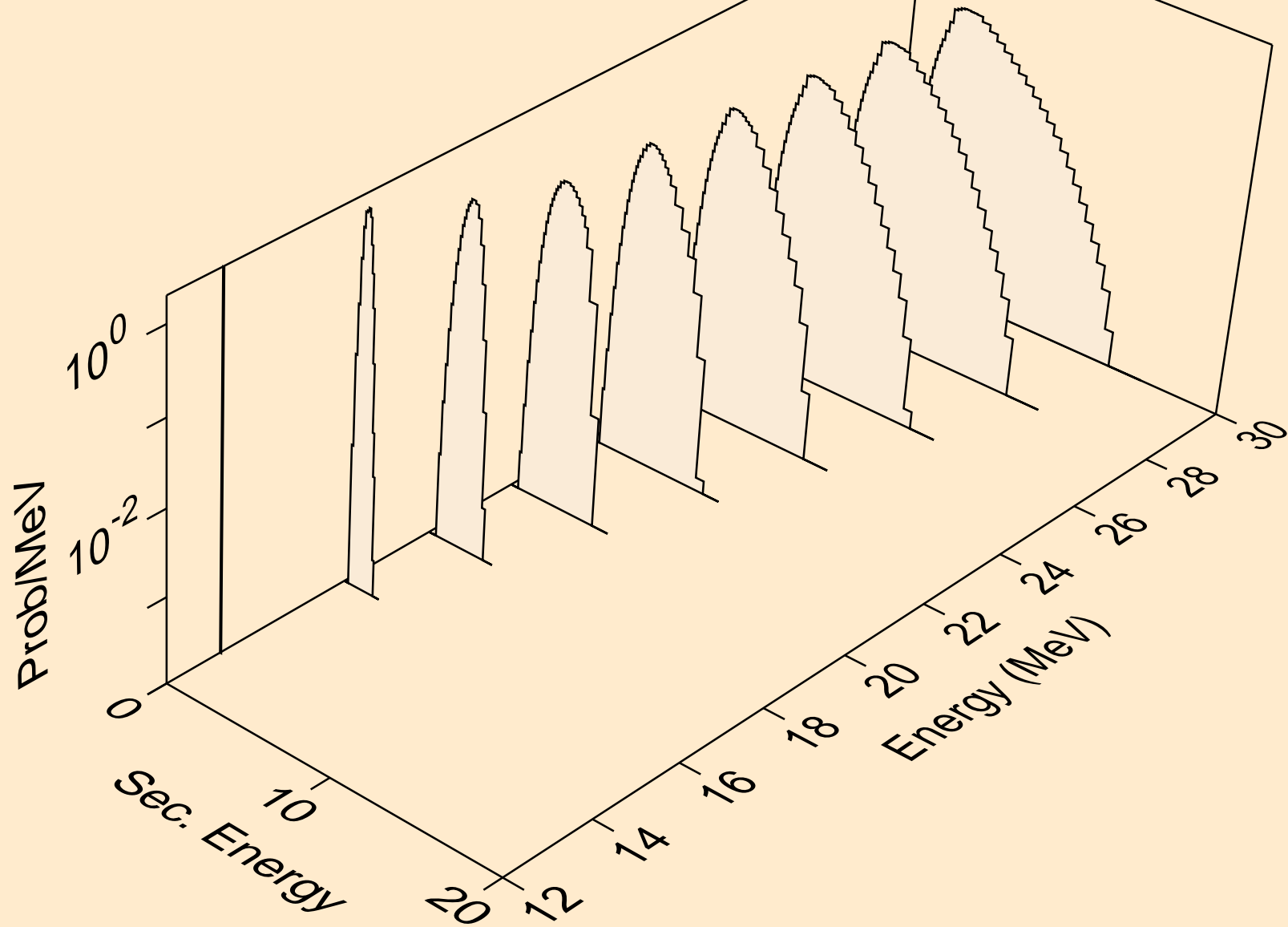

P029 NEUTRON ACER TENDL-2024 LIBRARY; T=293.6K  
protons from (n,p)

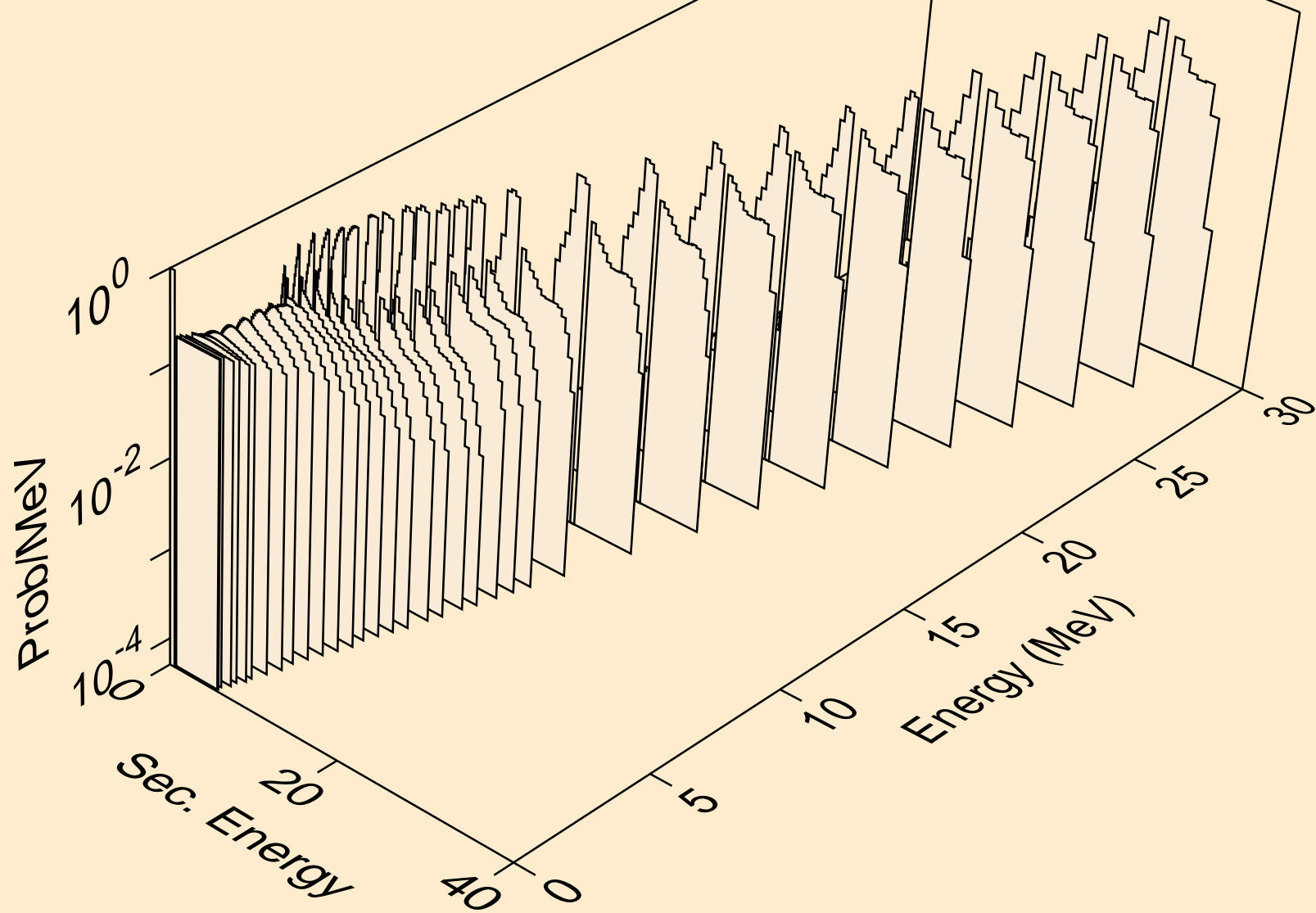

P029 NEUTRON ACER TENDL-2024 LIBRARY; T=293.6K  
protons from (n,2p)

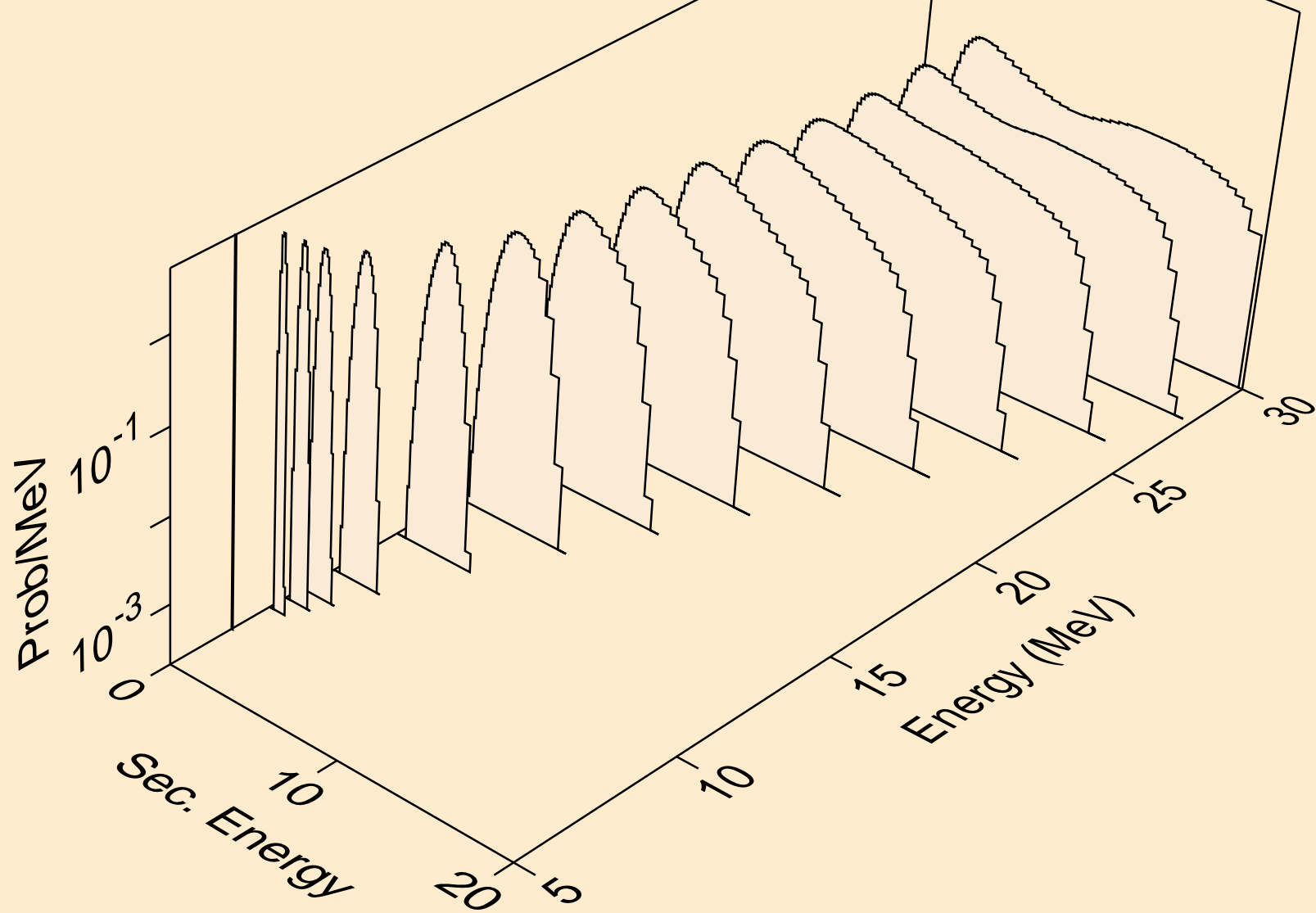

P029 NEUTRON ACER TENDL-2024 LIBRARY; T=293.6K  
protons from (n,p)

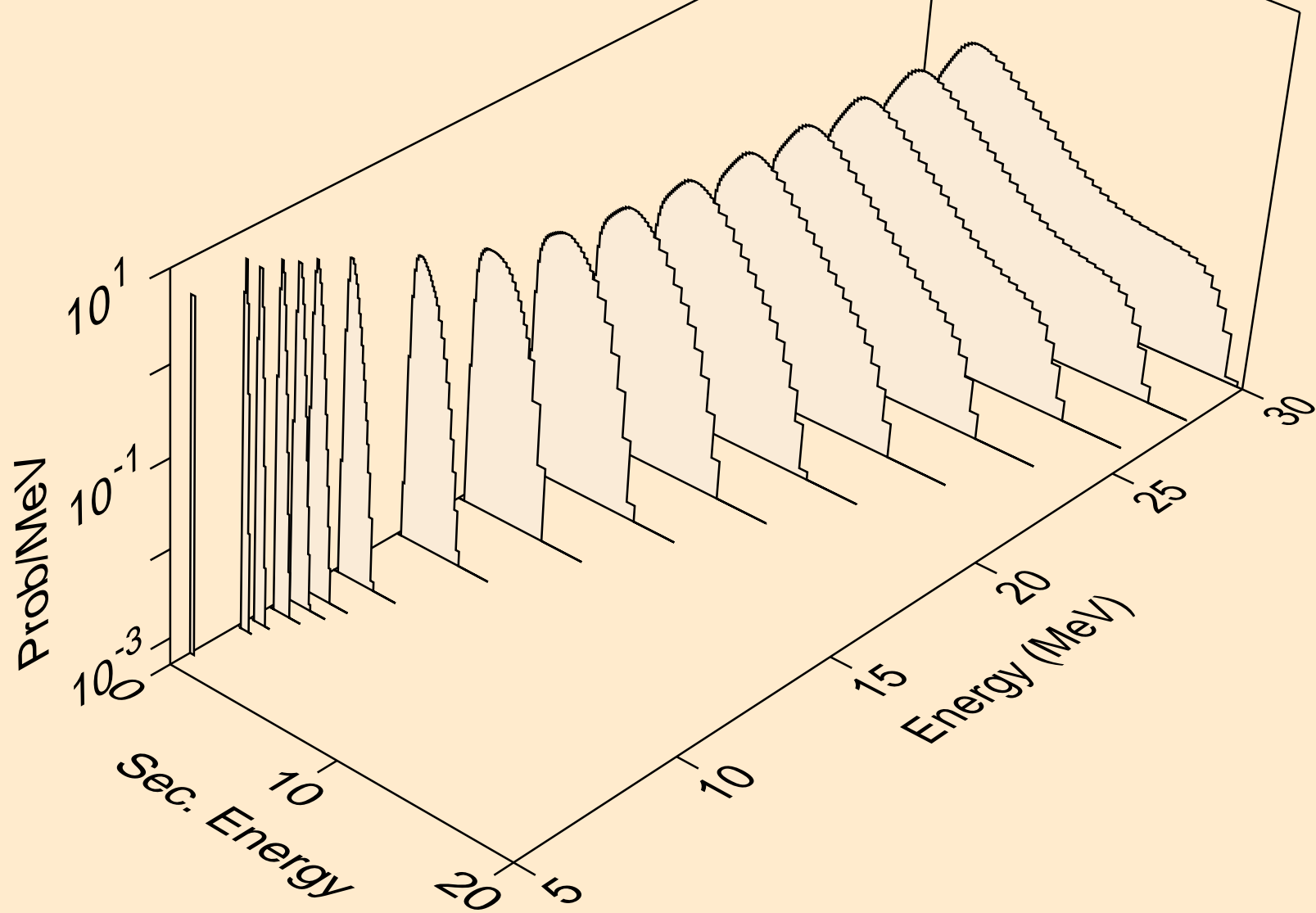

P029 NEUTRON ACER TENDL-2024 LIBRARY; T=293.6K  
protons from (n,pd)

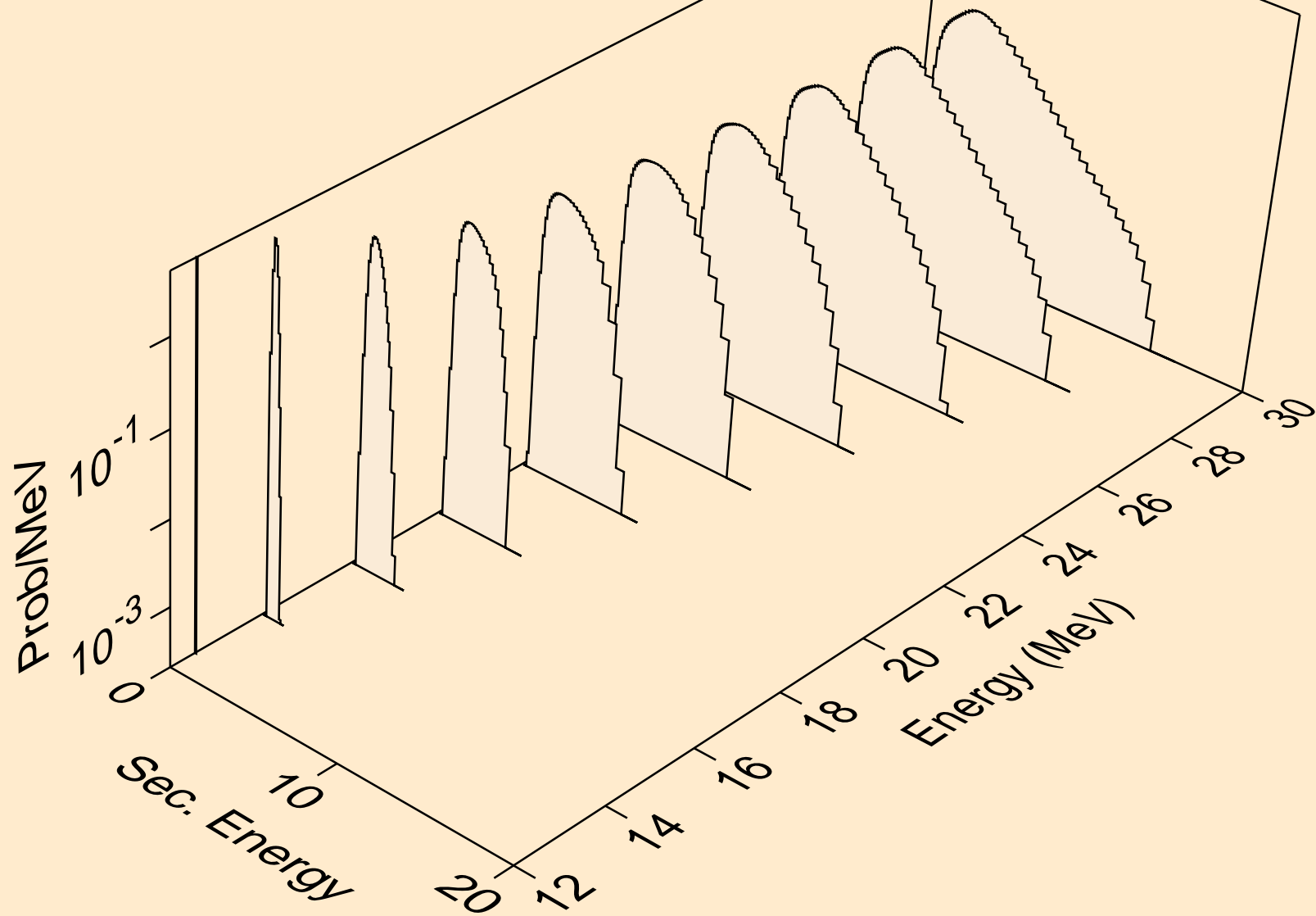

P029 NEUTRON ACER TENDL-2024 LIBRARY; T=293.6K  
protons from (n,pt)

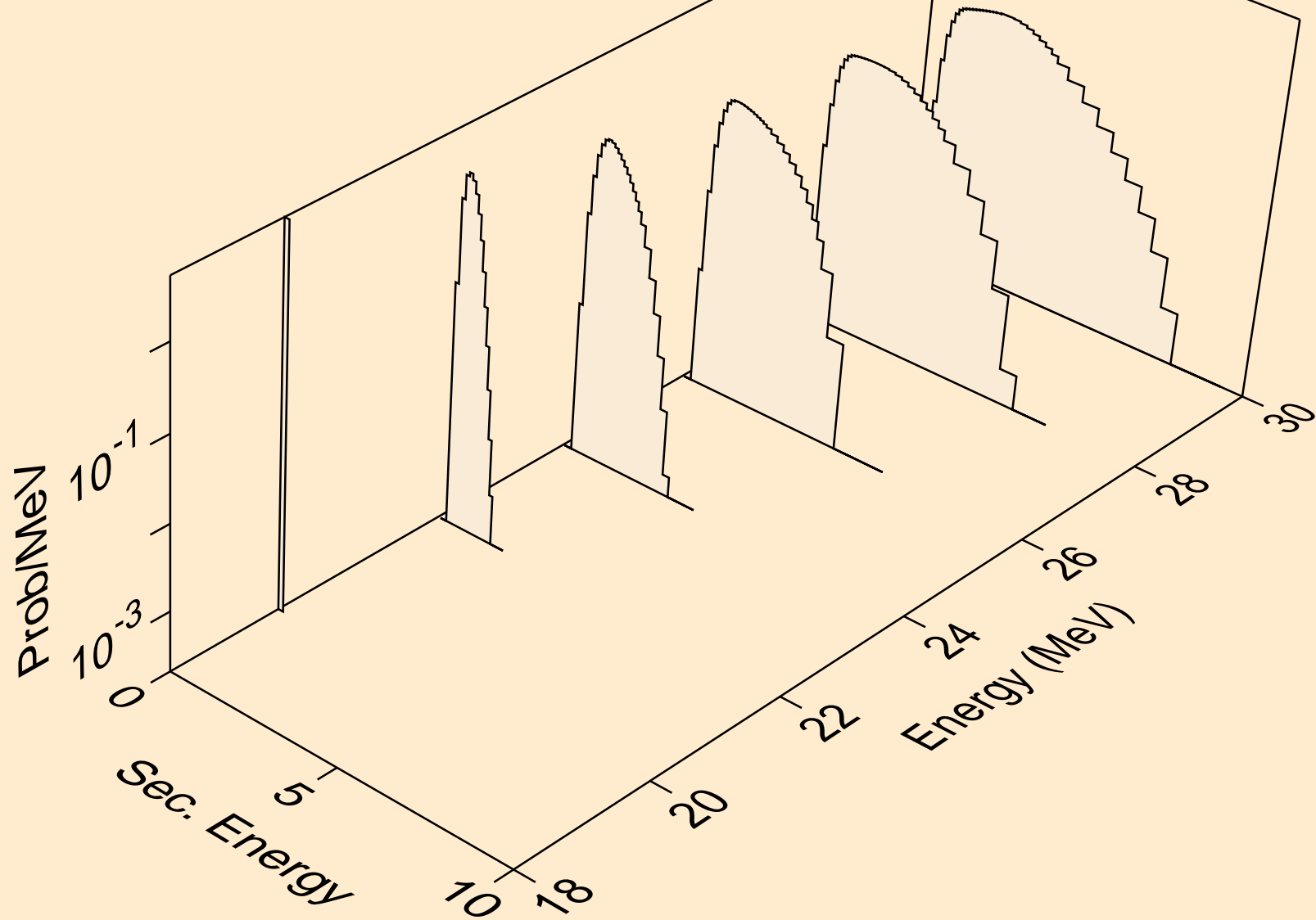

P029 NEUTRON ACER TENDL-2024 LIBRARY; T=293.6K  
deuterons from (n,x)

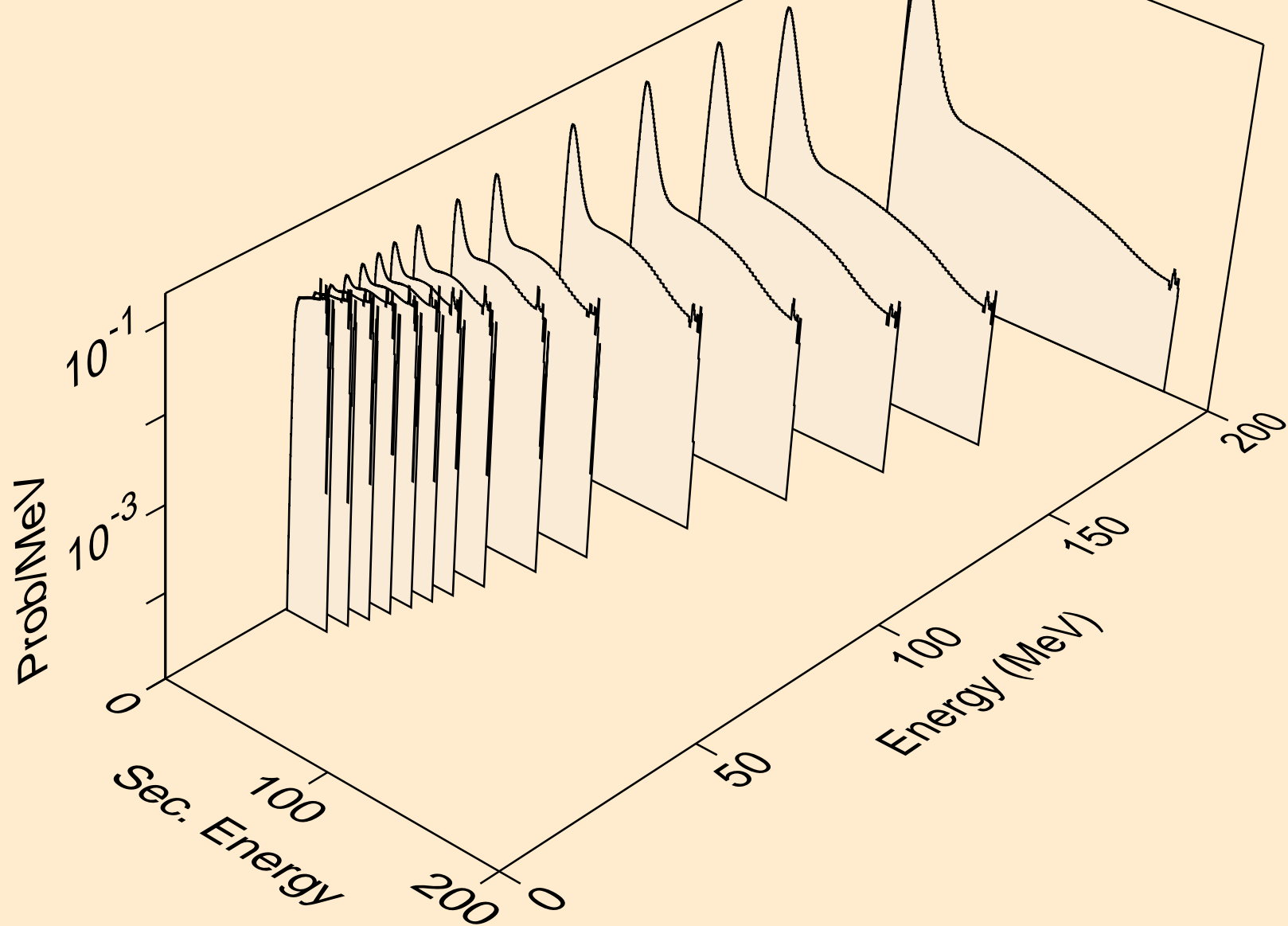

P029 NEUTRON ACER TENDL-2024 LIBRARY; T=293.6K  
deuterons from (n,n\*)d

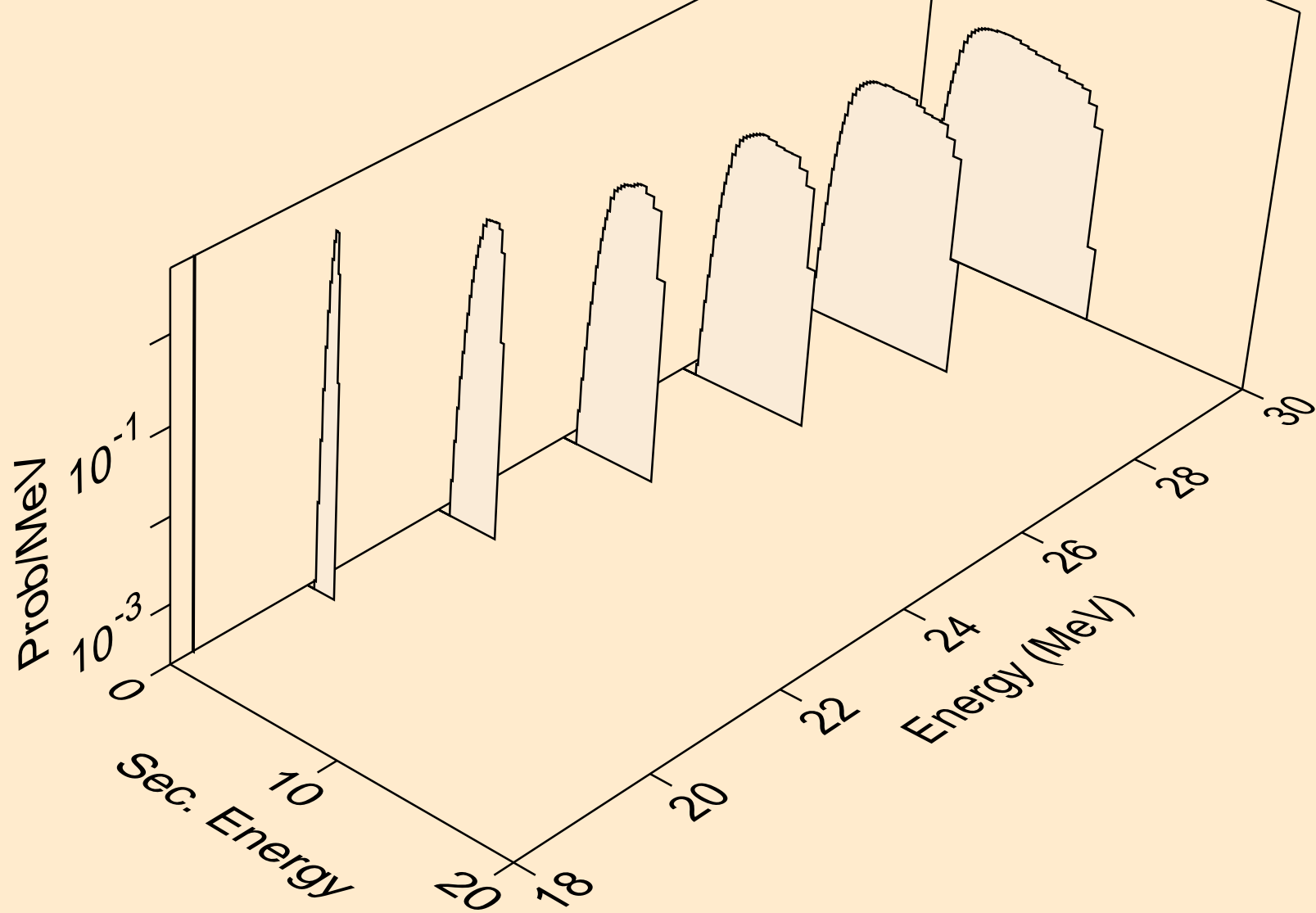

P029 NEUTRON ACER TENDL-2024 LIBRARY; T=293.6K  
deuterons from (n,d)

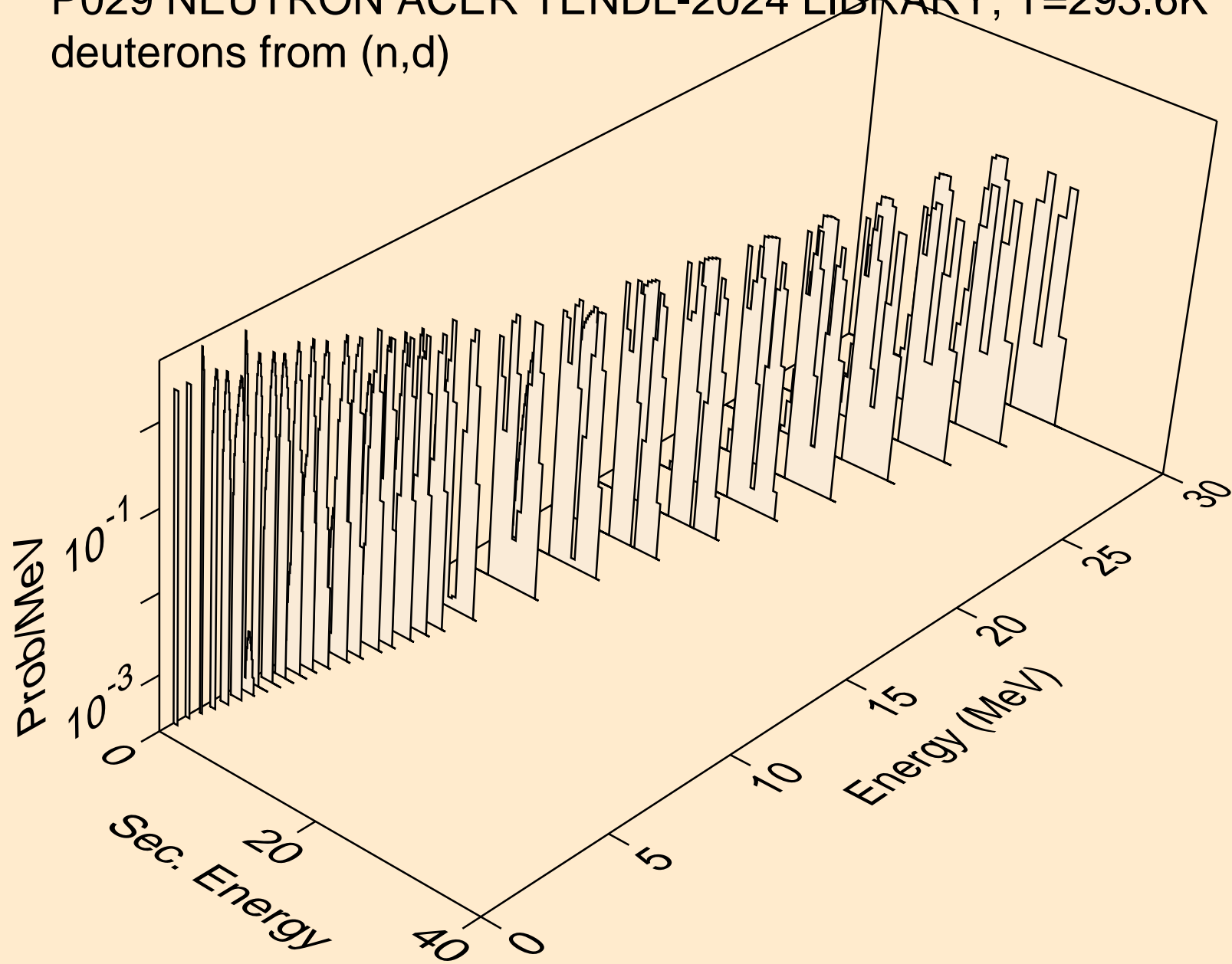

P029 NEUTRON ACER TENDL-2024 LIBRARY; T=293.6K  
deuterons from (n,d2a)

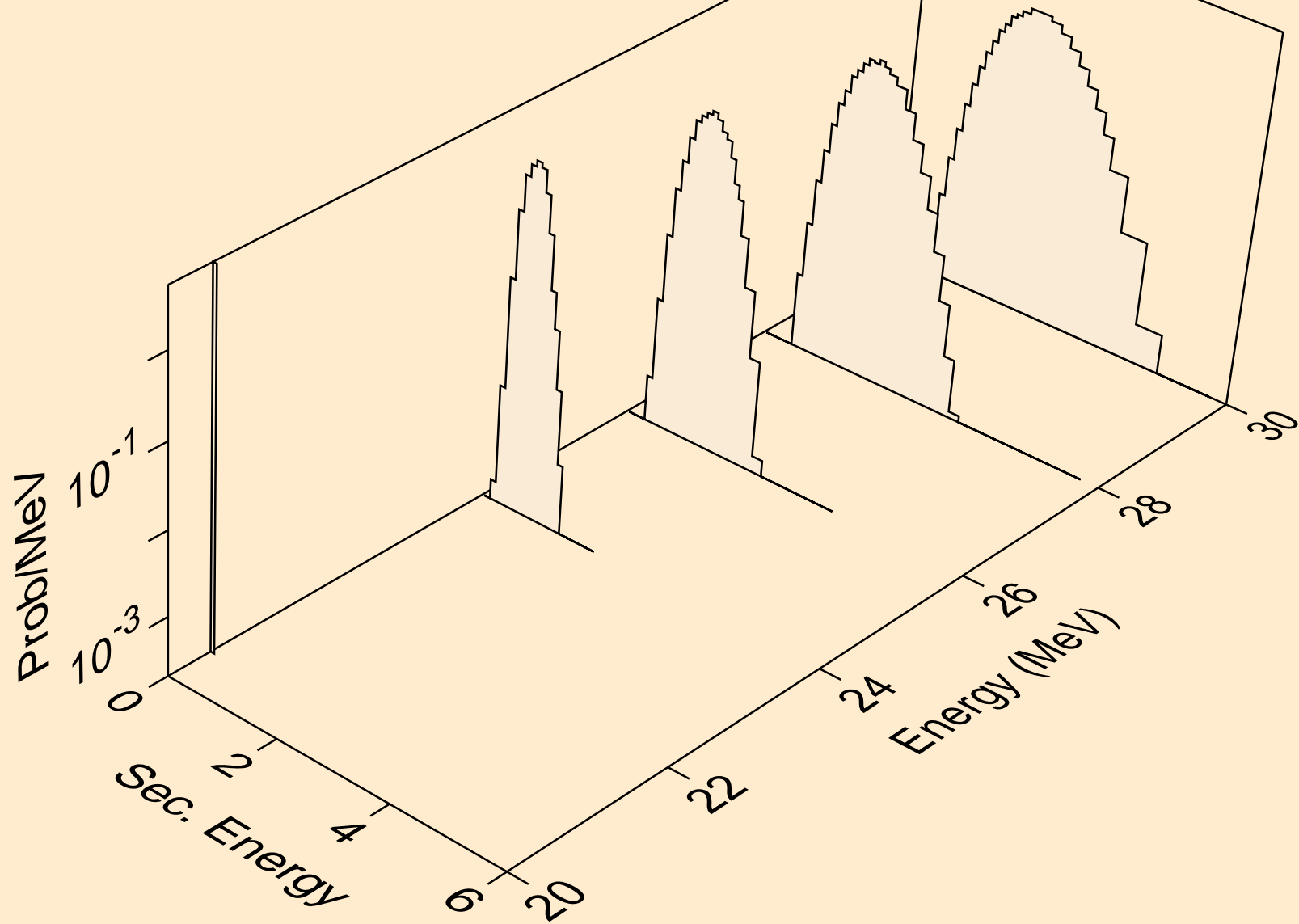

P029 NEUTRON ACER TENDL-2024 LIBRARY; T=293.6K  
deuterons from (n,pd)

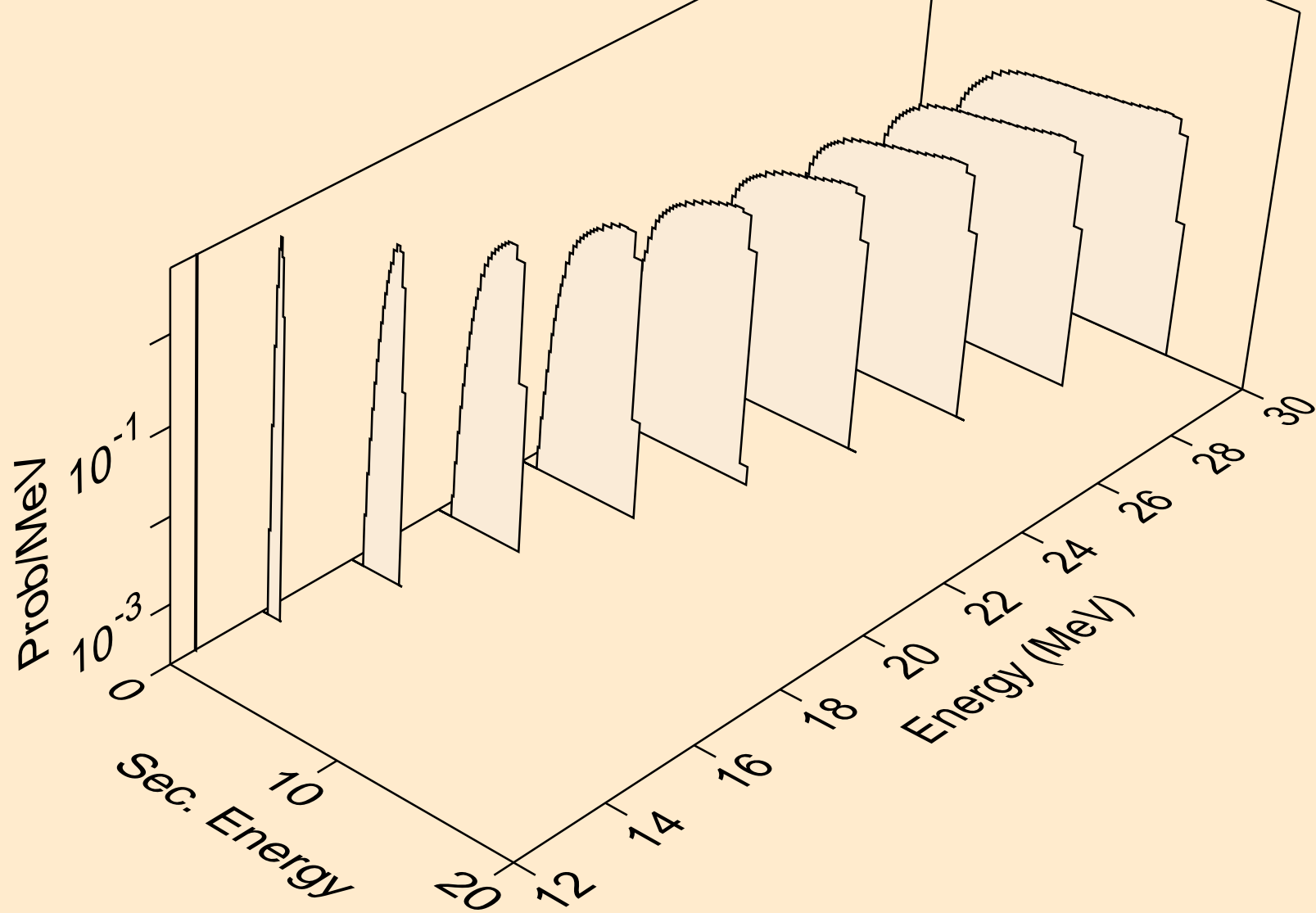

P029 NEUTRON ACER TENDL-2024 LIBRARY; T=293.6K  
deuterons from (n,da)

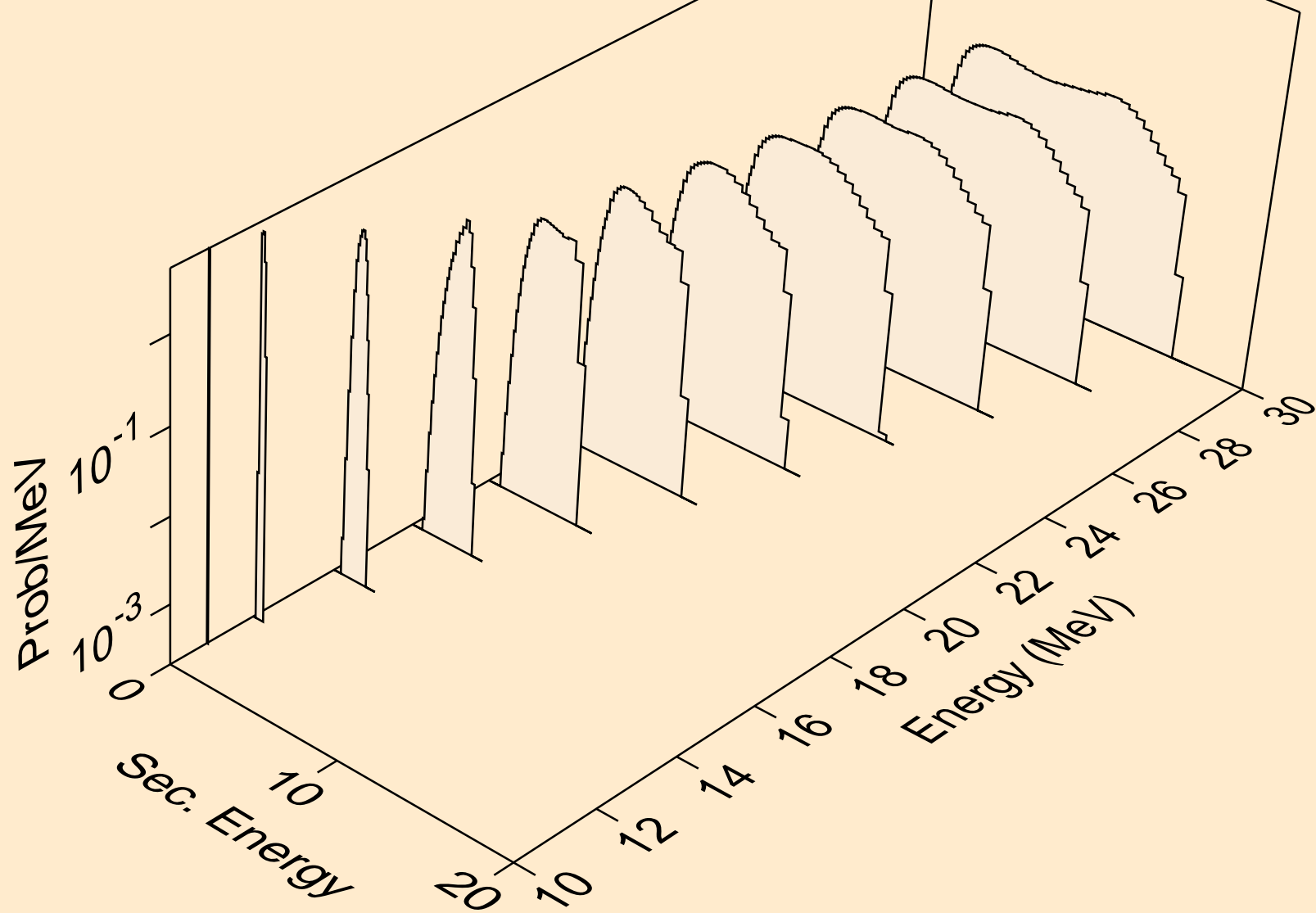

P029 NEUTRON ACER TENDL-2024 LIBRARY; T=293.6K  
tritons from (n,x)

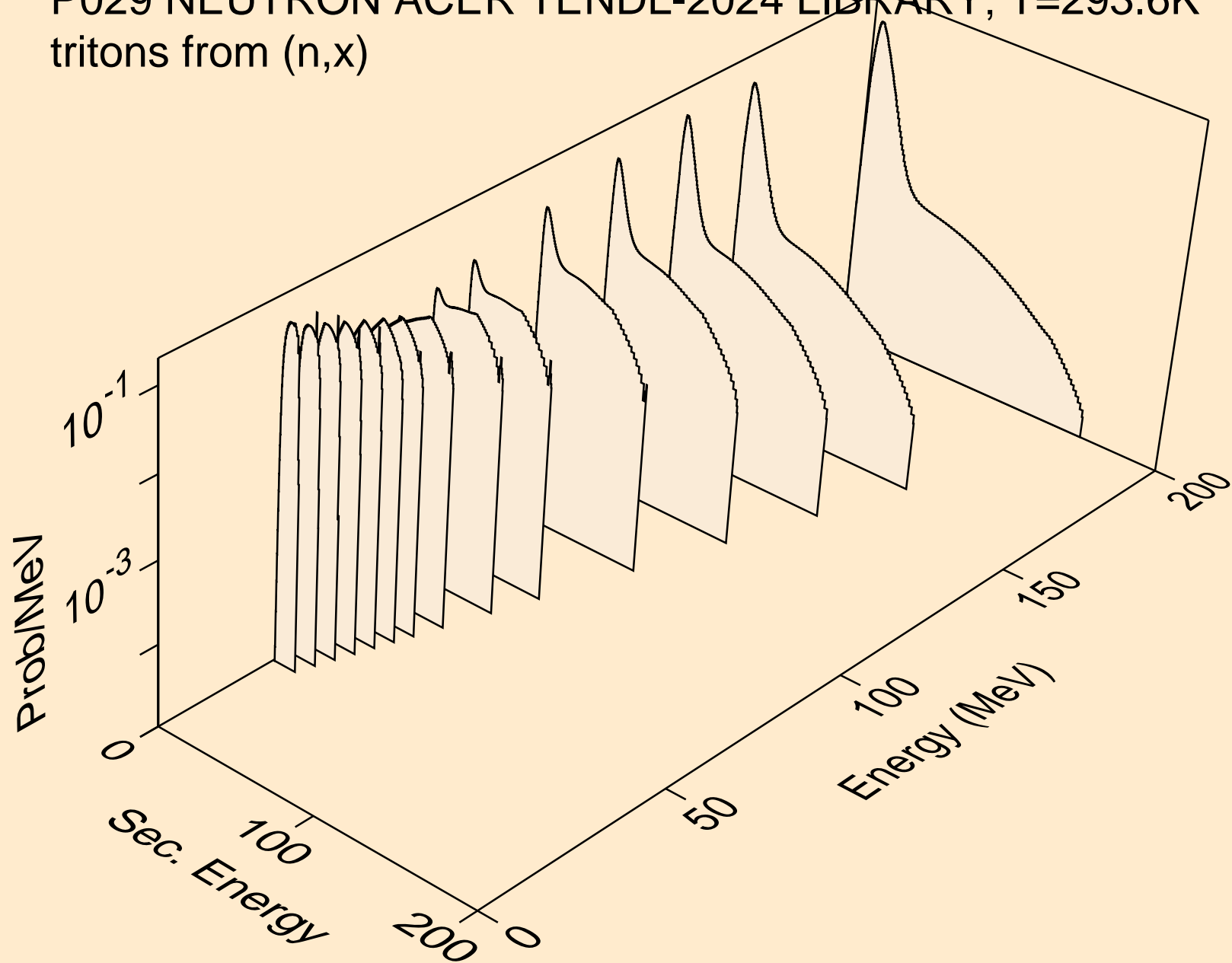

P029 NEUTRON ACER TENDL-2024 LIBRARY; T=293.6K  
tritons from (n,n\*)t

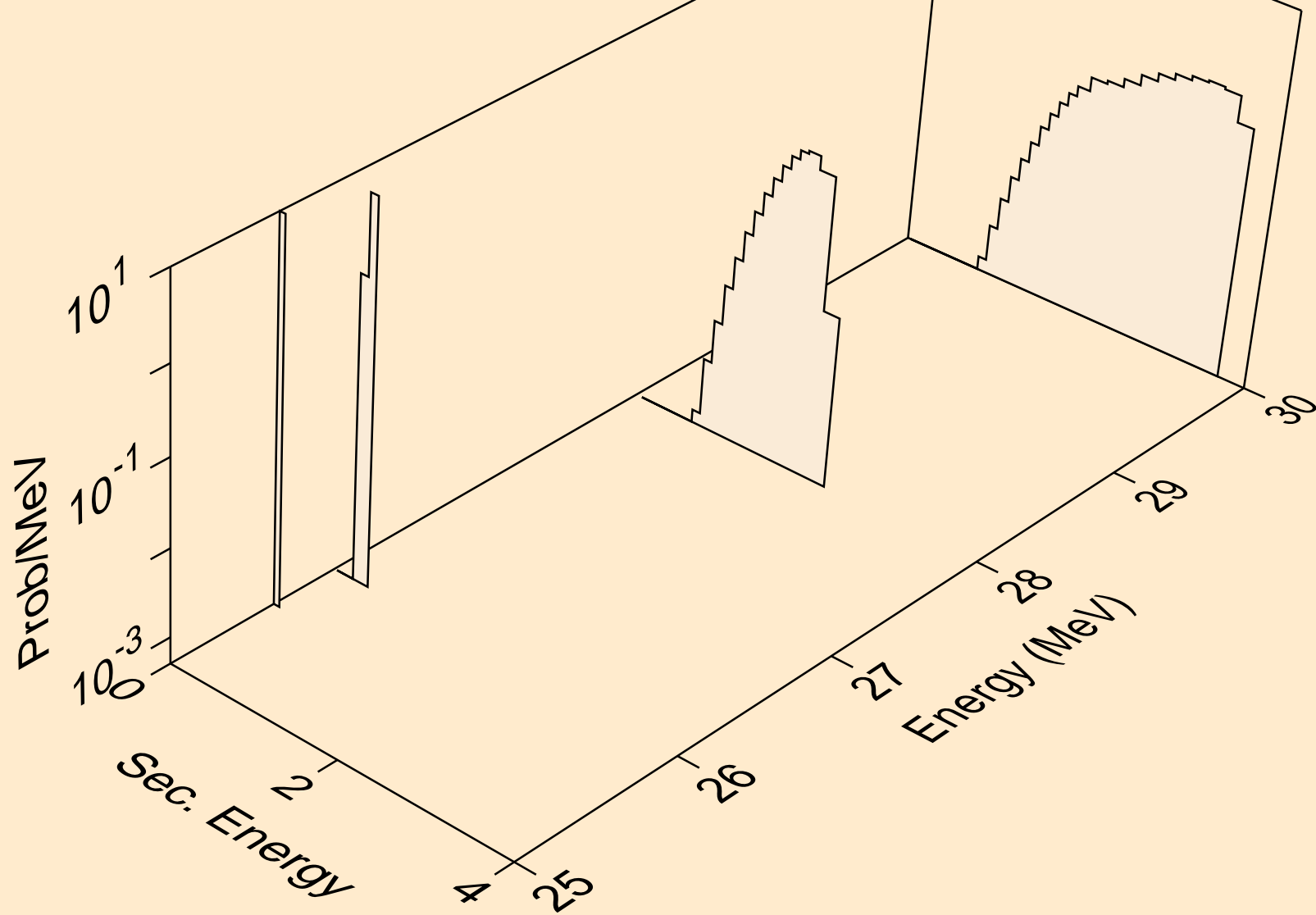

P029 NEUTRON ACER TENDL-2024 LIBRARY; T=293.6K  
tritons from (n,t)

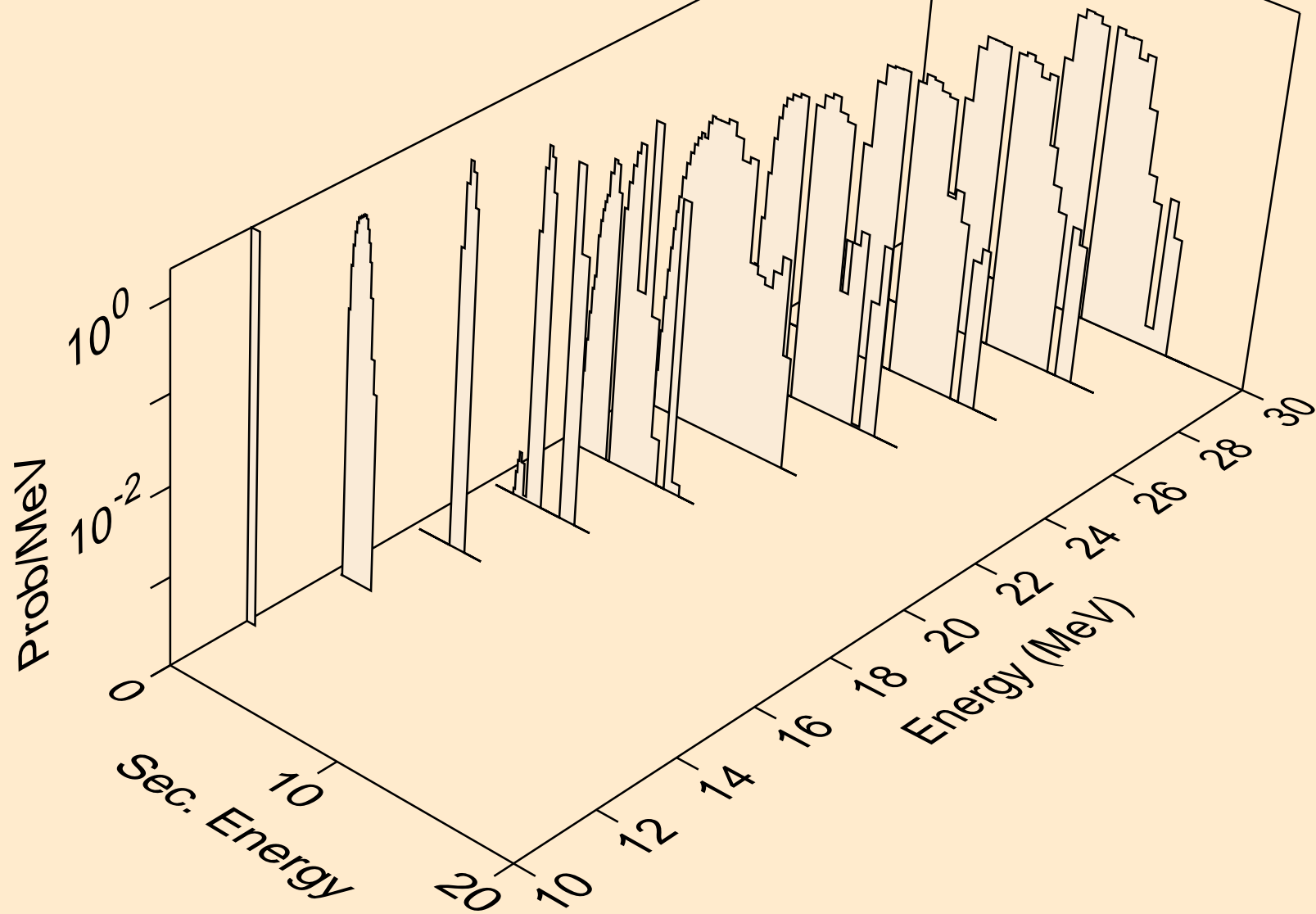

P029 NEUTRON ACER TENDL-2024 LIBRARY; T=293.6K  
tritons from (n,pt)

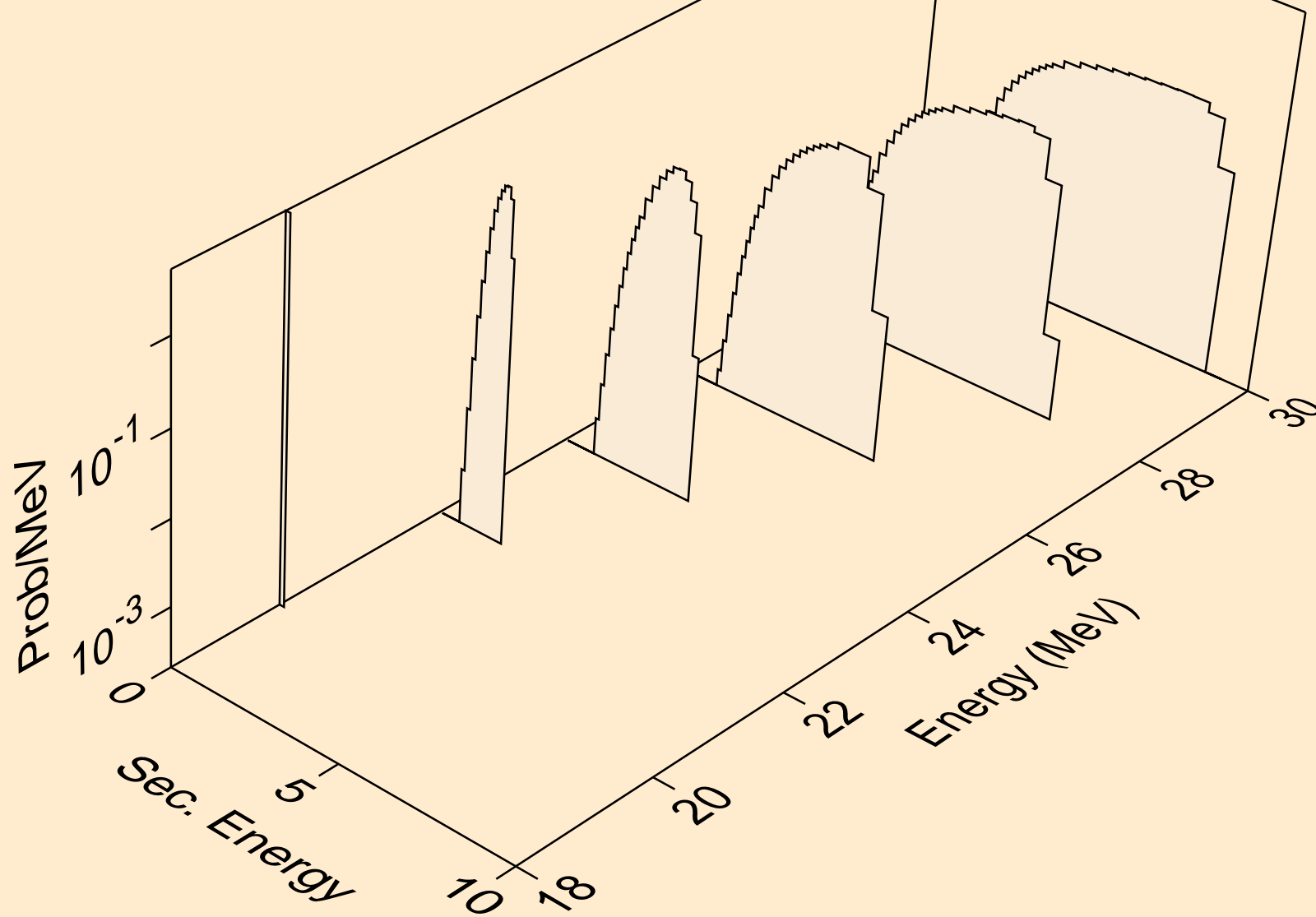

P029 NEUTRON ACER TENDL-2024 LIBRARY; T=293.6K  
he3s from (n,x)

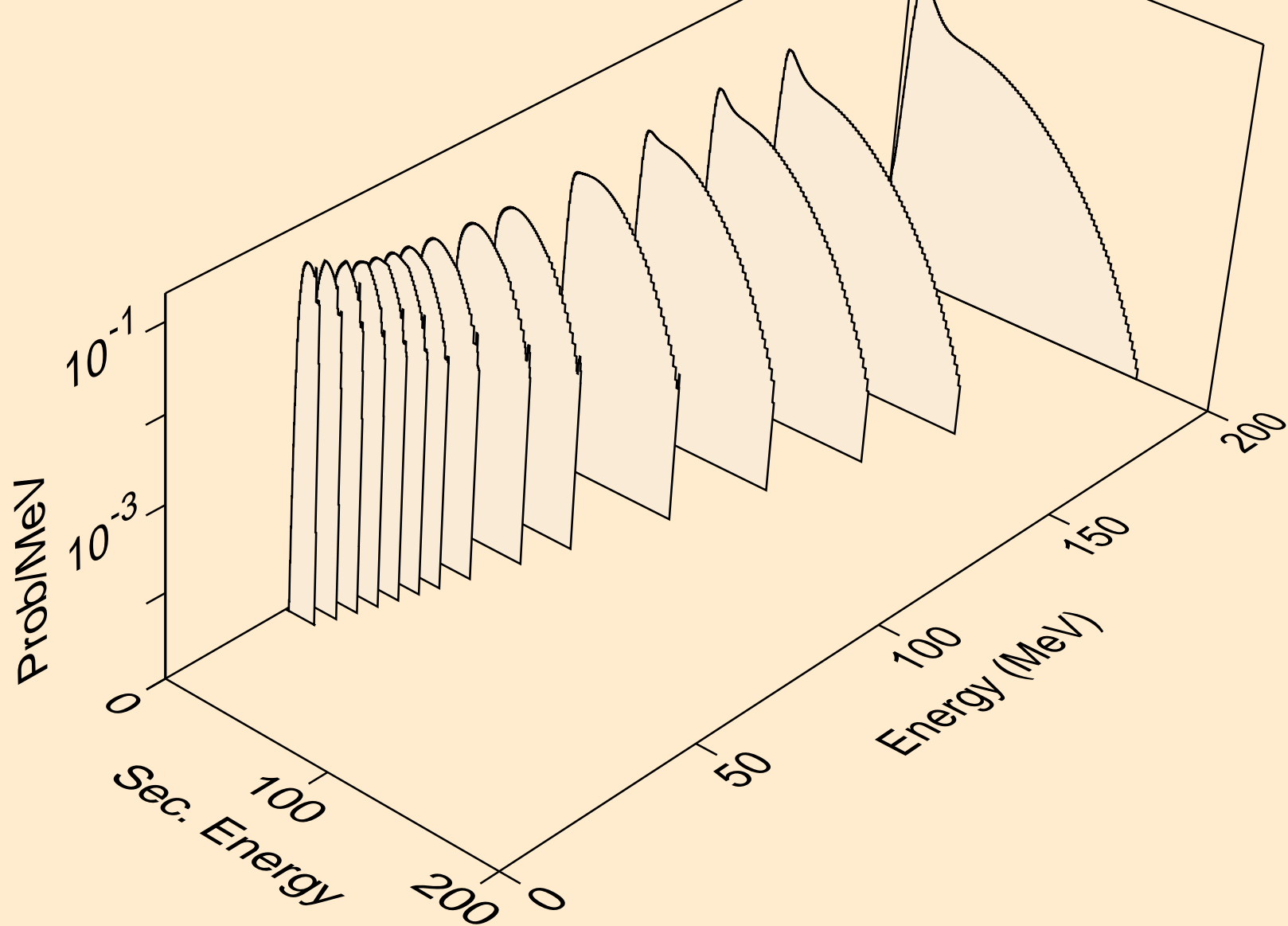

P029 NEUTRON ACER TENDL-2024 LIBRARY; T=293.6K  
he3s from (n,n\*)he3

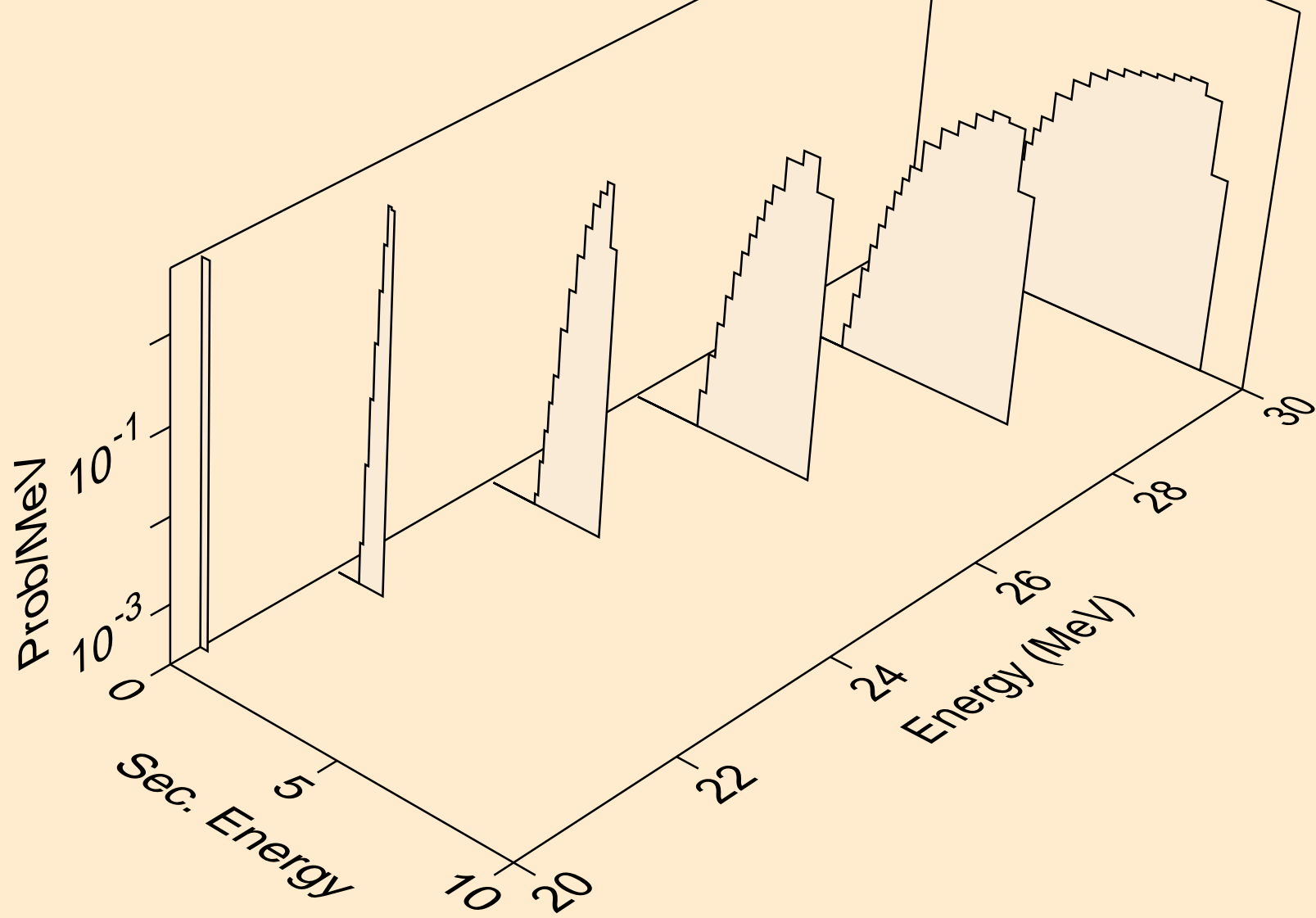

P029 NEUTRON ACER TENDL-2024 LIBRARY; T=293.6K  
he3s from (n,he3)

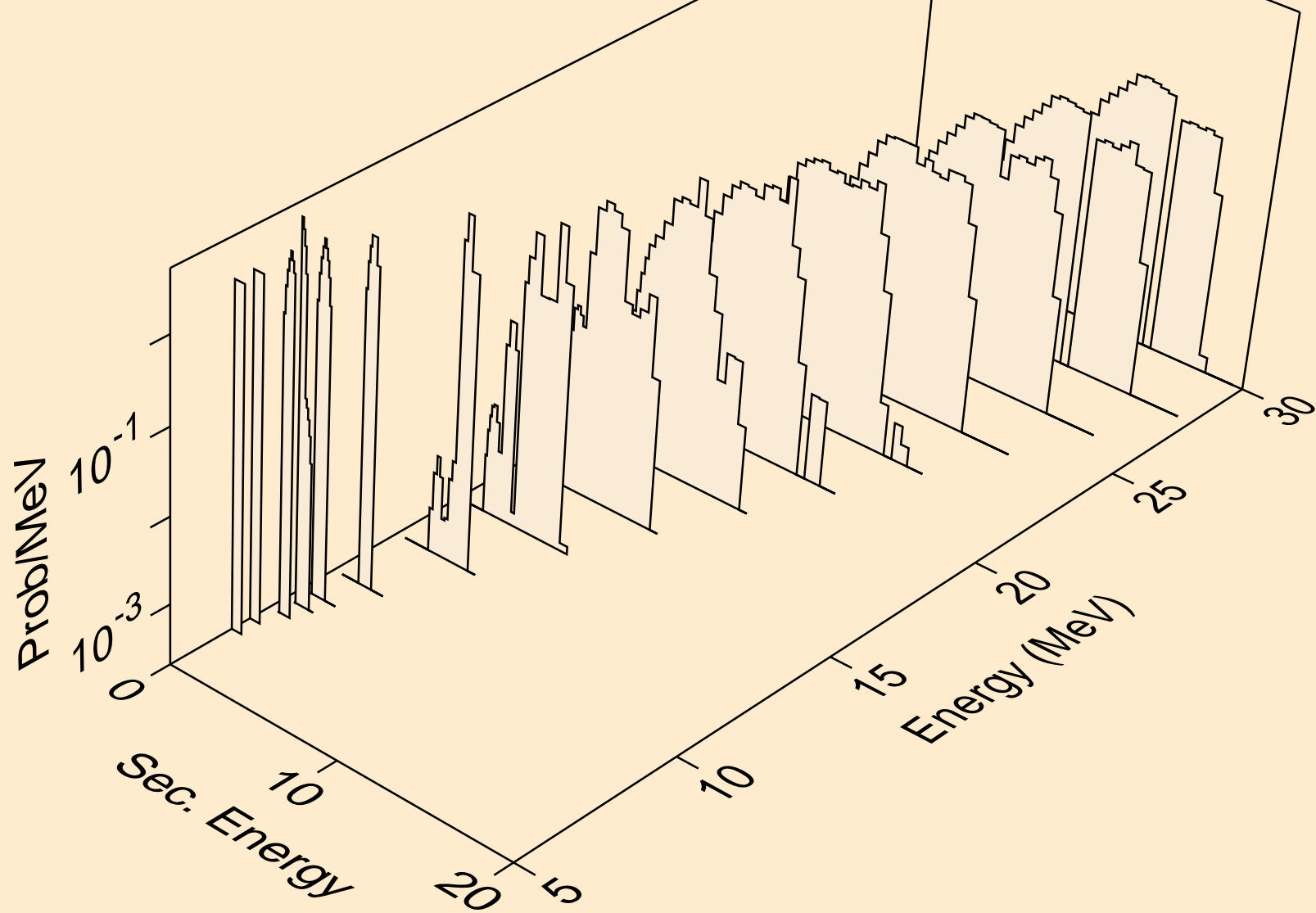

P029 NEUTRON ACER TENDL-2024 LIBRARY; T=293.6K  
alphas from (n,x)

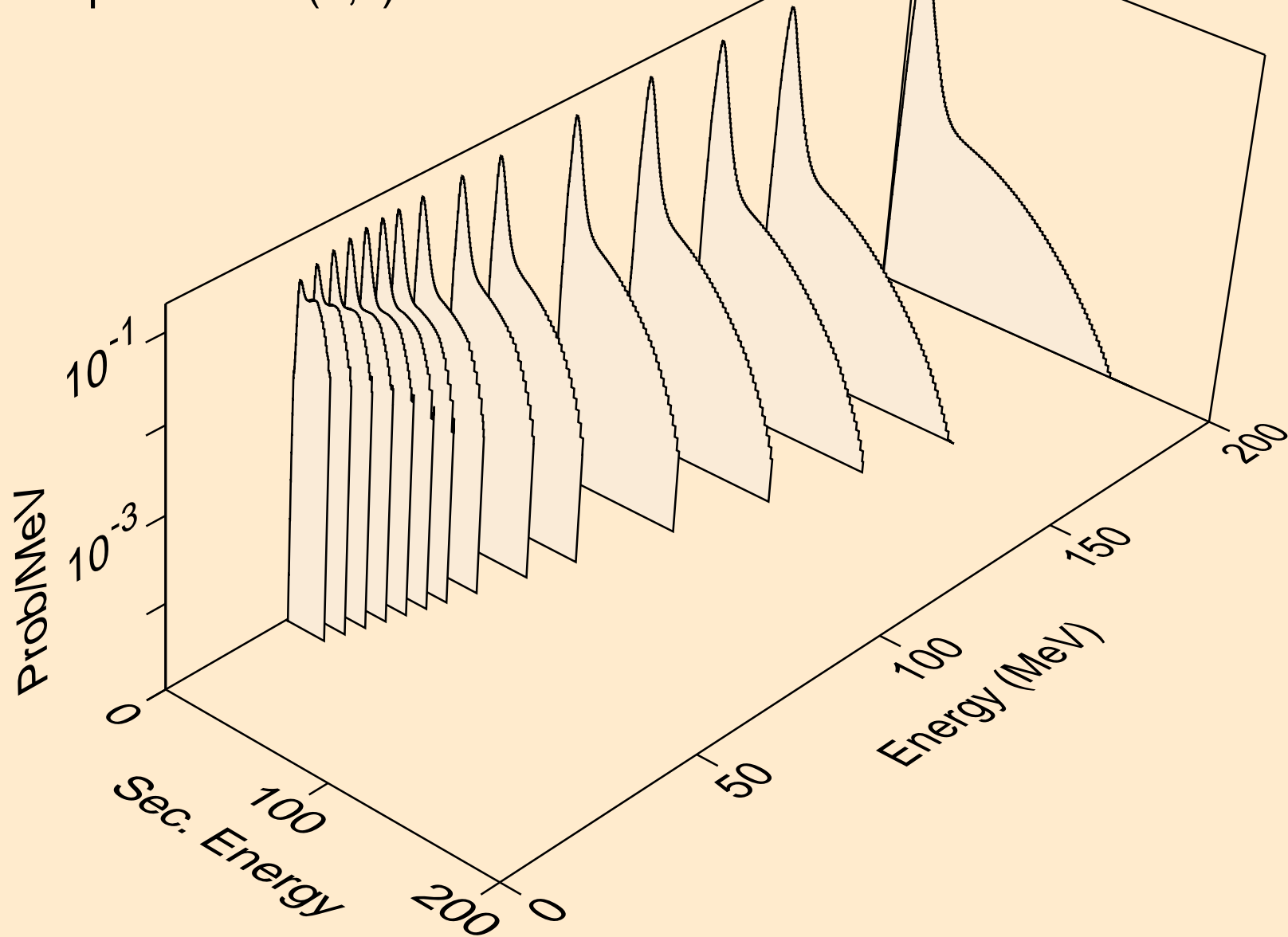

P029 NEUTRON ACER TENDL-2024 LIBRARY; T=293.6K  
alphas from (n,n\*)a

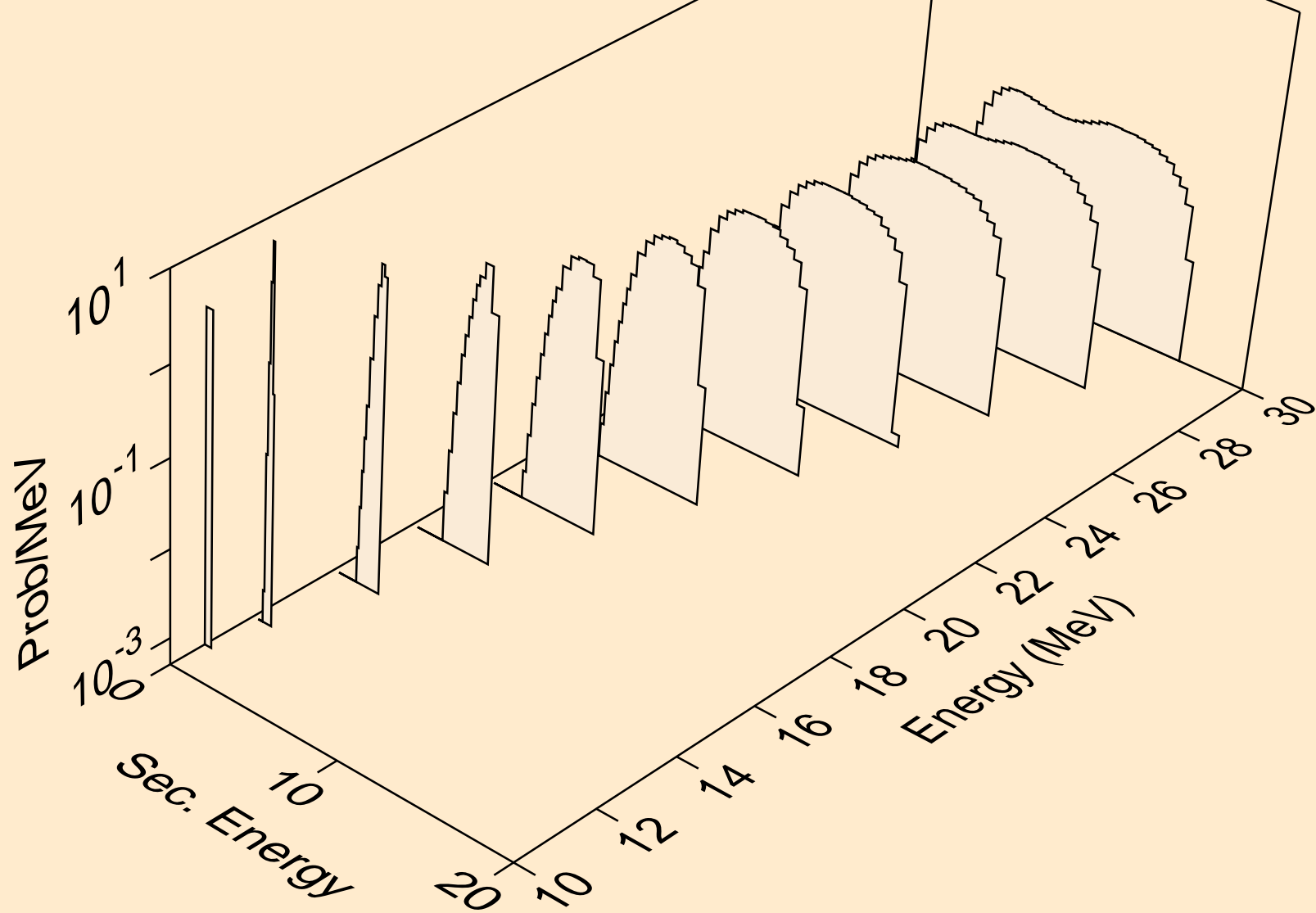

P029 NEUTRON ACER TENDL-2024 LIBRARY; T=293.6K  
alphas from (n,n\*)2a

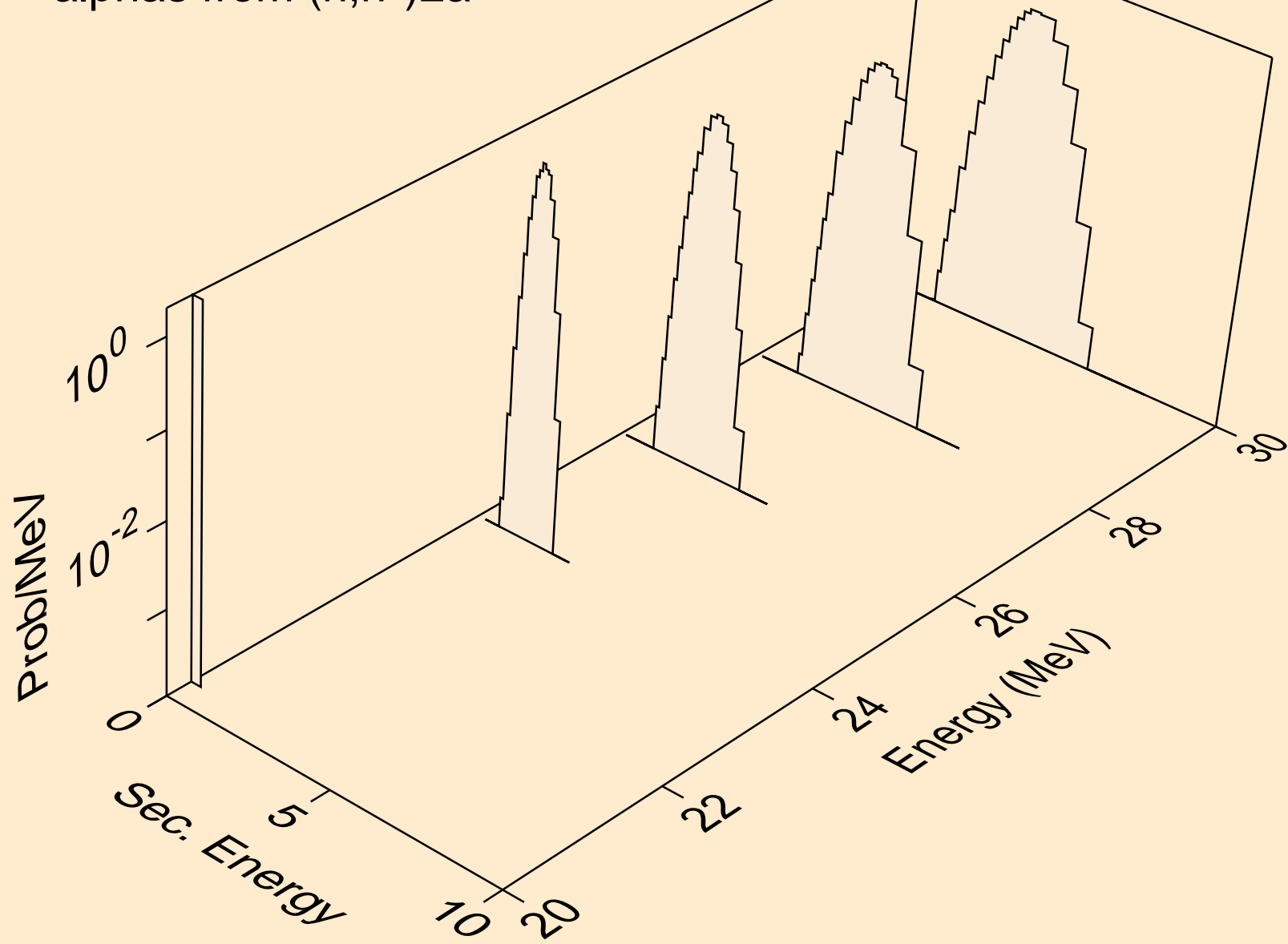

P029 NEUTRON ACER TENDL-2024 LIBRARY; T=293.6K  
alphas from (n,npa)

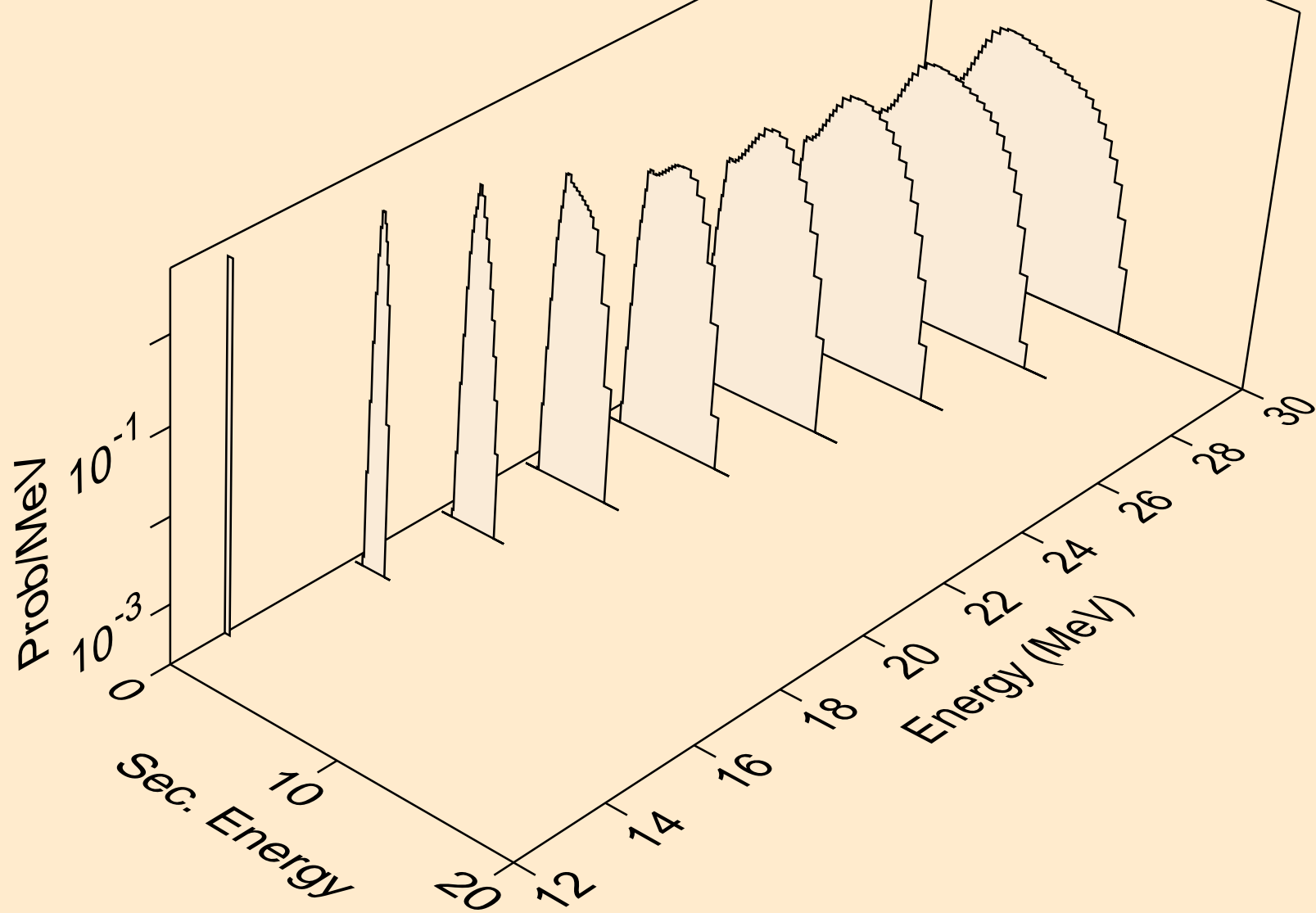

P029 NEUTRON ACER TENDL-2024 LIBRARY; T=293.6K  
alphas from (n,a)

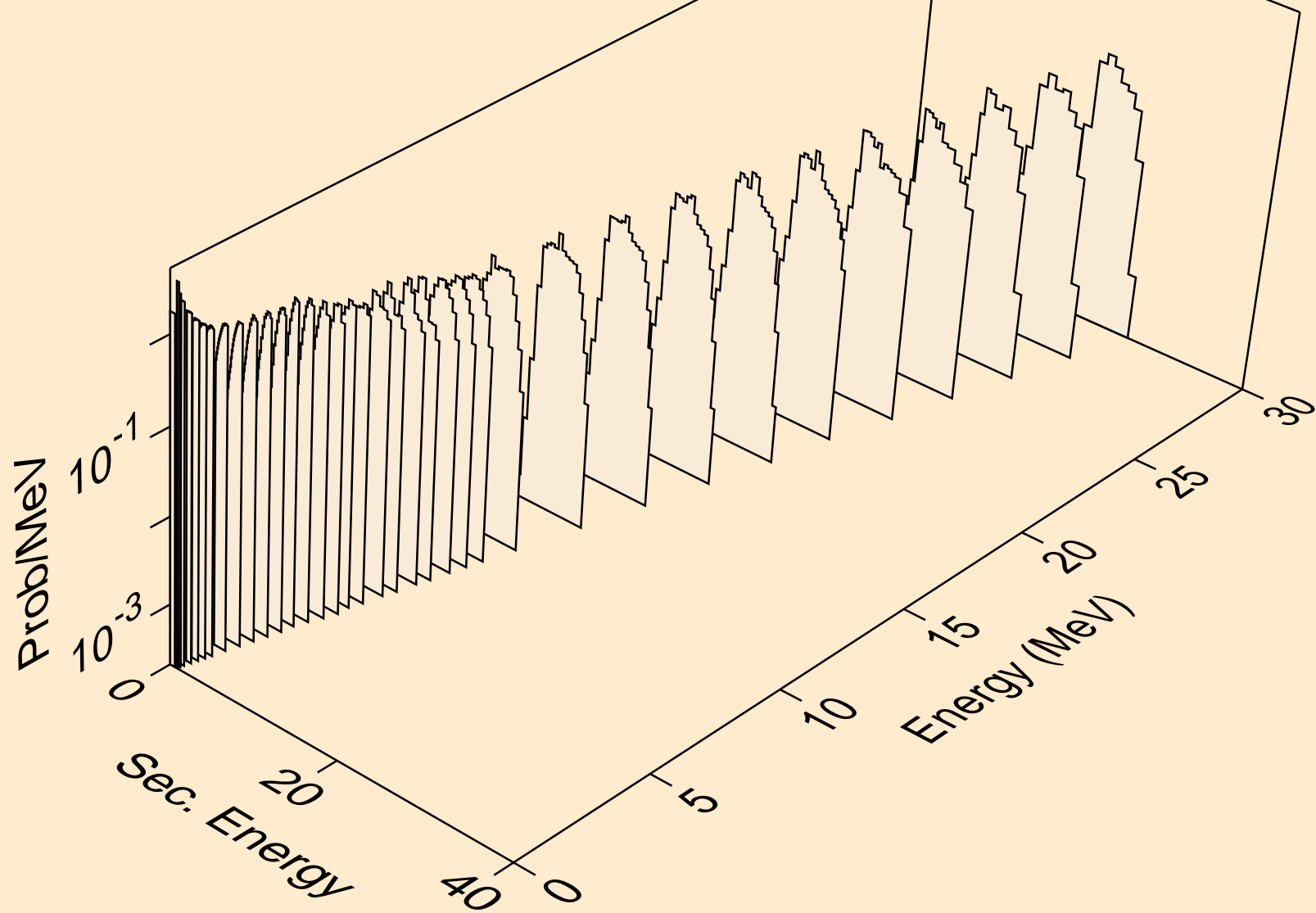

P029 NEUTRON ACER TENDL-2024 LIBRARY; T=293.6K  
alphas from (n,2a)

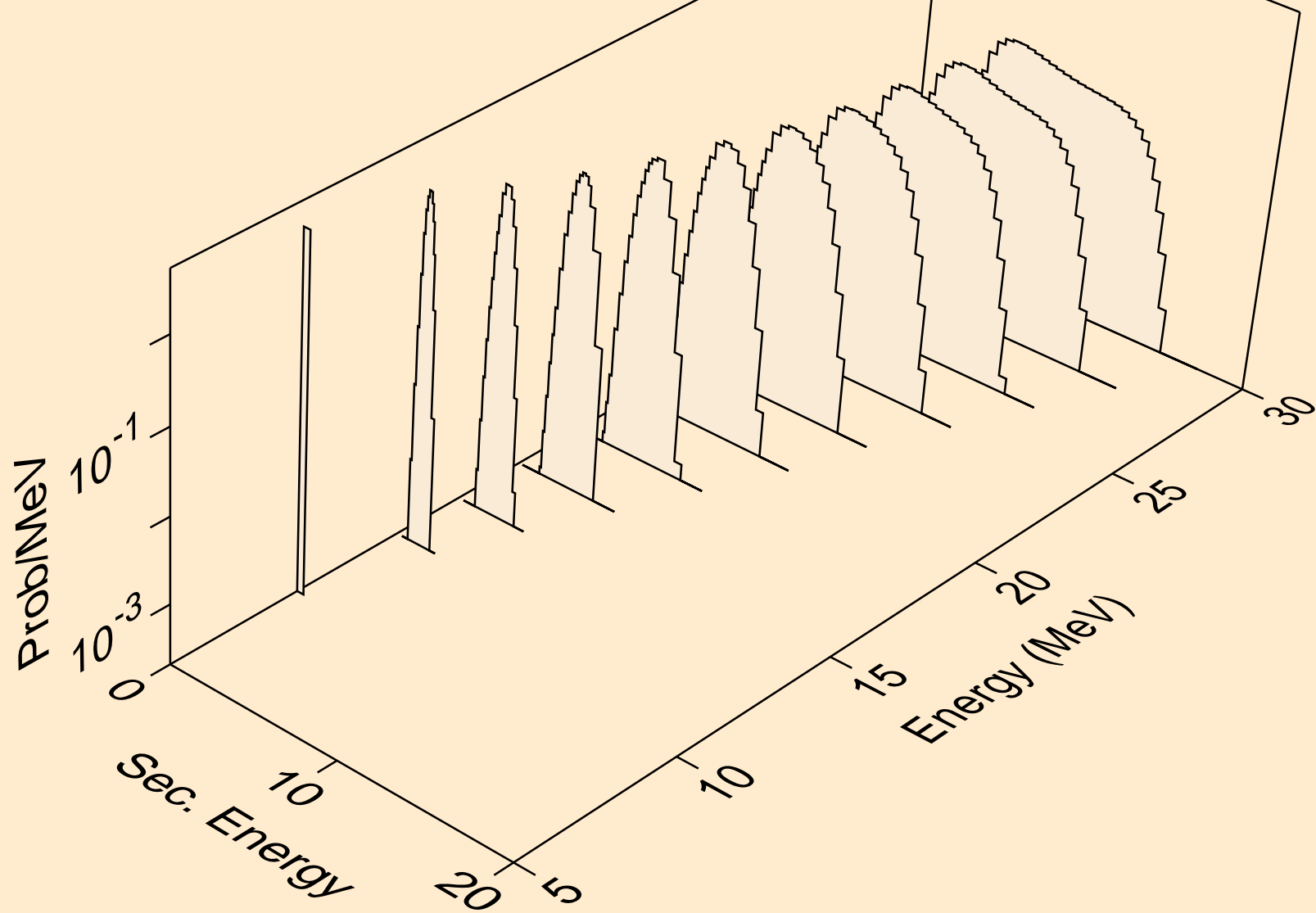

P029 NEUTRON ACER TENDL-2024 LIBRARY; T=293.6K  
alphas from (n,3a)

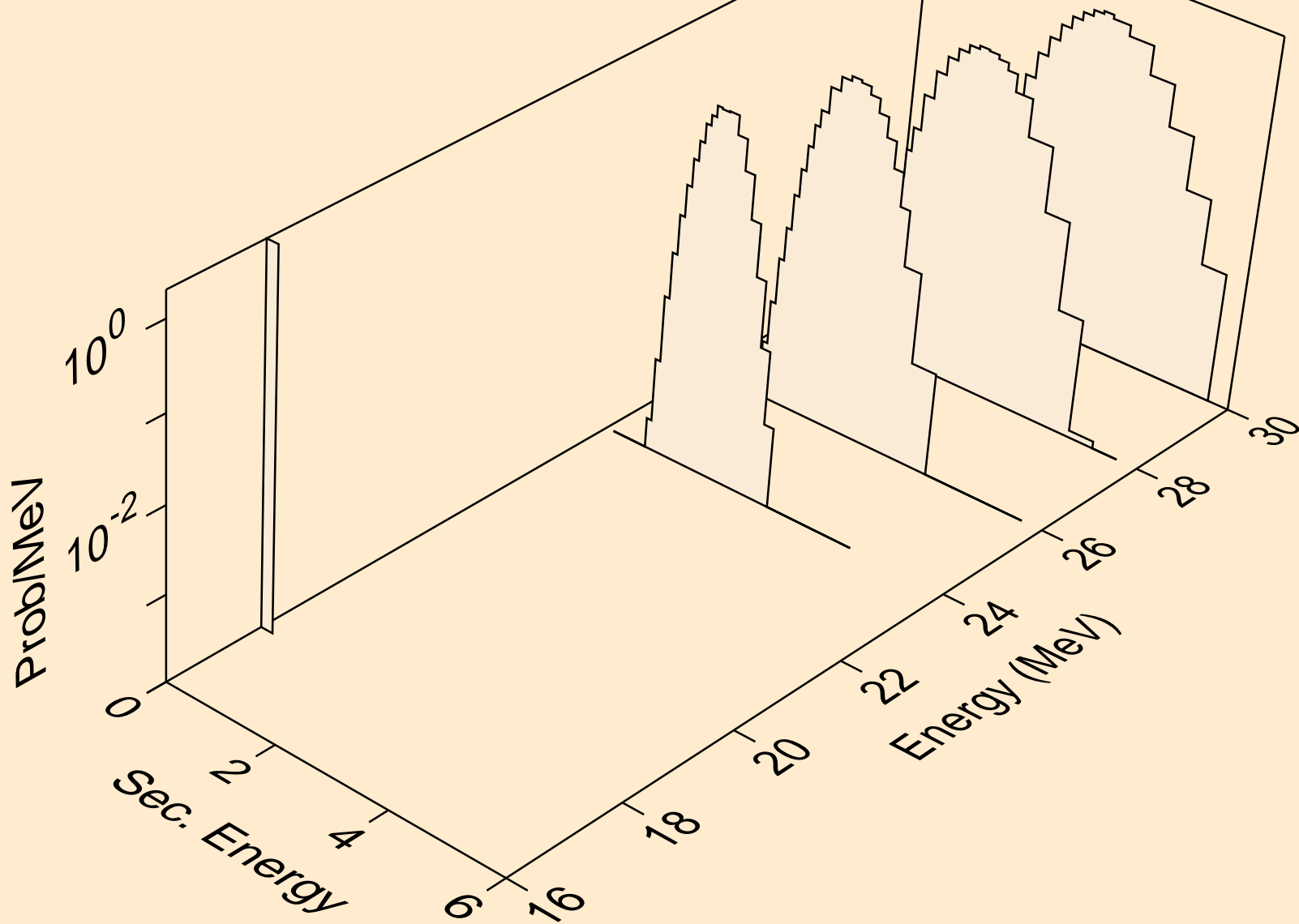

P029 NEUTRON ACER TENDL-2024 LIBRARY; T=293.6K  
alphas from (n,pa)

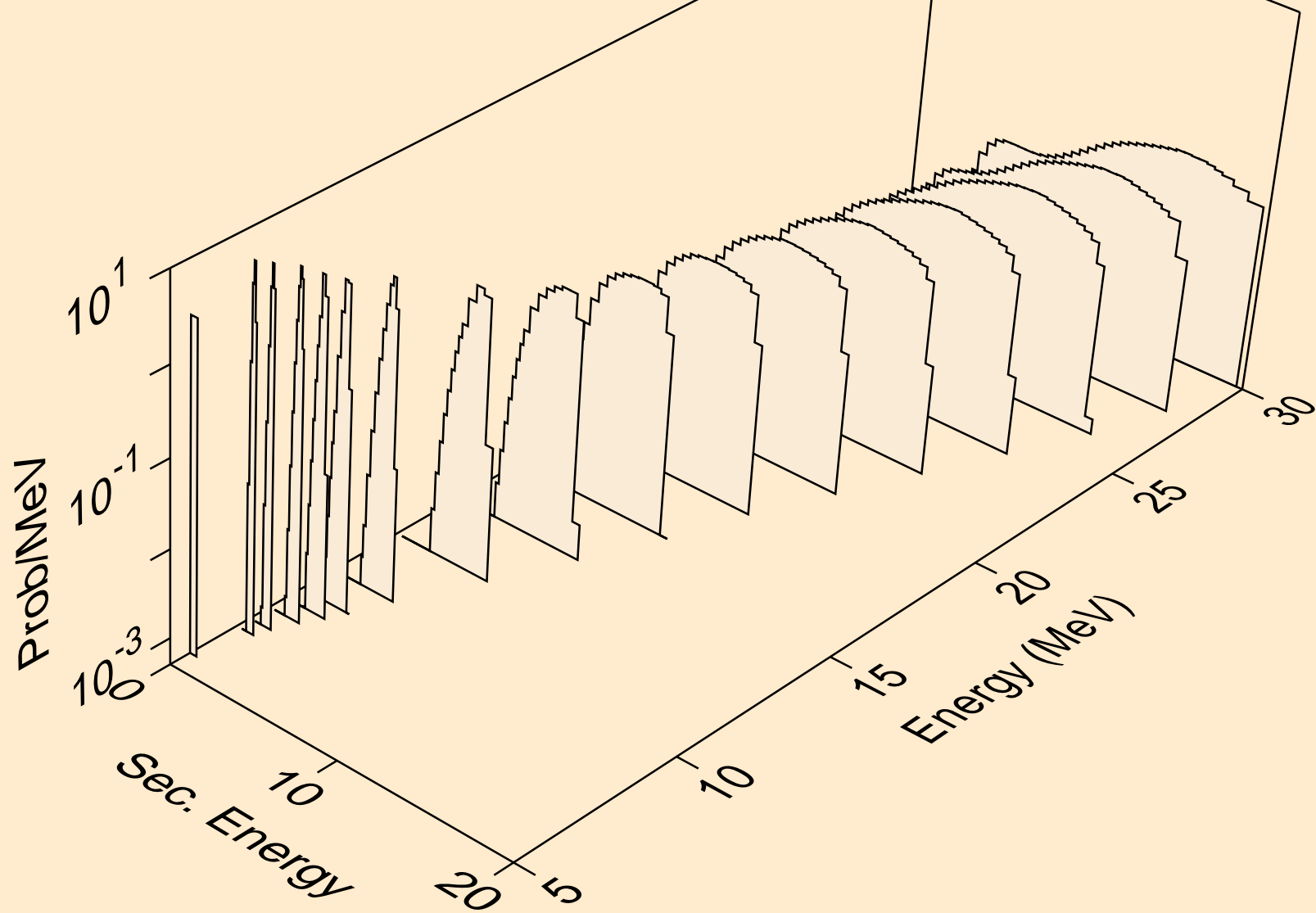

P029 NEUTRON ACER TENDL-2024 LIBRARY; T=293.6K  
alphas from (n,d2a)

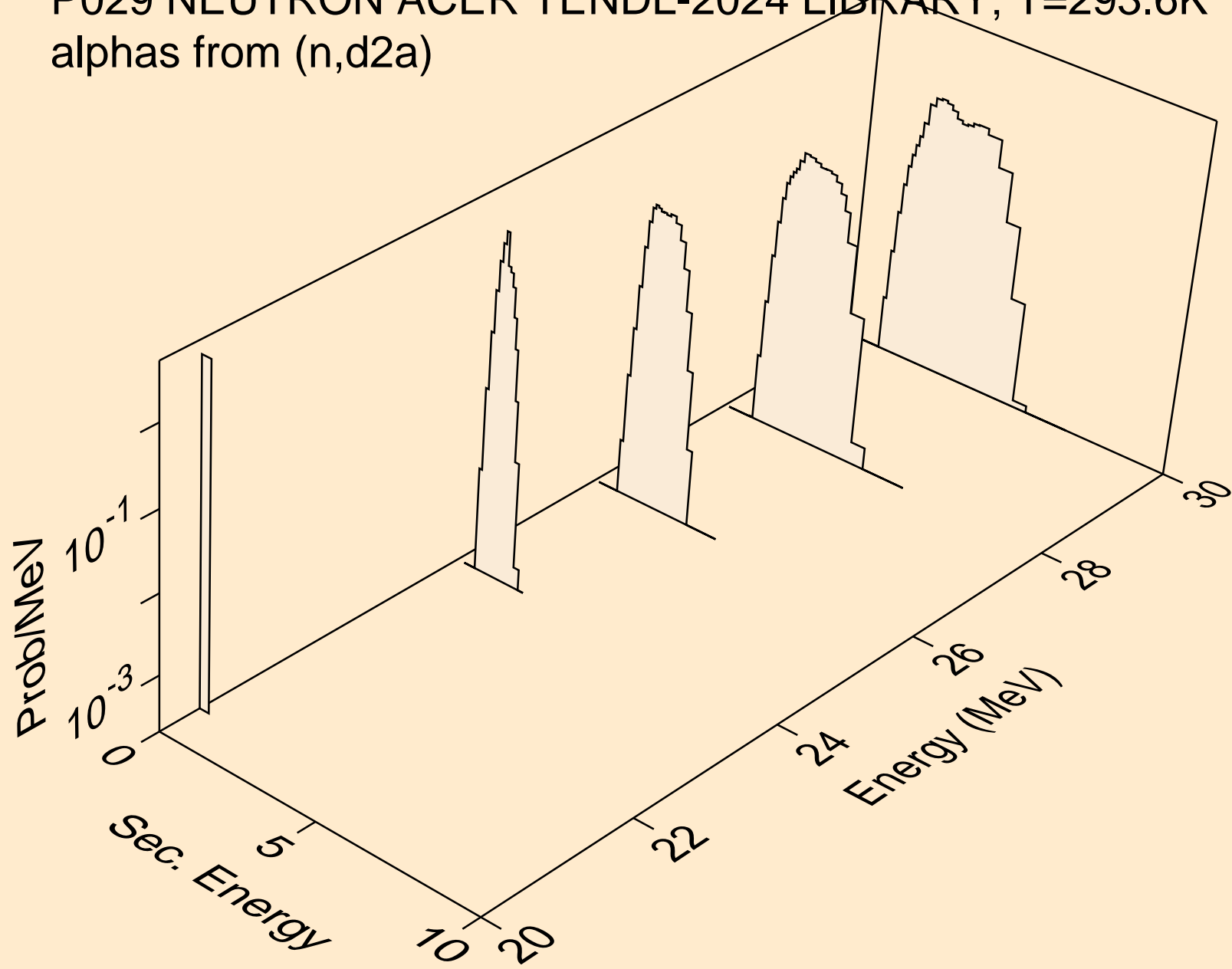

P029 NEUTRON ACER TENDL-2024 LIBRARY; T=293.6K  
alphas from (n,da)

