

P031 NEUTRON ACER TENDL-2024 LIBRARY; T=293.6K
Principal cross sections

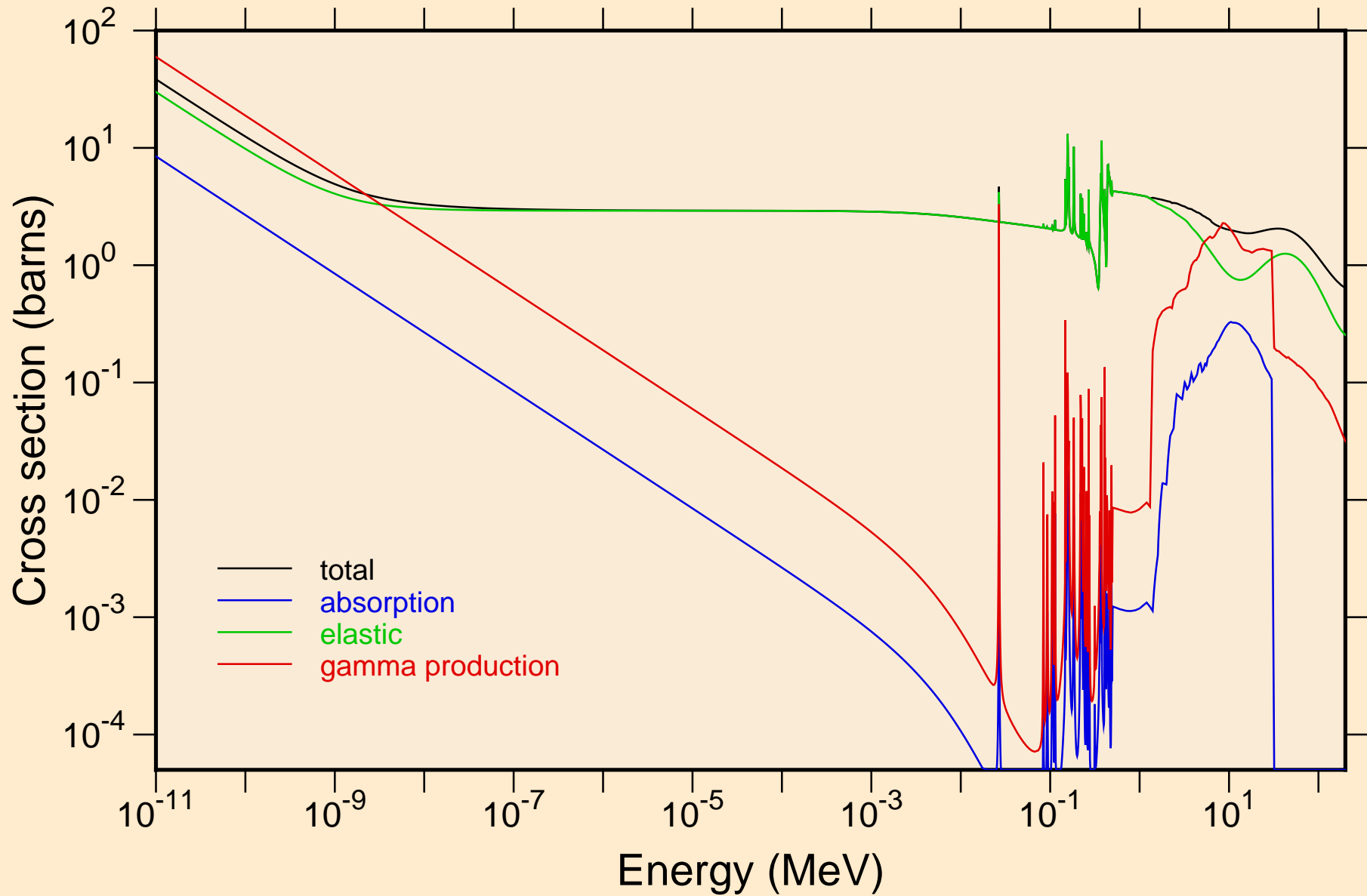

P031 NEUTRON ACER TENDL-2024 LIBRARY; T=293.6K
resonance total cross section

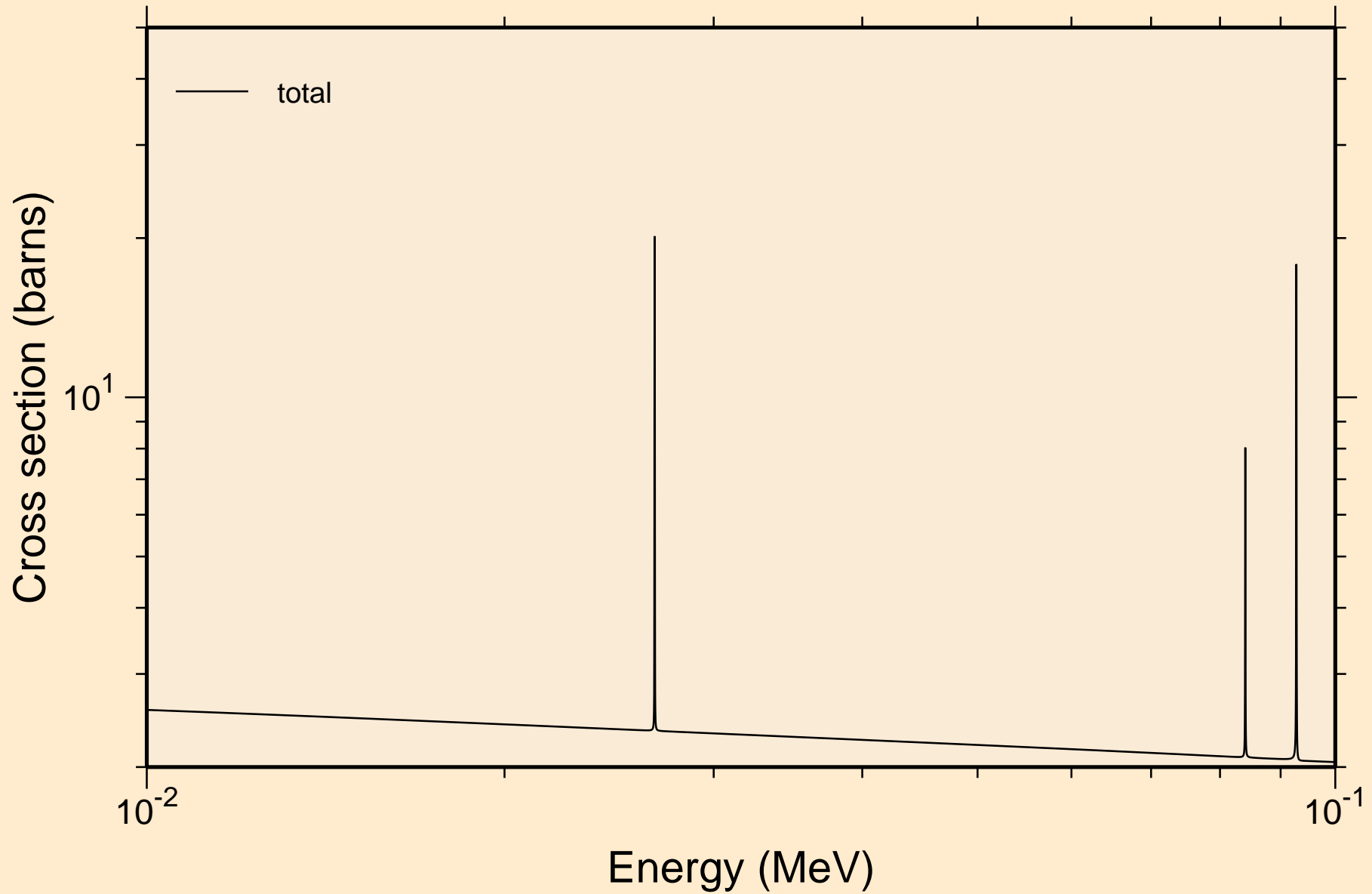

P031 NEUTRON ACER TENDL-2024 LIBRARY; T=293.6K
resonance total cross section

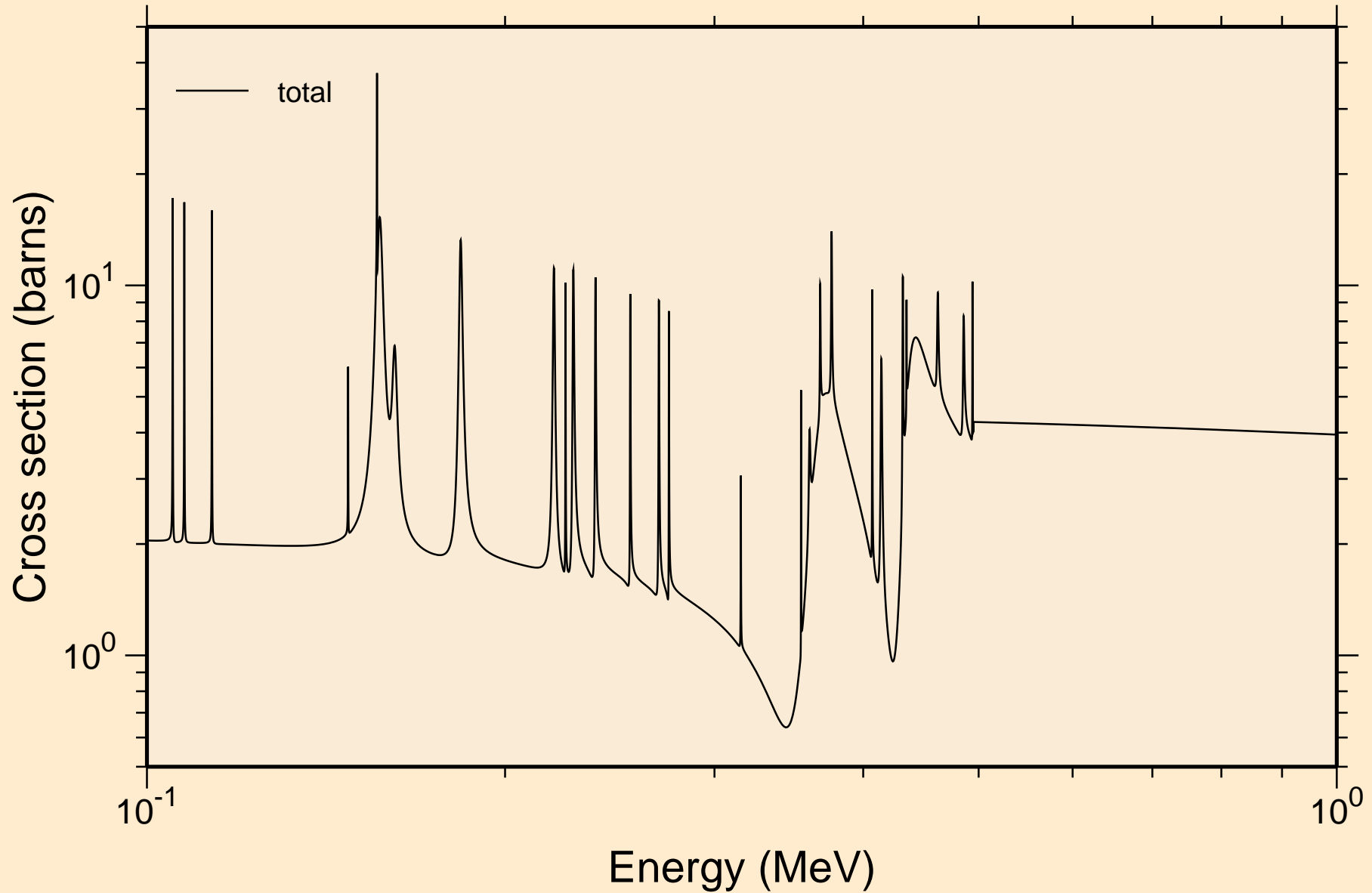

P031 NEUTRON ACER TENDL-2024 LIBRARY; T=293.6K
resonance total cross section

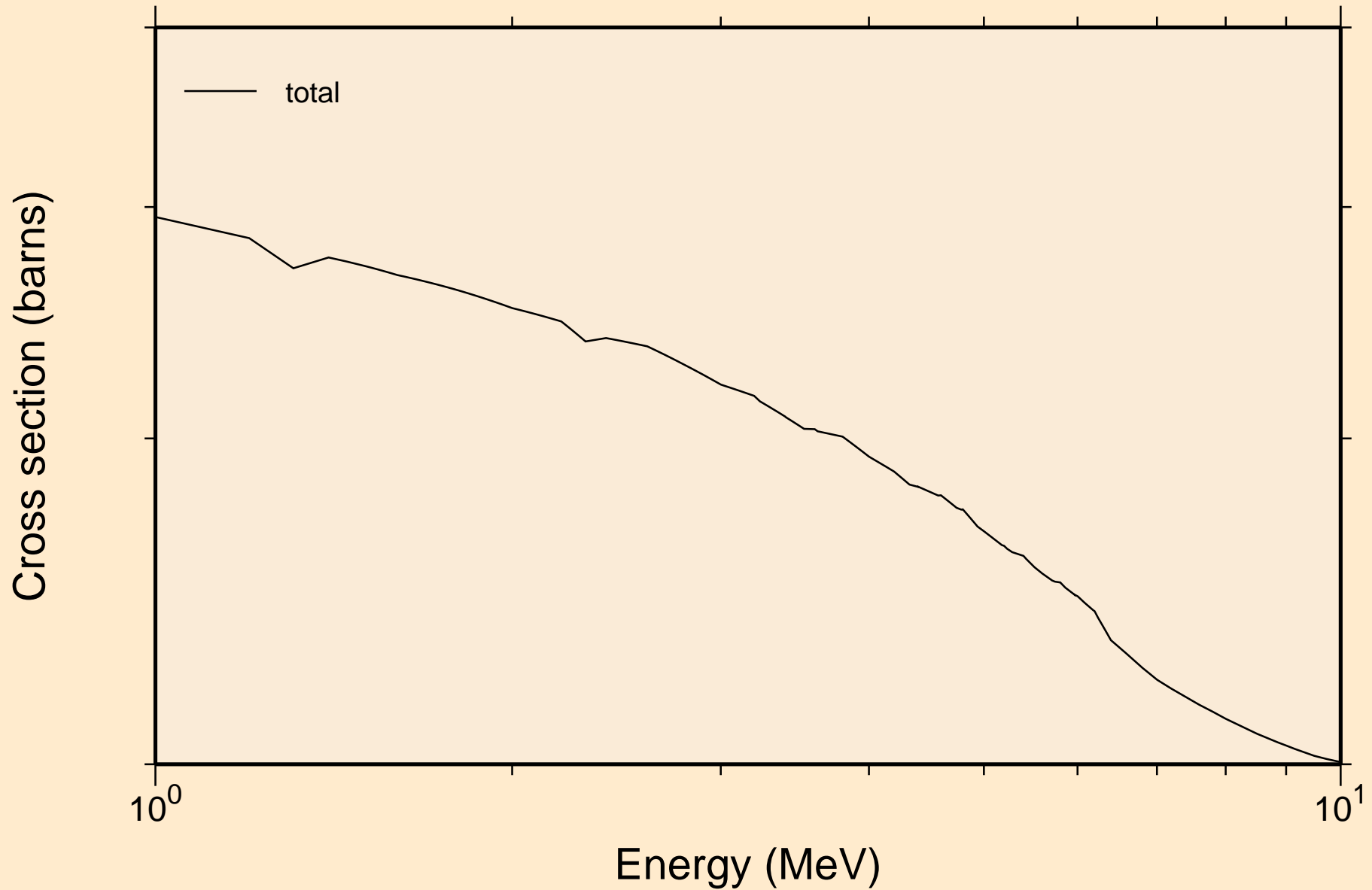

P031 NEUTRON ACER TENDL-2024 LIBRARY; T=293.6K
resonance absorption cross sections

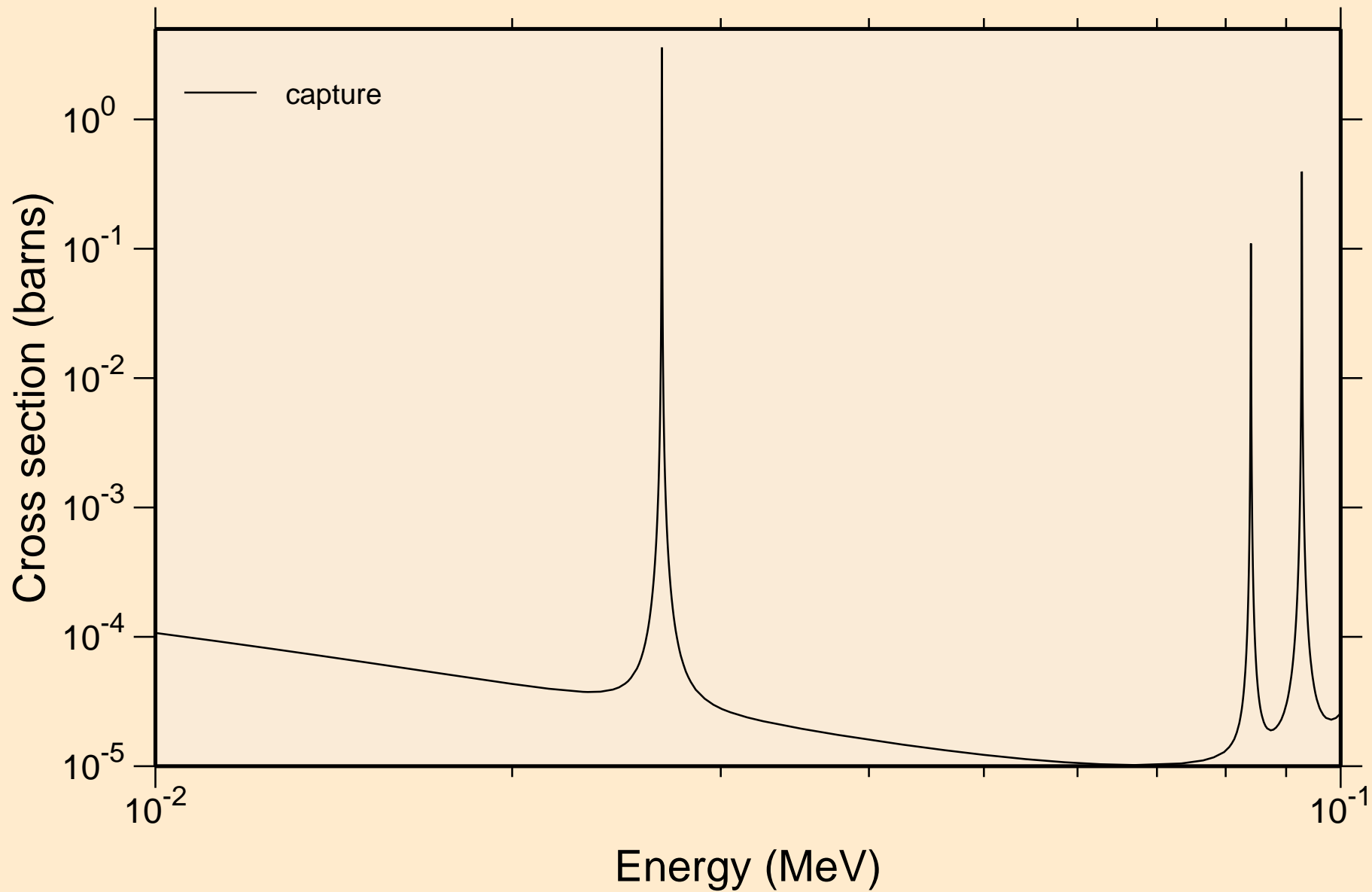

P031 NEUTRON ACER TENDL-2024 LIBRARY; T=293.6K
resonance absorption cross sections

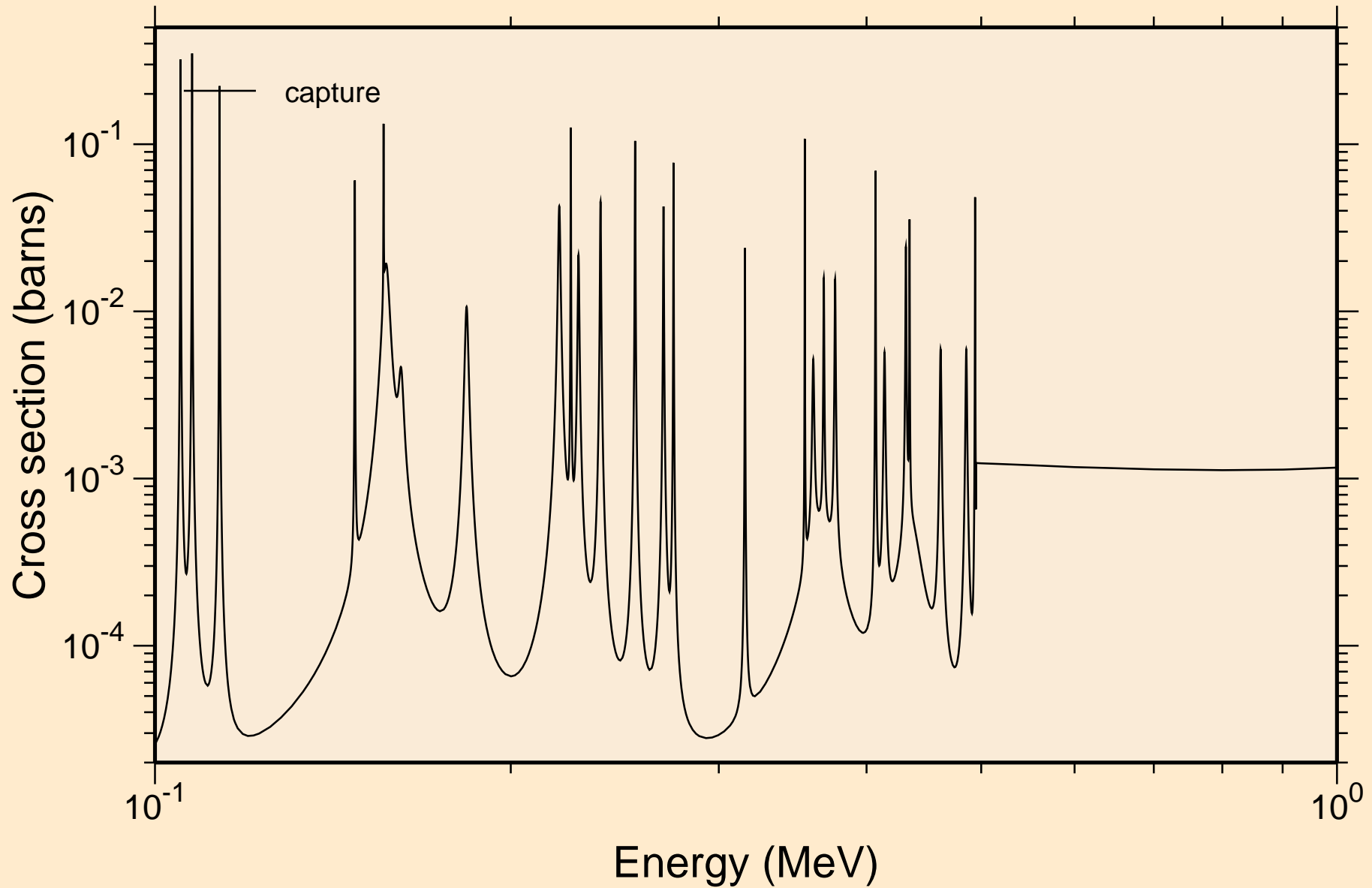

P031 NEUTRON ACER TENDL-2024 LIBRARY; T=293.6K
resonance absorption cross sections

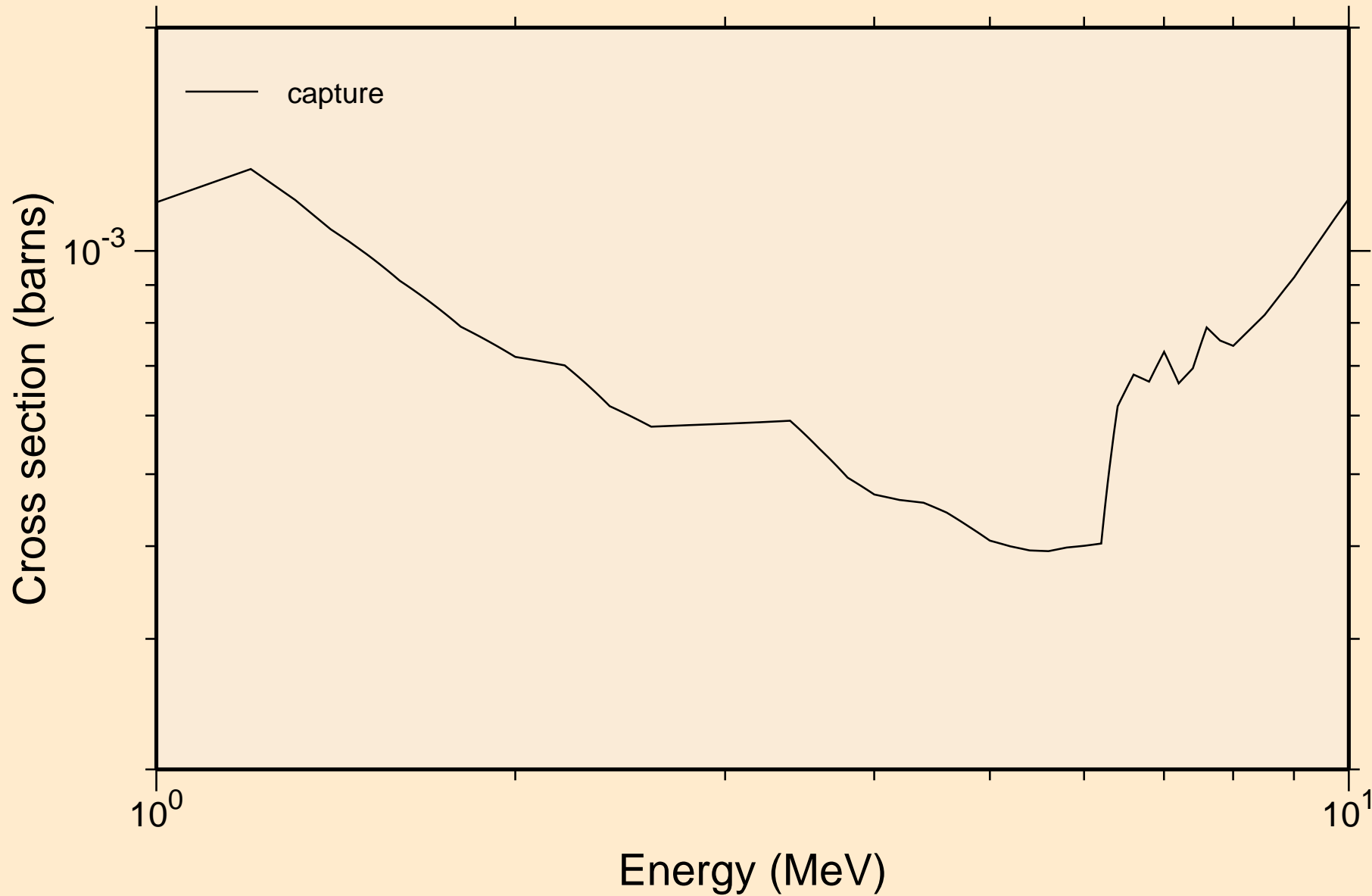

P031 NEUTRON ACER TENDL-2024 LIBRARY; T=293.6K
Heating

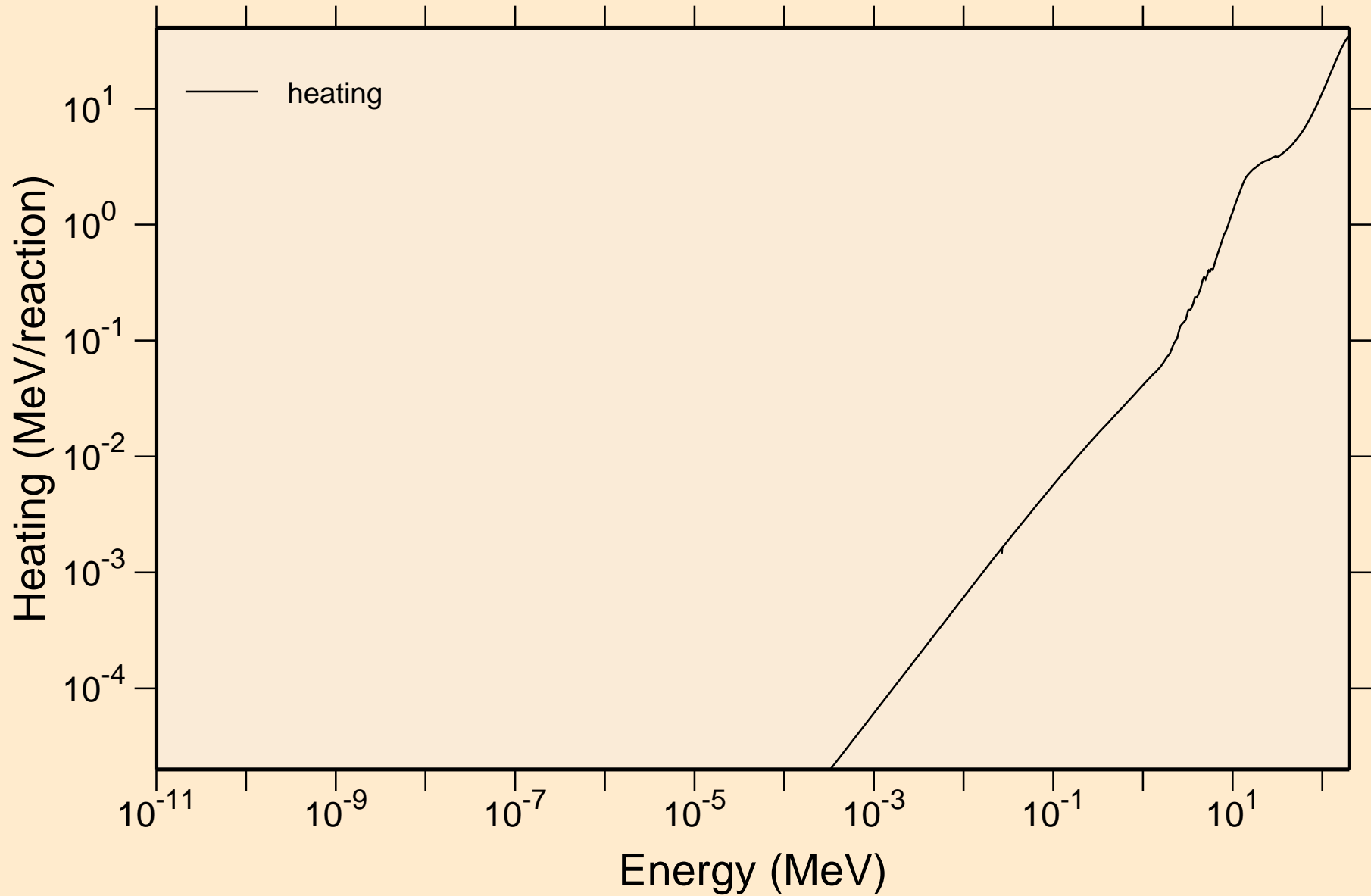

P031 NEUTRON ACER TENDL-2024 LIBRARY; T=293.6K
Damage

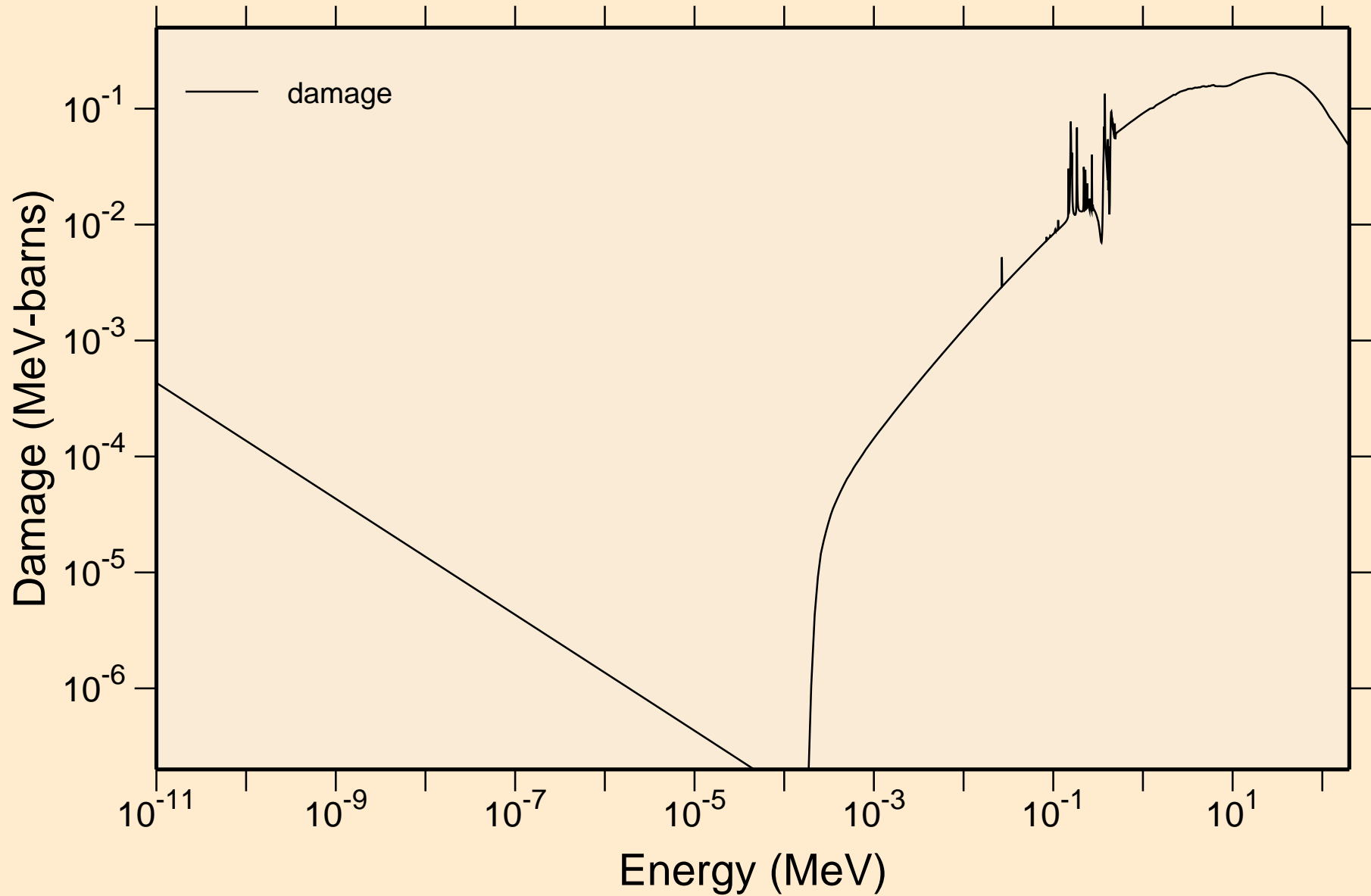

P031 NEUTRON ACER TENDL-2024 LIBRARY; T=293.6K
Non-threshold reactions

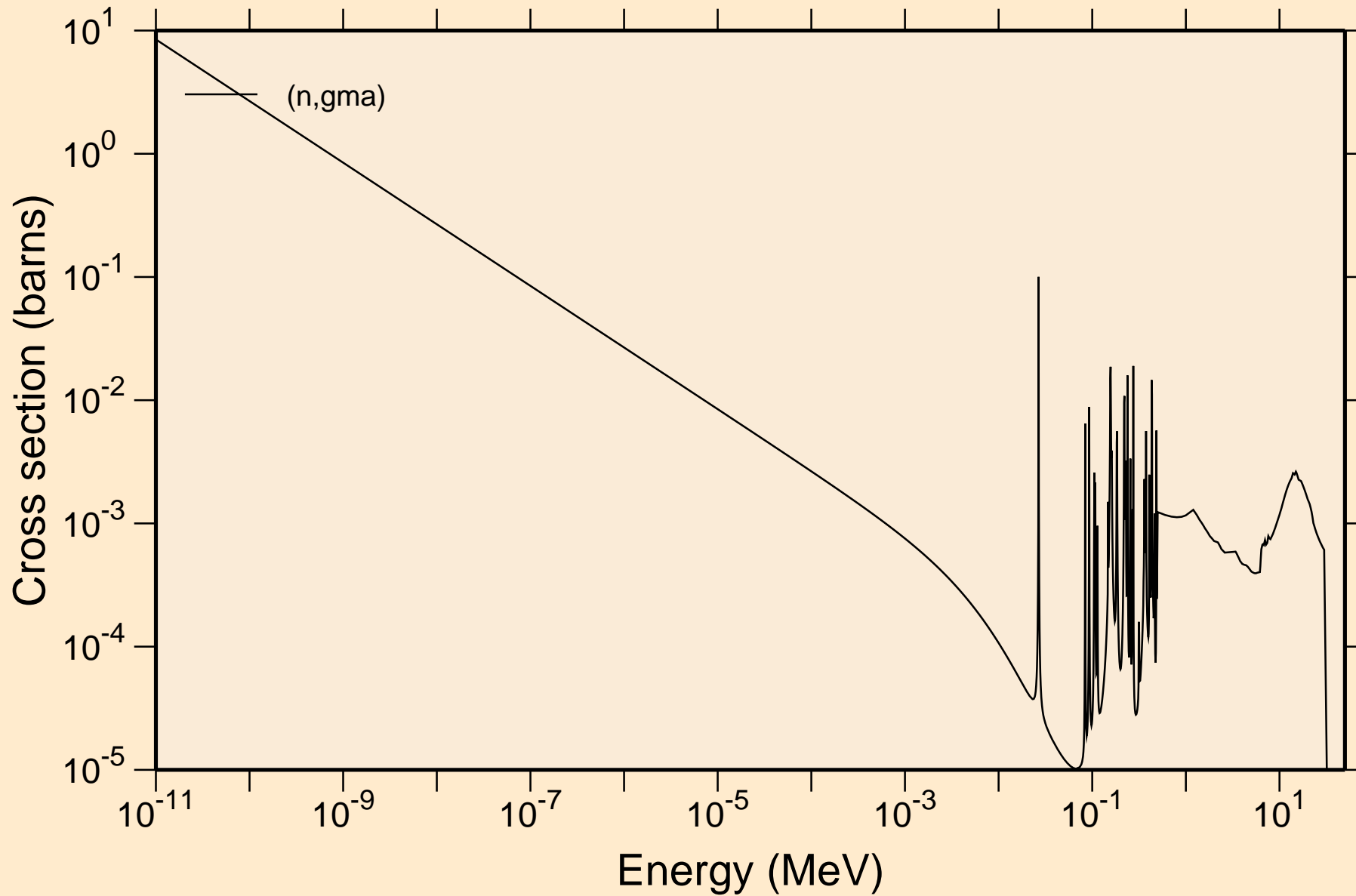

P031 NEUTRON ACER TENDL-2024 LIBRARY; T=293.6K

Principal cross sections

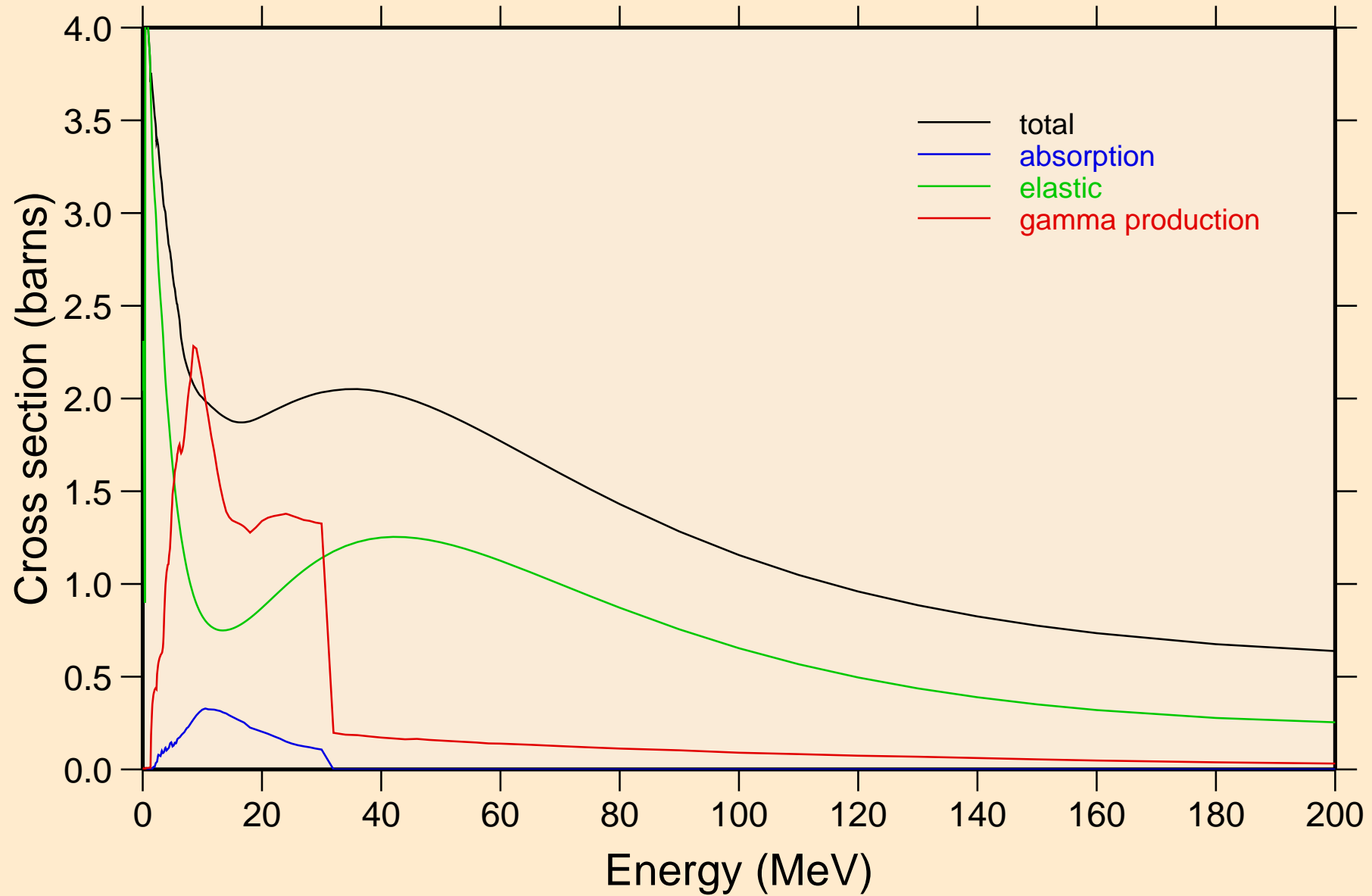

P031 NEUTRON ACER TENDL-2024 LIBRARY; T=293.6K

Heating

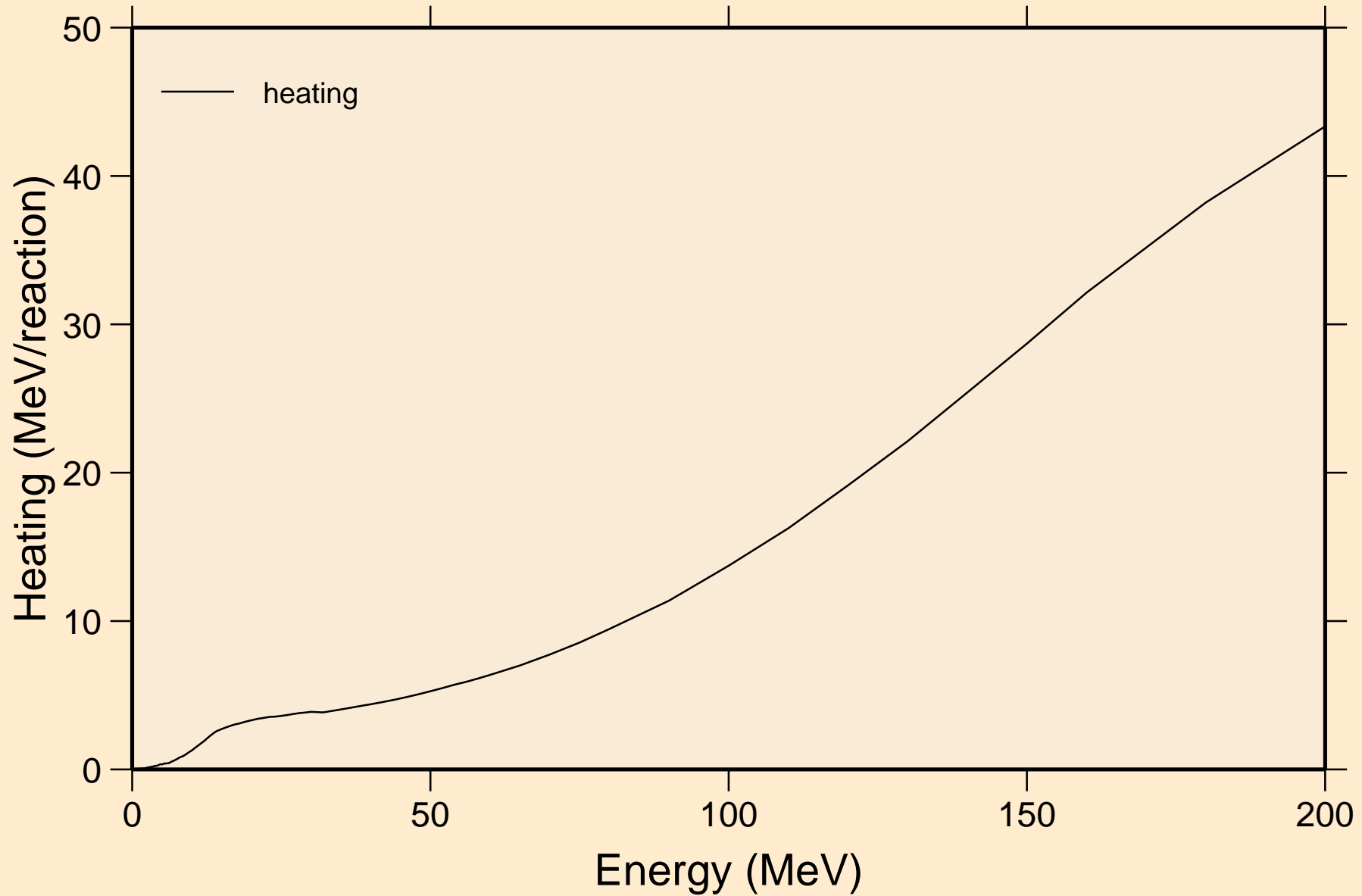

P031 NEUTRON ACER TENDL-2024 LIBRARY; T=293.6K
Damage

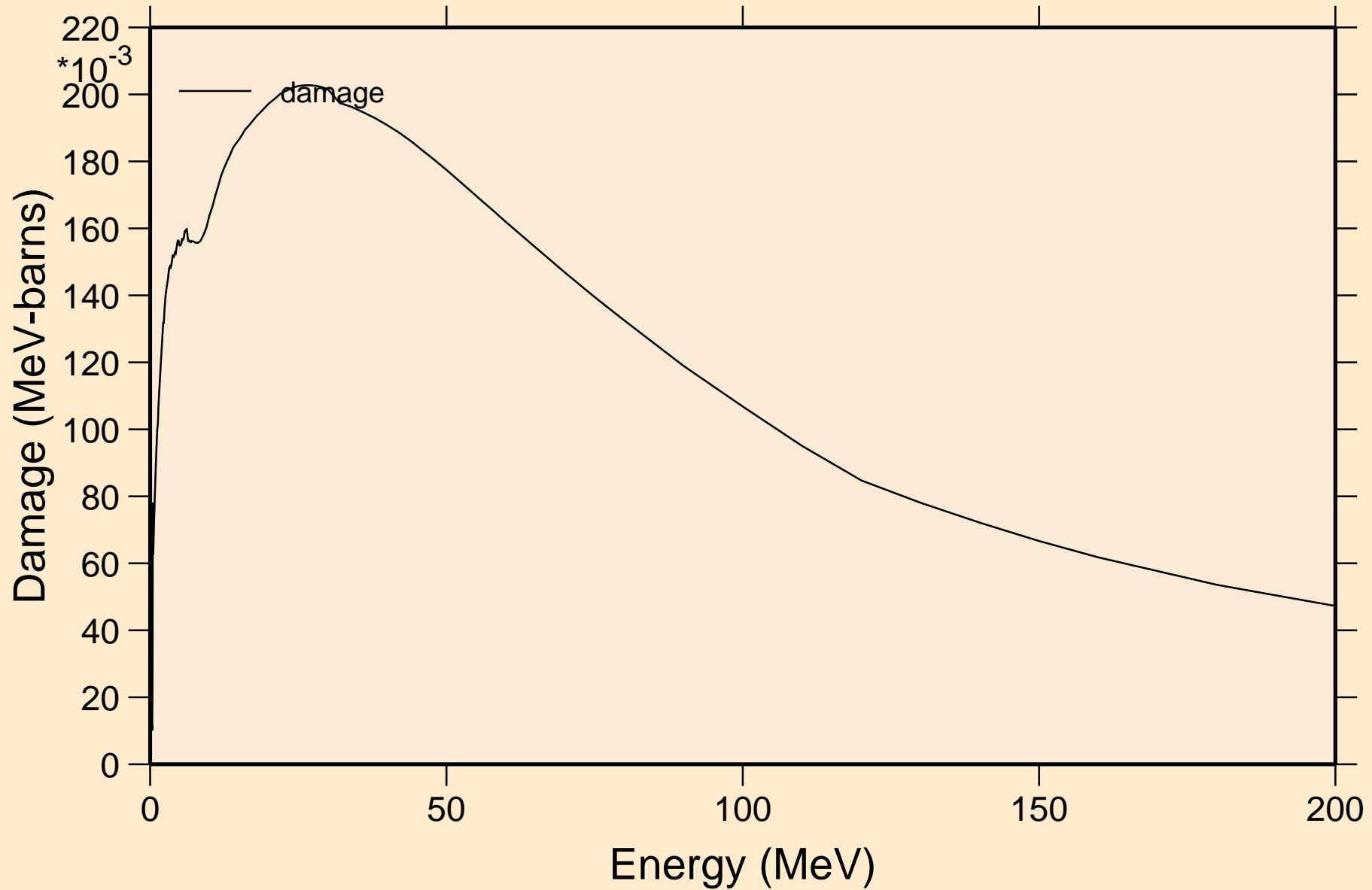

P031 NEUTRON ACER TENDL-2024 LIBRARY; T=293.6K
Non-threshold reactions

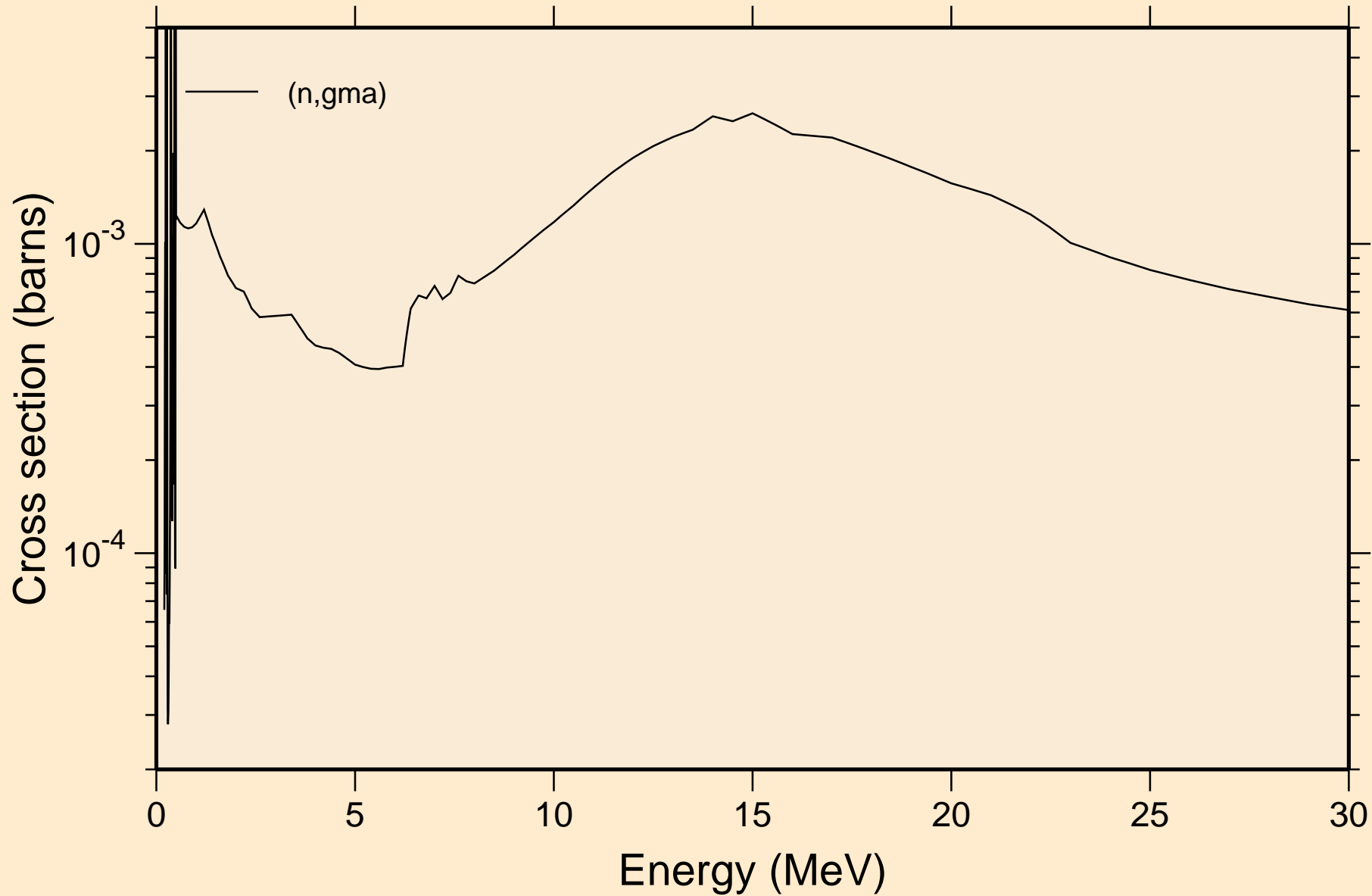

P031 NEUTRON ACER TENDL-2024 LIBRARY; T=293.6K
Inelastic levels

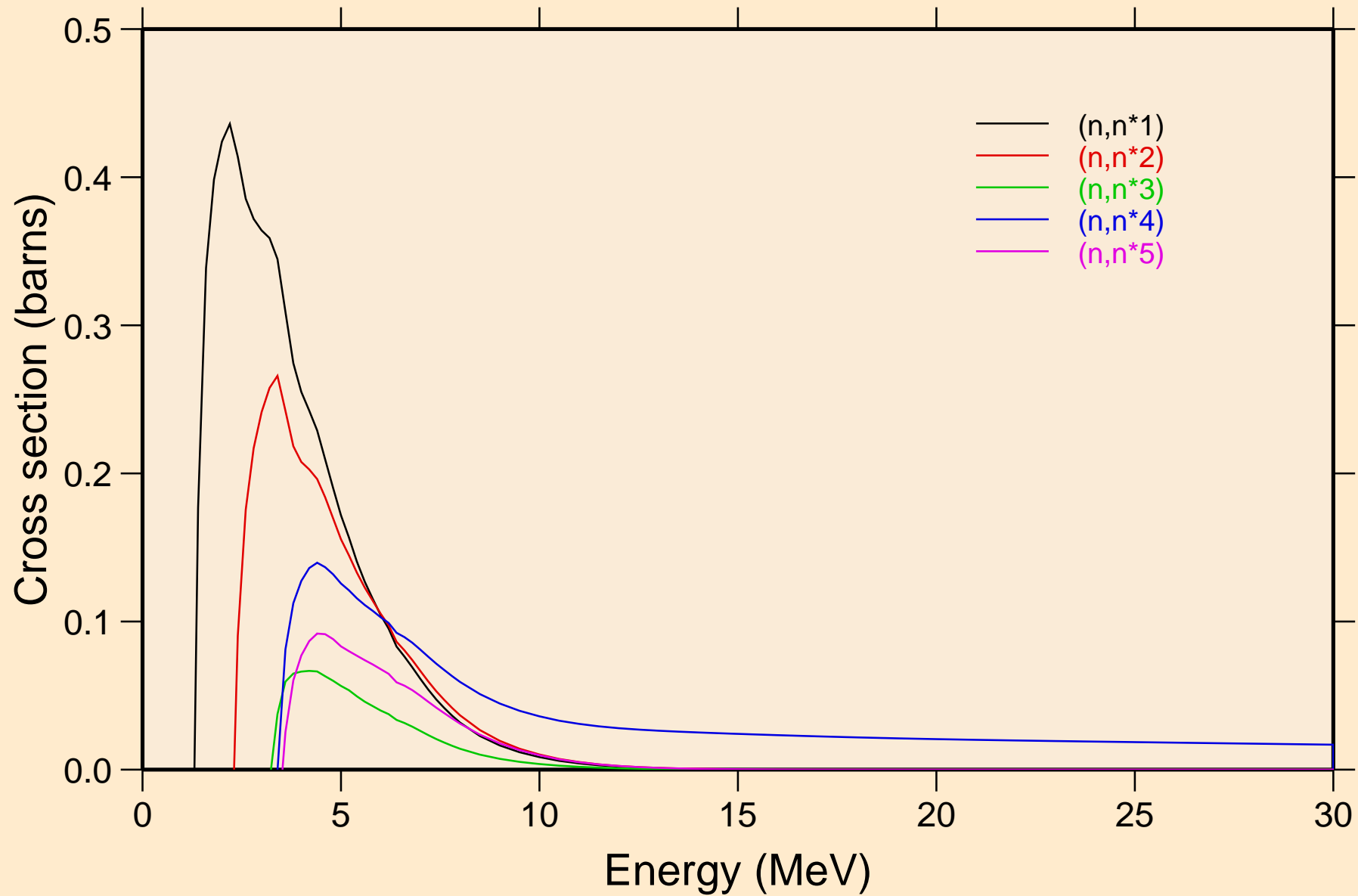

P031 NEUTRON ACER TENDL-2024 LIBRARY; T=293.6K
Inelastic levels

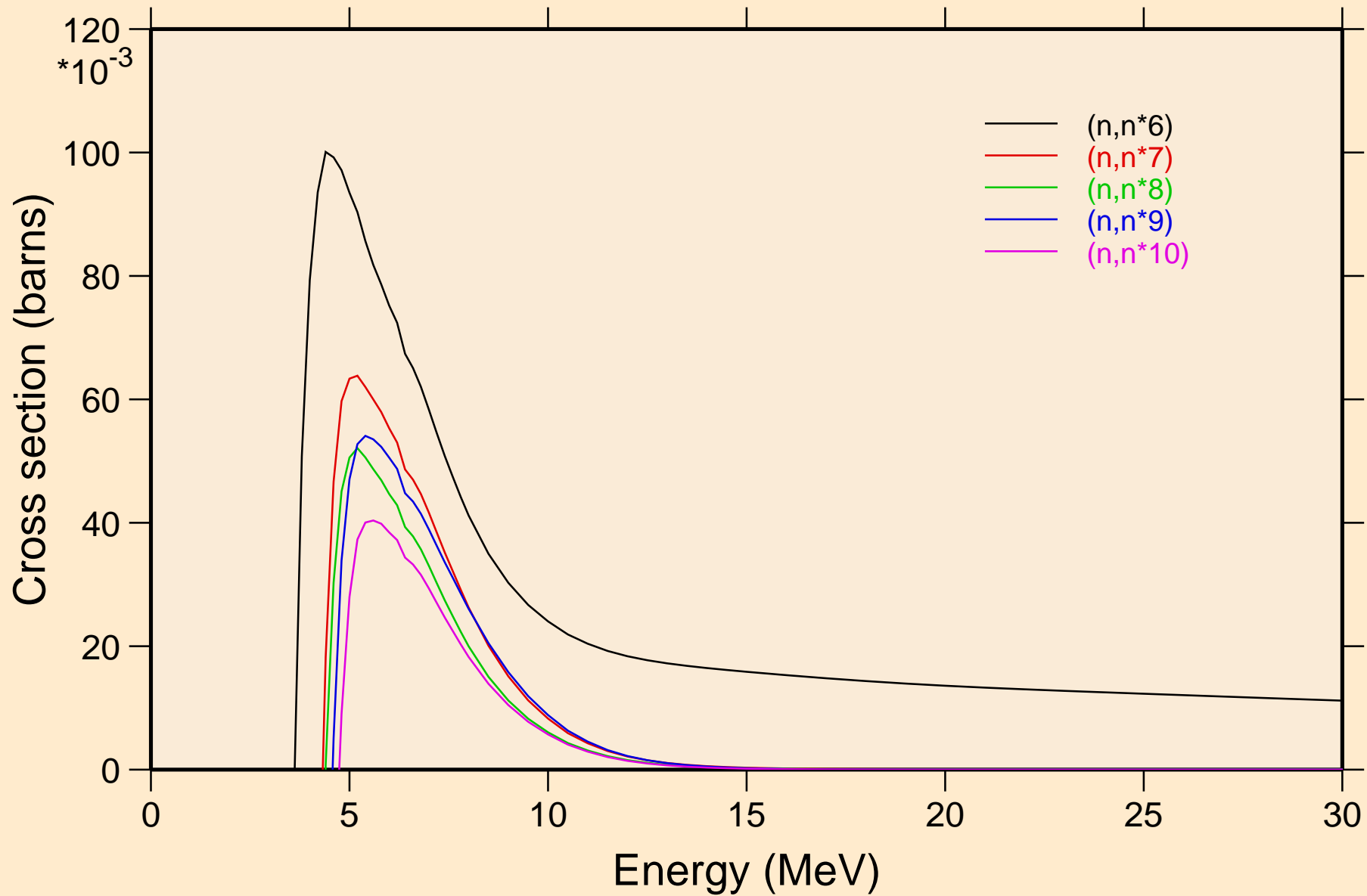

P031 NEUTRON ACER TENDL-2024 LIBRARY; T=293.6K
Inelastic levels

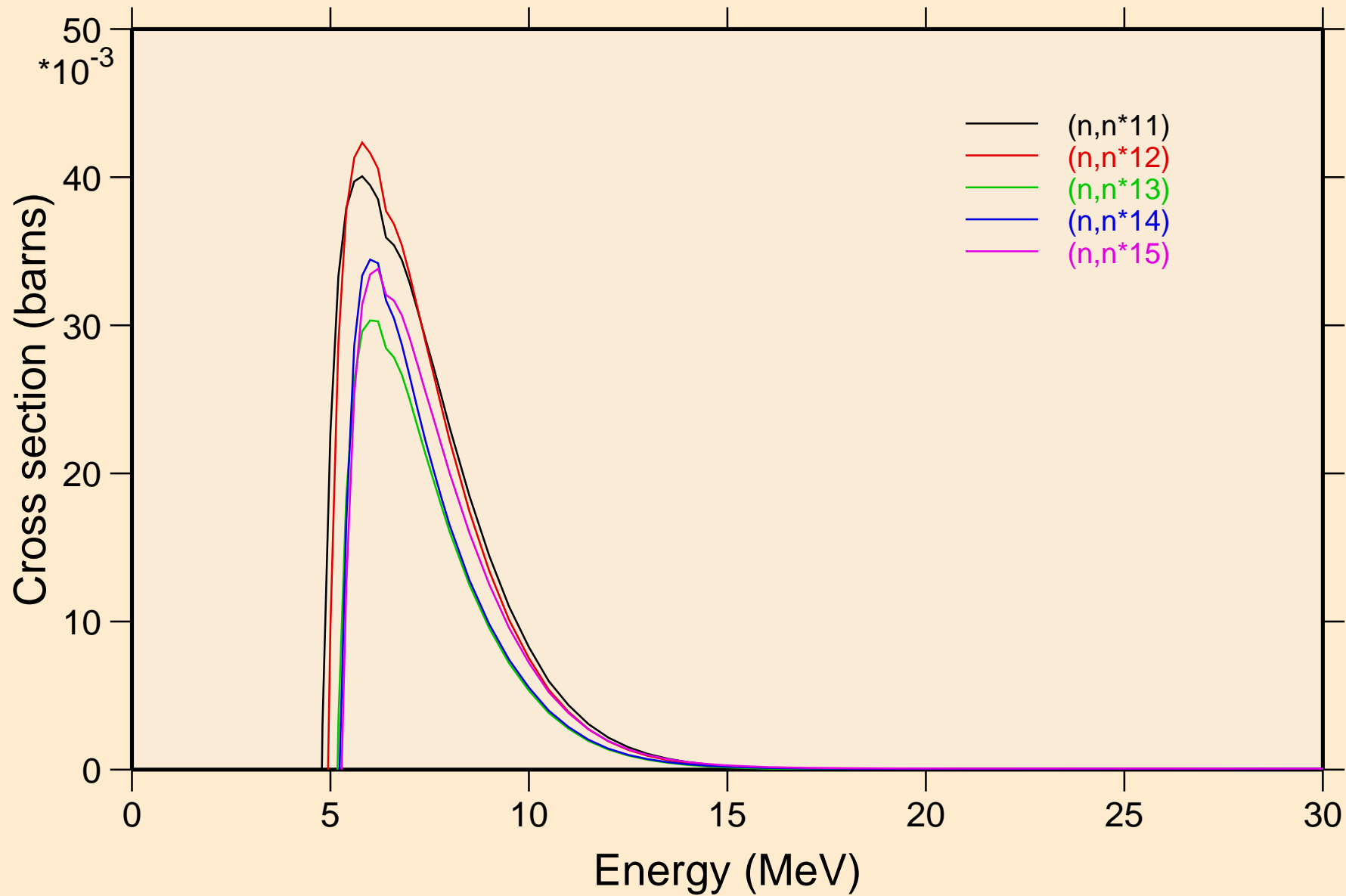

P031 NEUTRON ACER TENDL-2024 LIBRARY; T=293.6K
Inelastic levels

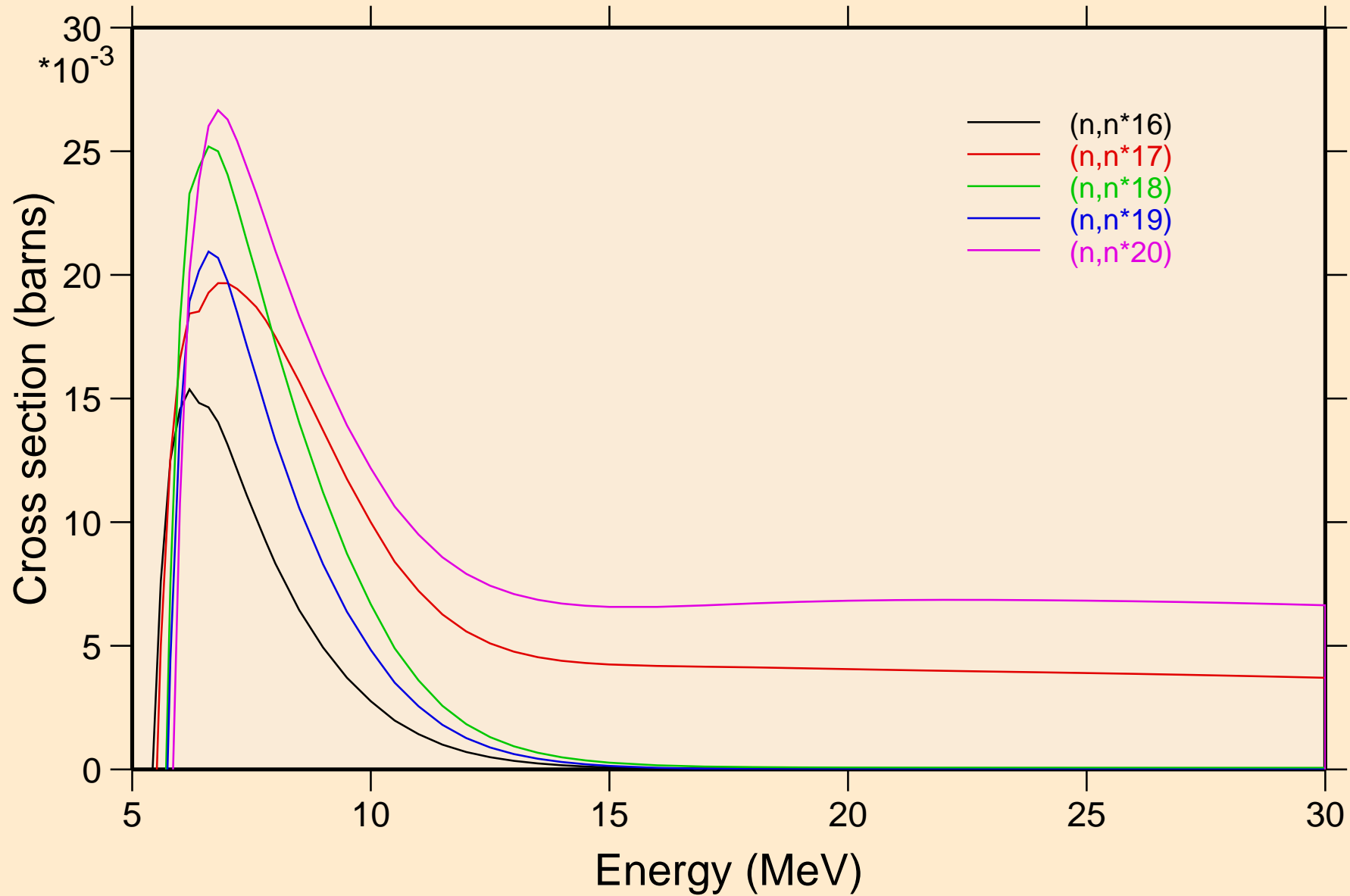

P031 NEUTRON ACER TENDL-2024 LIBRARY; T=293.6K
Inelastic levels

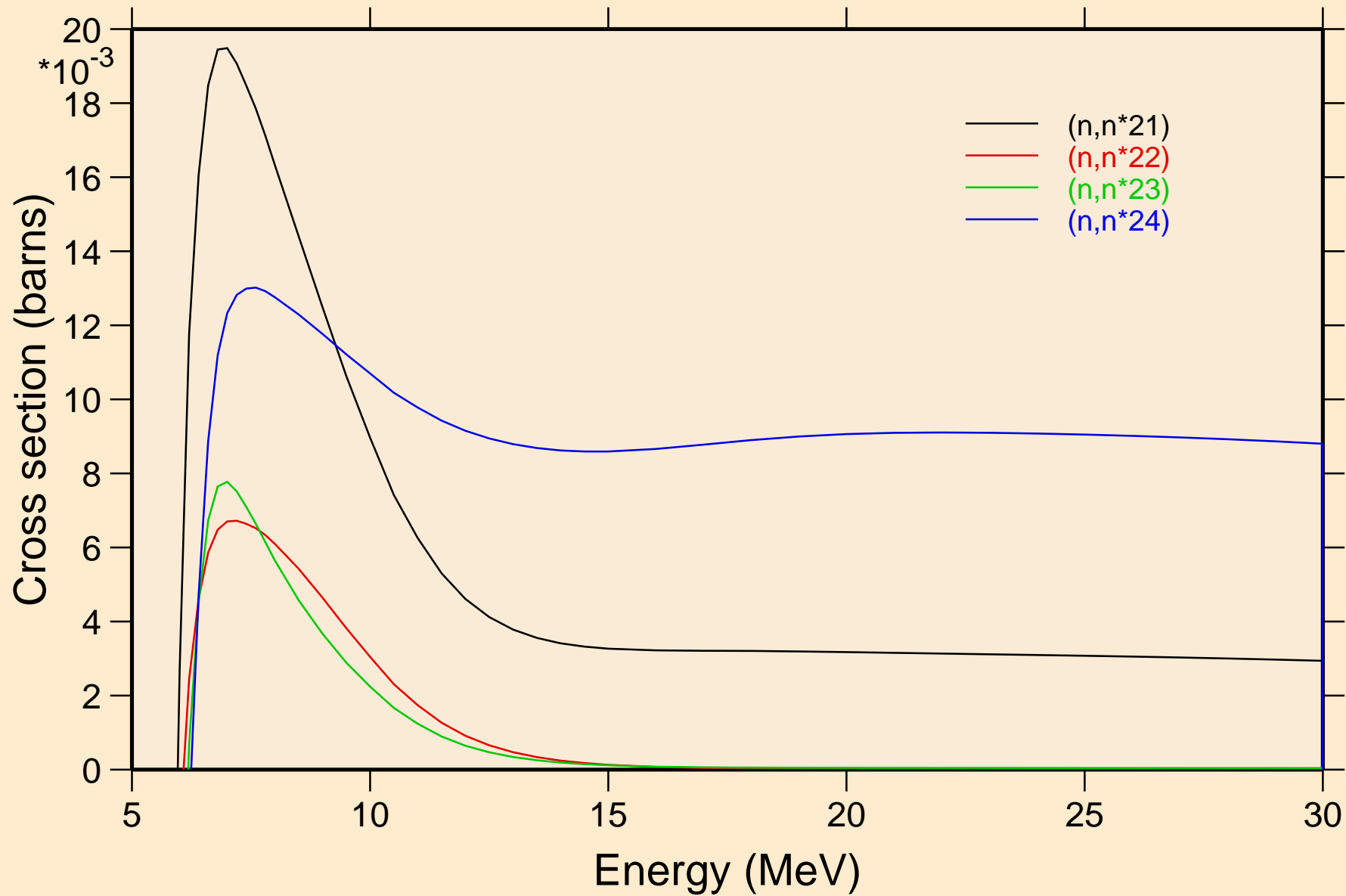

P031 NEUTRON ACER TENDL-2024 LIBRARY; T=293.6K
Threshold reactions

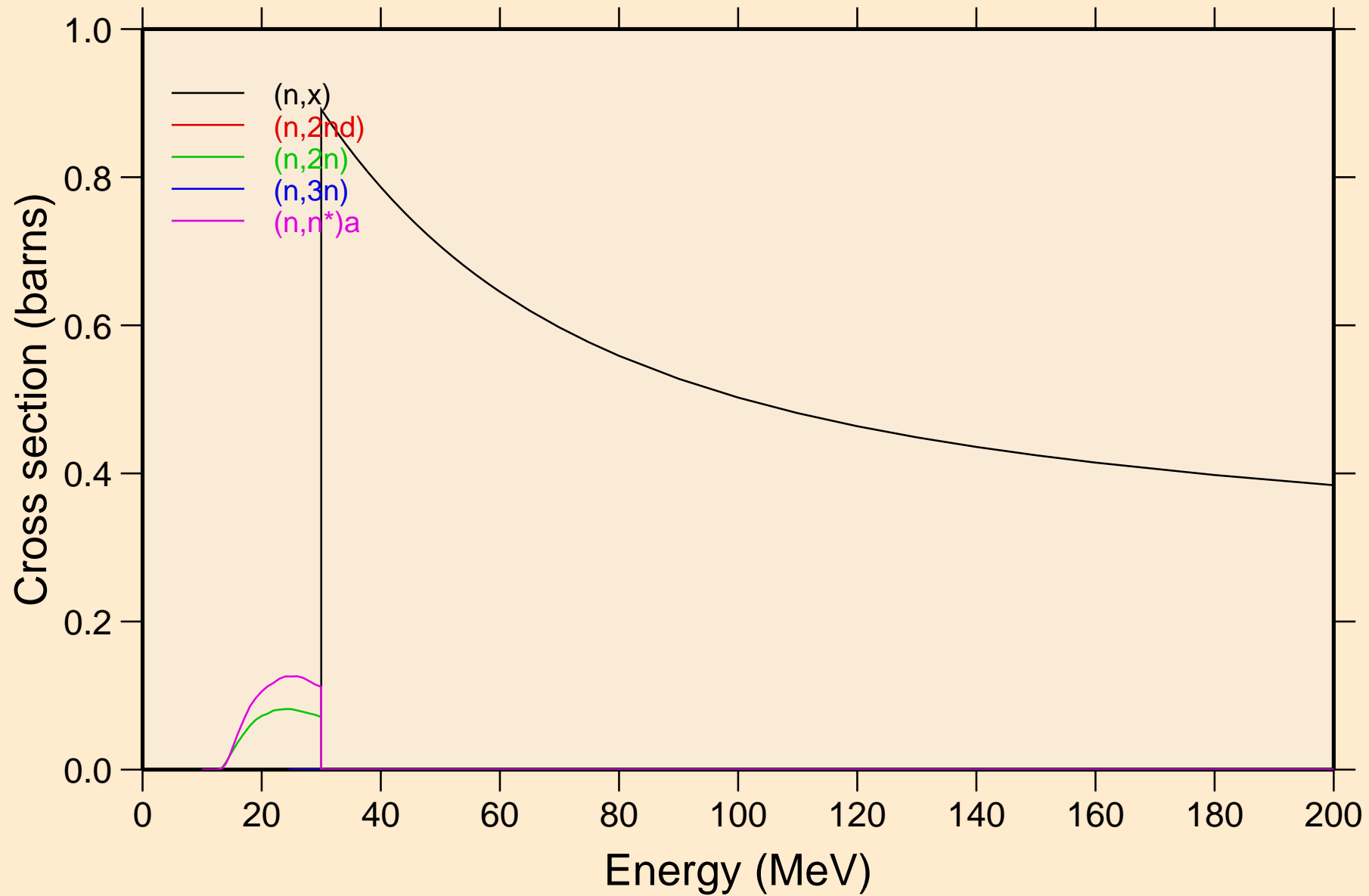

P031 NEUTRON ACER TENDL-2024 LIBRARY; T=293.6K
Threshold reactions

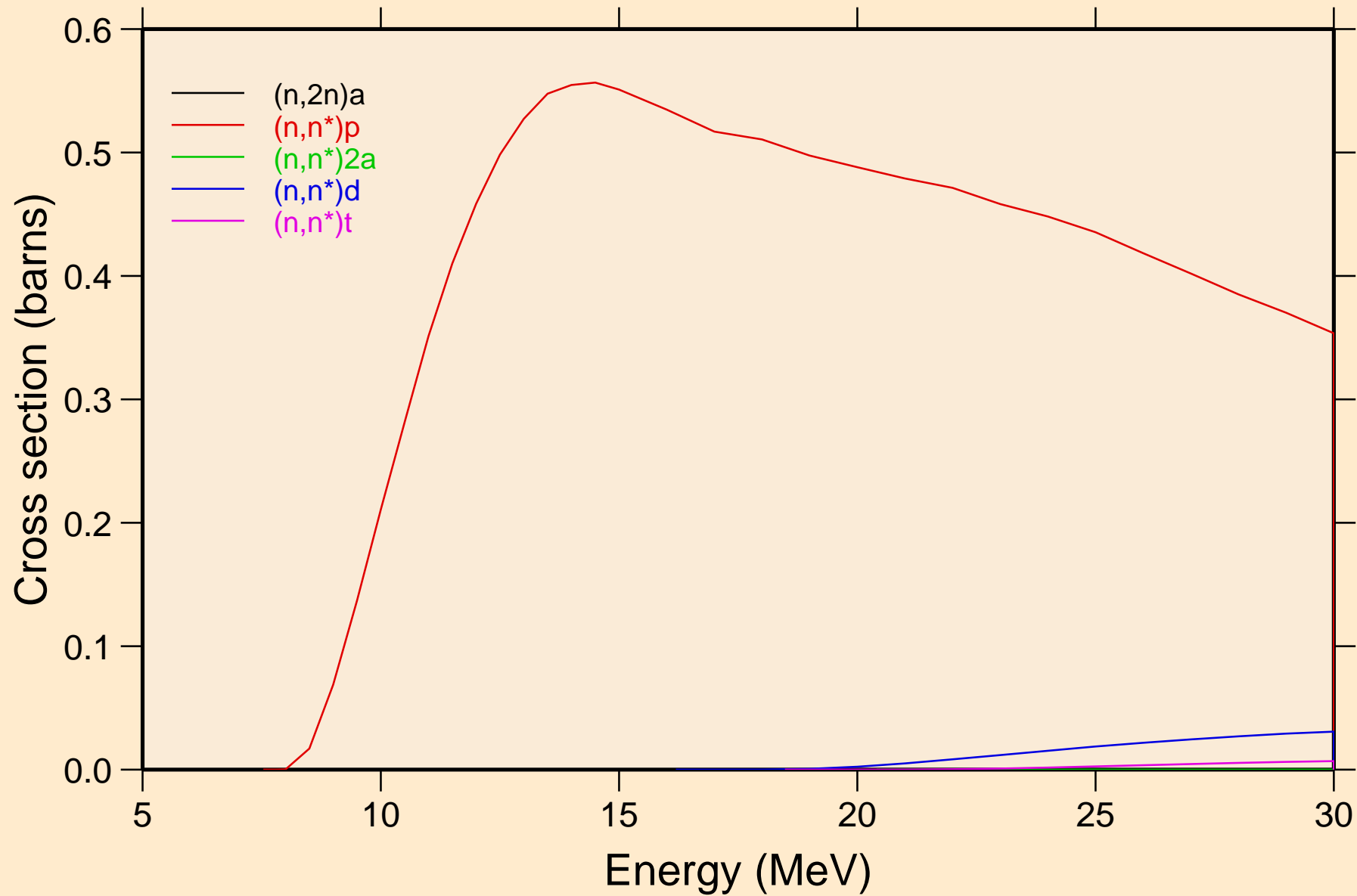

P031 NEUTRON ACER TENDL-2024 LIBRARY; T=293.6K
Threshold reactions

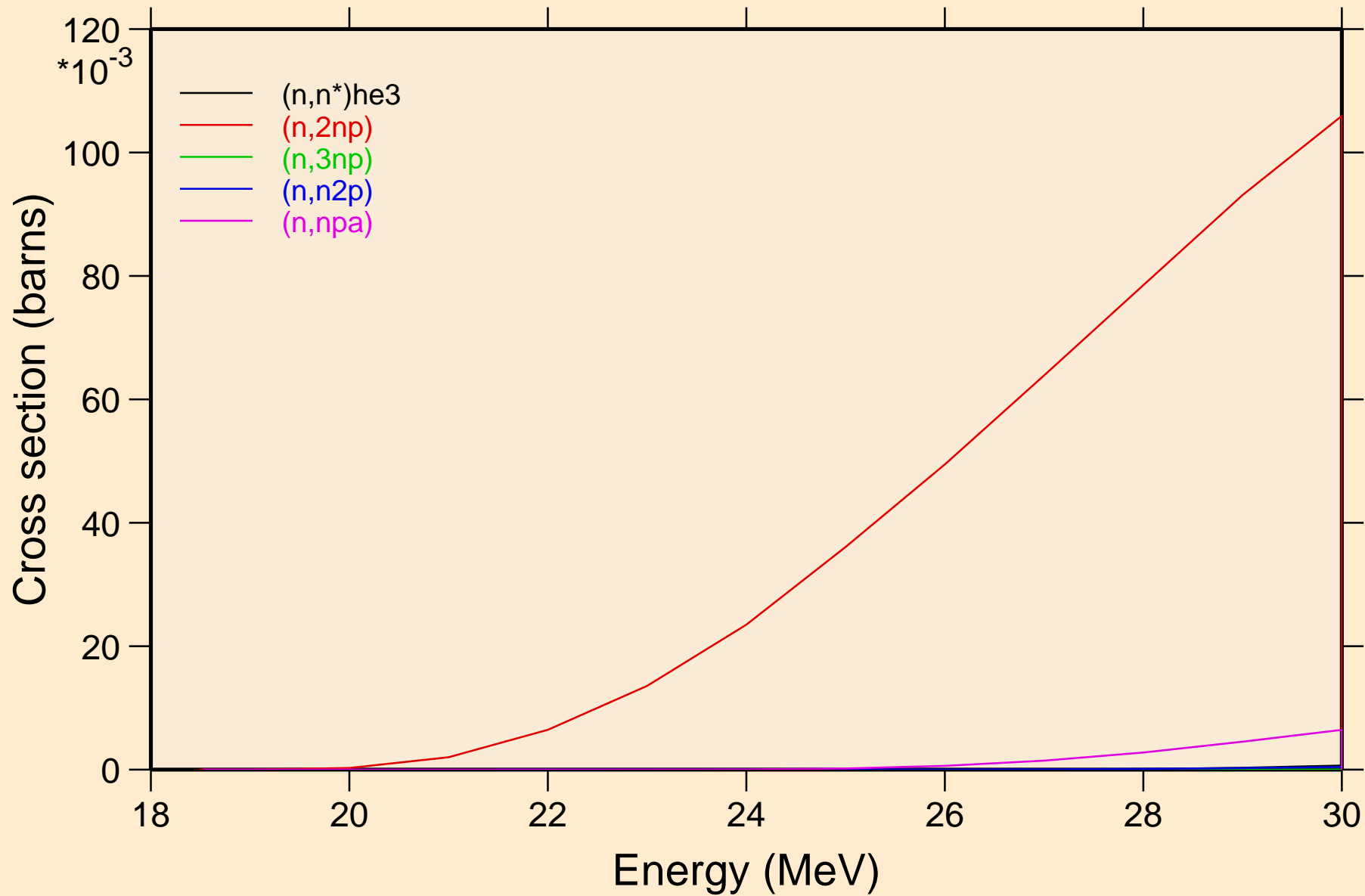

P031 NEUTRON ACER TENDL-2024 LIBRARY; T=293.6K
Threshold reactions

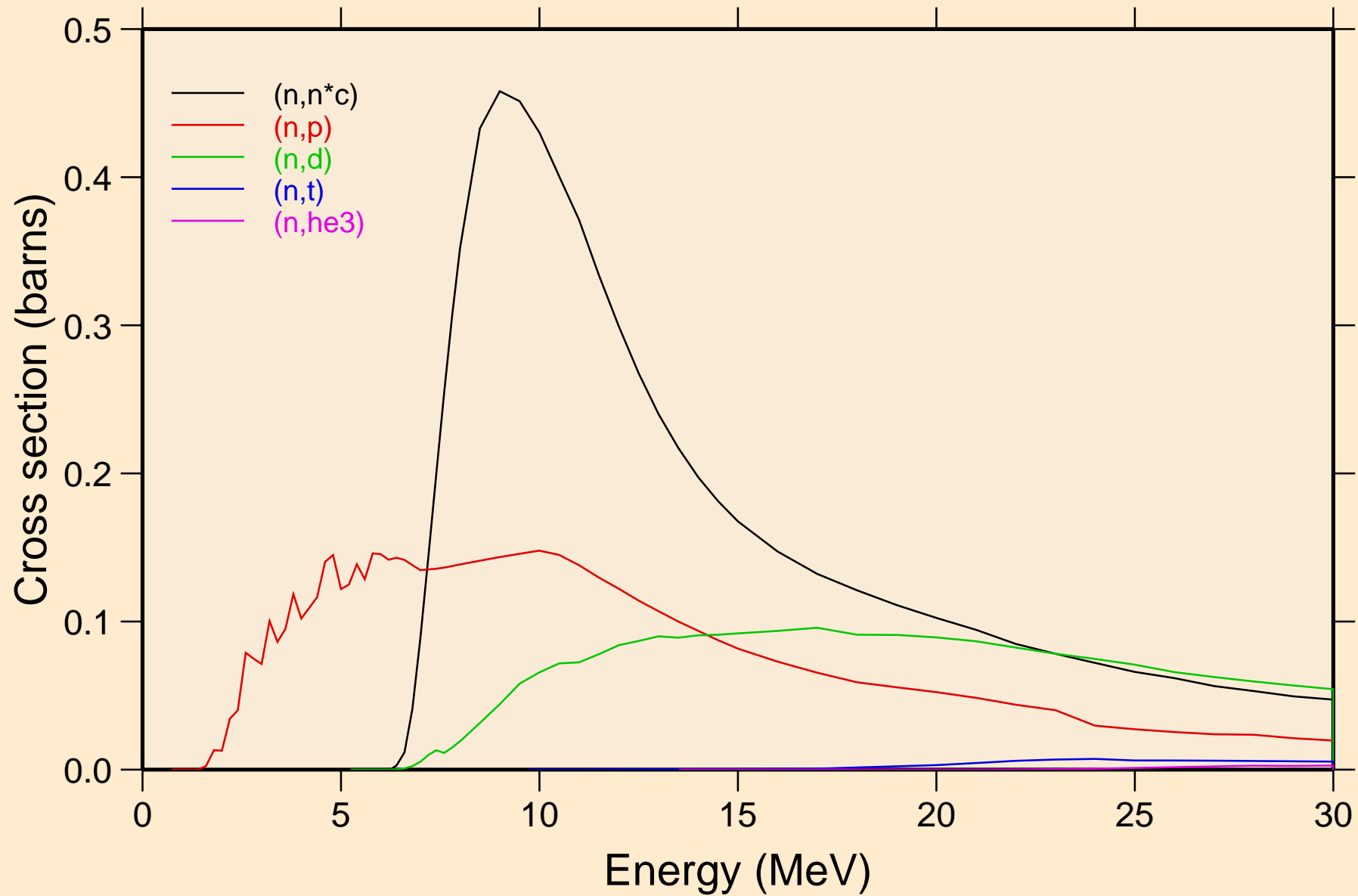

P031 NEUTRON ACER TENDL-2024 LIBRARY; T=293.6K
Threshold reactions

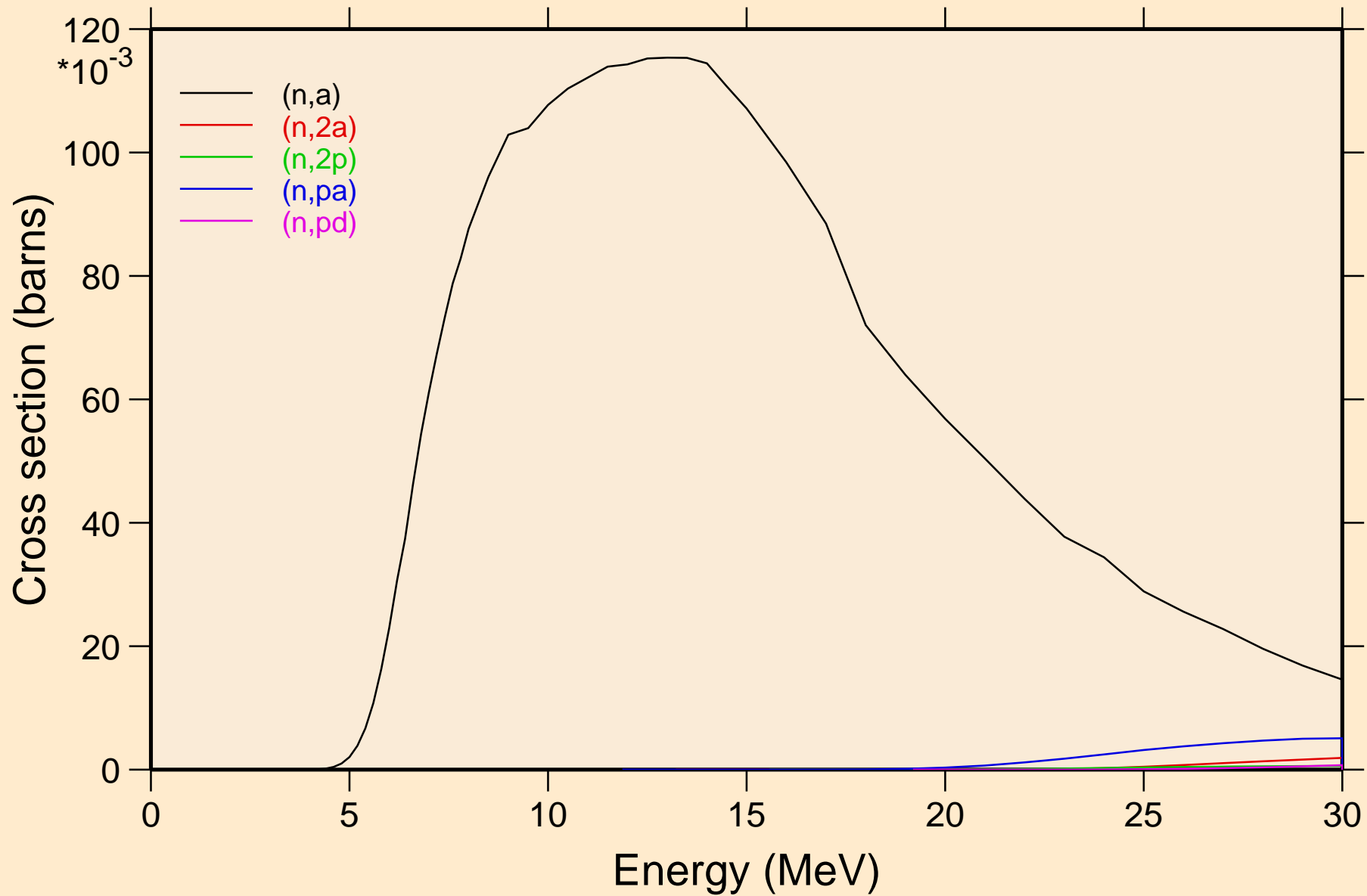

P031 NEUTRON ACER TENDL-2024 LIBRARY; T=293.6K
Threshold reactions

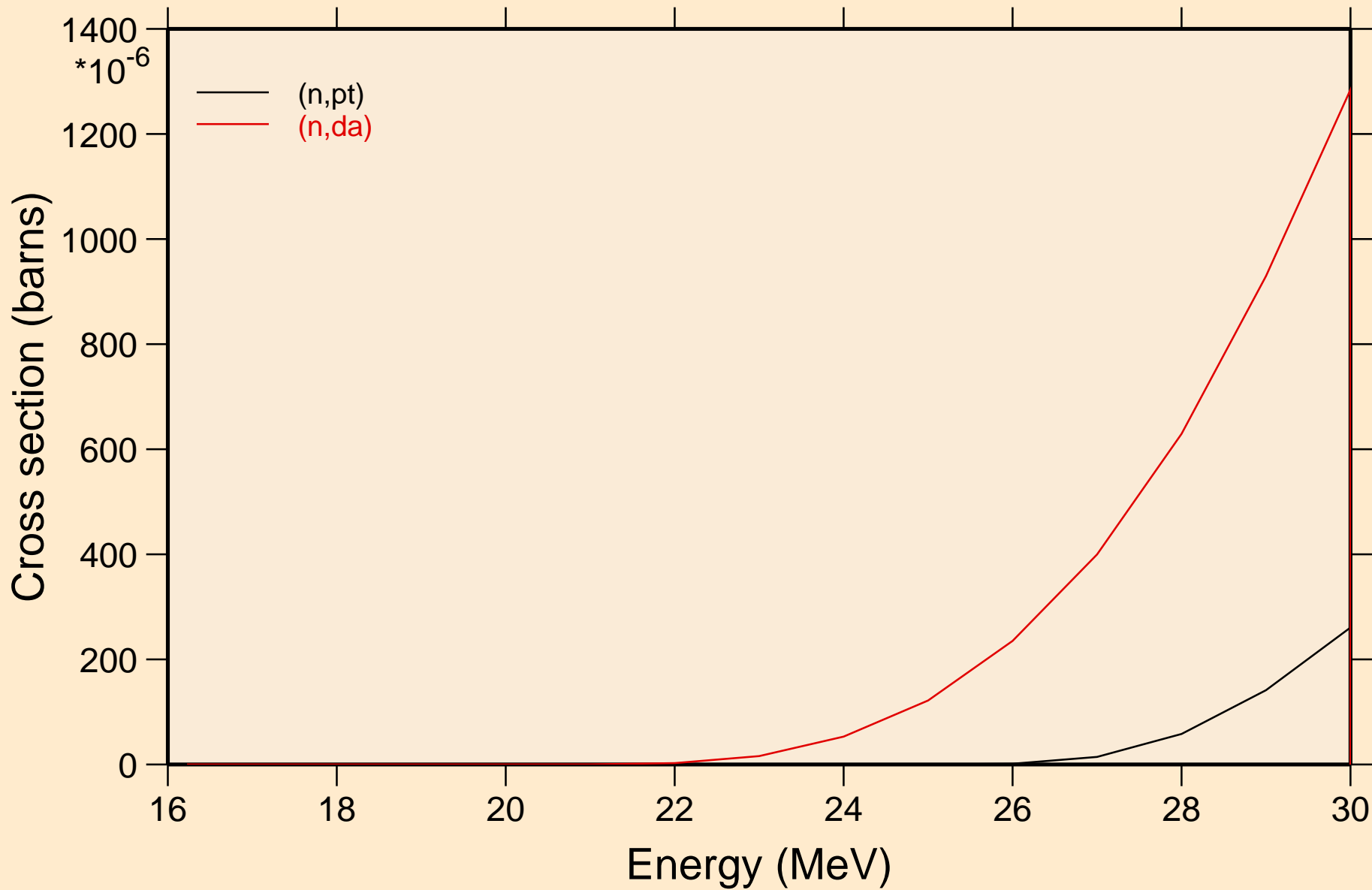

P031 NEUTRON ACER TENDL-2024 LIBRARY; T=293.6K
Threshold reactions

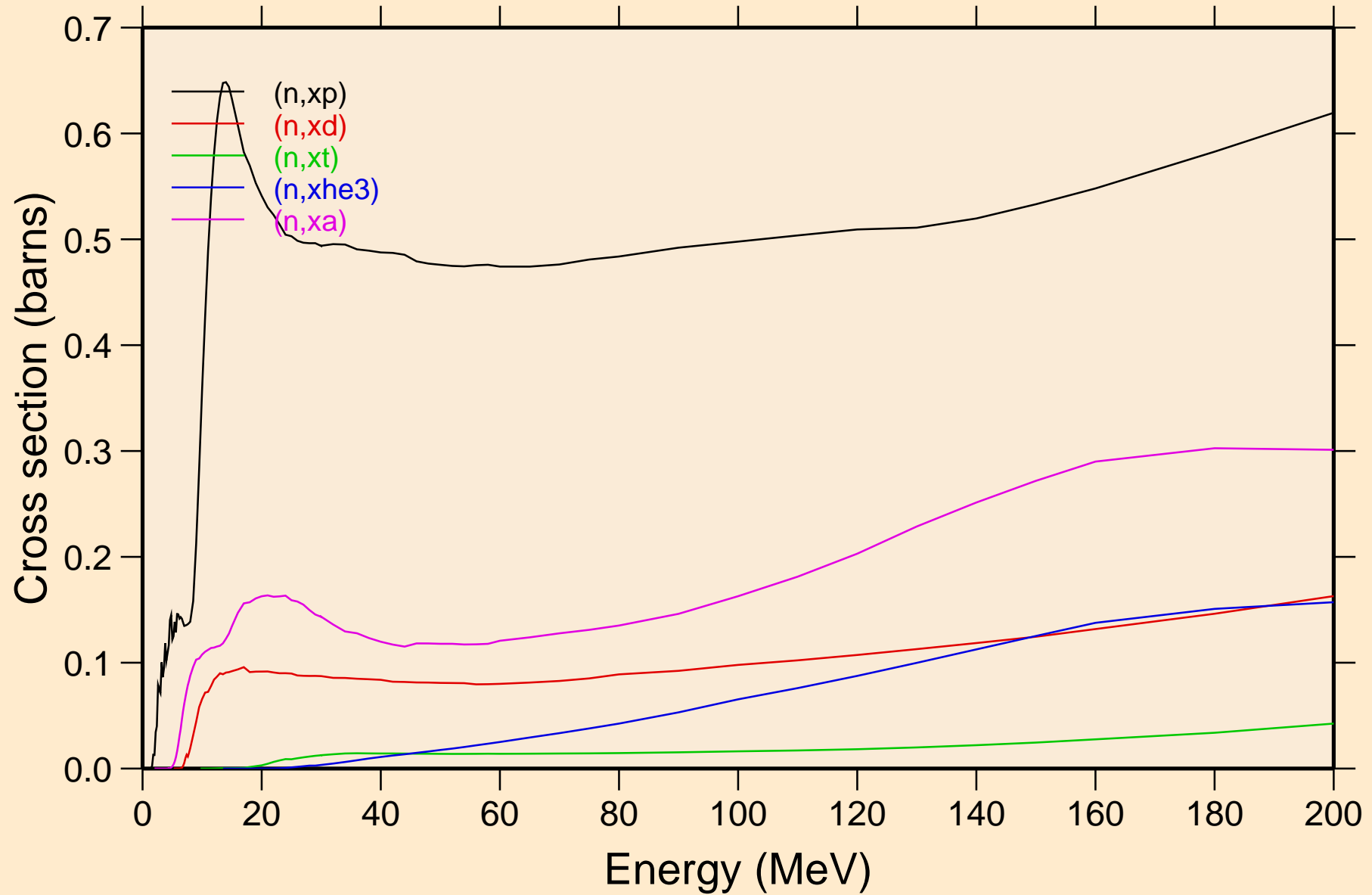

P031 NEUTRON ACER TENDL-2024 LIBRARY; T=293.6K
angular distribution for elastic

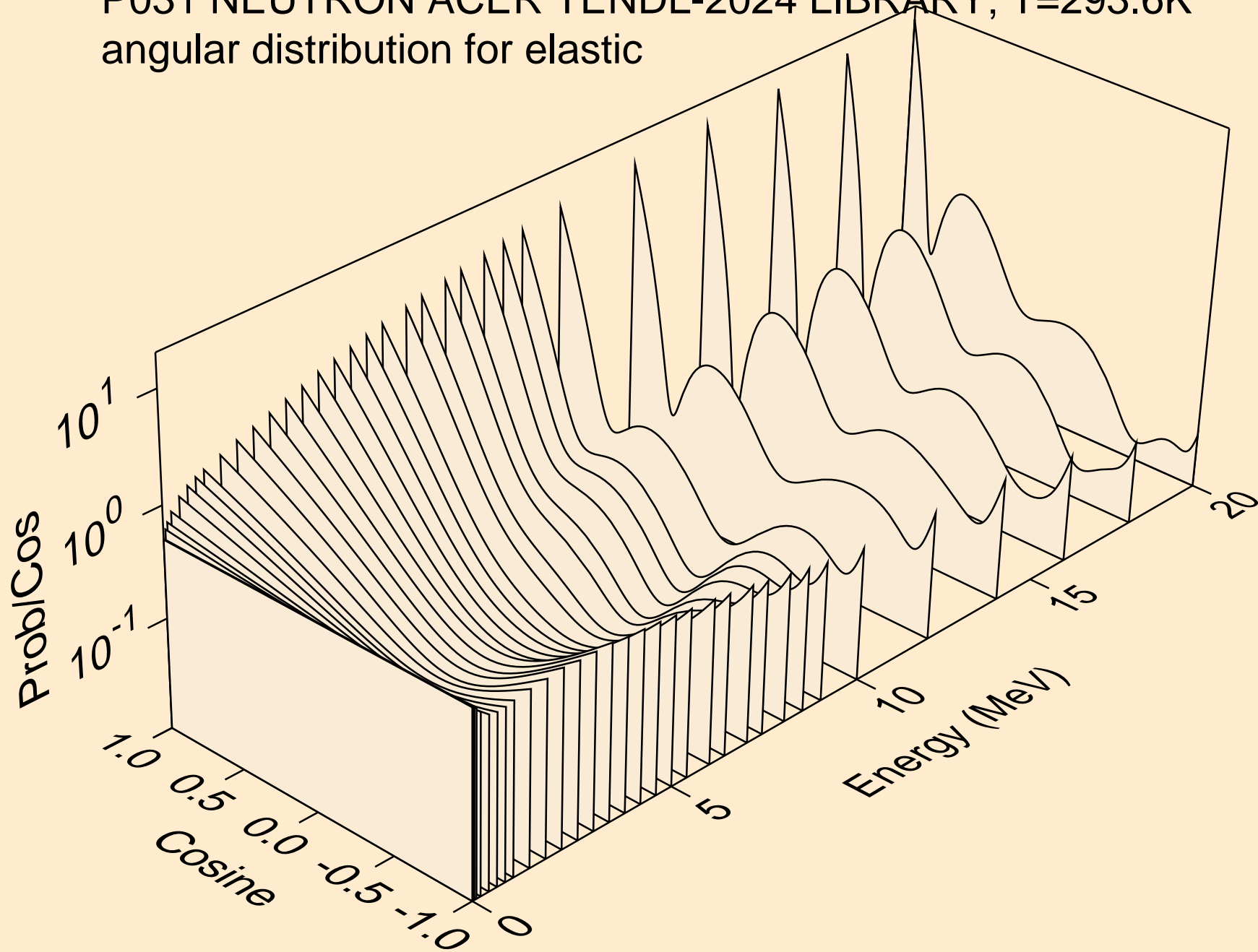

P031 NEUTRON ACER TENDL-2024 LIBRARY; T=293.6K
angular distribution for elastic

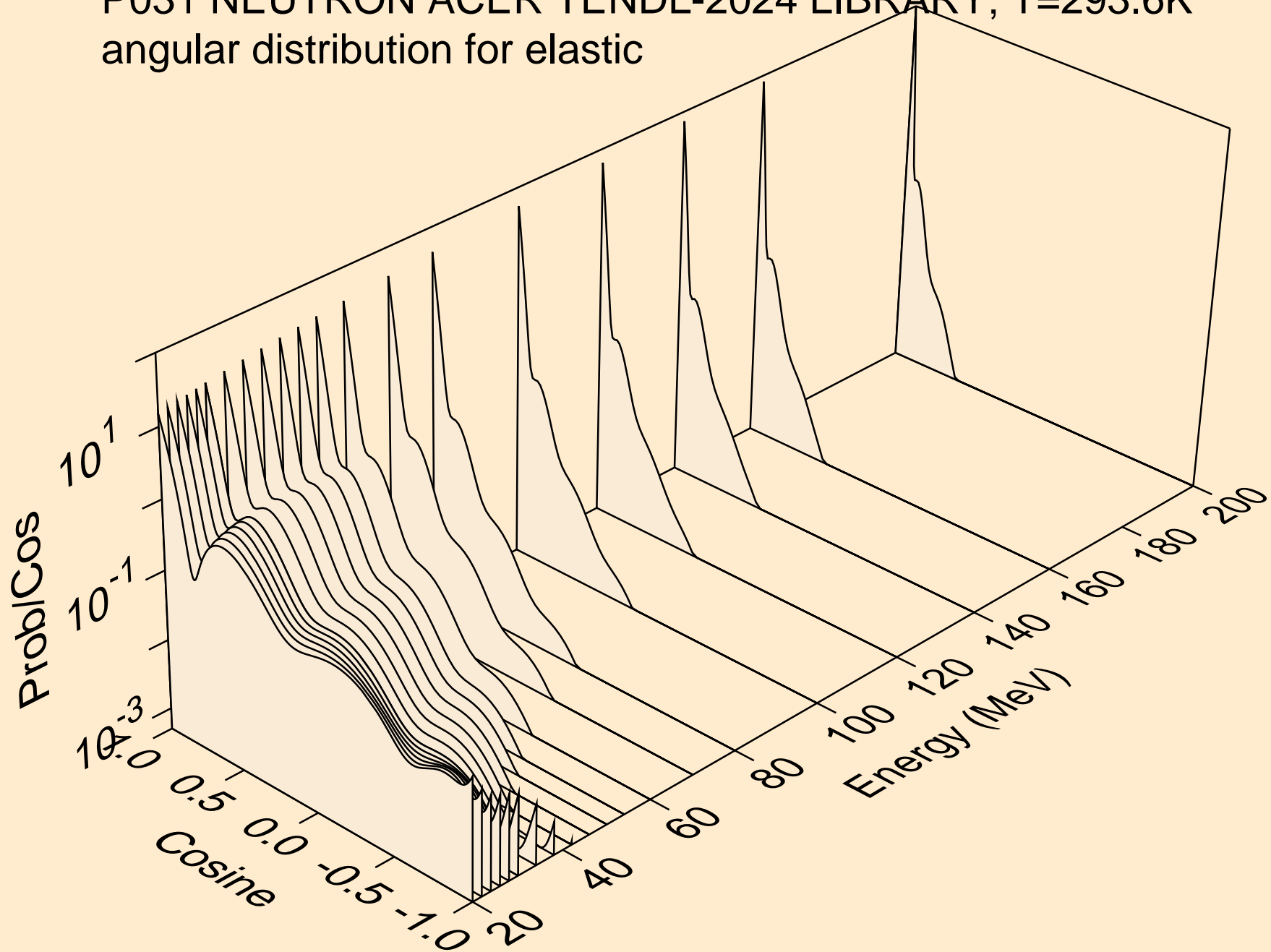

P031 NEUTRON ACER TENDL-2024 LIBRARY; T=293.6K
angular distribution for (n,n*1)

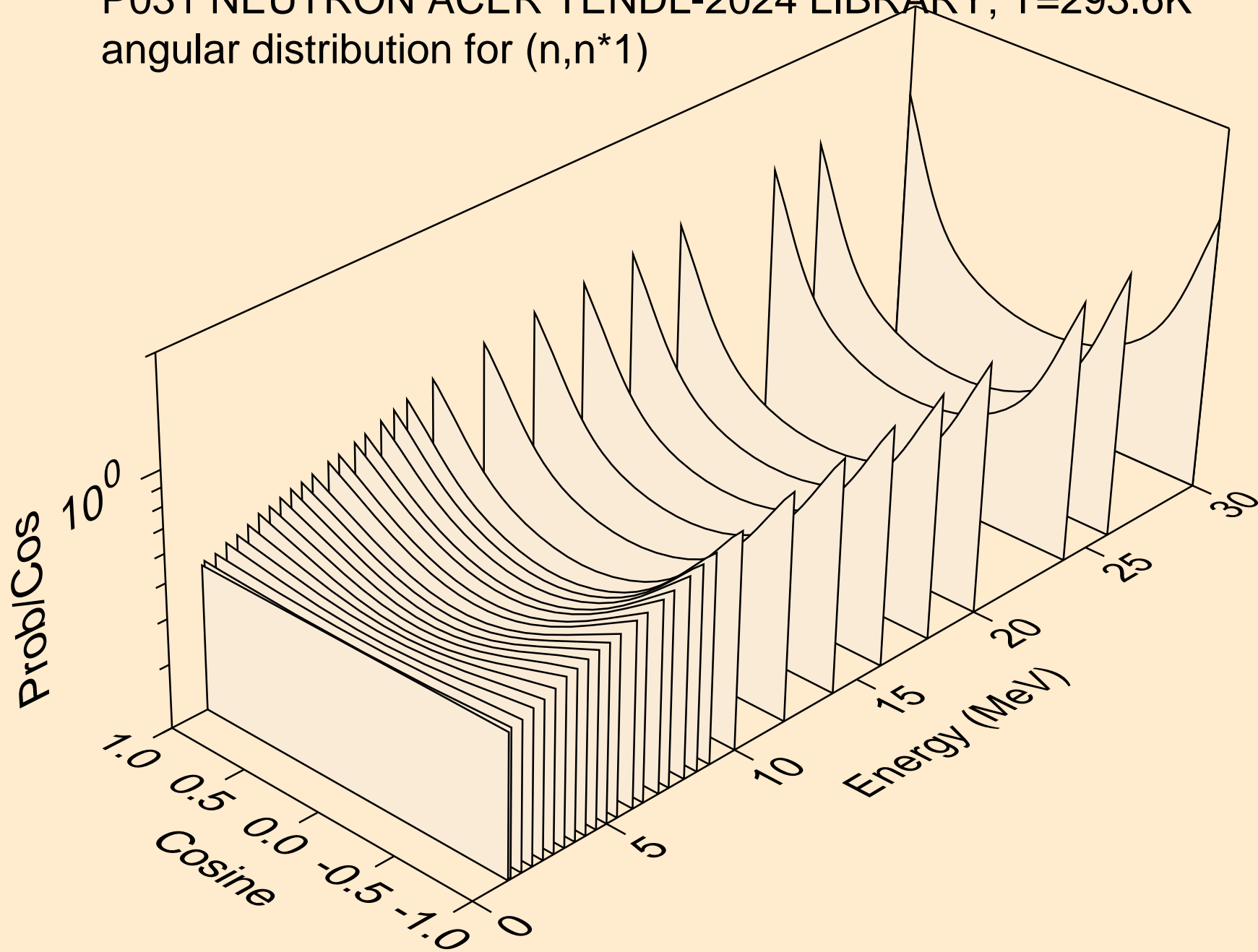

P031 NEUTRON ACER TENDL-2024 LIBRARY; T=293.6K
angular distribution for (n,n*2)

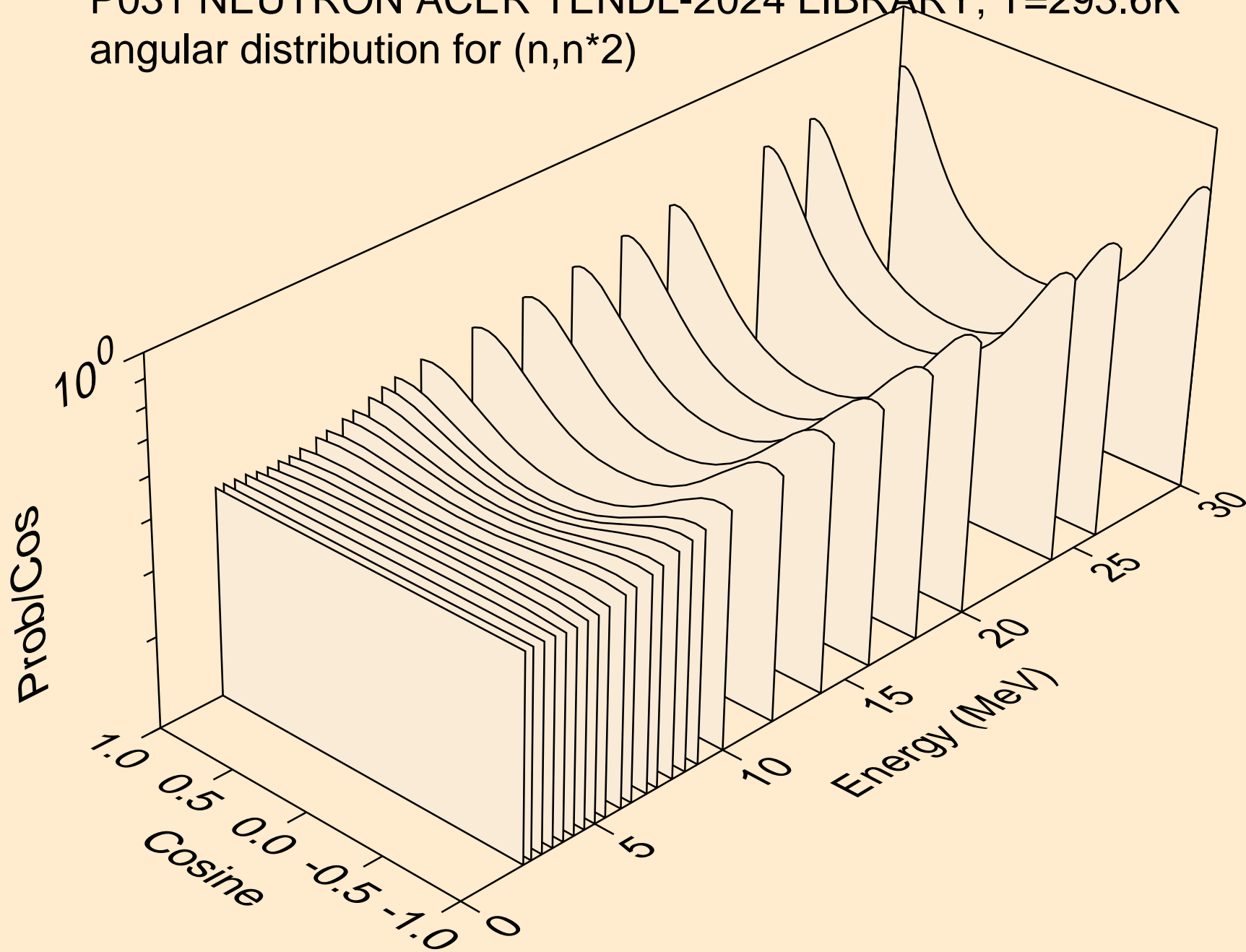

P031 NEUTRON ACER TENDL-2024 LIBRARY; T=293.6K
angular distribution for (n,n*3)

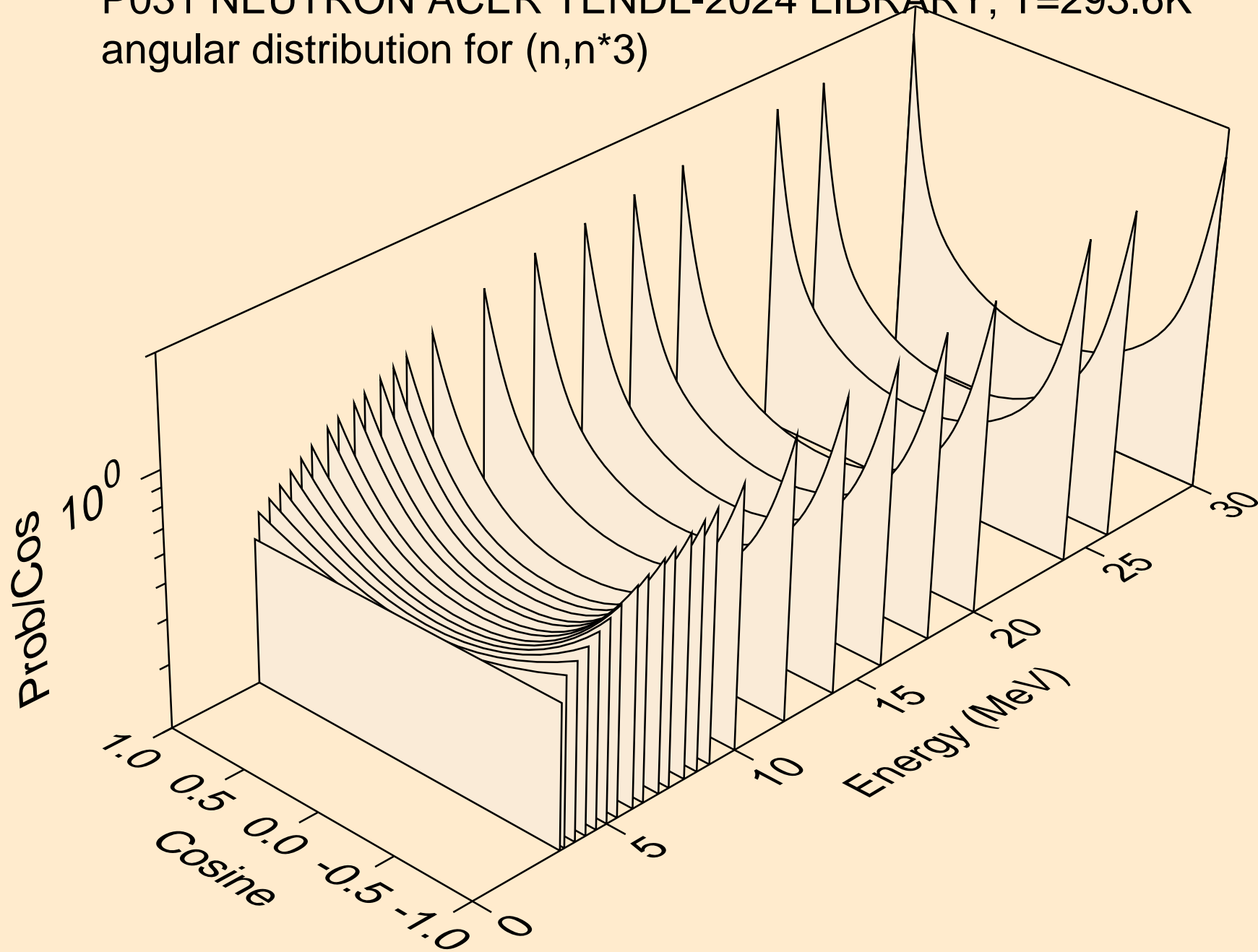

P031 NEUTRON ACER TENDL-2024 LIBRARY; T=293.6K
angular distribution for (n,n*4)

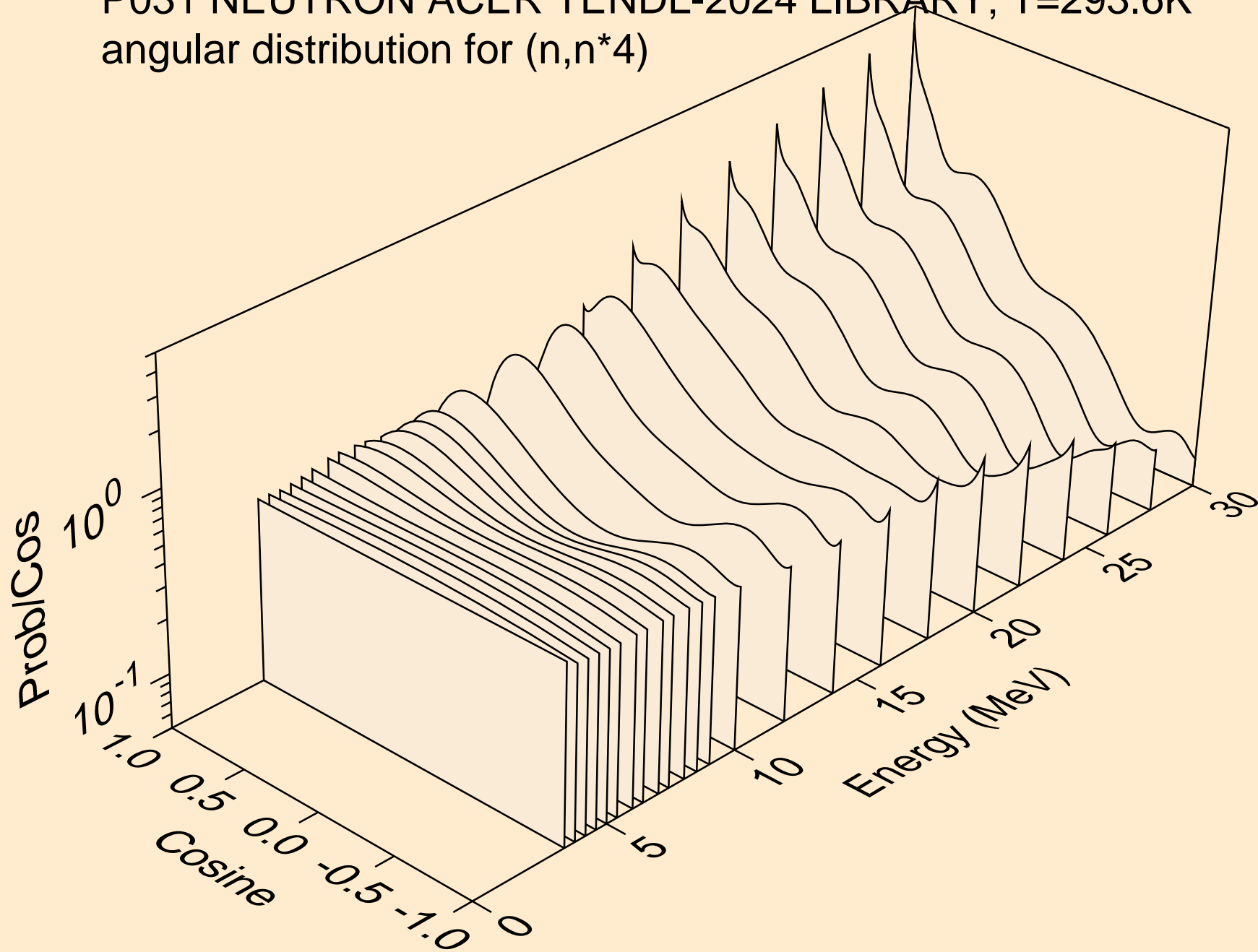

P031 NEUTRON ACER TENDL-2024 LIBRARY; T=293.6K
angular distribution for (n,n*5)

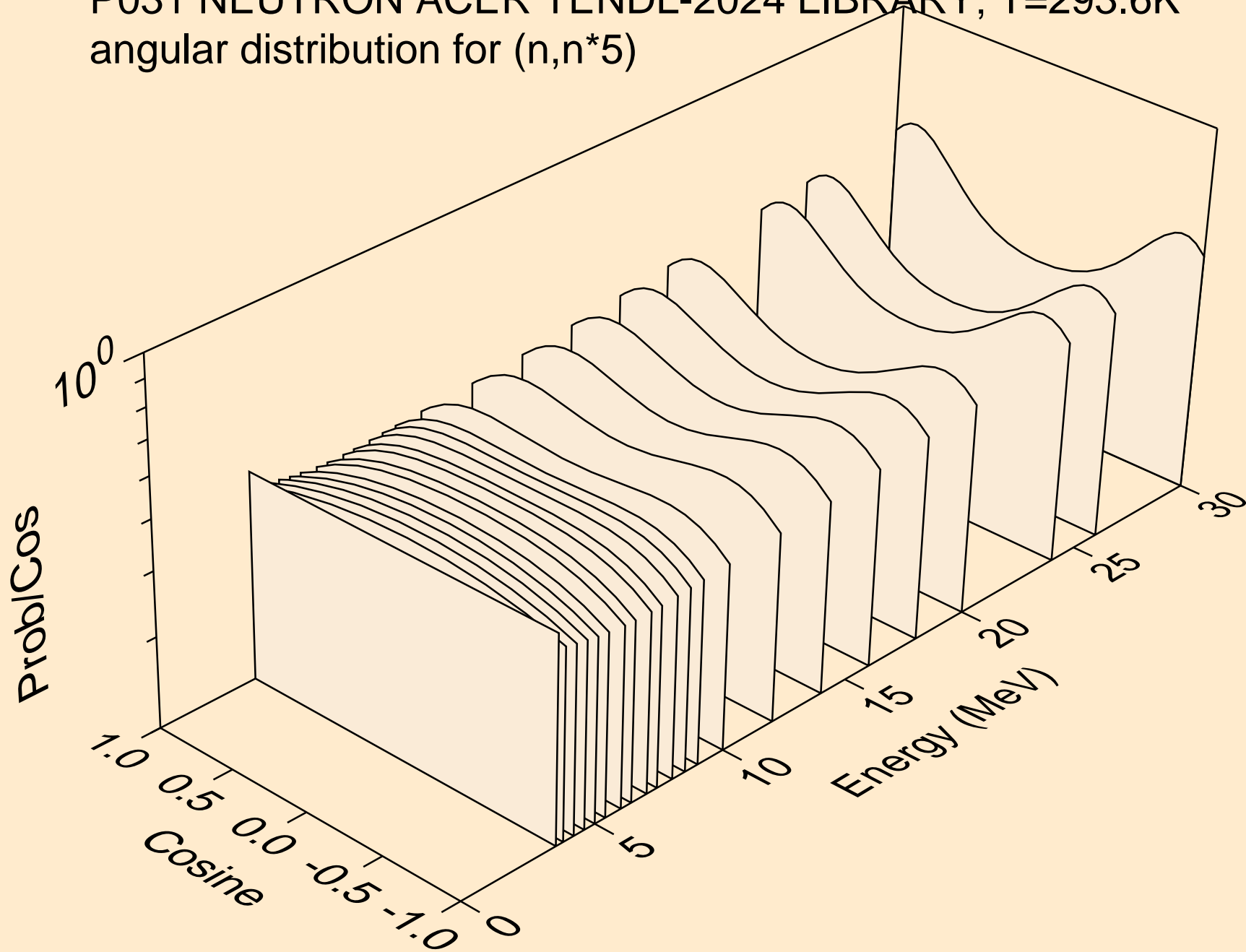

P031 NEUTRON ACER TENDL-2024 LIBRARY; T=293.6K
angular distribution for (n,n*6)

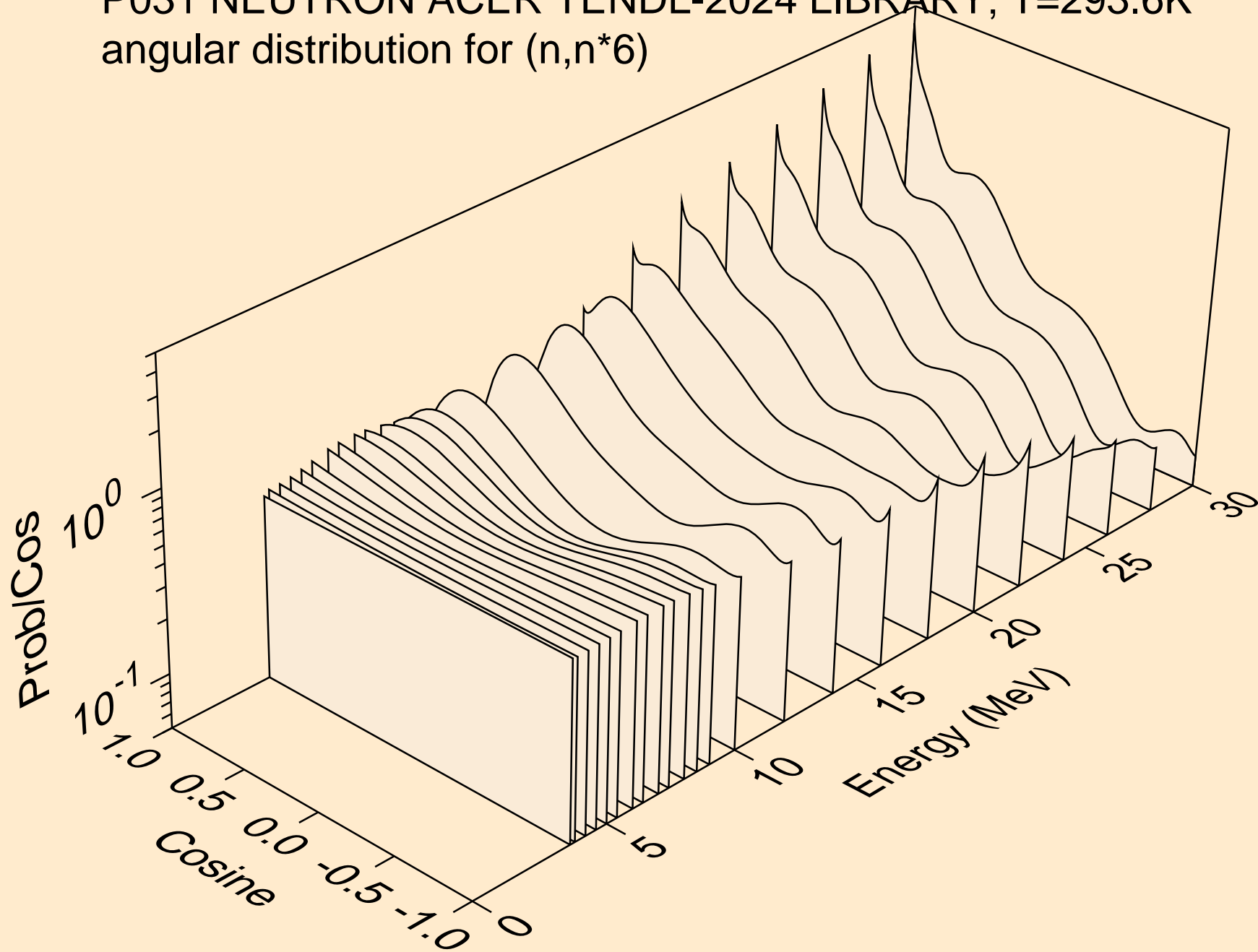

P031 NEUTRON ACER TENDL-2024 LIBRARY; T=293.6K
angular distribution for (n,n*7)

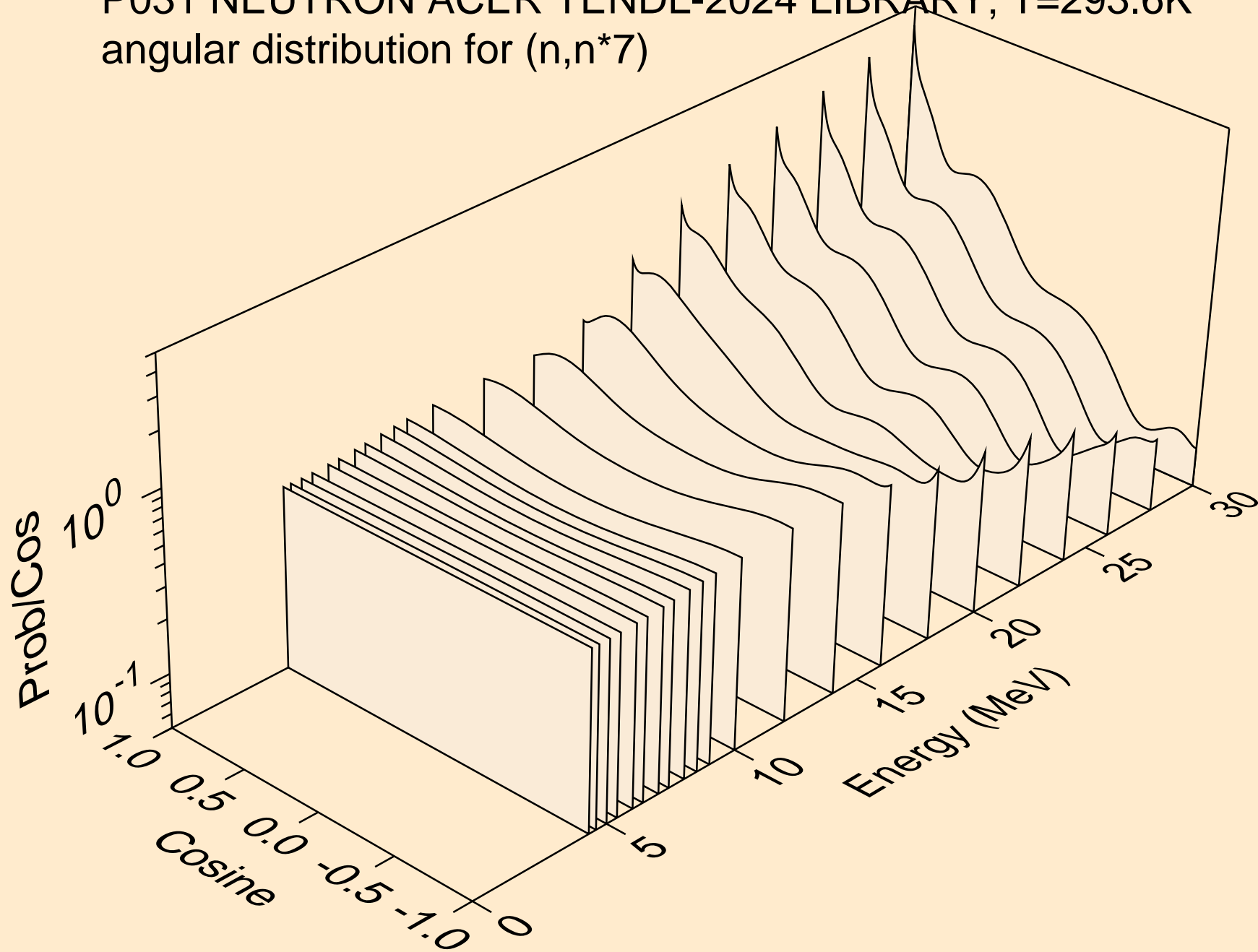

P031 NEUTRON ACER TENDL-2024 LIBRARY; T=293.6K
angular distribution for (n,n*8)

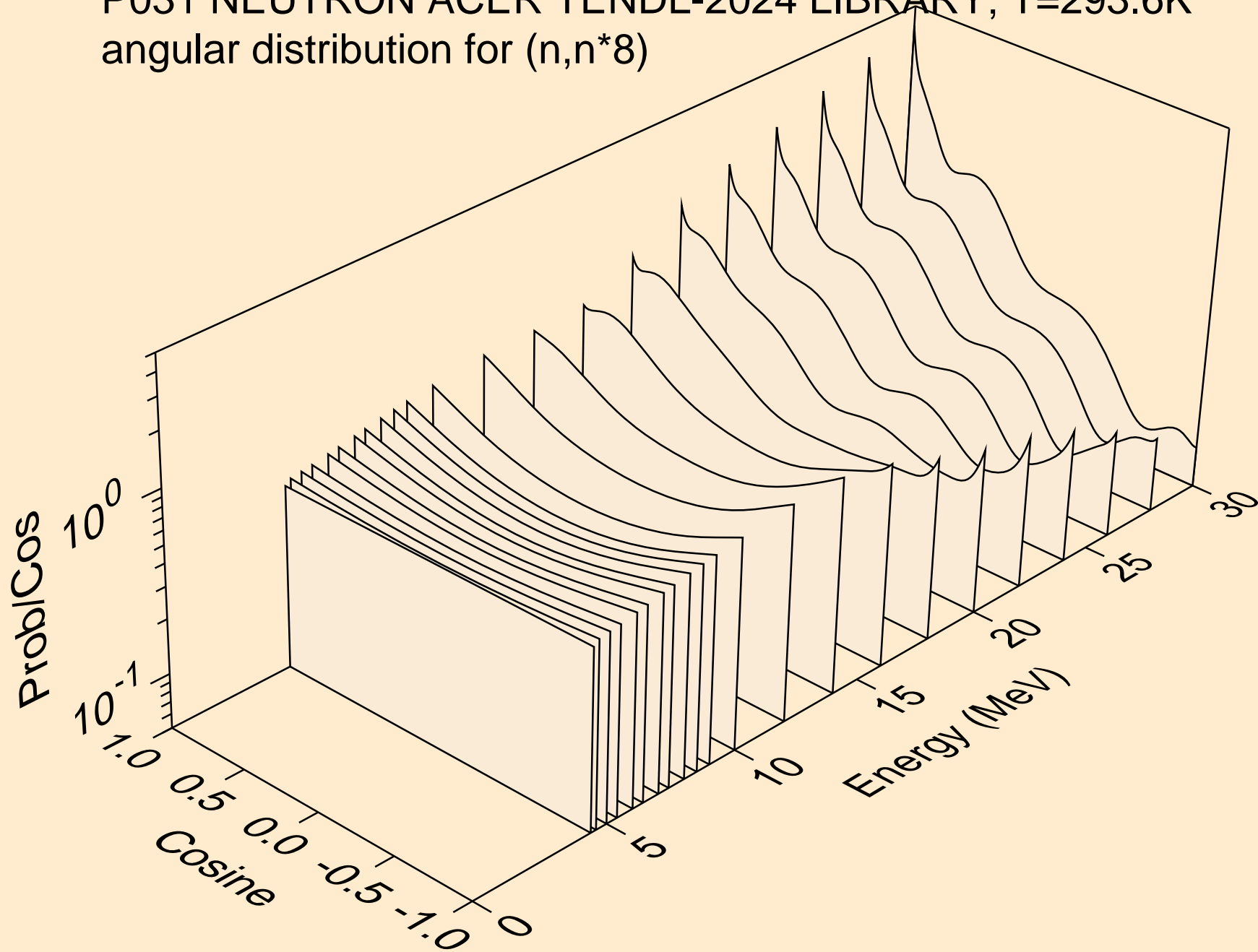

P031 NEUTRON ACER TENDL-2024 LIBRARY; T=293.6K
angular distribution for (n,n*9)

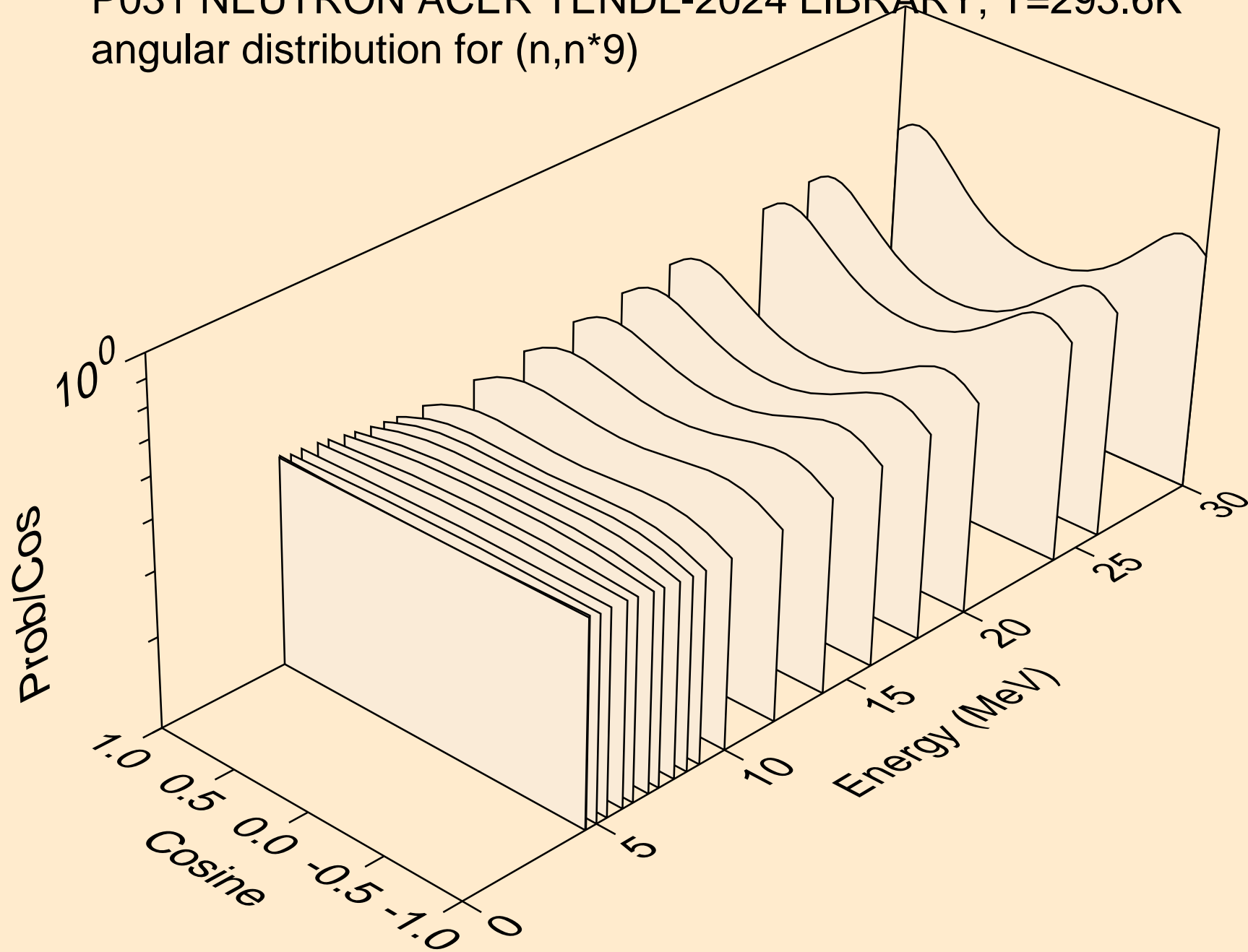

P031 NEUTRON ACER TENDL-2024 LIBRARY; T=293.6K
angular distribution for (n,n*10)

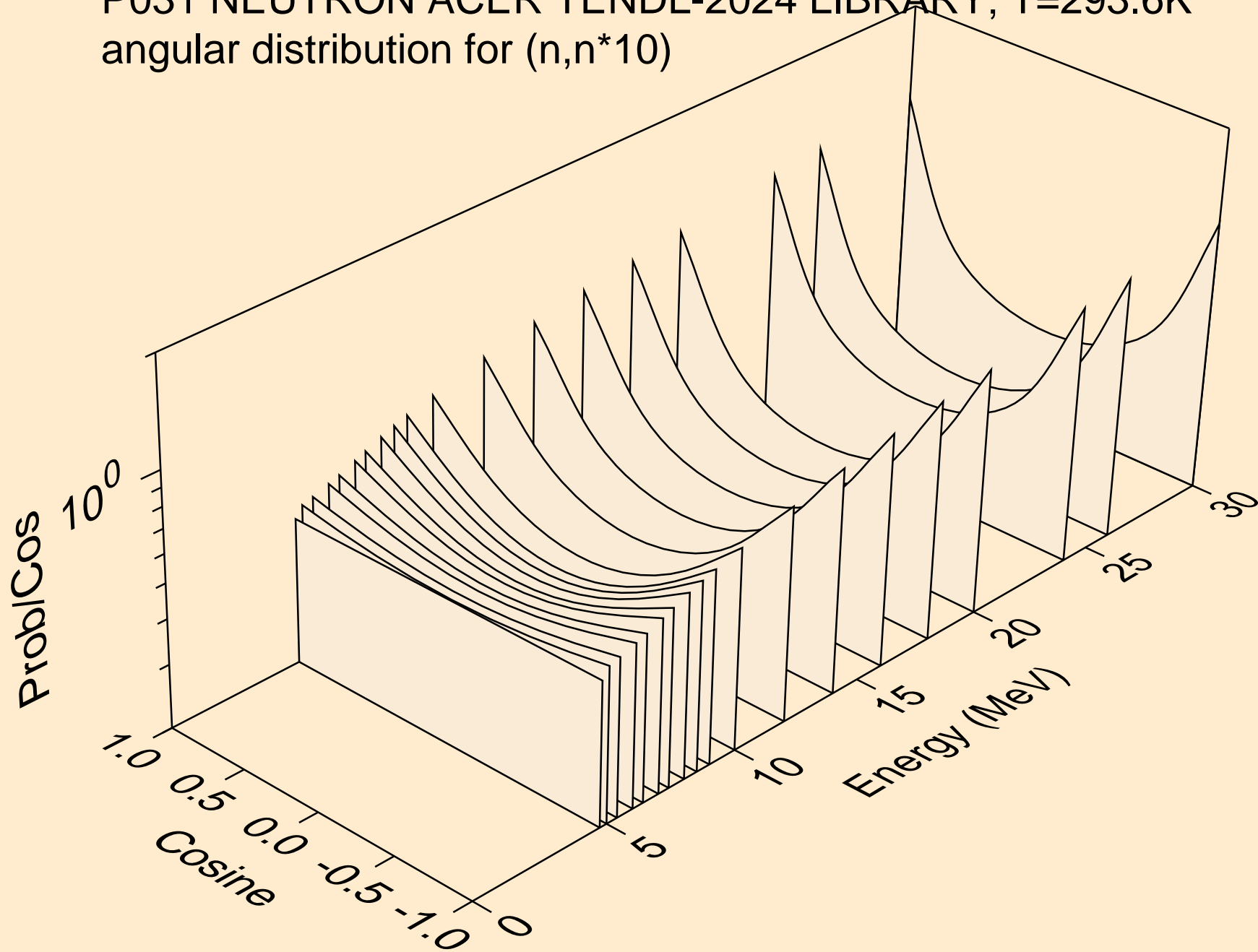

P031 NEUTRON ACER TENDL-2024 LIBRARY; T=293.6K
angular distribution for (n,n*11)

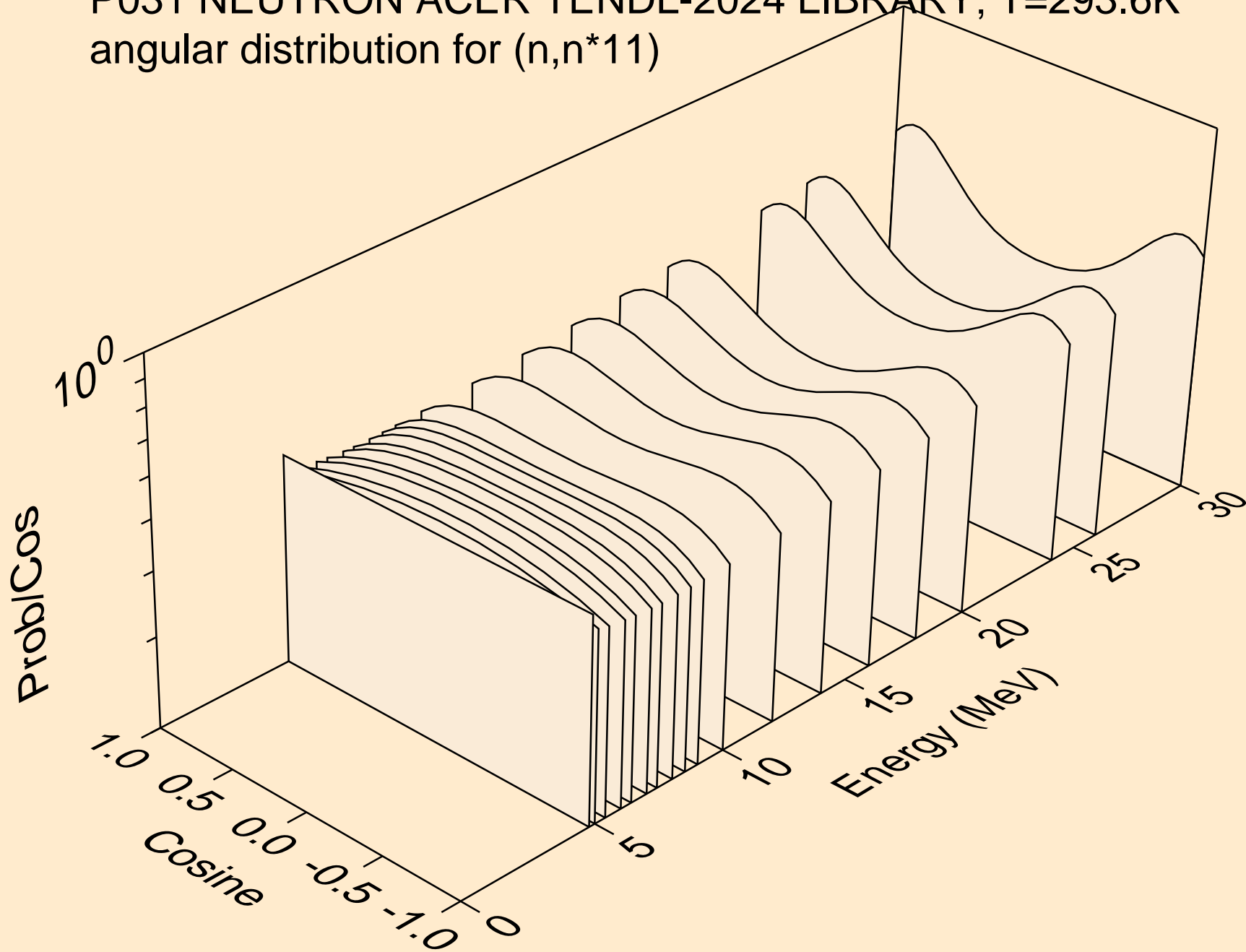

P031 NEUTRON ACER TENDL-2024 LIBRARY; T=293.6K
angular distribution for (n,n*12)

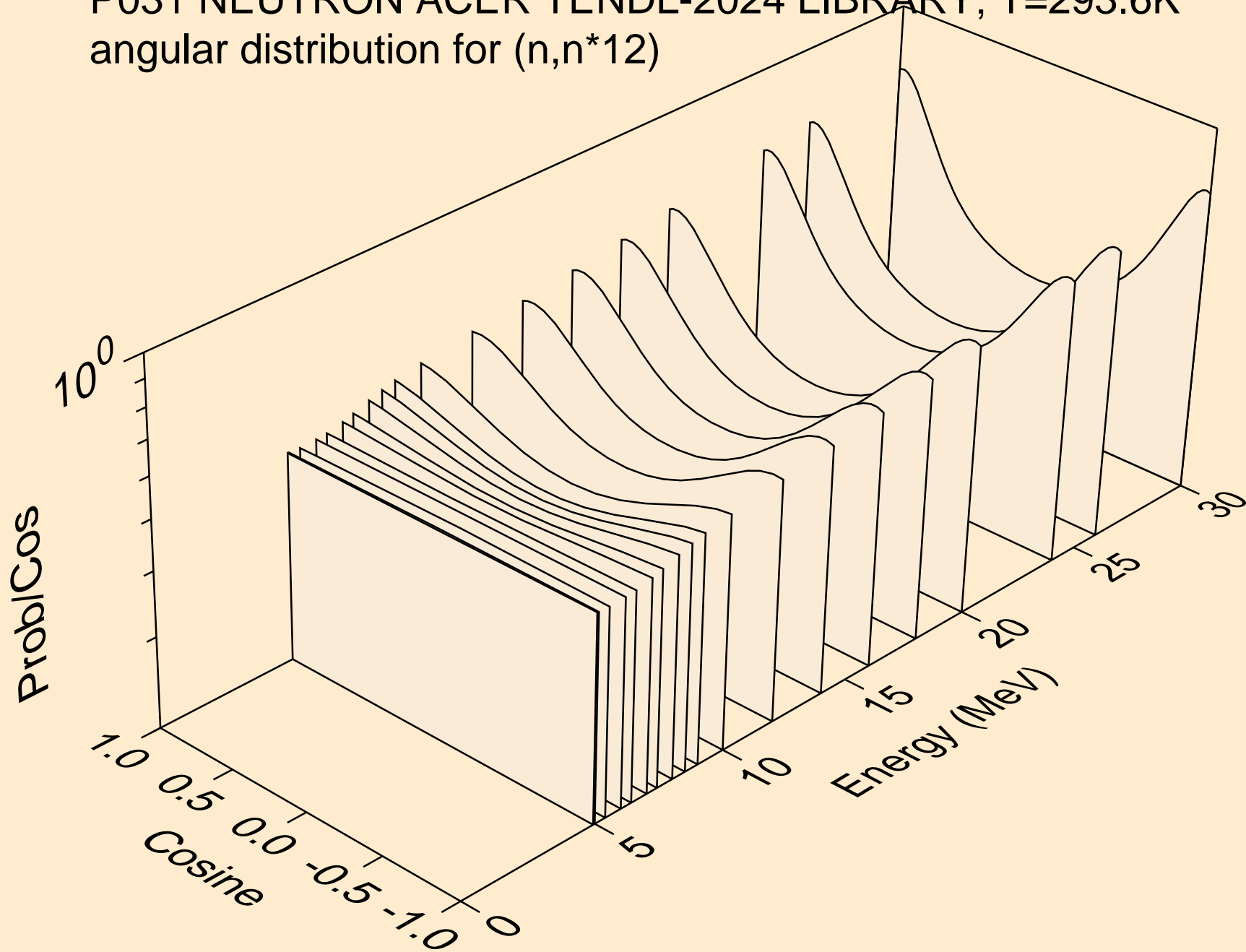

P031 NEUTRON ACER TENDL-2024 LIBRARY; T=293.6K
angular distribution for (n,n*13)

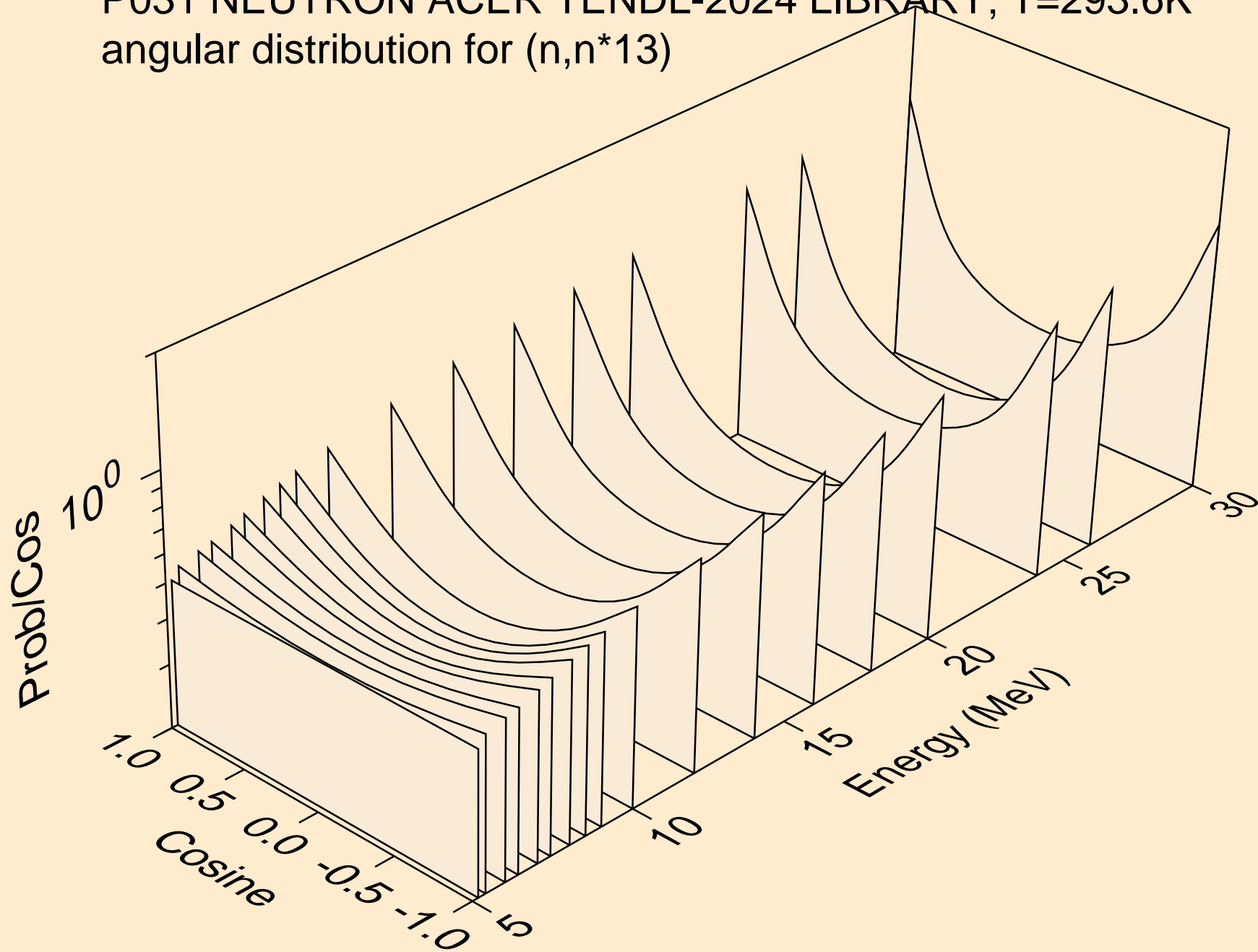

P031 NEUTRON ACER TENDL-2024 LIBRARY; T=293.6K
angular distribution for (n,n*14)

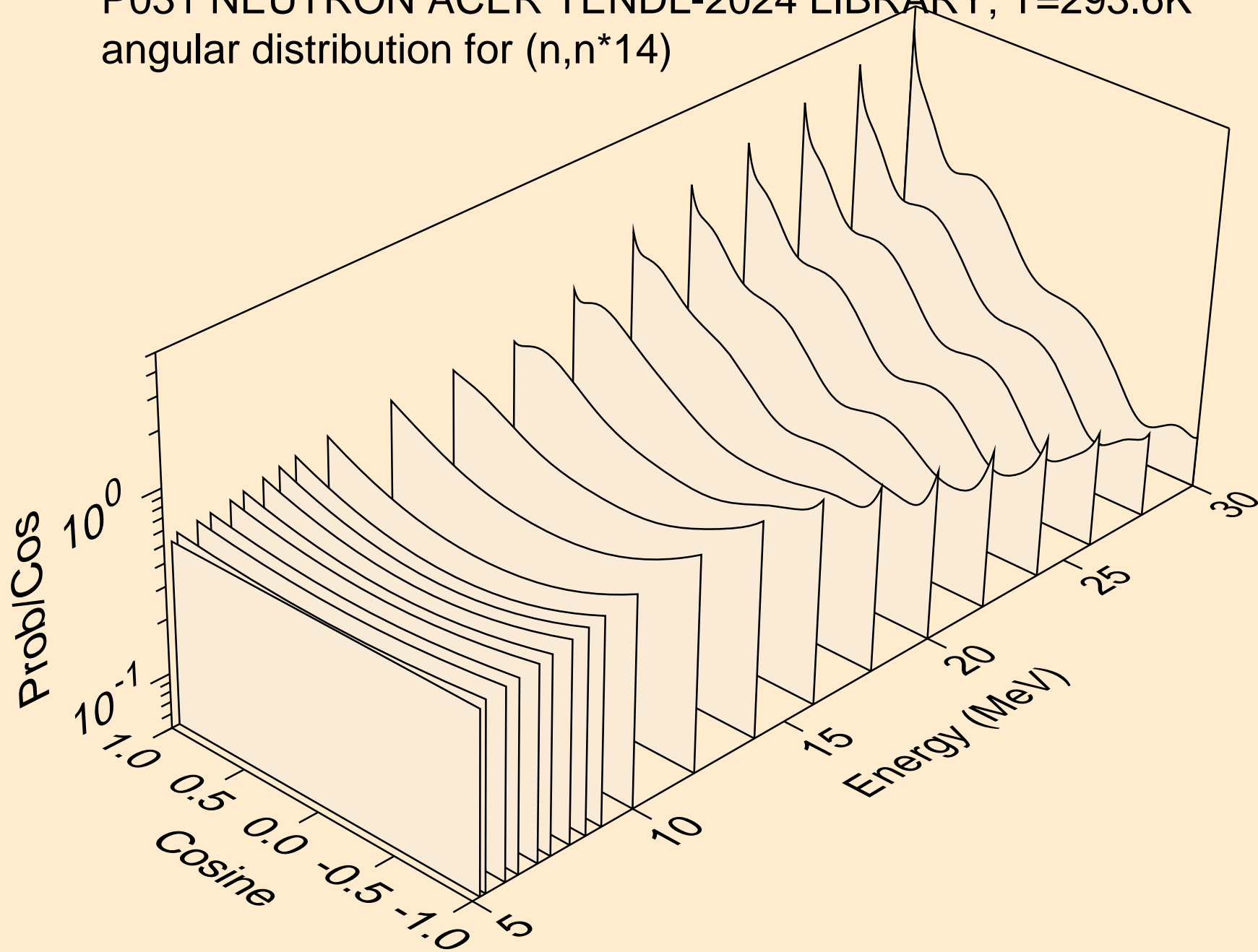

P031 NEUTRON ACER TENDL-2024 LIBRARY; T=293.6K
angular distribution for (n,n*15)

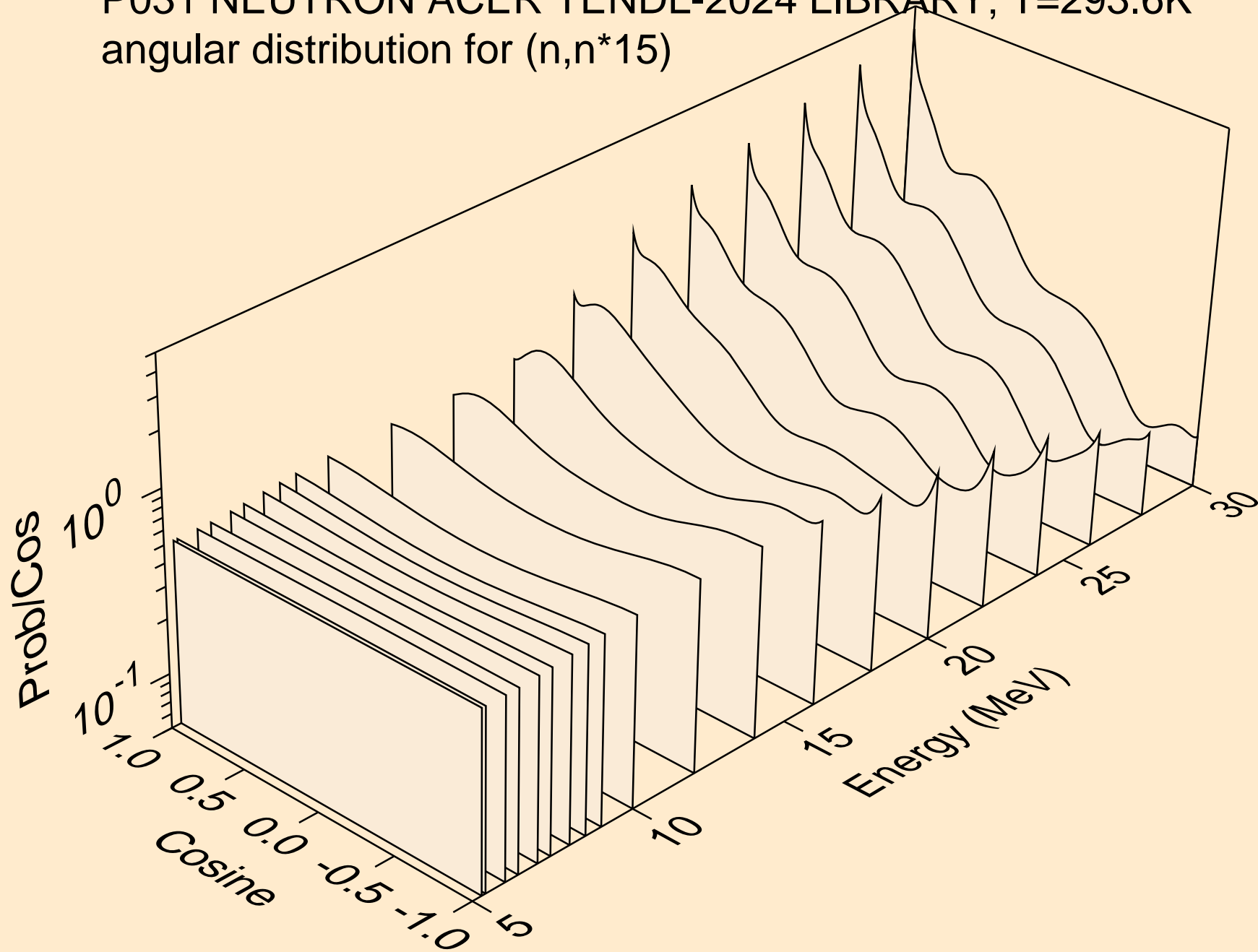

P031 NEUTRON ACER TENDL-2024 LIBRARY; T=293.6K
angular distribution for (n,n*16)

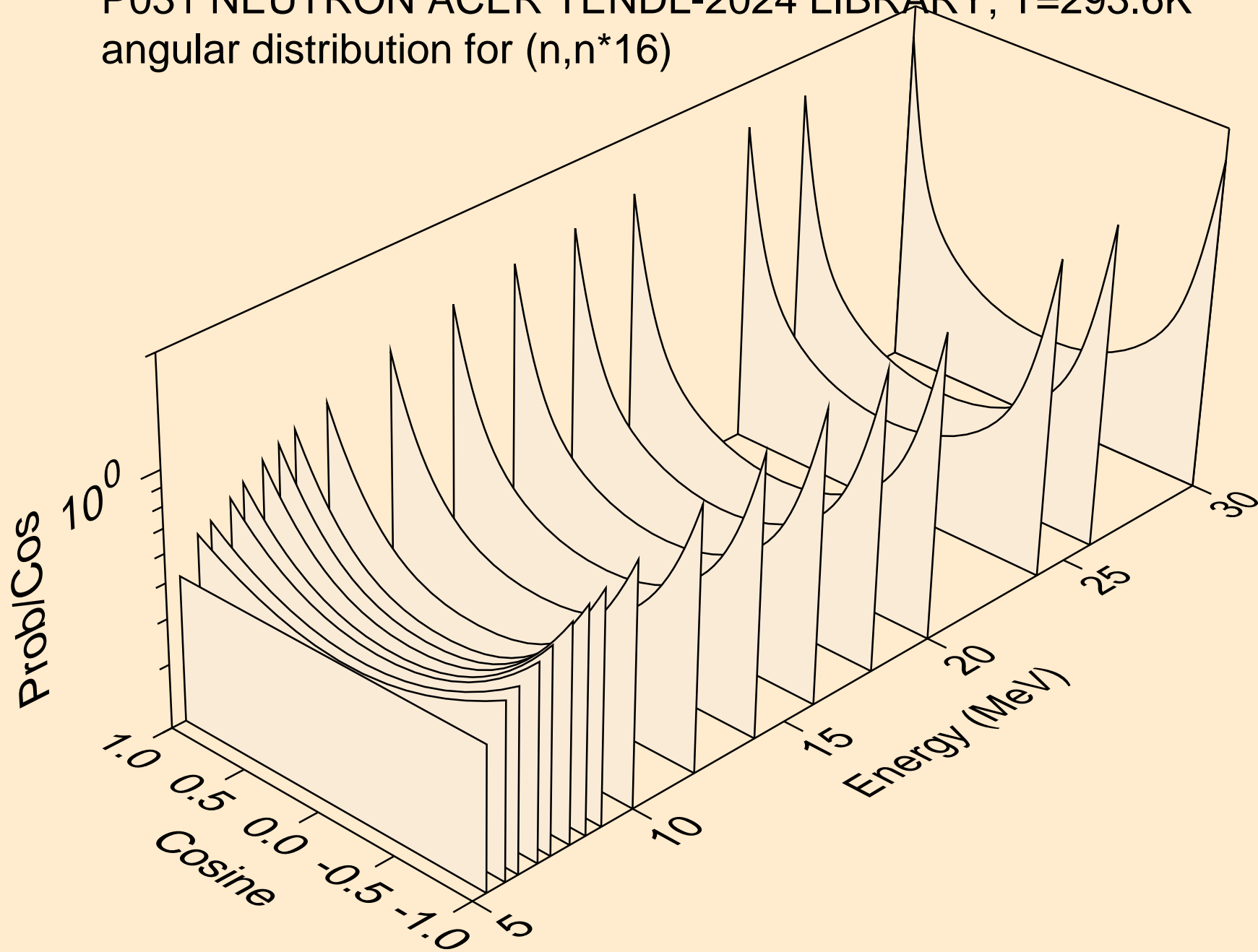

P031 NEUTRON ACER TENDL-2024 LIBRARY; T=293.6K
angular distribution for (n,n*17)

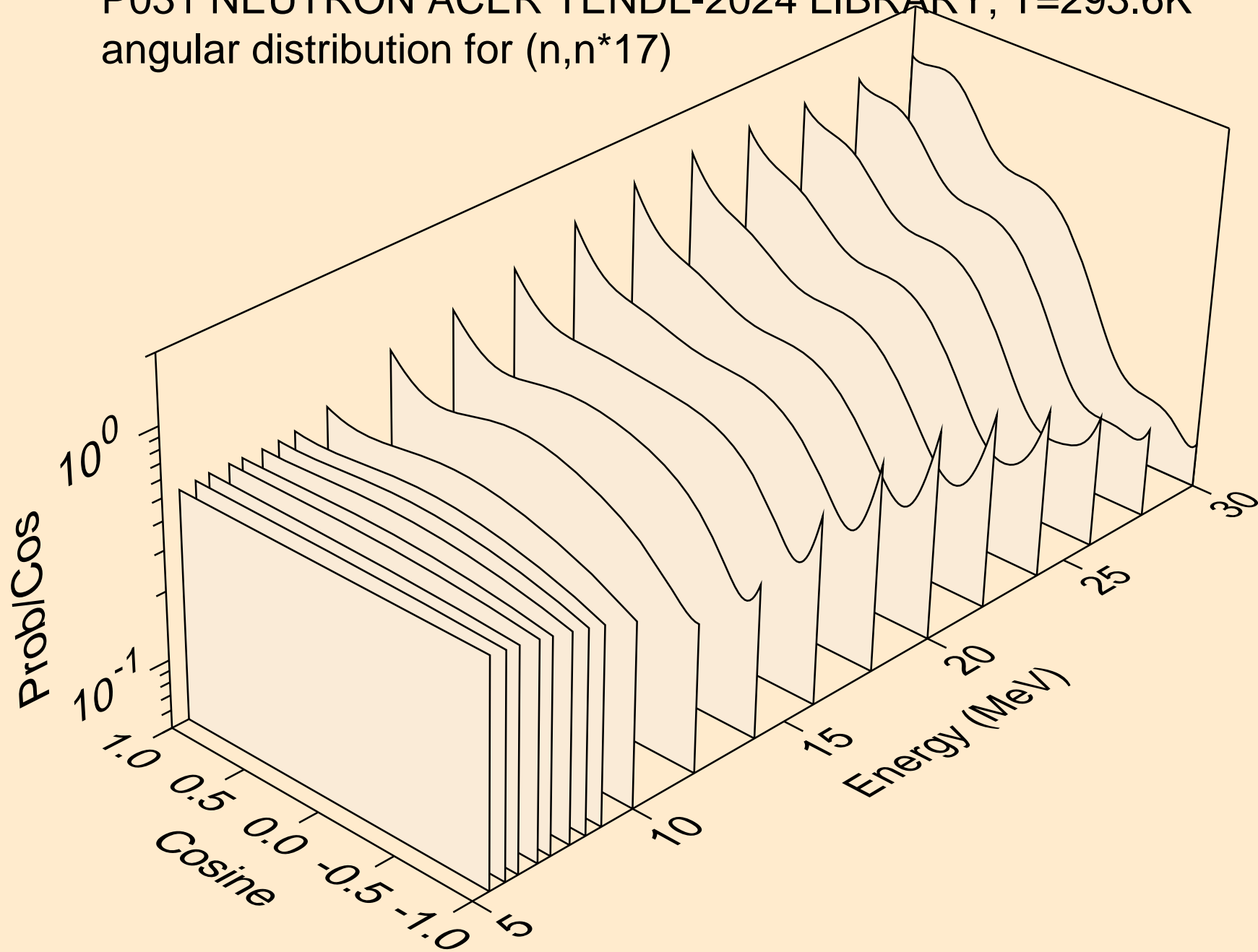

P031 NEUTRON ACER TENDL-2024 LIBRARY; T=293.6K
angular distribution for (n,n*18)

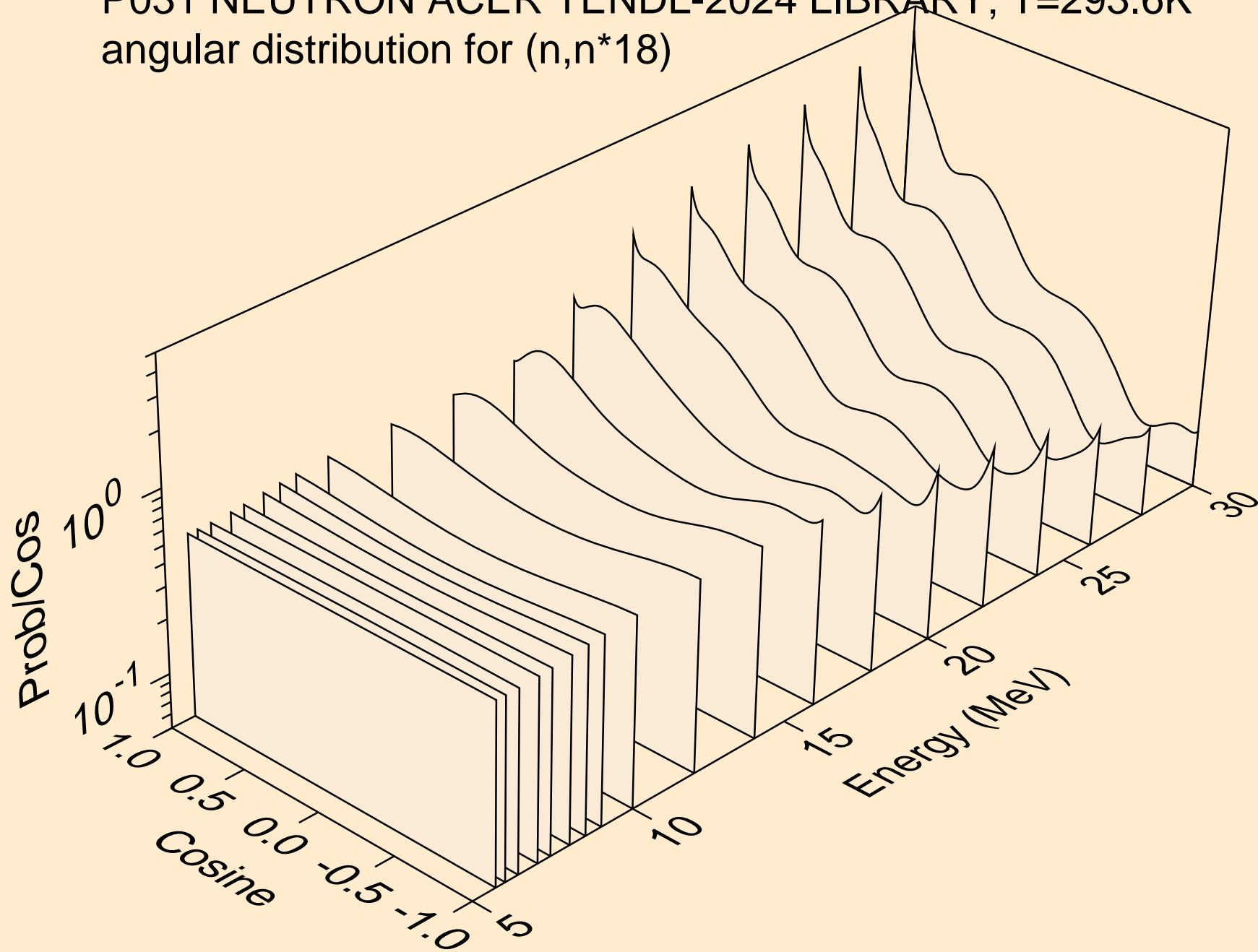

P031 NEUTRON ACER TENDL-2024 LIBRARY; T=293.6K
angular distribution for (n,n*19)

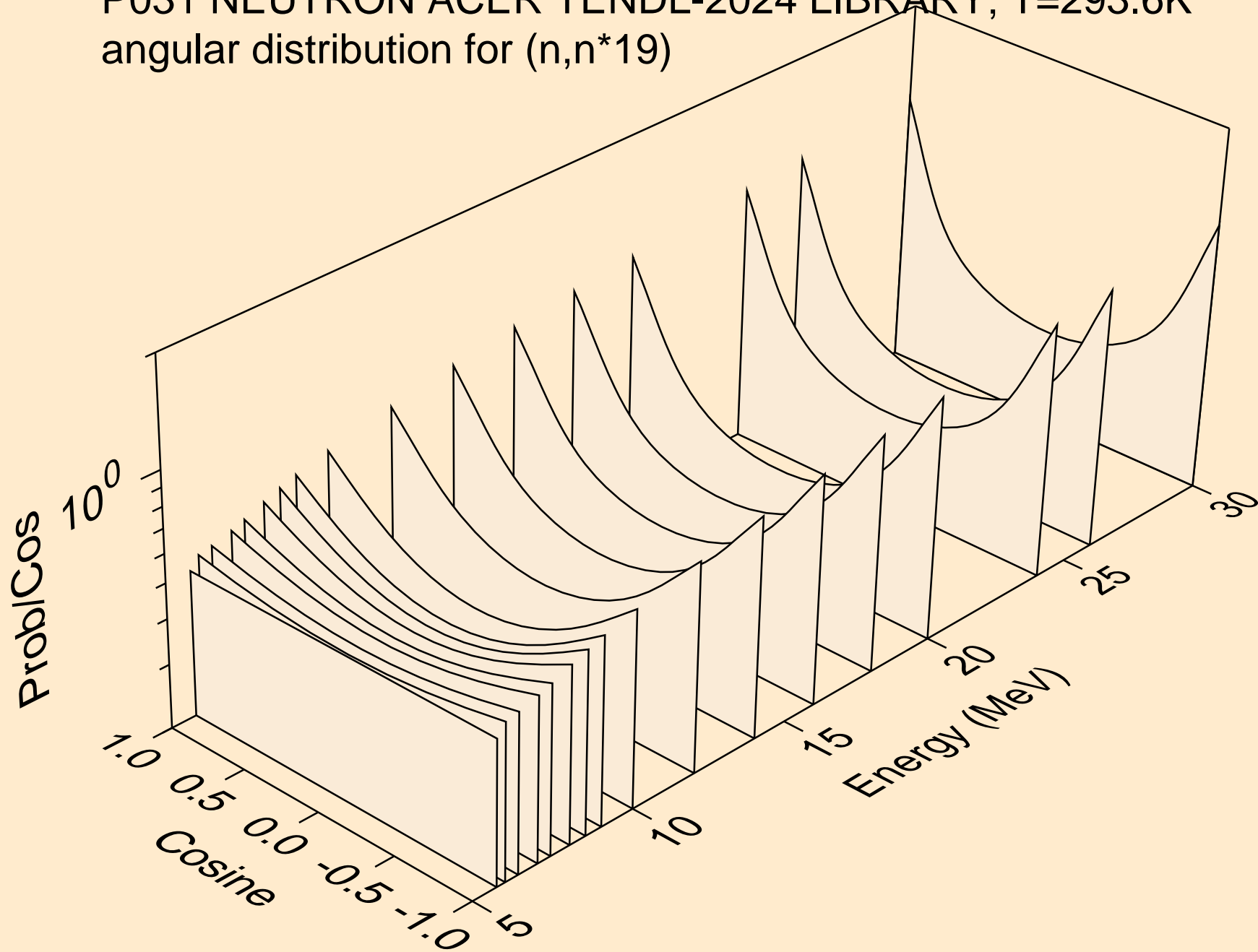

P031 NEUTRON ACER TENDL-2024 LIBRARY; T=293.6K
angular distribution for (n,n*20)

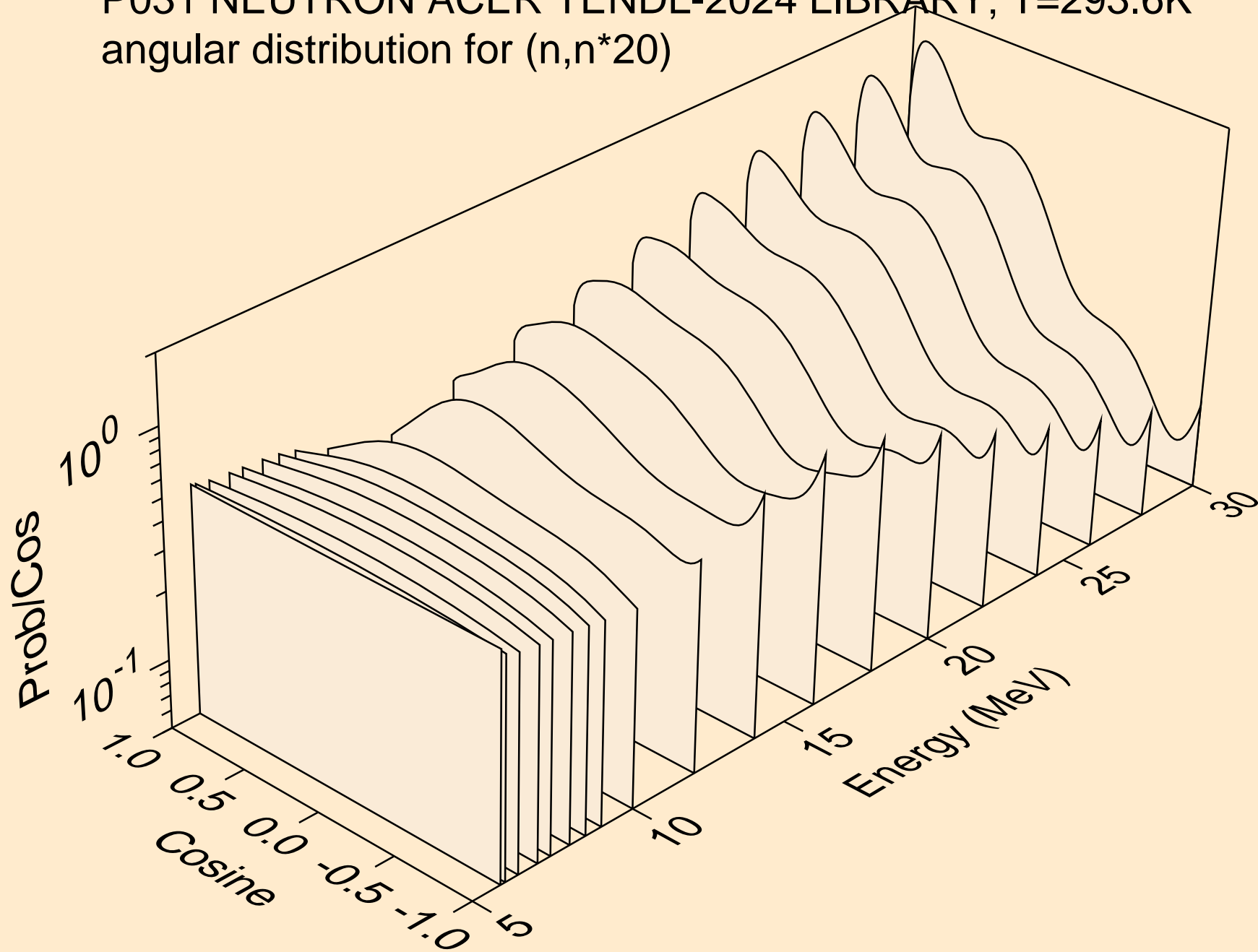

P031 NEUTRON ACER TENDL-2024 LIBRARY; T=293.6K
angular distribution for (n,n*21)

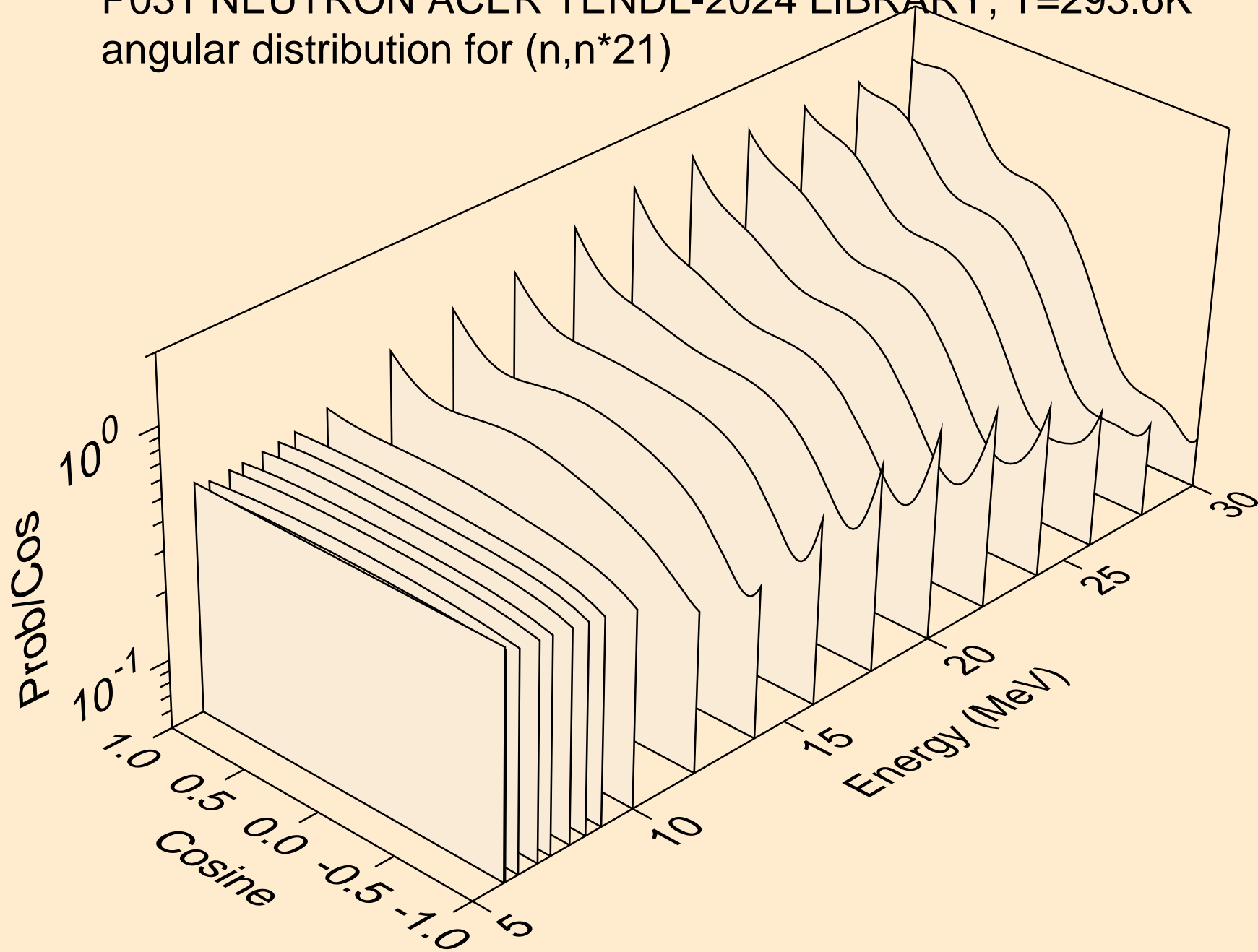

P031 NEUTRON ACER TENDL-2024 LIBRARY; T=293.6K
angular distribution for (n,n*22)

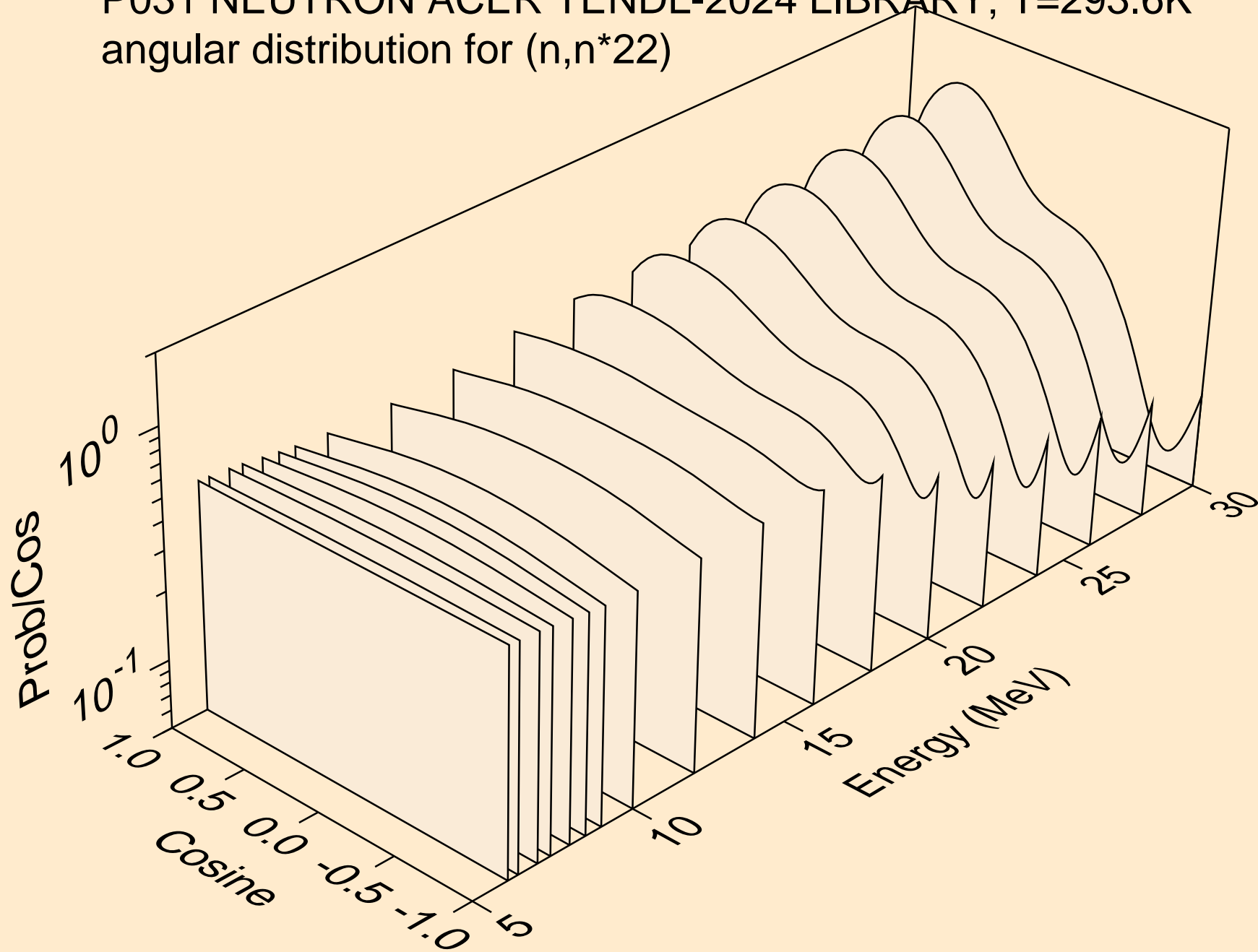

P031 NEUTRON ACER TENDL-2024 LIBRARY; T=293.6K
angular distribution for (n,n*23)

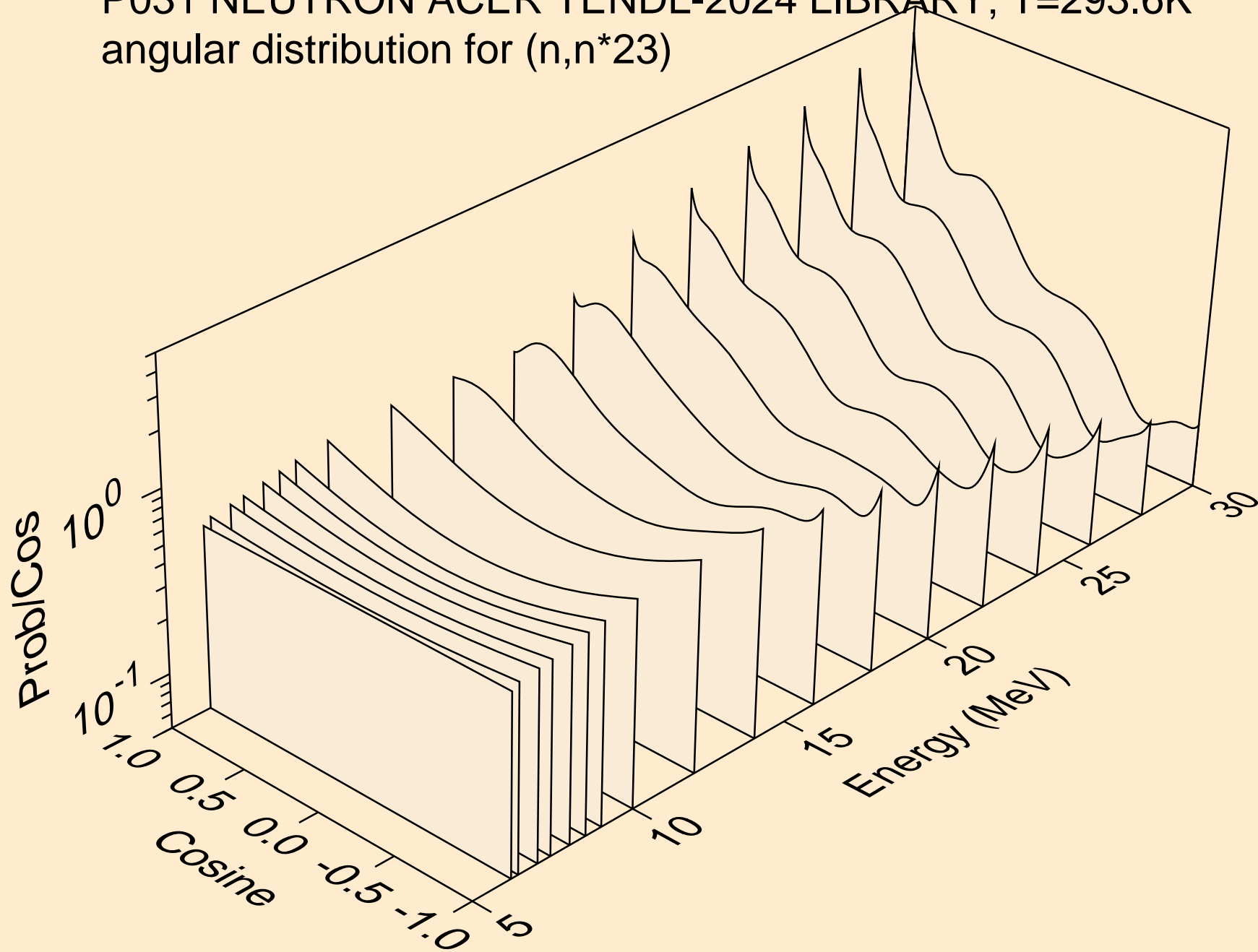

P031 NEUTRON ACER TENDL-2024 LIBRARY; T=293.6K
angular distribution for (n,n*24)

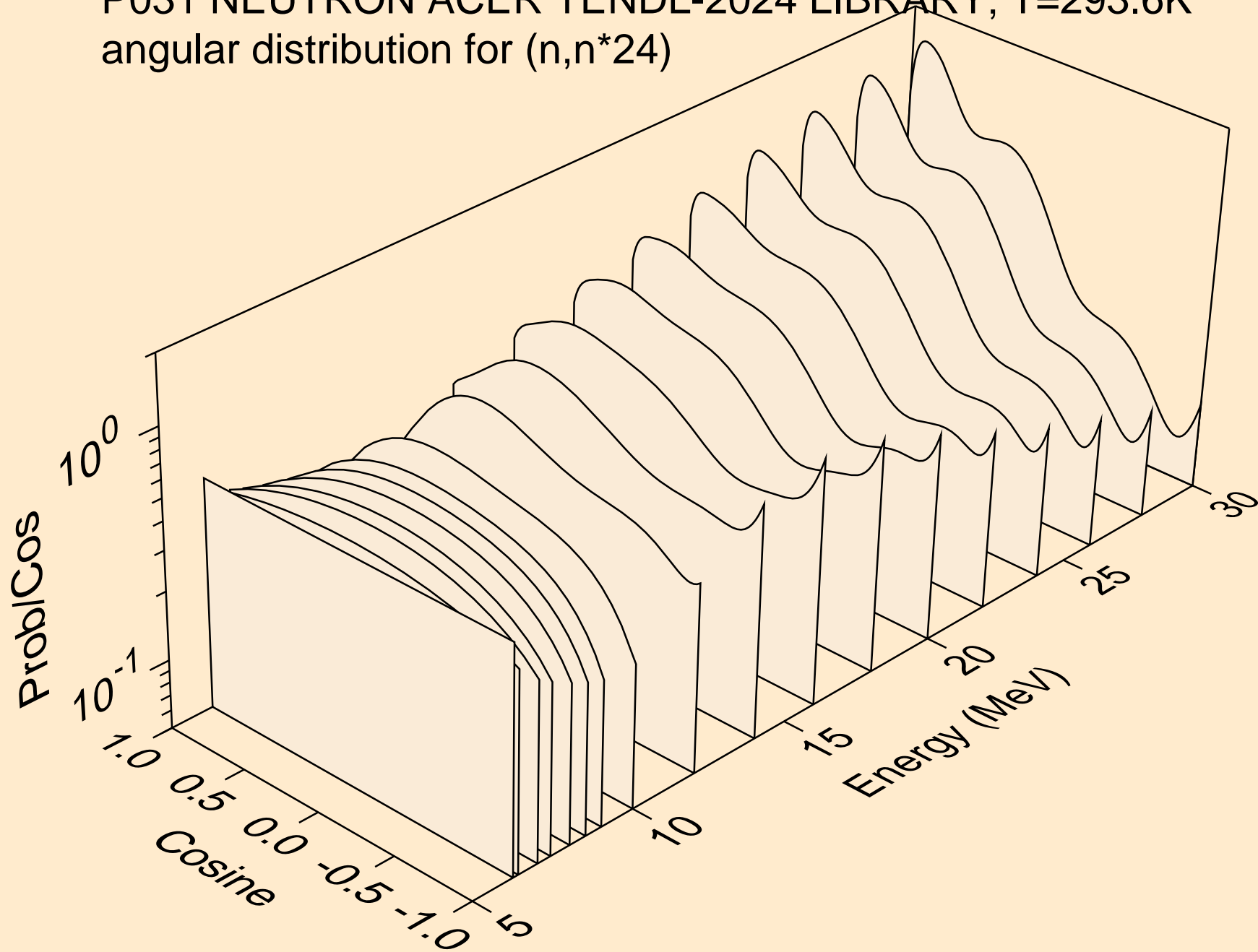

P031 NEUTRON ACER TENDL-2024 LIBRARY; T=293.6K
Neutron emission for (n,x)

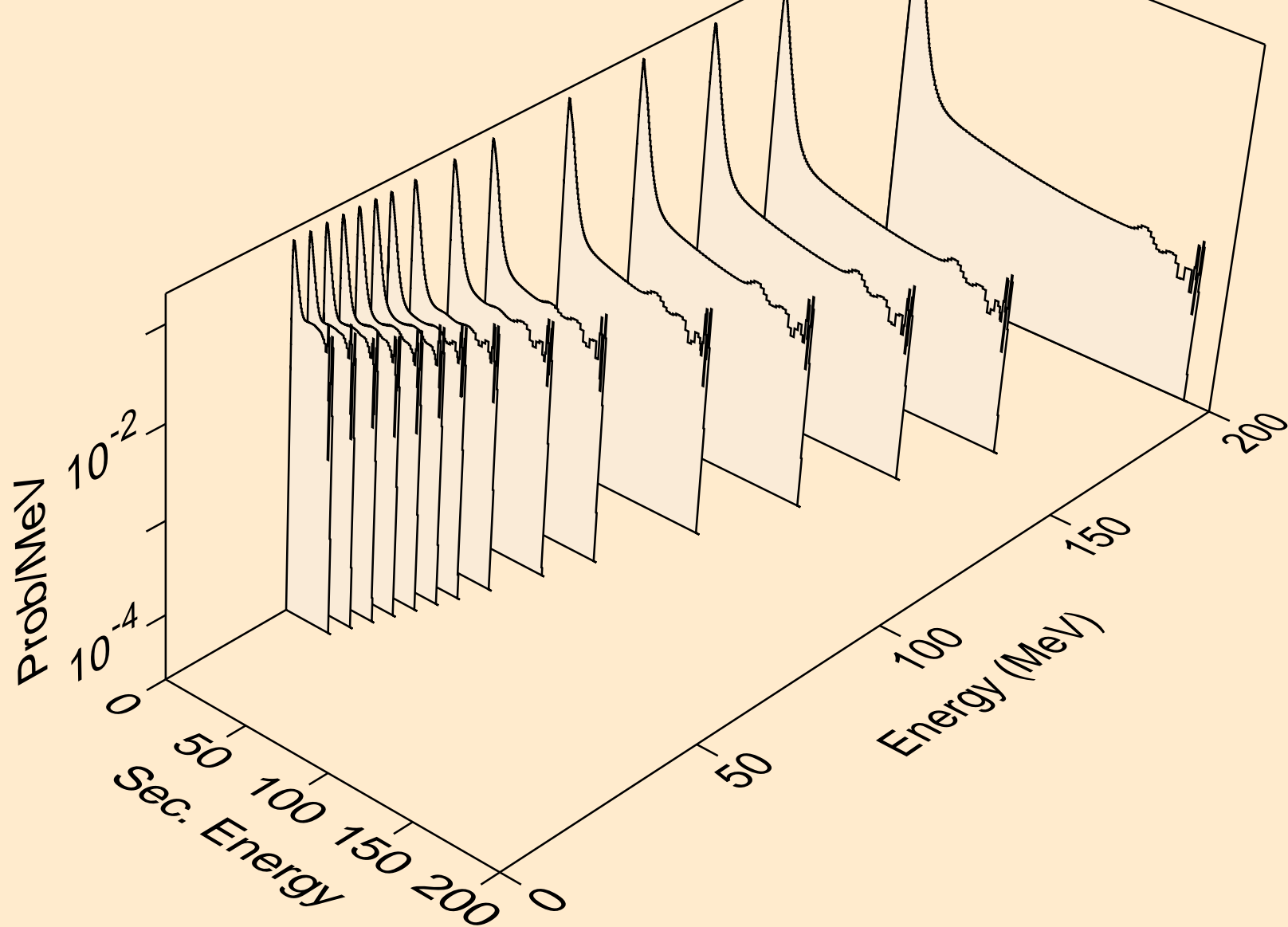

P031 NEUTRON ACER TENDL-2024 LIBRARY; T=293.6K
Neutron emission for (n,2nd)

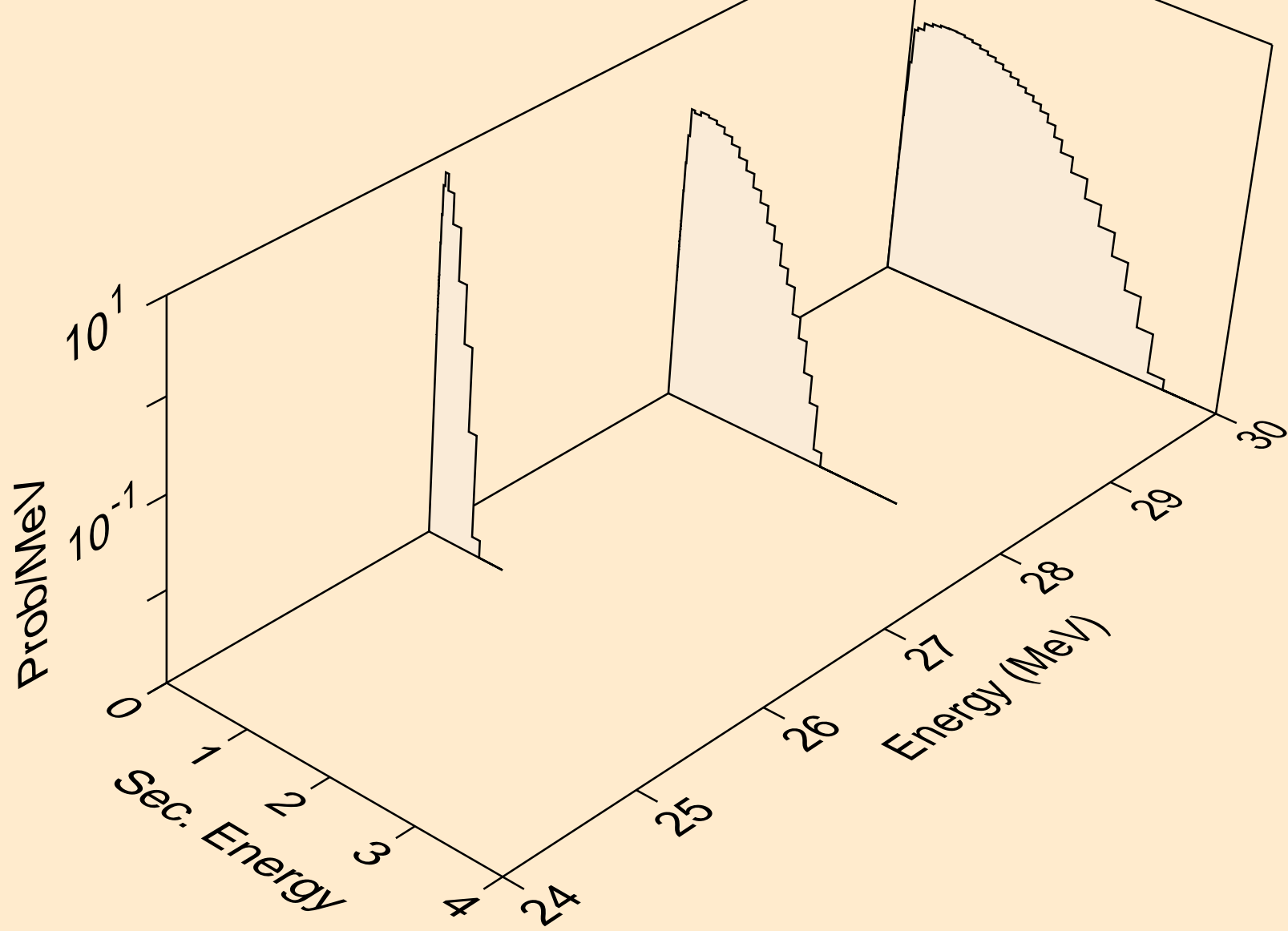

P031 NEUTRON ACER TENDL-2024 LIBRARY; T=293.6K
Neutron emission for (n,2n)

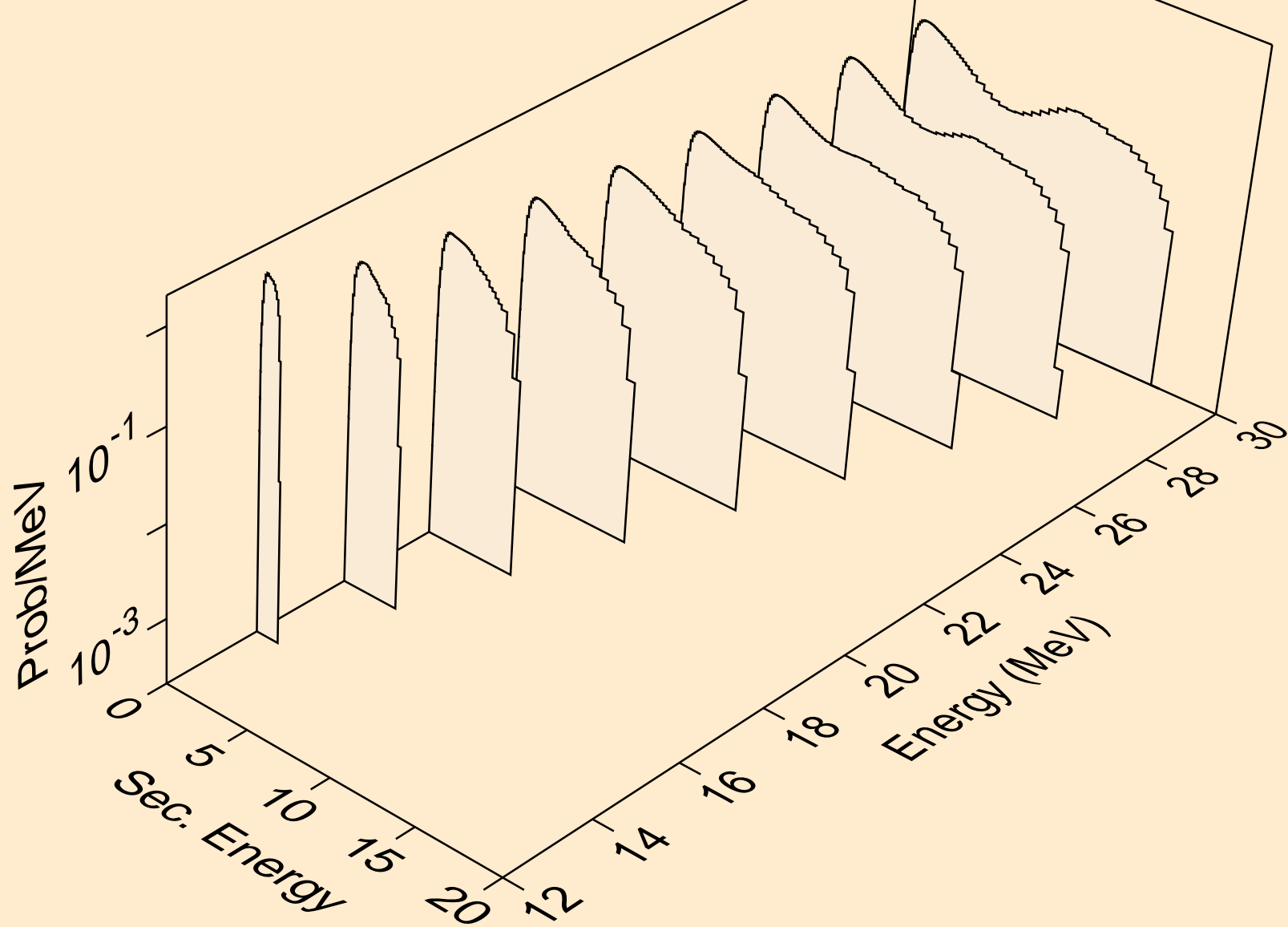

P031 NEUTRON ACER TENDL-2024 LIBRARY; T=293.6K
Neutron emission for (n,3n)

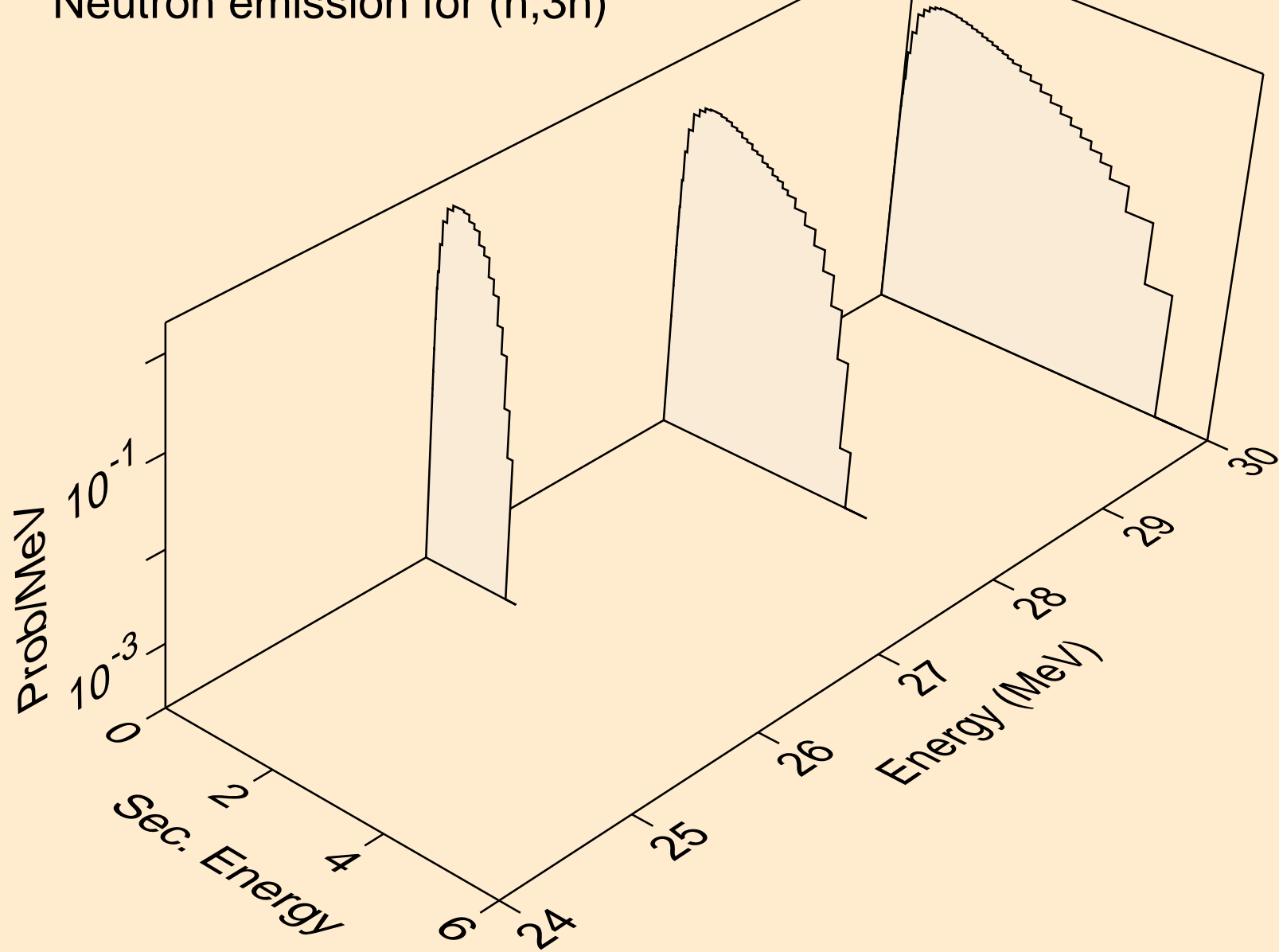

P031 NEUTRON ACER TENDL-2024 LIBRARY; T=293.6K
Neutron emission for (n,n*)a

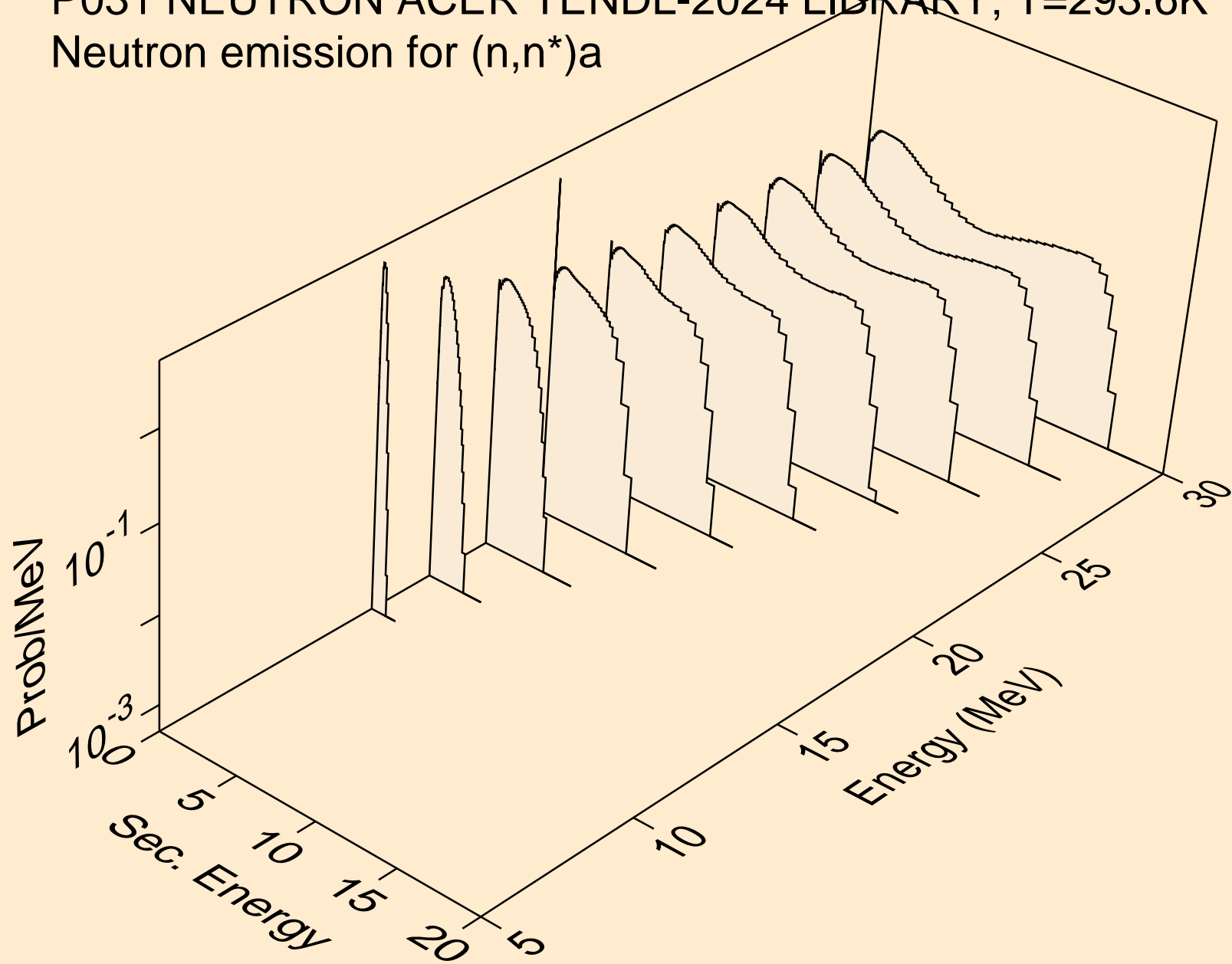

P031 NEUTRON ACER TENDL-2024 LIBRARY; T=293.6K
Neutron emission for (n,2n)a

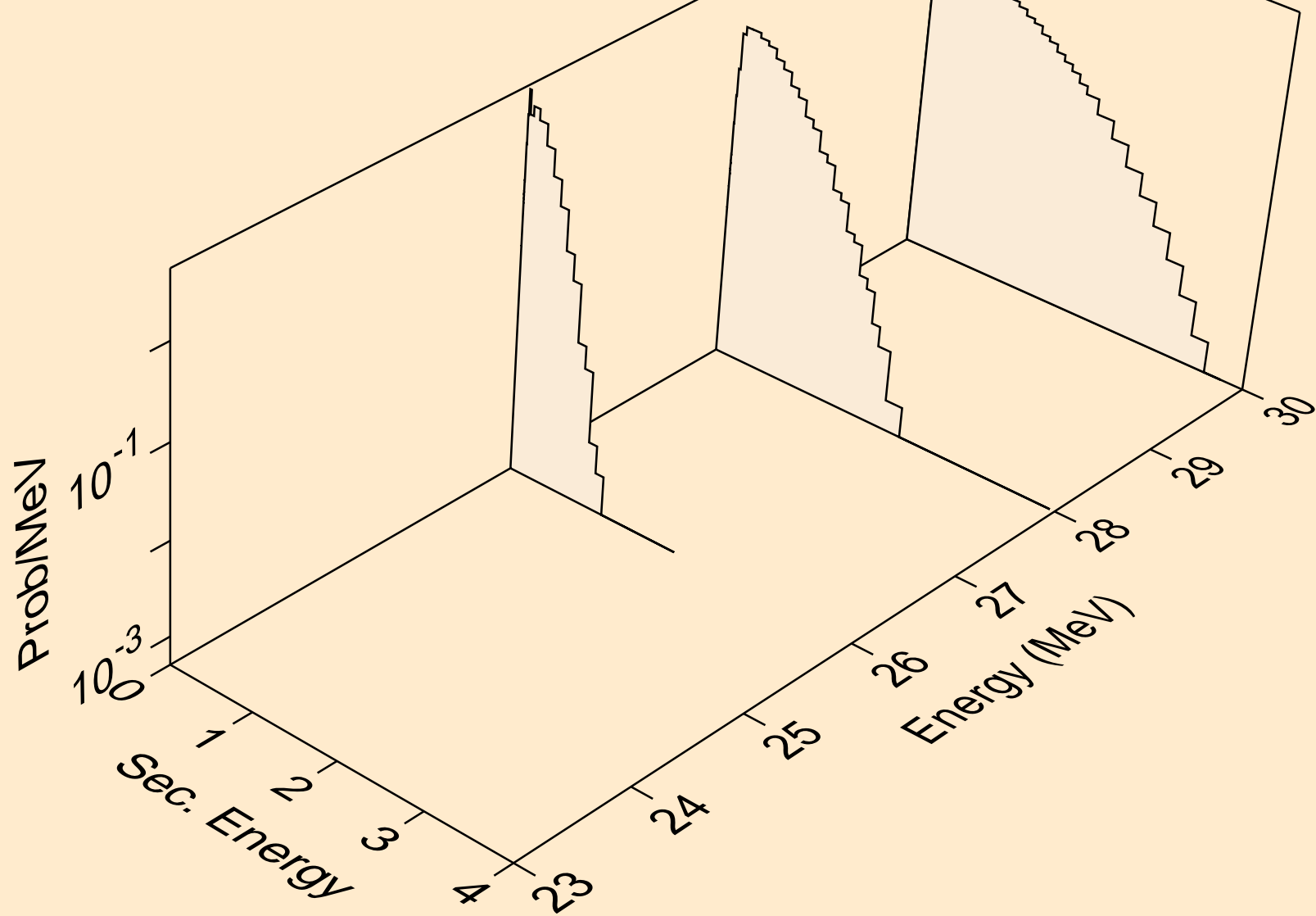

P031 NEUTRON ACER TENDL-2024 LIBRARY; T=293.6K
Neutron emission for (n,n*)p

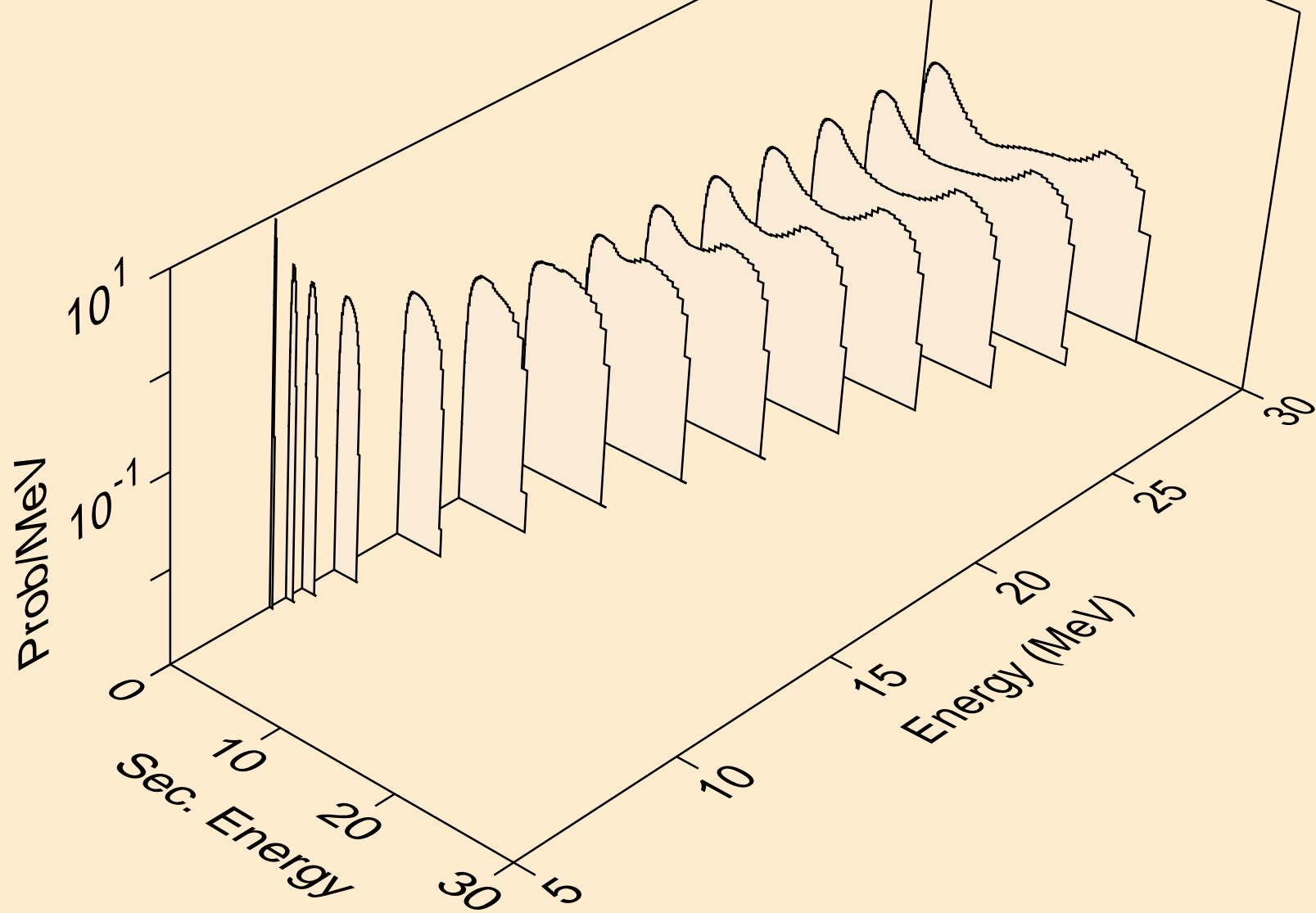

P031 NEUTRON ACER TENDL-2024 LIBRARY; T=293.6K
Neutron emission for (n,n*)2a

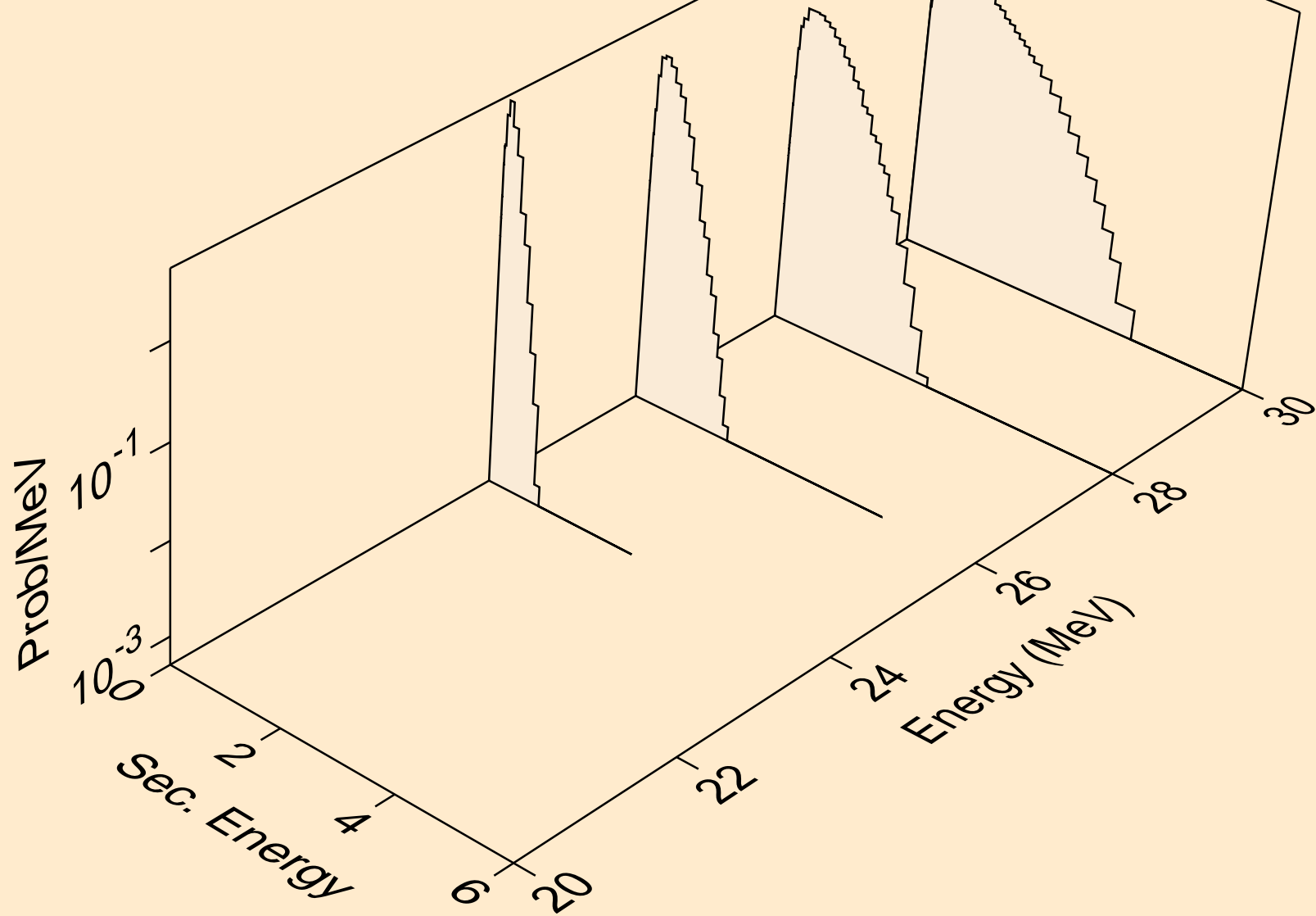

P031 NEUTRON ACER TENDL-2024 LIBRARY; T=293.6K
Neutron emission for (n,n*)d

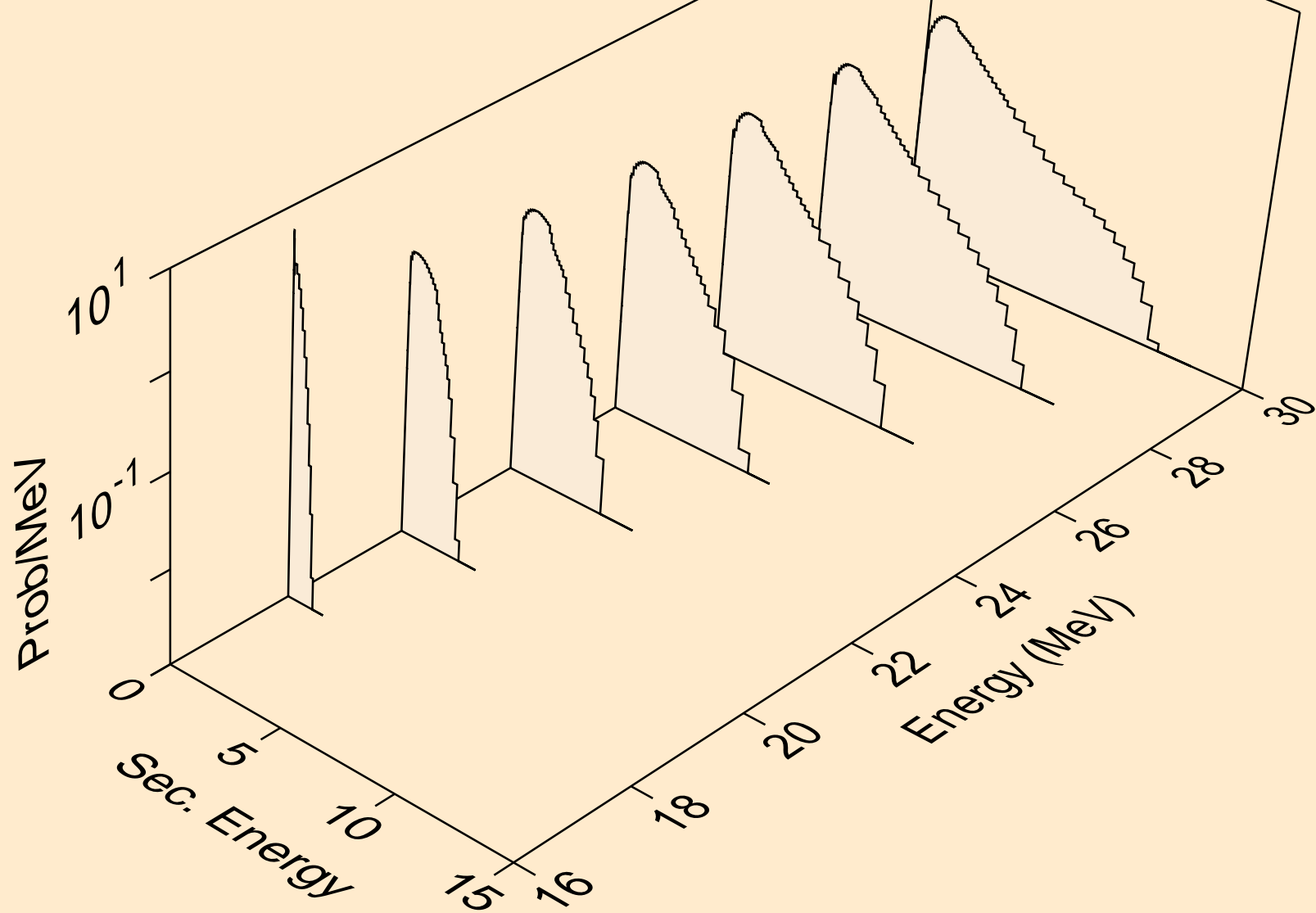

P031 NEUTRON ACER TENDL-2024 LIBRARY; T=293.6K
Neutron emission for (n,n*)t

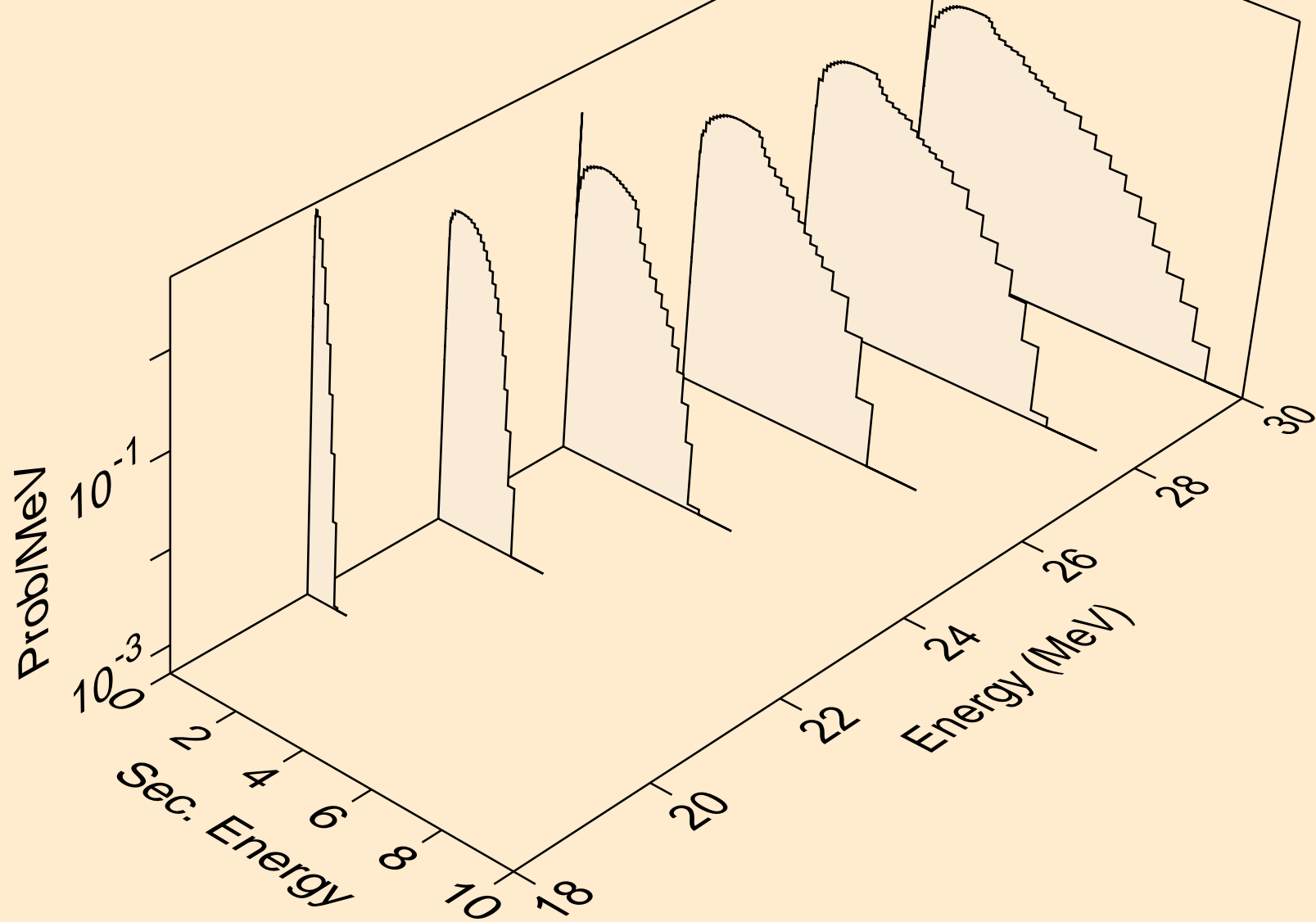

P031 NEUTRON ACER TENDL-2024 LIBRARY; T=293.6K
Neutron emission for (n,n*)he3

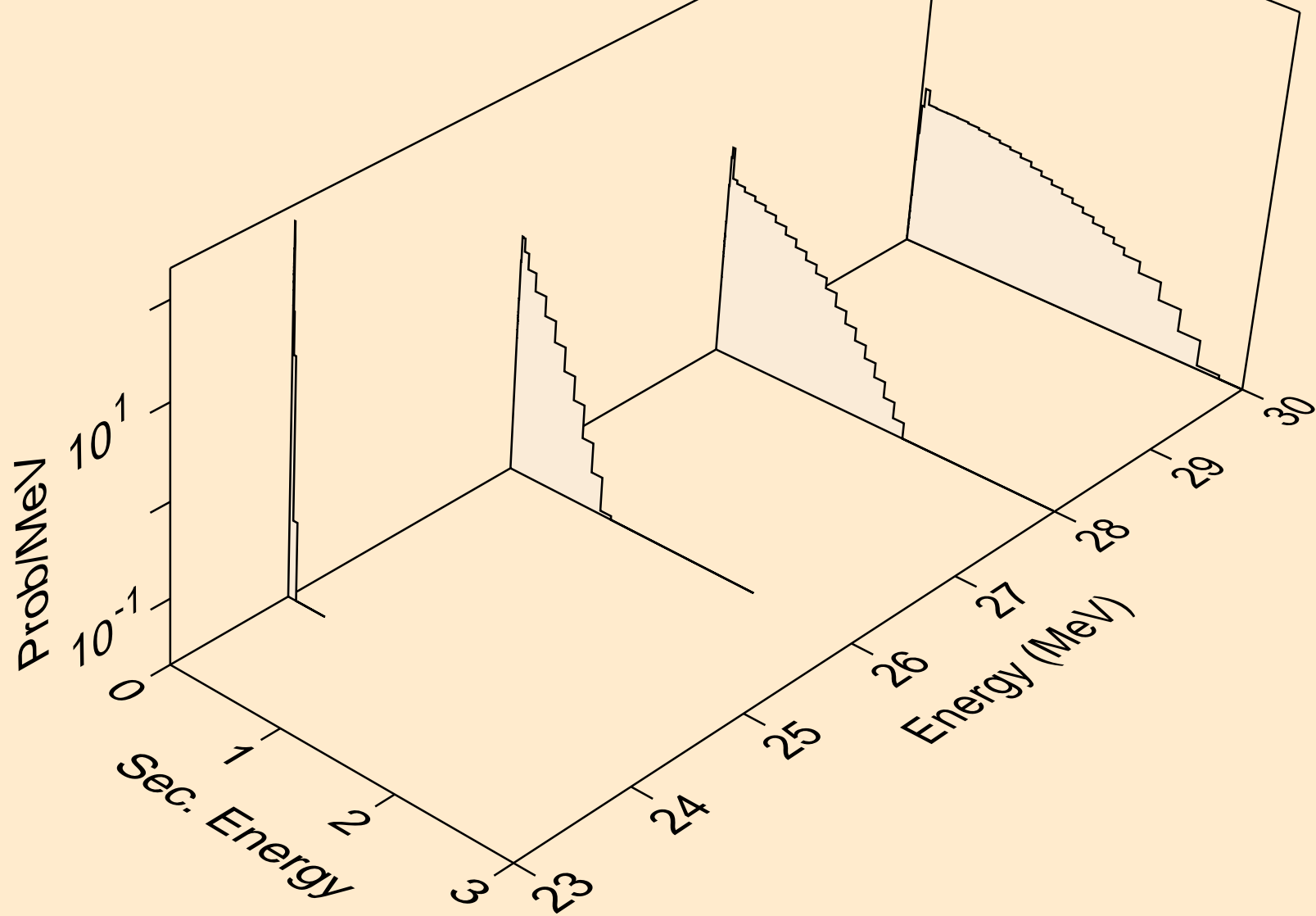

P031 NEUTRON ACER TENDL-2024 LIBRARY; T=293.6K
Neutron emission for (n,2np)

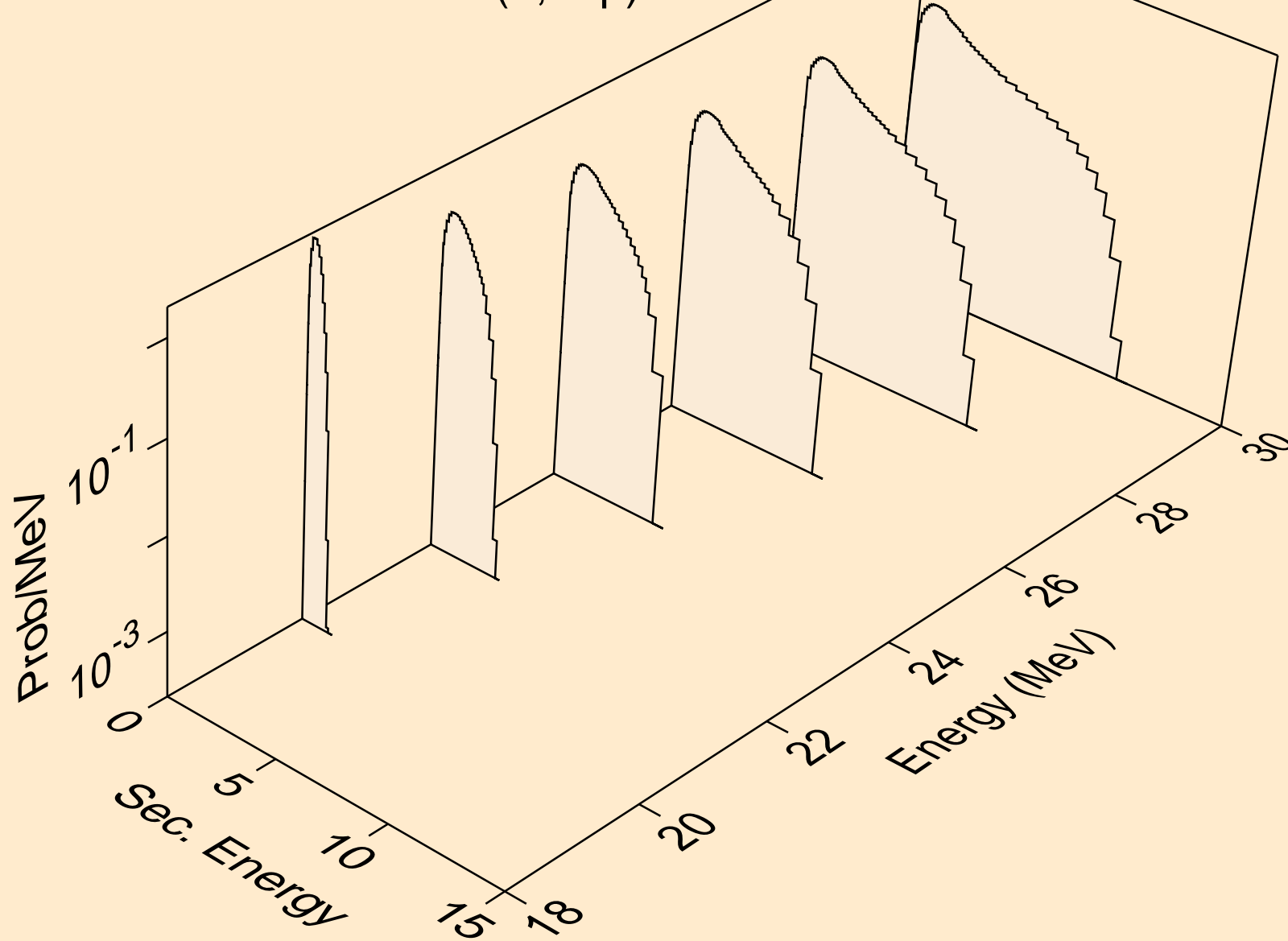

P031 NEUTRON ACER TENDL-2024 LIBRARY; T=293.6K
Neutron emission for (n,3np)

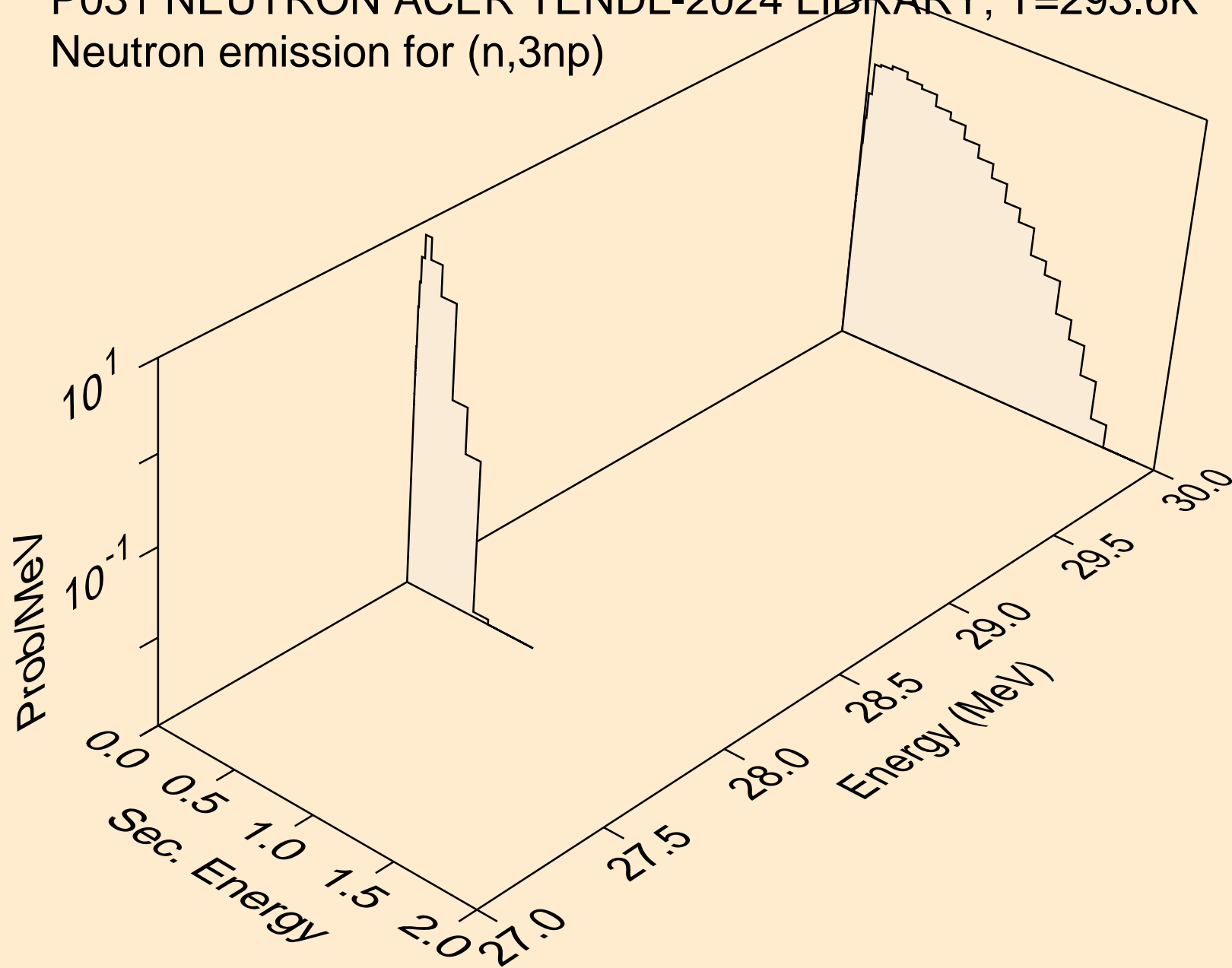

P031 NEUTRON ACER TENDL-2024 LIBRARY; T=293.6K
Neutron emission for (n,n2p)

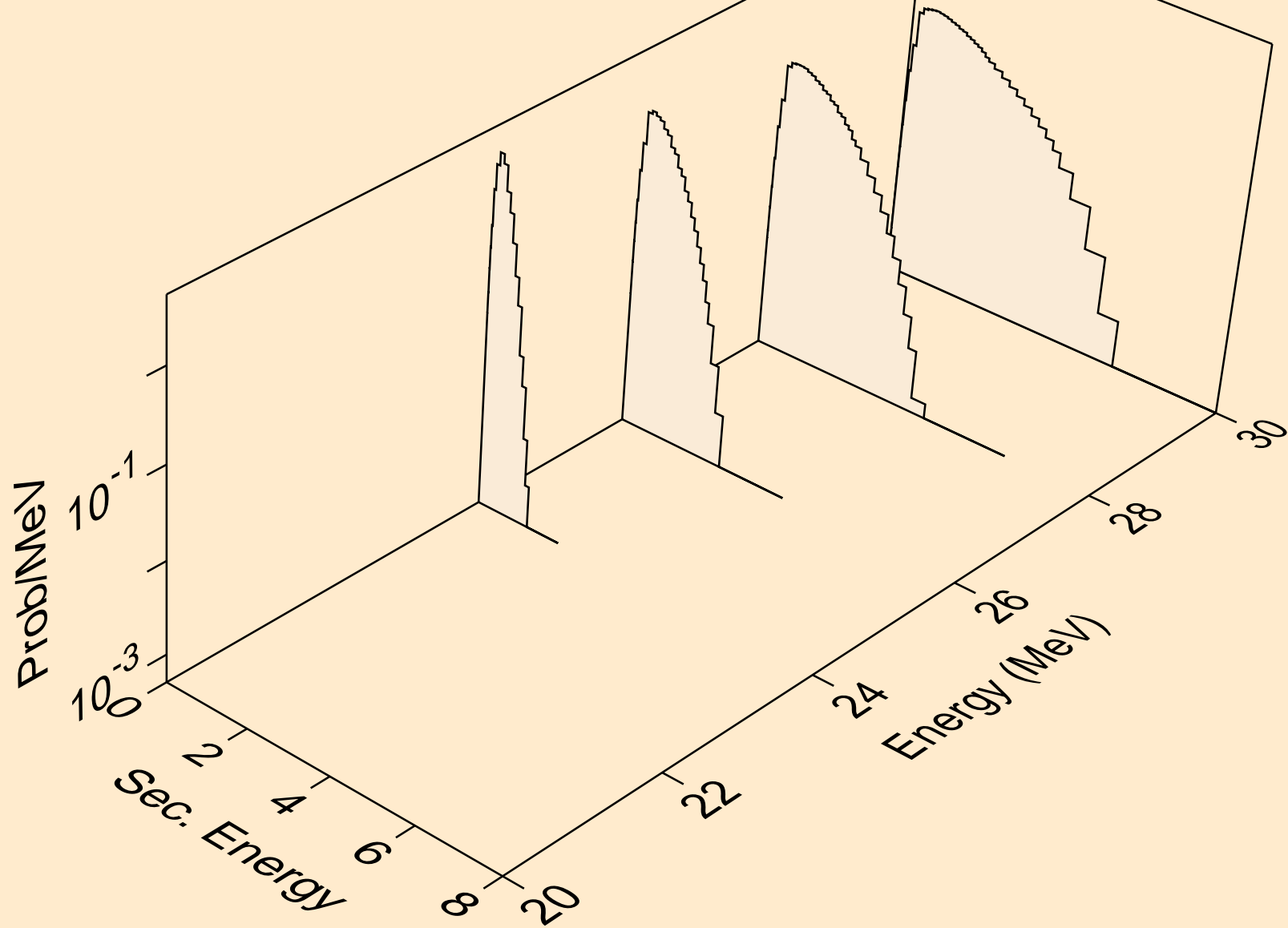

P031 NEUTRON ACER TENDL-2024 LIBRARY; T=293.6K
Neutron emission for (n,npa)

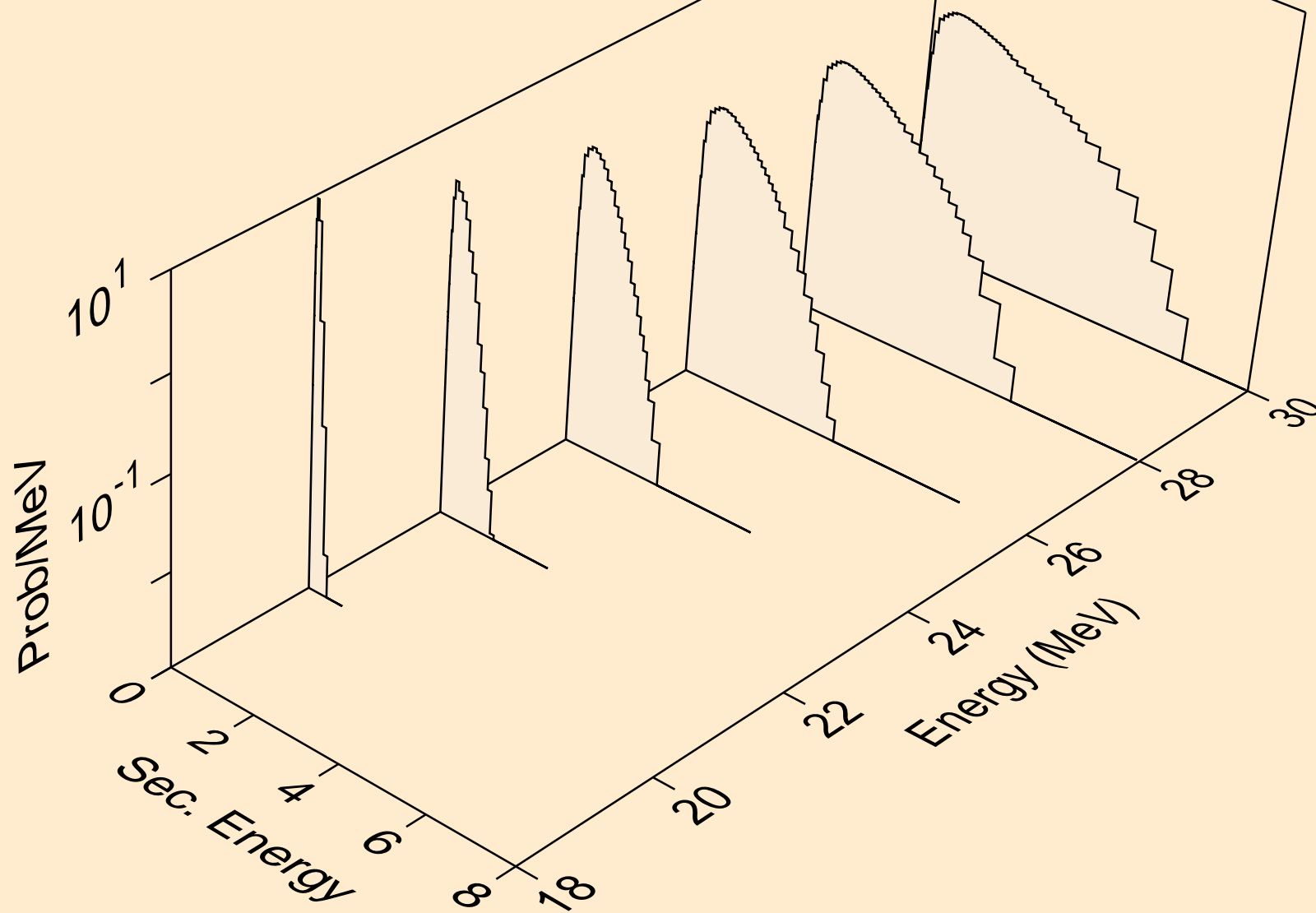

P031 NEUTRON ACER TENDL-2024 LIBRARY; T=293.6K
Neutron emission for (n,n*c)

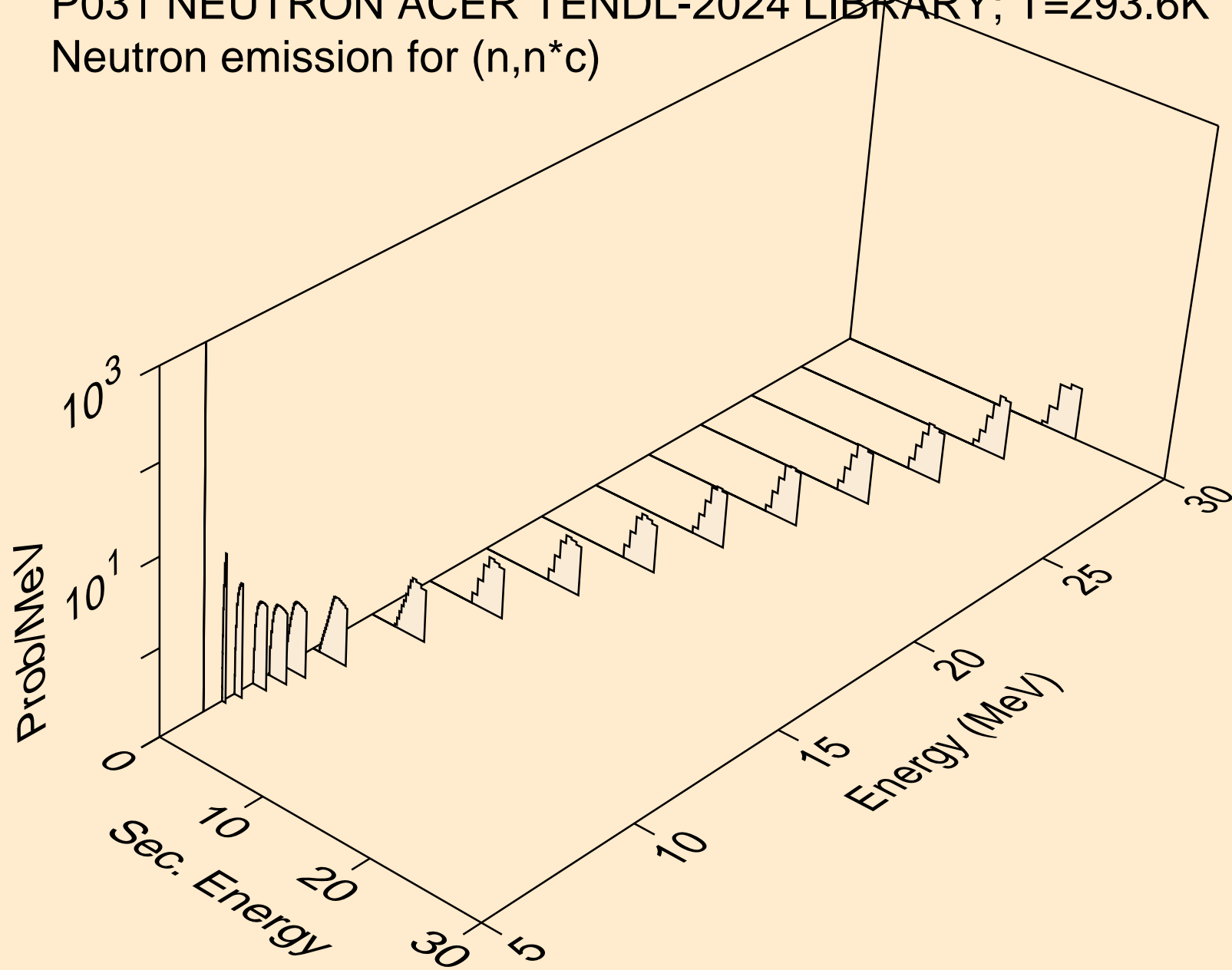

P031 NEUTRON ACER TENDL-2024 LIBRARY; T=293.6K
Photon emission for (n,x)

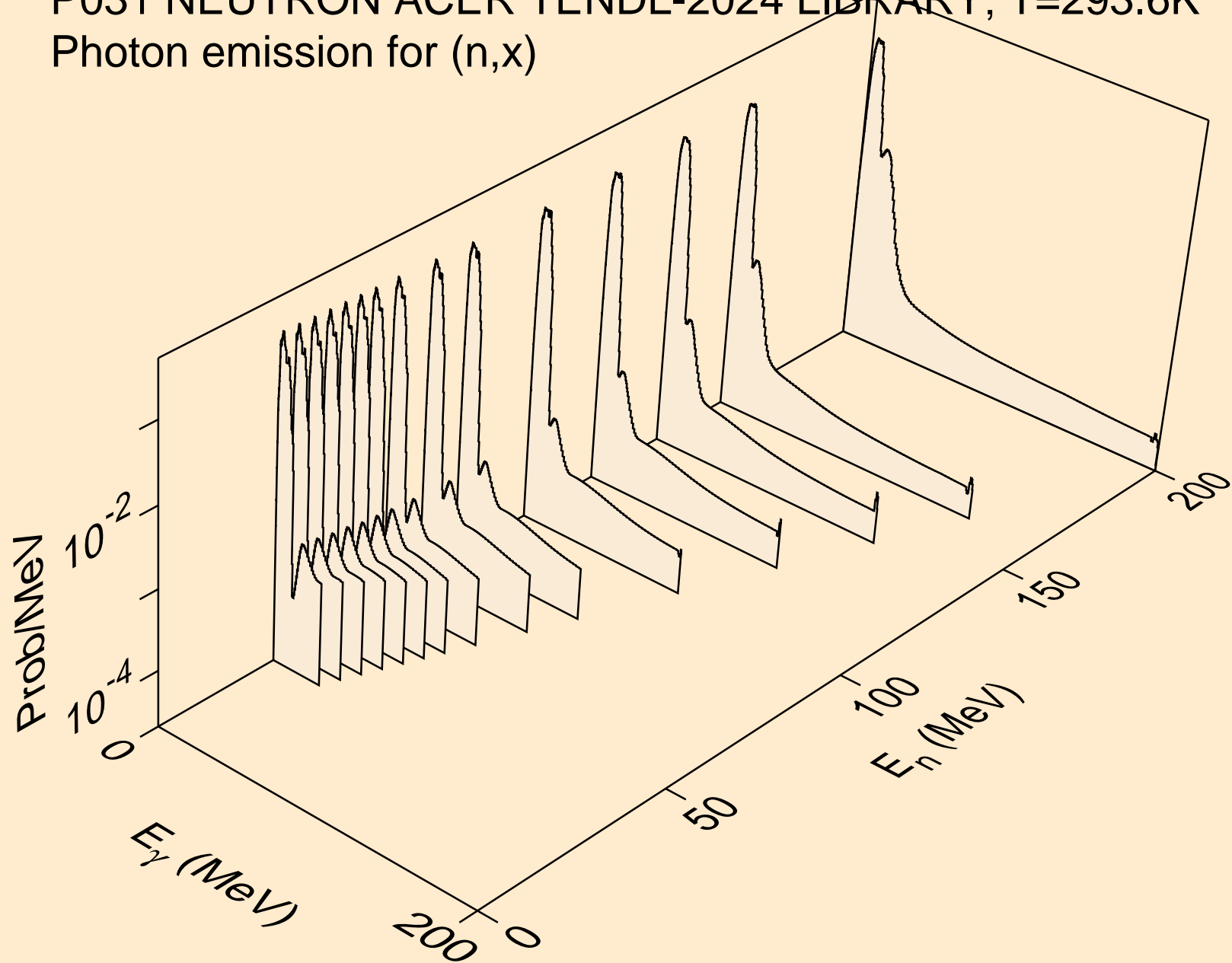

P031 NEUTRON ACER TENDL-2024 LIBRARY; T=293.6K
Photon emission for (n,2nd)

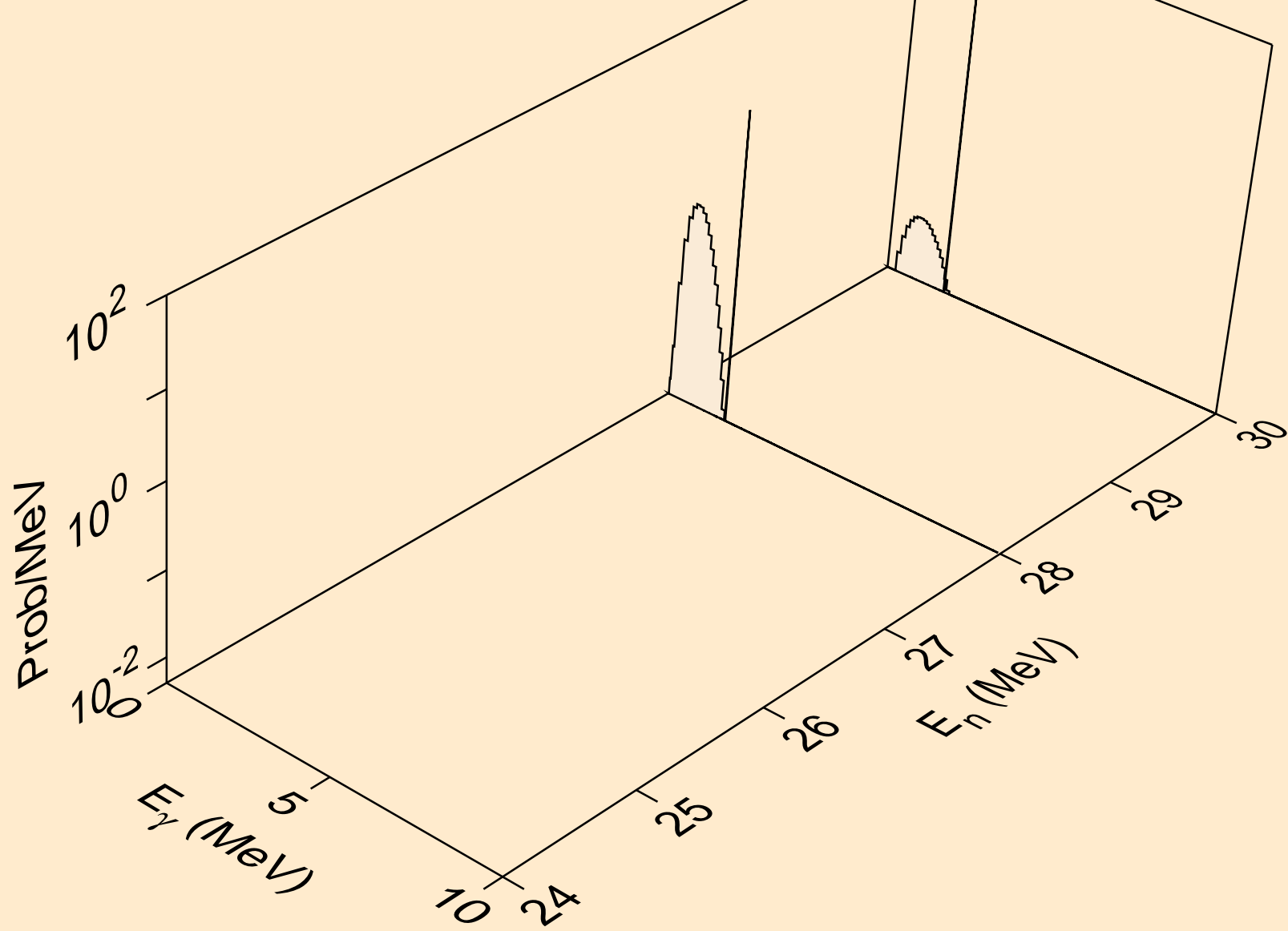

P031 NEUTRON ACER TENDL-2024 LIBRARY; T=293.6K
Photon emission for (n,2n)

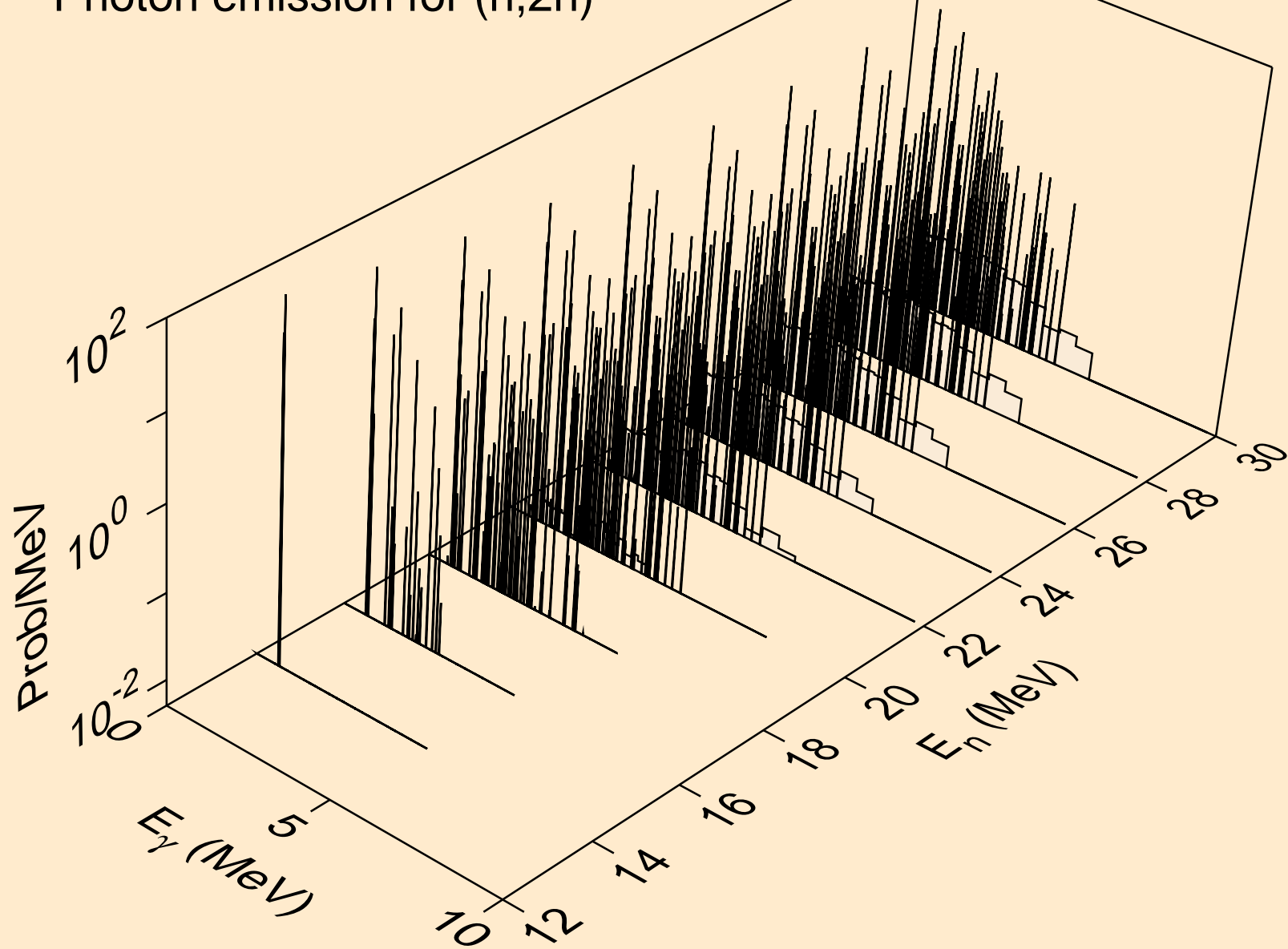

P031 NEUTRON ACER TENDL-2024 LIBRARY; T=293.6K
Photon emission for (n,3n)

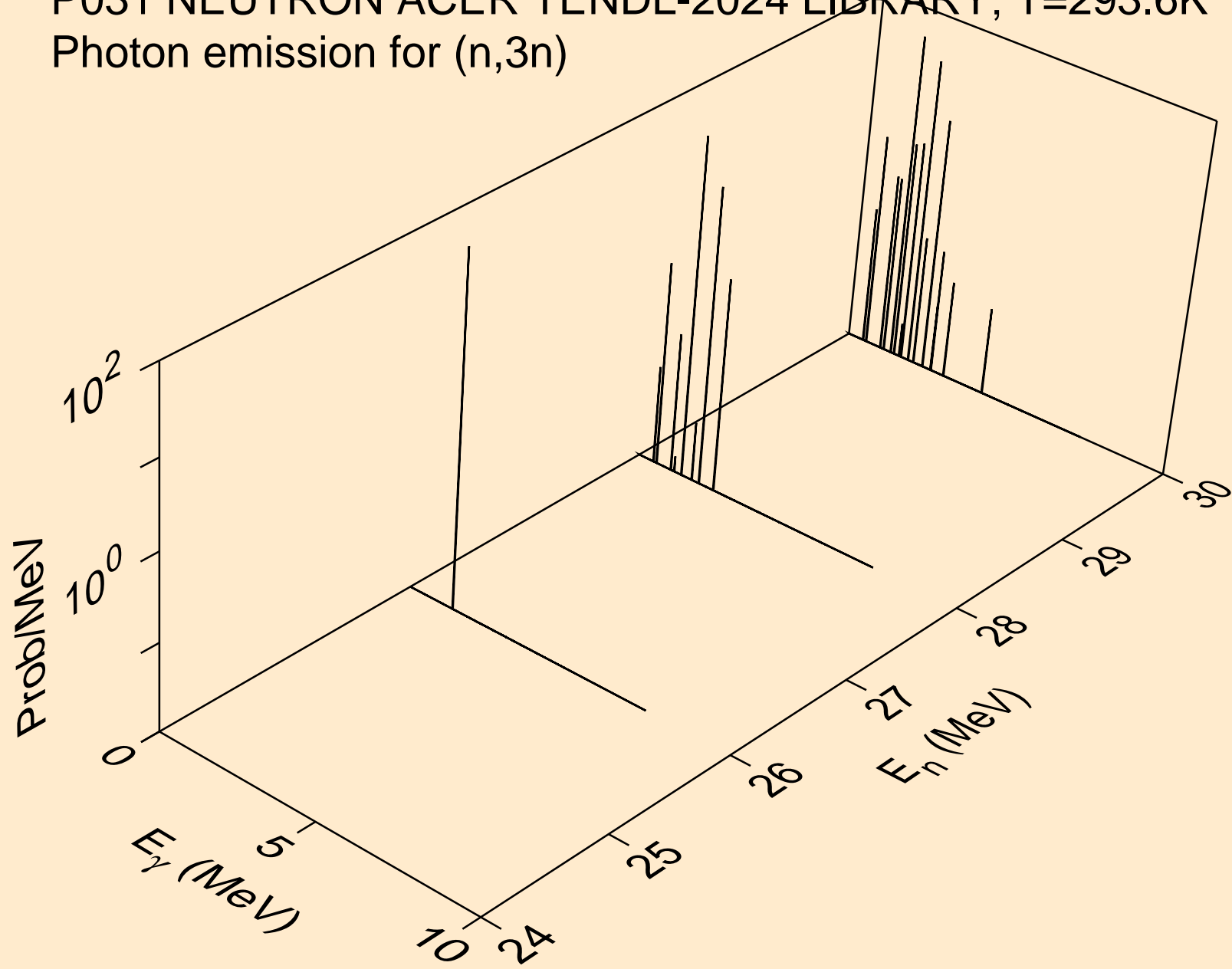

P031 NEUTRON ACER TENDL-2024 LIBRARY; T=293.6K
Photon emission for (n,n*)a

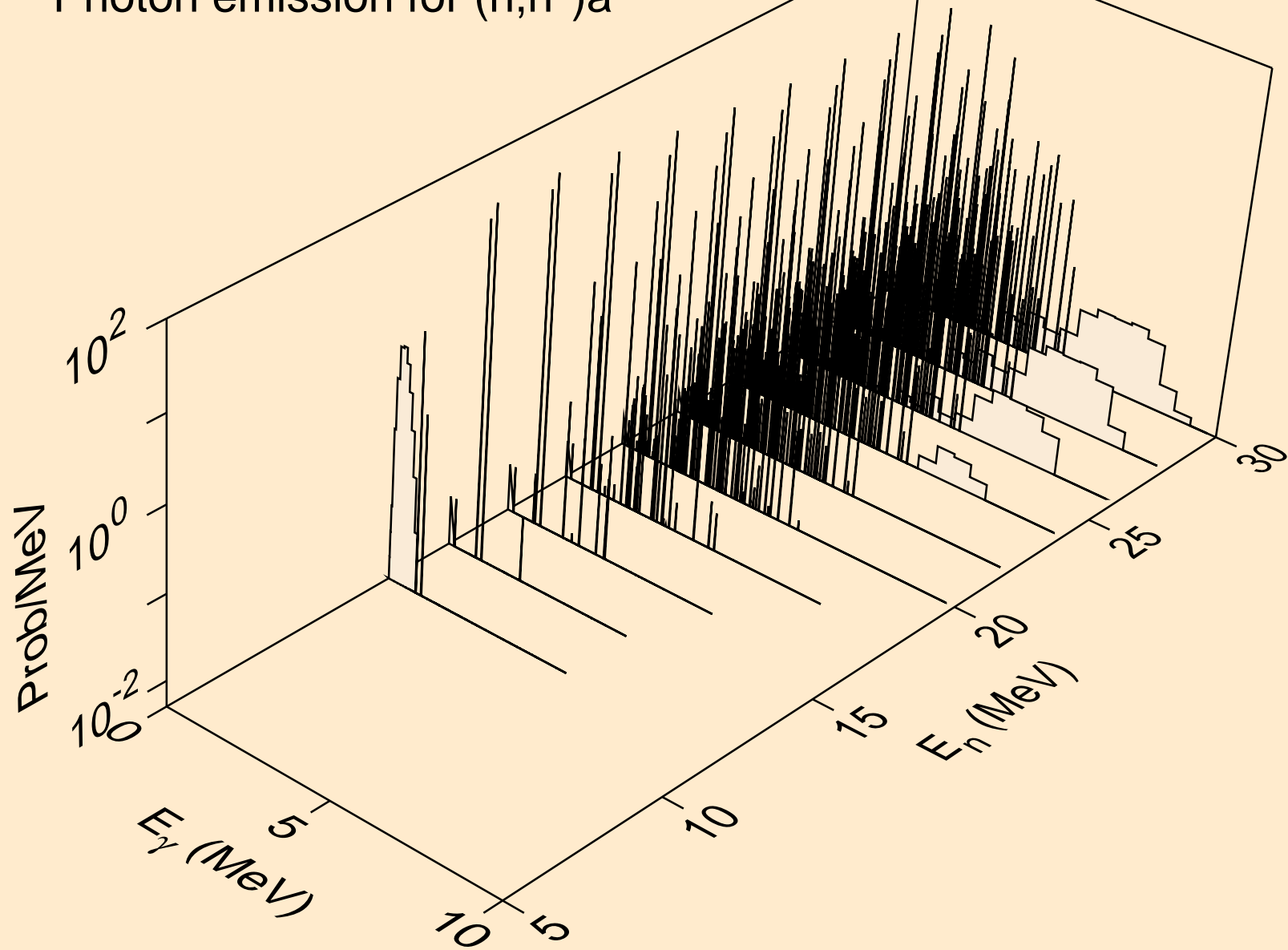

P031 NEUTRON ACER TENDL-2024 LIBRARY; T=293.6K
Photon emission for (n,2n)a

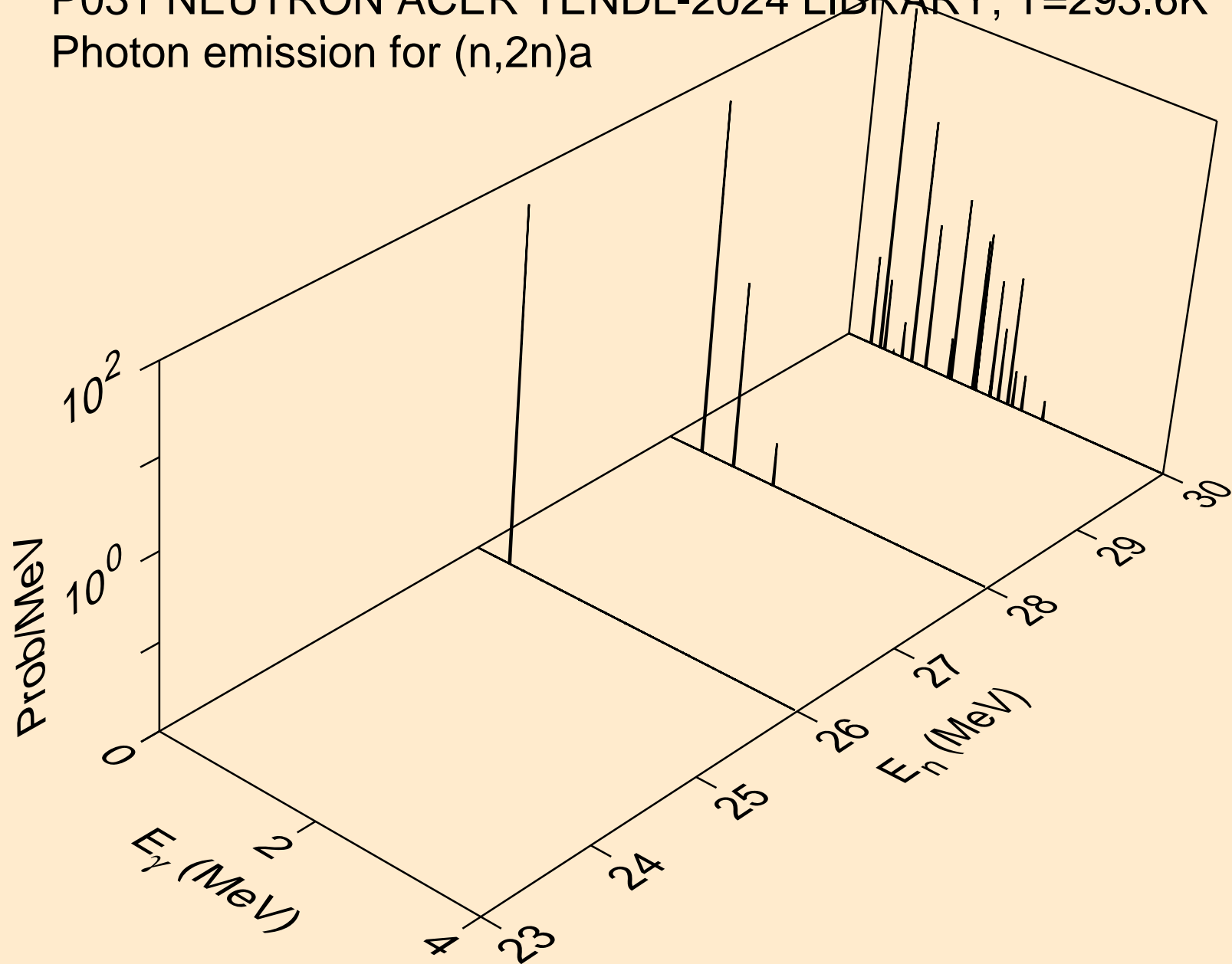

P031 NEUTRON ACER TENDL-2024 LIBRARY; T=293.6K
Photon emission for (n,n*)p

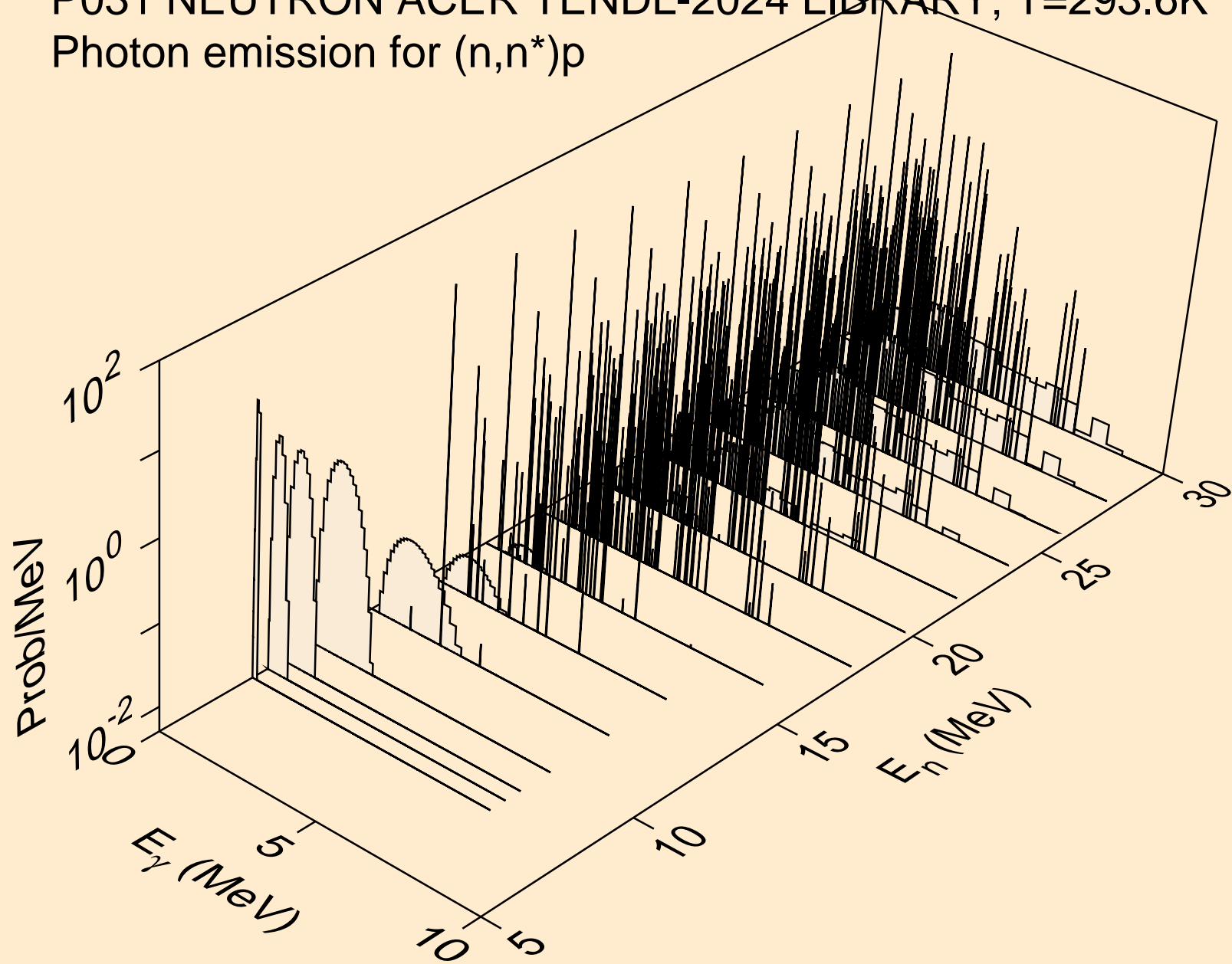

P031 NEUTRON ACER TENDL-2024 LIBRARY; T=293.6K
Photon emission for (n,n*)2a

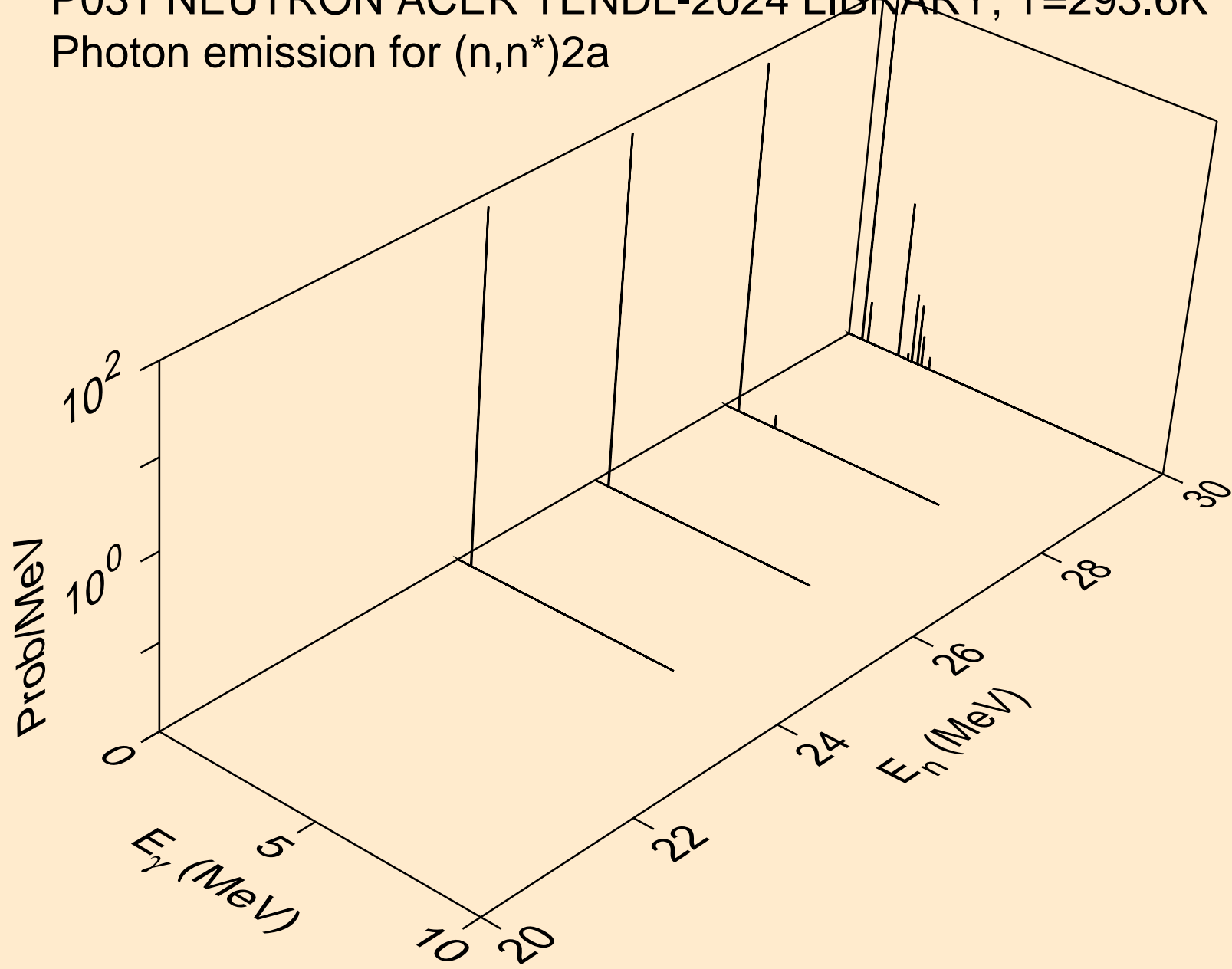

P031 NEUTRON ACER TENDL-2024 LIBRARY; T=293.6K
Photon emission for (n,n*)d

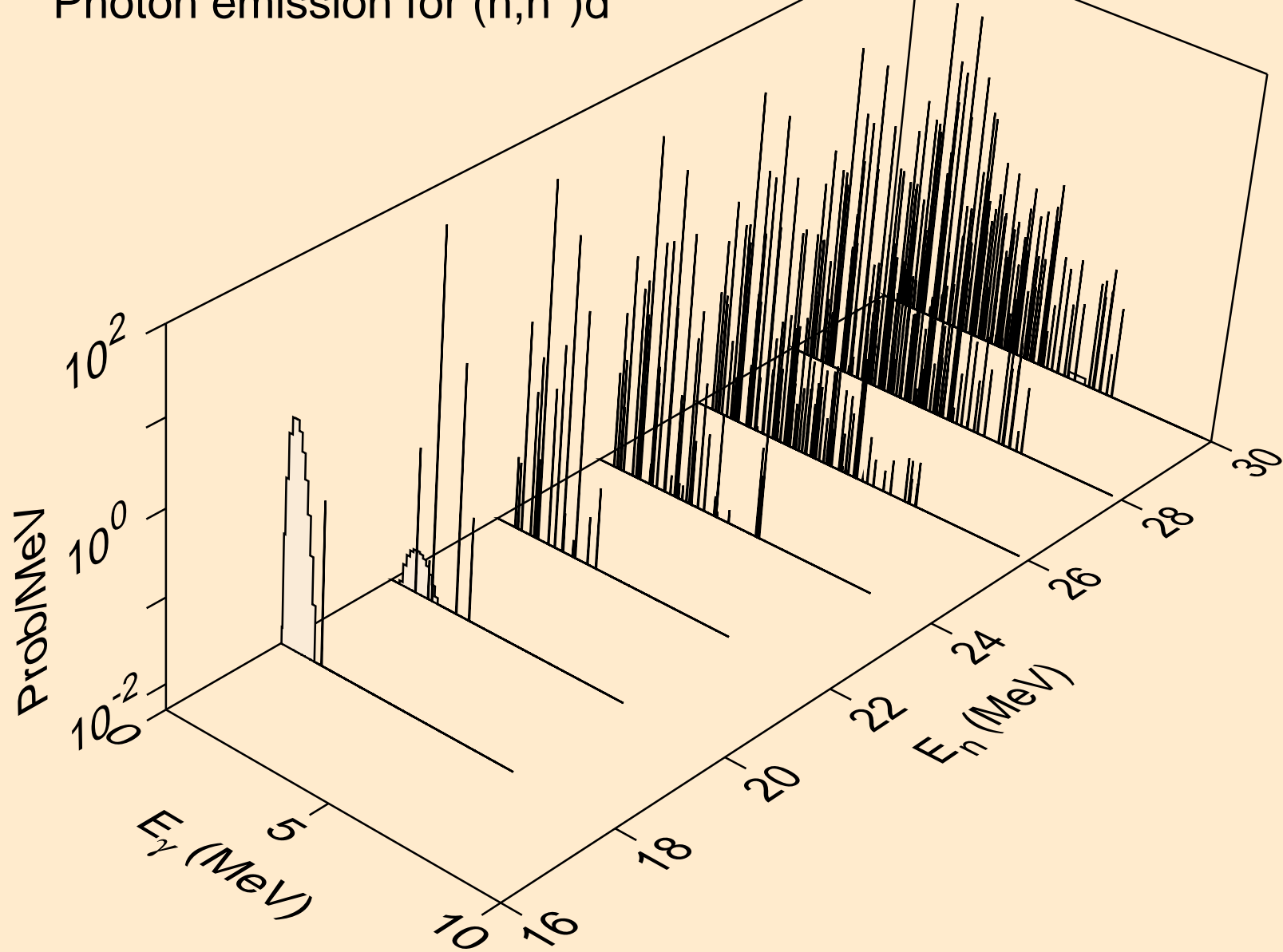

P031 NEUTRON ACER TENDL-2024 LIBRARY; T=293.6K
Photon emission for (n,n*)t

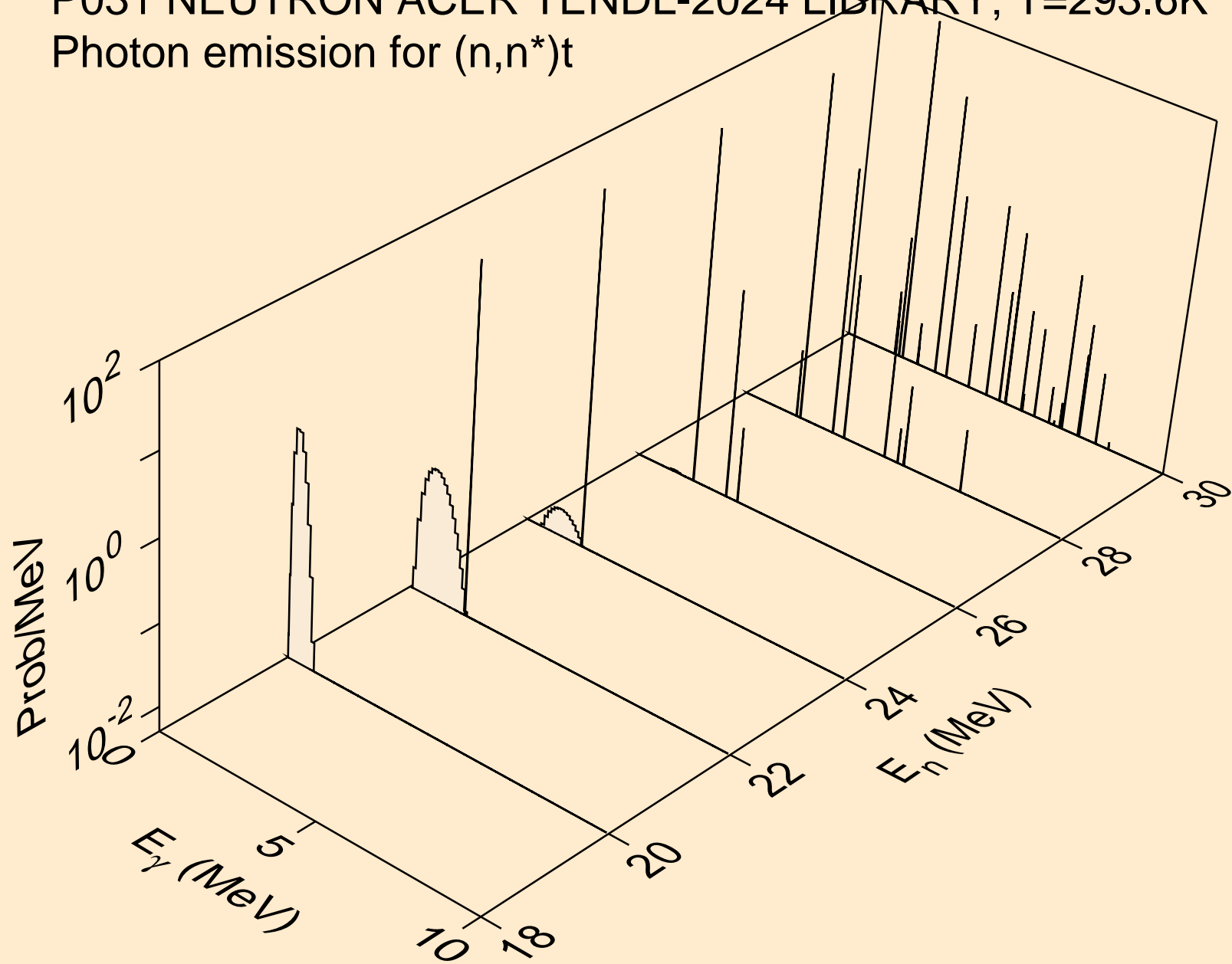

P031 NEUTRON ACER TENDL-2024 LIBRARY; T=293.6K
Photon emission for (n,n*)he3

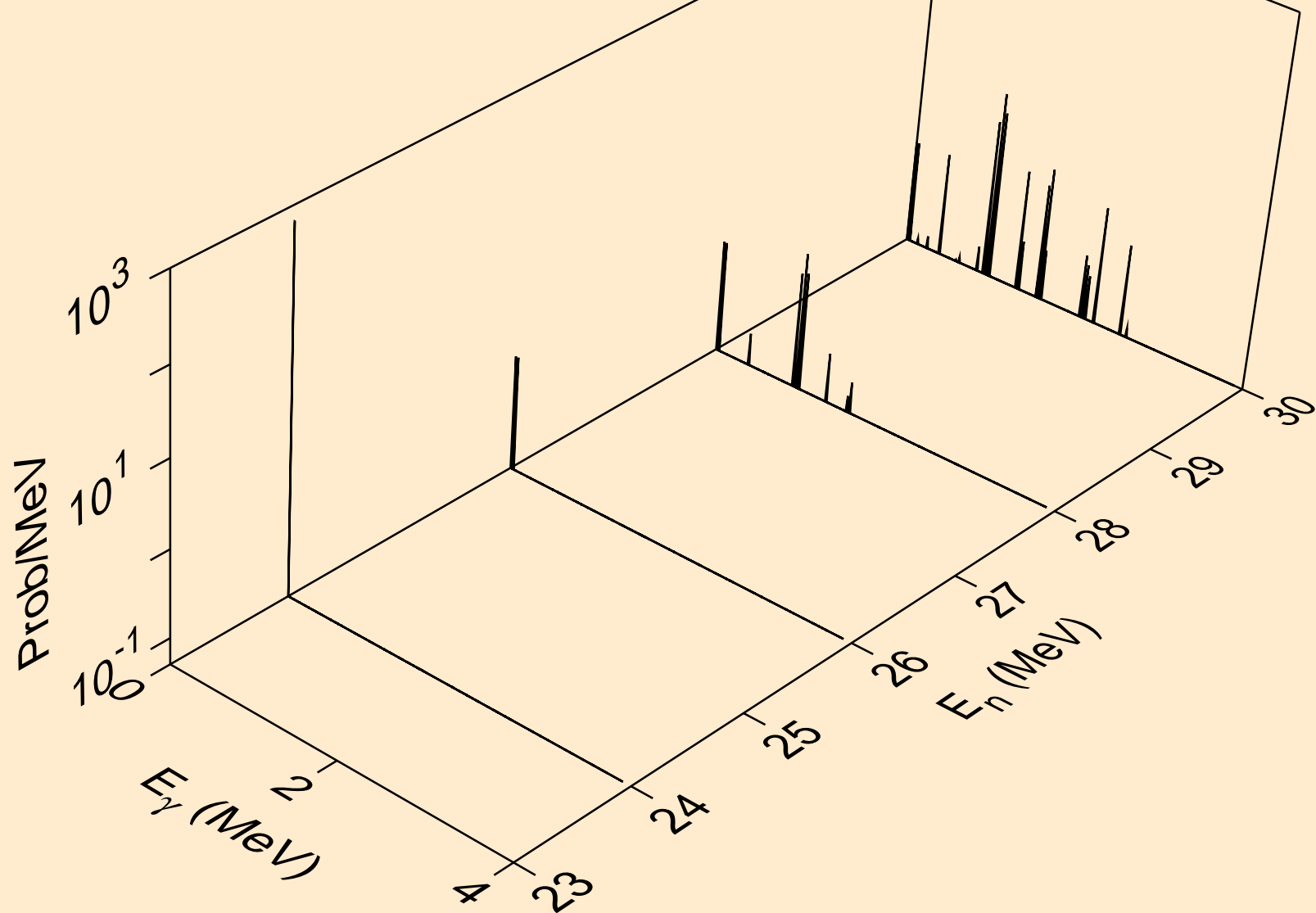

P031 NEUTRON ACER TENDL-2024 LIBRARY; T=293.6K
Photon emission for (n,2np)

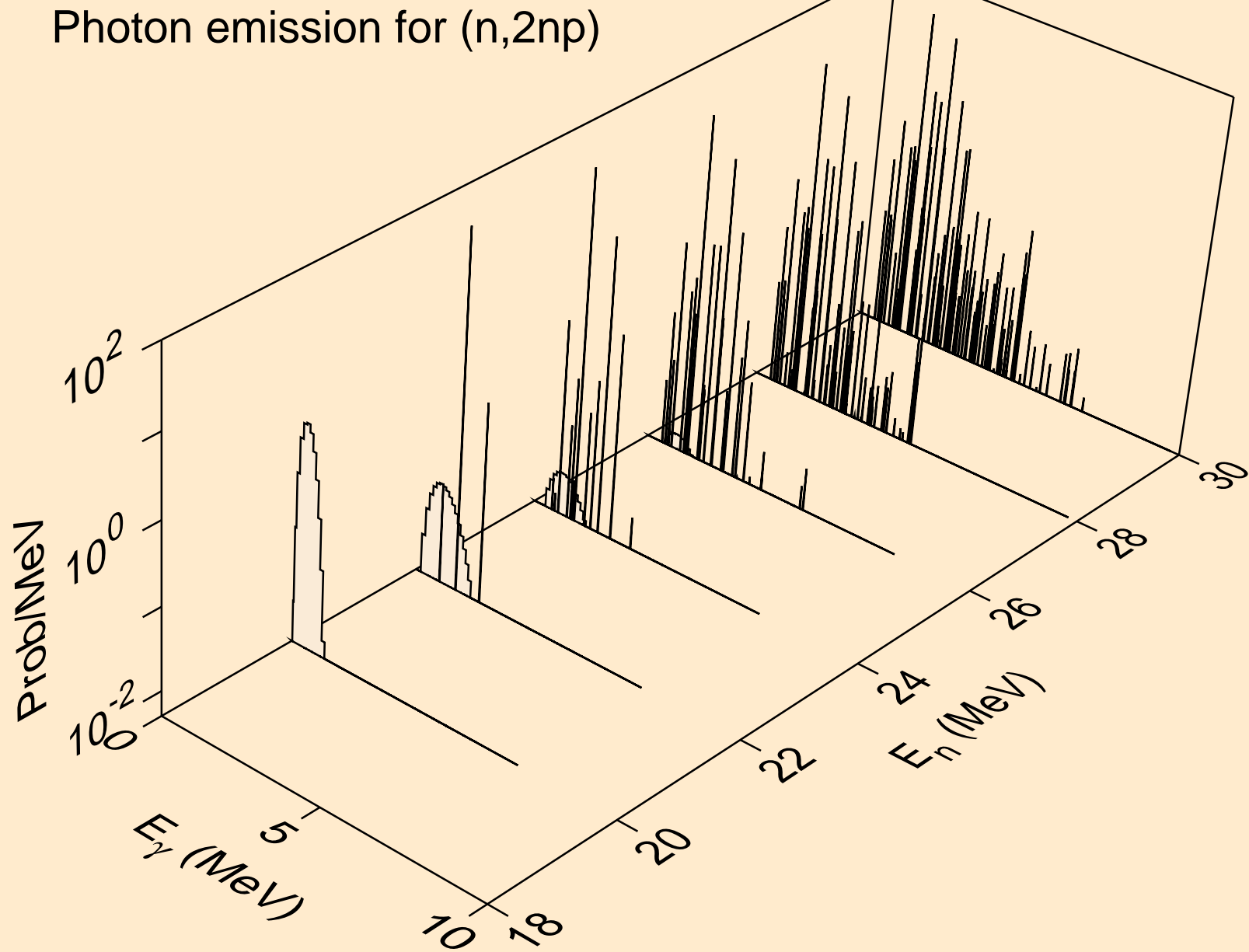

P031 NEUTRON ACER TENDL-2024 LIBRARY; T=293.6K
Photon emission for (n,3np)

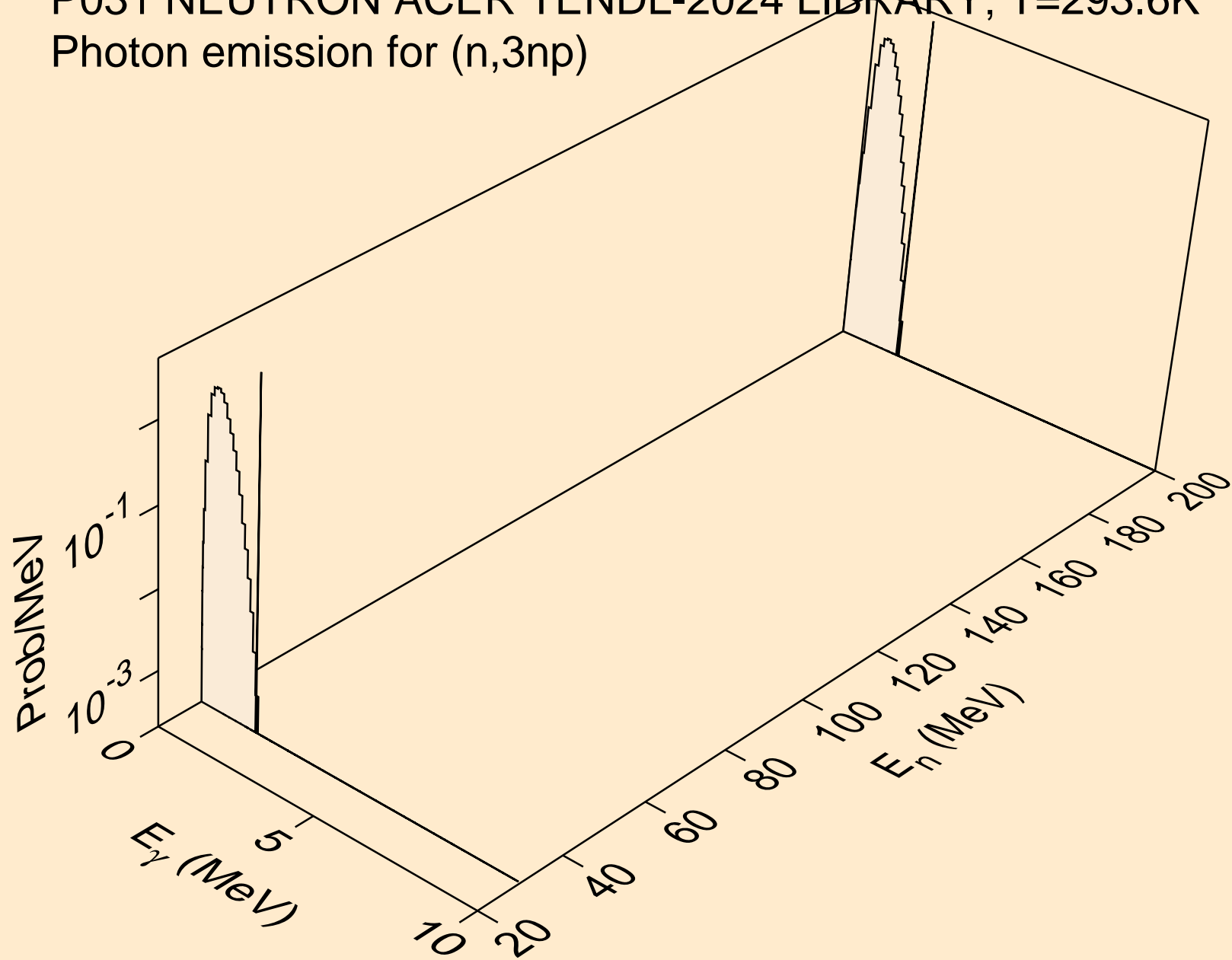

P031 NEUTRON ACER TENDL-2024 LIBRARY; T=293.6K
Photon emission for (n,n2p)

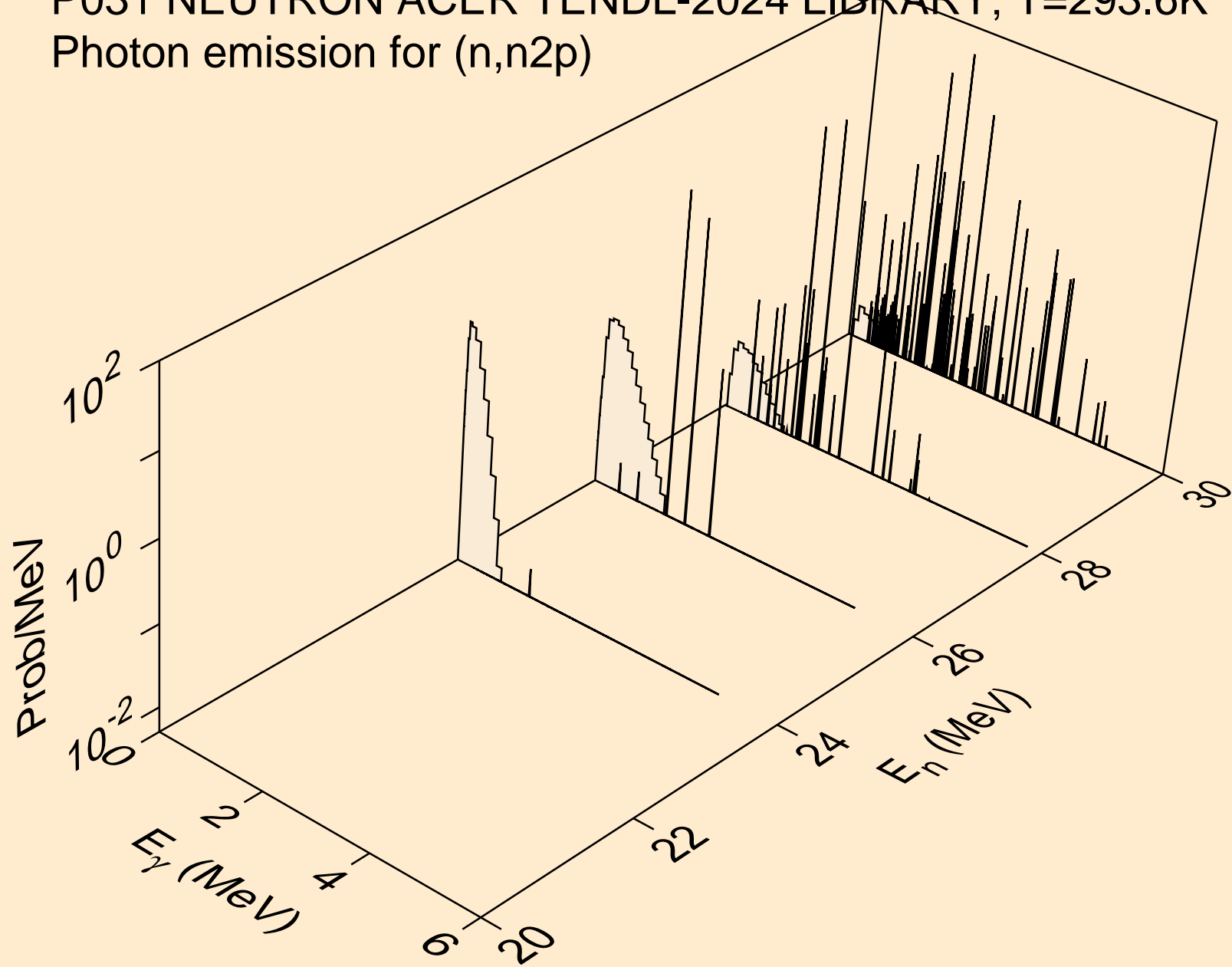

P031 NEUTRON ACER TENDL-2024 LIBRARY; T=293.6K
Photon emission for (n,npa)

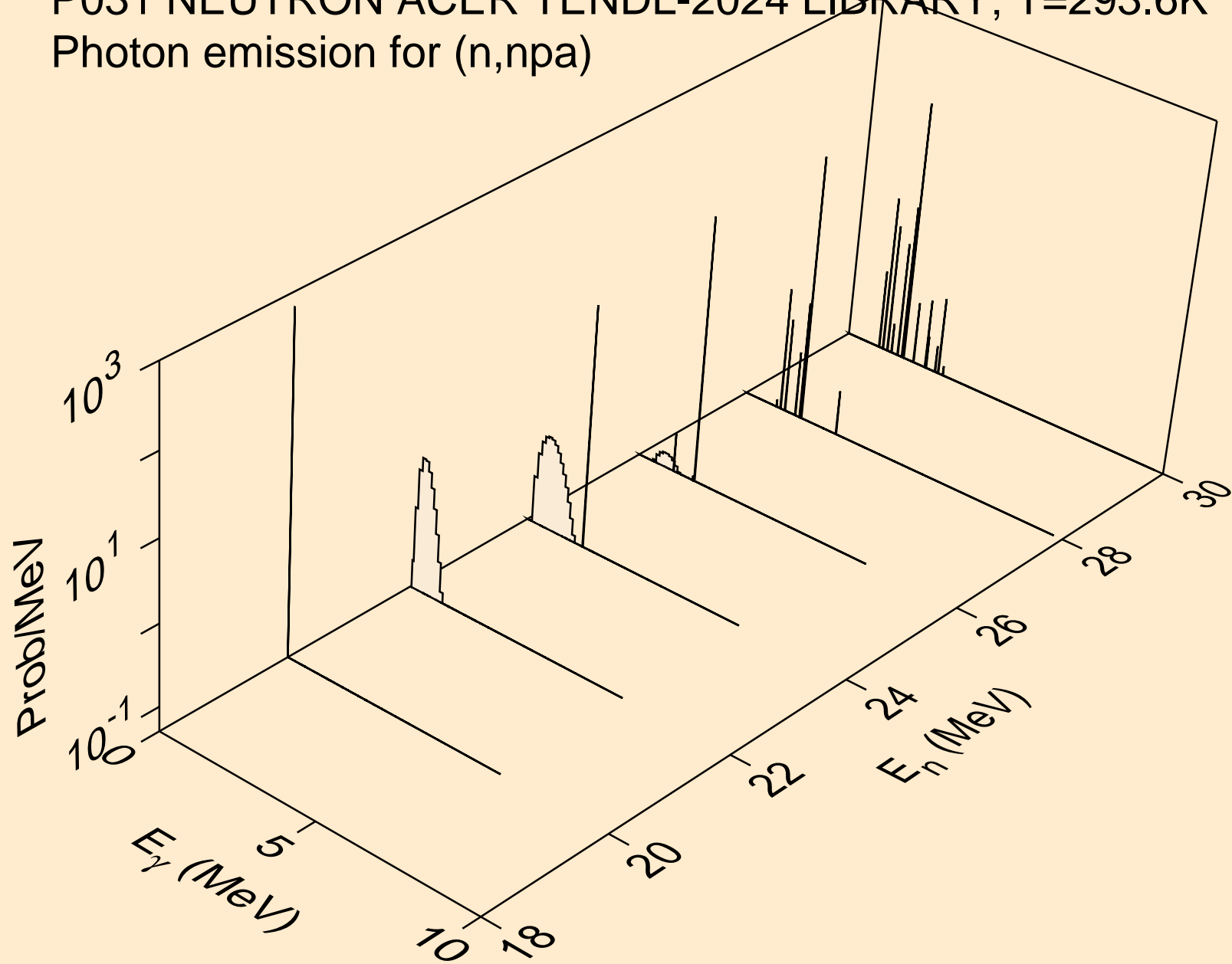

P031 NEUTRON ACER TENDL-2024 LIBRARY; T=293.6K
Photon emission for (n,n*c)

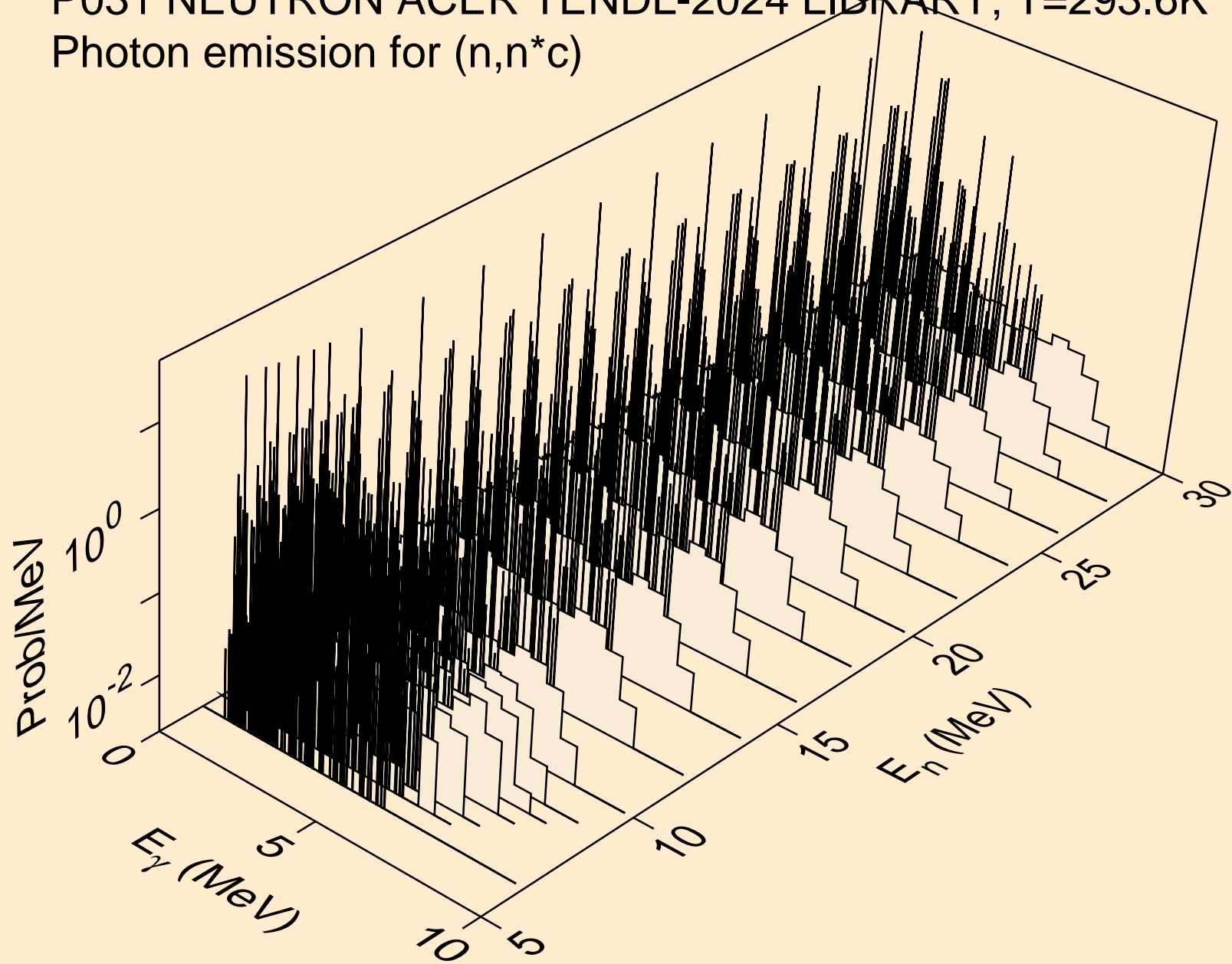

P031 NEUTRON ACER TENDL-2024 LIBRARY; T=293.6K
Photon emission for (n,gma)

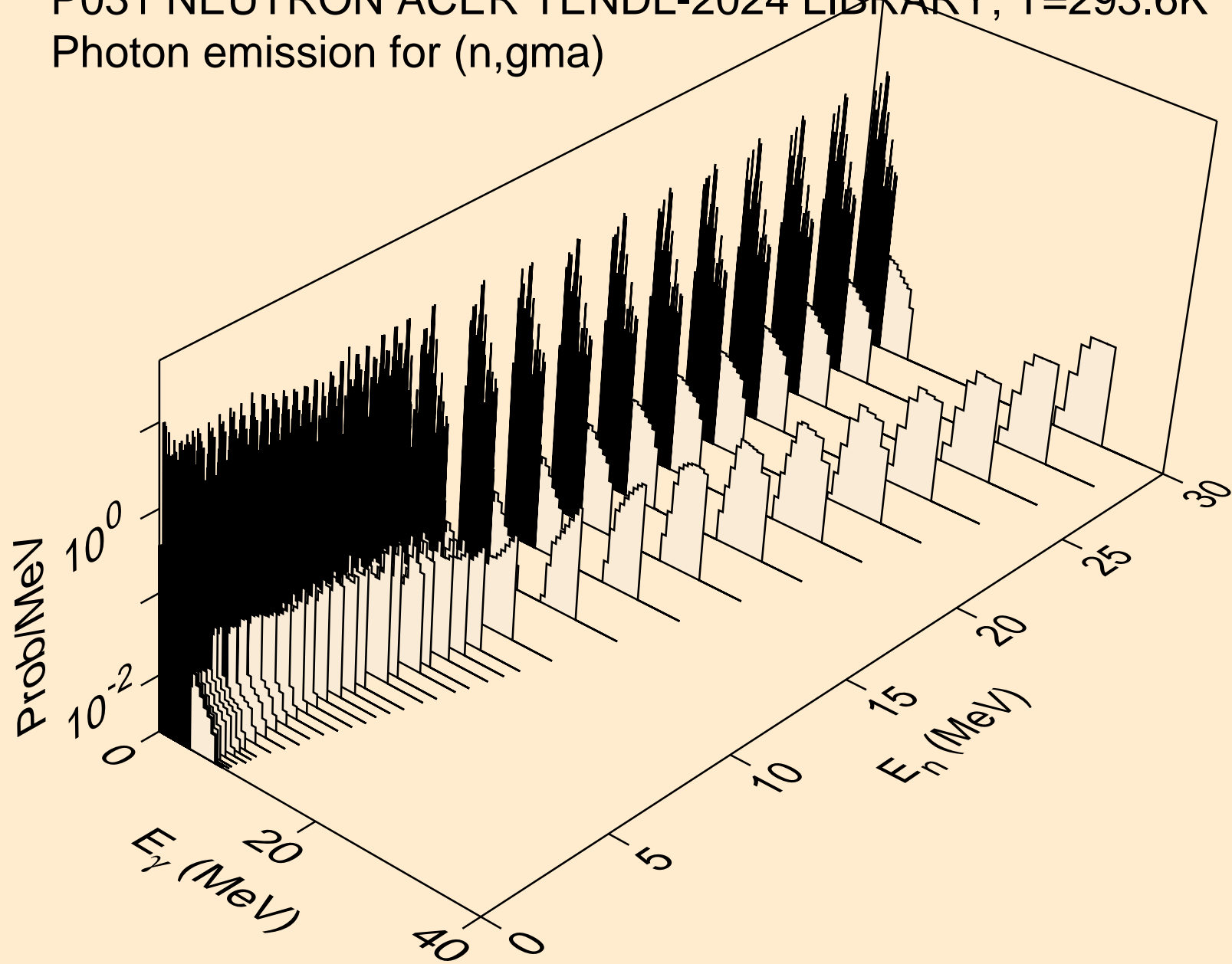

P031 NEUTRON ACER TENDL-2024 LIBRARY; T=293.6K
Photon emission for (n,p)

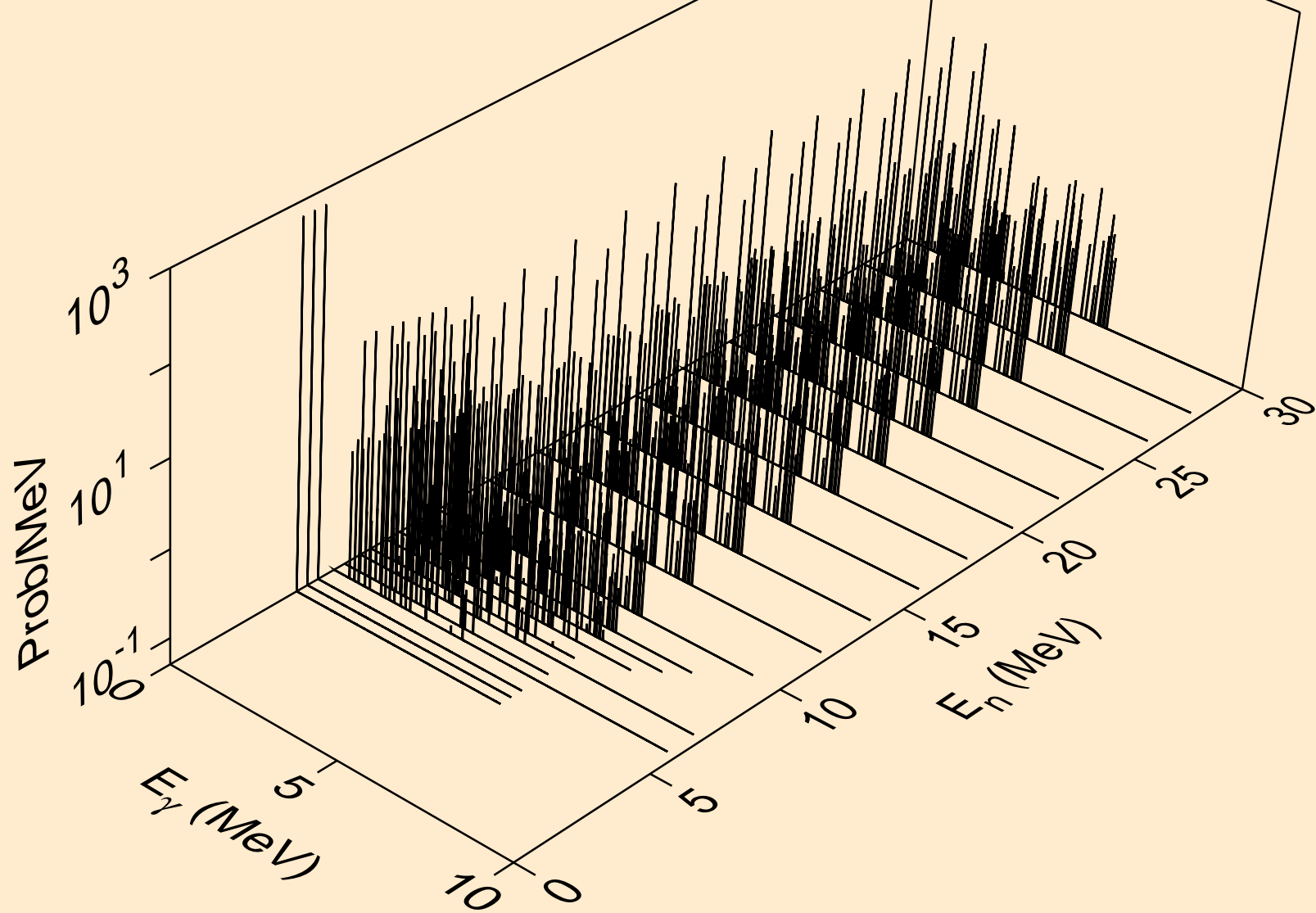

P031 NEUTRON ACER TENDL-2024 LIBRARY; T=293.6K
Photon emission for (n,d)

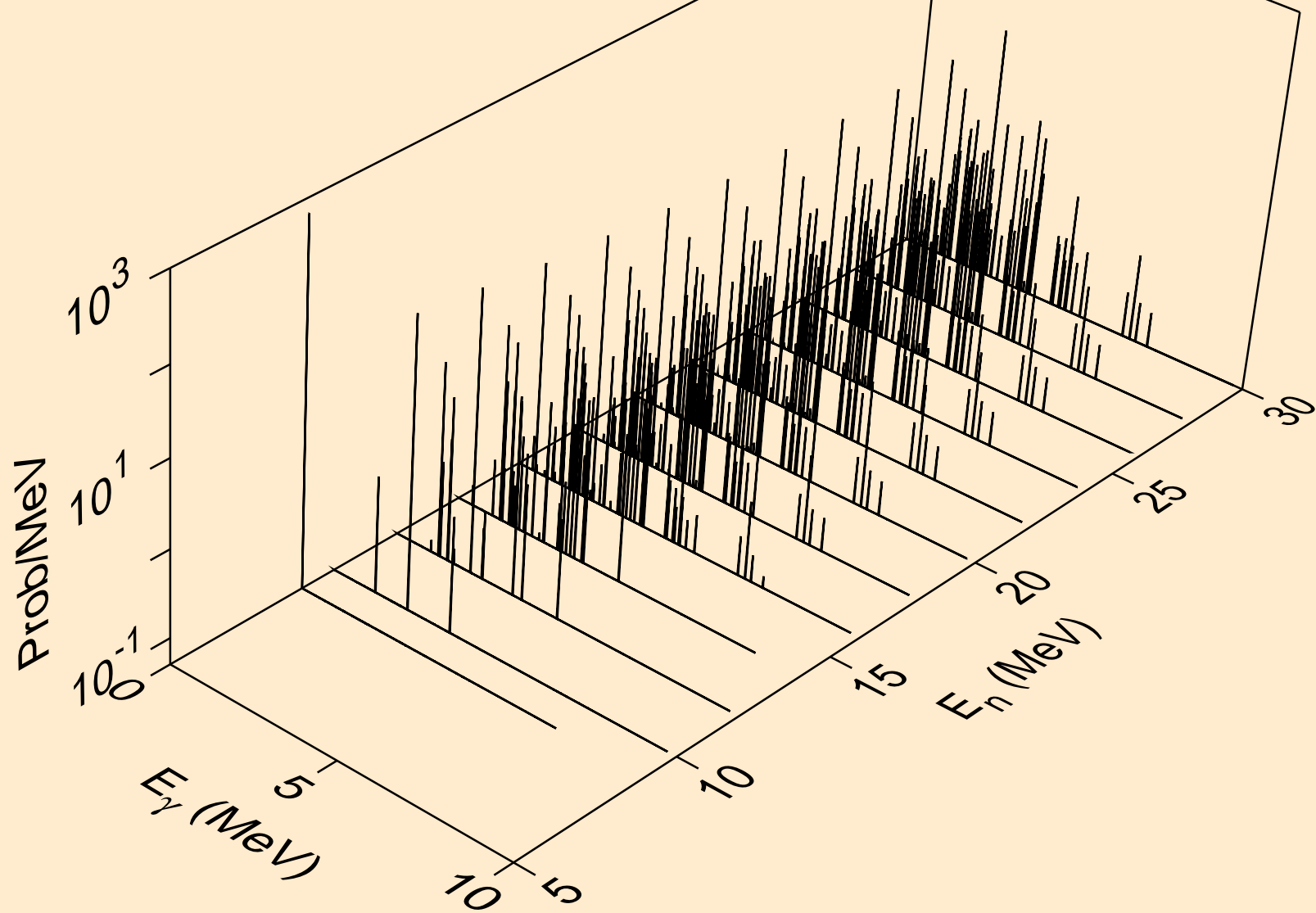

P031 NEUTRON ACER TENDL-2024 LIBRARY; T=293.6K
Photon emission for (n,t)

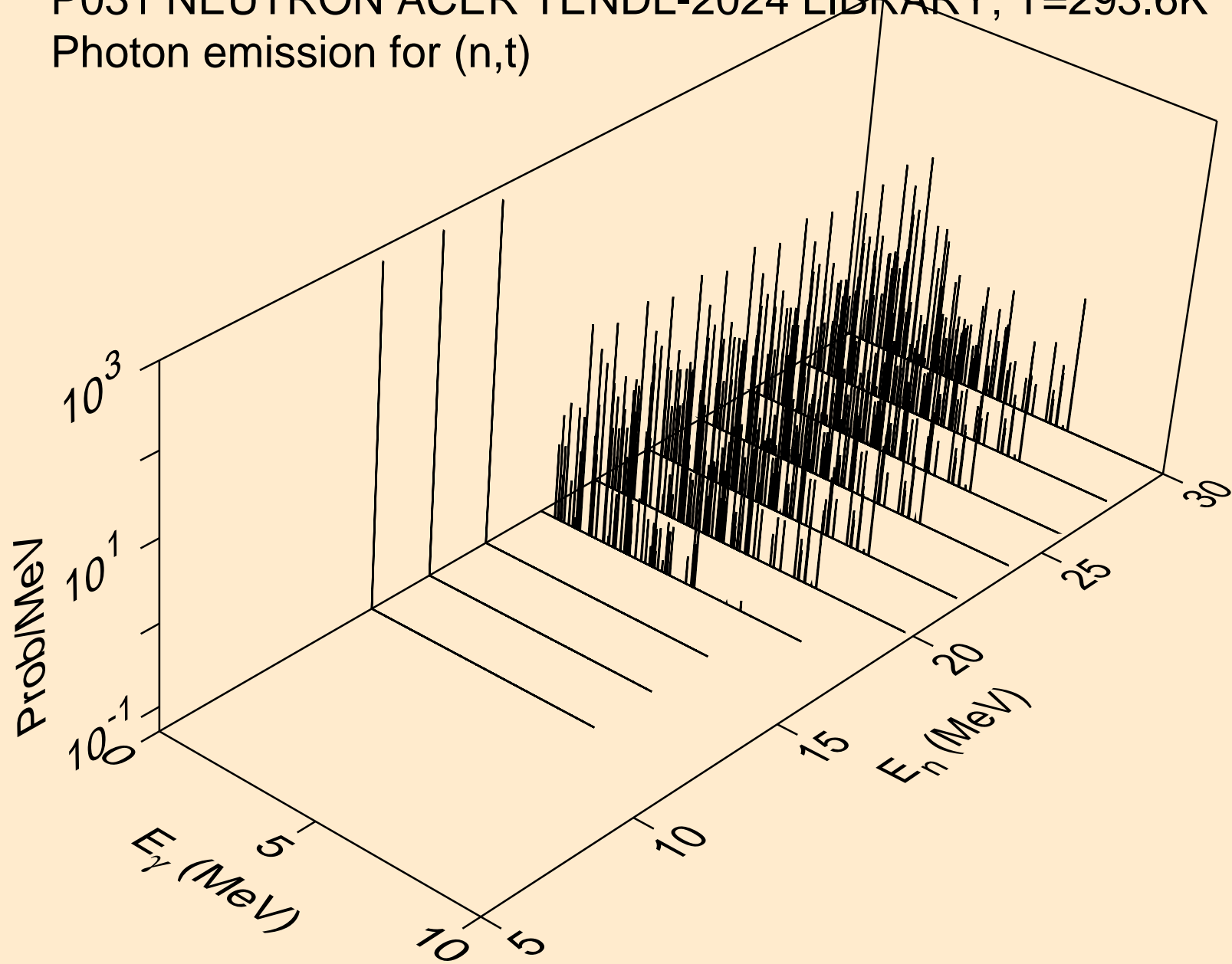

P031 NEUTRON ACER TENDL-2024 LIBRARY; T=293.6K
Photon emission for (n,he3)

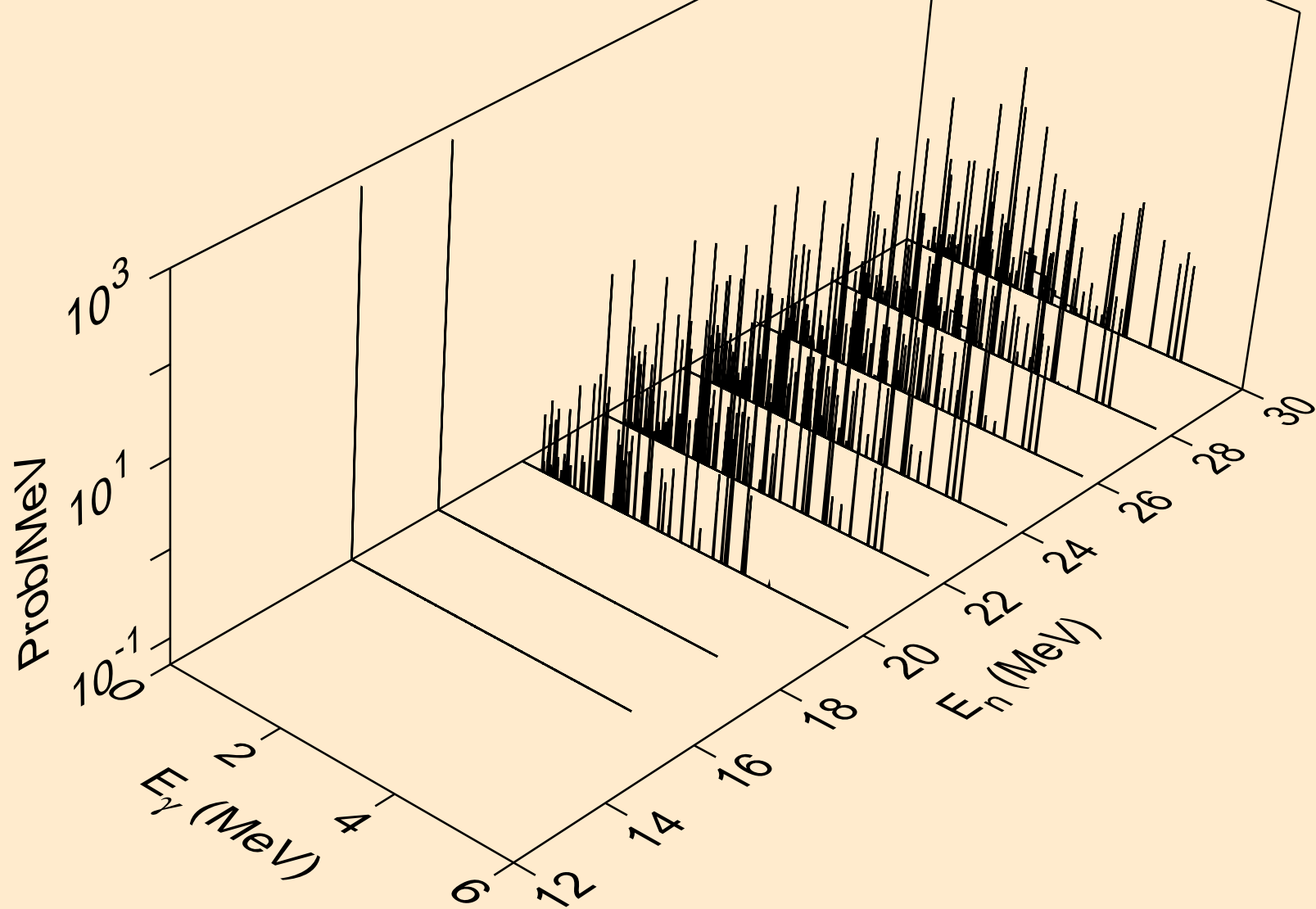

P031 NEUTRON ACER TENDL-2024 LIBRARY; T=293.6K
Photon emission for (n,a)

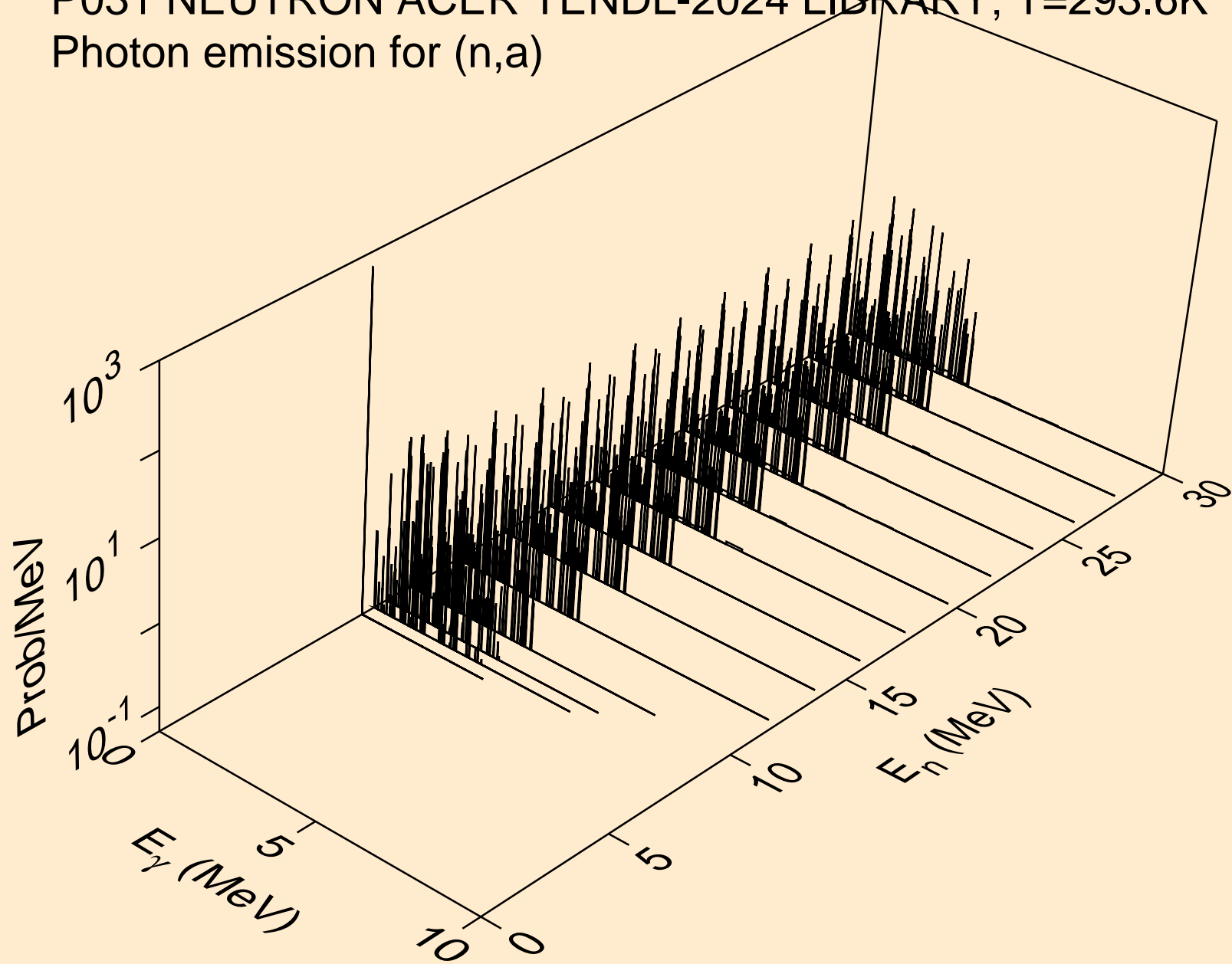

P031 NEUTRON ACER TENDL-2024 LIBRARY; T=293.6K
Photon emission for (n,2a)

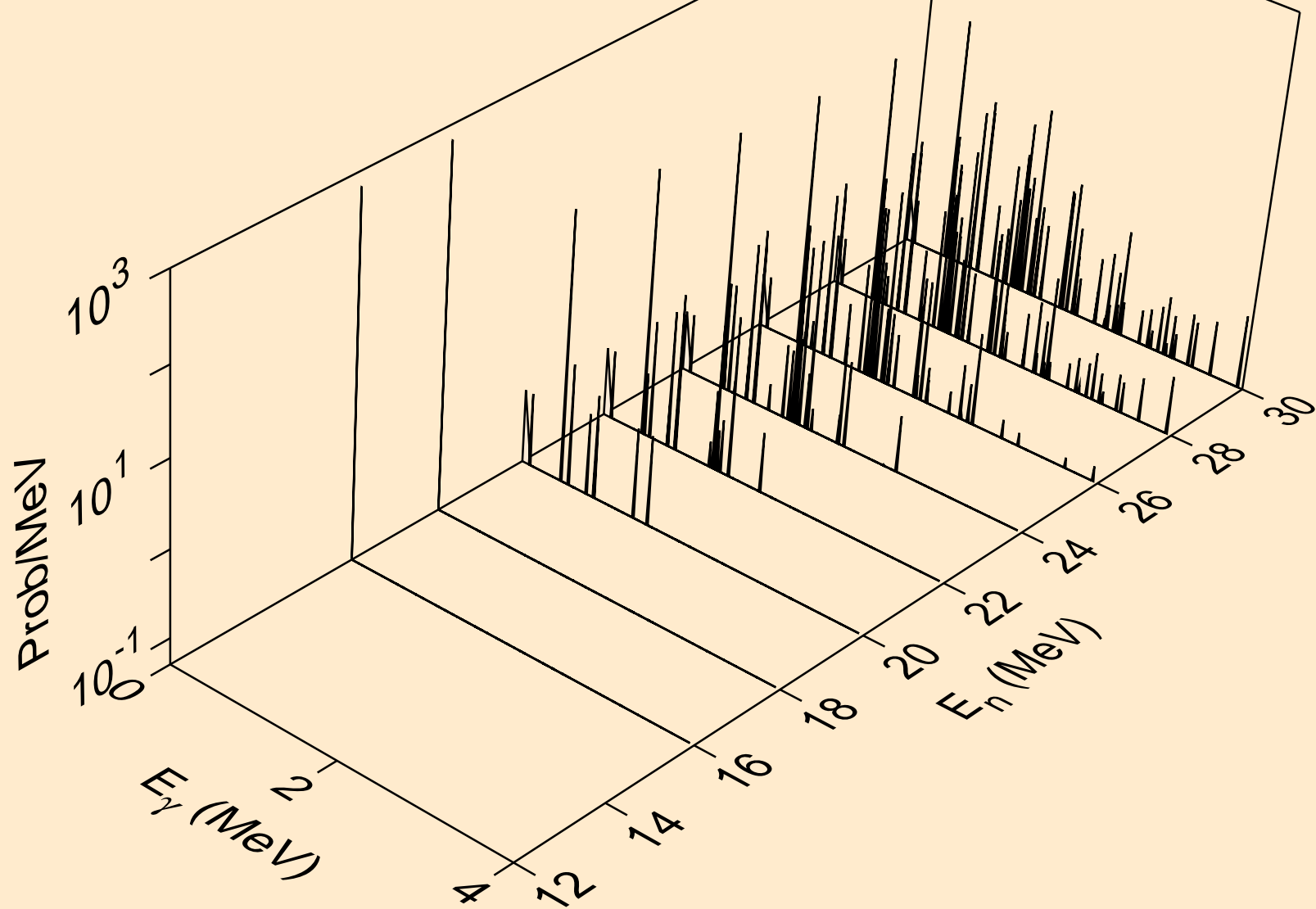

P031 NEUTRON ACER TENDL-2024 LIBRARY; T=293.6K
Photon emission for (n,2p)

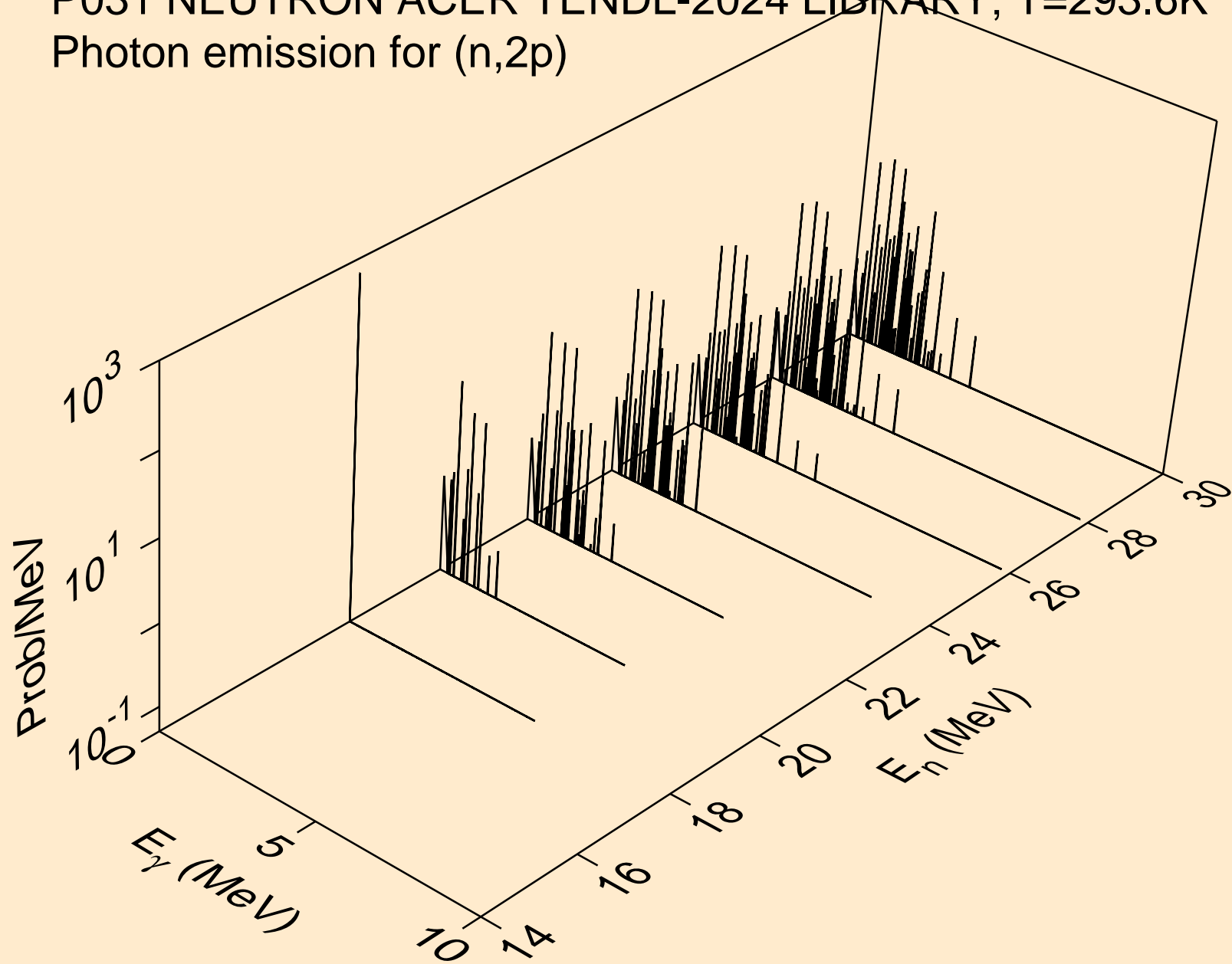

P031 NEUTRON ACER TENDL-2024 LIBRARY; T=293.6K
Photon emission for (n,p α)

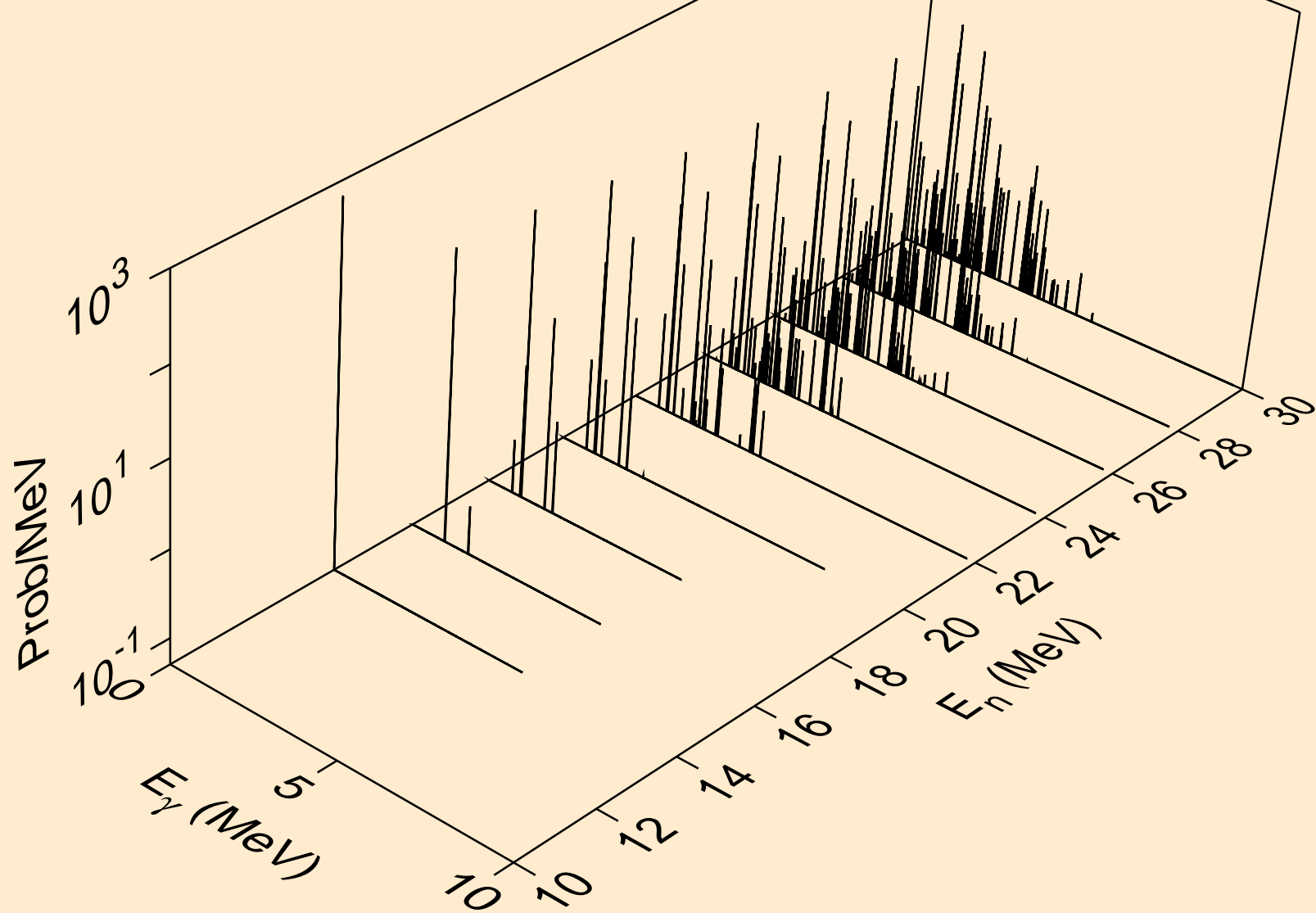

P031 NEUTRON ACER TENDL-2024 LIBRARY; T=293.6K
Photon emission for (n,pd)

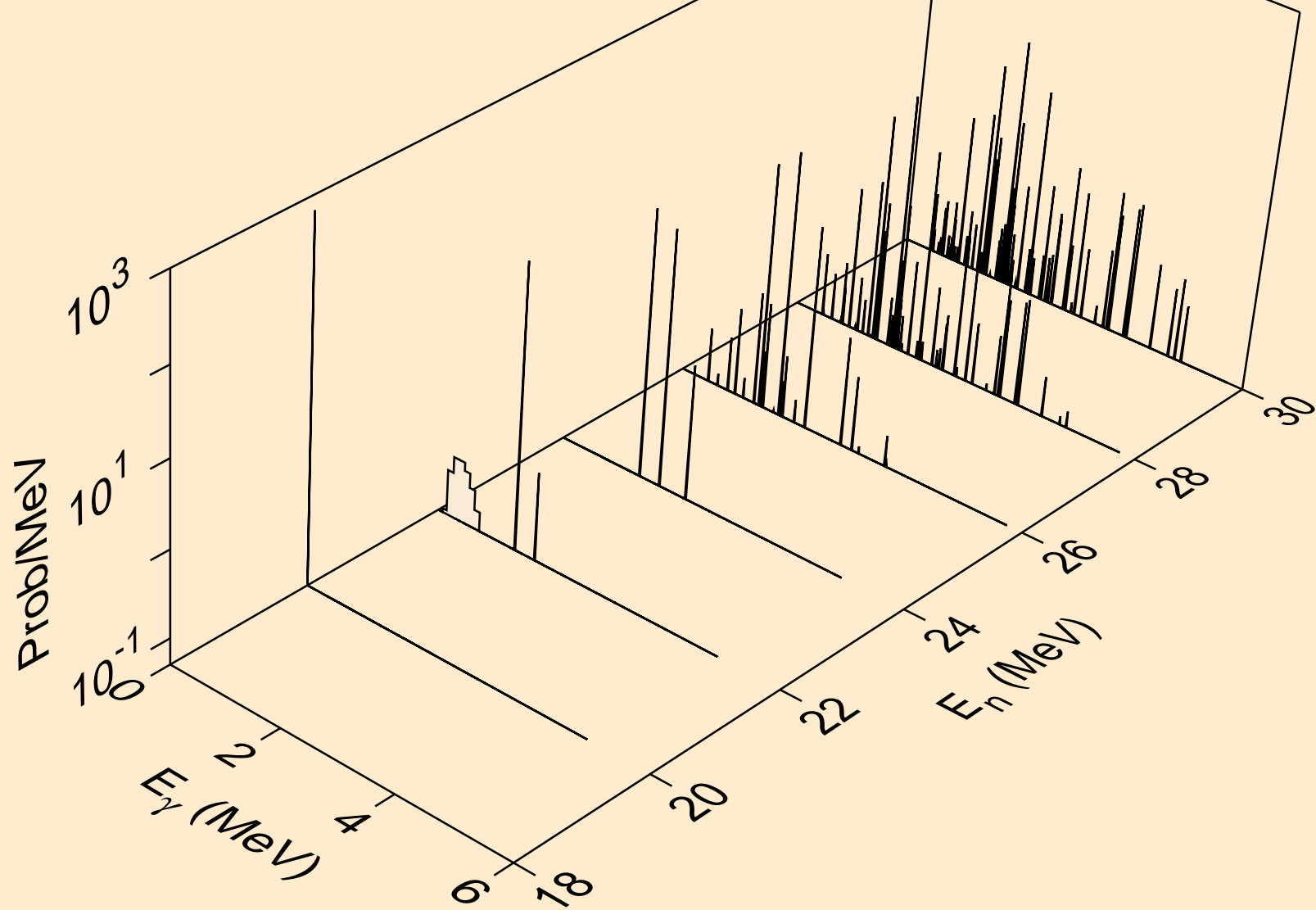

P031 NEUTRON ACER TENDL-2024 LIBRARY; T=293.6K
Photon emission for (n,pt)

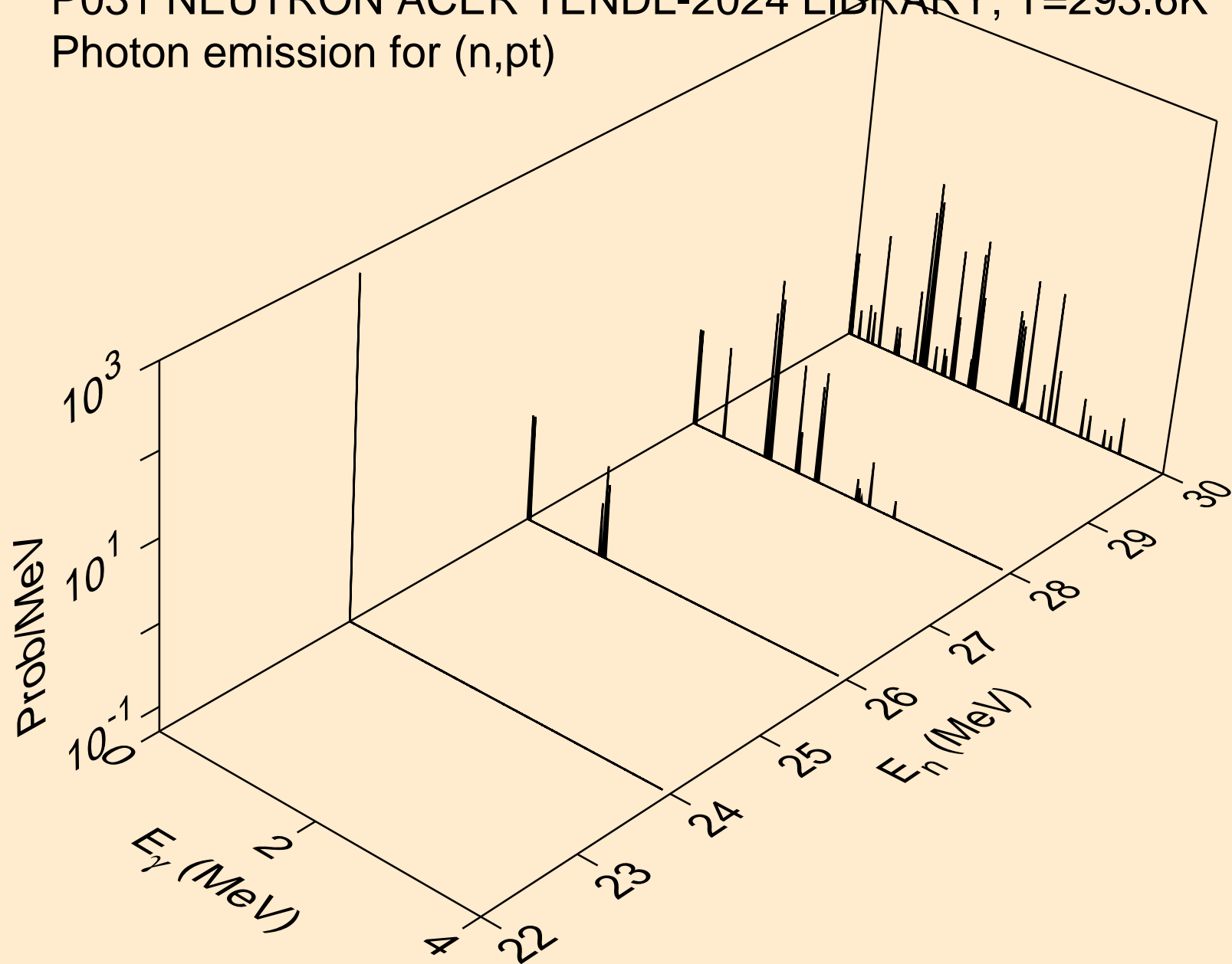

P031 NEUTRON ACER TENDL-2024 LIBRARY; T=293.6K
Photon emission for (n,da)

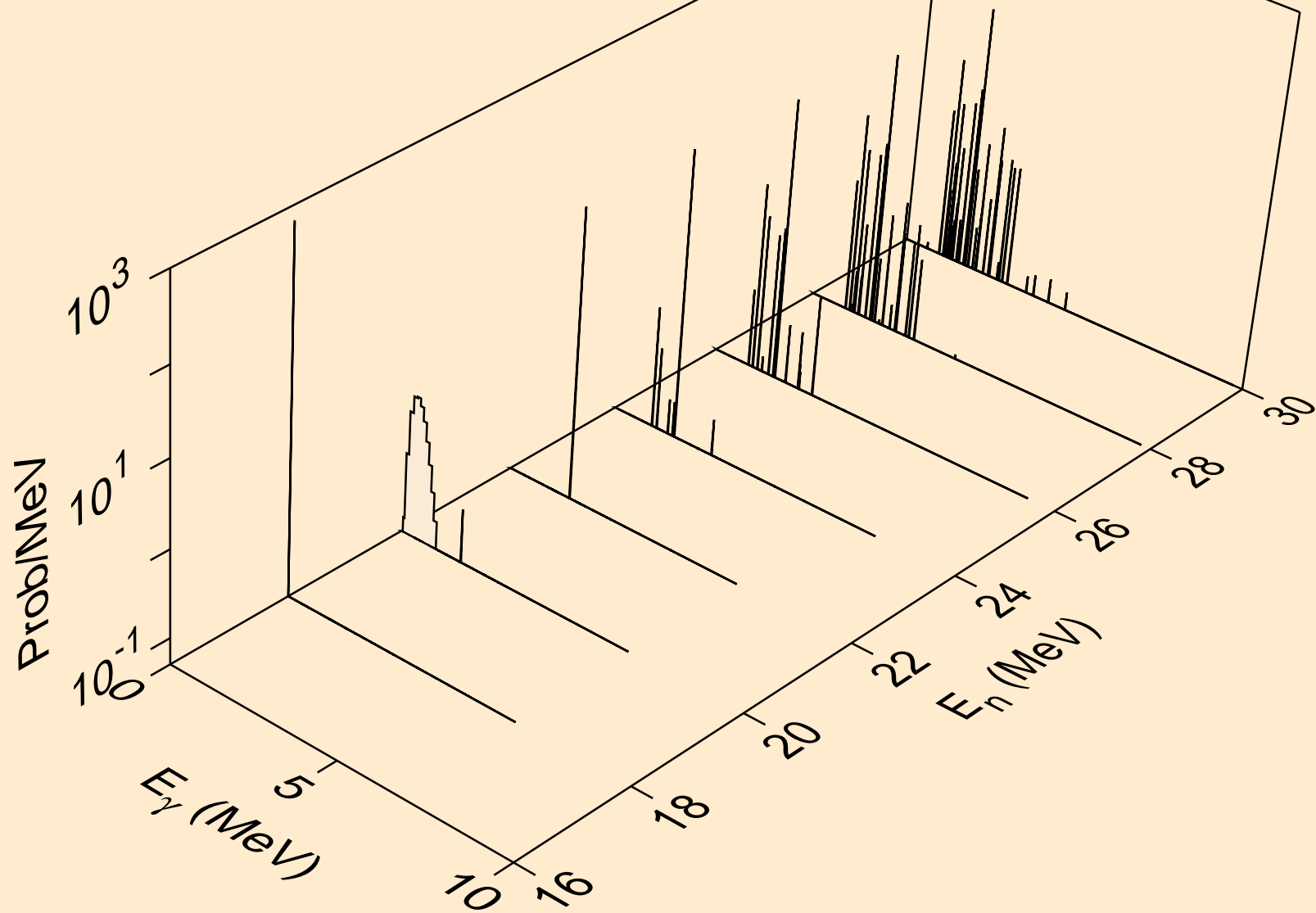

P031 NEUTRON ACER TENDL-2024 LIBRARY; T=293.6K
thermal capture photon spectrum

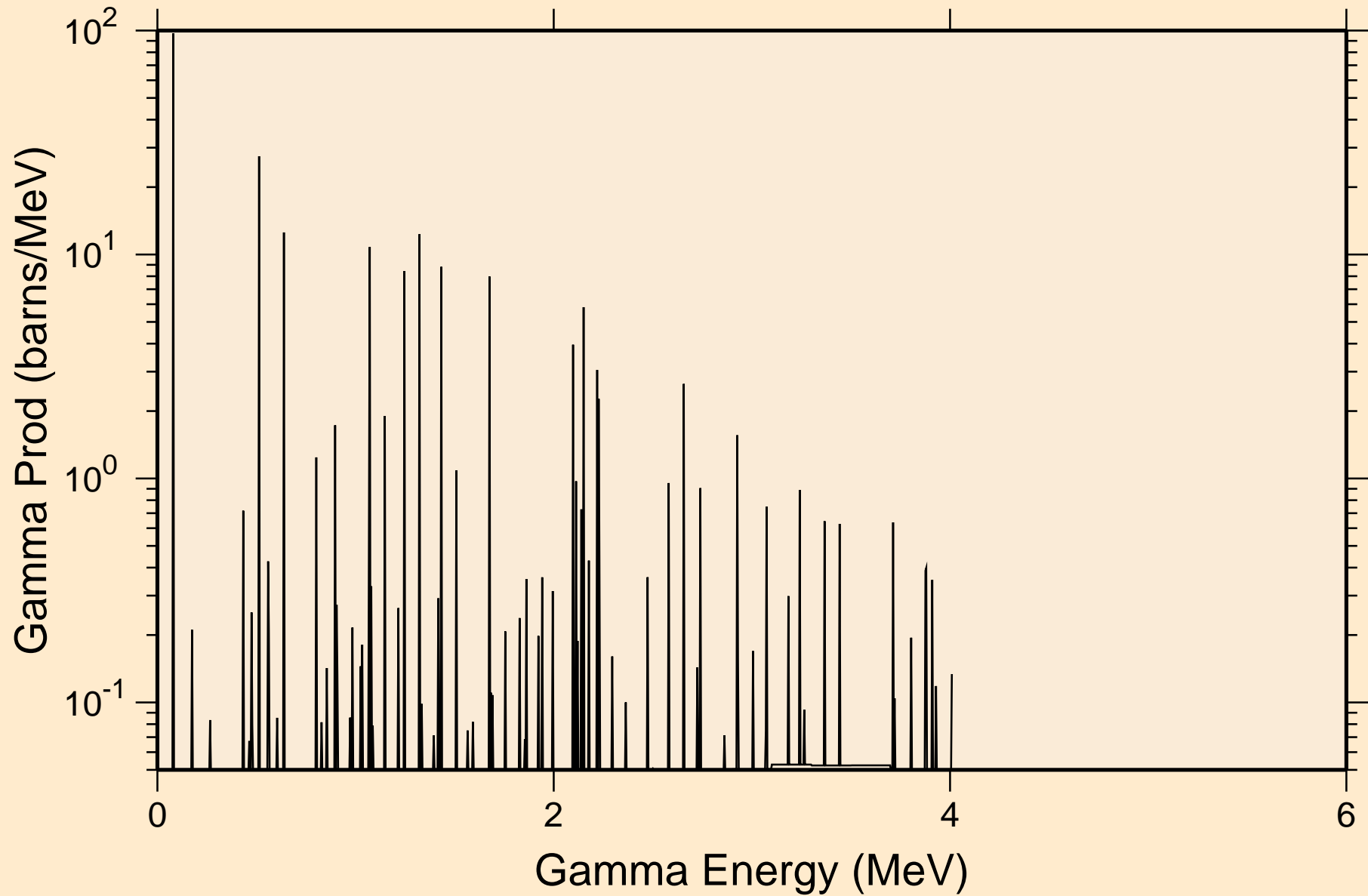

P031 NEUTRON ACER TENDL-2024 LIBRARY; T=293.6K
14 MeV photon spectrum

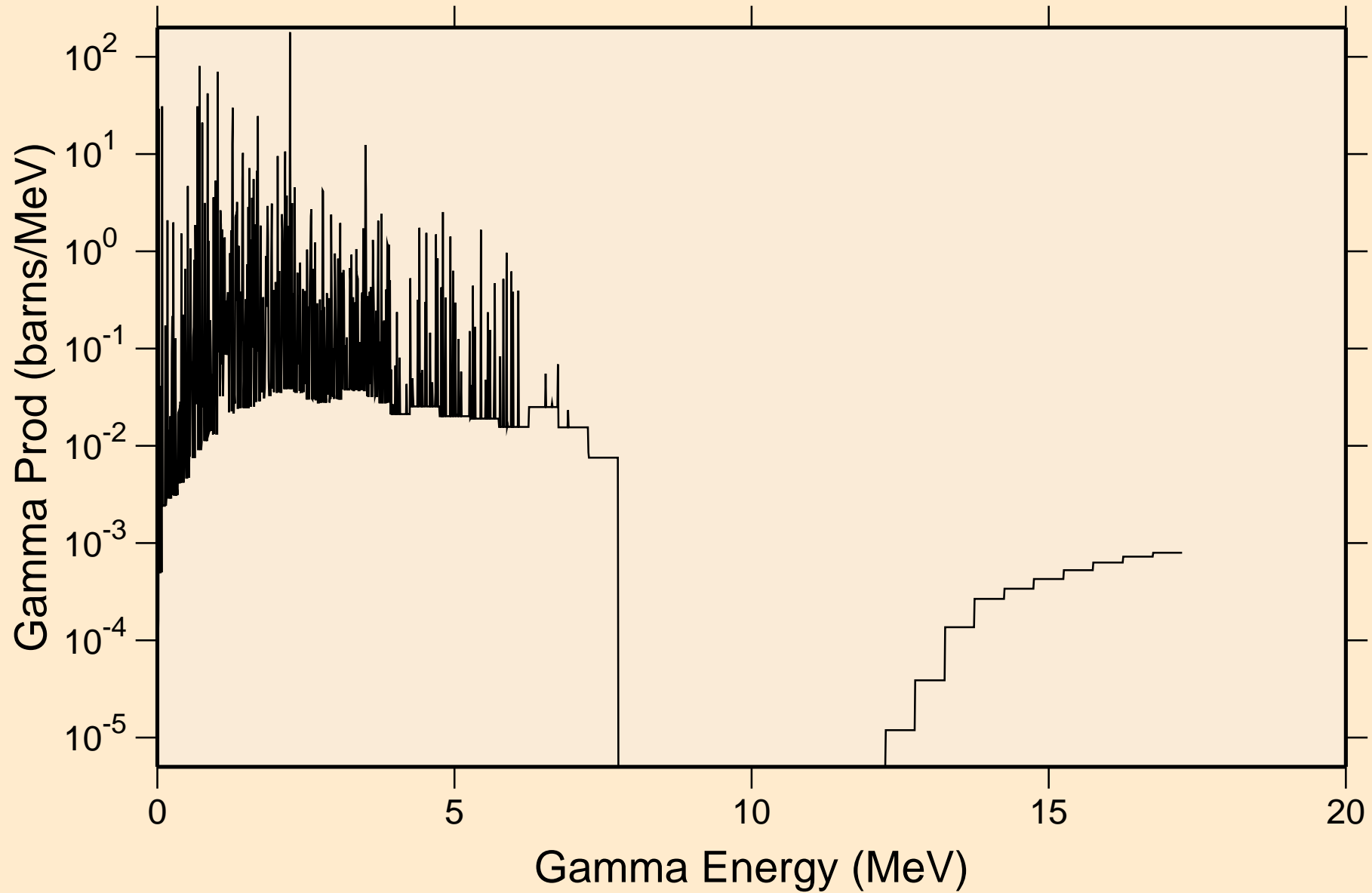

P031 NEUTRON ACER TENDL-2024 LIBRARY; T=293.6K
Particle heating contributions

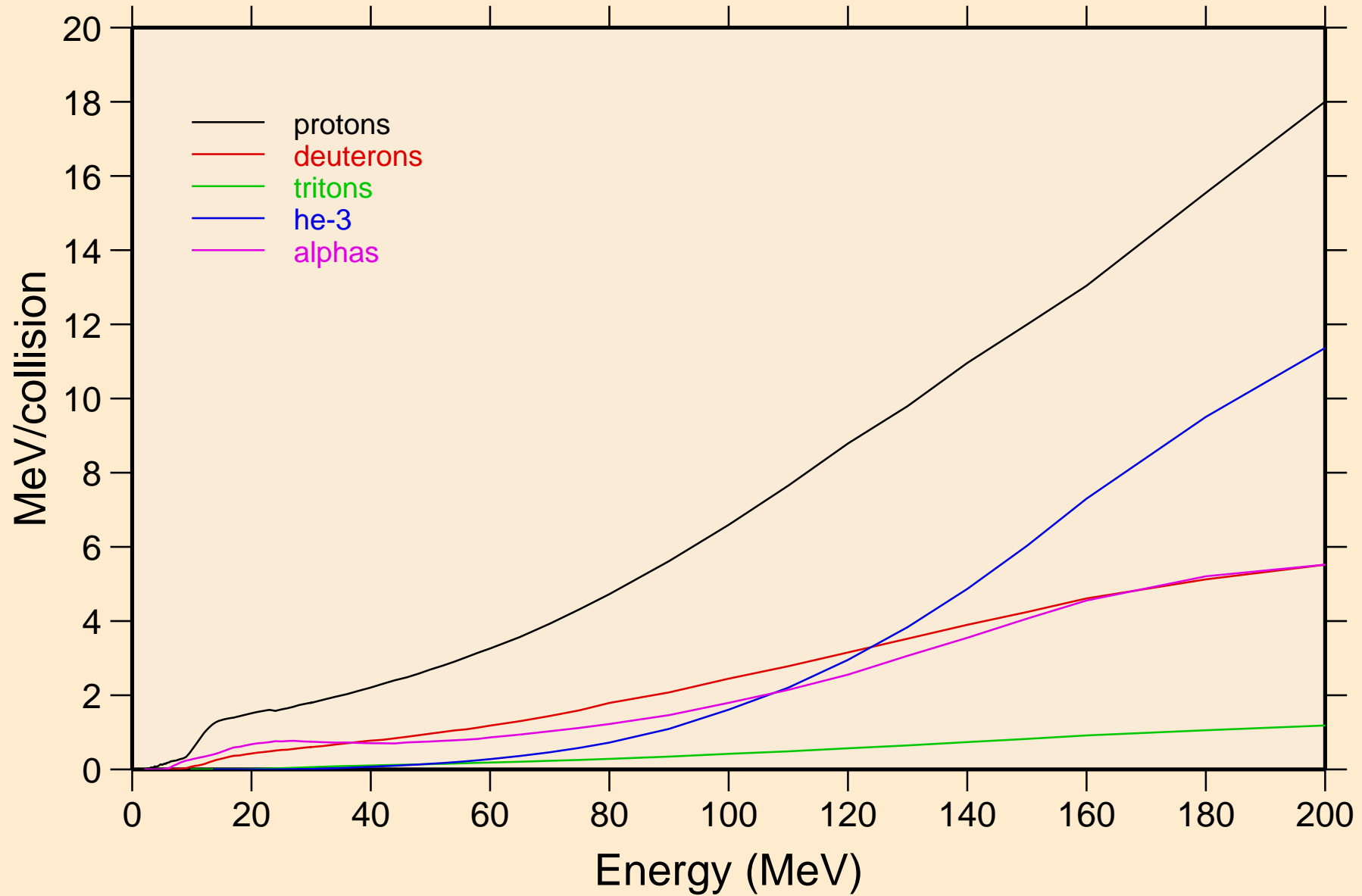

P031 NEUTRON ACER TENDL-2024 LIBRARY; T=293.6K
Recoil Heating

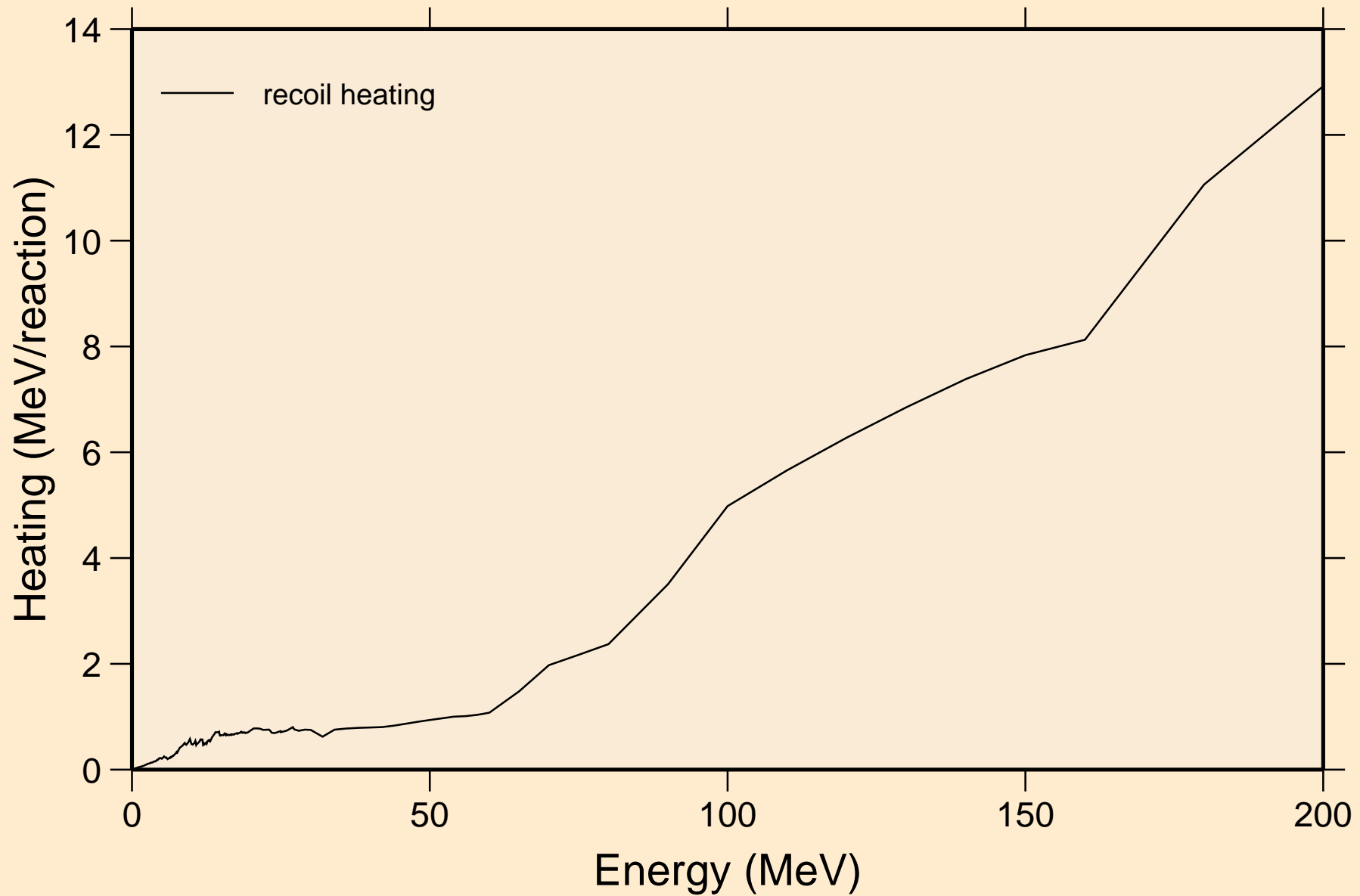

P031 NEUTRON ACER TENDL-2024 LIBRARY; T=293.6K
Particle production cross sections

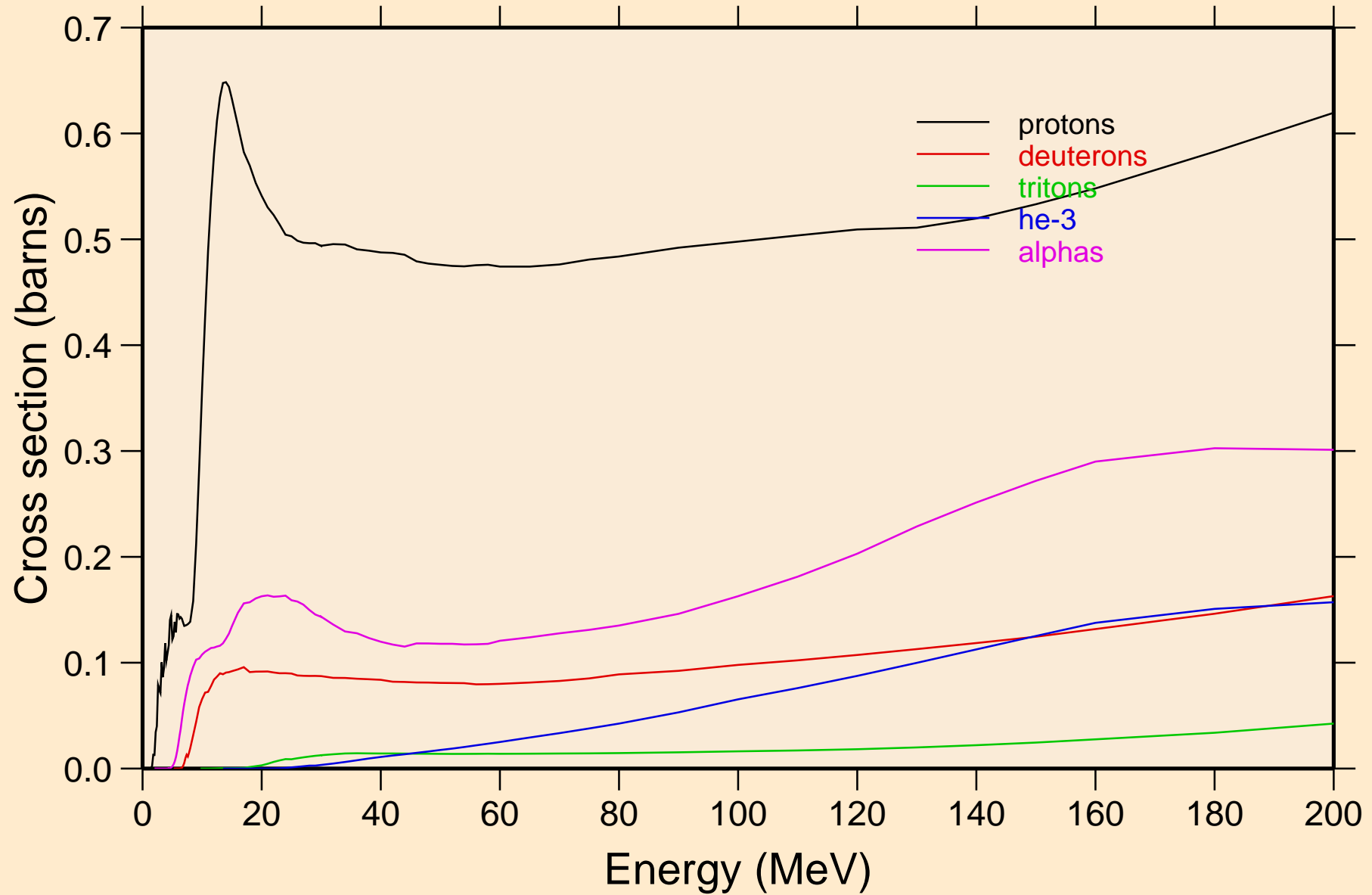

P031 NEUTRON ACER TENDL-2024 LIBRARY; T=293.6K
protons from (n,x)

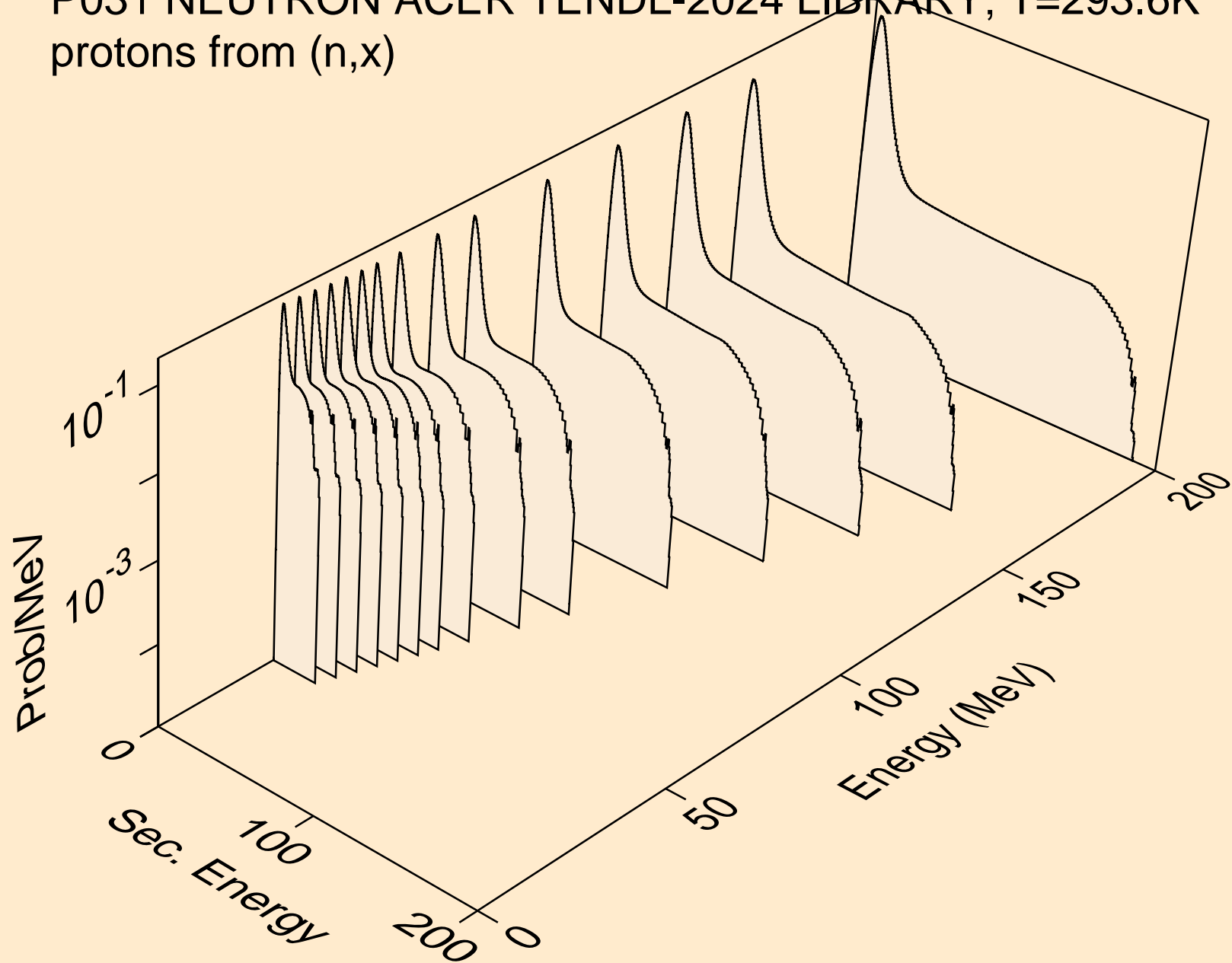

P031 NEUTRON ACER TENDL-2024 LIBRARY; T=293.6K
protons from (n,n*)p

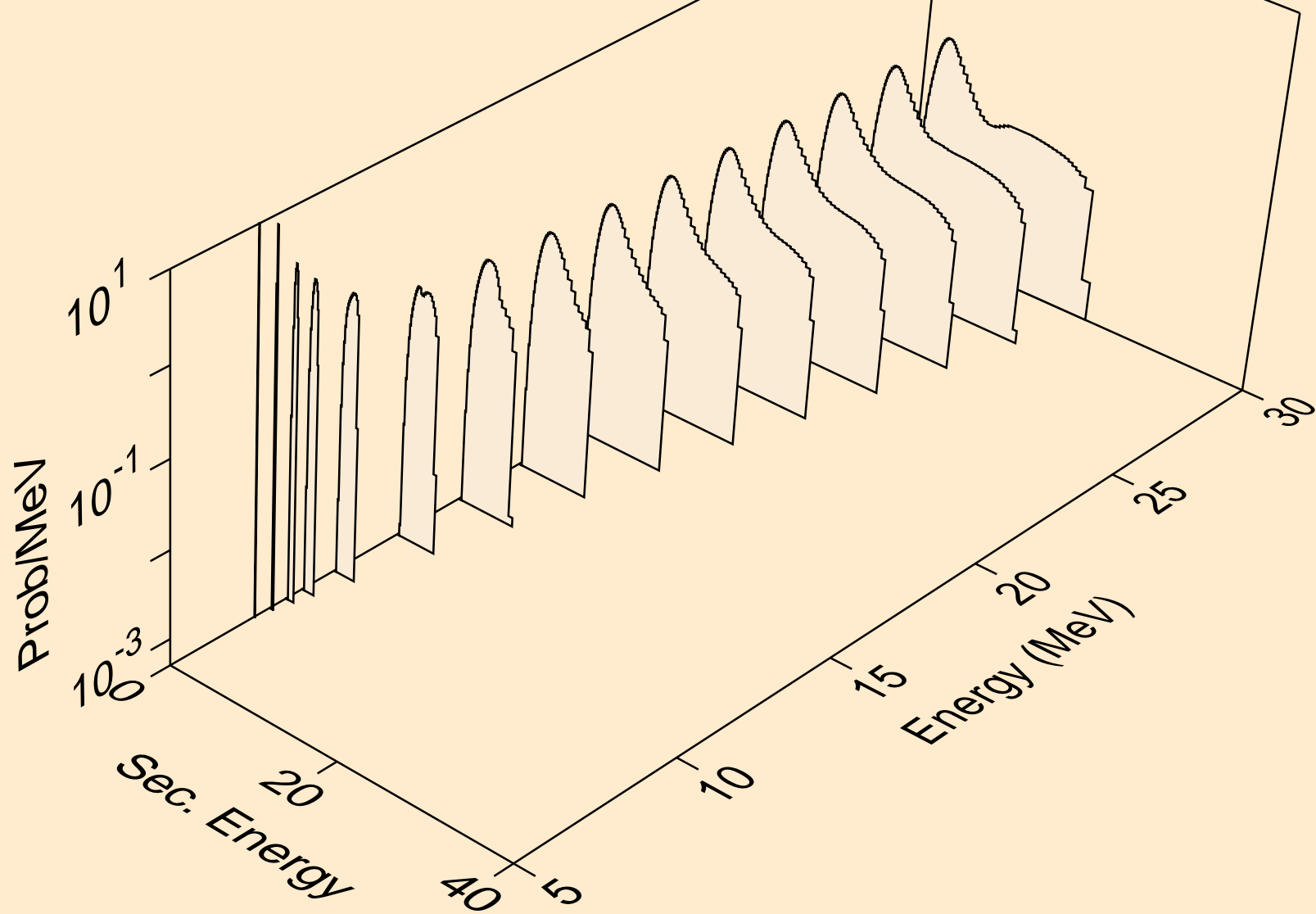

P031 NEUTRON ACER TENDL-2024 LIBRARY; T=293.6K
protons from (n,2np)

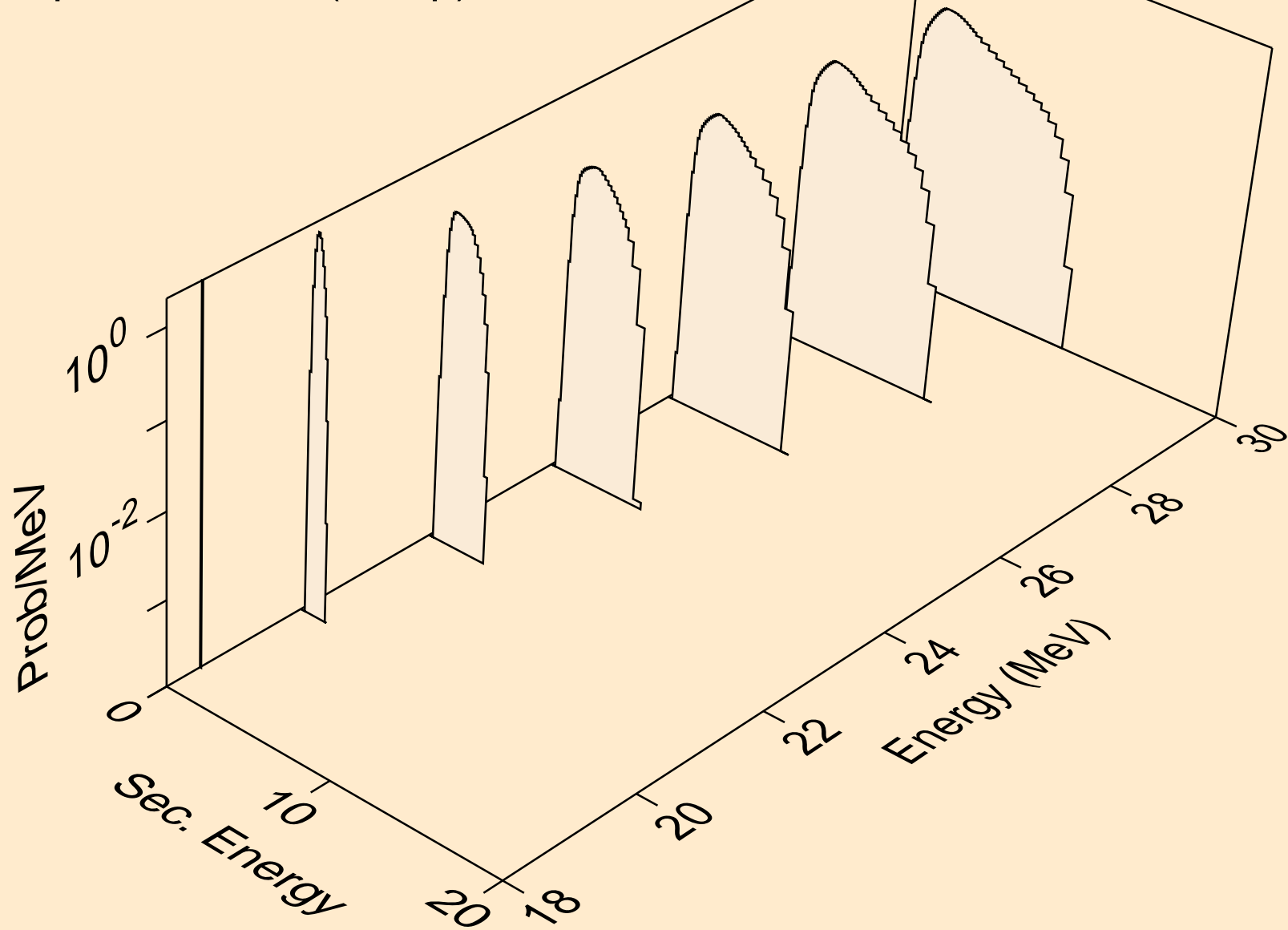

P031 NEUTRON ACER TENDL-2024 LIBRARY; T=293.6K
protons from (n,3np)

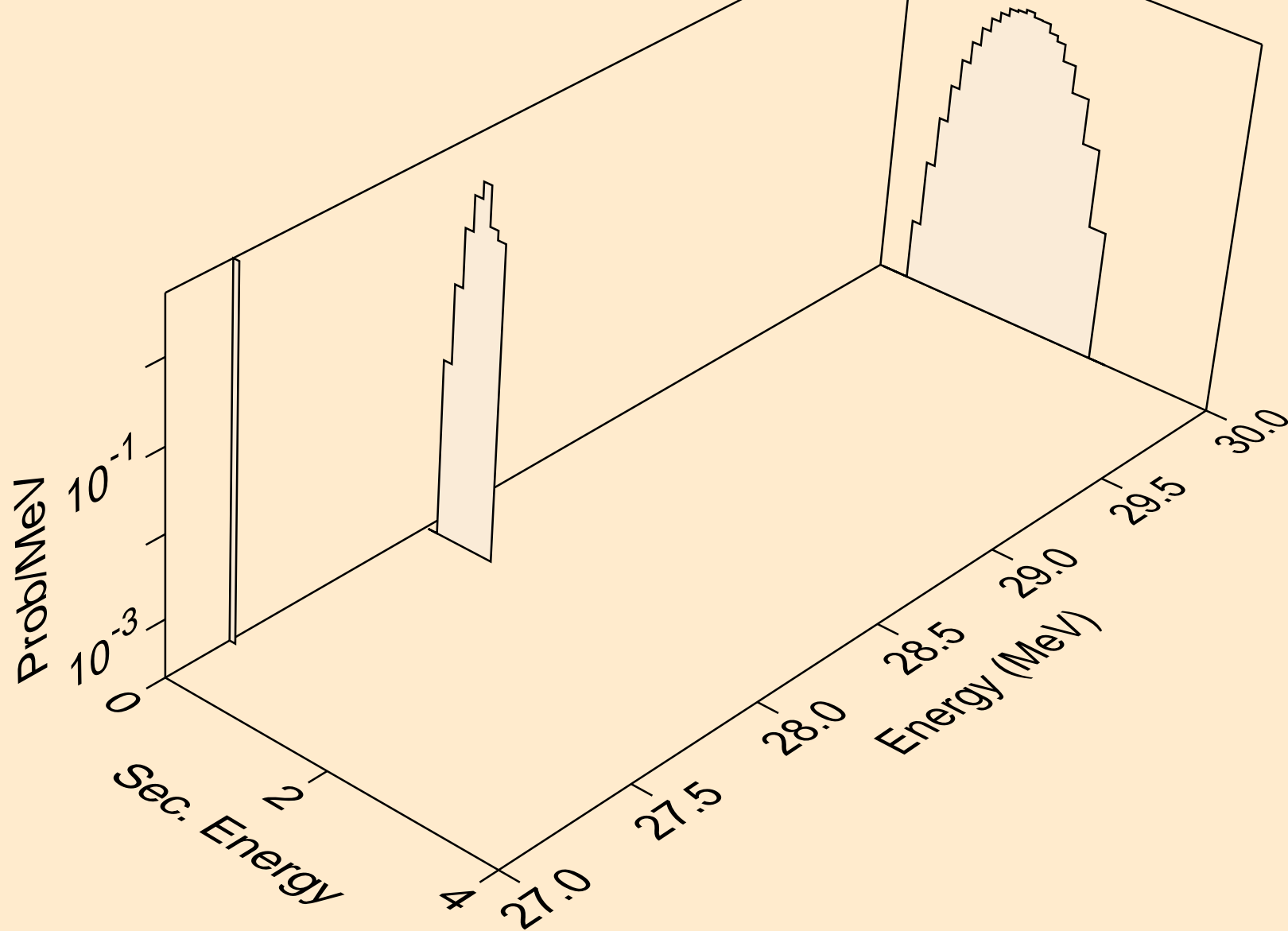

P031 NEUTRON ACER TENDL-2024 LIBRARY; T=293.6K
protons from (n,n2p)

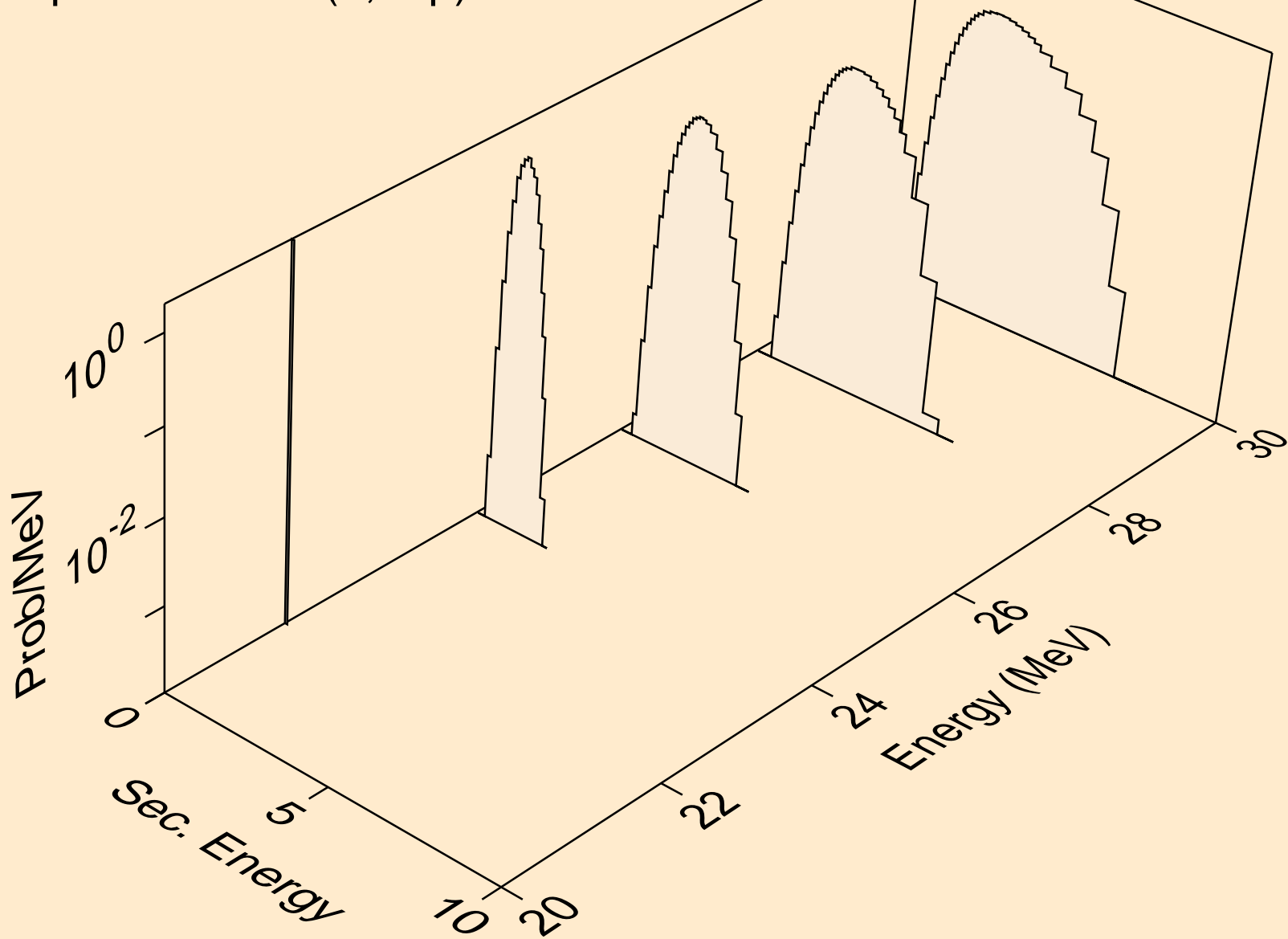

P031 NEUTRON ACER TENDL-2024 LIBRARY; T=293.6K
protons from (n,npa)

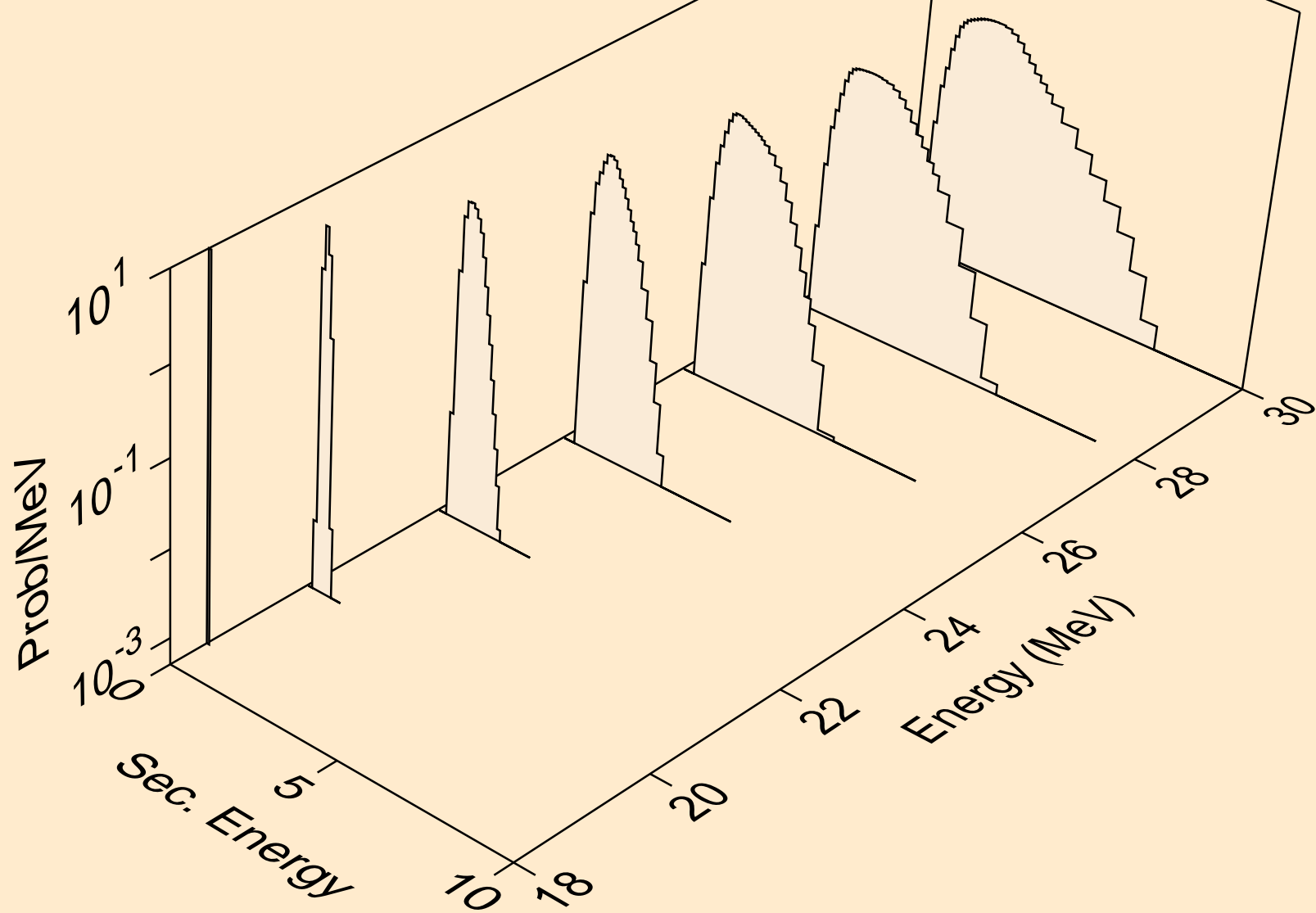

P031 NEUTRON ACER TENDL-2024 LIBRARY; T=293.6K
protons from (n,p)

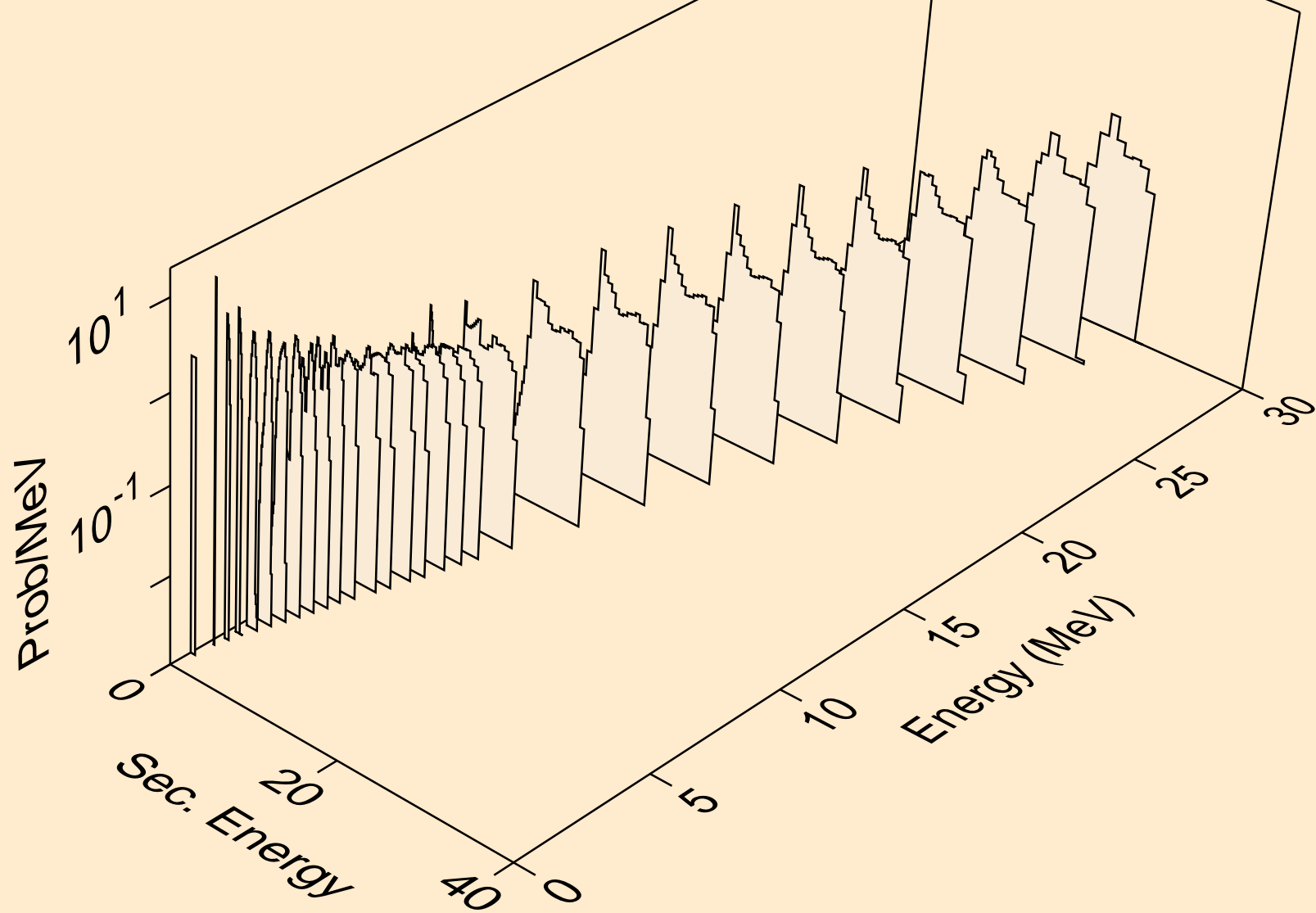

P031 NEUTRON ACER TENDL-2024 LIBRARY; T=293.6K
protons from (n,2p)

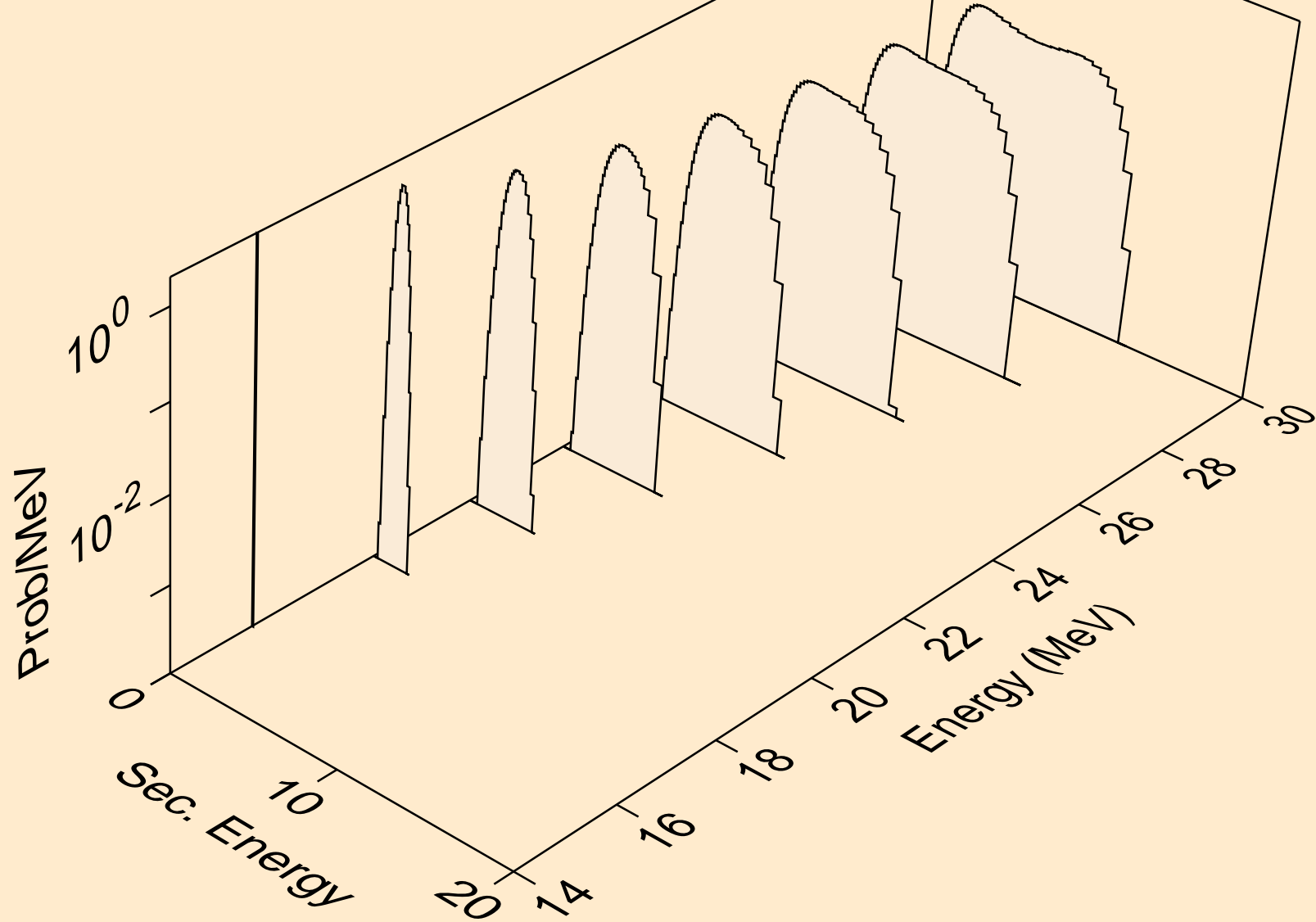

P031 NEUTRON ACER TENDL-2024 LIBRARY; T=293.6K
protons from (n,p)

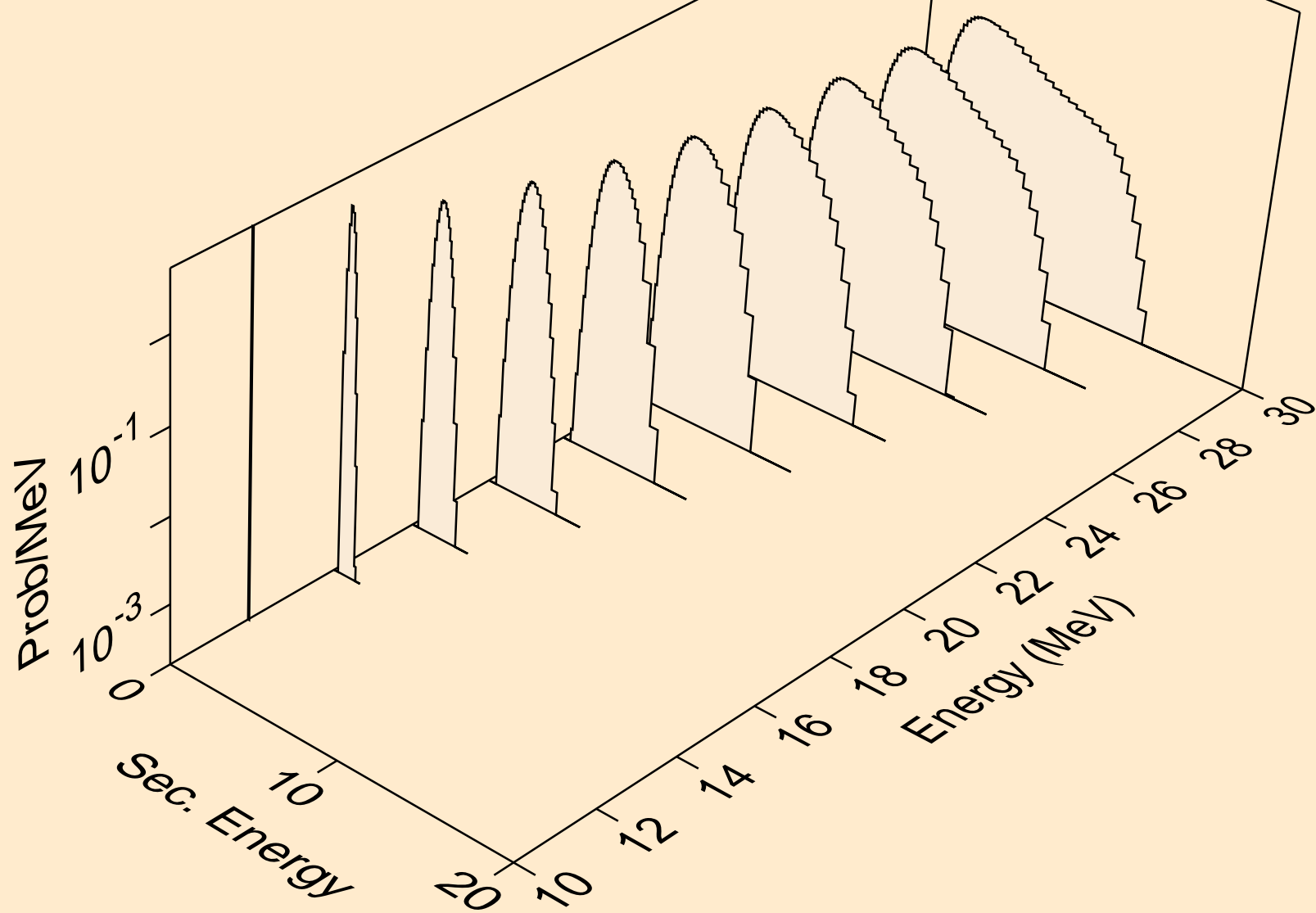

P031 NEUTRON ACER TENDL-2024 LIBRARY; T=293.6K
protons from (n,pd)

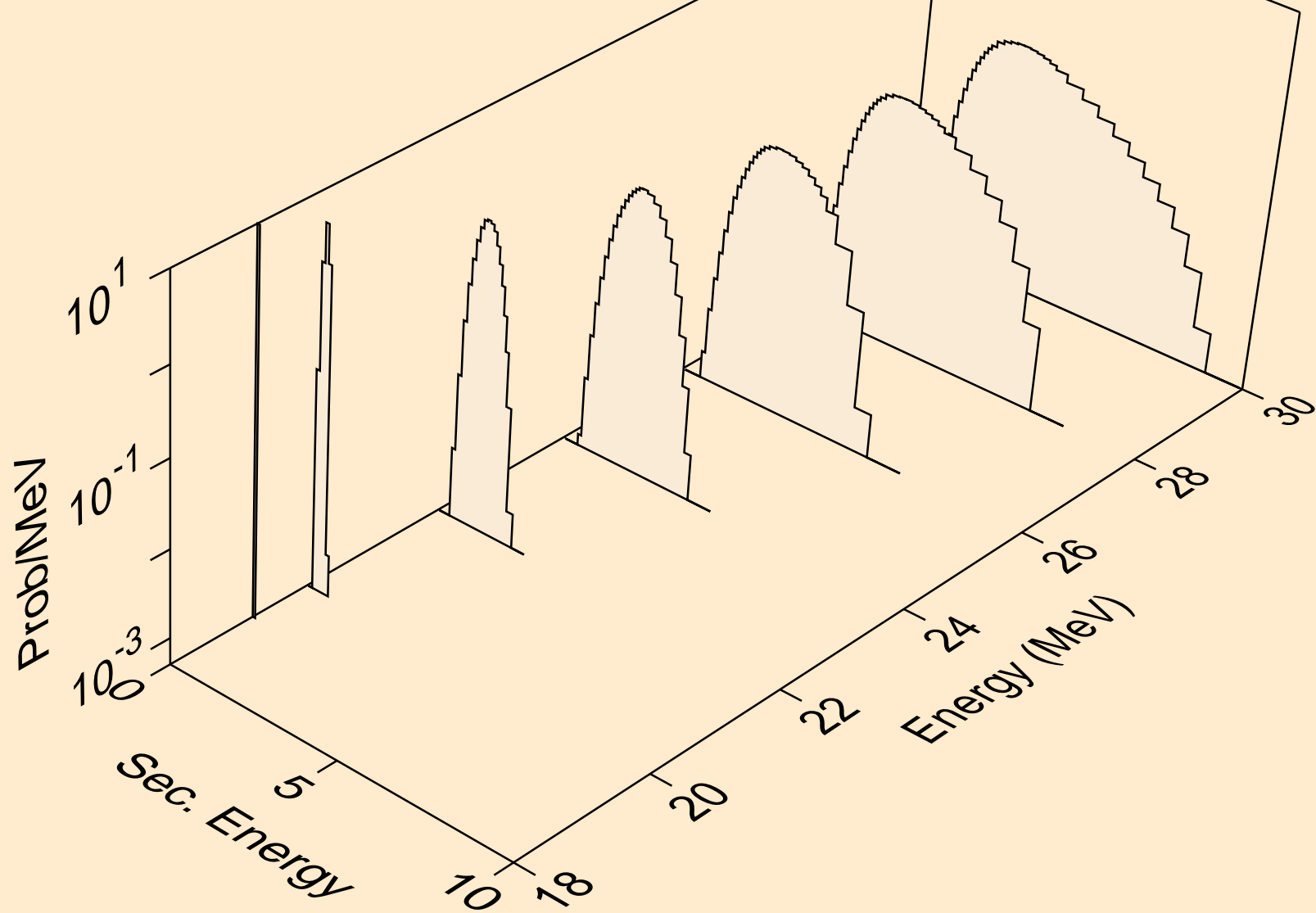

P031 NEUTRON ACER TENDL-2024 LIBRARY; T=293.6K
protons from (n,pt)

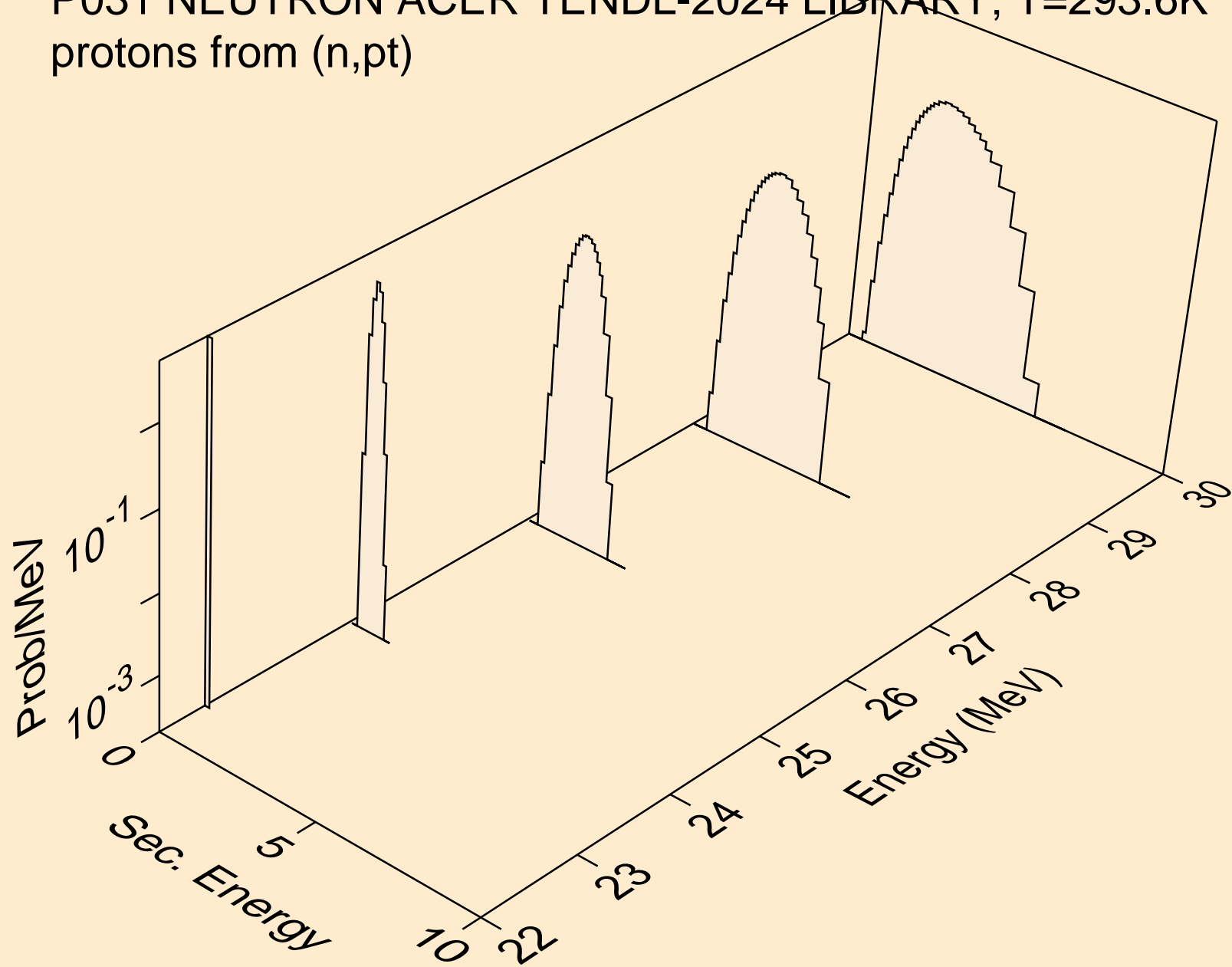

P031 NEUTRON ACER TENDL-2024 LIBRARY; T=293.6K
deuterons from (n,x)

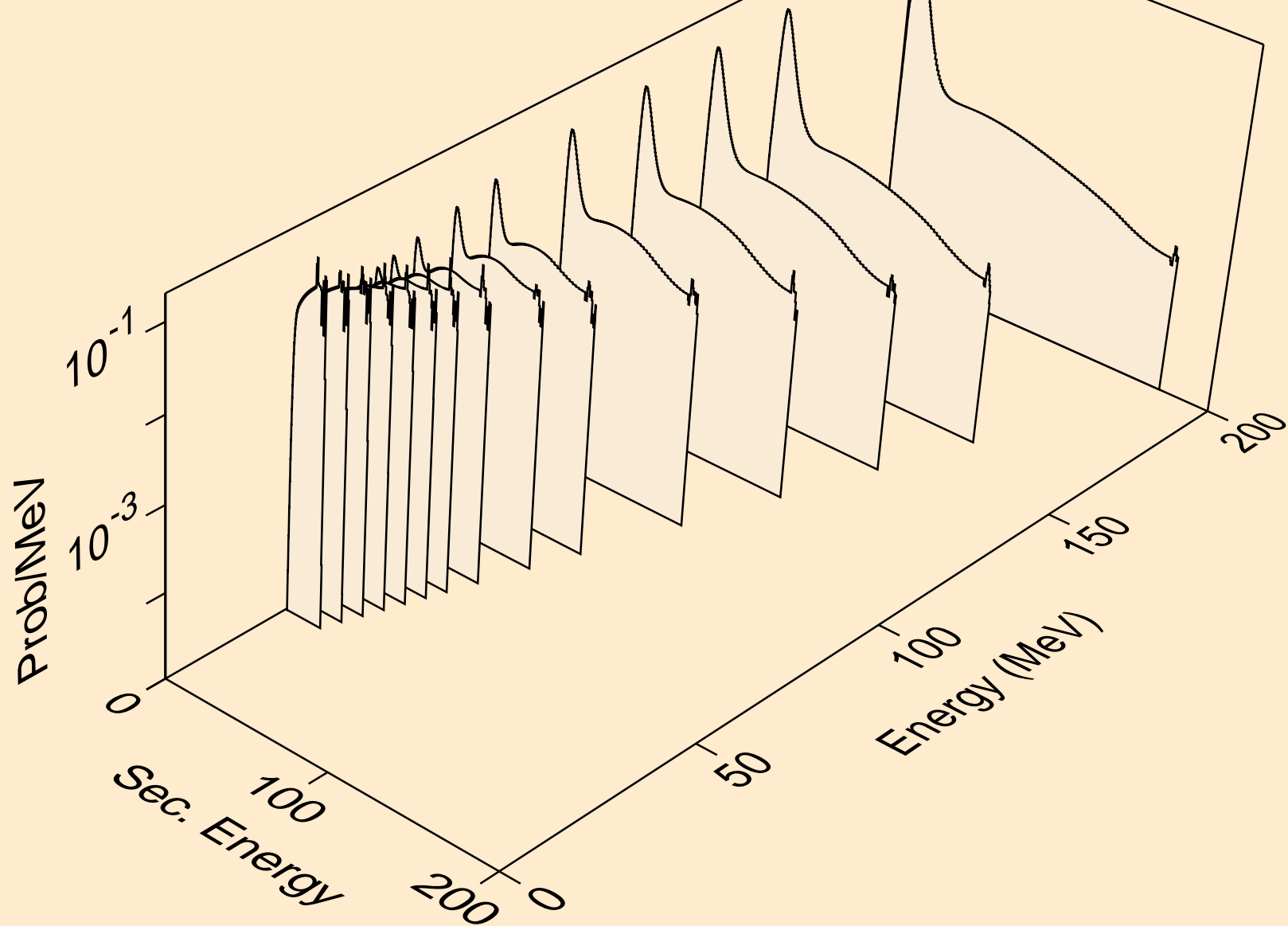

P031 NEUTRON ACER TENDL-2024 LIBRARY; T=293.6K
deuterons from (n,2nd)

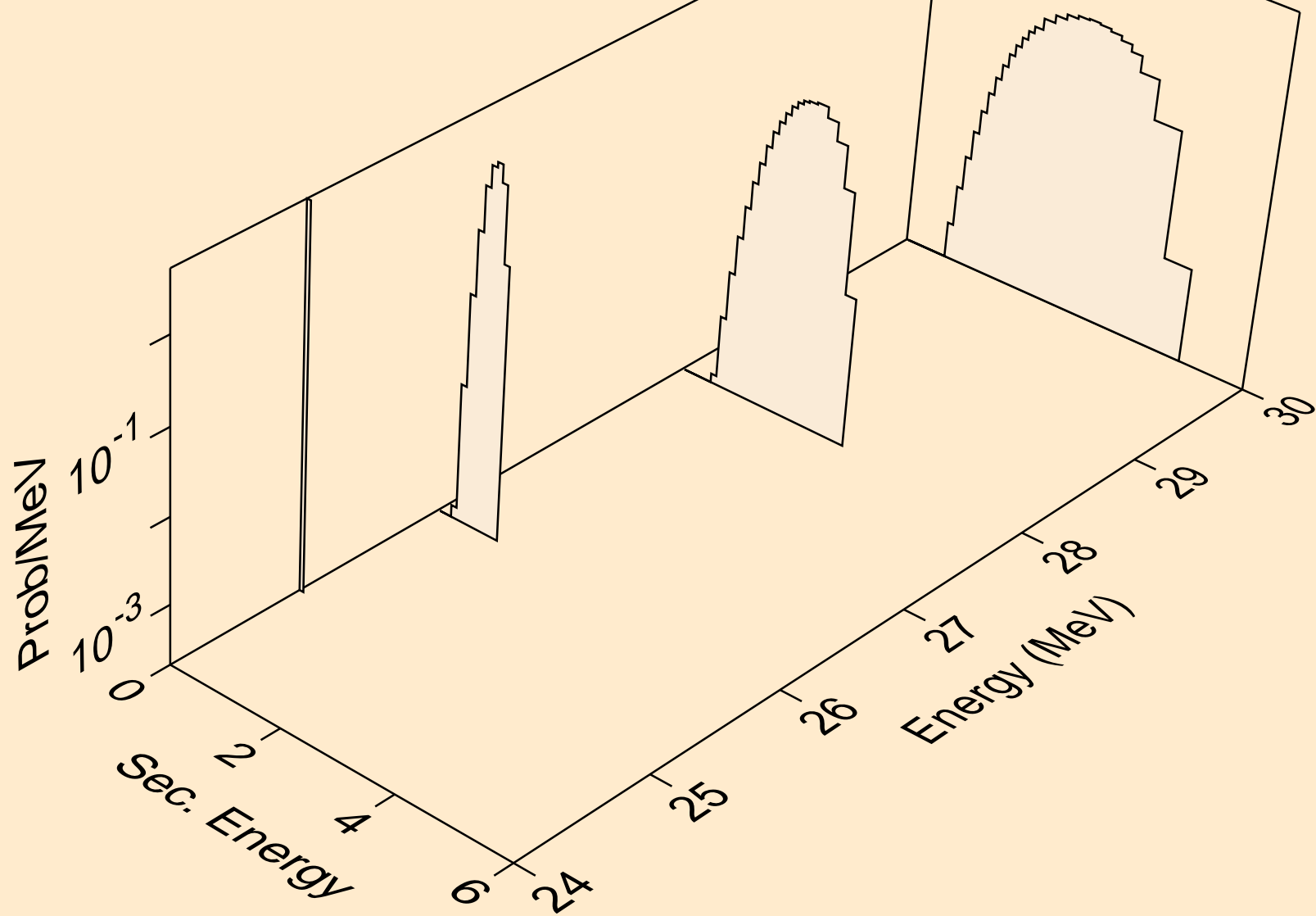

P031 NEUTRON ACER TENDL-2024 LIBRARY; T=293.6K
deuterons from (n,n*)d

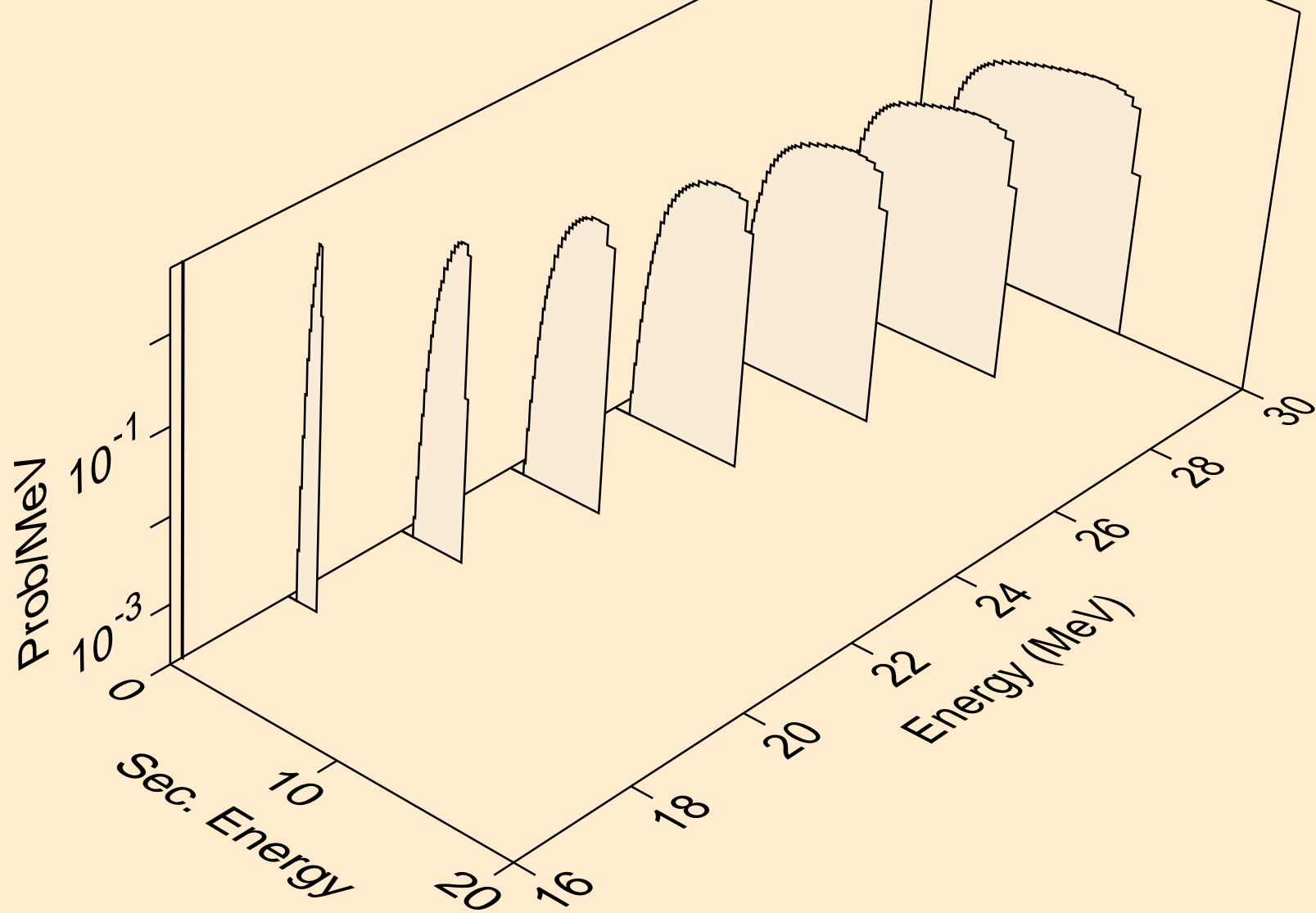

P031 NEUTRON ACER TENDL-2024 LIBRARY; T=293.6K
deuterons from (n,d)

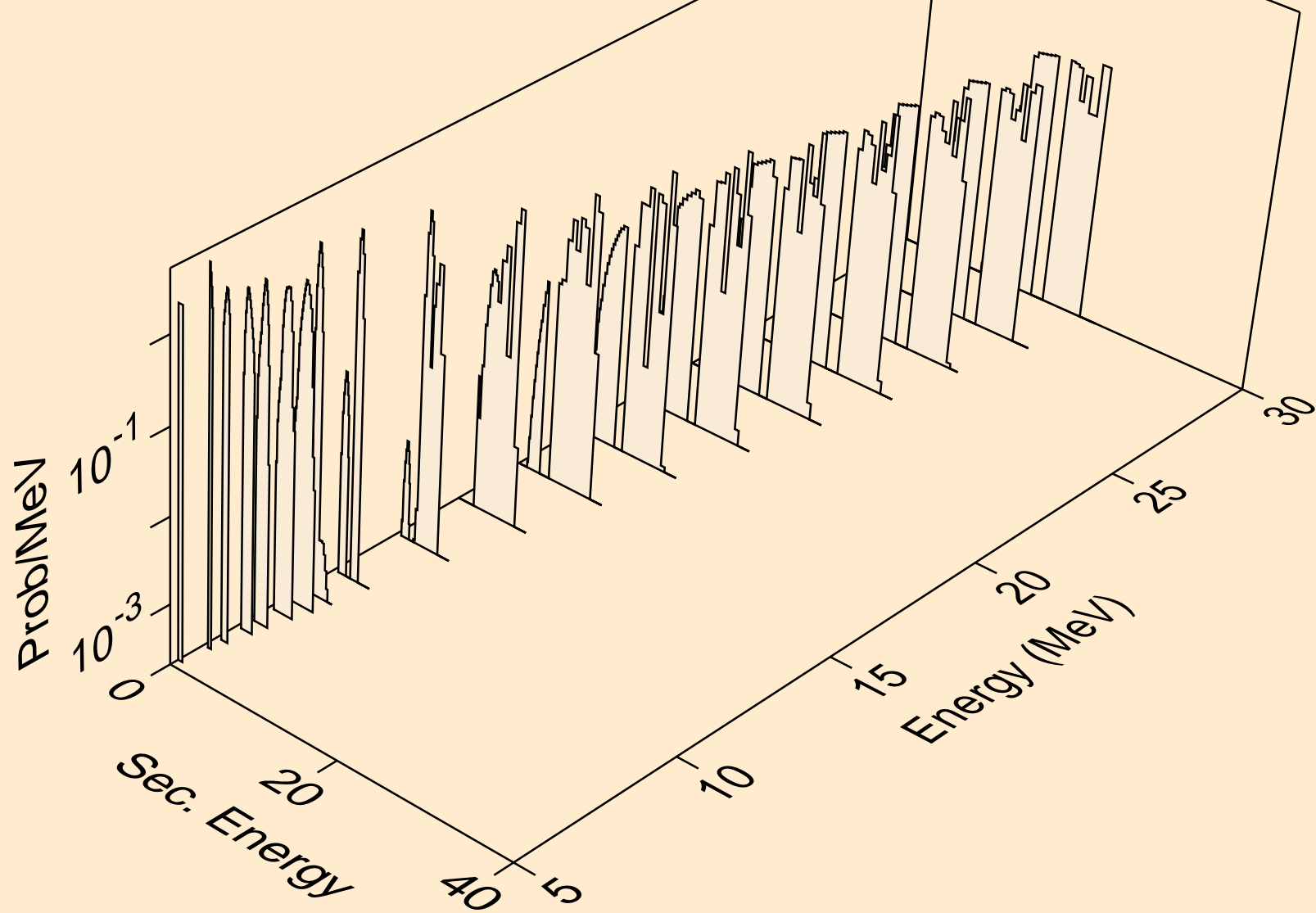

P031 NEUTRON ACER TENDL-2024 LIBRARY; T=293.6K
deuterons from (n,pd)

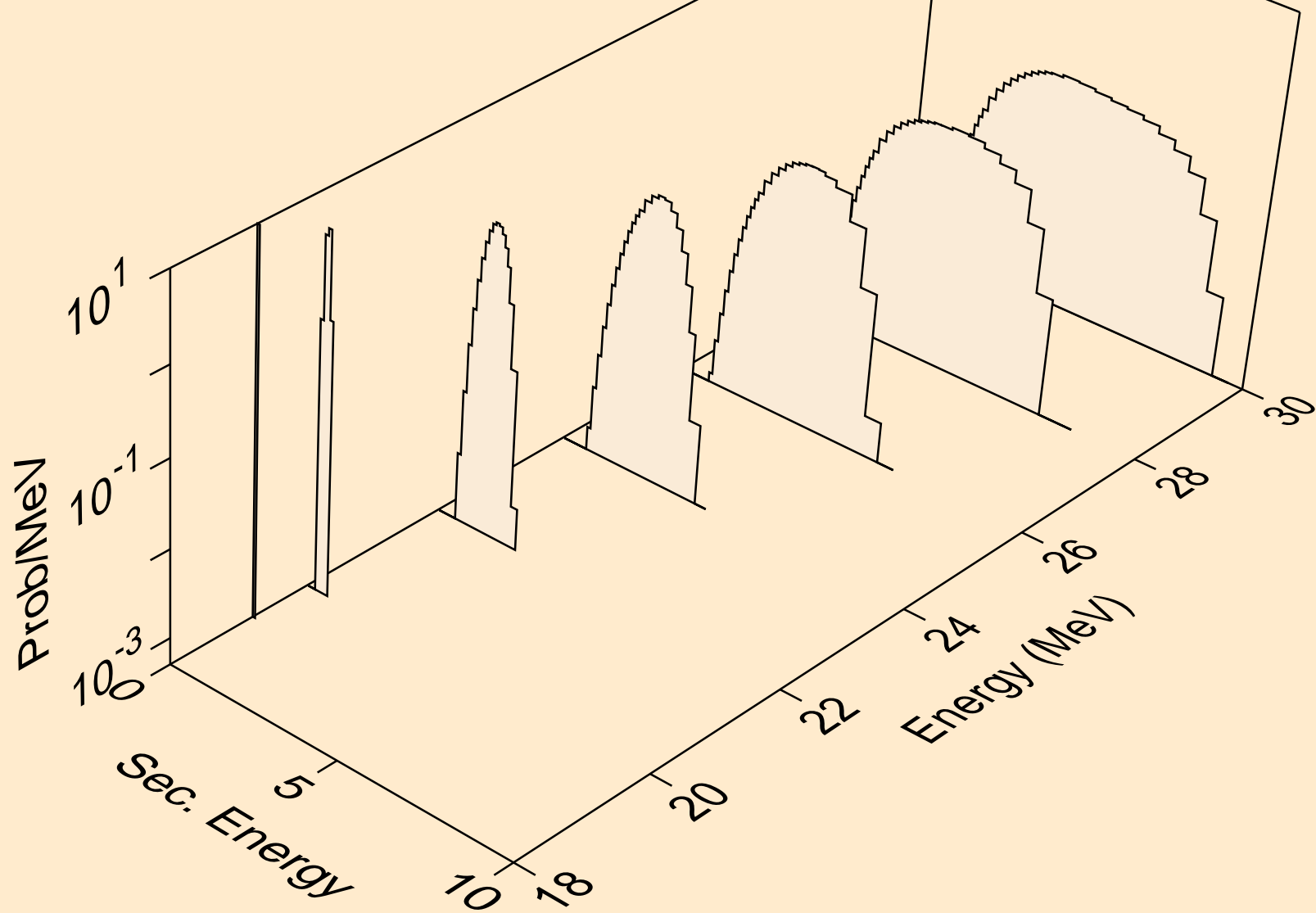

P031 NEUTRON ACER TENDL-2024 LIBRARY; T=293.6K
deuterons from (n,da)

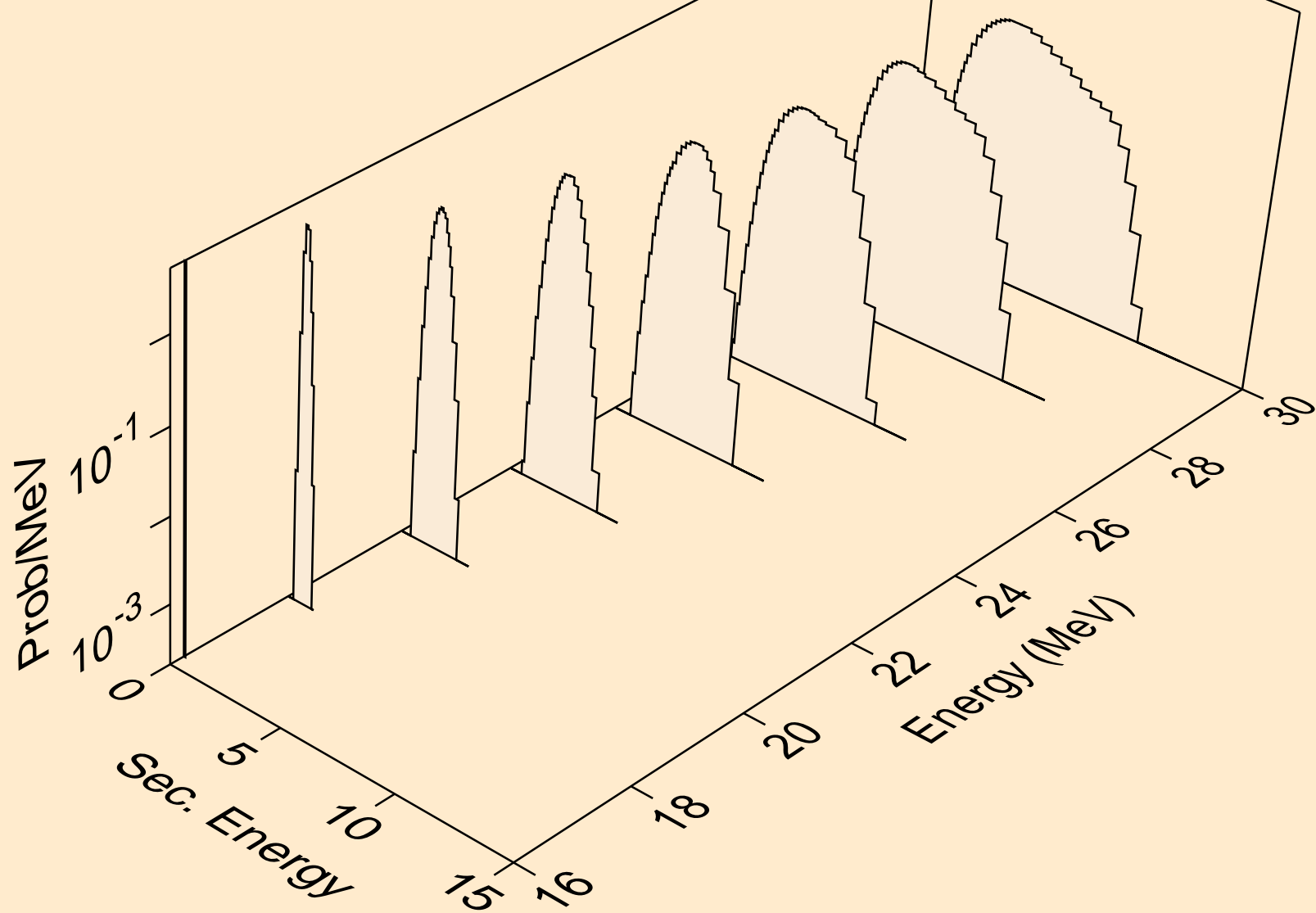

P031 NEUTRON ACER TENDL-2024 LIBRARY; T=293.6K
tritons from (n,x)

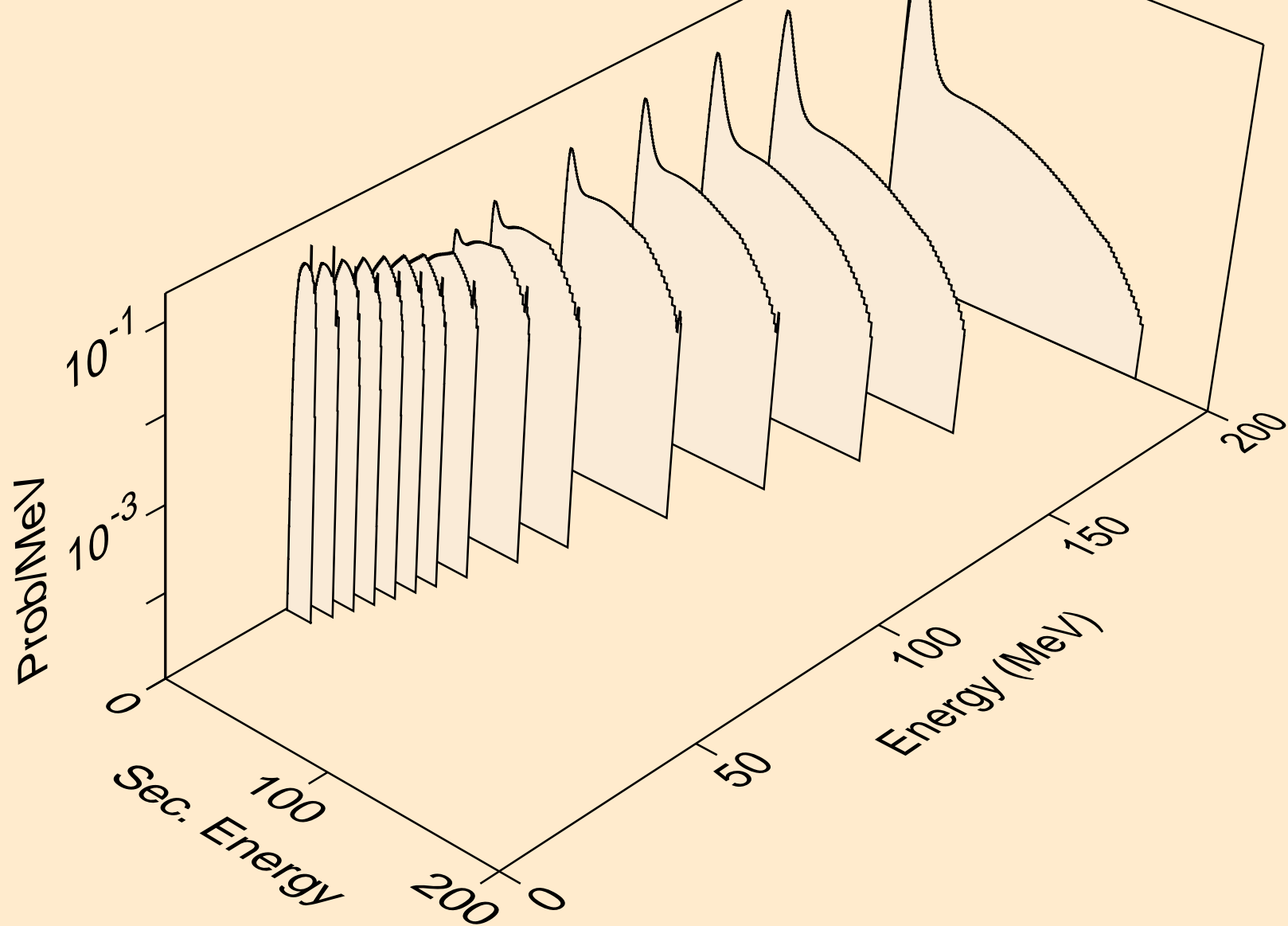

P031 NEUTRON ACER TENDL-2024 LIBRARY; T=293.6K
tritons from (n,n*)t

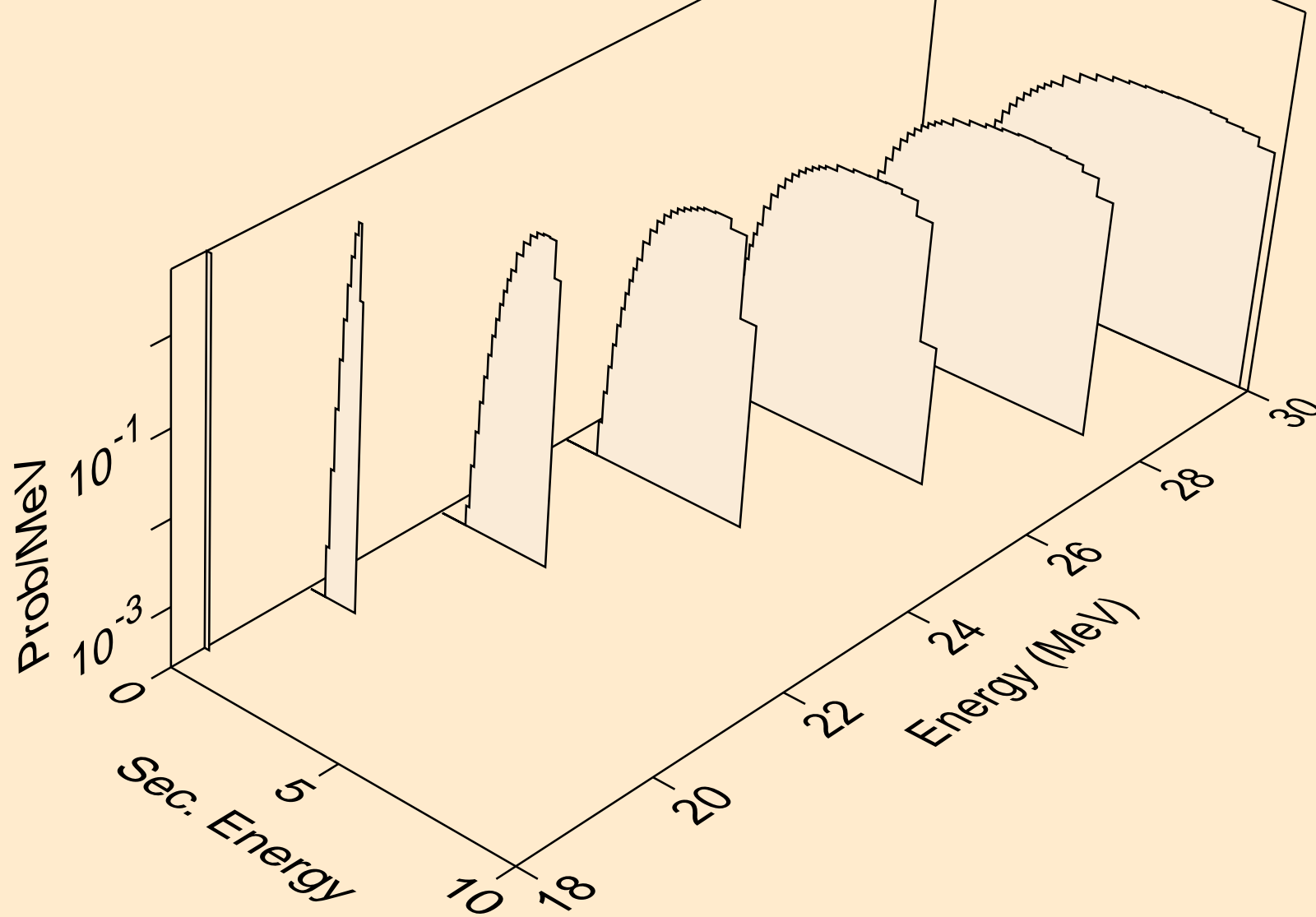

P031 NEUTRON ACER TENDL-2024 LIBRARY; T=293.6K
tritons from (n,t)

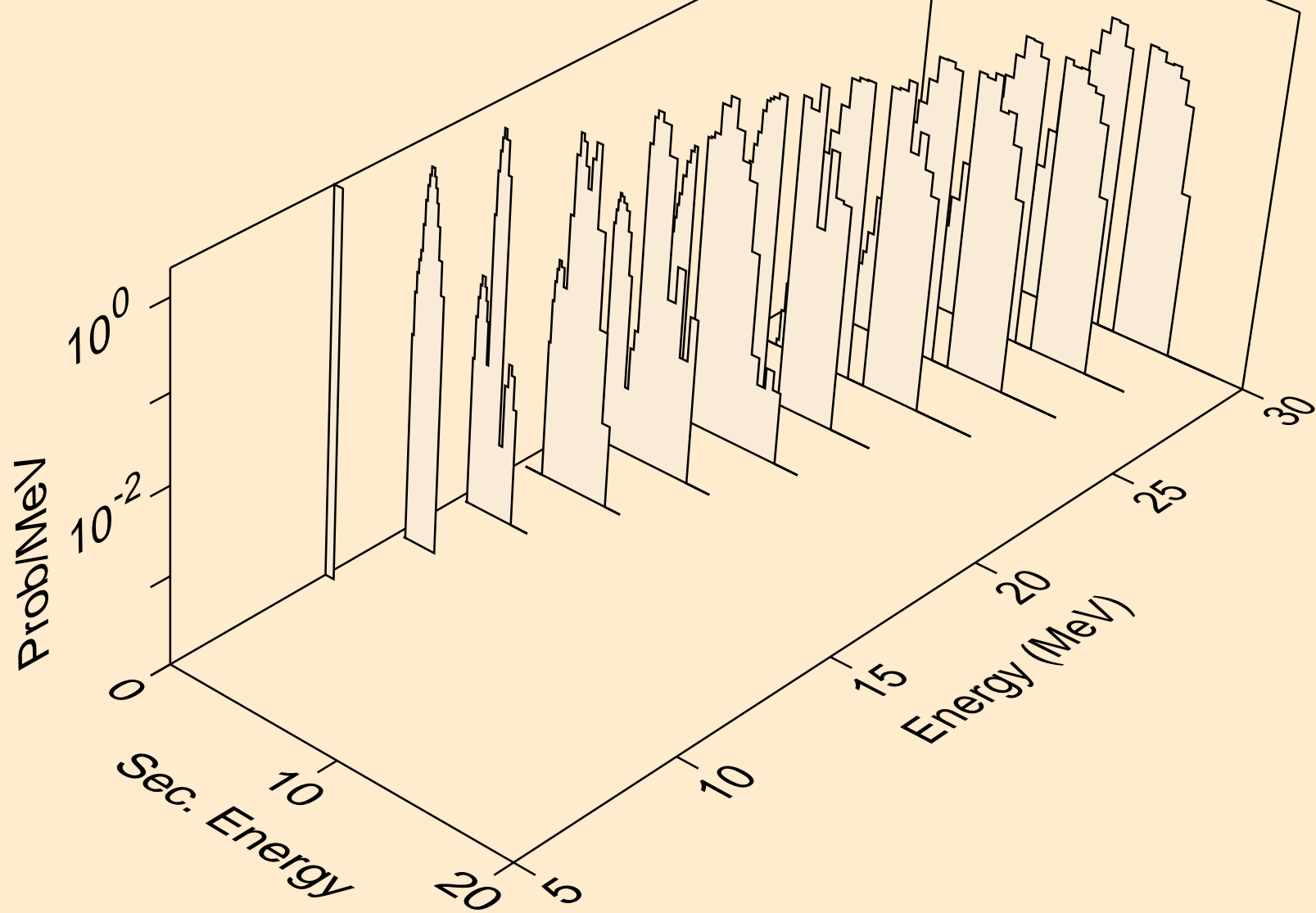

P031 NEUTRON ACER TENDL-2024 LIBRARY; T=293.6K
tritons from (n,pt)

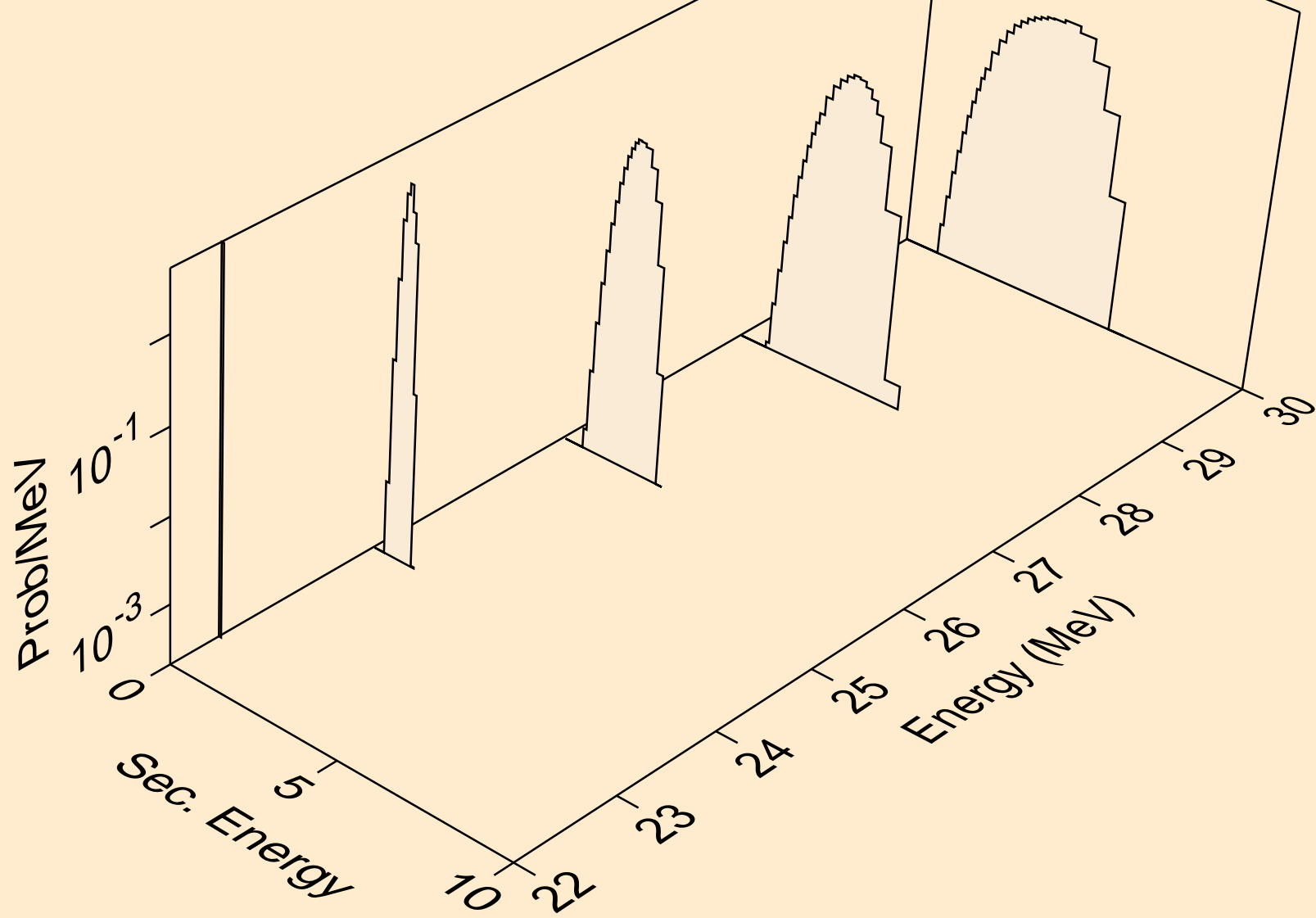

P031 NEUTRON ACER TENDL-2024 LIBRARY; T=293.6K
he3s from (n,x)

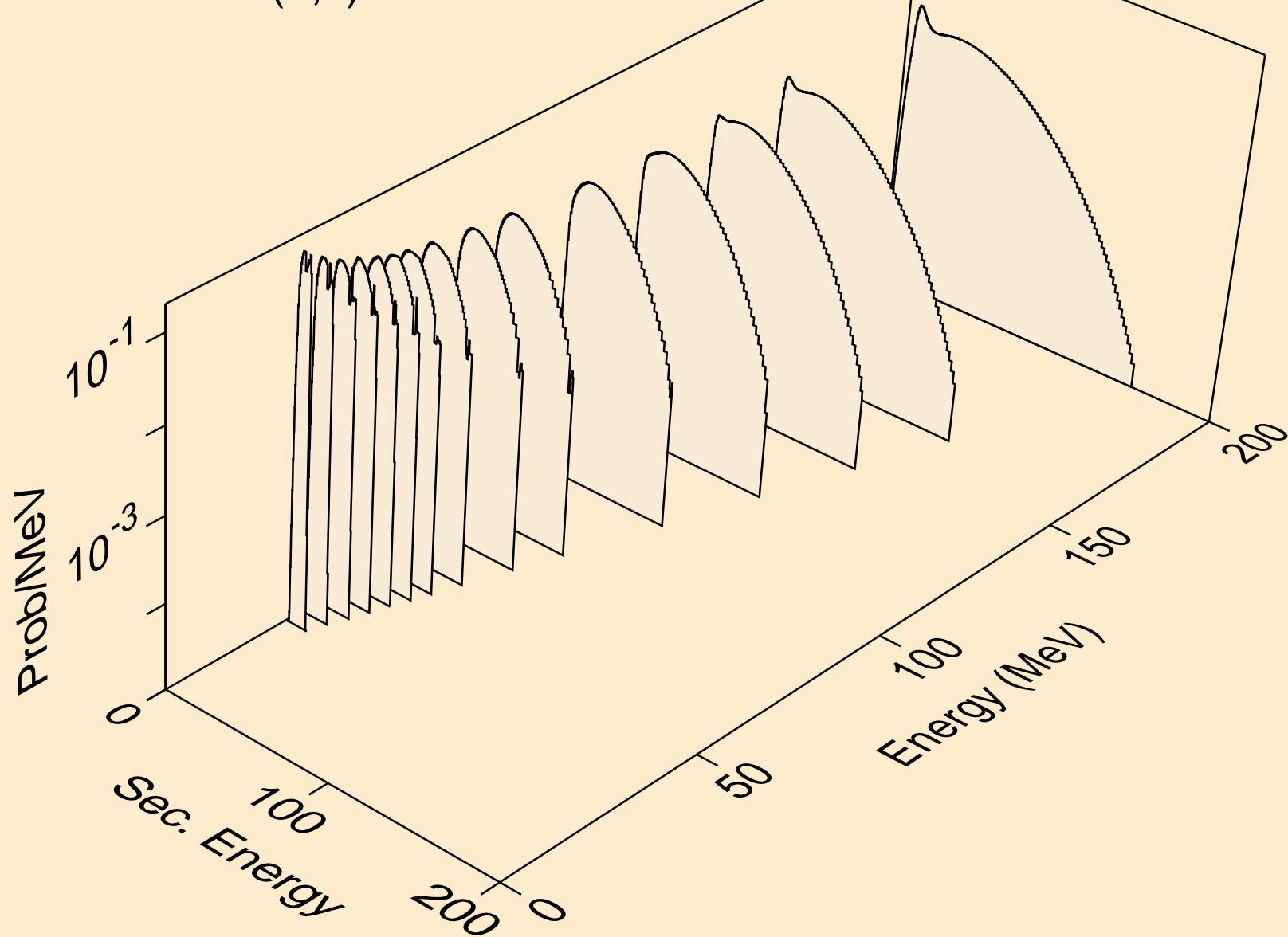

P031 NEUTRON ACER TENDL-2024 LIBRARY; T=293.6K
he3s from (n,n*)he3

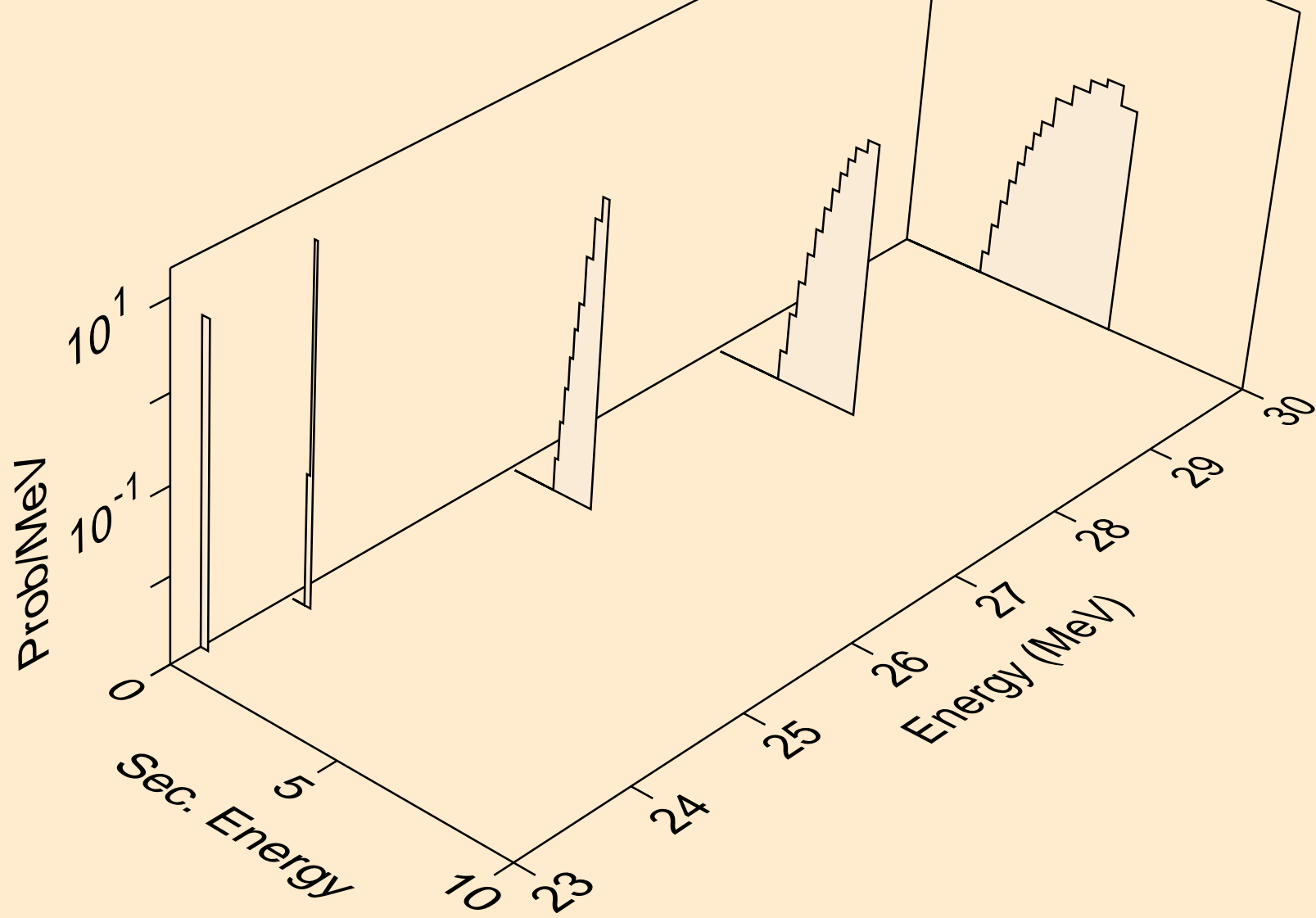

P031 NEUTRON ACER TENDL-2024 LIBRARY; T=293.6K
he3s from (n,he3)

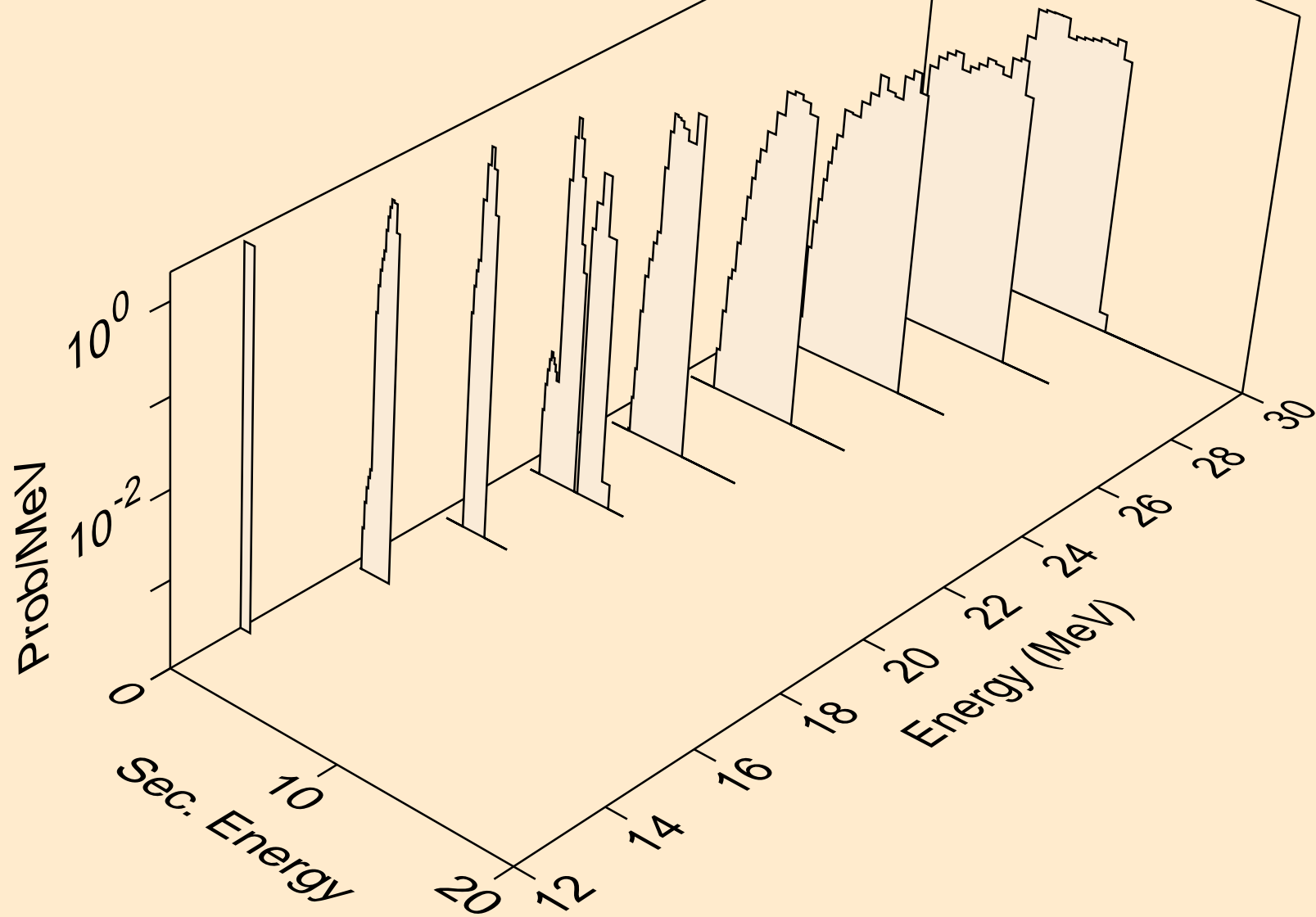

P031 NEUTRON ACER TENDL-2024 LIBRARY; T=293.6K
alphas from (n,x)

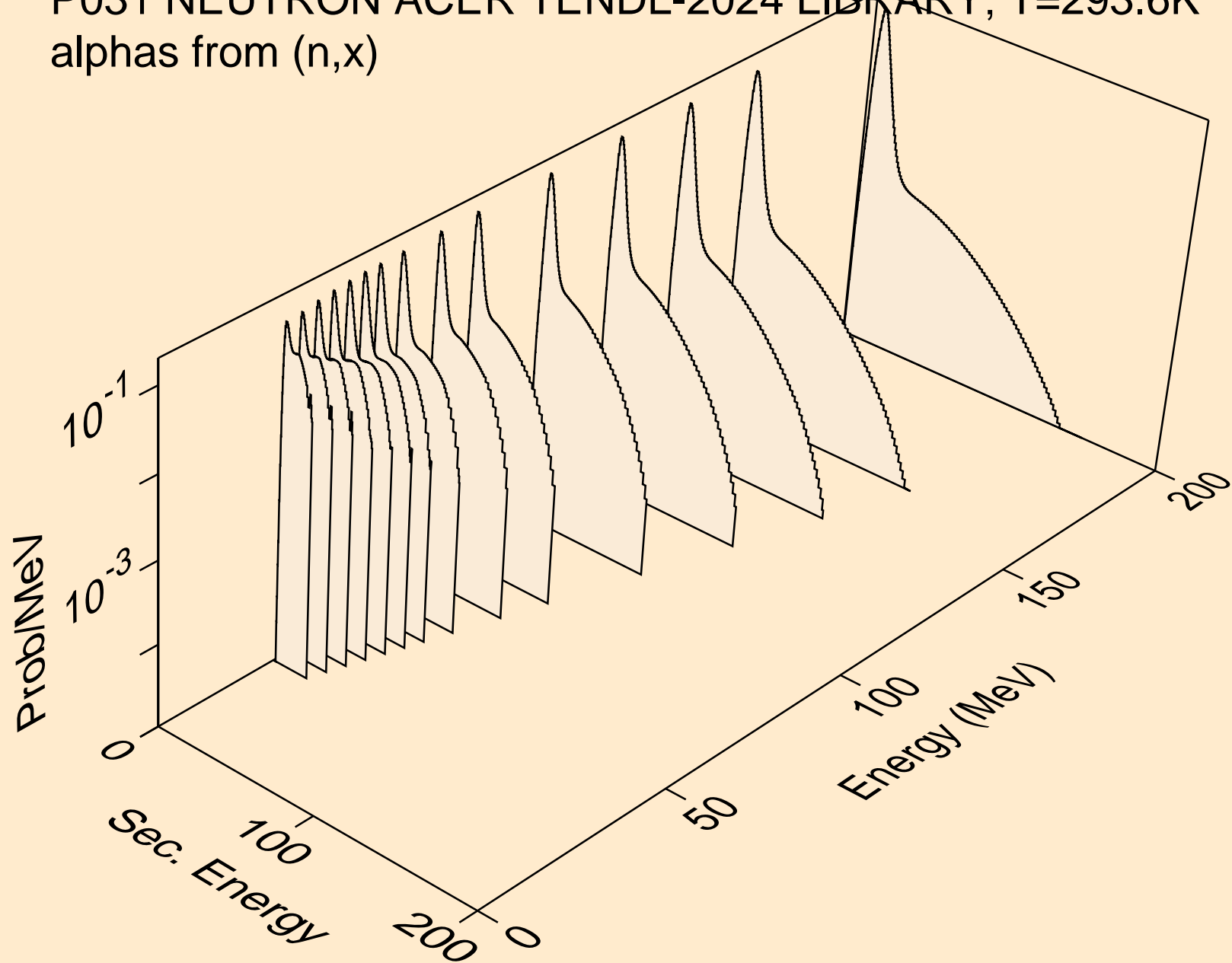

P031 NEUTRON ACER TENDL-2024 LIBRARY; T=293.6K
alphas from (n,n*)a

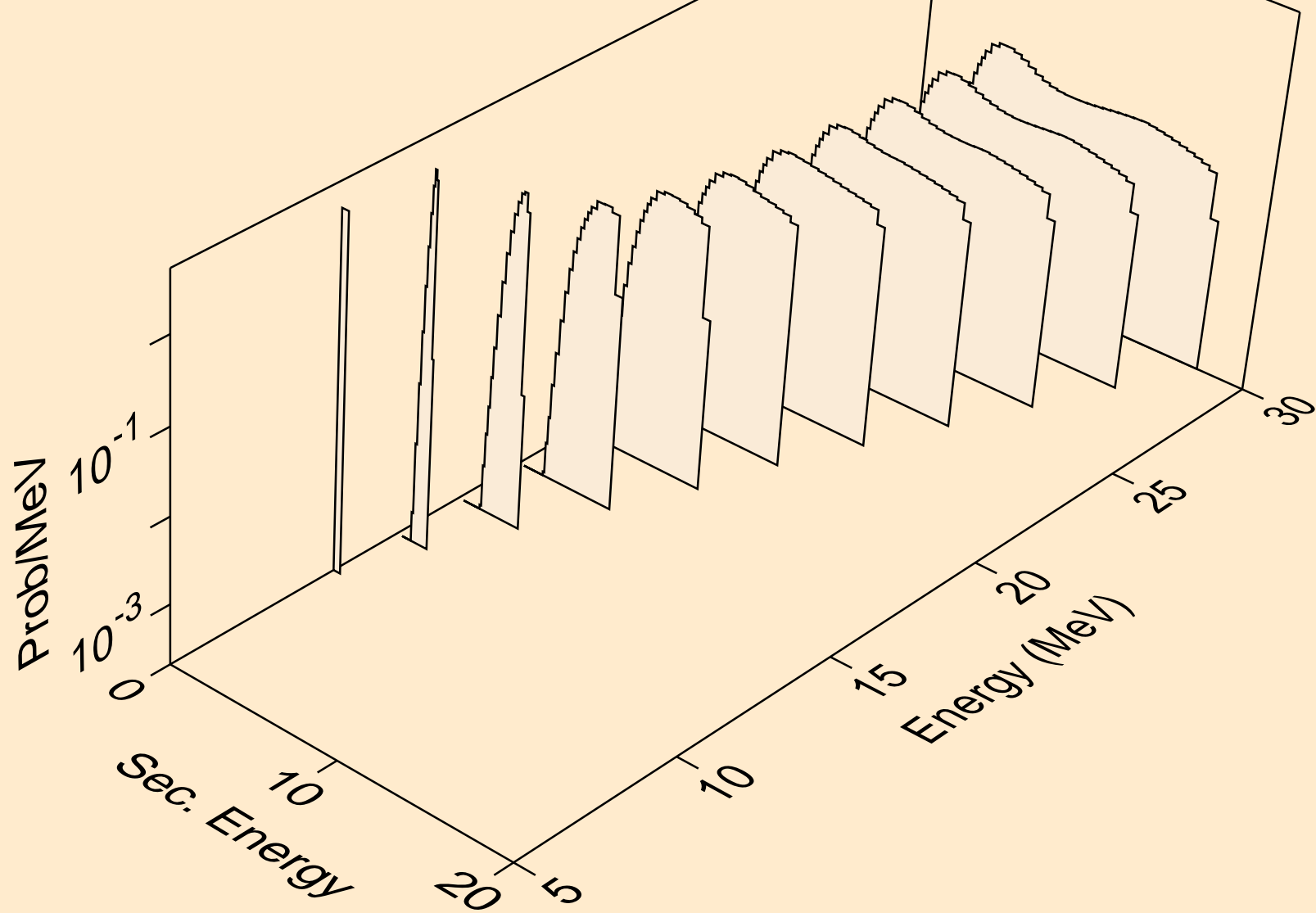

P031 NEUTRON ACER TENDL-2024 LIBRARY; T=293.6K
alphas from (n,2n)a

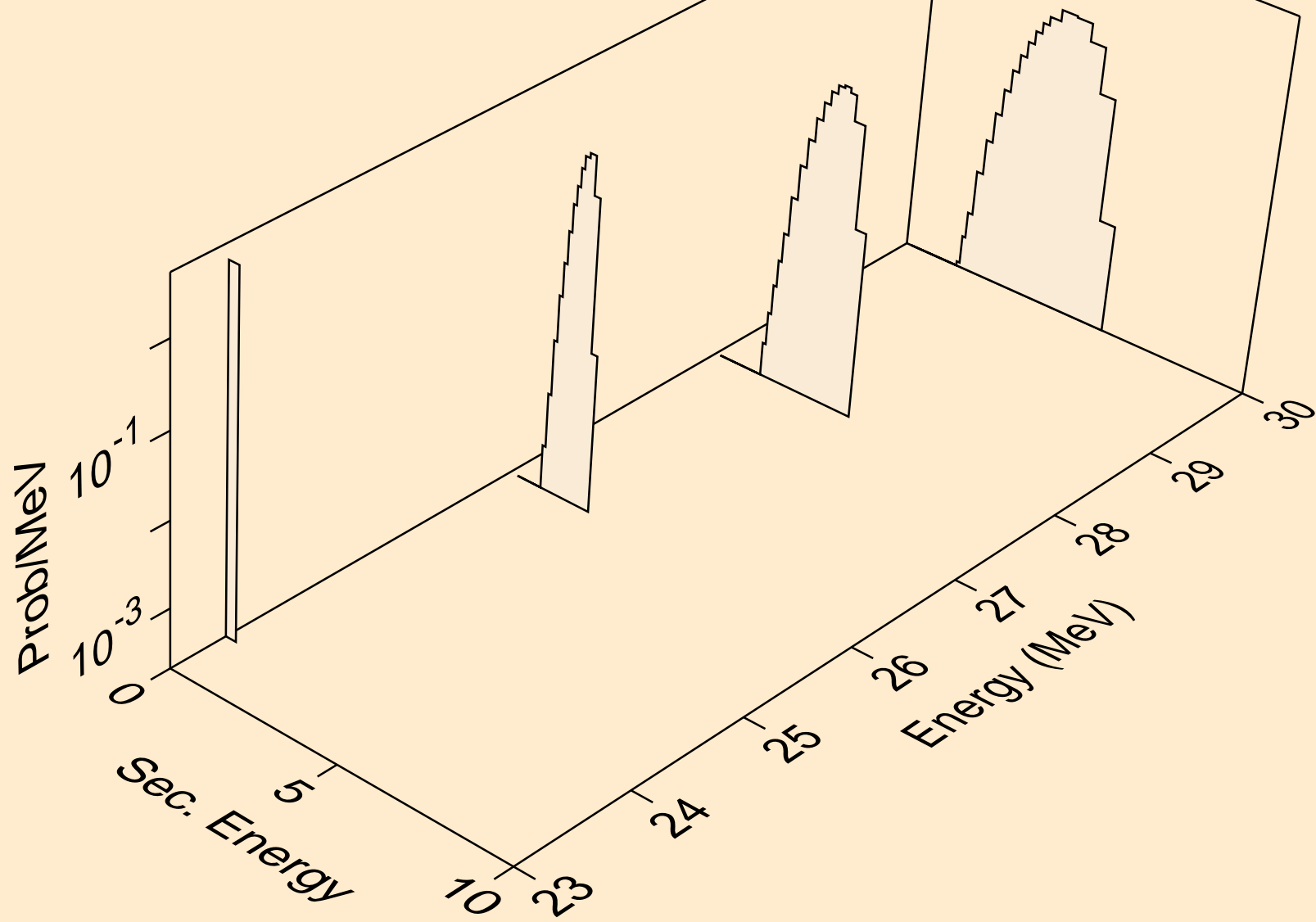

P031 NEUTRON ACER TENDL-2024 LIBRARY; T=293.6K
alphas from (n,n*)2a

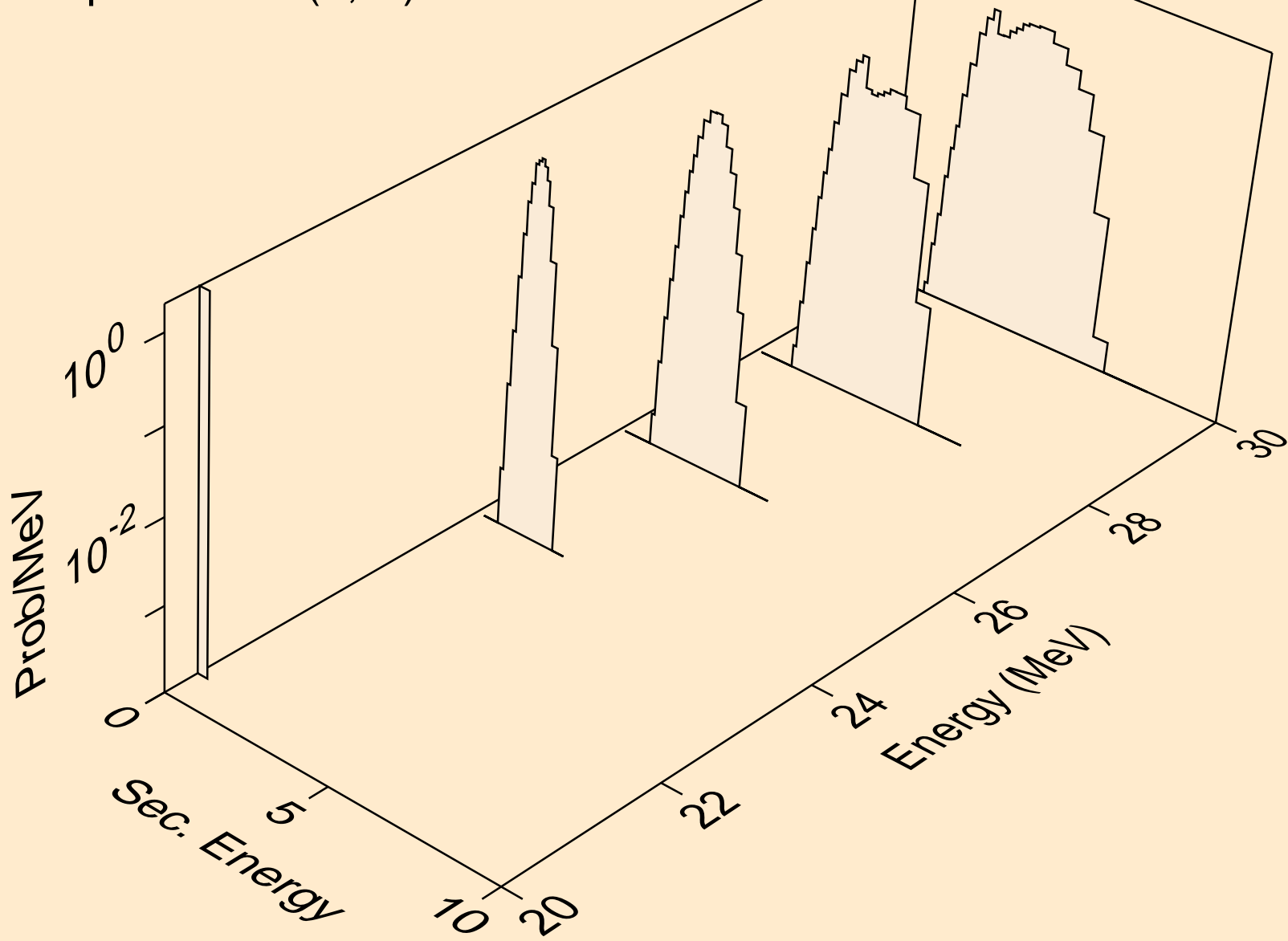

P031 NEUTRON ACER TENDL-2024 LIBRARY; T=293.6K
alphas from (n,npa)

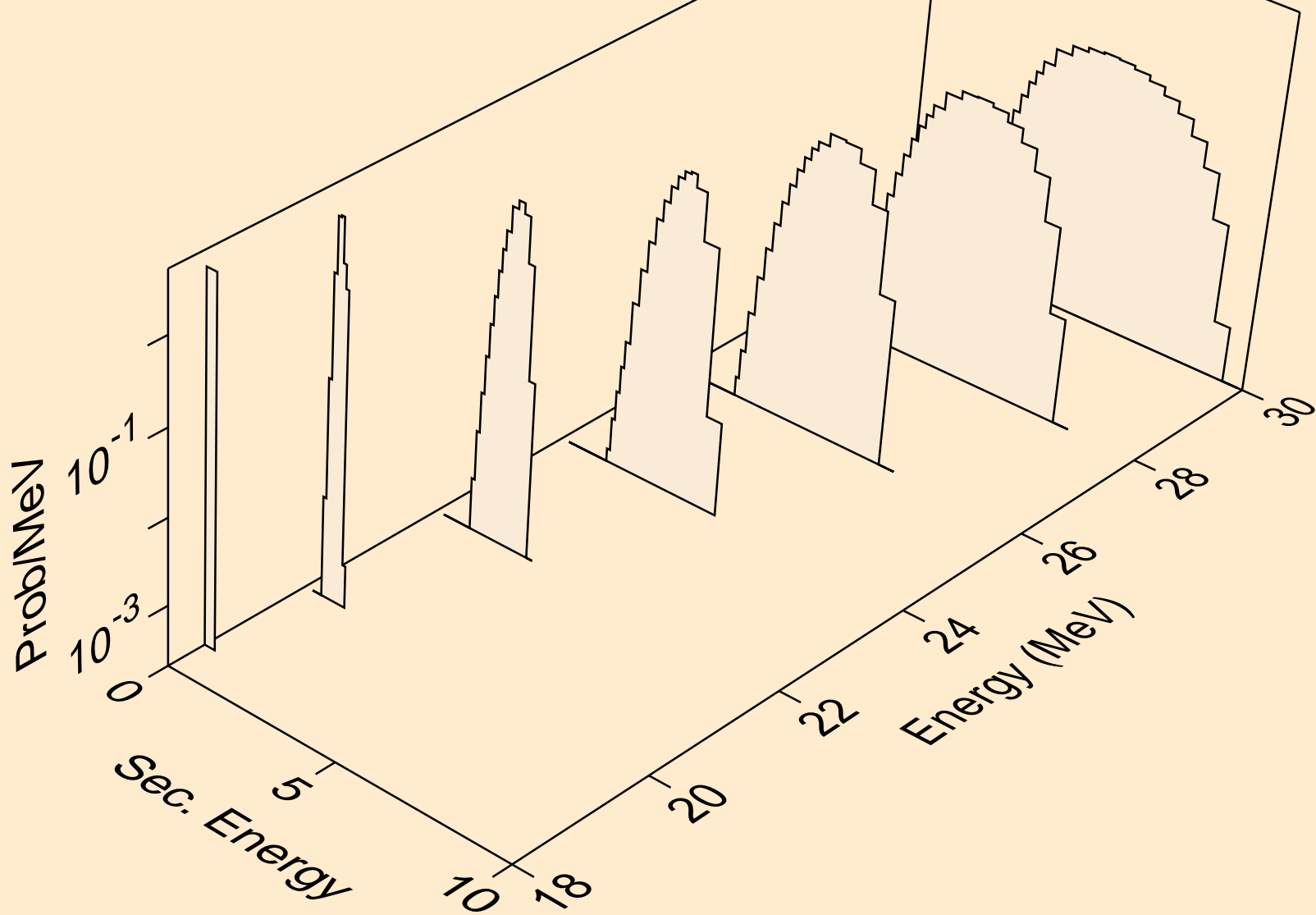

P031 NEUTRON ACER TENDL-2024 LIBRARY; T=293.6K
alphas from (n,a)

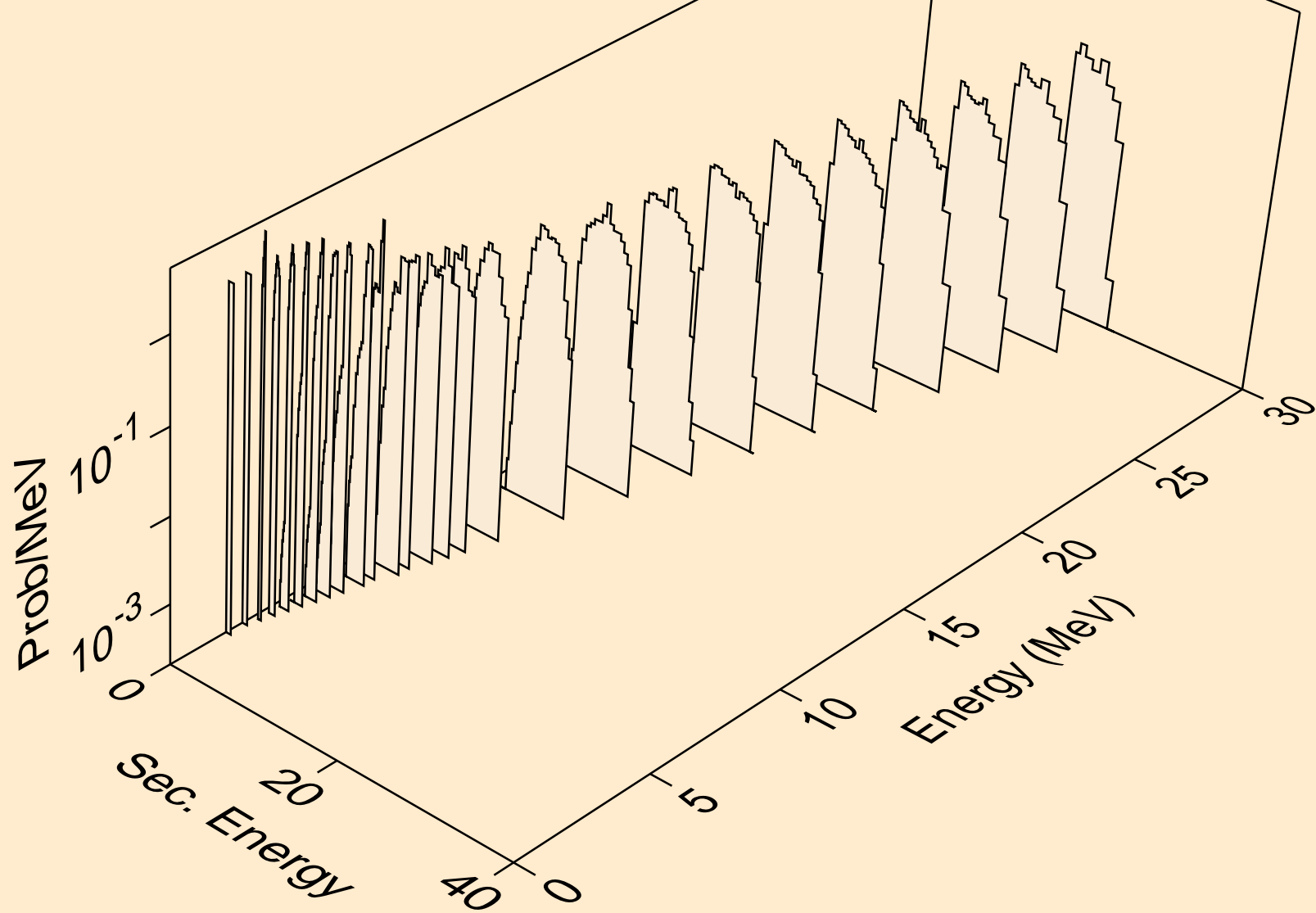

P031 NEUTRON ACER TENDL-2024 LIBRARY; T=293.6K
alphas from (n,2a)

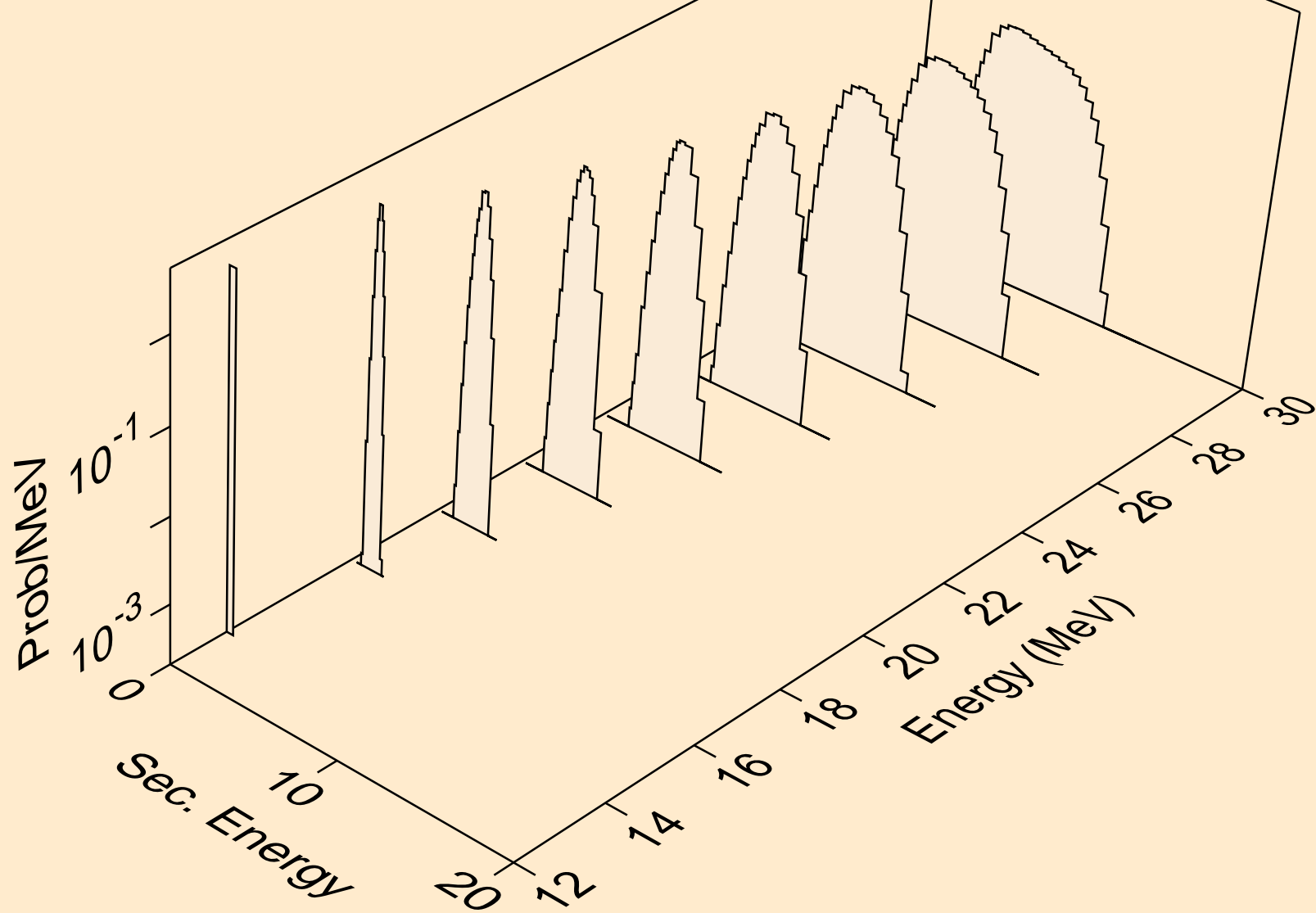

P031 NEUTRON ACER TENDL-2024 LIBRARY; T=293.6K
alphas from (n,pa)

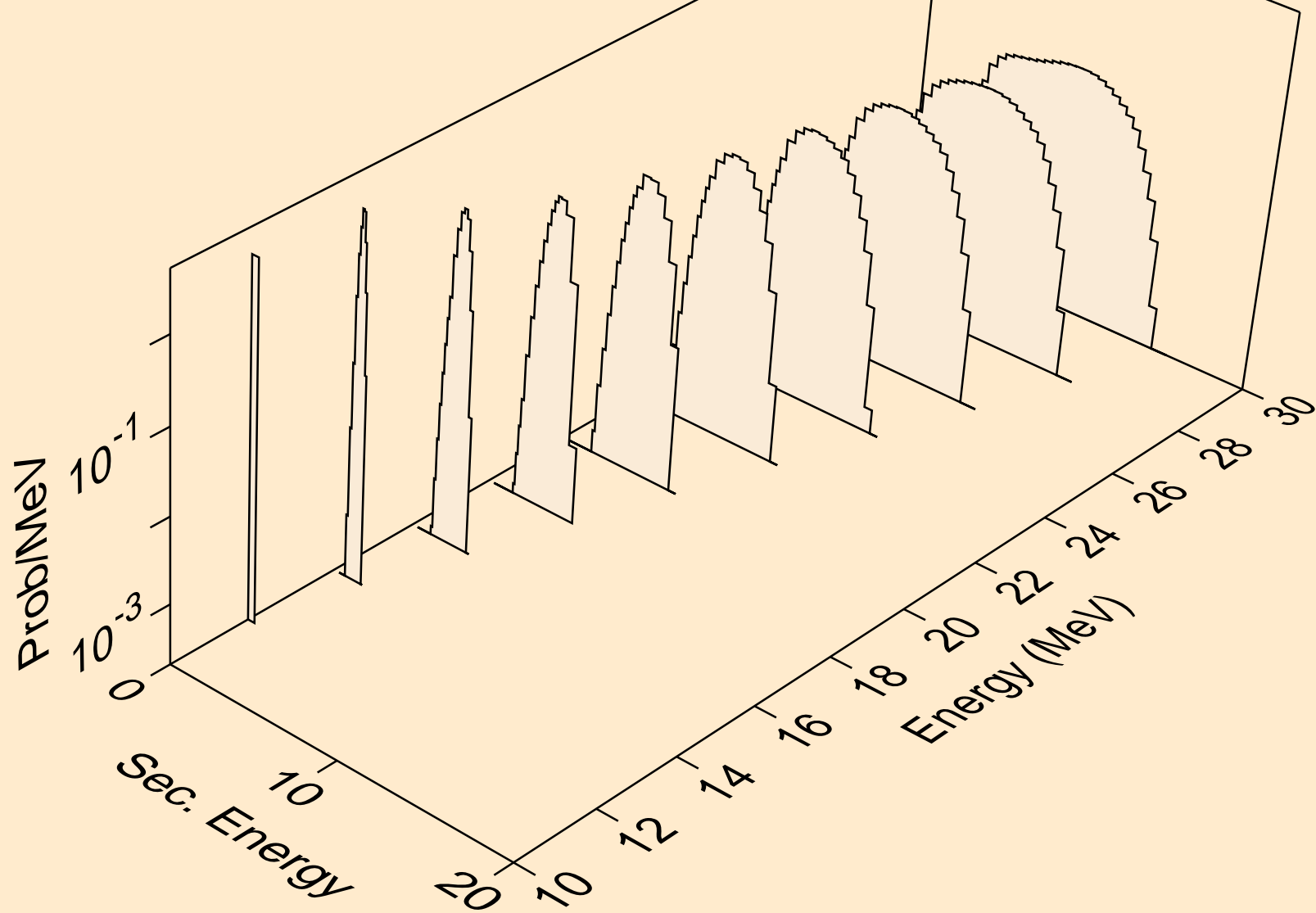

P031 NEUTRON ACER TENDL-2024 LIBRARY; T=293.6K
alphas from (n,da)

