

PB207 NEUTRON ACER TENDL-2024 LIBRARY; T=293.6K  
Principal cross sections

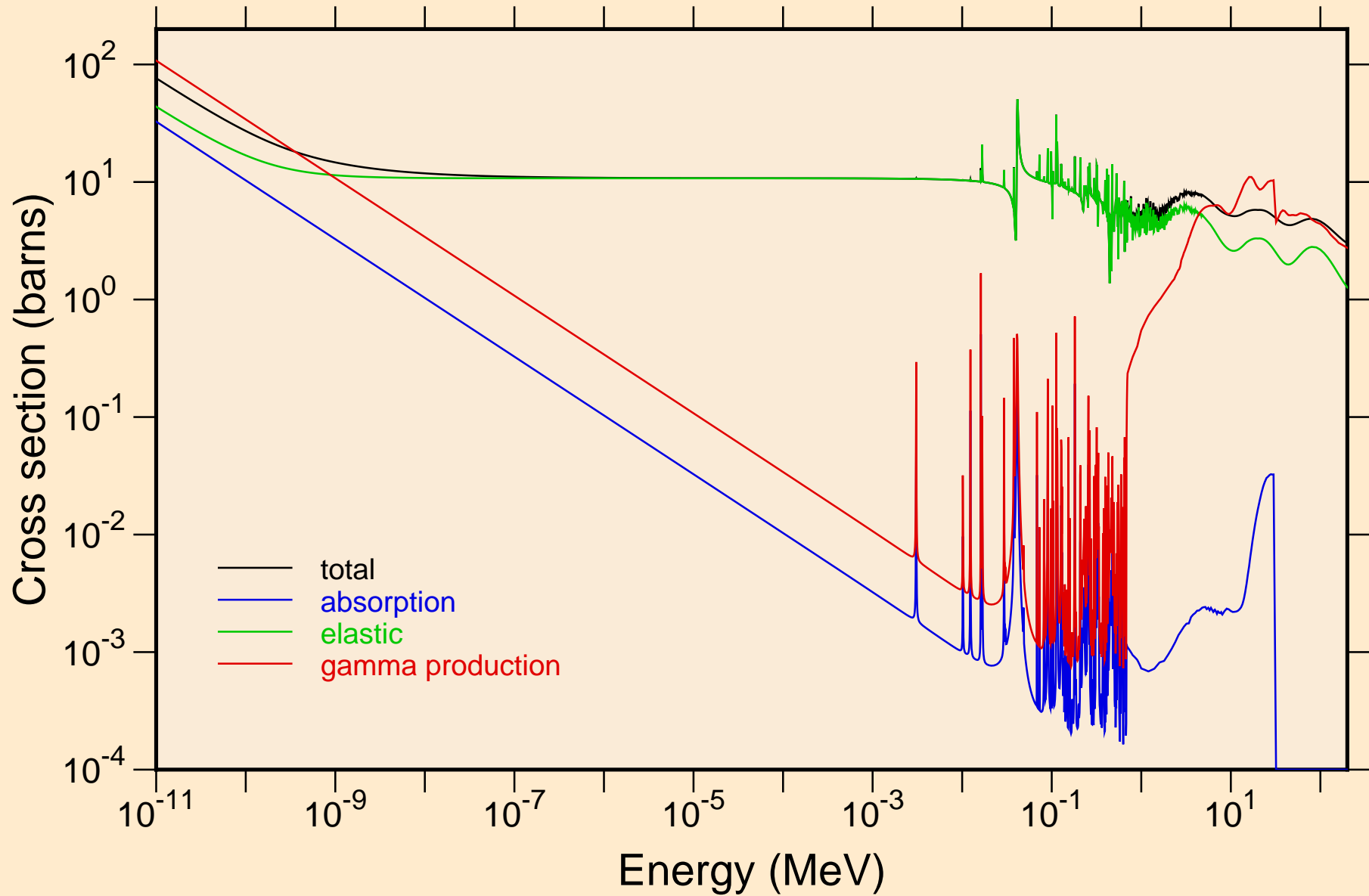

PB207 NEUTRON ACER TENDL-2024 LIBRARY; T=293.6K  
resonance total cross section

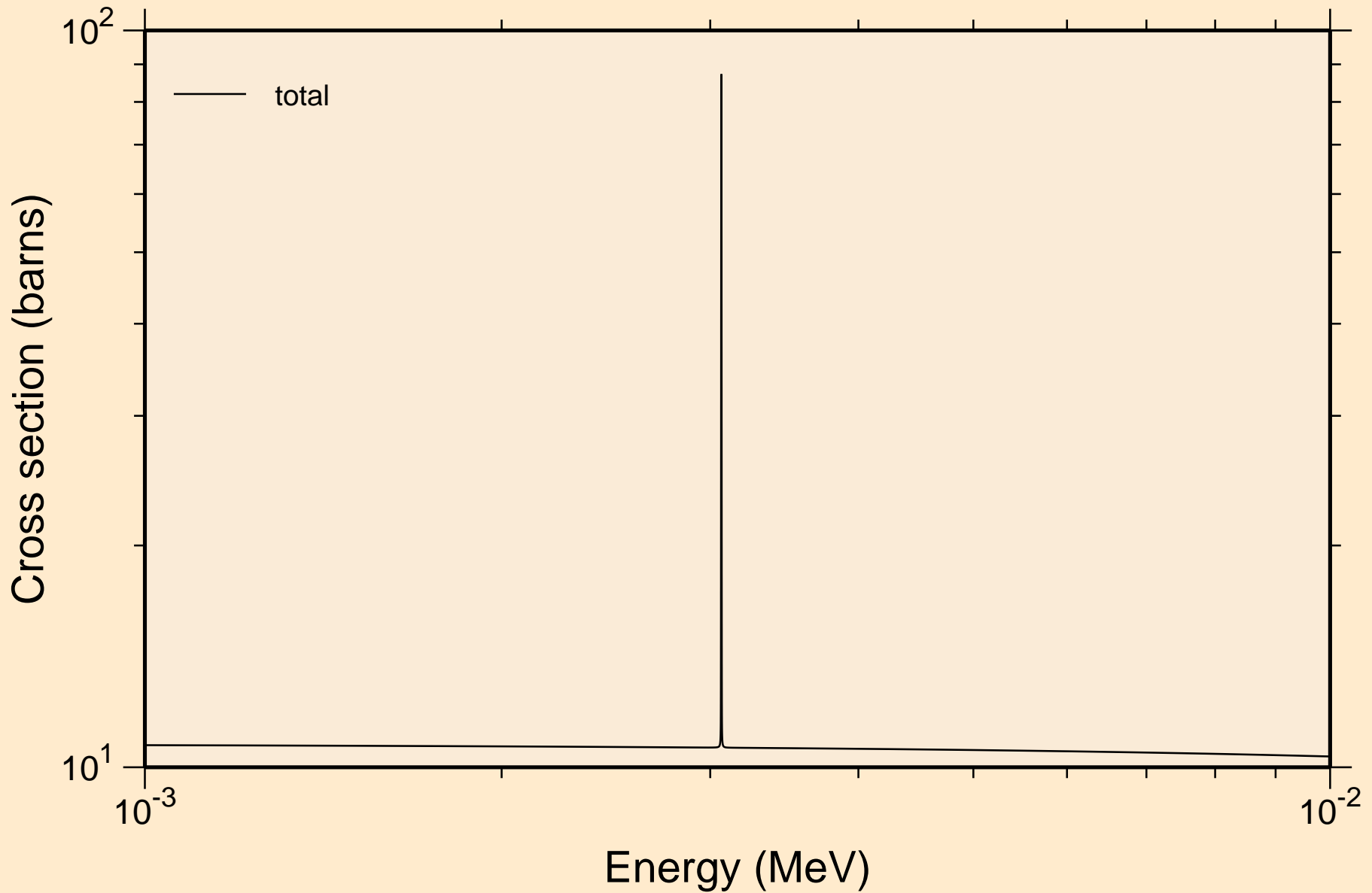

PB207 NEUTRON ACER TENDL-2024 LIBRARY; T=293.6K  
resonance total cross section

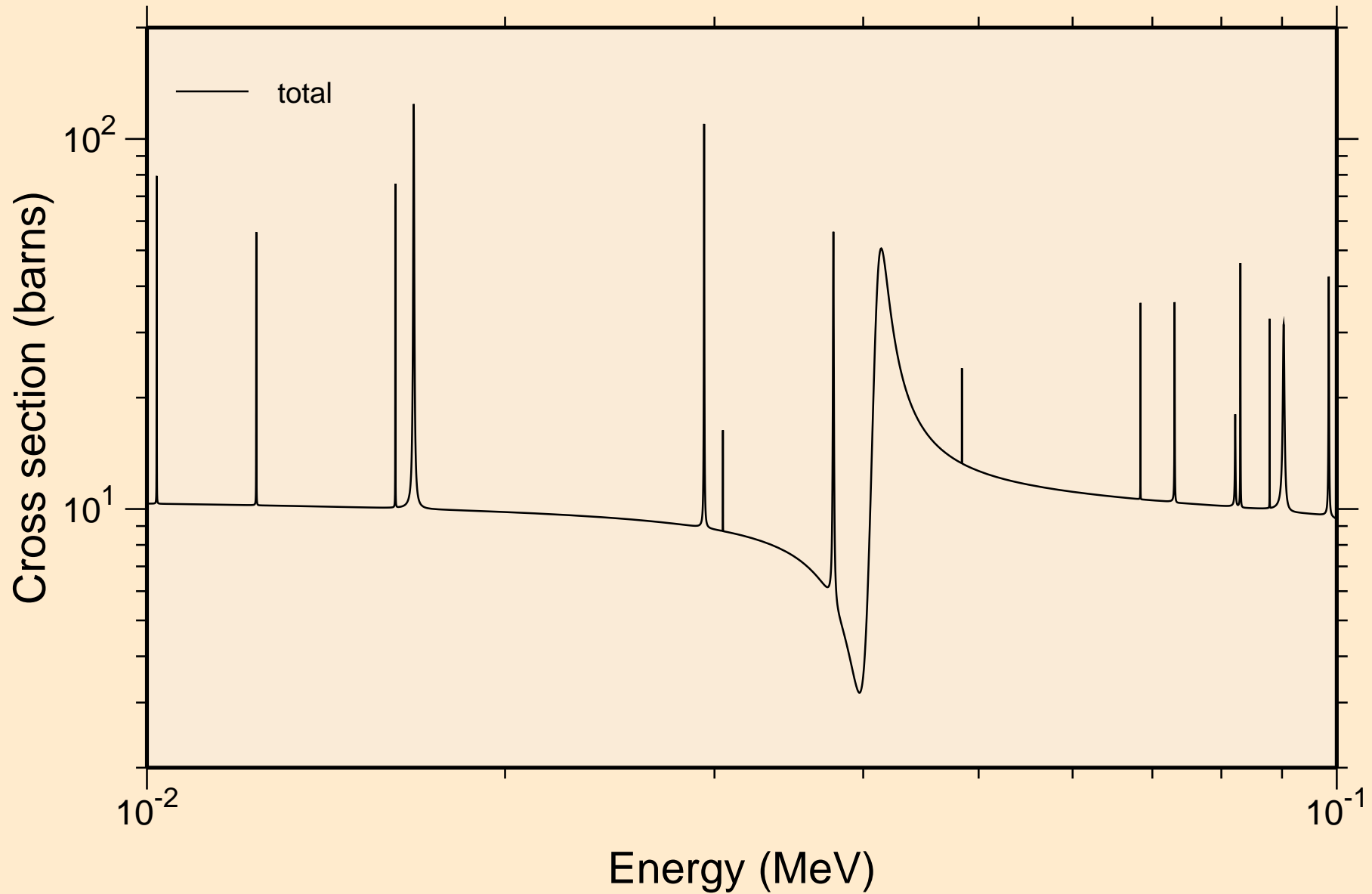

PB207 NEUTRON ACER TENDL-2024 LIBRARY; T=293.6K  
resonance total cross section

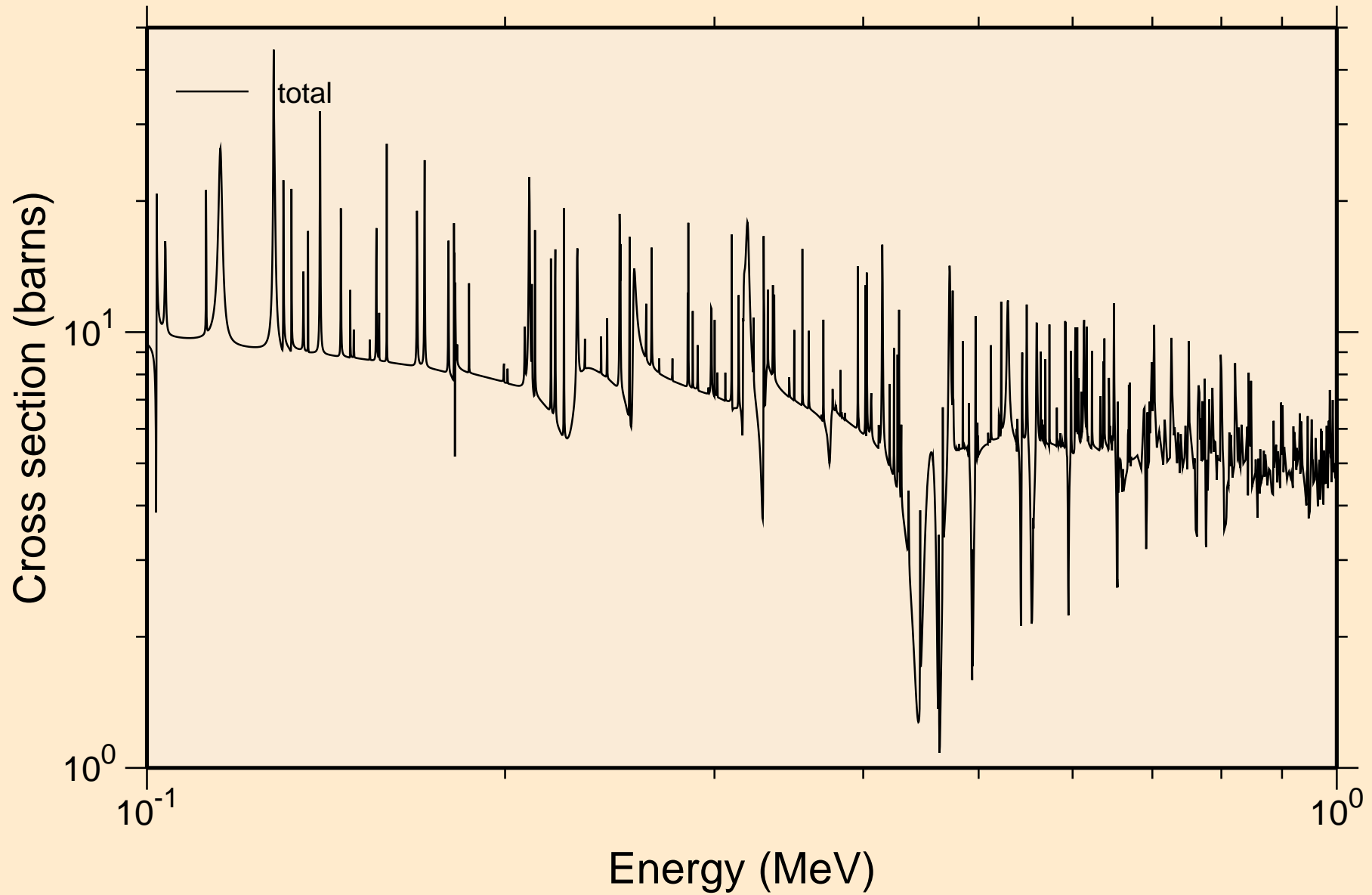

PB207 NEUTRON ACER TENDL-2024 LIBRARY; T=293.6K  
resonance total cross section

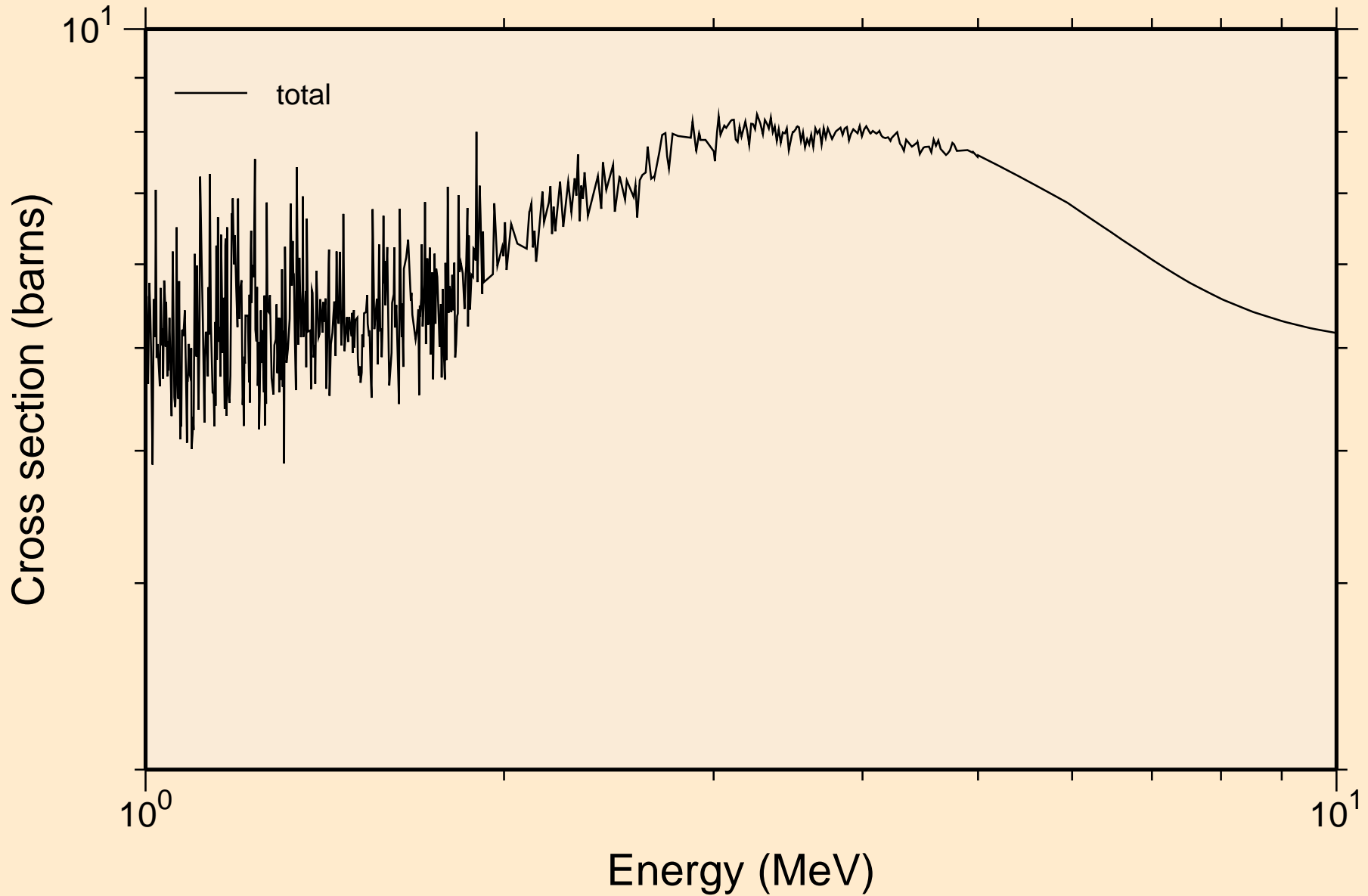

PB207 NEUTRON ACER TENDL-2024 LIBRARY; T=293.6K  
resonance absorption cross sections

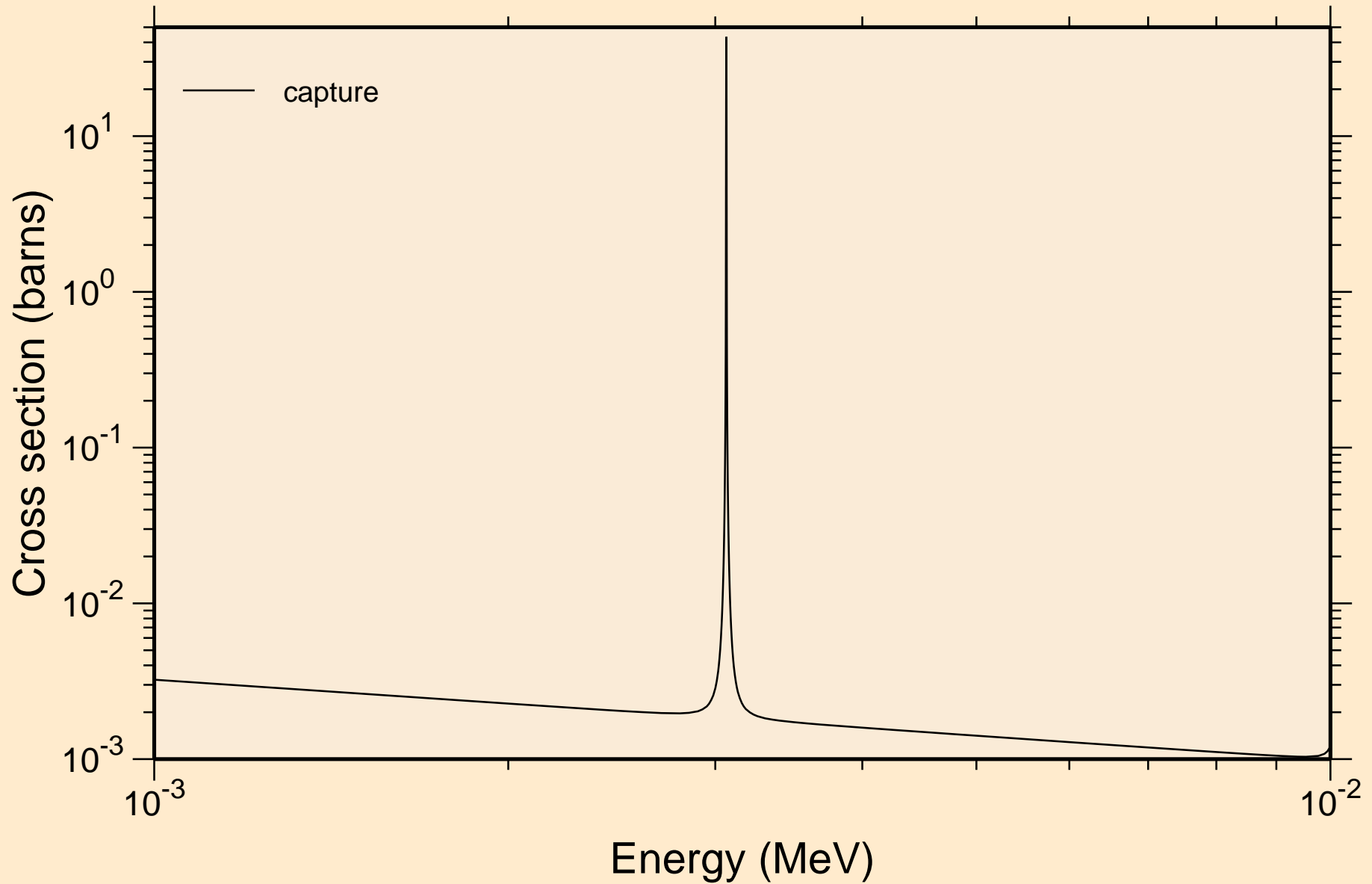

PB207 NEUTRON ACER TENDL-2024 LIBRARY; T=293.6K  
resonance absorption cross sections

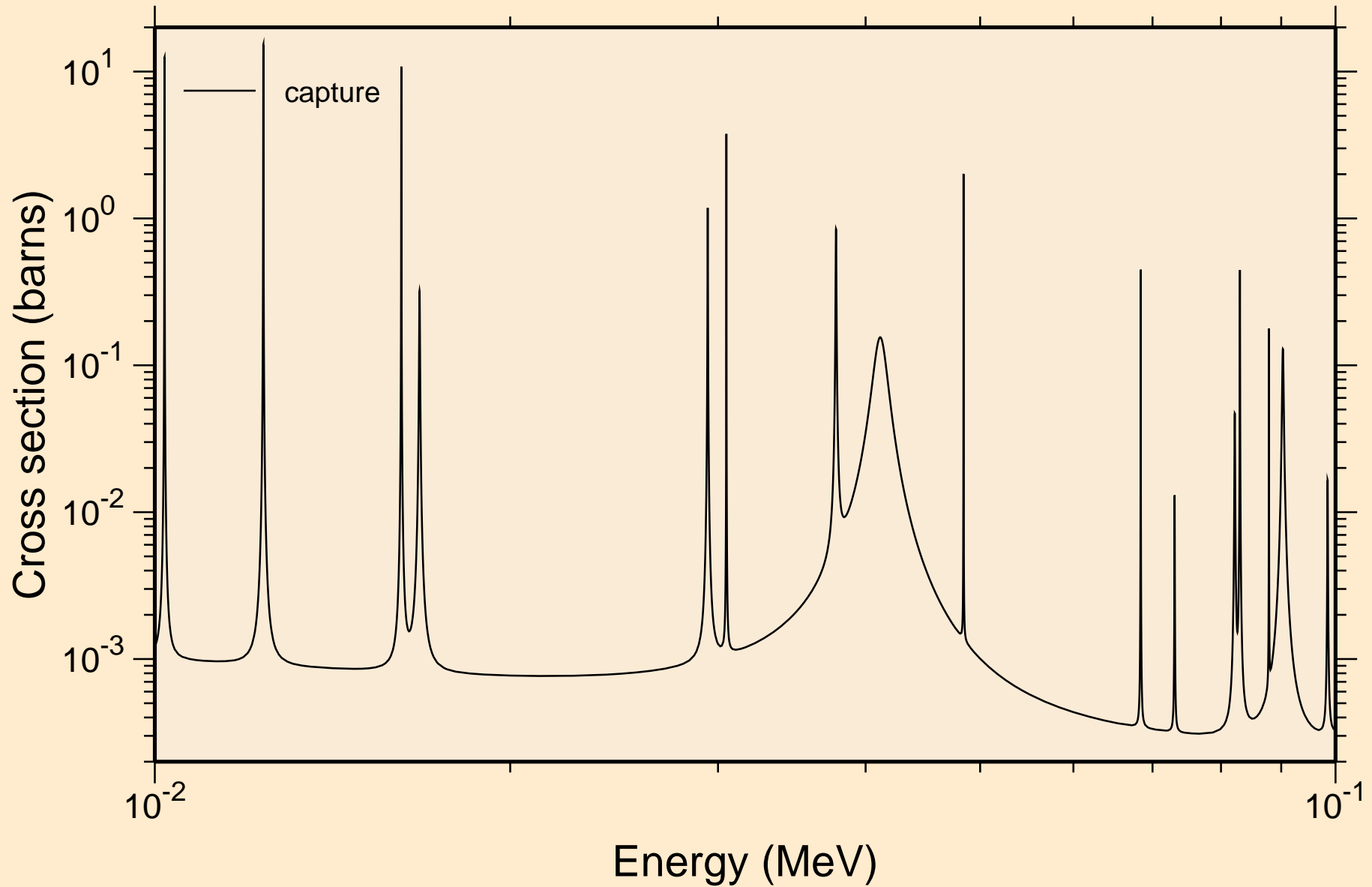

PB207 NEUTRON ACER TENDL-2024 LIBRARY; T=293.6K  
resonance absorption cross sections

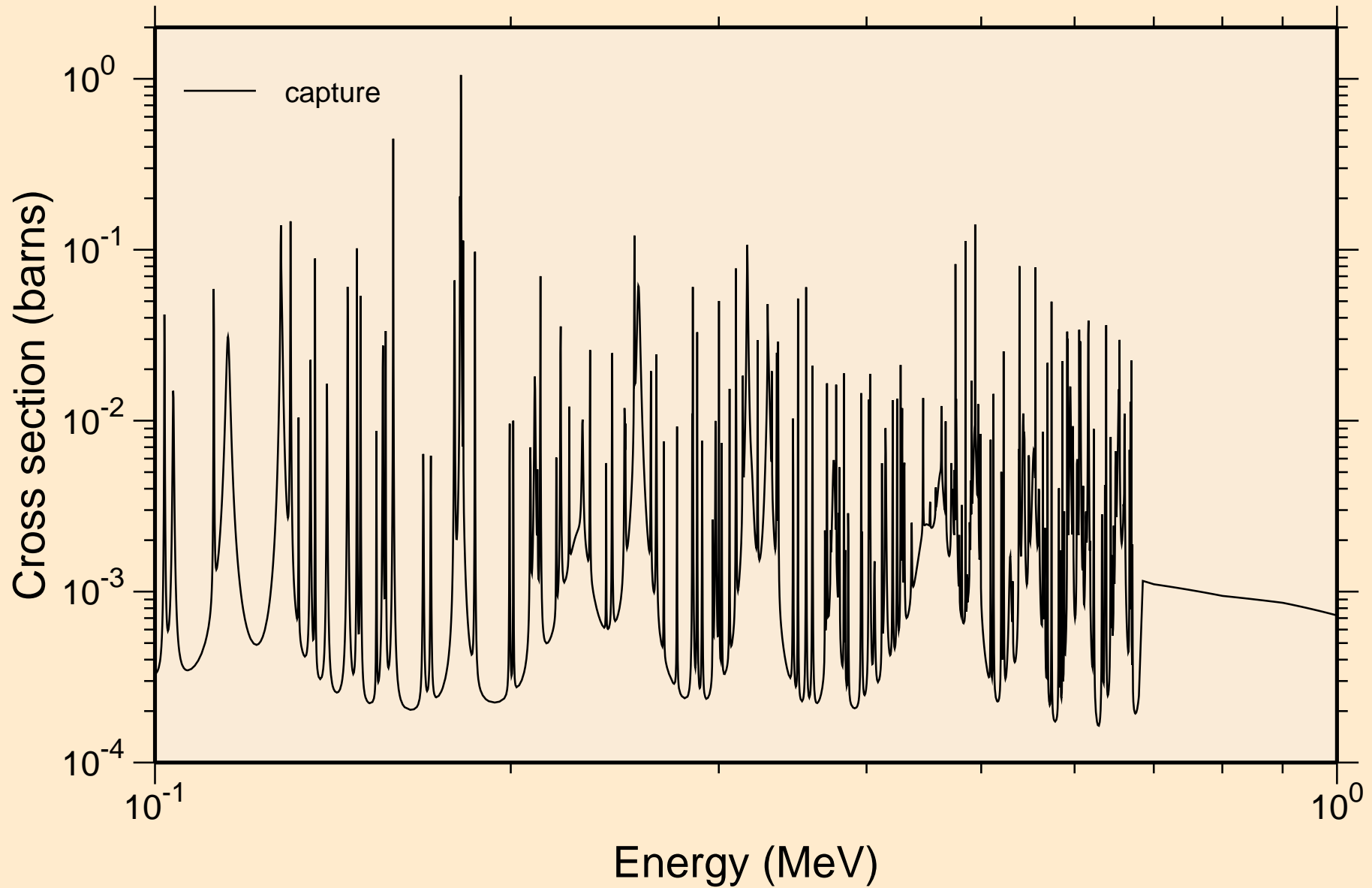

PB207 NEUTRON ACER TENDL-2024 LIBRARY; T=293.6K  
resonance absorption cross sections

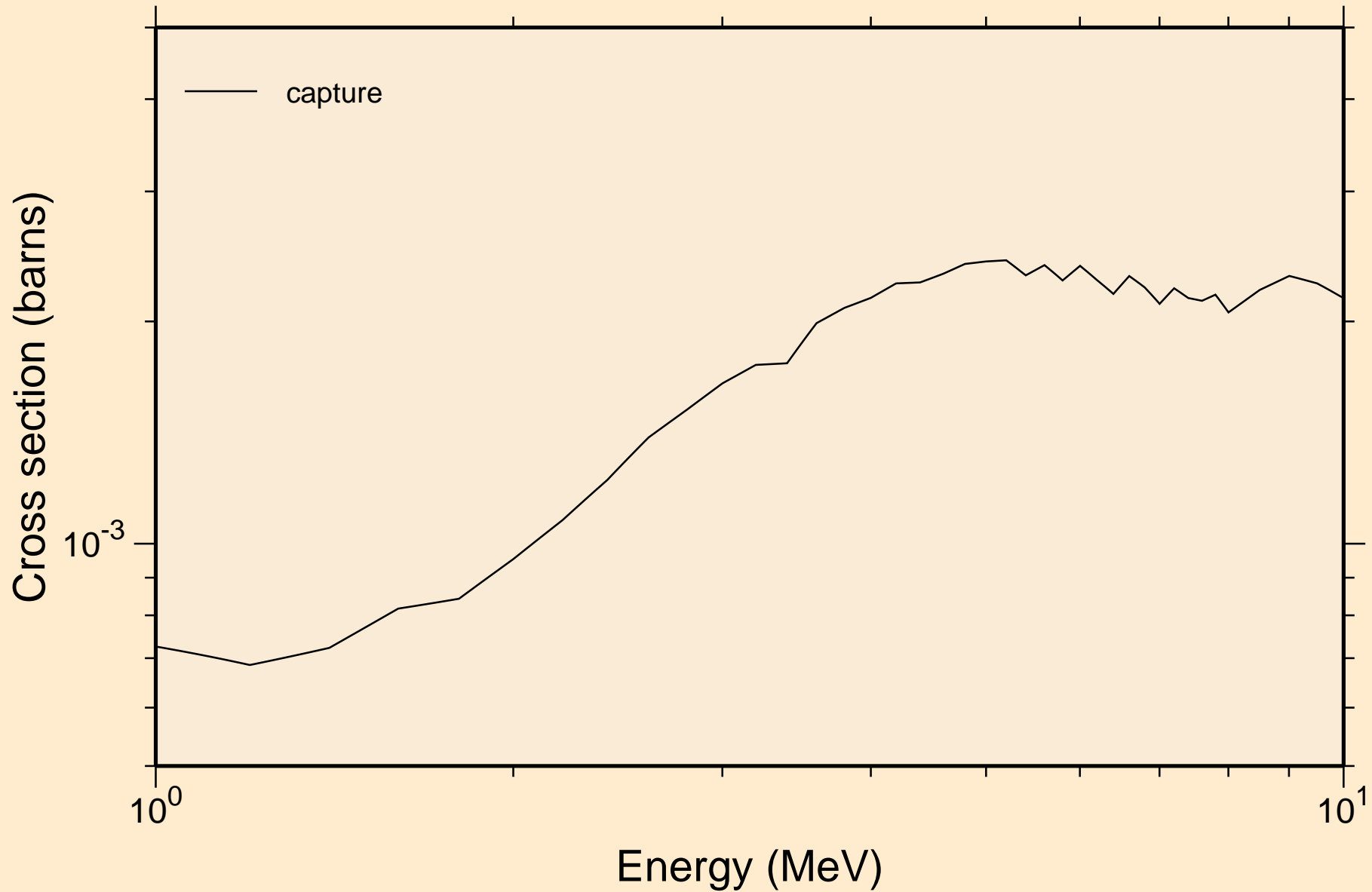

PB207 NEUTRON ACER TENDL-2024 LIBRARY; T=293.6K  
Heating

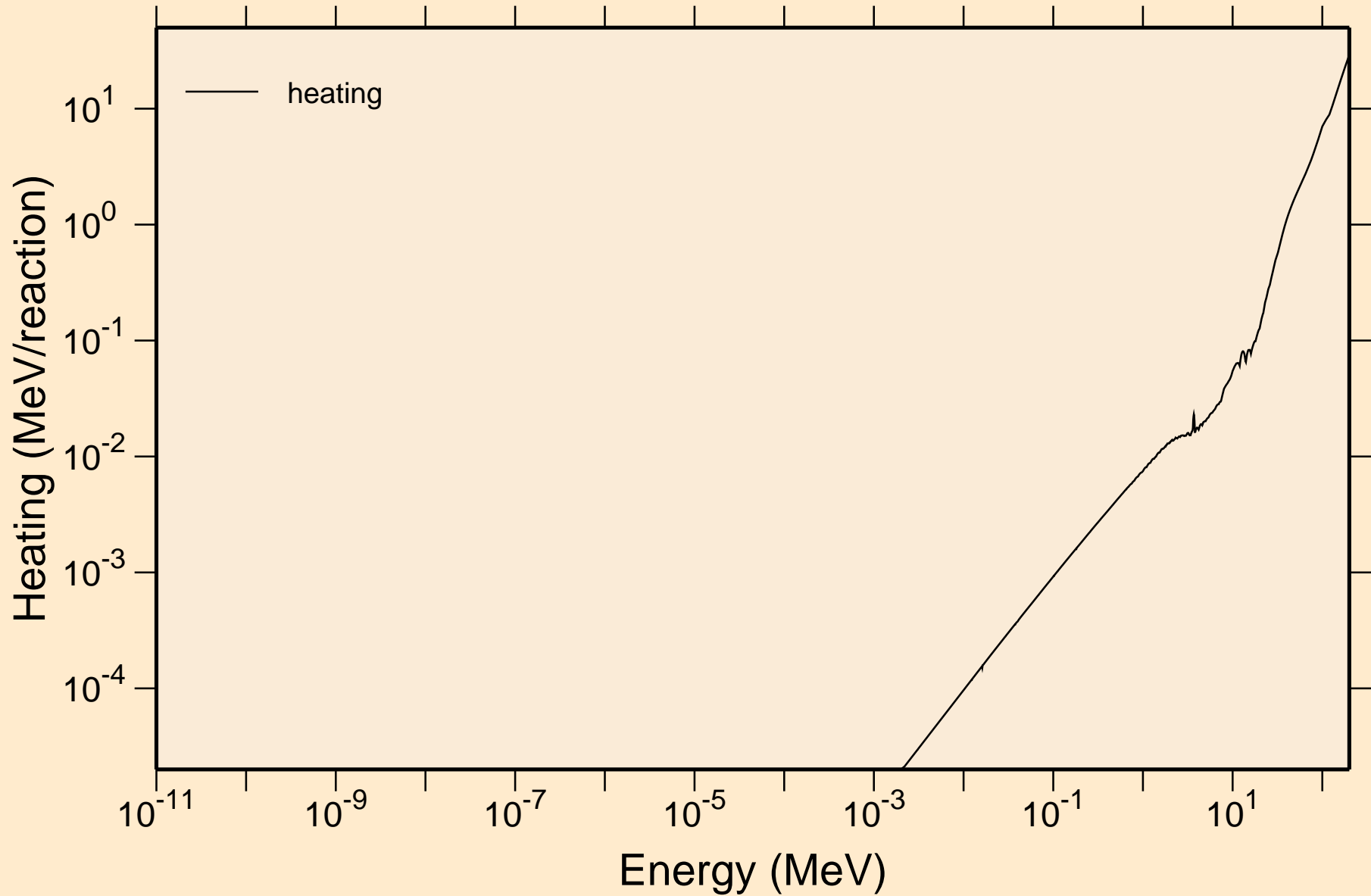

PB207 NEUTRON ACER TENDL-2024 LIBRARY; T=293.6K  
Damage

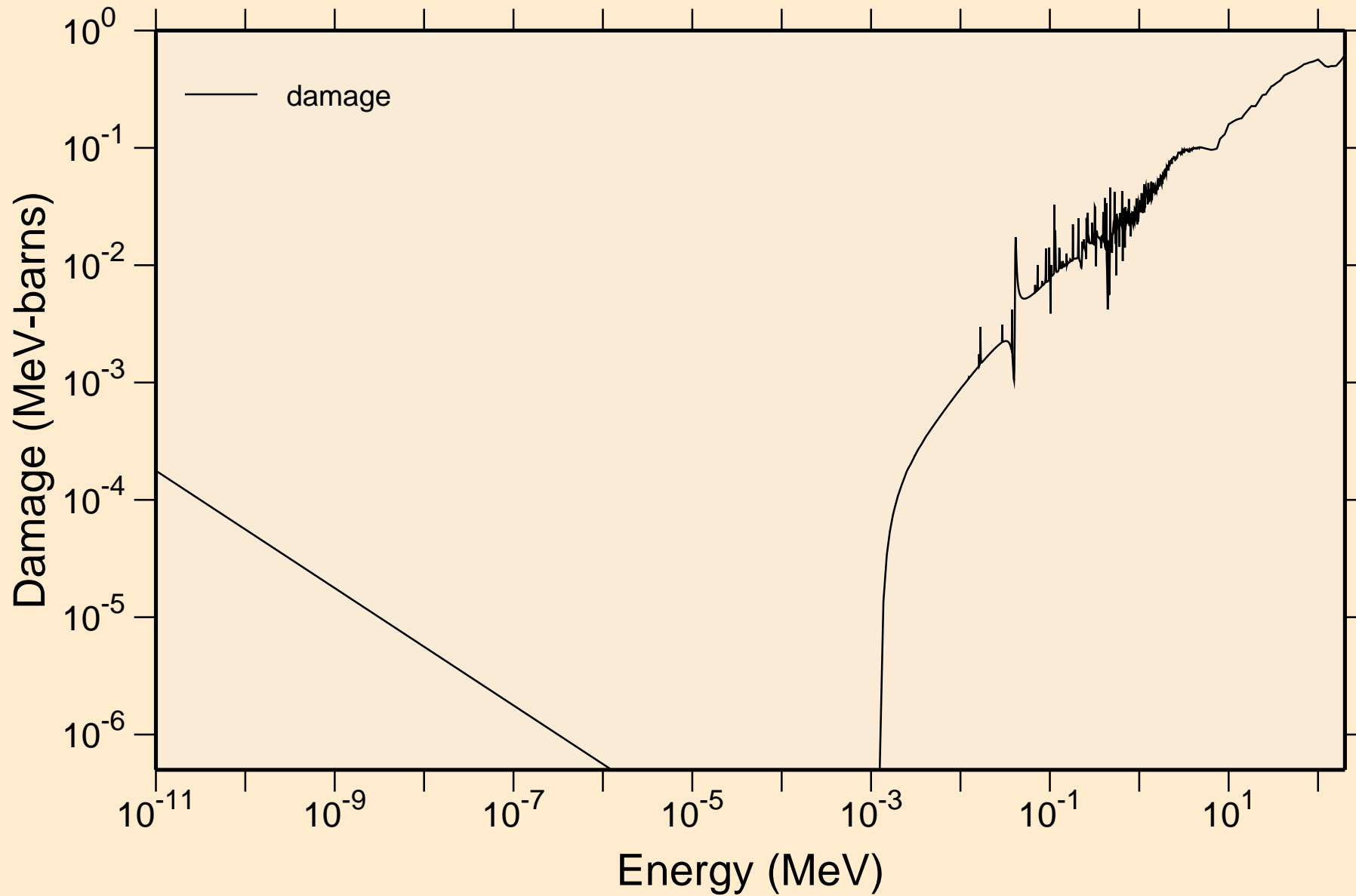

PB207 NEUTRON ACER TENDL-2024 LIBRARY; T=293.6K  
Non-threshold reactions

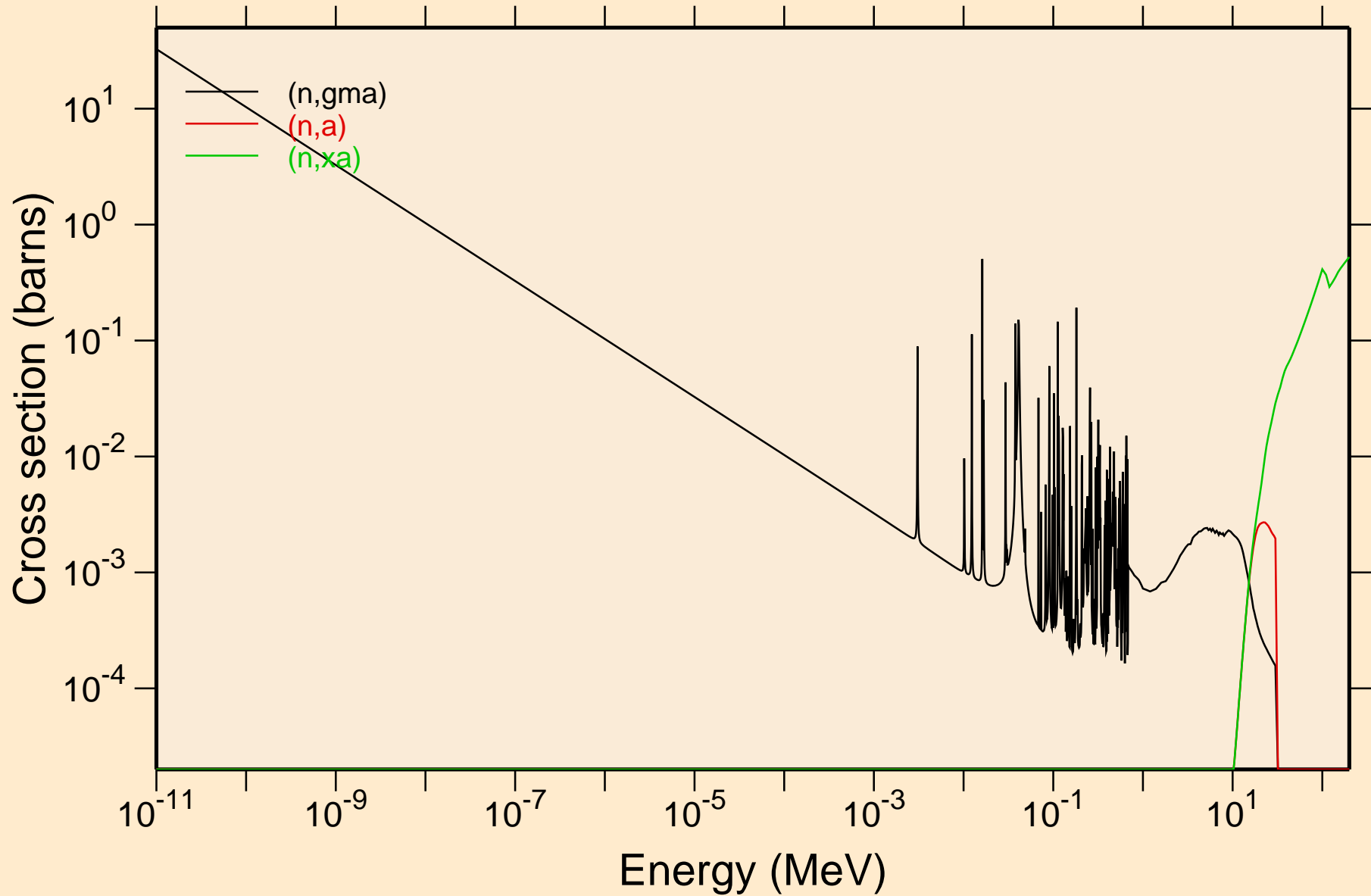

PB207 NEUTRON ACER TENDL-2024 LIBRARY; T=293.6K  
Principal cross sections

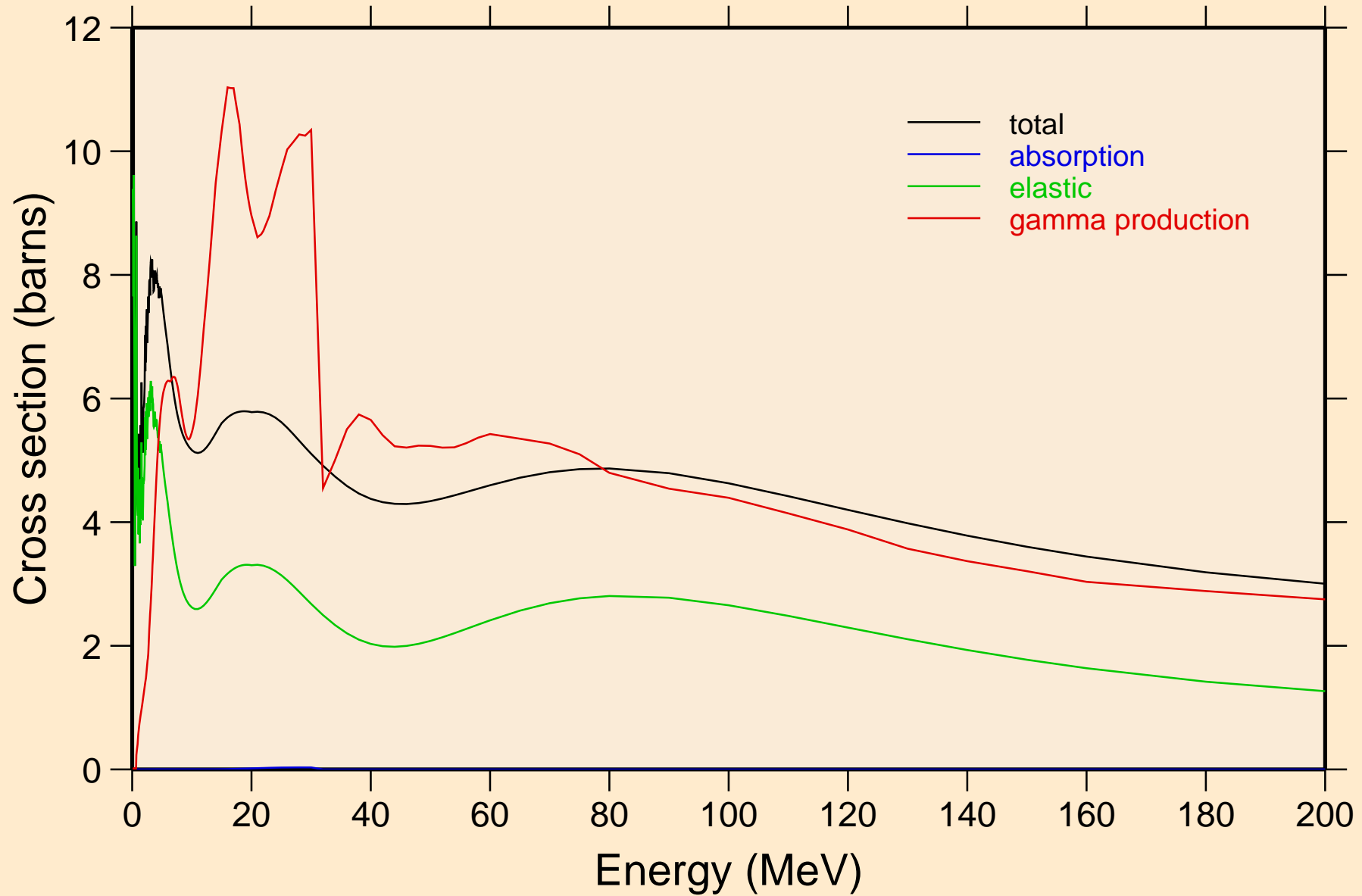

PB207 NEUTRON ACER TENDL-2024 LIBRARY; T=293.6K  
Heating

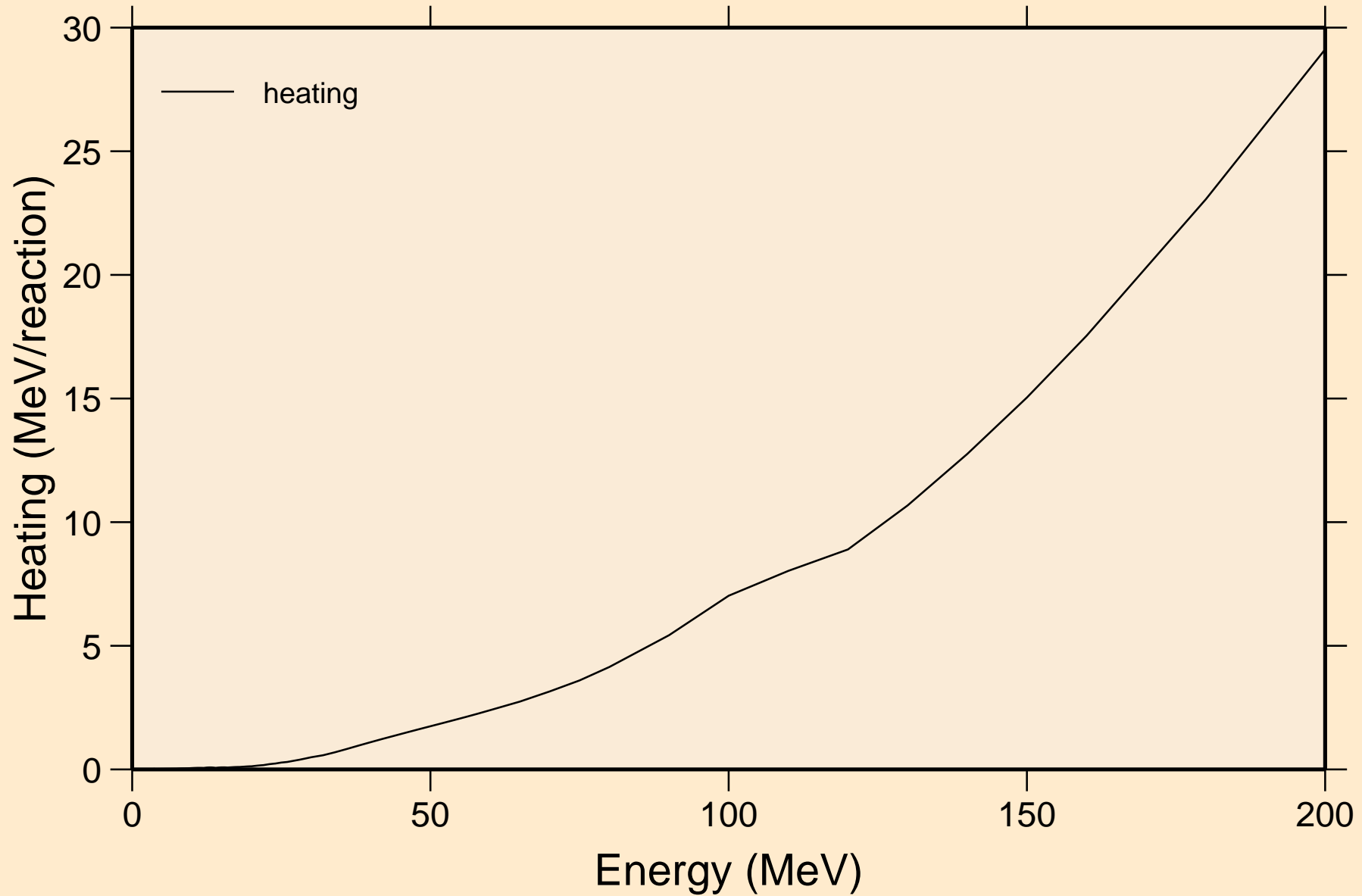

PB207 NEUTRON ACER TENDL-2024 LIBRARY; T=293.6K  
Damage

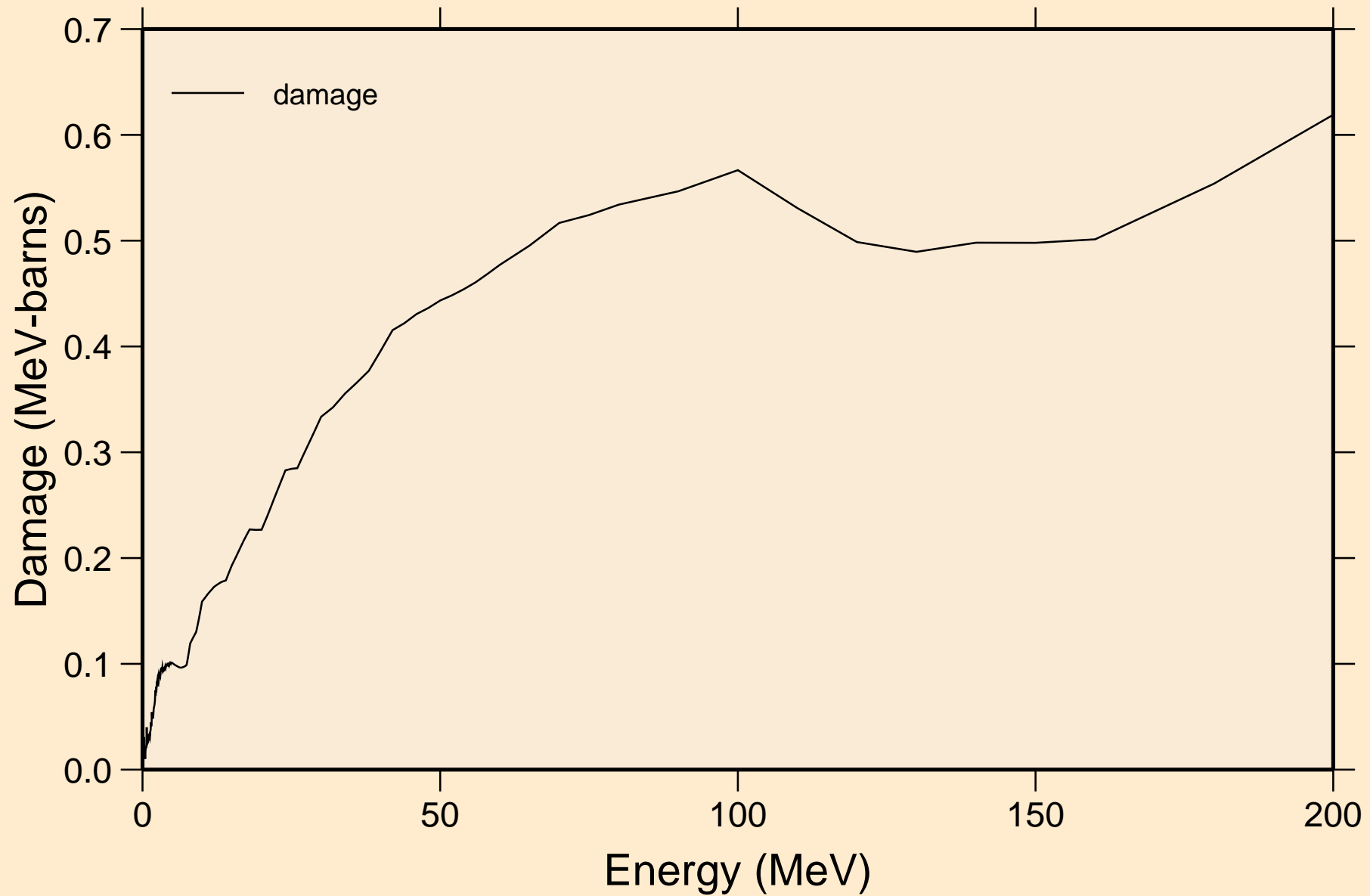

PB207 NEUTRON ACER TENDL-2024 LIBRARY; T=293.6K  
Non-threshold reactions

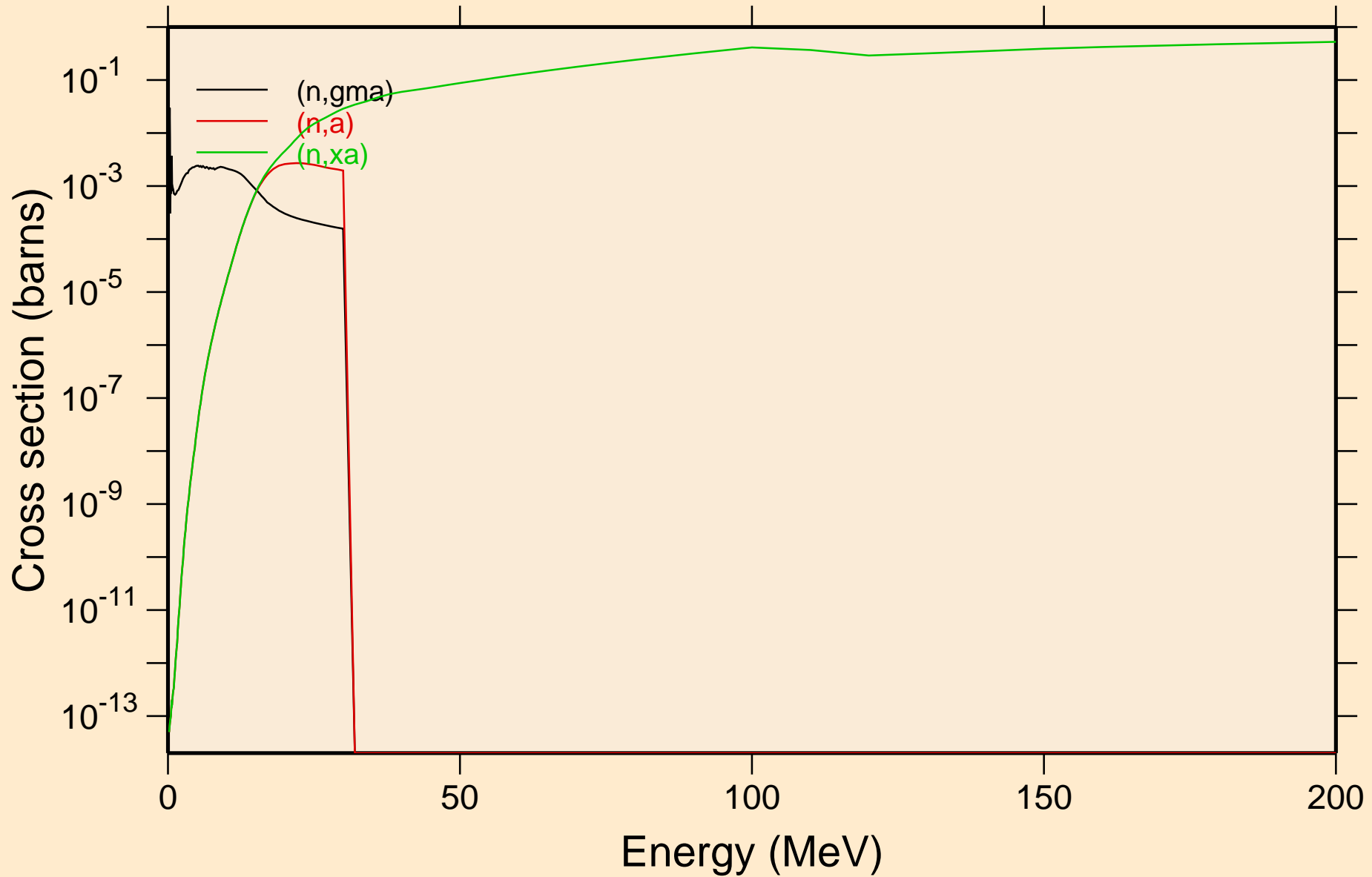

PB207 NEUTRON ACER TENDL-2024 LIBRARY; T=293.6K  
Inelastic levels

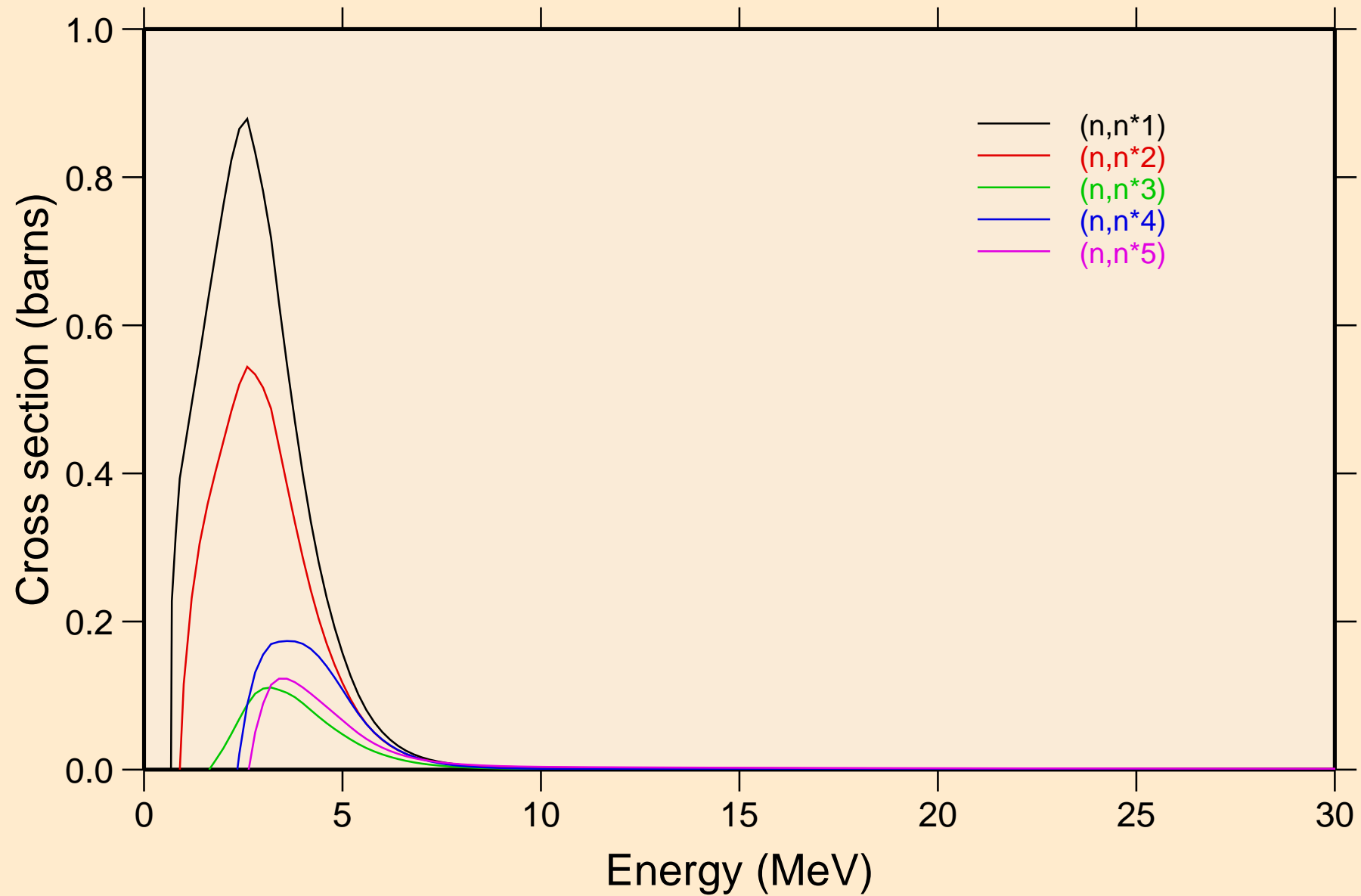

PB207 NEUTRON ACER TENDL-2024 LIBRARY; T=293.6K  
Inelastic levels

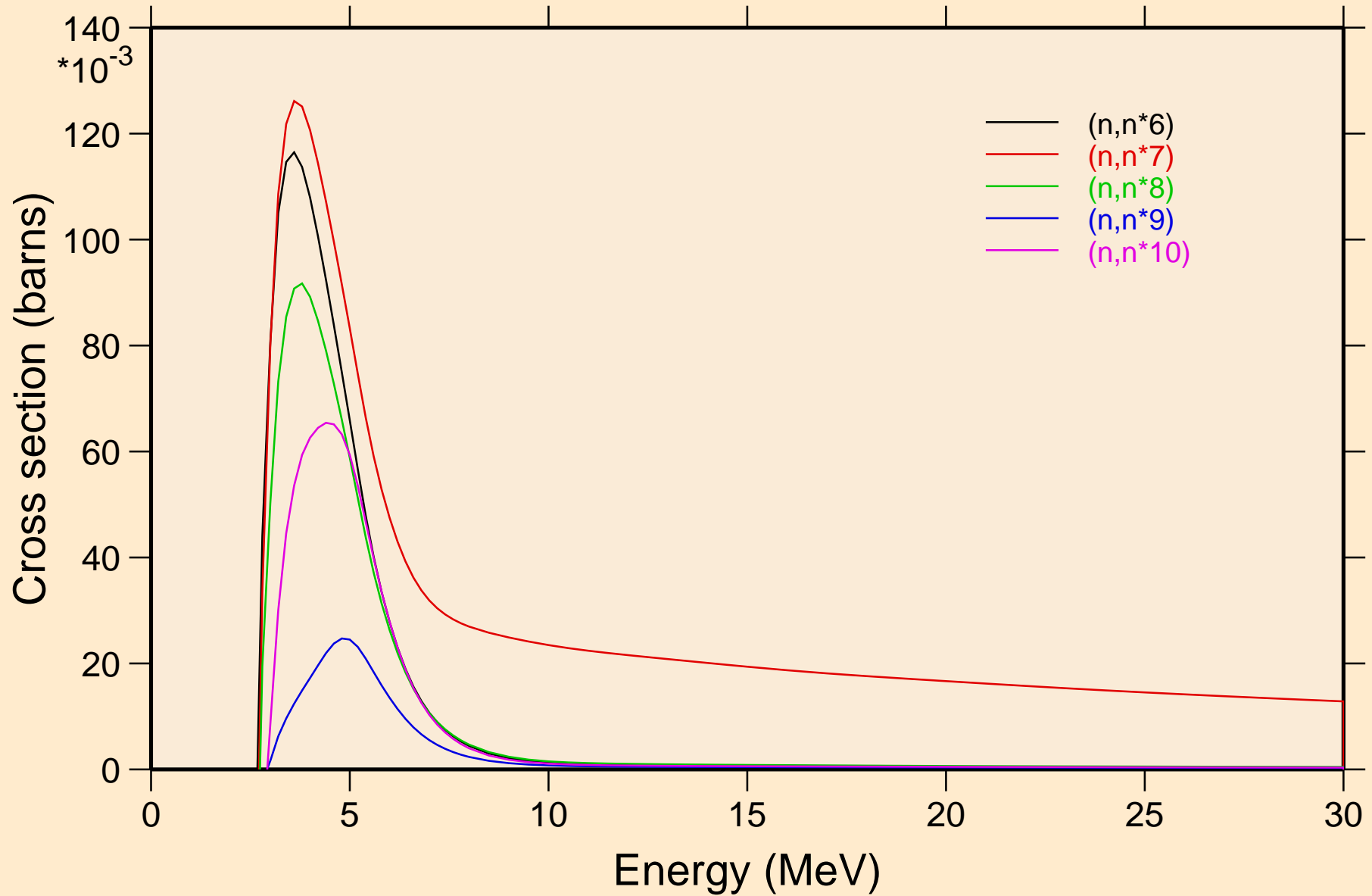

PB207 NEUTRON ACER TENDL-2024 LIBRARY; T=293.6K  
Inelastic levels

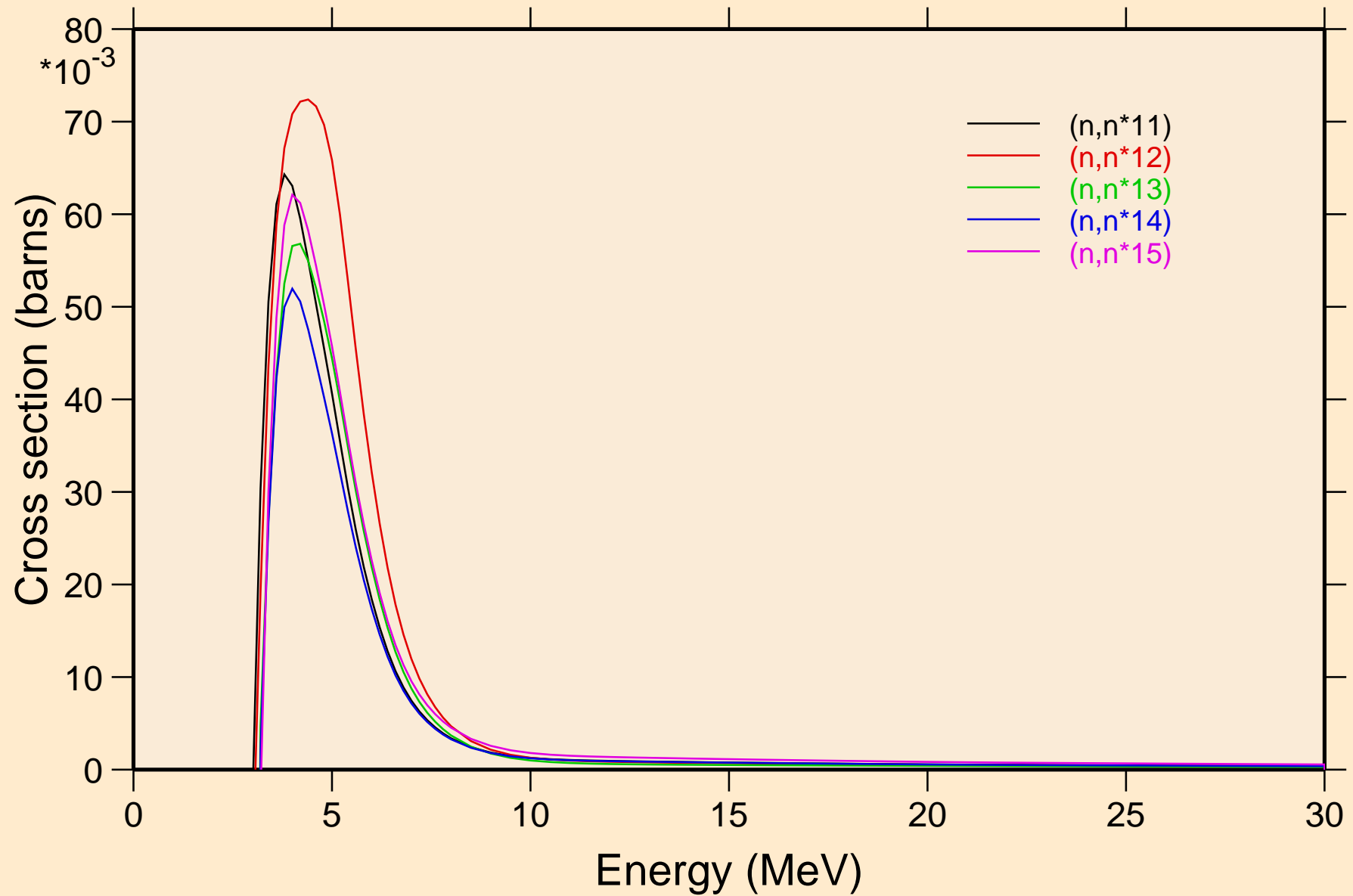

PB207 NEUTRON ACER TENDL-2024 LIBRARY; T=293.6K  
Inelastic levels

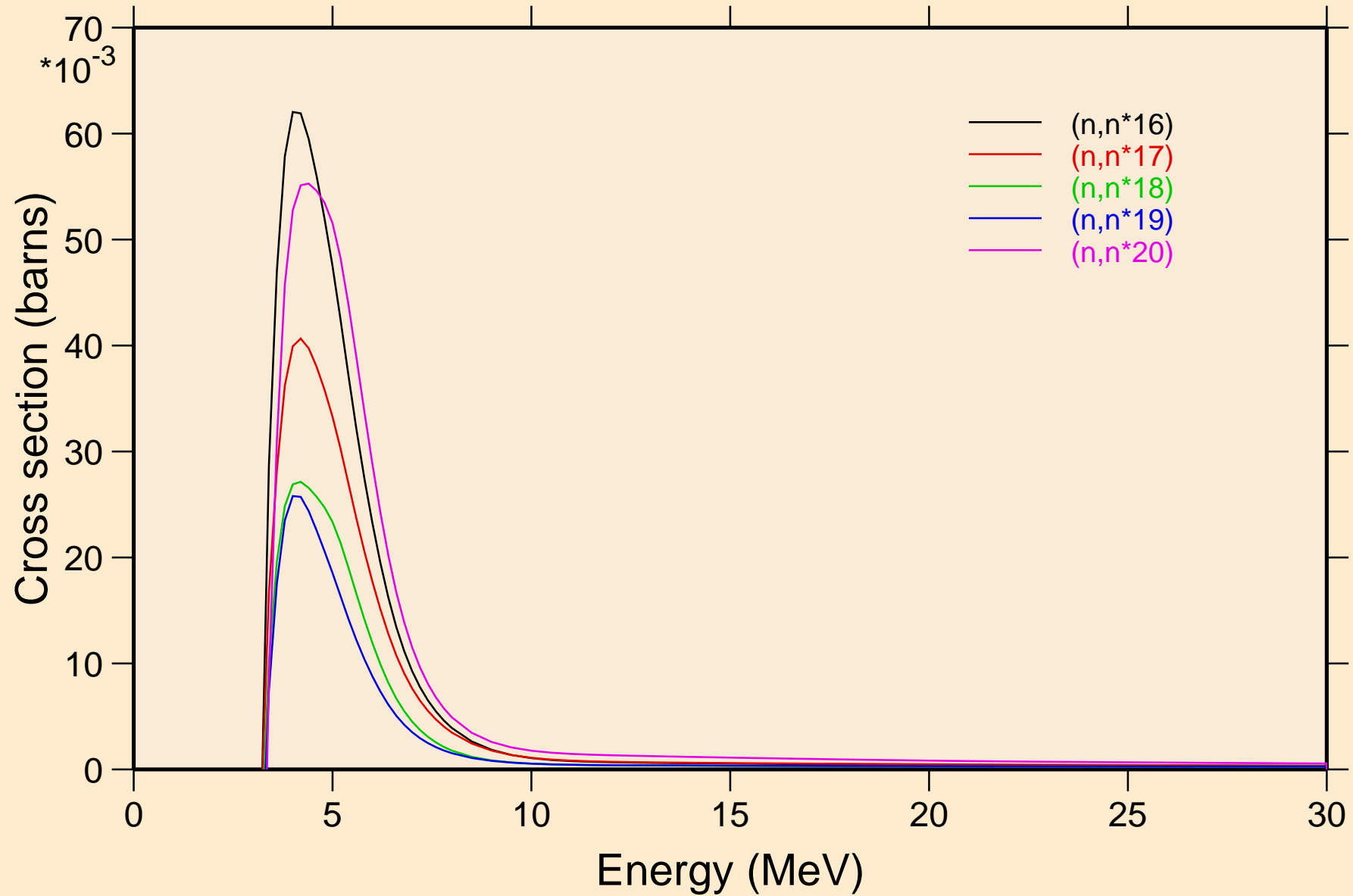

PB207 NEUTRON ACER TENDL-2024 LIBRARY; T=293.6K  
Inelastic levels

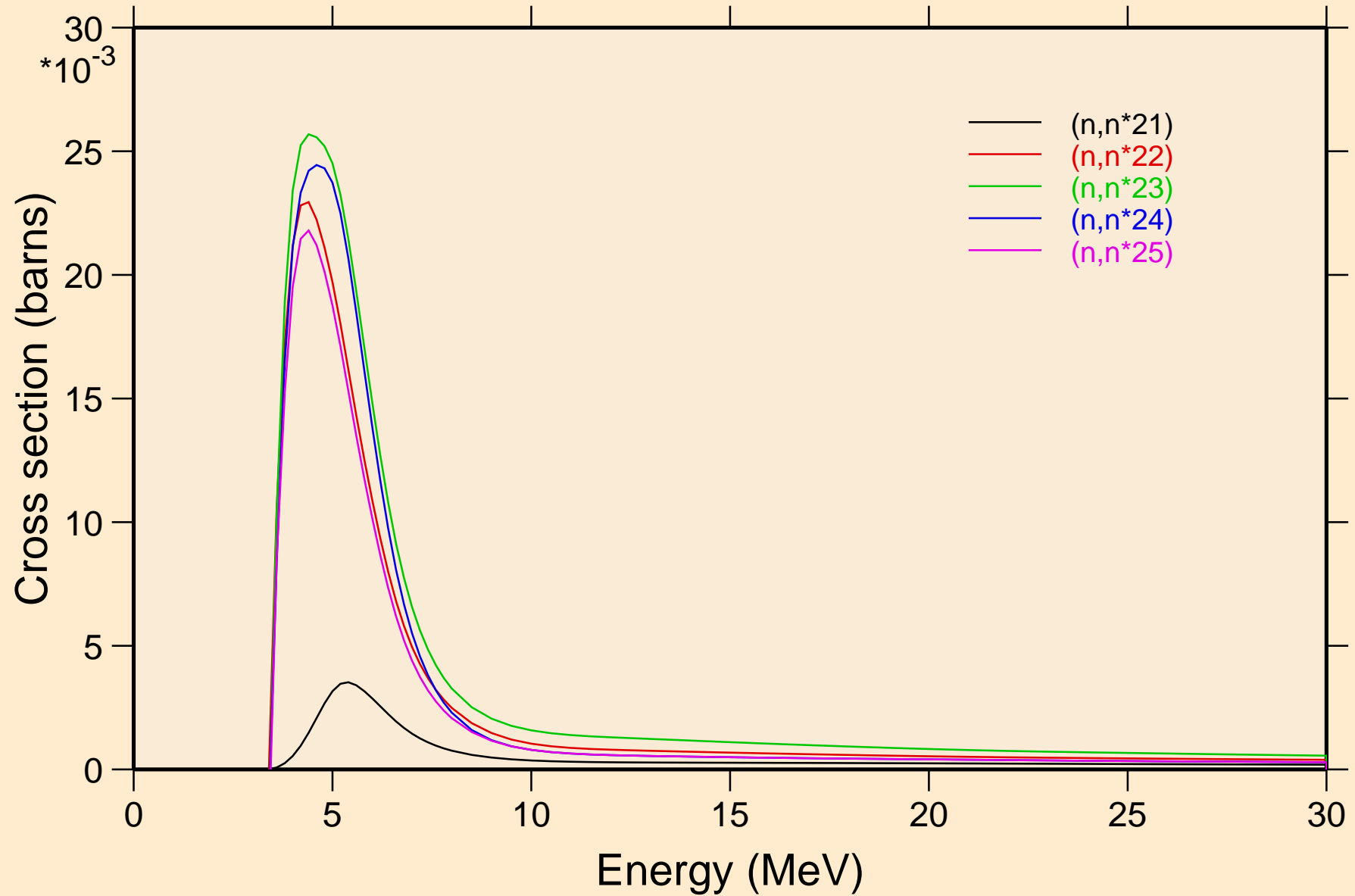

PB207 NEUTRON ACER TENDL-2024 LIBRARY; T=293.6K  
Inelastic levels

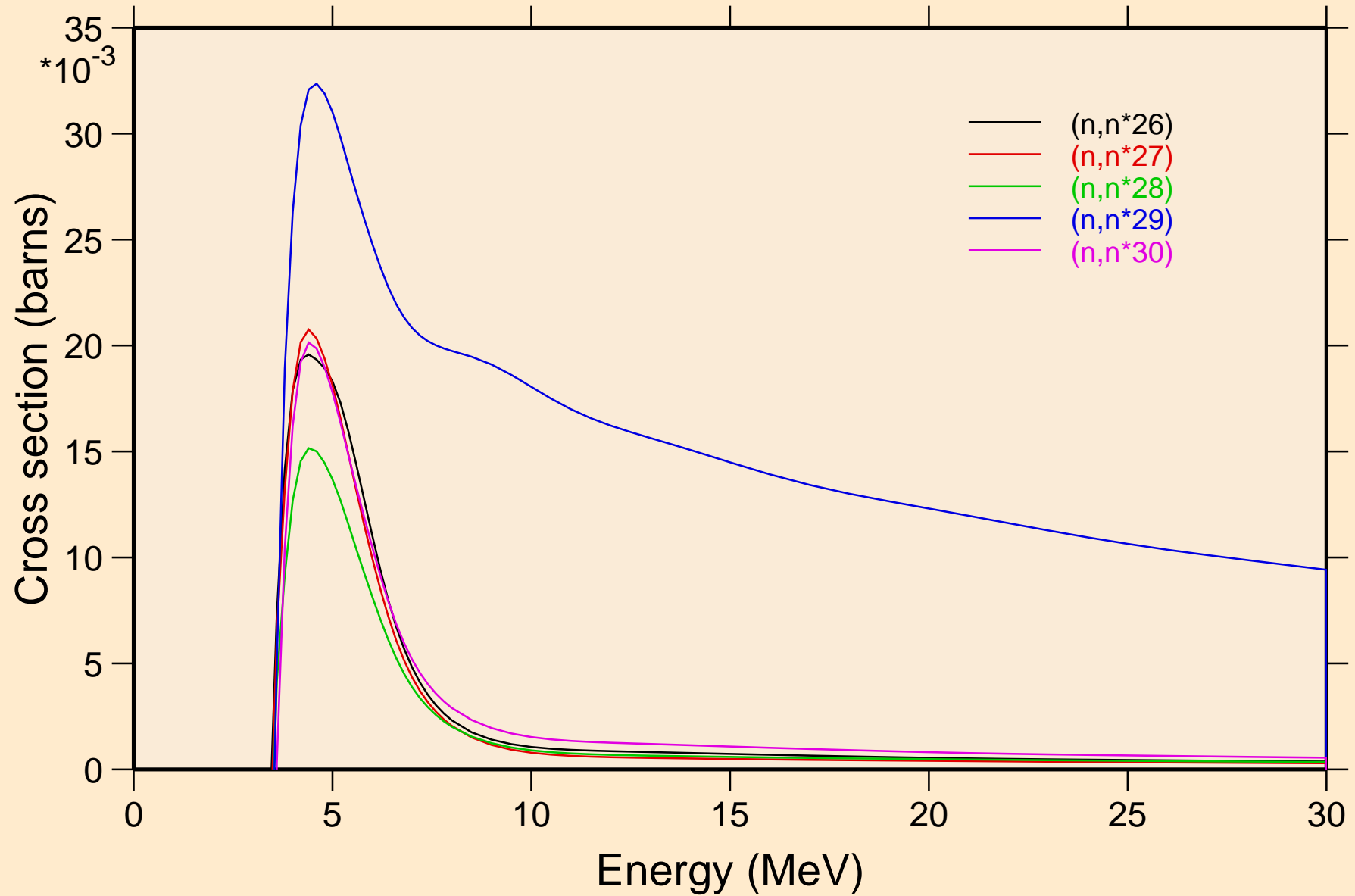

PB207 NEUTRON ACER TENDL-2024 LIBRARY; T=293.6K  
Threshold reactions

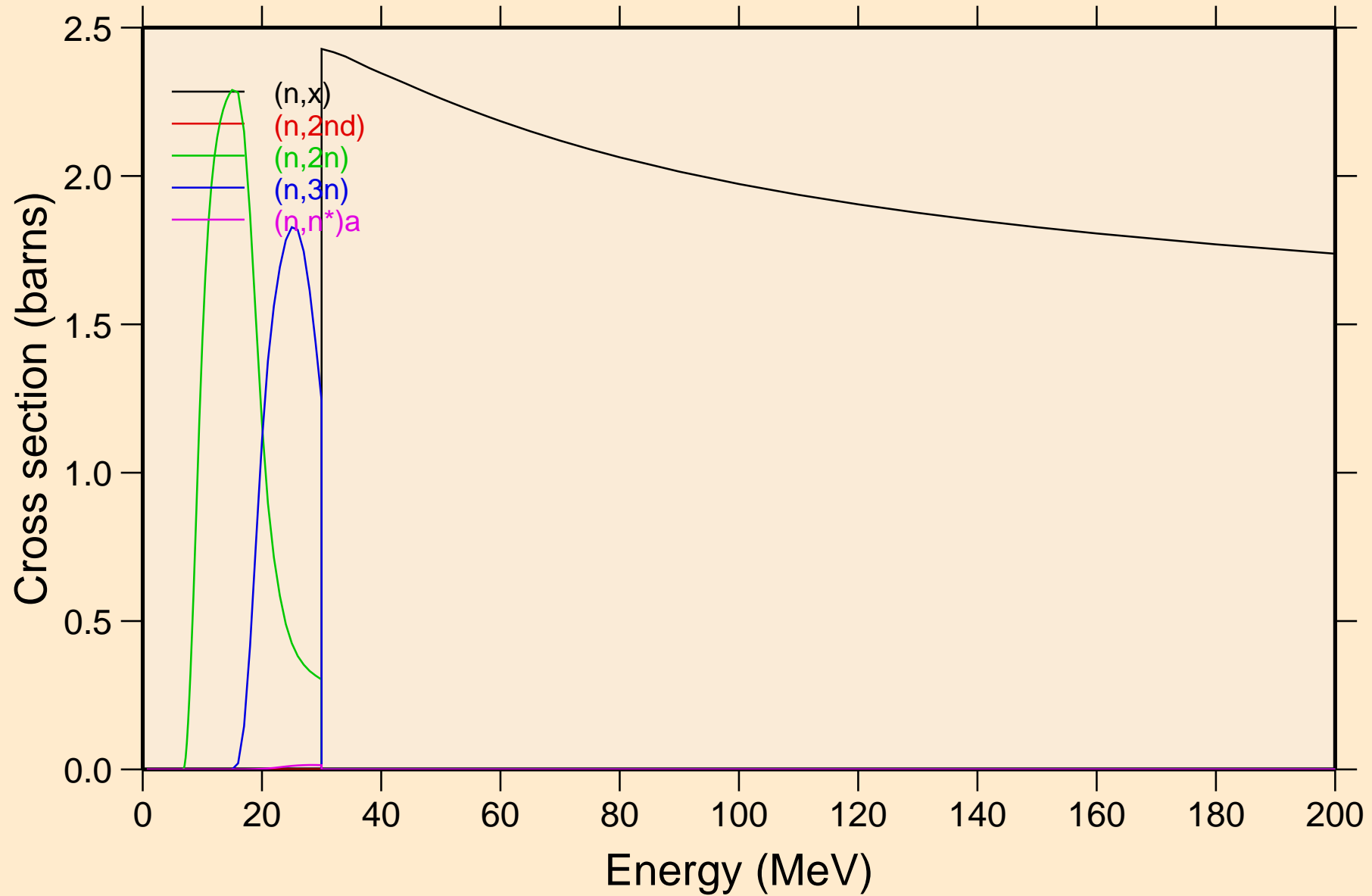

PB207 NEUTRON ACER TENDL-2024 LIBRARY; T=293.6K  
Threshold reactions

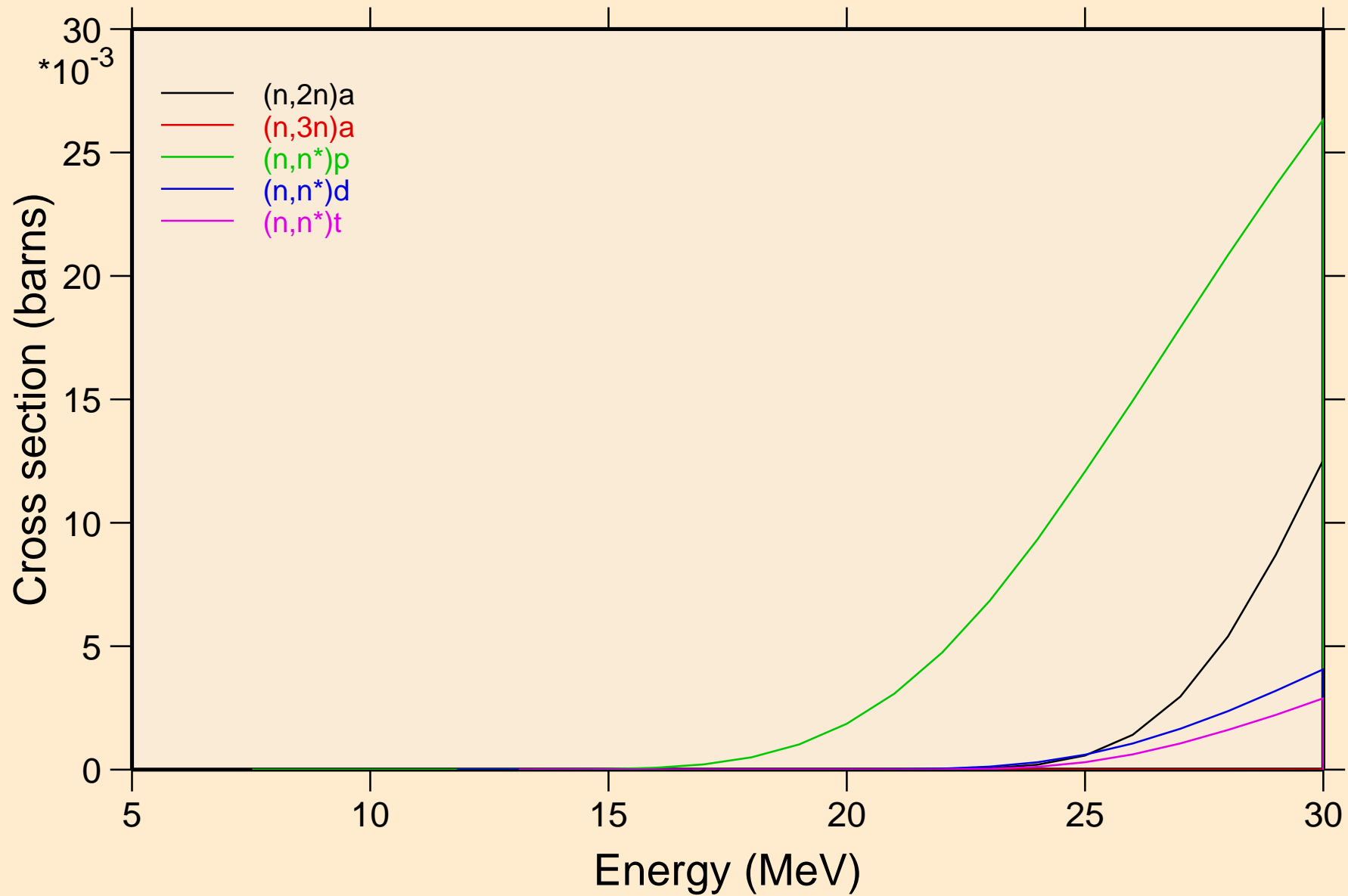

PB207 NEUTRON ACER TENDL-2024 LIBRARY; T=293.6K  
Threshold reactions

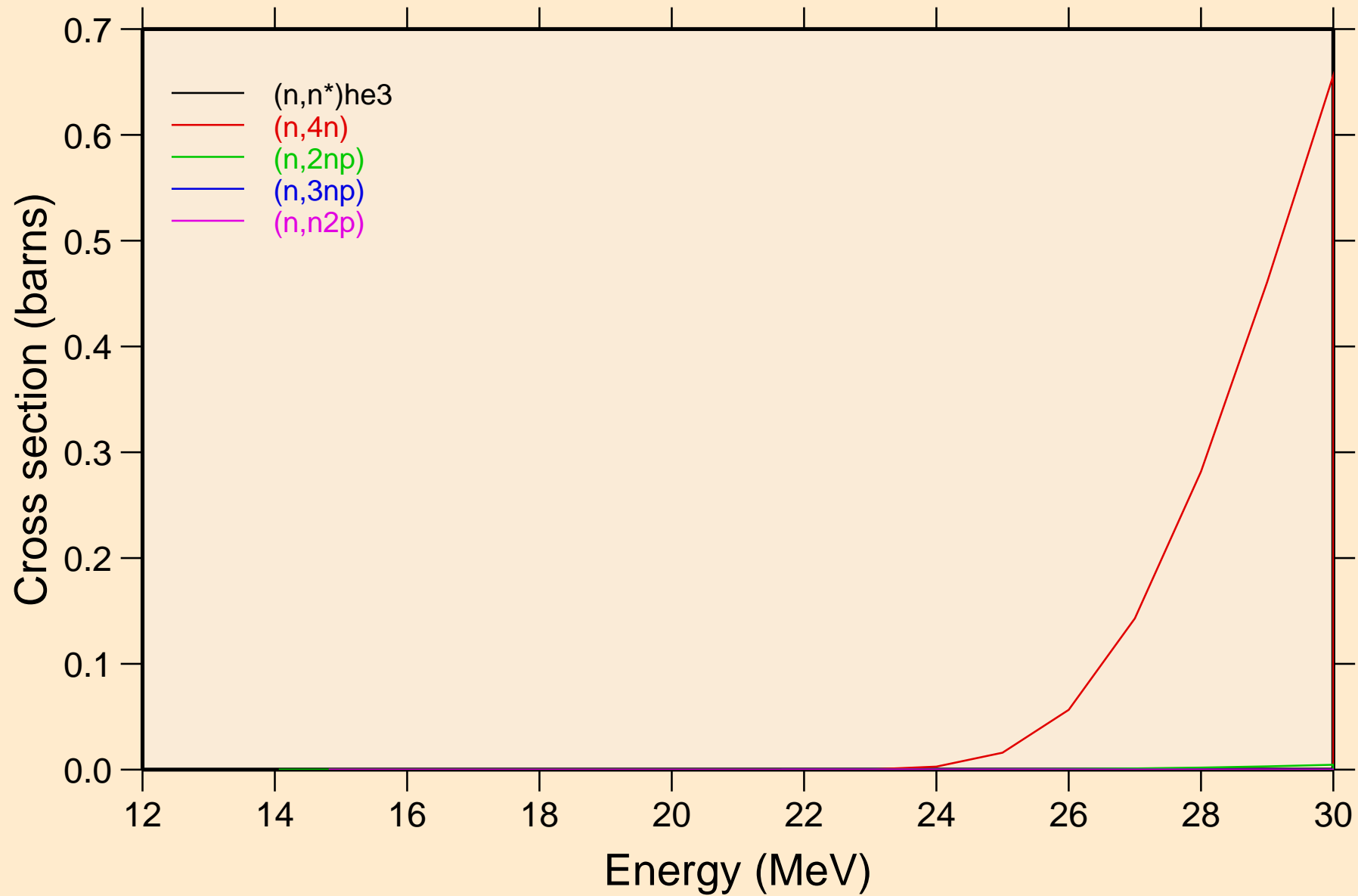

PB207 NEUTRON ACER TENDL-2024 LIBRARY; T=293.6K  
Threshold reactions

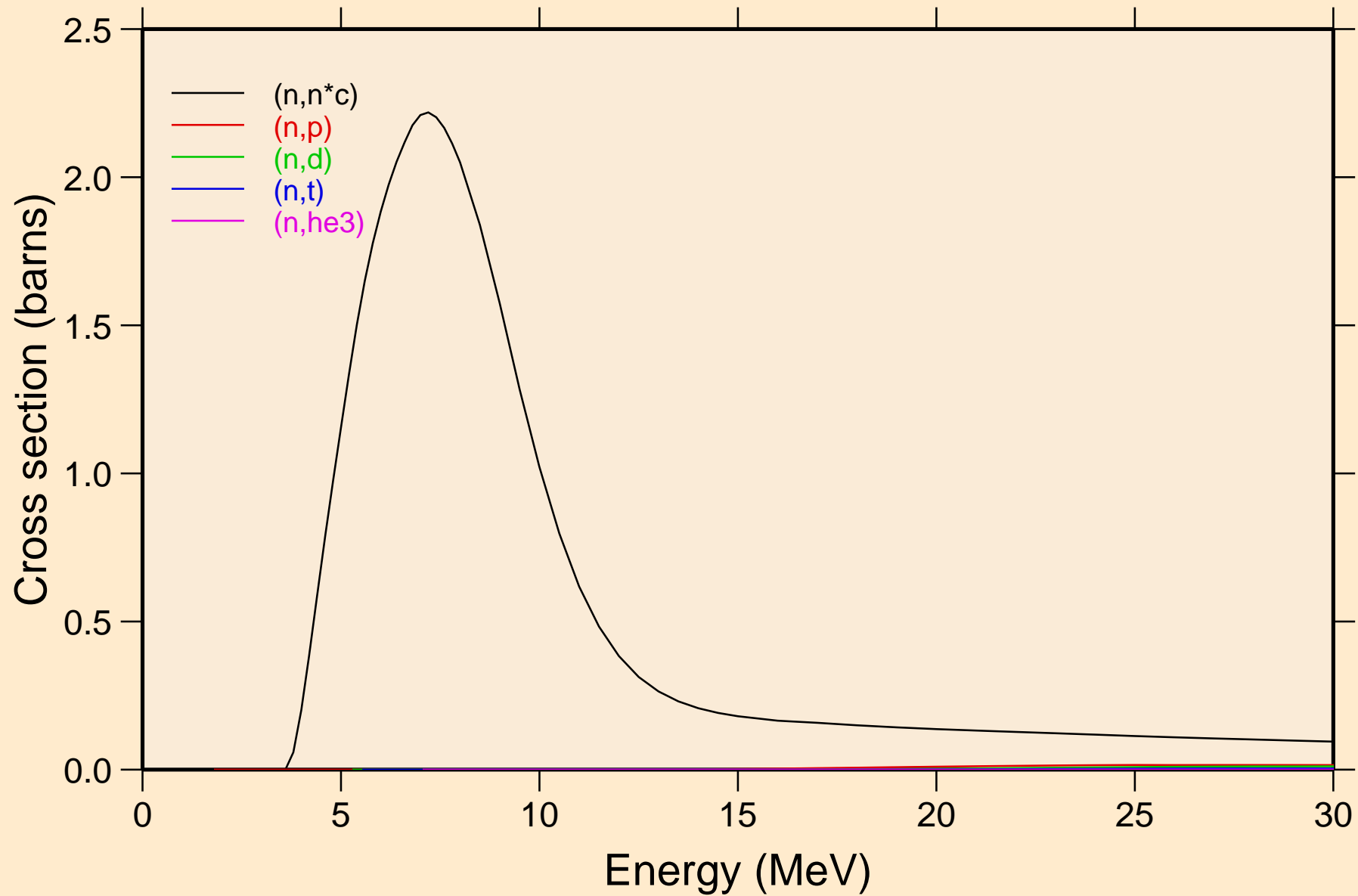

PB207 NEUTRON ACER TENDL-2024 LIBRARY; T=293.6K  
Threshold reactions

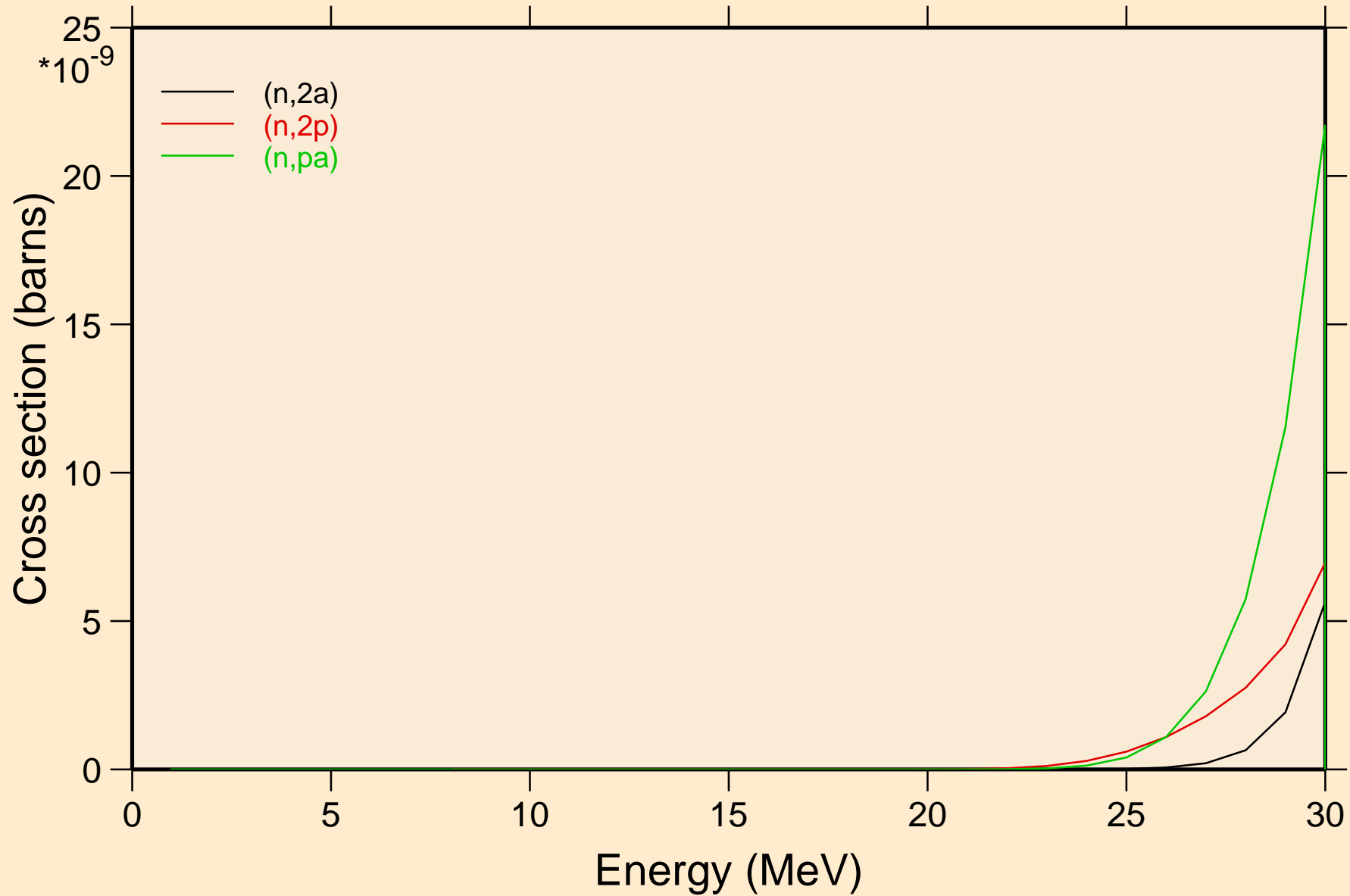

PB207 NEUTRON ACER TENDL-2024 LIBRARY; T=293.6K  
Threshold reactions

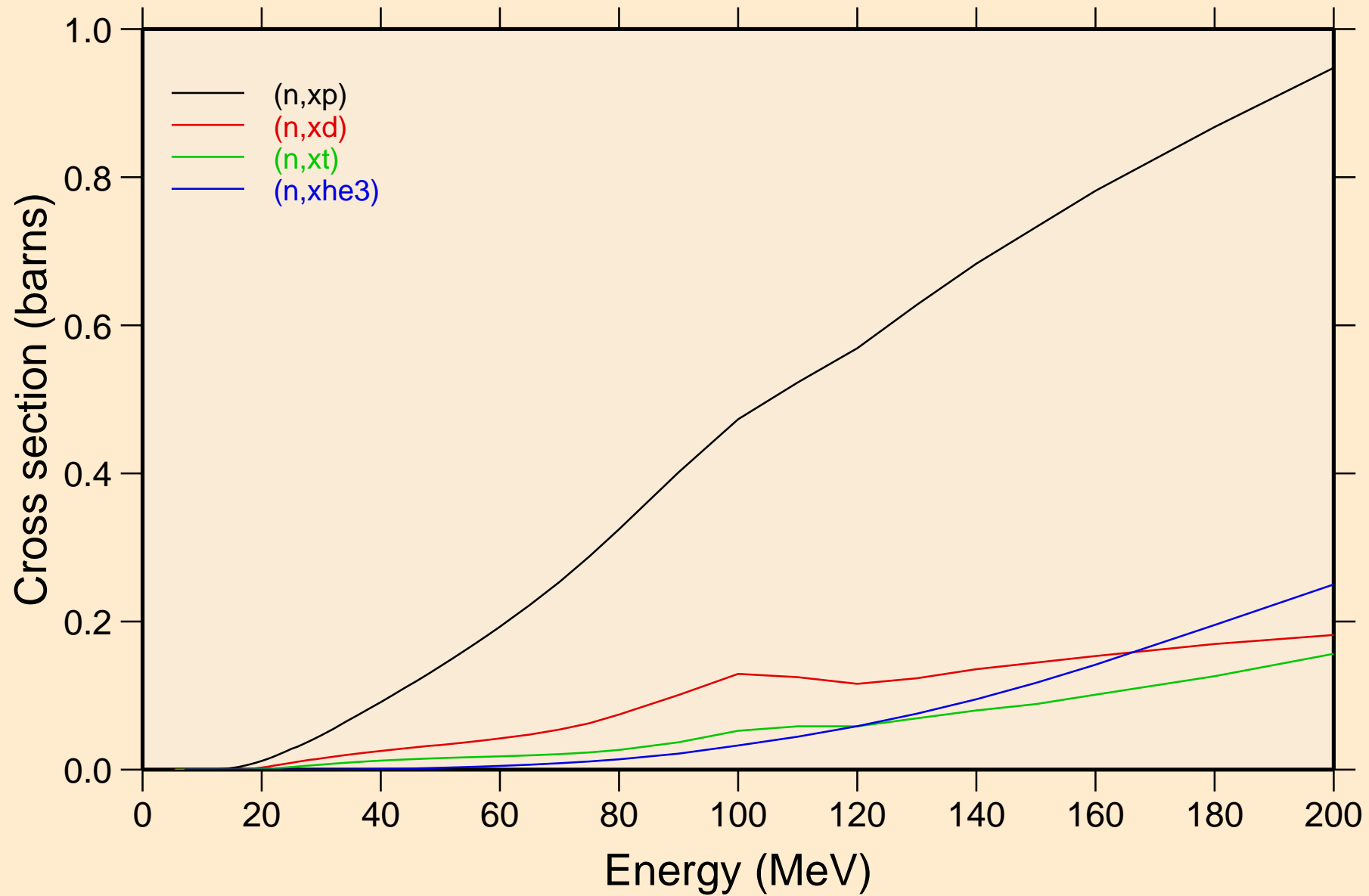

PB207 NEUTRON ACER TENDL-2024 LIBRARY; T=293.6K  
angular distribution for elastic

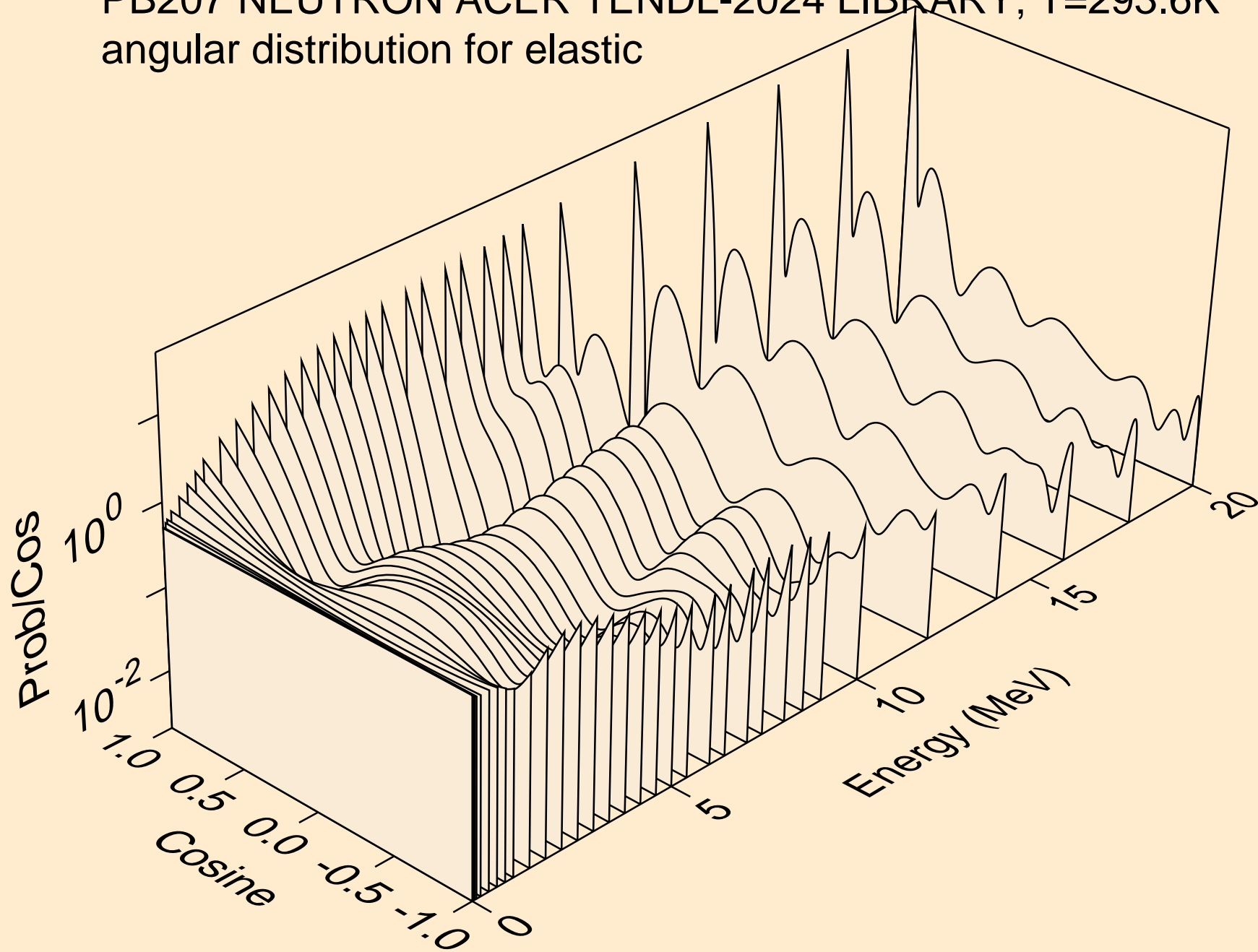

PB207 NEUTRON ACER TENDL-2024 LIBRARY; T=293.6K  
angular distribution for elastic

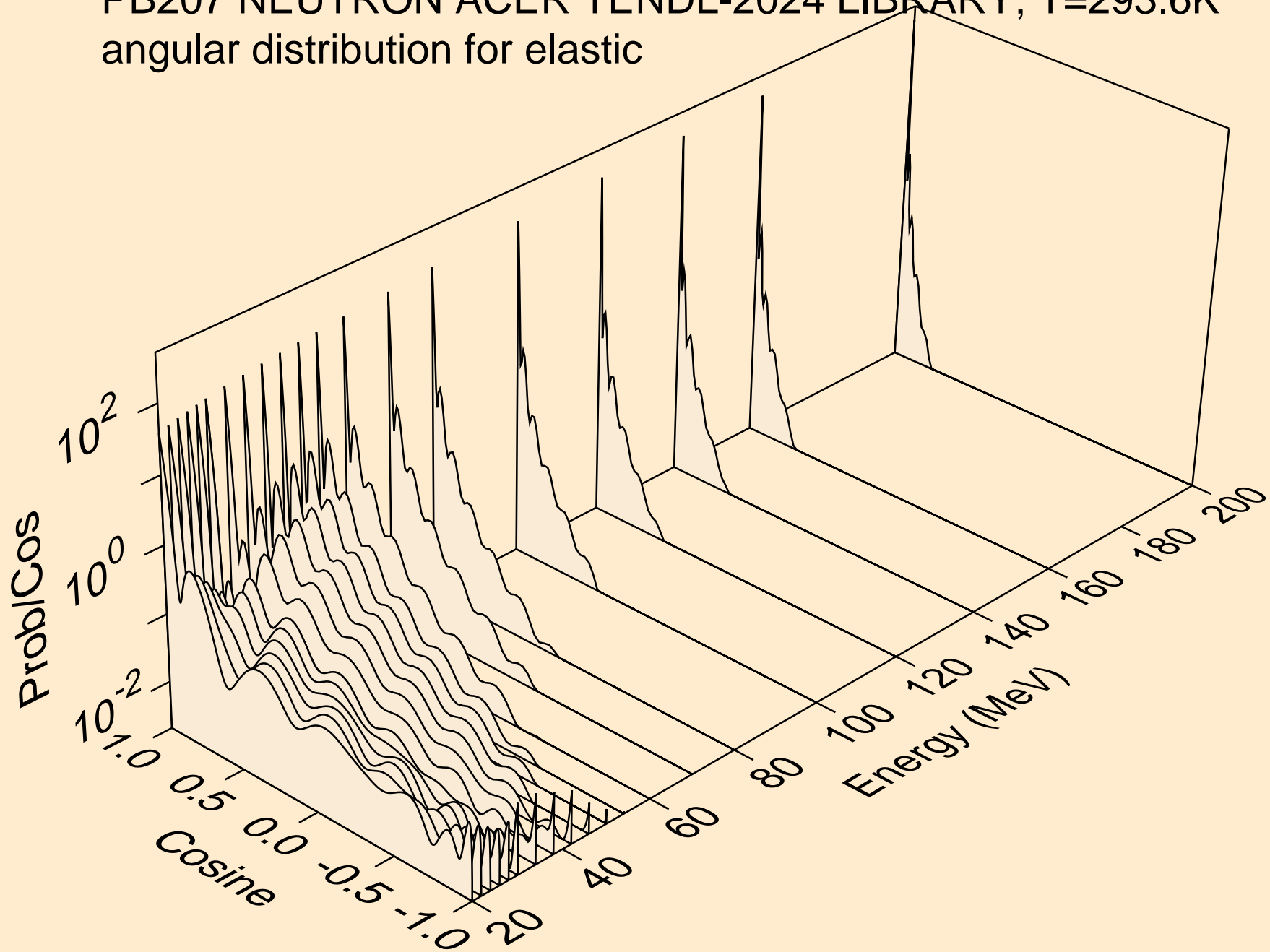

PB207 NEUTRON ACER TENDL-2024 LIBRARY; T=293.6K  
angular distribution for (n,n\*1)

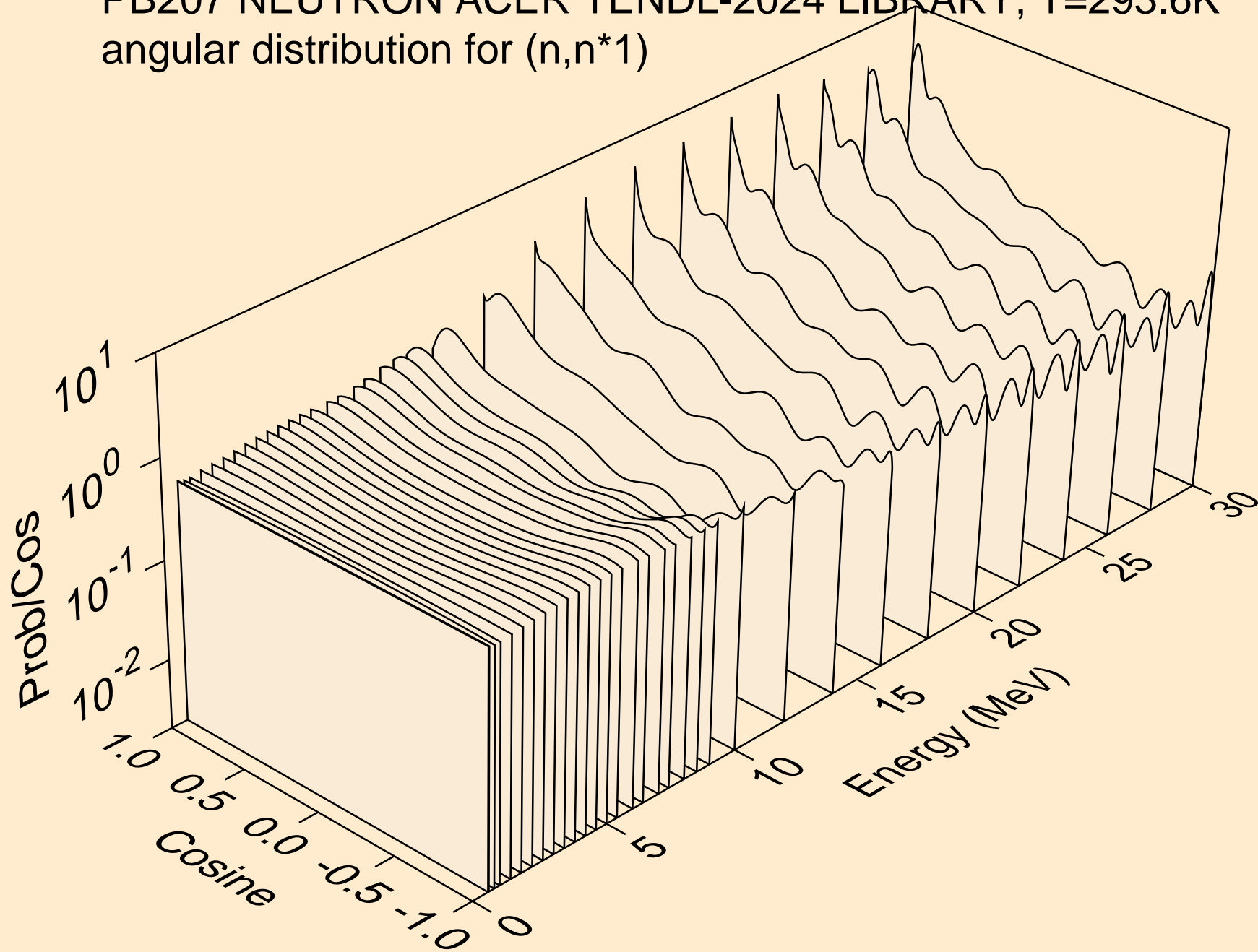

PB207 NEUTRON ACER TENDL-2024 LIBRARY; T=293.6K  
angular distribution for (n,n\*2)

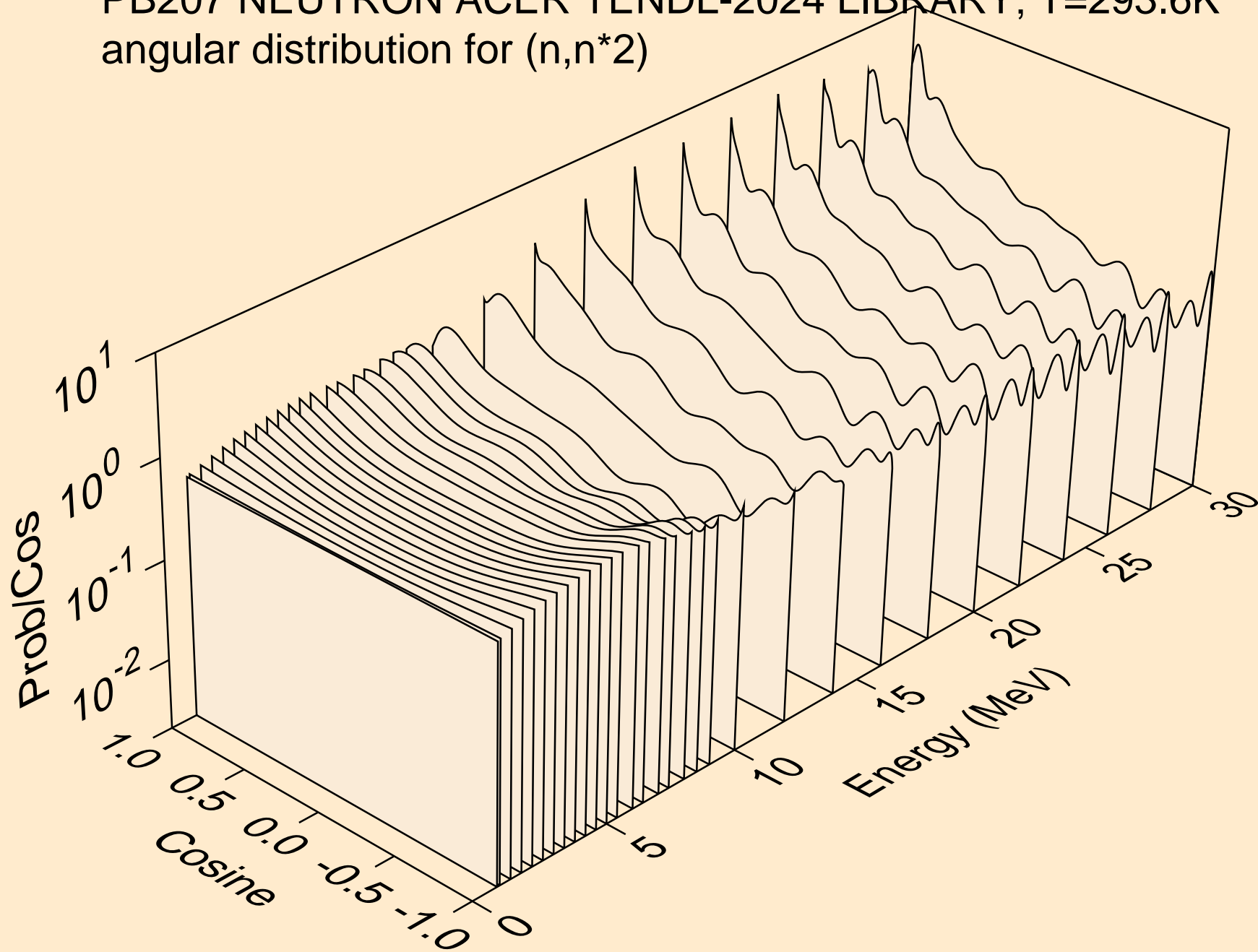

PB207 NEUTRON ACER TENDL-2024 LIBRARY; T=293.6K  
angular distribution for (n,n\*3)

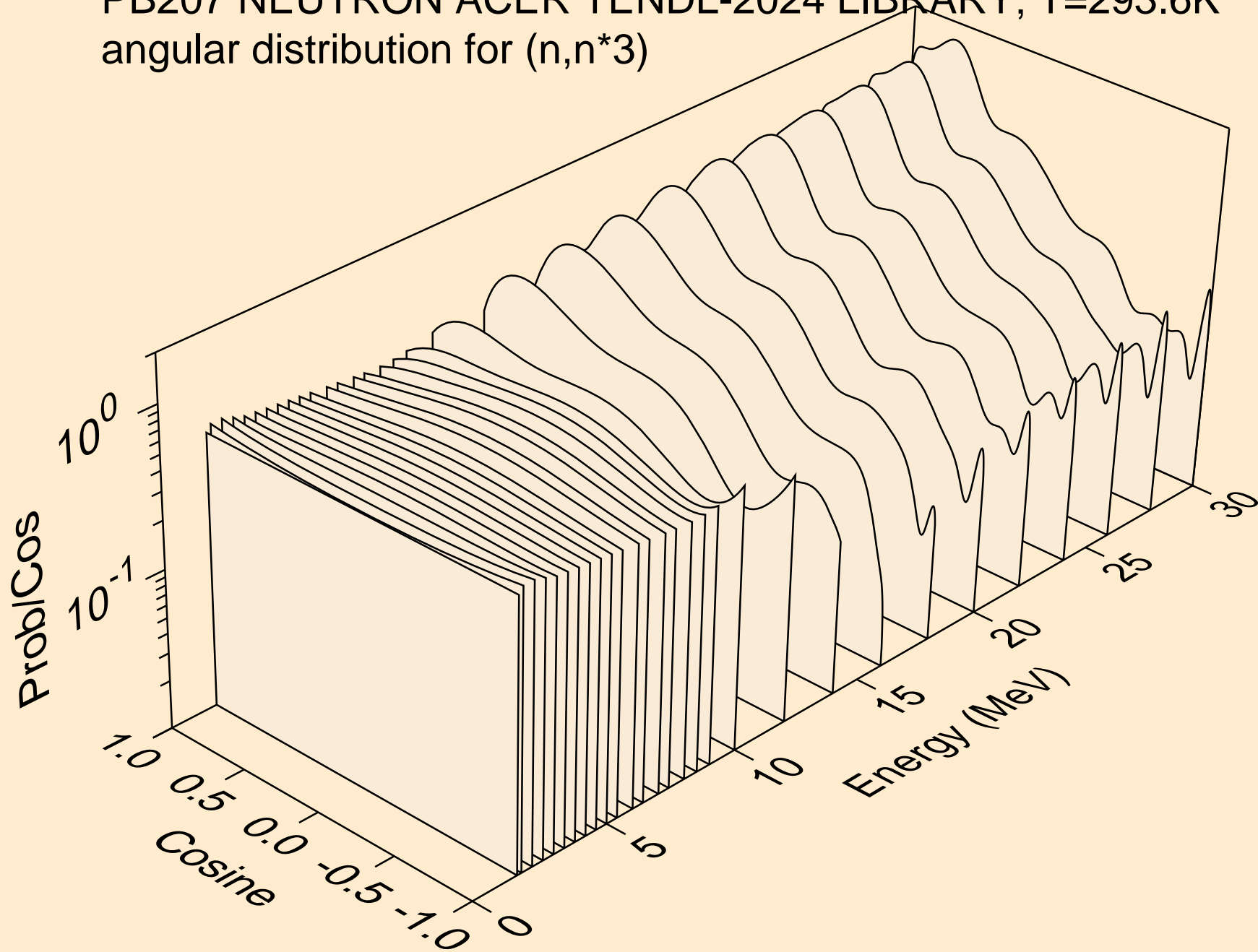

PB207 NEUTRON ACER TENDL-2024 LIBRARY; T=293.6K  
angular distribution for (n,n\*4)

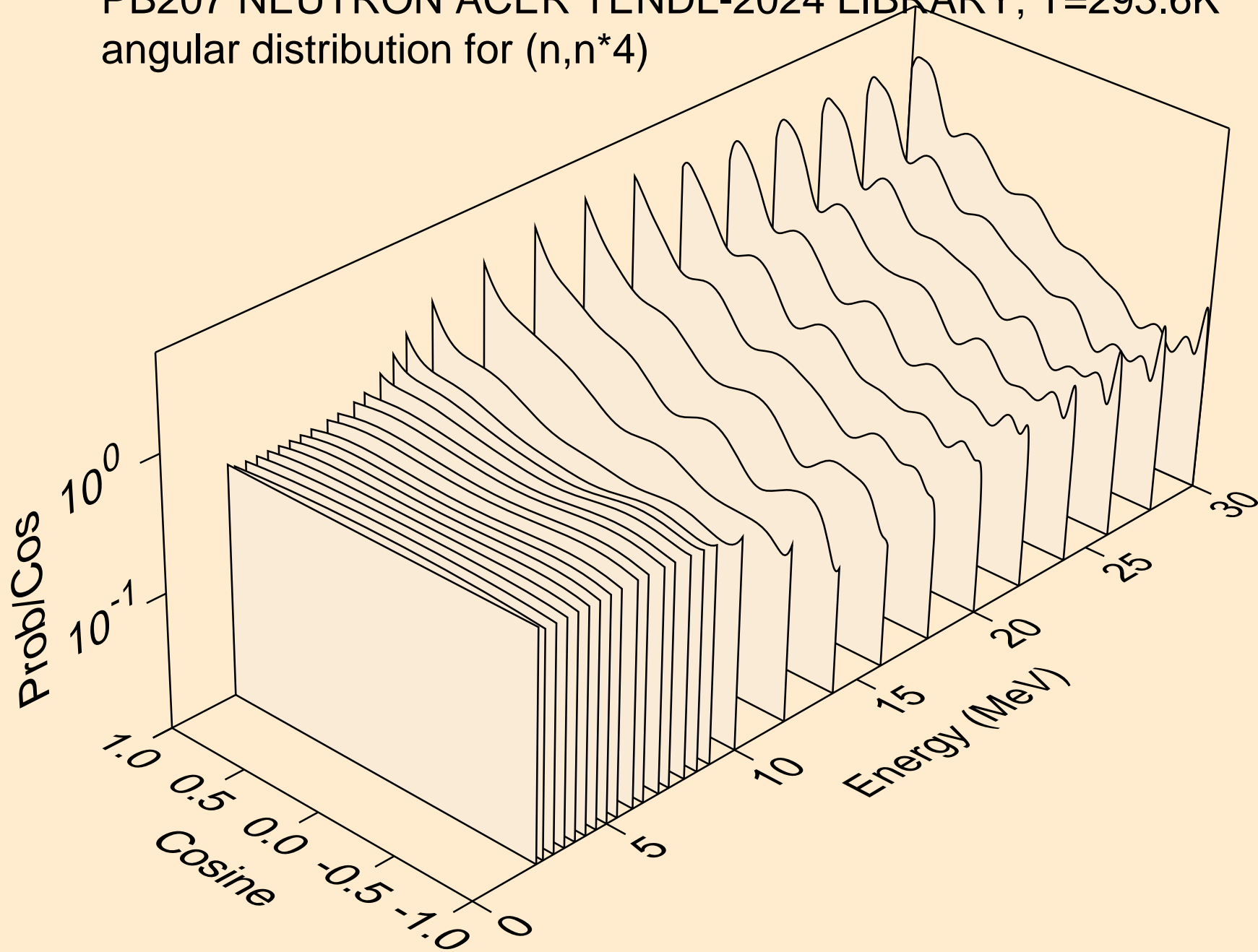

PB207 NEUTRON ACER TENDL-2024 LIBRARY; T=293.6K  
angular distribution for (n,n\*5)

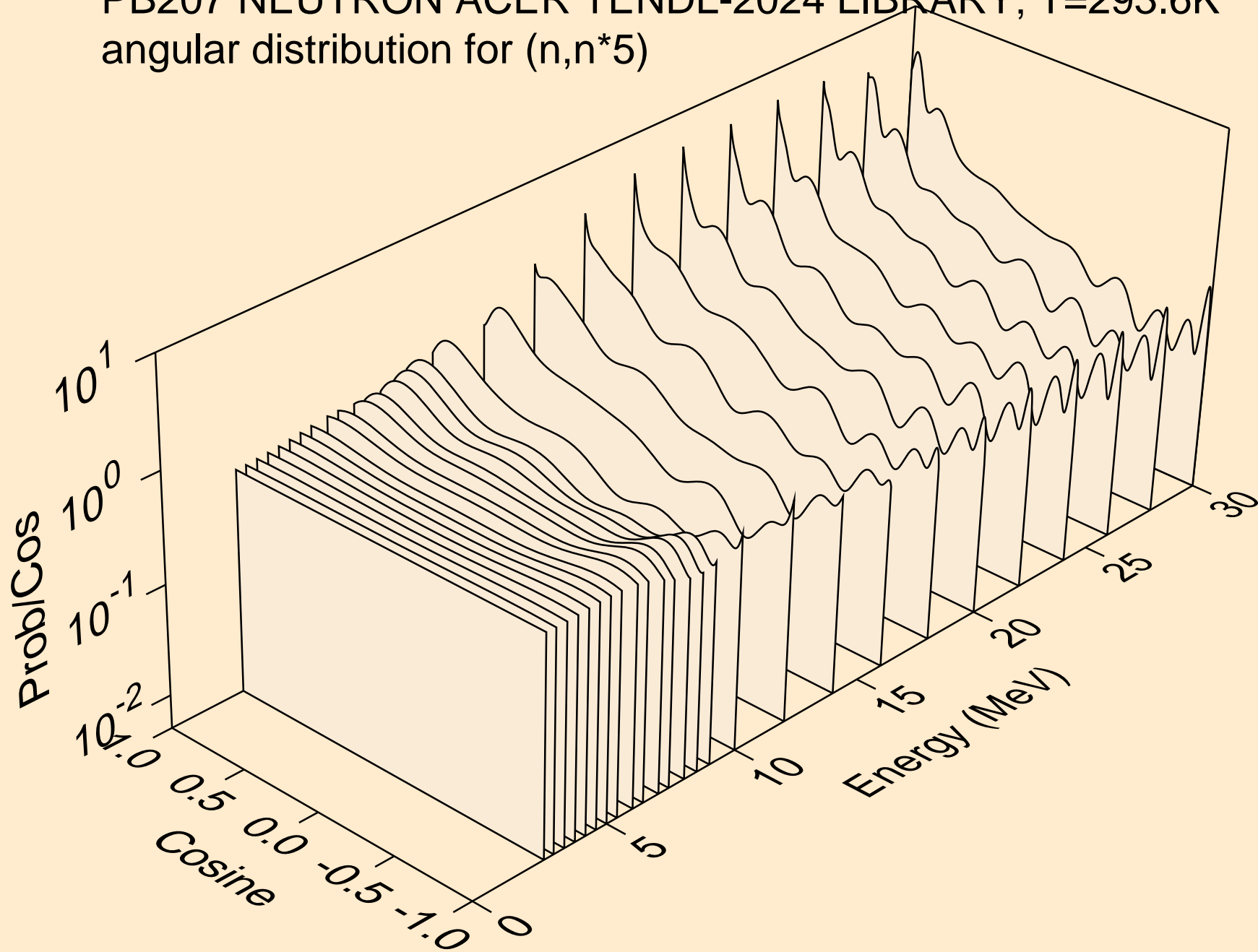

PB207 NEUTRON ACER TENDL-2024 LIBRARY; T=293.6K  
angular distribution for (n,n\*6)

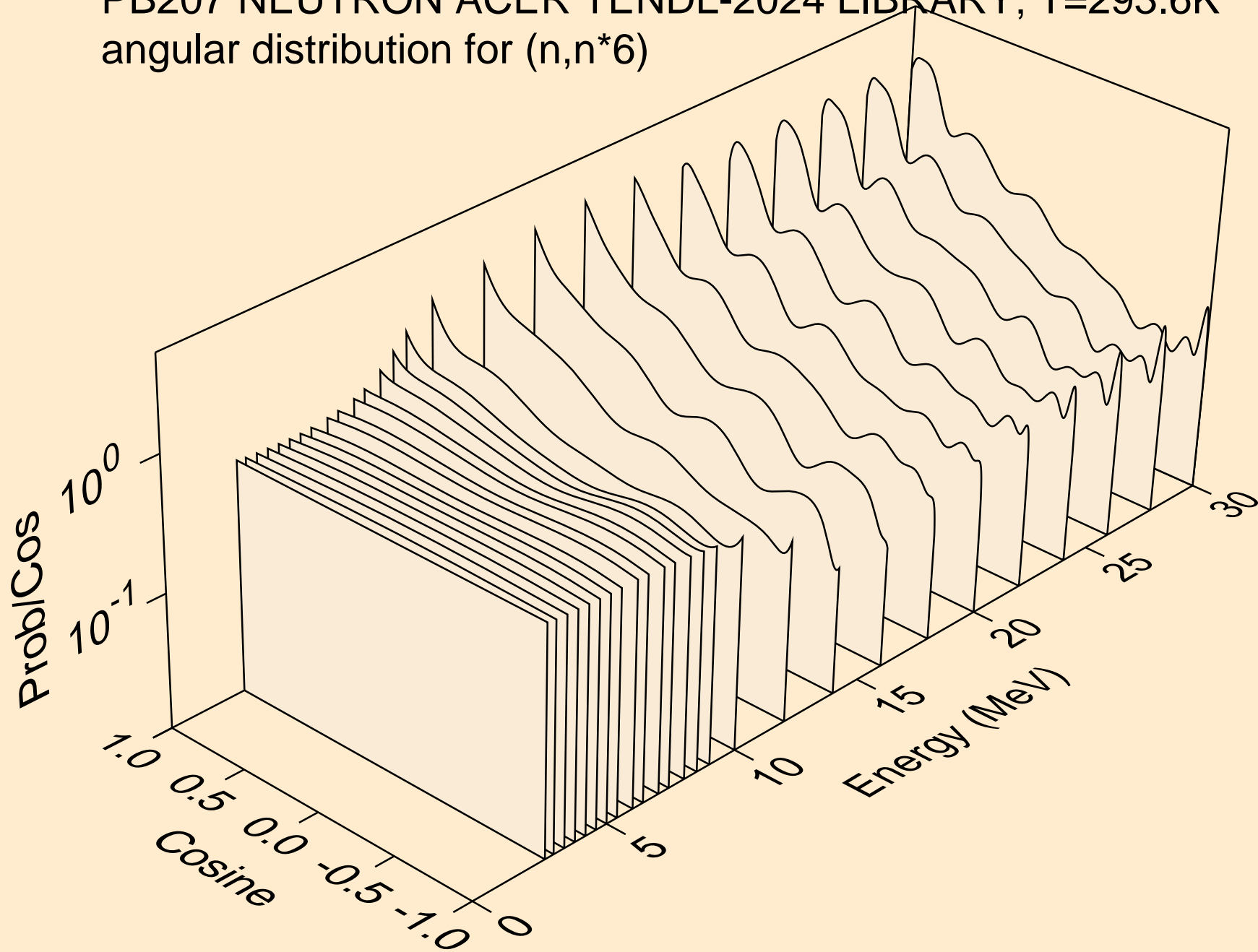

PB207 NEUTRON ACER TENDL-2024 LIBRARY; T=293.6K  
angular distribution for (n,n\*7)

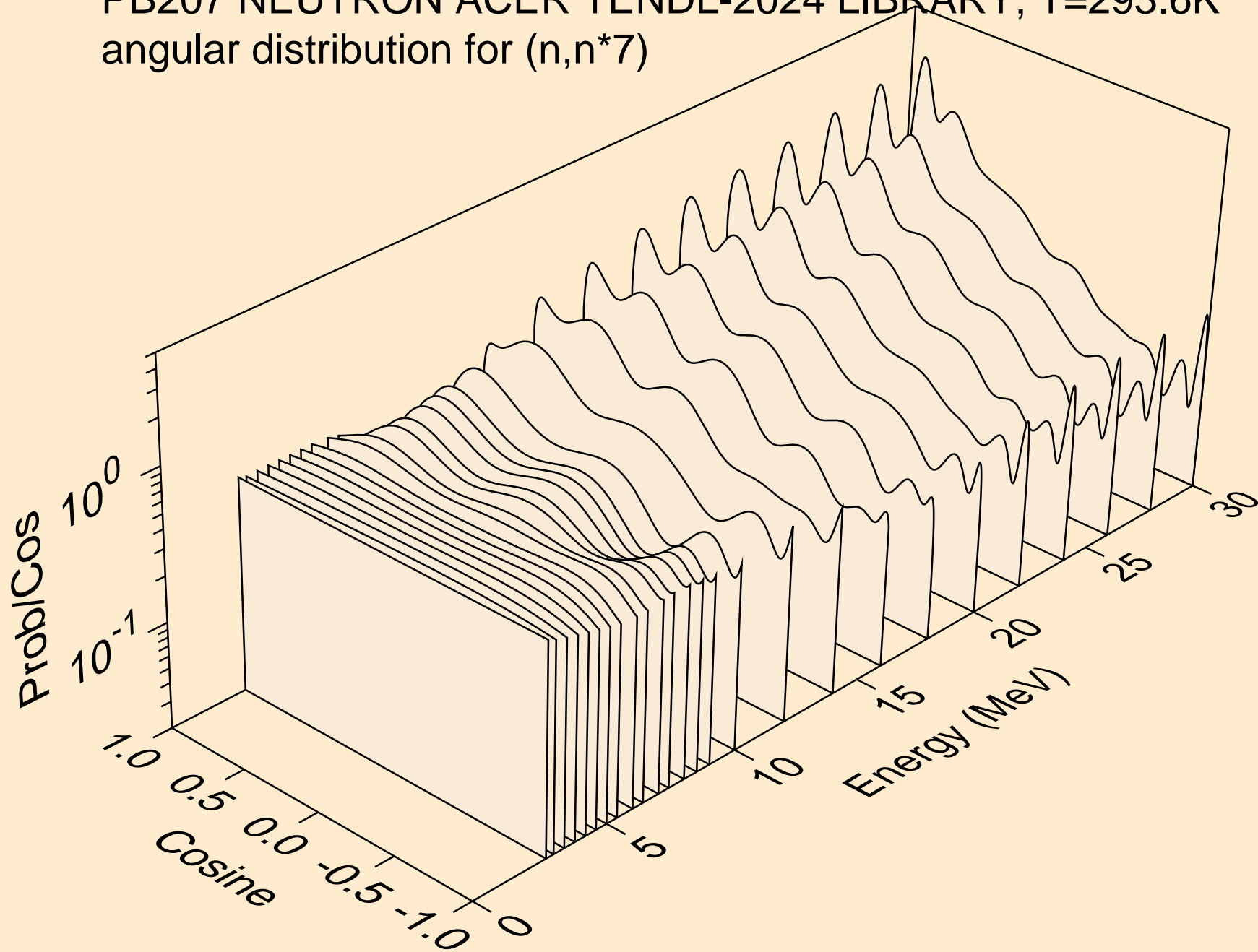

PB207 NEUTRON ACER TENDL-2024 LIBRARY; T=293.6K  
angular distribution for (n,n\*8)

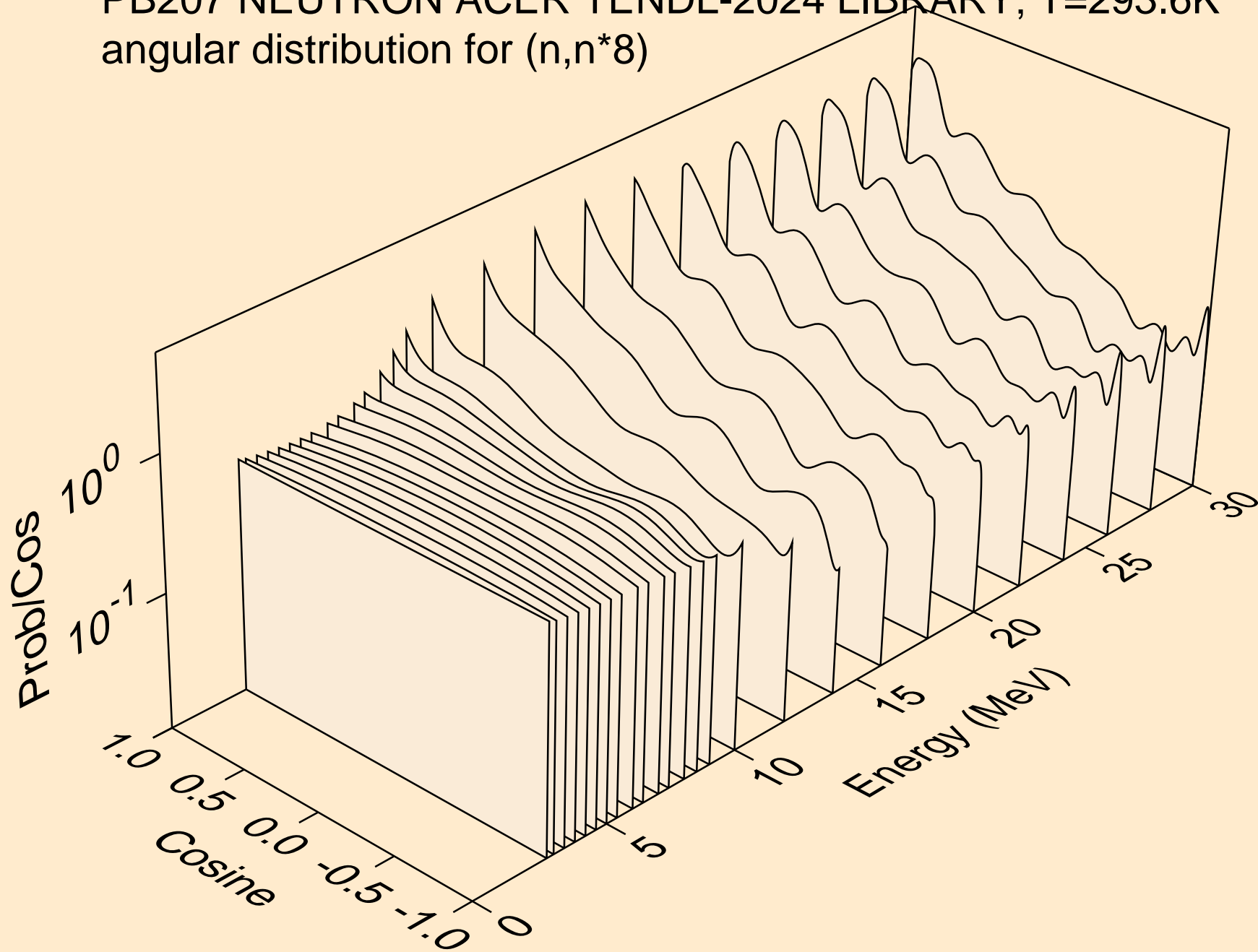

PB207 NEUTRON ACER TENDL-2024 LIBRARY; T=293.6K  
angular distribution for (n,n\*9)

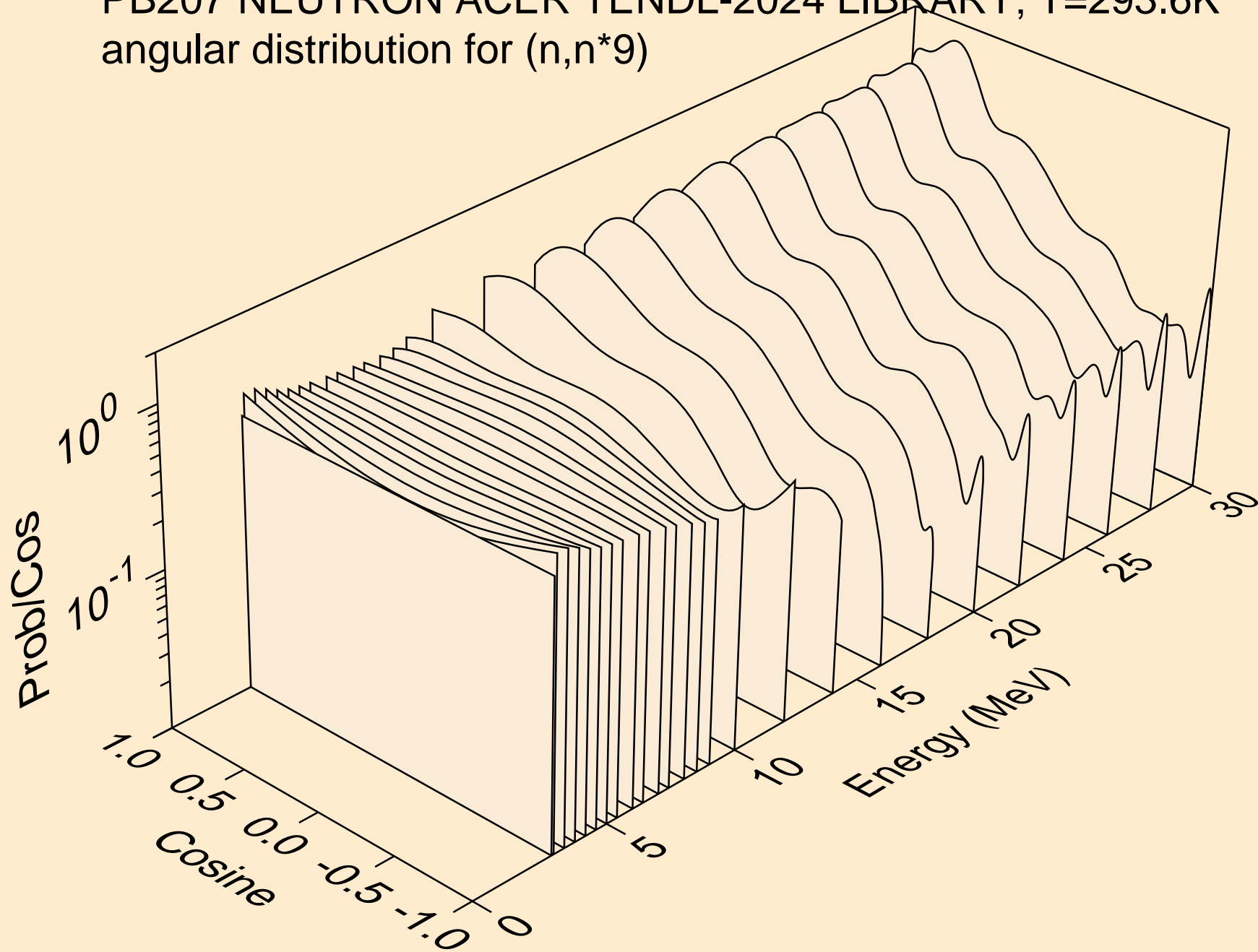

PB207 NEUTRON ACER TENDL-2024 LIBRARY; T=293.6K  
angular distribution for (n,n\*10)

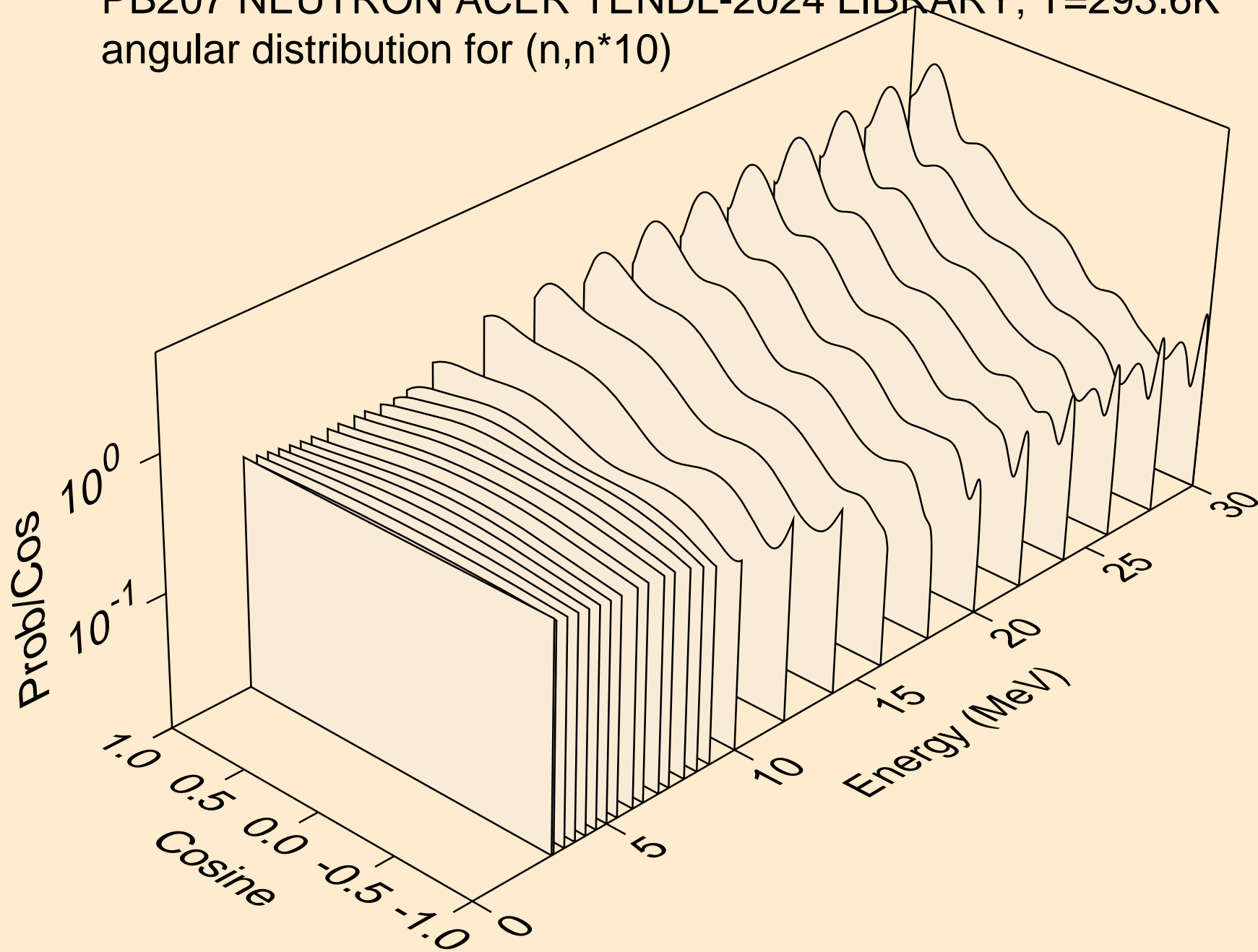

PB207 NEUTRON ACER TENDL-2024 LIBRARY; T=293.6K  
angular distribution for (n,n\*11)

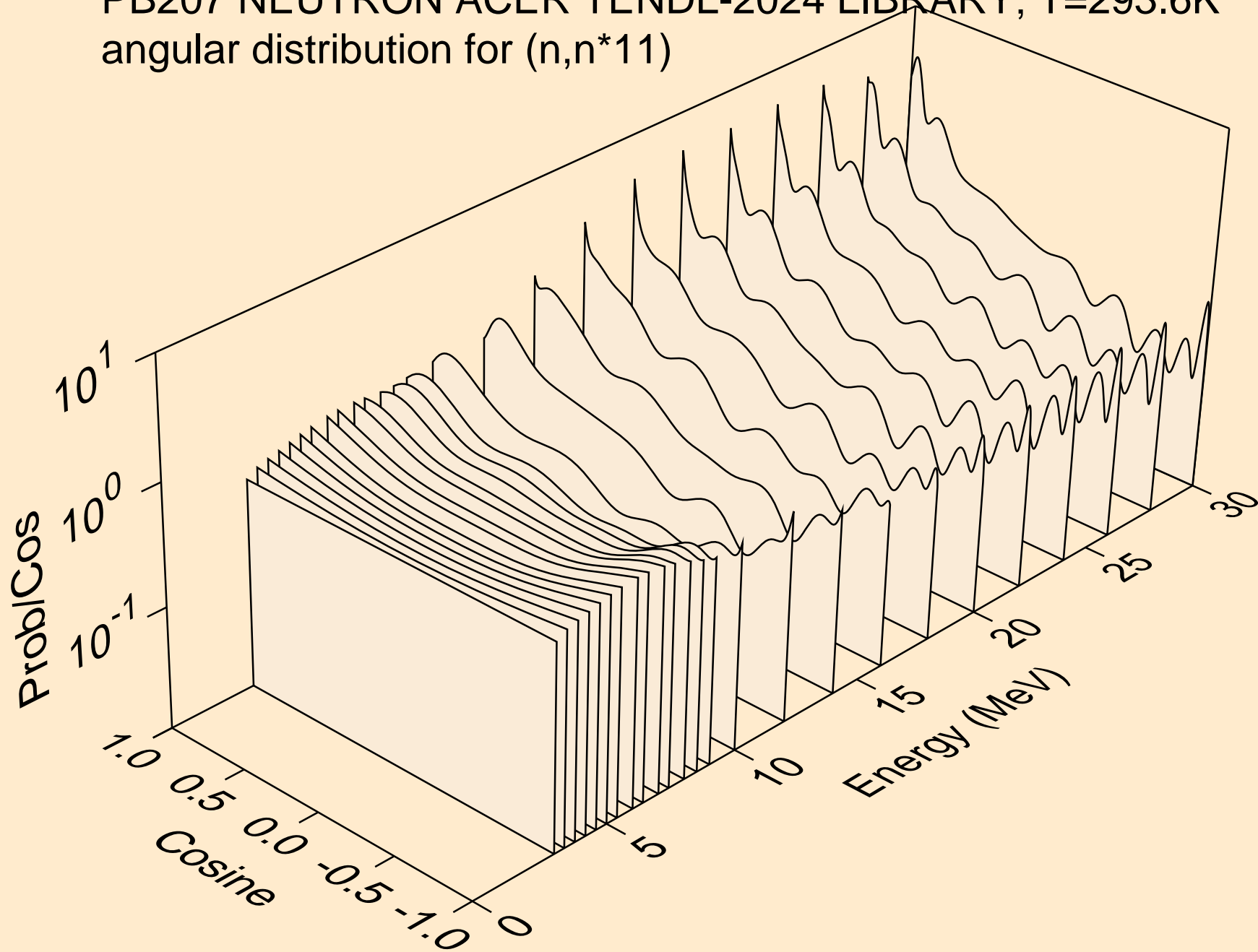

PB207 NEUTRON ACER TENDL-2024 LIBRARY; T=293.6K  
angular distribution for (n,n\*12)

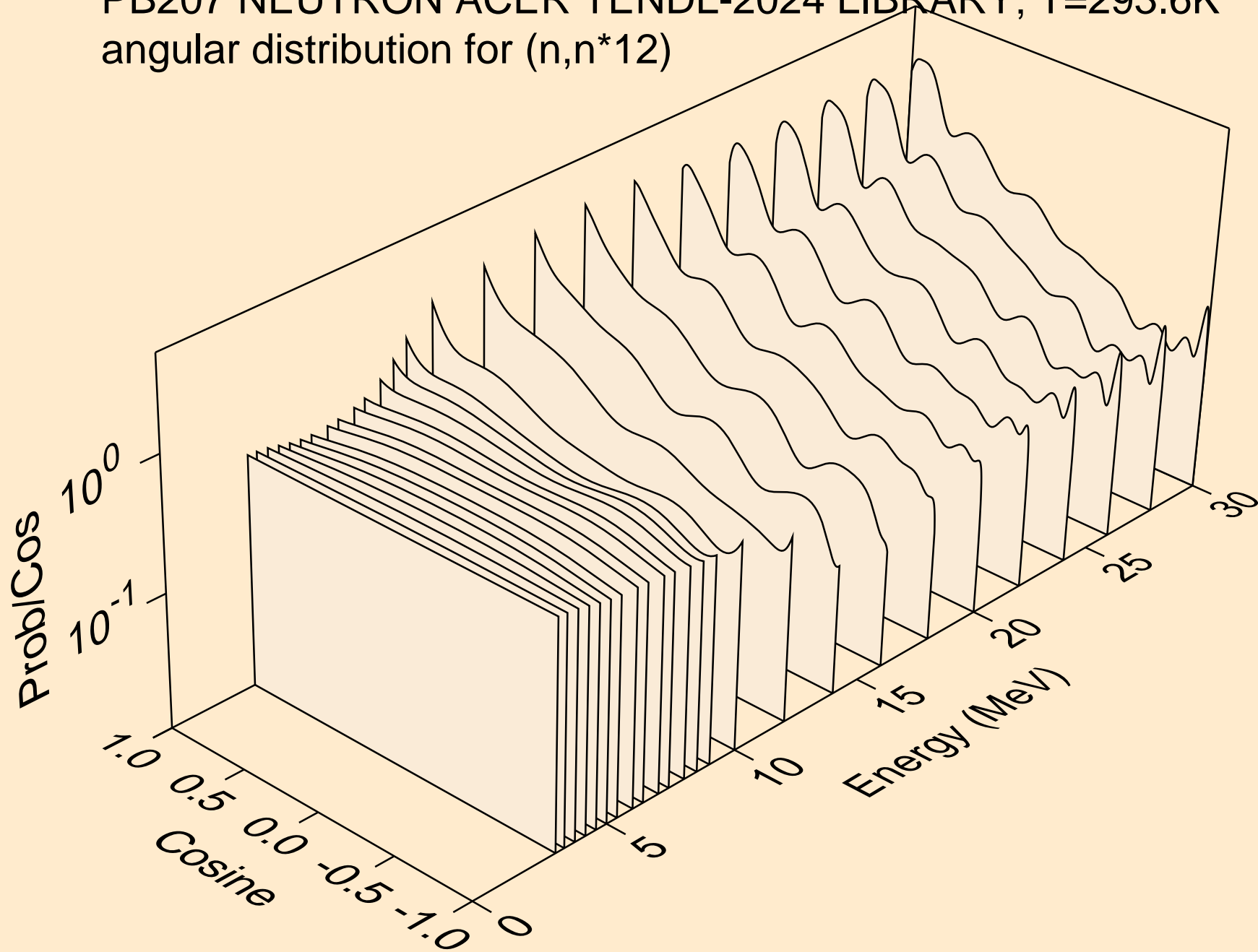

PB207 NEUTRON ACER TENDL-2024 LIBRARY; T=293.6K  
angular distribution for (n,n\*13)

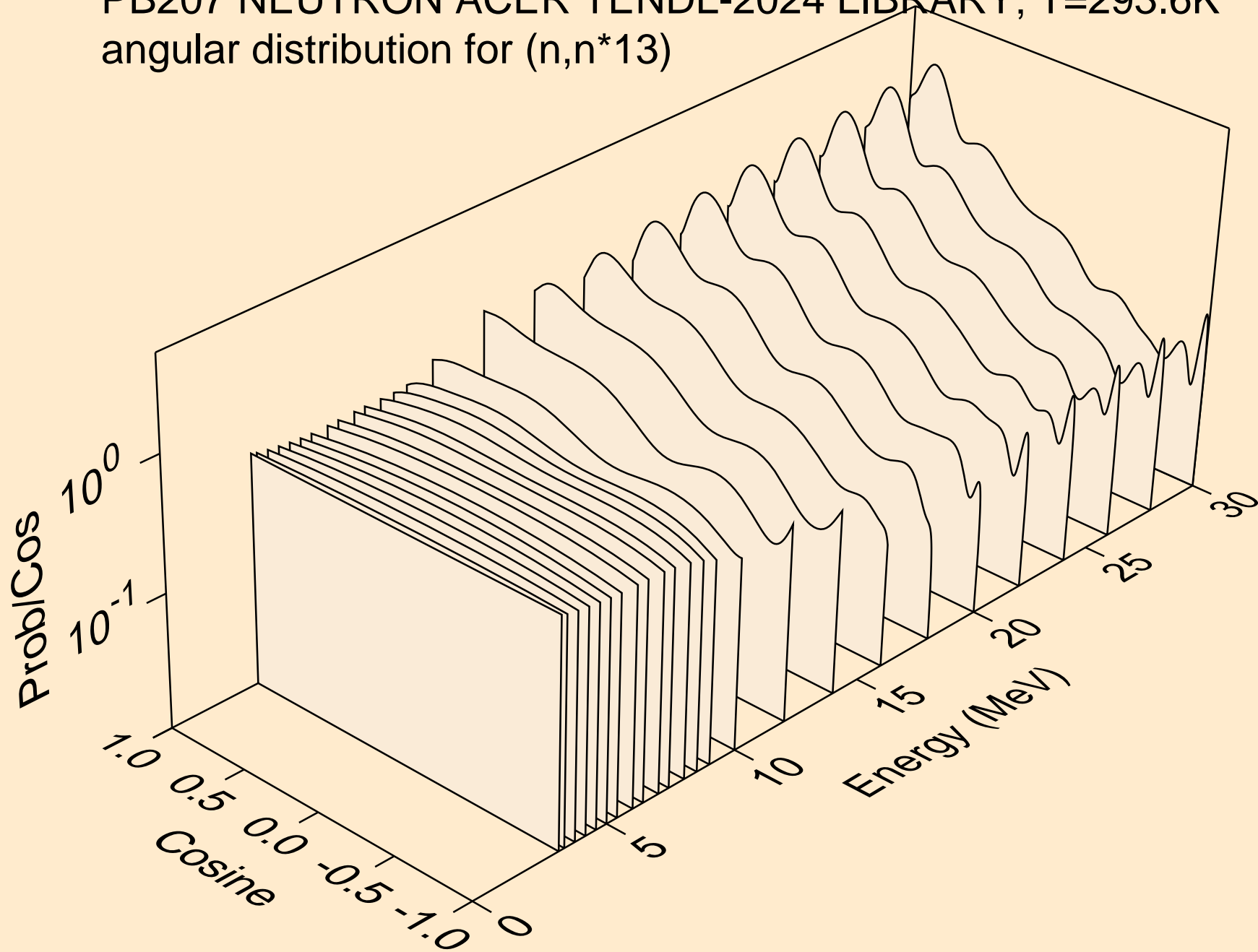

PB207 NEUTRON ACER TENDL-2024 LIBRARY; T=293.6K  
angular distribution for (n,n\*14)

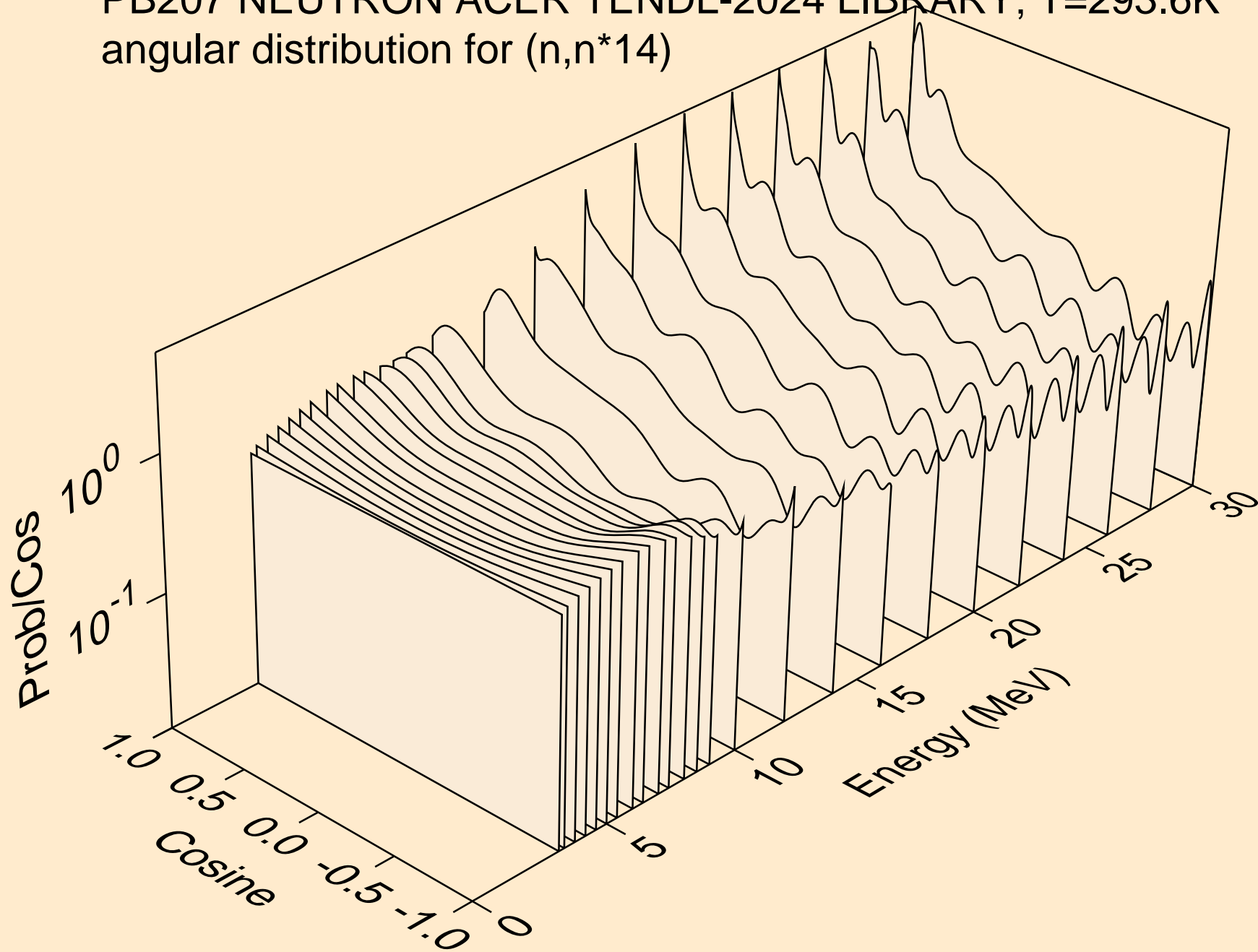

PB207 NEUTRON ACER TENDL-2024 LIBRARY; T=293.6K  
angular distribution for (n,n\*15)

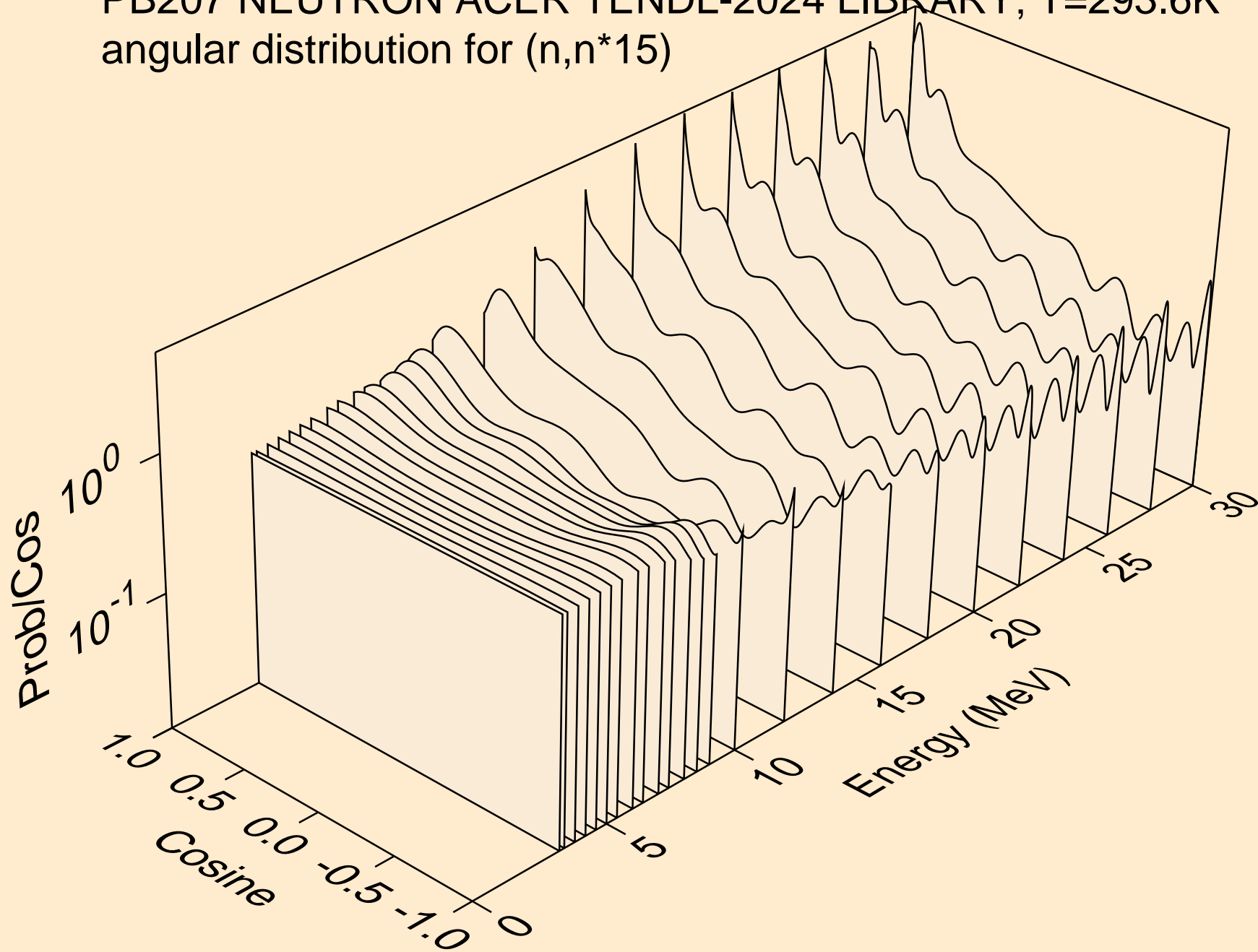

PB207 NEUTRON ACER TENDL-2024 LIBRARY; T=293.6K  
angular distribution for (n,n\*16)

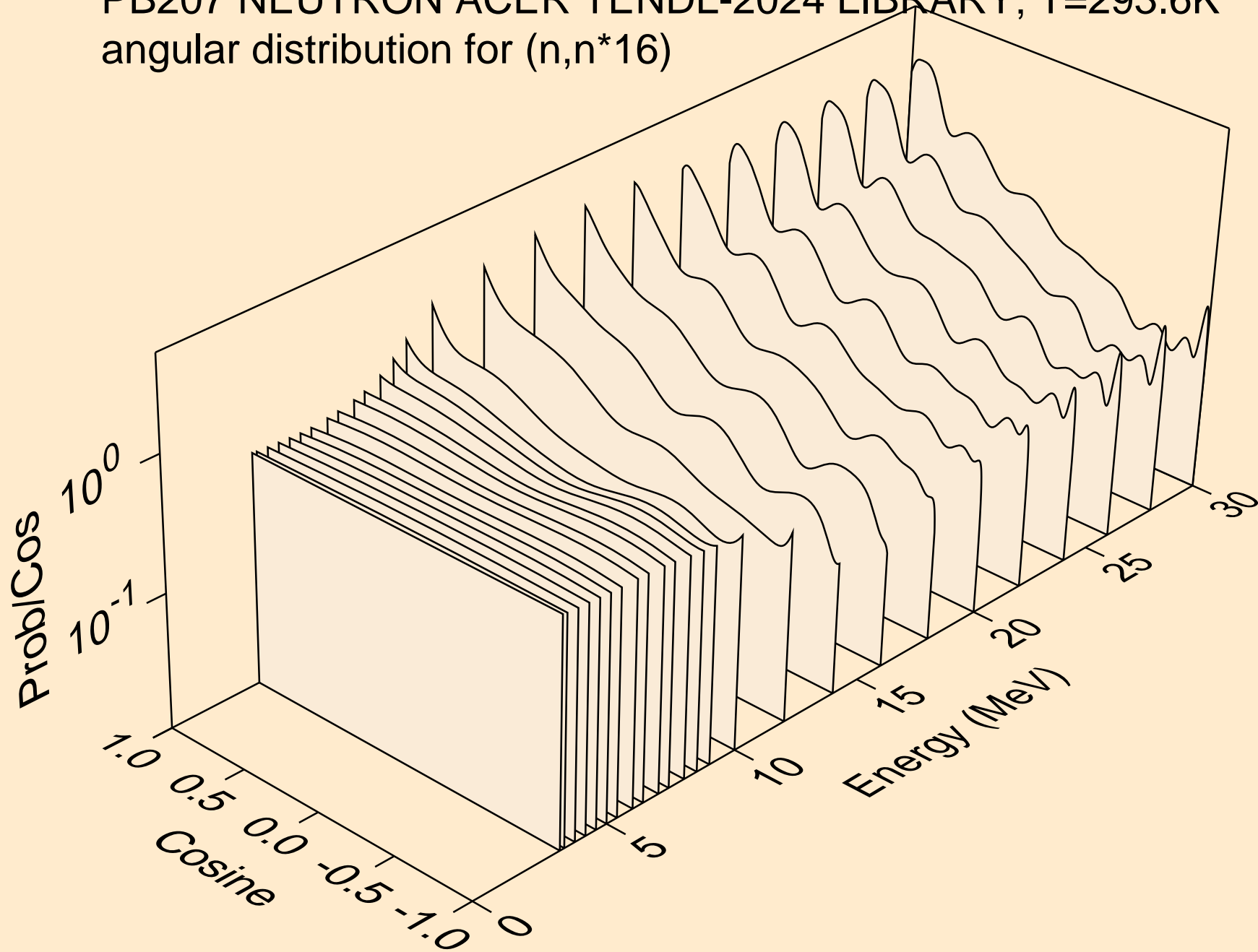

PB207 NEUTRON ACER TENDL-2024 LIBRARY; T=293.6K  
angular distribution for (n,n\*17)

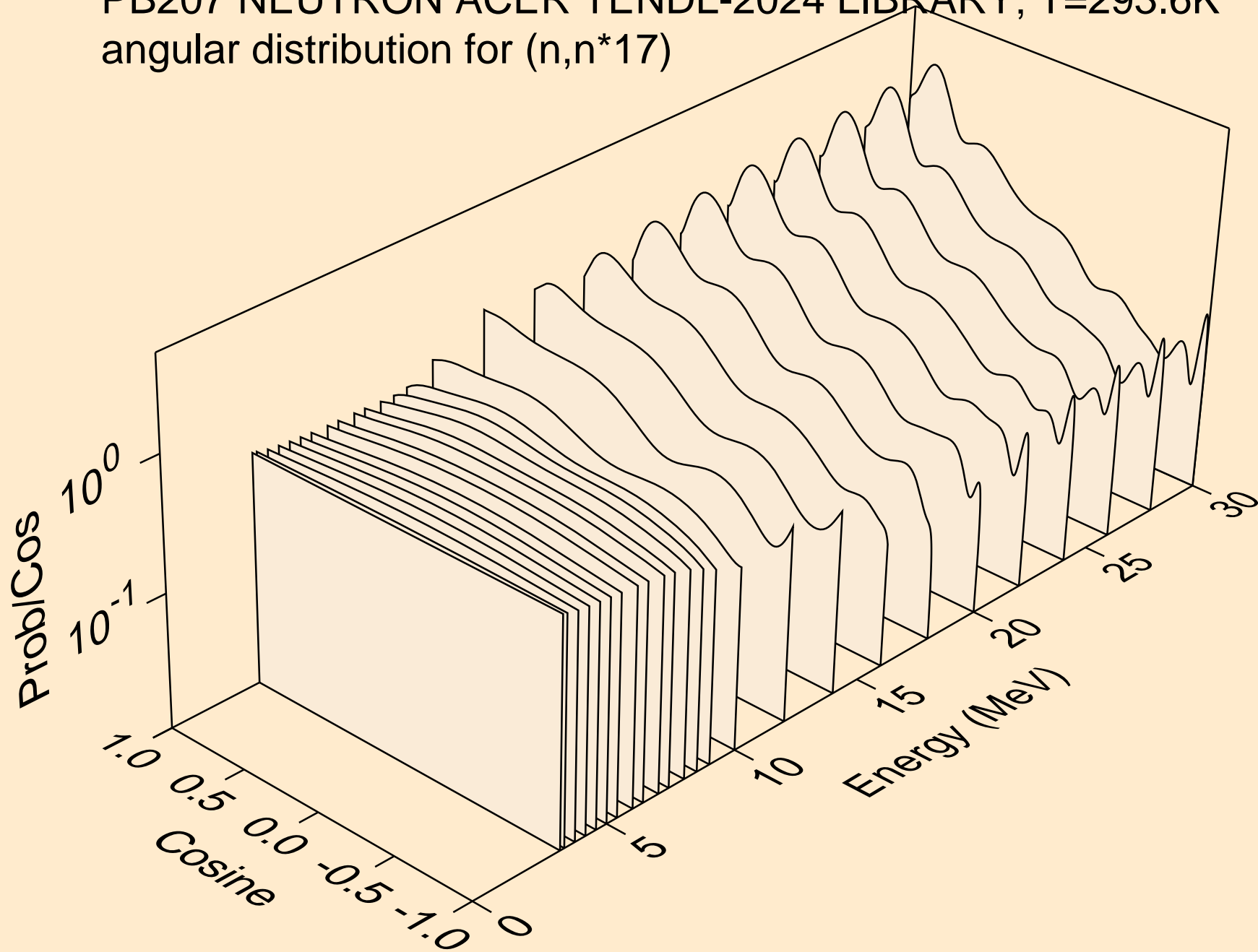

PB207 NEUTRON ACER TENDL-2024 LIBRARY; T=293.6K  
angular distribution for (n,n\*18)

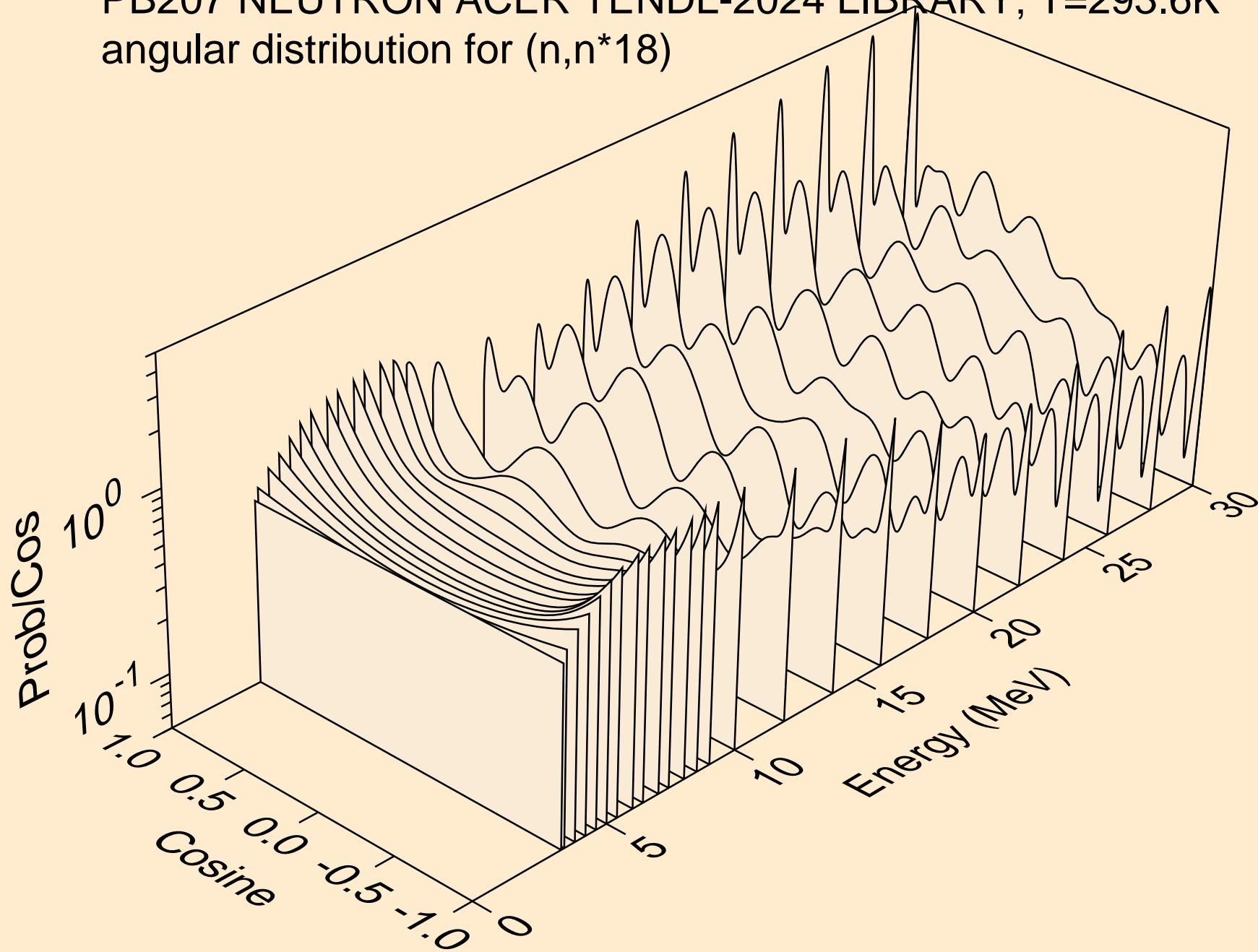

PB207 NEUTRON ACER TENDL-2024 LIBRARY; T=293.6K  
angular distribution for (n,n\*19)

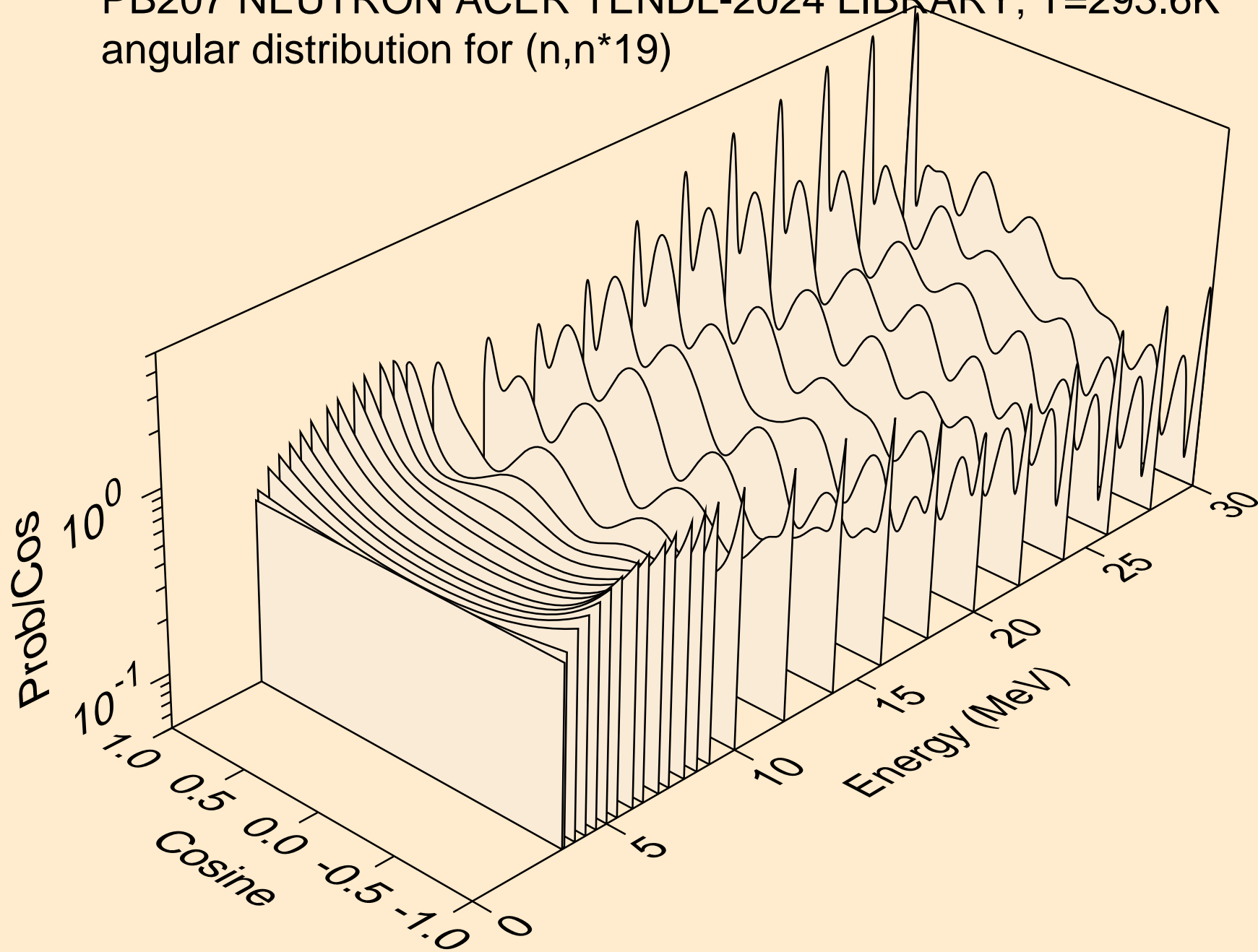

PB207 NEUTRON ACER TENDL-2024 LIBRARY; T=293.6K  
angular distribution for (n,n\*20)

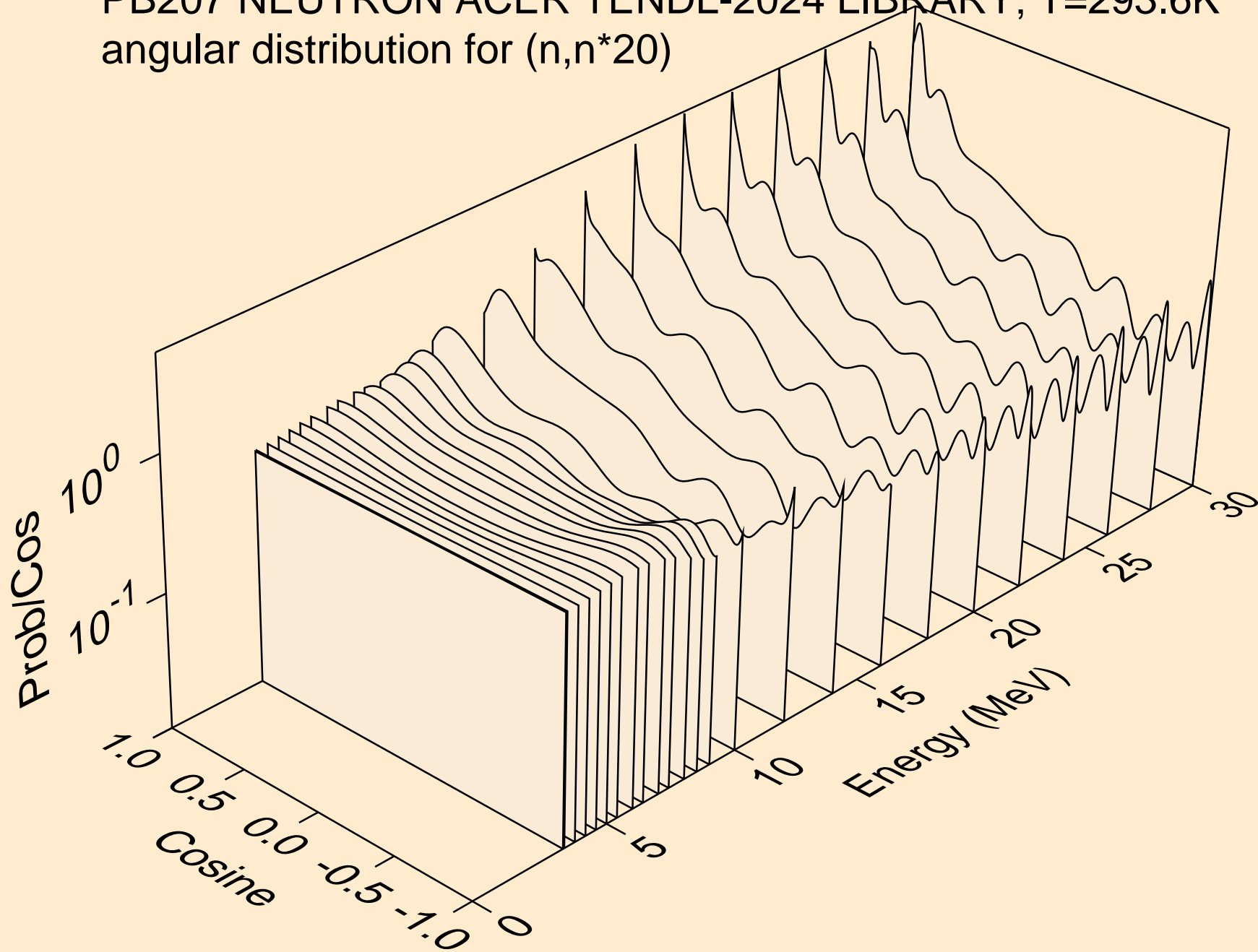

PB207 NEUTRON ACER TENDL-2024 LIBRARY; T=293.6K  
angular distribution for (n,n\*21)

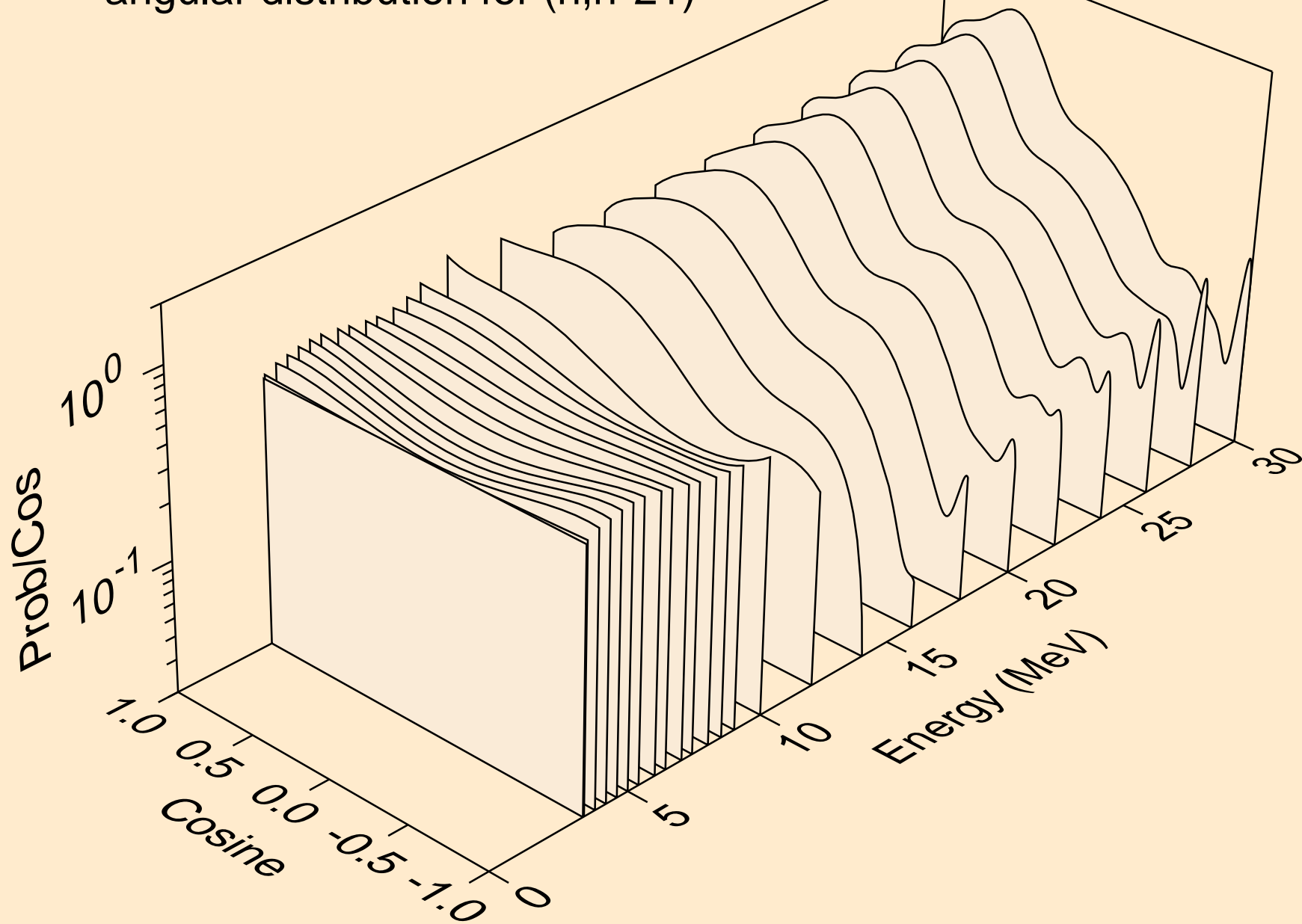

PB207 NEUTRON ACER TENDL-2024 LIBRARY; T=293.6K  
angular distribution for (n,n\*22)

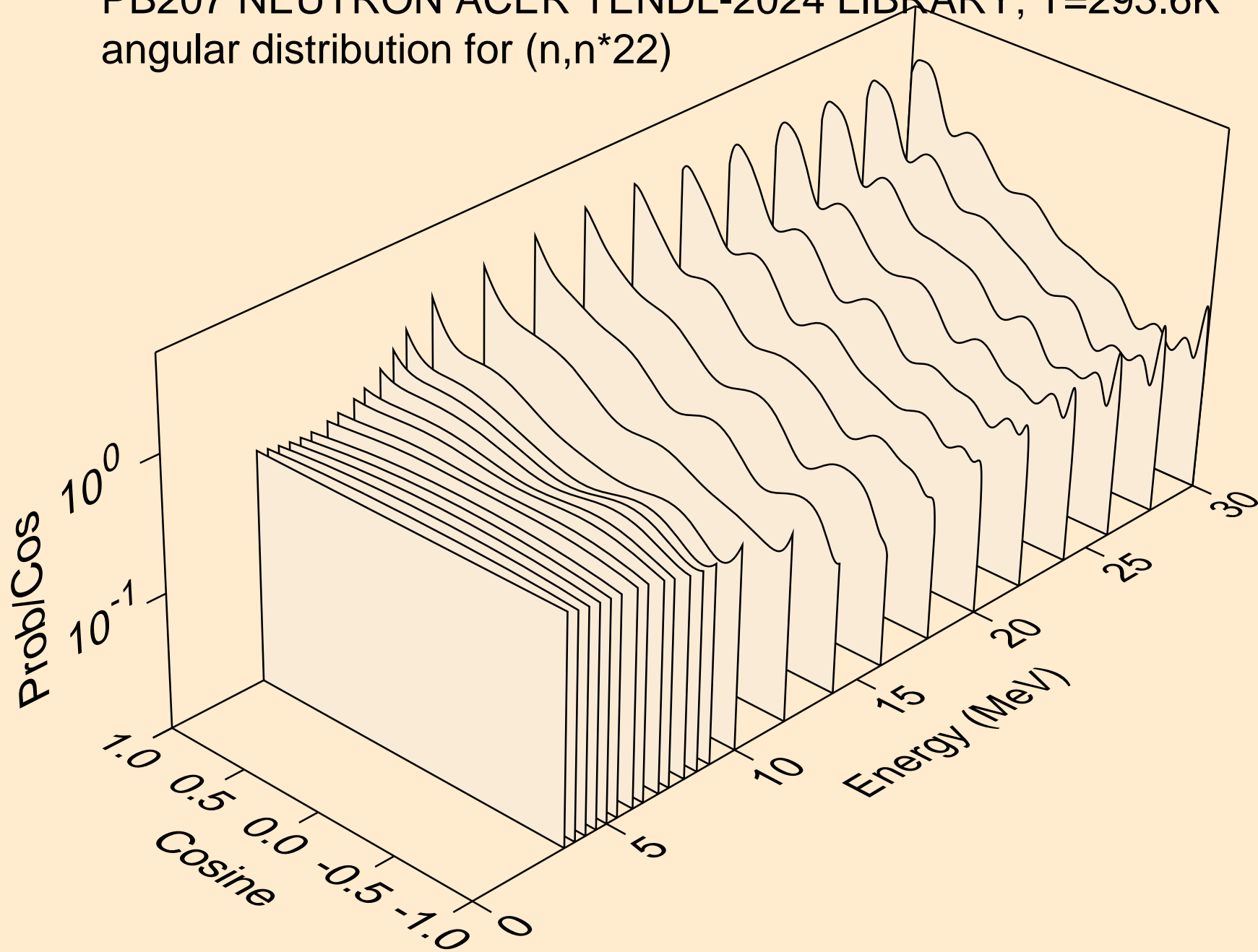

PB207 NEUTRON ACER TENDL-2024 LIBRARY; T=293.6K  
angular distribution for (n,n\*23)

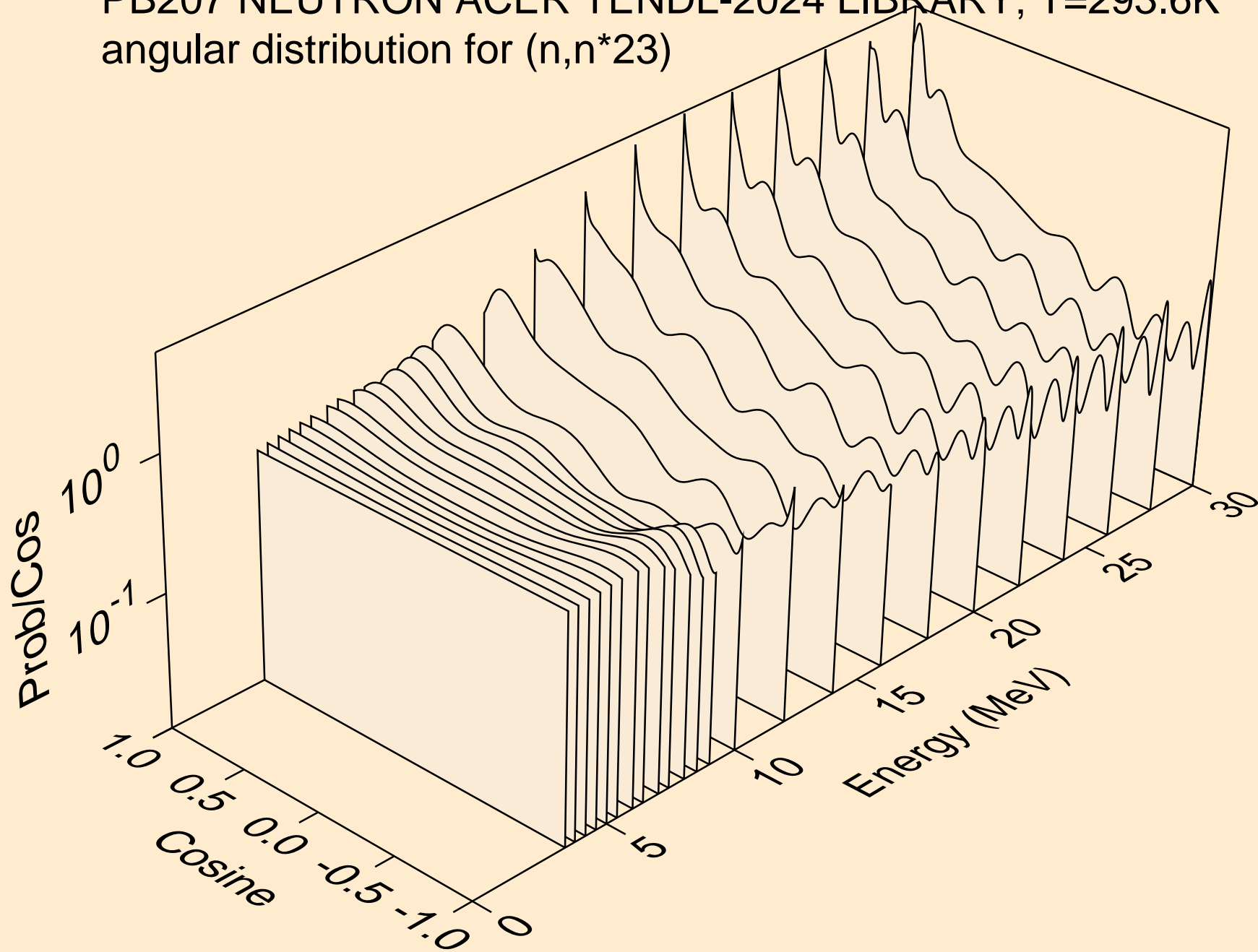

PB207 NEUTRON ACER TENDL-2024 LIBRARY; T=293.6K  
angular distribution for (n,n\*24)

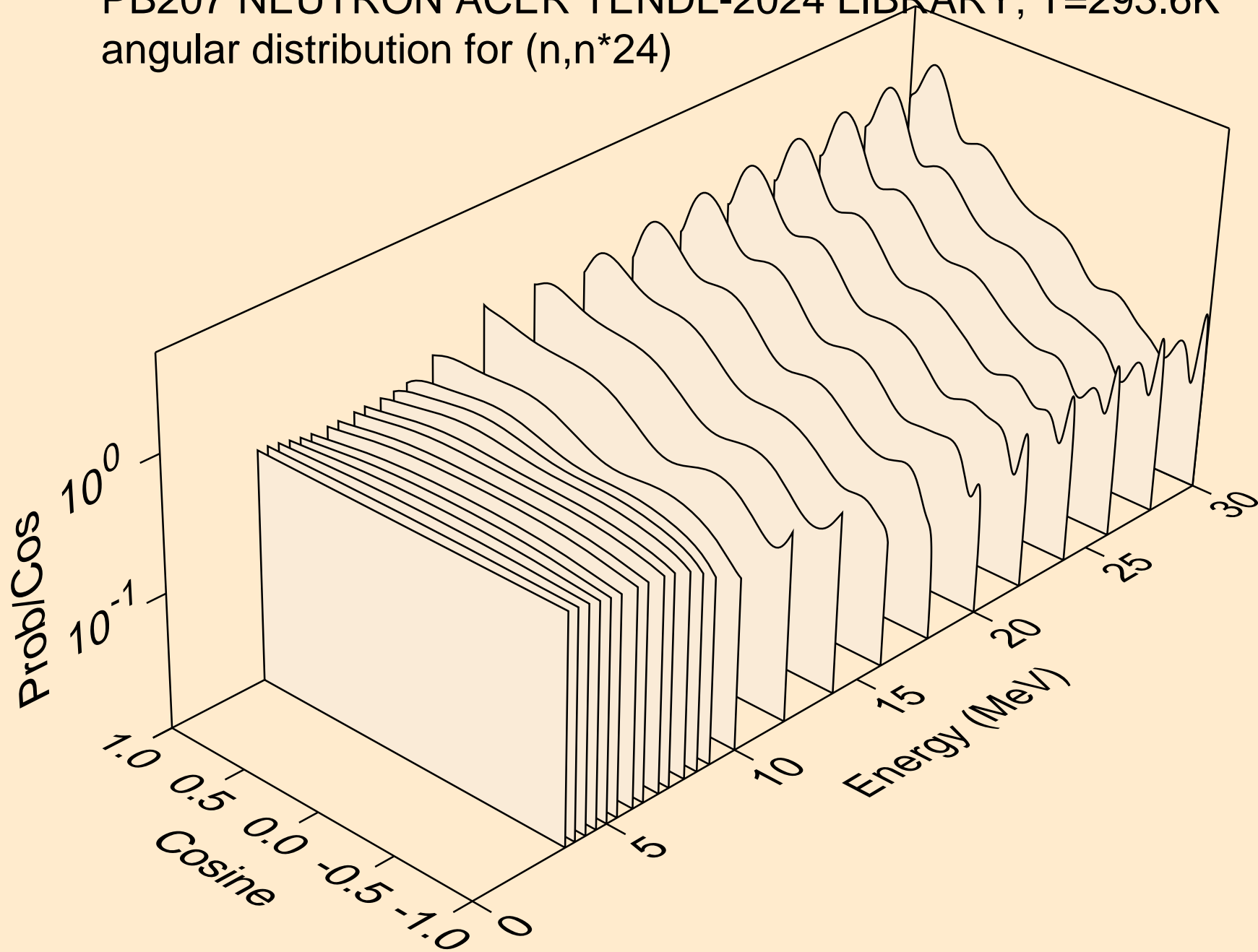

PB207 NEUTRON ACER TENDL-2024 LIBRARY; T=293.6K  
angular distribution for (n,n\*25)

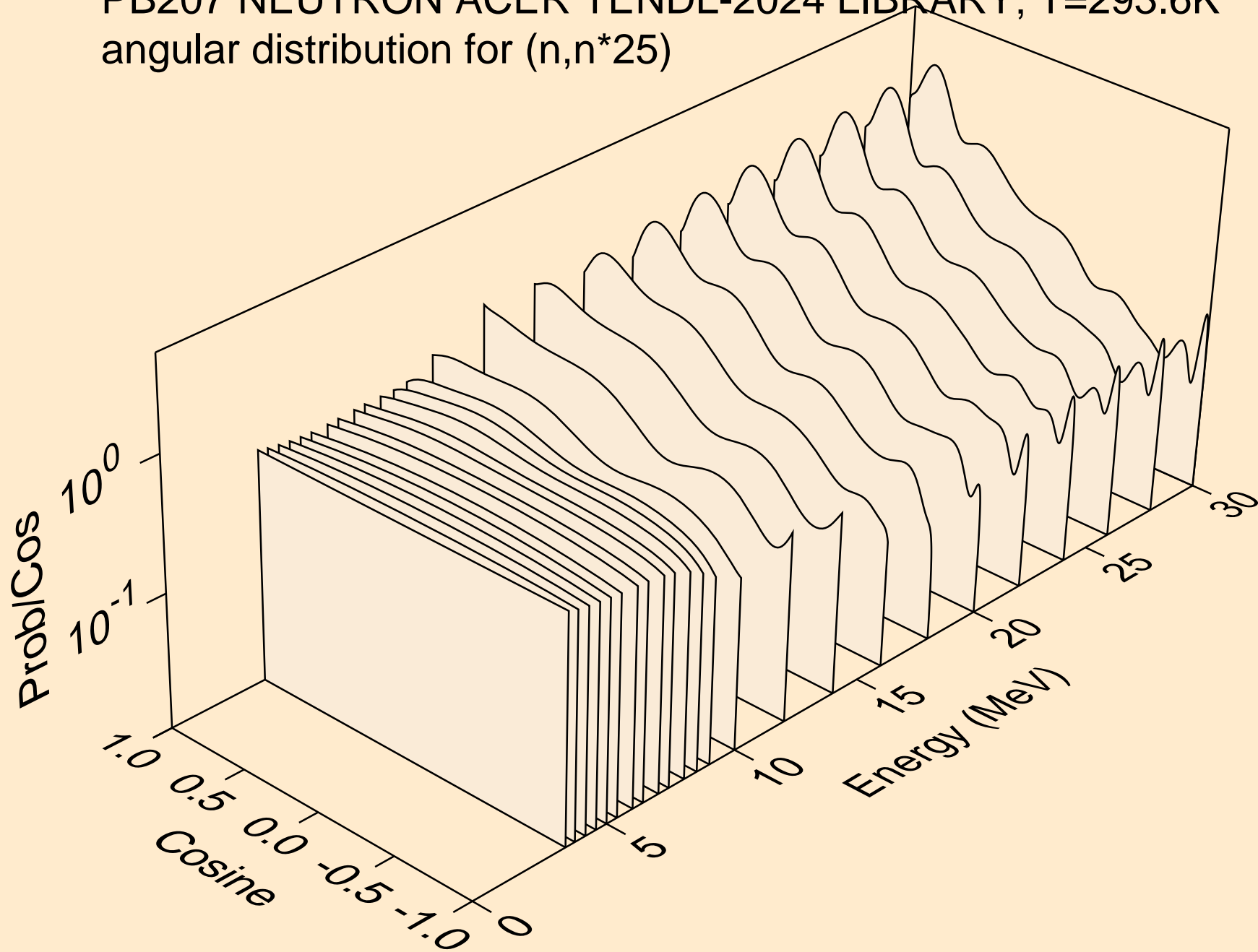

PB207 NEUTRON ACER TENDL-2024 LIBRARY; T=293.6K  
angular distribution for (n,n\*26)

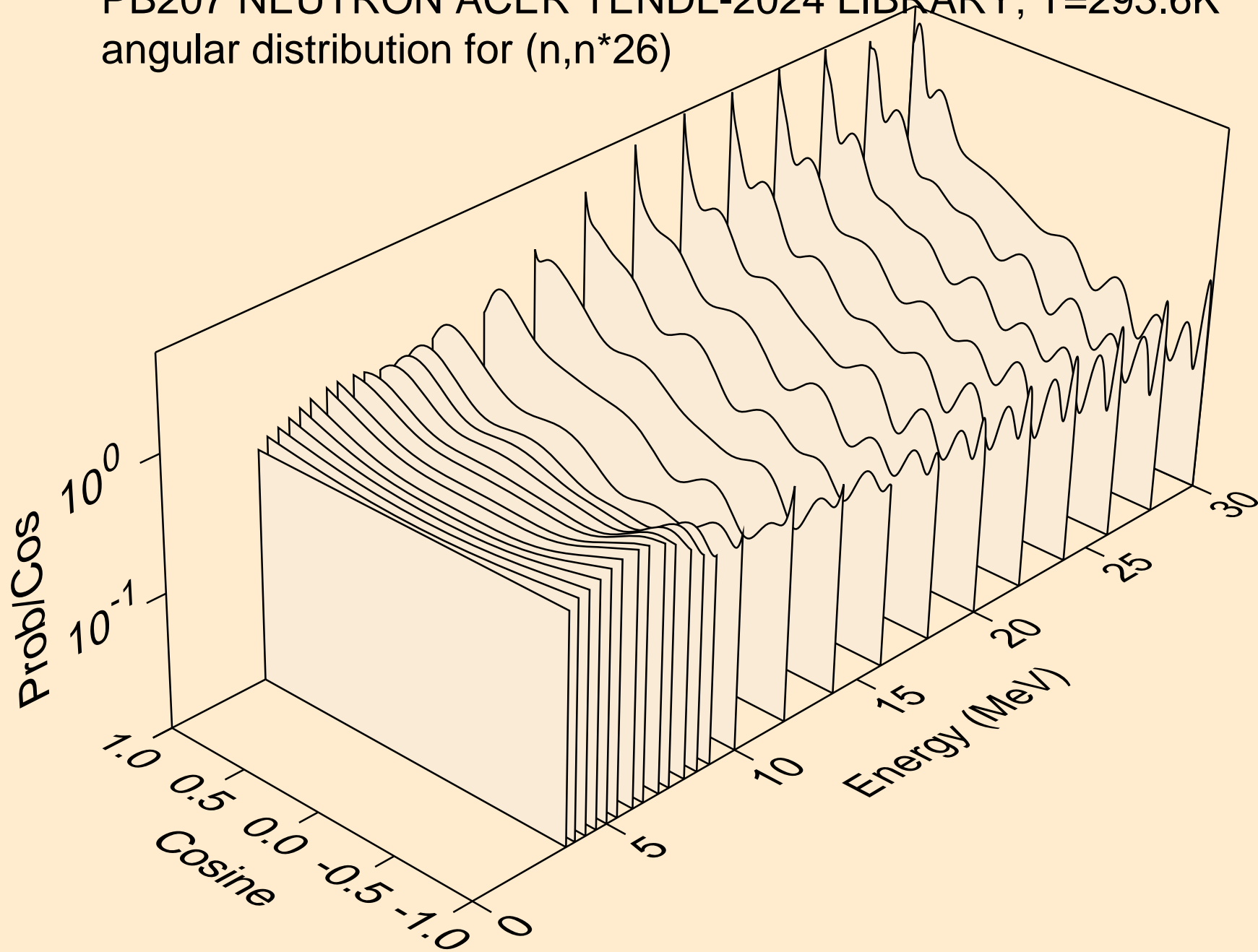

PB207 NEUTRON ACER TENDL-2024 LIBRARY; T=293.6K  
angular distribution for (n,n\*27)

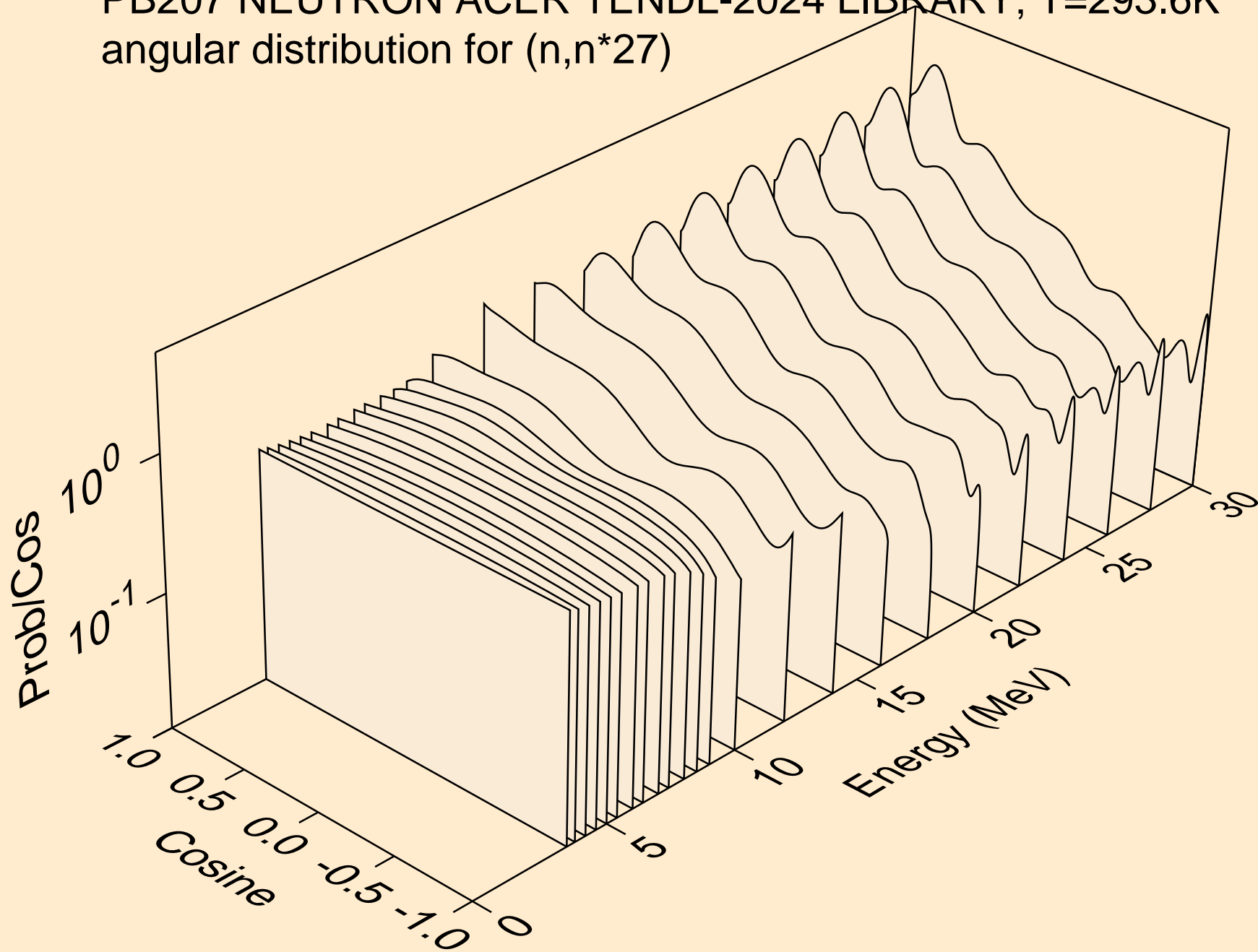

PB207 NEUTRON ACER TENDL-2024 LIBRARY; T=293.6K  
angular distribution for (n,n\*28)

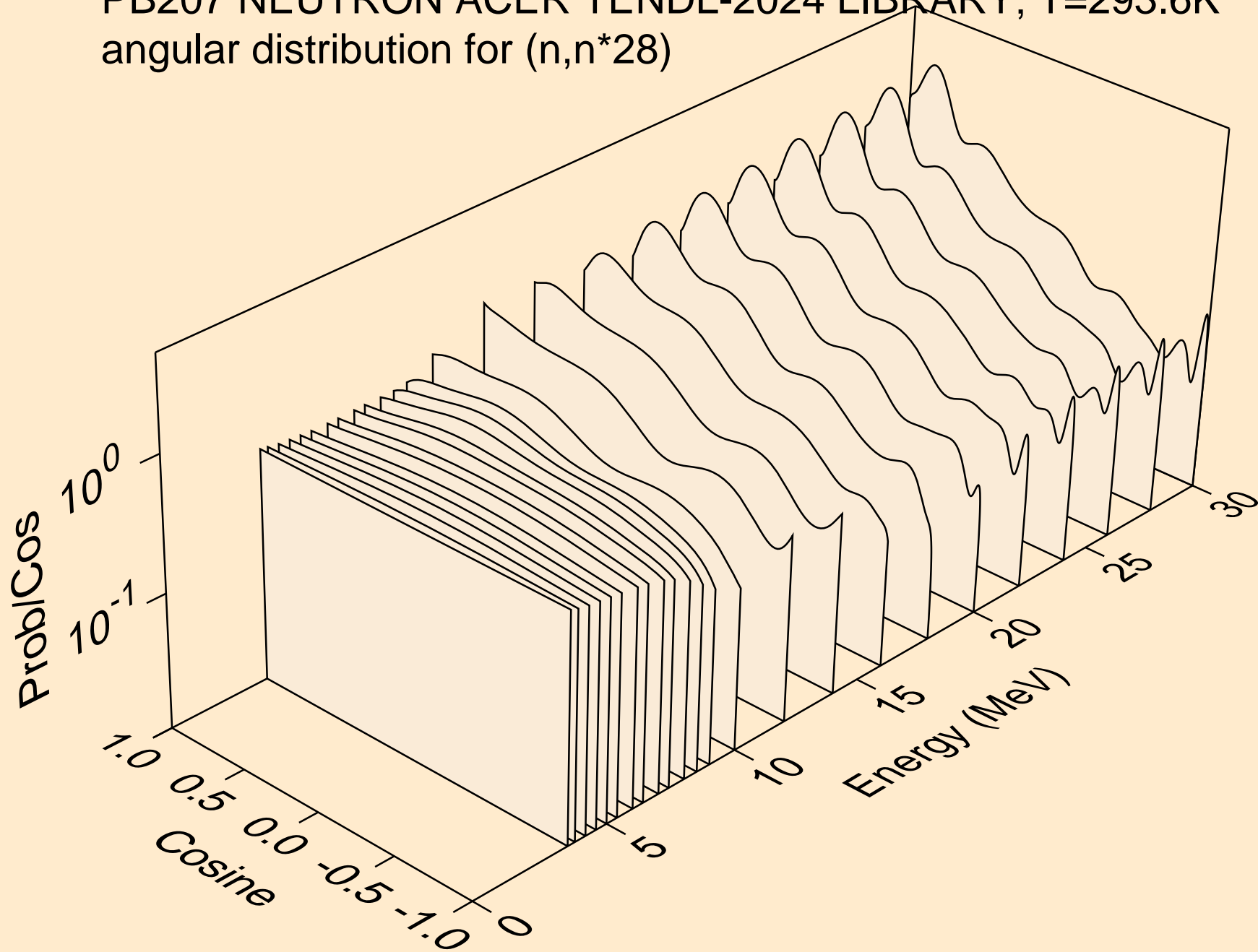

PB207 NEUTRON ACER TENDL-2024 LIBRARY; T=293.6K  
angular distribution for (n,n\*29)

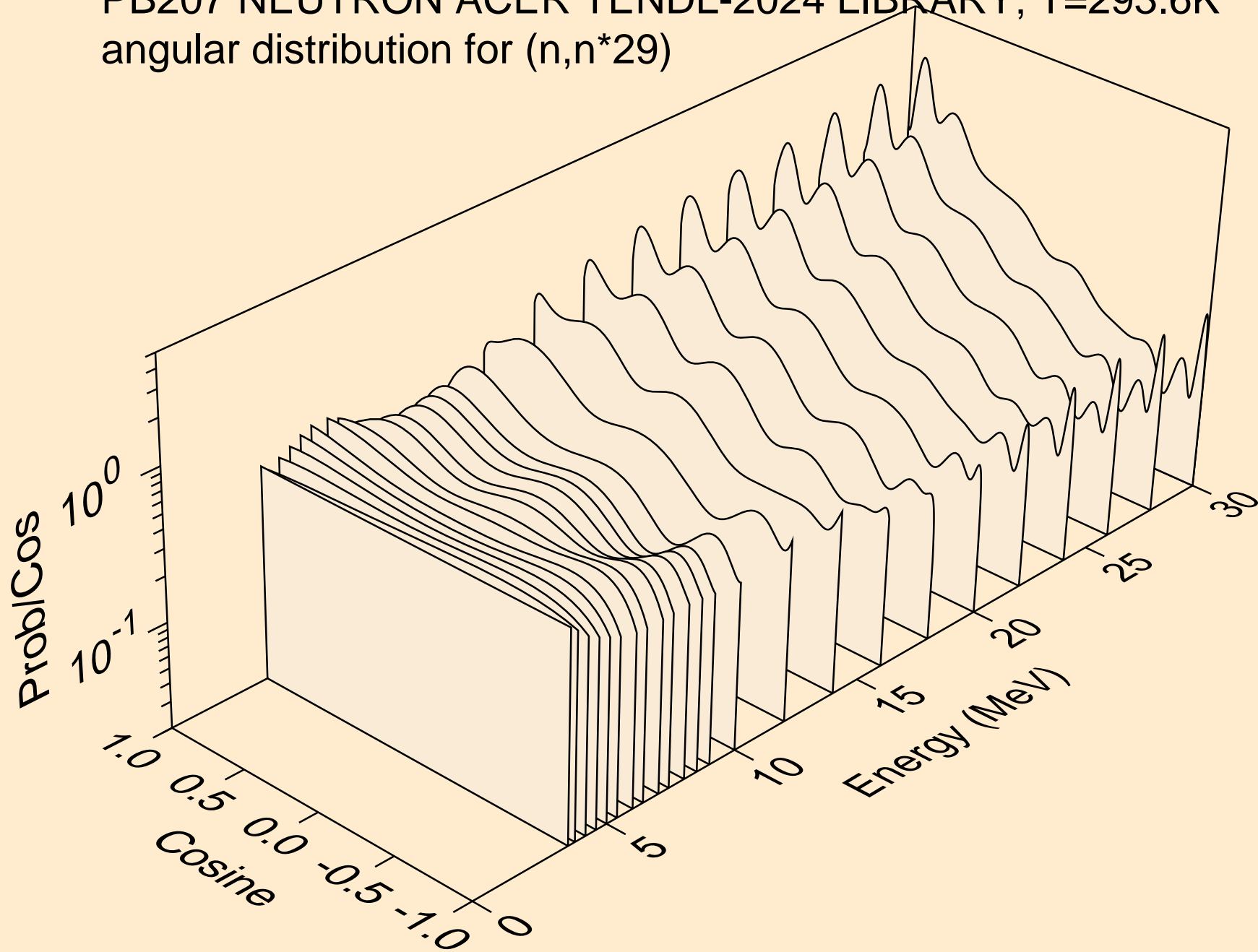

PB207 NEUTRON ACER TENDL-2024 LIBRARY; T=293.6K  
angular distribution for (n,n\*30)

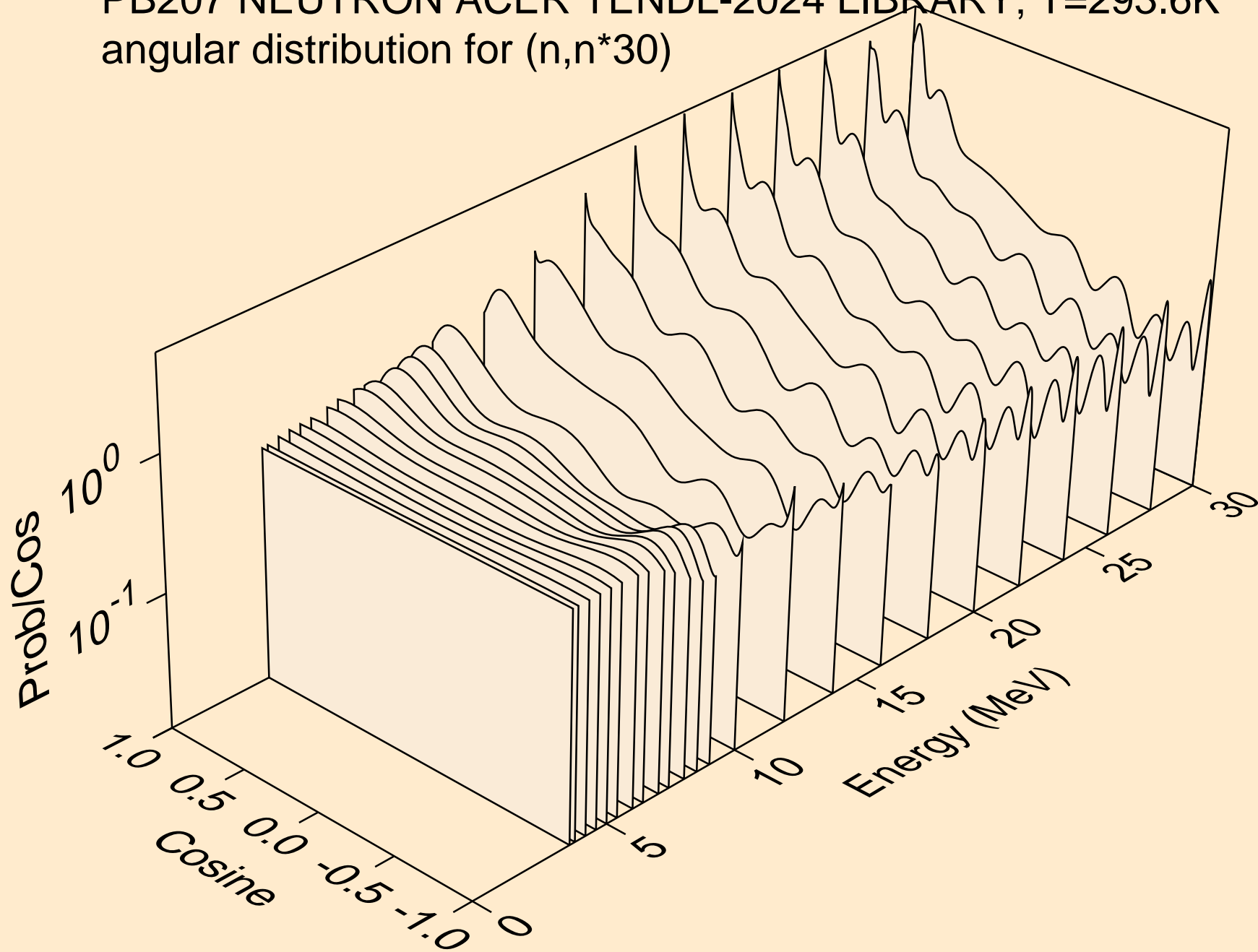

PB207 NEUTRON ACER TENDL-2024 LIBRARY; T=293.6K  
Neutron emission for (n,x)

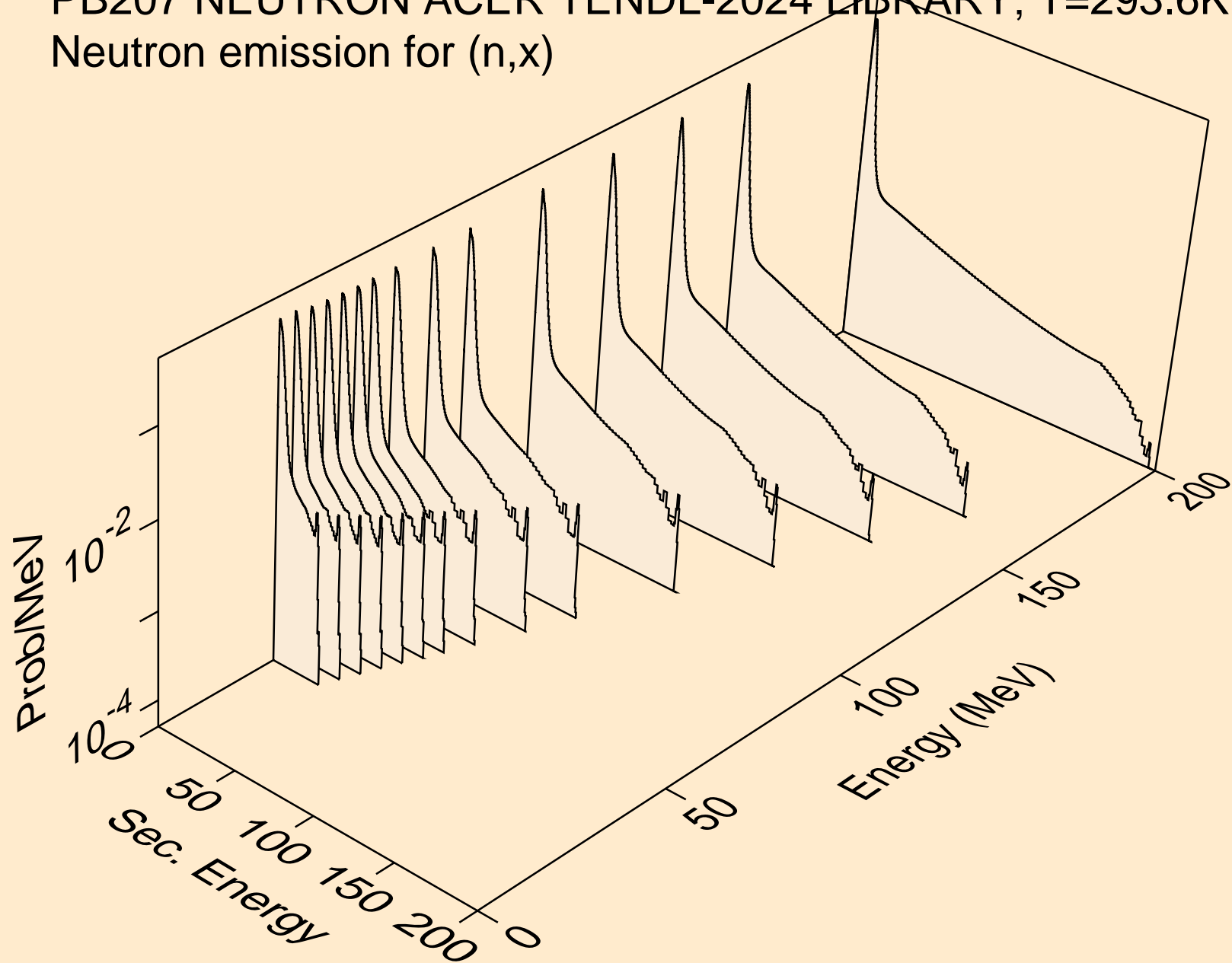

PB207 NEUTRON ACER TENDL-2024 LIBRARY; T=293.6K  
Neutron emission for (n,2nd)

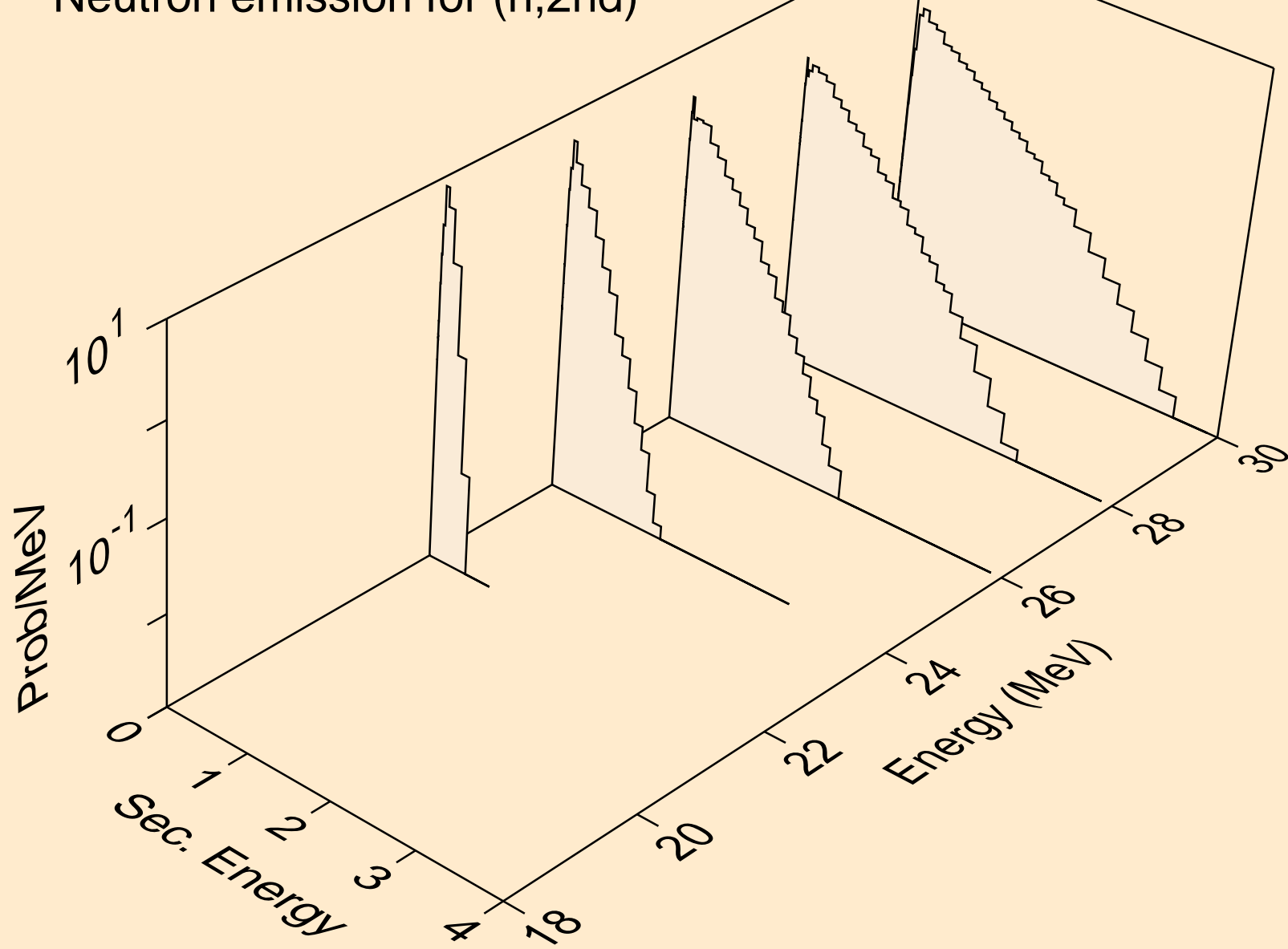

PB207 NEUTRON ACER TENDL-2024 LIBRARY; T=293.6K  
Neutron emission for (n,2n)

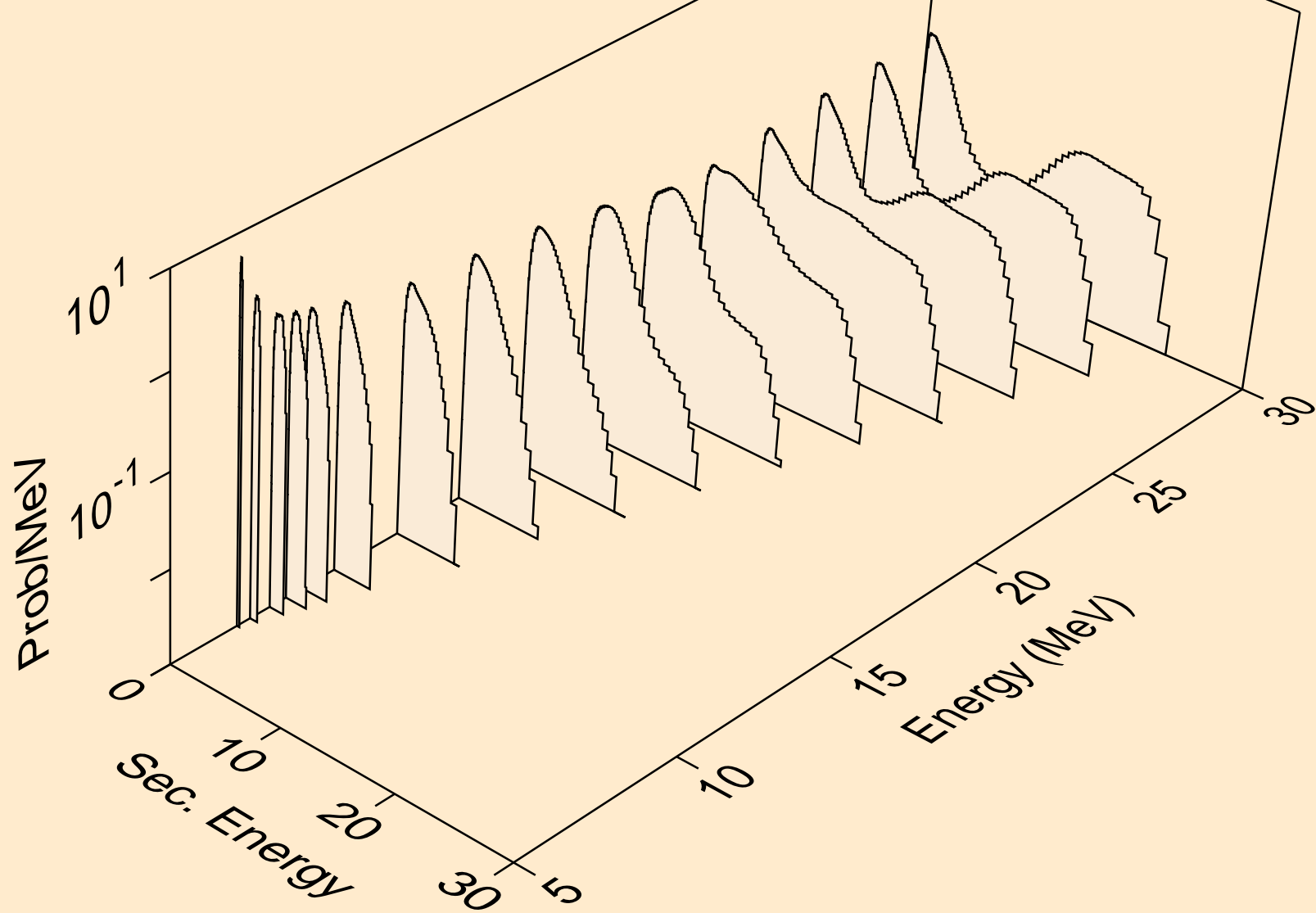

PB207 NEUTRON ACER TENDL-2024 LIBRARY; T=293.6K  
Neutron emission for (n,3n)

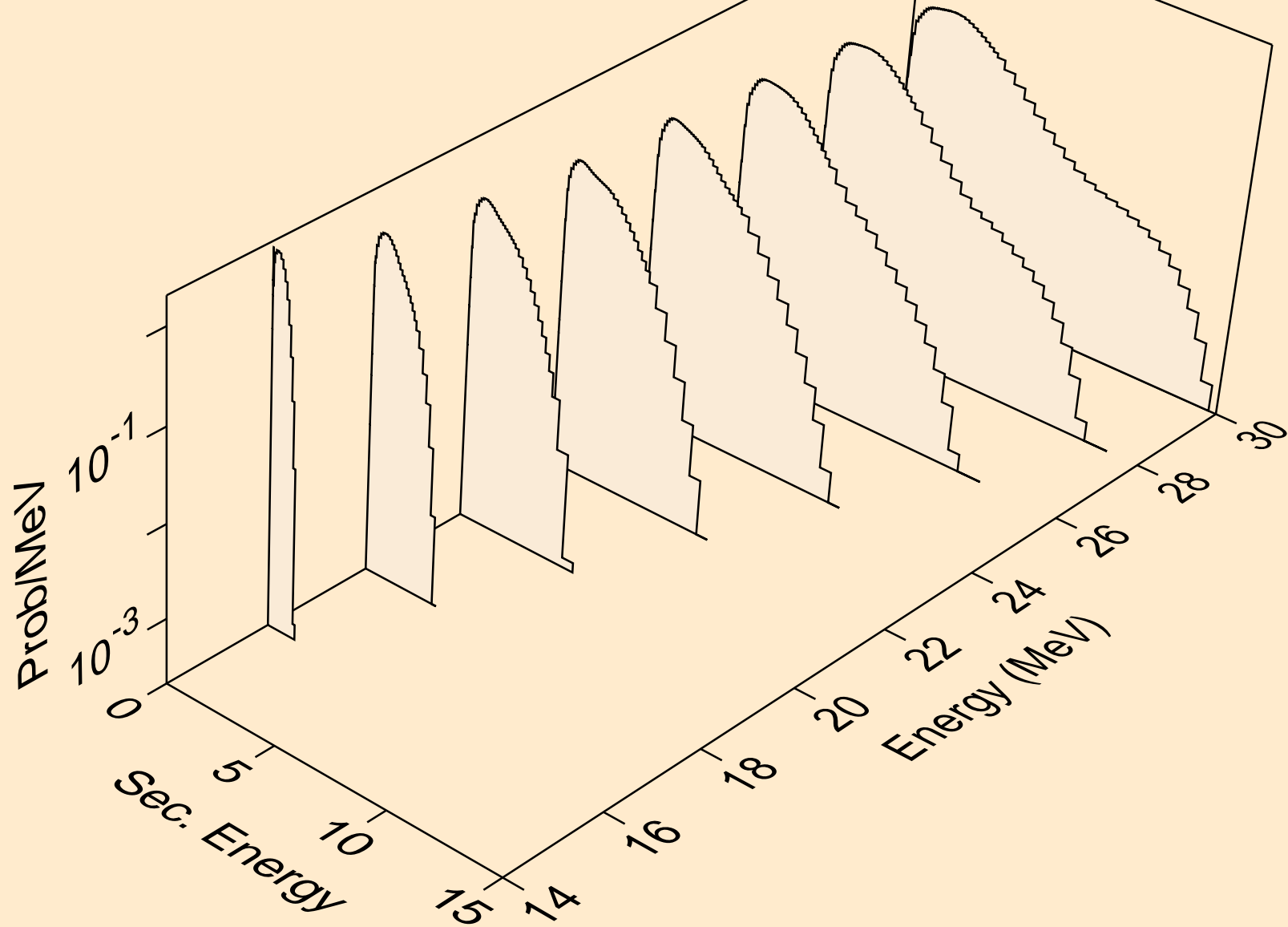

PB207 NEUTRON ACER TENDL-2024 LIBRARY; T=293.6K  
Neutron emission for (n,n\*)a

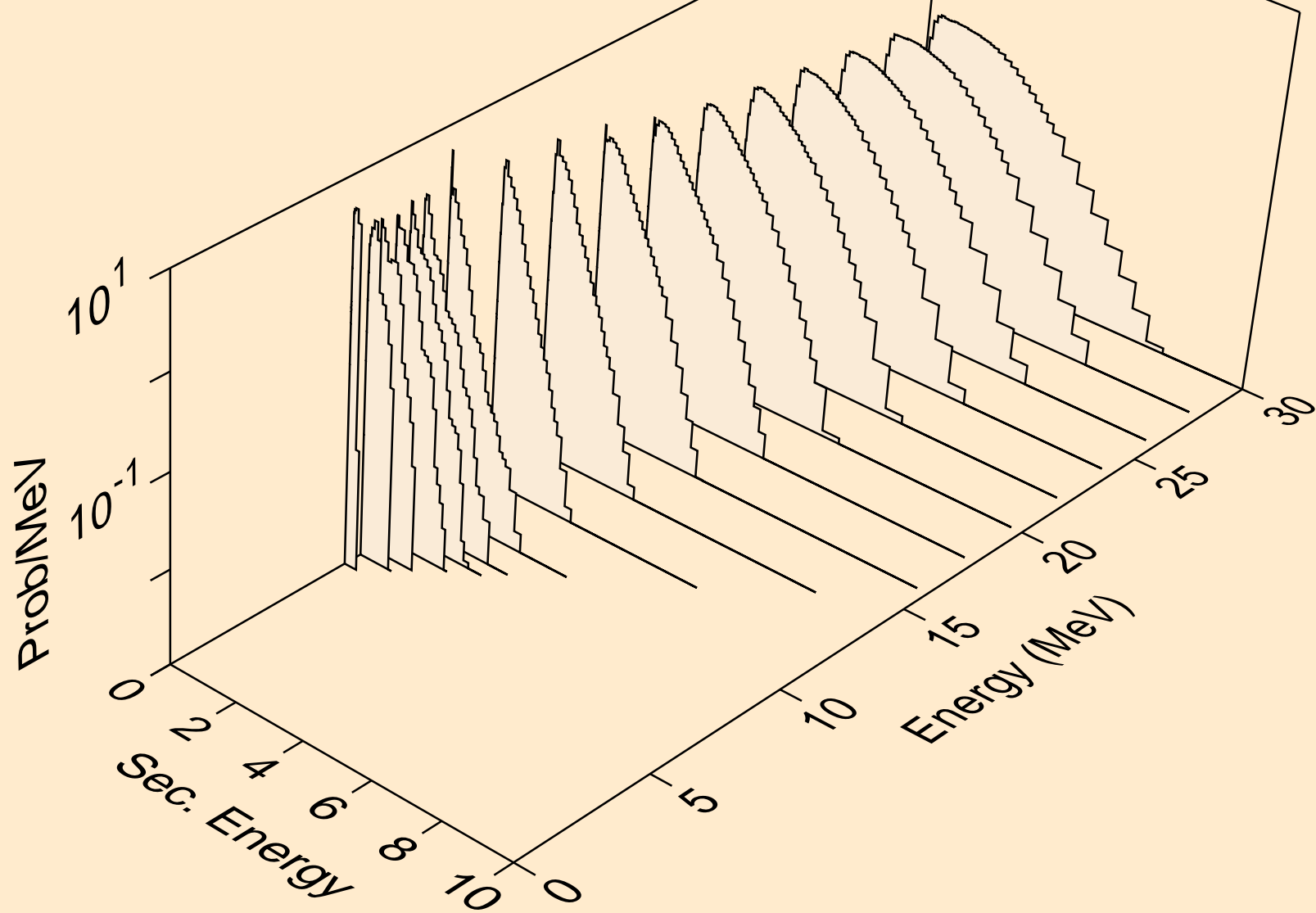

PB207 NEUTRON ACER TENDL-2024 LIBRARY; T=293.6K  
Neutron emission for (n,2n)<sub>a</sub>

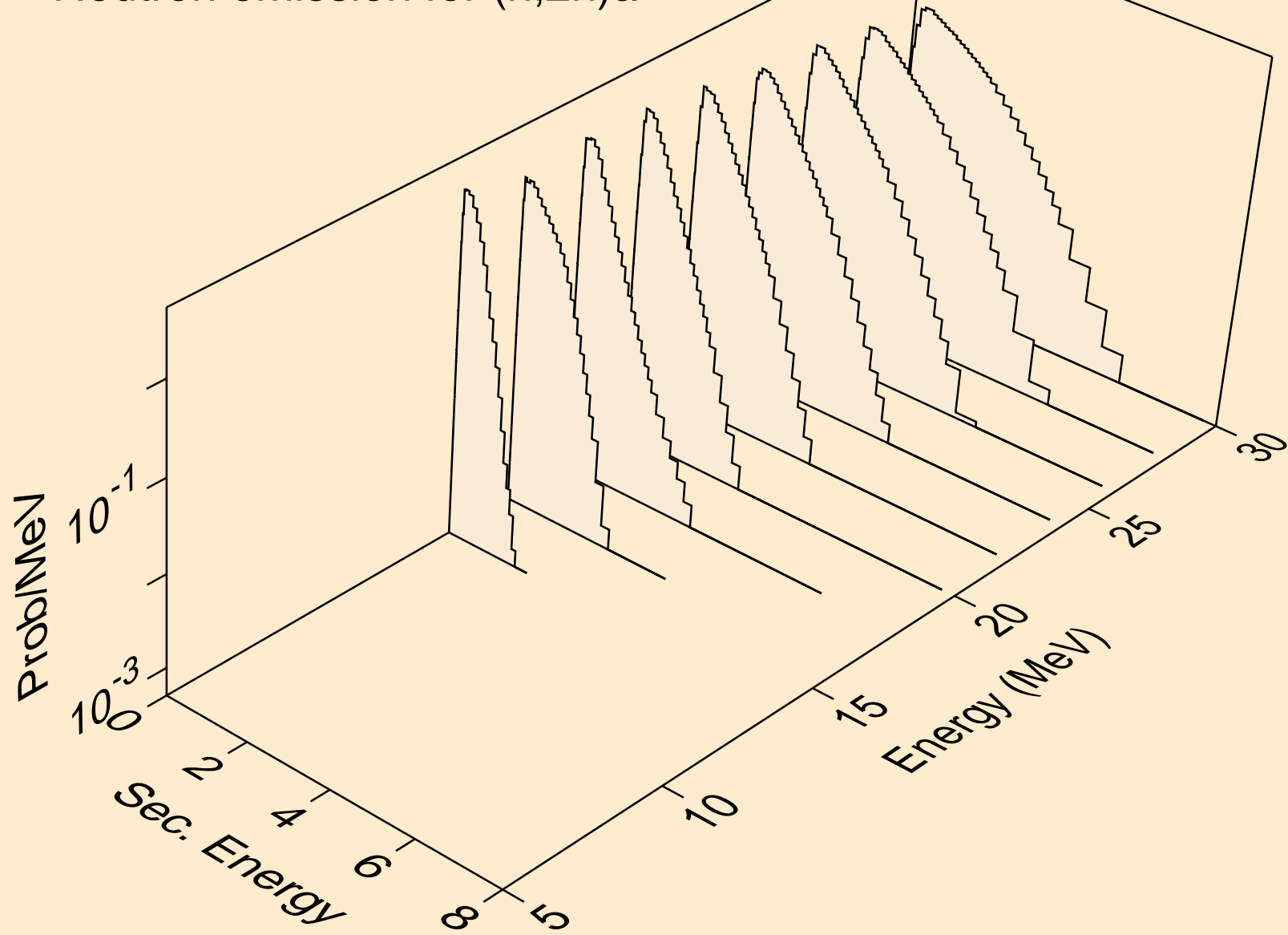

PB207 NEUTRON ACER TENDL-2024 LIBRARY; T=293.6K  
Neutron emission for (n,3n)a

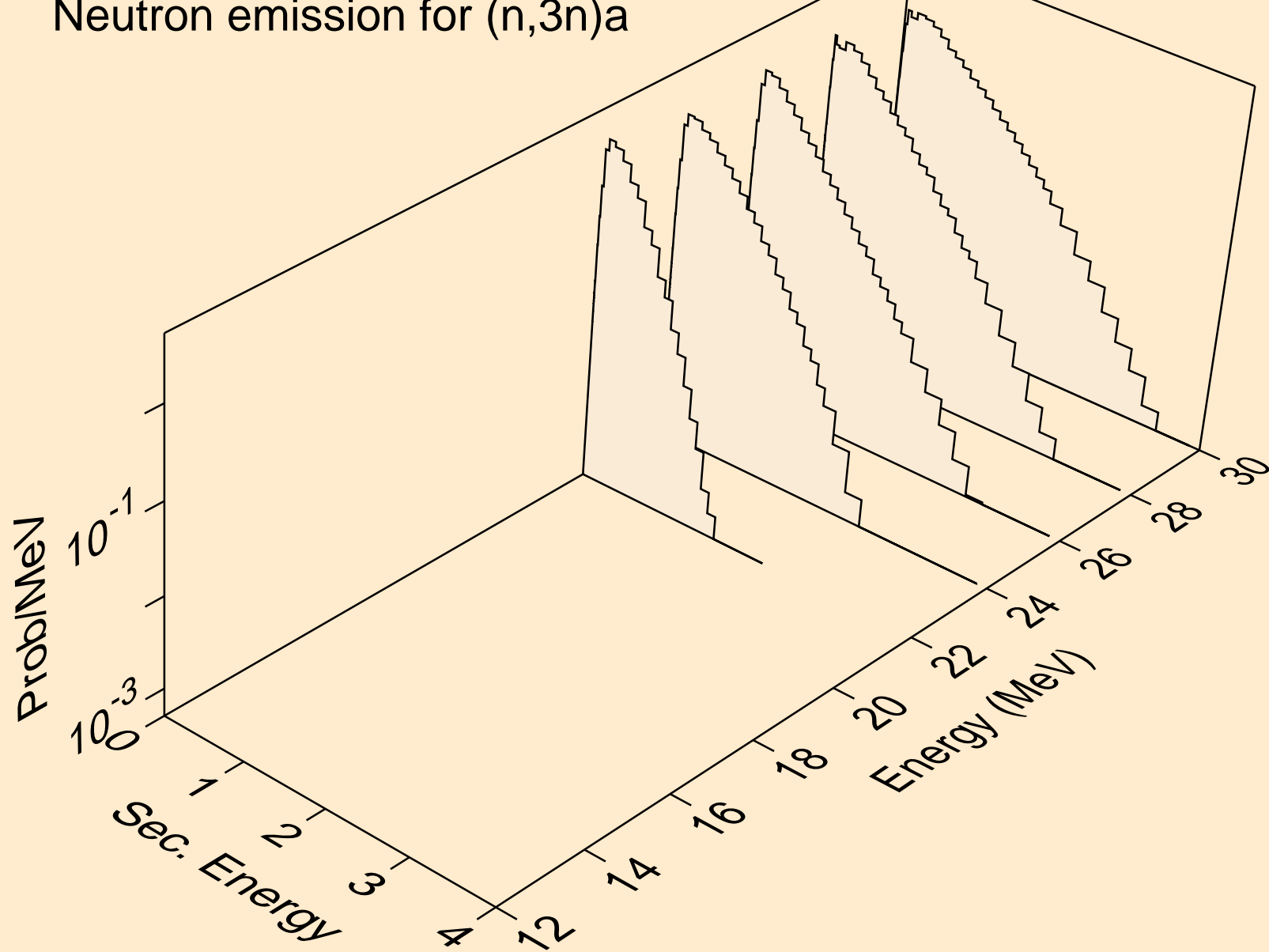

PB207 NEUTRON ACER TENDL-2024 LIBRARY; T=293.6K  
Neutron emission for (n,n\*)p

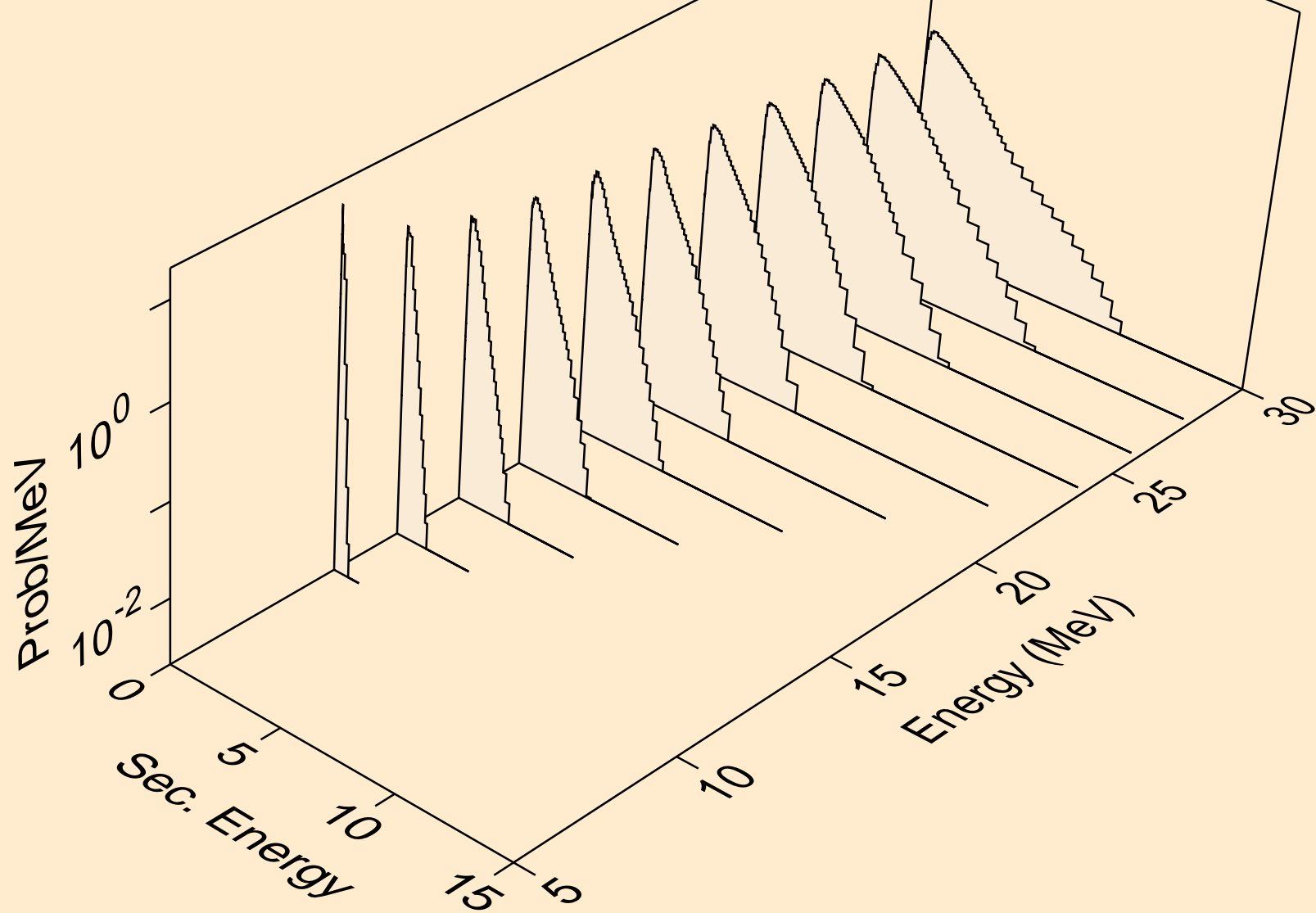

PB207 NEUTRON ACER TENDL-2024 LIBRARY; T=293.6K  
Neutron emission for (n,n\*)d

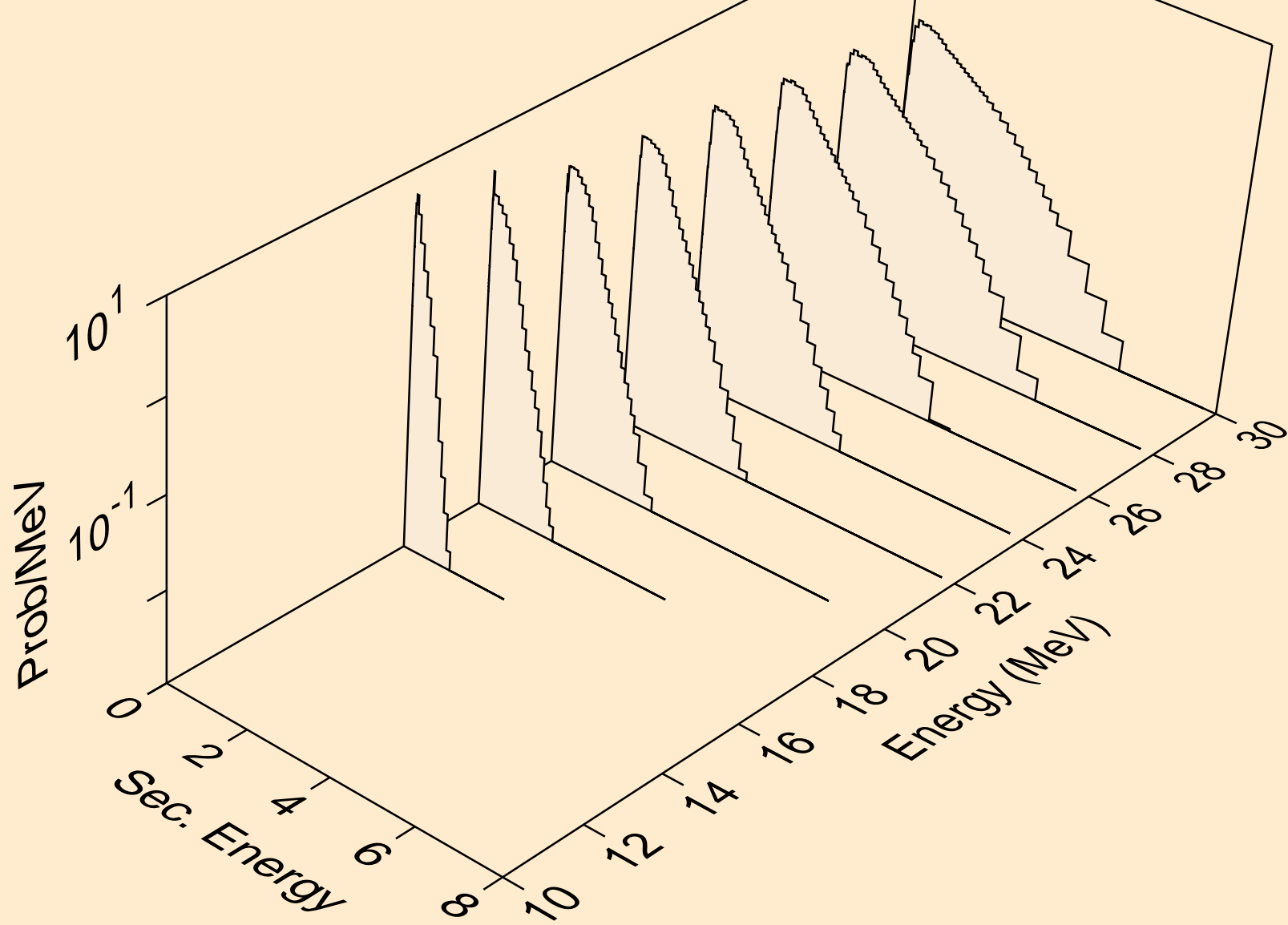

PB207 NEUTRON ACER TENDL-2024 LIBRARY; T=293.6K  
Neutron emission for (n,n\*)t

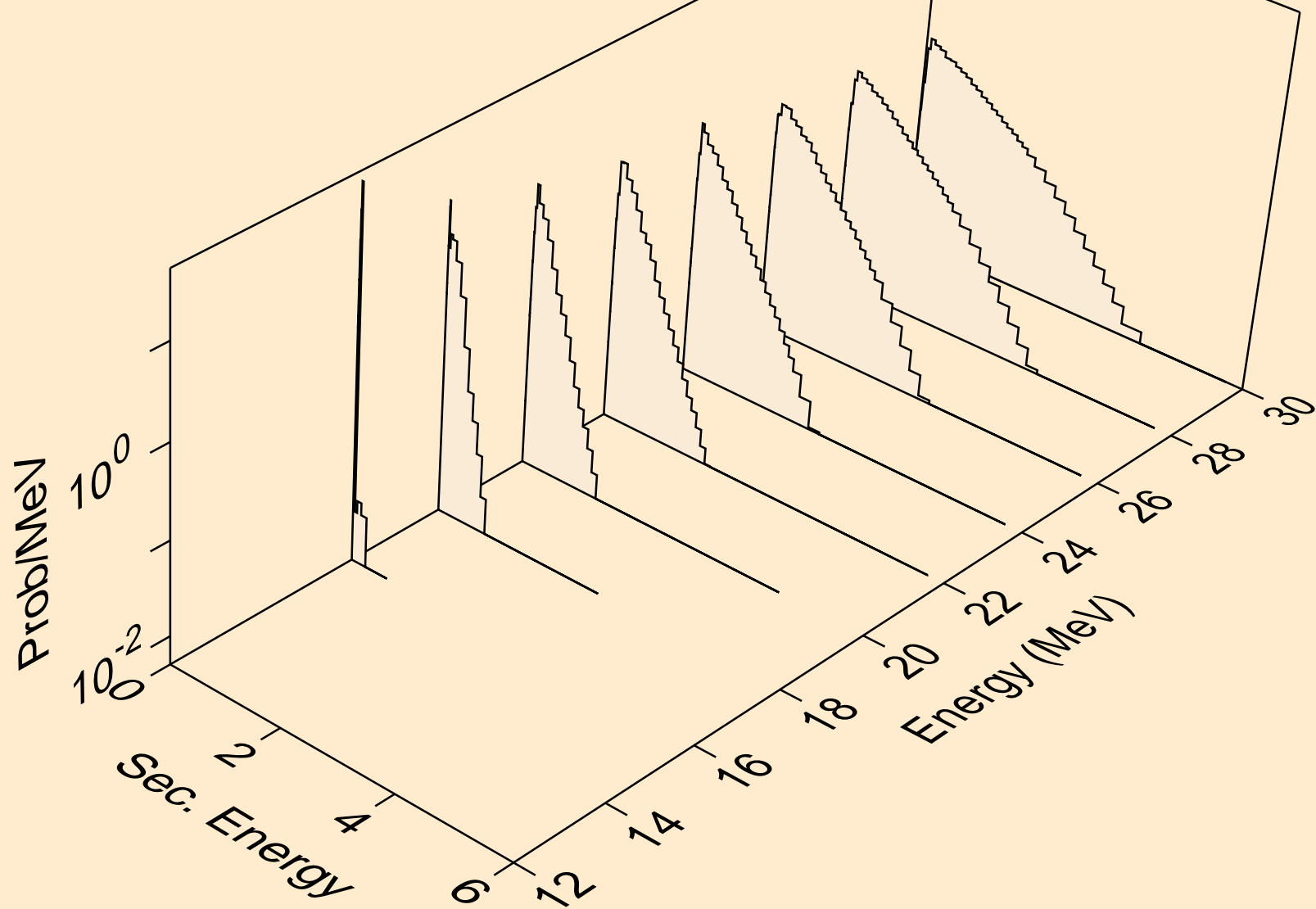

PB207 NEUTRON ACER TENDL-2024 LIBRARY; T=293.6K  
Neutron emission for (n,n\*)he3

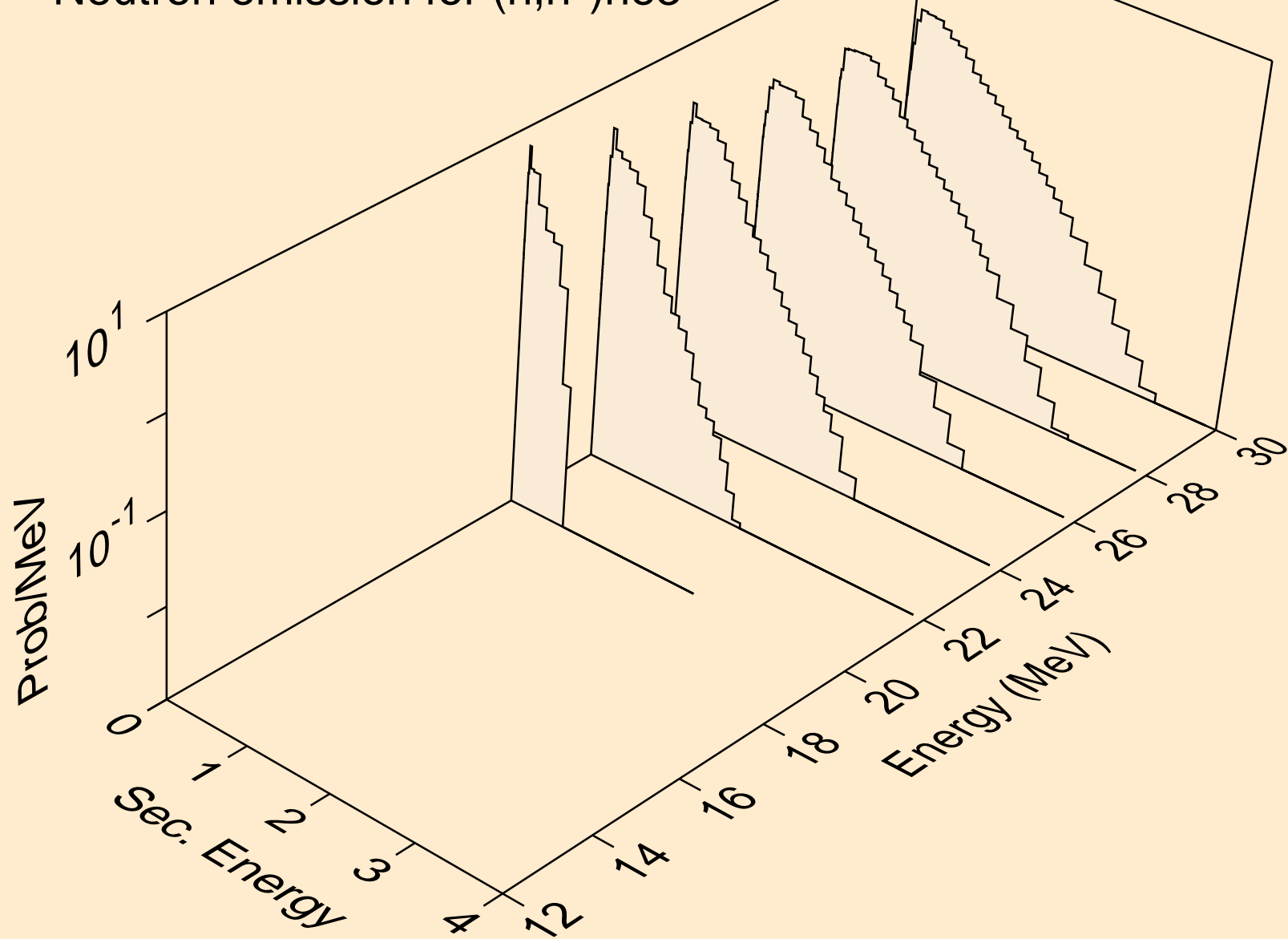

PB207 NEUTRON ACER TENDL-2024 LIBRARY; T=293.6K  
Neutron emission for (n,4n)

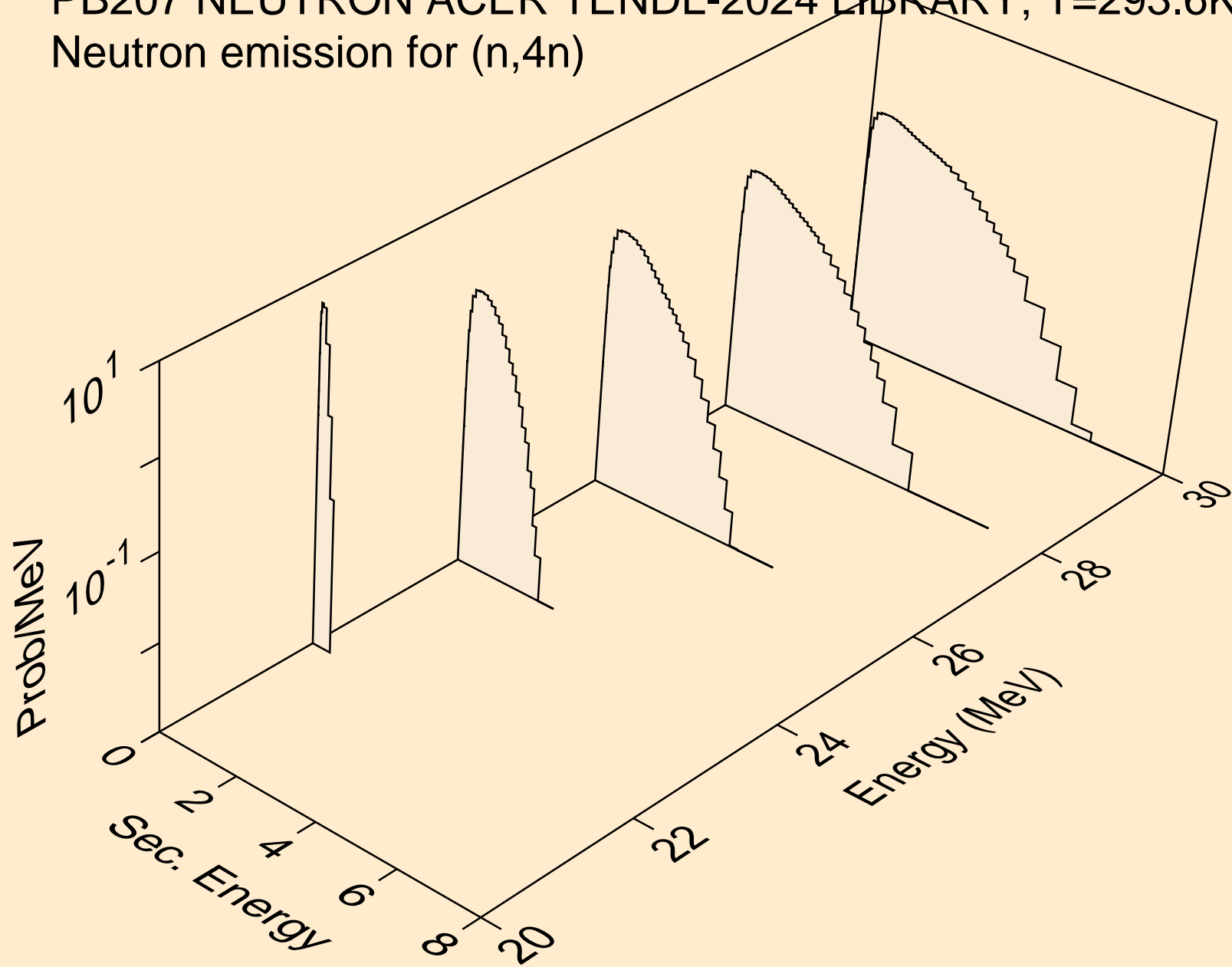

PB207 NEUTRON ACER TENDL-2024 LIBRARY; T=293.6K  
Neutron emission for (n,2np)

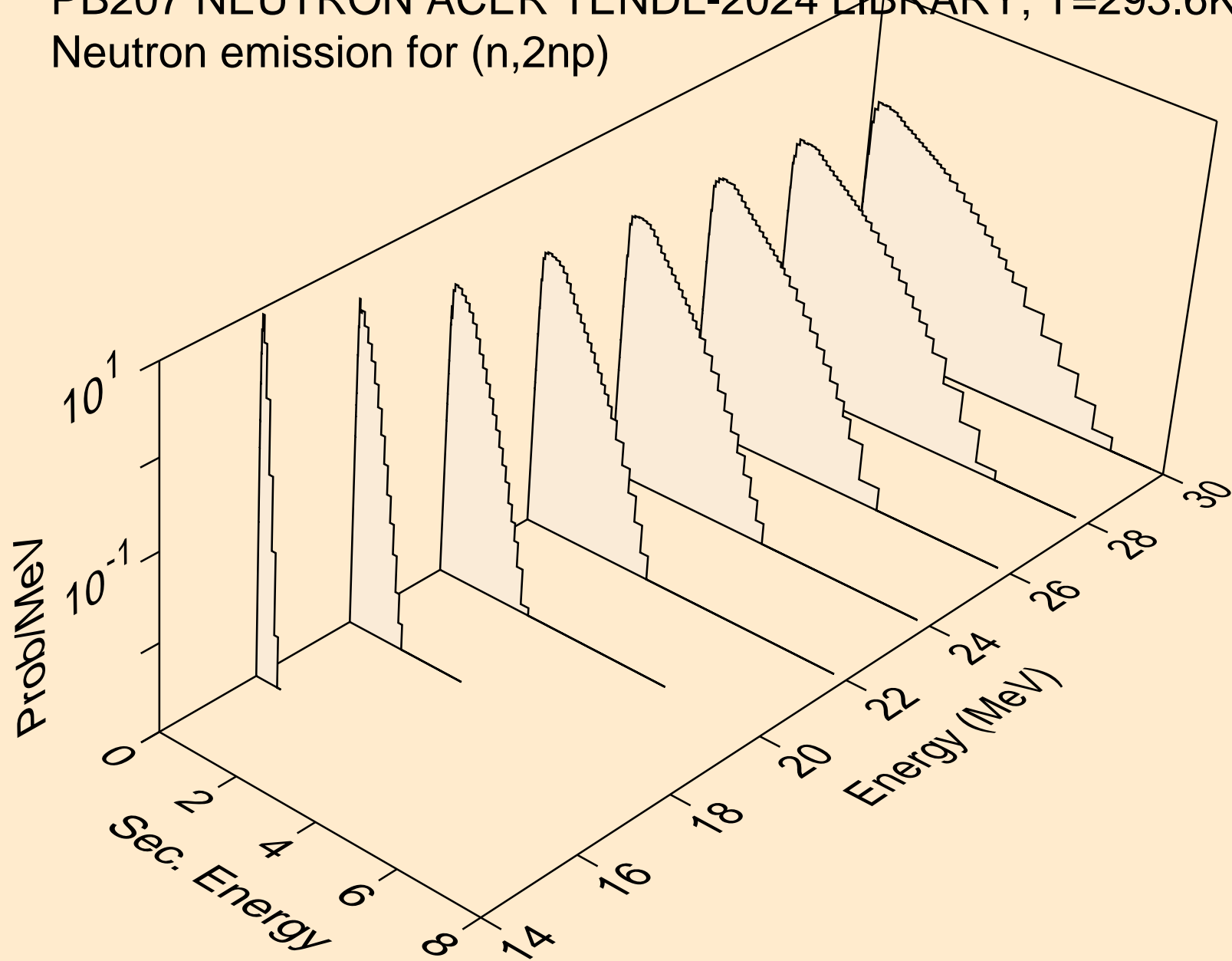

PB207 NEUTRON ACER TENDL-2024 LIBRARY; T=293.6K  
Neutron emission for (n,3np)

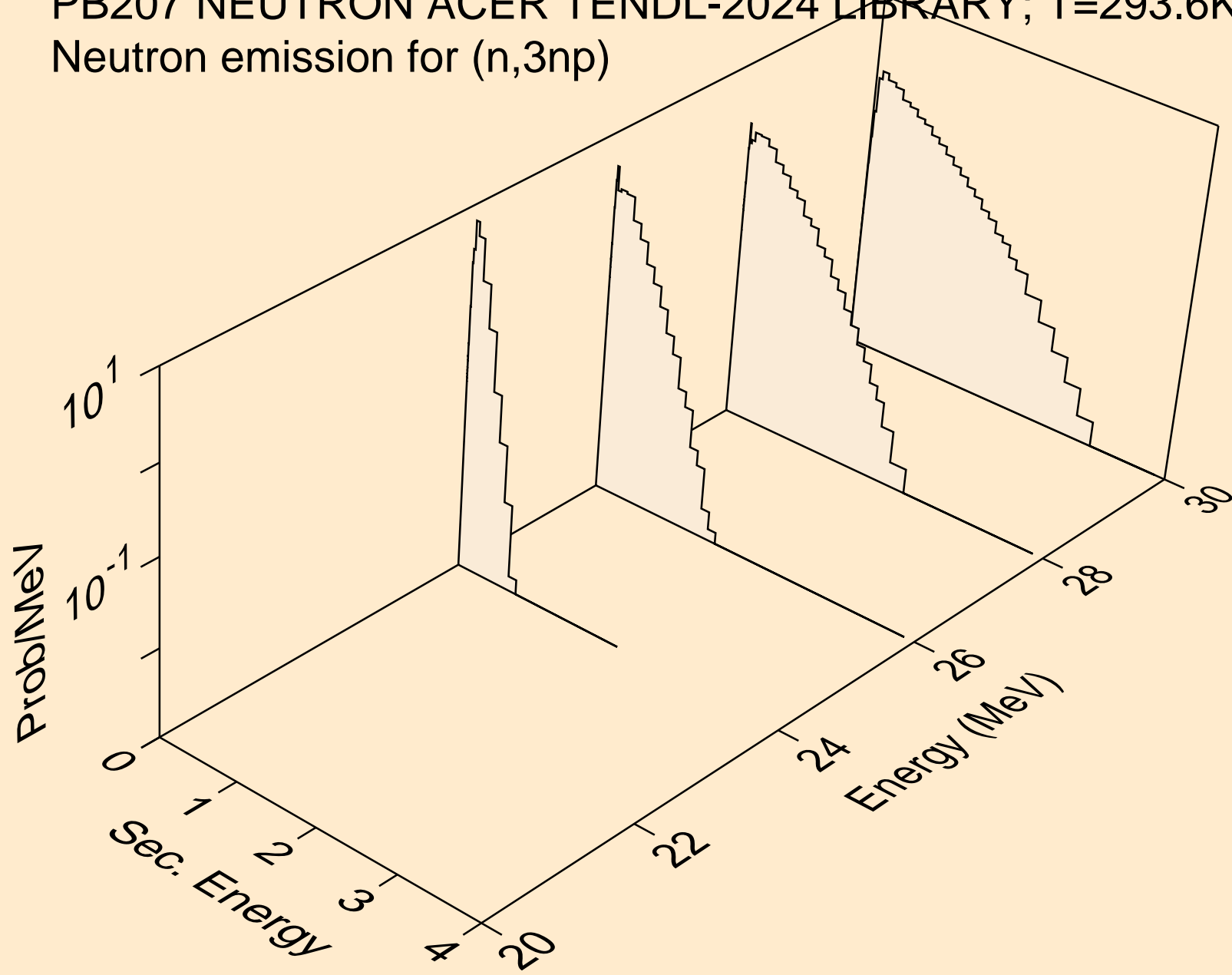

PB207 NEUTRON ACER TENDL-2024 LIBRARY; T=293.6K  
Neutron emission for (n,n2p)

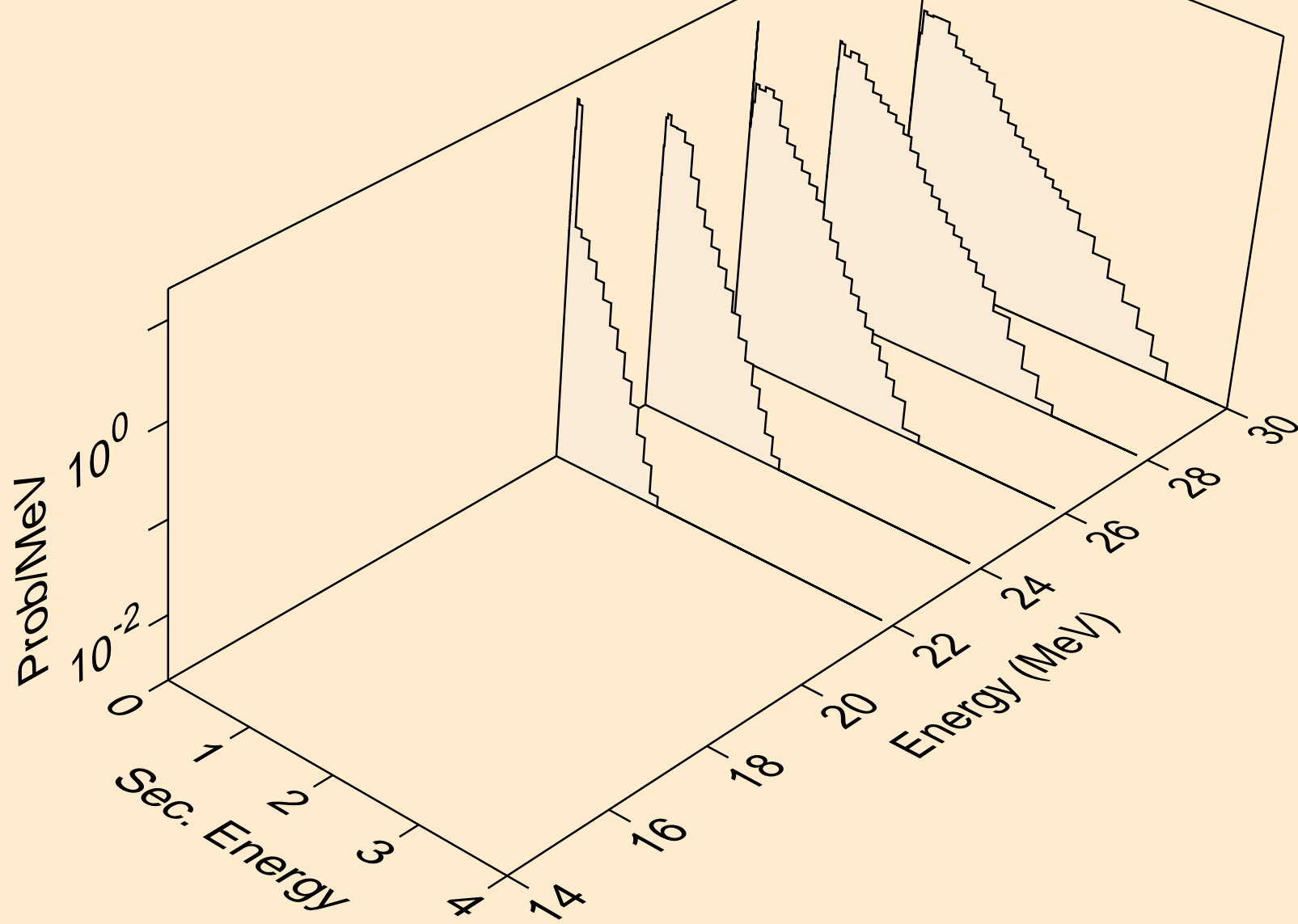

PB207 NEUTRON ACER TENDL-2024 LIBRARY; T=293.6K  
Neutron emission for (n,n\*c)

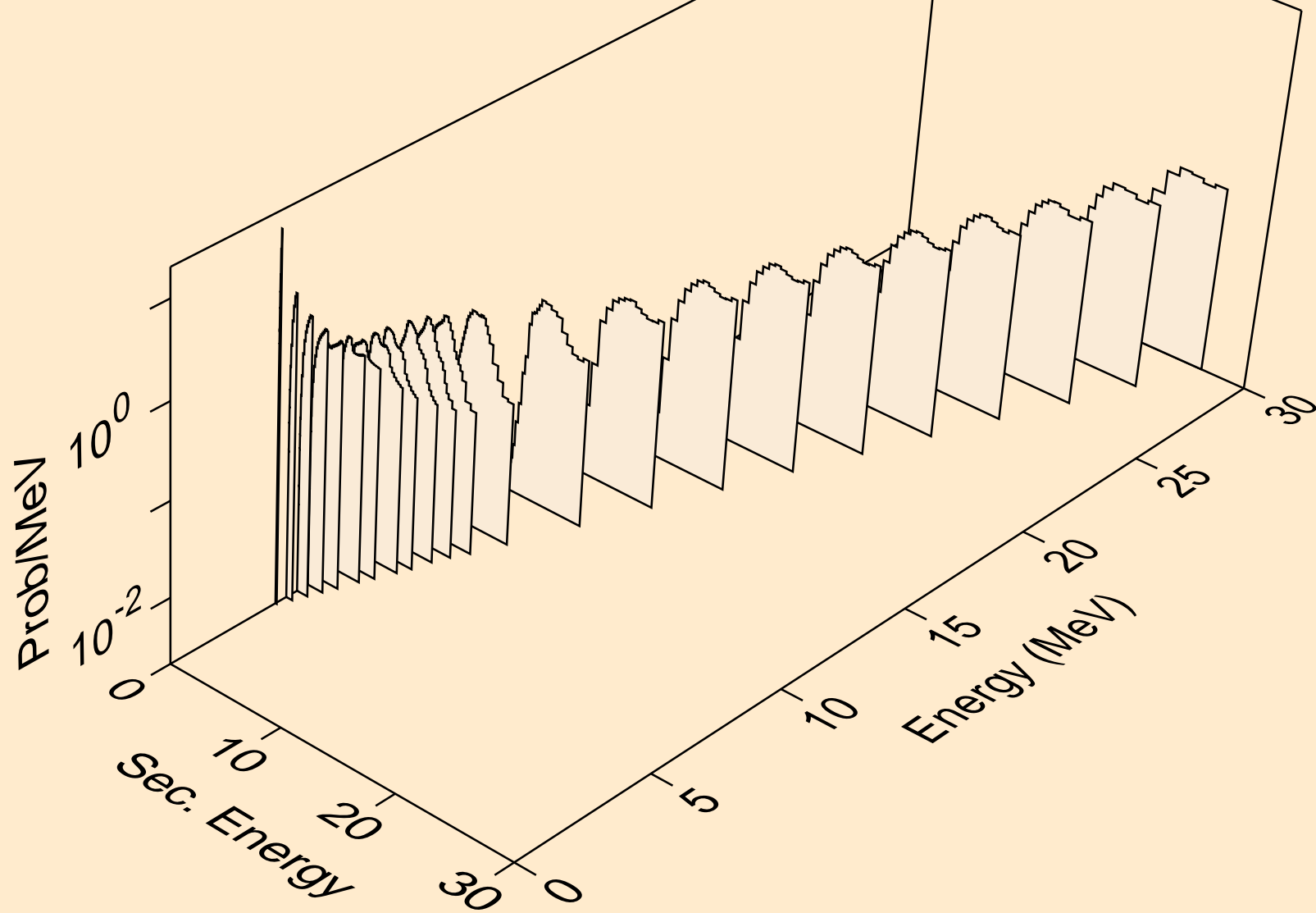

PB207 NEUTRON ACER TENDL-2024 LIBRARY; T=293.6K  
Photon emission for (n,x)

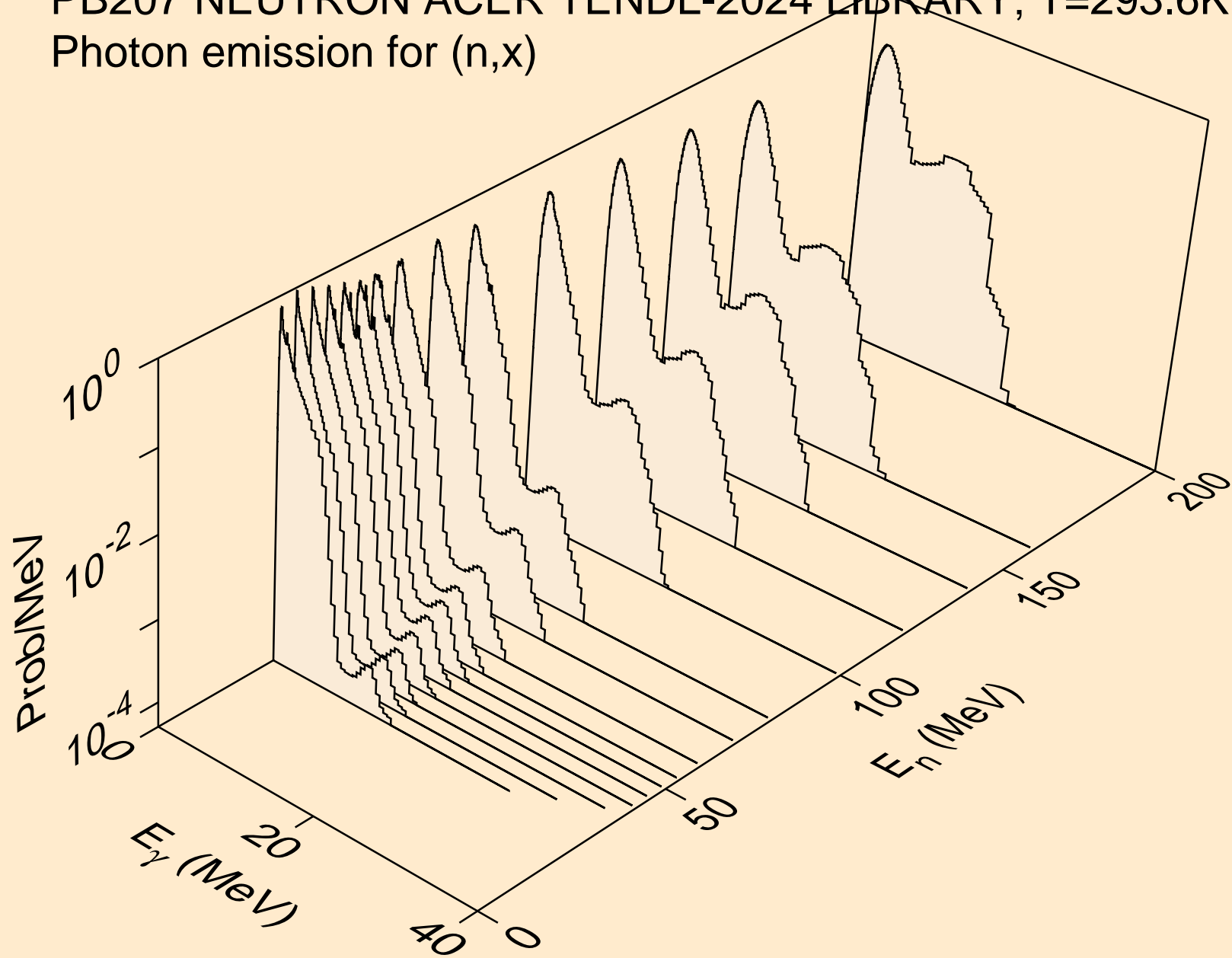

PB207 NEUTRON ACER TENDL-2024 LIBRARY; T=293.6K  
Photon emission for (n,2nd)

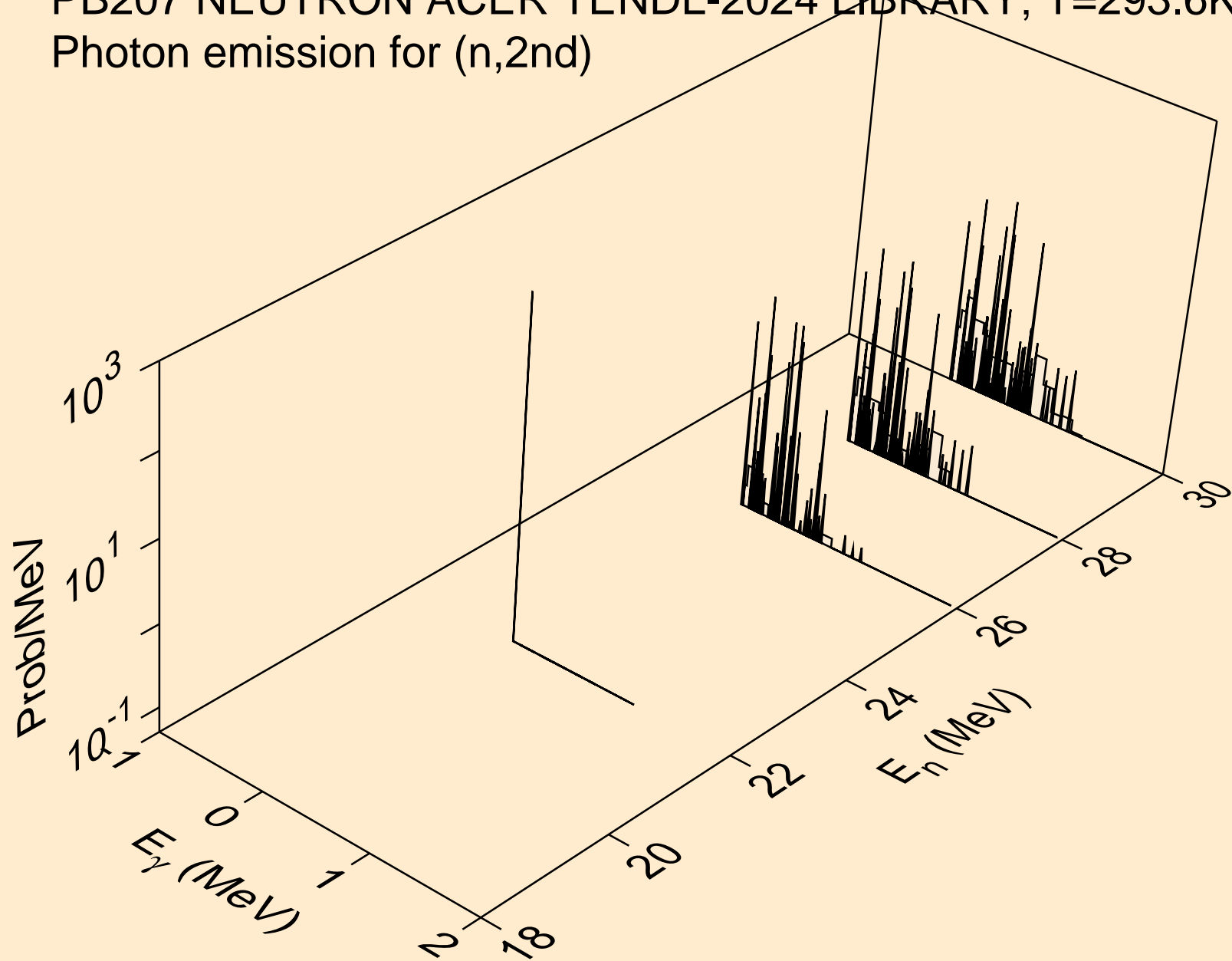

PB207 NEUTRON ACER TENDL-2024 LIBRARY; T=293.6K  
Photon emission for (n,2n)

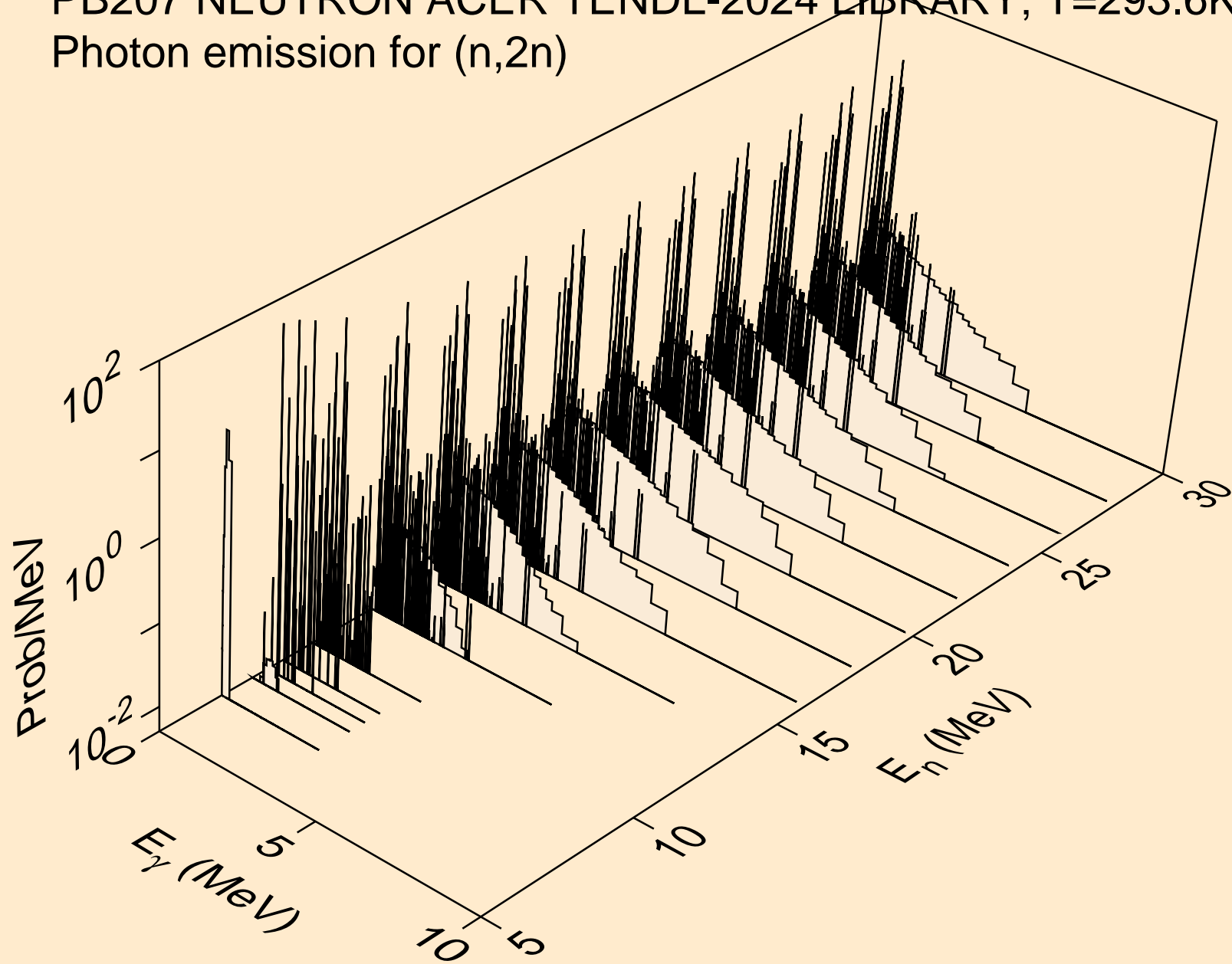

PB207 NEUTRON ACER TENDL-2024 LIBRARY; T=293.6K  
Photon emission for (n,3n)

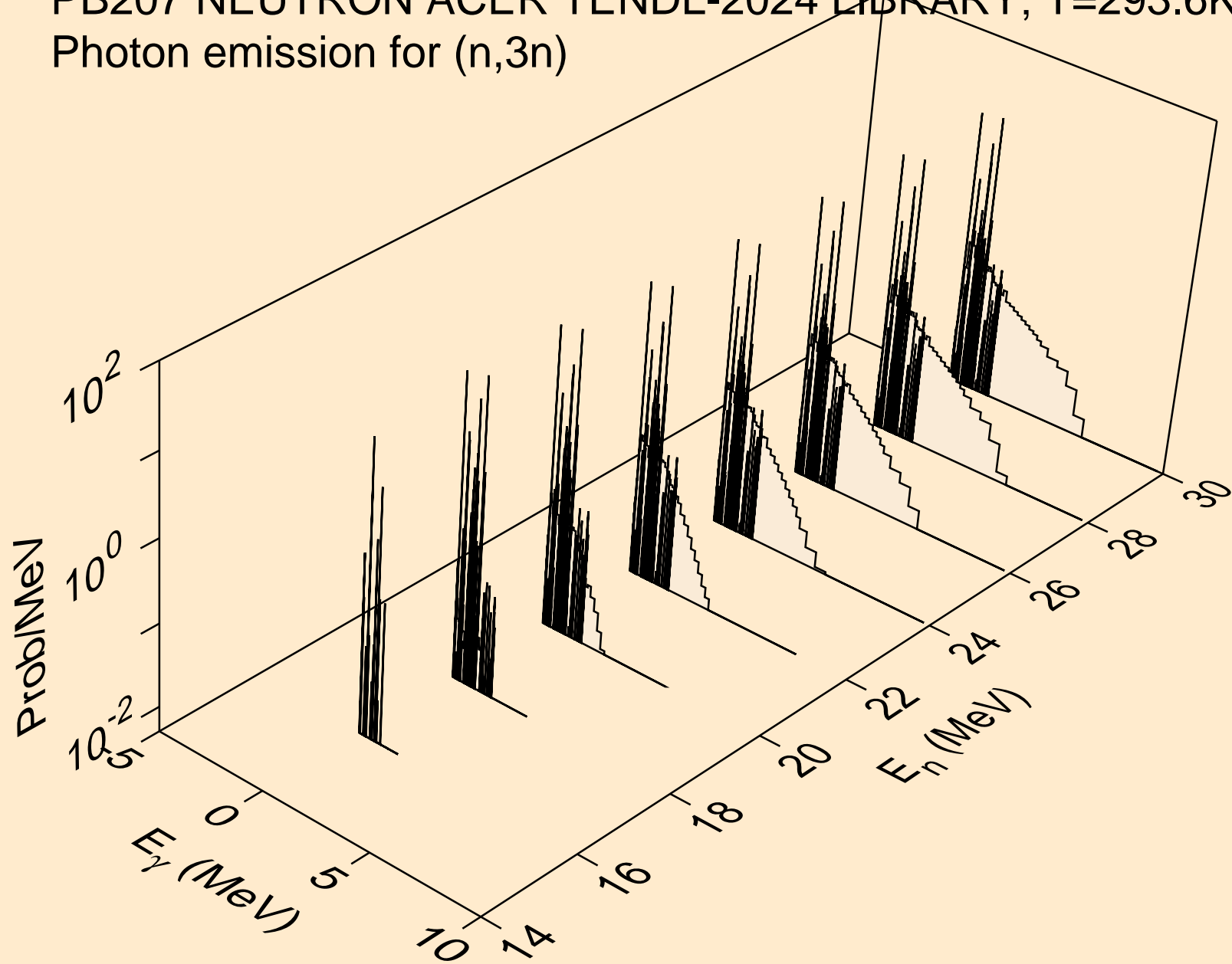

PB207 NEUTRON ACER TENDL-2024 LIBRARY; T=293.6K  
Photon emission for (n,n\*)a

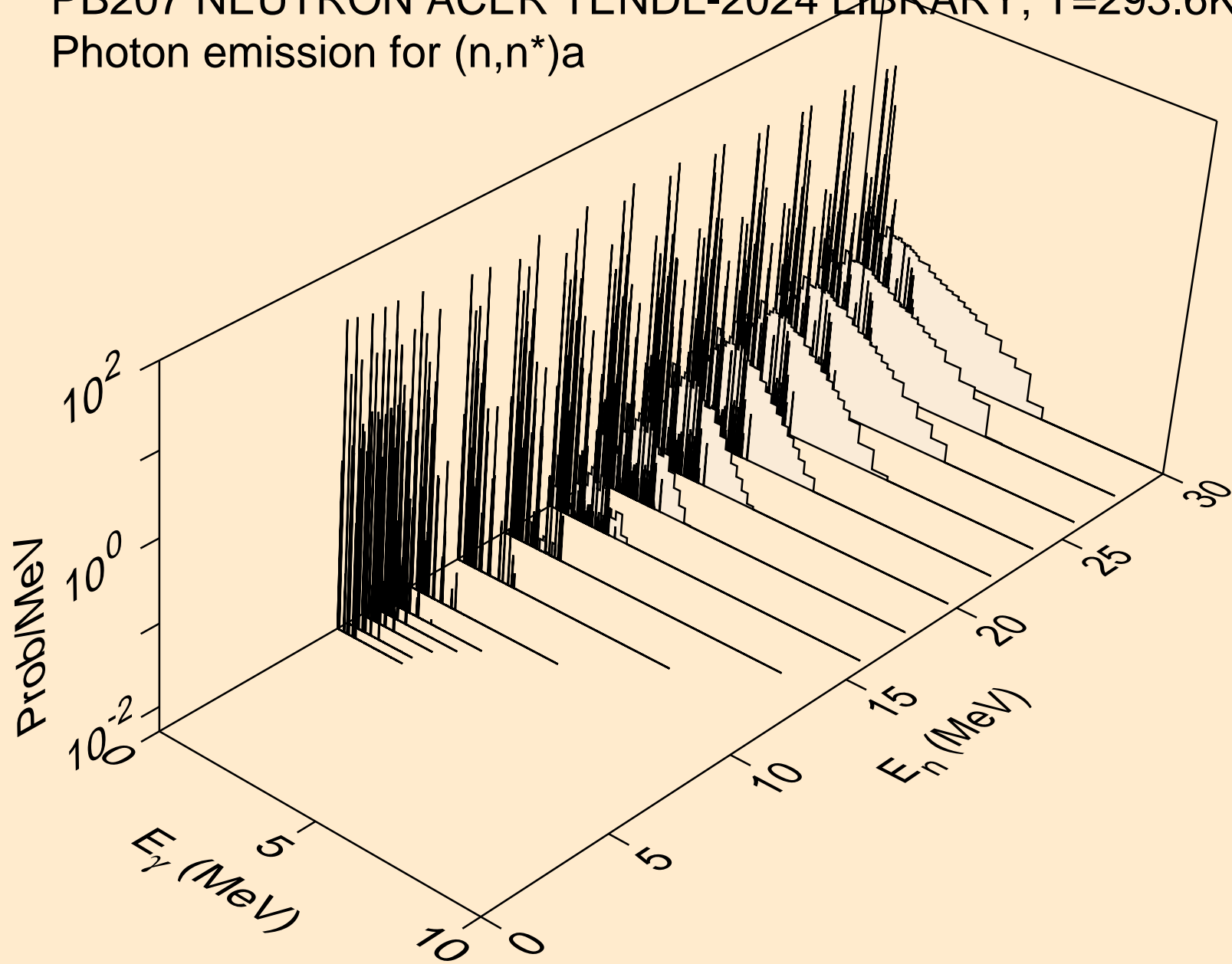

PB207 NEUTRON ACER TENDL-2024 LIBRARY; T=293.6K  
Photon emission for (n,2n)a

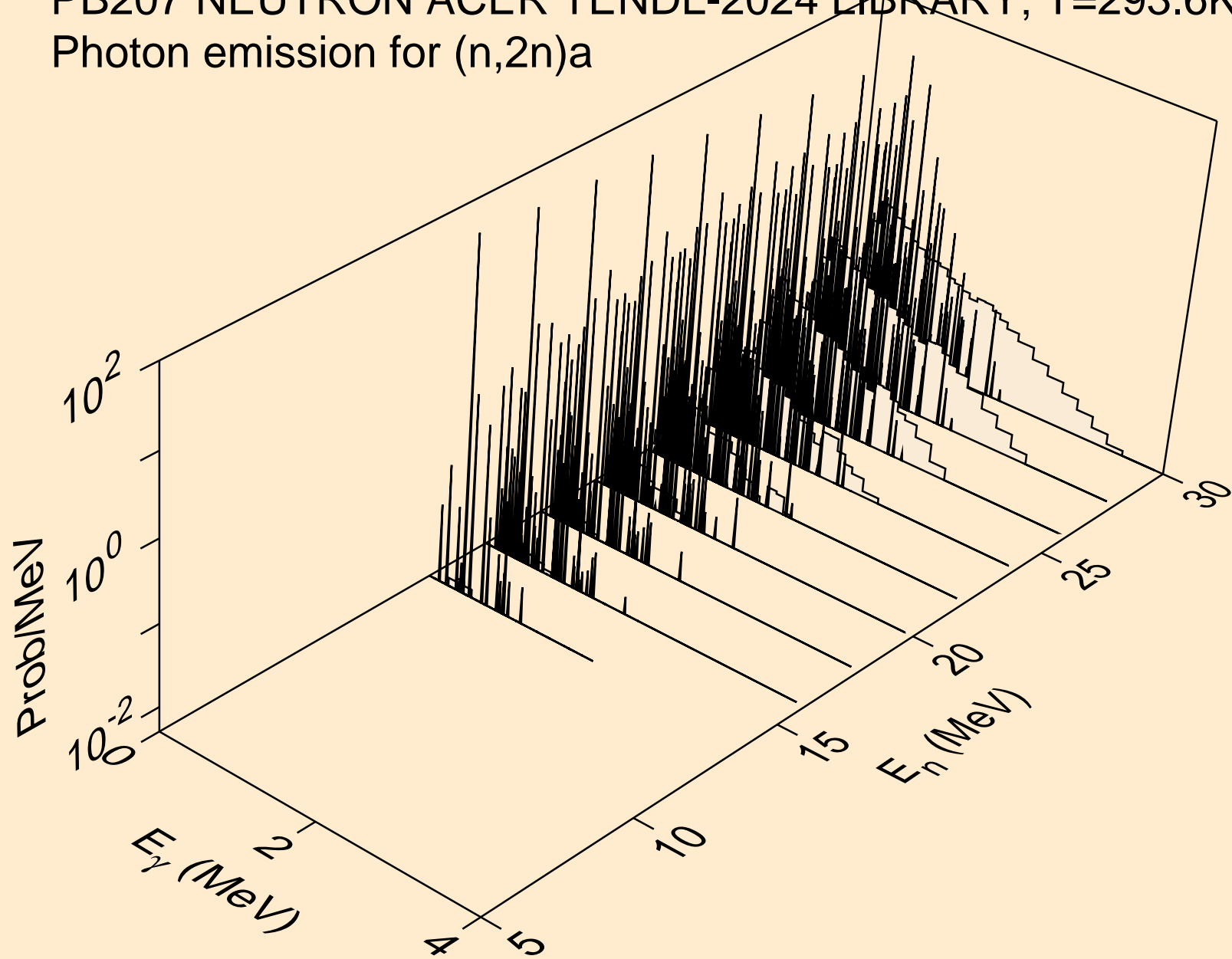

PB207 NEUTRON ACER TENDL-2024 LIBRARY; T=293.6K  
Photon emission for (n,3n)a

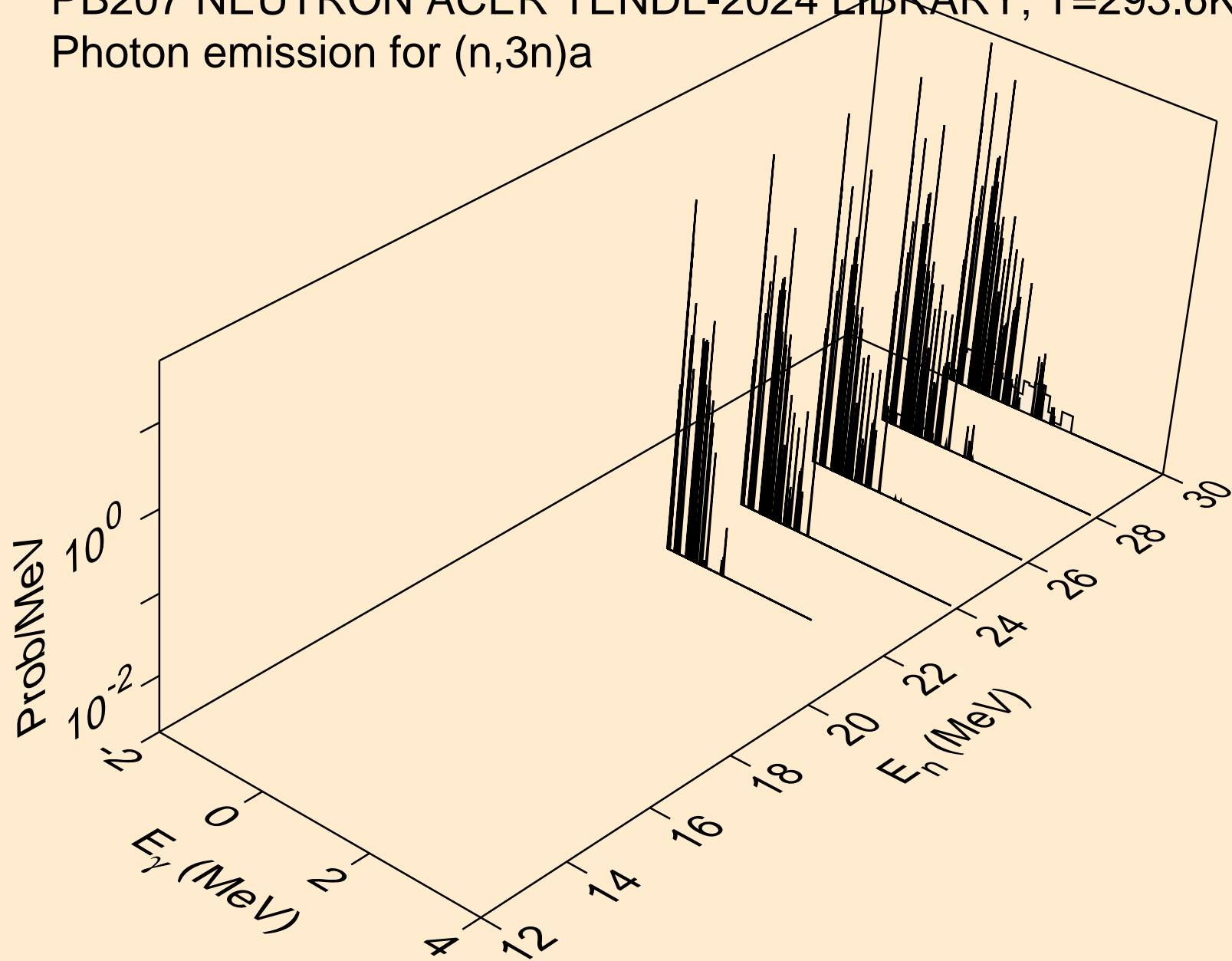

PB207 NEUTRON ACER TENDL-2024 LIBRARY; T=293.6K  
Photon emission for (n,n\*)p

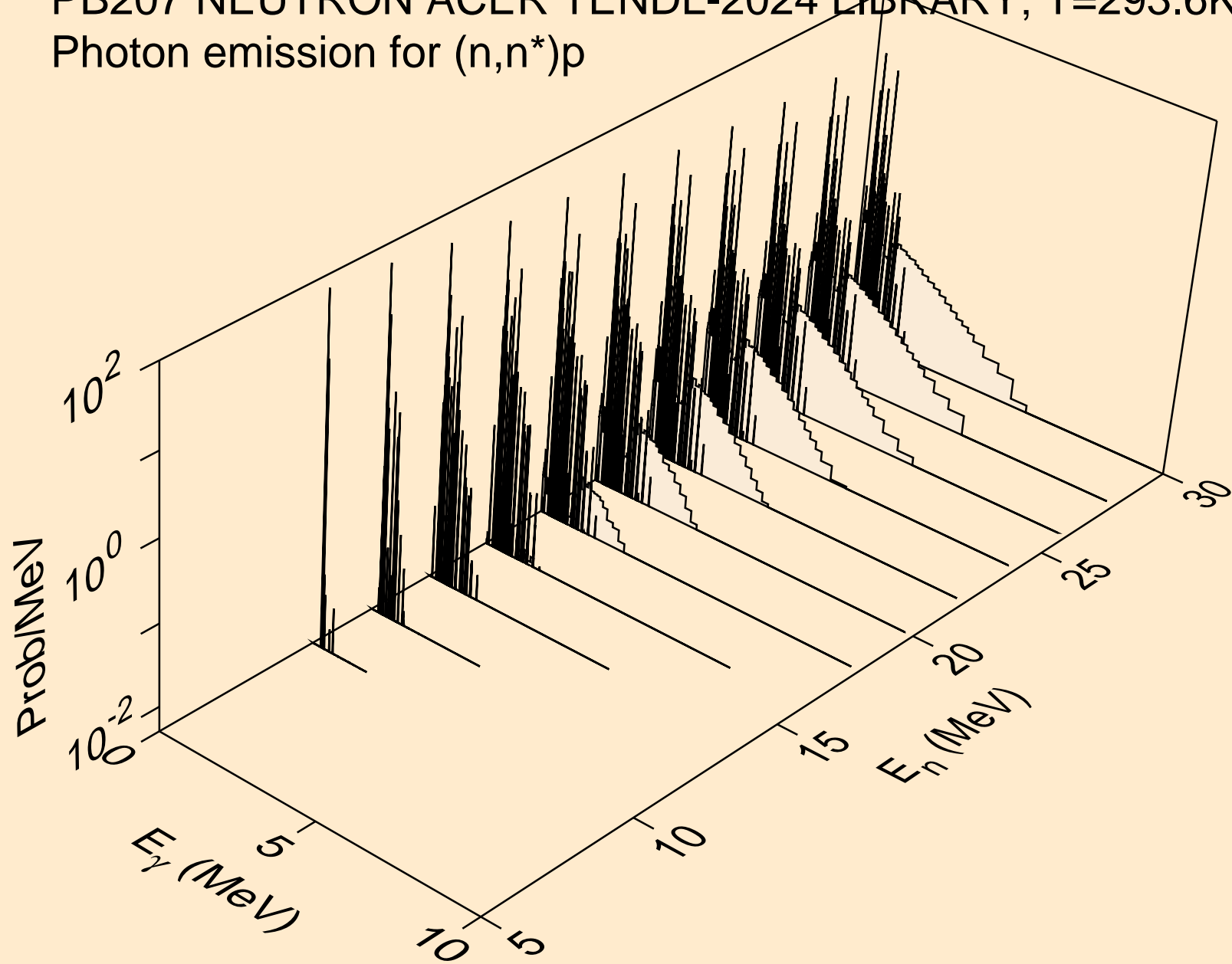

PB207 NEUTRON ACER TENDL-2024 LIBRARY; T=293.6K  
Photon emission for (n,n\*)d

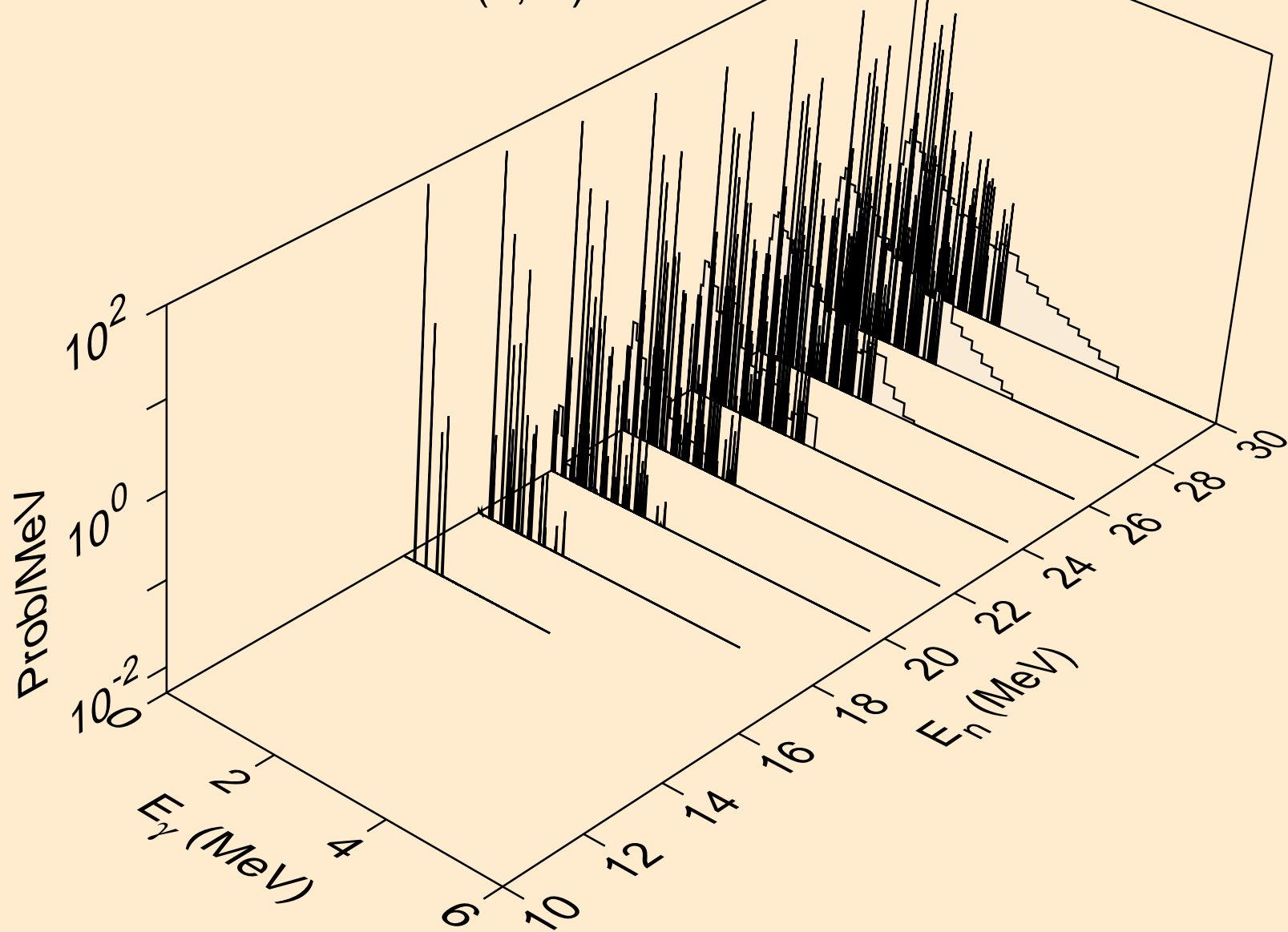

PB207 NEUTRON ACER TENDL-2024 LIBRARY; T=293.6K  
Photon emission for (n,n\*)t

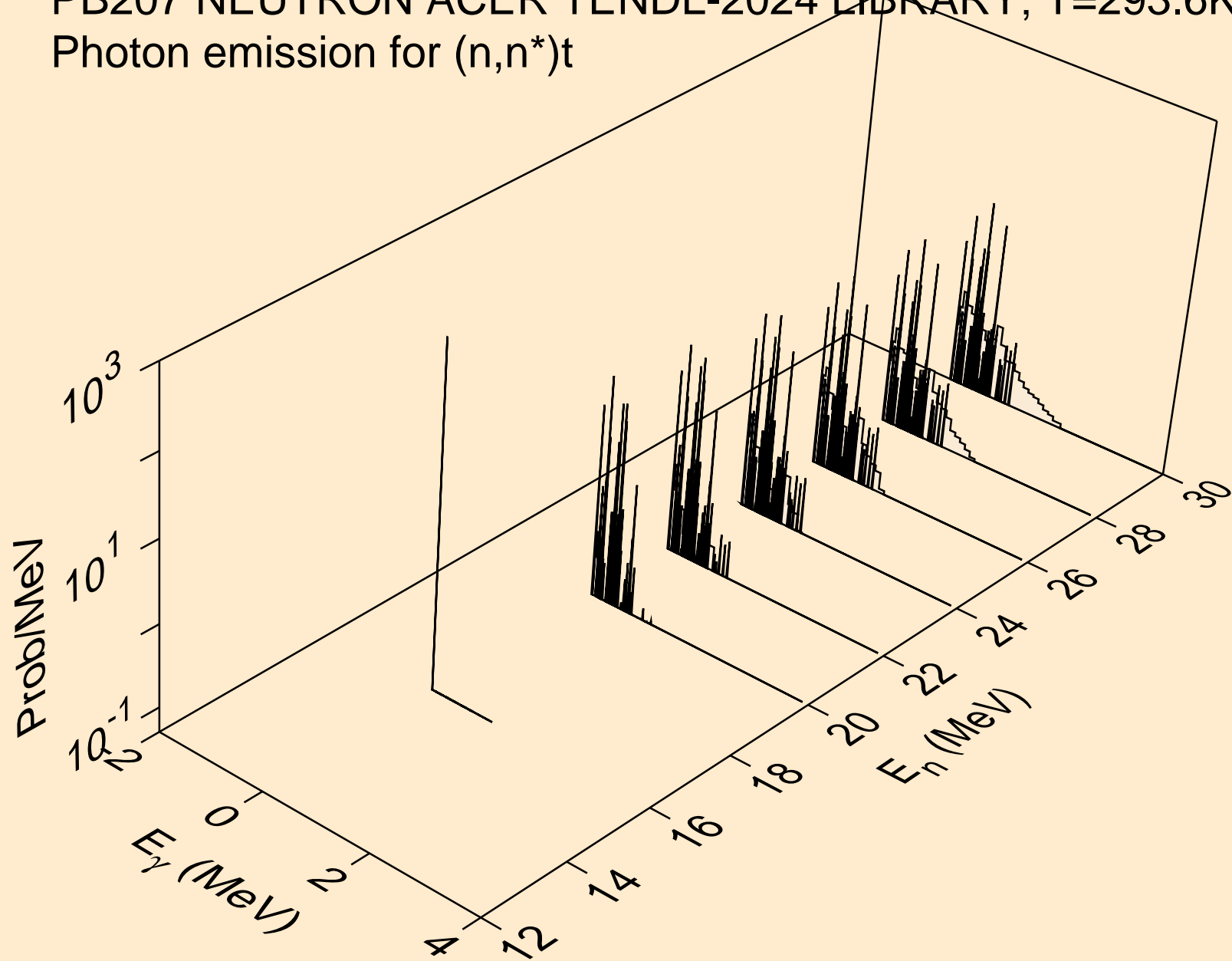

PB207 NEUTRON ACER TENDL-2024 LIBRARY; T=293.6K  
Photon emission for (n,n\*)he3

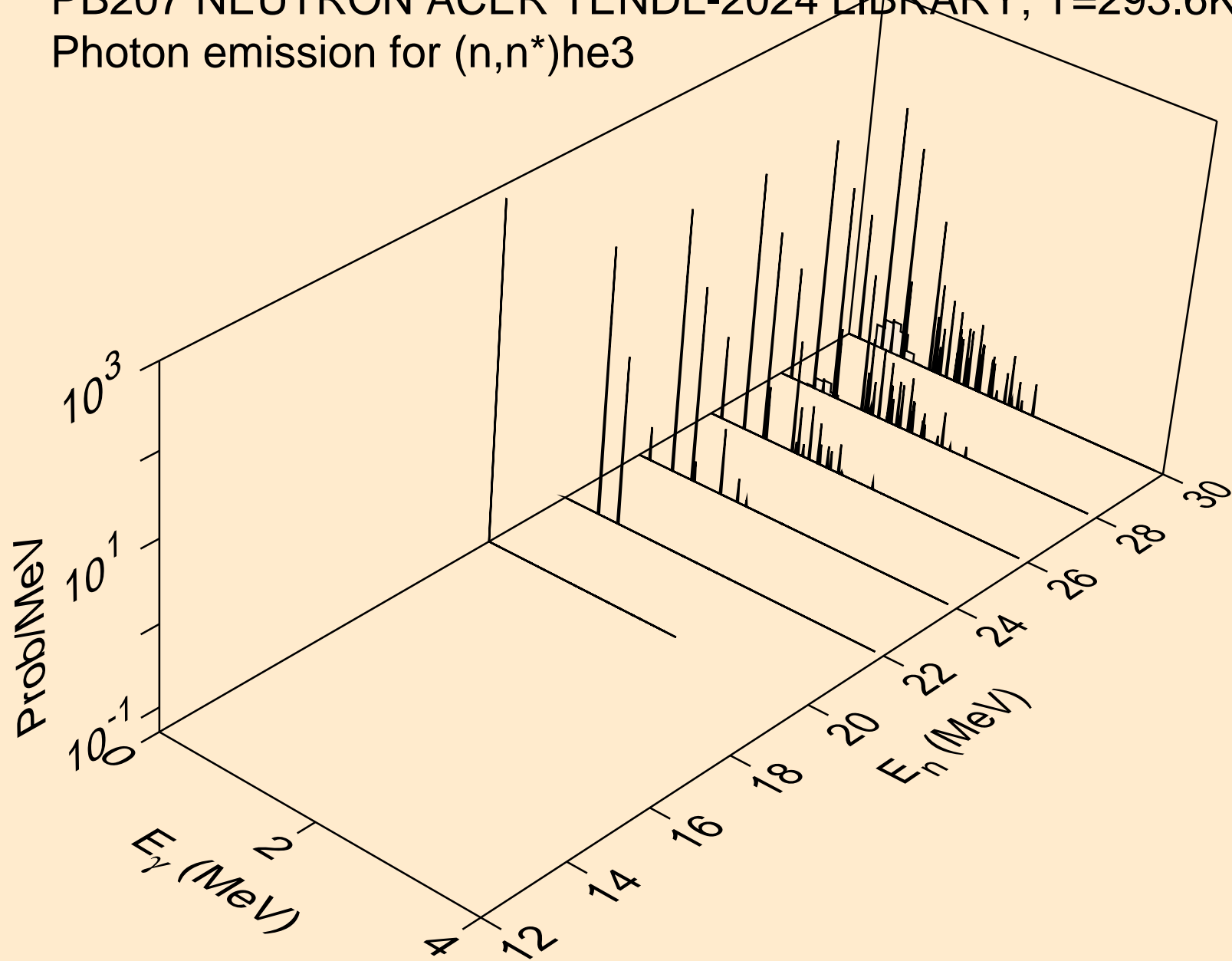

PB207 NEUTRON ACER TENDL-2024 LIBRARY; T=293.6K  
Photon emission for (n,4n)

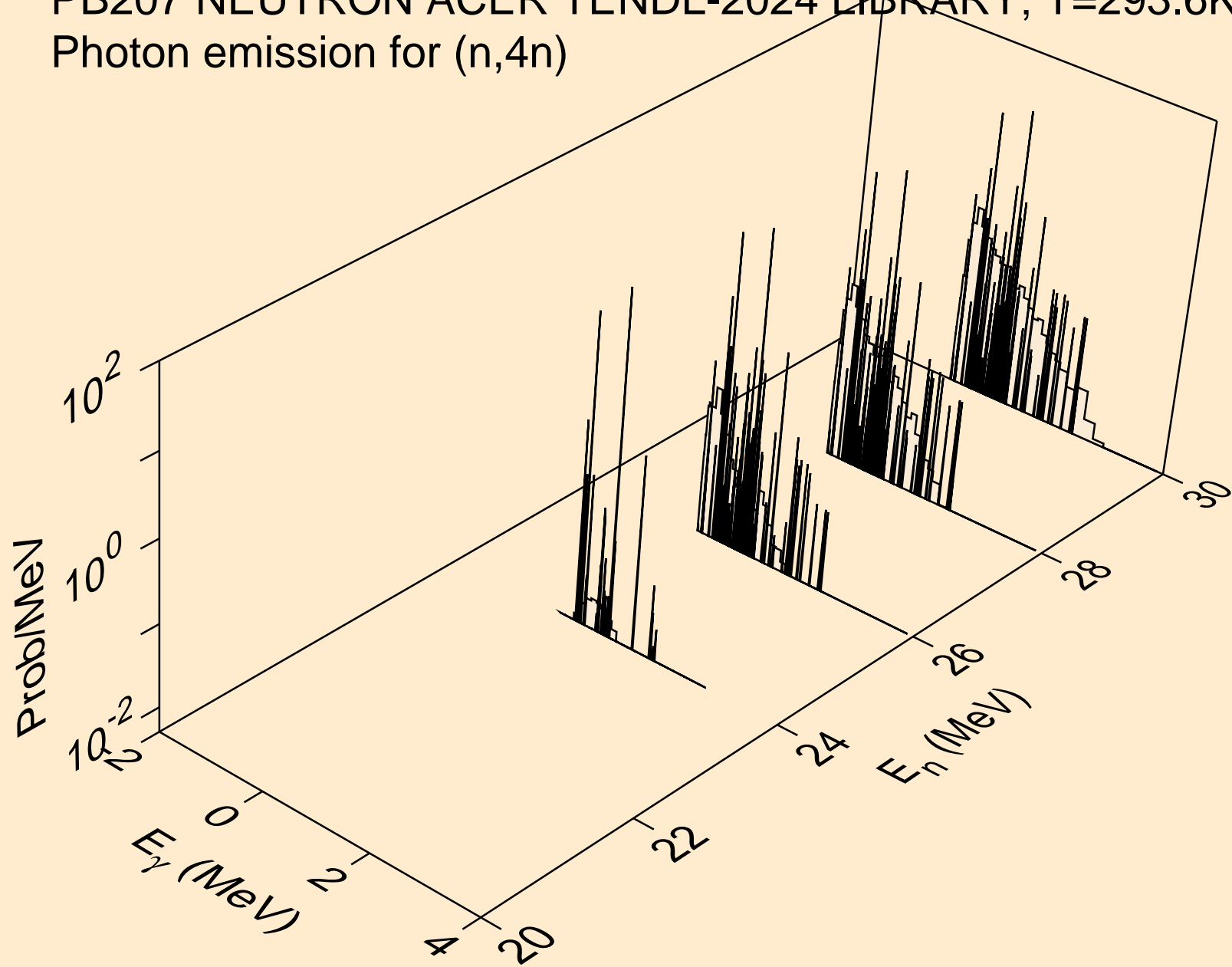

PB207 NEUTRON ACER TENDL-2024 LIBRARY; T=293.6K  
Photon emission for (n,2np)

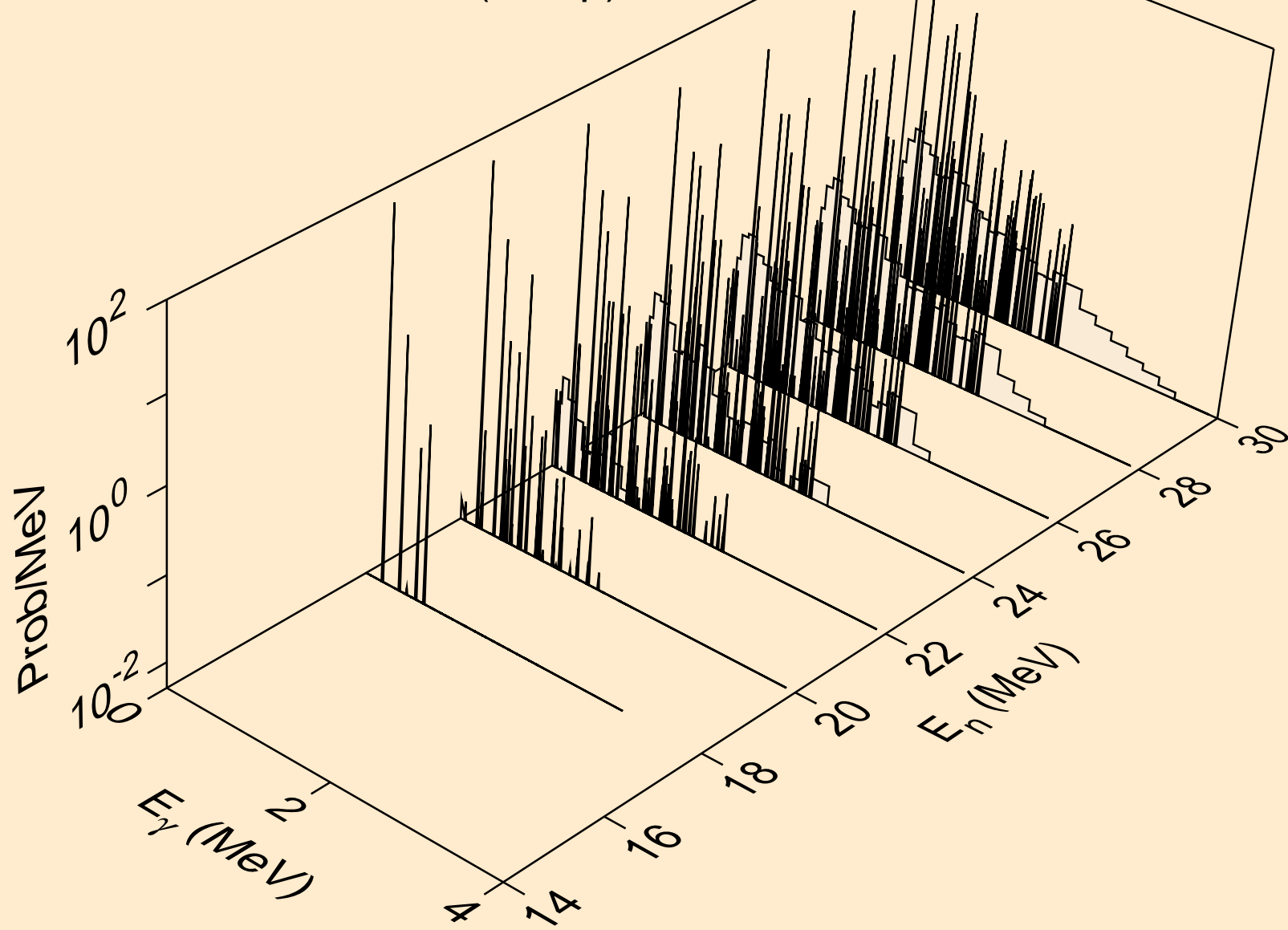

PB207 NEUTRON ACER TENDL-2024 LIBRARY; T=293.6K  
Photon emission for (n,3np)

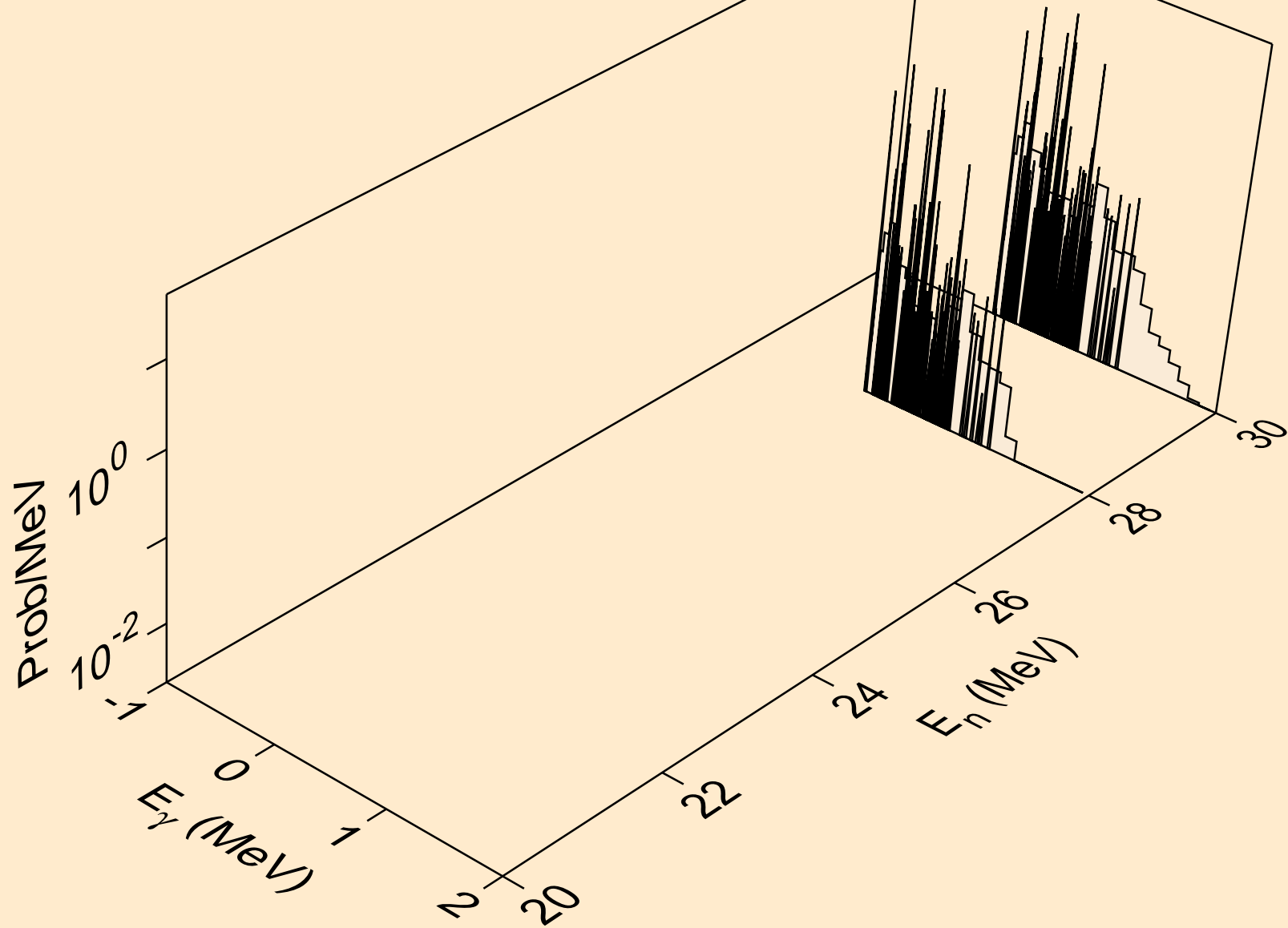

PB207 NEUTRON ACER TENDL-2024 LIBRARY; T=293.6K  
Photon emission for (n,n2p)

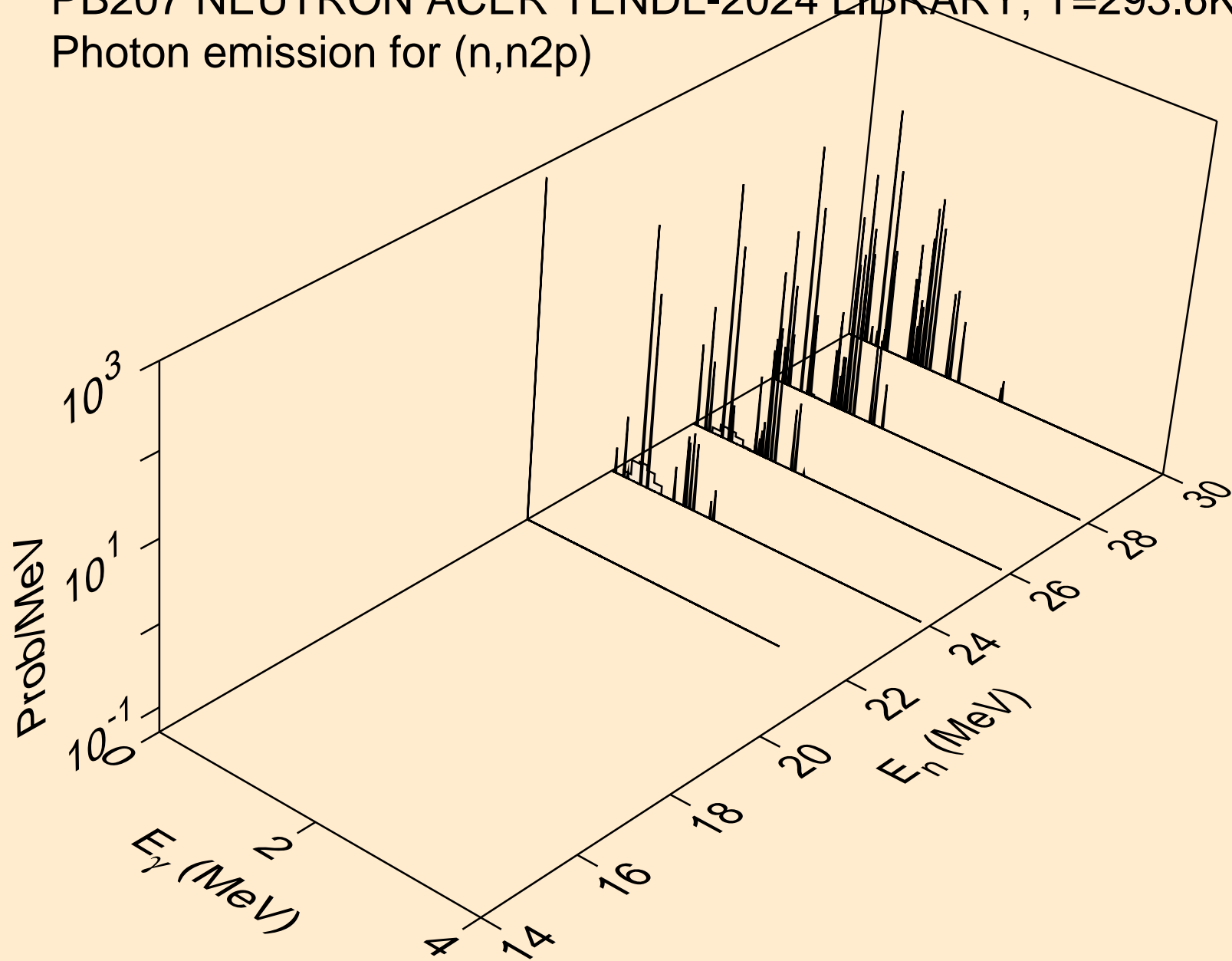

PB207 NEUTRON ACER TENDL-2024 LIBRARY; T=293.6K  
Photon emission for (n,n\*c)

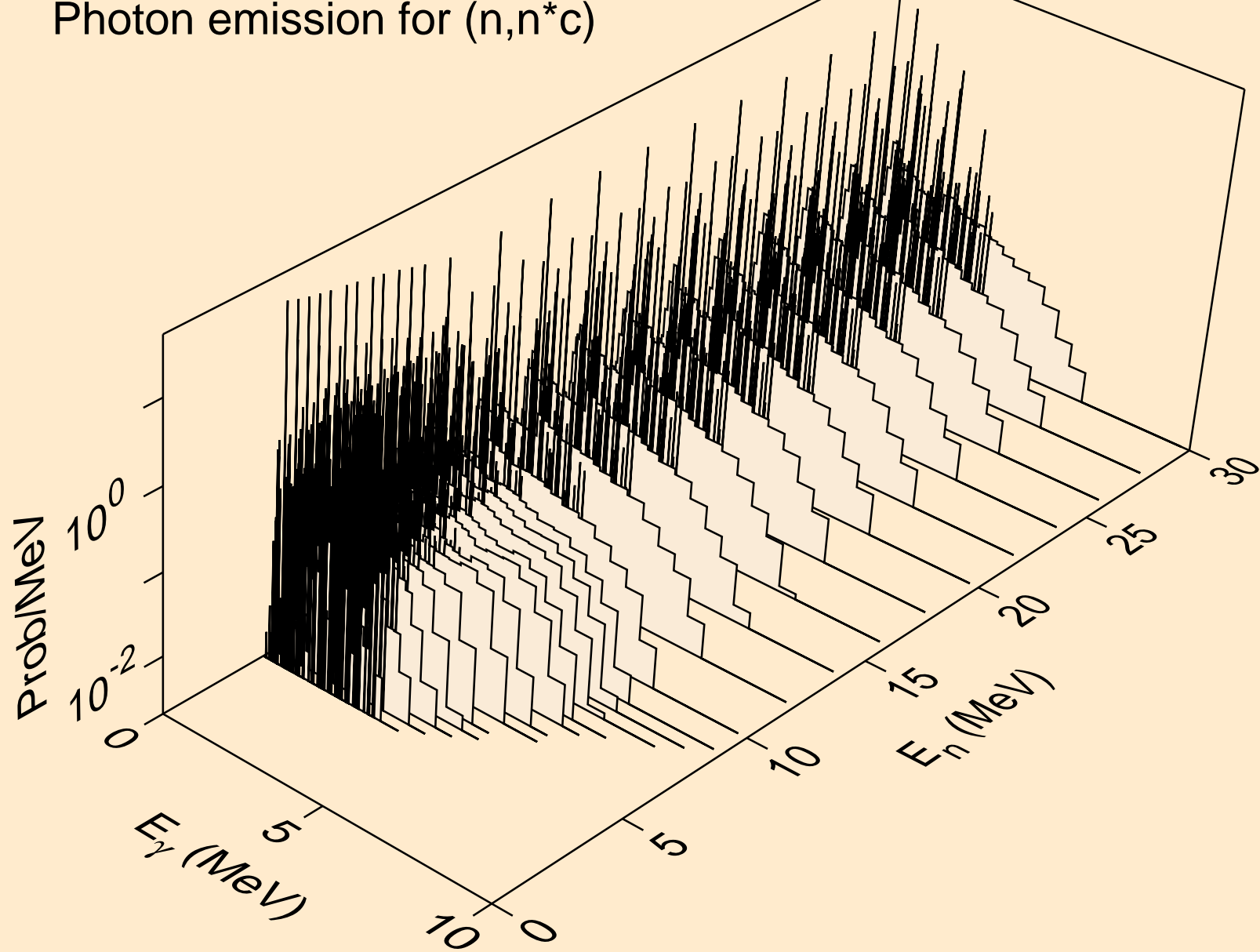

PB207 NEUTRON ACER TENDL-2024 LIBRARY; T=293.6K  
Photon emission for (n,gma)

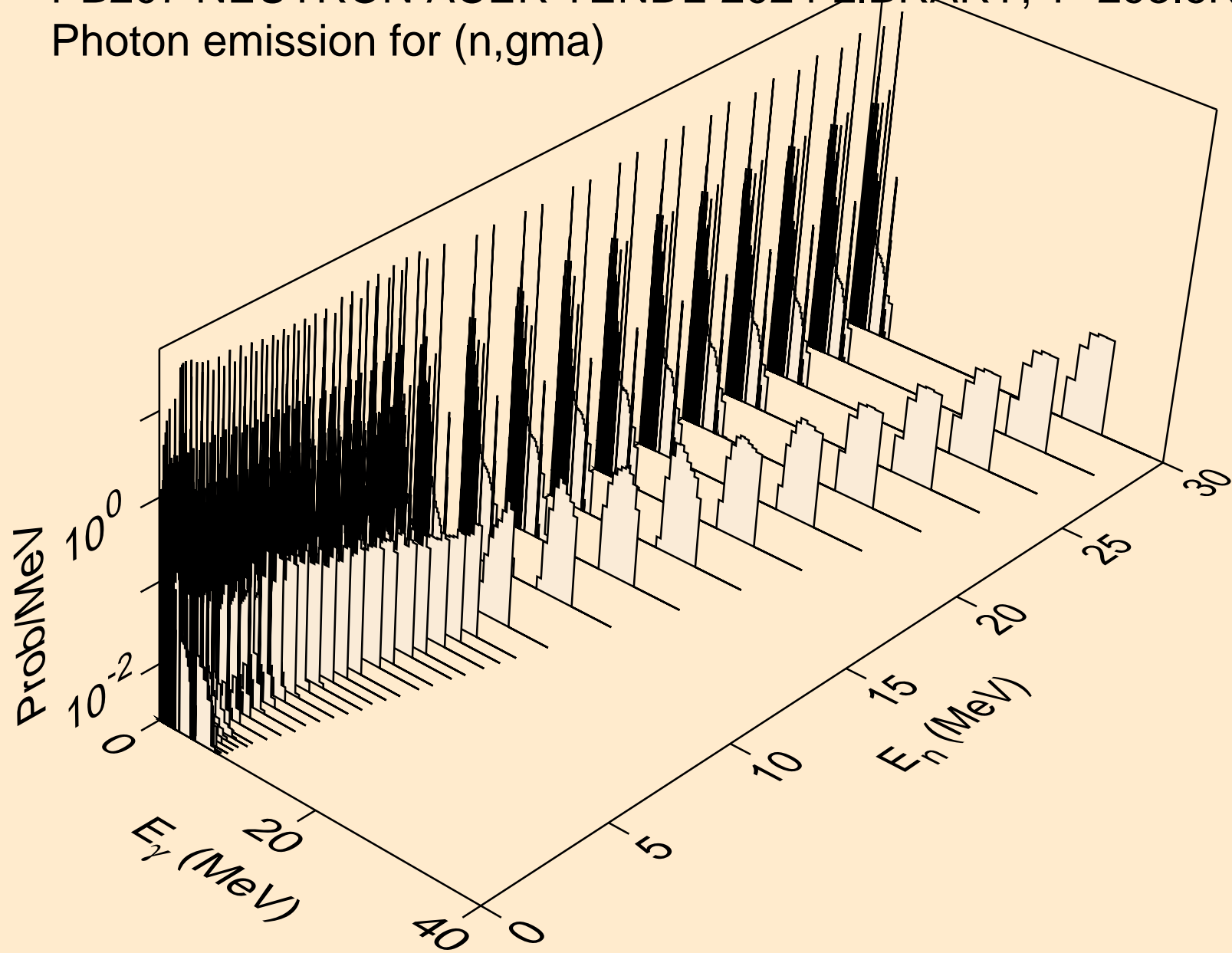

PB207 NEUTRON ACER TENDL-2024 LIBRARY; T=293.6K  
Photon emission for (n,p)

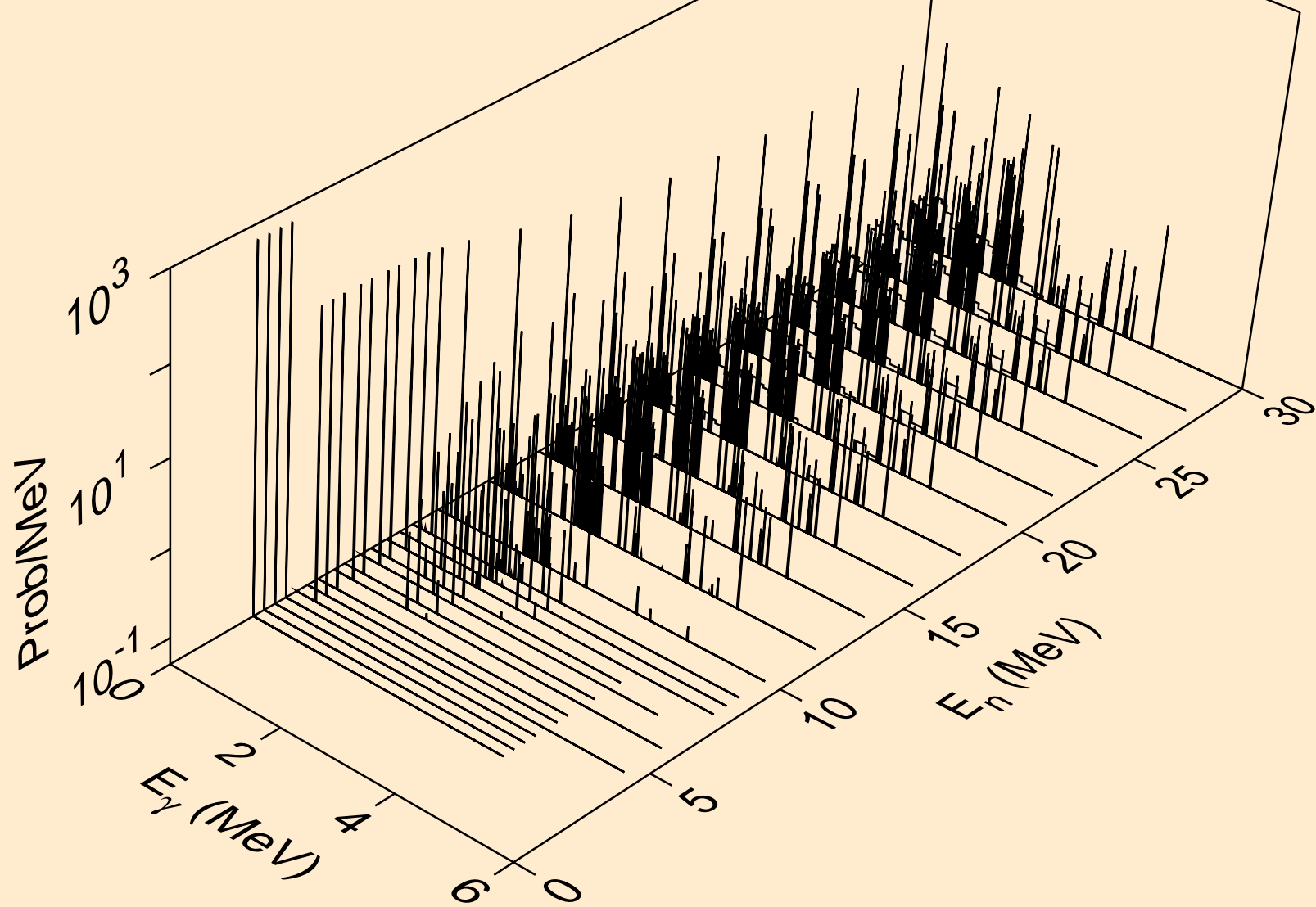

PB207 NEUTRON ACER TENDL-2024 LIBRARY; T=293.6K  
Photon emission for (n,d)

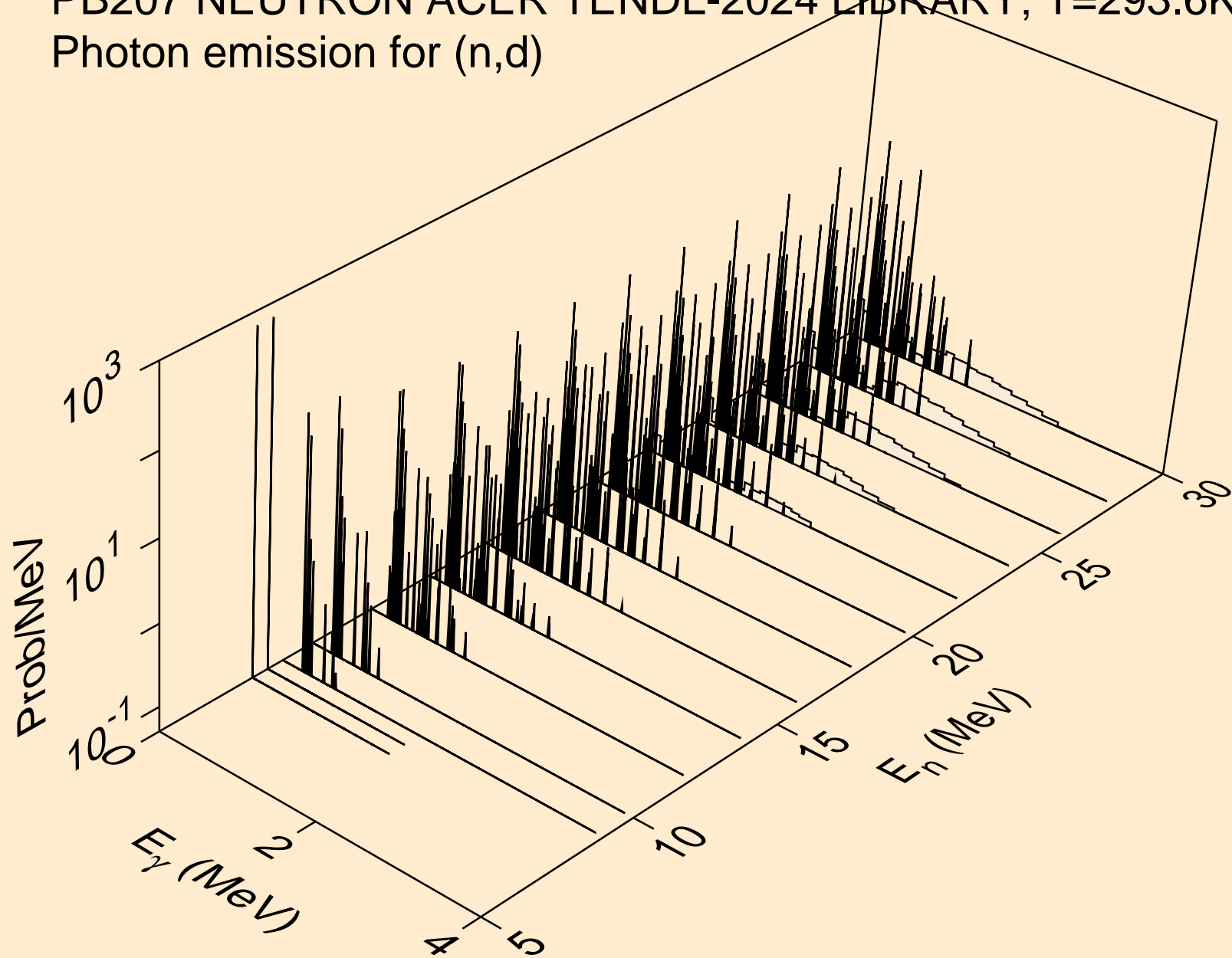

PB207 NEUTRON ACER TENDL-2024 LIBRARY; T=293.6K  
Photon emission for (n,t)

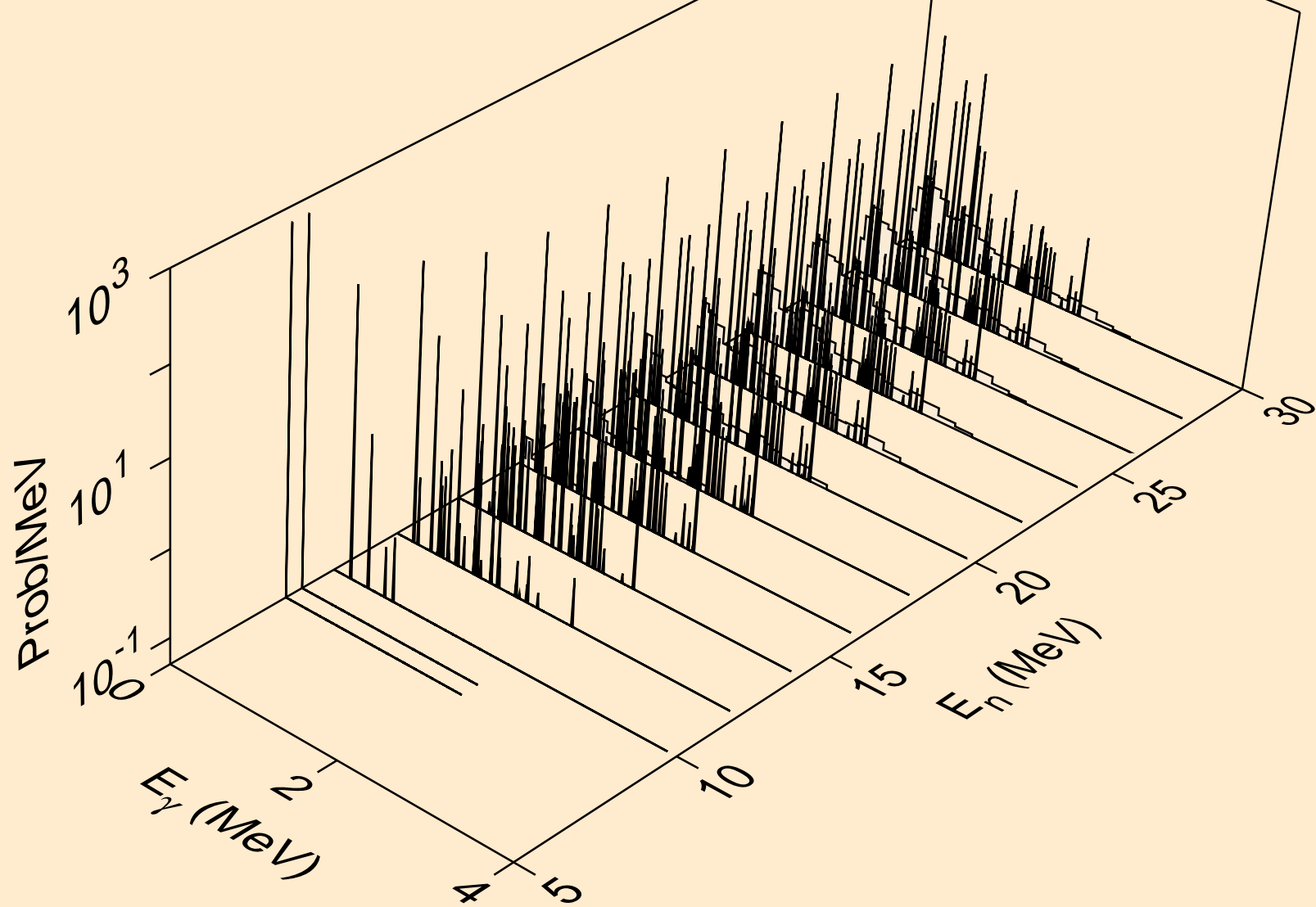

PB207 NEUTRON ACER TENDL-2024 LIBRARY; T=293.6K  
Photon emission for (n,he3)

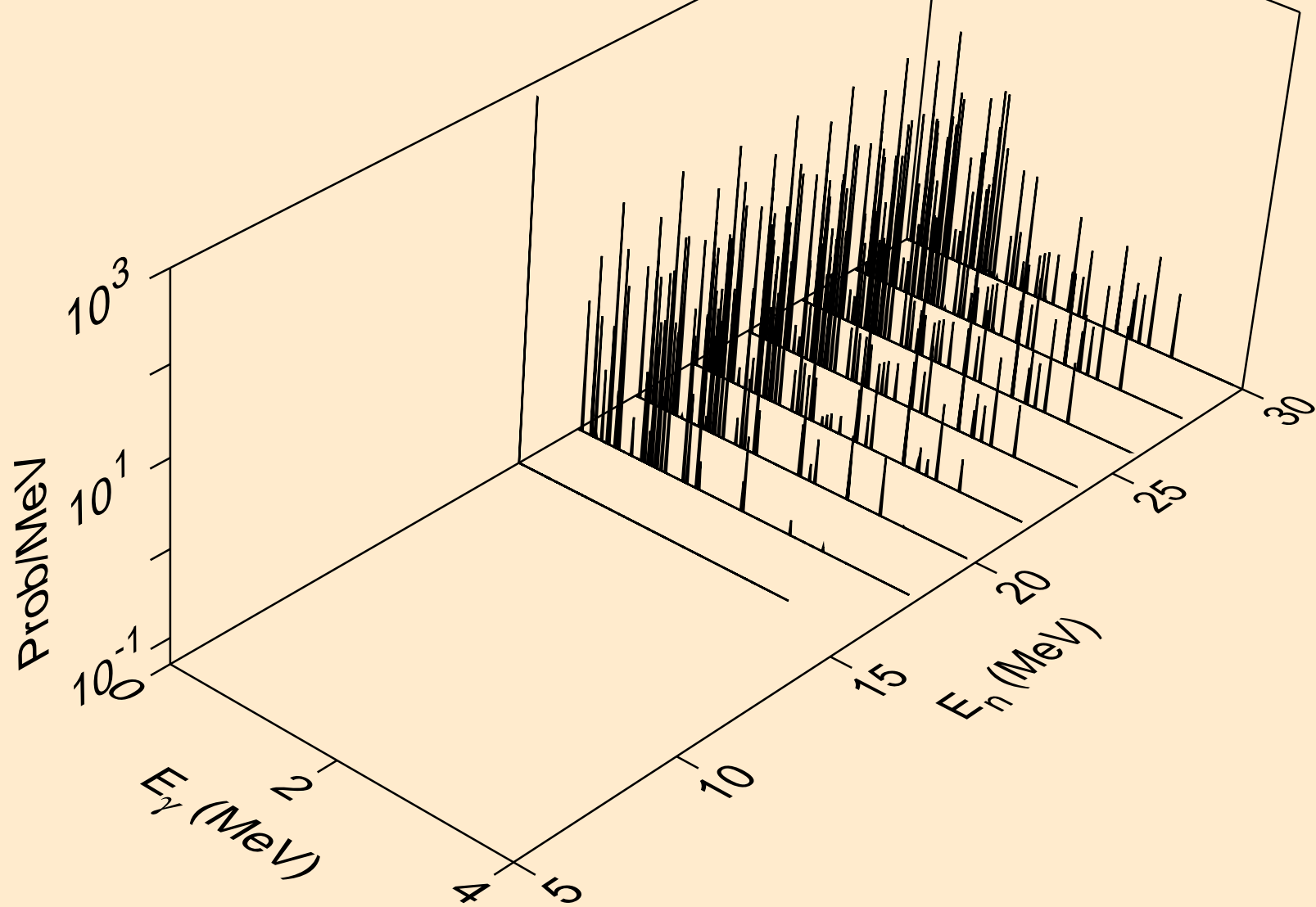

PB207 NEUTRON ACER TENDL-2024 LIBRARY; T=293.6K  
Photon emission for (n,a)

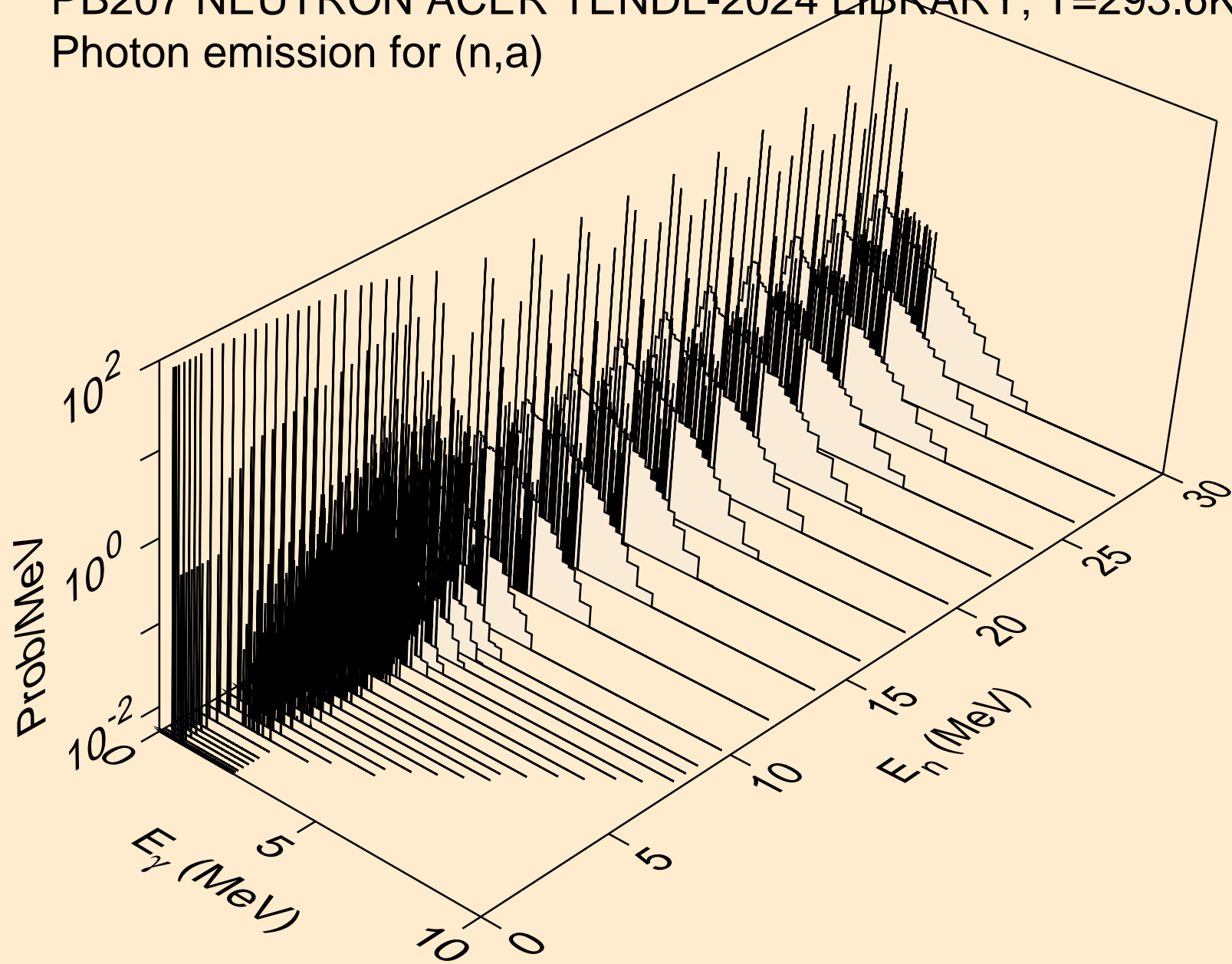

PB207 NEUTRON ACER TENDL-2024 LIBRARY; T=293.6K  
Photon emission for (n,2a)

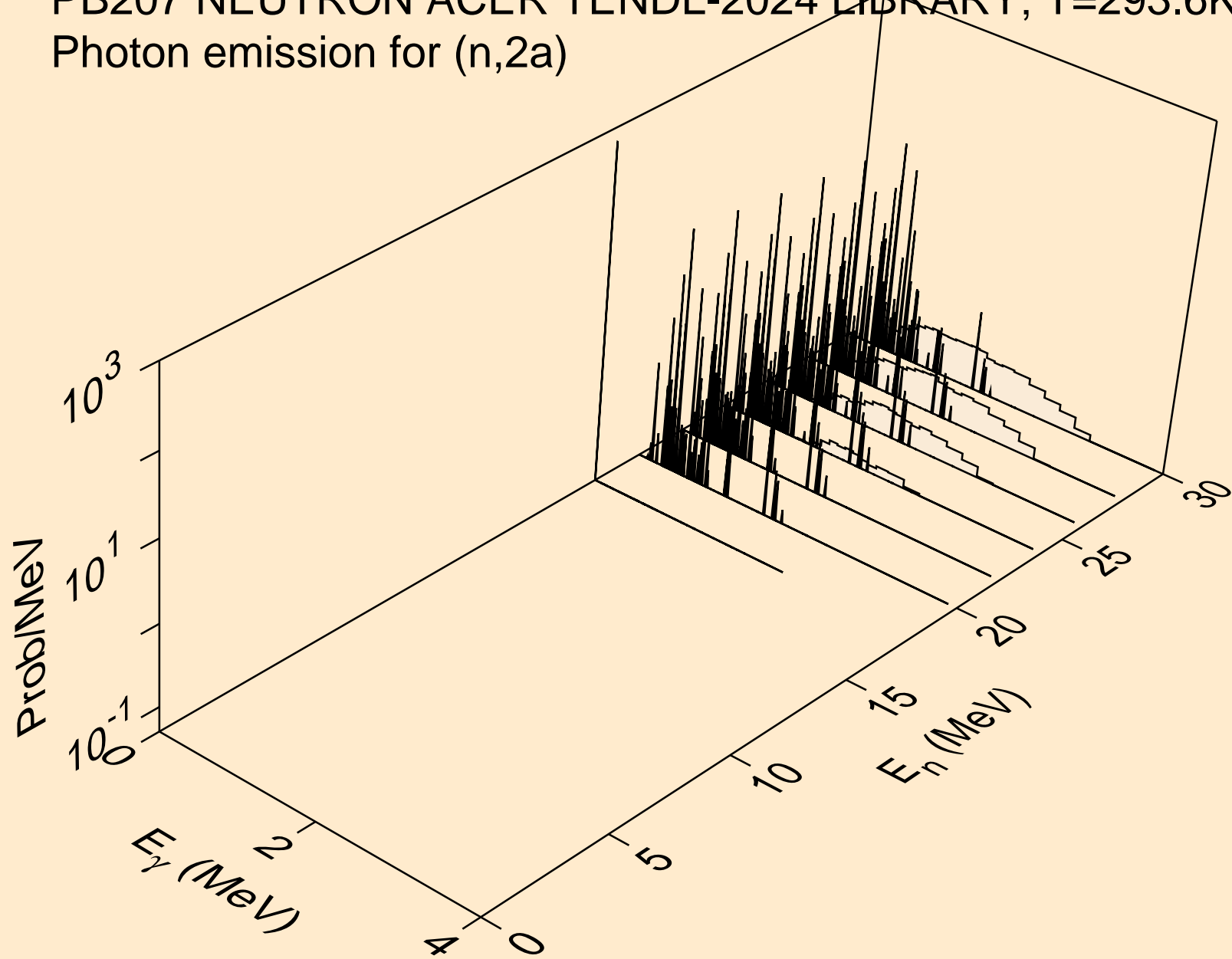

PB207 NEUTRON ACER TENDL-2024 LIBRARY; T=293.6K  
Photon emission for (n,2p)

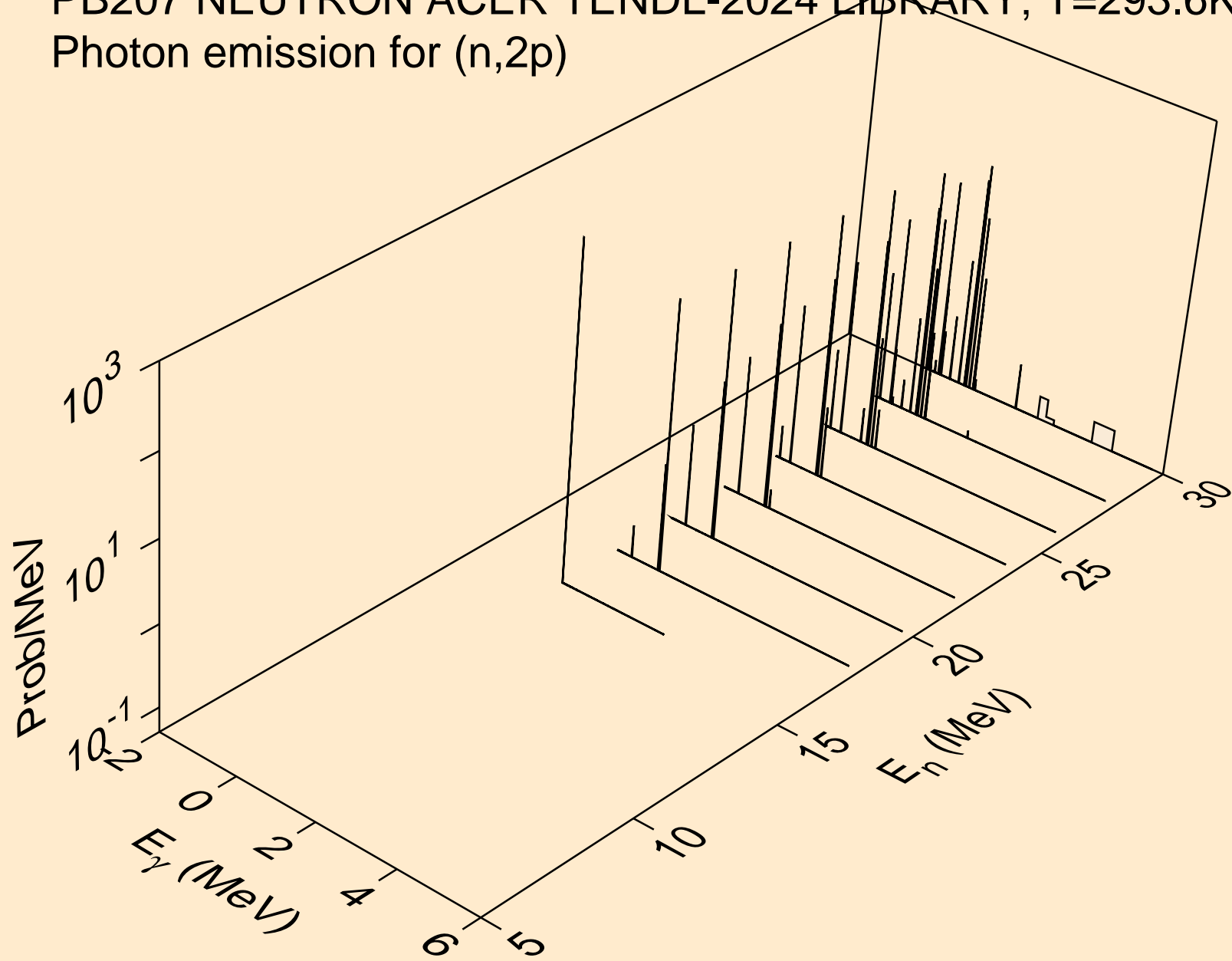

PB207 NEUTRON ACER TENDL-2024 LIBRARY; T=293.6K  
Photon emission for (n,p)

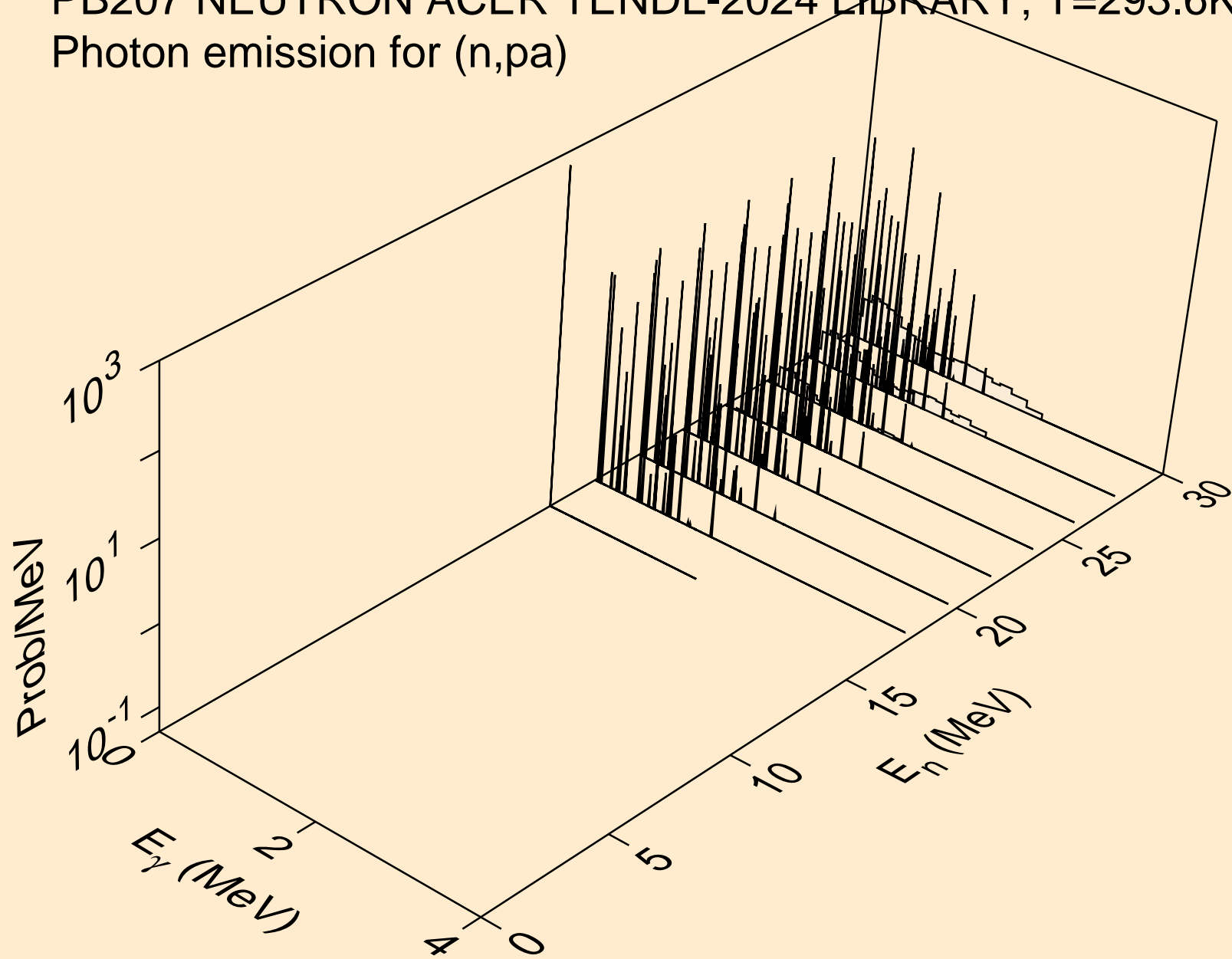

PB207 NEUTRON ACER TENDL-2024 LIBRARY; T=293.6K  
thermal capture photon spectrum

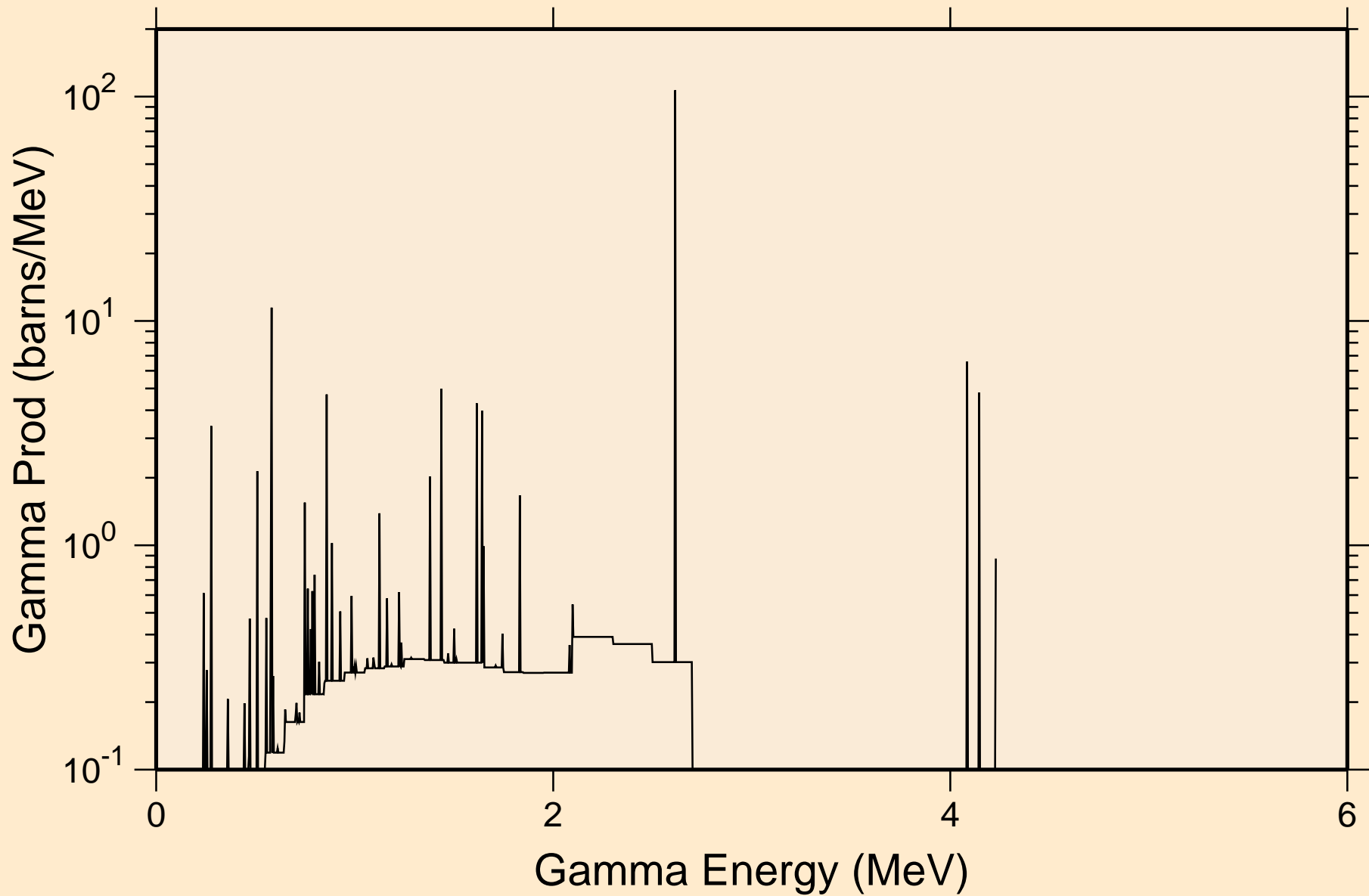

PB207 NEUTRON ACER TENDL-2024 LIBRARY; T=293.6K  
14 MeV photon spectrum

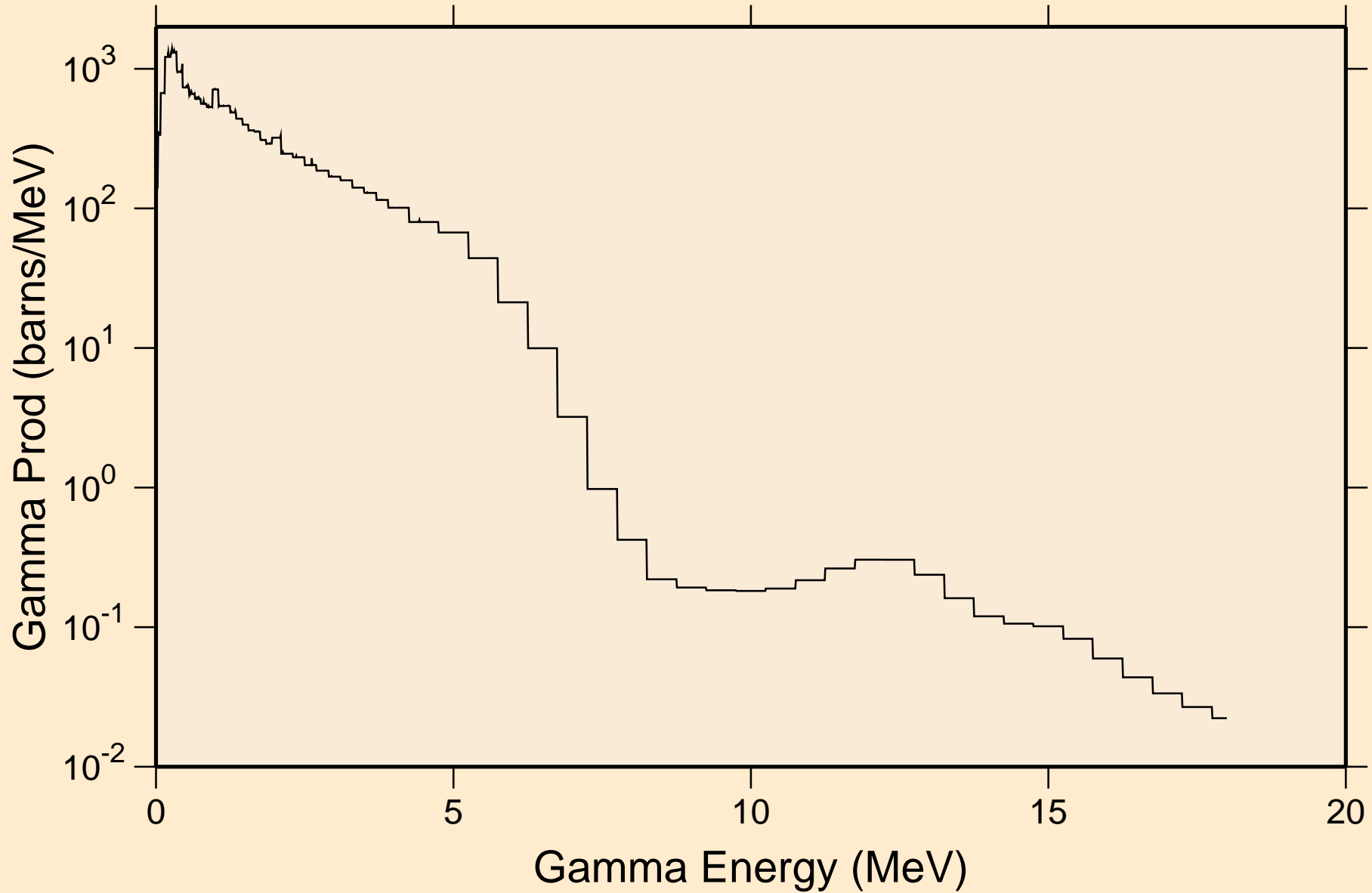

PB207 NEUTRON ACER TENDL-2024 LIBRARY; T=293.6K  
Particle heating contributions

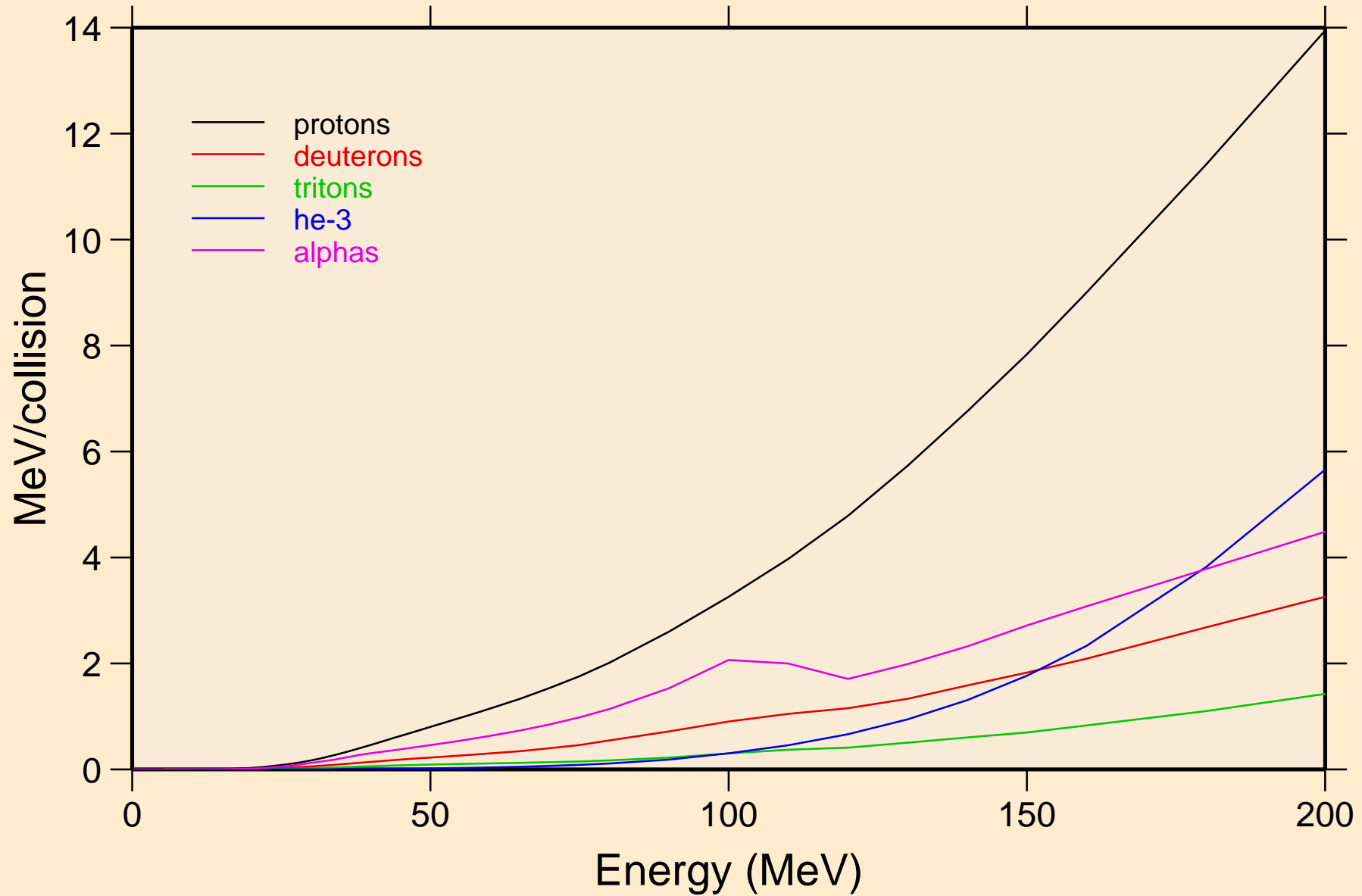

PB207 NEUTRON ACER TENDL-2024 LIBRARY; T=293.6K  
Recoil Heating

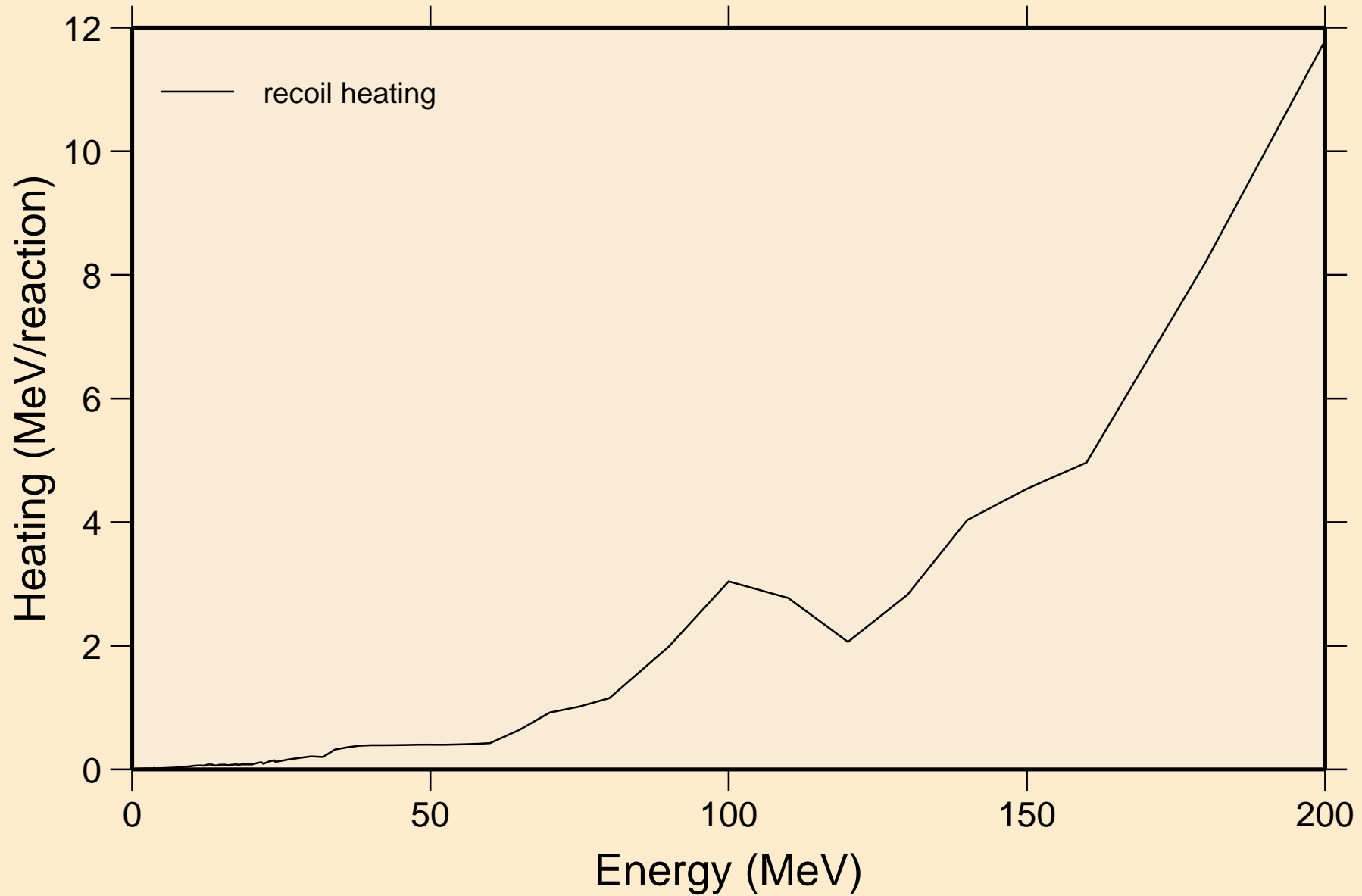

PB207 NEUTRON ACER TENDL-2024 LIBRARY; T=293.6K  
Particle production cross sections

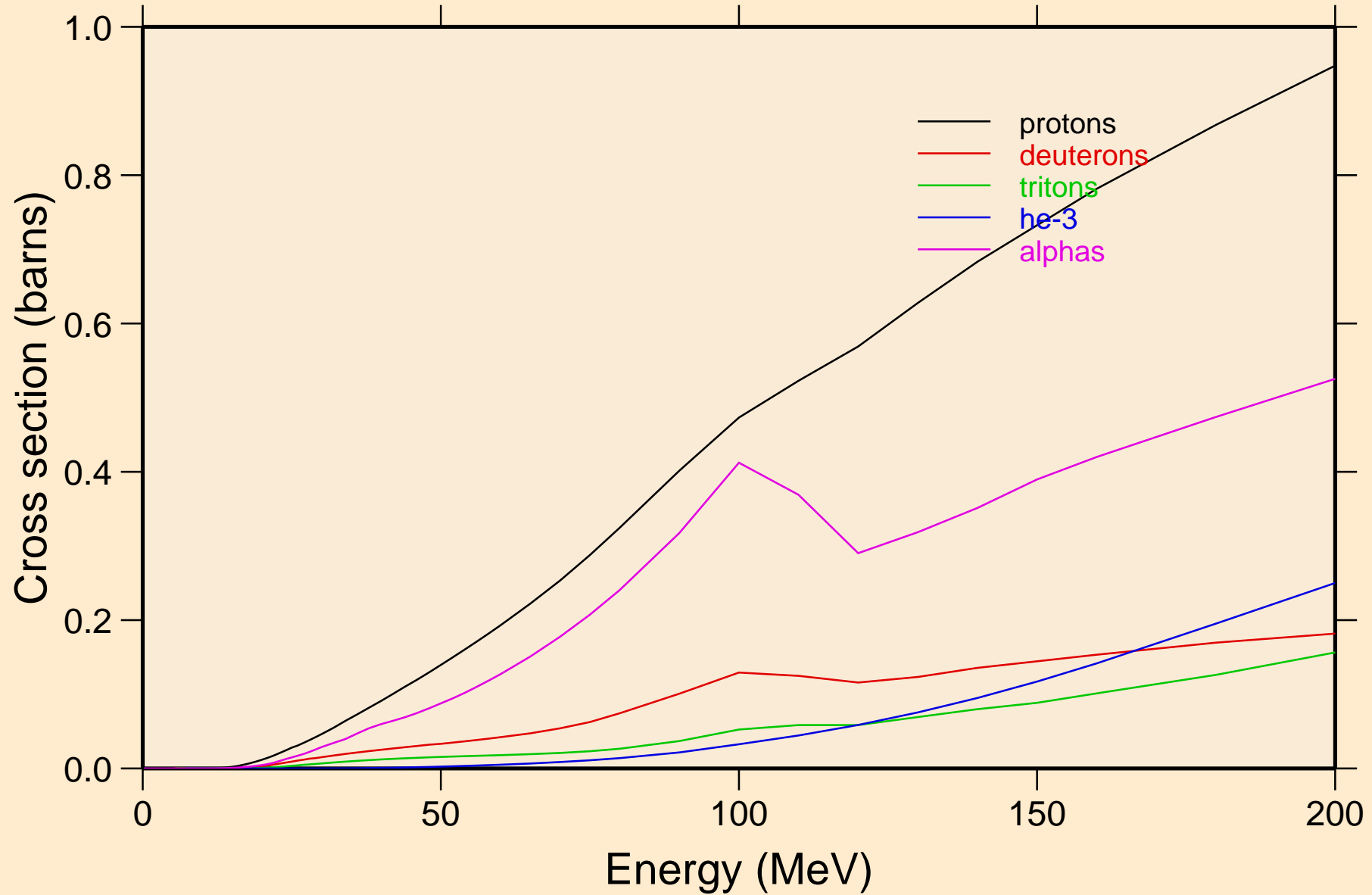

PB207 NEUTRON ACER TENDL-2024 LIBRARY; T=293.6K  
protons from (n,x)

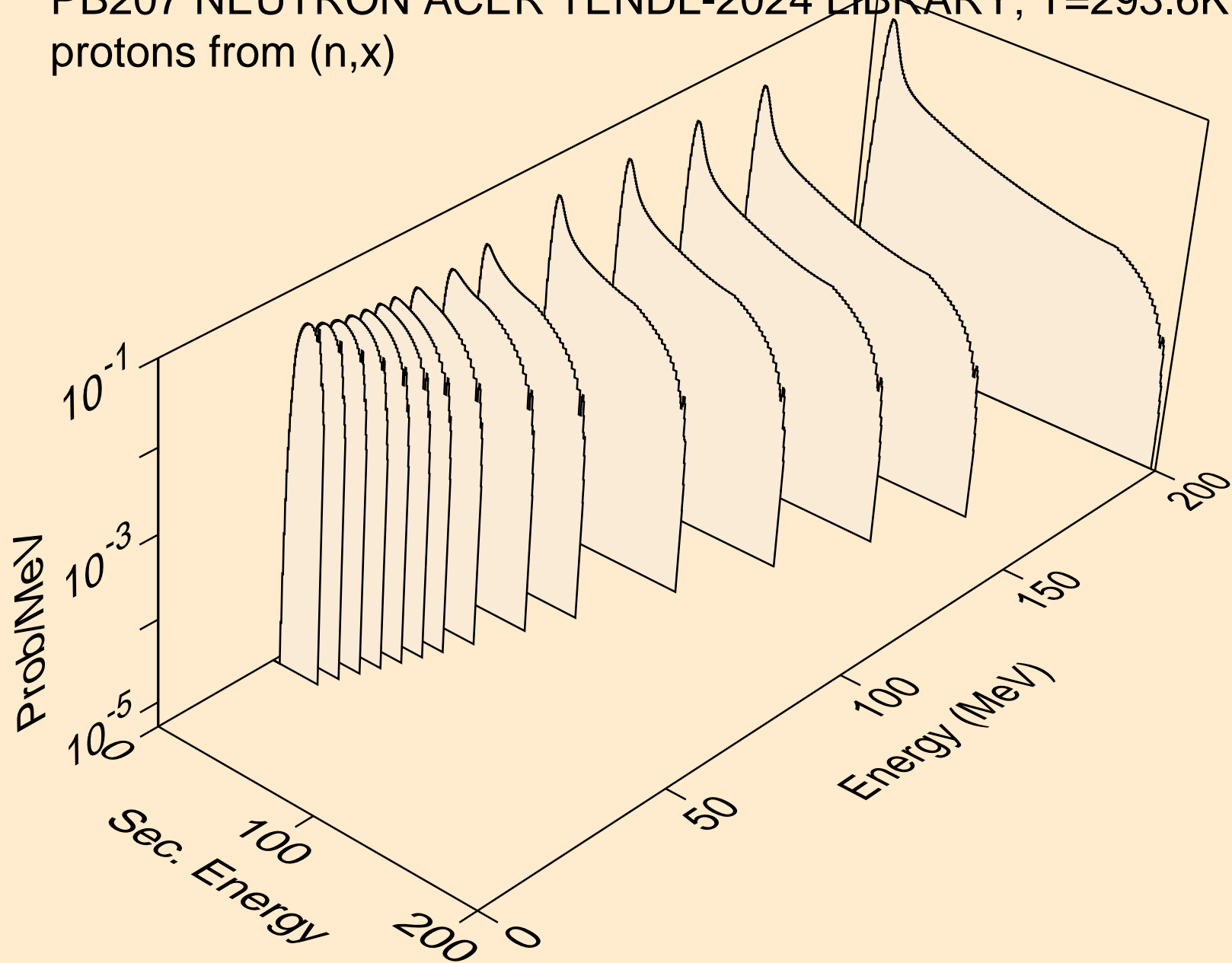

PB207 NEUTRON ACER TENDL-2024 LIBRARY; T=293.6K  
protons from (n,n\*)p

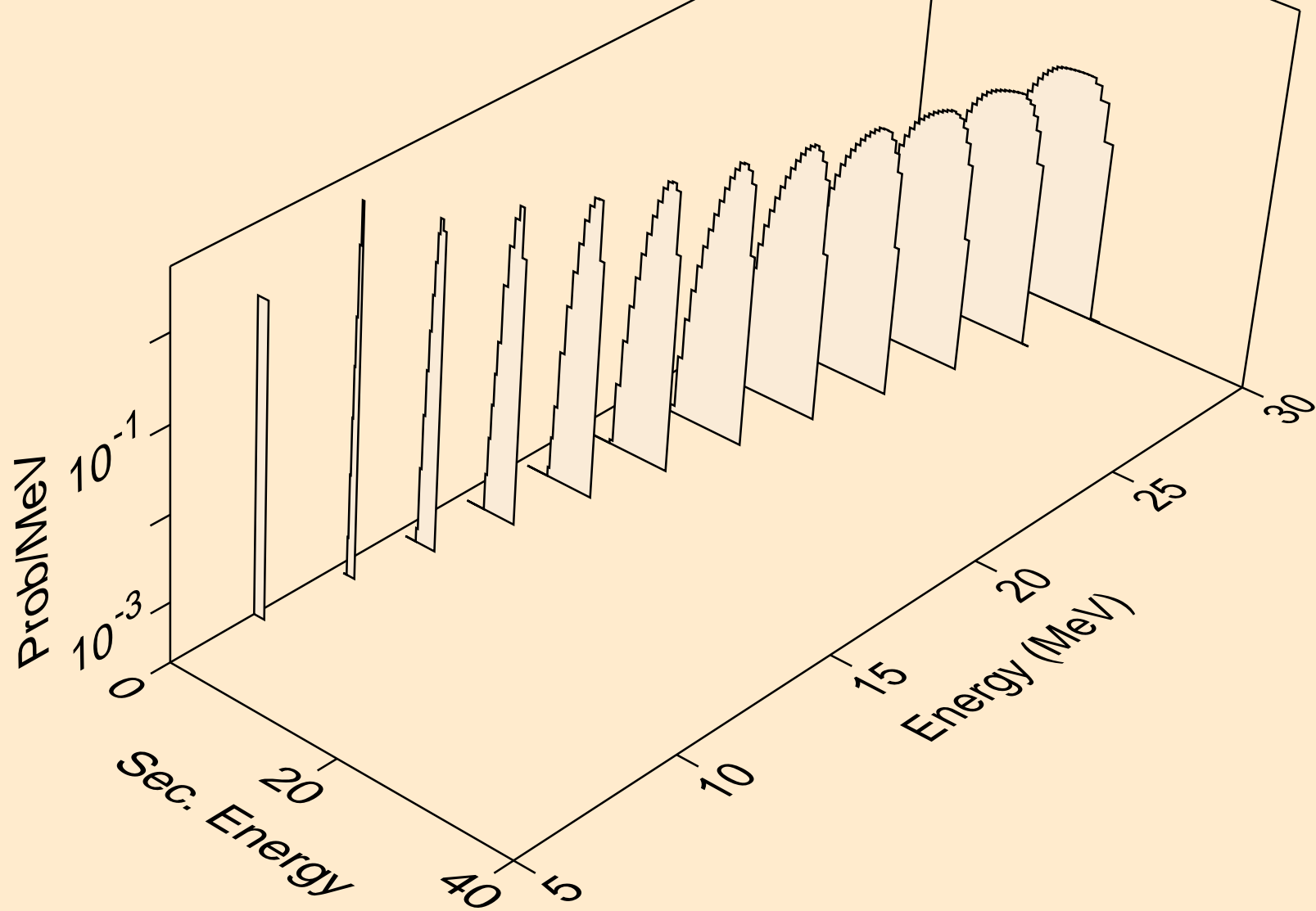

PB207 NEUTRON ACER TENDL-2024 LIBRARY; T=293.6K  
protons from (n,2np)

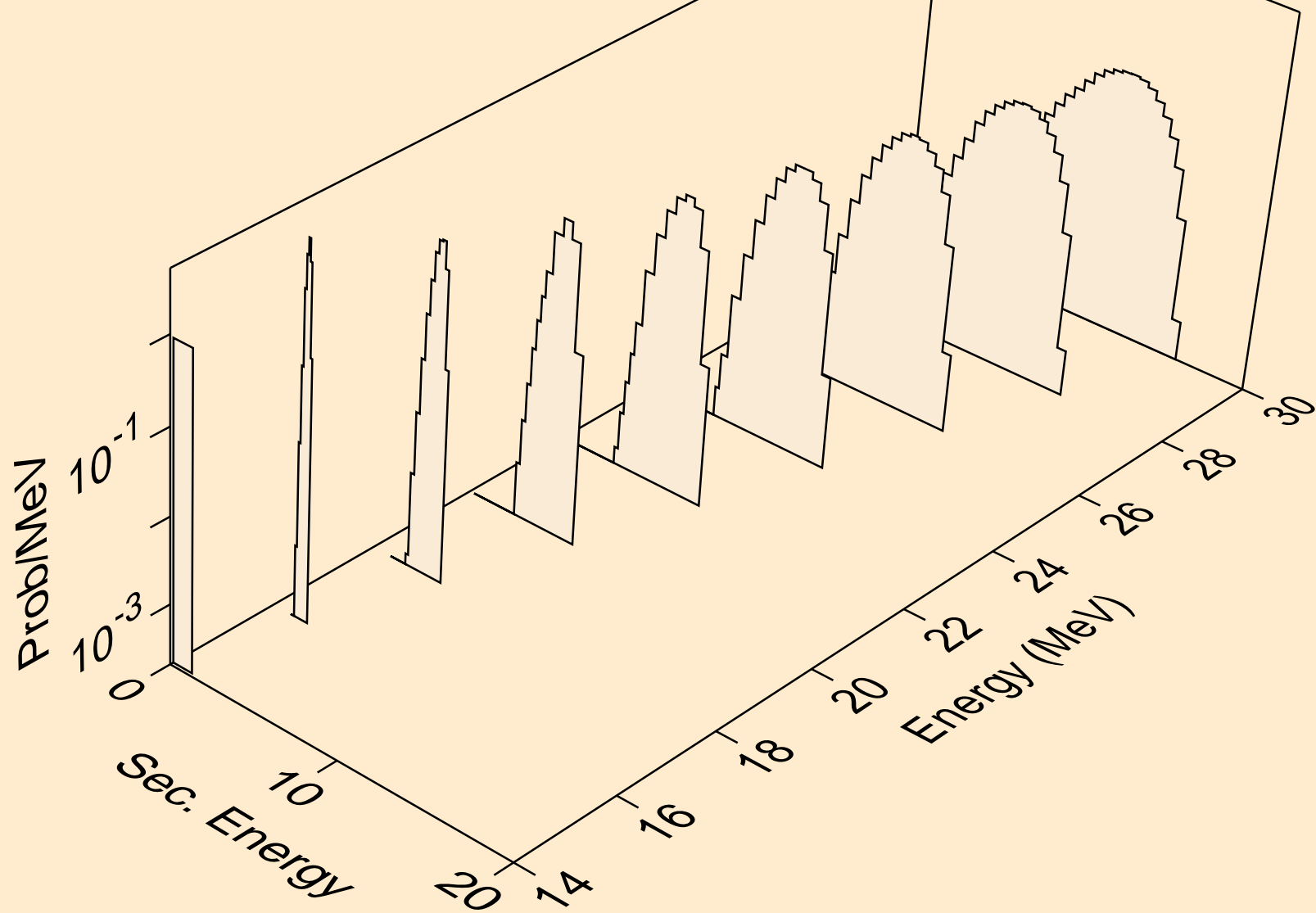

PB207 NEUTRON ACER TENDL-2024 LIBRARY; T=293.6K  
protons from (n,3np)

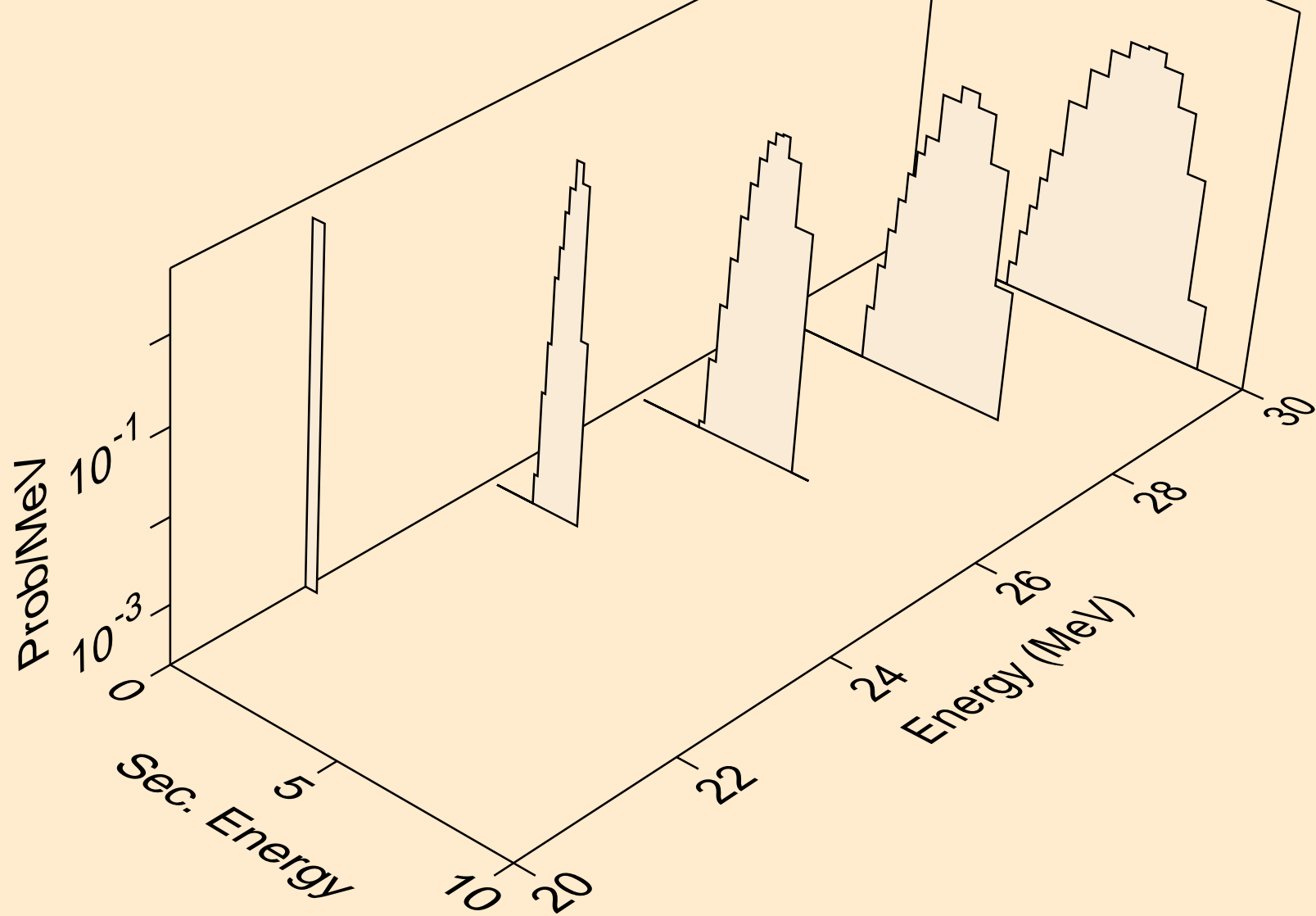

PB207 NEUTRON ACER TENDL-2024 LIBRARY; T=293.6K  
protons from (n,n2p)

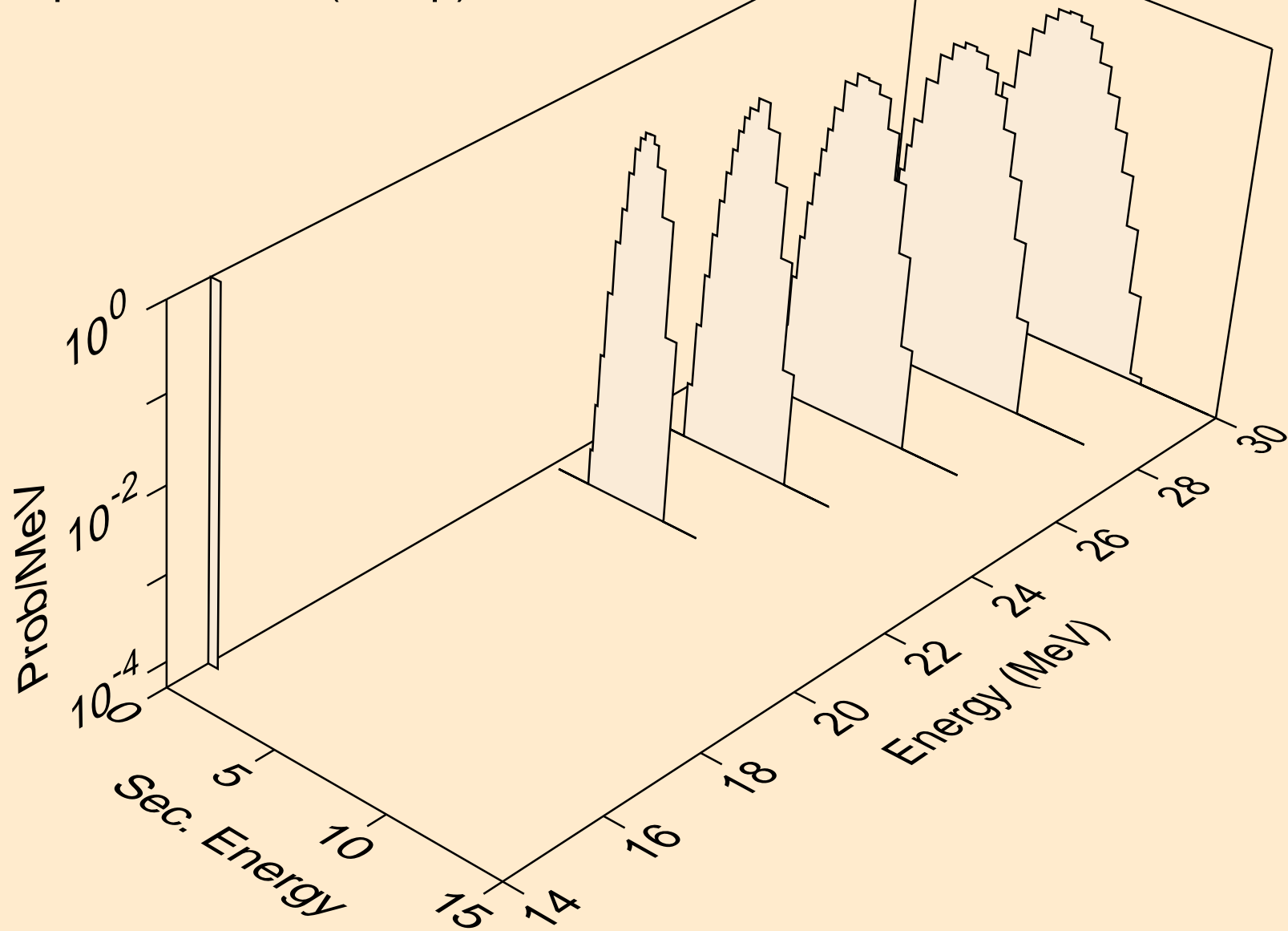

PB207 NEUTRON ACER TENDL-2024 LIBRARY; T=293.6K  
protons from (n,p)

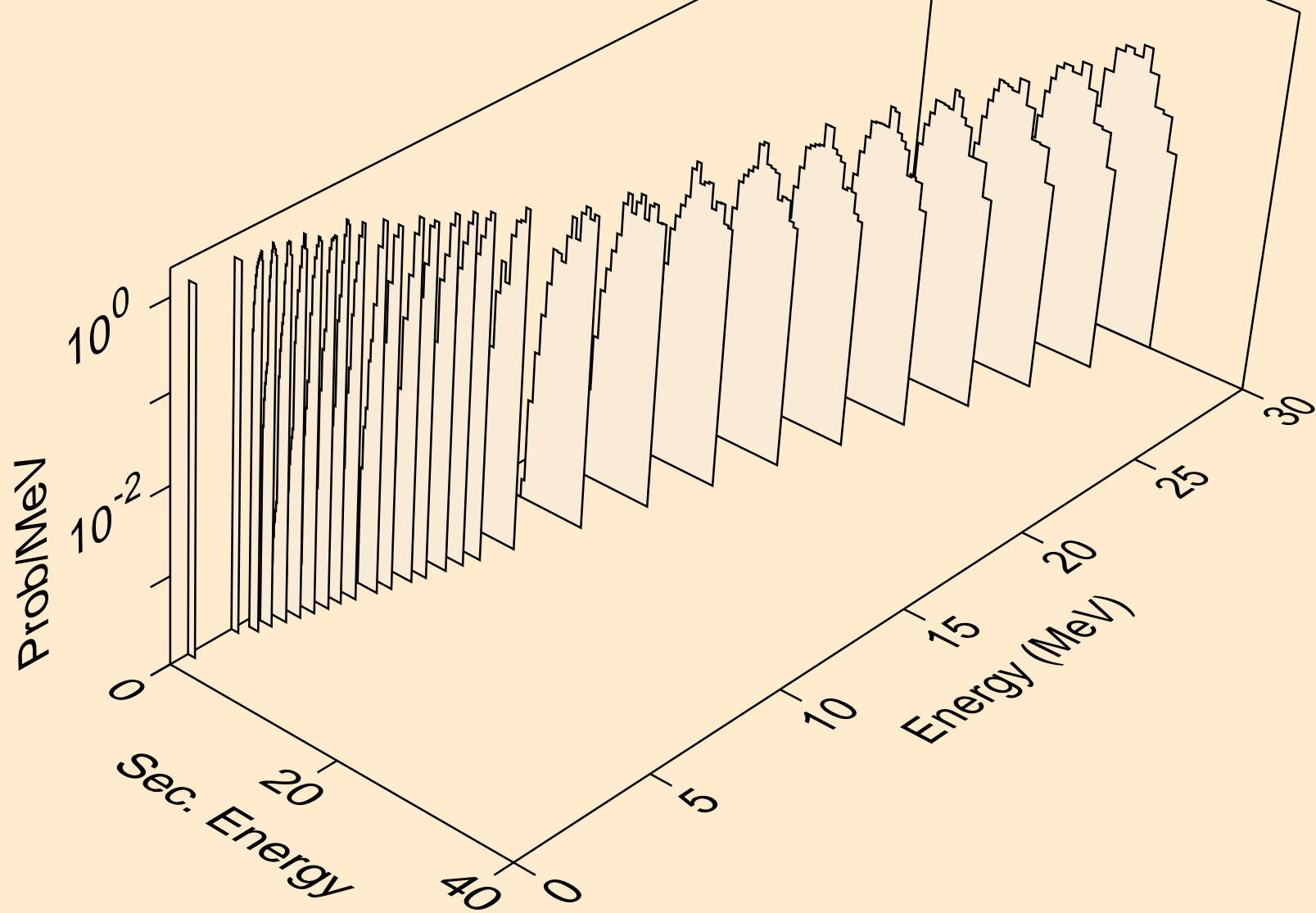

PB207 NEUTRON ACER TENDL-2024 LIBRARY; T=293.6K  
protons from (n,2p)

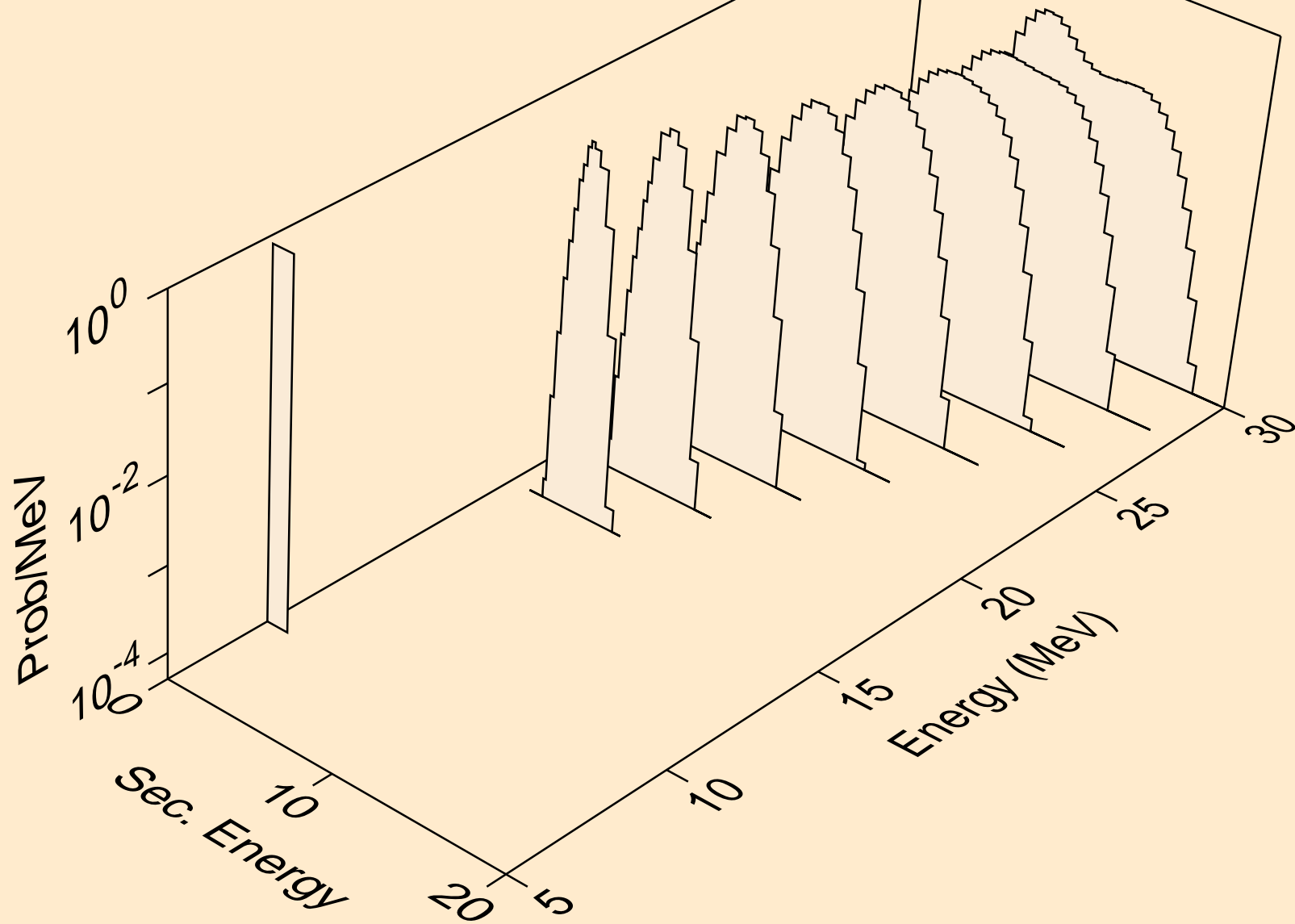

PB207 NEUTRON ACER TENDL-2024 LIBRARY; T=293.6K  
protons from (n,p)

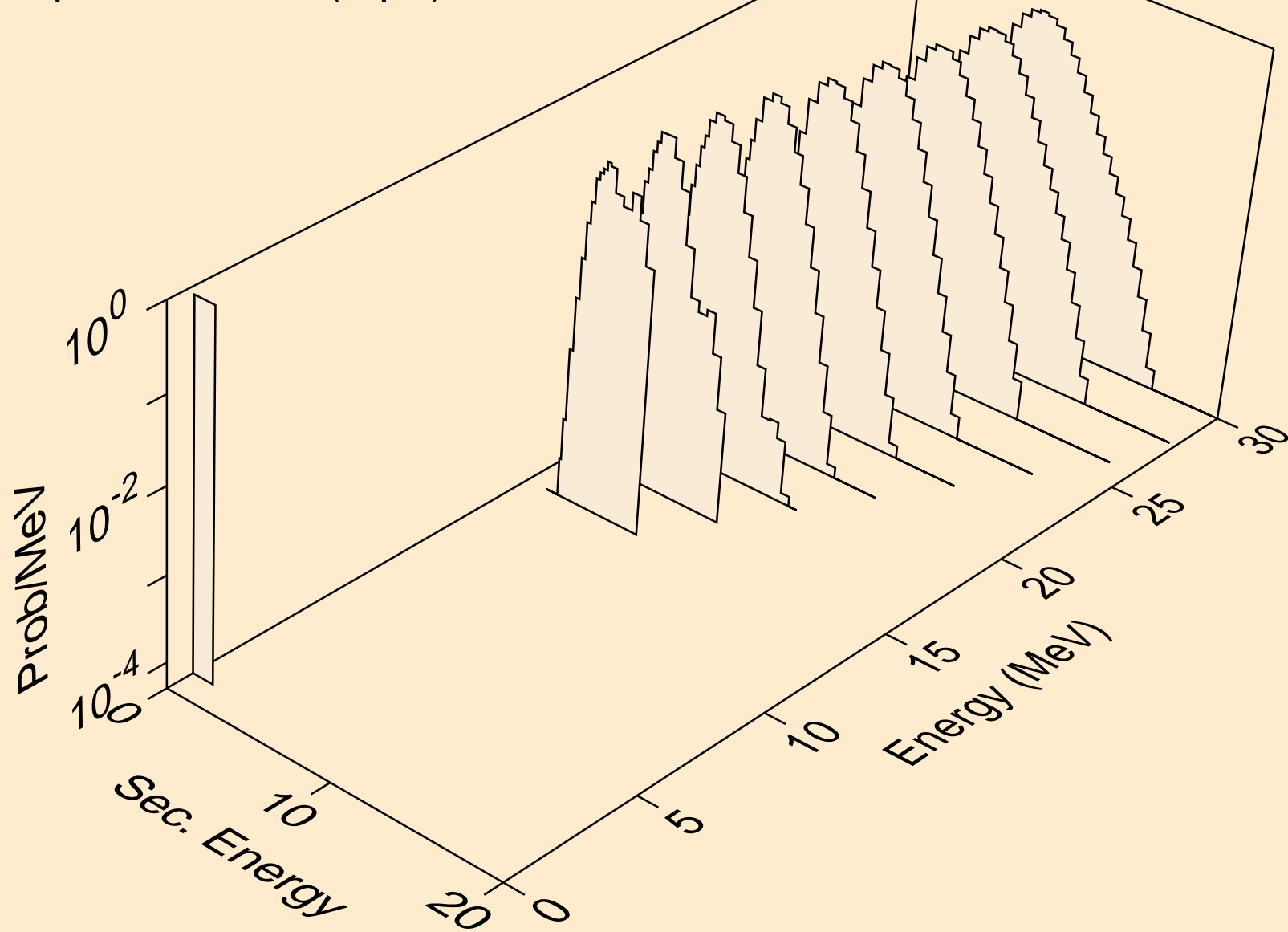

PB207 NEUTRON ACER TENDL-2024 LIBRARY; T=293.6K  
deuterons from (n,x)

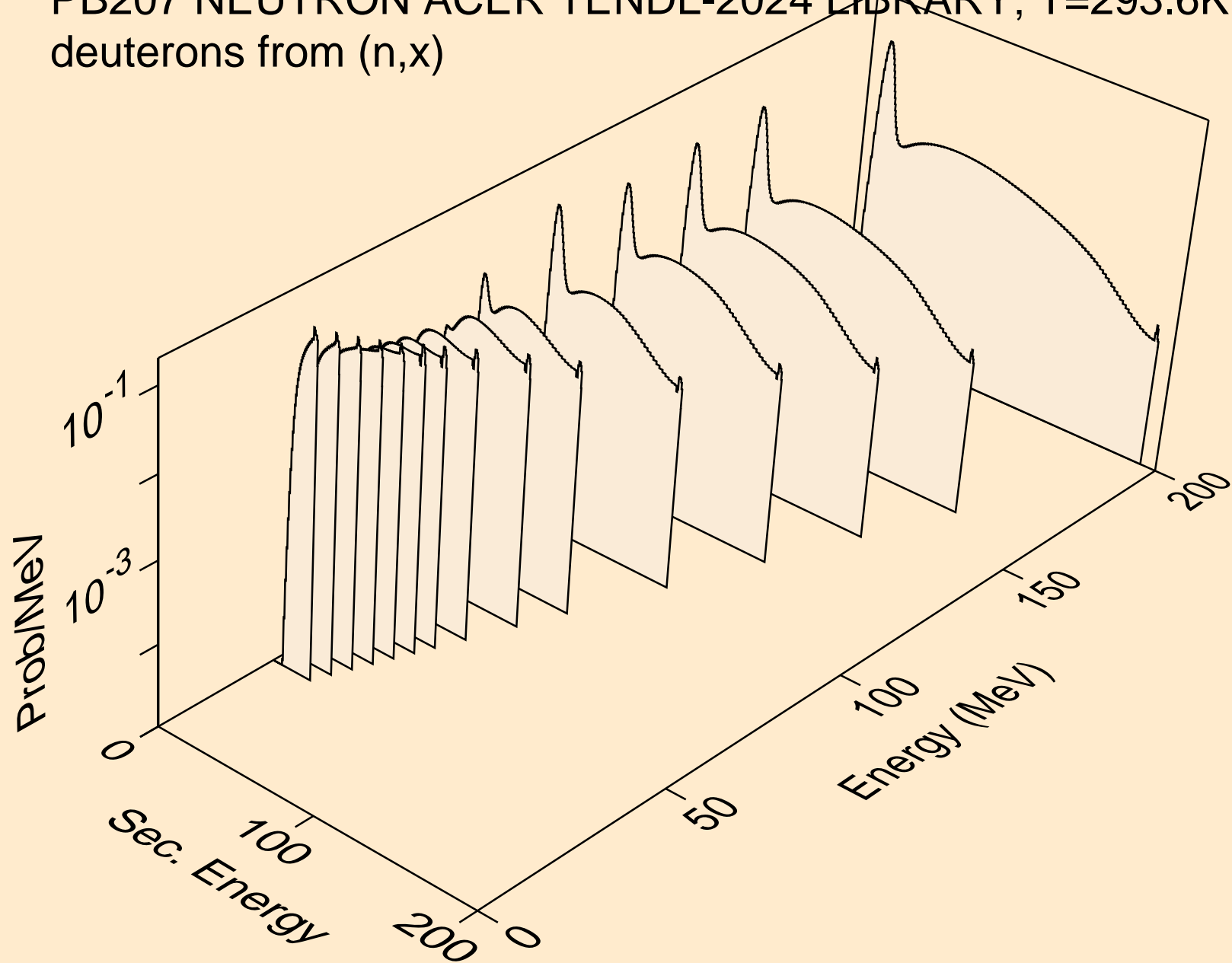

PB207 NEUTRON ACER TENDL-2024 LIBRARY; T=293.6K  
deuterons from (n,2nd)

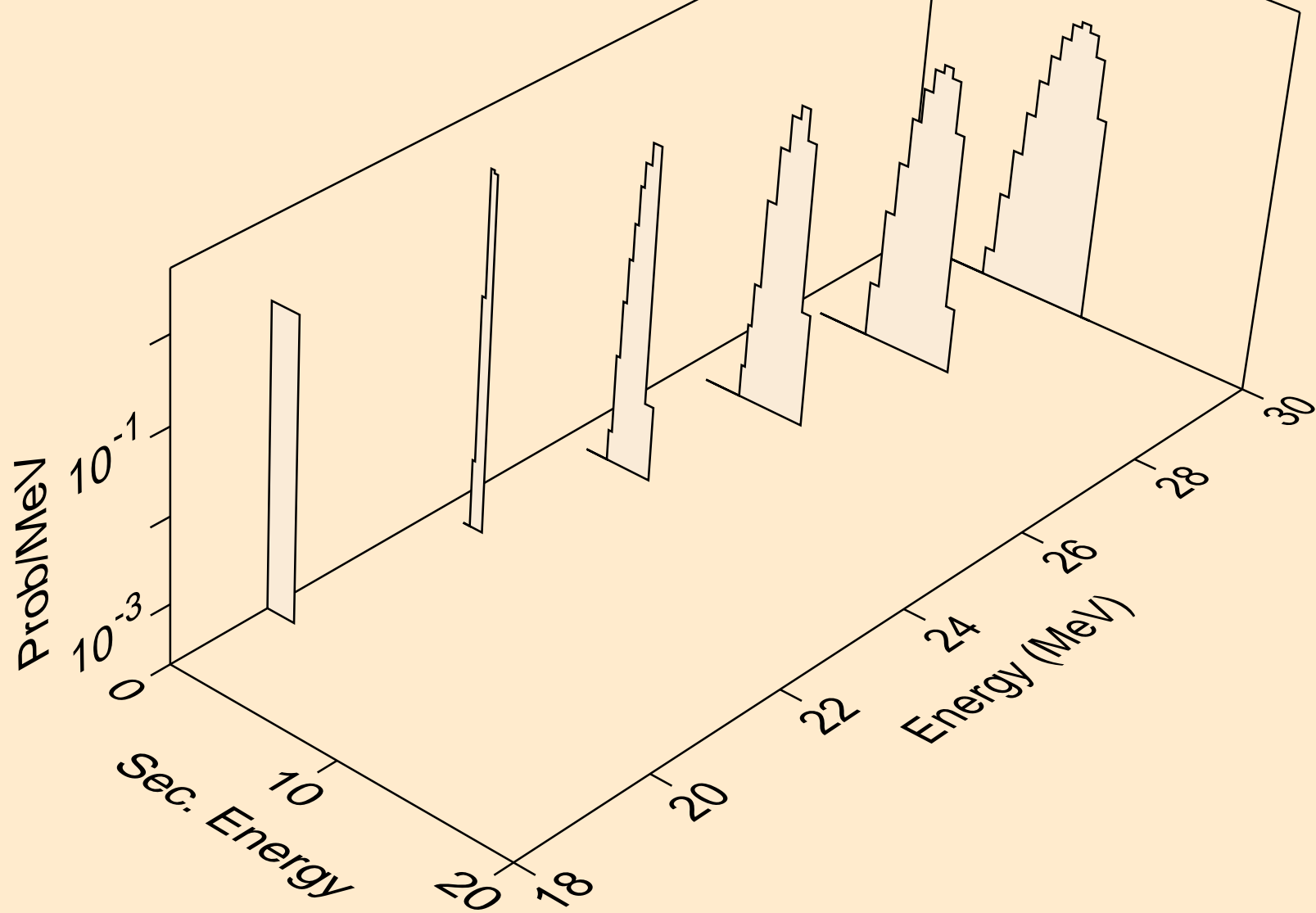

PB207 NEUTRON ACER TENDL-2024 LIBRARY; T=293.6K  
deuterons from (n,n\*)d

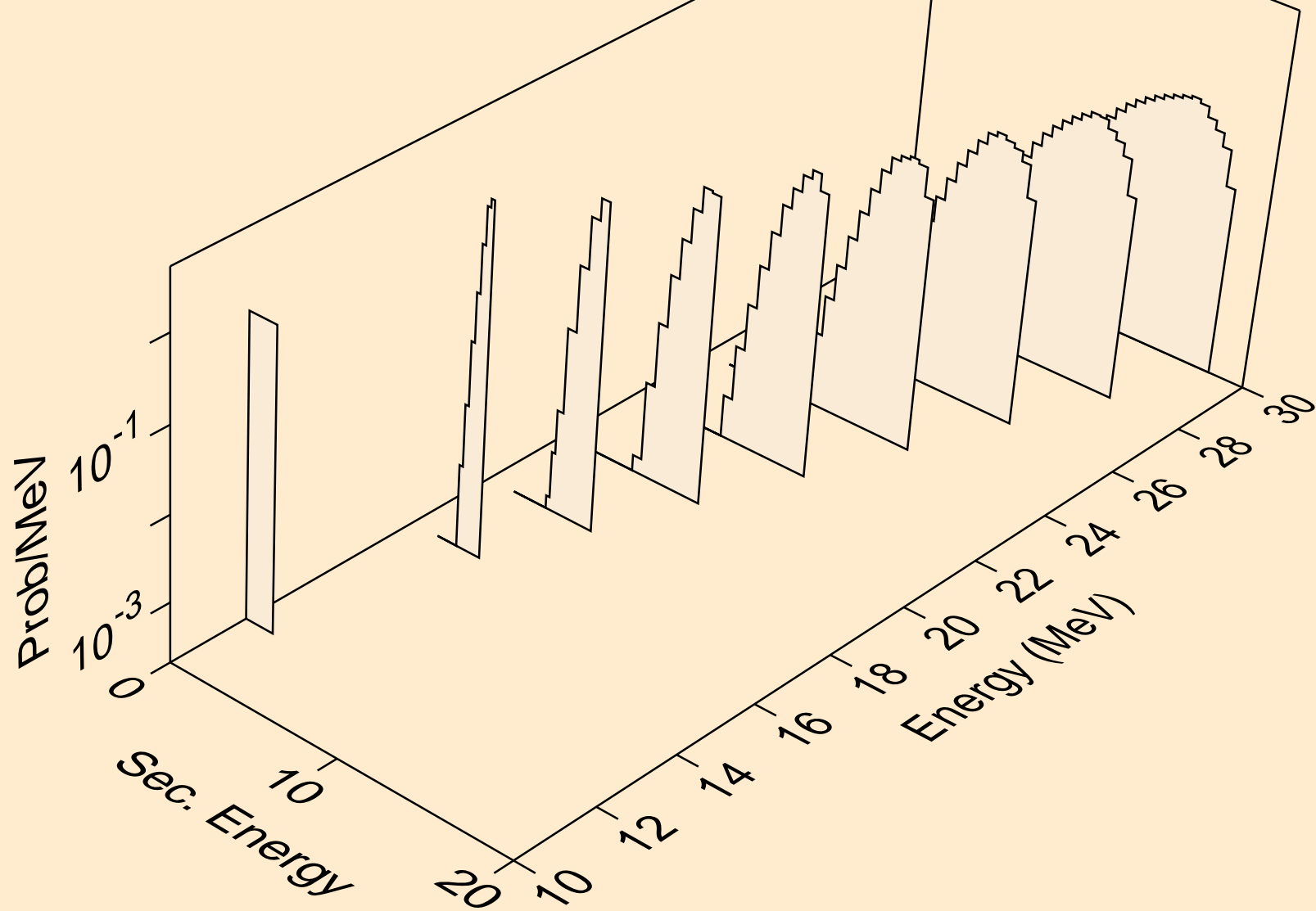

PB207 NEUTRON ACER TENDL-2024 LIBRARY; T=293.6K  
deuterons from (n,d)

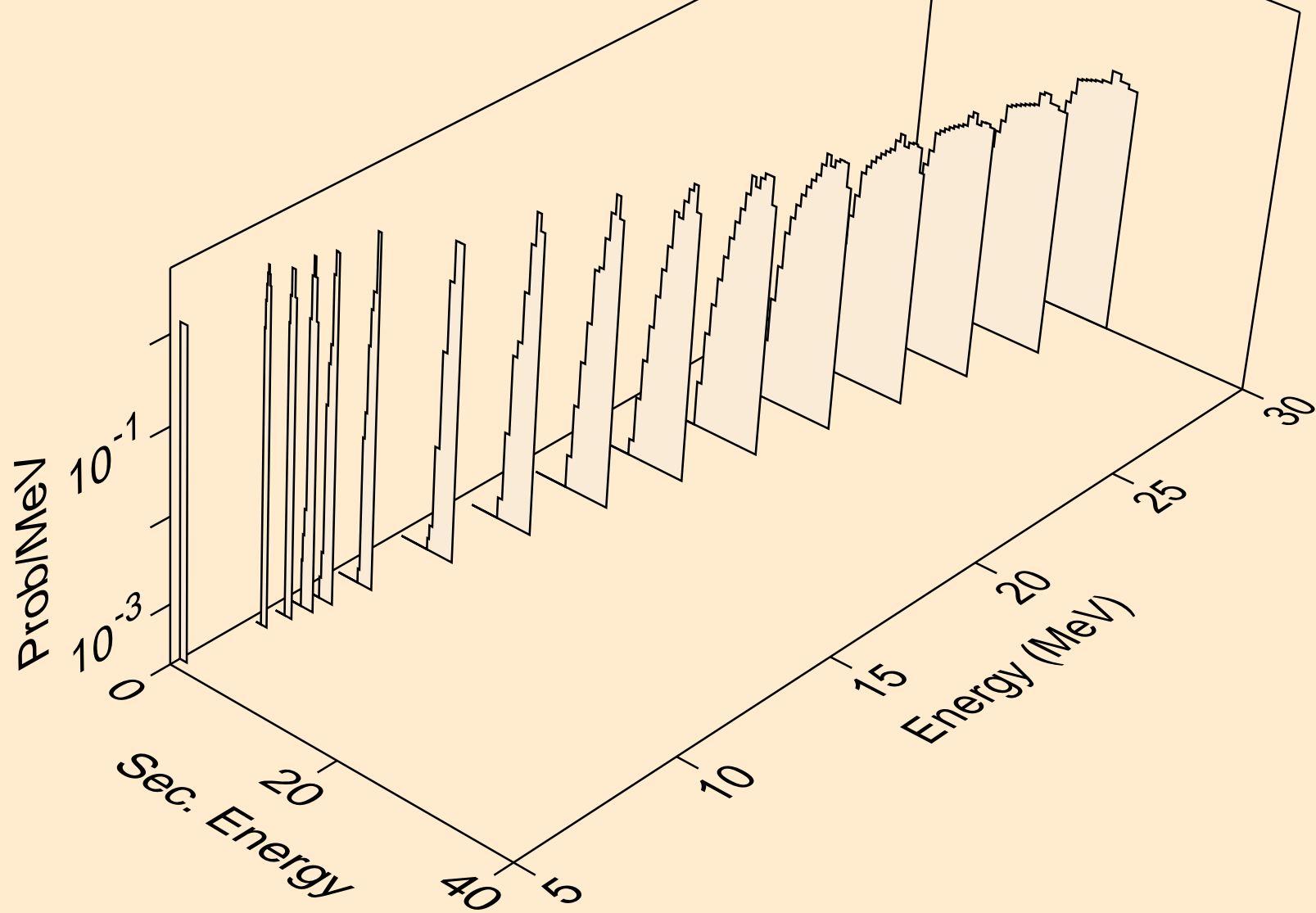

PB207 NEUTRON ACER TENDL-2024 LIBRARY; T=293.6K  
tritons from (n,x)

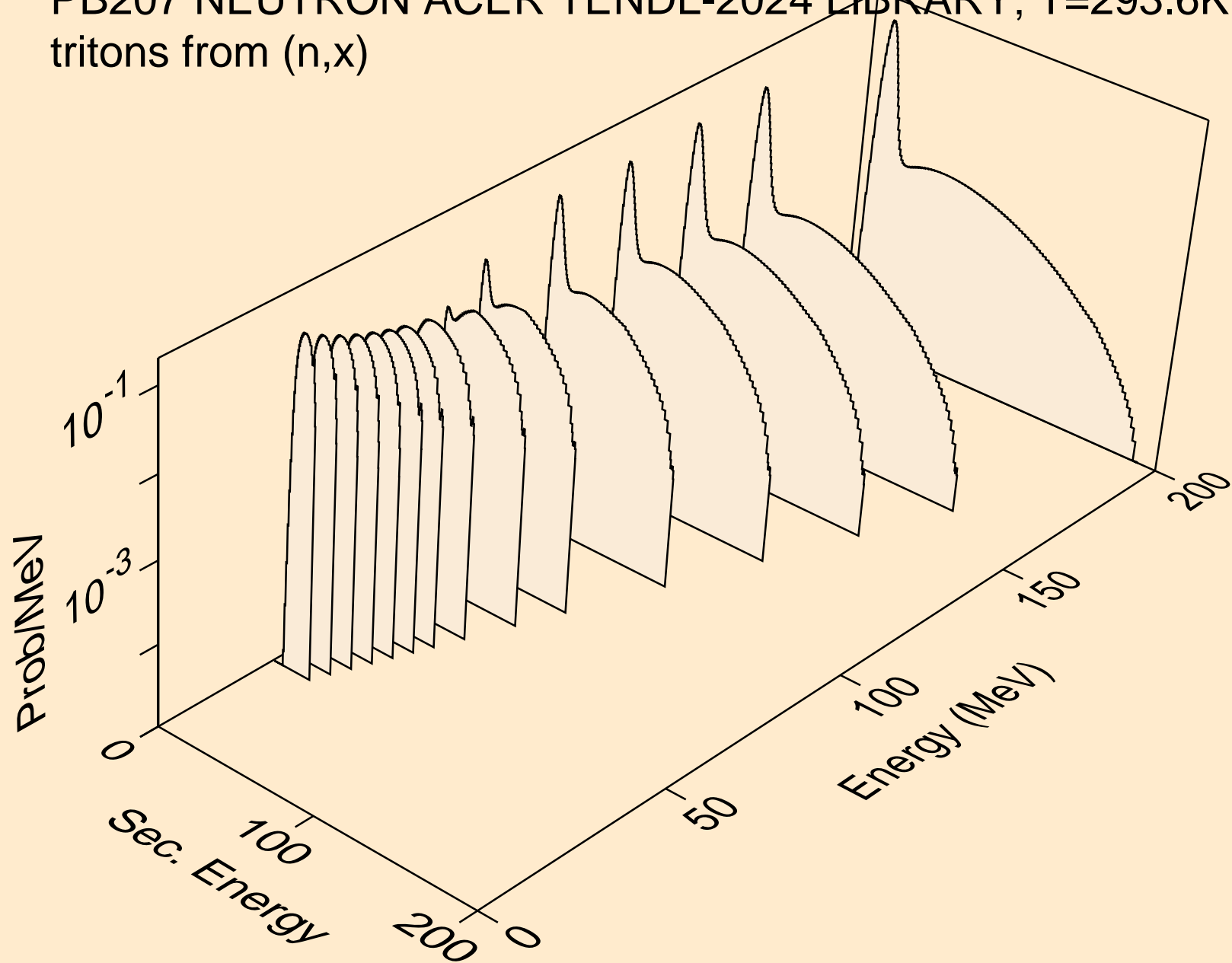

PB207 NEUTRON ACER TENDL-2024 LIBRARY; T=293.6K  
tritons from (n,n\*)t

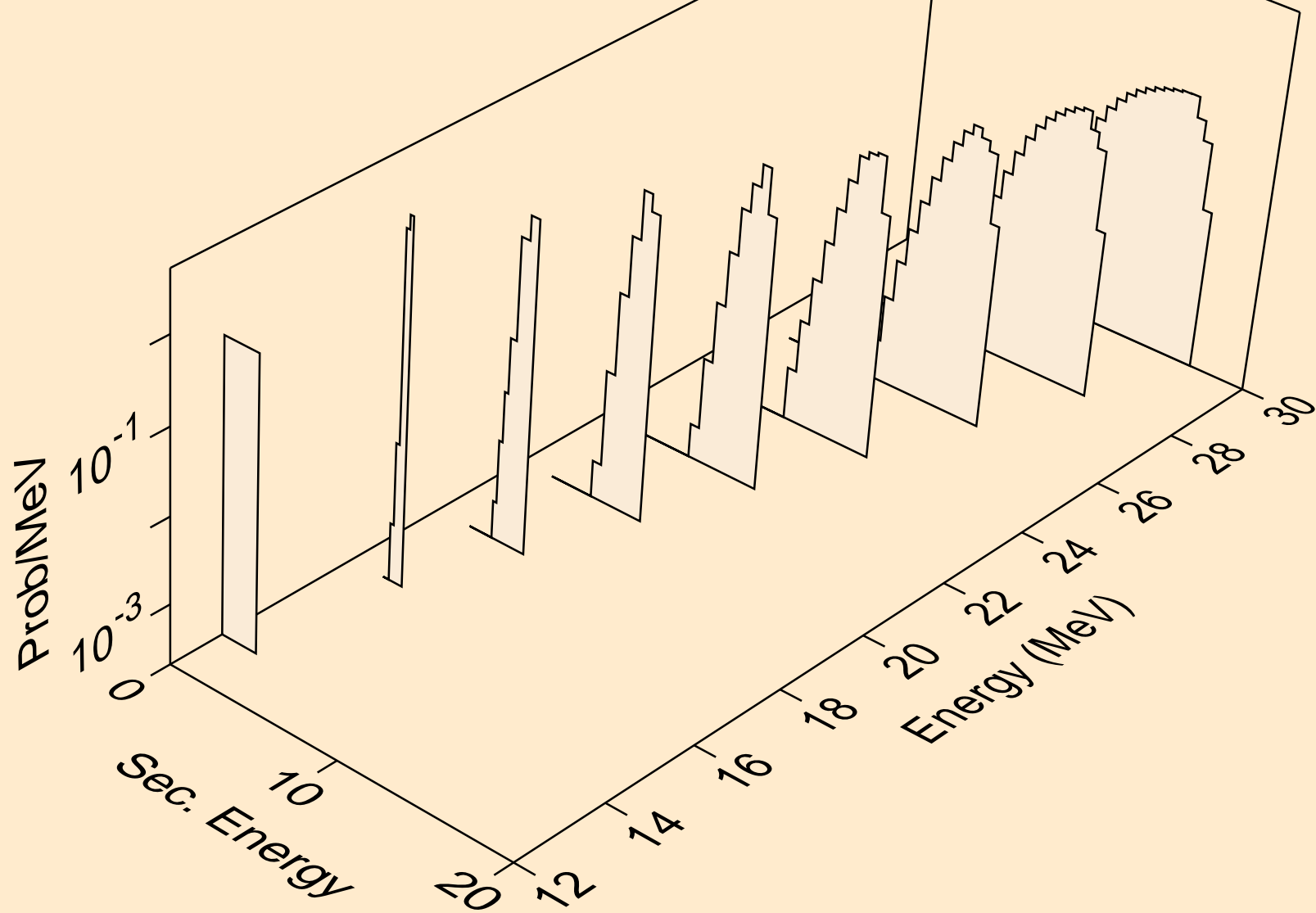

PB207 NEUTRON ACER TENDL-2024 LIBRARY; T=293.6K  
tritons from (n,t)

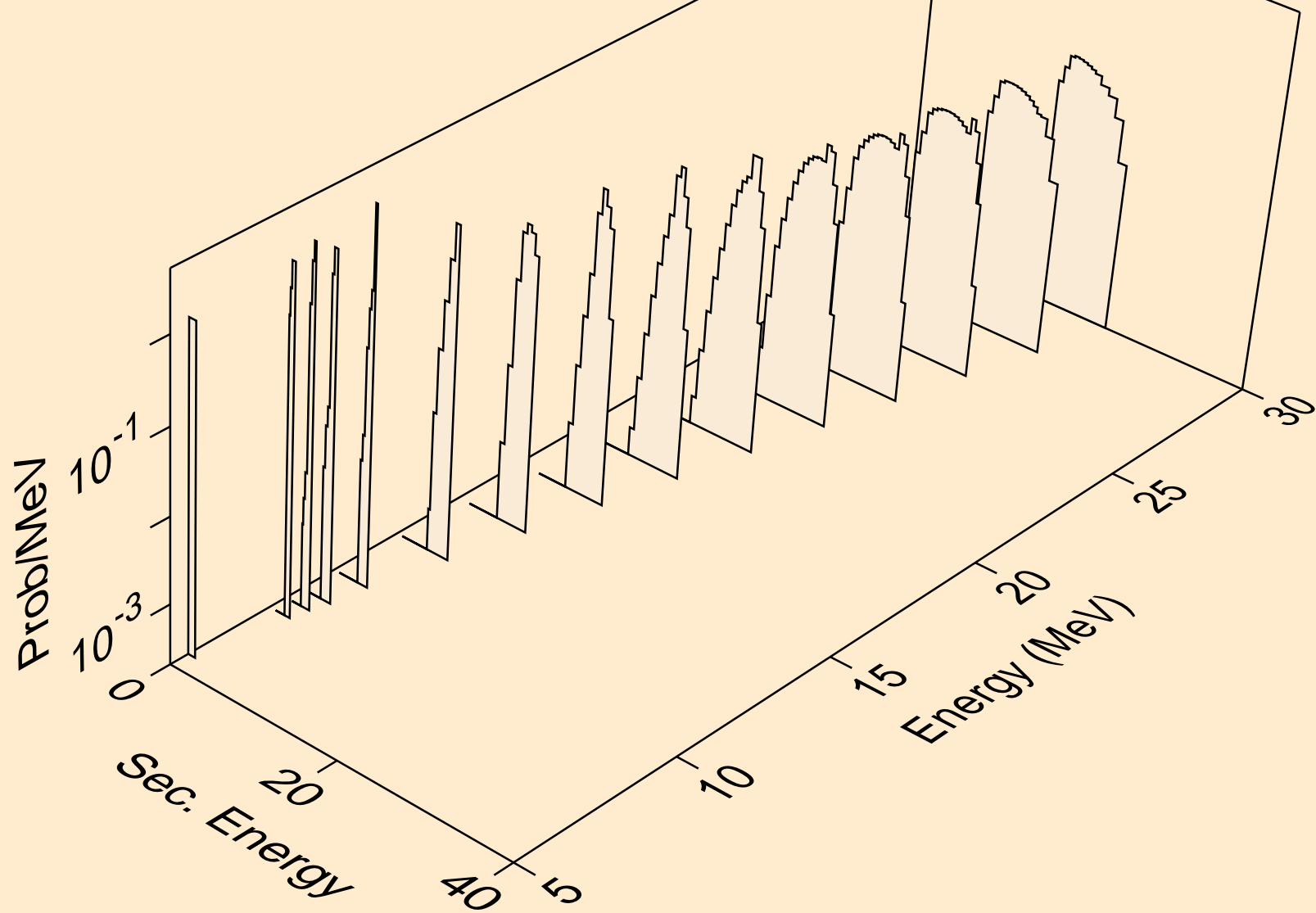

PB207 NEUTRON ACER TENDL-2024 LIBRARY; T=293.6K  
he3s from (n,x)

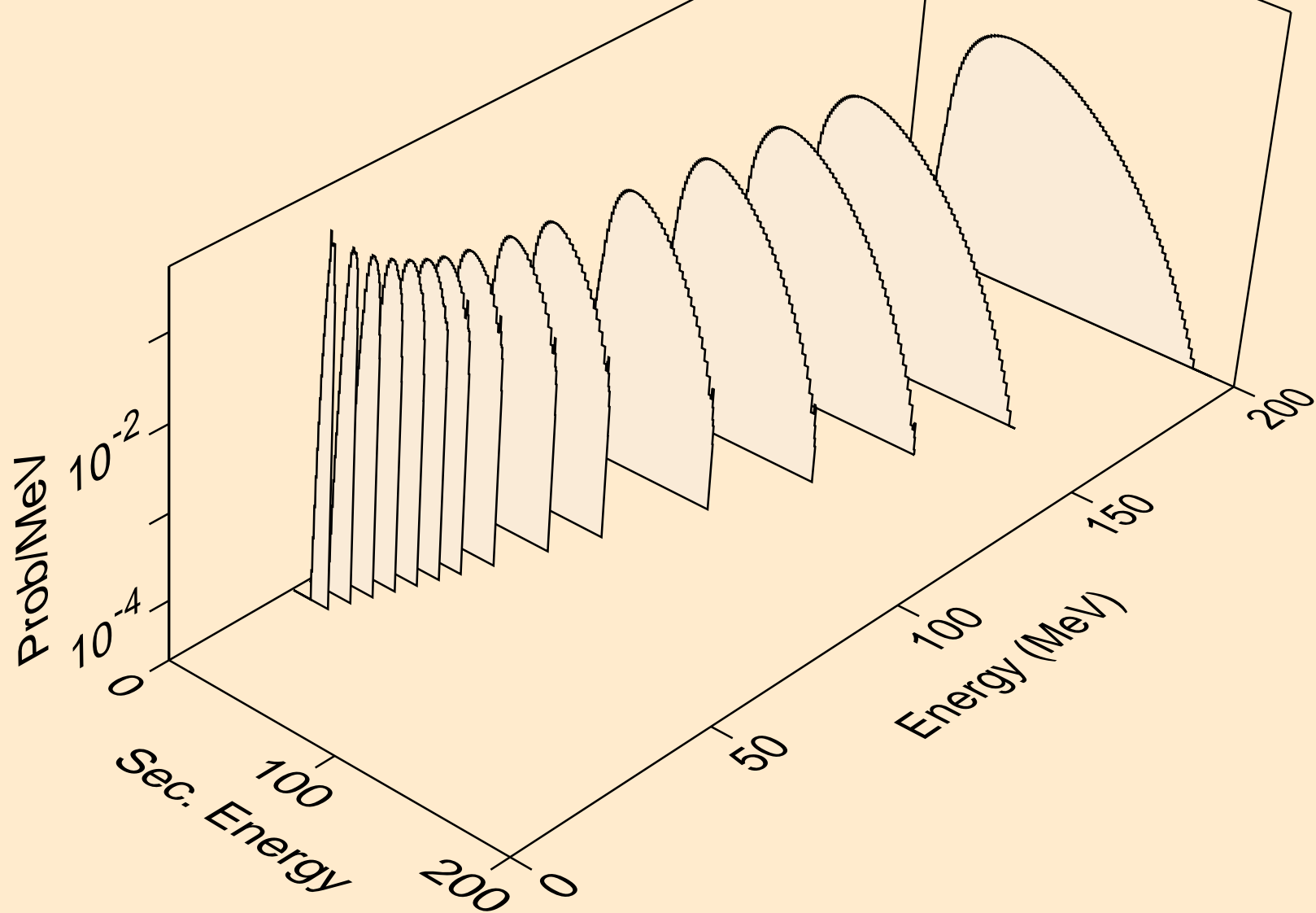

PB207 NEUTRON ACER TENDL-2024 LIBRARY; T=293.6K  
he3s from (n,n\*)he3

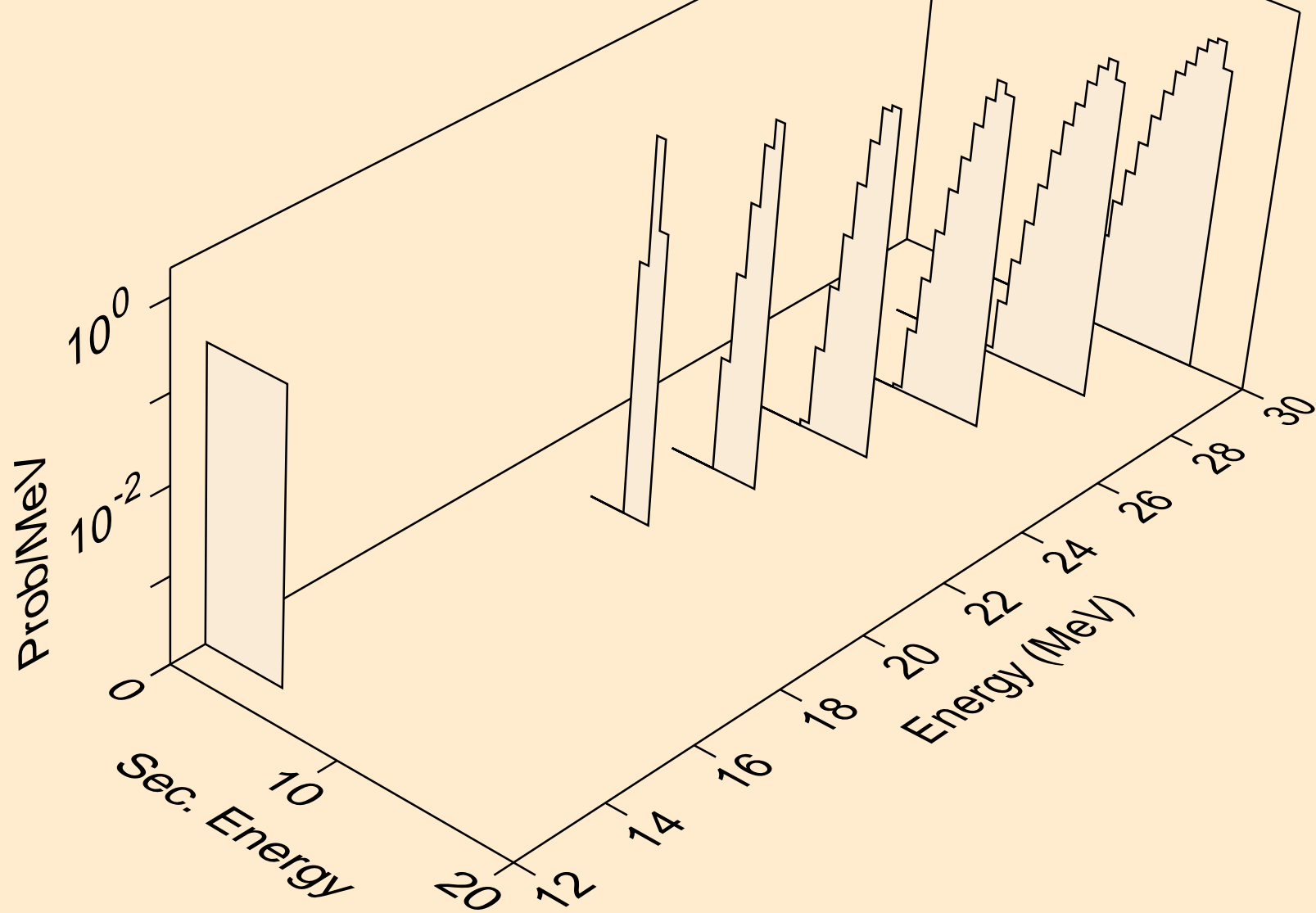

PB207 NEUTRON ACER TENDL-2024 LIBRARY; T=293.6K  
he3s from (n,he3)

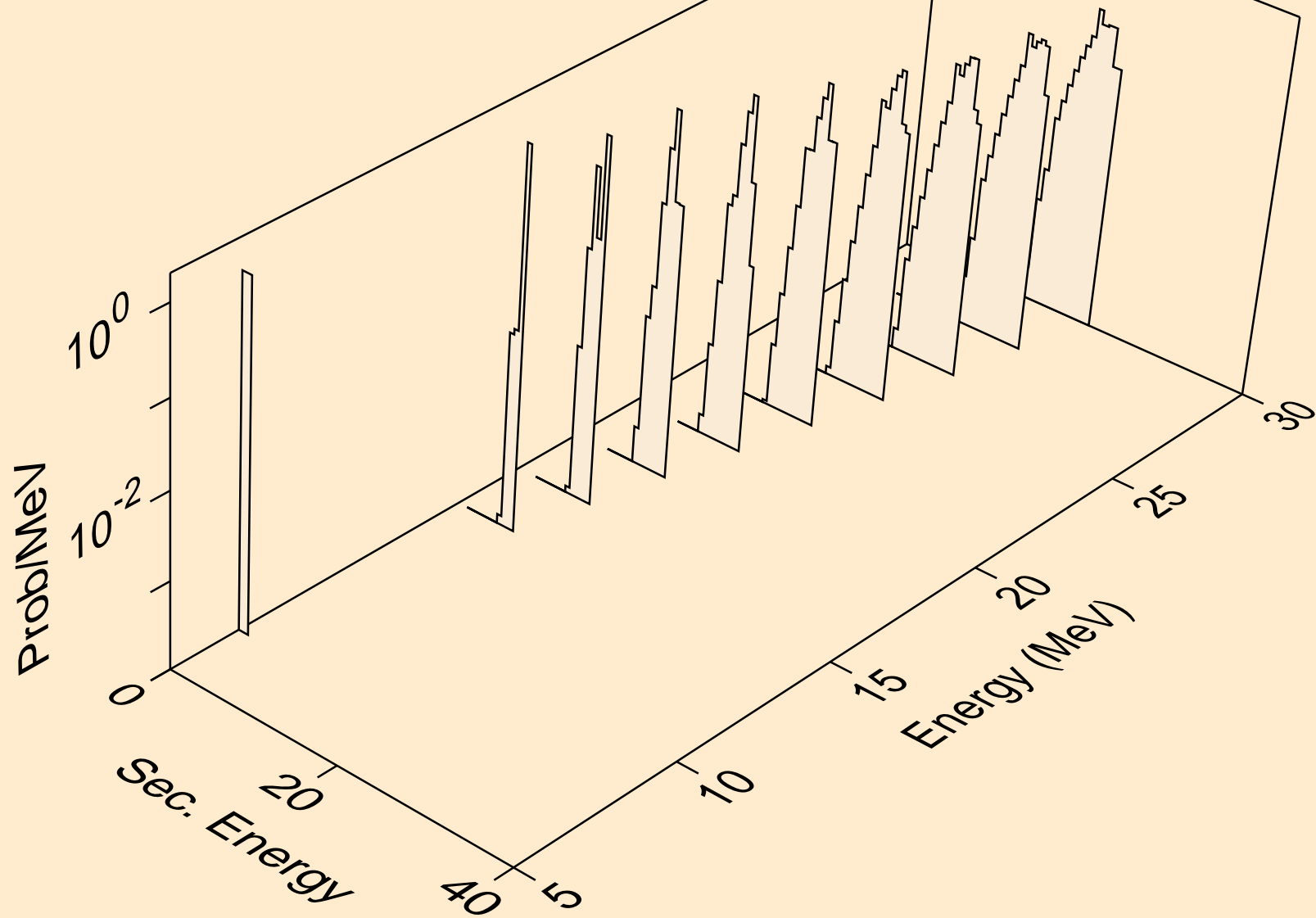

PB207 NEUTRON ACER TENDL-2024 LIBRARY; T=293.6K  
alphas from (n,x)

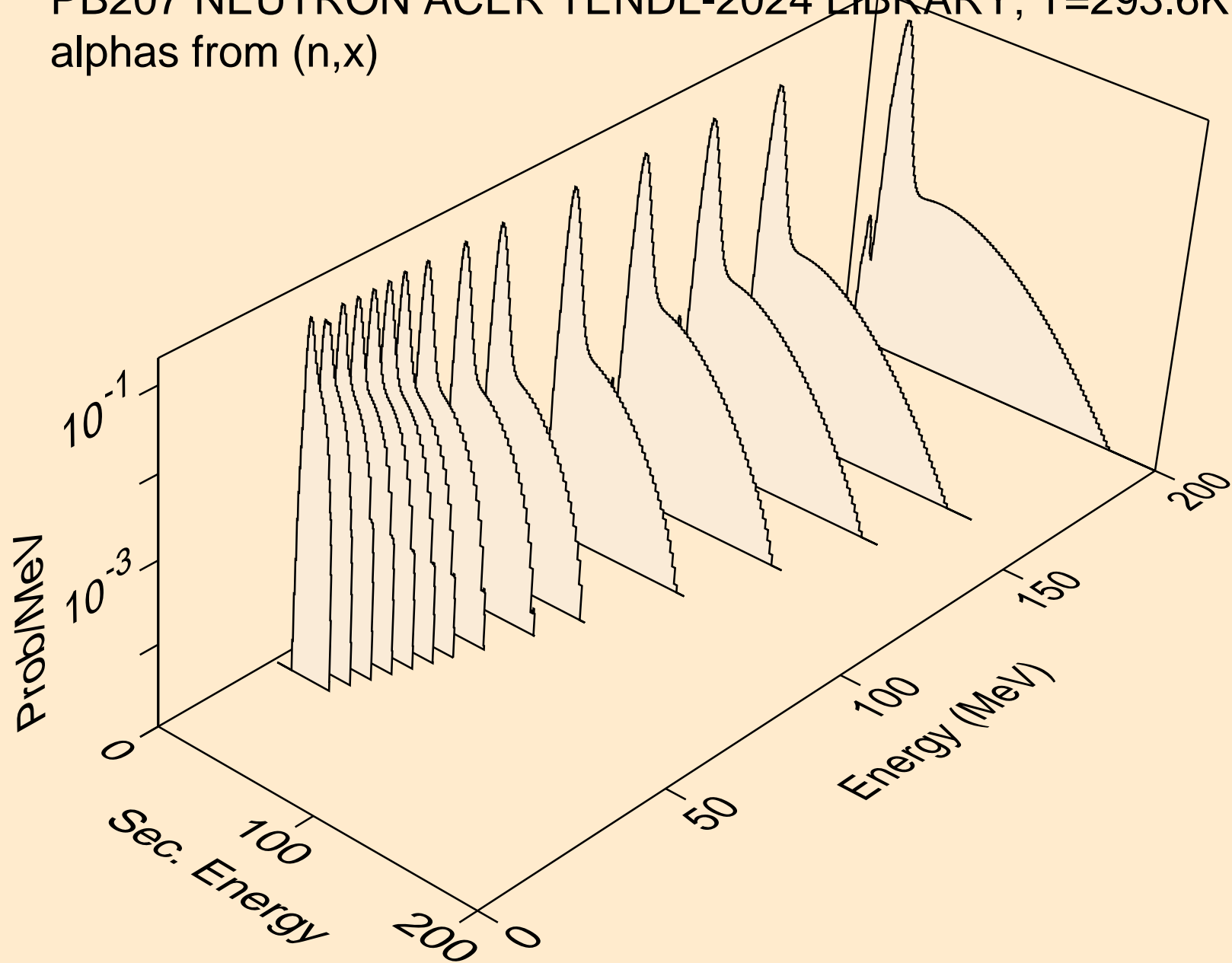

PB207 NEUTRON ACER TENDL-2024 LIBRARY; T=293.6K  
alphas from (n,n\*)a

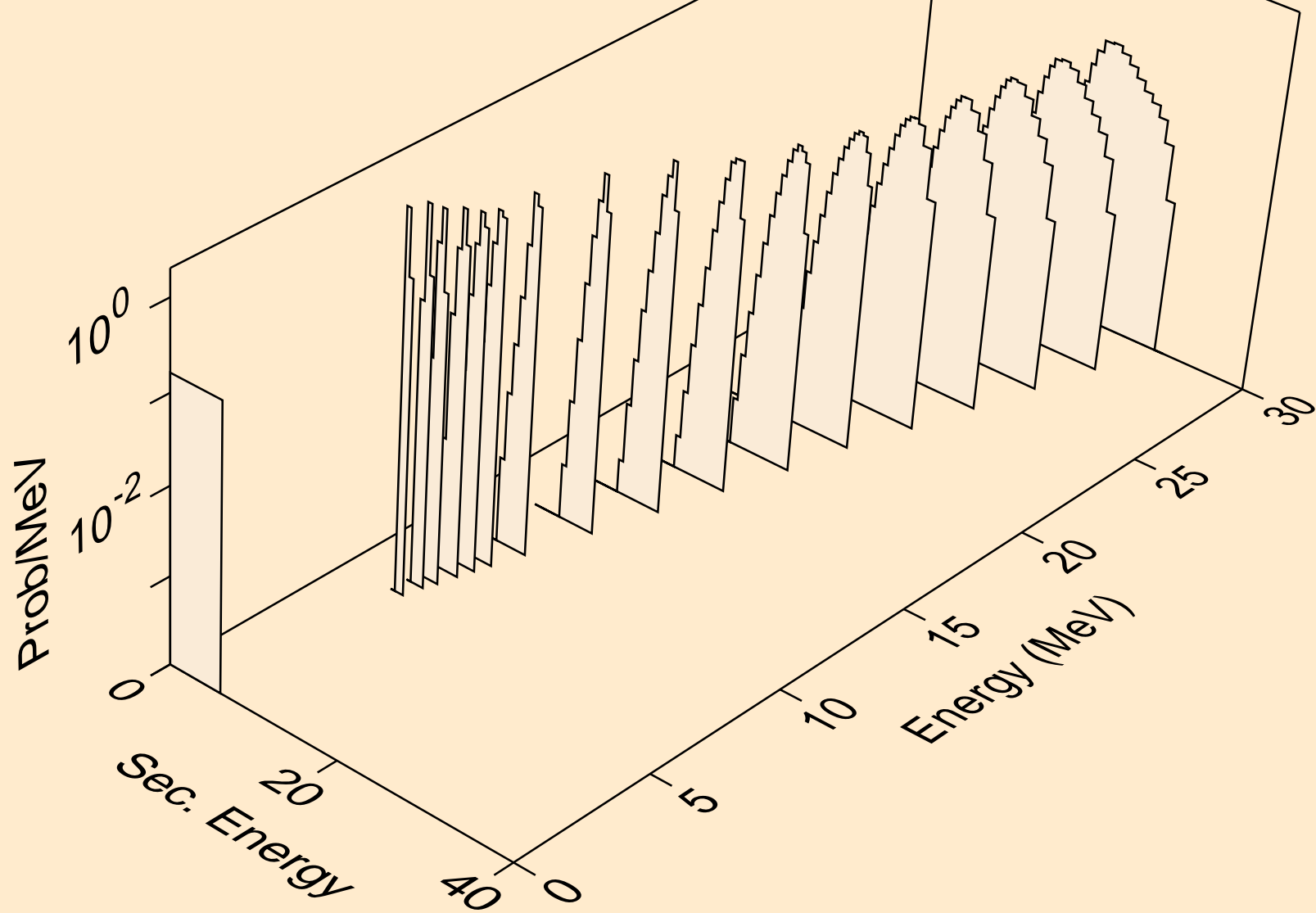

PB207 NEUTRON ACER TENDL-2024 LIBRARY; T=293.6K  
alphas from (n,2n)a

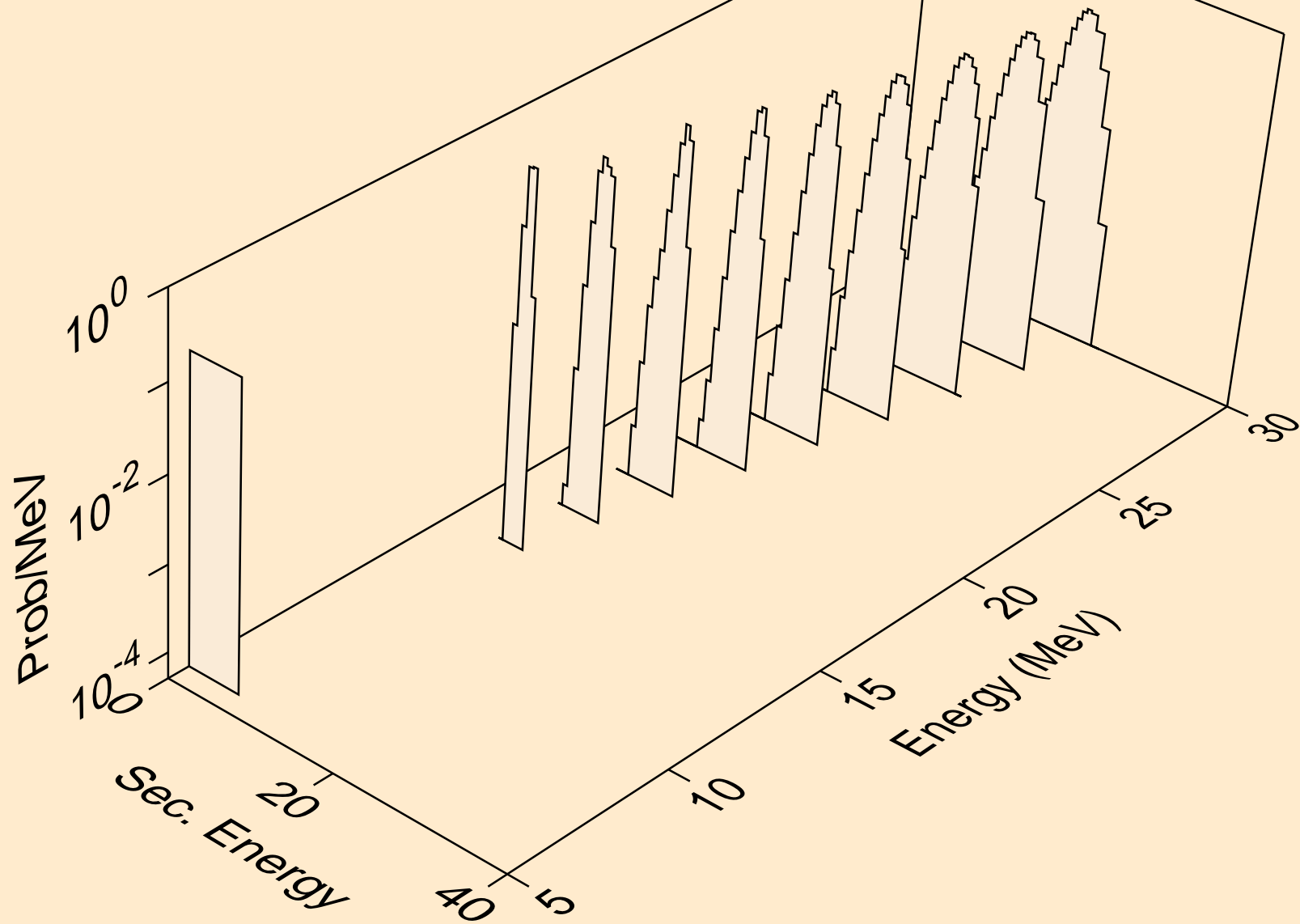

PB207 NEUTRON ACER TENDL-2024 LIBRARY; T=293.6K  
alphas from (n,3n) $\alpha$

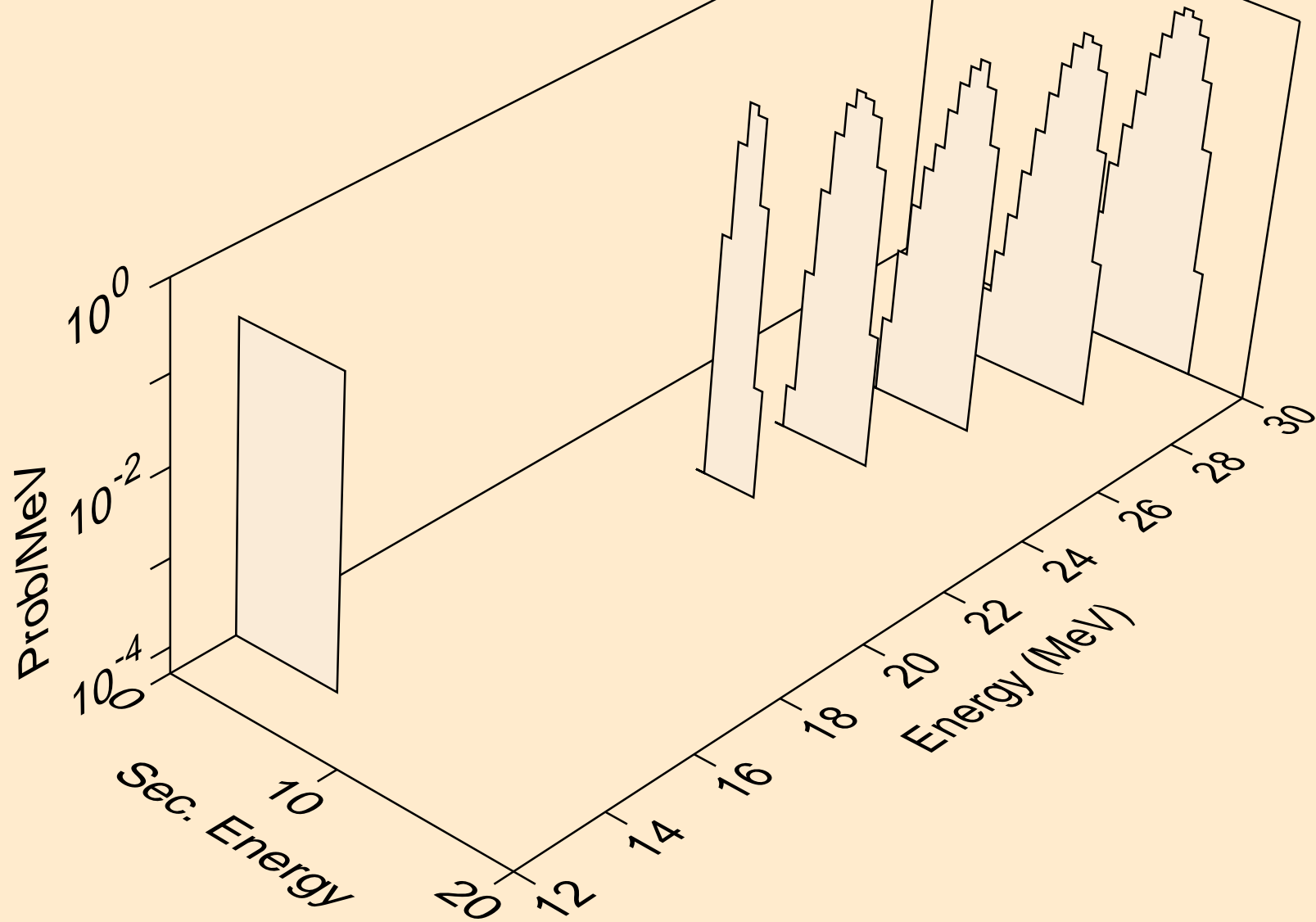

PB207 NEUTRON ACER TENDL-2024 LIBRARY; T=293.6K  
alphas from (n,a)

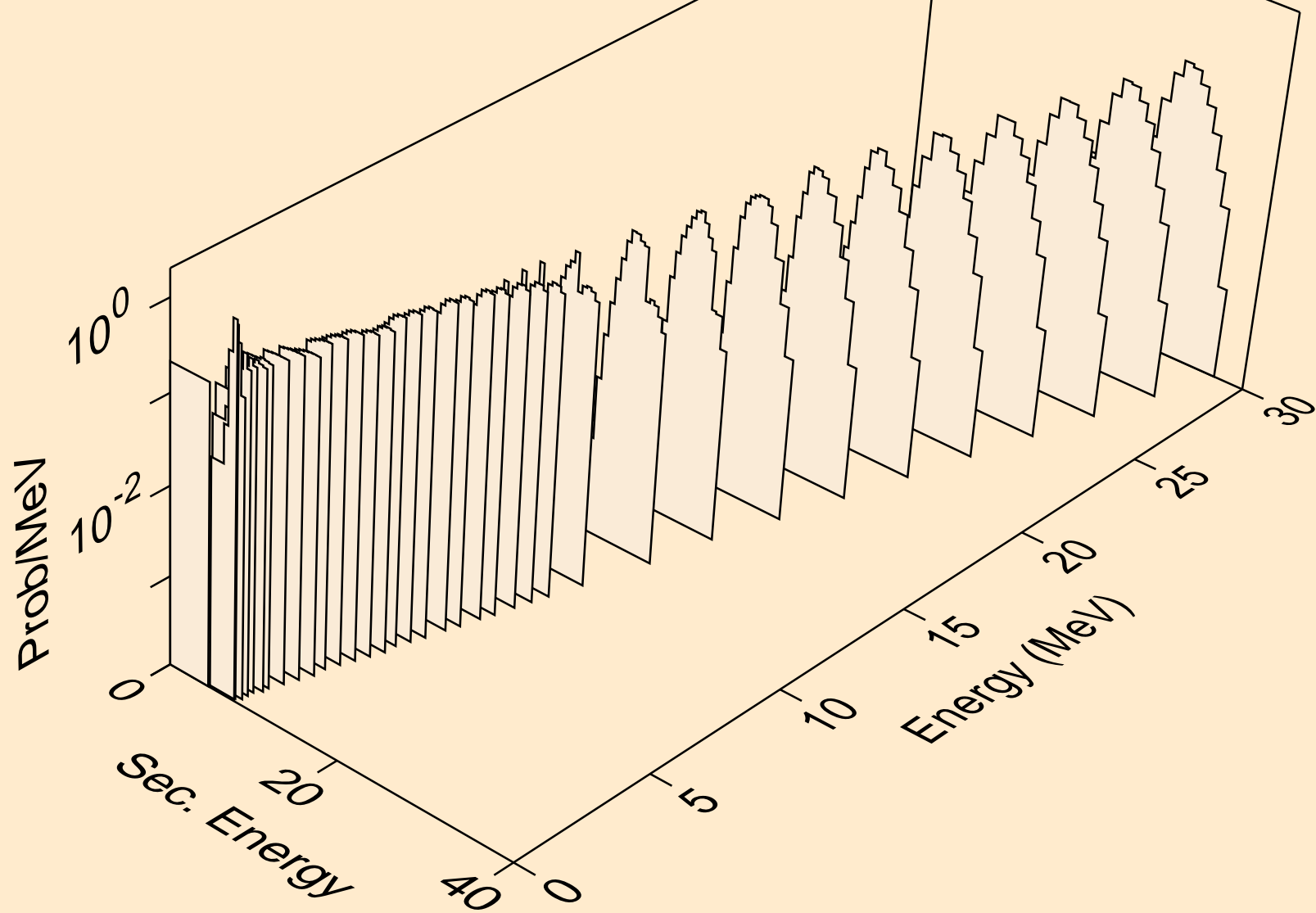

PB207 NEUTRON ACER TENDL-2024 LIBRARY; T=293.6K  
alphas from (n,2a)

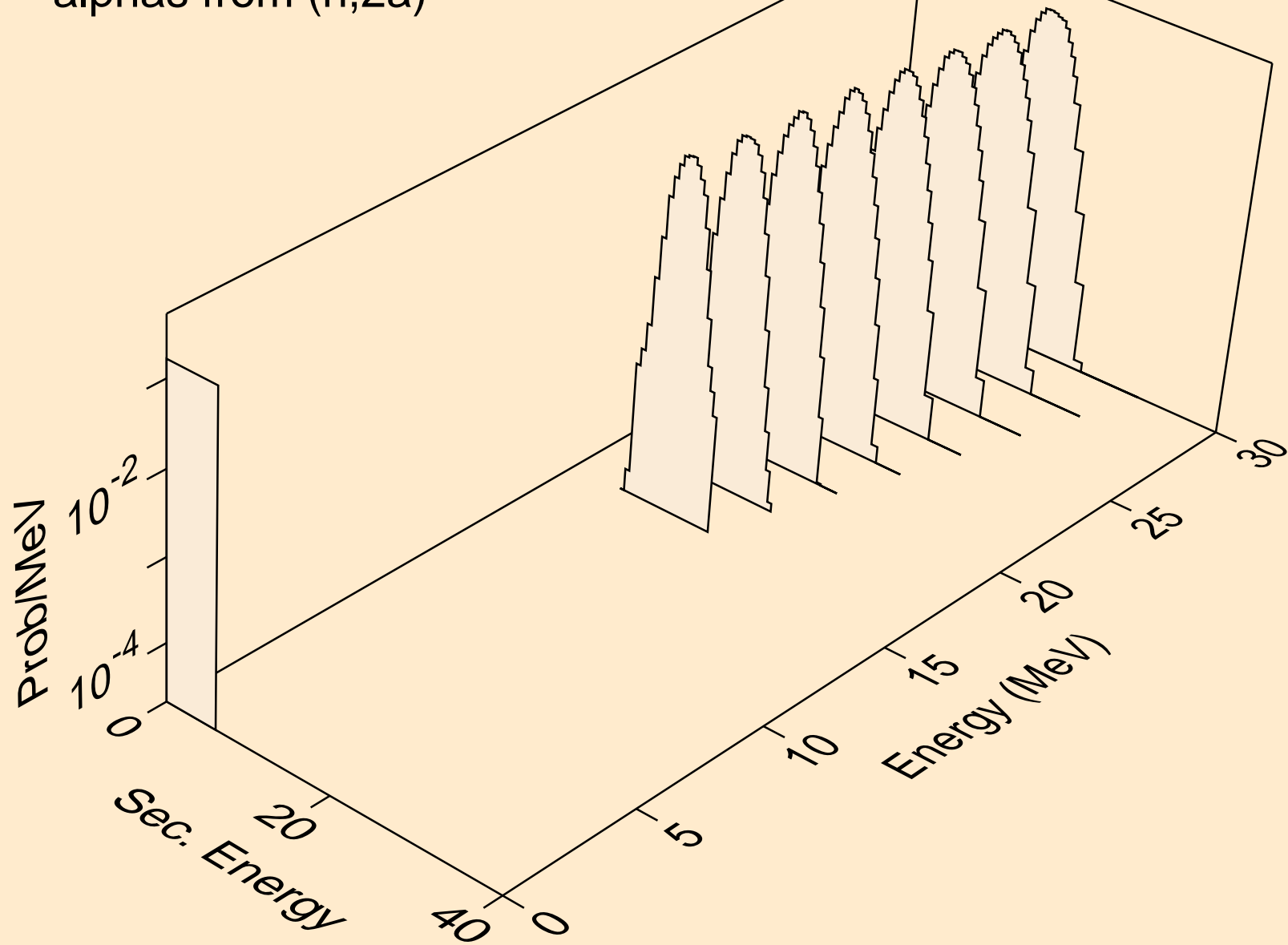

PB207 NEUTRON ACER TENDL-2024 LIBRARY; T=293.6K  
alphas from (n,pa)

