

PD098 NEUTRON ACER TENDL-2024 LIBRARY; T=293.6K  
Principal cross sections

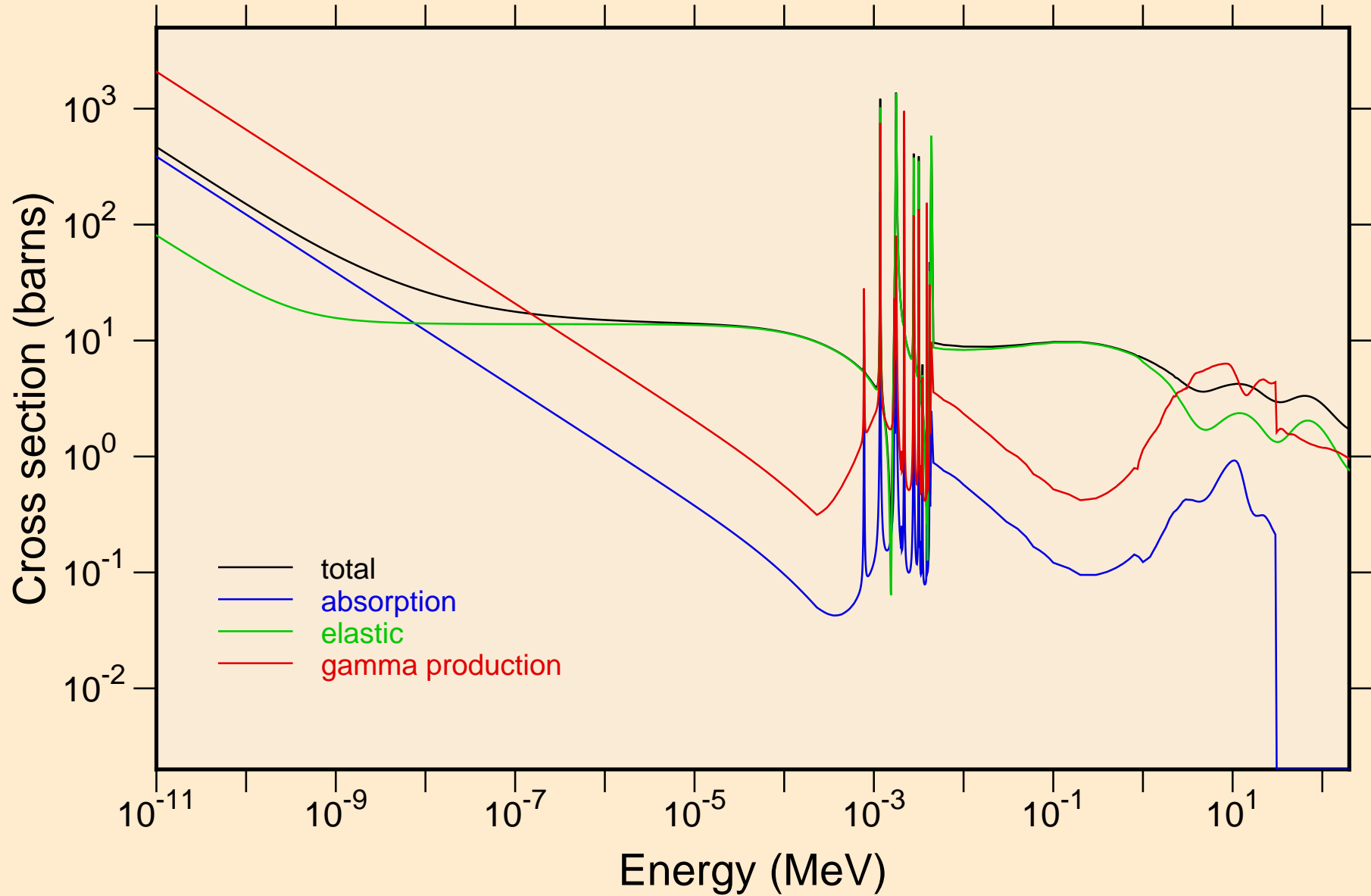

PD098 NEUTRON ACER TENDL-2024 LIBRARY; T=293.6K  
resonance total cross section

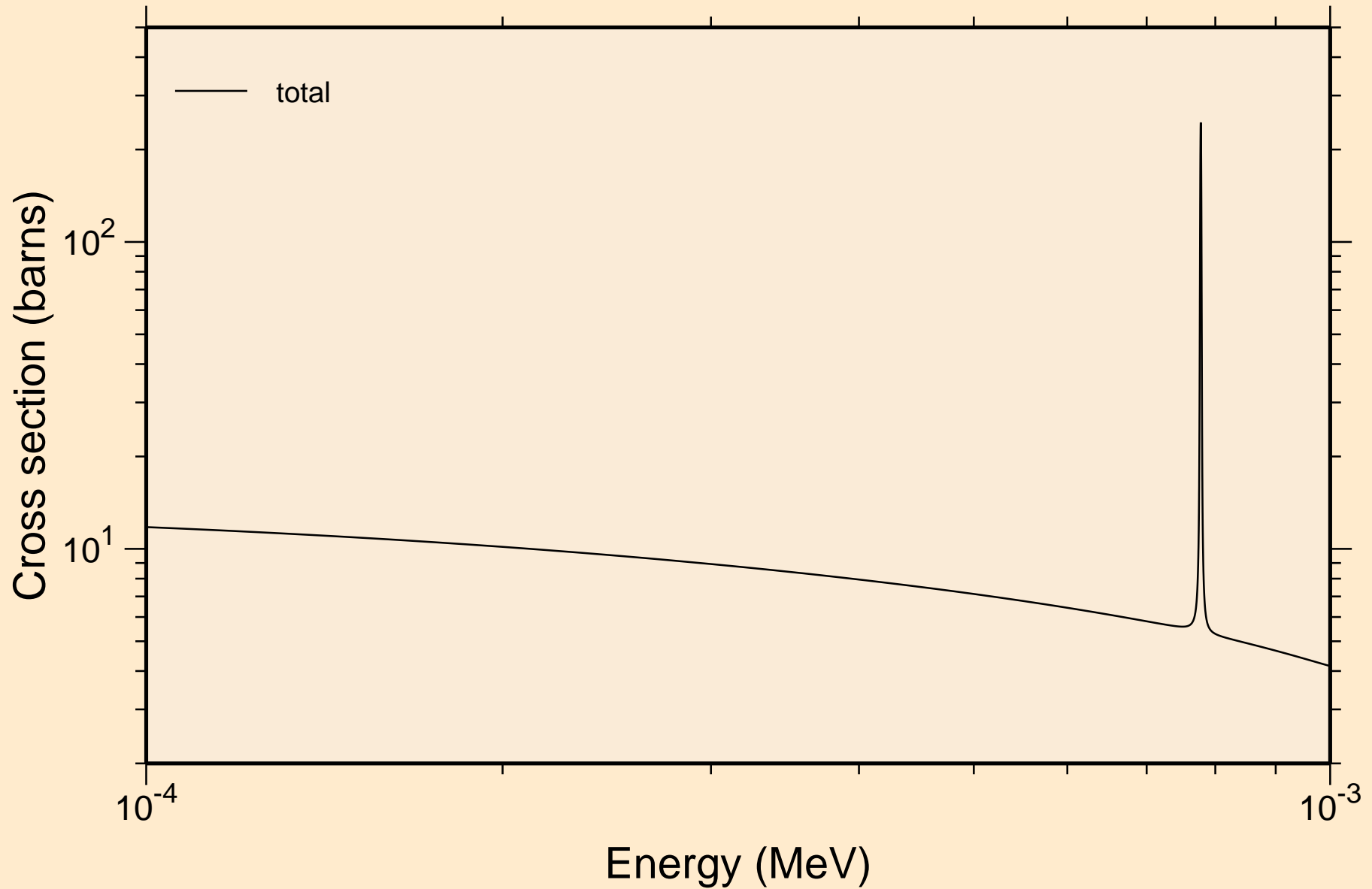

PD098 NEUTRON ACER TENDL-2024 LIBRARY; T=293.6K  
resonance total cross section

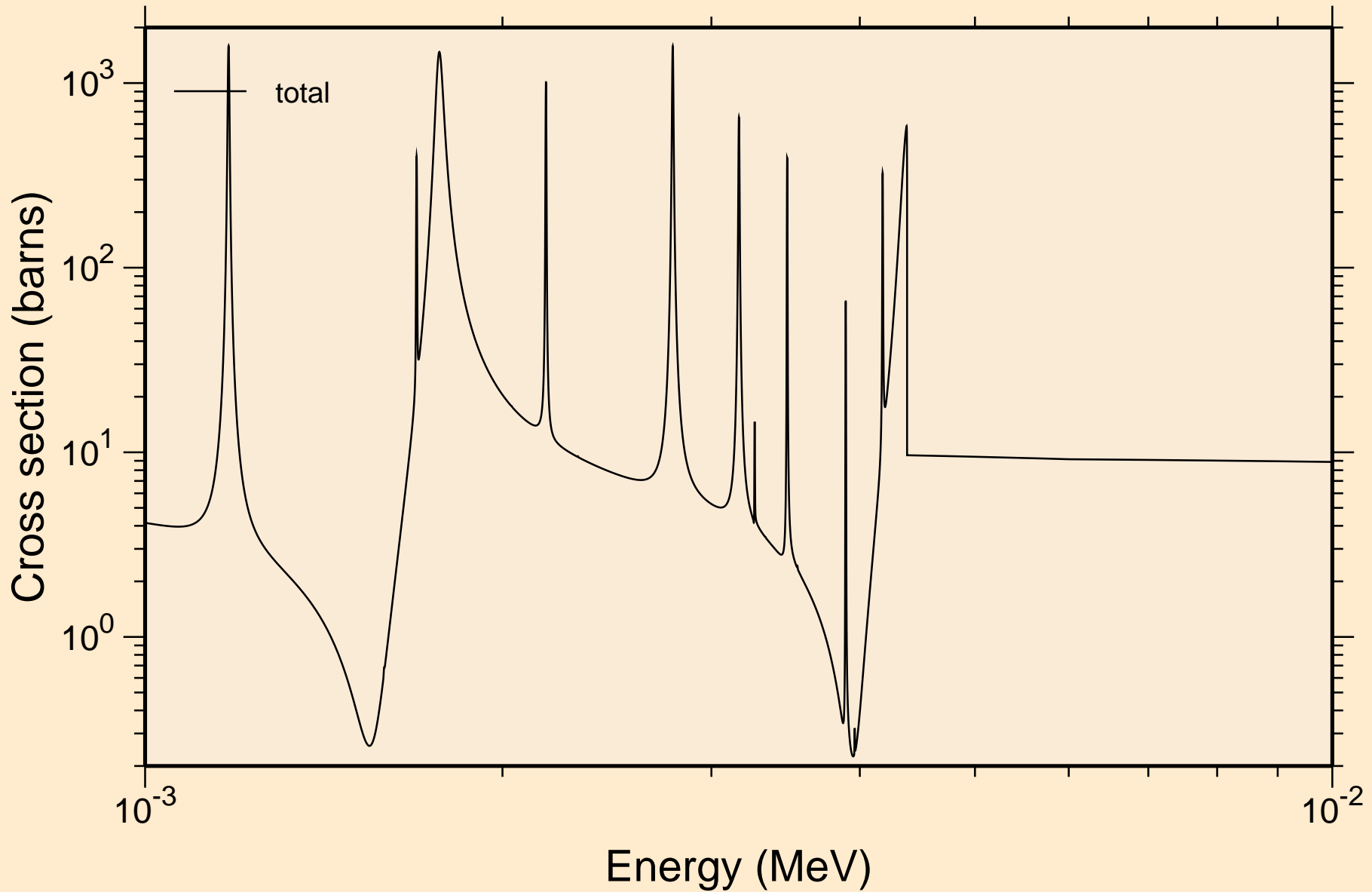

PD098 NEUTRON ACER TENDL-2024 LIBRARY; T=293.6K  
resonance total cross section

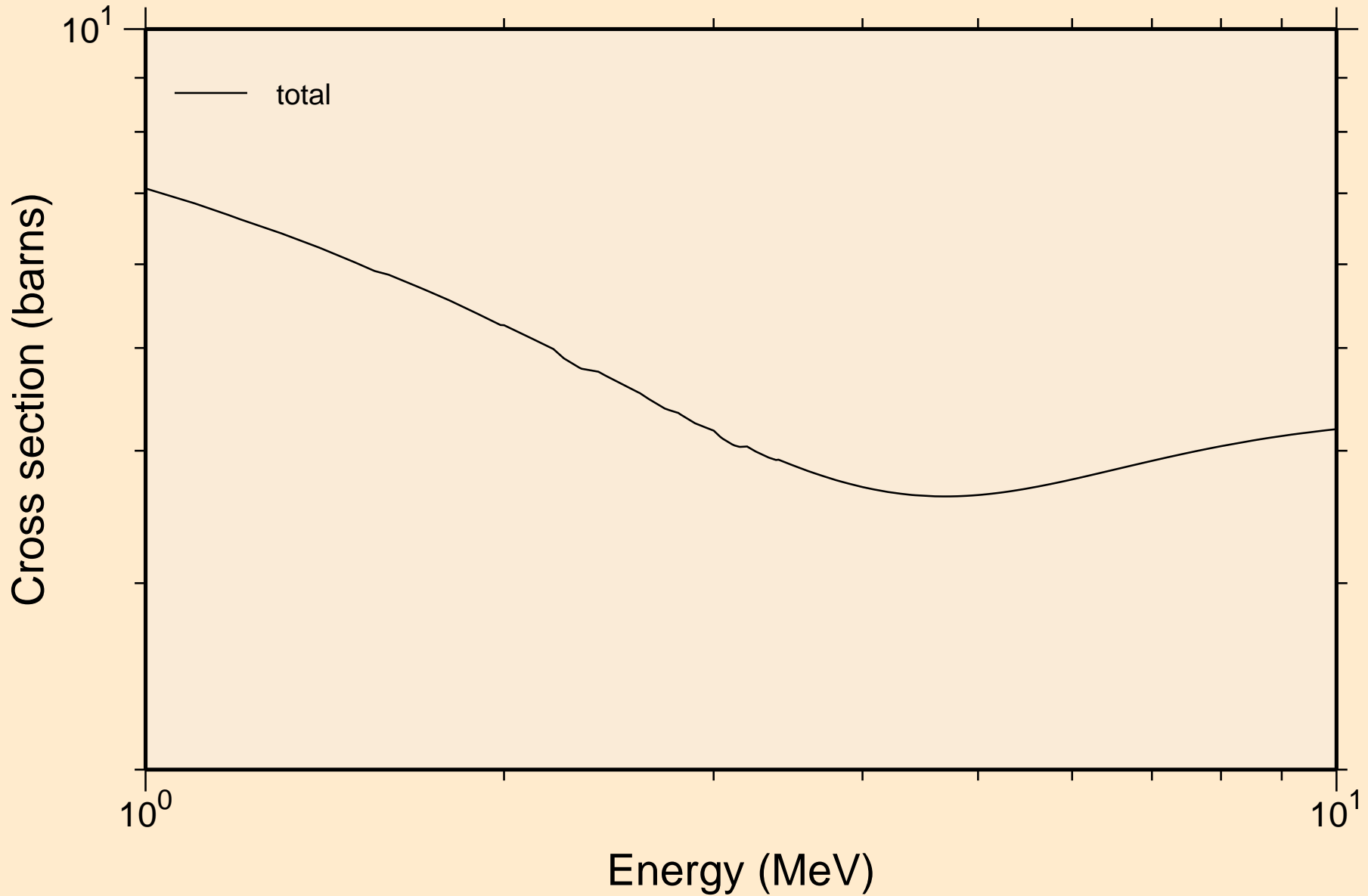

PD098 NEUTRON ACER TENDL-2024 LIBRARY; T=293.6K  
resonance absorption cross sections

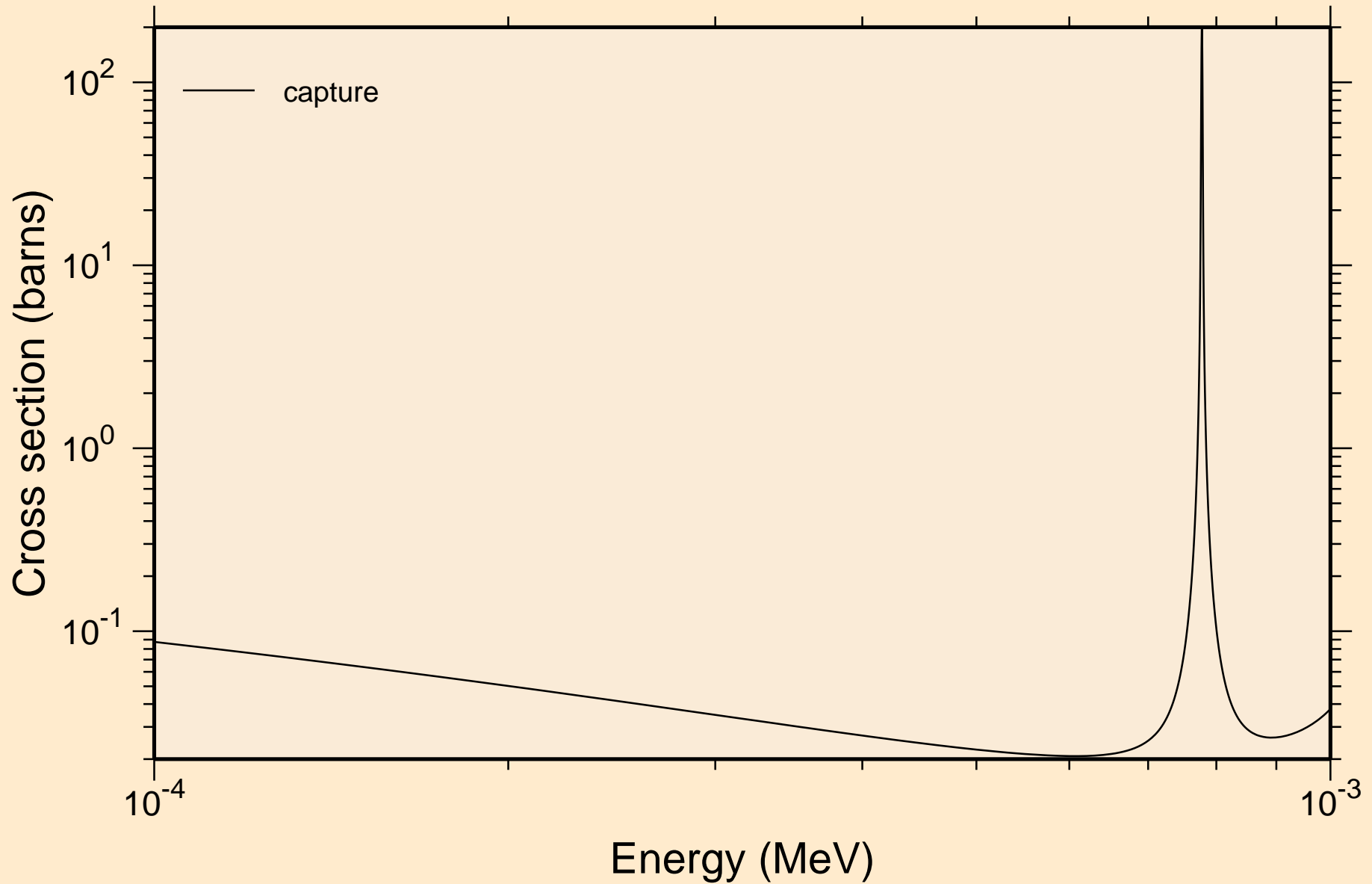

PD098 NEUTRON ACER TENDL-2024 LIBRARY; T=293.6K  
resonance absorption cross sections

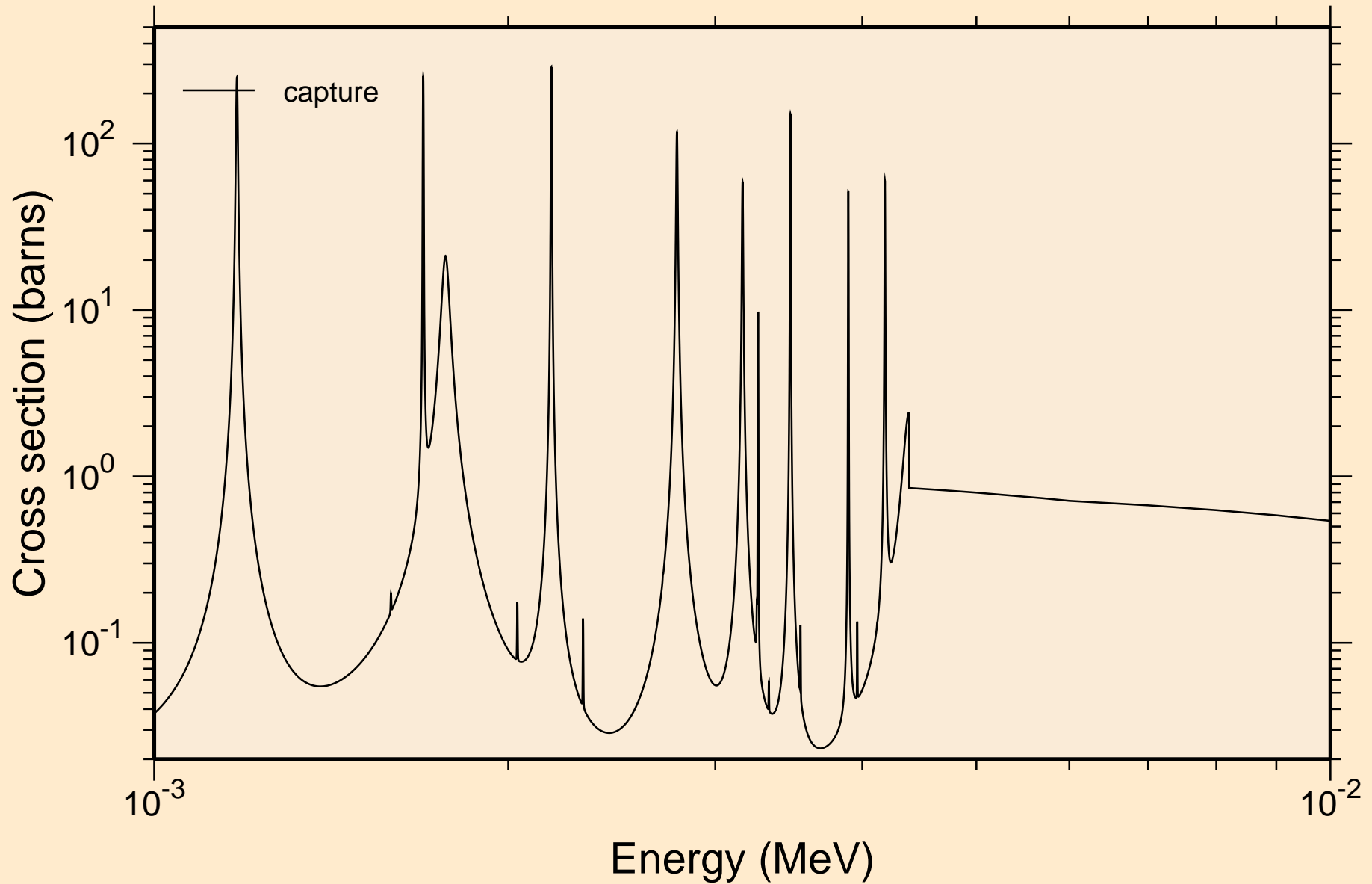

PD098 NEUTRON ACER TENDL-2024 LIBRARY; T=293.6K  
resonance absorption cross sections

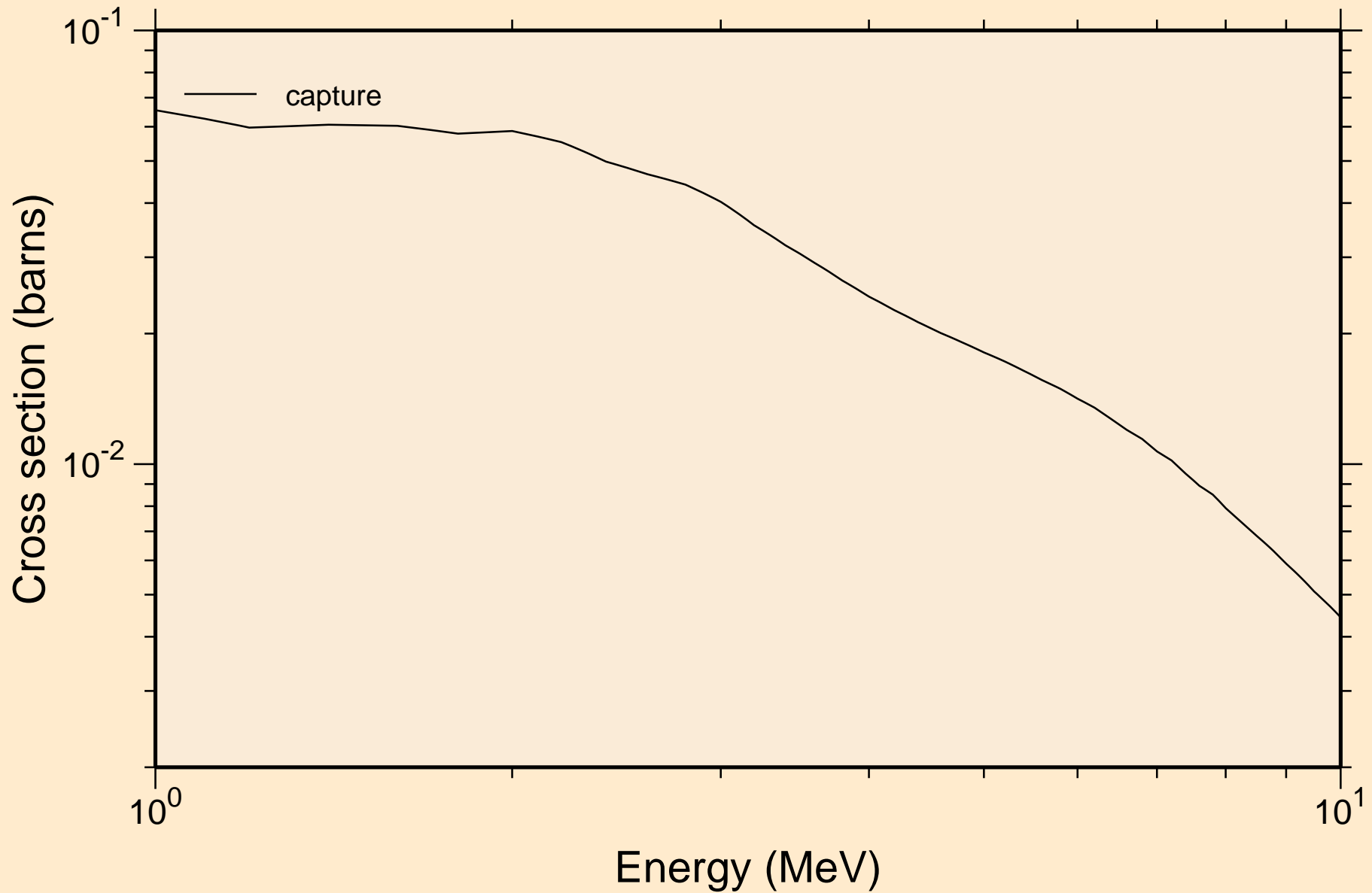

PD098 NEUTRON ACER TENDL-2024 LIBRARY; T=293.6K  
Heating

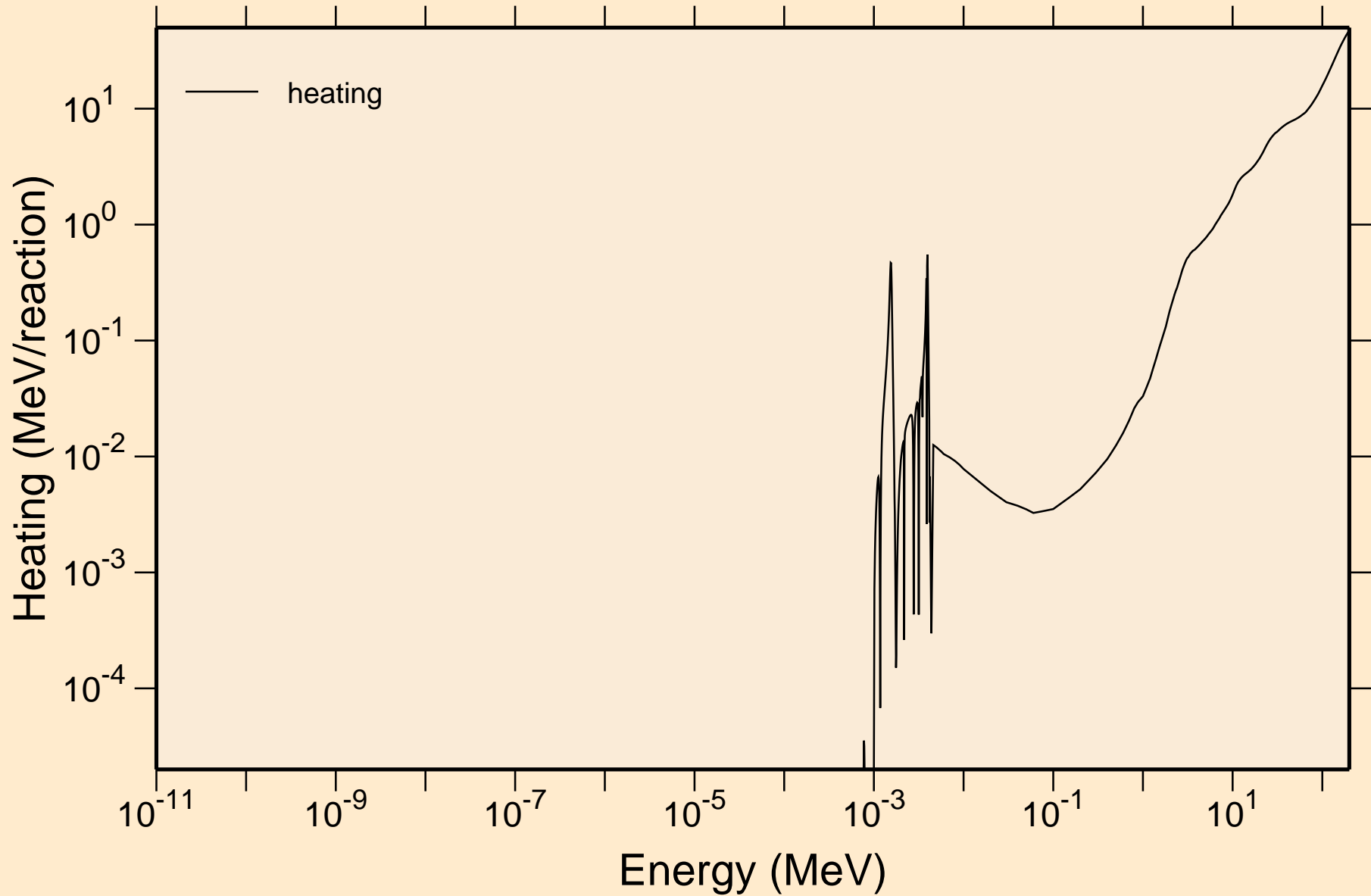

PD098 NEUTRON ACER TENDL-2024 LIBRARY; T=293.6K  
Damage

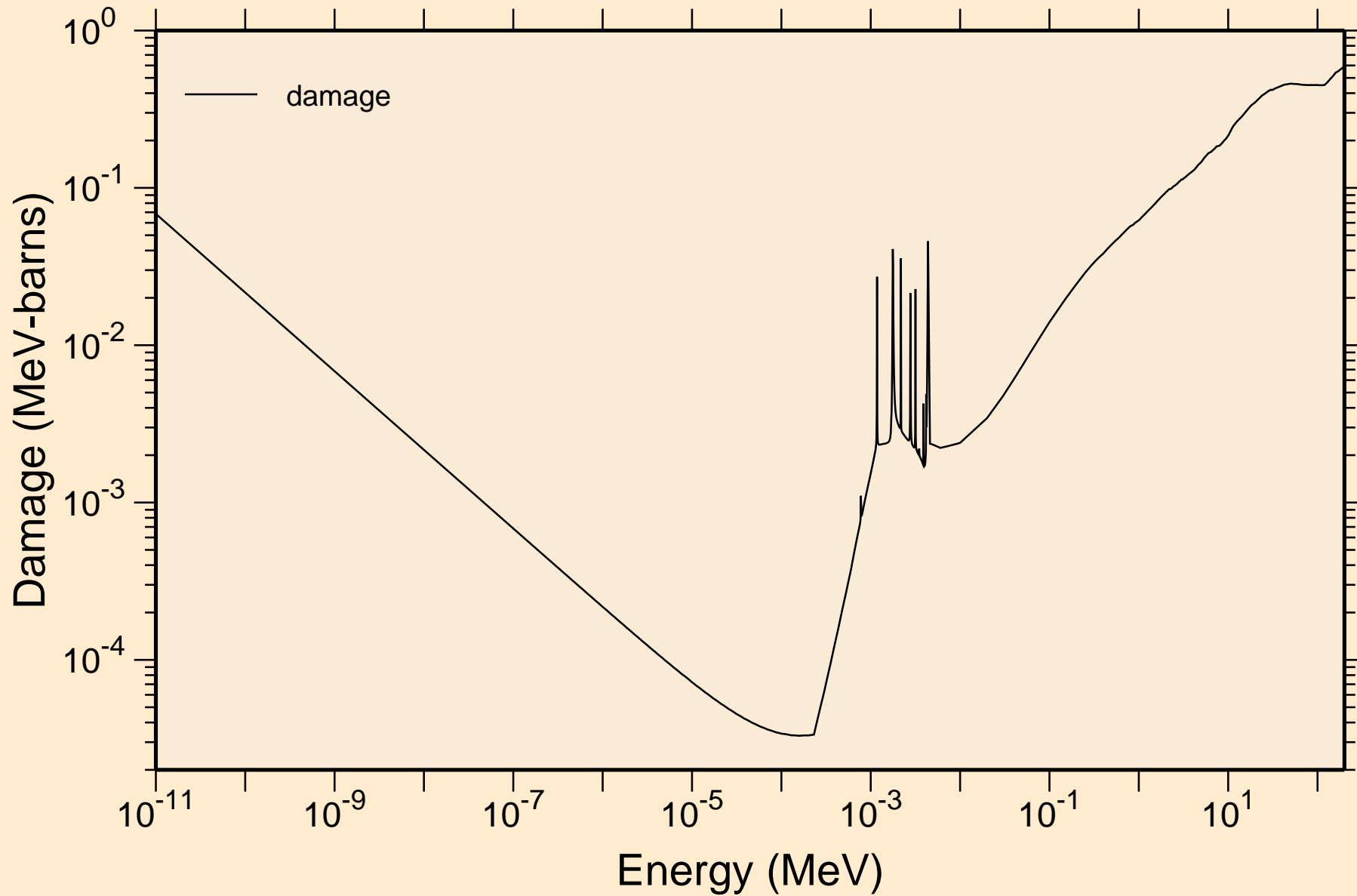

PD098 NEUTRON ACER TENDL-2024 LIBRARY; T=293.6K  
Non-threshold reactions

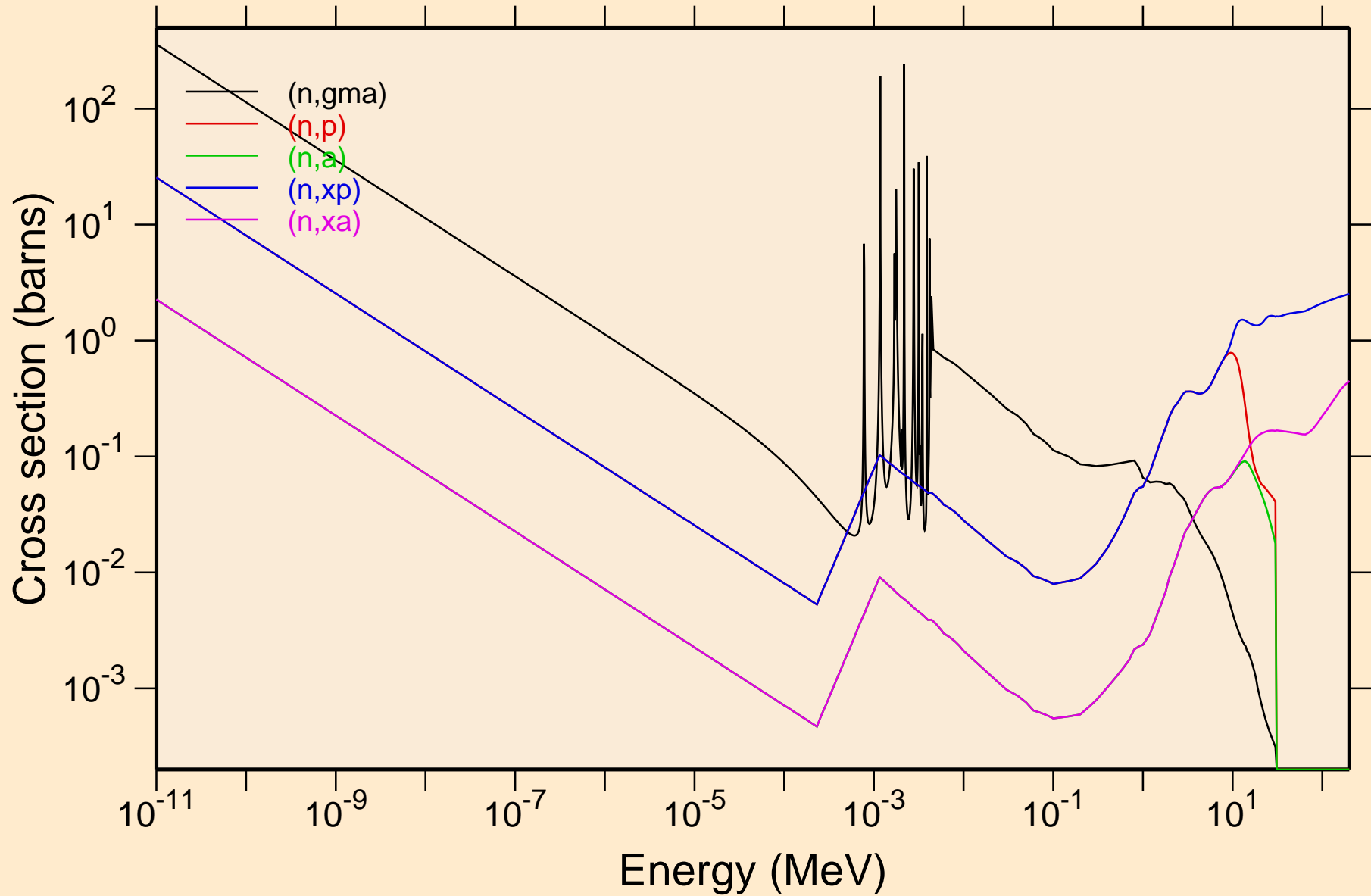

PD098 NEUTRON ACER TENDL-2024 LIBRARY; T=293.6K  
Principal cross sections

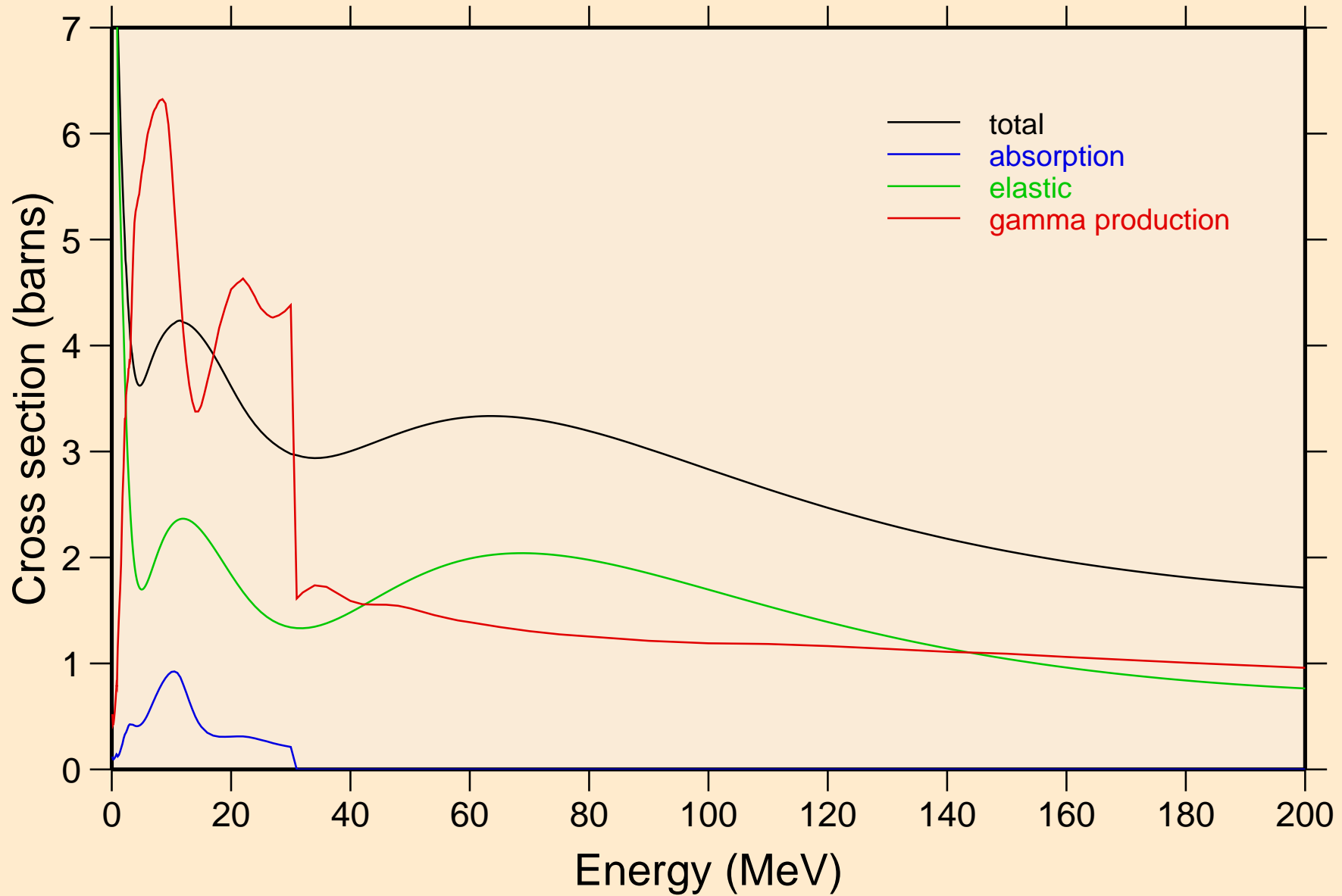

PD098 NEUTRON ACER TENDL-2024 LIBRARY; T=293.6K

Heating

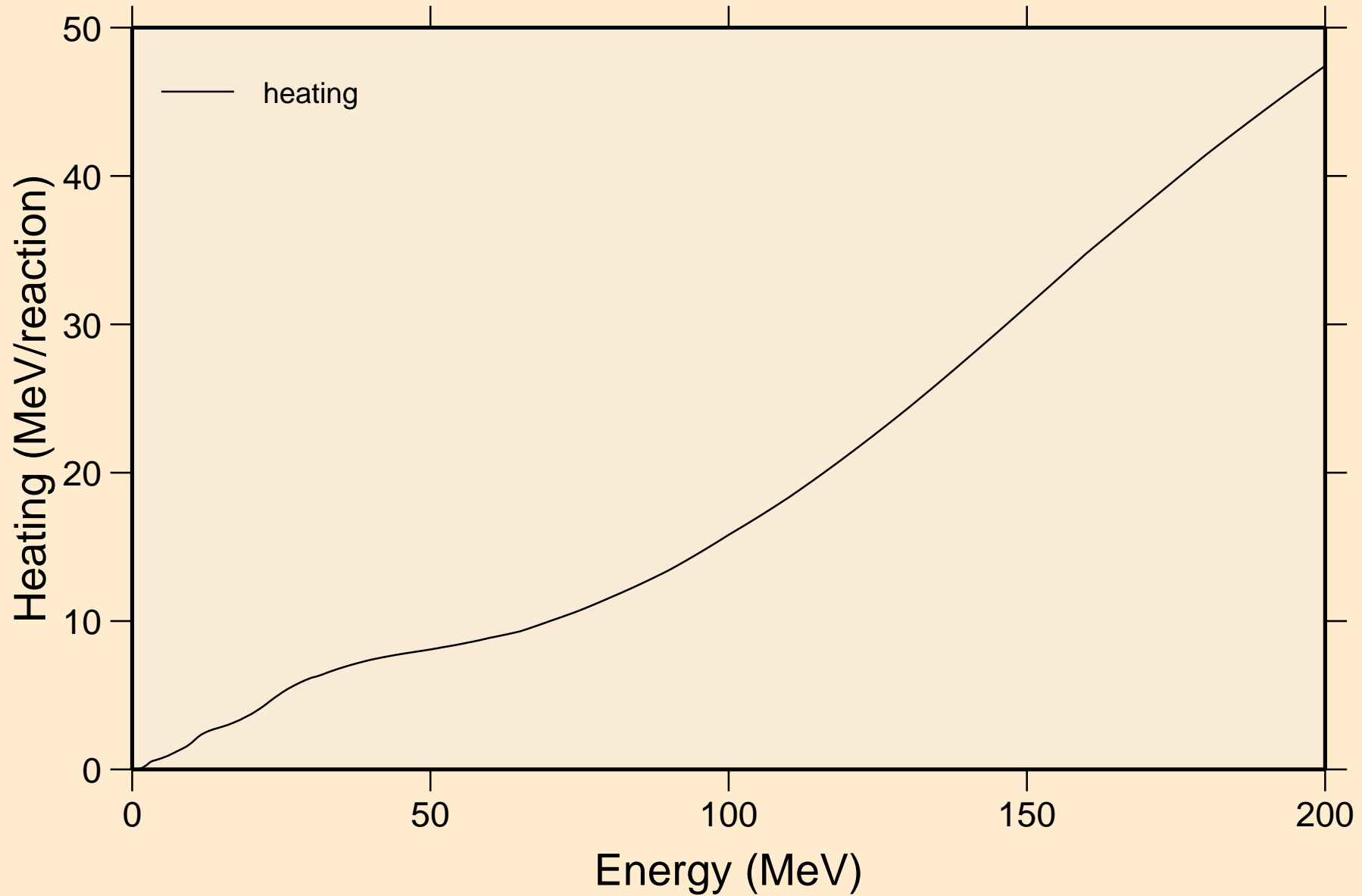

PD098 NEUTRON ACER TENDL-2024 LIBRARY; T=293.6K  
Damage

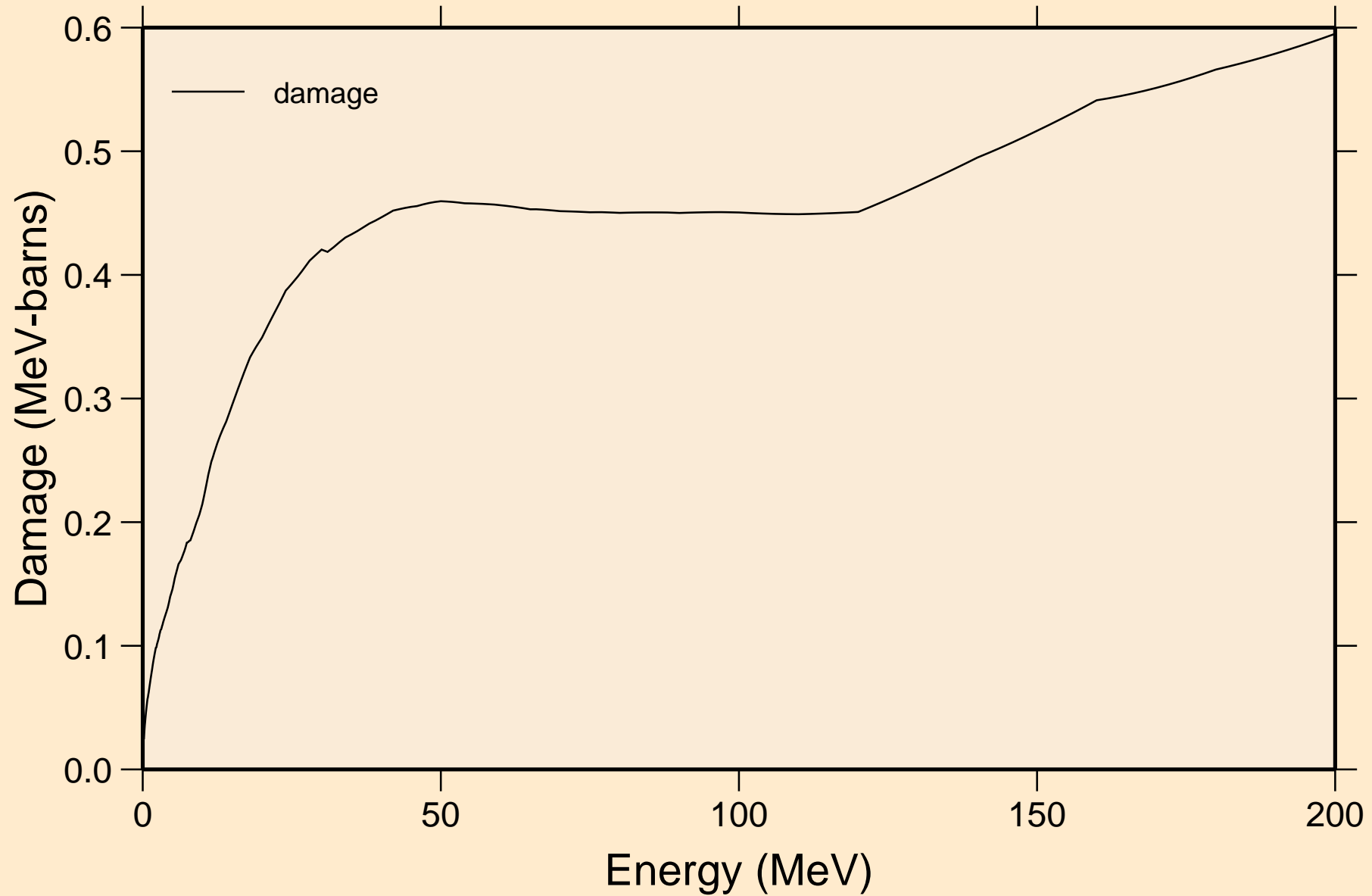

PD098 NEUTRON ACER TENDL-2024 LIBRARY; T=293.6K  
Non-threshold reactions

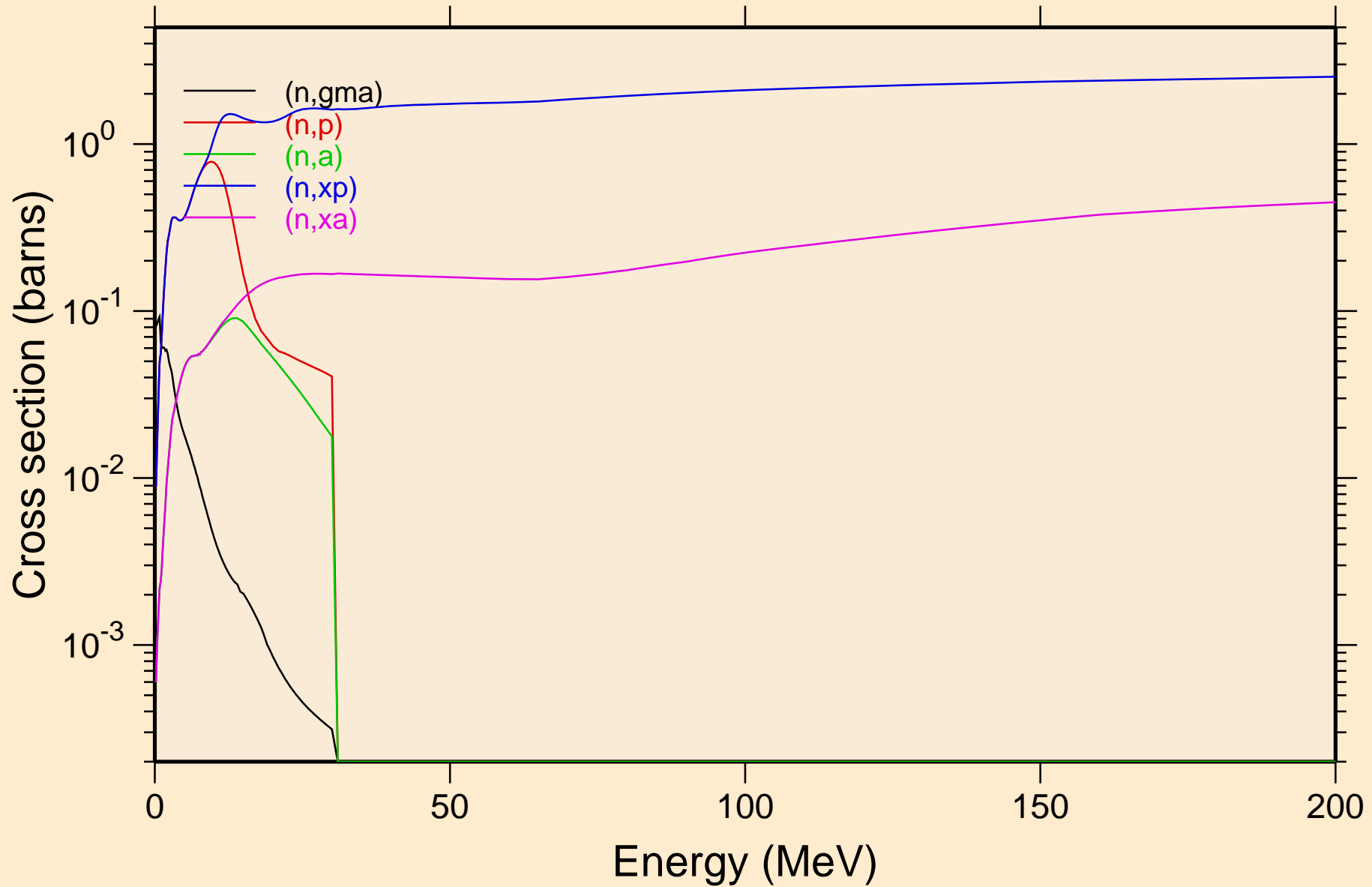

PD098 NEUTRON ACER TENDL-2024 LIBRARY; T=293.6K  
Inelastic levels

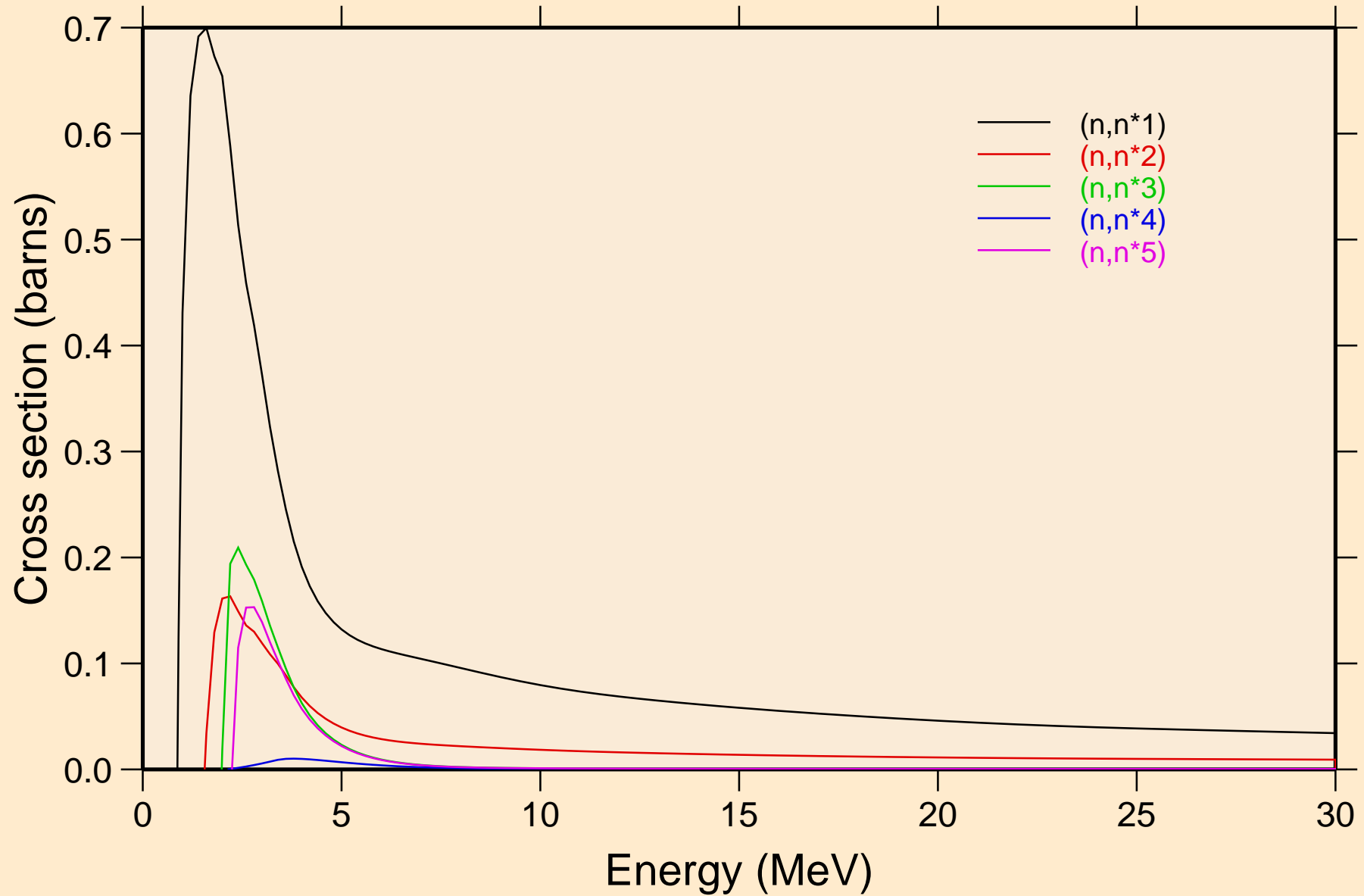

PD098 NEUTRON ACER TENDL-2024 LIBRARY; T=293.6K  
Inelastic levels

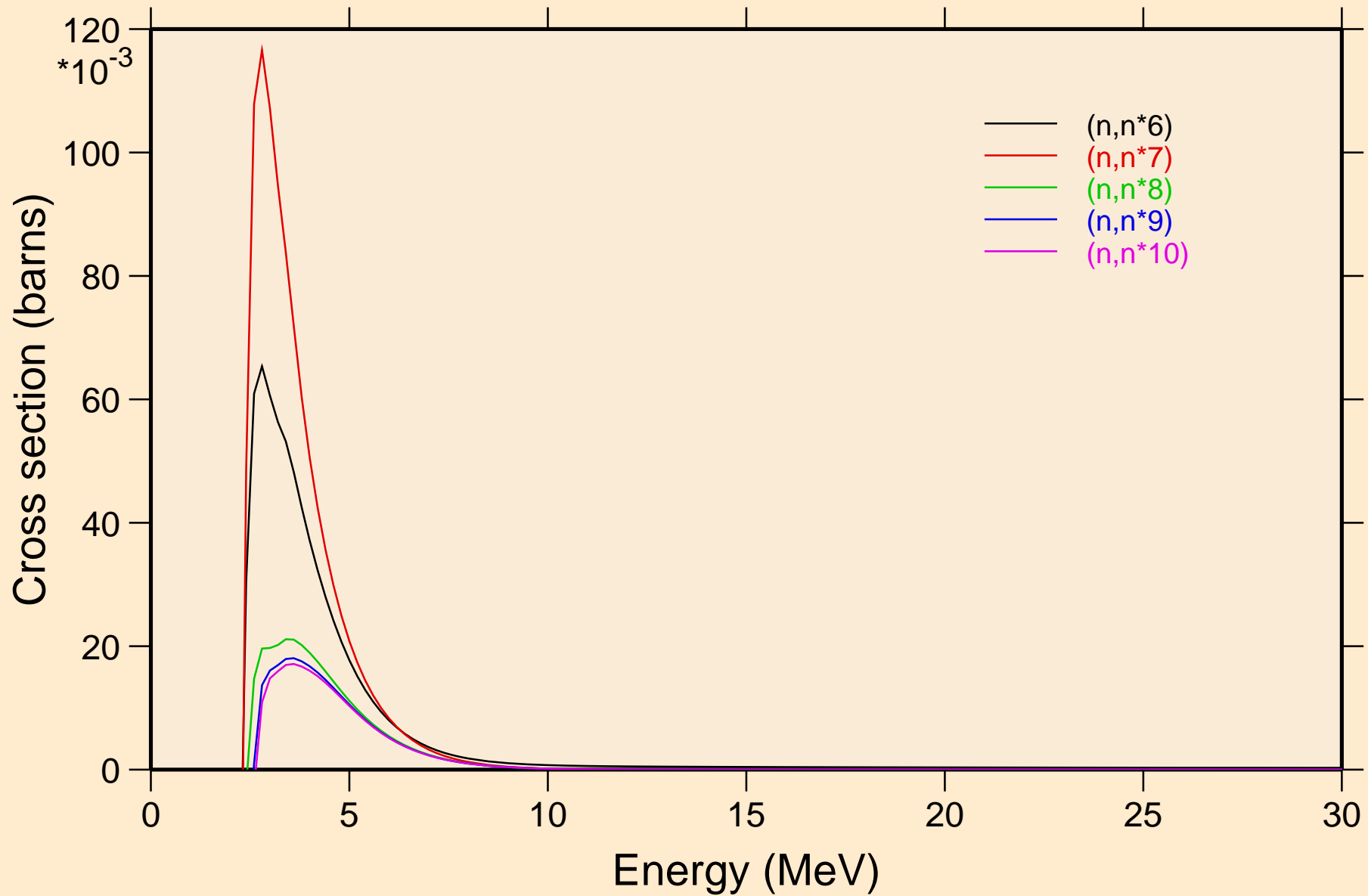

PD098 NEUTRON ACER TENDL-2024 LIBRARY; T=293.6K  
Inelastic levels

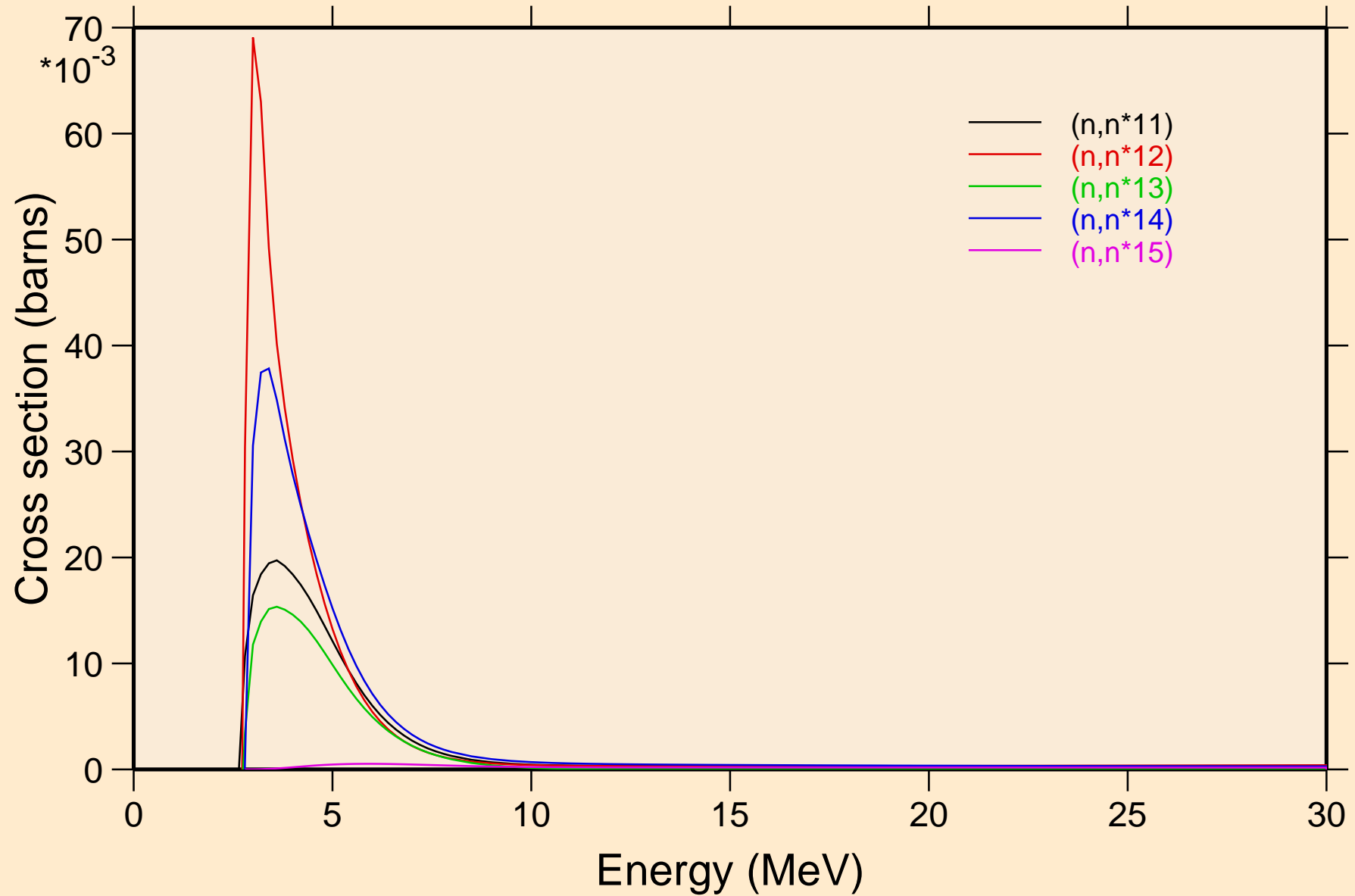

PD098 NEUTRON ACER TENDL-2024 LIBRARY; T=293.6K  
Inelastic levels

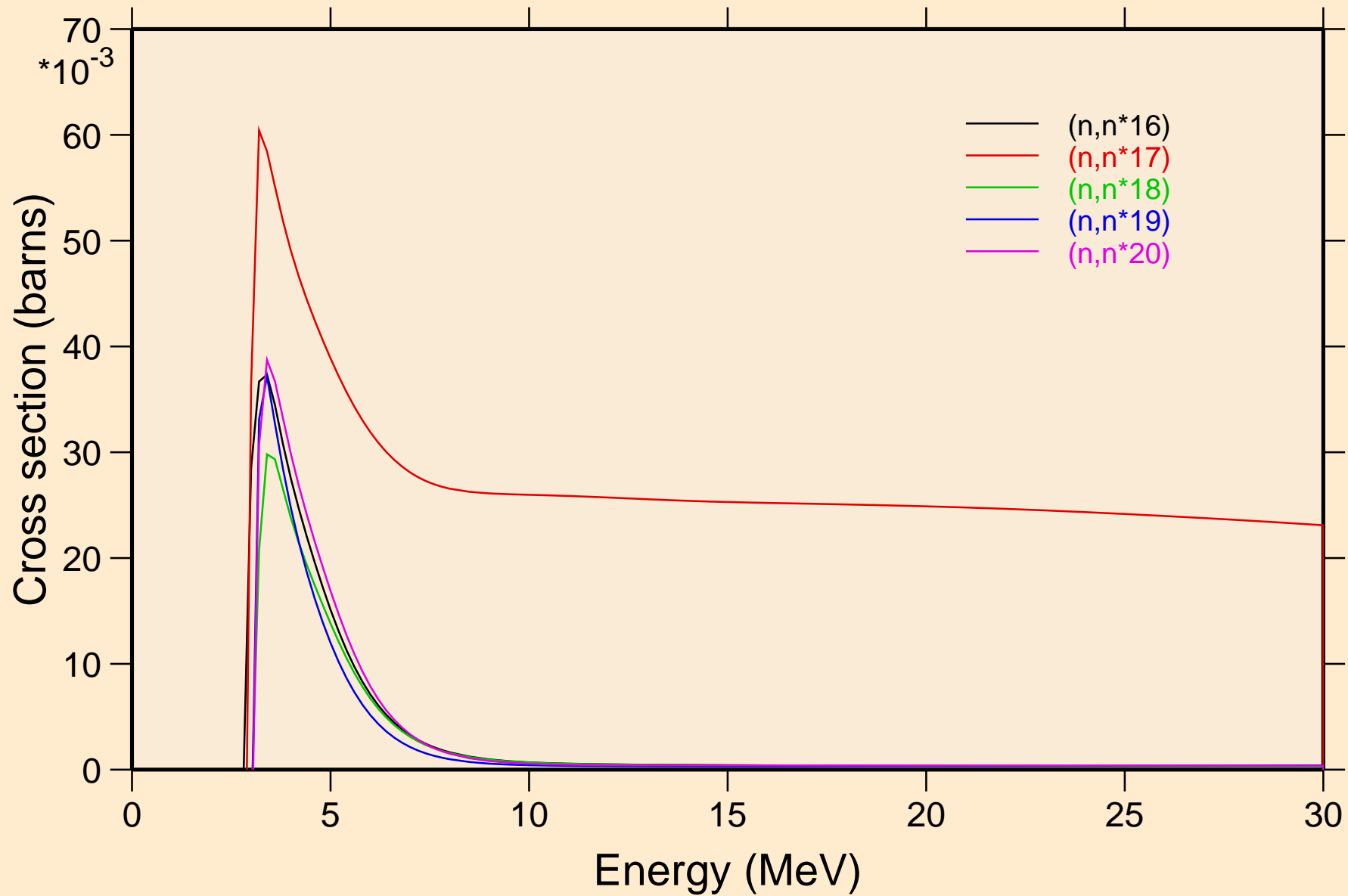

PD098 NEUTRON ACER TENDL-2024 LIBRARY; T=293.6K  
Inelastic levels

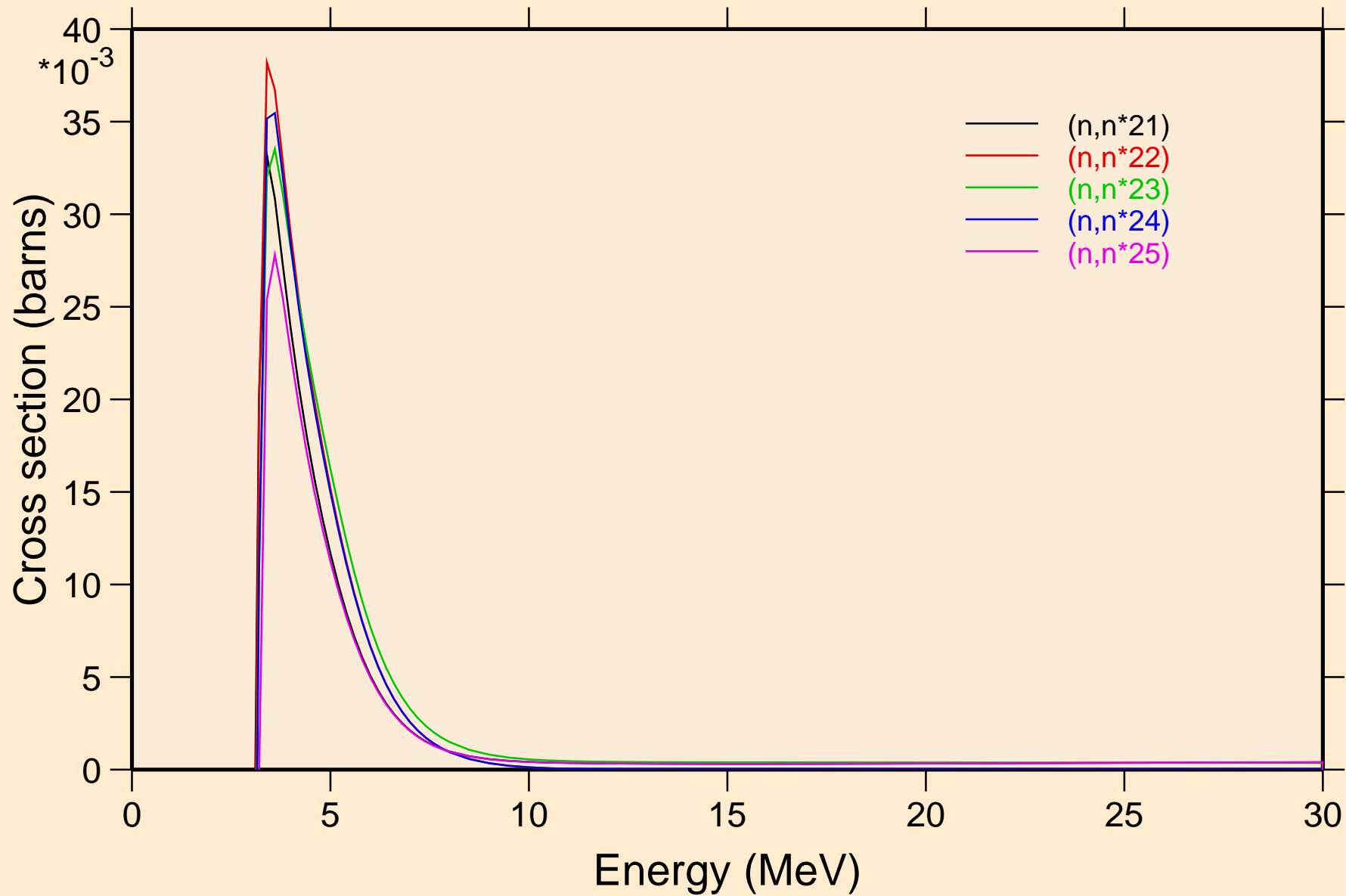

PD098 NEUTRON ACER TENDL-2024 LIBRARY; T=293.6K  
Inelastic levels

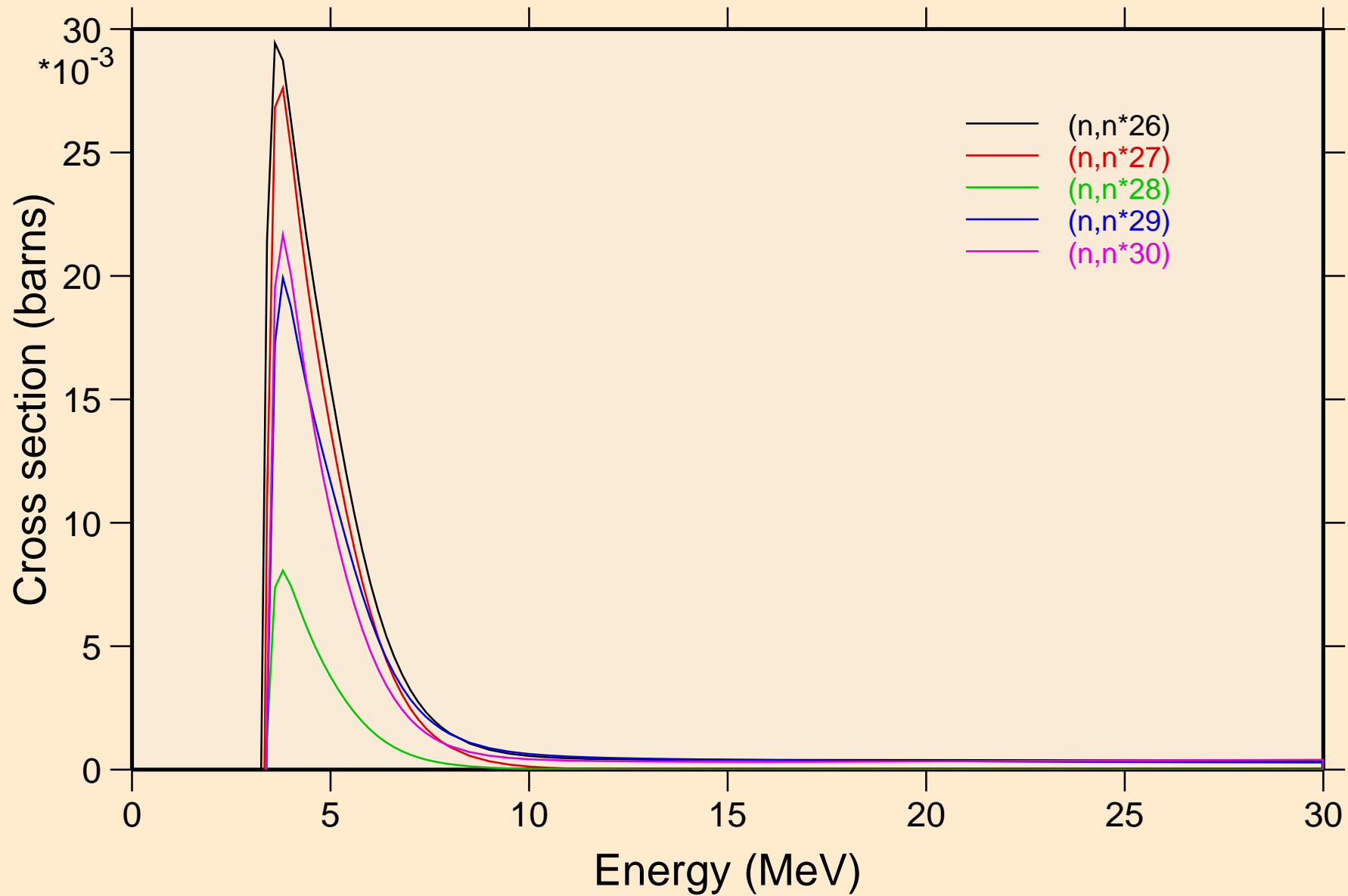

PD098 NEUTRON ACER TENDL-2024 LIBRARY; T=293.6K  
Threshold reactions

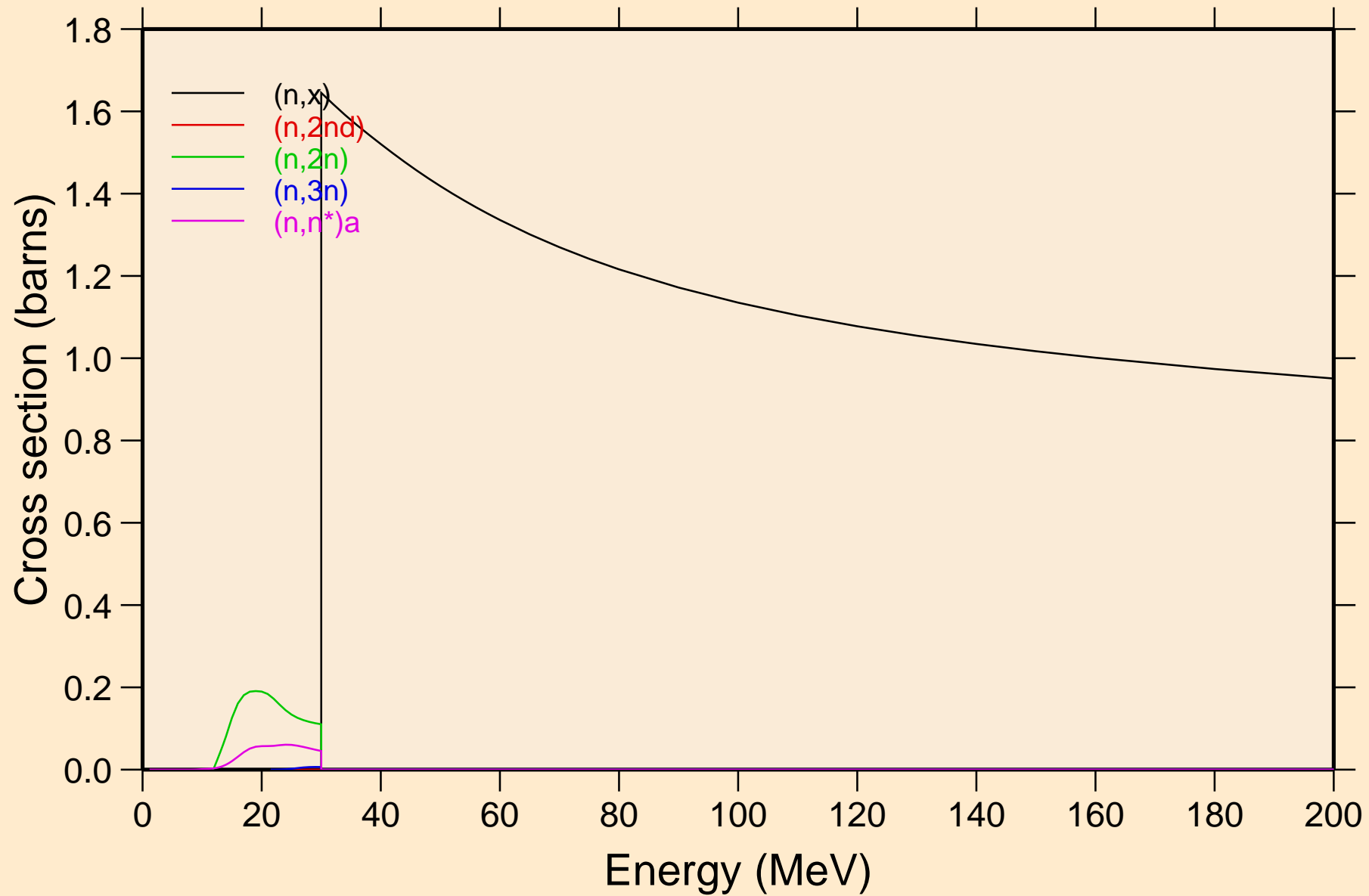

PD098 NEUTRON ACER TENDL-2024 LIBRARY; T=293.6K  
Threshold reactions

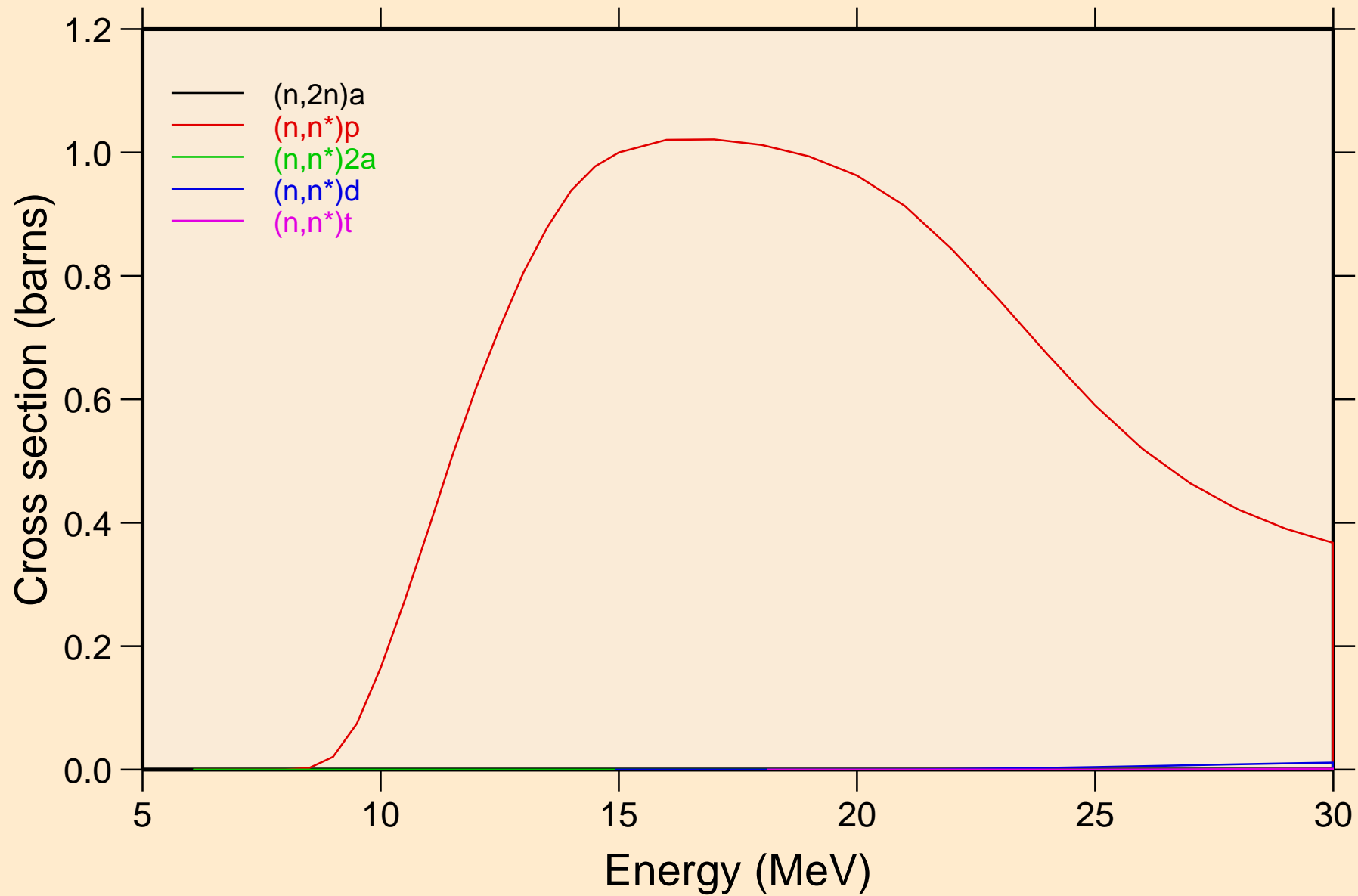

PD098 NEUTRON ACER TENDL-2024 LIBRARY; T=293.6K  
Threshold reactions

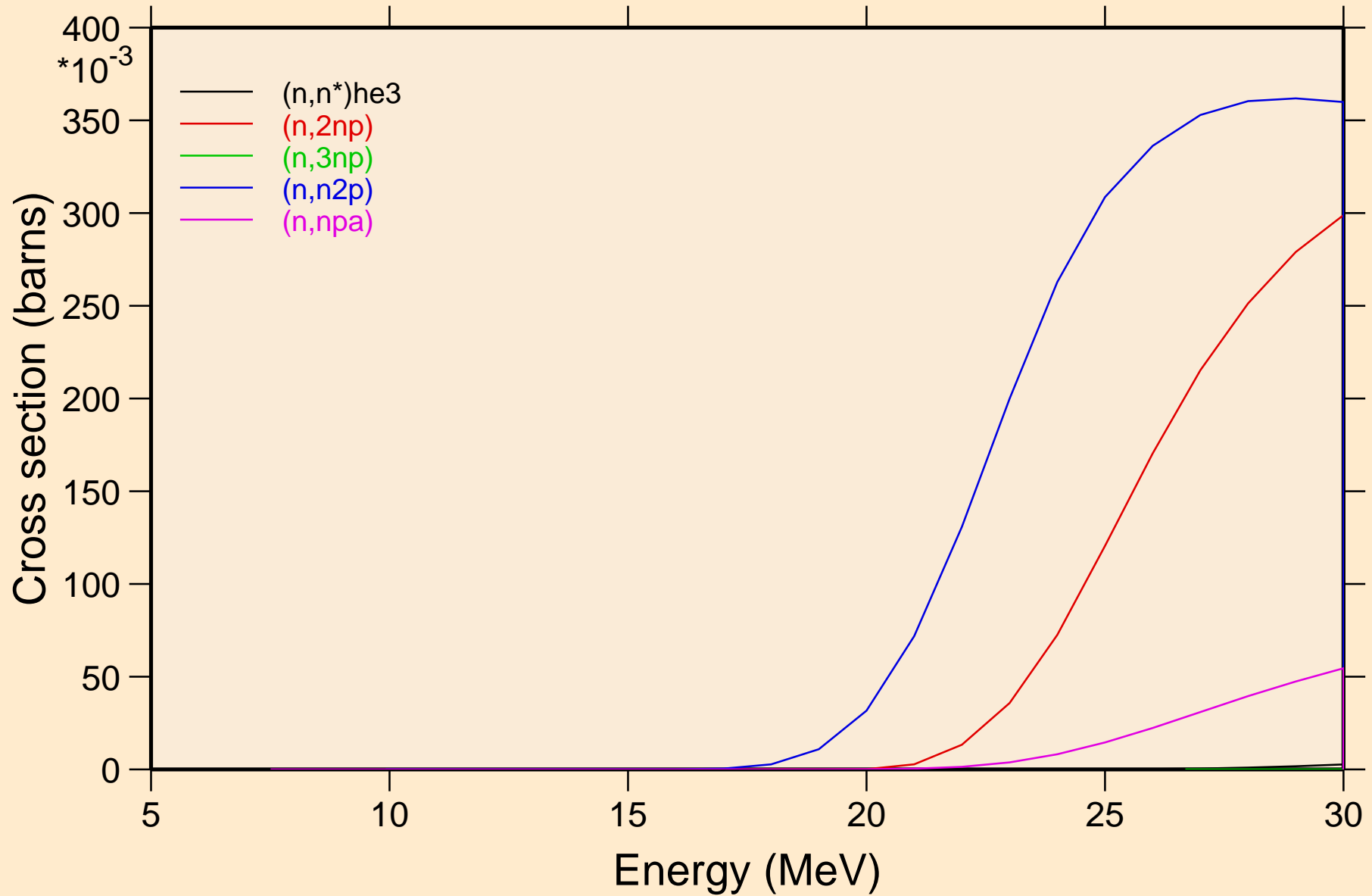

PD098 NEUTRON ACER TENDL-2024 LIBRARY; T=293.6K  
Threshold reactions

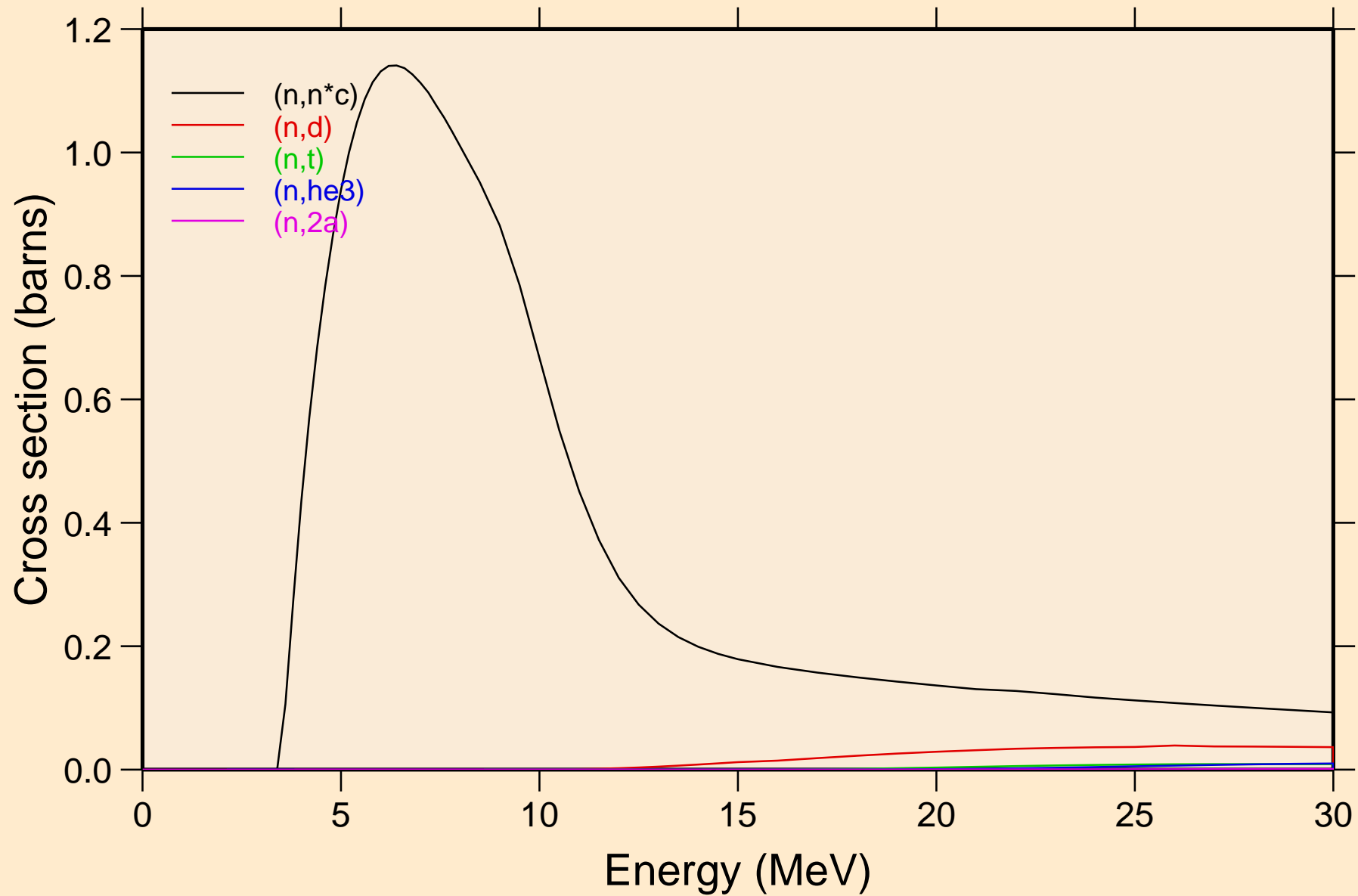

PD098 NEUTRON ACER TENDL-2024 LIBRARY; T=293.6K  
Threshold reactions

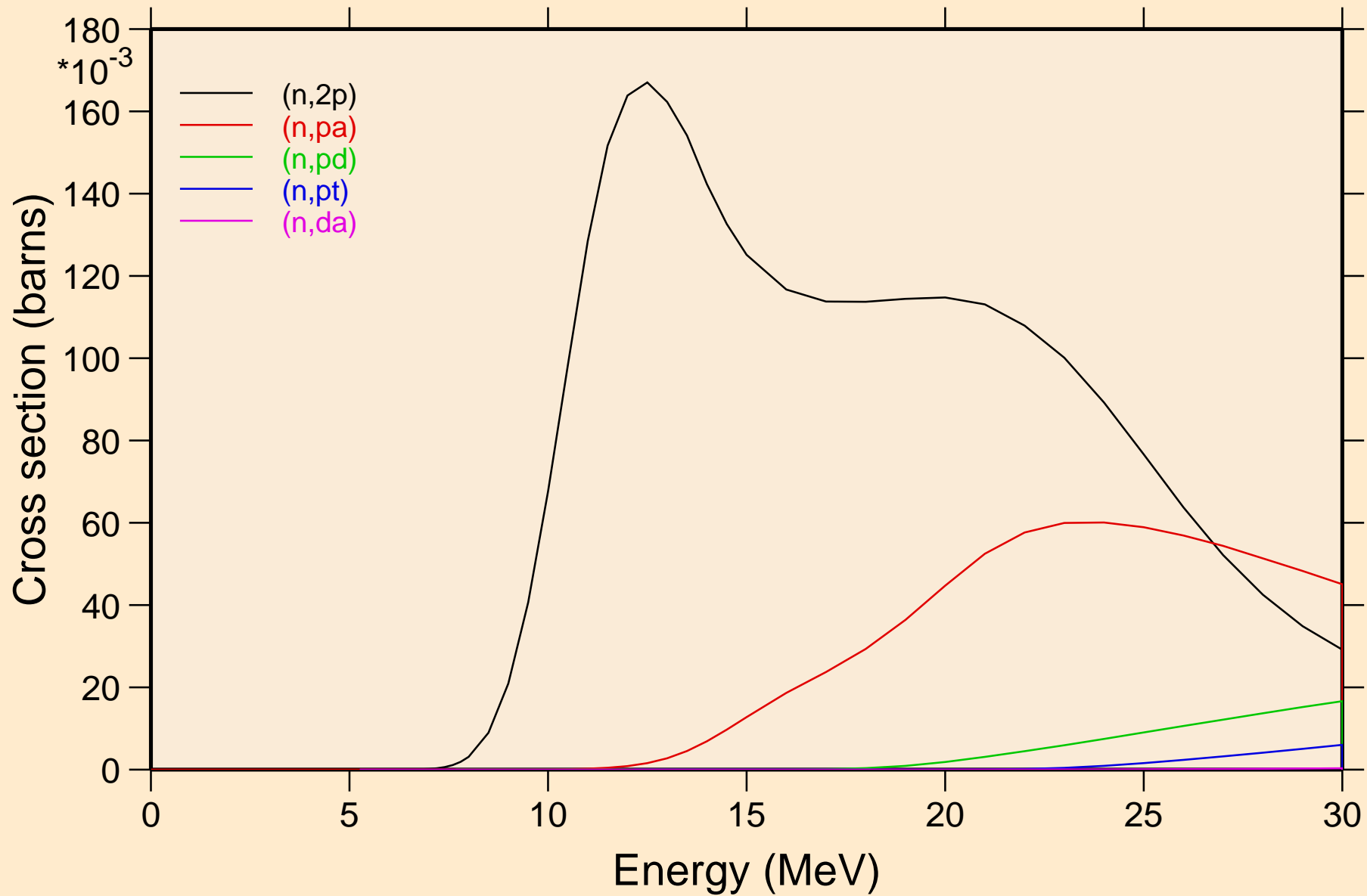

PD098 NEUTRON ACER TENDL-2024 LIBRARY; T=293.6K  
Threshold reactions

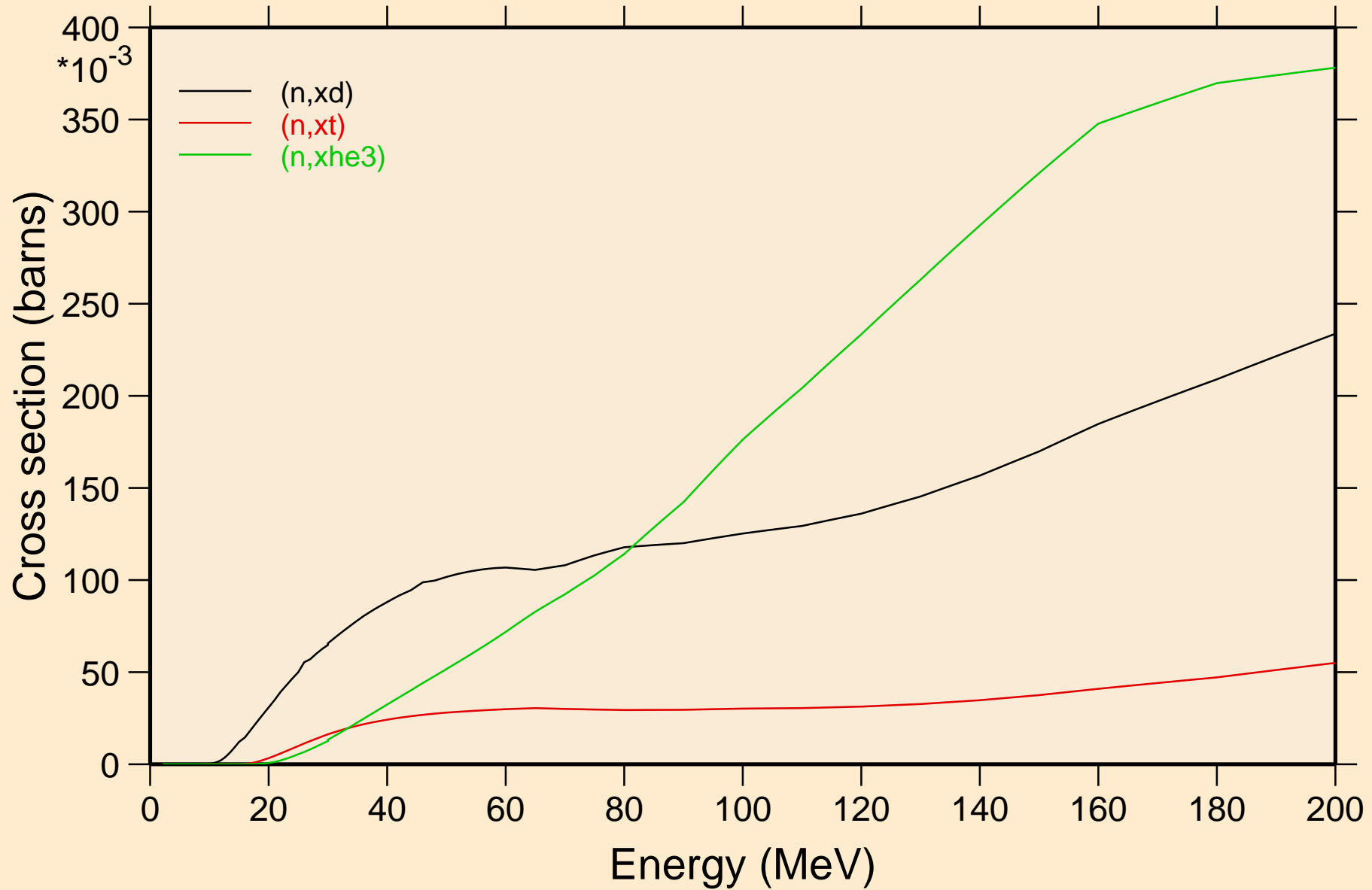

PD098 NEUTRON ACER TENDL-2024 LIBRARY; T=293.6K  
angular distribution for elastic

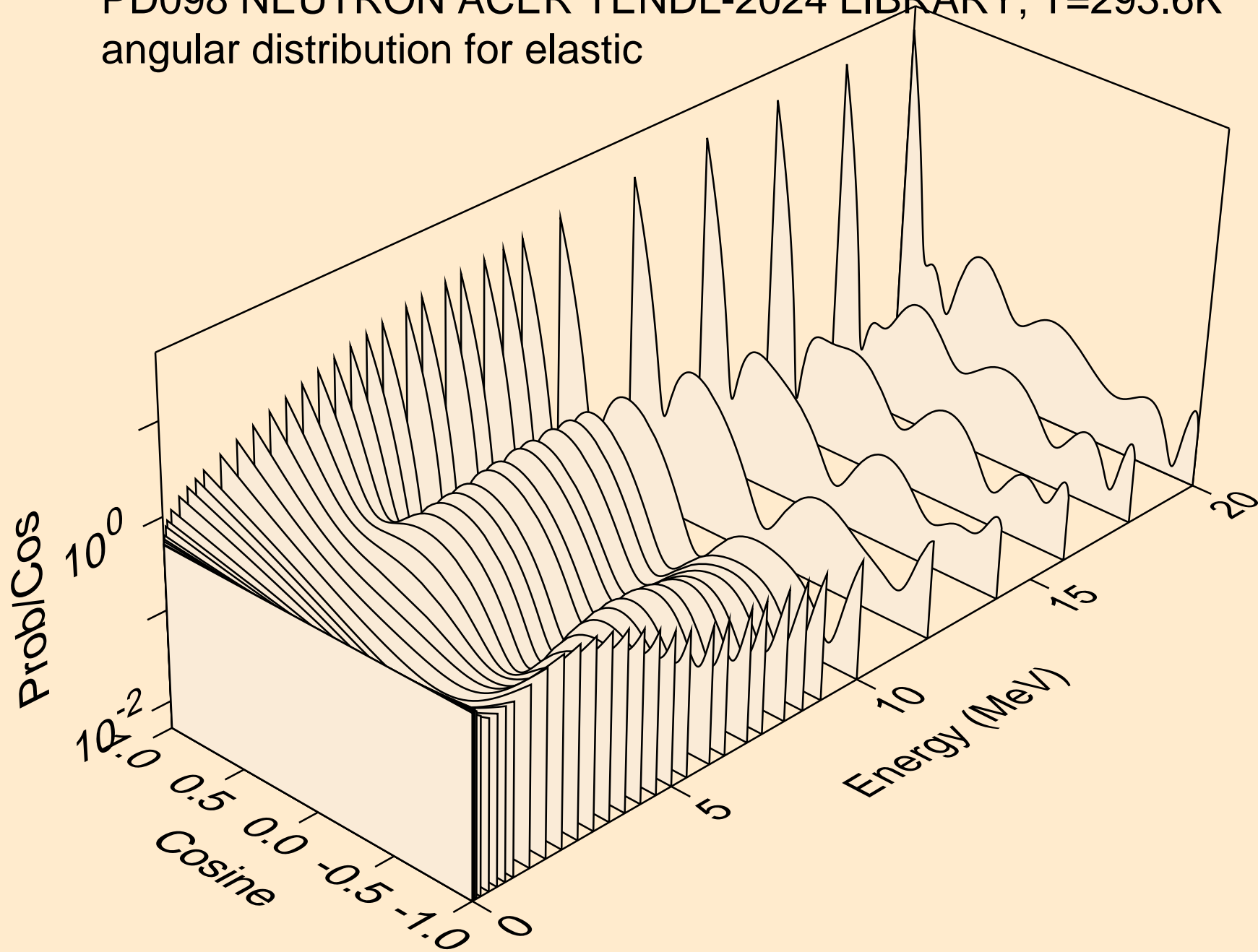

PD098 NEUTRON ACER TENDL-2024 LIBRARY; T=293.6K  
angular distribution for elastic

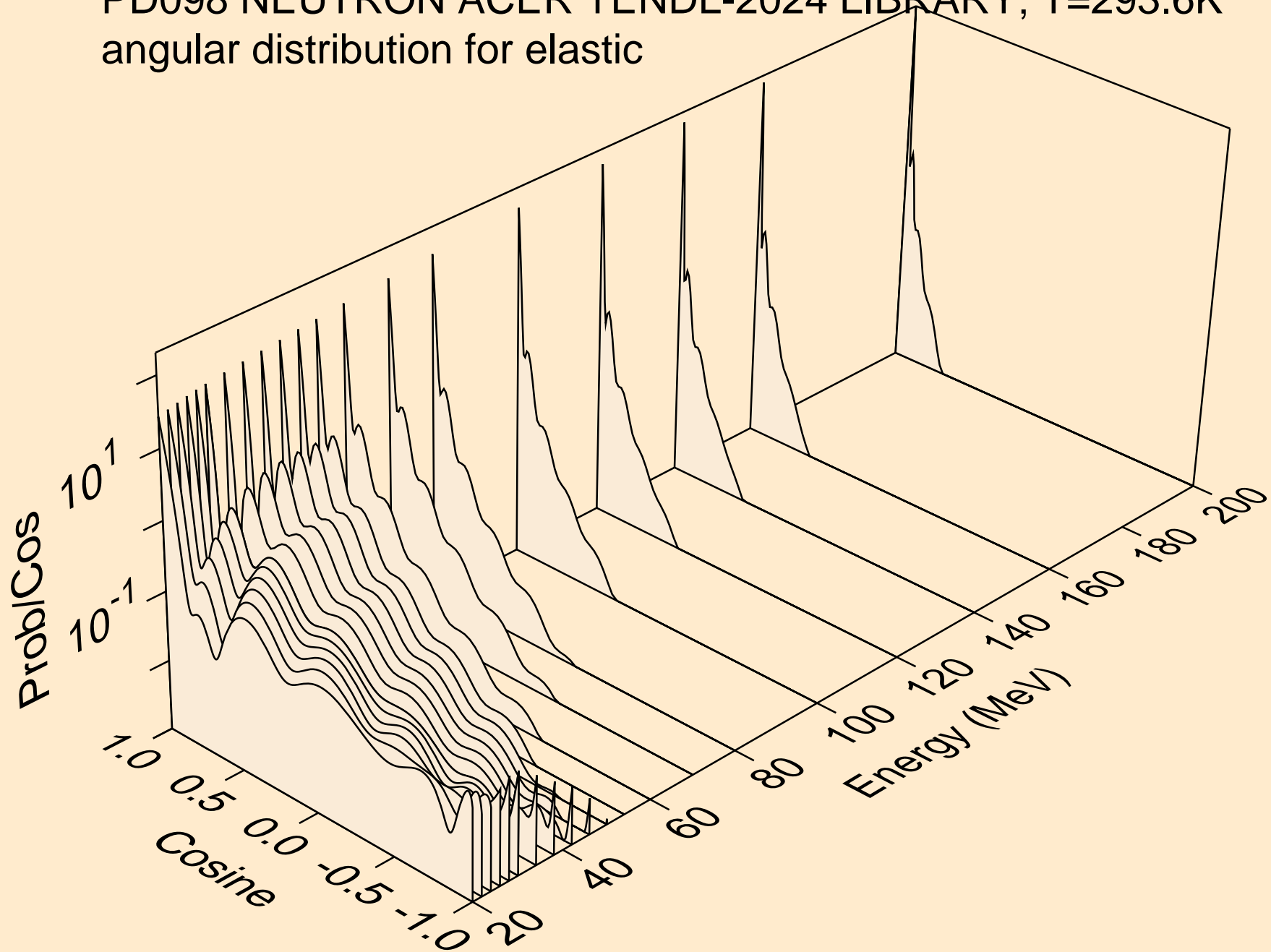

PD098 NEUTRON ACER TENDL-2024 LIBRARY; T=293.6K  
angular distribution for (n,n\*1)

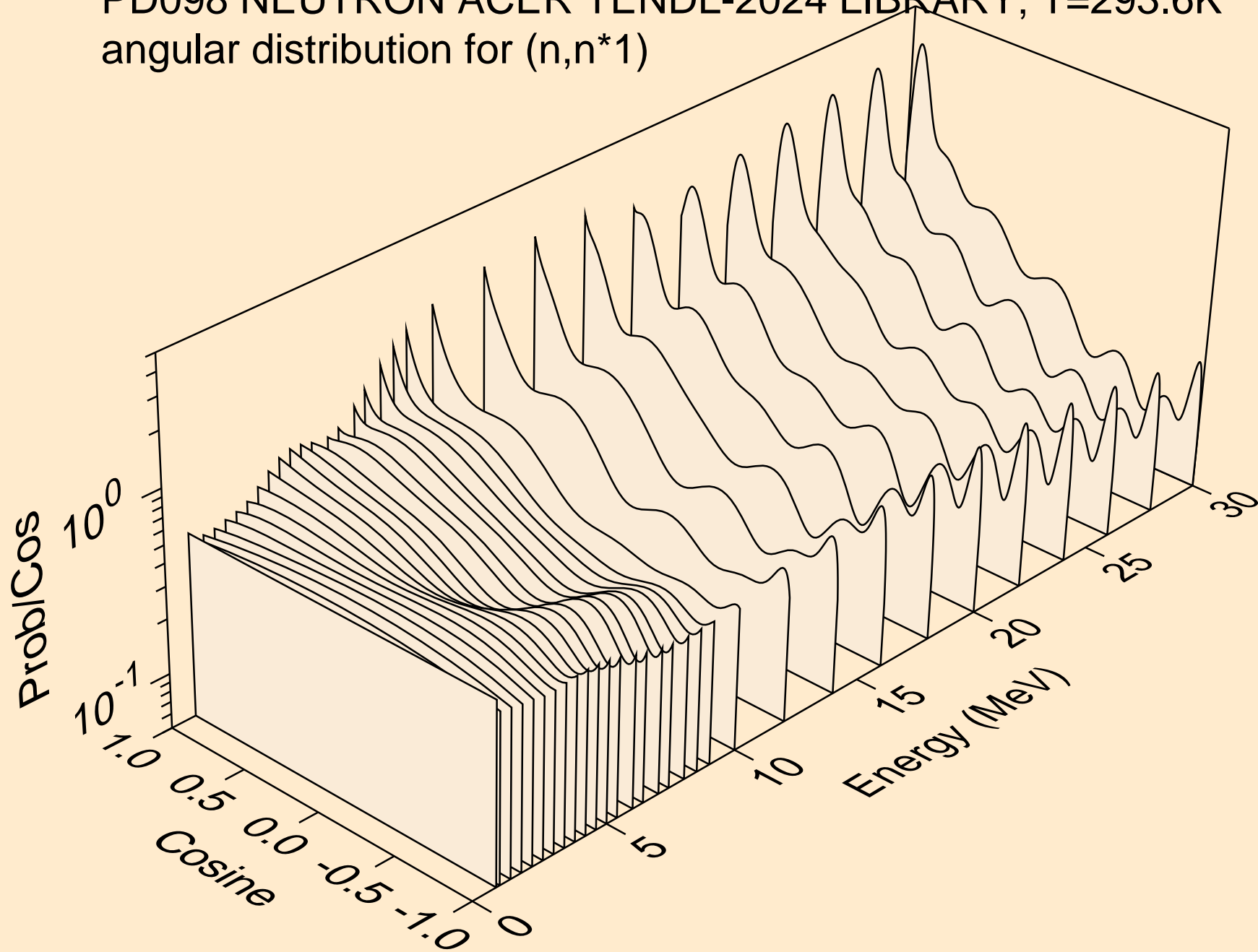

PD098 NEUTRON ACER TENDL-2024 LIBRARY; T=293.6K  
angular distribution for (n,n\*2)

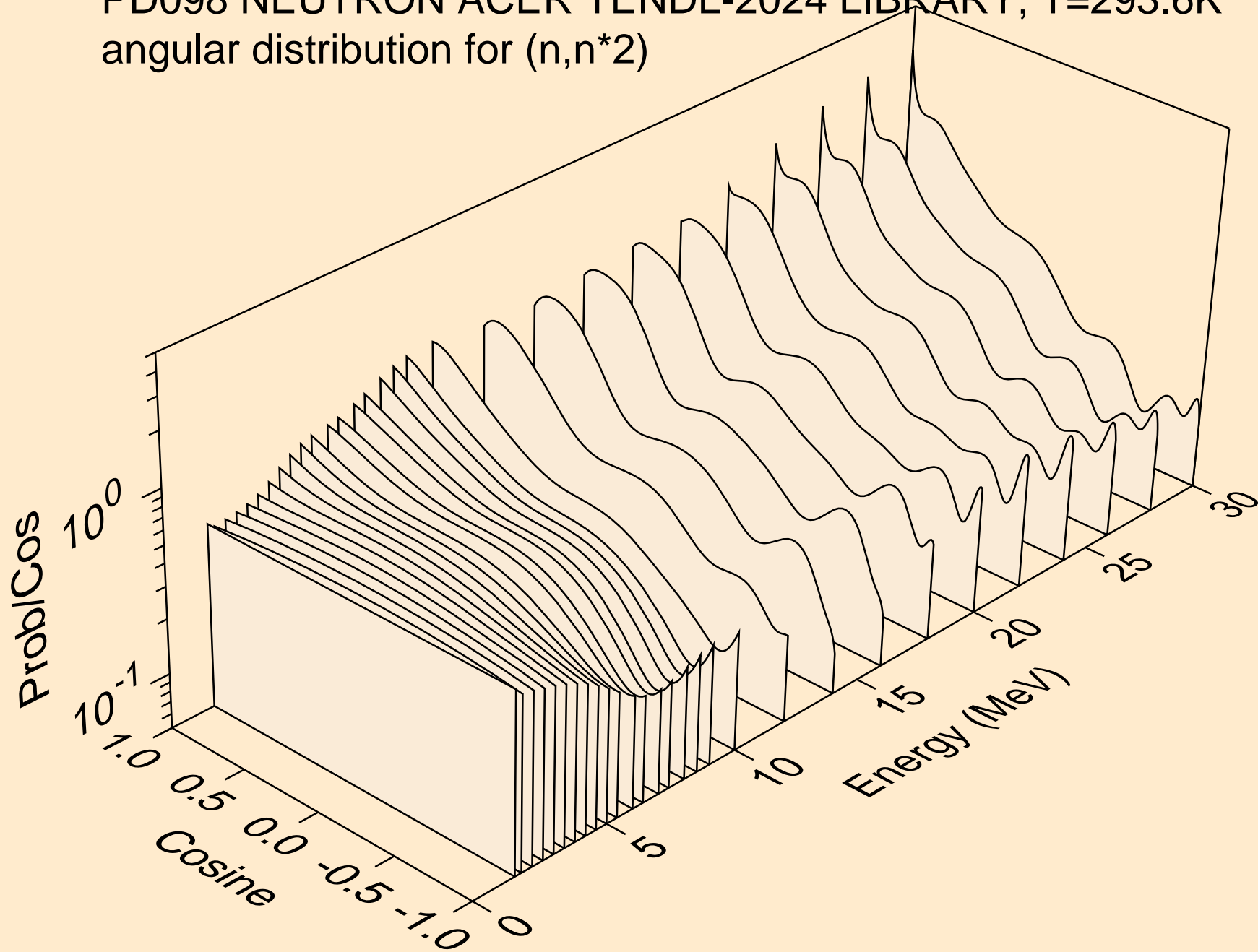

PD098 NEUTRON ACER TENDL-2024 LIBRARY; T=293.6K  
angular distribution for (n,n\*3)

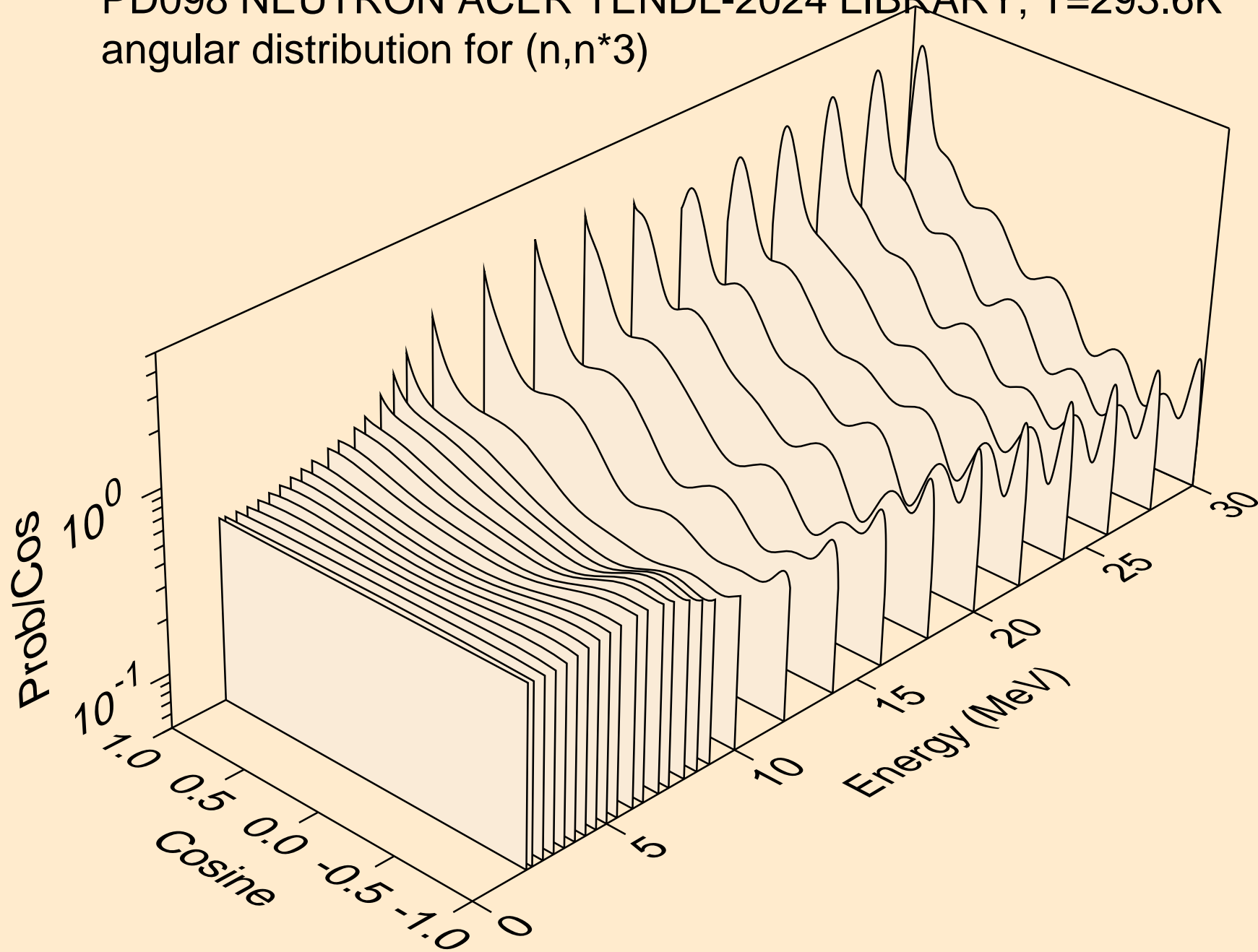

PD098 NEUTRON ACER TENDL-2024 LIBRARY; T=293.6K  
angular distribution for (n,n\*4)

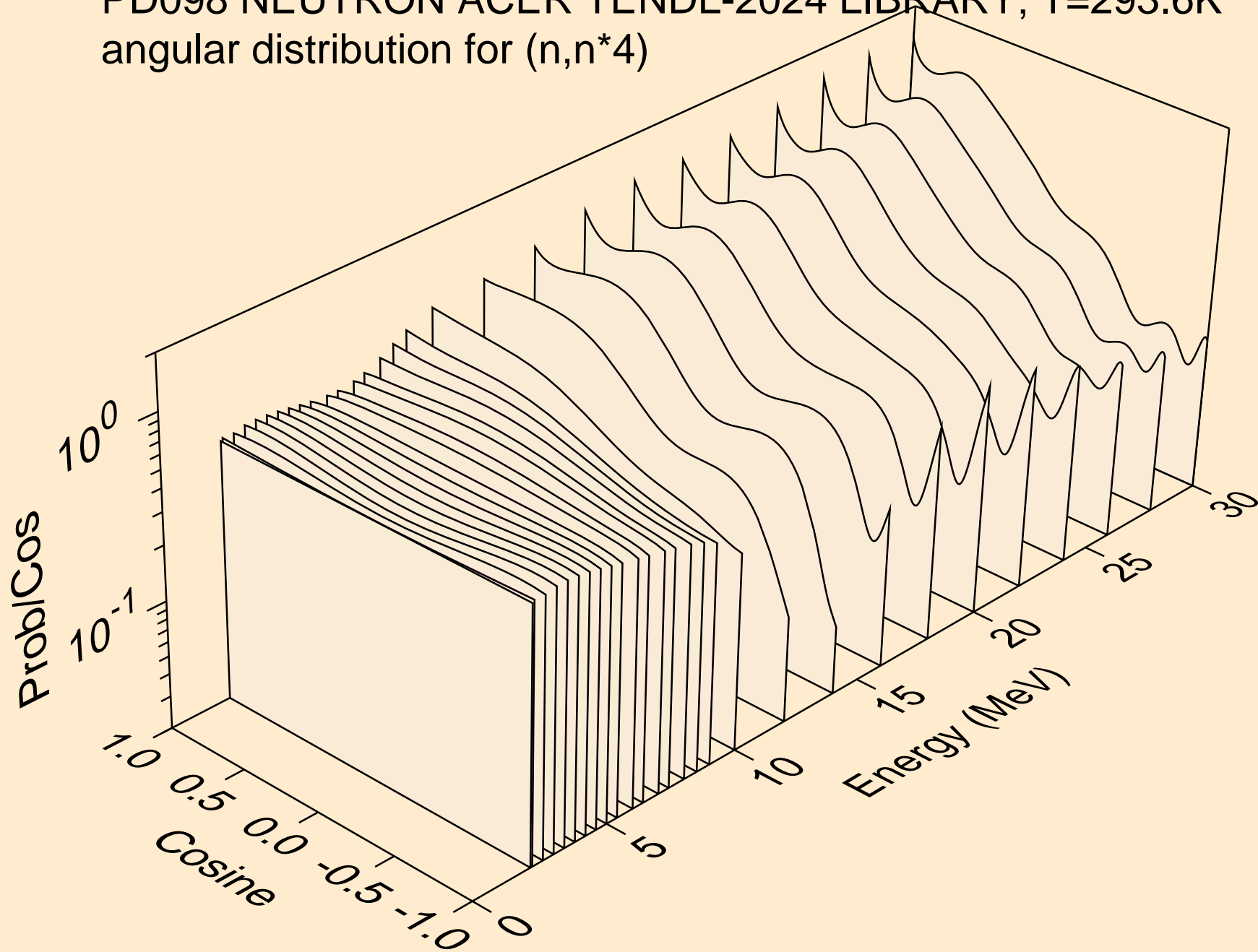

PD098 NEUTRON ACER TENDL-2024 LIBRARY; T=293.6K  
angular distribution for (n,n\*5)

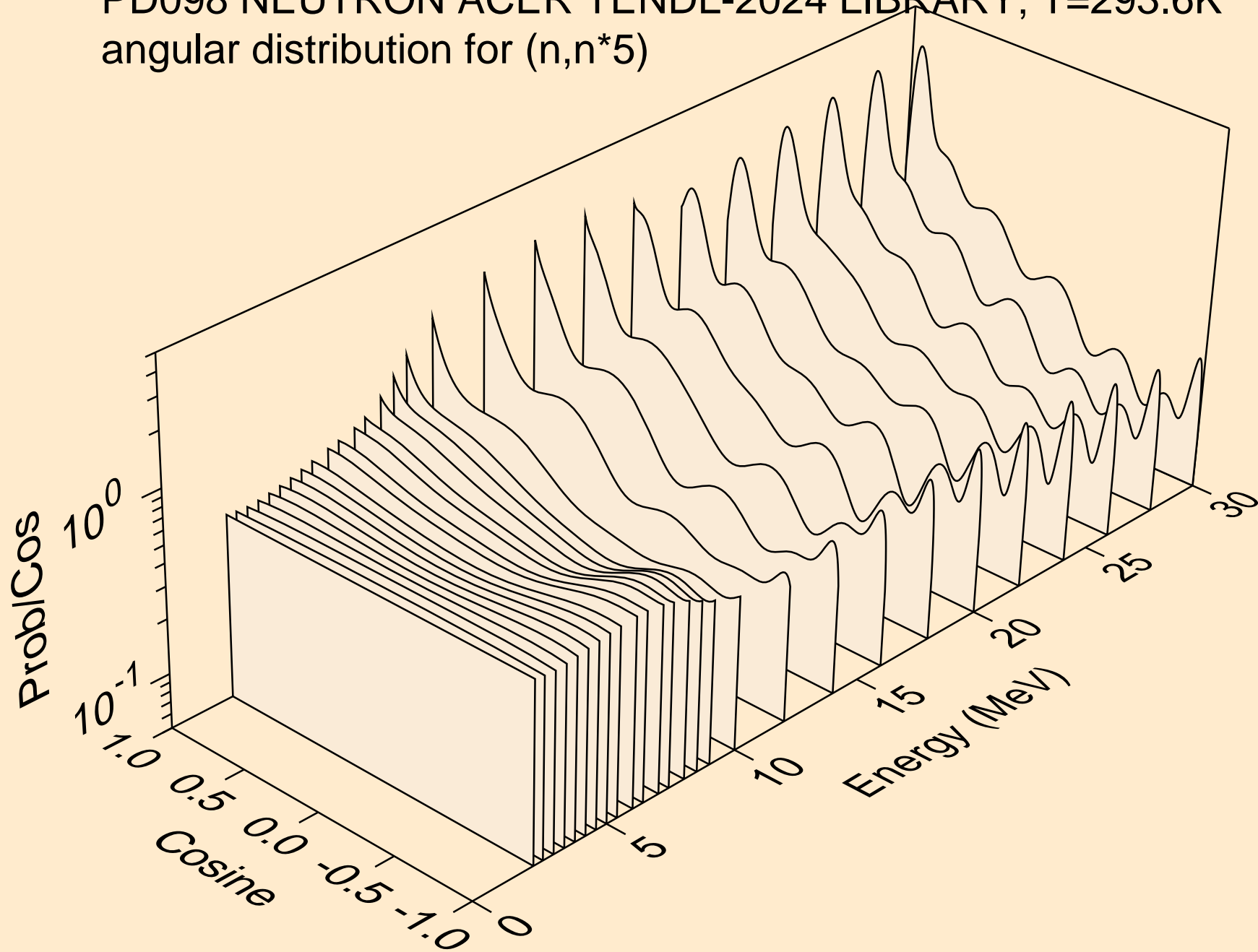

PD098 NEUTRON ACER TENDL-2024 LIBRARY; T=293.6K  
angular distribution for (n,n\*6)

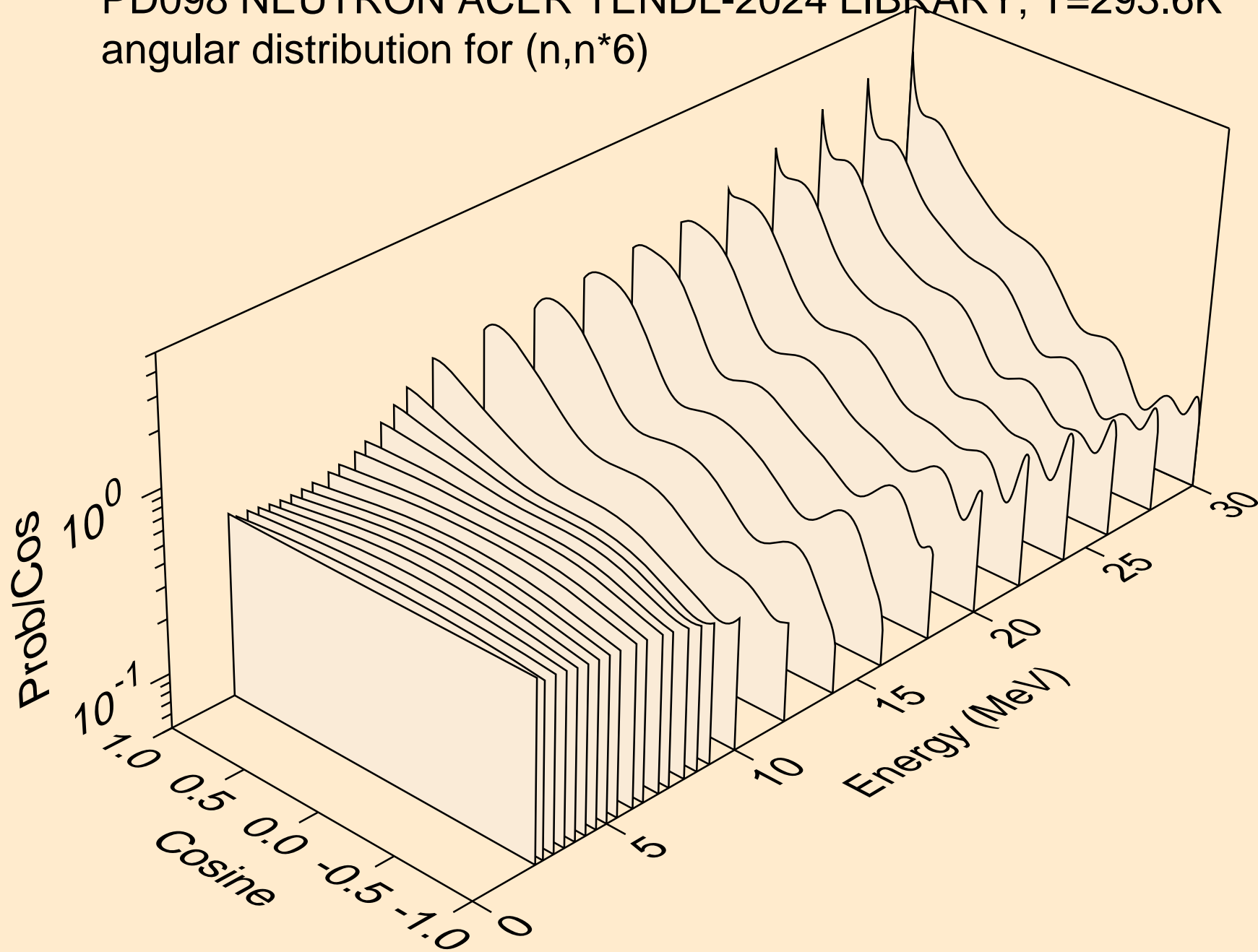

PD098 NEUTRON ACER TENDL-2024 LIBRARY; T=293.6K  
angular distribution for (n,n\*7)

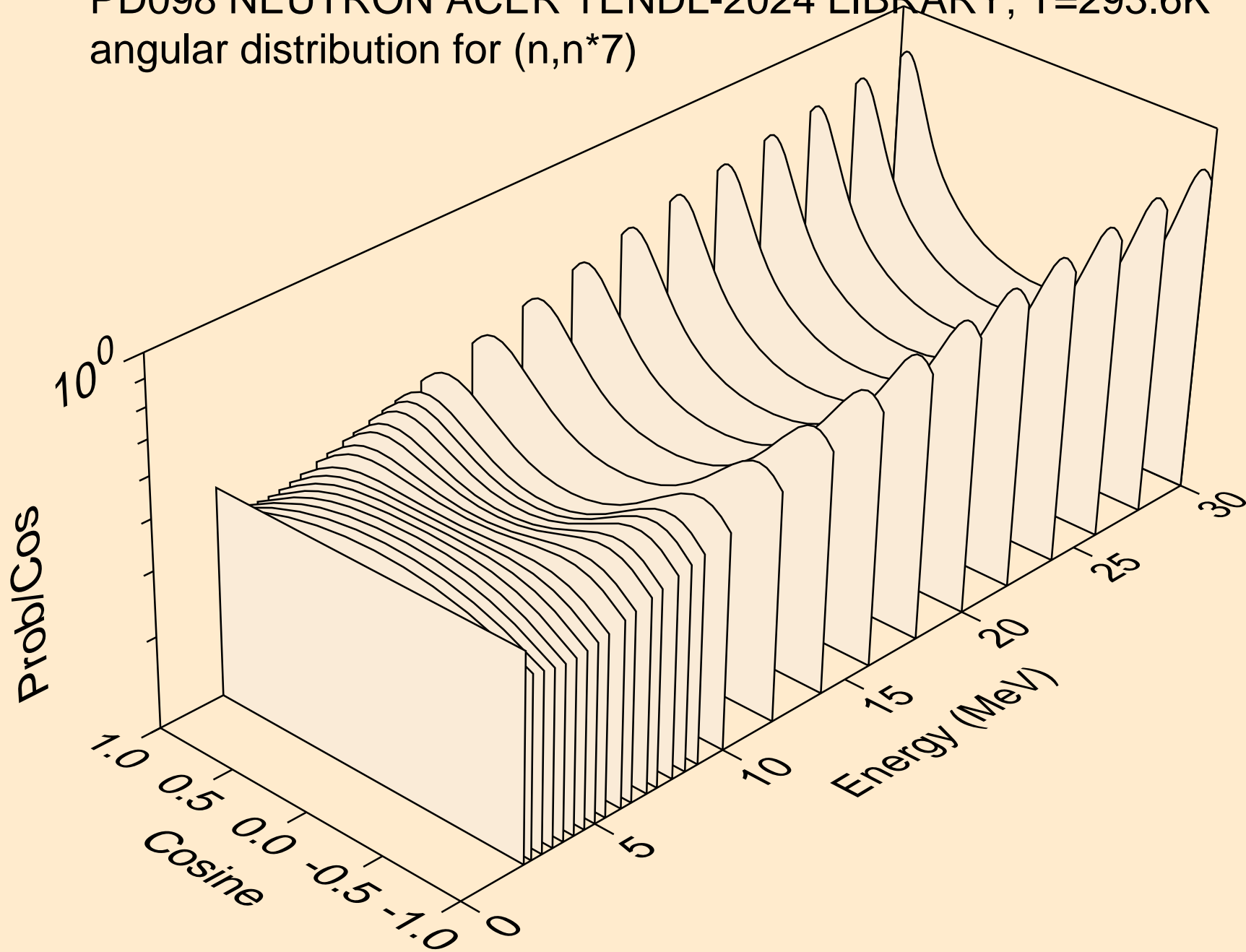

PD098 NEUTRON ACER TENDL-2024 LIBRARY; T=293.6K  
angular distribution for (n,n\*8)

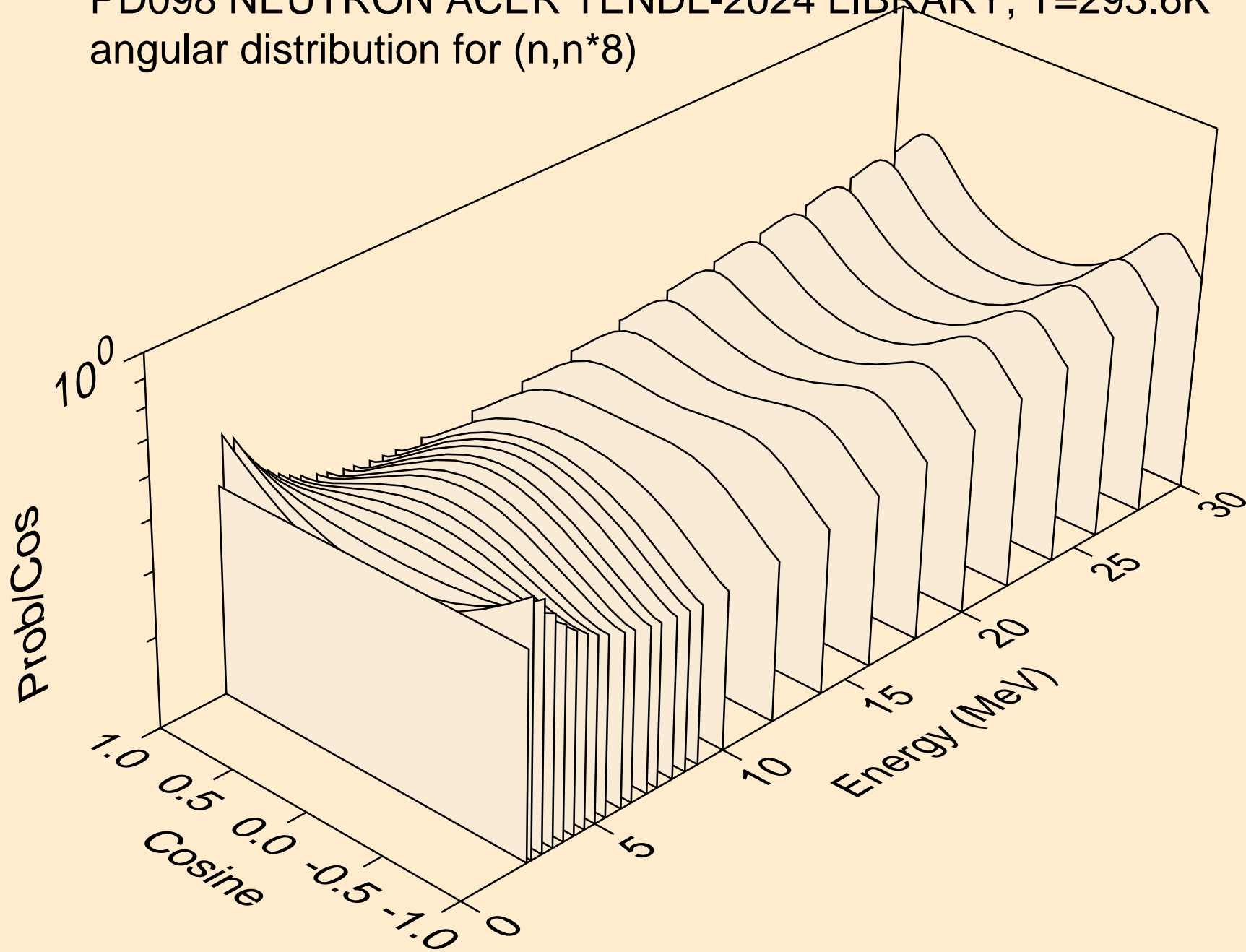

PD098 NEUTRON ACER TENDL-2024 LIBRARY; T=293.6K  
angular distribution for (n,n\*9)

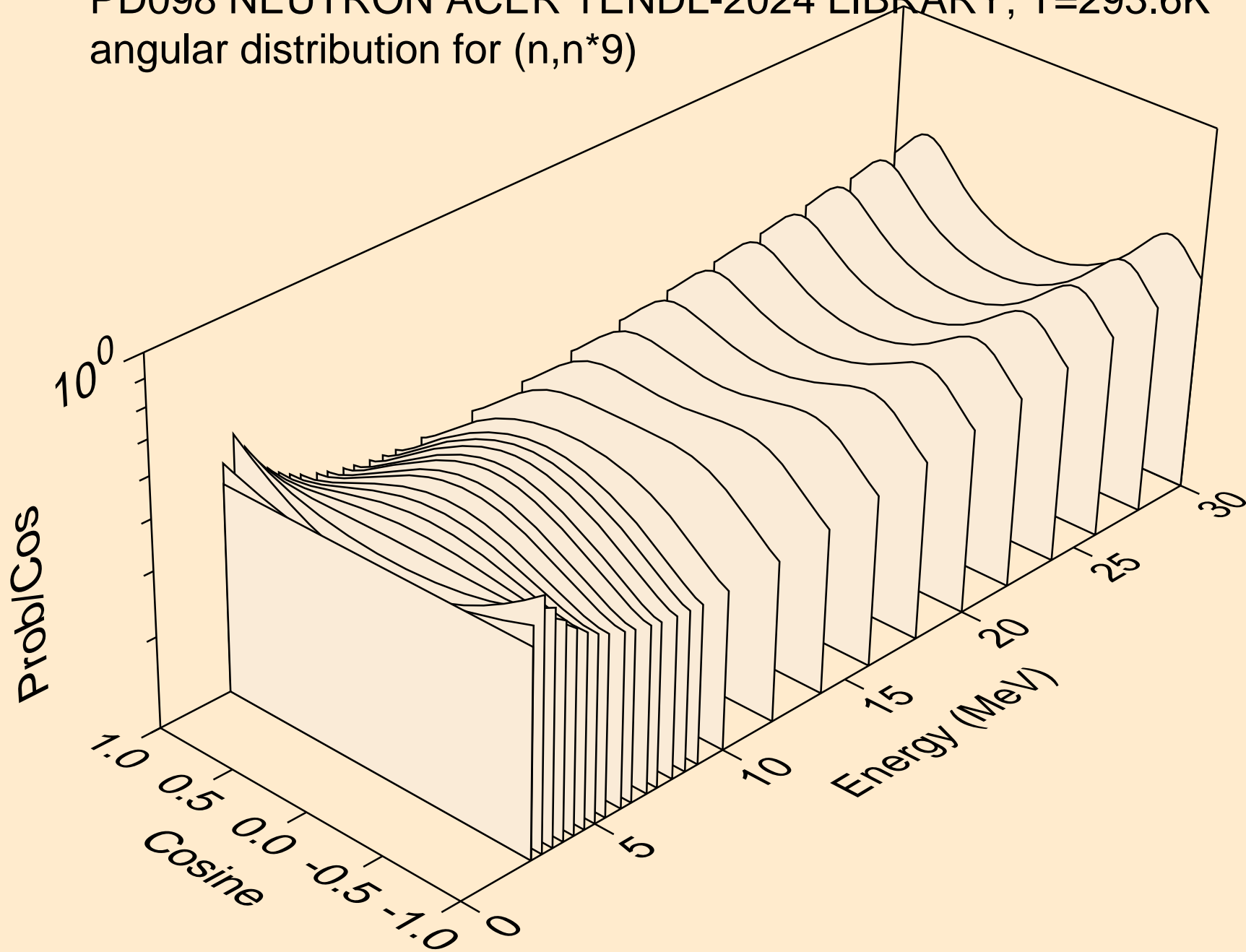

PD098 NEUTRON ACER TENDL-2024 LIBRARY; T=293.6K  
angular distribution for (n,n\*10)

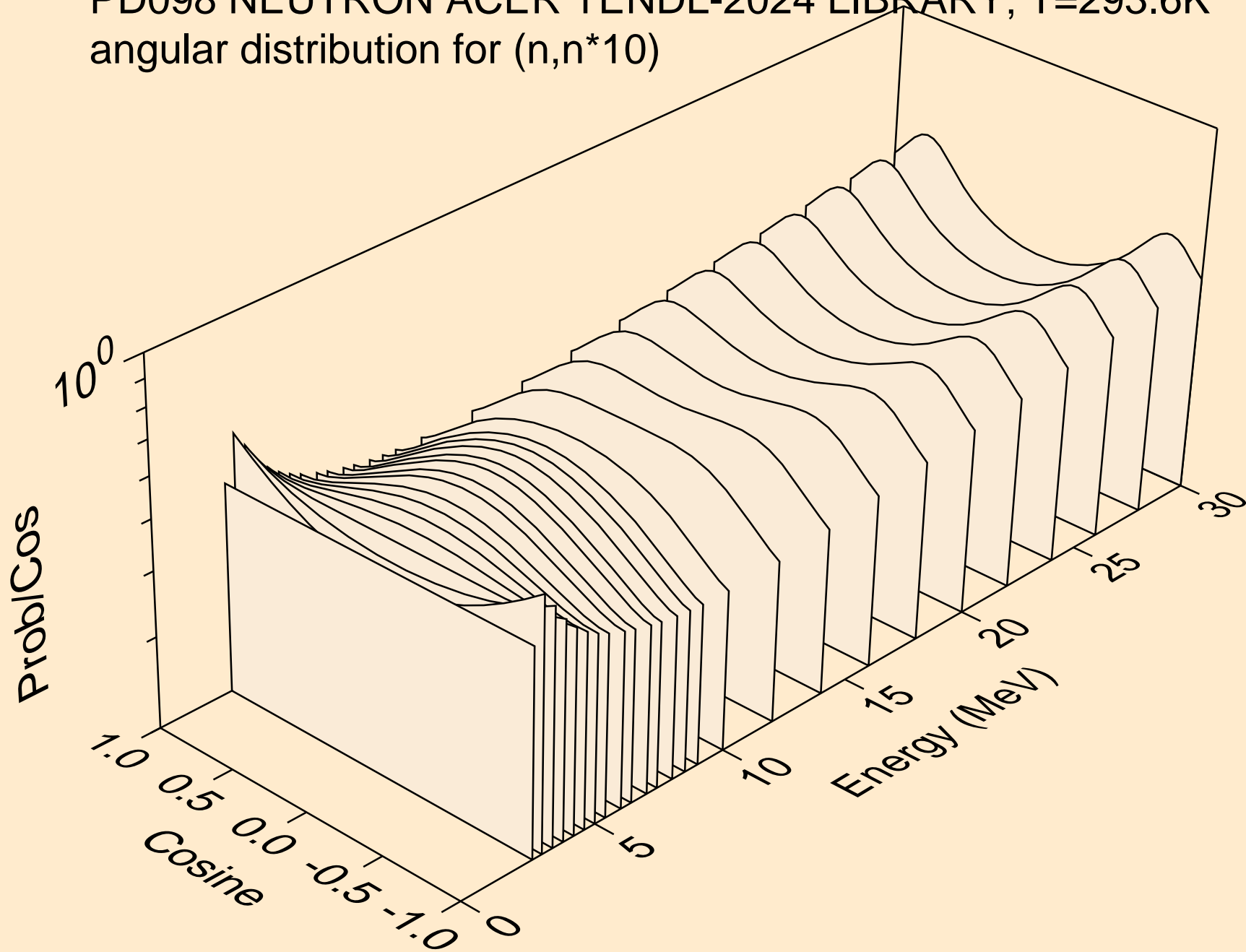

PD098 NEUTRON ACER TENDL-2024 LIBRARY; T=293.6K  
angular distribution for (n,n\*11)

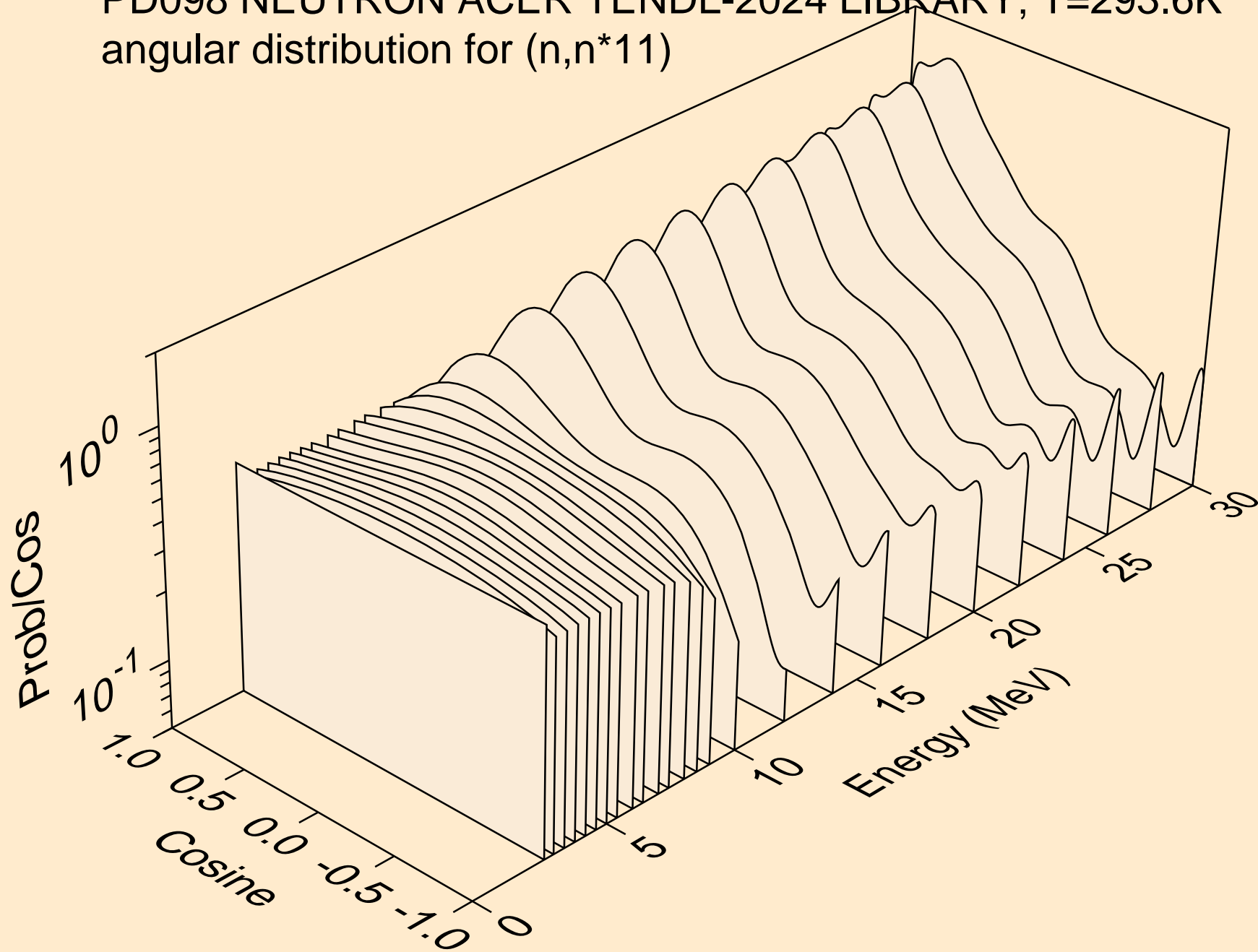

PD098 NEUTRON ACER TENDL-2024 LIBRARY; T=293.6K  
angular distribution for (n,n\*12)

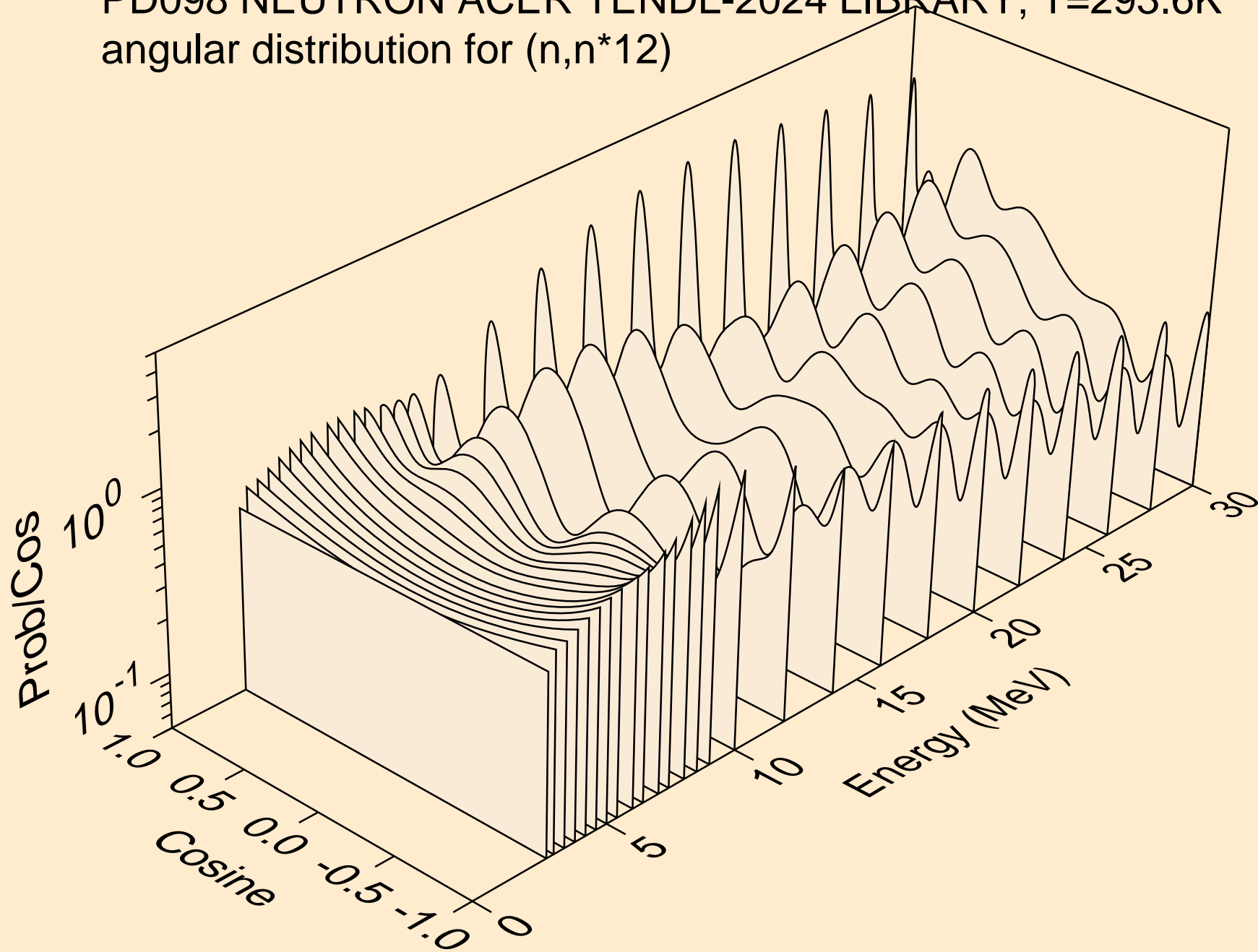

PD098 NEUTRON ACER TENDL-2024 LIBRARY; T=293.6K  
angular distribution for (n,n\*13)

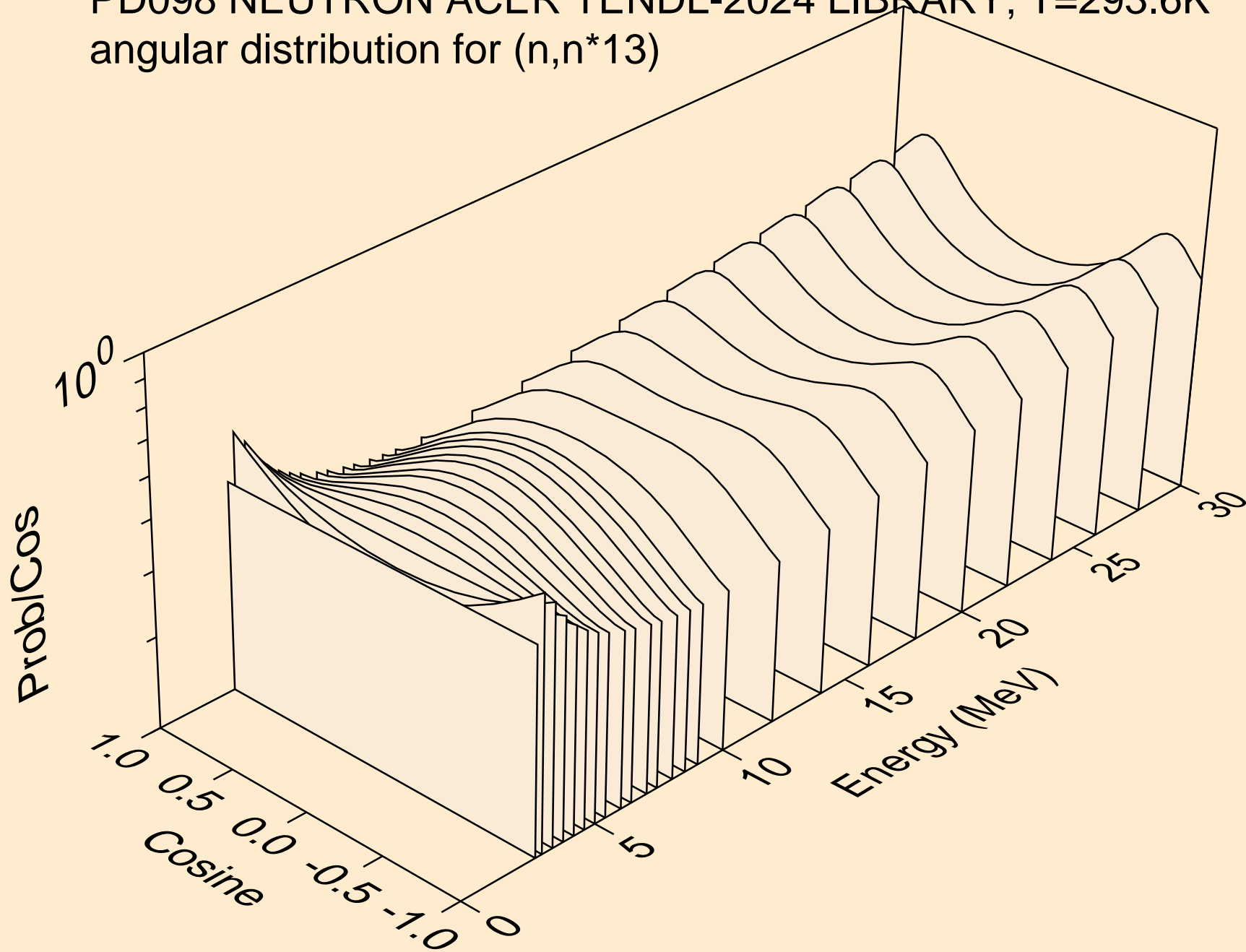

PD098 NEUTRON ACER TENDL-2024 LIBRARY; T=293.6K  
angular distribution for (n,n\*14)

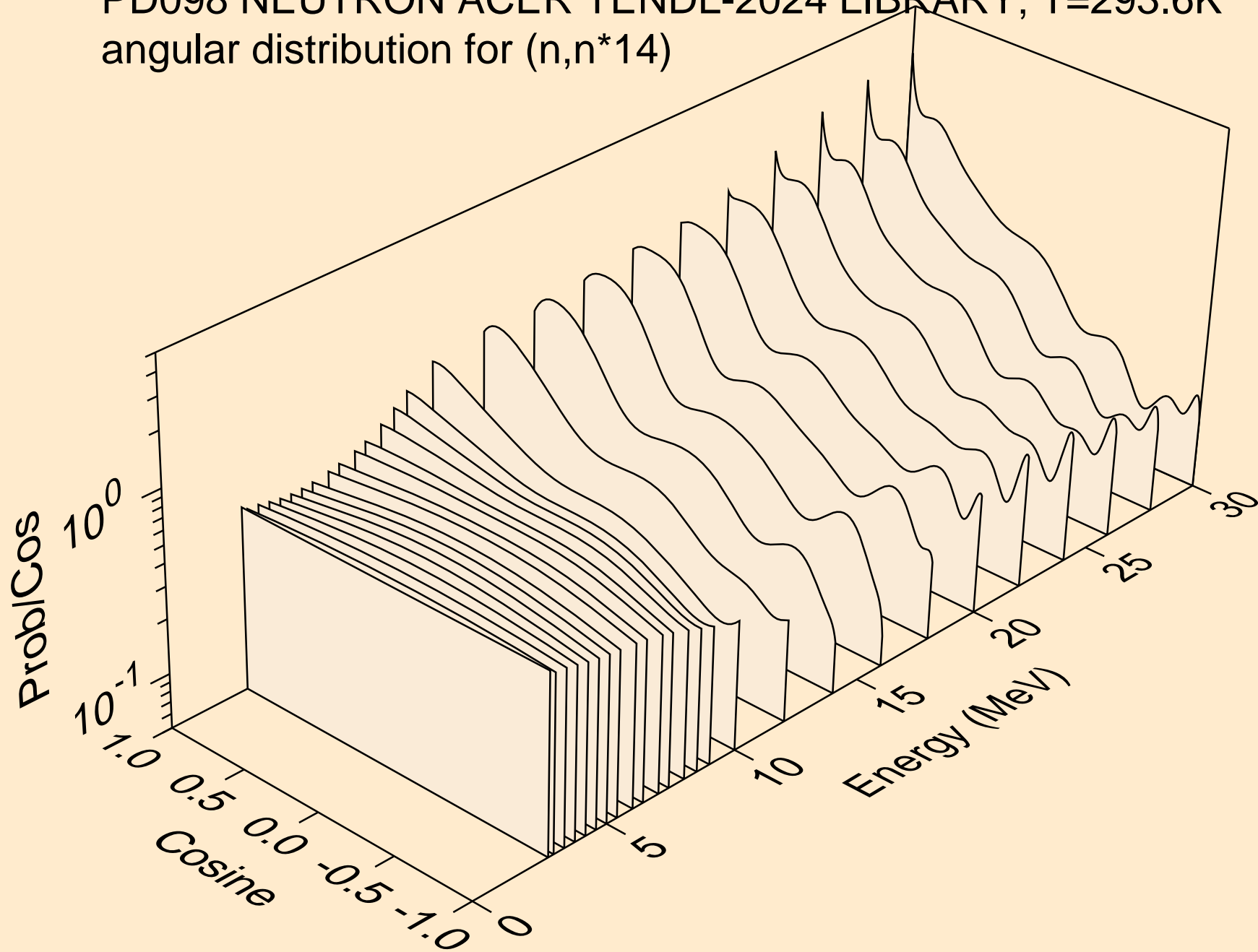

PD098 NEUTRON ACER TENDL-2024 LIBRARY; T=293.6K  
angular distribution for (n,n\*15)

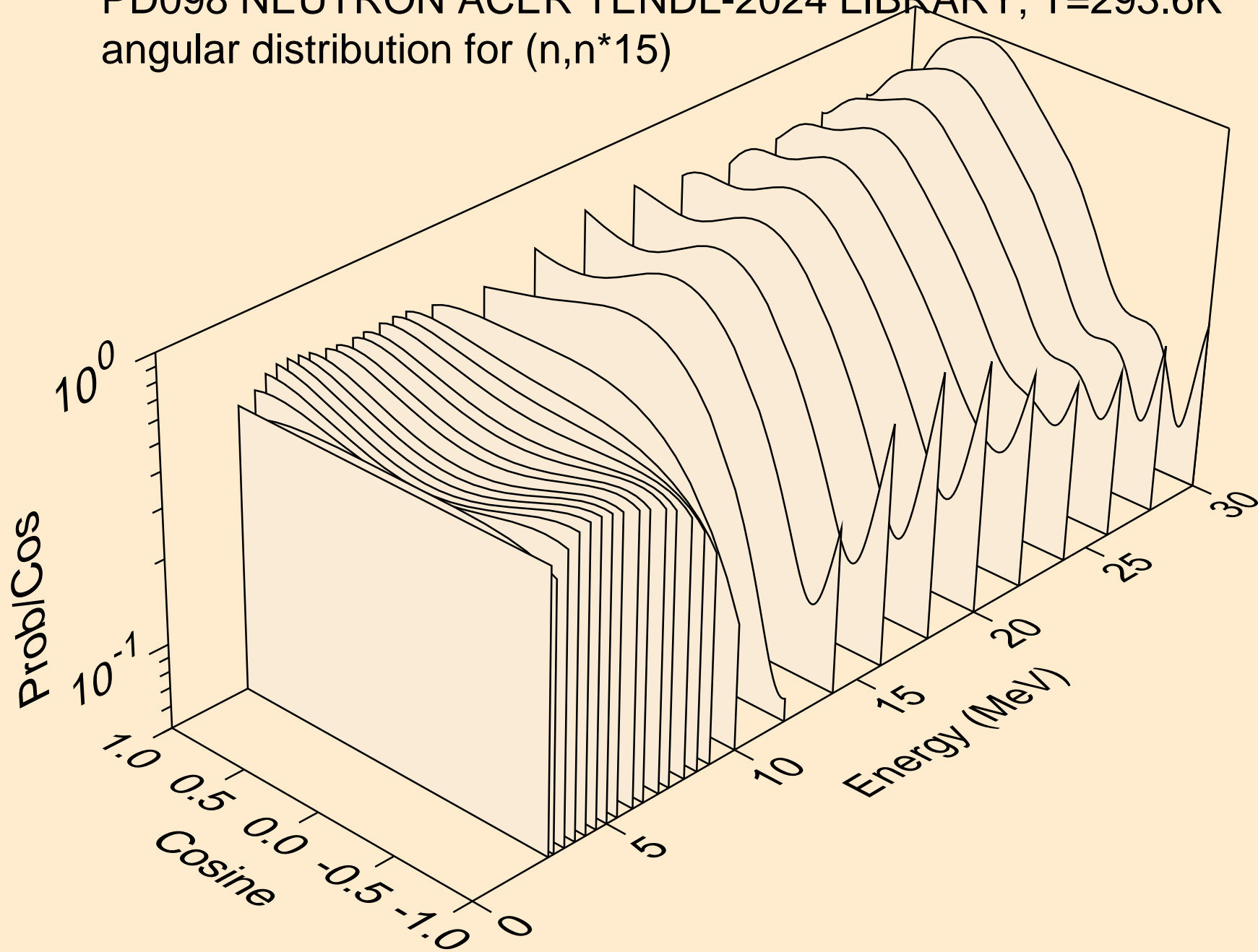

PD098 NEUTRON ACER TENDL-2024 LIBRARY; T=293.6K  
angular distribution for (n,n\*16)

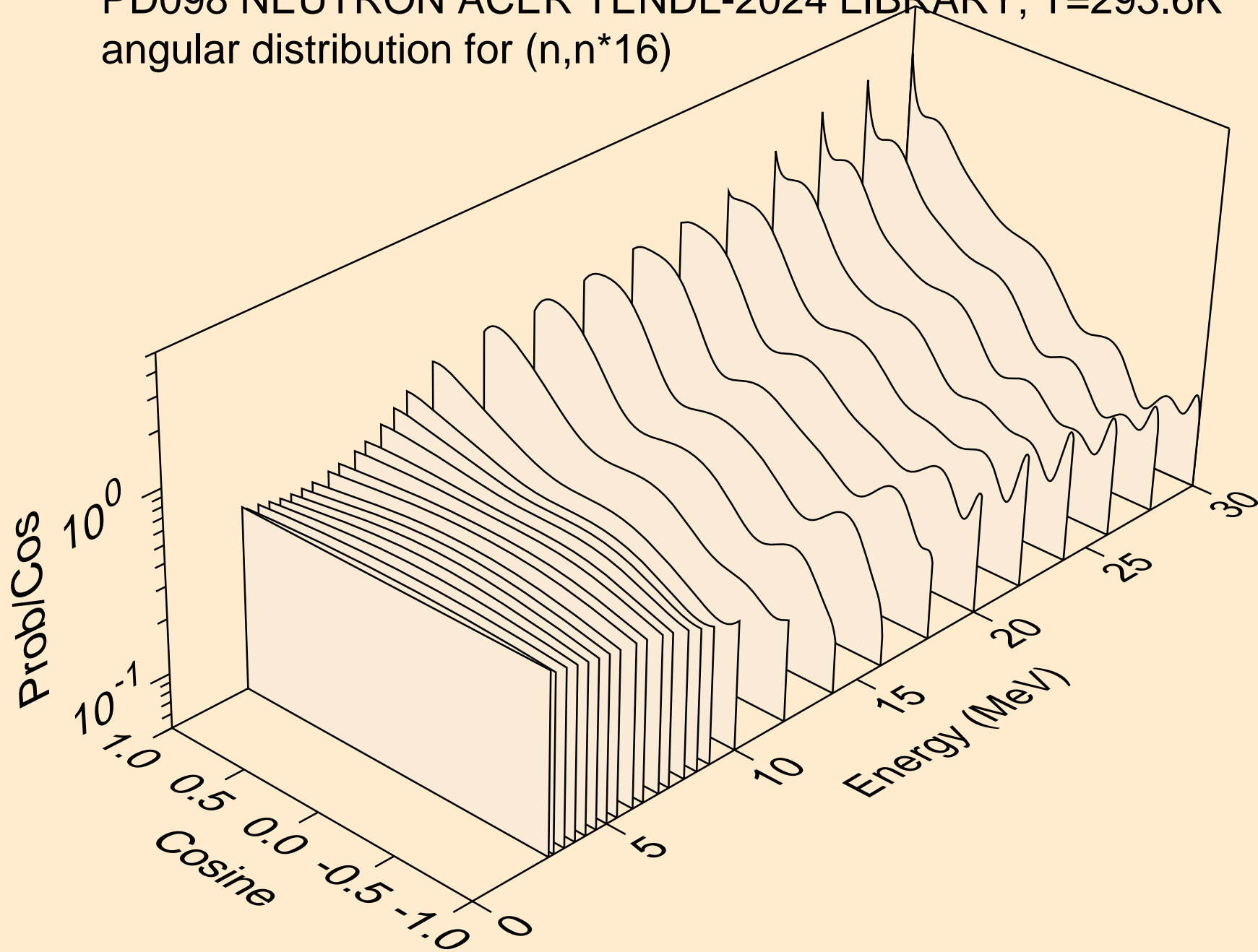

PD098 NEUTRON ACER TENDL-2024 LIBRARY; T=293.6K  
angular distribution for (n,n\*17)

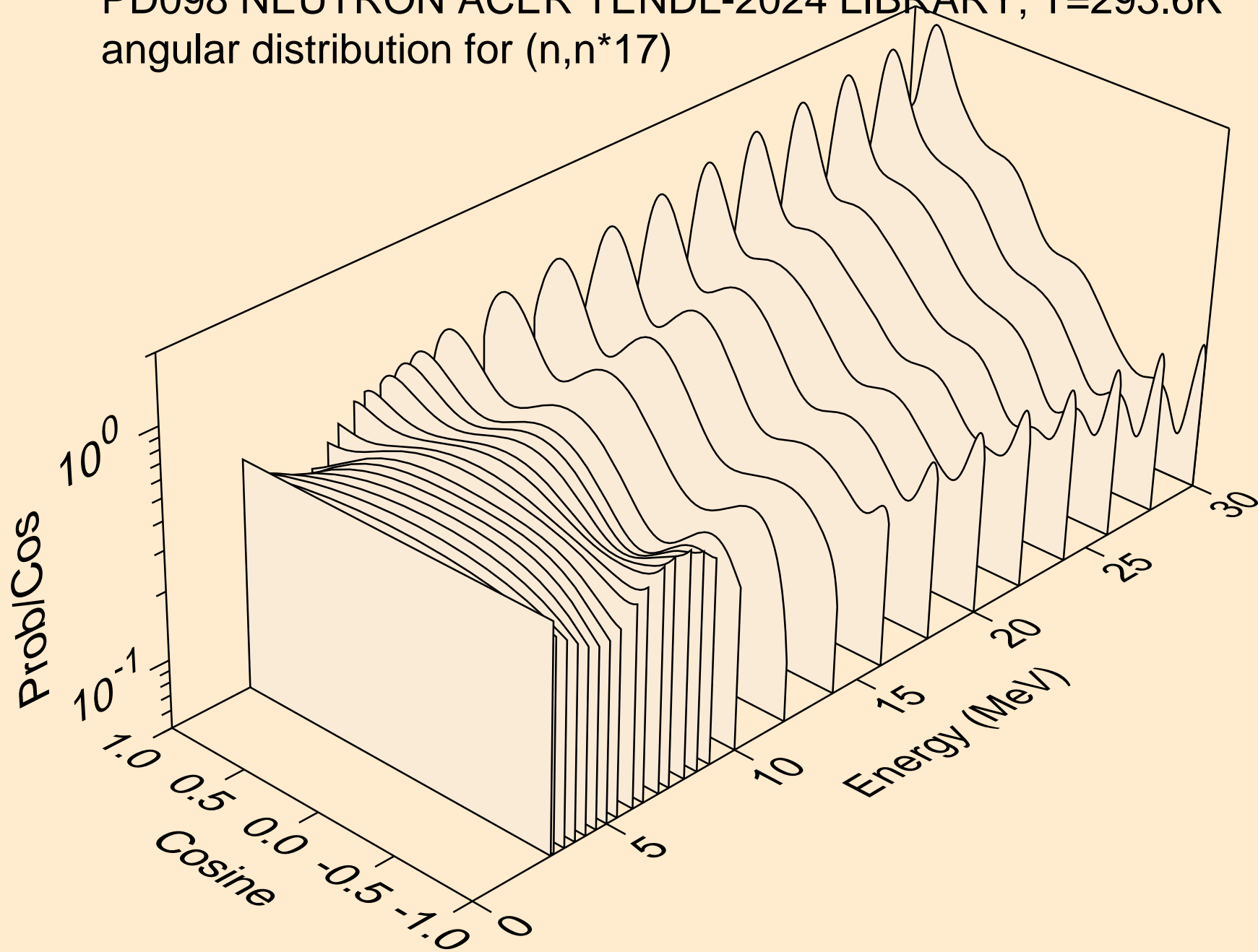

PD098 NEUTRON ACER TENDL-2024 LIBRARY; T=293.6K  
angular distribution for (n,n\*18)

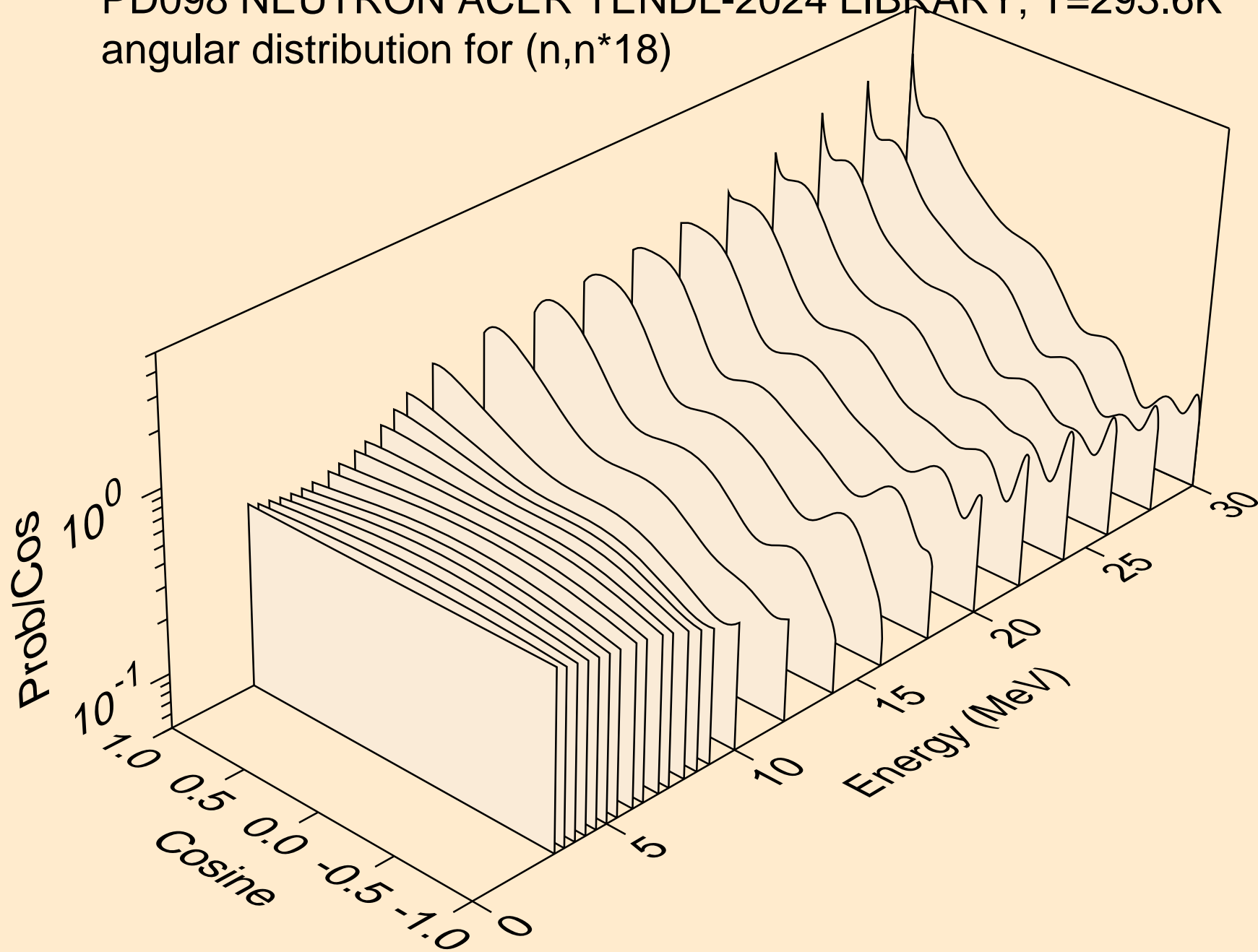

PD098 NEUTRON ACER TENDL-2024 LIBRARY; T=293.6K  
angular distribution for (n,n\*19)

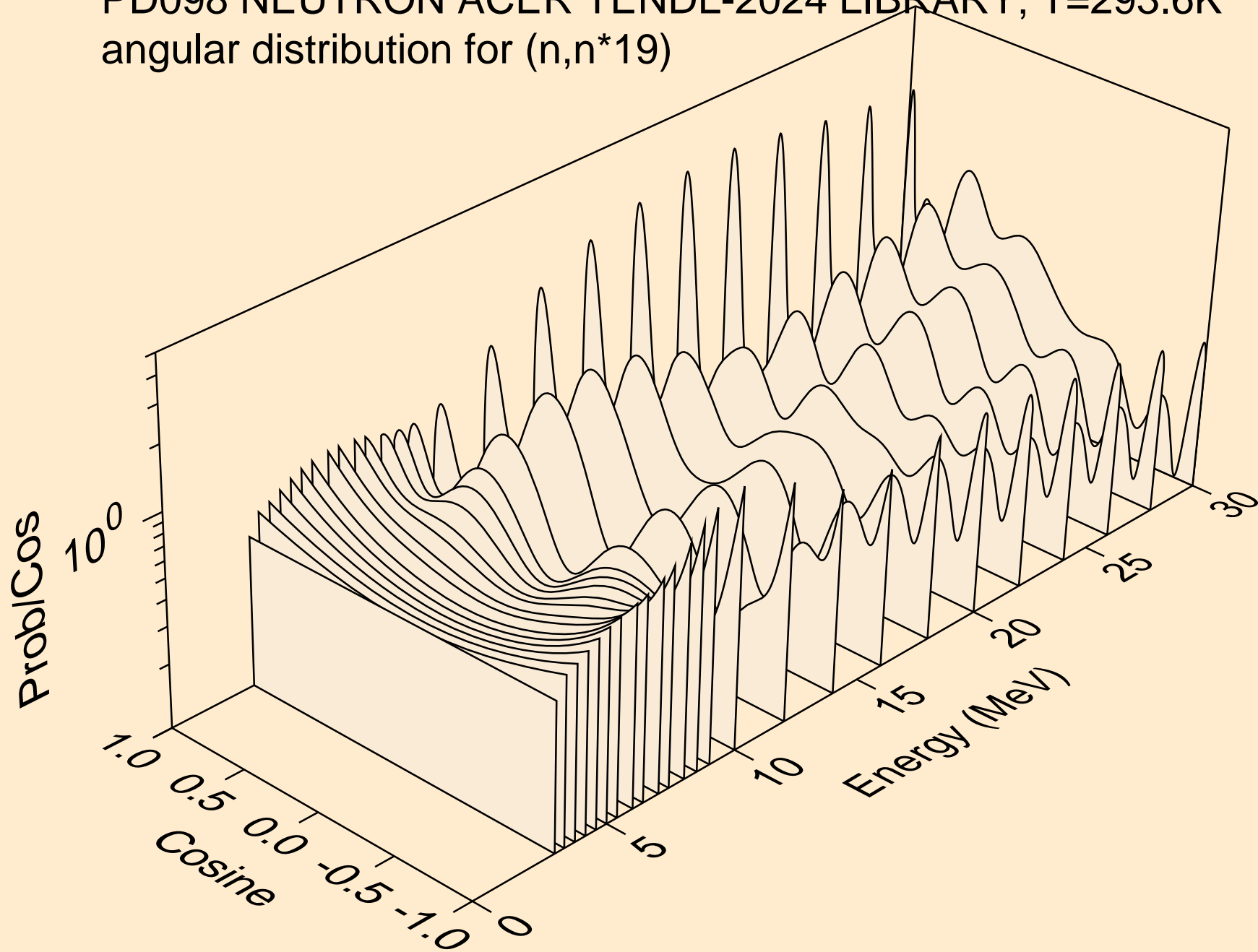

PD098 NEUTRON ACER TENDL-2024 LIBRARY; T=293.6K  
angular distribution for (n,n\*20)

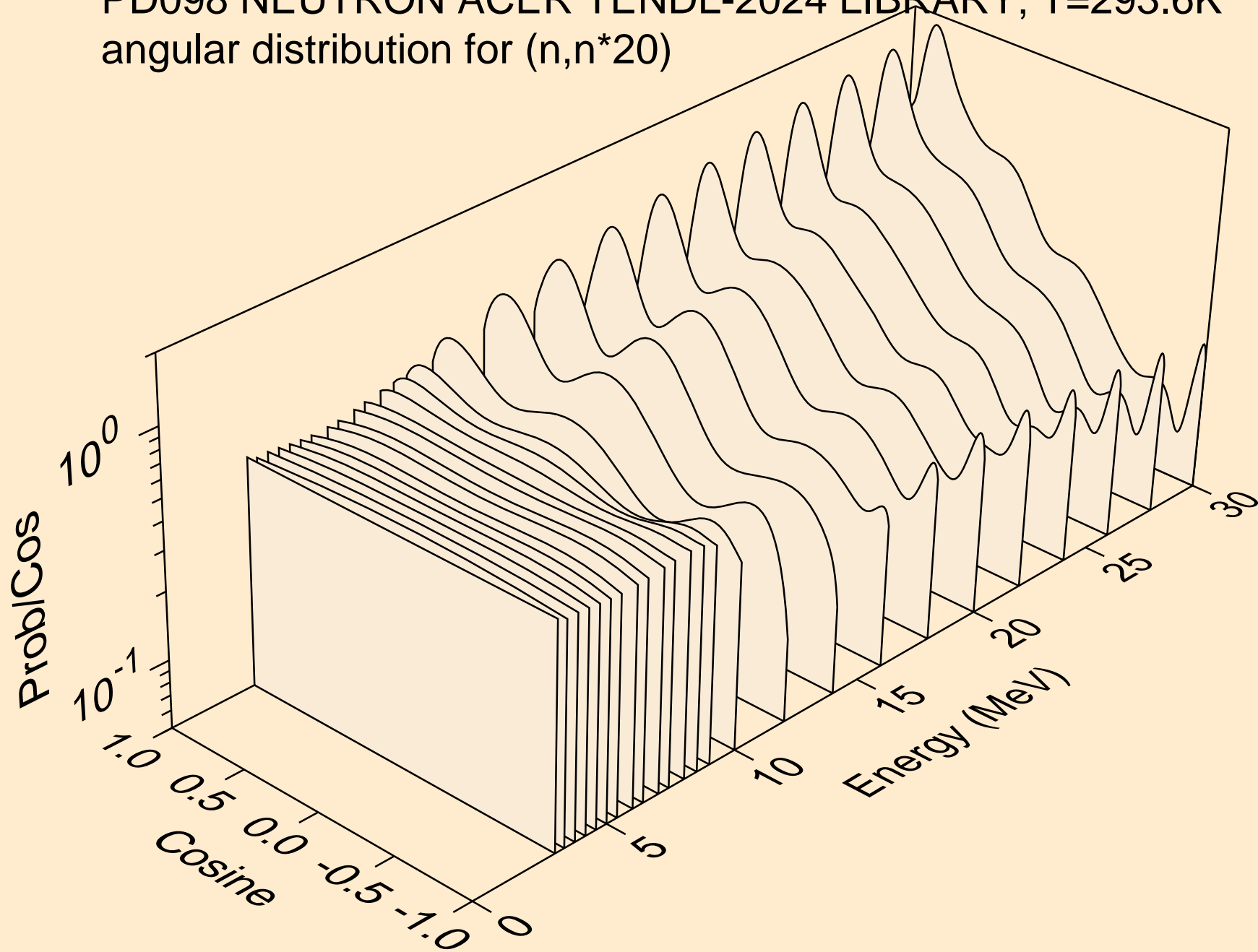

PD098 NEUTRON ACER TENDL-2024 LIBRARY; T=293.6K  
angular distribution for (n,n\*21)

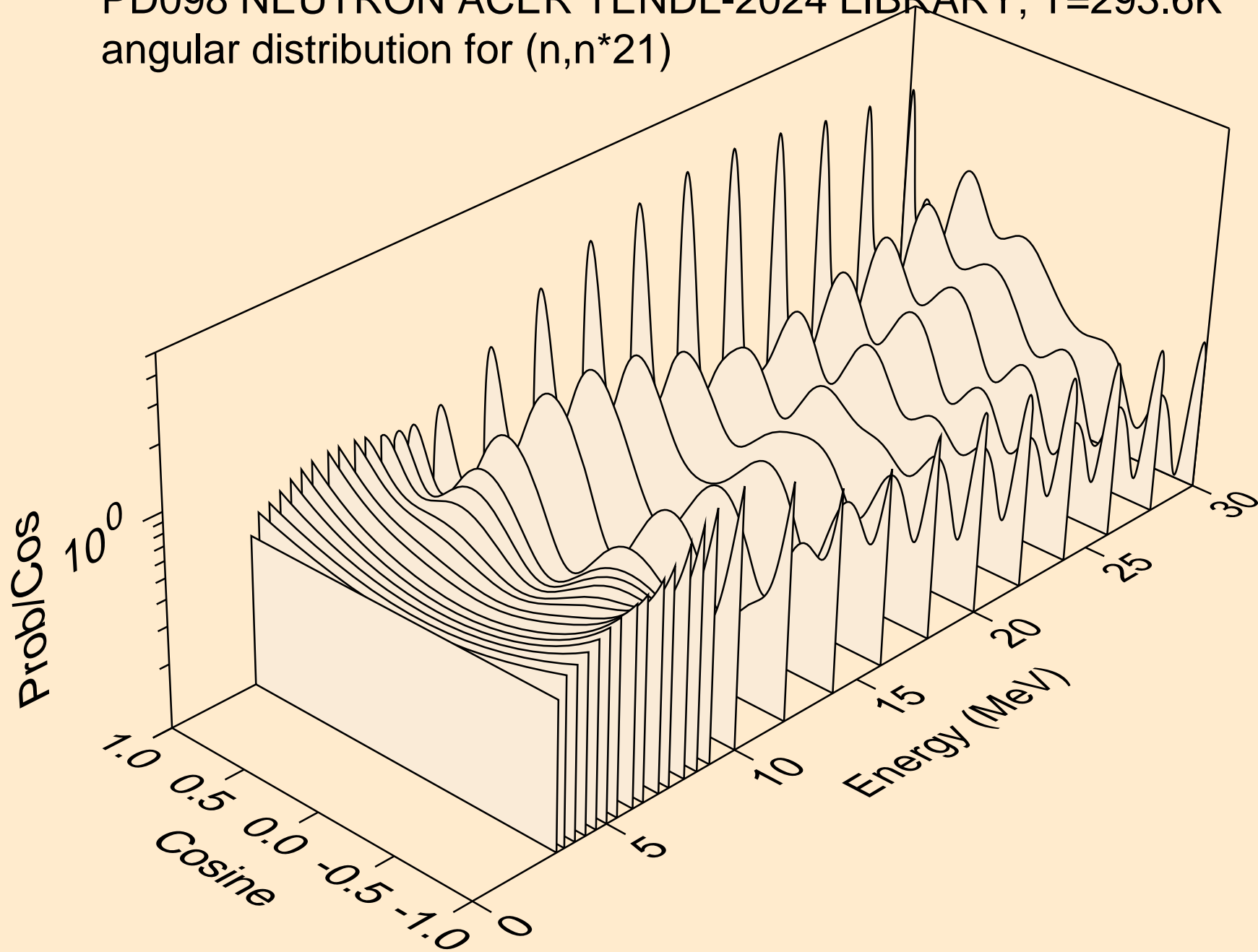

PD098 NEUTRON ACER TENDL-2024 LIBRARY; T=293.6K  
angular distribution for (n,n\*22)

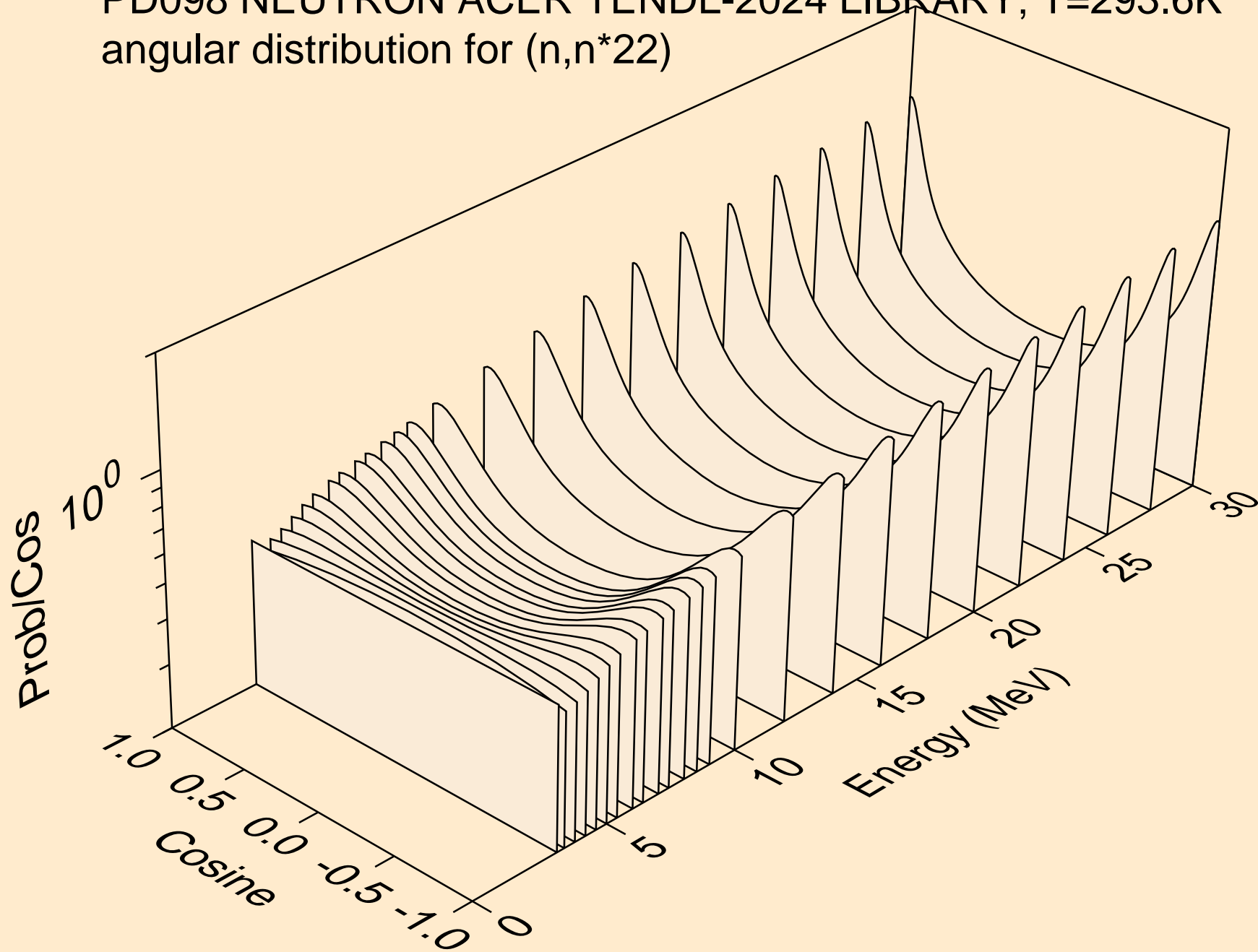

PD098 NEUTRON ACER TENDL-2024 LIBRARY; T=293.6K  
angular distribution for (n,n\*23)

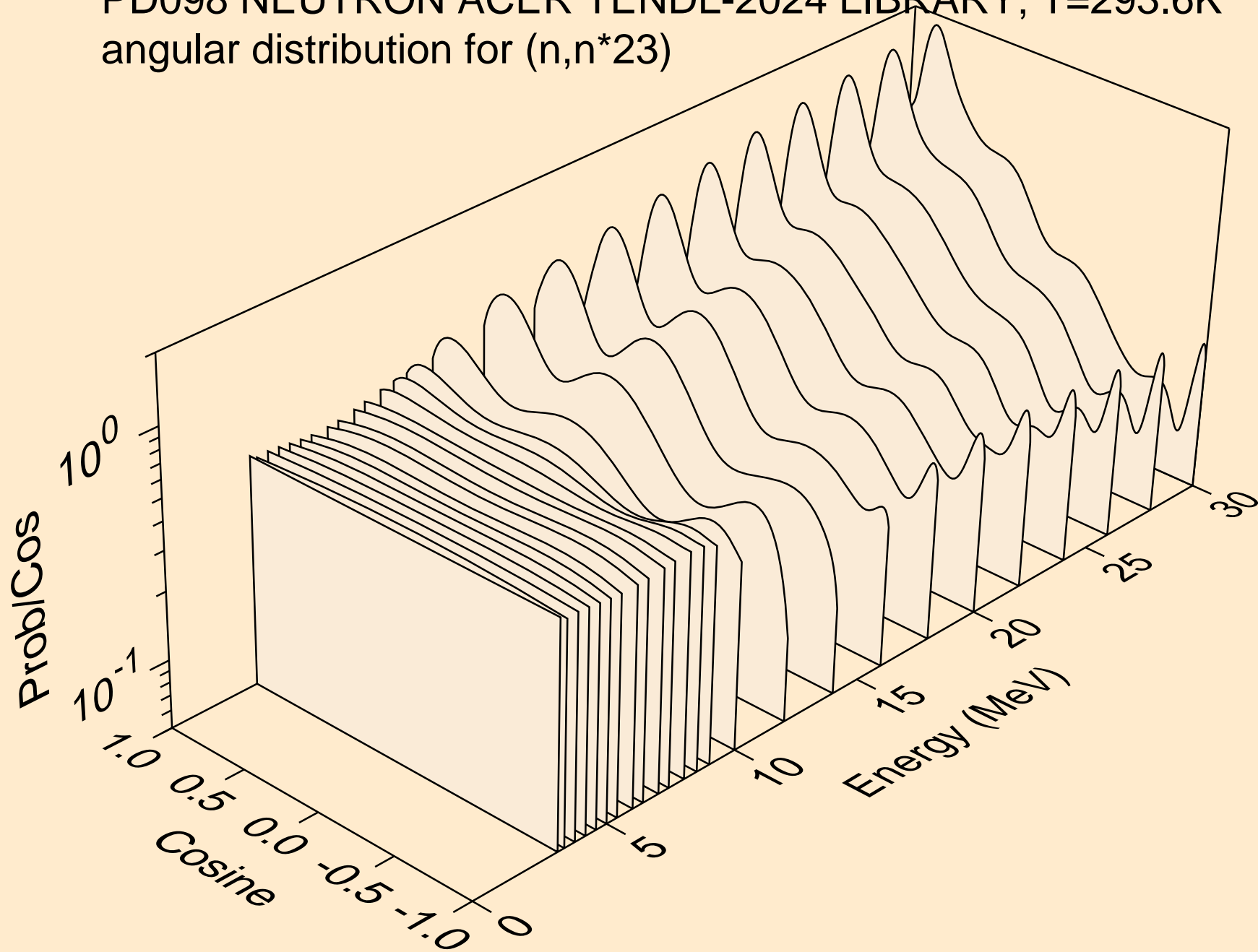

PD098 NEUTRON ACER TENDL-2024 LIBRARY; T=293.6K  
angular distribution for (n,n\*24)

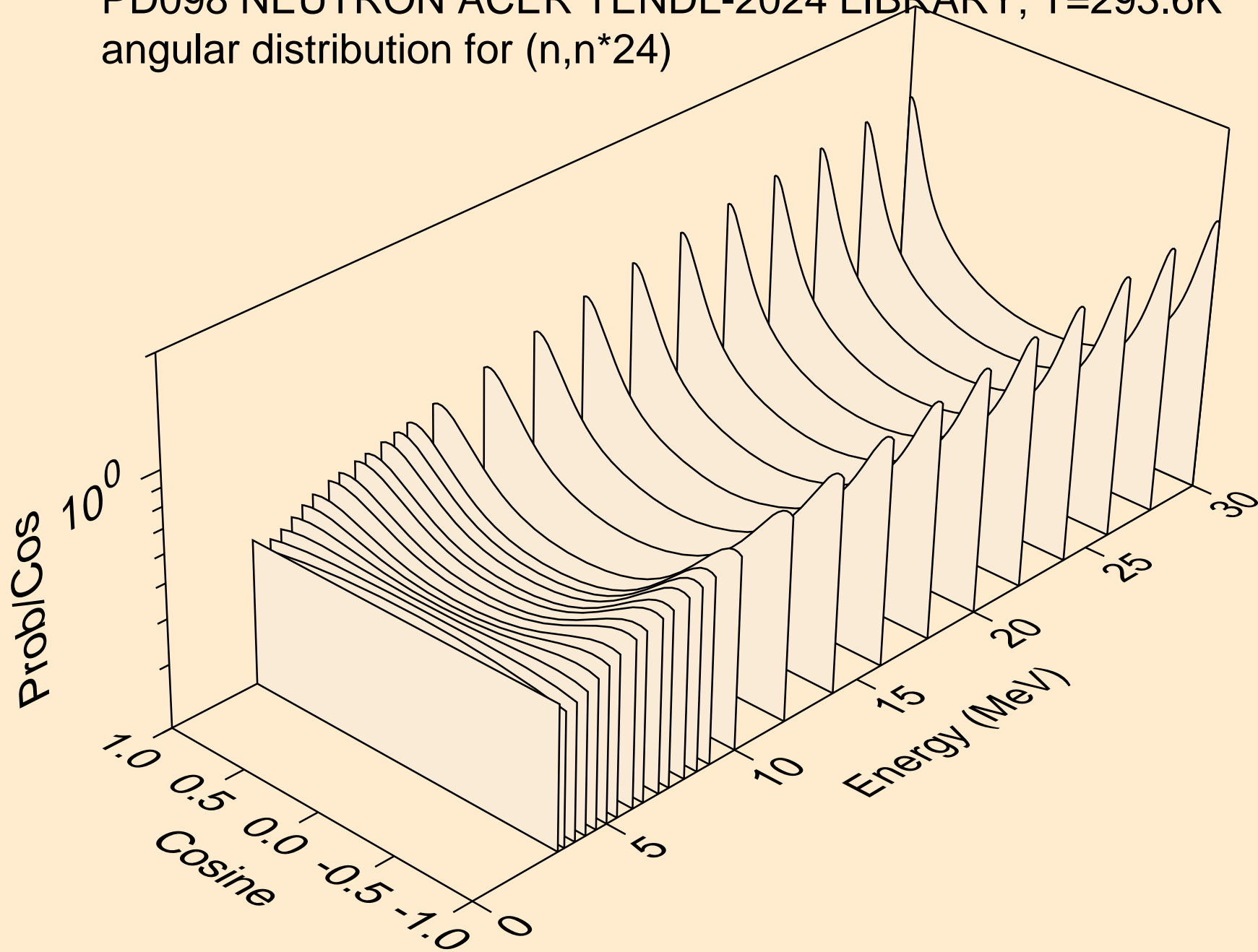

PD098 NEUTRON ACER TENDL-2024 LIBRARY; T=293.6K  
angular distribution for (n,n\*25)

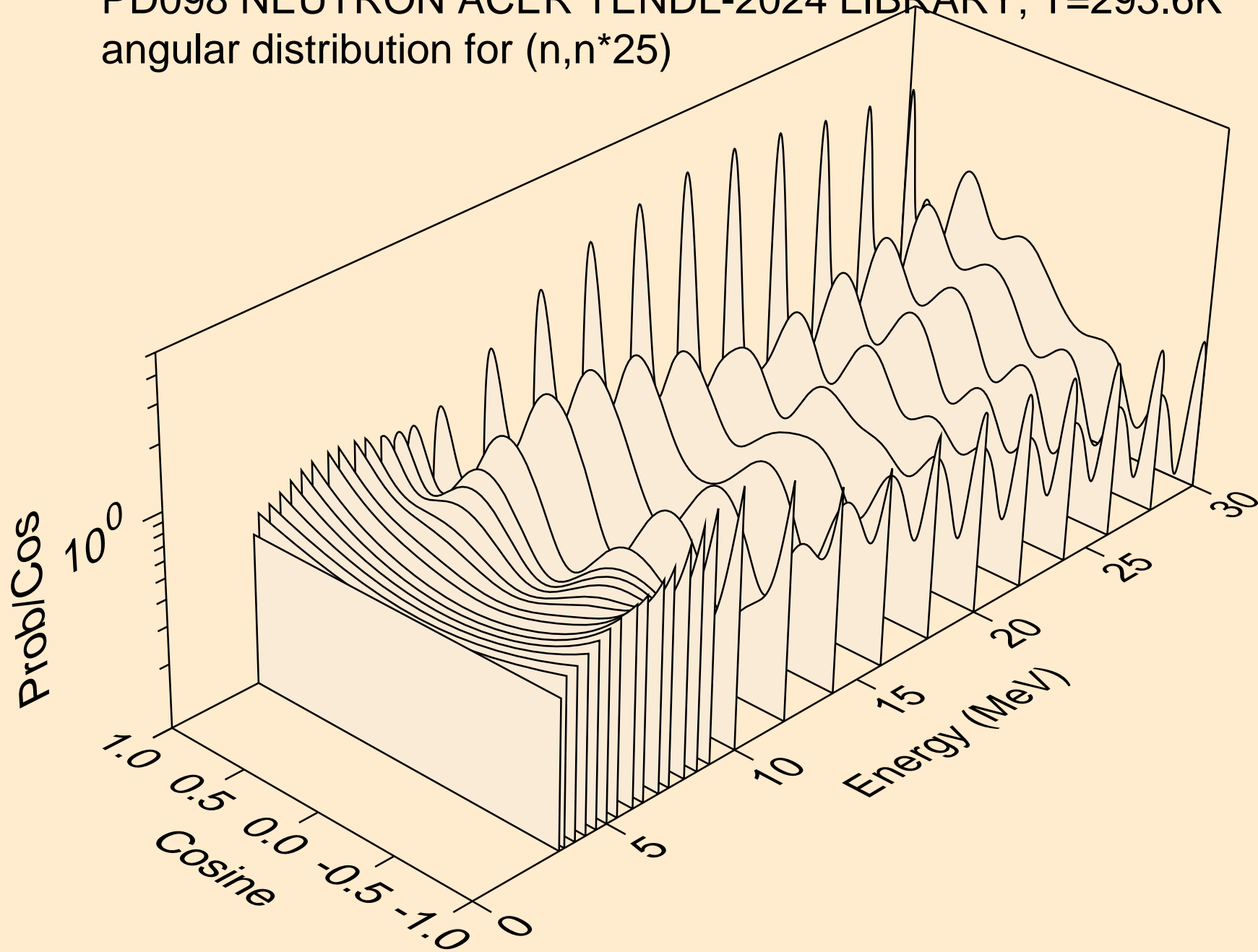

PD098 NEUTRON ACER TENDL-2024 LIBRARY; T=293.6K  
angular distribution for (n,n\*26)

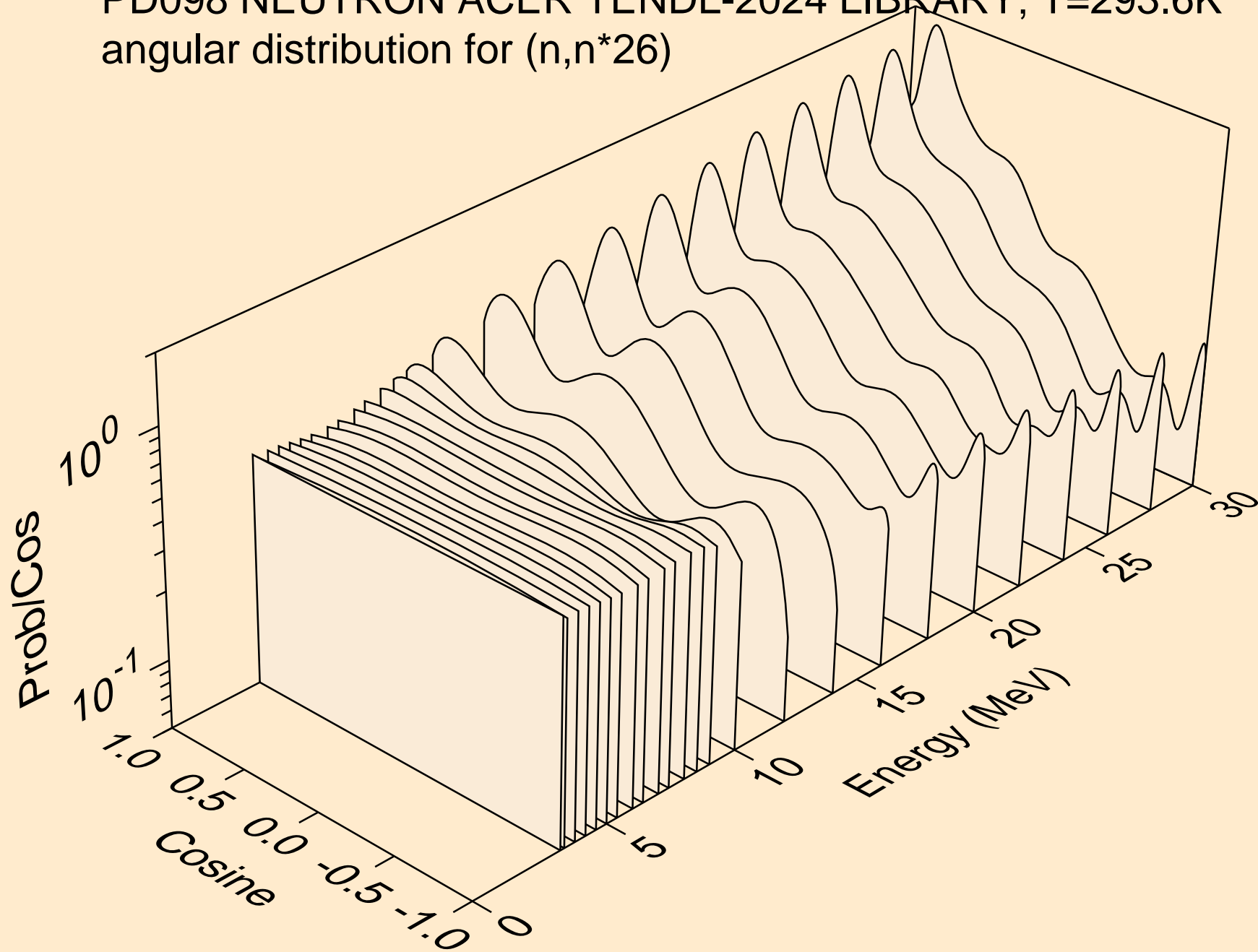

PD098 NEUTRON ACER TENDL-2024 LIBRARY; T=293.6K  
angular distribution for (n,n\*27)

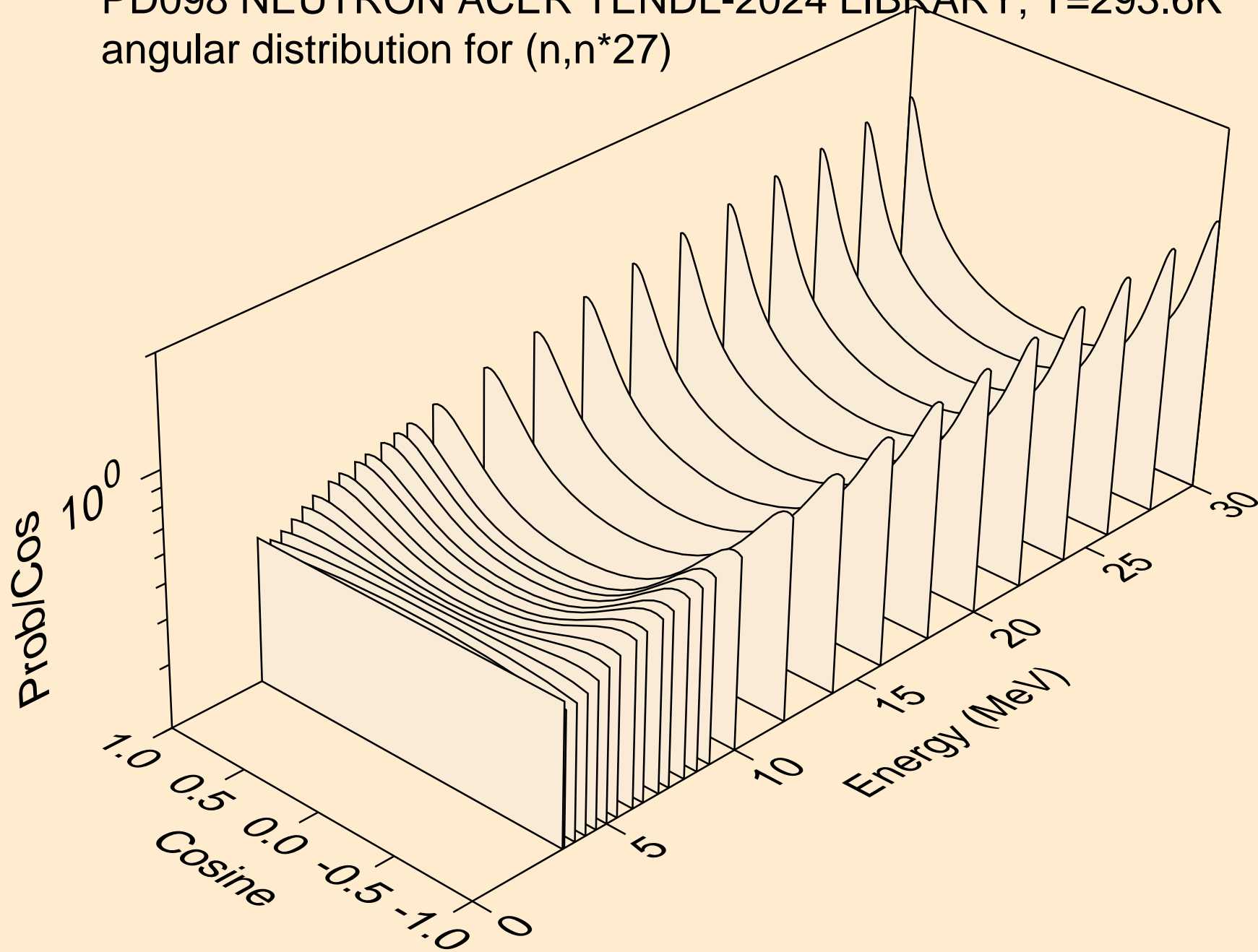

PD098 NEUTRON ACER TENDL-2024 LIBRARY; T=293.6K  
angular distribution for (n,n\*28)

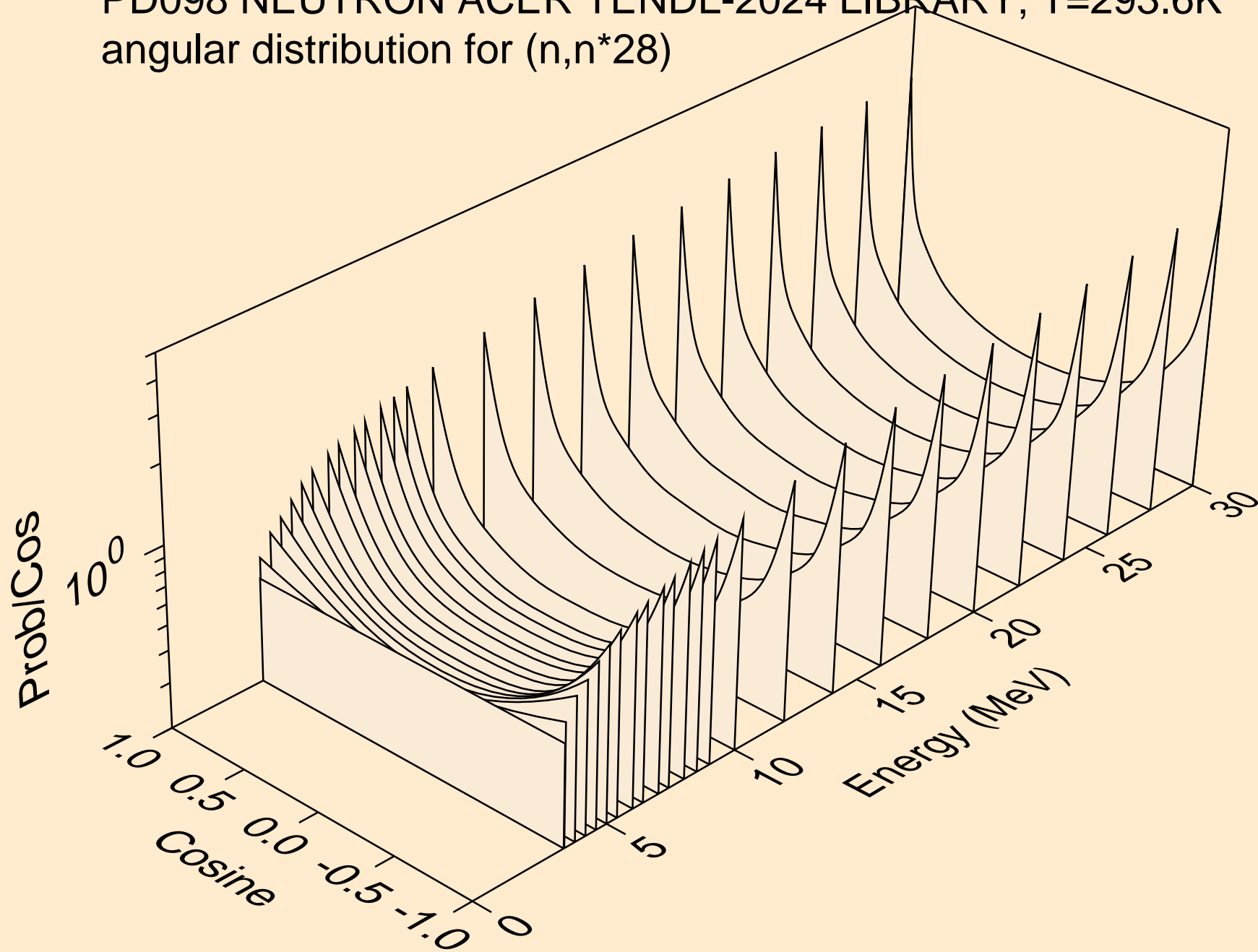

PD098 NEUTRON ACER TENDL-2024 LIBRARY; T=293.6K  
angular distribution for (n,n\*29)

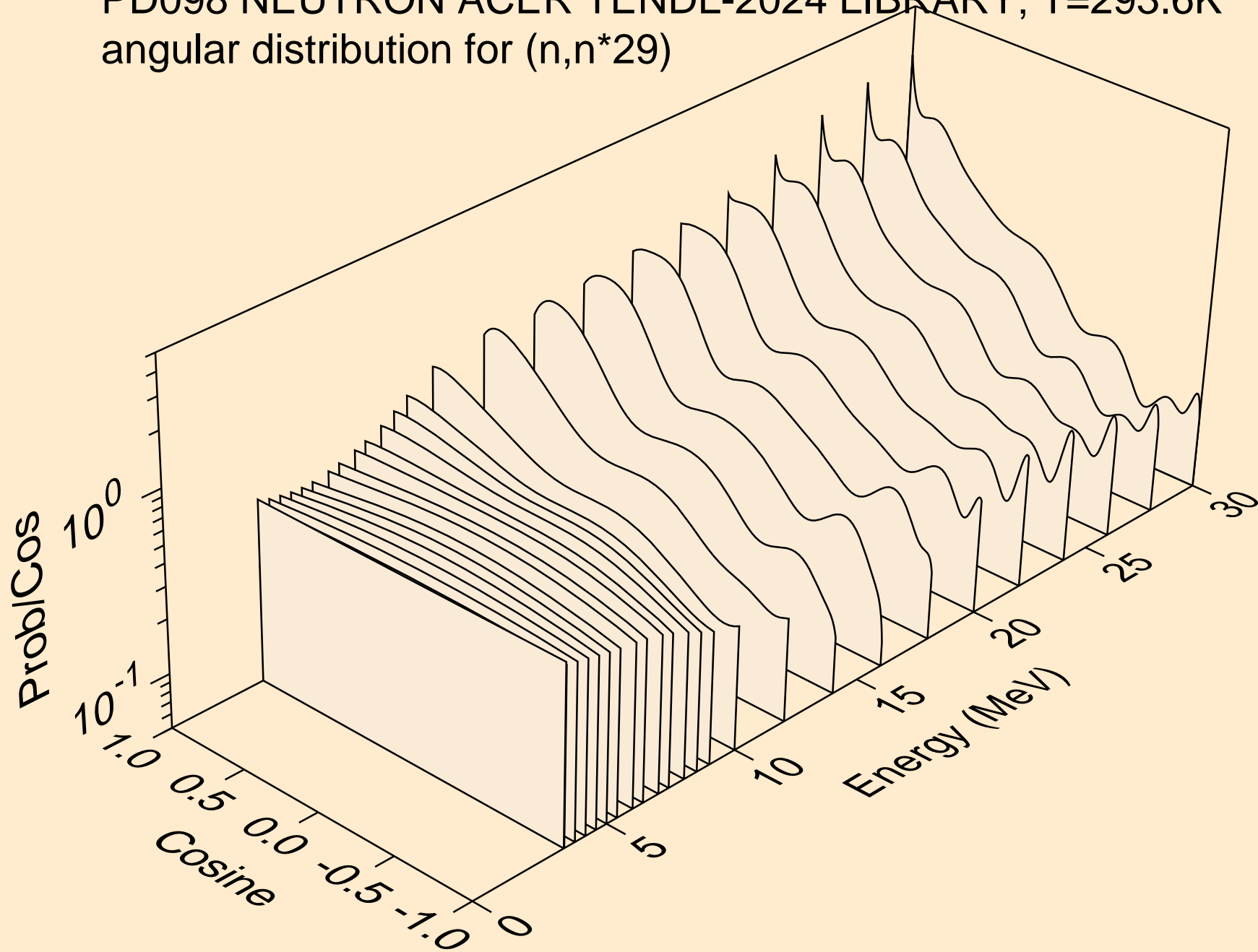

PD098 NEUTRON ACER TENDL-2024 LIBRARY; T=293.6K  
angular distribution for (n,n\*30)

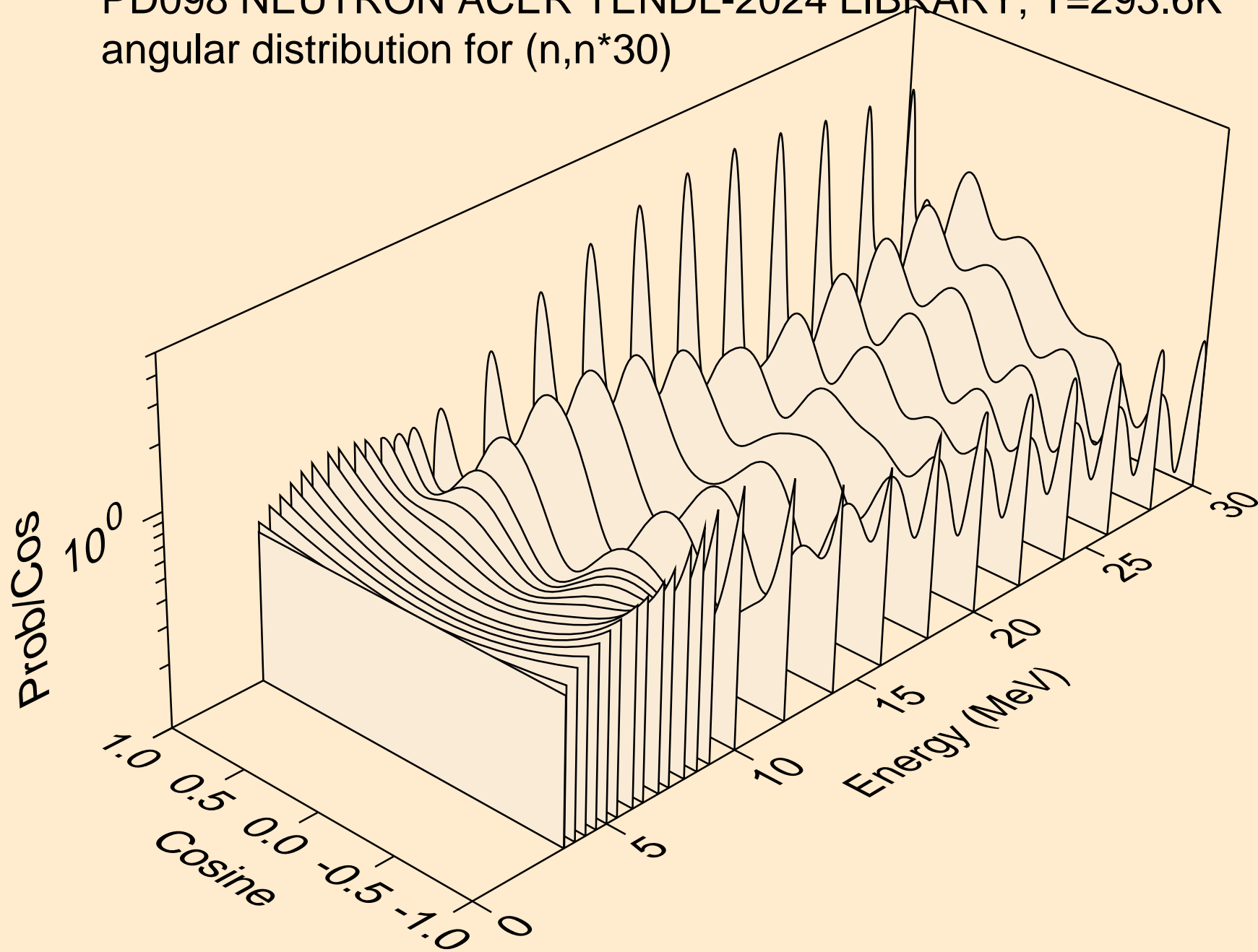

PD098 NEUTRON ACER TENDL-2024 LIBRARY; T=293.6K  
Neutron emission for (n,x)

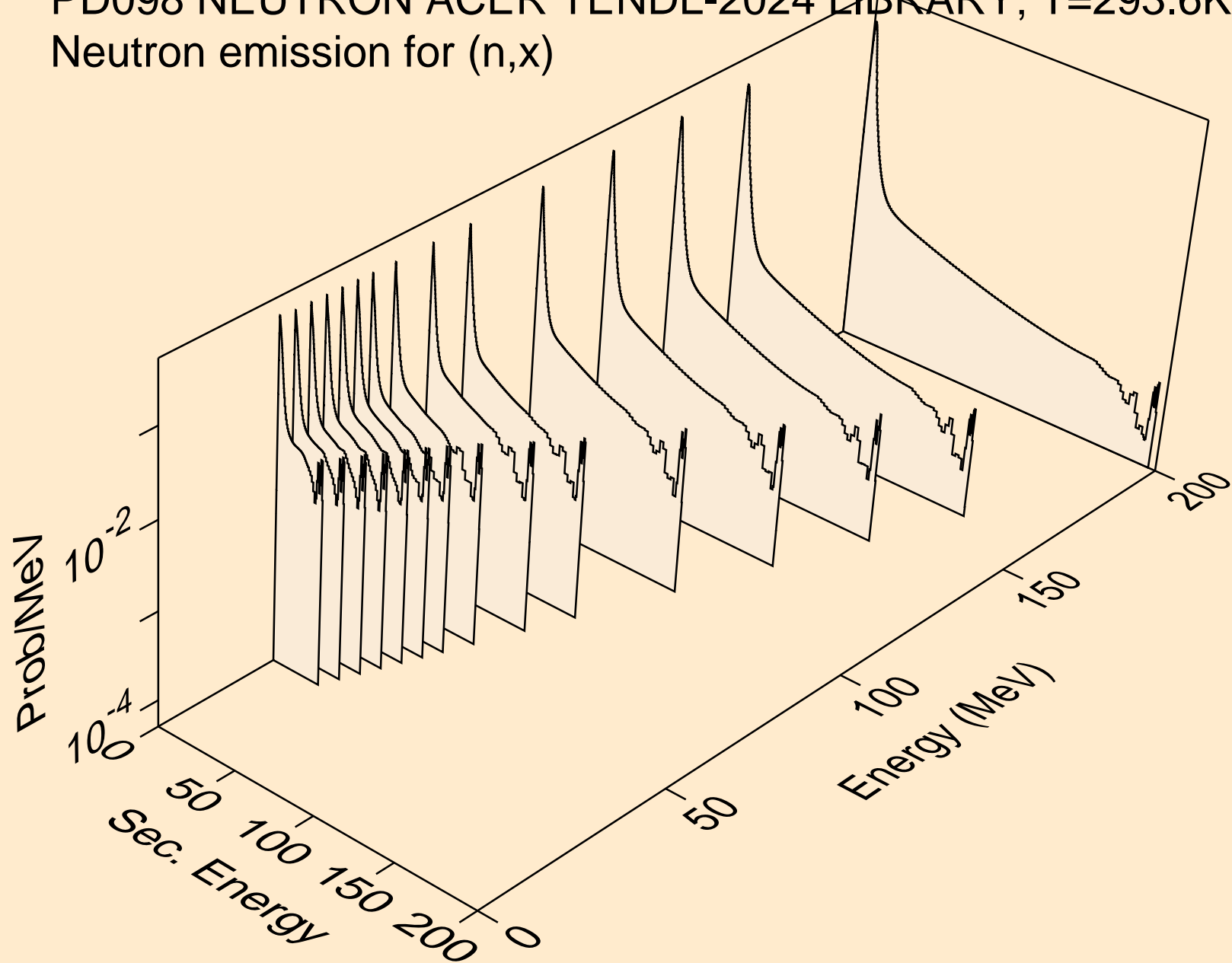

PD098 NEUTRON ACER TENDL-2024 LIBRARY; T=293.6K  
Neutron emission for (n,2nd)

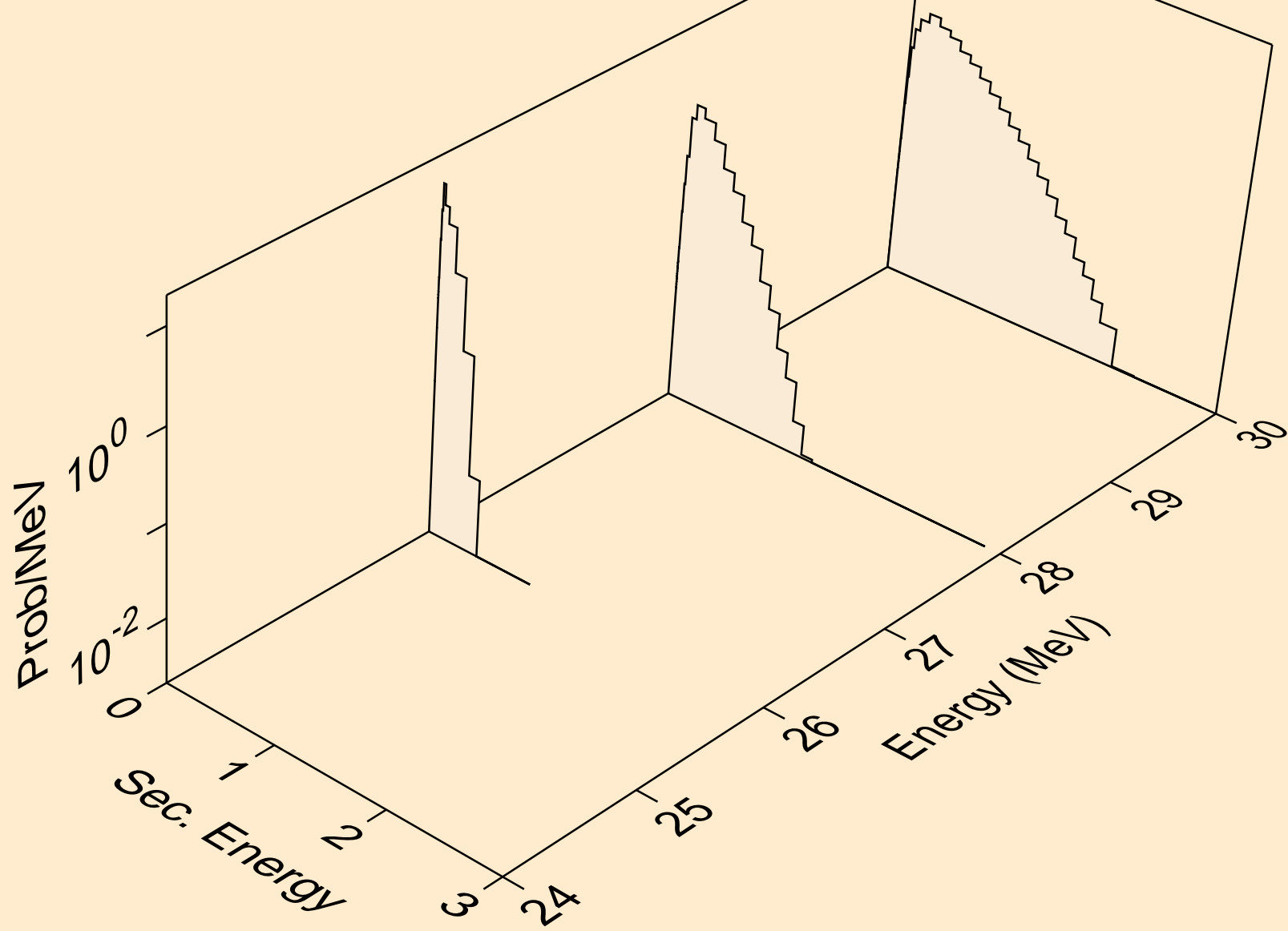

PD098 NEUTRON ACER TENDL-2024 LIBRARY; T=293.6K  
Neutron emission for (n,2n)

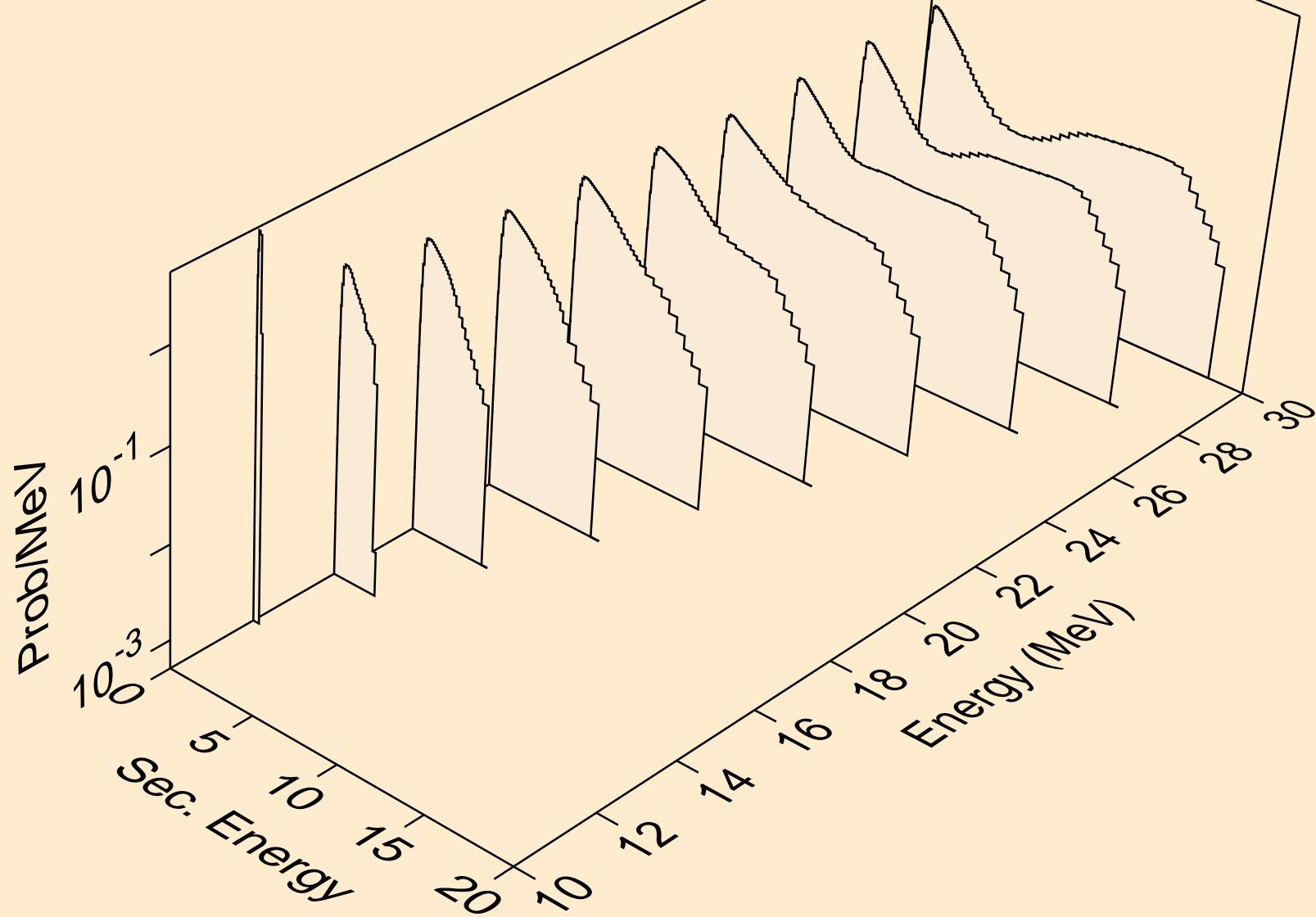

PD098 NEUTRON ACER TENDL-2024 LIBRARY; T=293.6K  
Neutron emission for (n,3n)

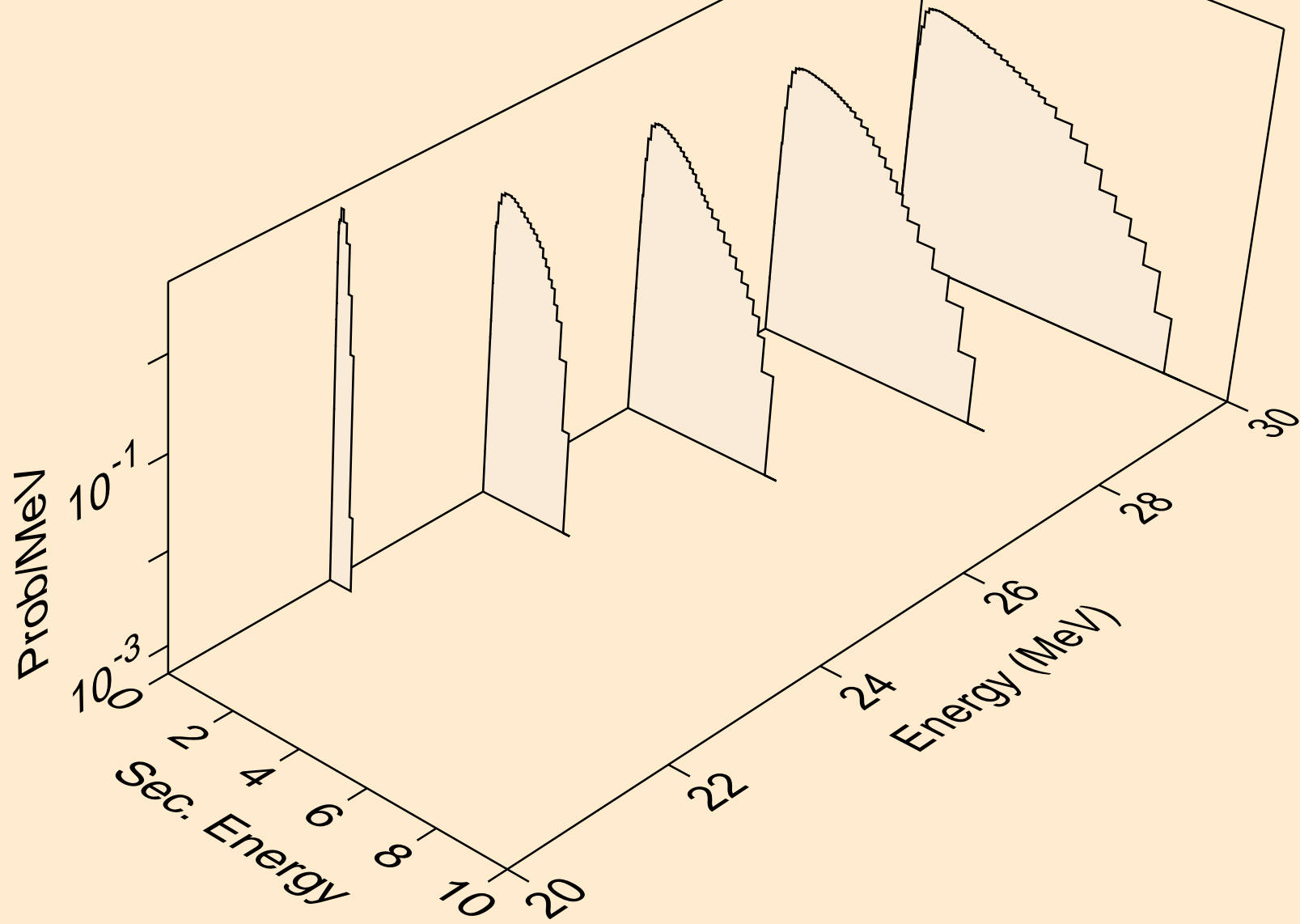

PD098 NEUTRON ACER TENDL-2024 LIBRARY; T=293.6K  
Neutron emission for (n,n\*)a

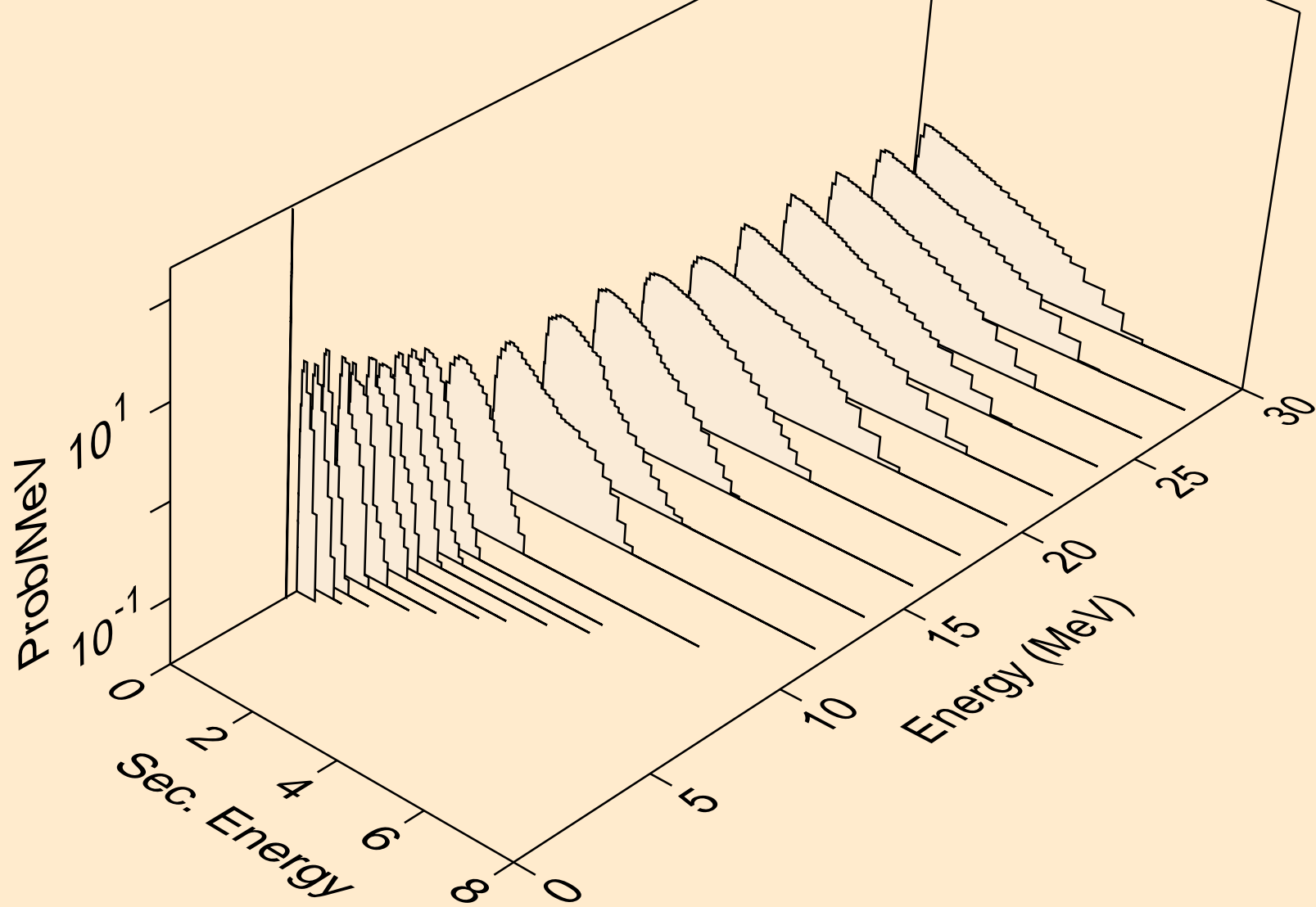

PD098 NEUTRON ACER TENDL-2024 LIBRARY; T=293.6K  
Neutron emission for (n,2n)a

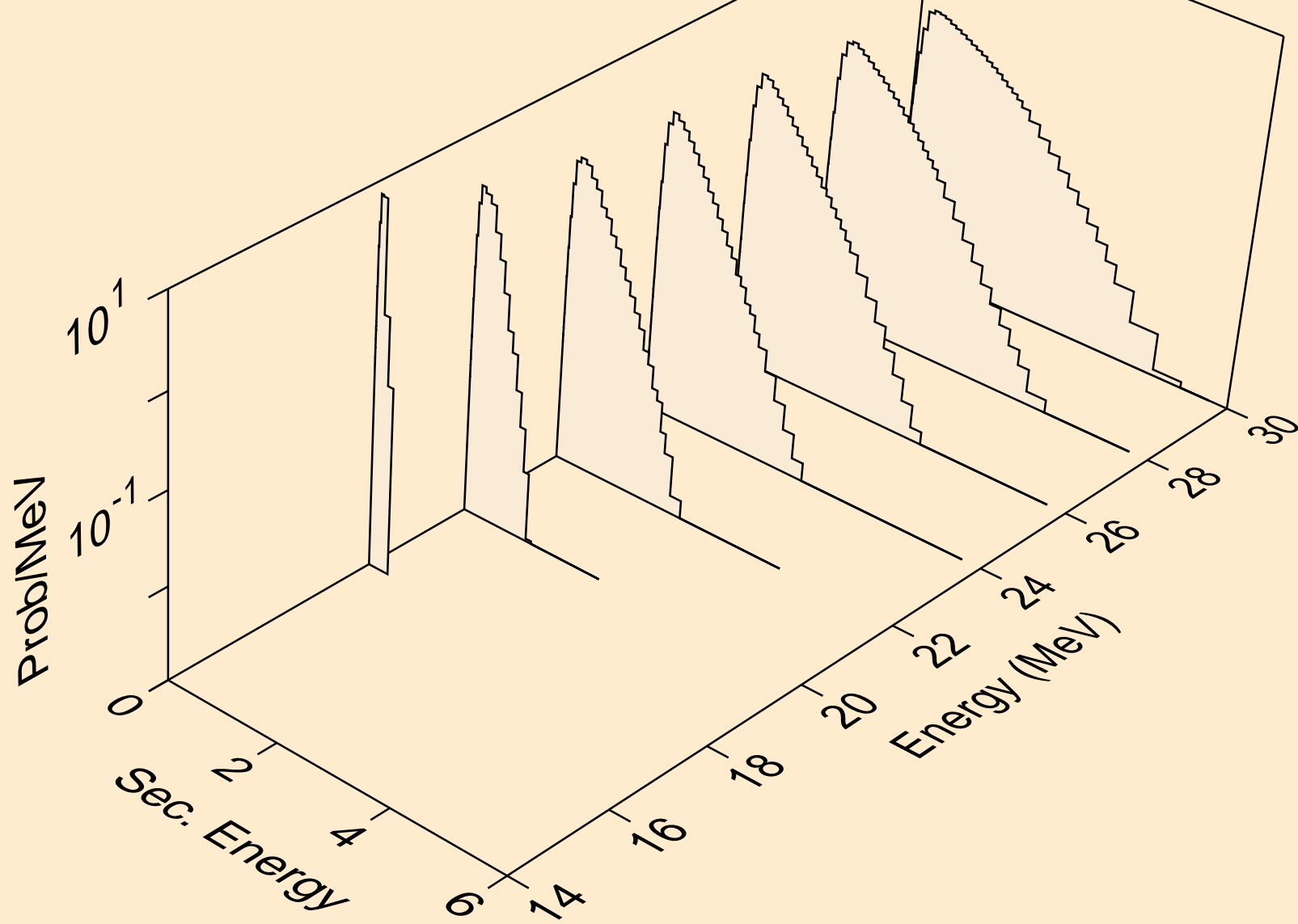

PD098 NEUTRON ACER TENDL-2024 LIBRARY; T=293.6K  
Neutron emission for (n,n\*)p

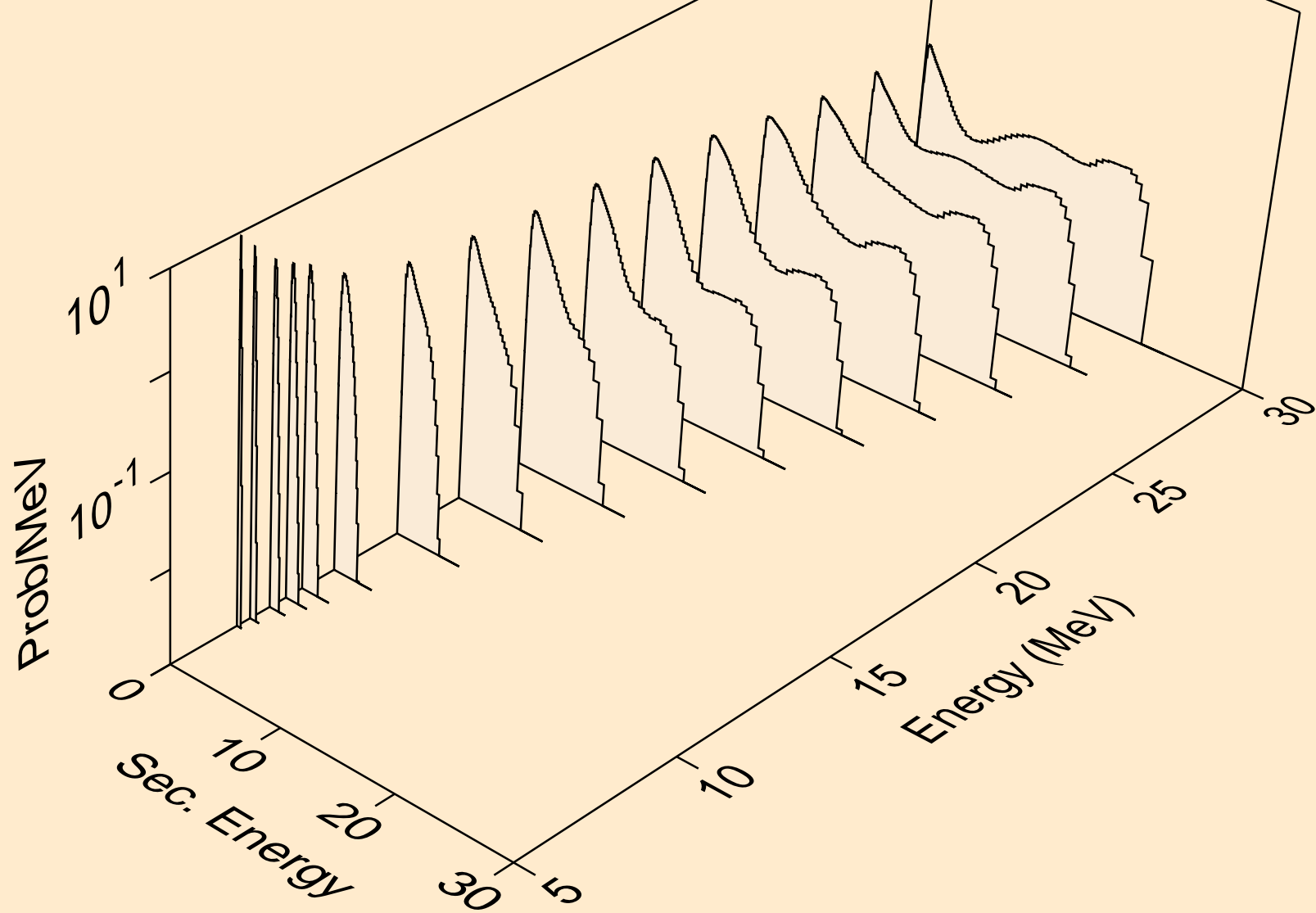

PD098 NEUTRON ACER TENDL-2024 LIBRARY; T=293.6K  
Neutron emission for (n,n\*)2a

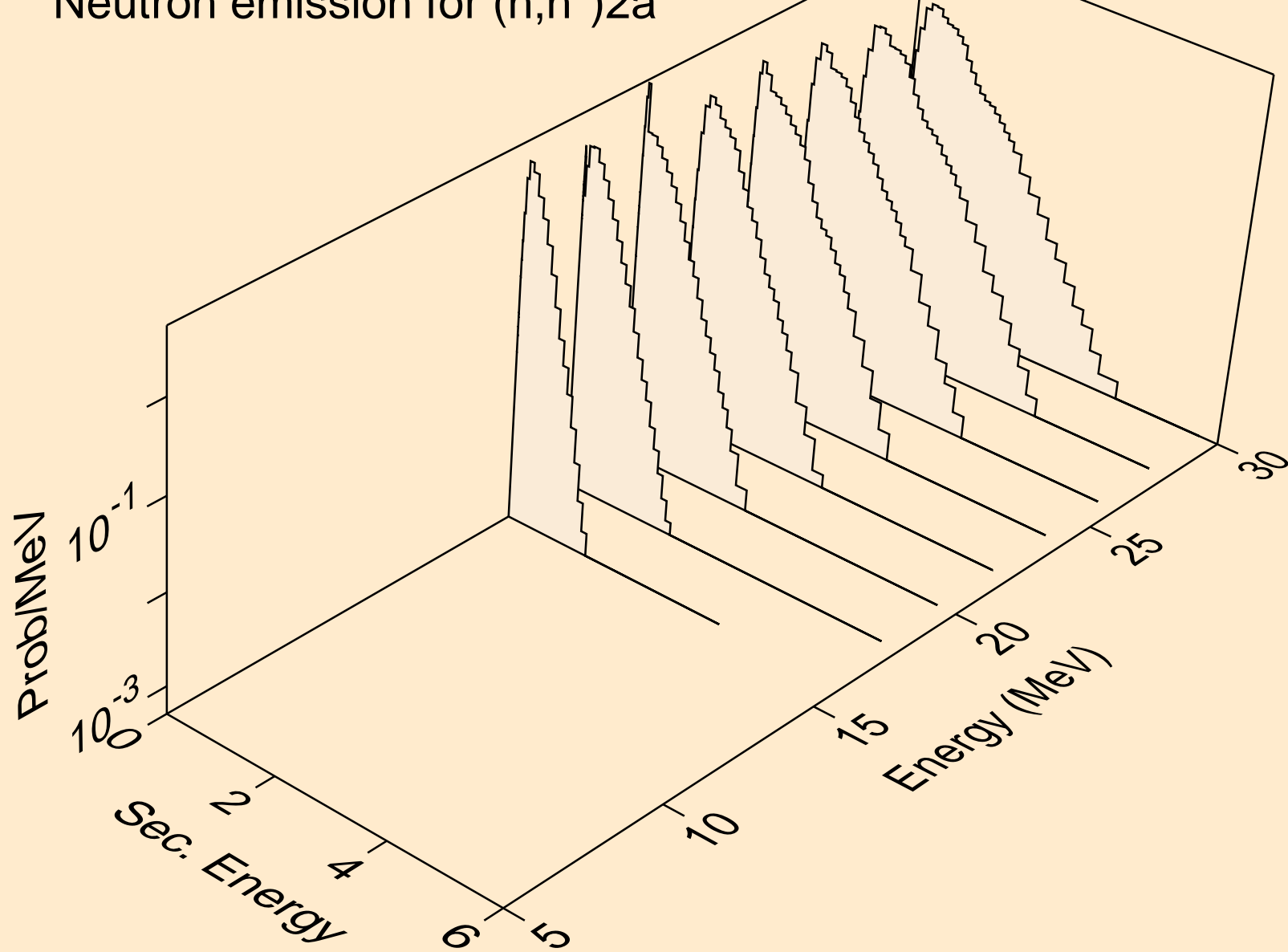

PD098 NEUTRON ACER TENDL-2024 LIBRARY; T=293.6K  
Neutron emission for (n,n\*)d

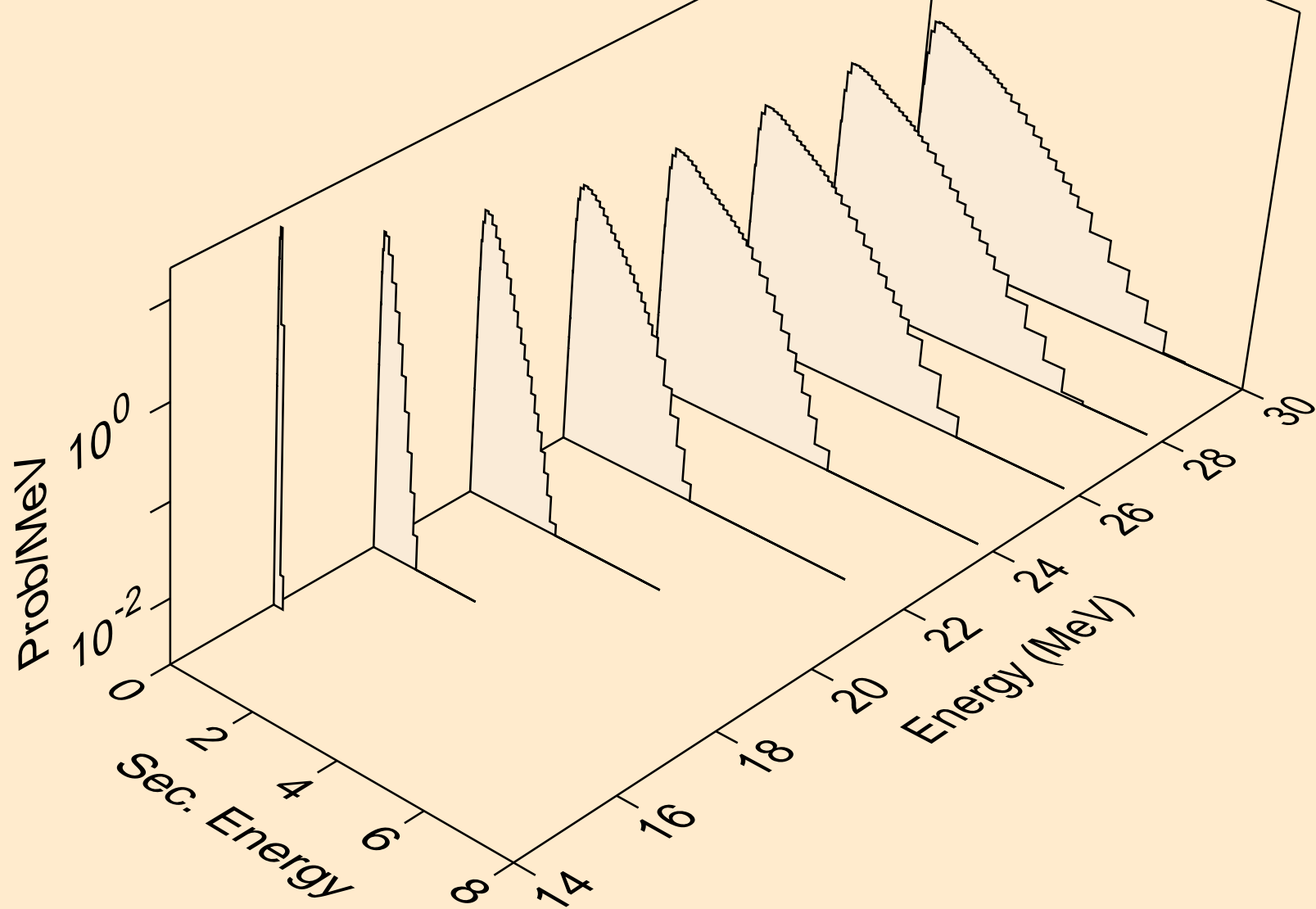

PD098 NEUTRON ACER TENDL-2024 LIBRARY; T=293.6K  
Neutron emission for (n,n\*)t

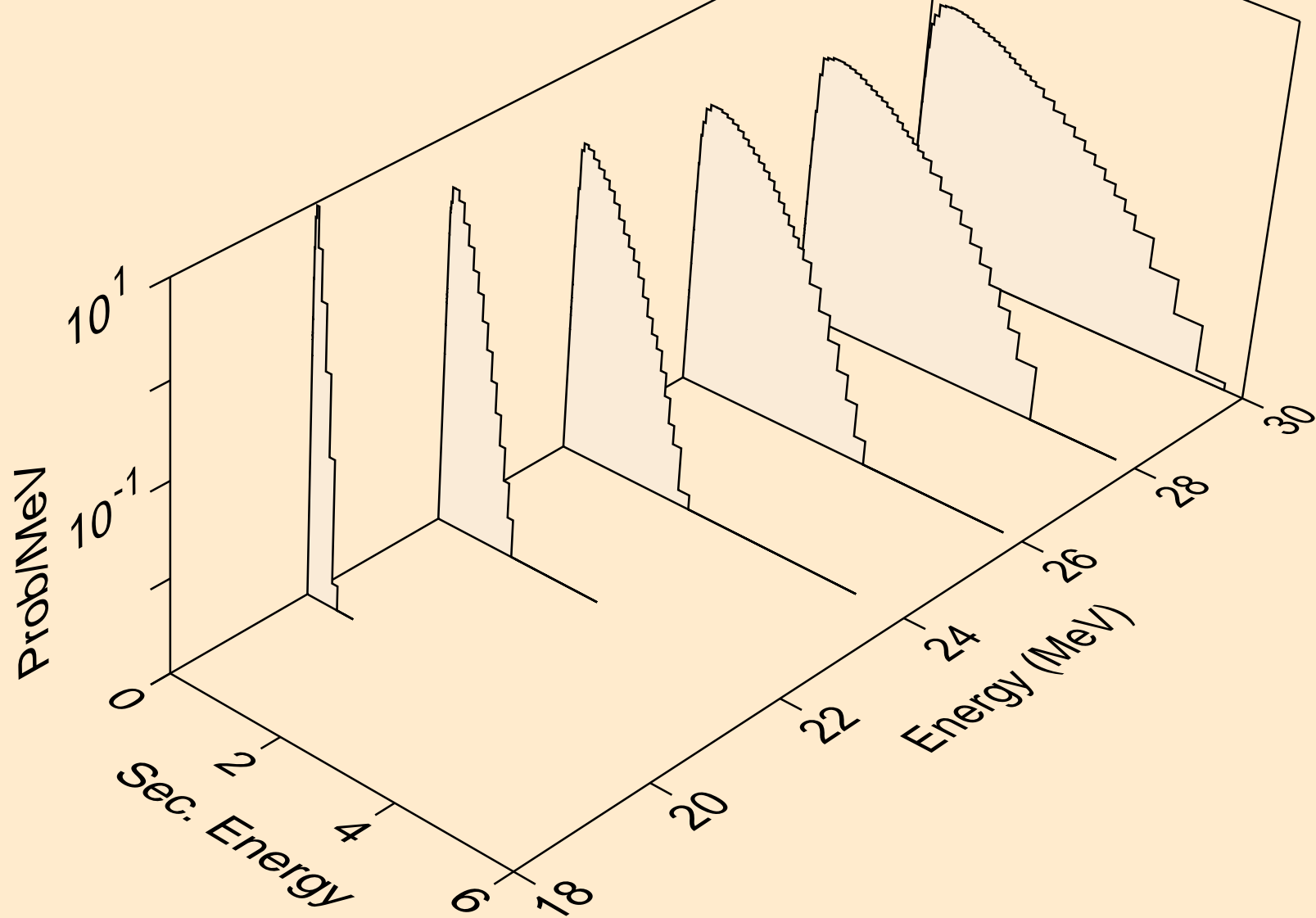

PD098 NEUTRON ACER TENDL-2024 LIBRARY; T=293.6K  
Neutron emission for (n,n\*)he3

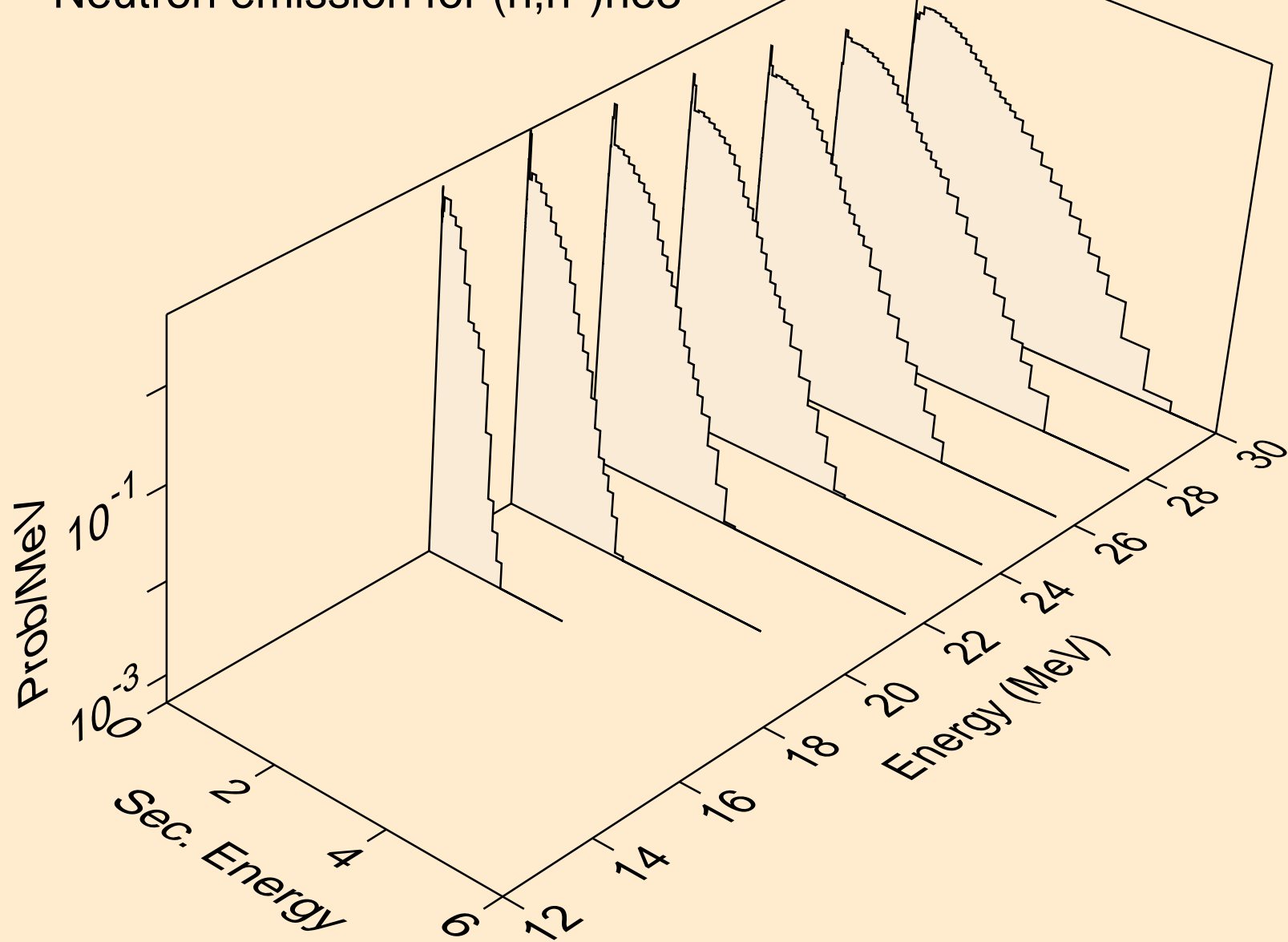

PD098 NEUTRON ACER TENDL-2024 LIBRARY; T=293.6K  
Neutron emission for (n,2np)

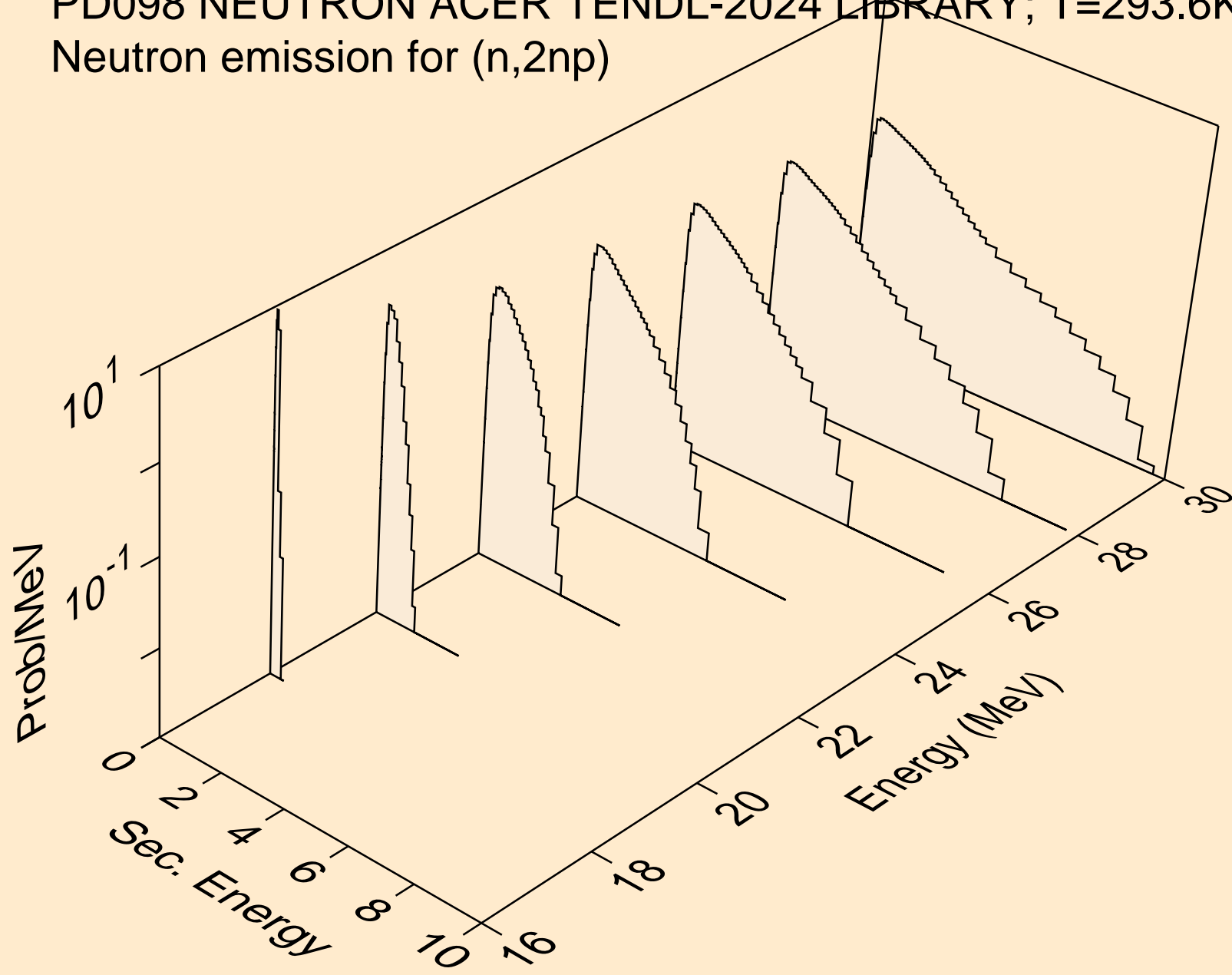

PD098 NEUTRON ACER TENDL-2024 LIBRARY; T=293.6K  
Neutron emission for (n,3np)

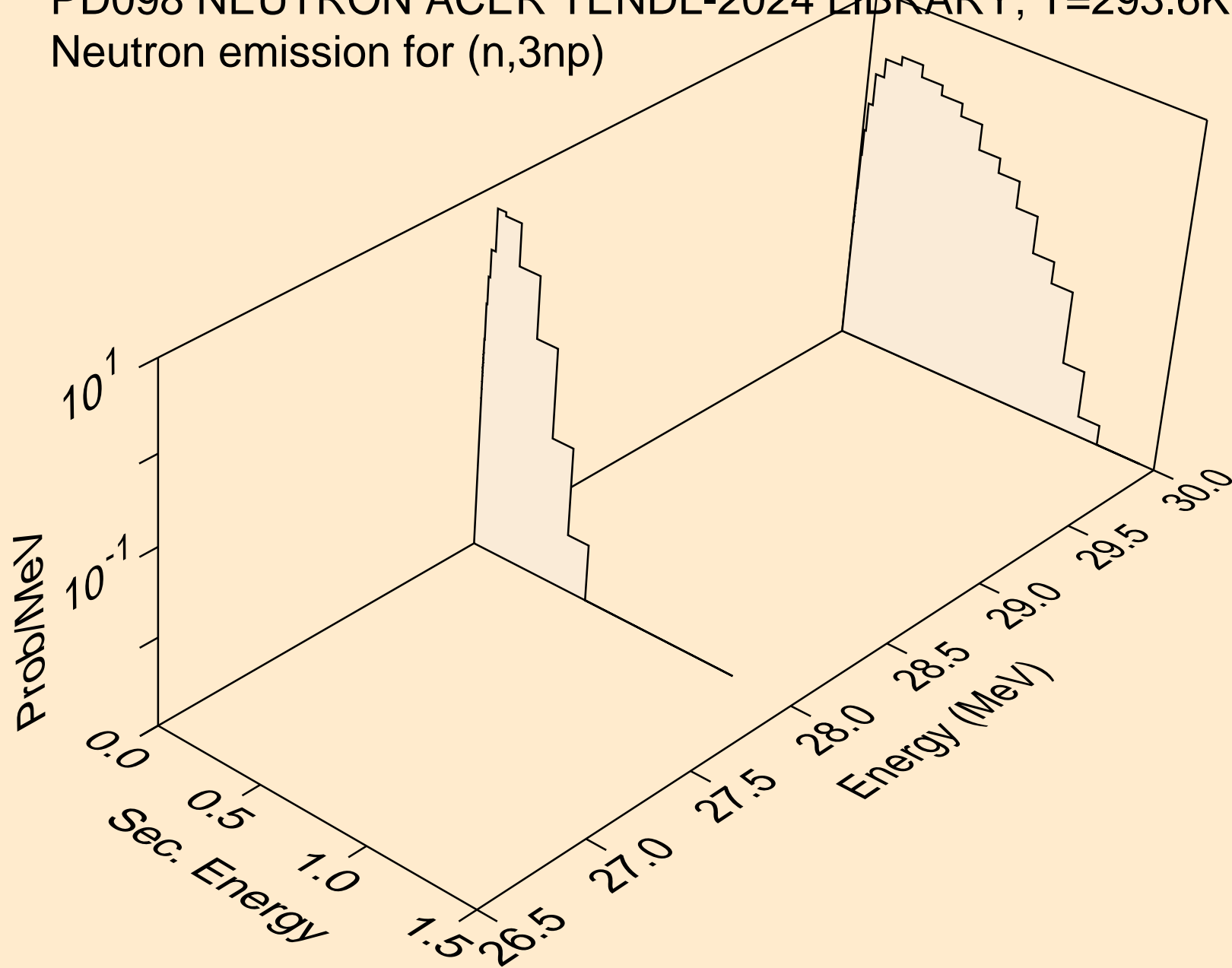

PD098 NEUTRON ACER TENDL-2024 LIBRARY; T=293.6K  
Neutron emission for (n,n2p)

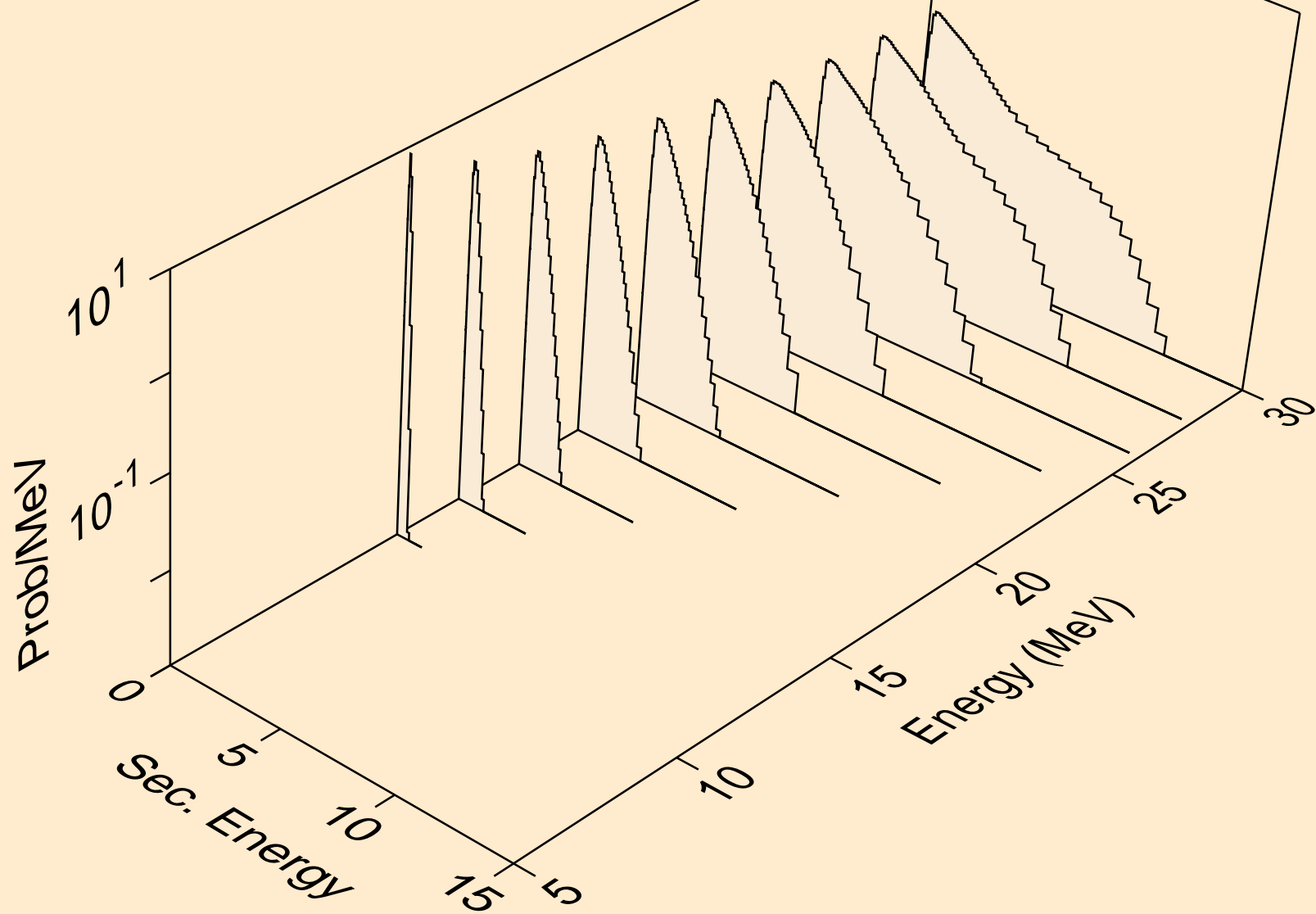

PD098 NEUTRON ACER TENDL-2024 LIBRARY; T=293.6K  
Neutron emission for (n,npa)

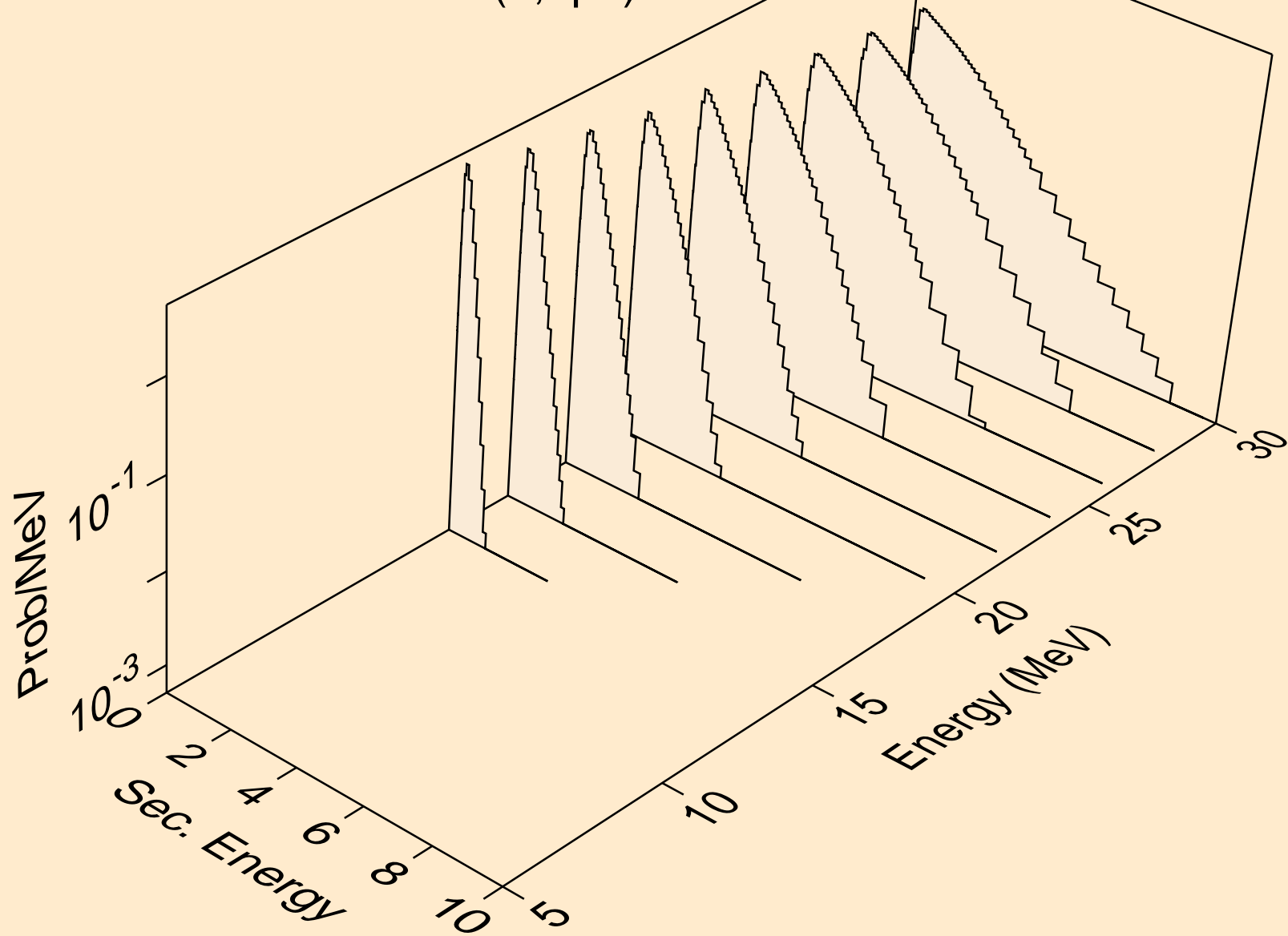

PD098 NEUTRON ACER TENDL-2024 LIBRARY; T=293.6K  
Neutron emission for (n,n\*c)

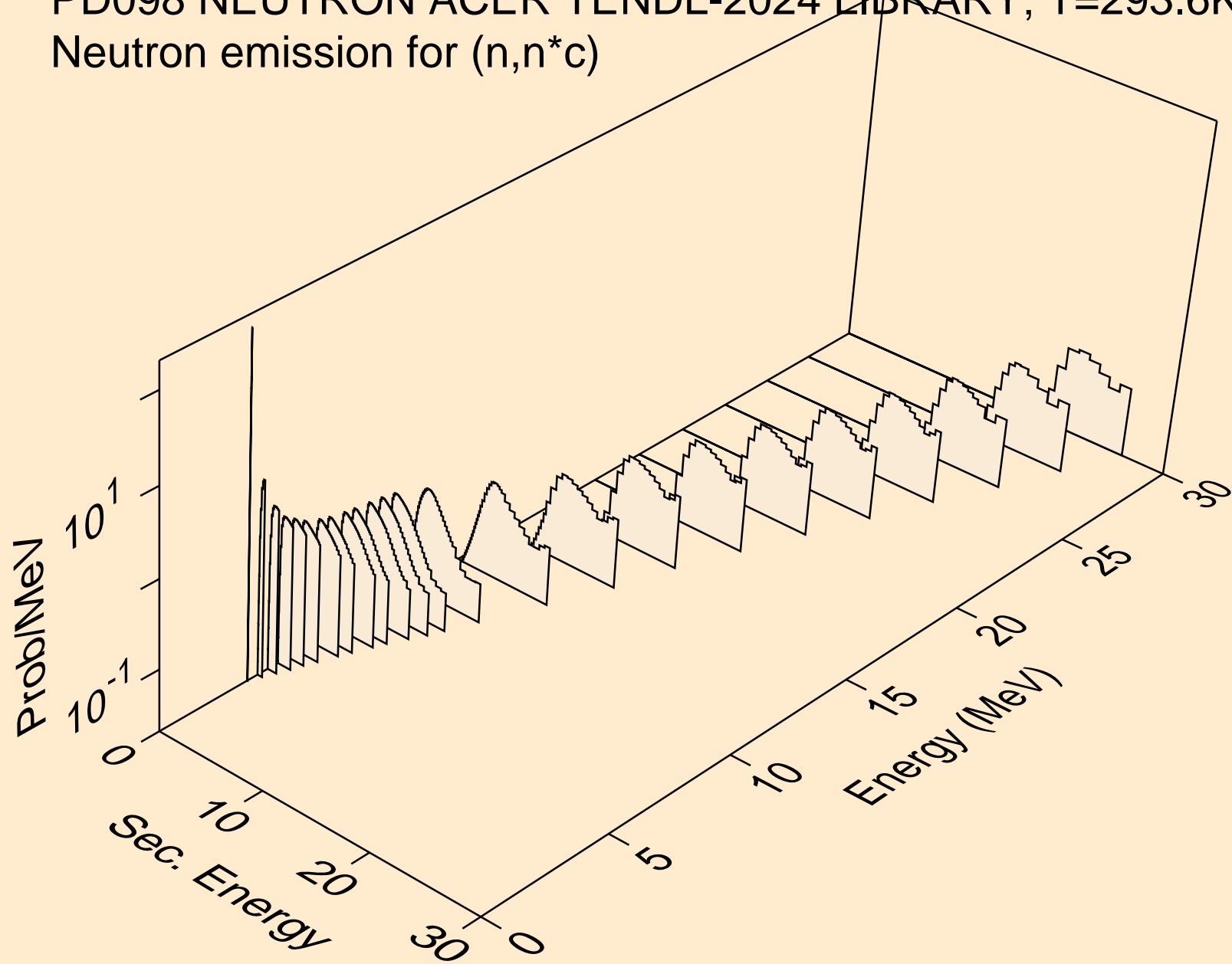

PD098 NEUTRON ACER TENDL-2024 LIBRARY; T=293.6K  
Photon emission for (n,x)

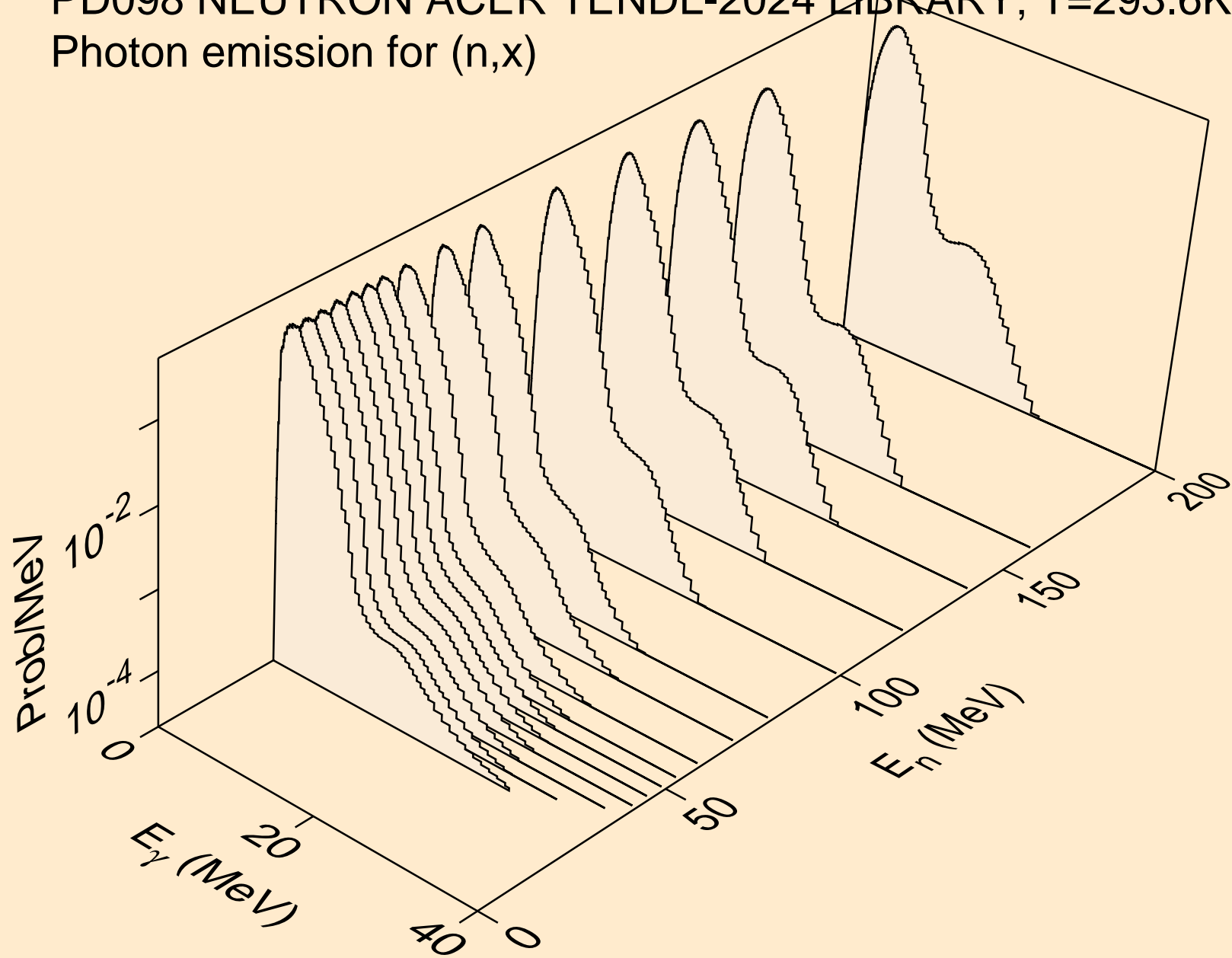

PD098 NEUTRON ACER TENDL-2024 LIBRARY; T=293.6K  
Photon emission for (n,2nd)

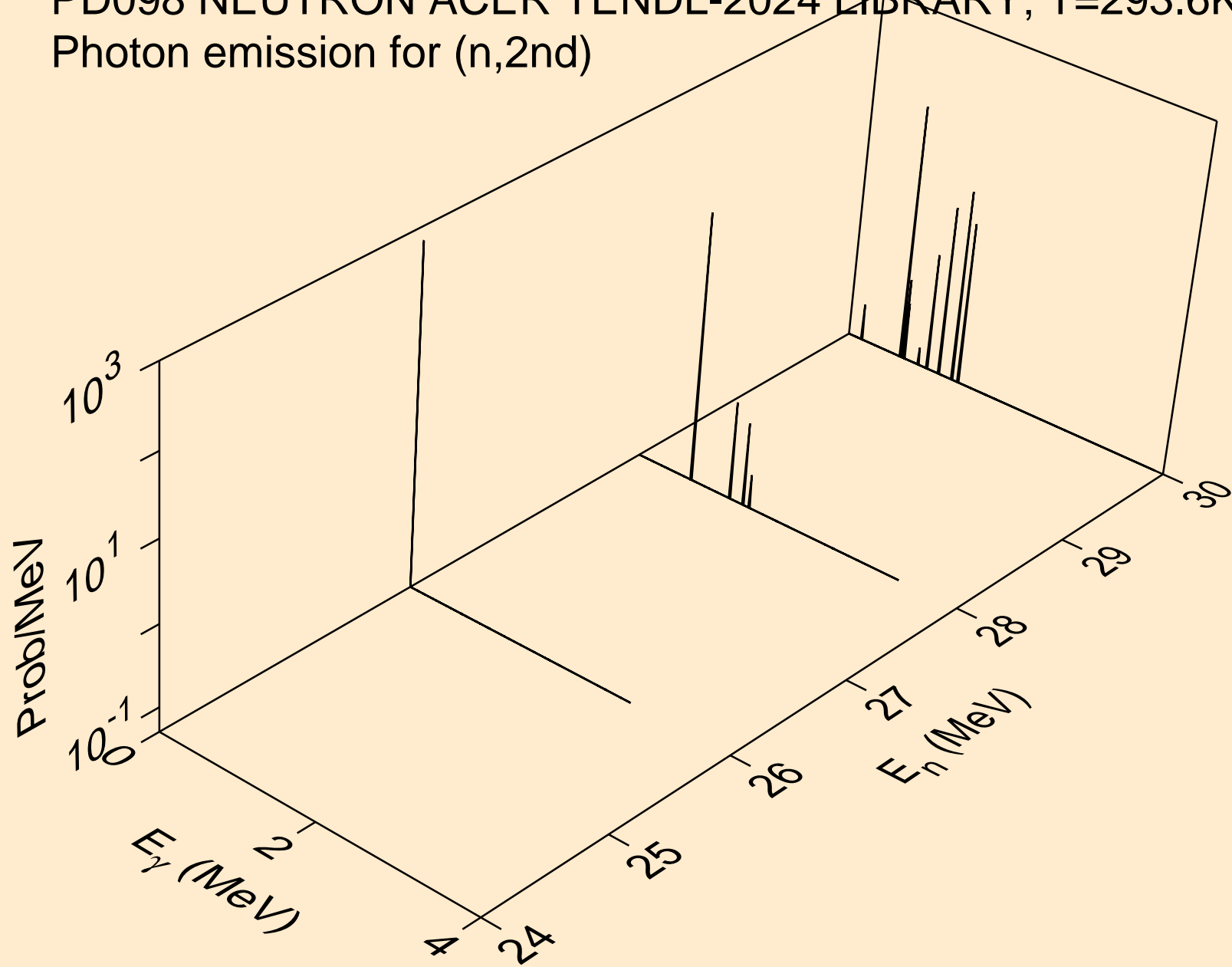

PD098 NEUTRON ACER TENDL-2024 LIBRARY; T=293.6K  
Photon emission for (n,2n)

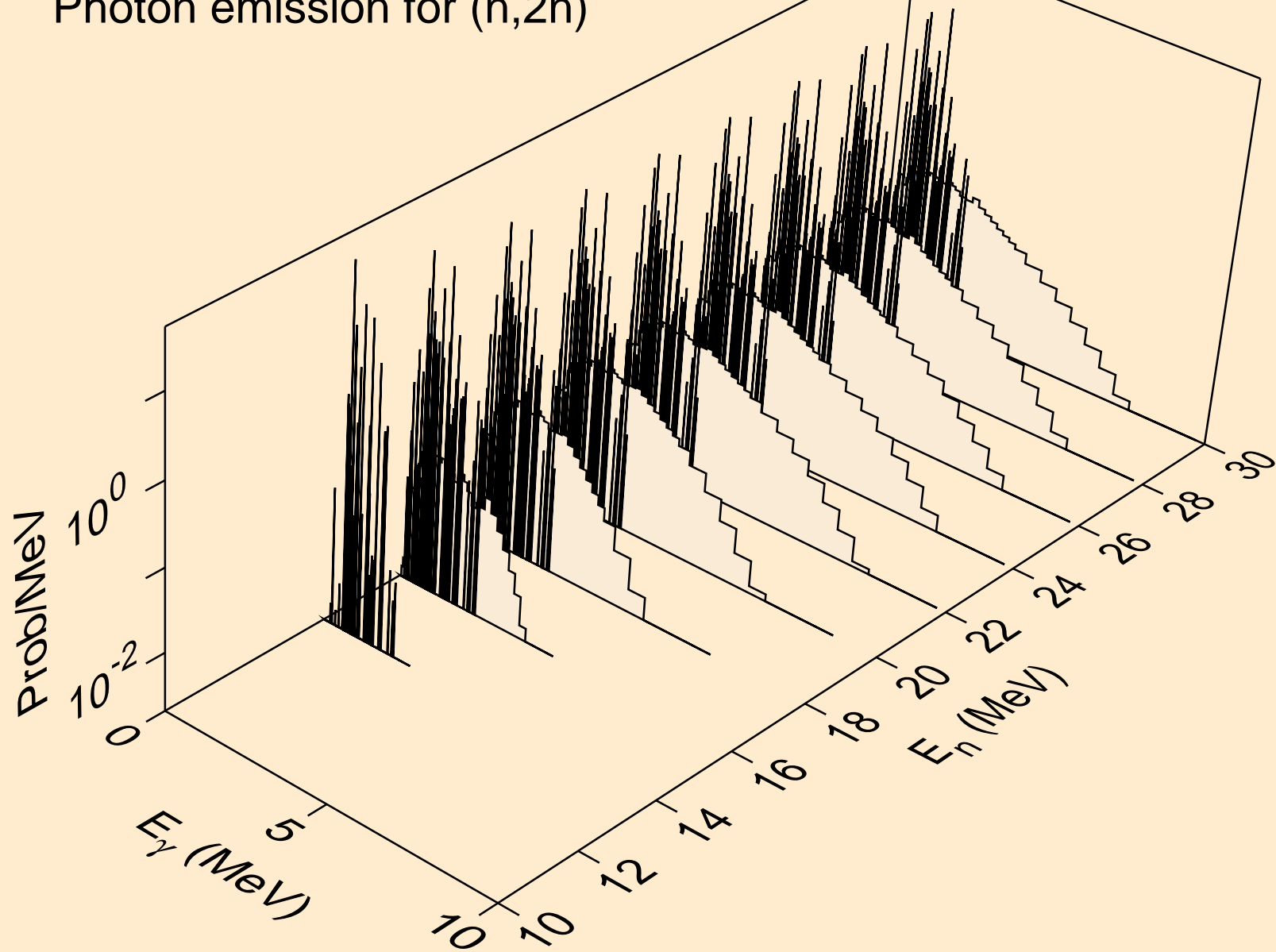

PD098 NEUTRON ACER TENDL-2024 LIBRARY; T=293.6K  
Photon emission for (n,3n)

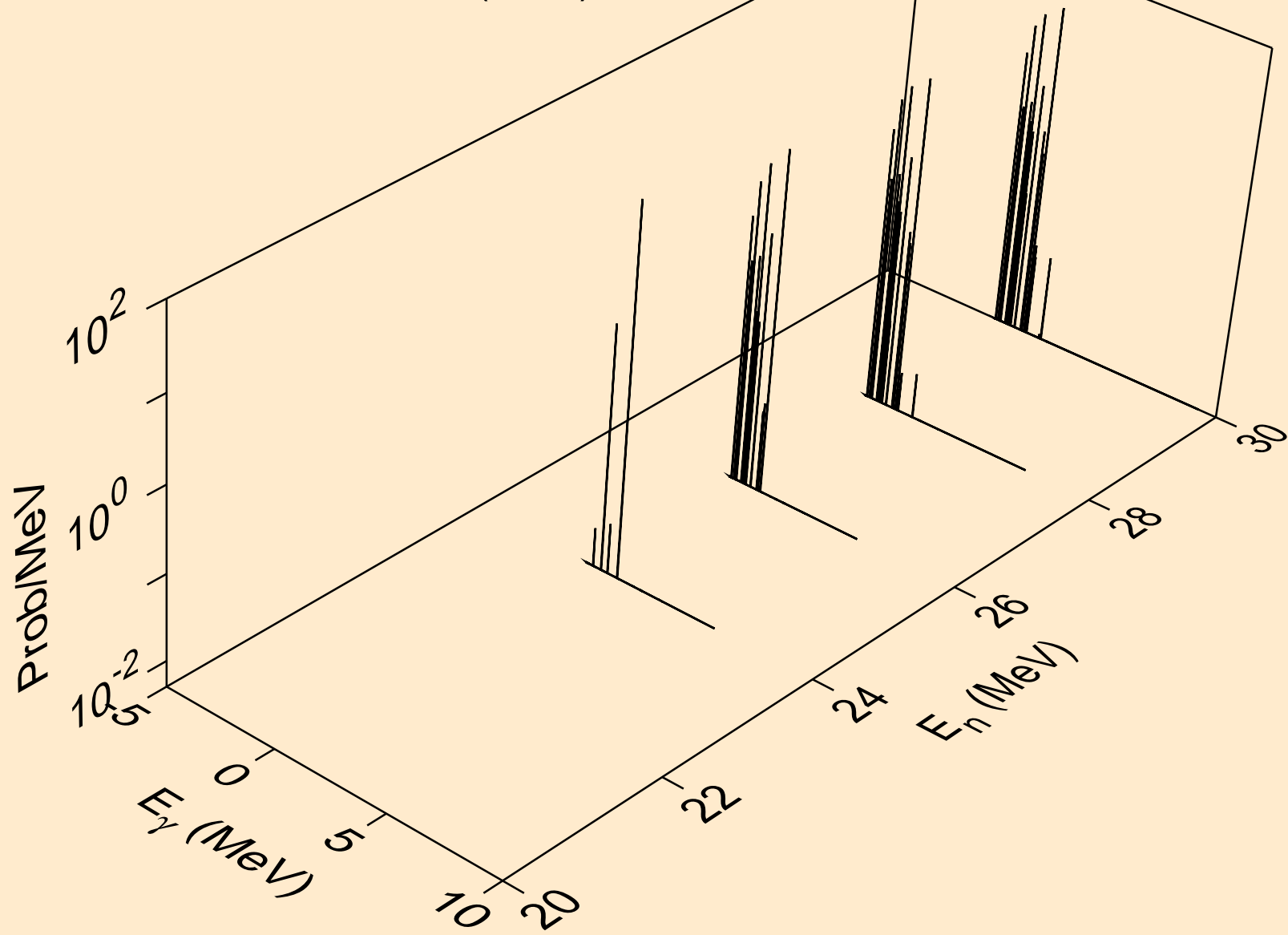

PD098 NEUTRON ACER TENDL-2024 LIBRARY; T=293.6K  
Photon emission for (n,n\*)a

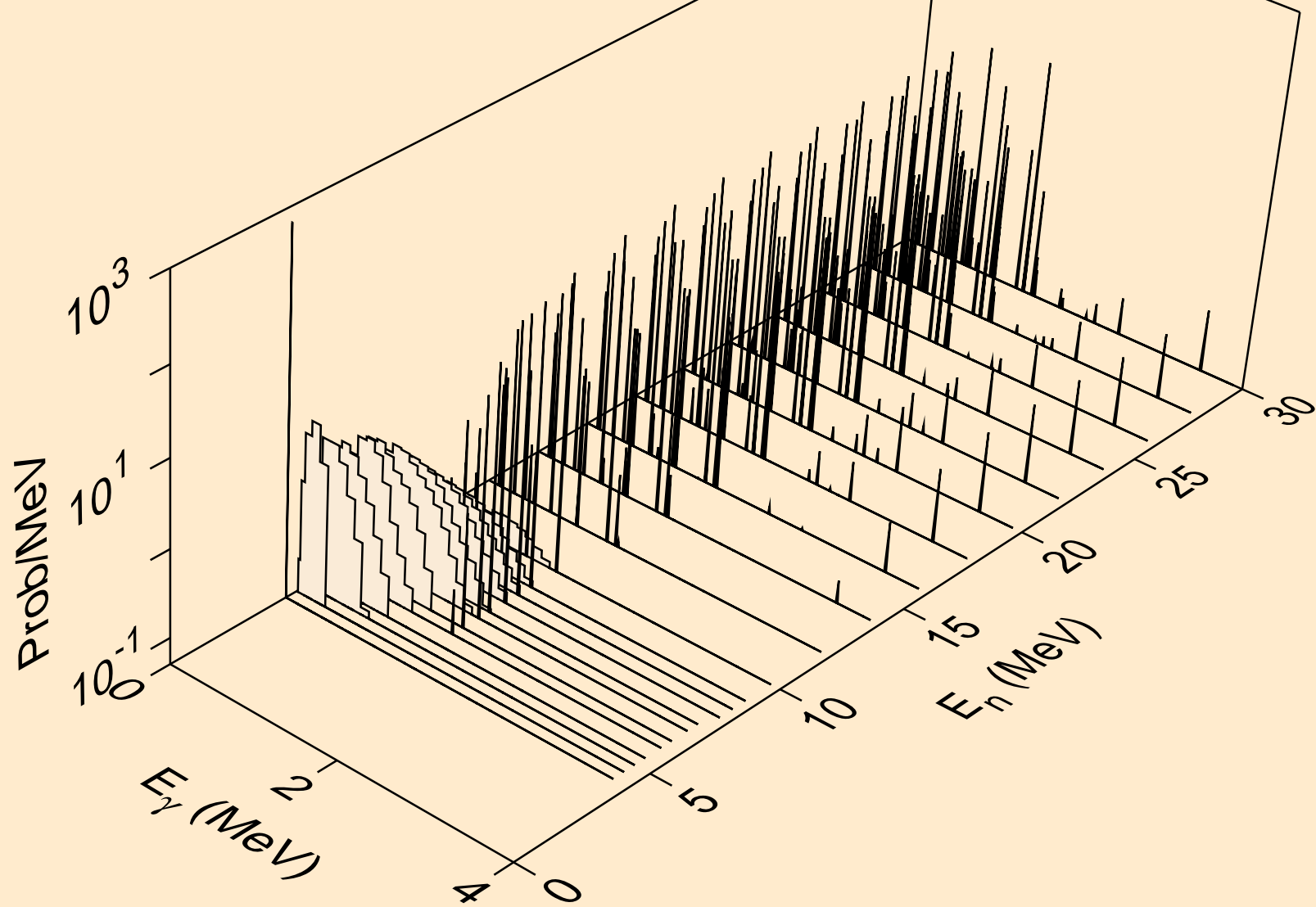

PD098 NEUTRON ACER TENDL-2024 LIBRARY; T=293.6K  
Photon emission for (n,2n)a

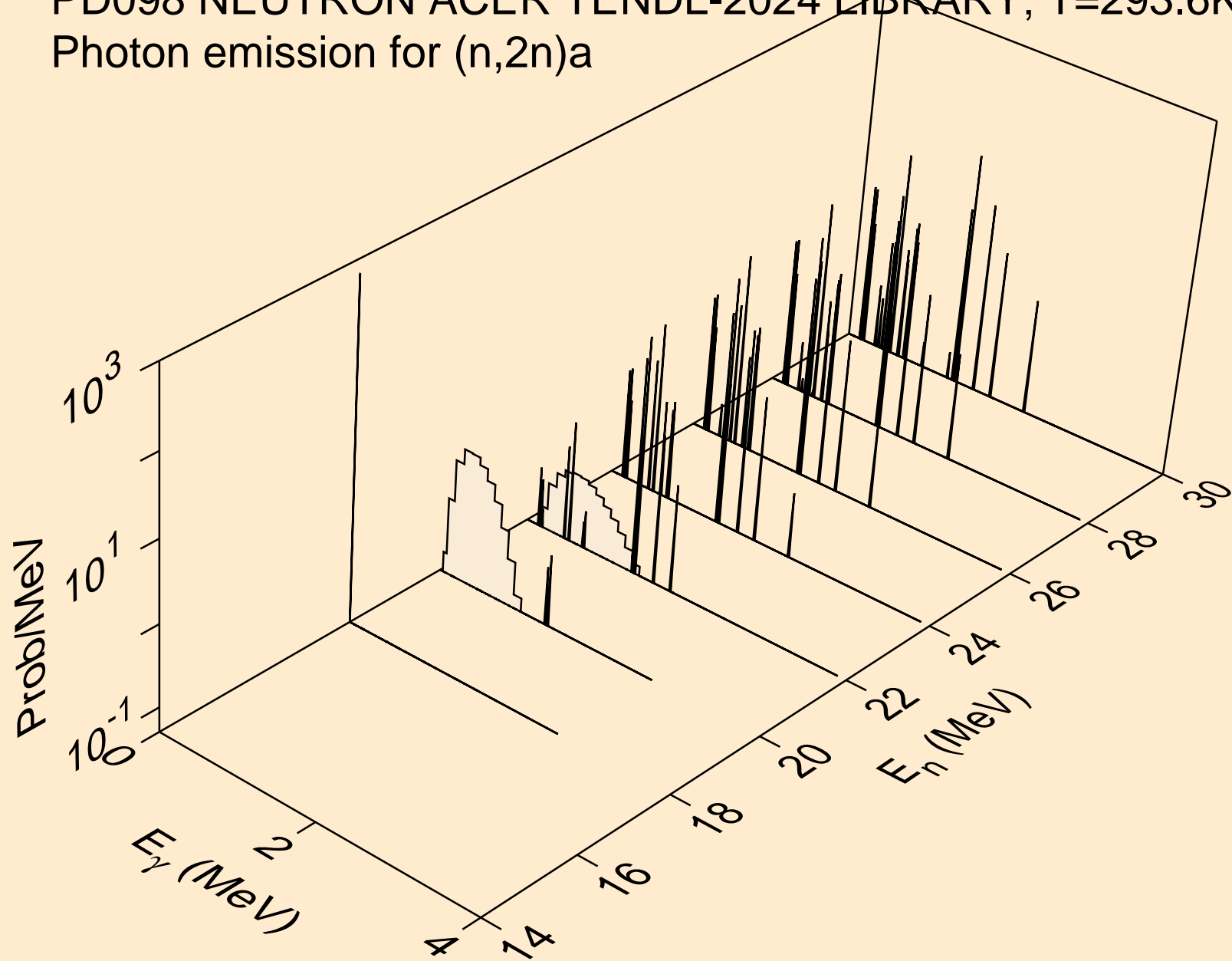

PD098 NEUTRON ACER TENDL-2024 LIBRARY; T=293.6K  
Photon emission for (n,n\*)p

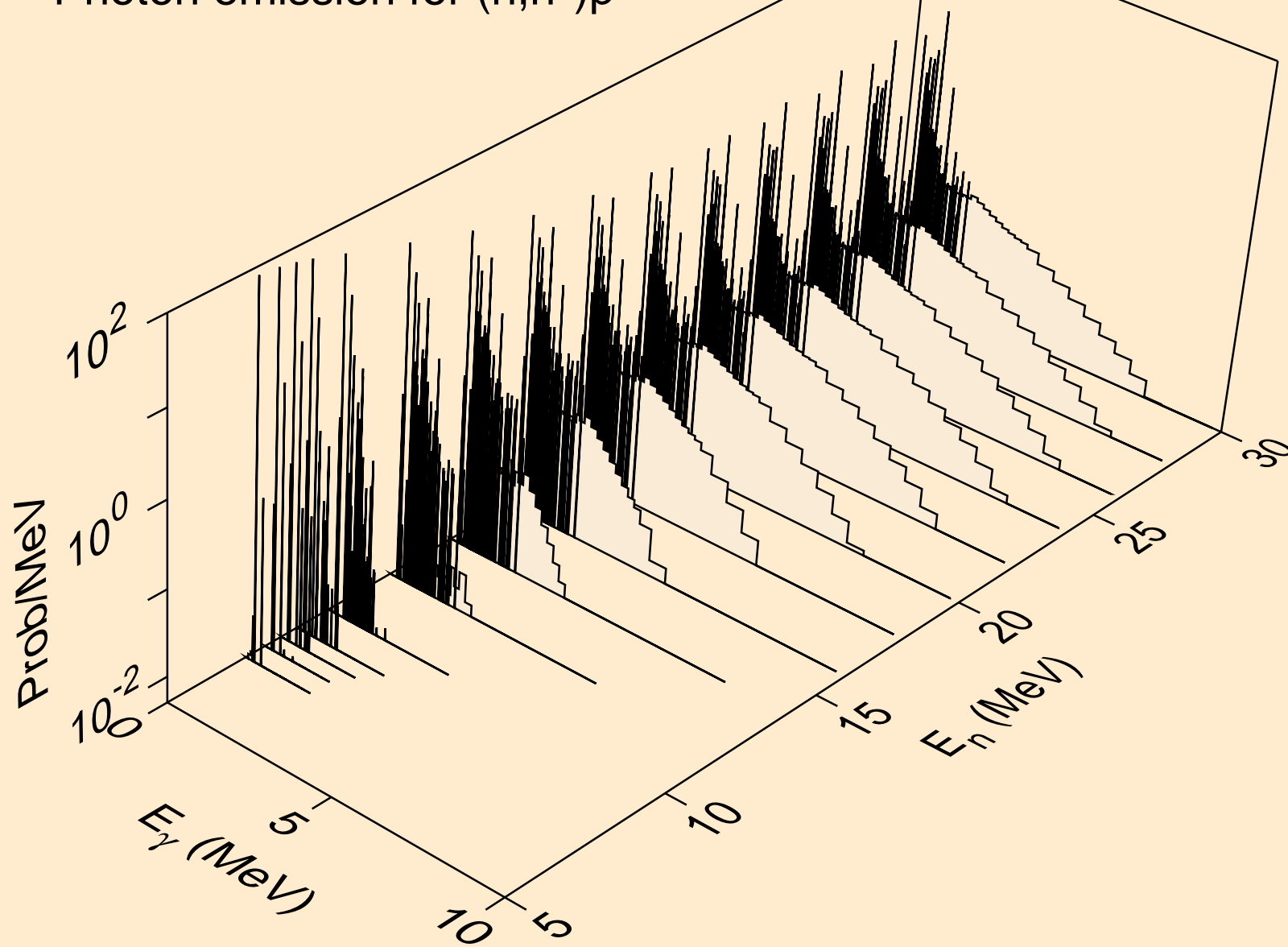

PD098 NEUTRON ACER TENDL-2024 LIBRARY; T=293.6K  
Photon emission for (n,n\*)2a

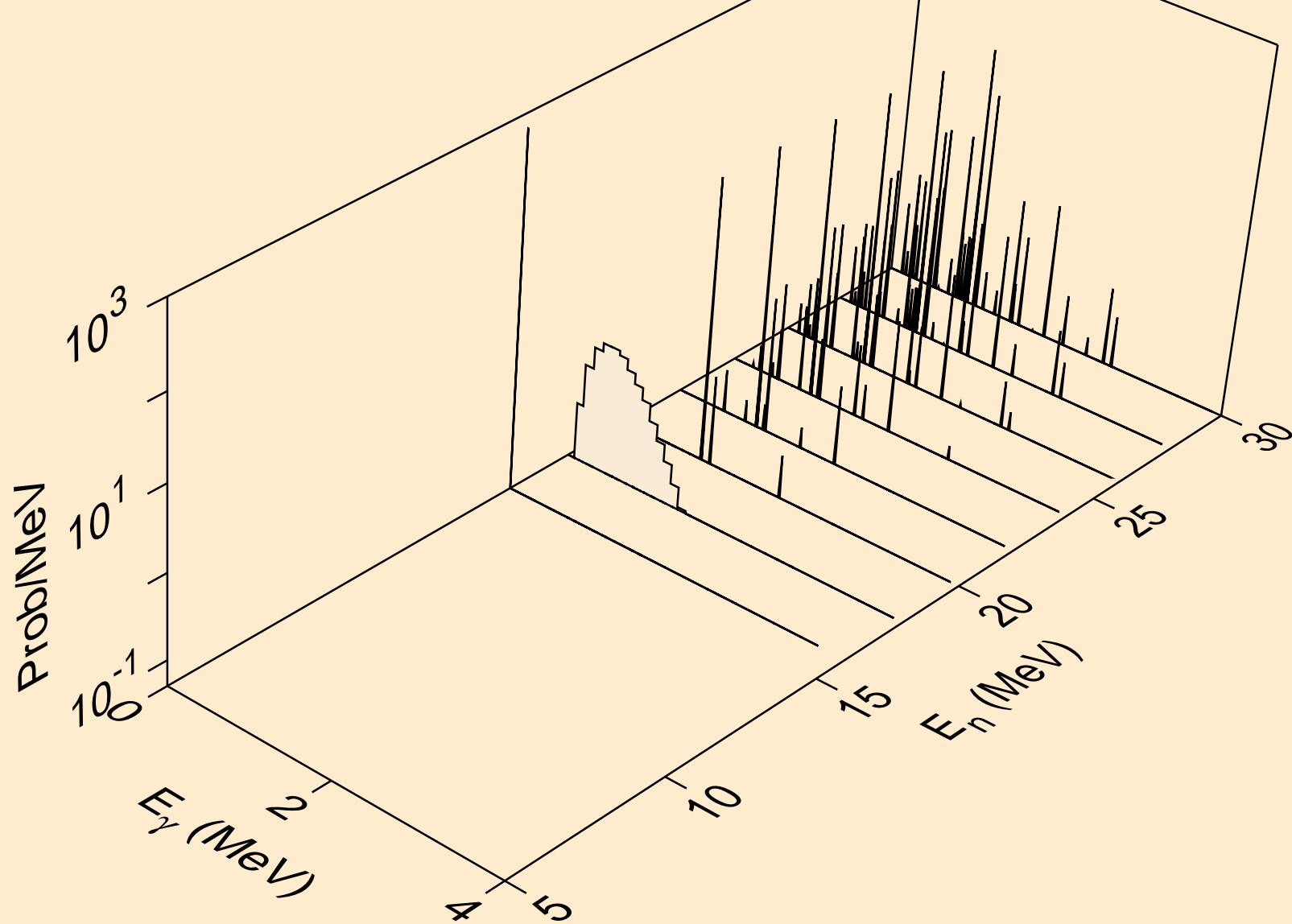

PD098 NEUTRON ACER TENDL-2024 LIBRARY; T=293.6K  
Photon emission for (n,n\*)d

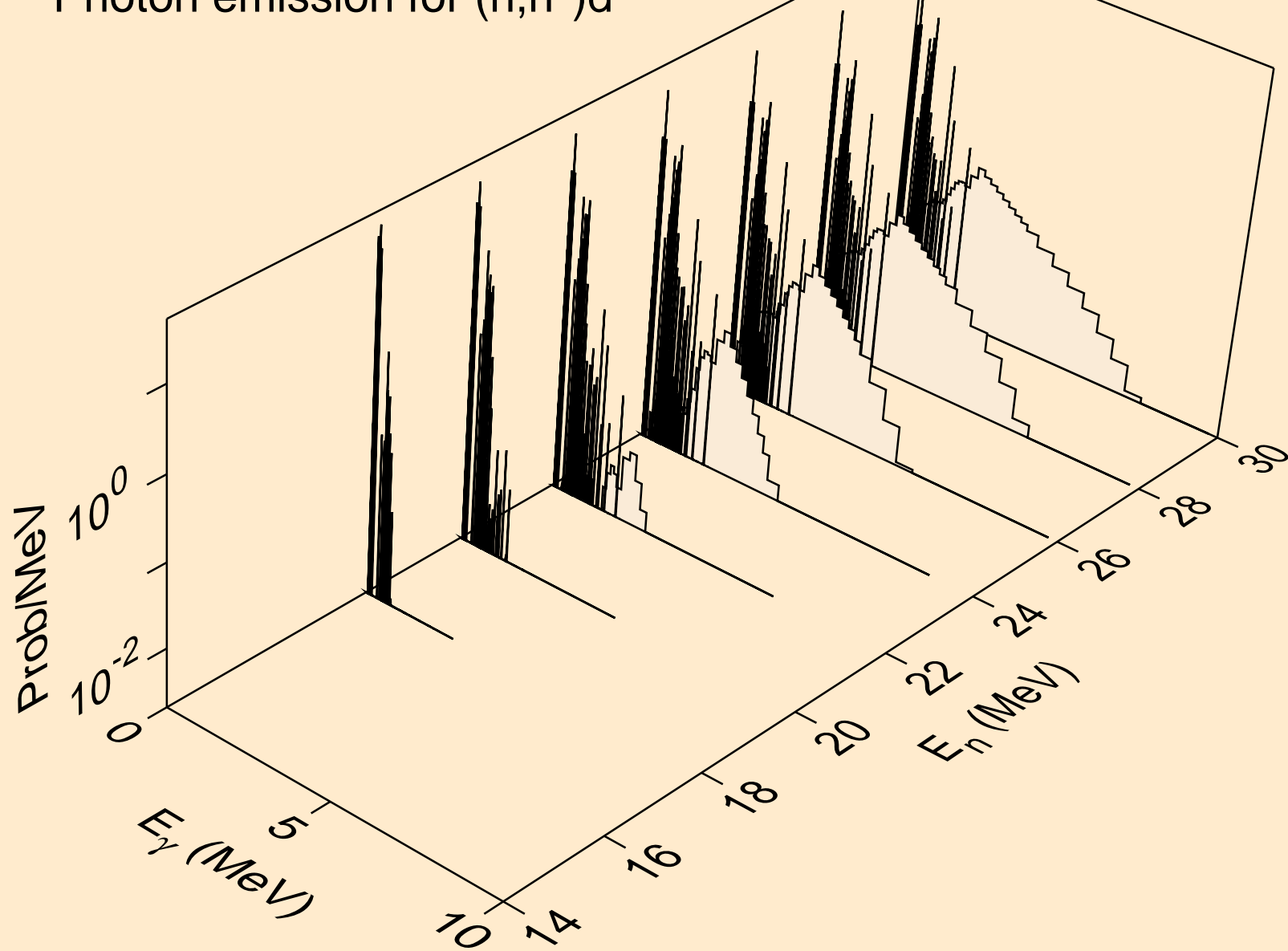

PD098 NEUTRON ACER TENDL-2024 LIBRARY; T=293.6K  
Photon emission for (n,n\*)t

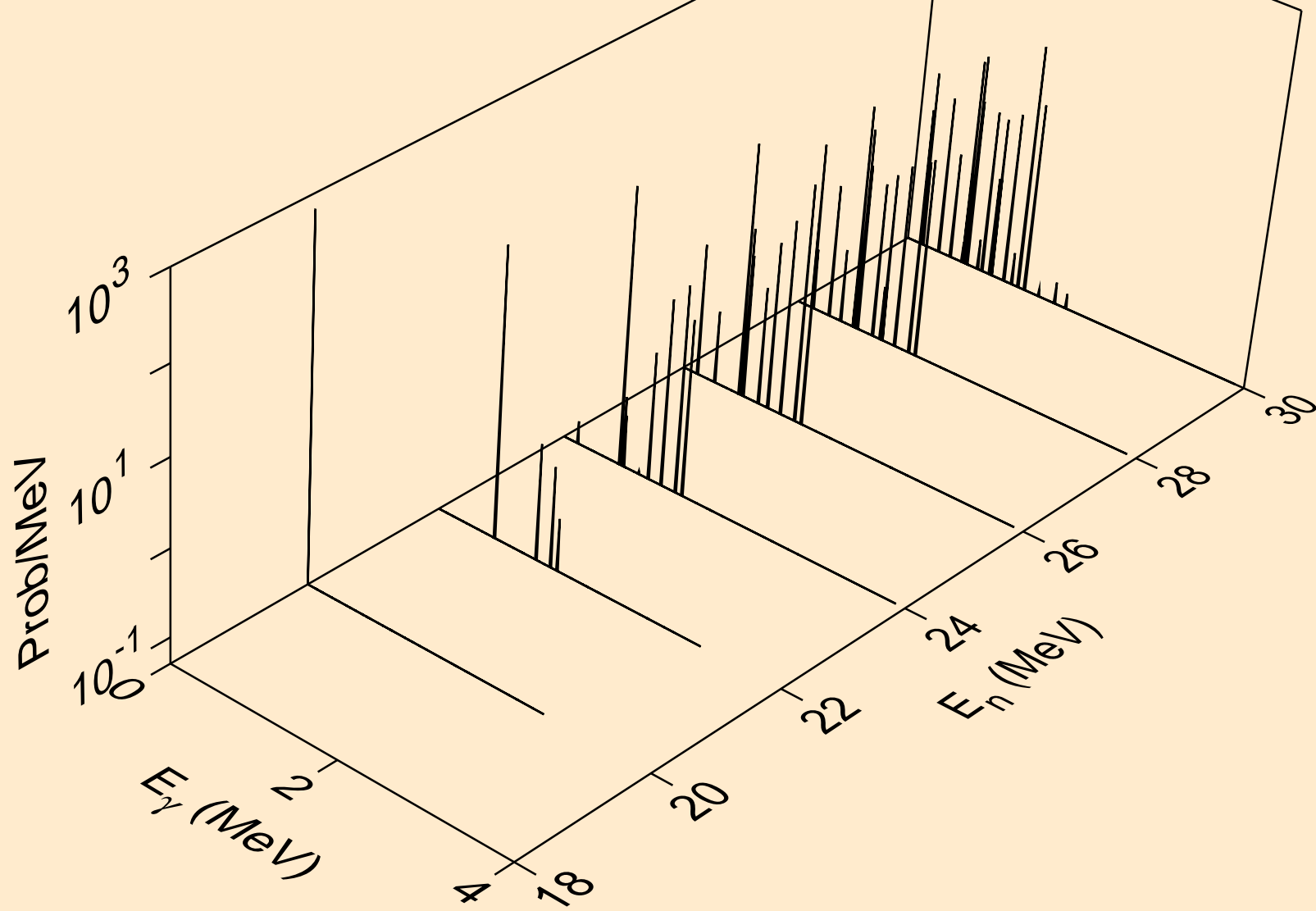

PD098 NEUTRON ACER TENDL-2024 LIBRARY; T=293.6K  
Photon emission for (n,n\*)he3

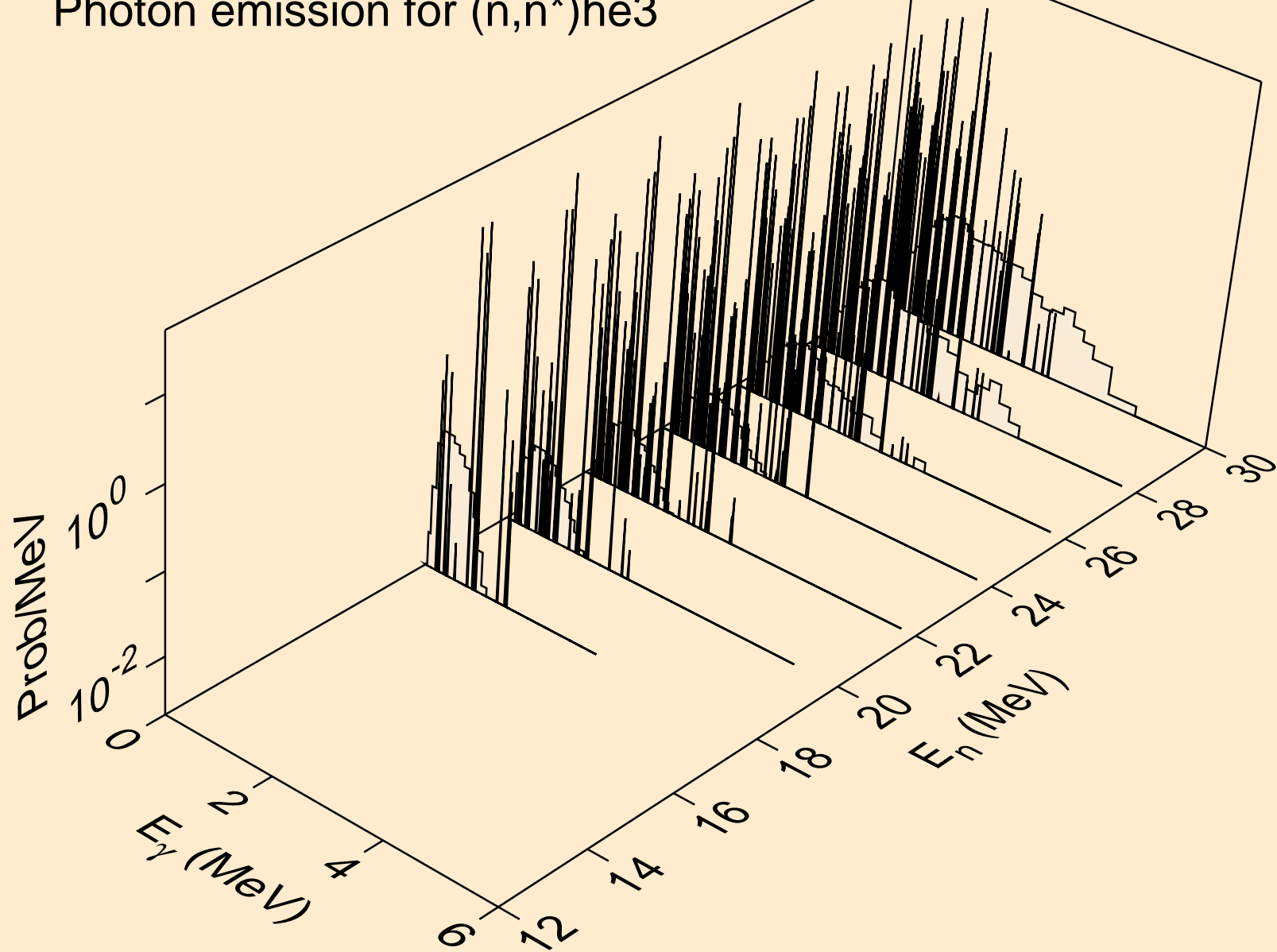

PD098 NEUTRON ACER TENDL-2024 LIBRARY; T=293.6K  
Photon emission for (n,2np)

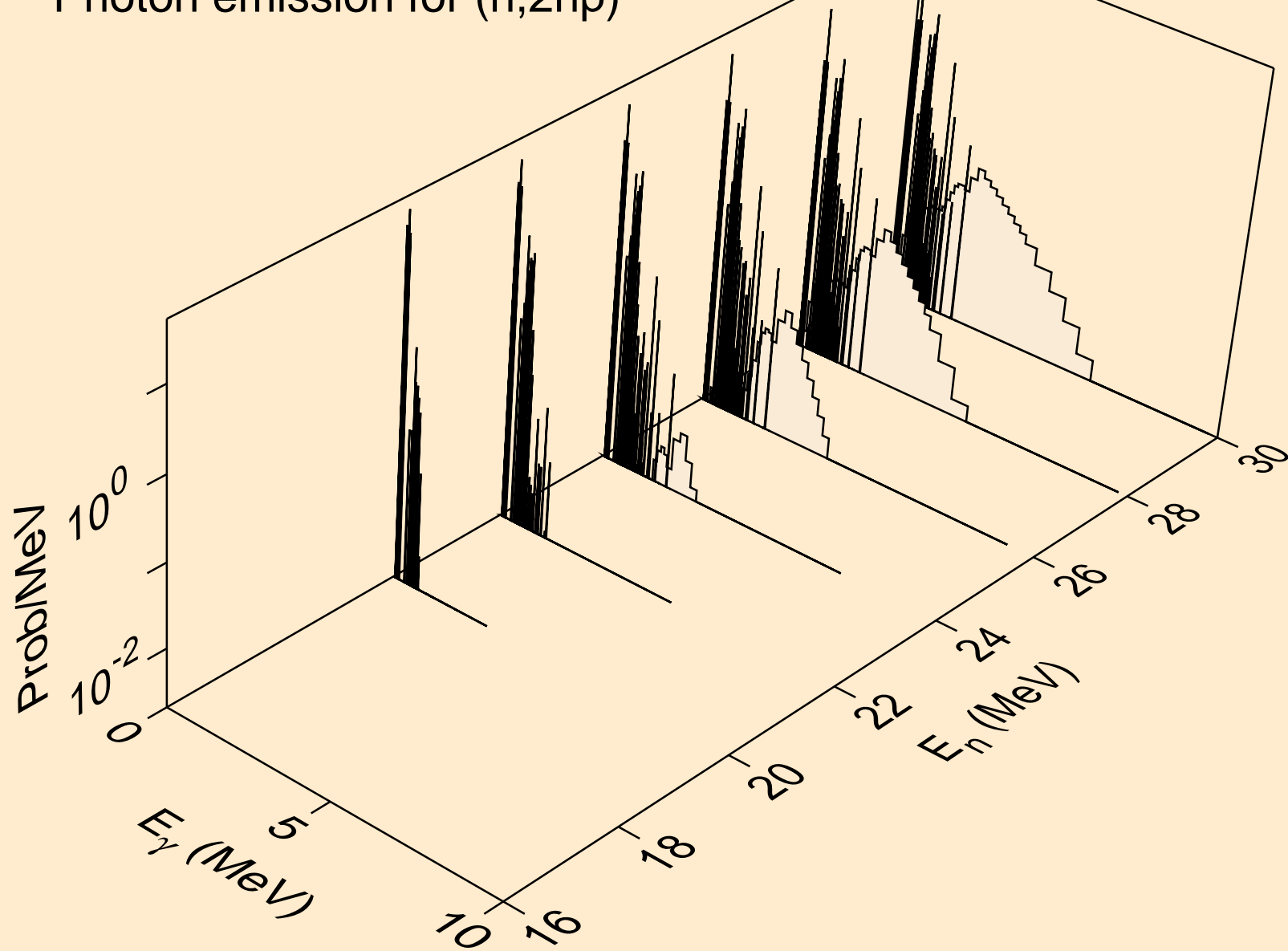

PD098 NEUTRON ACER TENDL-2024 LIBRARY; T=293.6K  
Photon emission for (n,3np)

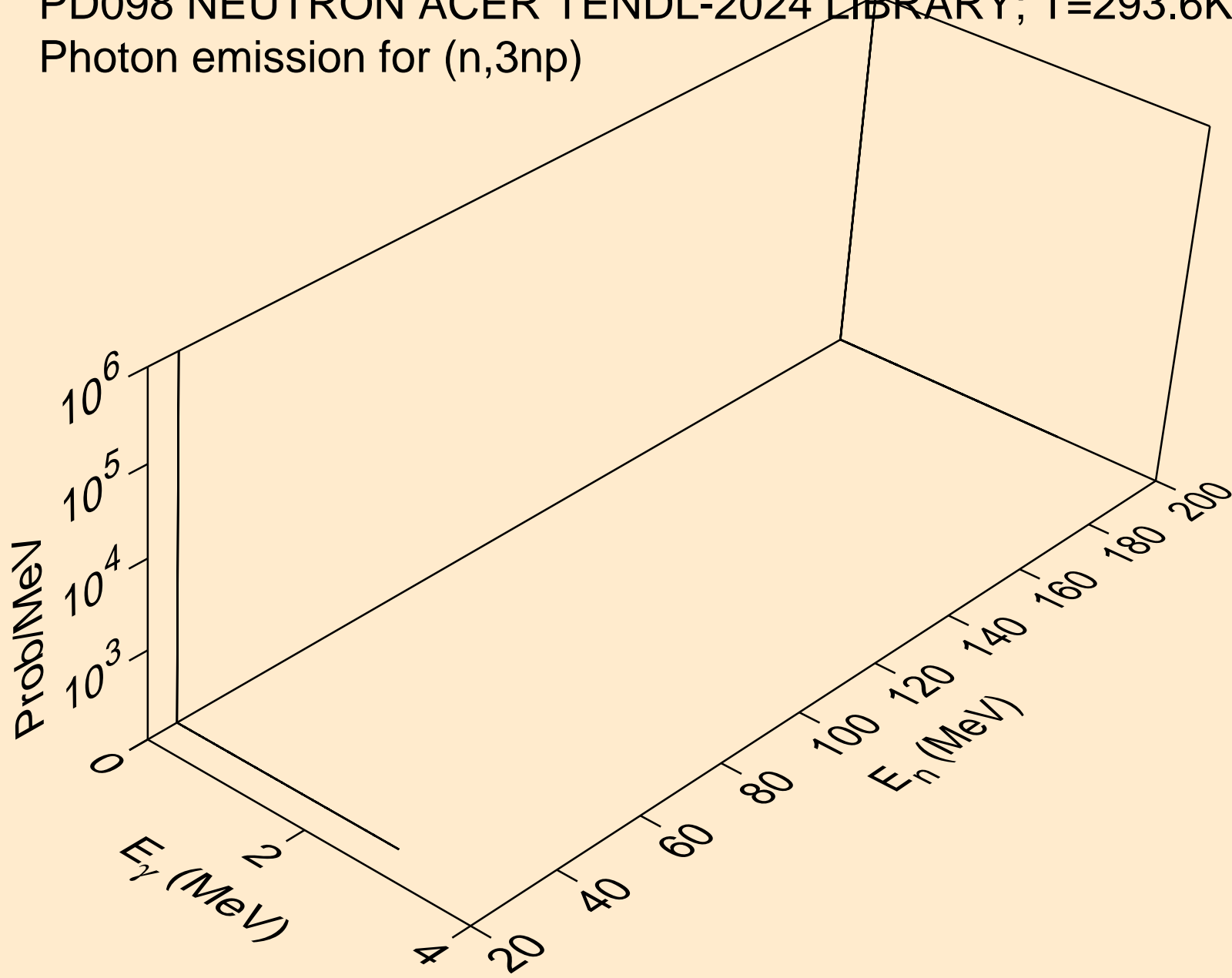

PD098 NEUTRON ACER TENDL-2024 LIBRARY; T=293.6K  
Photon emission for (n,n2p)

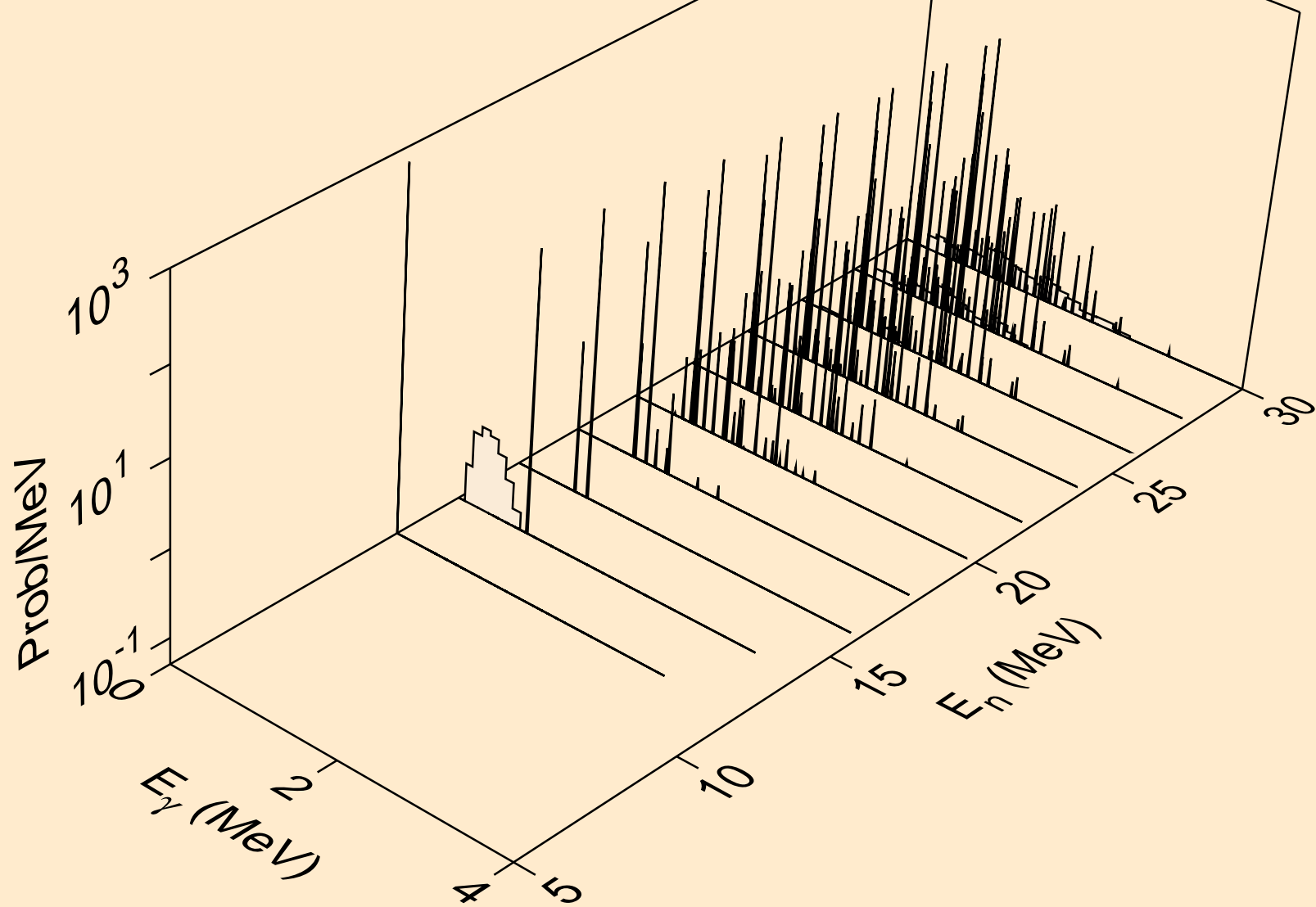

PD098 NEUTRON ACER TENDL-2024 LIBRARY; T=293.6K  
Photon emission for (n,npa)

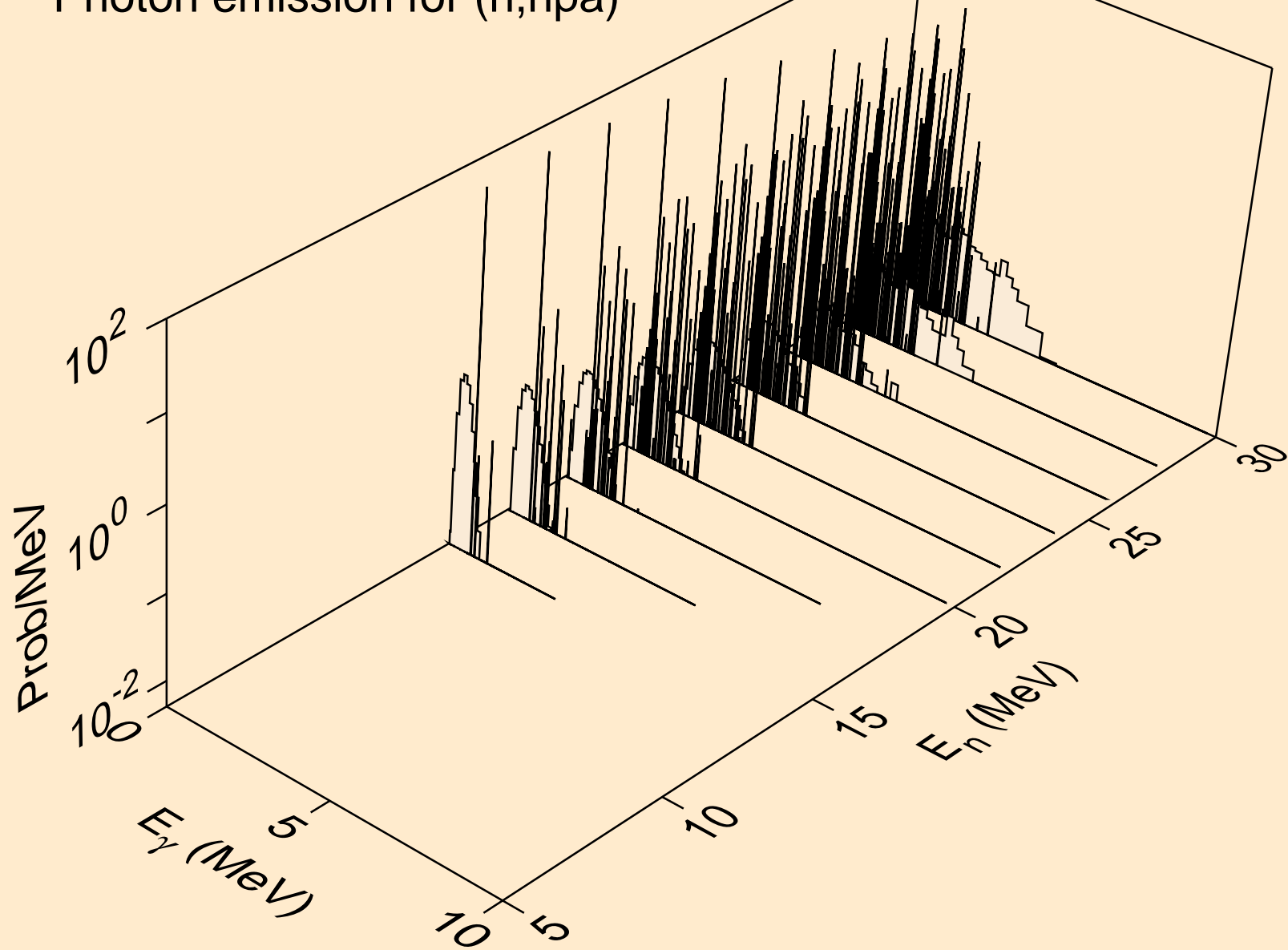

PD098 NEUTRON ACER TENDL-2024 LIBRARY; T=293.6K  
Photon emission for (n,n\*c)

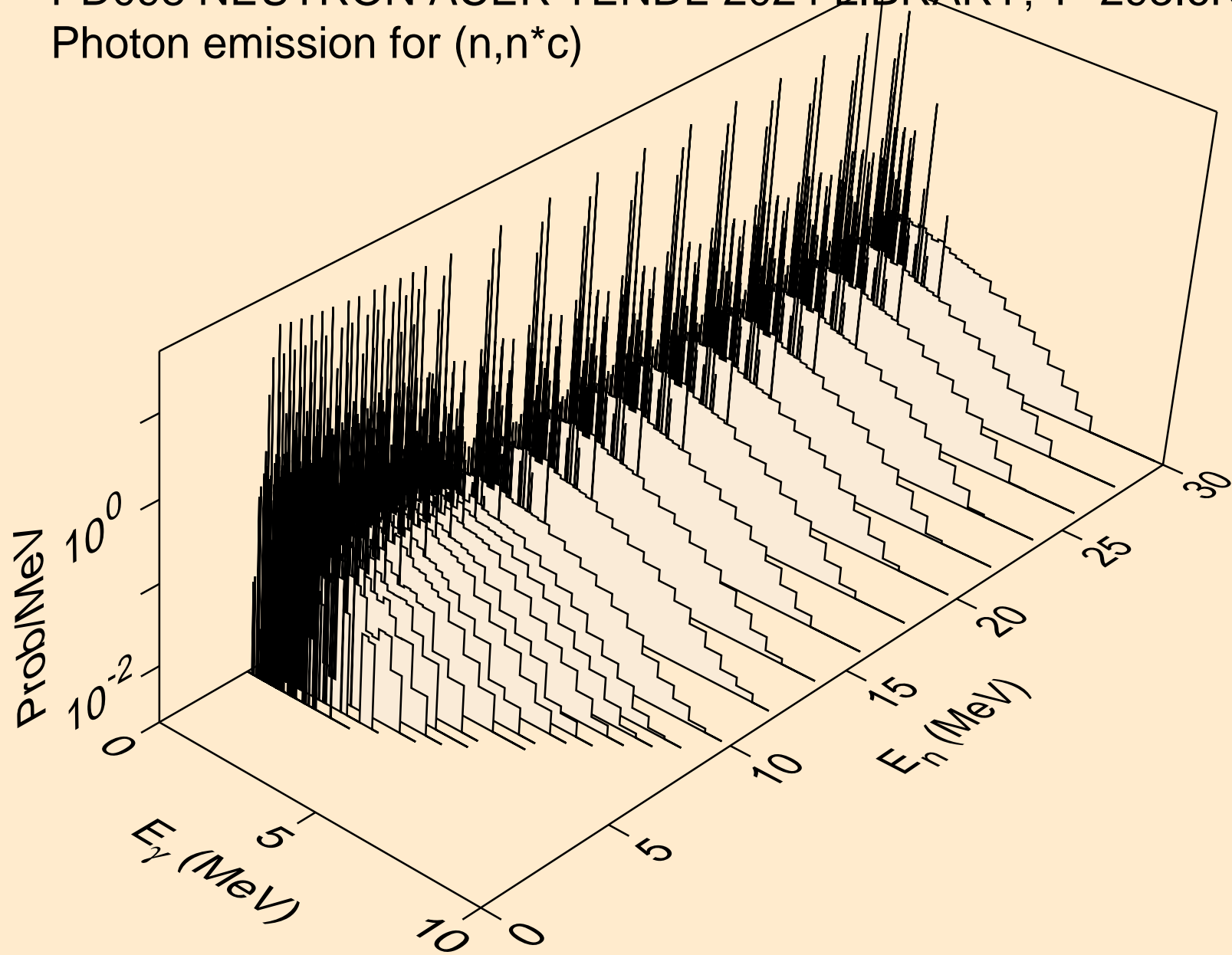

PD098 NEUTRON ACER TENDL-2024 LIBRARY; T=293.6K  
Photon emission for (n,gma)

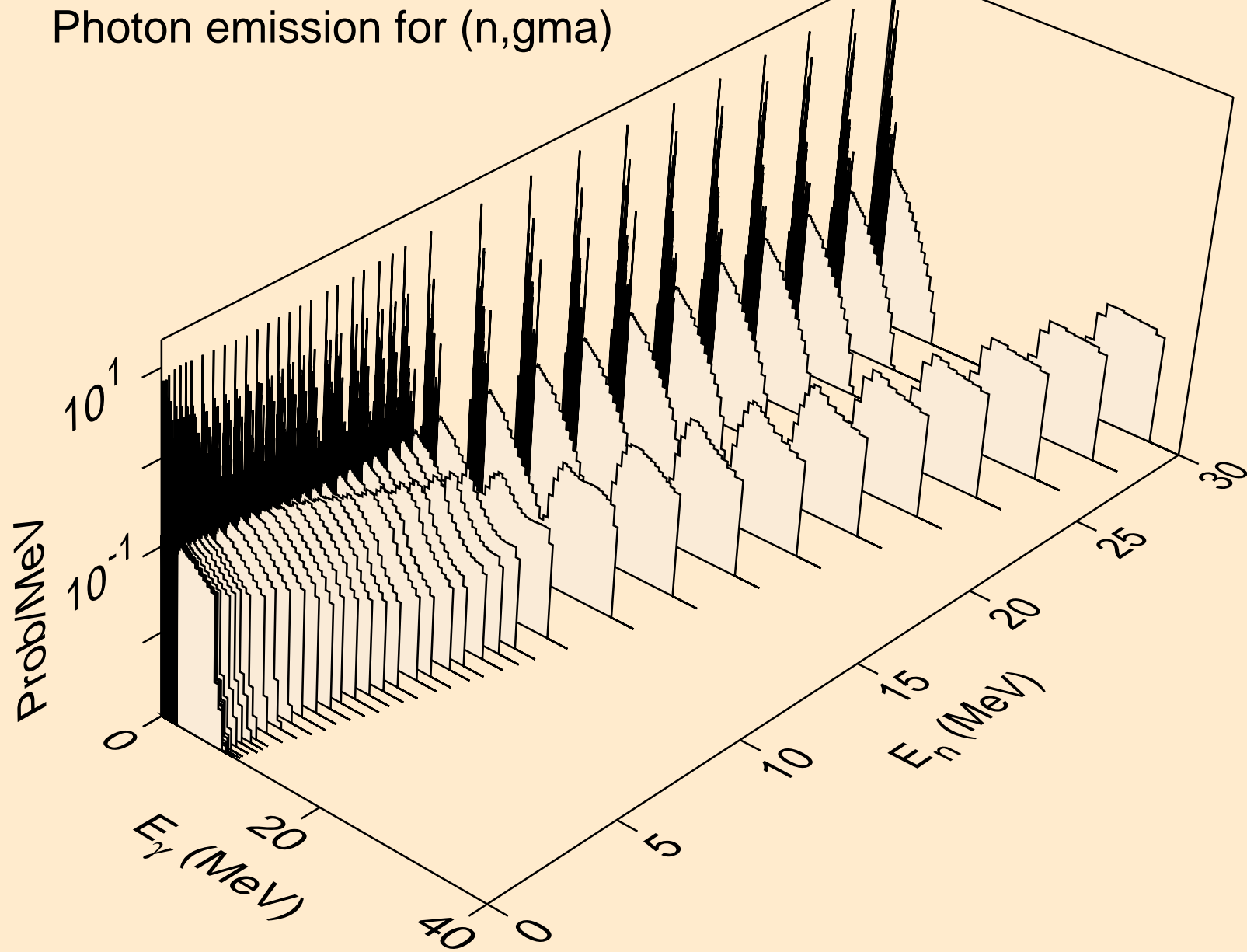

PD098 NEUTRON ACER TENDL-2024 LIBRARY; T=293.6K  
Photon emission for (n,p)

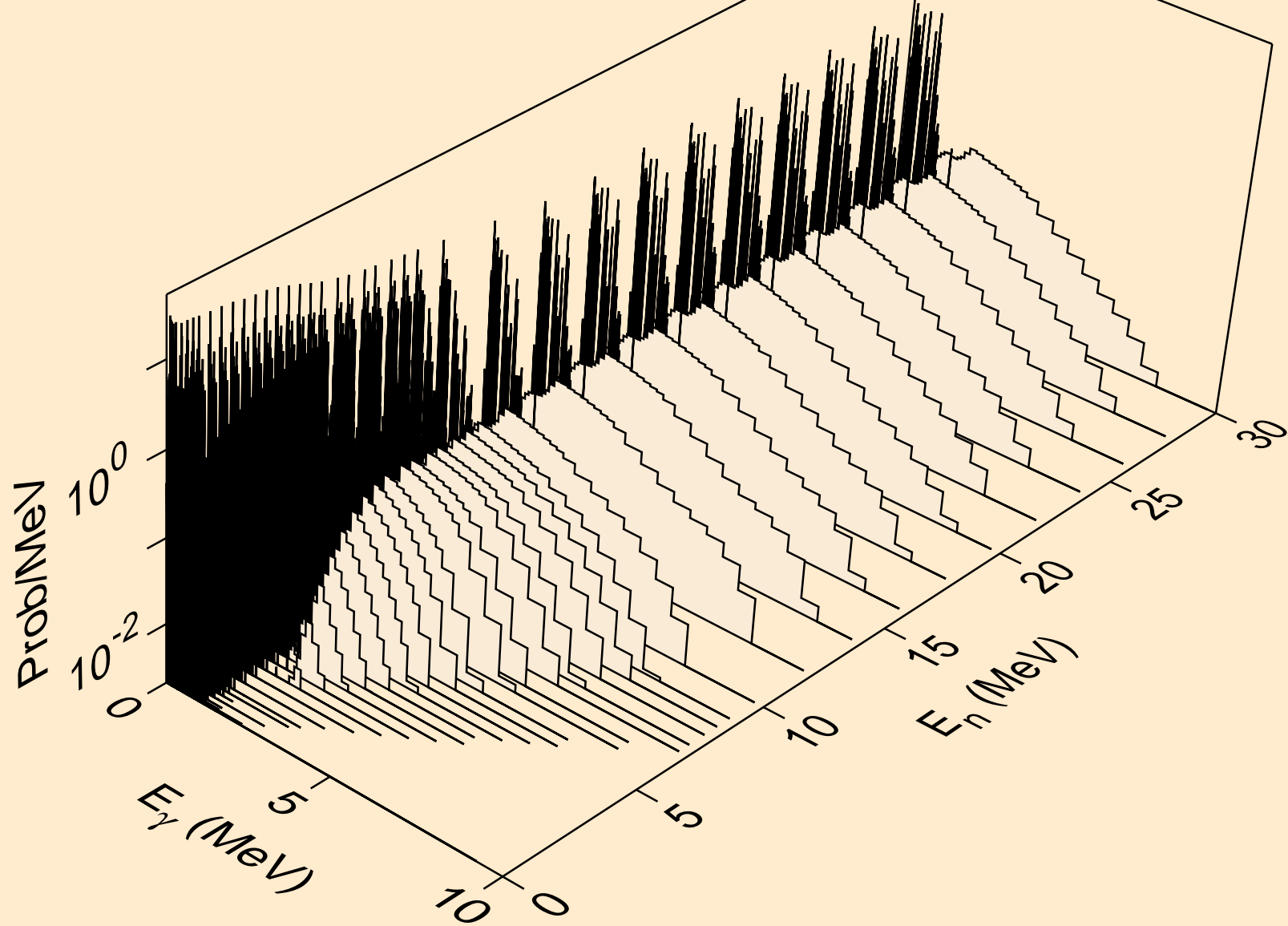

PD098 NEUTRON ACER TENDL-2024 LIBRARY; T=293.6K  
Photon emission for (n,d)

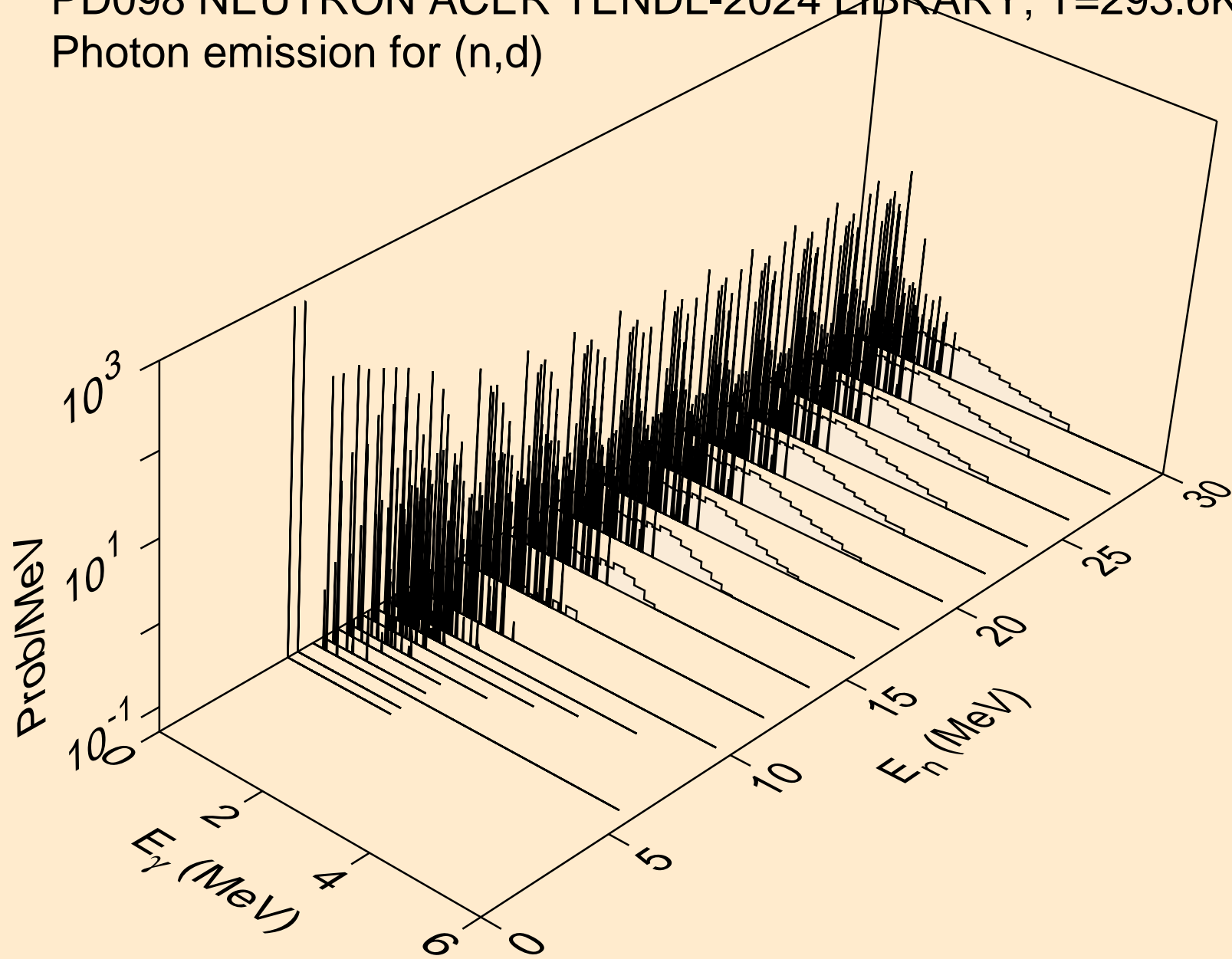

PD098 NEUTRON ACER TENDL-2024 LIBRARY; T=293.6K  
Photon emission for (n,t)

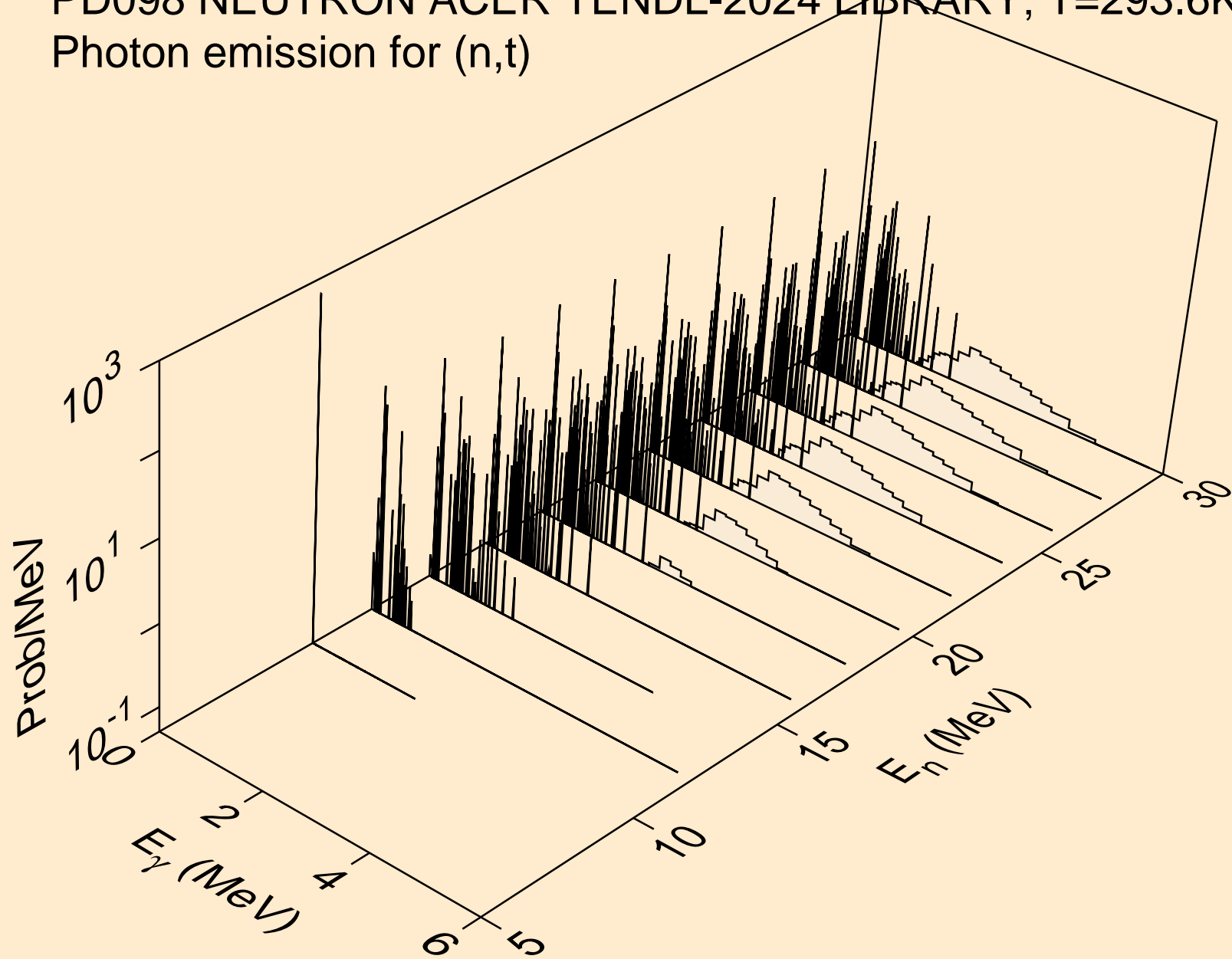

PD098 NEUTRON ACER TENDL-2024 LIBRARY; T=293.6K  
Photon emission for (n,he3)

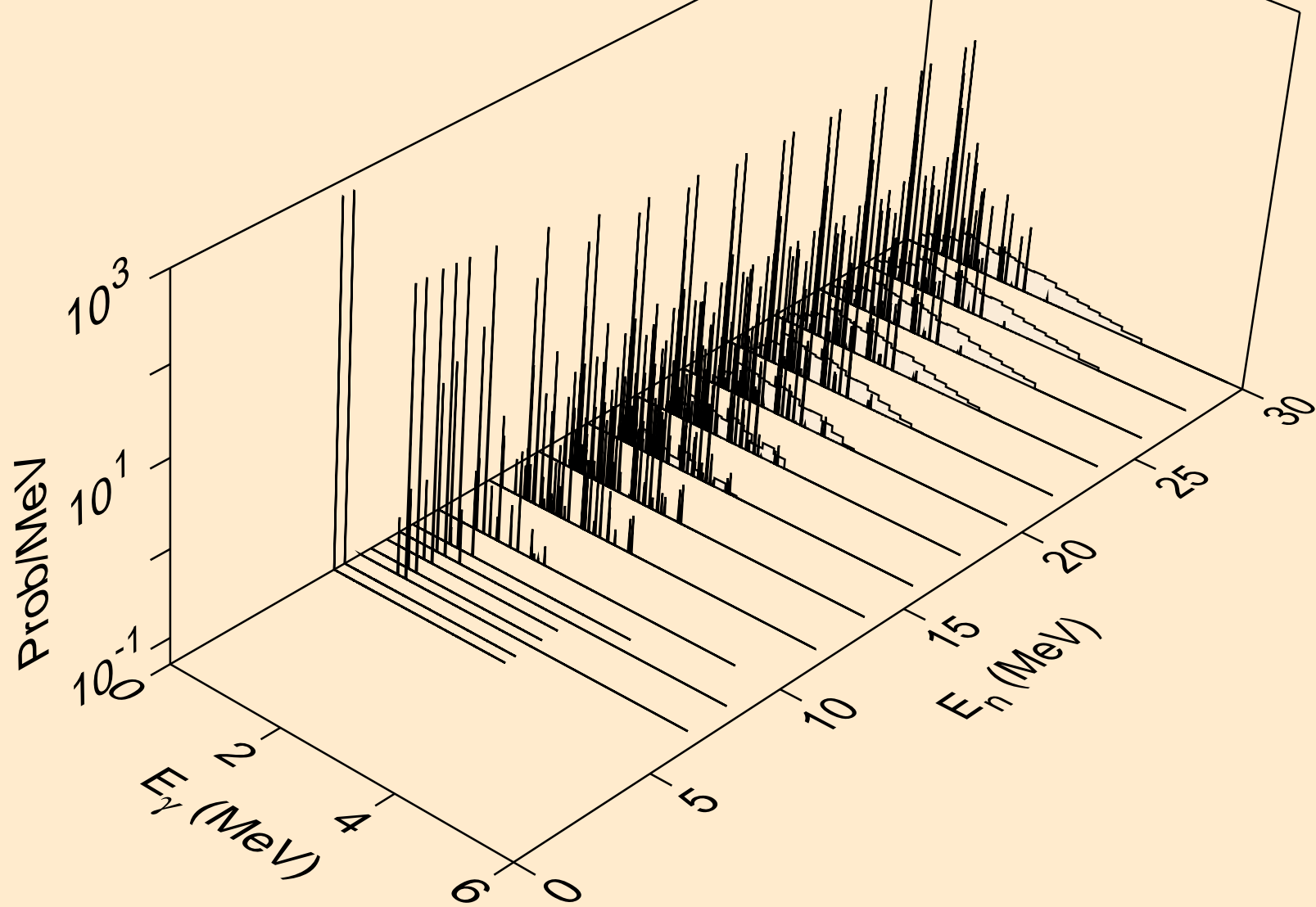

PD098 NEUTRON ACER TENDL-2024 LIBRARY; T=293.6K  
Photon emission for (n,a)

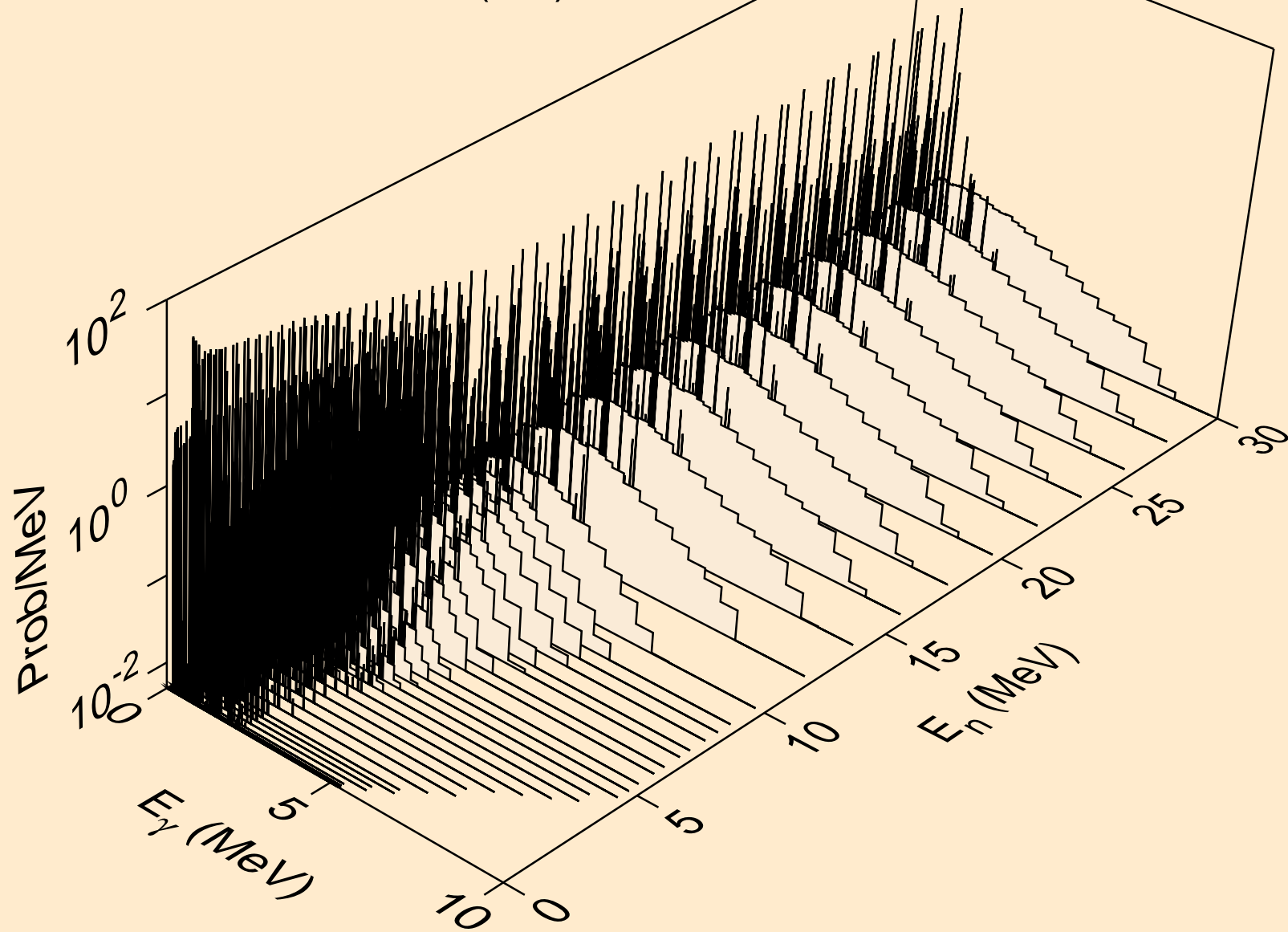

PD098 NEUTRON ACER TENDL-2024 LIBRARY; T=293.6K  
Photon emission for (n,2a)

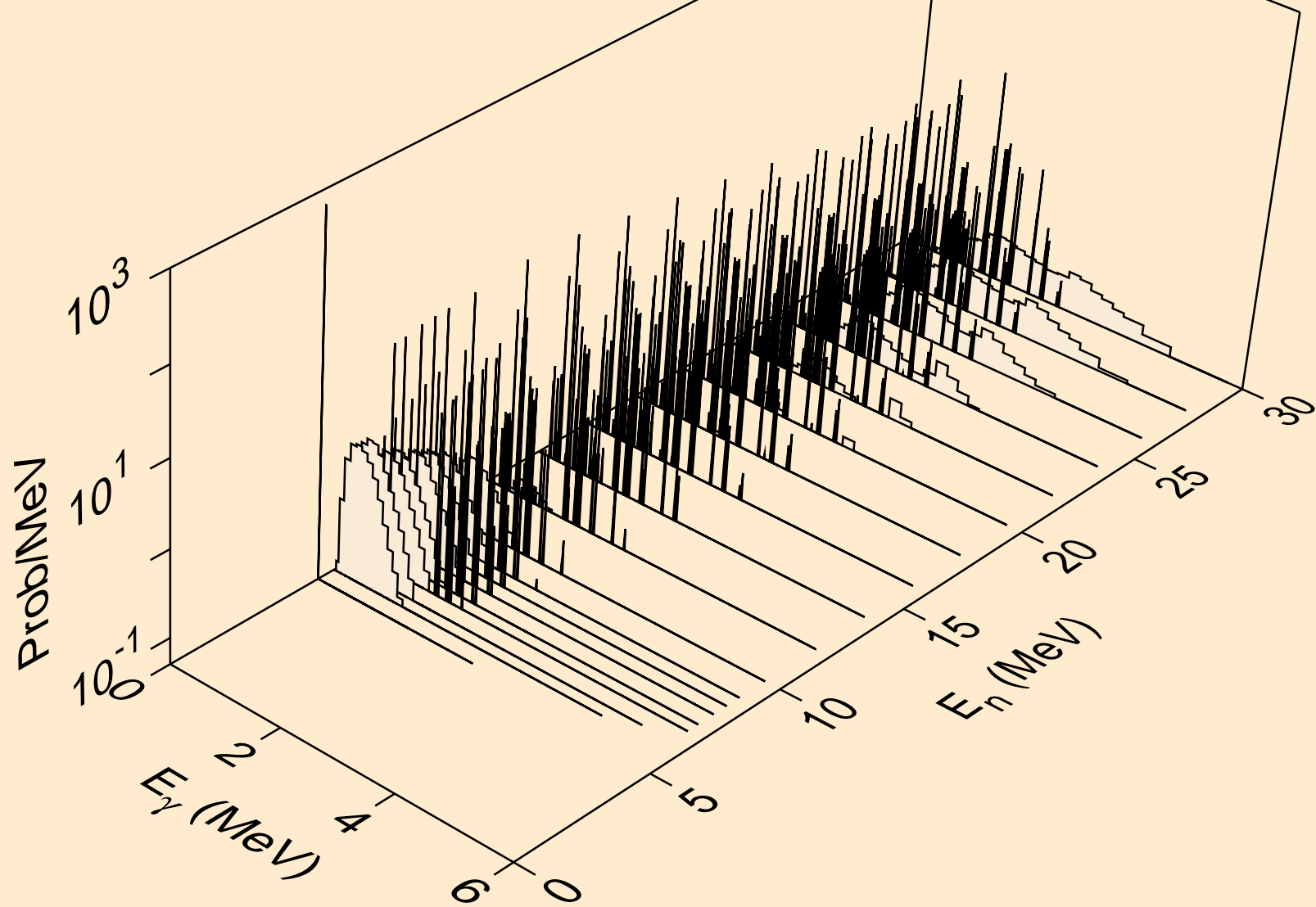

PD098 NEUTRON ACER TENDL-2024 LIBRARY; T=293.6K  
Photon emission for (n,2p)

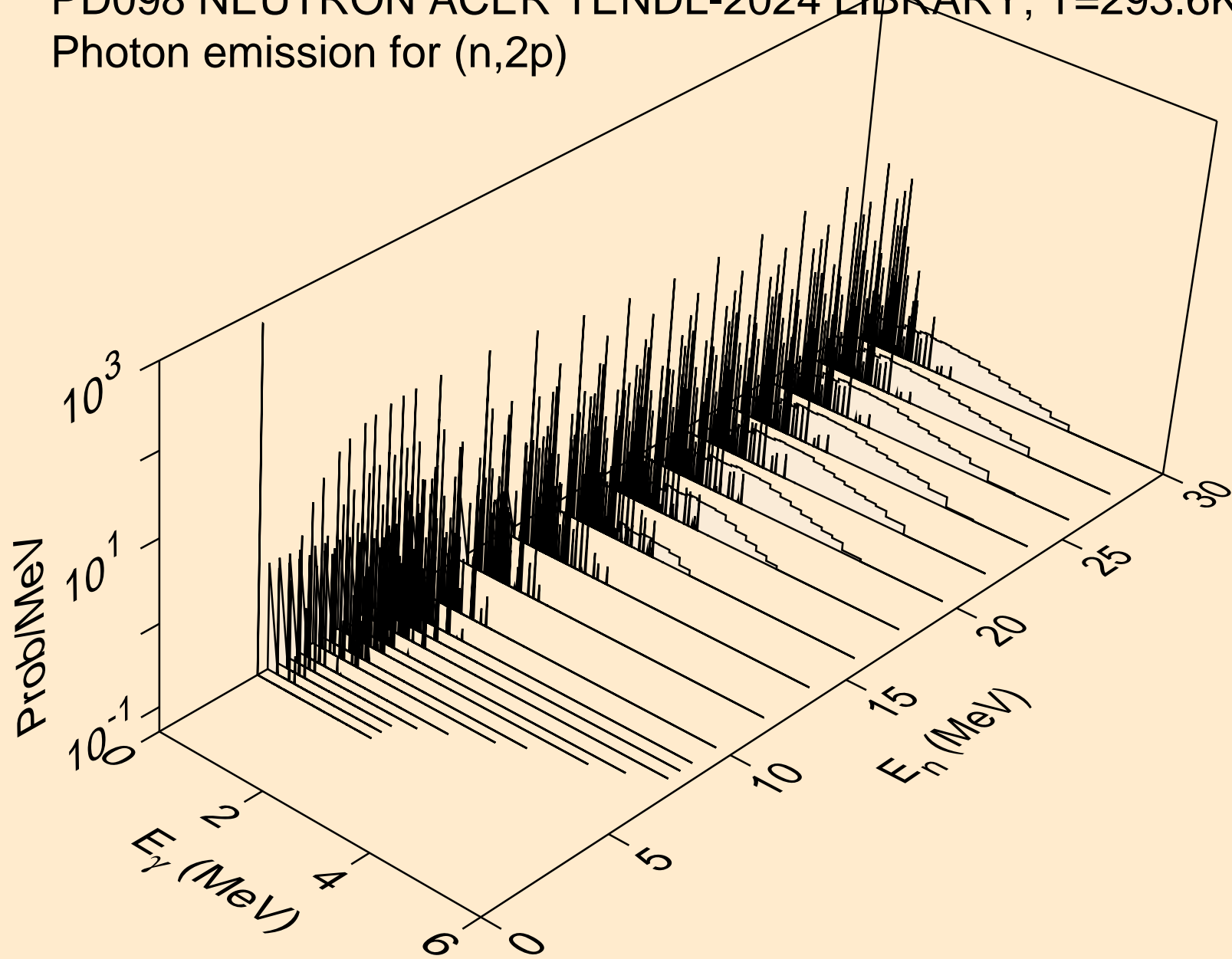

PD098 NEUTRON ACER TENDL-2024 LIBRARY; T=293.6K  
Photon emission for (n,p $\alpha$ )

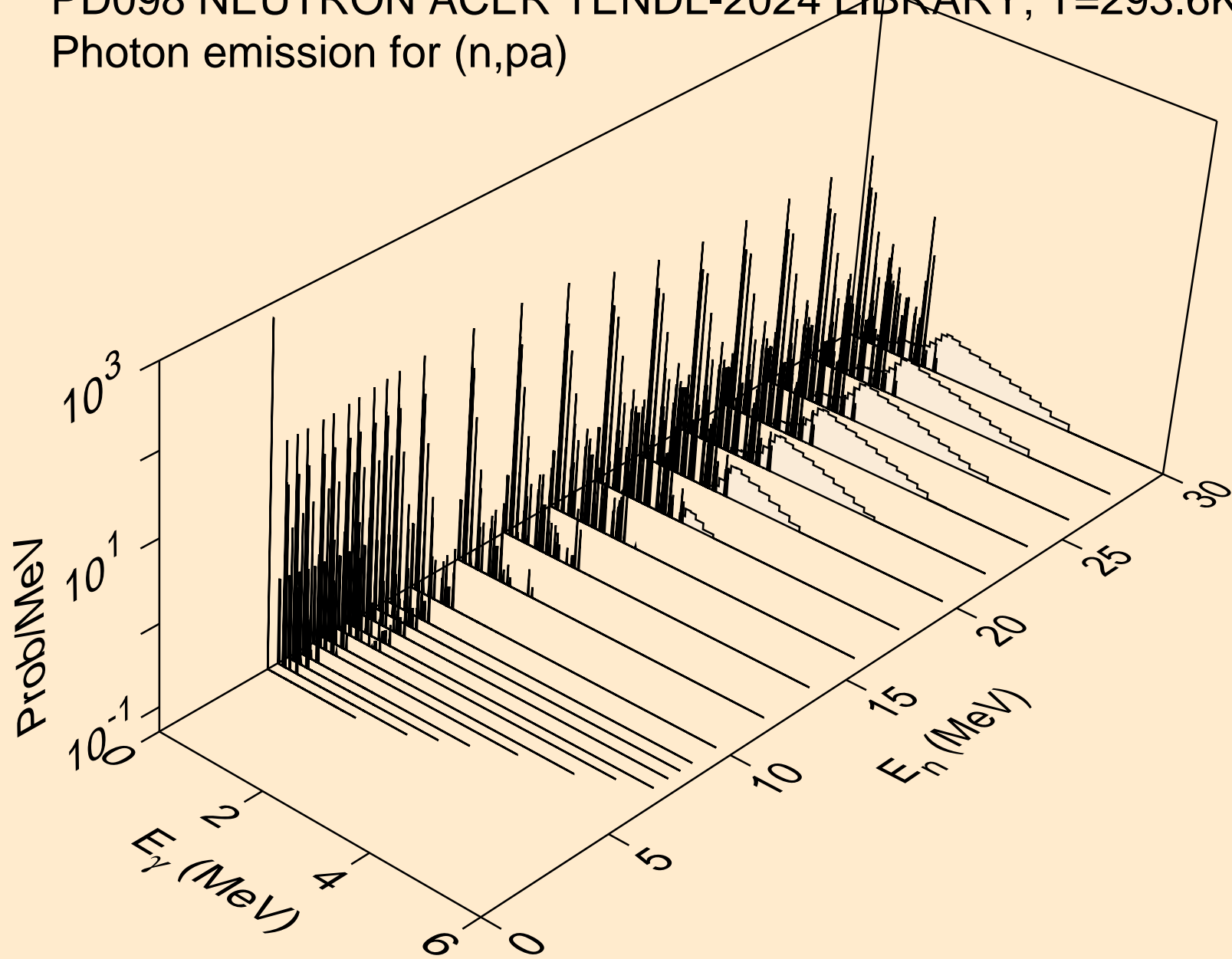

PD098 NEUTRON ACER TENDL-2024 LIBRARY; T=293.6K  
Photon emission for (n,pd)

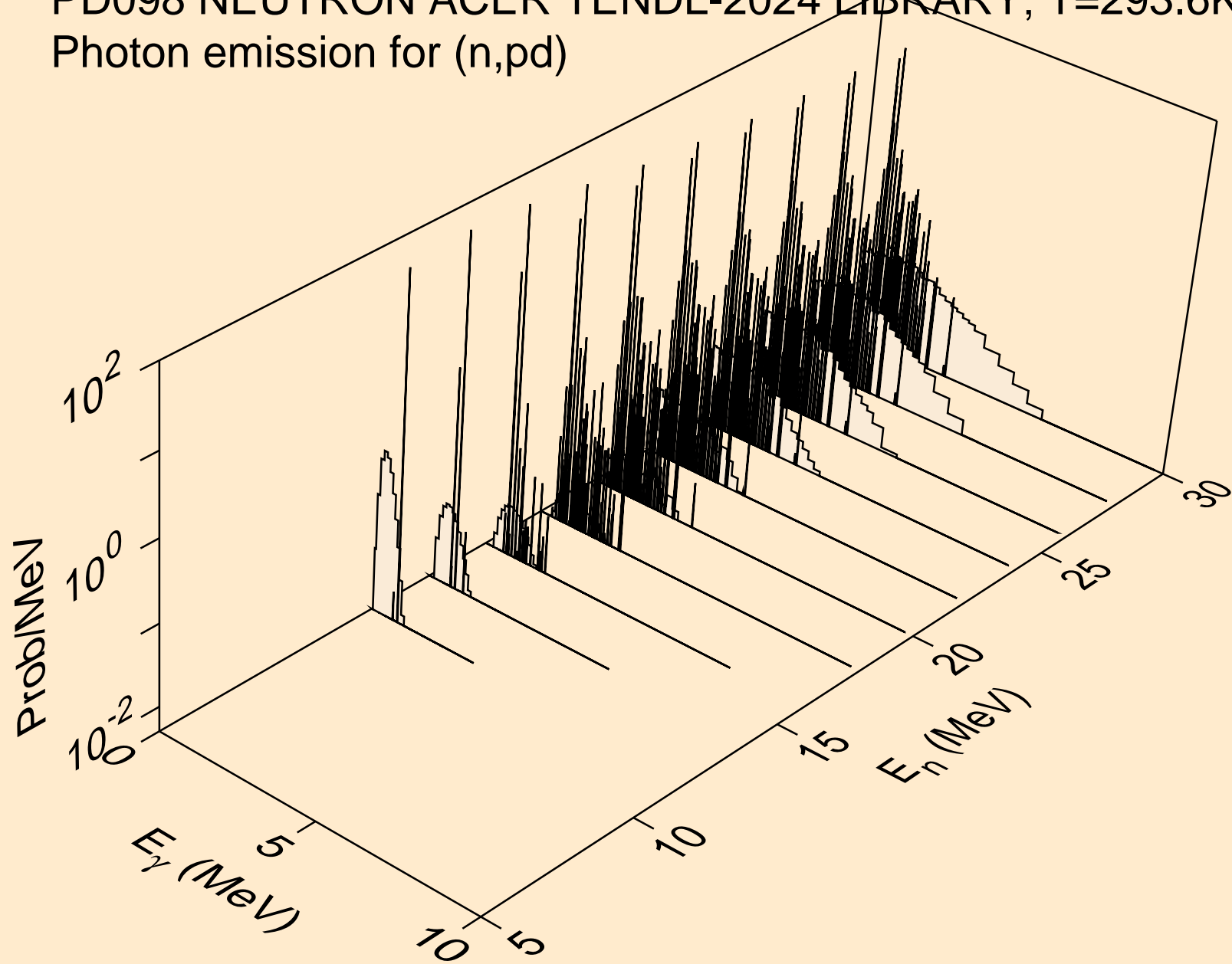

PD098 NEUTRON ACER TENDL-2024 LIBRARY; T=293.6K  
Photon emission for (n,pt)

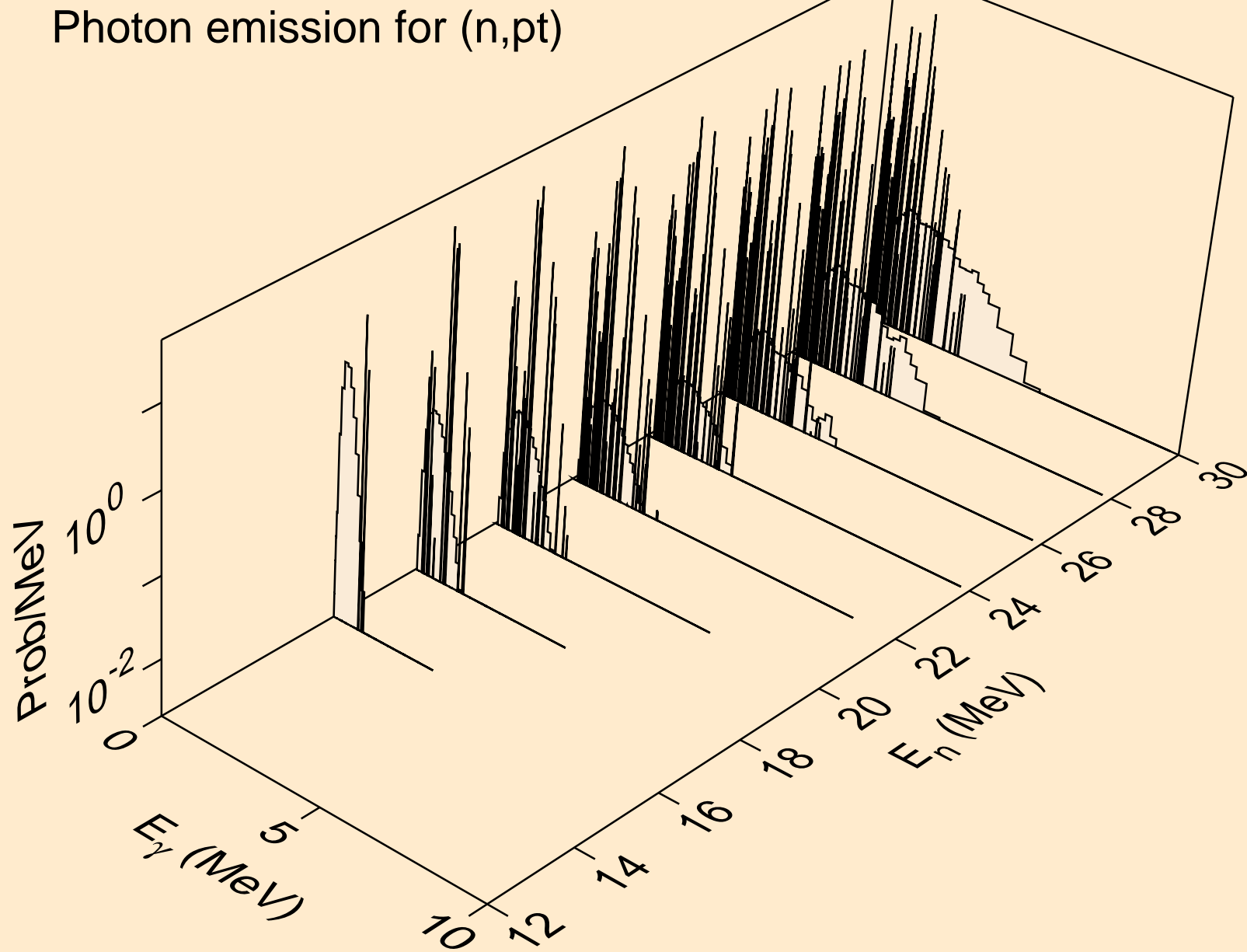

PD098 NEUTRON ACER TENDL-2024 LIBRARY; T=293.6K  
Photon emission for (n,da)

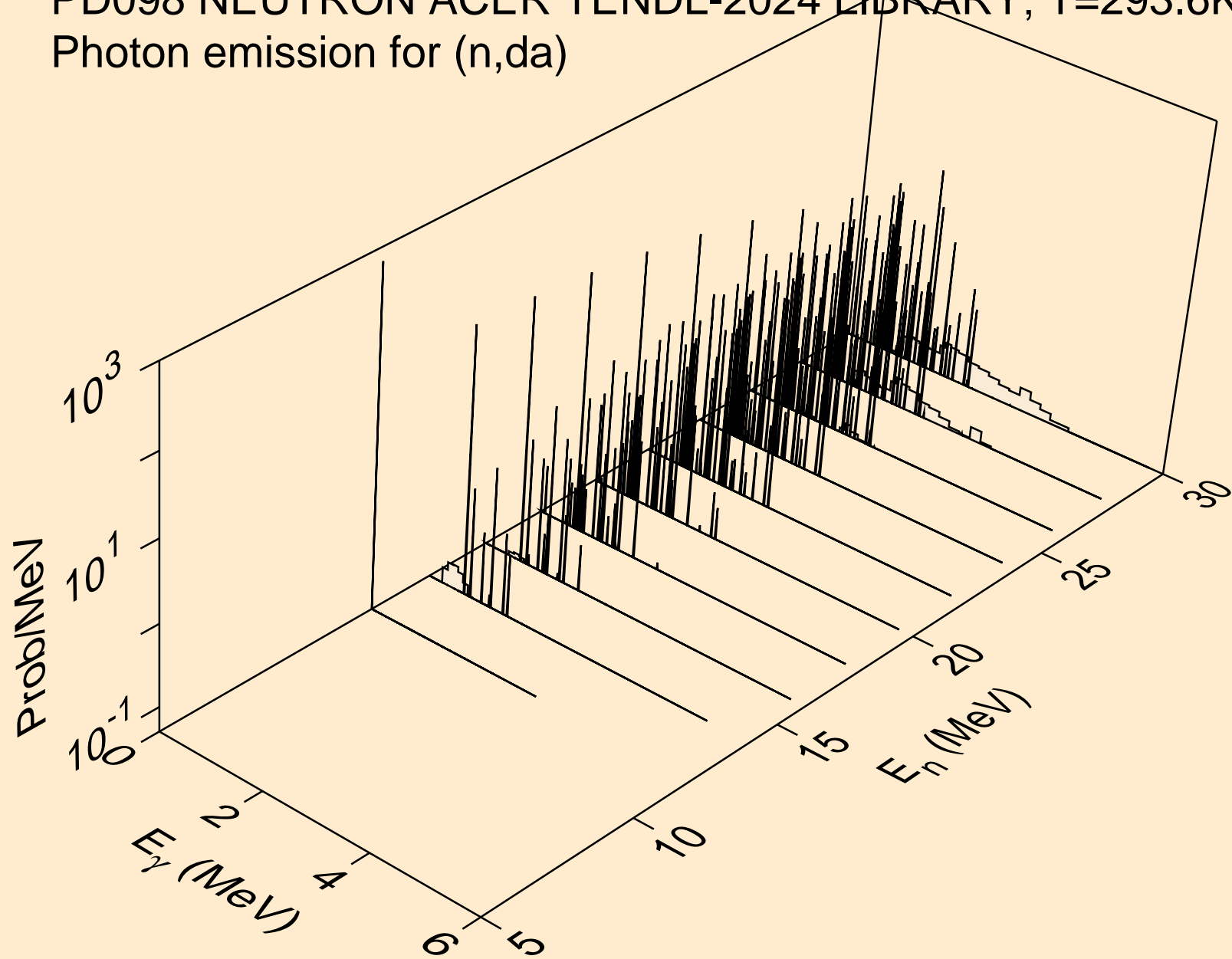

PD098 NEUTRON ACER TENDL-2024 LIBRARY; T=293.6K  
thermal capture photon spectrum

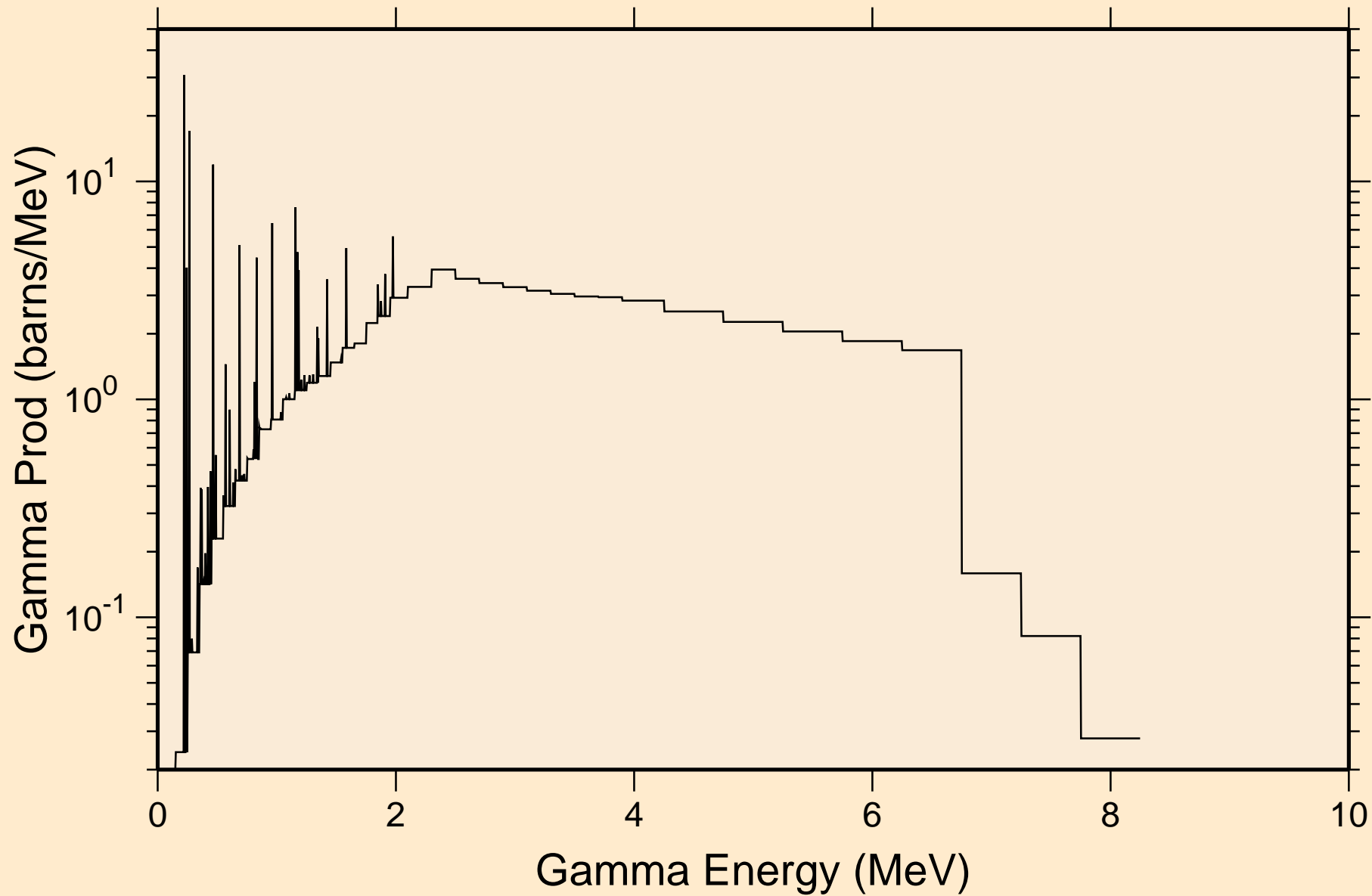

PD098 NEUTRON ACER TENDL-2024 LIBRARY; T=293.6K  
14 MeV photon spectrum

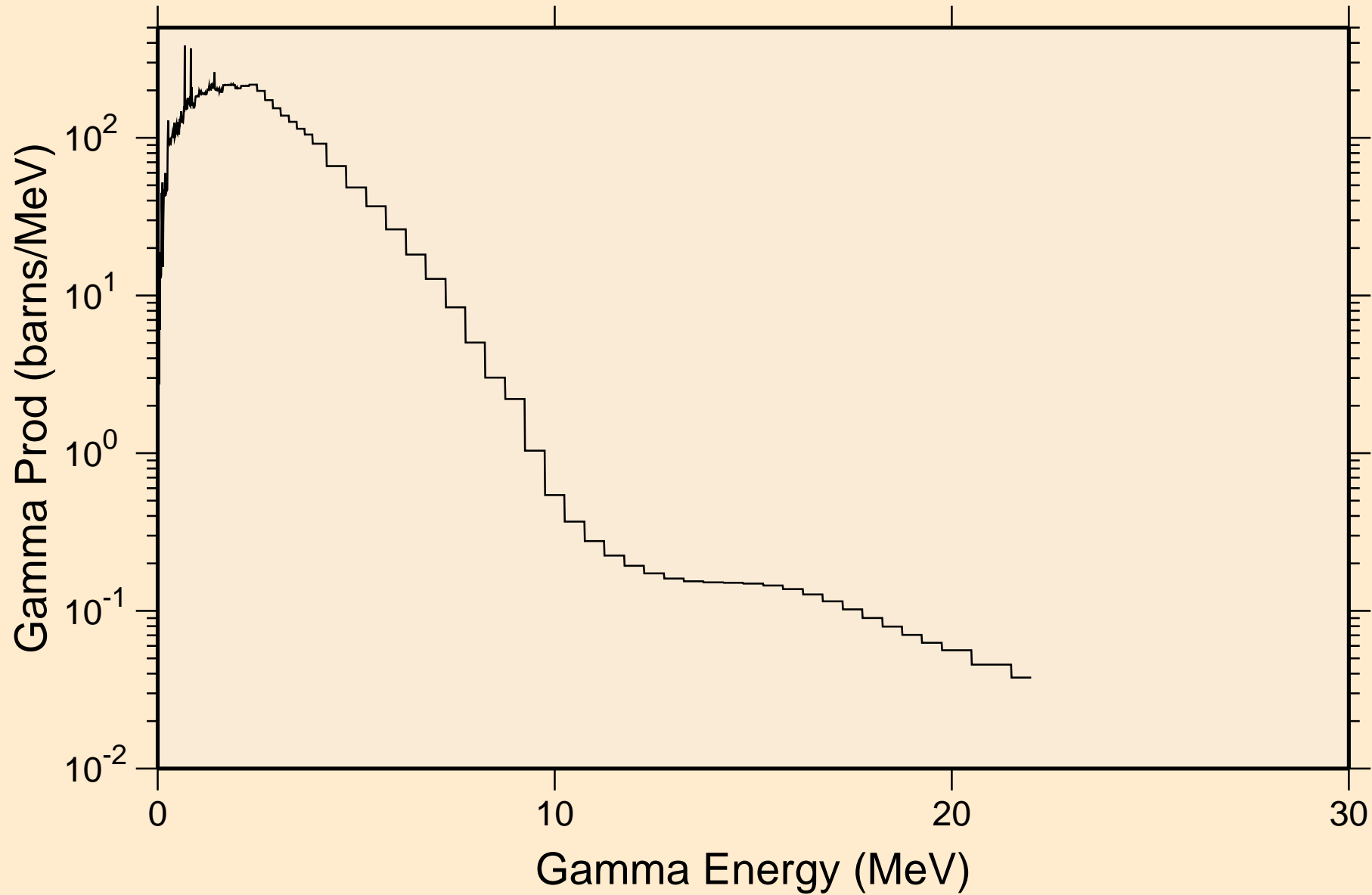

PD098 NEUTRON ACER TENDL-2024 LIBRARY; T=293.6K  
Particle heating contributions

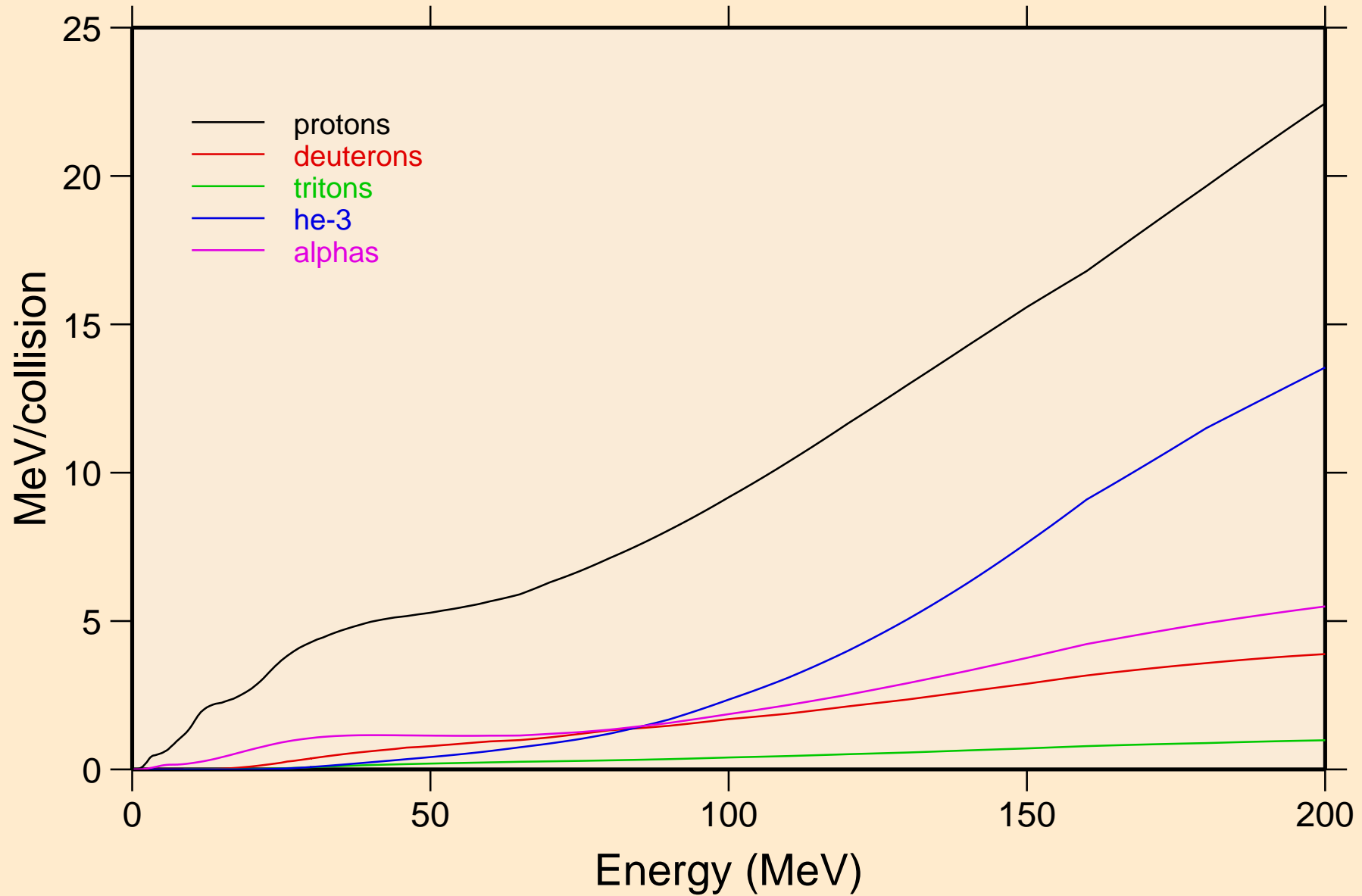

PD098 NEUTRON ACER TENDL-2024 LIBRARY; T=293.6K  
Recoil Heating

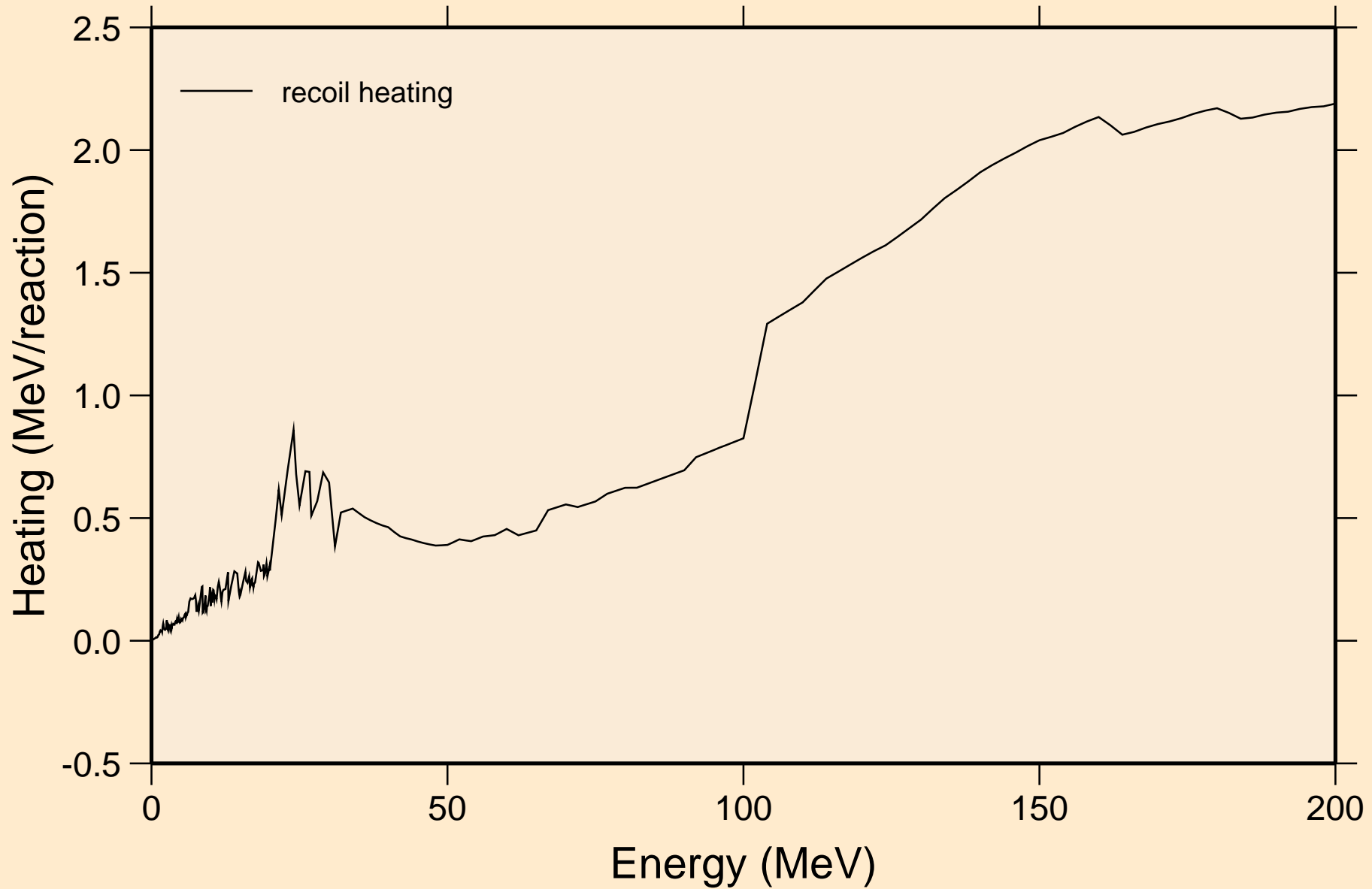

PD098 NEUTRON ACER TENDL-2024 LIBRARY; T=293.6K  
Particle production cross sections

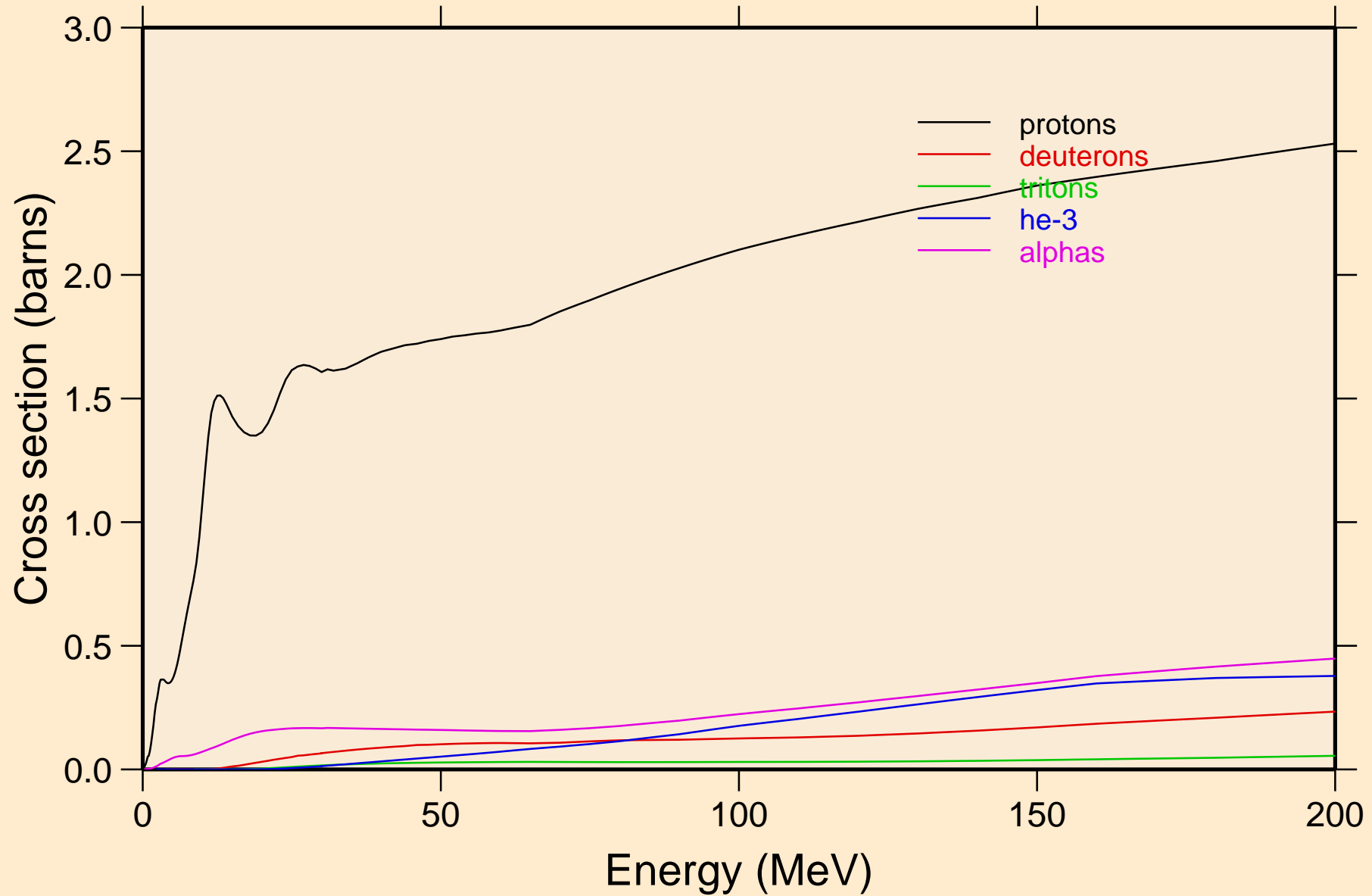

PD098 NEUTRON ACER TENDL-2024 LIBRARY; T=293.6K  
protons from (n,x)

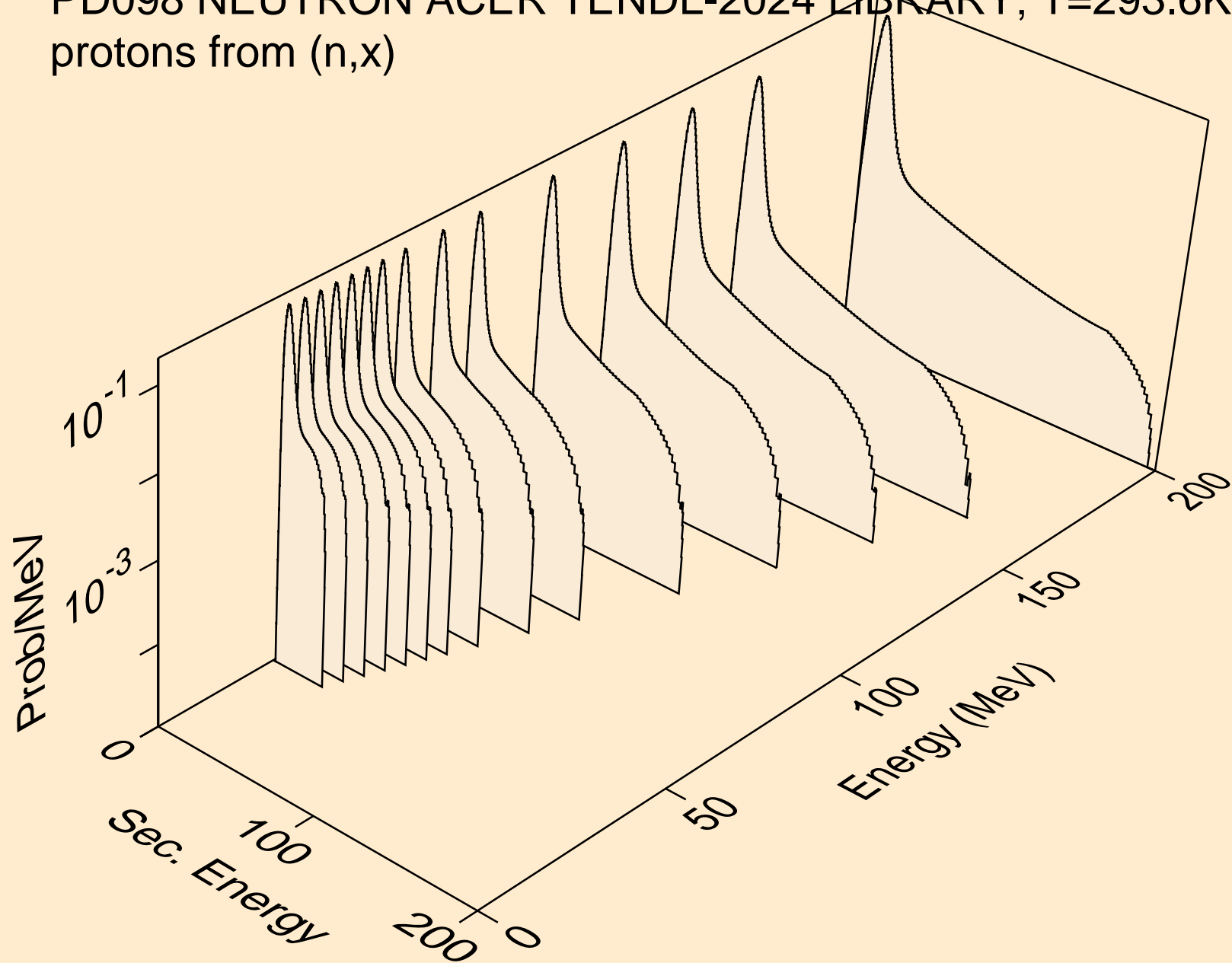

PD098 NEUTRON ACER TENDL-2024 LIBRARY; T=293.6K  
protons from (n,n\*)p

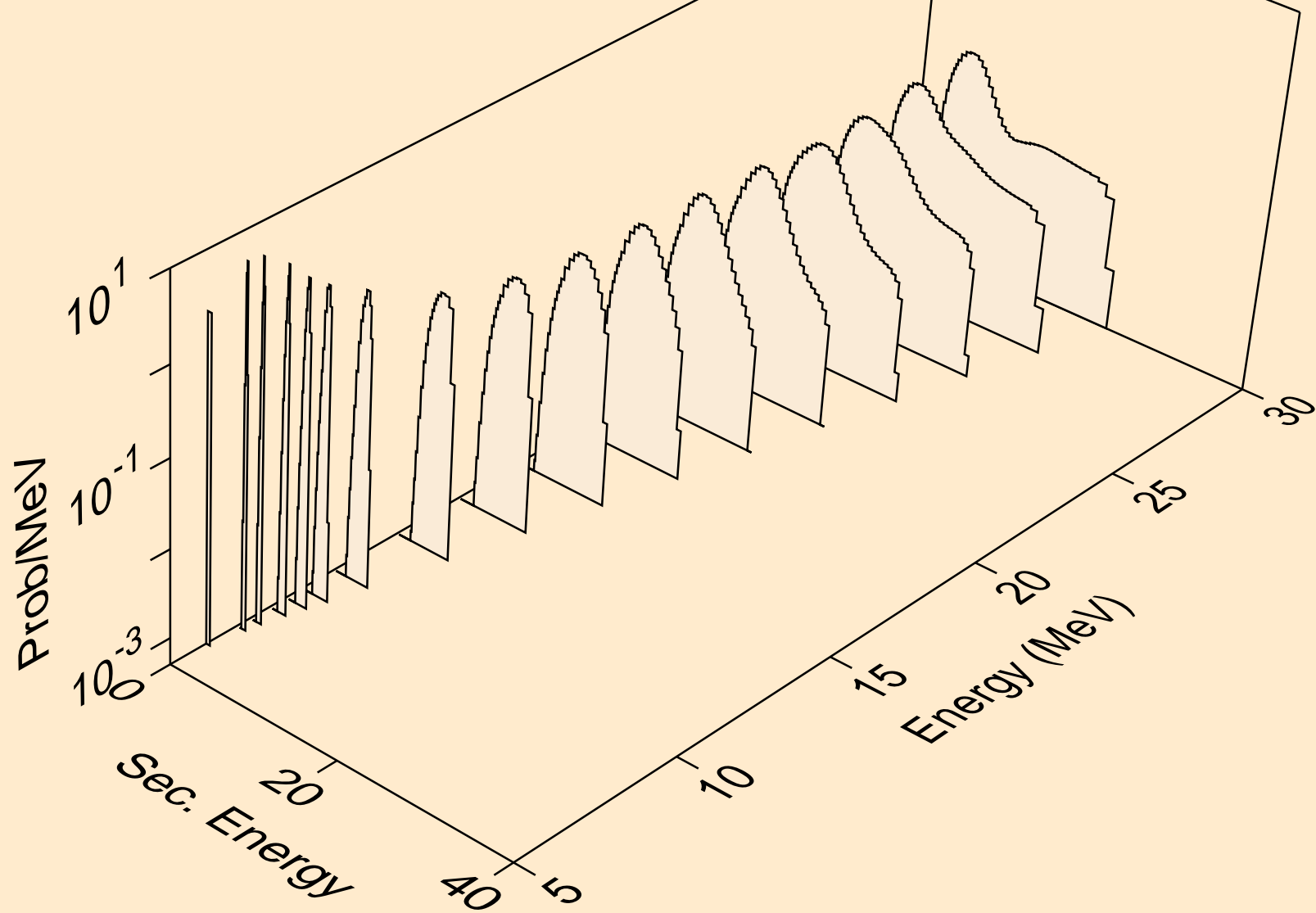

PD098 NEUTRON ACER TENDL-2024 LIBRARY; T=293.6K  
protons from (n,2np)

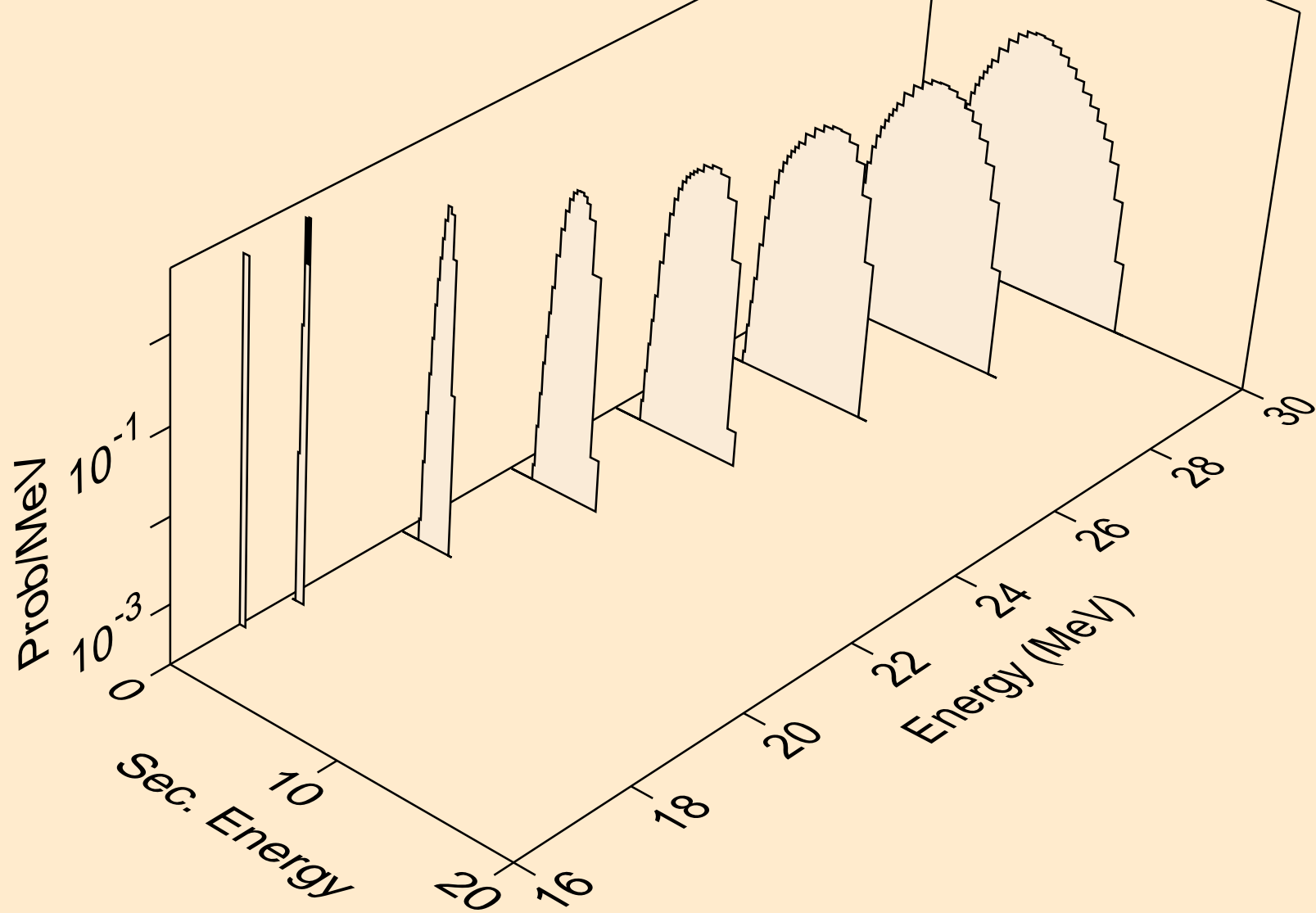

PD098 NEUTRON ACER TENDL-2024 LIBRARY; T=293.6K  
protons from (n,3np)

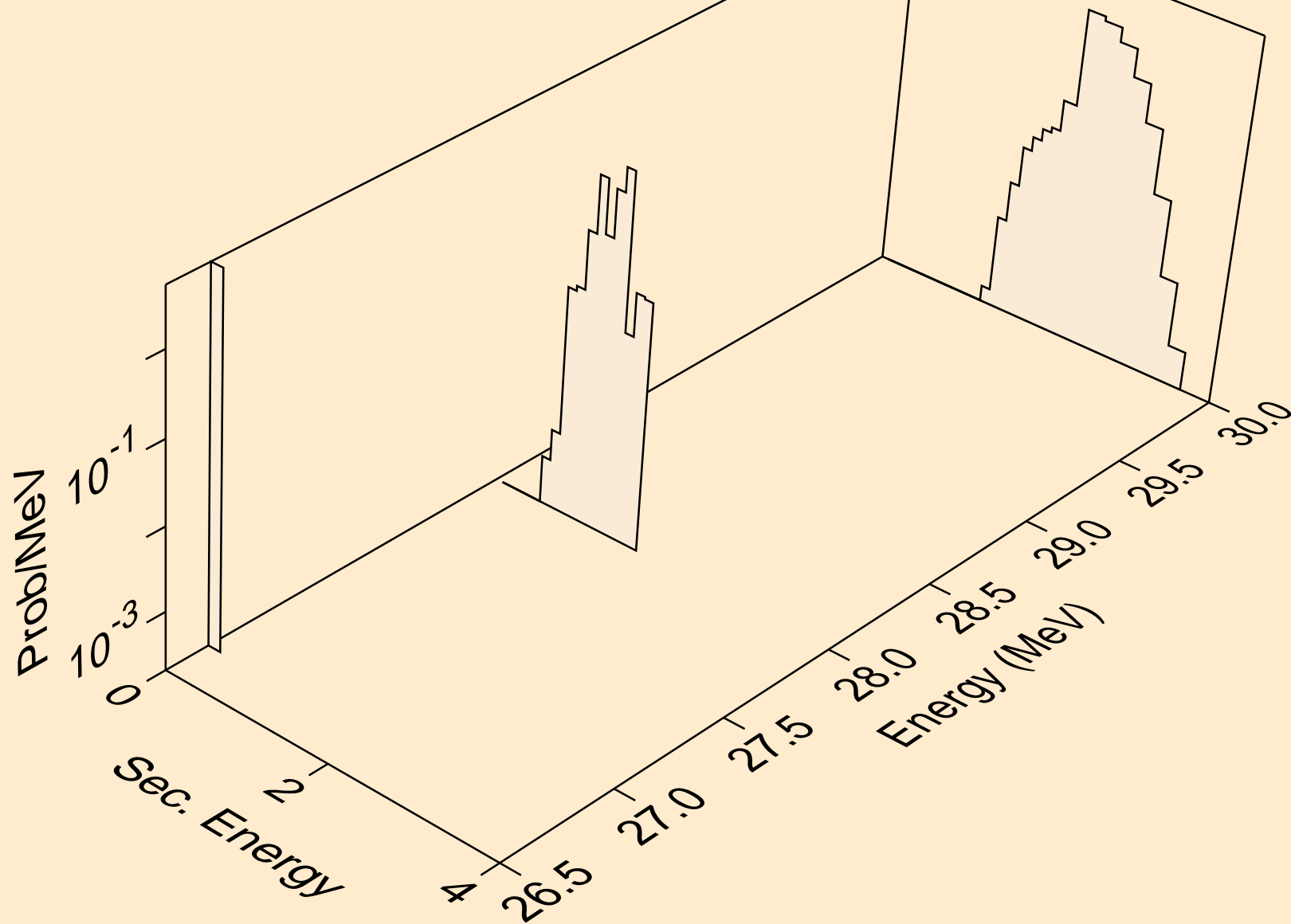

PD098 NEUTRON ACER TENDL-2024 LIBRARY; T=293.6K  
protons from (n,n2p)

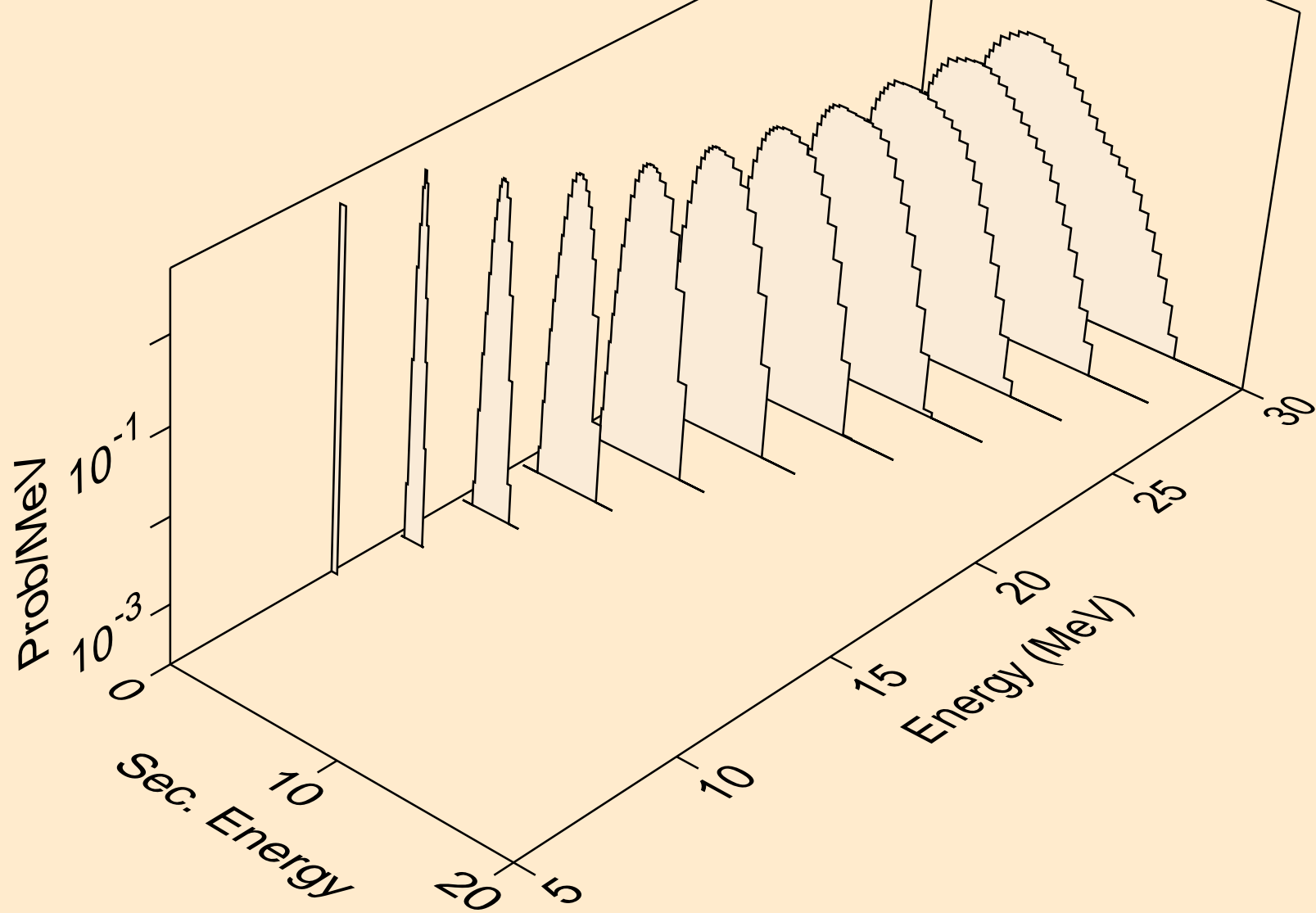

PD098 NEUTRON ACER TENDL-2024 LIBRARY; T=293.6K  
protons from (n,npa)

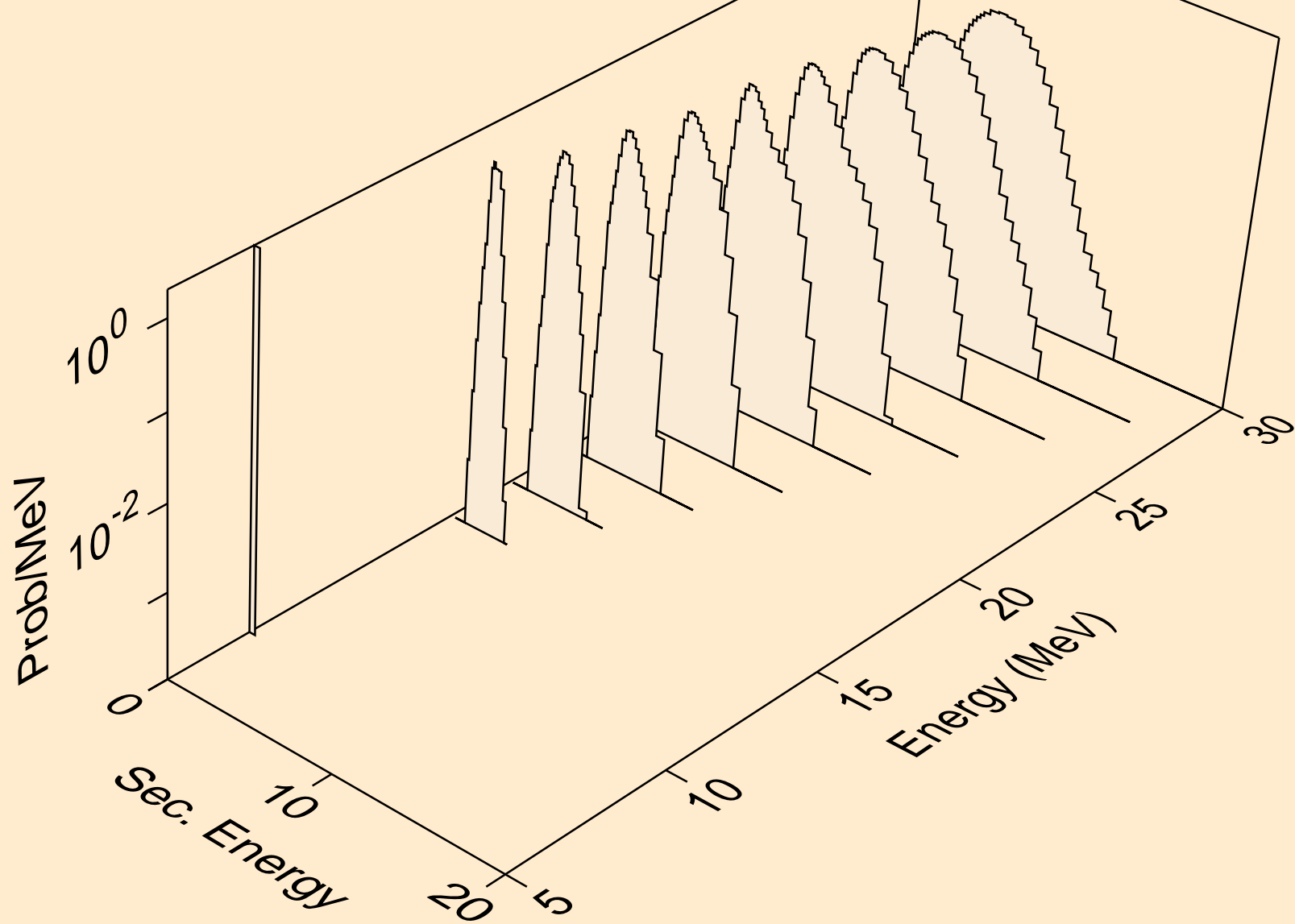

PD098 NEUTRON ACER TENDL-2024 LIBRARY; T=293.6K  
protons from (n,p)

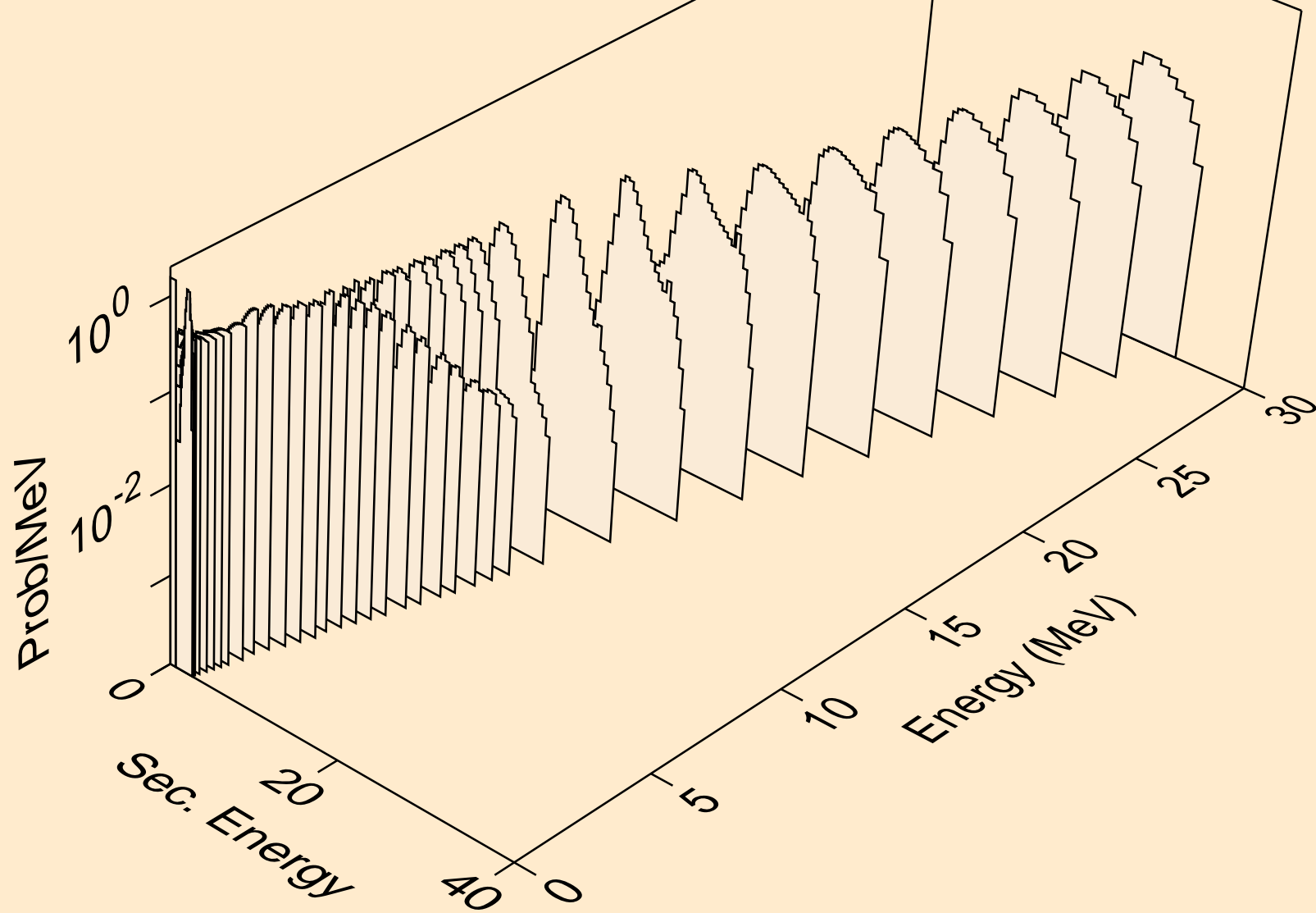

PD098 NEUTRON ACER TENDL-2024 LIBRARY; T=293.6K  
protons from (n,2p)

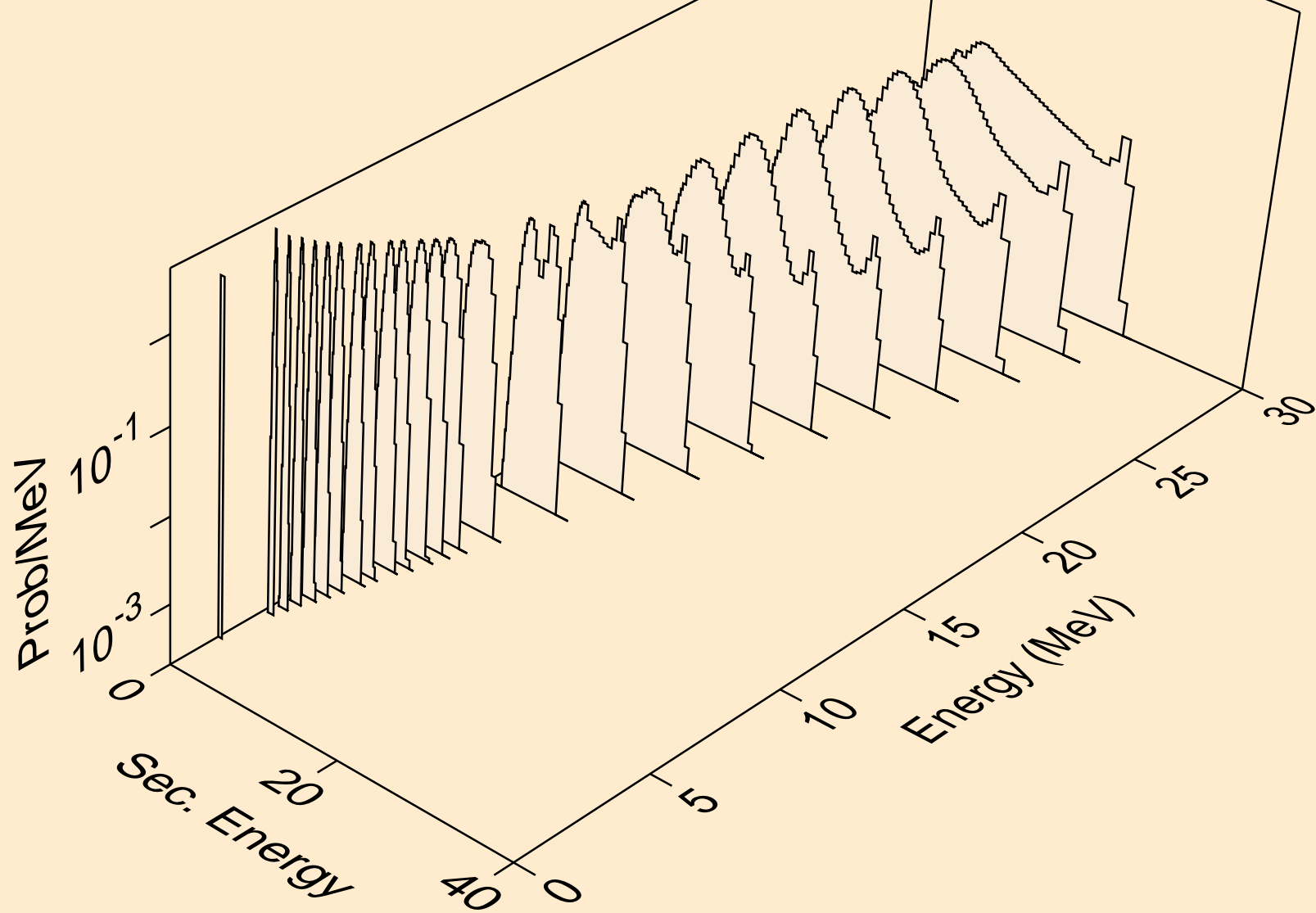

PD098 NEUTRON ACER TENDL-2024 LIBRARY; T=293.6K  
protons from (n,p)

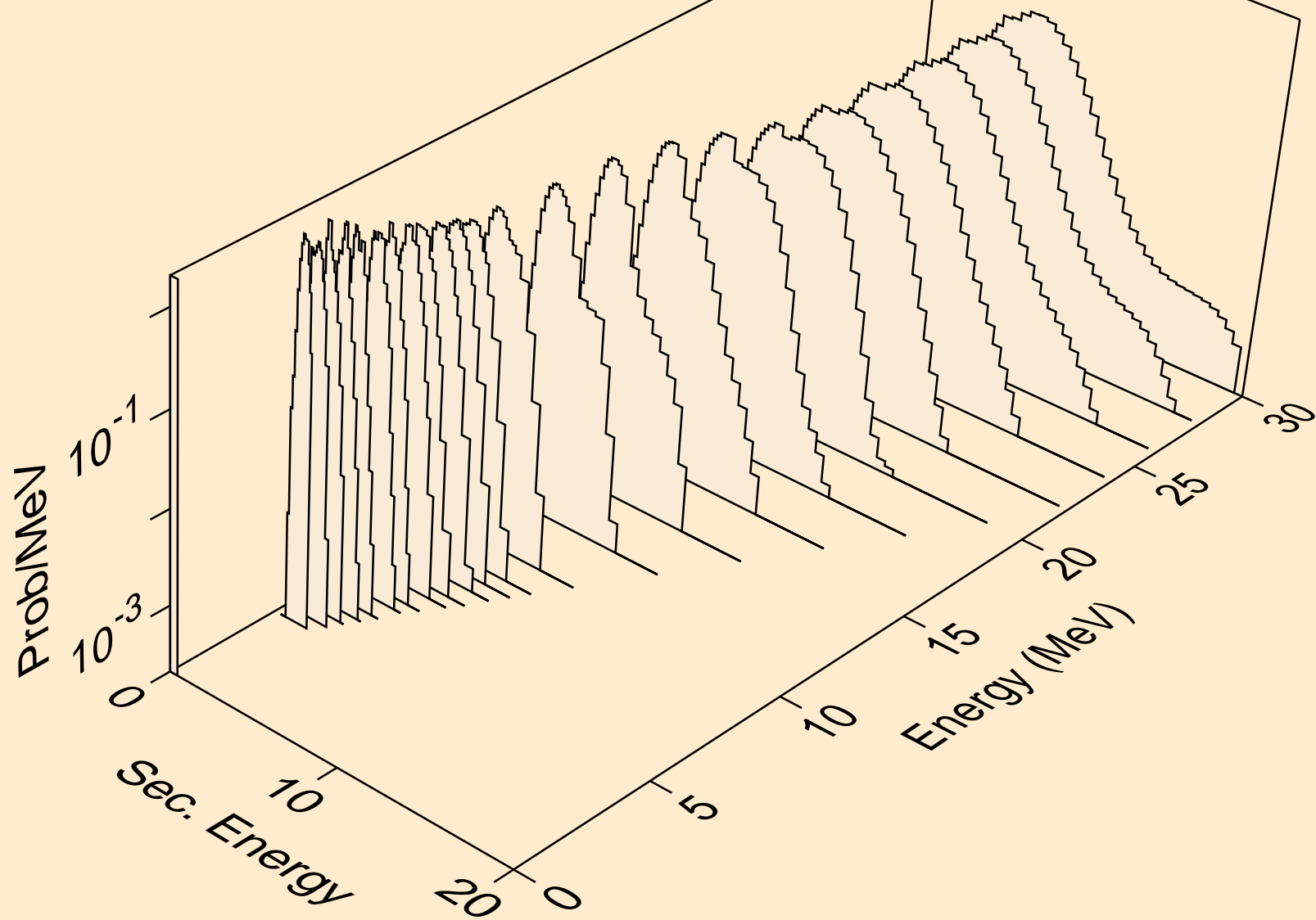

PD098 NEUTRON ACER TENDL-2024 LIBRARY; T=293.6K  
protons from (n,pd)

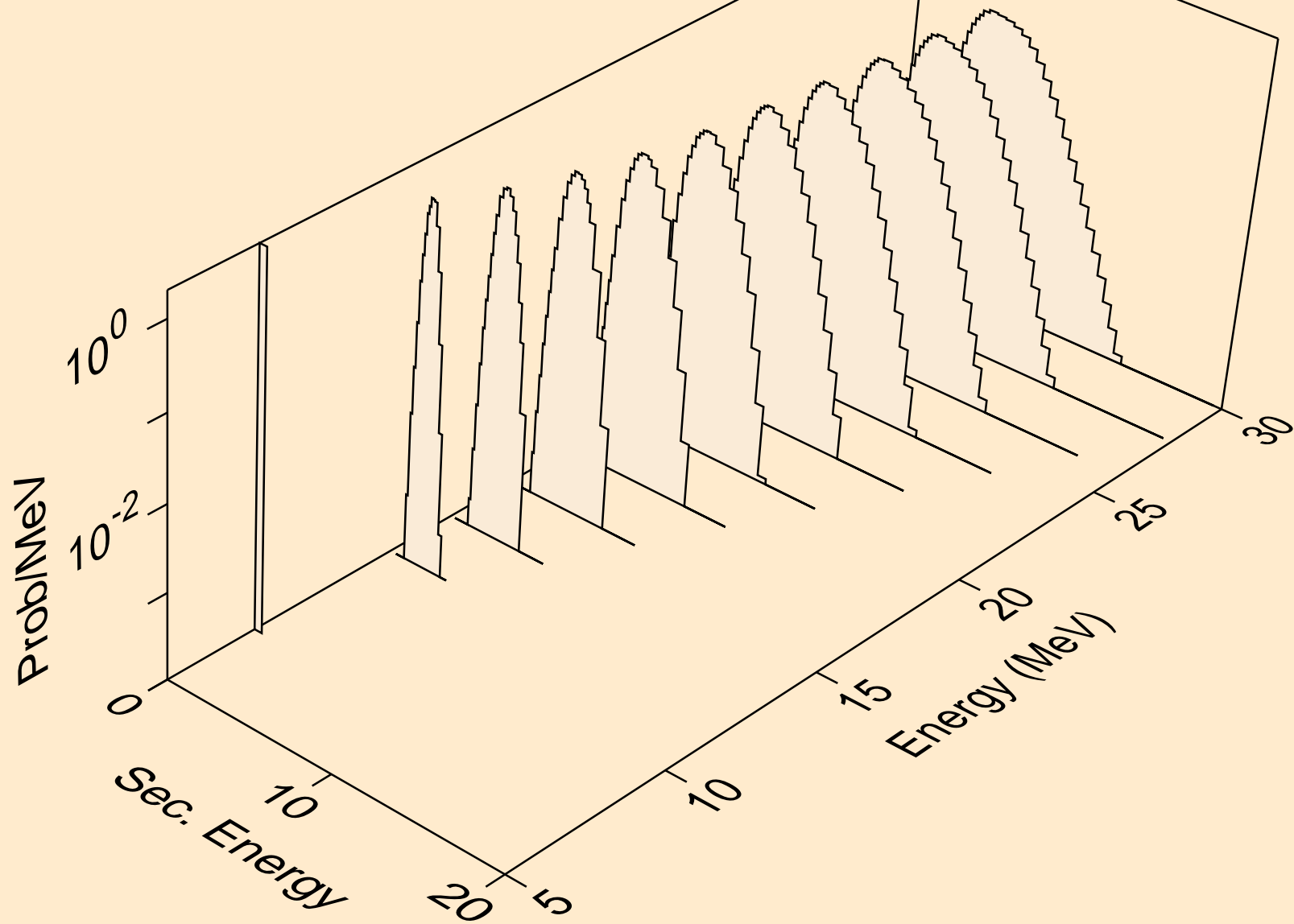

PD098 NEUTRON ACER TENDL-2024 LIBRARY; T=293.6K  
protons from (n,pt)

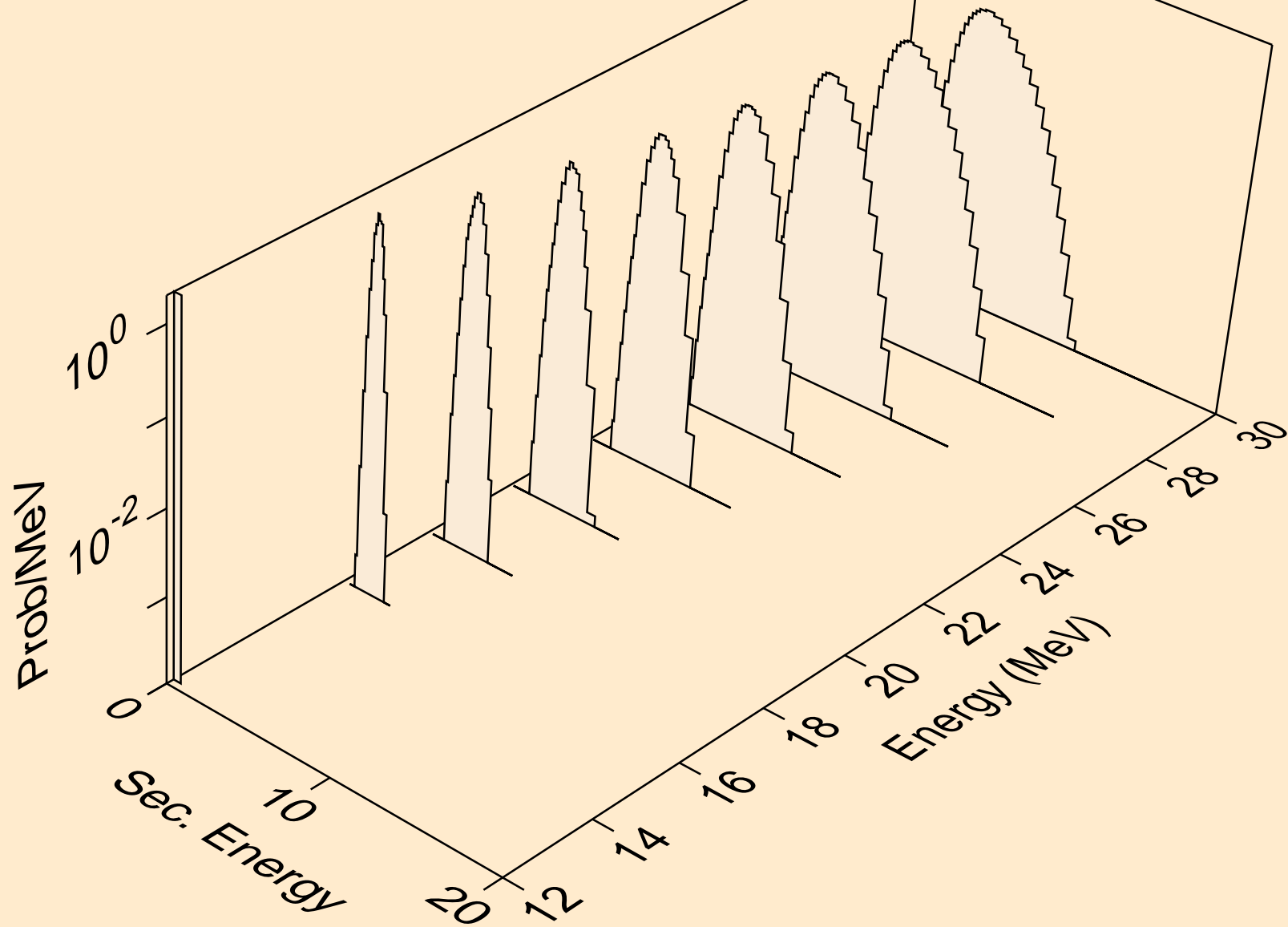

PD098 NEUTRON ACER TENDL-2024 LIBRARY; T=293.6K  
deuterons from (n,x)

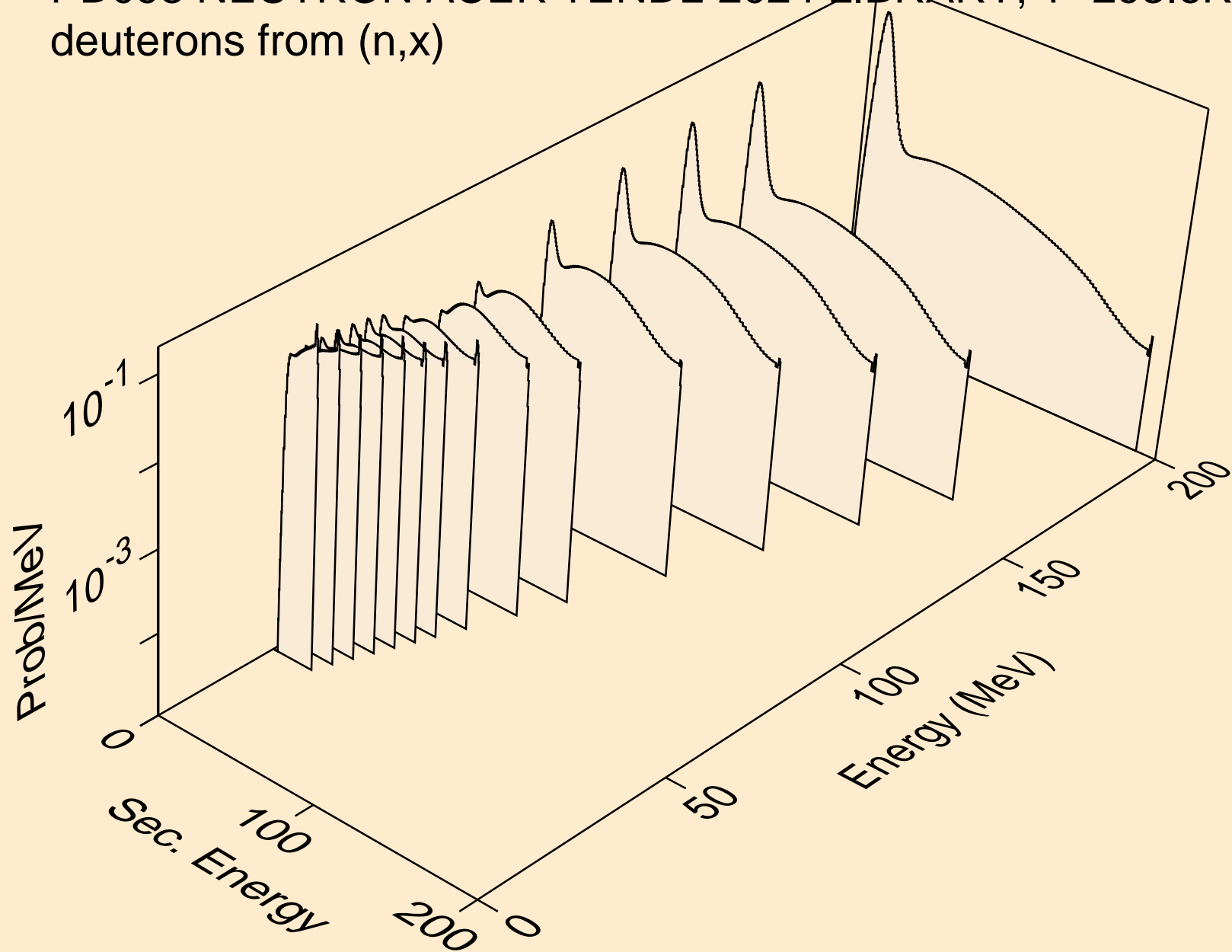

PD098 NEUTRON ACER TENDL-2024 LIBRARY; T=293.6K  
deuterons from (n,2nd)

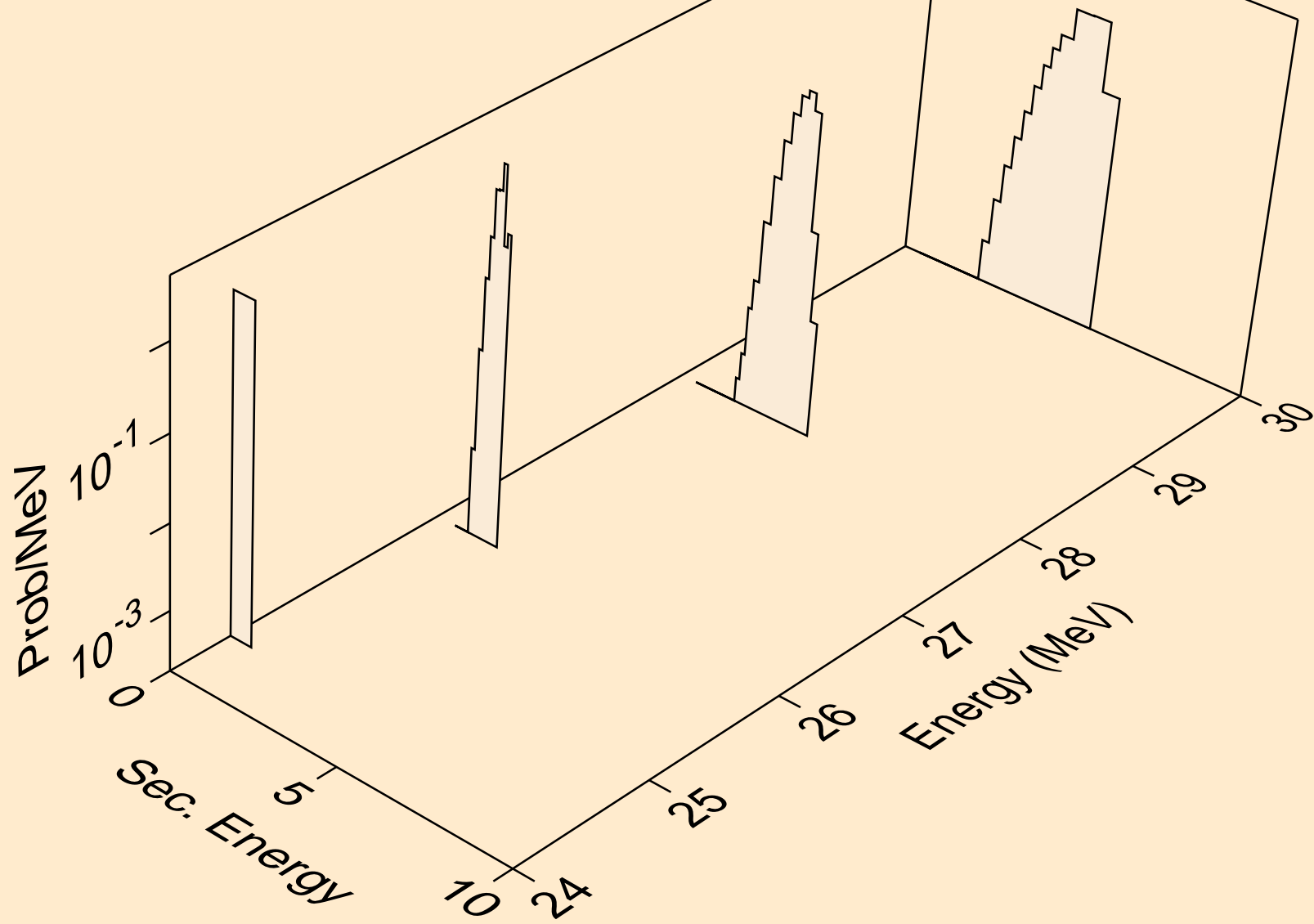

PD098 NEUTRON ACER TENDL-2024 LIBRARY; T=293.6K  
deuterons from (n,n\*)d

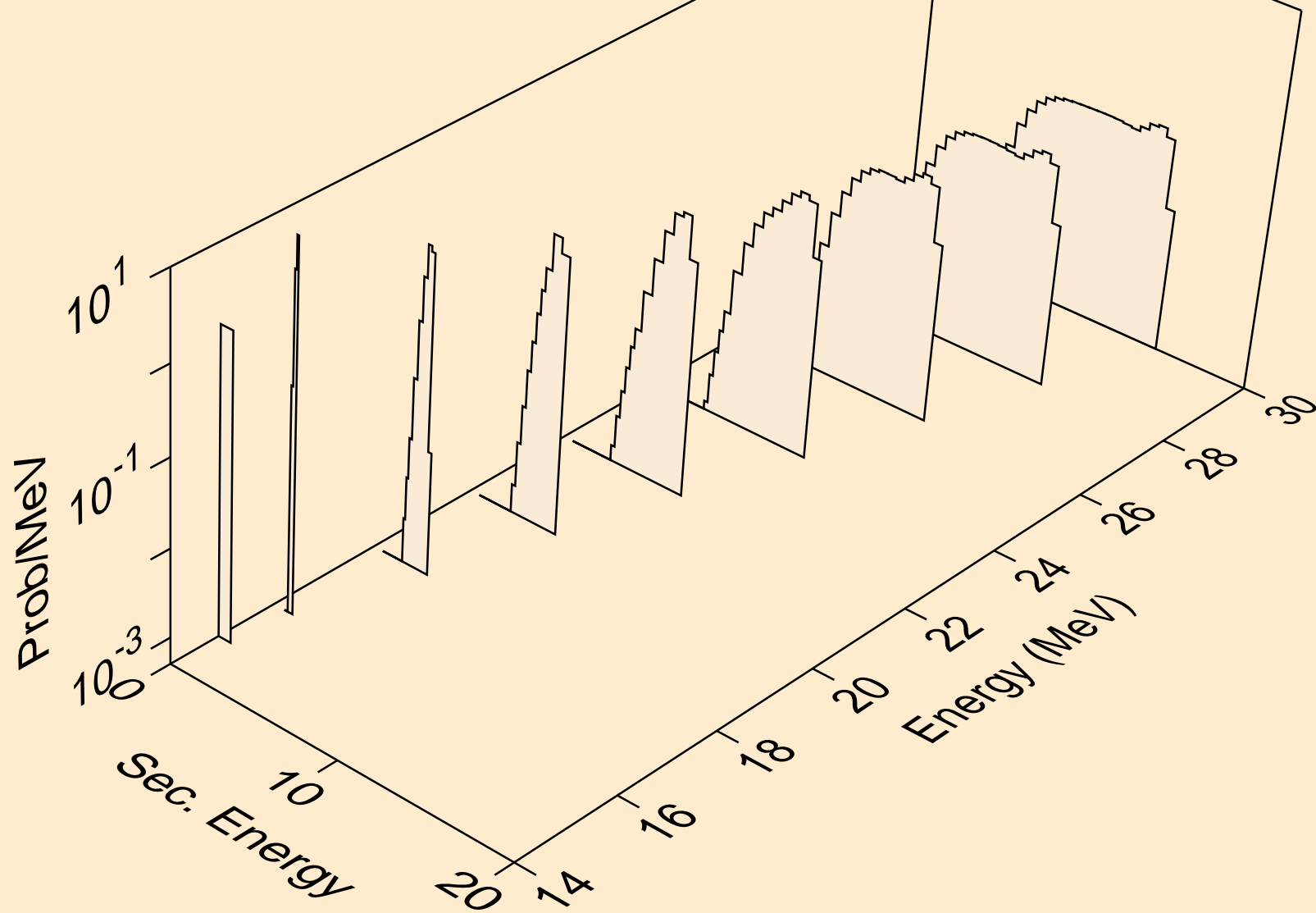

PD098 NEUTRON ACER TENDL-2024 LIBRARY; T=293.6K  
deuterons from (n,d)

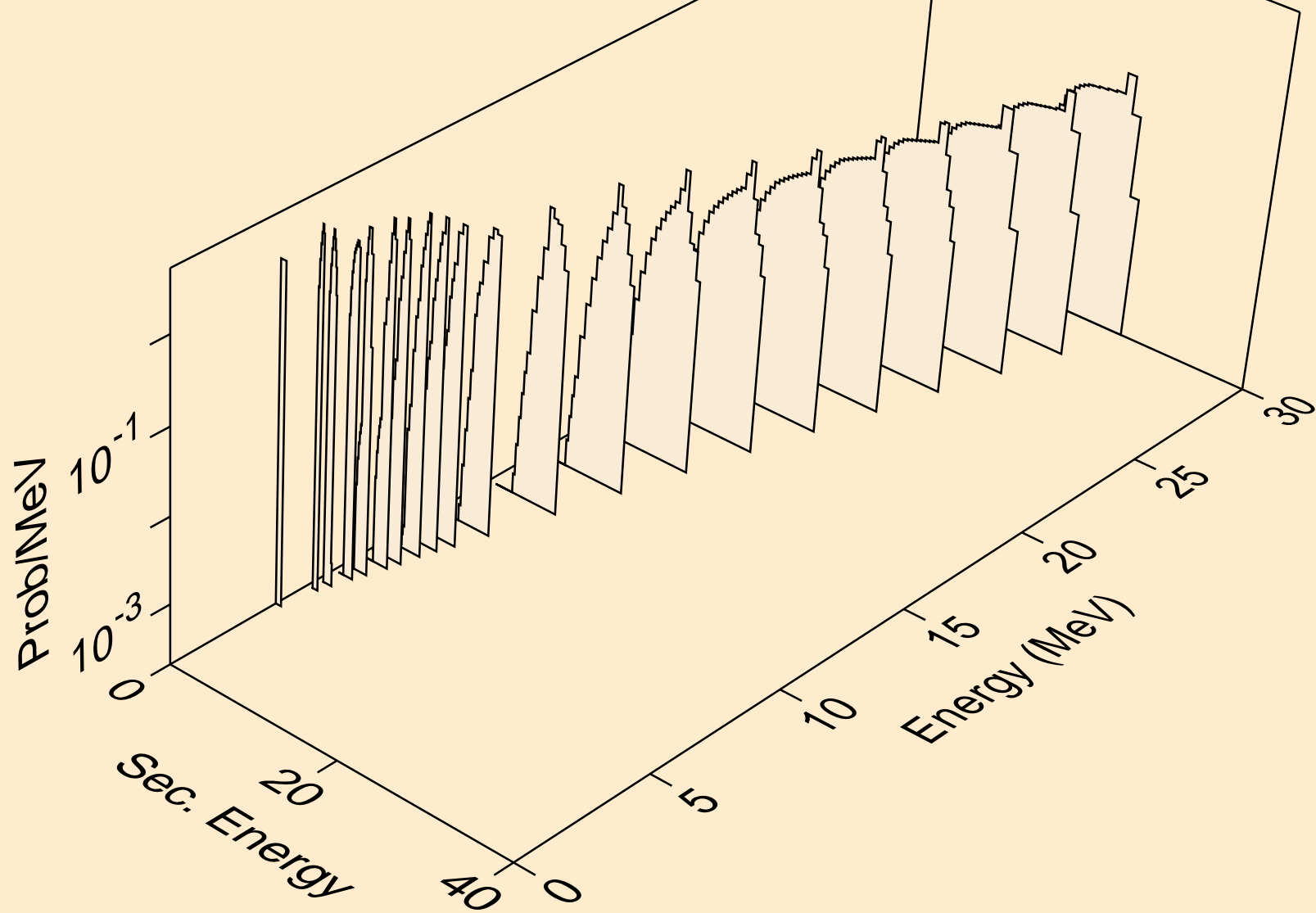

PD098 NEUTRON ACER TENDL-2024 LIBRARY; T=293.6K  
deuterons from (n,pd)

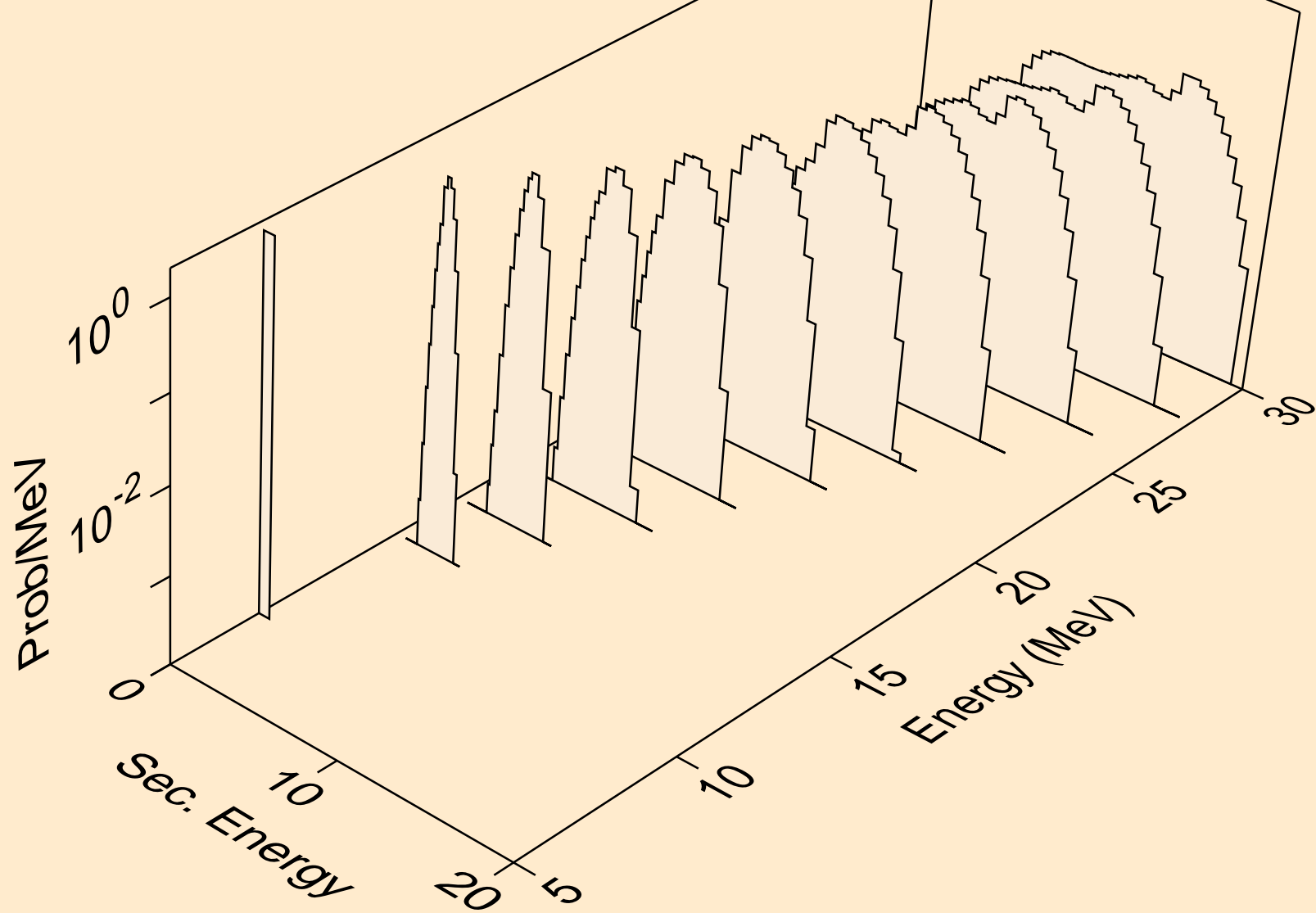

PD098 NEUTRON ACER TENDL-2024 LIBRARY; T=293.6K  
deuterons from (n,da)

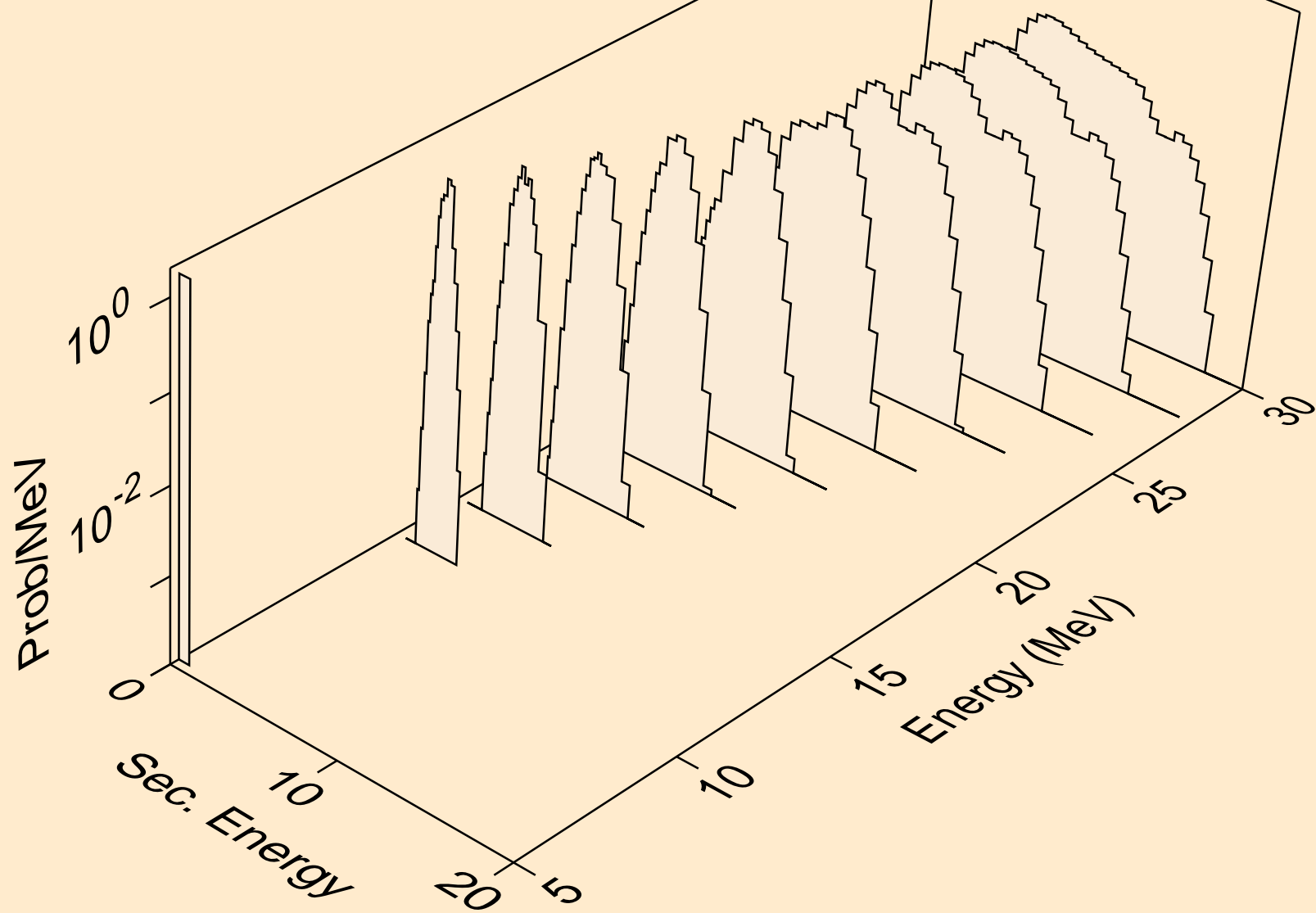

PD098 NEUTRON ACER TENDL-2024 LIBRARY; T=293.6K  
tritons from (n,x)

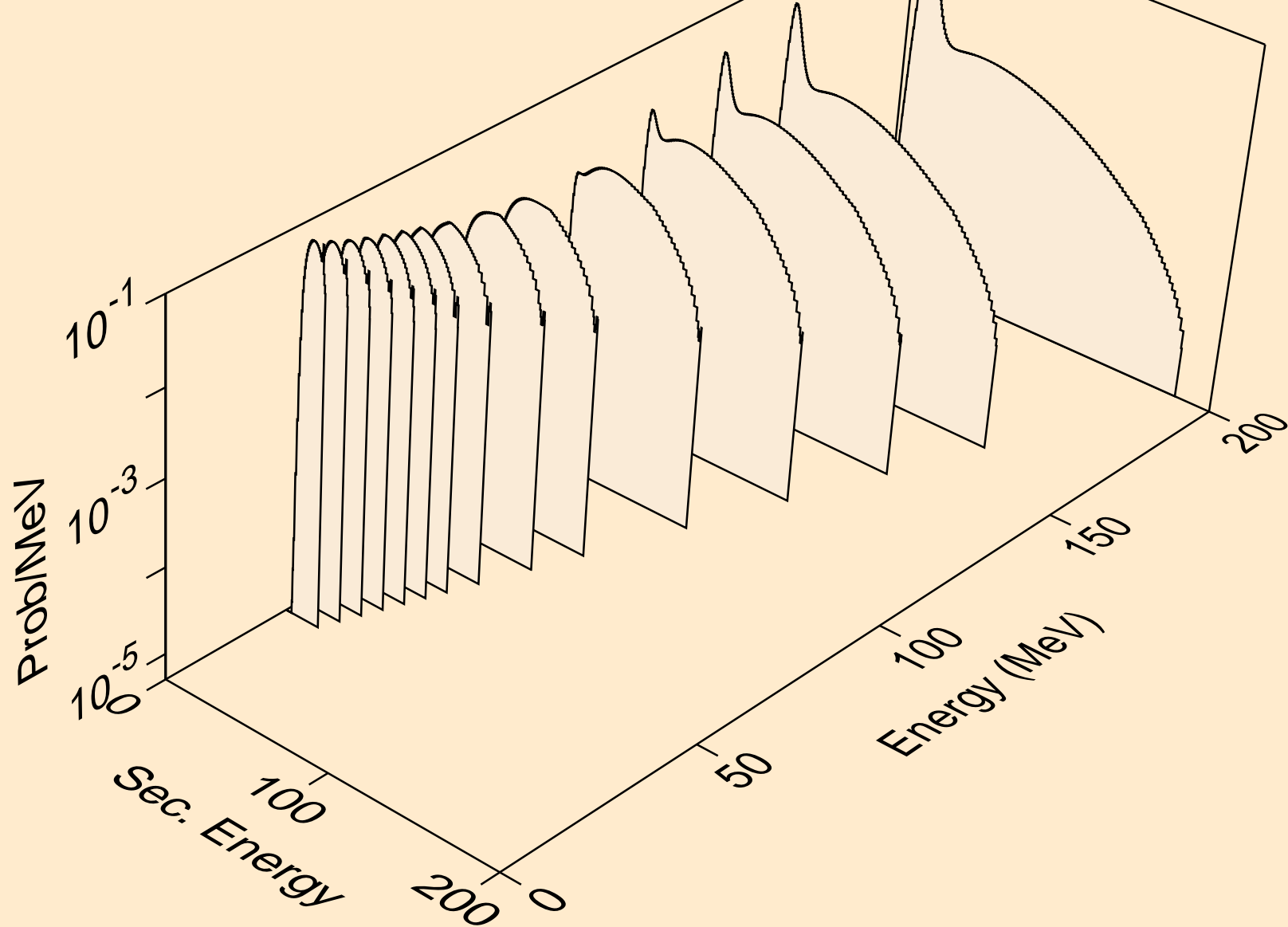

PD098 NEUTRON ACER TENDL-2024 LIBRARY; T=293.6K  
tritons from (n,n\*)t

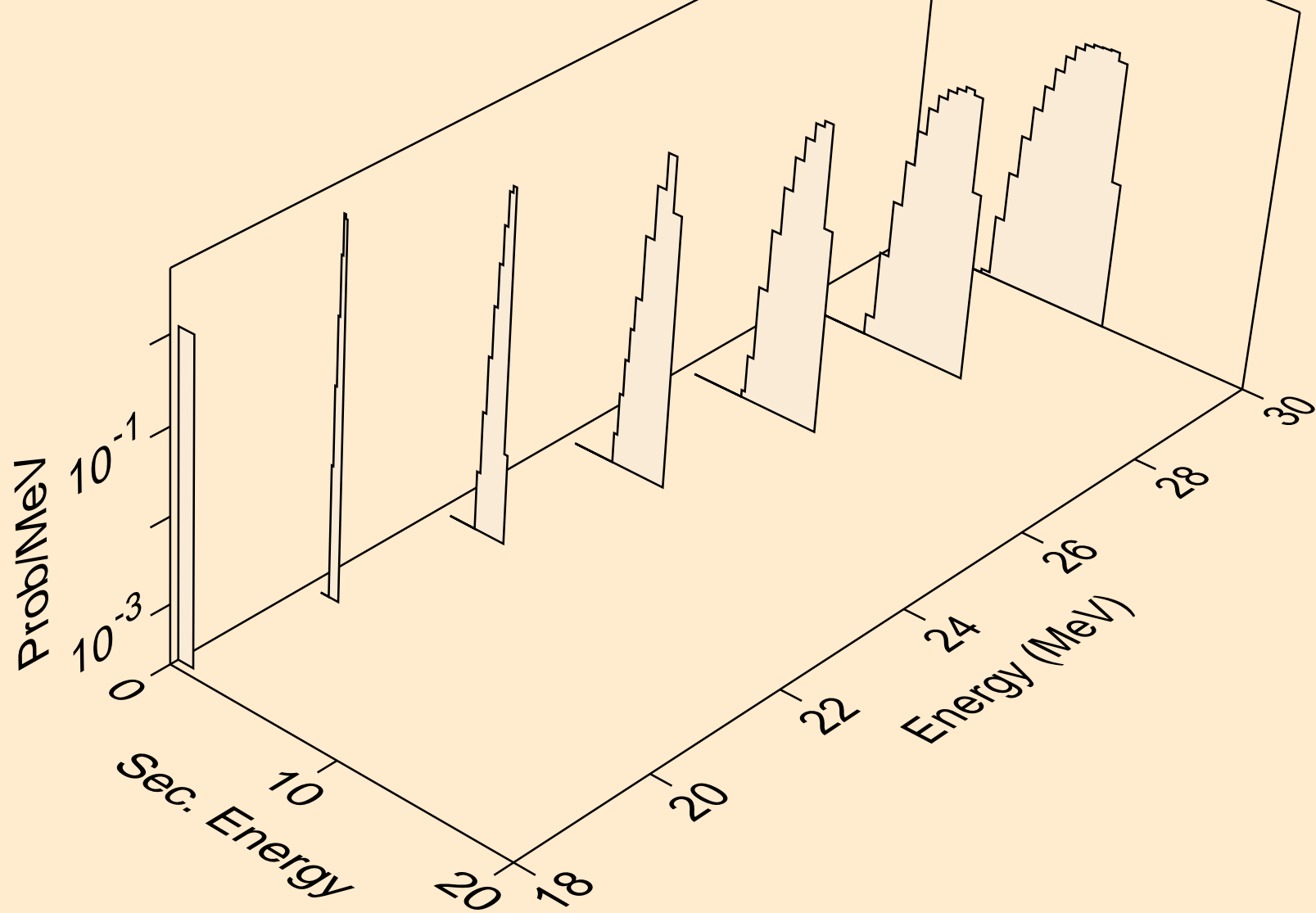

PD098 NEUTRON ACER TENDL-2024 LIBRARY; T=293.6K  
tritons from (n,t)

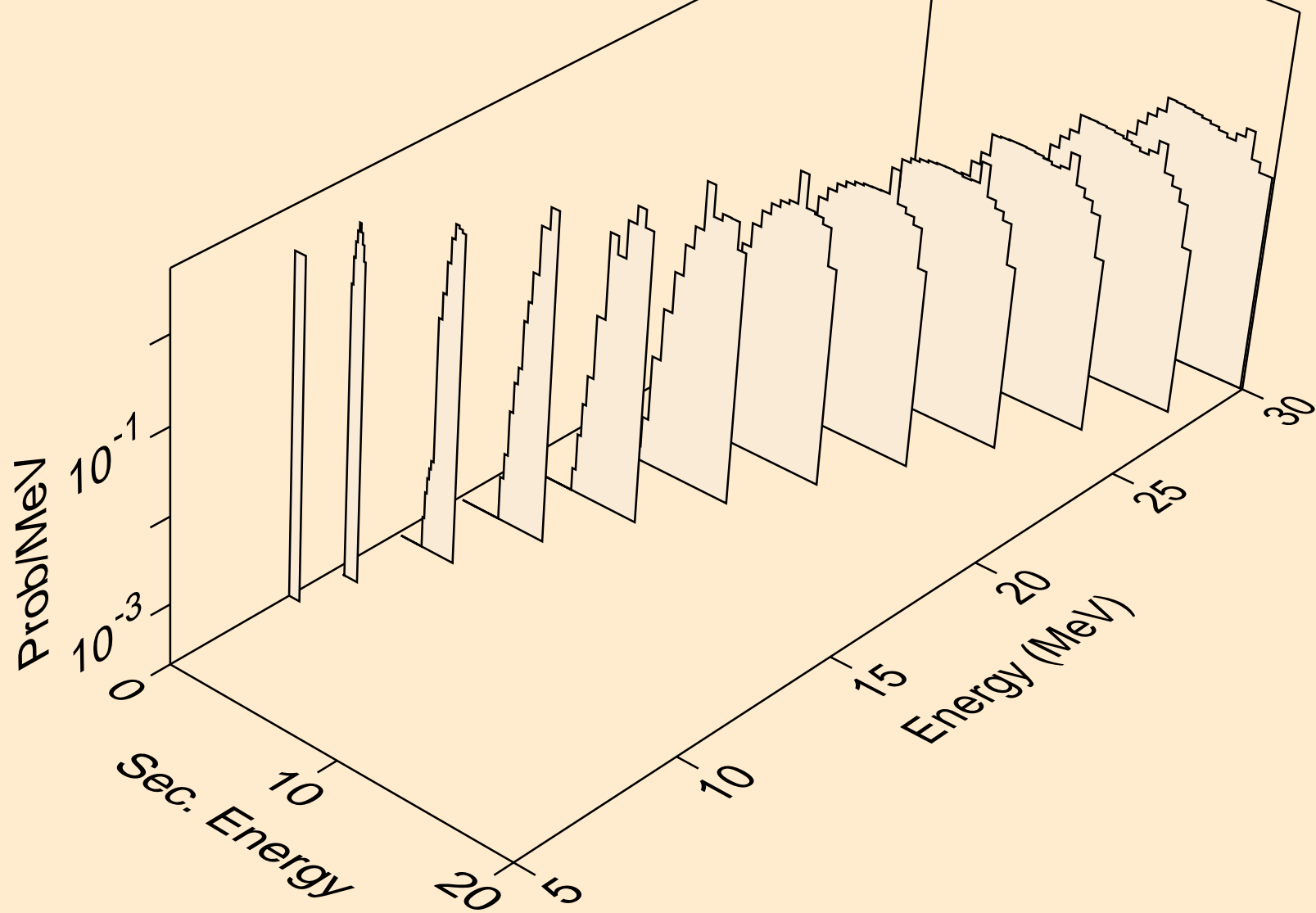

PD098 NEUTRON ACER TENDL-2024 LIBRARY; T=293.6K  
tritons from (n,pt)

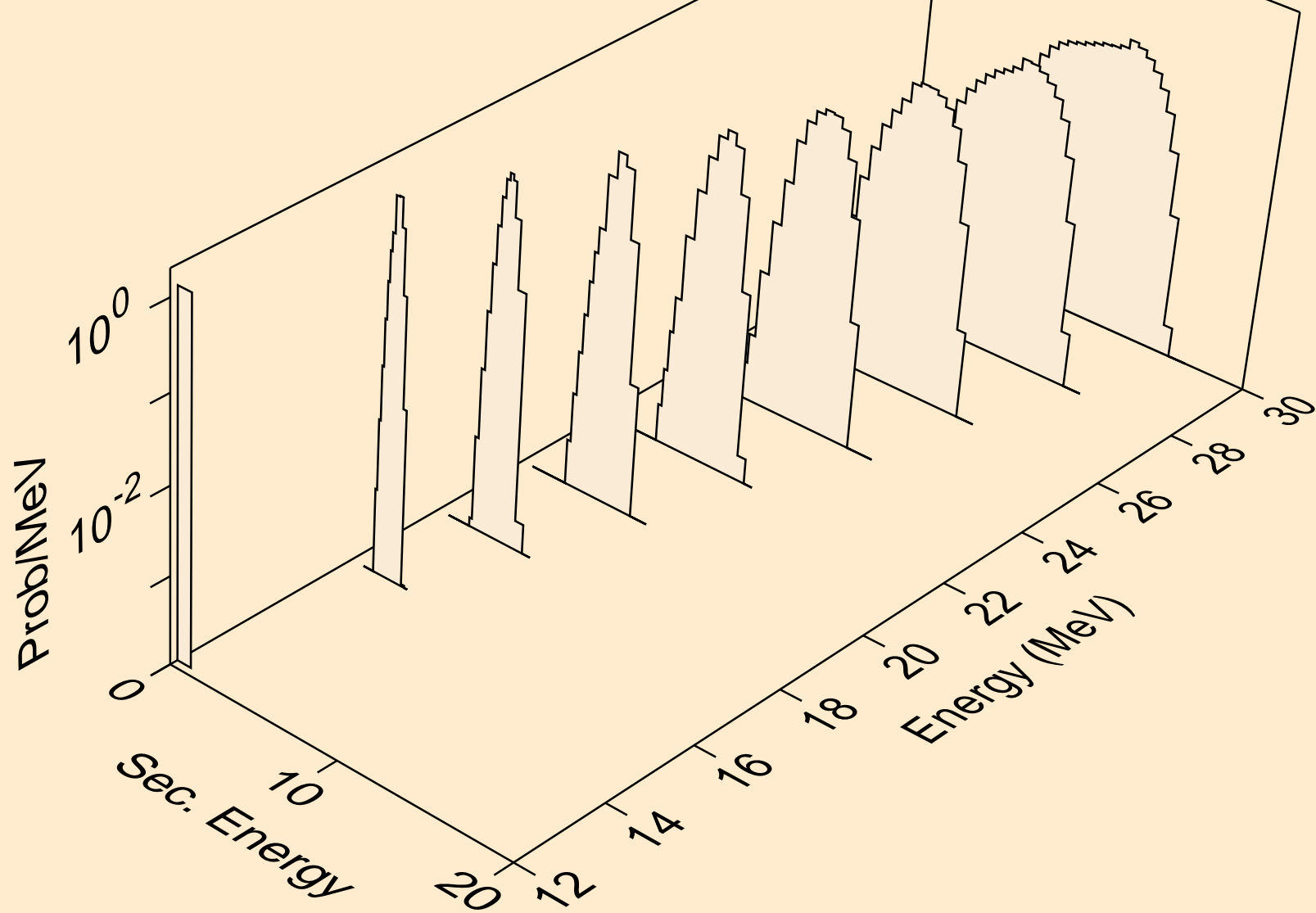

PD098 NEUTRON ACER TENDL-2024 LIBRARY; T=293.6K  
he3s from (n,x)

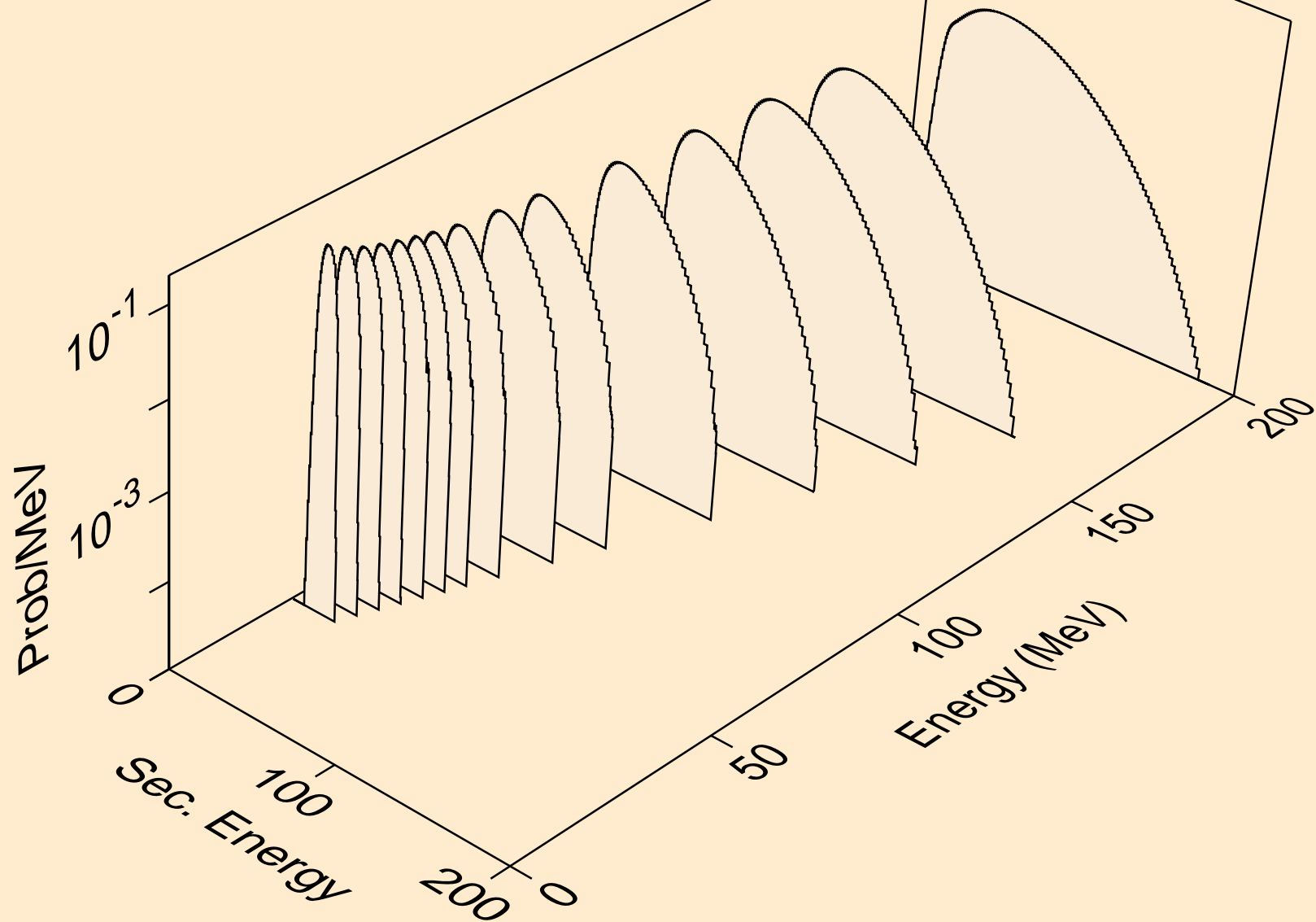

PD098 NEUTRON ACER TENDL-2024 LIBRARY; T=293.6K  
he3s from (n,n\*)he3

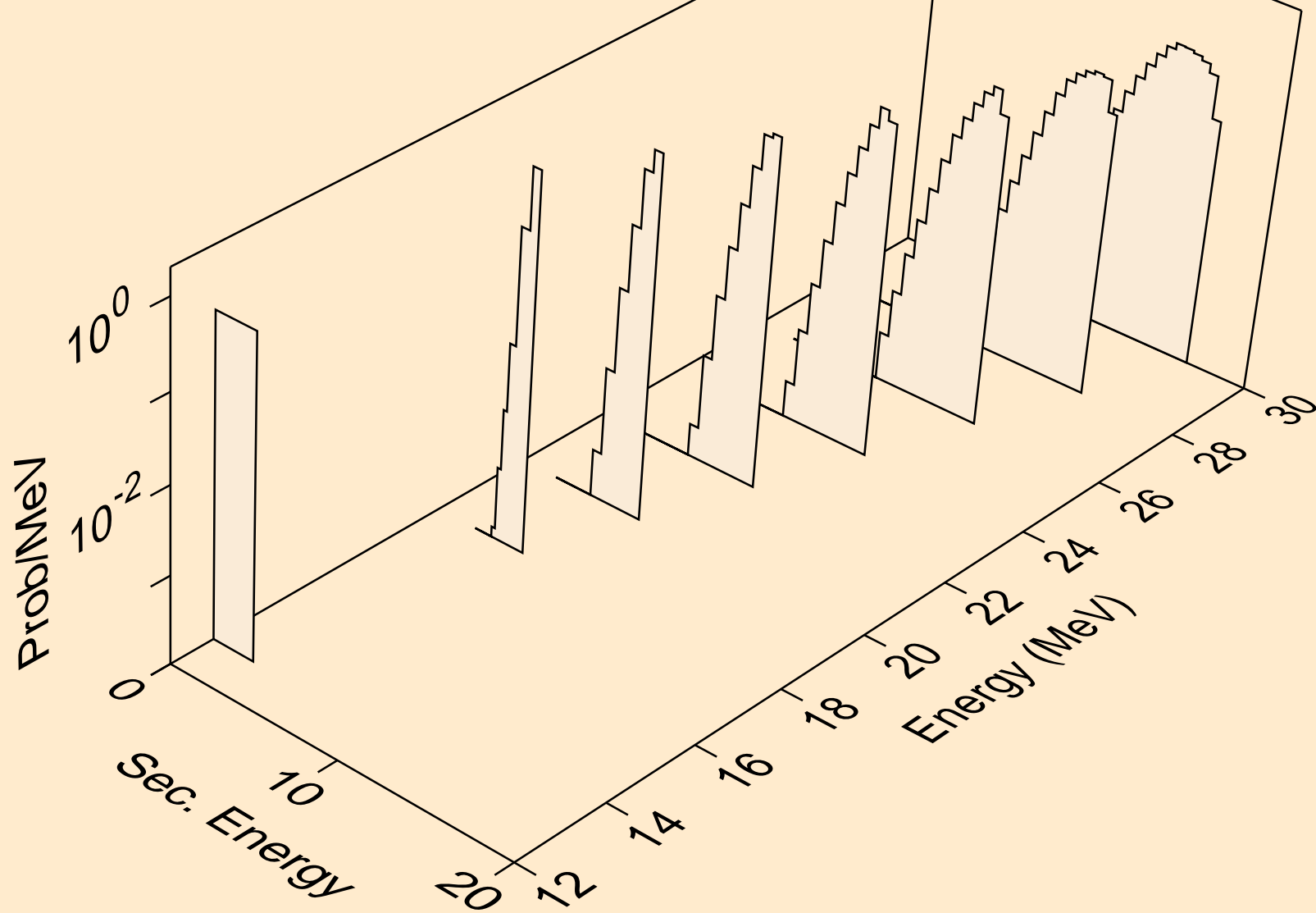

PD098 NEUTRON ACER TENDL-2024 LIBRARY; T=293.6K  
he3s from (n,he3)

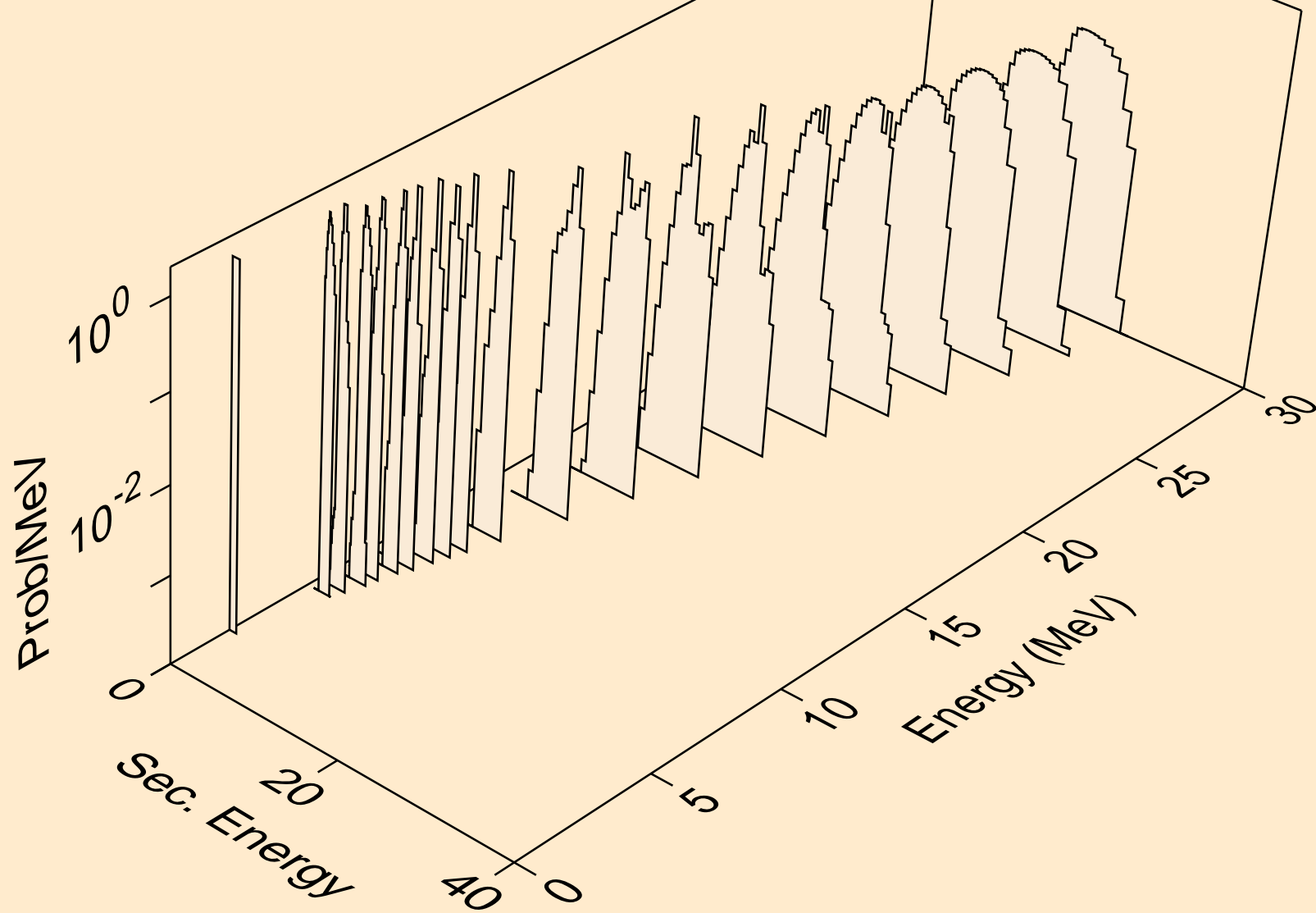

PD098 NEUTRON ACER TENDL-2024 LIBRARY; T=293.6K  
alphas from (n,x)

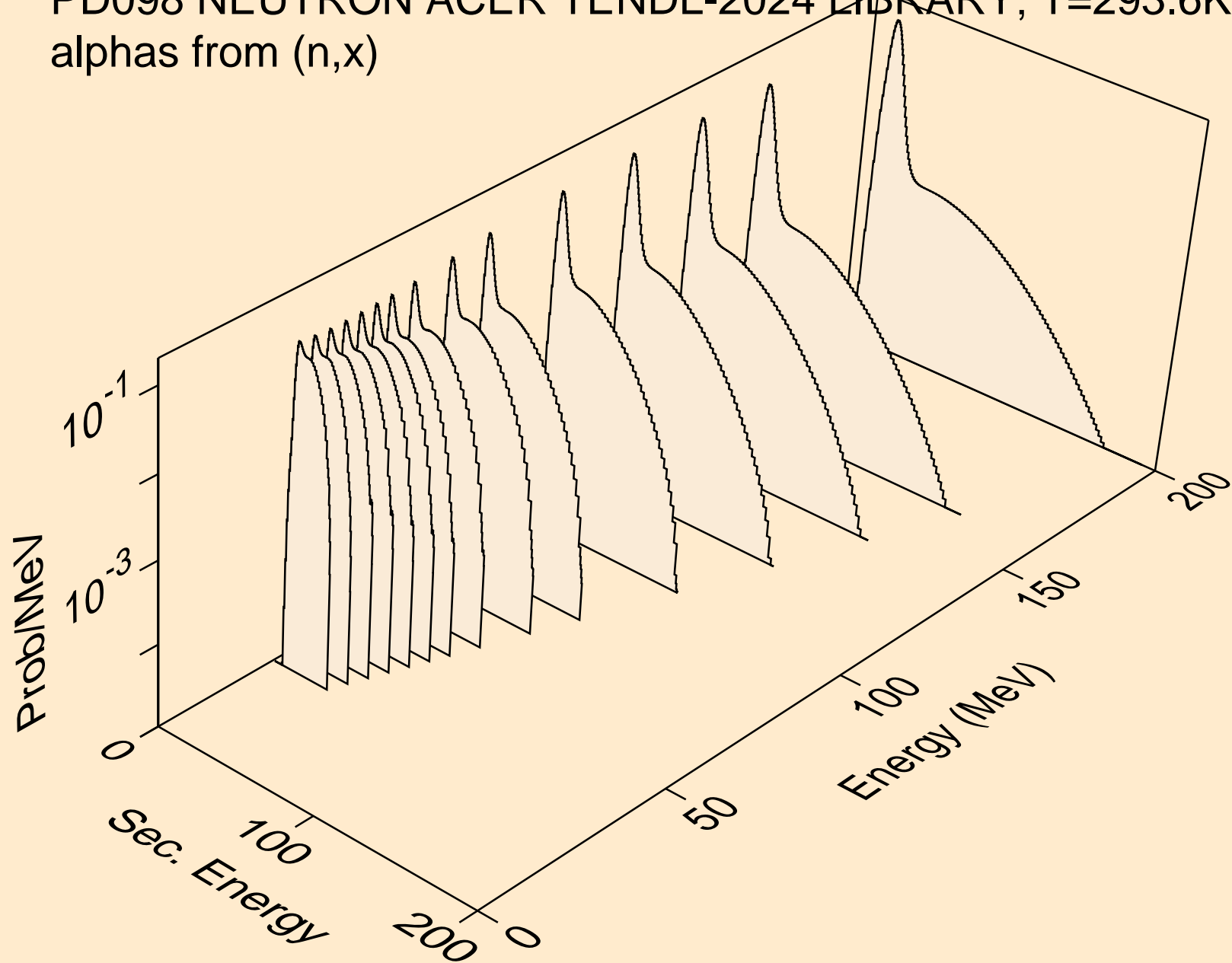

PD098 NEUTRON ACER TENDL-2024 LIBRARY; T=293.6K  
alphas from (n,n\*)a

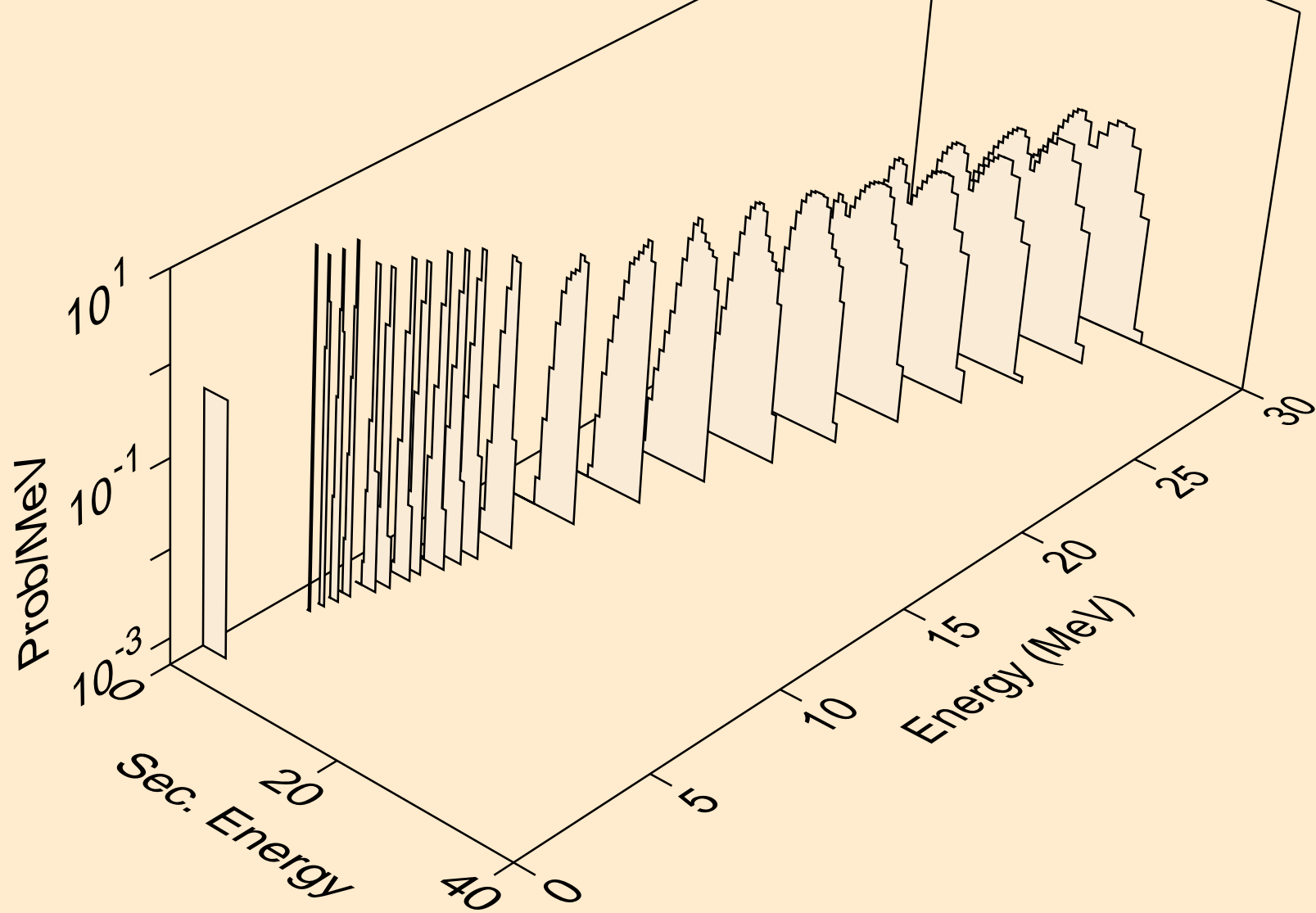

PD098 NEUTRON ACER TENDL-2024 LIBRARY; T=293.6K  
alphas from (n,2n)a

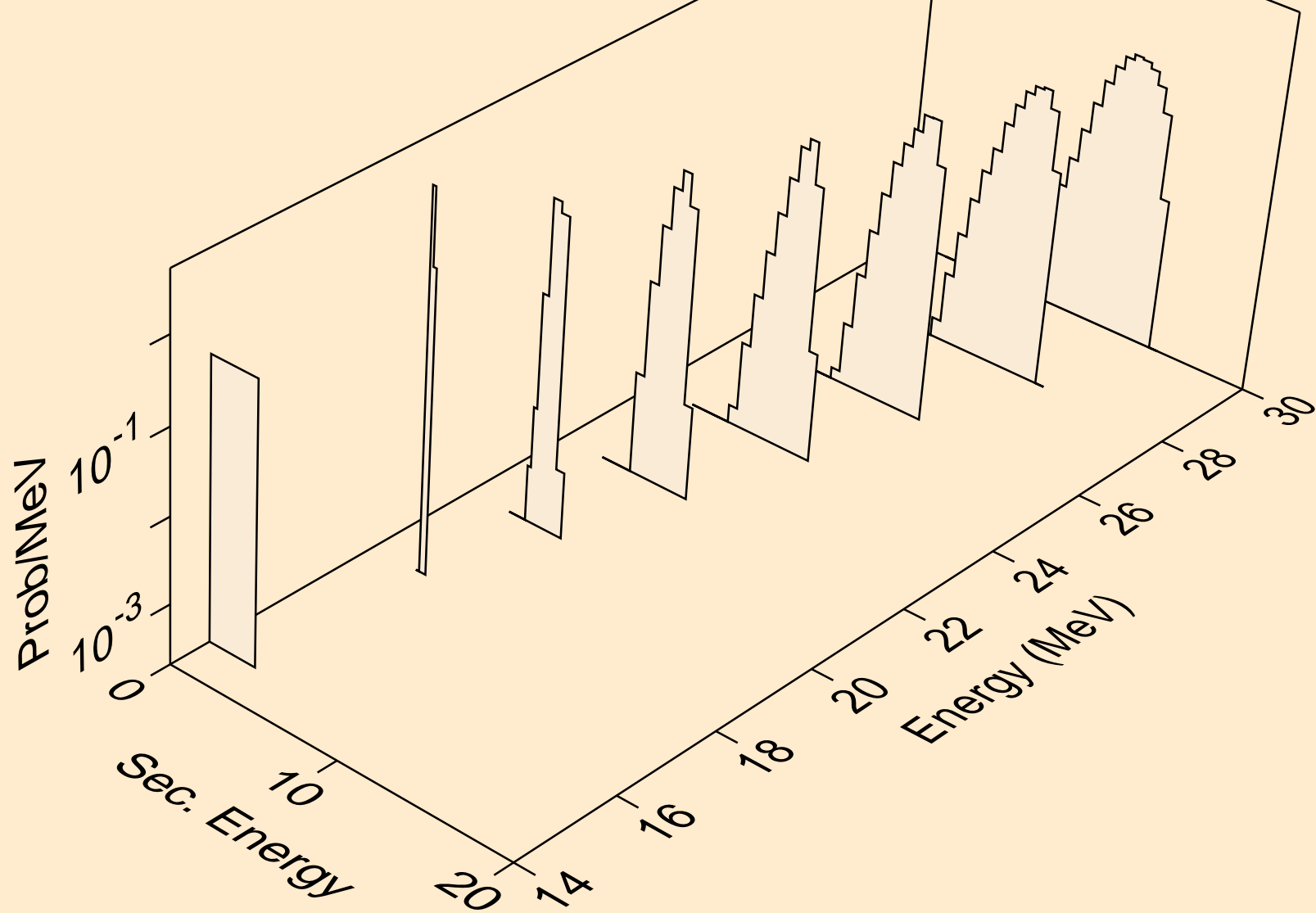

PD098 NEUTRON ACER TENDL-2024 LIBRARY; T=293.6K  
alphas from (n,n\*)2a

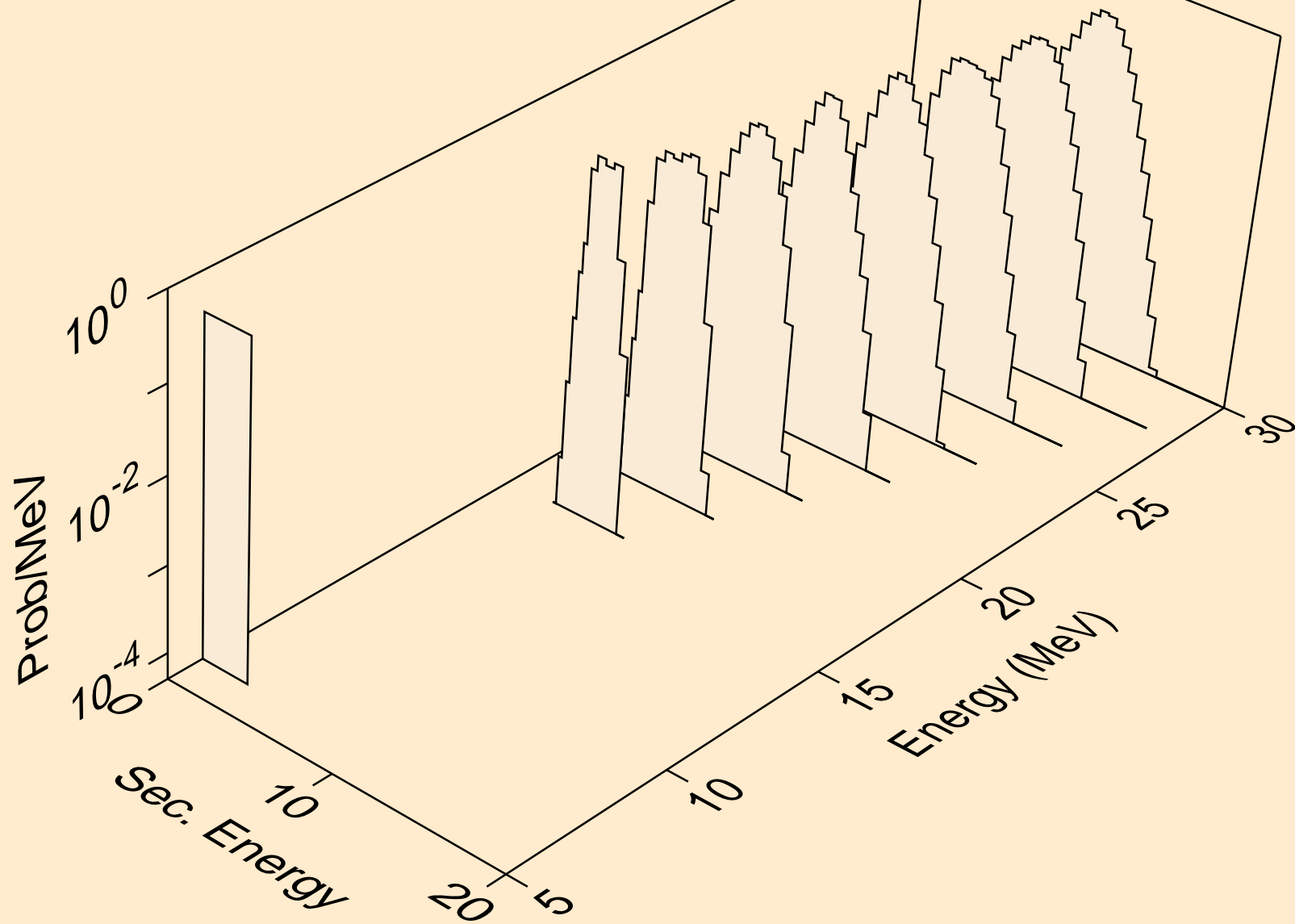

PD098 NEUTRON ACER TENDL-2024 LIBRARY; T=293.6K  
alphas from (n,npa)

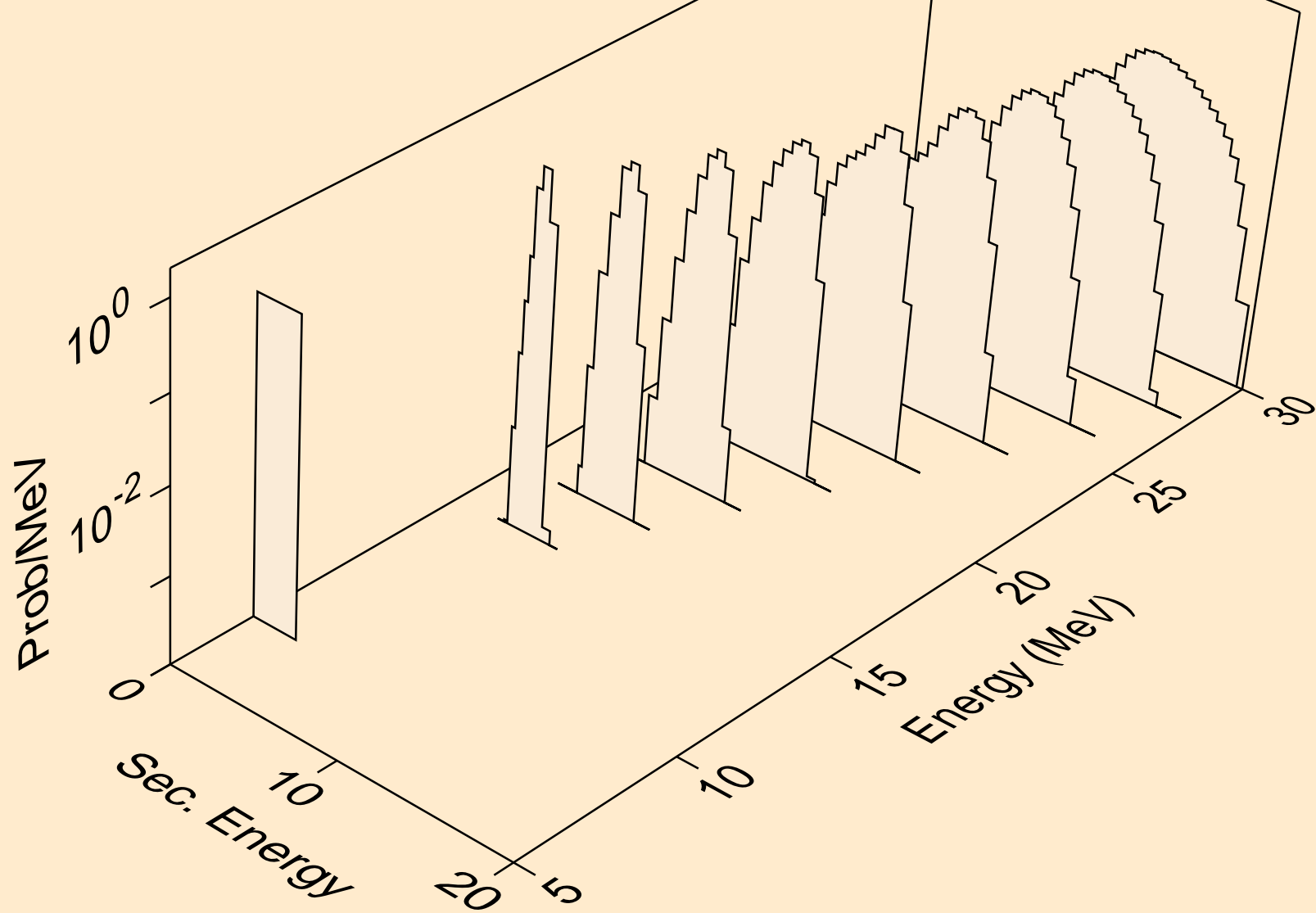

PD098 NEUTRON ACER TENDL-2024 LIBRARY; T=293.6K  
alphas from (n,a)

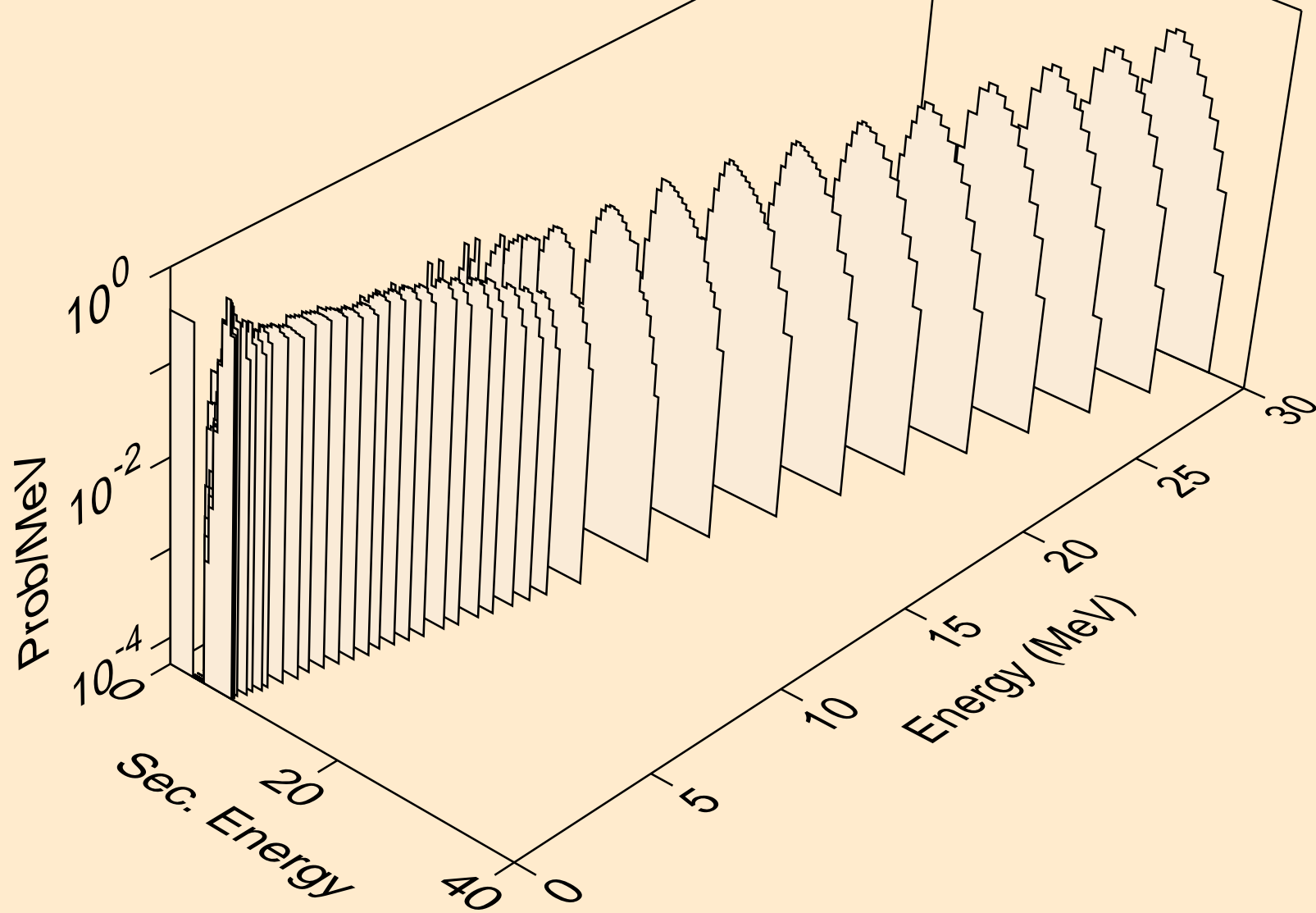

PD098 NEUTRON ACER TENDL-2024 LIBRARY; T=293.6K  
alphas from (n,2a)

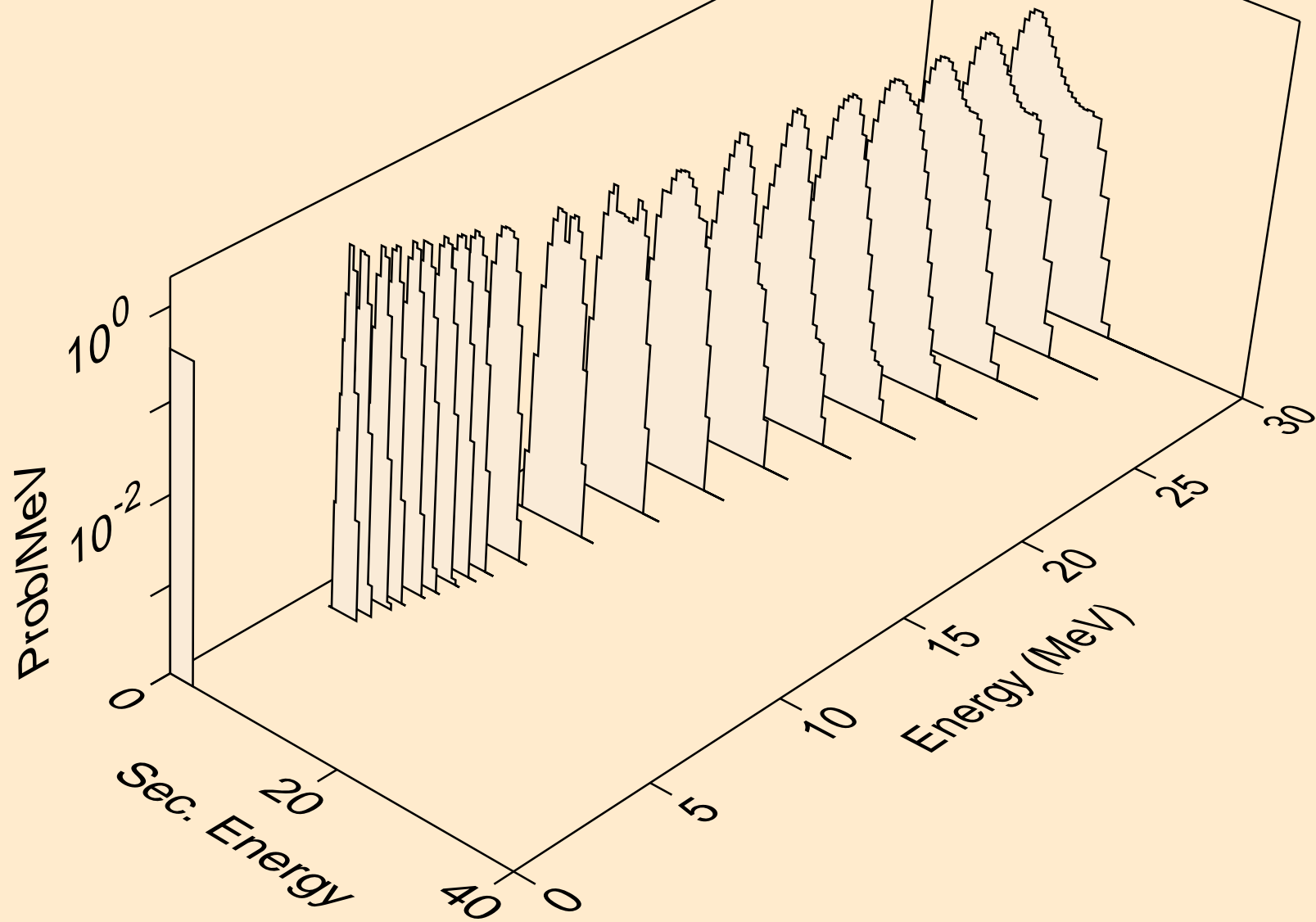

PD098 NEUTRON ACER TENDL-2024 LIBRARY; T=293.6K  
alphas from (n,pa)

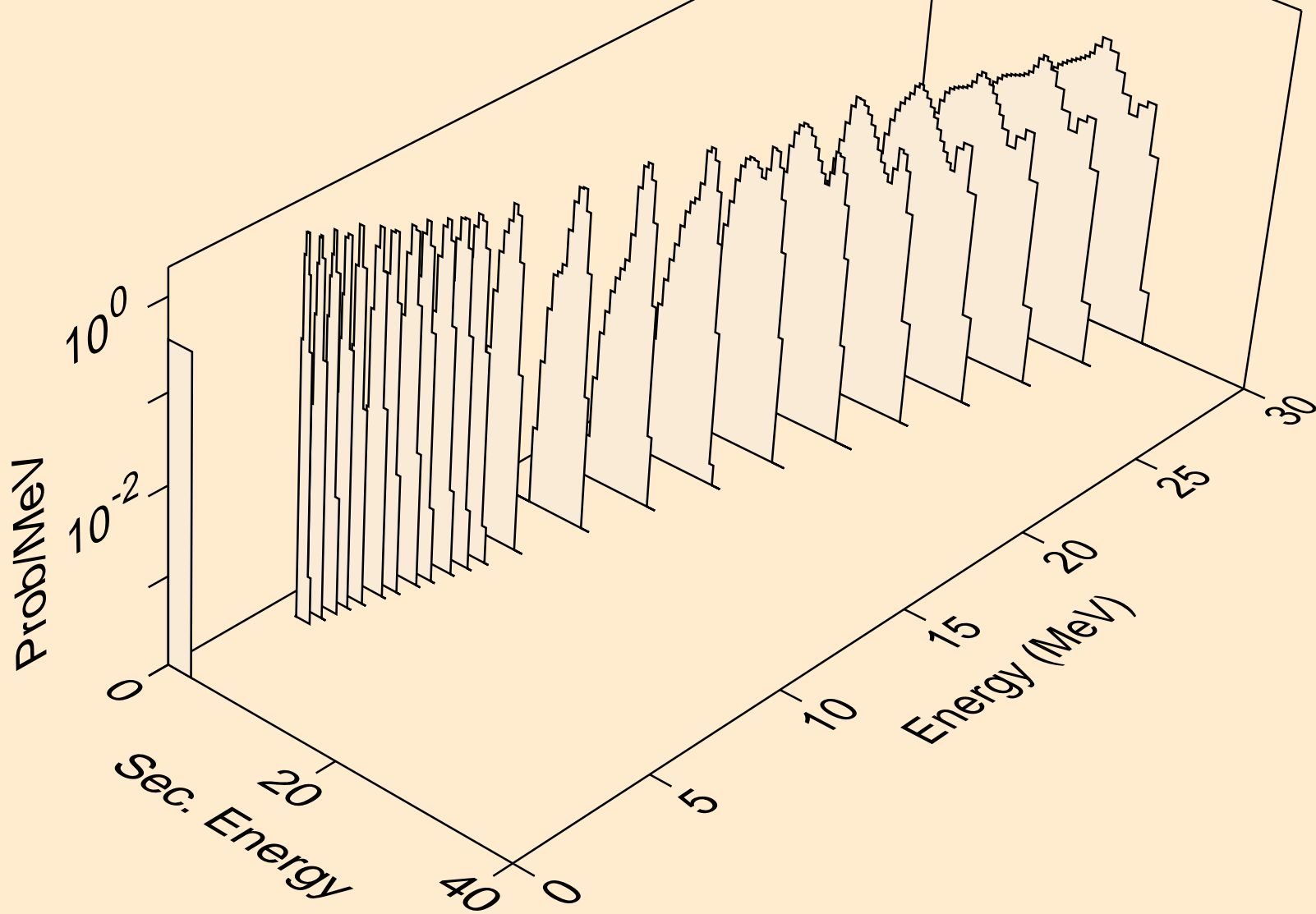

PD098 NEUTRON ACER TENDL-2024 LIBRARY; T=293.6K  
alphas from (n,da)

