

PD116 NEUTRON ACER TENDL-2024 LIBRARY; T=293.6K

Principal cross sections

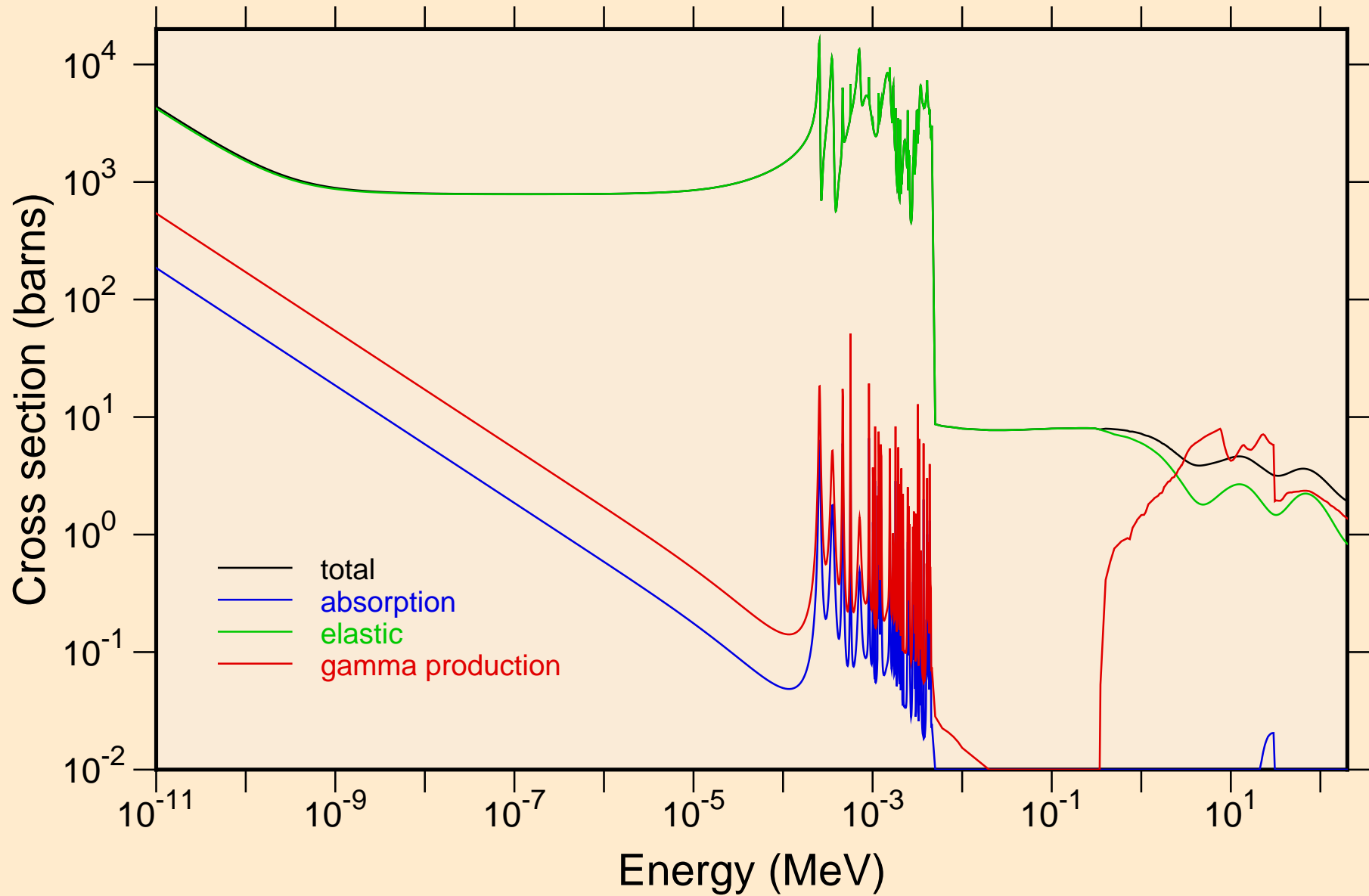

PD116 NEUTRON ACER TENDL-2024 LIBRARY; T=293.6K
resonance total cross section

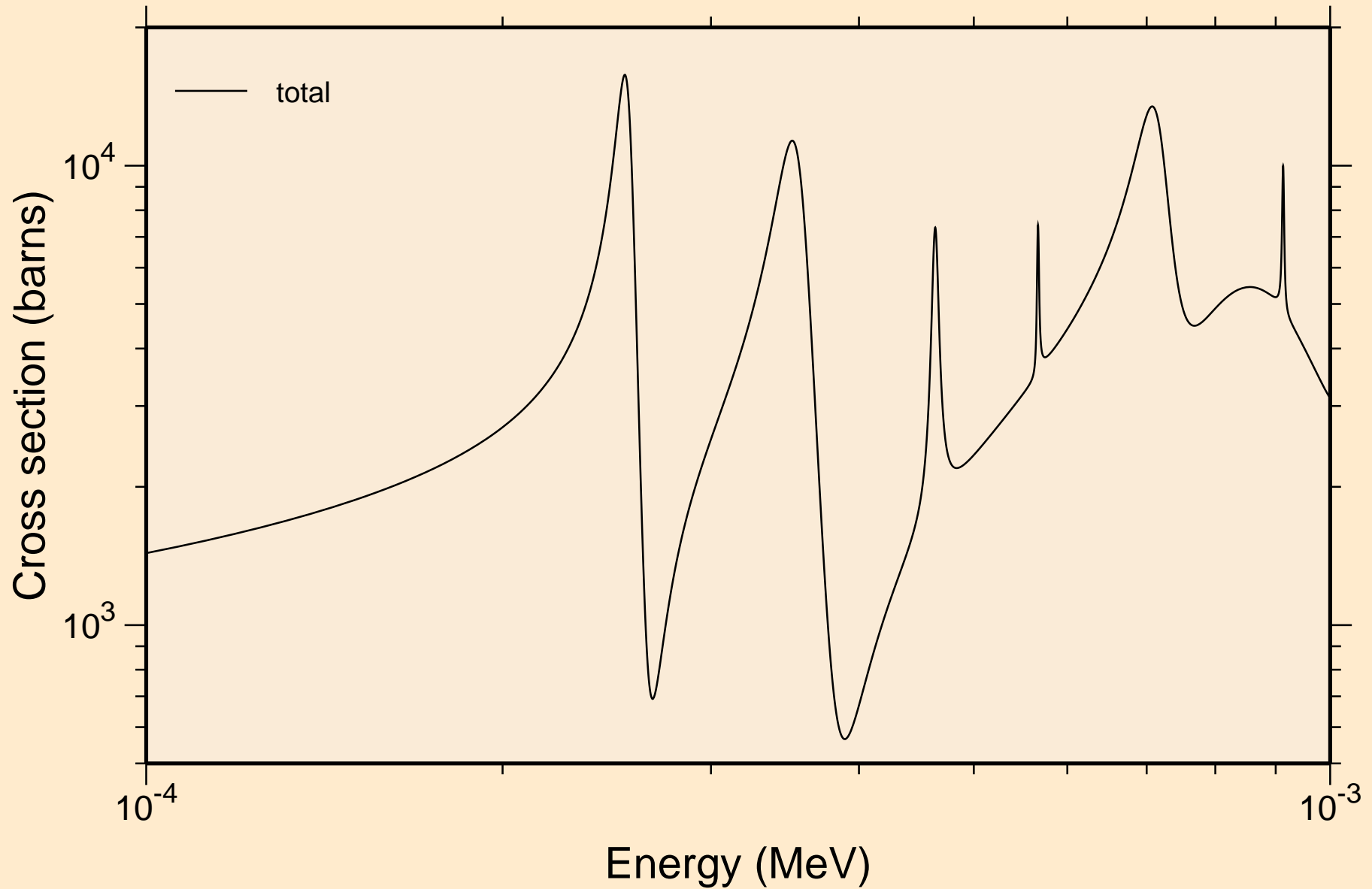

PD116 NEUTRON ACER TENDL-2024 LIBRARY; T=293.6K
resonance total cross section

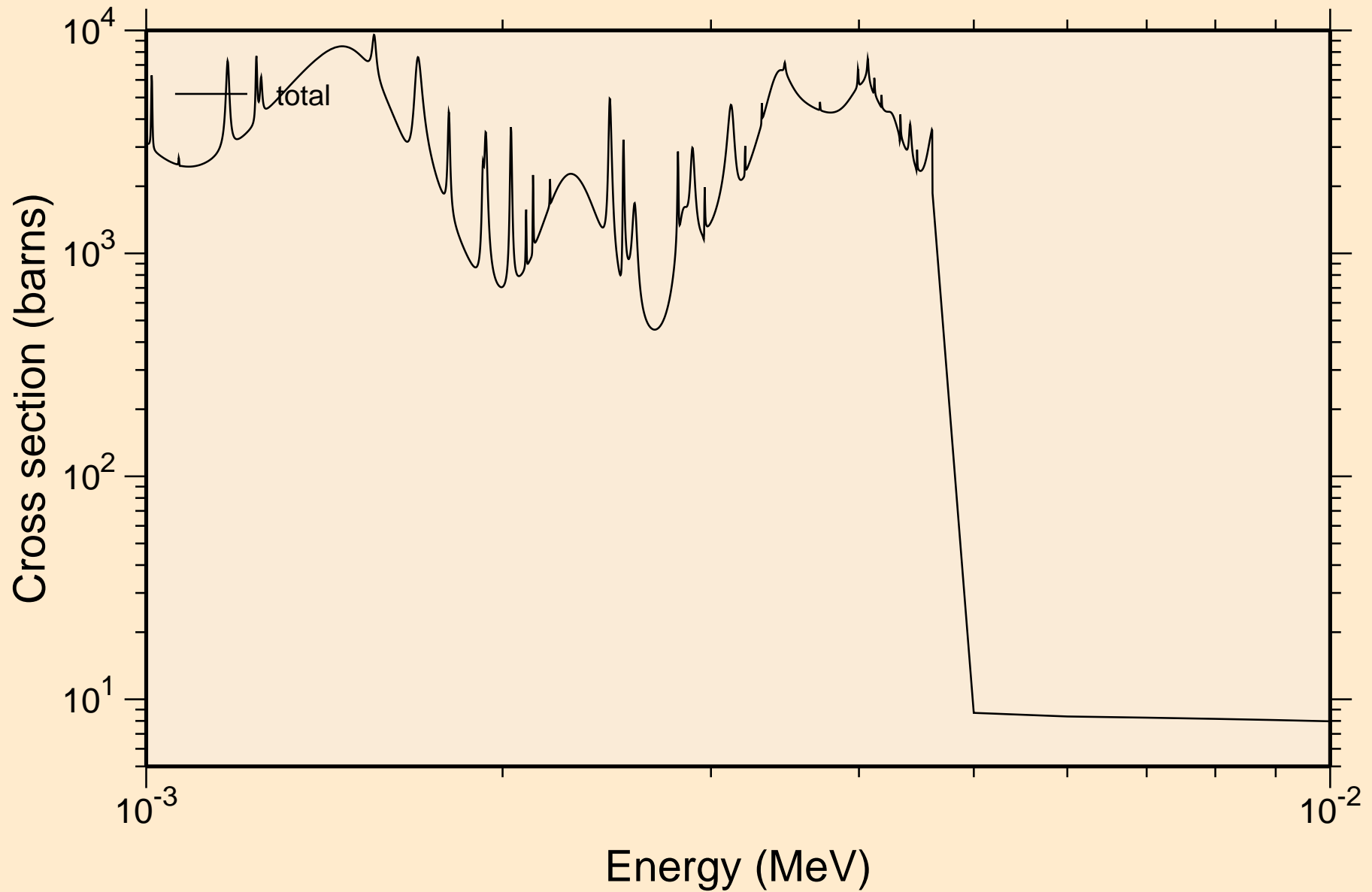

PD116 NEUTRON ACER TENDL-2024 LIBRARY; T=293.6K
resonance total cross section

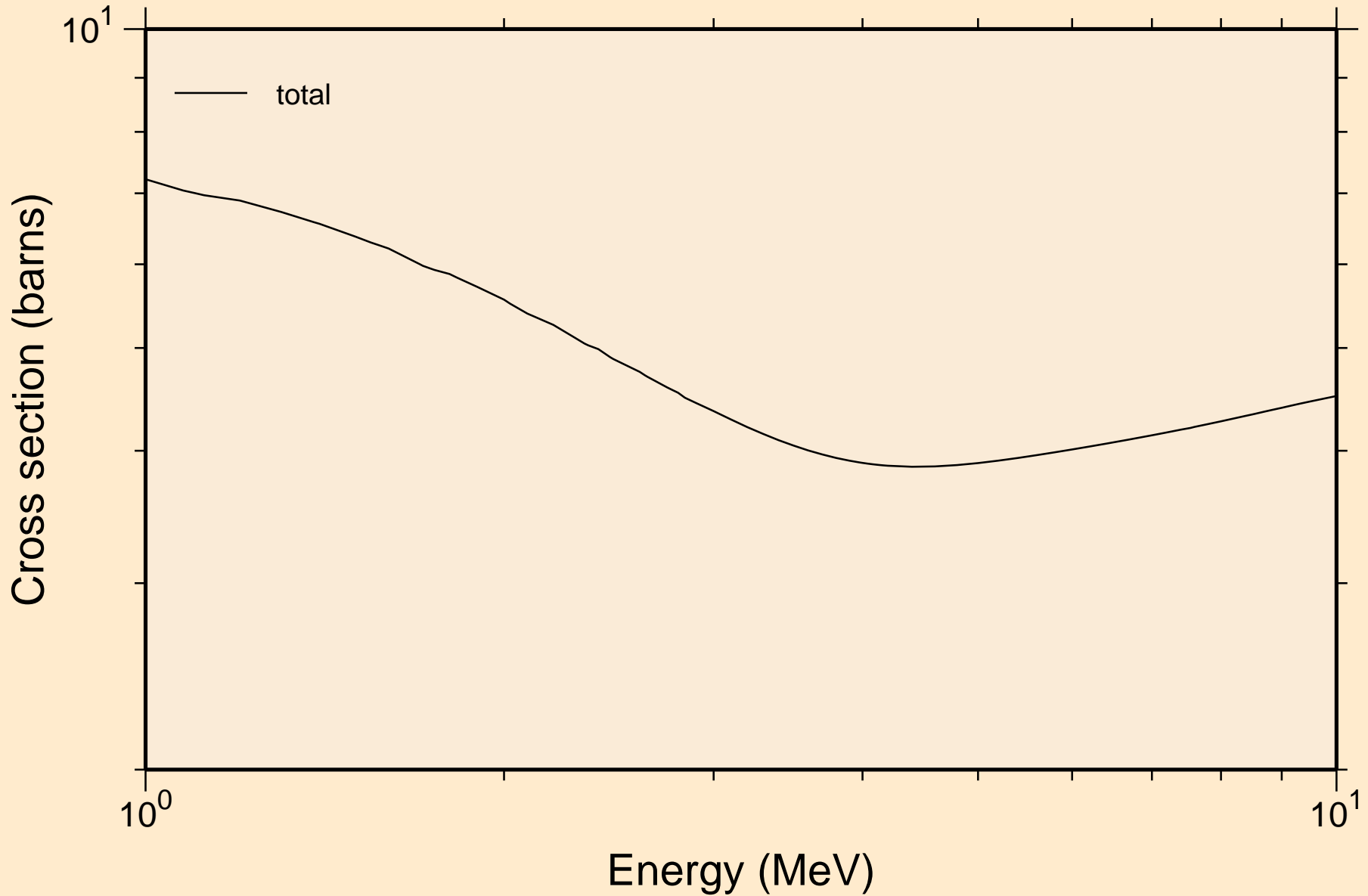

PD116 NEUTRON ACER TENDL-2024 LIBRARY; T=293.6K
resonance absorption cross sections

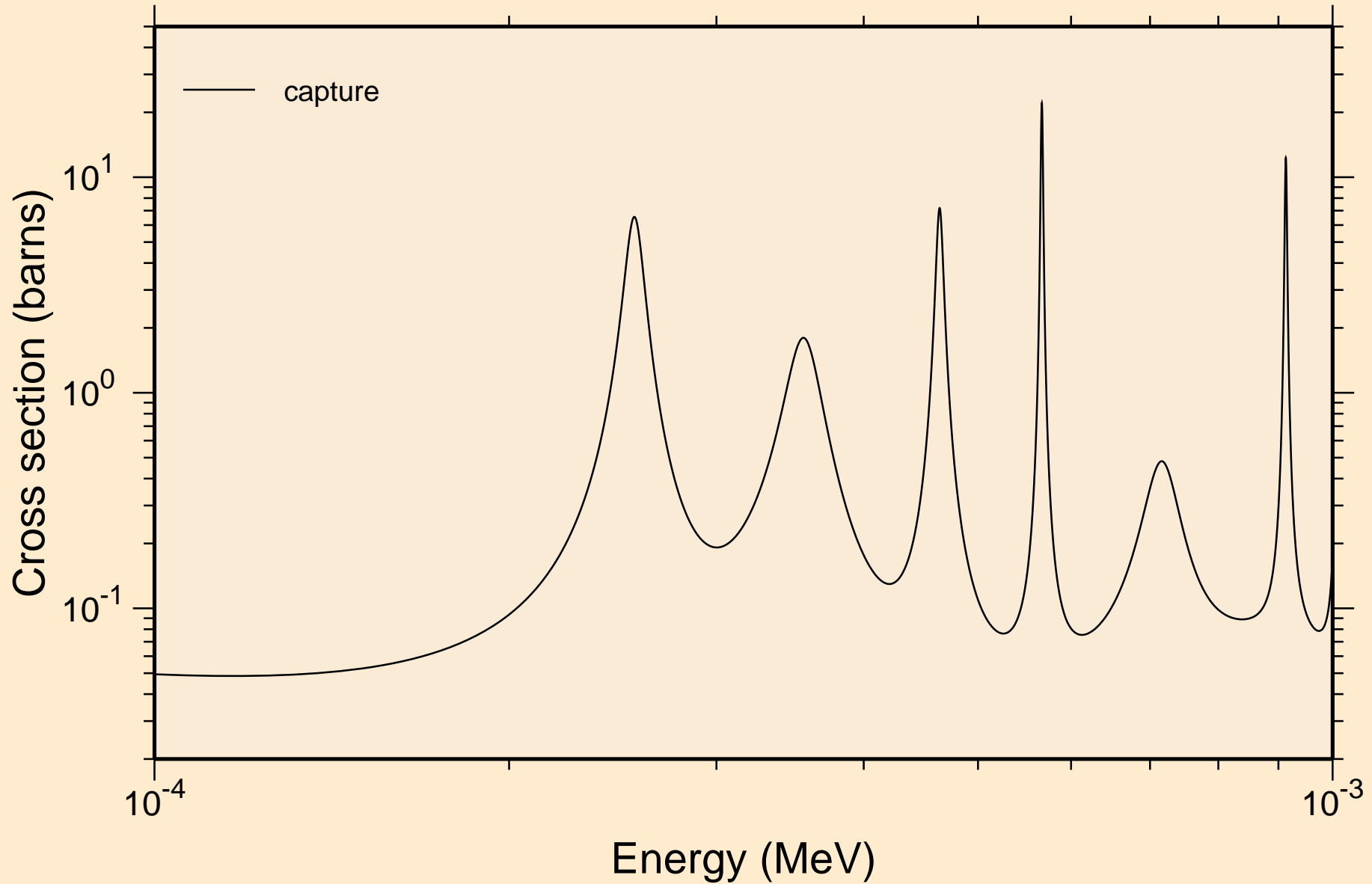

PD116 NEUTRON ACER TENDL-2024 LIBRARY; T=293.6K
resonance absorption cross sections

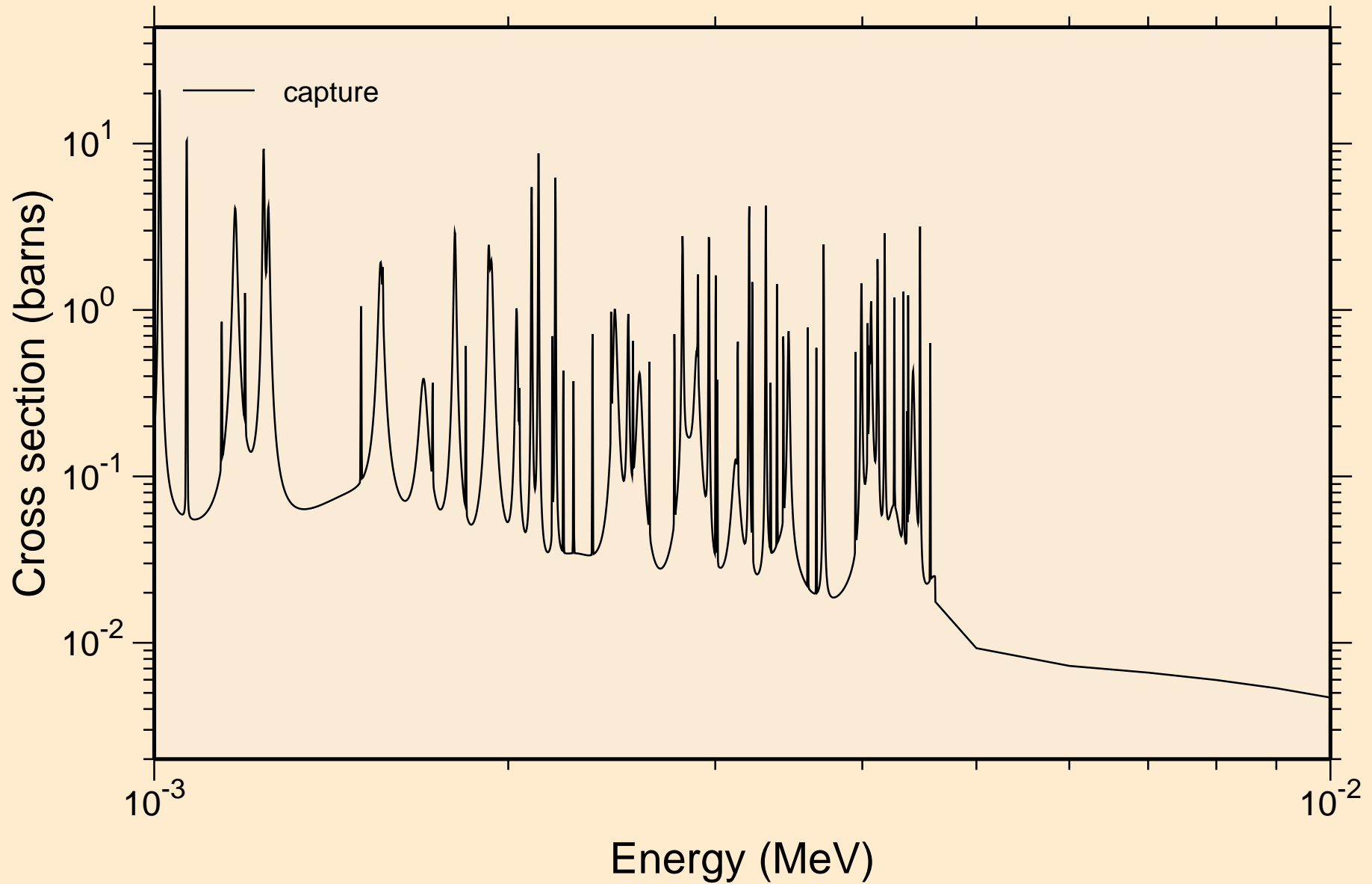

PD116 NEUTRON ACER TENDL-2024 LIBRARY; T=293.6K
resonance absorption cross sections

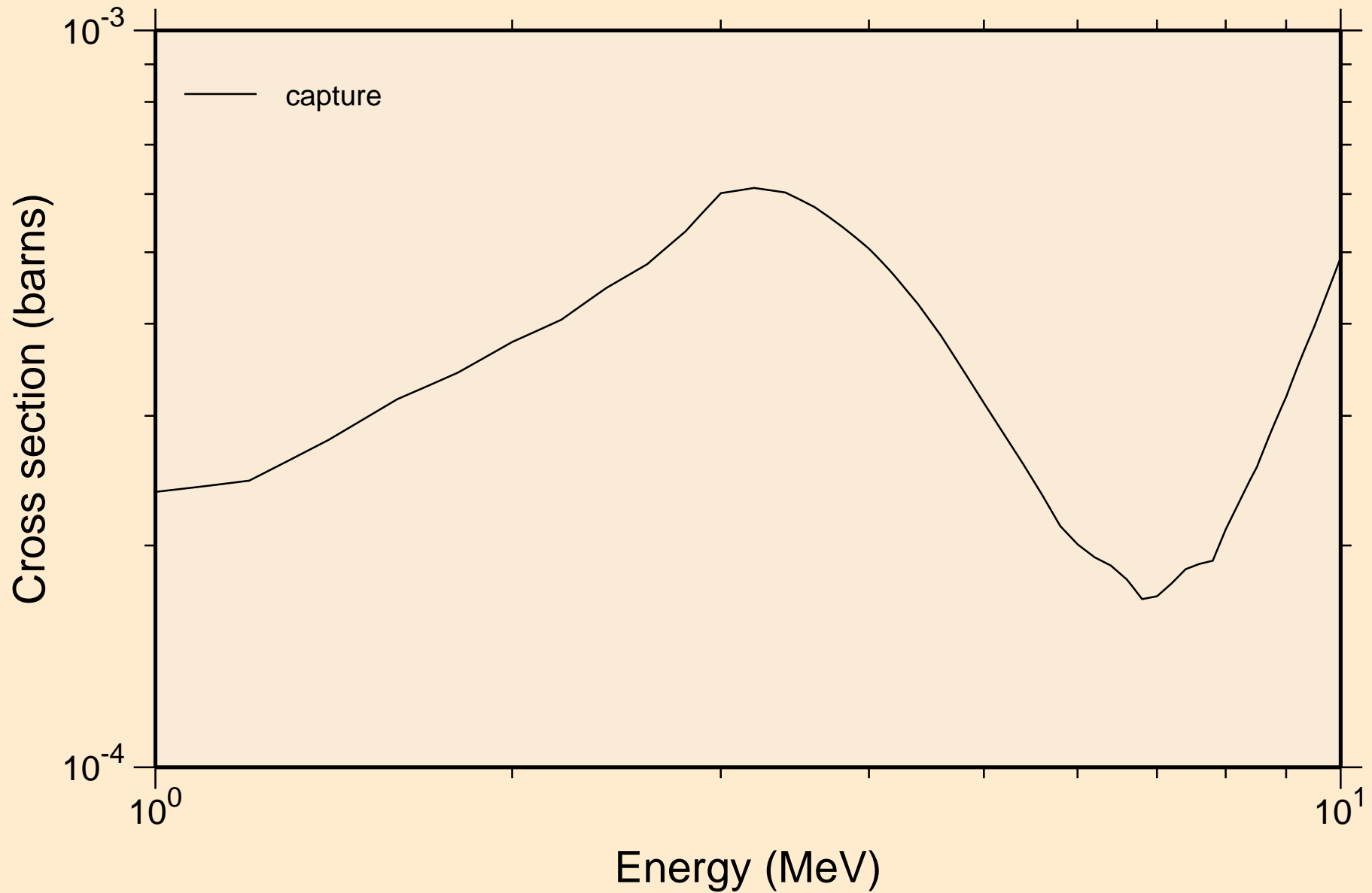

PD116 NEUTRON ACER TENDL-2024 LIBRARY; T=293.6K
Heating

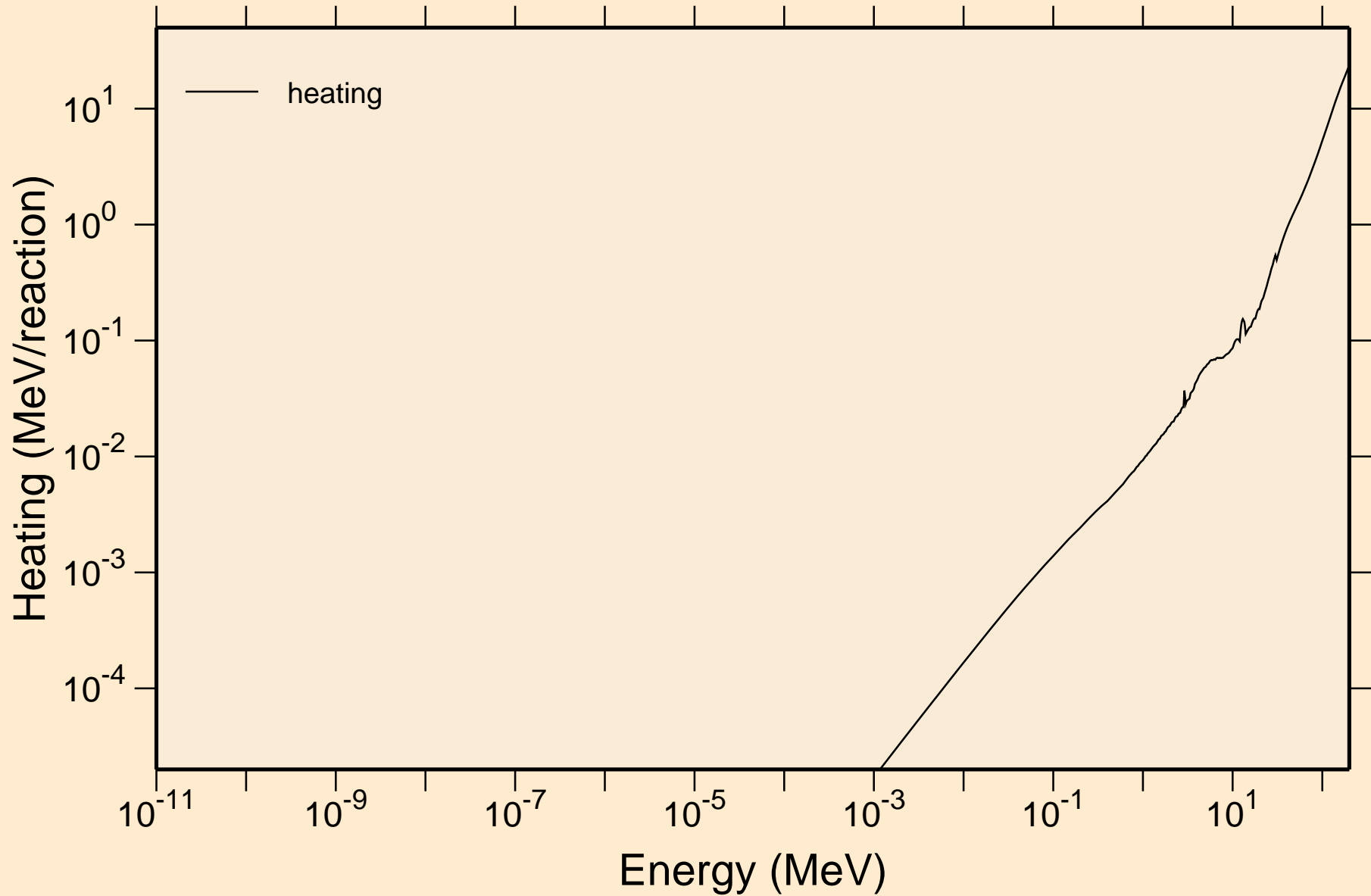

PD116 NEUTRON ACER TENDL-2024 LIBRARY; T=293.6K
Damage

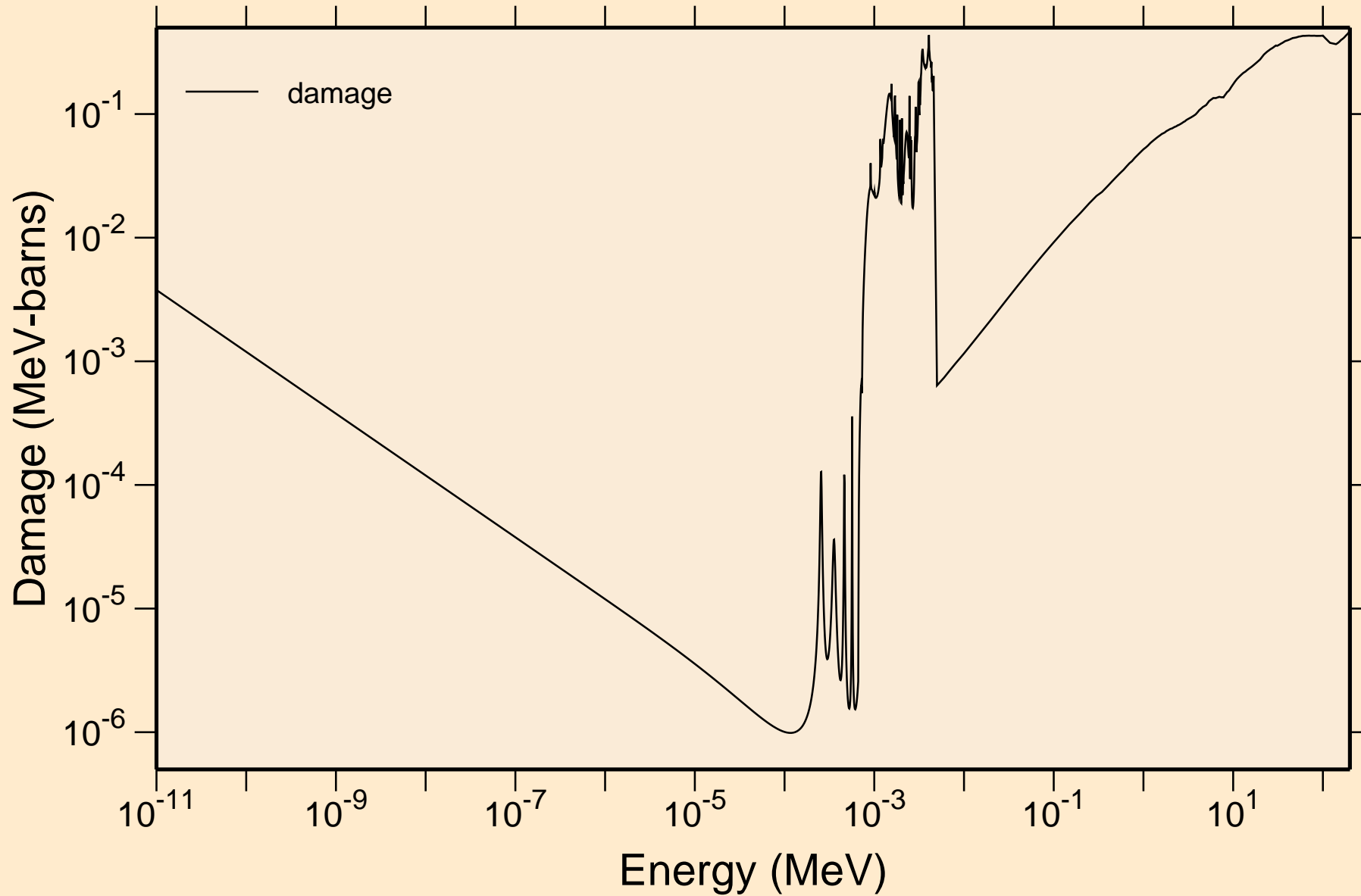

PD116 NEUTRON ACER TENDL-2024 LIBRARY; T=293.6K
Non-threshold reactions

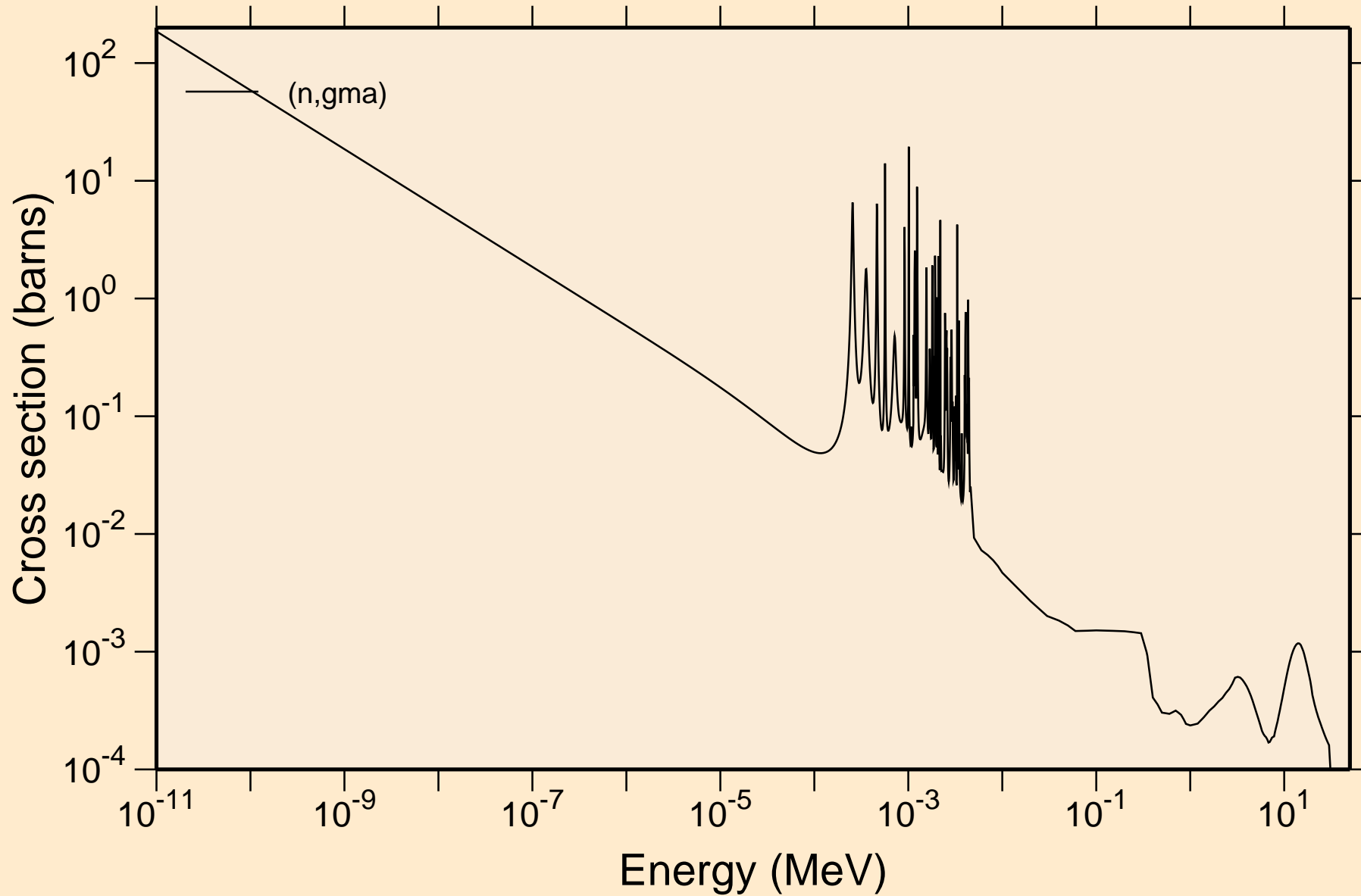

PD116 NEUTRON ACER TENDL-2024 LIBRARY; T=293.6K
Principal cross sections

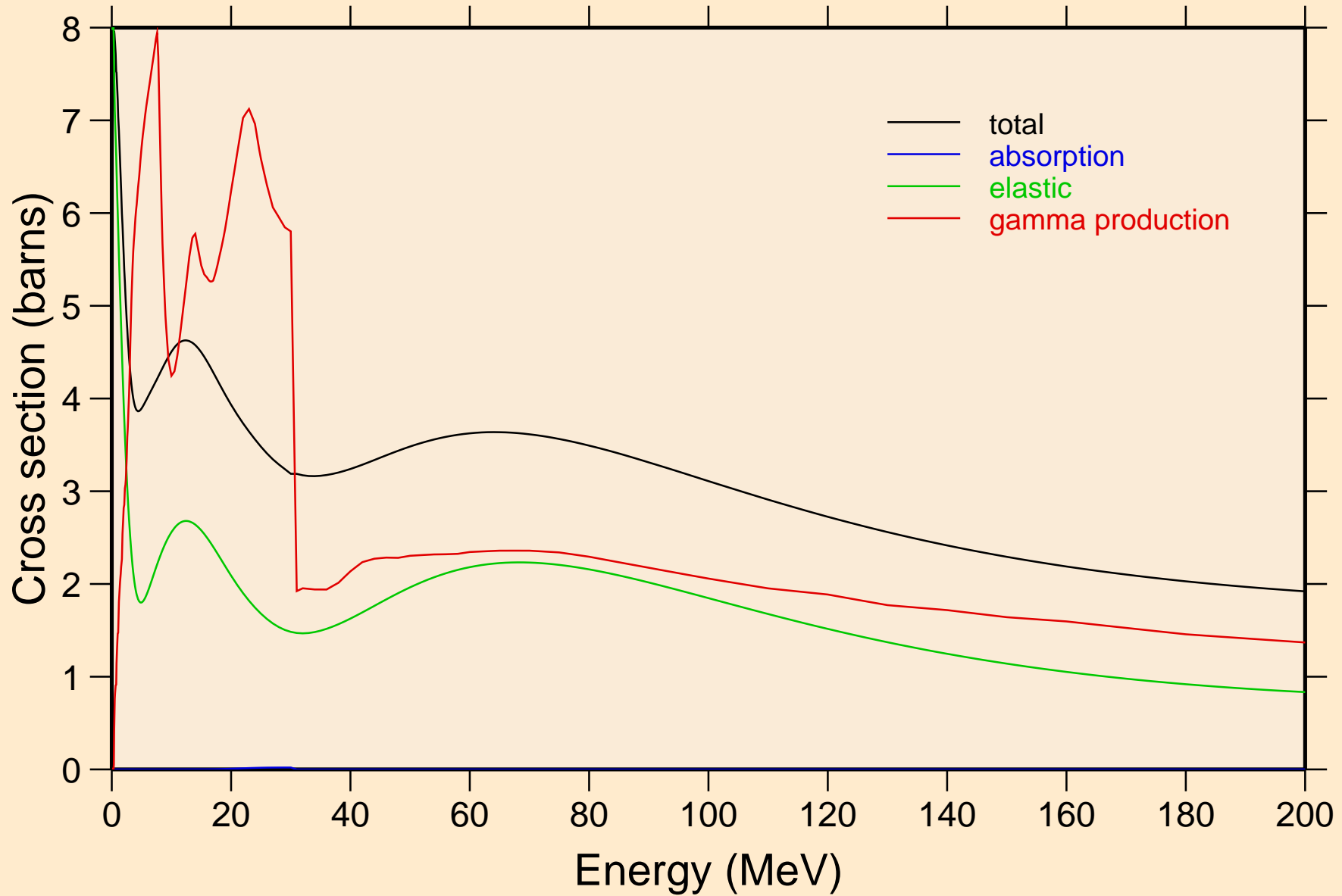

PD116 NEUTRON ACER TENDL-2024 LIBRARY; T=293.6K
Heating

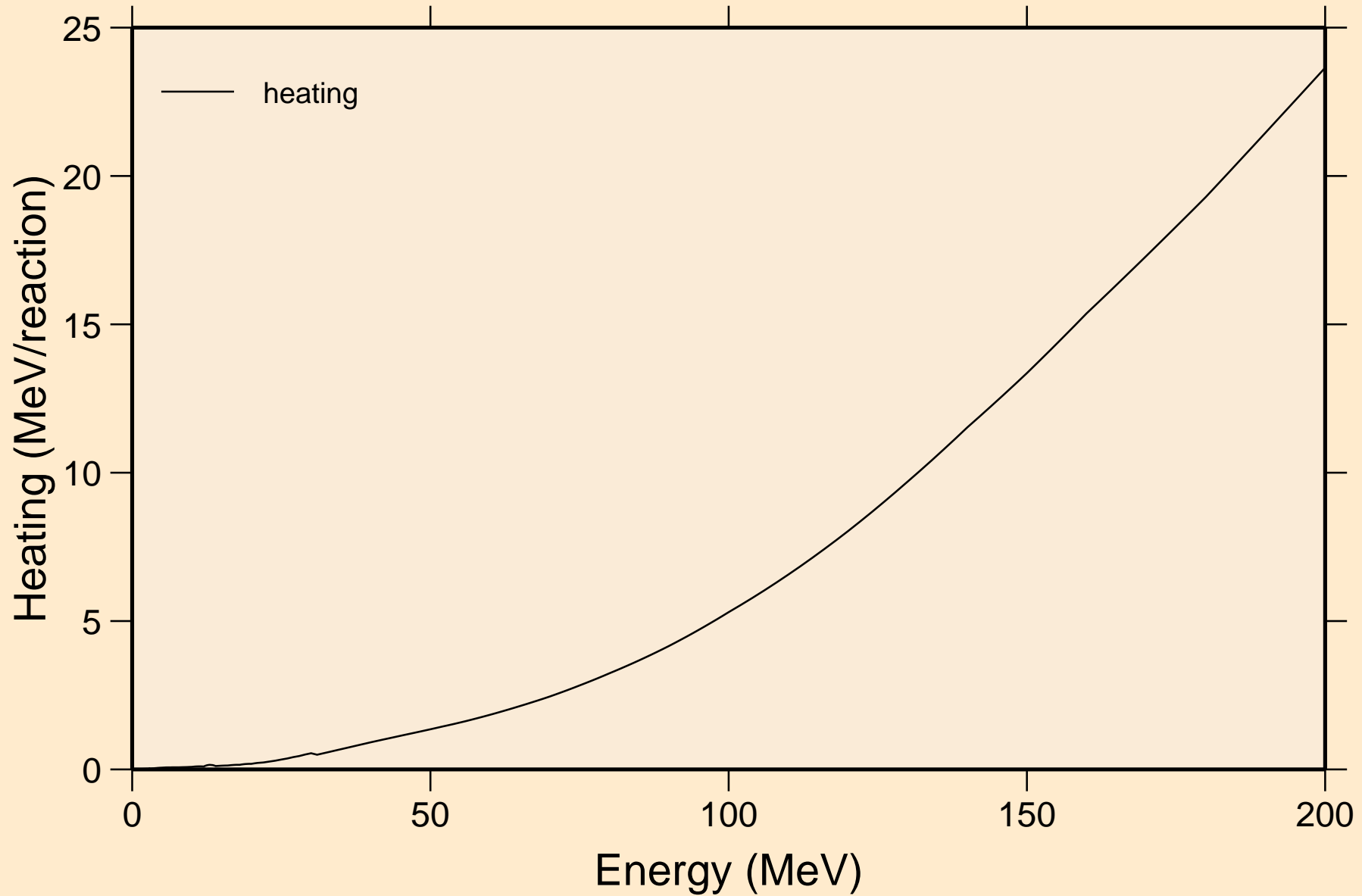

PD116 NEUTRON ACER TENDL-2024 LIBRARY; T=293.6K
Damage

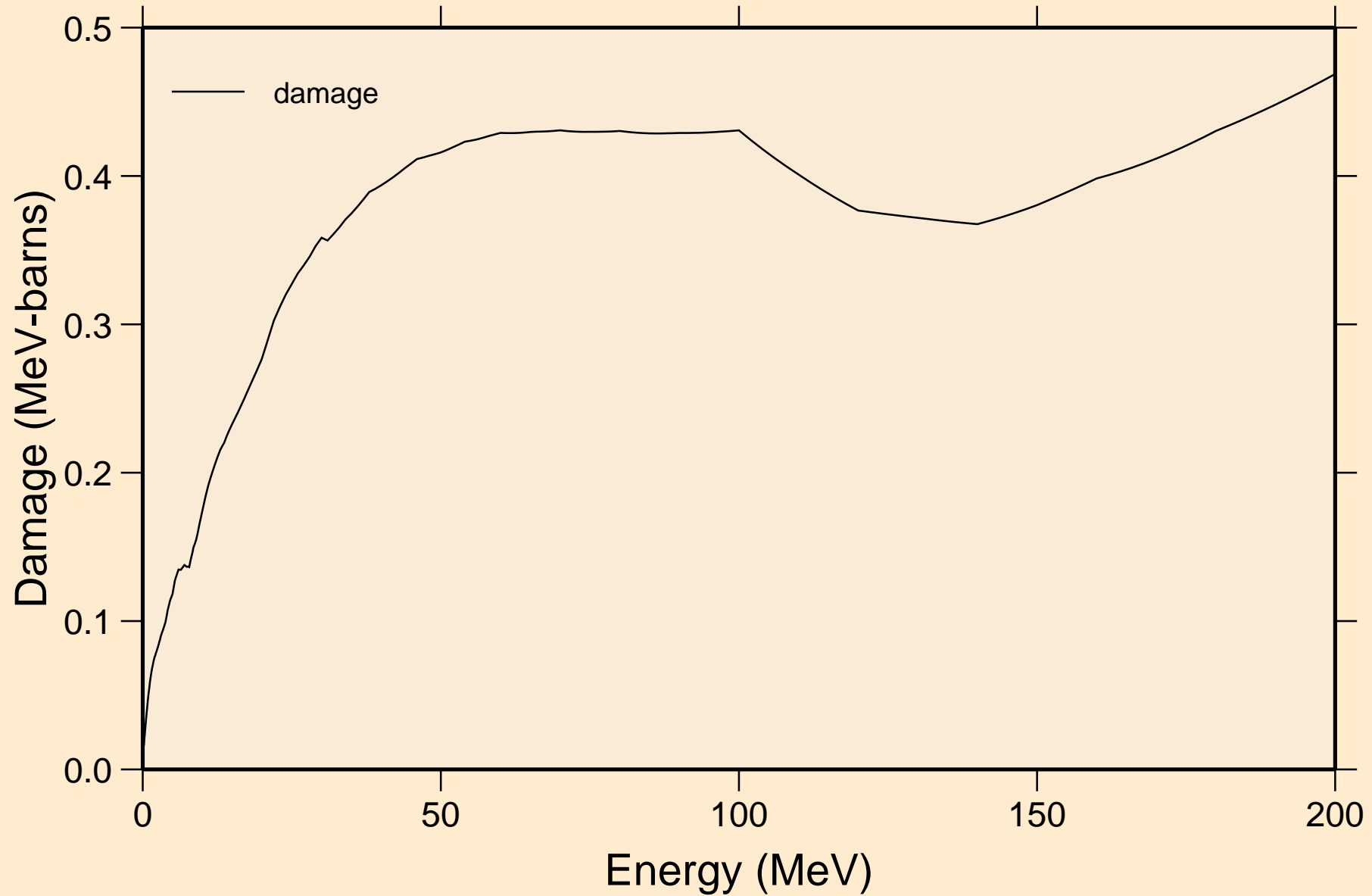

PD116 NEUTRON ACER TENDL-2024 LIBRARY; T=293.6K
Non-threshold reactions

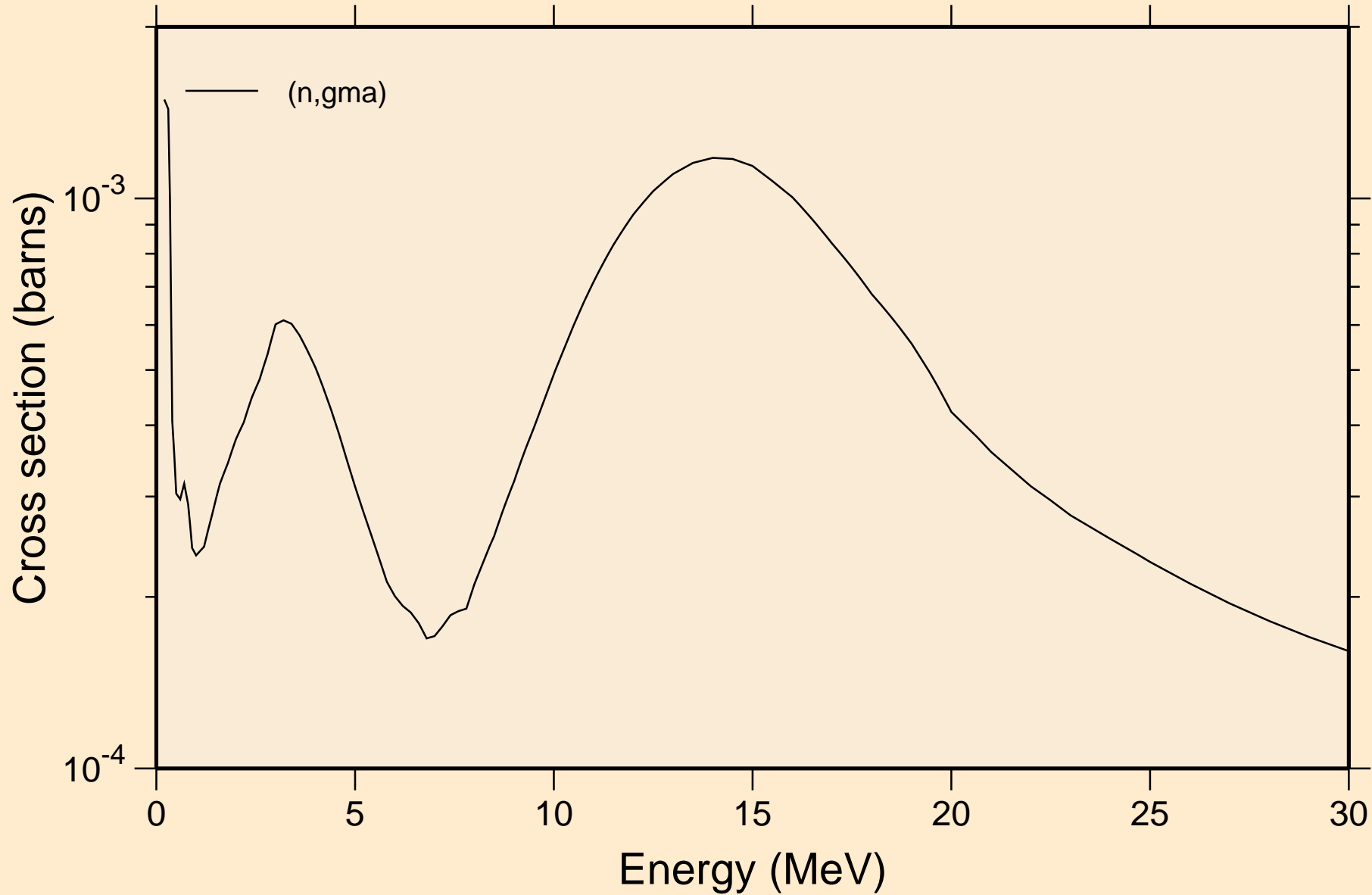

PD116 NEUTRON ACER TENDL-2024 LIBRARY; T=293.6K
Inelastic levels

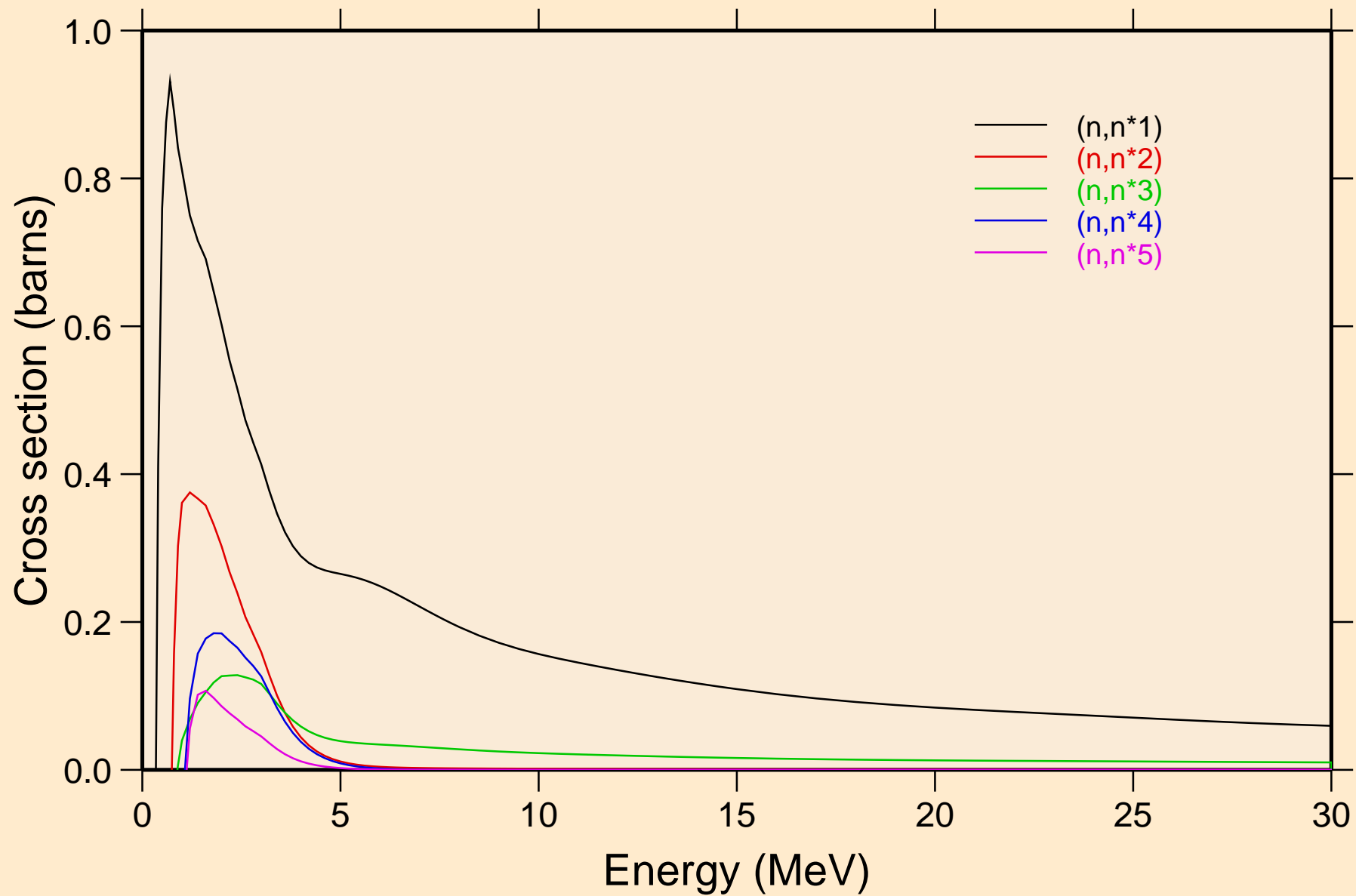

PD116 NEUTRON ACER TENDL-2024 LIBRARY; T=293.6K
Inelastic levels

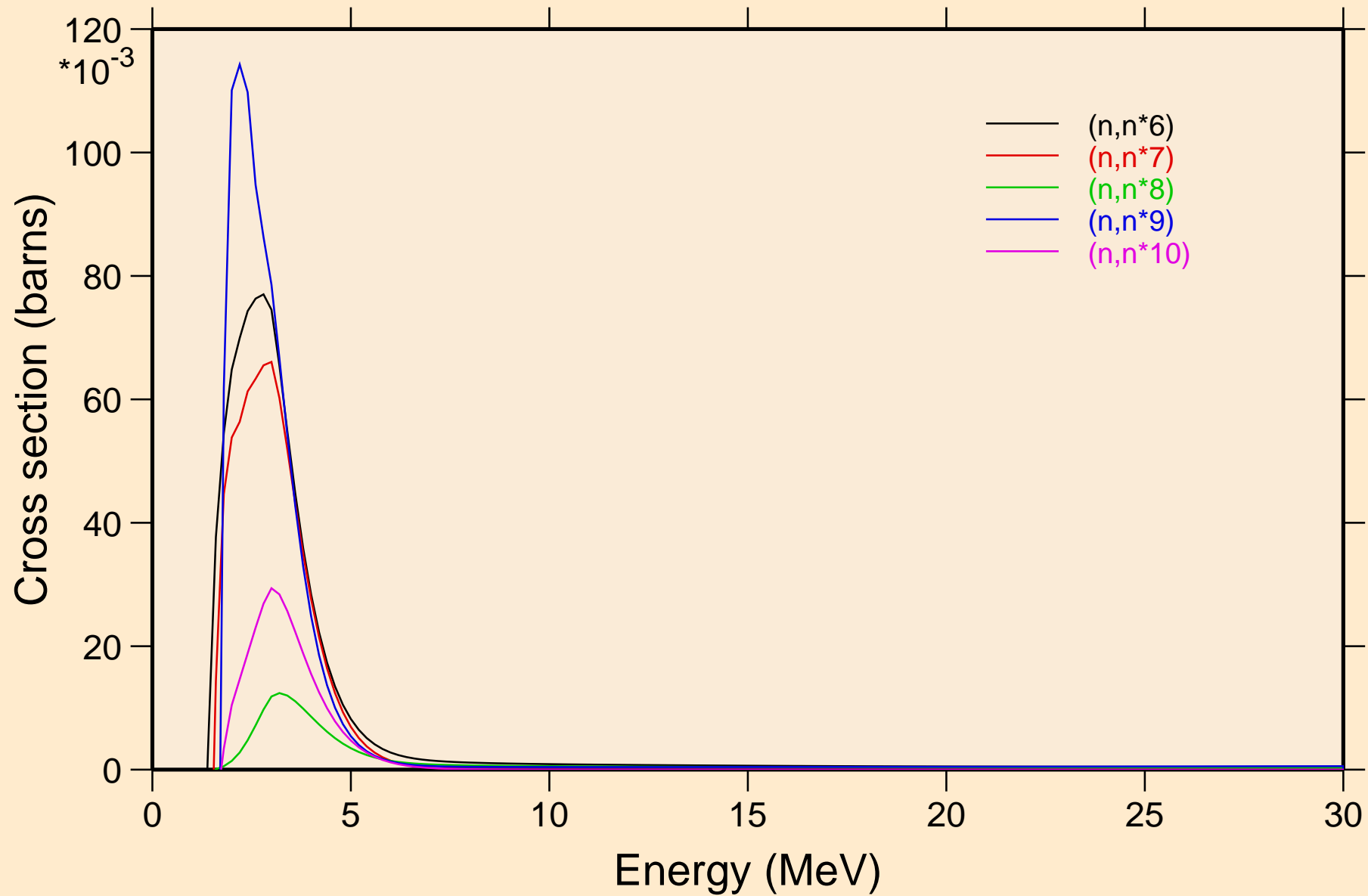

PD116 NEUTRON ACER TENDL-2024 LIBRARY; T=293.6K
Inelastic levels

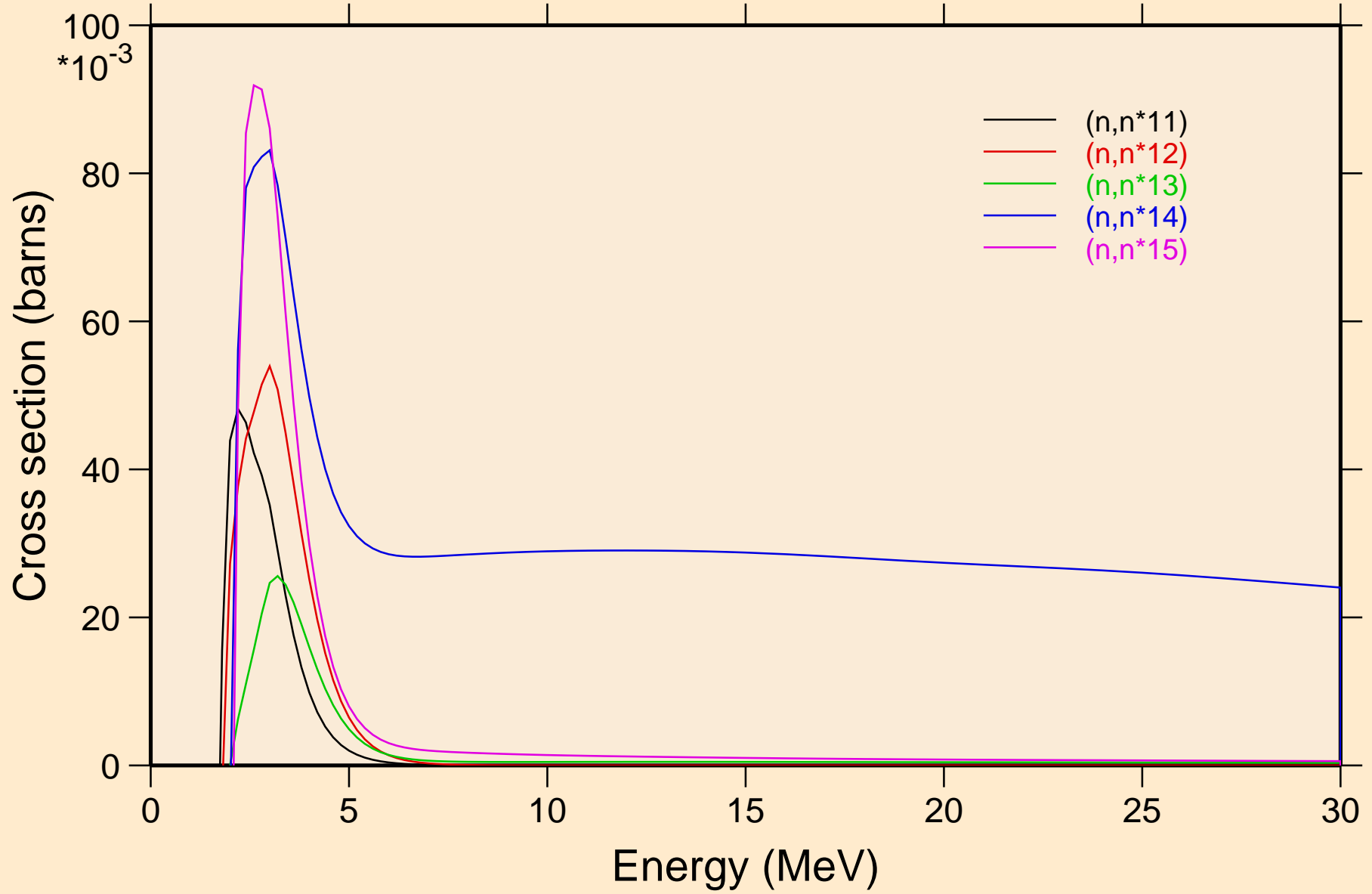

PD116 NEUTRON ACER TENDL-2024 LIBRARY; T=293.6K
Inelastic levels

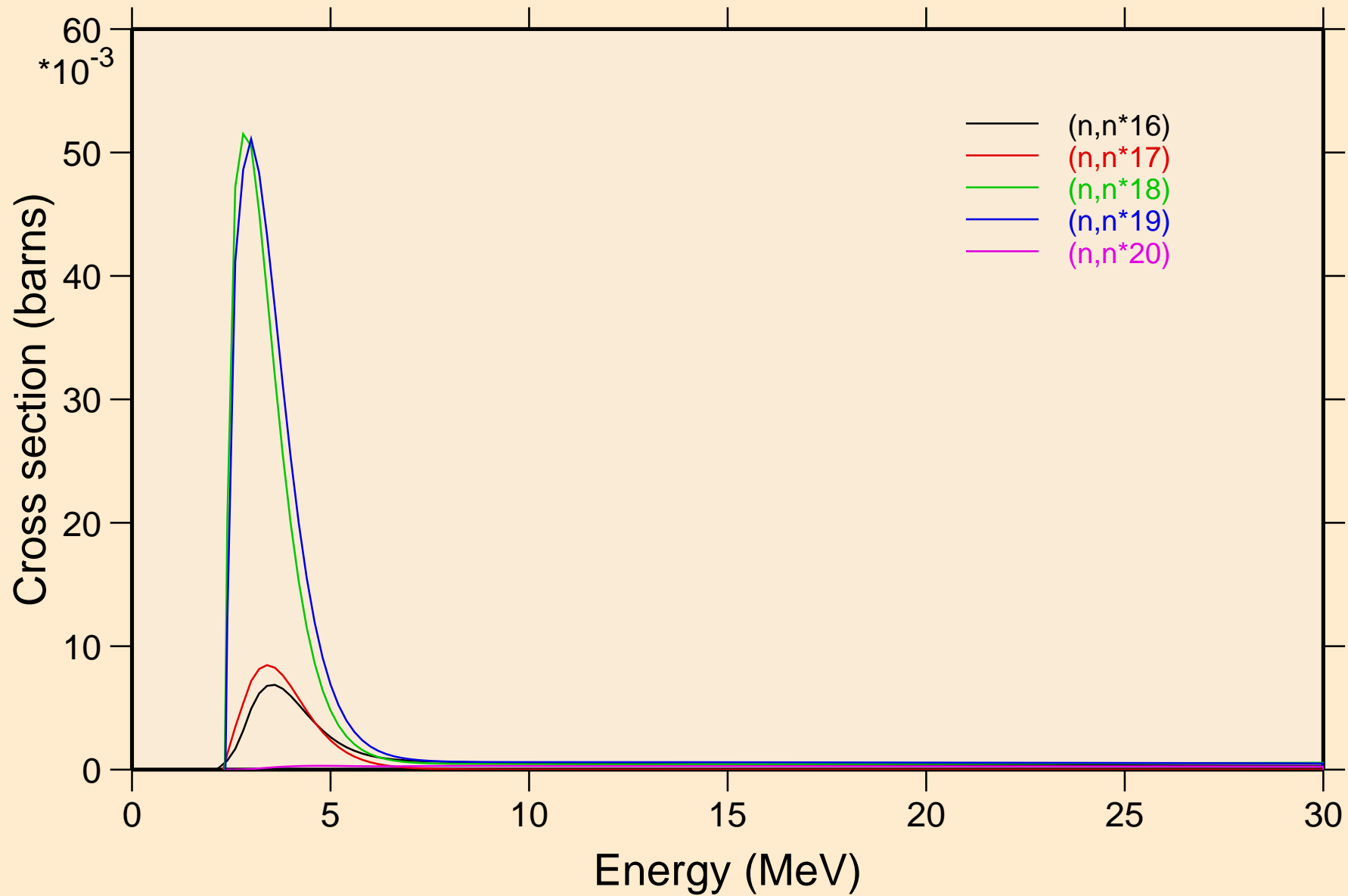

PD116 NEUTRON ACER TENDL-2024 LIBRARY; T=293.6K
Inelastic levels

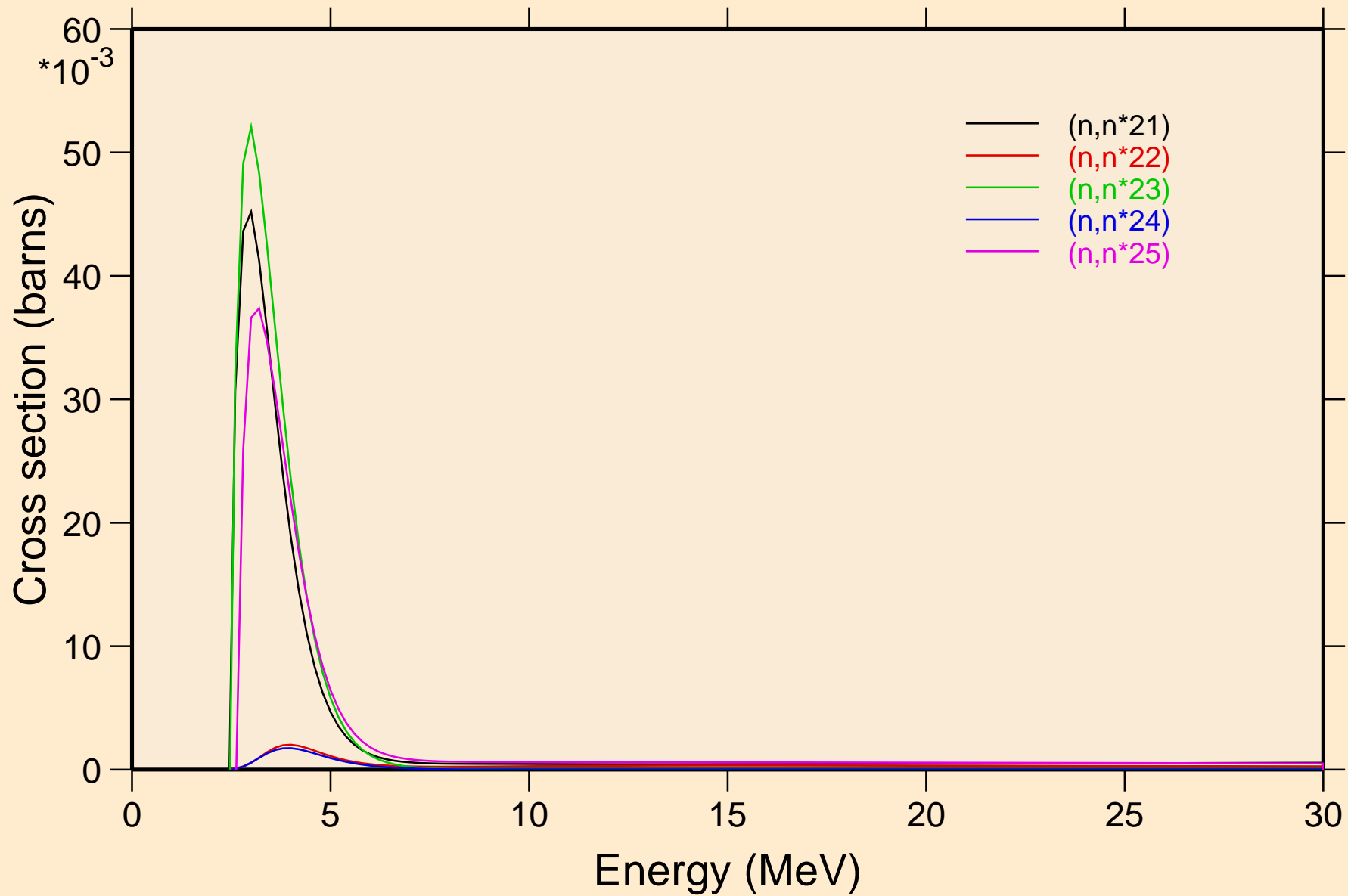

PD116 NEUTRON ACER TENDL-2024 LIBRARY; T=293.6K
Inelastic levels

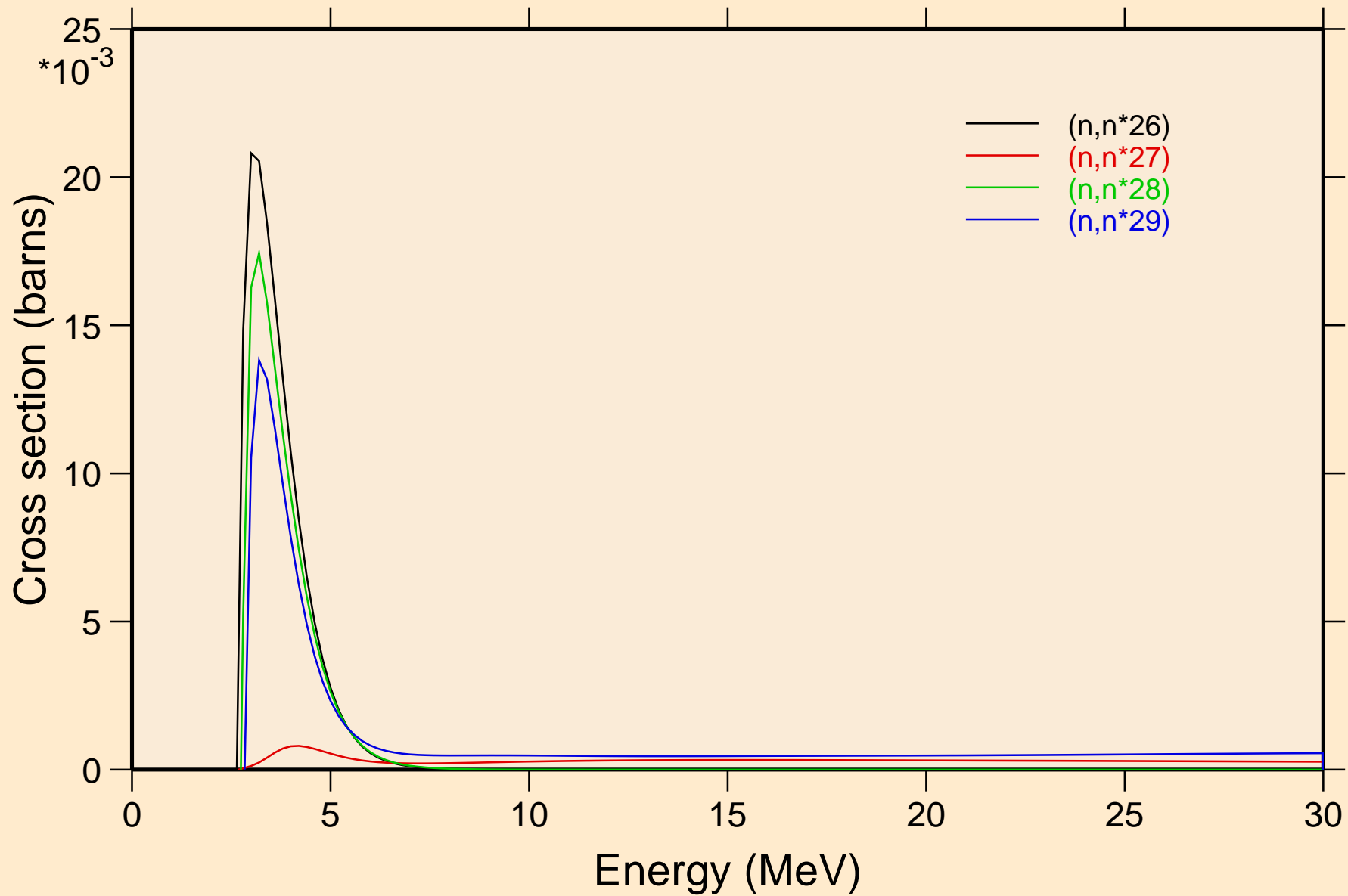

PD116 NEUTRON ACER TENDL-2024 LIBRARY; T=293.6K
Threshold reactions

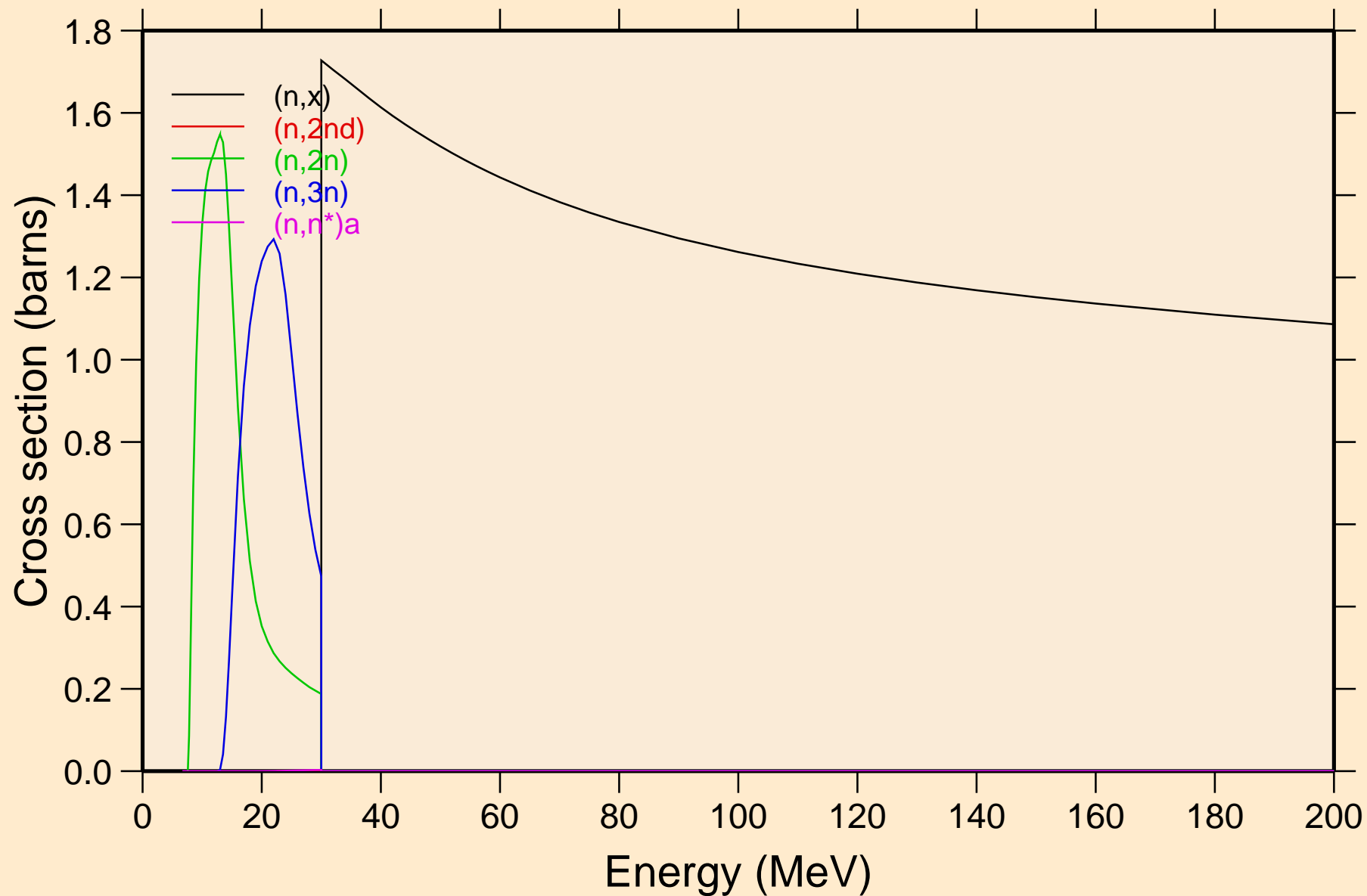

PD116 NEUTRON ACER TENDL-2024 LIBRARY; T=293.6K
Threshold reactions

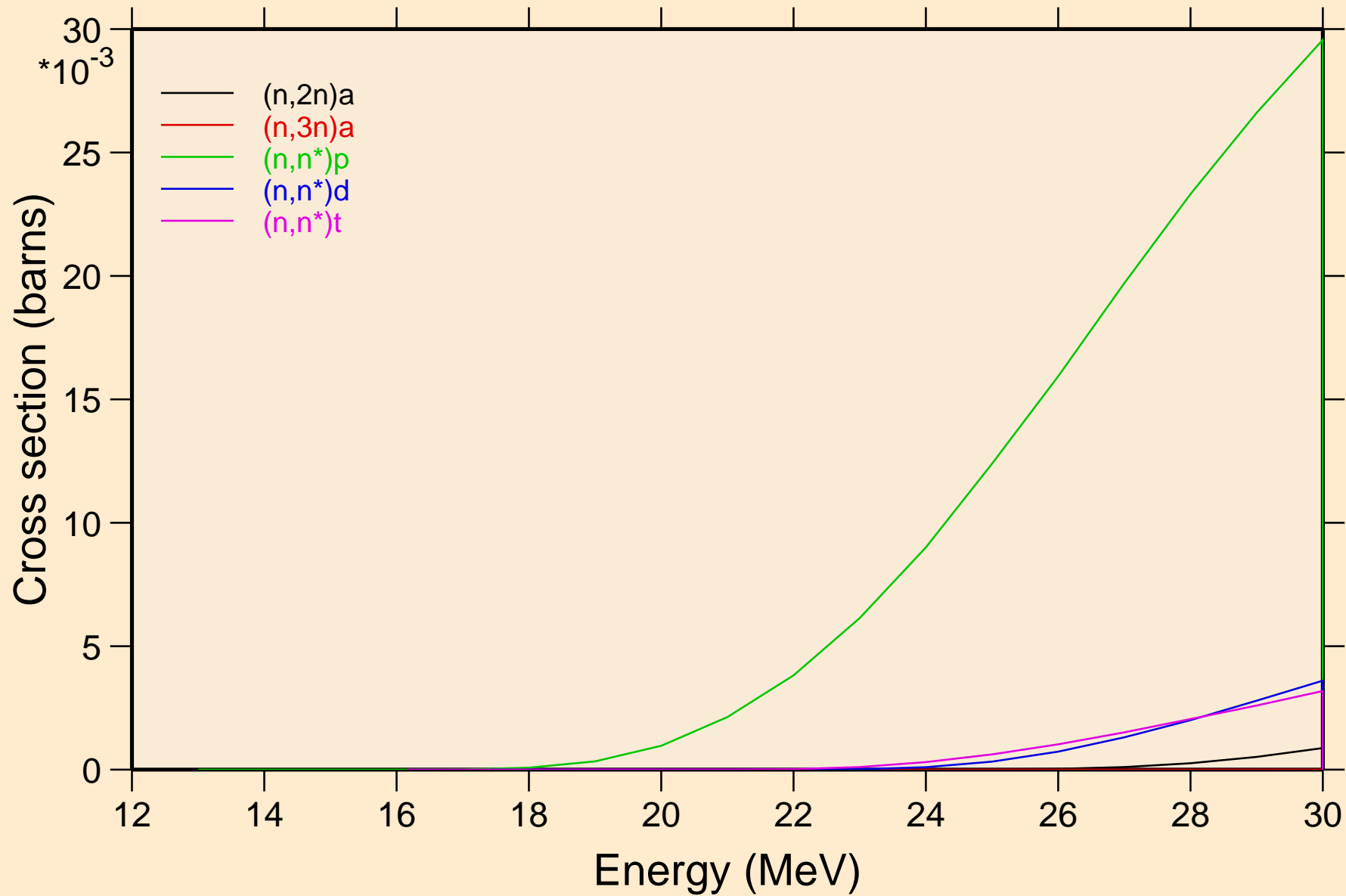

PD116 NEUTRON ACER TENDL-2024 LIBRARY; T=293.6K
Threshold reactions

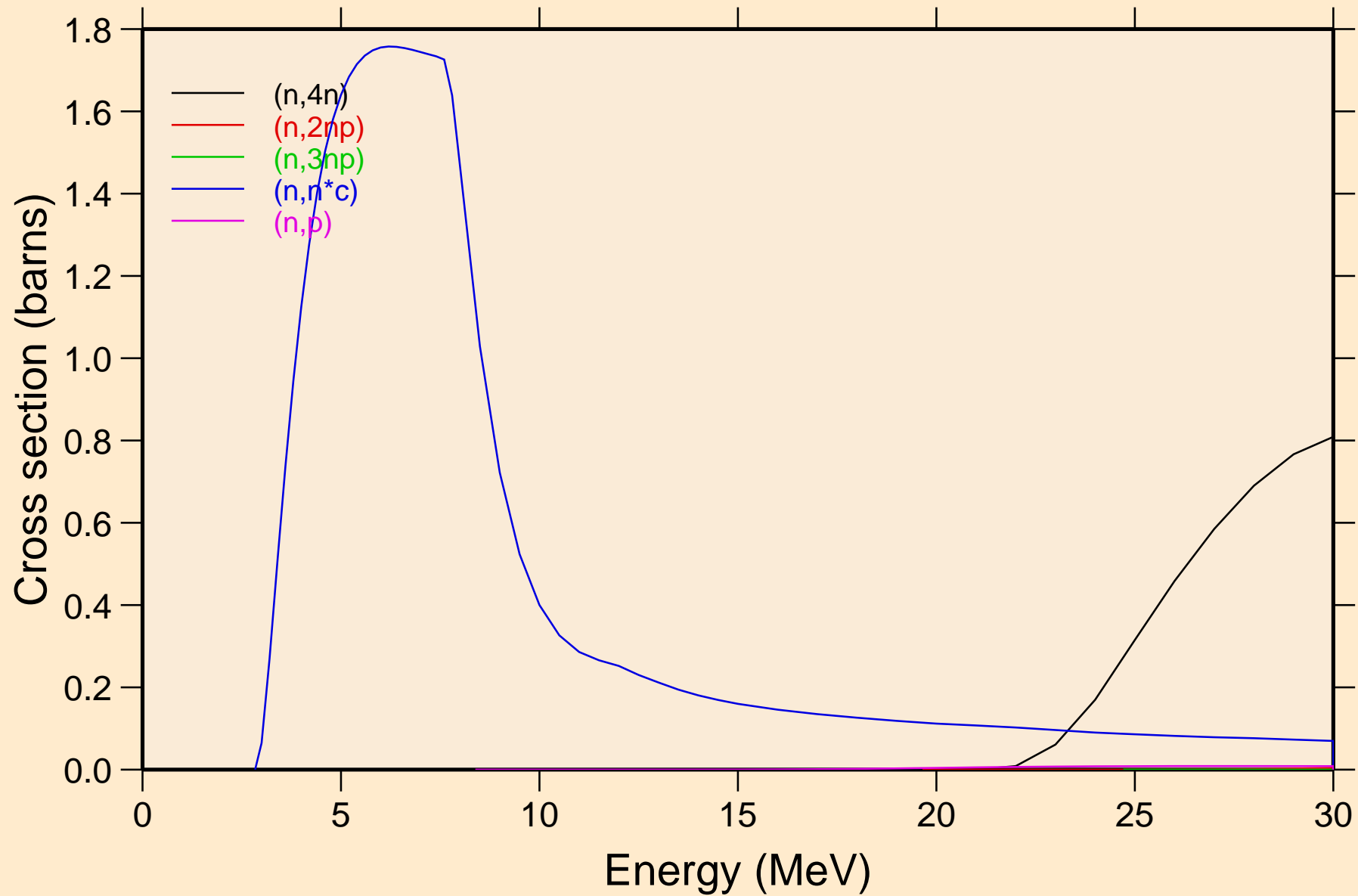

PD116 NEUTRON ACER TENDL-2024 LIBRARY; T=293.6K
Threshold reactions

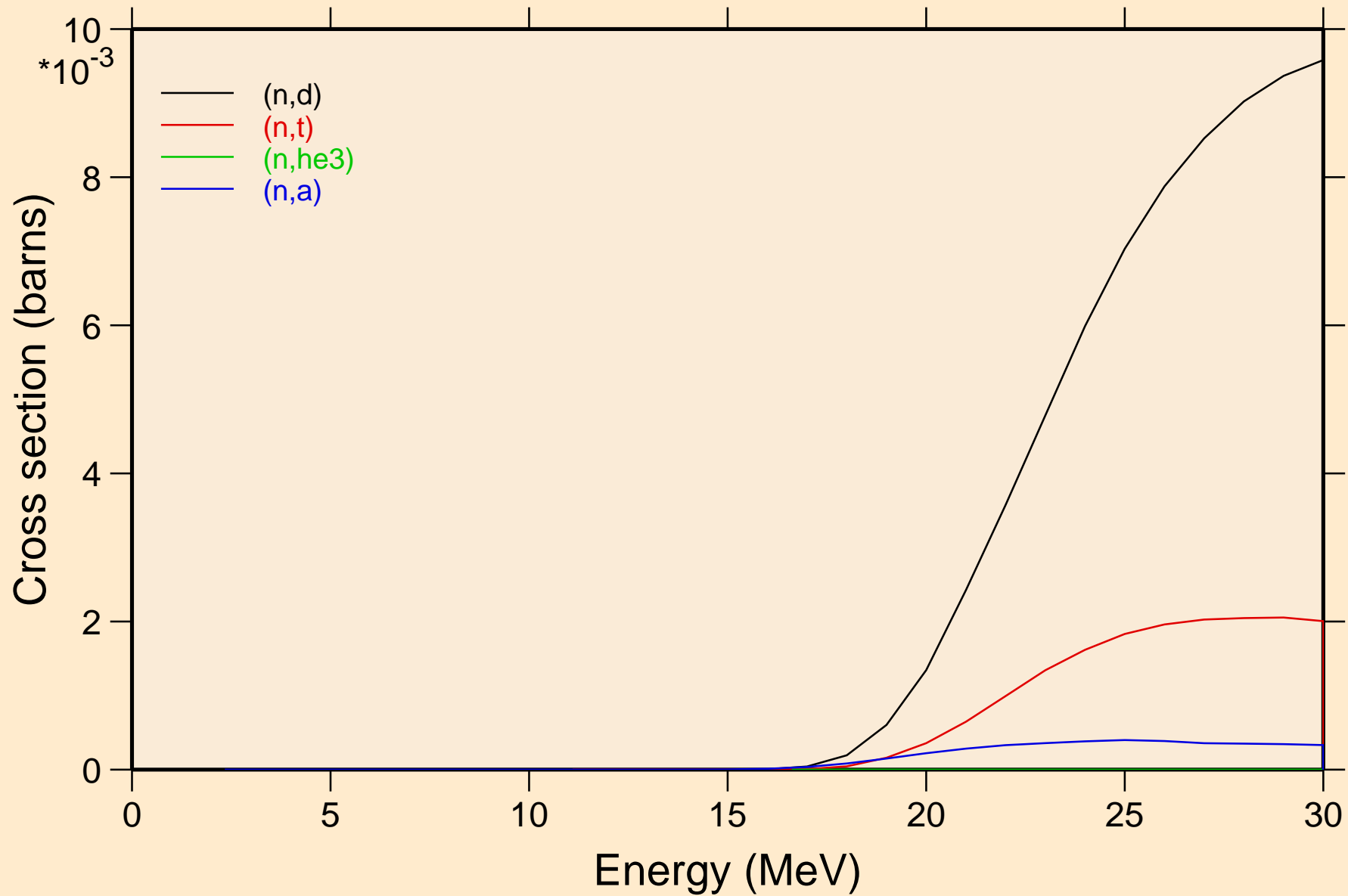

PD116 NEUTRON ACER TENDL-2024 LIBRARY; T=293.6K
Threshold reactions

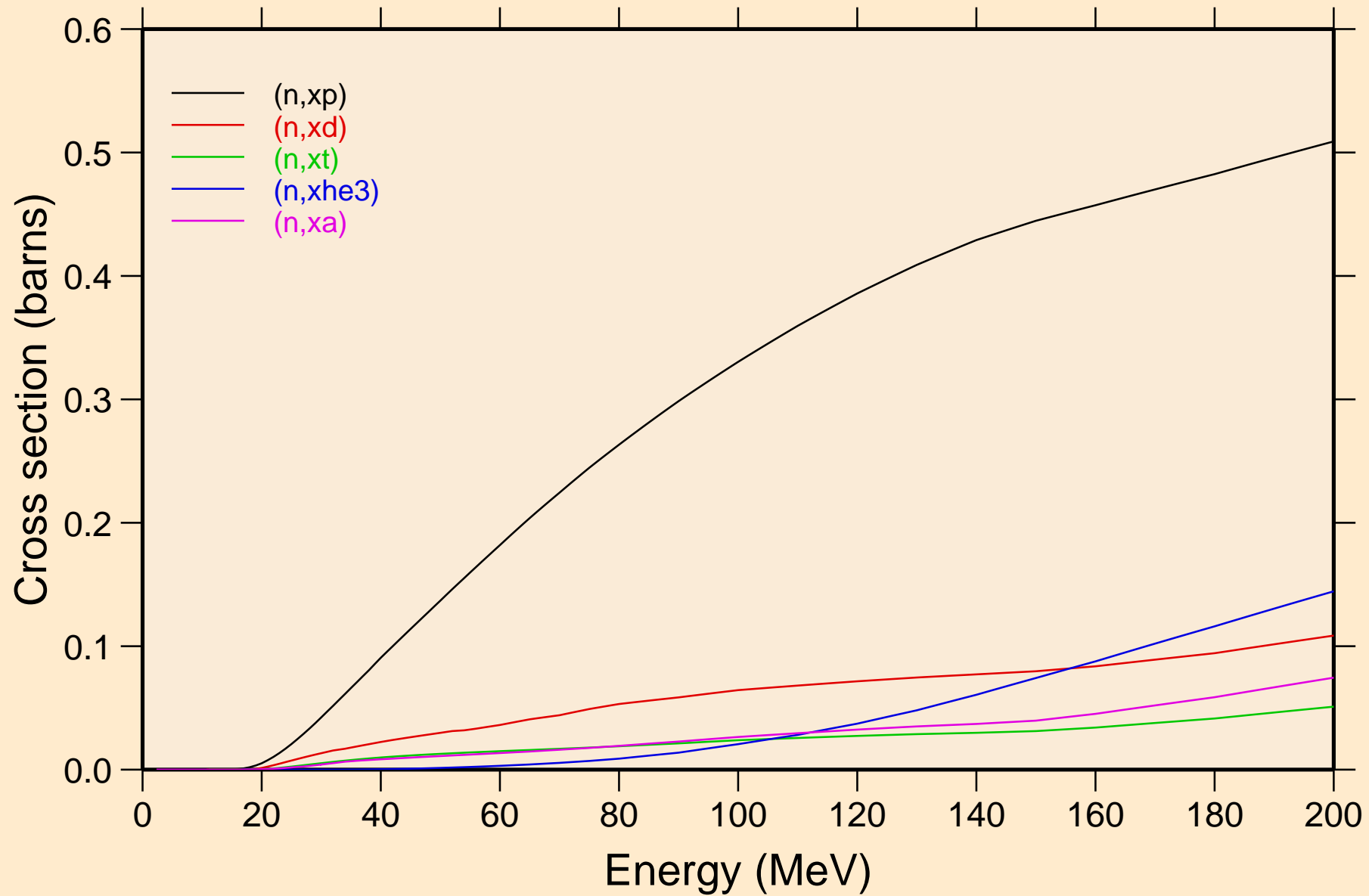

PD116 NEUTRON ACER TENDL-2024 LIBRARY; T=293.6K
angular distribution for elastic

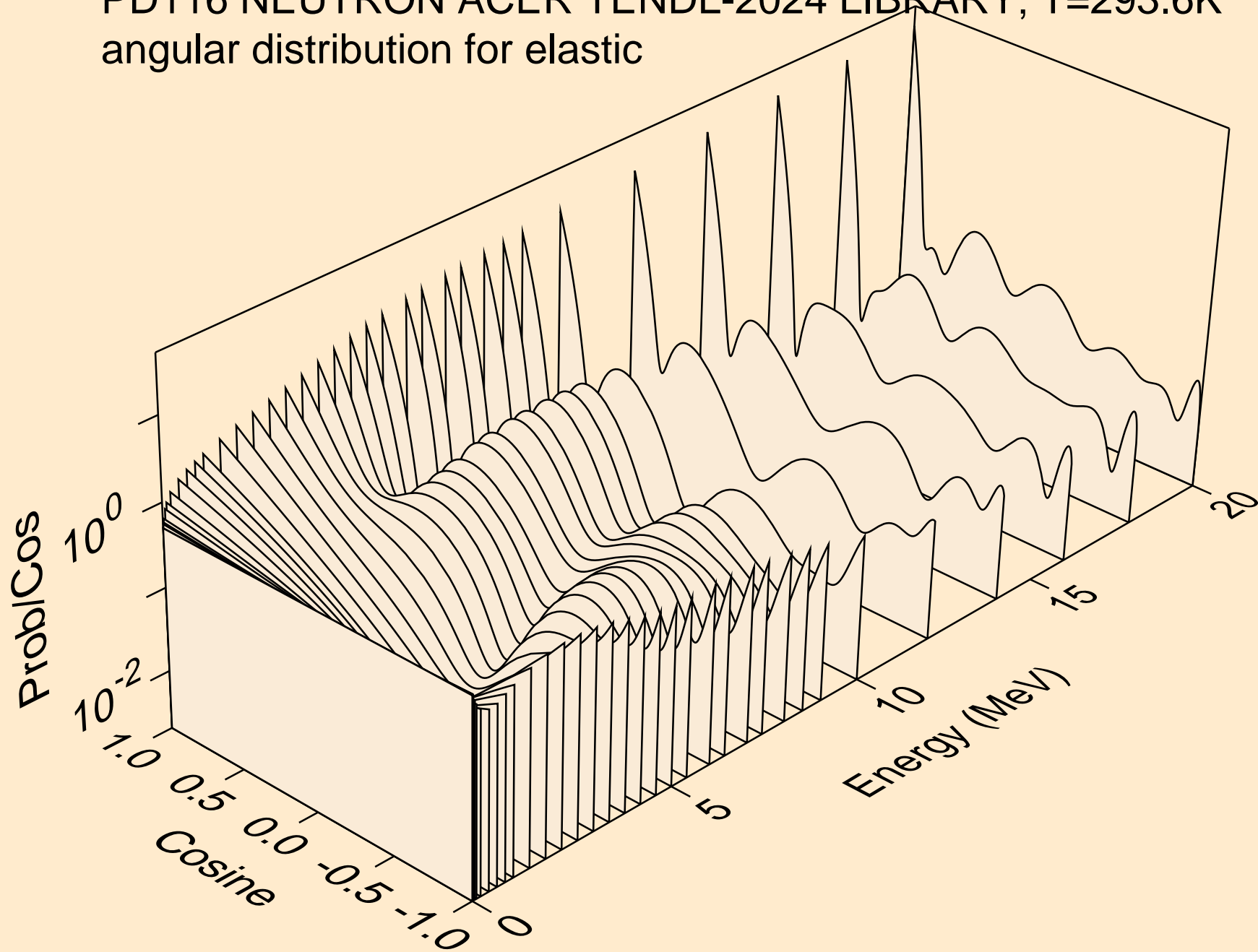

PD116 NEUTRON ACER TENDL-2024 LIBRARY; T=293.6K
angular distribution for elastic

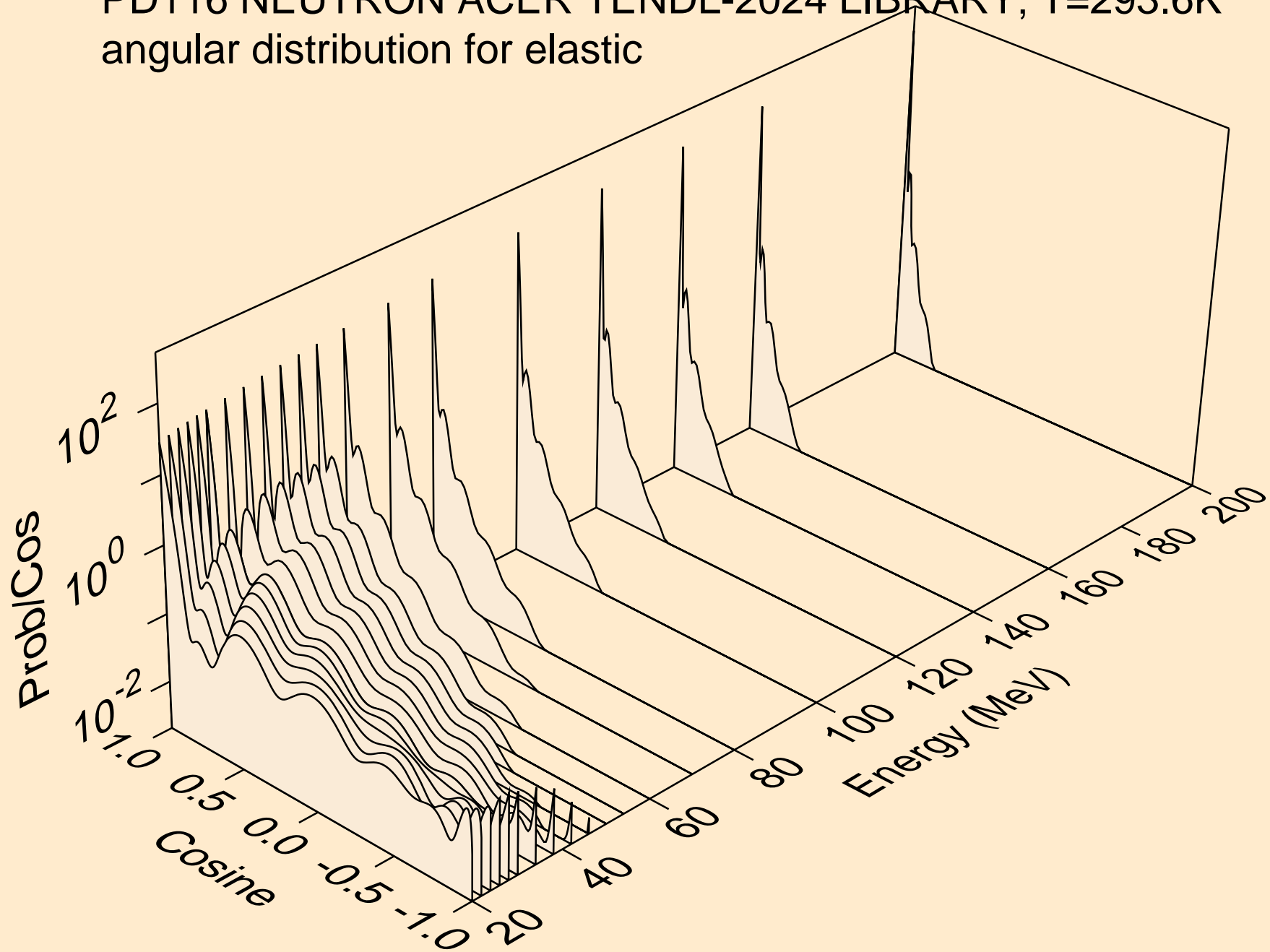

PD116 NEUTRON ACER TENDL-2024 LIBRARY; T=293.6K
angular distribution for (n,n*1)

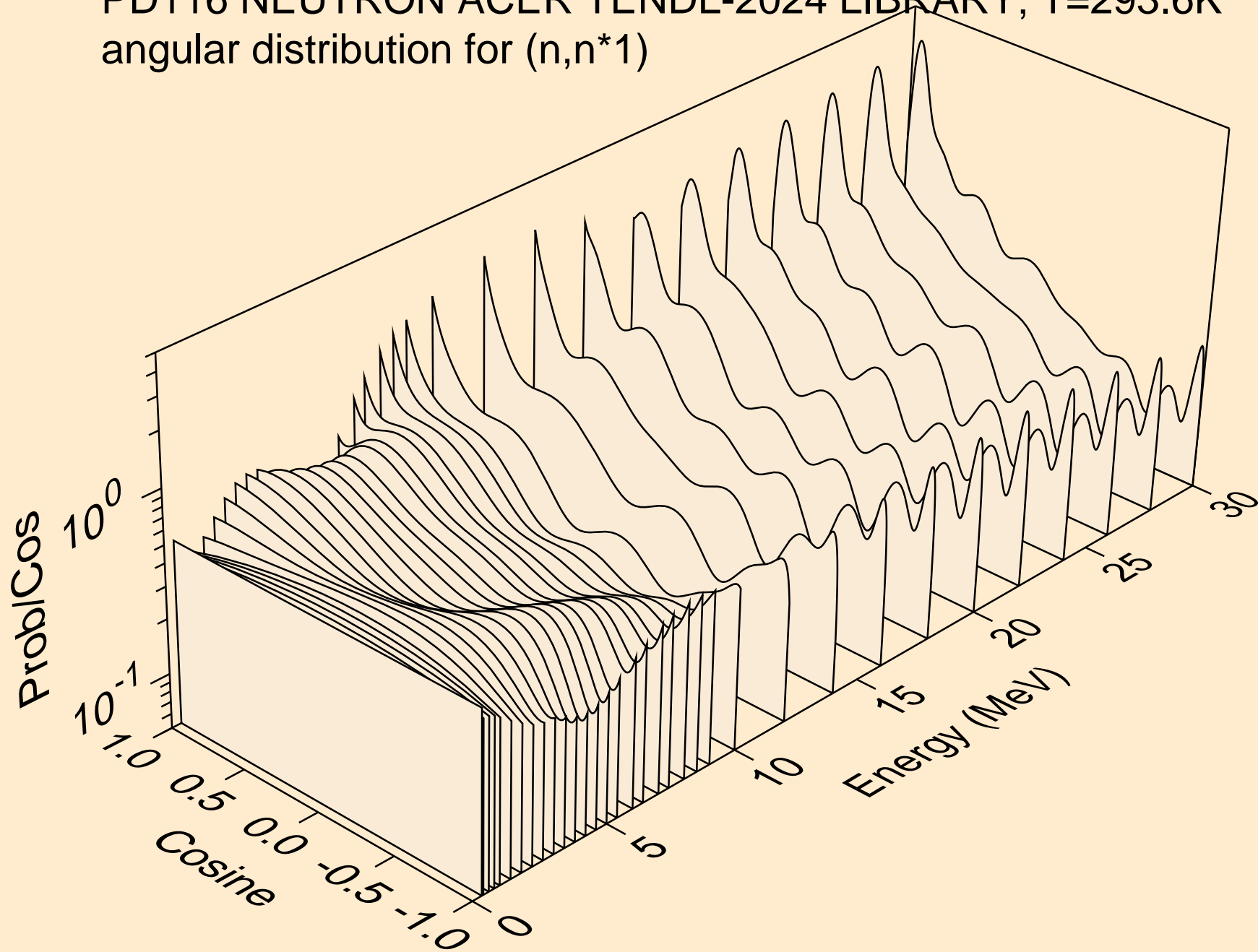

PD116 NEUTRON ACER TENDL-2024 LIBRARY; T=293.6K
angular distribution for (n,n*2)

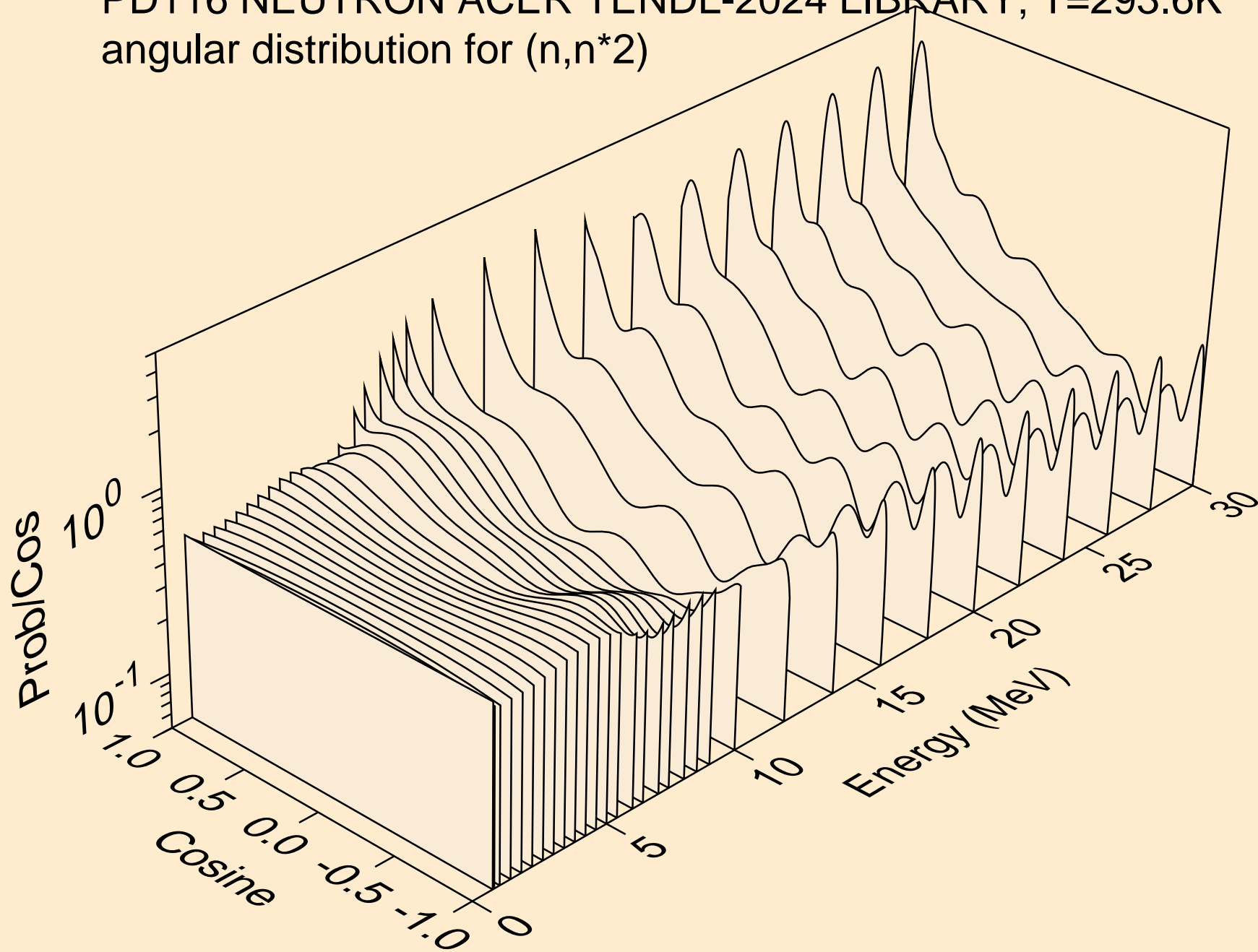

PD116 NEUTRON ACER TENDL-2024 LIBRARY; T=293.6K
angular distribution for (n,n*3)

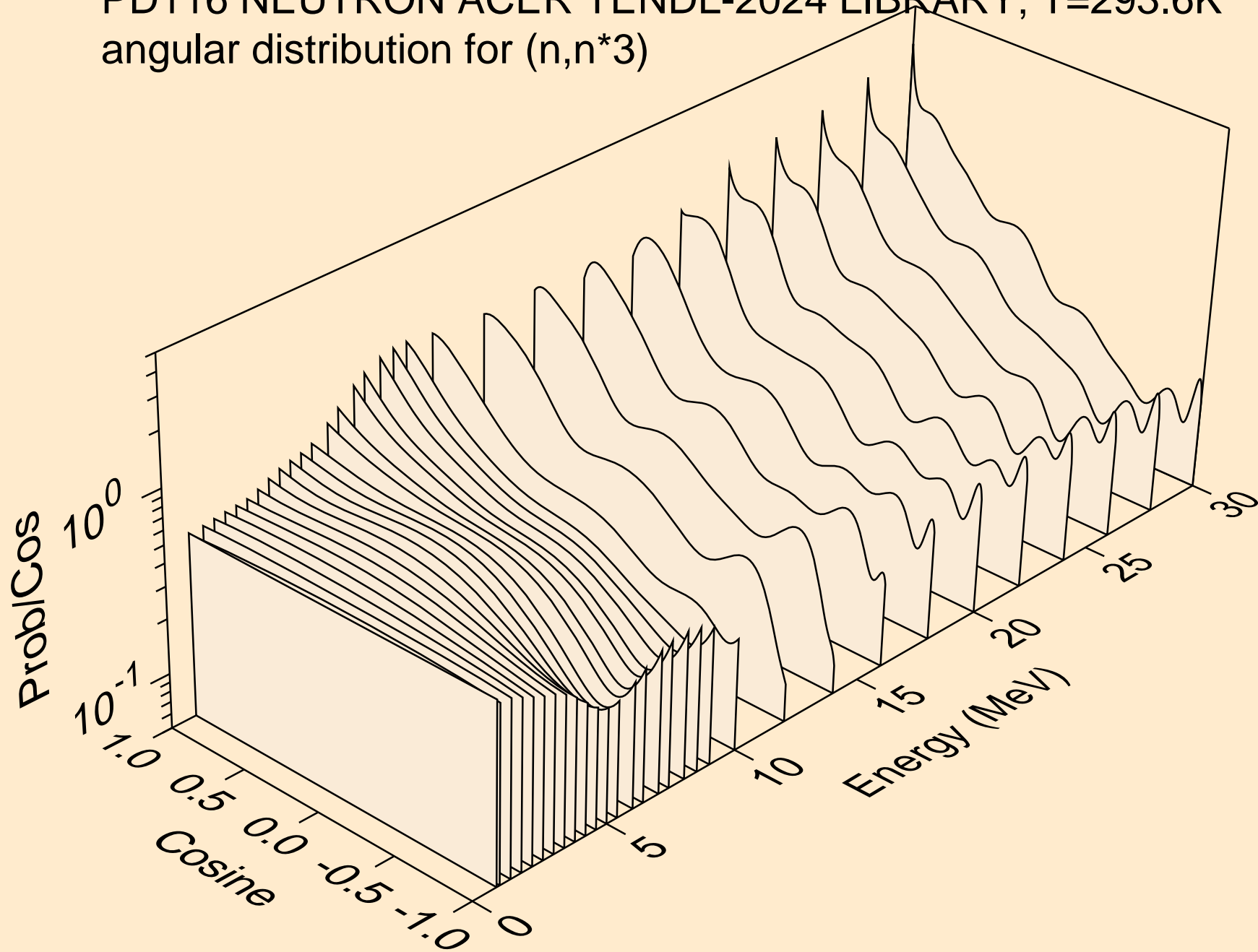

PD116 NEUTRON ACER TENDL-2024 LIBRARY; T=293.6K
angular distribution for (n,n*4)

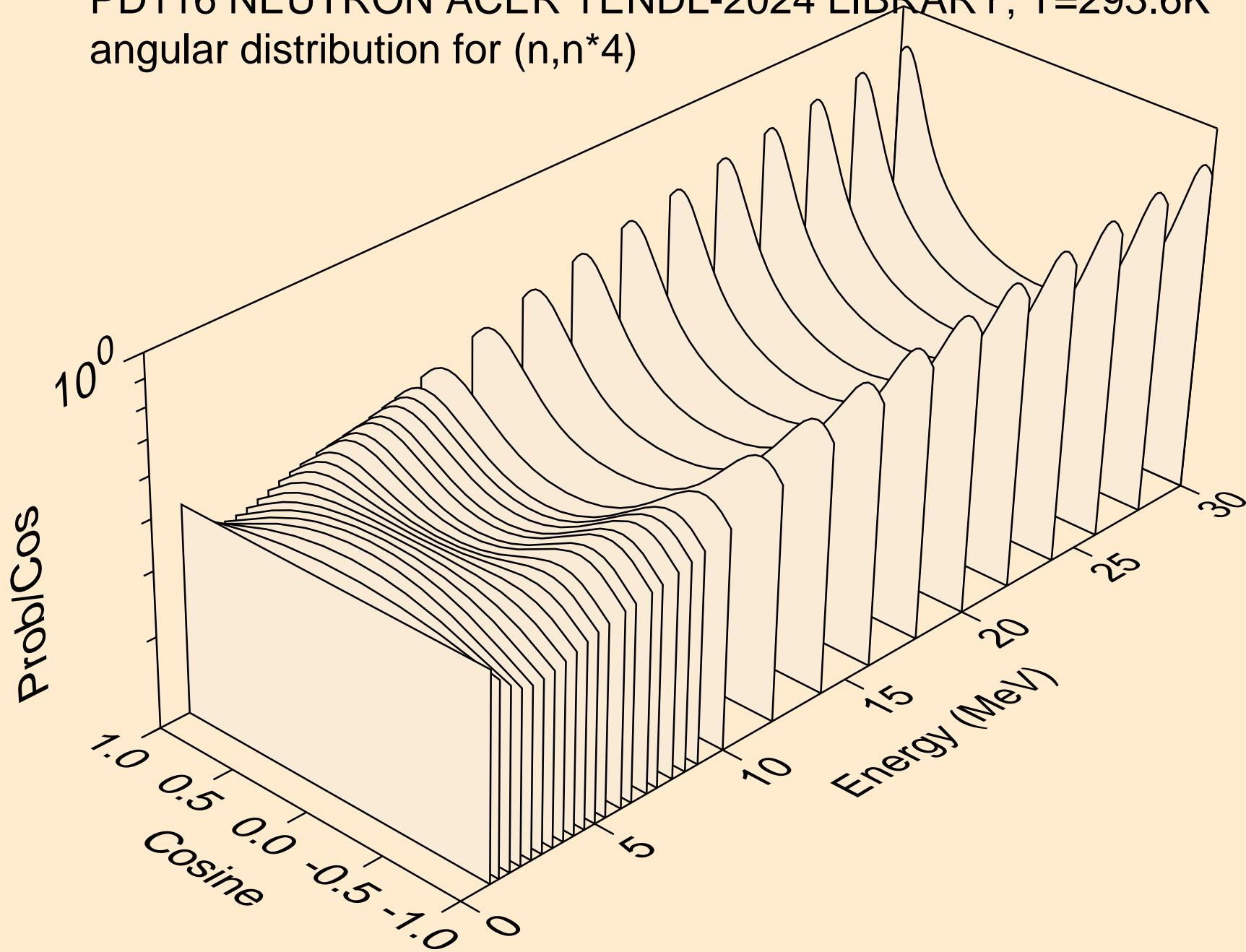

PD116 NEUTRON ACER TENDL-2024 LIBRARY; T=293.6K
angular distribution for (n,n*5)

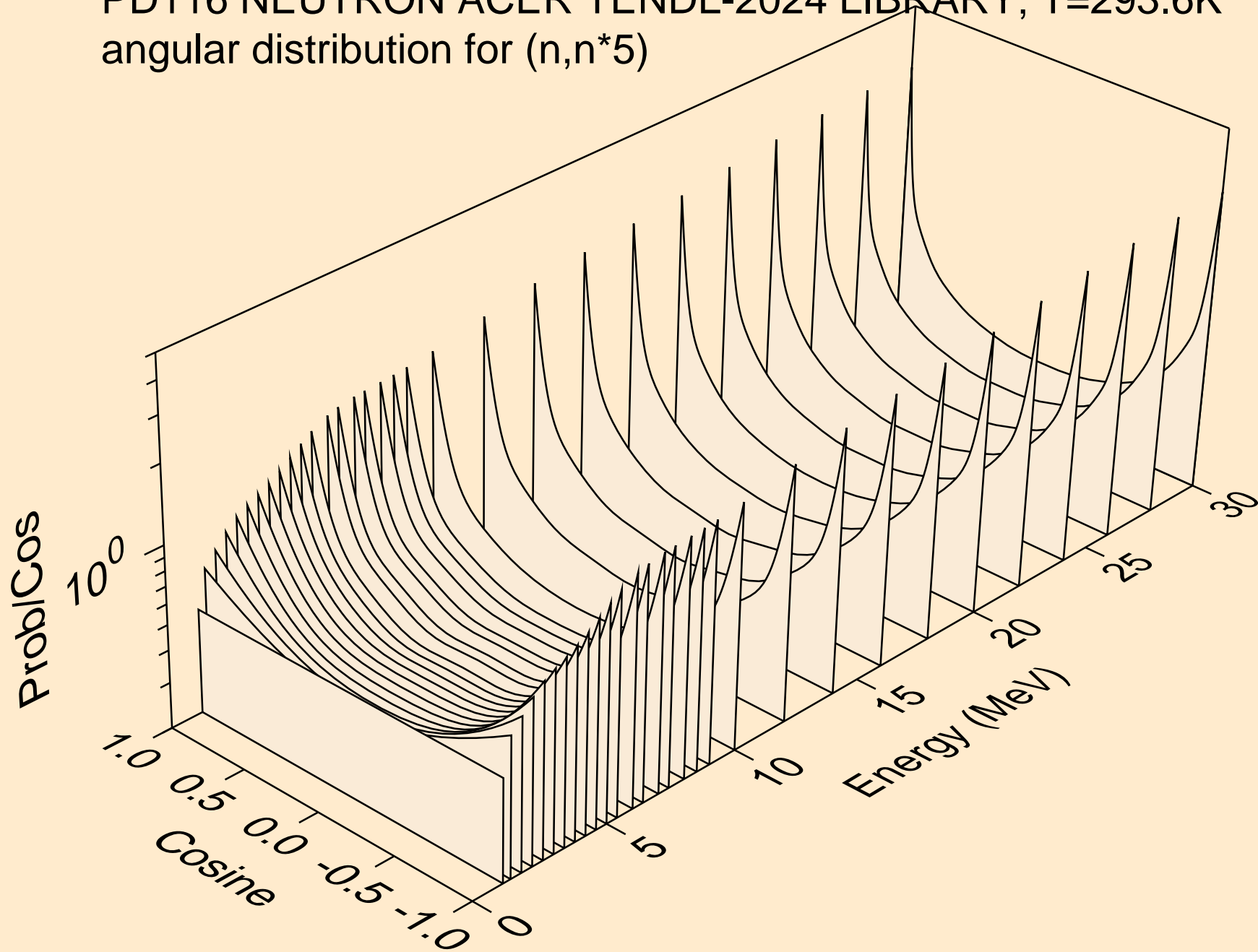

PD116 NEUTRON ACER TENDL-2024 LIBRARY; T=293.6K
angular distribution for (n,n*6)

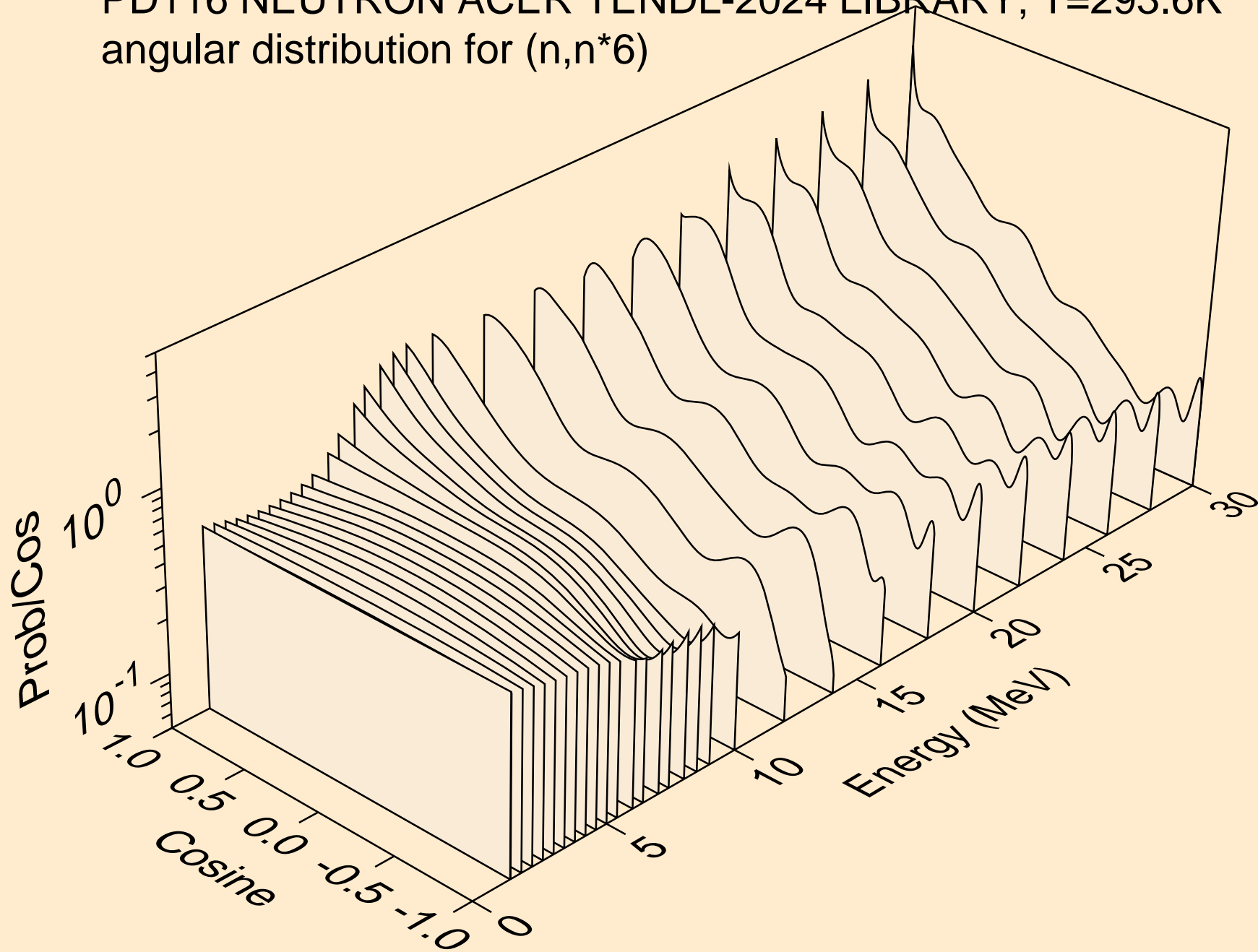

PD116 NEUTRON ACER TENDL-2024 LIBRARY; T=293.6K
angular distribution for (n,n*7)

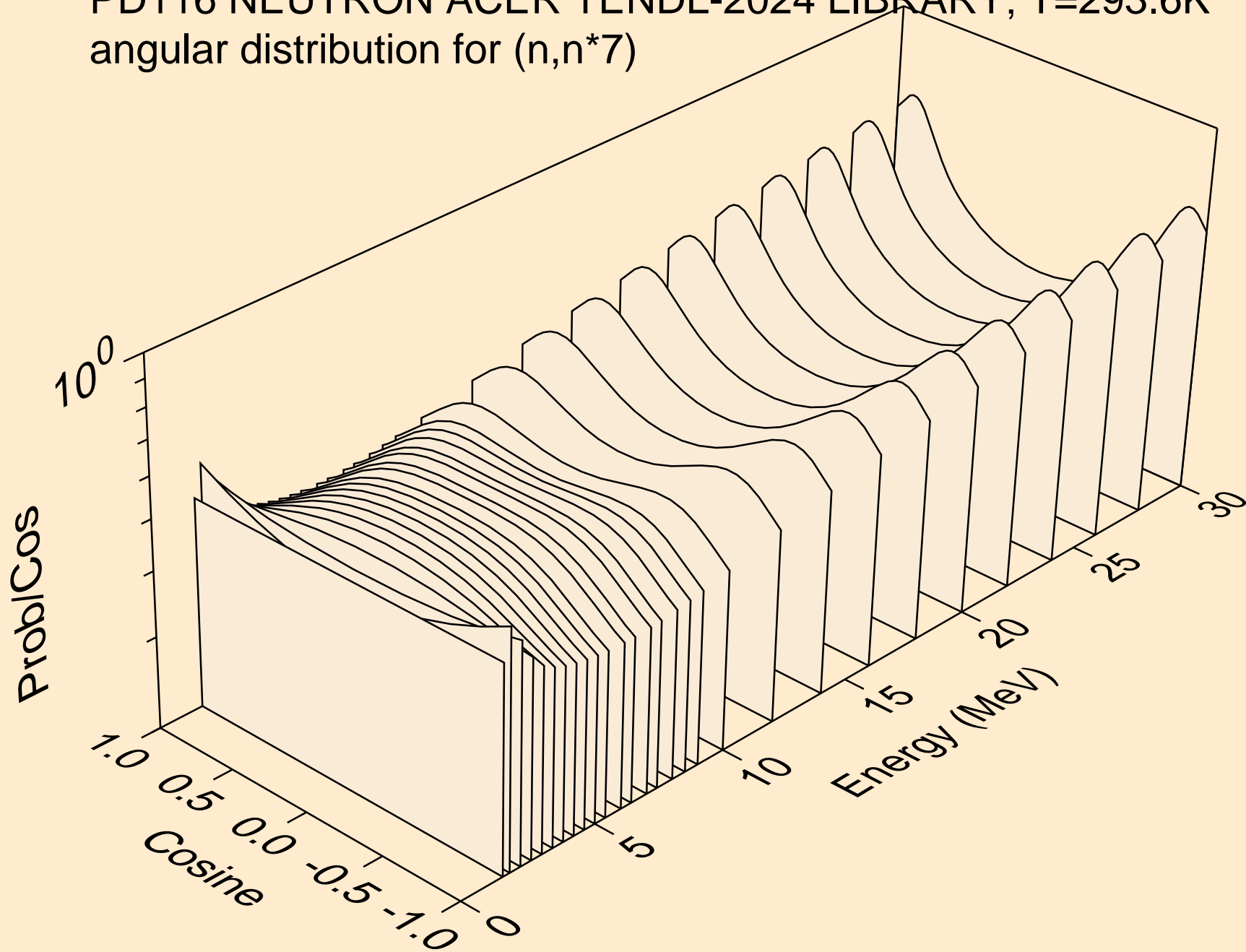

PD116 NEUTRON ACER TENDL-2024 LIBRARY; T=293.6K
angular distribution for (n,n*8)

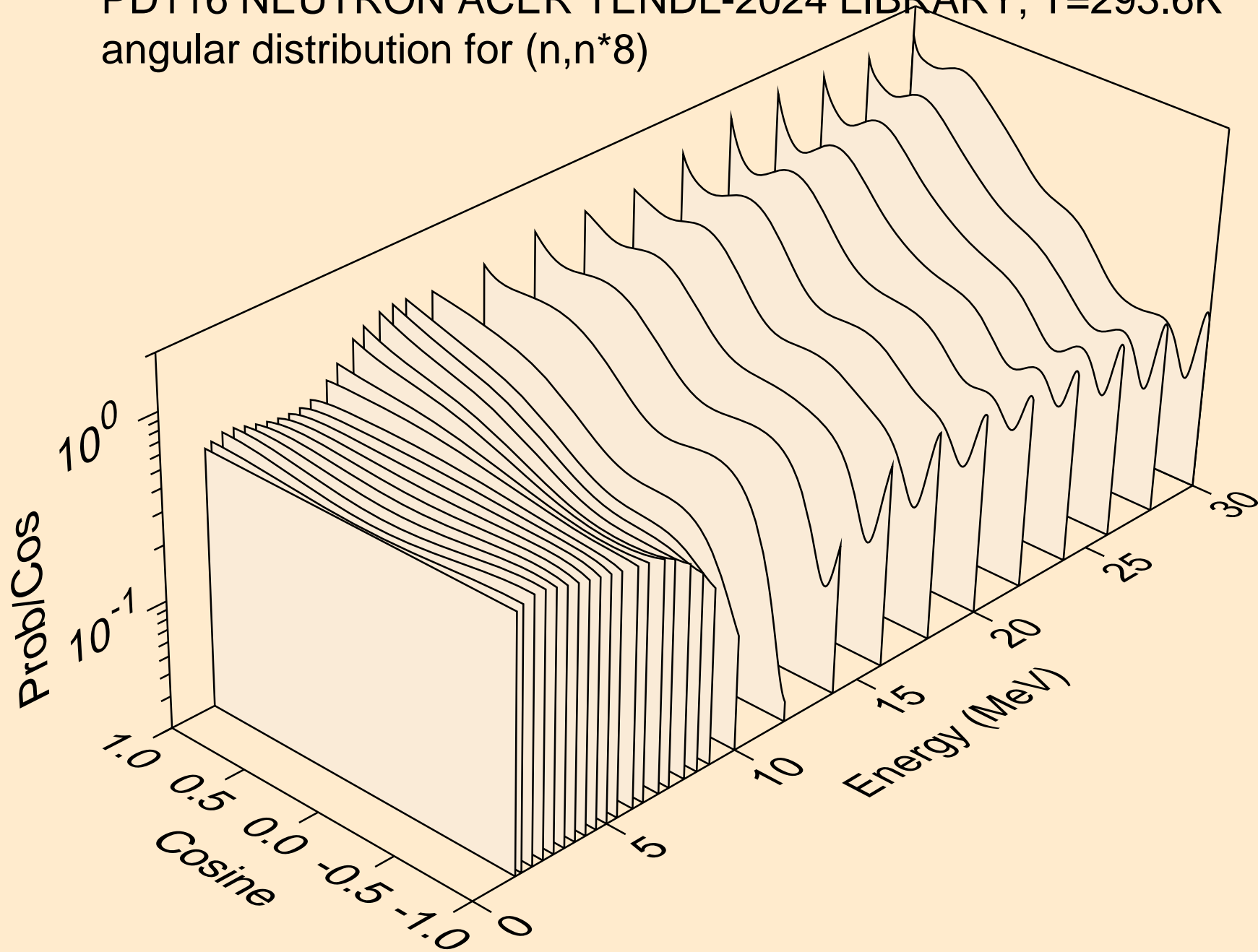

PD116 NEUTRON ACER TENDL-2024 LIBRARY; T=293.6K
angular distribution for (n,n*9)

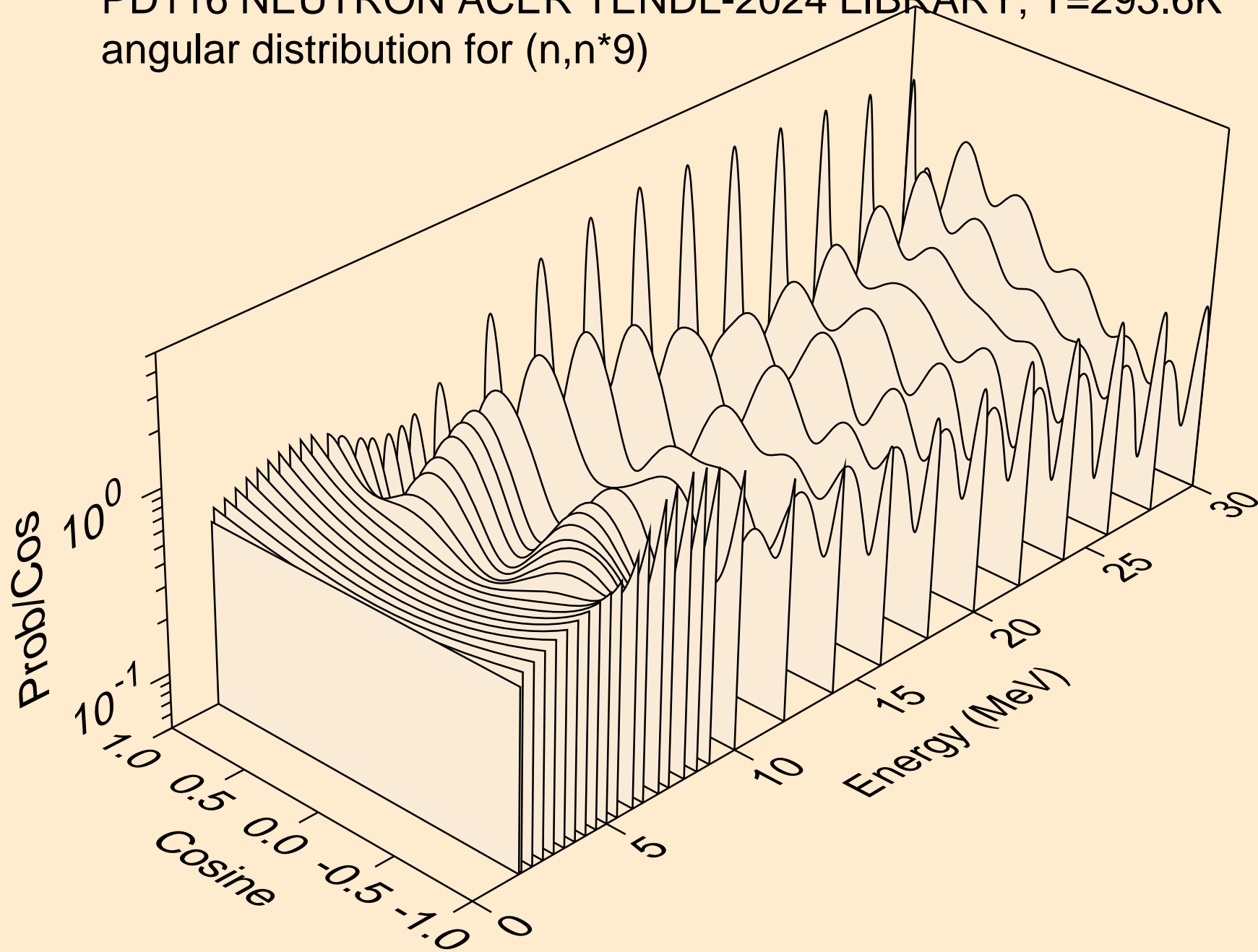

PD116 NEUTRON ACER TENDL-2024 LIBRARY; T=293.6K
angular distribution for (n,n*10)

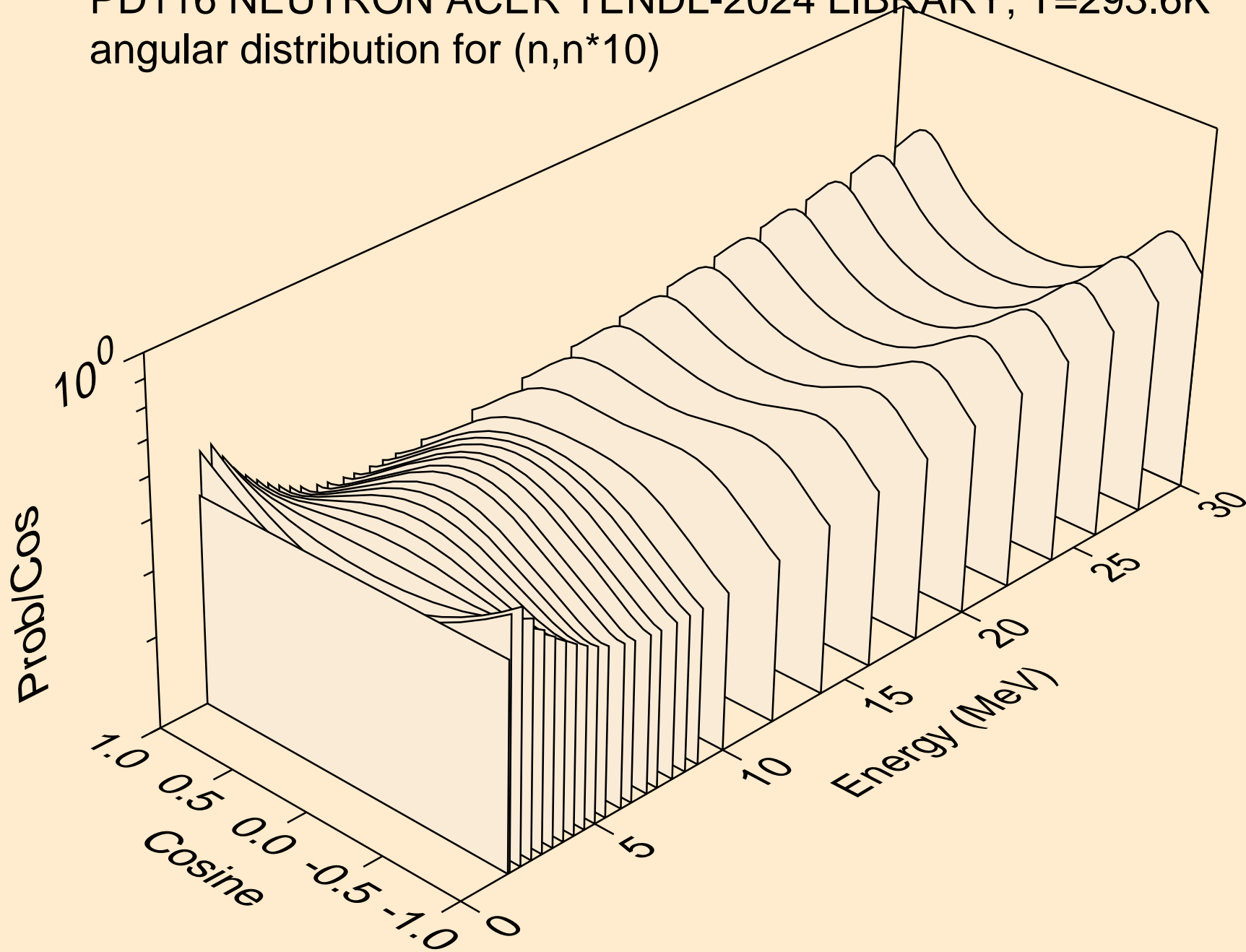

PD116 NEUTRON ACER TENDL-2024 LIBRARY; T=293.6K
angular distribution for (n,n*11)

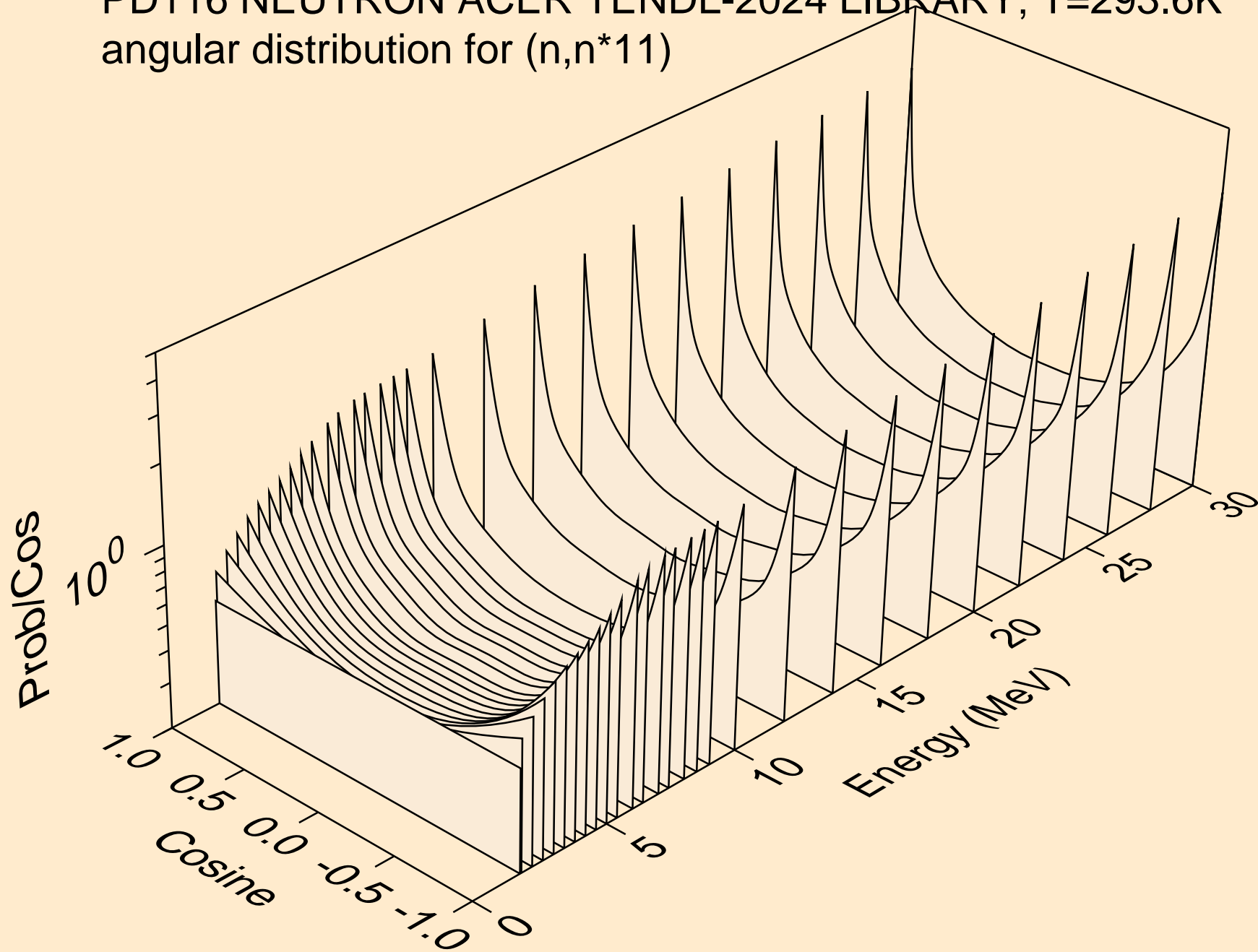

PD116 NEUTRON ACER TENDL-2024 LIBRARY; T=293.6K
angular distribution for (n,n*12)

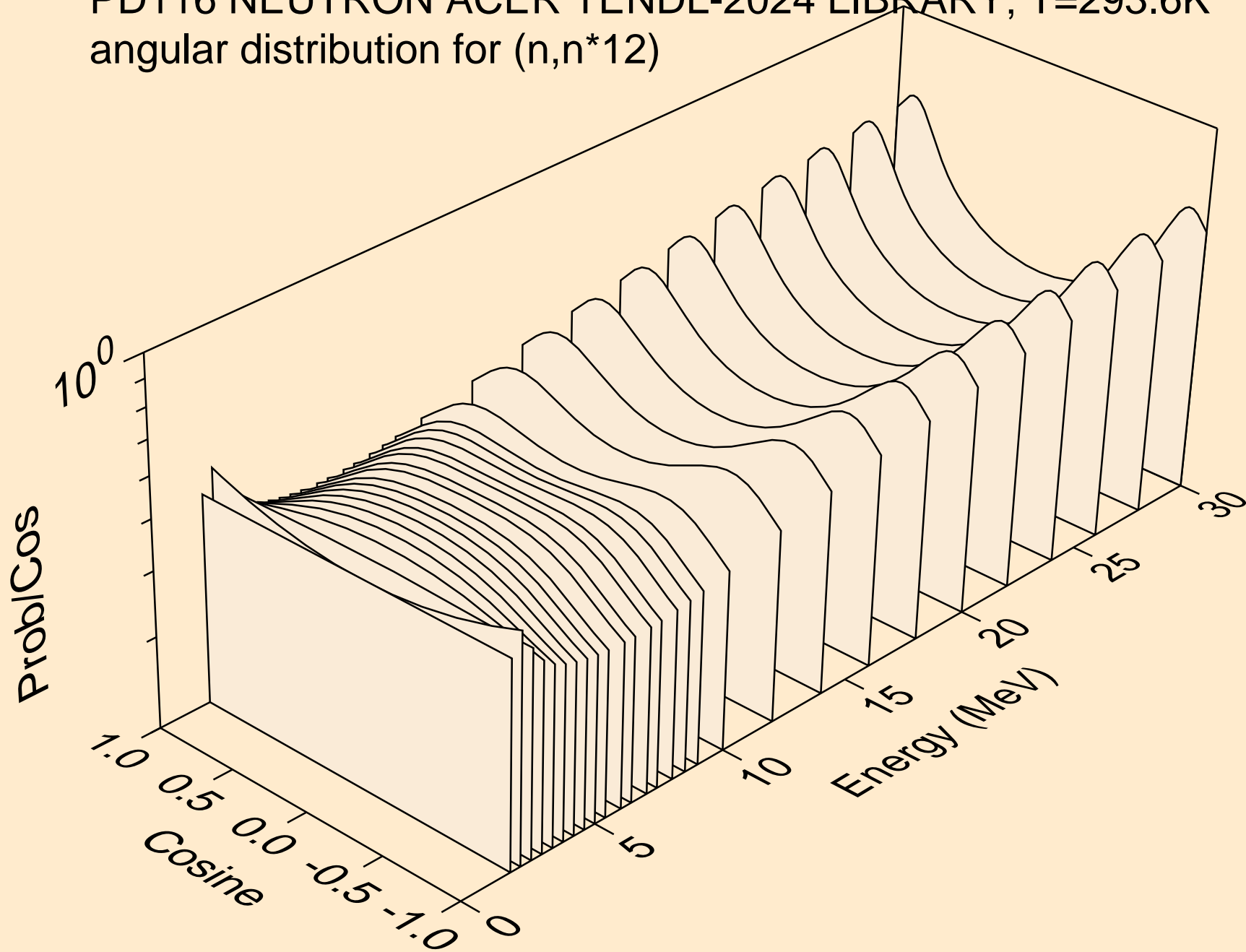

PD116 NEUTRON ACER TENDL-2024 LIBRARY; T=293.6K
angular distribution for (n,n*13)

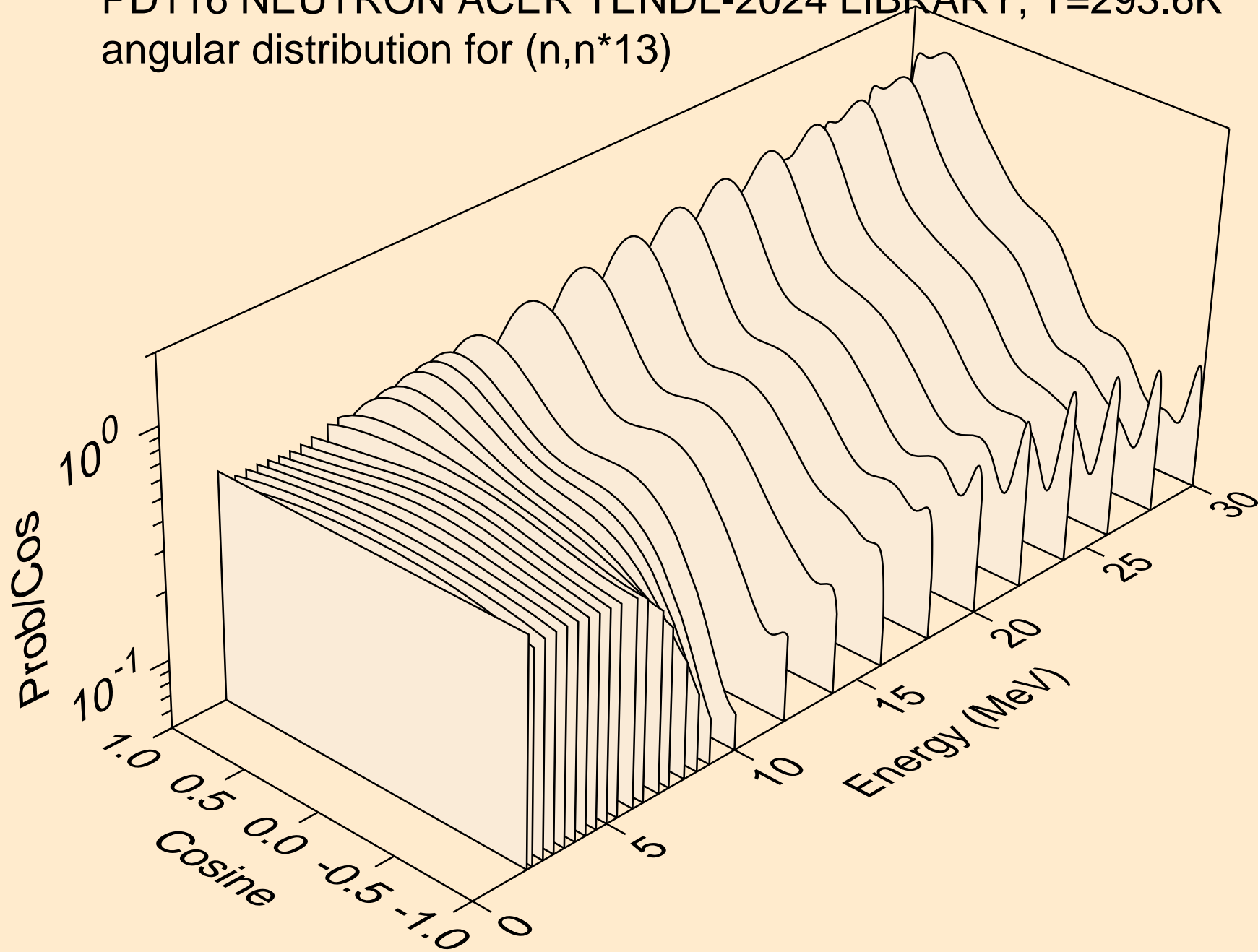

PD116 NEUTRON ACER TENDL-2024 LIBRARY; T=293.6K
angular distribution for (n,n*14)

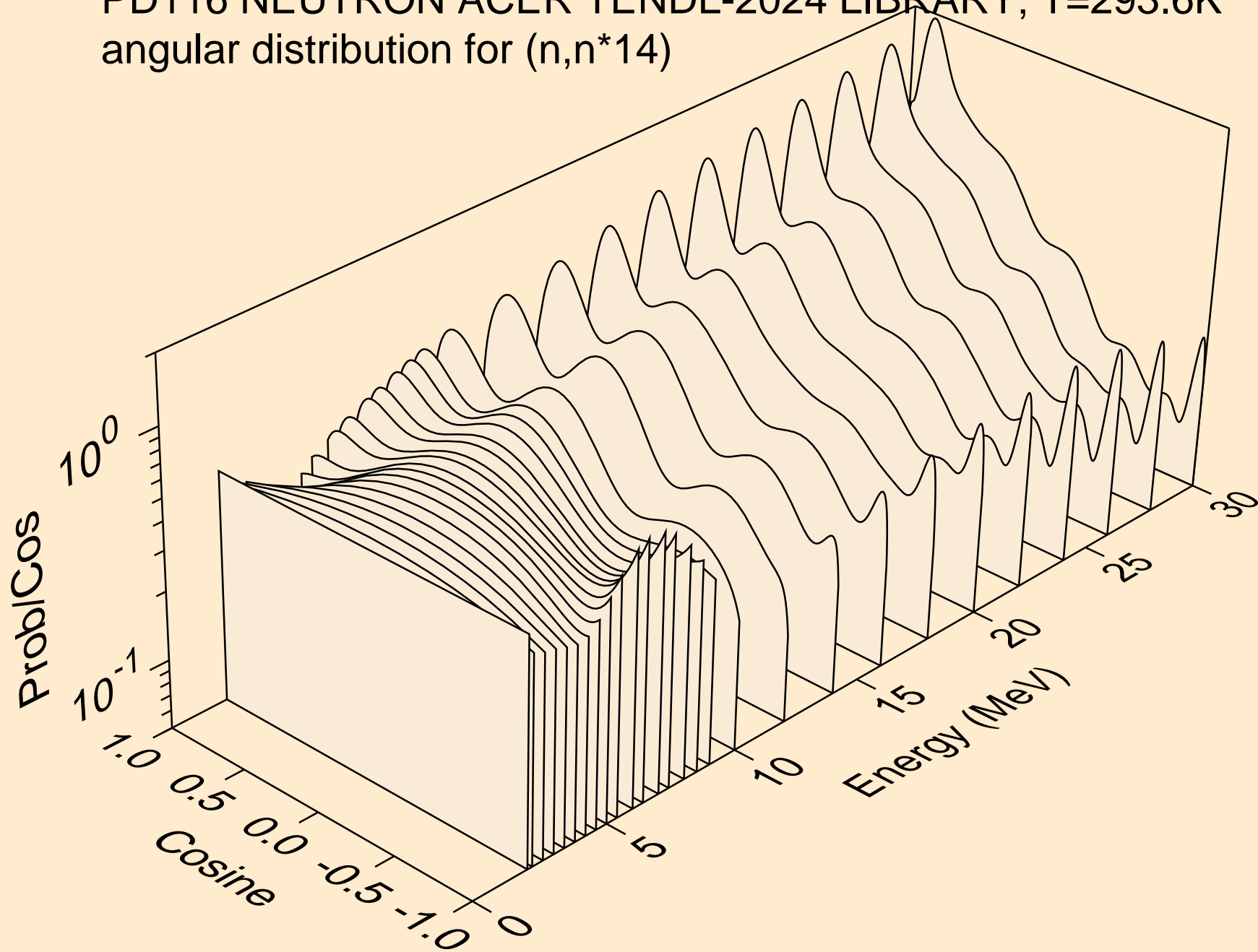

PD116 NEUTRON ACER TENDL-2024 LIBRARY; T=293.6K
angular distribution for (n,n*15)

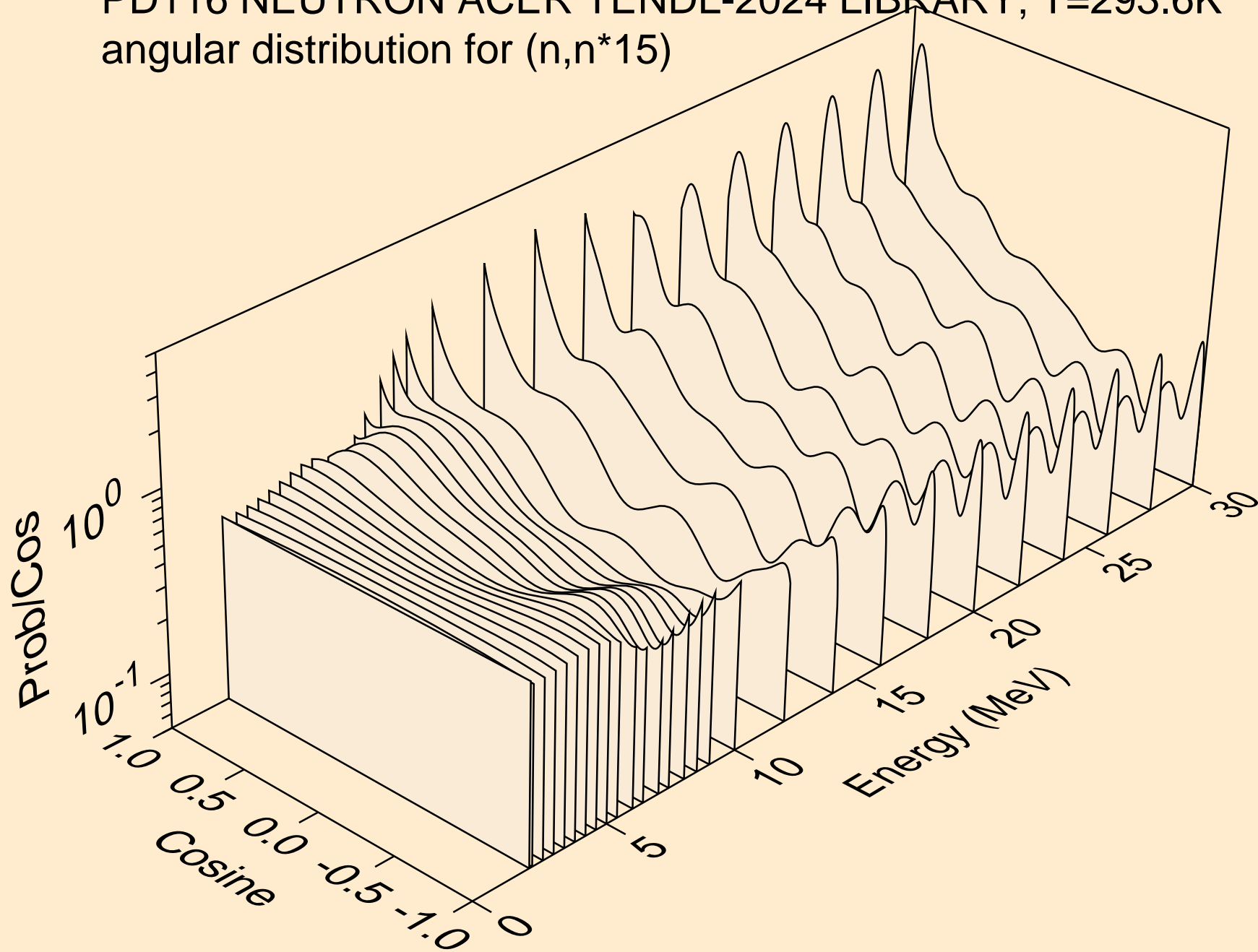

PD116 NEUTRON ACER TENDL-2024 LIBRARY; T=293.6K
angular distribution for (n,n*16)

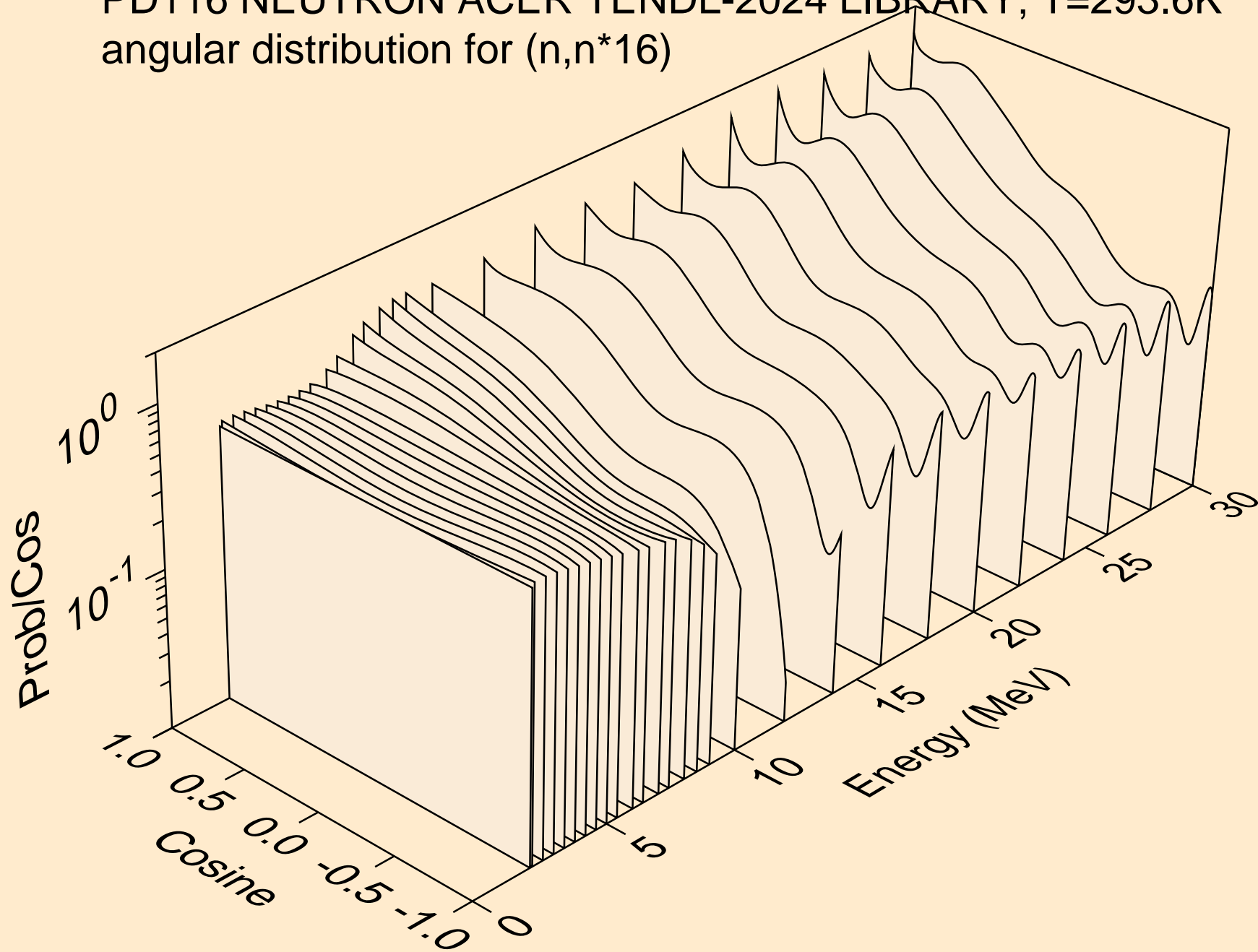

PD116 NEUTRON ACER TENDL-2024 LIBRARY; T=293.6K
angular distribution for (n,n*17)

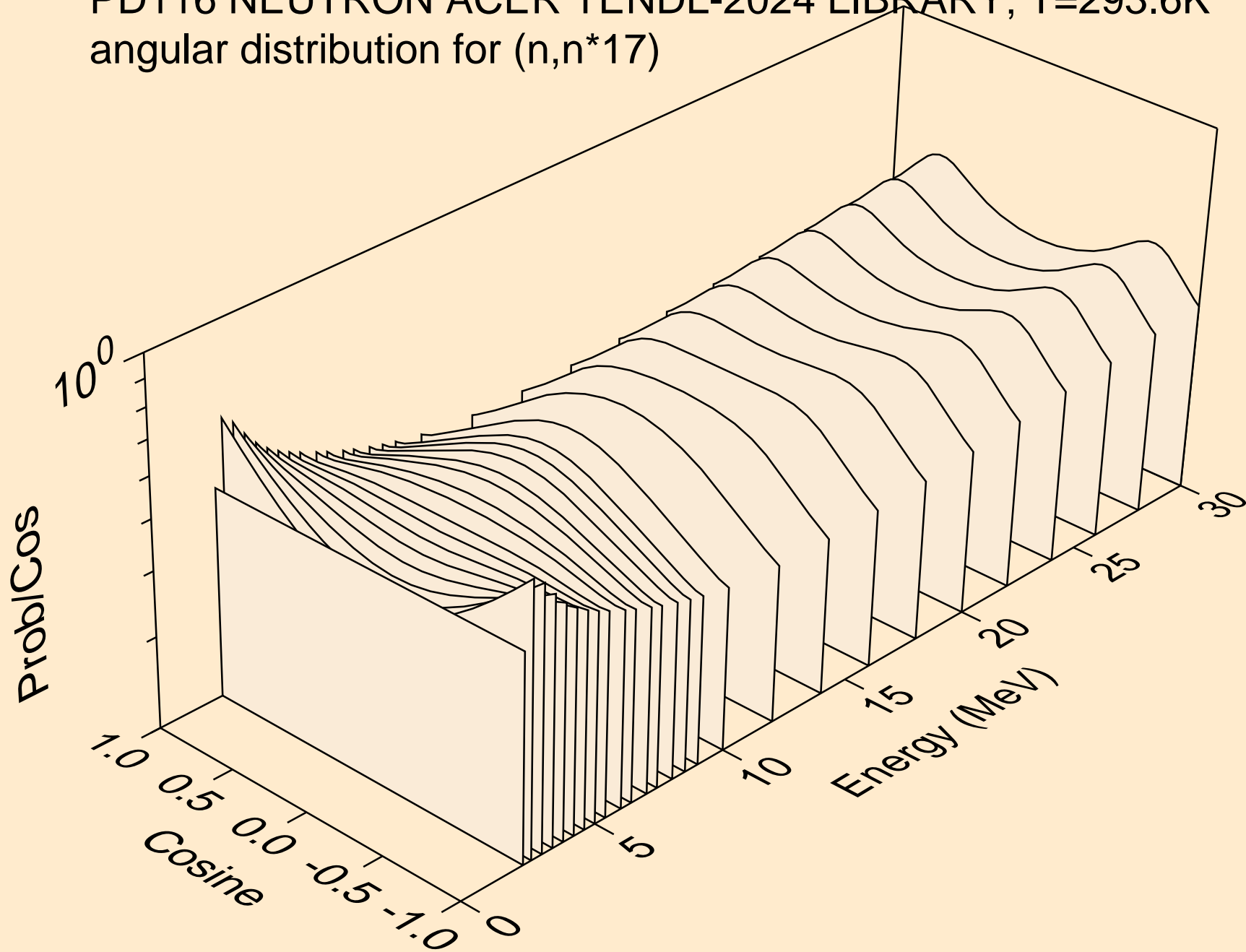

PD116 NEUTRON ACER TENDL-2024 LIBRARY; T=293.6K
angular distribution for (n,n*18)

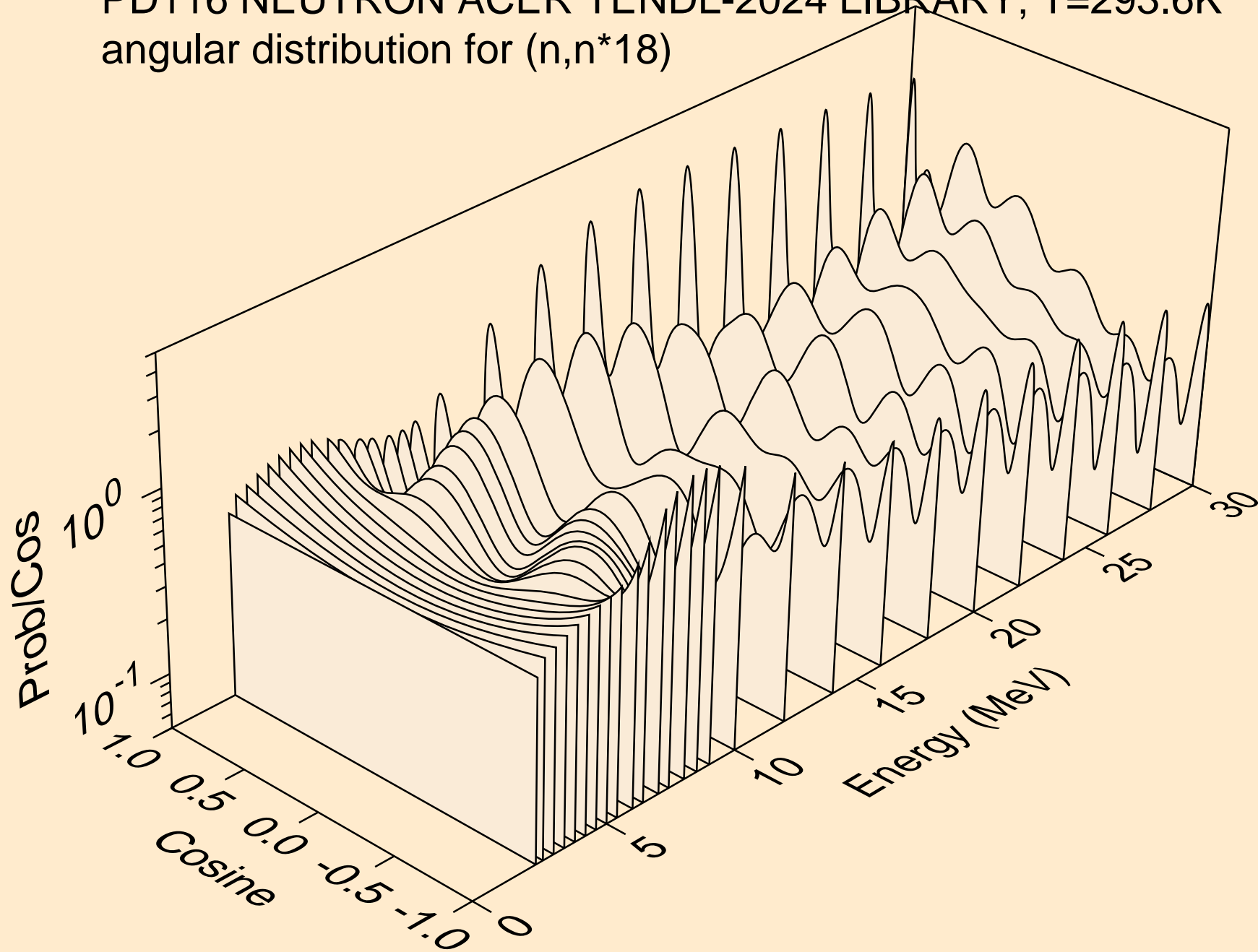

PD116 NEUTRON ACER TENDL-2024 LIBRARY; T=293.6K
angular distribution for (n,n*19)

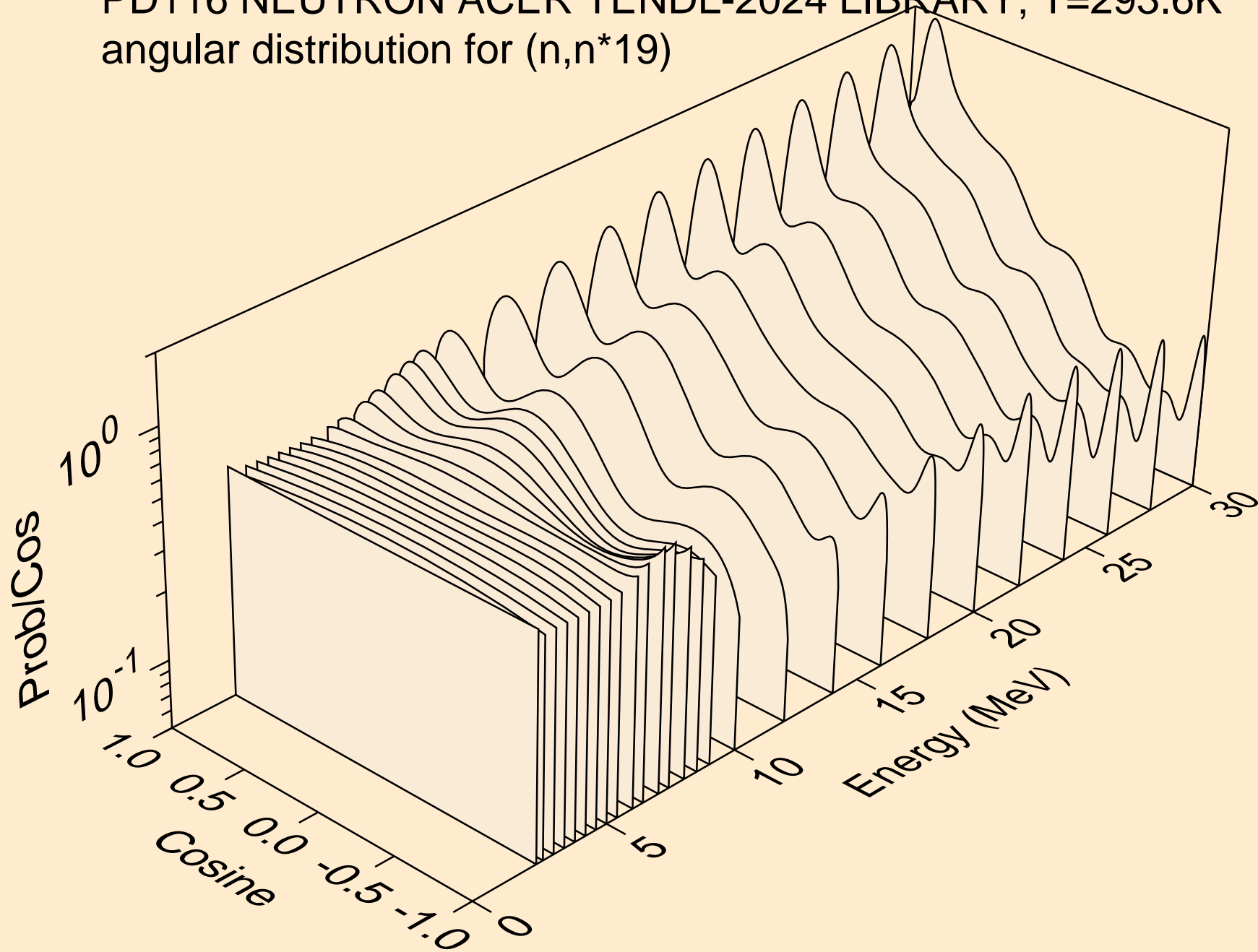

PD116 NEUTRON ACER TENDL-2024 LIBRARY; T=293.6K
angular distribution for (n,n*20)

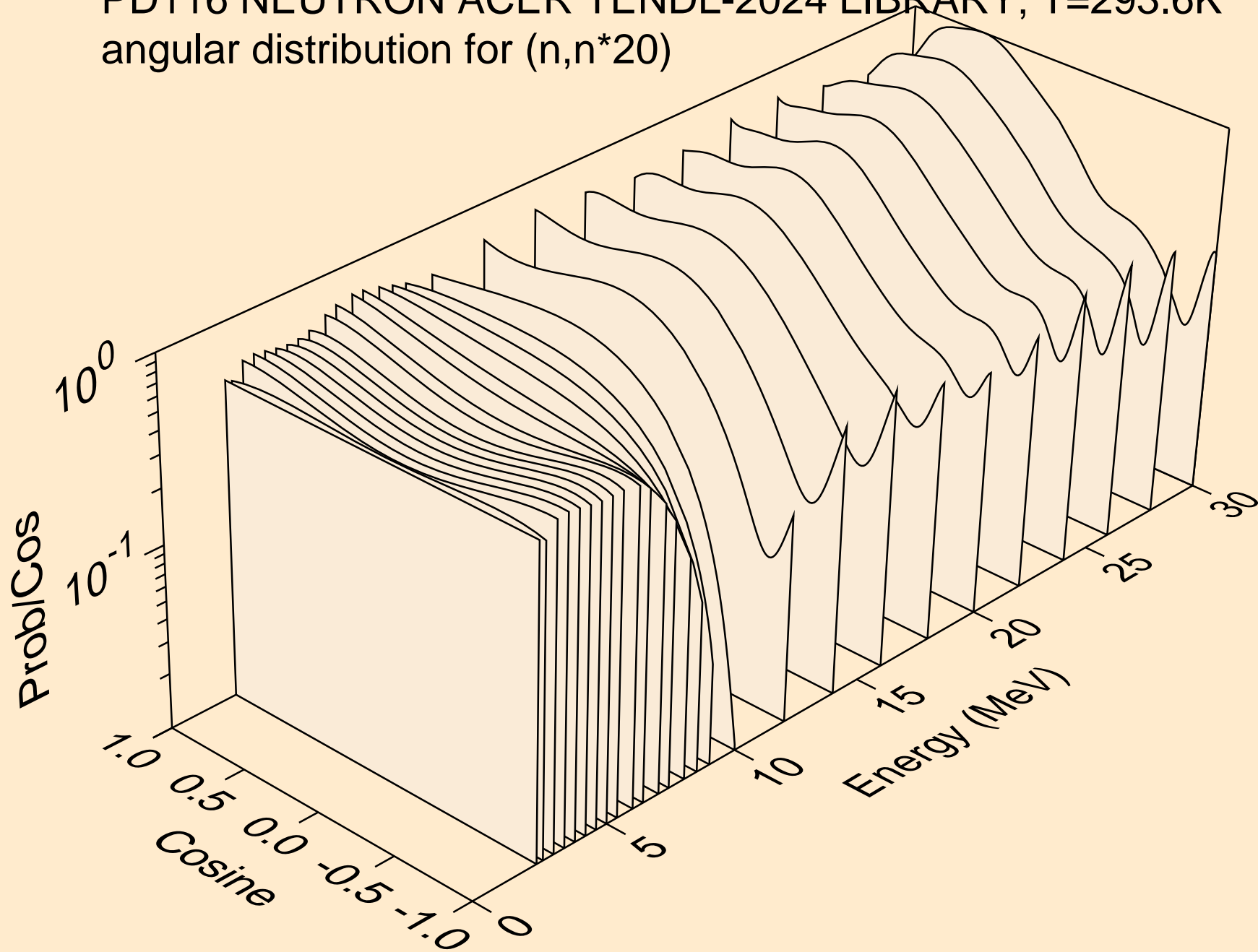

PD116 NEUTRON ACER TENDL-2024 LIBRARY; T=293.6K
angular distribution for (n,n*21)

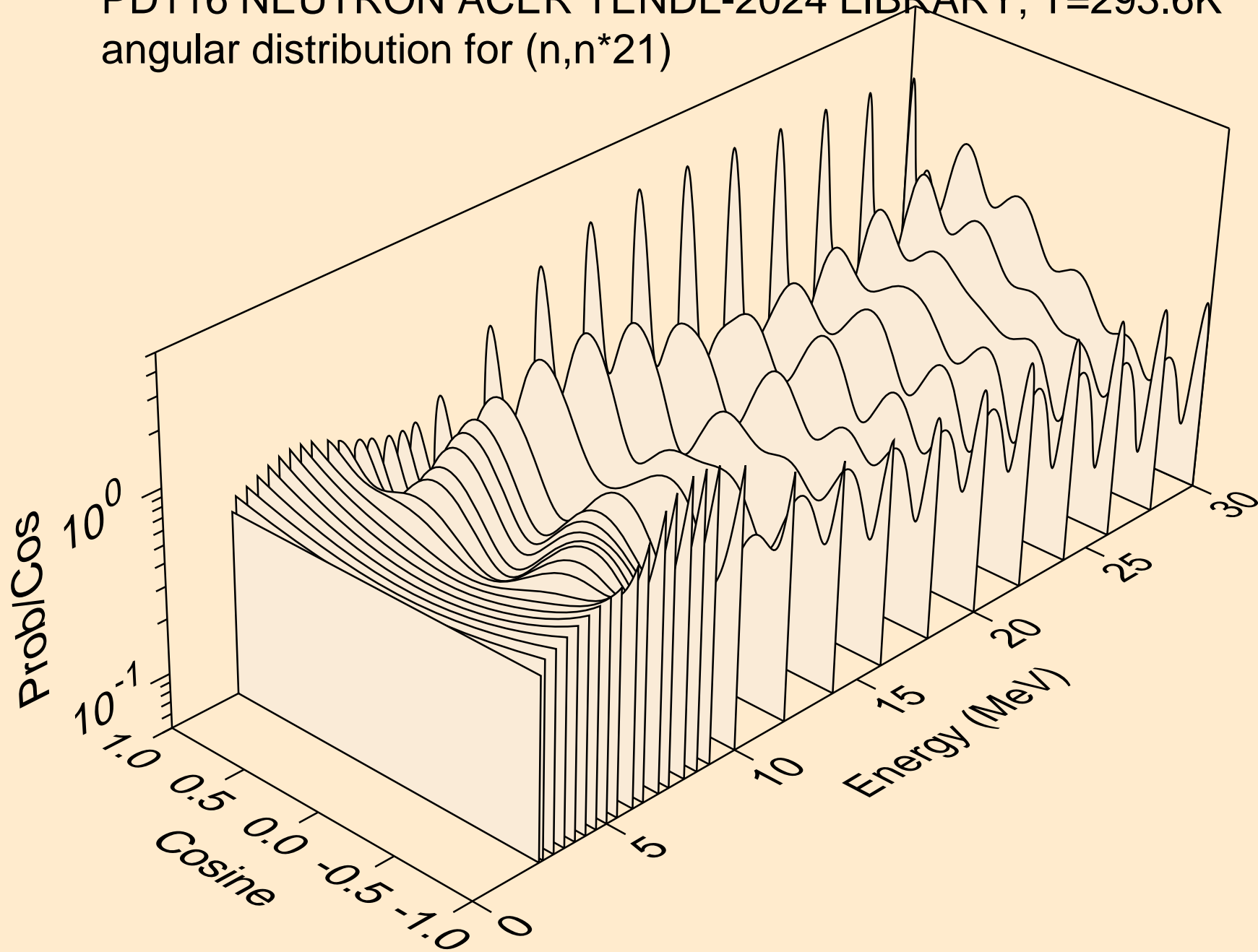

PD116 NEUTRON ACER TENDL-2024 LIBRARY; T=293.6K
angular distribution for (n,n*22)

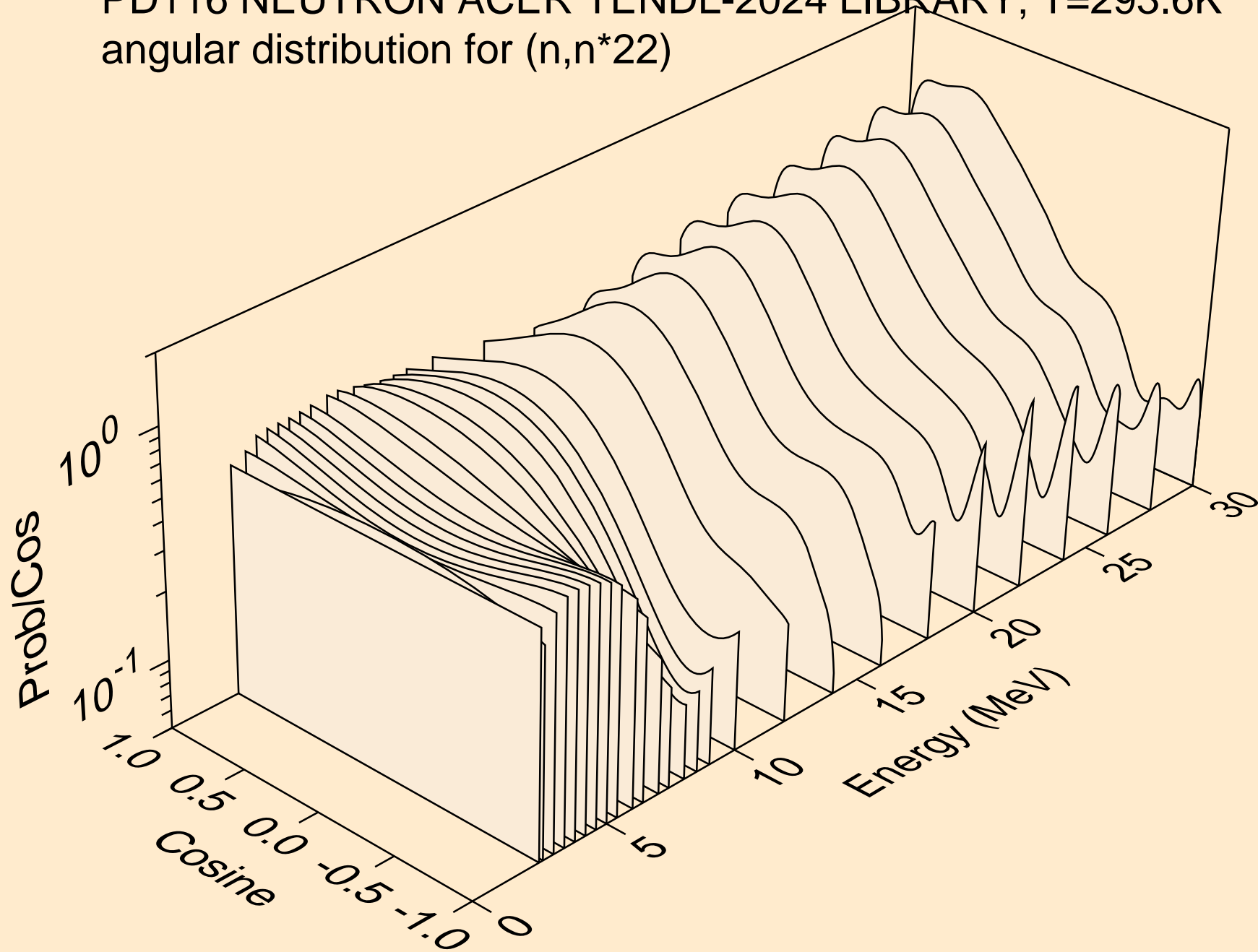

PD116 NEUTRON ACER TENDL-2024 LIBRARY; T=293.6K
angular distribution for (n,n*23)

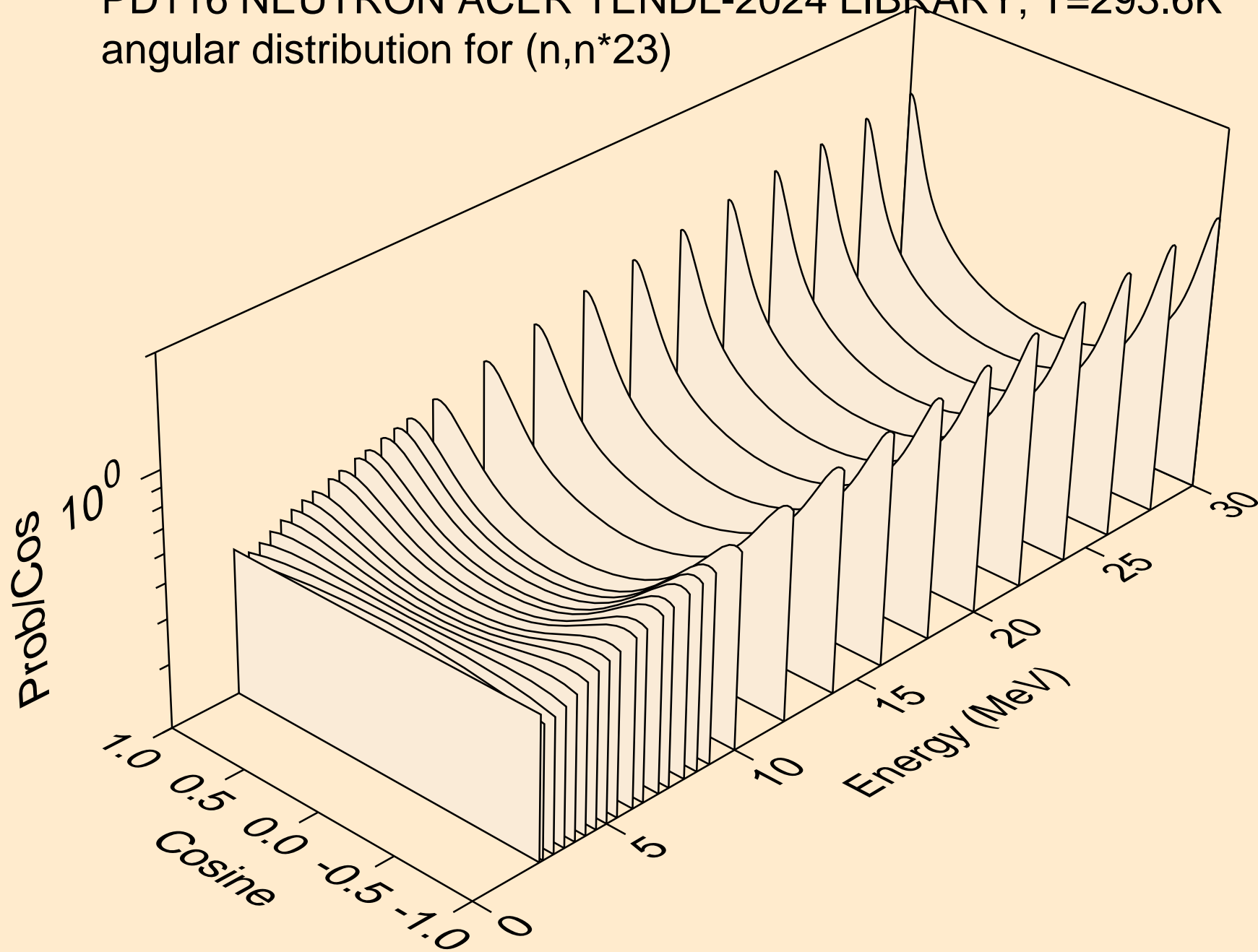

PD116 NEUTRON ACER TENDL-2024 LIBRARY; T=293.6K
angular distribution for (n,n*24)

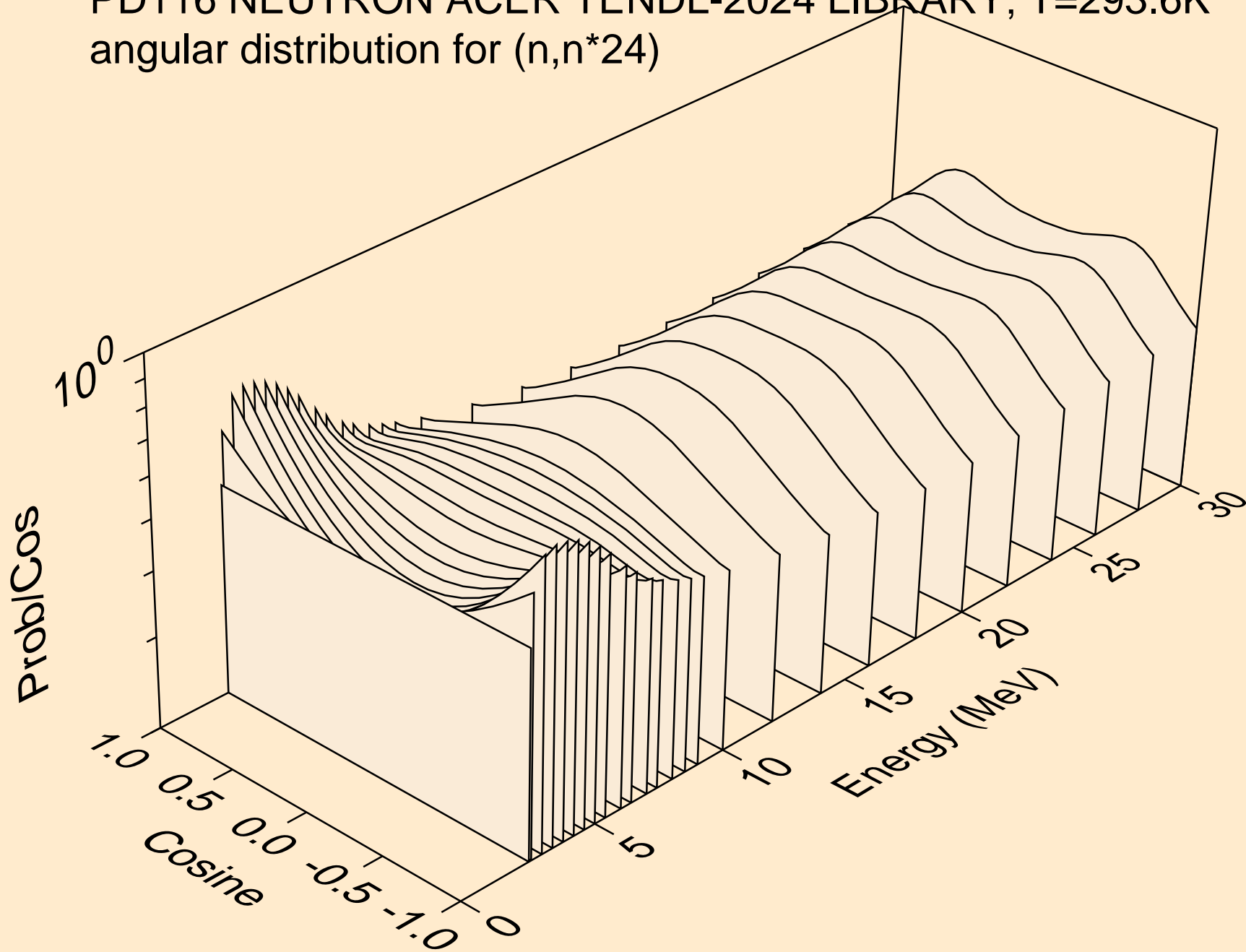

PD116 NEUTRON ACER TENDL-2024 LIBRARY; T=293.6K
angular distribution for (n,n*25)

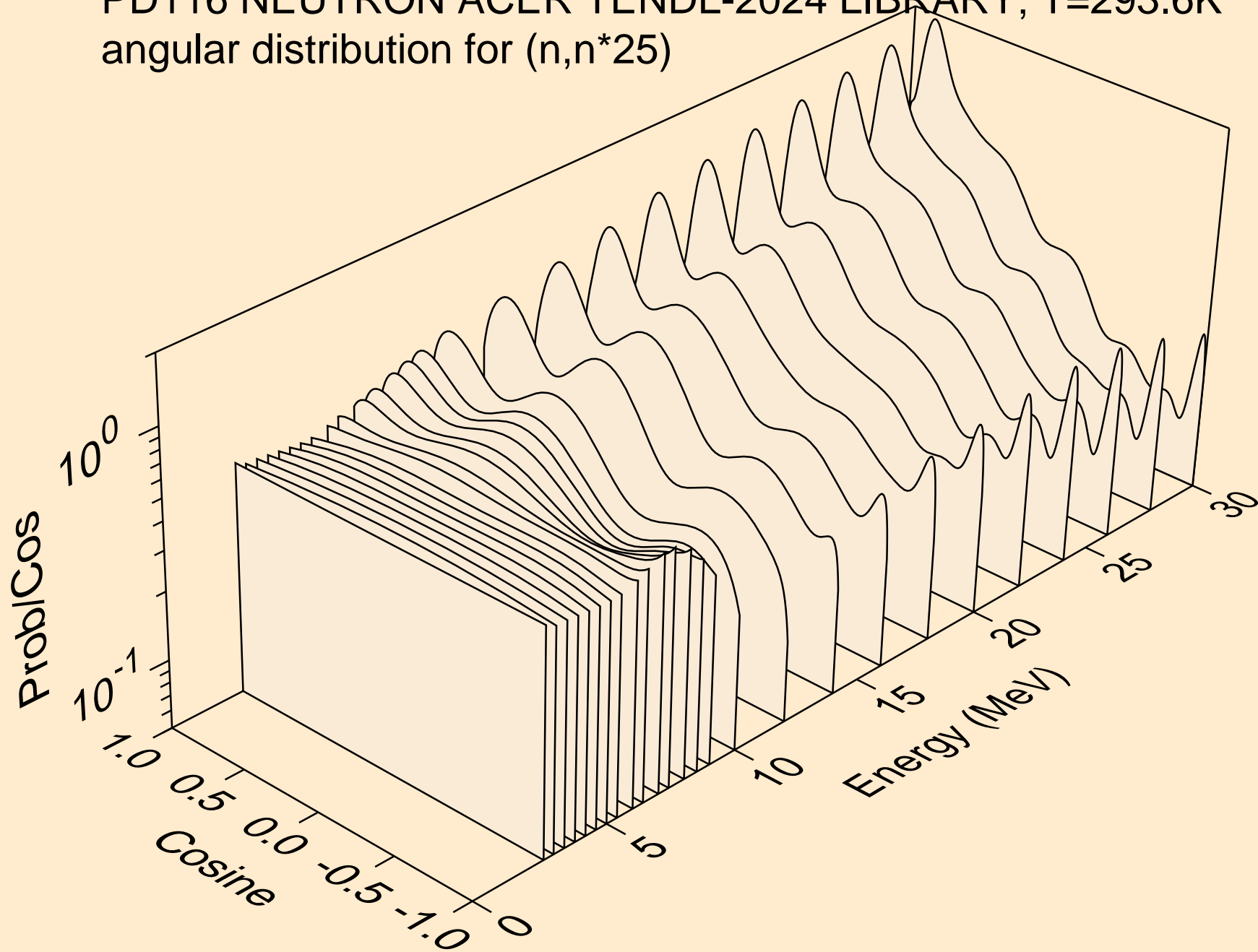

PD116 NEUTRON ACER TENDL-2024 LIBRARY; T=293.6K
angular distribution for (n,n*26)

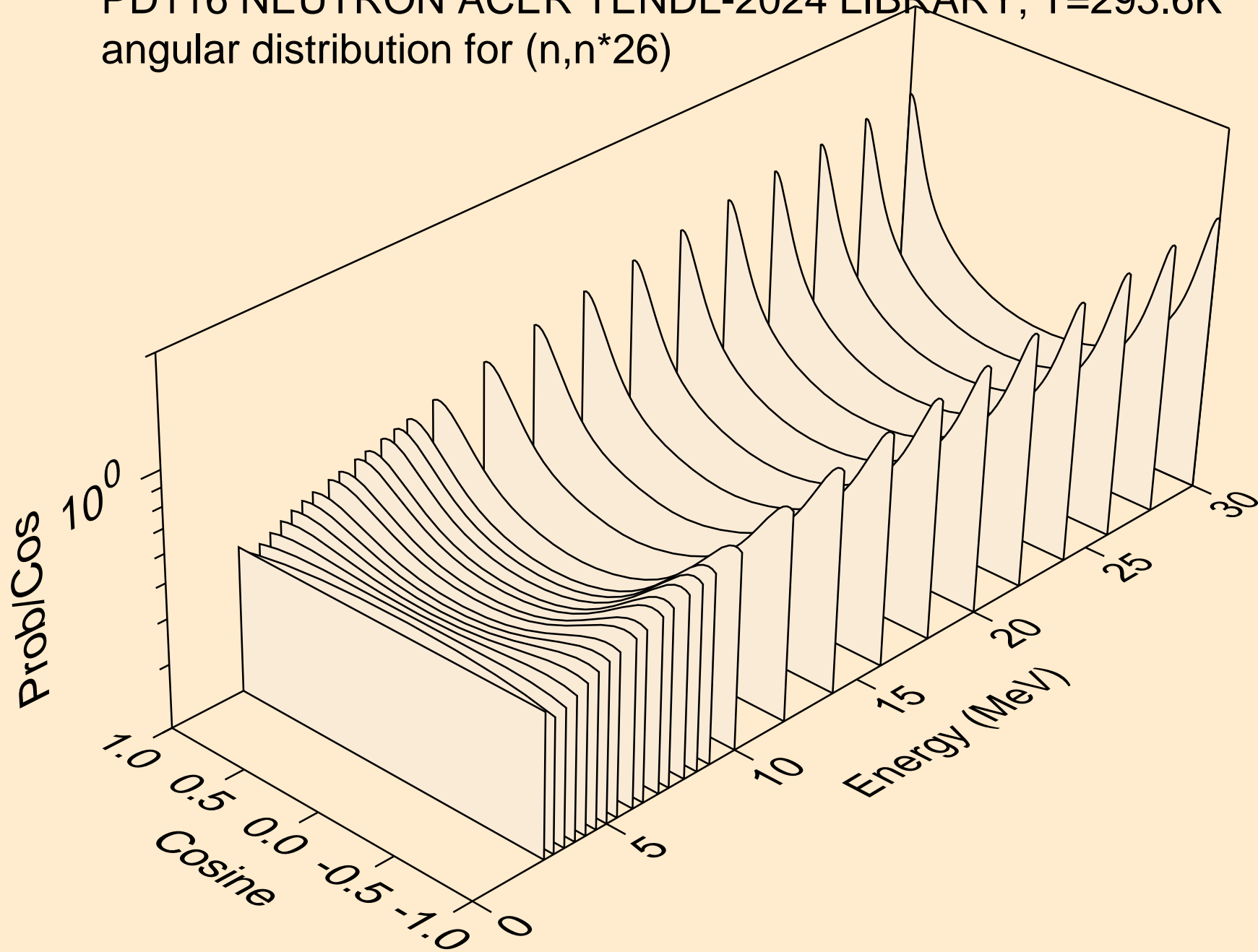

PD116 NEUTRON ACER TENDL-2024 LIBRARY; T=293.6K
angular distribution for (n,n*27)

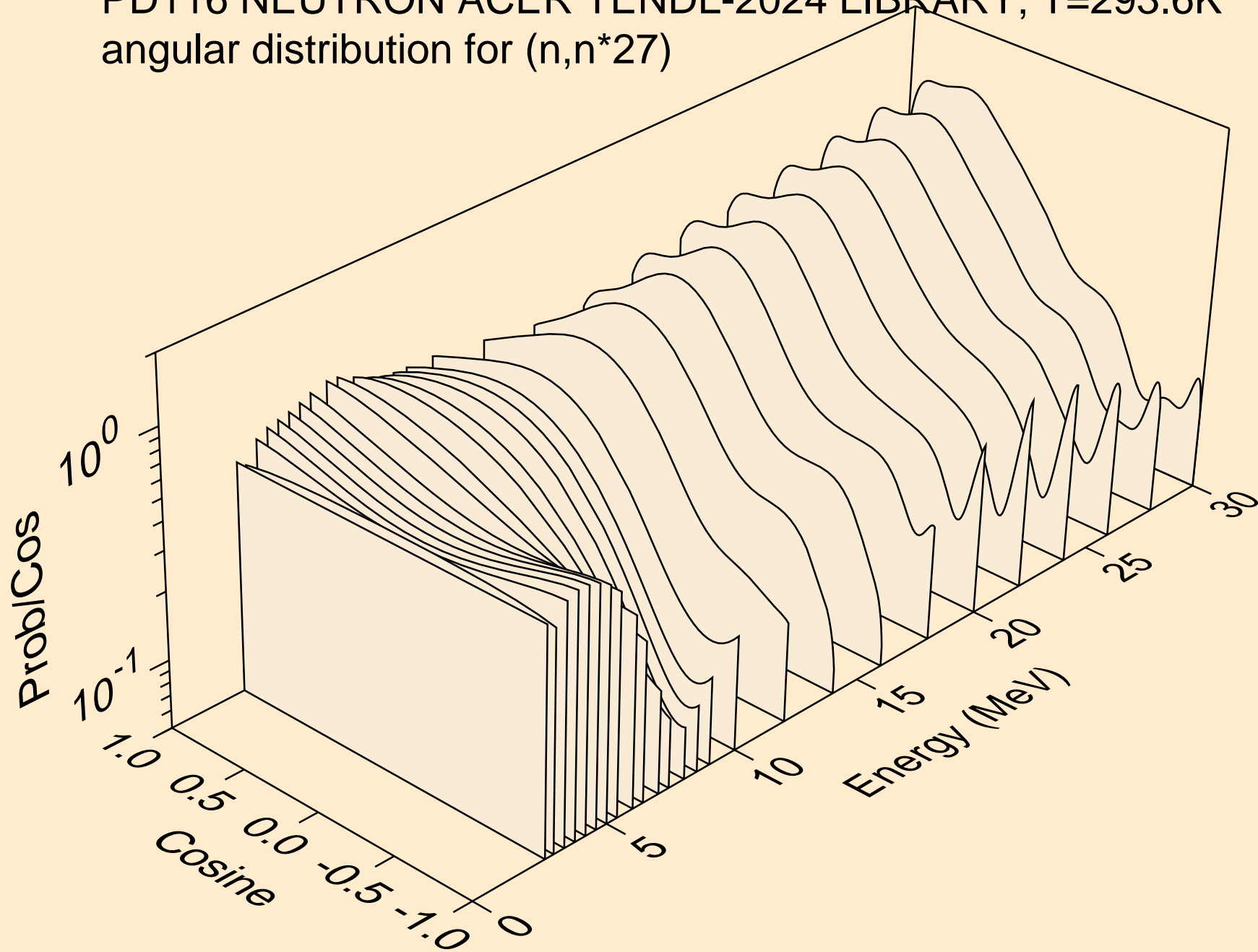

PD116 NEUTRON ACER TENDL-2024 LIBRARY; T=293.6K
angular distribution for (n,n*28)

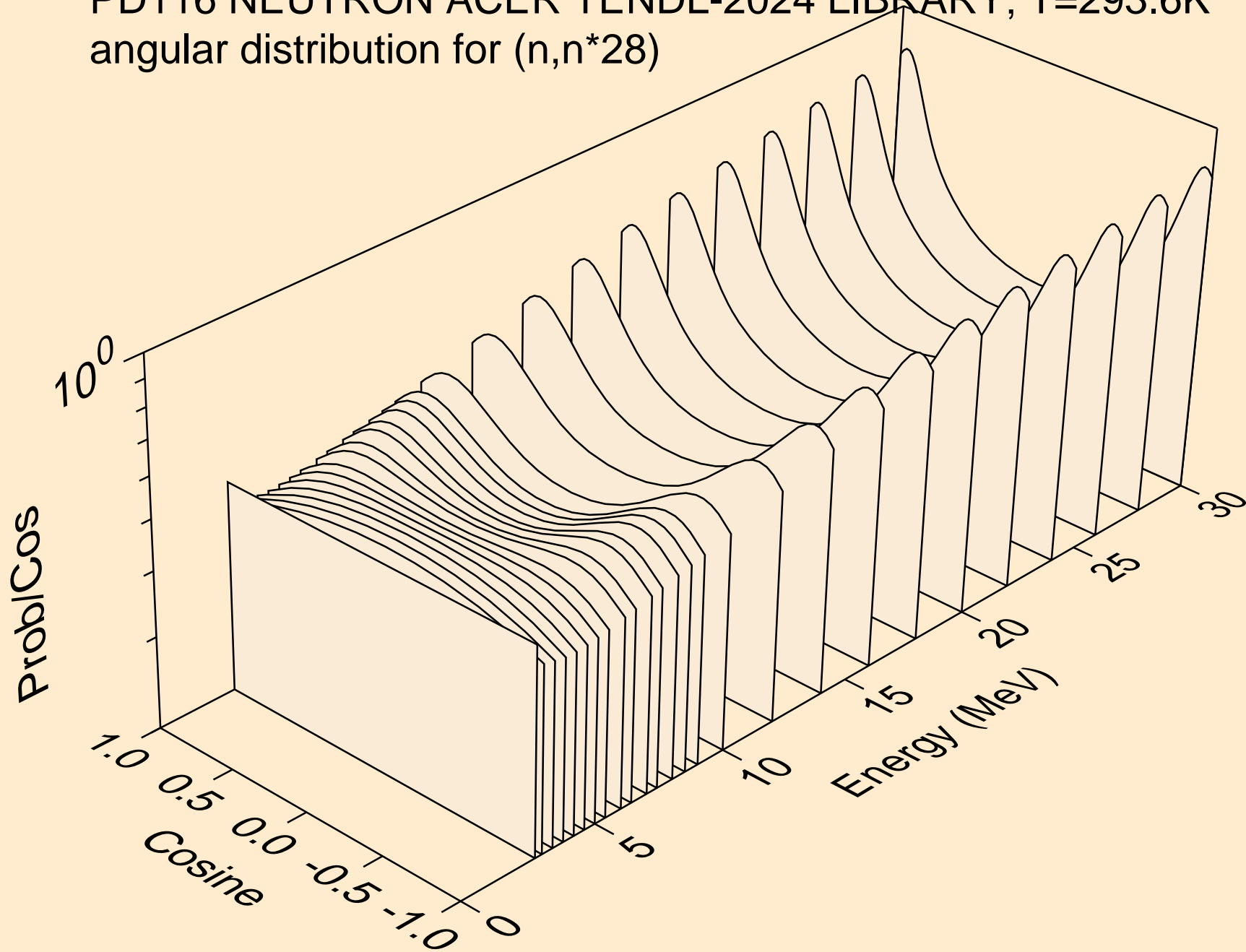

PD116 NEUTRON ACER TENDL-2024 LIBRARY; T=293.6K
angular distribution for (n,n*29)

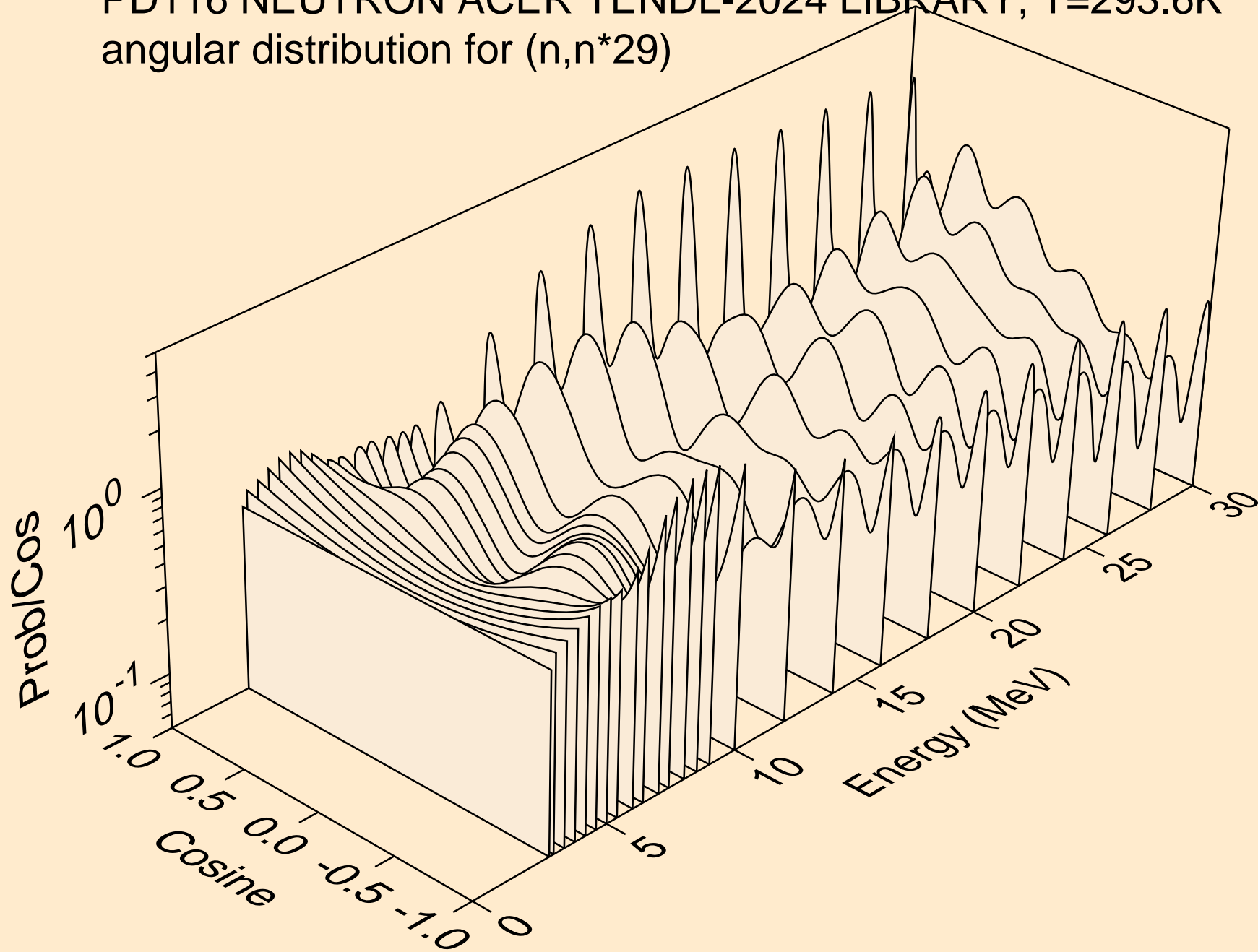

PD116 NEUTRON ACER TENDL-2024 LIBRARY; T=293.6K
Neutron emission for (n,x)

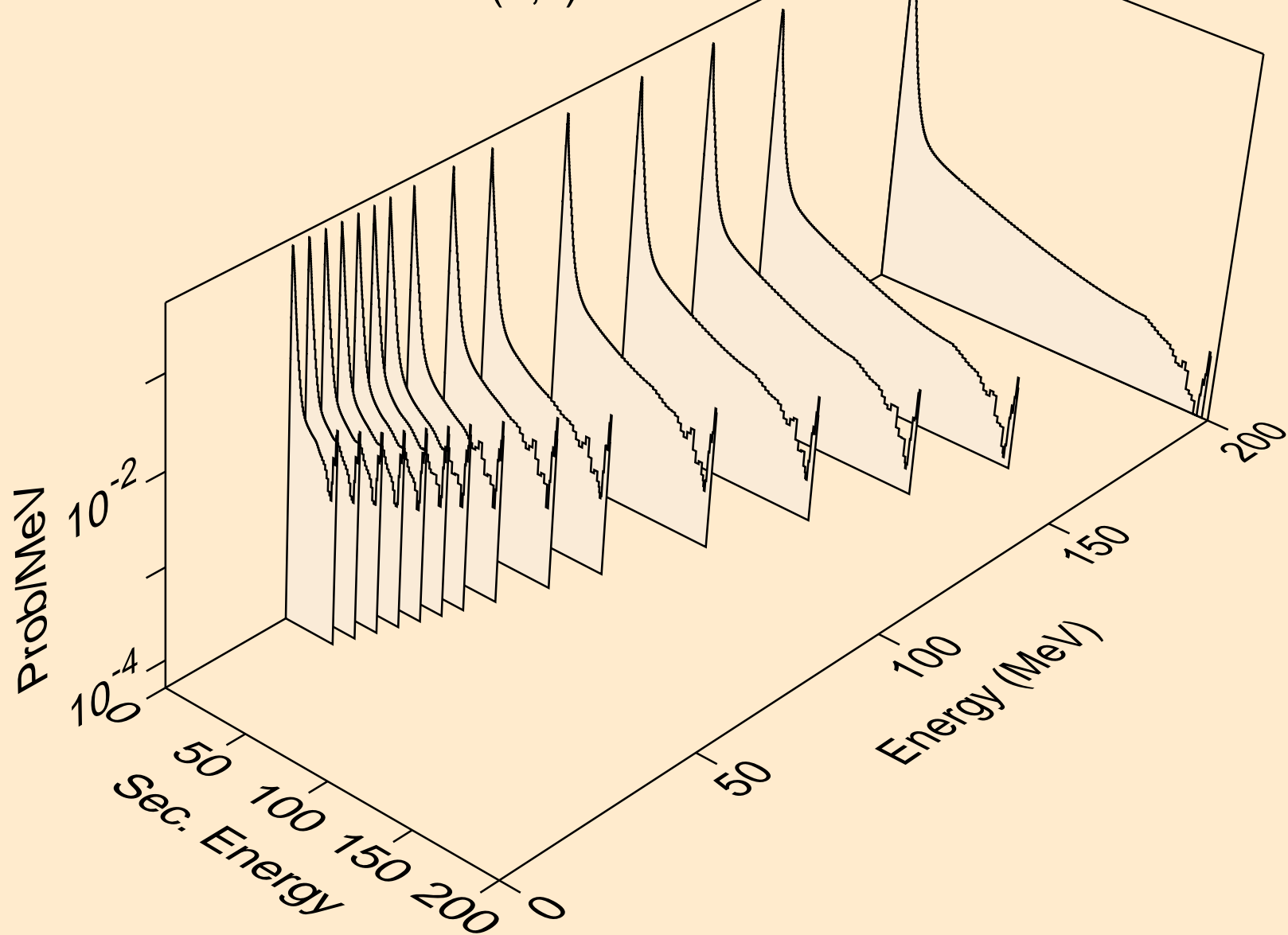

PD116 NEUTRON ACER TENDL-2024 LIBRARY; T=293.6K
Neutron emission for (n,2nd)

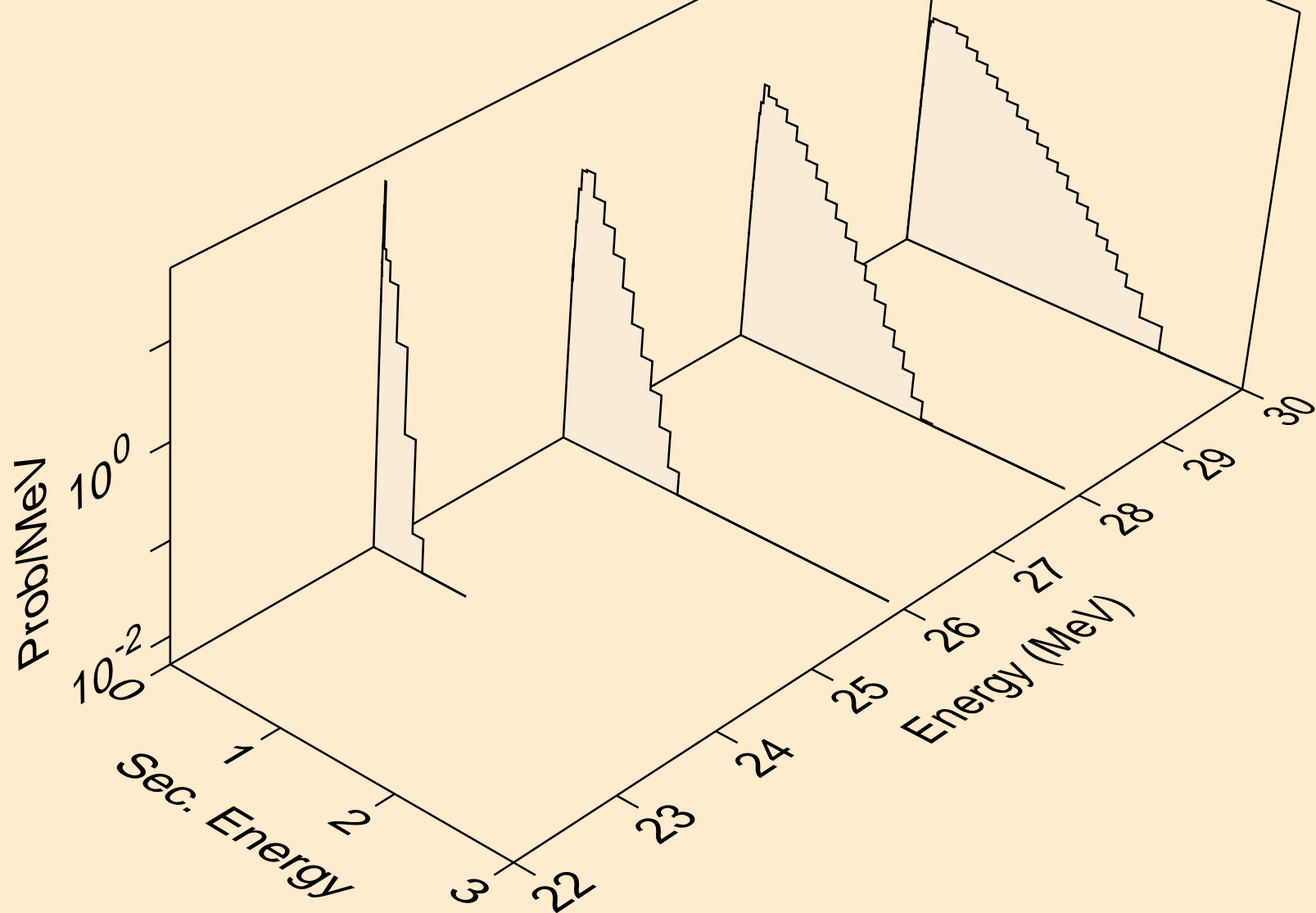

PD116 NEUTRON ACER TENDL-2024 LIBRARY; T=293.6K
Neutron emission for (n,2n)

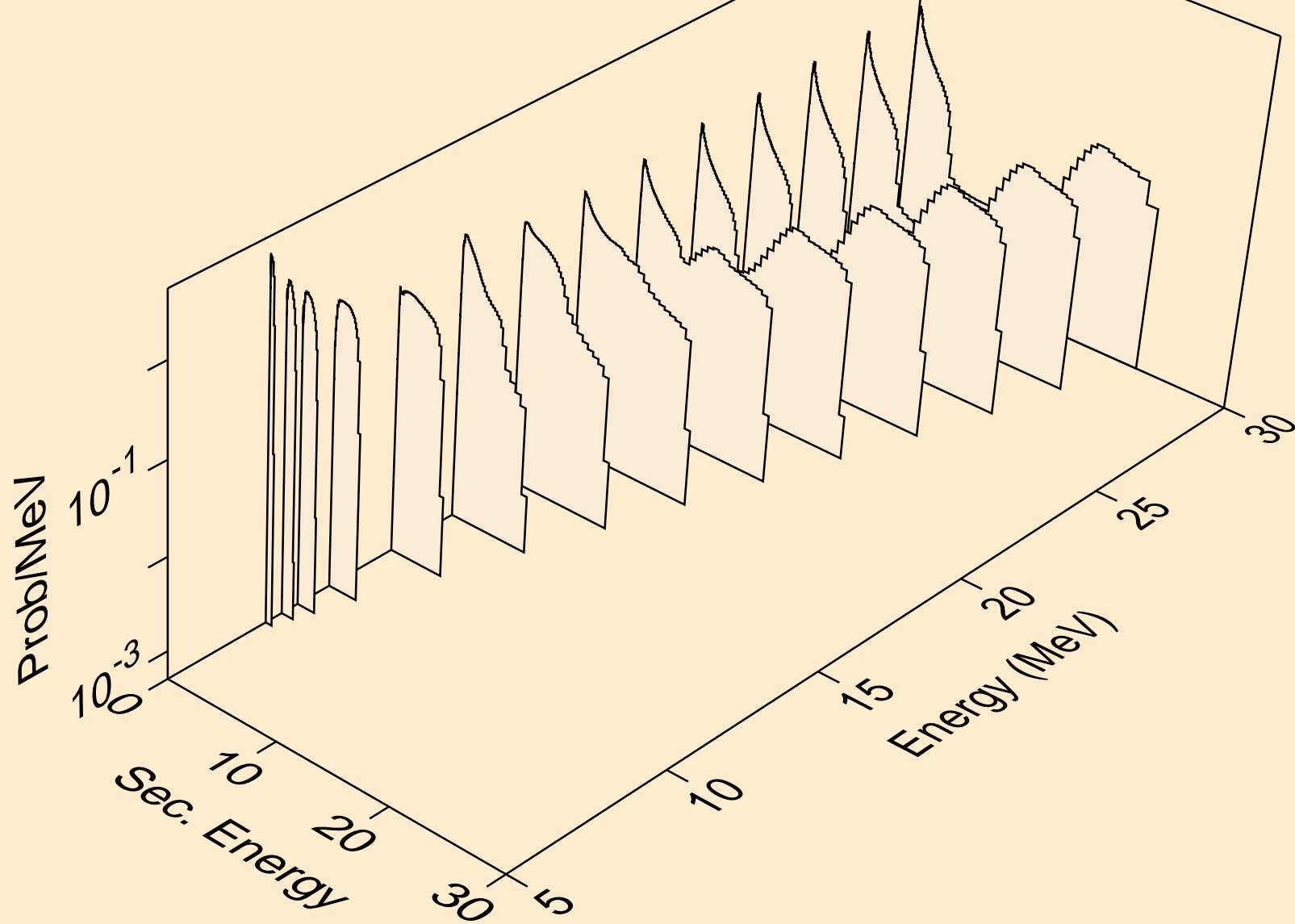

PD116 NEUTRON ACER TENDL-2024 LIBRARY; T=293.6K
Neutron emission for (n,3n)

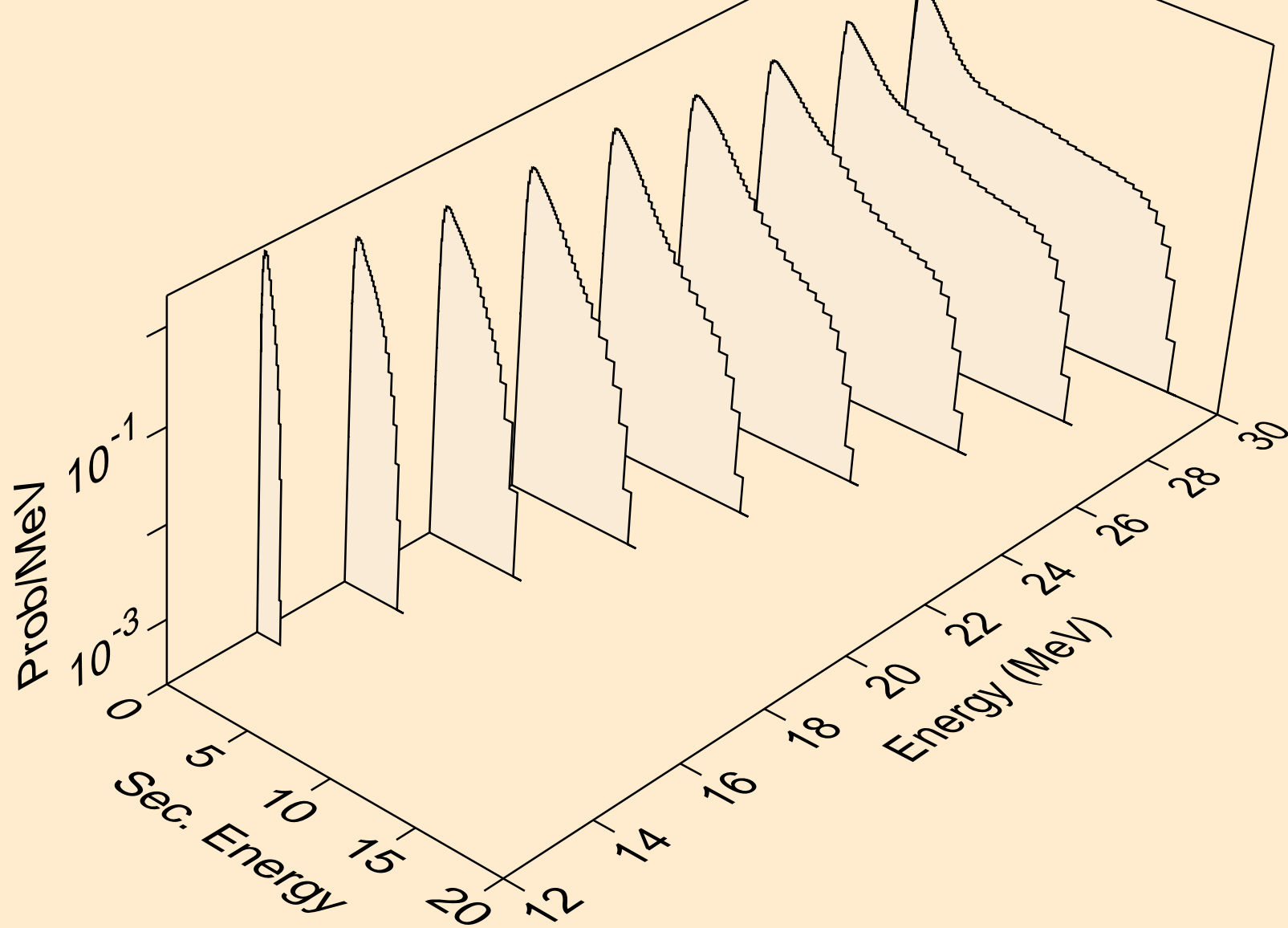

PD116 NEUTRON ACER TENDL-2024 LIBRARY; T=293.6K
Neutron emission for (n,n*)a

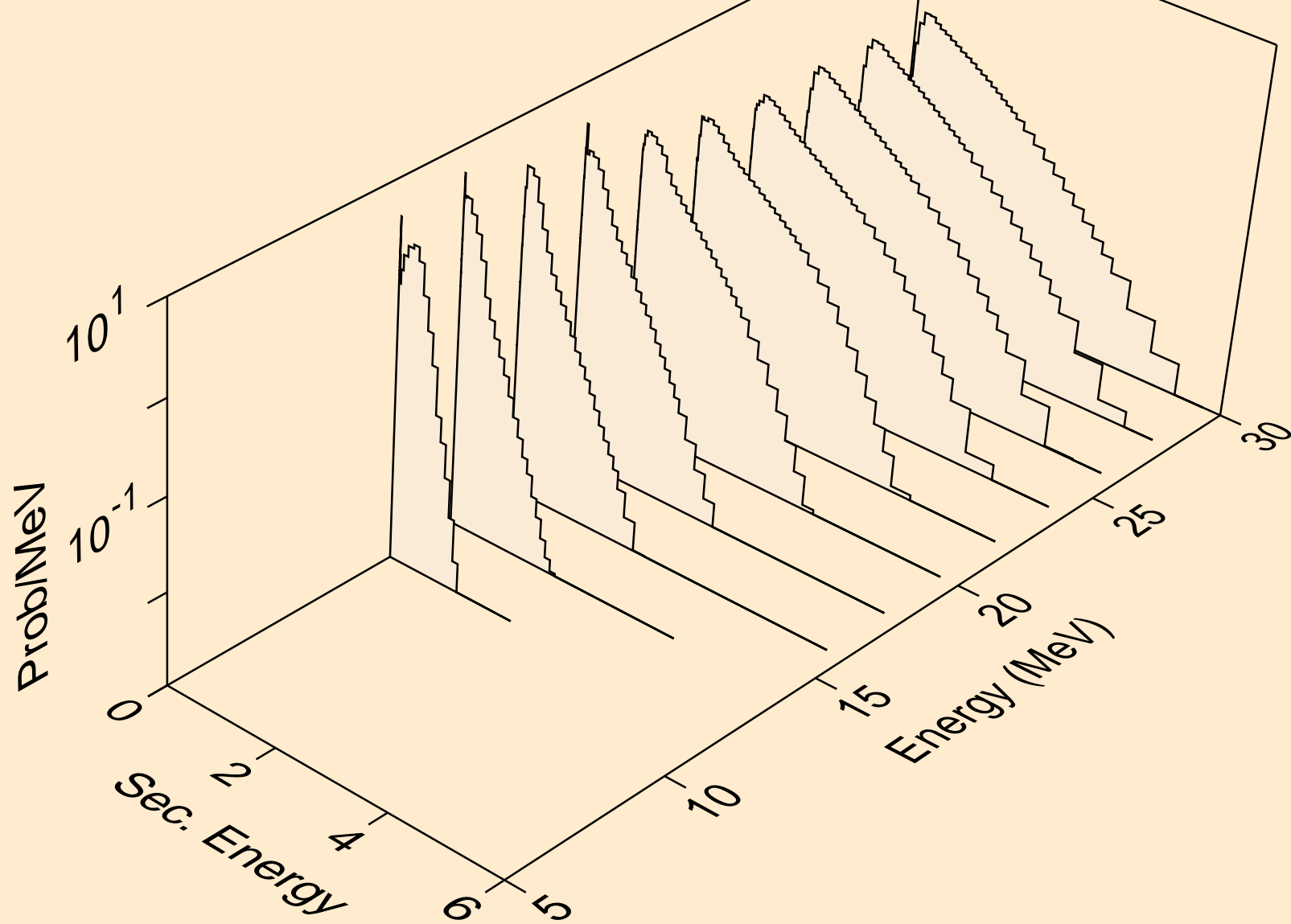

PD116 NEUTRON ACER TENDL-2024 LIBRARY; T=293.6K
Neutron emission for (n,2n)_a

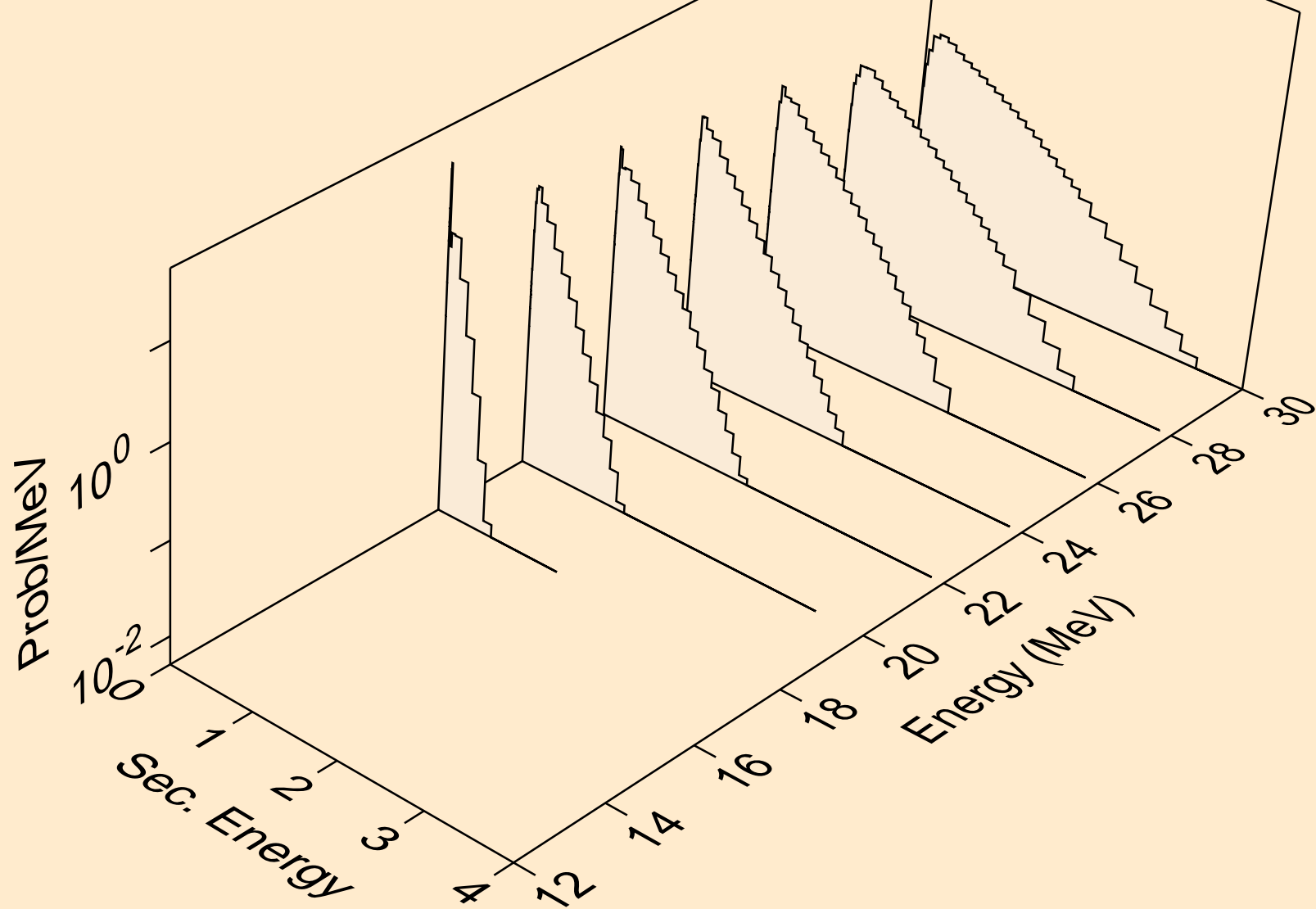

PD116 NEUTRON ACER TENDL-2024 LIBRARY; T=293.6K
Neutron emission for (n,3n)a

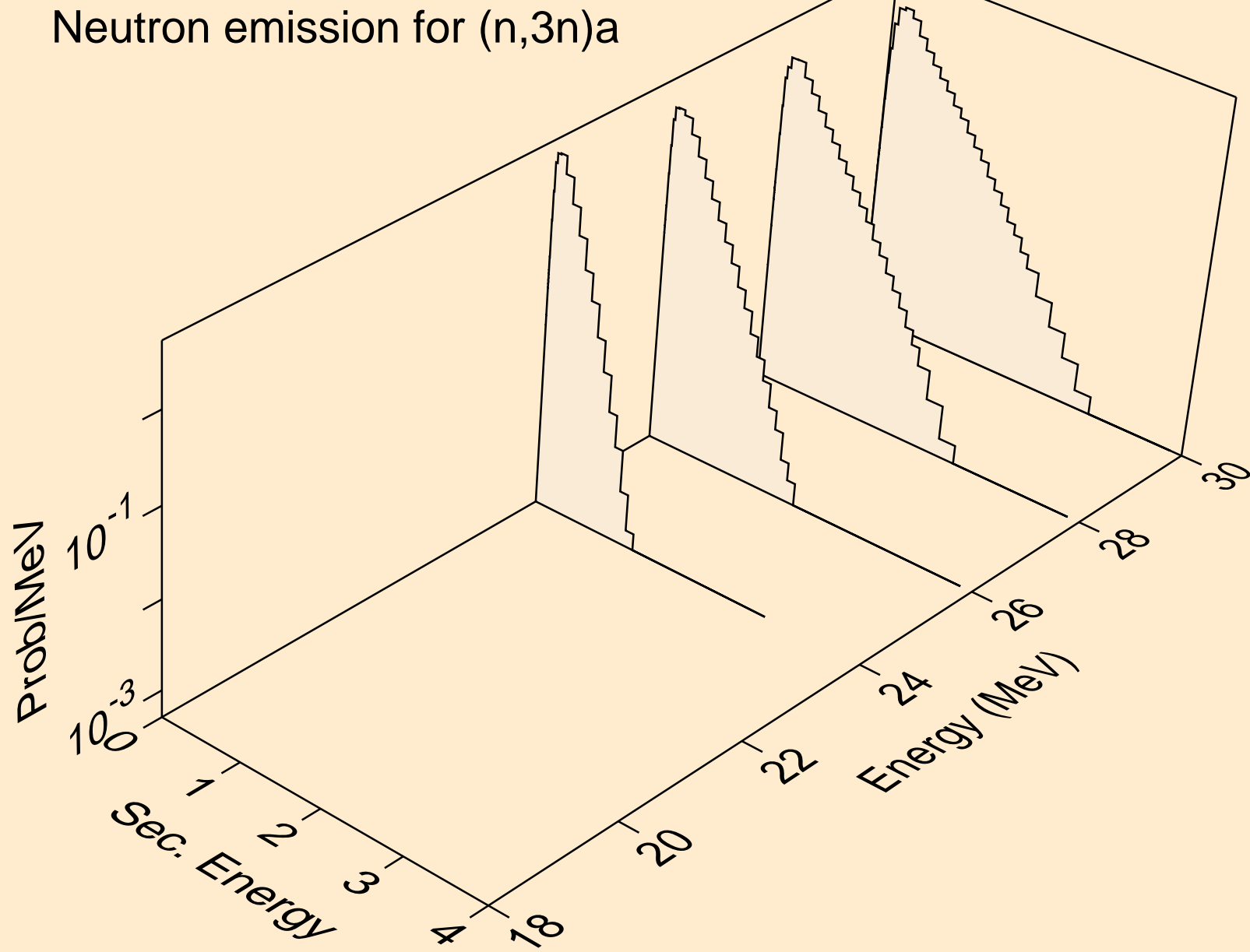

PD116 NEUTRON ACER TENDL-2024 LIBRARY; T=293.6K
Neutron emission for (n,n*)p

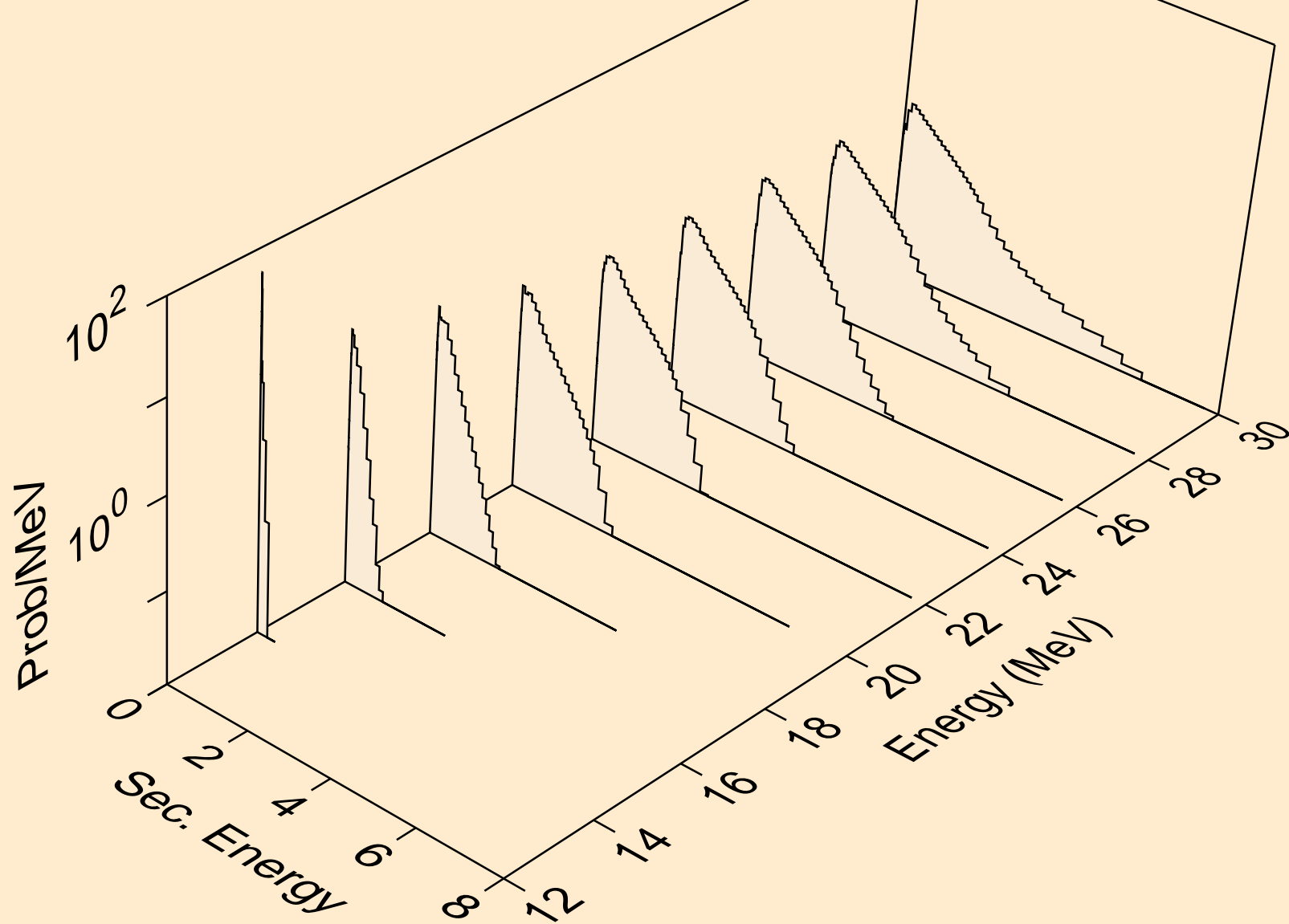

PD116 NEUTRON ACER TENDL-2024 LIBRARY; T=293.6K
Neutron emission for (n,n*)d

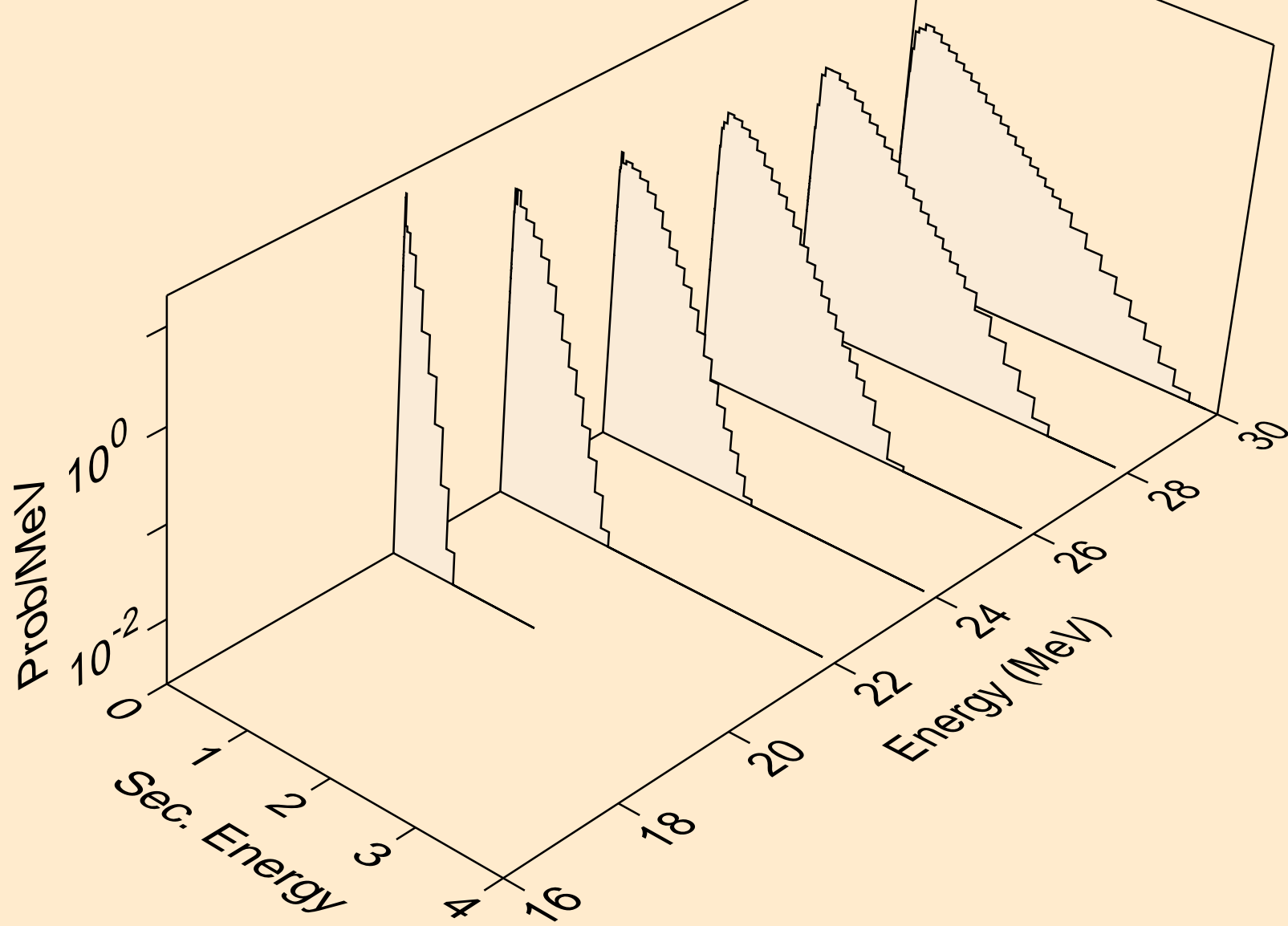

PD116 NEUTRON ACER TENDL-2024 LIBRARY; T=293.6K
Neutron emission for (n,n*)t

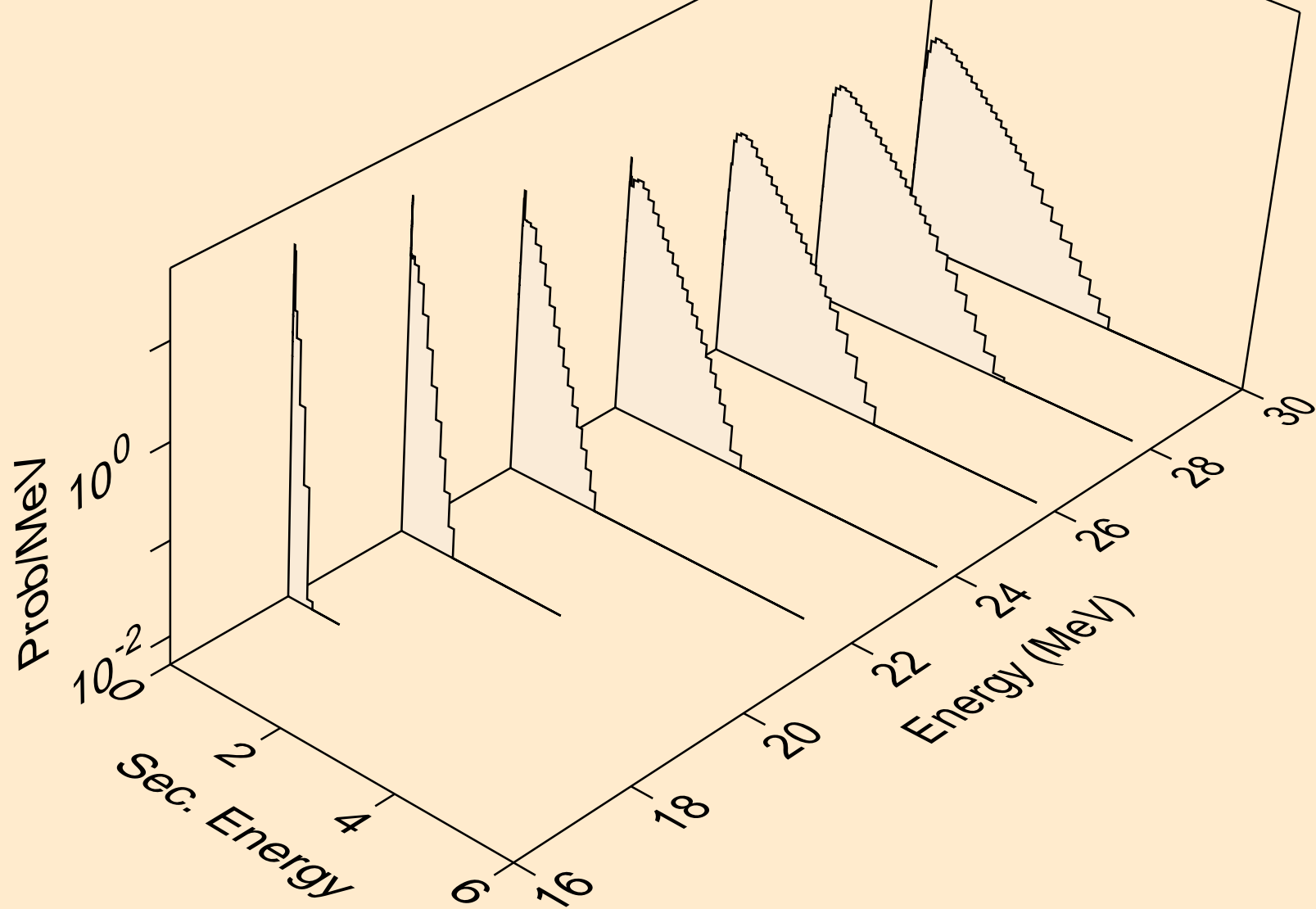

PD116 NEUTRON ACER TENDL-2024 LIBRARY; T=293.6K
Neutron emission for (n,4n)

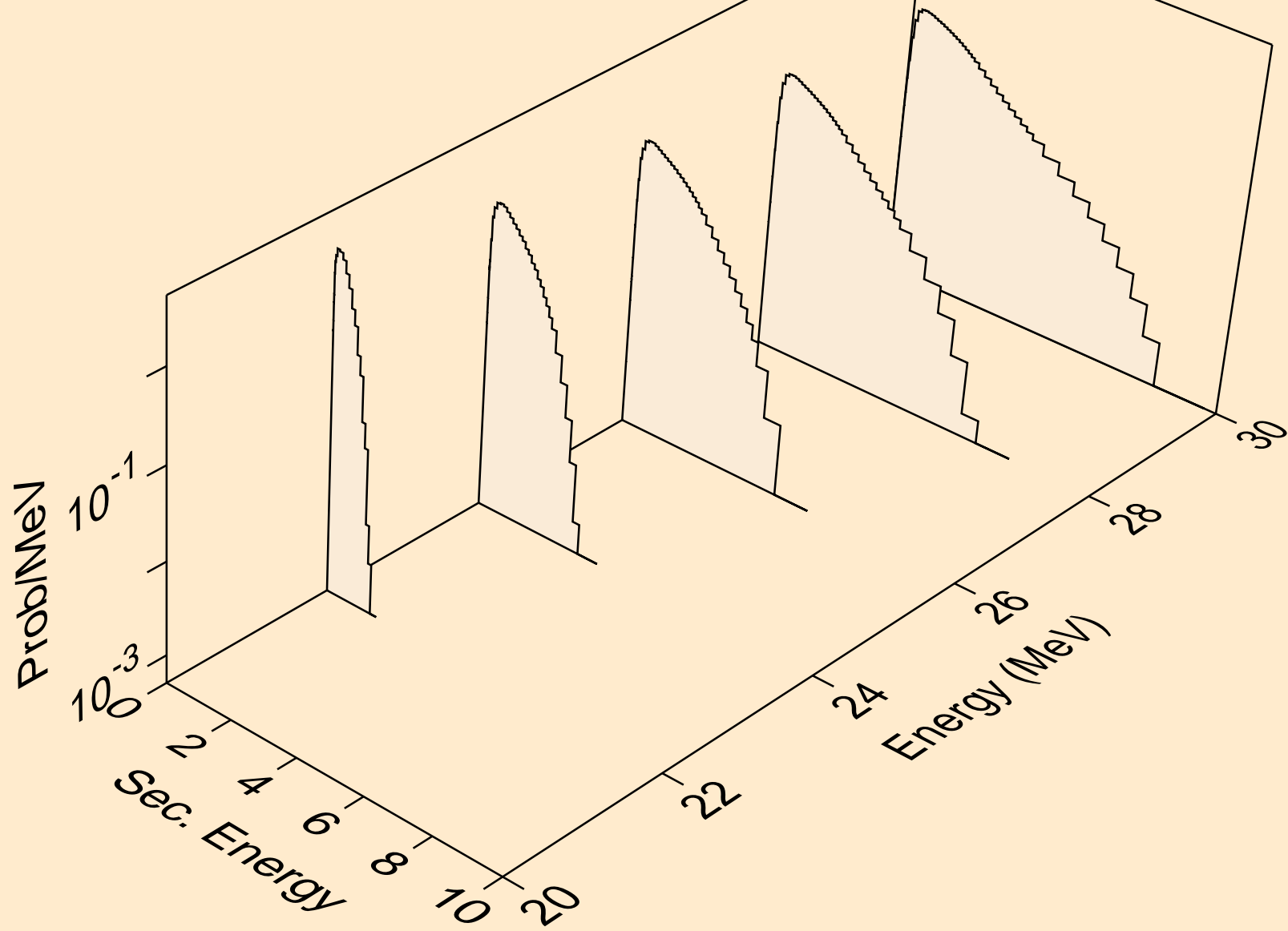

PD116 NEUTRON ACER TENDL-2024 LIBRARY; T=293.6K
Neutron emission for (n,2np)

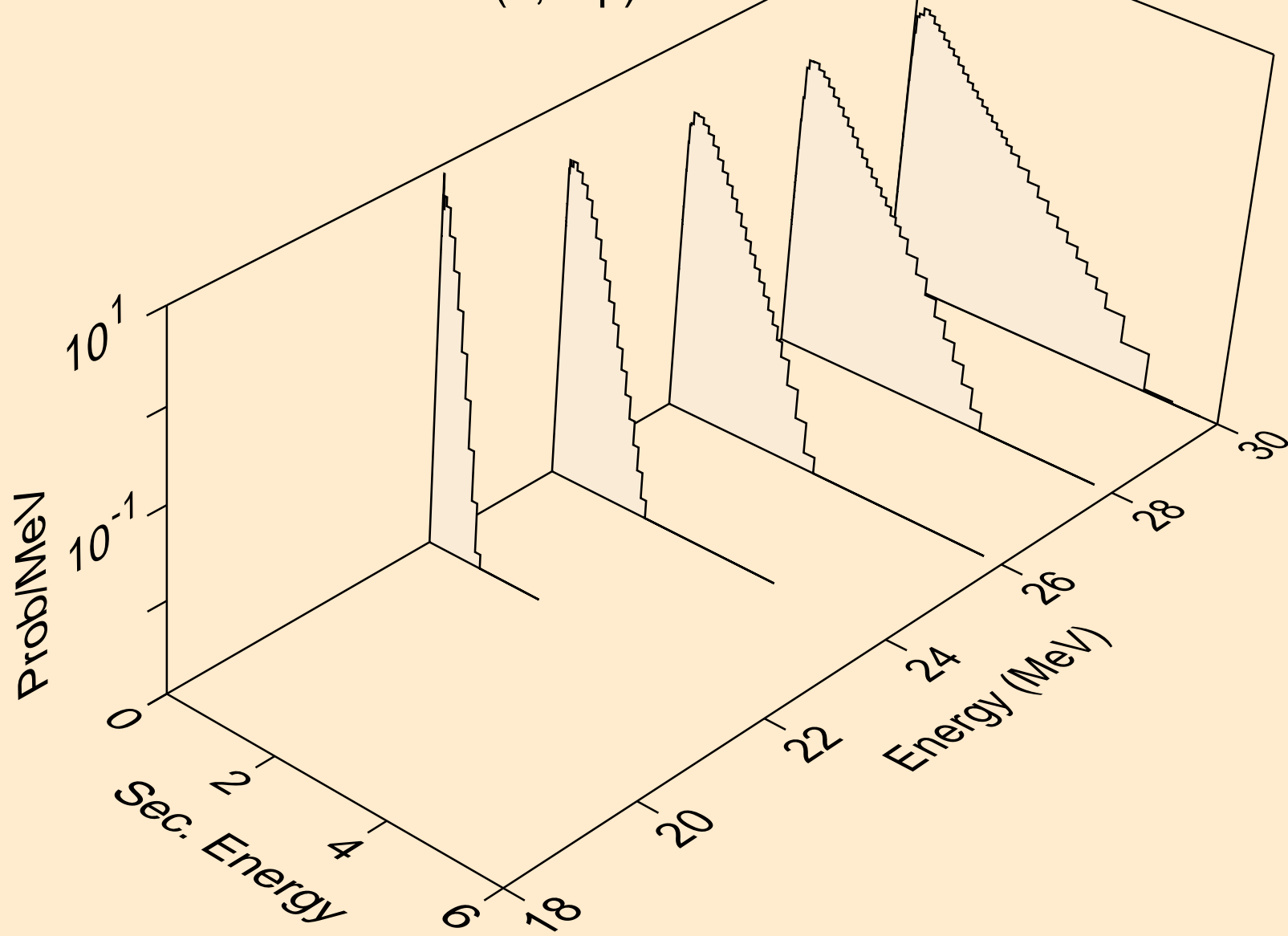

PD116 NEUTRON ACER TENDL-2024 LIBRARY; T=293.6K
Neutron emission for (n,3np)

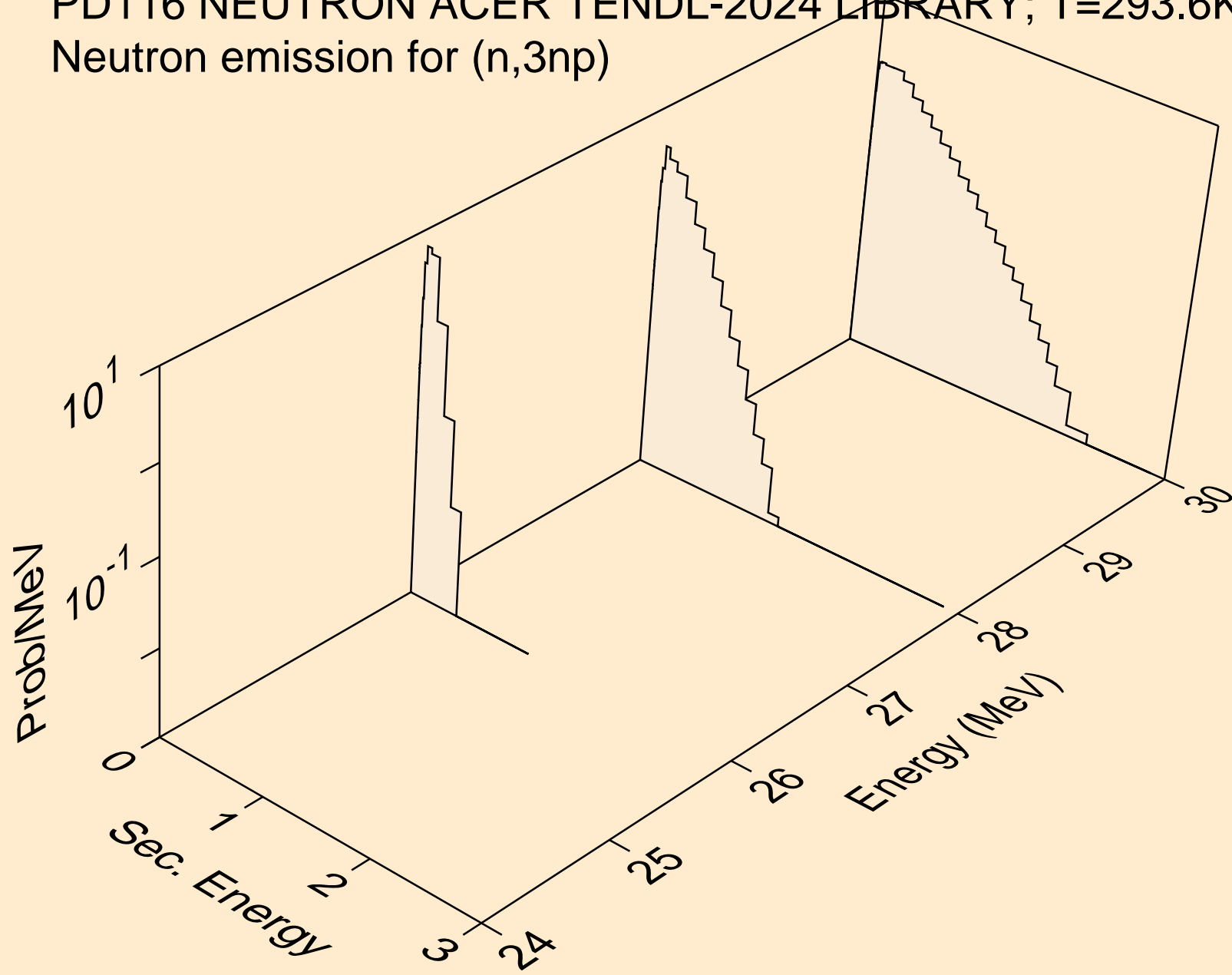

PD116 NEUTRON ACER TENDL-2024 LIBRARY; T=293.6K
Neutron emission for (n,n*c)

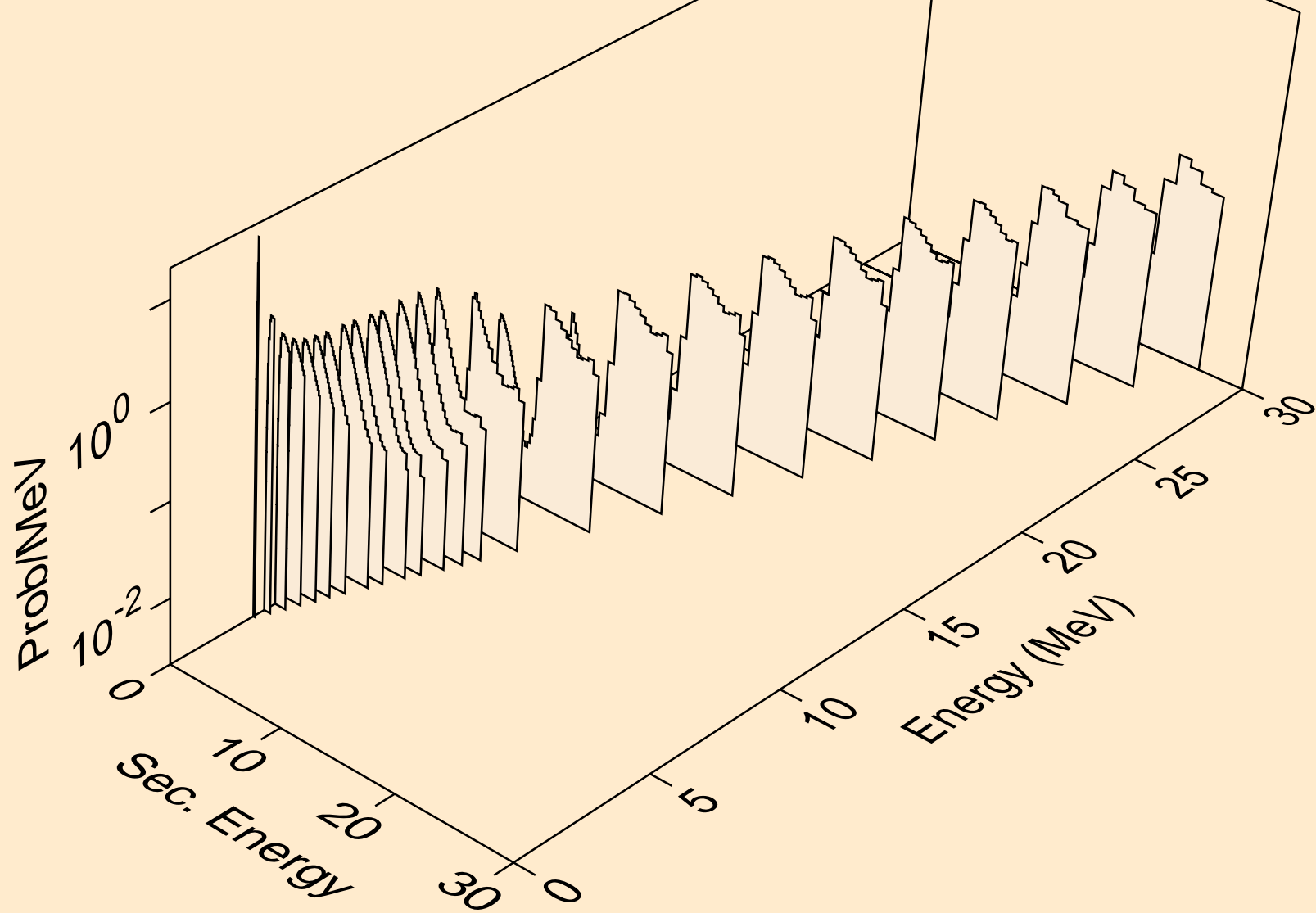

PD116 NEUTRON ACER TENDL-2024 LIBRARY; T=293.6K
Photon emission for (n,x)

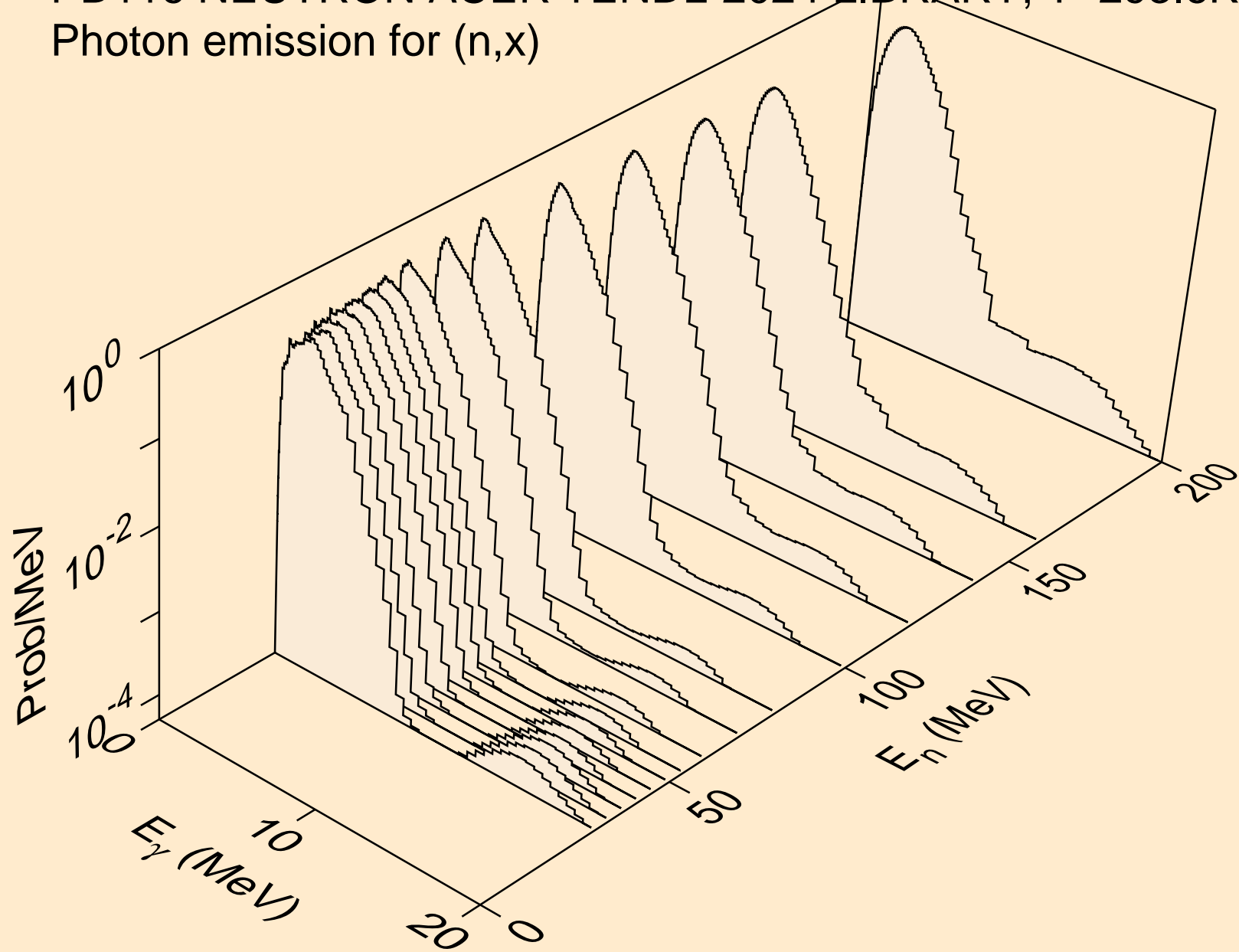

PD116 NEUTRON ACER TENDL-2024 LIBRARY; T=293.6K
Photon emission for (n,2nd)

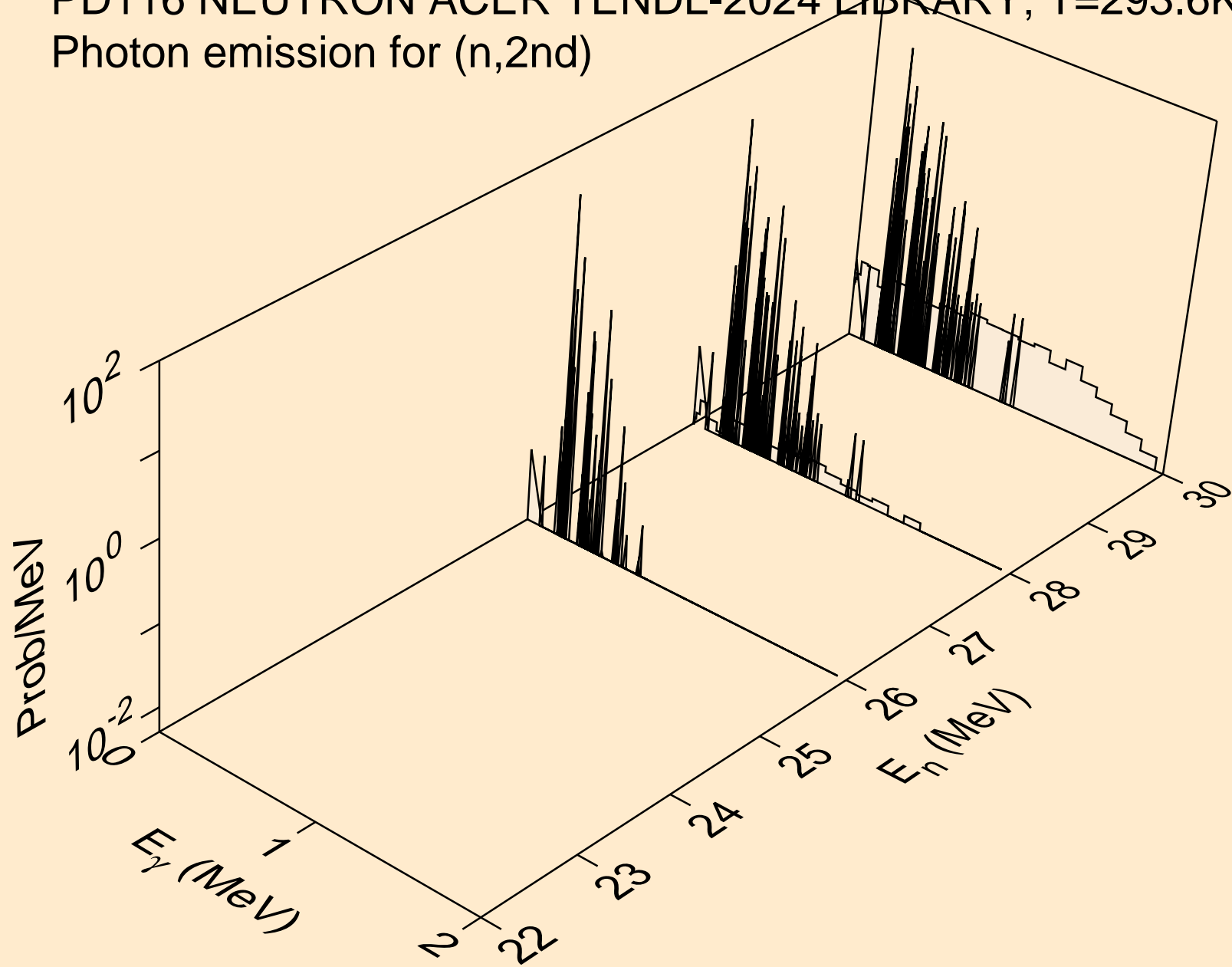

PD116 NEUTRON ACER TENDL-2024 LIBRARY; T=293.6K
Photon emission for (n,2n)

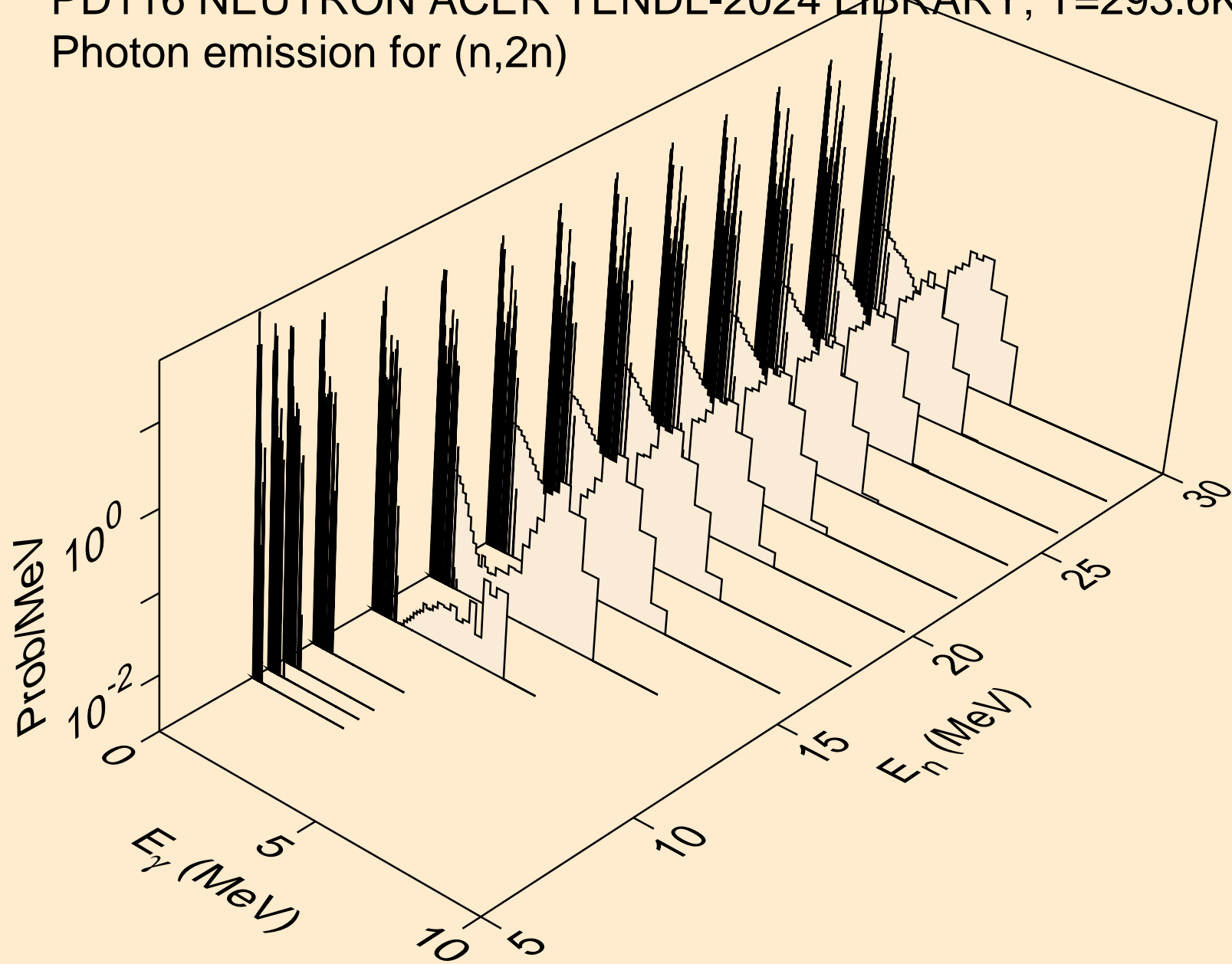

PD116 NEUTRON ACER TENDL-2024 LIBRARY; T=293.6K
Photon emission for (n,3n)

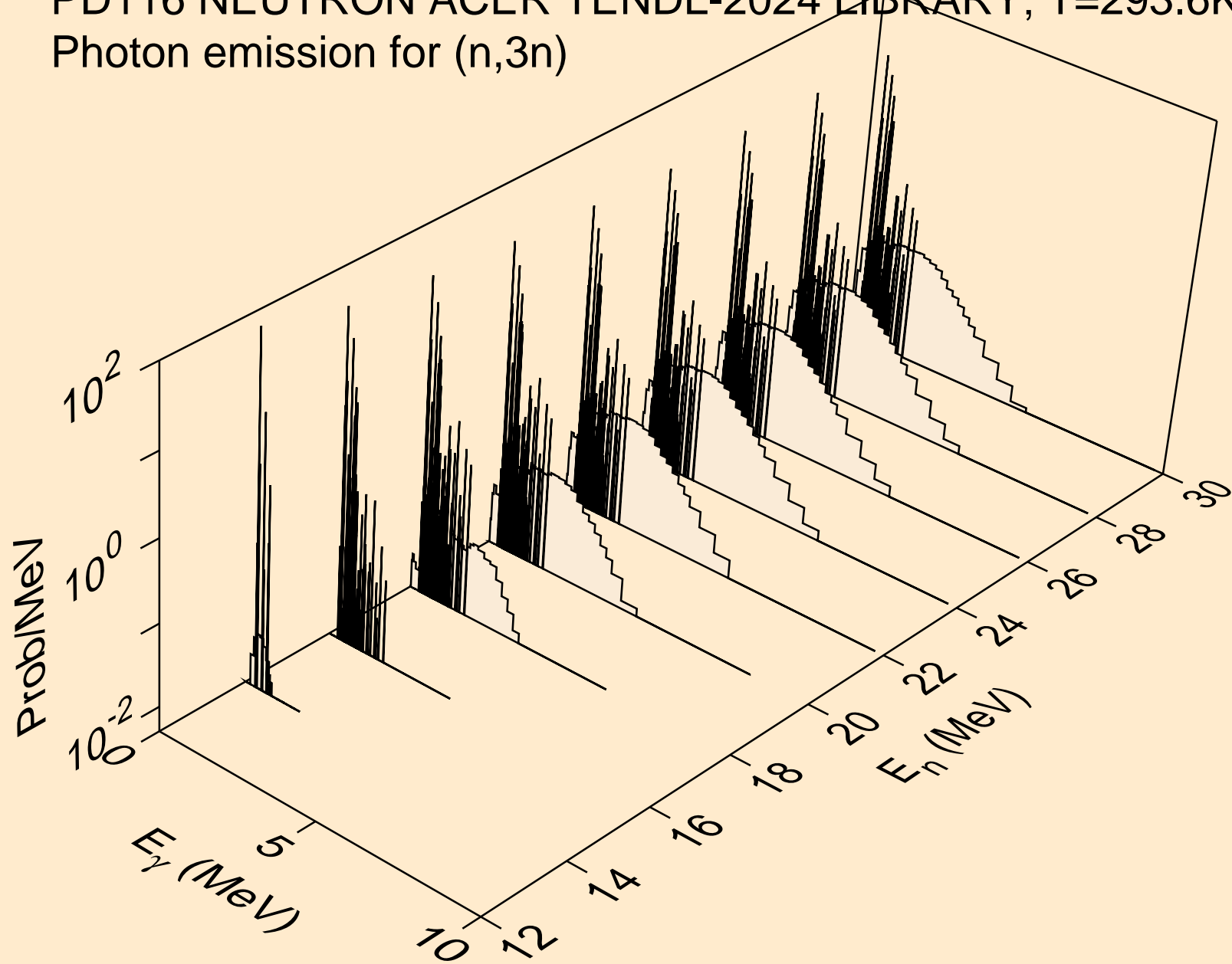

PD116 NEUTRON ACER TENDL-2024 LIBRARY; T=293.6K
Photon emission for (n,n*)a

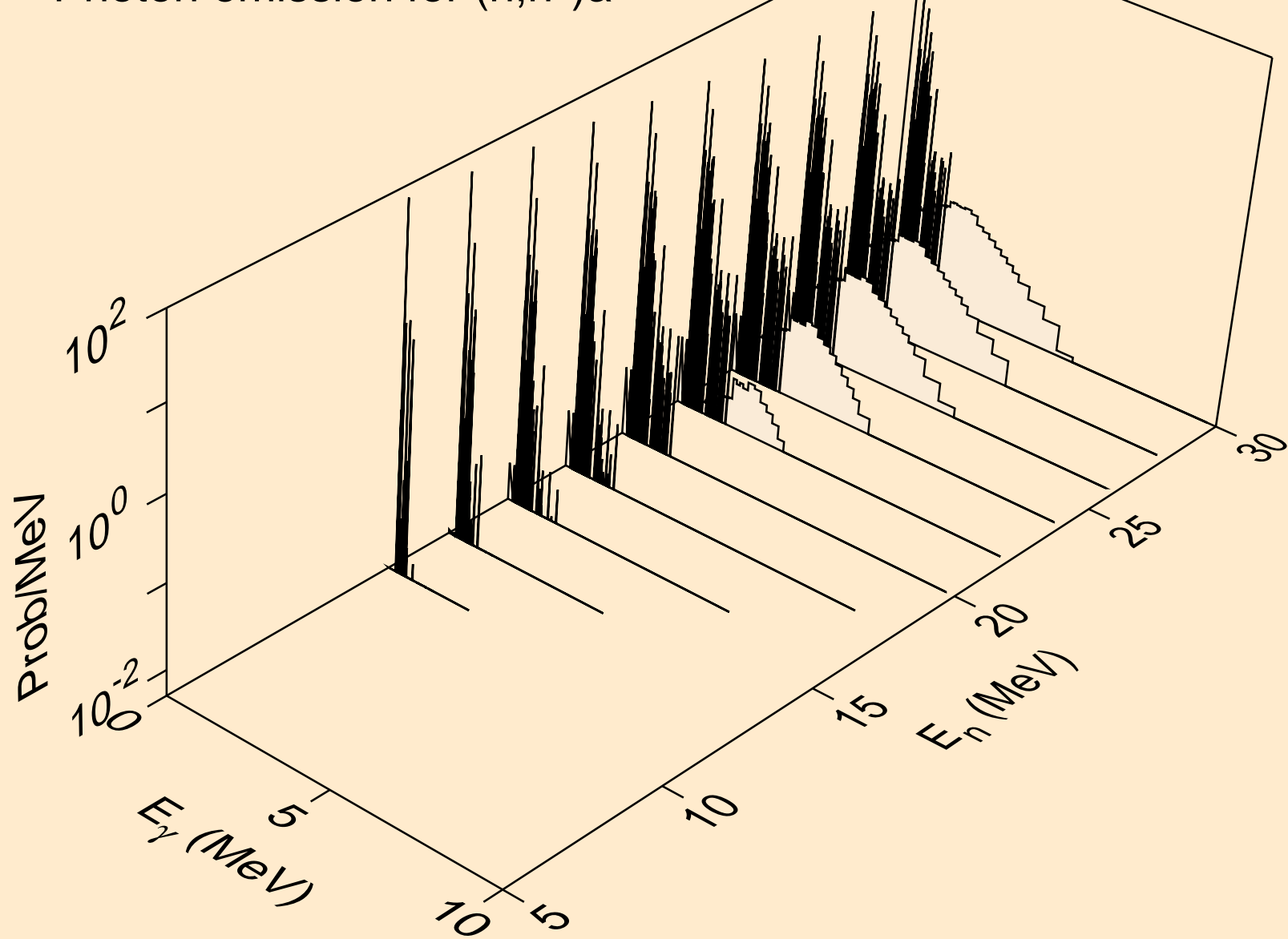

PD116 NEUTRON ACER TENDL-2024 LIBRARY; T=293.6K
Photon emission for (n,2n)a

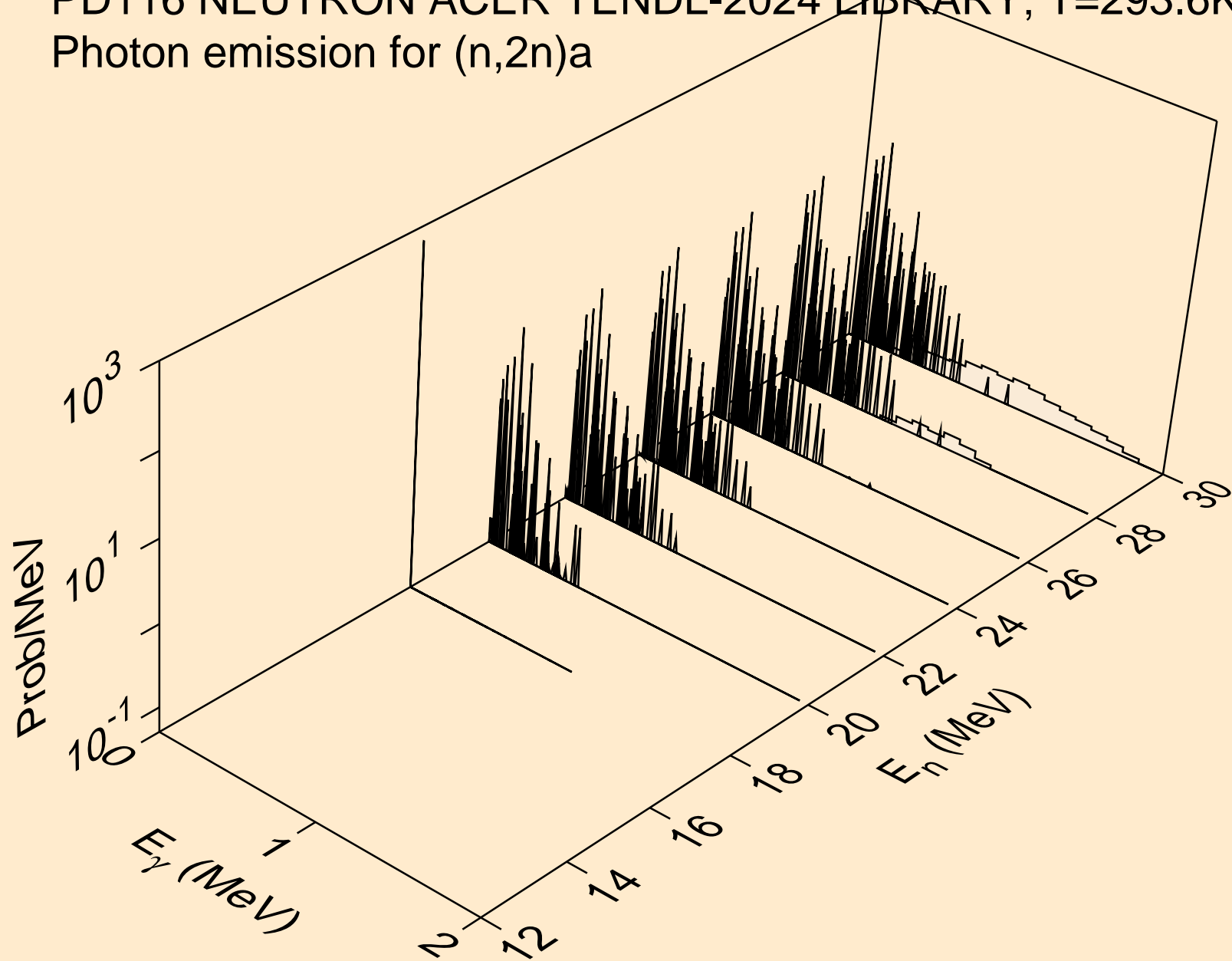

PD116 NEUTRON ACER TENDL-2024 LIBRARY; T=293.6K
Photon emission for (n,3n)a

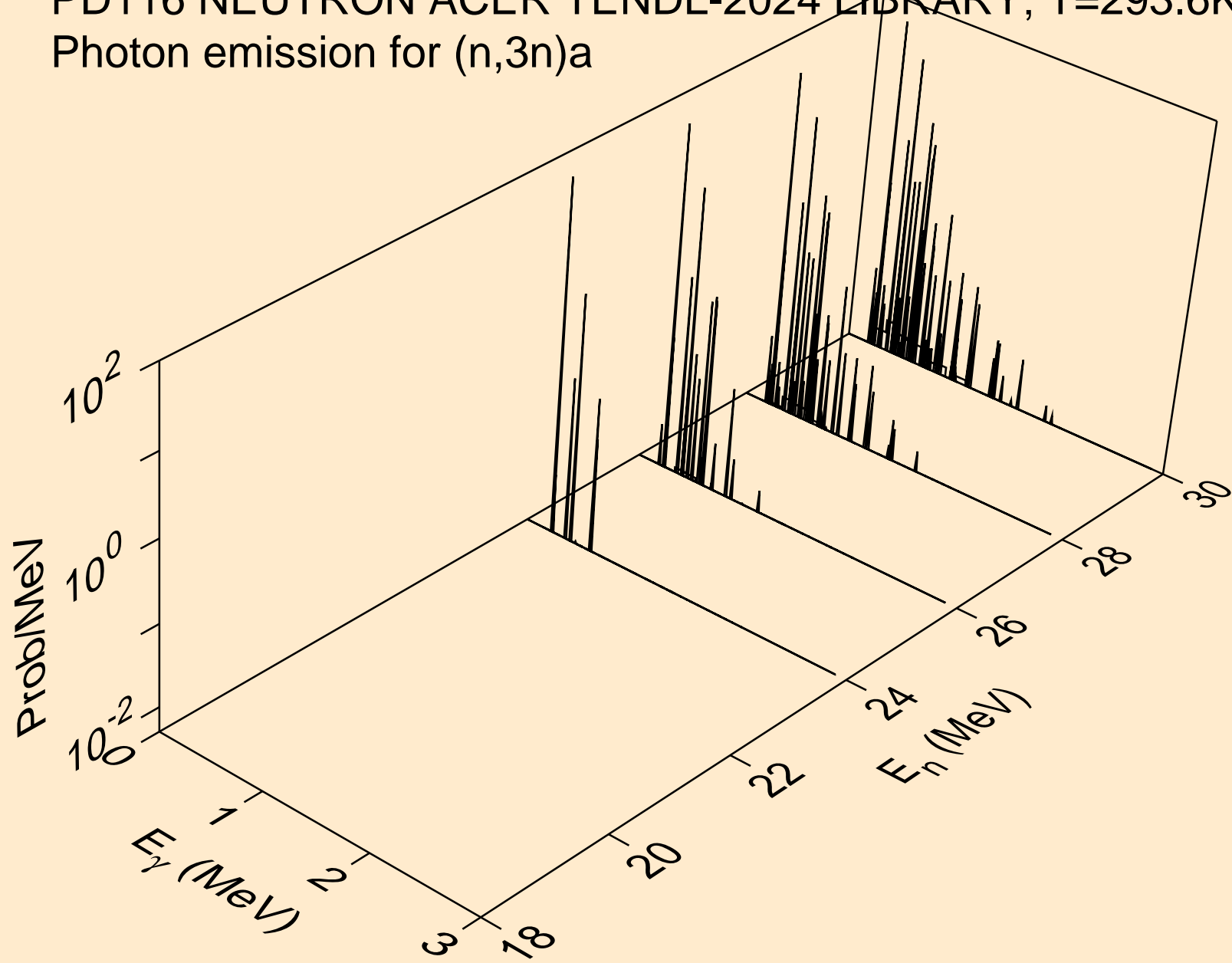

PD116 NEUTRON ACER TENDL-2024 LIBRARY; T=293.6K
Photon emission for (n,n*)p

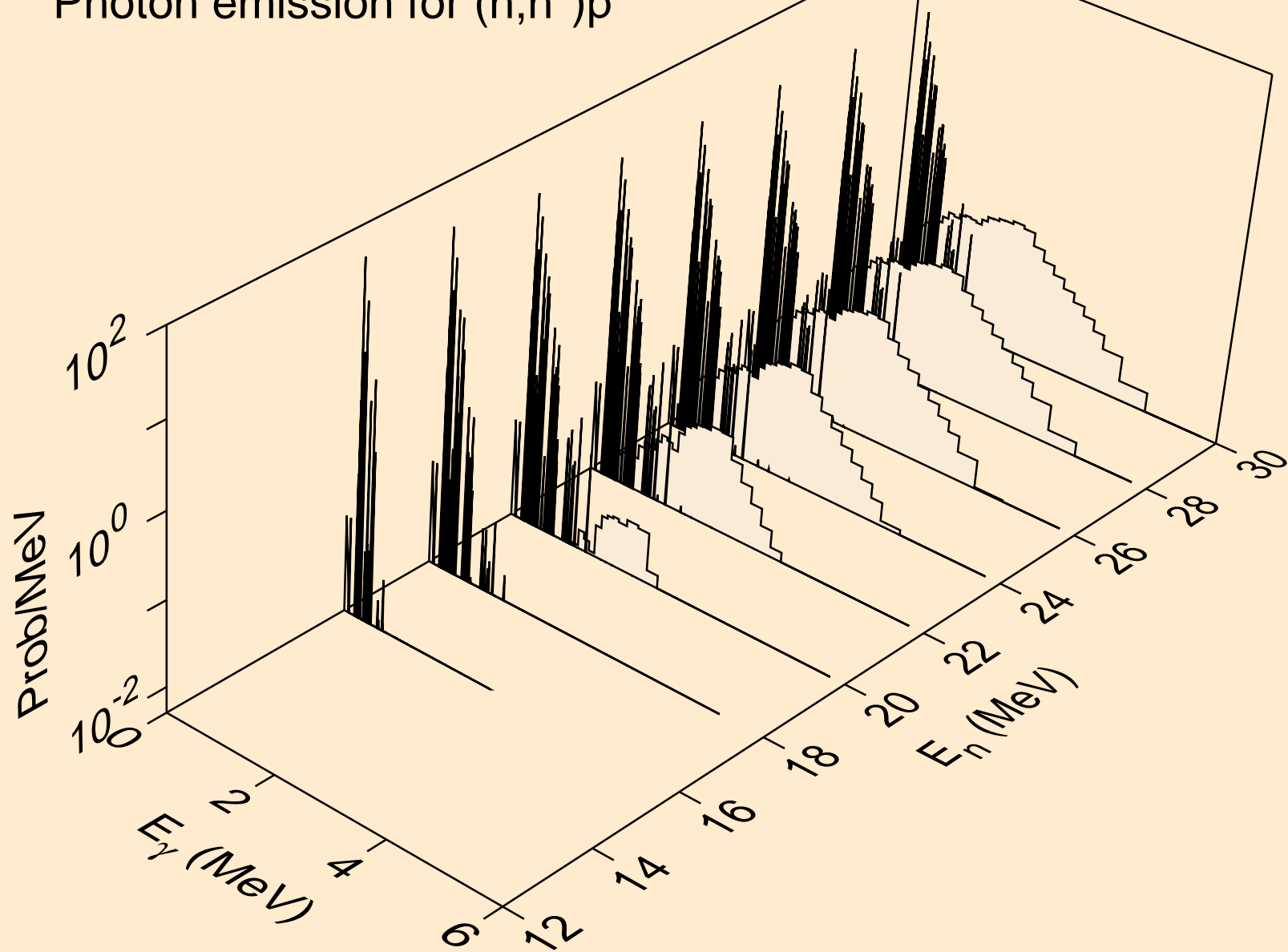

PD116 NEUTRON ACER TENDL-2024 LIBRARY; T=293.6K
Photon emission for (n,n*)d

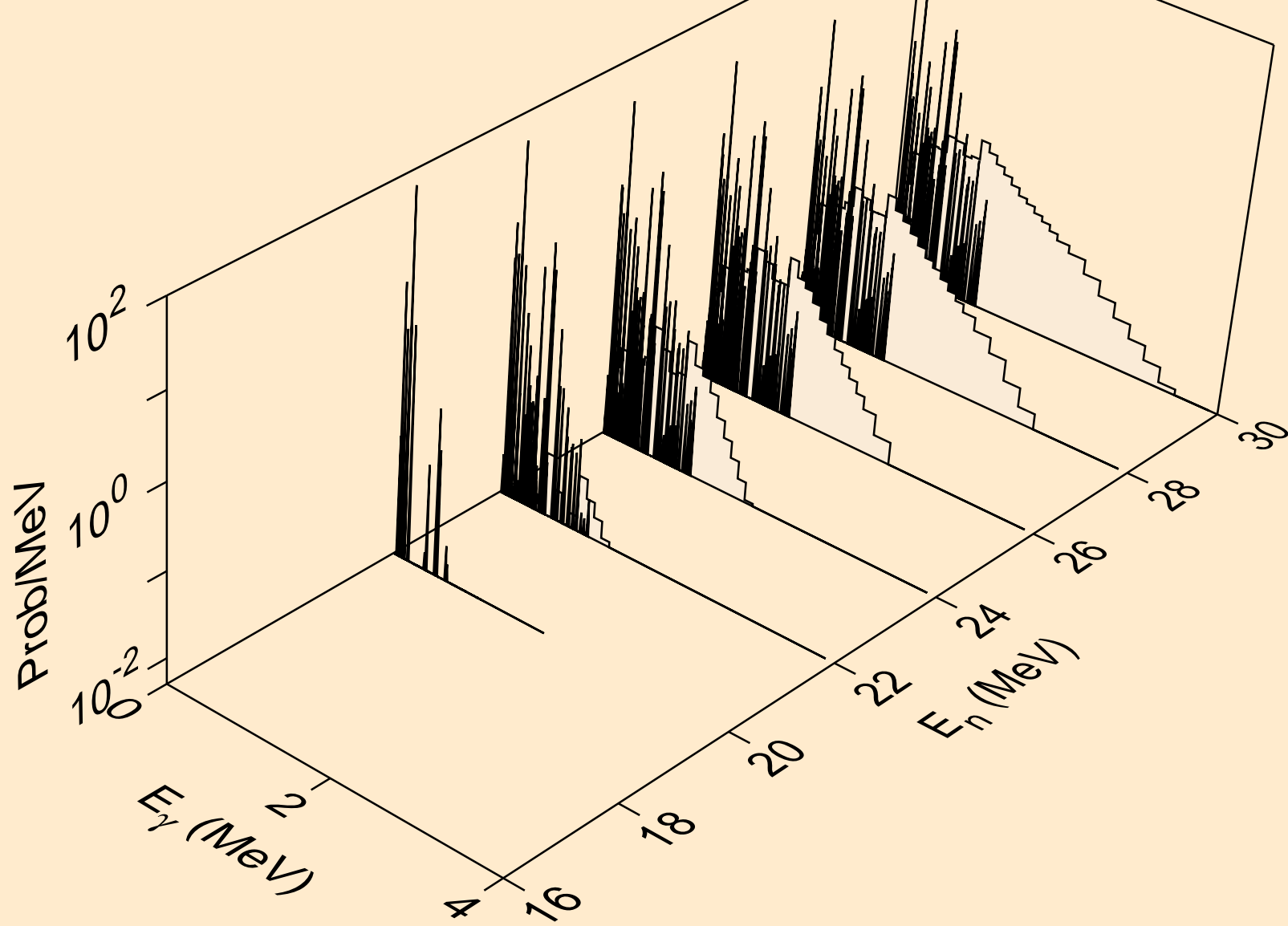

PD116 NEUTRON ACER TENDL-2024 LIBRARY; T=293.6K
Photon emission for (n,n*)t

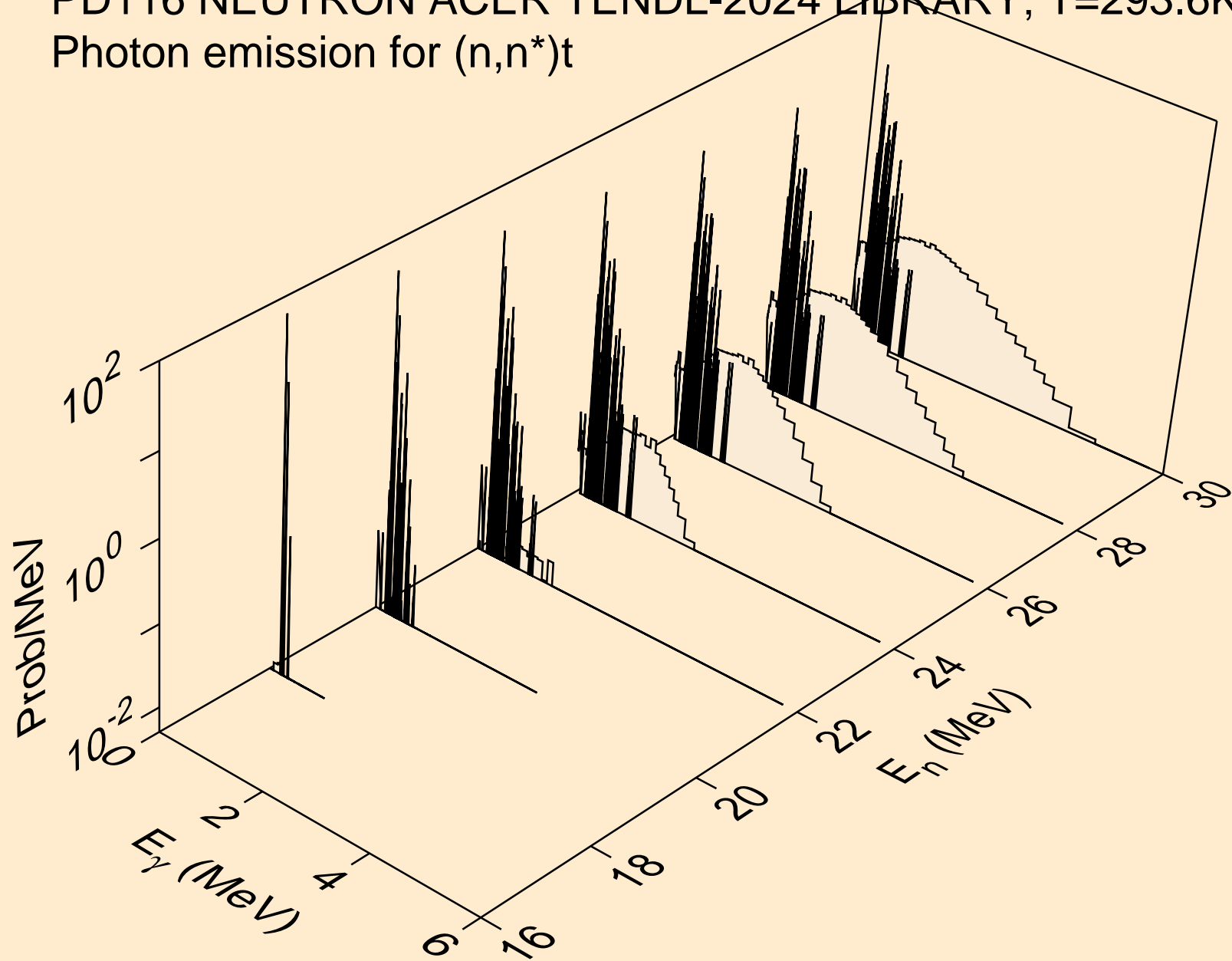

PD116 NEUTRON ACER TENDL-2024 LIBRARY; T=293.6K
Photon emission for (n,4n)

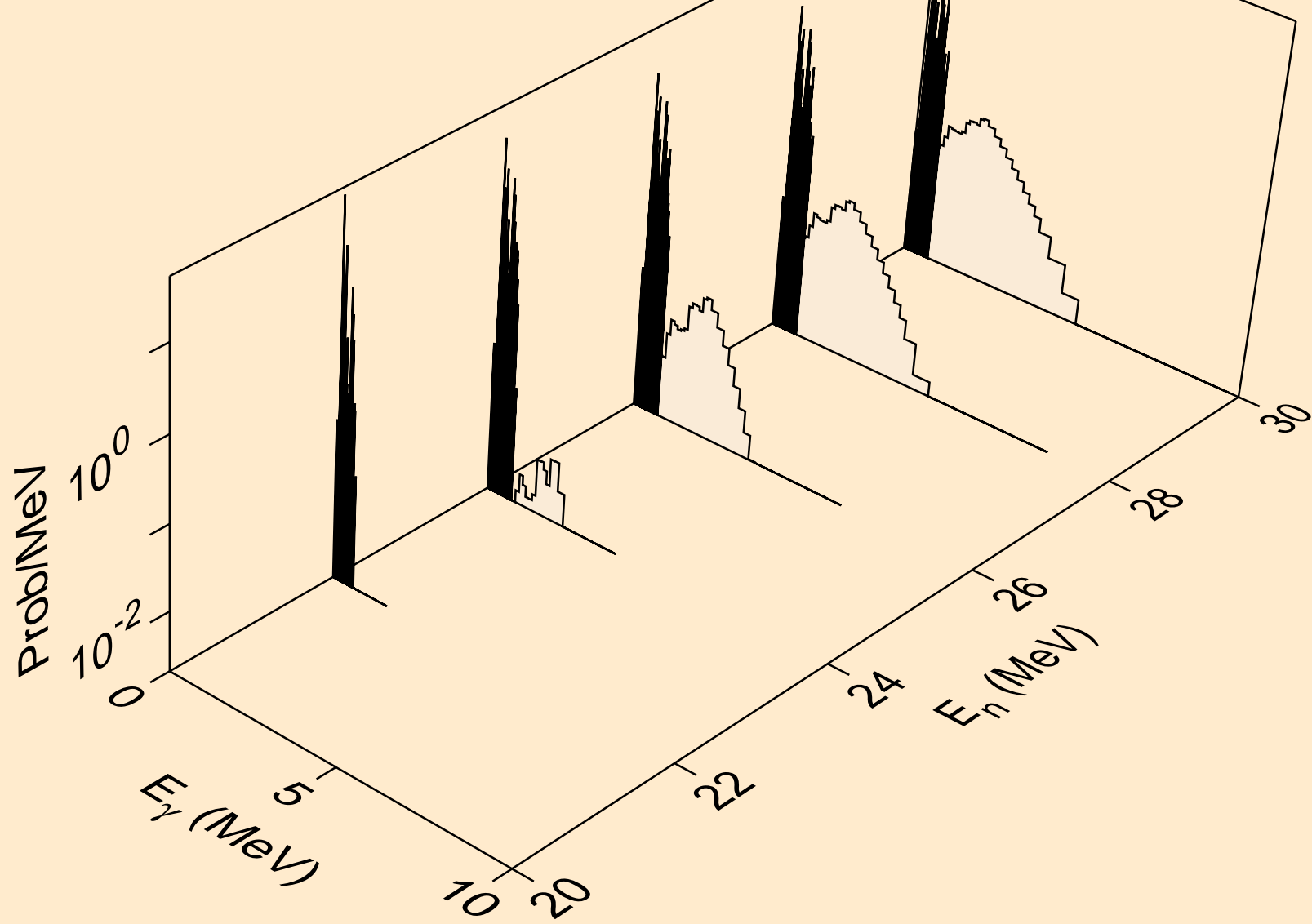

PD116 NEUTRON ACER TENDL-2024 LIBRARY; T=293.6K
Photon emission for (n,2np)

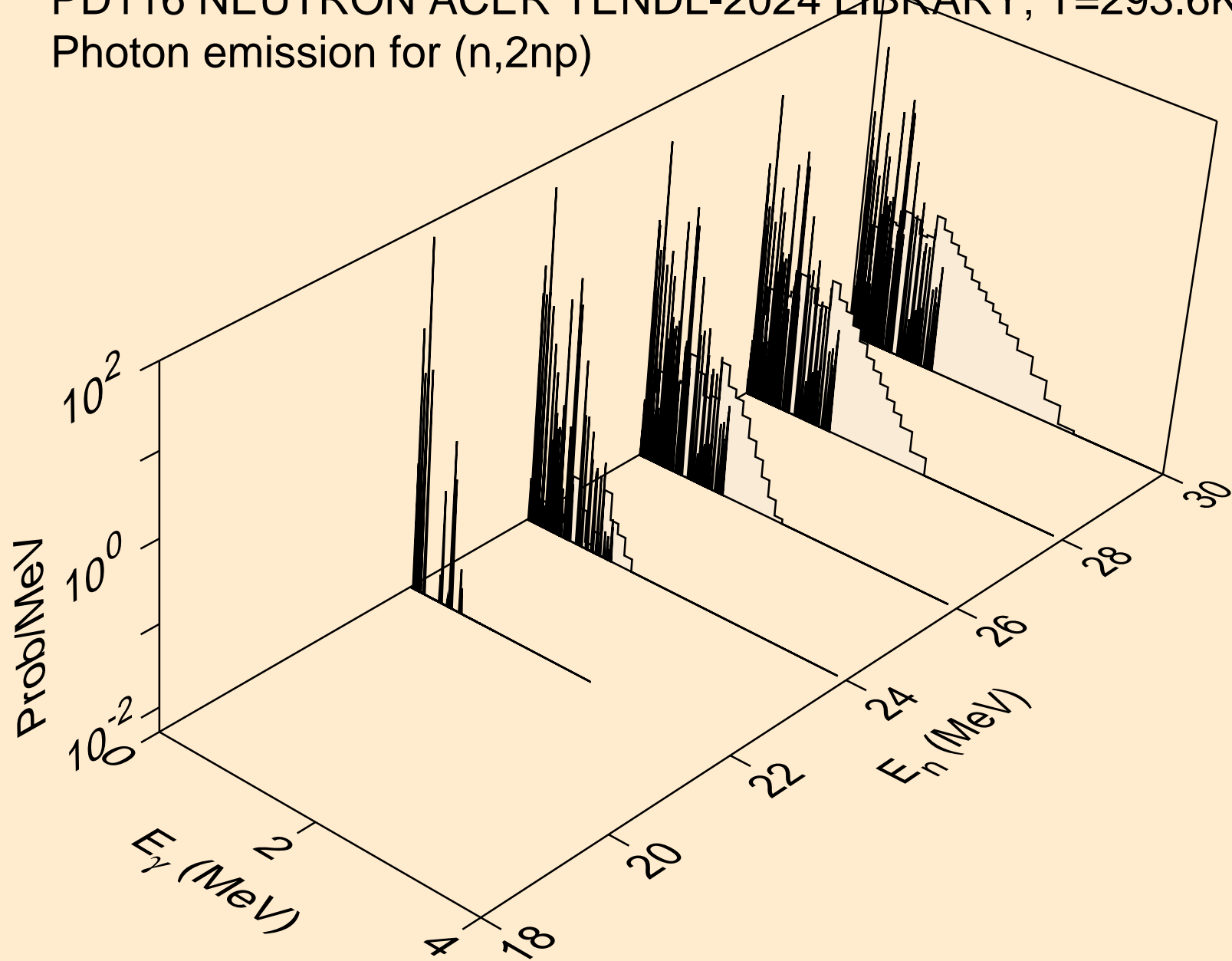

PD116 NEUTRON ACER TENDL-2024 LIBRARY; T=293.6K
Photon emission for (n,3np)

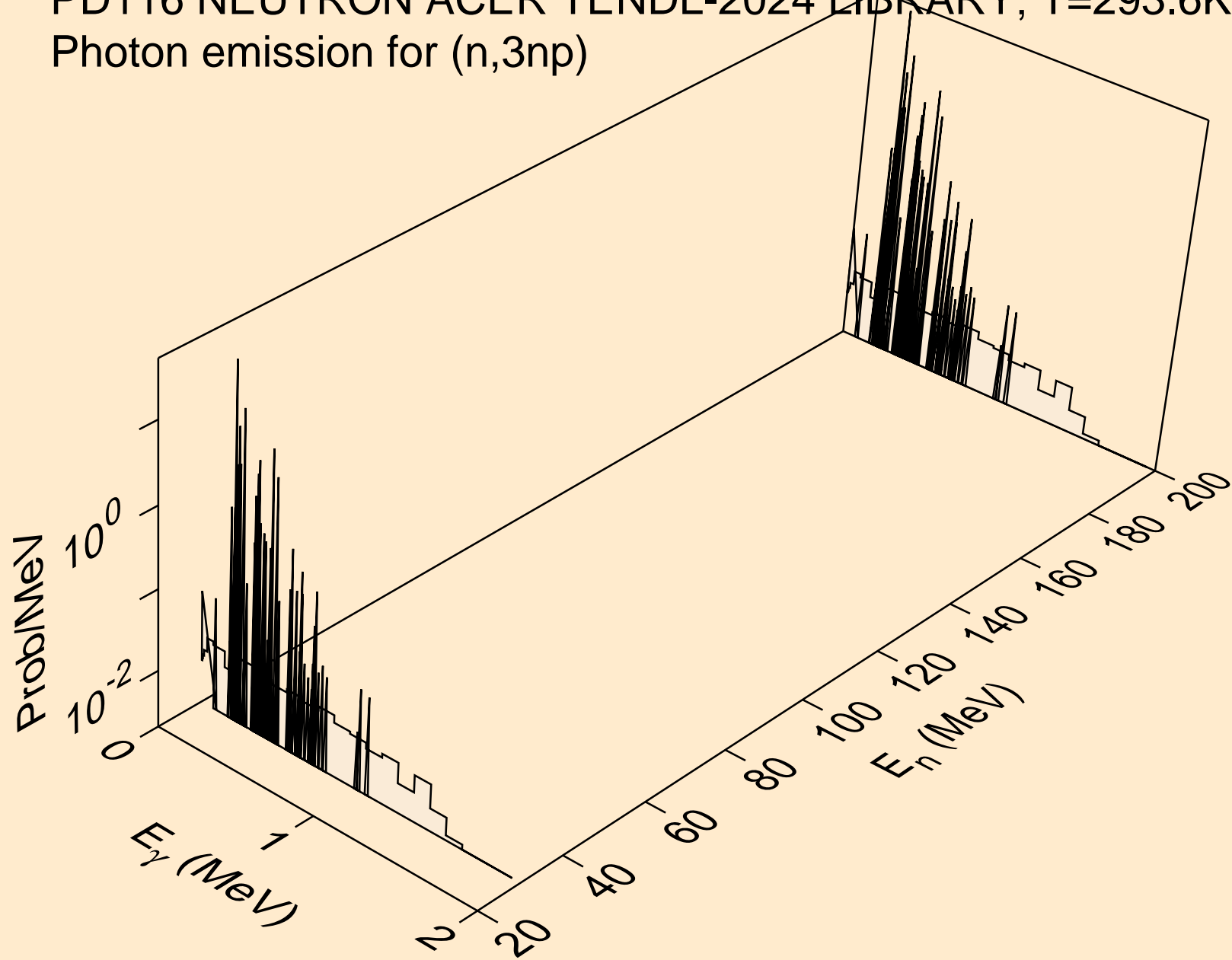

PD116 NEUTRON ACER TENDL-2024 LIBRARY; T=293.6K
Photon emission for (n,n*c)

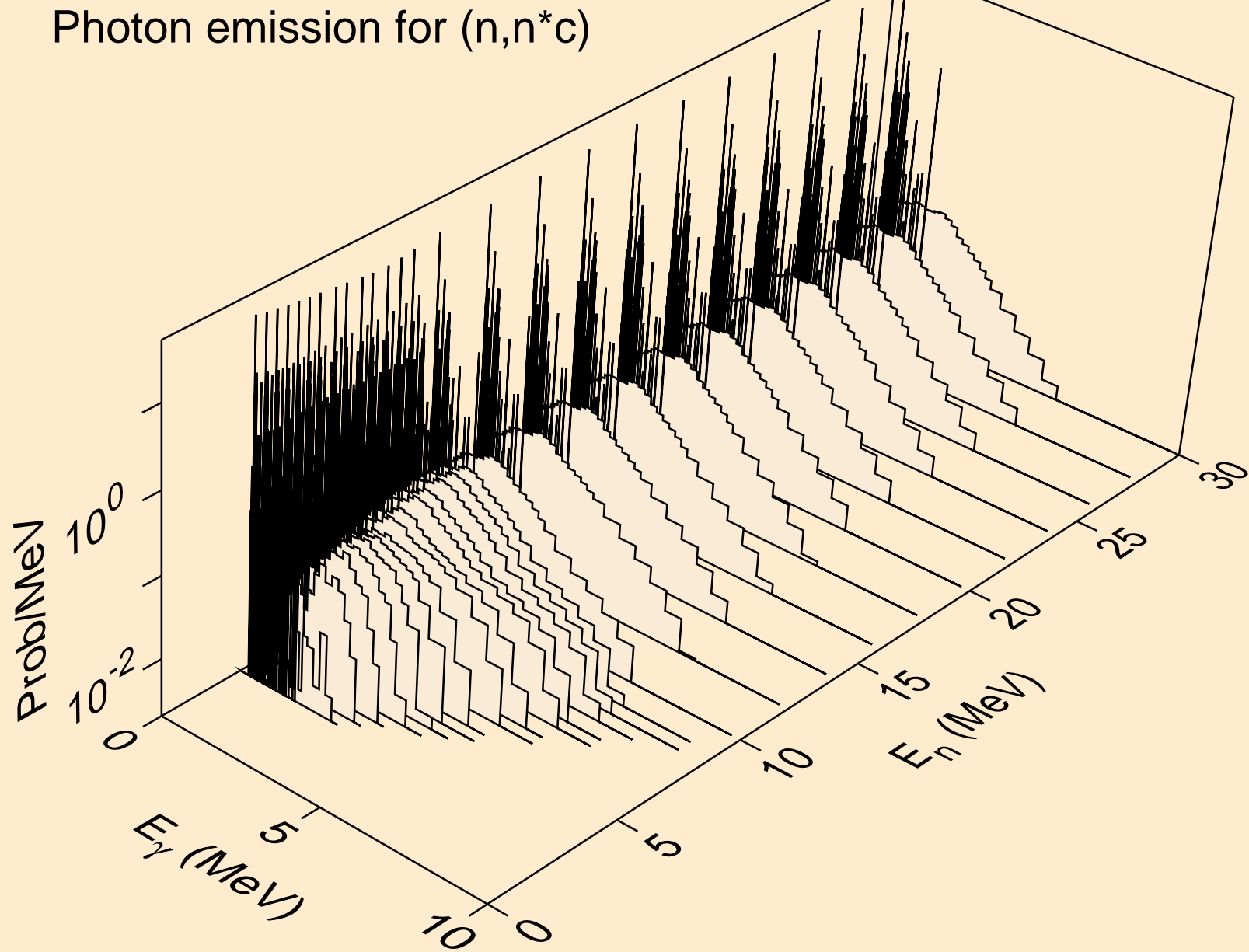

PD116 NEUTRON ACER TENDL-2024 LIBRARY; T=293.6K
Photon emission for (n,gma)

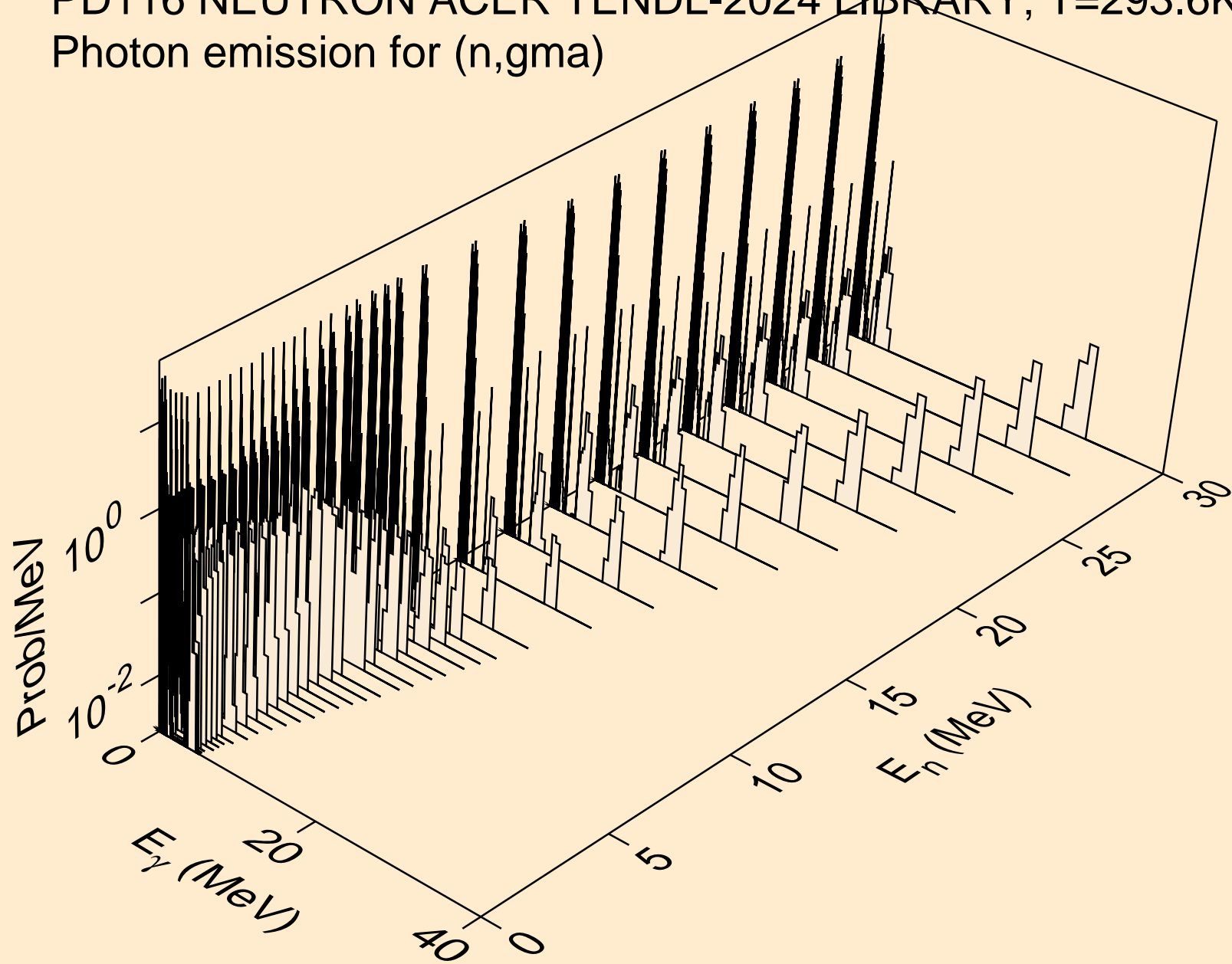

PD116 NEUTRON ACER TENDL-2024 LIBRARY; T=293.6K
Photon emission for (n,p)

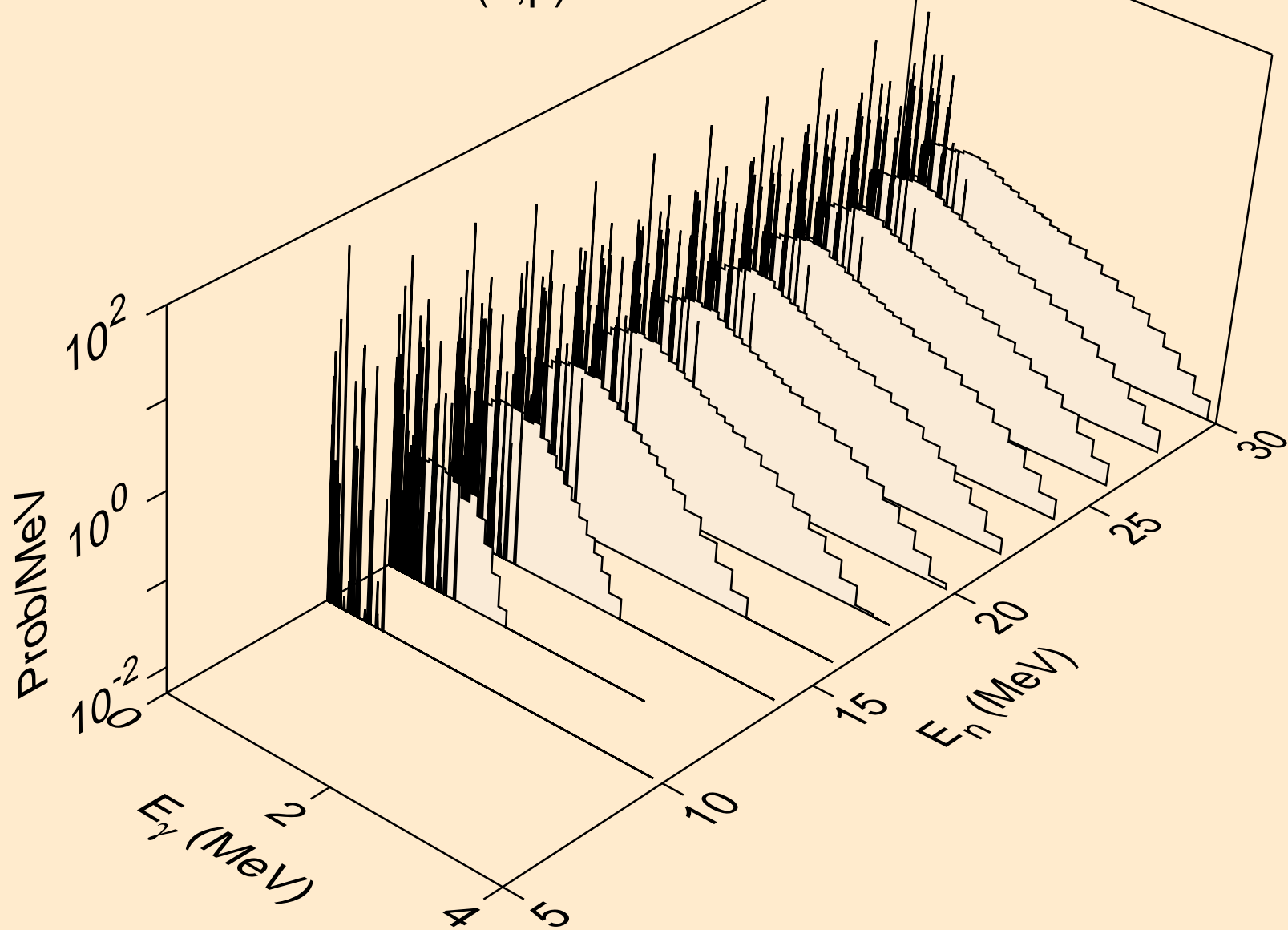

PD116 NEUTRON ACER TENDL-2024 LIBRARY; T=293.6K
Photon emission for (n,d)

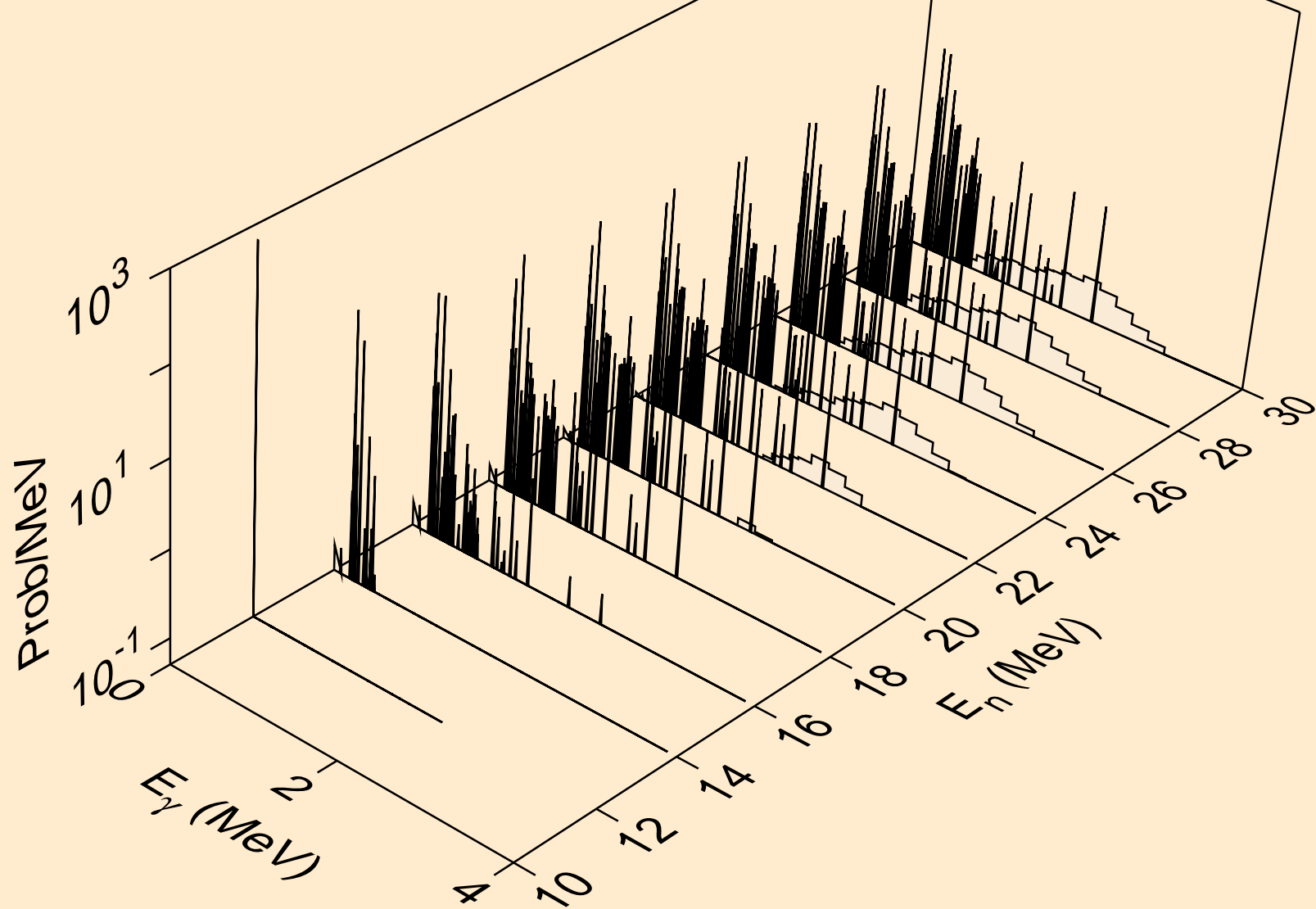

PD116 NEUTRON ACER TENDL-2024 LIBRARY; T=293.6K
Photon emission for (n,t)

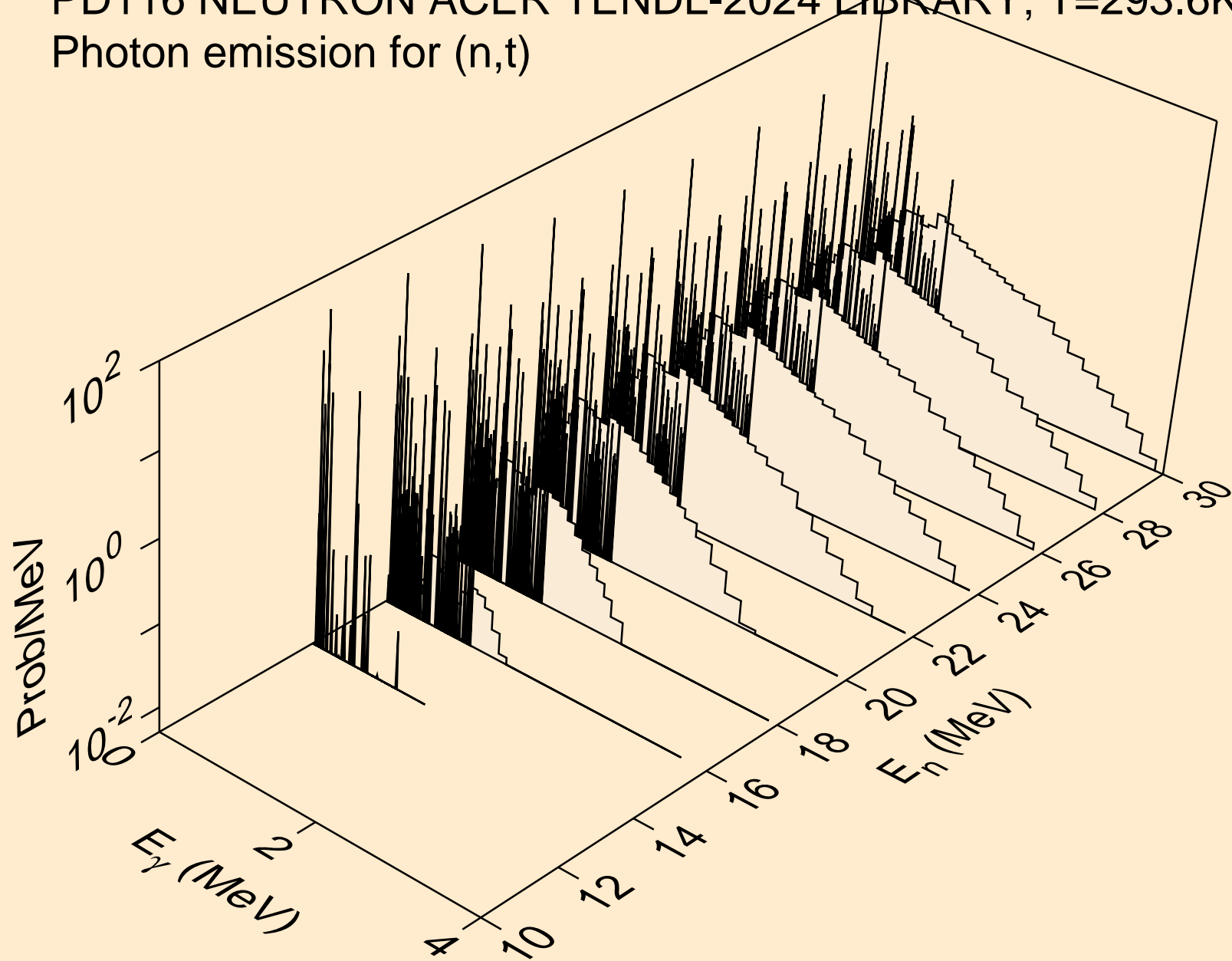

PD116 NEUTRON ACER TENDL-2024 LIBRARY; T=293.6K
Photon emission for (n,he3)

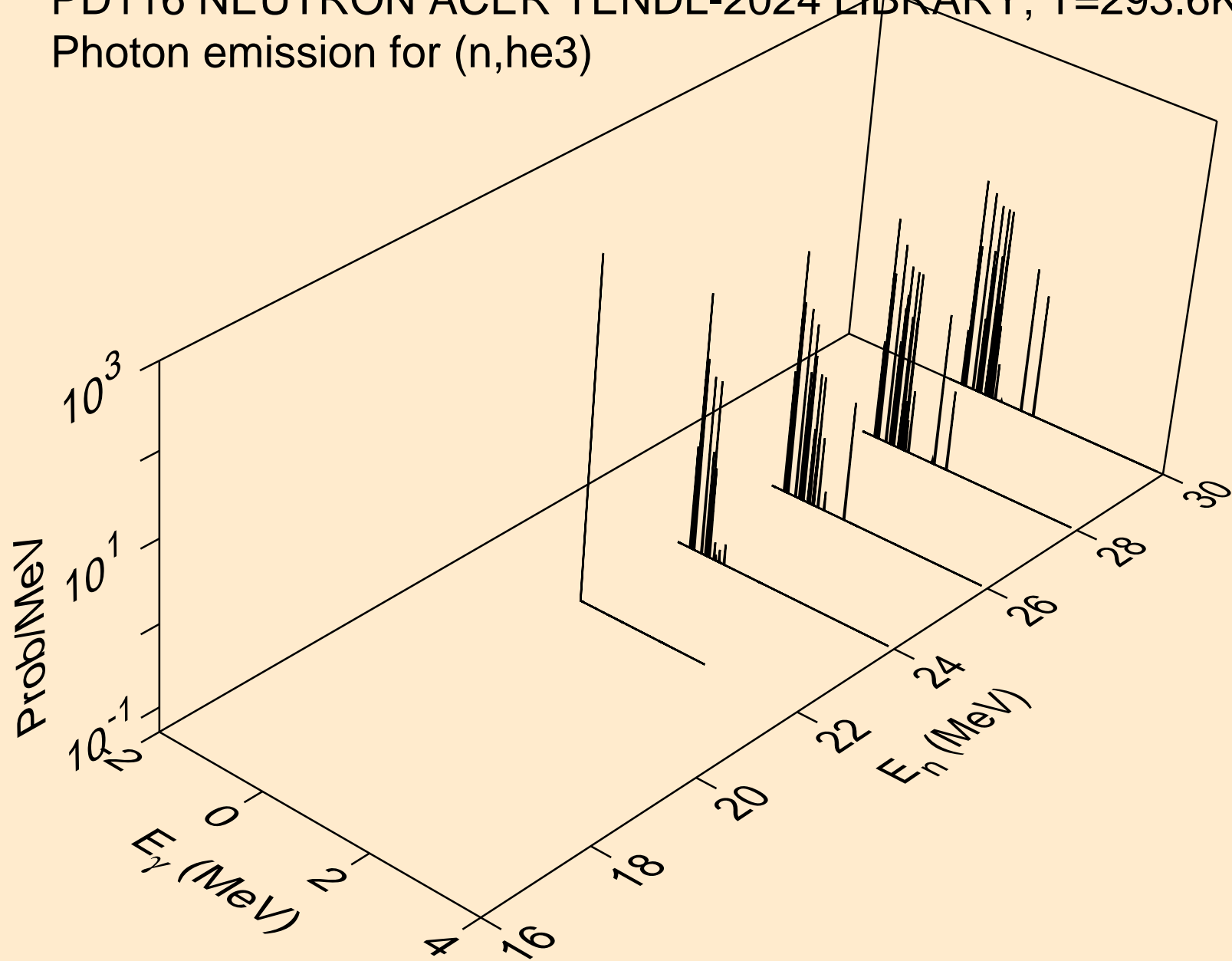

PD116 NEUTRON ACER TENDL-2024 LIBRARY; T=293.6K
Photon emission for (n,a)

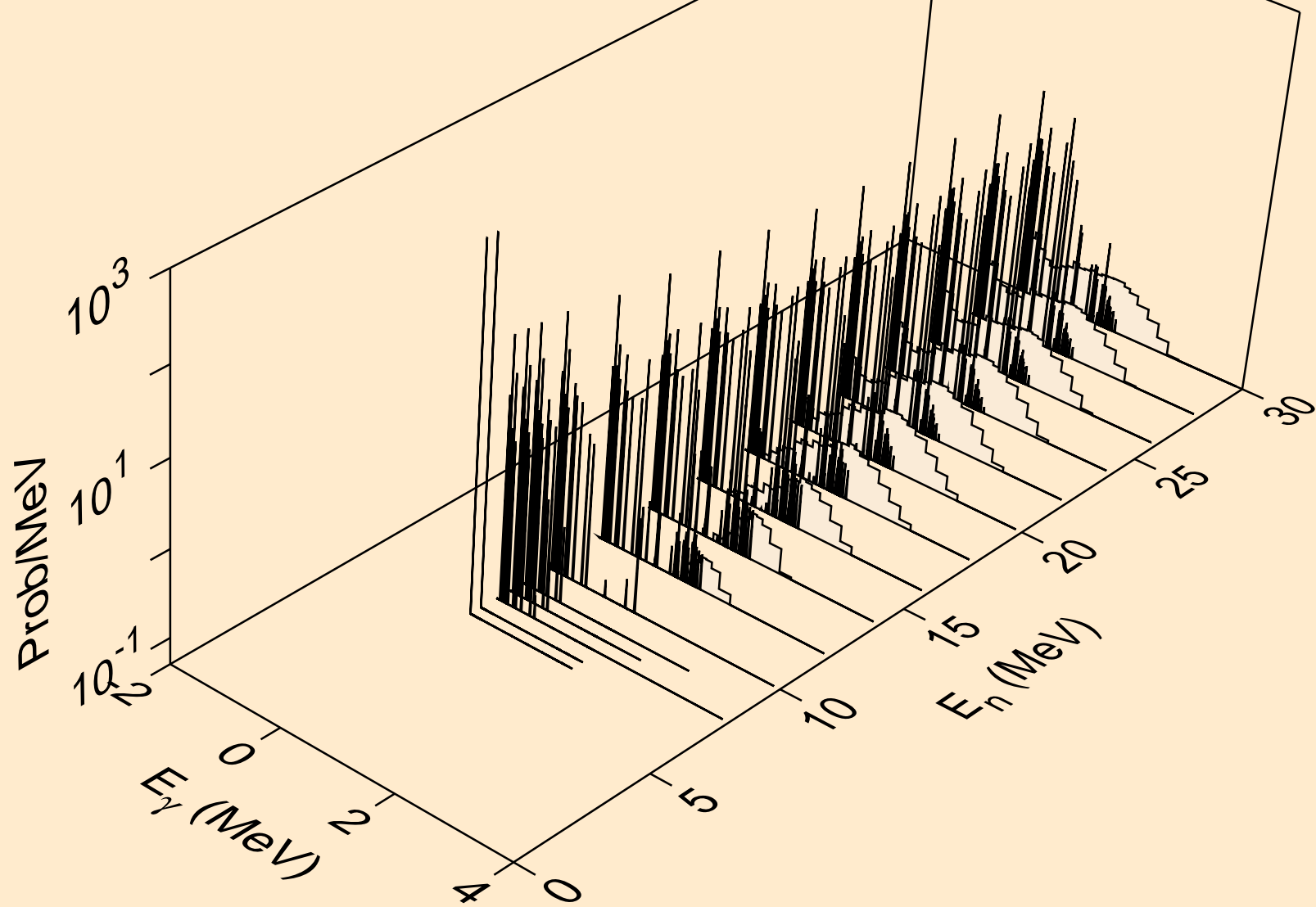

PD116 NEUTRON ACER TENDL-2024 LIBRARY; T=293.6K
thermal capture photon spectrum

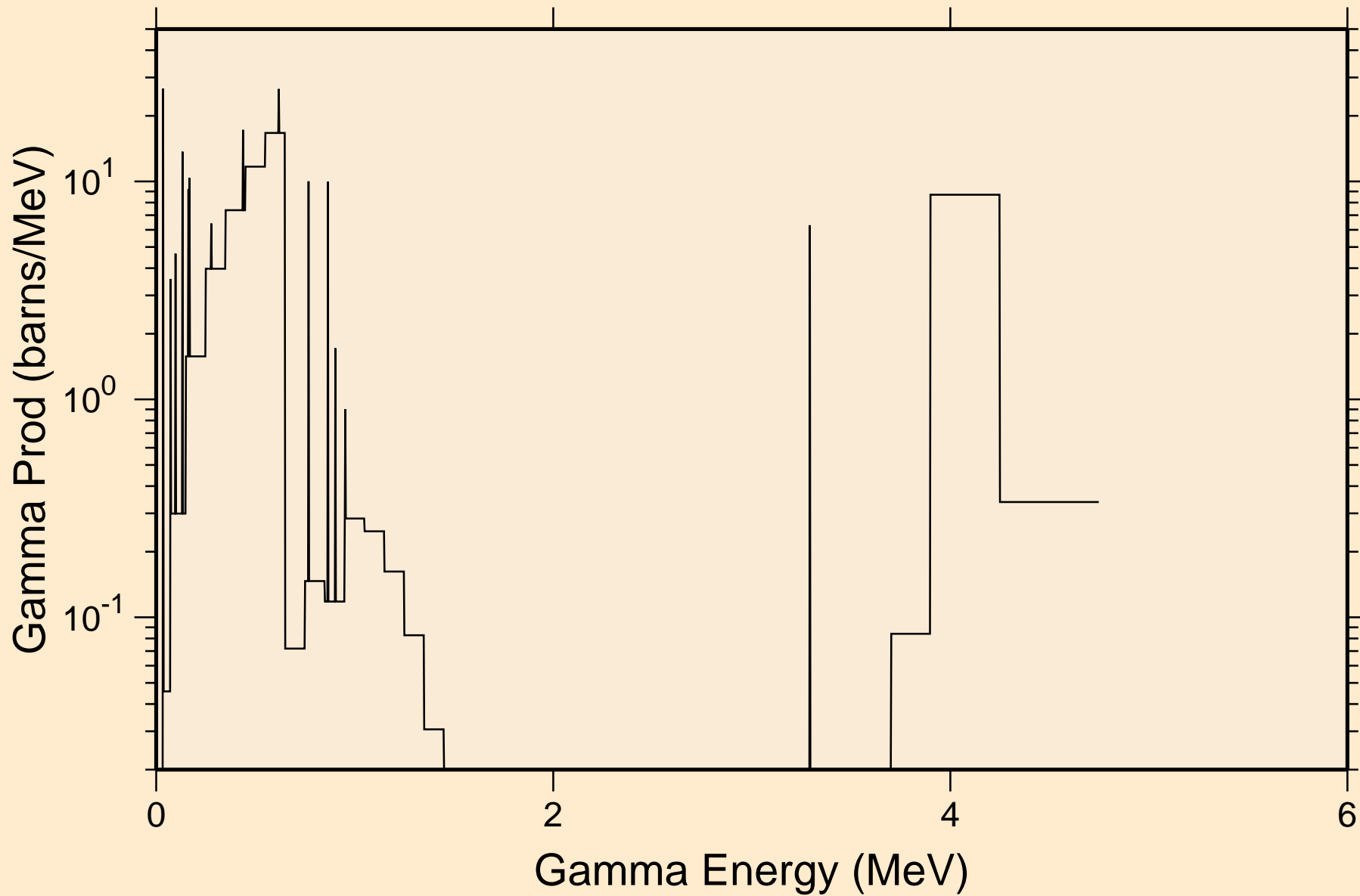

PD116 NEUTRON ACER TENDL-2024 LIBRARY; T=293.6K
14 MeV photon spectrum

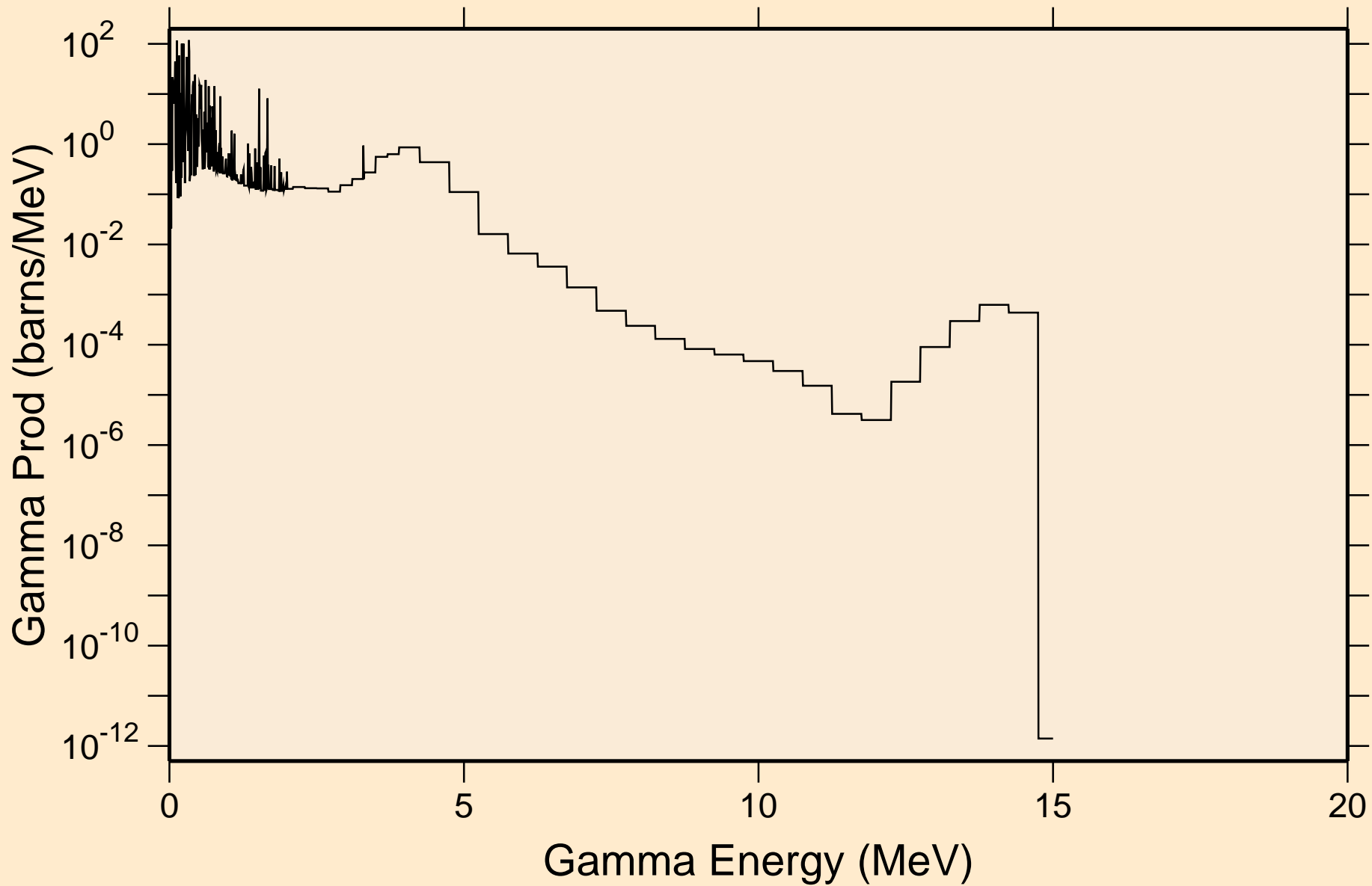

PD116 NEUTRON ACER TENDL-2024 LIBRARY; T=293.6K
Particle heating contributions

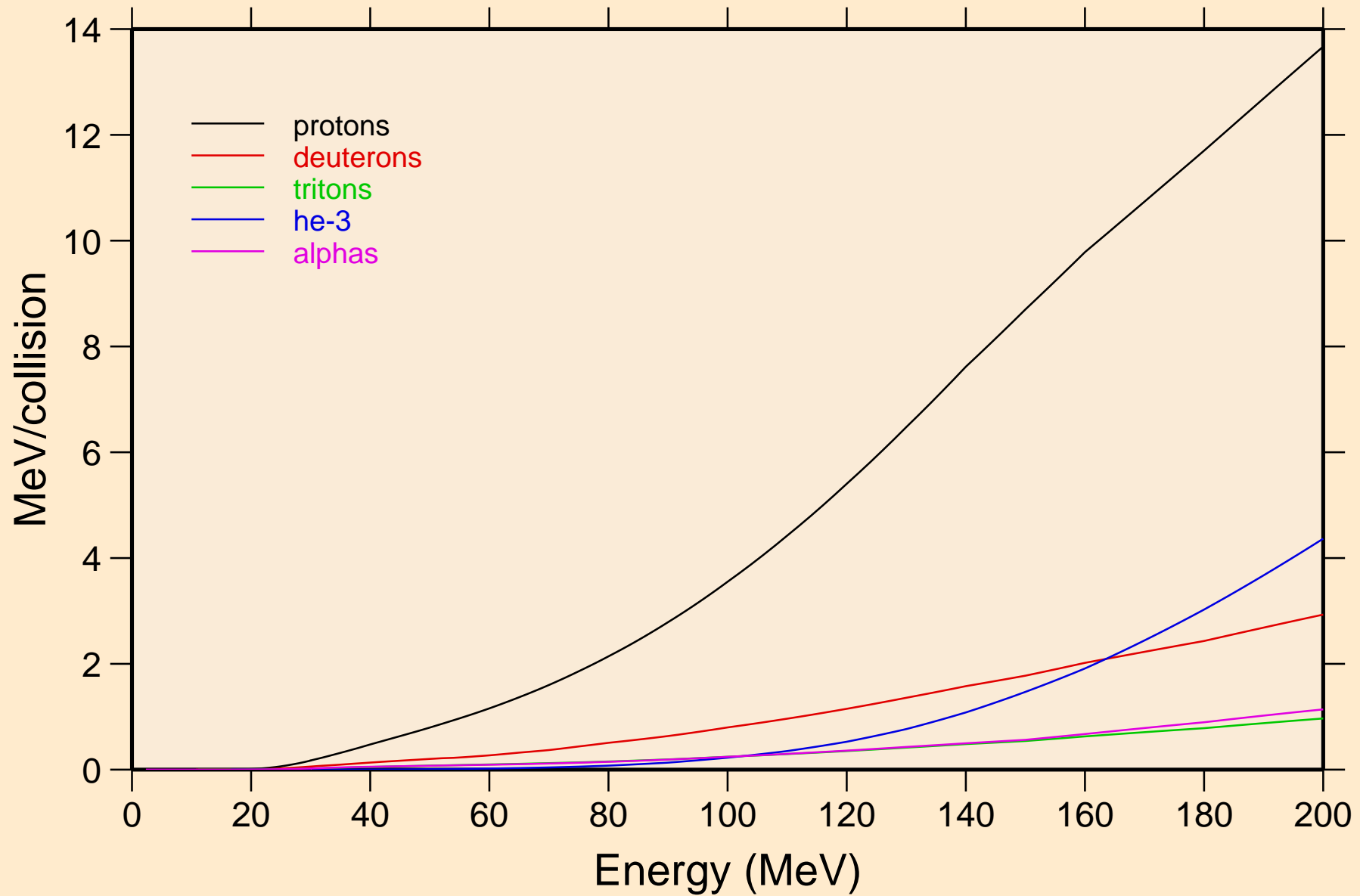

PD116 NEUTRON ACER TENDL-2024 LIBRARY; T=293.6K
Recoil Heating

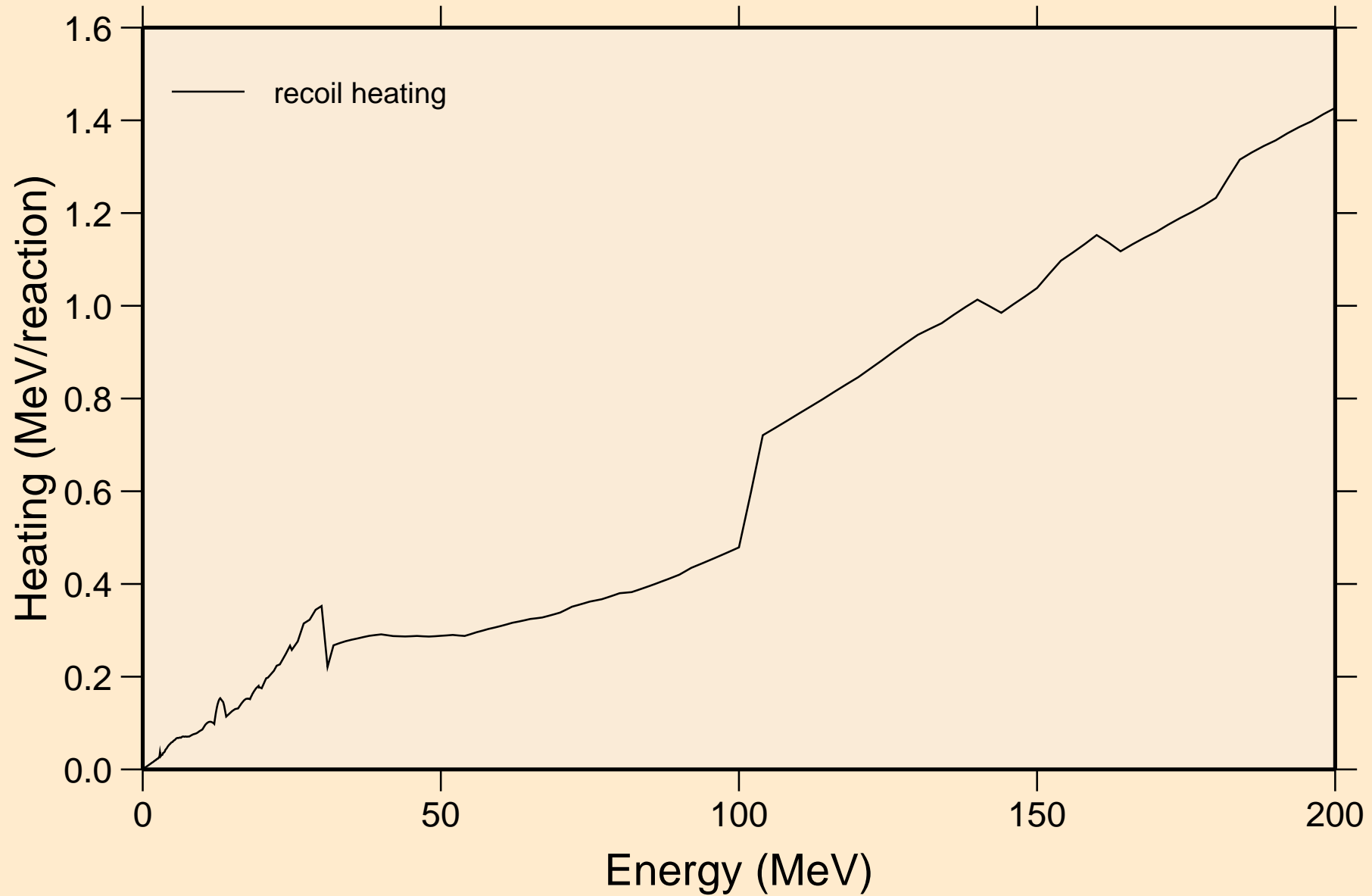

PD116 NEUTRON ACER TENDL-2024 LIBRARY; T=293.6K
Particle production cross sections

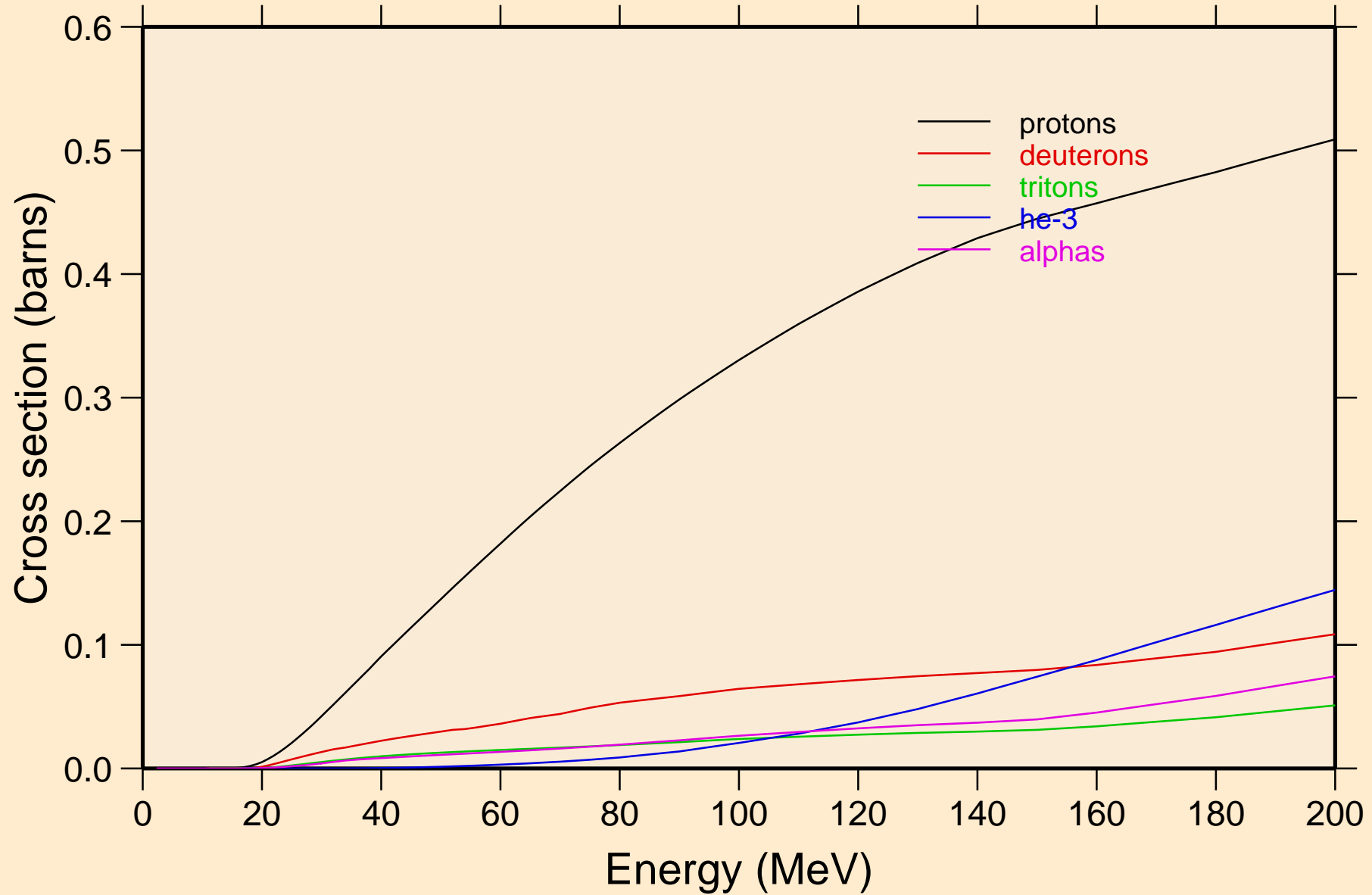

PD116 NEUTRON ACER TENDL-2024 LIBRARY; T=293.6K
protons from (n,x)

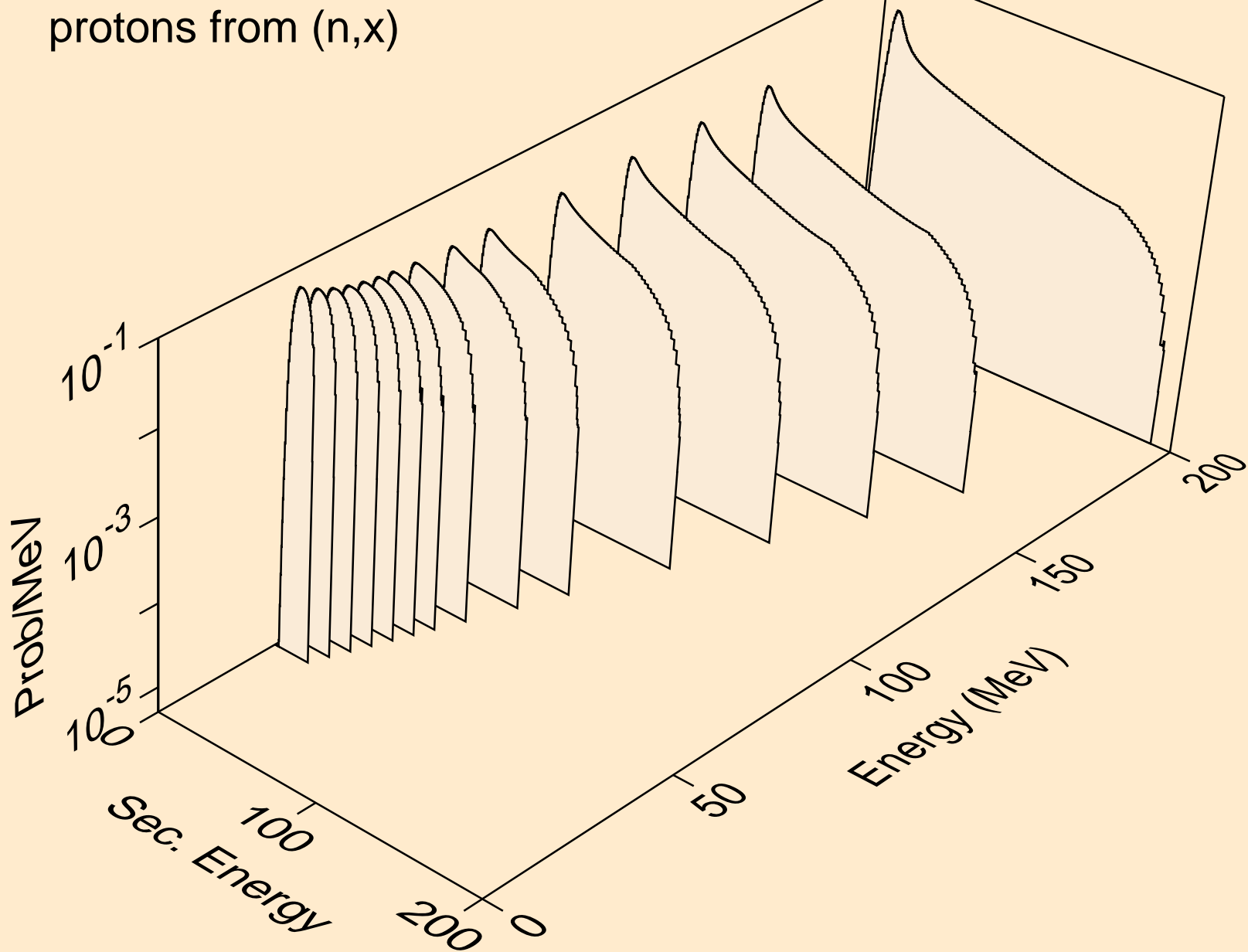

PD116 NEUTRON ACER TENDL-2024 LIBRARY; T=293.6K
protons from (n,n*)p

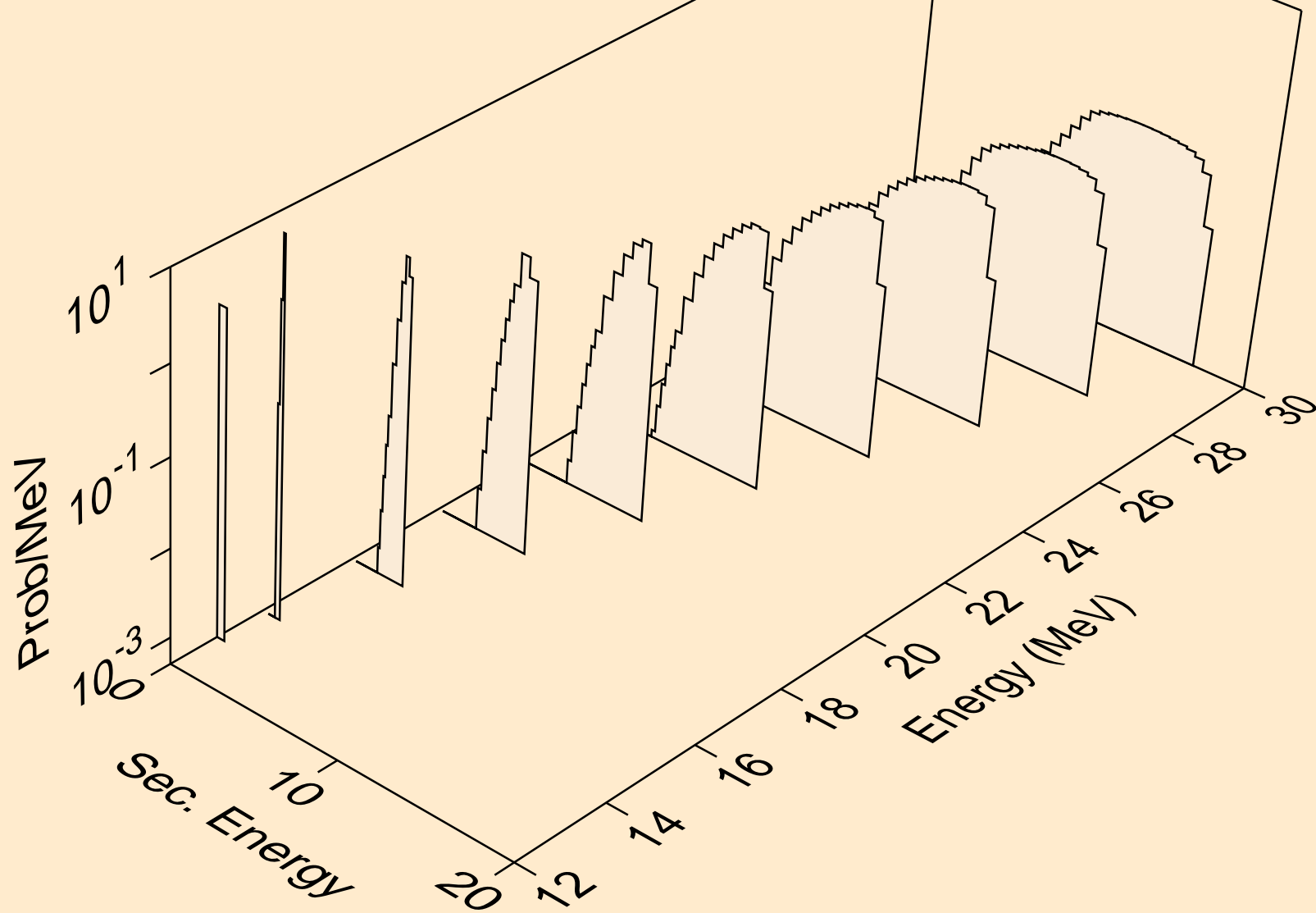

PD116 NEUTRON ACER TENDL-2024 LIBRARY; T=293.6K
protons from (n,2np)

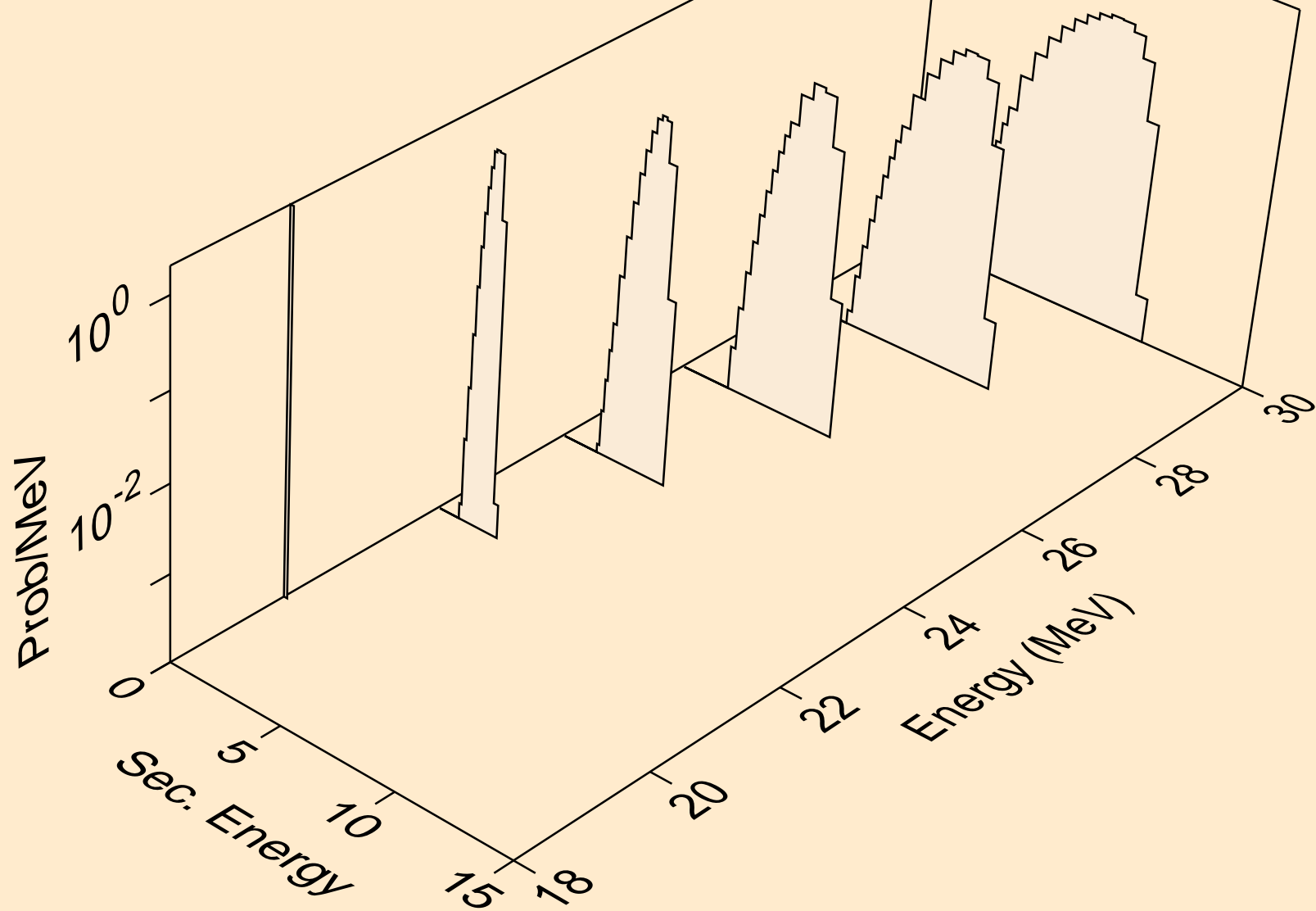

PD116 NEUTRON ACER TENDL-2024 LIBRARY; T=293.6K
protons from (n,3np)

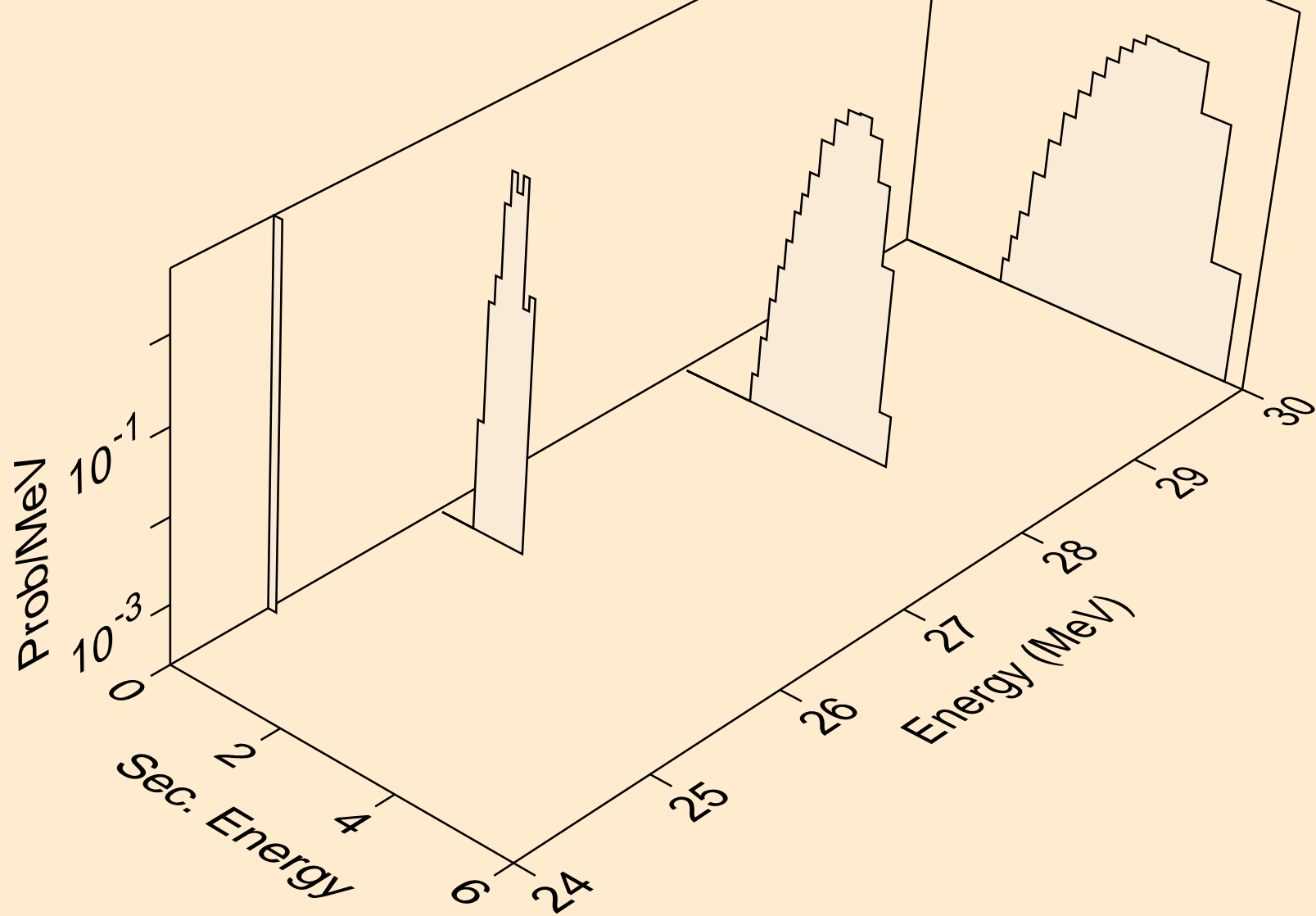

PD116 NEUTRON ACER TENDL-2024 LIBRARY; T=293.6K
protons from (n,p)

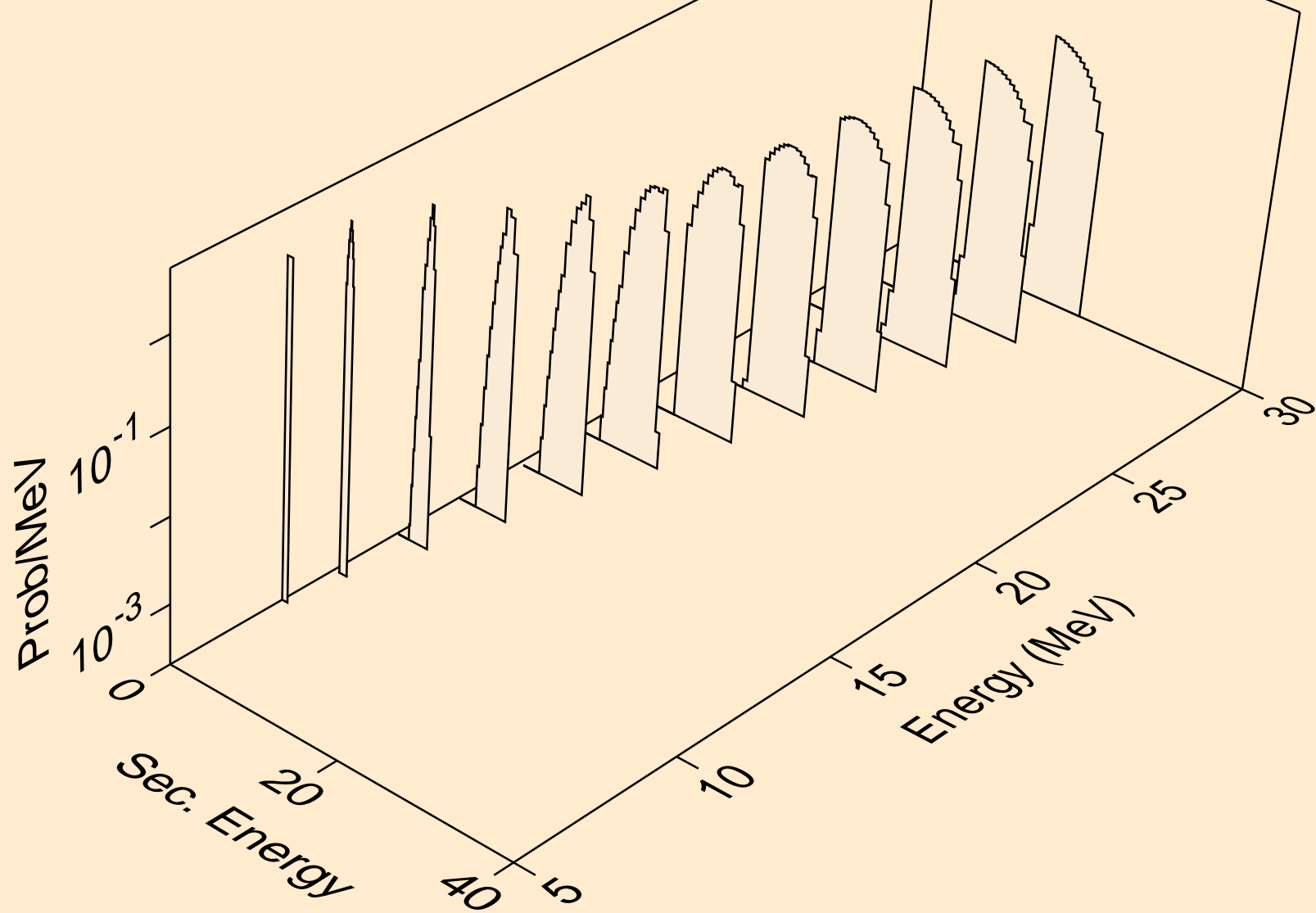

PD116 NEUTRON ACER TENDL-2024 LIBRARY; T=293.6K
deuterons from (n,x)

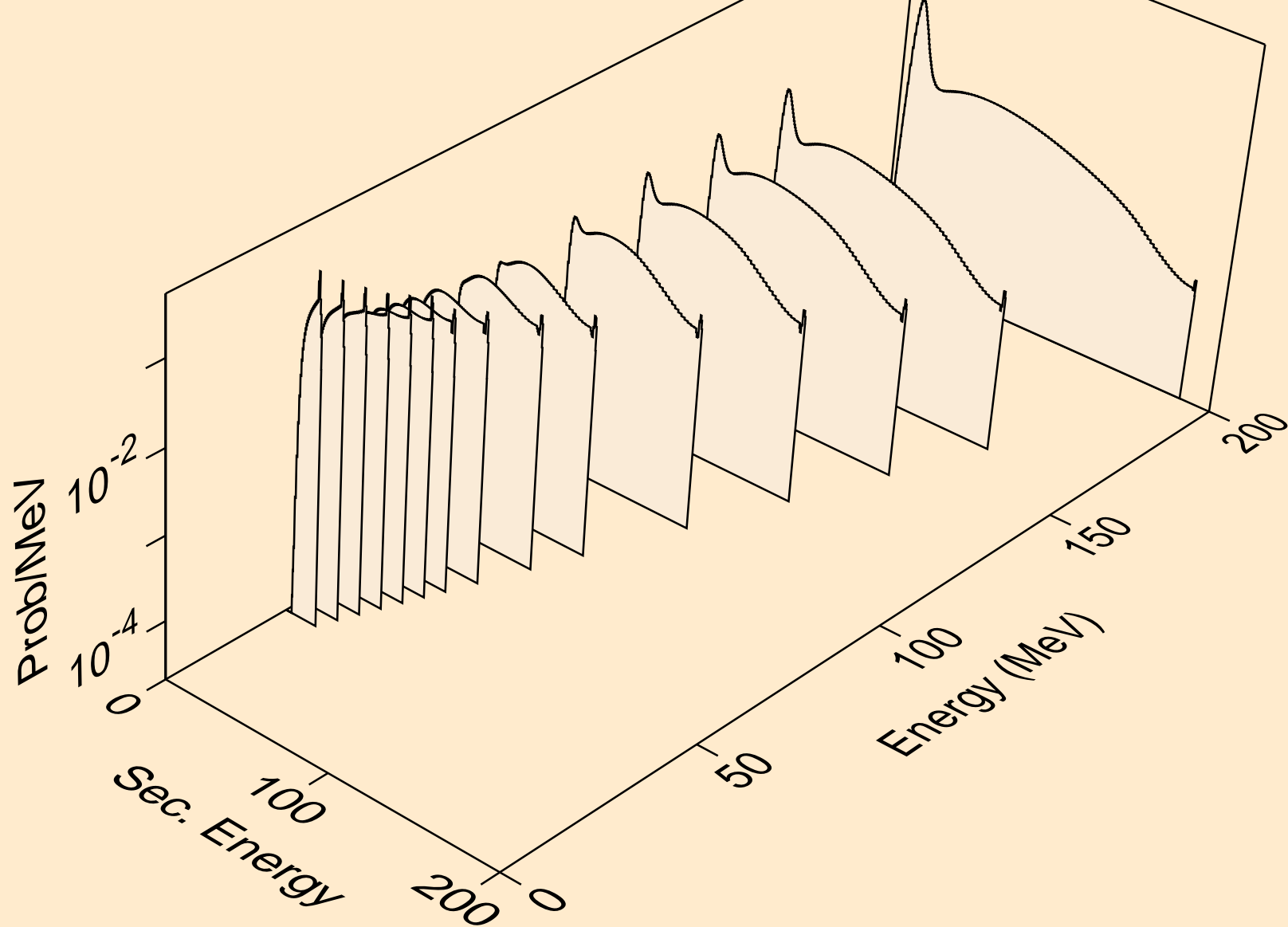

PD116 NEUTRON ACER TENDL-2024 LIBRARY; T=293.6K
deuterons from (n,2nd)

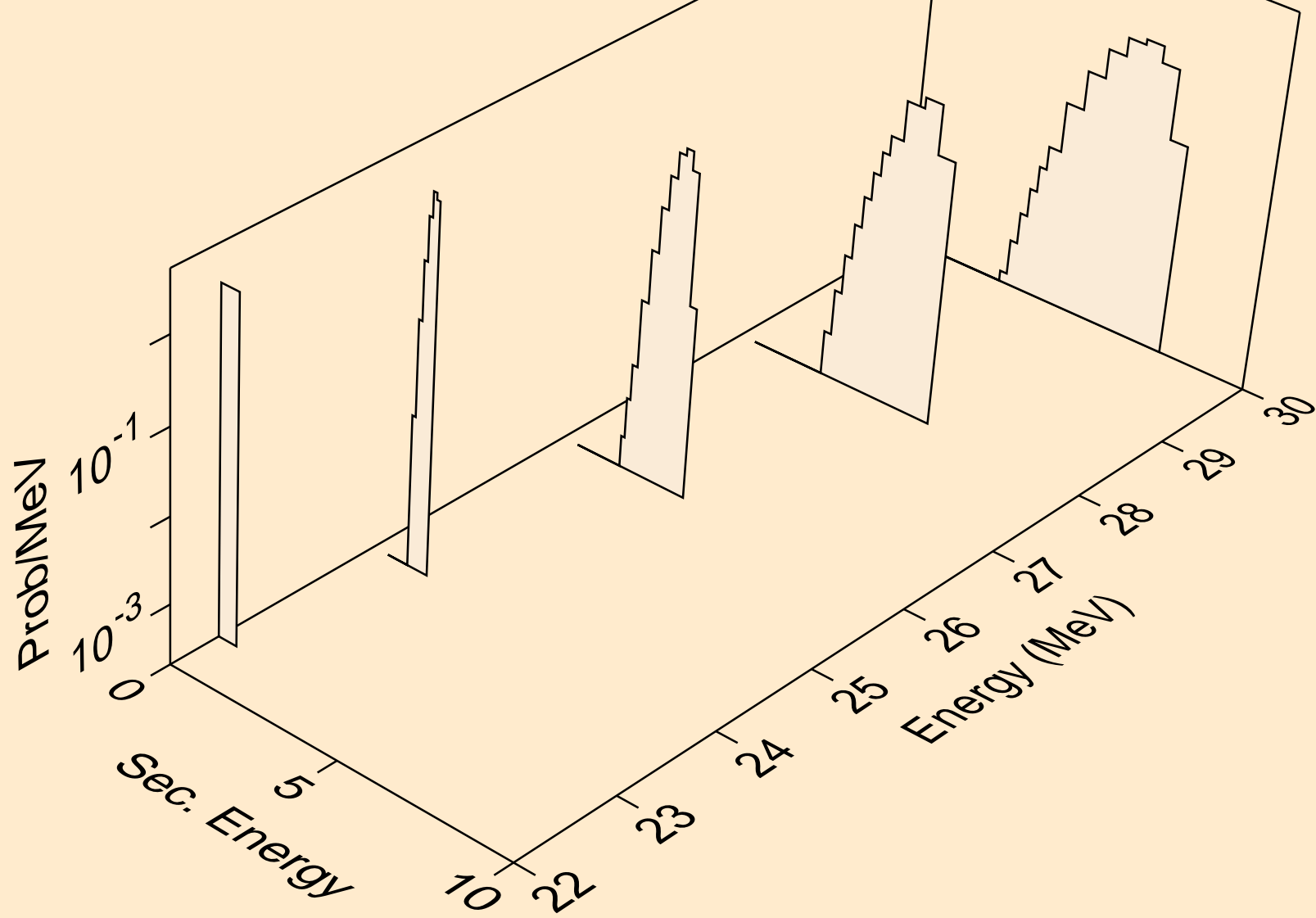

PD116 NEUTRON ACER TENDL-2024 LIBRARY; T=293.6K
deuterons from (n,n*)d

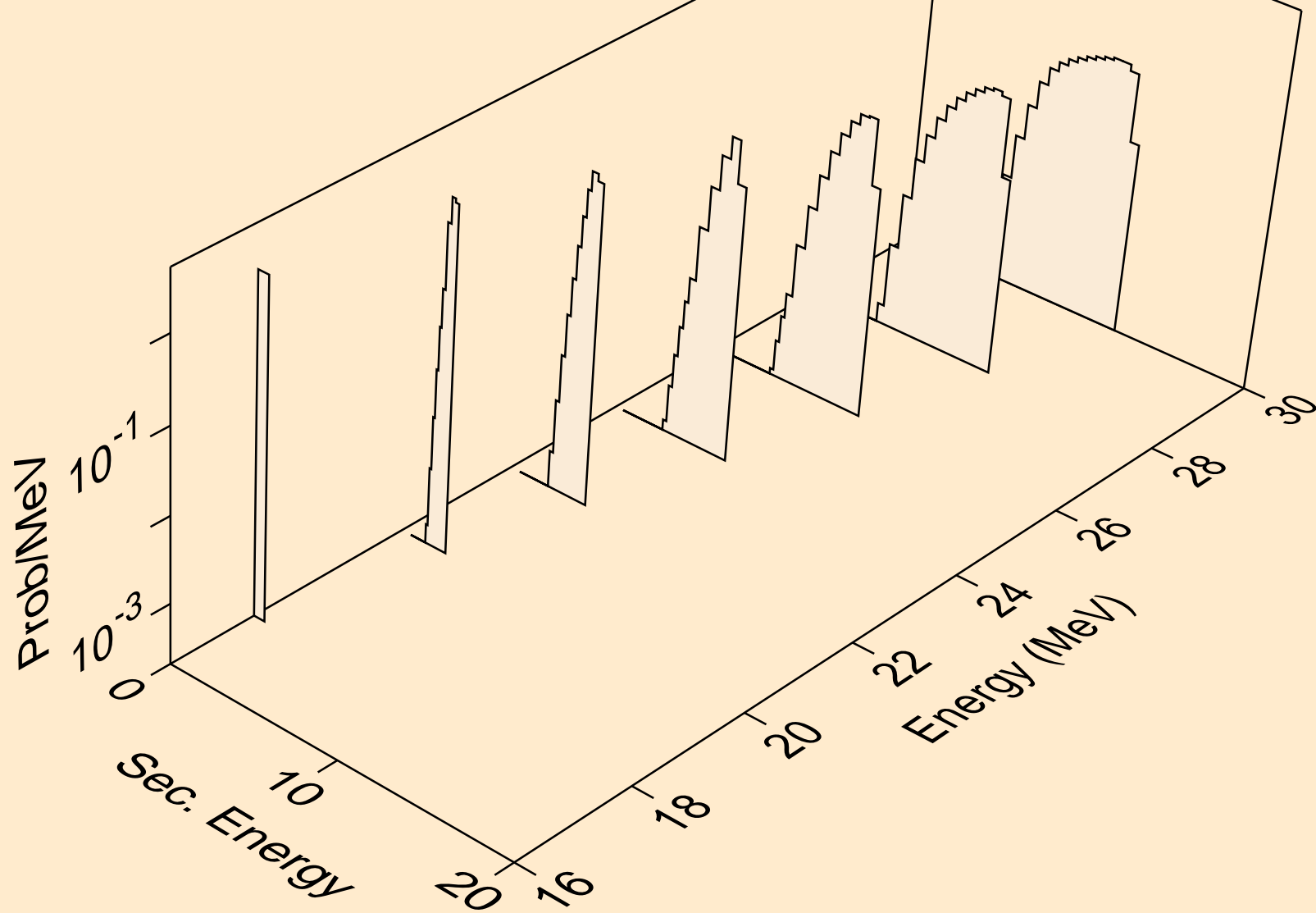

PD116 NEUTRON ACER TENDL-2024 LIBRARY; T=293.6K
deuterons from (n,d)

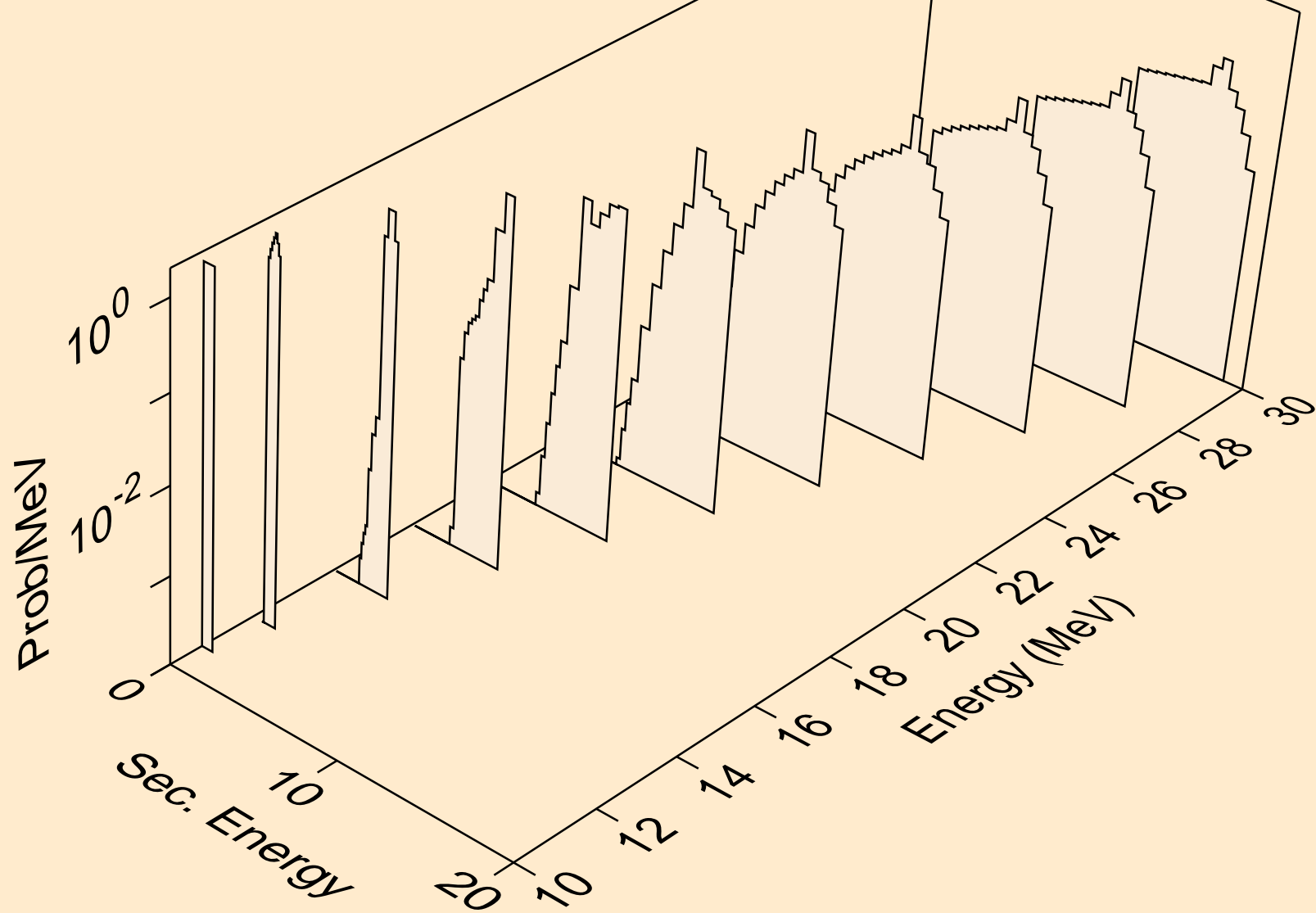

PD116 NEUTRON ACER TENDL-2024 LIBRARY; T=293.6K
tritons from (n,x)

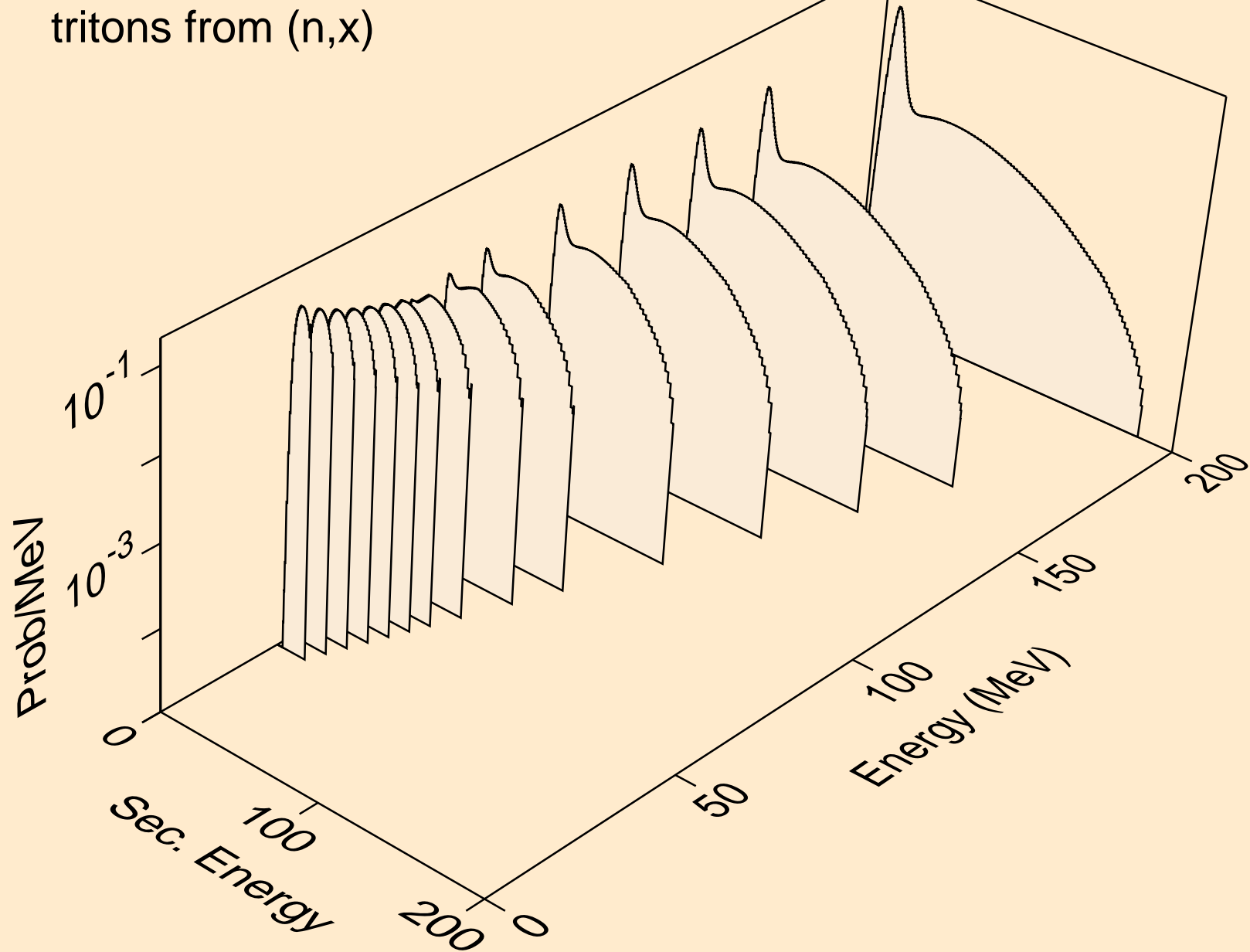

PD116 NEUTRON ACER TENDL-2024 LIBRARY; T=293.6K
tritons from (n,n*)t

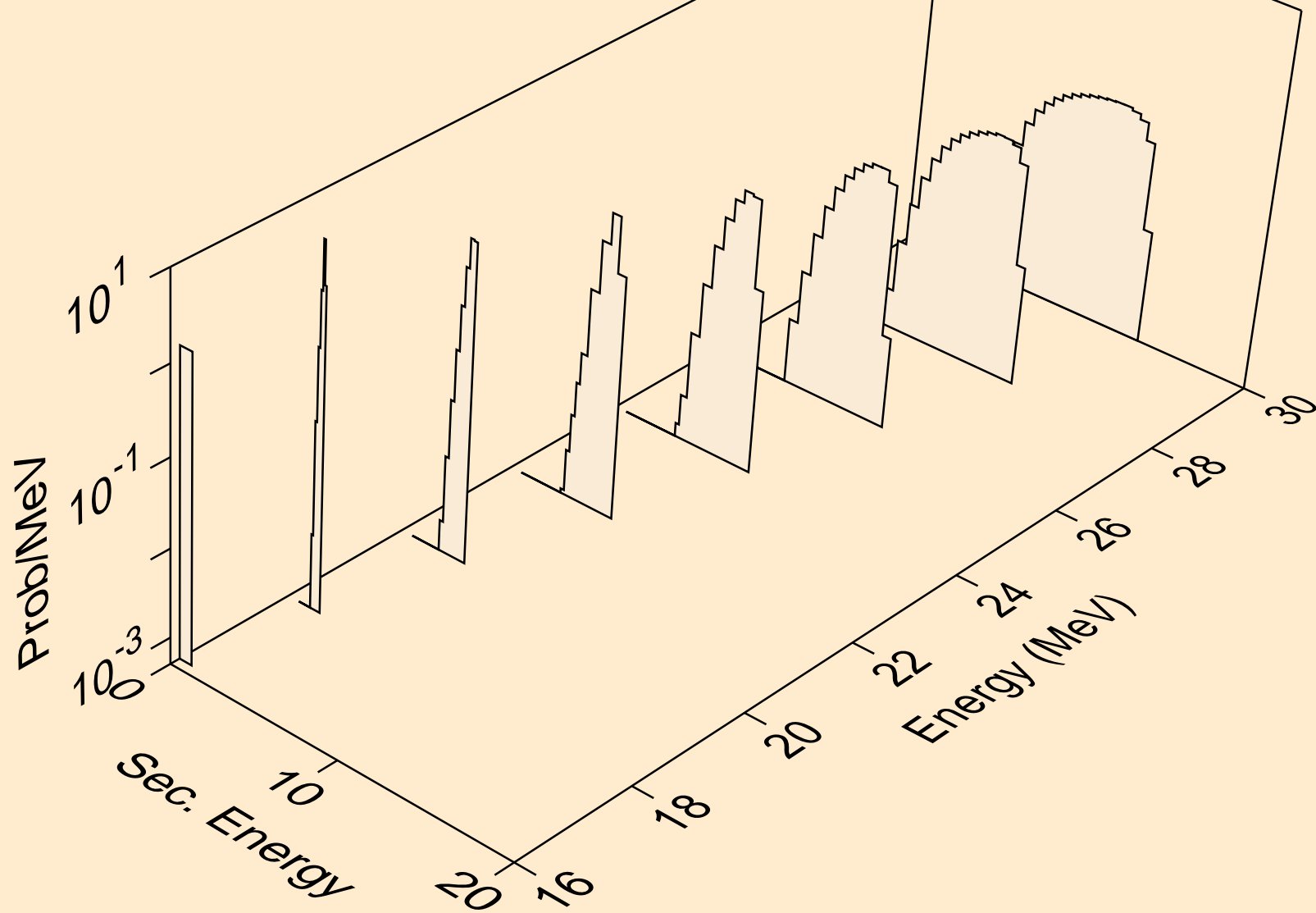

PD116 NEUTRON ACER TENDL-2024 LIBRARY; T=293.6K
tritons from (n,t)

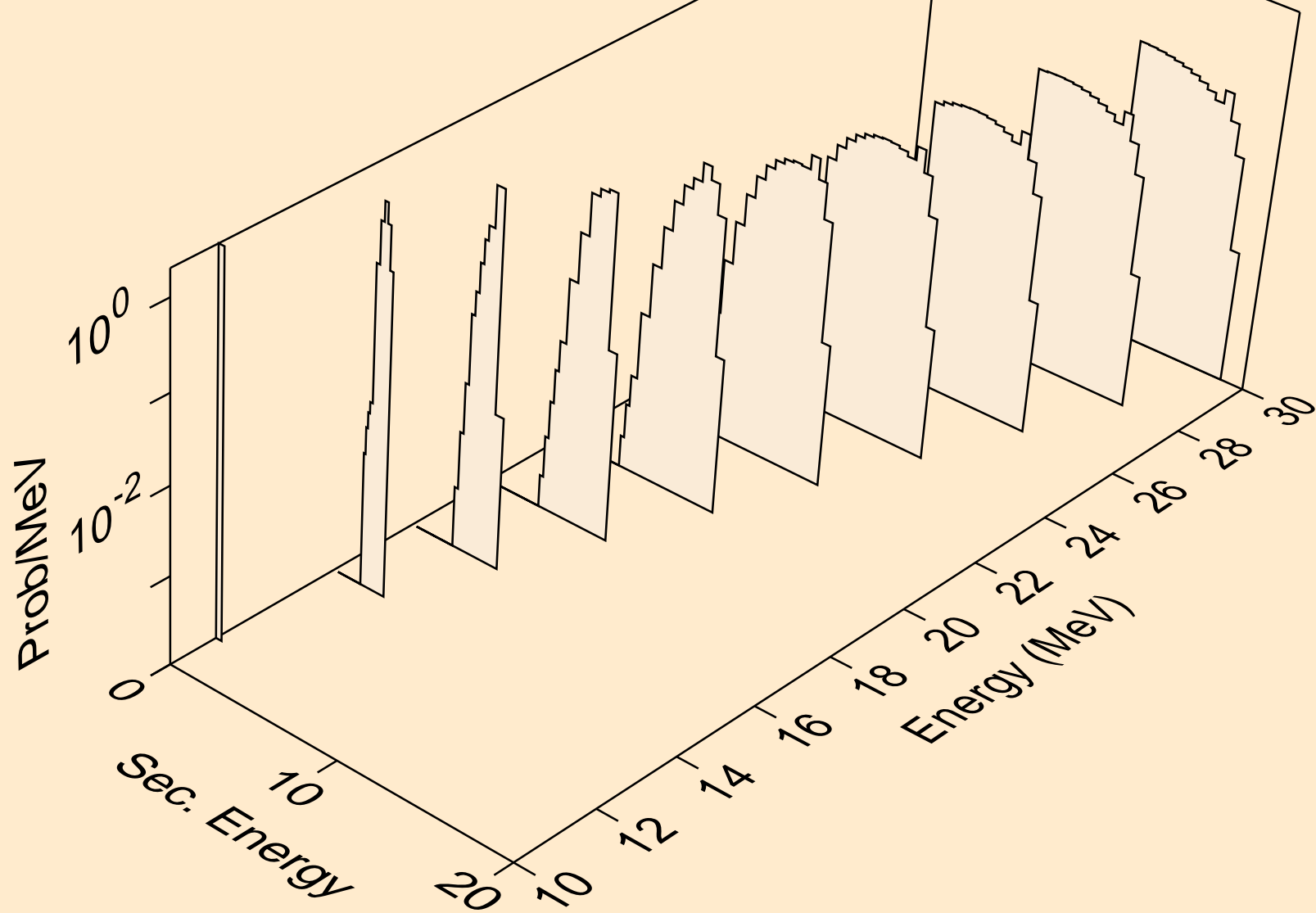

PD116 NEUTRON ACER TENDL-2024 LIBRARY; T=293.6K
he3s from (n,x)

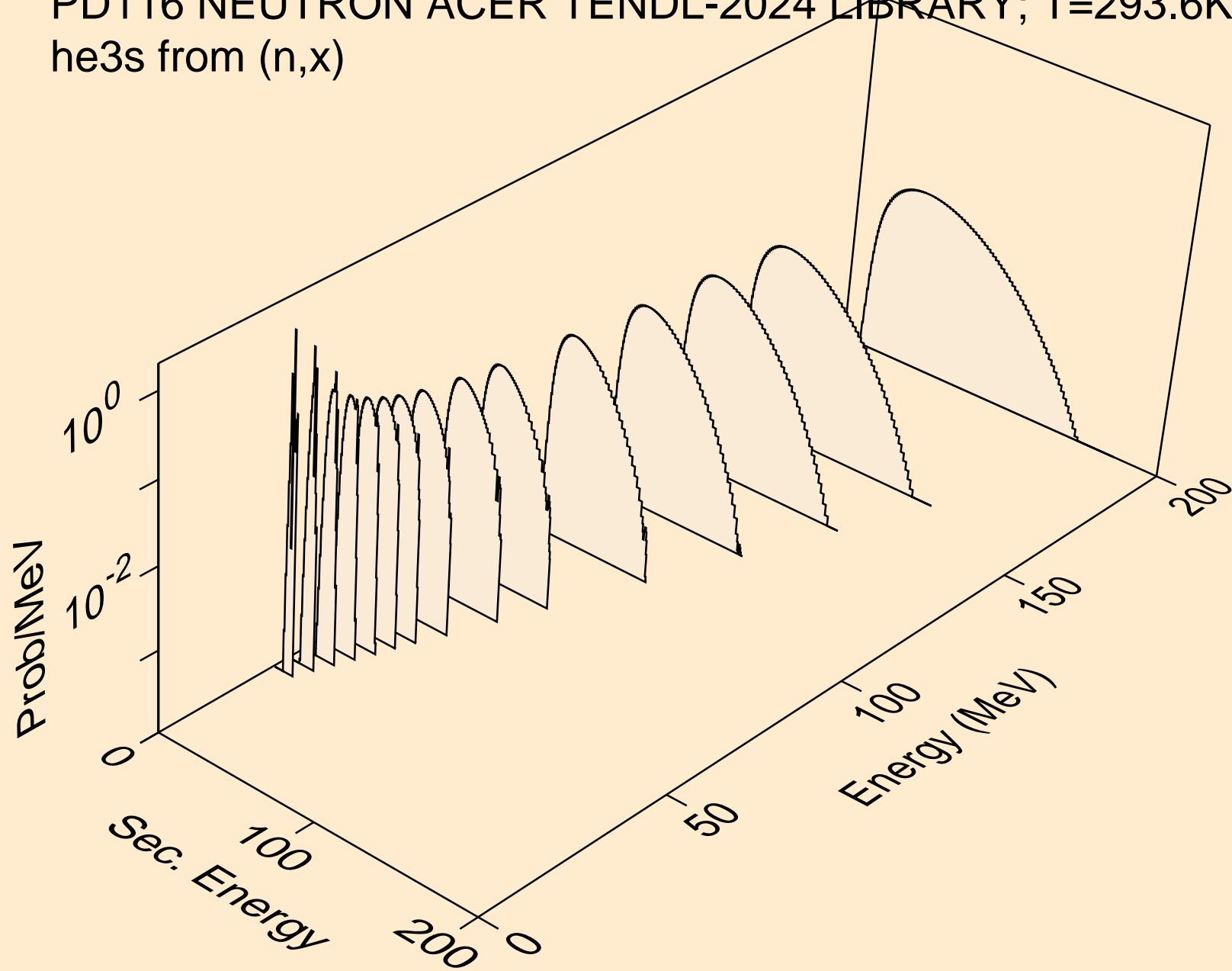

PD116 NEUTRON ACER TENDL-2024 LIBRARY; T=293.6K
he3s from (n,he3)

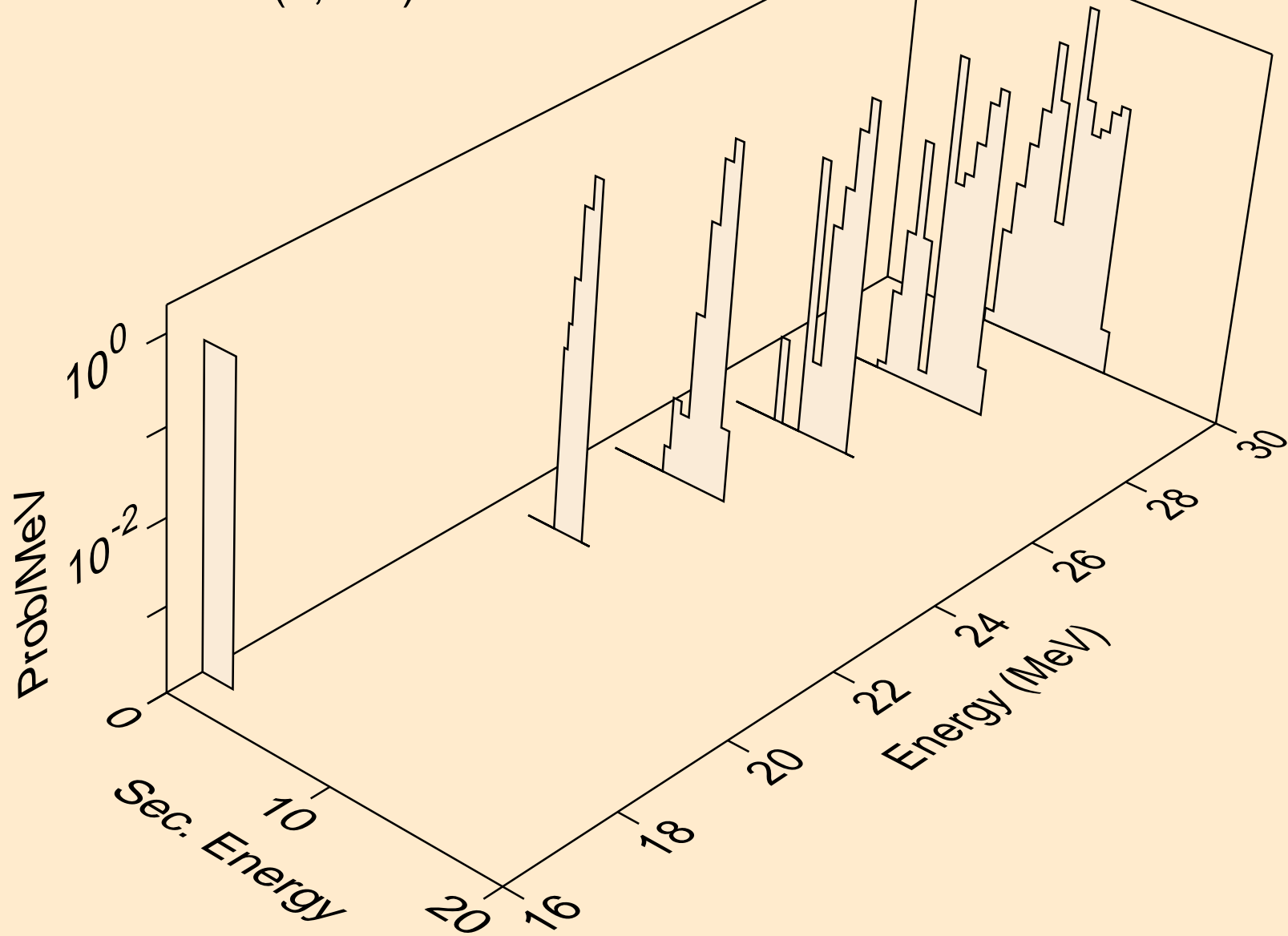

PD116 NEUTRON ACER TENDL-2024 LIBRARY; T=293.6K
alphas from (n,x)

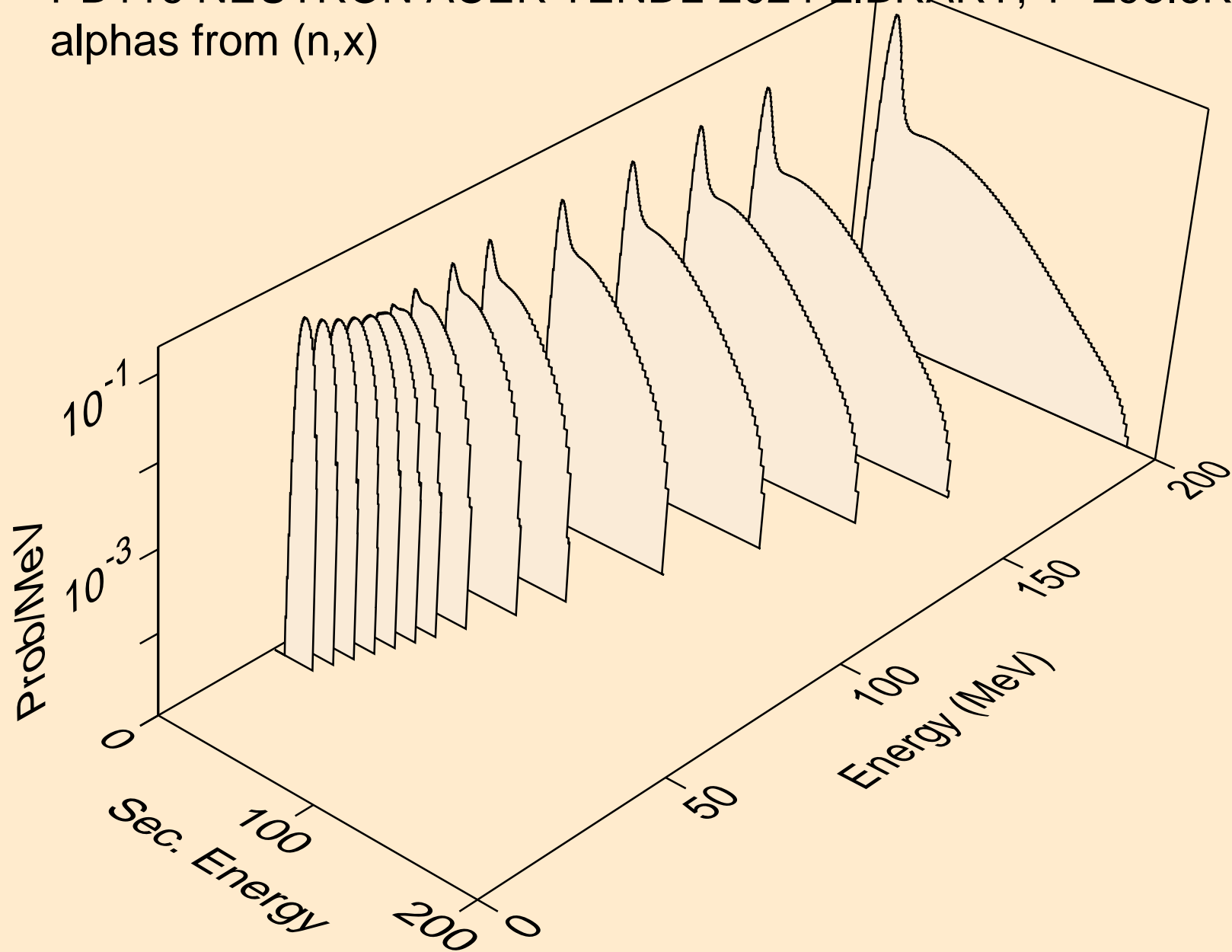

PD116 NEUTRON ACER TENDL-2024 LIBRARY; T=293.6K
alphas from (n,n*)a

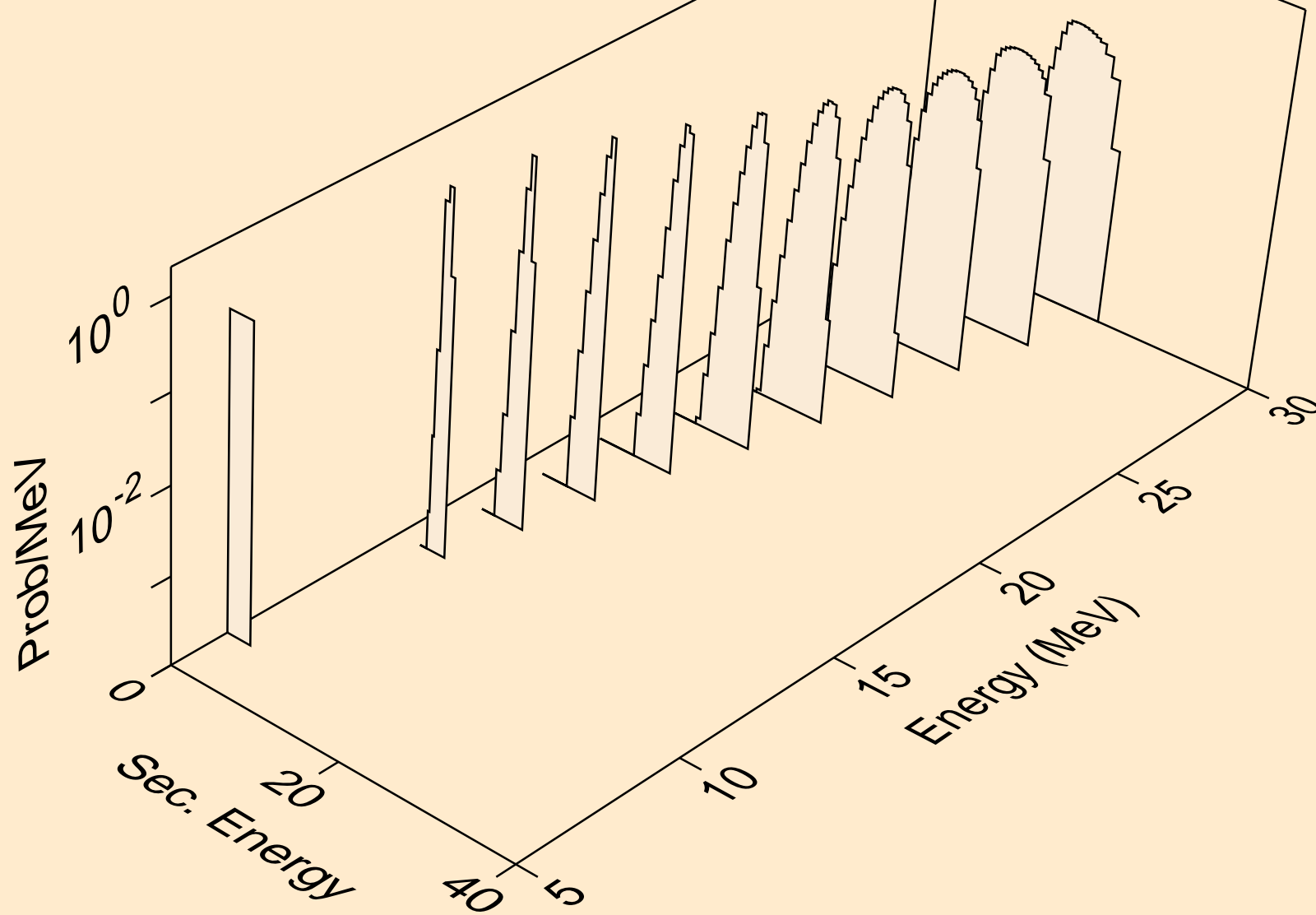

PD116 NEUTRON ACER TENDL-2024 LIBRARY; T=293.6K
alphas from (n,2n)a

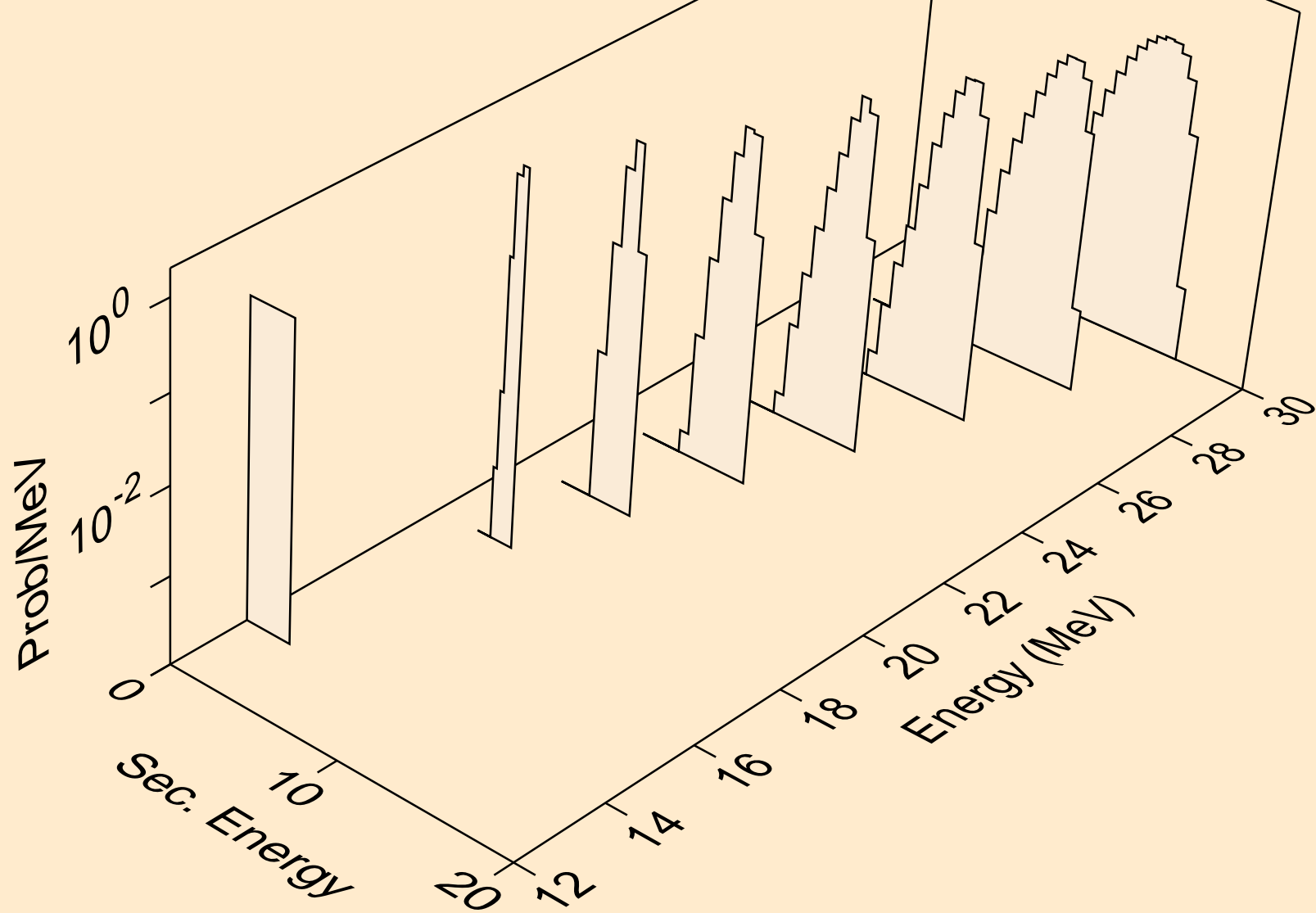

PD116 NEUTRON ACER TENDL-2024 LIBRARY; T=293.6K
alphas from (n,3n)a

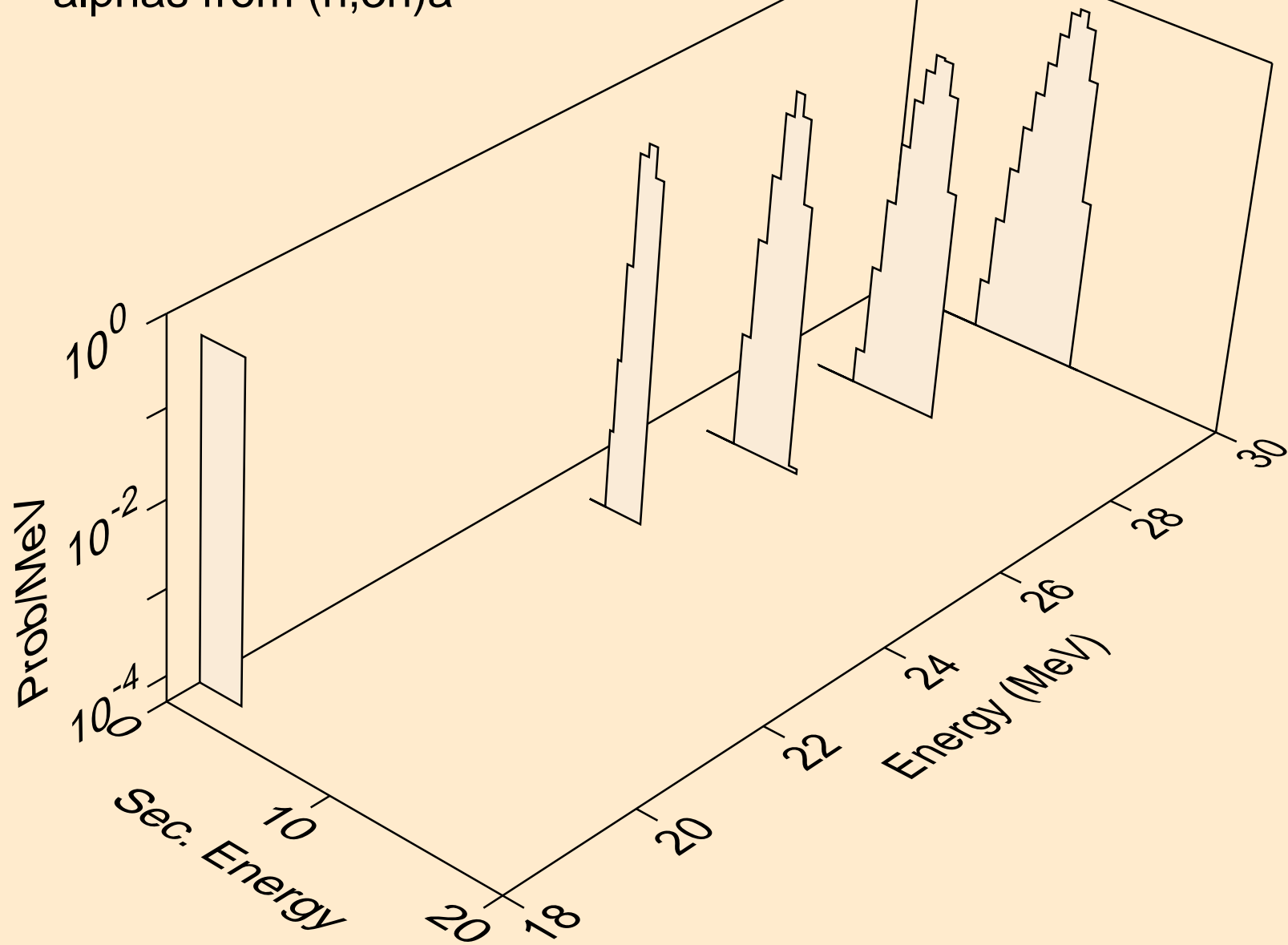

PD116 NEUTRON ACER TENDL-2024 LIBRARY; T=293.6K
alphas from (n,a)

