

PM152 NEUTRON ACER TENDL-2024 LIBRARY; T=293.6K  
Principal cross sections

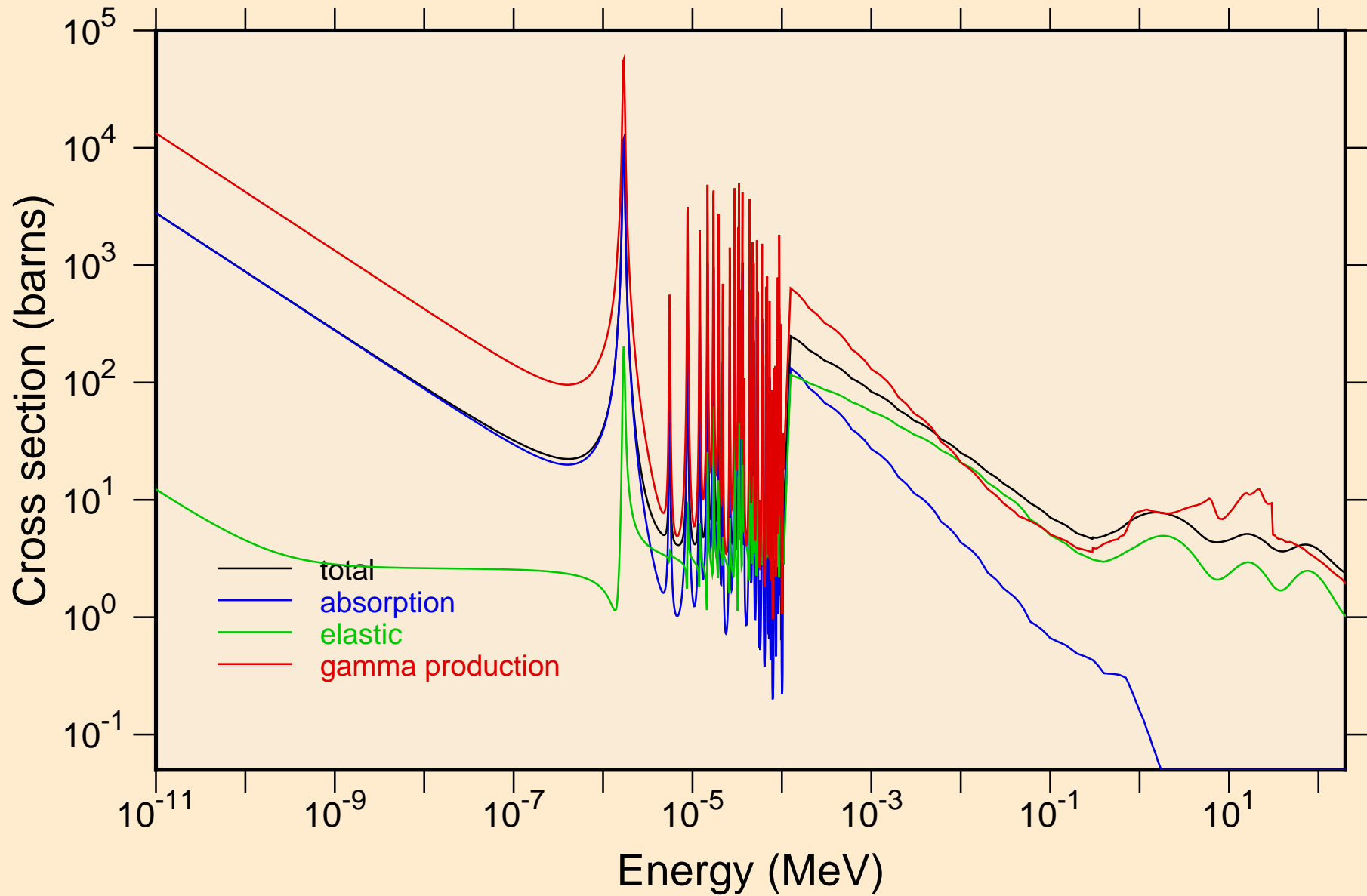

PM152 NEUTRON ACER TENDL-2024 LIBRARY; T=293.6K  
resonance total cross section

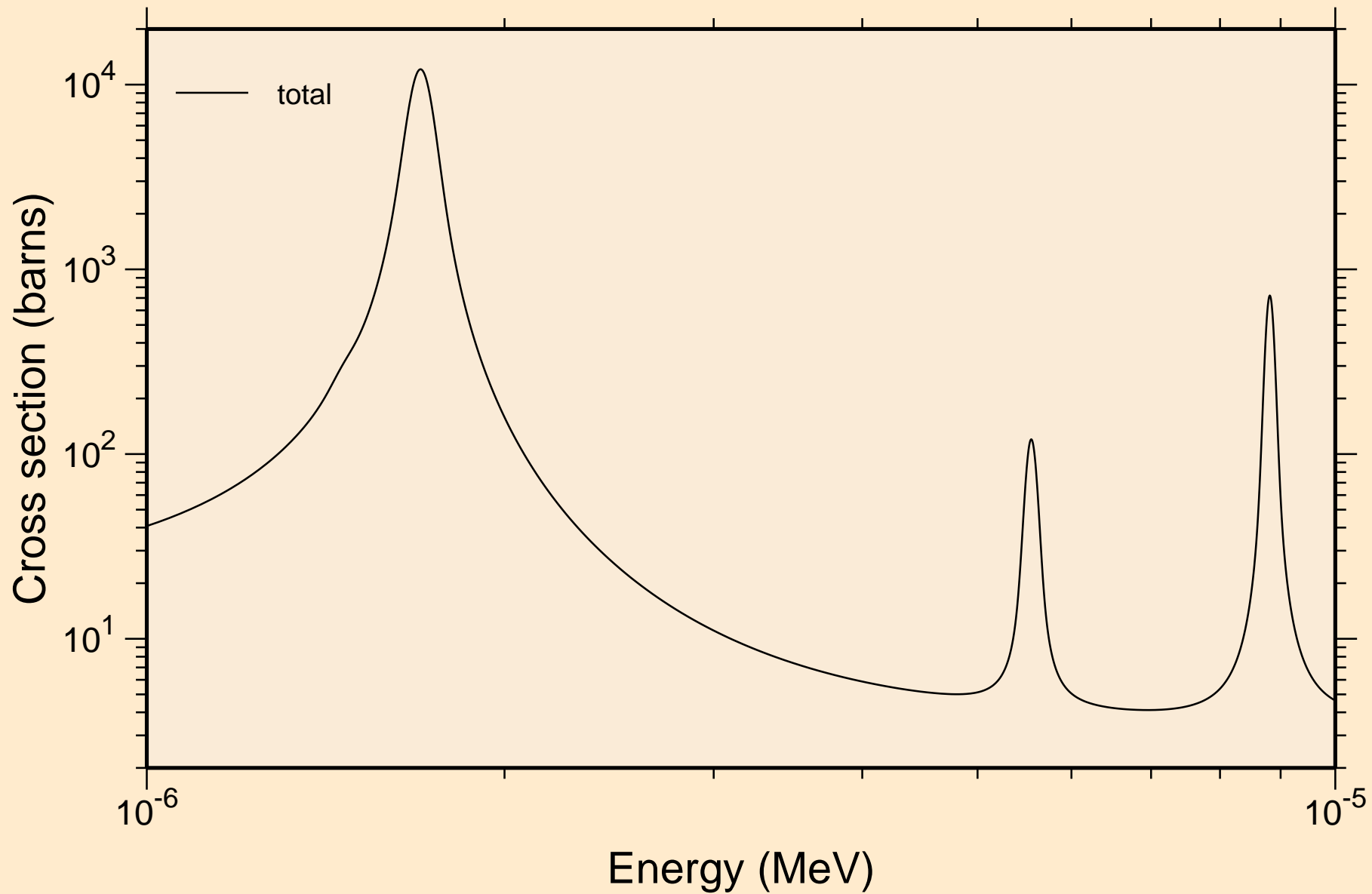

PM152 NEUTRON ACER TENDL-2024 LIBRARY; T=293.6K  
resonance total cross section

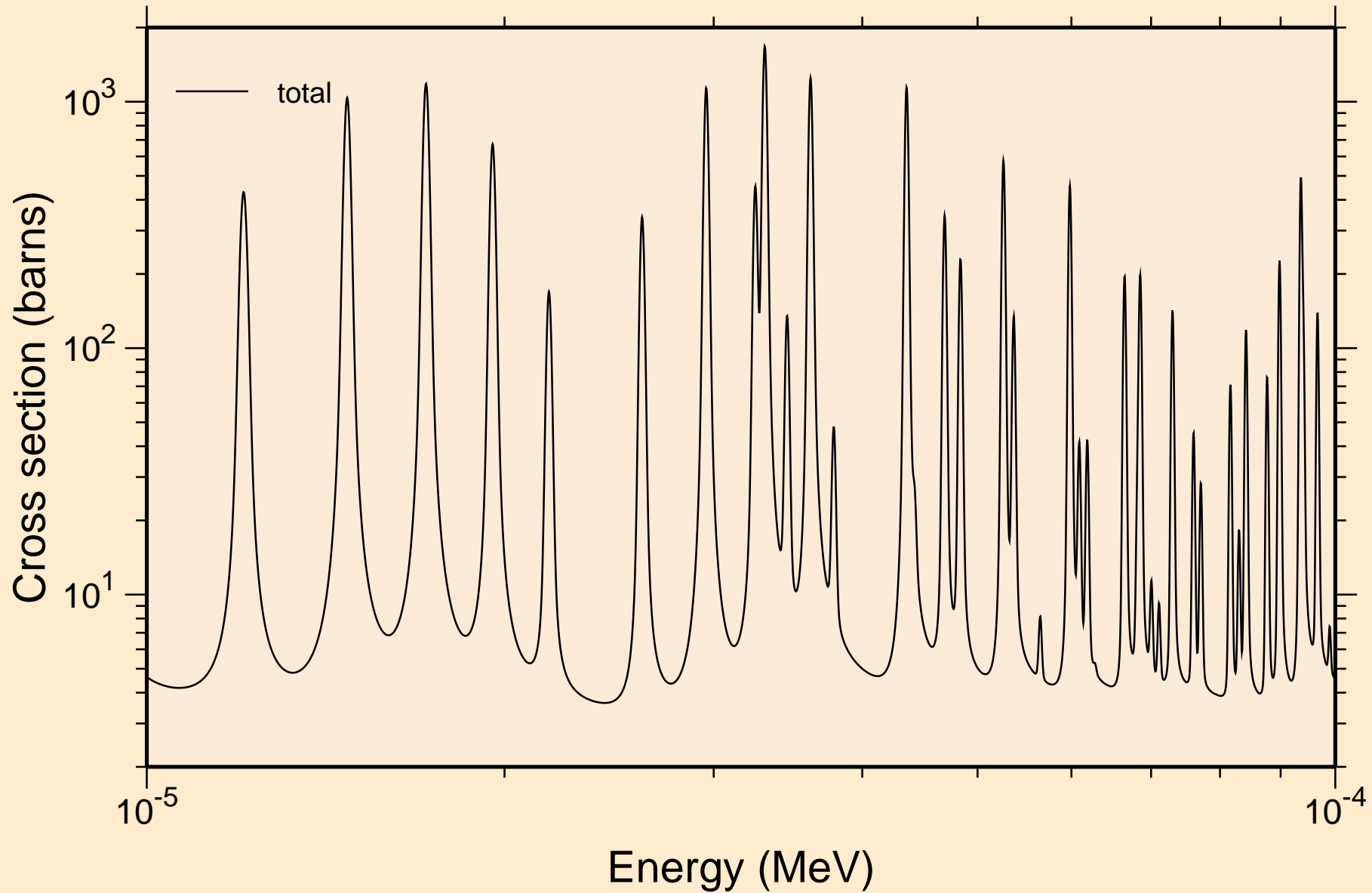

PM152 NEUTRON ACER TENDL-2024 LIBRARY; T=293.6K  
resonance total cross section

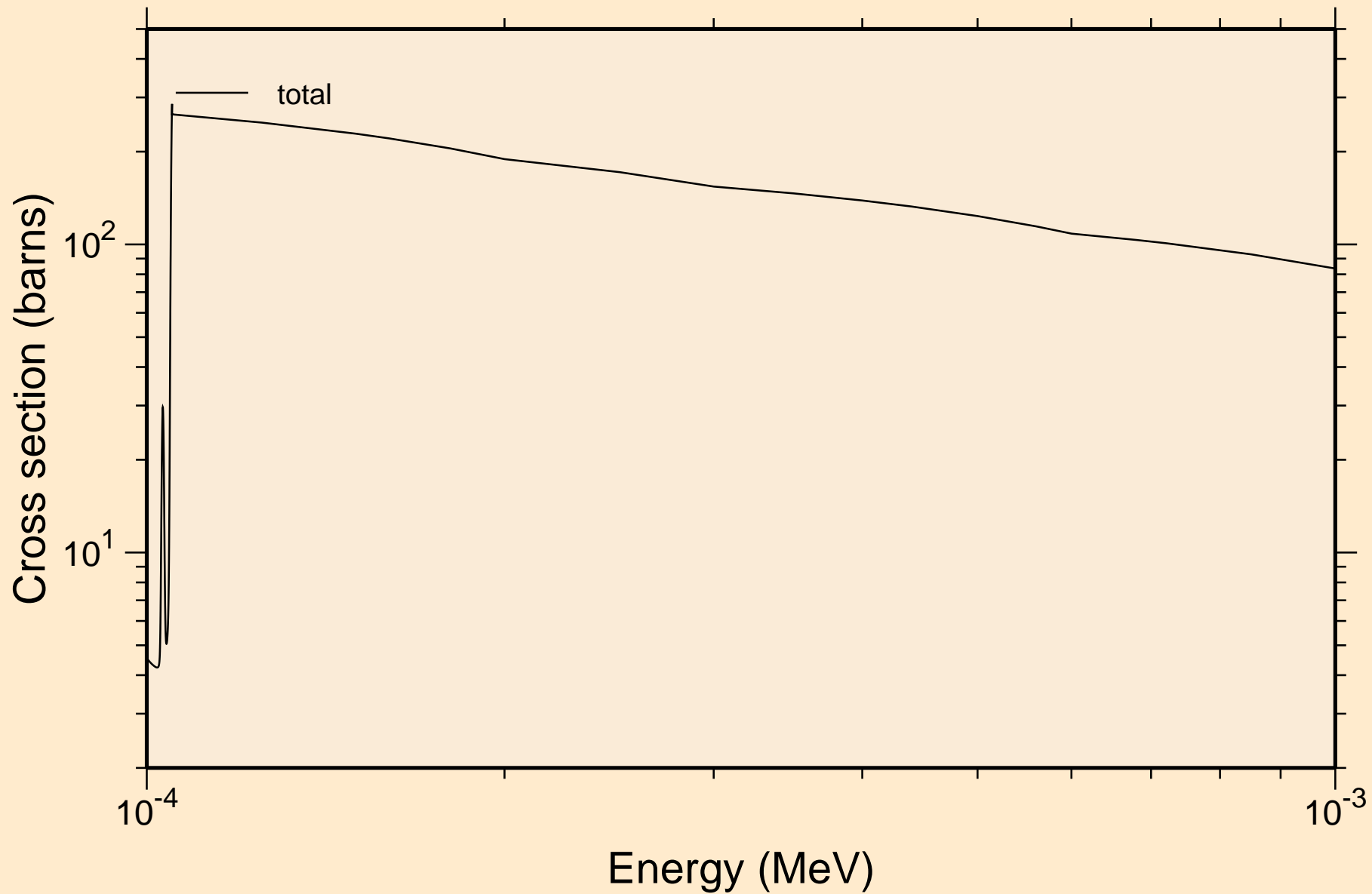

PM152 NEUTRON ACER TENDL-2024 LIBRARY; T=293.6K  
resonance total cross section

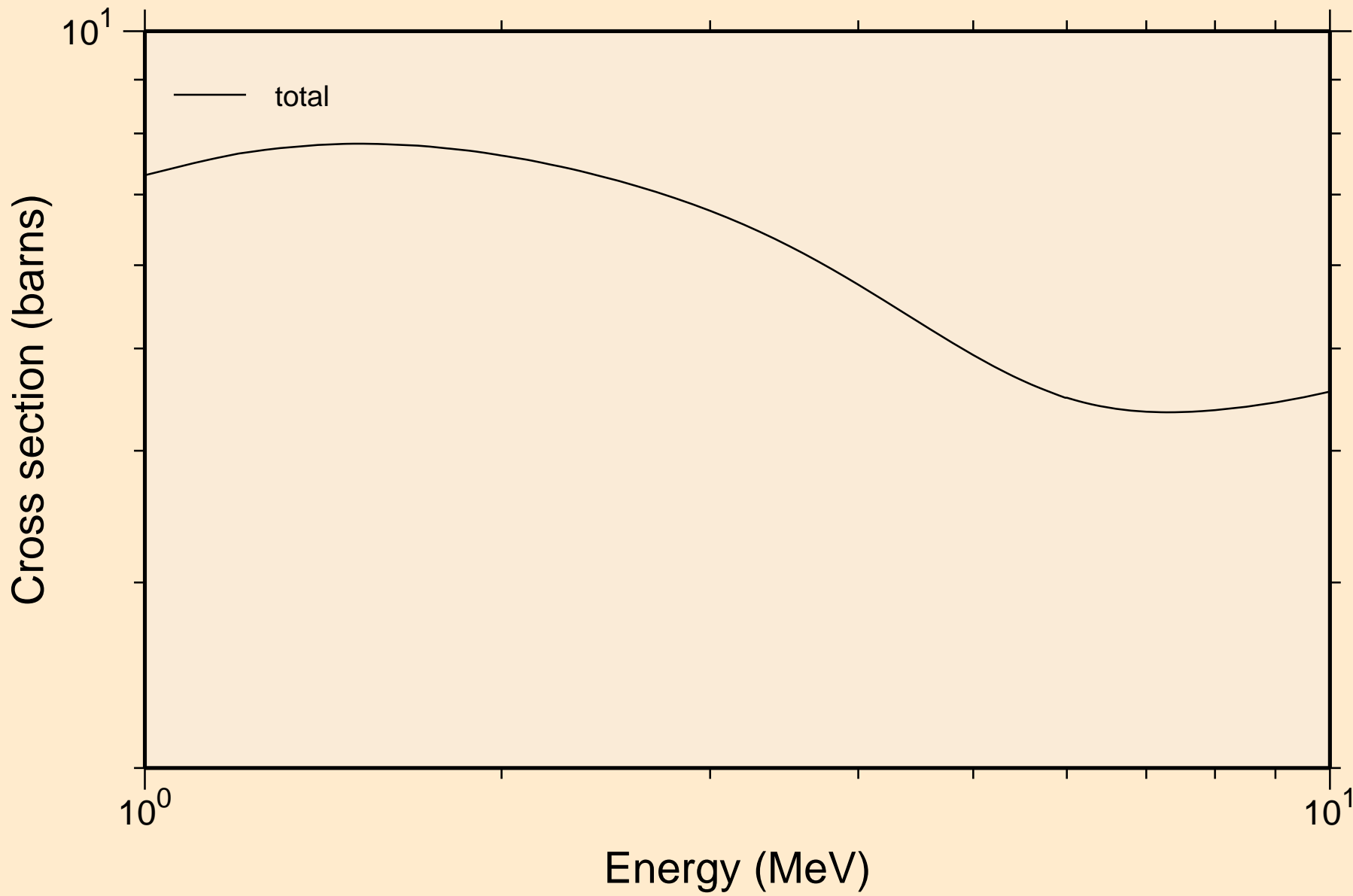

PM152 NEUTRON ACER TENDL-2024 LIBRARY; T=293.6K  
resonance absorption cross sections

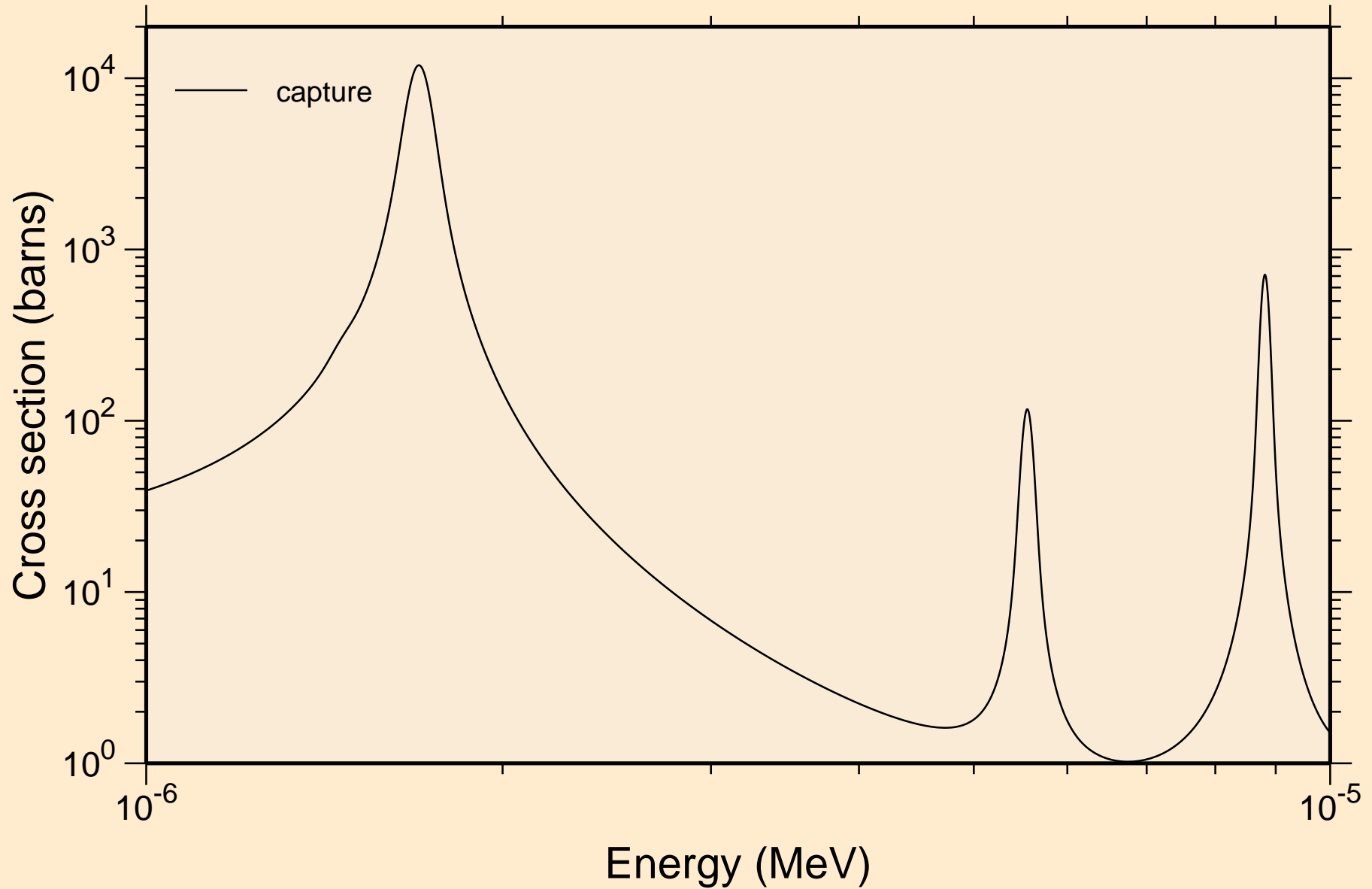

PM152 NEUTRON ACER TENDL-2024 LIBRARY; T=293.6K  
resonance absorption cross sections

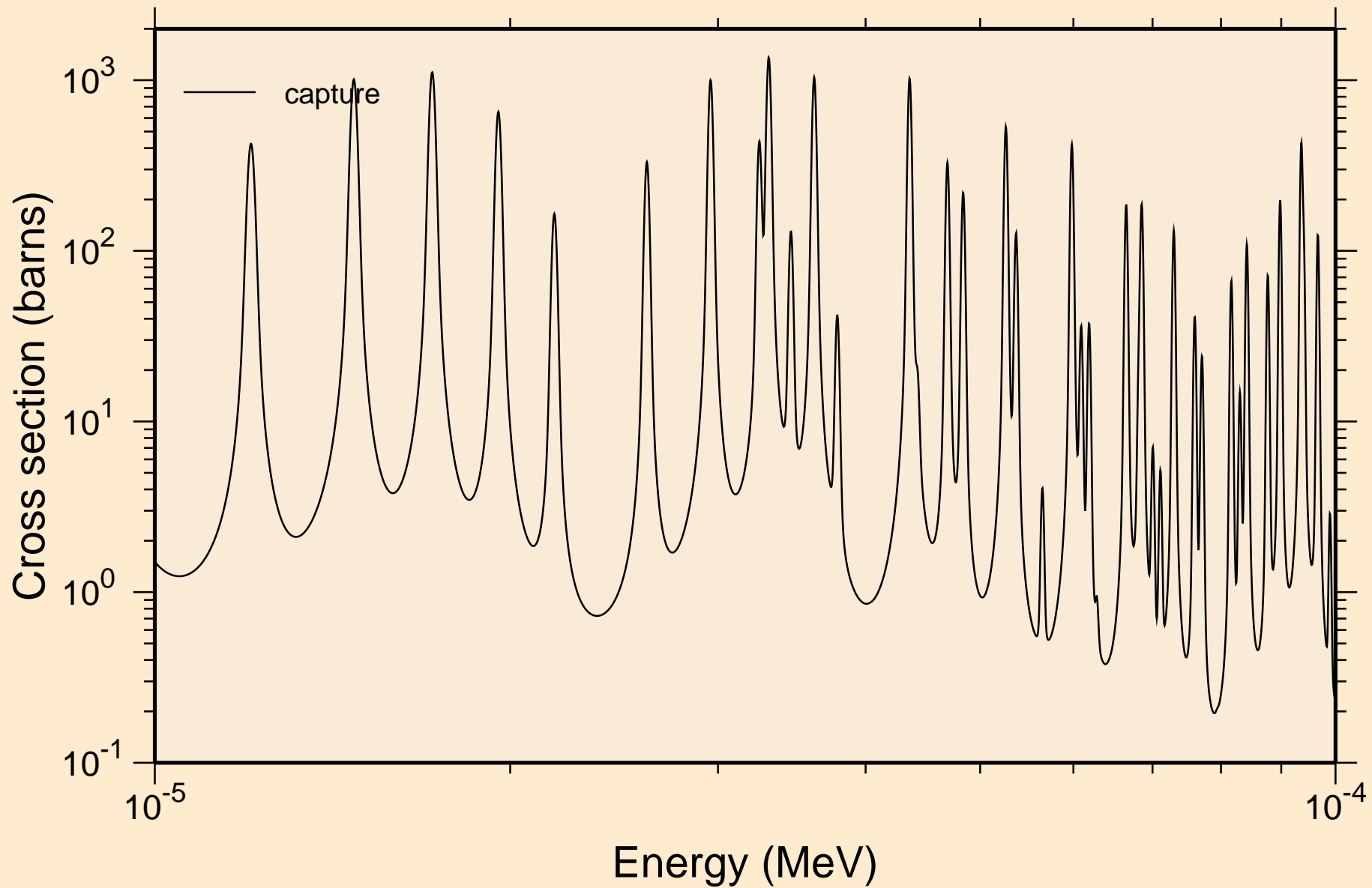

PM152 NEUTRON ACER TENDL-2024 LIBRARY; T=293.6K  
resonance absorption cross sections

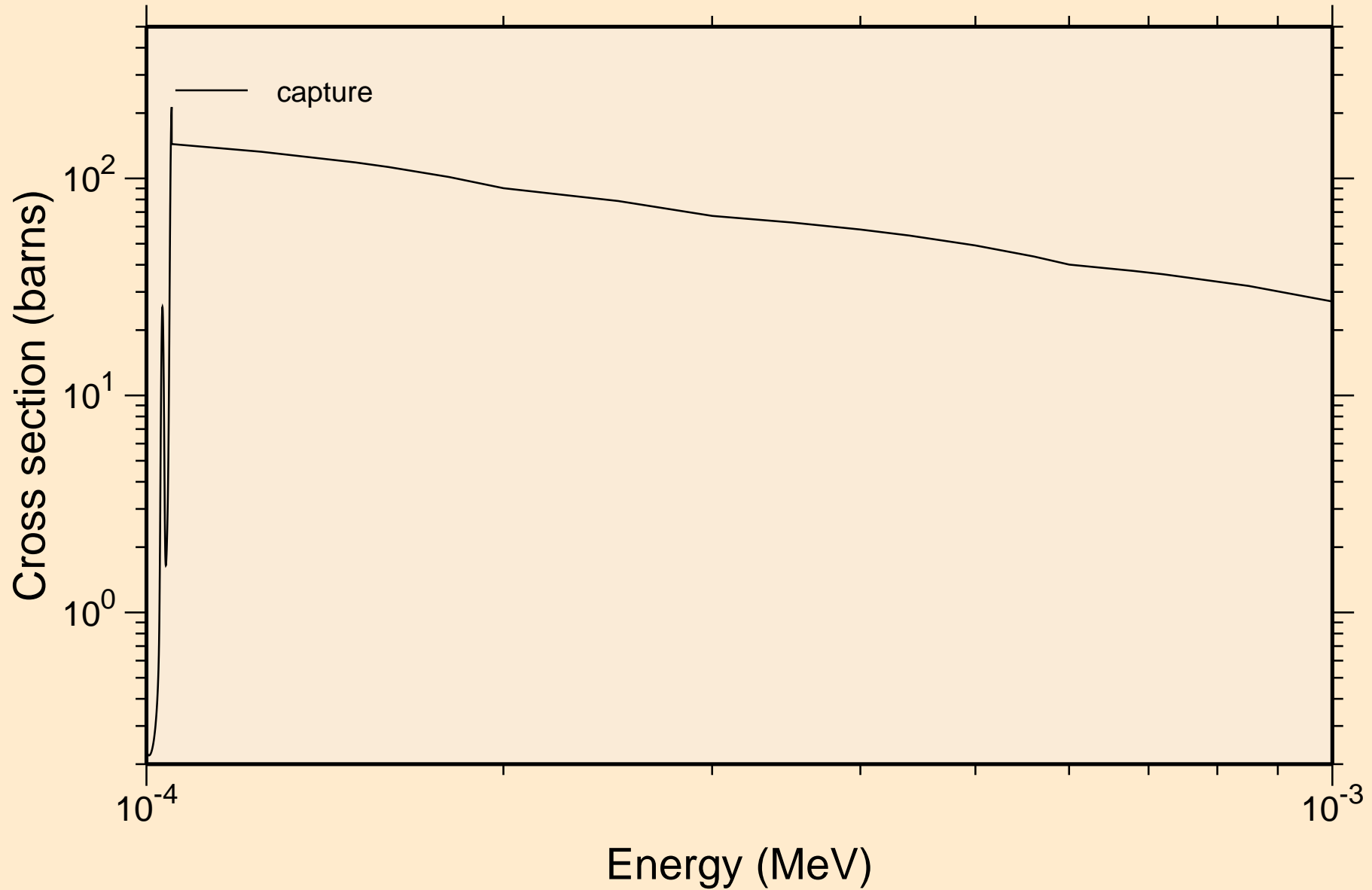

PM152 NEUTRON ACER TENDL-2024 LIBRARY; T=293.6K  
resonance absorption cross sections

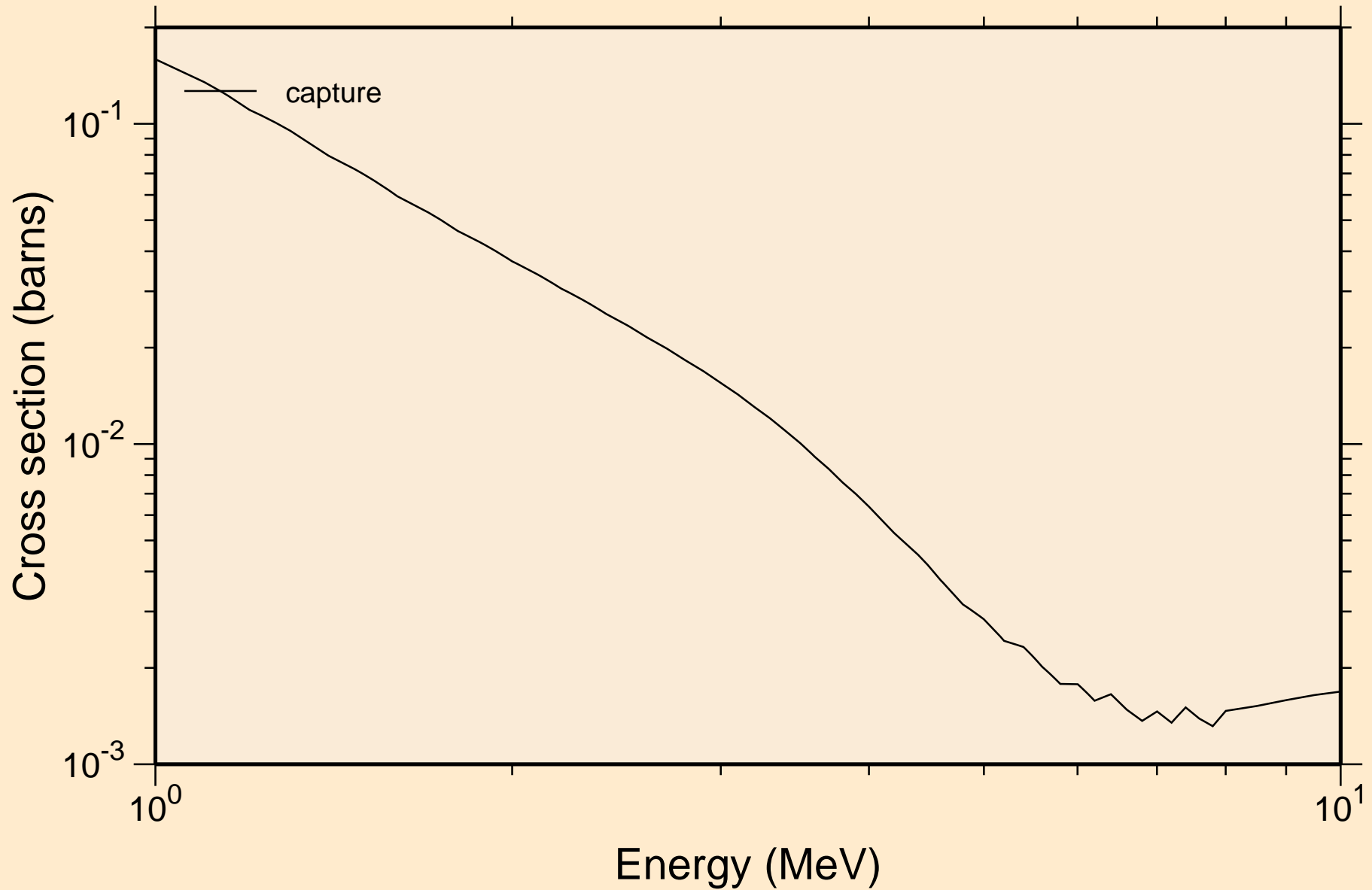

PM152 NEUTRON ACER TENDL-2024 LIBRARY; T=293.6K  
Heating

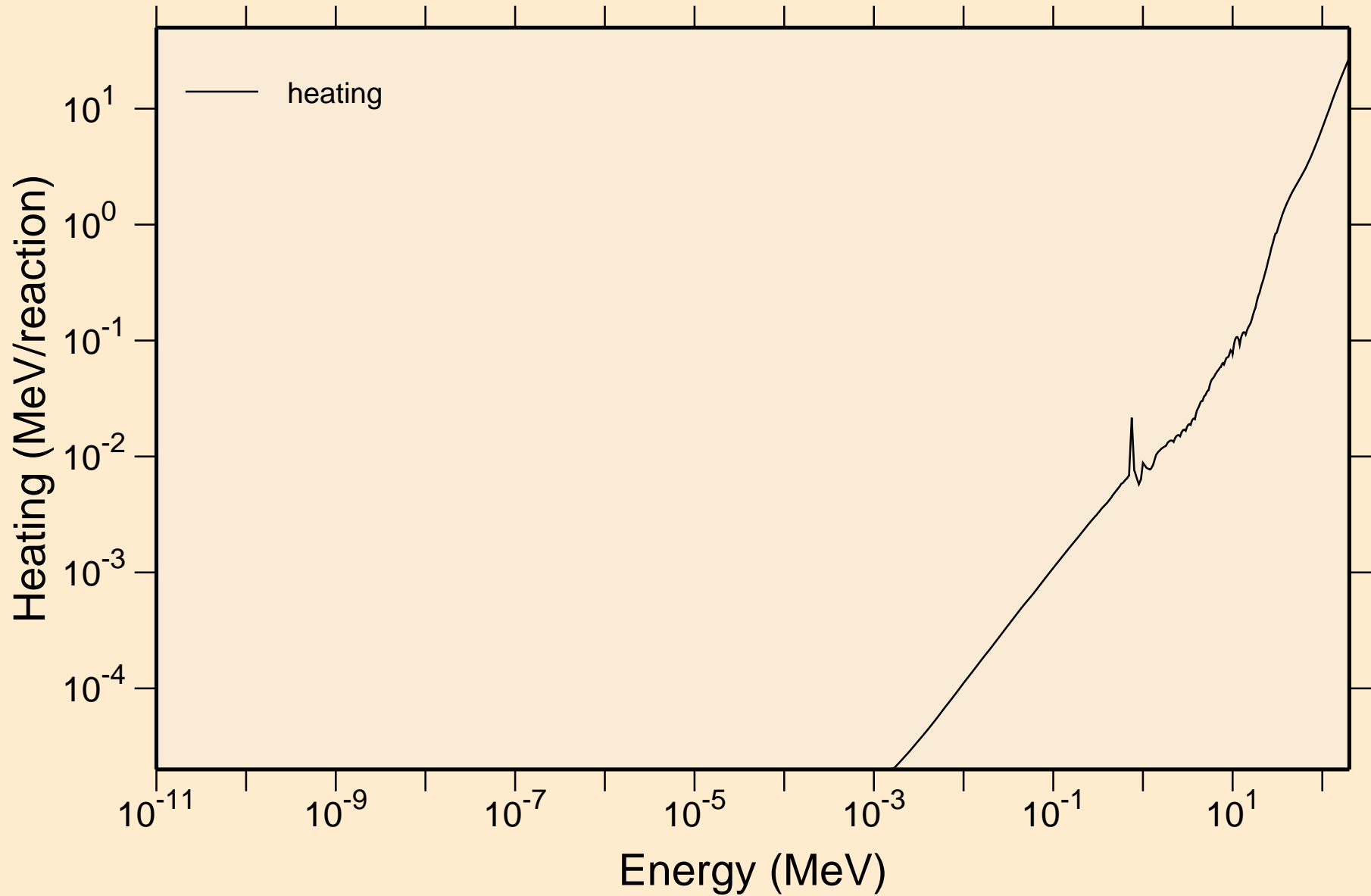

PM152 NEUTRON ACER TENDL-2024 LIBRARY; T=293.6K  
Damage

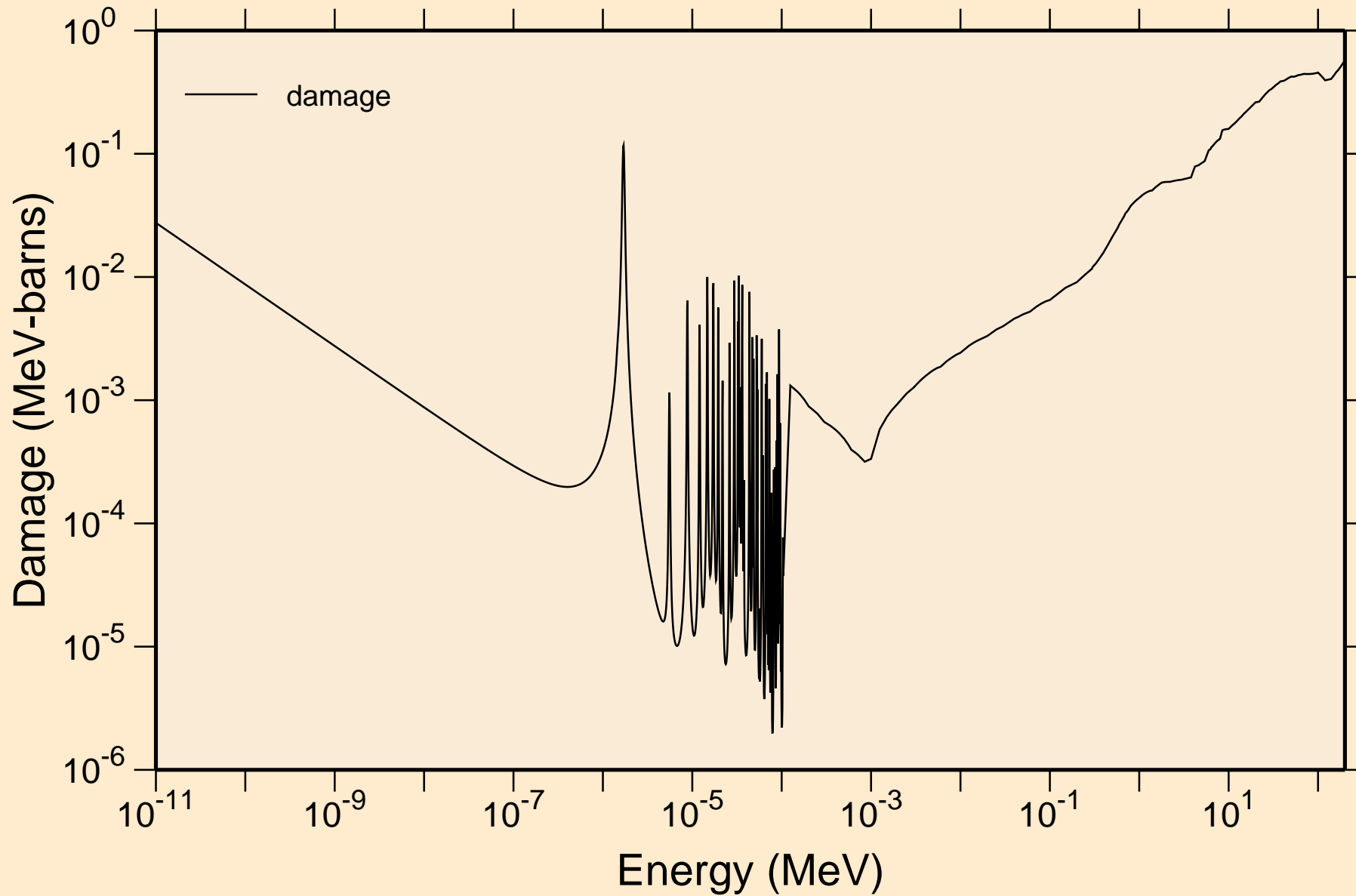

PM152 NEUTRON ACER TENDL-2024 LIBRARY; T=293.6K  
Non-threshold reactions

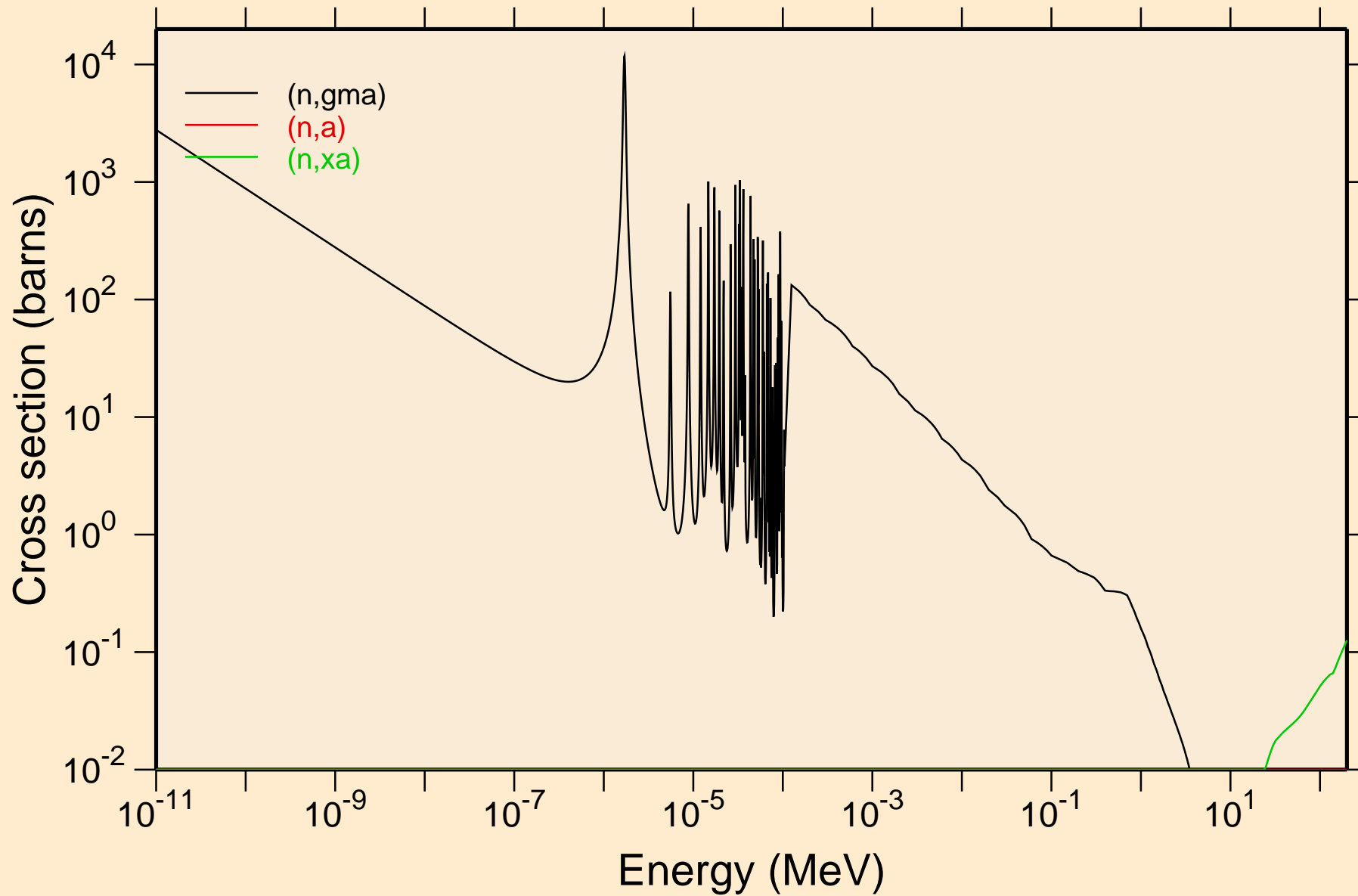

PM152 NEUTRON ACER TENDL-2024 LIBRARY; T=293.6K  
Principal cross sections

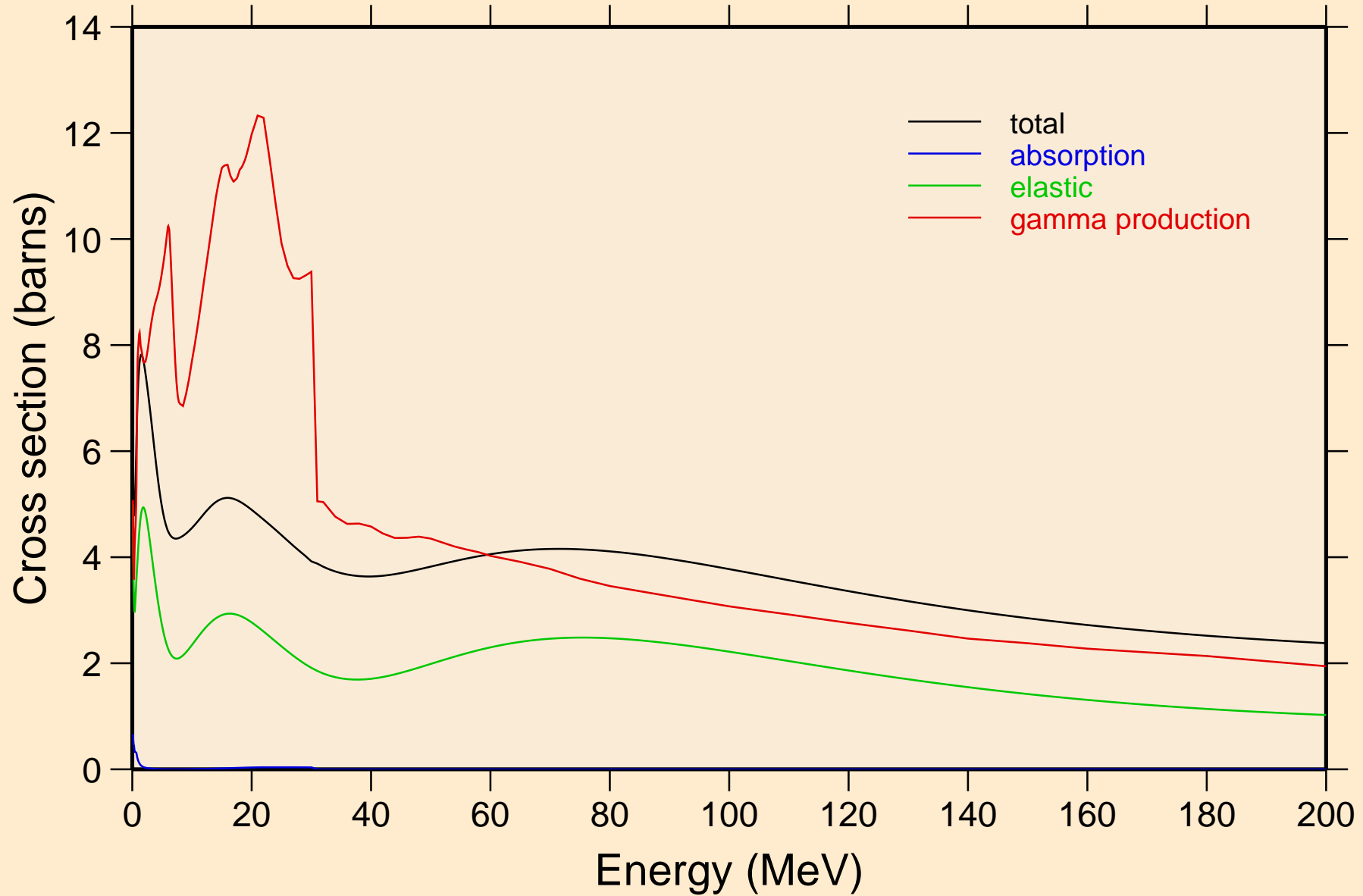

PM152 NEUTRON ACER TENDL-2024 LIBRARY; T=293.6K  
Heating

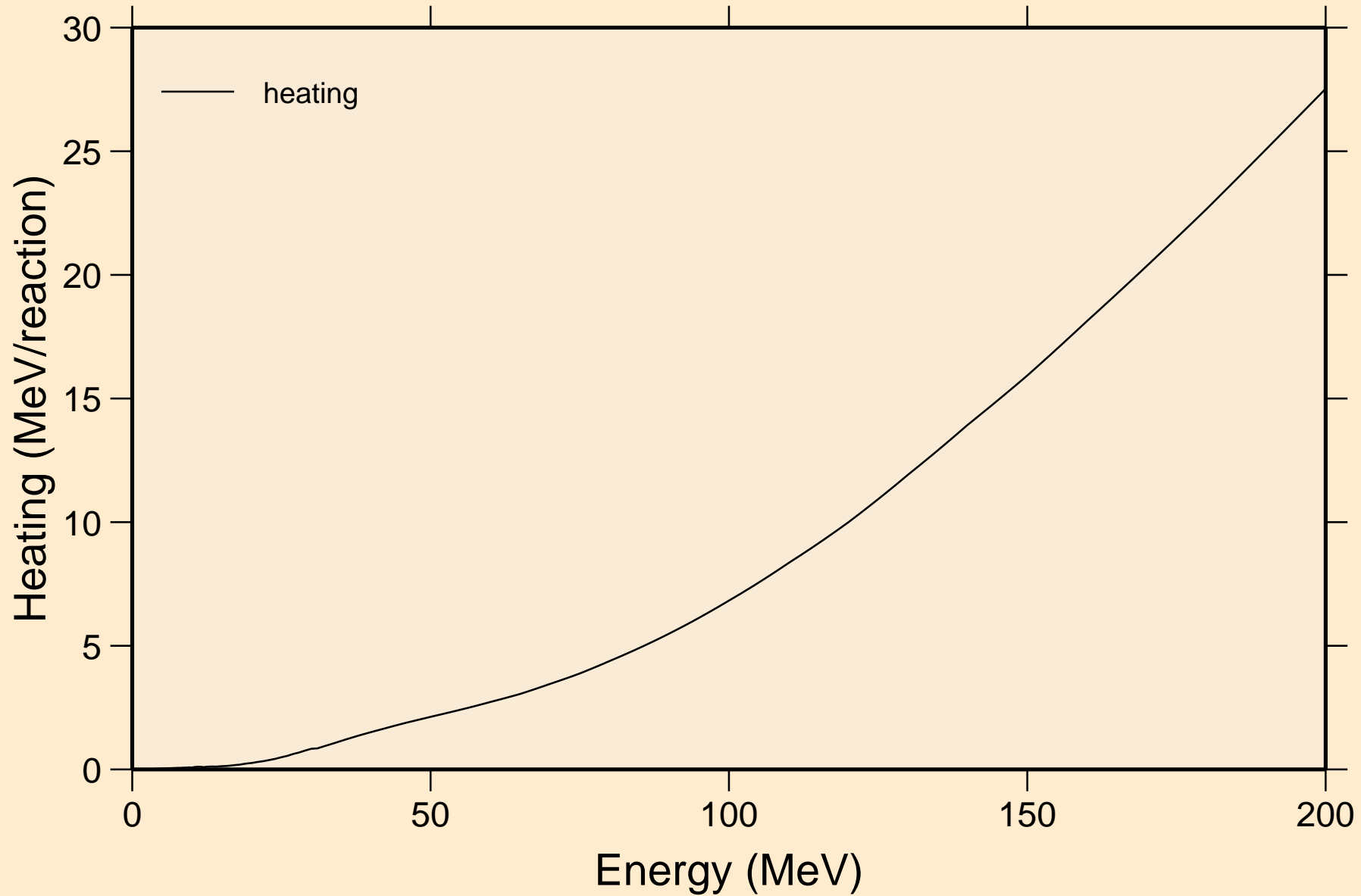

PM152 NEUTRON ACER TENDL-2024 LIBRARY; T=293.6K  
Damage

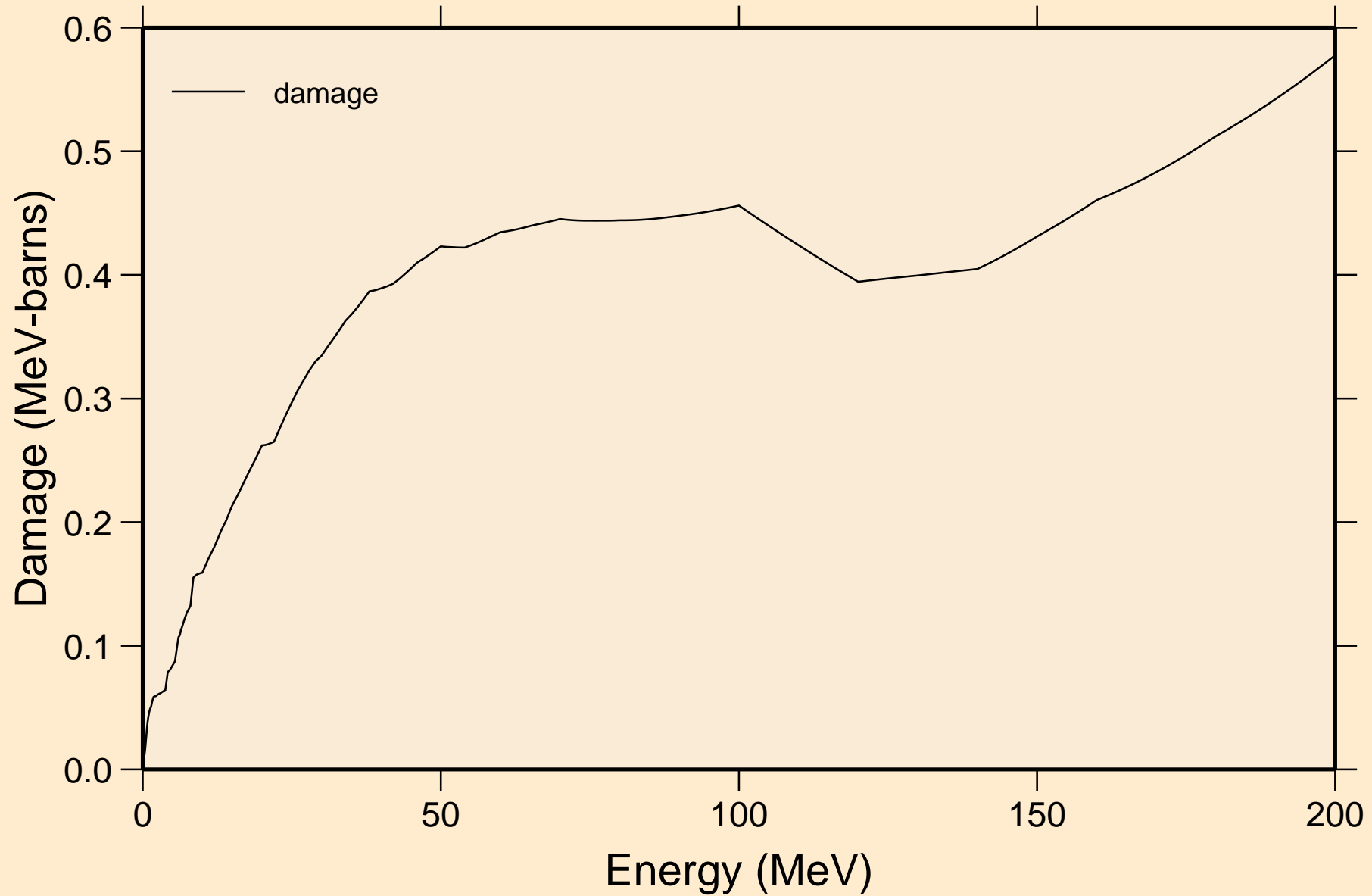

PM152 NEUTRON ACER TENDL-2024 LIBRARY; T=293.6K  
Non-threshold reactions

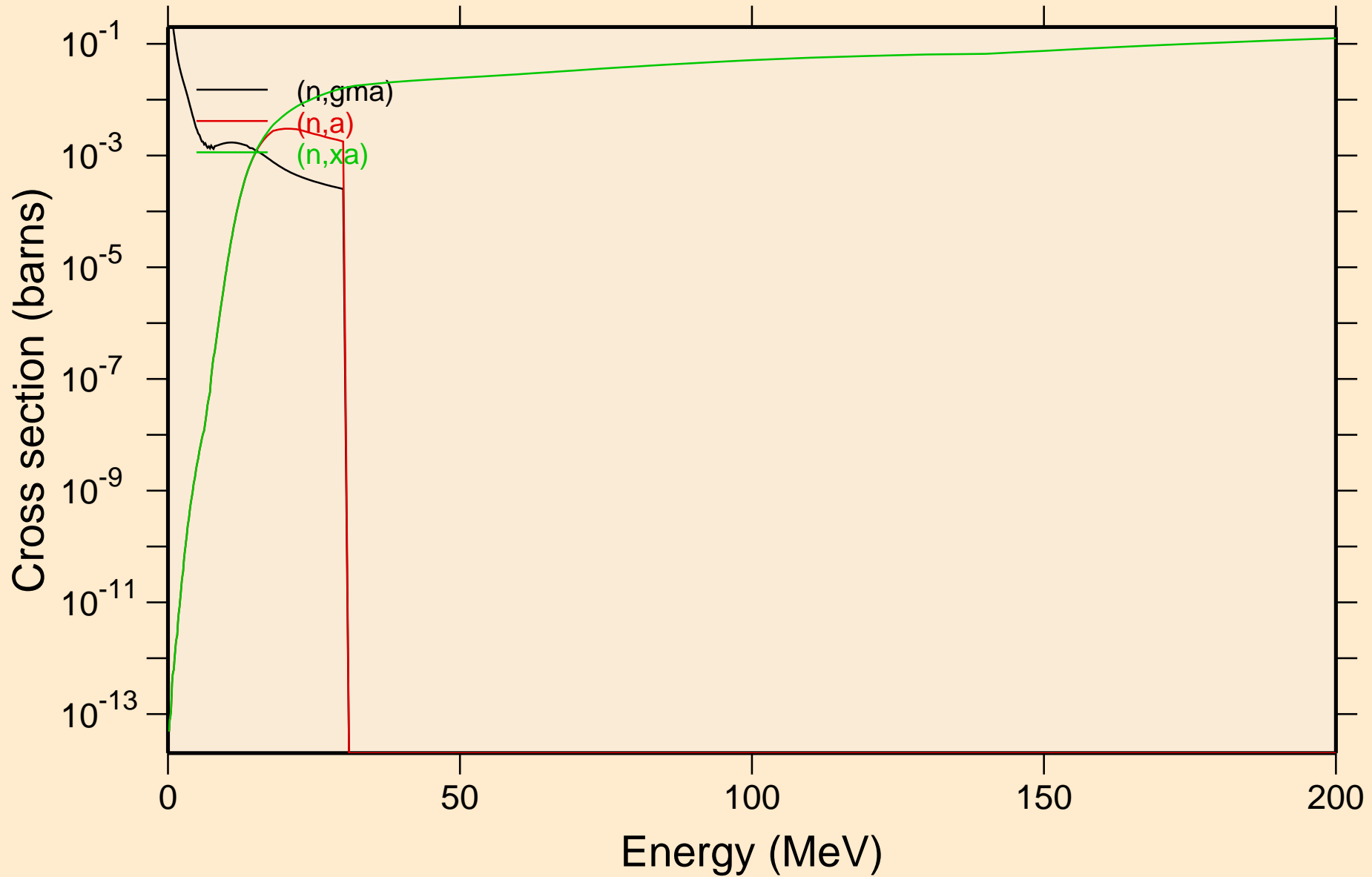

PM152 NEUTRON ACER TENDL-2024 LIBRARY; T=293.6K  
Inelastic levels

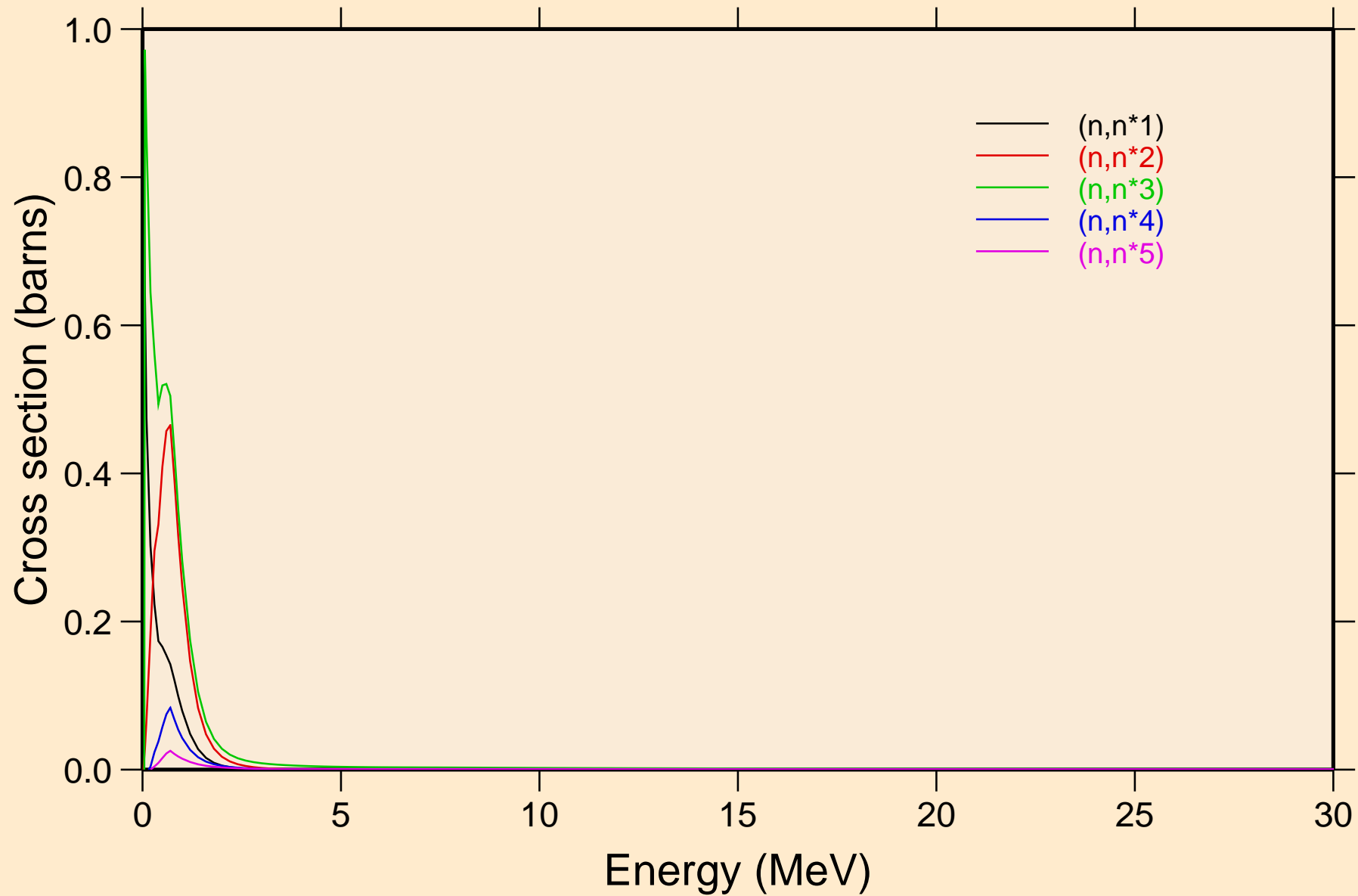

PM152 NEUTRON ACER TENDL-2024 LIBRARY; T=293.6K  
Inelastic levels

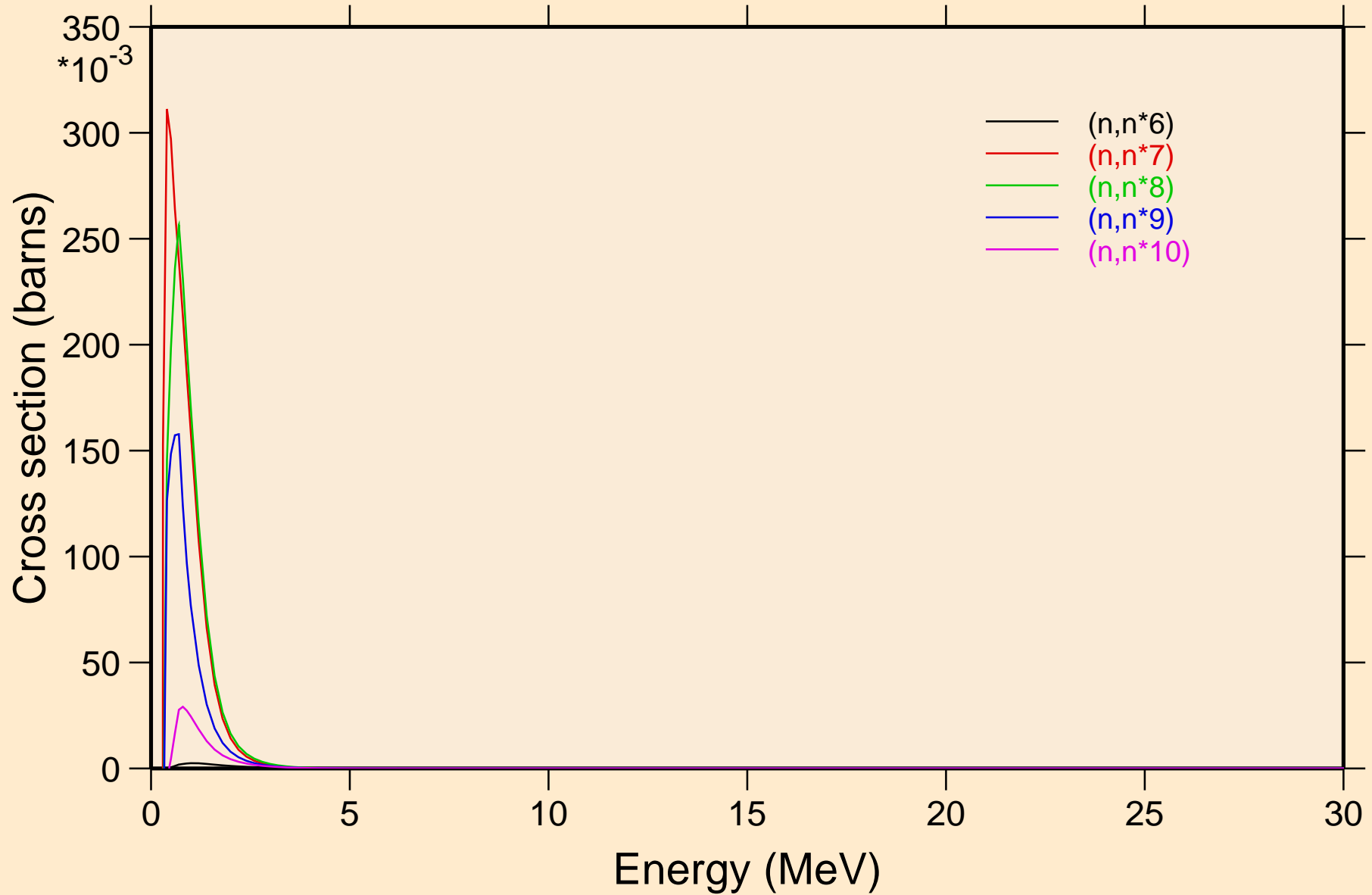

PM152 NEUTRON ACER TENDL-2024 LIBRARY; T=293.6K  
Inelastic levels

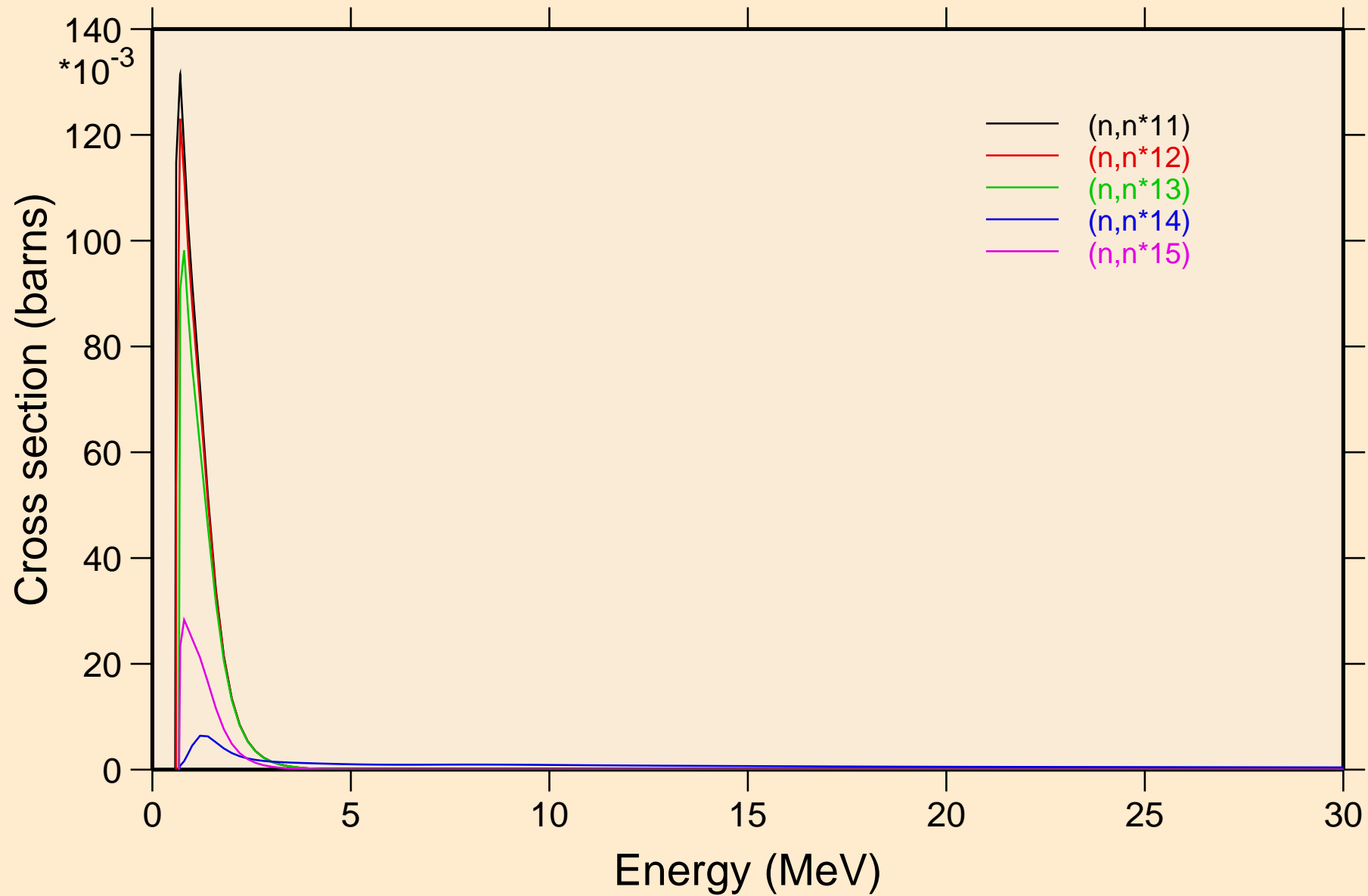

PM152 NEUTRON ACER TENDL-2024 LIBRARY; T=293.6K  
Inelastic levels

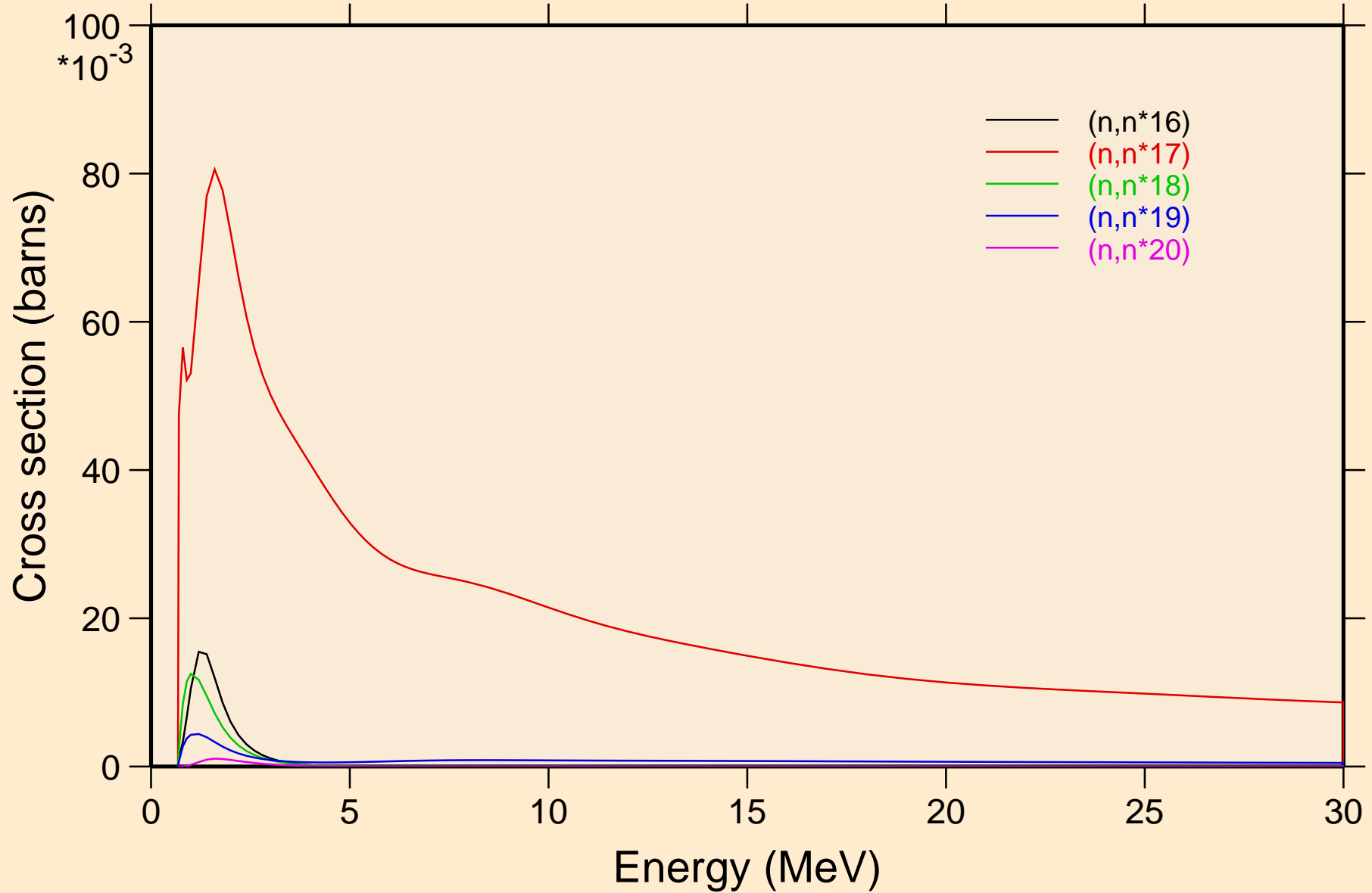

PM152 NEUTRON ACER TENDL-2024 LIBRARY; T=293.6K  
Inelastic levels

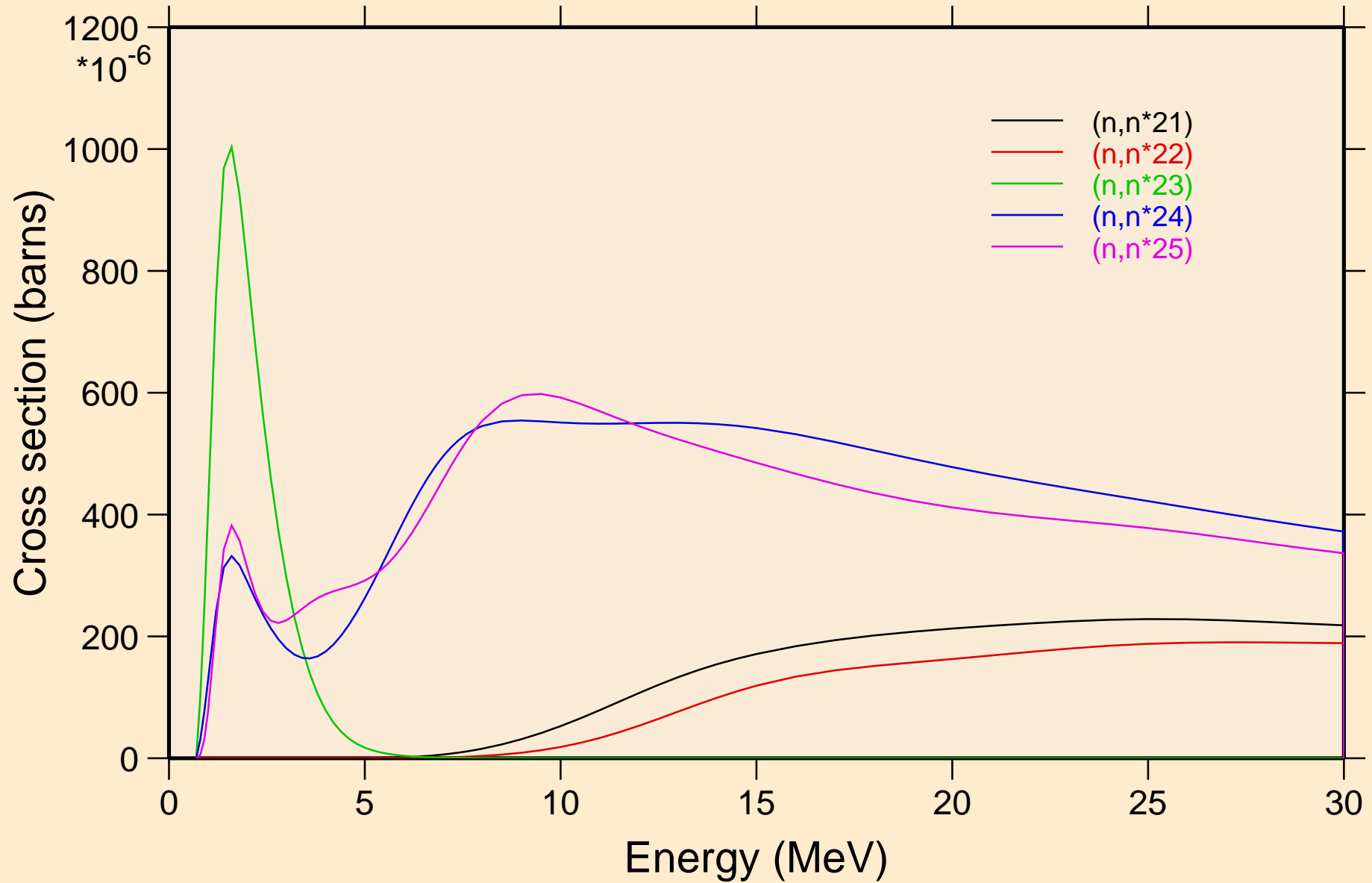

PM152 NEUTRON ACER TENDL-2024 LIBRARY; T=293.6K  
Inelastic levels

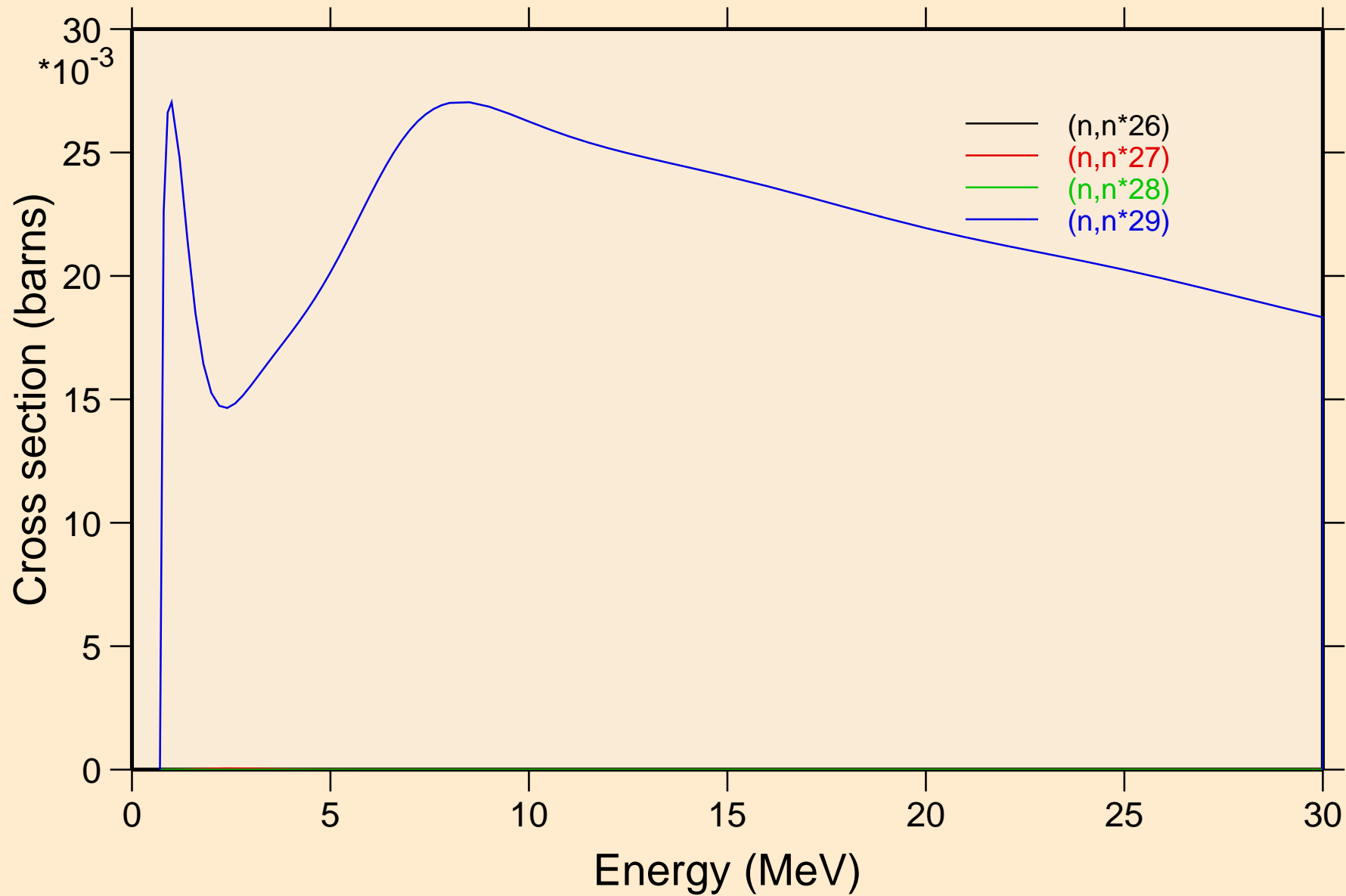

PM152 NEUTRON ACER TENDL-2024 LIBRARY; T=293.6K  
Threshold reactions

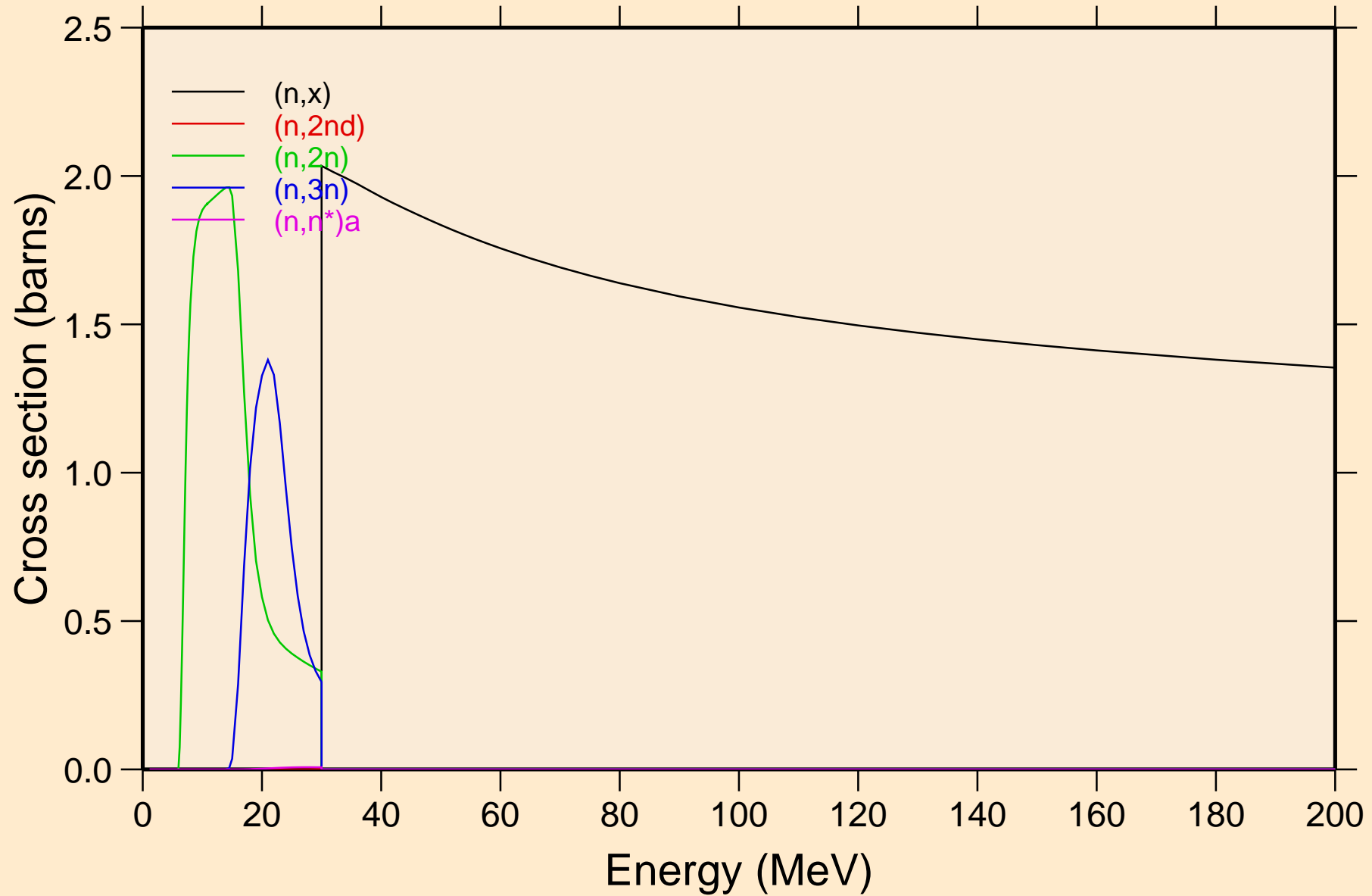

PM152 NEUTRON ACER TENDL-2024 LIBRARY; T=293.6K  
Threshold reactions

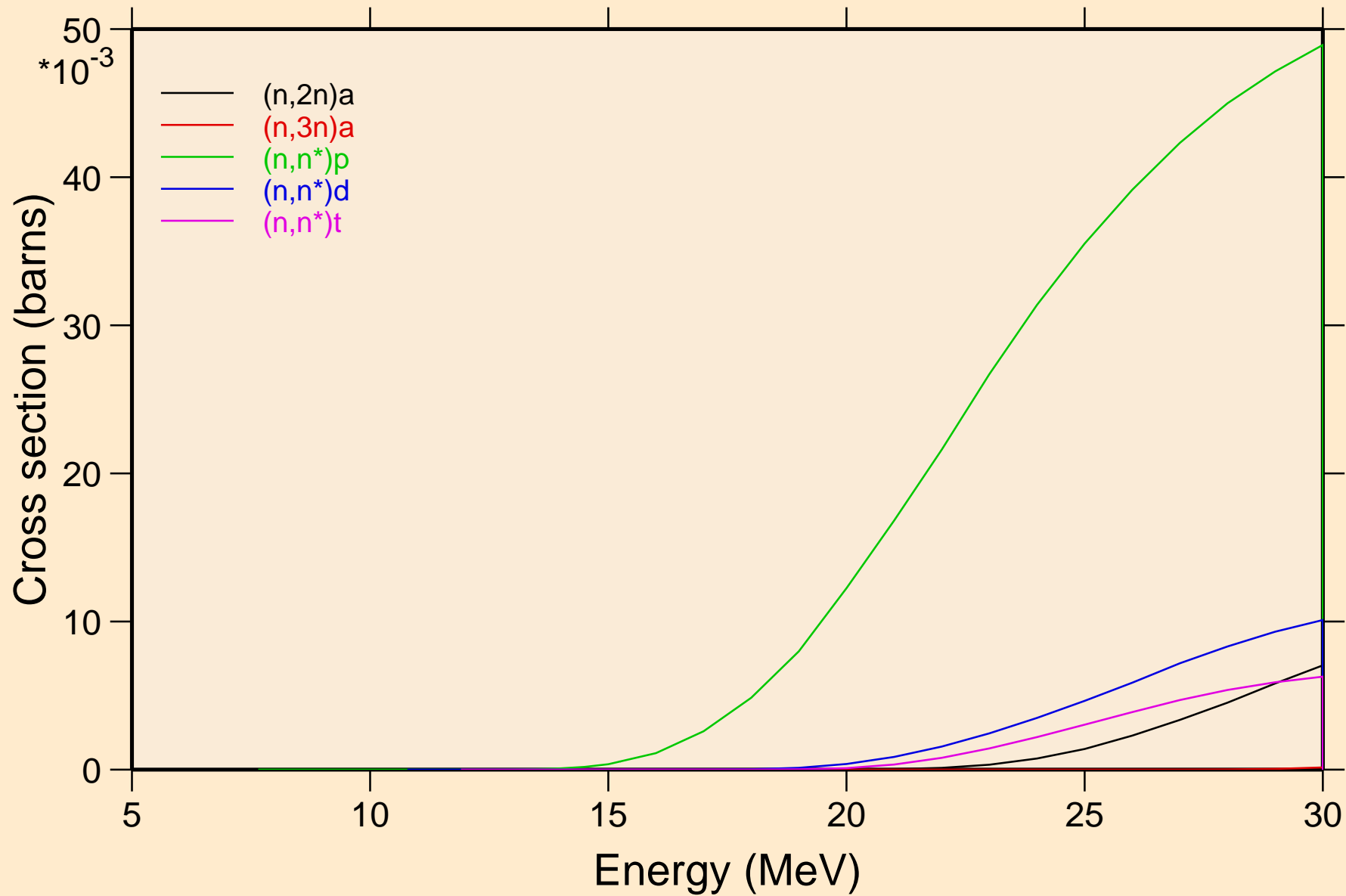

PM152 NEUTRON ACER TENDL-2024 LIBRARY; T=293.6K  
Threshold reactions

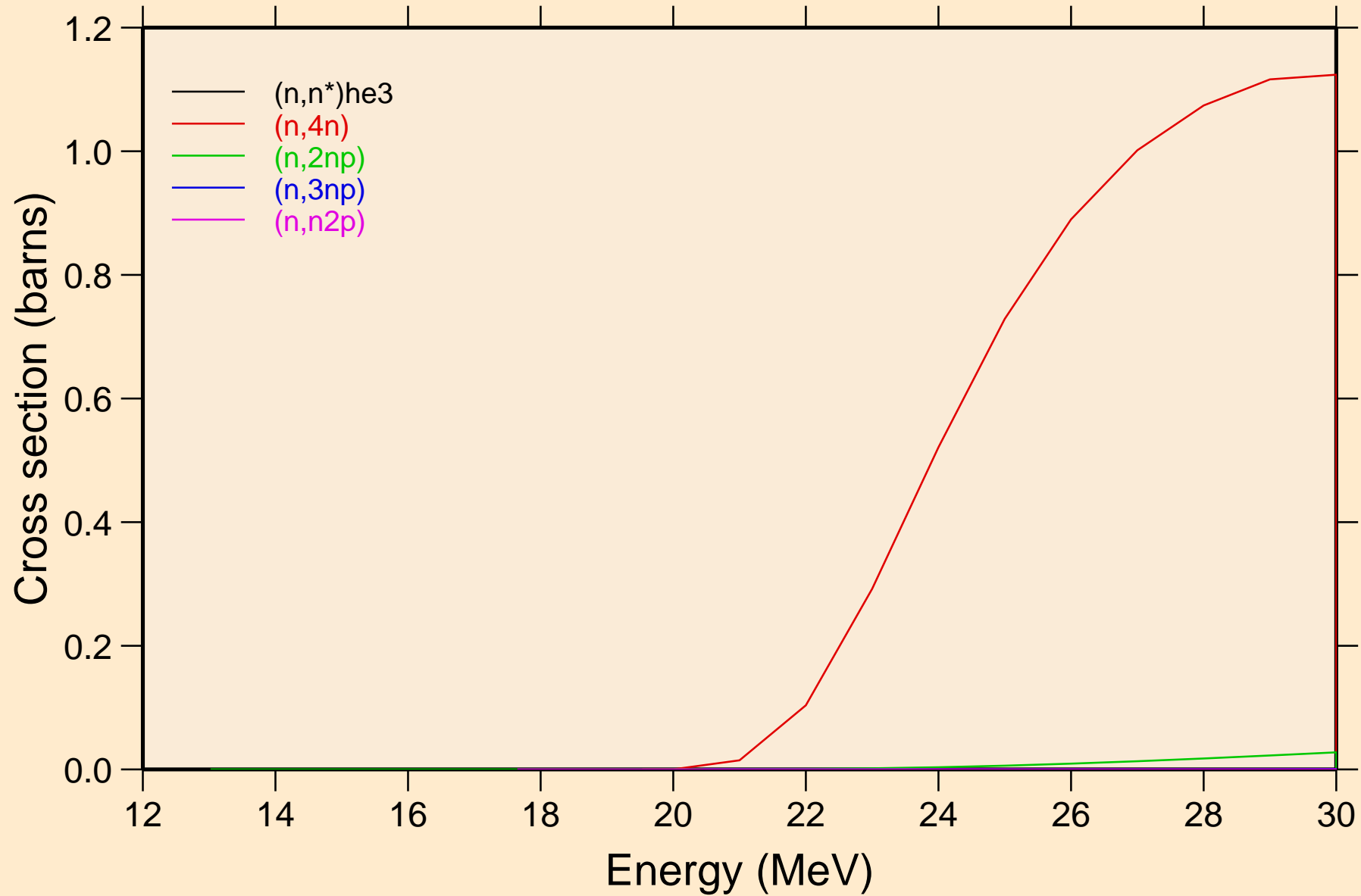

PM152 NEUTRON ACER TENDL-2024 LIBRARY; T=293.6K  
Threshold reactions

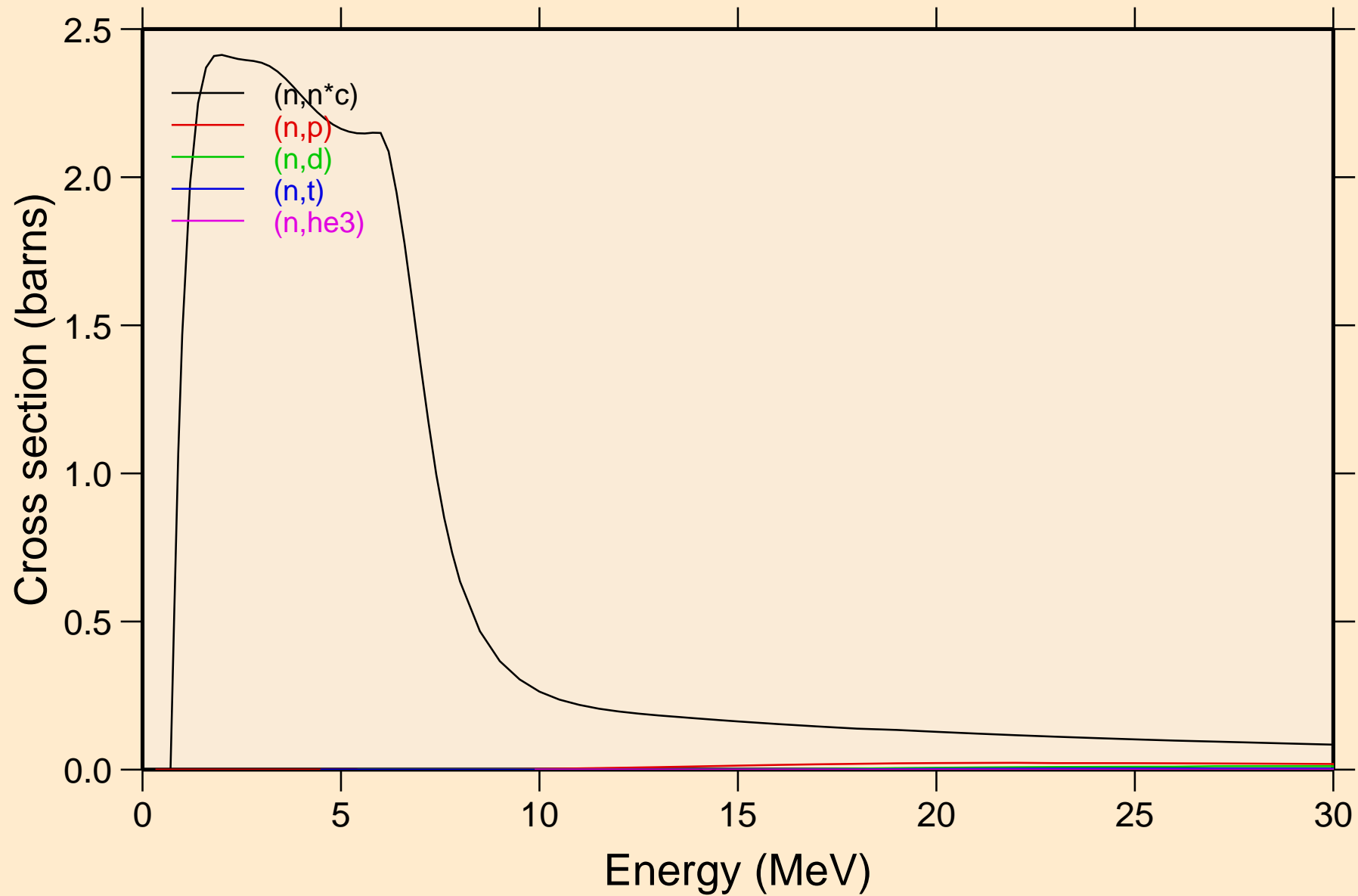

PM152 NEUTRON ACER TENDL-2024 LIBRARY; T=293.6K  
Threshold reactions

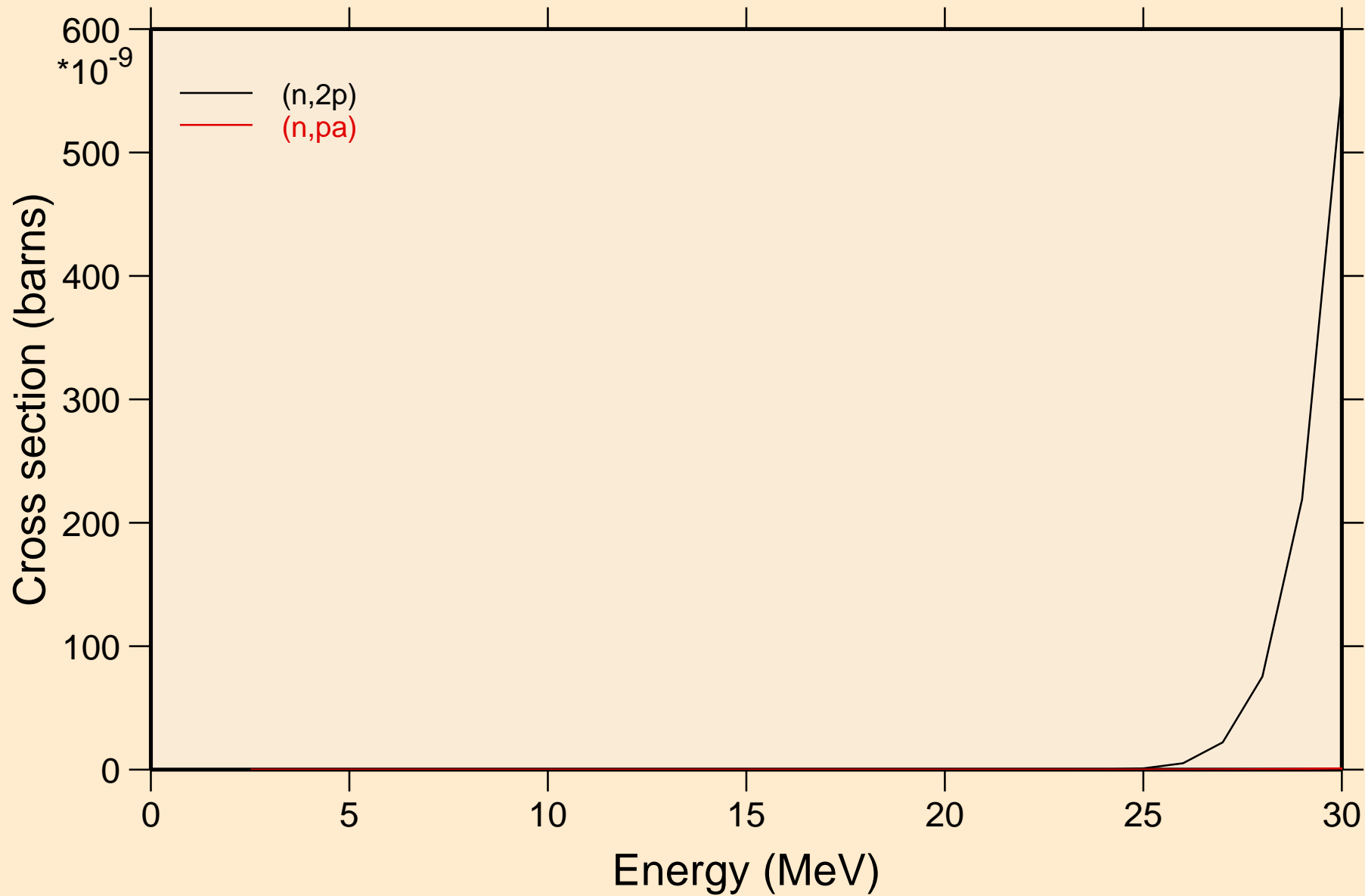

PM152 NEUTRON ACER TENDL-2024 LIBRARY; T=293.6K  
Threshold reactions

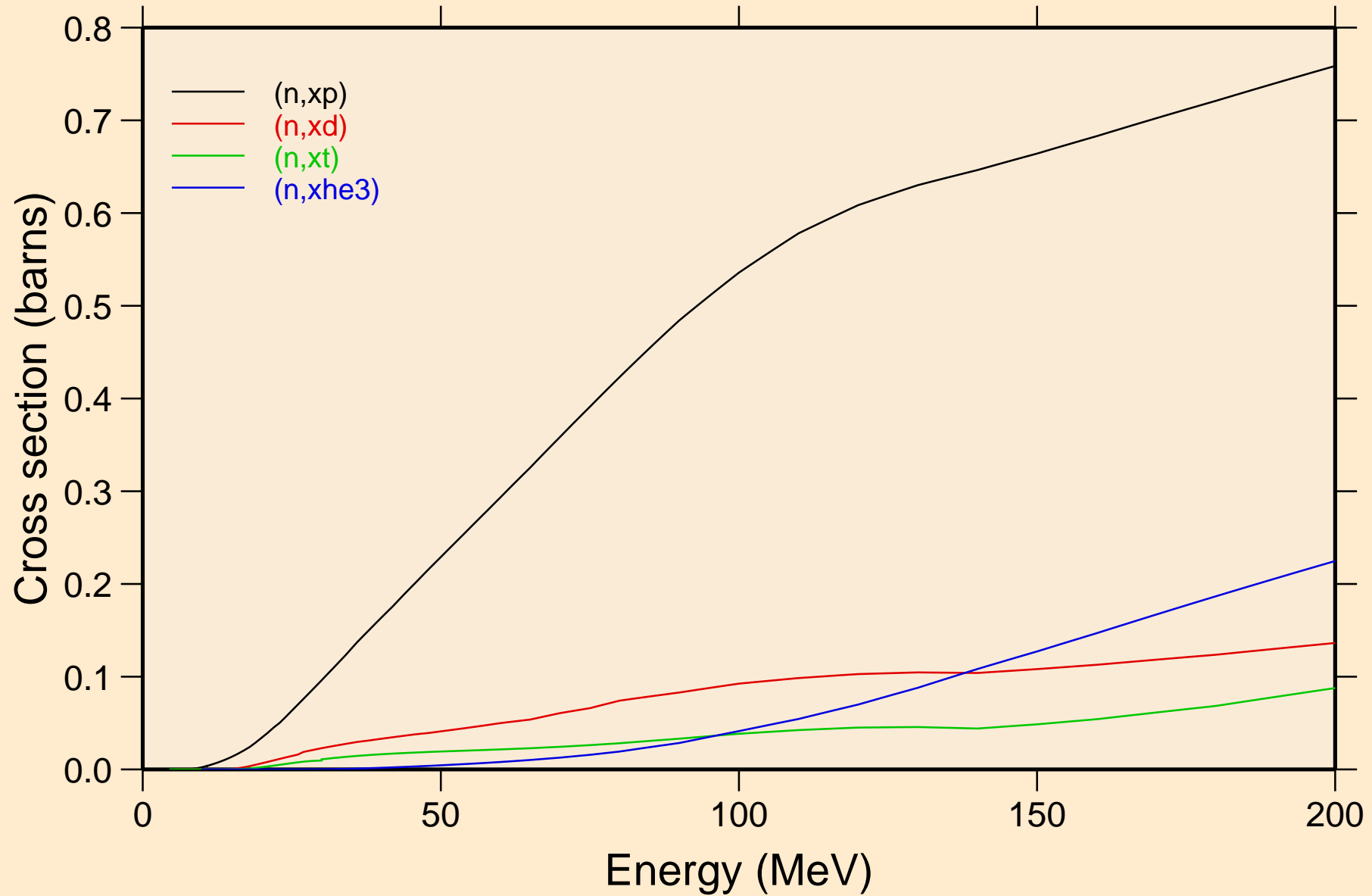

PM152 NEUTRON ACER TENDL-2024 LIBRARY; T=293.6K  
angular distribution for elastic

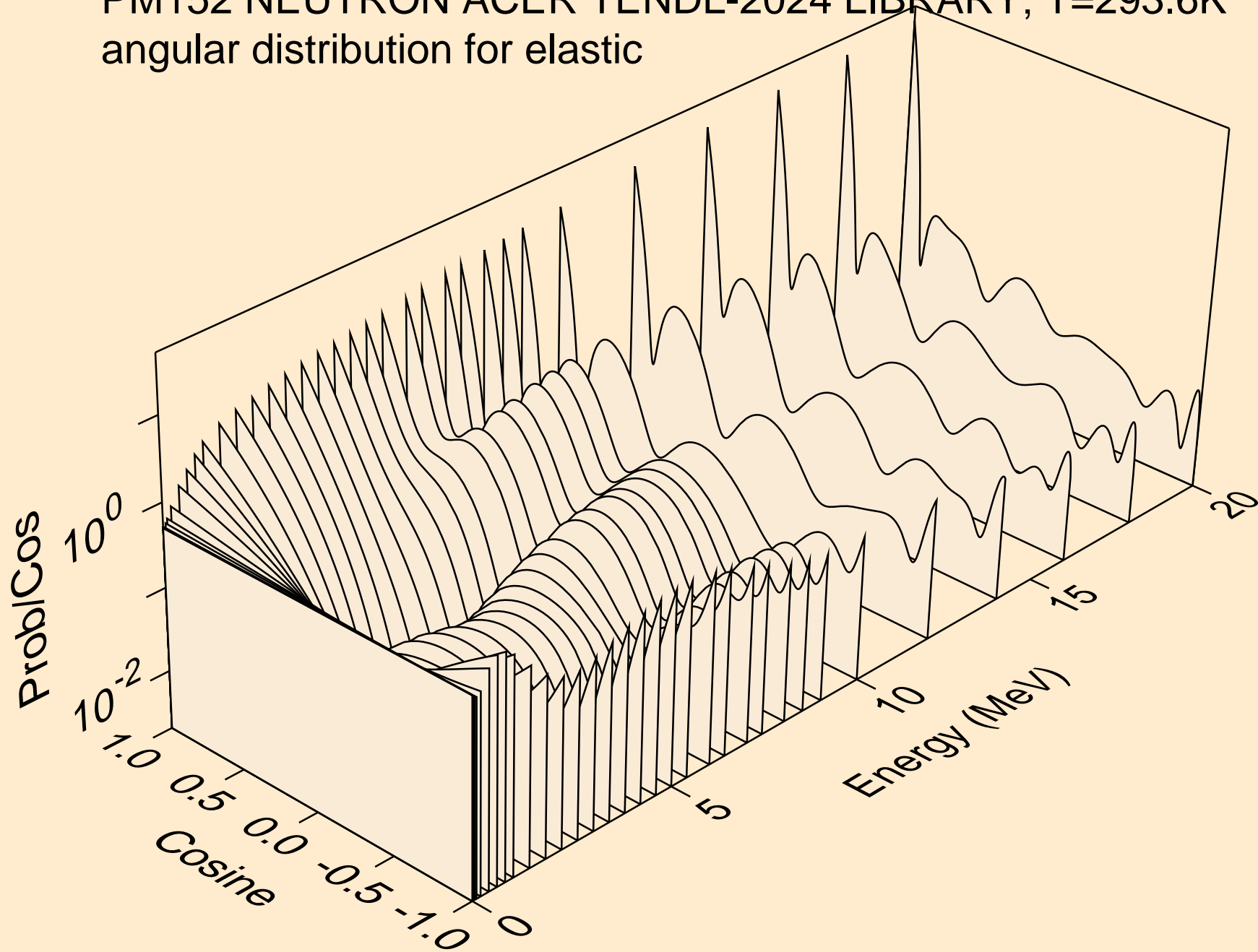

PM152 NEUTRON ACER TENDL-2024 LIBRARY; T=293.6K  
angular distribution for elastic

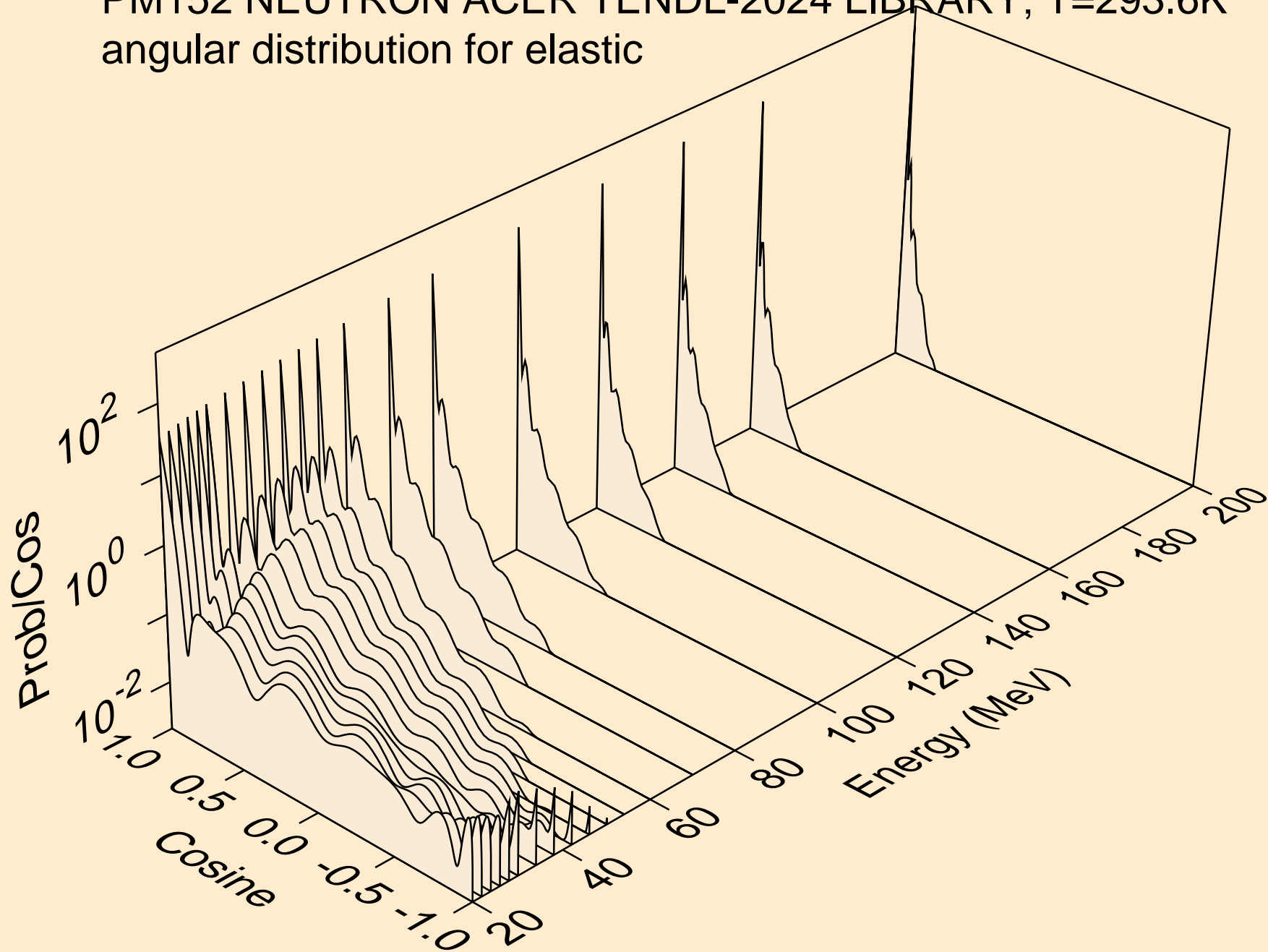

PM152 NEUTRON ACER TENDL-2024 LIBRARY; T=293.6K  
angular distribution for (n,n\*1)

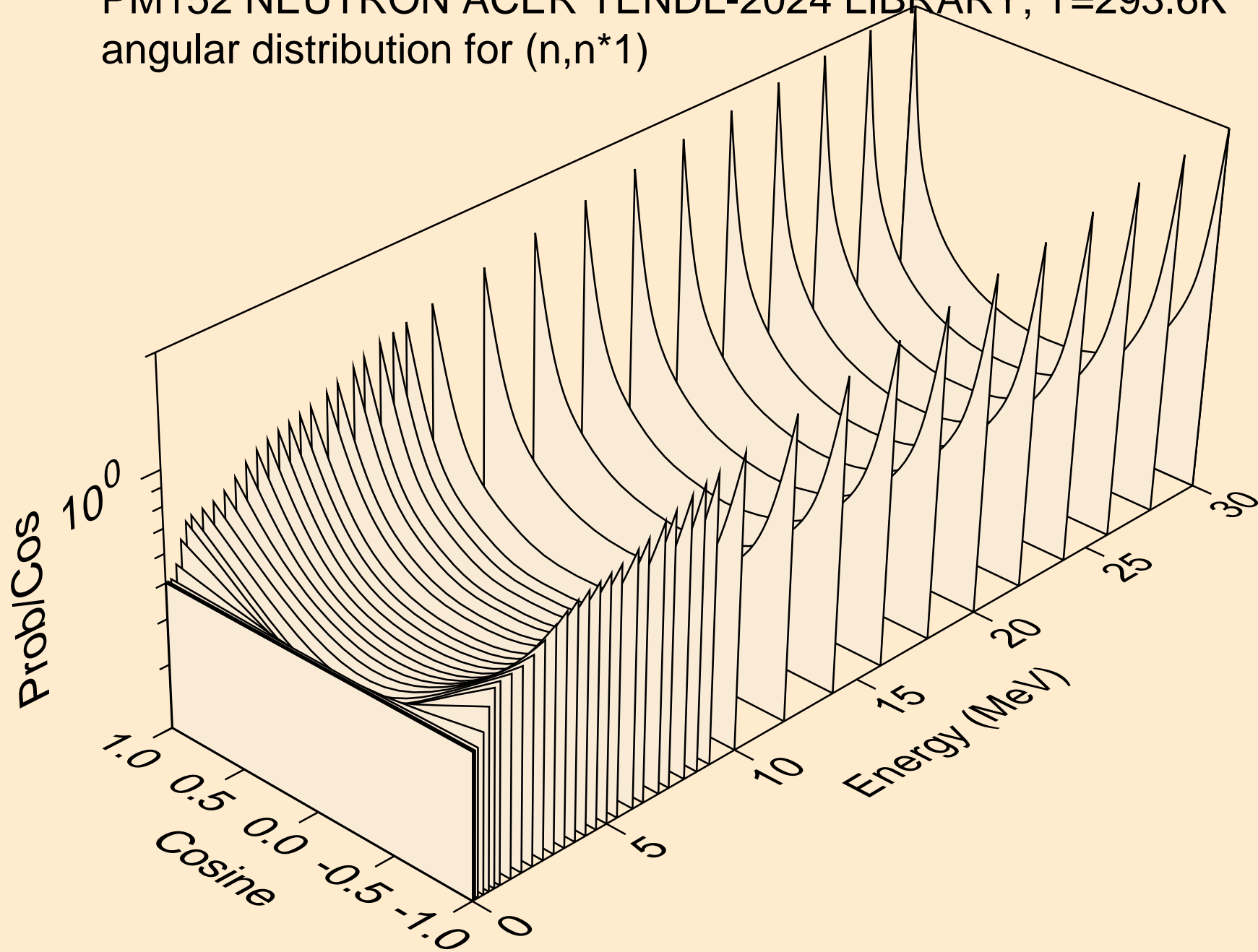

PM152 NEUTRON ACER TENDL-2024 LIBRARY; T=293.6K  
angular distribution for (n,n\*2)

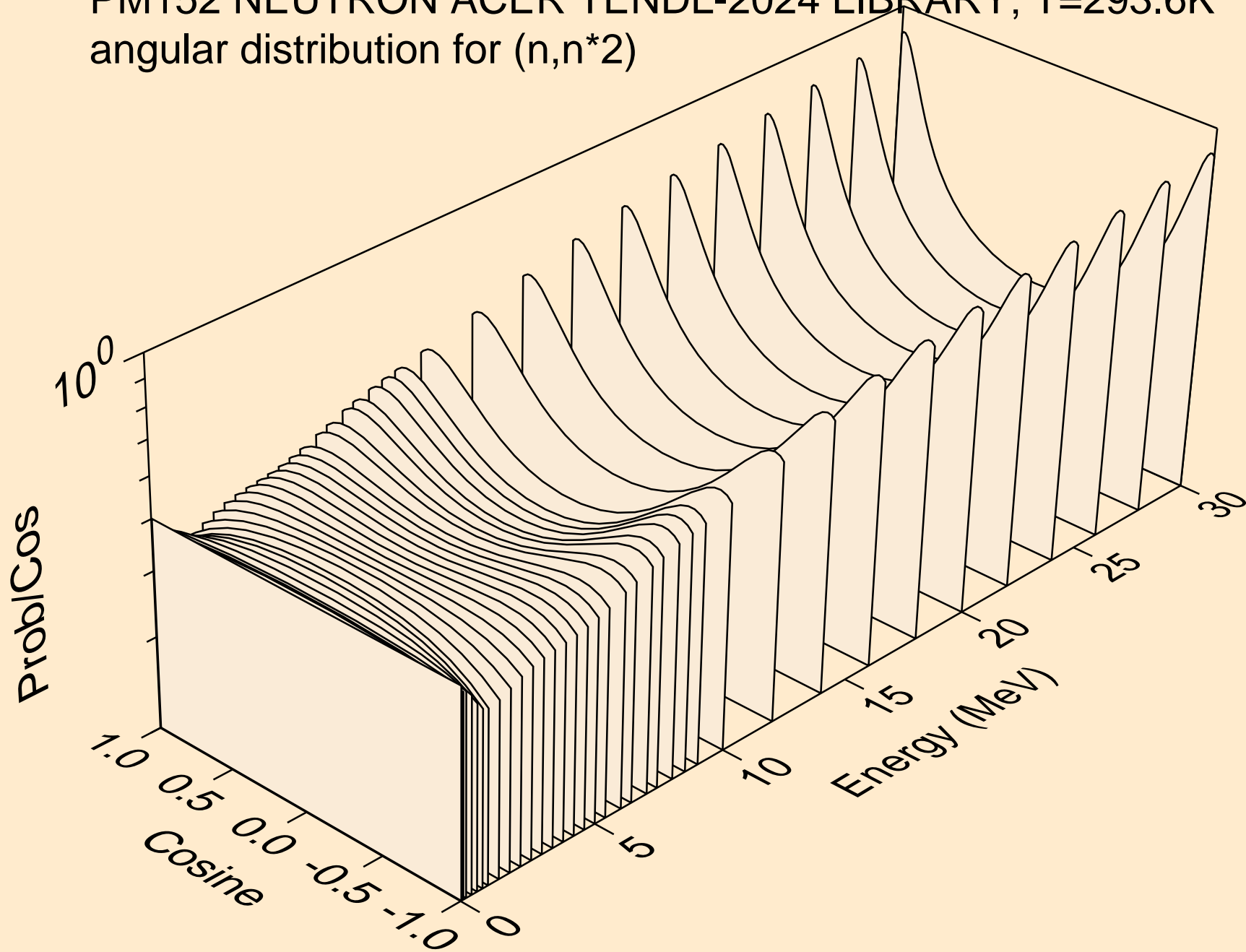

PM152 NEUTRON ACER TENDL-2024 LIBRARY; T=293.6K  
angular distribution for (n,n\*3)

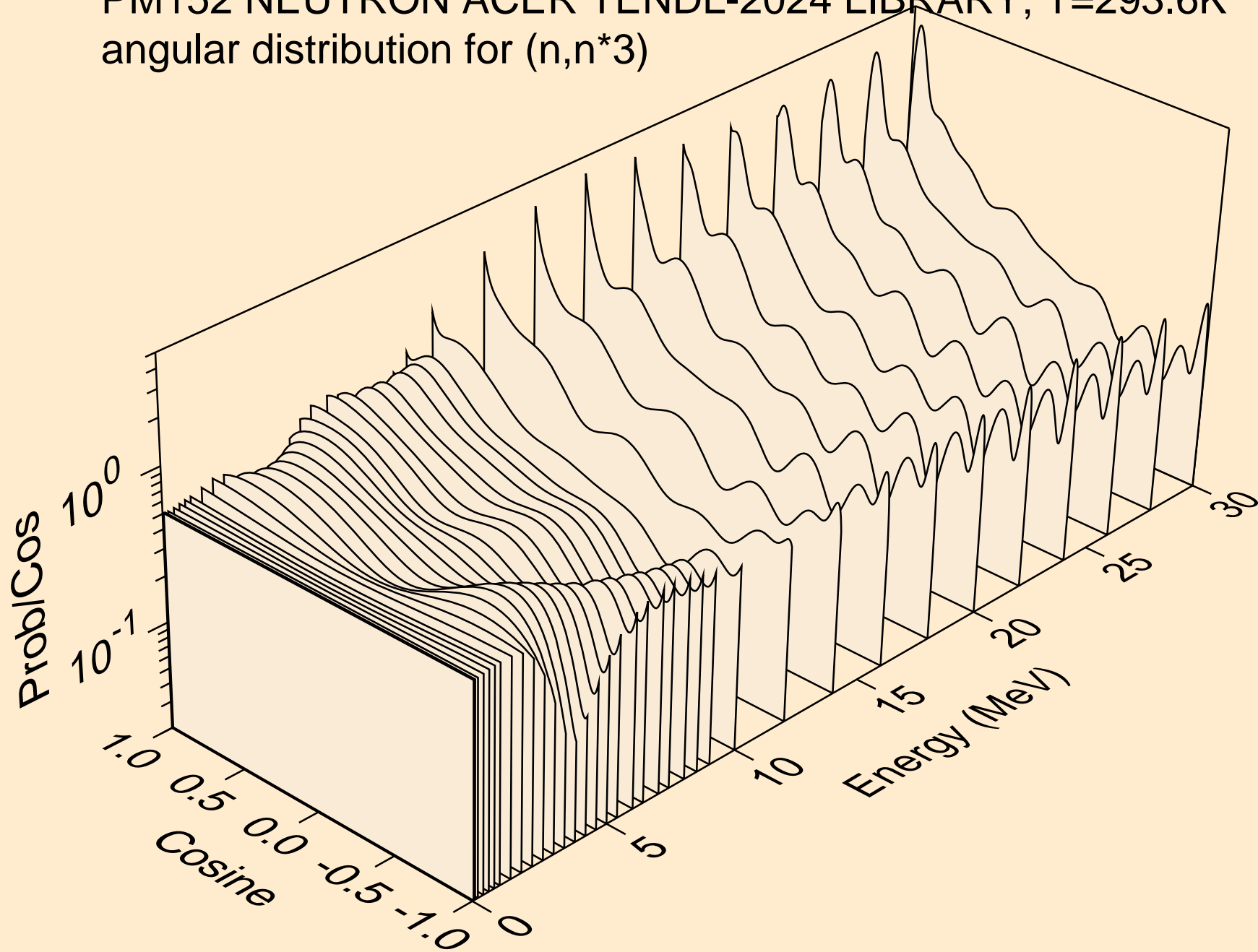

PM152 NEUTRON ACER TENDL-2024 LIBRARY; T=293.6K  
angular distribution for (n,n\*4)

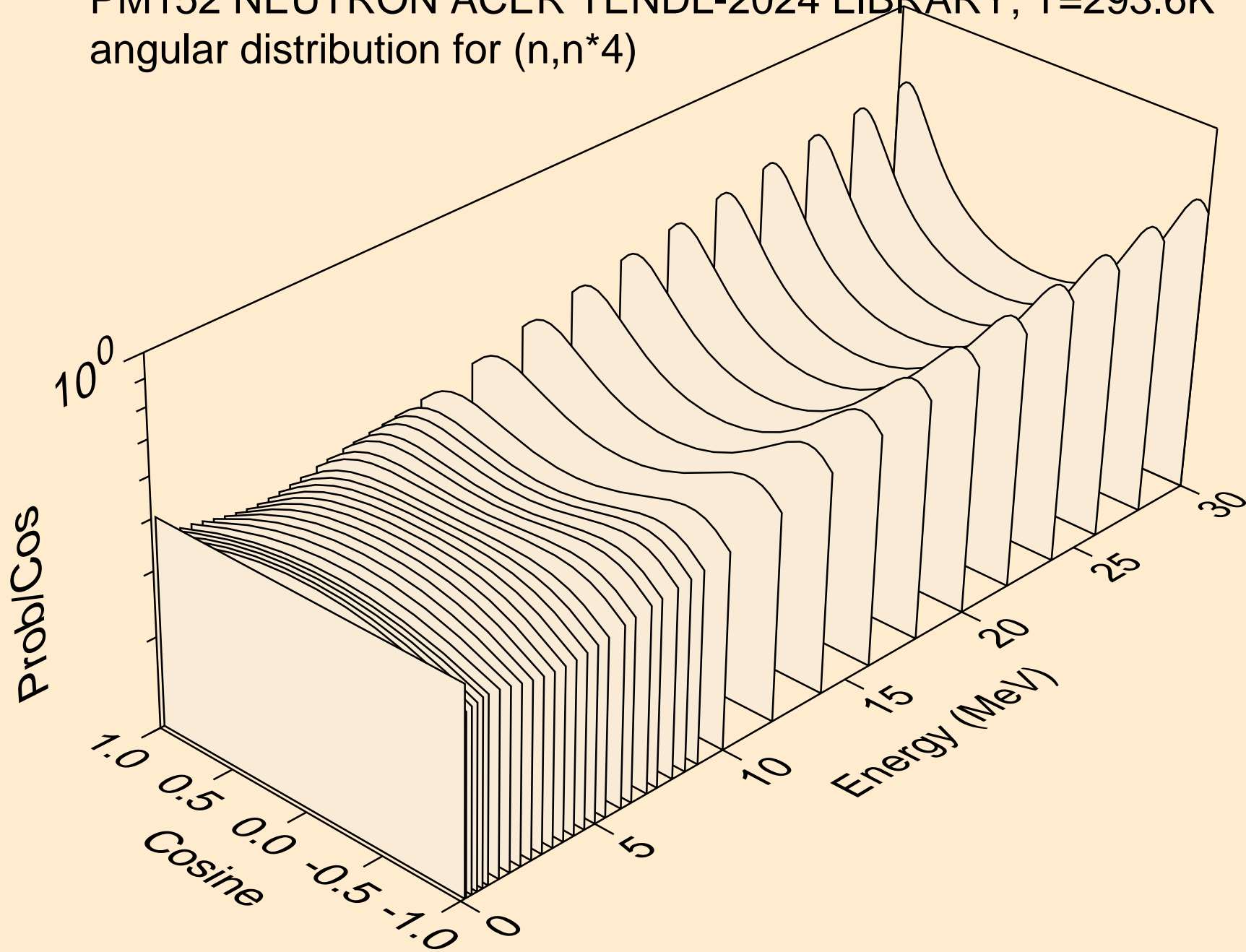

PM152 NEUTRON ACER TENDL-2024 LIBRARY; T=293.6K  
angular distribution for (n,n\*5)

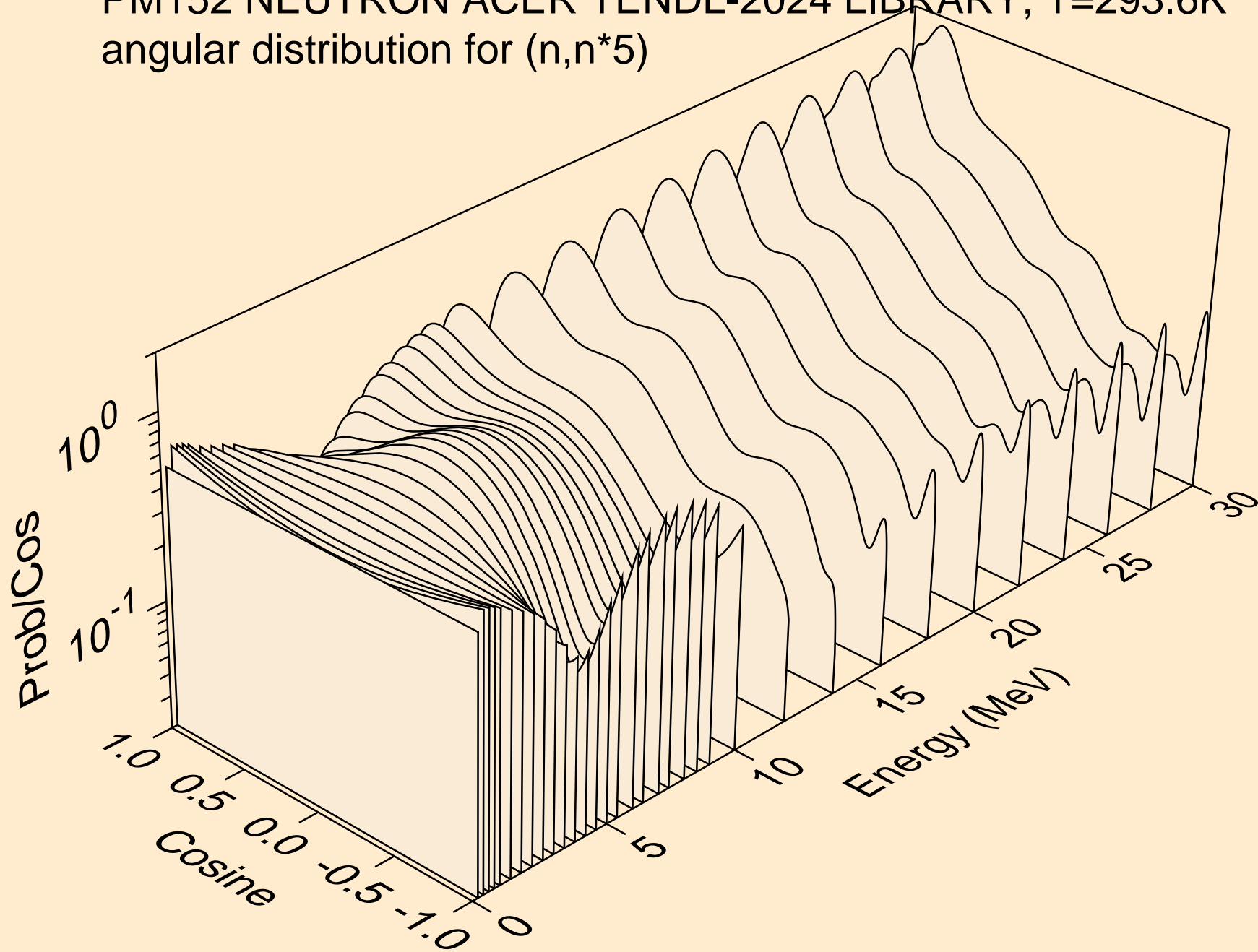

PM152 NEUTRON ACER TENDL-2024 LIBRARY; T=293.6K  
angular distribution for (n,n\*6)

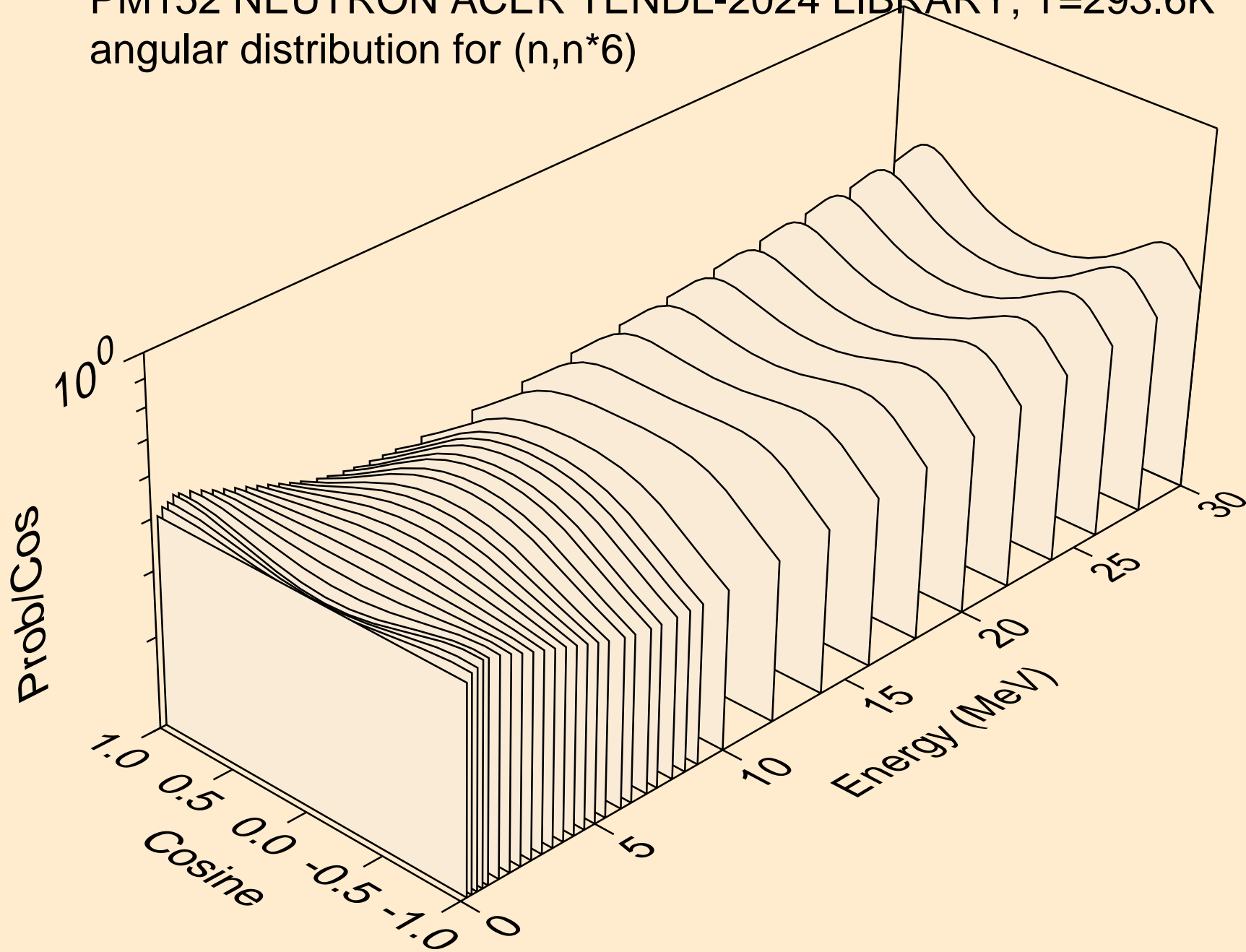

PM152 NEUTRON ACER TENDL-2024 LIBRARY; T=293.6K  
angular distribution for (n,n\*7)

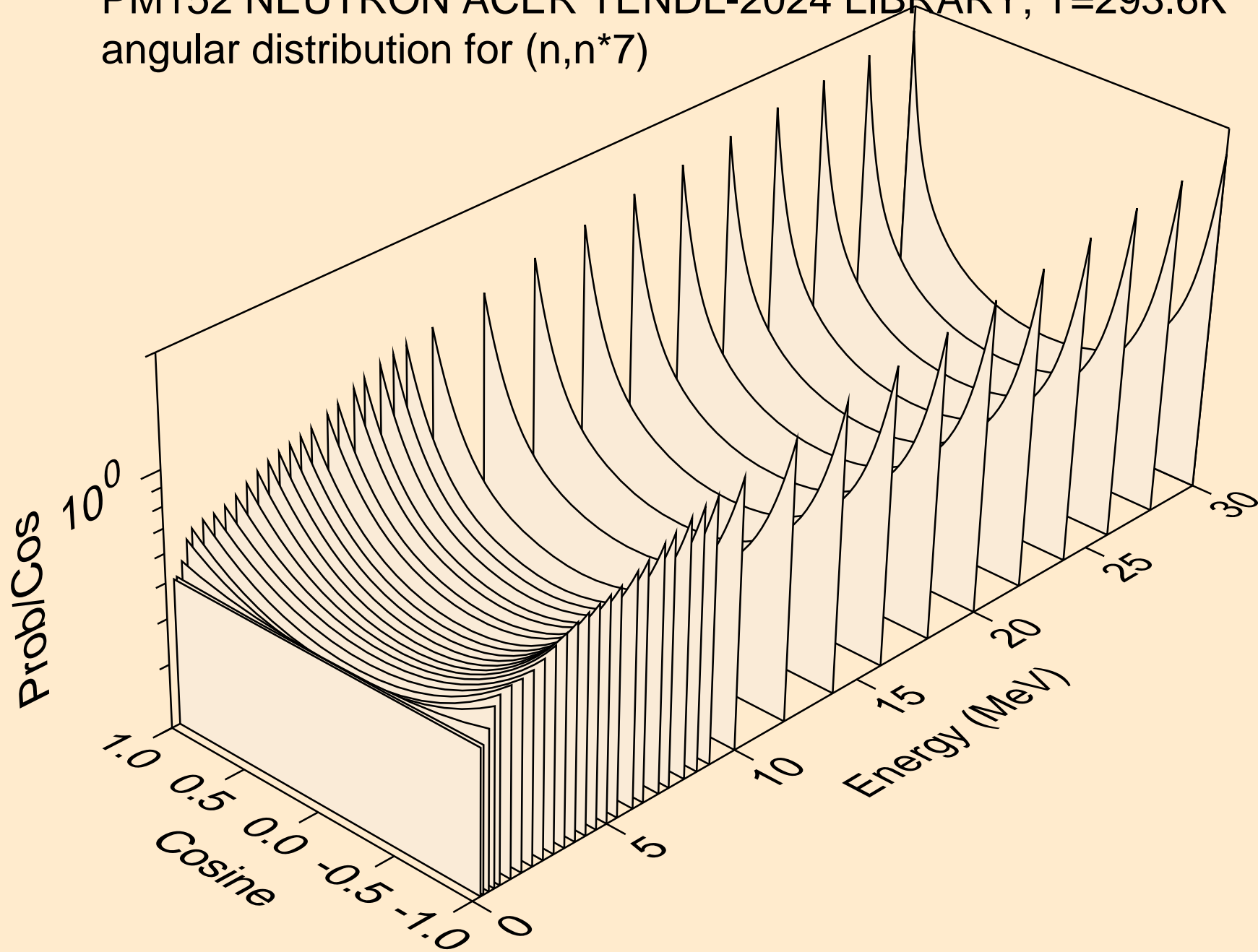

PM152 NEUTRON ACER TENDL-2024 LIBRARY; T=293.6K  
angular distribution for (n,n\*8)

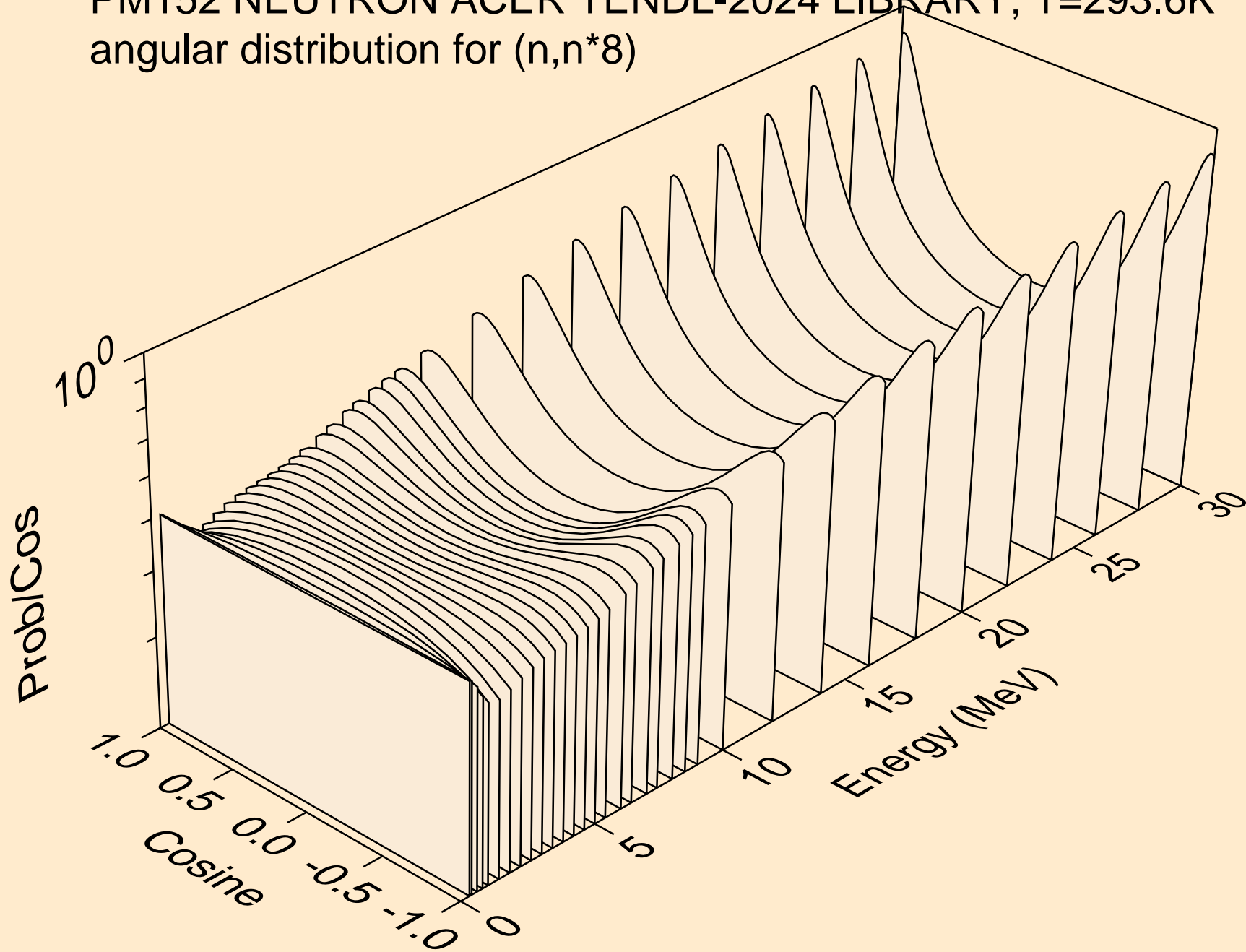

PM152 NEUTRON ACER TENDL-2024 LIBRARY; T=293.6K  
angular distribution for (n,n\*9)

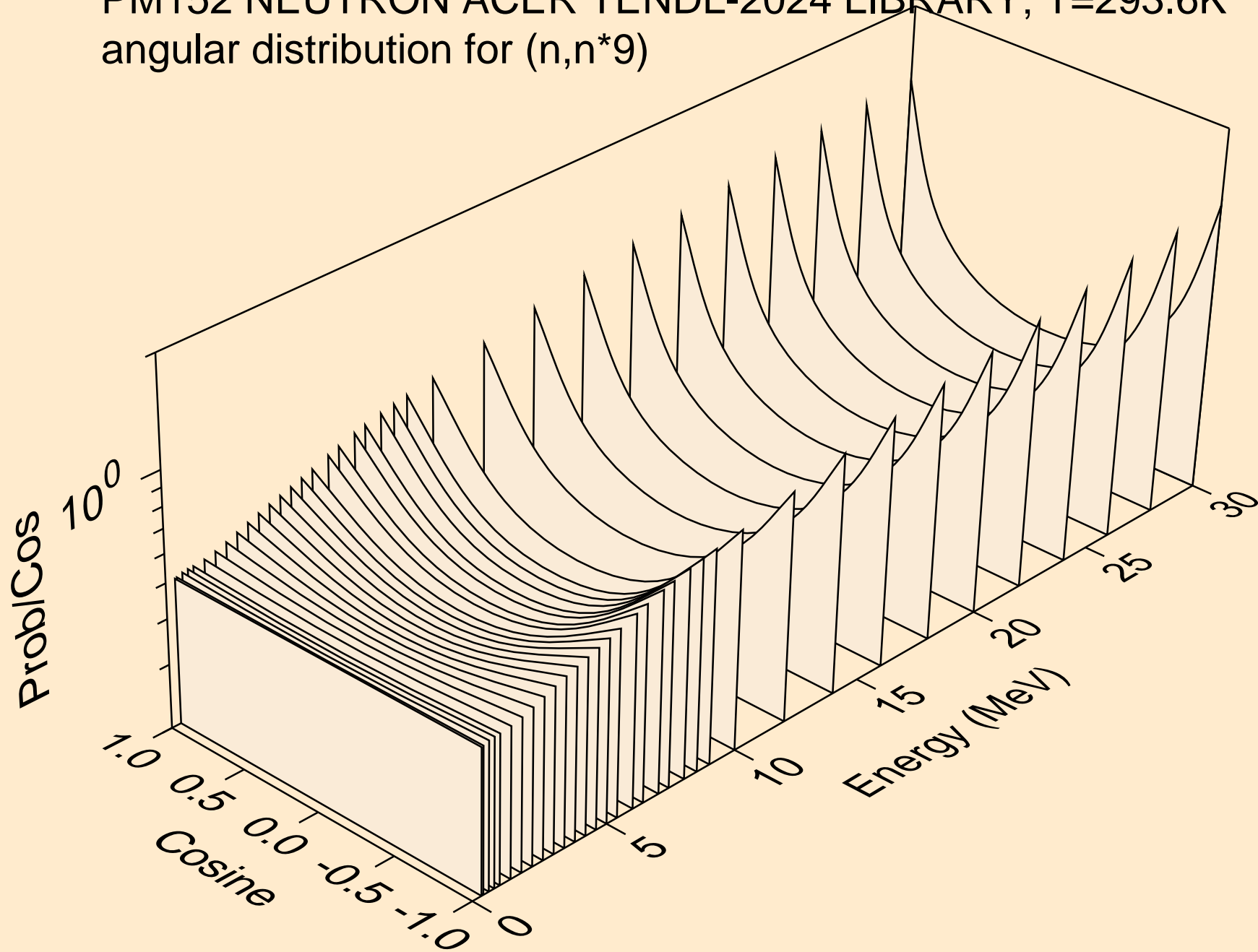

PM152 NEUTRON ACER TENDL-2024 LIBRARY; T=293.6K  
angular distribution for (n,n\*10)

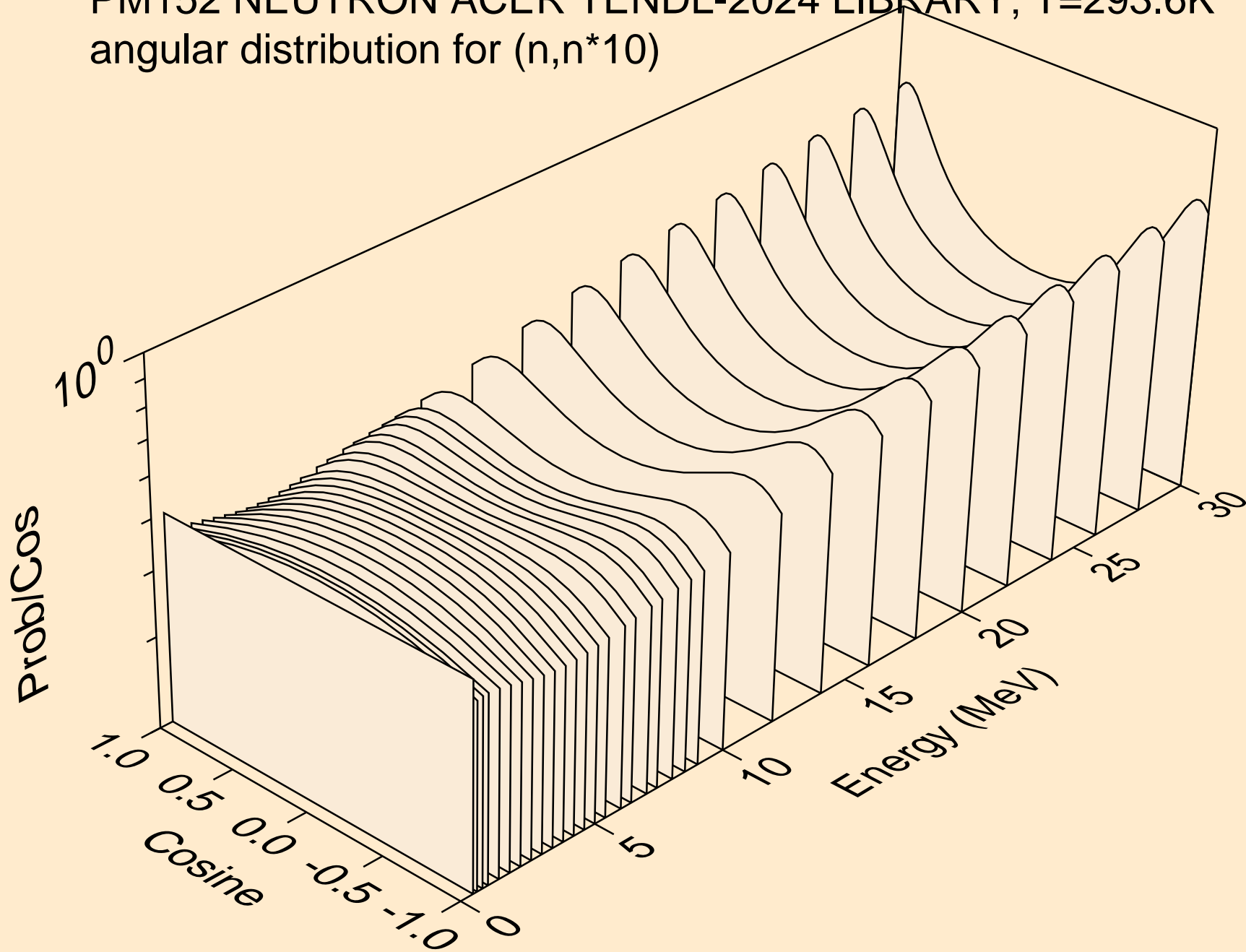

PM152 NEUTRON ACER TENDL-2024 LIBRARY; T=293.6K  
angular distribution for (n,n\*11)

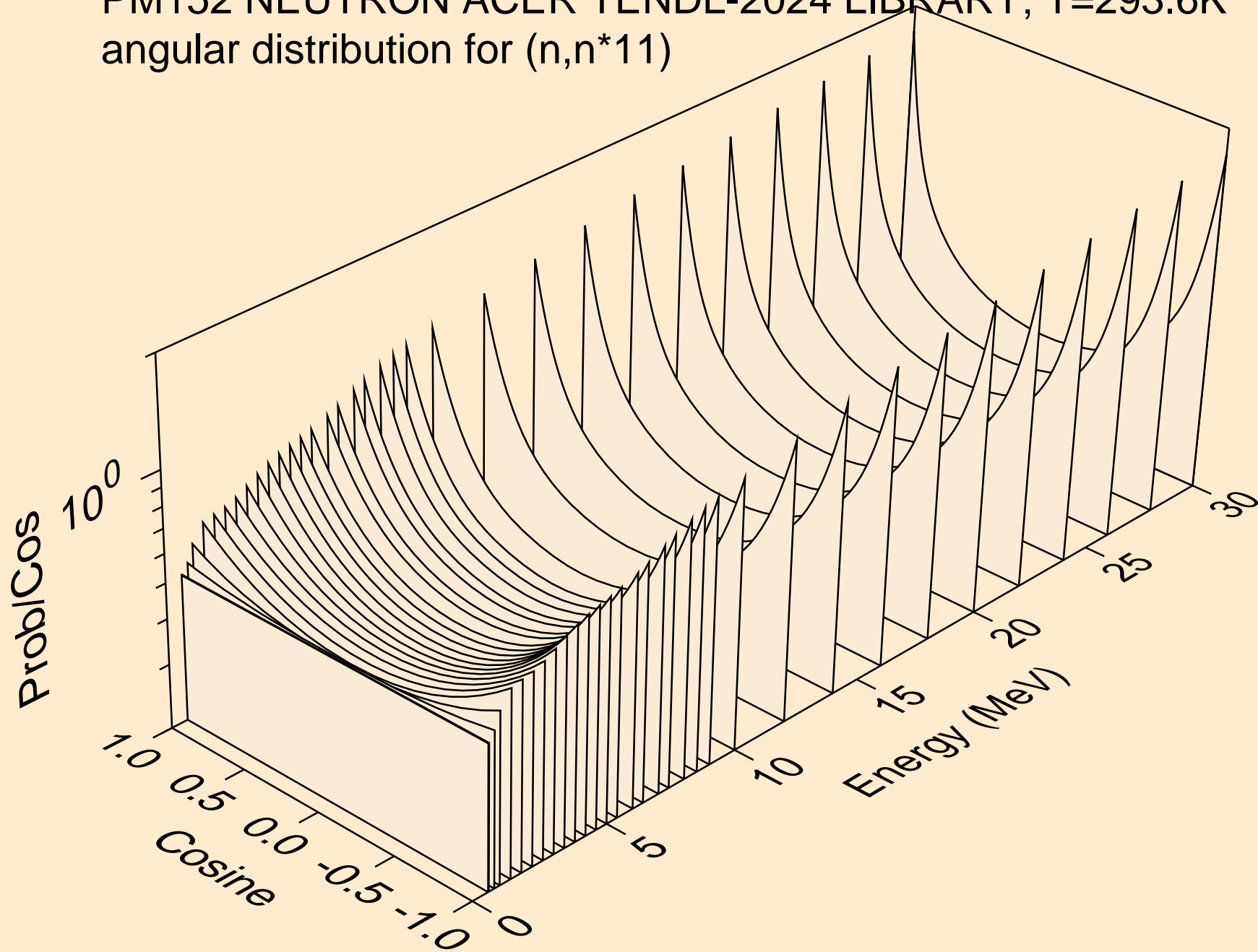

PM152 NEUTRON ACER TENDL-2024 LIBRARY; T=293.6K  
angular distribution for (n,n\*12)

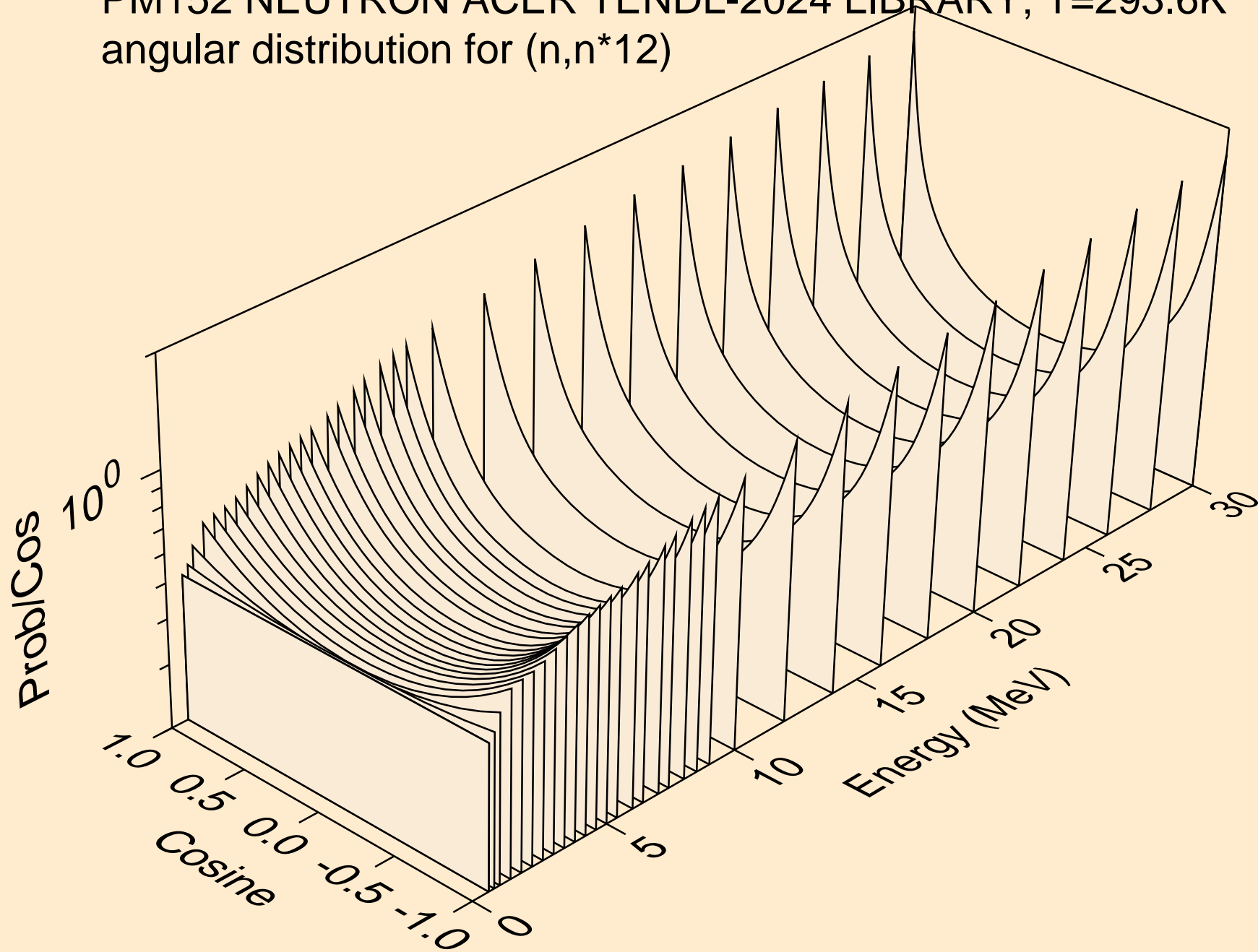

PM152 NEUTRON ACER TENDL-2024 LIBRARY; T=293.6K  
angular distribution for (n,n\*13)

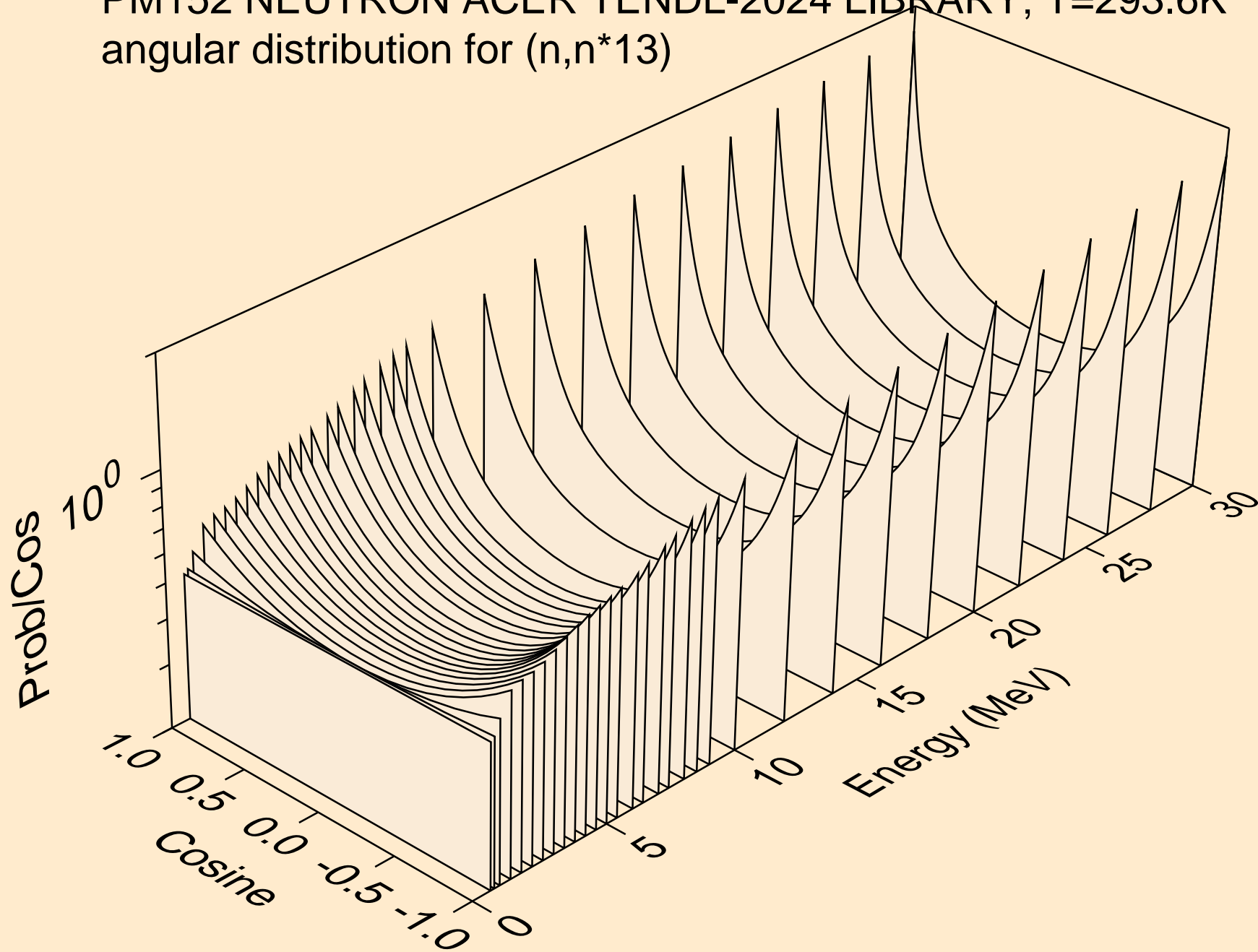

PM152 NEUTRON ACER TENDL-2024 LIBRARY; T=293.6K  
angular distribution for (n,n\*14)

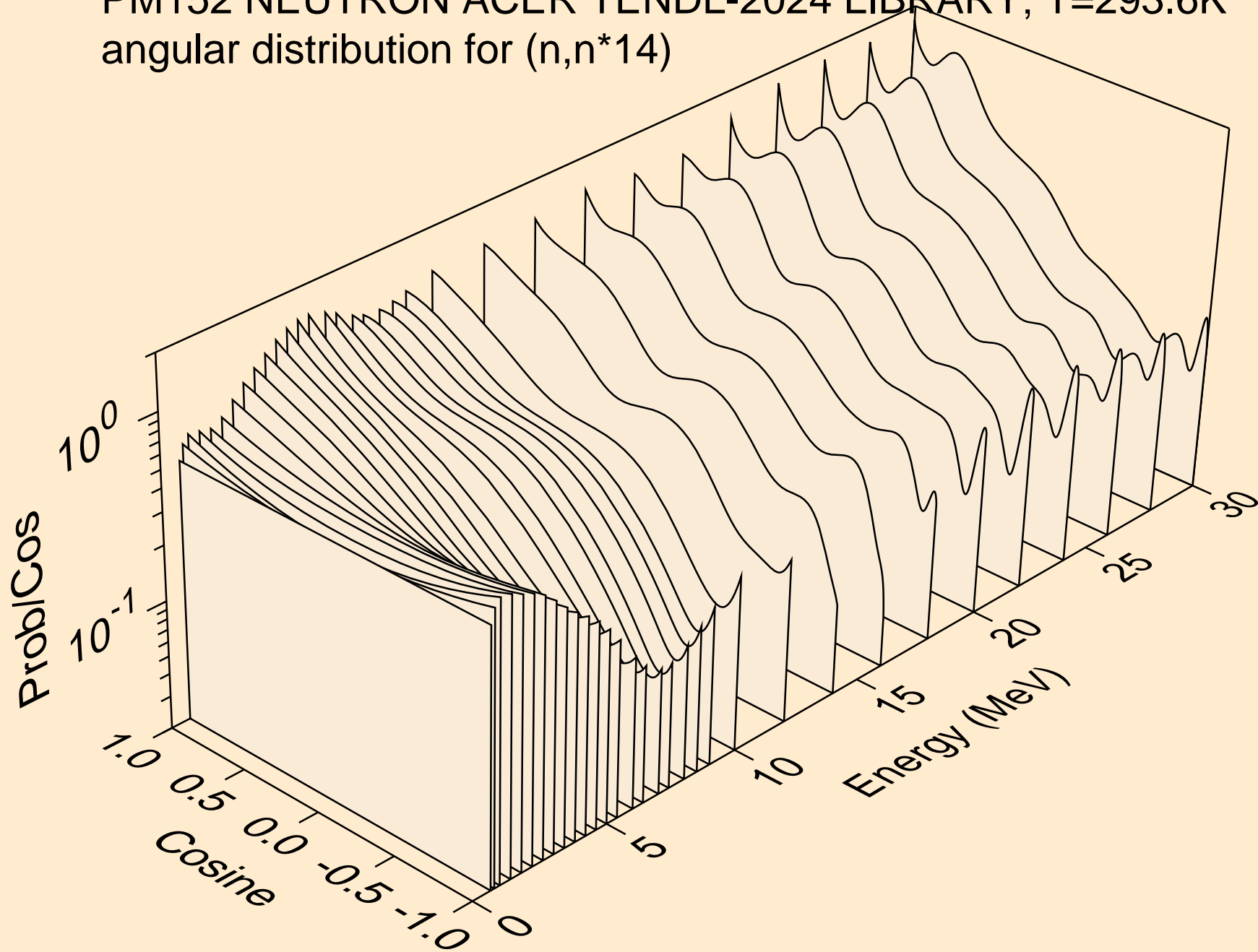

PM152 NEUTRON ACER TENDL-2024 LIBRARY; T=293.6K  
angular distribution for (n,n\*15)

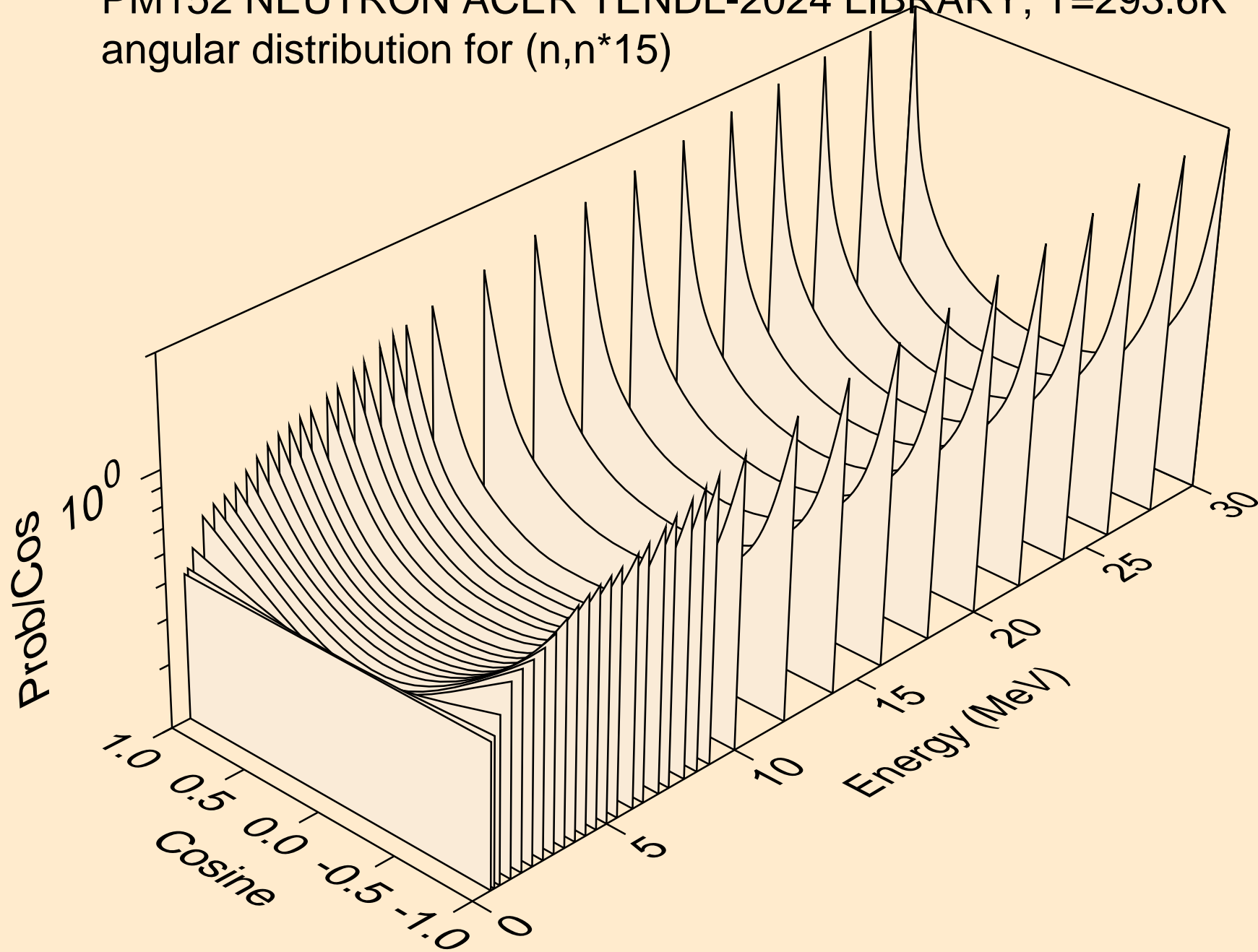

PM152 NEUTRON ACER TENDL-2024 LIBRARY; T=293.6K  
angular distribution for (n,n\*16)

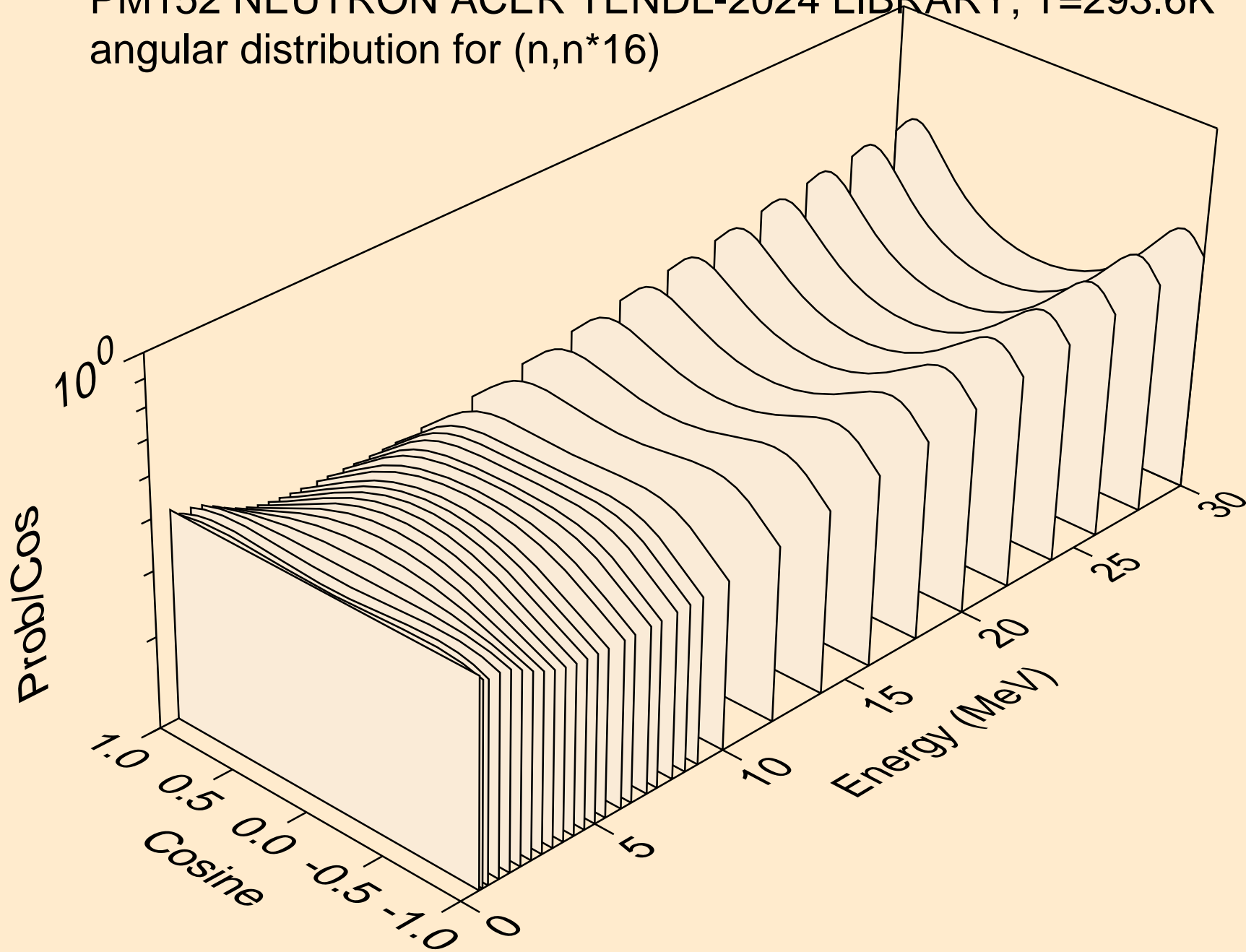

PM152 NEUTRON ACER TENDL-2024 LIBRARY; T=293.6K  
angular distribution for (n,n\*17)

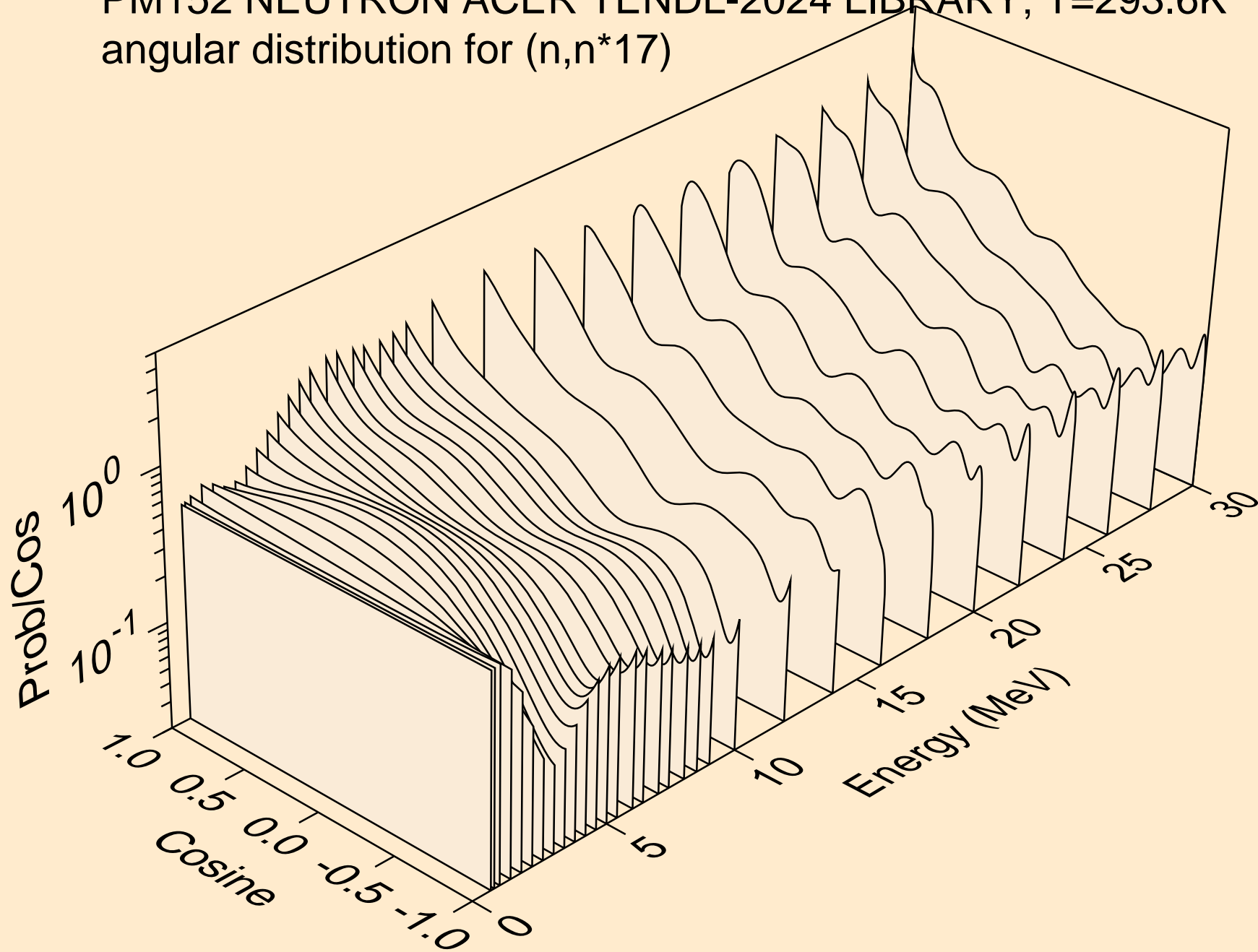

PM152 NEUTRON ACER TENDL-2024 LIBRARY; T=293.6K  
angular distribution for (n,n\*18)

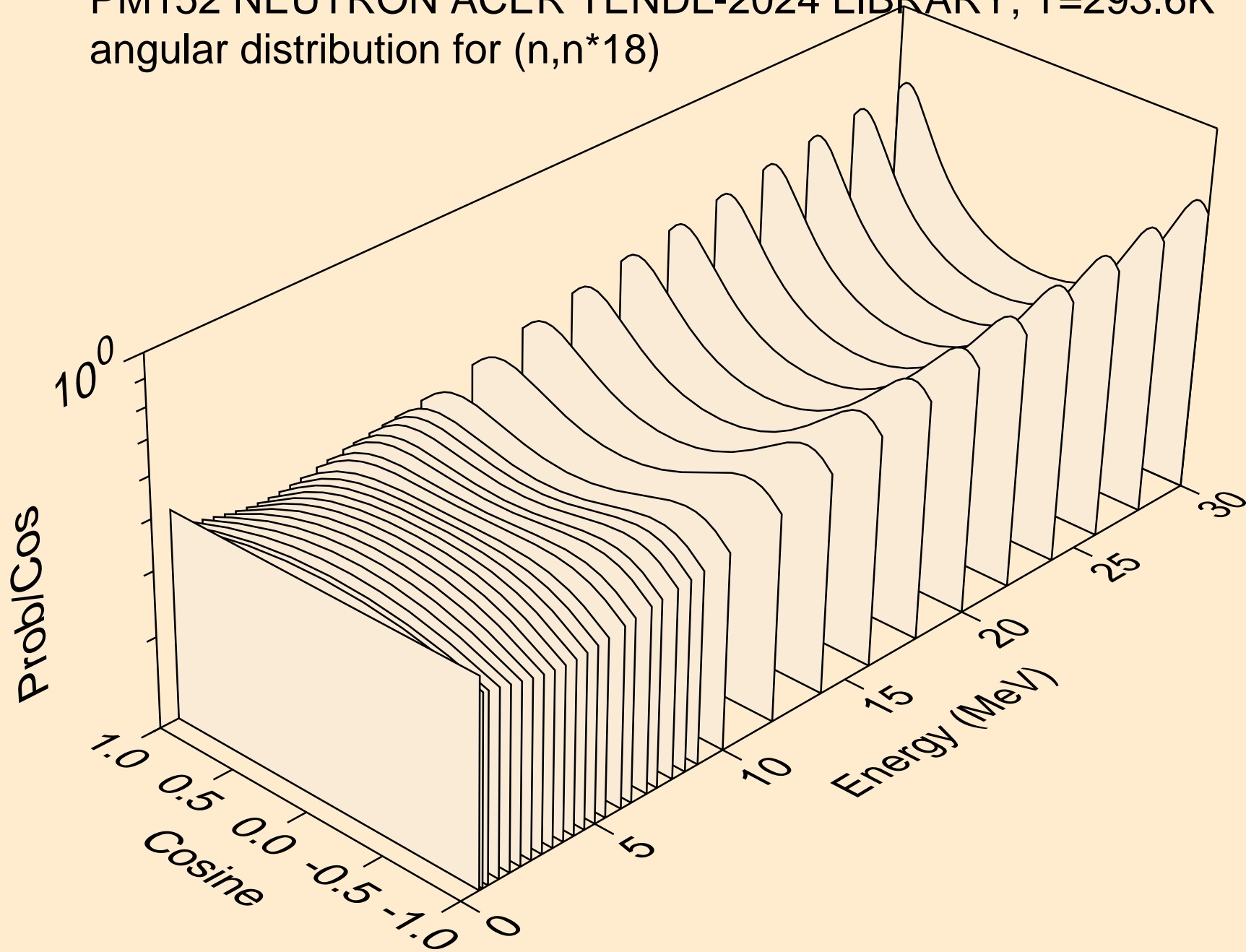

PM152 NEUTRON ACER TENDL-2024 LIBRARY; T=293.6K  
angular distribution for (n,n\*19)

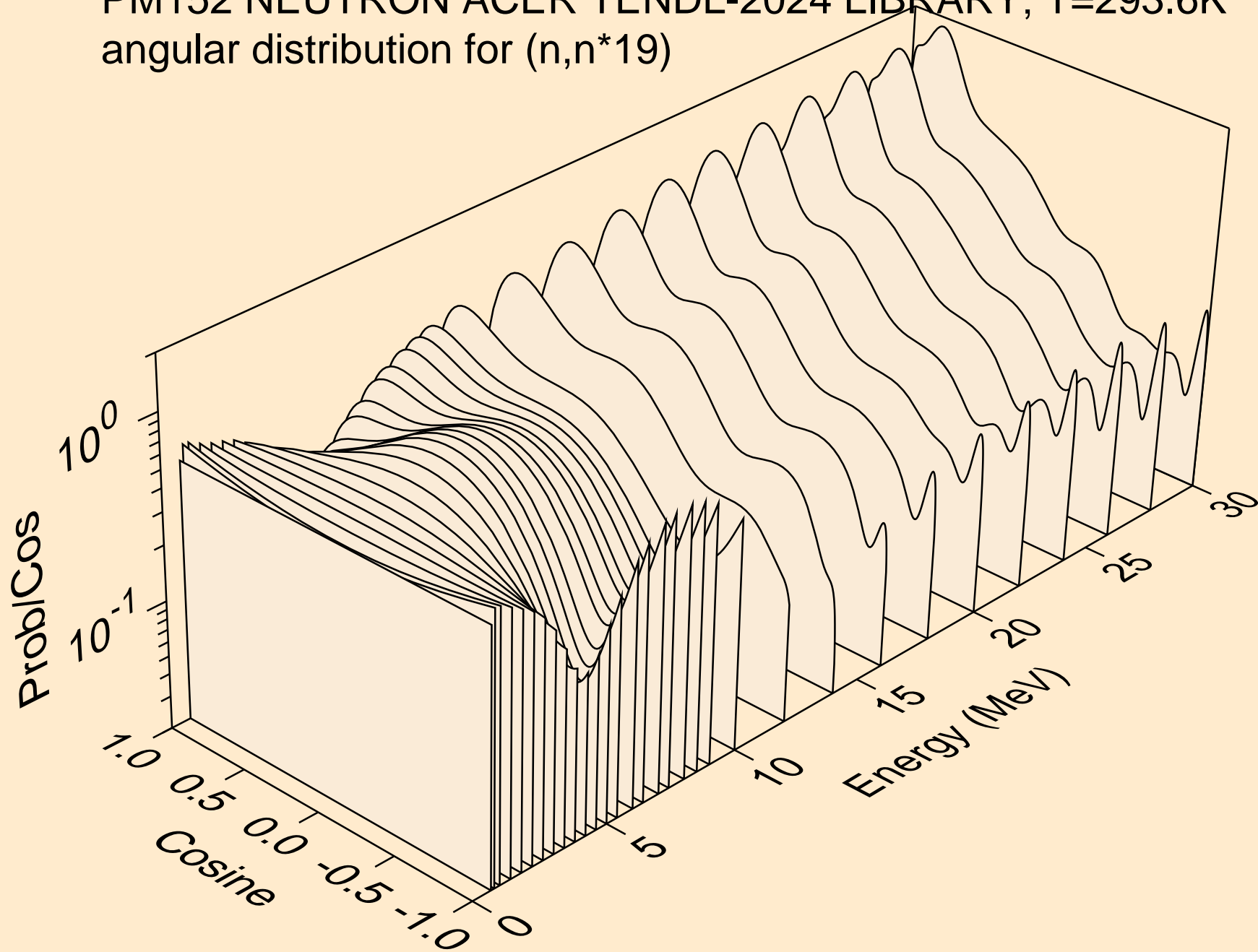

PM152 NEUTRON ACER TENDL-2024 LIBRARY; T=293.6K  
angular distribution for (n,n\*20)

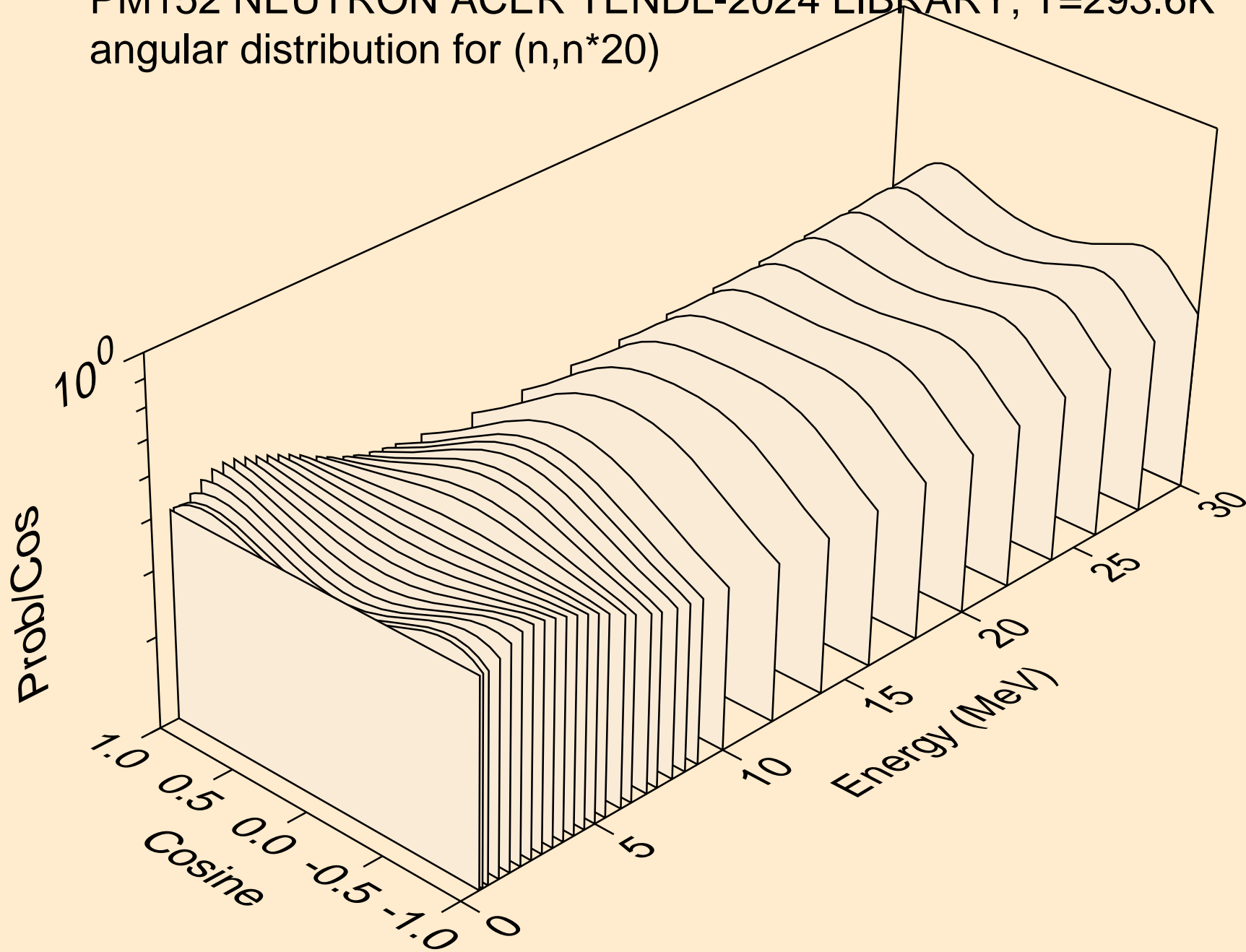

PM152 NEUTRON ACER TENDL-2024 LIBRARY; T=293.6K  
angular distribution for (n,n\*21)

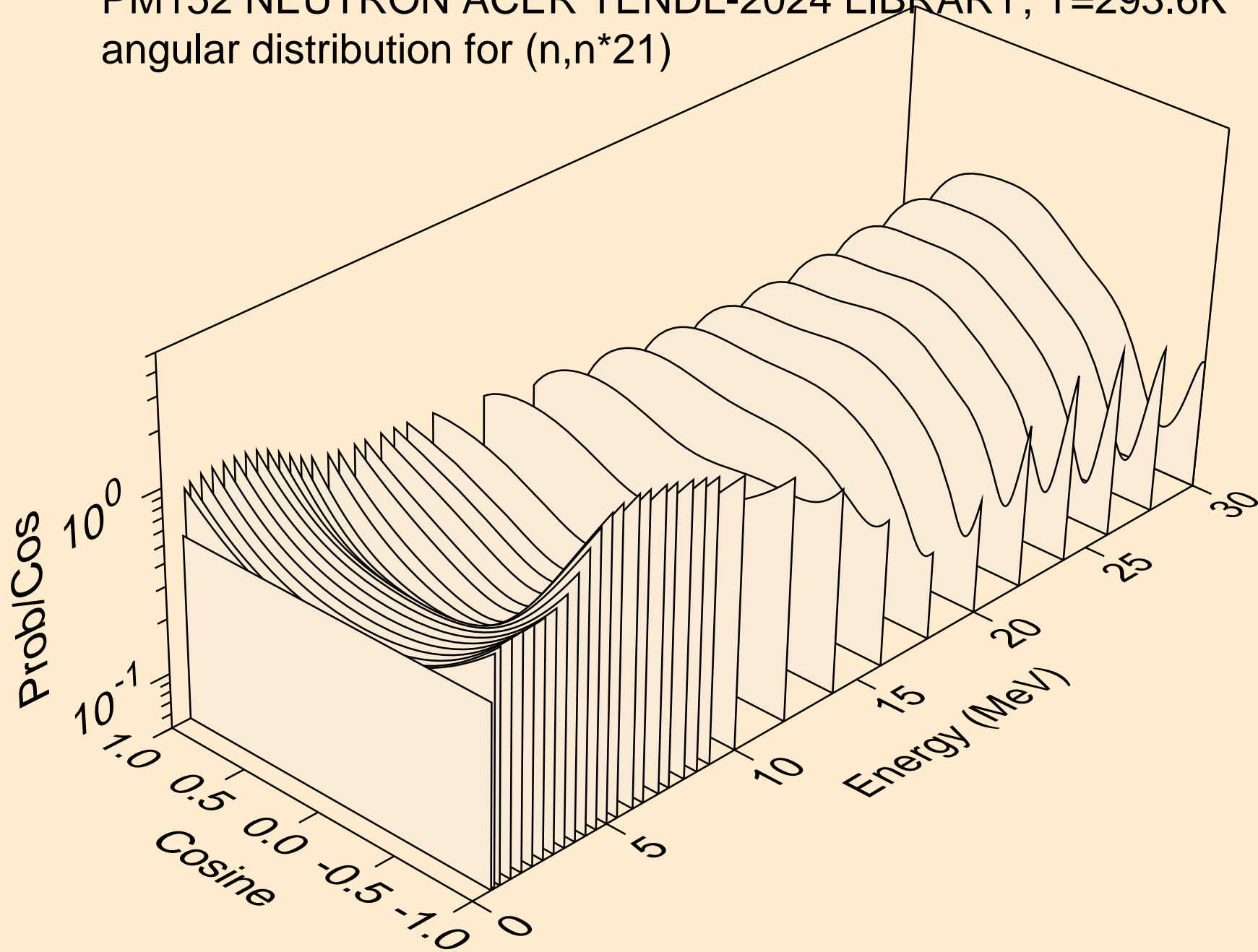

PM152 NEUTRON ACER TENDL-2024 LIBRARY; T=293.6K  
angular distribution for (n,n\*22)

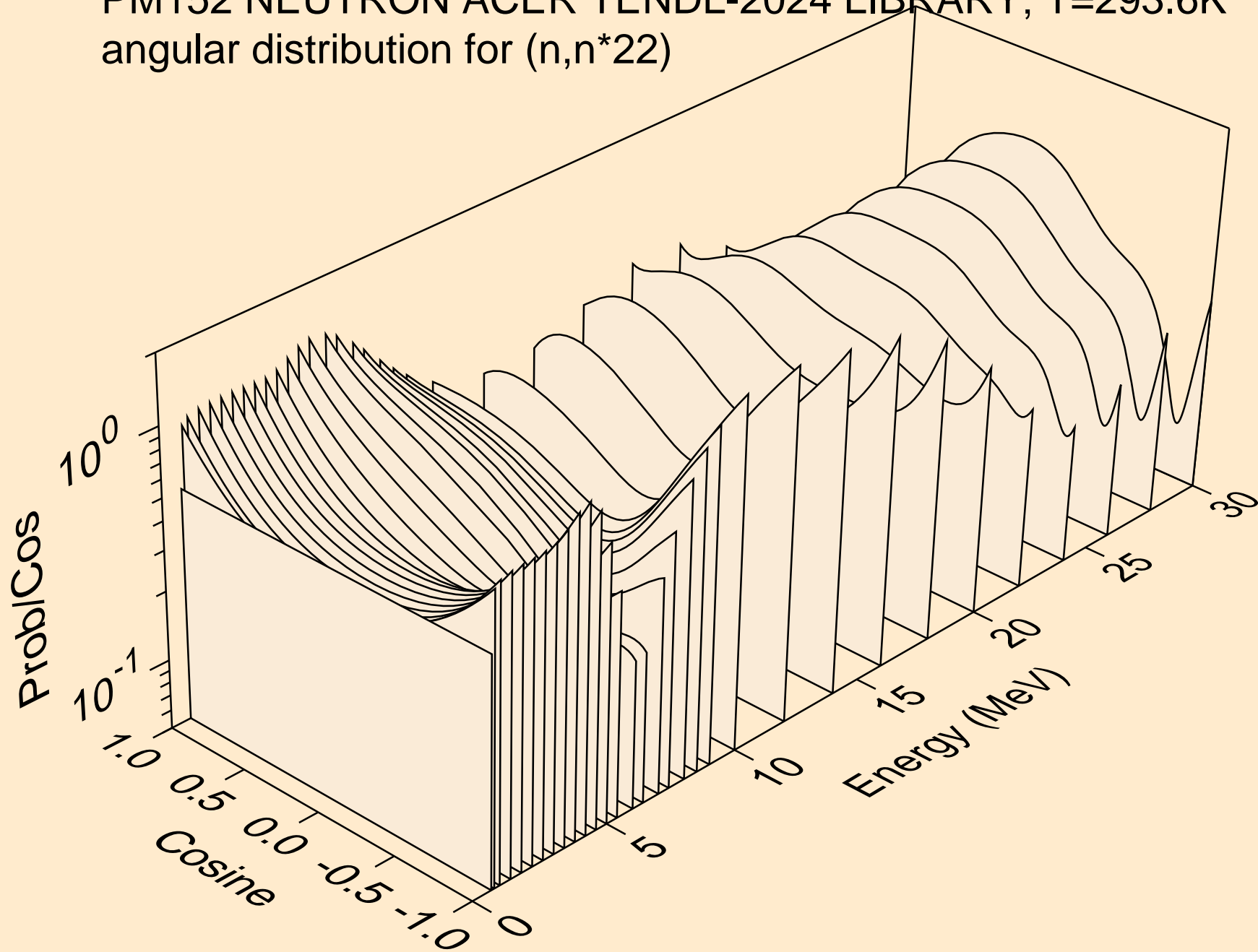

PM152 NEUTRON ACER TENDL-2024 LIBRARY; T=293.6K  
angular distribution for (n,n\*23)

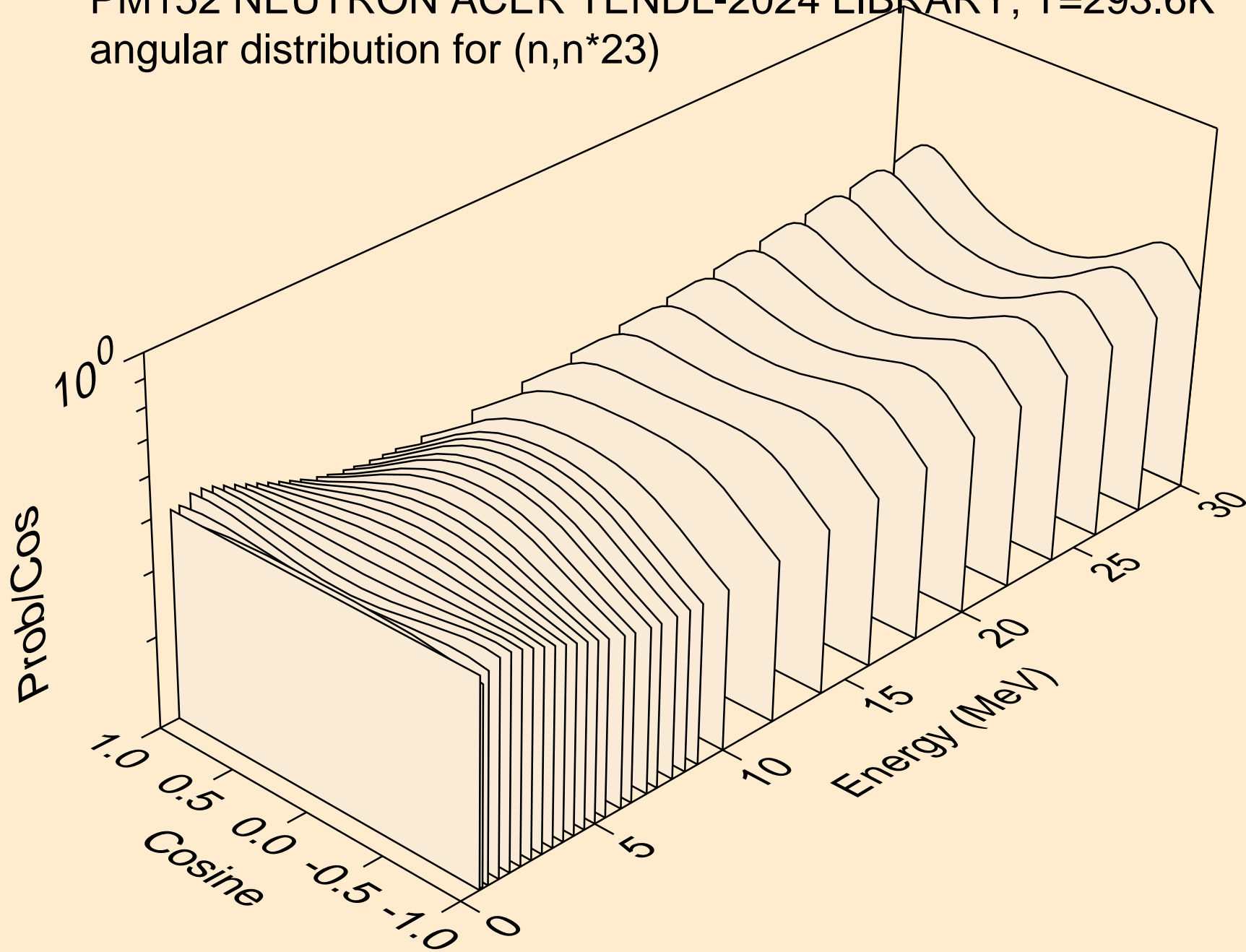

PM152 NEUTRON ACER TENDL-2024 LIBRARY; T=293.6K  
angular distribution for (n,n\*24)

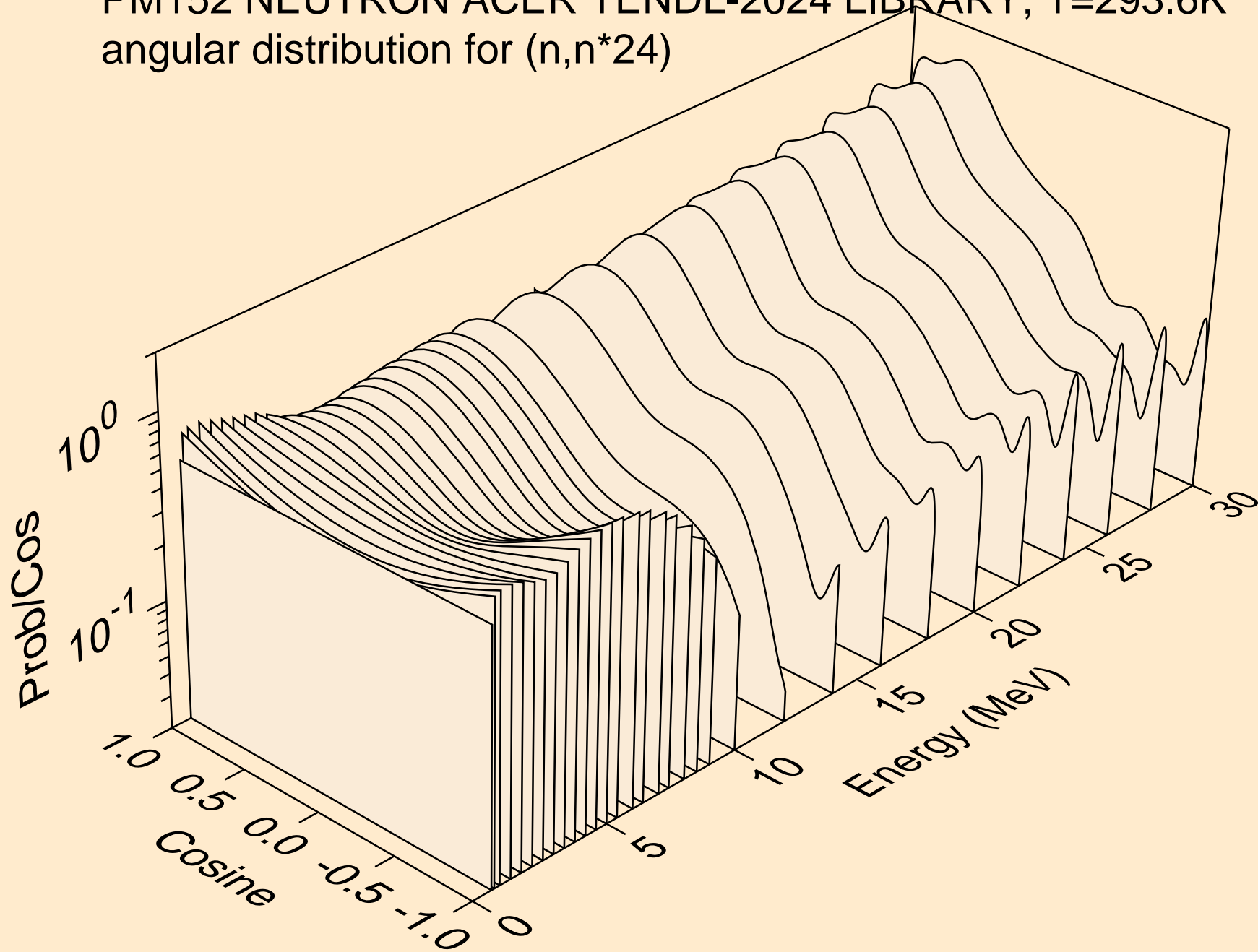

PM152 NEUTRON ACER TENDL-2024 LIBRARY; T=293.6K  
angular distribution for (n,n\*25)

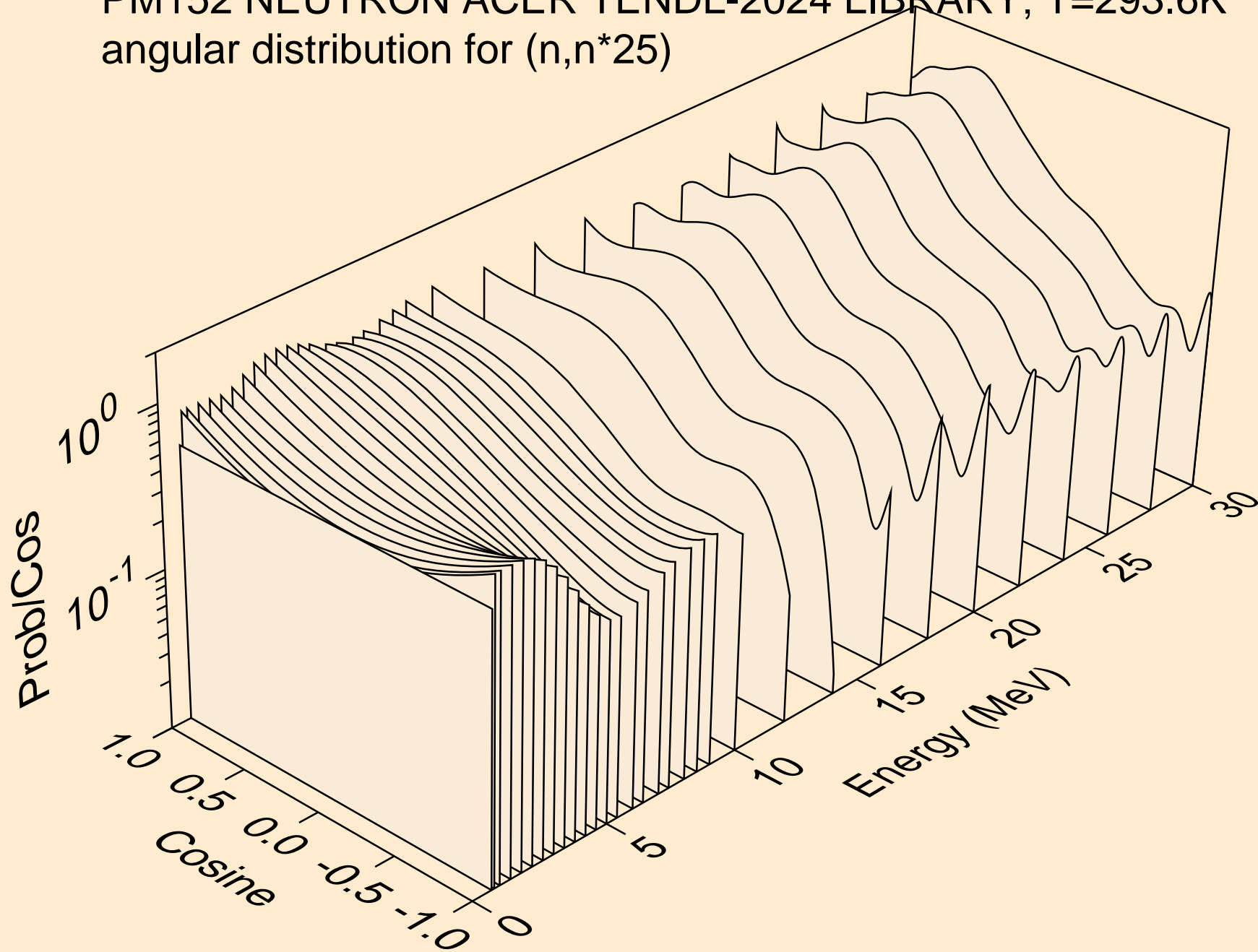

PM152 NEUTRON ACER TENDL-2024 LIBRARY; T=293.6K  
angular distribution for (n,n\*26)

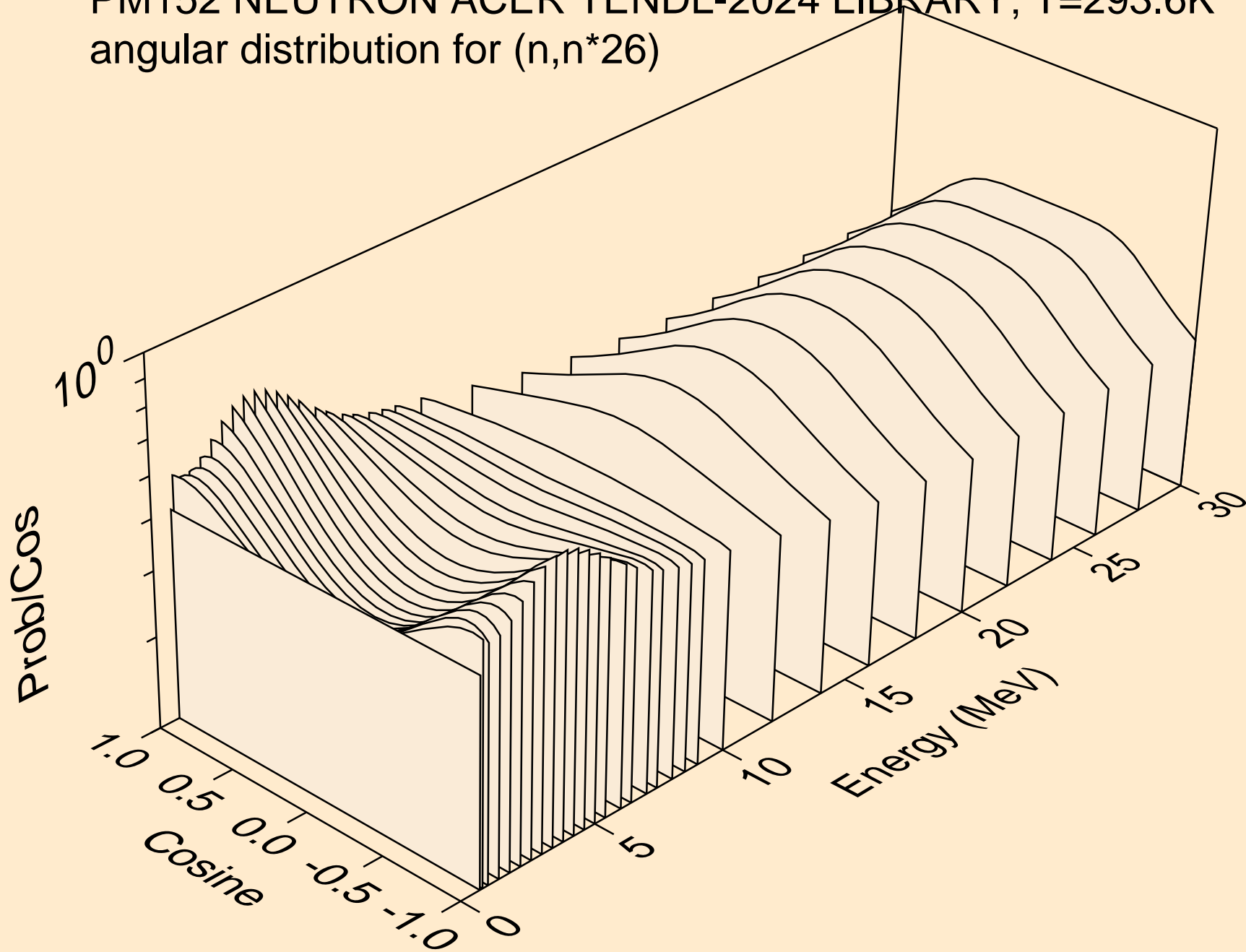

PM152 NEUTRON ACER TENDL-2024 LIBRARY; T=293.6K  
angular distribution for (n,n\*27)

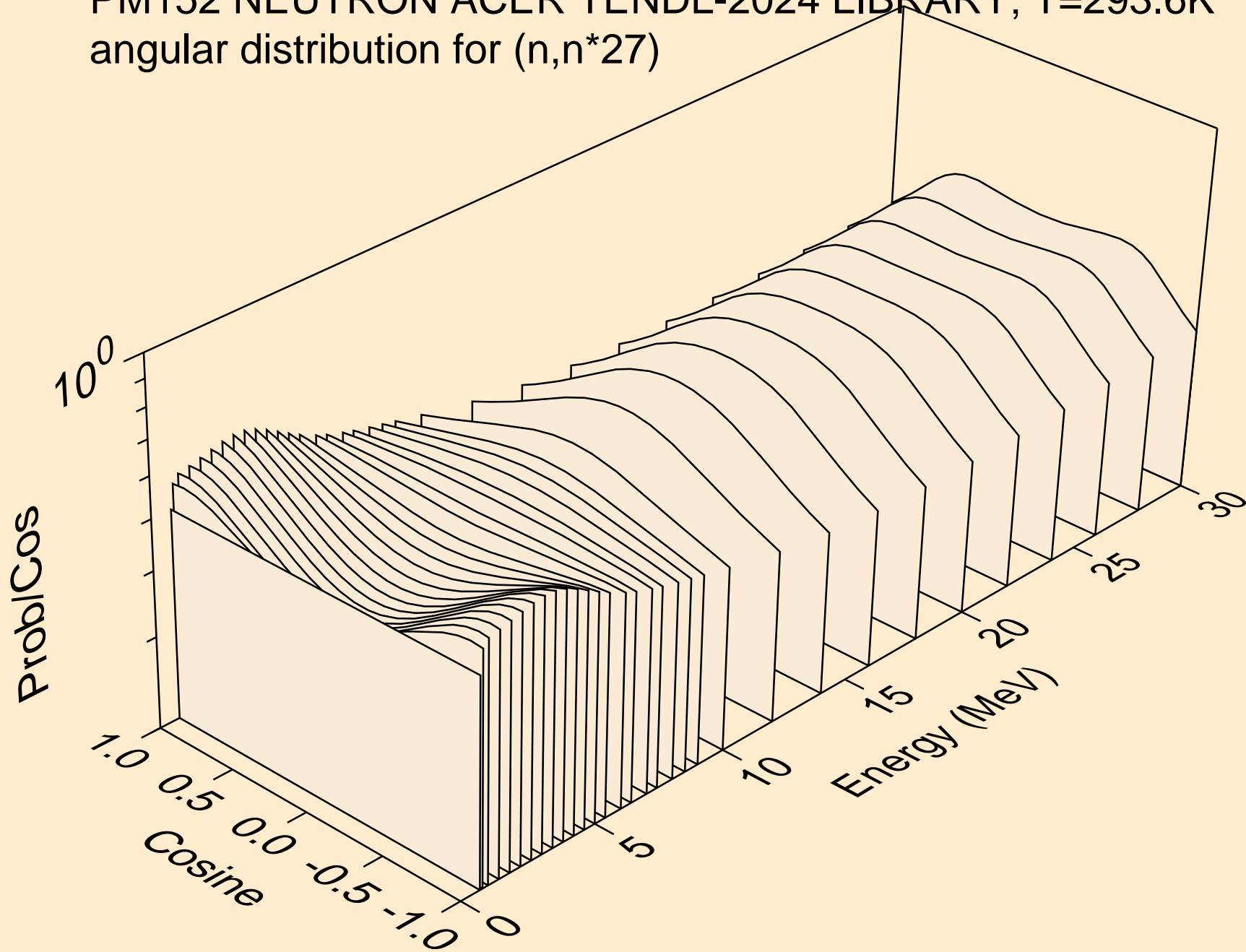

PM152 NEUTRON ACER TENDL-2024 LIBRARY; T=293.6K  
angular distribution for (n,n\*28)

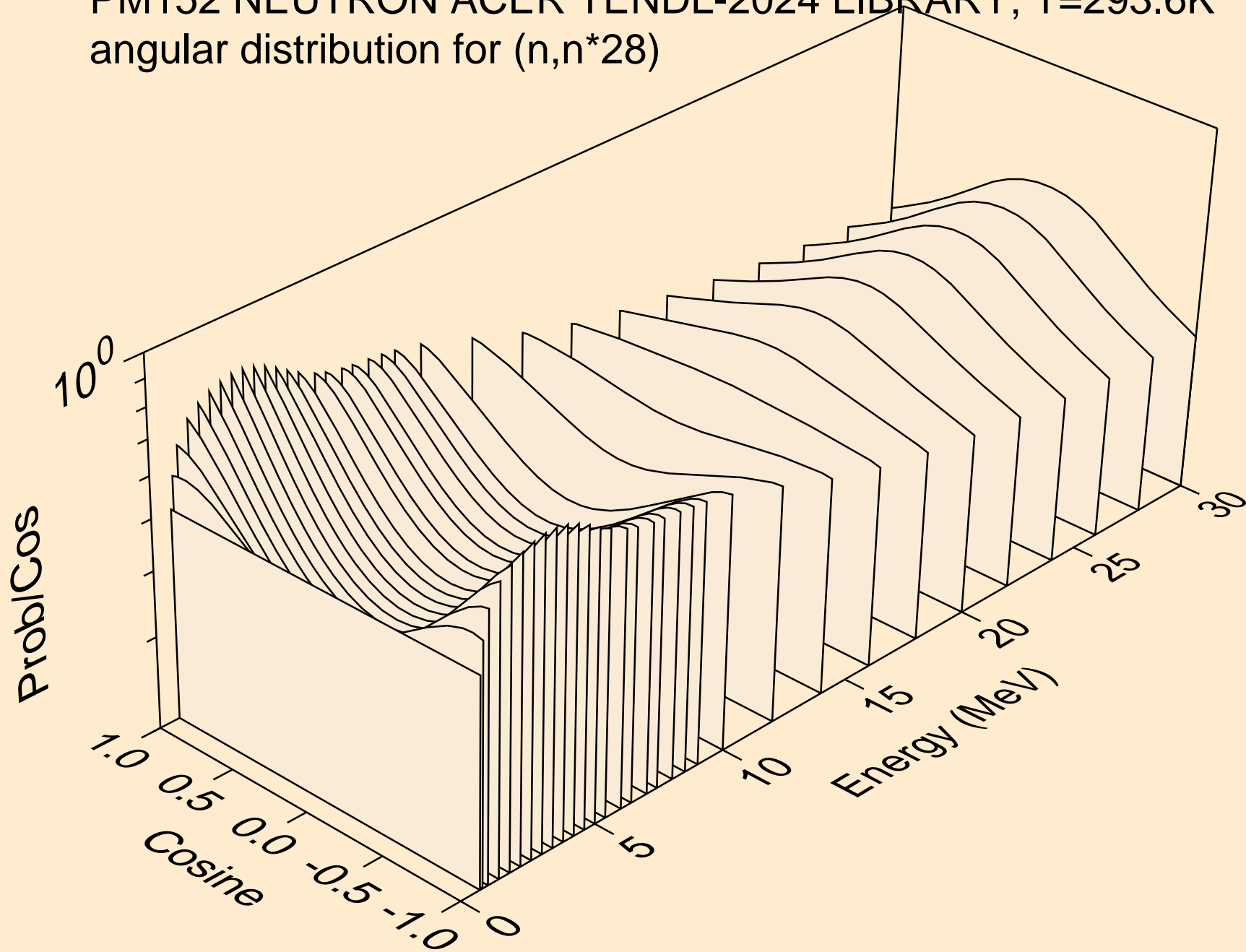

PM152 NEUTRON ACER TENDL-2024 LIBRARY; T=293.6K  
angular distribution for (n,n\*29)

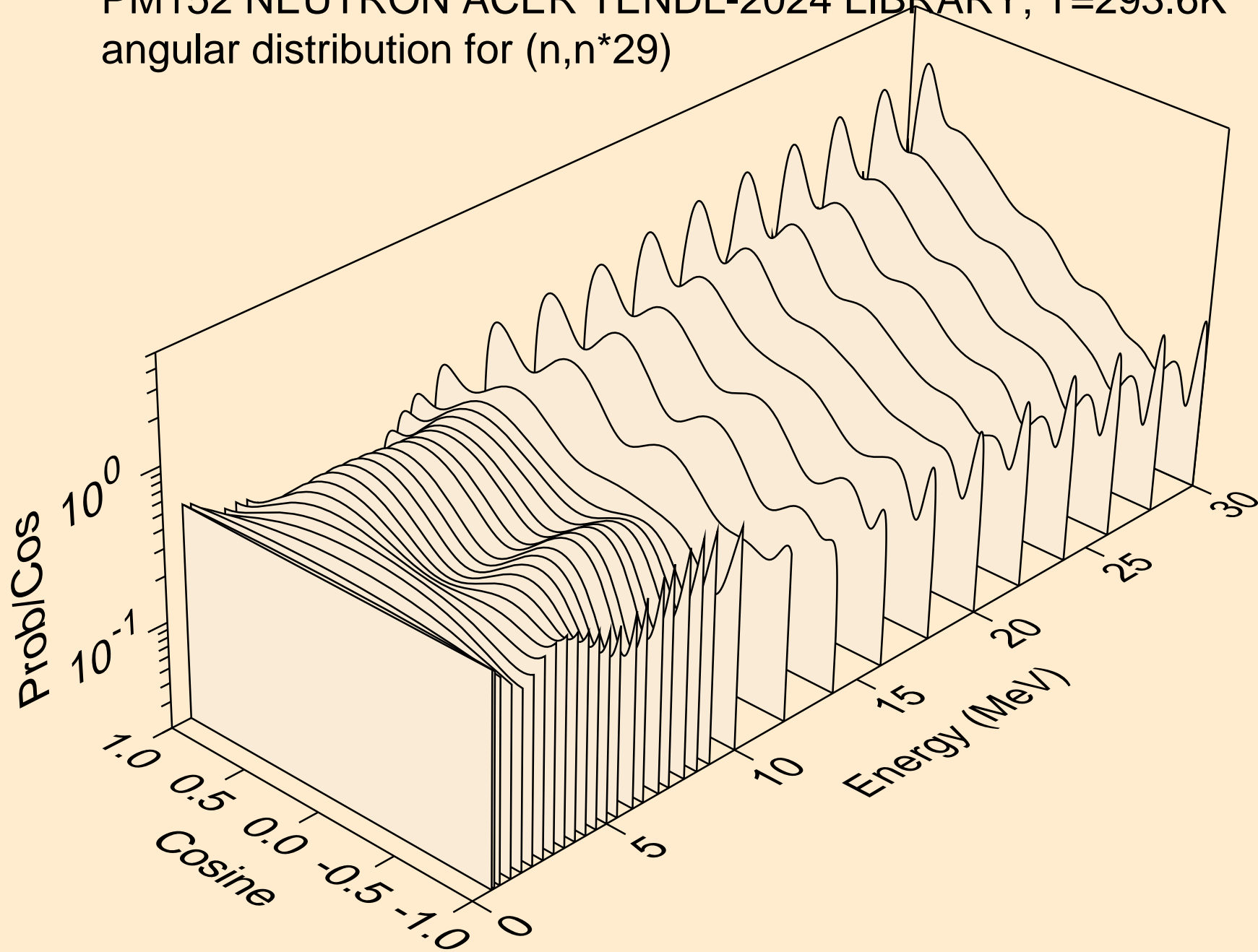

PM152 NEUTRON ACER TENDL-2024 LIBRARY; T=293.6K  
Neutron emission for (n,x)

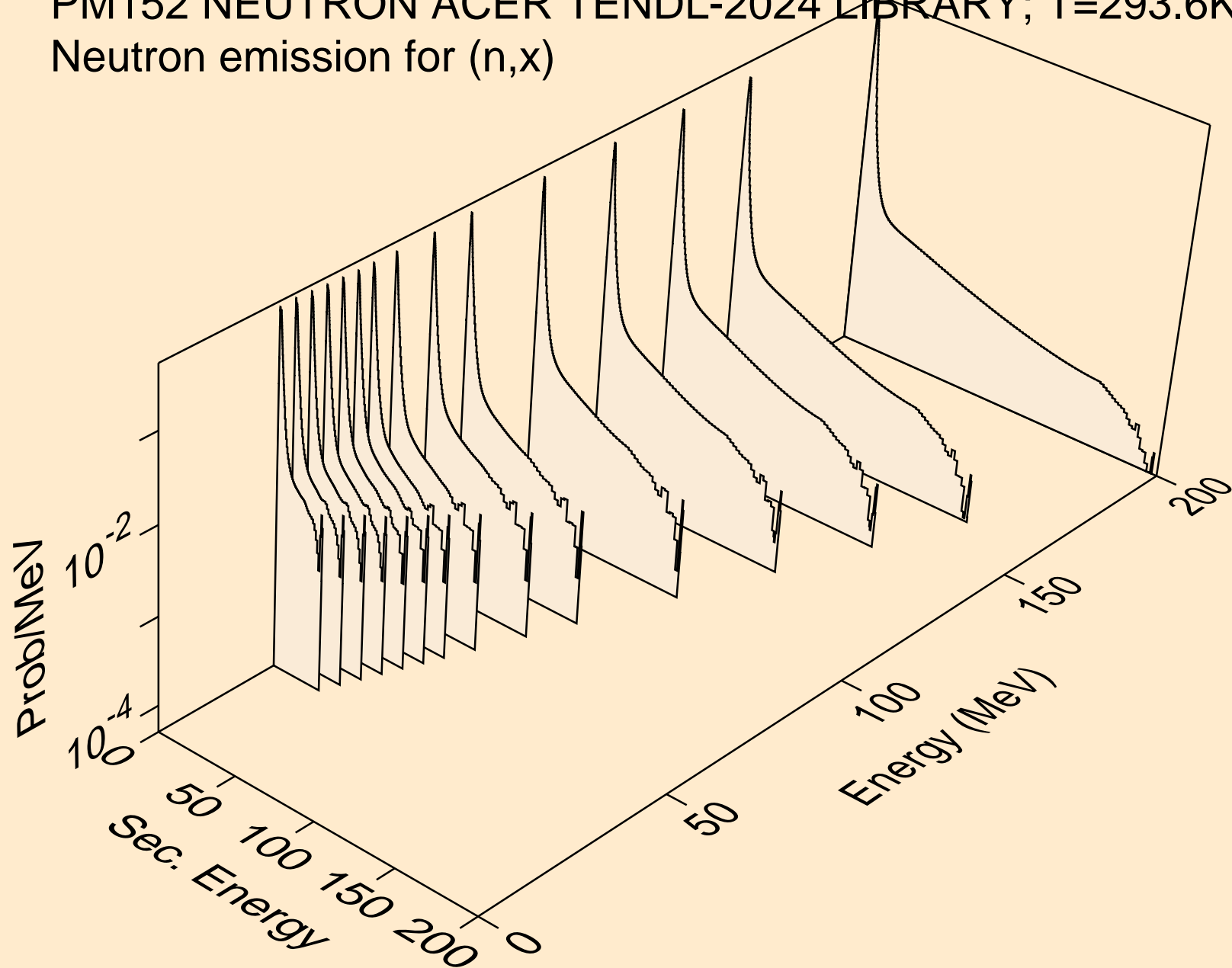

PM152 NEUTRON ACER TENDL-2024 LIBRARY; T=293.6K  
Neutron emission for (n,2nd)

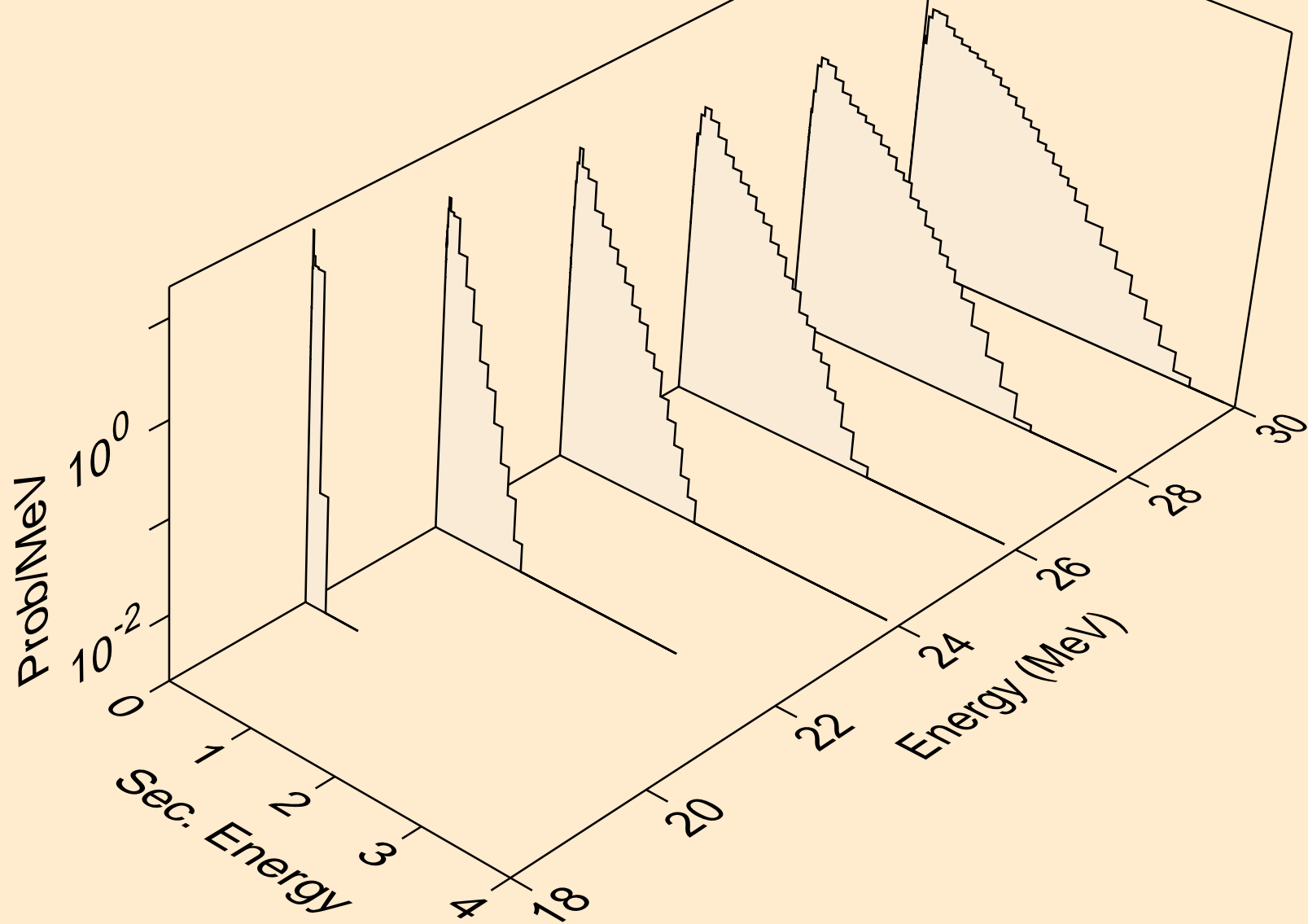

PM152 NEUTRON ACER TENDL-2024 LIBRARY; T=293.6K  
Neutron emission for (n,2n)

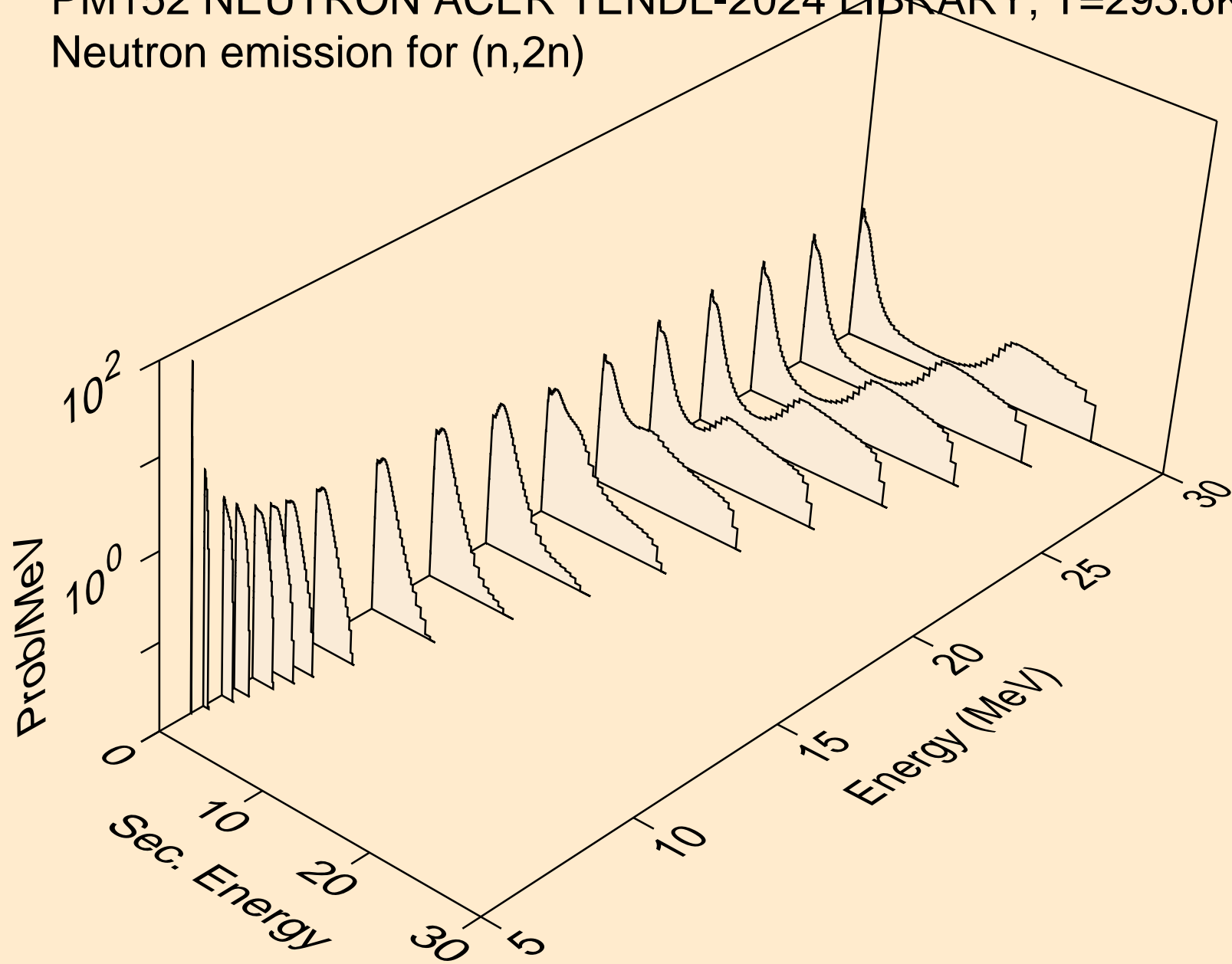

PM152 NEUTRON ACER TENDL-2024 LIBRARY; T=293.6K  
Neutron emission for (n,3n)

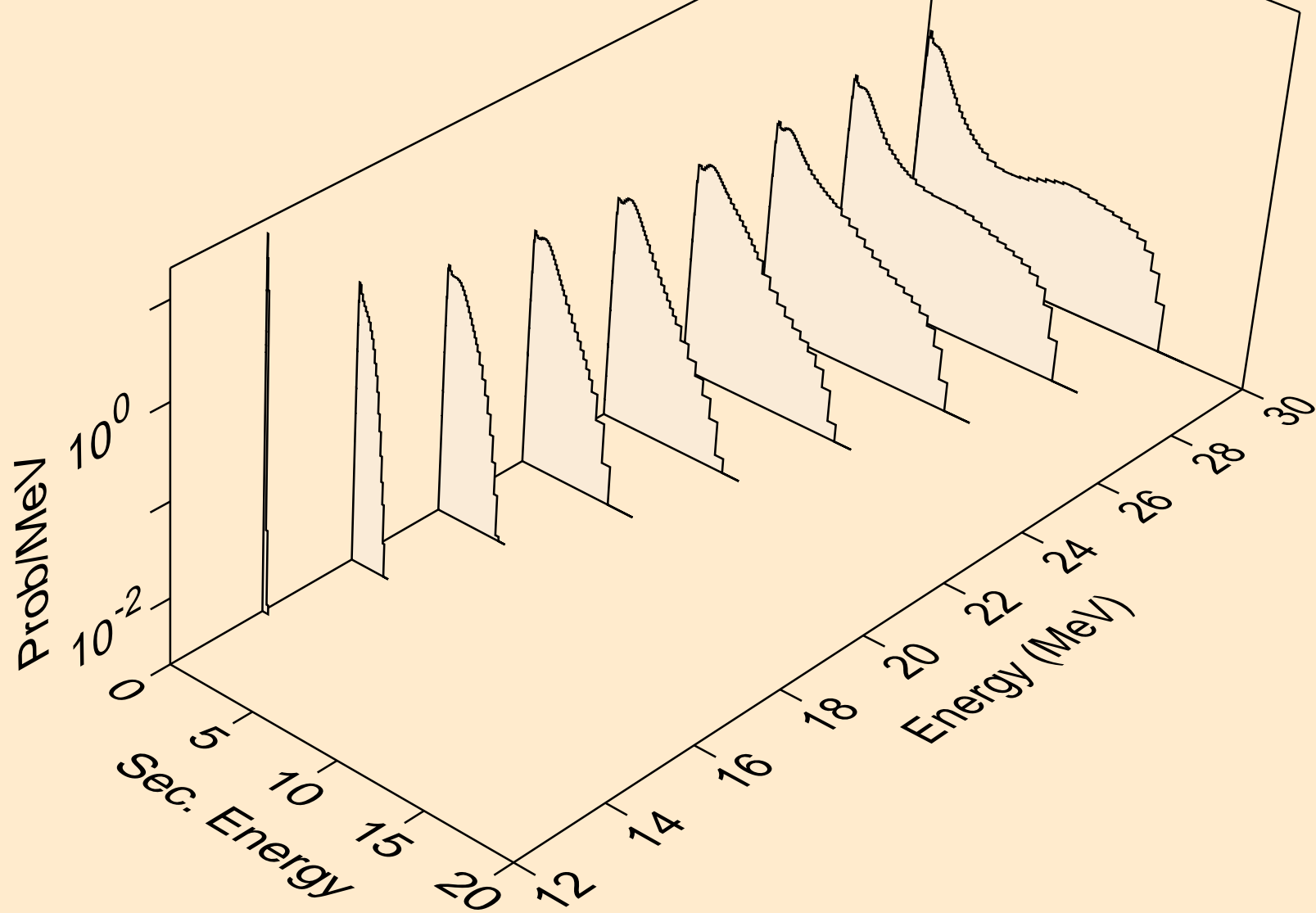

PM152 NEUTRON ACER TENDL-2024 LIBRARY; T=293.6K  
Neutron emission for (n,n\*)a

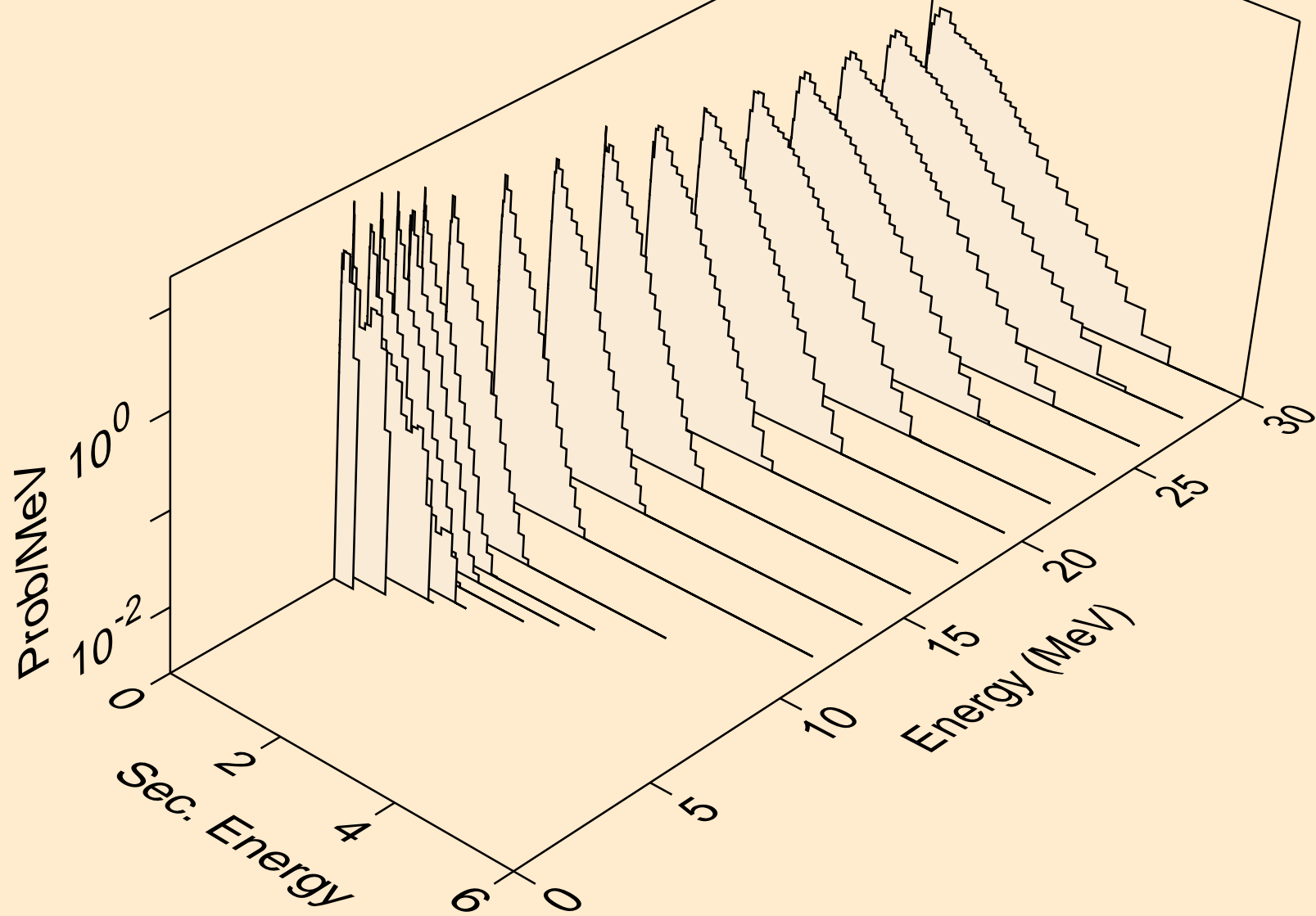

PM152 NEUTRON ACER TENDL-2024 LIBRARY; T=293.6K  
Neutron emission for (n,2n)<sub>a</sub>

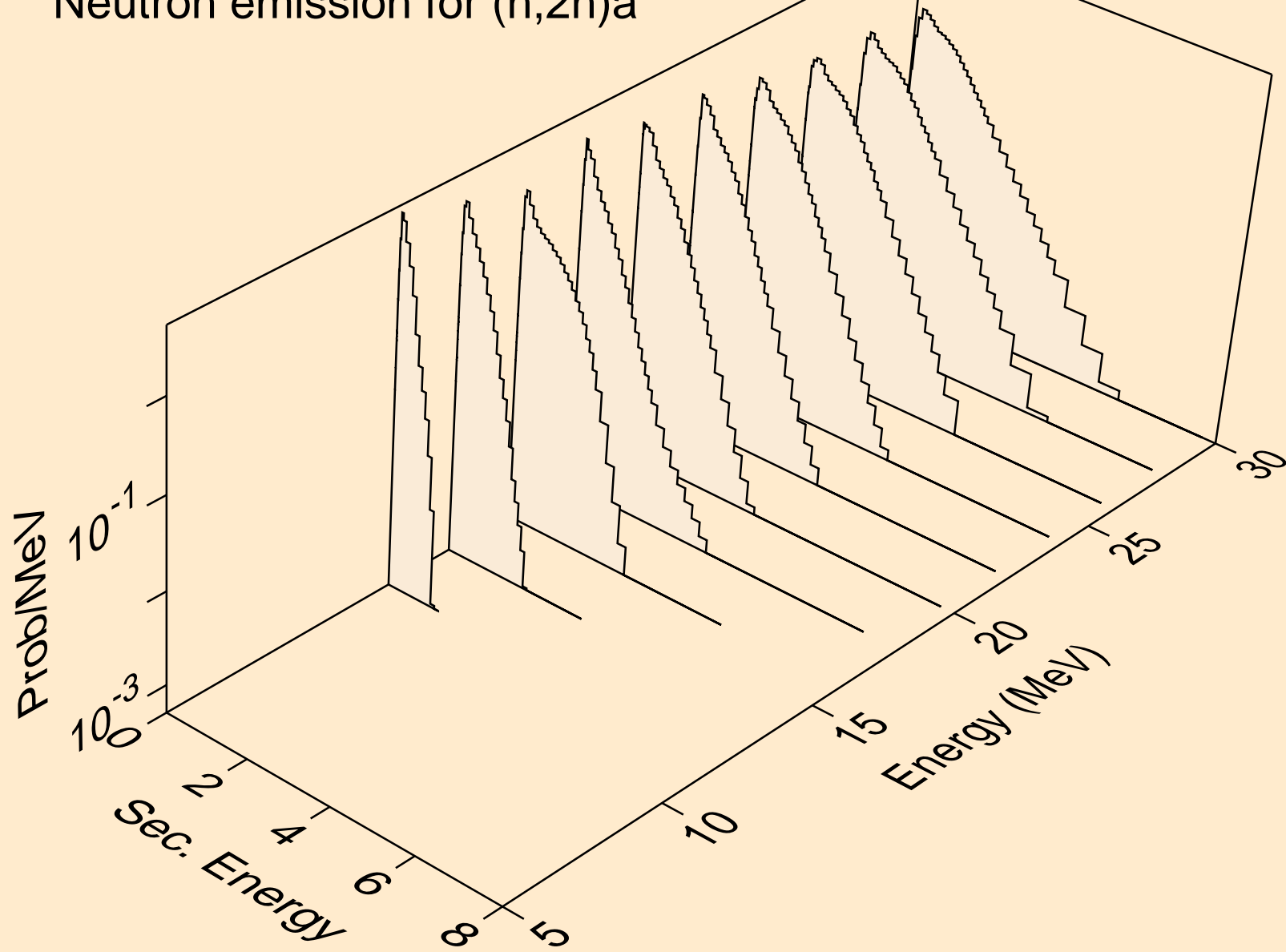

PM152 NEUTRON ACER TENDL-2024 LIBRARY; T=293.6K  
Neutron emission for (n,3n)a

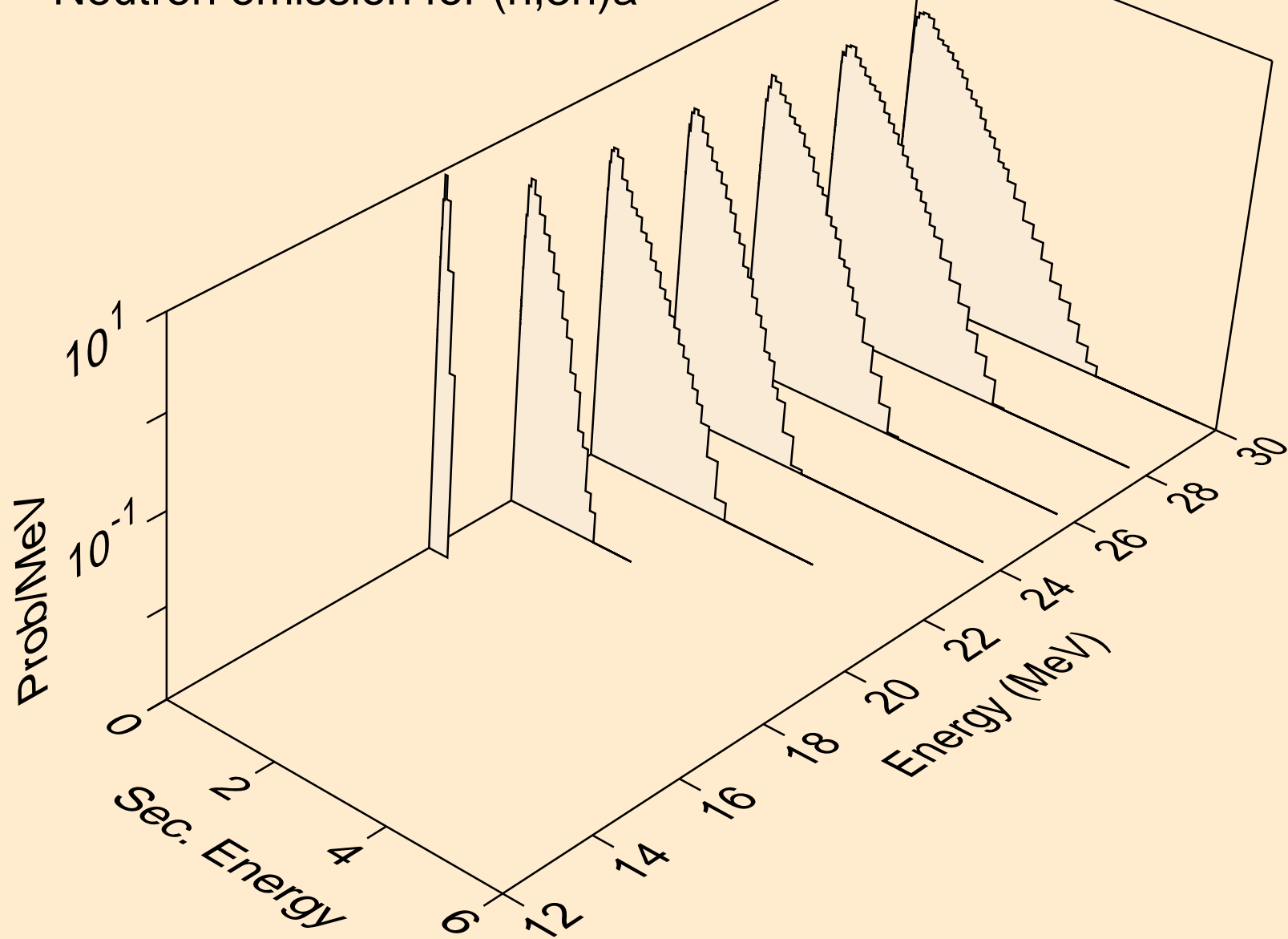

PM152 NEUTRON ACER TENDL-2024 LIBRARY; T=293.6K  
Neutron emission for (n,n\*)p

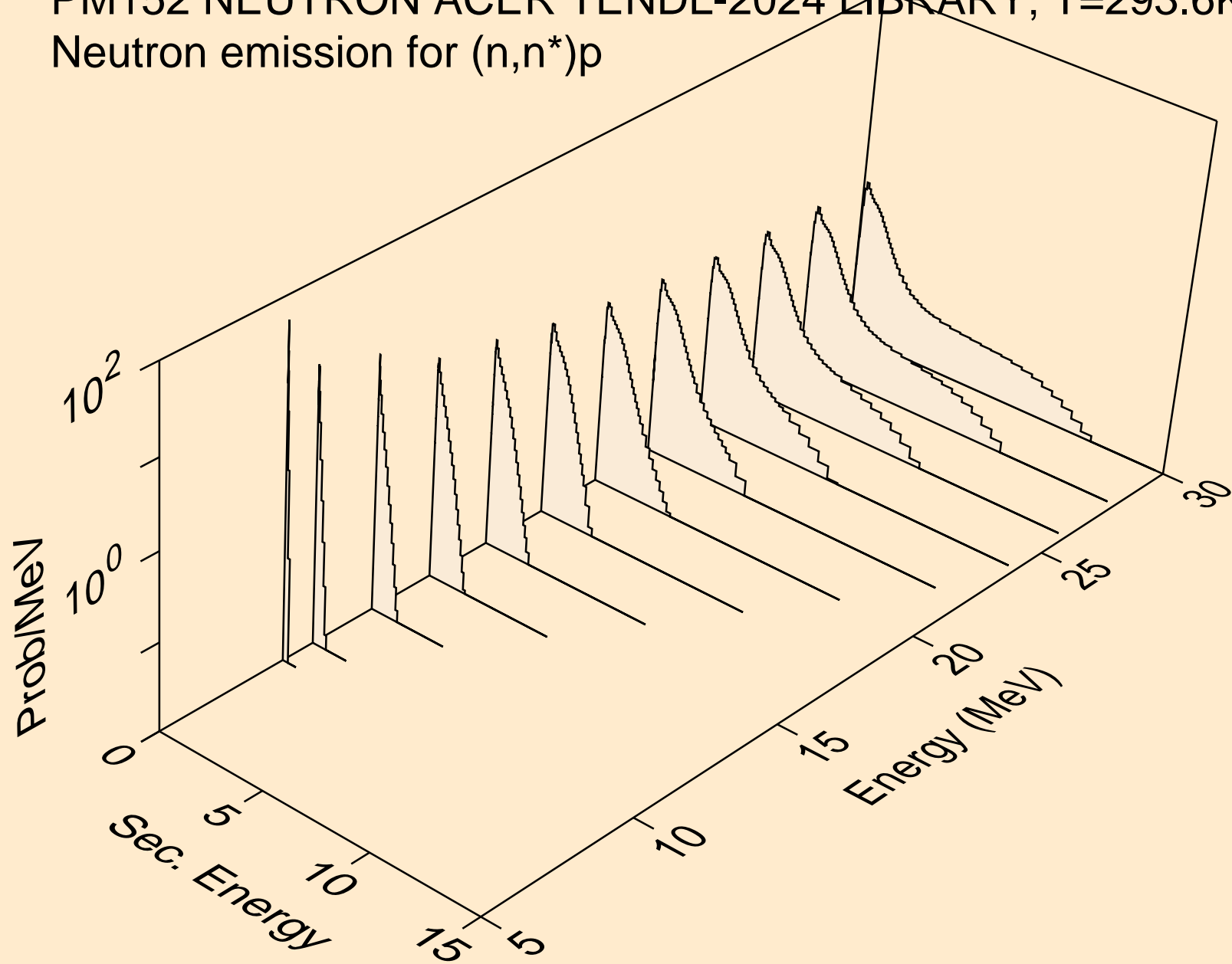

PM152 NEUTRON ACER TENDL-2024 LIBRARY; T=293.6K  
Neutron emission for (n,n\*)d

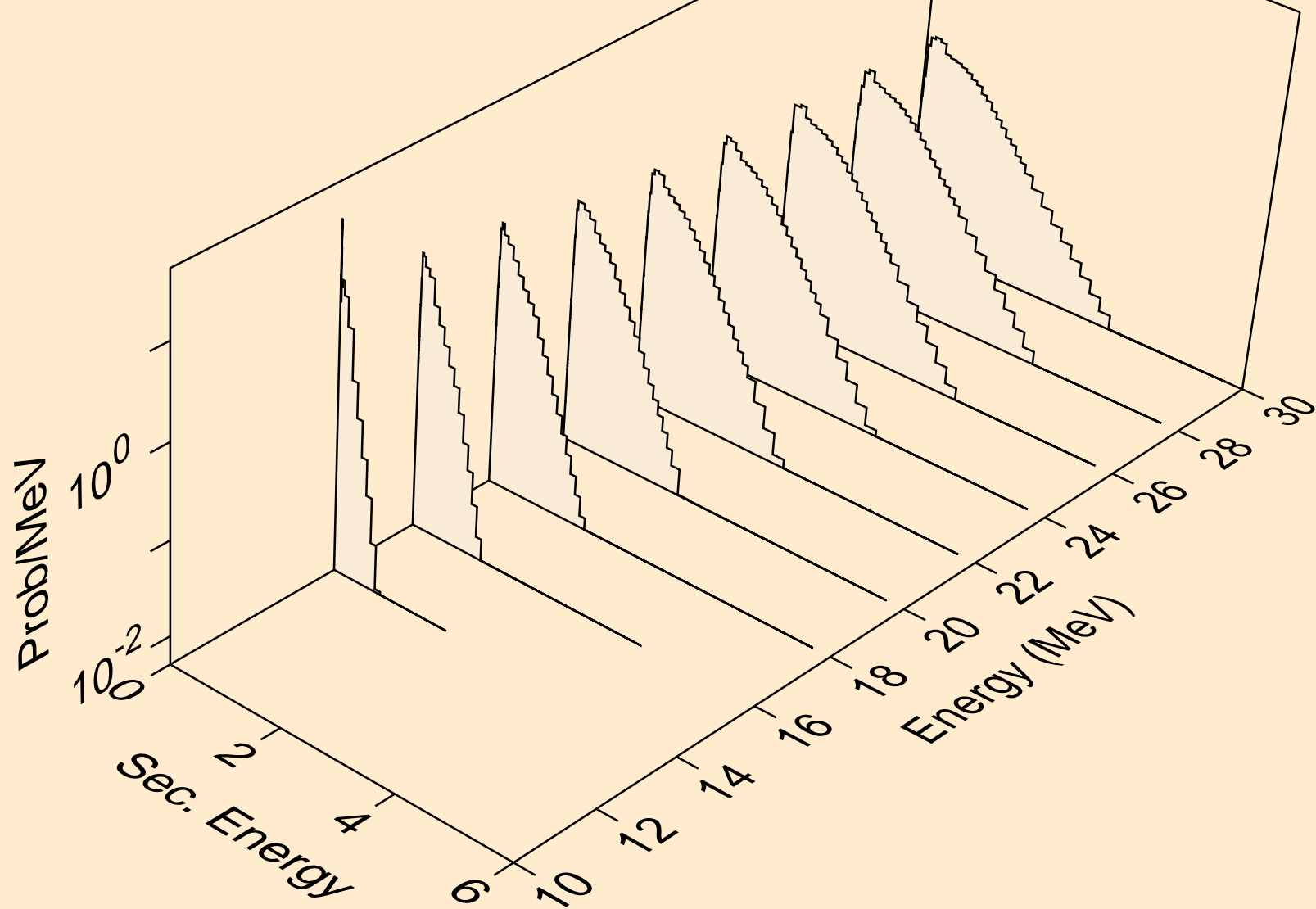

PM152 NEUTRON ACER TENDL-2024 LIBRARY; T=293.6K  
Neutron emission for (n,n\*)t

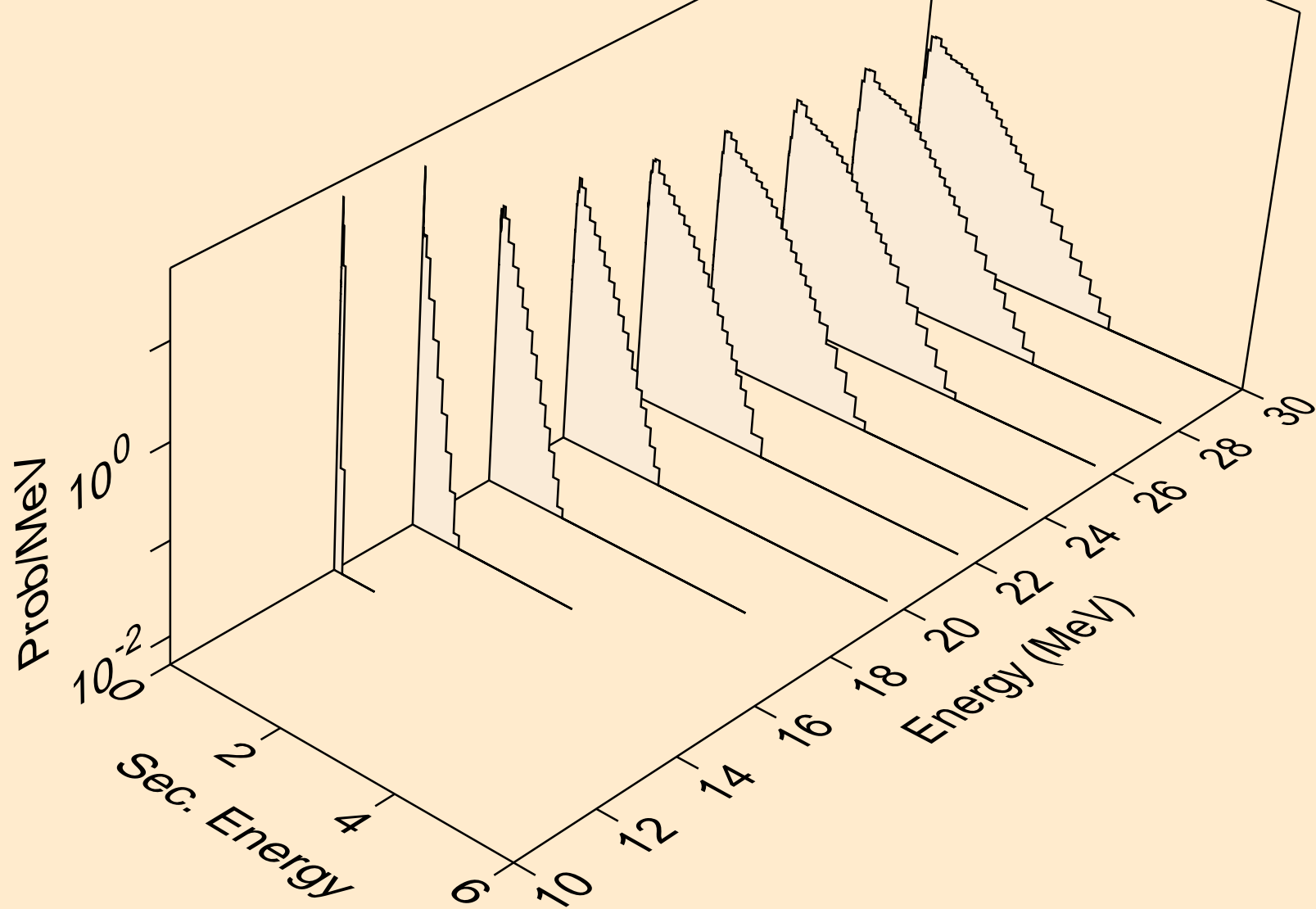

PM152 NEUTRON ACER TENDL-2024 LIBRARY; T=293.6K  
Neutron emission for (n,n\*)he3

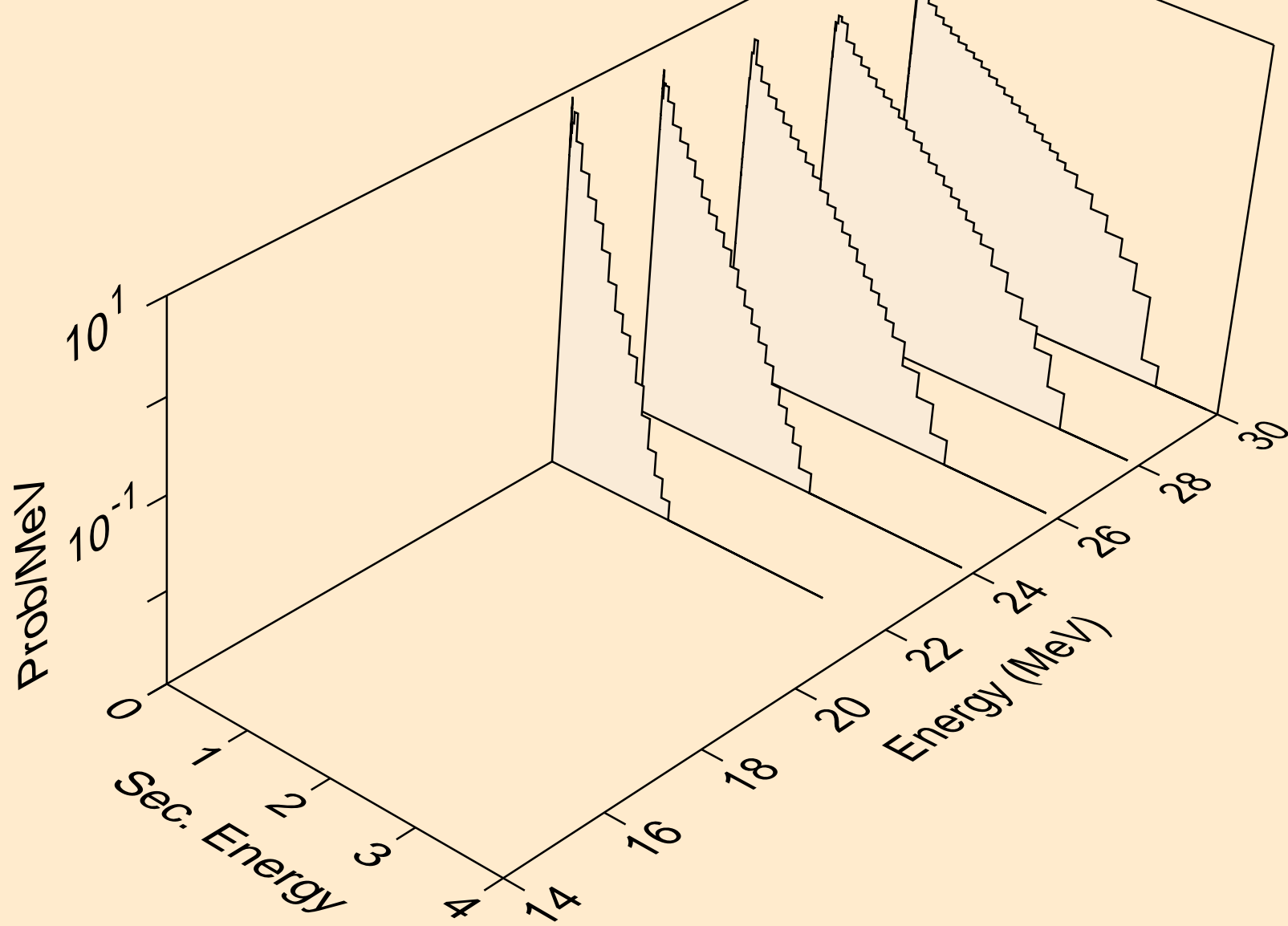

PM152 NEUTRON ACER TENDL-2024 LIBRARY; T=293.6K  
Neutron emission for (n,4n)

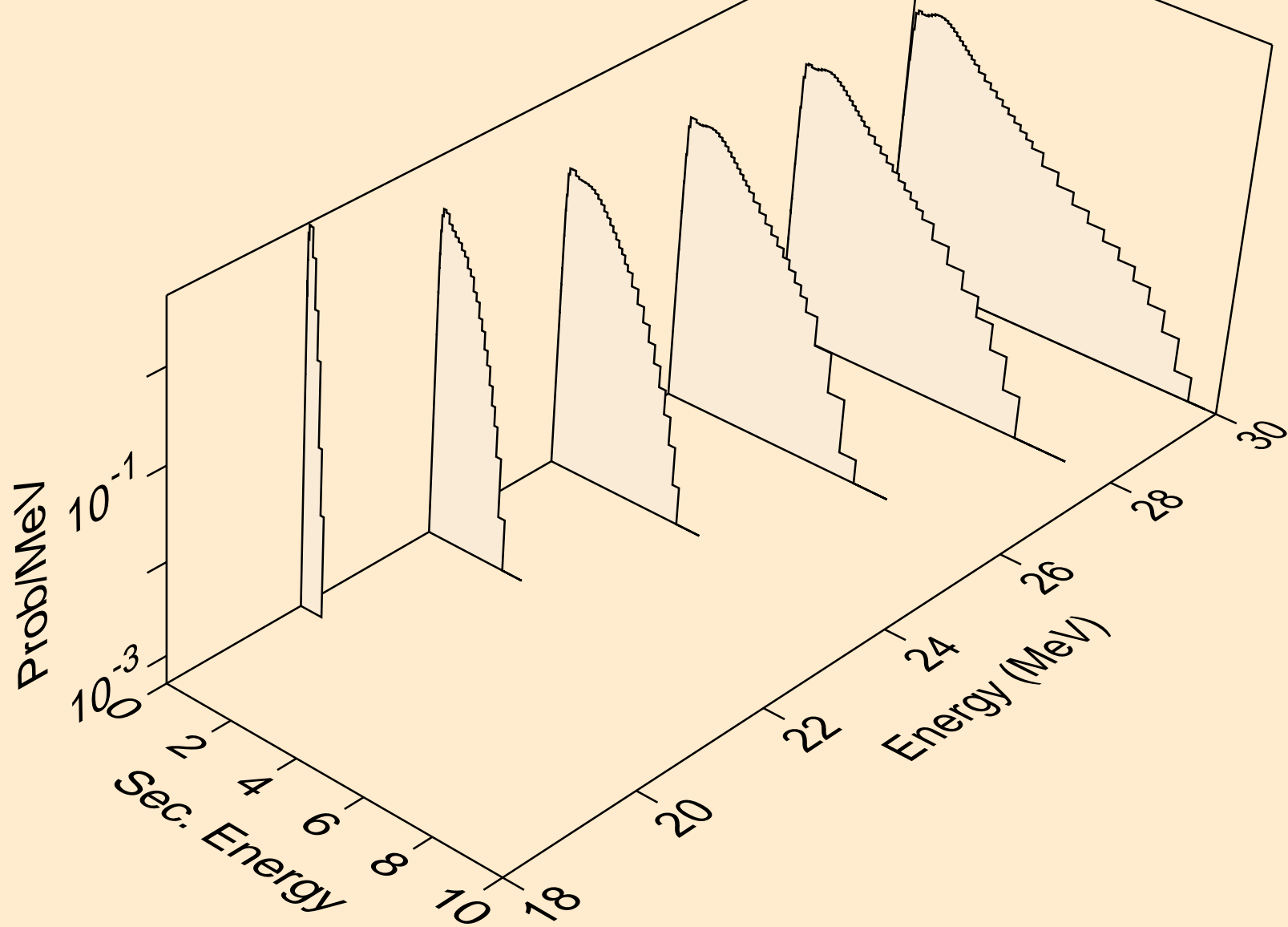

PM152 NEUTRON ACER TENDL-2024 LIBRARY; T=293.6K  
Neutron emission for (n,2np)

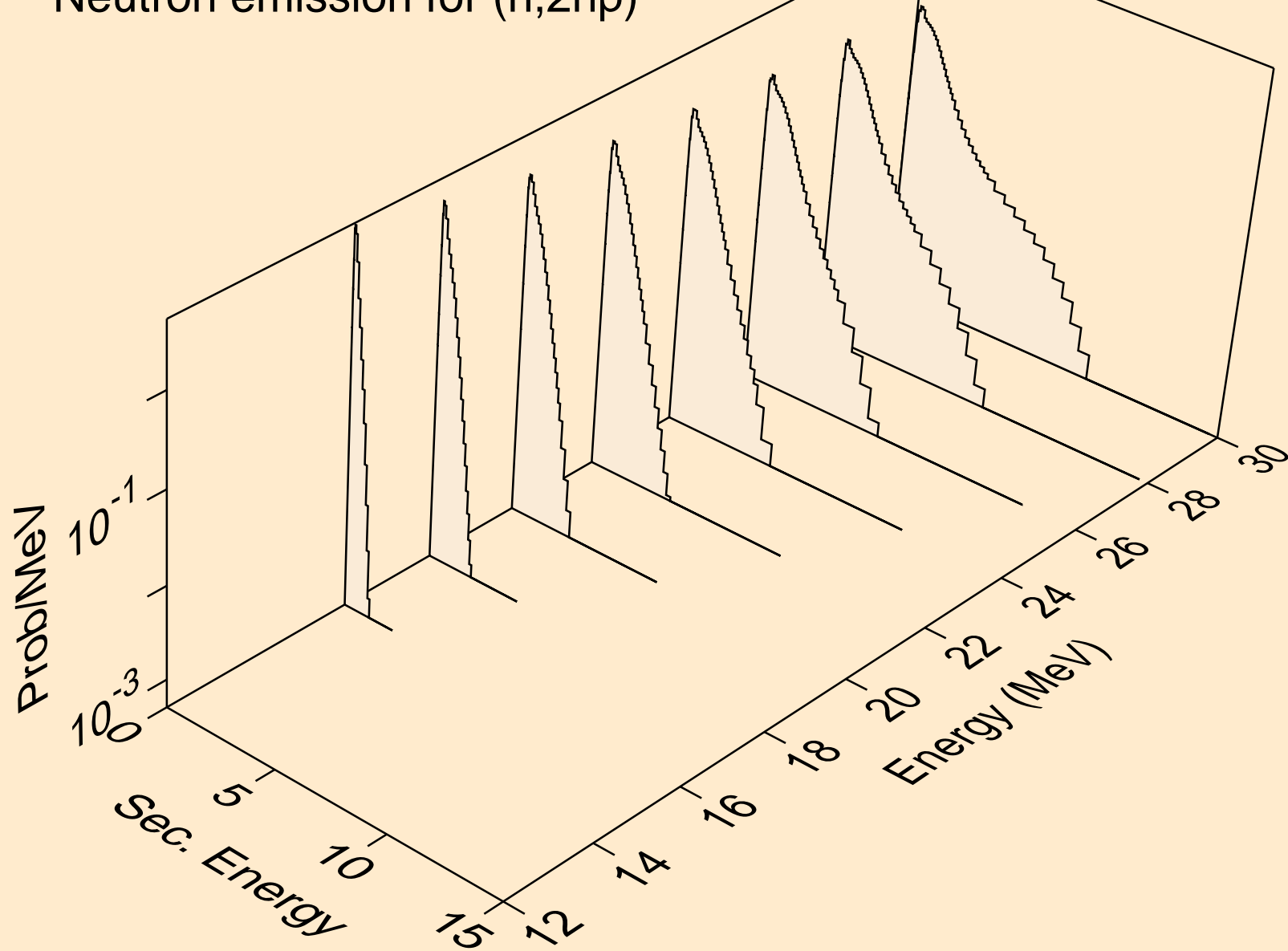

PM152 NEUTRON ACER TENDL-2024 LIBRARY; T=293.6K  
Neutron emission for (n,3np)

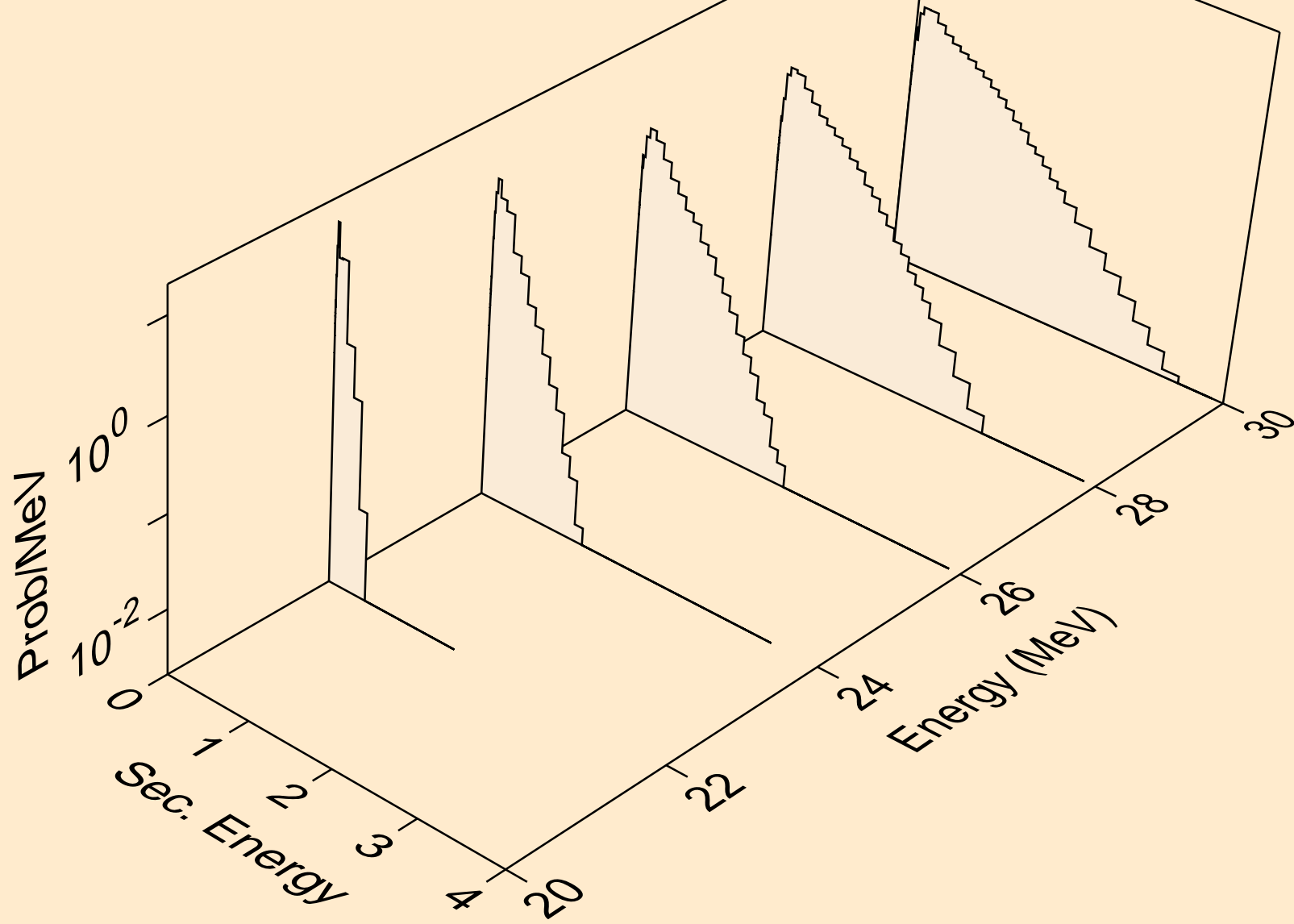

PM152 NEUTRON ACER TENDL-2024 LIBRARY; T=293.6K  
Neutron emission for (n,n2p)

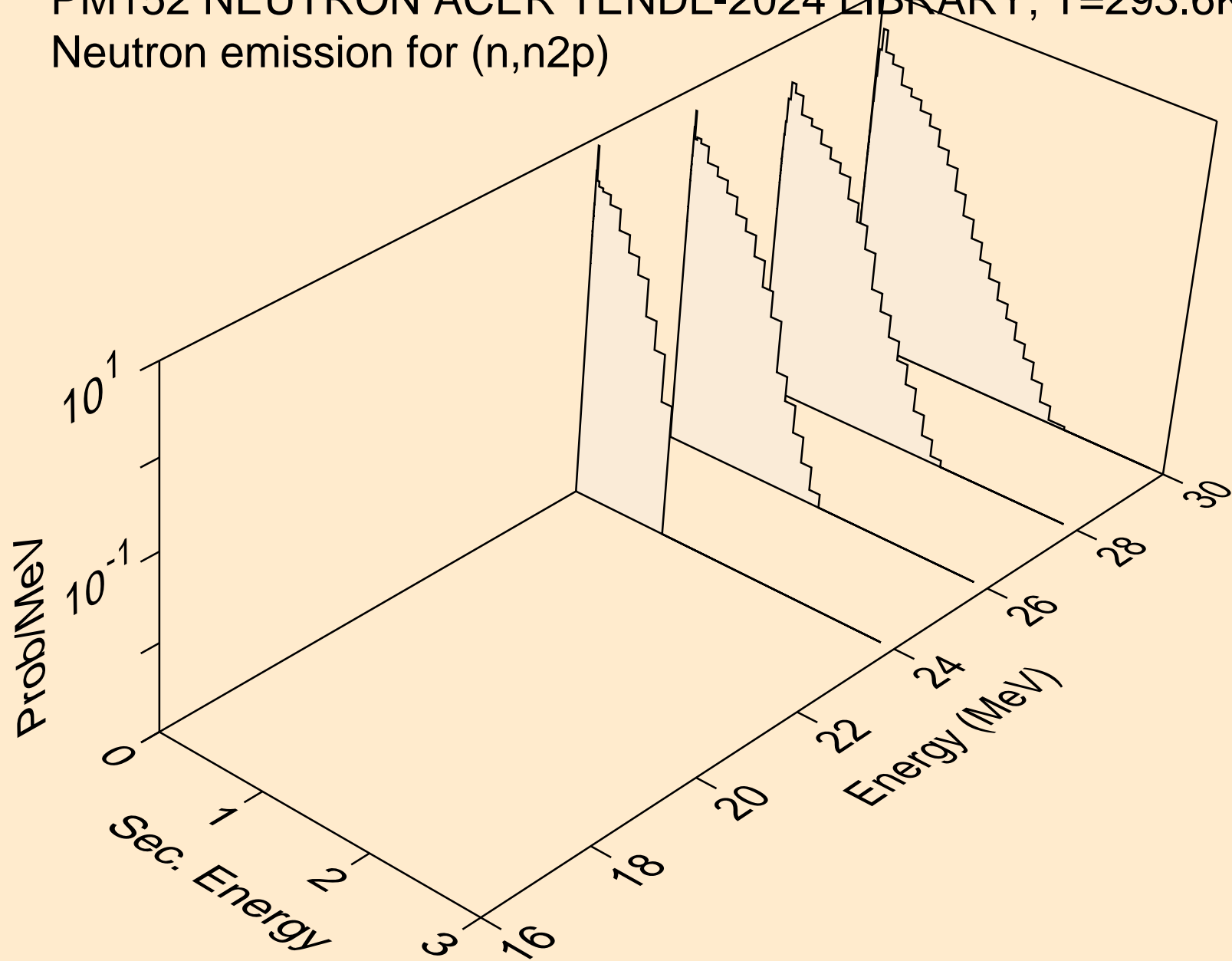

PM152 NEUTRON ACER TENDL-2024 LIBRARY; T=293.6K  
Neutron emission for (n,n\*c)

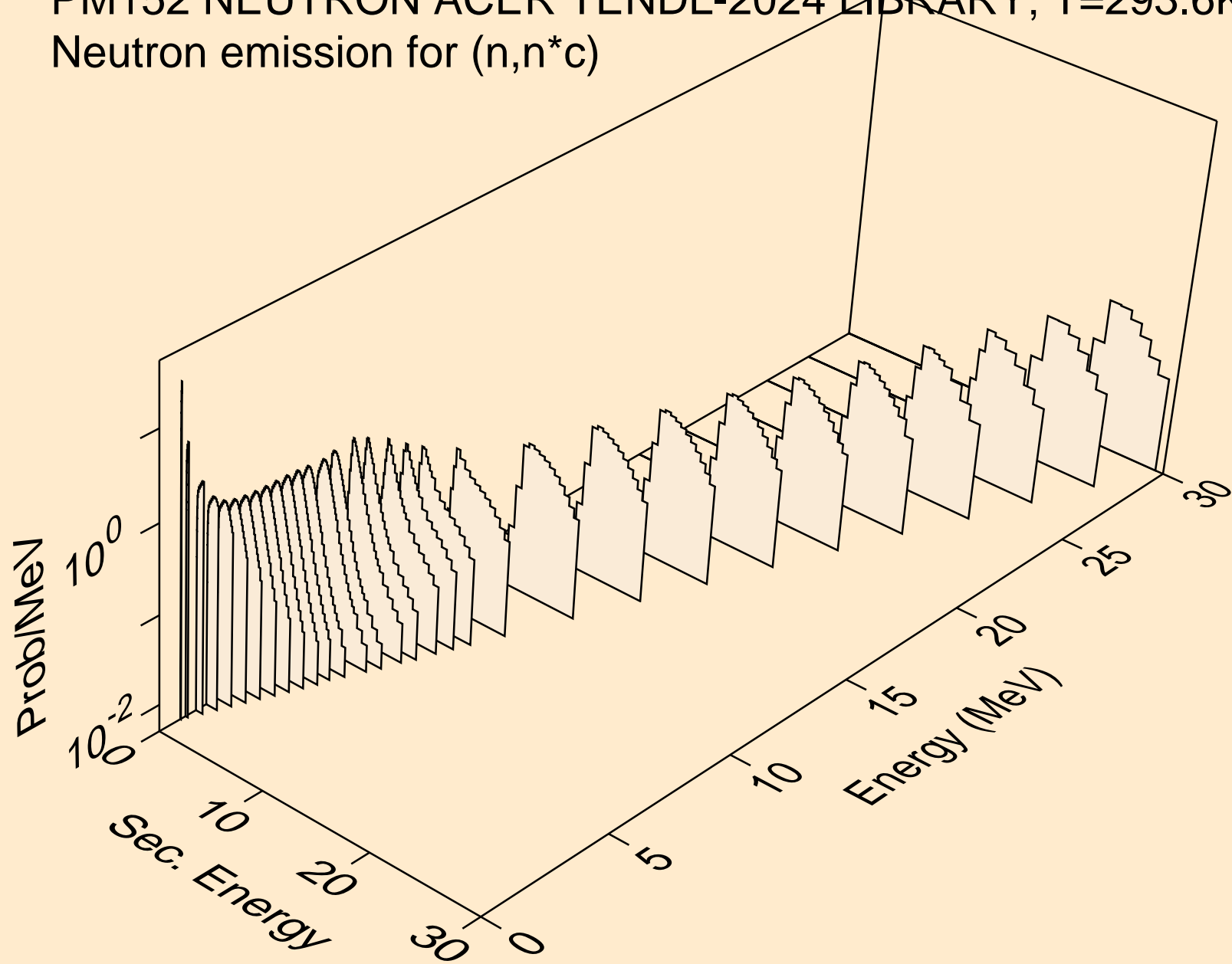

PM152 NEUTRON ACER TENDL-2024 LIBRARY; T=293.6K  
Photon emission for (n,x)

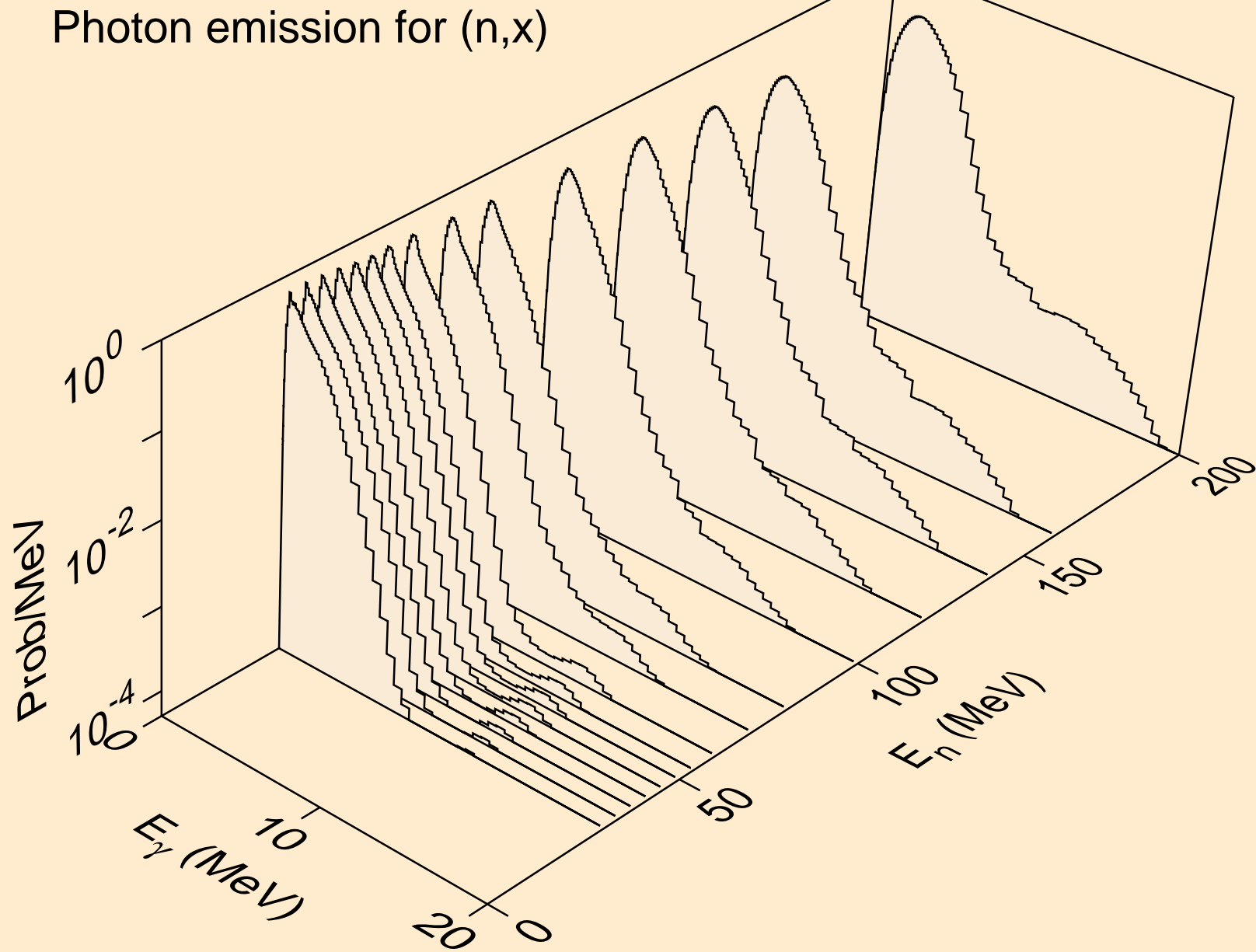

PM152 NEUTRON ACER TENDL-2024 LIBRARY; T=293.6K  
Photon emission for (n,2nd)

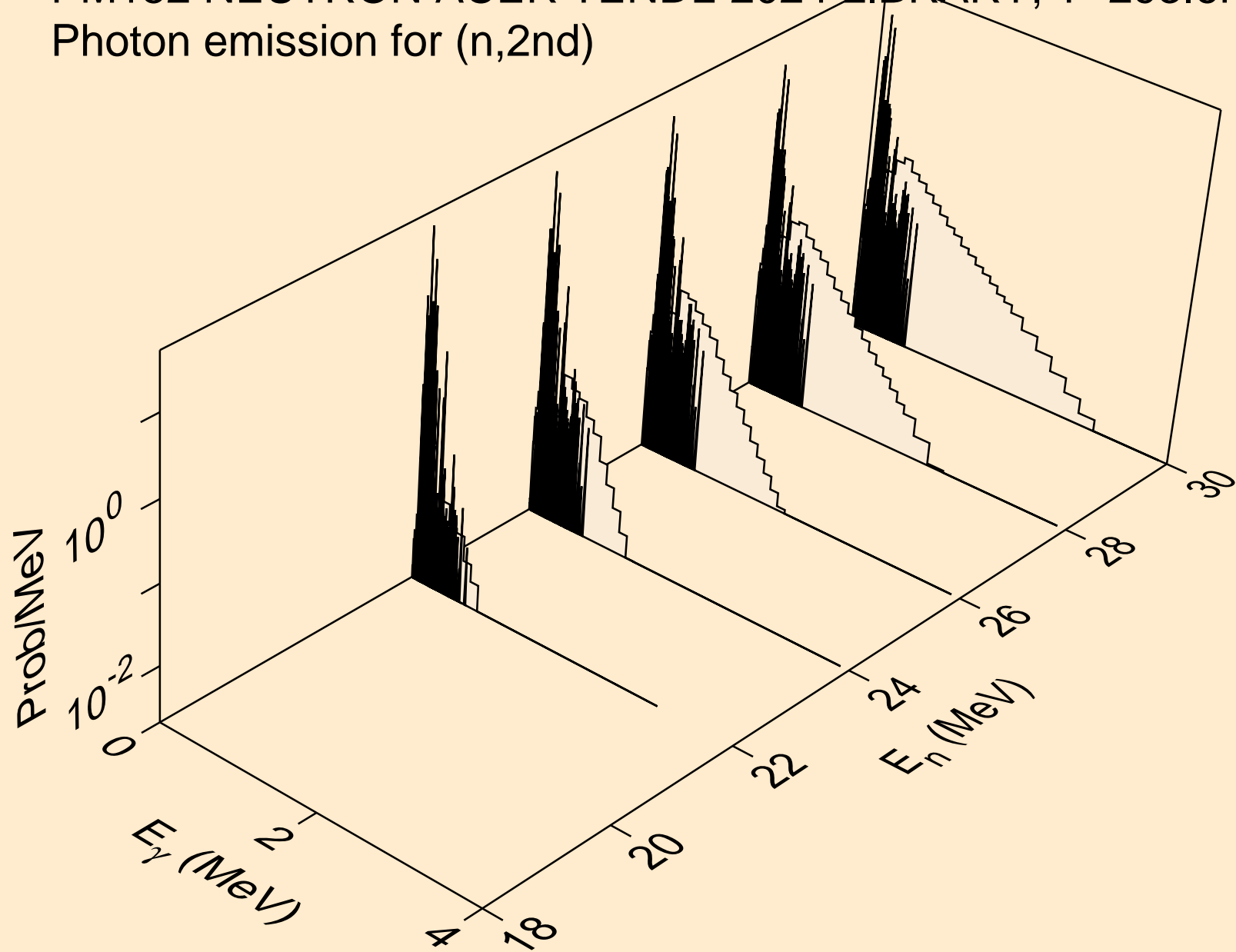

PM152 NEUTRON ACER TENDL-2024 LIBRARY; T=293.6K  
Photon emission for (n,2n)

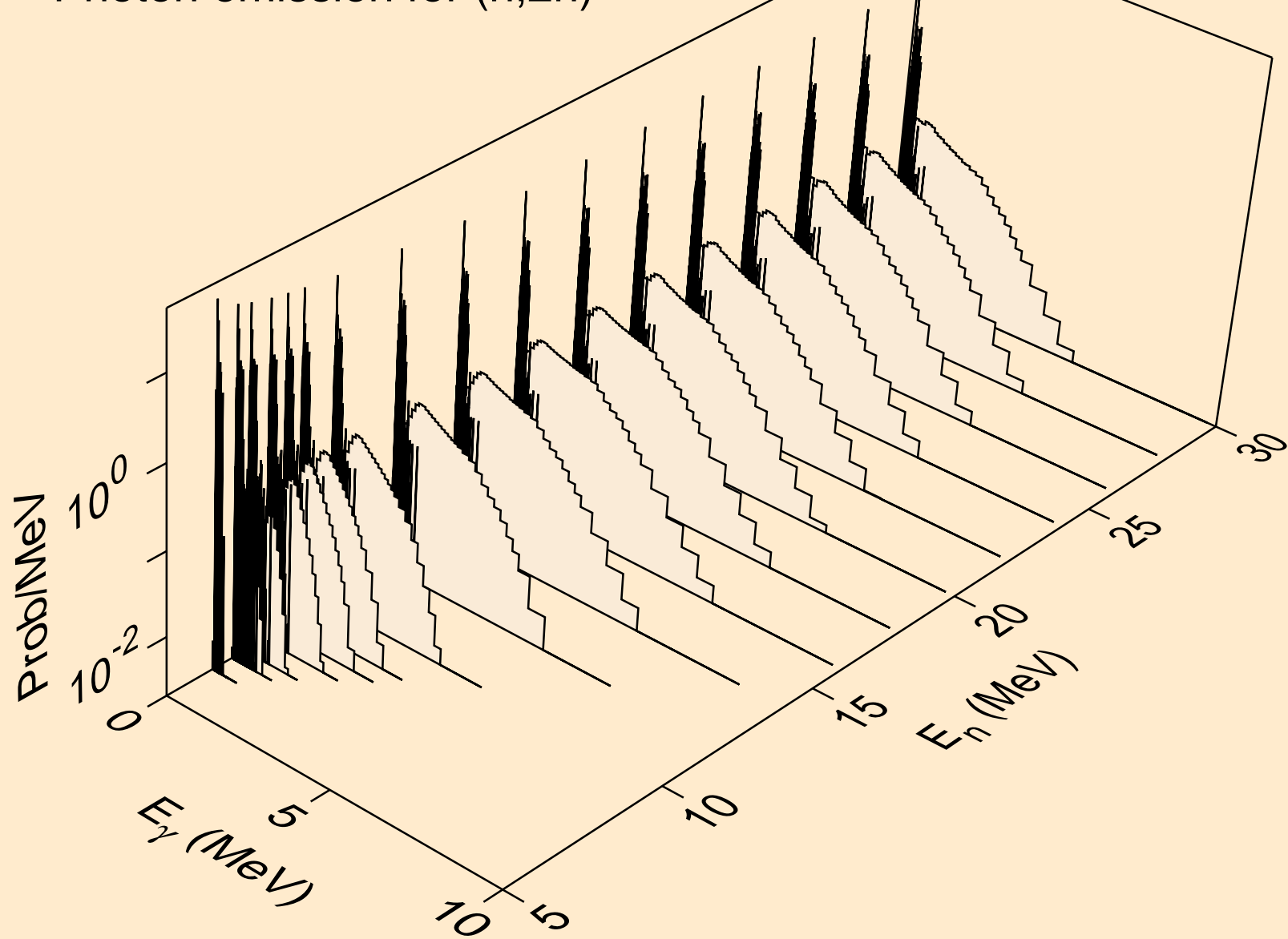

PM152 NEUTRON ACER TENDL-2024 LIBRARY; T=293.6K  
Photon emission for (n,3n)

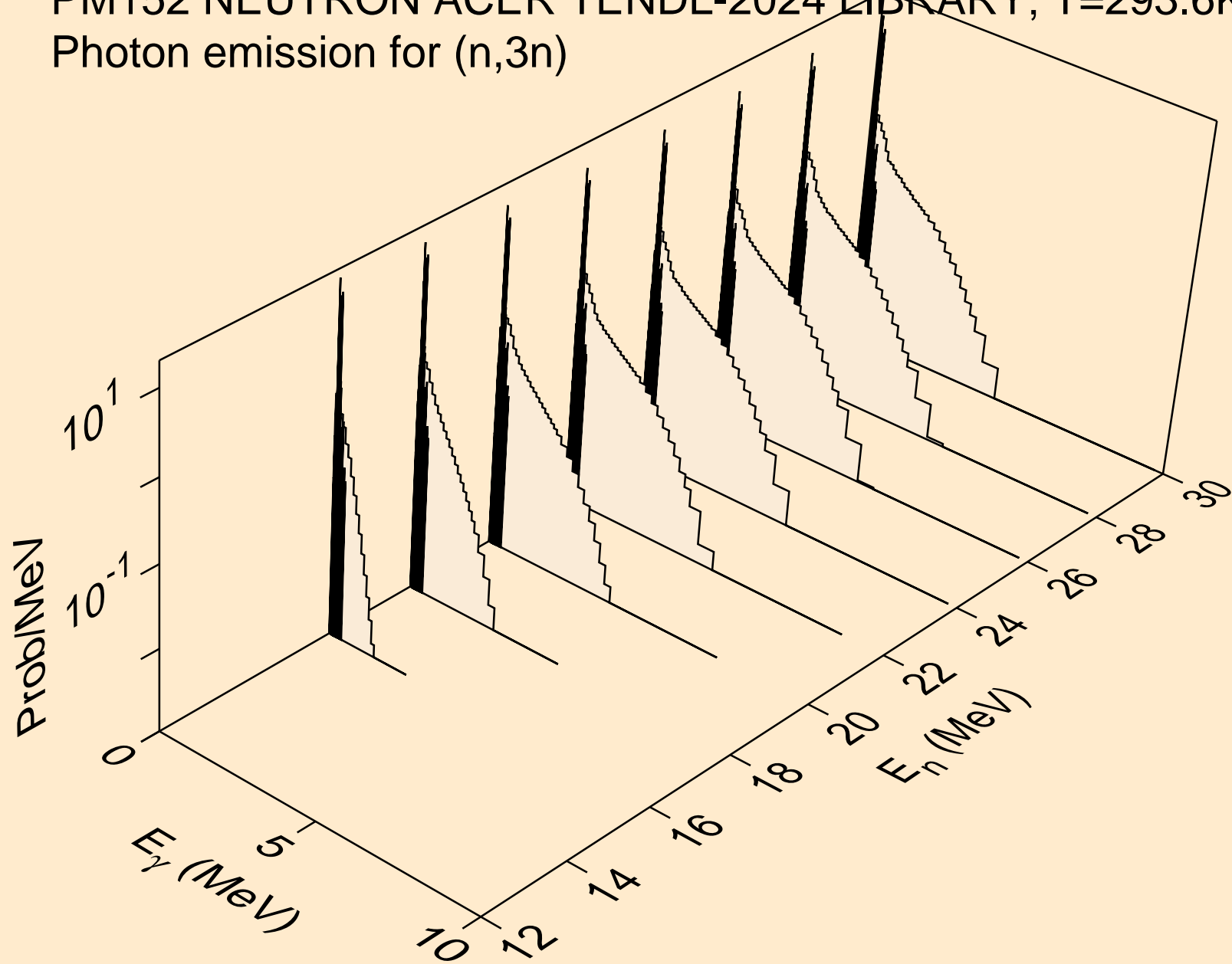

PM152 NEUTRON ACER TENDL-2024 LIBRARY; T=293.6K  
Photon emission for (n,n\*)a

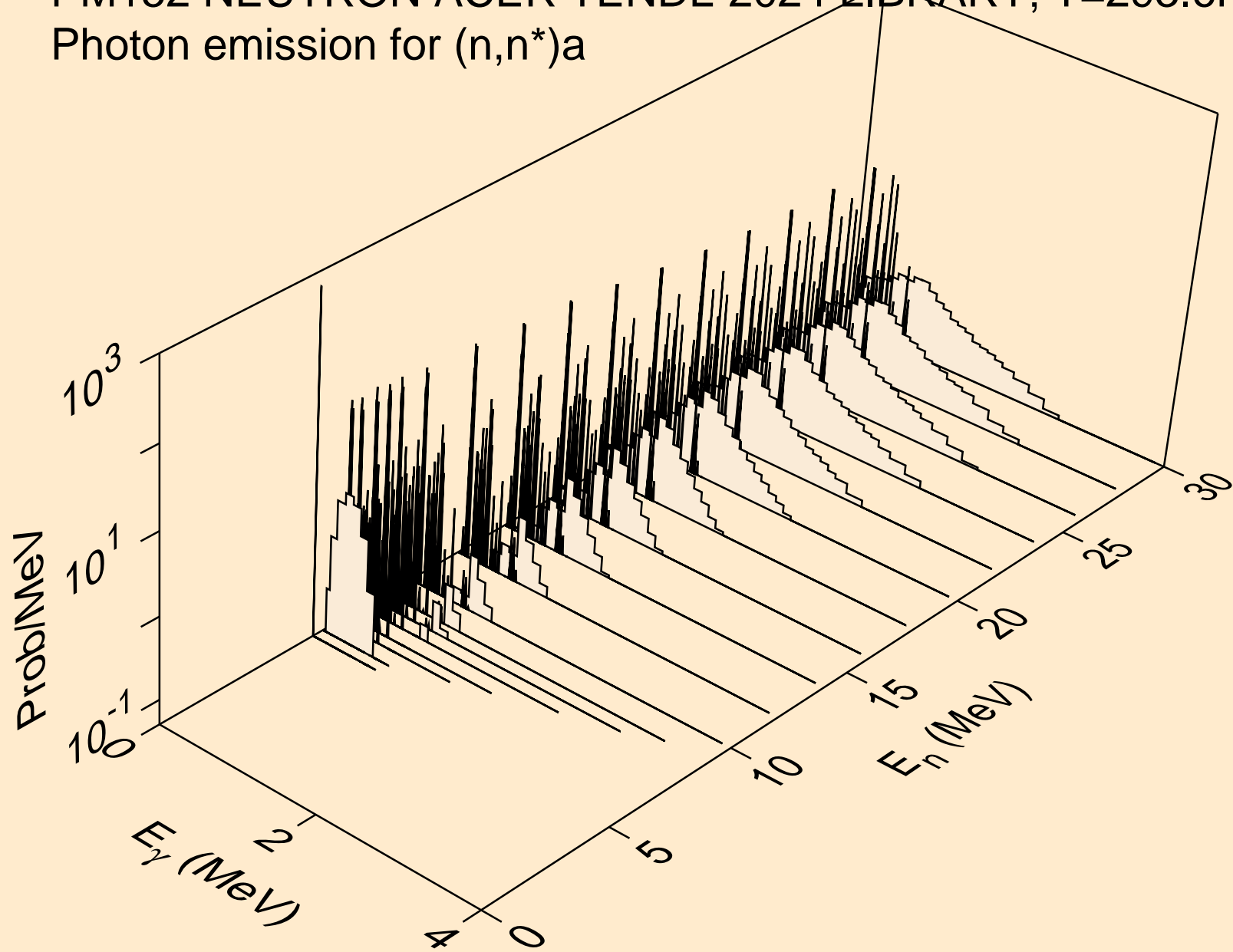

PM152 NEUTRON ACER TENDL-2024 LIBRARY; T=293.6K  
Photon emission for (n,2n)a

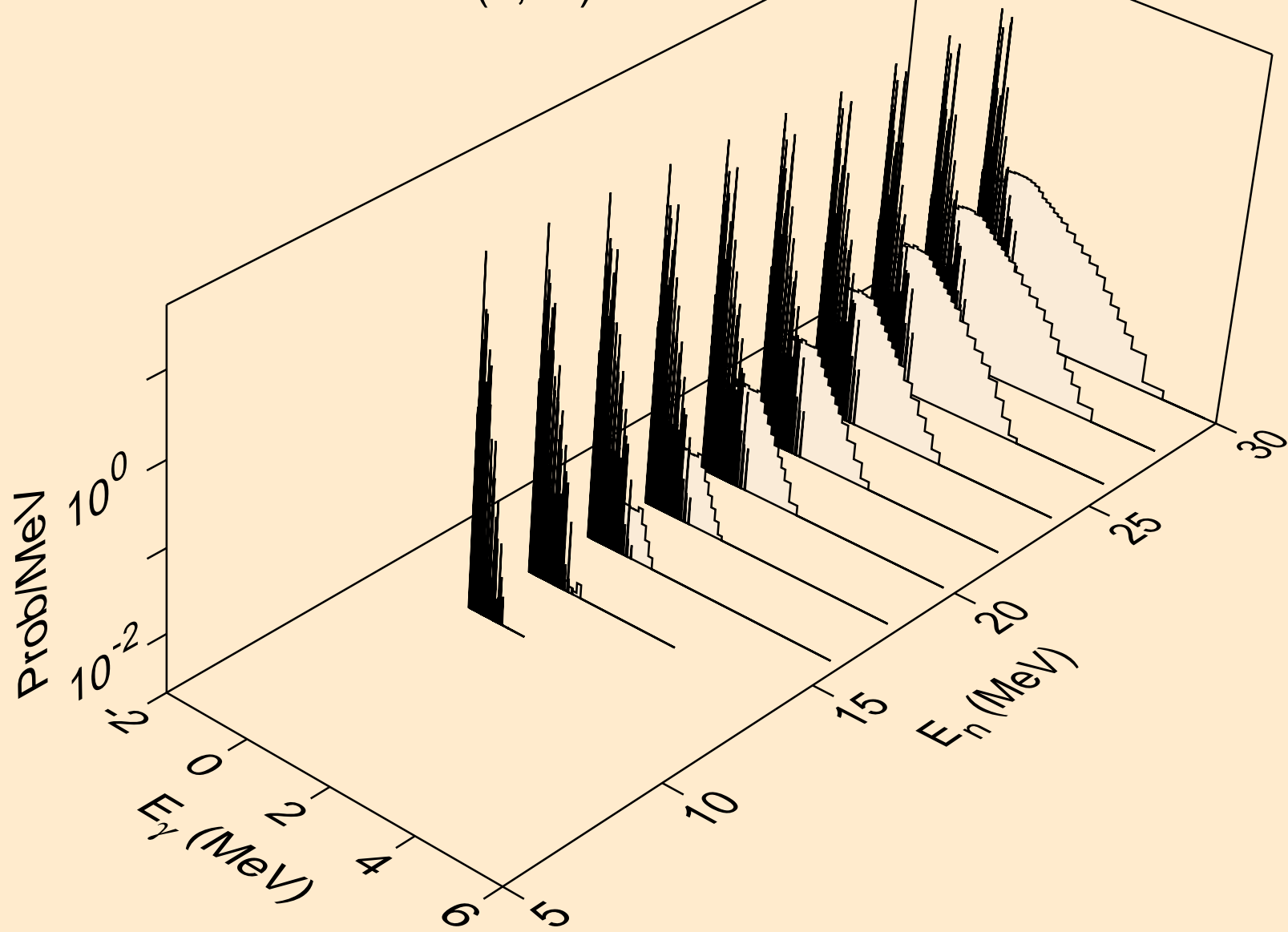

PM152 NEUTRON ACER TENDL-2024 LIBRARY; T=293.6K  
Photon emission for (n,3n)a

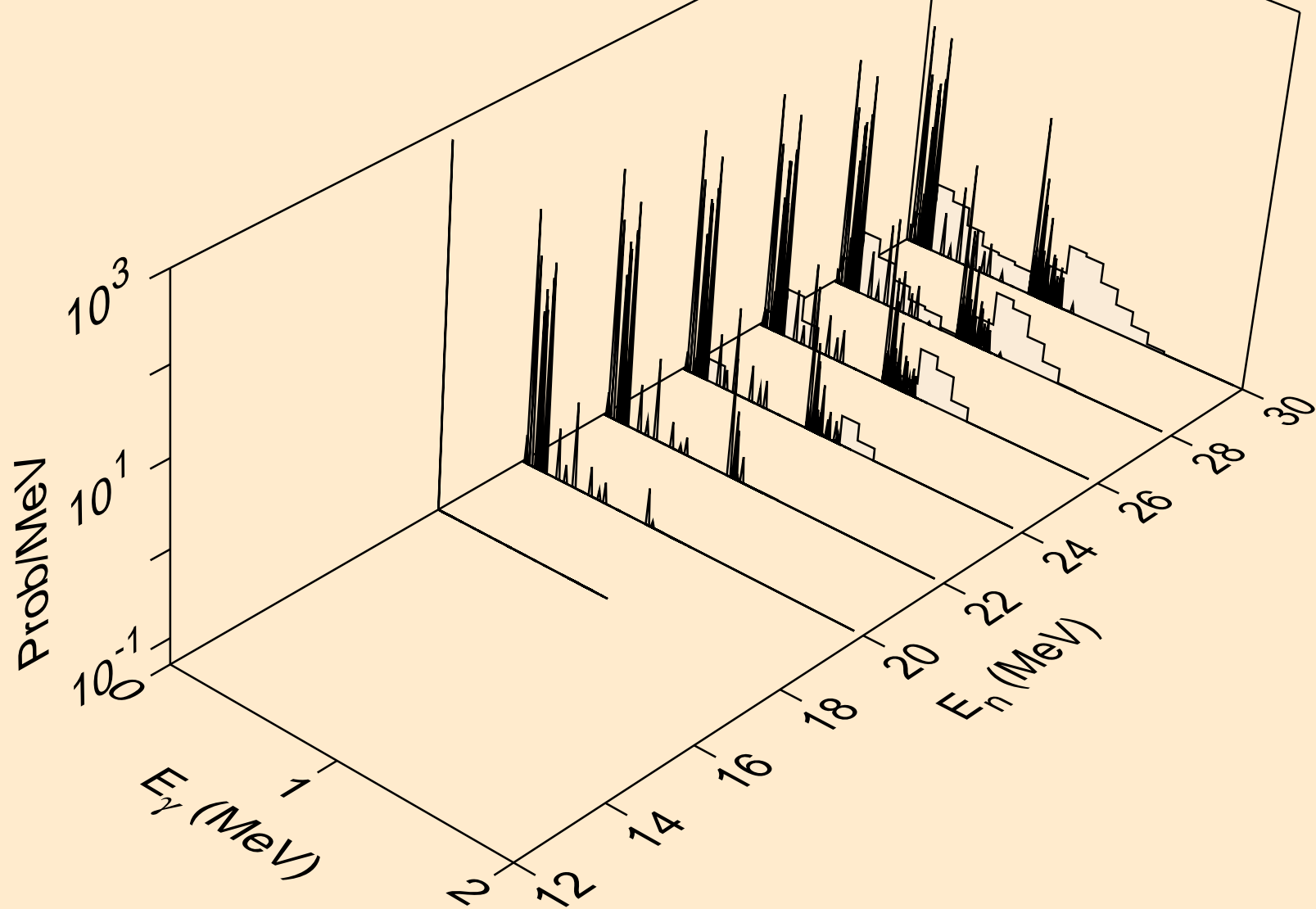

PM152 NEUTRON ACER TENDL-2024 LIBRARY; T=293.6K  
Photon emission for (n,n\*)p

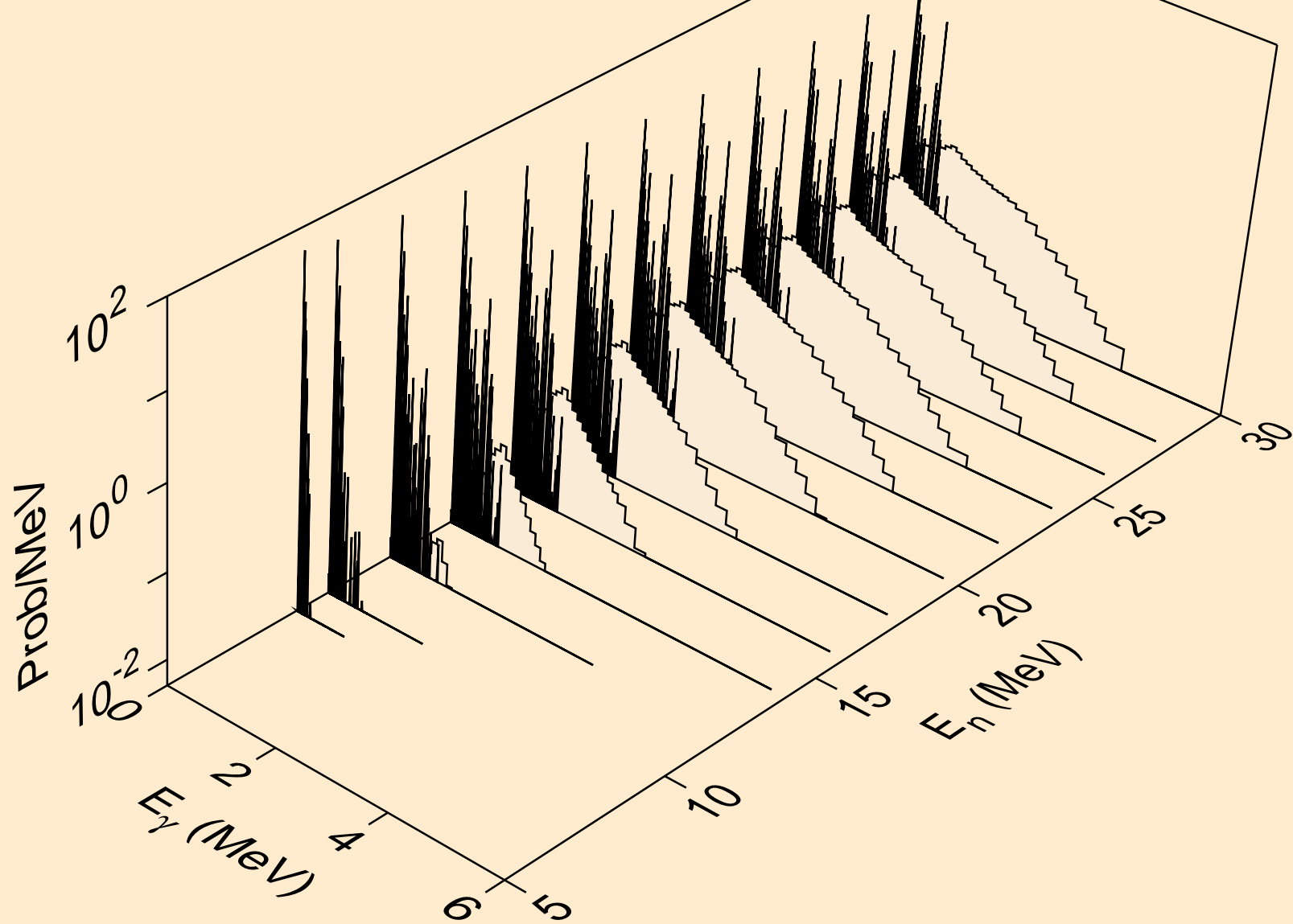

PM152 NEUTRON ACER TENDL-2024 LIBRARY; T=293.6K  
Photon emission for (n,n\*)d

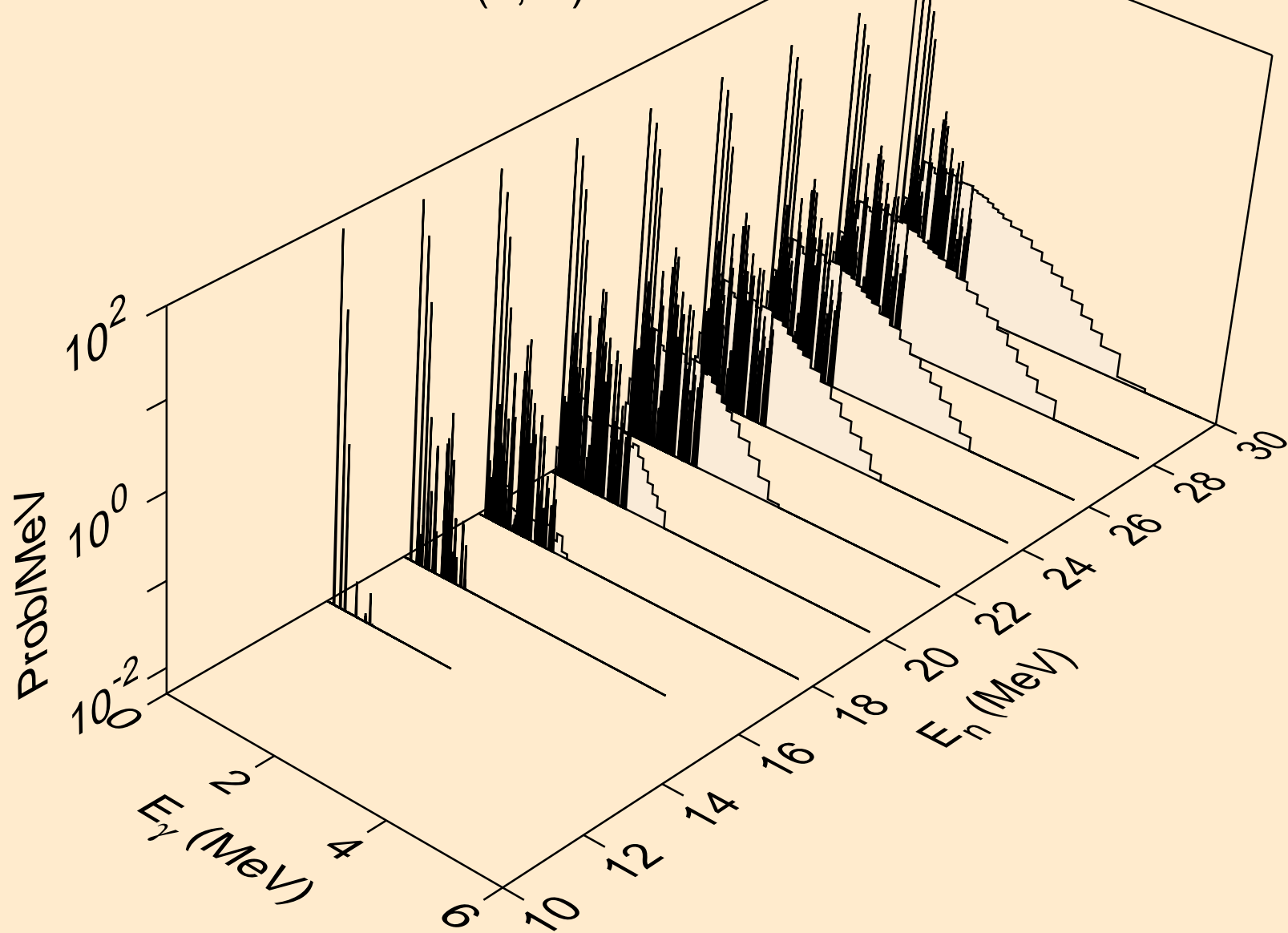

PM152 NEUTRON ACER TENDL-2024 LIBRARY; T=293.6K  
Photon emission for (n,n\*)t

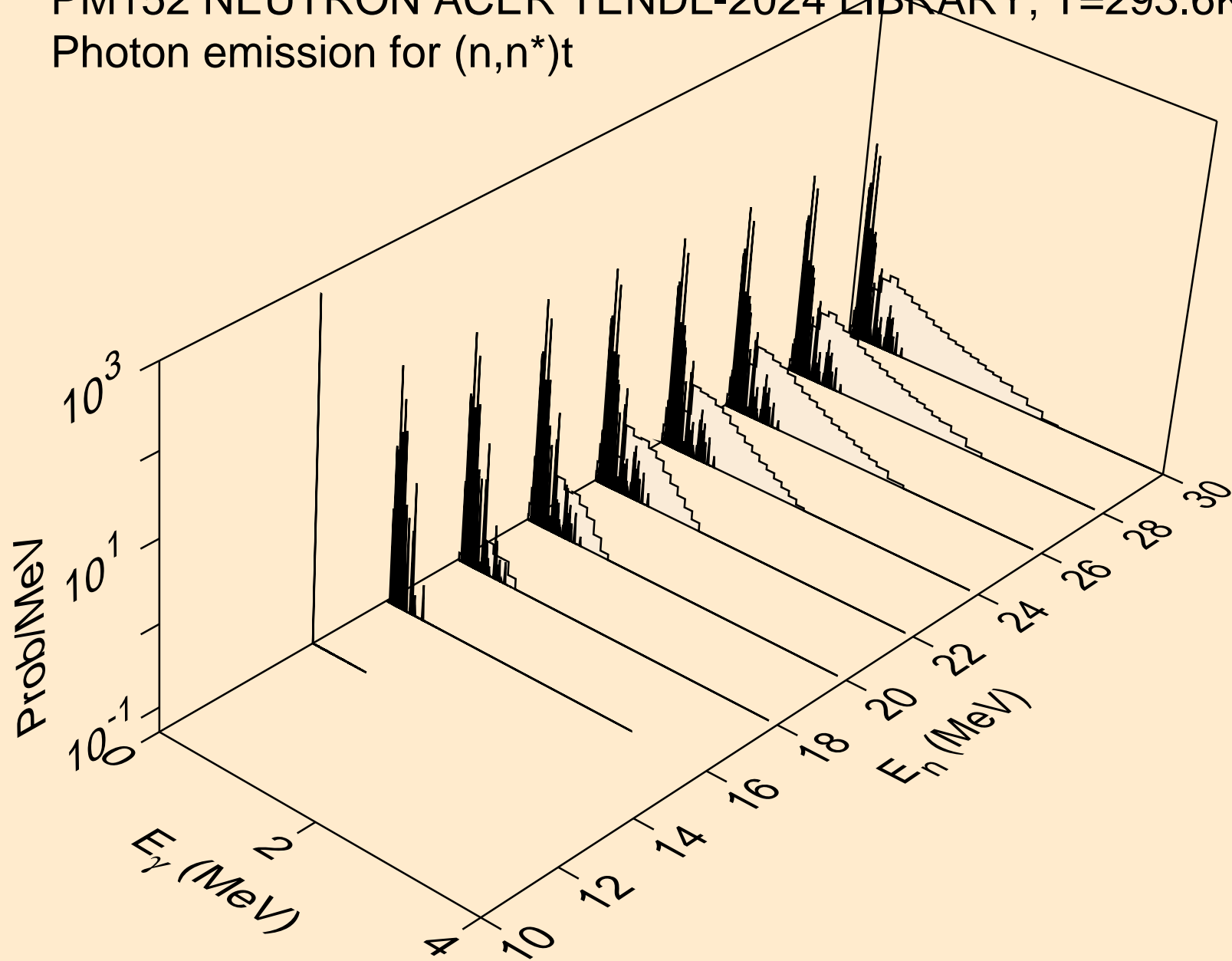

PM152 NEUTRON ACER TENDL-2024 LIBRARY; T=293.6K  
Photon emission for (n,n\*)he3

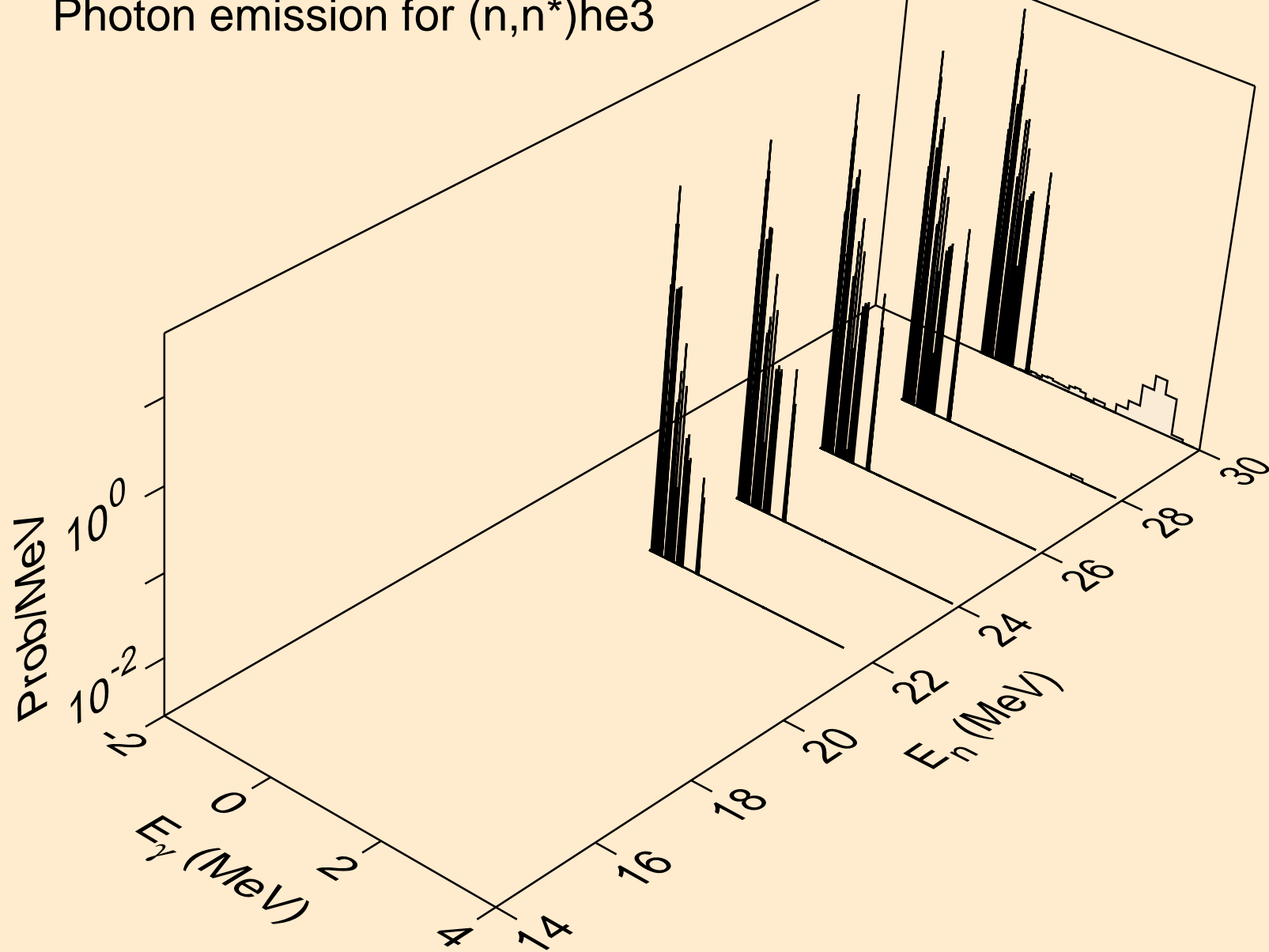

PM152 NEUTRON ACER TENDL-2024 LIBRARY; T=293.6K  
Photon emission for (n,4n)

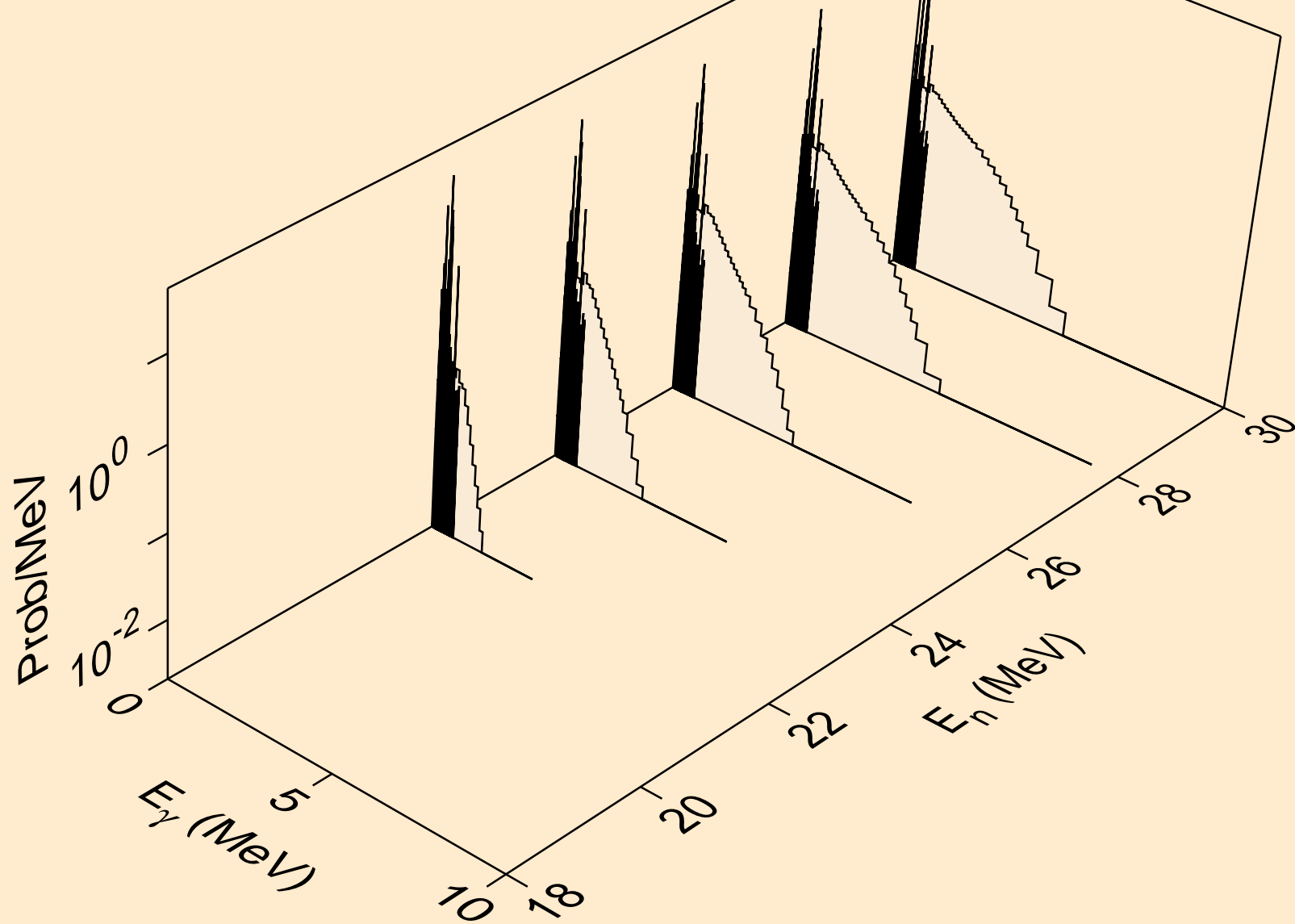

PM152 NEUTRON ACER TENDL-2024 LIBRARY; T=293.6K  
Photon emission for (n,2np)

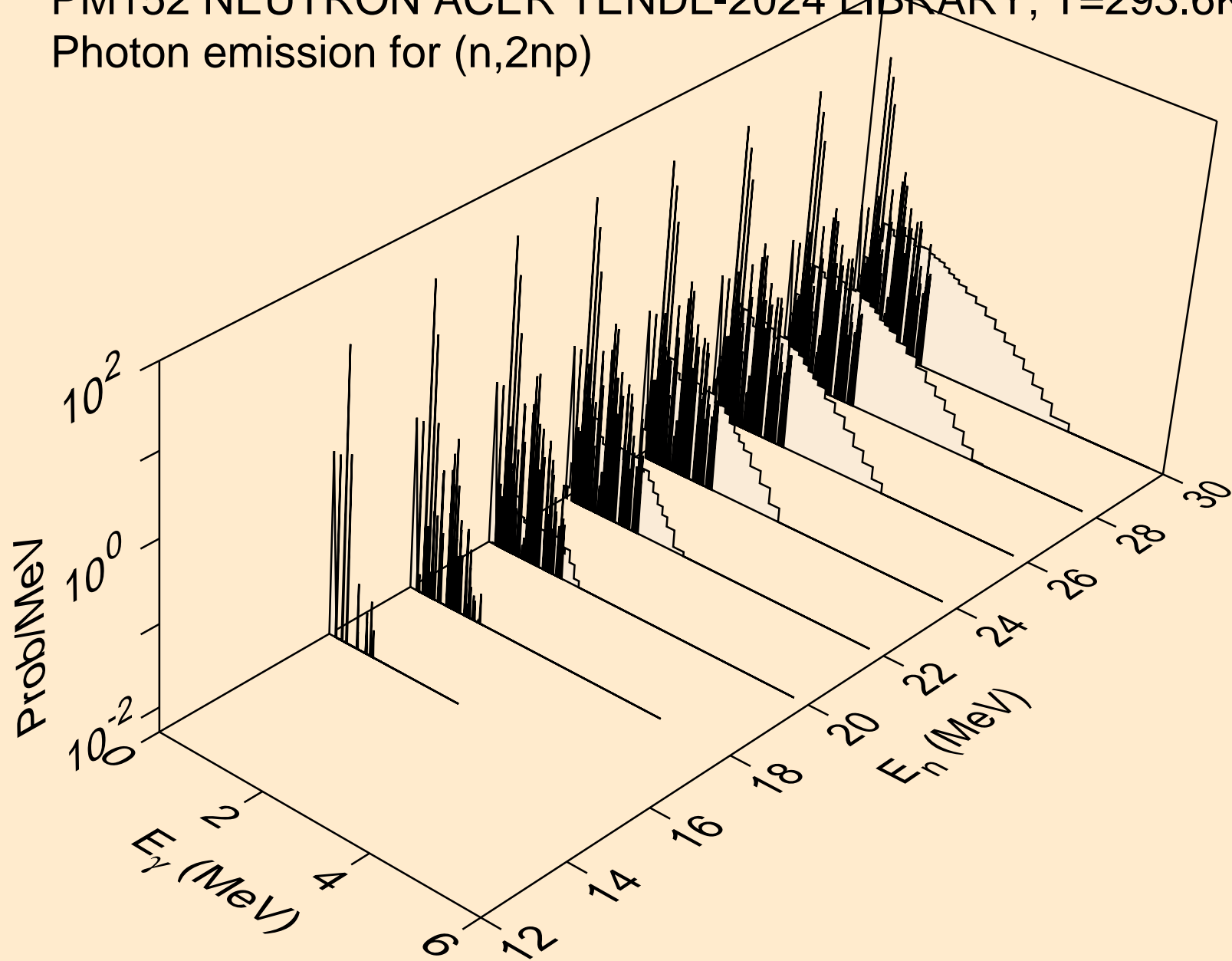

PM152 NEUTRON ACER TENDL-2024 LIBRARY; T=293.6K  
Photon emission for (n,3np)

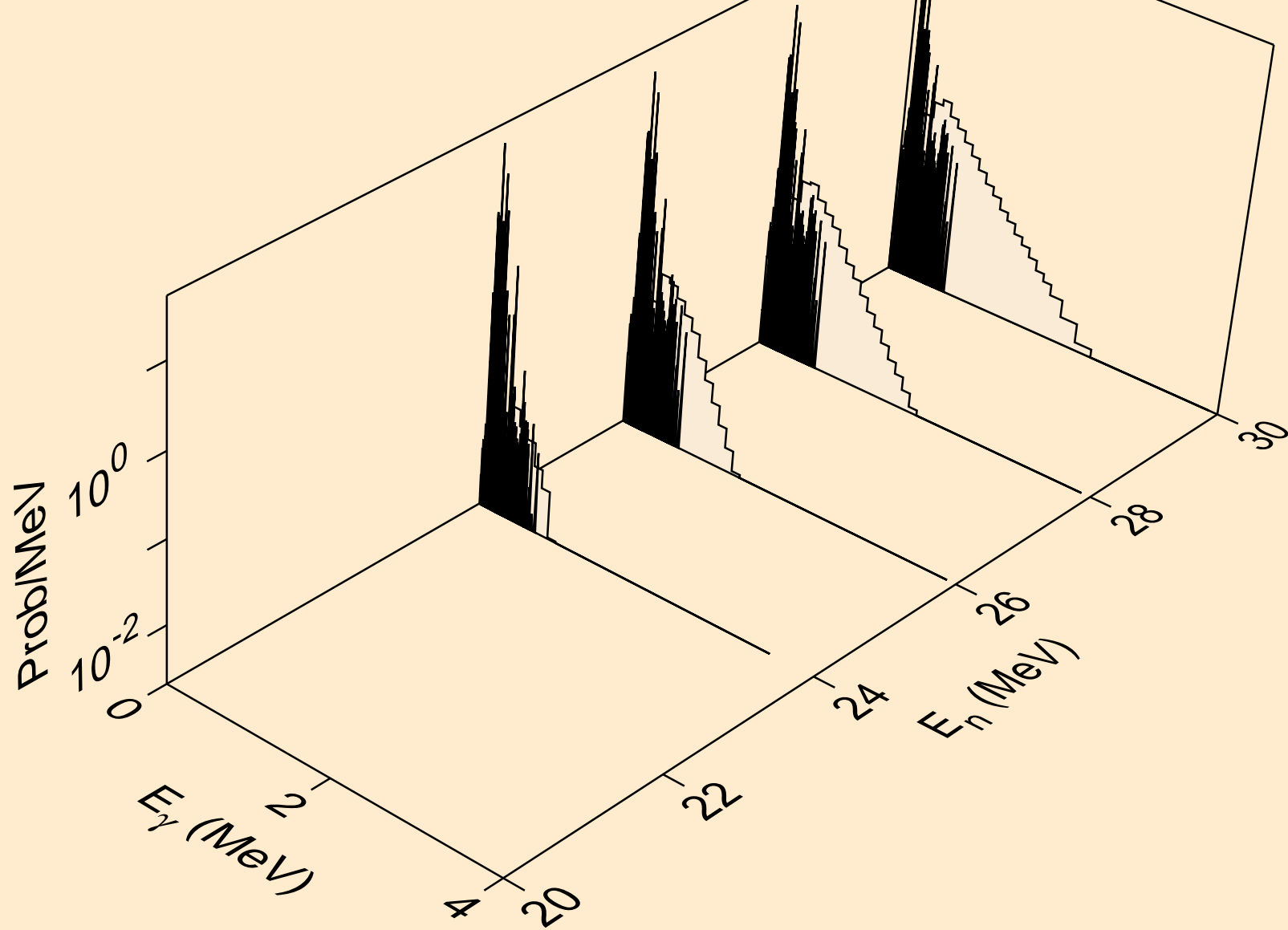

PM152 NEUTRON ACER TENDL-2024 LIBRARY; T=293.6K  
Photon emission for (n,n2p)

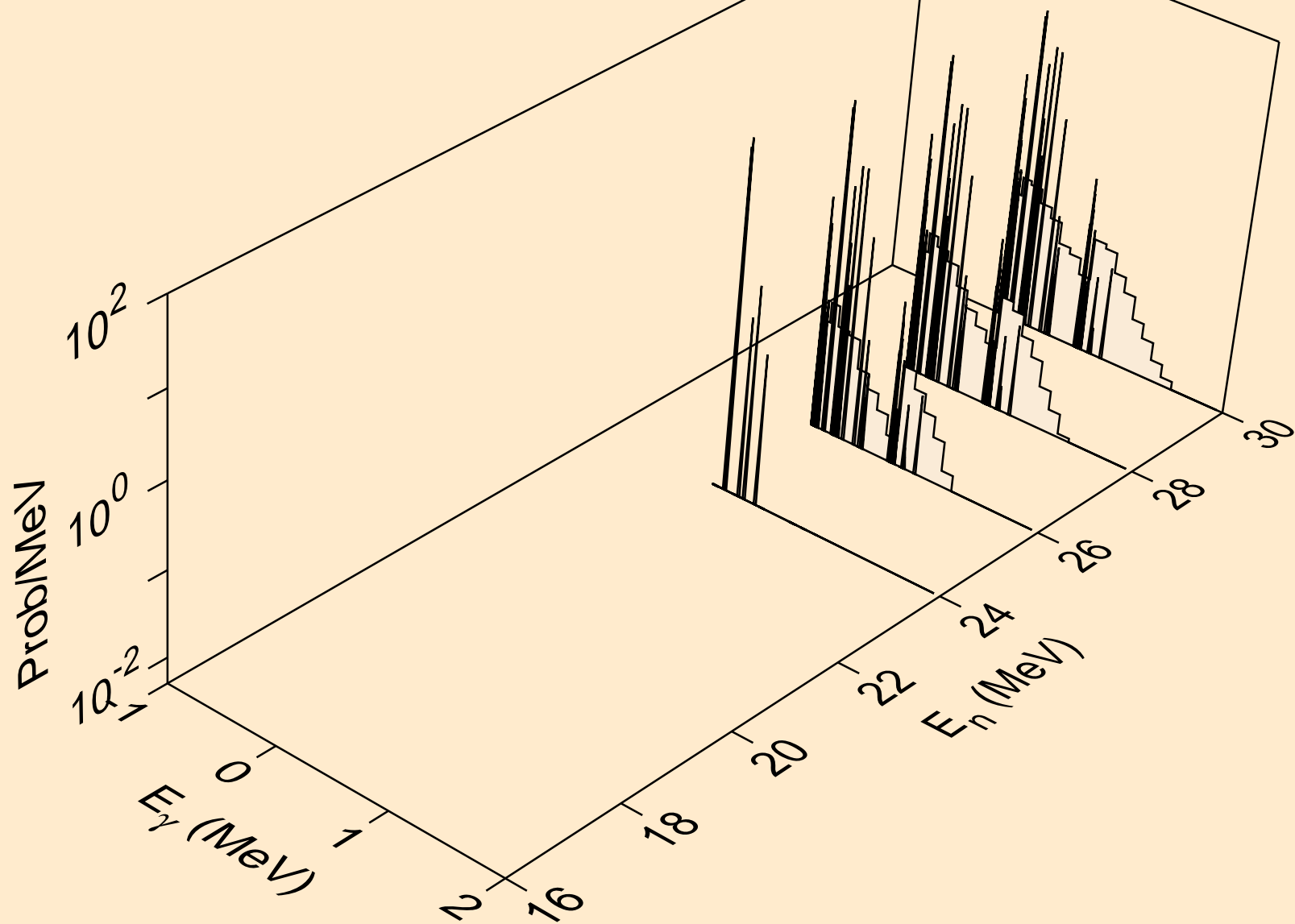

PM152 NEUTRON ACER TENDL-2024 LIBRARY; T=293.6K  
Photon emission for (n,n\*c)

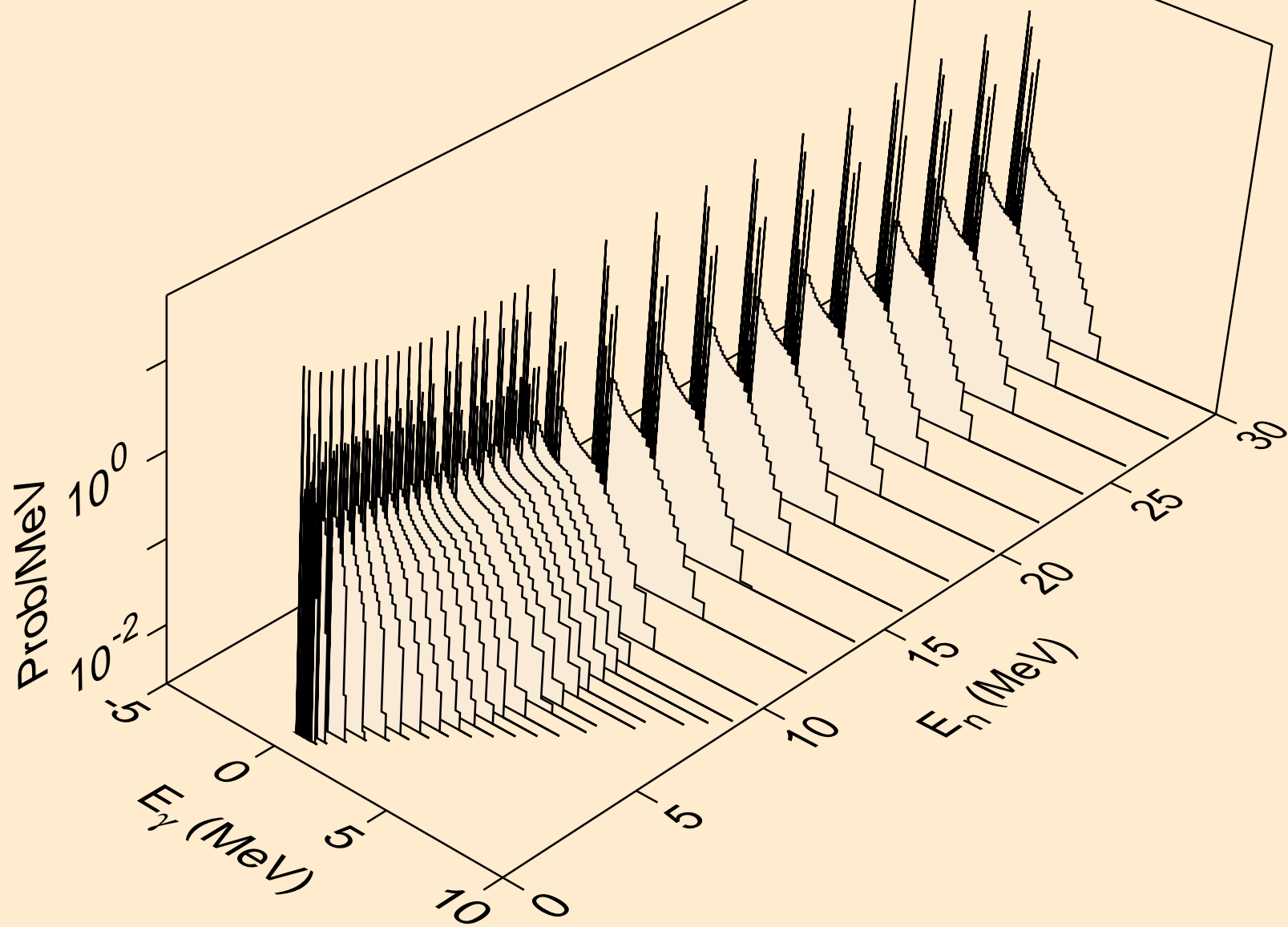

PM152 NEUTRON ACER TENDL-2024 LIBRARY; T=293.6K  
Photon emission for (n,gma)

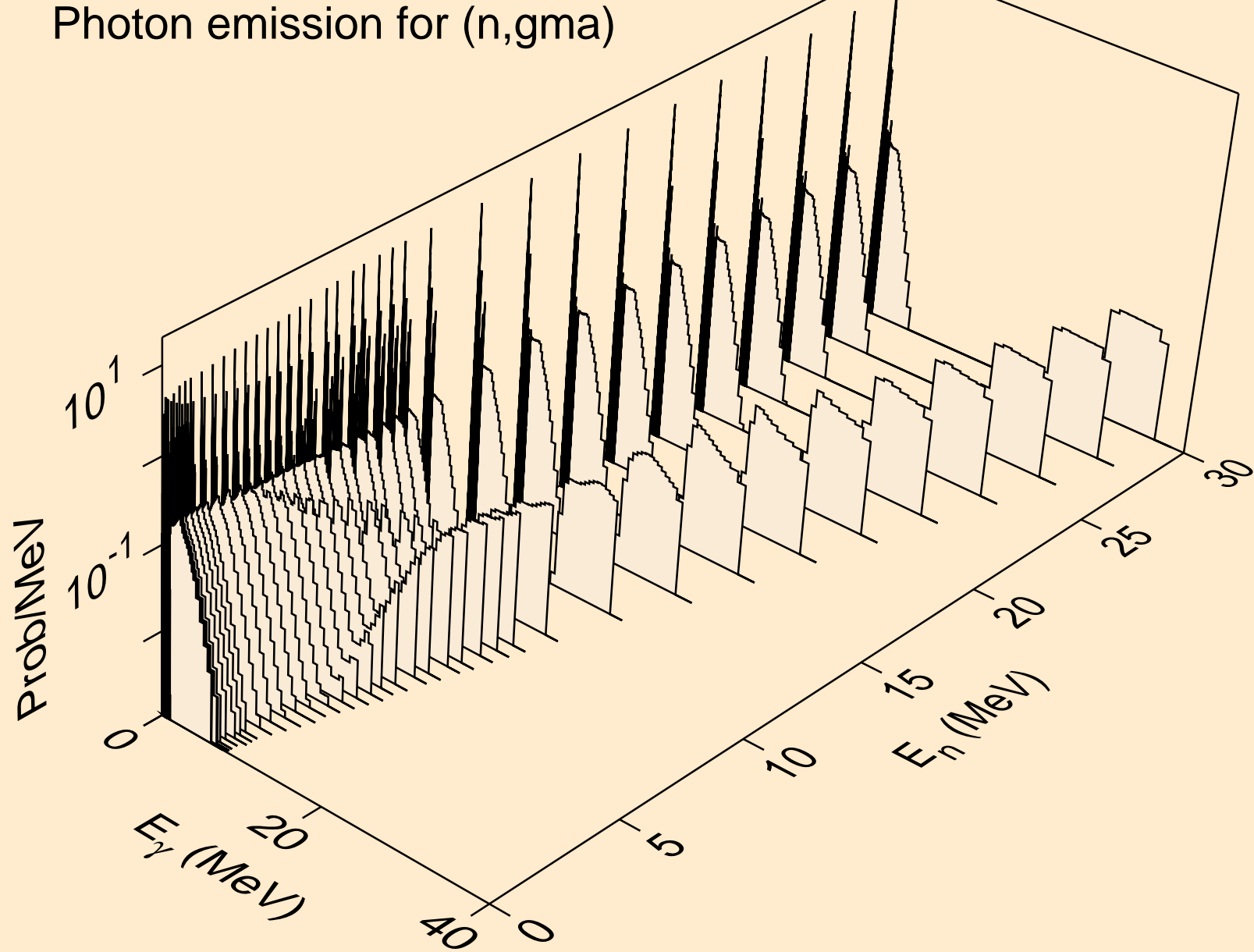

PM152 NEUTRON ACER TENDL-2024 LIBRARY; T=293.6K  
Photon emission for (n,p)

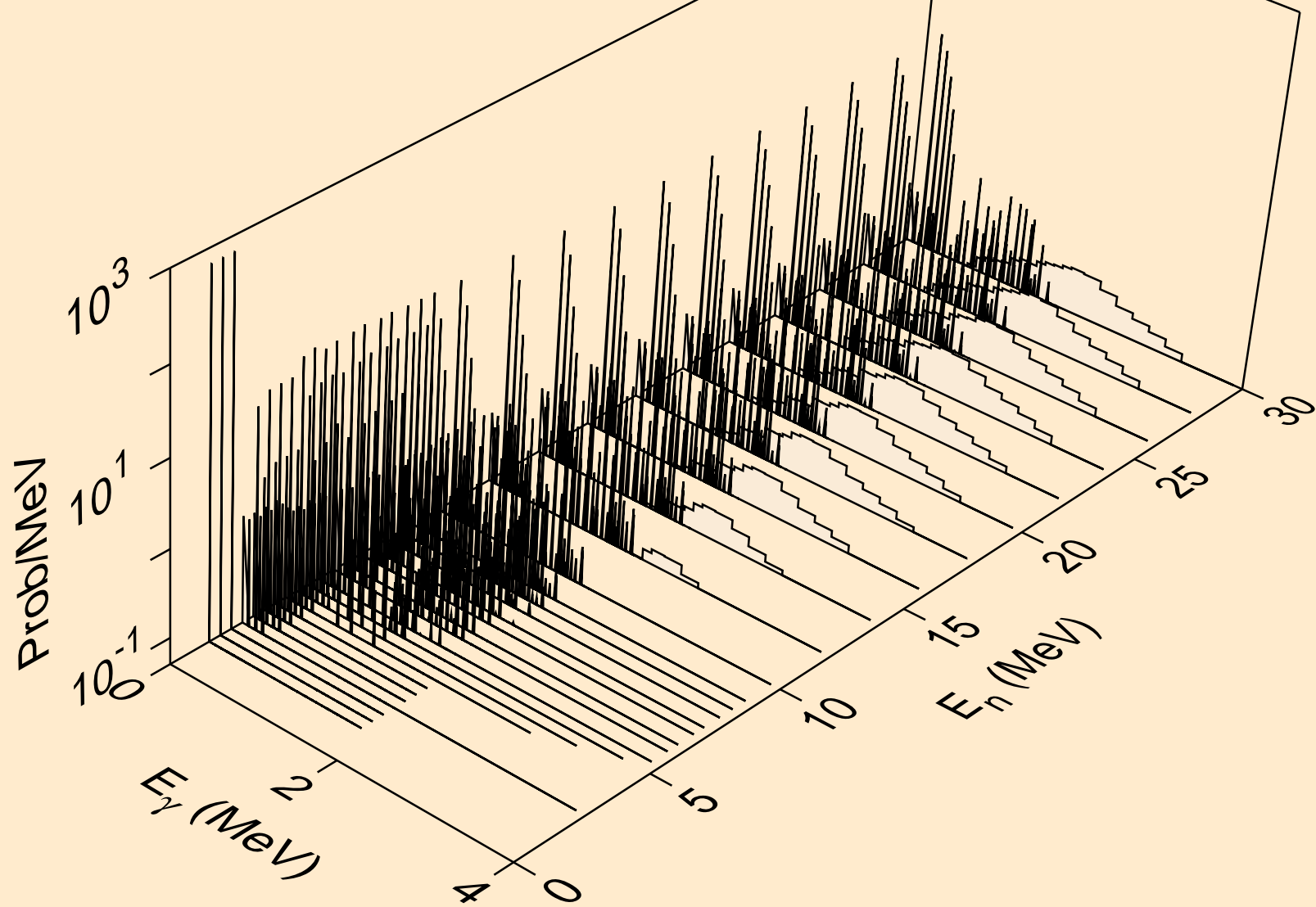

PM152 NEUTRON ACER TENDL-2024 LIBRARY; T=293.6K  
Photon emission for (n,d)

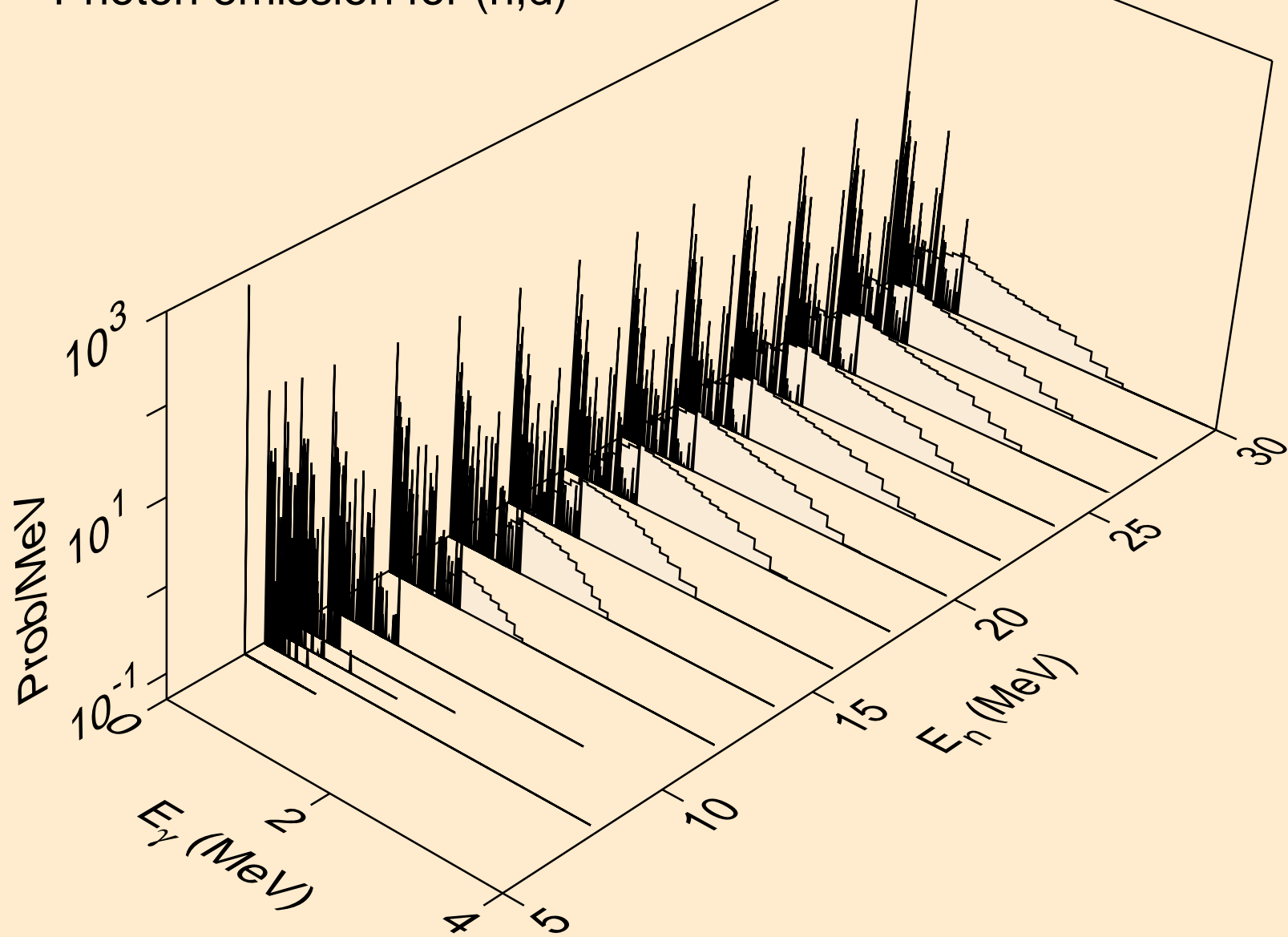

PM152 NEUTRON ACER TENDL-2024 LIBRARY; T=293.6K  
Photon emission for (n,t)

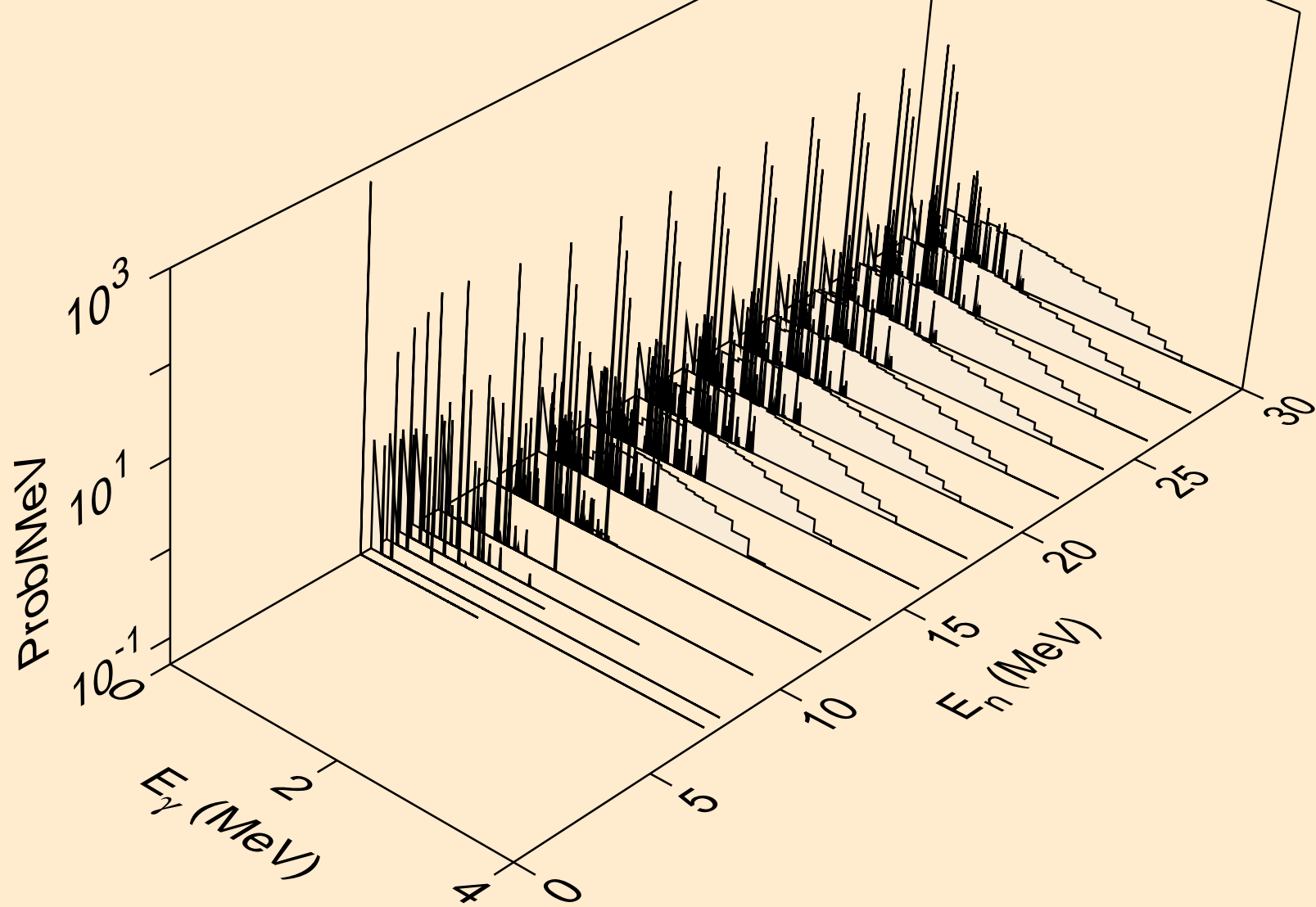

PM152 NEUTRON ACER TENDL-2024 LIBRARY; T=293.6K  
Photon emission for (n,he3)

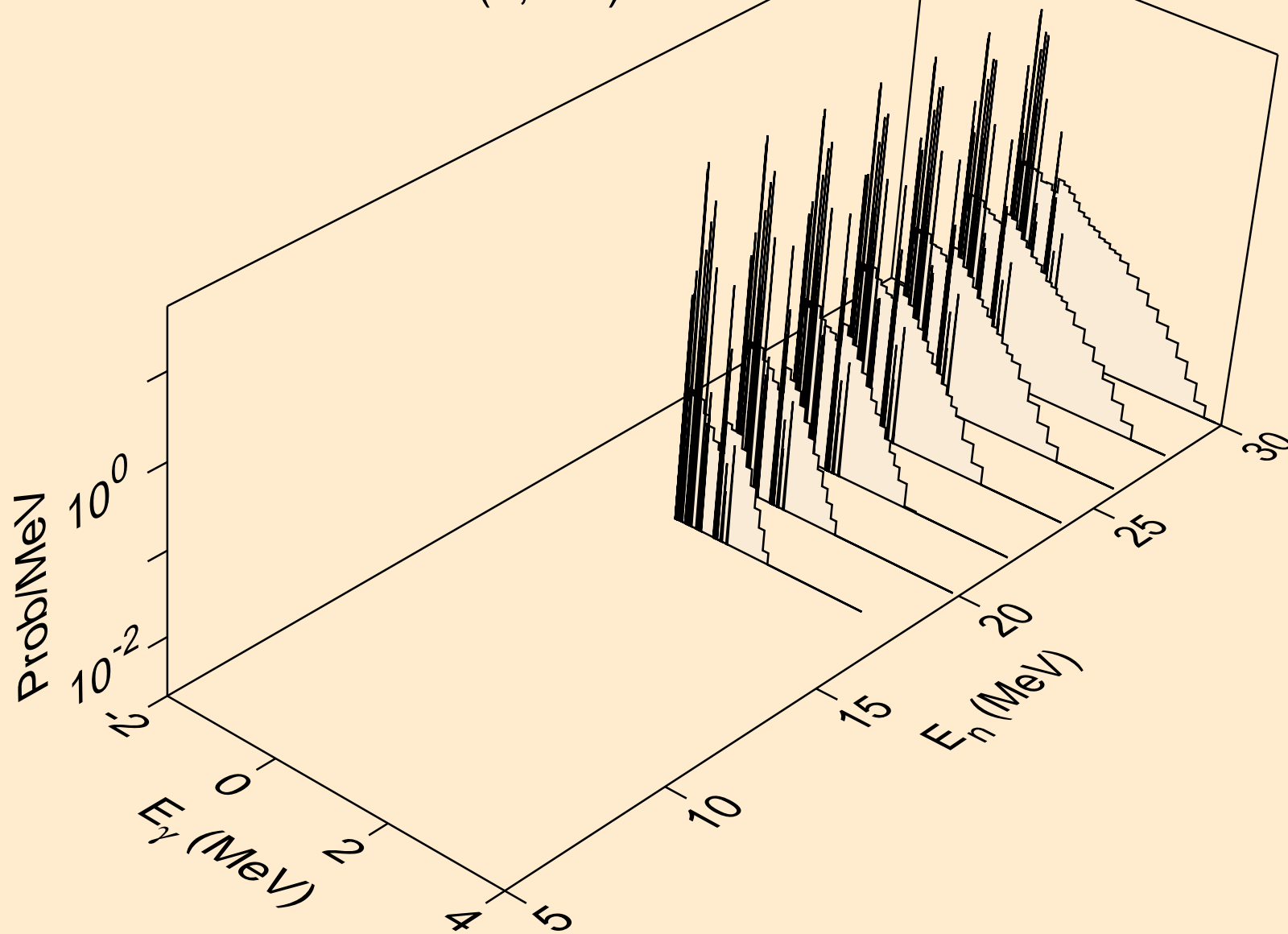

PM152 NEUTRON ACER TENDL-2024 LIBRARY; T=293.6K  
Photon emission for (n,a)

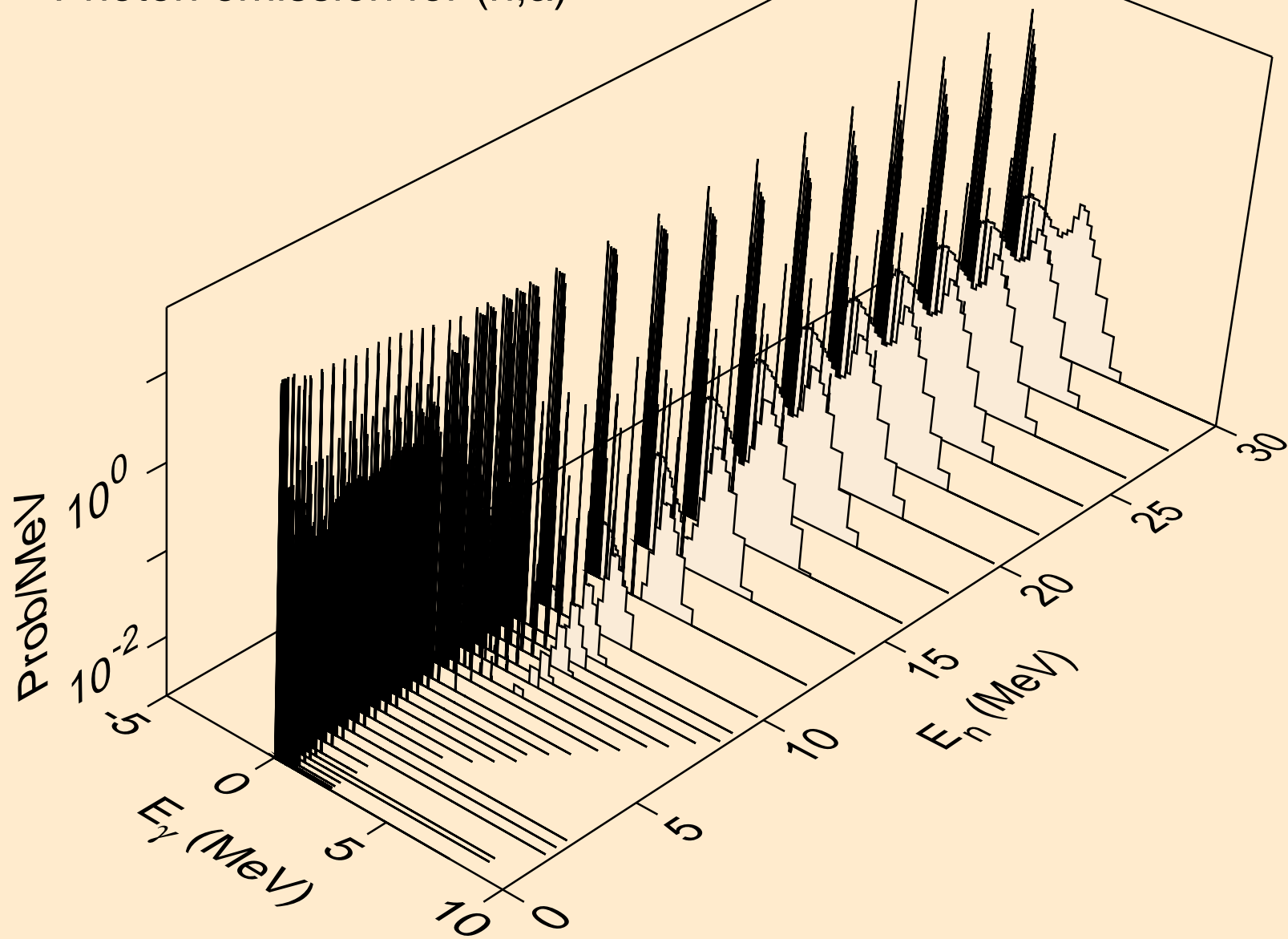

PM152 NEUTRON ACER TENDL-2024 LIBRARY; T=293.6K  
Photon emission for (n,2p)

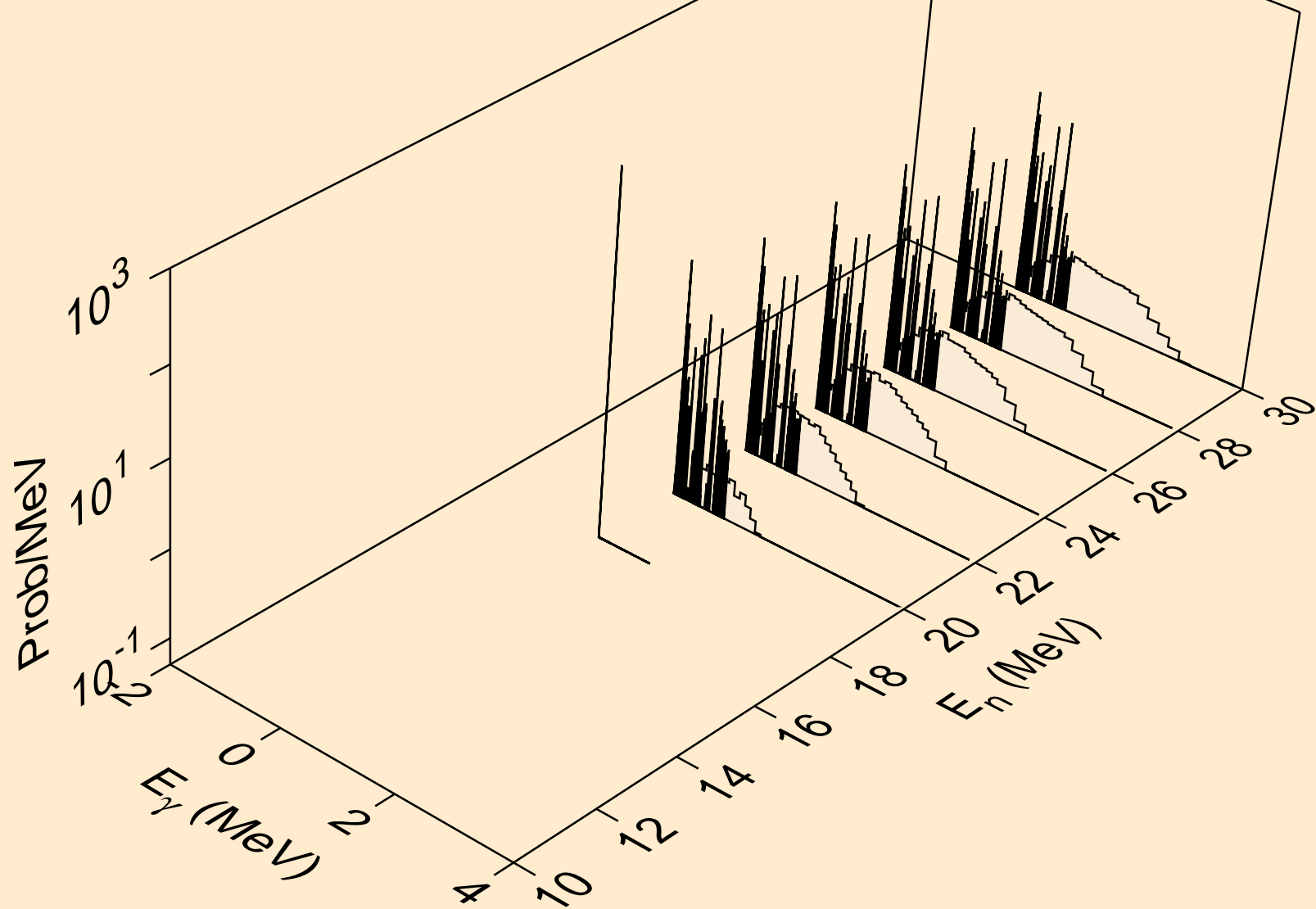

PM152 NEUTRON ACER TENDL-2024 LIBRARY; T=293.6K  
Photon emission for (n,p $\alpha$ )

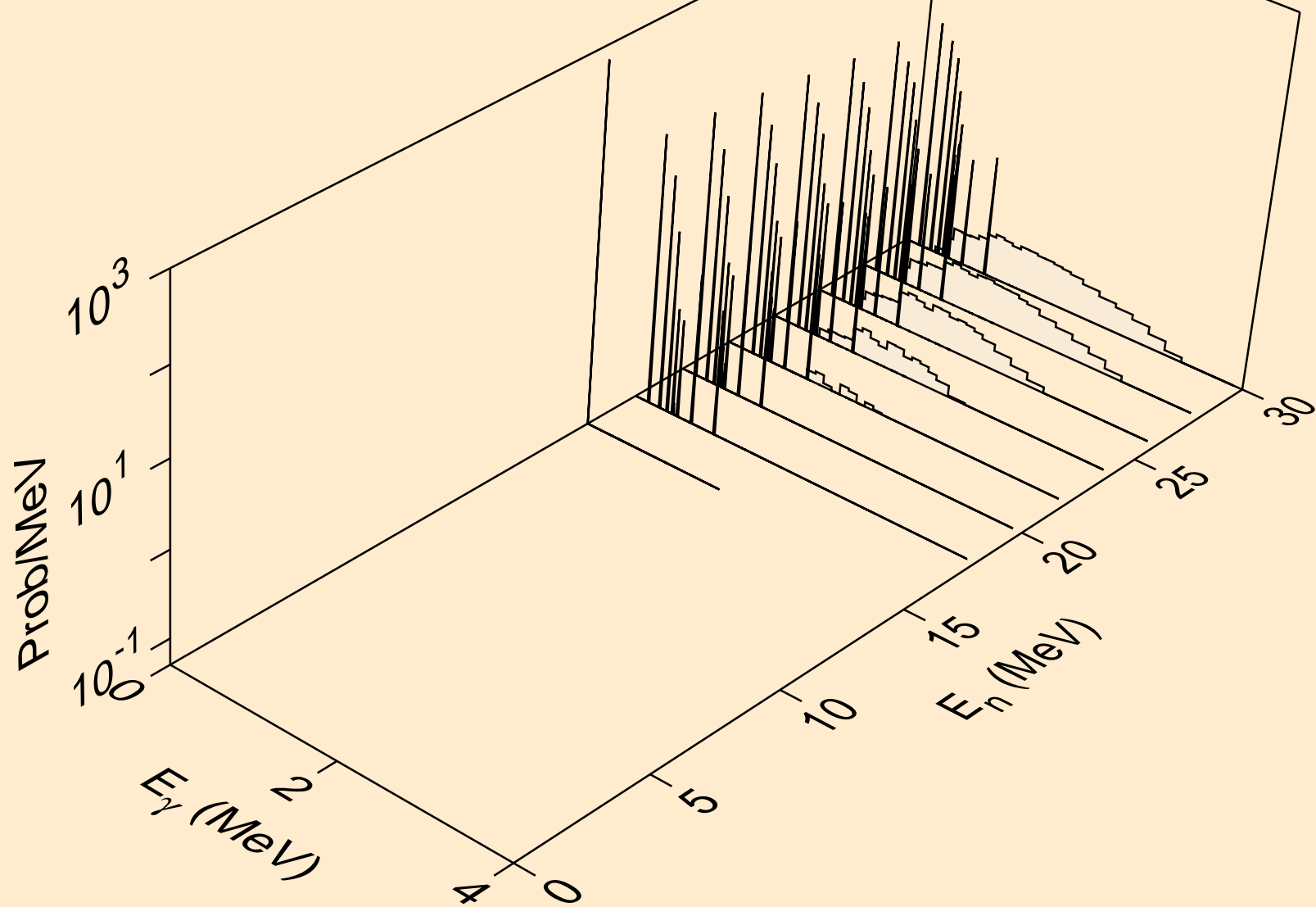

PM152 NEUTRON ACER TENDL-2024 LIBRARY; T=293.6K  
thermal capture photon spectrum

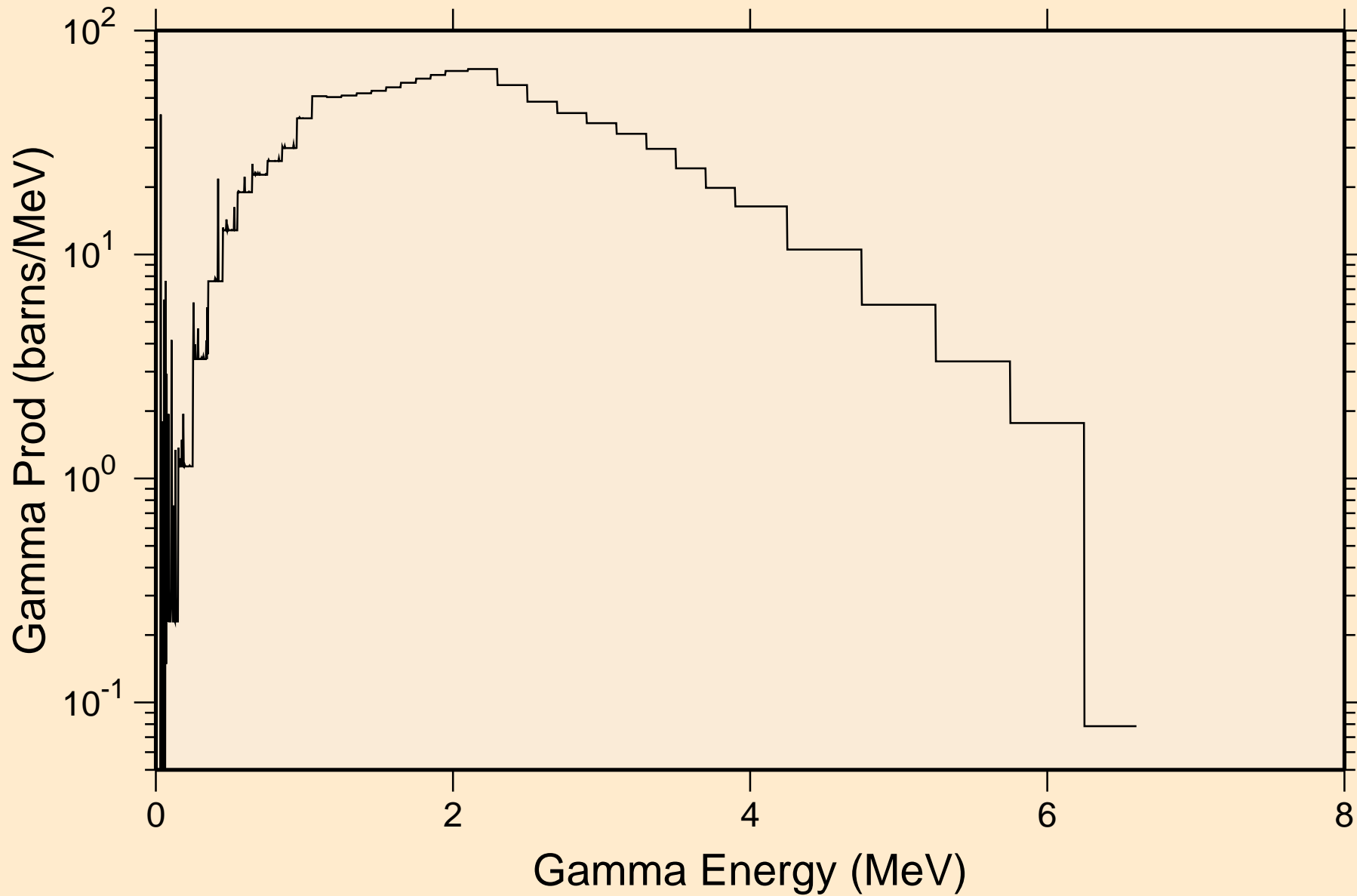

PM152 NEUTRON ACER TENDL-2024 LIBRARY; T=293.6K  
14 MeV photon spectrum

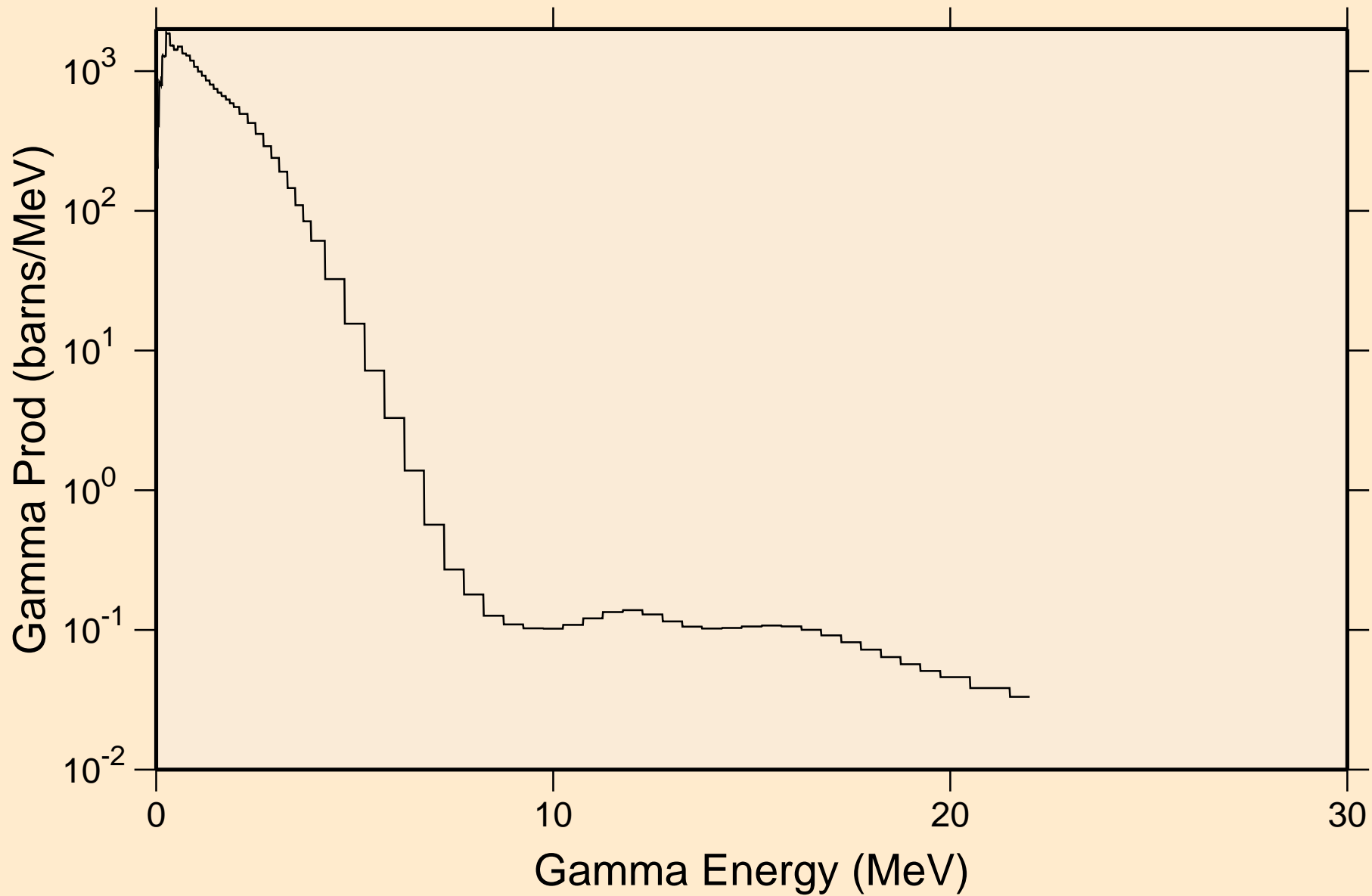

PM152 NEUTRON ACER TENDL-2024 LIBRARY; T=293.6K  
Particle heating contributions

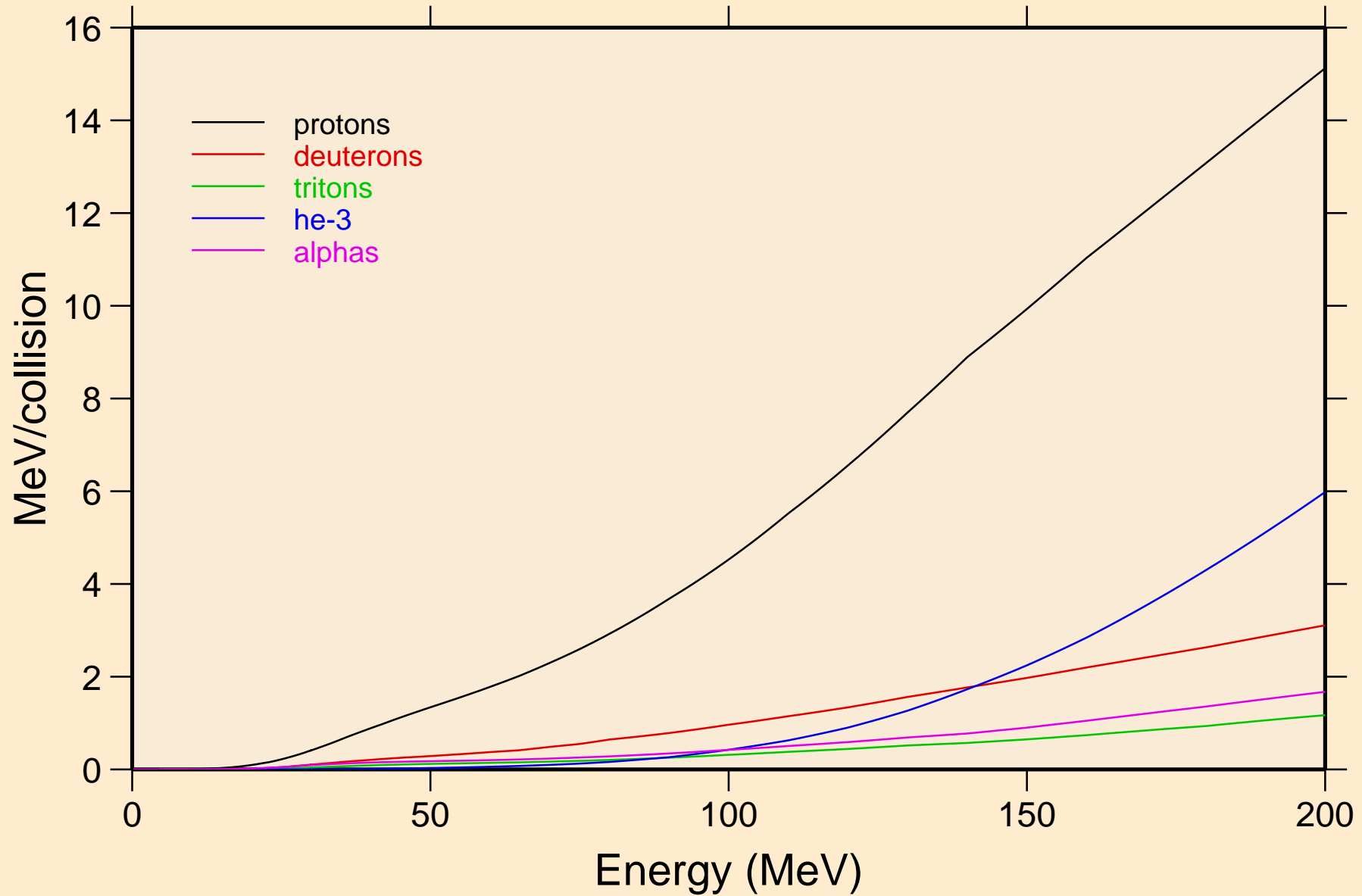

PM152 NEUTRON ACER TENDL-2024 LIBRARY; T=293.6K  
Recoil Heating

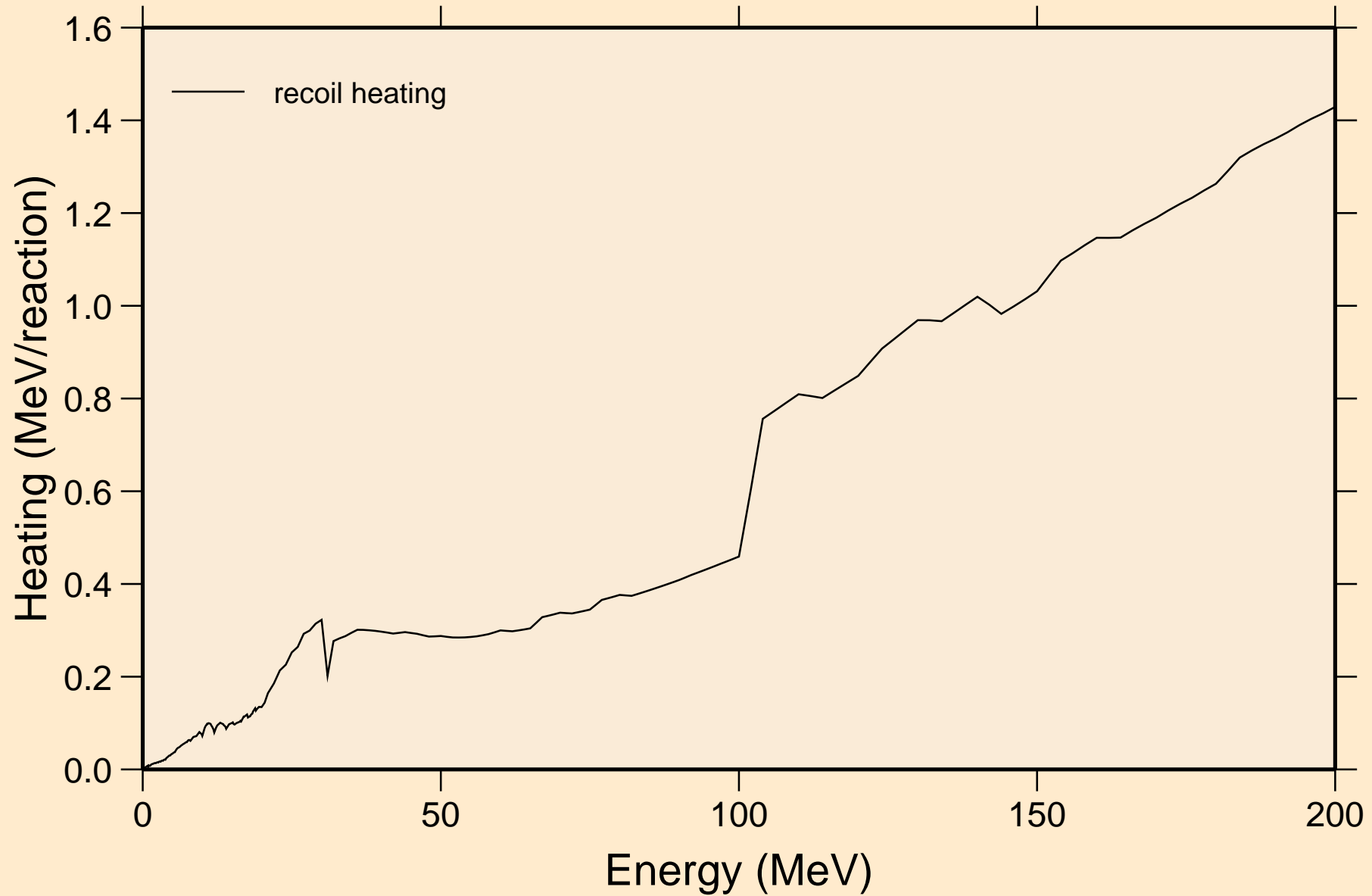

# PM152 NEUTRON ACER TENDL-2024 LIBRARY; T=293.6K

## Particle production cross sections

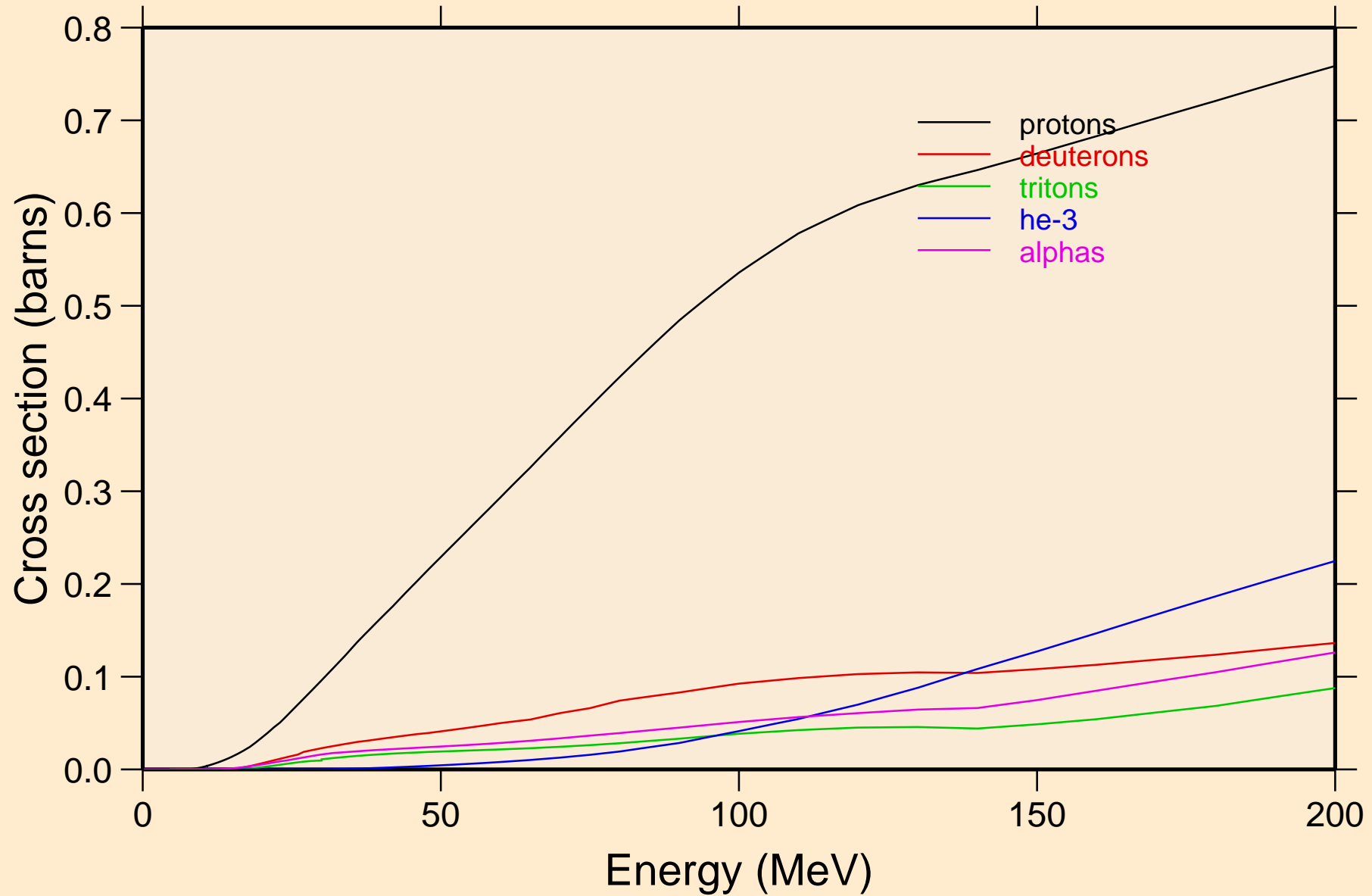

PM152 NEUTRON ACER TENDL-2024 LIBRARY; T=293.6K  
protons from (n,x)

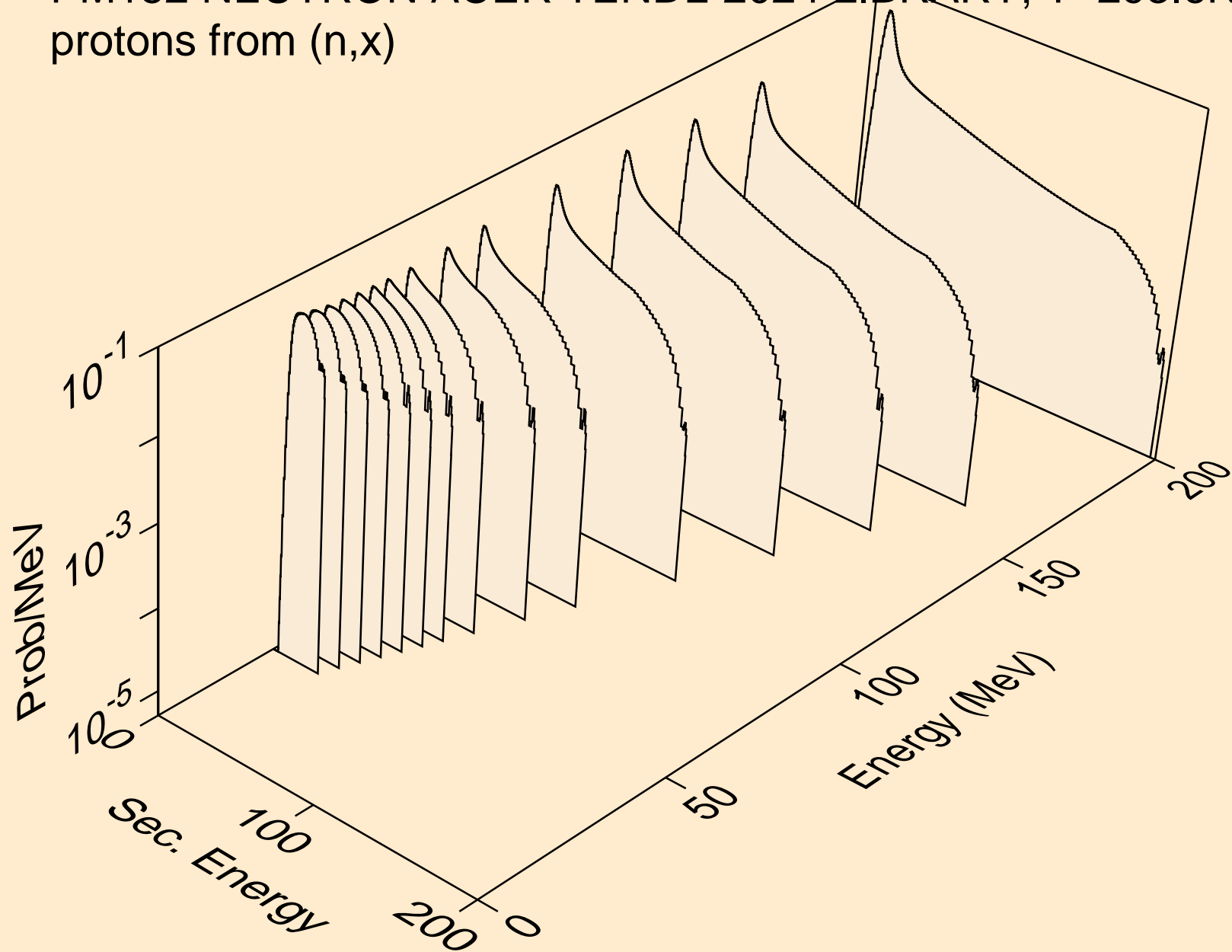

PM152 NEUTRON ACER TENDL-2024 LIBRARY; T=293.6K  
protons from (n,n\*)p

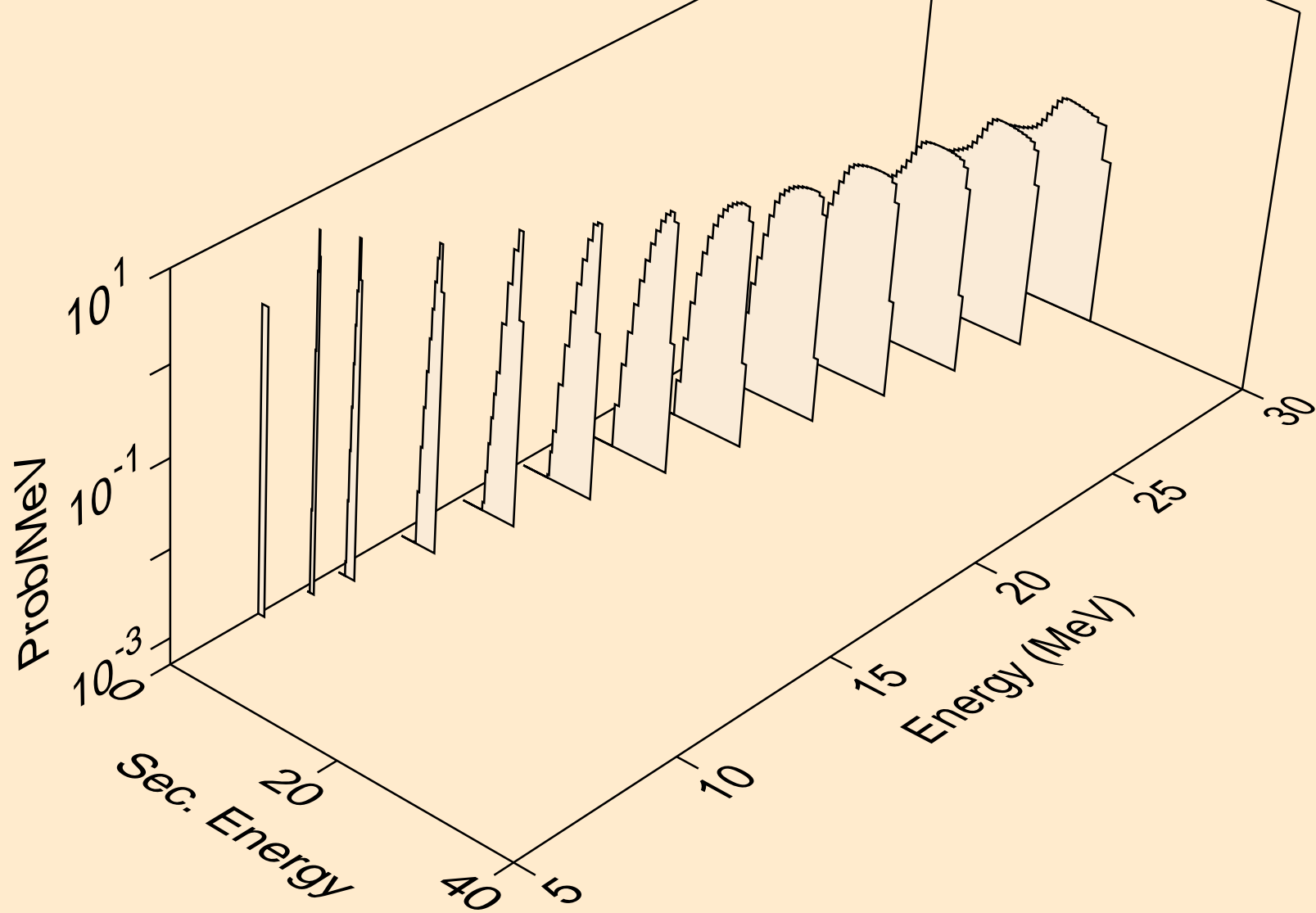

PM152 NEUTRON ACER TENDL-2024 LIBRARY; T=293.6K  
protons from (n,2np)

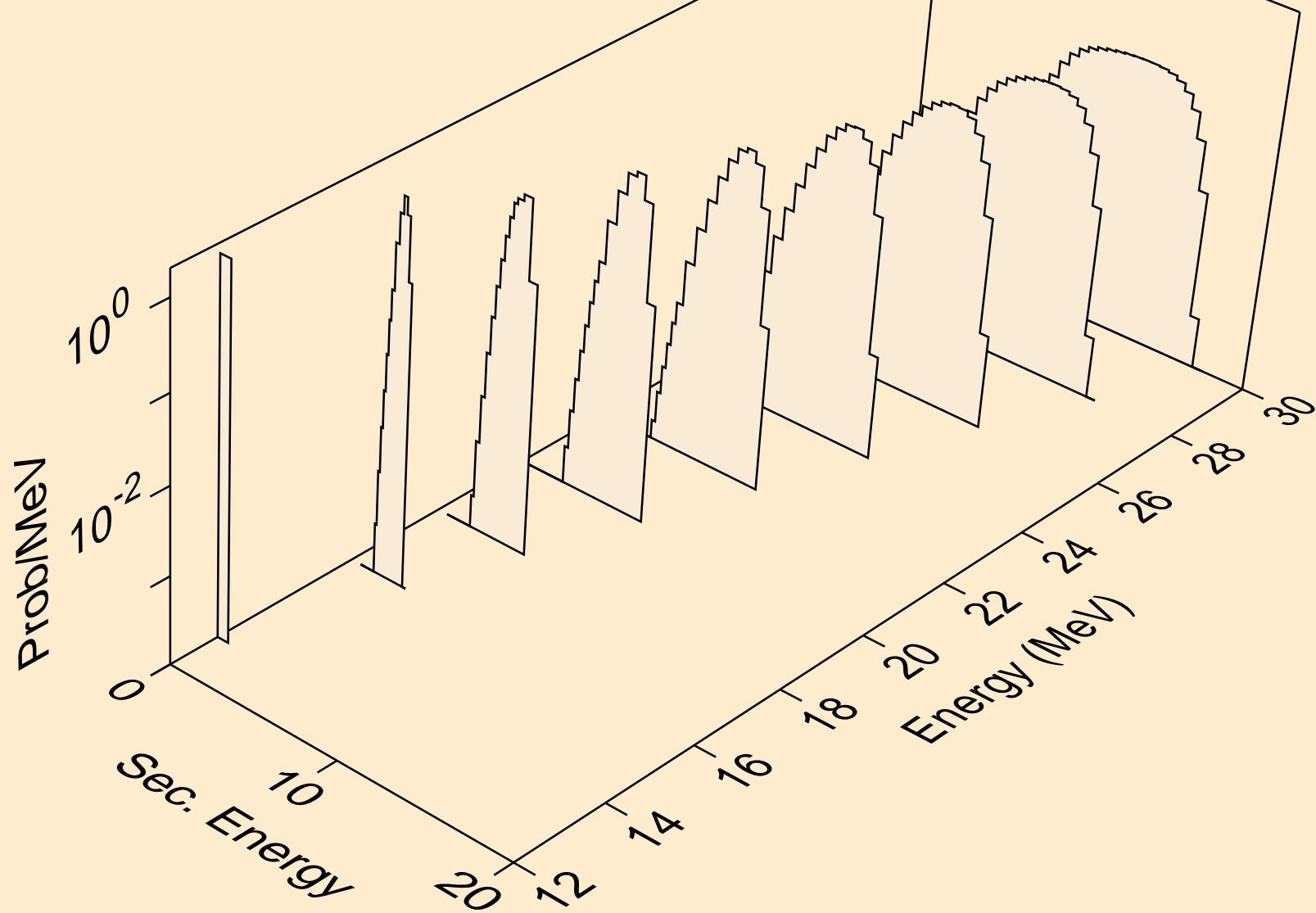

PM152 NEUTRON ACER TENDL-2024 LIBRARY; T=293.6K  
protons from (n,3np)

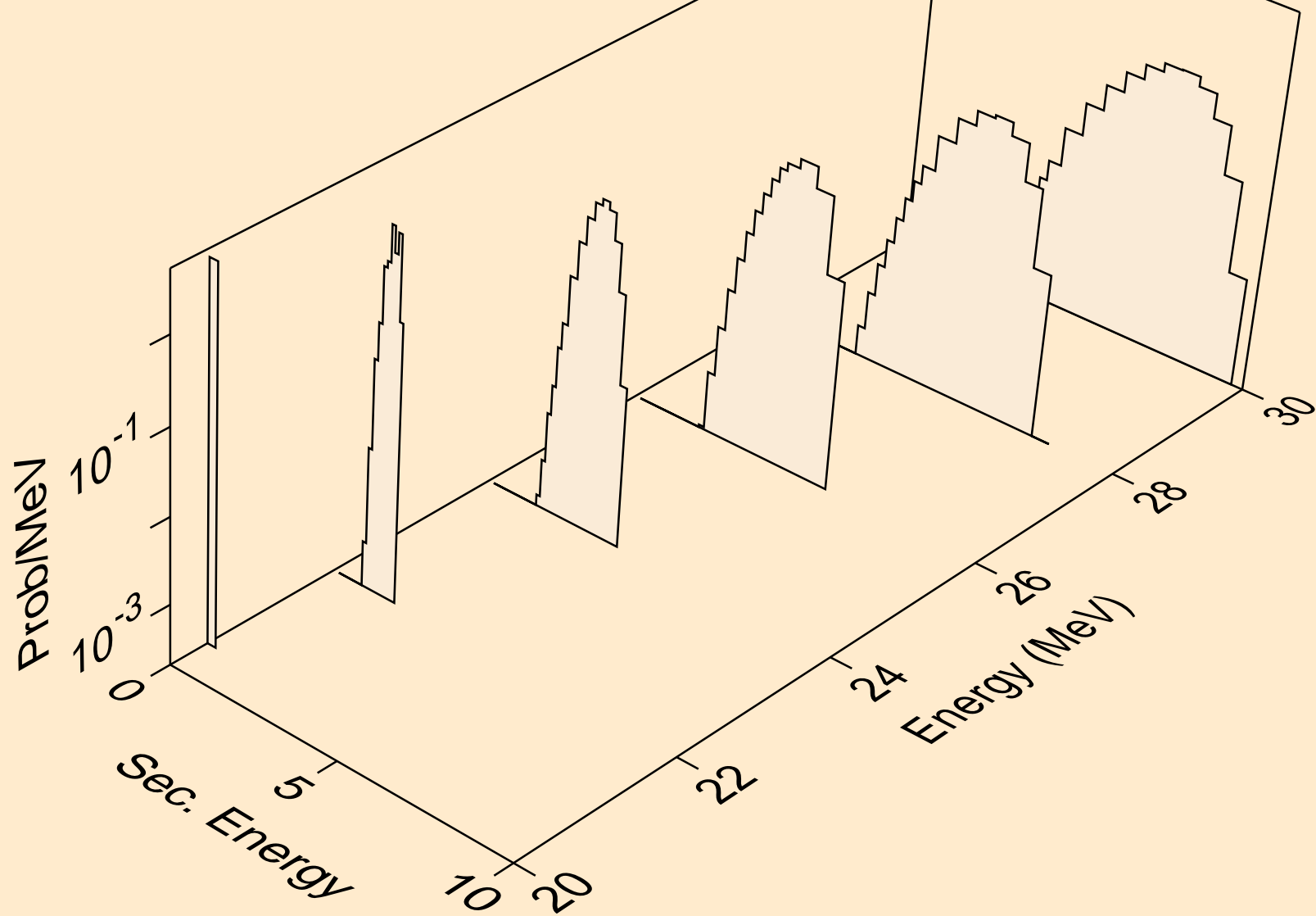

PM152 NEUTRON ACER TENDL-2024 LIBRARY; T=293.6K  
protons from (n,n2p)

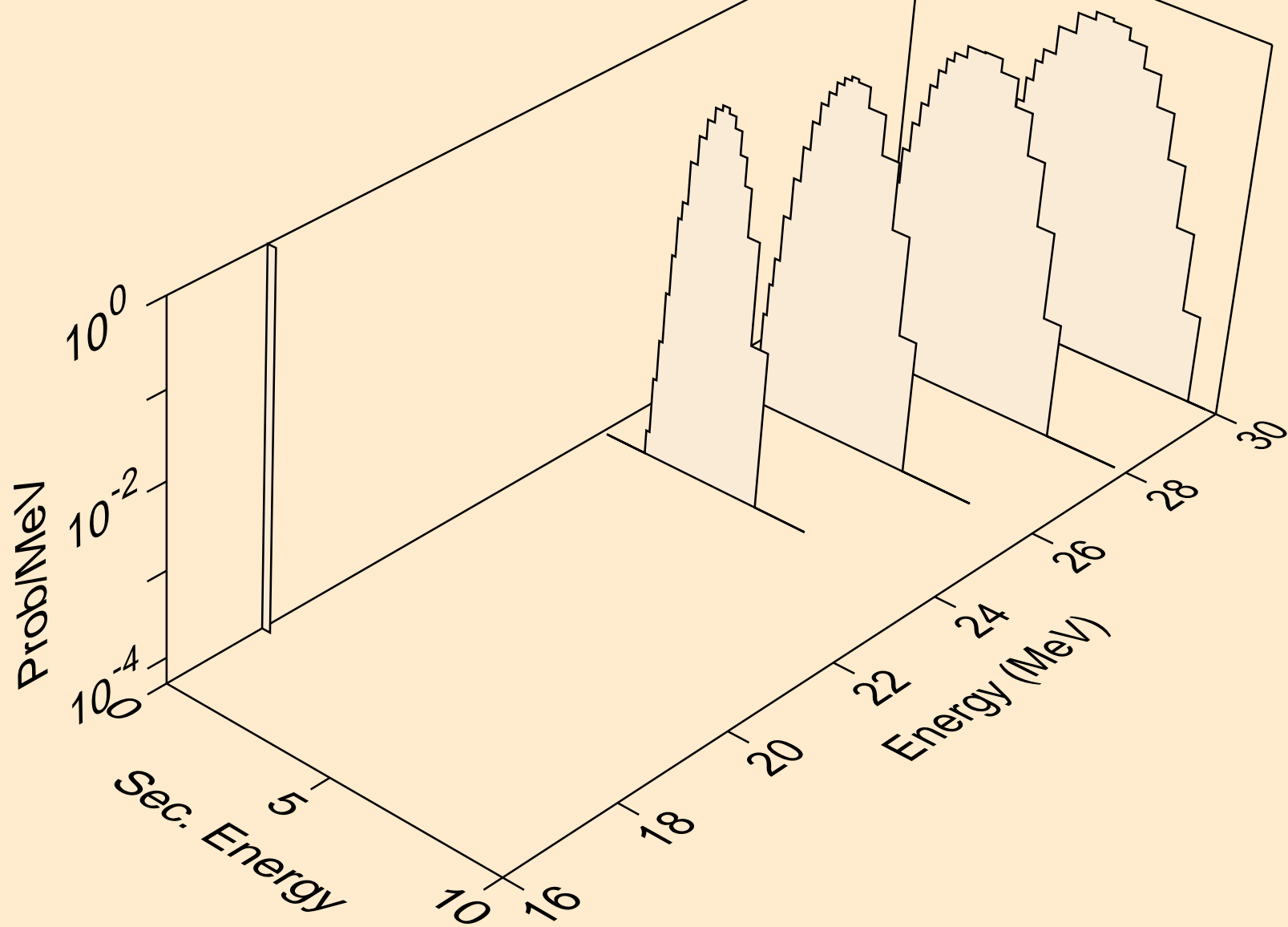

PM152 NEUTRON ACER TENDL-2024 LIBRARY; T=293.6K  
protons from (n,p)

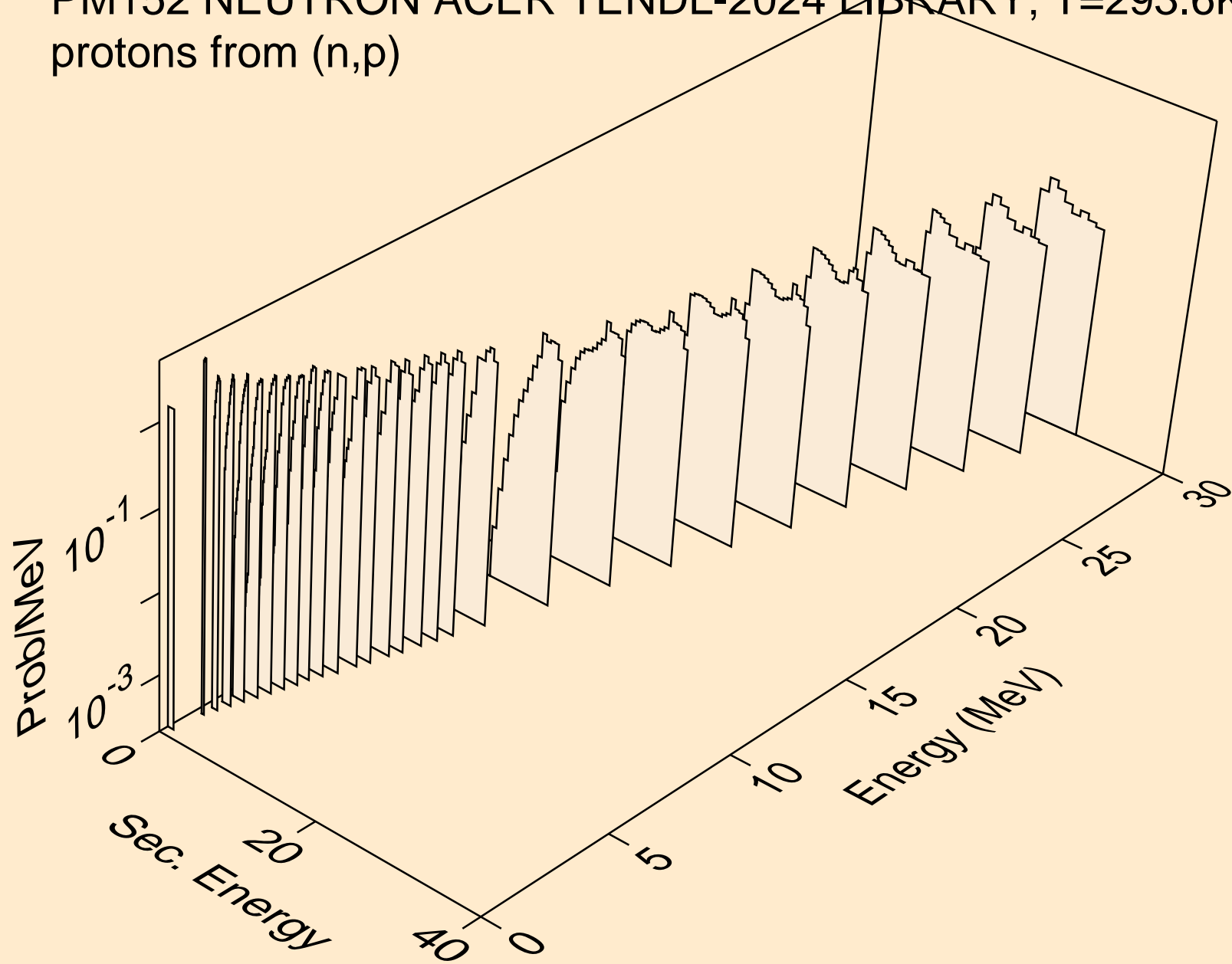

PM152 NEUTRON ACER TENDL-2024 LIBRARY; T=293.6K  
protons from (n,2p)

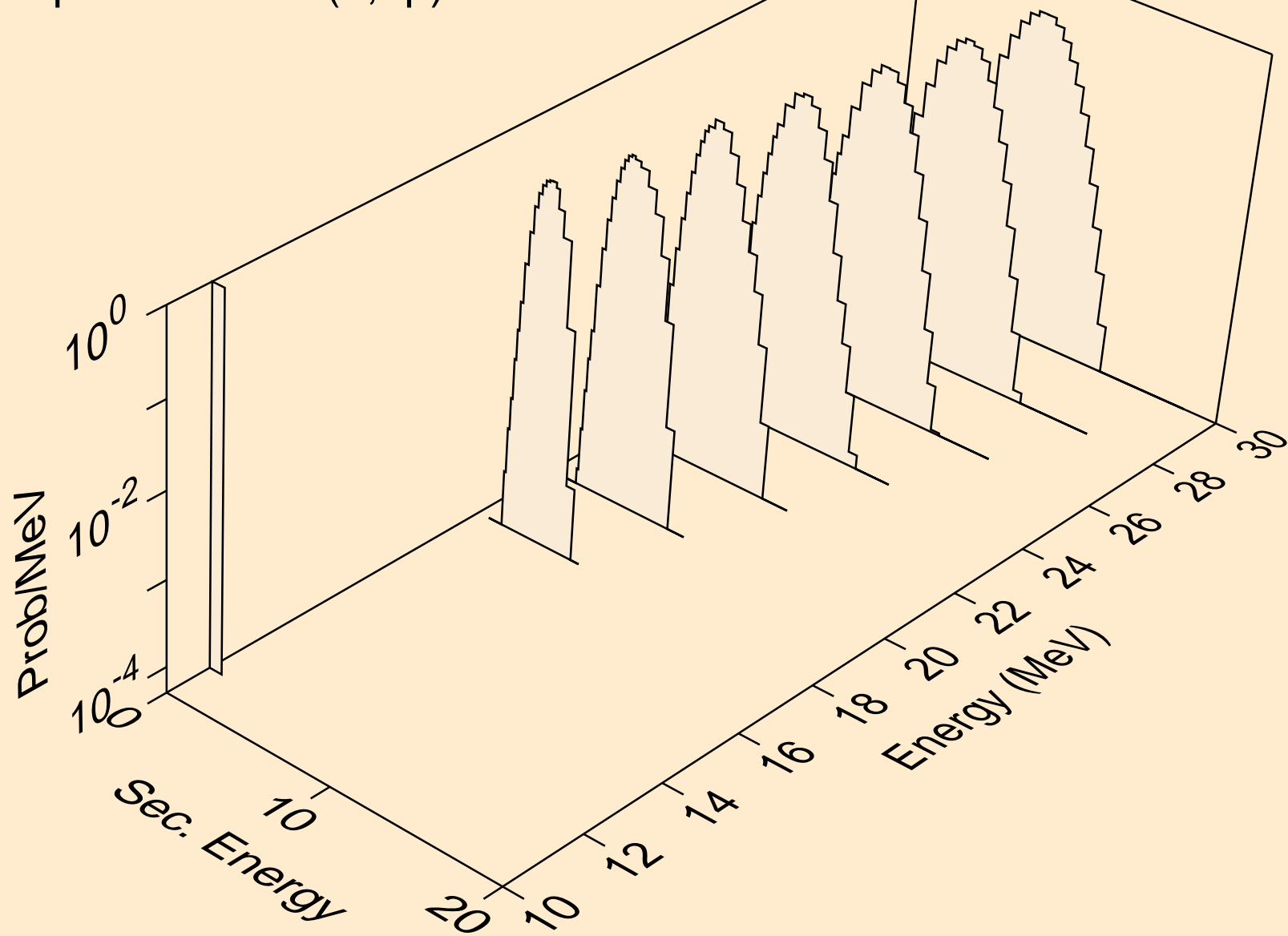

PM152 NEUTRON ACER TENDL-2024 LIBRARY; T=293.6K  
protons from (n,p)

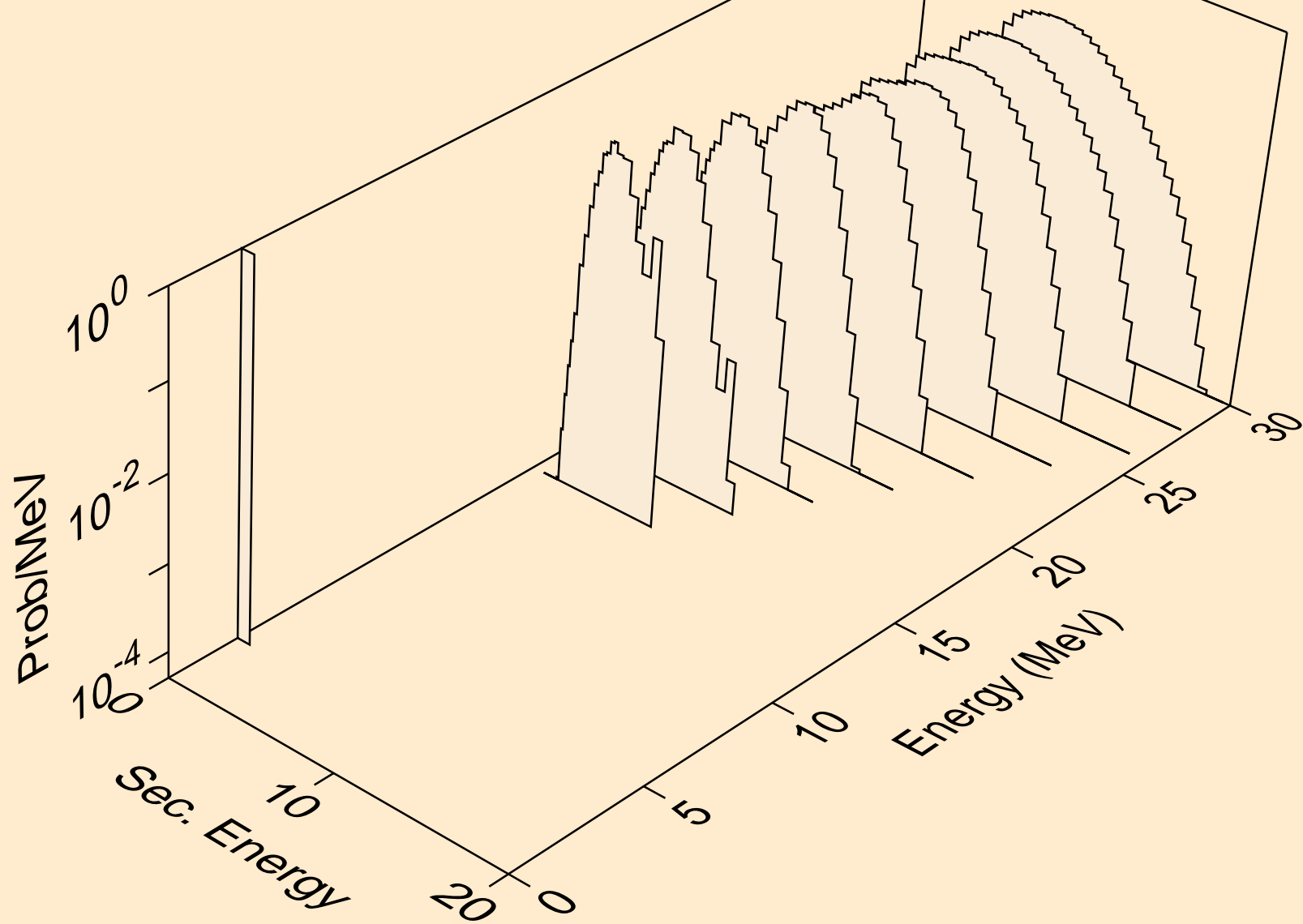

PM152 NEUTRON ACER TENDL-2024 LIBRARY; T=293.6K  
deuterons from (n,x)

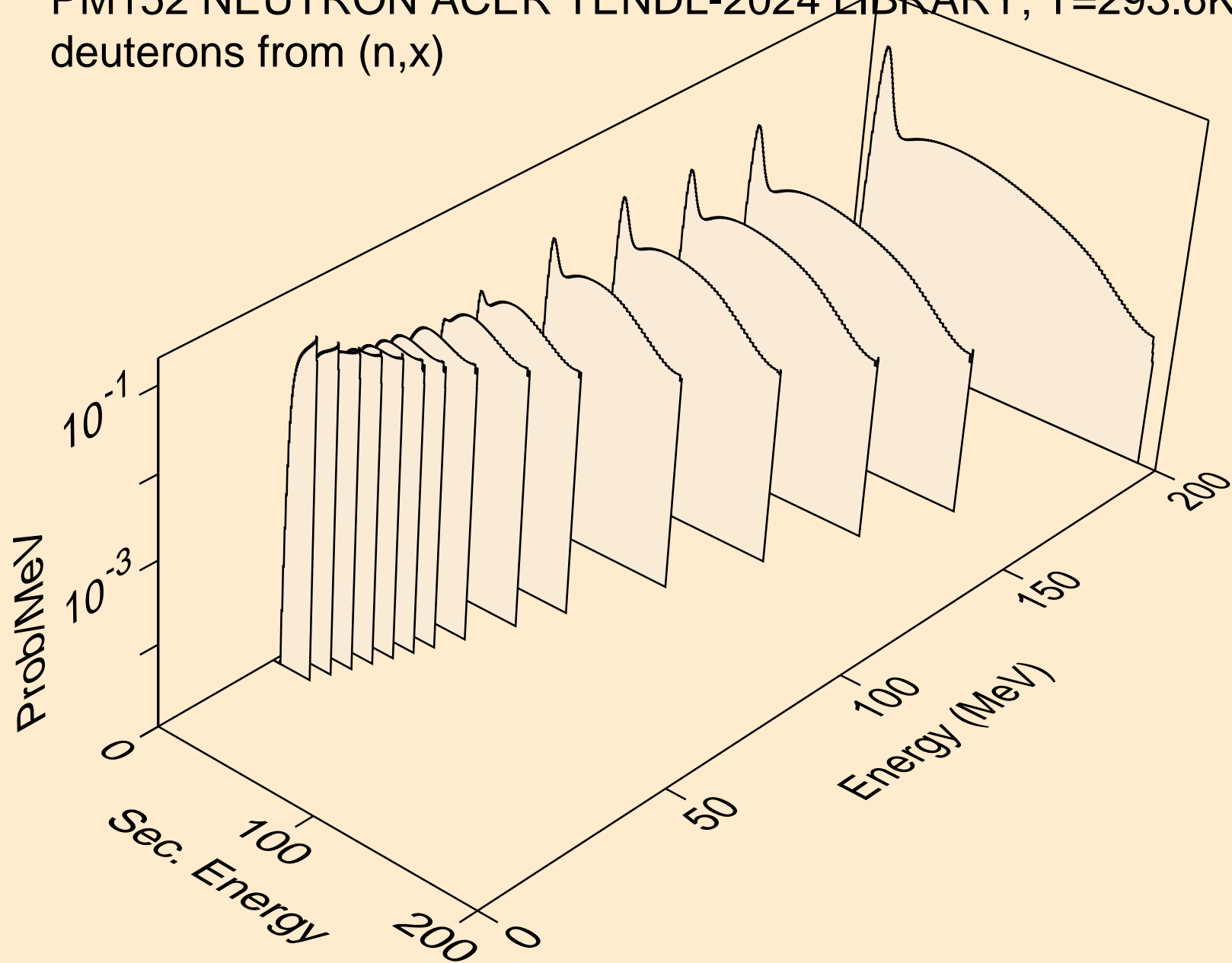

PM152 NEUTRON ACER TENDL-2024 LIBRARY; T=293.6K  
deuterons from (n,2nd)

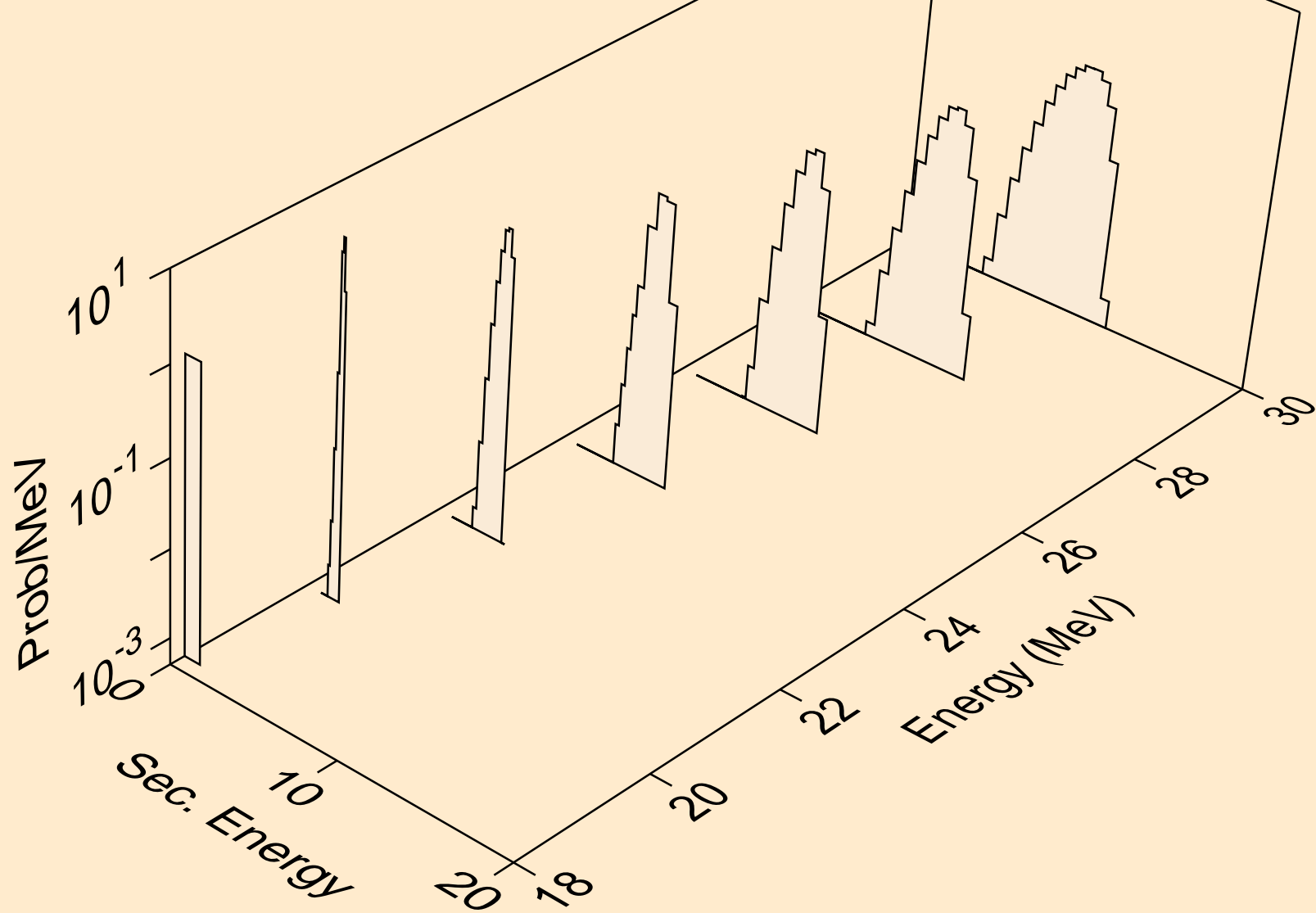

PM152 NEUTRON ACER TENDL-2024 LIBRARY; T=293.6K  
deuterons from (n,n\*)d

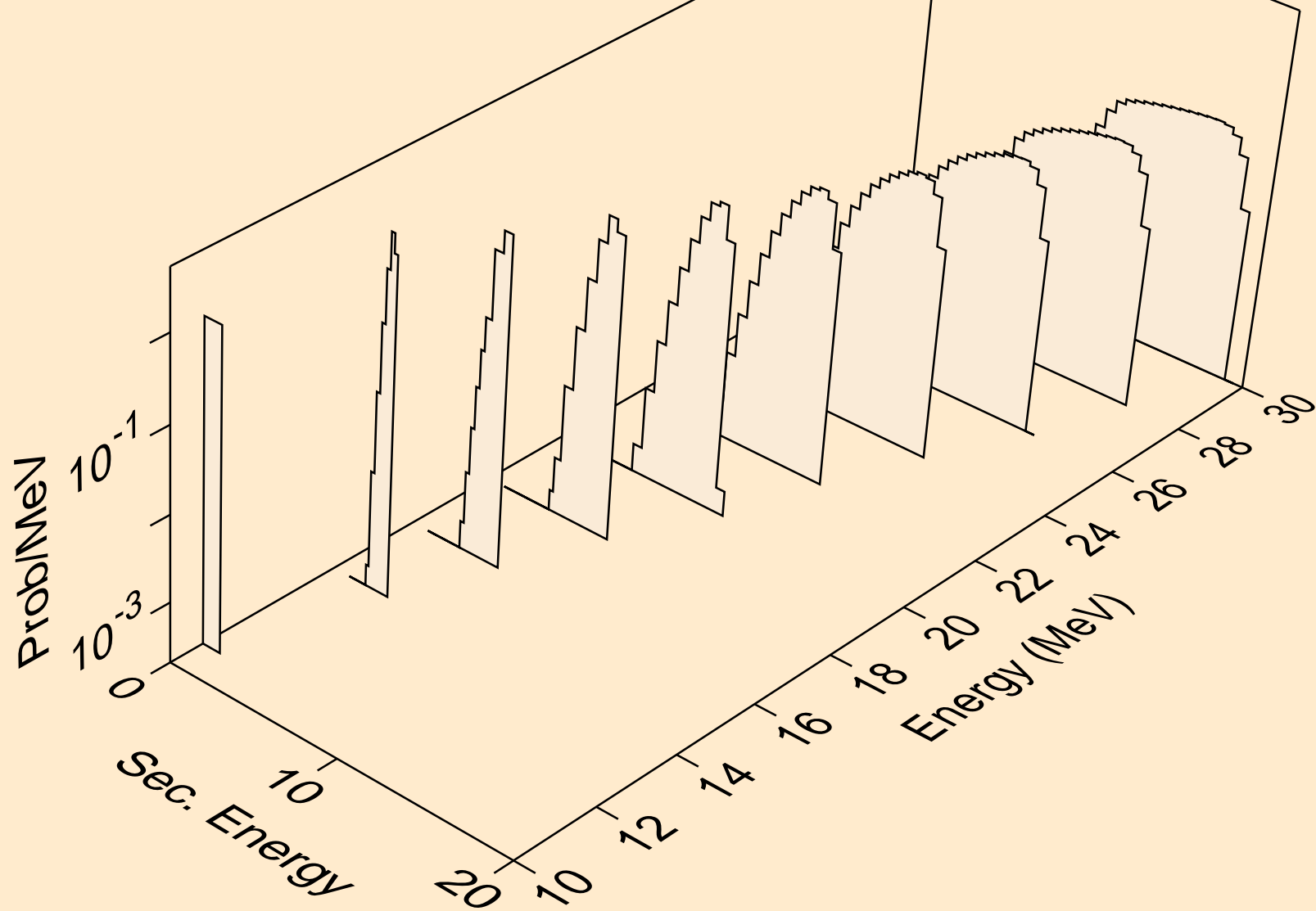

PM152 NEUTRON ACER TENDL-2024 LIBRARY; T=293.6K  
deuterons from (n,d)

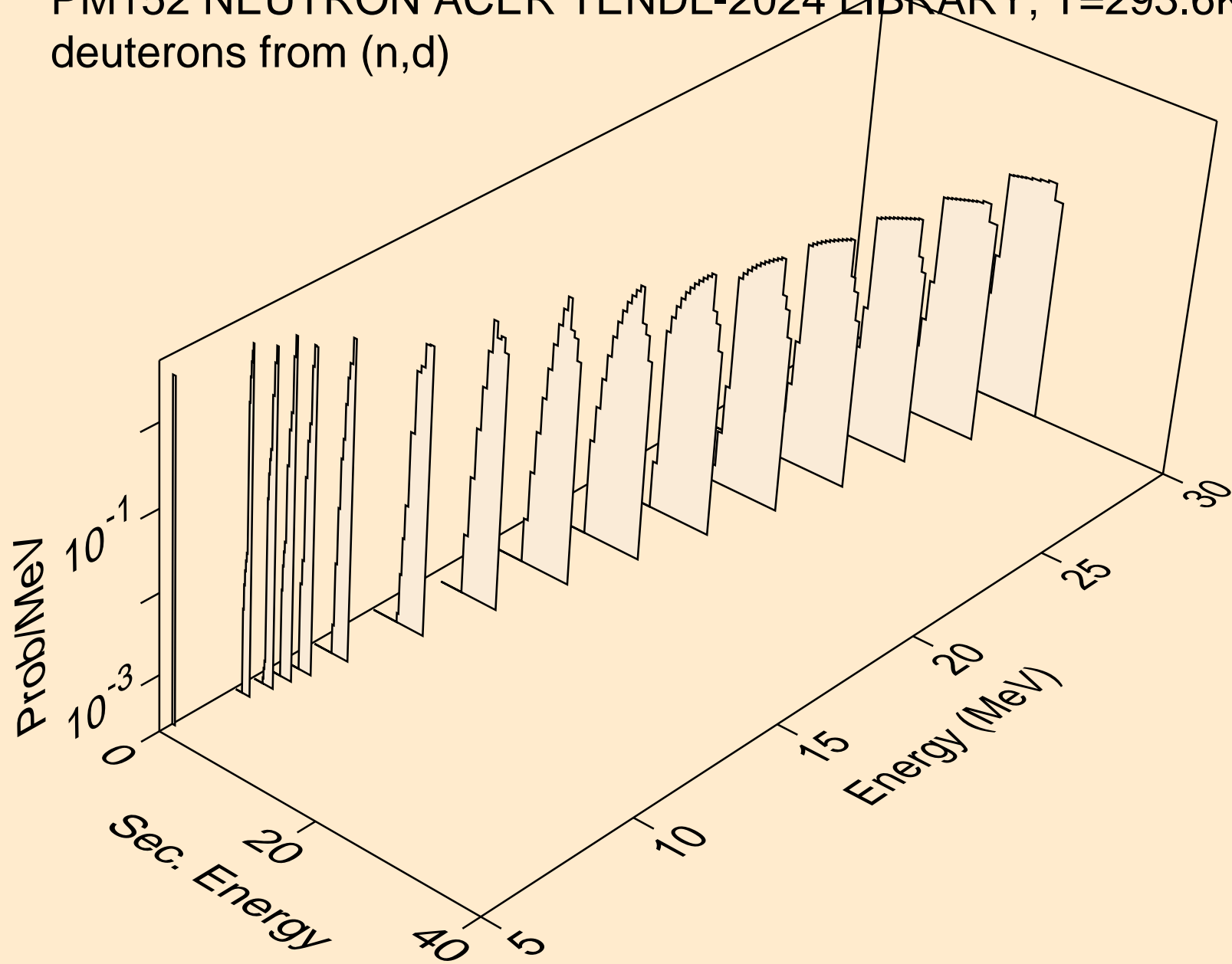

PM152 NEUTRON ACER TENDL-2024 LIBRARY; T=293.6K  
tritons from (n,x)

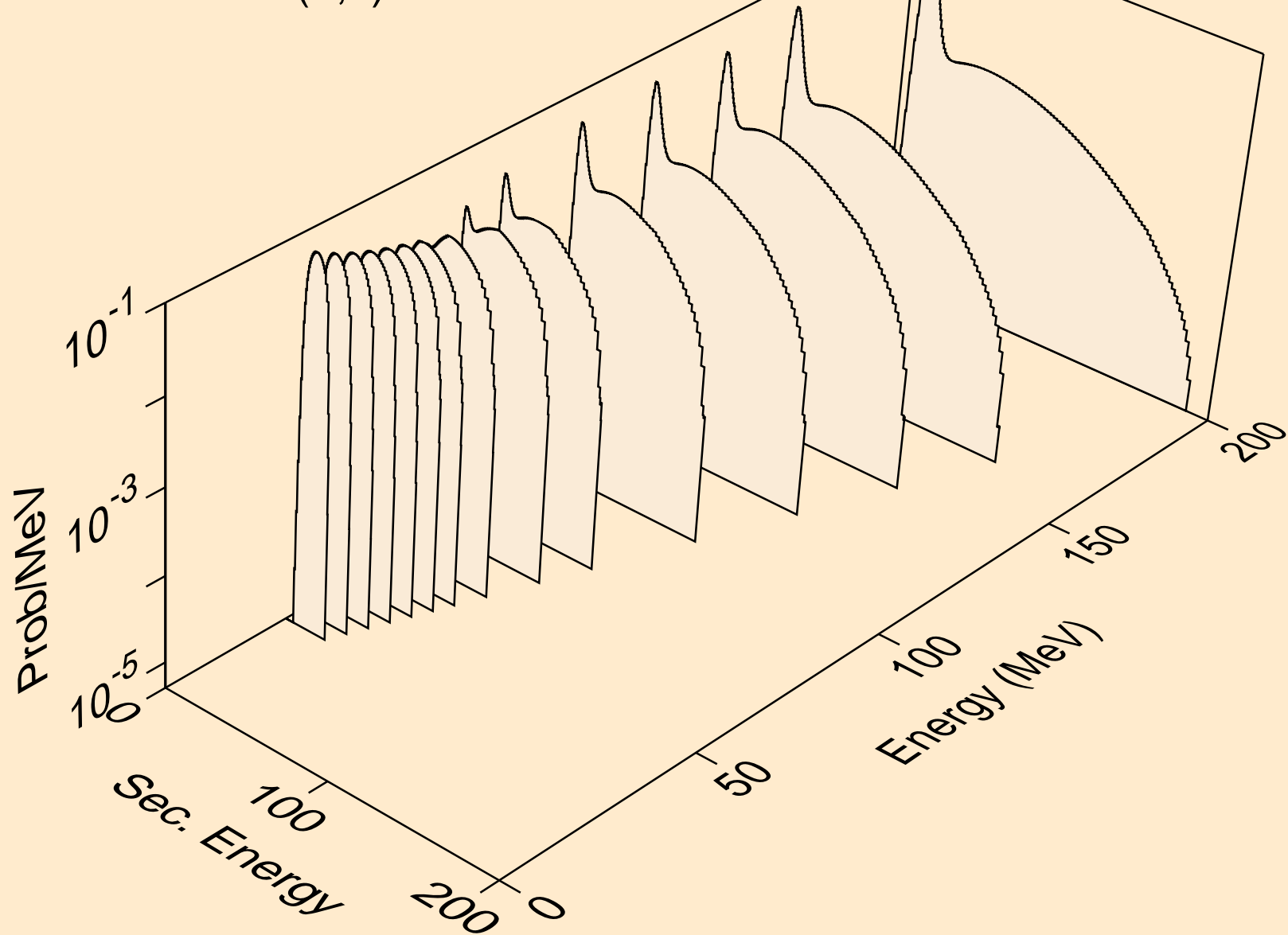

PM152 NEUTRON ACER TENDL-2024 LIBRARY; T=293.6K  
tritons from (n,n\*)t

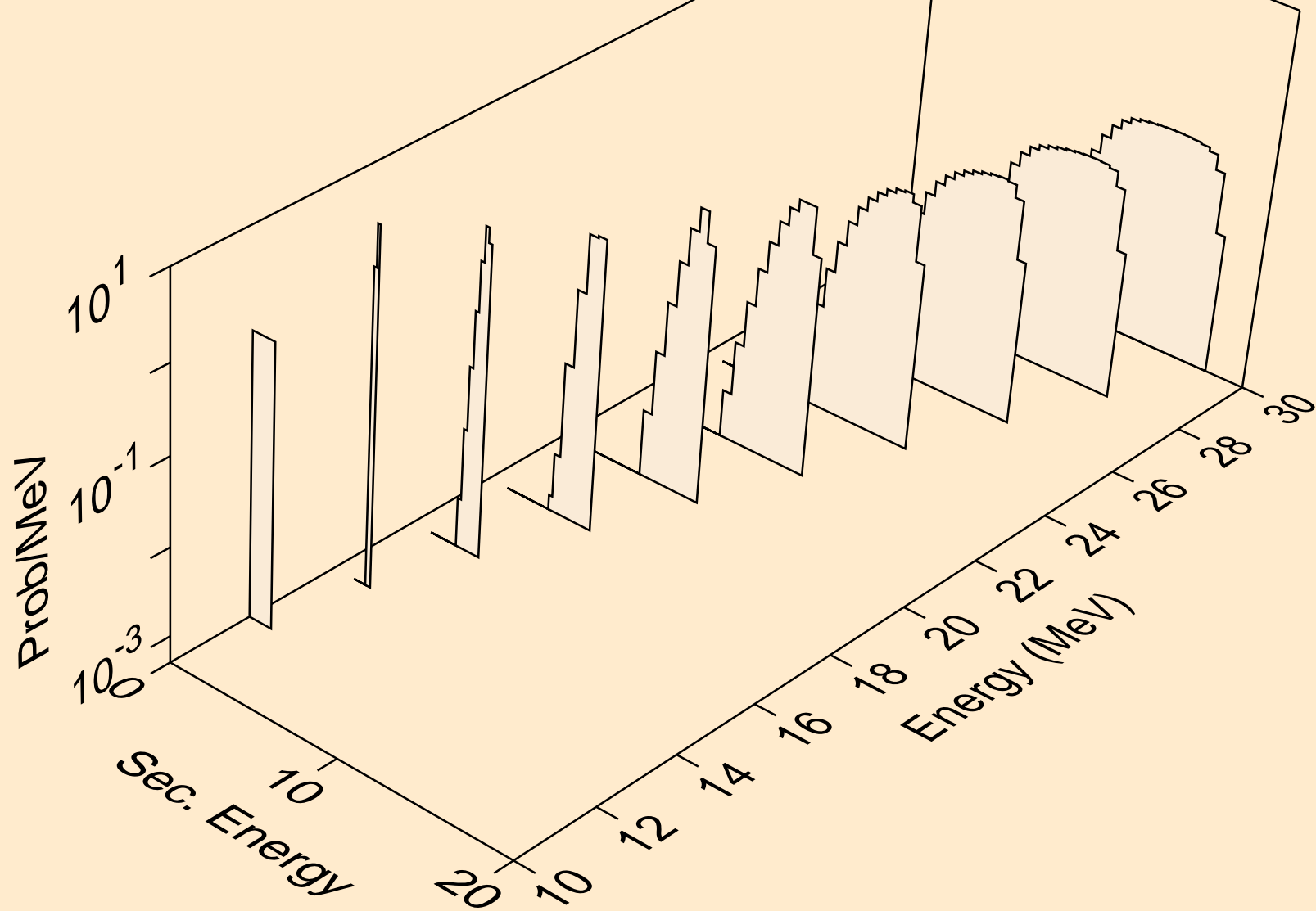

PM152 NEUTRON ACER TENDL-2024 LIBRARY; T=293.6K  
tritons from (n,t)

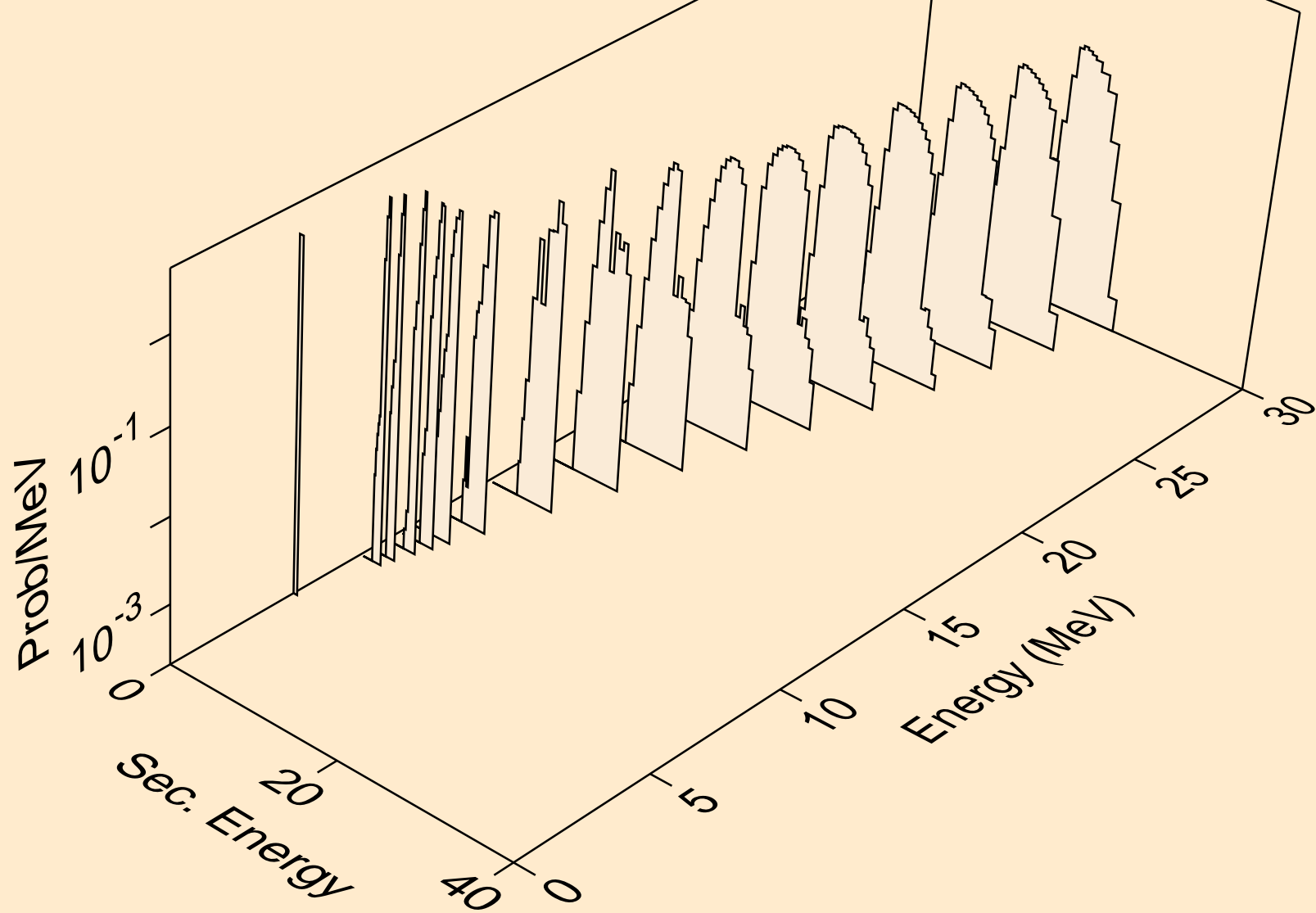

PM152 NEUTRON ACER TENDL-2024 LIBRARY; T=293.6K  
he3s from (n,x)

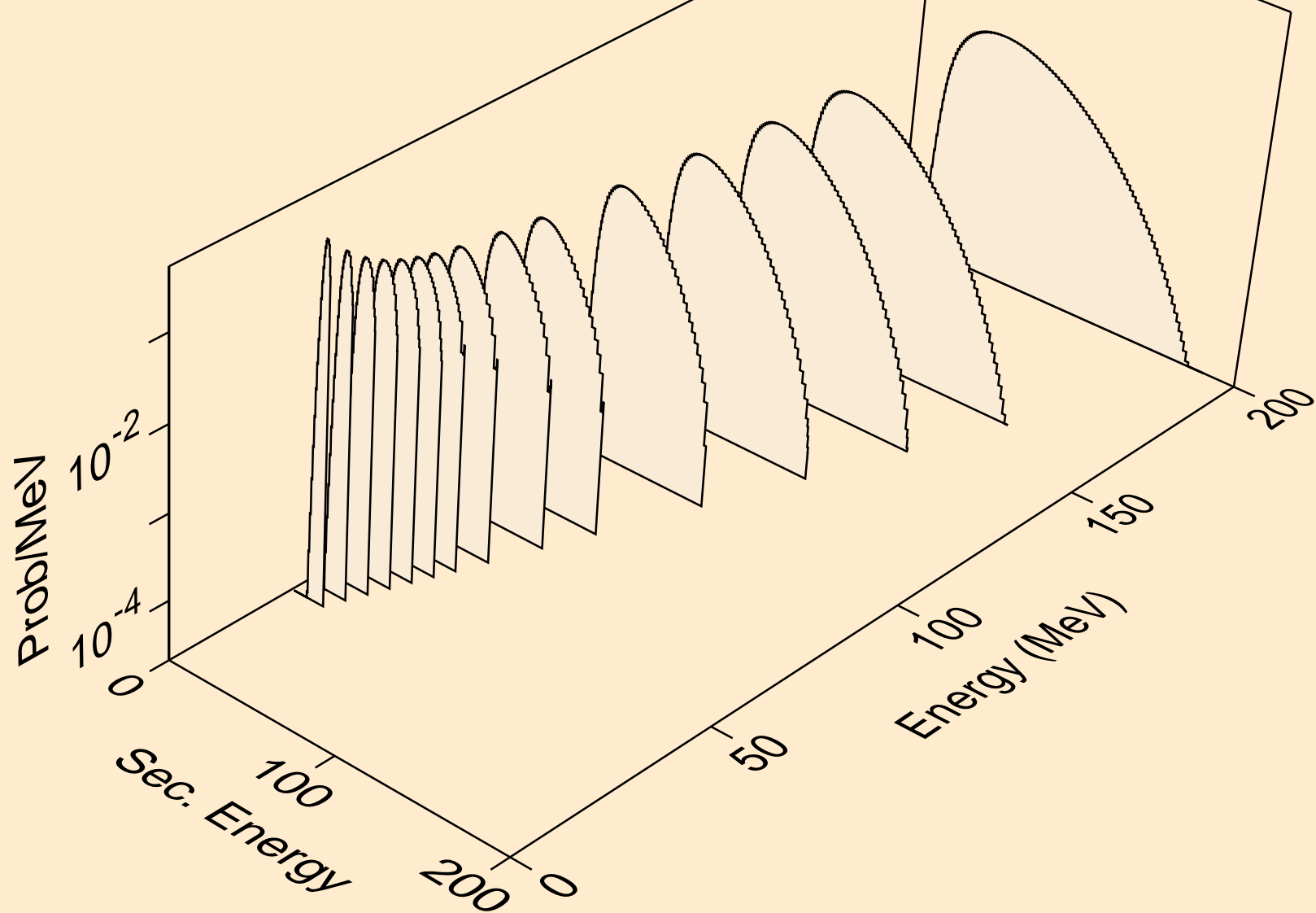

PM152 NEUTRON ACER TENDL-2024 LIBRARY; T=293.6K  
he3s from (n,n\*)he3

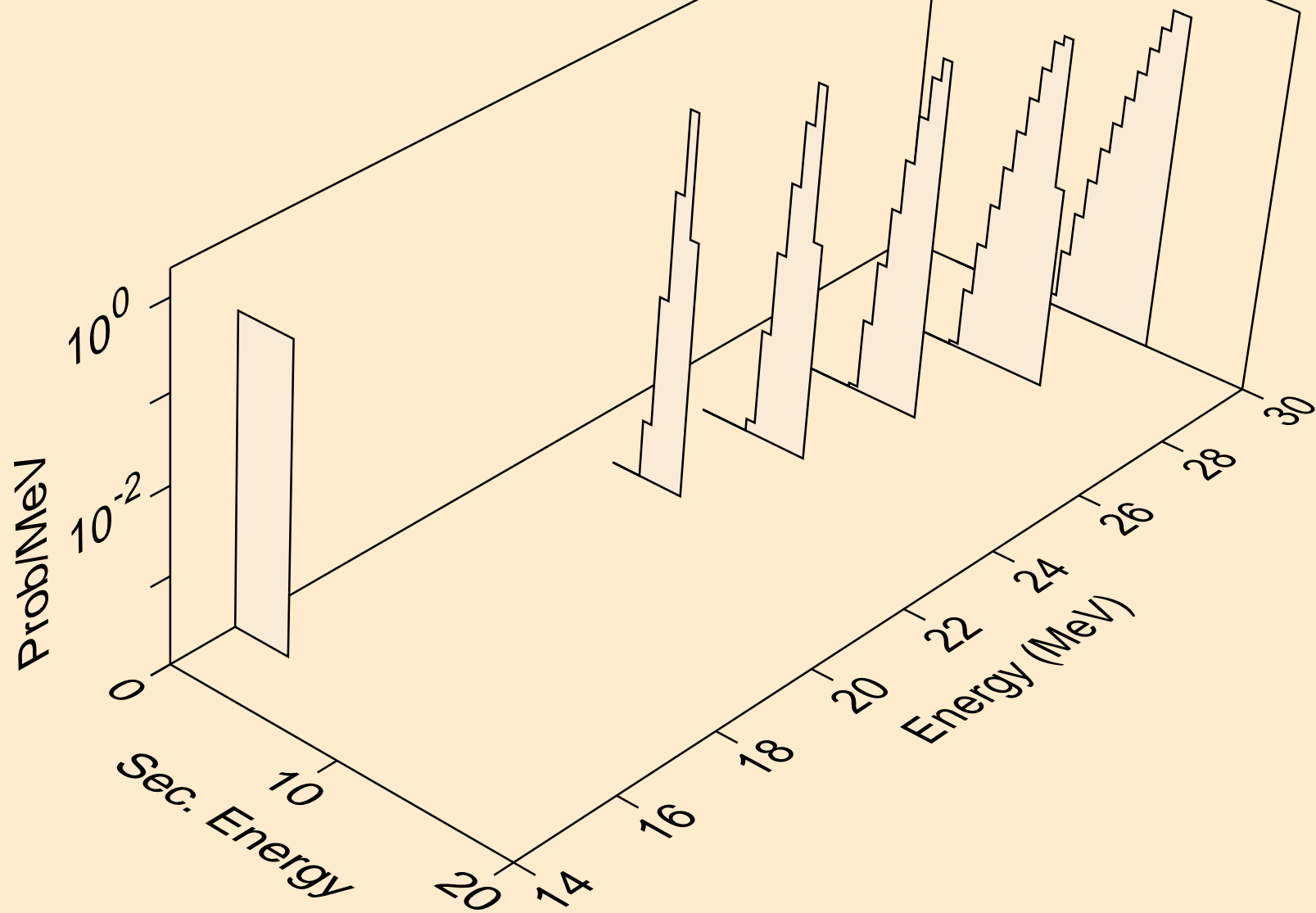

PM152 NEUTRON ACER TENDL-2024 LIBRARY; T=293.6K  
he3s from (n,he3)

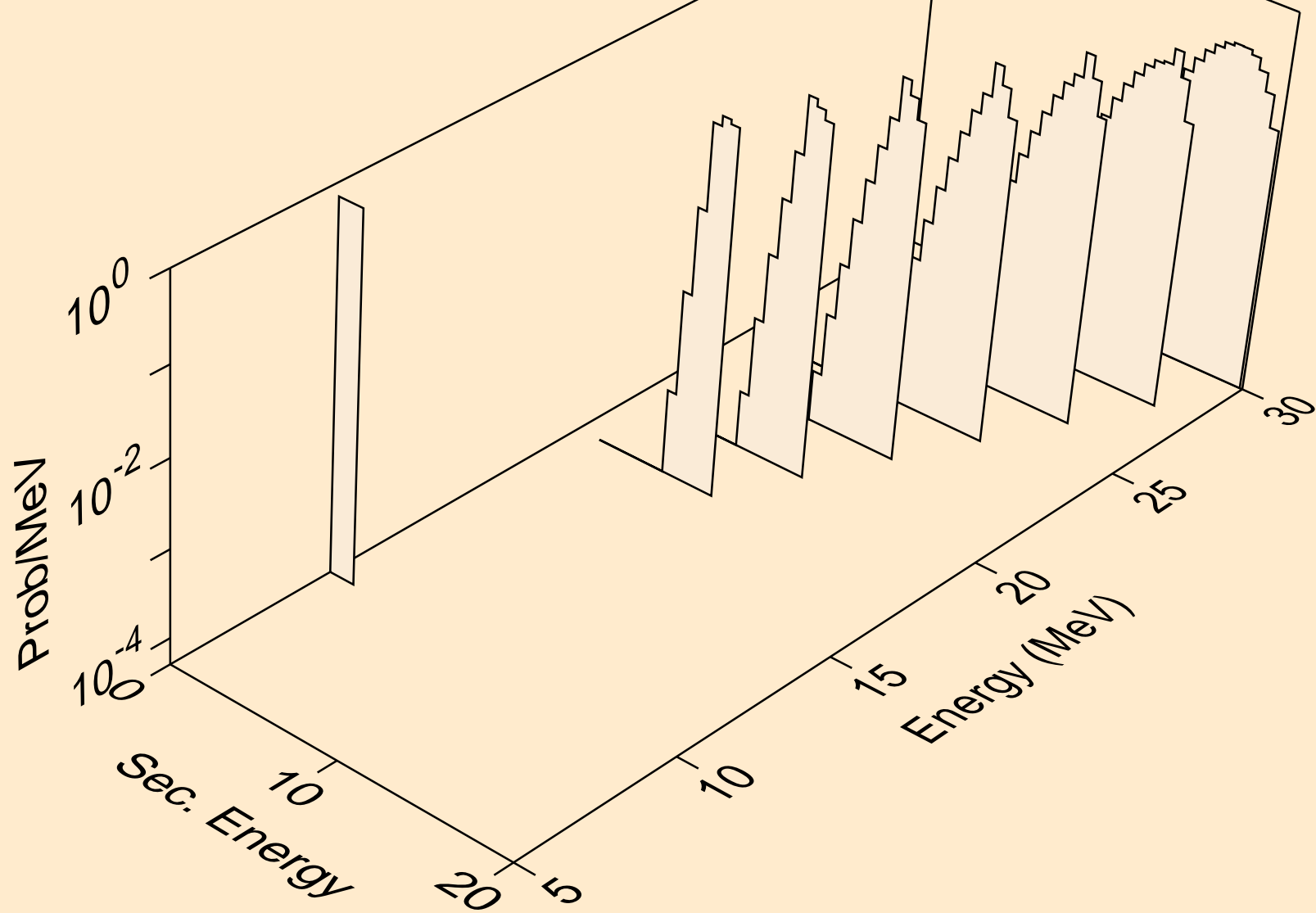

PM152 NEUTRON ACER TENDL-2024 LIBRARY; T=293.6K  
alphas from (n,x)

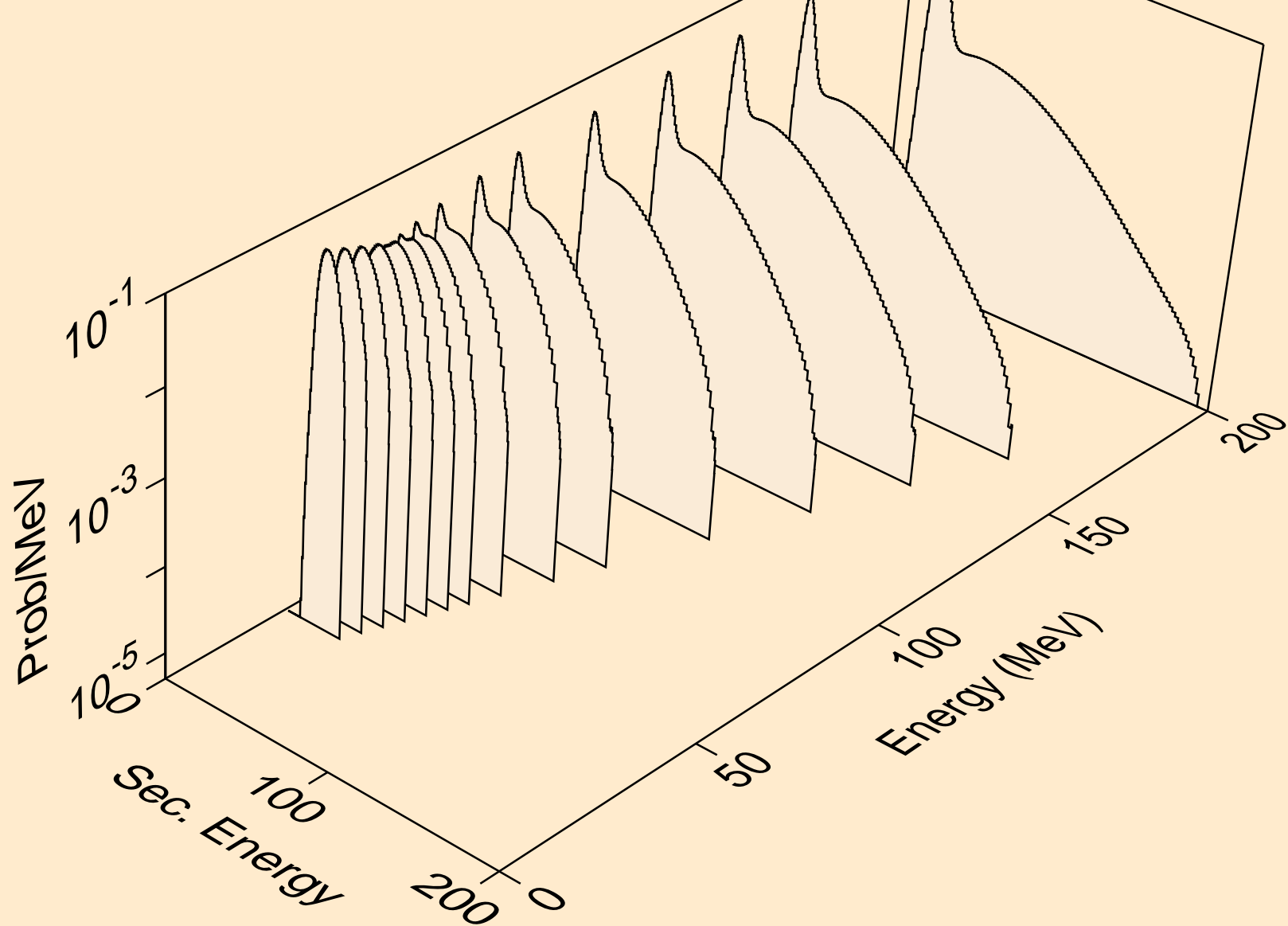

PM152 NEUTRON ACER TENDL-2024 LIBRARY; T=293.6K  
alphas from (n,n\*)a

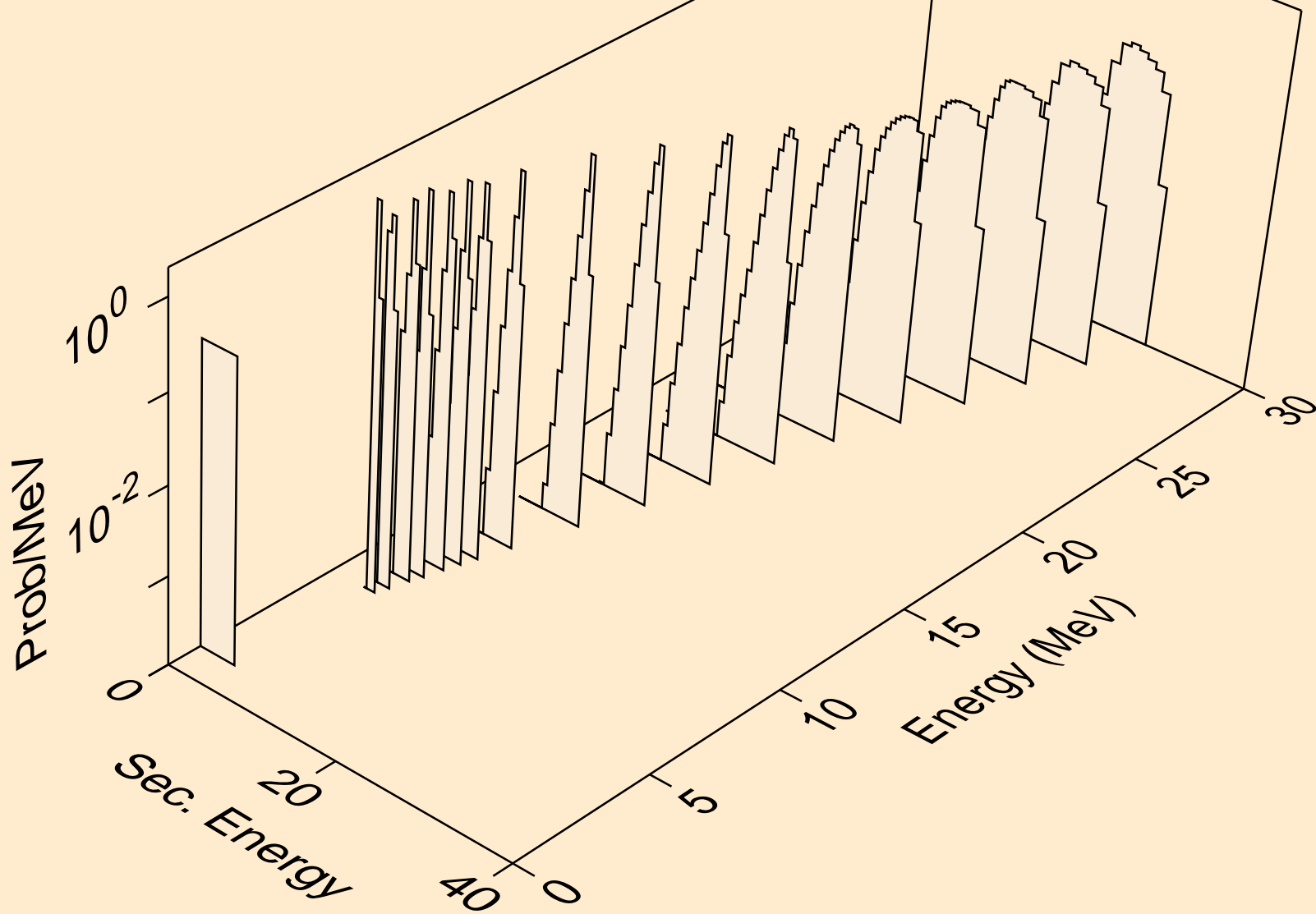

PM152 NEUTRON ACER TENDL-2024 LIBRARY; T=293.6K  
alphas from (n,2n)a

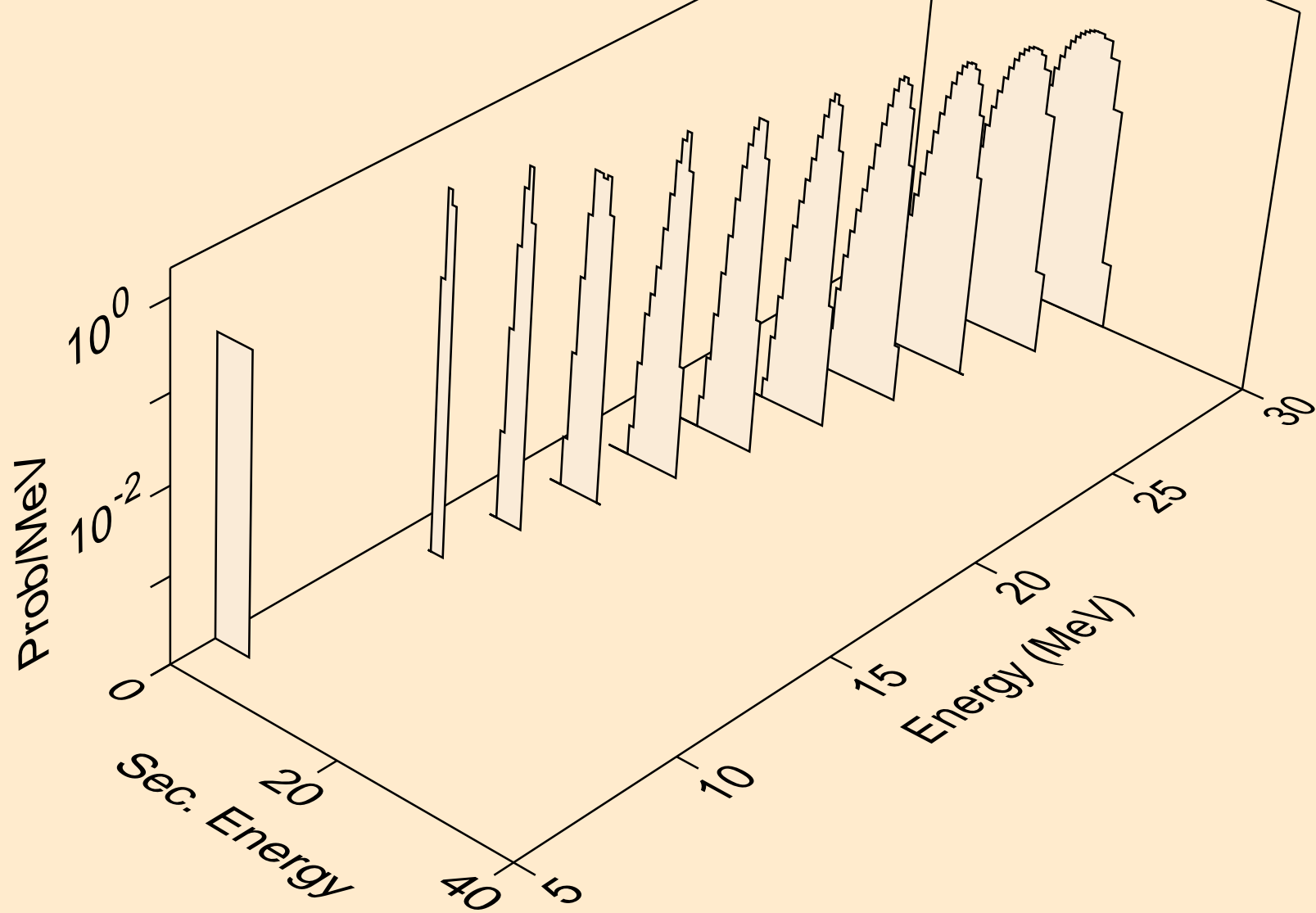

PM152 NEUTRON ACER TENDL-2024 LIBRARY; T=293.6K  
alphas from (n,3n)a

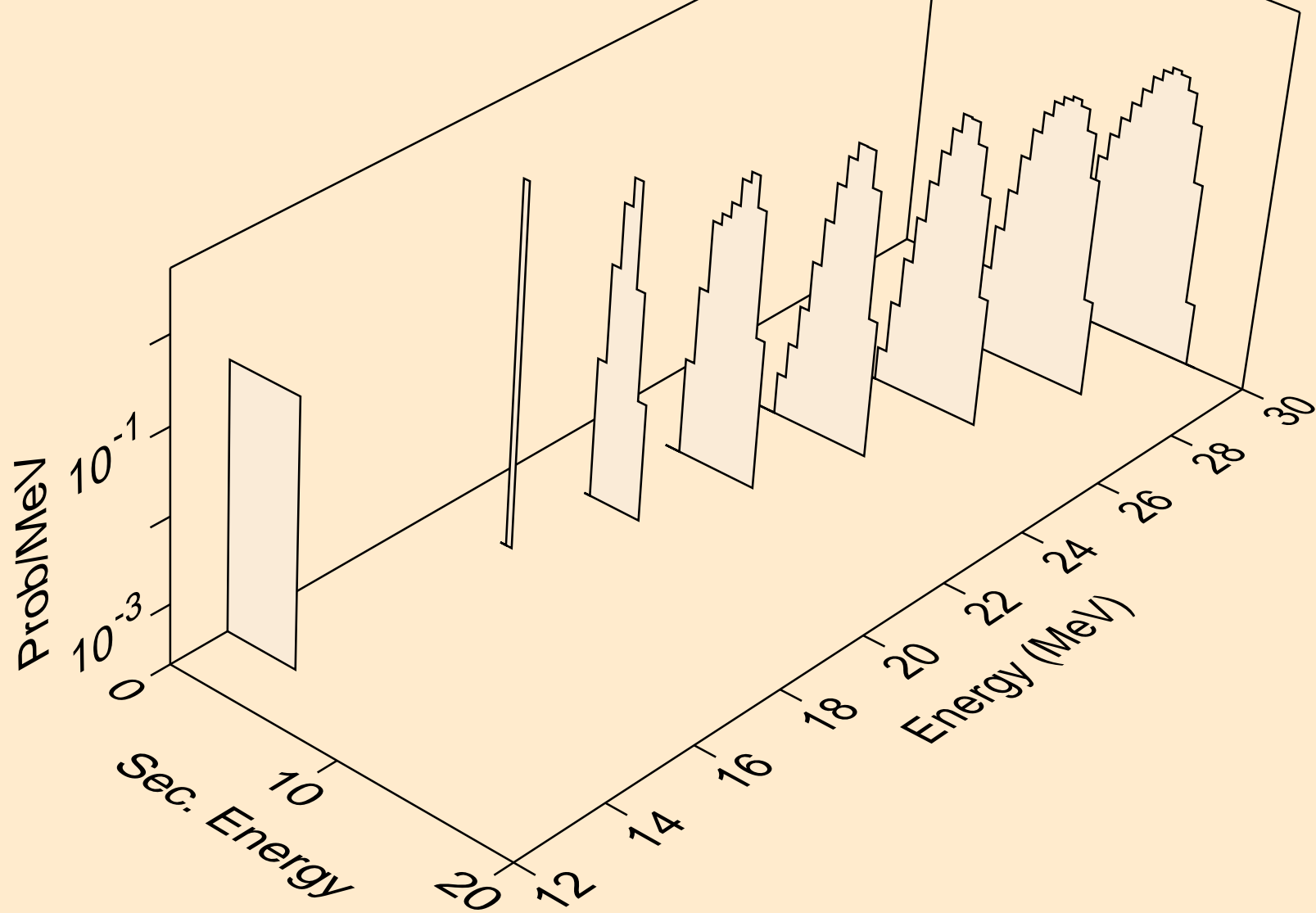

PM152 NEUTRON ACER TENDL-2024 LIBRARY; T=293.6K  
alphas from (n,a)

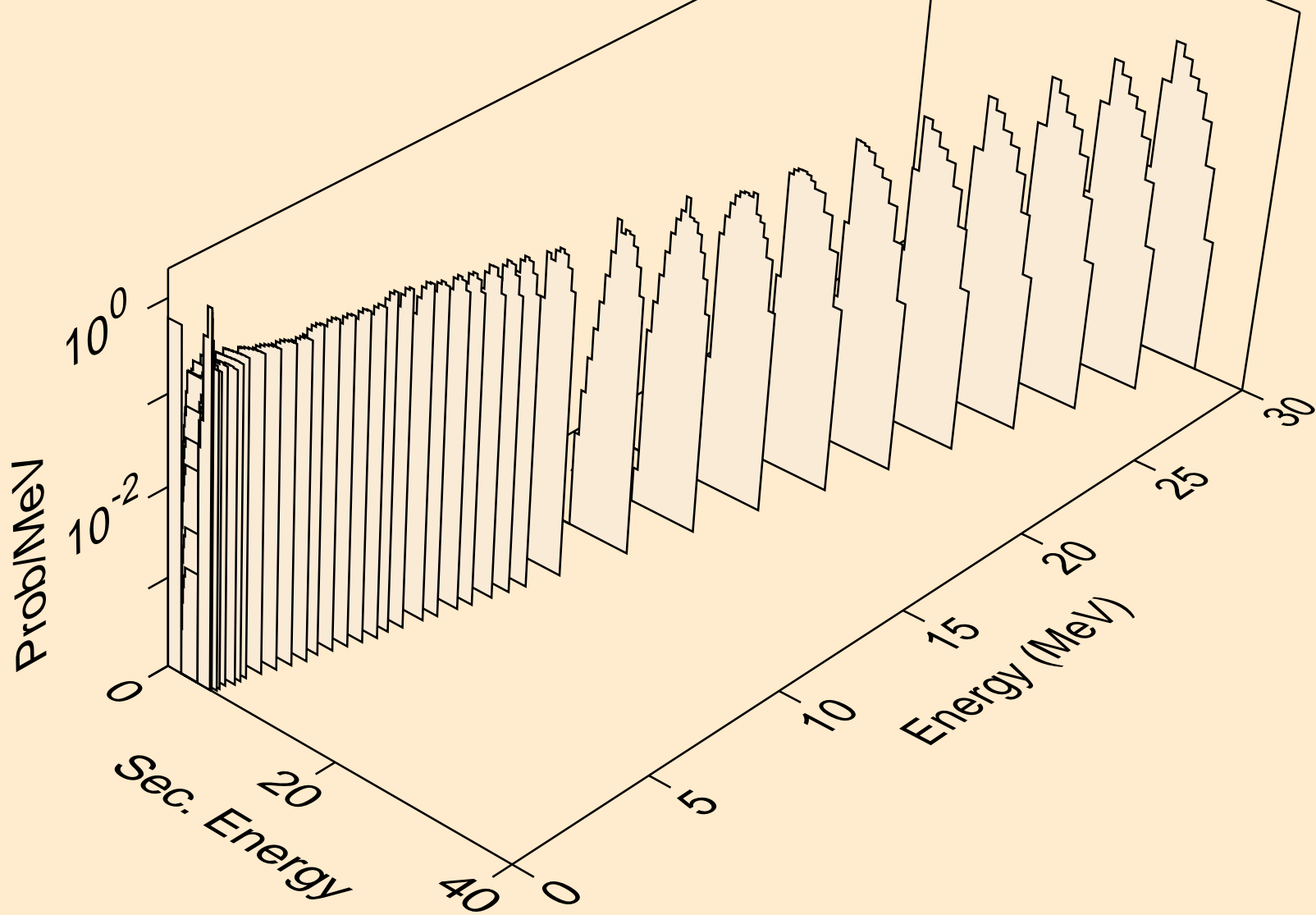

PM152 NEUTRON ACER TENDL-2024 LIBRARY; T=293.6K  
alphas from (n,pa)

