

PO201 NEUTRON ACER TENDL-2024 LIBRARY; T=293.6K
Principal cross sections

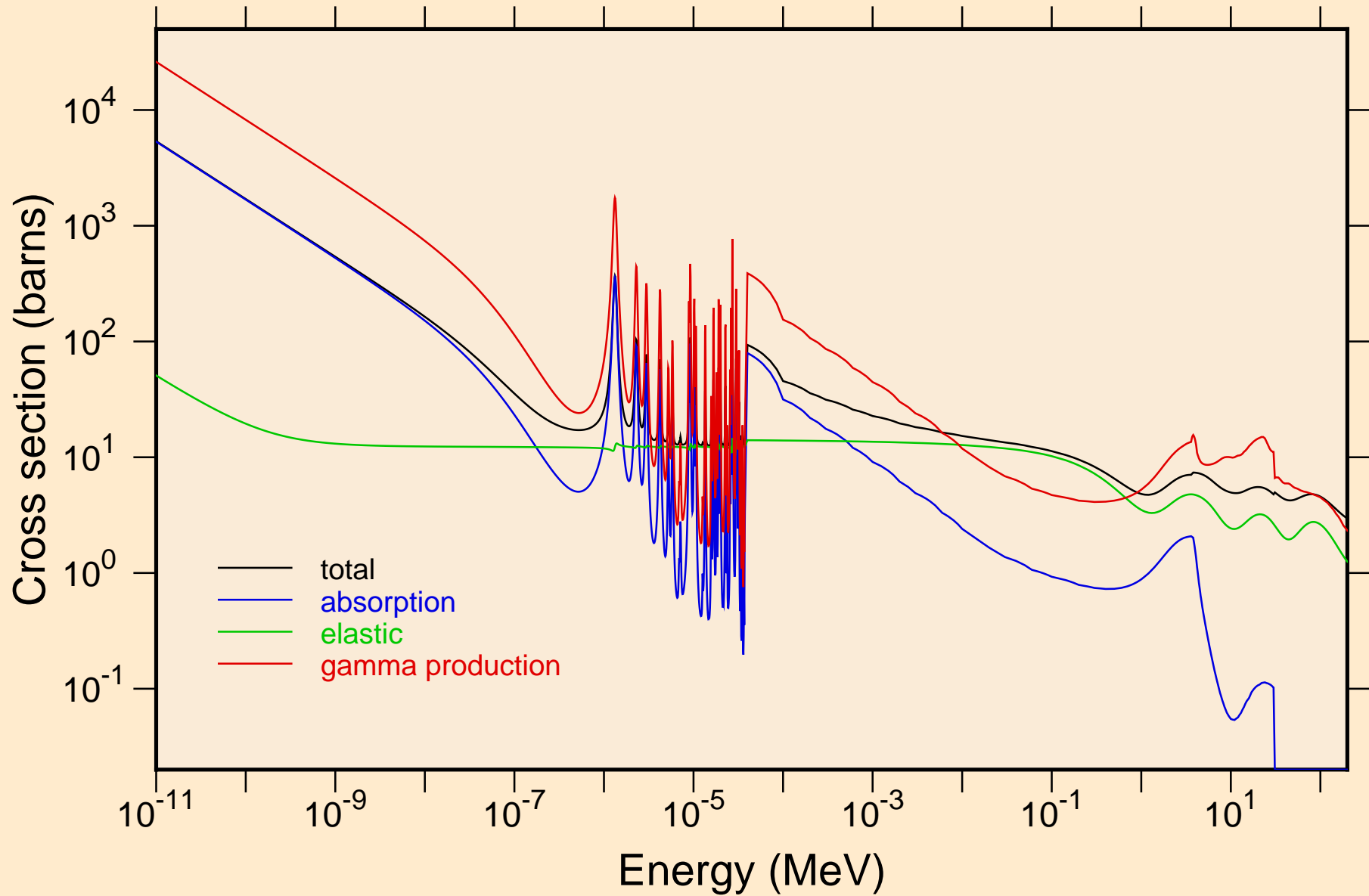

PO201 NEUTRON ACER TENDL-2024 LIBRARY; T=293.6K
resonance total cross section

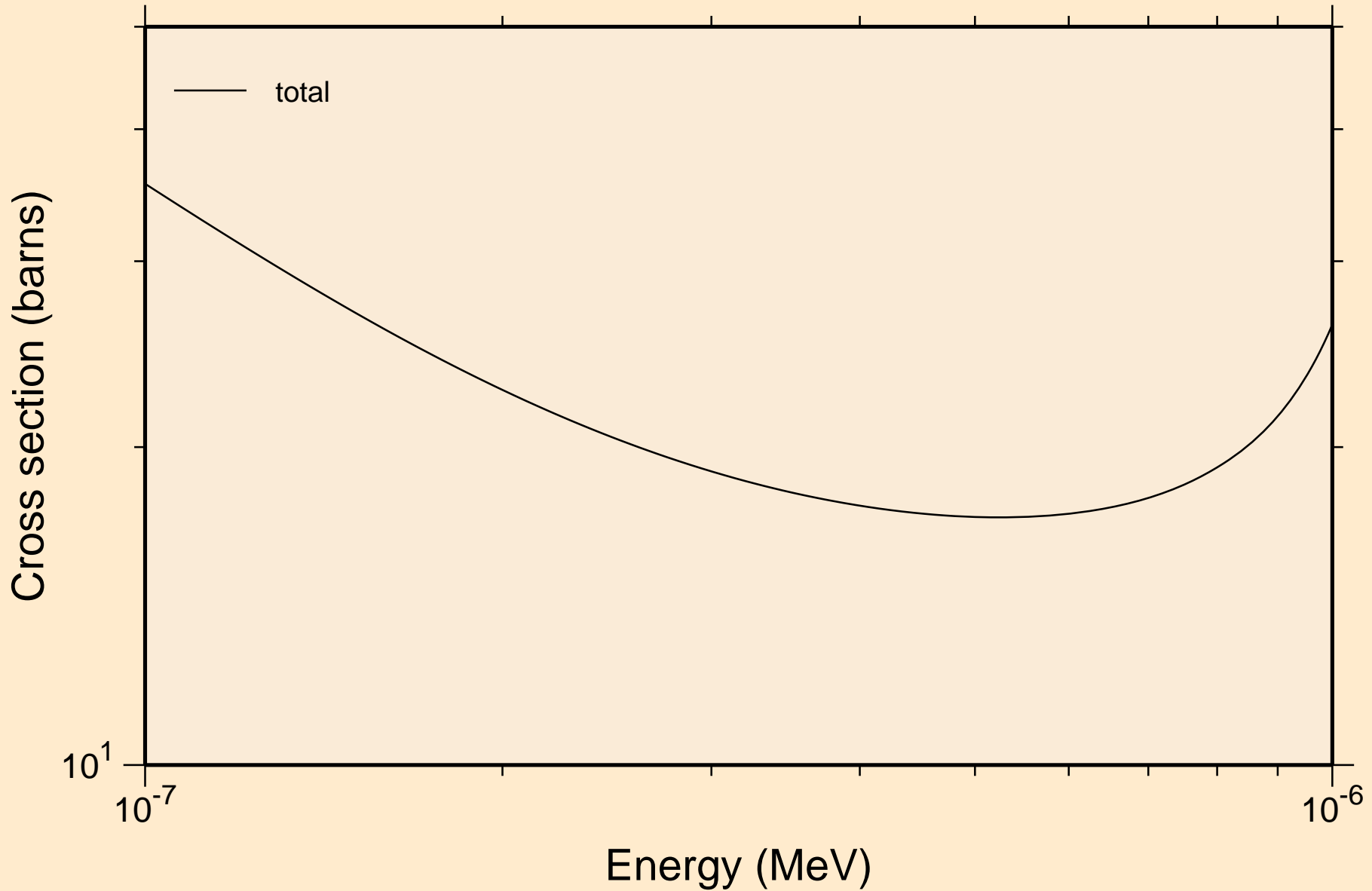

PO201 NEUTRON ACER TENDL-2024 LIBRARY; T=293.6K
resonance total cross section

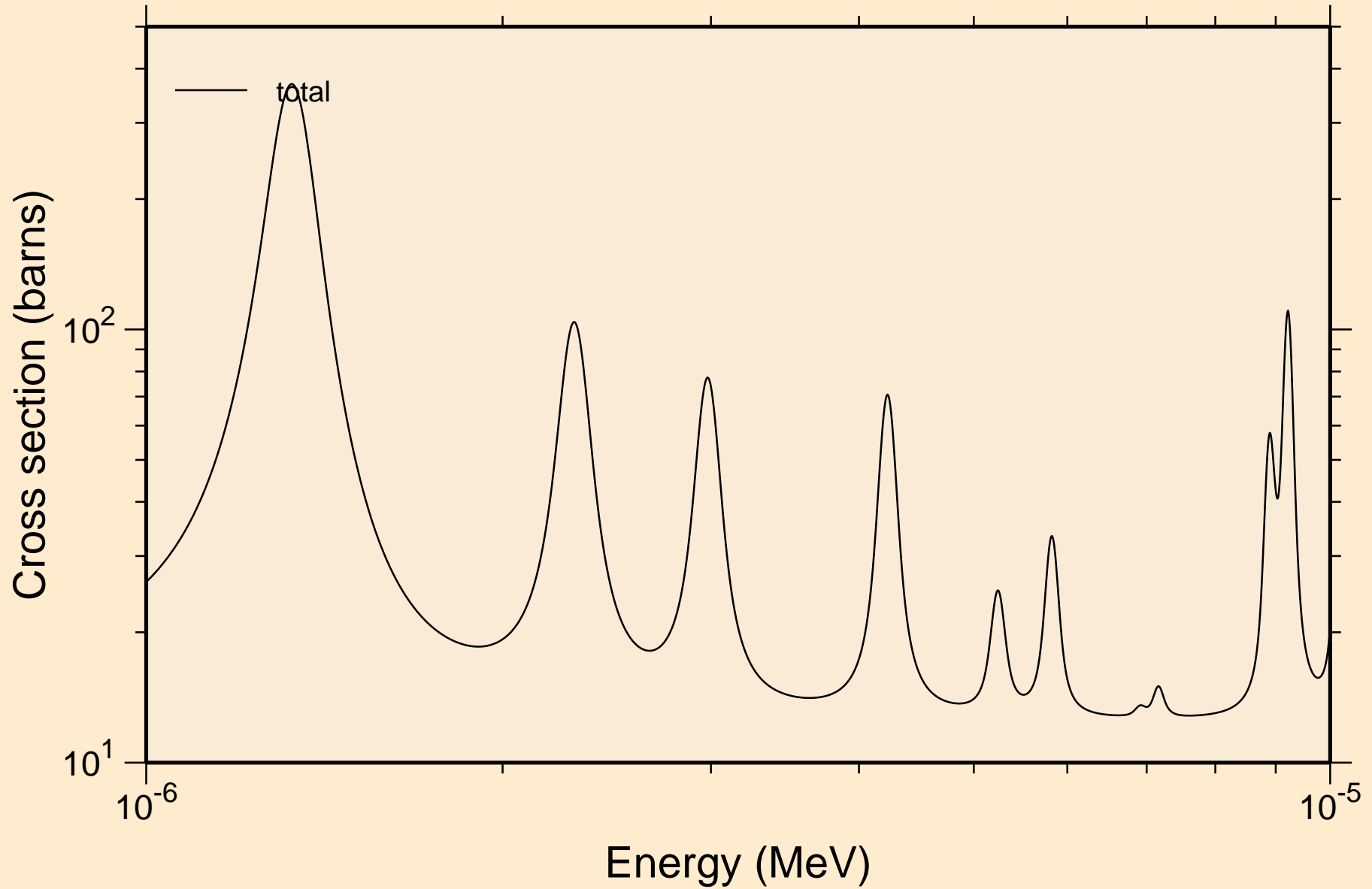

PO201 NEUTRON ACER TENDL-2024 LIBRARY; T=293.6K
resonance total cross section

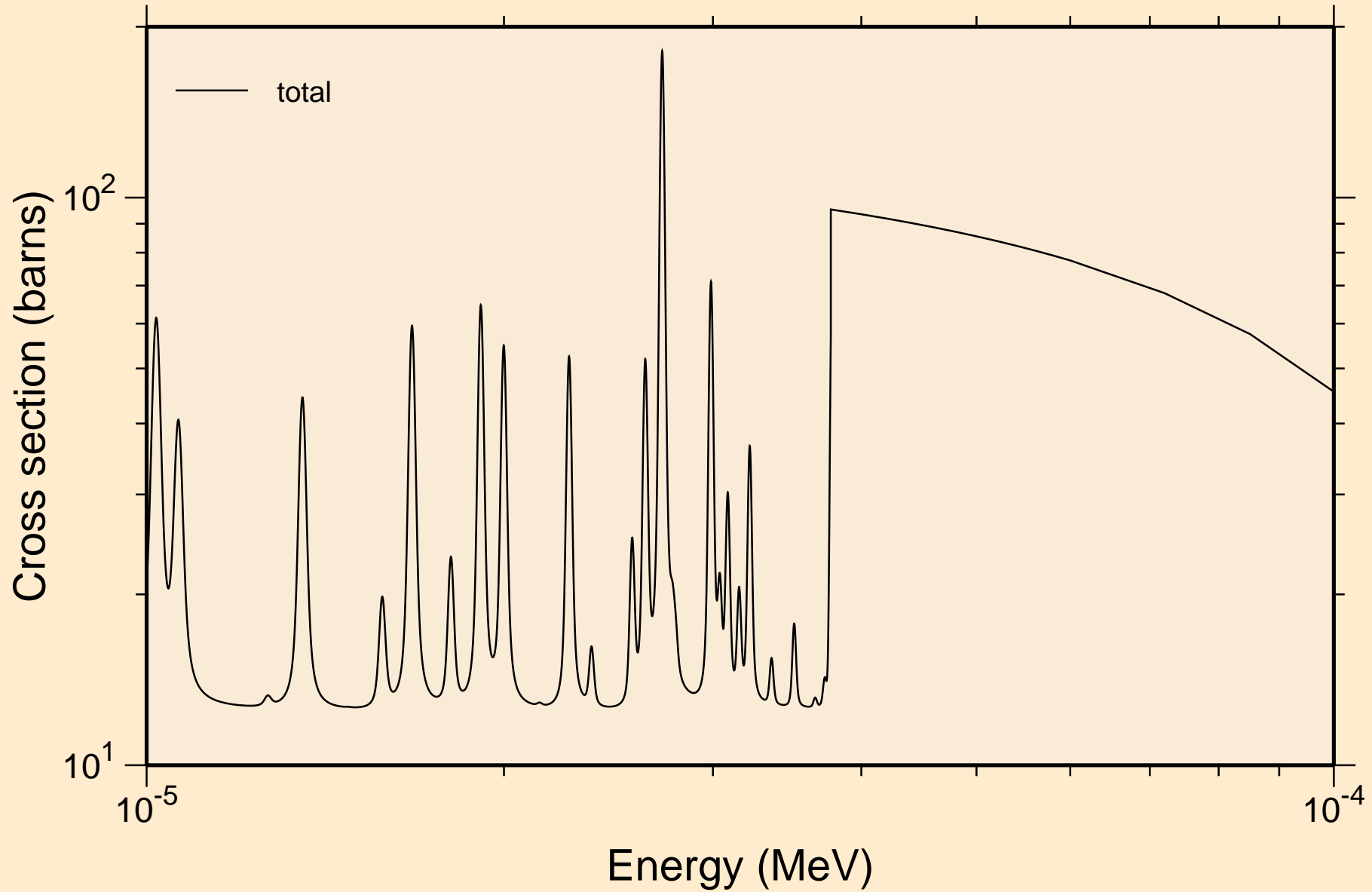

PO201 NEUTRON ACER TENDL-2024 LIBRARY; T=293.6K
resonance total cross section

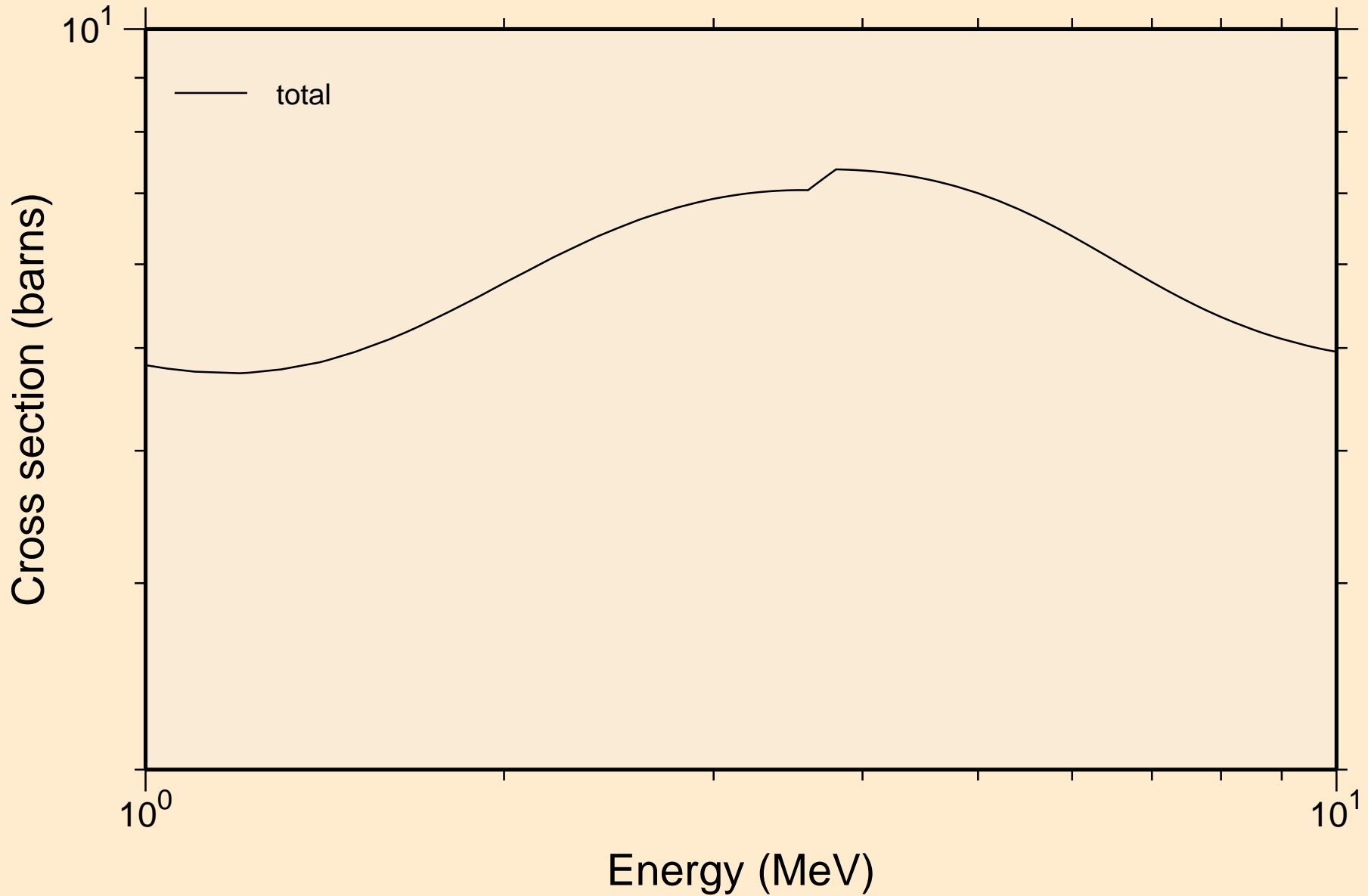

PO201 NEUTRON ACER TENDL-2024 LIBRARY; T=293.6K
resonance absorption cross sections

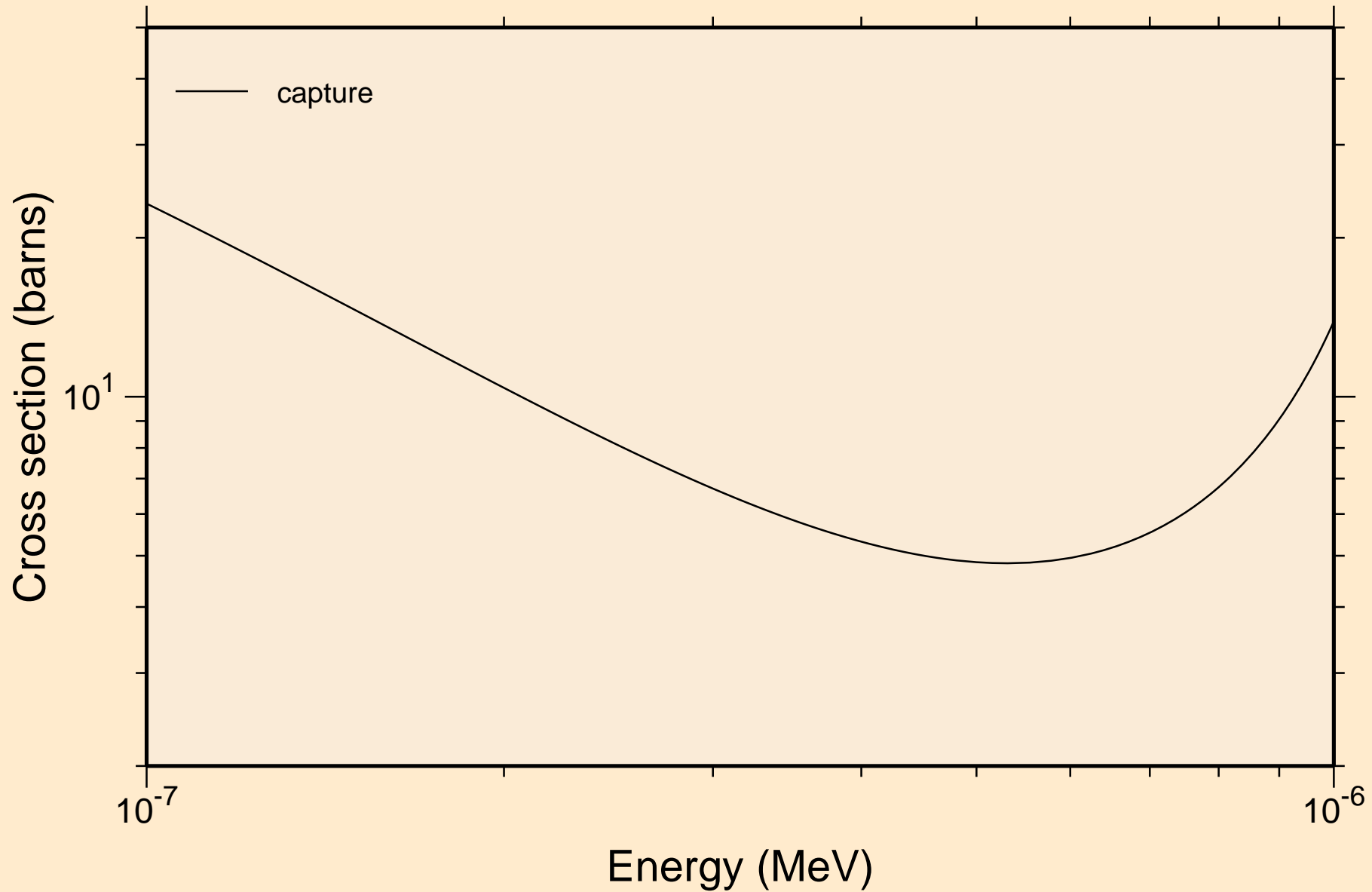

PO201 NEUTRON ACER TENDL-2024 LIBRARY; T=293.6K
resonance absorption cross sections

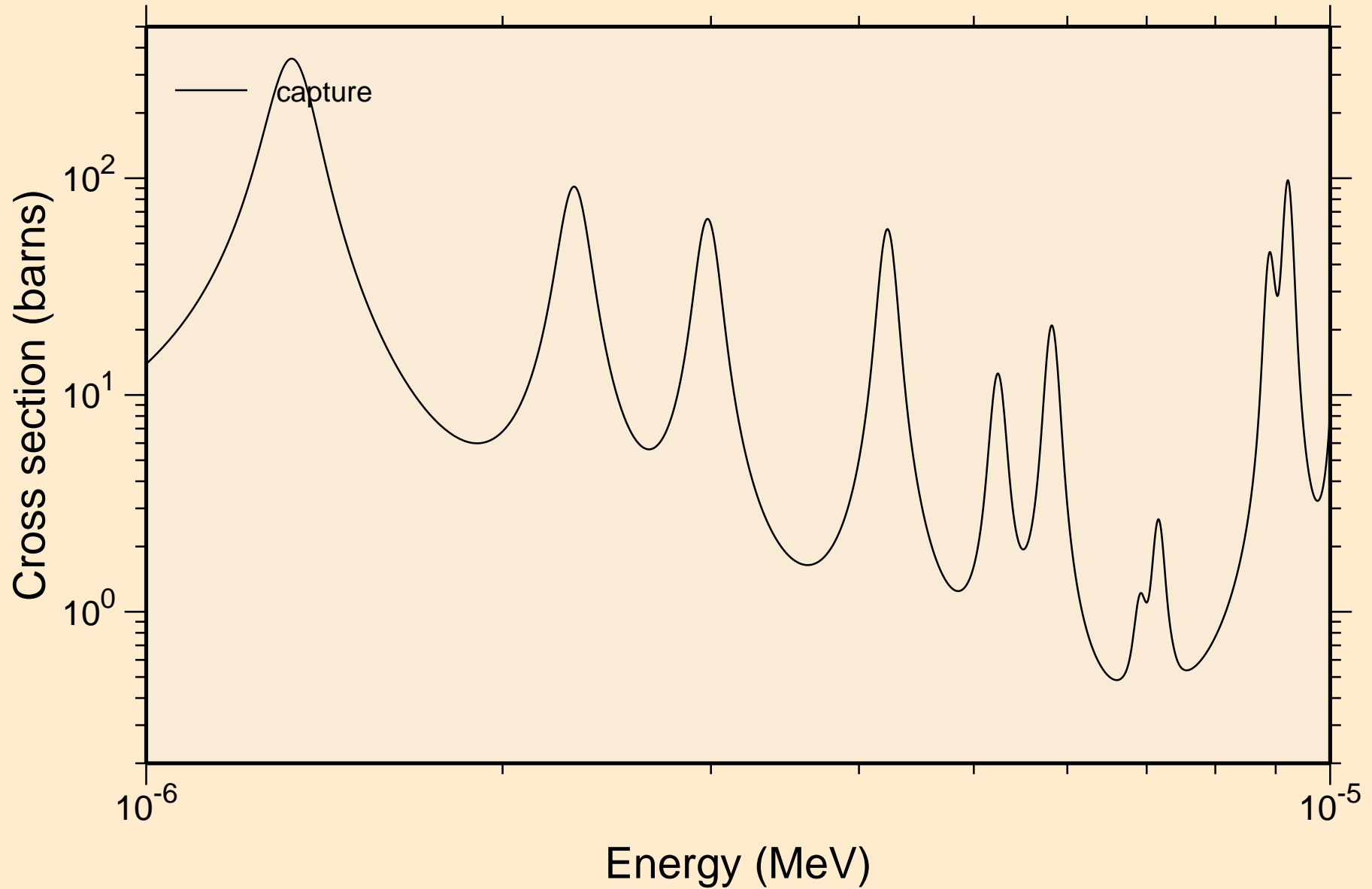

PO201 NEUTRON ACER TENDL-2024 LIBRARY; T=293.6K
resonance absorption cross sections

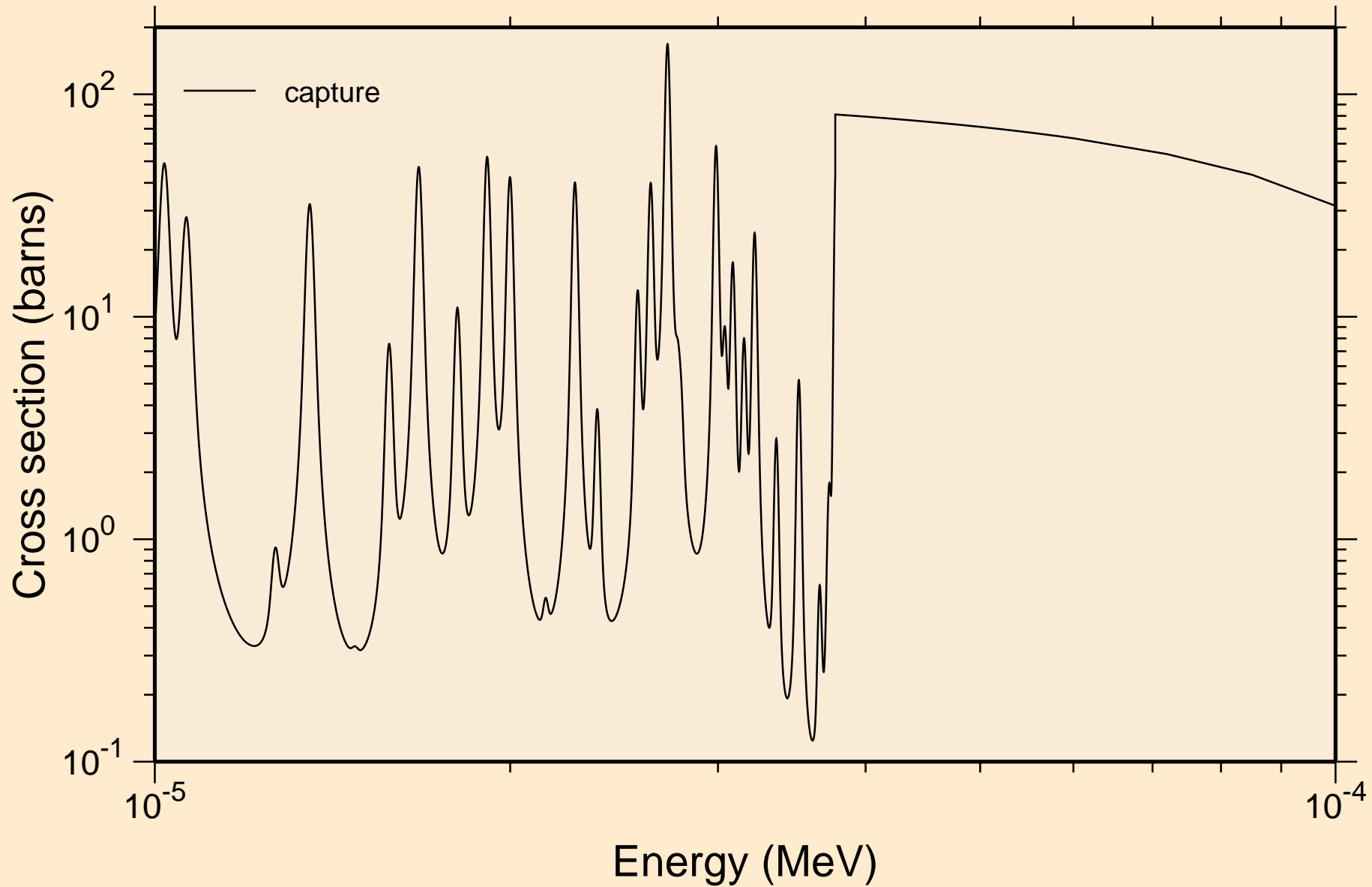

PO201 NEUTRON ACER TENDL-2024 LIBRARY; T=293.6K
resonance absorption cross sections

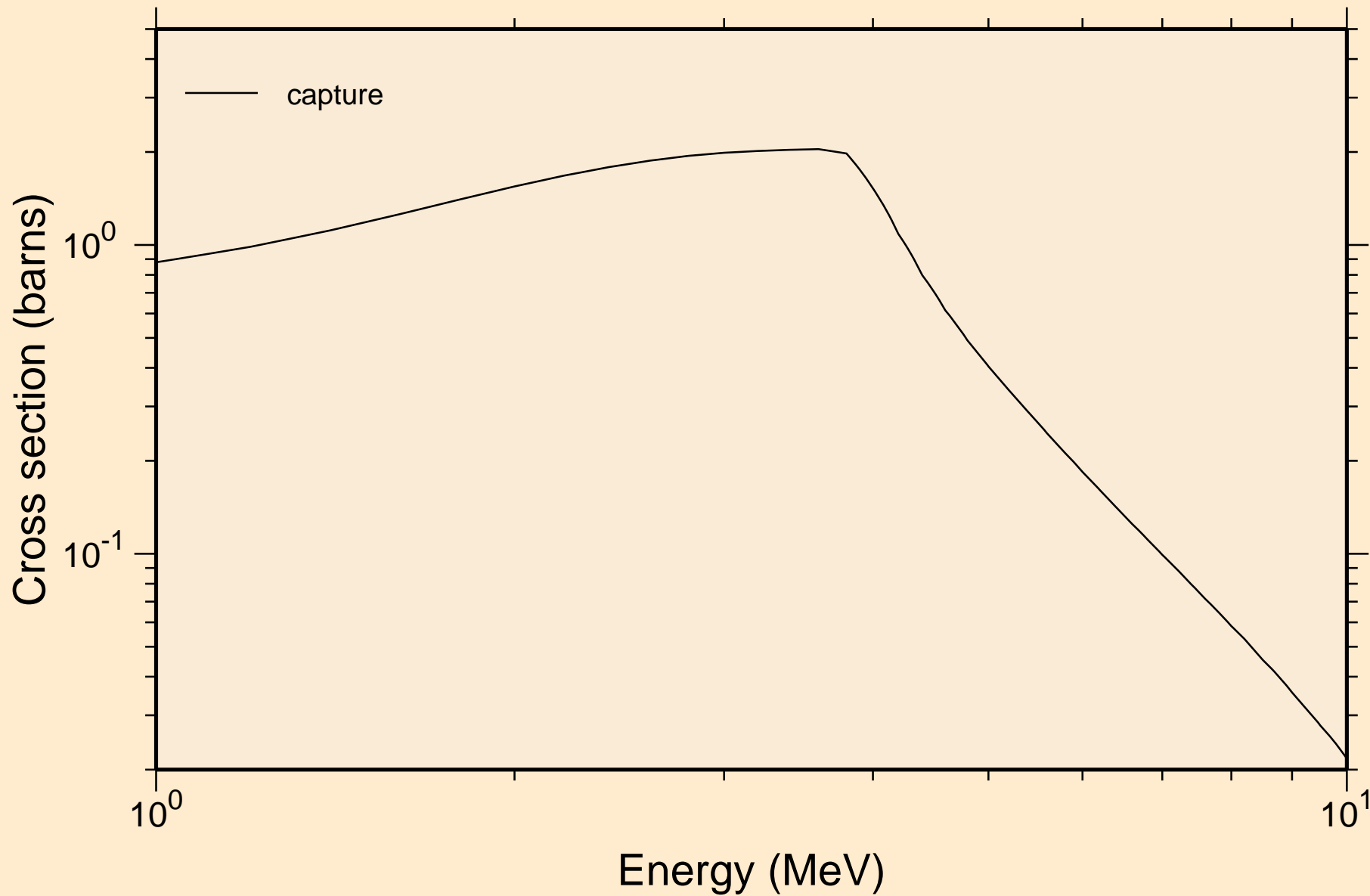

PO201 NEUTRON ACER TENDL-2024 LIBRARY; T=293.6K
Heating

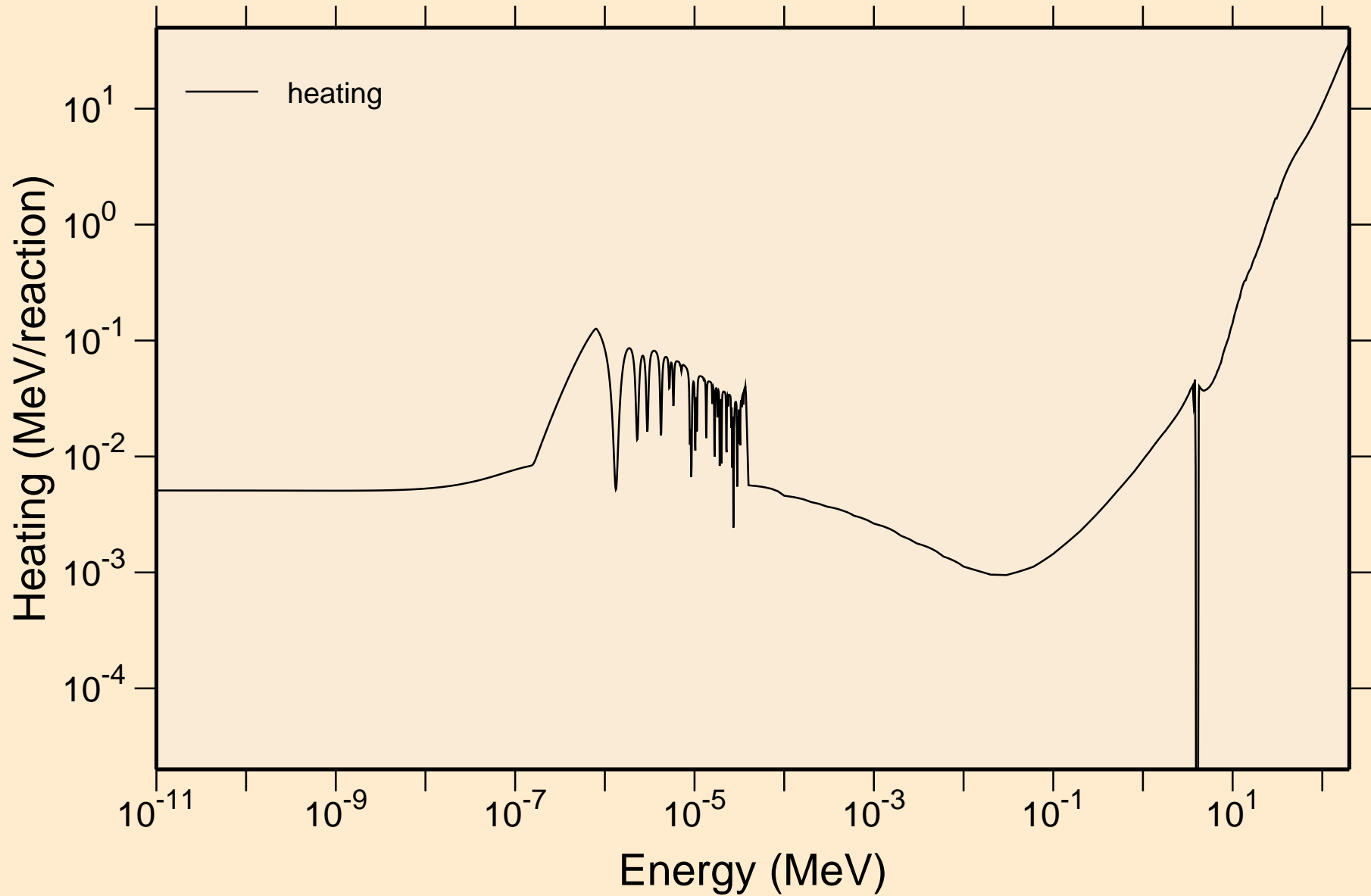

PO201 NEUTRON ACER TENDL-2024 LIBRARY; T=293.6K
Damage

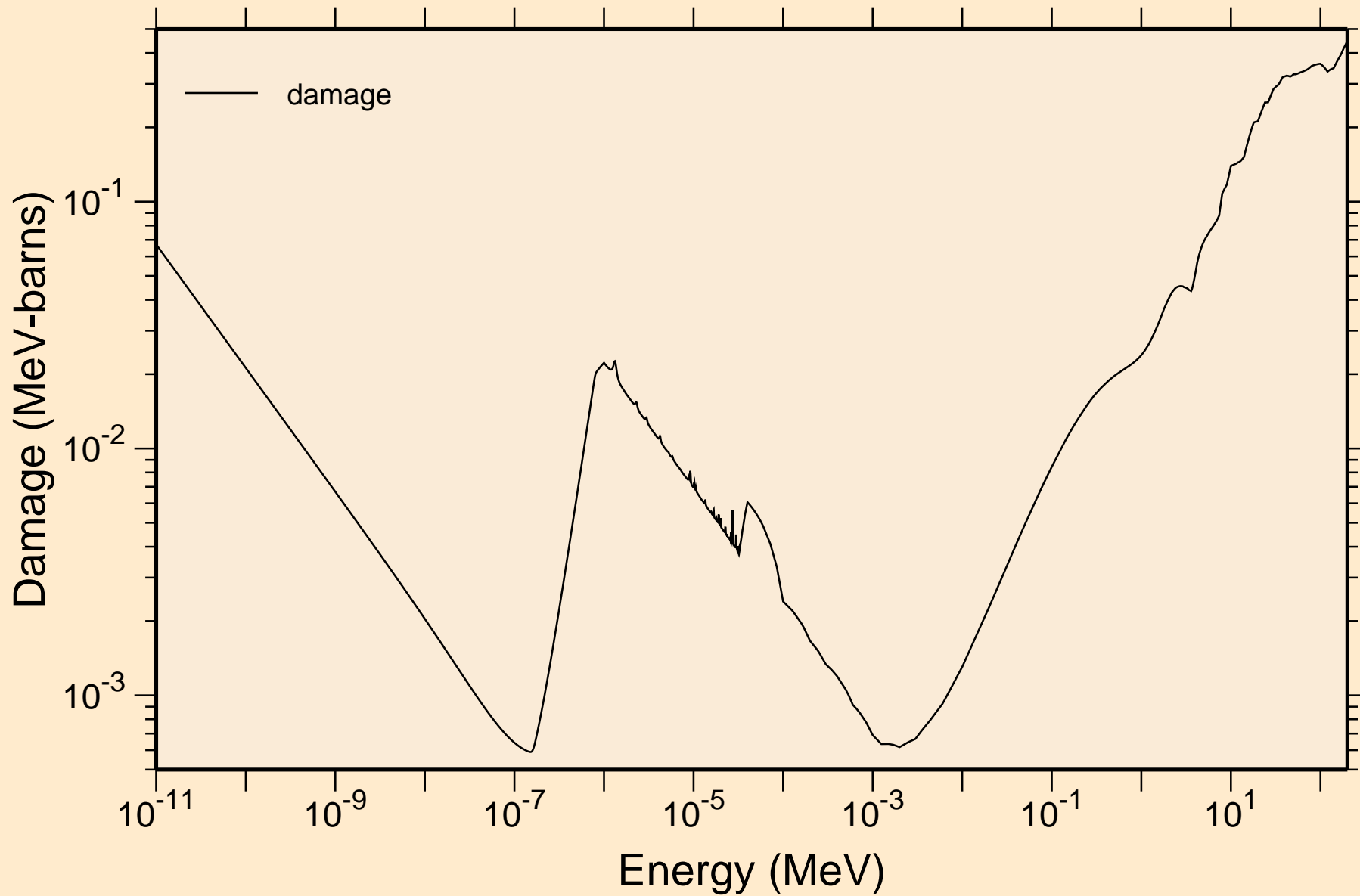

PO201 NEUTRON ACER TENDL-2024 LIBRARY; T=293.6K
Non-threshold reactions

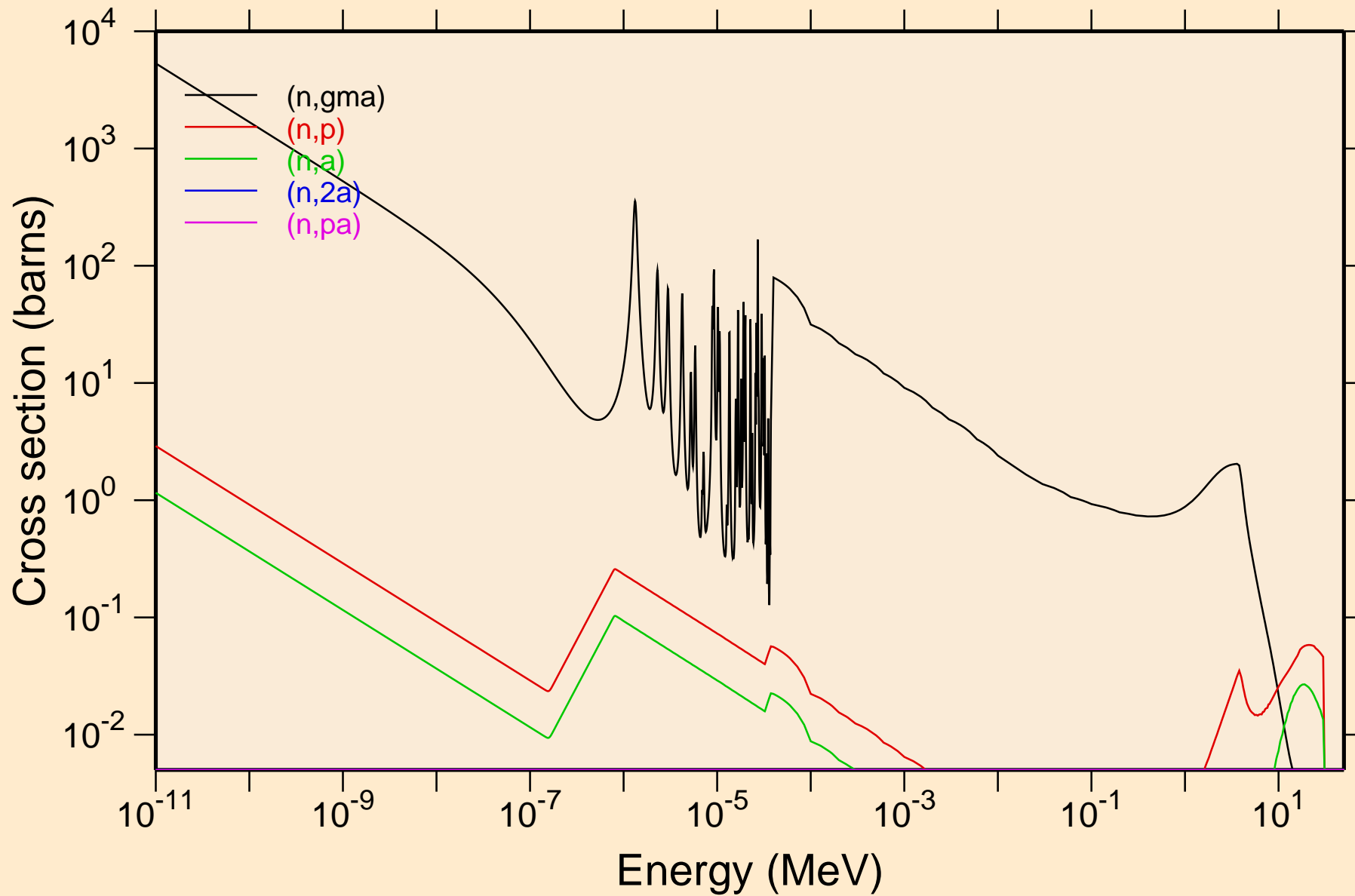

PO201 NEUTRON ACER TENDL-2024 LIBRARY; T=293.6K
Non-threshold reactions

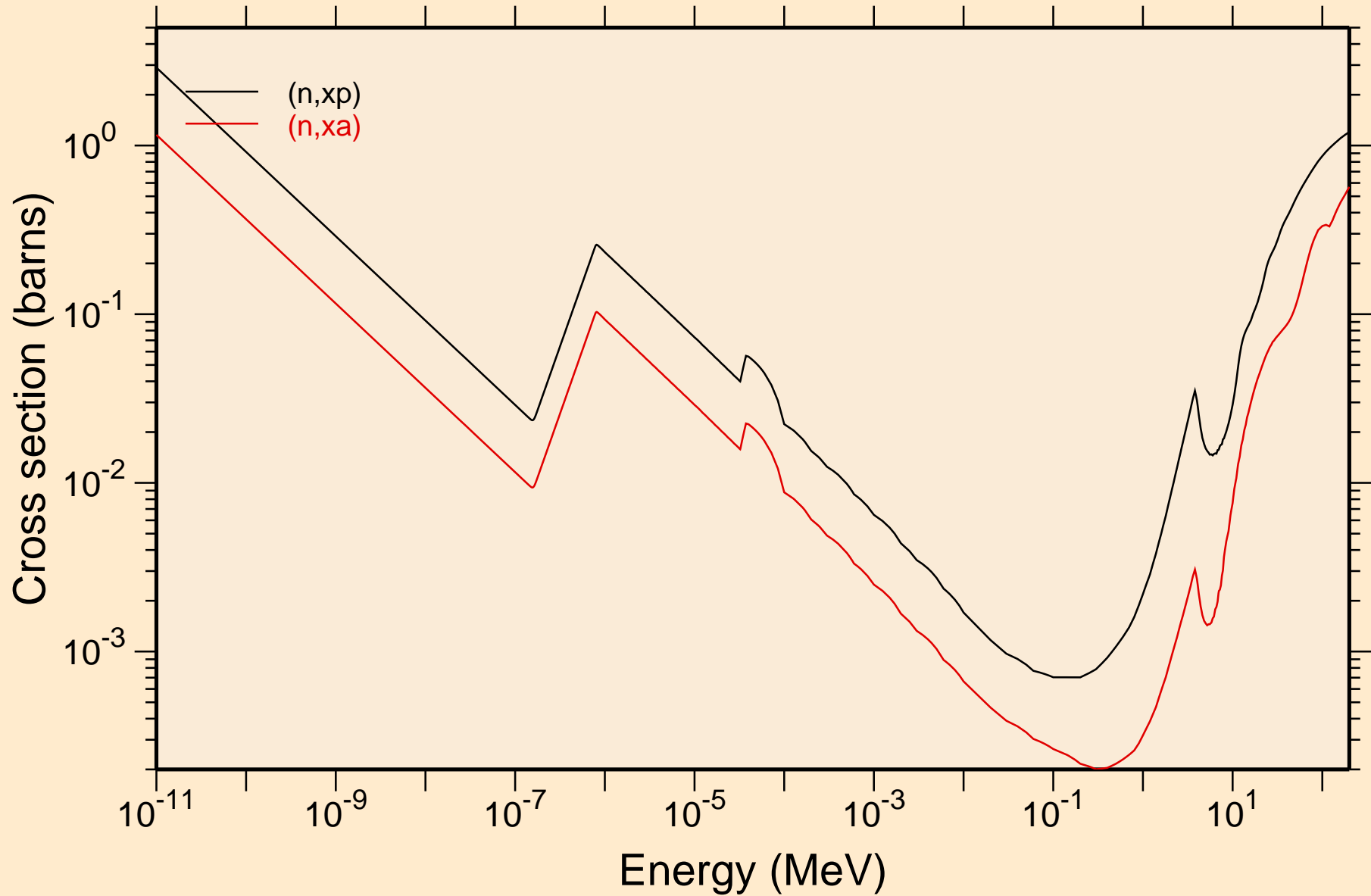

PO201 NEUTRON ACER TENDL-2024 LIBRARY; T=293.6K
Principal cross sections

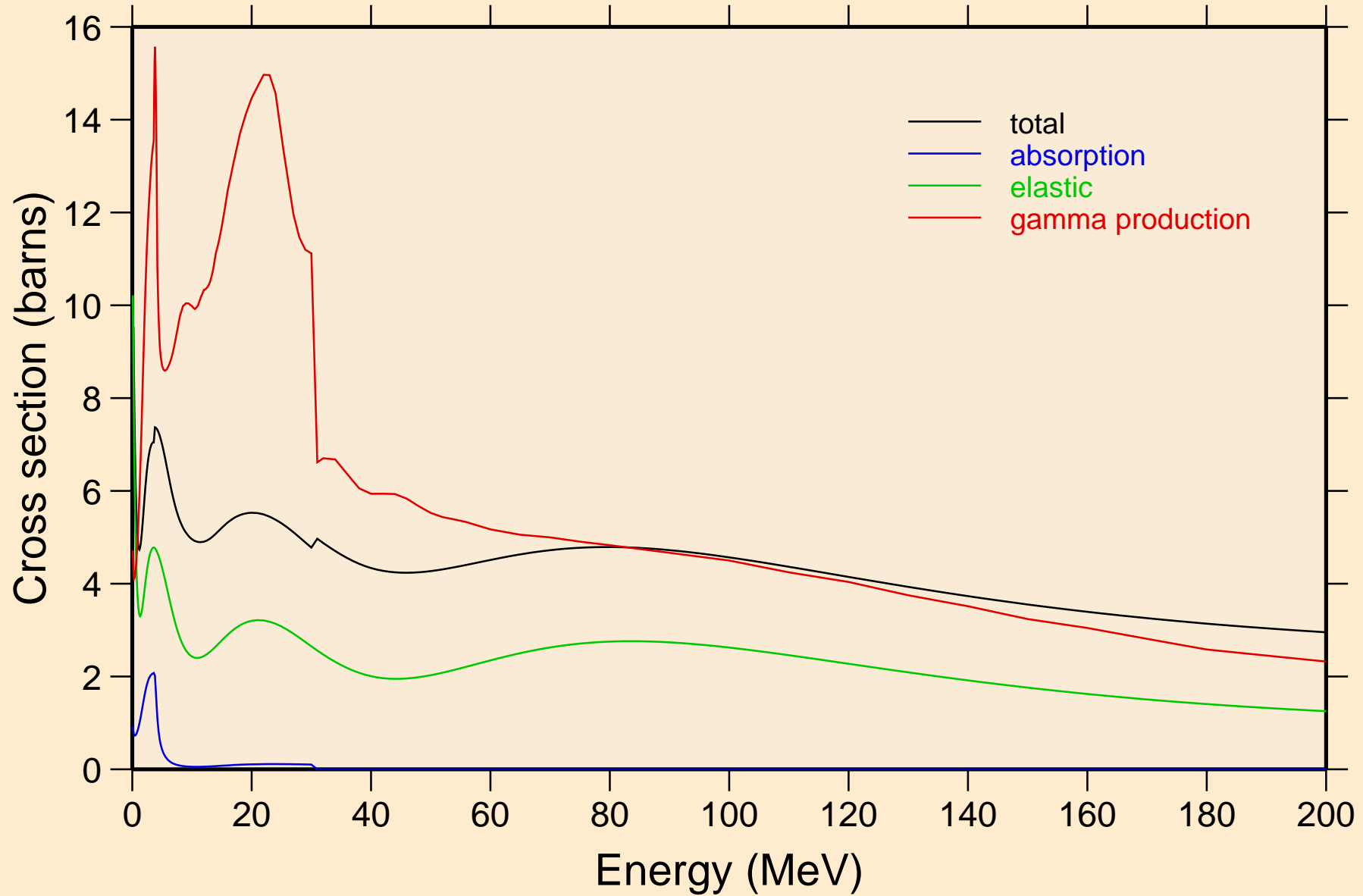

PO201 NEUTRON ACER TENDL-2024 LIBRARY; T=293.6K
Heating

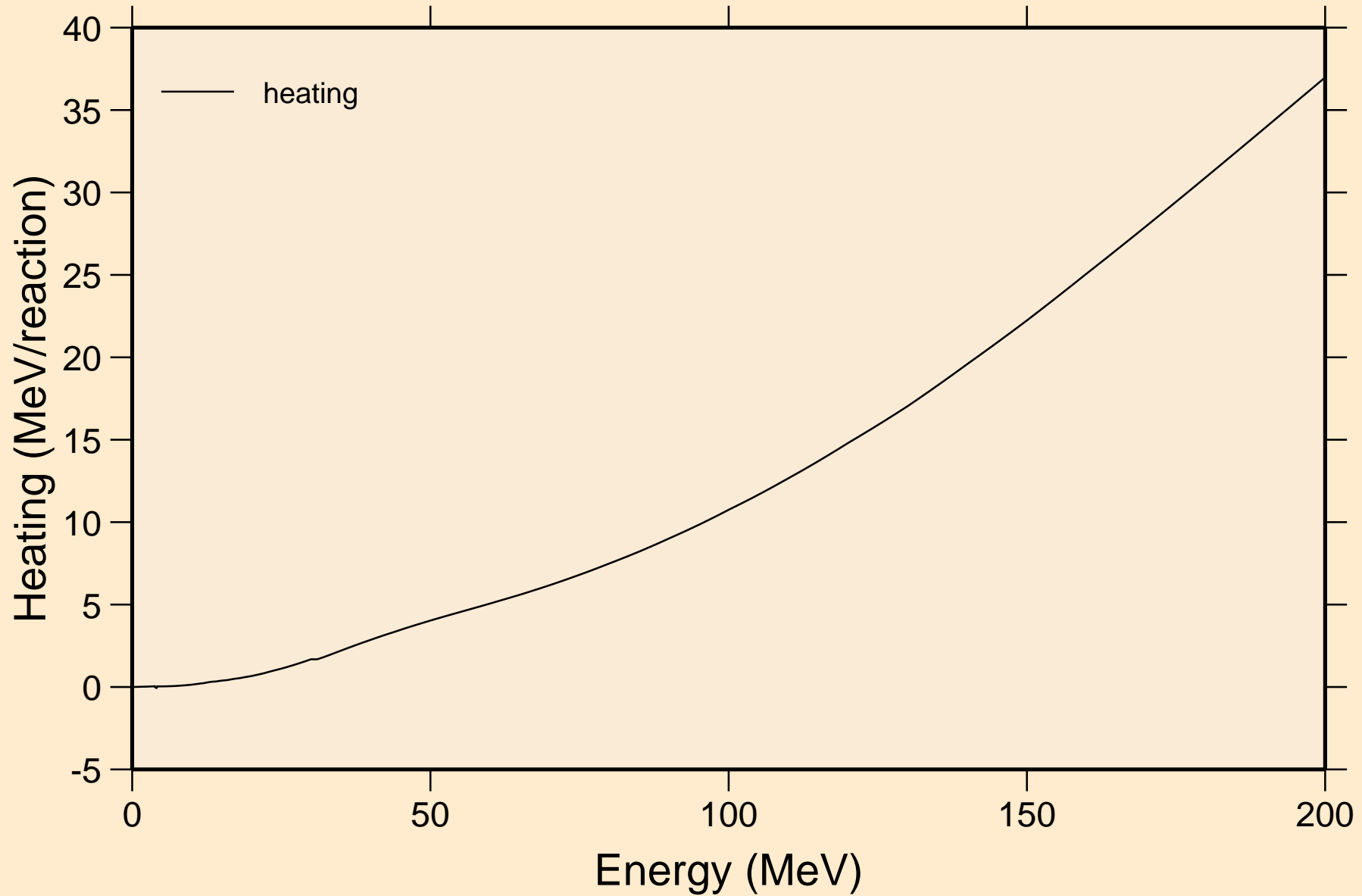

PO201 NEUTRON ACER TENDL-2024 LIBRARY; T=293.6K
Damage

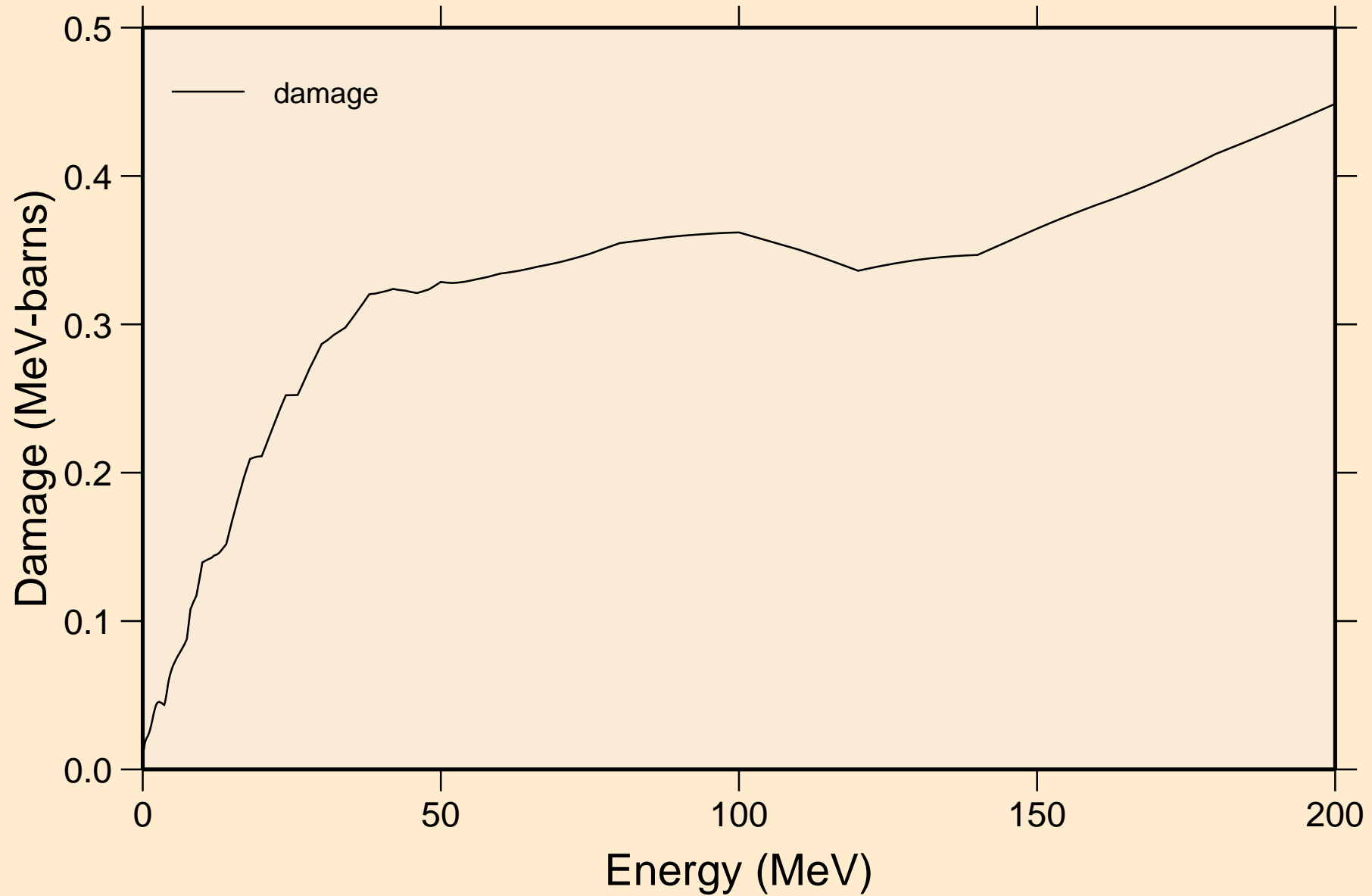

PO201 NEUTRON ACER TENDL-2024 LIBRARY; T=293.6K
Non-threshold reactions

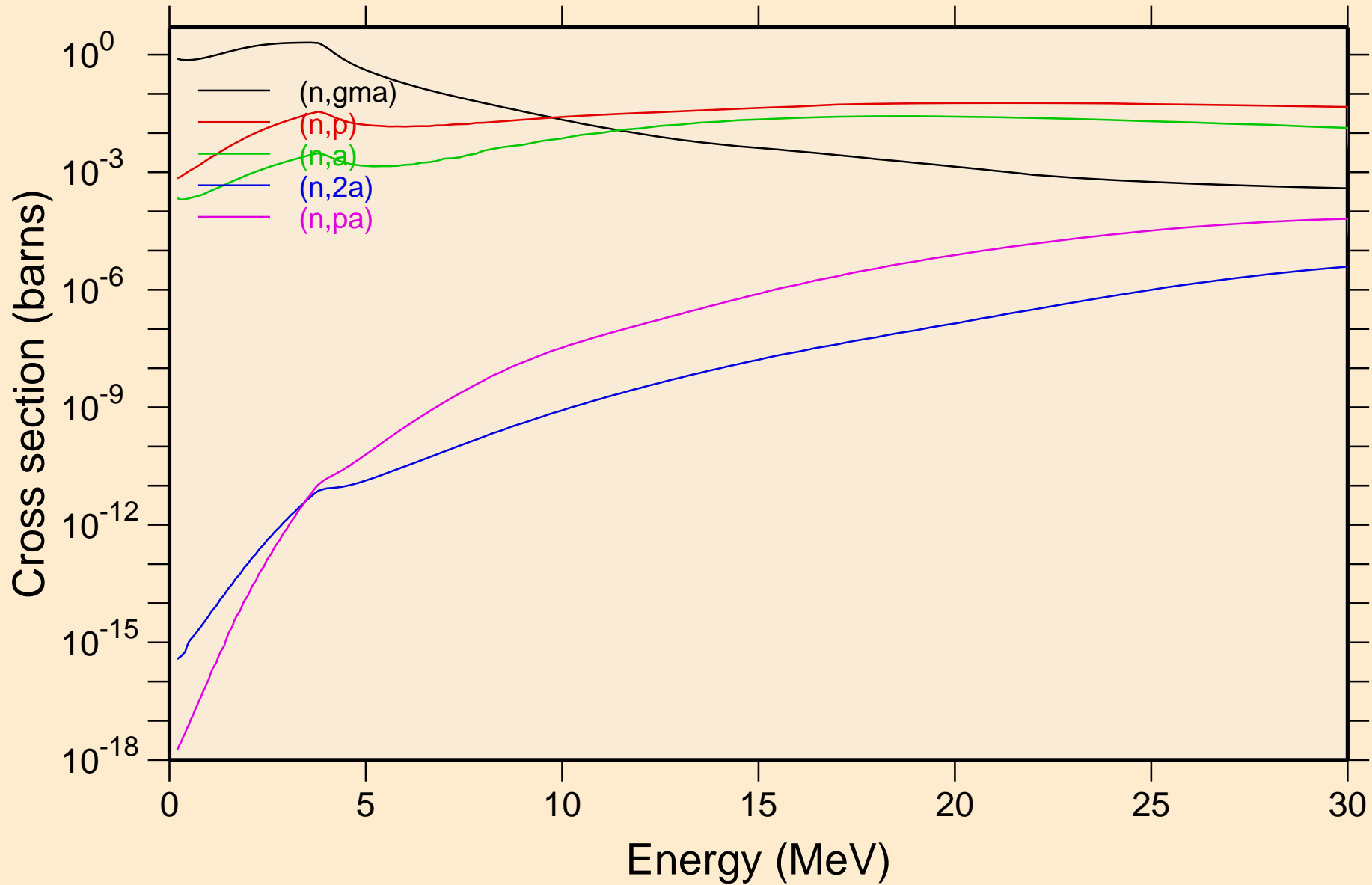

PO201 NEUTRON ACER TENDL-2024 LIBRARY; T=293.6K
Non-threshold reactions

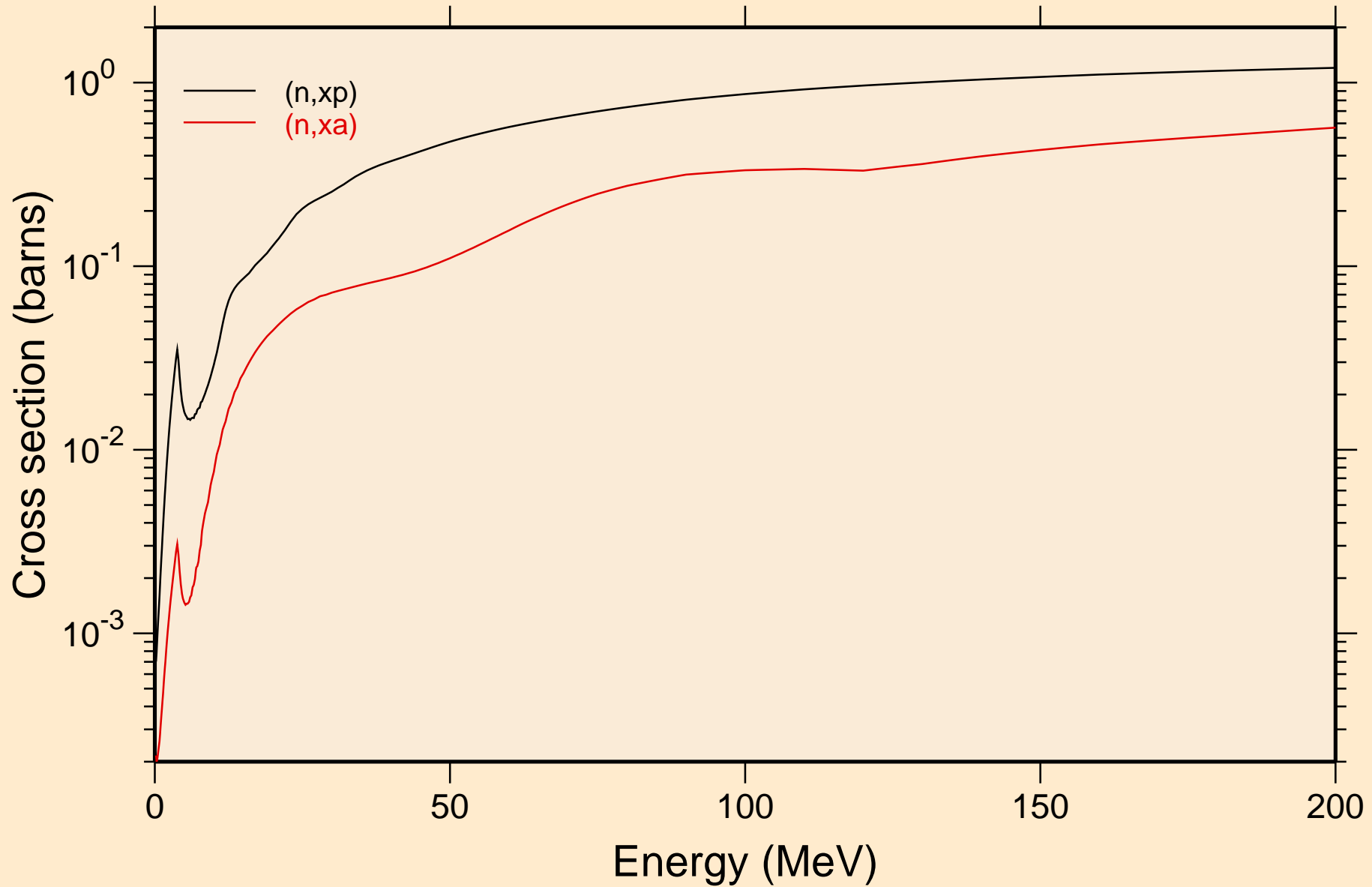

PO201 NEUTRON ACER TENDL-2024 LIBRARY; T=293.6K
Inelastic levels

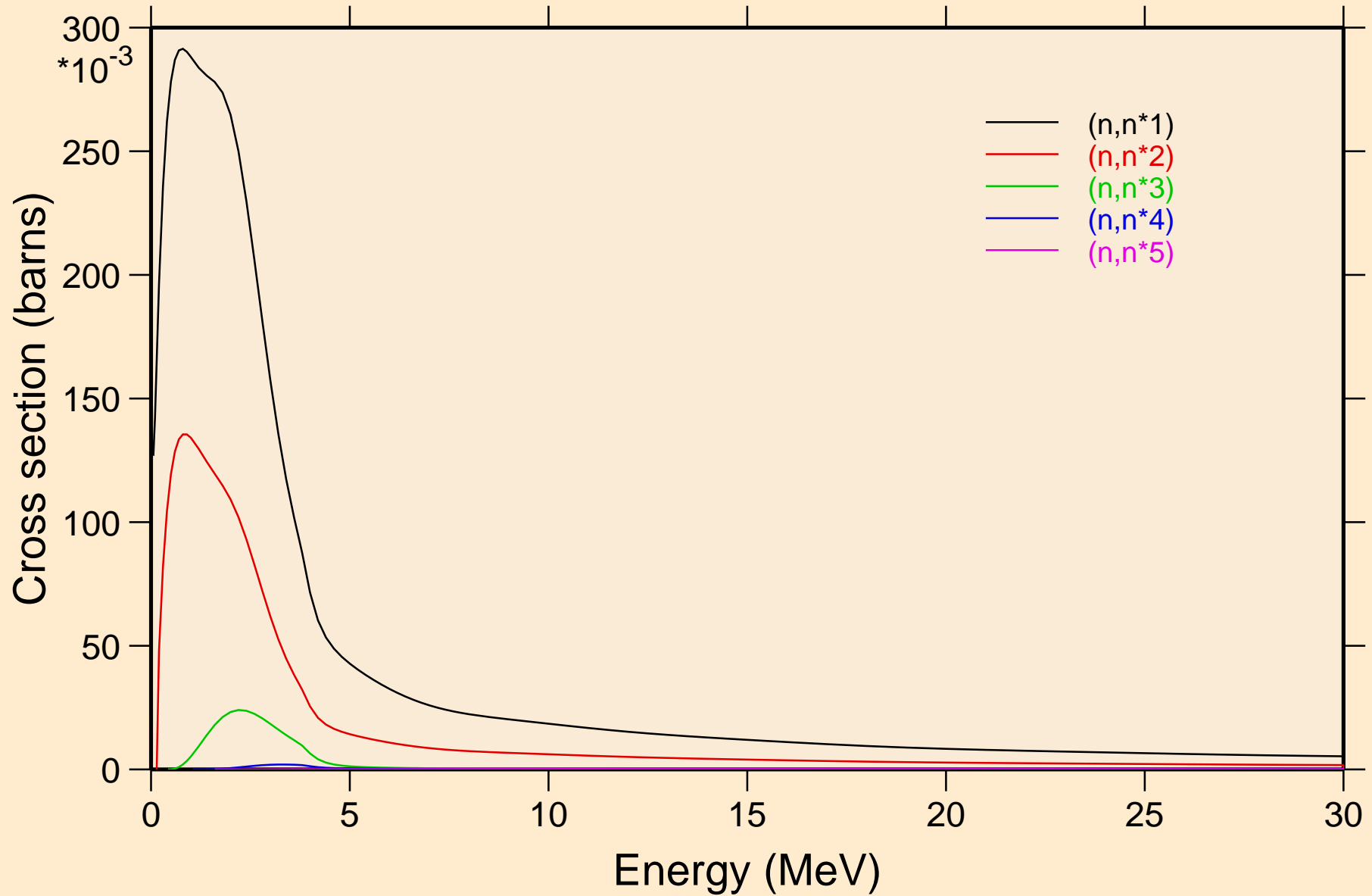

PO201 NEUTRON ACER TENDL-2024 LIBRARY; T=293.6K
Inelastic levels

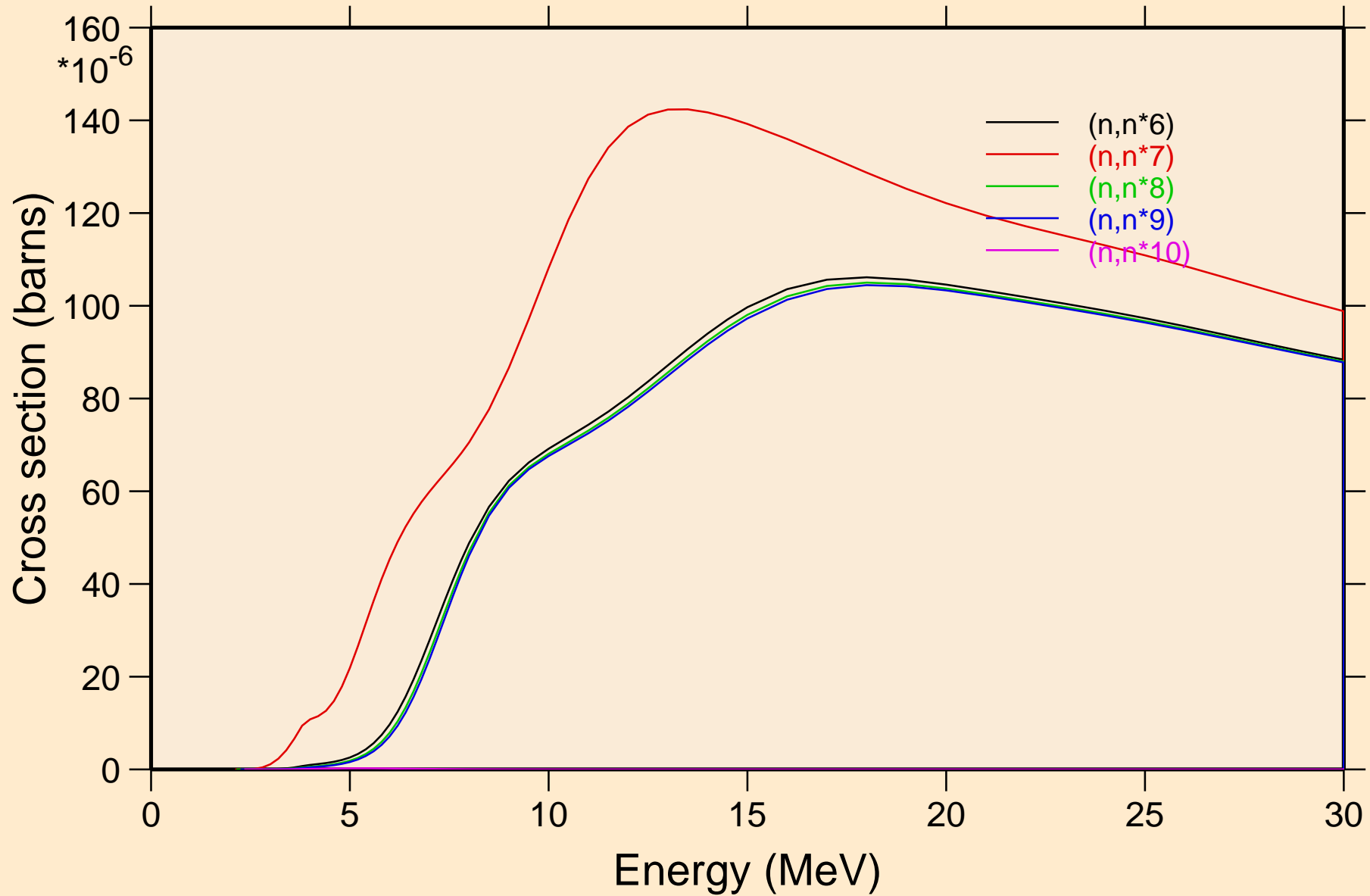

PO201 NEUTRON ACER TENDL-2024 LIBRARY; T=293.6K
Inelastic levels

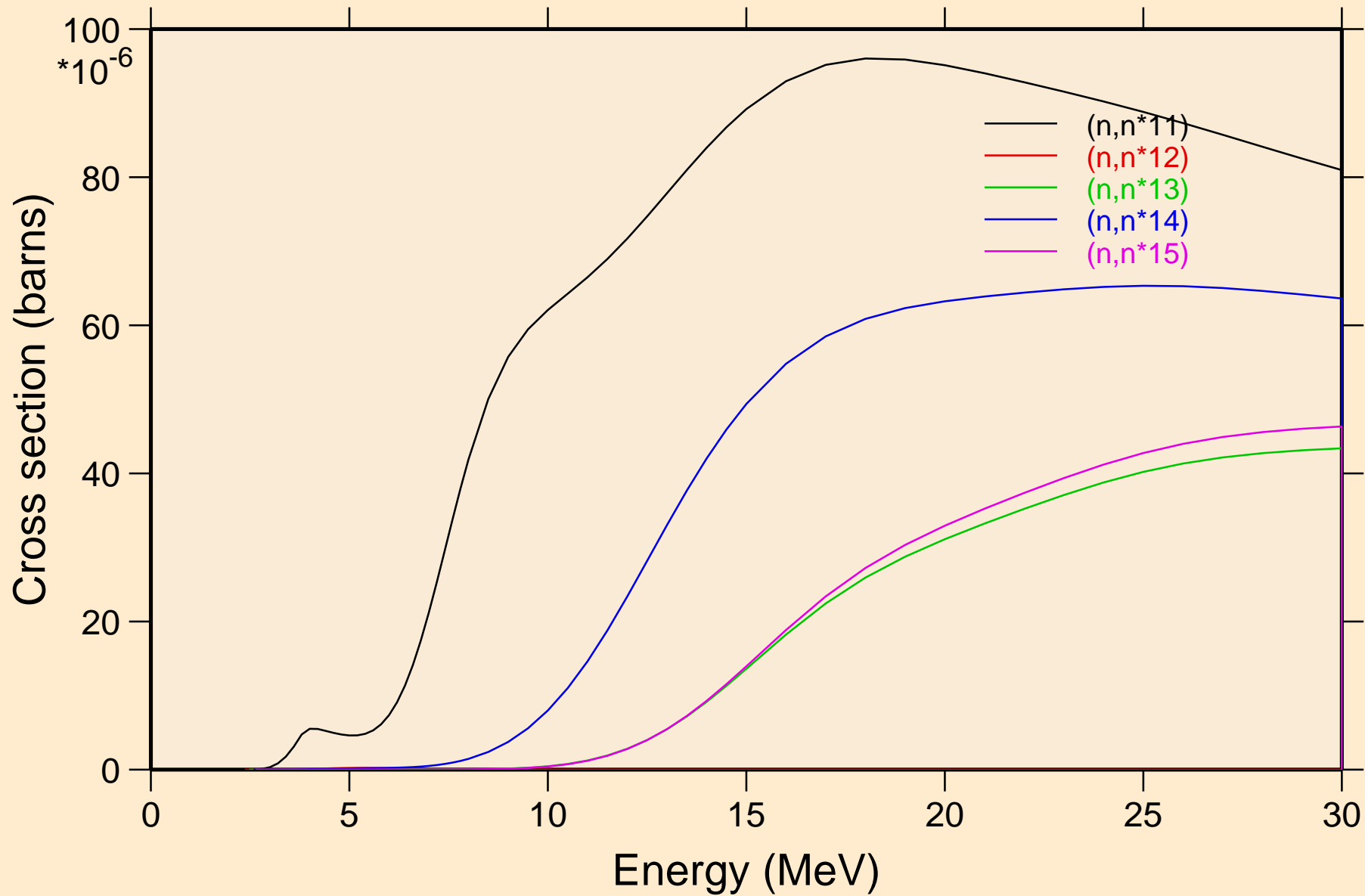

PO201 NEUTRON ACER TENDL-2024 LIBRARY; T=293.6K
Inelastic levels

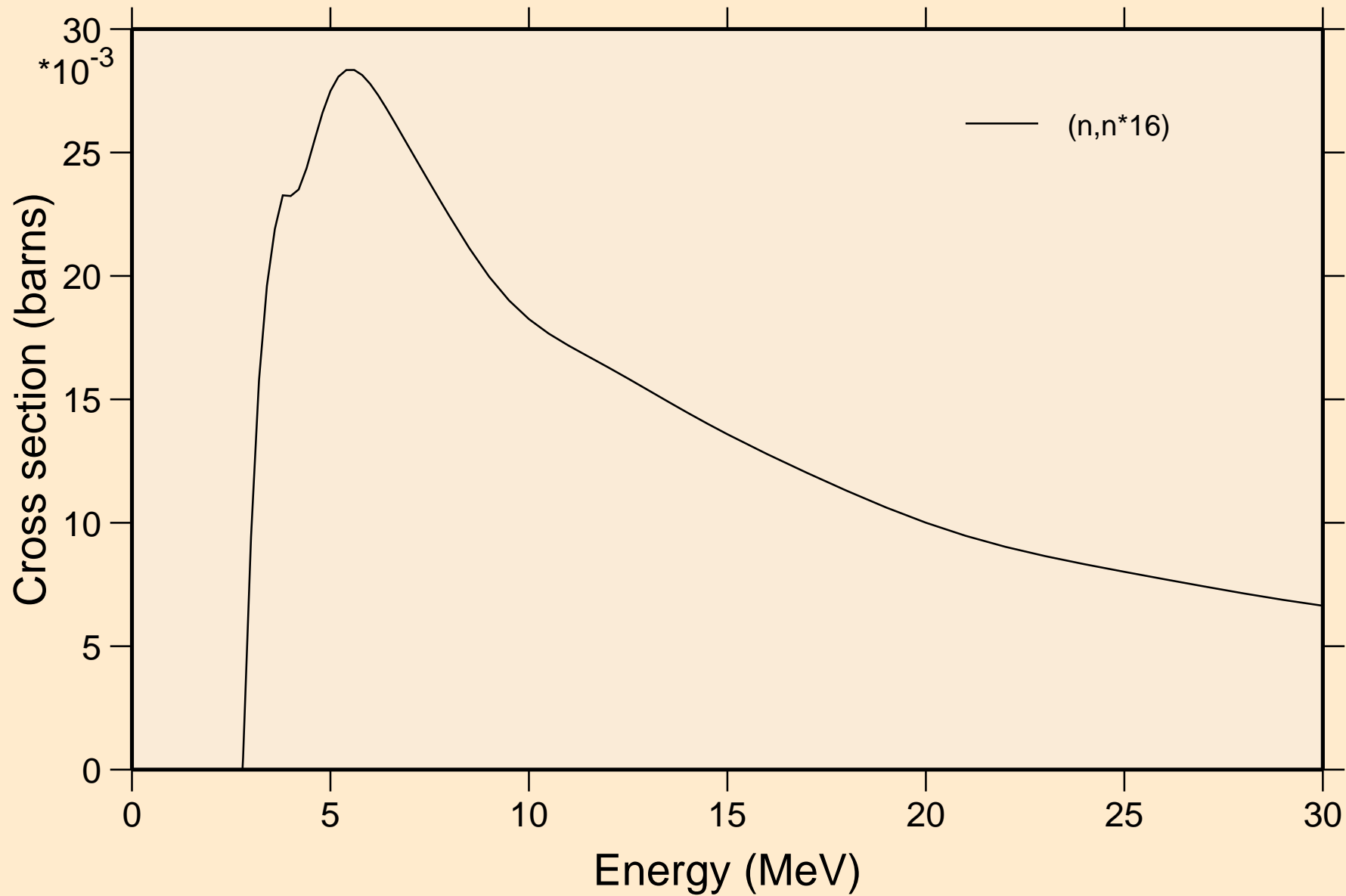

PO201 NEUTRON ACER TENDL-2024 LIBRARY; T=293.6K
Threshold reactions

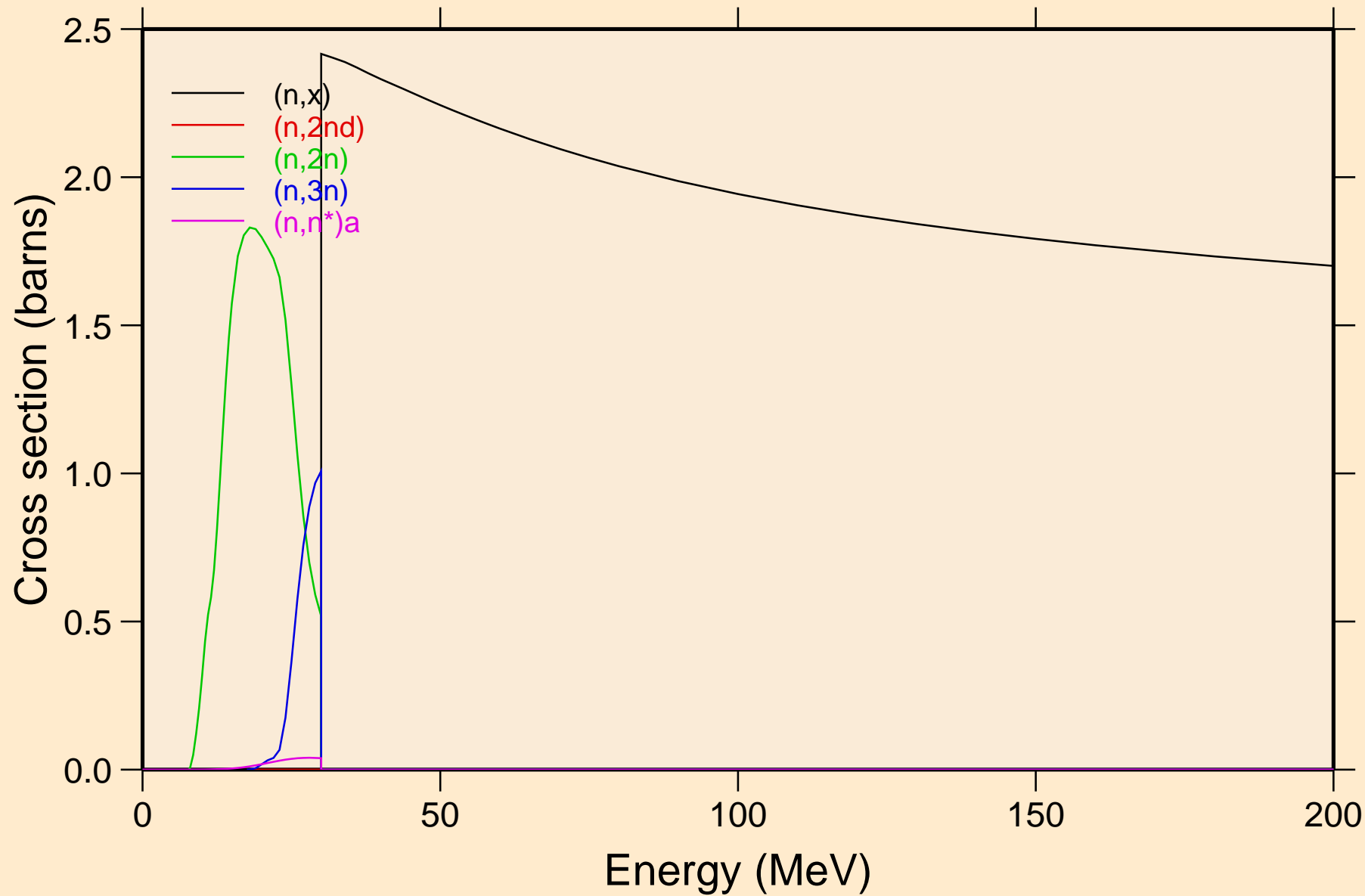

PO201 NEUTRON ACER TENDL-2024 LIBRARY; T=293.6K
Threshold reactions

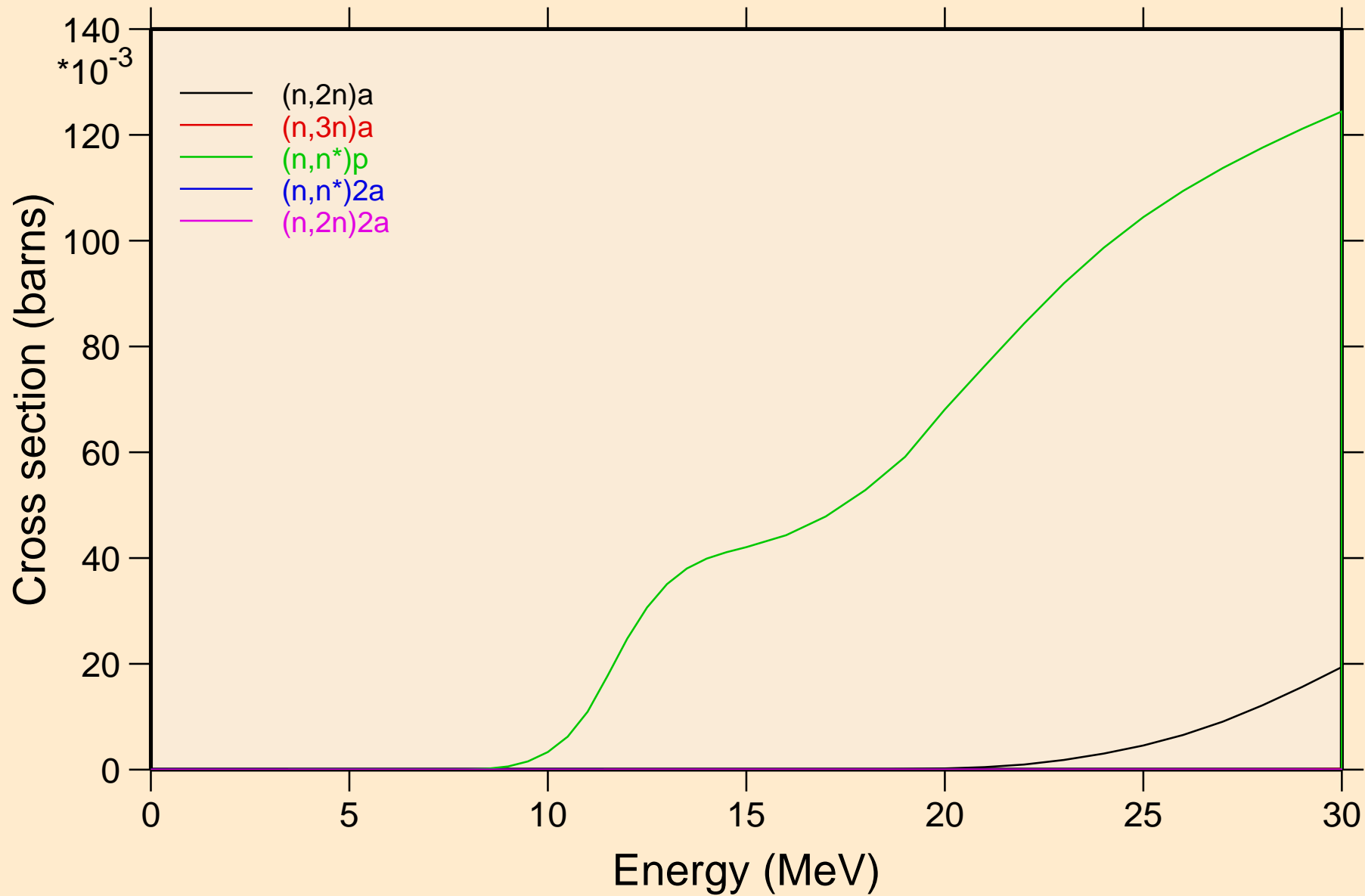

PO201 NEUTRON ACER TENDL-2024 LIBRARY; T=293.6K
Threshold reactions

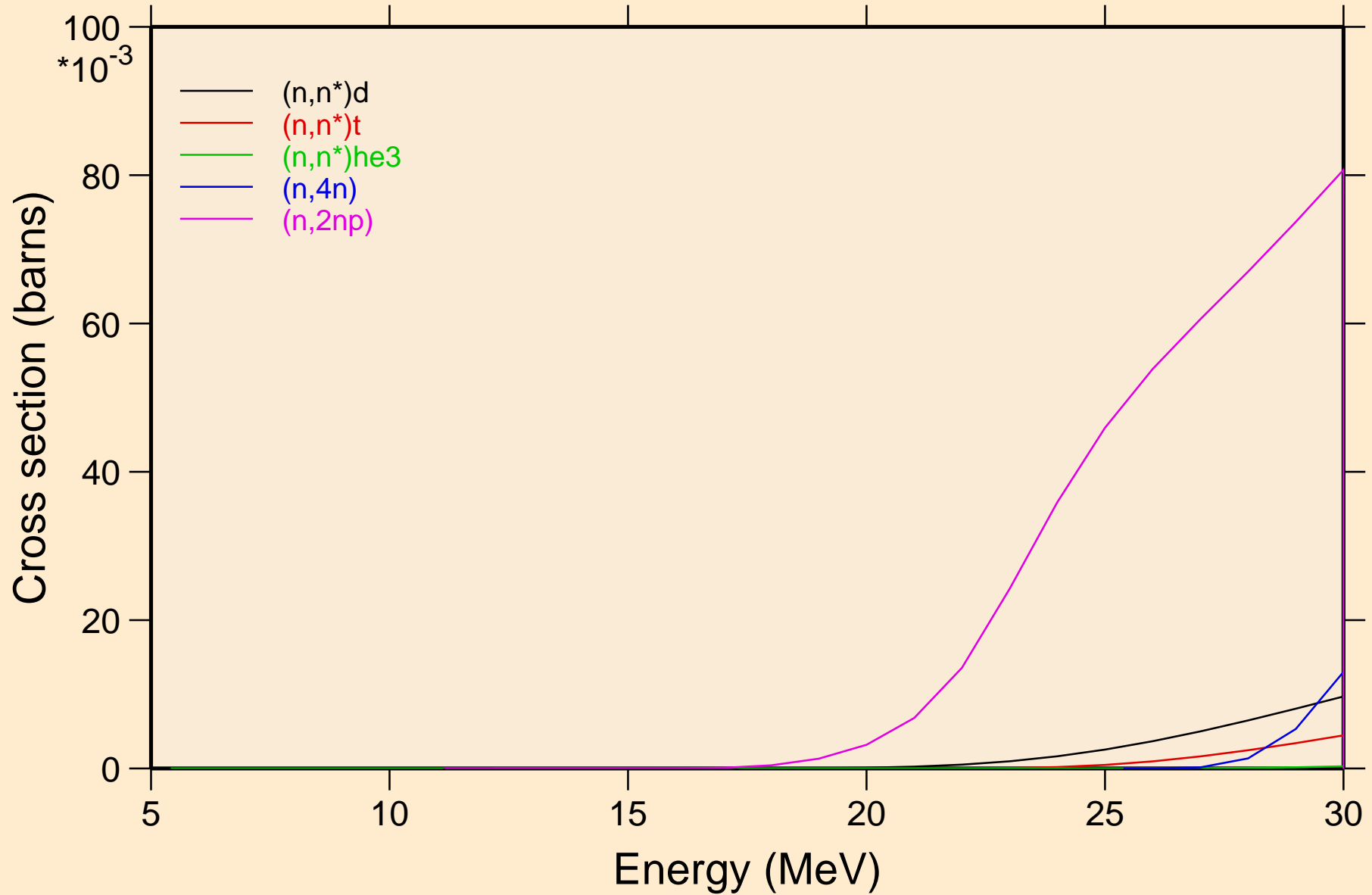

PO201 NEUTRON ACER TENDL-2024 LIBRARY; T=293.6K
Threshold reactions

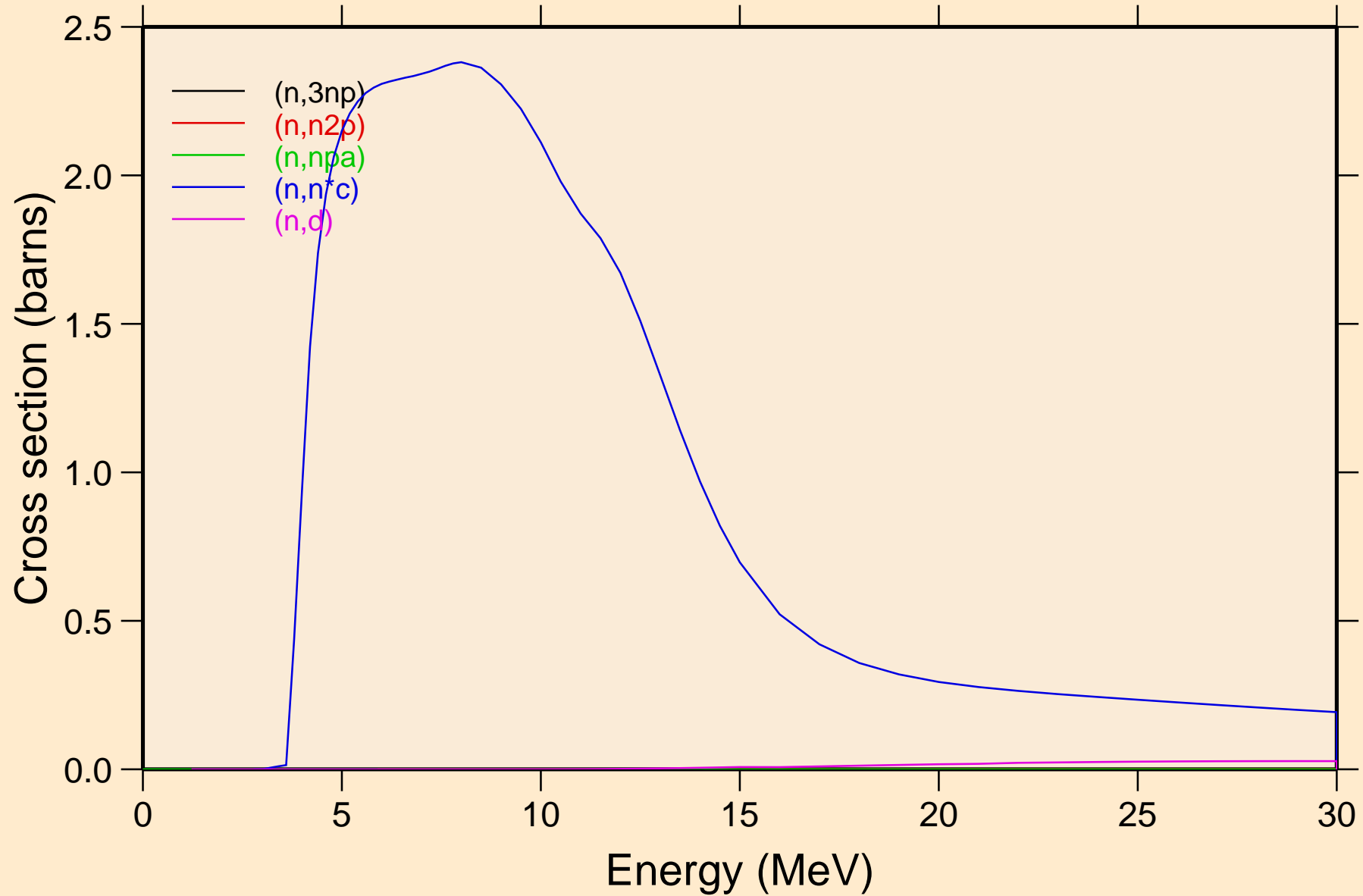

PO201 NEUTRON ACER TENDL-2024 LIBRARY; T=293.6K
Threshold reactions

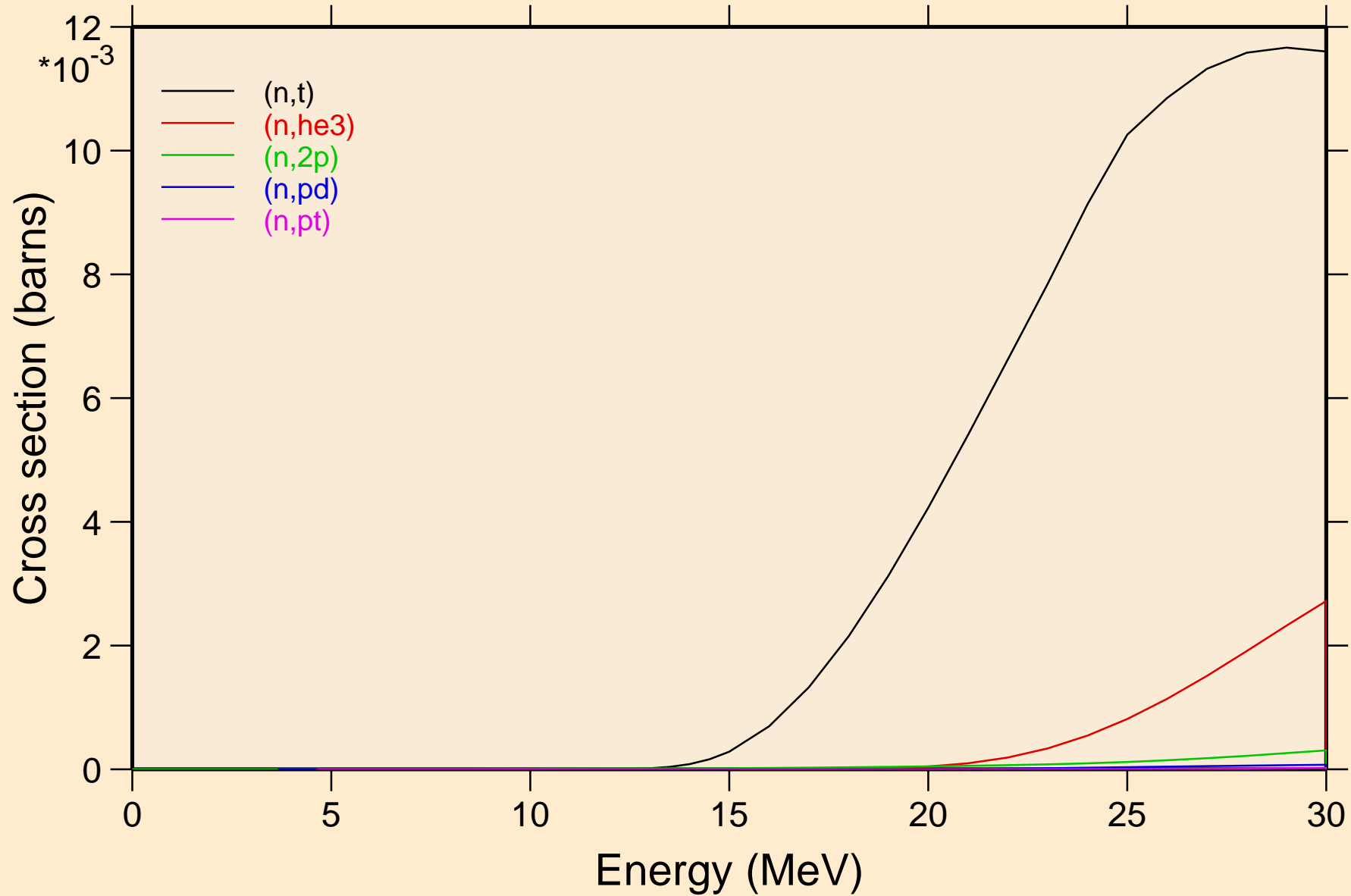

PO201 NEUTRON ACER TENDL-2024 LIBRARY; T=293.6K
Threshold reactions

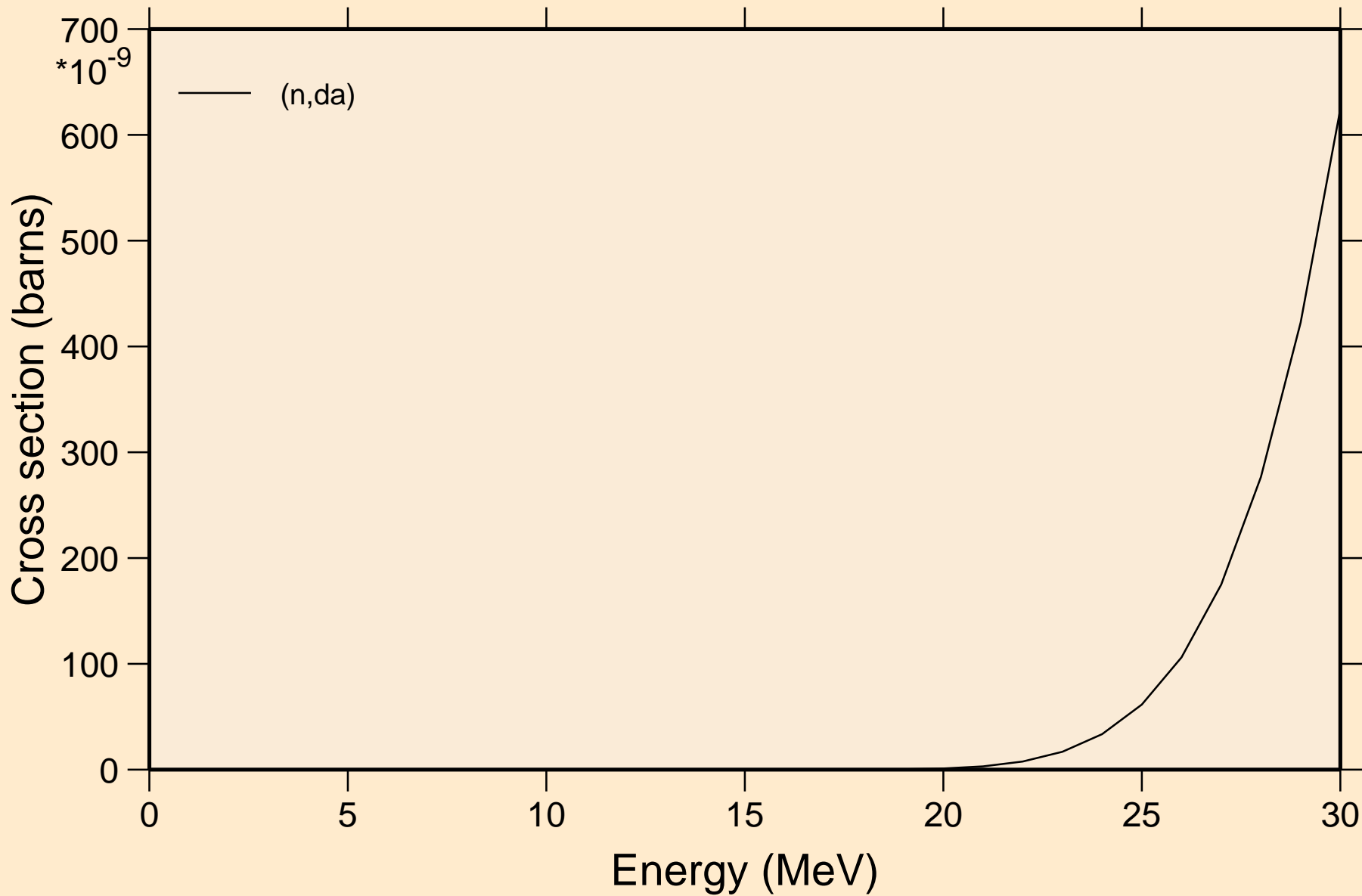

PO201 NEUTRON ACER TENDL-2024 LIBRARY; T=293.6K
Threshold reactions

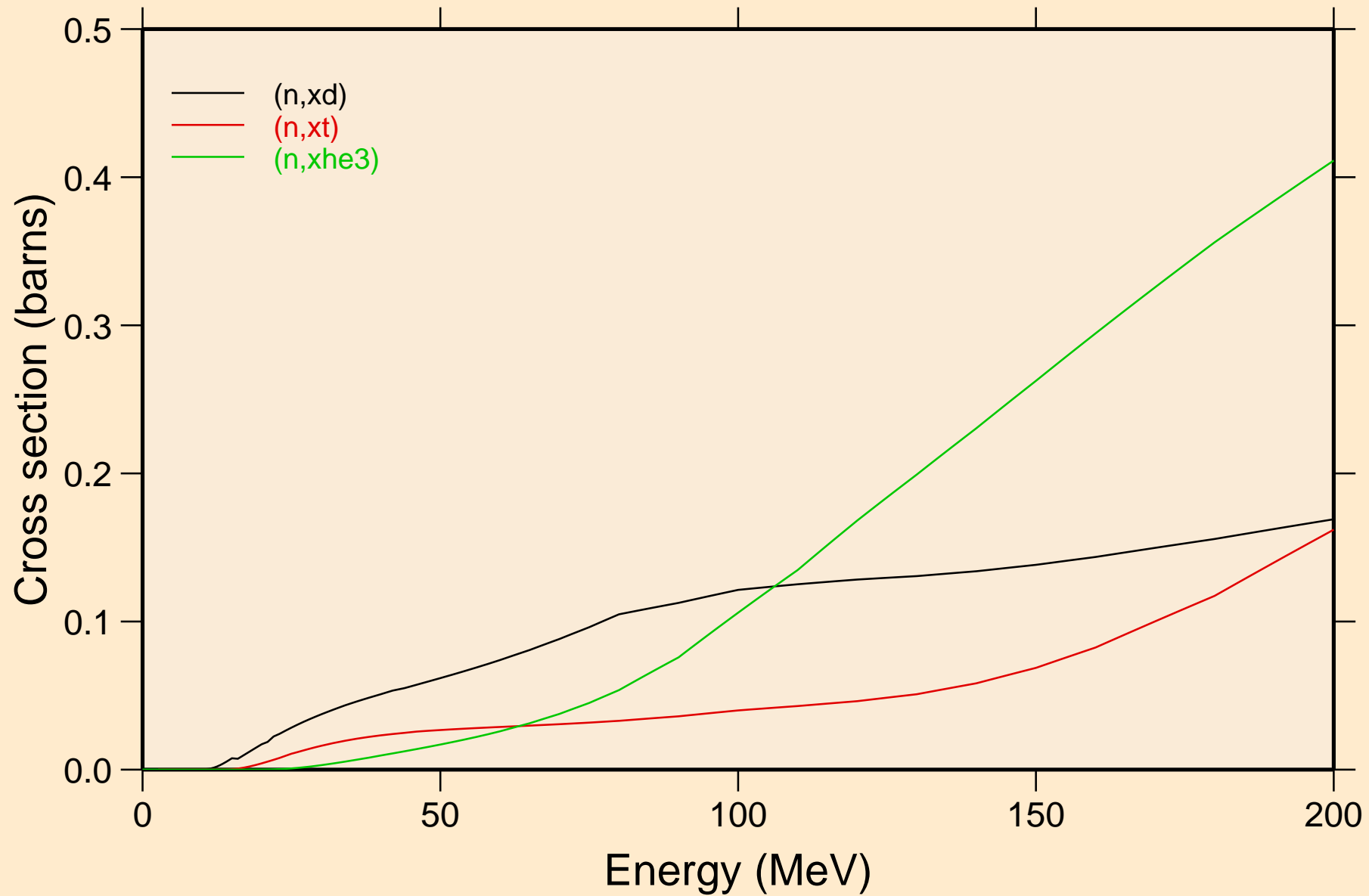

PO201 NEUTRON ACER TENDL-2024 LIBRARY; T=293.6K
angular distribution for elastic

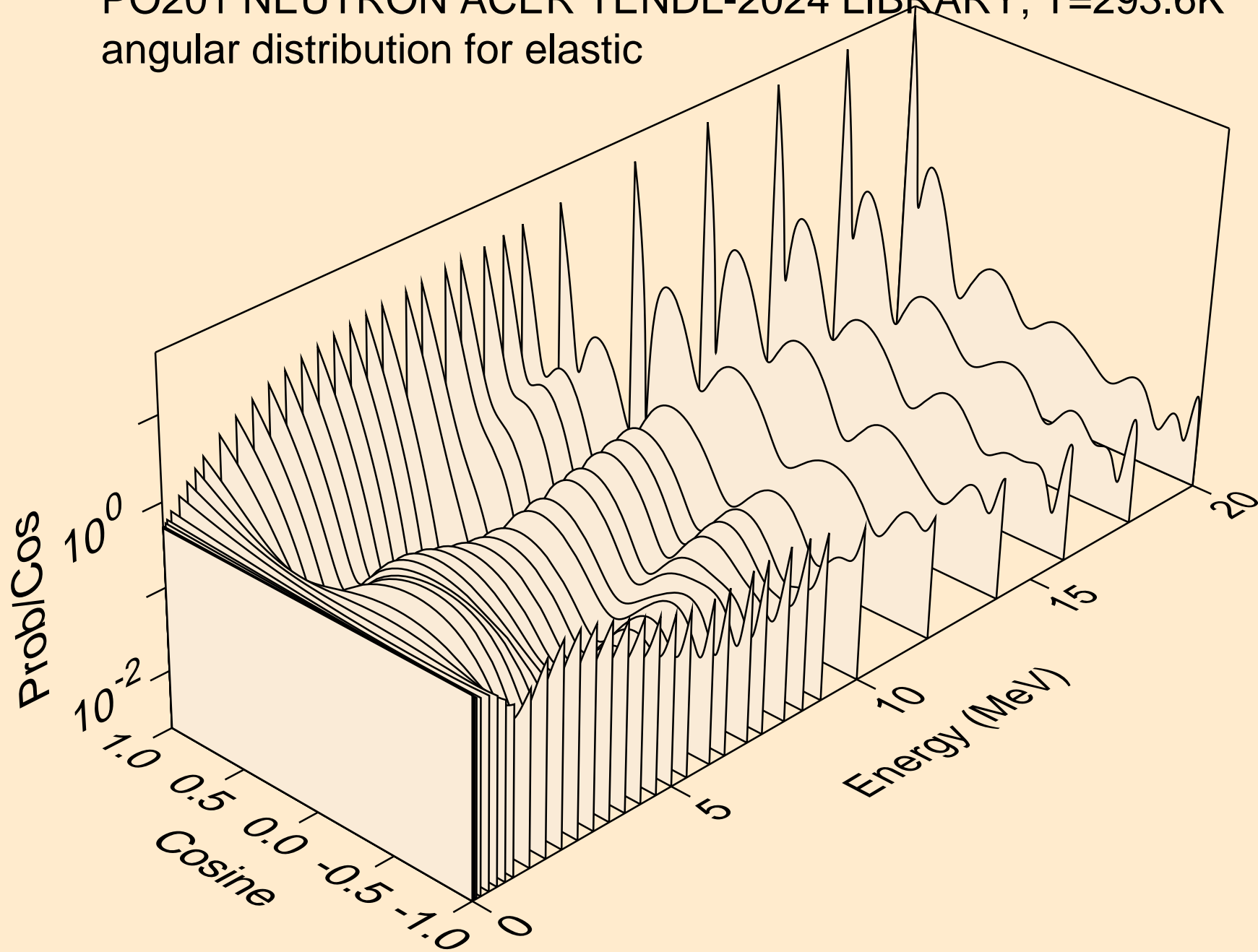

PO201 NEUTRON ACER TENDL-2024 LIBRARY; T=293.6K
angular distribution for elastic

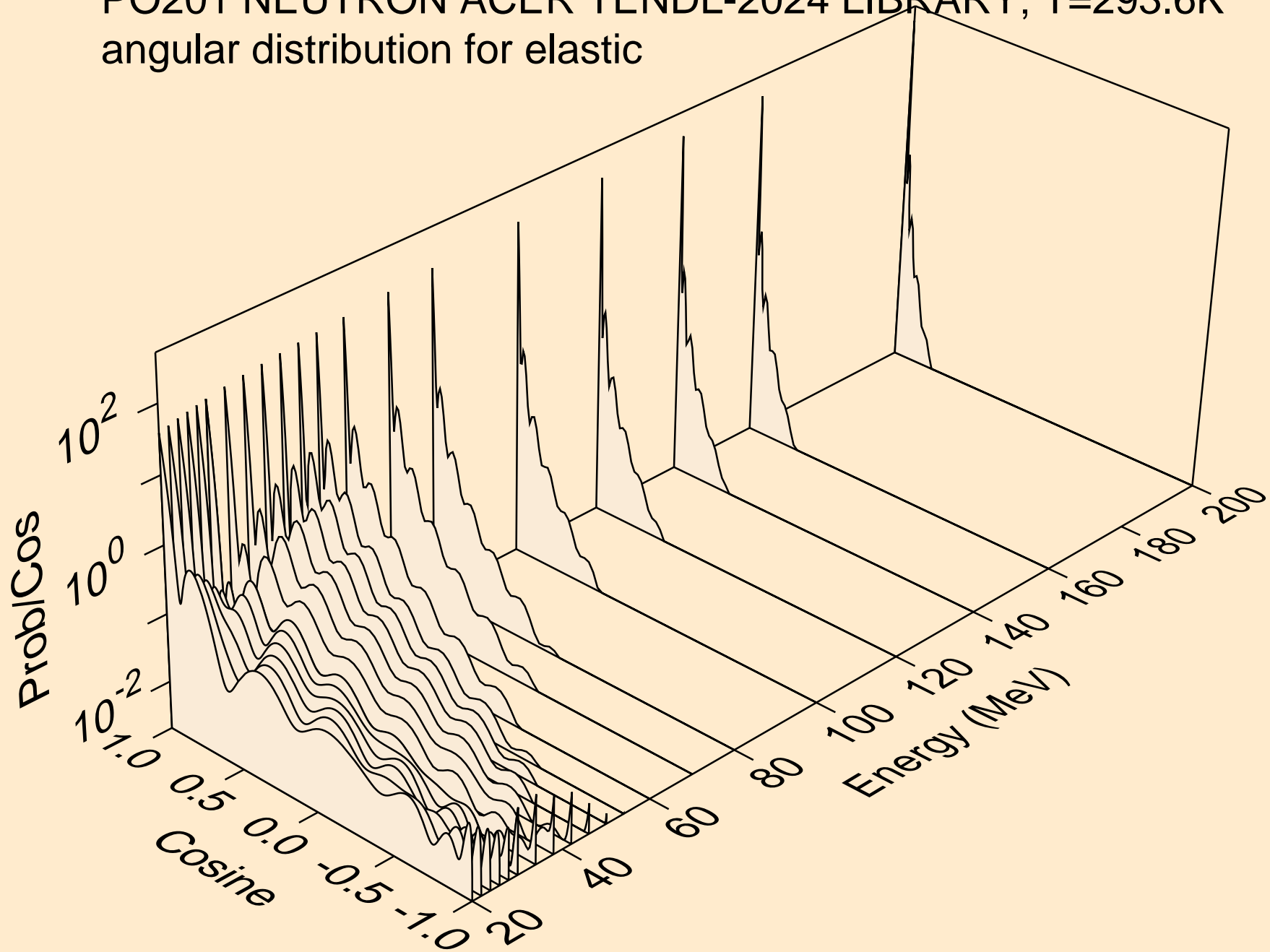

PO201 NEUTRON ACER TENDL-2024 LIBRARY; T=293.6K
angular distribution for (n,n*1)

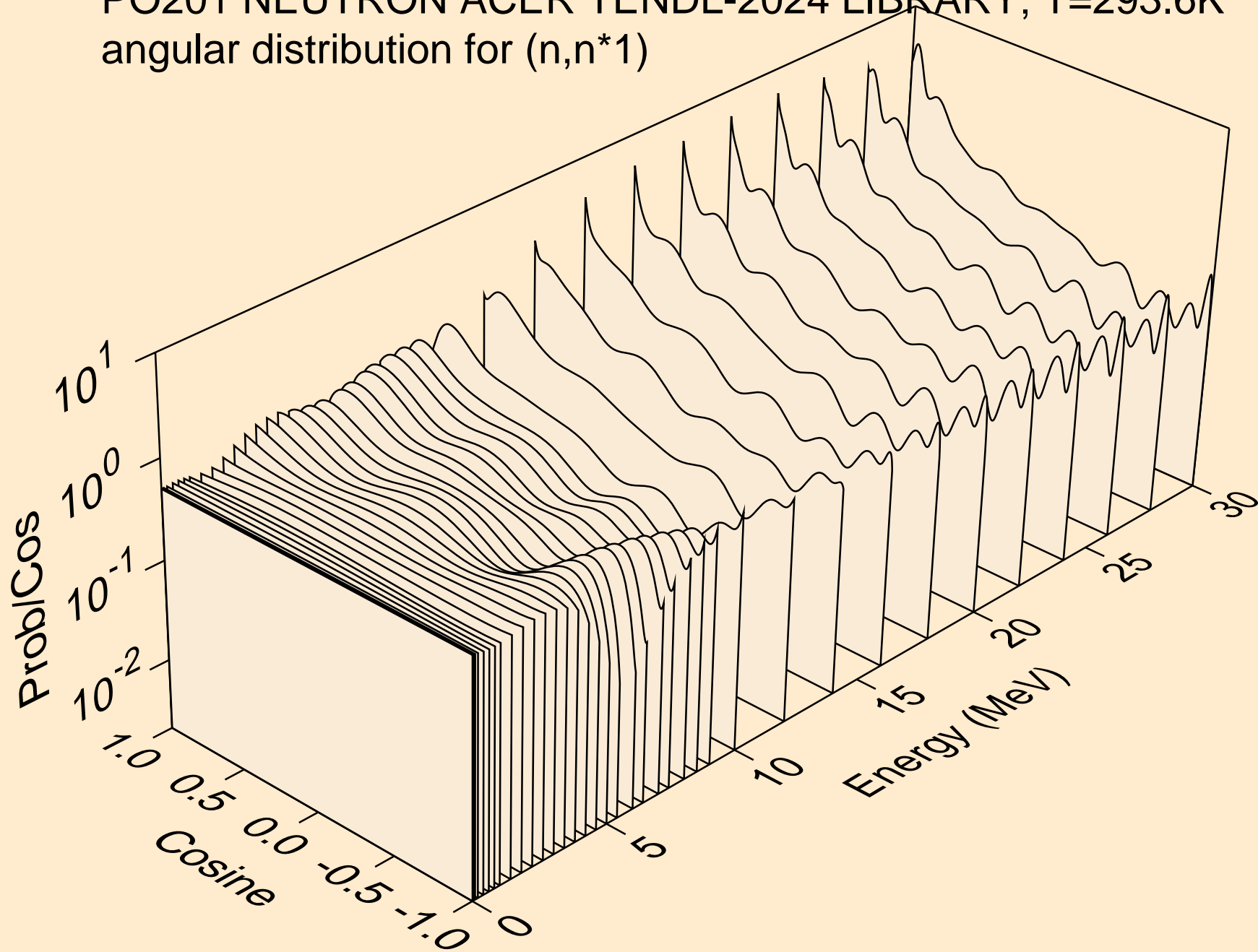

PO201 NEUTRON ACER TENDL-2024 LIBRARY; T=293.6K
angular distribution for (n,n*2)

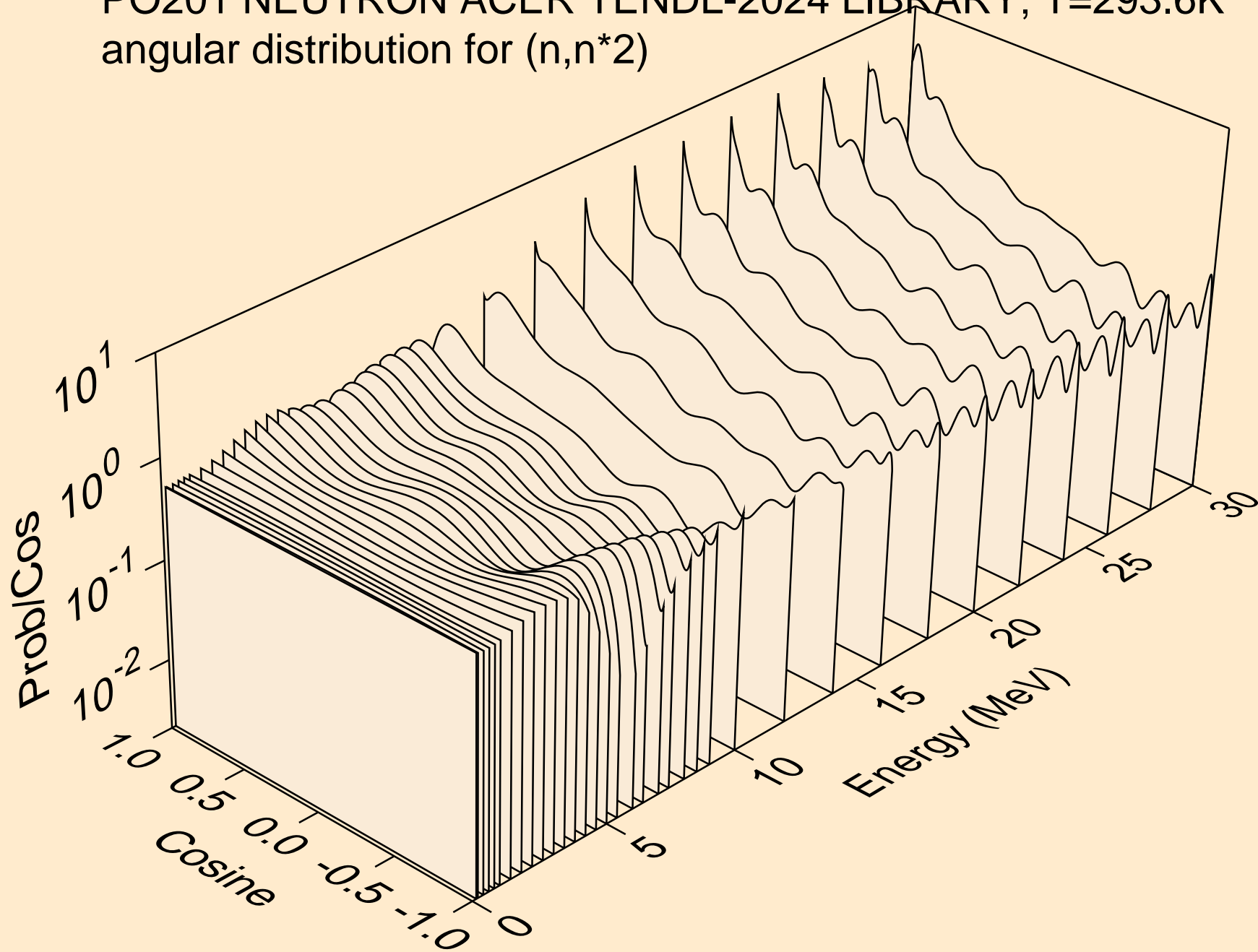

PO201 NEUTRON ACER TENDL-2024 LIBRARY; T=293.6K
angular distribution for (n,n*3)

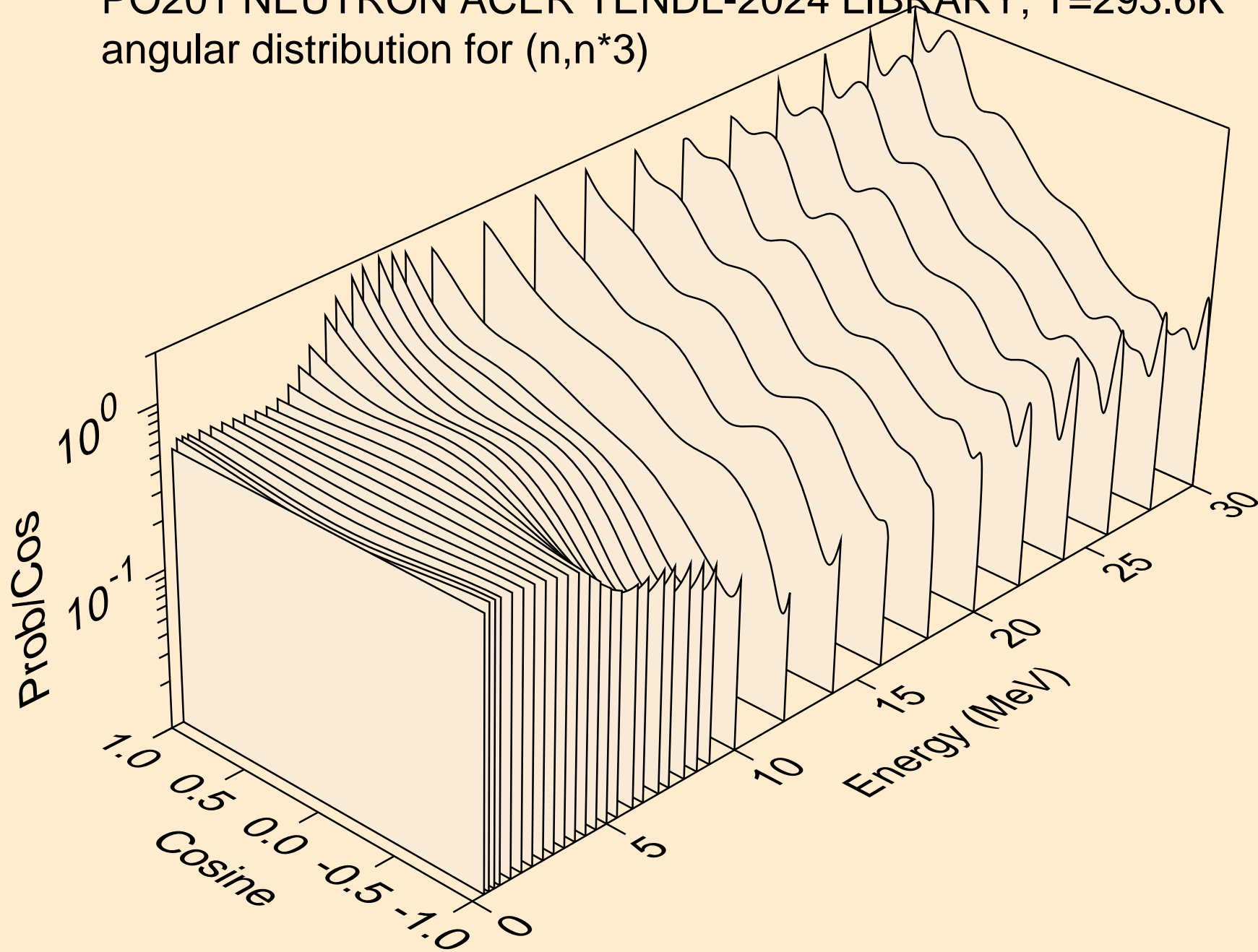

PO201 NEUTRON ACER TENDL-2024 LIBRARY; T=293.6K
angular distribution for (n,n*4)

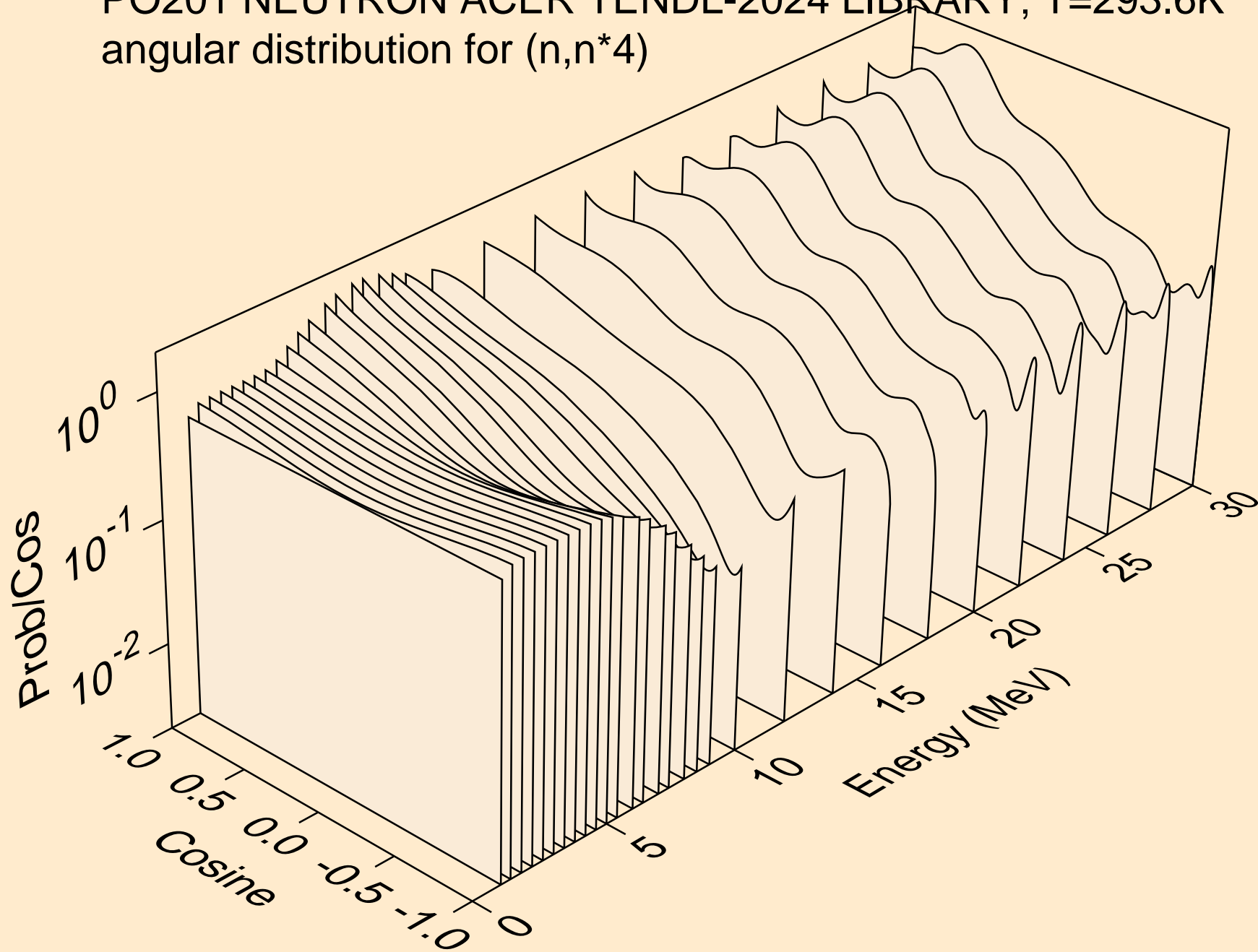

PO201 NEUTRON ACER TENDL-2024 LIBRARY; T=293.6K
angular distribution for (n,n*5)

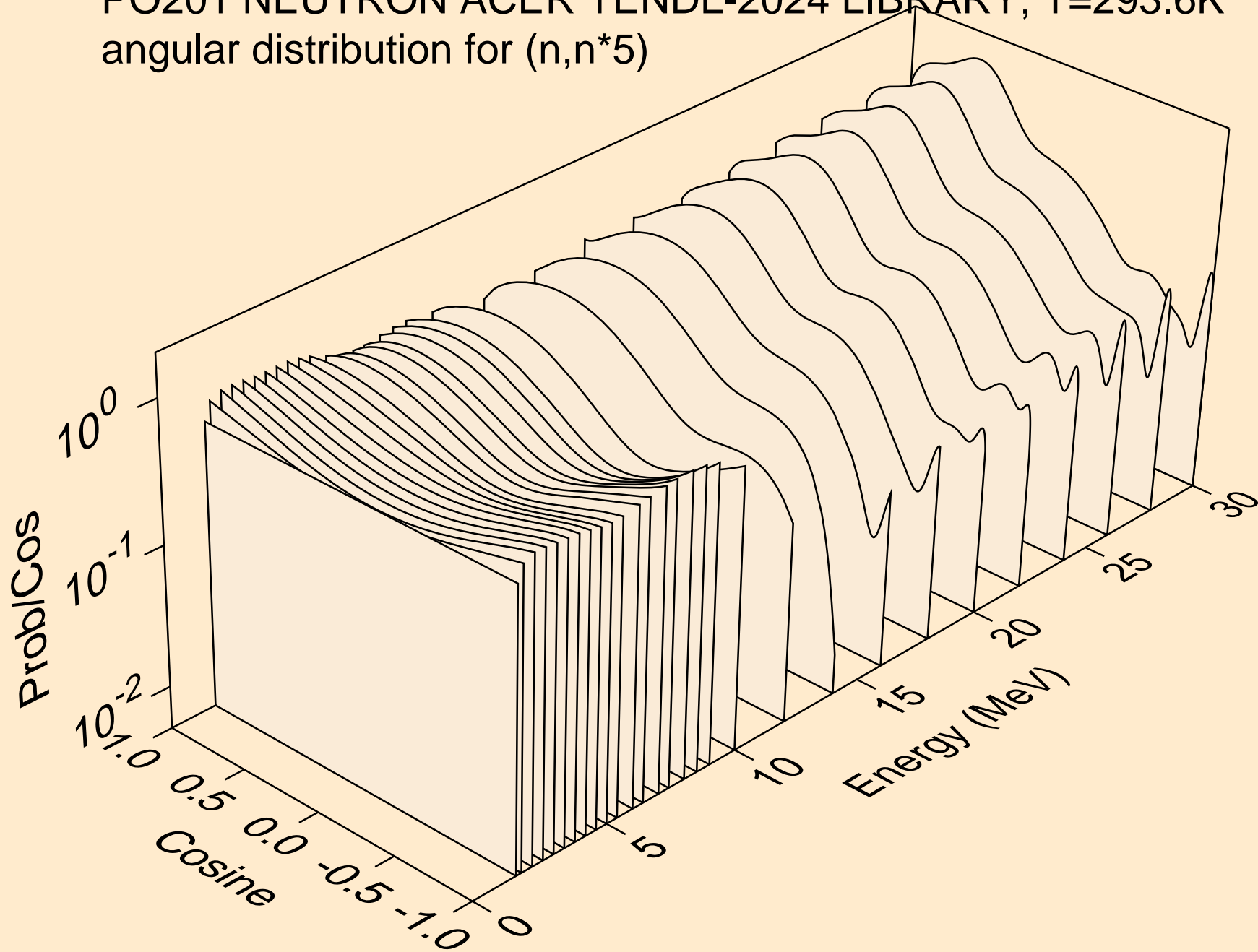

PO201 NEUTRON ACER TENDL-2024 LIBRARY; T=293.6K
angular distribution for (n,n*6)

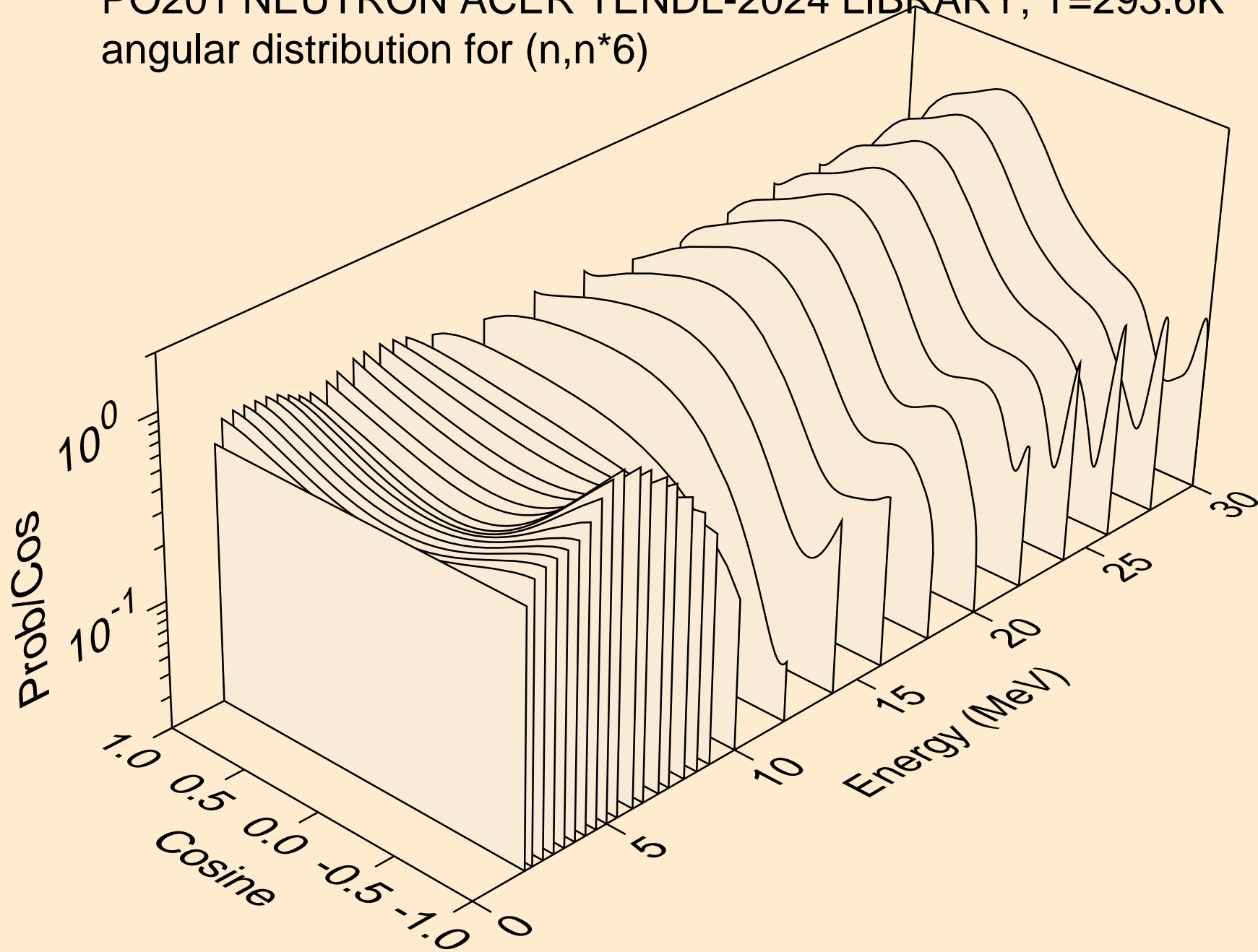

PO201 NEUTRON ACER TENDL-2024 LIBRARY; T=293.6K
angular distribution for (n,n*7)

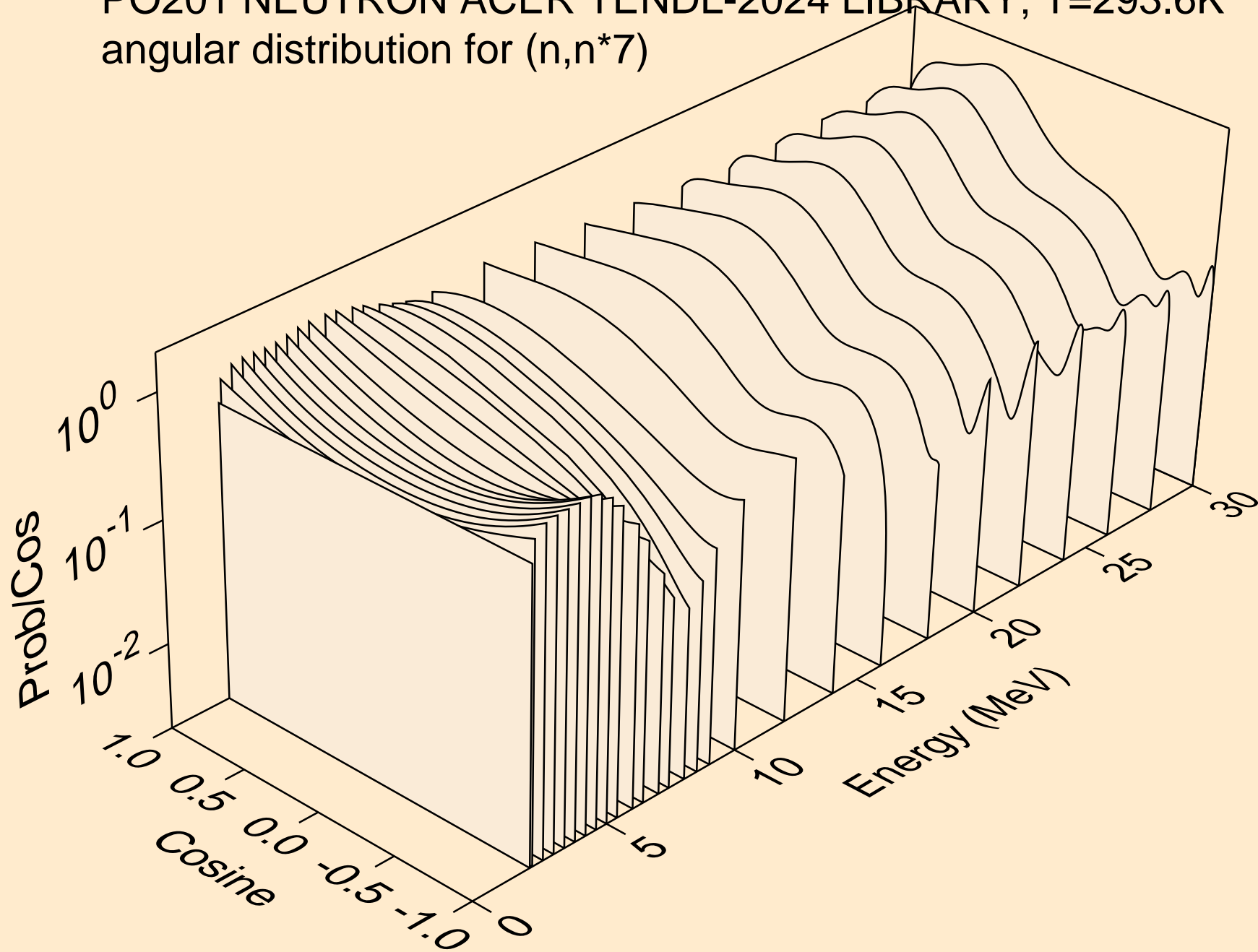

PO201 NEUTRON ACER TENDL-2024 LIBRARY; T=293.6K
angular distribution for (n,n*8)

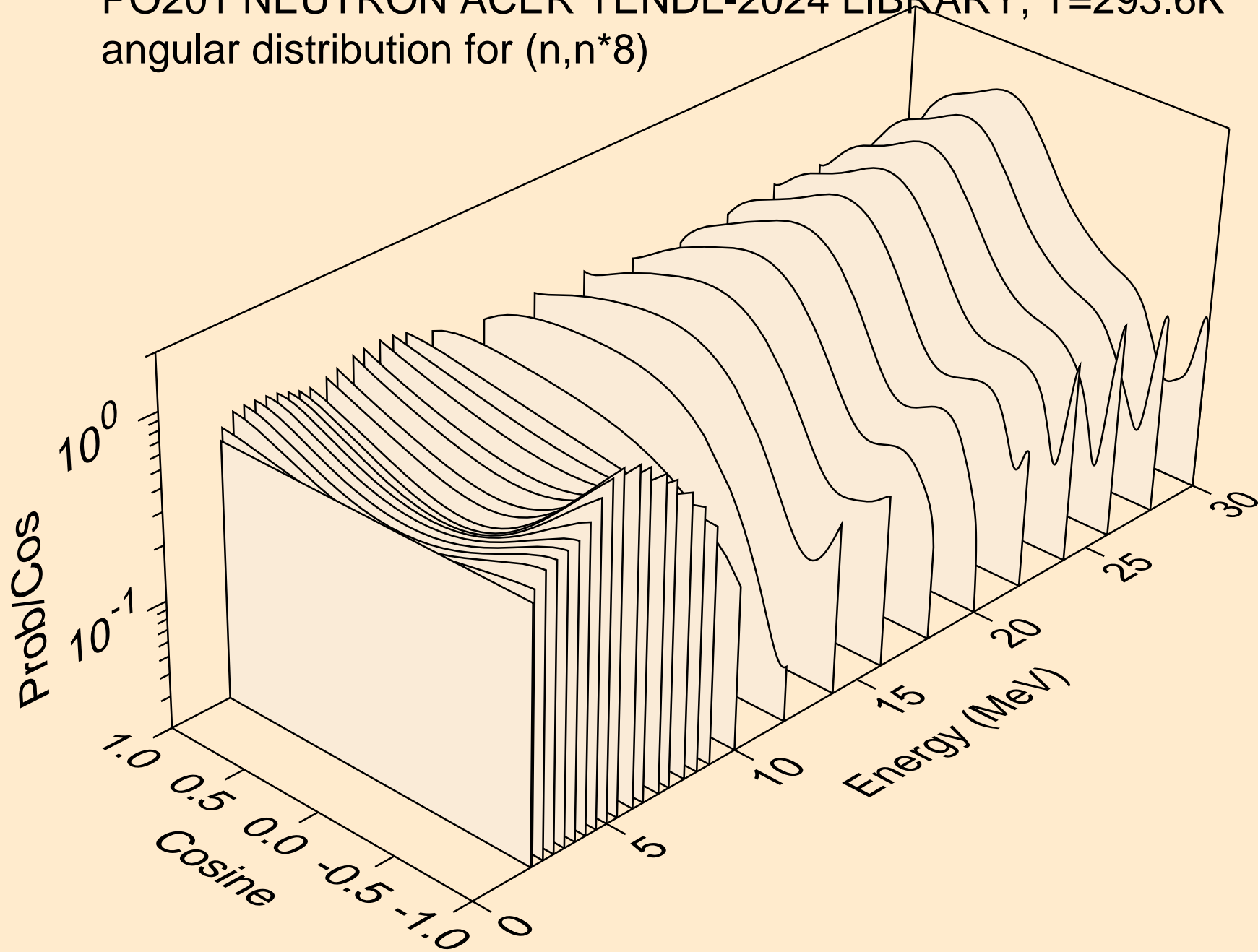

PO201 NEUTRON ACER TENDL-2024 LIBRARY; T=293.6K
angular distribution for (n,n*9)

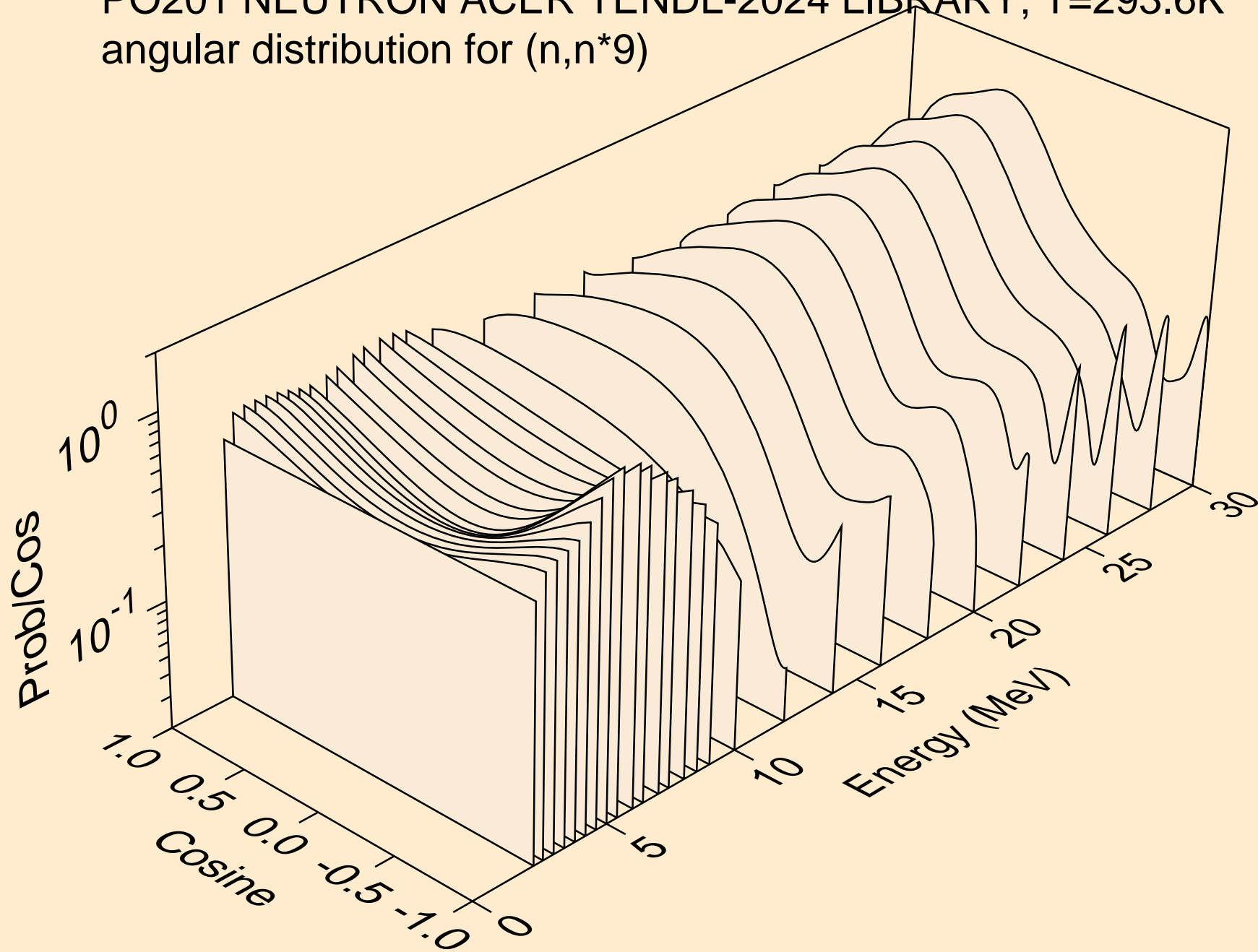

PO201 NEUTRON ACER TENDL-2024 LIBRARY; T=293.6K
angular distribution for (n,n*10)

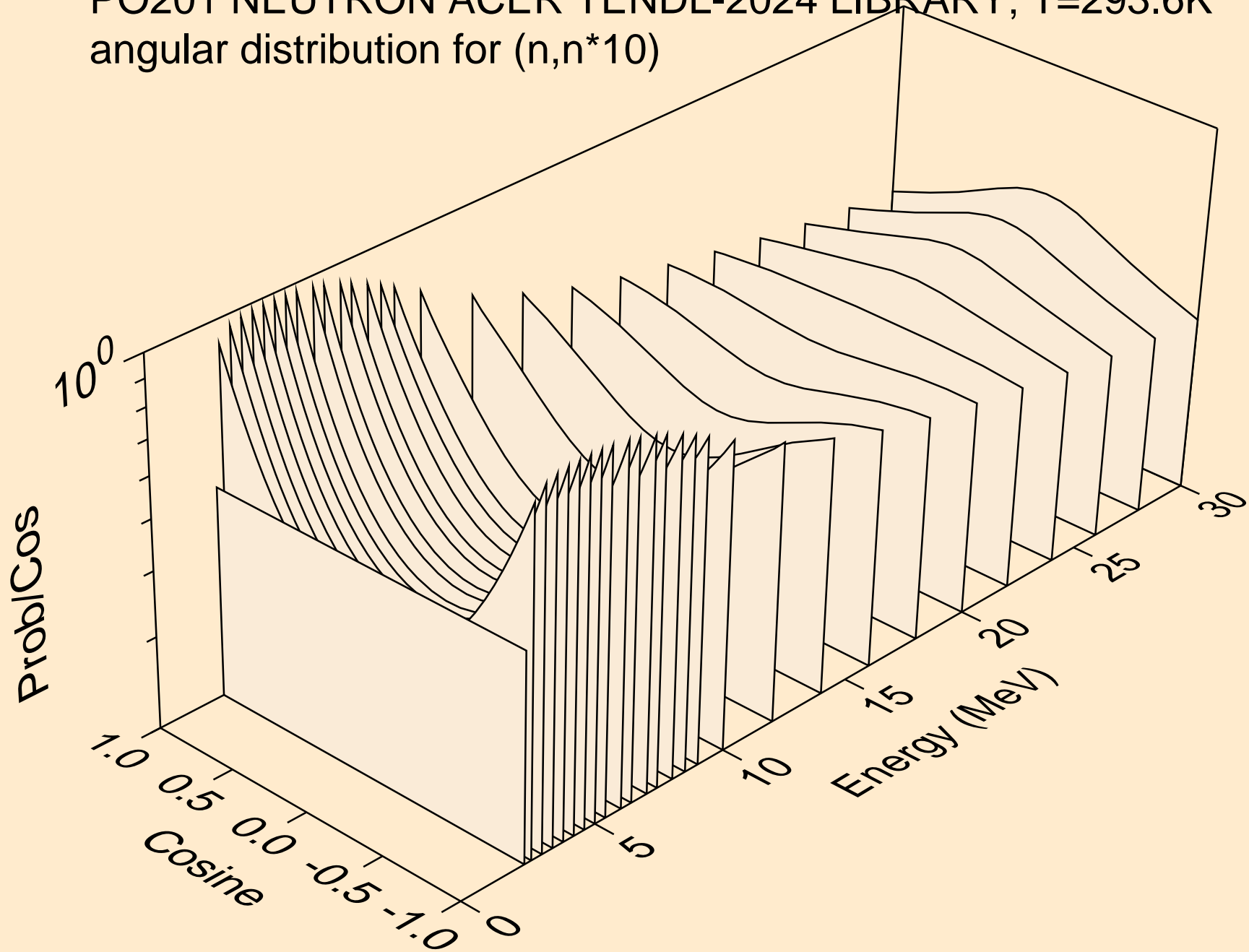

PO201 NEUTRON ACER TENDL-2024 LIBRARY; T=293.6K
angular distribution for (n,n*11)

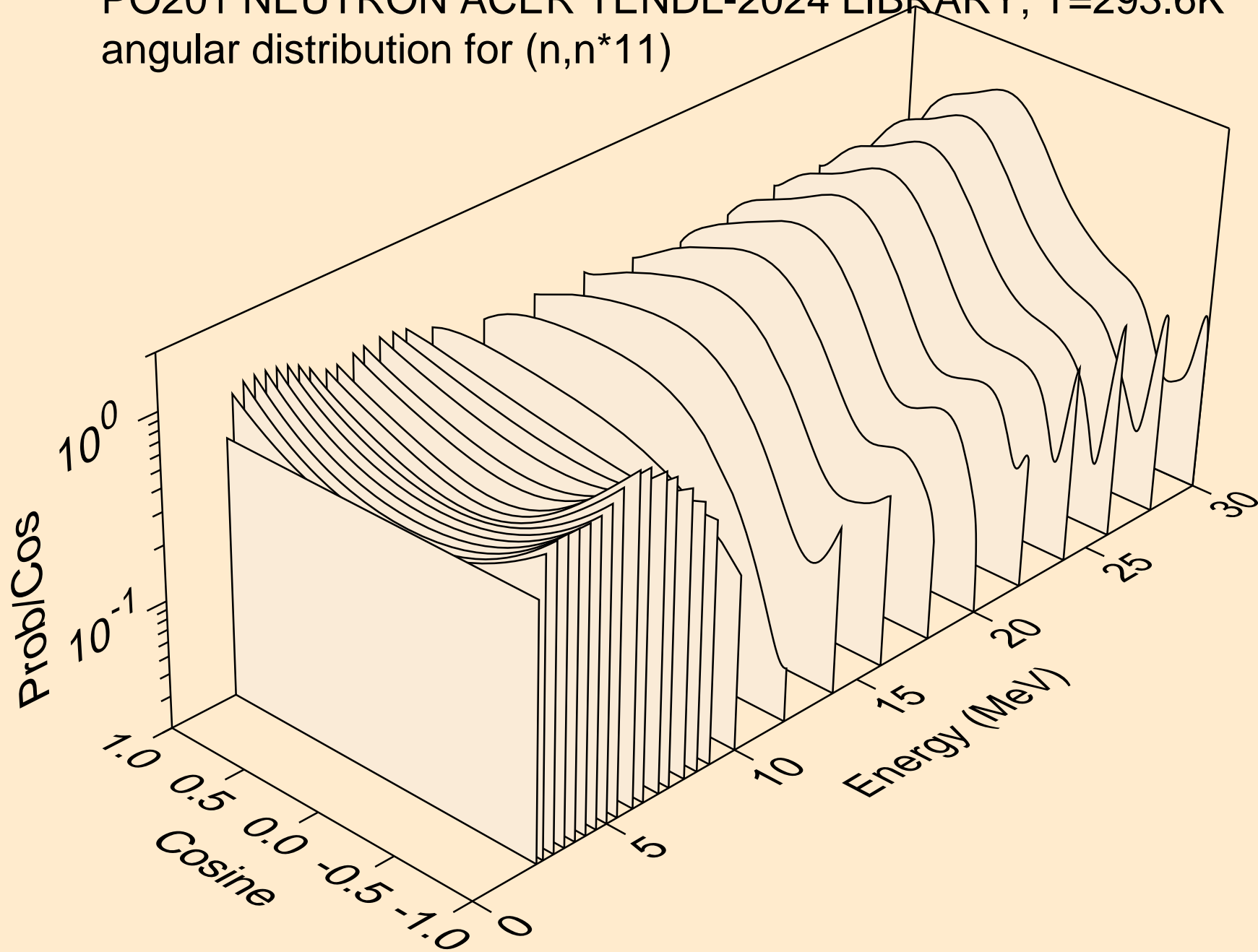

PO201 NEUTRON ACER TENDL-2024 LIBRARY; T=293.6K
angular distribution for (n,n*12)

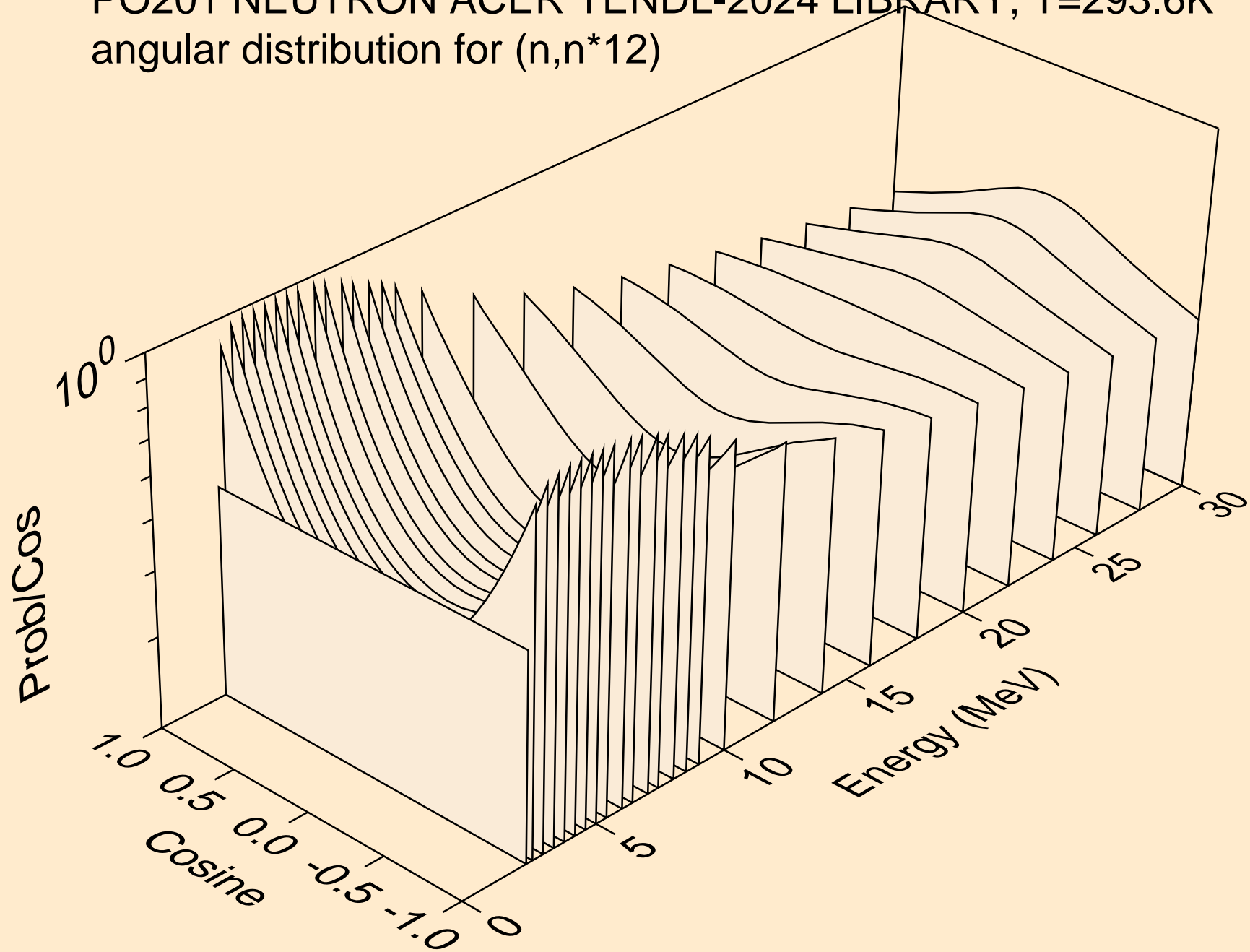

PO201 NEUTRON ACER TENDL-2024 LIBRARY; T=293.6K
angular distribution for (n,n*13)

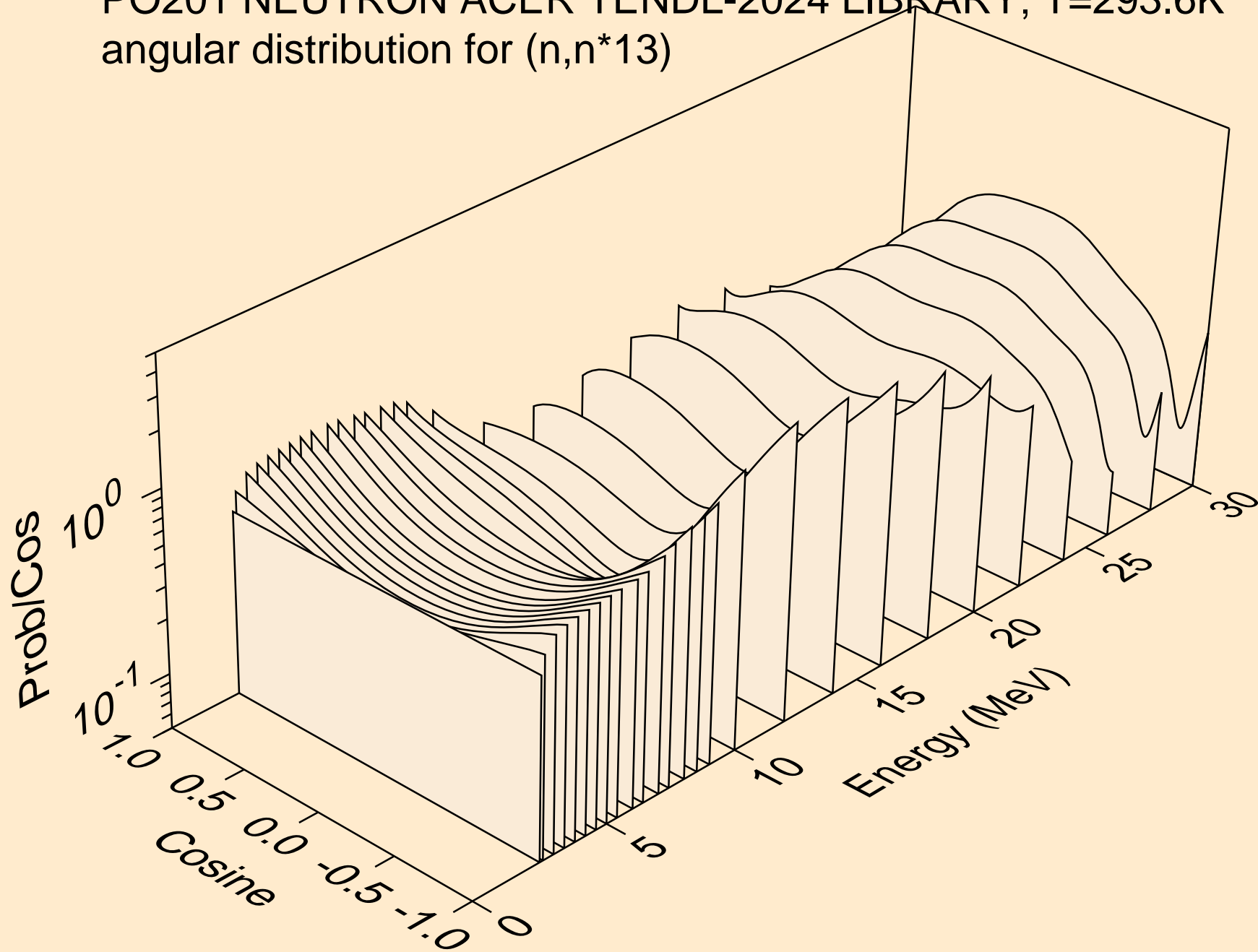

PO201 NEUTRON ACER TENDL-2024 LIBRARY; T=293.6K
angular distribution for (n,n*14)

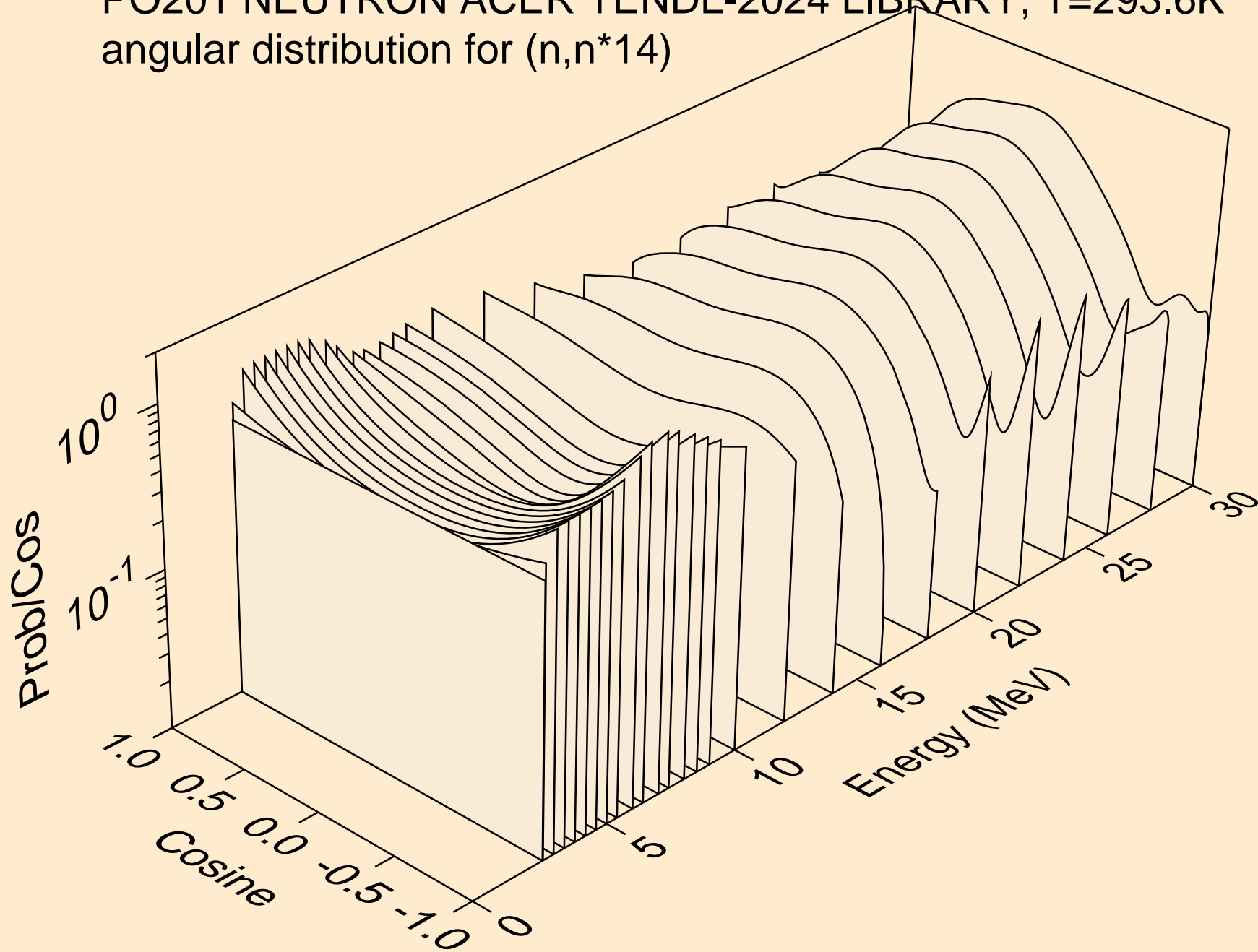

PO201 NEUTRON ACER TENDL-2024 LIBRARY; T=293.6K
angular distribution for (n,n*15)

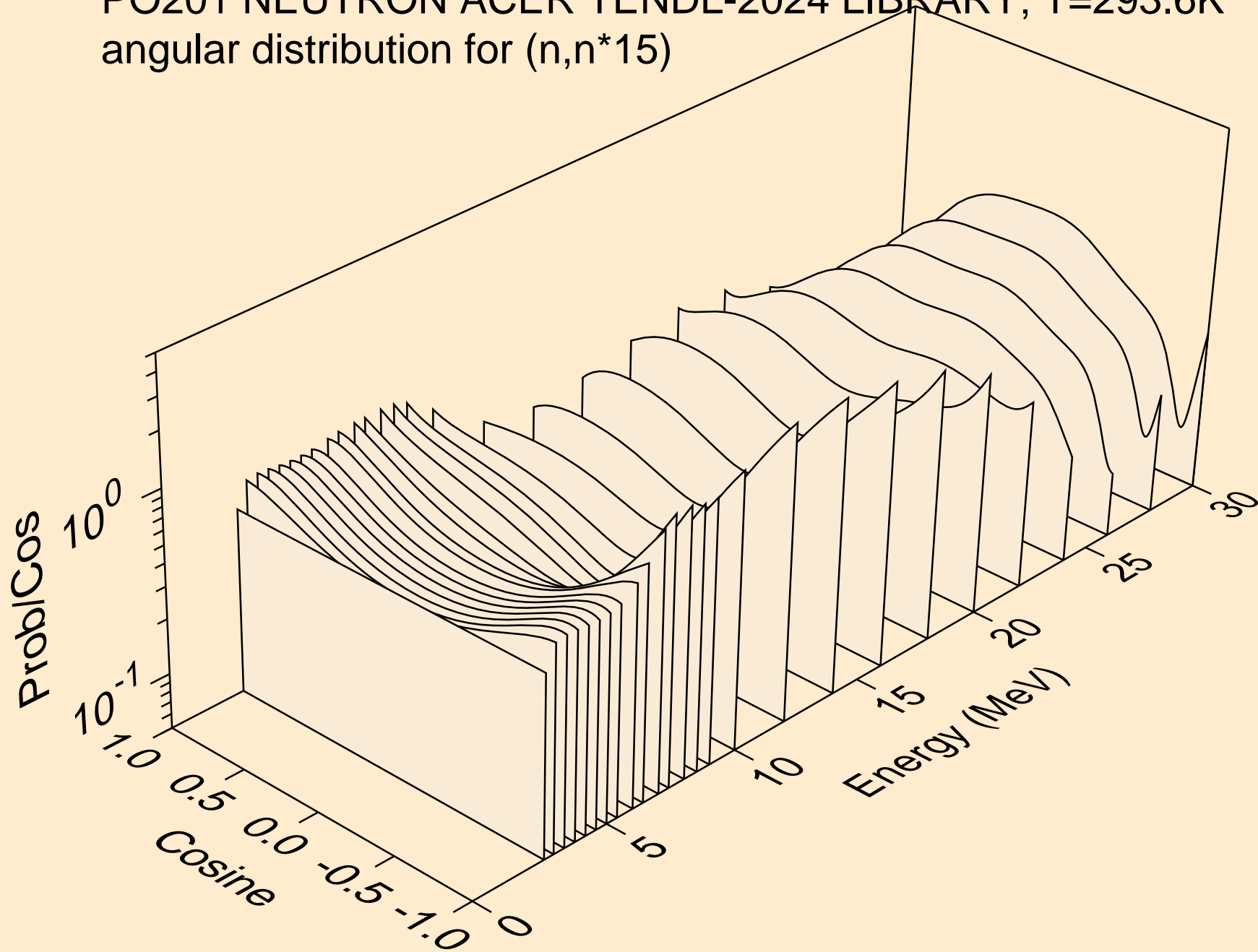

PO201 NEUTRON ACER TENDL-2024 LIBRARY; T=293.6K
angular distribution for (n,n*16)

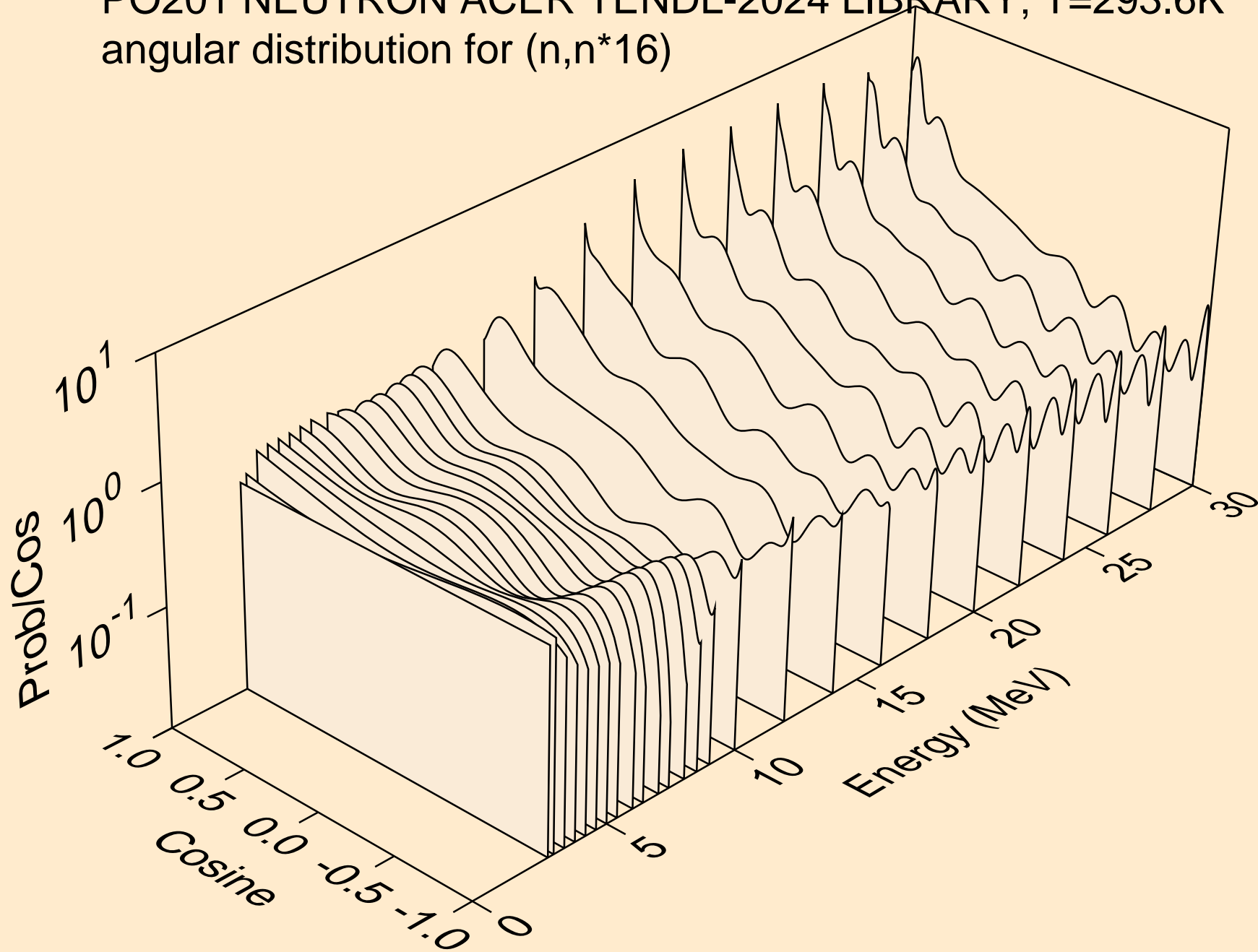

PO201 NEUTRON ACER TENDL-2024 LIBRARY; T=293.6K
Neutron emission for (n,x)

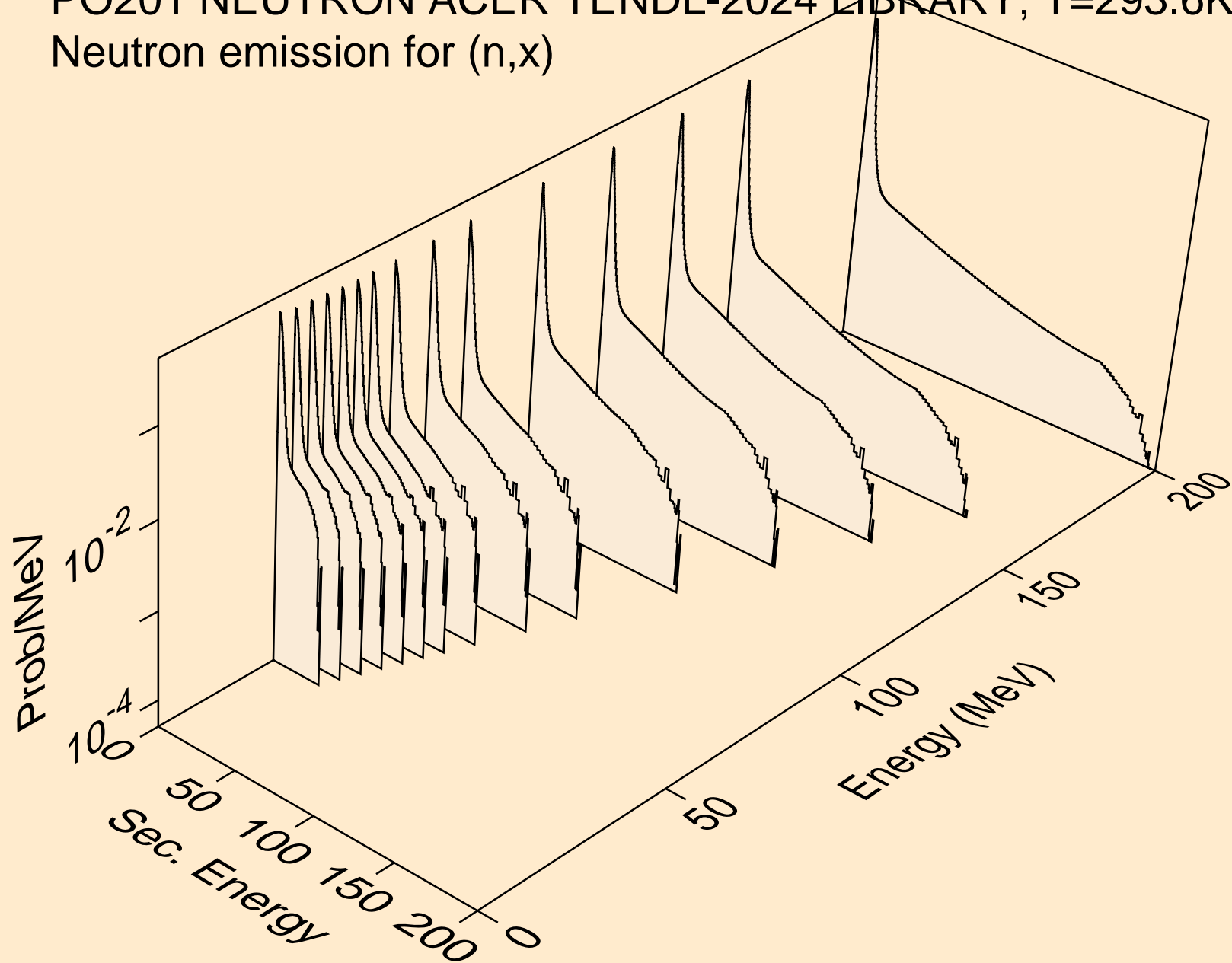

PO201 NEUTRON ACER TENDL-2024 LIBRARY; T=293.6K
Neutron emission for (n,2nd)

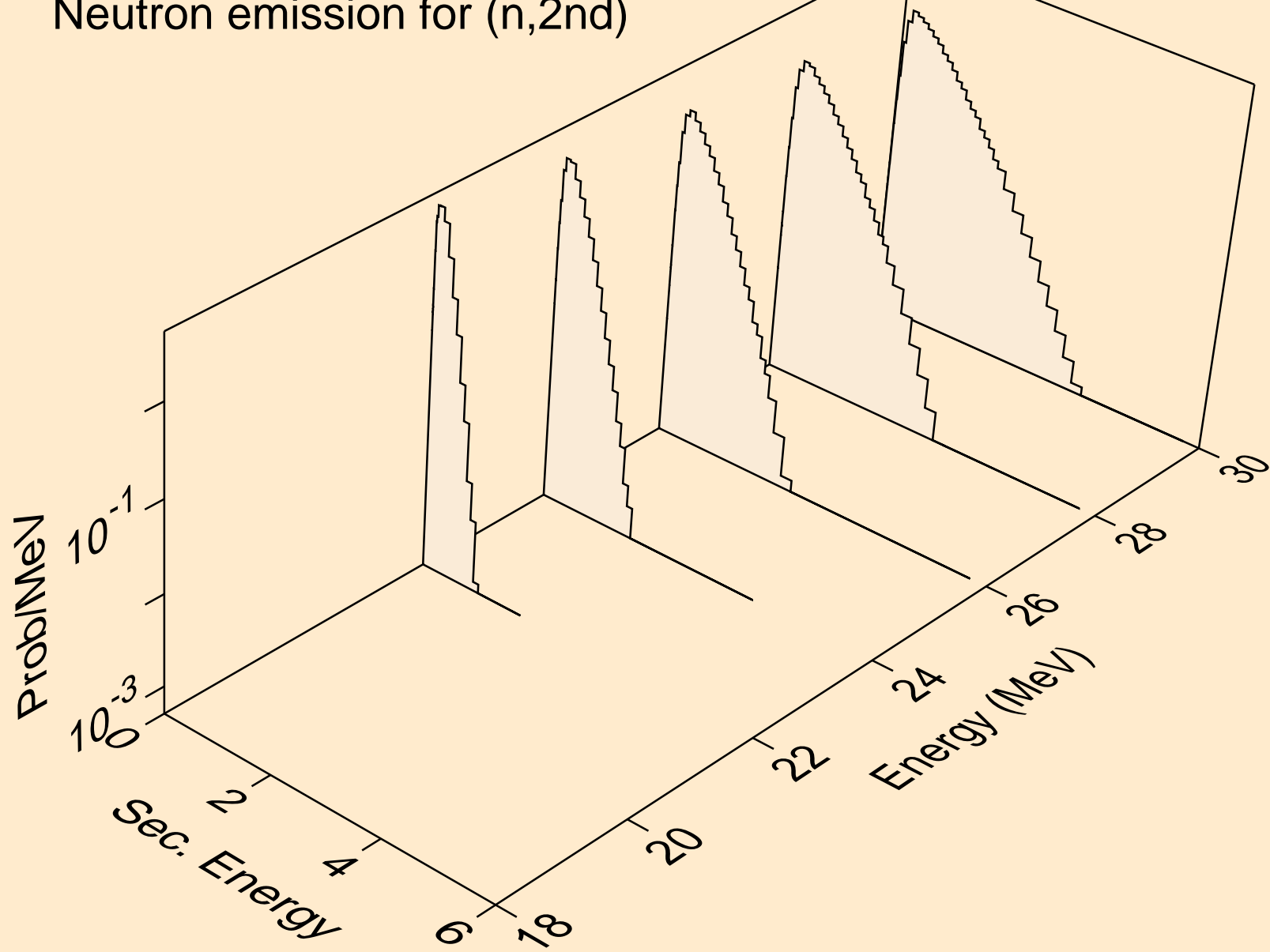

PO201 NEUTRON ACER TENDL-2024 LIBRARY; T=293.6K
Neutron emission for (n,2n)

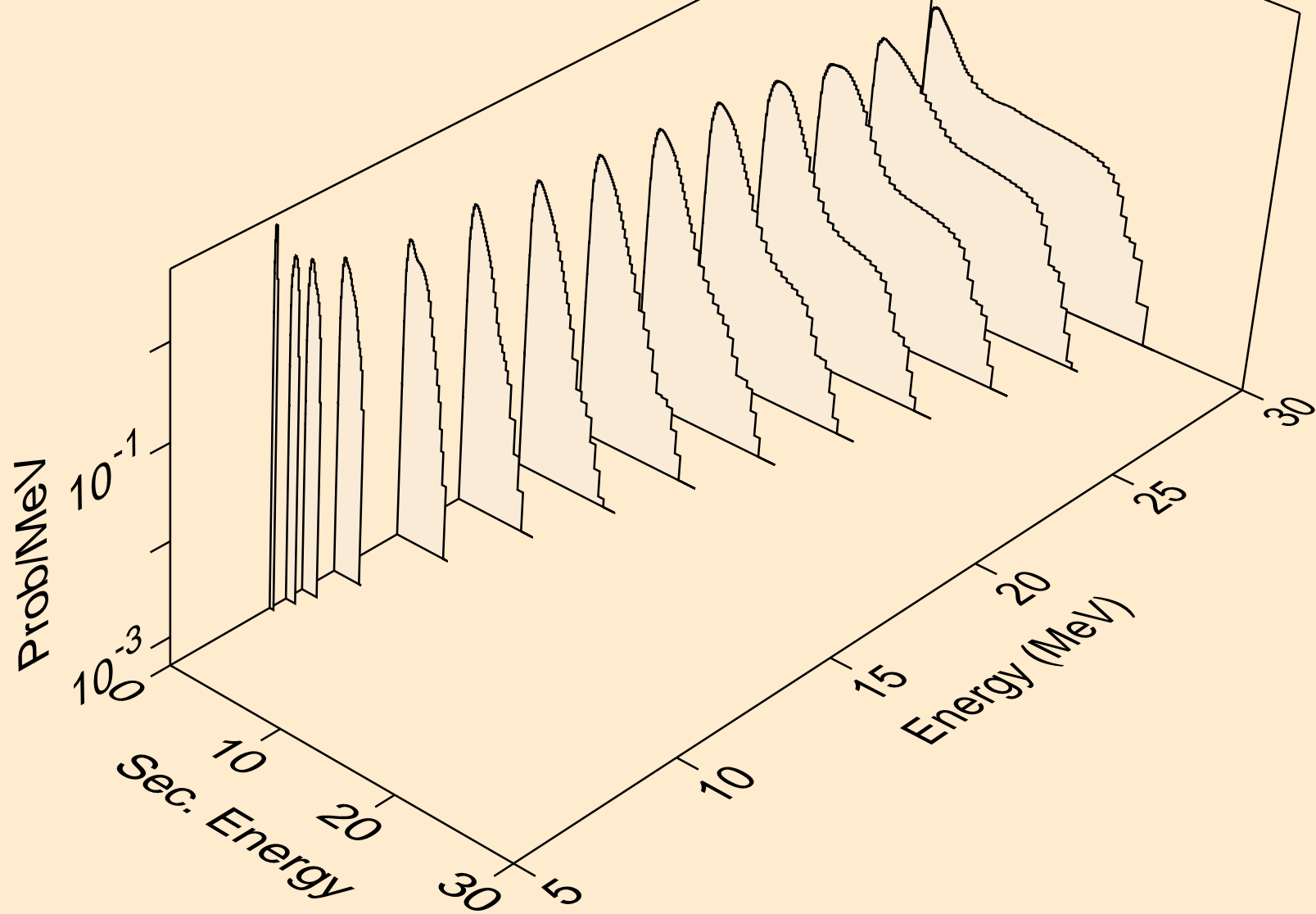

PO201 NEUTRON ACER TENDL-2024 LIBRARY; T=293.6K
Neutron emission for (n,3n)

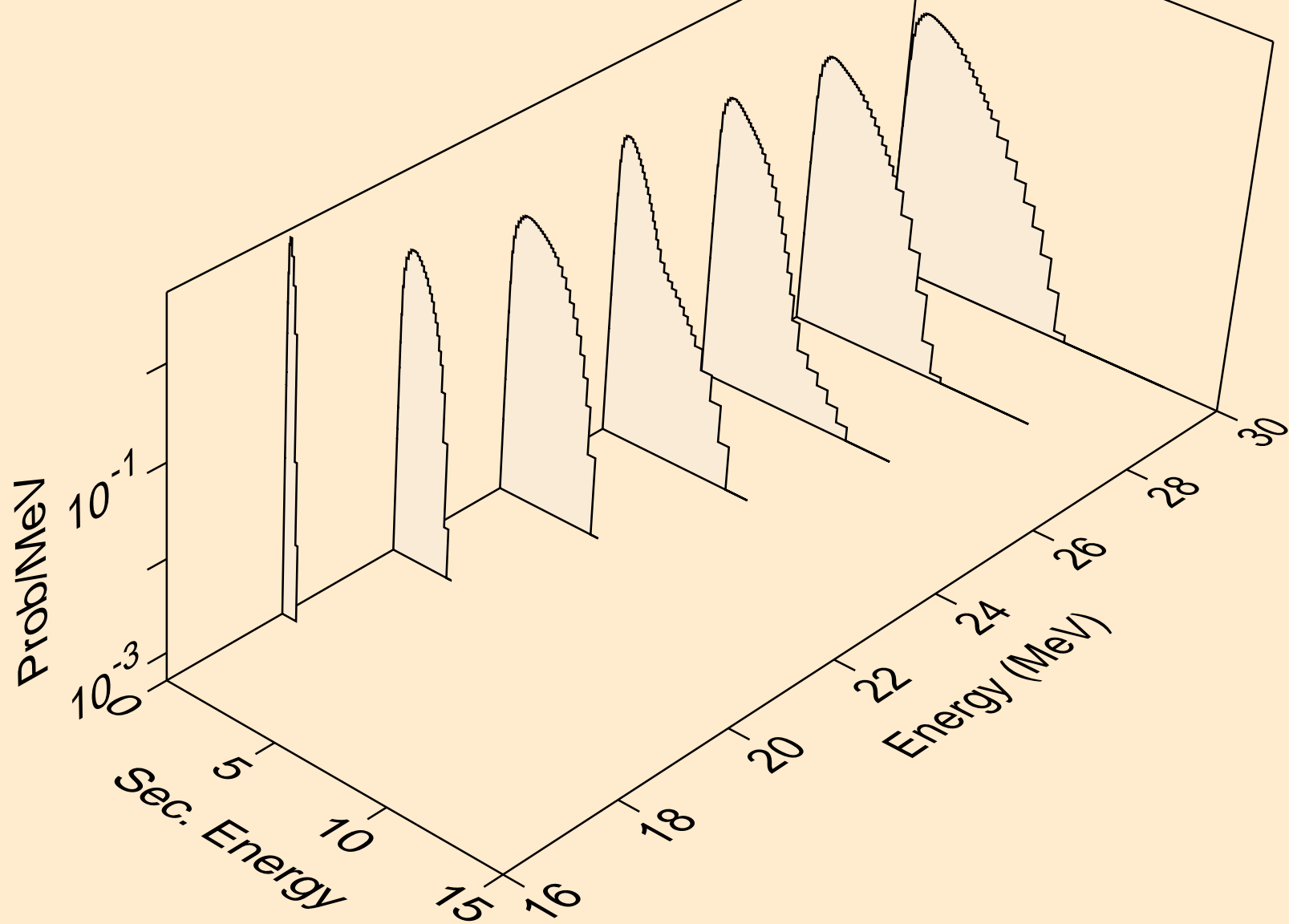

PO201 NEUTRON ACER TENDL-2024 LIBRARY; T=293.6K
Neutron emission for (n,n*)a

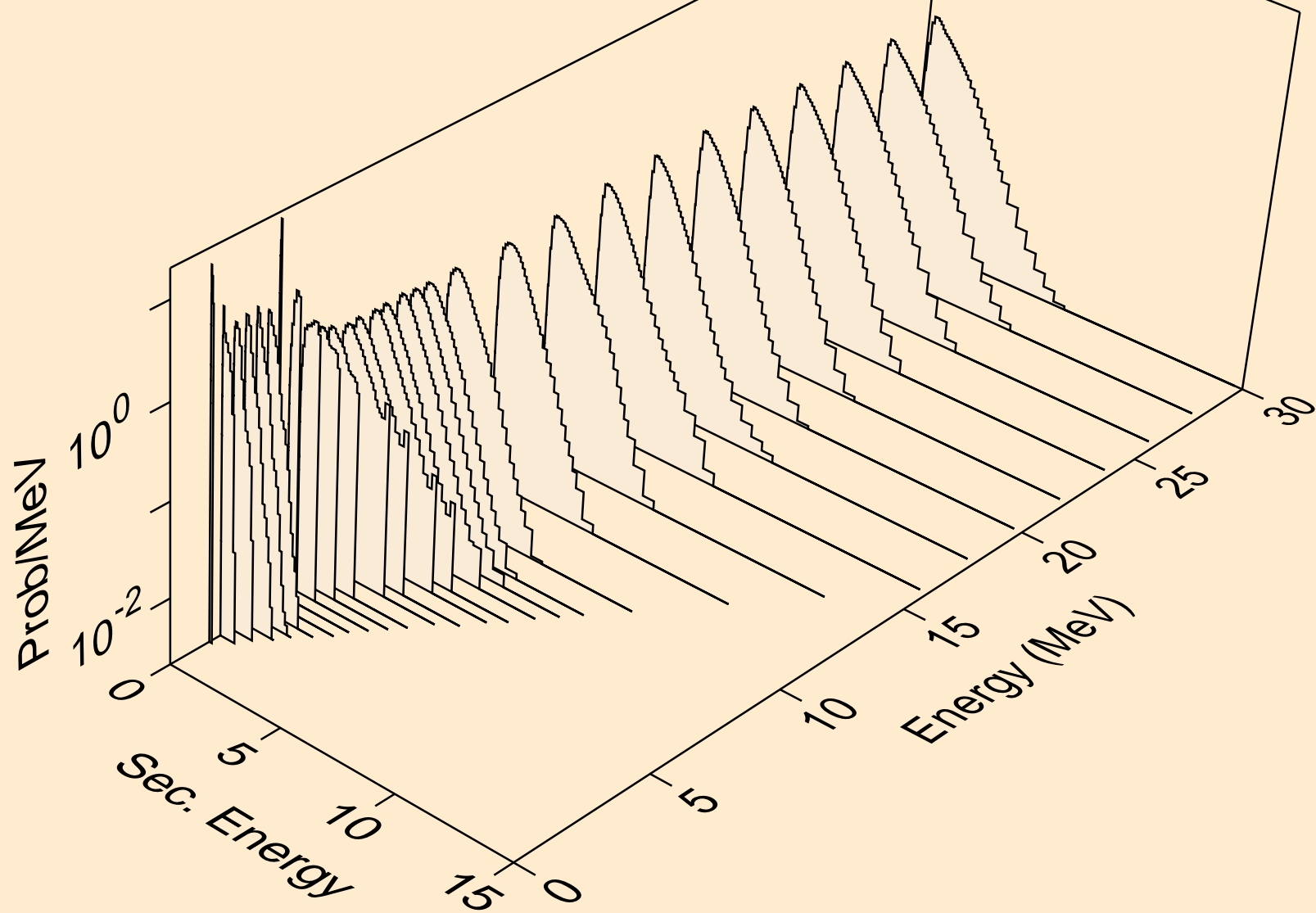

PO201 NEUTRON ACER TENDL-2024 LIBRARY; T=293.6K
Neutron emission for (n,2n)a

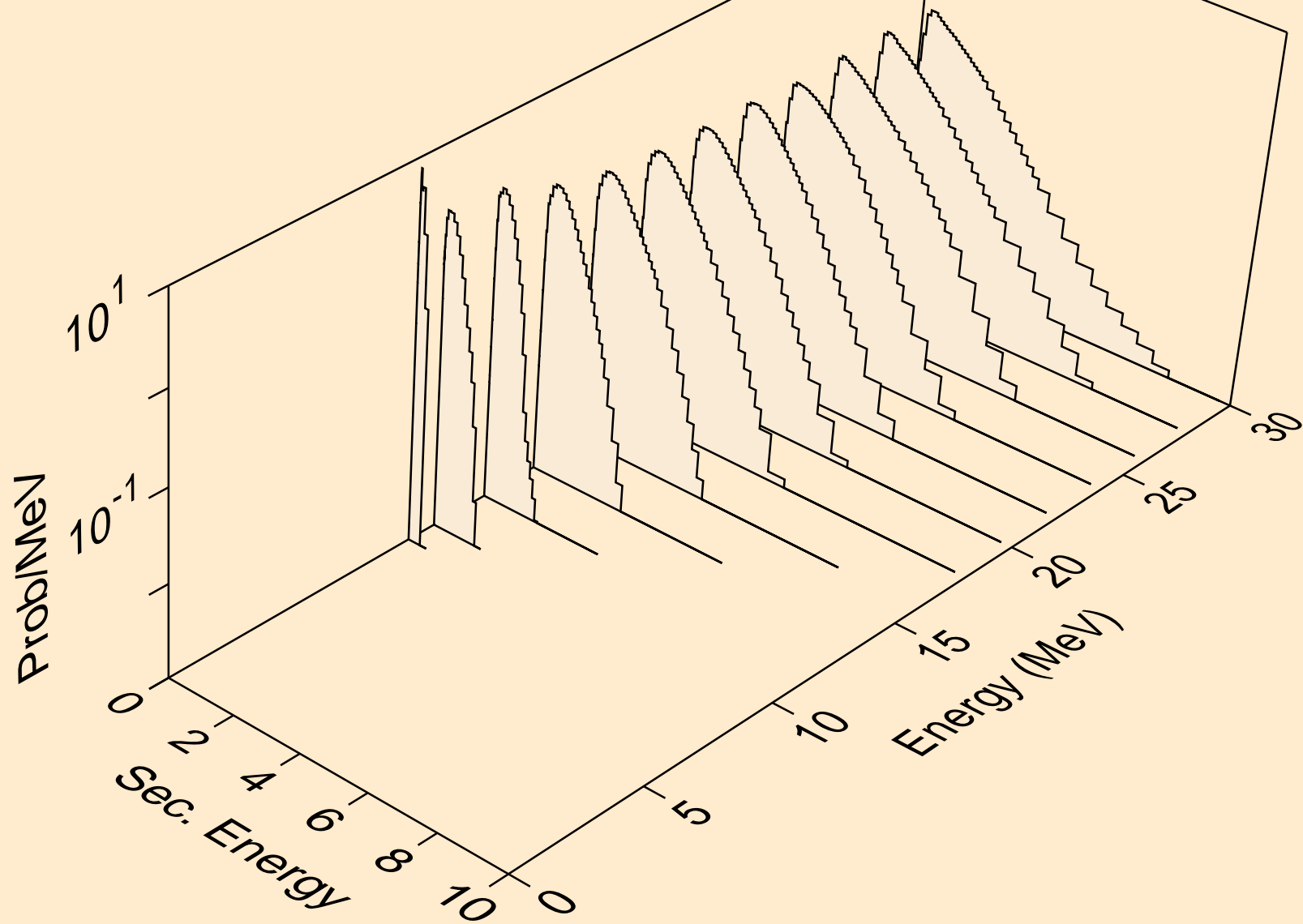

PO201 NEUTRON ACER TENDL-2024 LIBRARY; T=293.6K
Neutron emission for (n,3n)a

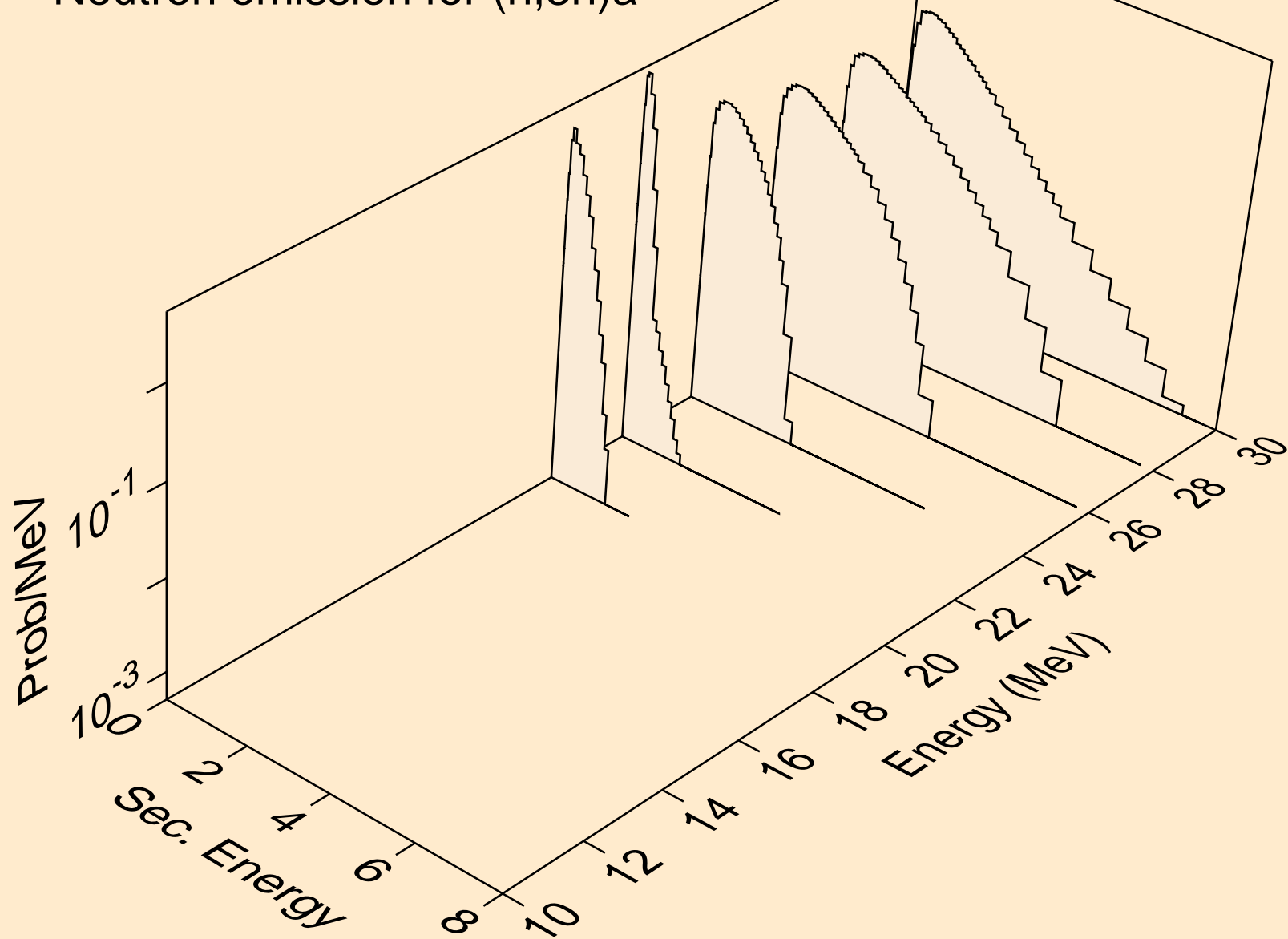

PO201 NEUTRON ACER TENDL-2024 LIBRARY; T=293.6K
Neutron emission for (n,n*)p

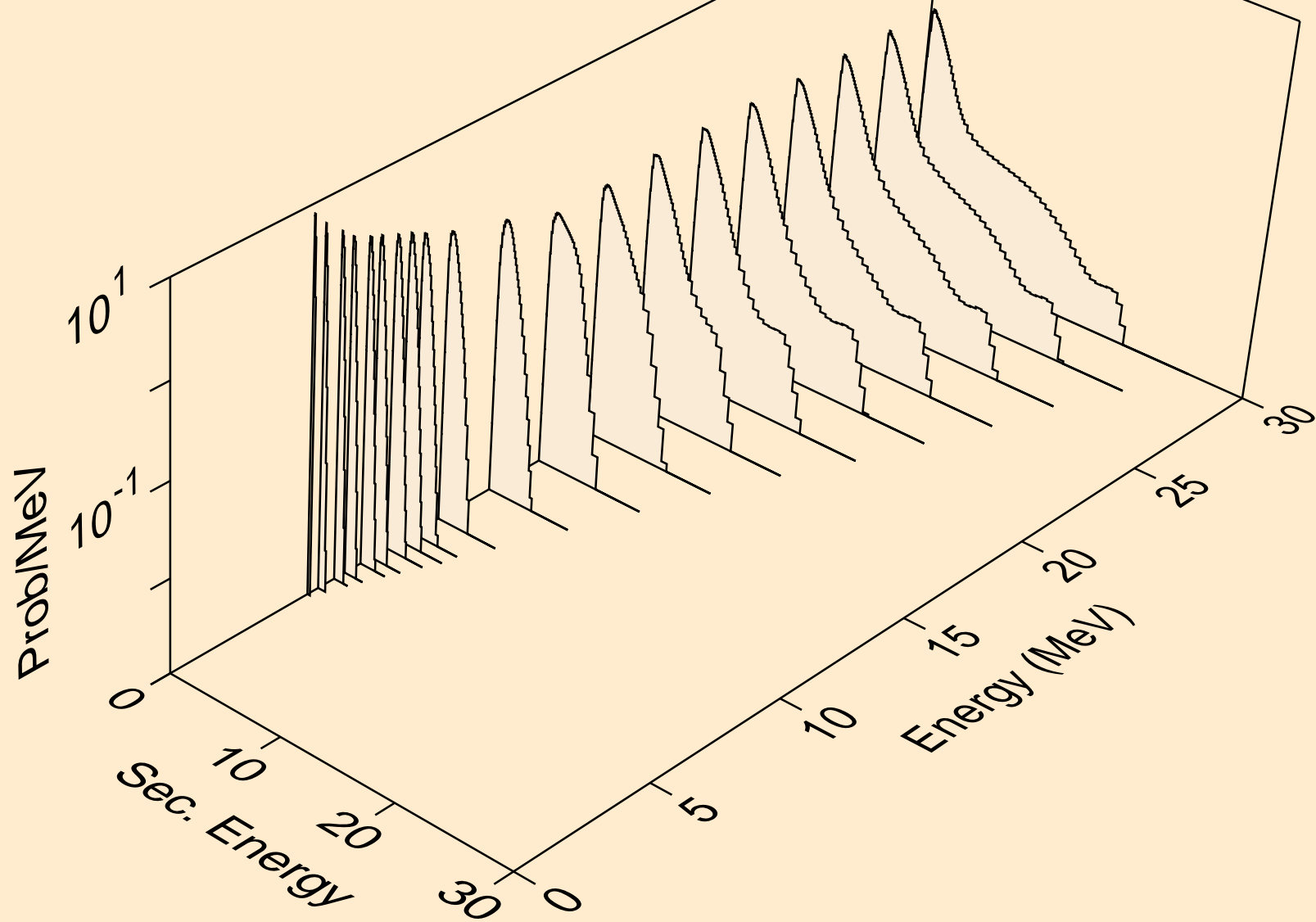

PO201 NEUTRON ACER TENDL-2024 LIBRARY; T=293.6K
Neutron emission for (n,n*)2a

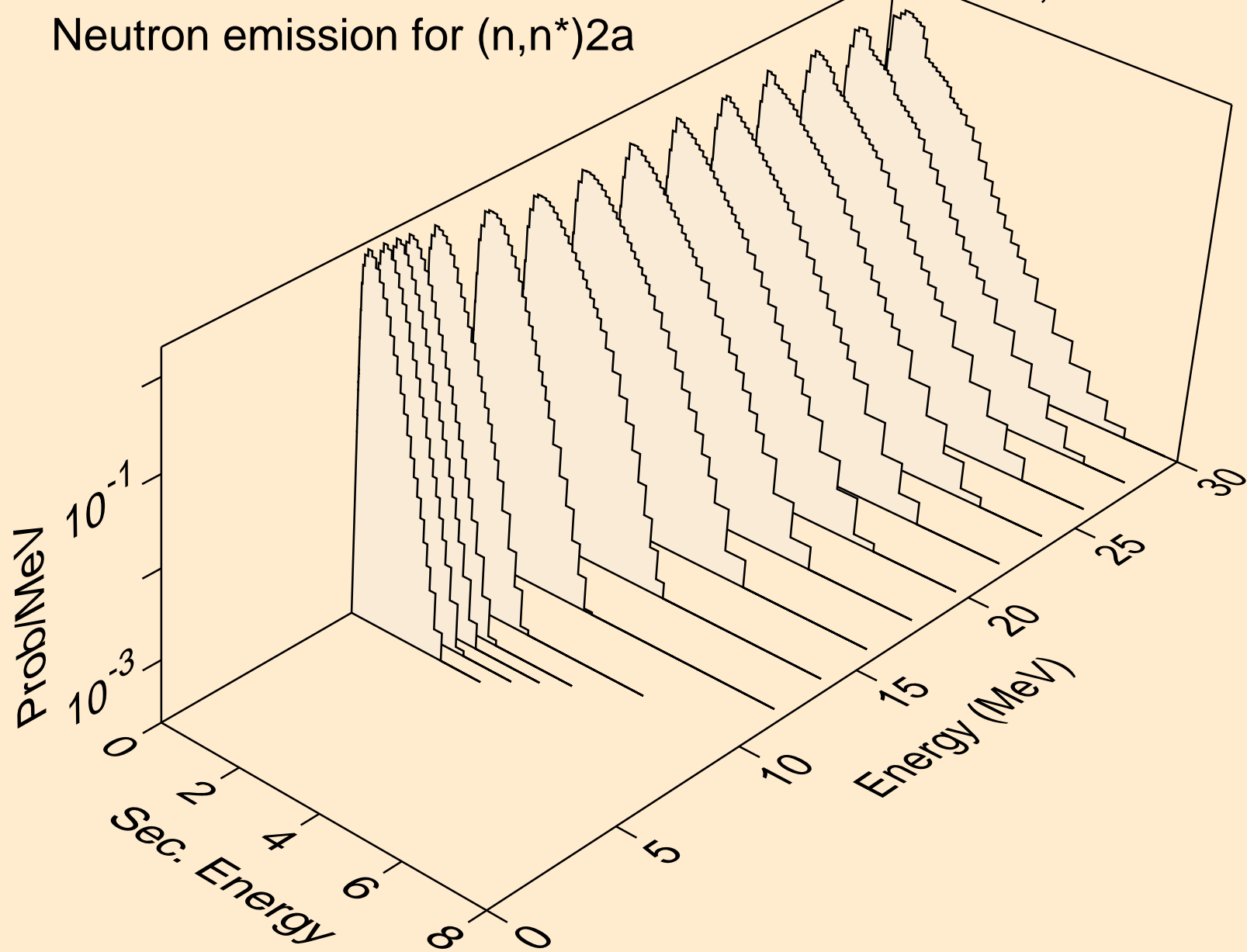

PO201 NEUTRON ACER TENDL-2024 LIBRARY; T=293.6K
Neutron emission for (n,2n)2a

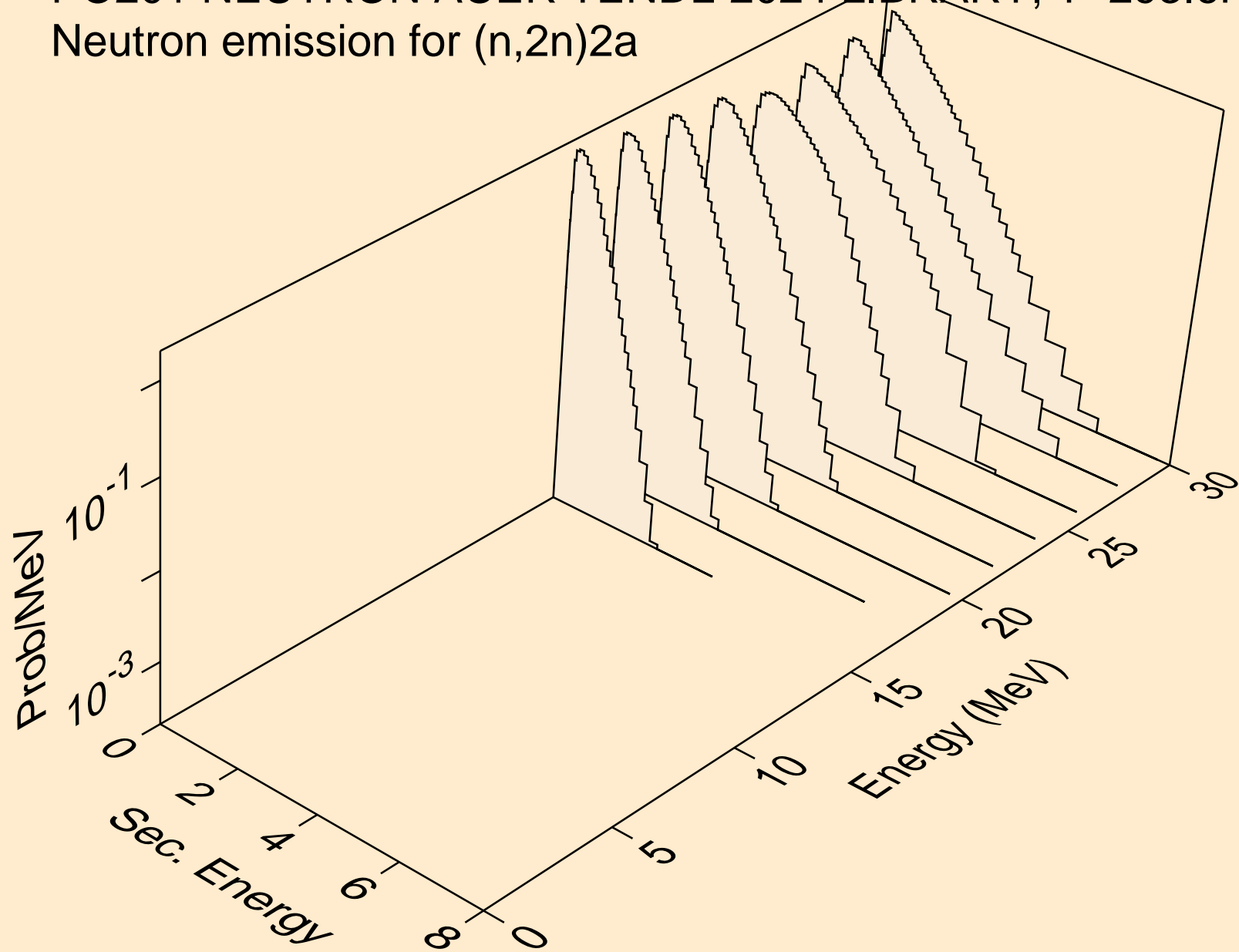

PO201 NEUTRON ACER TENDL-2024 LIBRARY; T=293.6K
Neutron emission for (n,n*)d

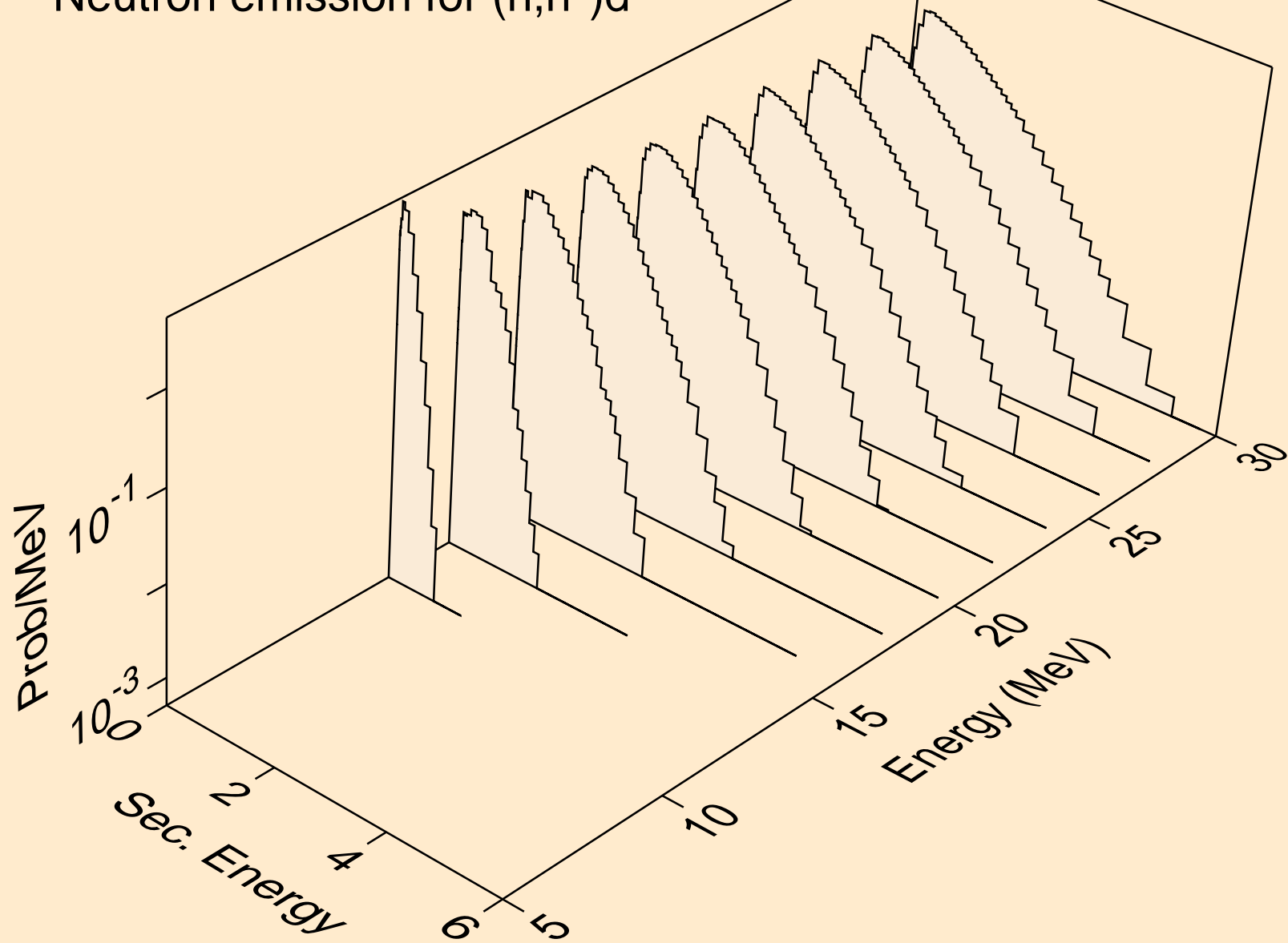

PO201 NEUTRON ACER TENDL-2024 LIBRARY; T=293.6K
Neutron emission for (n,n*)t

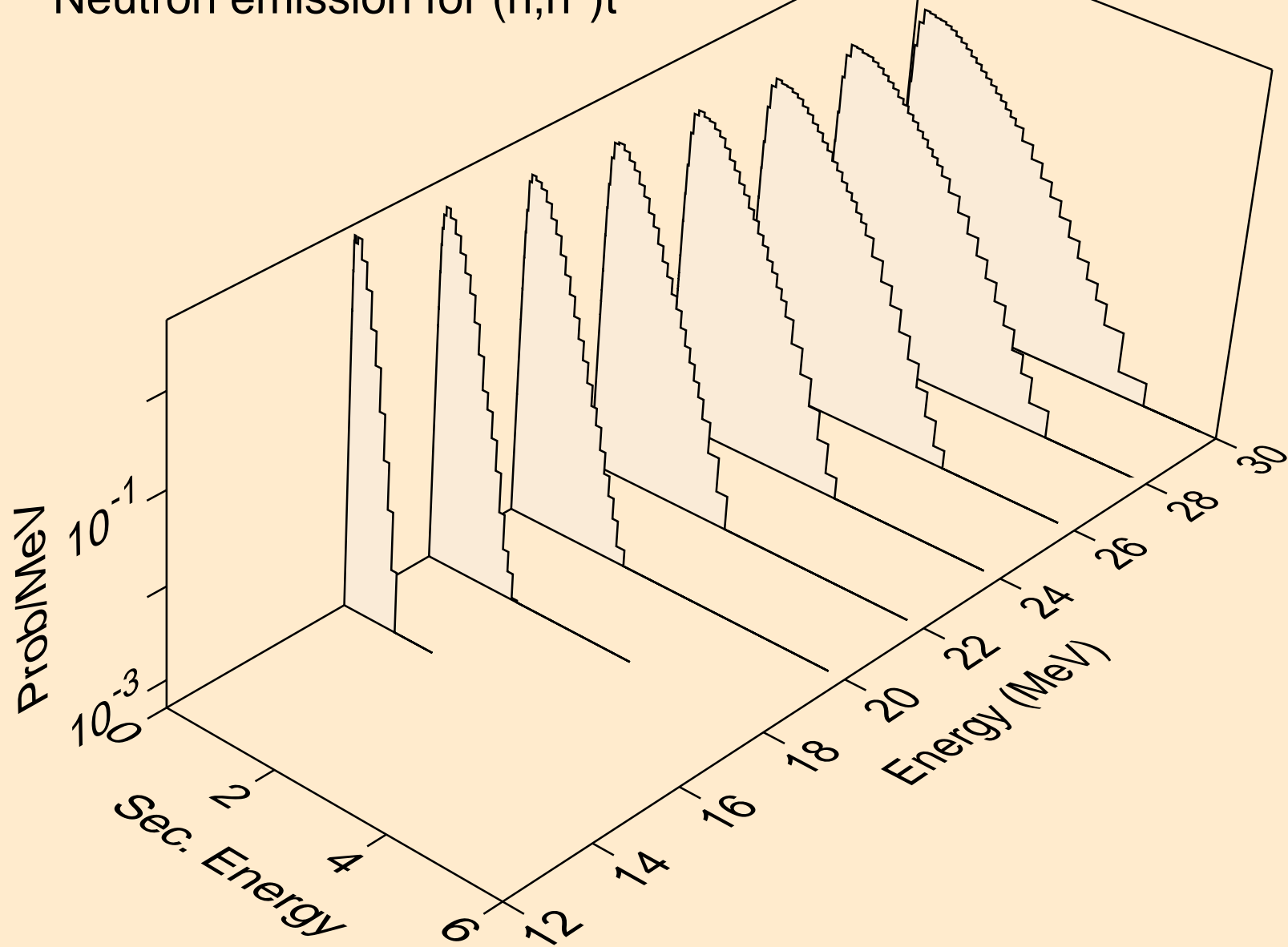

PO201 NEUTRON ACER TENDL-2024 LIBRARY; T=293.6K
Neutron emission for (n,n*)he3

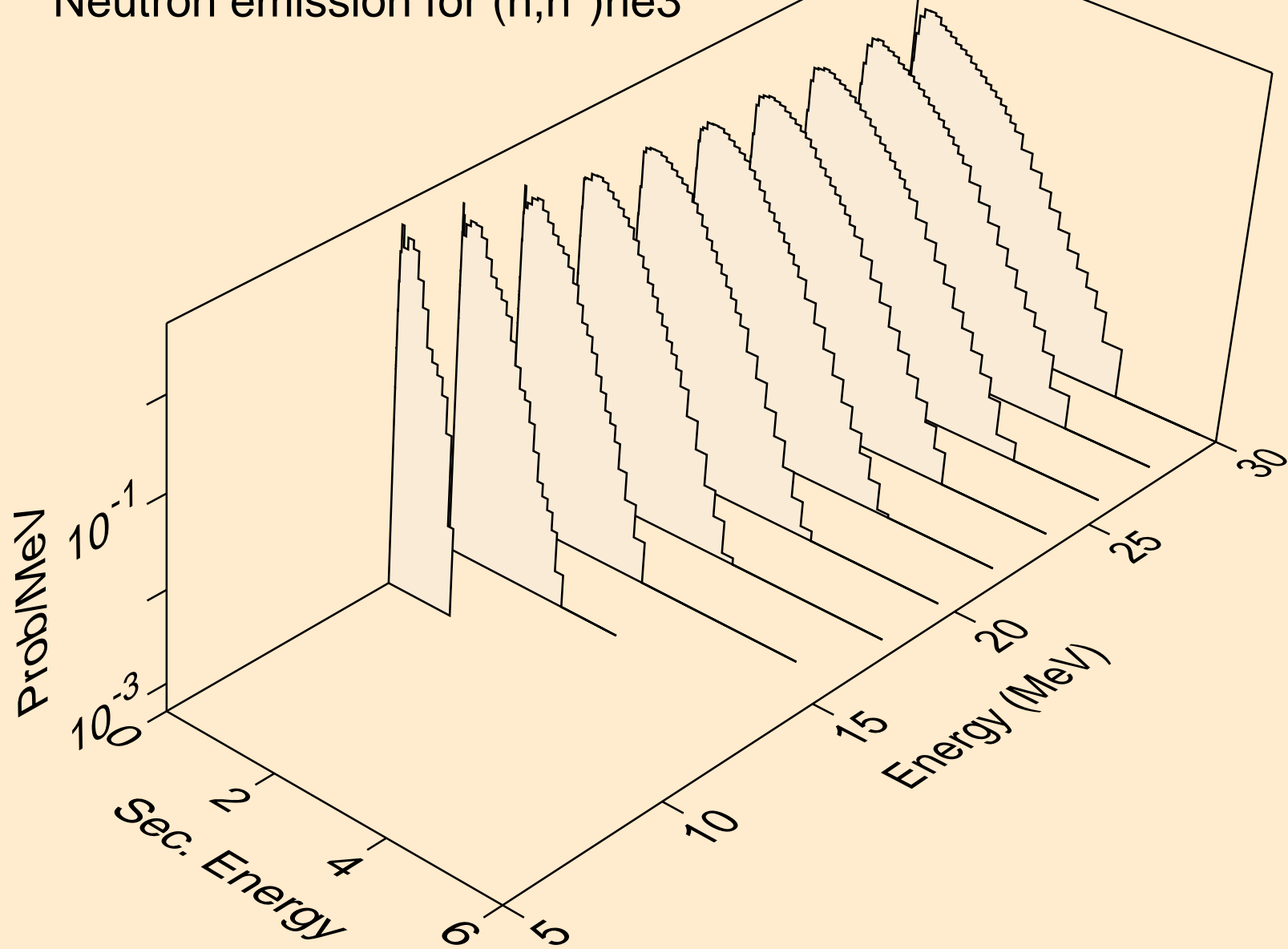

PO201 NEUTRON ACER TENDL-2024 LIBRARY; T=293.6K
Neutron emission for (n,4n)

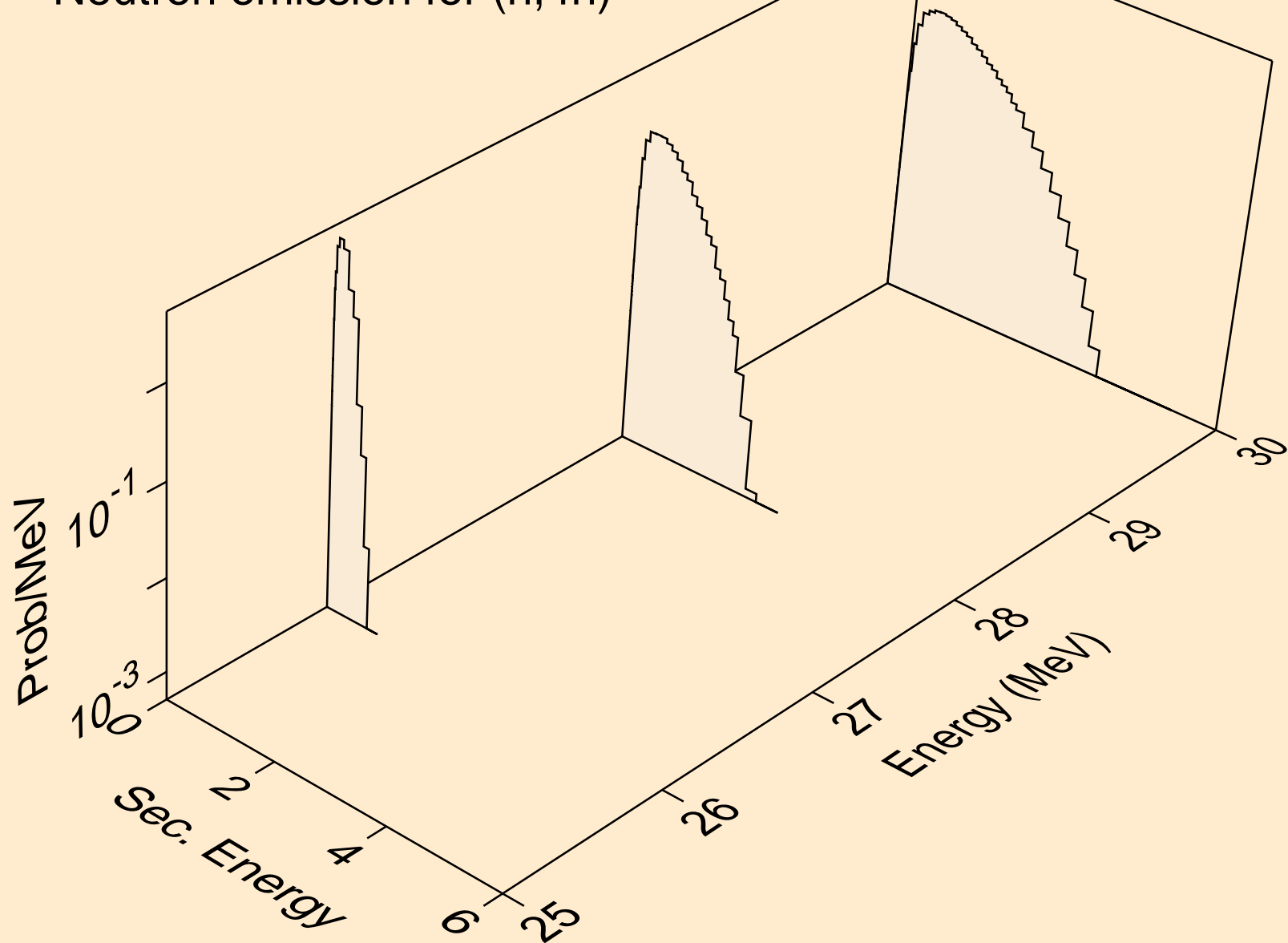

PO201 NEUTRON ACER TENDL-2024 LIBRARY; T=293.6K
Neutron emission for (n,2np)

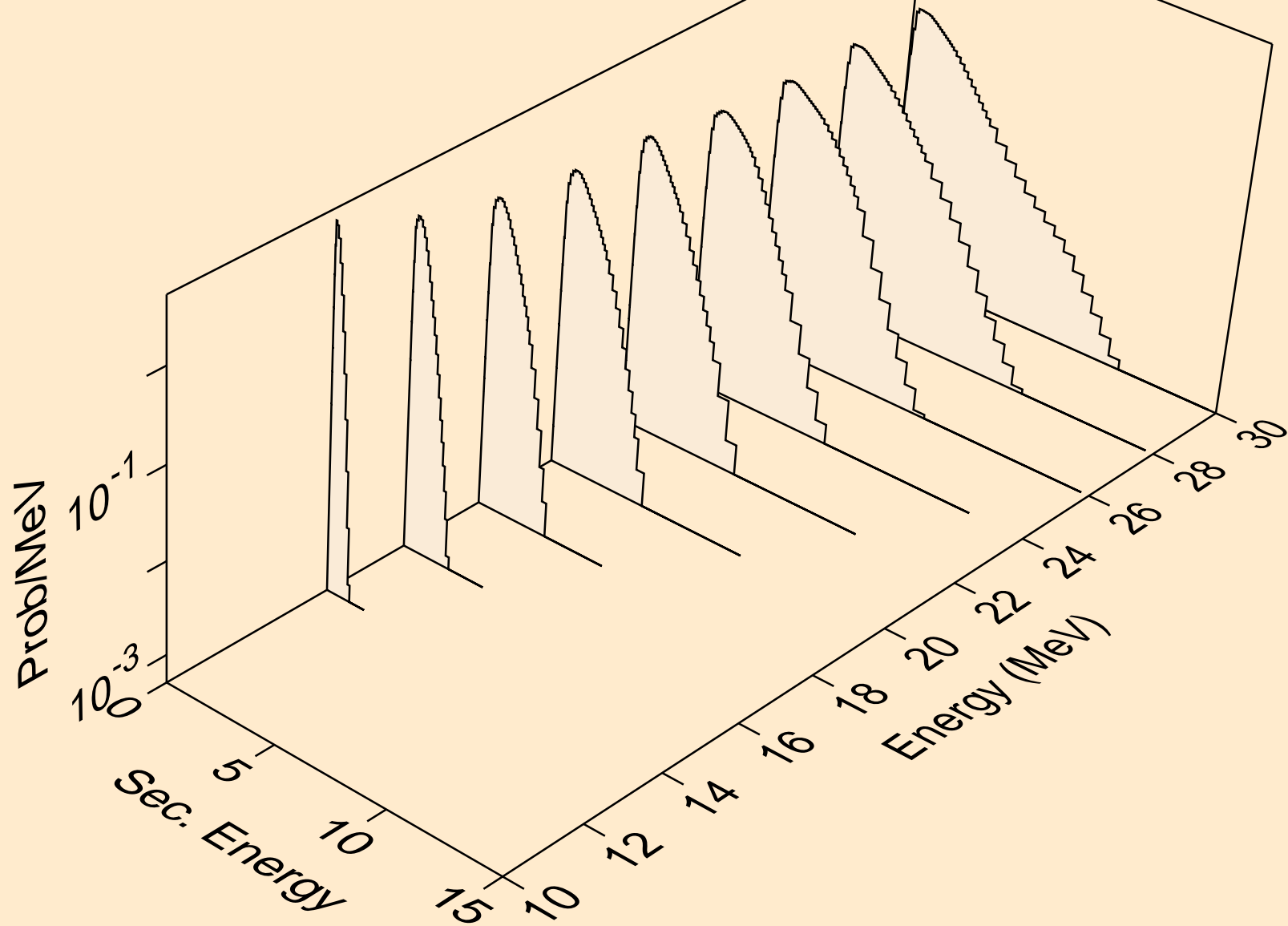

PO201 NEUTRON ACER TENDL-2024 LIBRARY; T=293.6K
Neutron emission for (n,3np)

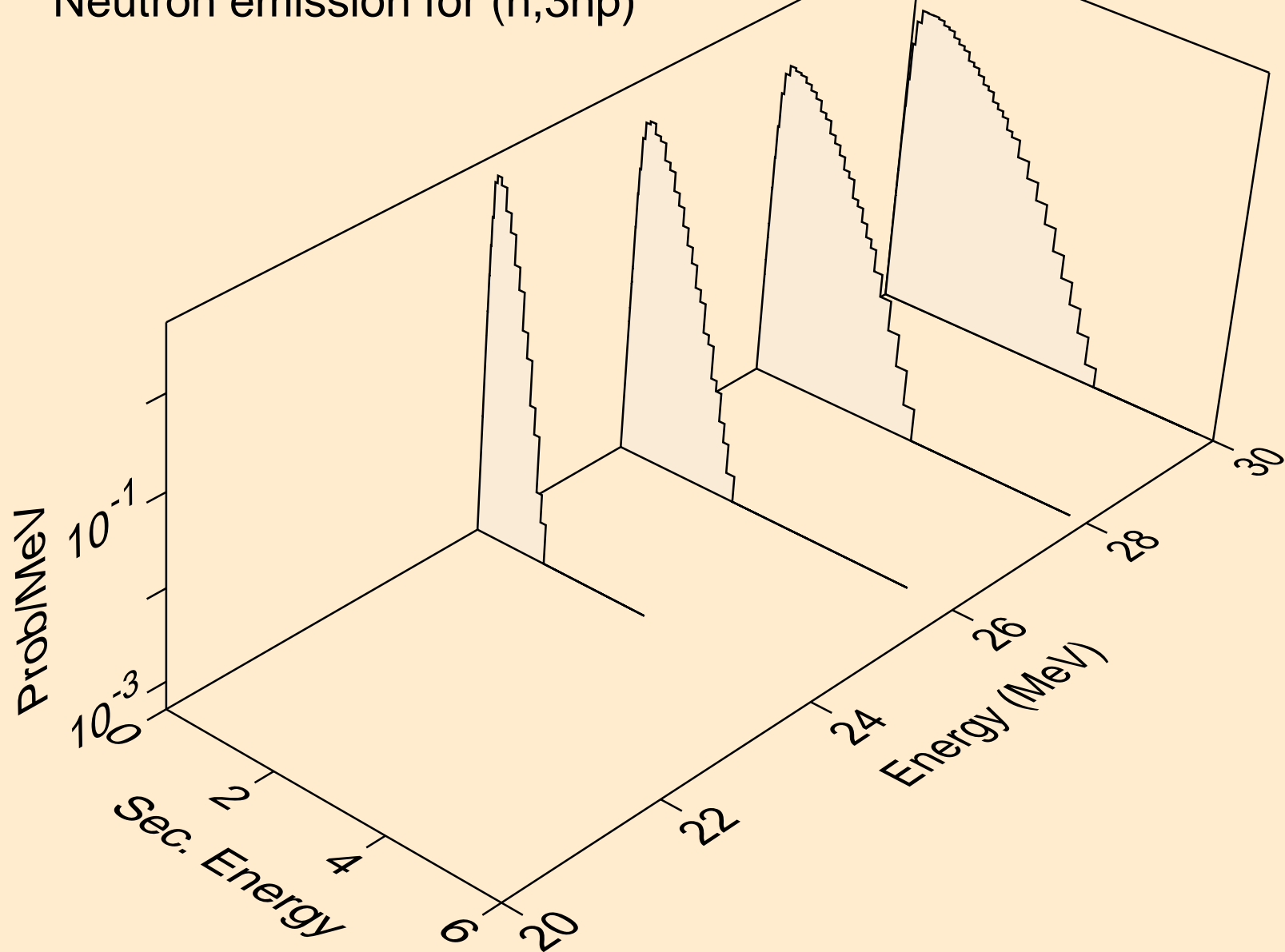

PO201 NEUTRON ACER TENDL-2024 LIBRARY; T=293.6K
Neutron emission for (n,n2p)

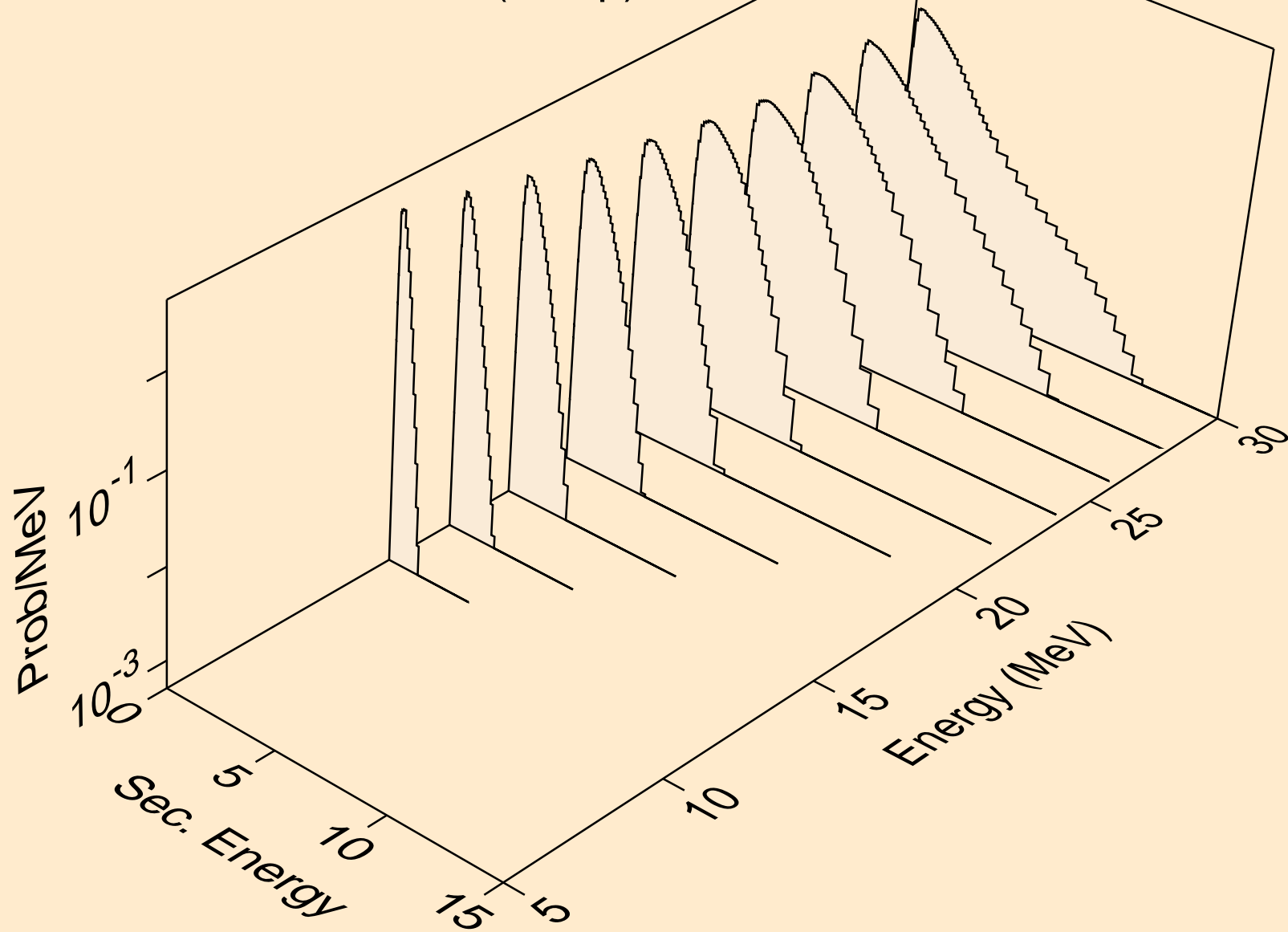

PO201 NEUTRON ACER TENDL-2024 LIBRARY; T=293.6K
Neutron emission for (n,npa)

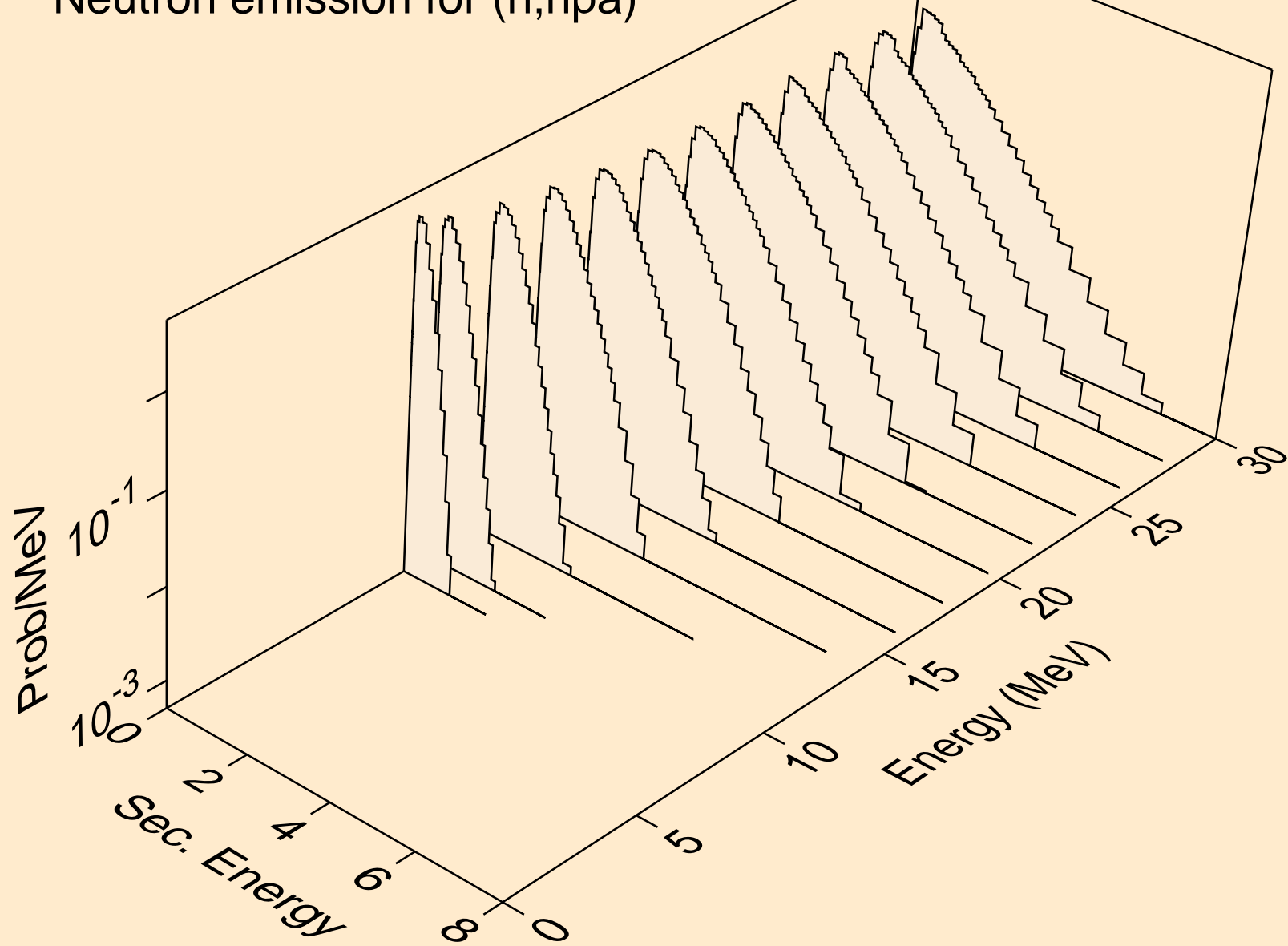

PO201 NEUTRON ACER TENDL-2024 LIBRARY; T=293.6K
Neutron emission for (n,n*c)

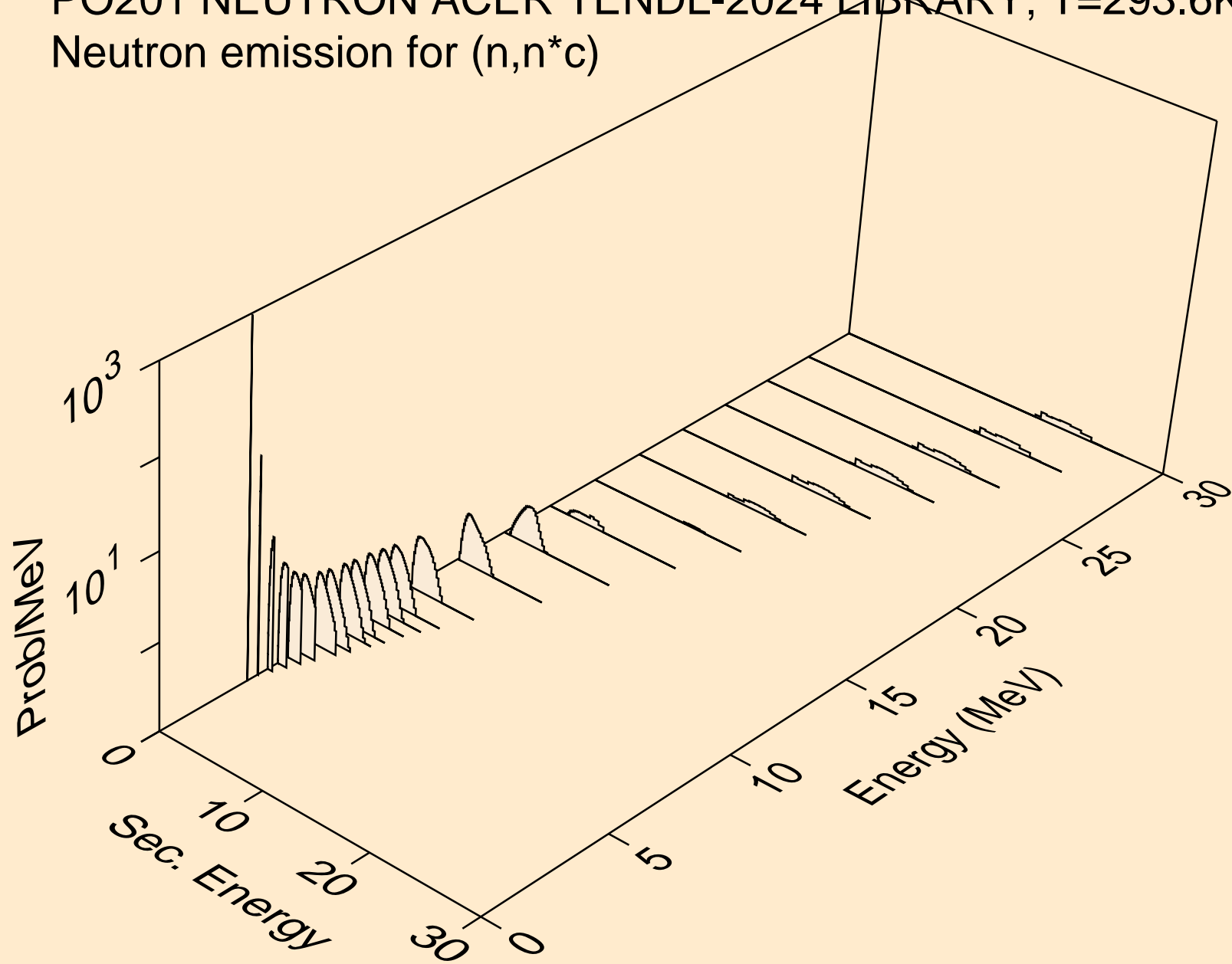

PO201 NEUTRON ACER TENDL-2024 LIBRARY; T=293.6K
Photon emission for (n,x)

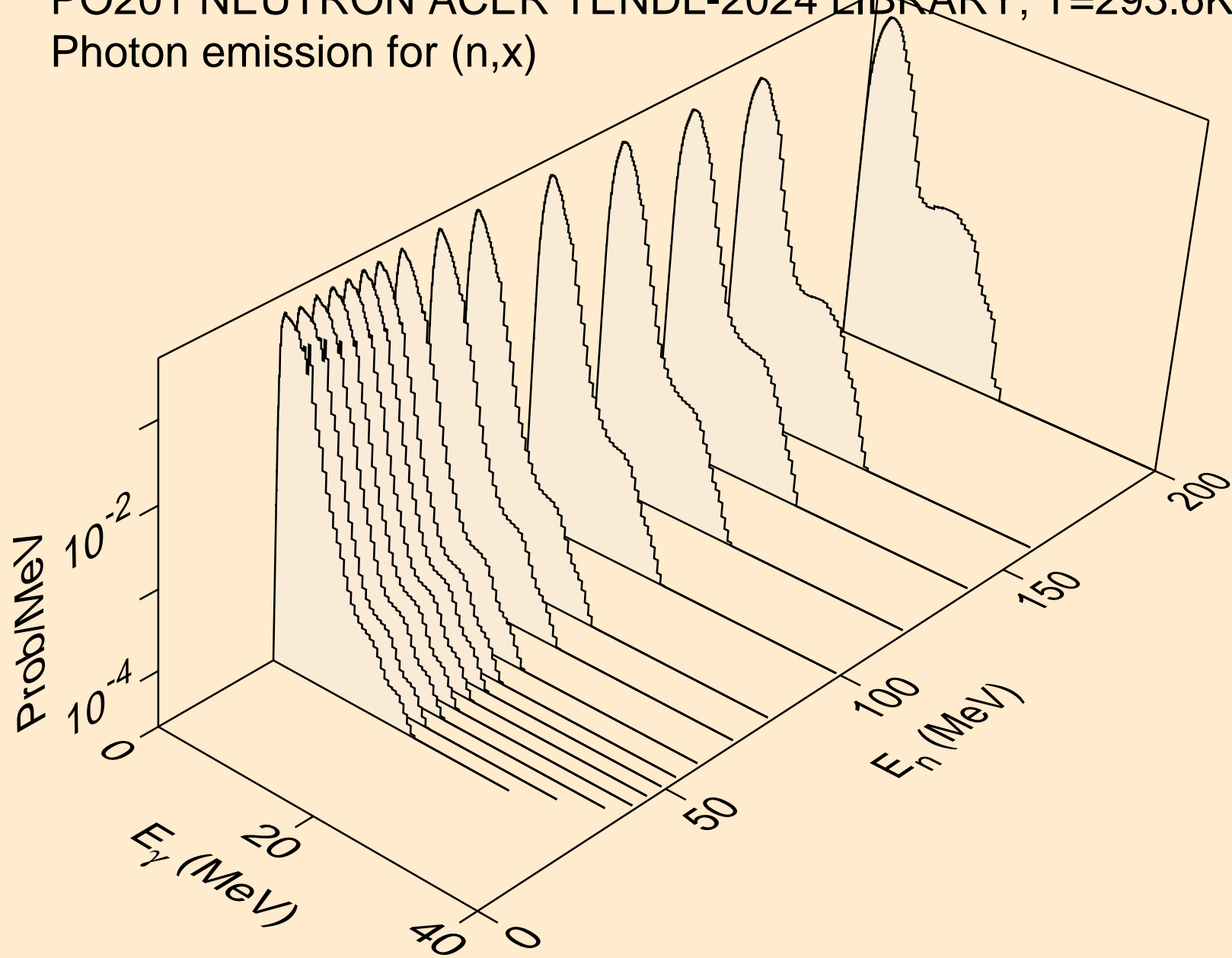

PO201 NEUTRON ACER TENDL-2024 LIBRARY; T=293.6K
Photon emission for (n,2nd)

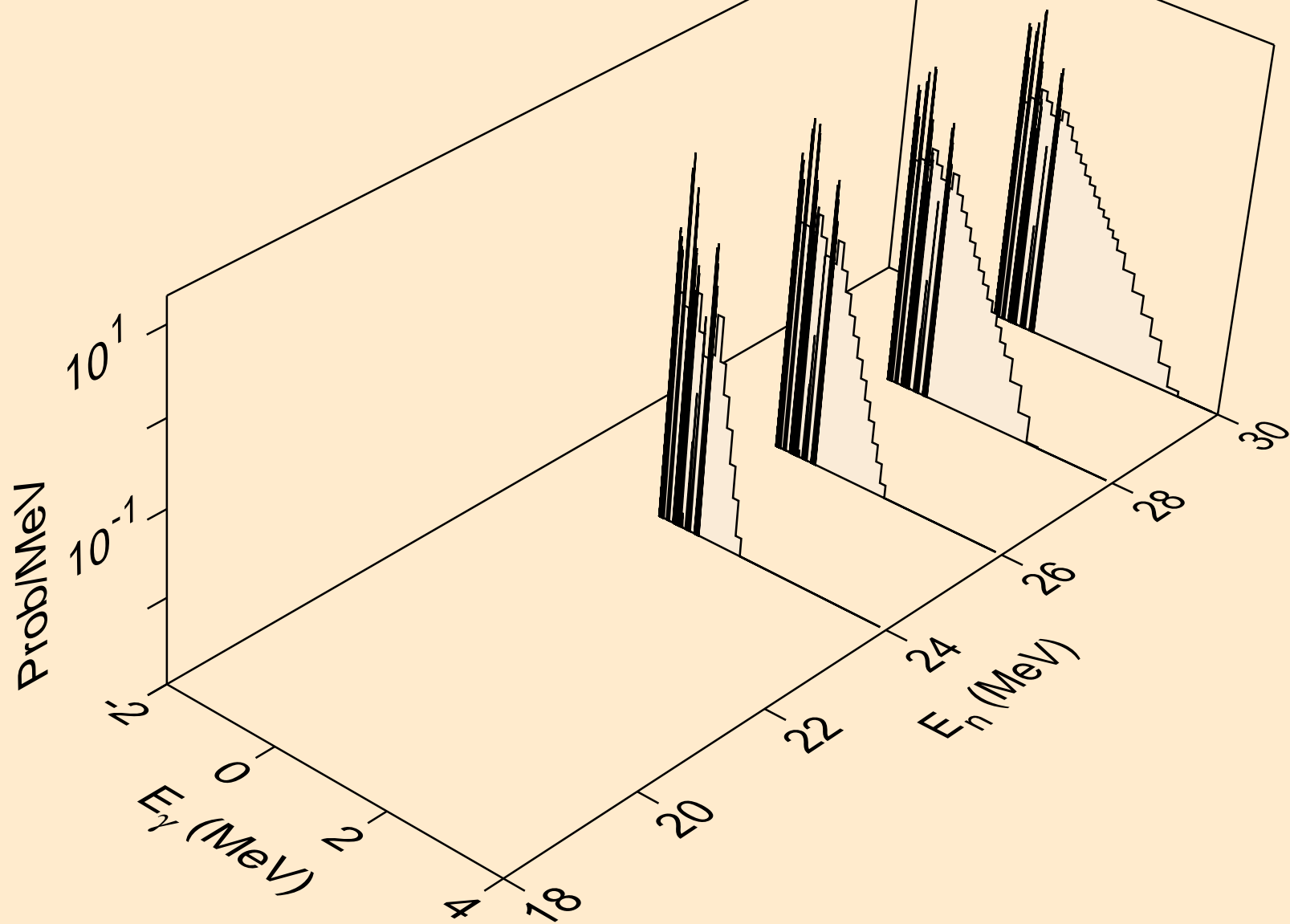

PO201 NEUTRON ACER TENDL-2024 LIBRARY; T=293.6K
Photon emission for (n,2n)

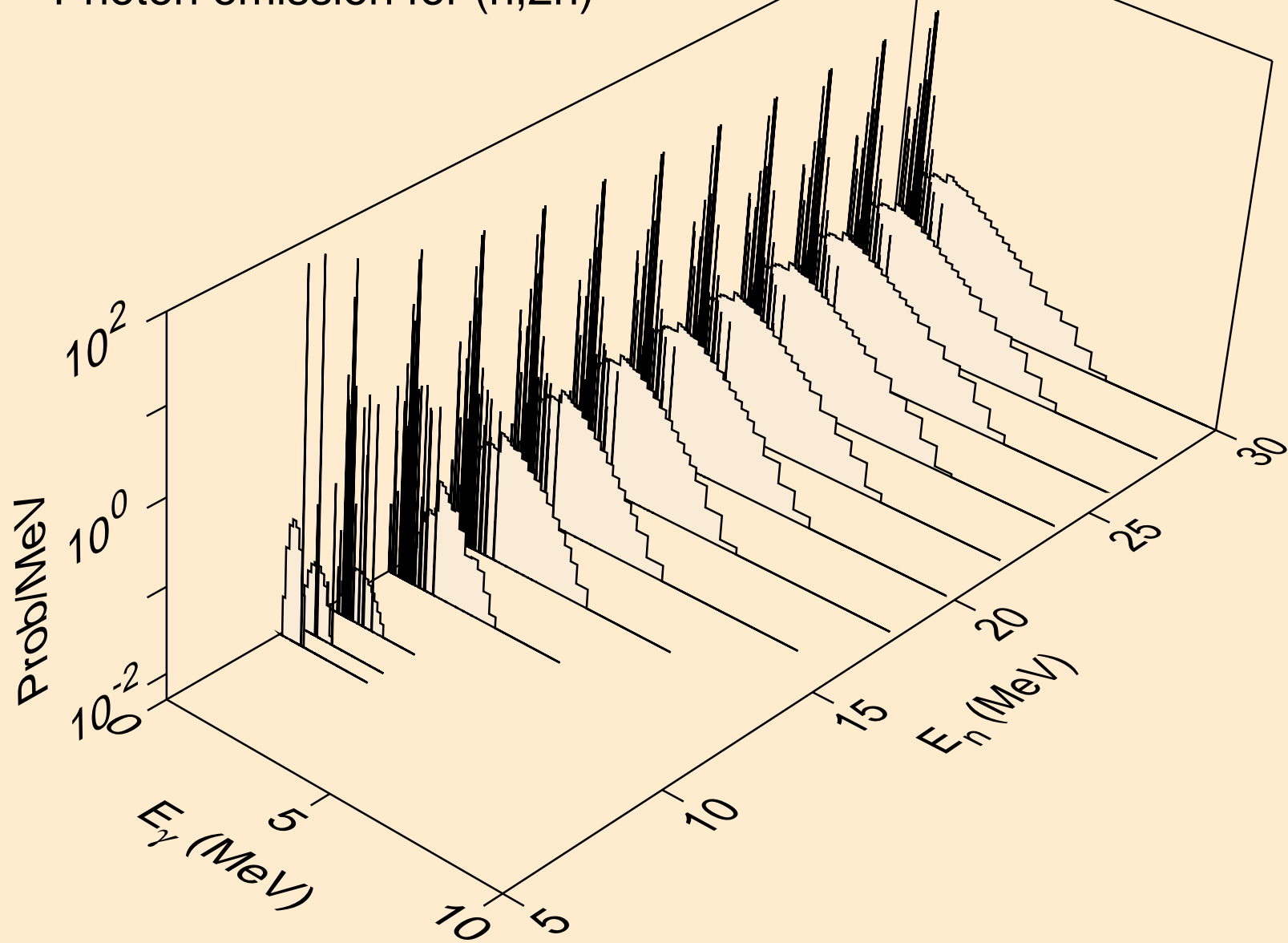

PO201 NEUTRON ACER TENDL-2024 LIBRARY; T=293.6K
Photon emission for (n,3n)

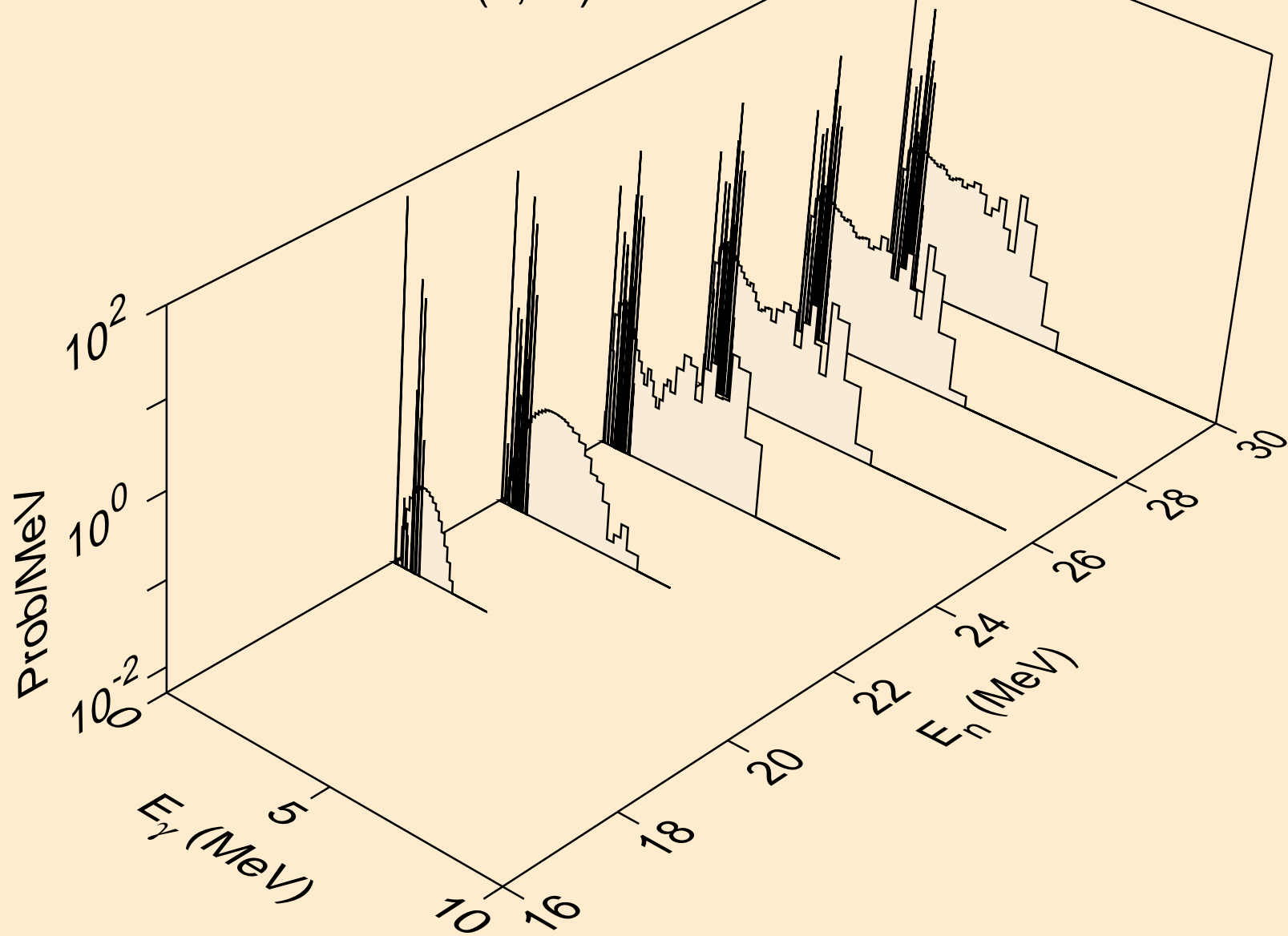

PO201 NEUTRON ACER TENDL-2024 LIBRARY; T=293.6K
Photon emission for (n,n*)a

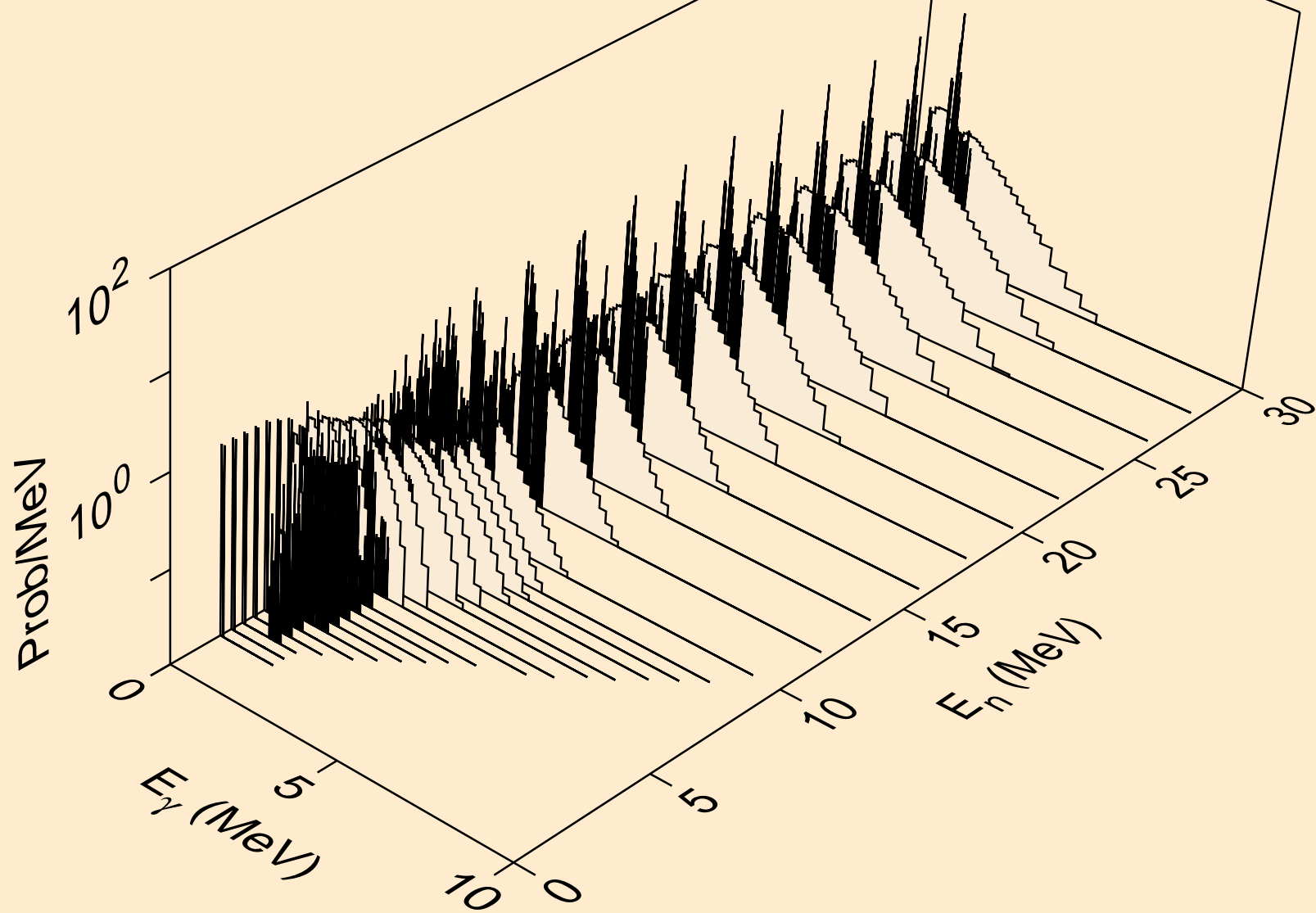

PO201 NEUTRON ACER TENDL-2024 LIBRARY; T=293.6K
Photon emission for (n,2n)a

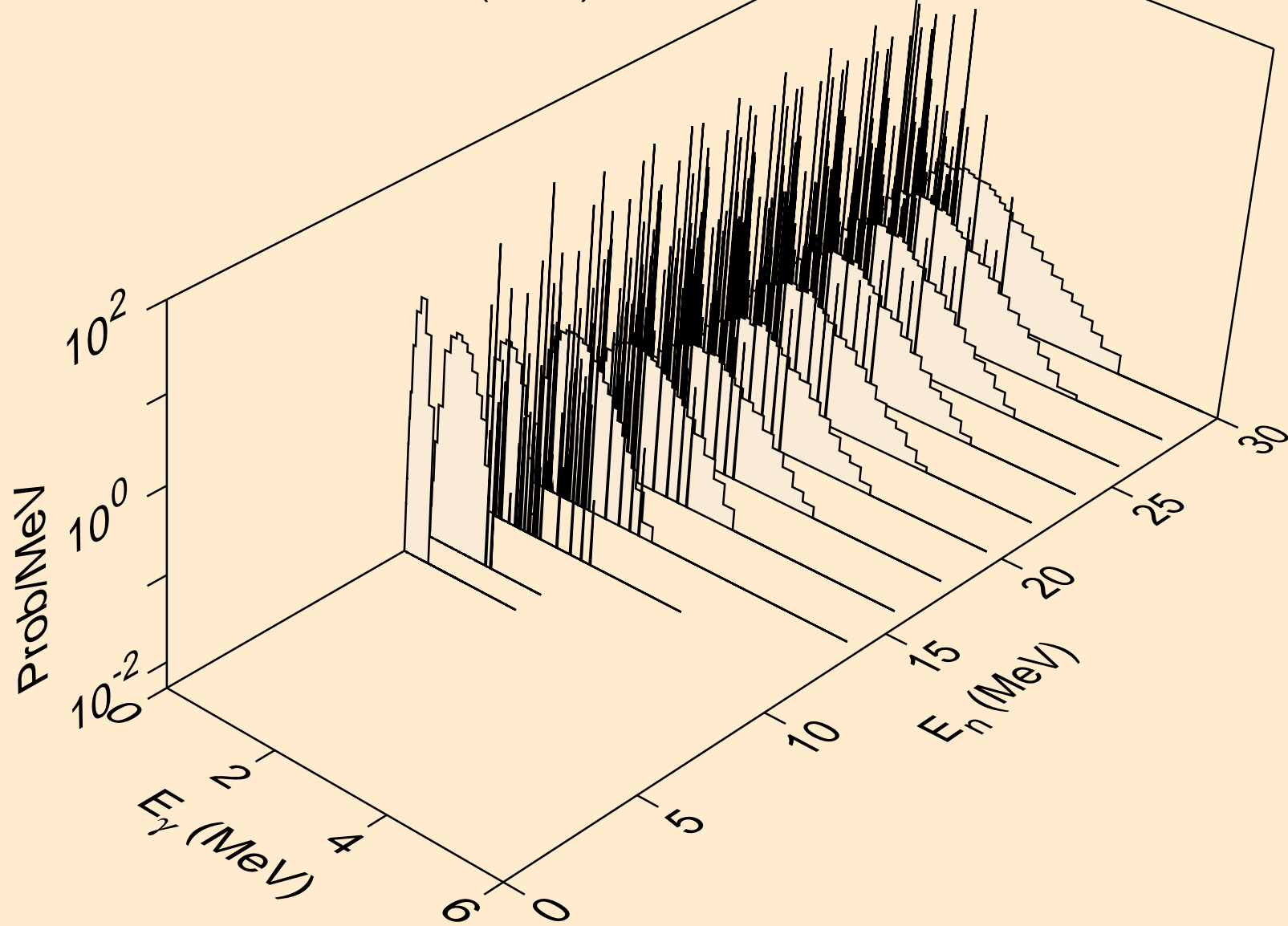

PO201 NEUTRON ACER TENDL-2024 LIBRARY; T=293.6K
Photon emission for (n,3n)a

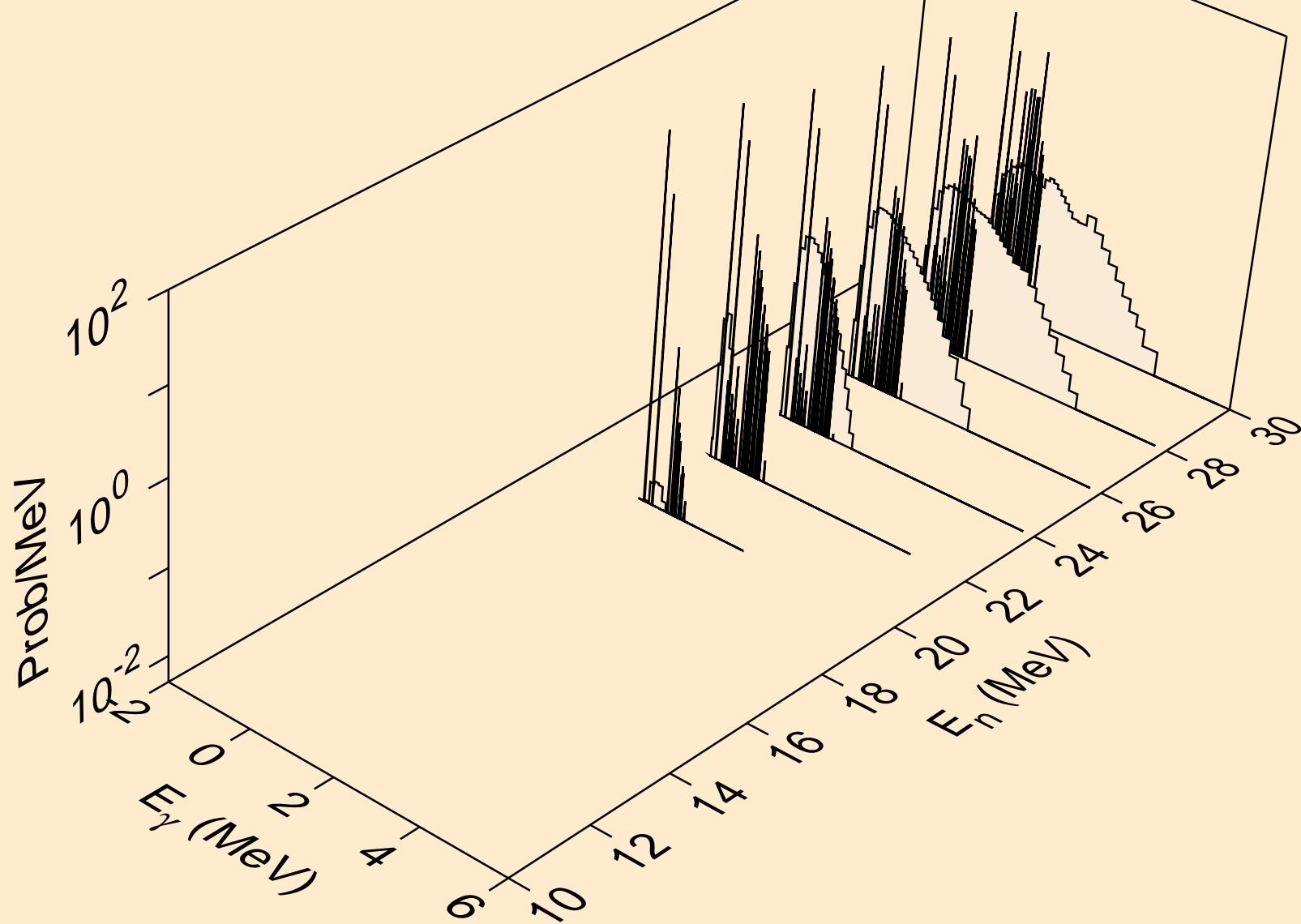

PO201 NEUTRON ACER TENDL-2024 LIBRARY; T=293.6K
Photon emission for (n,n*)p

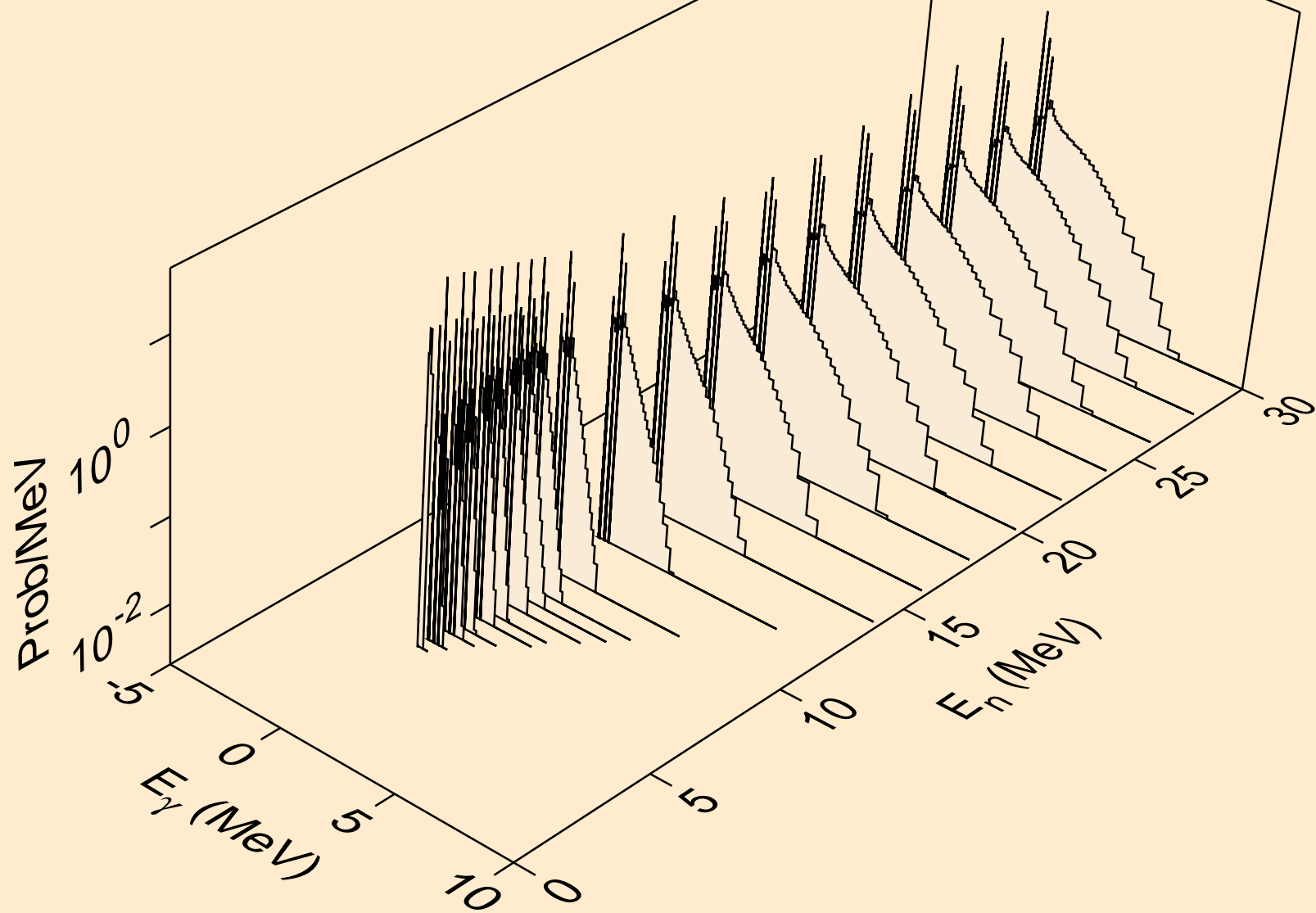

PO201 NEUTRON ACER TENDL-2024 LIBRARY; T=293.6K
Photon emission for (n,n*)2a

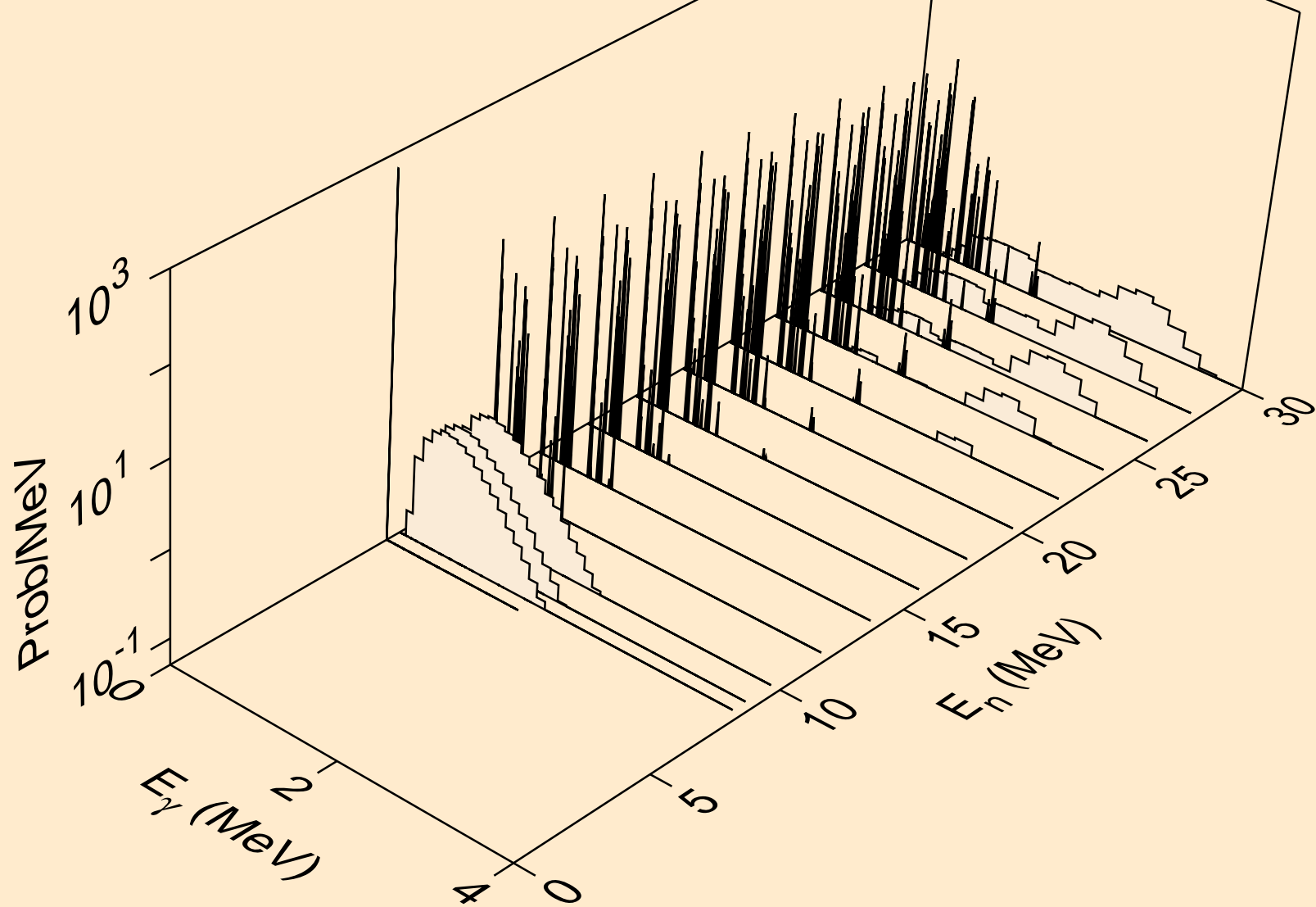

PO201 NEUTRON ACER TENDL-2024 LIBRARY; T=293.6K
Photon emission for (n,2n)2a

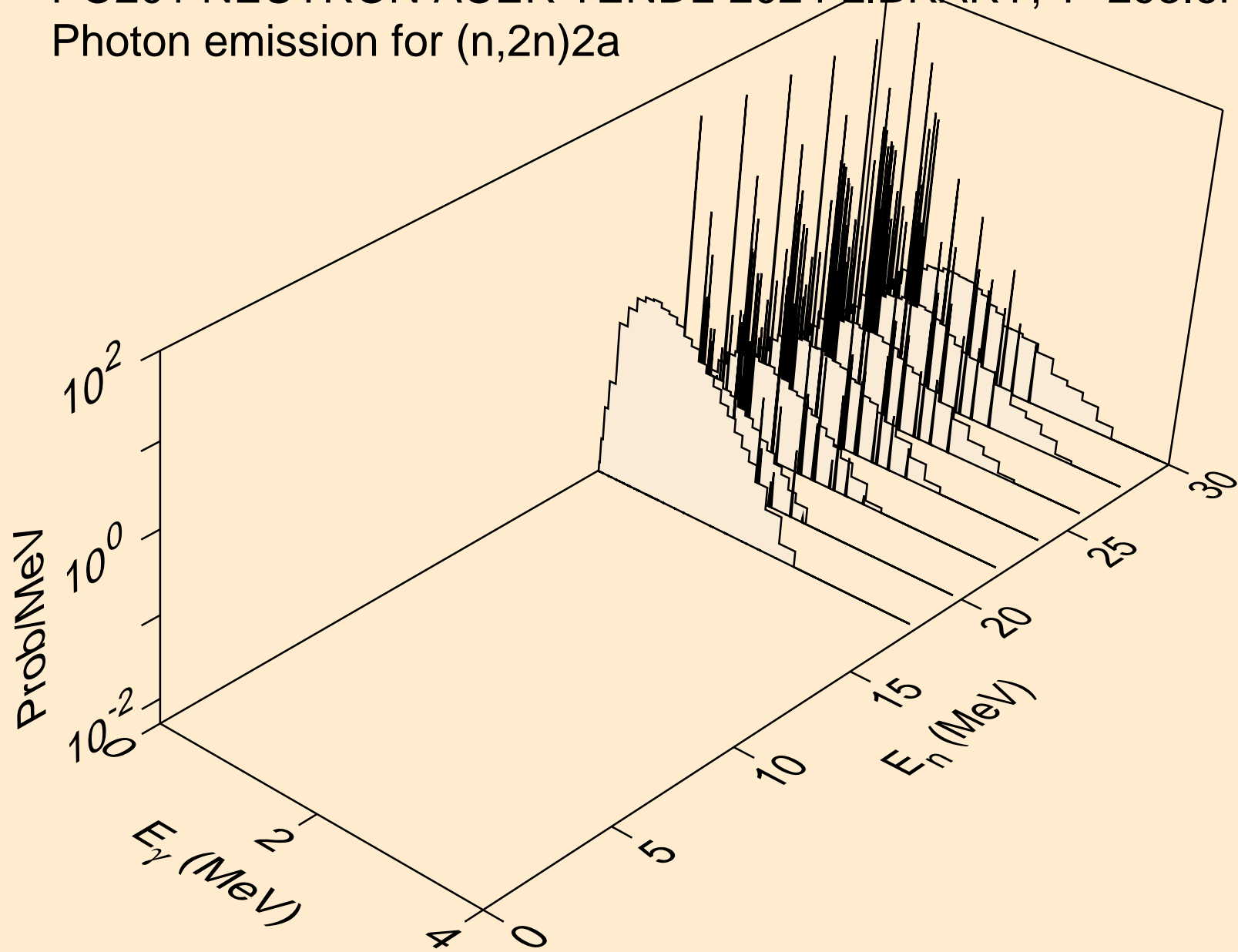

PO201 NEUTRON ACER TENDL-2024 LIBRARY; T=293.6K
Photon emission for (n,n*)d

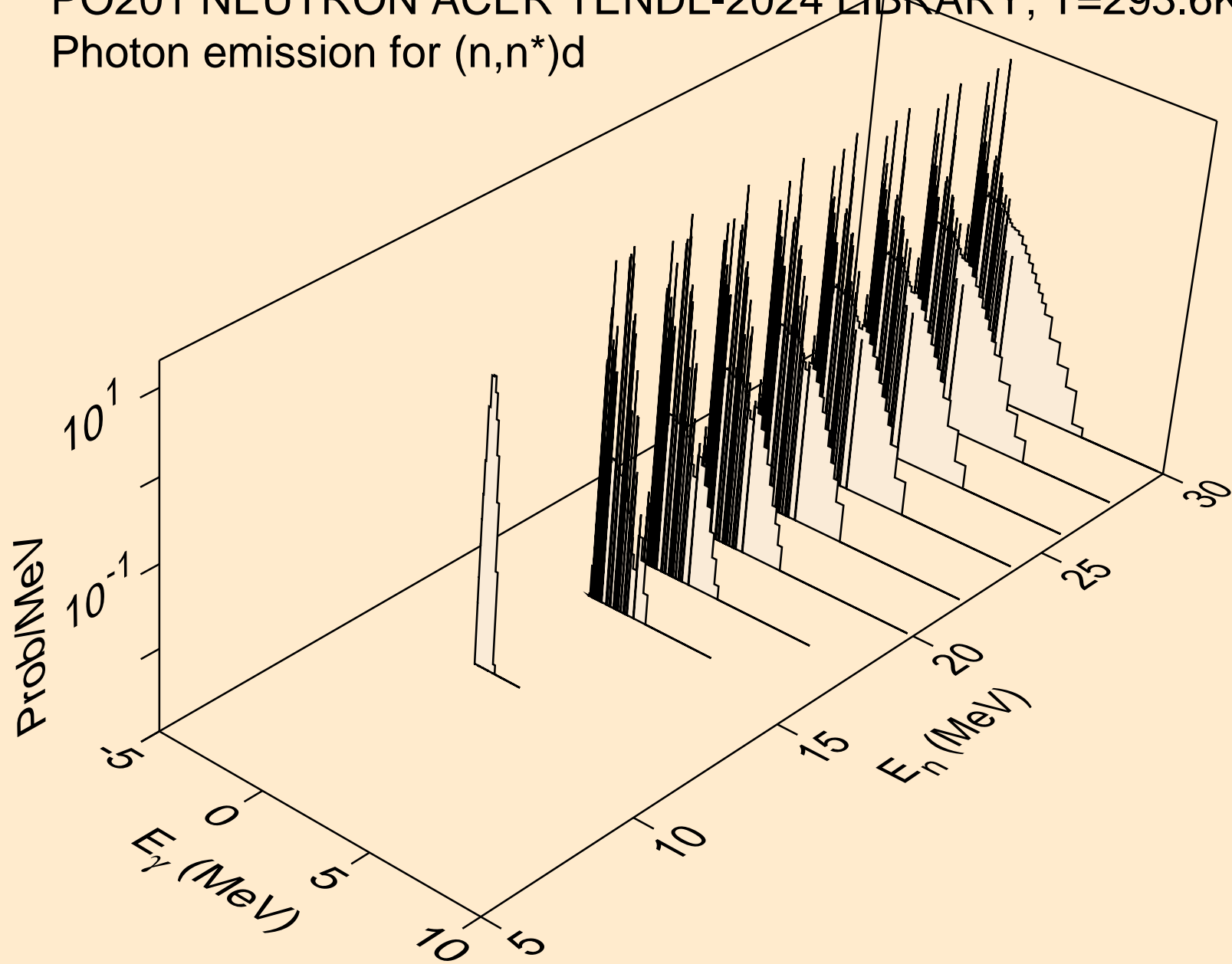

PO201 NEUTRON ACER TENDL-2024 LIBRARY; T=293.6K
Photon emission for (n,n*)t

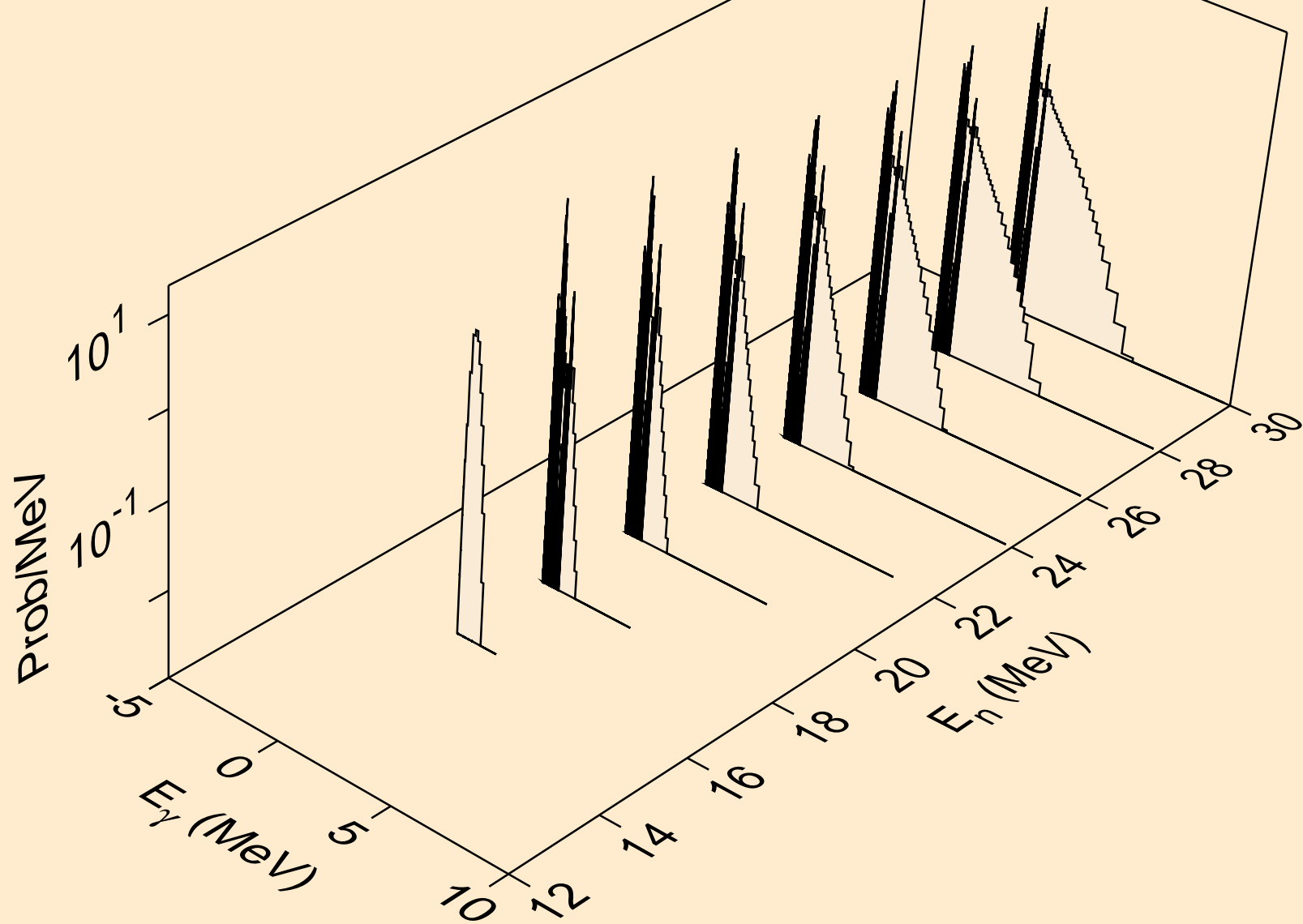

PO201 NEUTRON ACER TENDL-2024 LIBRARY; T=293.6K
Photon emission for (n,n*)he3

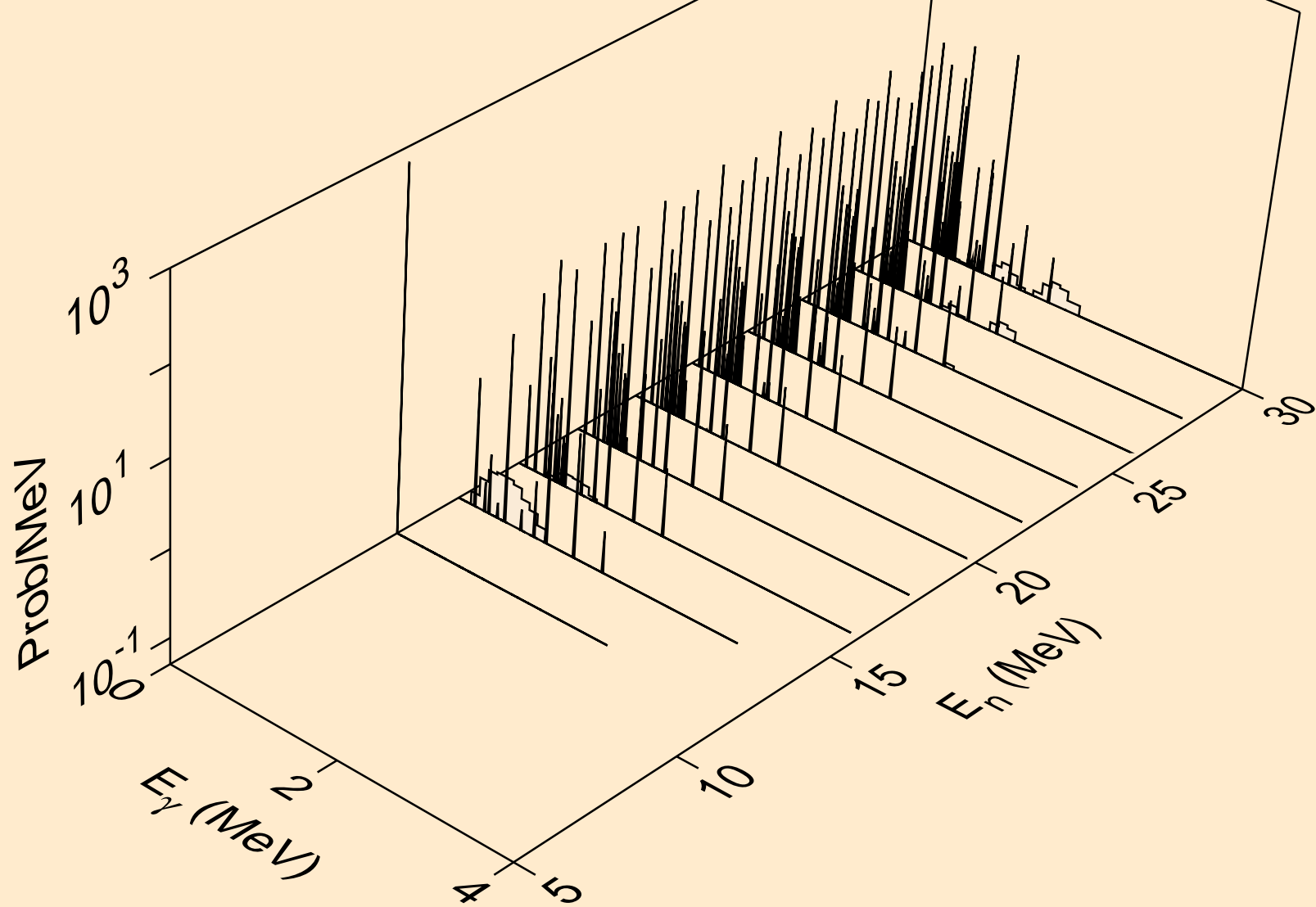

PO201 NEUTRON ACER TENDL-2024 LIBRARY; T=293.6K
Photon emission for (n,4n)

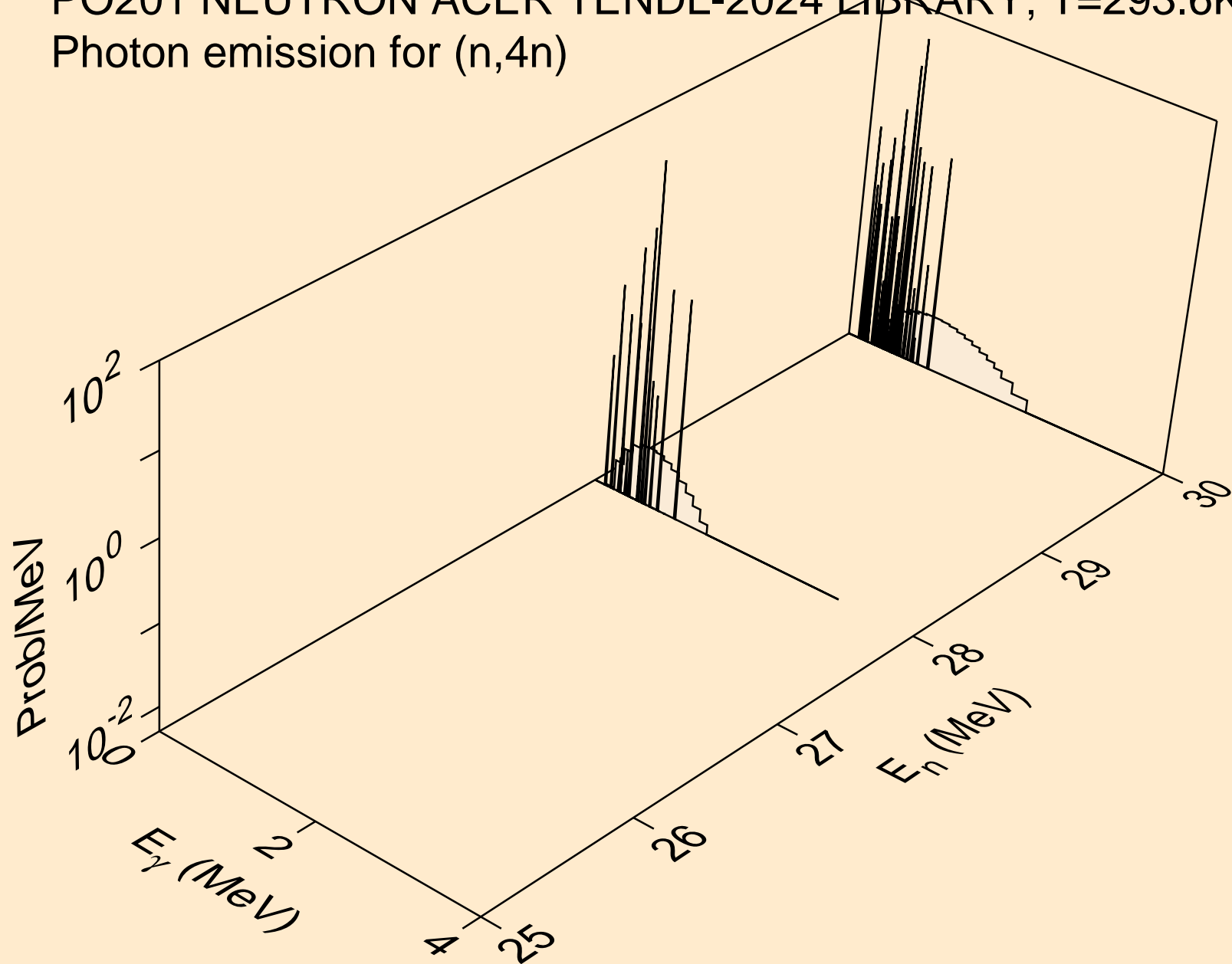

PO201 NEUTRON ACER TENDL-2024 LIBRARY; T=293.6K
Photon emission for (n,2np)

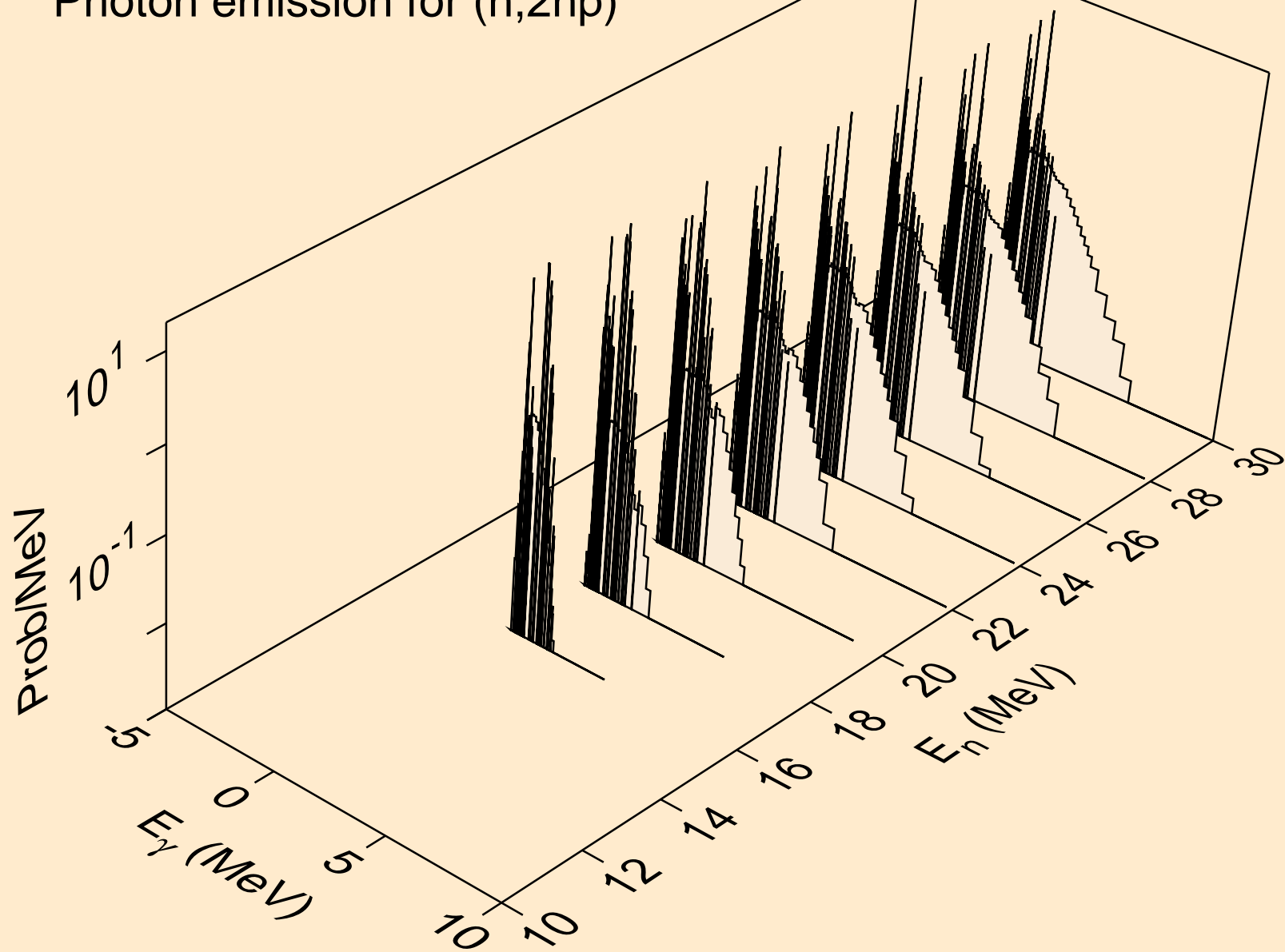

PO201 NEUTRON ACER TENDL-2024 LIBRARY; T=293.6K
Photon emission for (n,3np)

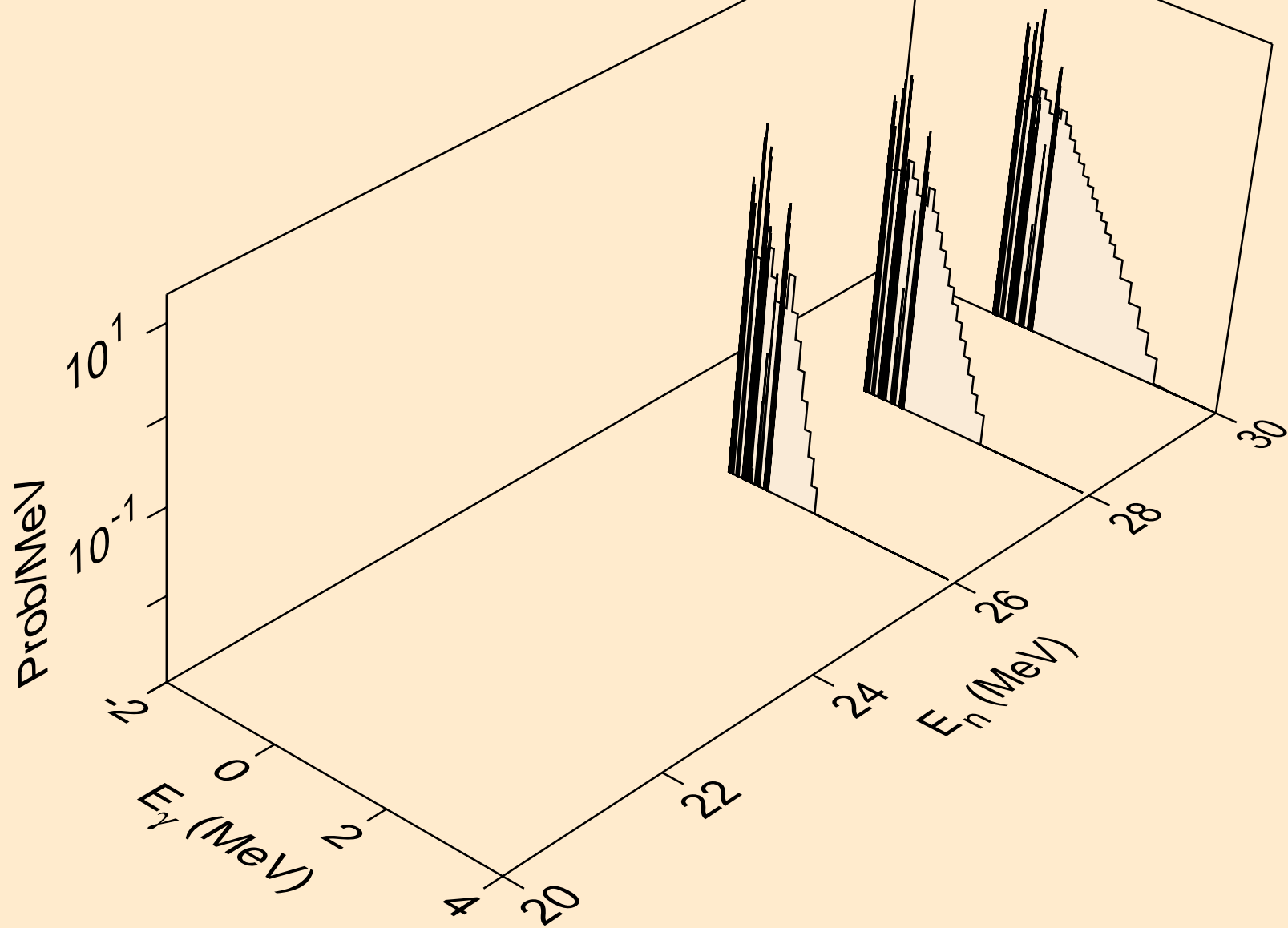

PO201 NEUTRON ACER TENDL-2024 LIBRARY; T=293.6K
Photon emission for (n,n2p)

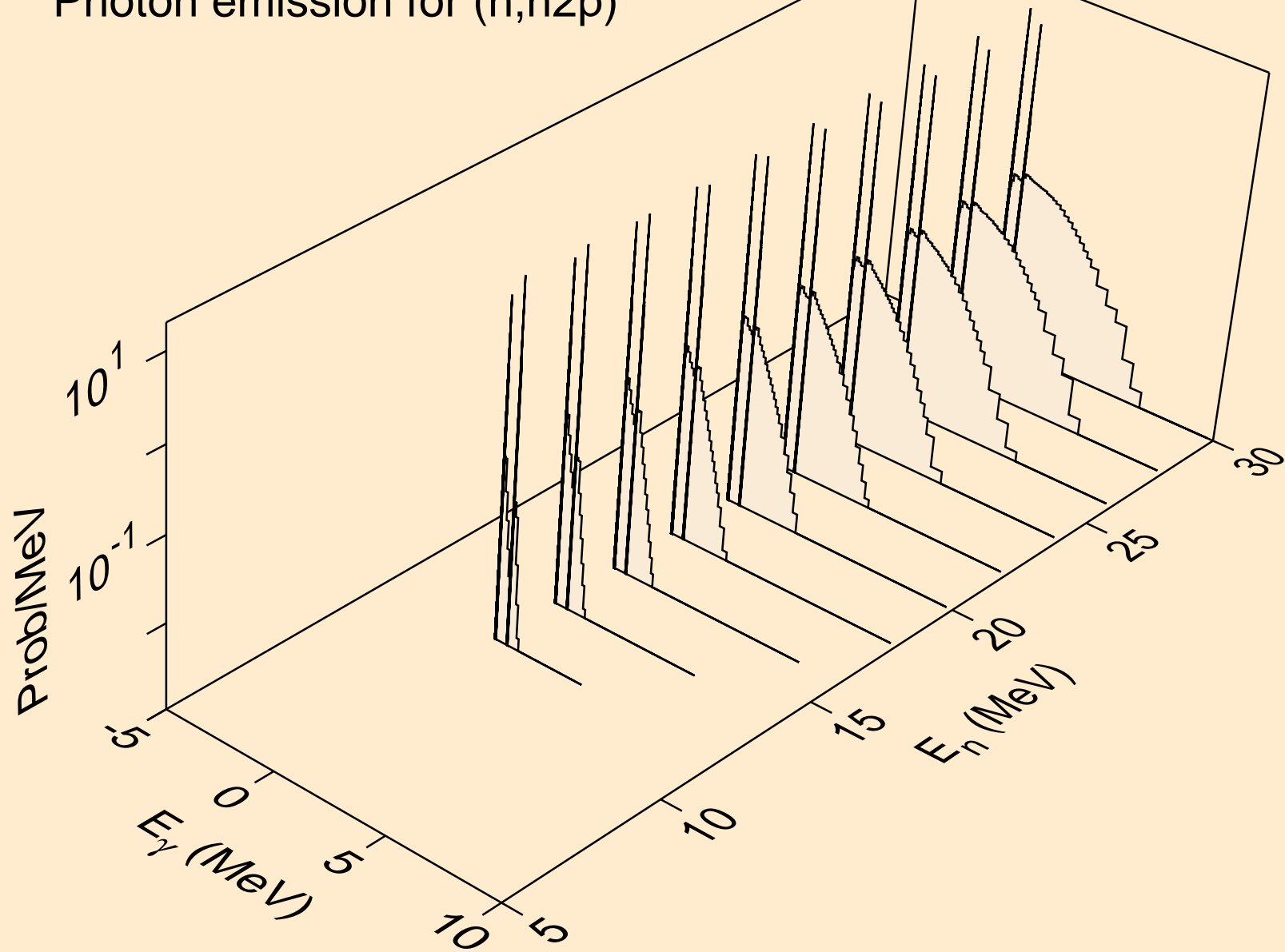

PO201 NEUTRON ACER TENDL-2024 LIBRARY; T=293.6K
Photon emission for (n,npa)

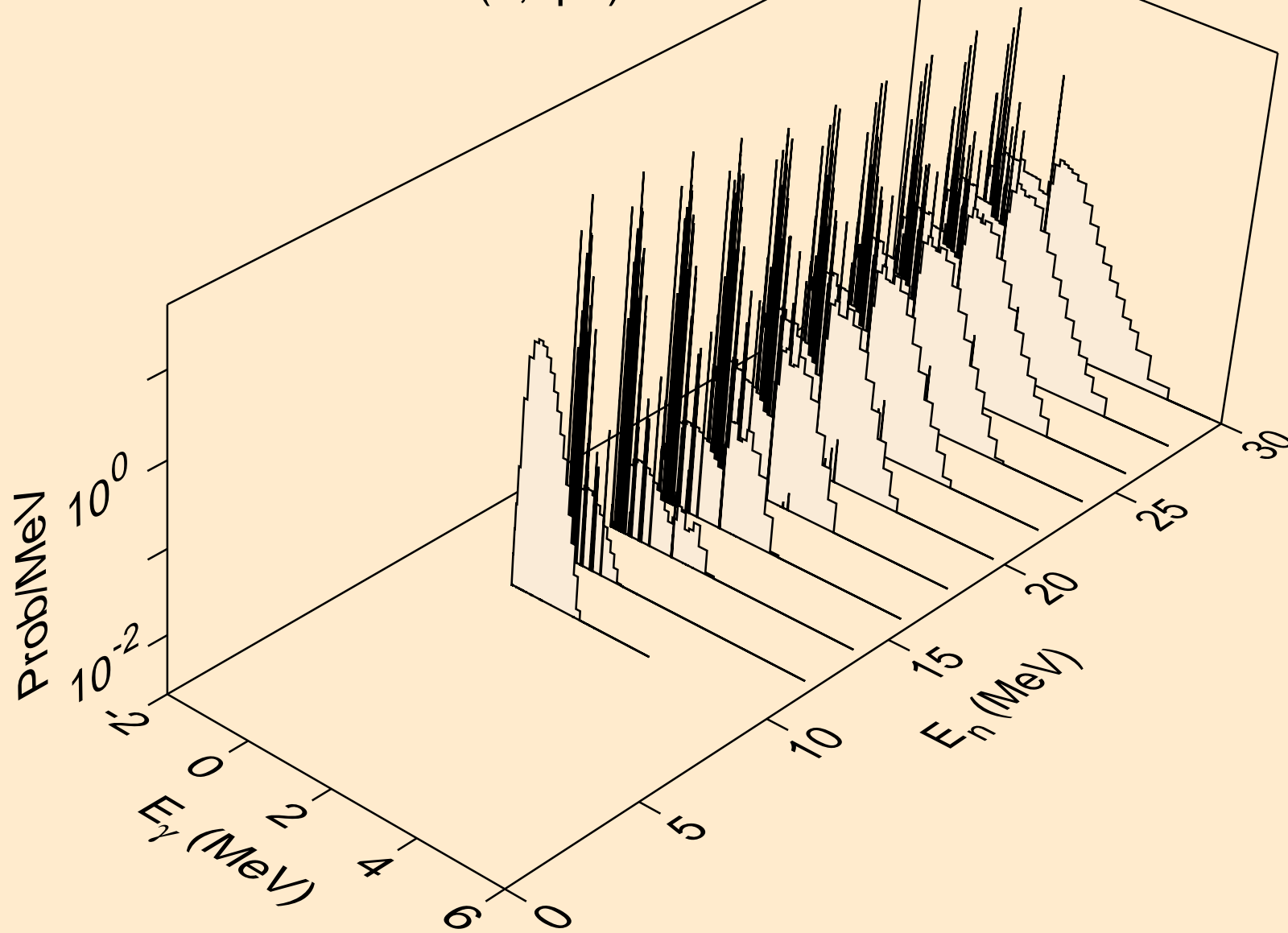

PO201 NEUTRON ACER TENDL-2024 LIBRARY; T=293.6K
Photon emission for (n,n*c)

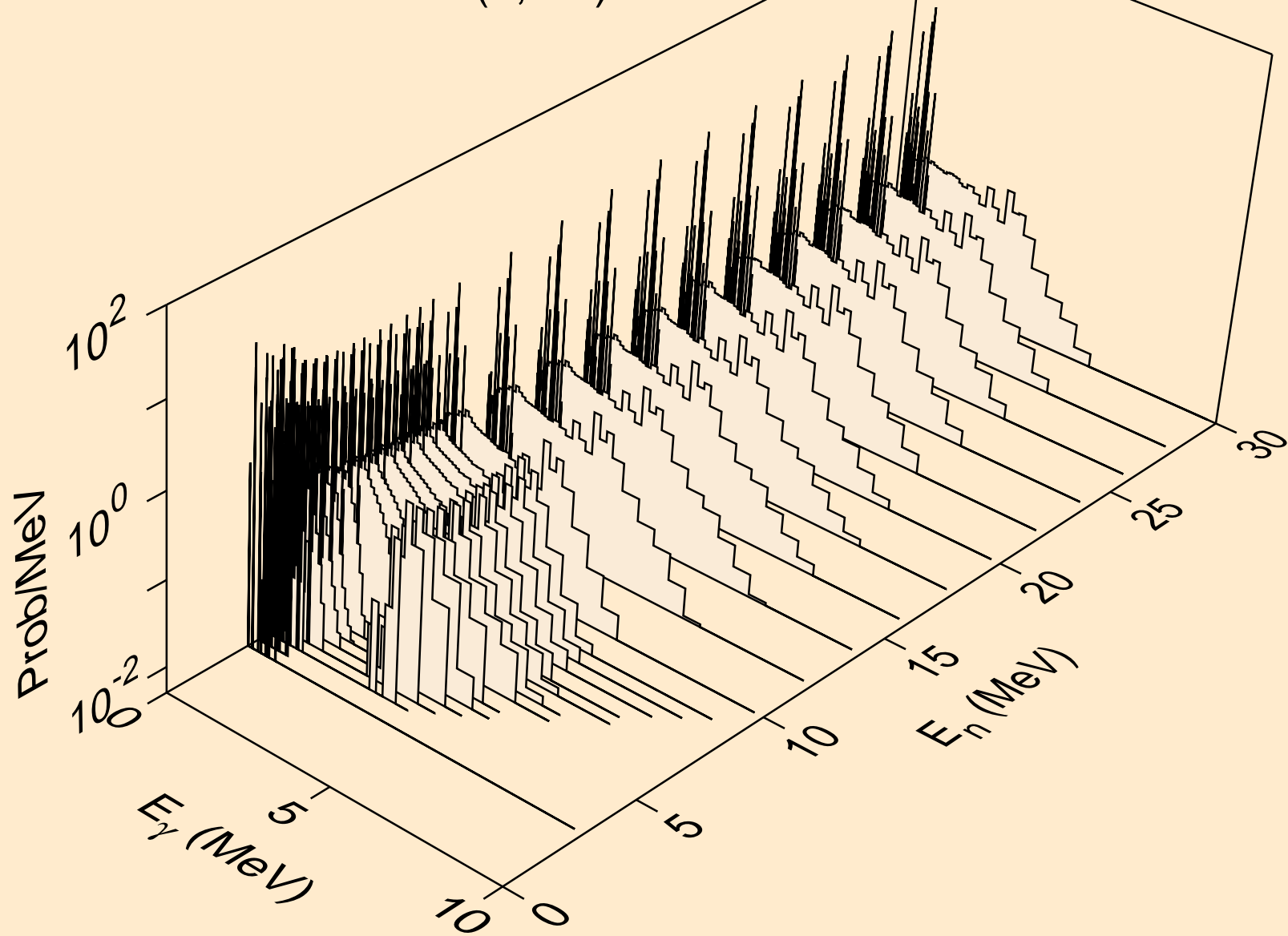

PO201 NEUTRON ACER TENDL-2024 LIBRARY; T=293.6K
Photon emission for (n,gma)

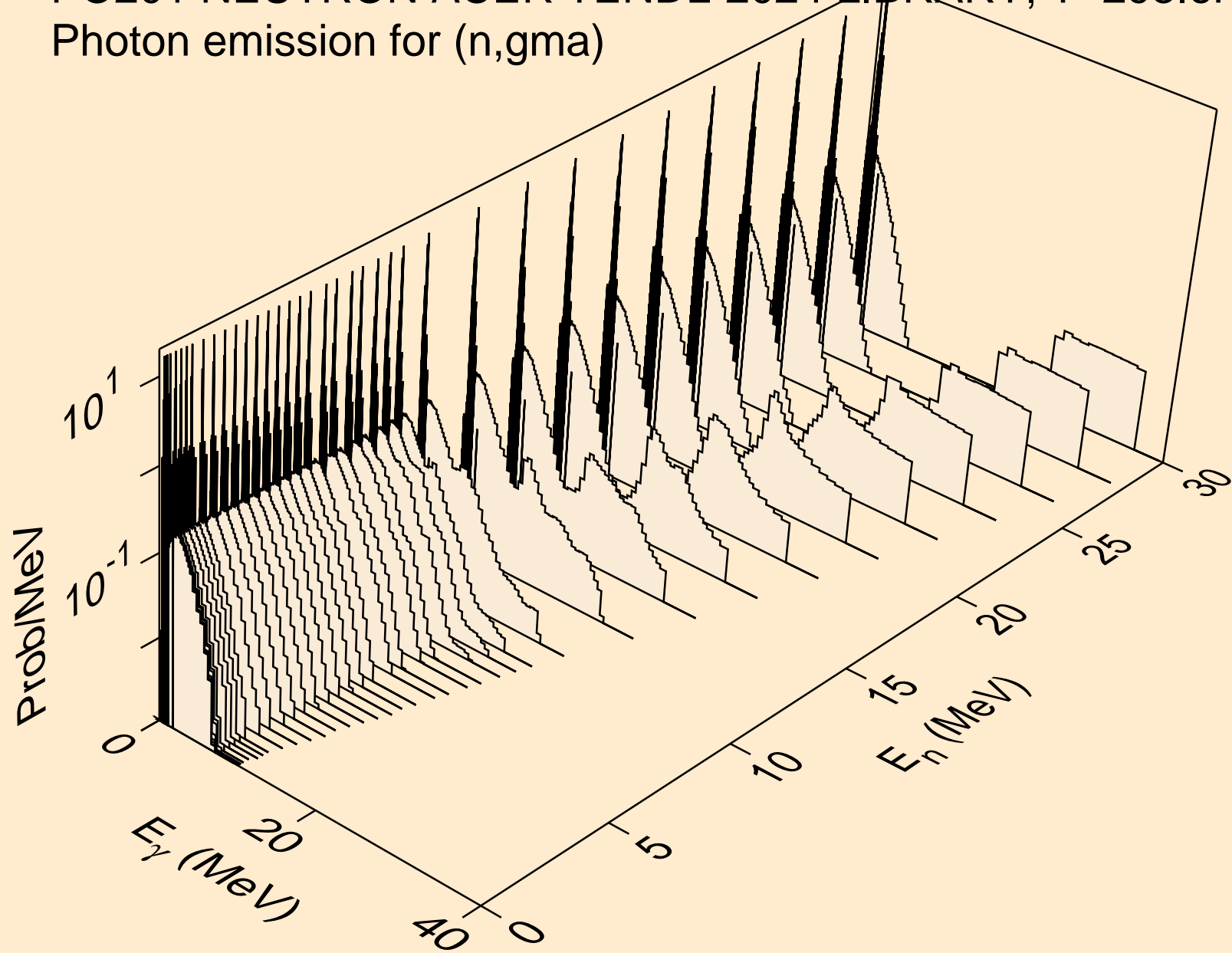

PO201 NEUTRON ACER TENDL-2024 LIBRARY; T=293.6K
Photon emission for (n,p)

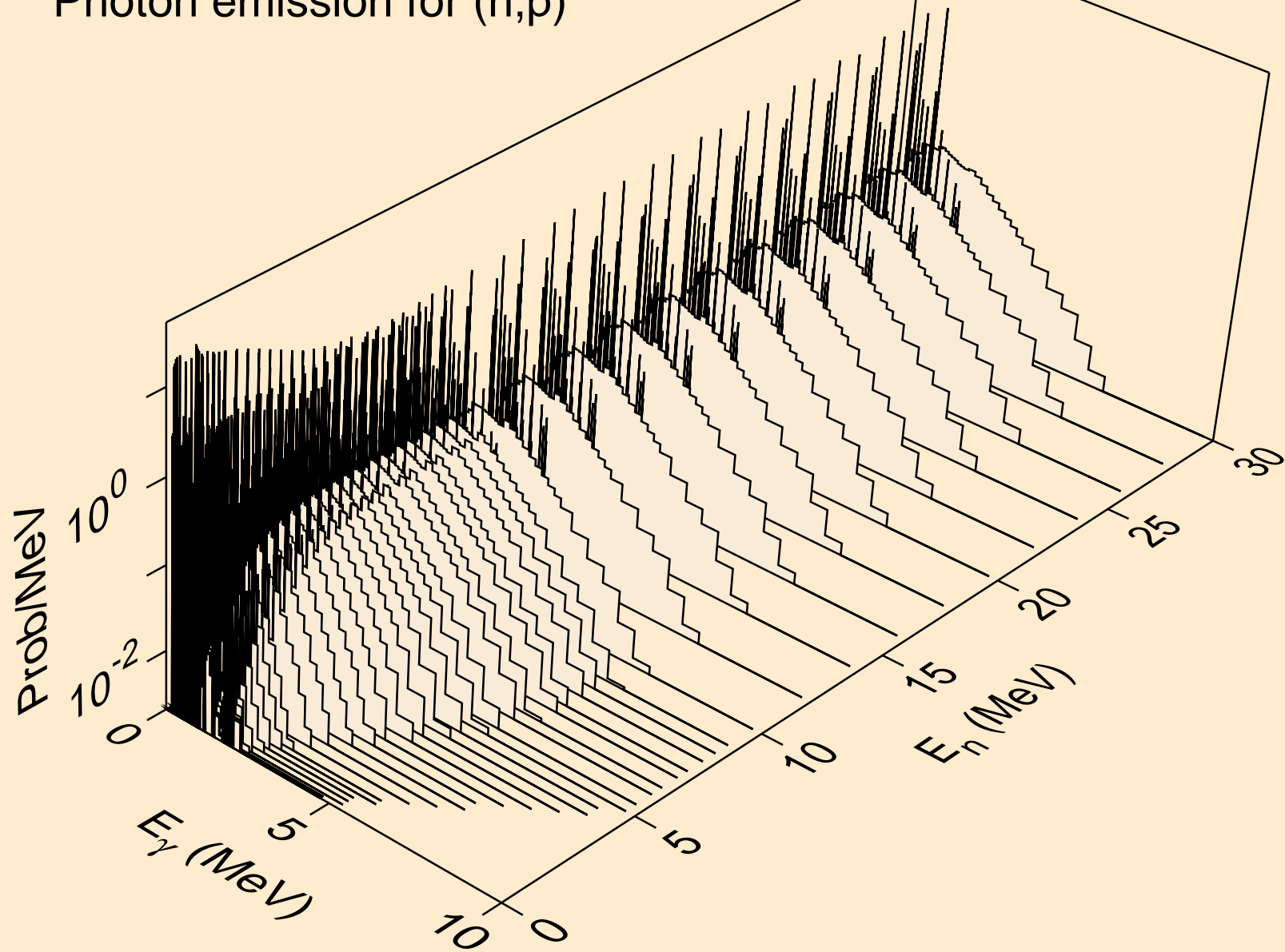

PO201 NEUTRON ACER TENDL-2024 LIBRARY; T=293.6K
Photon emission for (n,d)

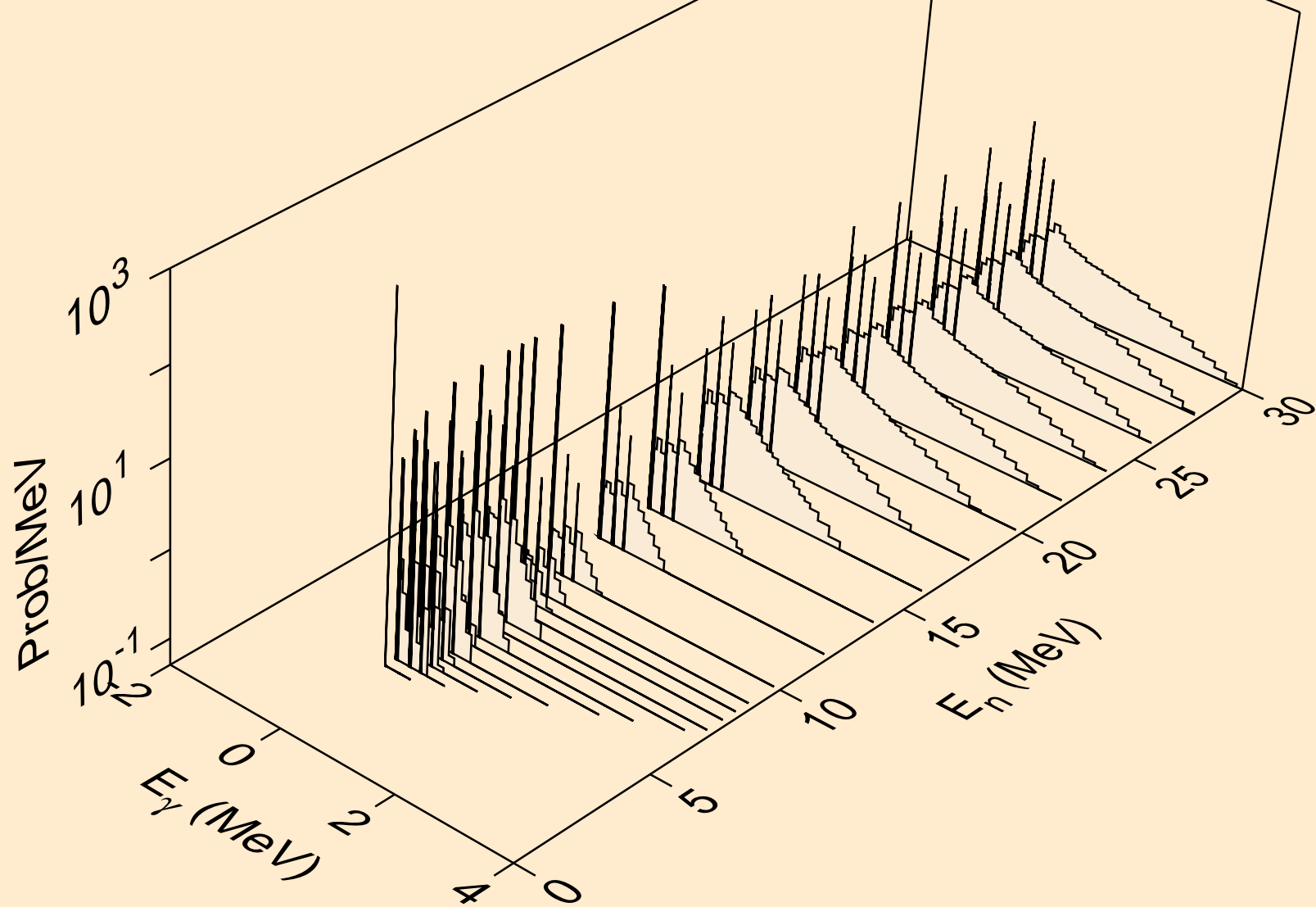

PO201 NEUTRON ACER TENDL-2024 LIBRARY; T=293.6K
Photon emission for (n,t)

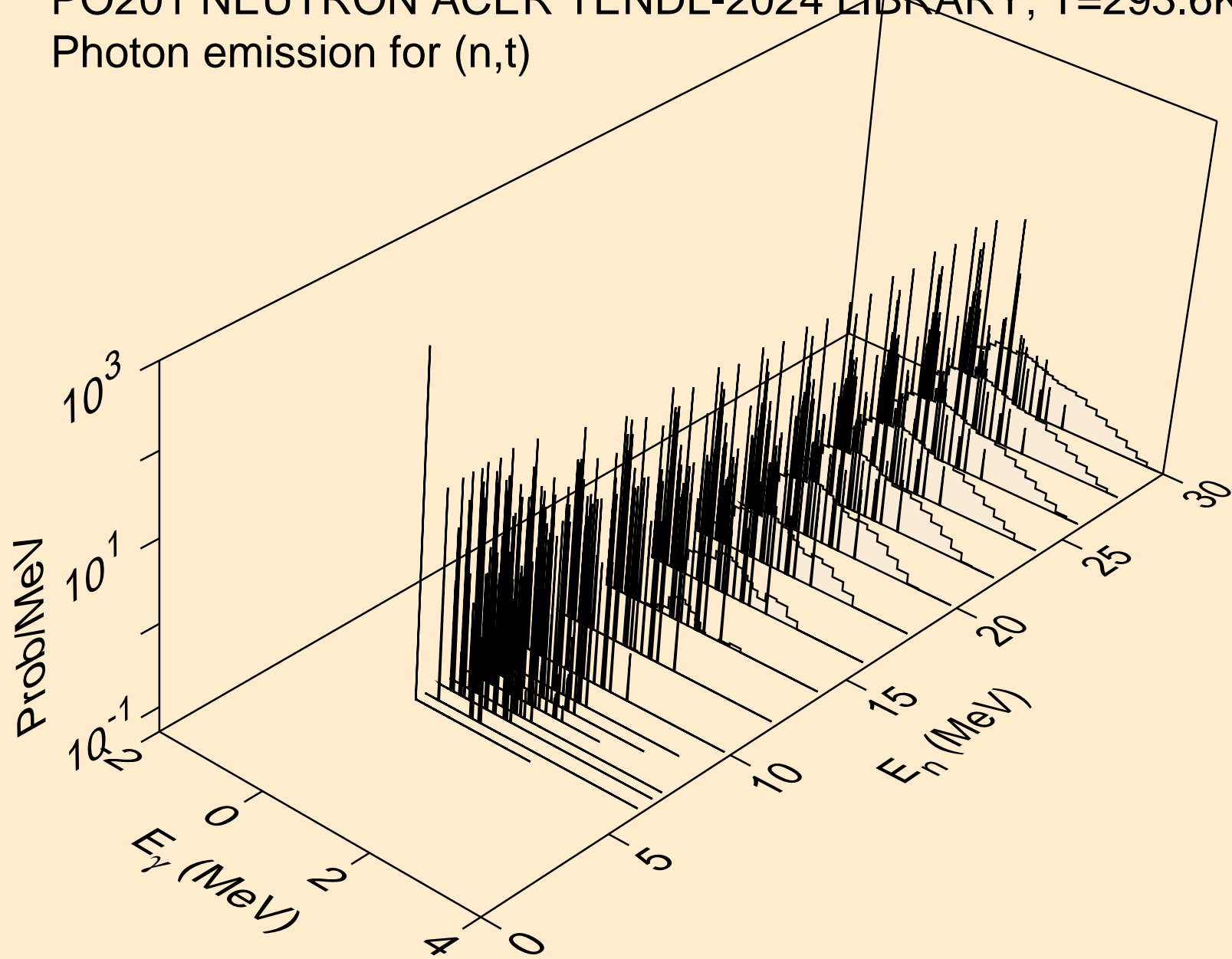

PO201 NEUTRON ACER TENDL-2024 LIBRARY; T=293.6K
Photon emission for (n,he3)

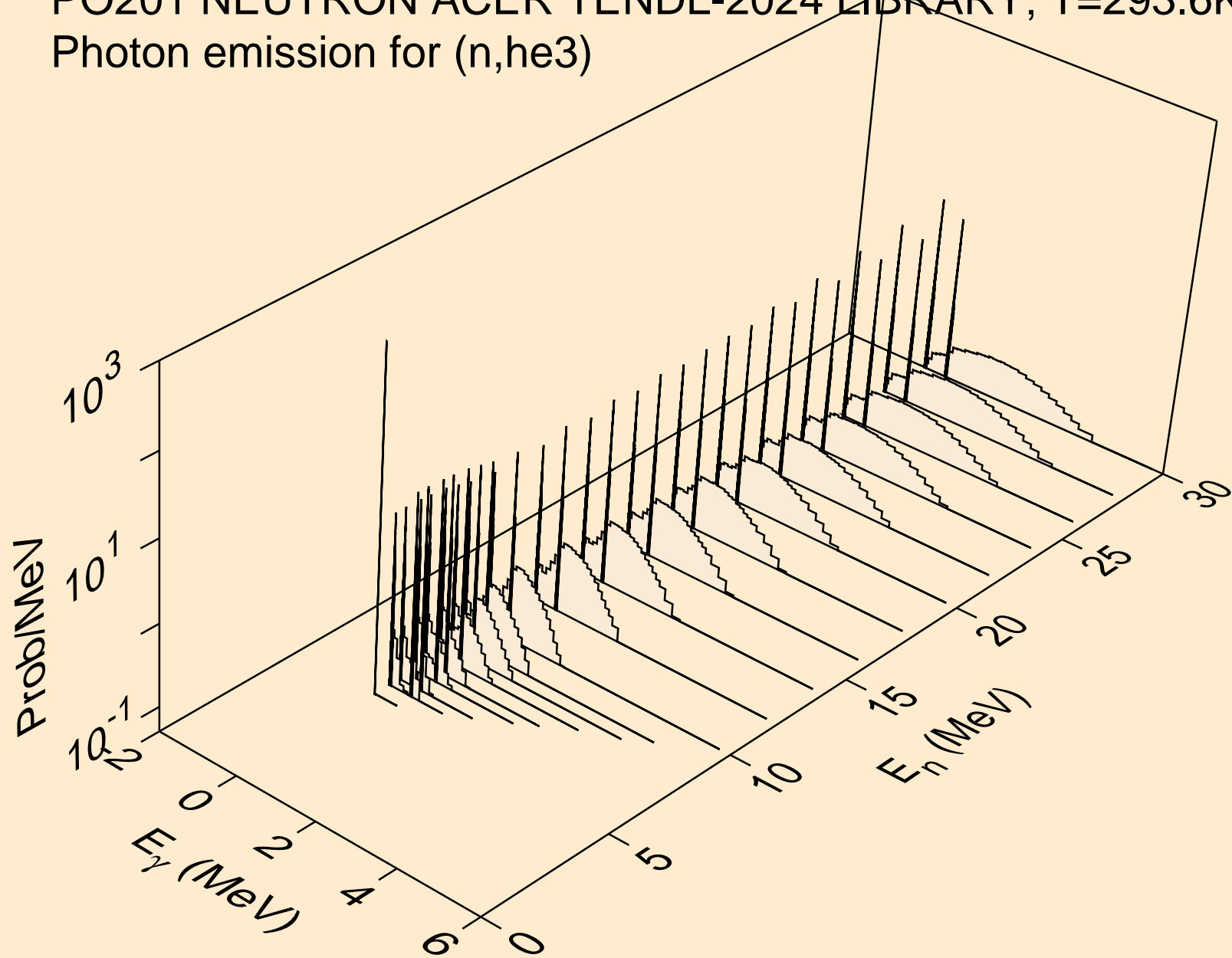

PO201 NEUTRON ACER TENDL-2024 LIBRARY; T=293.6K
Photon emission for (n,a)

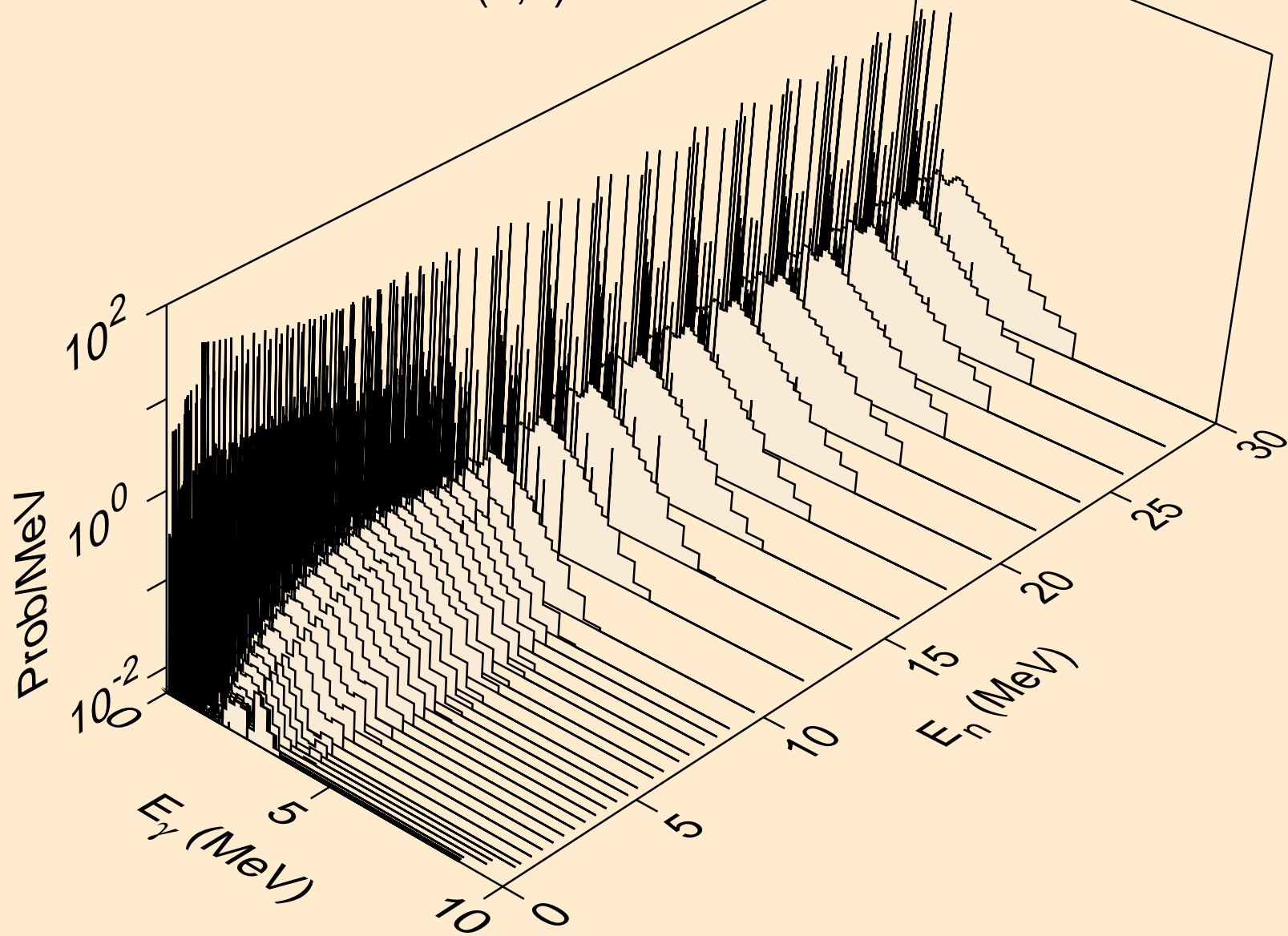

PO201 NEUTRON ACER TENDL-2024 LIBRARY; T=293.6K
Photon emission for (n,2a)

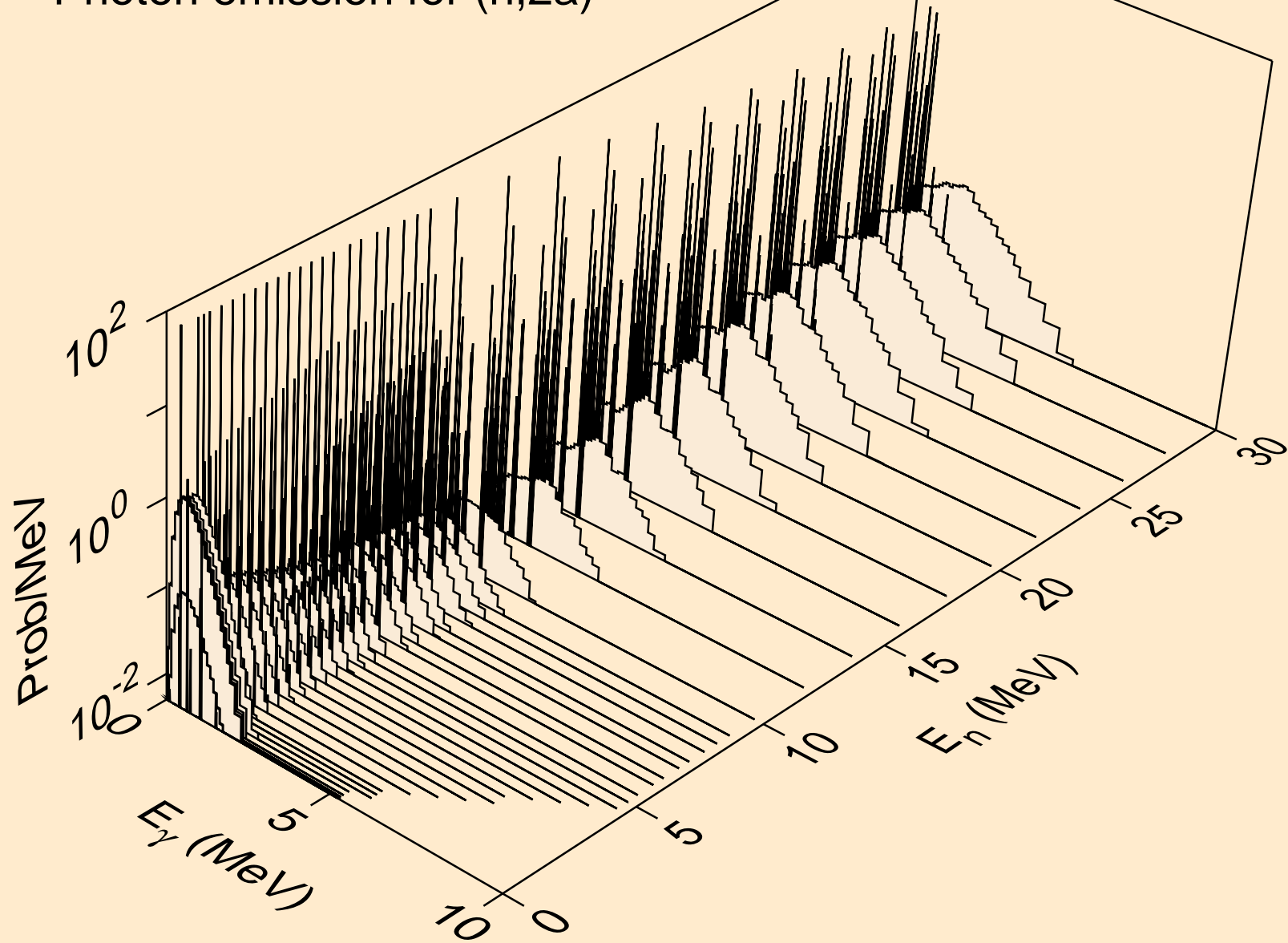

PO201 NEUTRON ACER TENDL-2024 LIBRARY; T=293.6K
Photon emission for (n,2p)

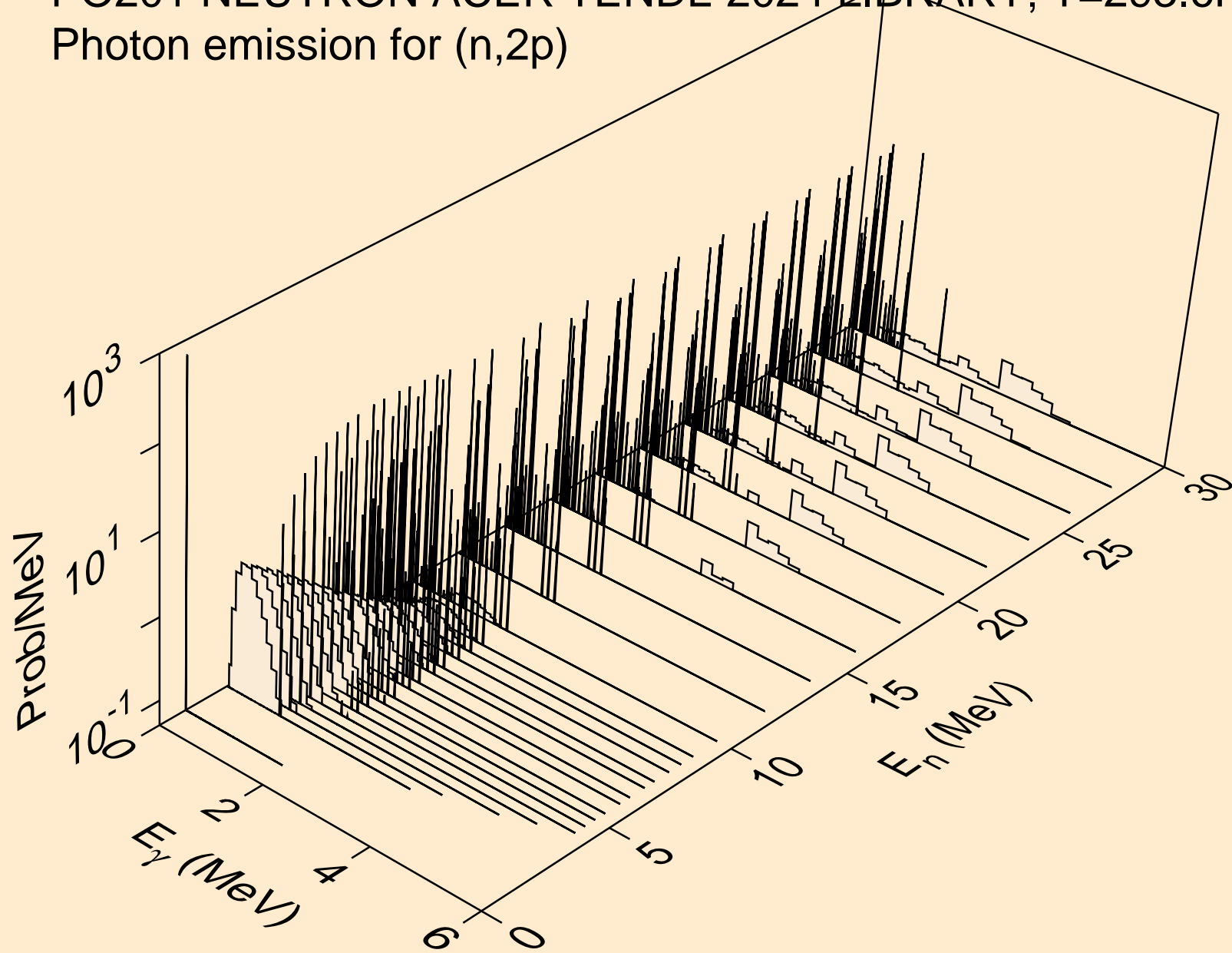

PO201 NEUTRON ACER TENDL-2024 LIBRARY; T=293.6K
Photon emission for (n,p)

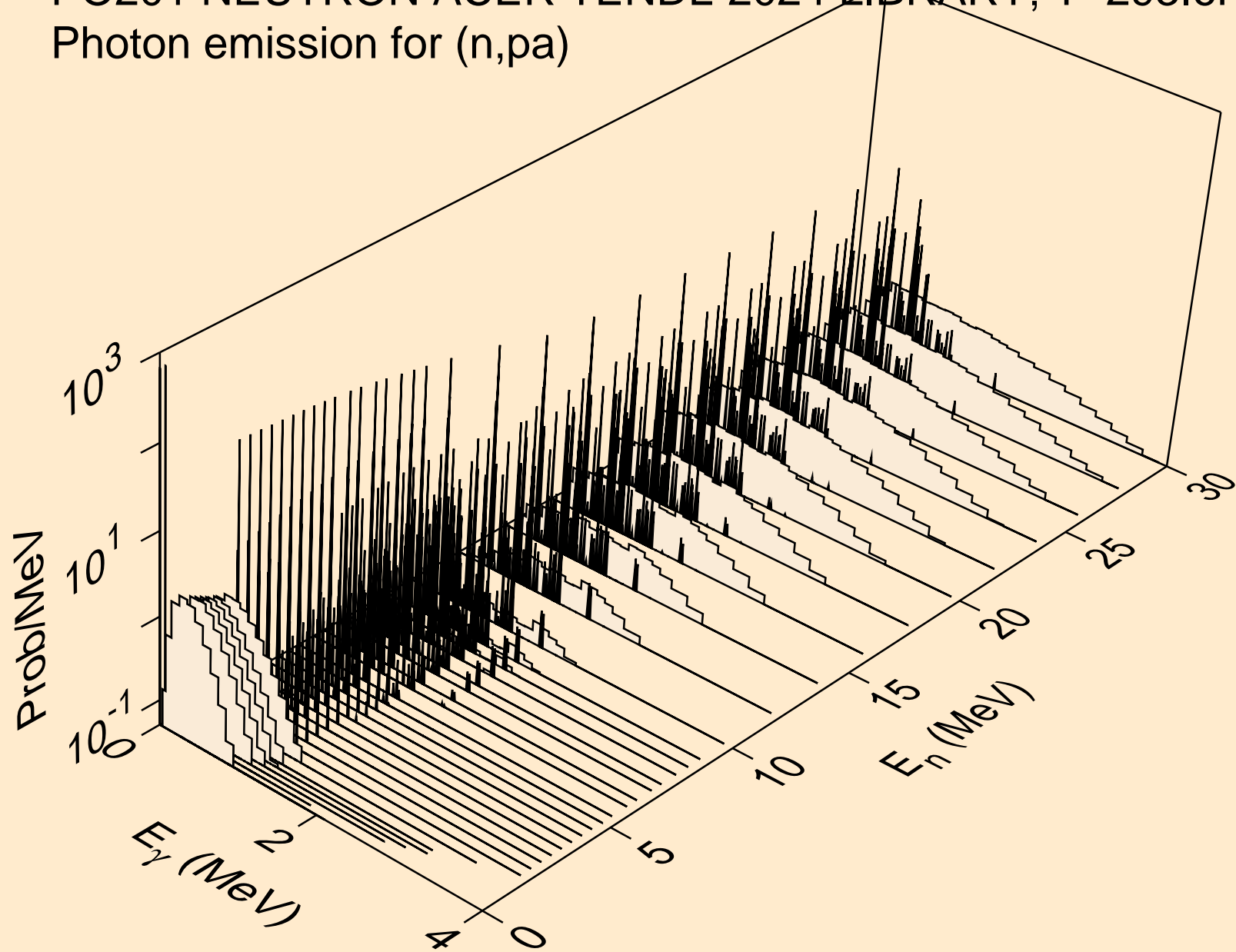

PO201 NEUTRON ACER TENDL-2024 LIBRARY; T=293.6K
Photon emission for (n,pd)

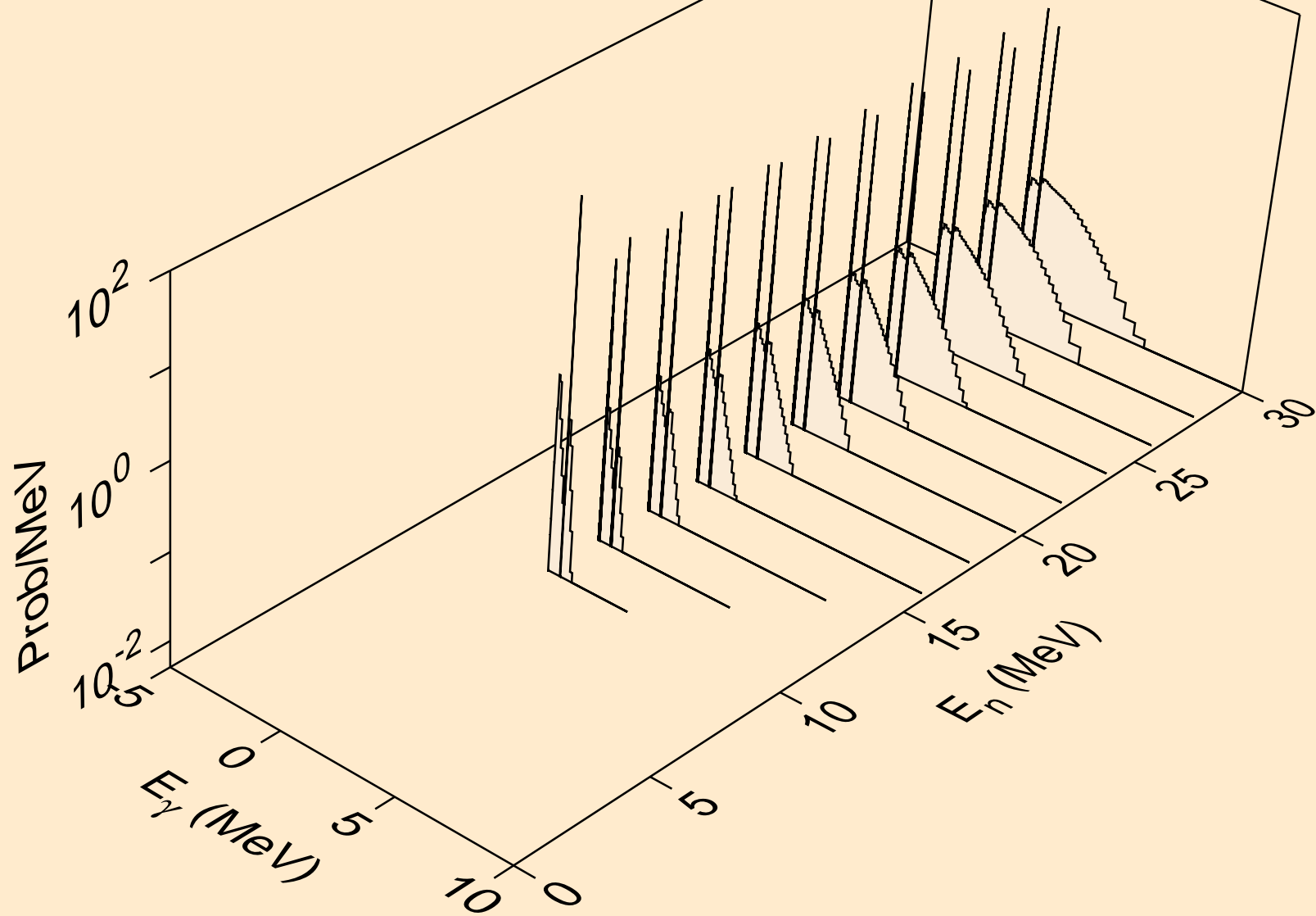

PO201 NEUTRON ACER TENDL-2024 LIBRARY; T=293.6K
Photon emission for (n,pt)

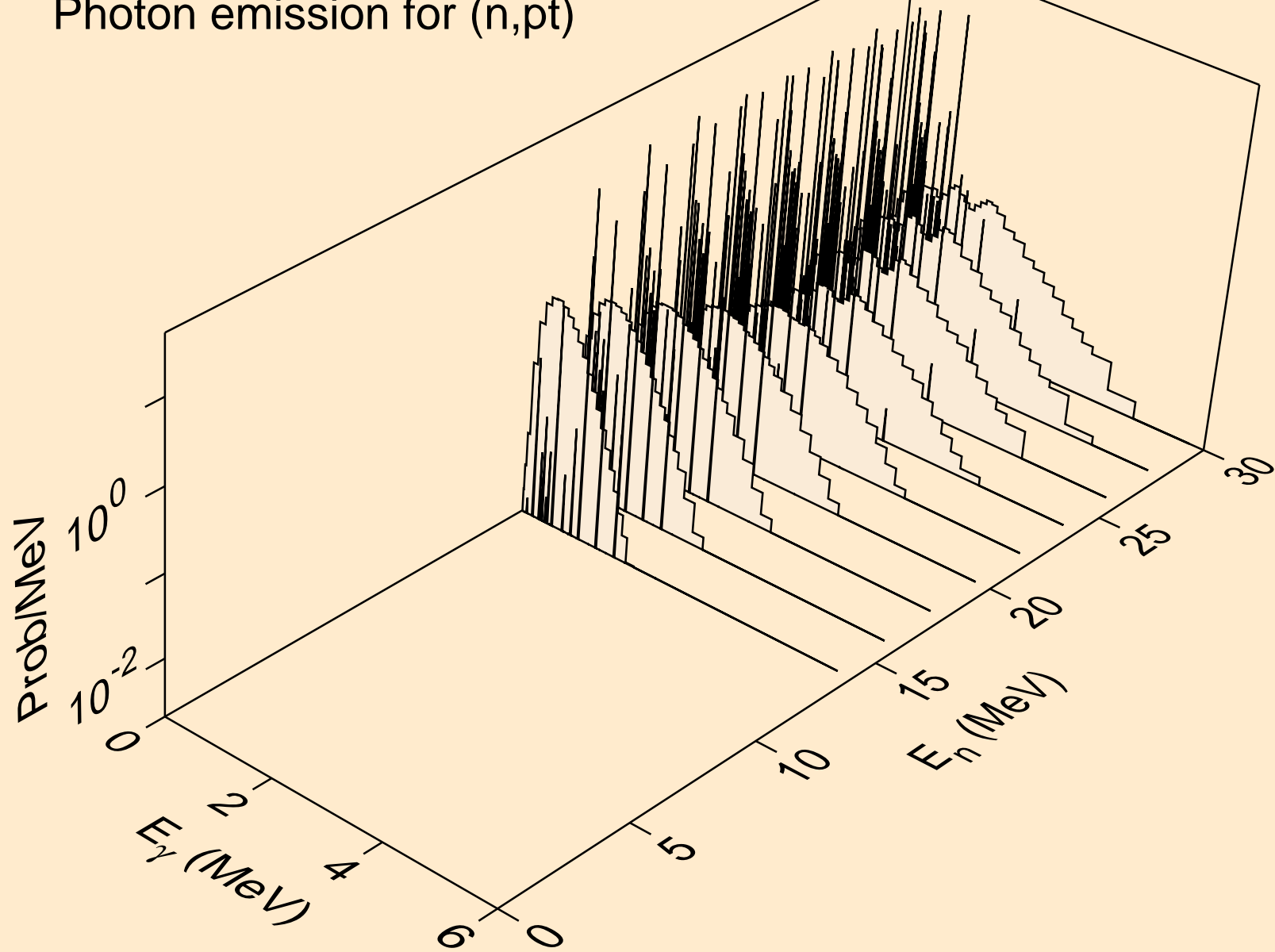

PO201 NEUTRON ACER TENDL-2024 LIBRARY; T=293.6K
Photon emission for (n,da)

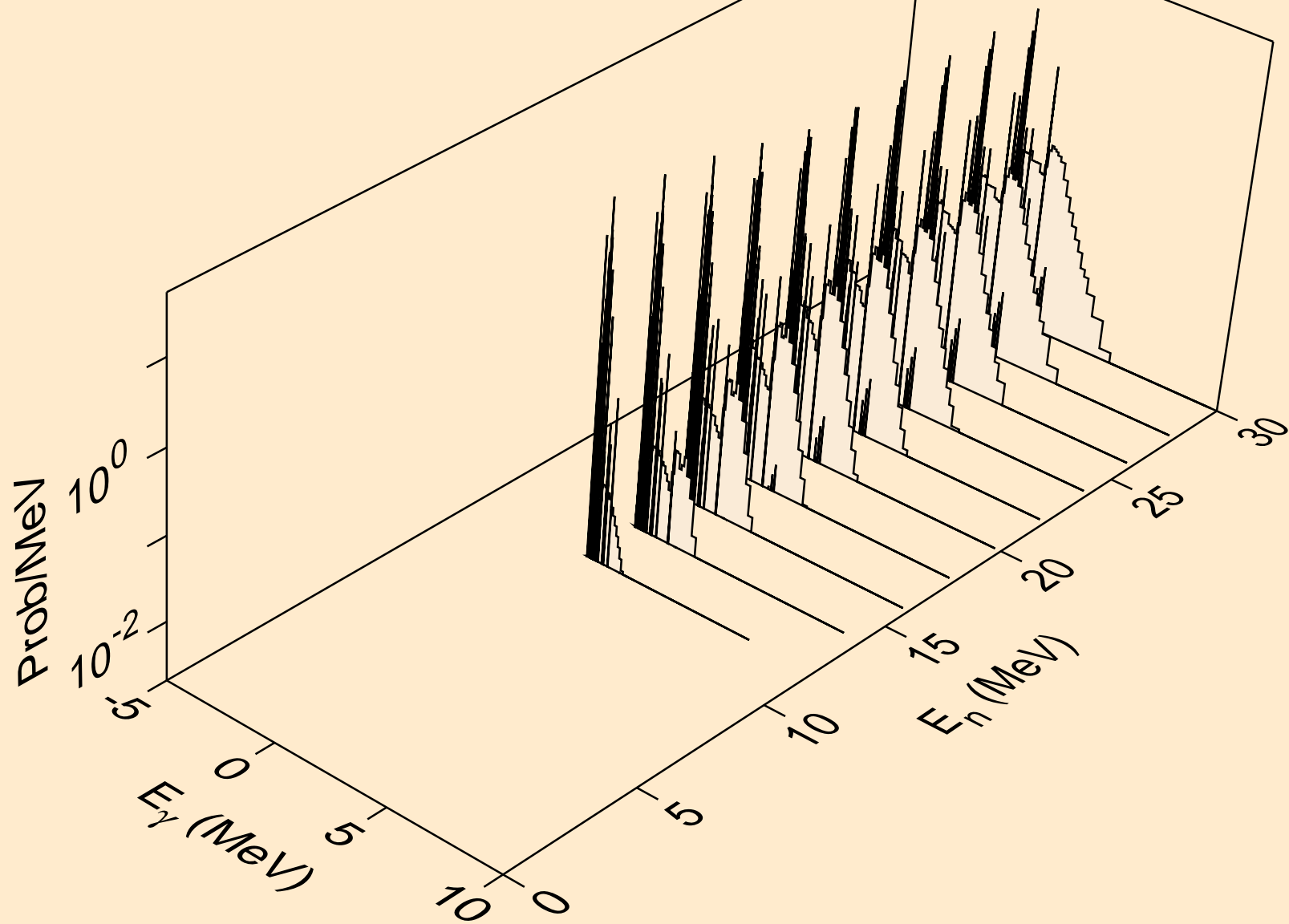

PO201 NEUTRON ACER TENDL-2024 LIBRARY; T=293.6K
thermal capture photon spectrum

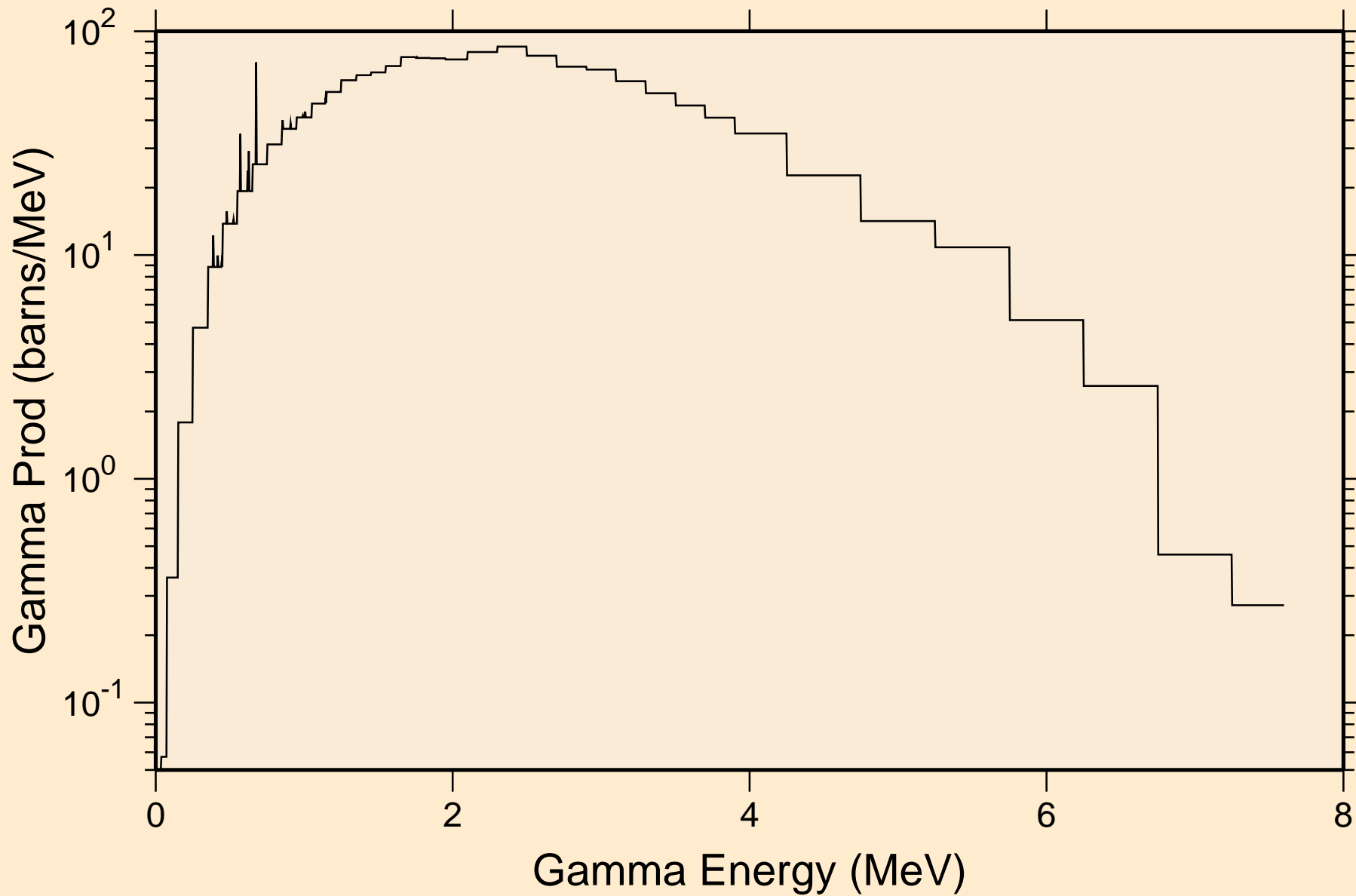

PO201 NEUTRON ACER TENDL-2024 LIBRARY; T=293.6K
14 MeV photon spectrum

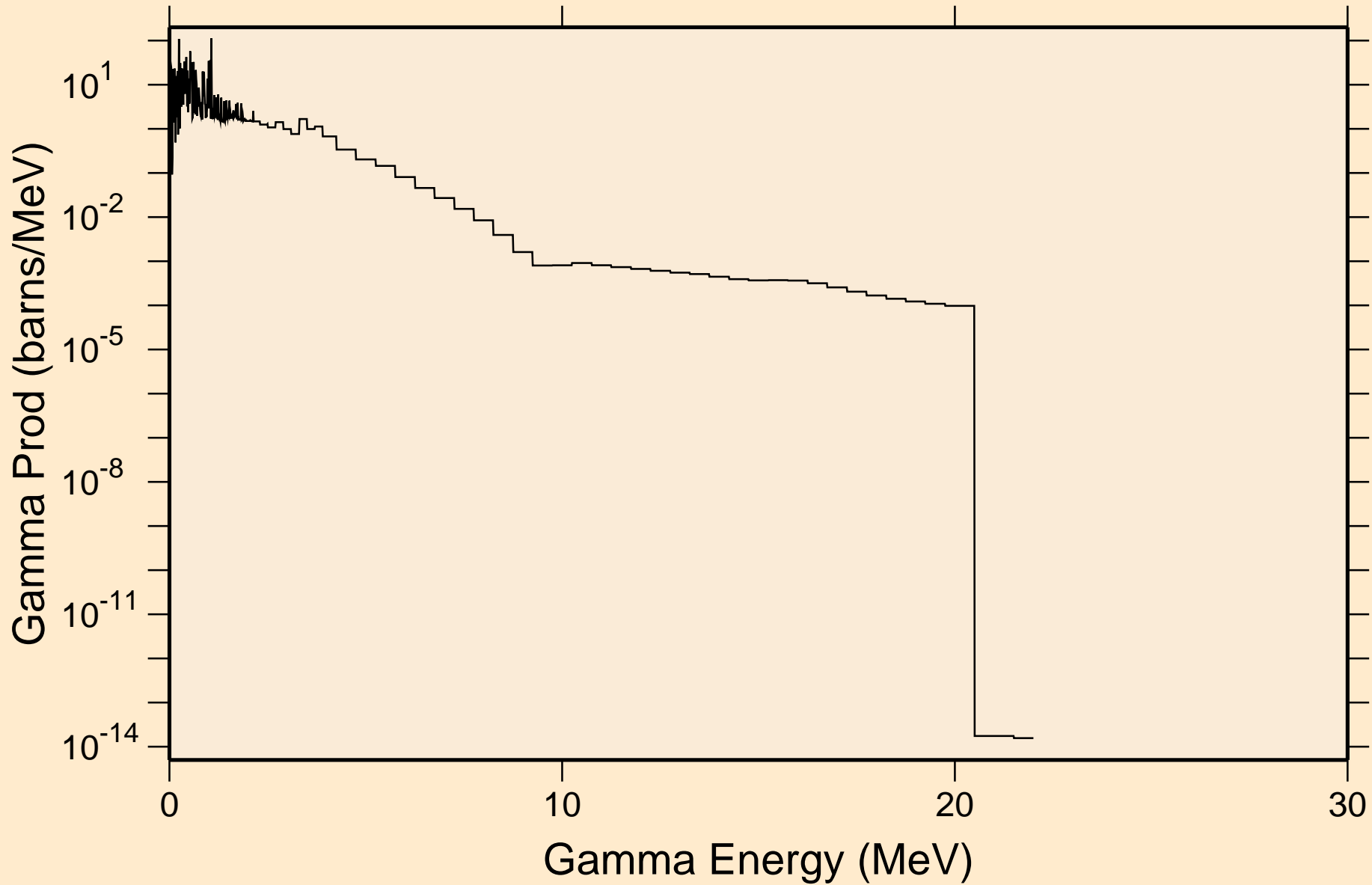

PO201 NEUTRON ACER TENDL-2024 LIBRARY; T=293.6K
Particle heating contributions

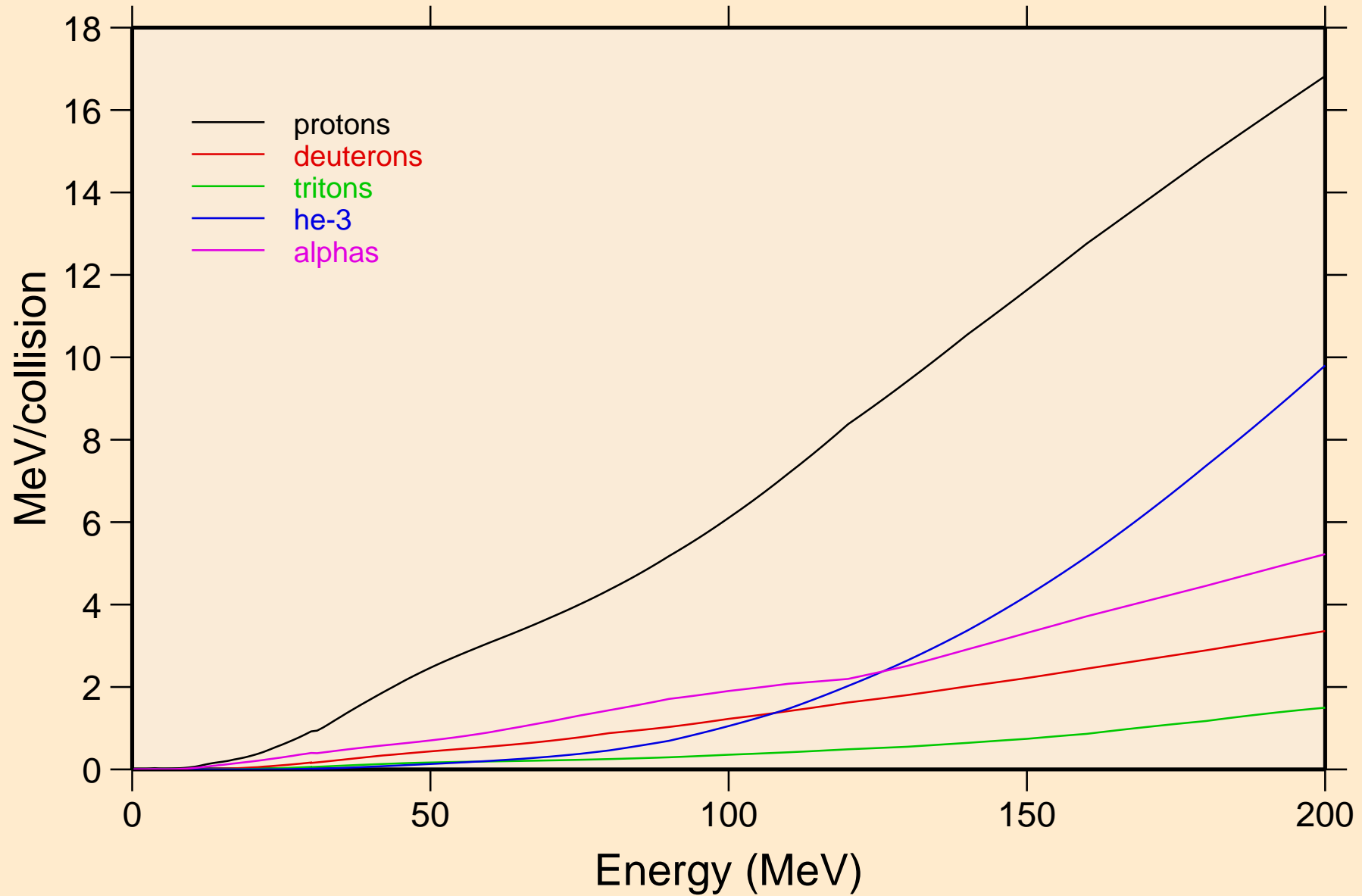

PO201 NEUTRON ACER TENDL-2024 LIBRARY; T=293.6K
Recoil Heating

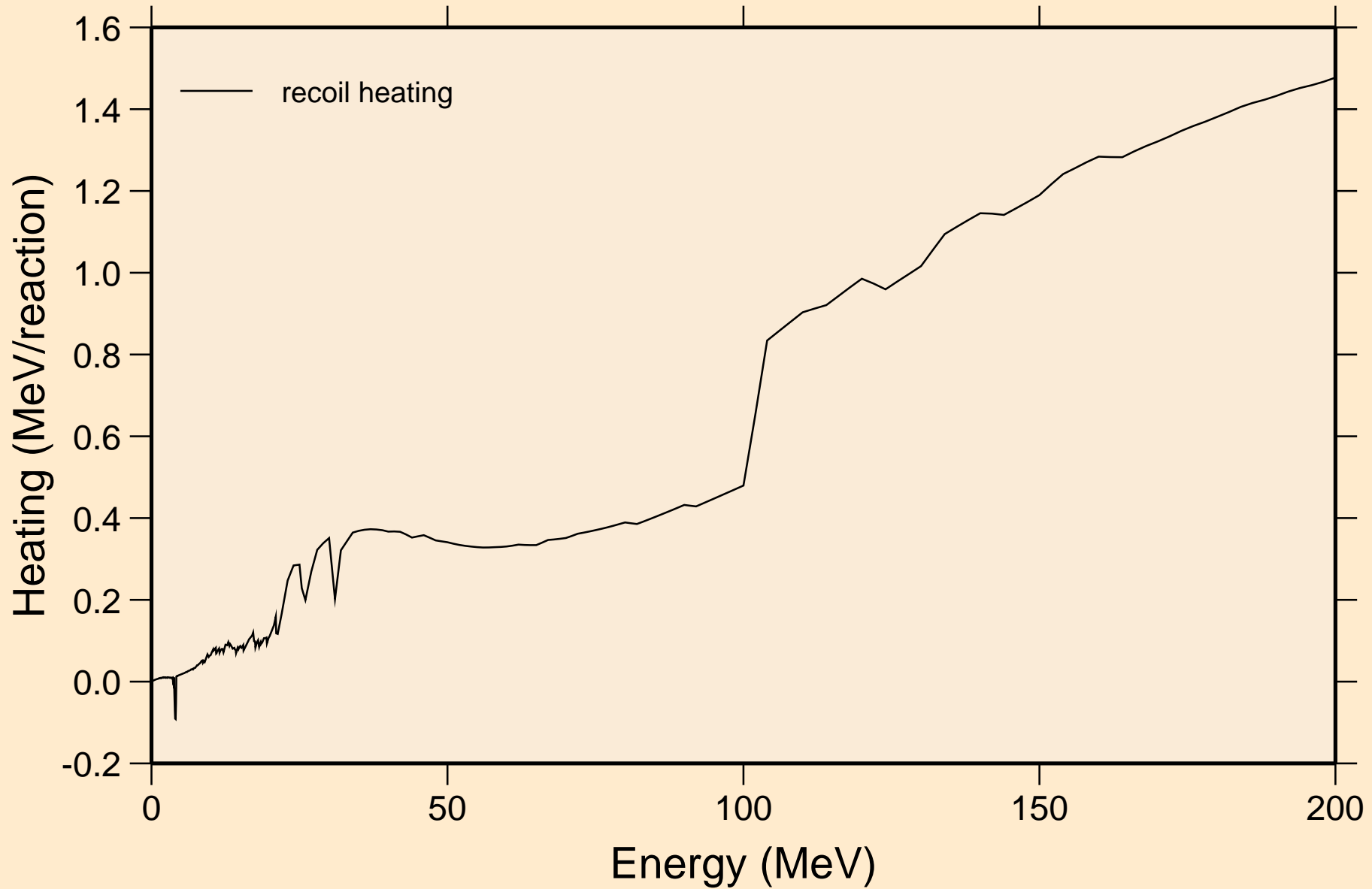

PO201 NEUTRON ACER TENDL-2024 LIBRARY; T=293.6K
Particle production cross sections

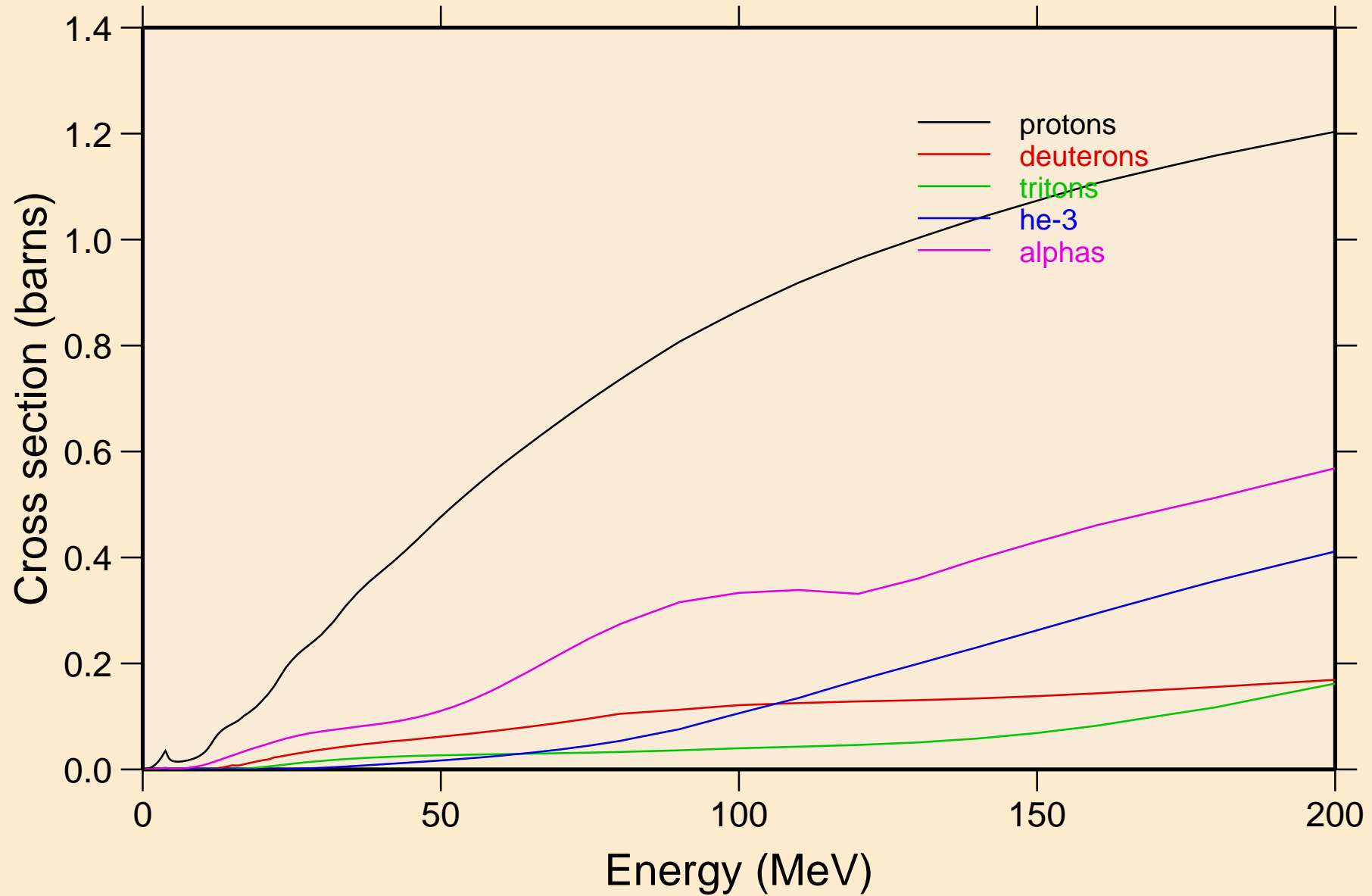

PO201 NEUTRON ACER TENDL-2024 LIBRARY; T=293.6K
protons from (n,x)

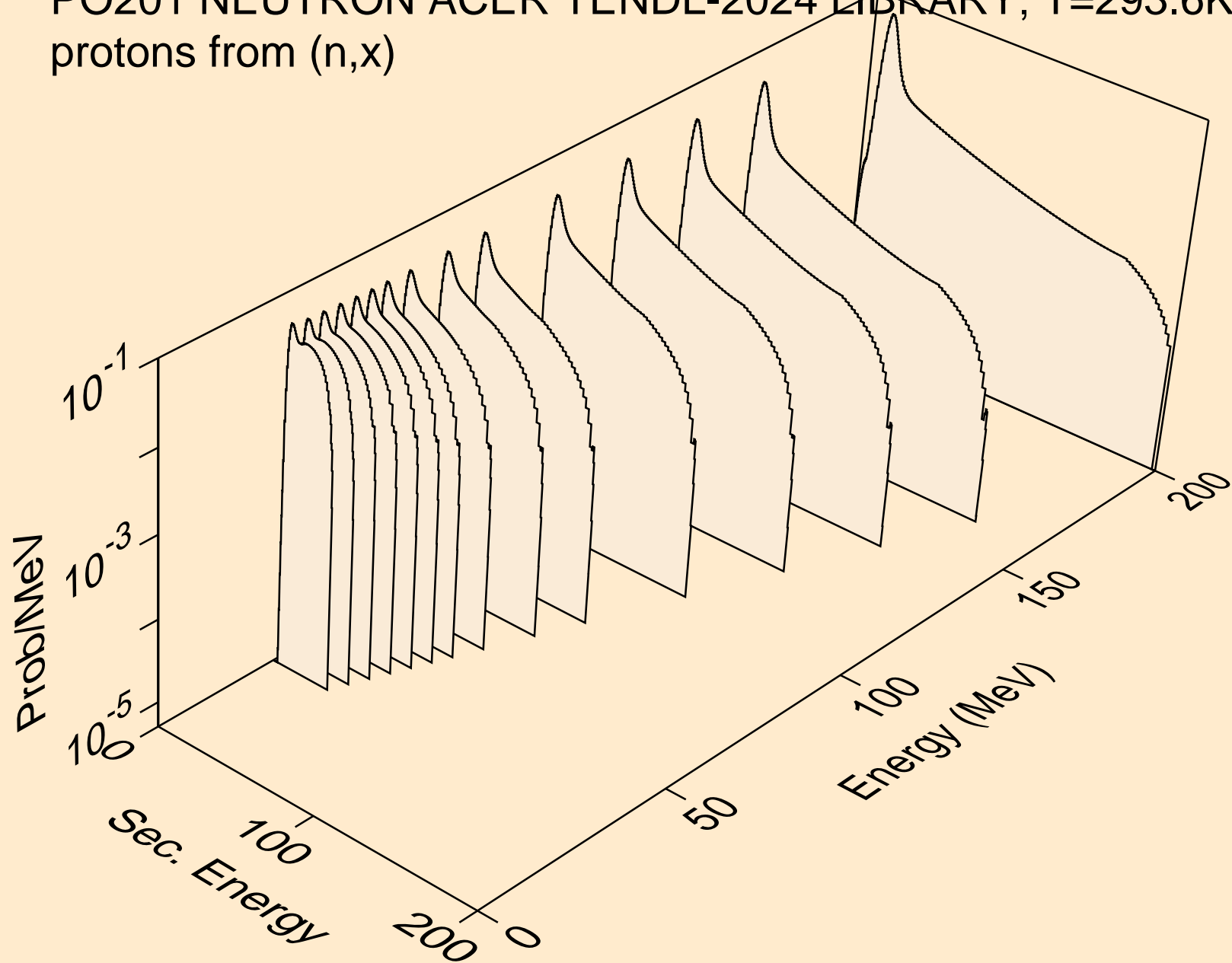

PO201 NEUTRON ACER TENDL-2024 LIBRARY; T=293.6K
protons from (n,n*)p

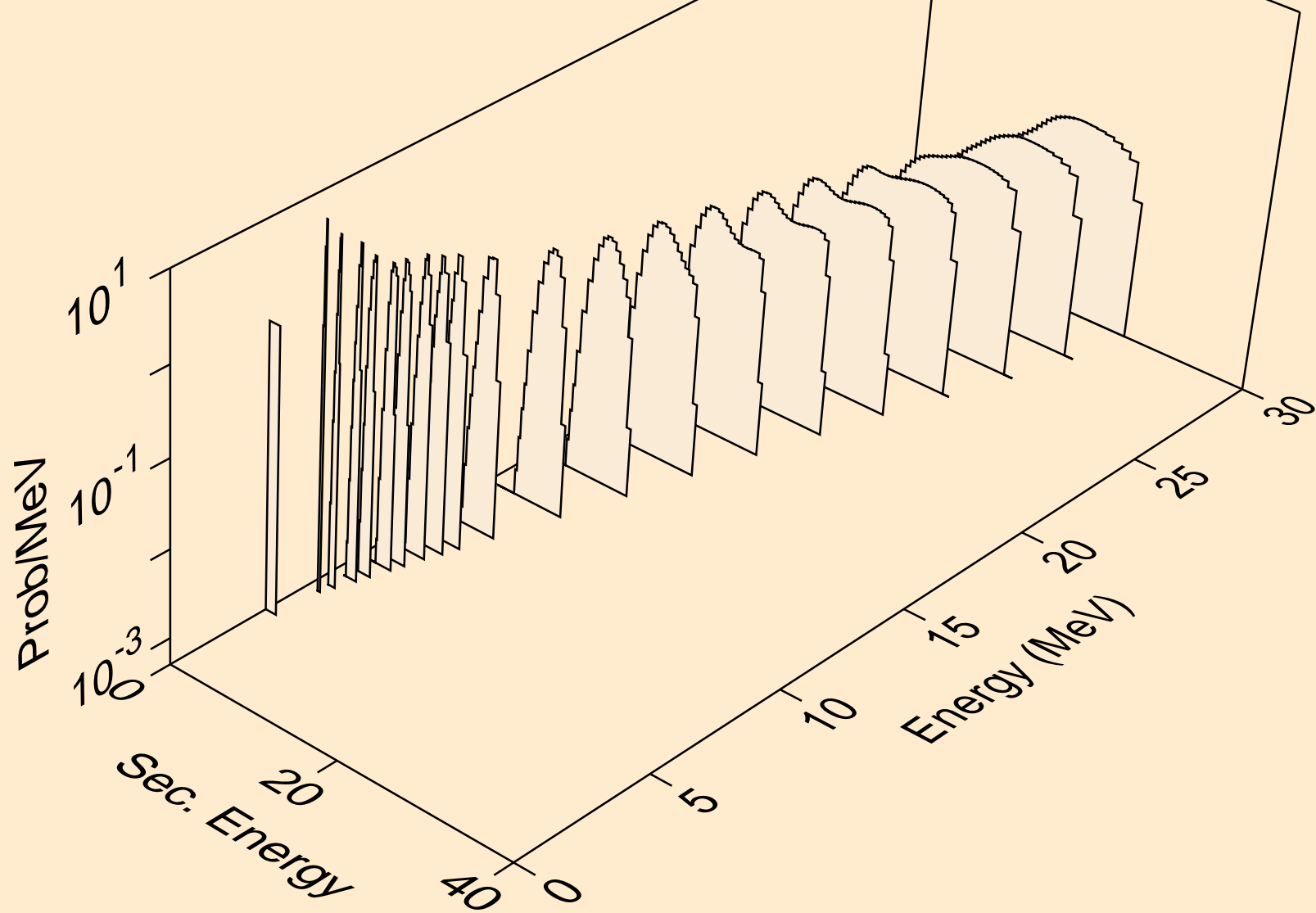

PO201 NEUTRON ACER TENDL-2024 LIBRARY; T=293.6K
protons from (n,2np)

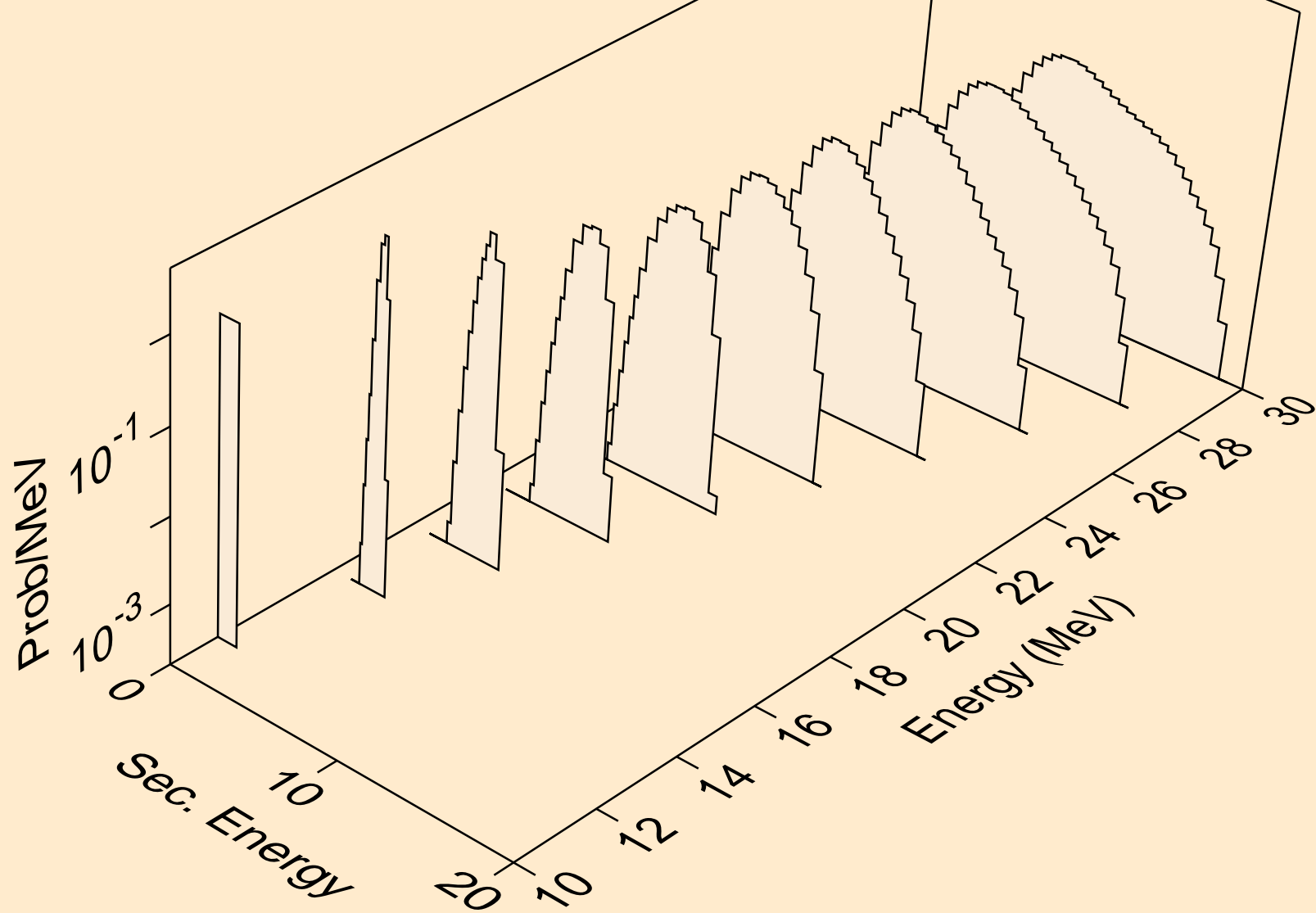

PO201 NEUTRON ACER TENDL-2024 LIBRARY; T=293.6K
protons from (n,3np)

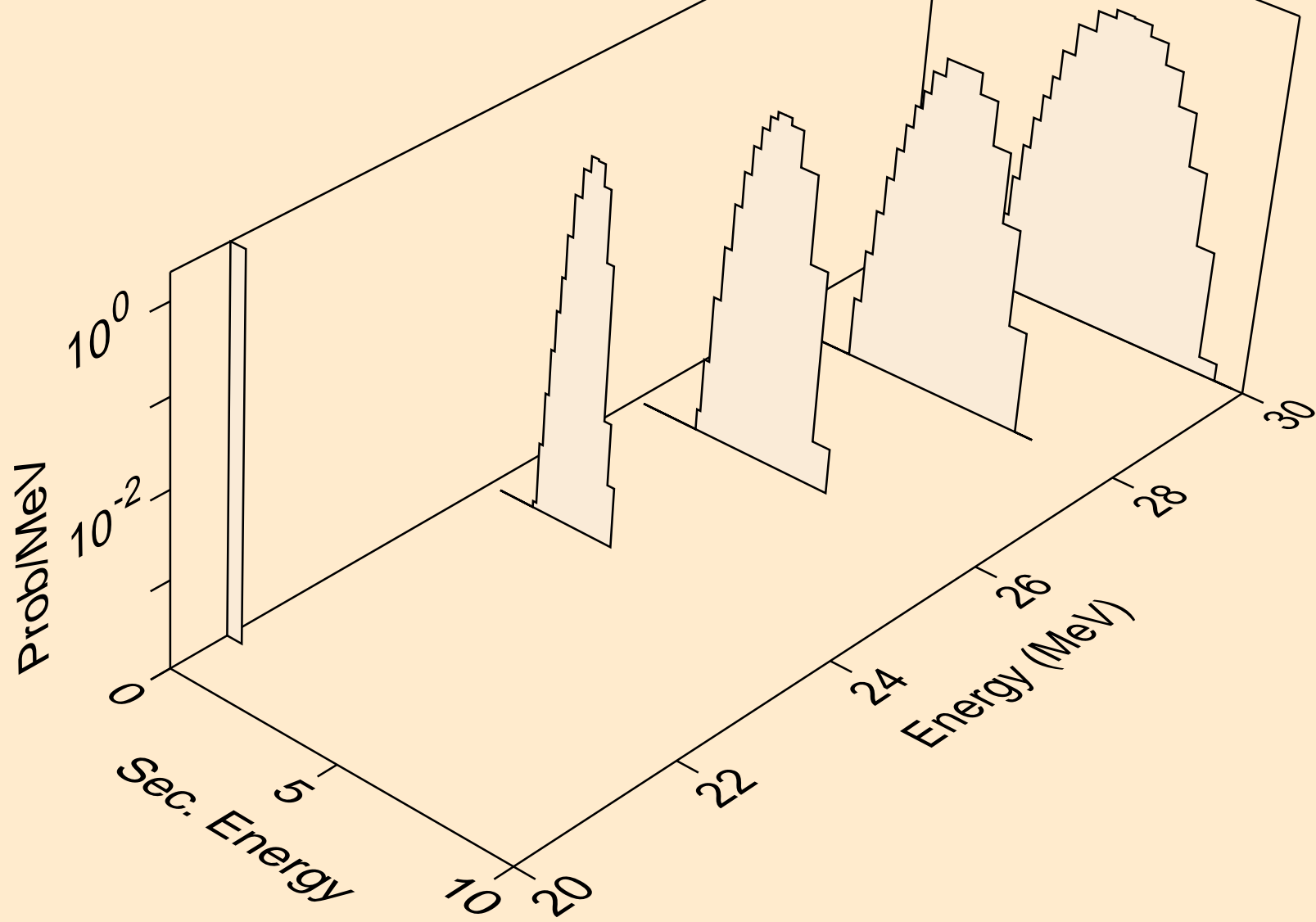

PO201 NEUTRON ACER TENDL-2024 LIBRARY; T=293.6K
protons from (n,n2p)

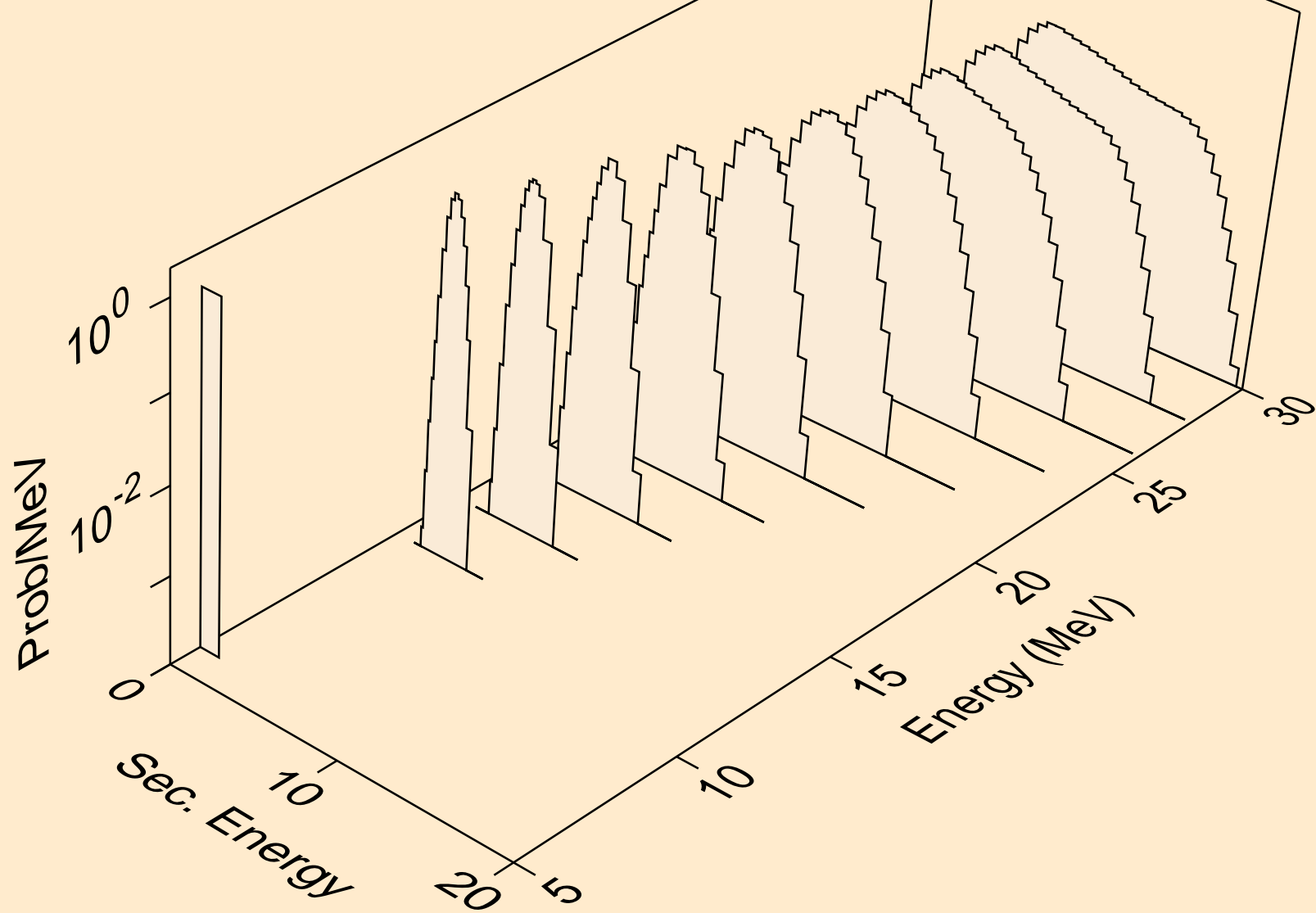

PO201 NEUTRON ACER TENDL-2024 LIBRARY; T=293.6K
protons from (n,npa)

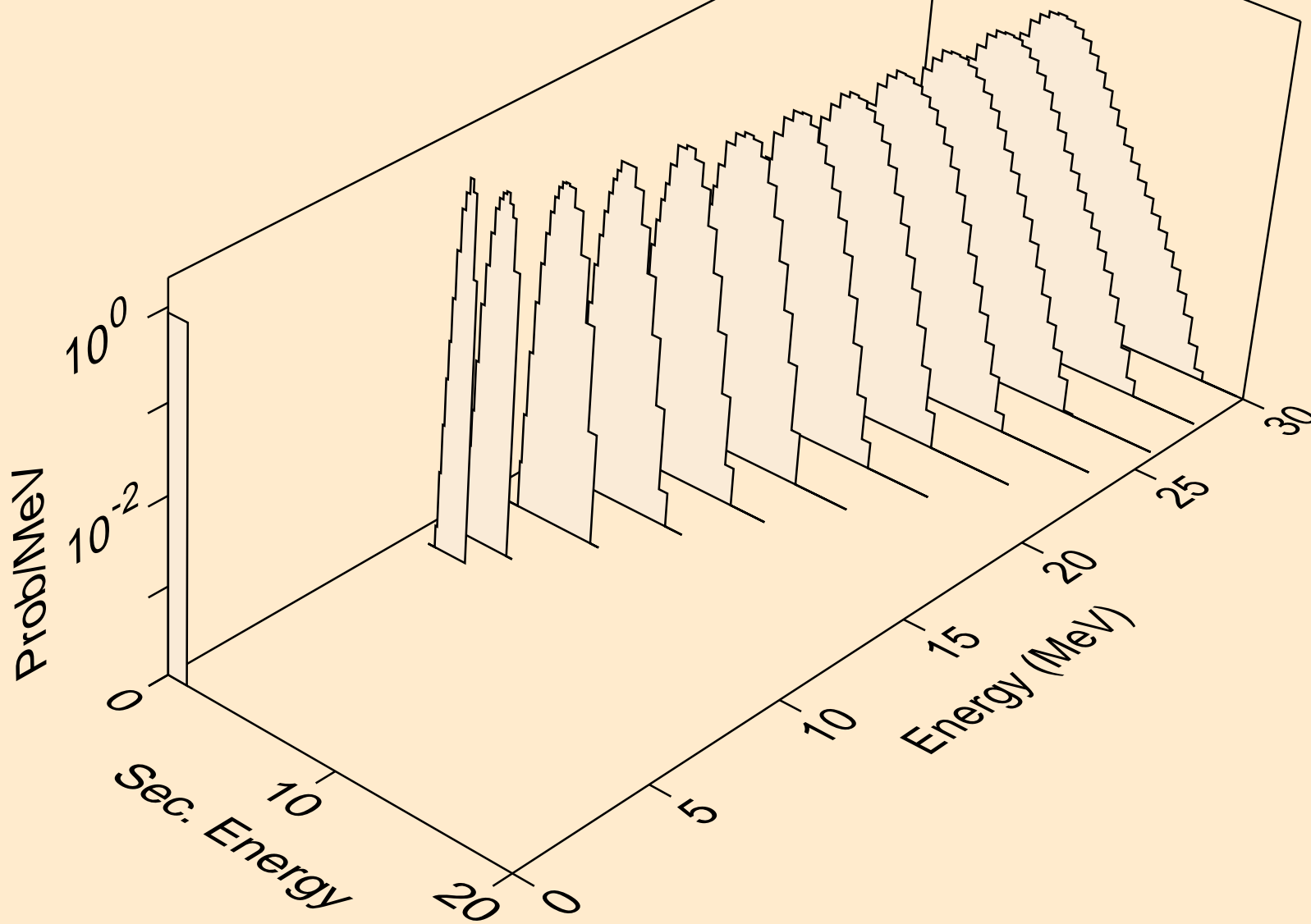

PO201 NEUTRON ACER TENDL-2024 LIBRARY; T=293.6K
protons from (n,p)

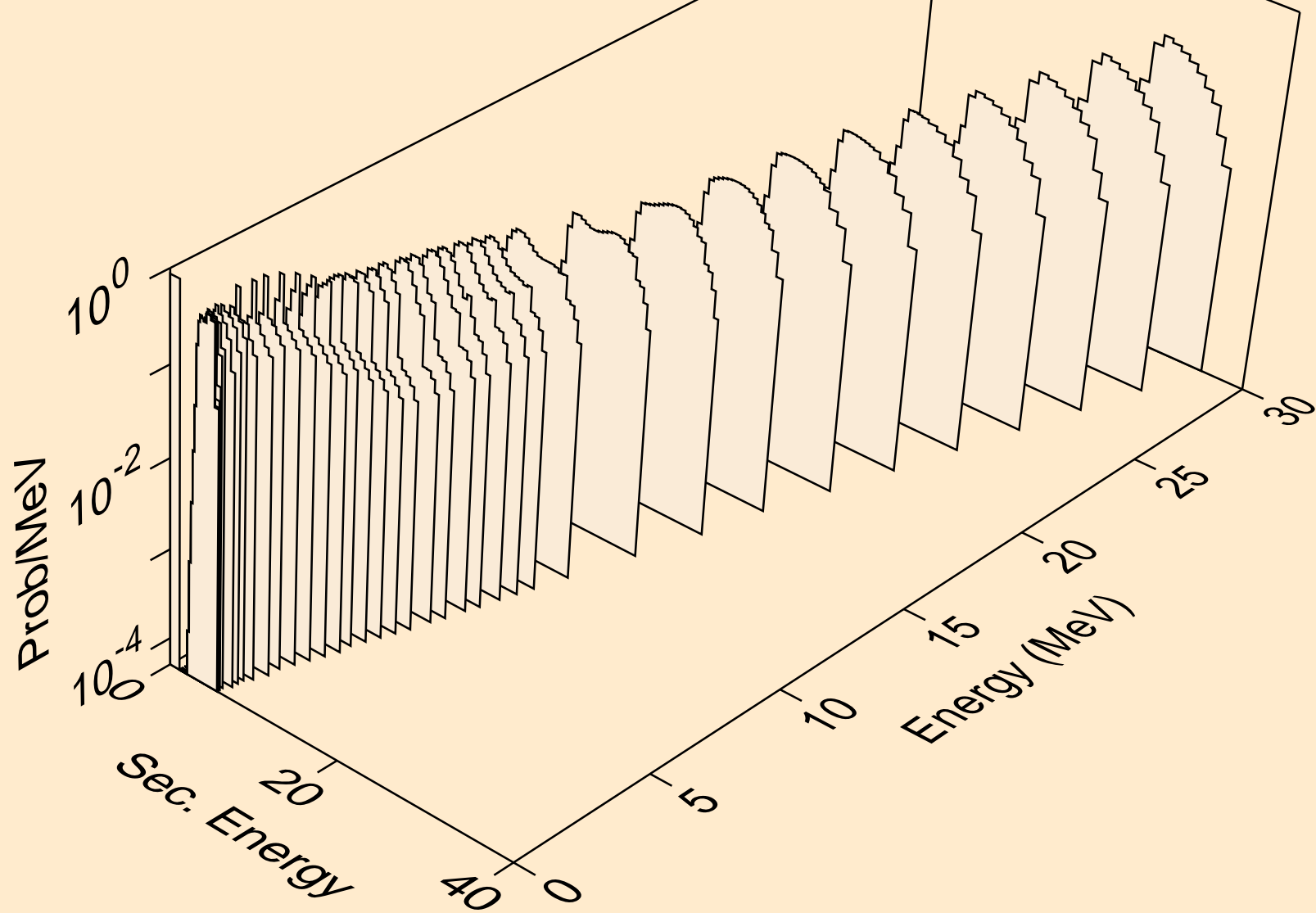

PO201 NEUTRON ACER TENDL-2024 LIBRARY; T=293.6K
protons from (n,2p)

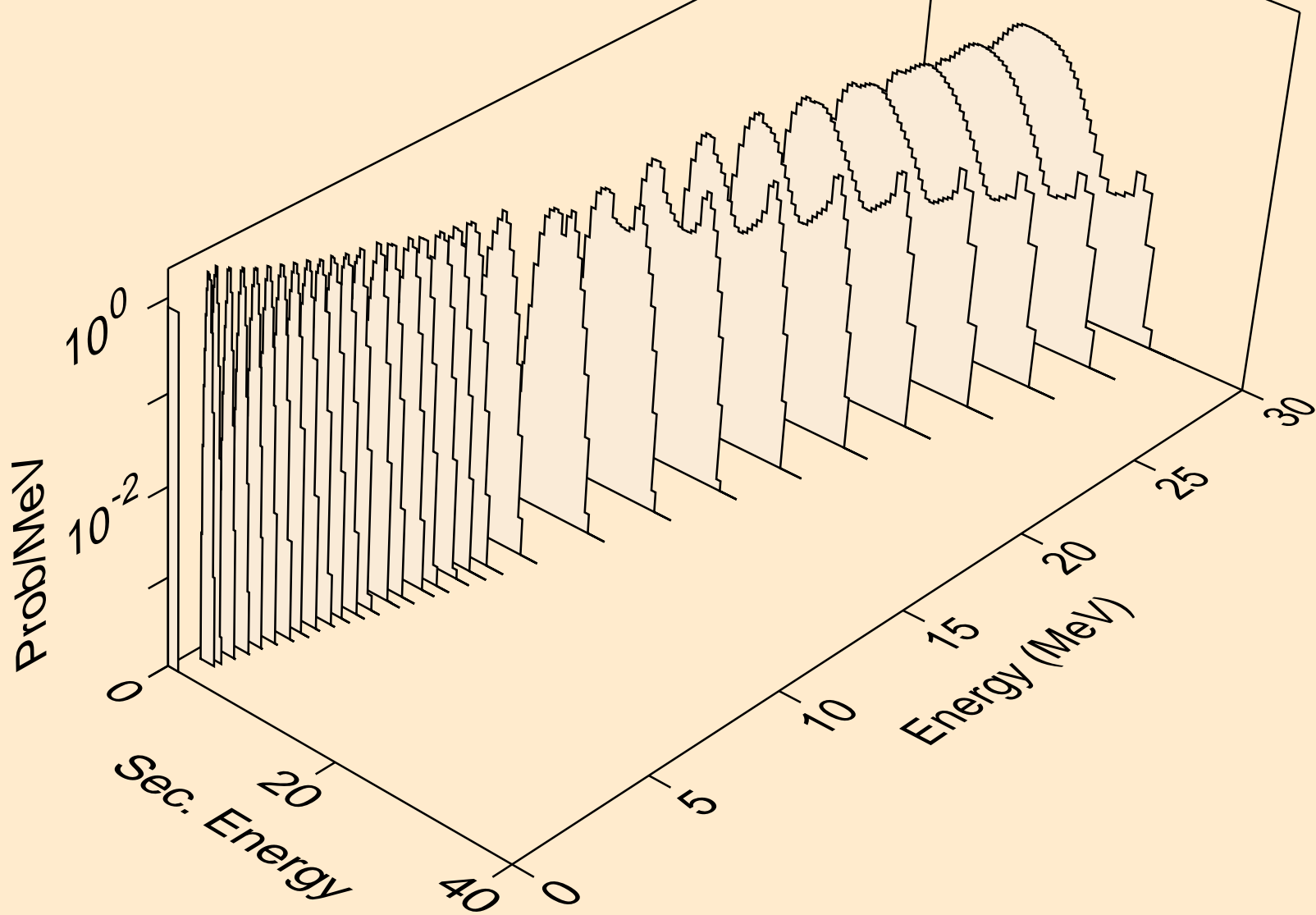

PO201 NEUTRON ACER TENDL-2024 LIBRARY; T=293.6K
protons from (n,p)

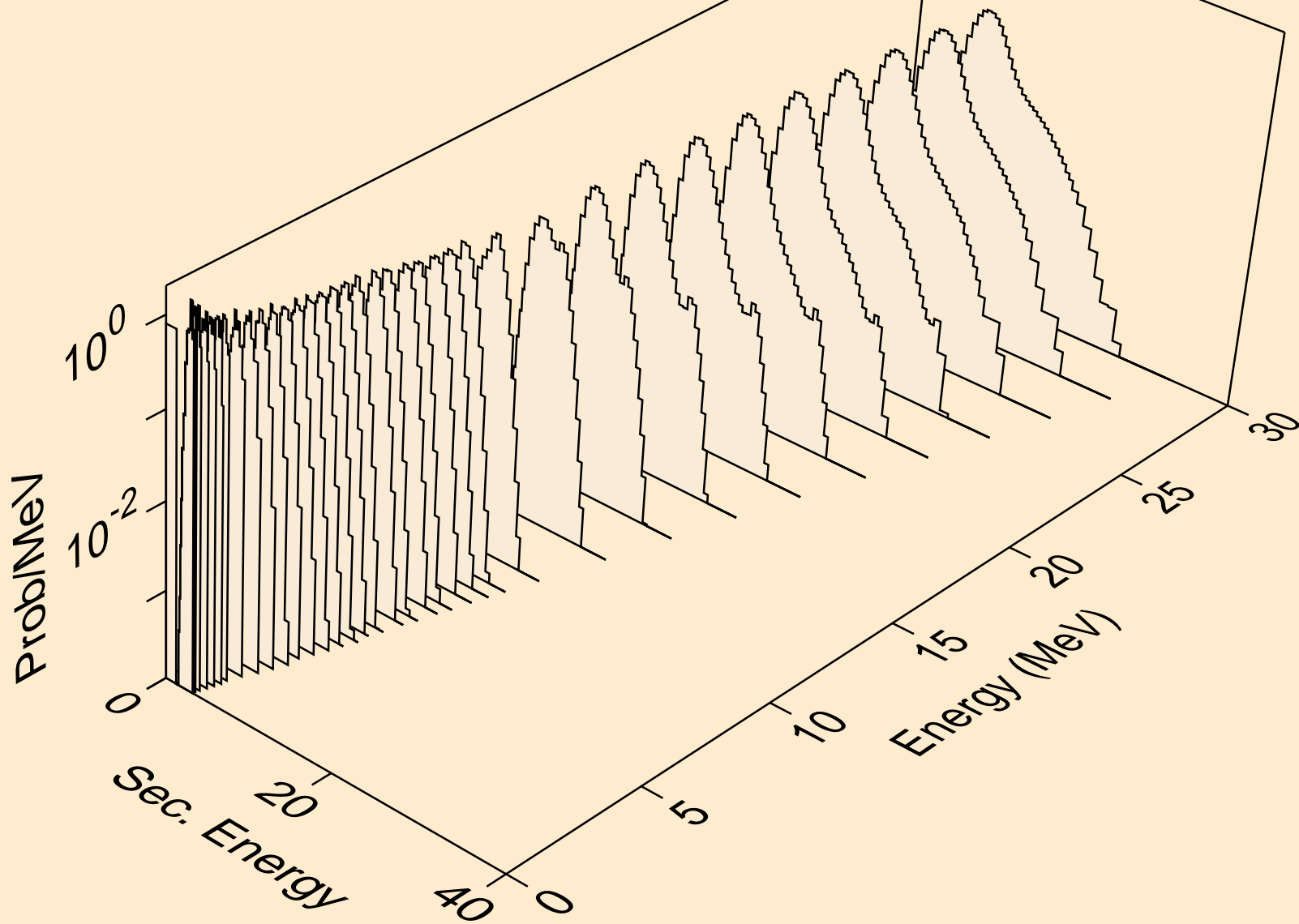

PO201 NEUTRON ACER TENDL-2024 LIBRARY; T=293.6K
protons from (n,pd)

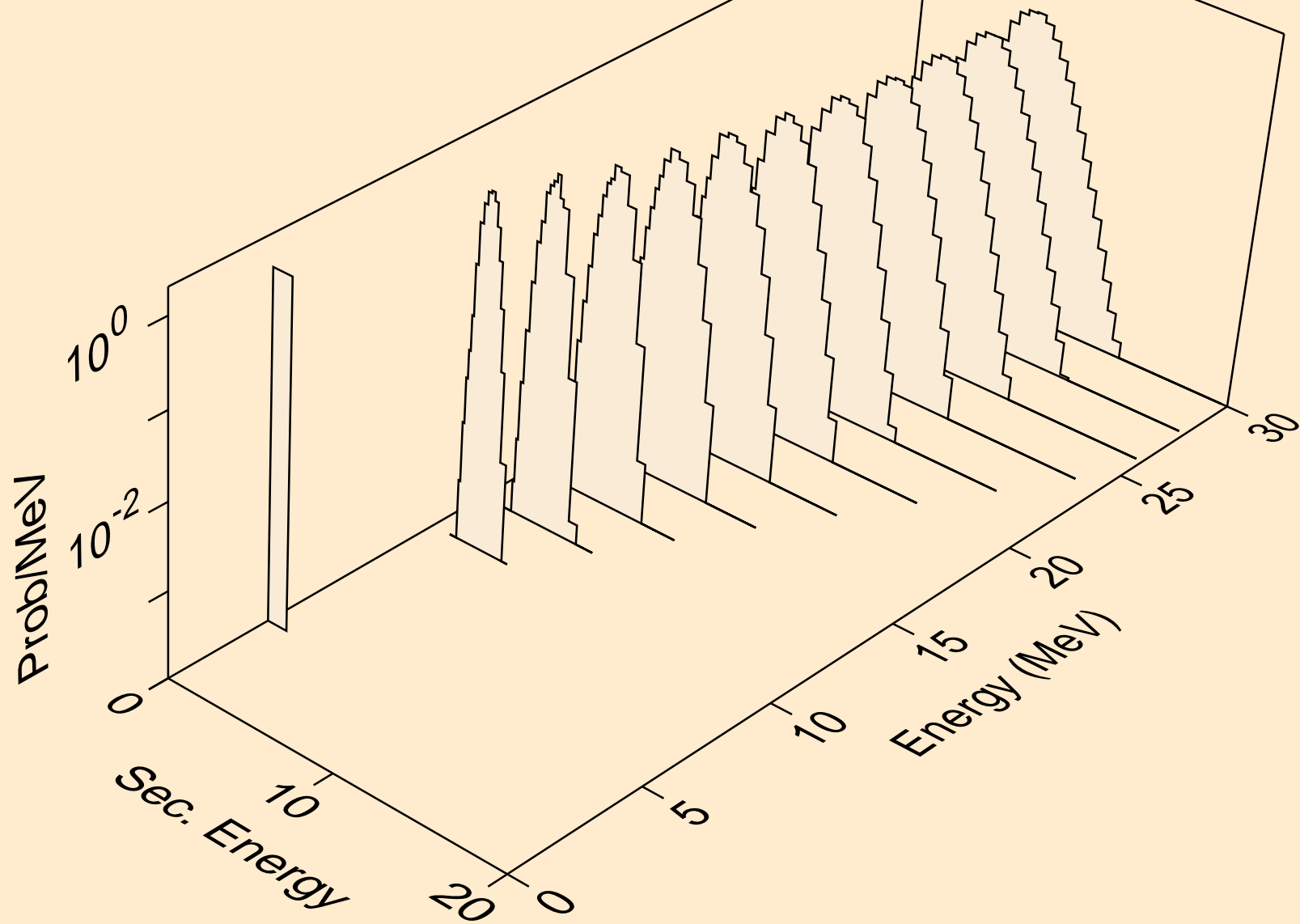

PO201 NEUTRON ACER TENDL-2024 LIBRARY; T=293.6K
protons from (n,pt)

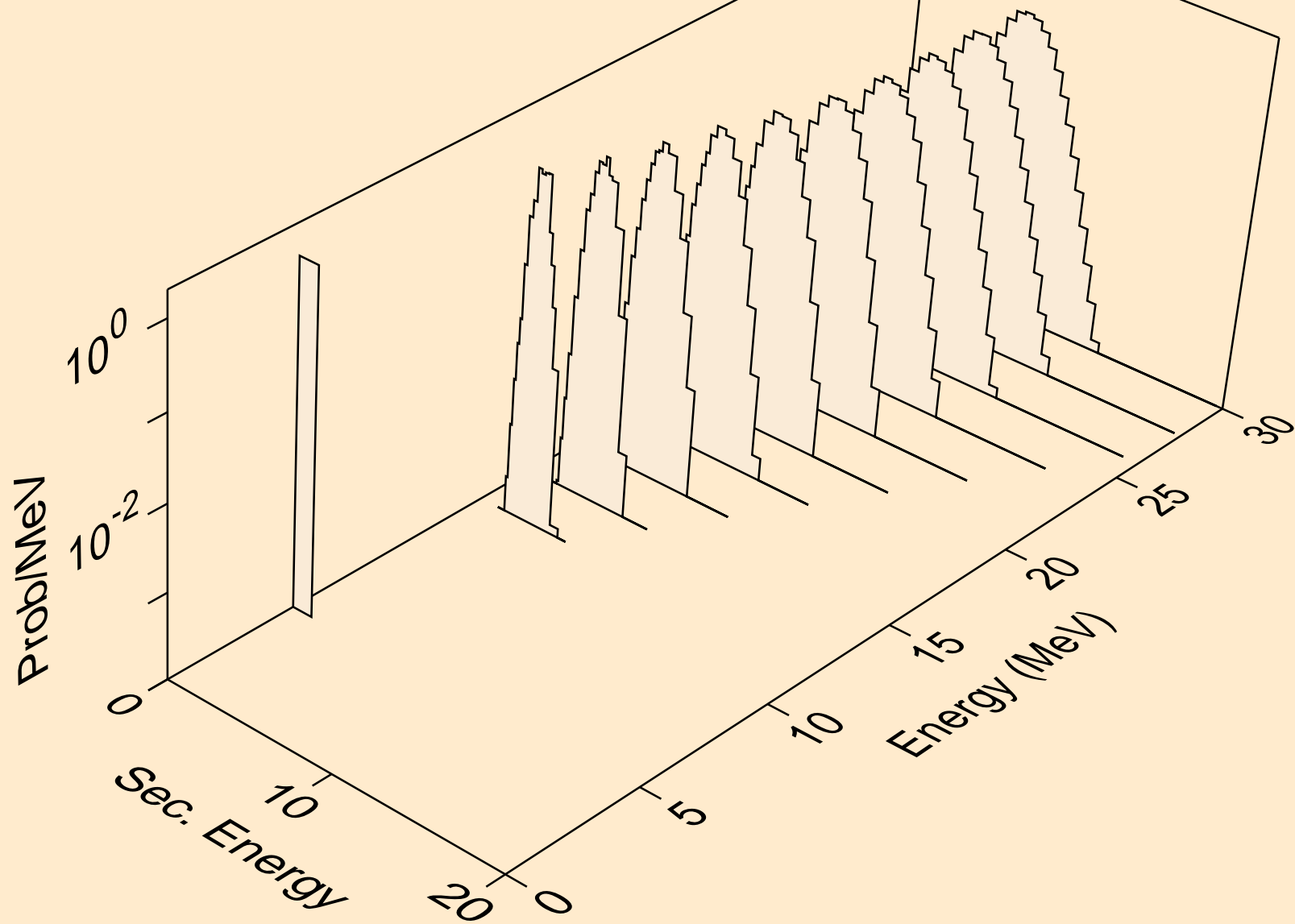

PO201 NEUTRON ACER TENDL-2024 LIBRARY; T=293.6K
deuterons from (n,x)

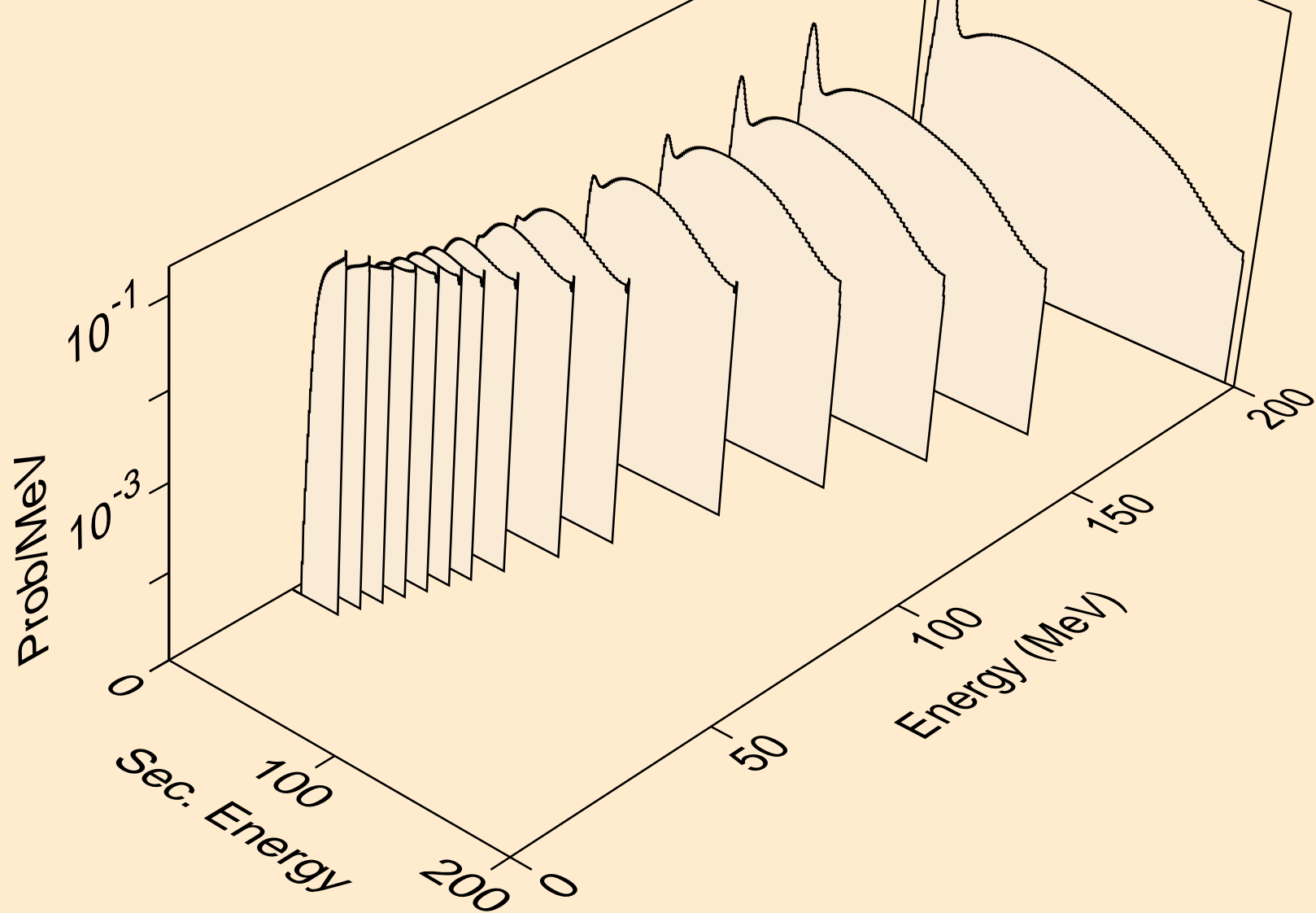

PO201 NEUTRON ACER TENDL-2024 LIBRARY; T=293.6K
deuterons from (n,2nd)

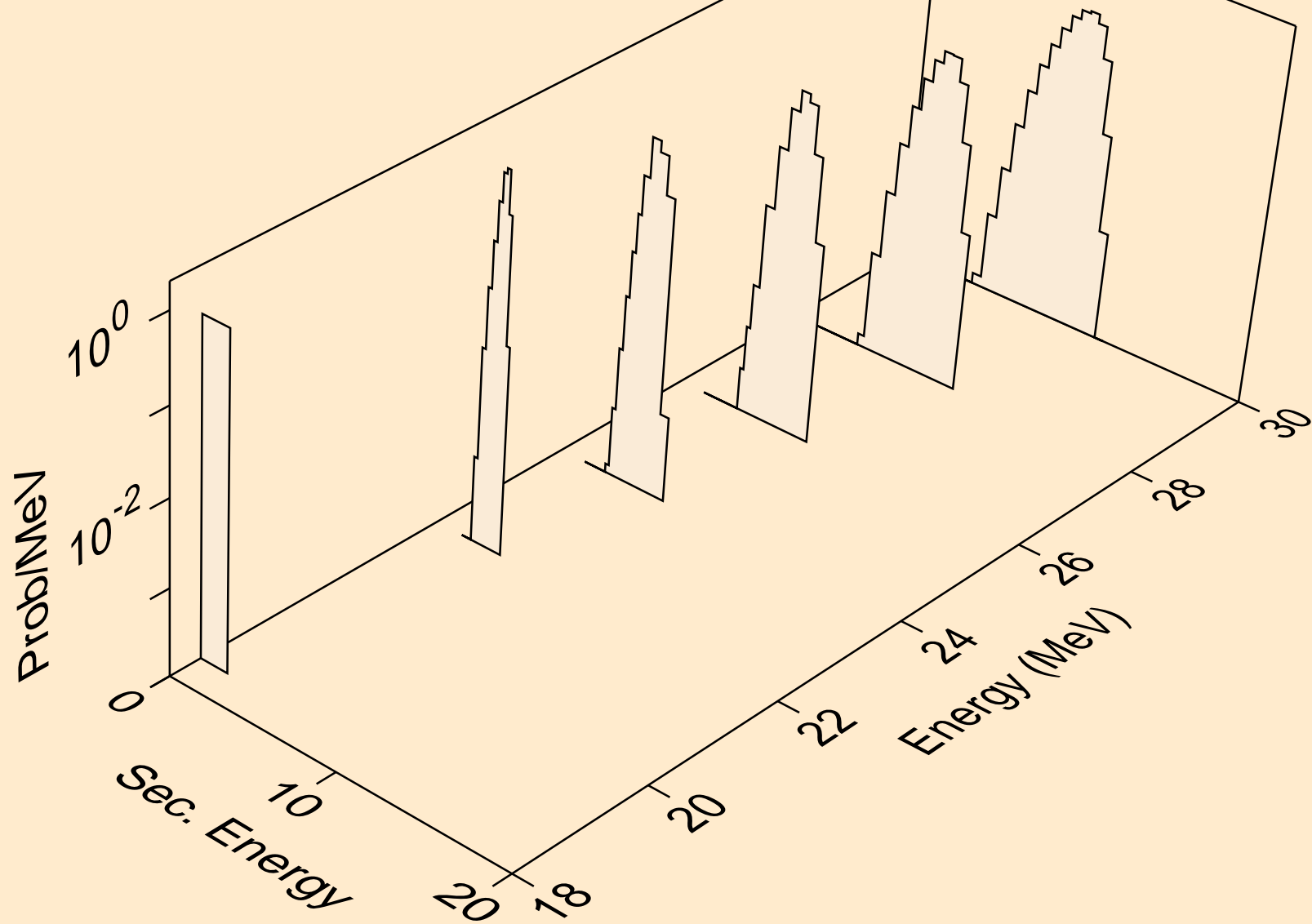

PO201 NEUTRON ACER TENDL-2024 LIBRARY; T=293.6K
deuterons from (n,n*)d

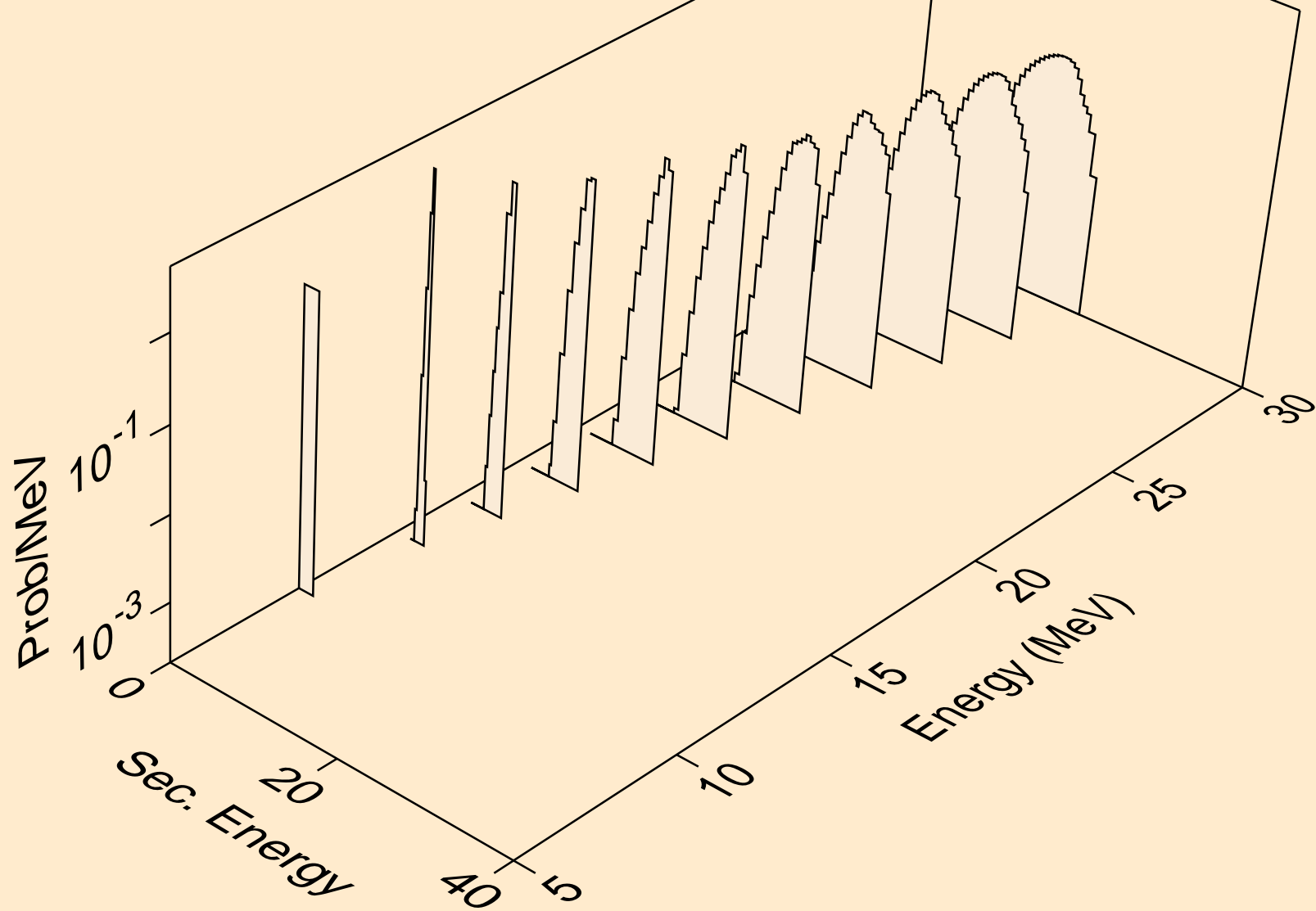

PO201 NEUTRON ACER TENDL-2024 LIBRARY; T=293.6K
deuterons from (n,d)

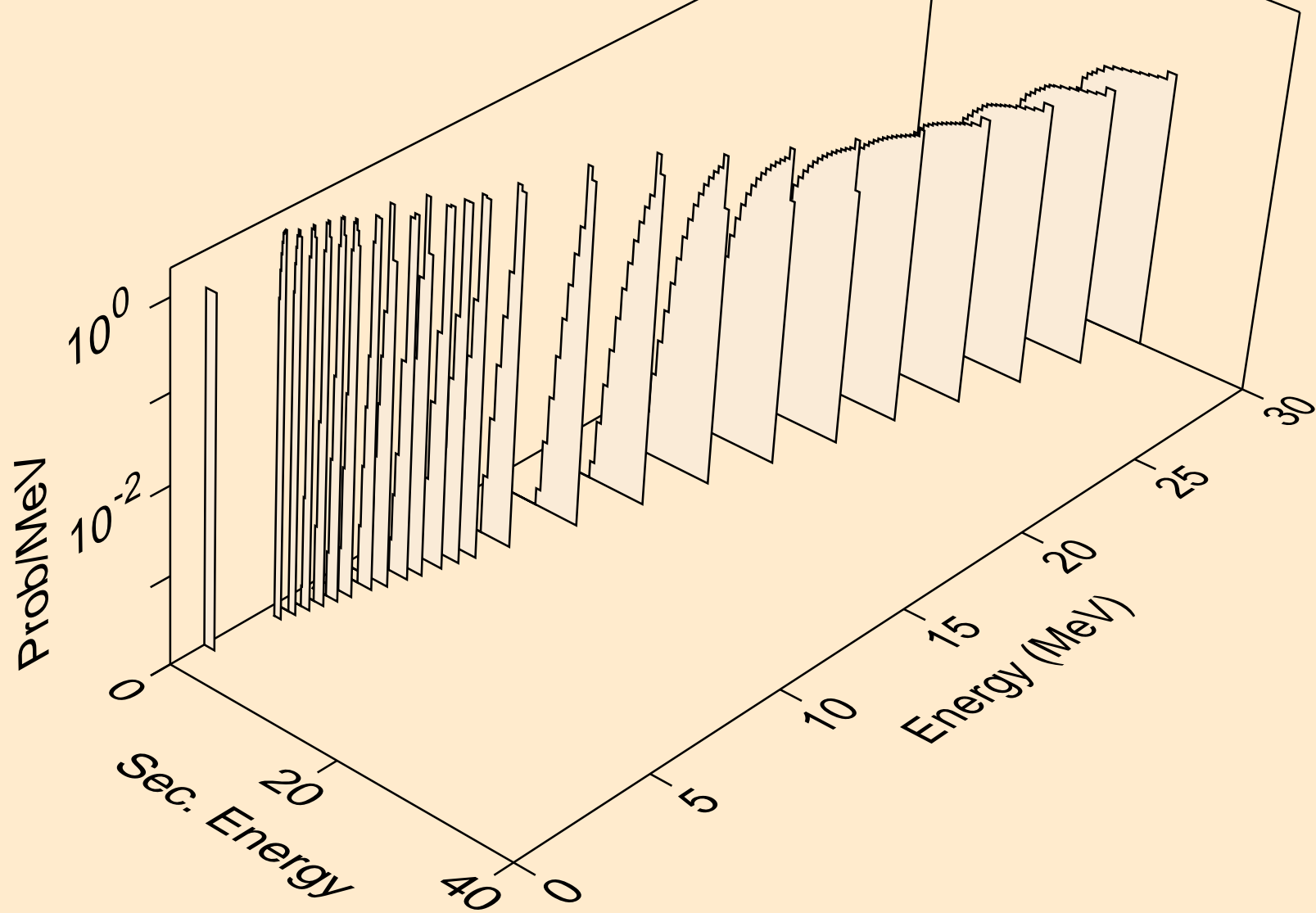

PO201 NEUTRON ACER TENDL-2024 LIBRARY; T=293.6K
deuterons from (n,pd)

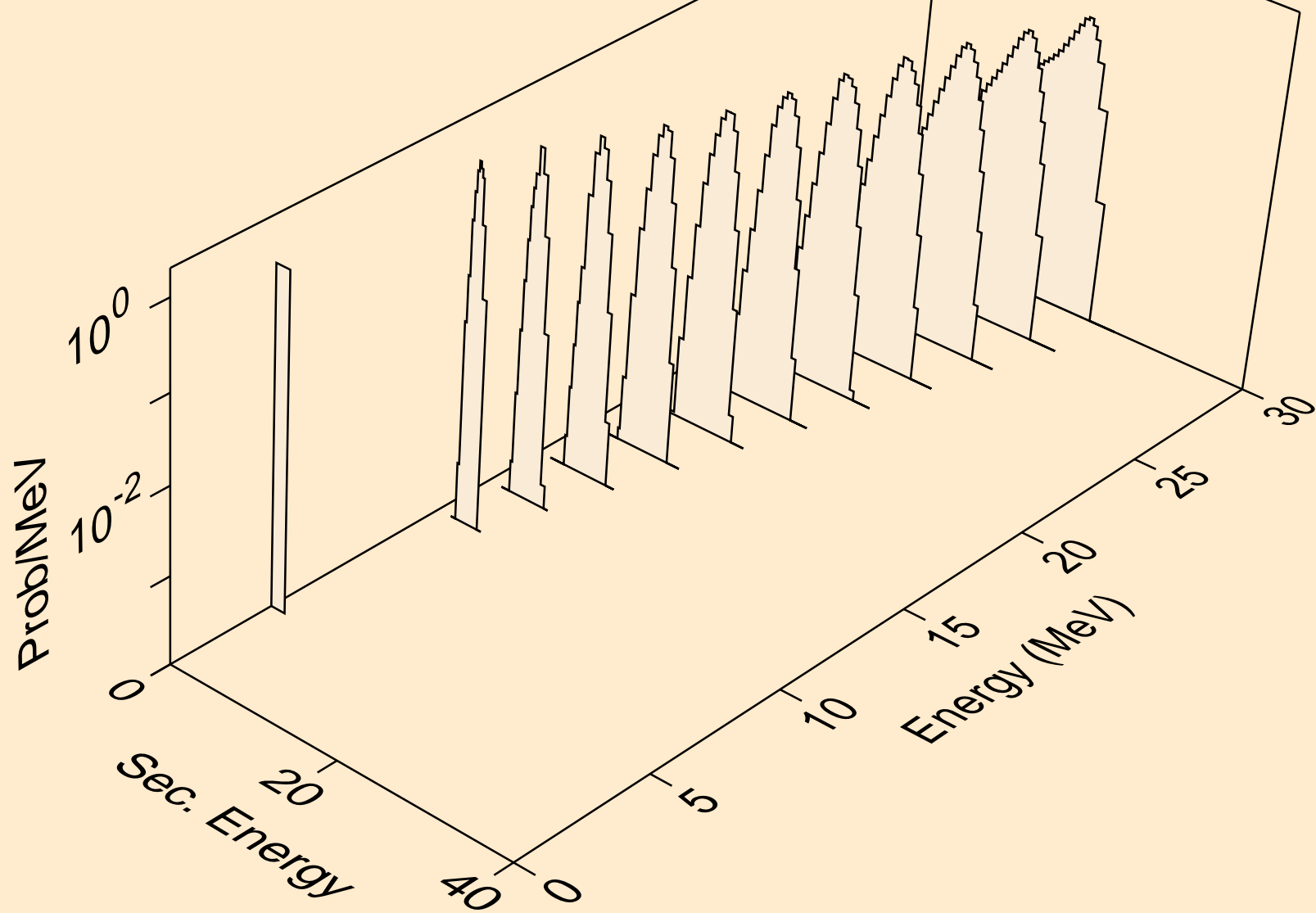

PO201 NEUTRON ACER TENDL-2024 LIBRARY; T=293.6K
deuterons from (n,da)

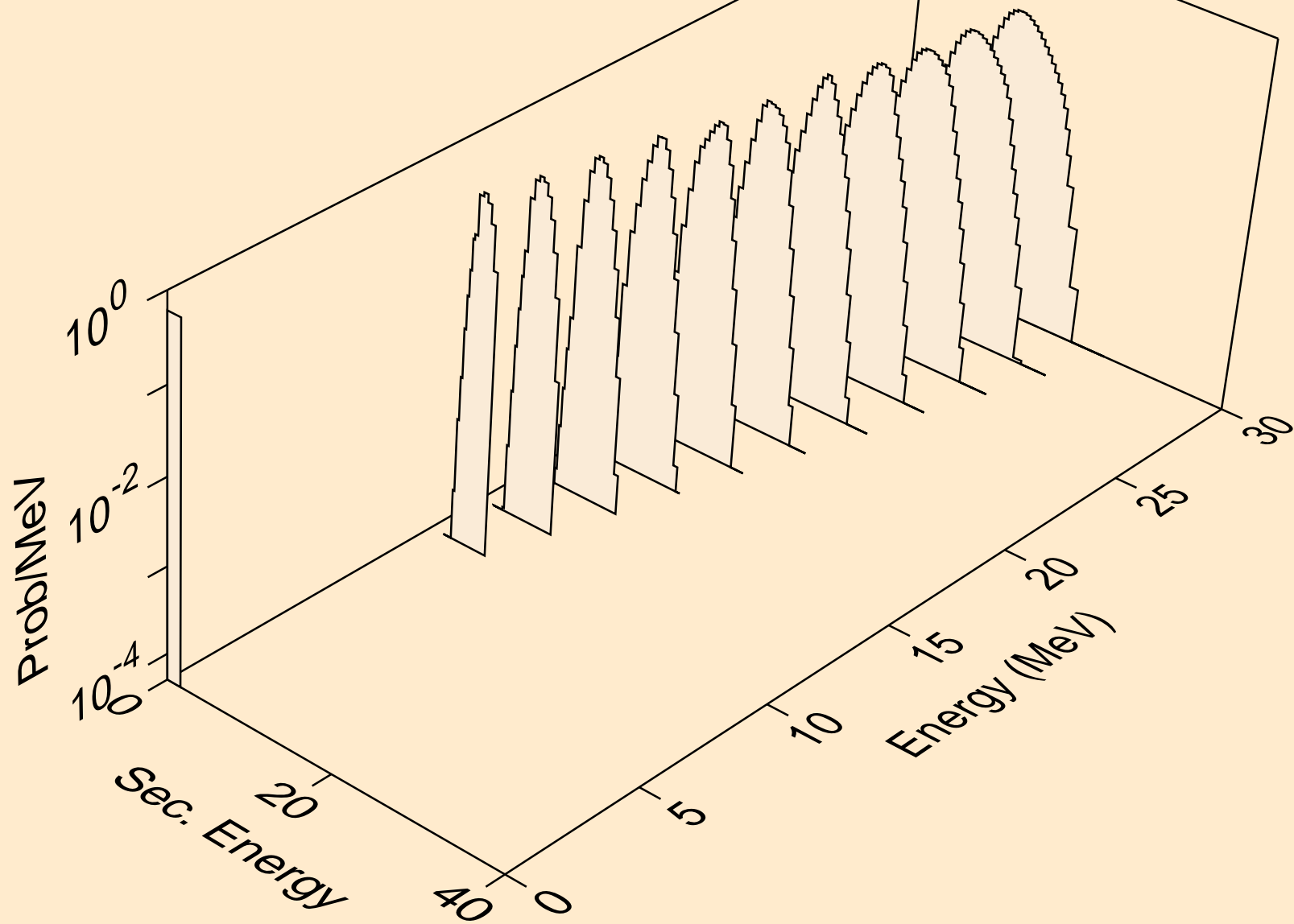

PO201 NEUTRON ACER TENDL-2024 LIBRARY; T=293.6K
tritons from (n,x)

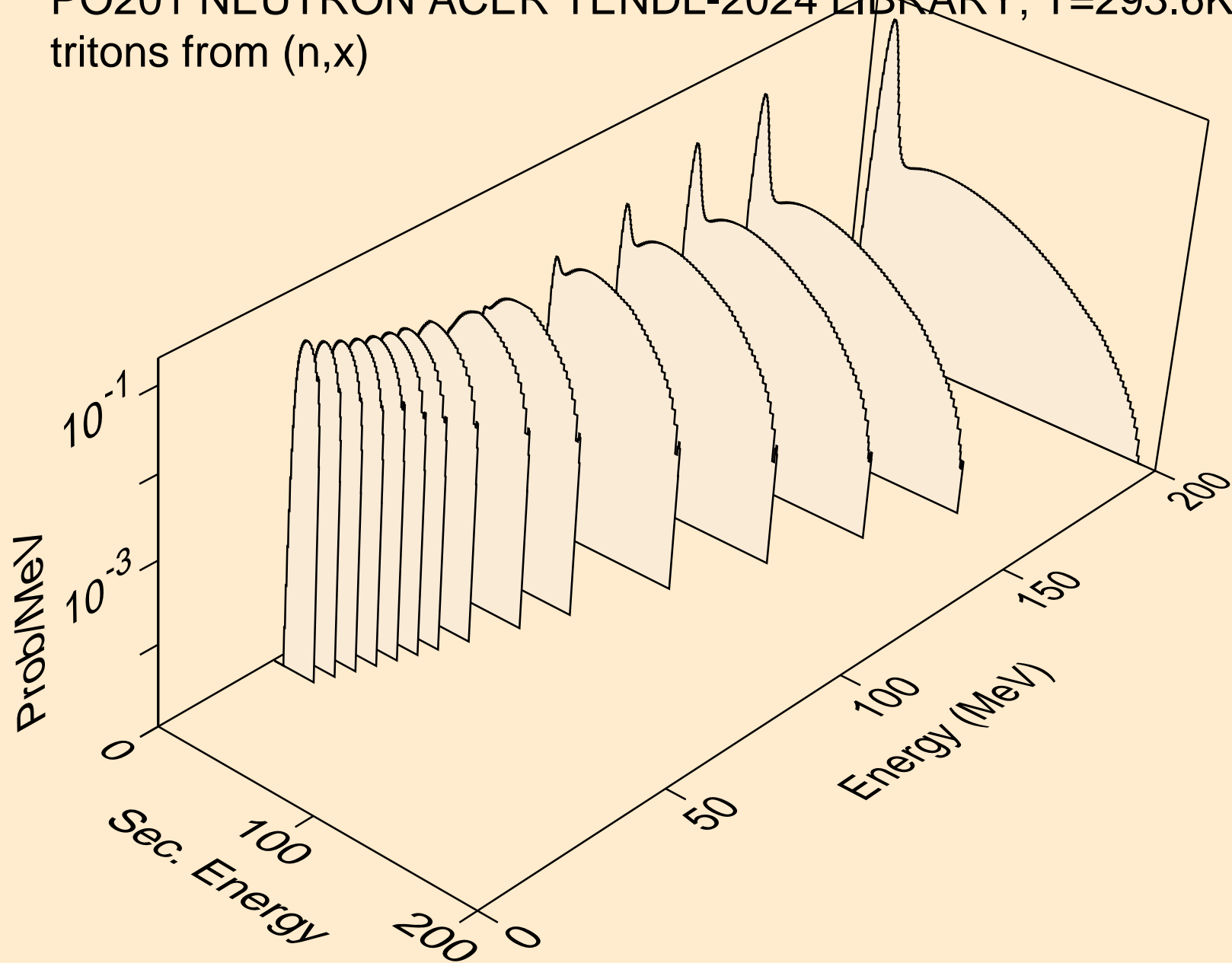

PO201 NEUTRON ACER TENDL-2024 LIBRARY; T=293.6K
tritons from (n,n*)t

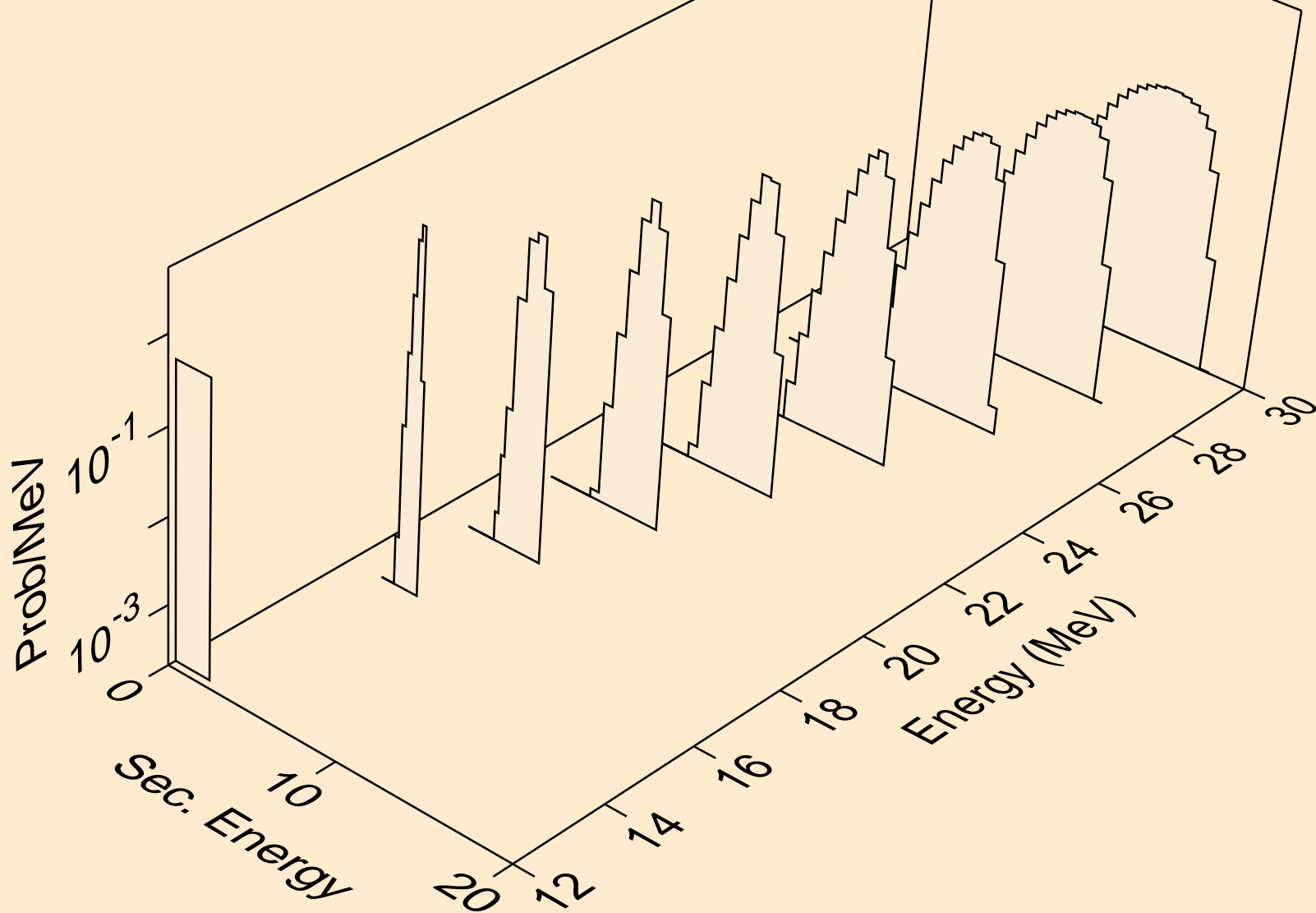

PO201 NEUTRON ACER TENDL-2024 LIBRARY; T=293.6K
tritons from (n,t)

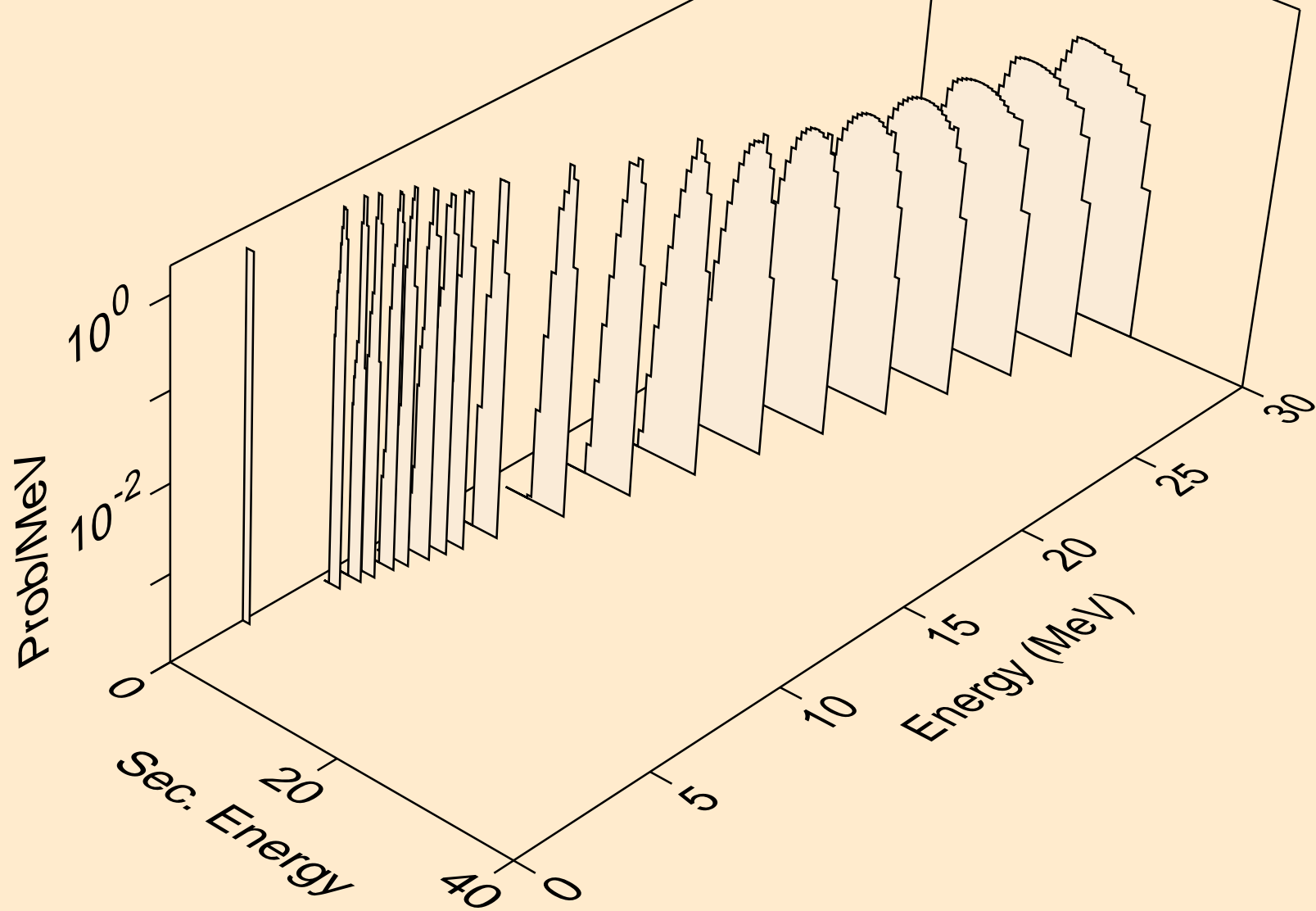

PO201 NEUTRON ACER TENDL-2024 LIBRARY; T=293.6K
tritons from (n,pt)

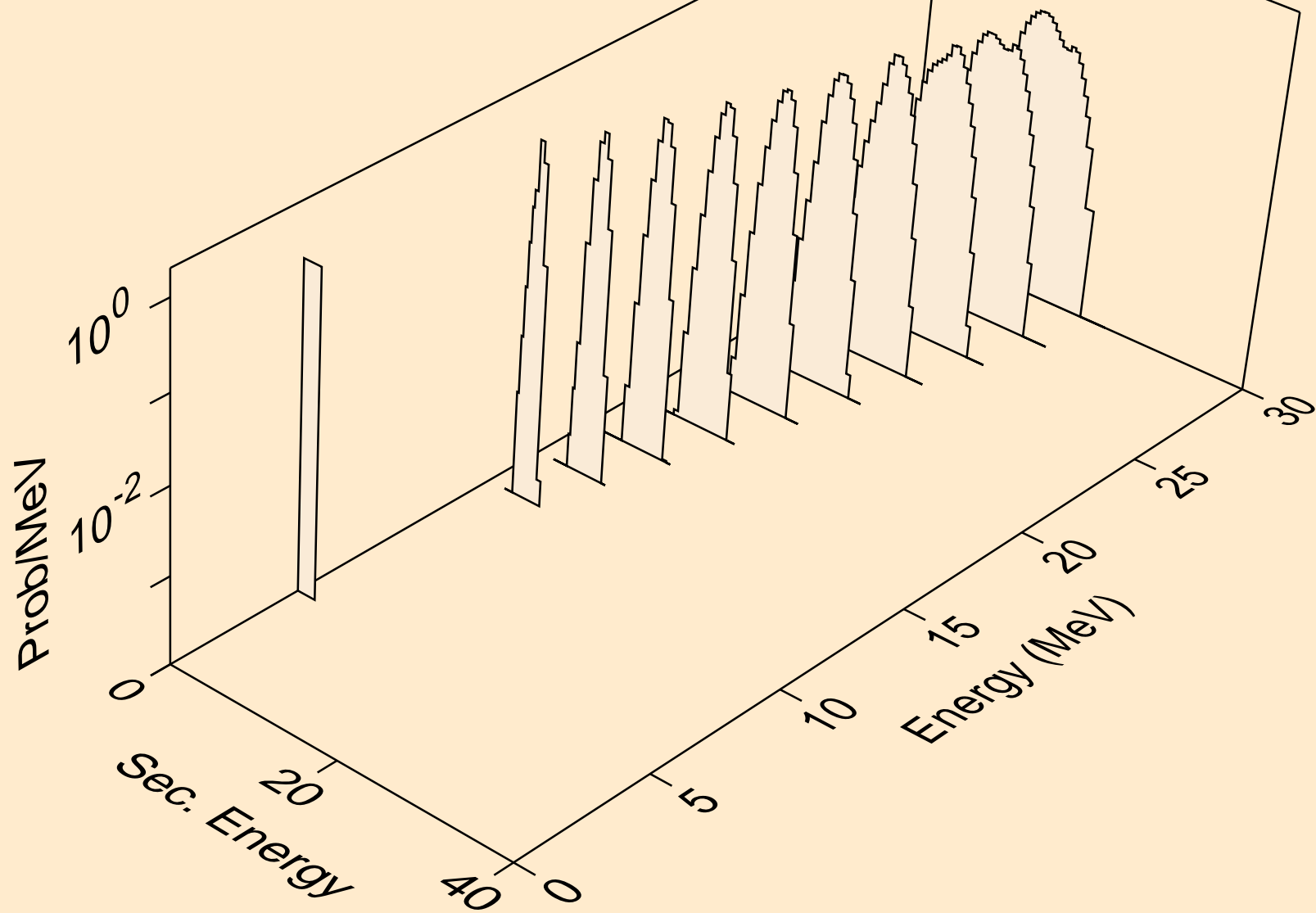

PO201 NEUTRON ACER TENDL-2024 LIBRARY; T=293.6K
he3s from (n,x)

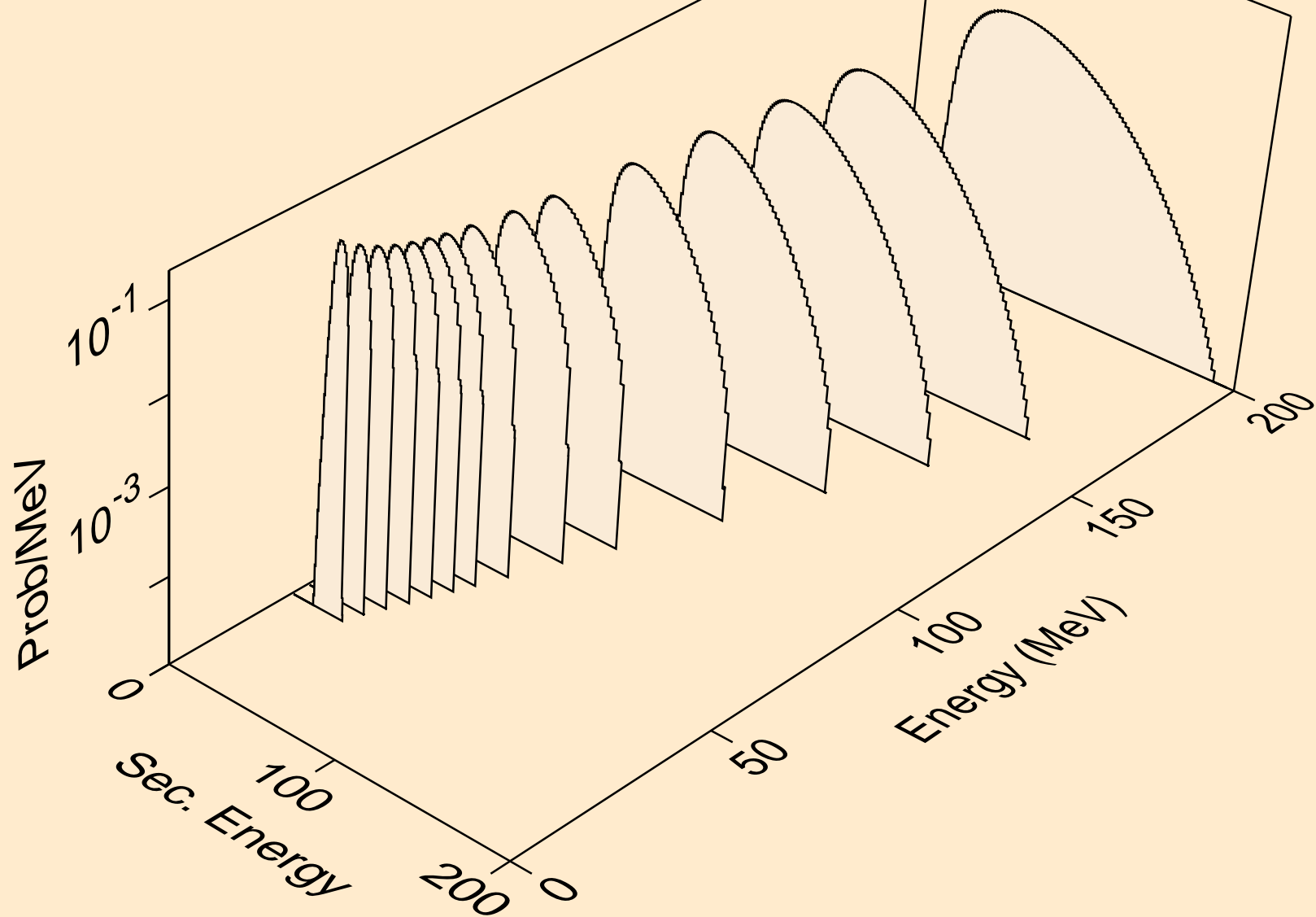

PO201 NEUTRON ACER TENDL-2024 LIBRARY; T=293.6K
he3s from (n,n*)he3

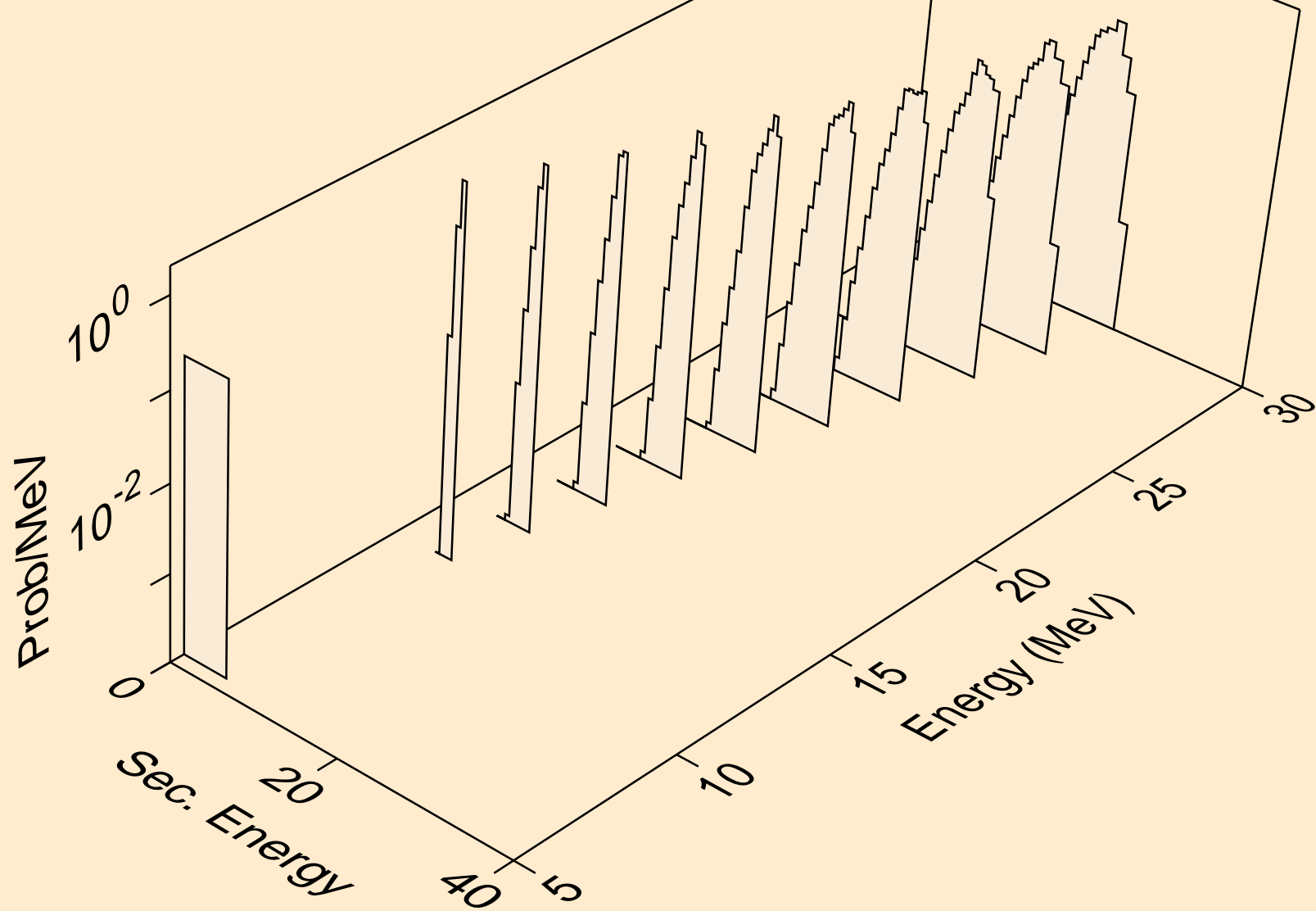

PO201 NEUTRON ACER TENDL-2024 LIBRARY; T=293.6K
he3s from (n,he3)

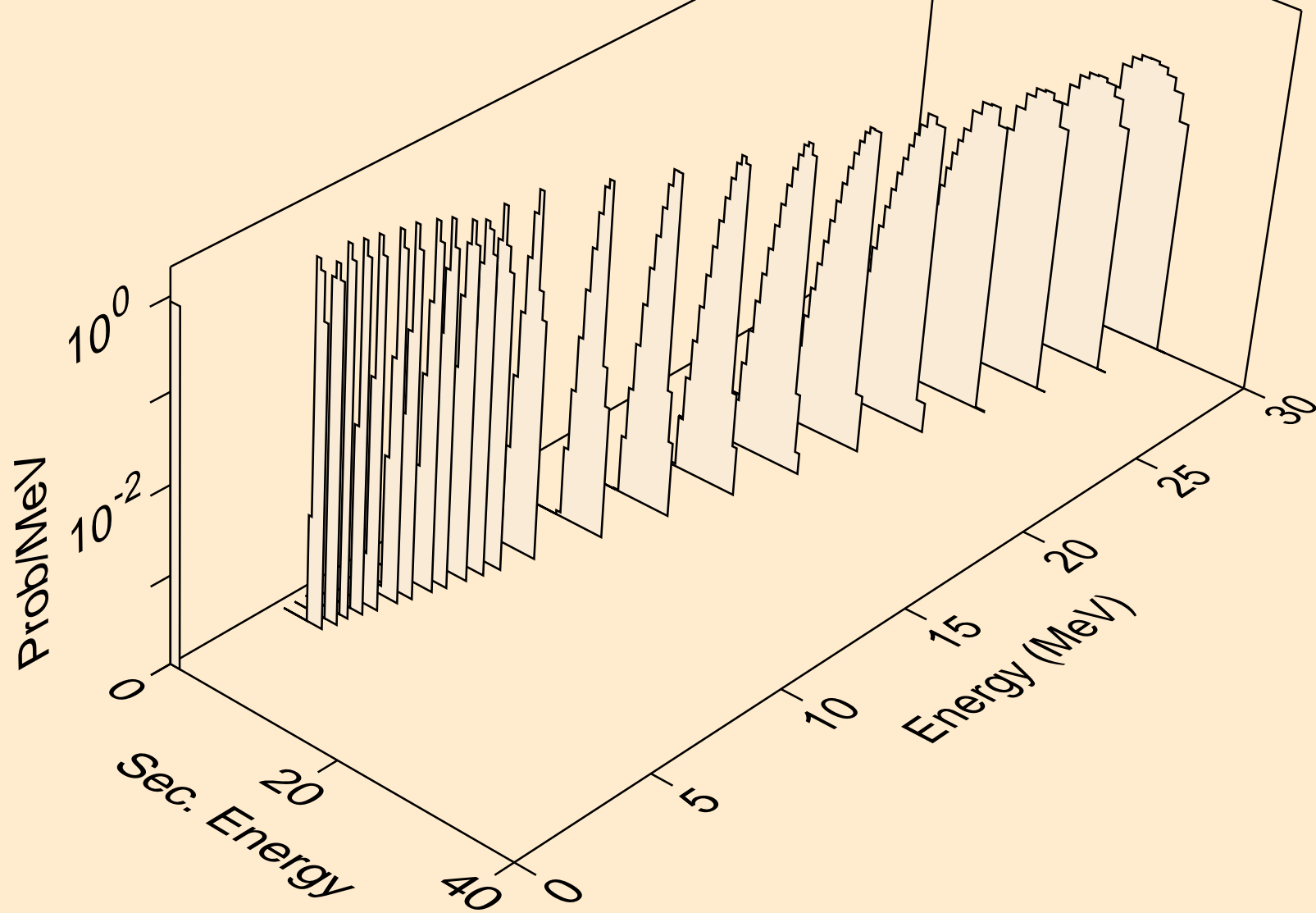

PO201 NEUTRON ACER TENDL-2024 LIBRARY; T=293.6K
alphas from (n,x)

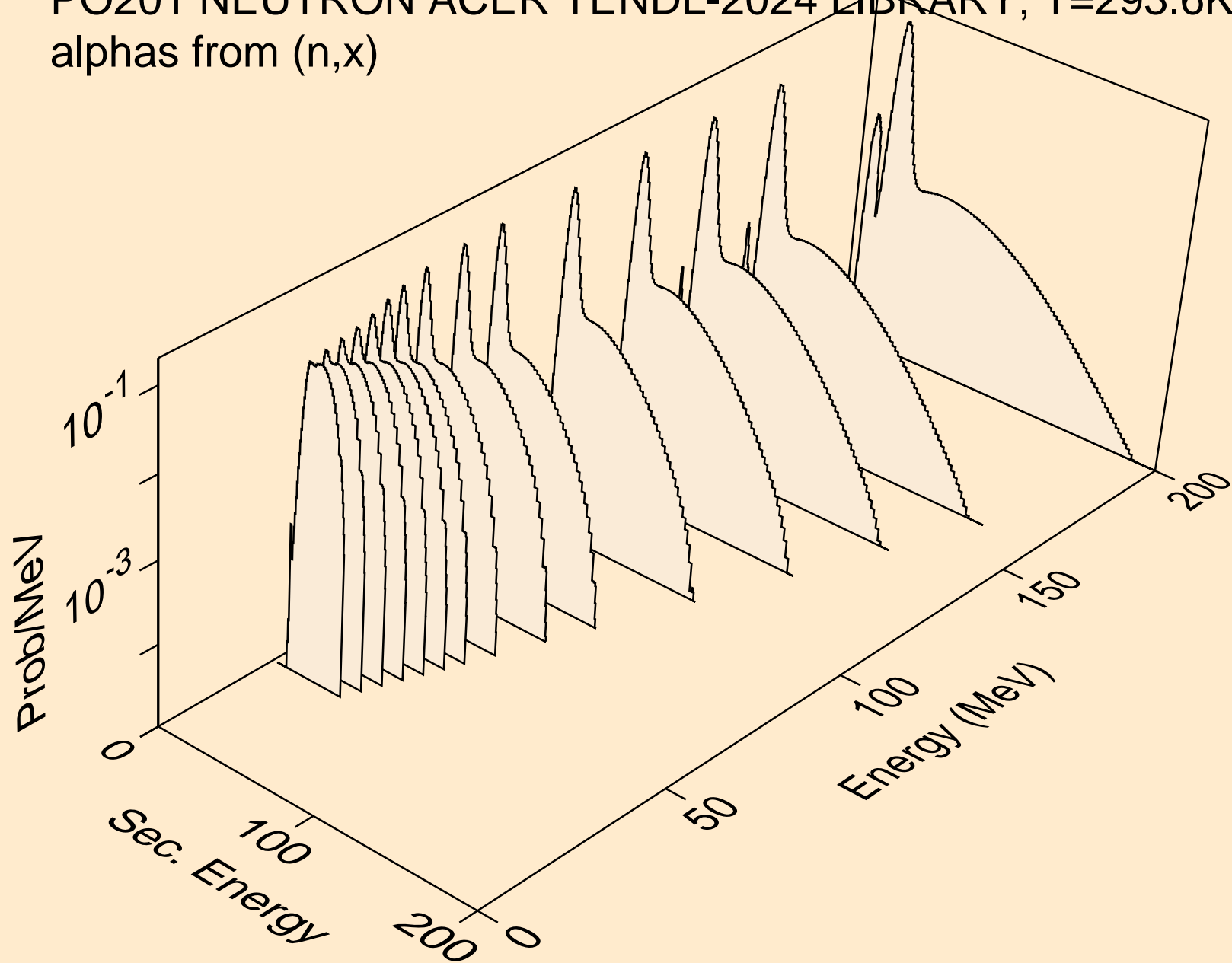

PO201 NEUTRON ACER TENDL-2024 LIBRARY; T=293.6K
alphas from (n,n*)a

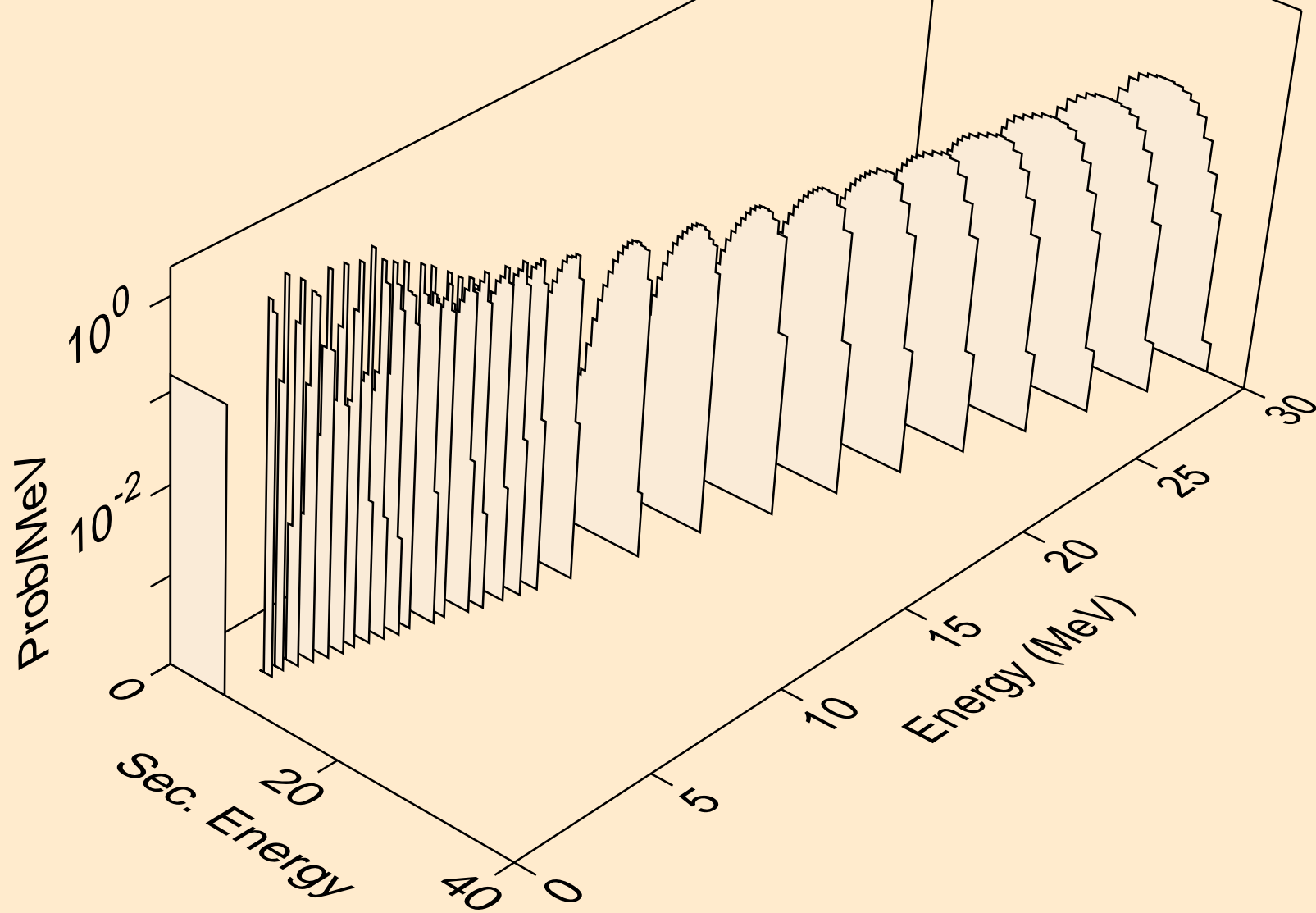

PO201 NEUTRON ACER TENDL-2024 LIBRARY; T=293.6K
alphas from (n,2n)a

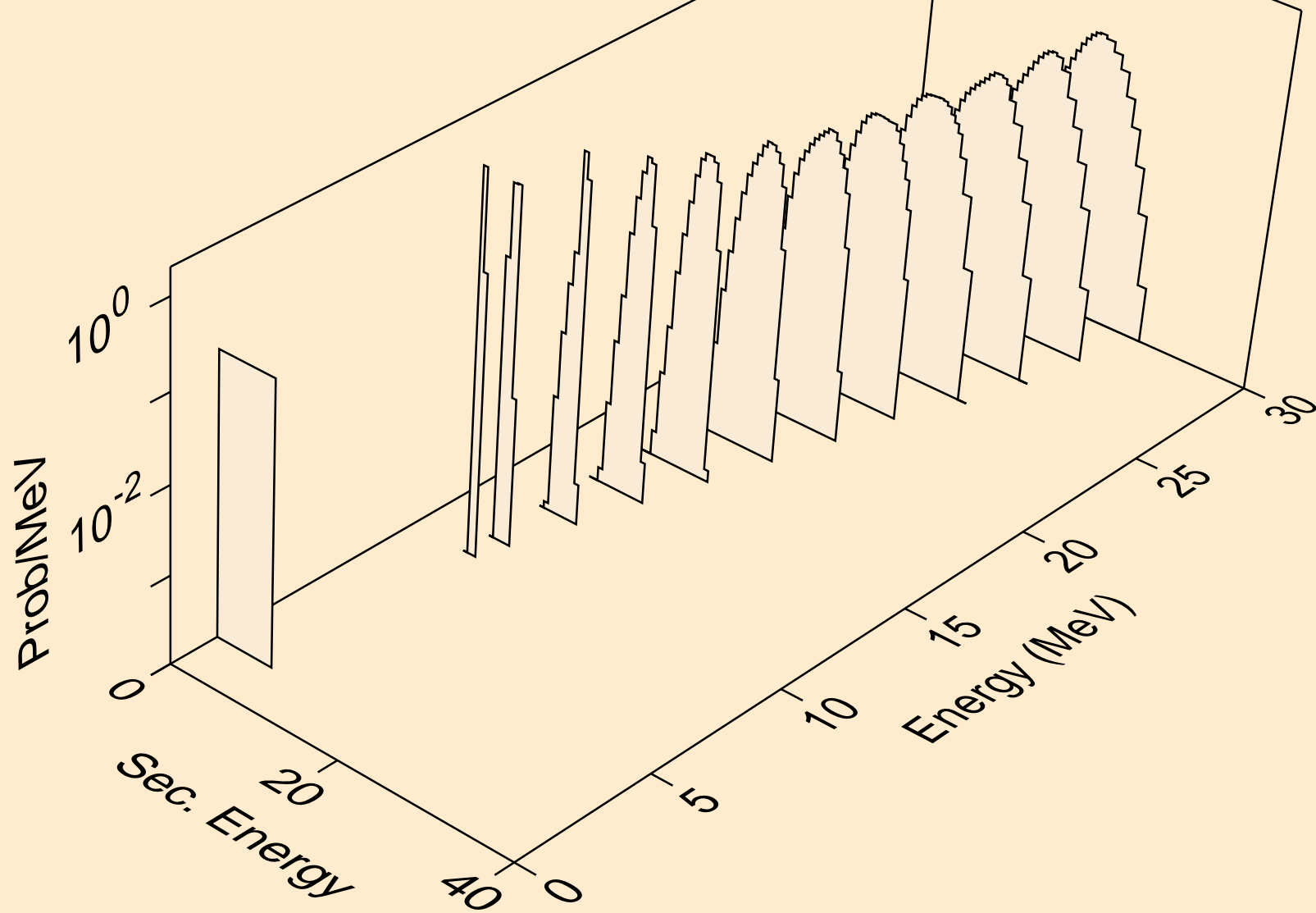

PO201 NEUTRON ACER TENDL-2024 LIBRARY; T=293.6K
alphas from (n,3n)a

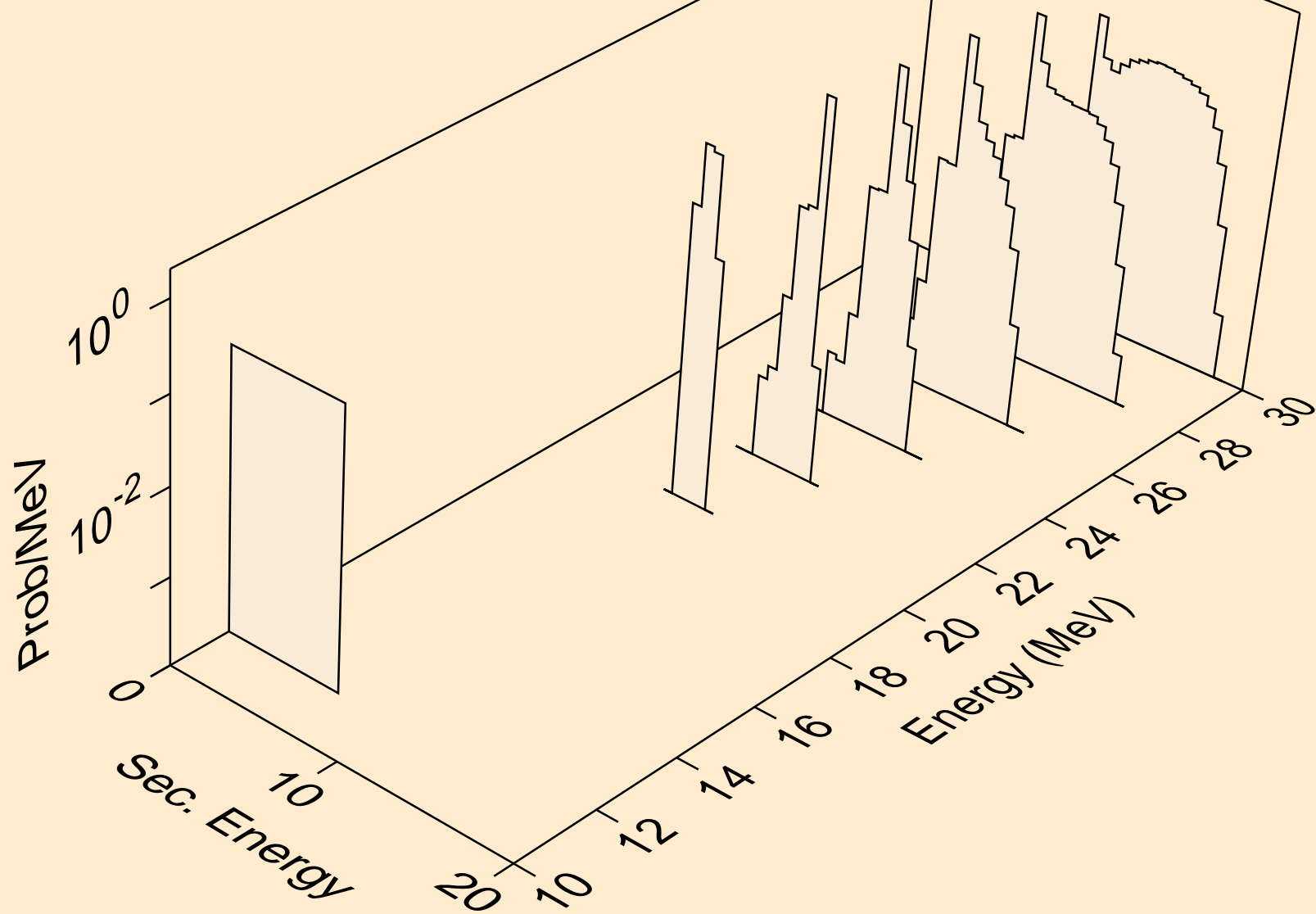

PO201 NEUTRON ACER TENDL-2024 LIBRARY; T=293.6K
alphas from (n,n*)2a

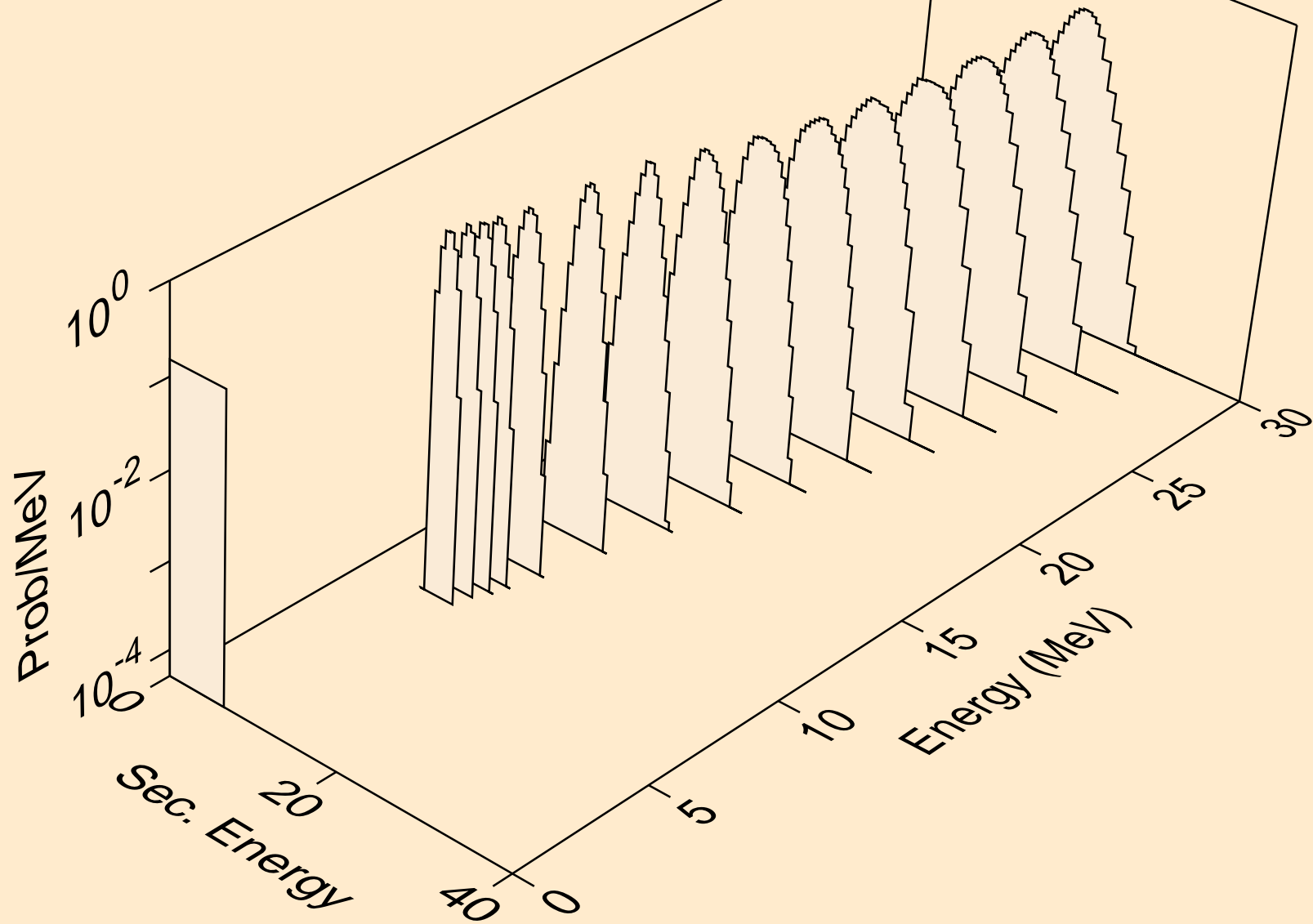

PO201 NEUTRON ACER TENDL-2024 LIBRARY; T=293.6K
alphas from (n,2n)2a

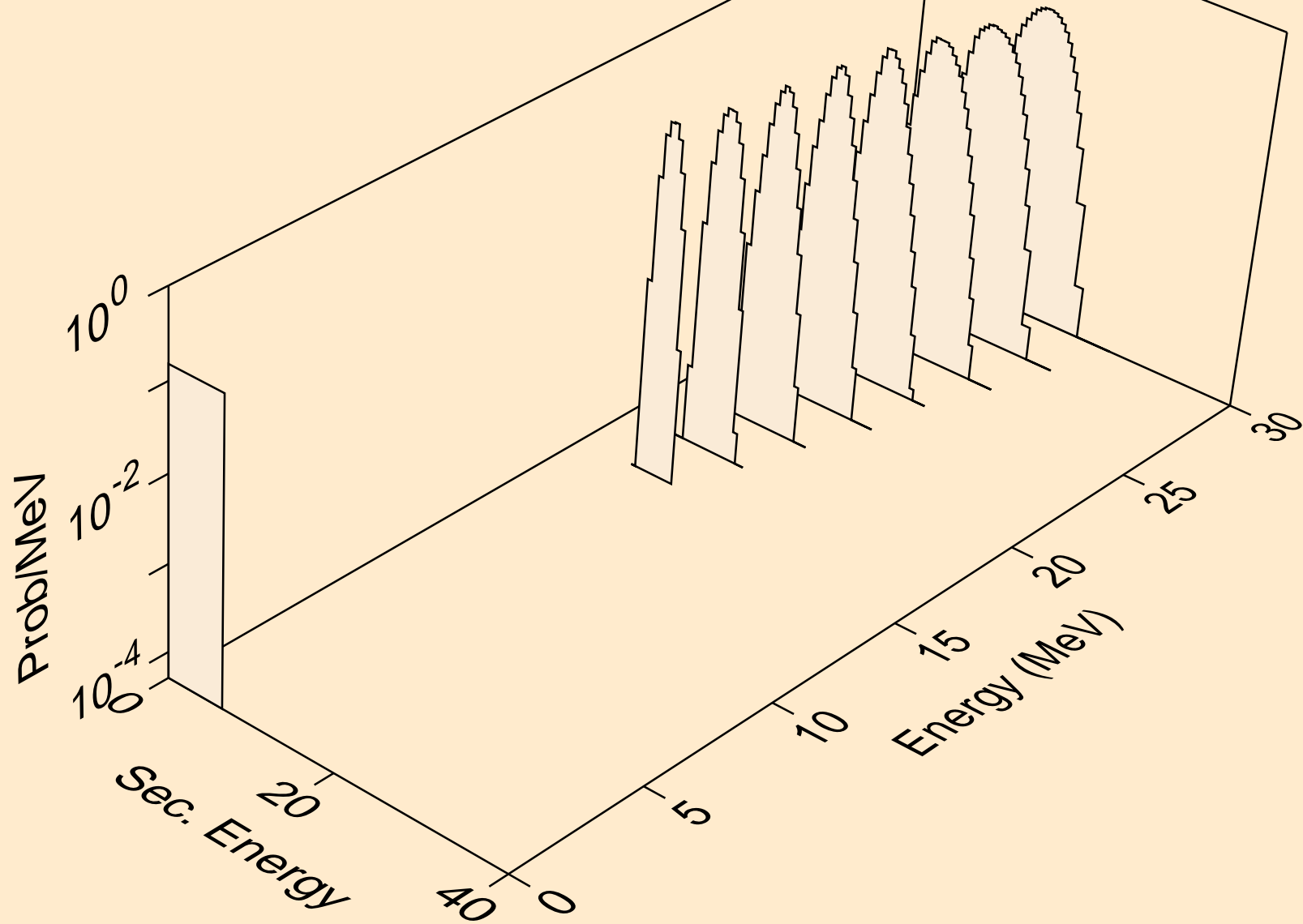

PO201 NEUTRON ACER TENDL-2024 LIBRARY; T=293.6K
alphas from (n,npa)

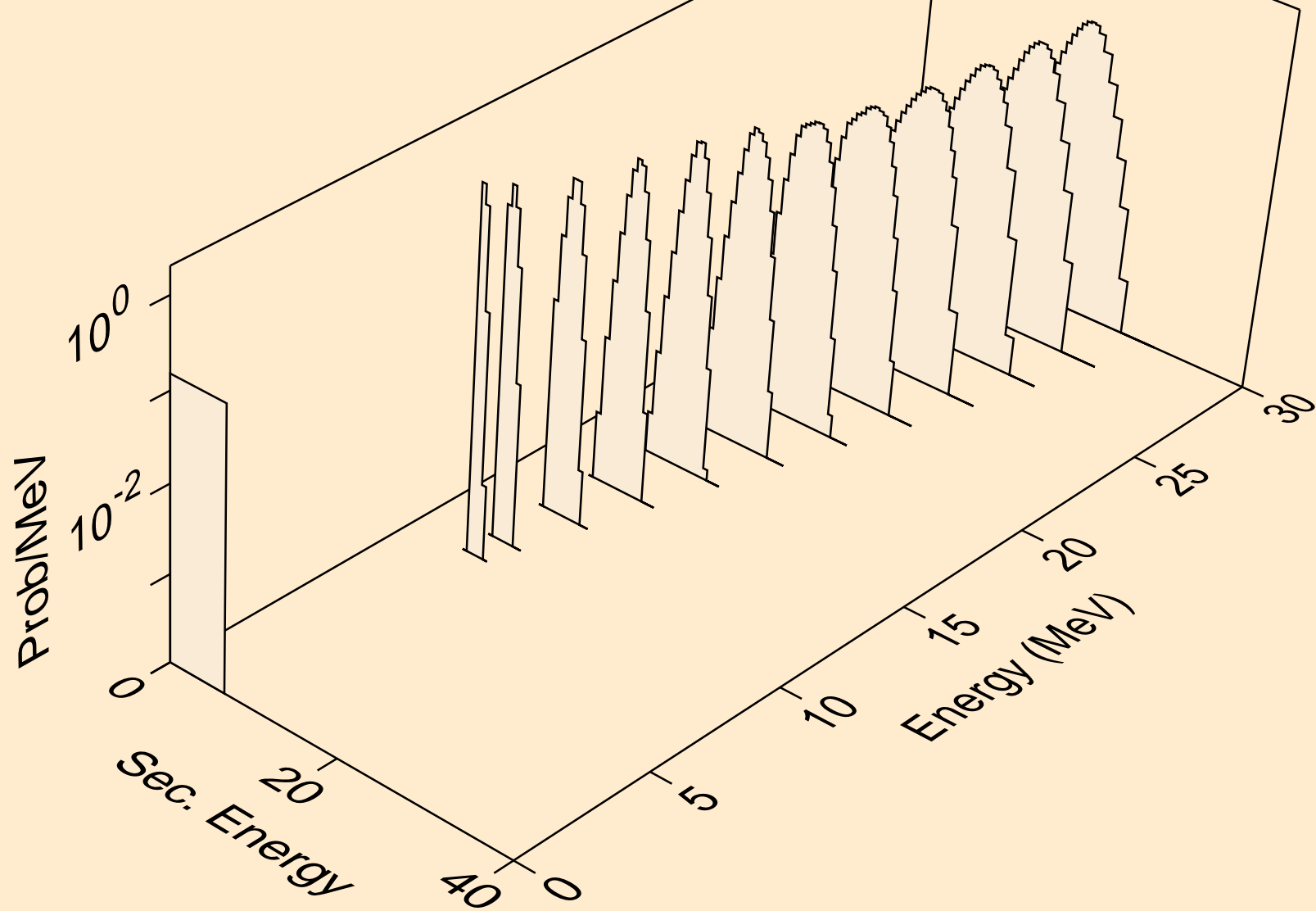

PO201 NEUTRON ACER TENDL-2024 LIBRARY; T=293.6K
alphas from (n,a)

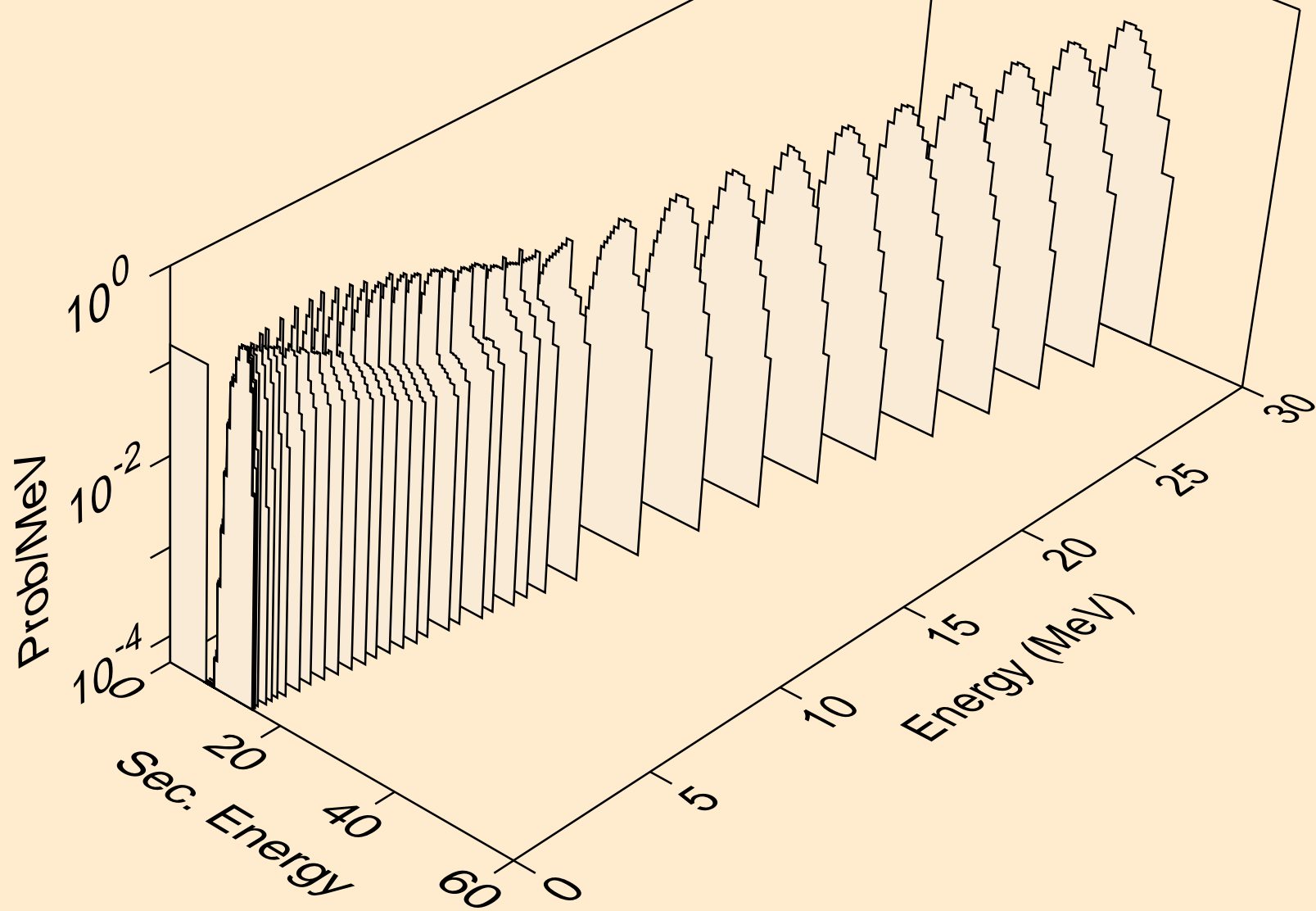

PO201 NEUTRON ACER TENDL-2024 LIBRARY; T=293.6K
alphas from (n,2a)

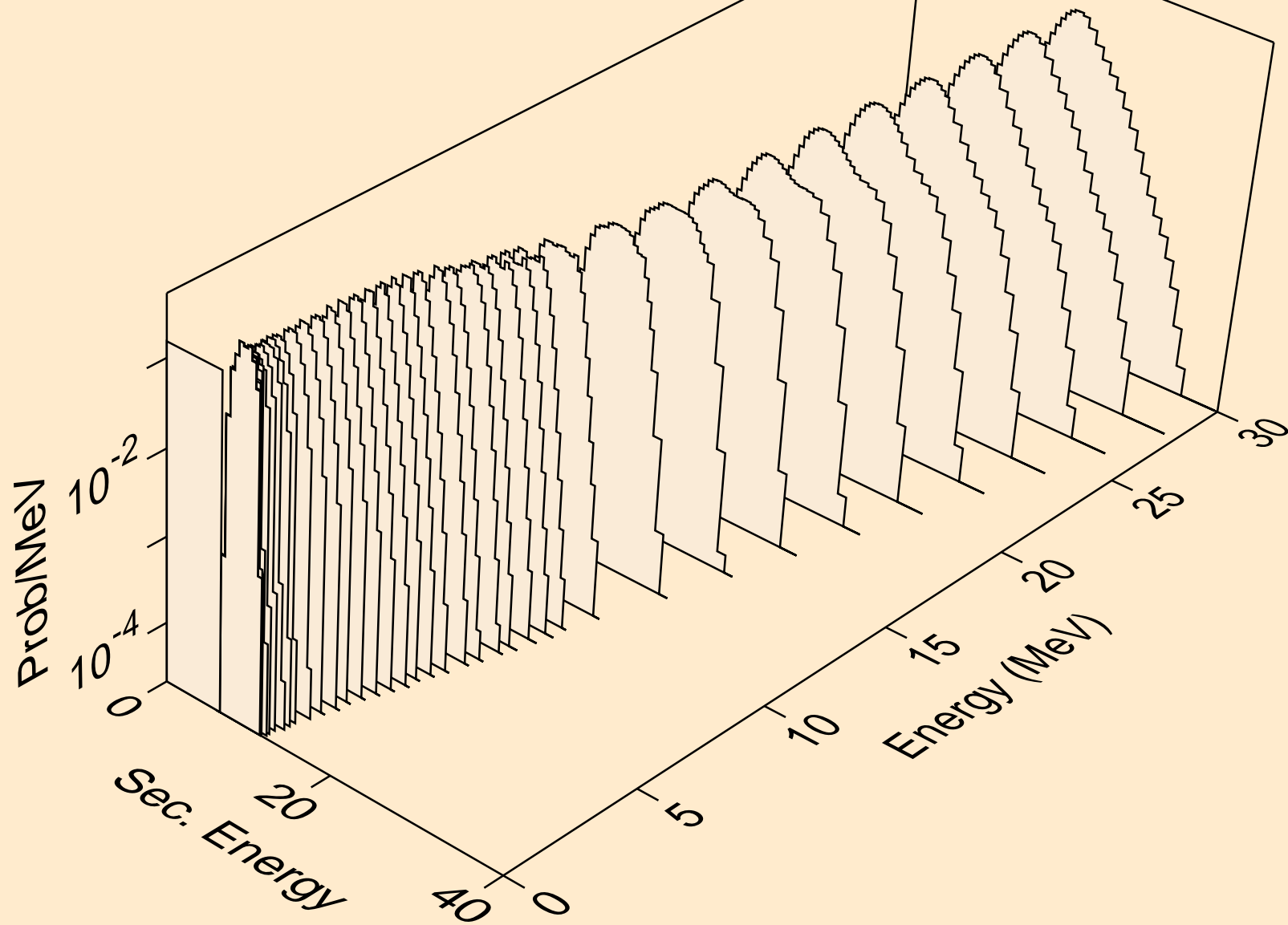

PO201 NEUTRON ACER TENDL-2024 LIBRARY; T=293.6K
alphas from (n,pa)

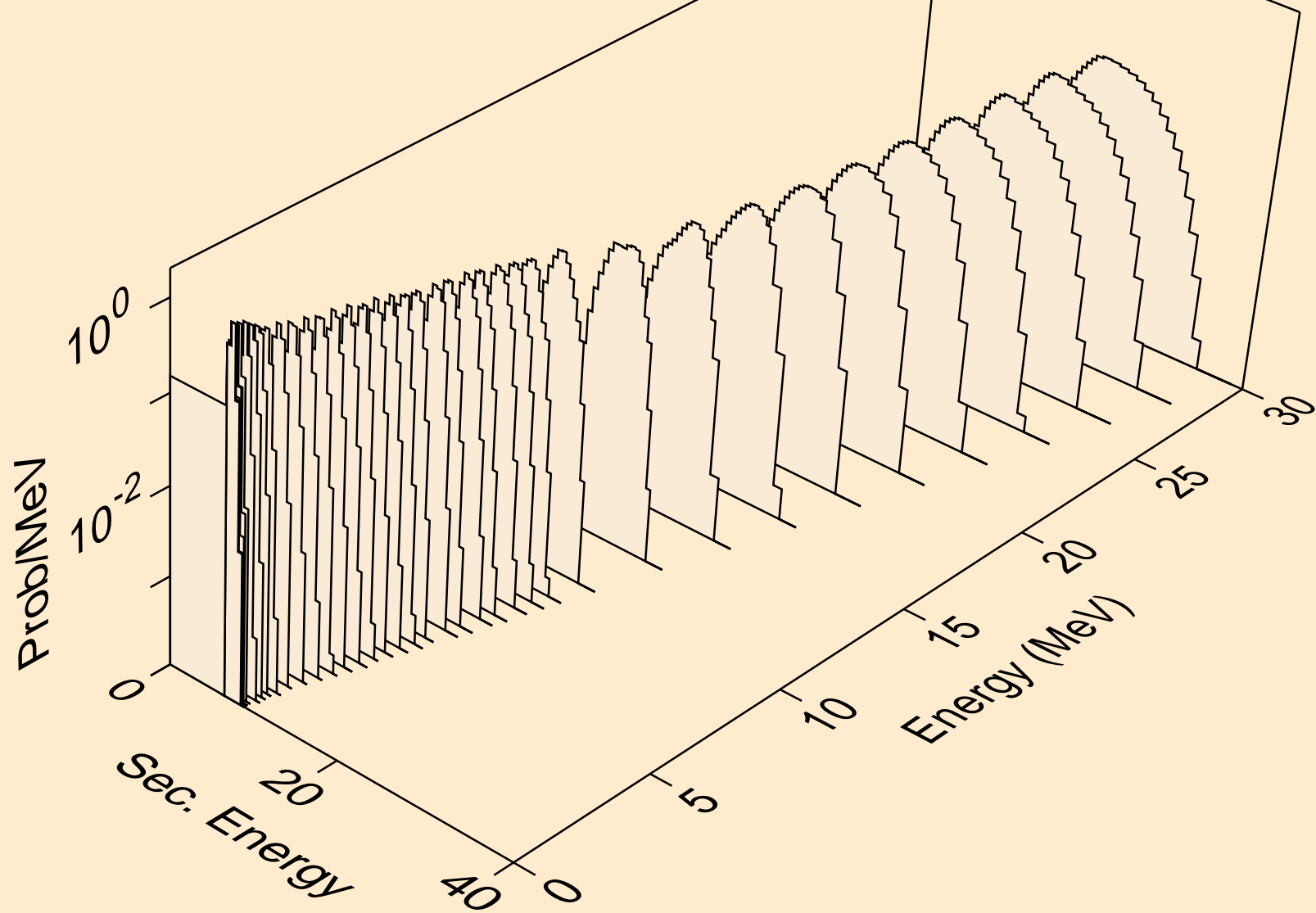

PO201 NEUTRON ACER TENDL-2024 LIBRARY; T=293.6K
alphas from (n,da)

