

PO207 NEUTRON ACER TENDL-2024 LIBRARY; T=293.6K  
Principal cross sections

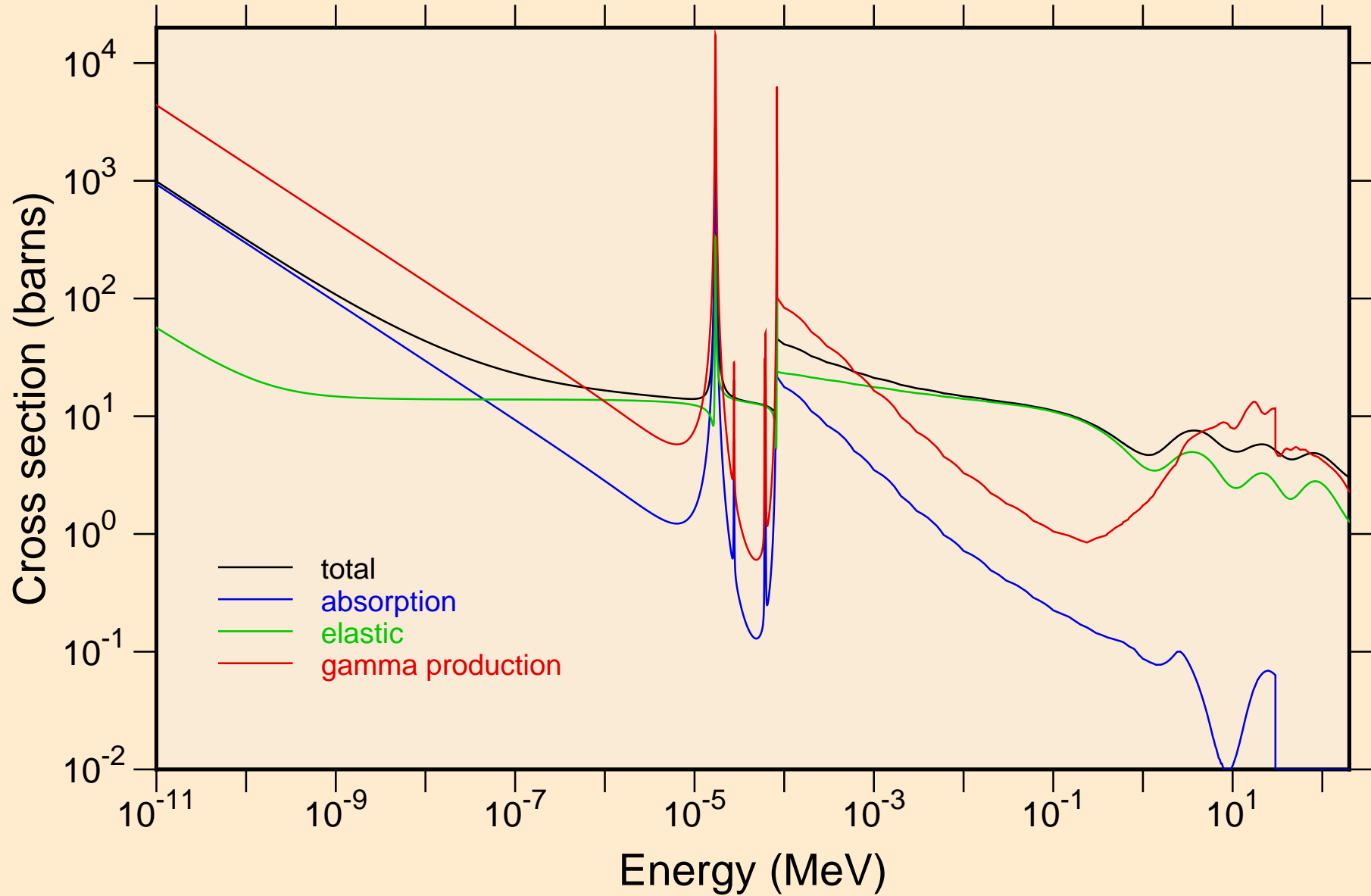

PO207 NEUTRON ACER TENDL-2024 LIBRARY; T=293.6K  
resonance total cross section

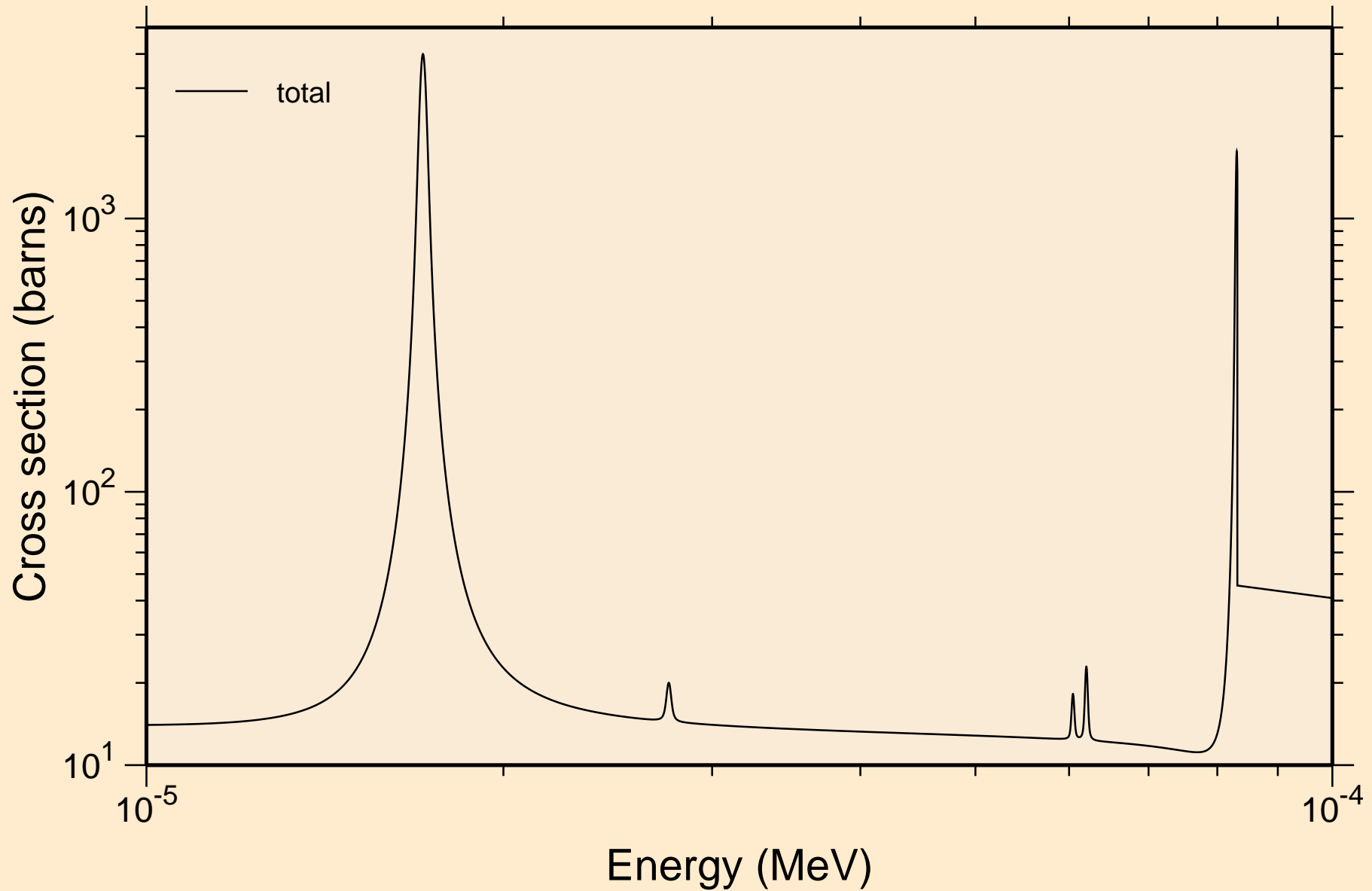

PO207 NEUTRON ACER TENDL-2024 LIBRARY; T=293.6K  
resonance total cross section

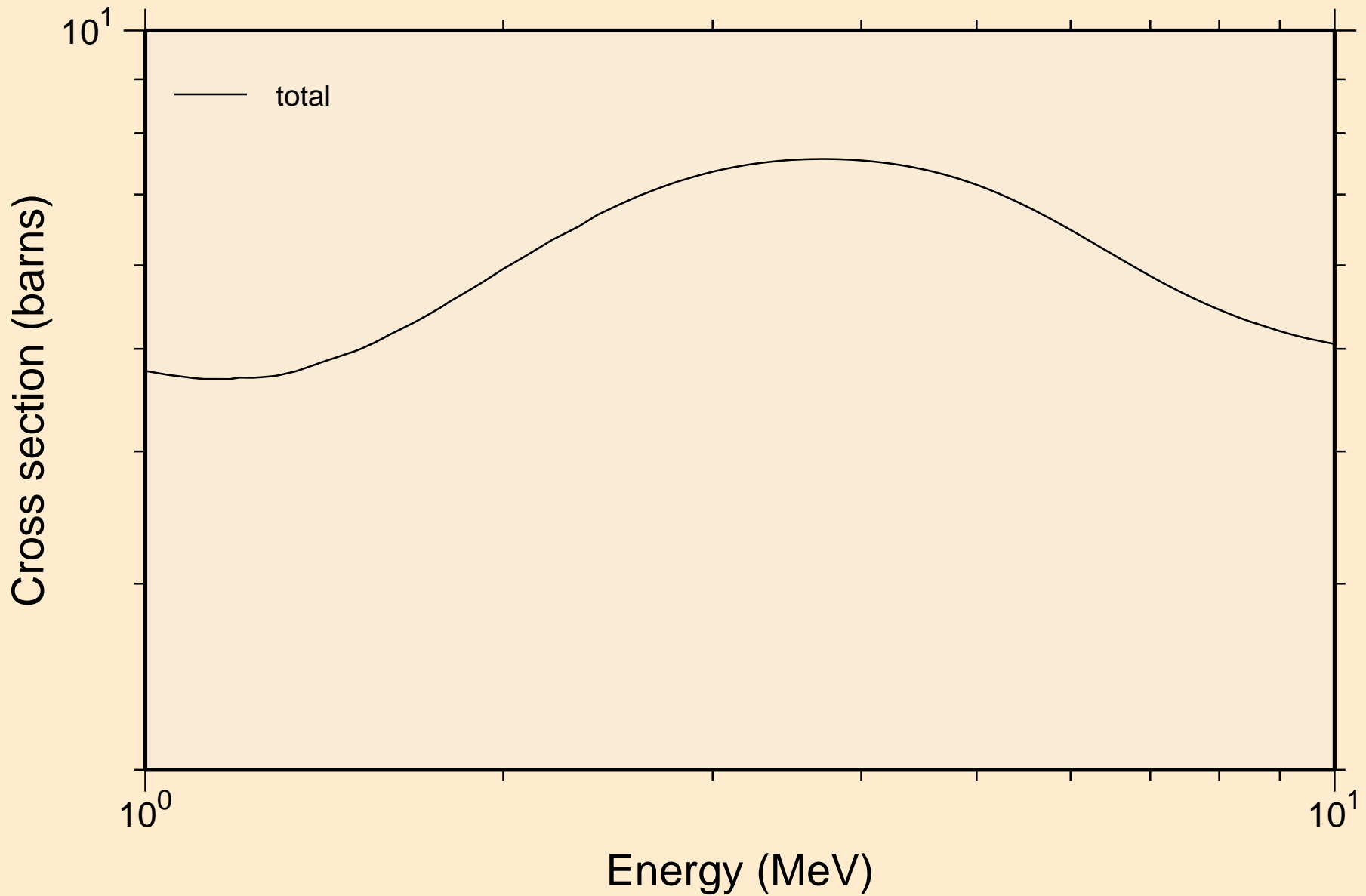

PO207 NEUTRON ACER TENDL-2024 LIBRARY; T=293.6K  
resonance absorption cross sections

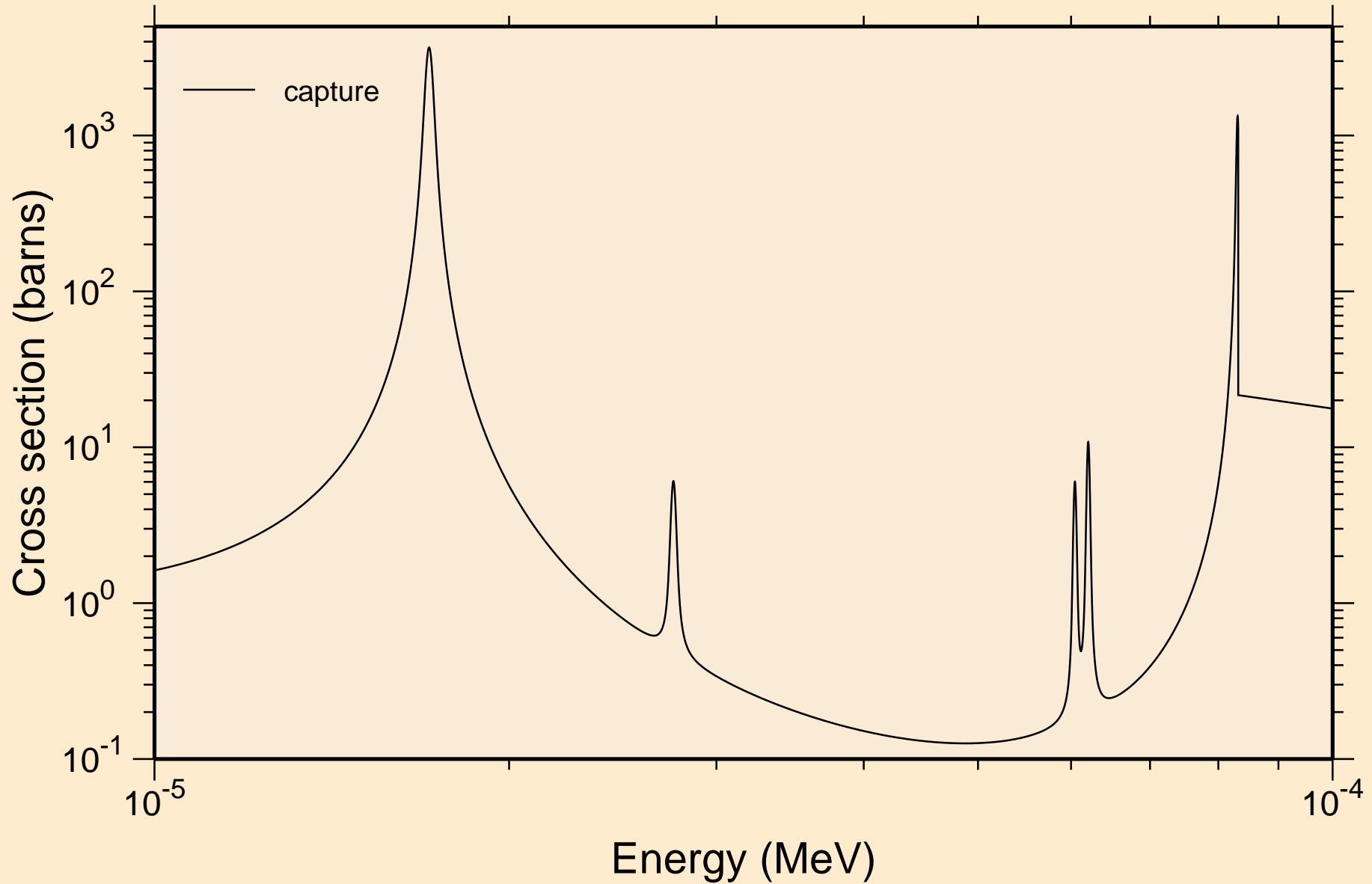

PO207 NEUTRON ACER TENDL-2024 LIBRARY; T=293.6K  
resonance absorption cross sections

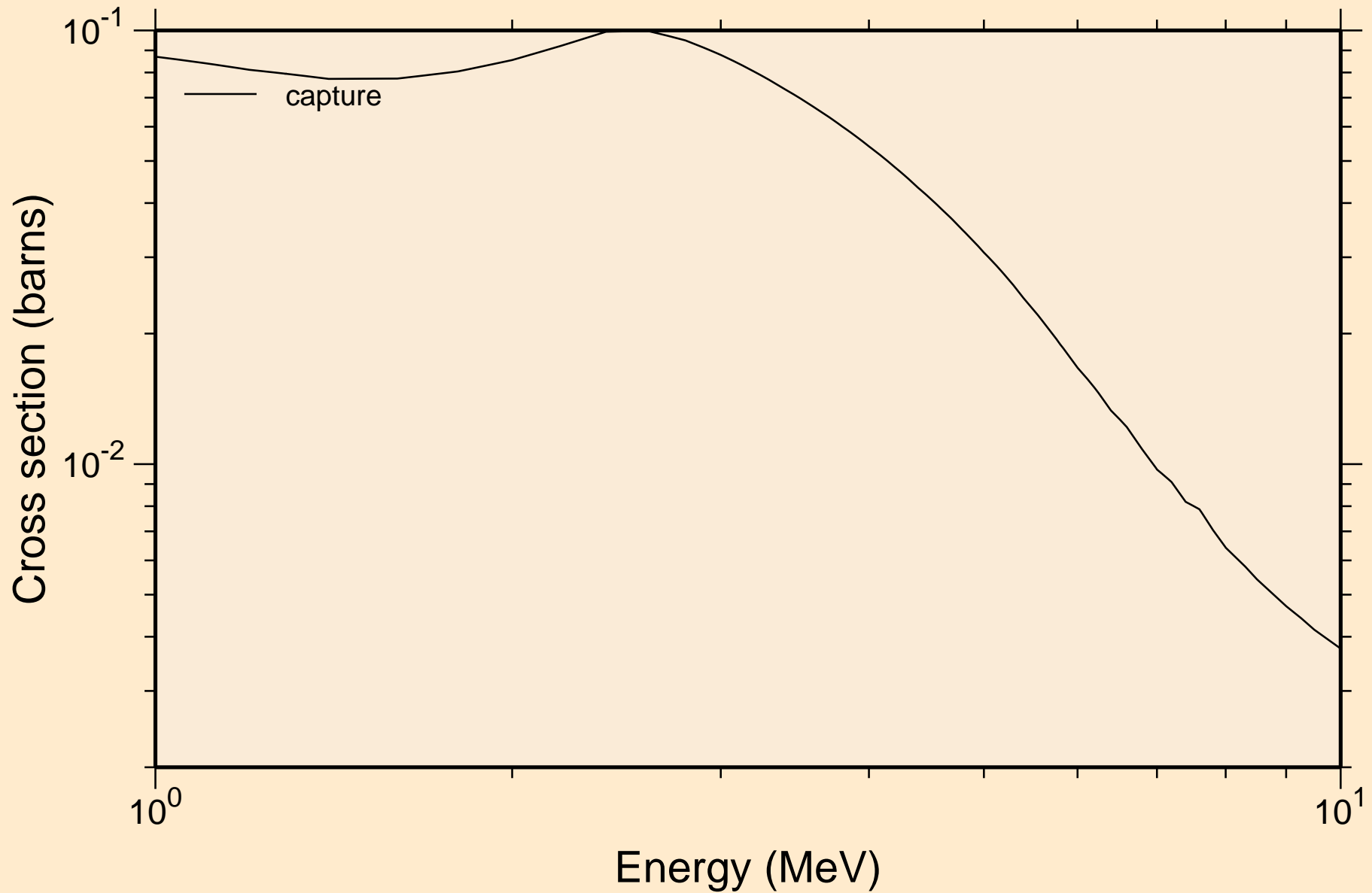

PO207 NEUTRON ACER TENDL-2024 LIBRARY; T=293.6K  
Heating

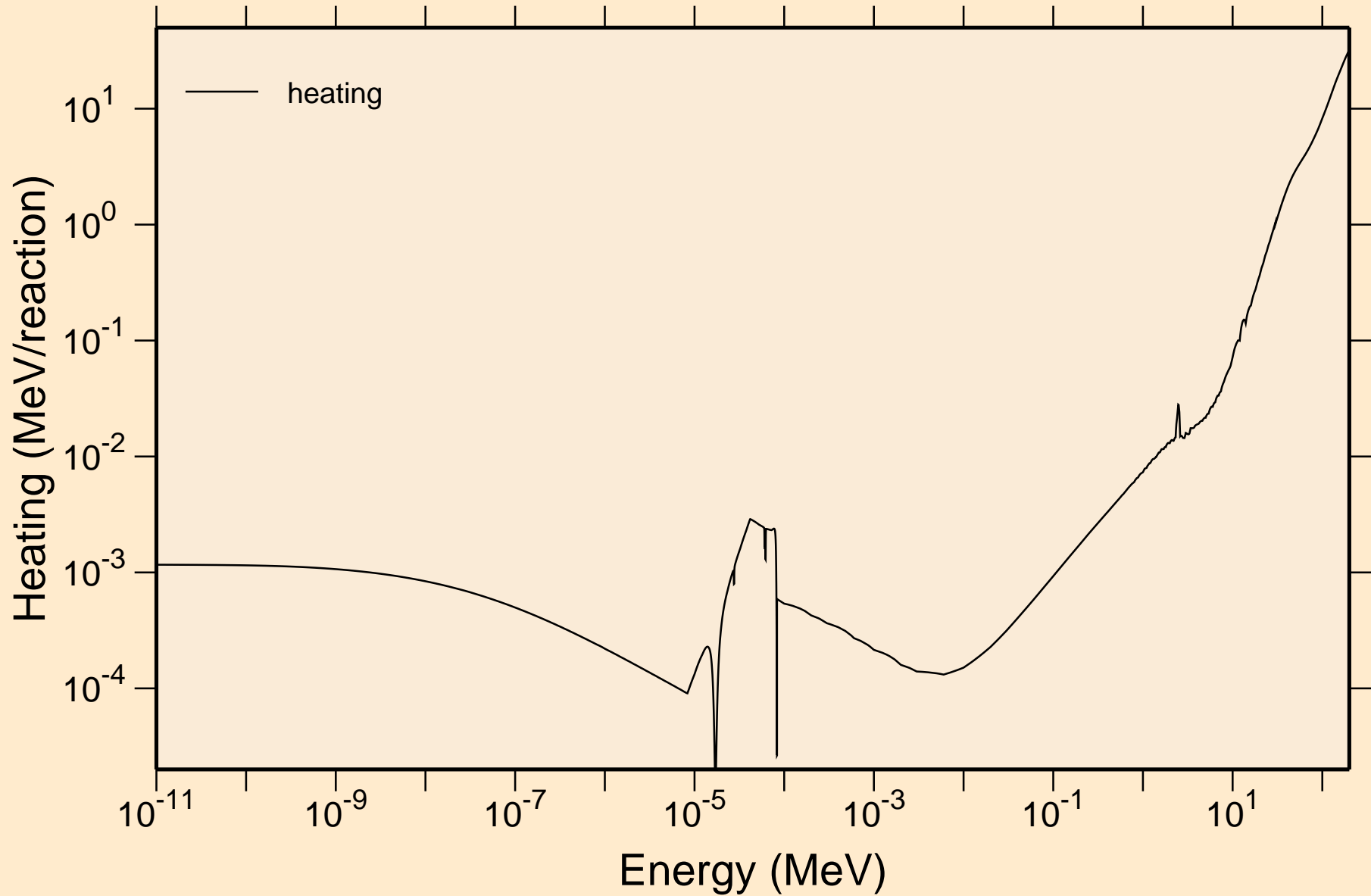

PO207 NEUTRON ACER TENDL-2024 LIBRARY; T=293.6K  
Damage

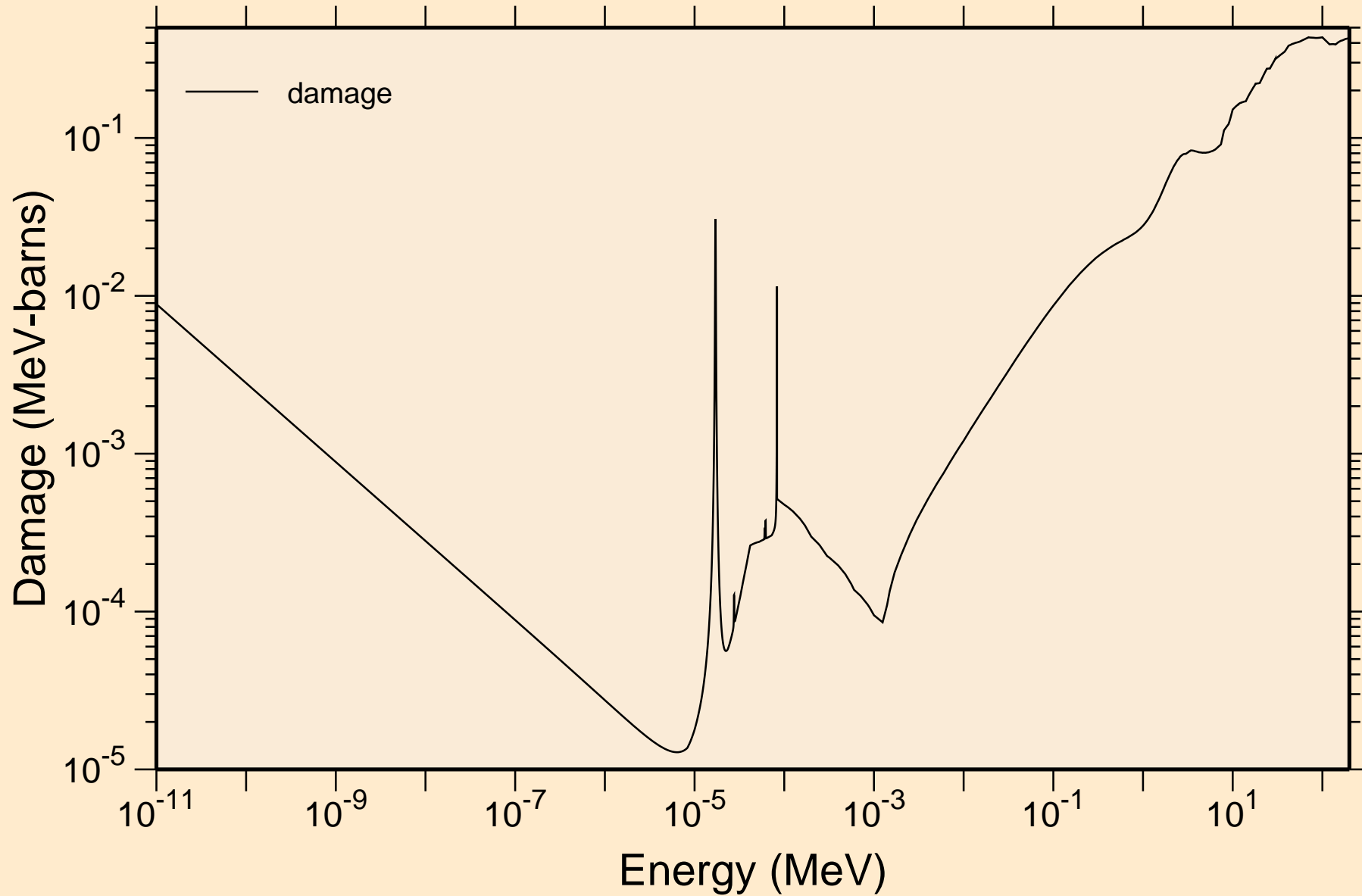

PO207 NEUTRON ACER TENDL-2024 LIBRARY; T=293.6K  
Non-threshold reactions

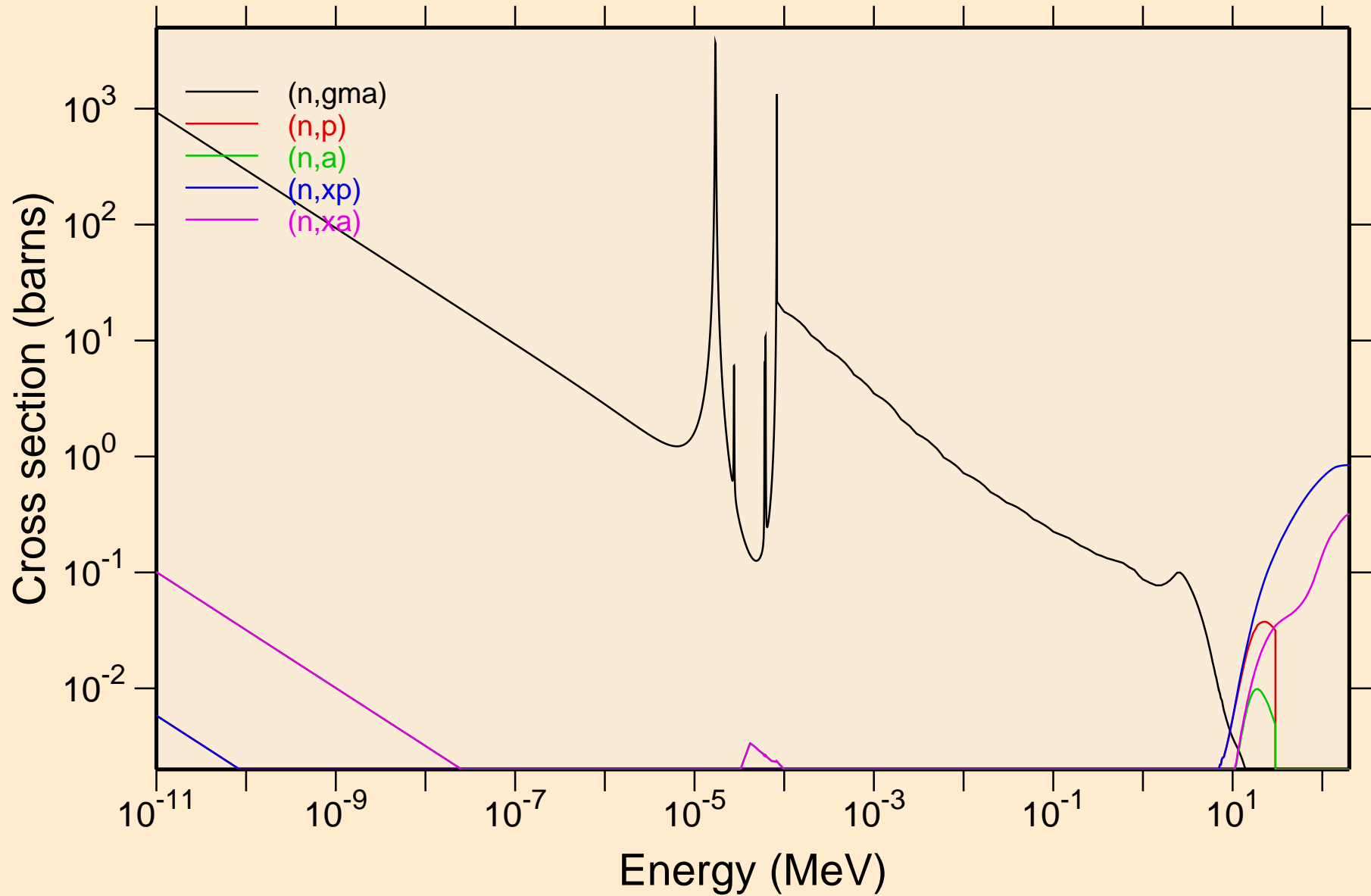

PO207 NEUTRON ACER TENDL-2024 LIBRARY; T=293.6K  
Principal cross sections

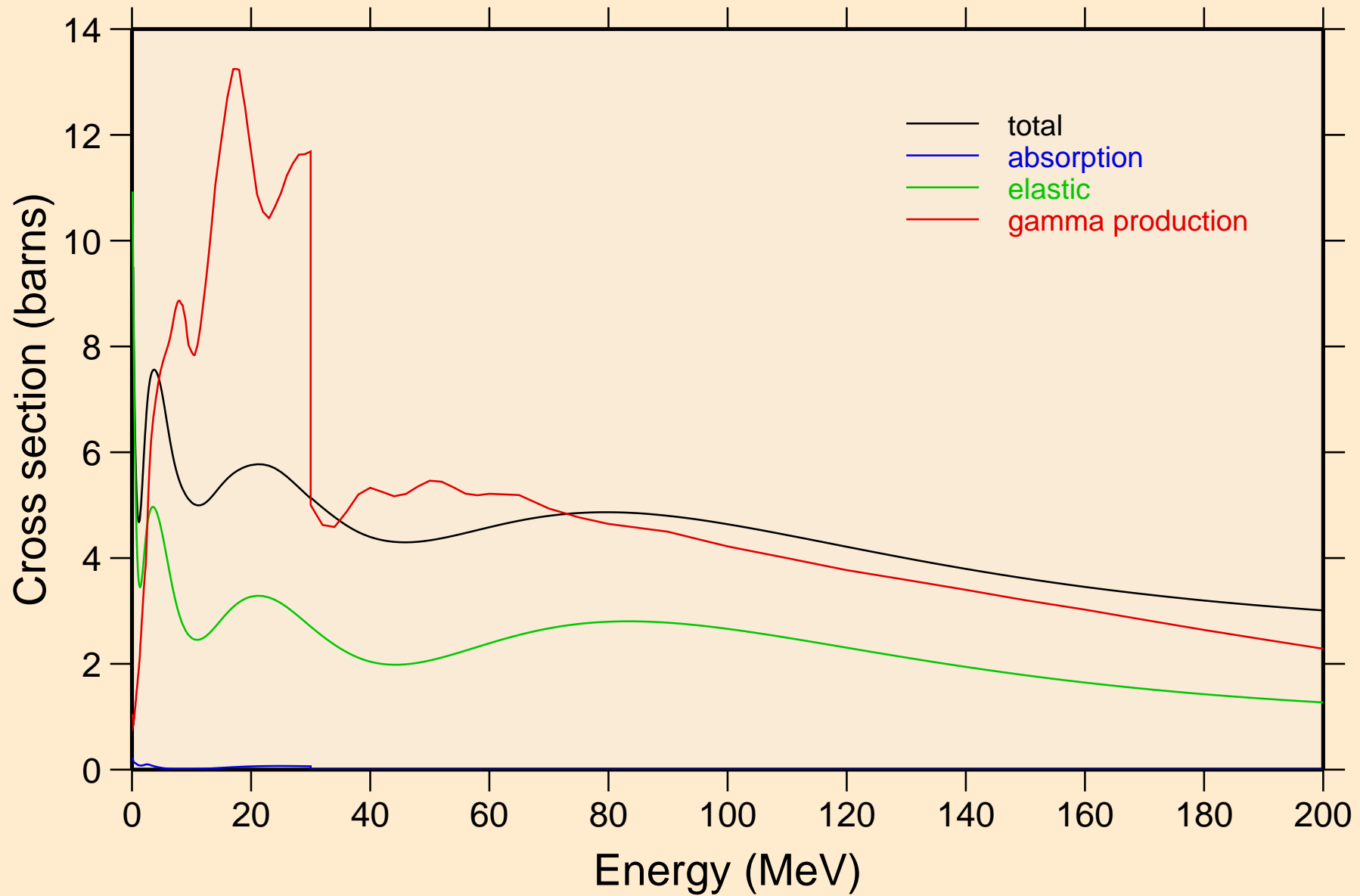

PO207 NEUTRON ACER TENDL-2024 LIBRARY; T=293.6K  
Heating

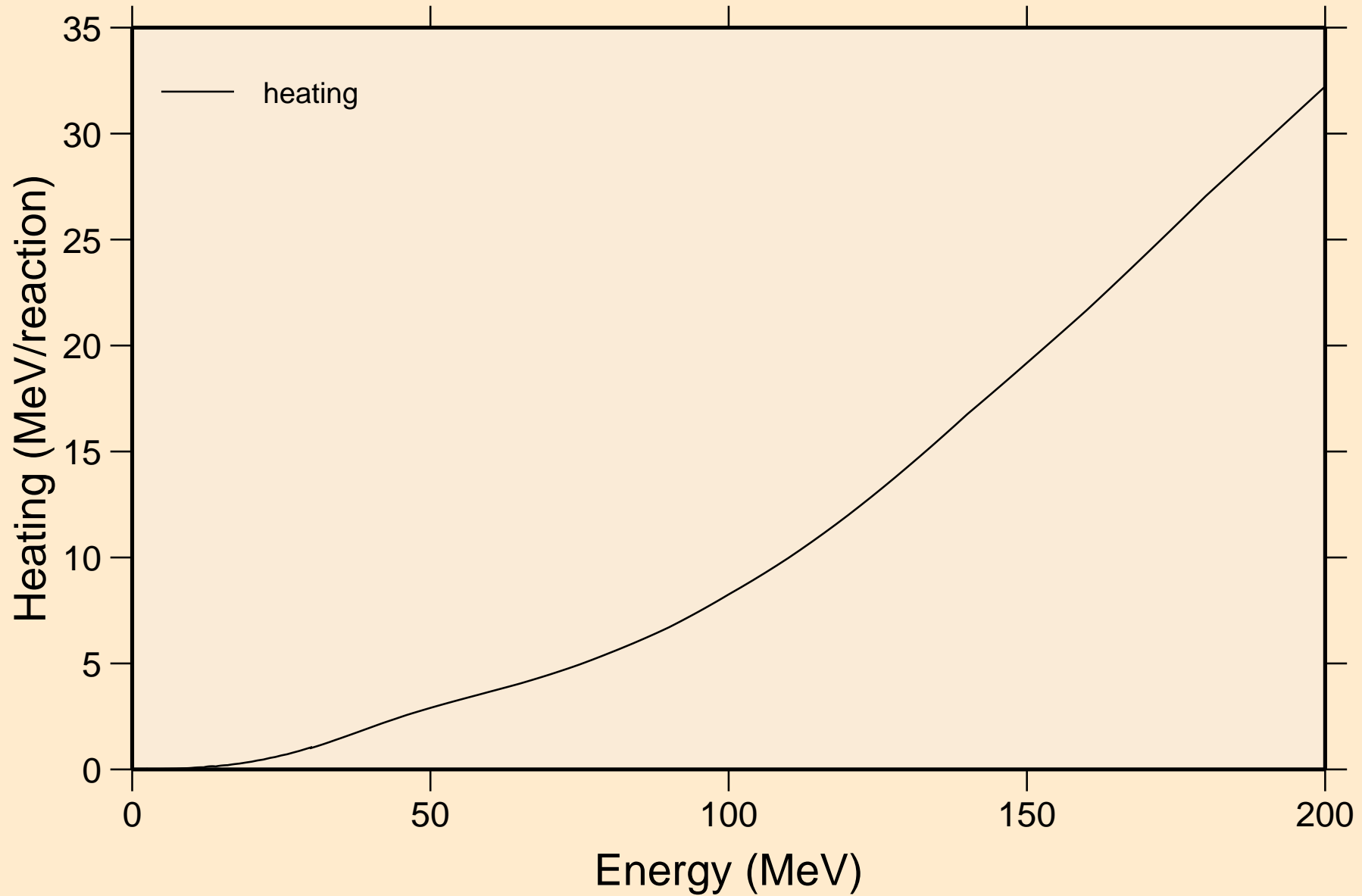

PO207 NEUTRON ACER TENDL-2024 LIBRARY; T=293.6K  
Damage

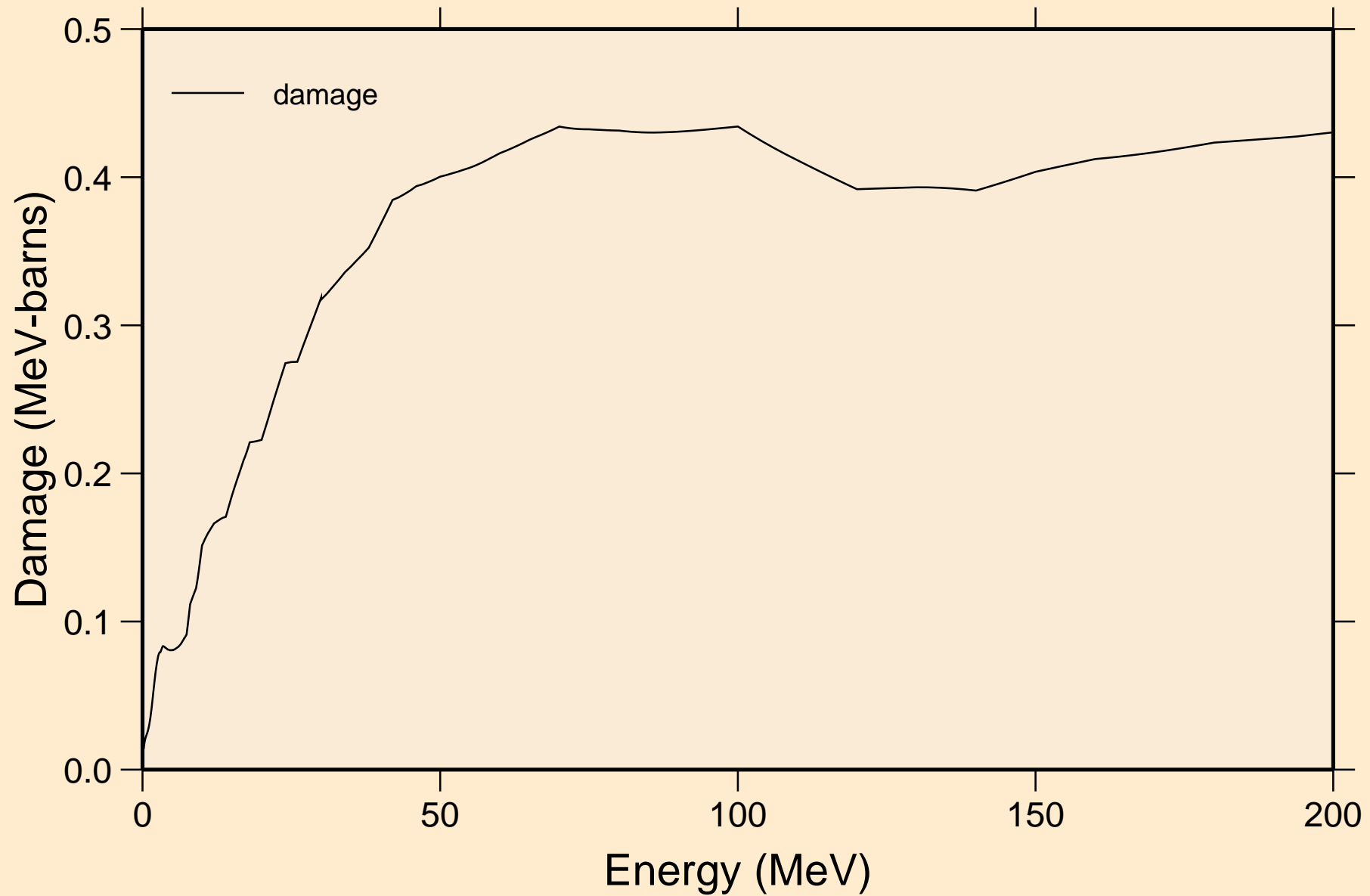

PO207 NEUTRON ACER TENDL-2024 LIBRARY; T=293.6K  
Non-threshold reactions

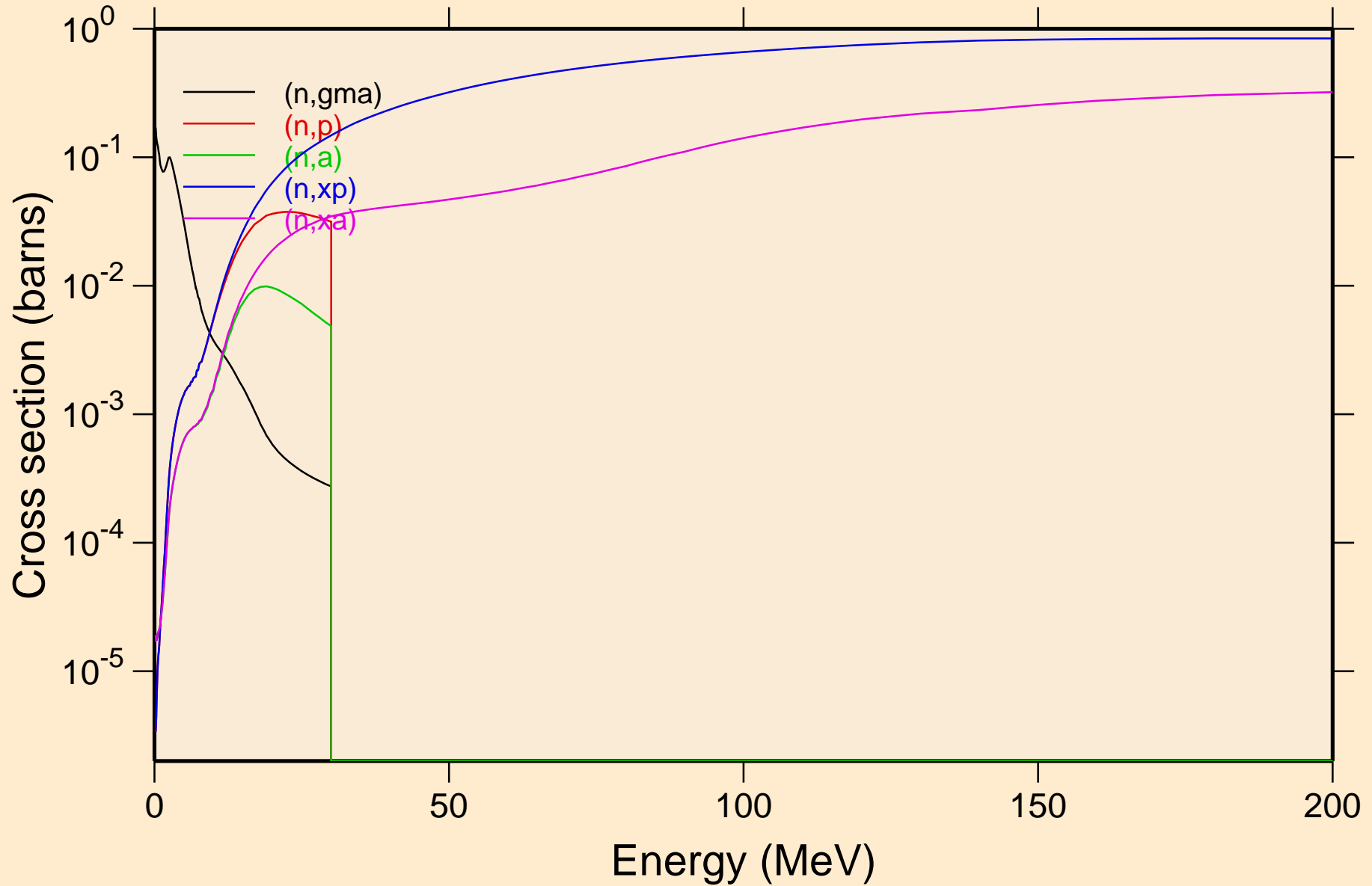

PO207 NEUTRON ACER TENDL-2024 LIBRARY; T=293.6K  
Inelastic levels

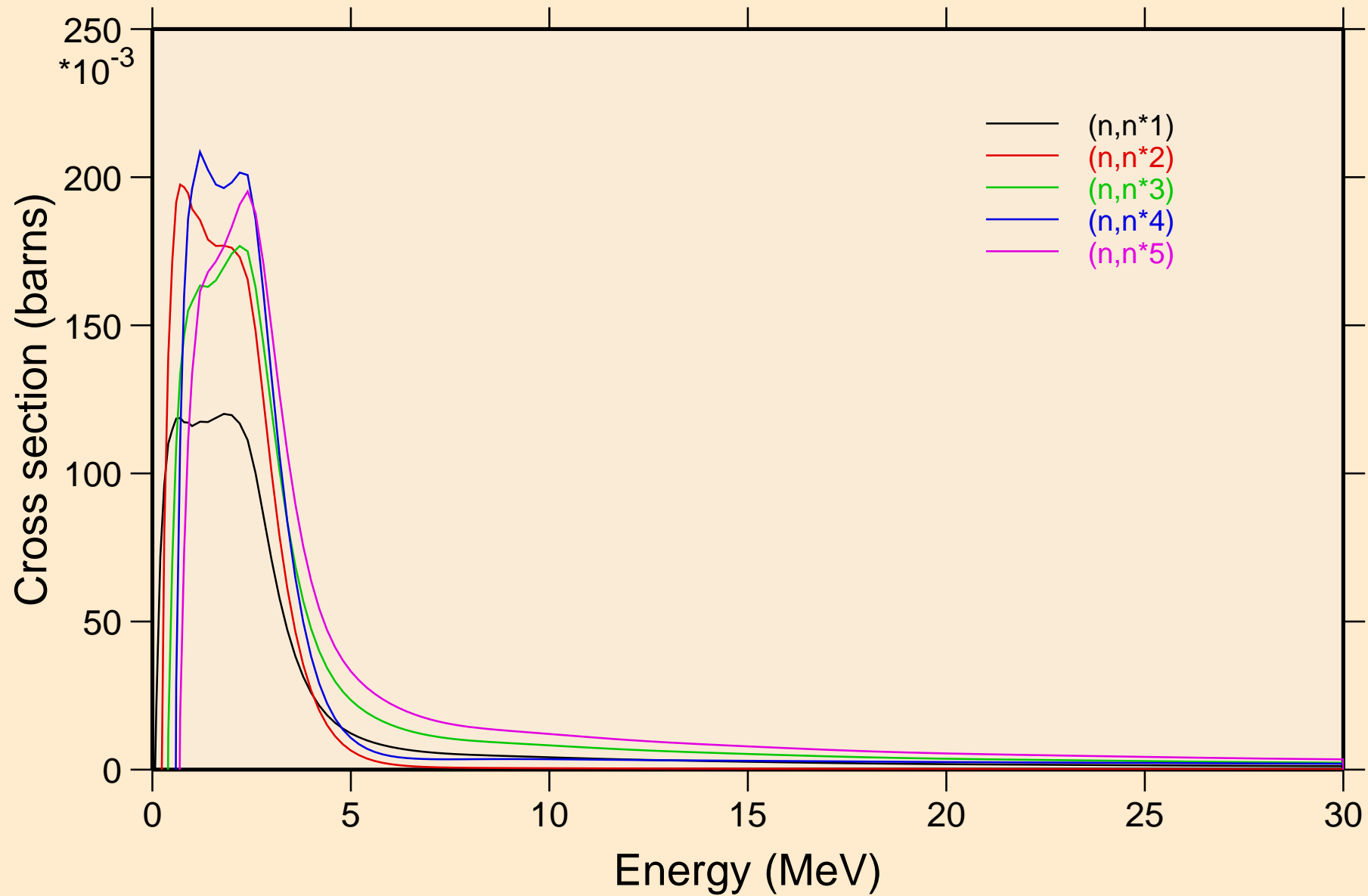

PO207 NEUTRON ACER TENDL-2024 LIBRARY; T=293.6K  
Inelastic levels

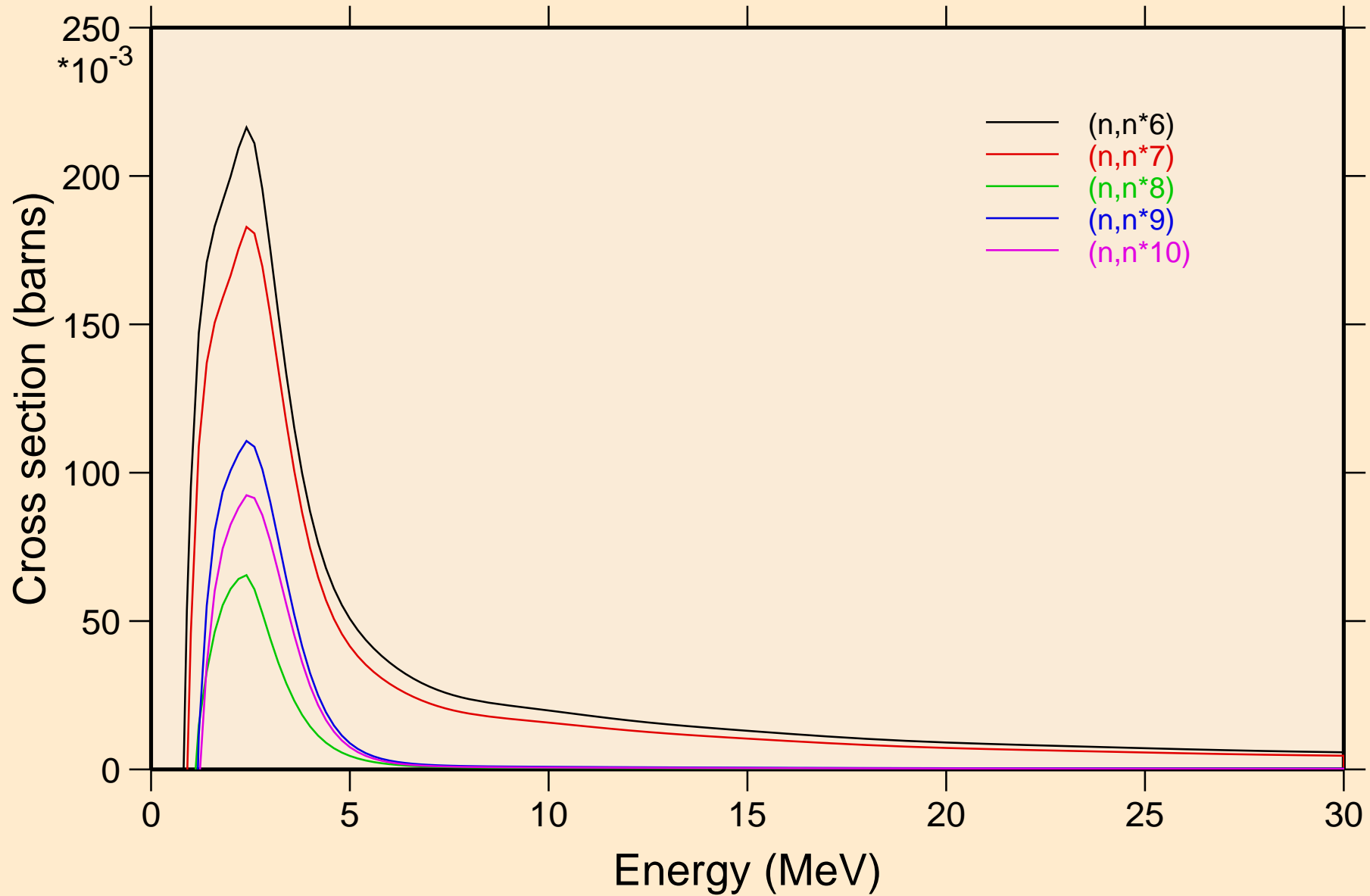

PO207 NEUTRON ACER TENDL-2024 LIBRARY; T=293.6K  
Inelastic levels

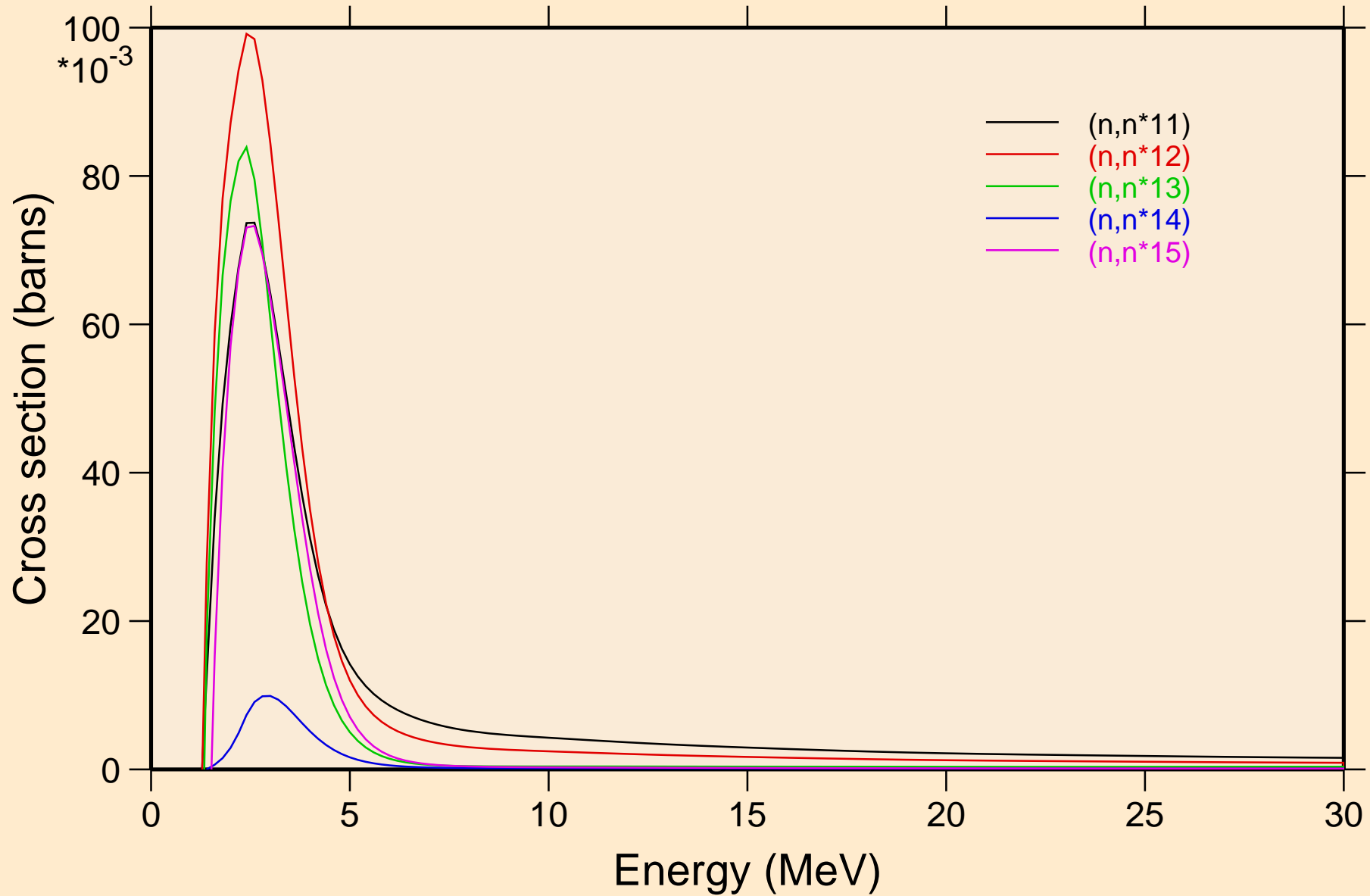

PO207 NEUTRON ACER TENDL-2024 LIBRARY; T=293.6K  
Inelastic levels

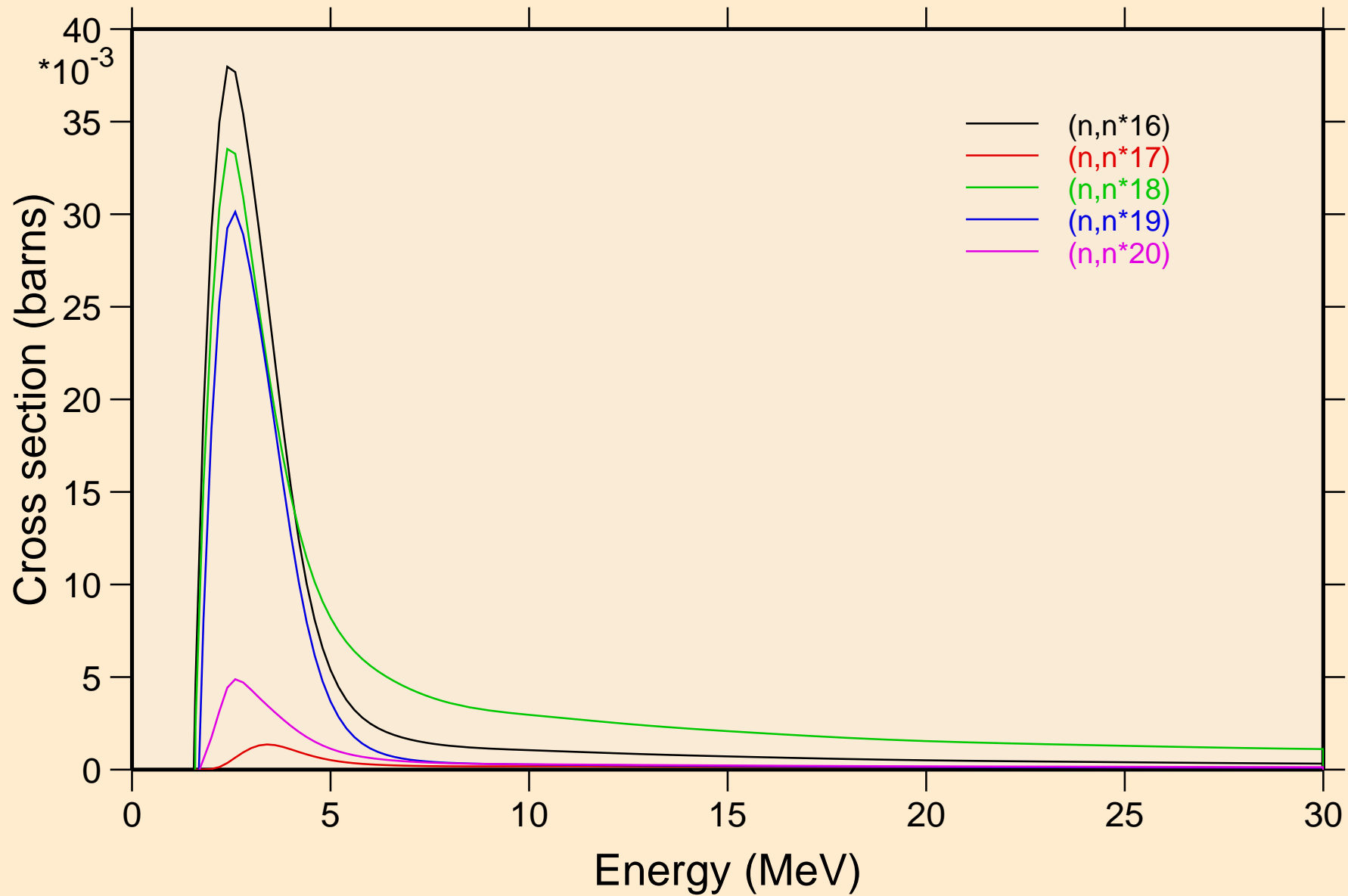

PO207 NEUTRON ACER TENDL-2024 LIBRARY; T=293.6K  
Inelastic levels

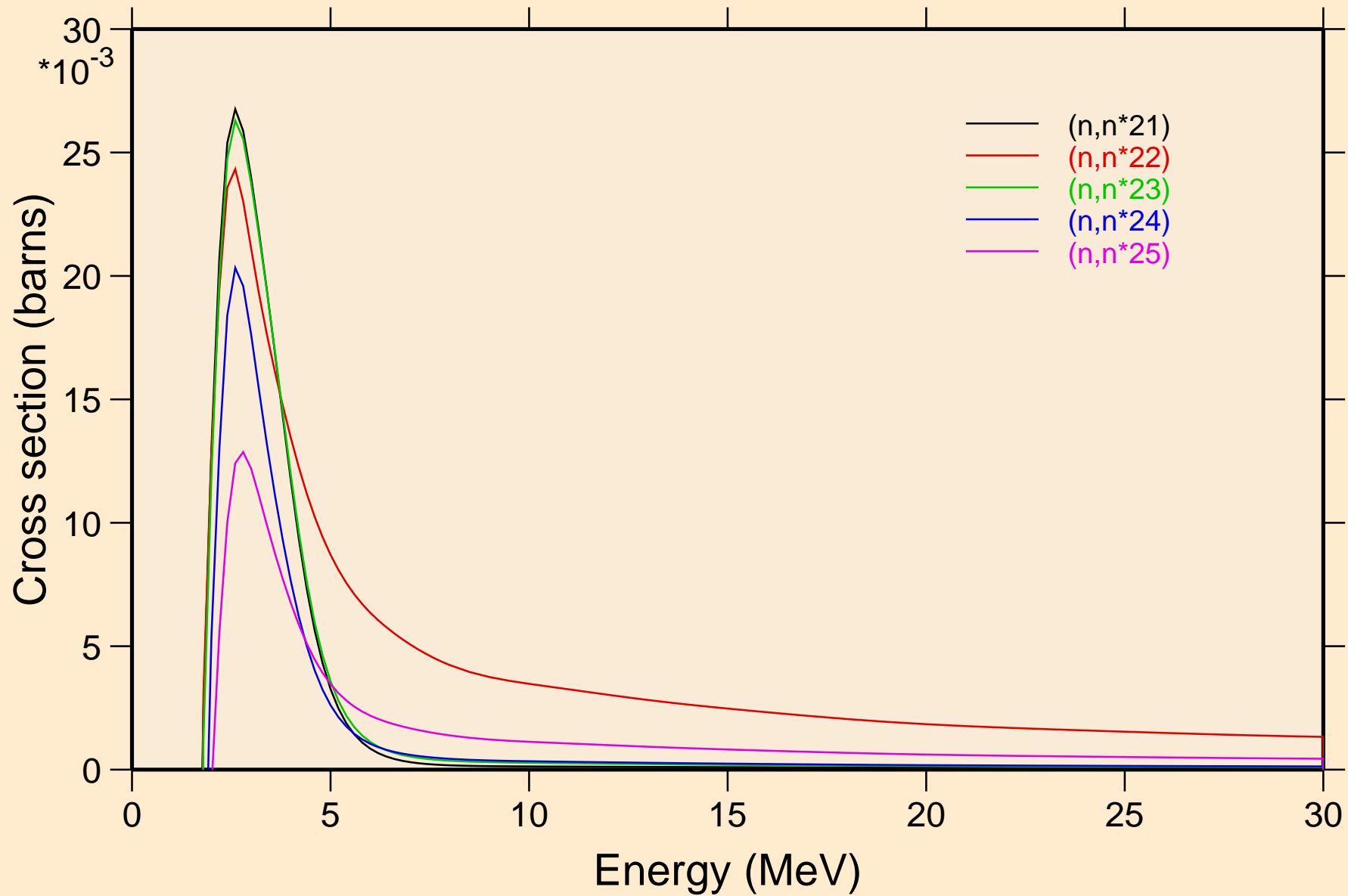

PO207 NEUTRON ACER TENDL-2024 LIBRARY; T=293.6K  
Inelastic levels

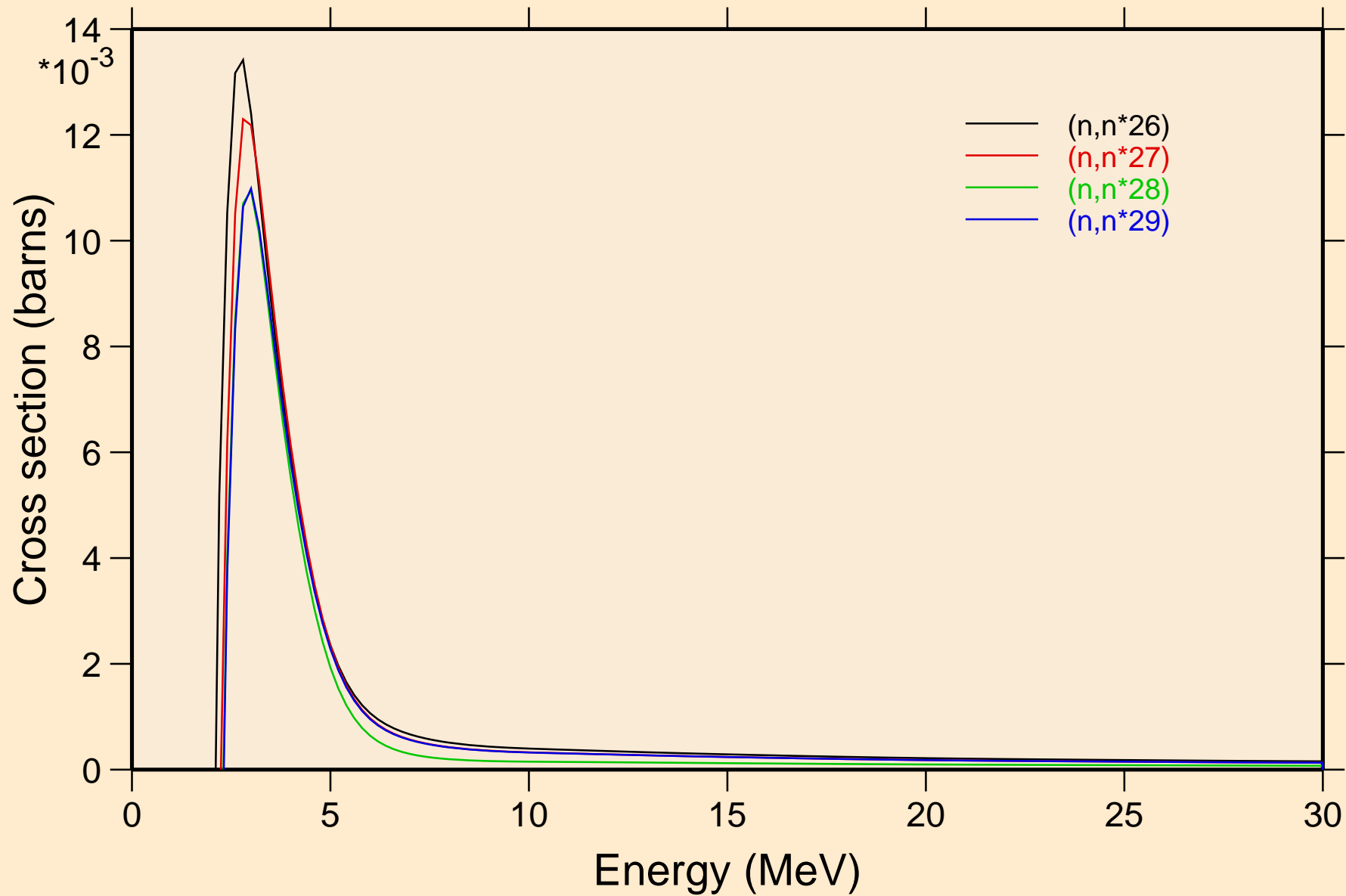

PO207 NEUTRON ACER TENDL-2024 LIBRARY; T=293.6K  
Threshold reactions

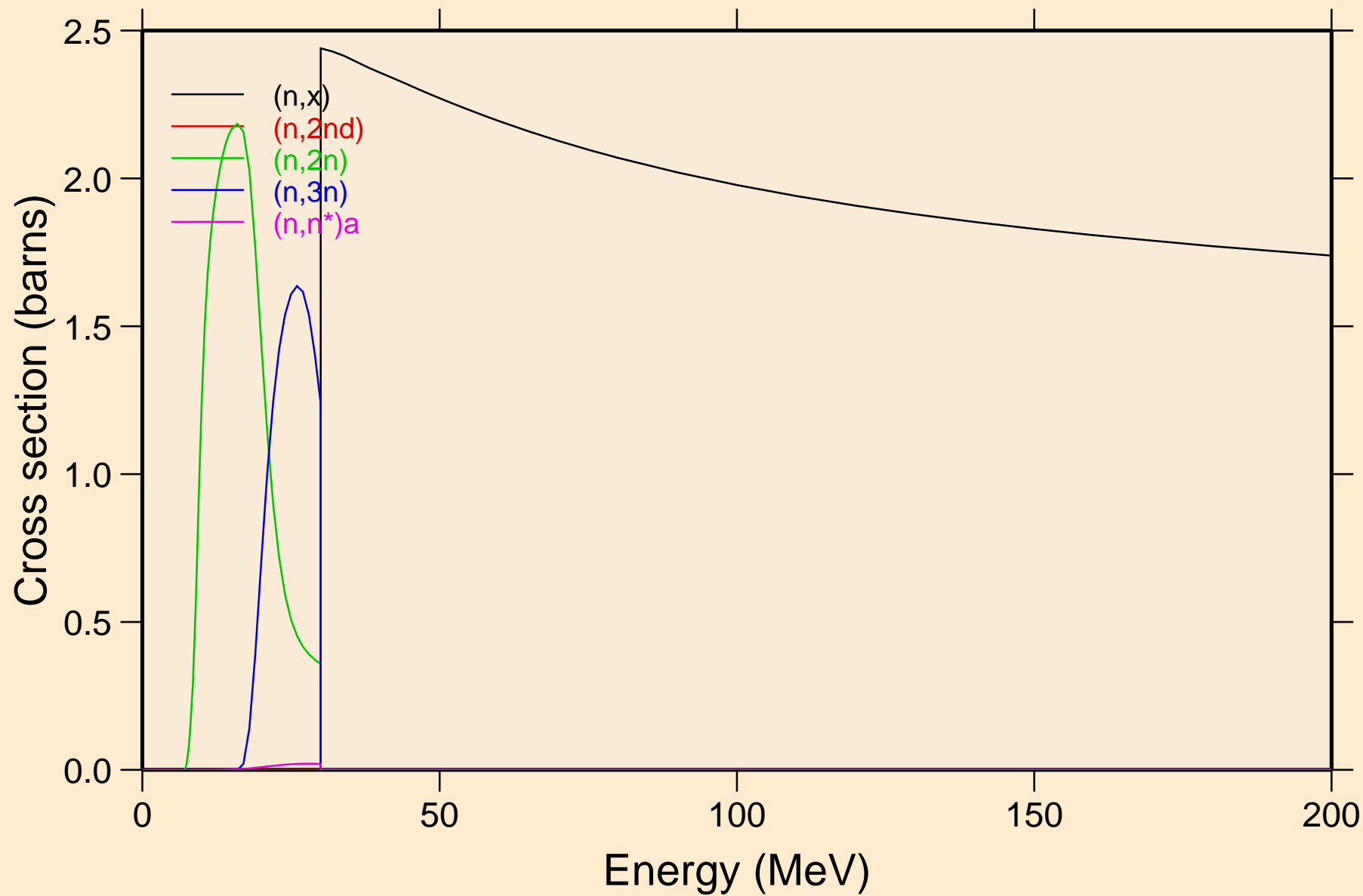

PO207 NEUTRON ACER TENDL-2024 LIBRARY; T=293.6K  
Threshold reactions

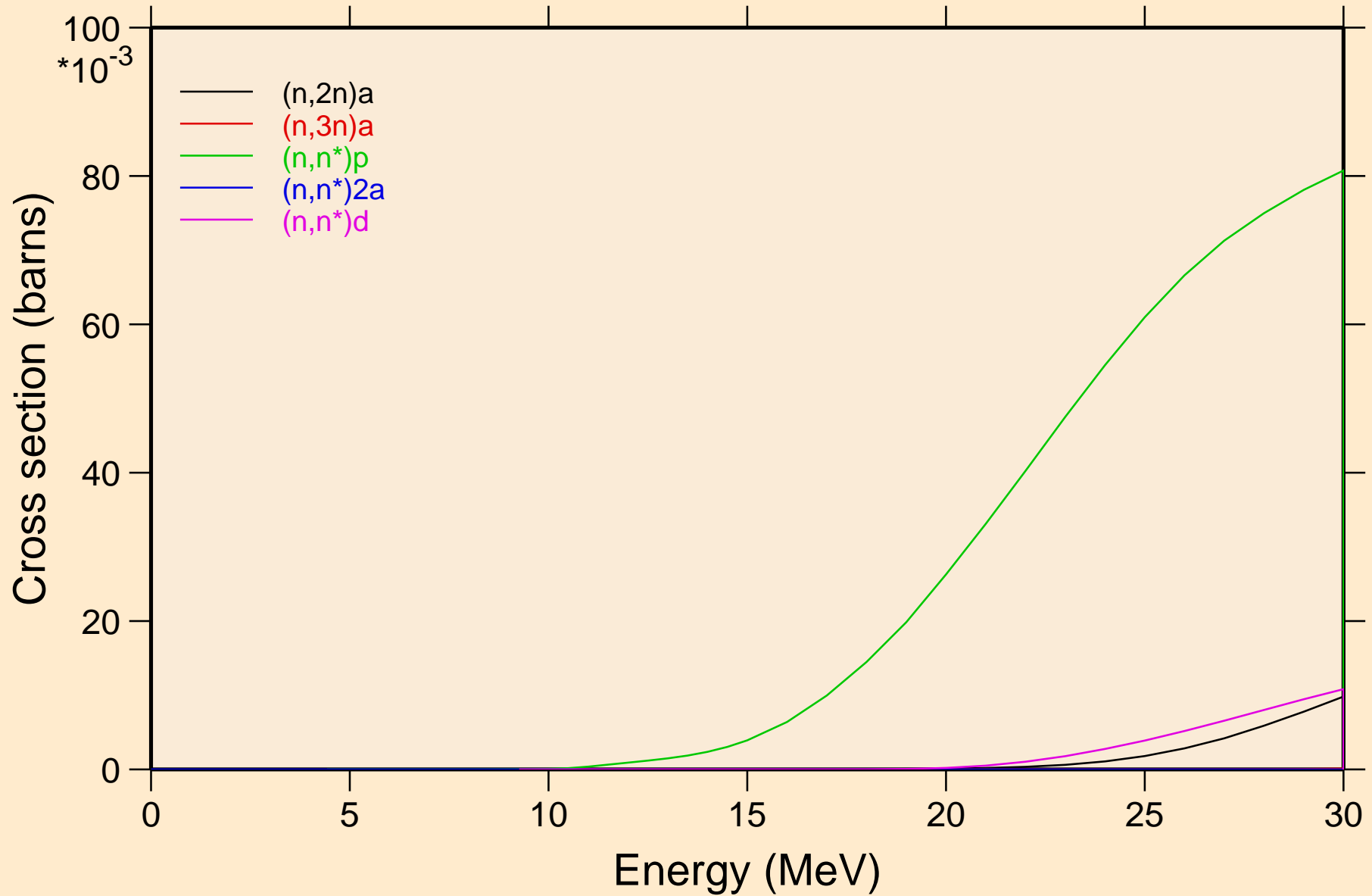

PO207 NEUTRON ACER TENDL-2024 LIBRARY; T=293.6K  
Threshold reactions

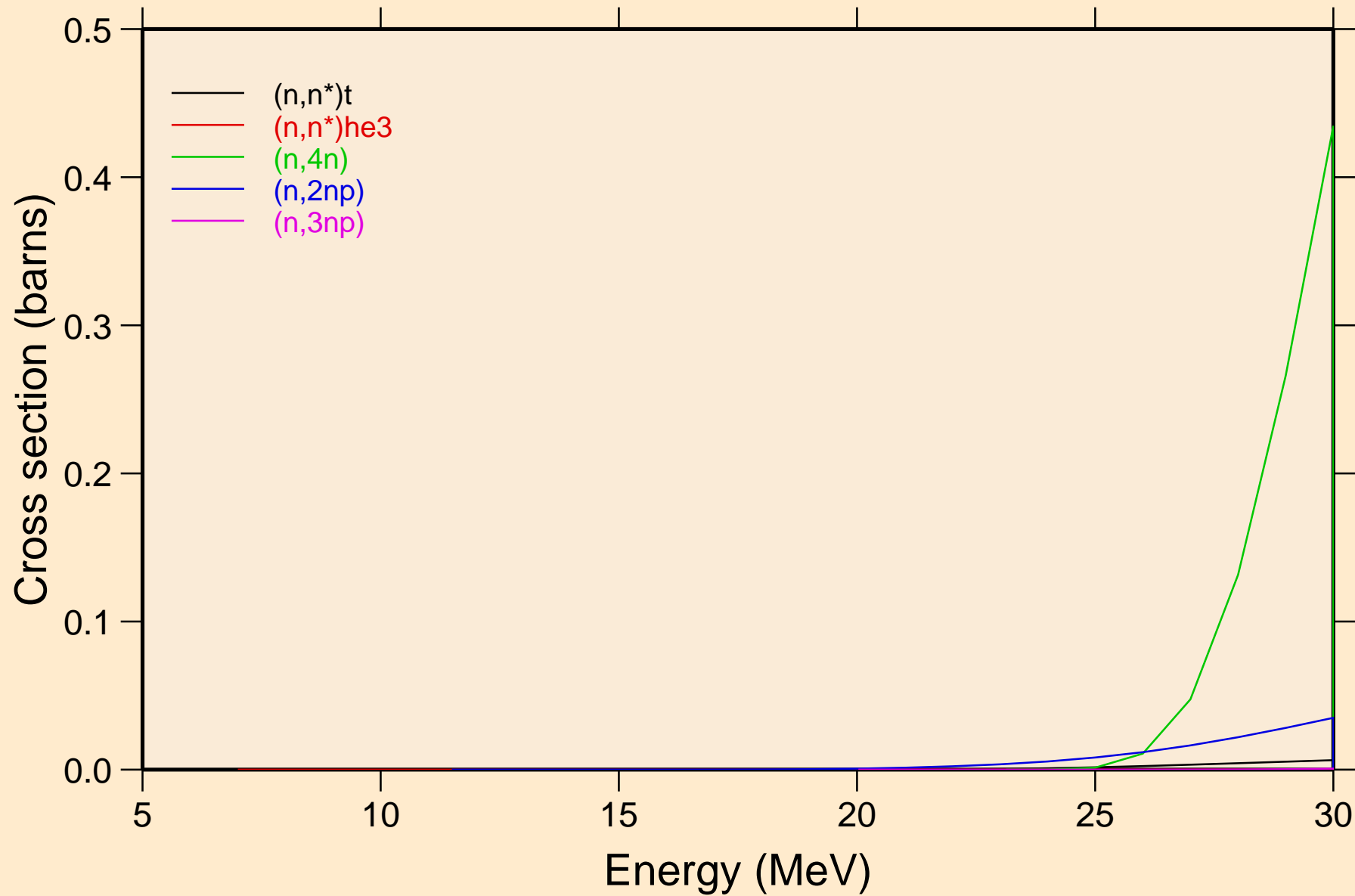

PO207 NEUTRON ACER TENDL-2024 LIBRARY; T=293.6K  
Threshold reactions

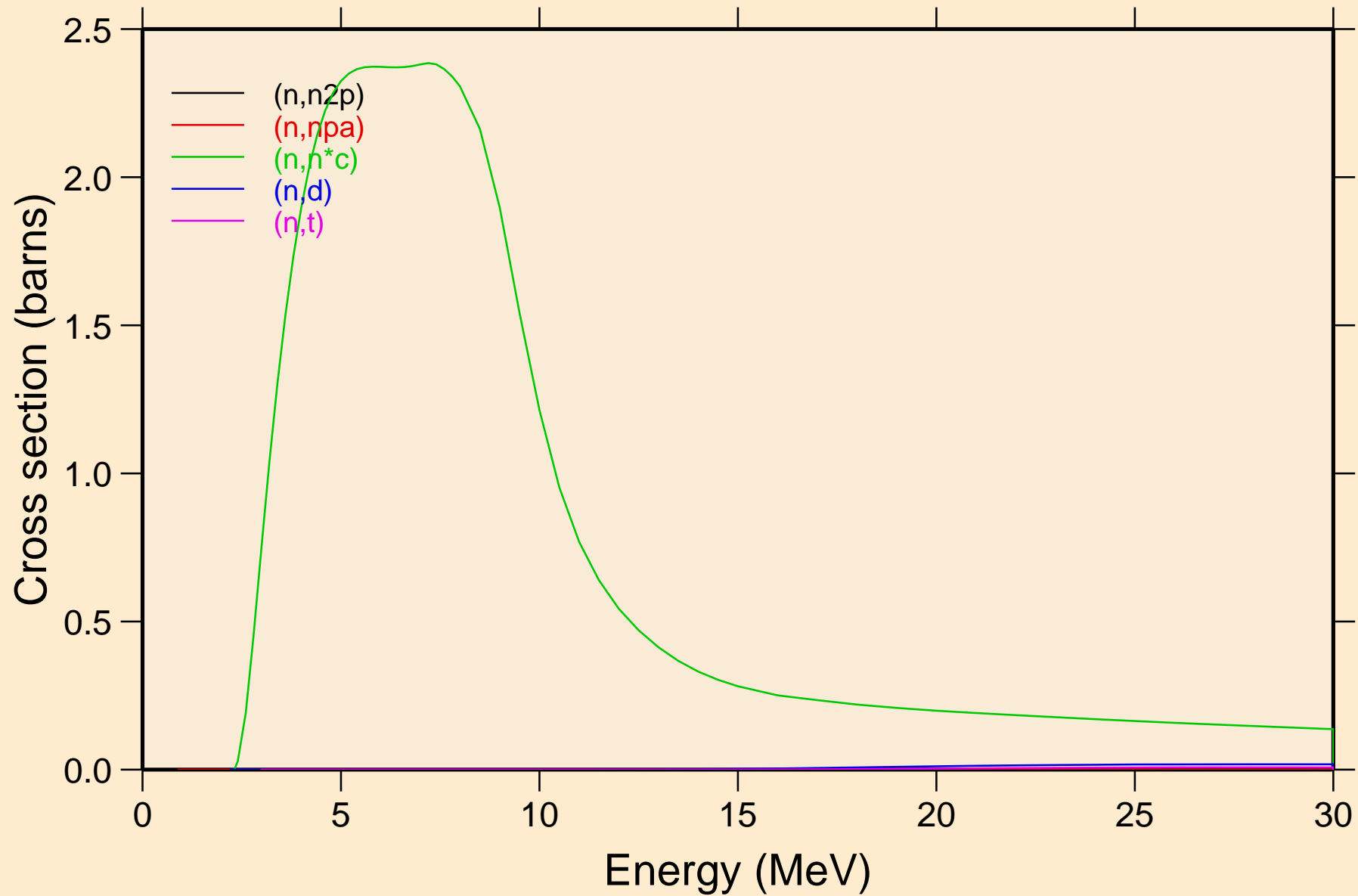

PO207 NEUTRON ACER TENDL-2024 LIBRARY; T=293.6K  
Threshold reactions

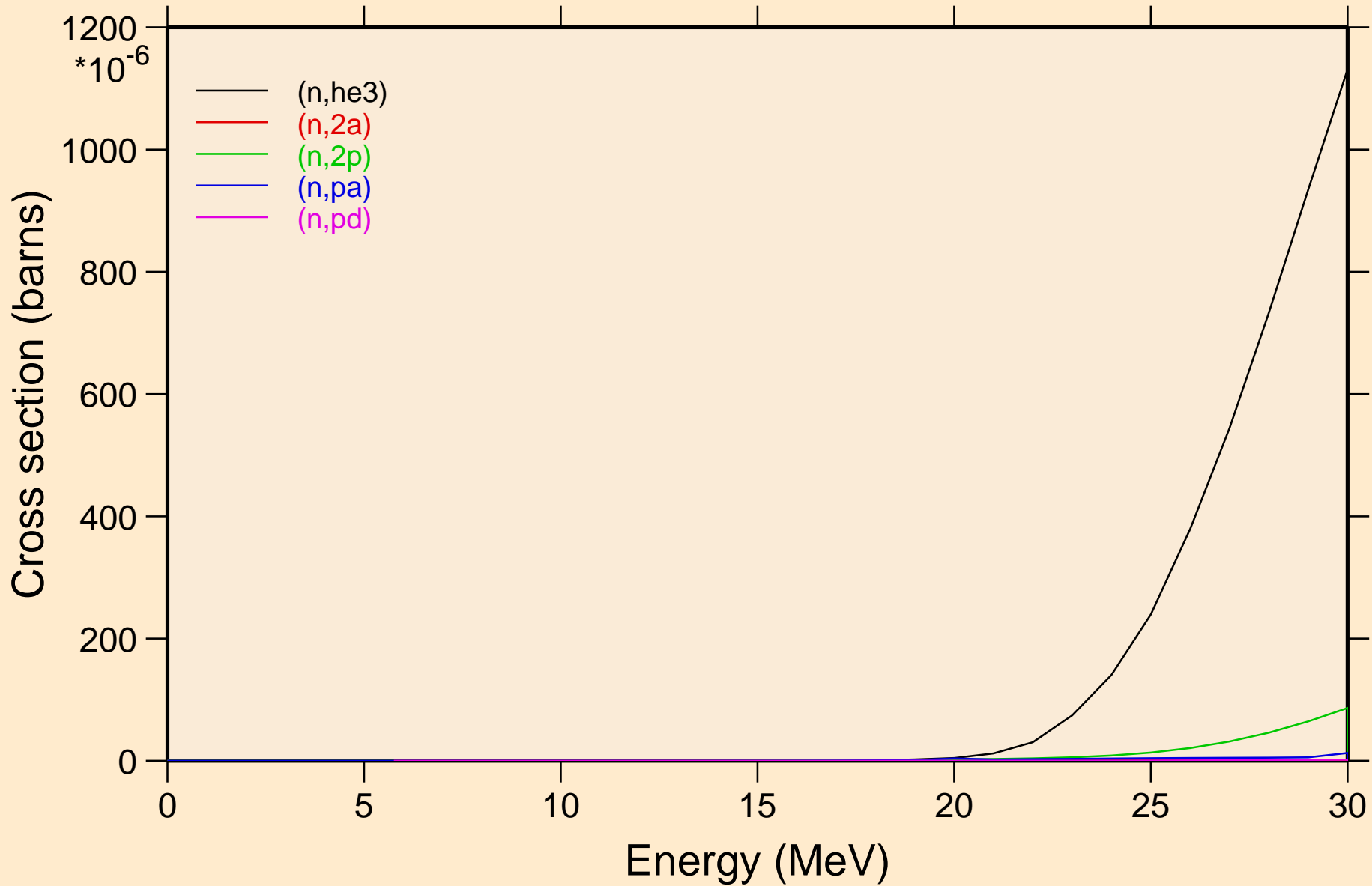

PO207 NEUTRON ACER TENDL-2024 LIBRARY; T=293.6K  
Threshold reactions

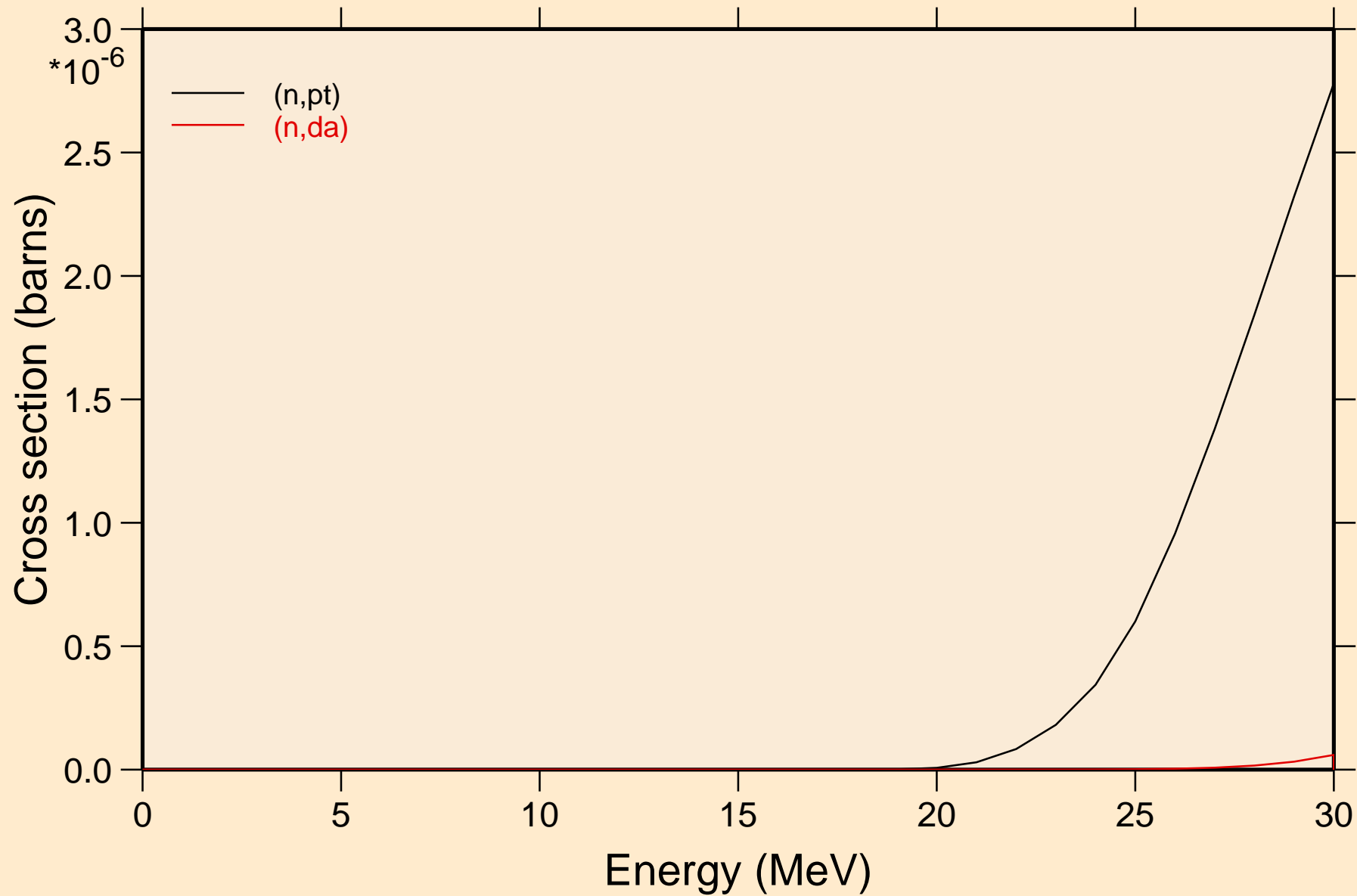

PO207 NEUTRON ACER TENDL-2024 LIBRARY; T=293.6K  
Threshold reactions

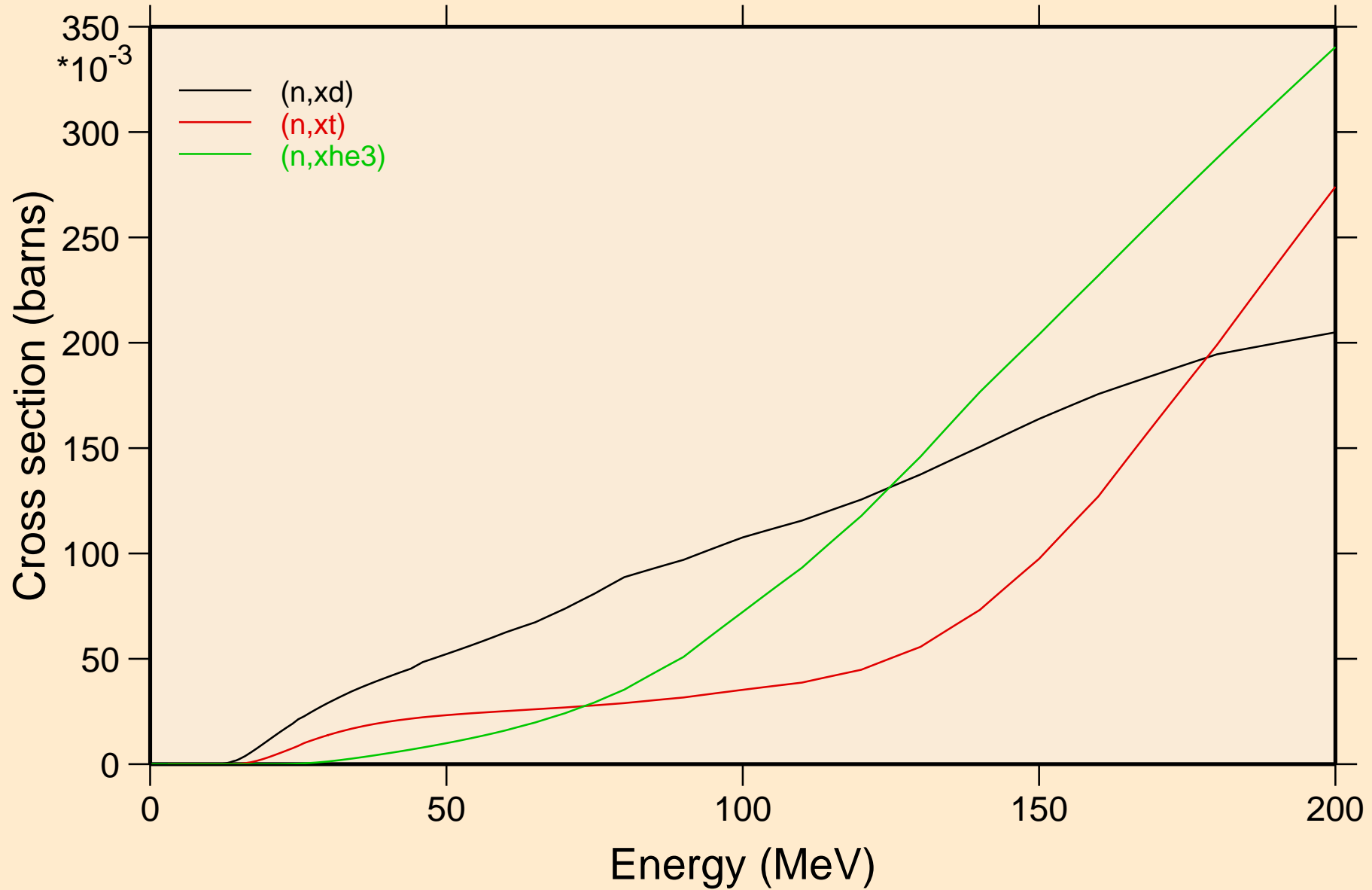

PO207 NEUTRON ACER TENDL-2024 LIBRARY; T=293.6K  
angular distribution for elastic

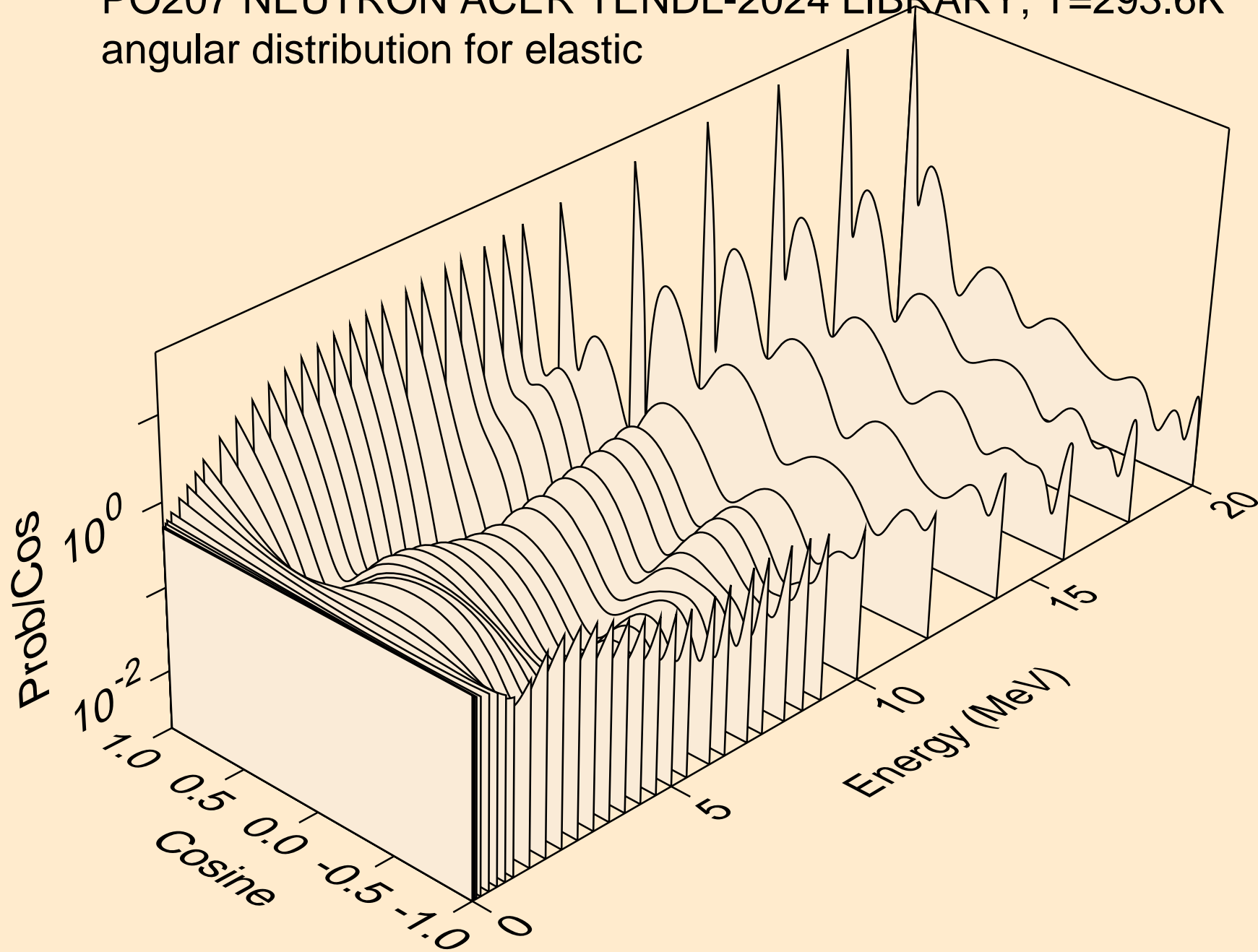

PO207 NEUTRON ACER TENDL-2024 LIBRARY; T=293.6K  
angular distribution for elastic

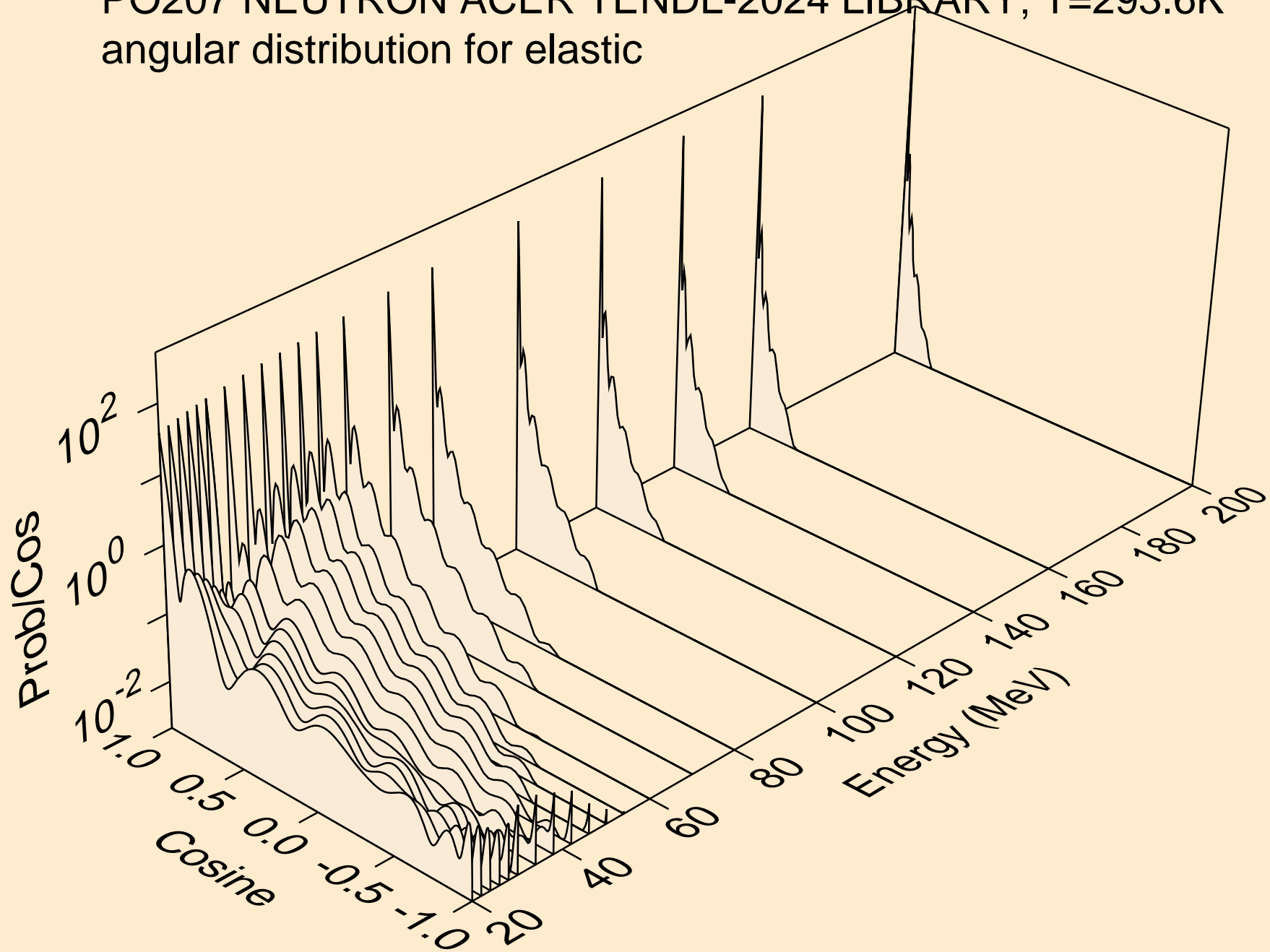

PO207 NEUTRON ACER TENDL-2024 LIBRARY; T=293.6K  
angular distribution for (n,n\*1)

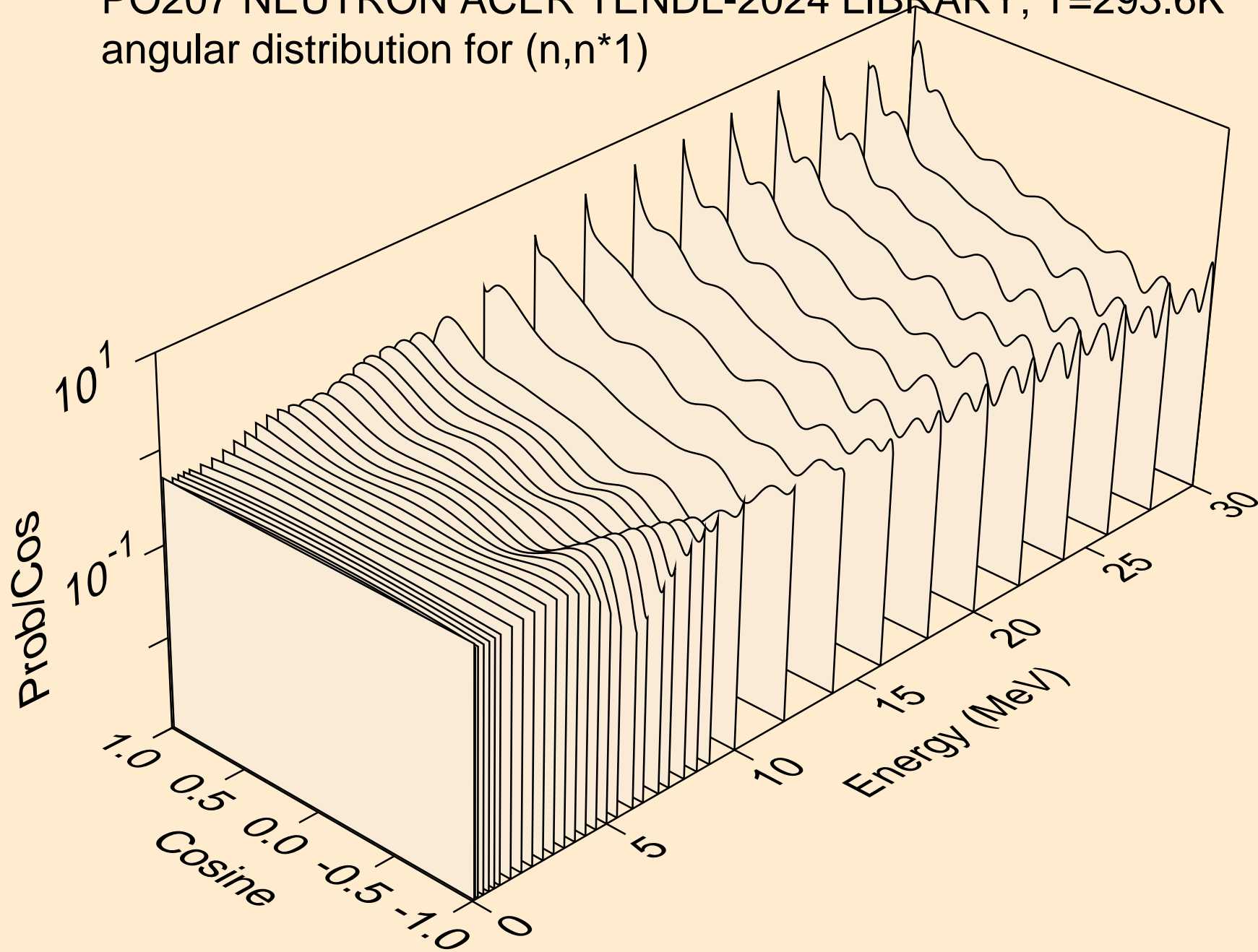

PO207 NEUTRON ACER TENDL-2024 LIBRARY; T=293.6K  
angular distribution for (n,n\*2)

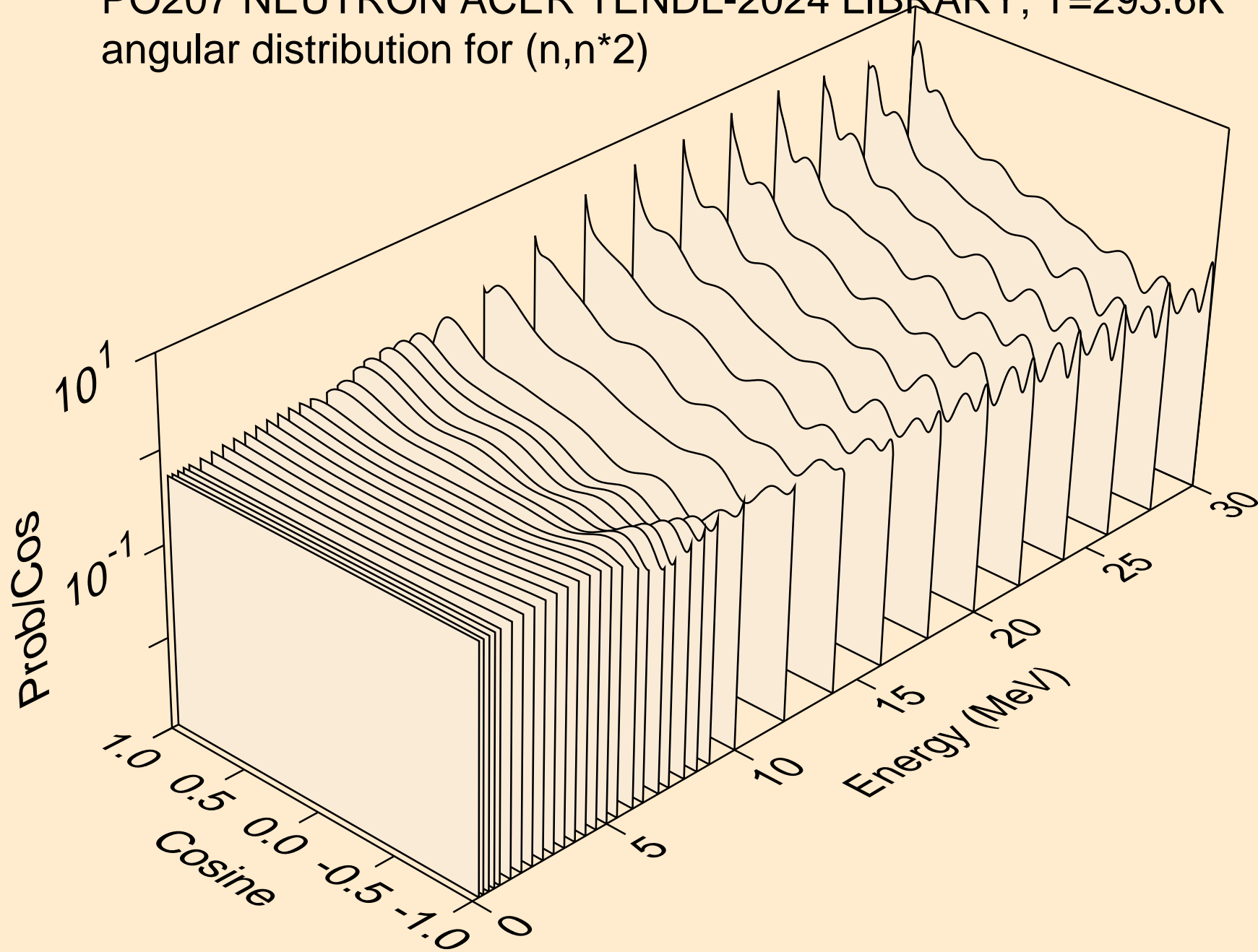

PO207 NEUTRON ACER TENDL-2024 LIBRARY; T=293.6K  
angular distribution for (n,n\*3)

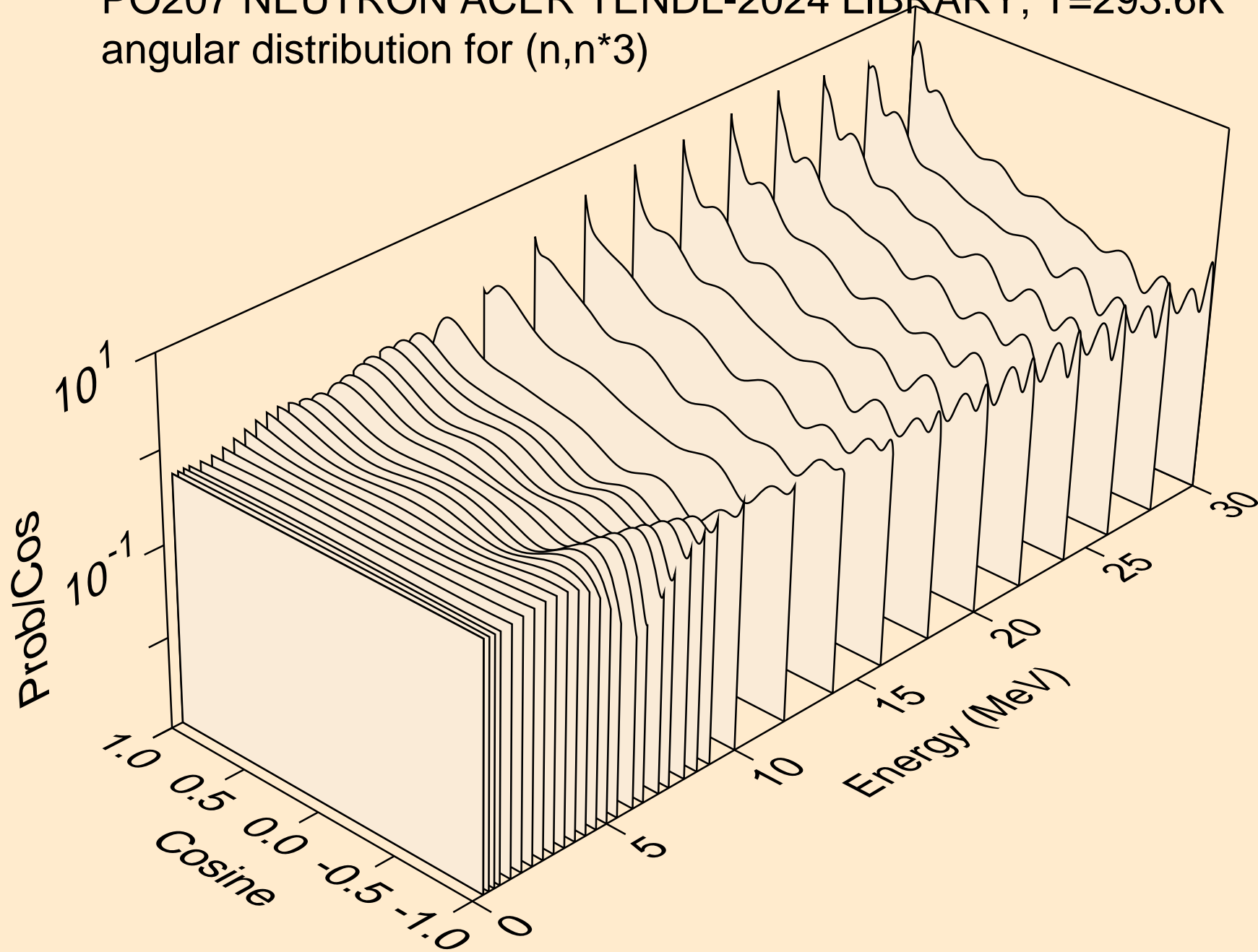

PO207 NEUTRON ACER TENDL-2024 LIBRARY; T=293.6K  
angular distribution for (n,n\*4)

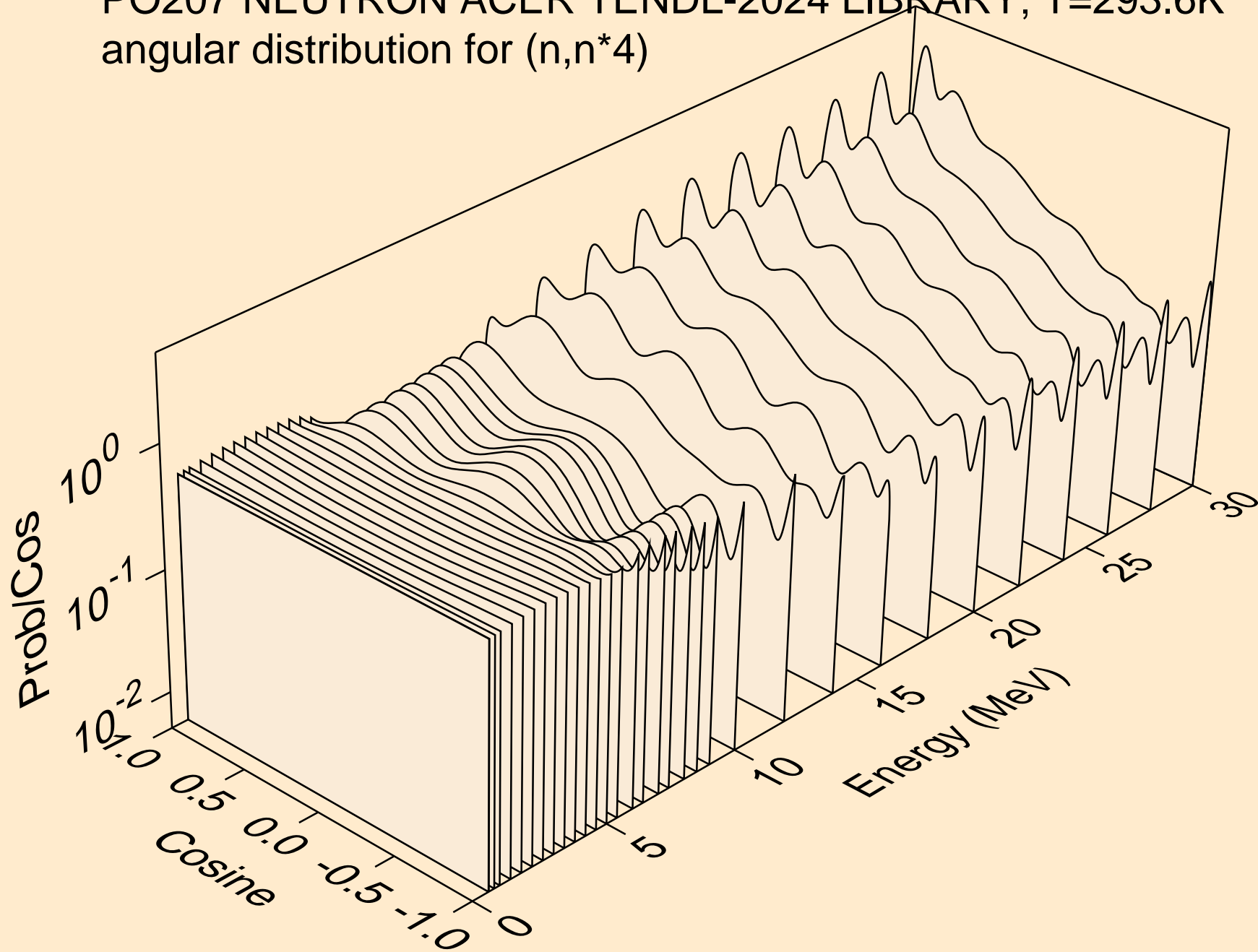

PO207 NEUTRON ACER TENDL-2024 LIBRARY; T=293.6K  
angular distribution for (n,n\*5)

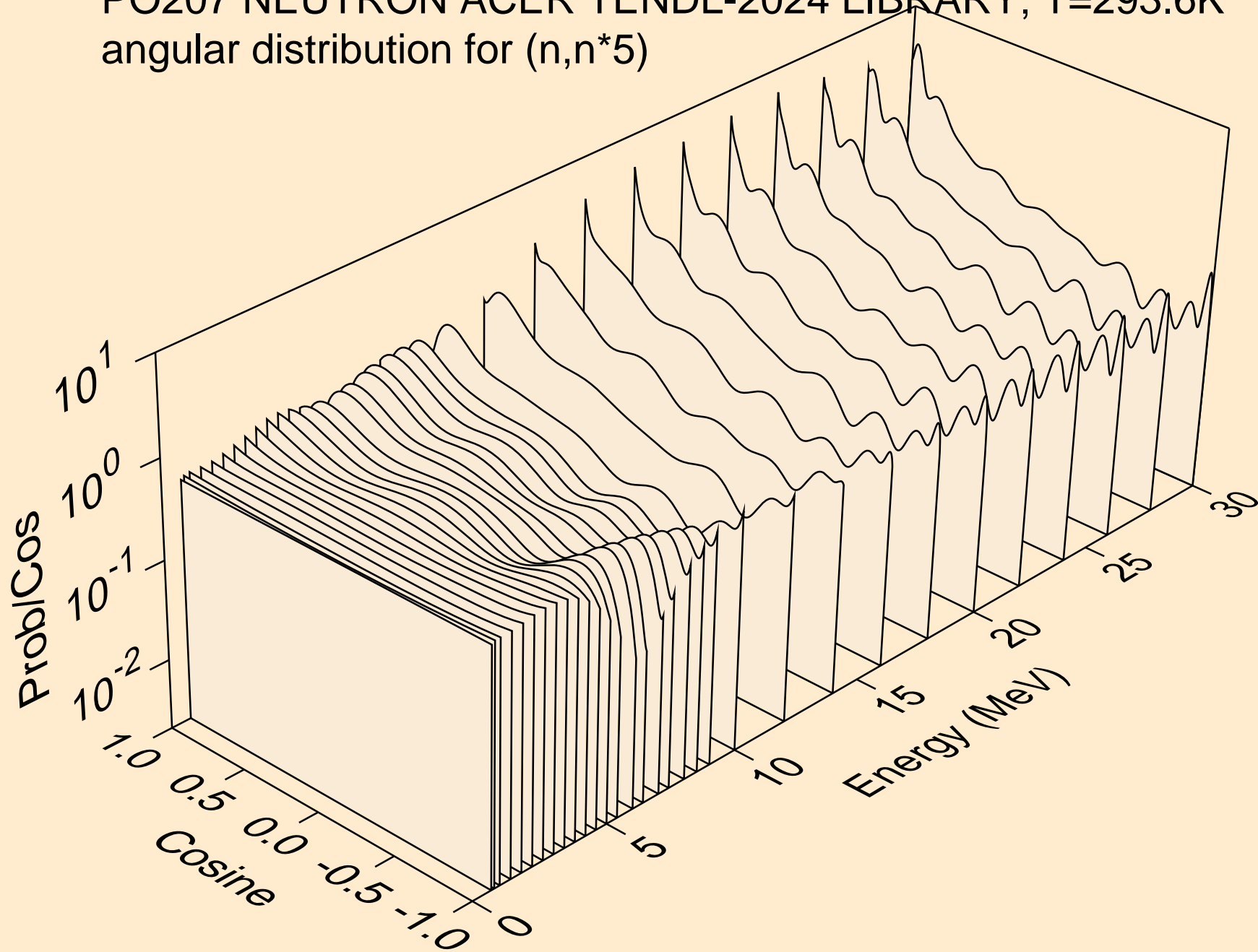

PO207 NEUTRON ACER TENDL-2024 LIBRARY; T=293.6K  
angular distribution for (n,n\*6)

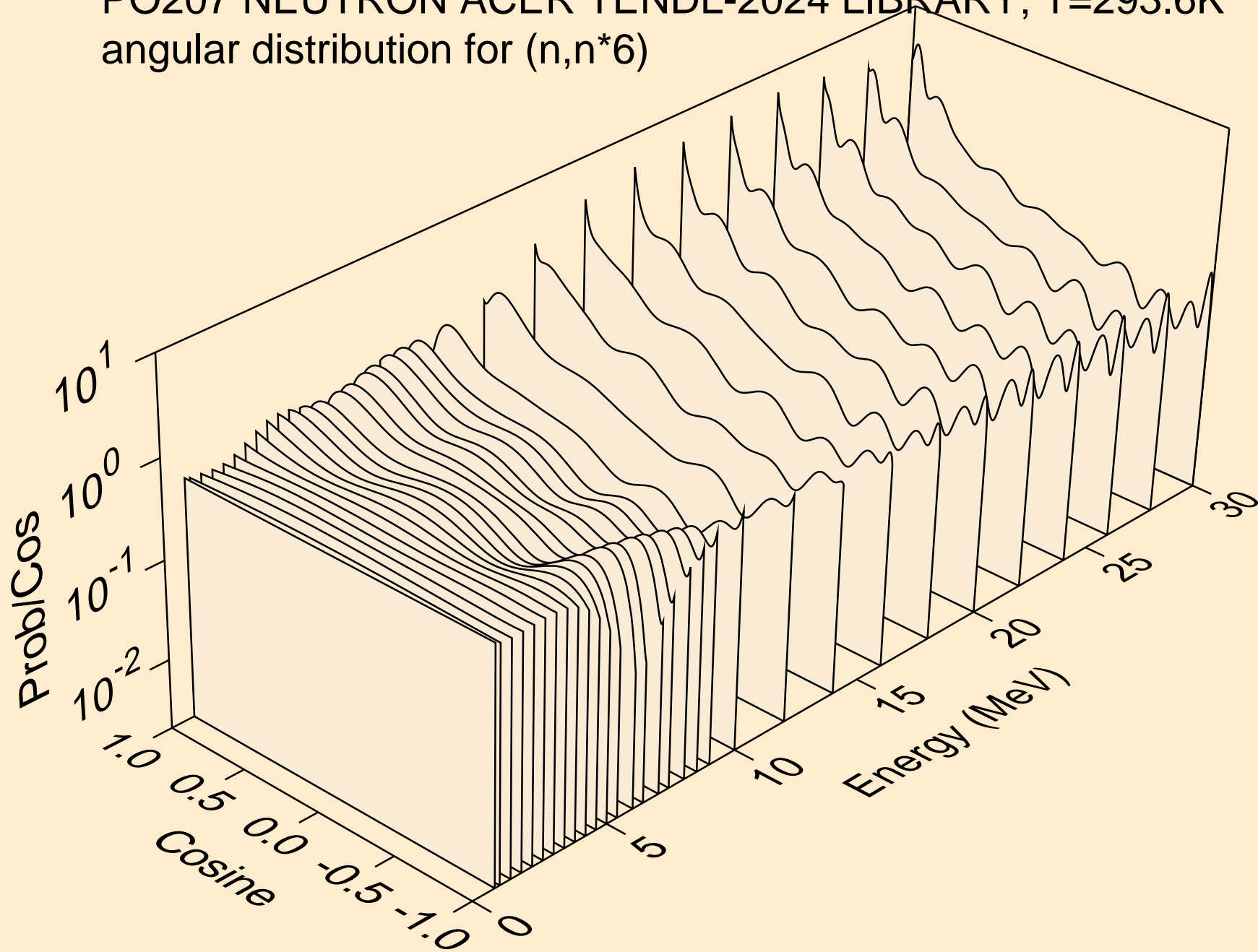

PO207 NEUTRON ACER TENDL-2024 LIBRARY; T=293.6K  
angular distribution for (n,n\*7)

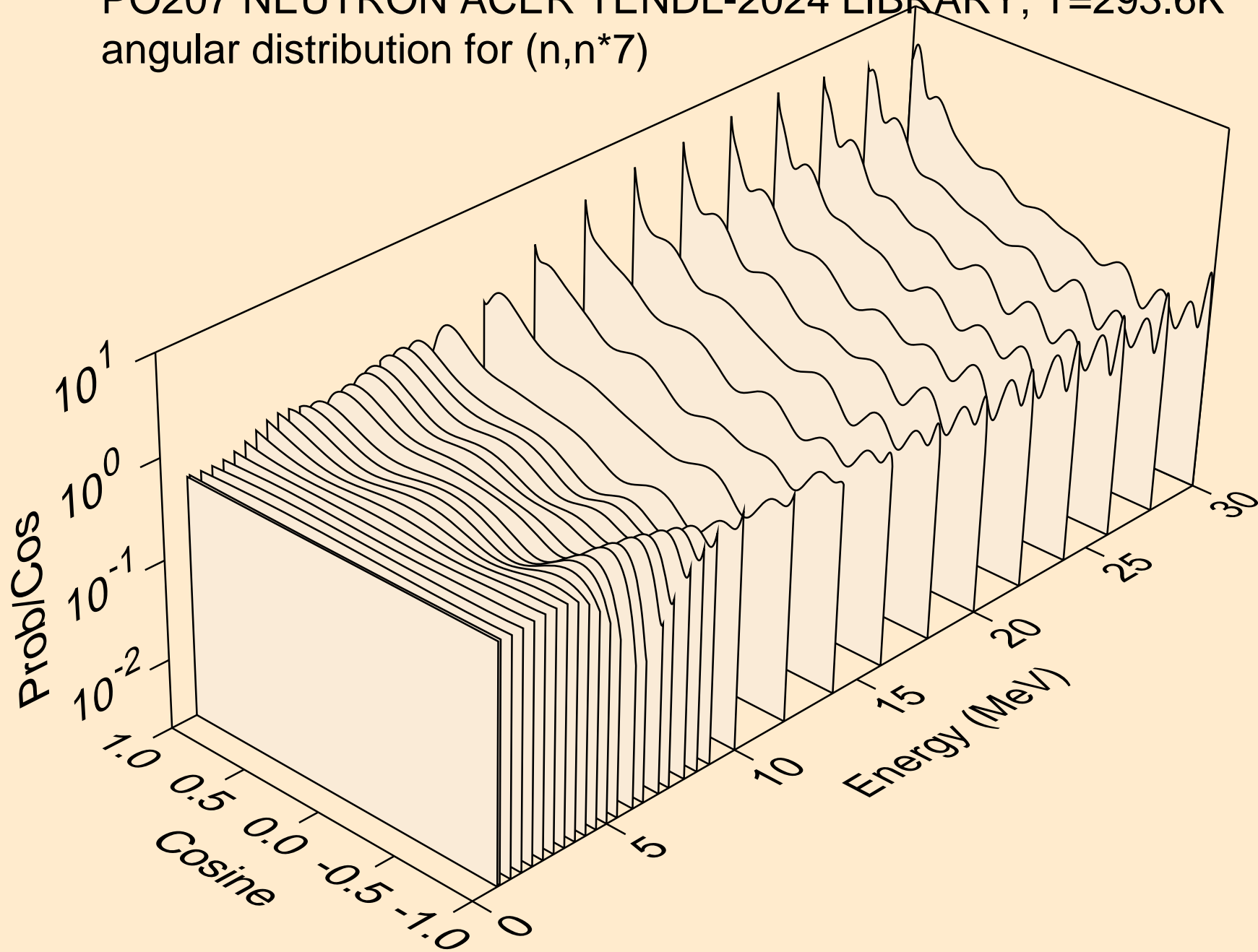

PO207 NEUTRON ACER TENDL-2024 LIBRARY; T=293.6K  
angular distribution for (n,n\*8)

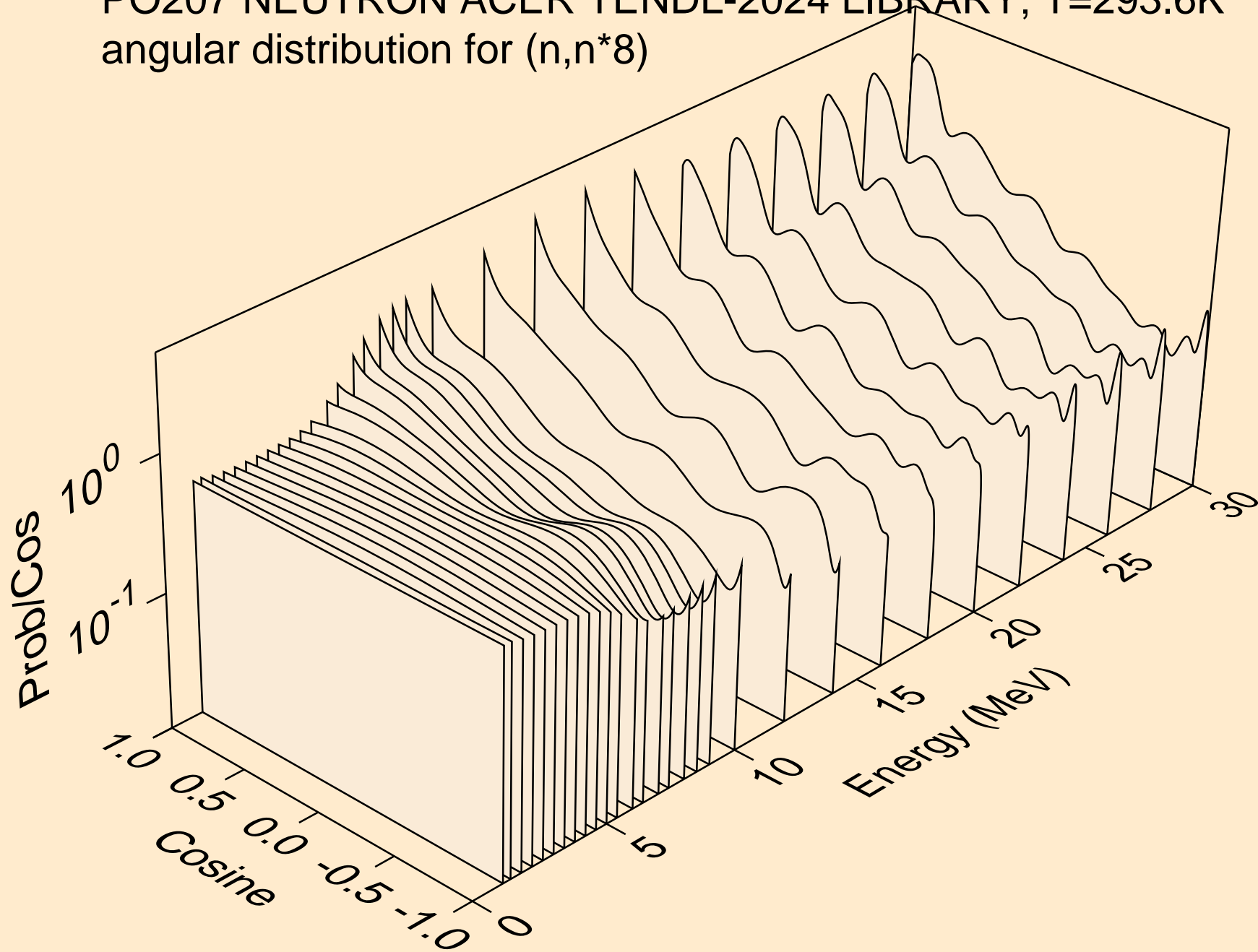

PO207 NEUTRON ACER TENDL-2024 LIBRARY; T=293.6K  
angular distribution for (n,n\*9)

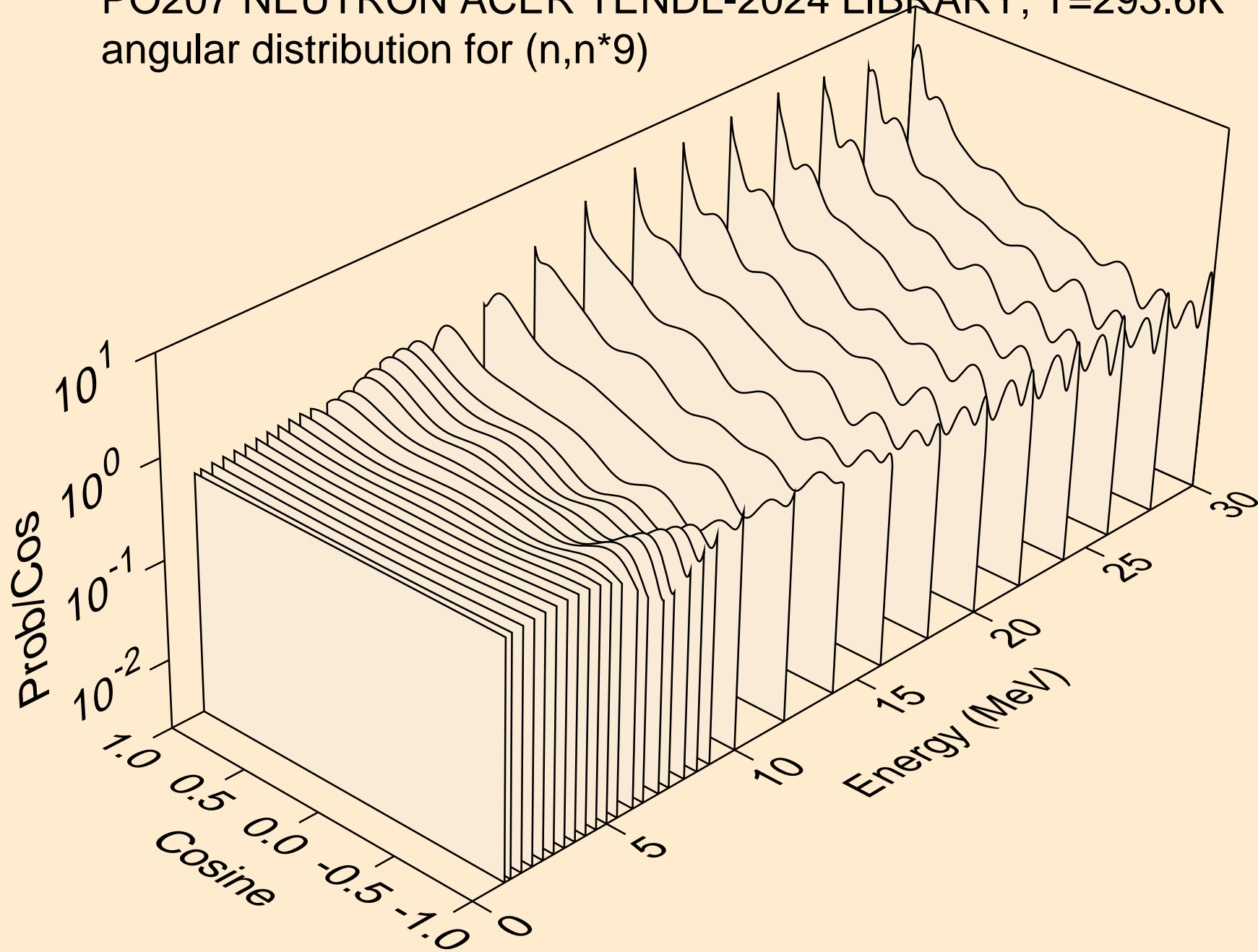

PO207 NEUTRON ACER TENDL-2024 LIBRARY; T=293.6K  
angular distribution for (n,n\*10)

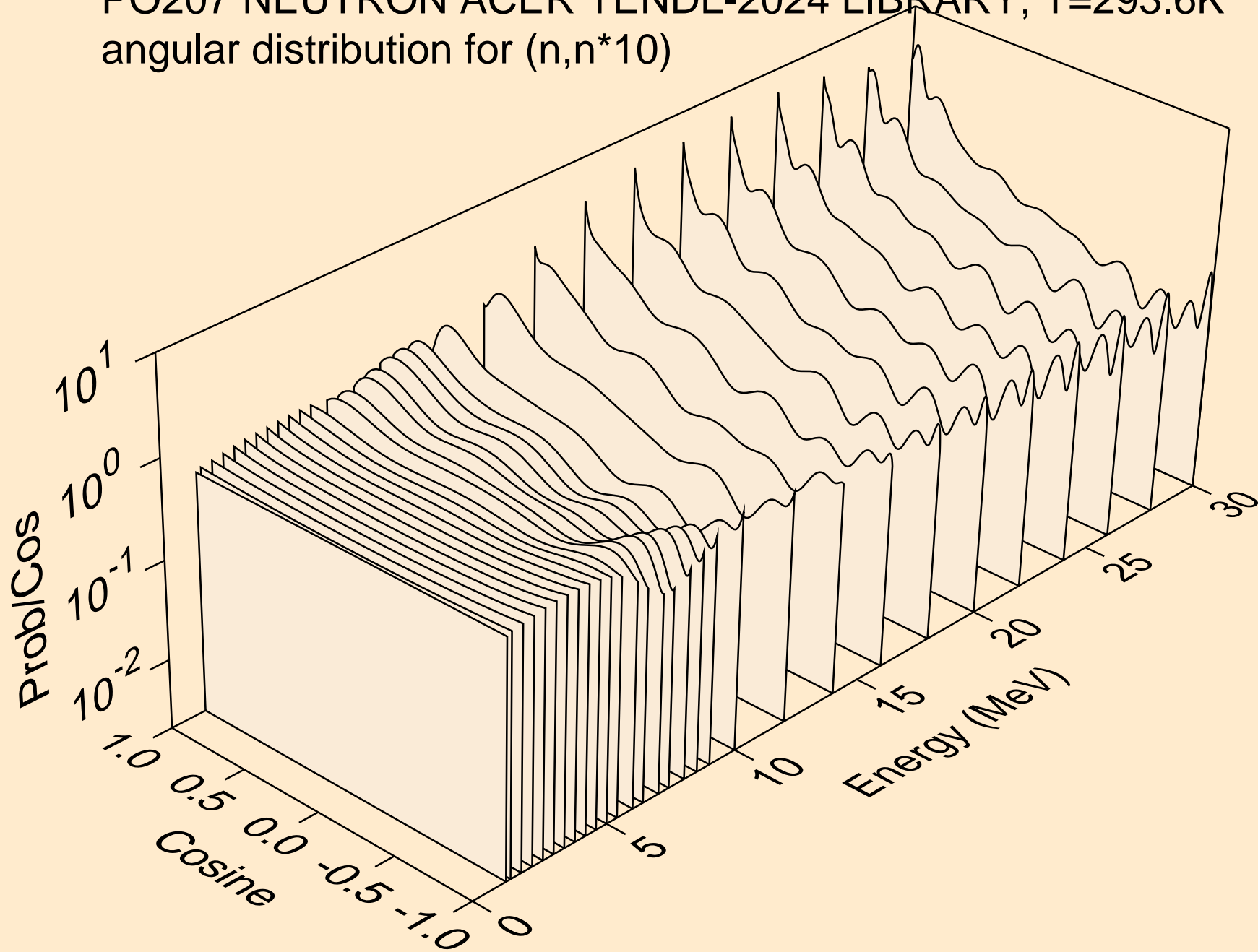

PO207 NEUTRON ACER TENDL-2024 LIBRARY; T=293.6K  
angular distribution for (n,n\*11)

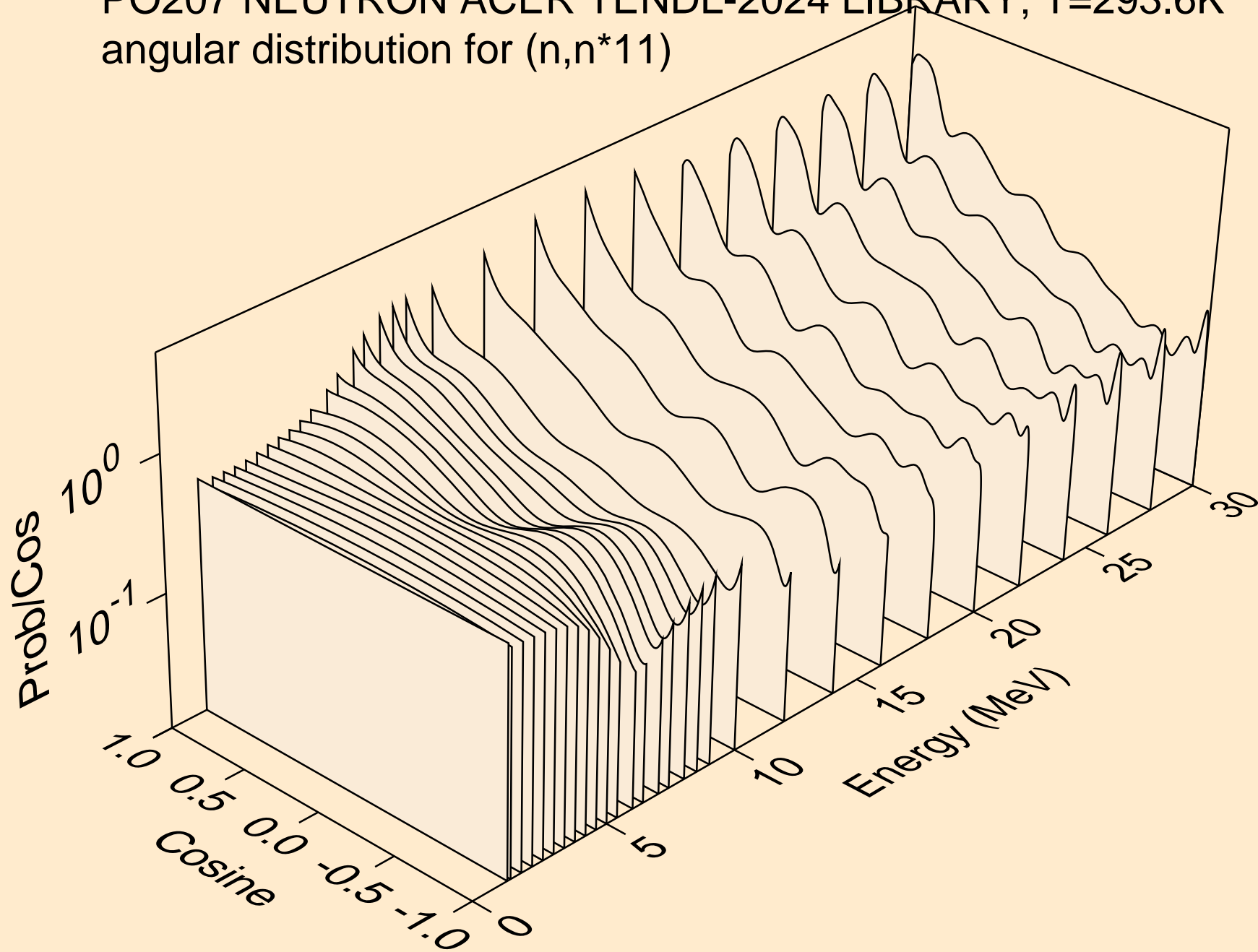

PO207 NEUTRON ACER TENDL-2024 LIBRARY; T=293.6K  
angular distribution for (n,n\*12)

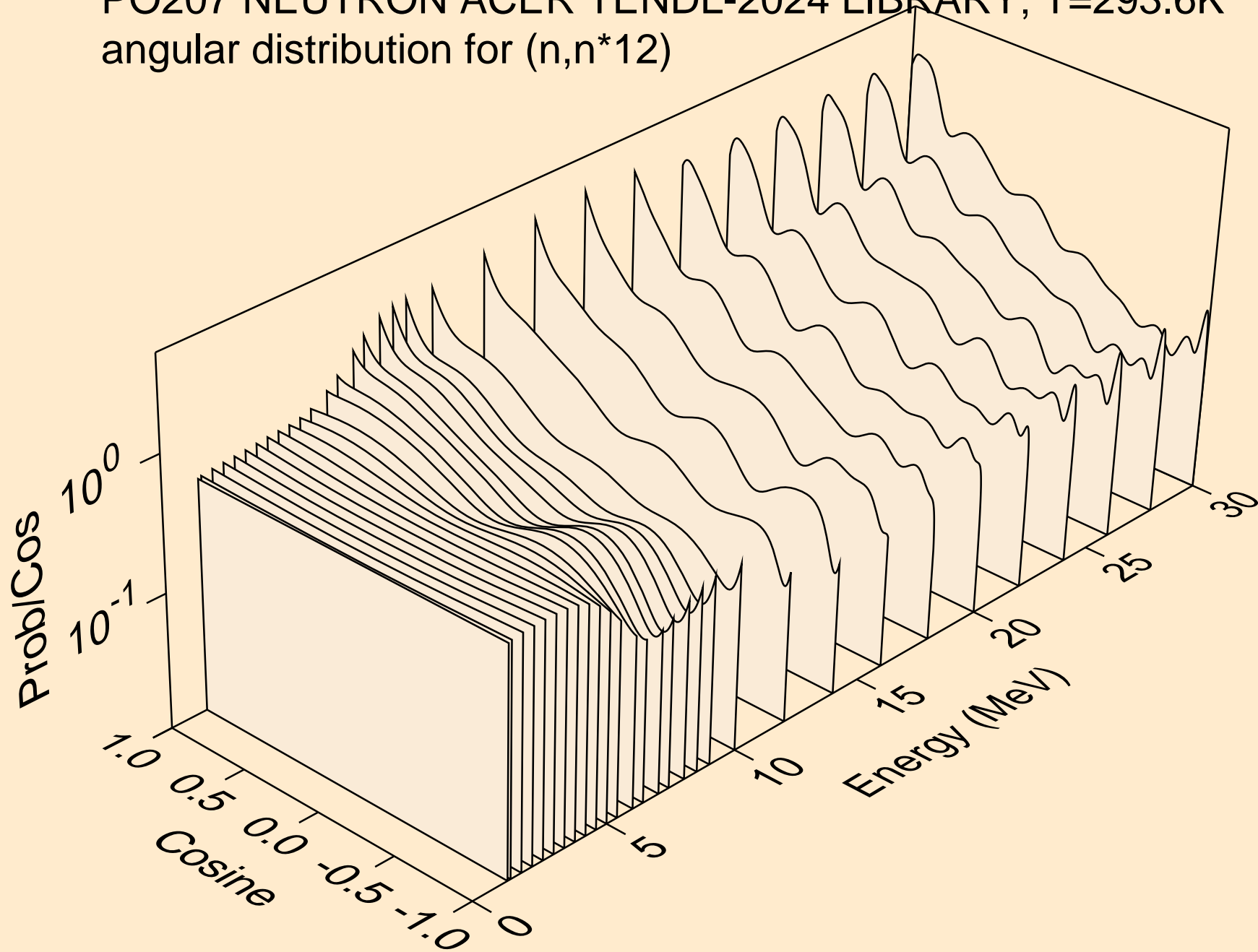

PO207 NEUTRON ACER TENDL-2024 LIBRARY; T=293.6K  
angular distribution for (n,n\*13)

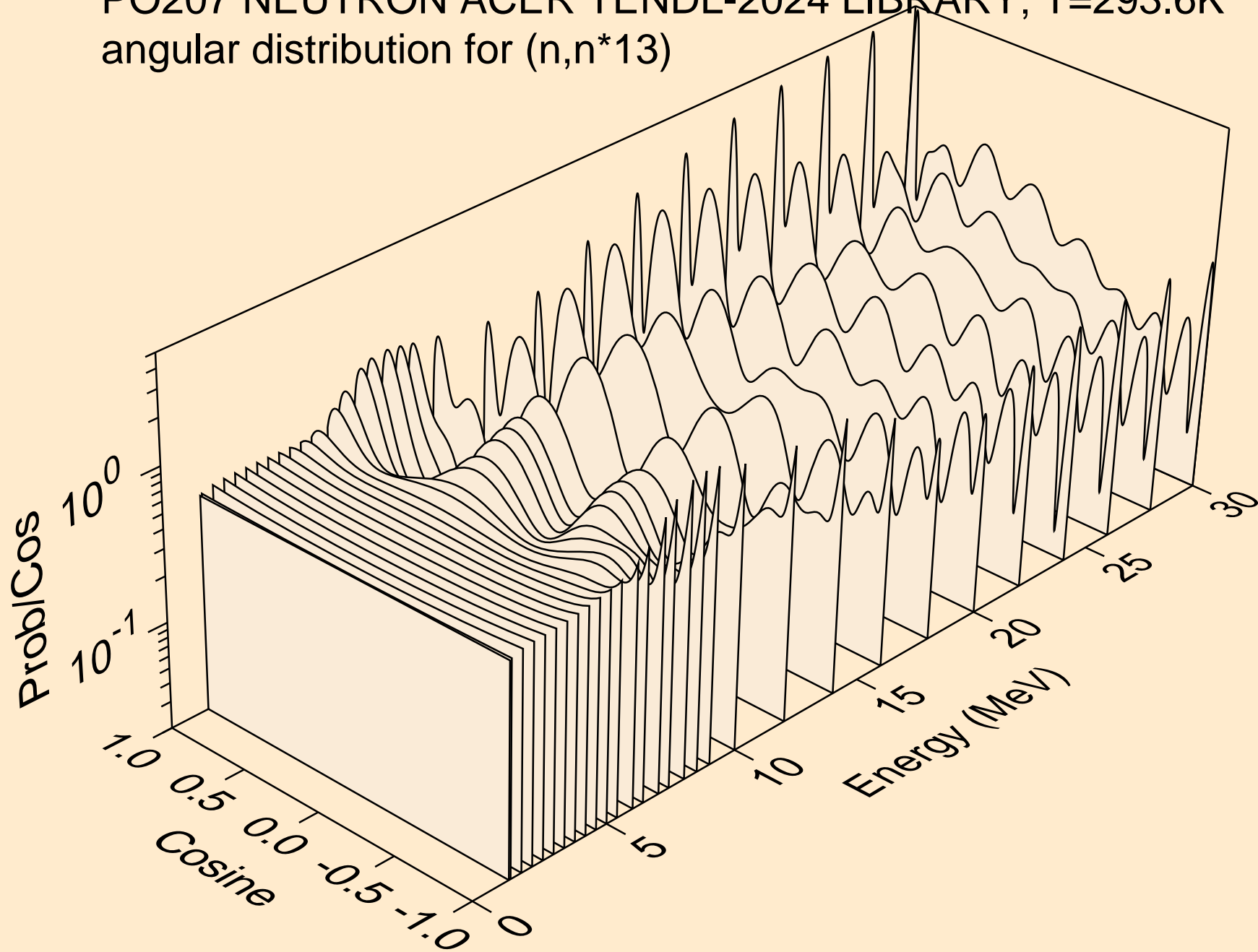

PO207 NEUTRON ACER TENDL-2024 LIBRARY; T=293.6K  
angular distribution for (n,n\*14)

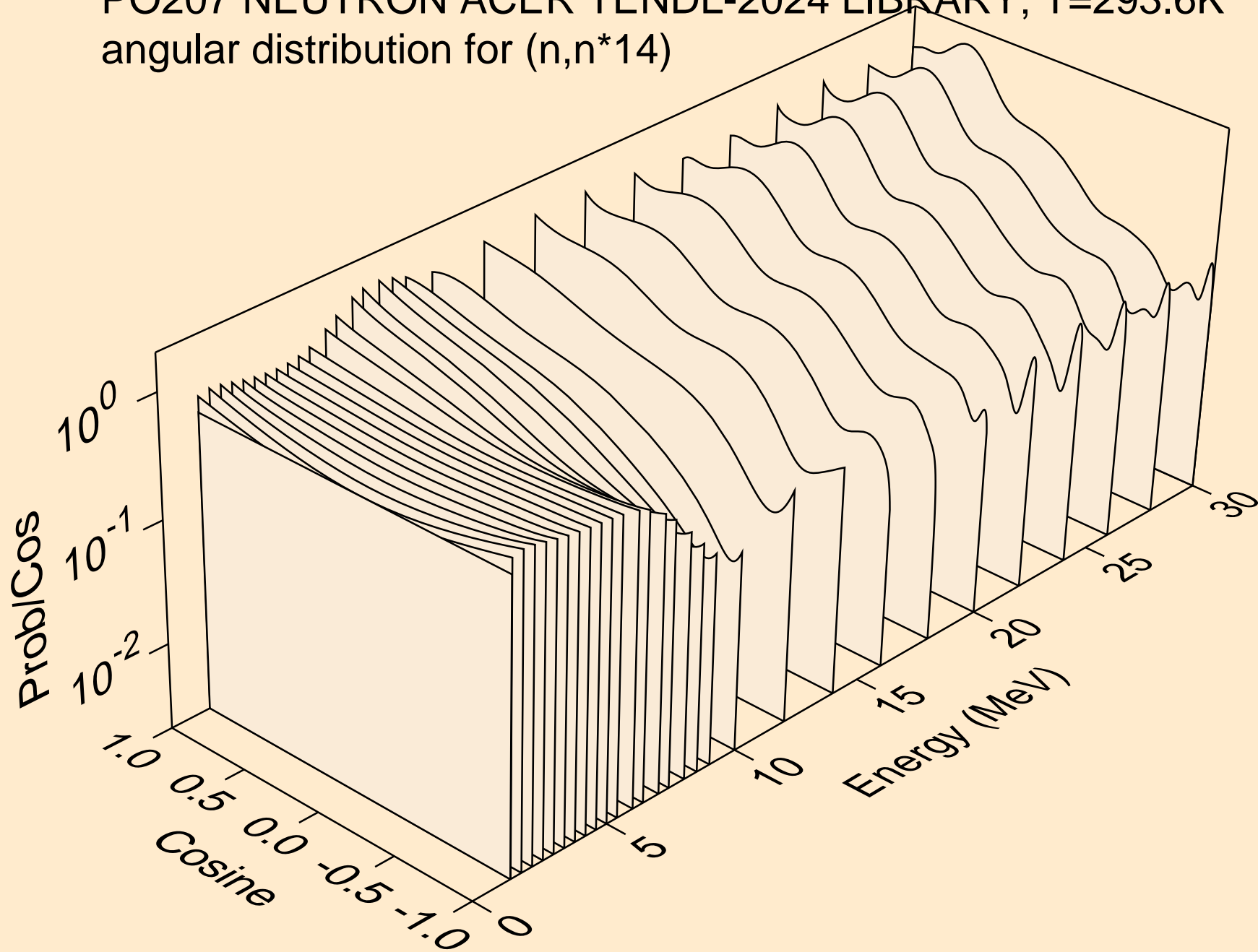

PO207 NEUTRON ACER TENDL-2024 LIBRARY; T=293.6K  
angular distribution for (n,n\*15)

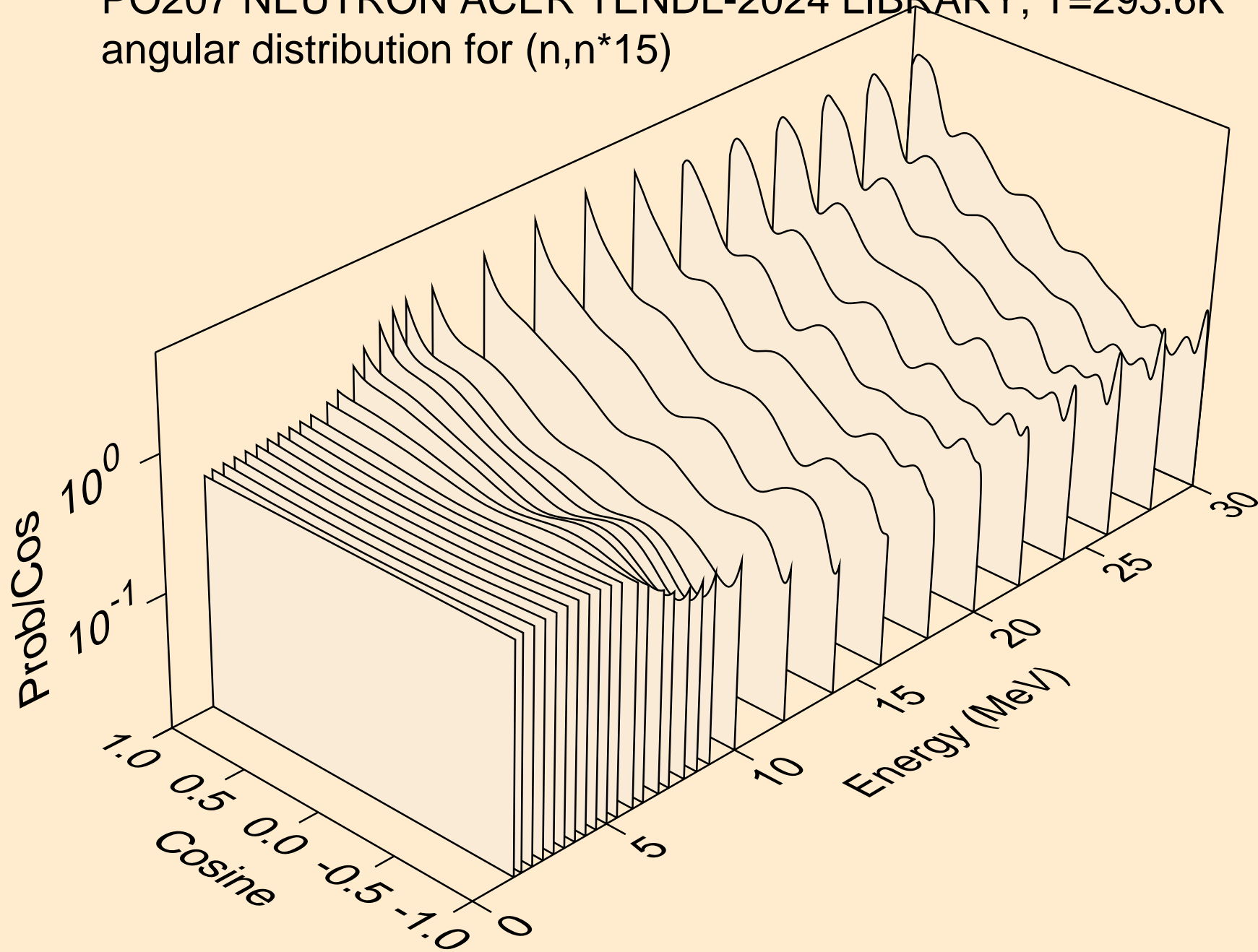

PO207 NEUTRON ACER TENDL-2024 LIBRARY; T=293.6K  
angular distribution for (n,n\*16)

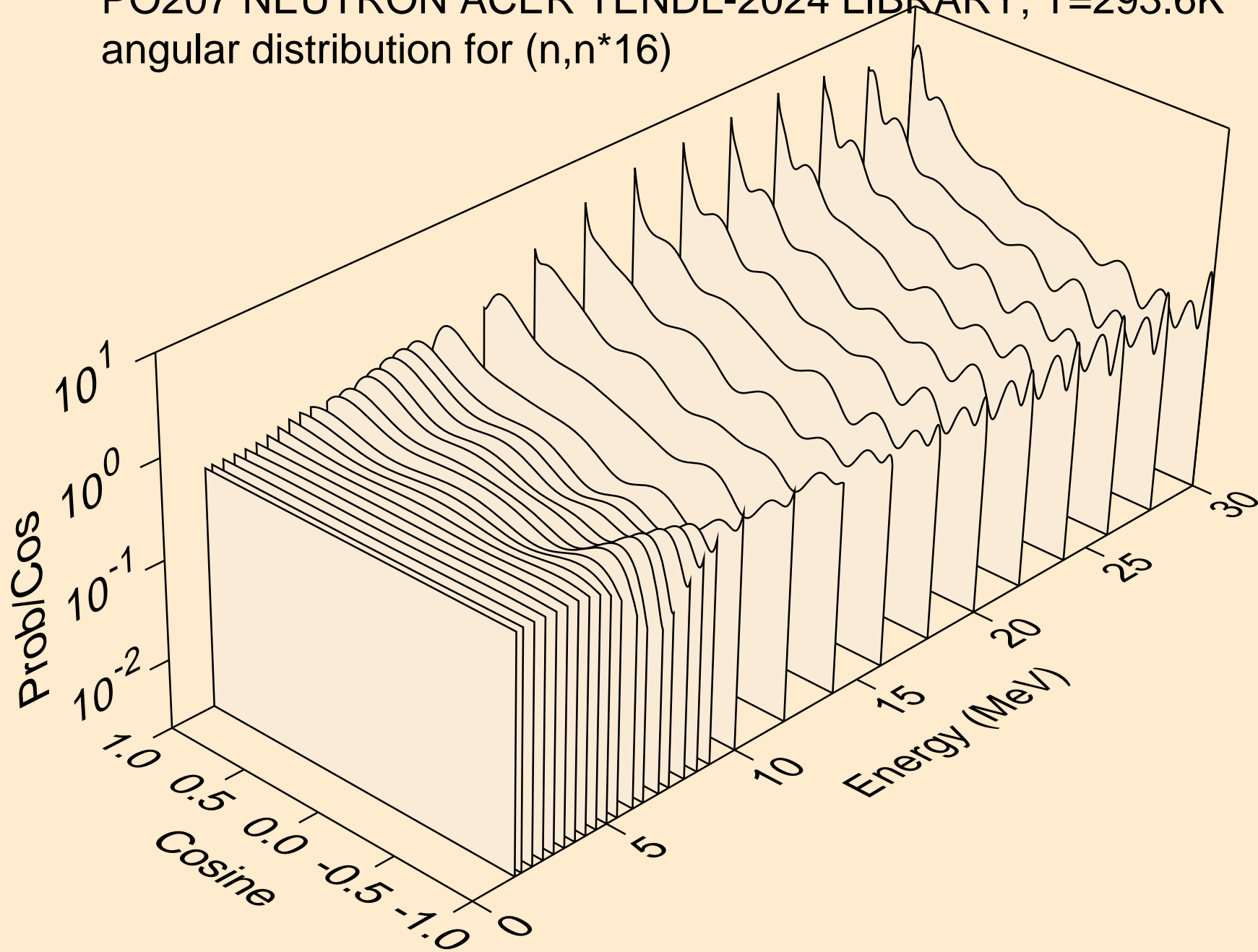

PO207 NEUTRON ACER TENDL-2024 LIBRARY; T=293.6K  
angular distribution for (n,n\*17)

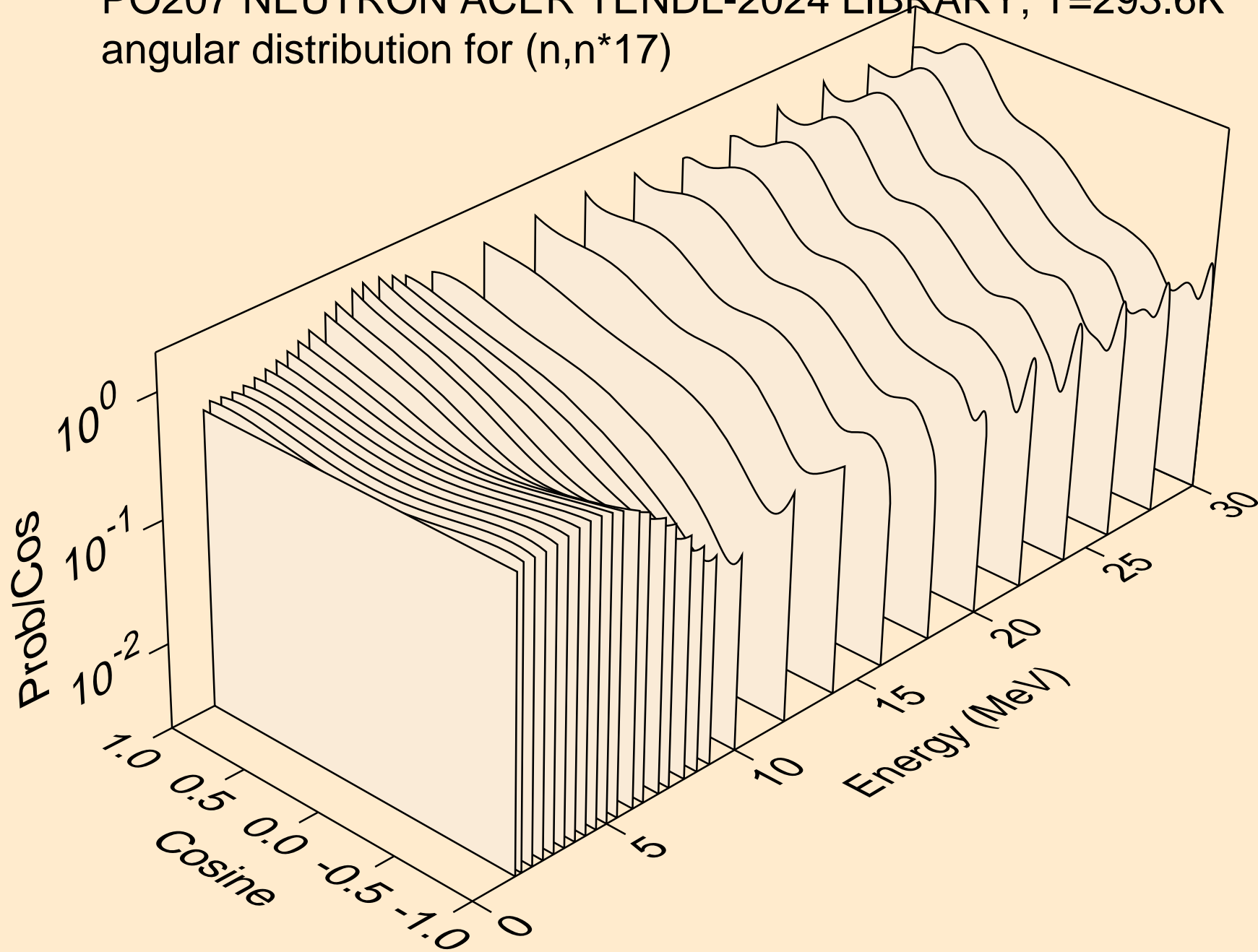

PO207 NEUTRON ACER TENDL-2024 LIBRARY; T=293.6K  
angular distribution for (n,n\*18)

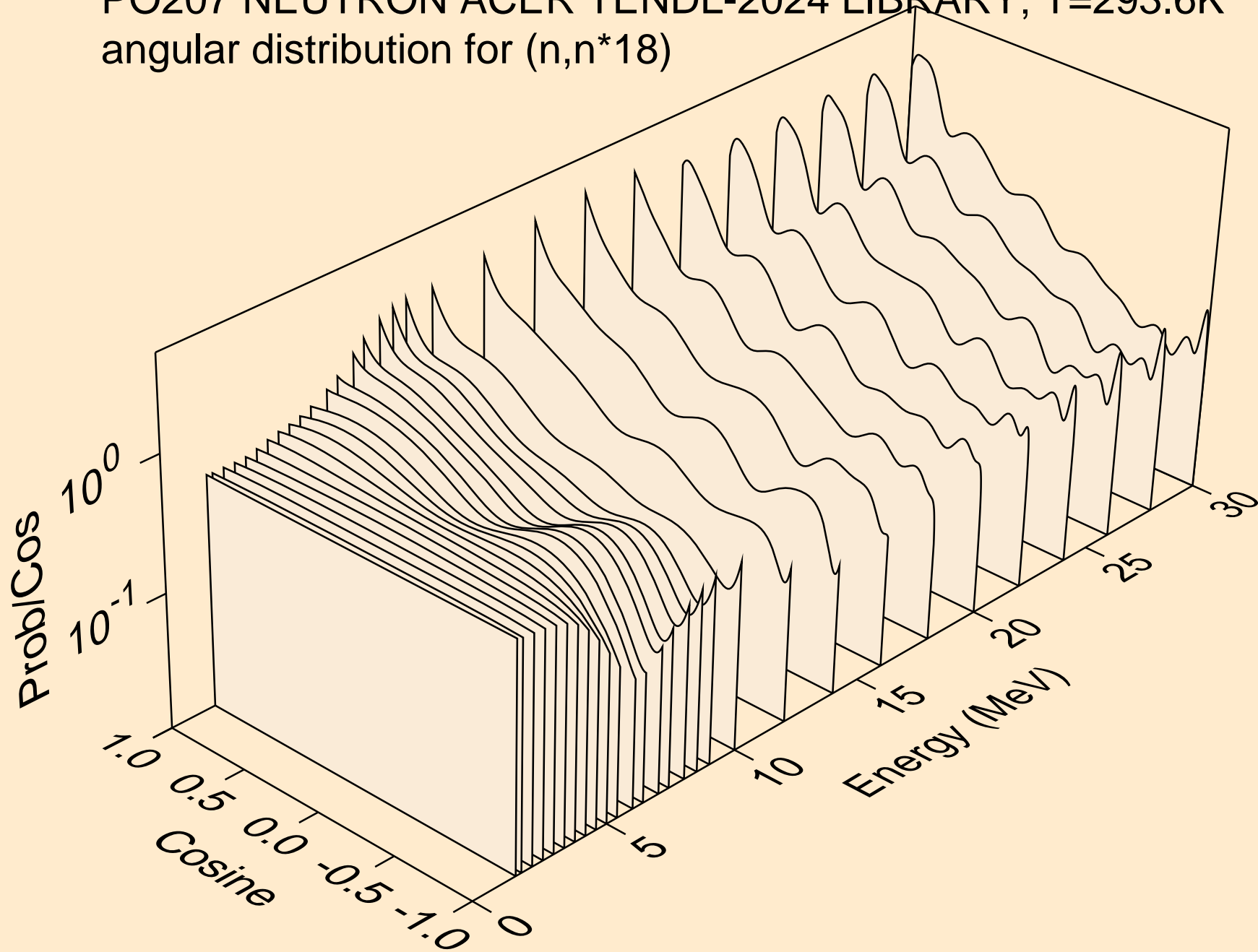

PO207 NEUTRON ACER TENDL-2024 LIBRARY; T=293.6K  
angular distribution for (n,n\*19)

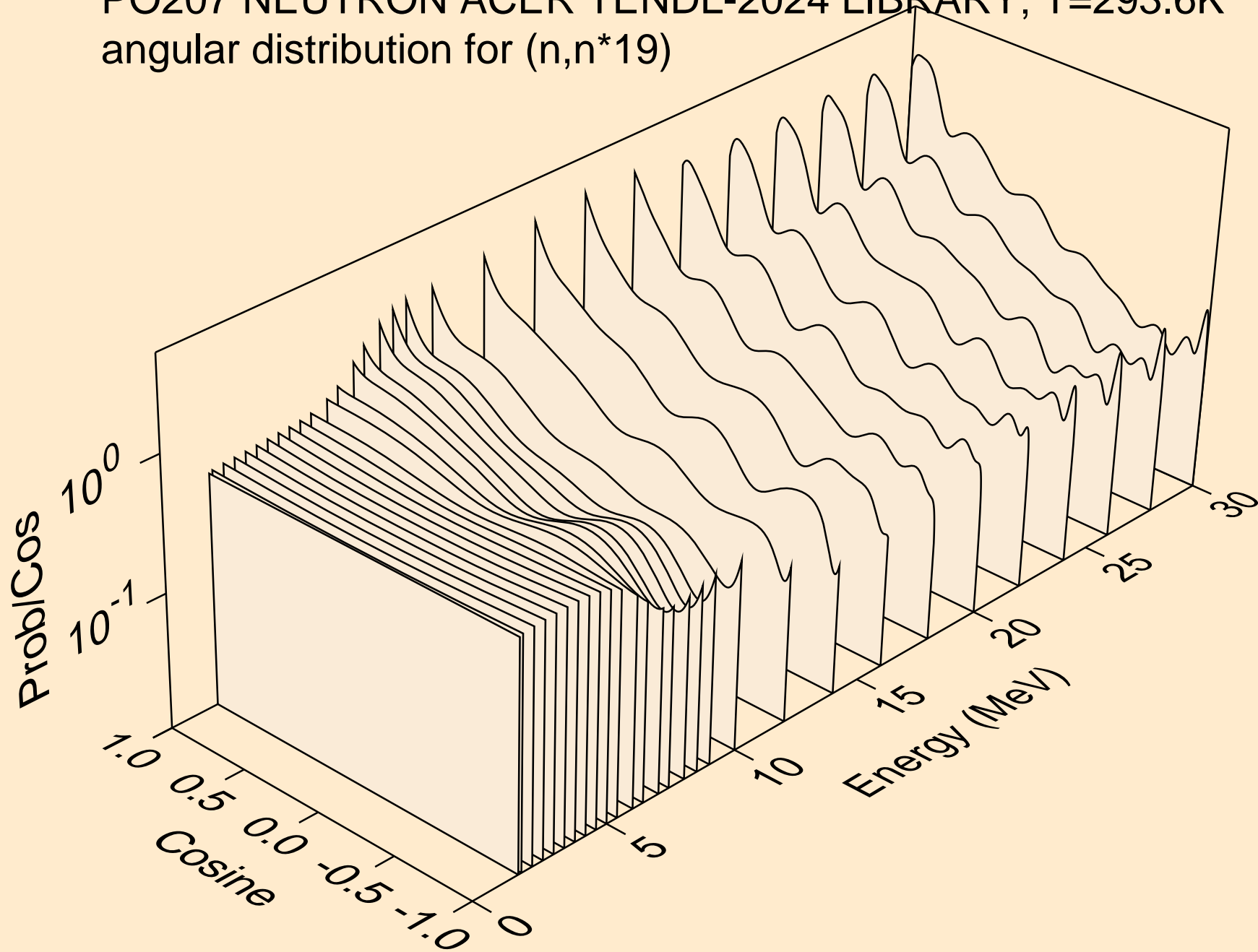

PO207 NEUTRON ACER TENDL-2024 LIBRARY; T=293.6K  
angular distribution for (n,n\*20)

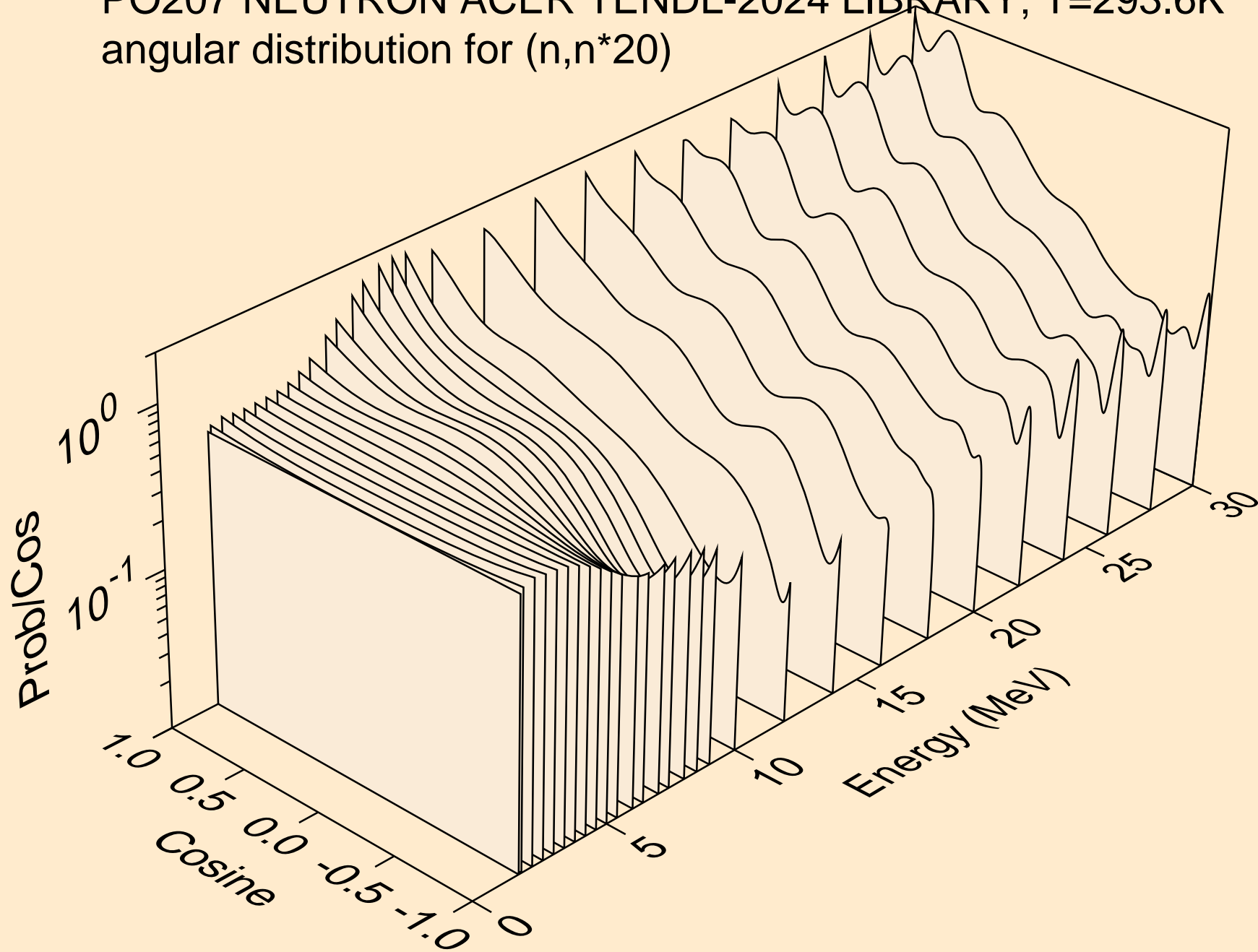

PO207 NEUTRON ACER TENDL-2024 LIBRARY; T=293.6K  
angular distribution for (n,n\*21)

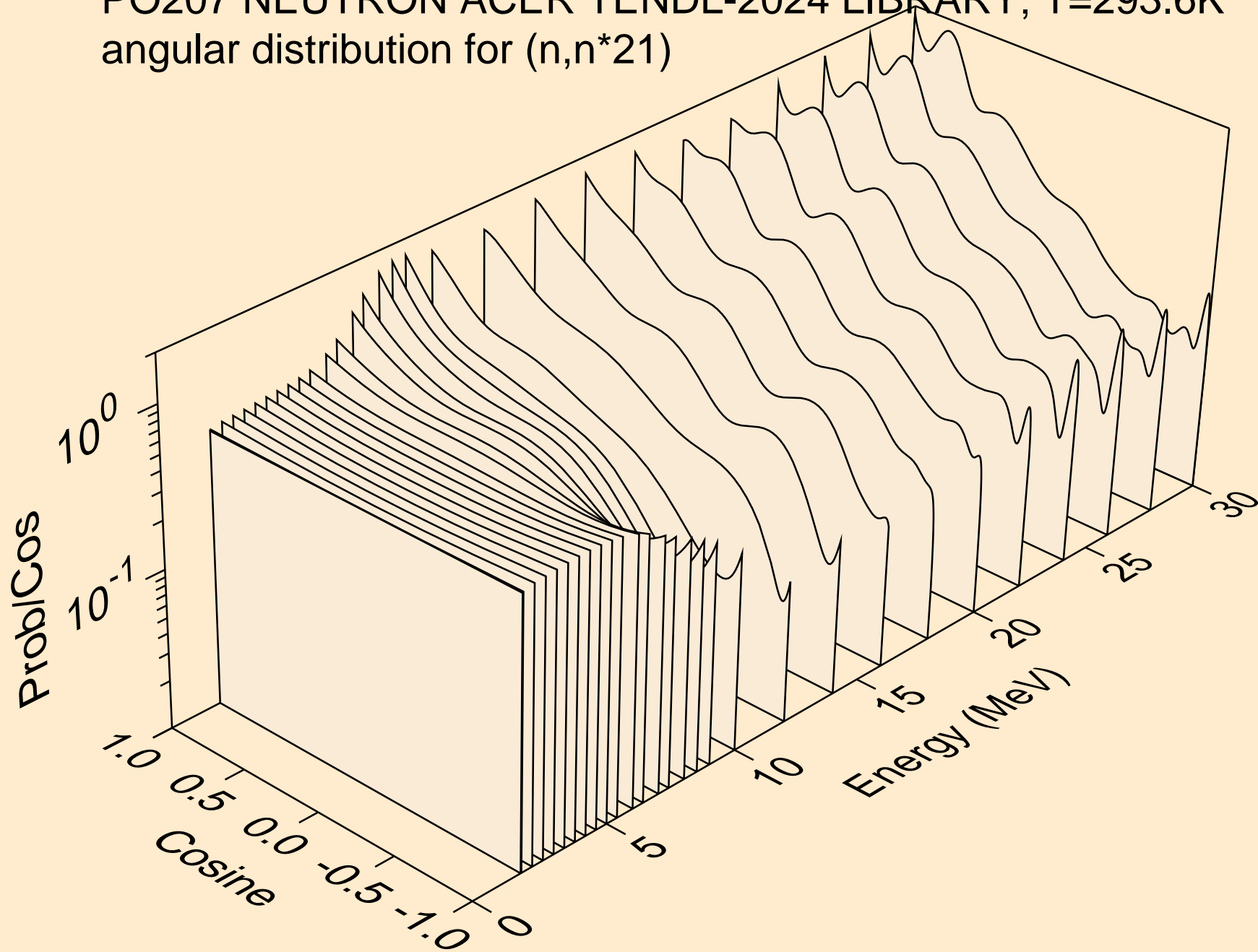

PO207 NEUTRON ACER TENDL-2024 LIBRARY; T=293.6K  
angular distribution for (n,n\*22)

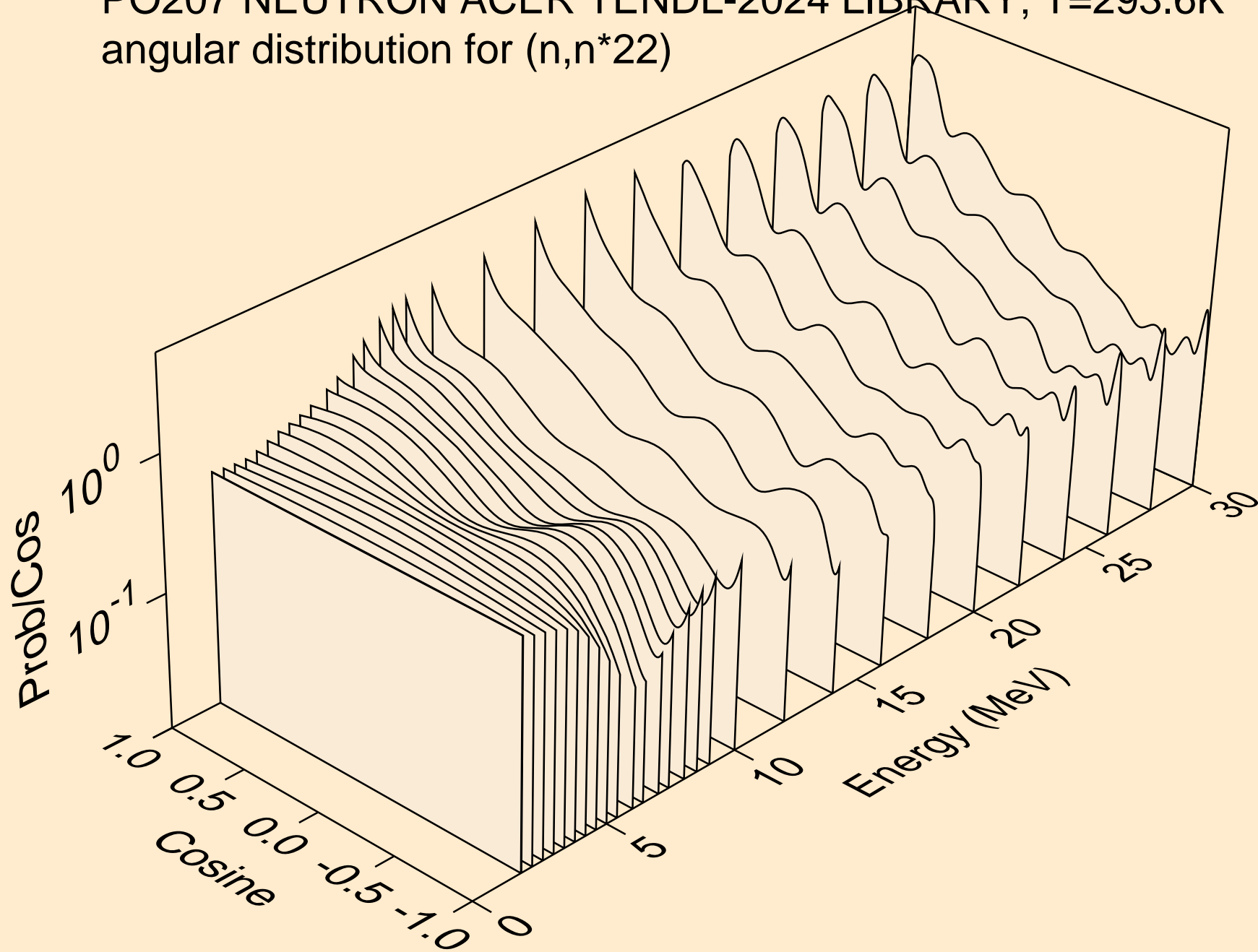

PO207 NEUTRON ACER TENDL-2024 LIBRARY; T=293.6K  
angular distribution for (n,n\*23)

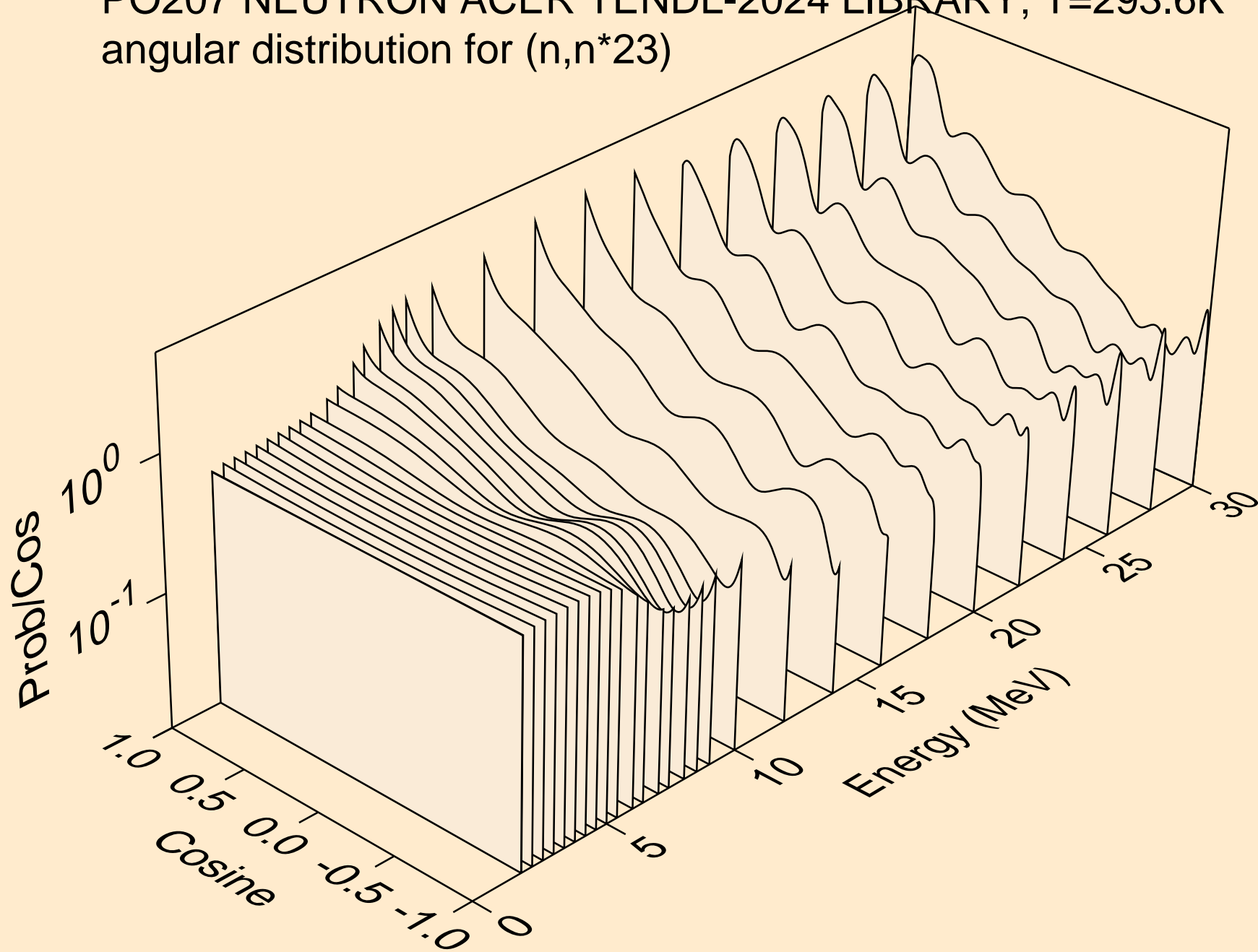

PO207 NEUTRON ACER TENDL-2024 LIBRARY; T=293.6K  
angular distribution for (n,n\*24)

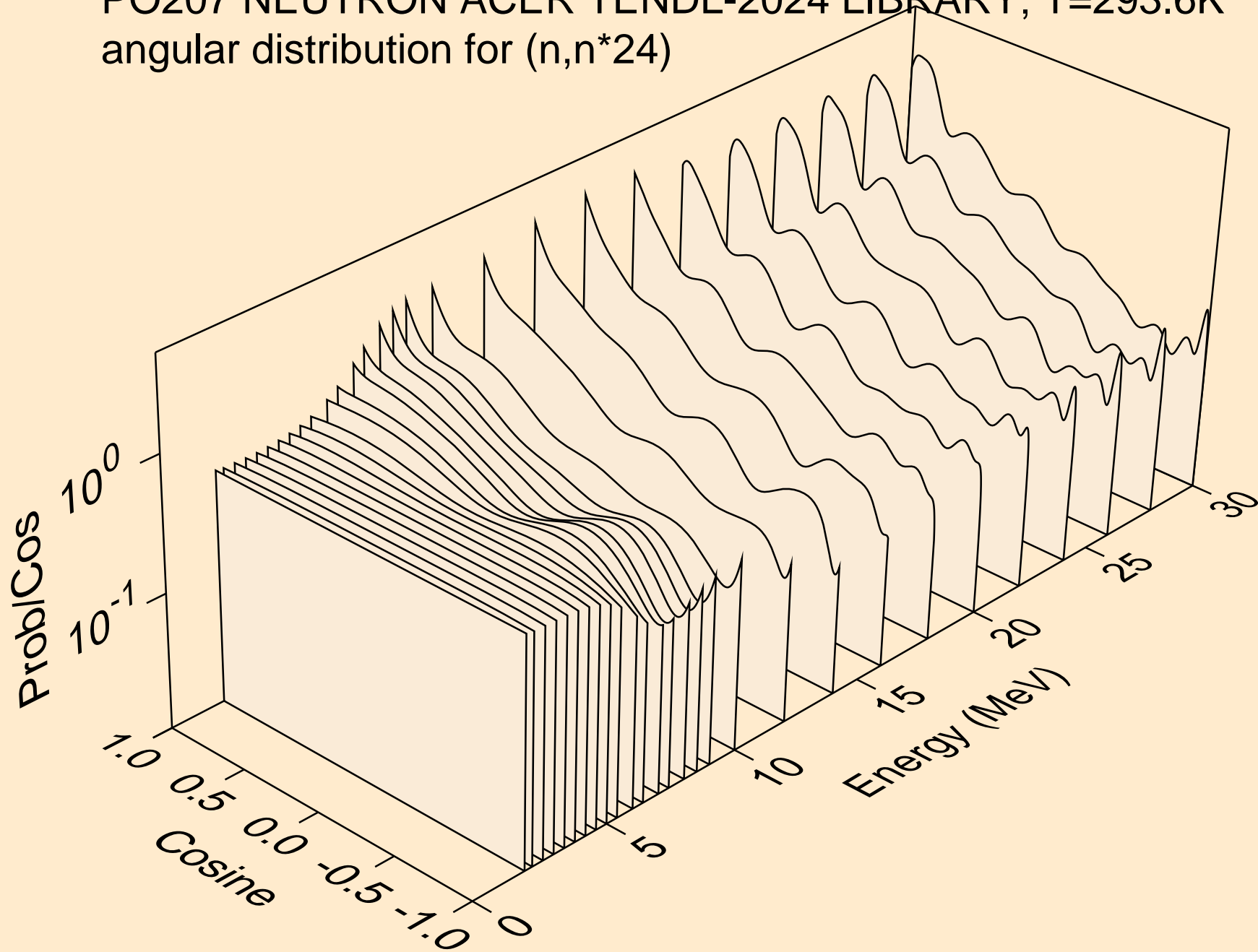

PO207 NEUTRON ACER TENDL-2024 LIBRARY; T=293.6K  
angular distribution for (n,n\*25)

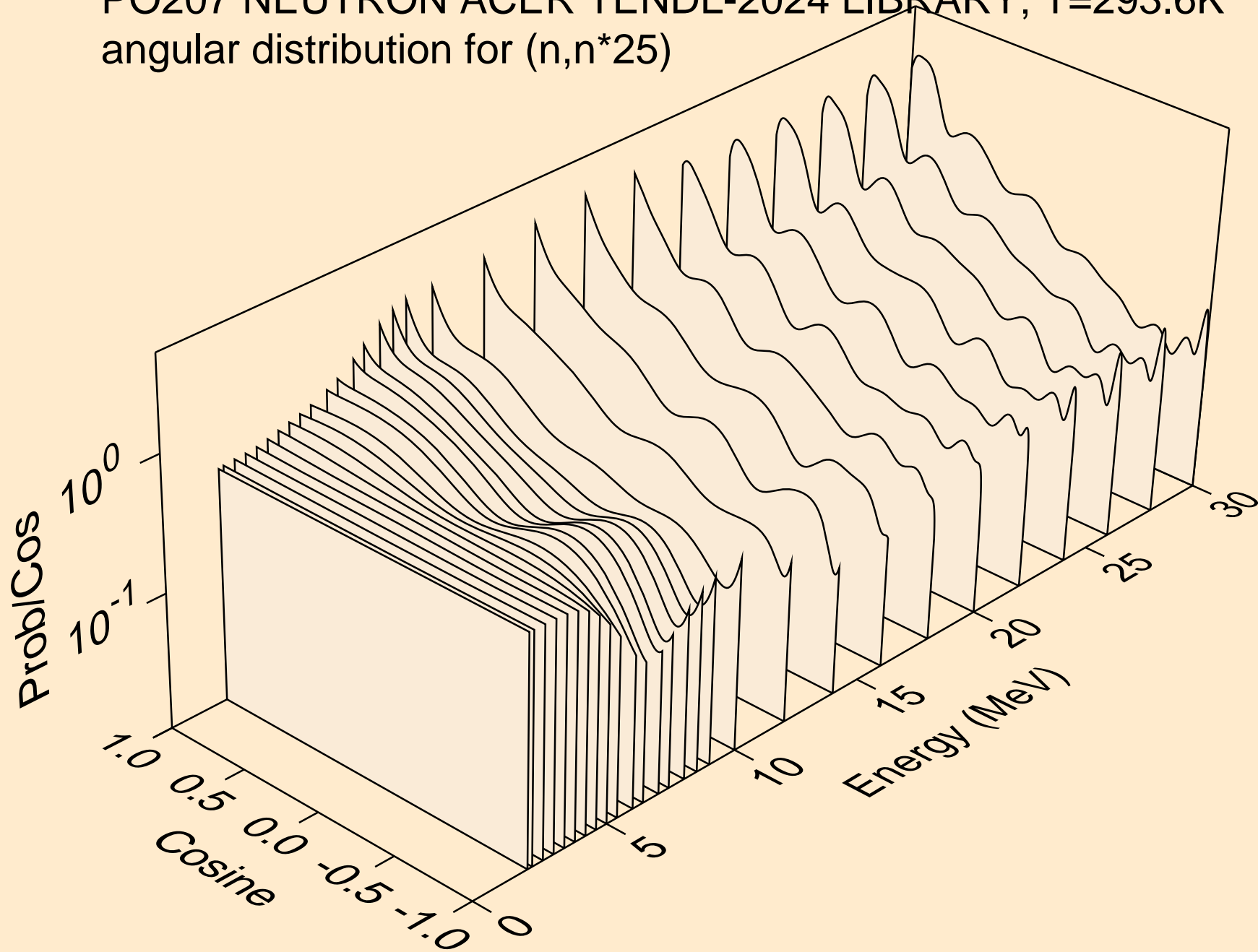

PO207 NEUTRON ACER TENDL-2024 LIBRARY; T=293.6K  
angular distribution for (n,n\*26)

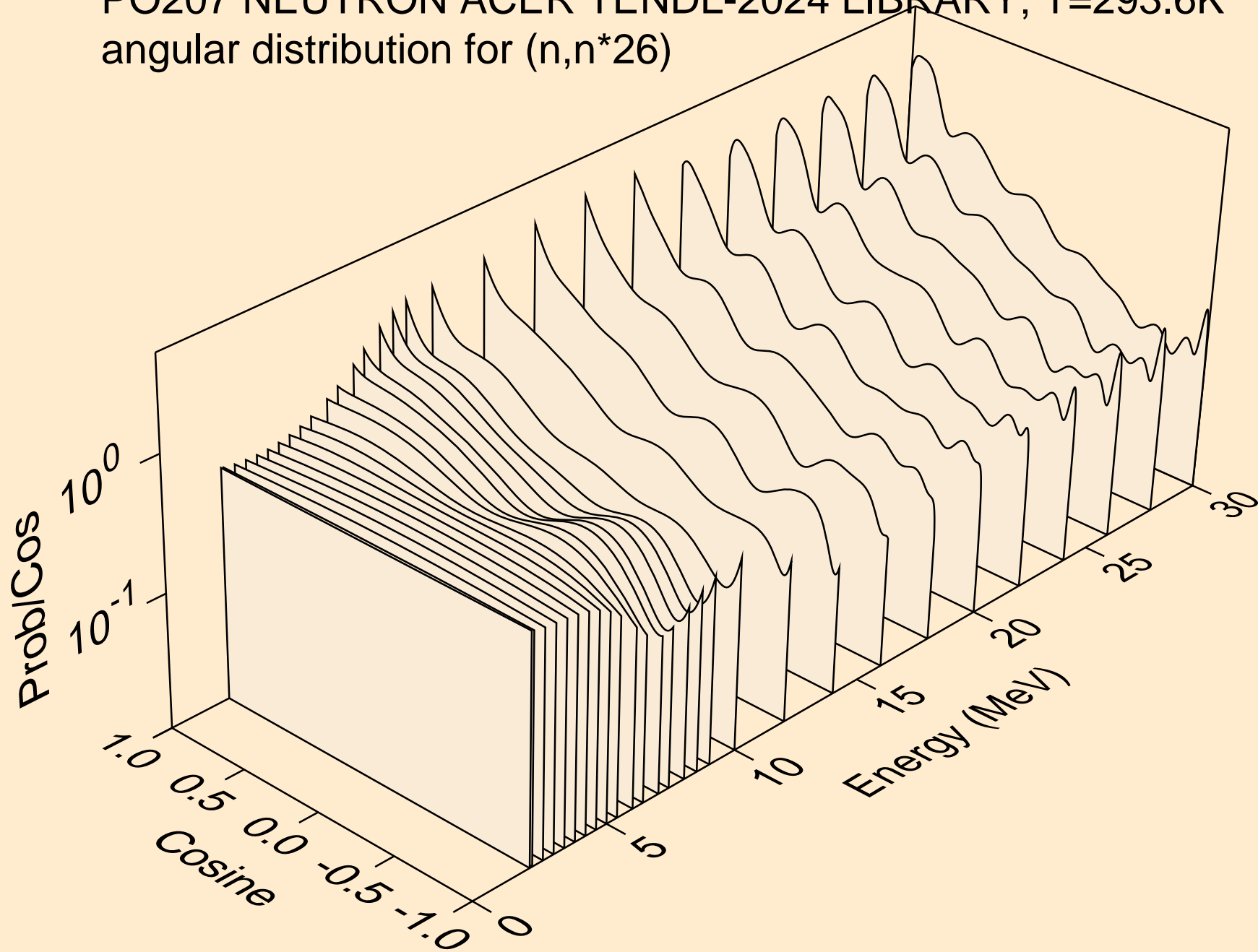

PO207 NEUTRON ACER TENDL-2024 LIBRARY; T=293.6K  
angular distribution for (n,n\*27)

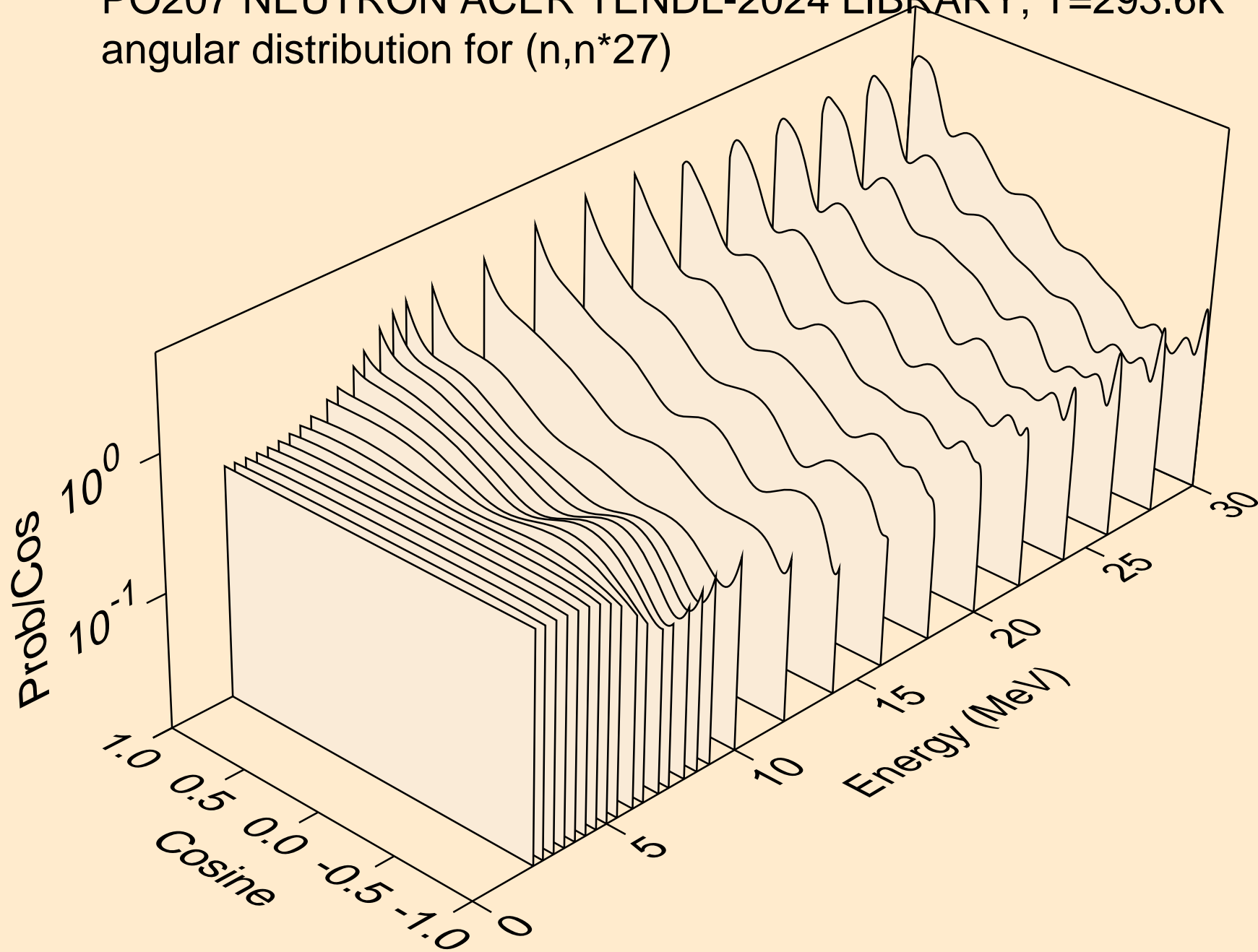

PO207 NEUTRON ACER TENDL-2024 LIBRARY; T=293.6K  
angular distribution for (n,n\*28)

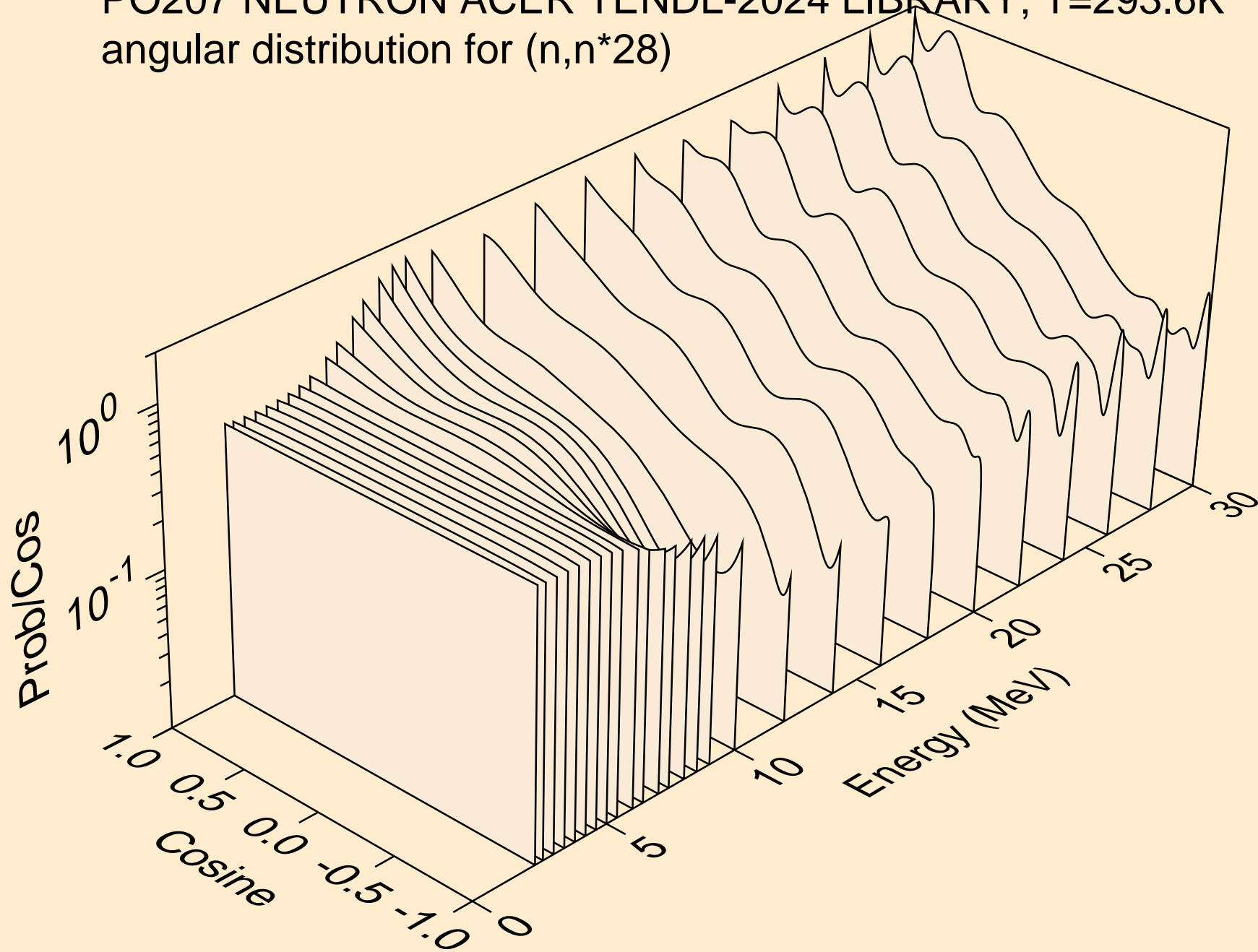

PO207 NEUTRON ACER TENDL-2024 LIBRARY; T=293.6K  
angular distribution for (n,n\*29)

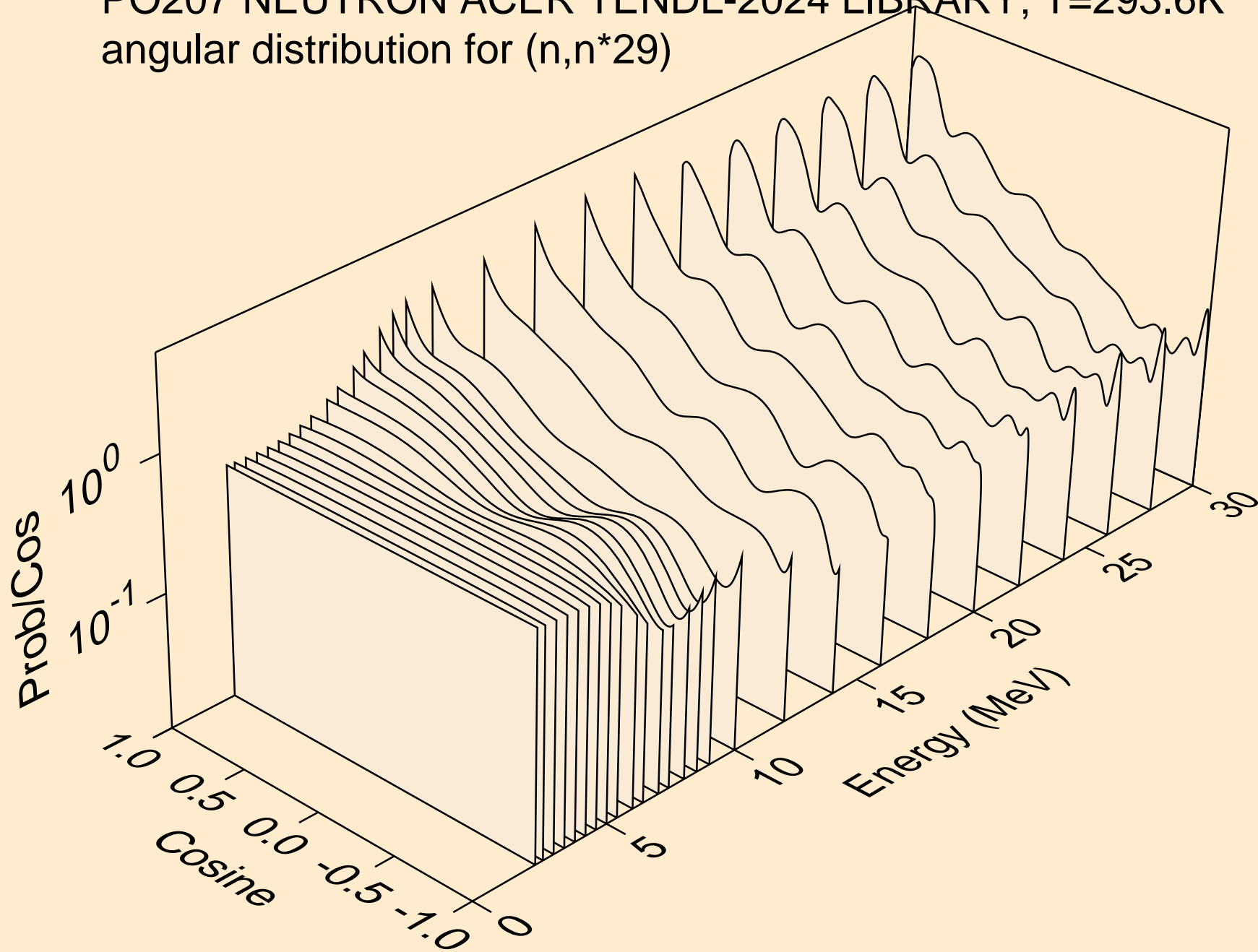

PO207 NEUTRON ACER TENDL-2024 LIBRARY; T=293.6K  
Neutron emission for (n,x)

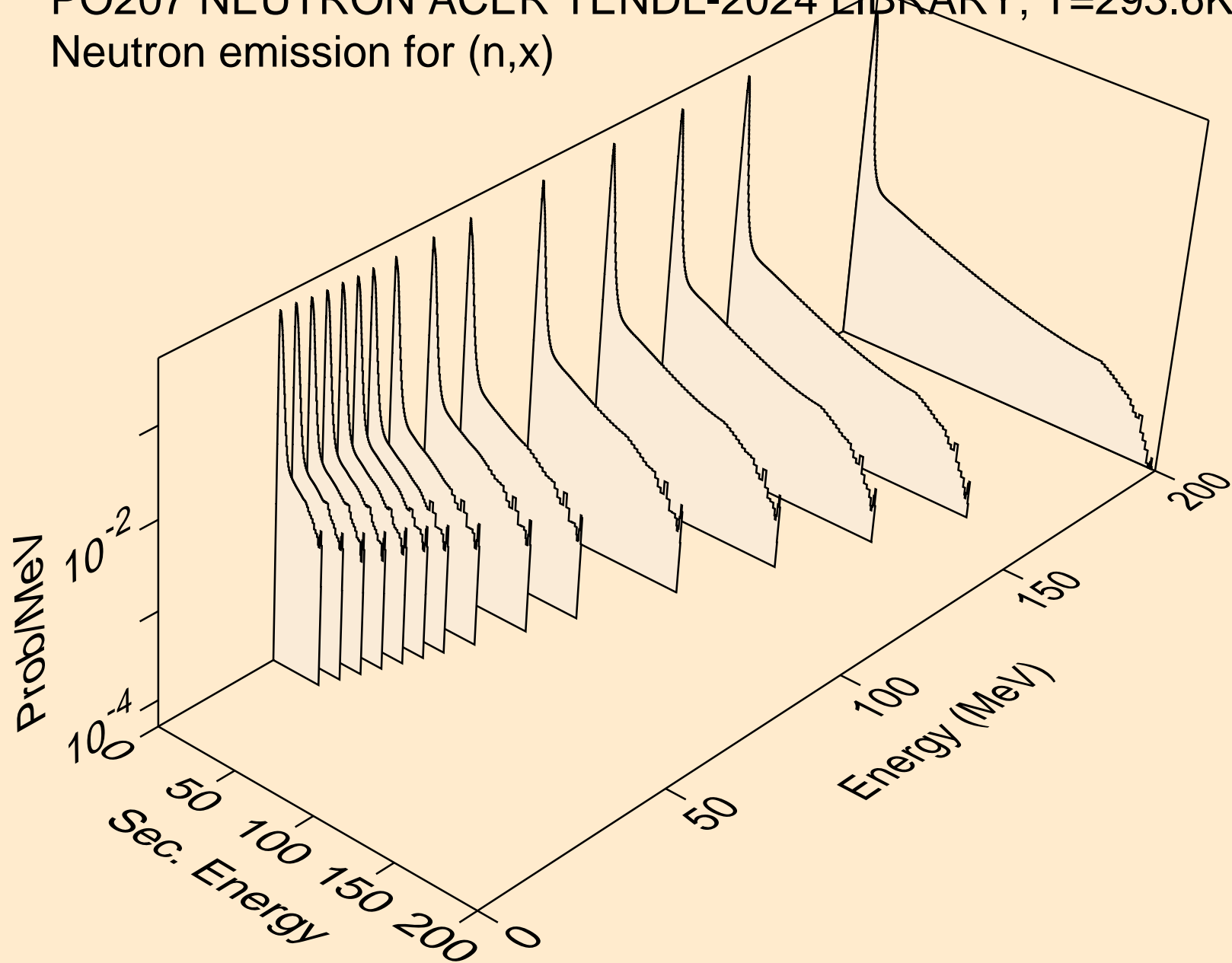

PO207 NEUTRON ACER TENDL-2024 LIBRARY; T=293.6K  
Neutron emission for (n,2nd)

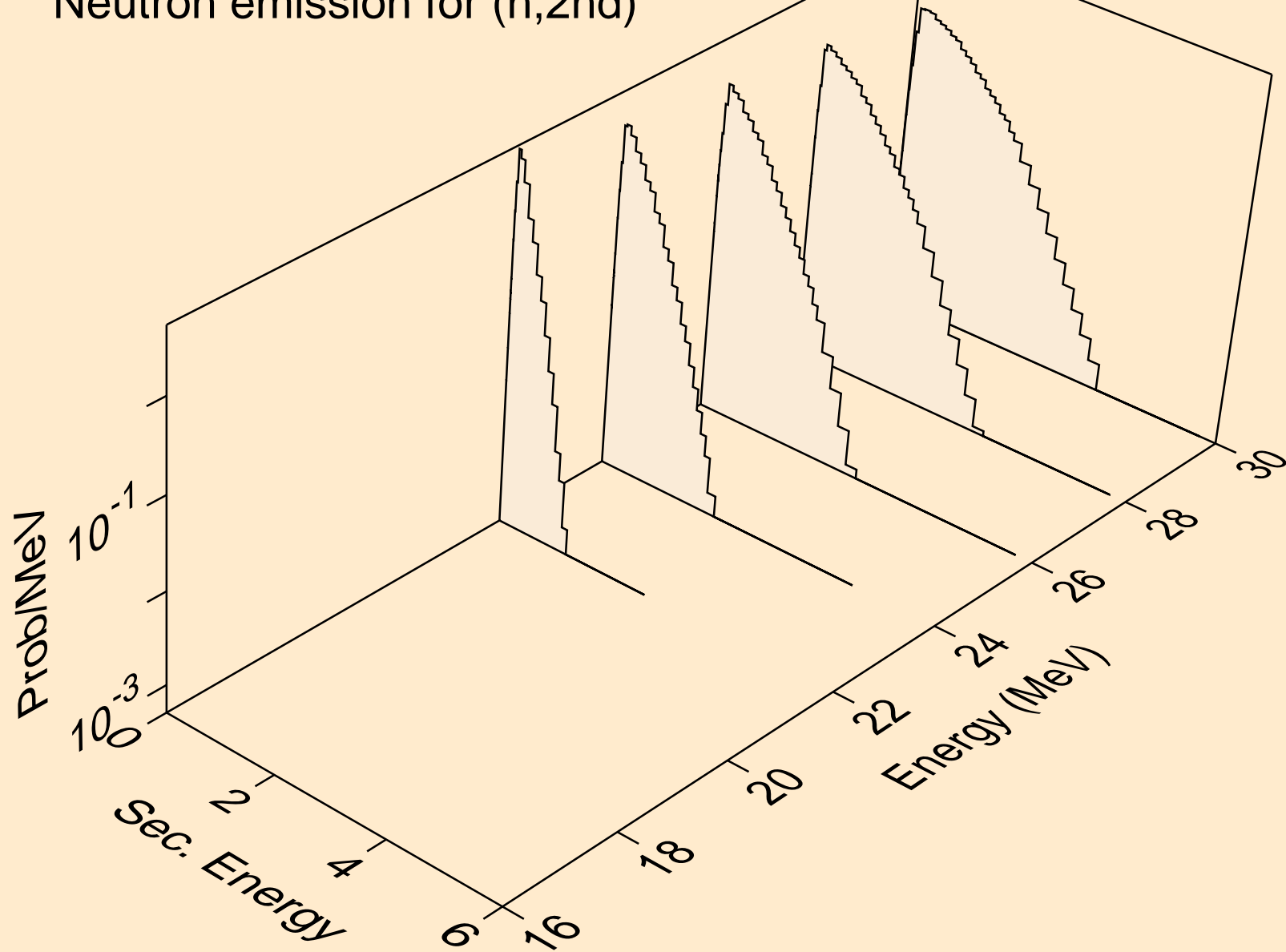

PO207 NEUTRON ACER TENDL-2024 LIBRARY; T=293.6K  
Neutron emission for (n,2n)

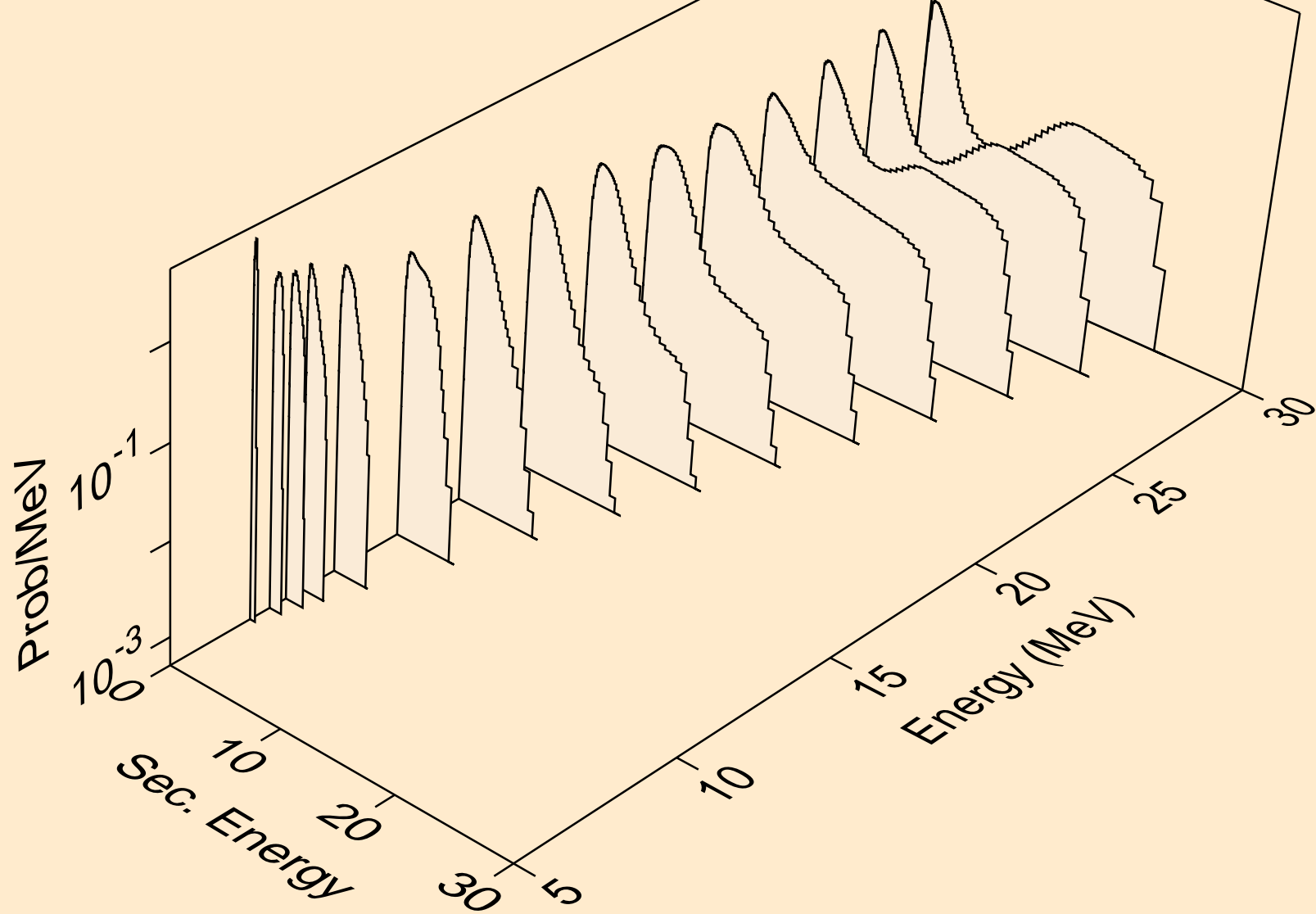

PO207 NEUTRON ACER TENDL-2024 LIBRARY; T=293.6K  
Neutron emission for (n,3n)

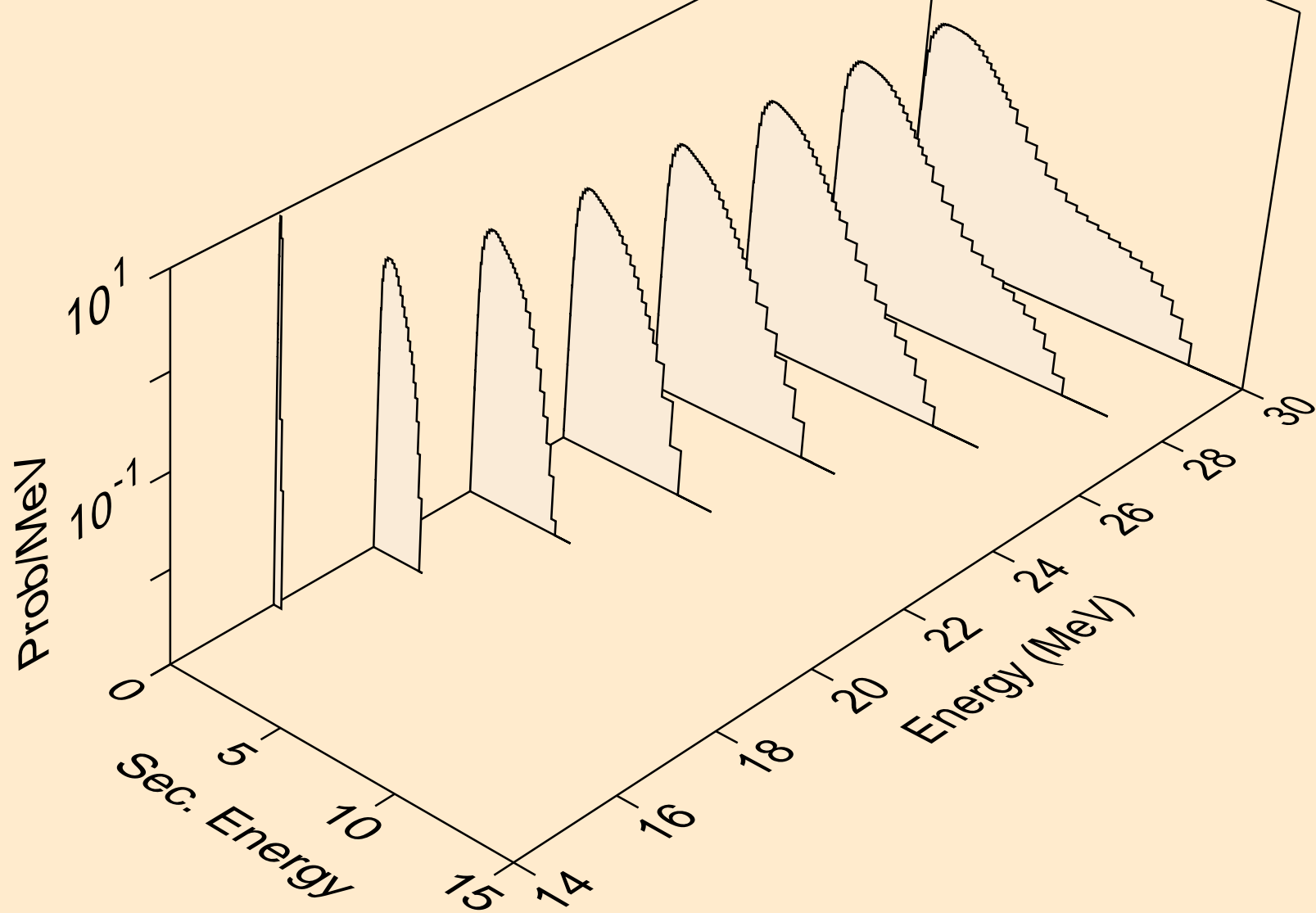

PO207 NEUTRON ACER TENDL-2024 LIBRARY; T=293.6K  
Neutron emission for (n,n\*)a

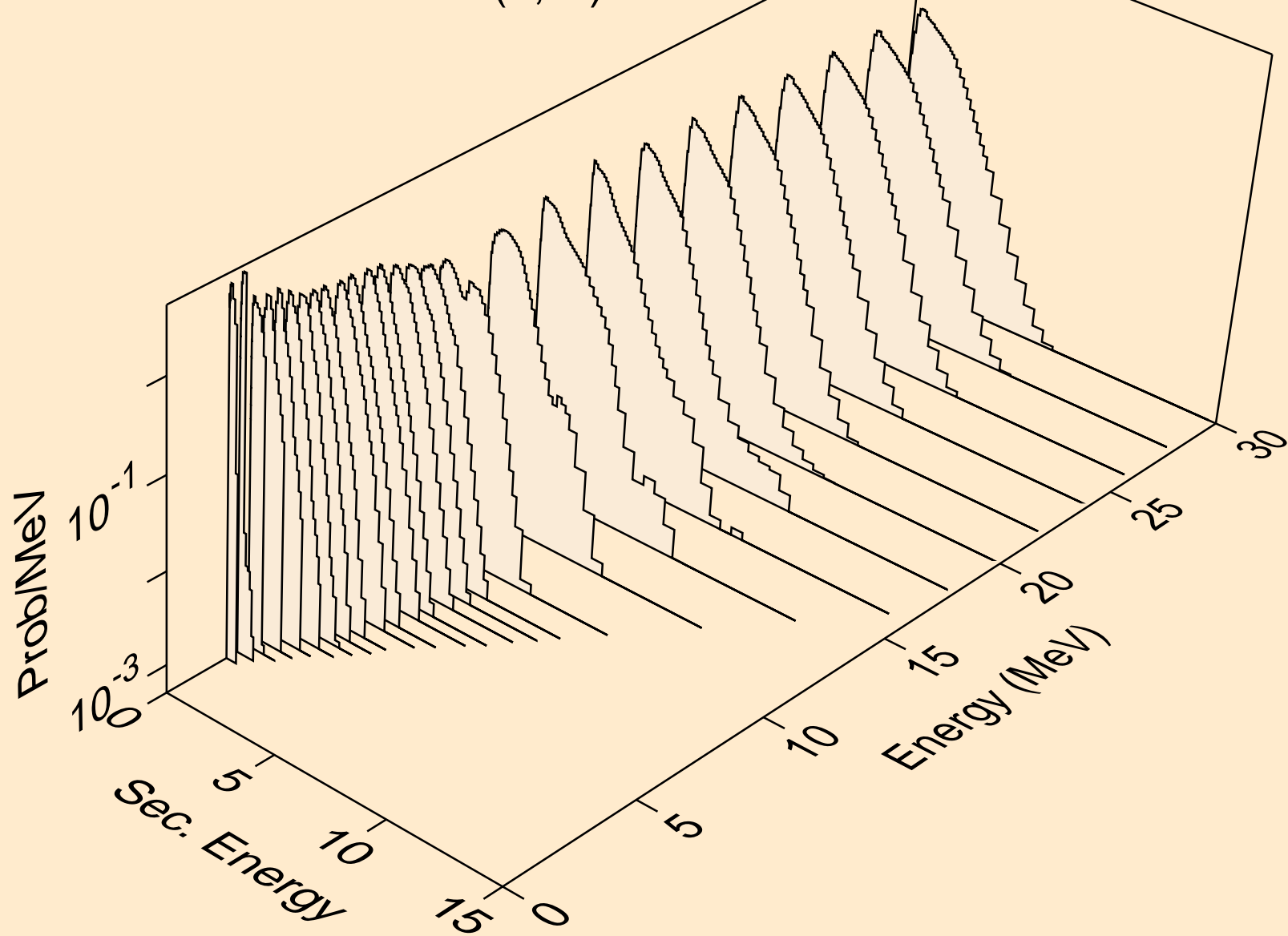

PO207 NEUTRON ACER TENDL-2024 LIBRARY; T=293.6K  
Neutron emission for (n,2n)a

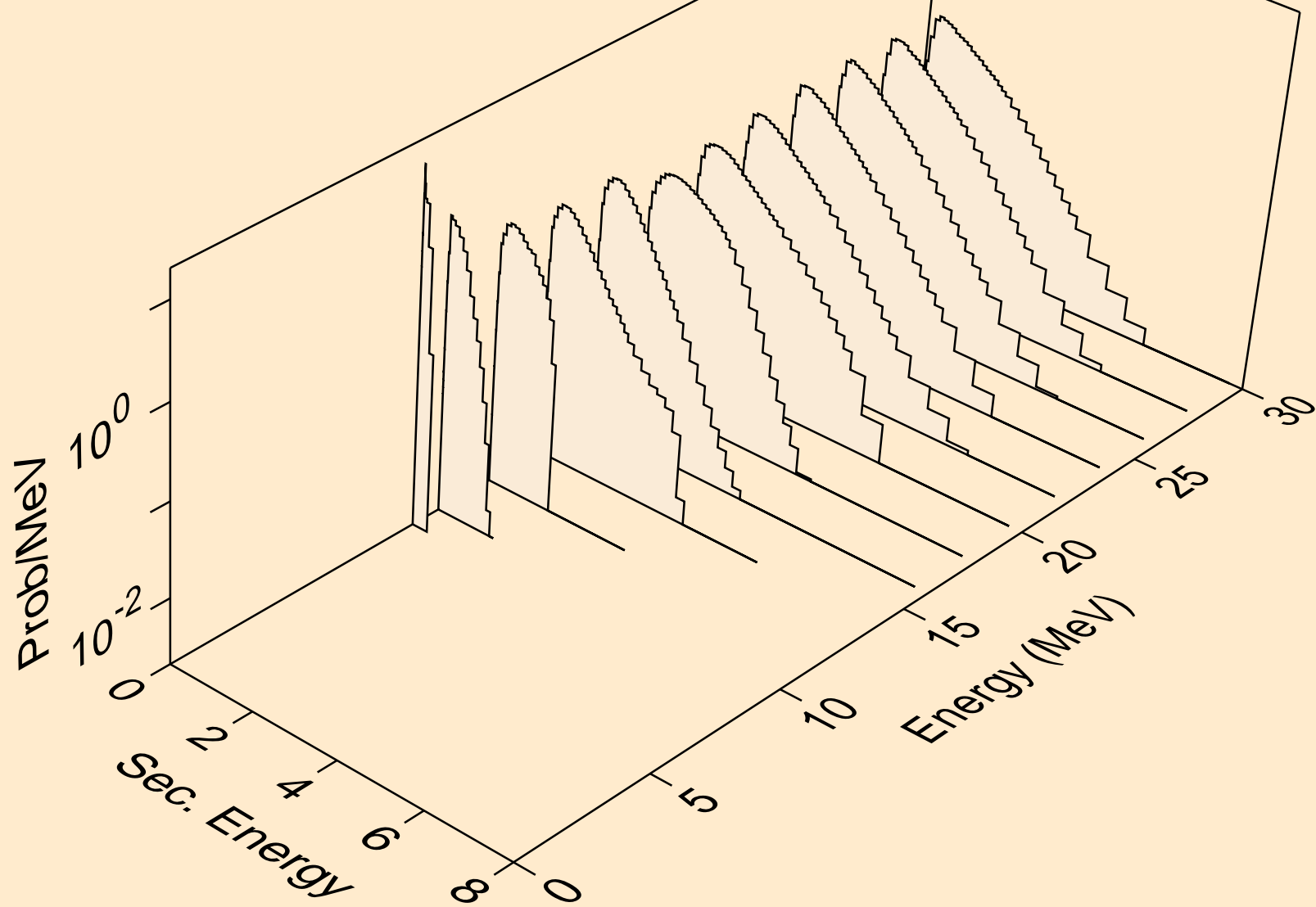

PO207 NEUTRON ACER TENDL-2024 LIBRARY; T=293.6K  
Neutron emission for (n,3n)a

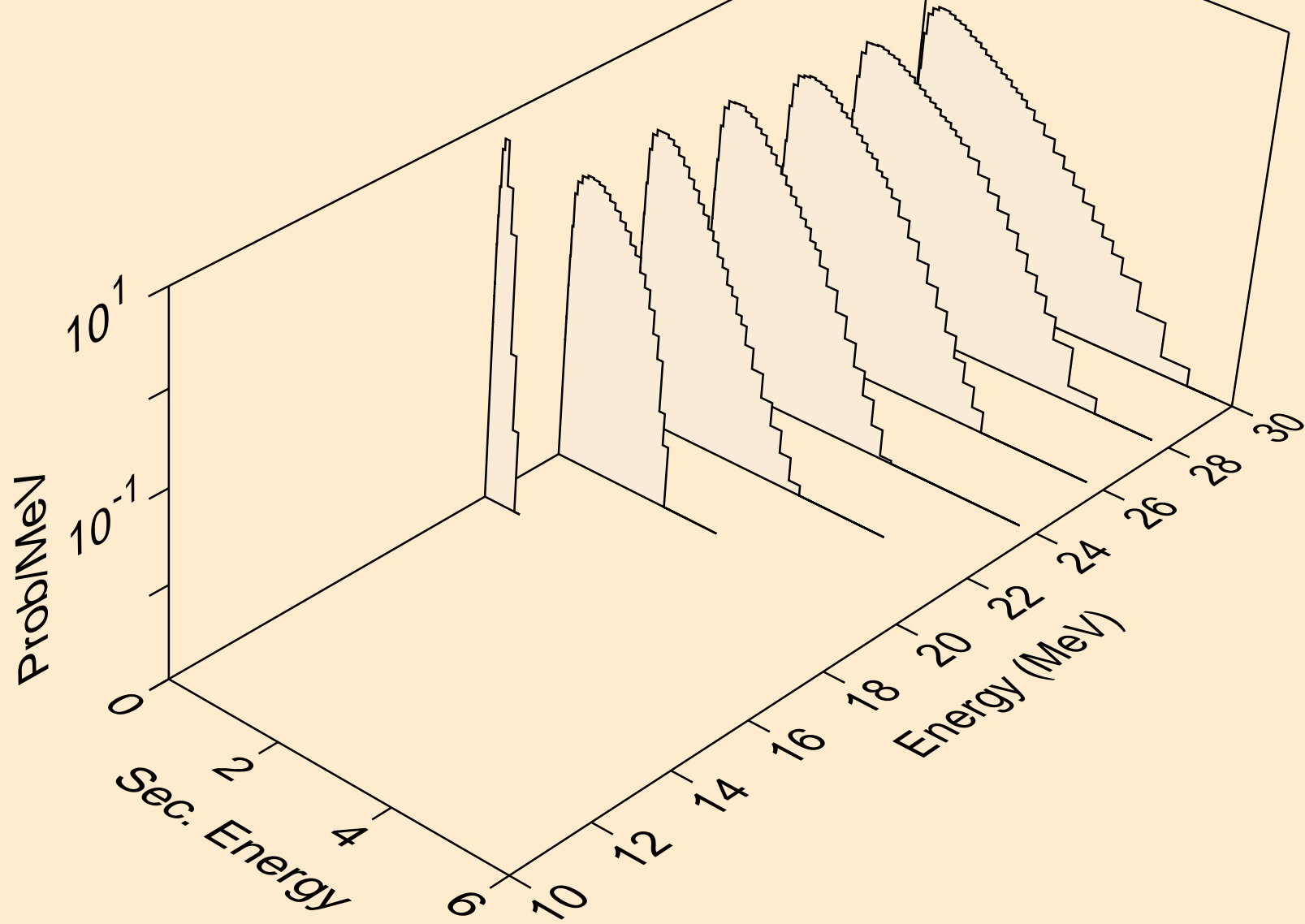

PO207 NEUTRON ACER TENDL-2024 LIBRARY; T=293.6K  
Neutron emission for (n,n\*)p

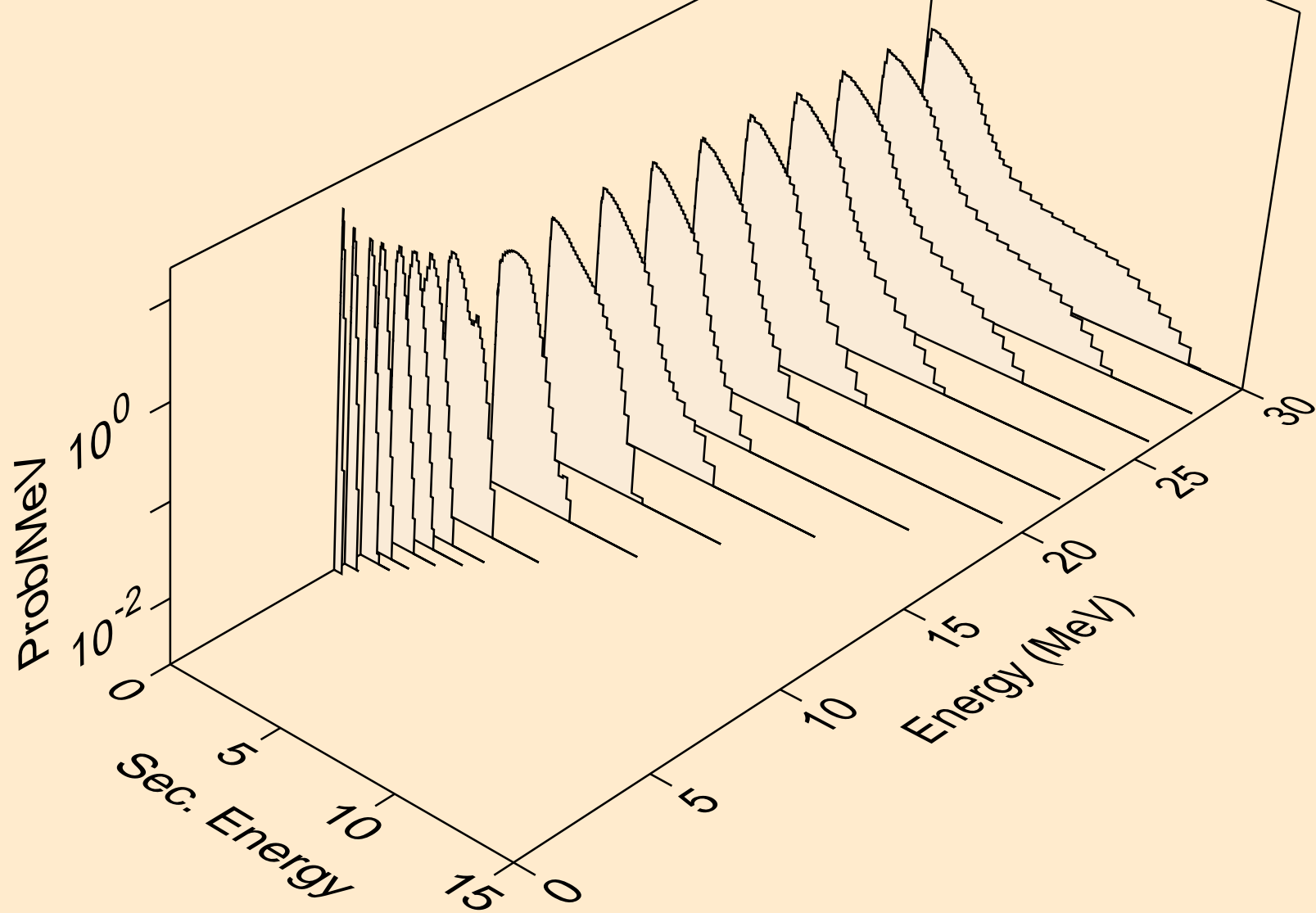

PO207 NEUTRON ACER TENDL-2024 LIBRARY; T=293.6K  
Neutron emission for (n,n\*)2a

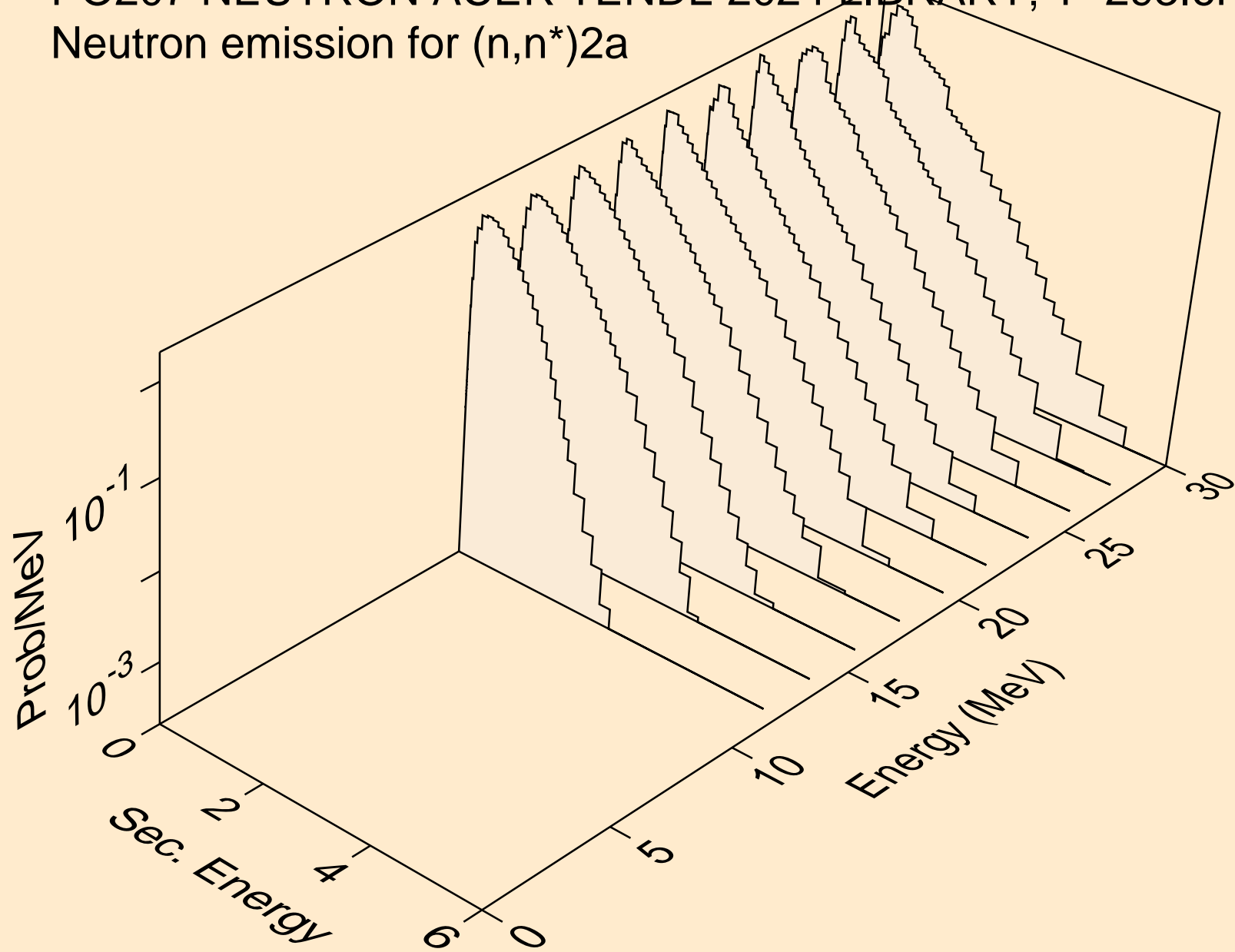

PO207 NEUTRON ACER TENDL-2024 LIBRARY; T=293.6K  
Neutron emission for (n,n\*)d

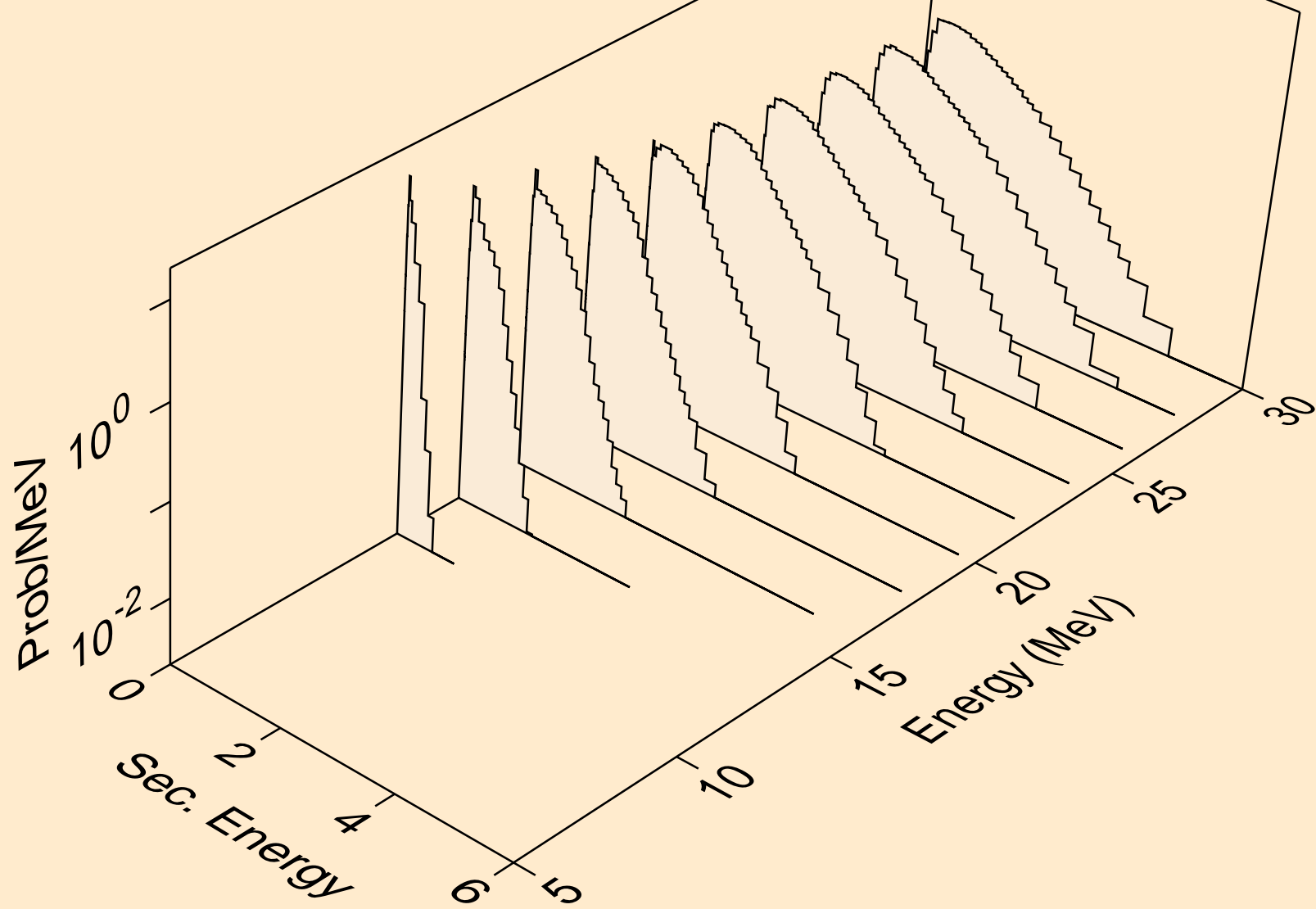

PO207 NEUTRON ACER TENDL-2024 LIBRARY; T=293.6K  
Neutron emission for (n,n\*)t

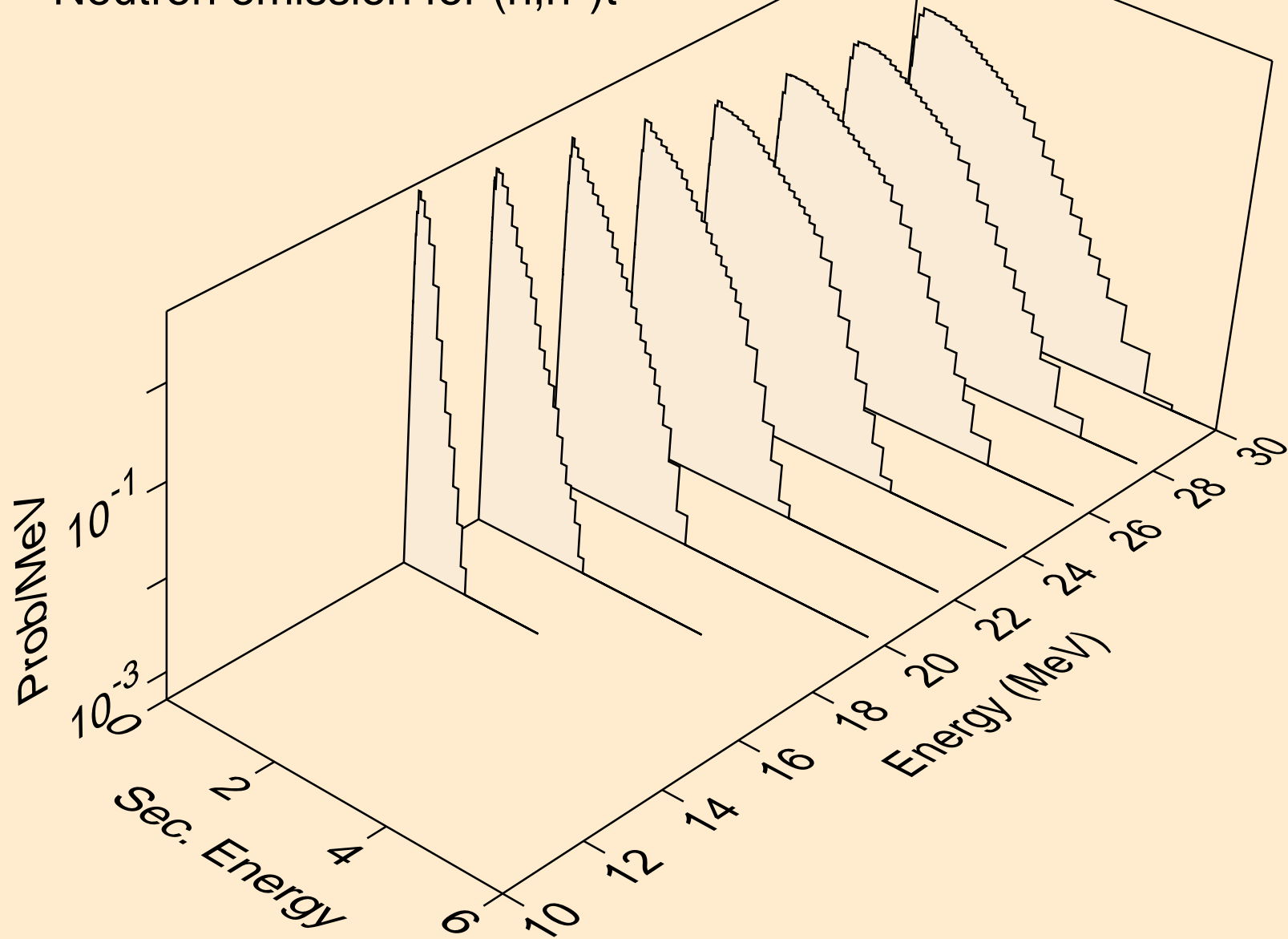

PO207 NEUTRON ACER TENDL-2024 LIBRARY; T=293.6K  
Neutron emission for (n,n\*)he3

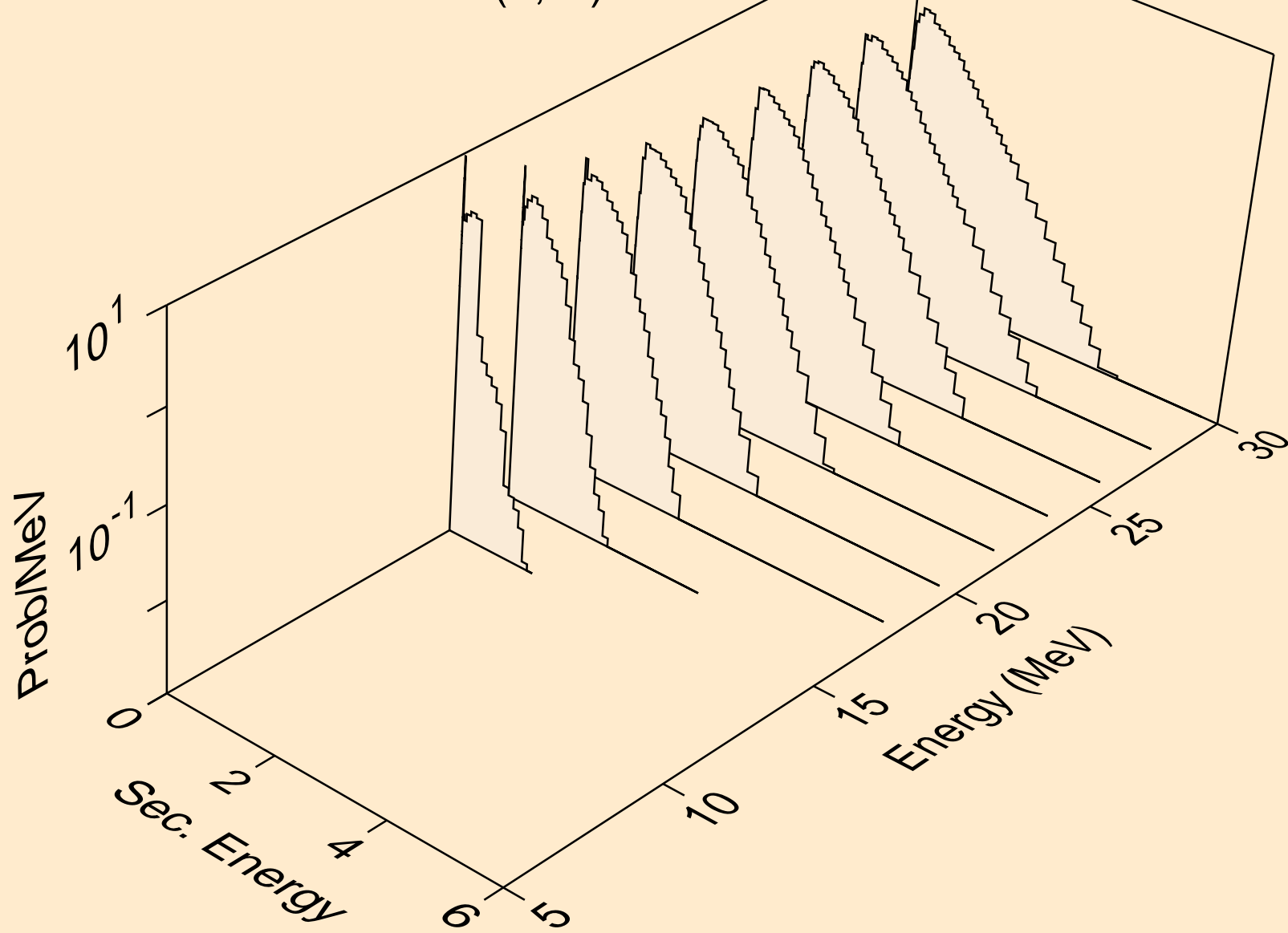

PO207 NEUTRON ACER TENDL-2024 LIBRARY; T=293.6K  
Neutron emission for (n,4n)

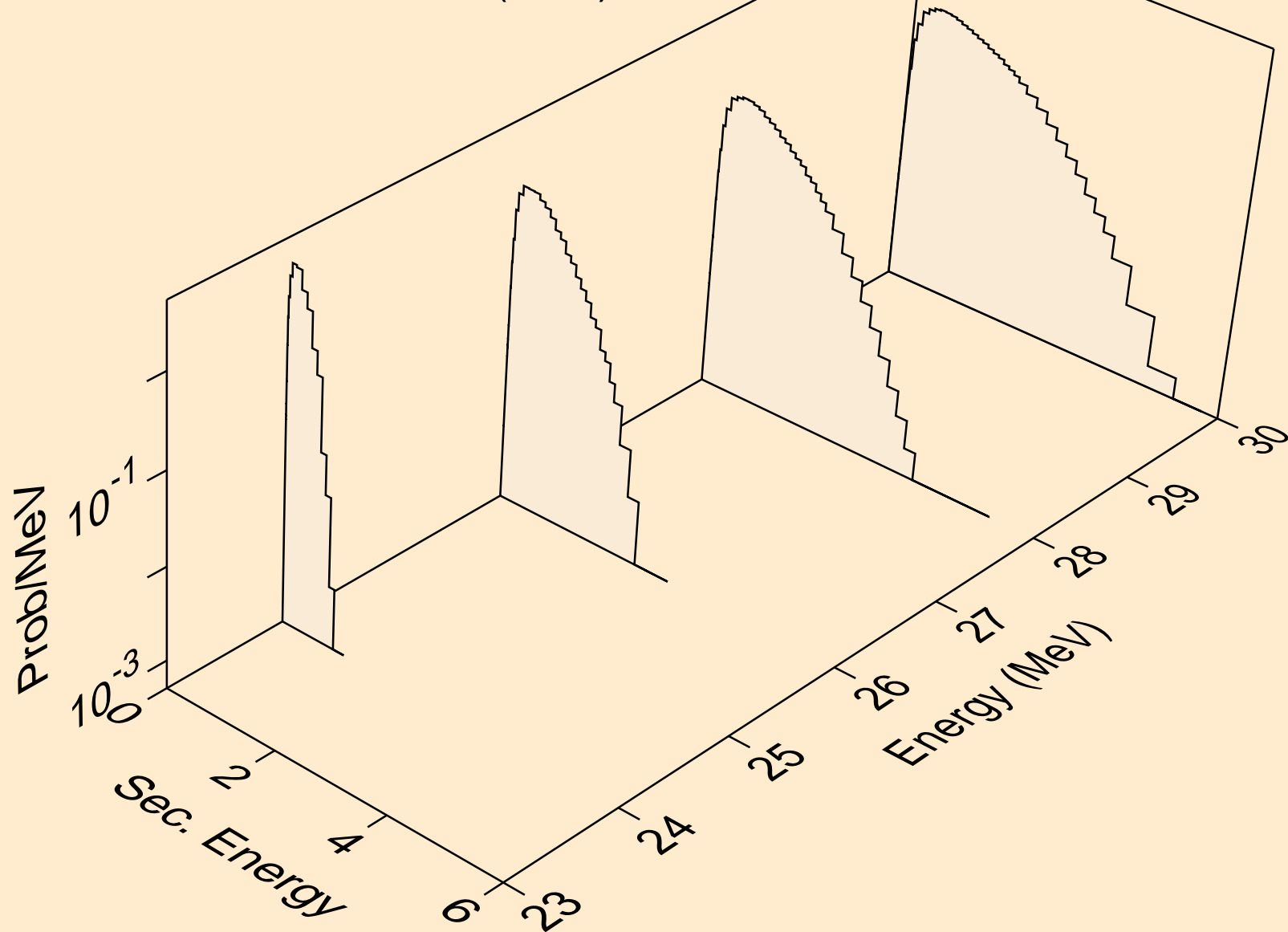

PO207 NEUTRON ACER TENDL-2024 LIBRARY; T=293.6K  
Neutron emission for (n,2np)

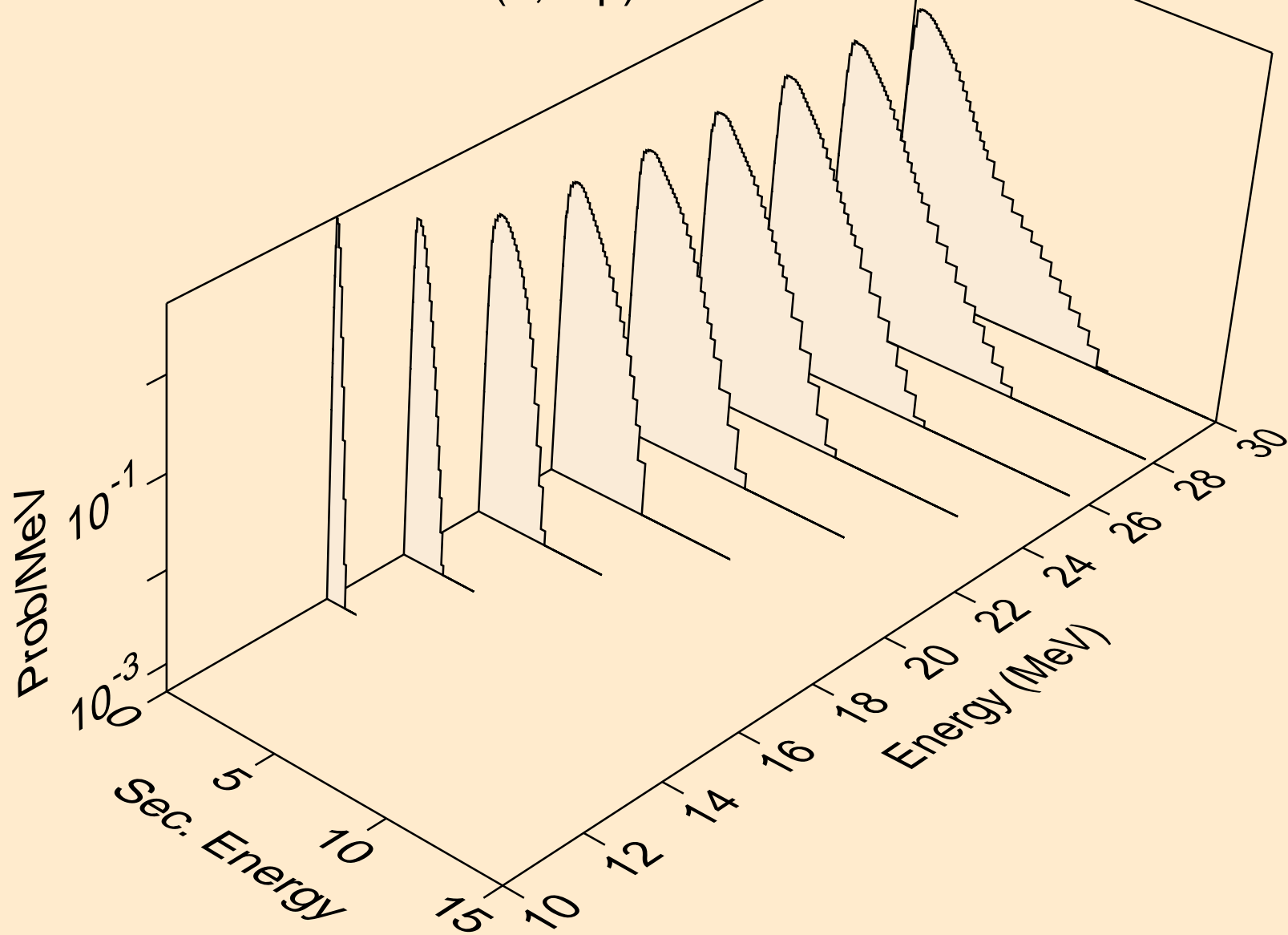

PO207 NEUTRON ACER TENDL-2024 LIBRARY; T=293.6K  
Neutron emission for (n,3np)

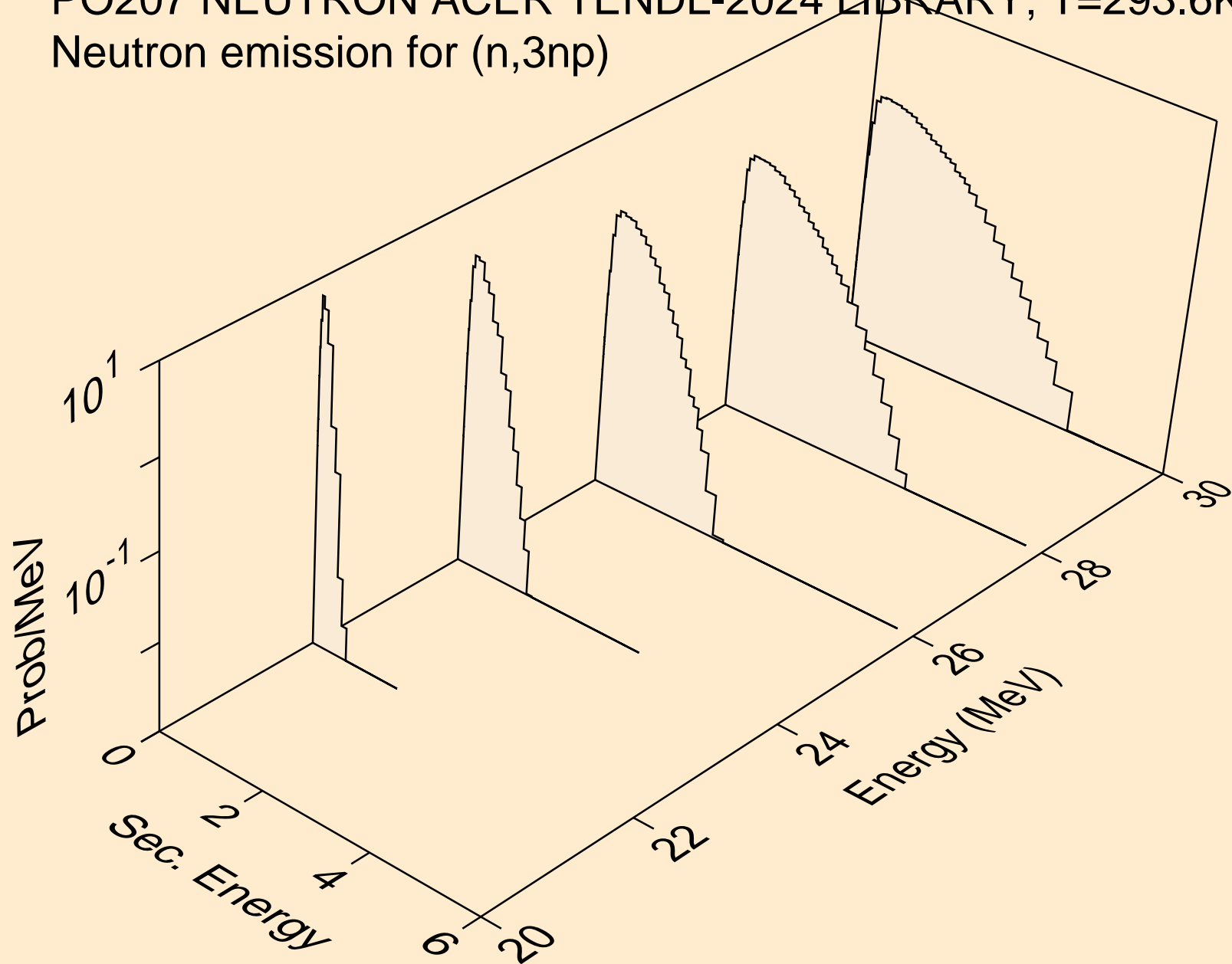

PO207 NEUTRON ACER TENDL-2024 LIBRARY; T=293.6K  
Neutron emission for (n,n2p)

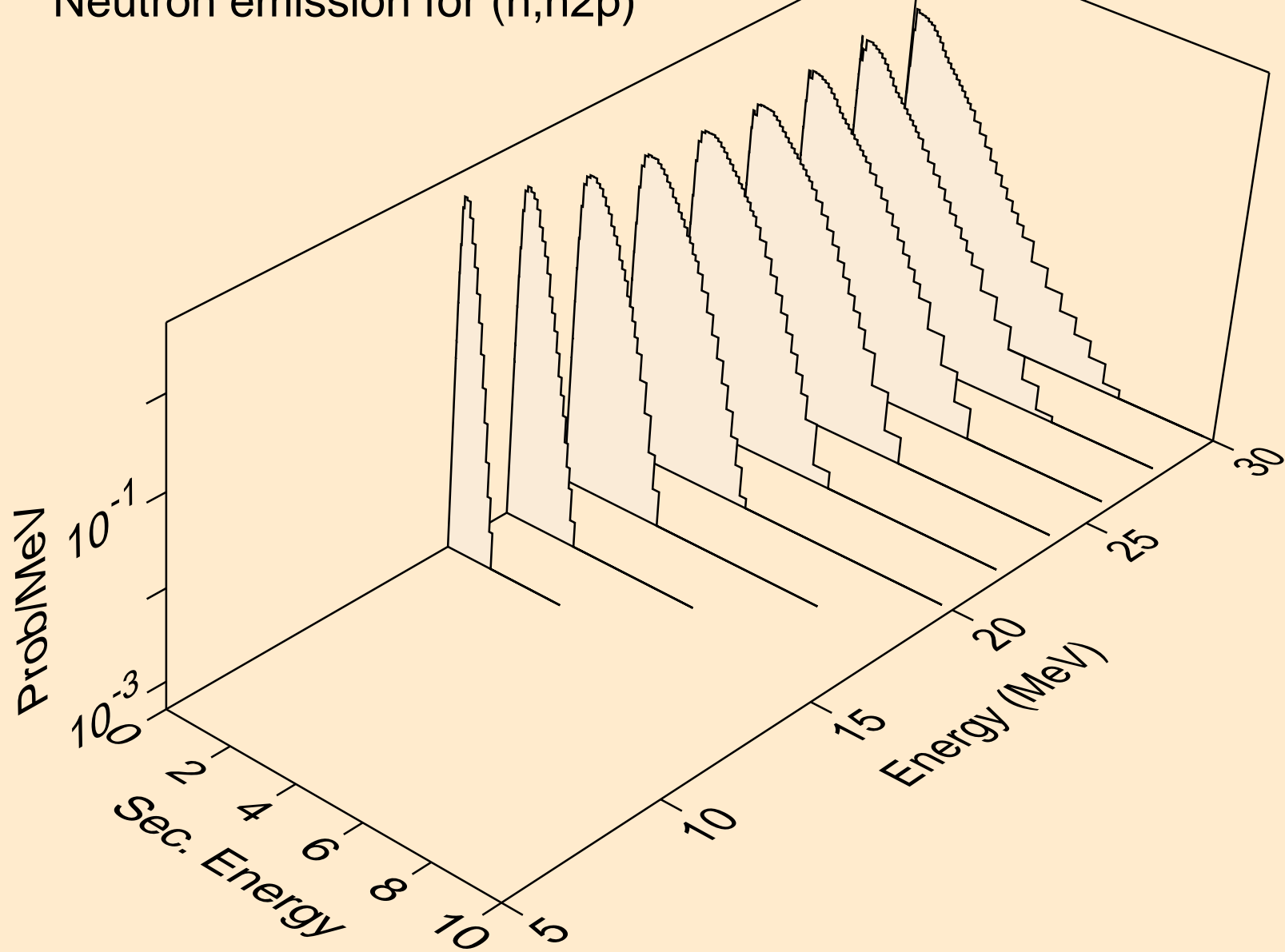

PO207 NEUTRON ACER TENDL-2024 LIBRARY; T=293.6K  
Neutron emission for (n,npa)

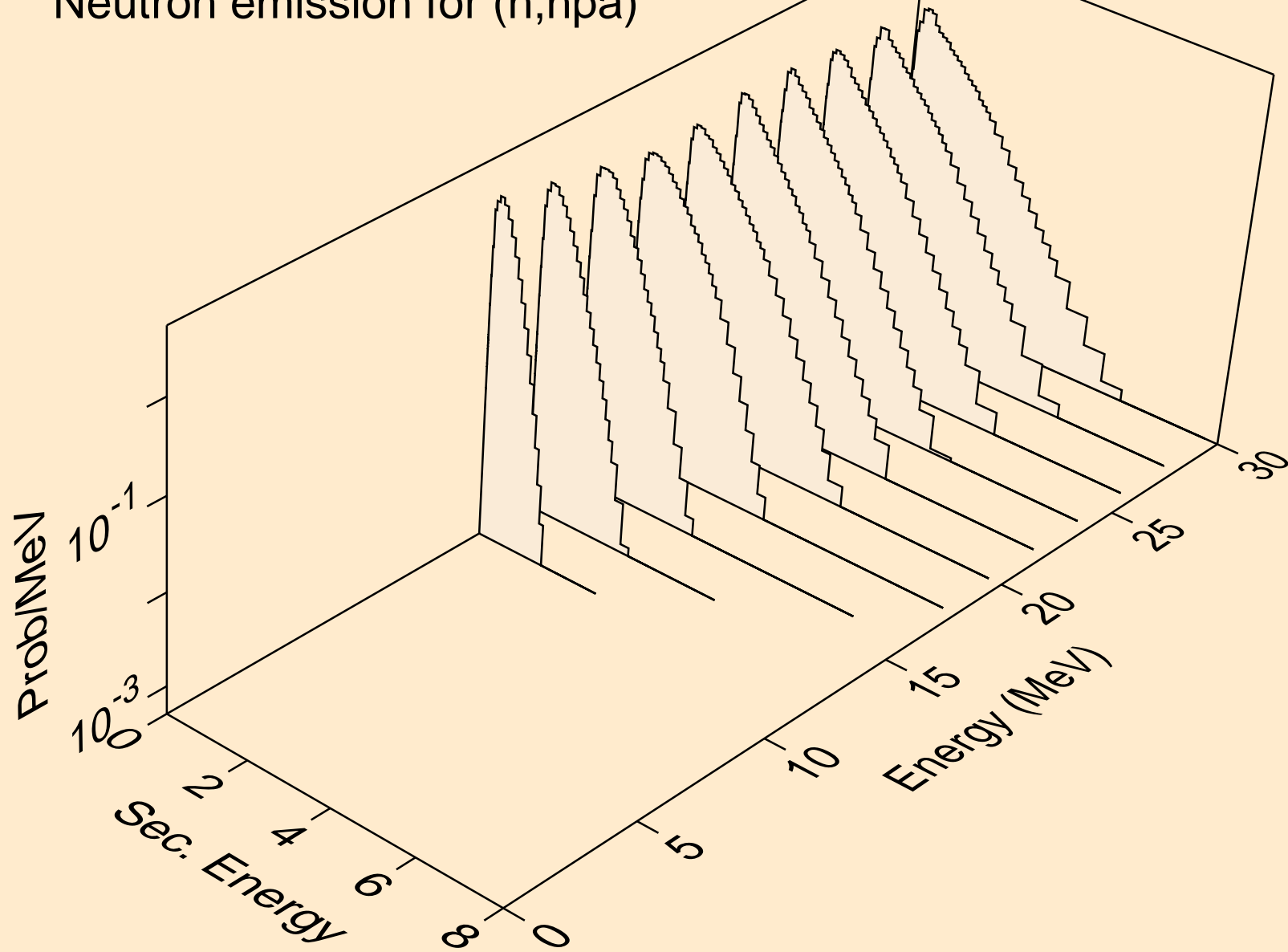

PO207 NEUTRON ACER TENDL-2024 LIBRARY; T=293.6K  
Neutron emission for (n,n\*c)

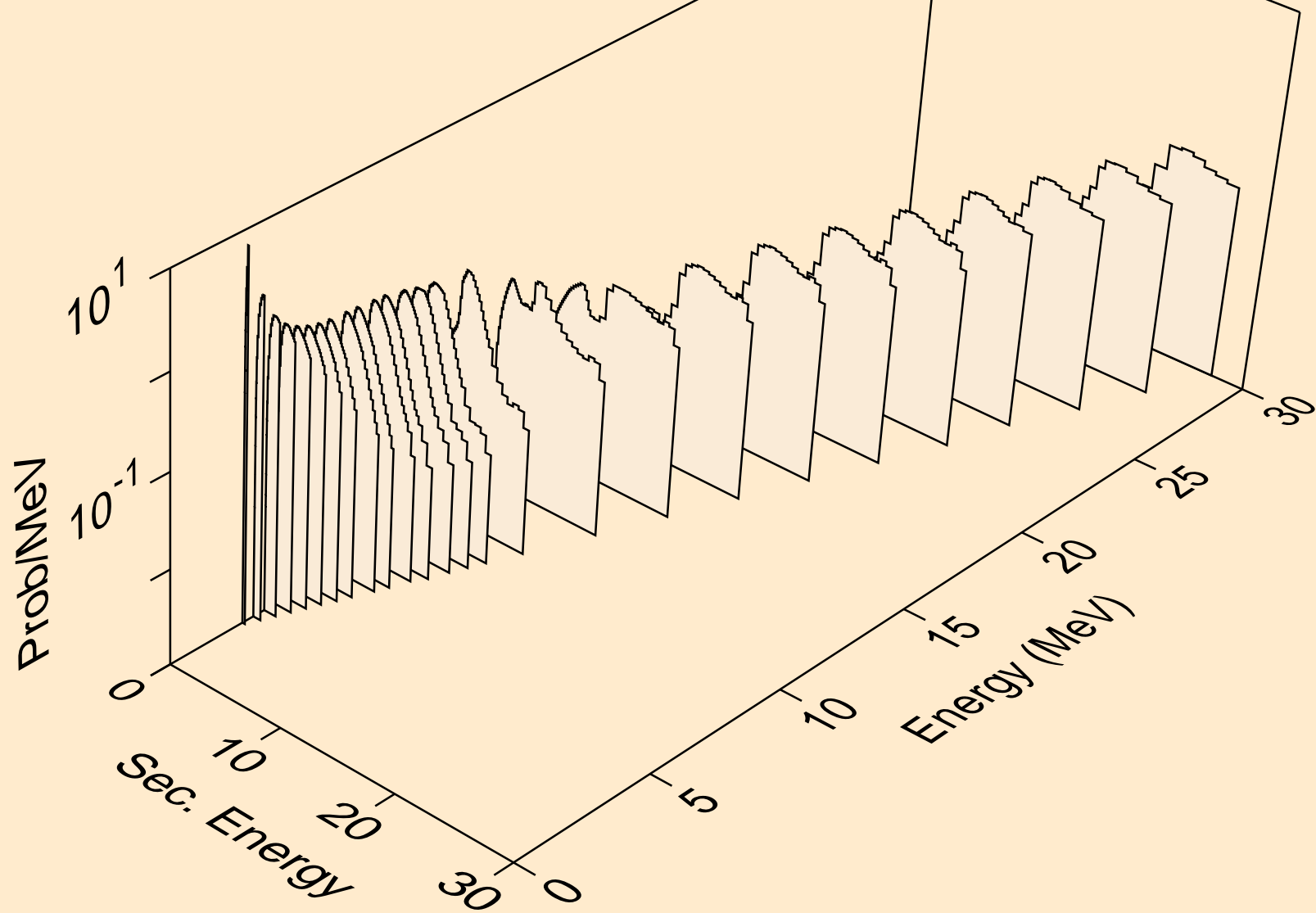

PO207 NEUTRON ACER TENDL-2024 LIBRARY; T=293.6K  
Photon emission for (n,x)

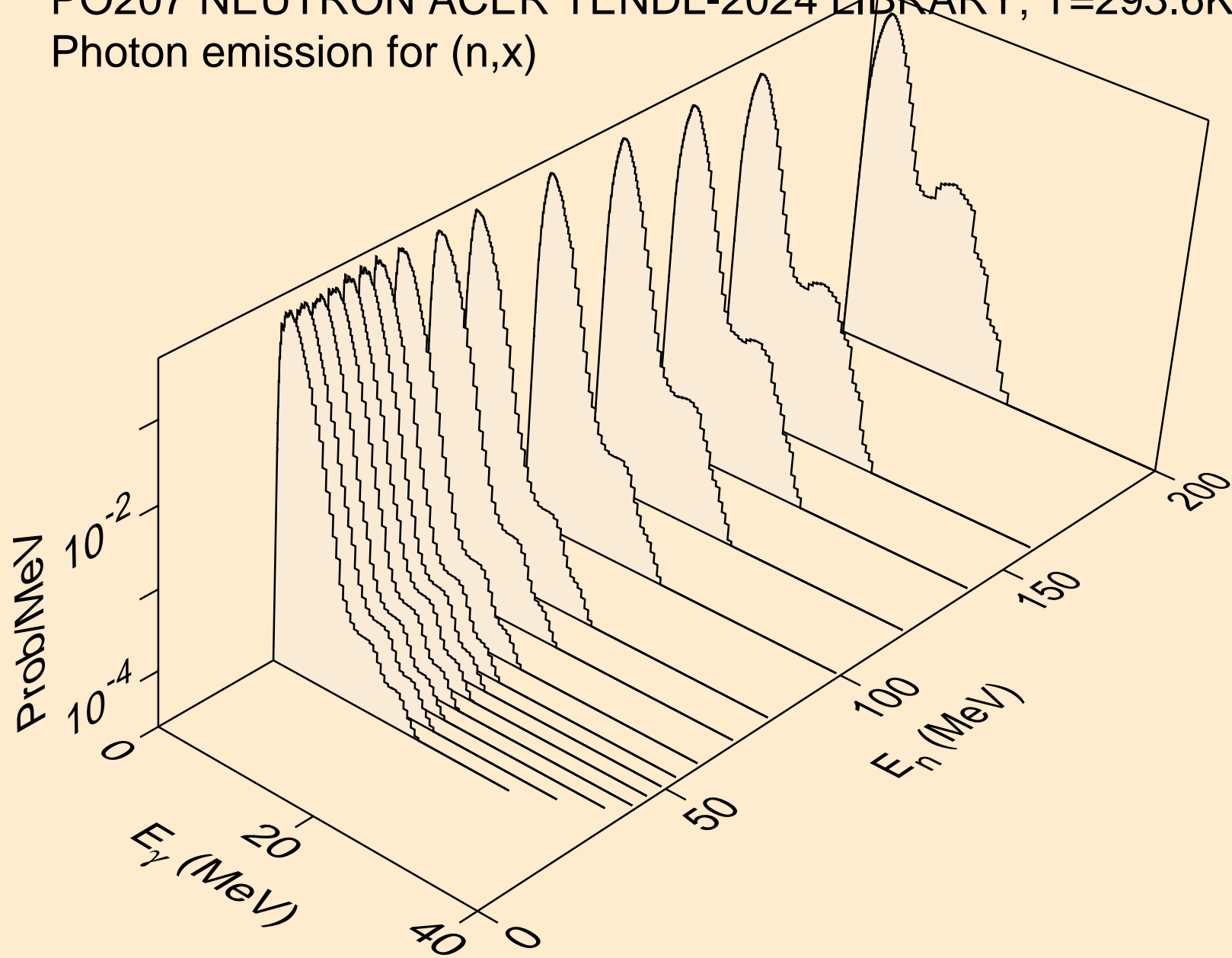

PO207 NEUTRON ACER TENDL-2024 LIBRARY; T=293.6K  
Photon emission for (n,2nd)

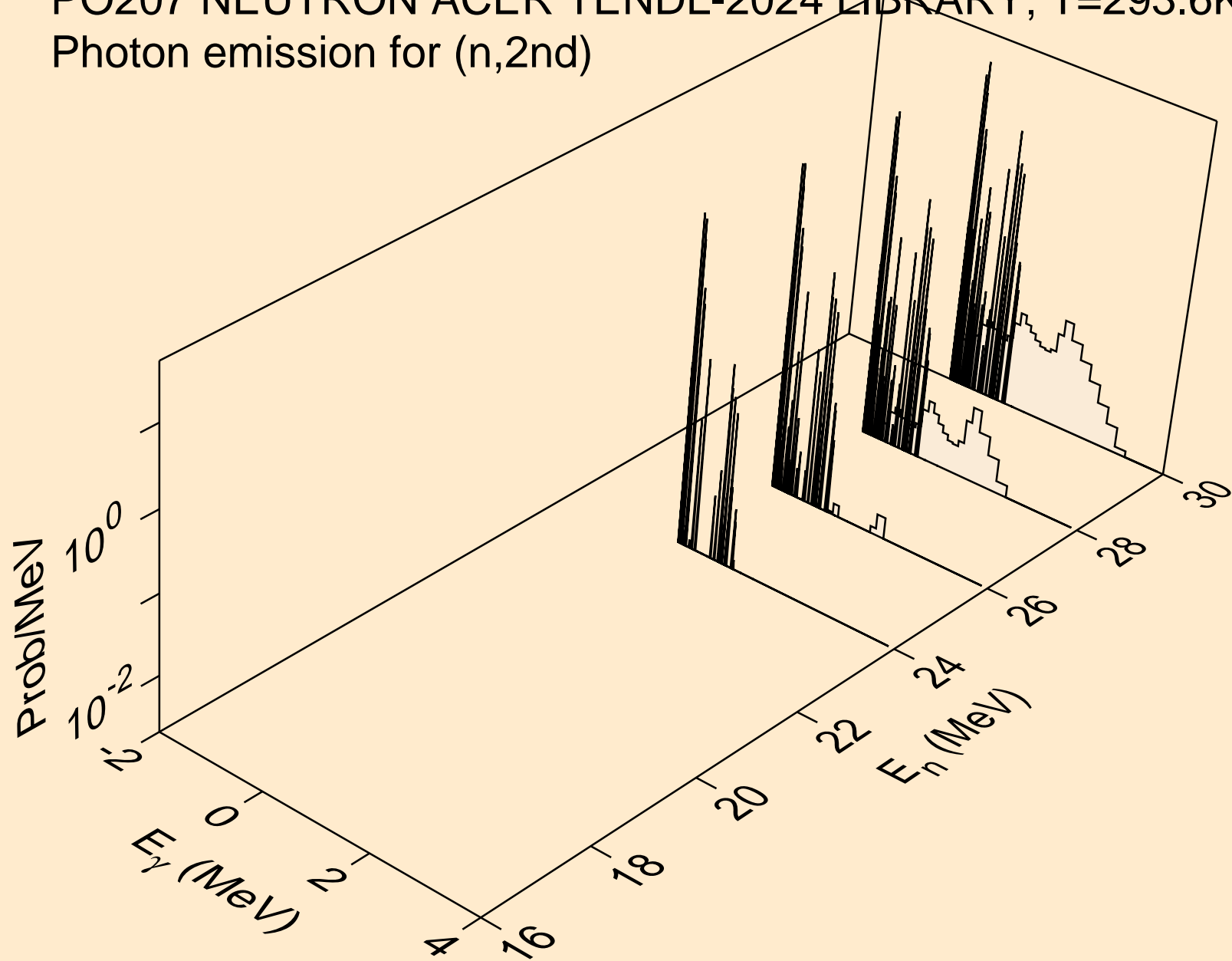

PO207 NEUTRON ACER TENDL-2024 LIBRARY; T=293.6K  
Photon emission for (n,2n)

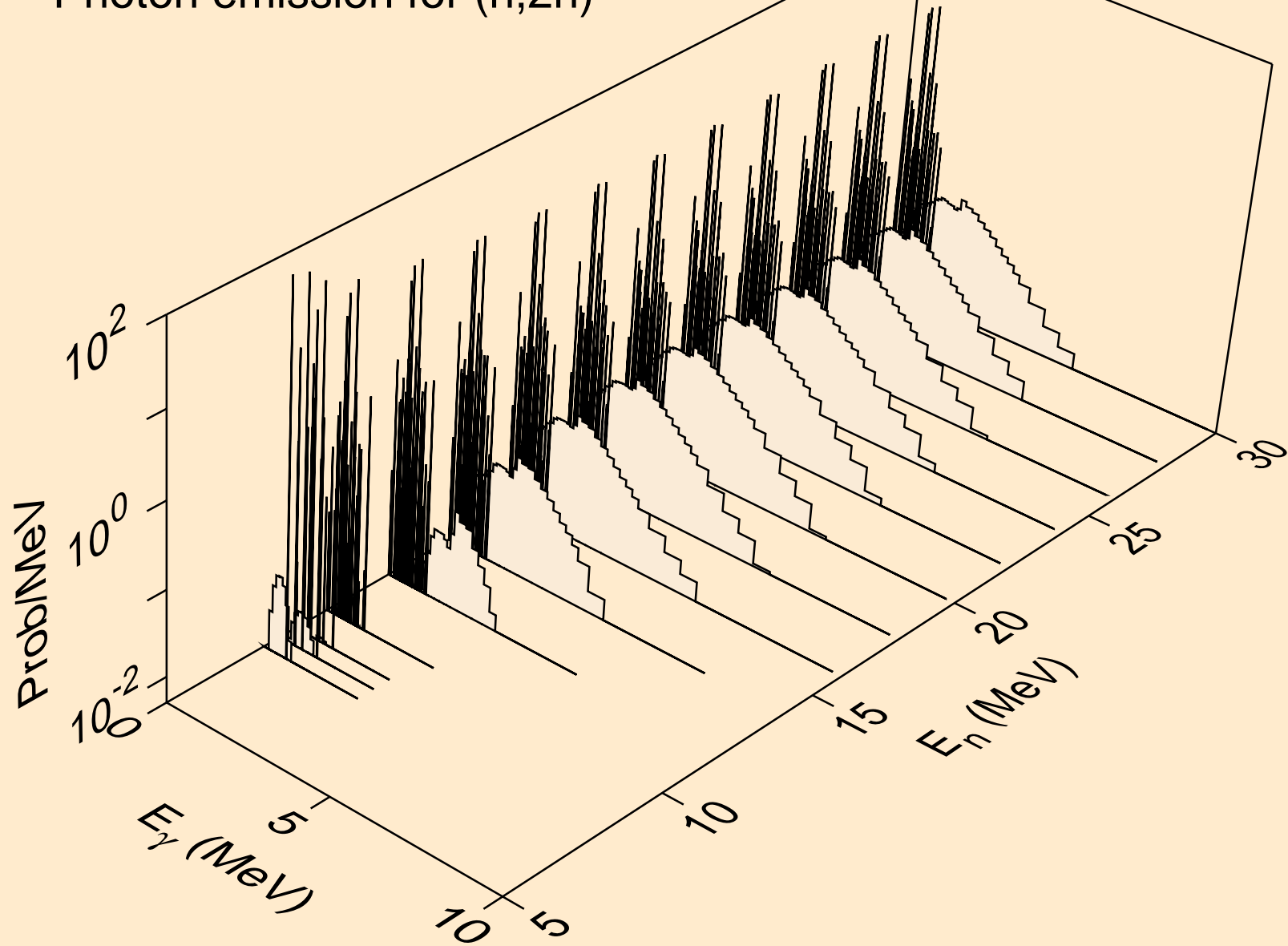

PO207 NEUTRON ACER TENDL-2024 LIBRARY; T=293.6K  
Photon emission for (n,3n)

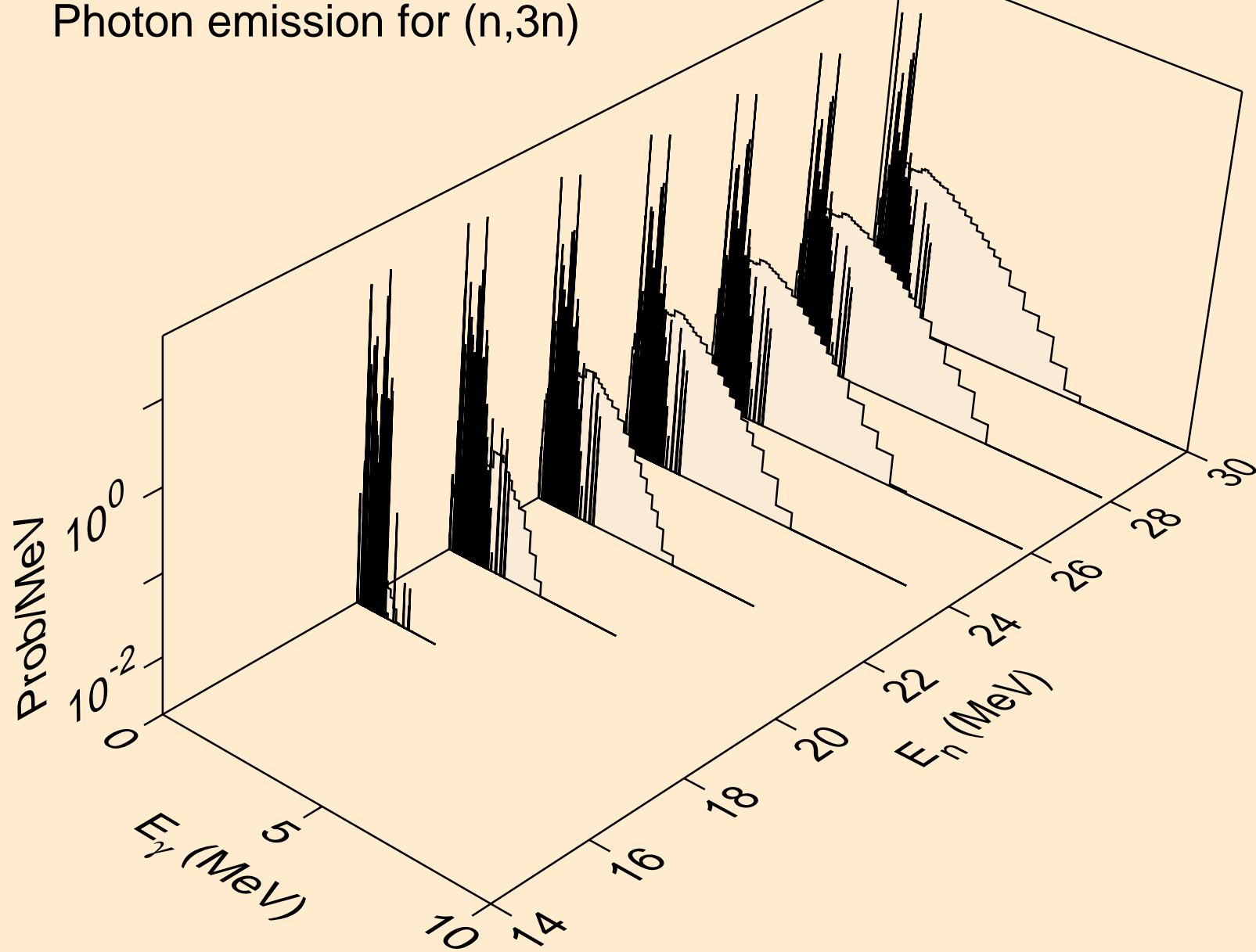

PO207 NEUTRON ACER TENDL-2024 LIBRARY; T=293.6K  
Photon emission for (n,n\*)a

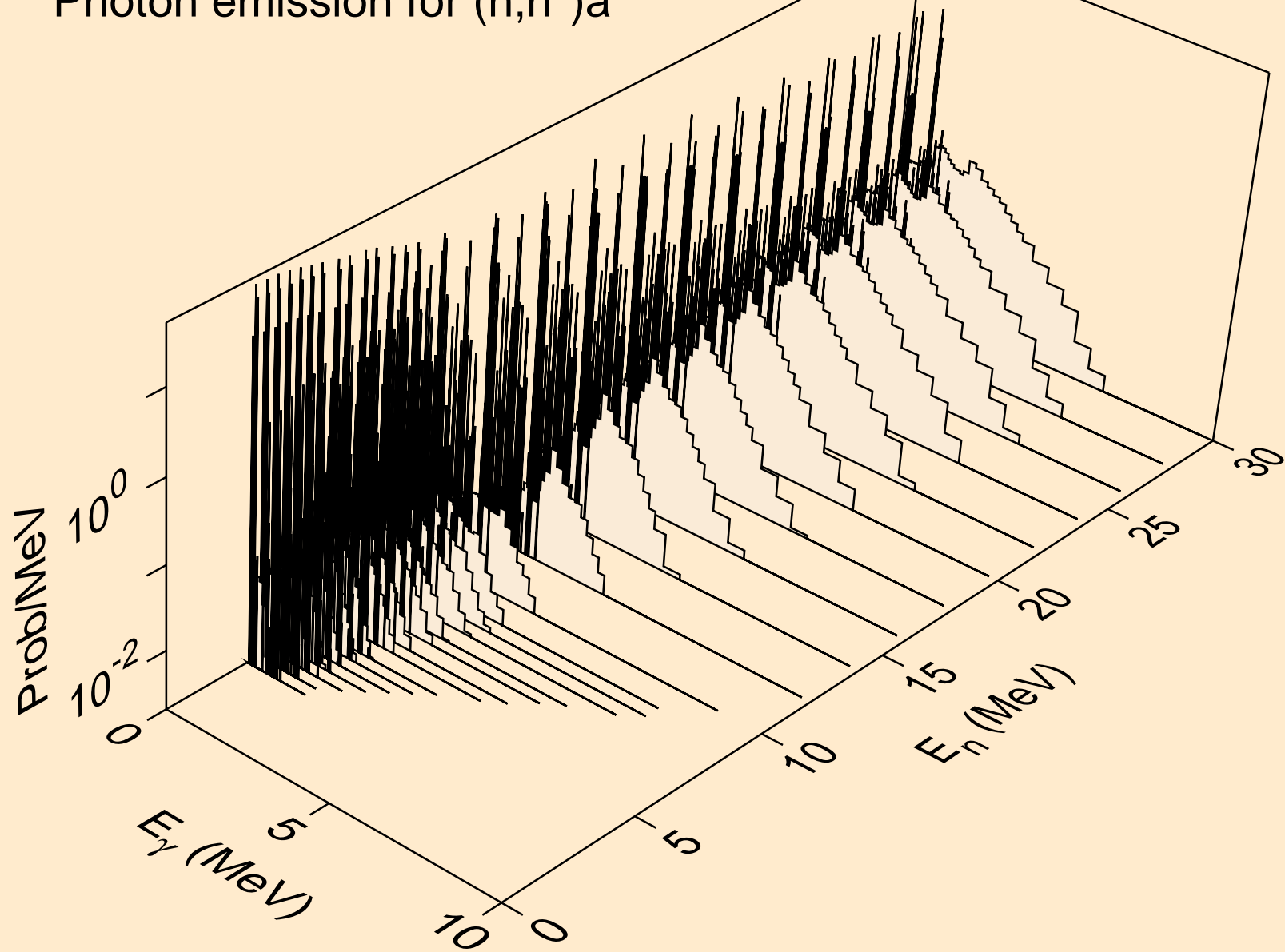

PO207 NEUTRON ACER TENDL-2024 LIBRARY; T=293.6K  
Photon emission for (n,2n)a

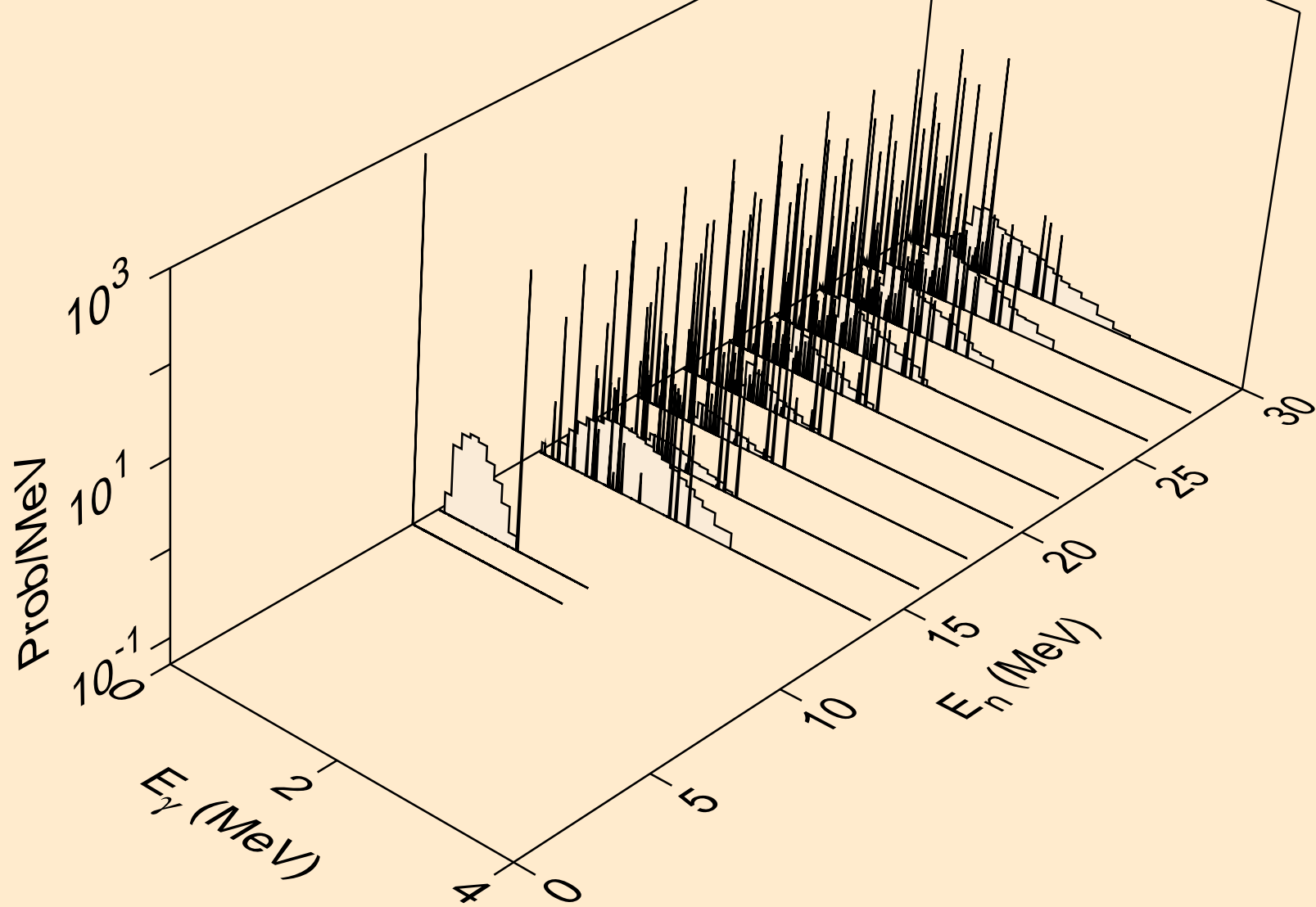

PO207 NEUTRON ACER TENDL-2024 LIBRARY; T=293.6K  
Photon emission for (n,3n)a

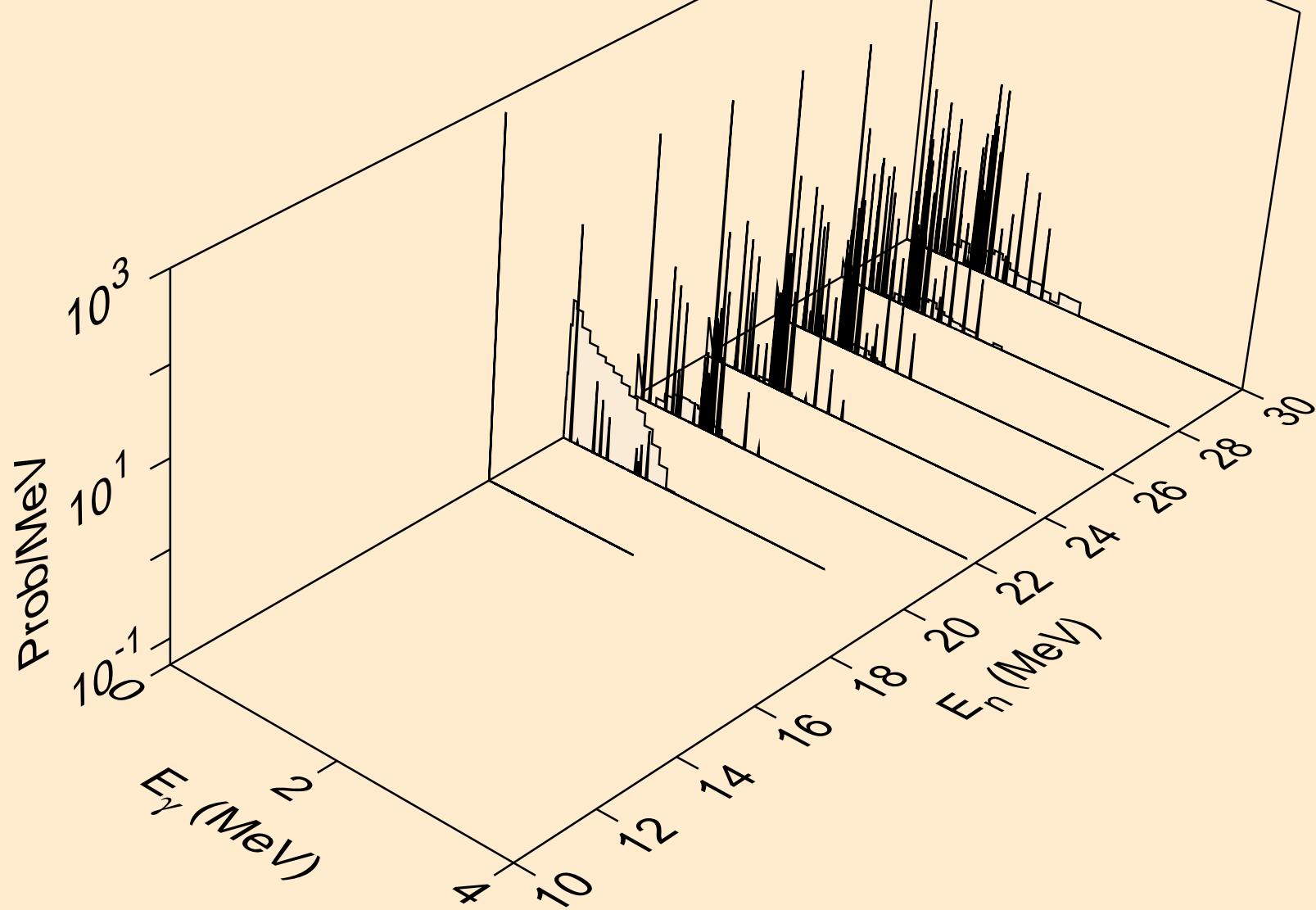

PO207 NEUTRON ACER TENDL-2024 LIBRARY; T=293.6K  
Photon emission for (n,n\*)p

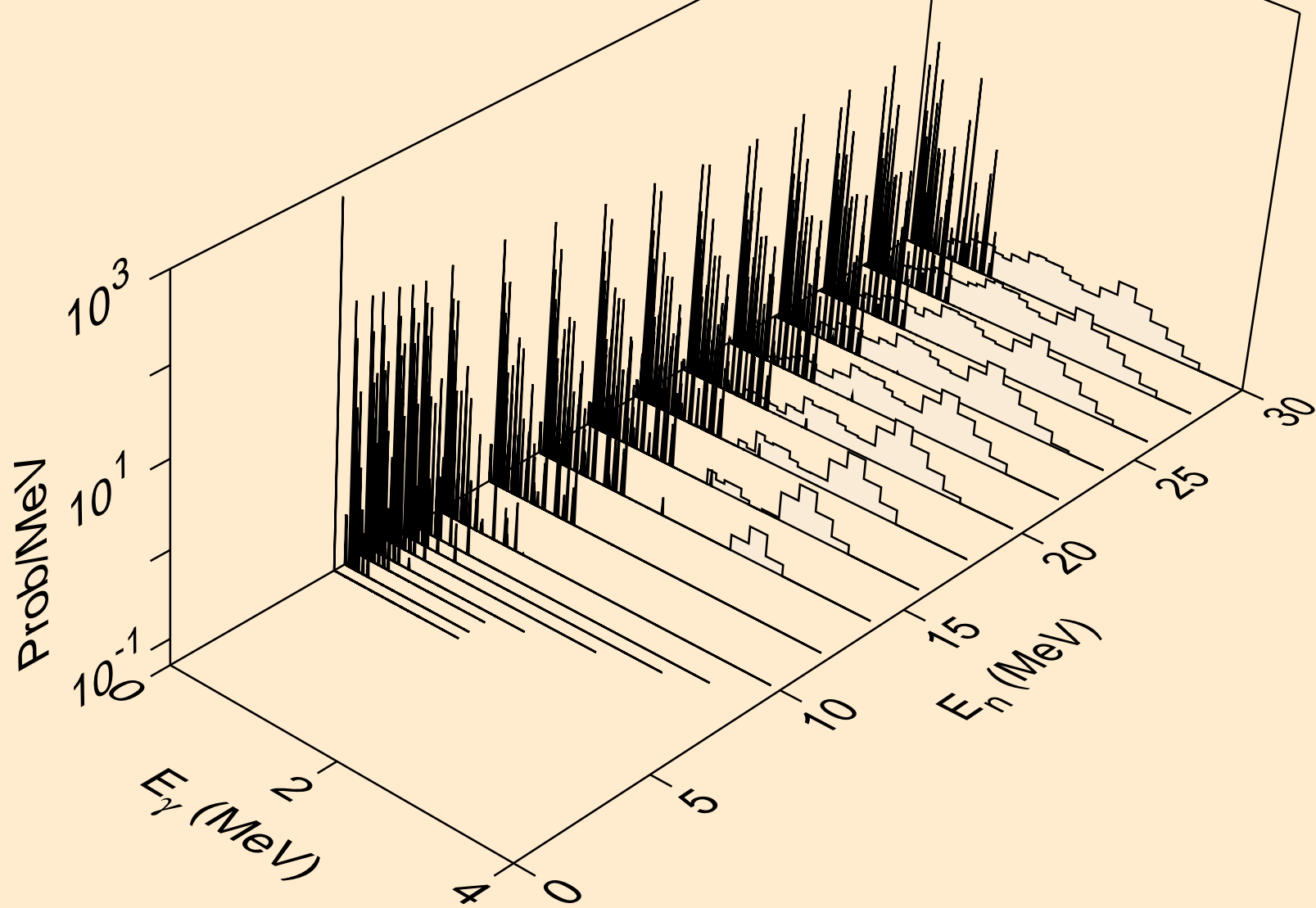

PO207 NEUTRON ACER TENDL-2024 LIBRARY; T=293.6K  
Photon emission for (n,n\*)2a

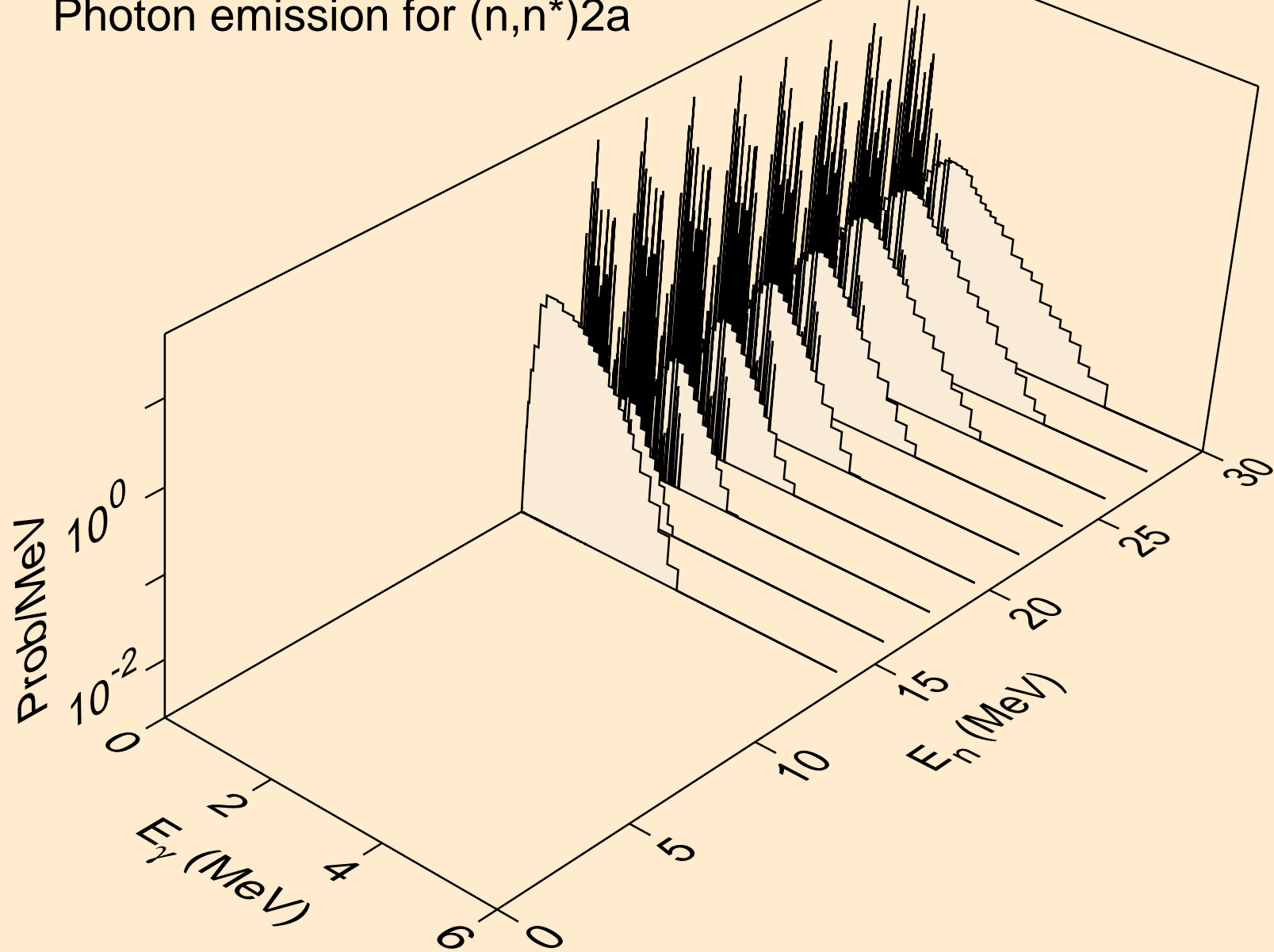

PO207 NEUTRON ACER TENDL-2024 LIBRARY; T=293.6K  
Photon emission for (n,n\*)d

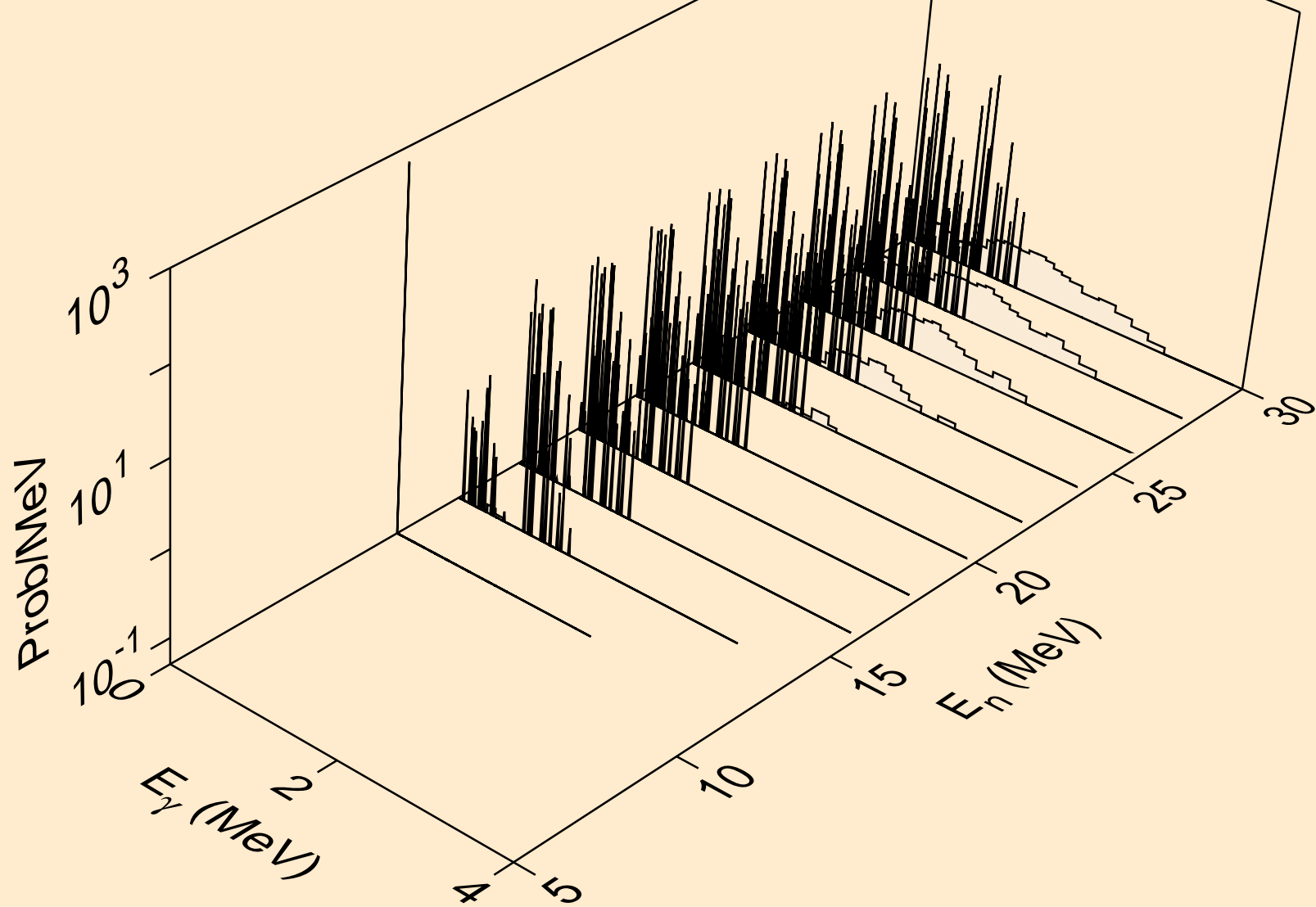

PO207 NEUTRON ACER TENDL-2024 LIBRARY; T=293.6K  
Photon emission for (n,n\*)t

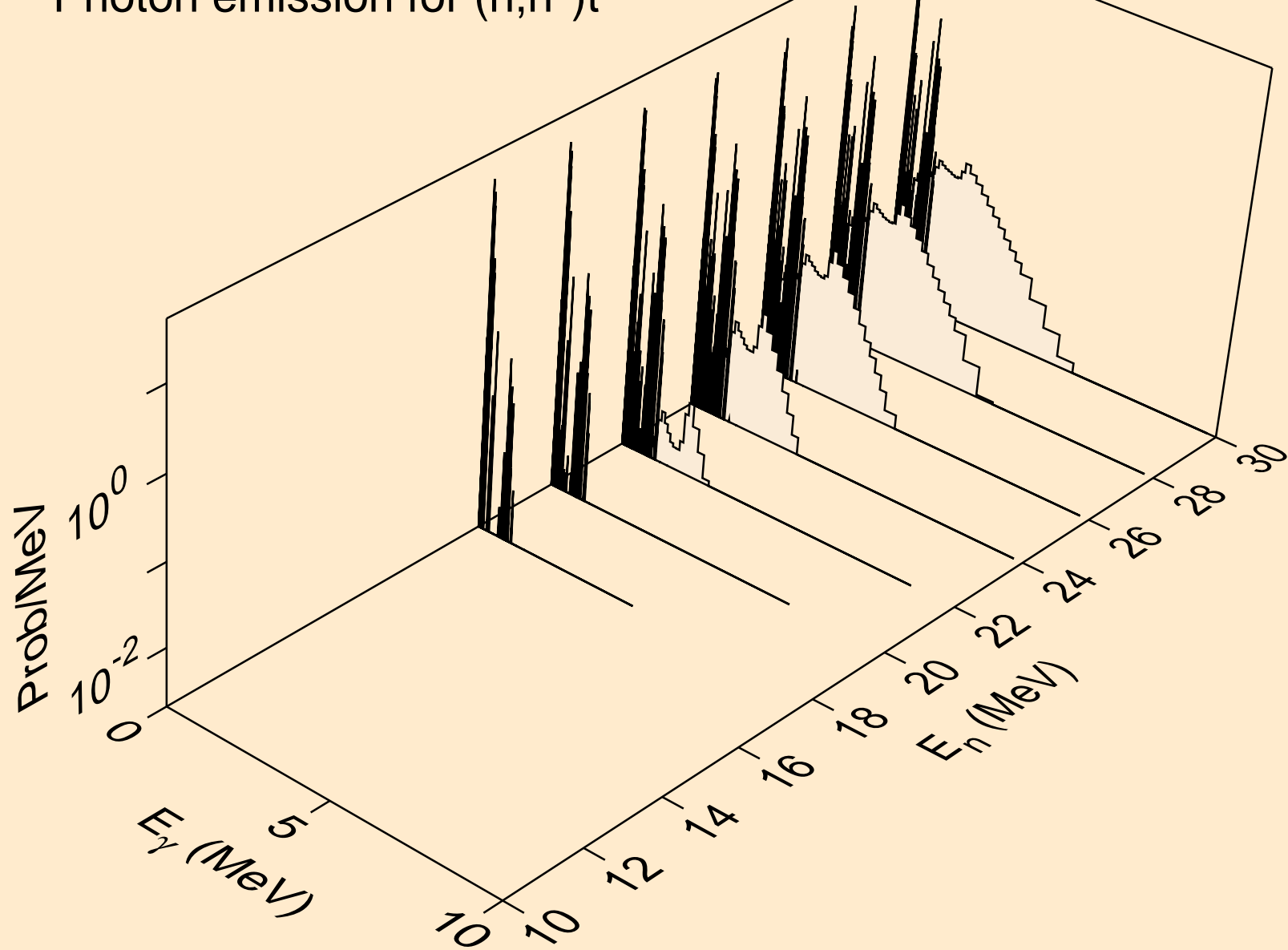

PO207 NEUTRON ACER TENDL-2024 LIBRARY; T=293.6K  
Photon emission for (n,n\*)he3

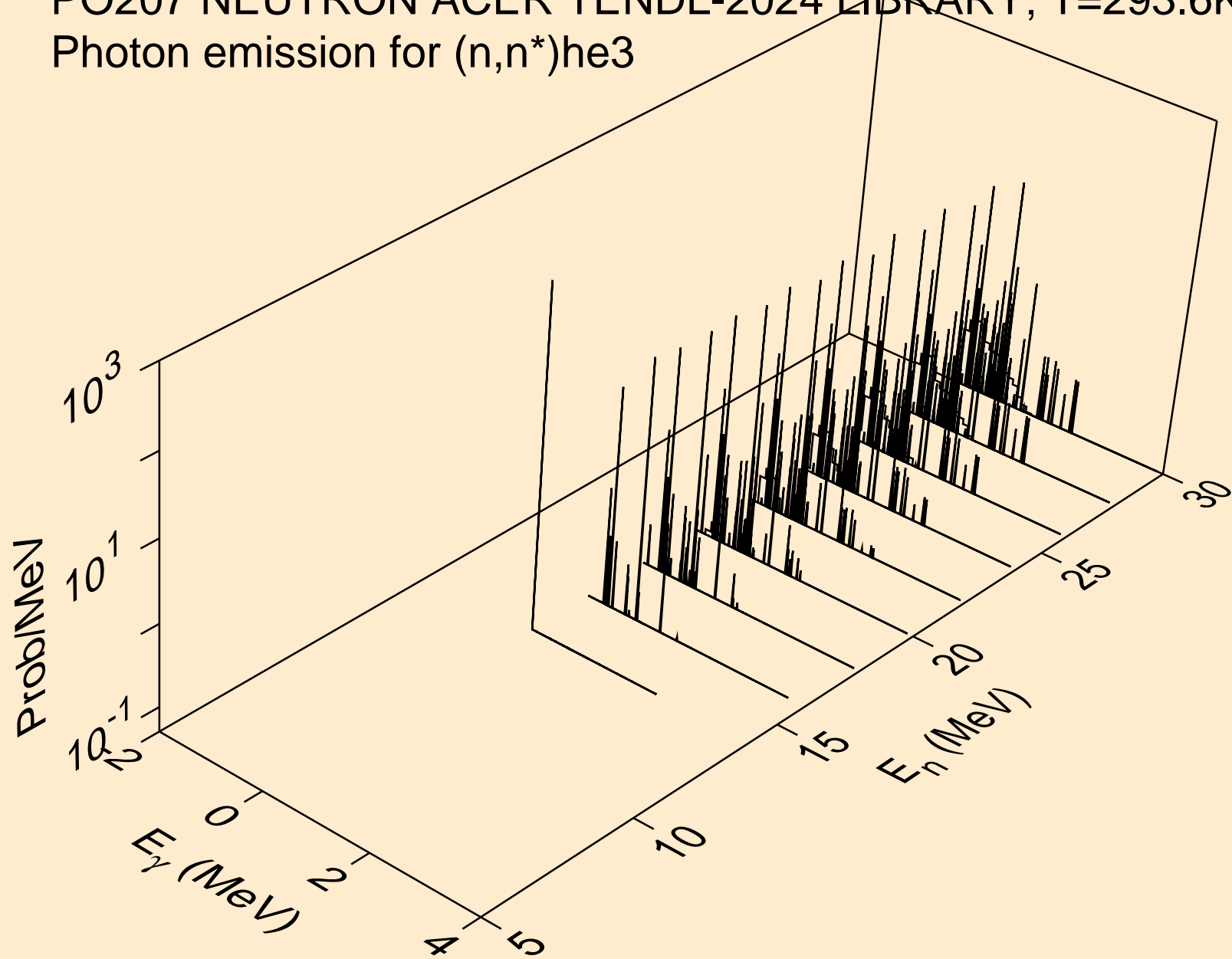

PO207 NEUTRON ACER TENDL-2024 LIBRARY; T=293.6K  
Photon emission for (n,4n)

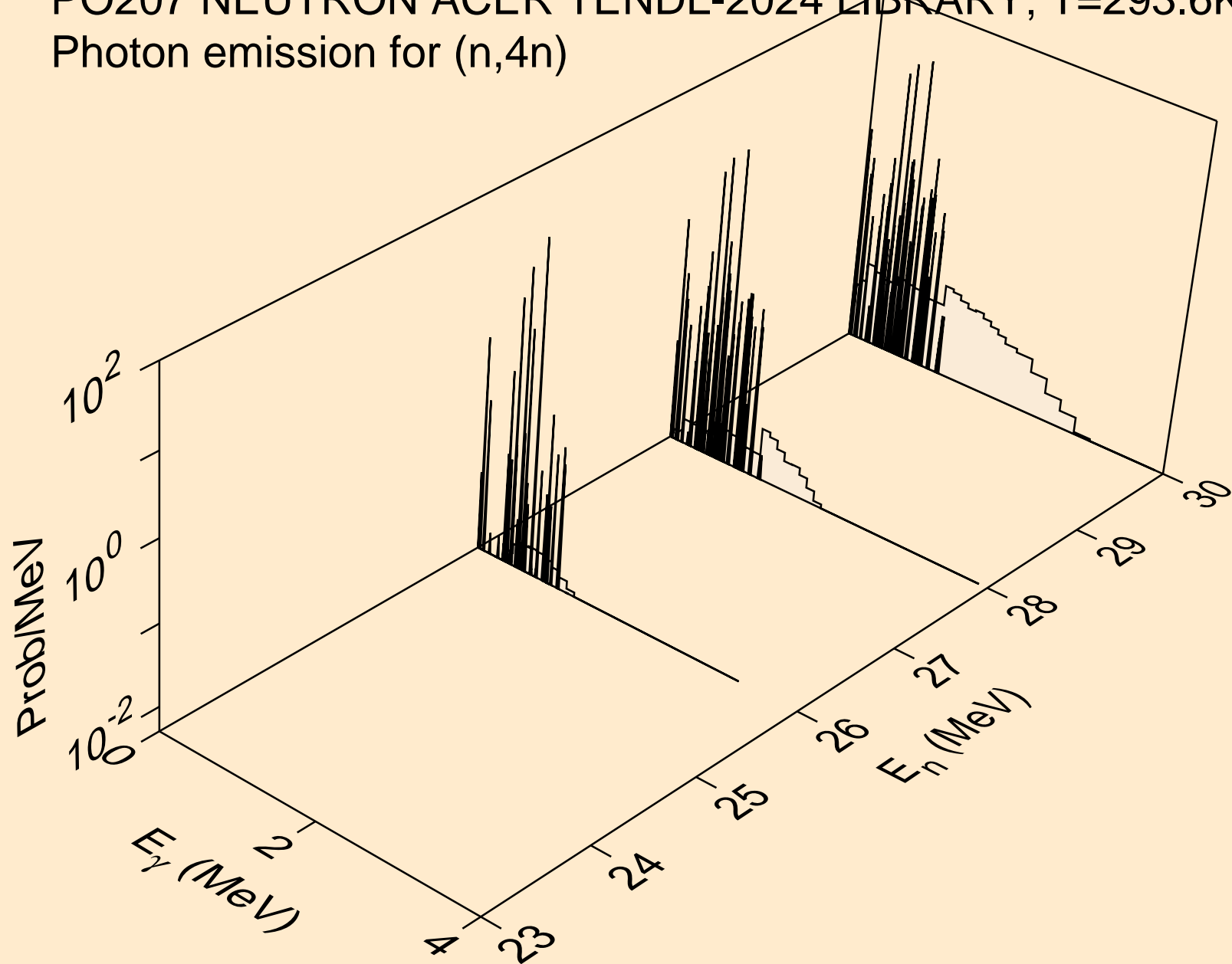

PO207 NEUTRON ACER TENDL-2024 LIBRARY; T=293.6K  
Photon emission for (n,2np)

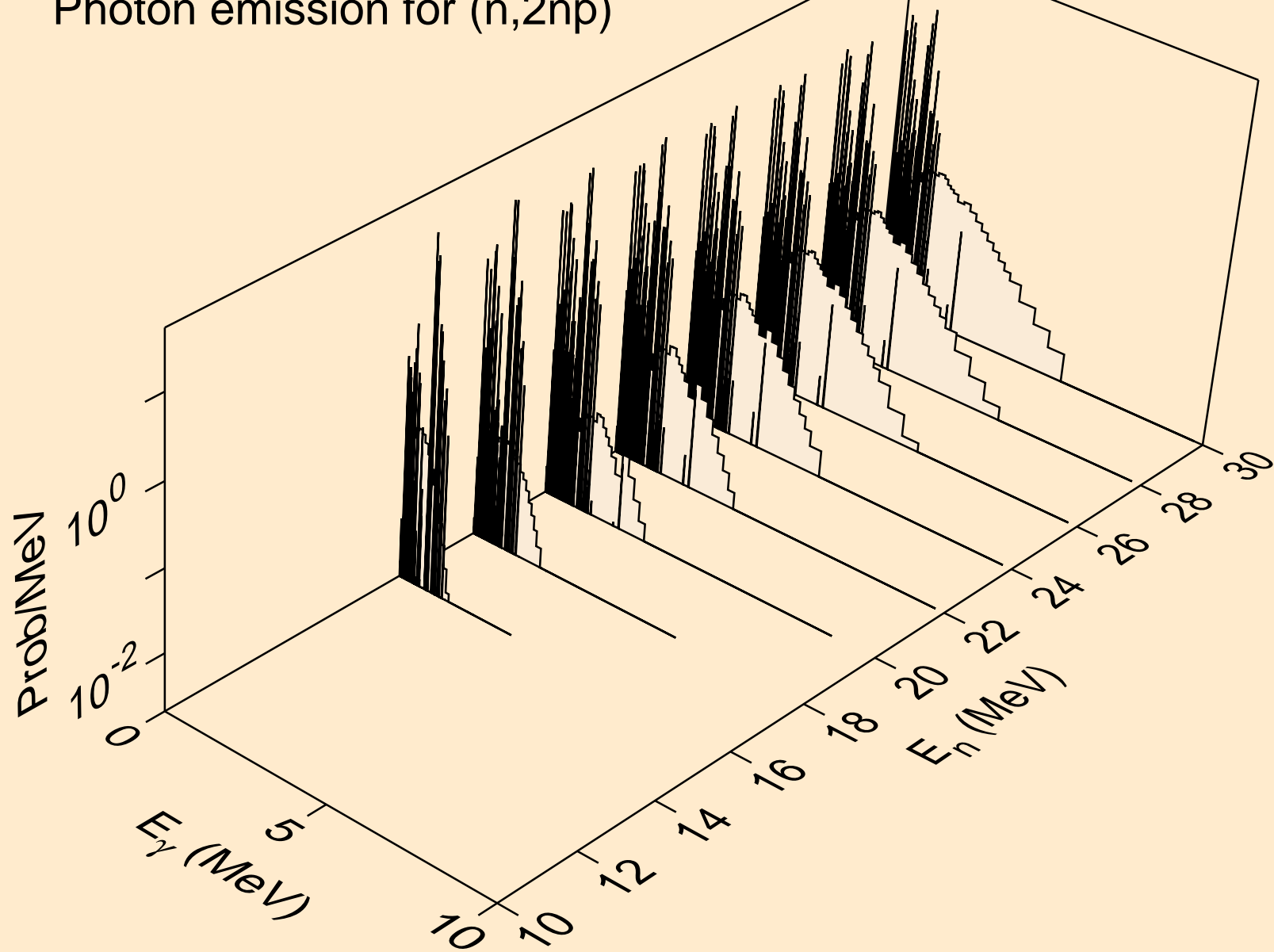

PO207 NEUTRON ACER TENDL-2024 LIBRARY; T=293.6K  
Photon emission for (n,3np)

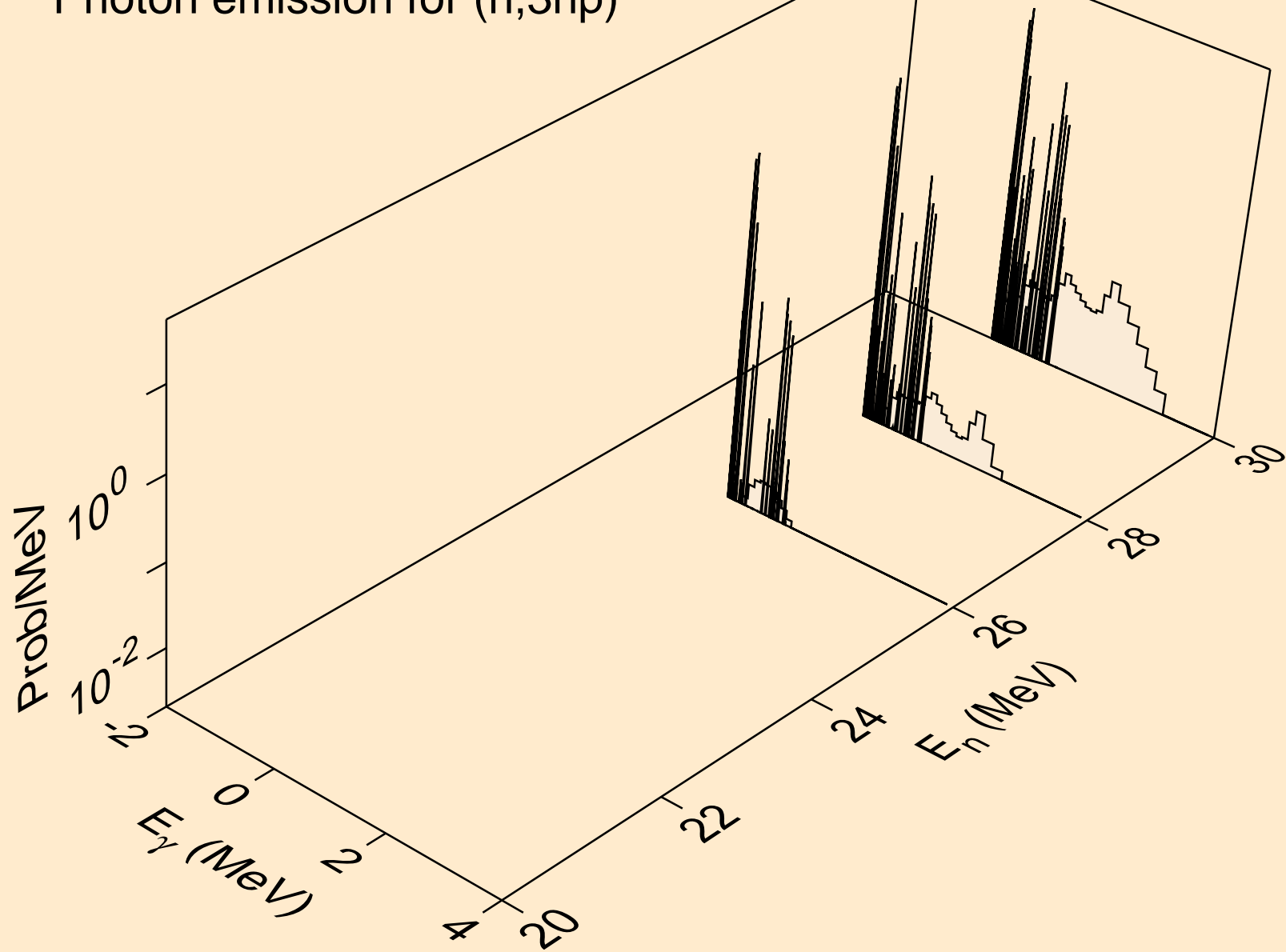

PO207 NEUTRON ACER TENDL-2024 LIBRARY; T=293.6K  
Photon emission for (n,n2p)

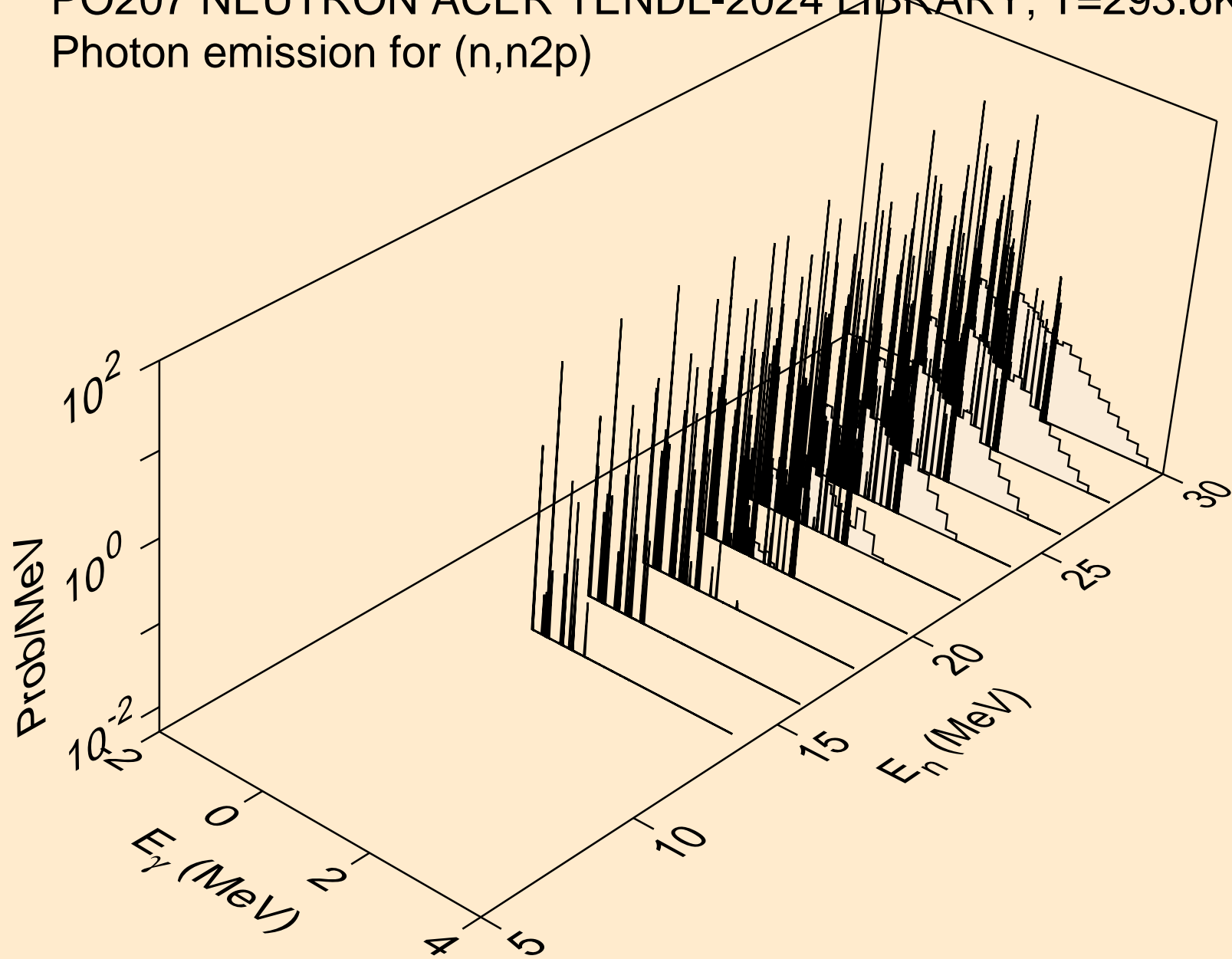

PO207 NEUTRON ACER TENDL-2024 LIBRARY; T=293.6K  
Photon emission for (n,npa)

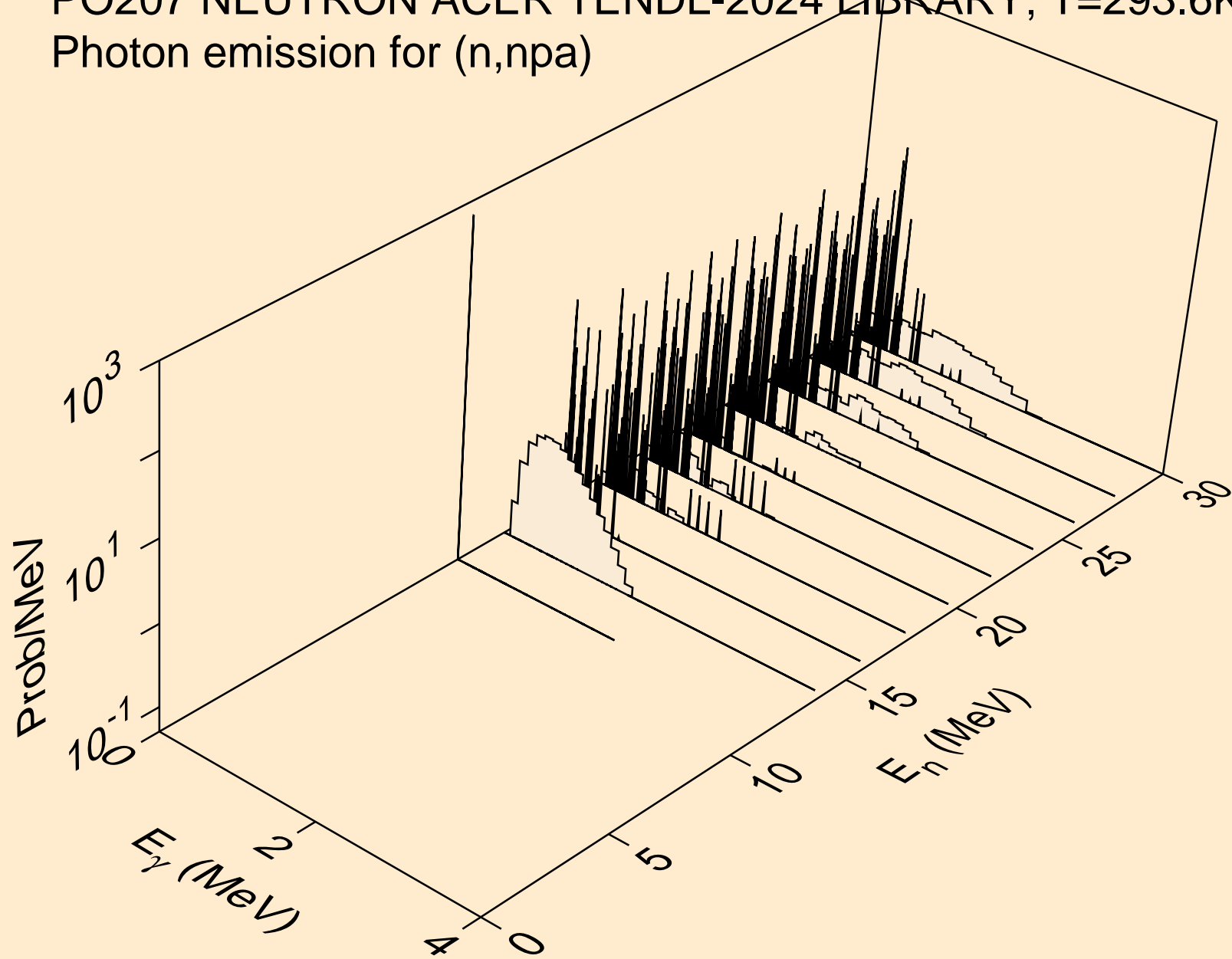

PO207 NEUTRON ACER TENDL-2024 LIBRARY; T=293.6K  
Photon emission for (n,n\*c)

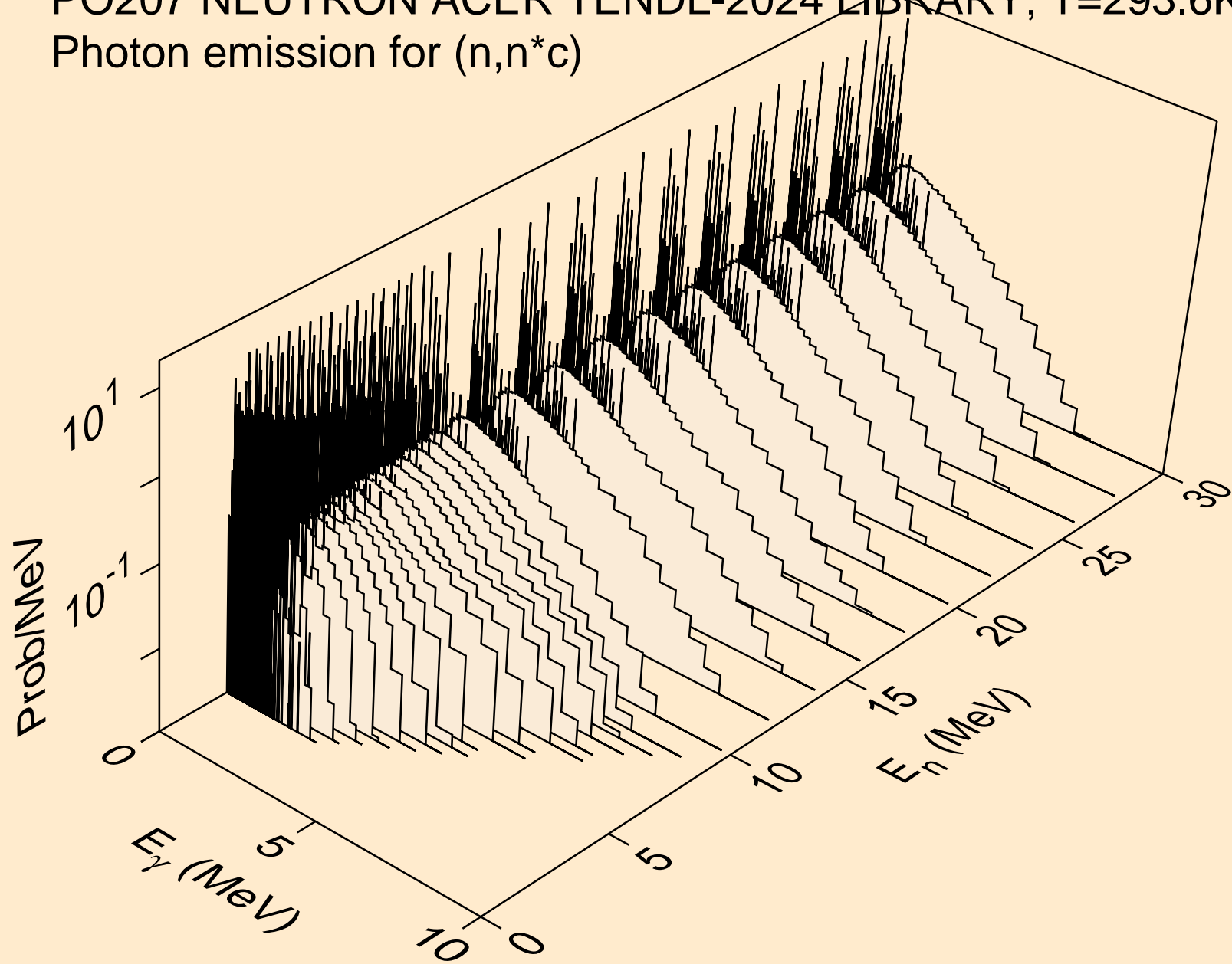

PO207 NEUTRON ACER TENDL-2024 LIBRARY; T=293.6K  
Photon emission for (n,gma)

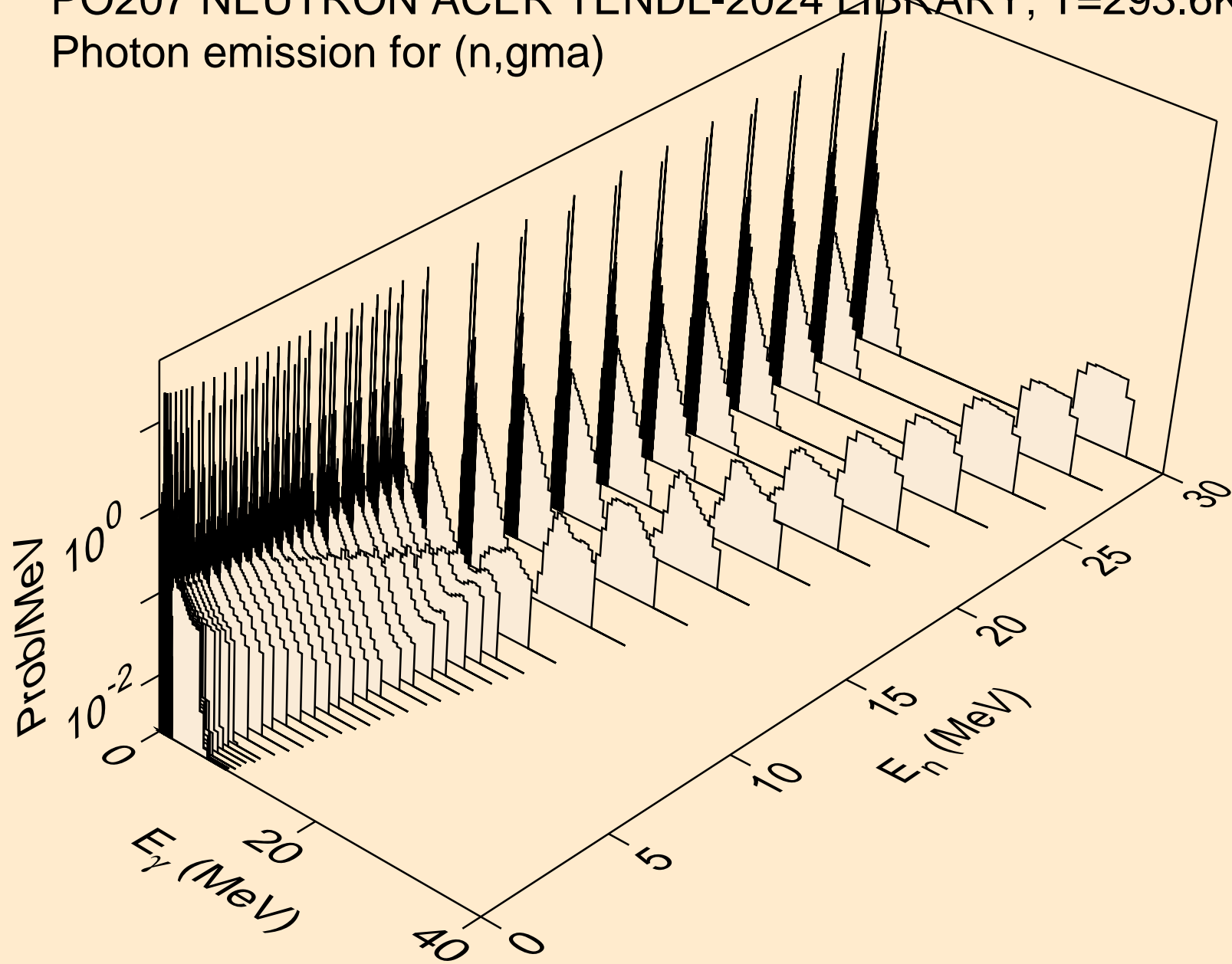

PO207 NEUTRON ACER TENDL-2024 LIBRARY; T=293.6K  
Photon emission for (n,p)

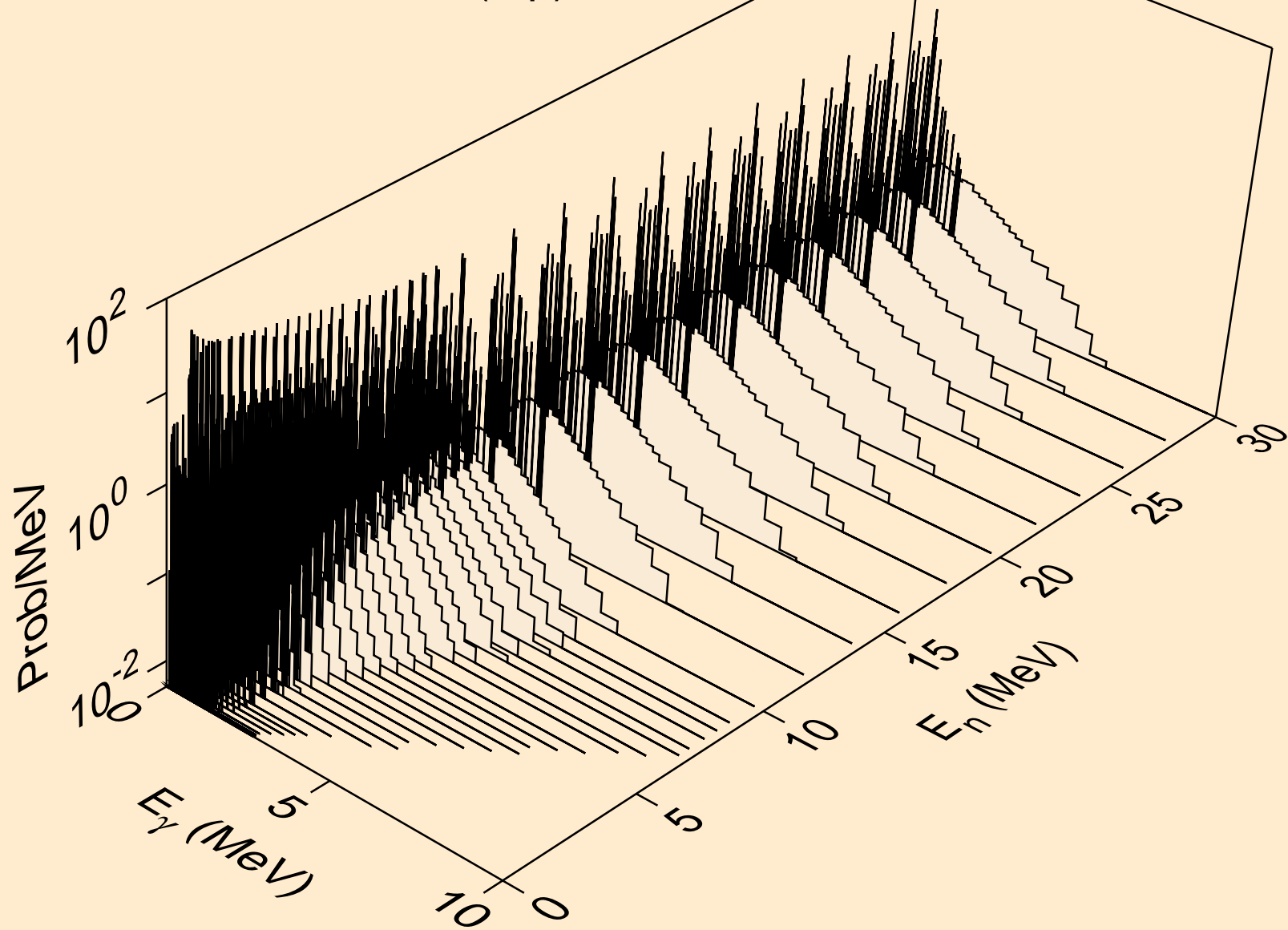

PO207 NEUTRON ACER TENDL-2024 LIBRARY; T=293.6K  
Photon emission for (n,d)

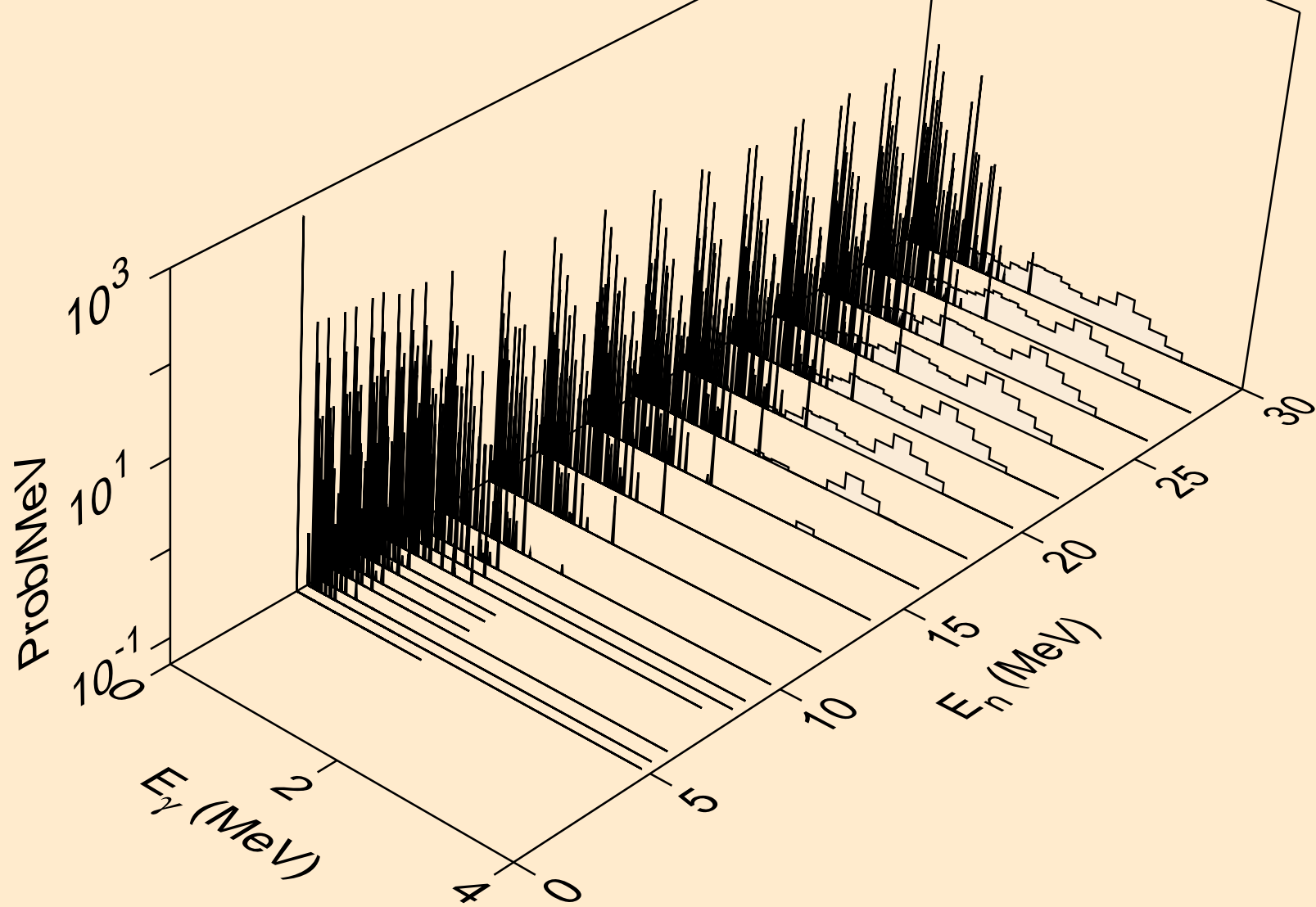

PO207 NEUTRON ACER TENDL-2024 LIBRARY; T=293.6K  
Photon emission for (n,t)

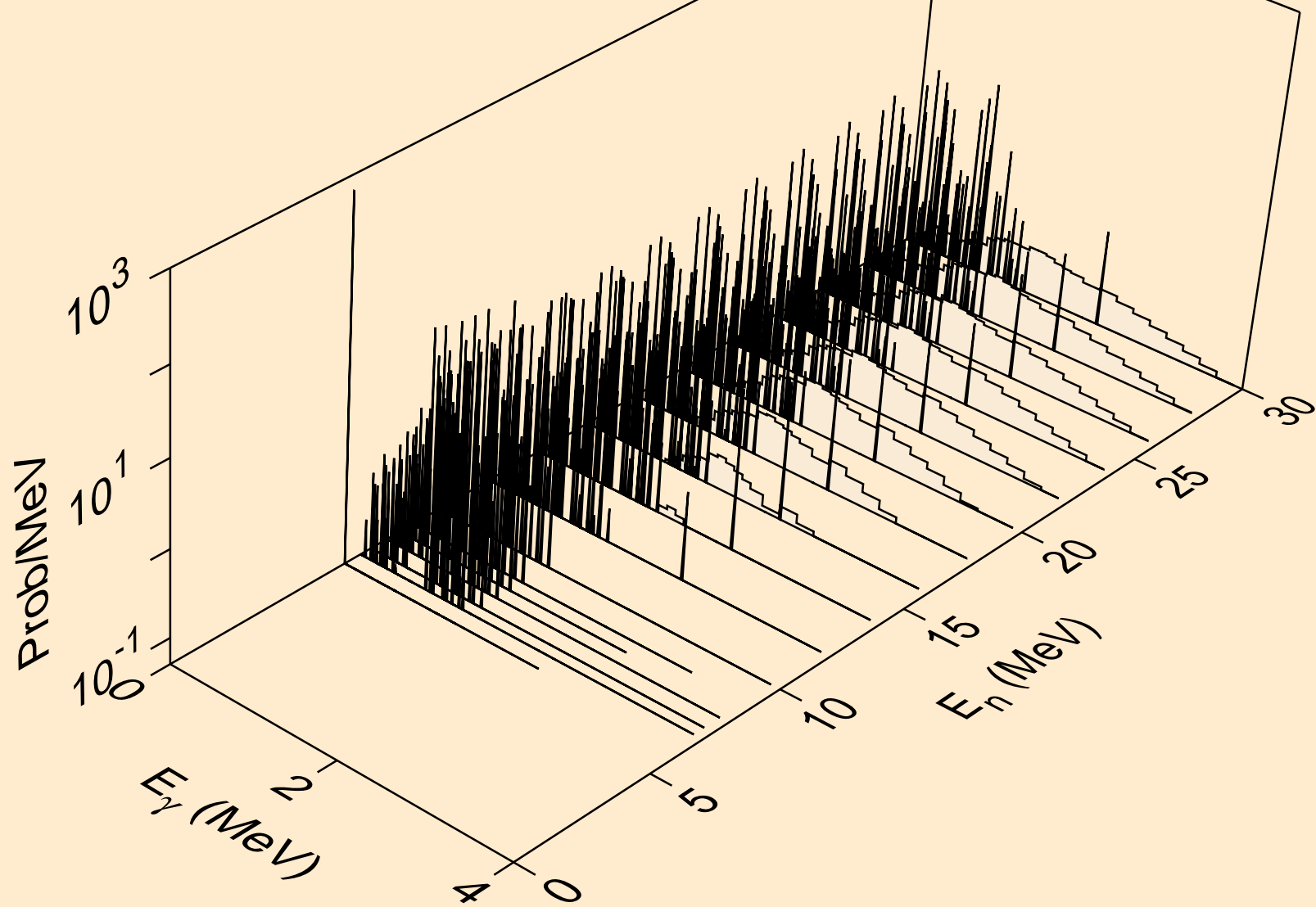

PO207 NEUTRON ACER TENDL-2024 LIBRARY; T=293.6K  
Photon emission for (n,he3)

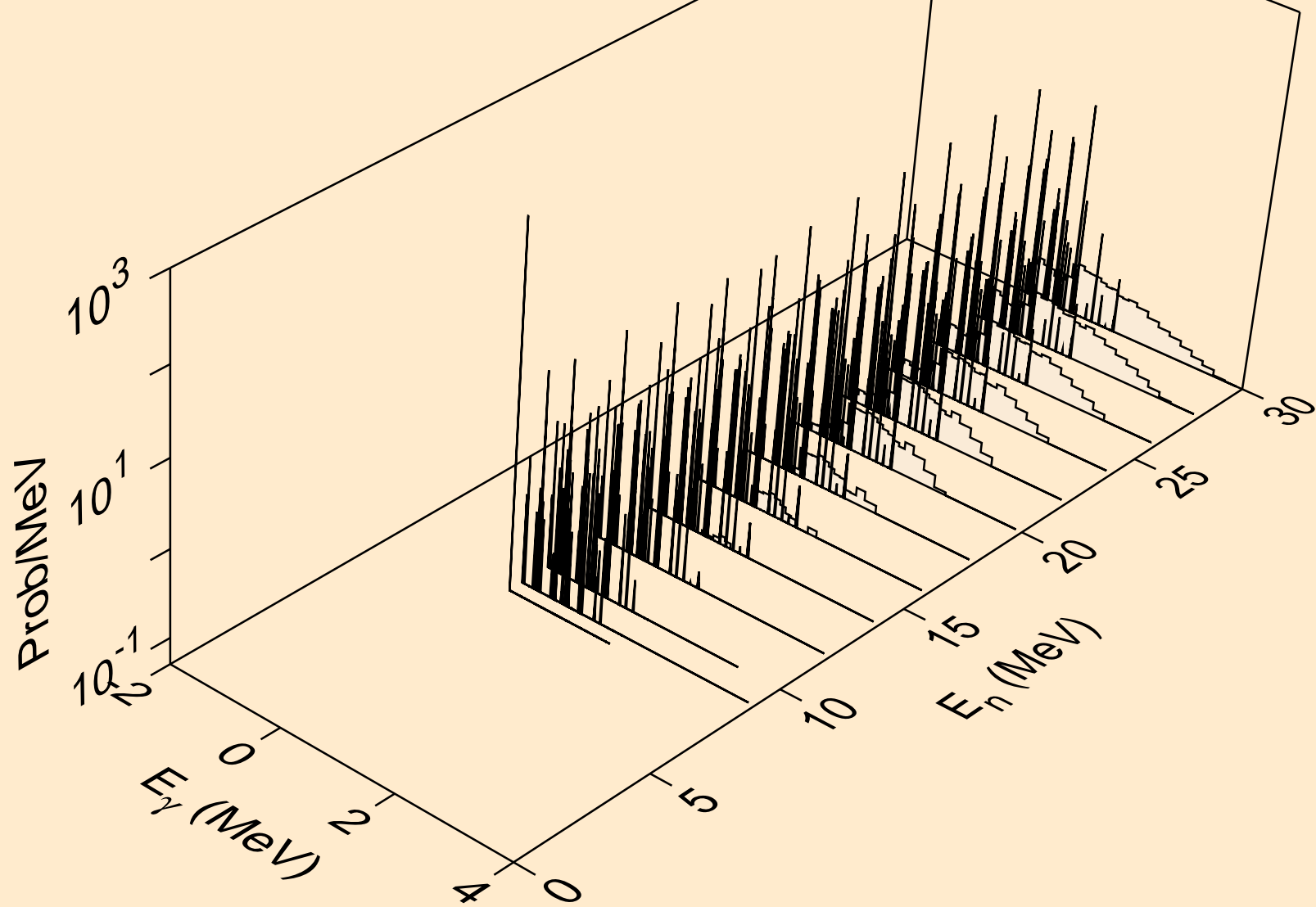

PO207 NEUTRON ACER TENDL-2024 LIBRARY; T=293.6K  
Photon emission for (n,a)

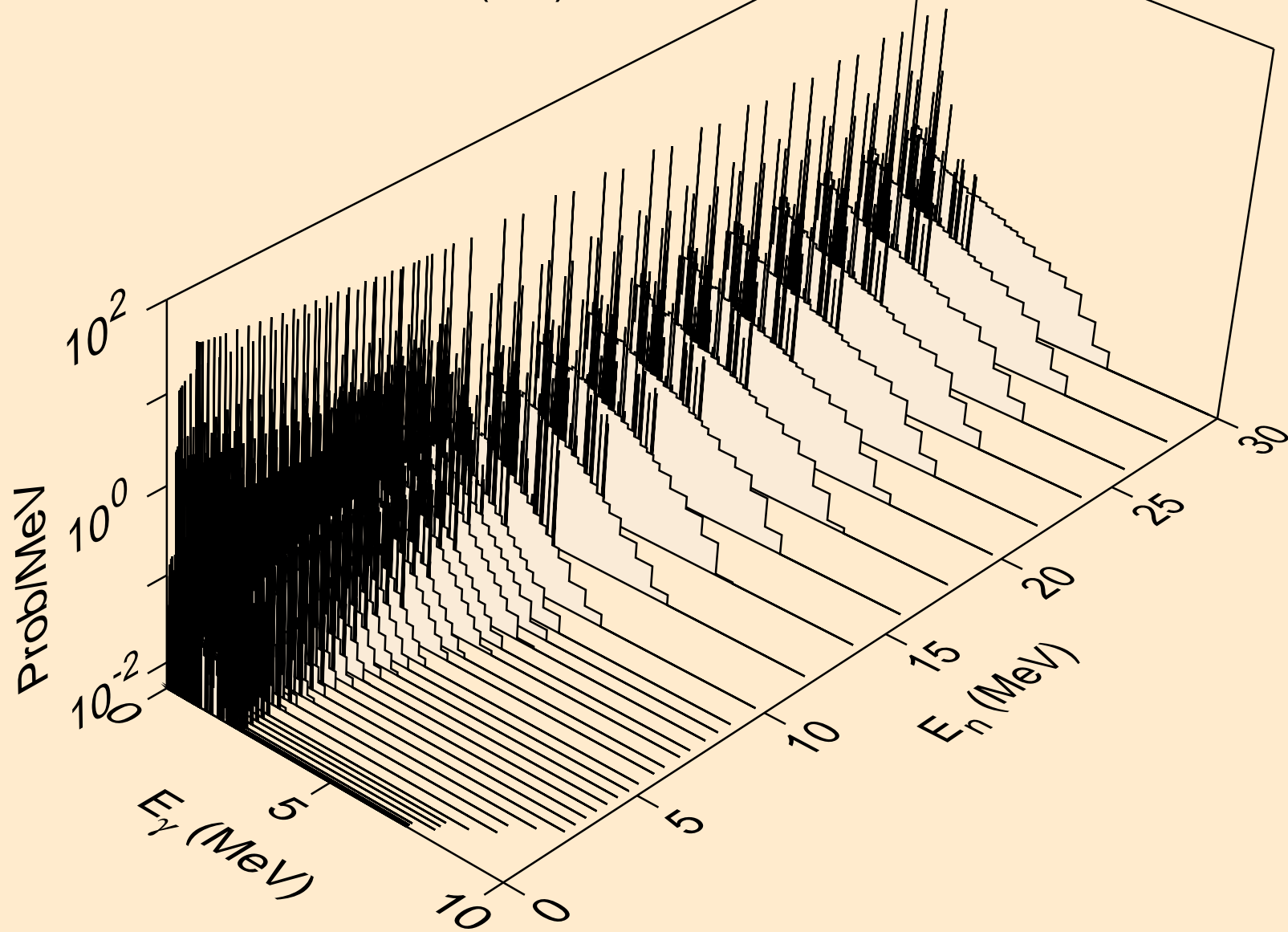

PO207 NEUTRON ACER TENDL-2024 LIBRARY; T=293.6K  
Photon emission for (n,2a)

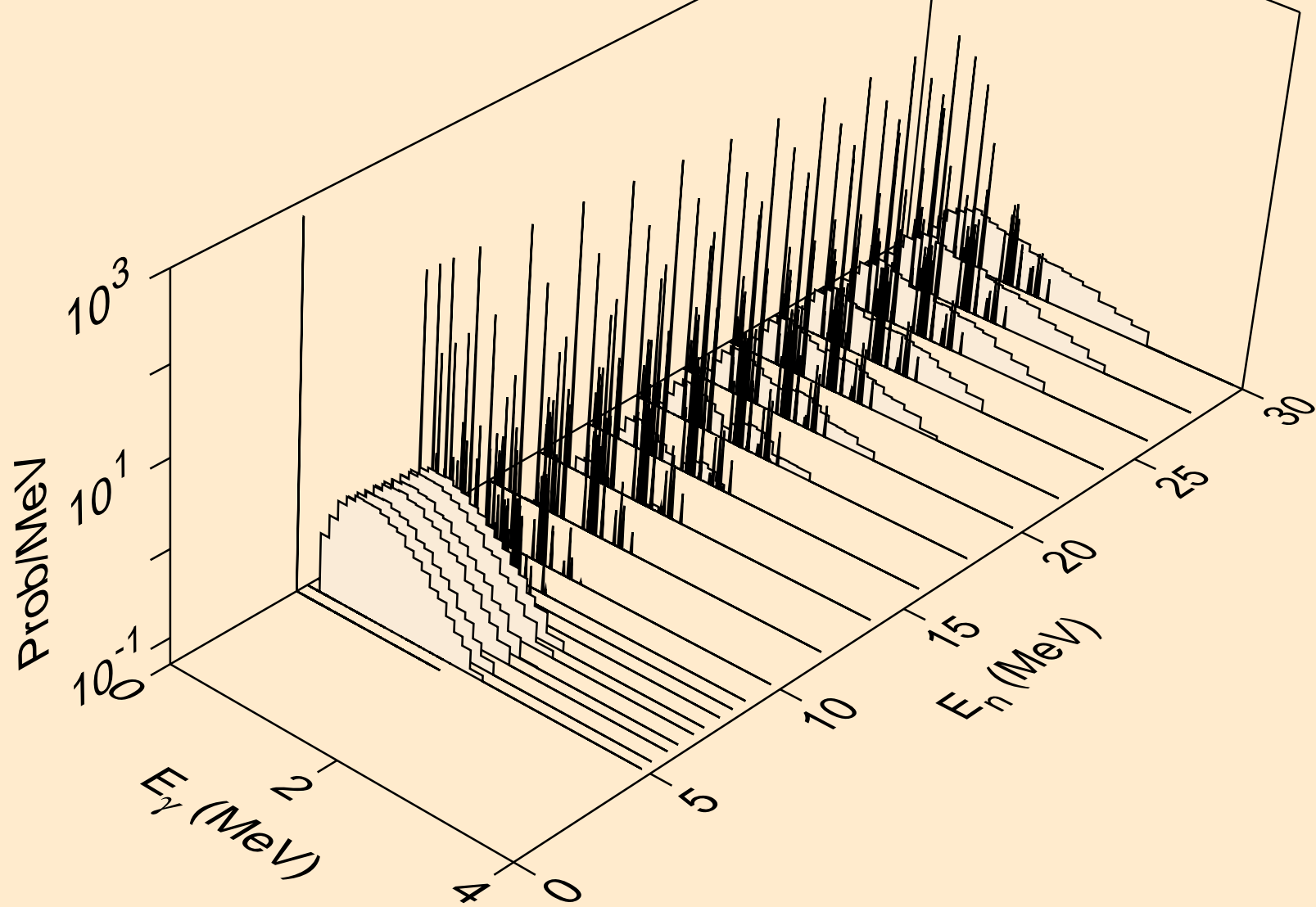

PO207 NEUTRON ACER TENDL-2024 LIBRARY; T=293.6K  
Photon emission for (n,2p)

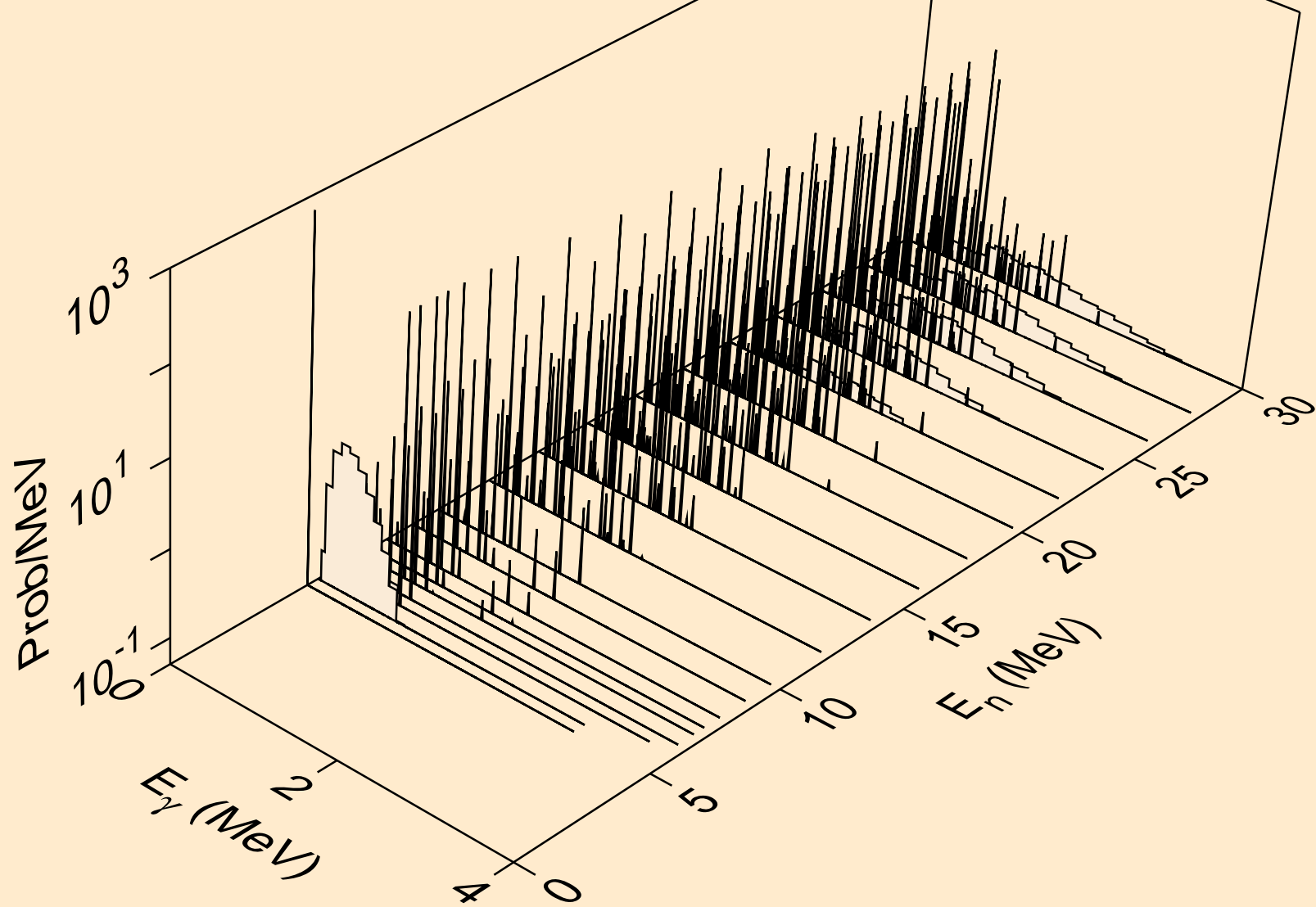

PO207 NEUTRON ACER TENDL-2024 LIBRARY; T=293.6K  
Photon emission for (n,p)

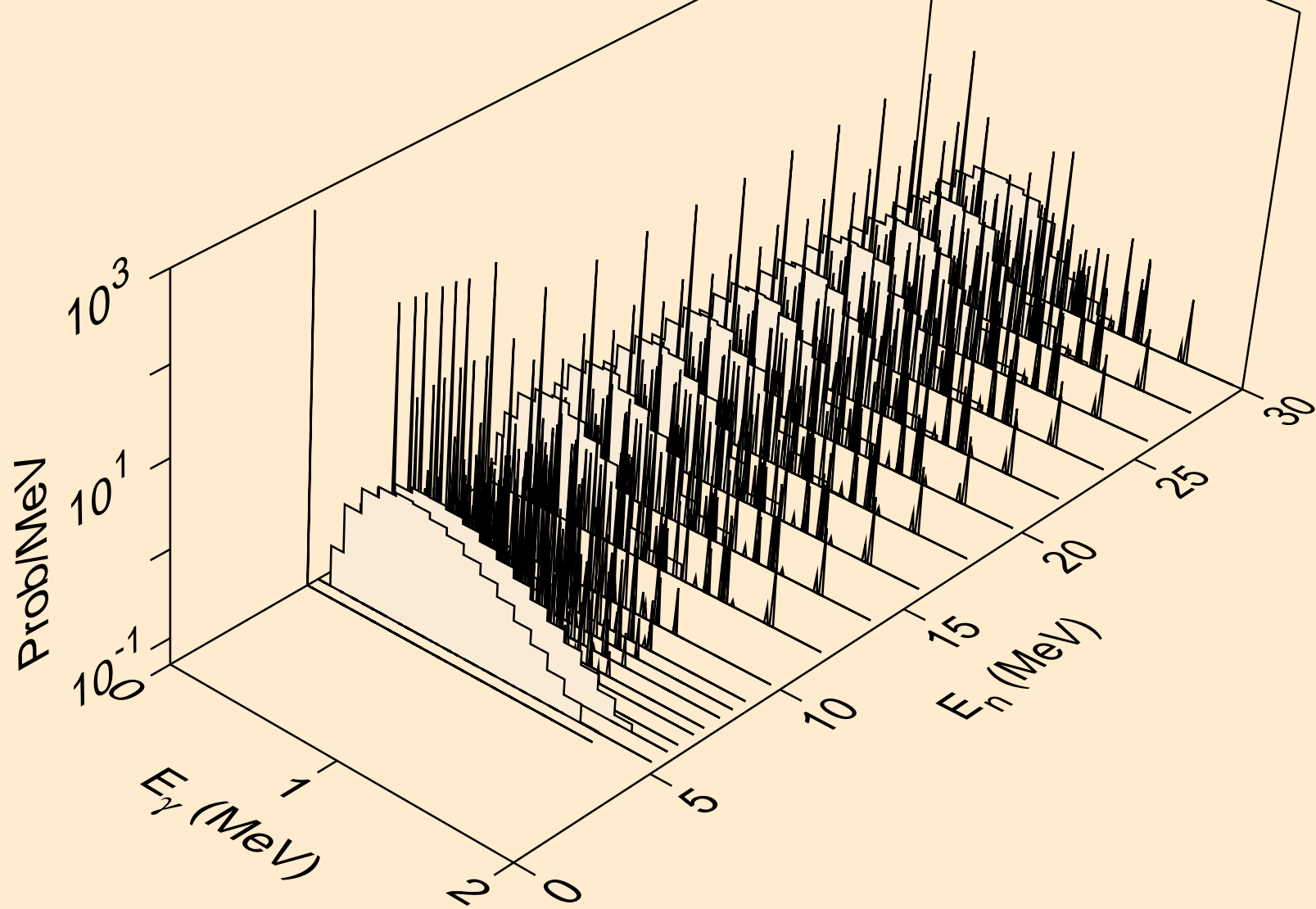

PO207 NEUTRON ACER TENDL-2024 LIBRARY; T=293.6K  
Photon emission for (n,pd)

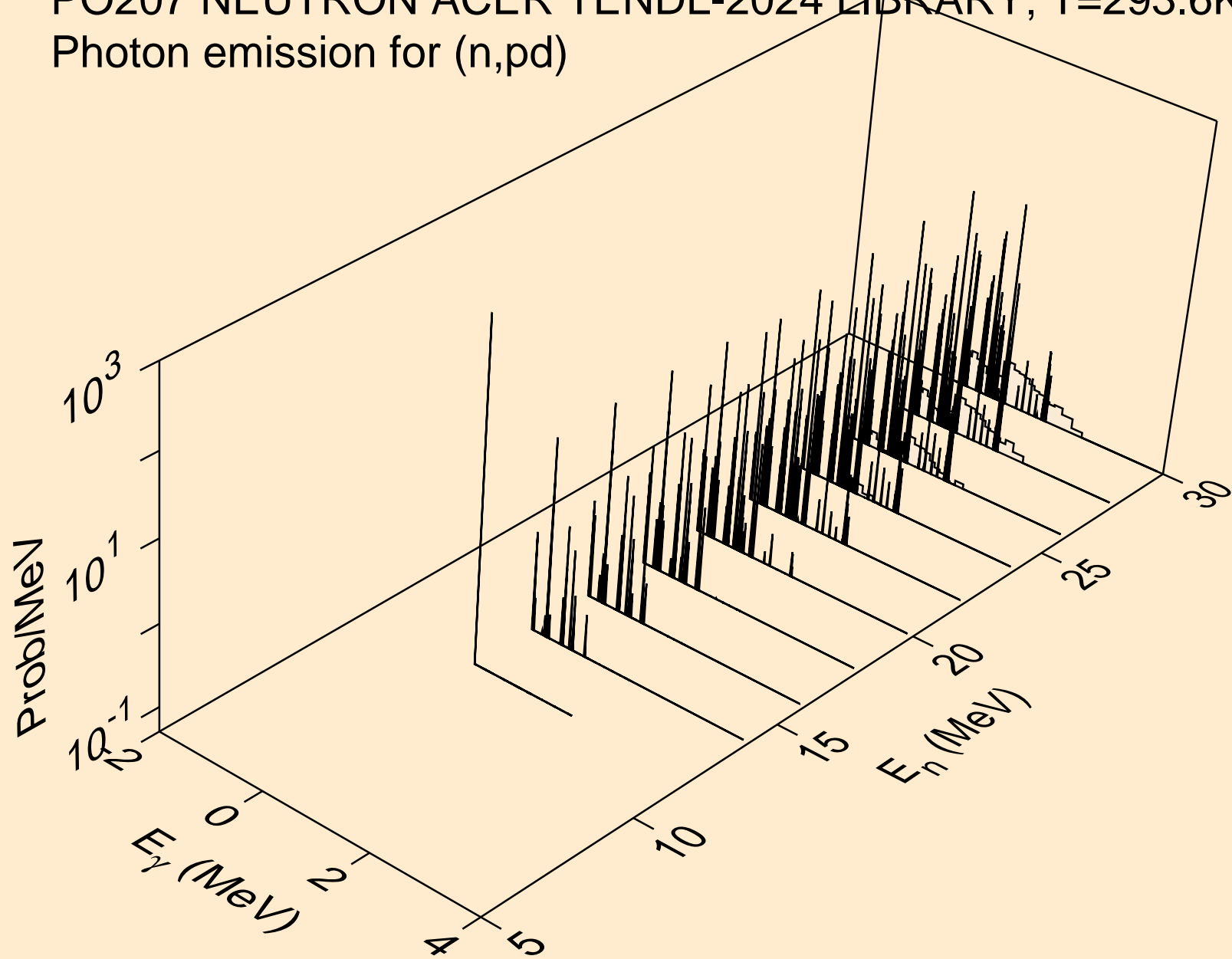

PO207 NEUTRON ACER TENDL-2024 LIBRARY; T=293.6K  
Photon emission for (n,pt)

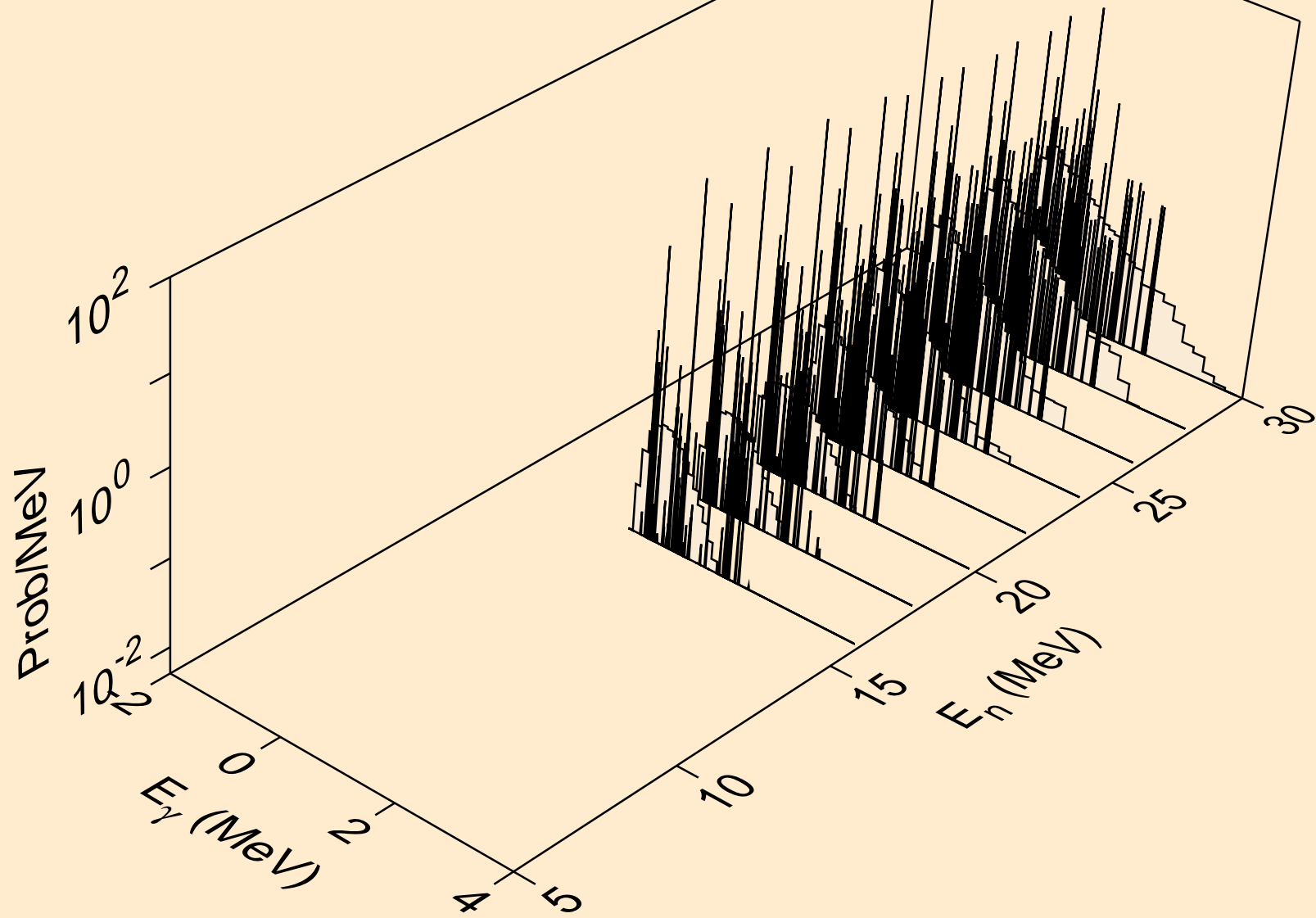

PO207 NEUTRON ACER TENDL-2024 LIBRARY; T=293.6K  
Photon emission for (n,da)

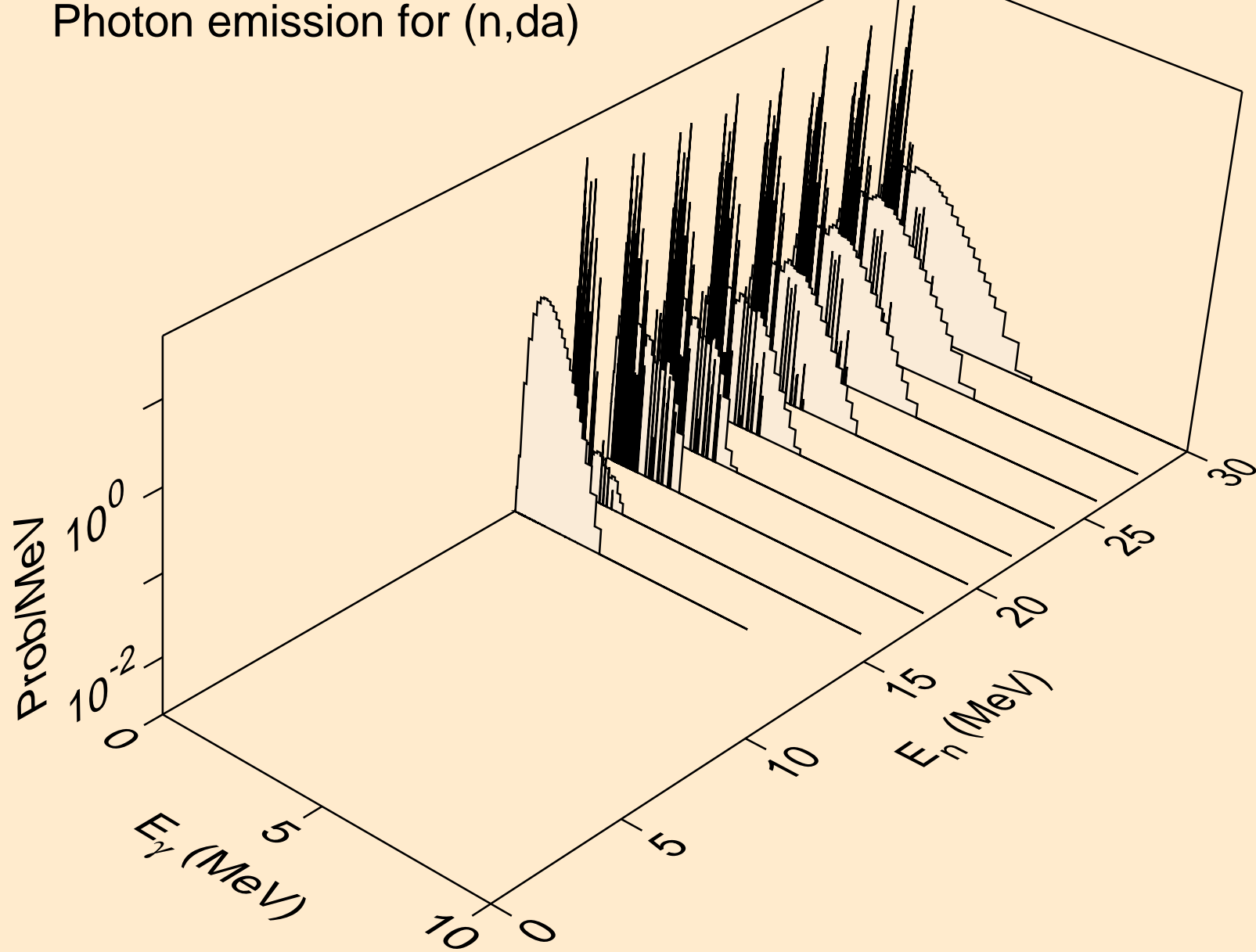

PO207 NEUTRON ACER TENDL-2024 LIBRARY; T=293.6K  
thermal capture photon spectrum

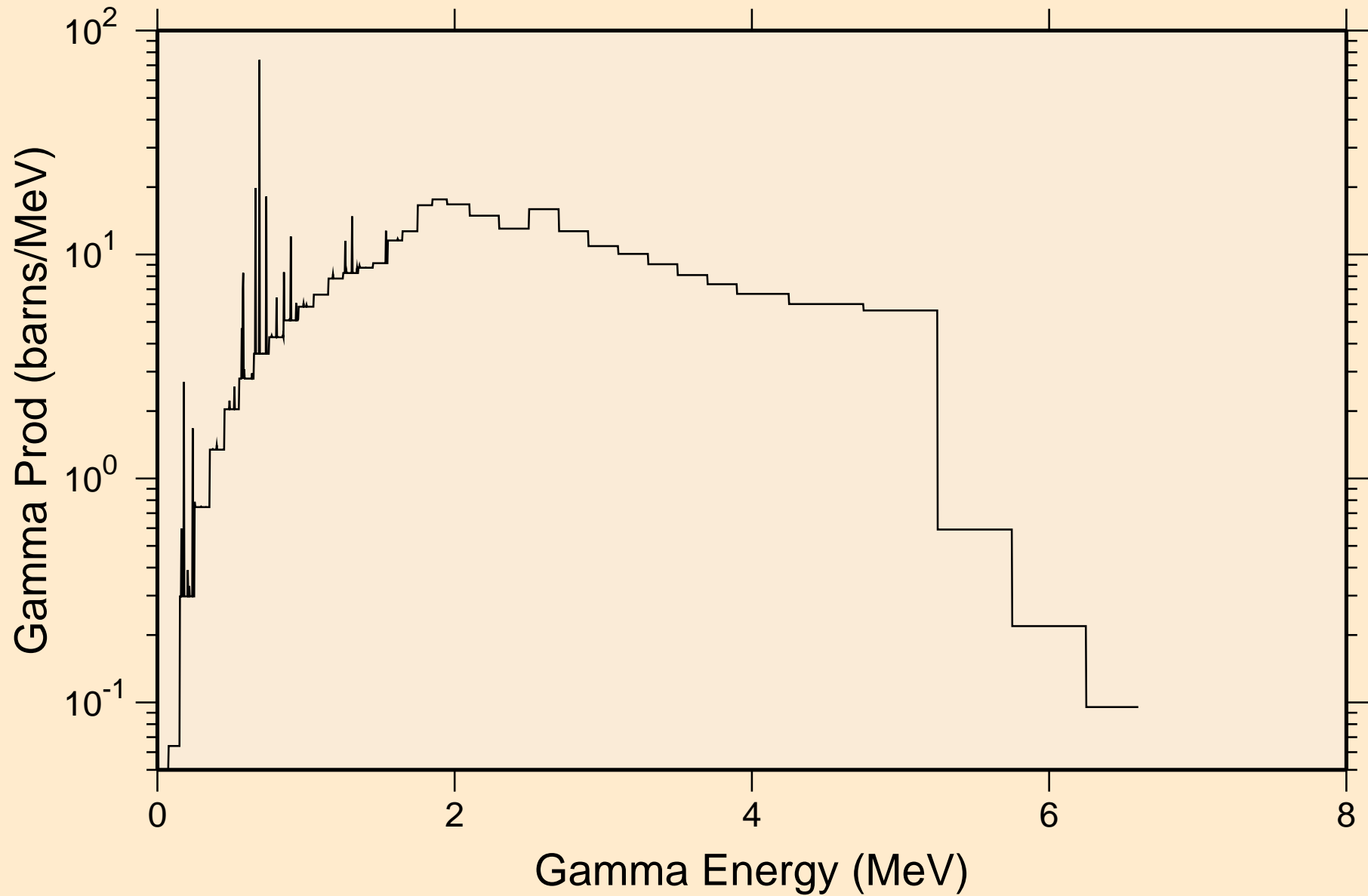

PO207 NEUTRON ACER TENDL-2024 LIBRARY; T=293.6K  
14 MeV photon spectrum

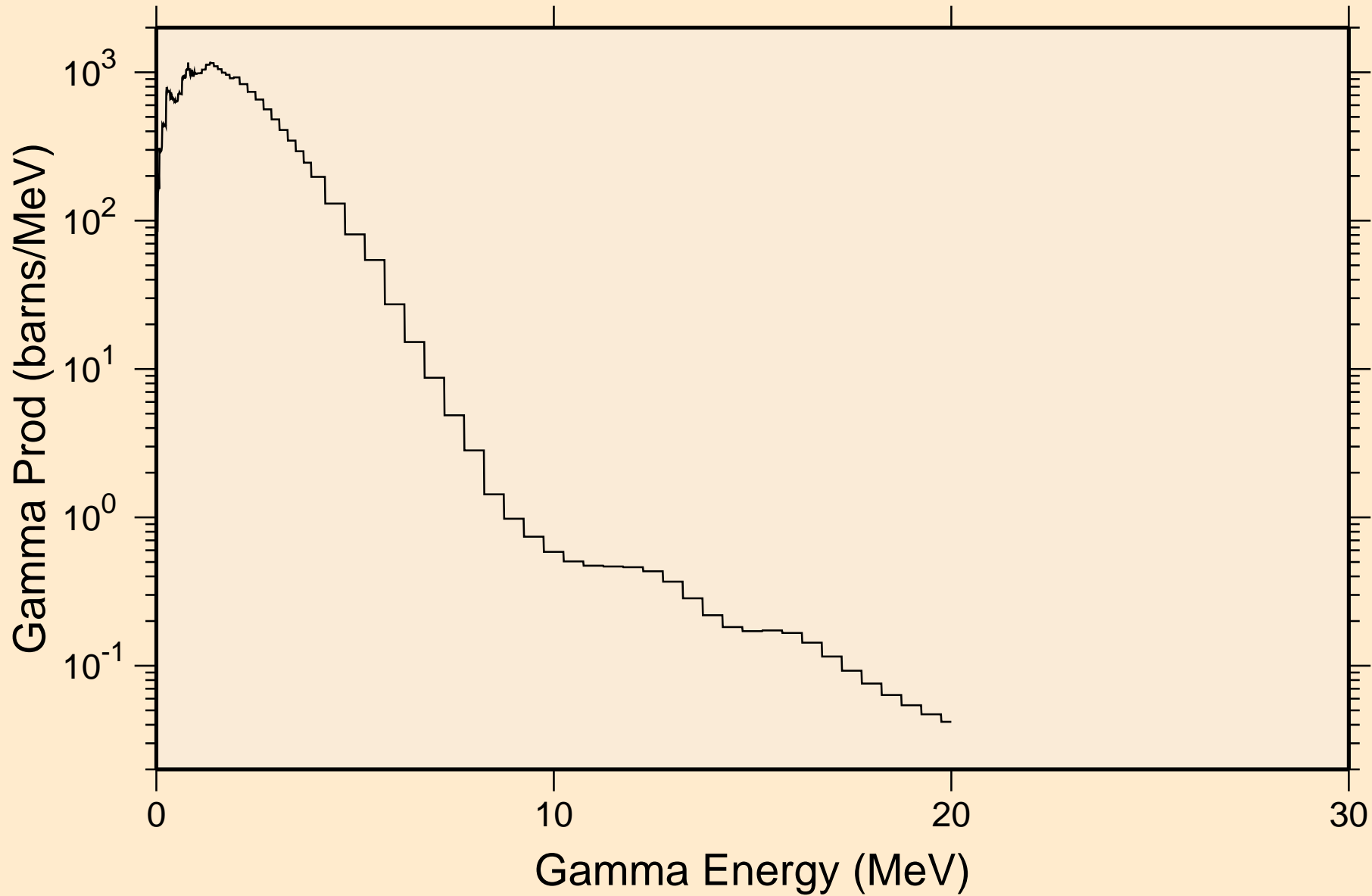

PO207 NEUTRON ACER TENDL-2024 LIBRARY; T=293.6K  
Particle heating contributions

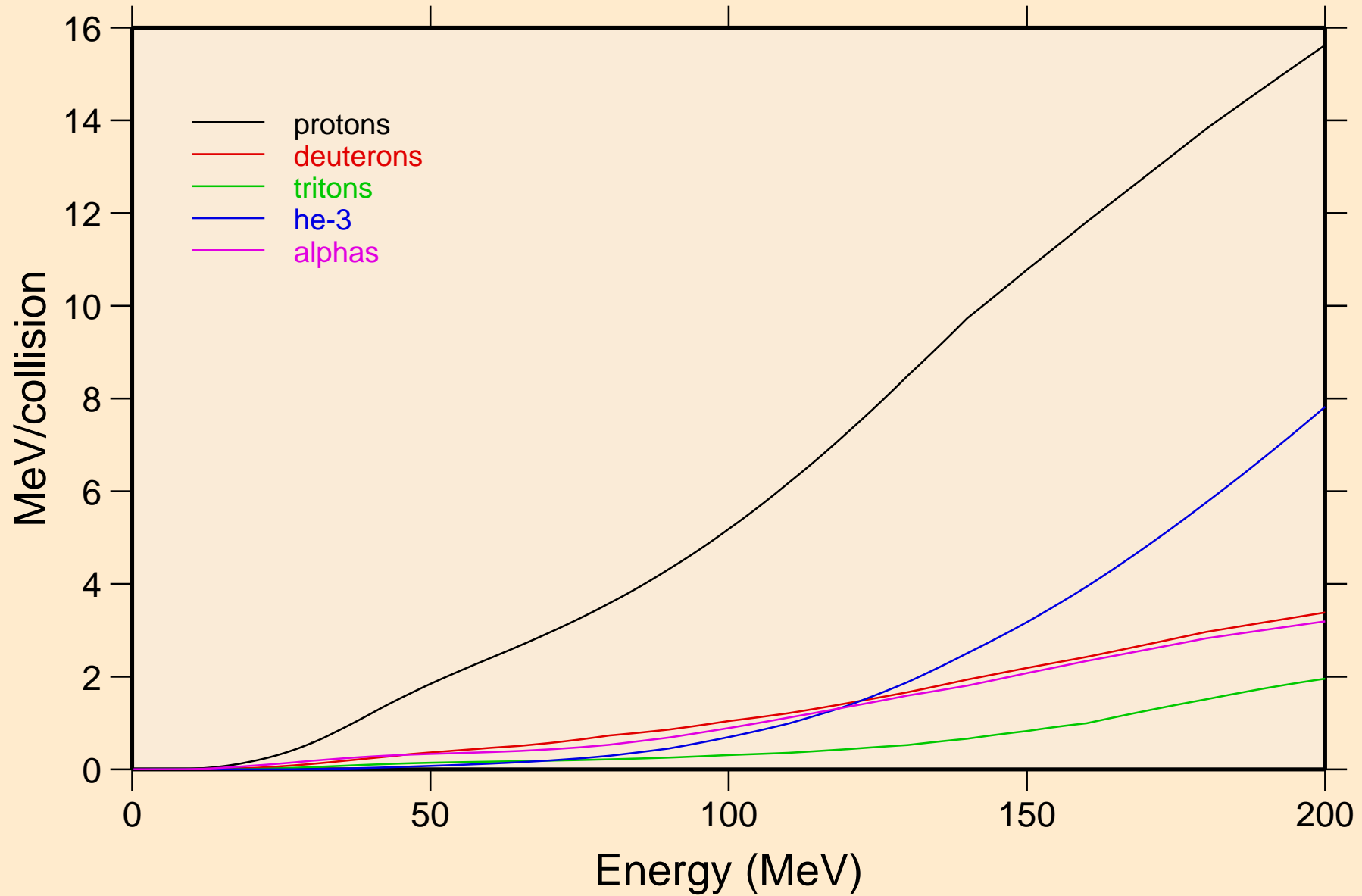

PO207 NEUTRON ACER TENDL-2024 LIBRARY; T=293.6K  
Recoil Heating

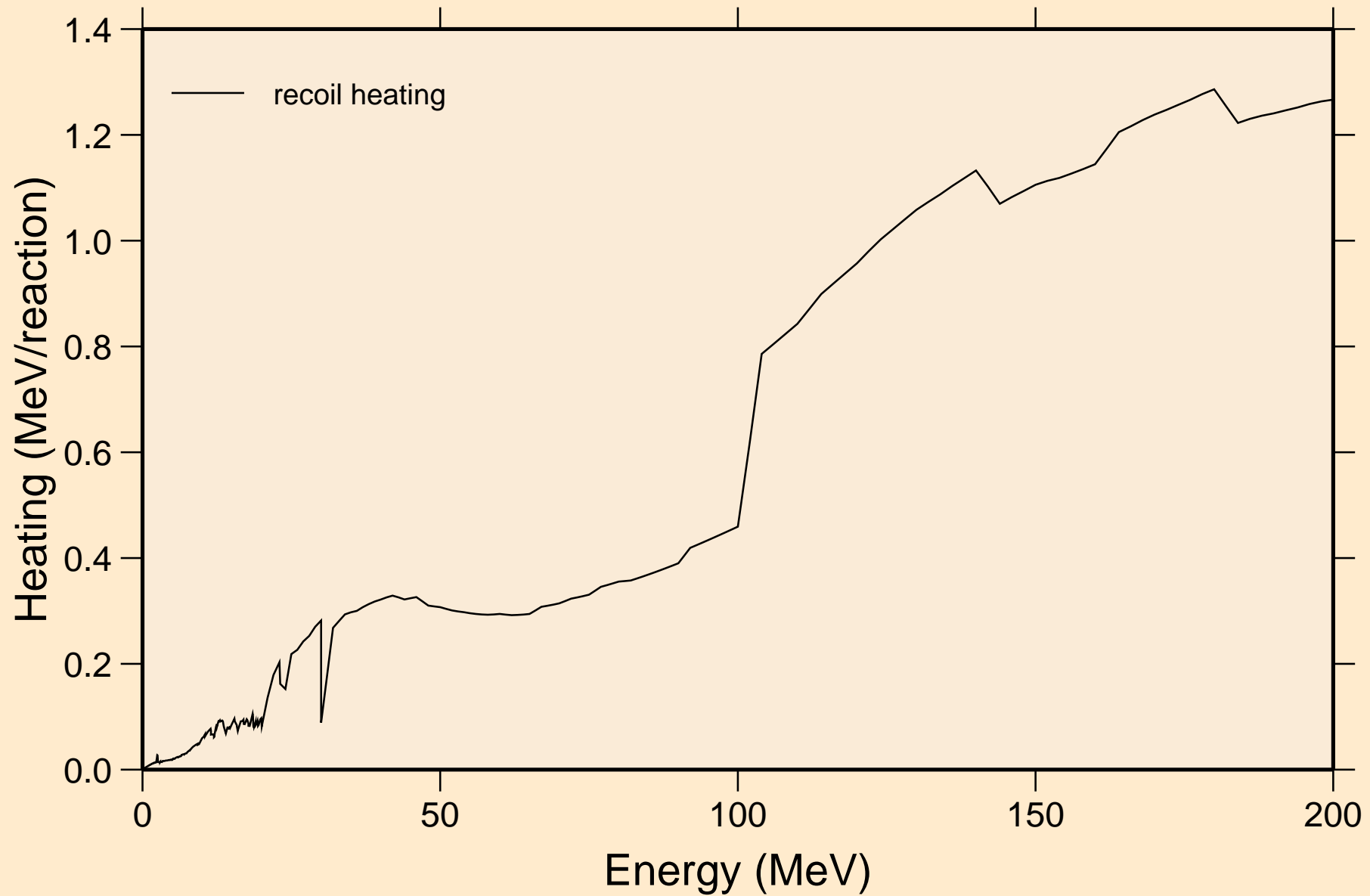

PO207 NEUTRON ACER TENDL-2024 LIBRARY; T=293.6K  
Particle production cross sections

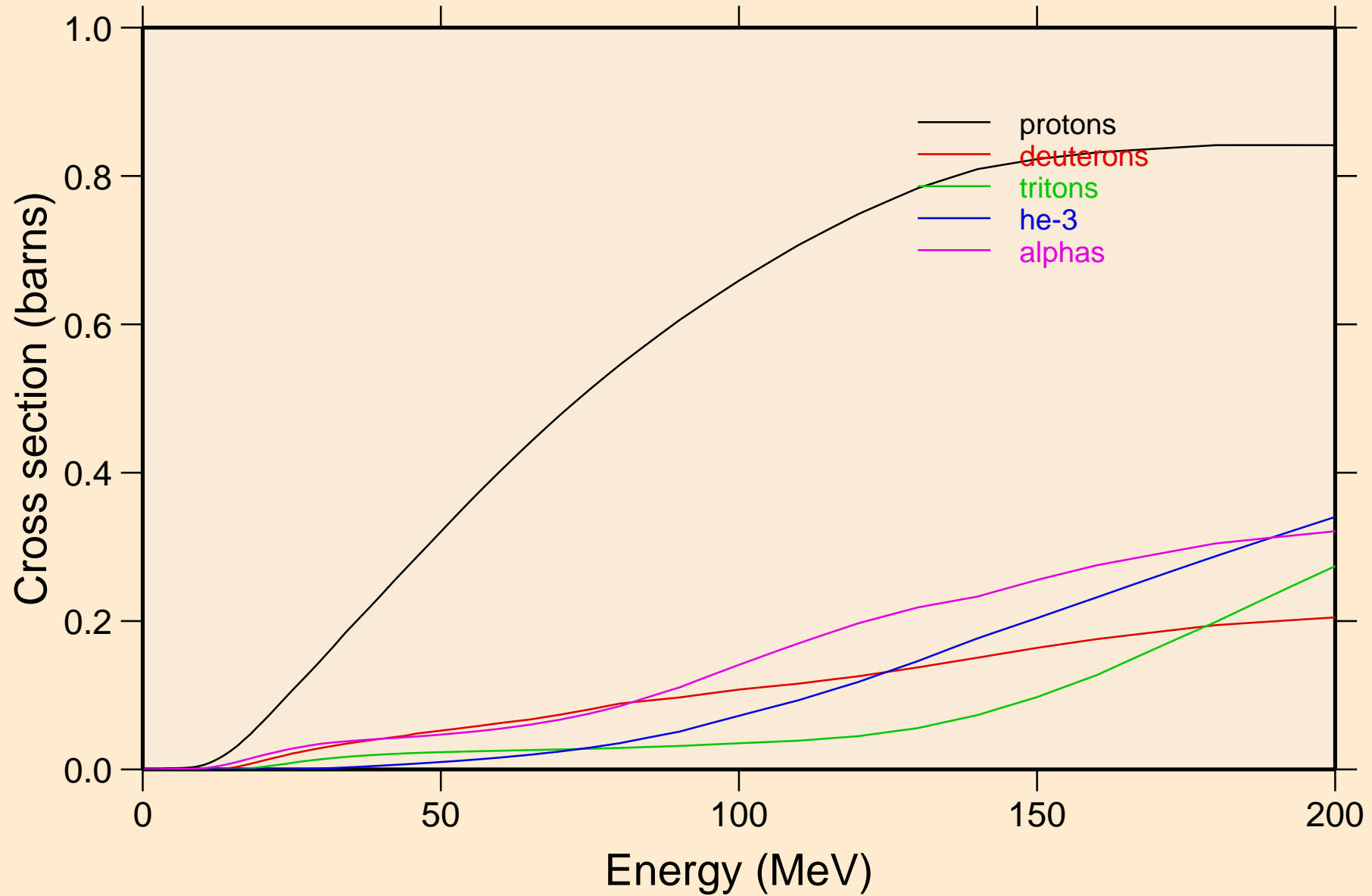

PO207 NEUTRON ACER TENDL-2024 LIBRARY; T=293.6K  
protons from (n,x)

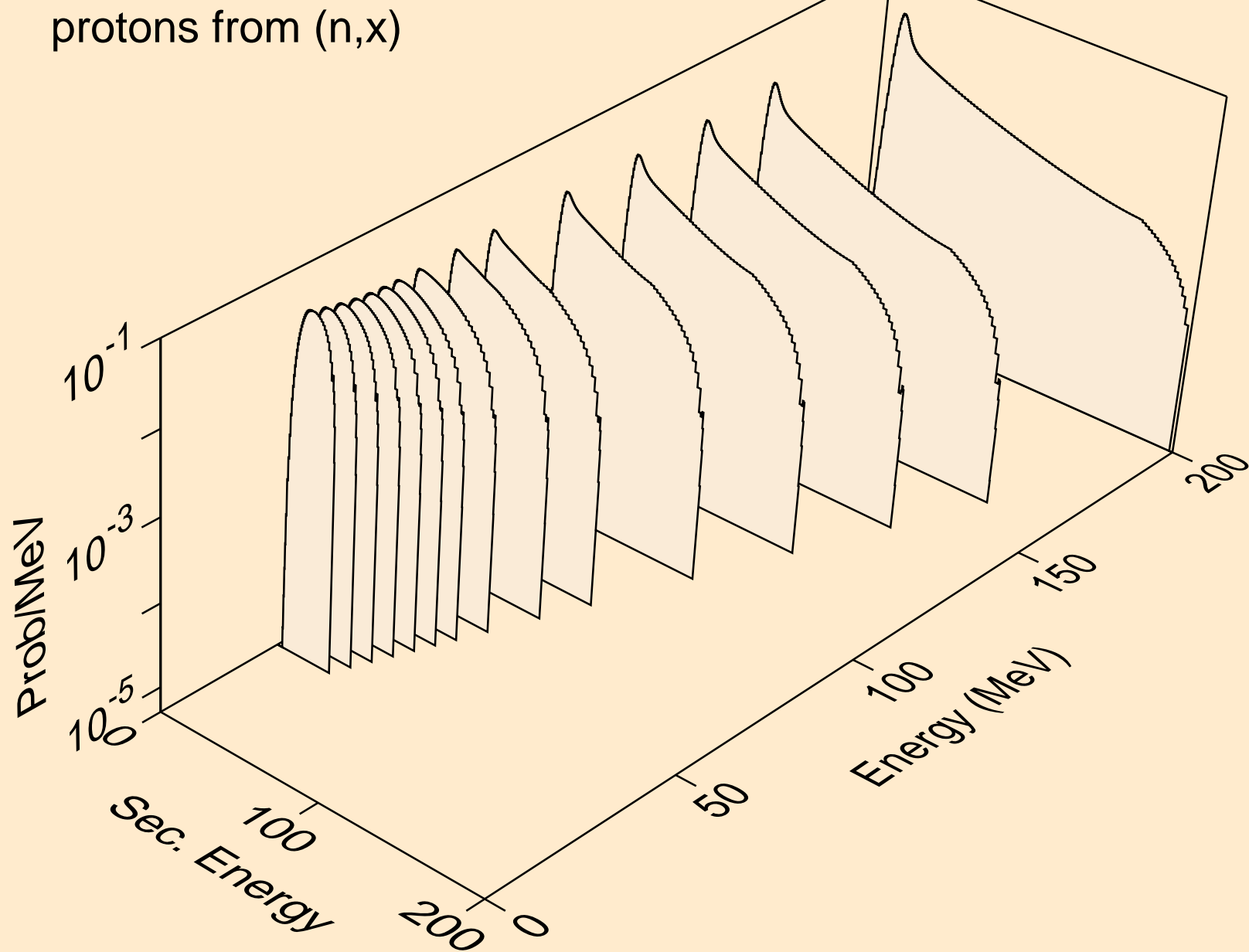

PO207 NEUTRON ACER TENDL-2024 LIBRARY; T=293.6K  
protons from (n,n\*)p

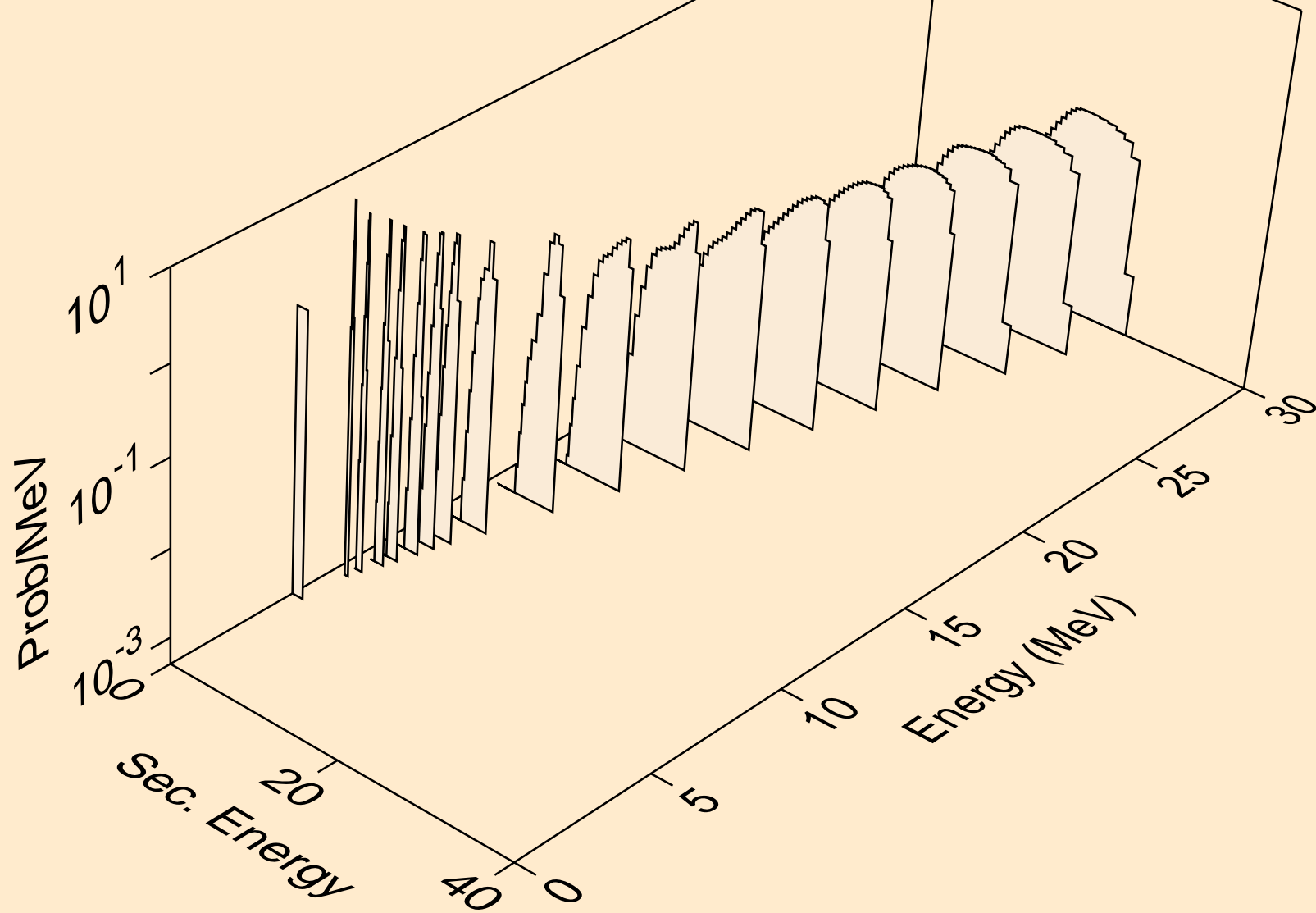

PO207 NEUTRON ACER TENDL-2024 LIBRARY; T=293.6K  
protons from (n,2np)

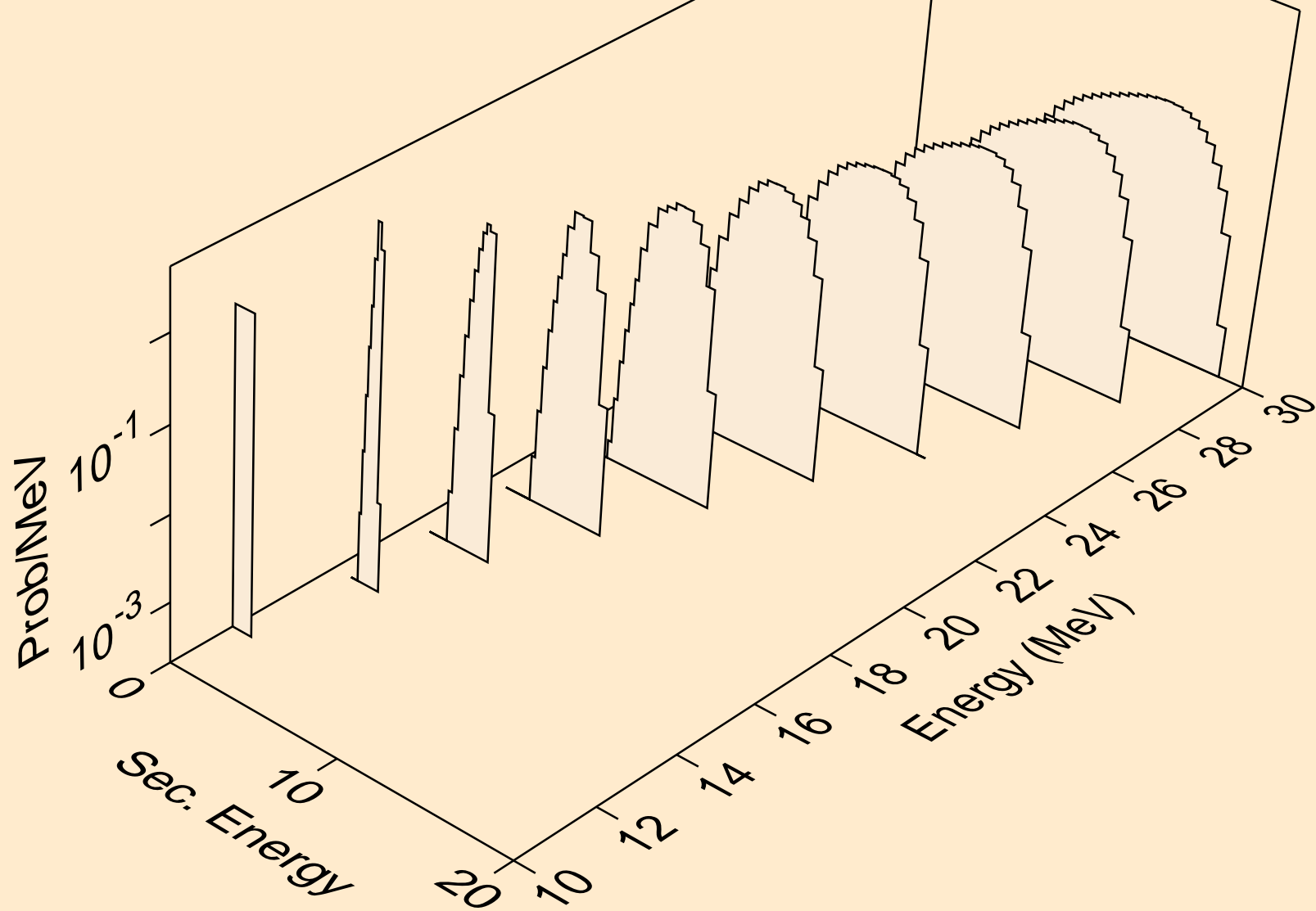

PO207 NEUTRON ACER TENDL-2024 LIBRARY; T=293.6K  
protons from (n,3np)

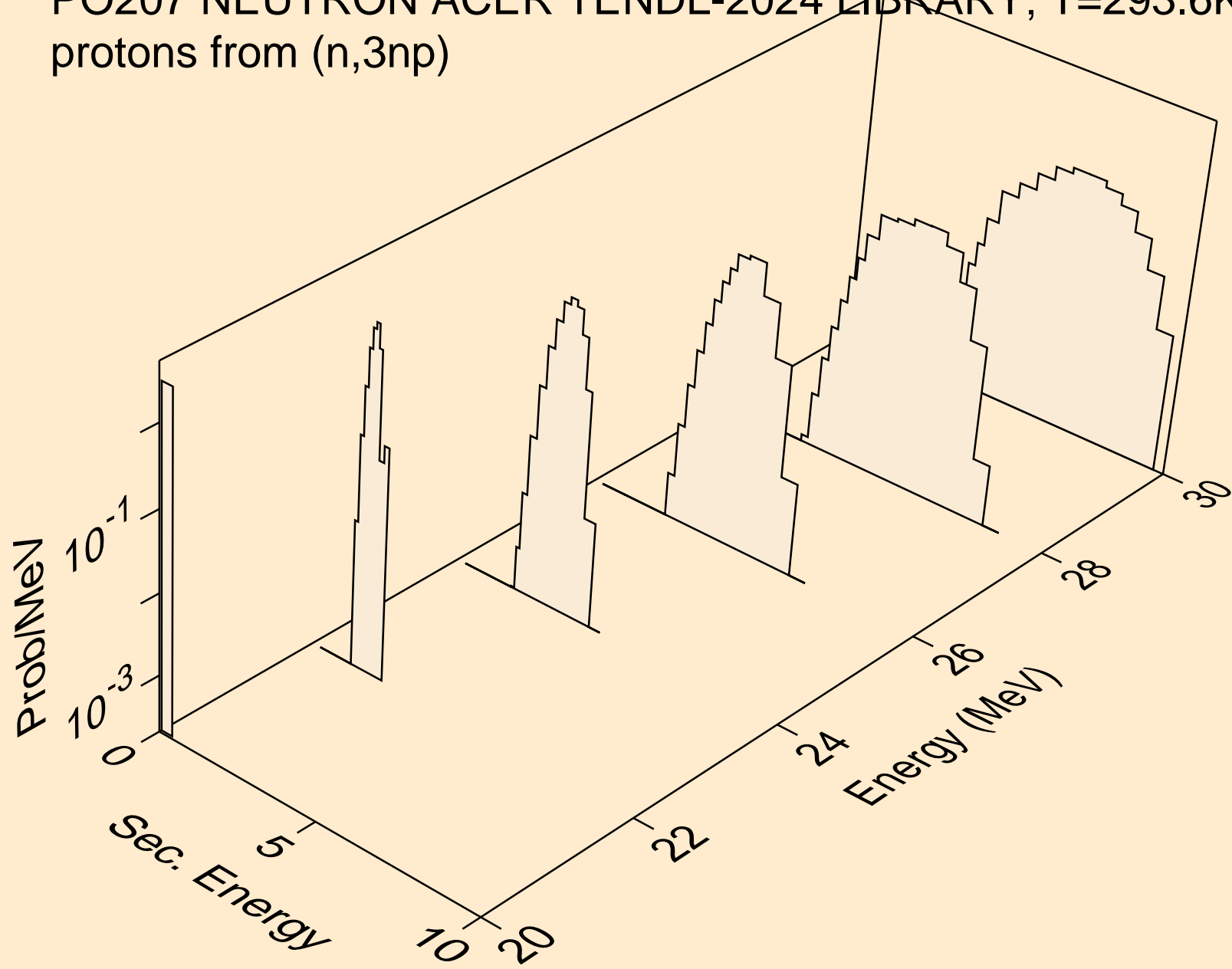

PO207 NEUTRON ACER TENDL-2024 LIBRARY; T=293.6K  
protons from (n,n2p)

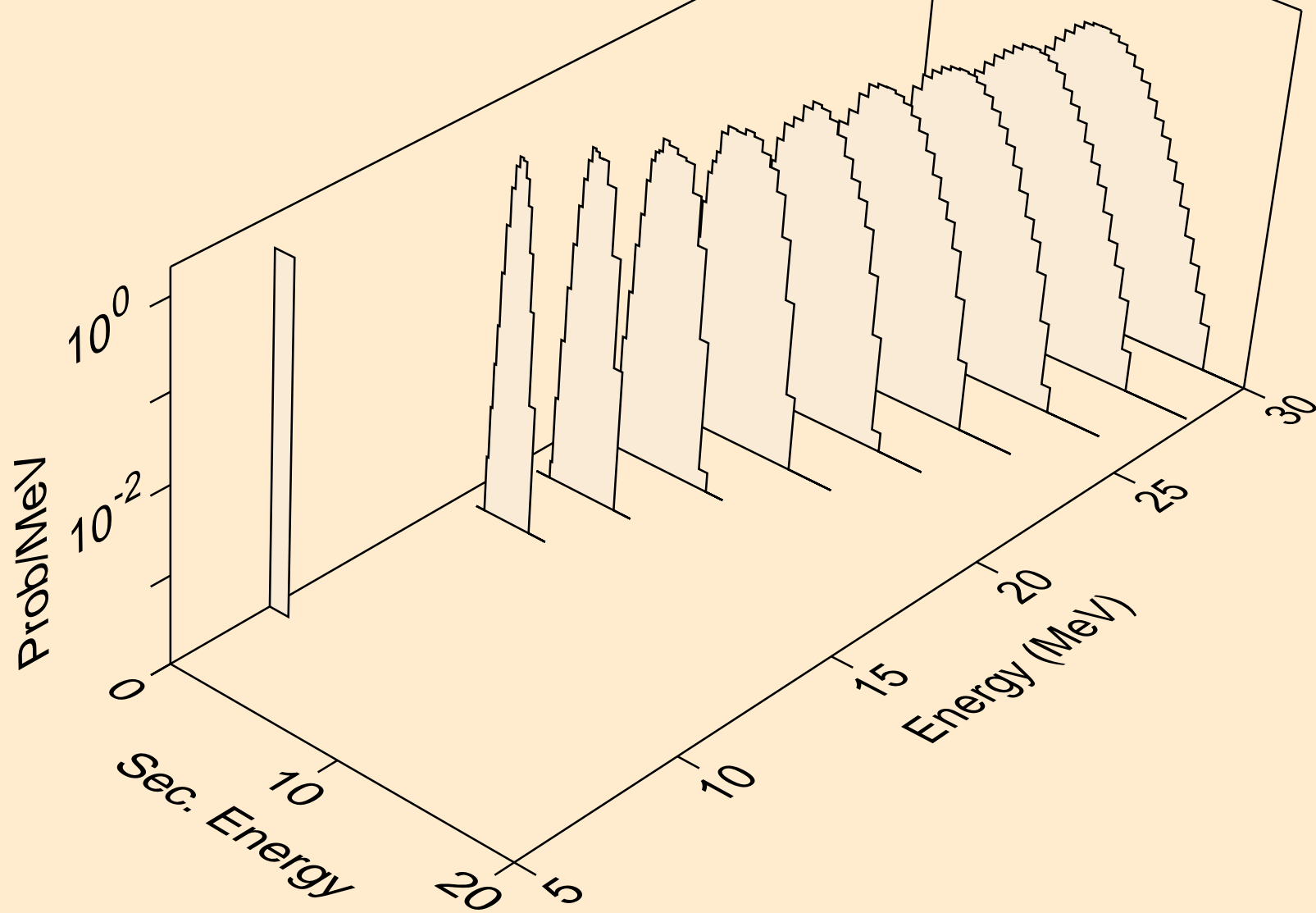

PO207 NEUTRON ACER TENDL-2024 LIBRARY; T=293.6K  
protons from (n,npa)

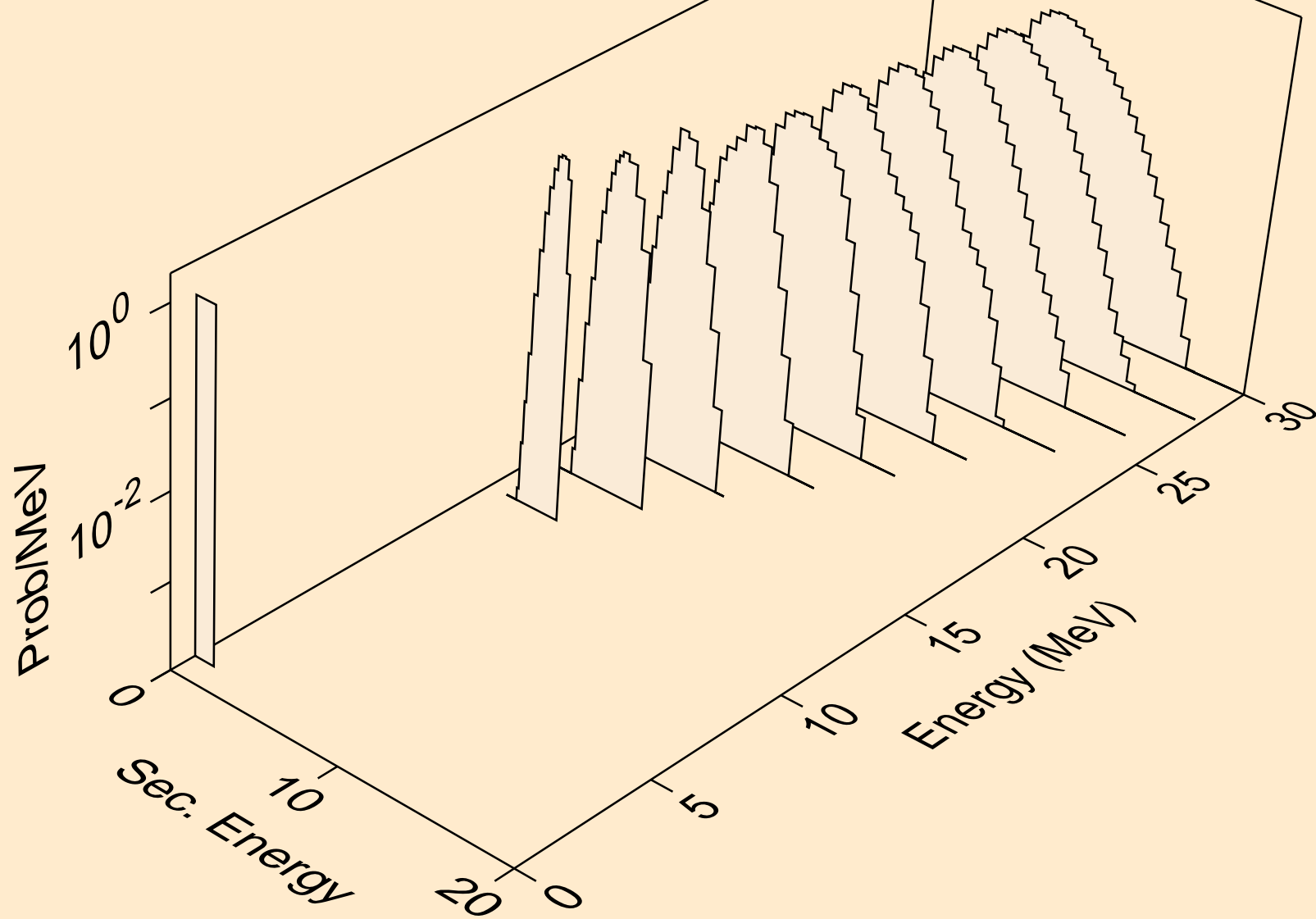

PO207 NEUTRON ACER TENDL-2024 LIBRARY; T=293.6K  
protons from (n,p)

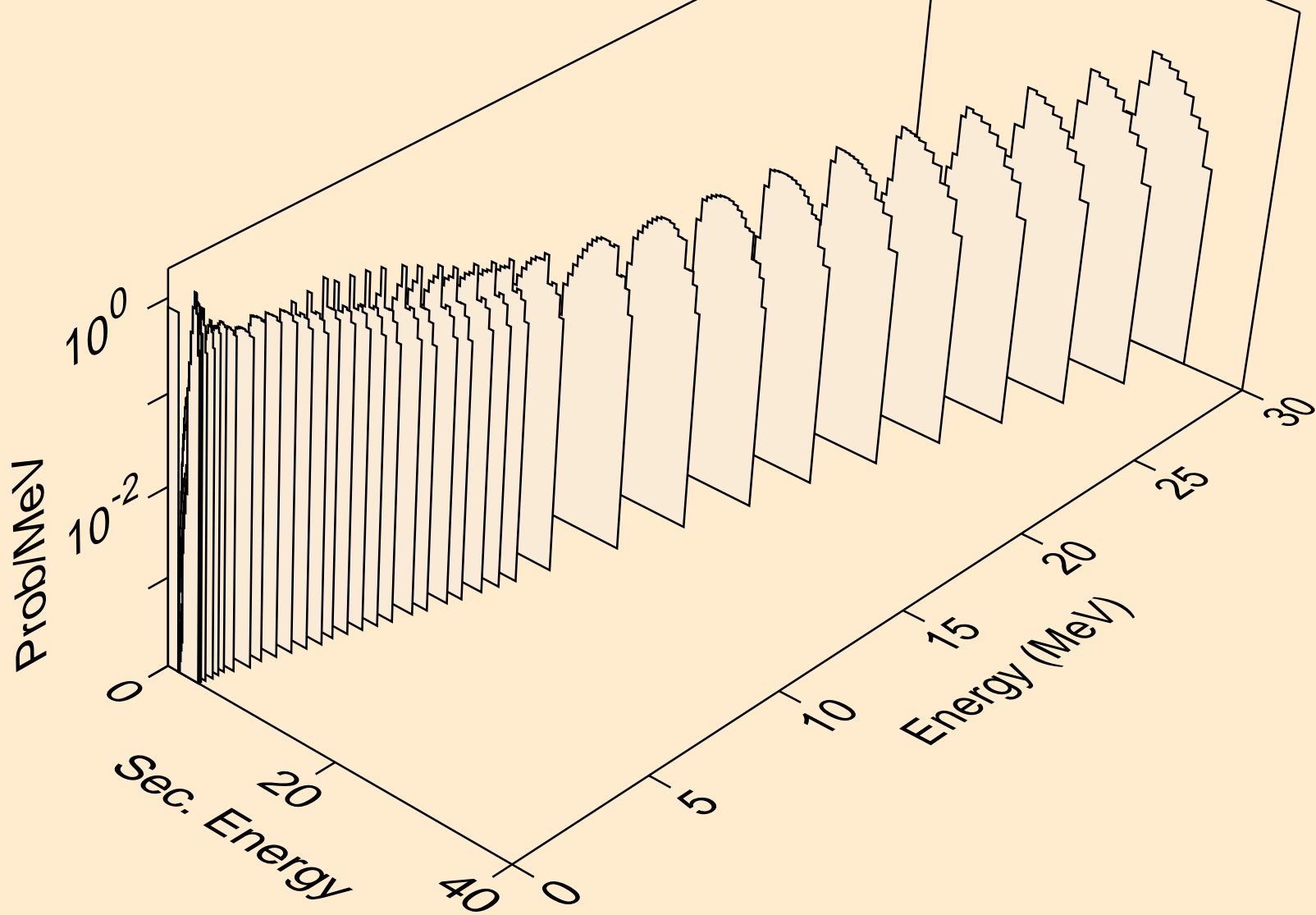

PO207 NEUTRON ACER TENDL-2024 LIBRARY; T=293.6K  
protons from (n,2p)

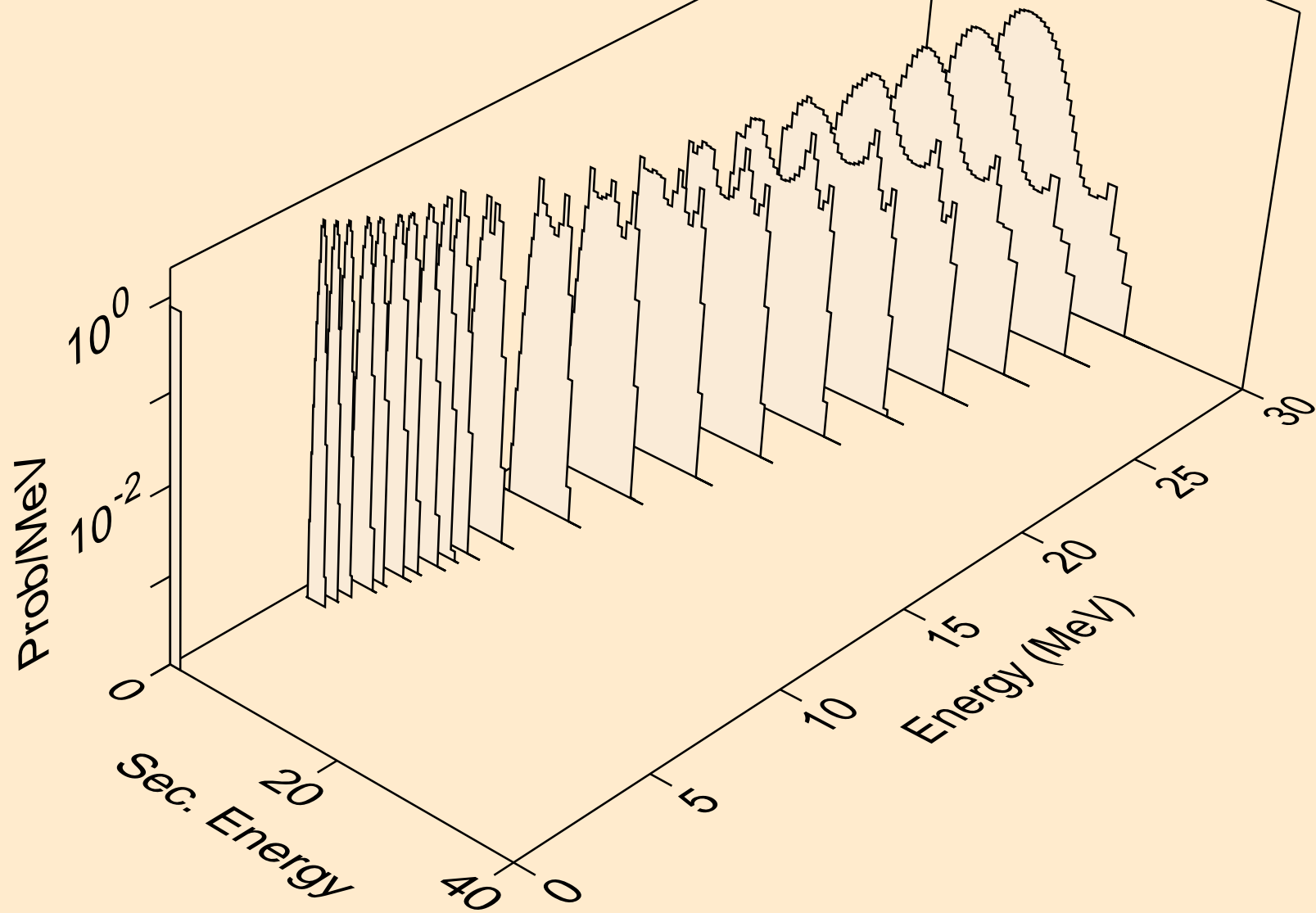

PO207 NEUTRON ACER TENDL-2024 LIBRARY; T=293.6K  
protons from (n,p)

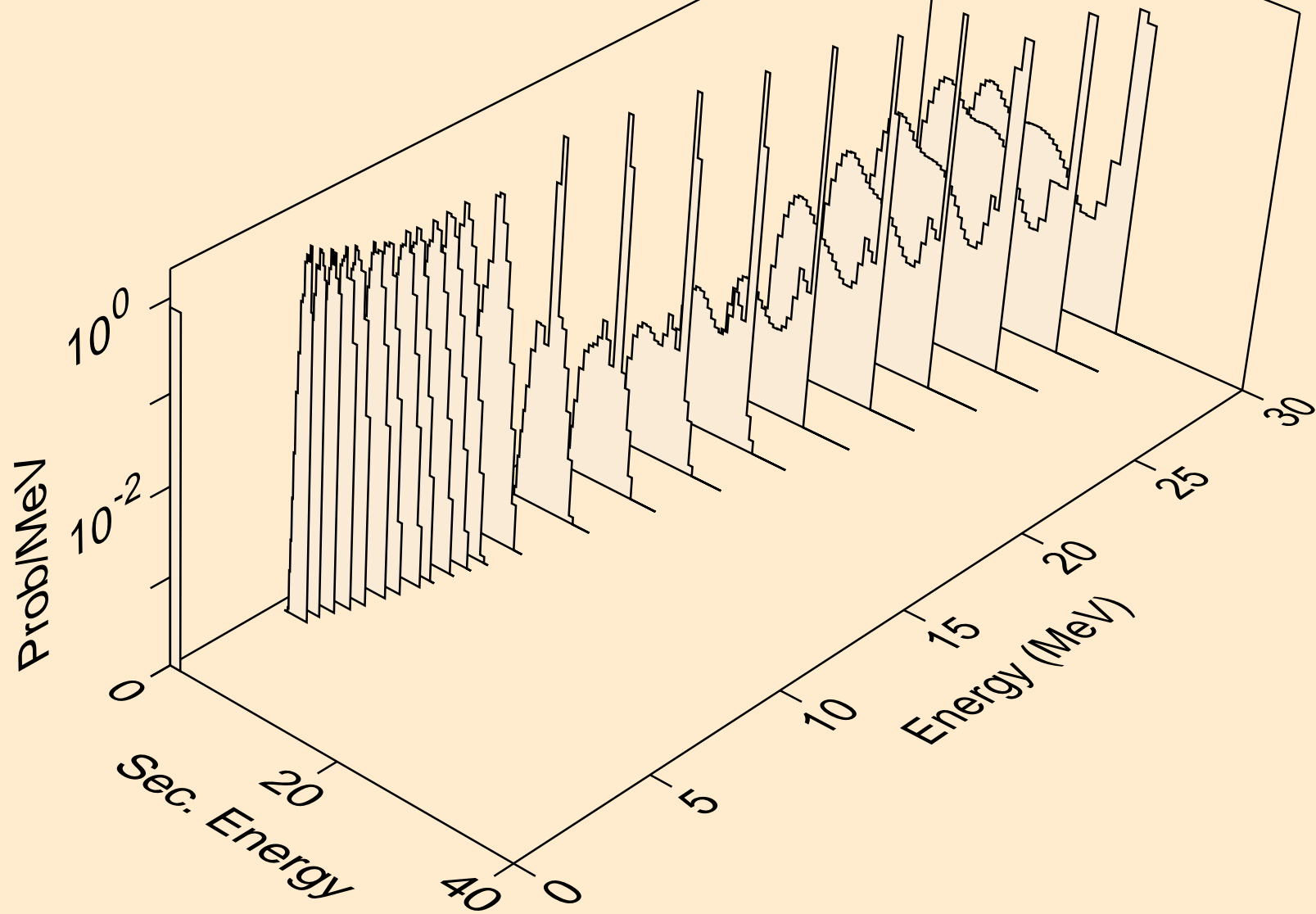

PO207 NEUTRON ACER TENDL-2024 LIBRARY; T=293.6K  
protons from (n,pd)

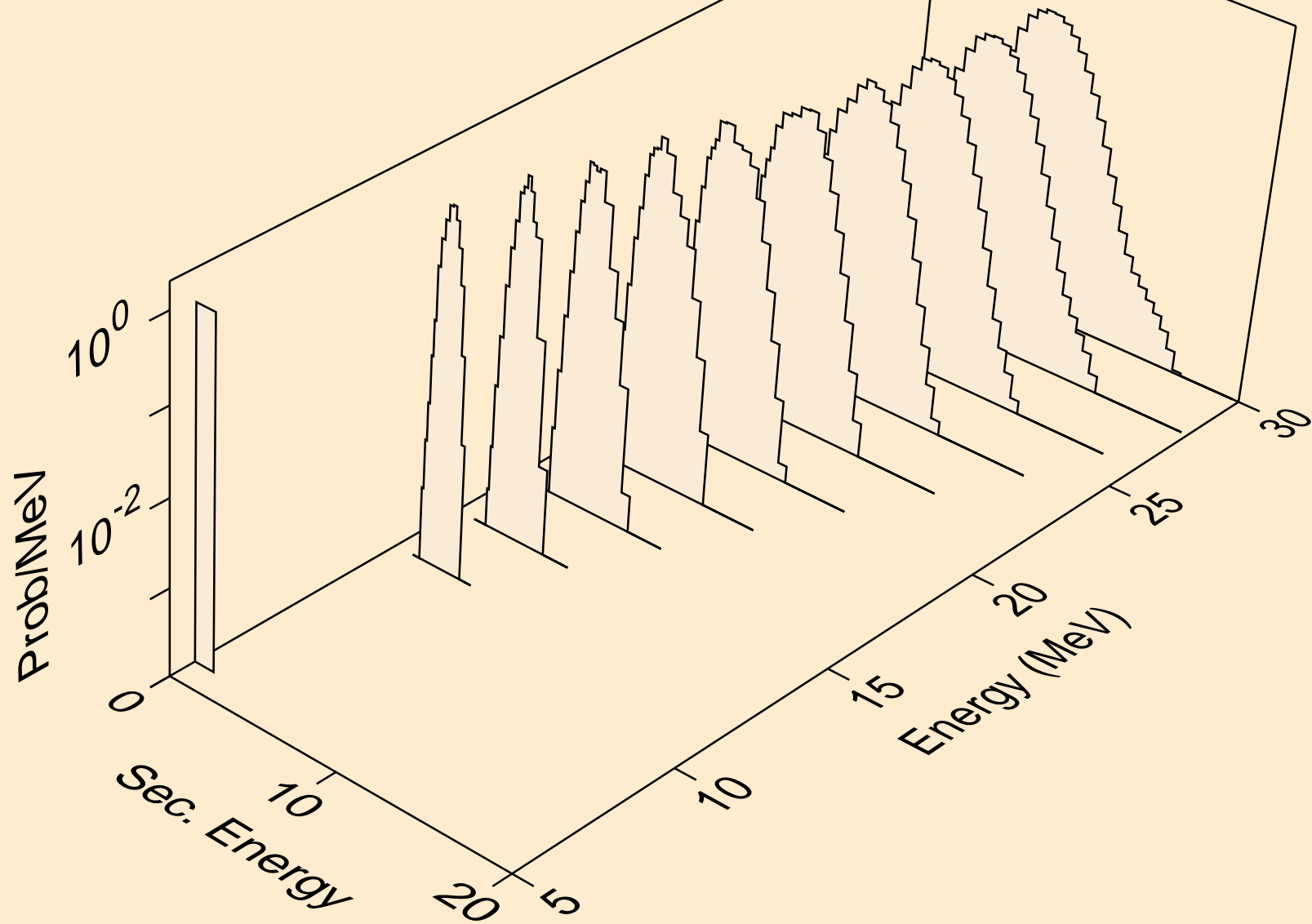

PO207 NEUTRON ACER TENDL-2024 LIBRARY; T=293.6K  
protons from (n,pt)

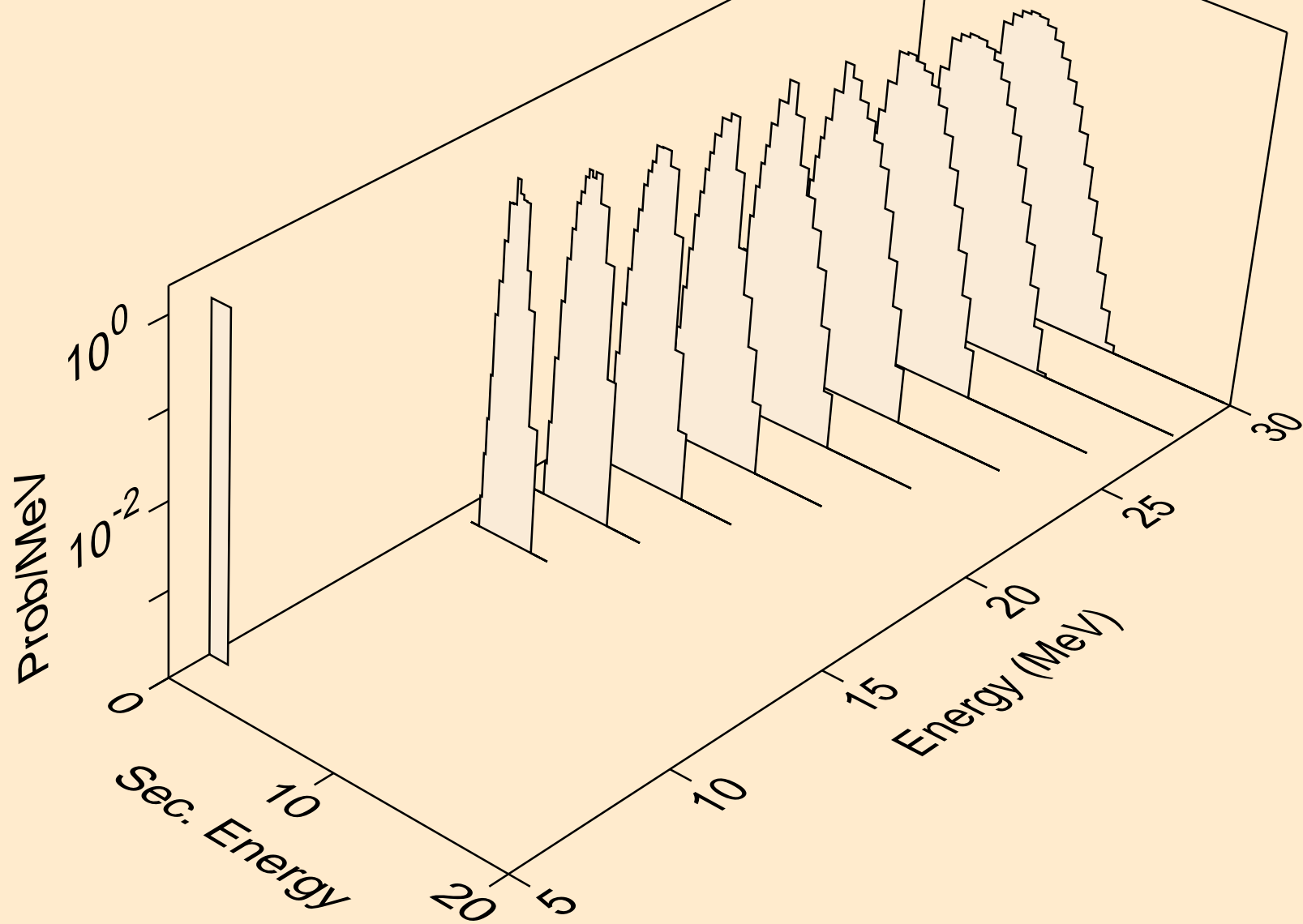

PO207 NEUTRON ACER TENDL-2024 LIBRARY; T=293.6K  
deuterons from (n,x)

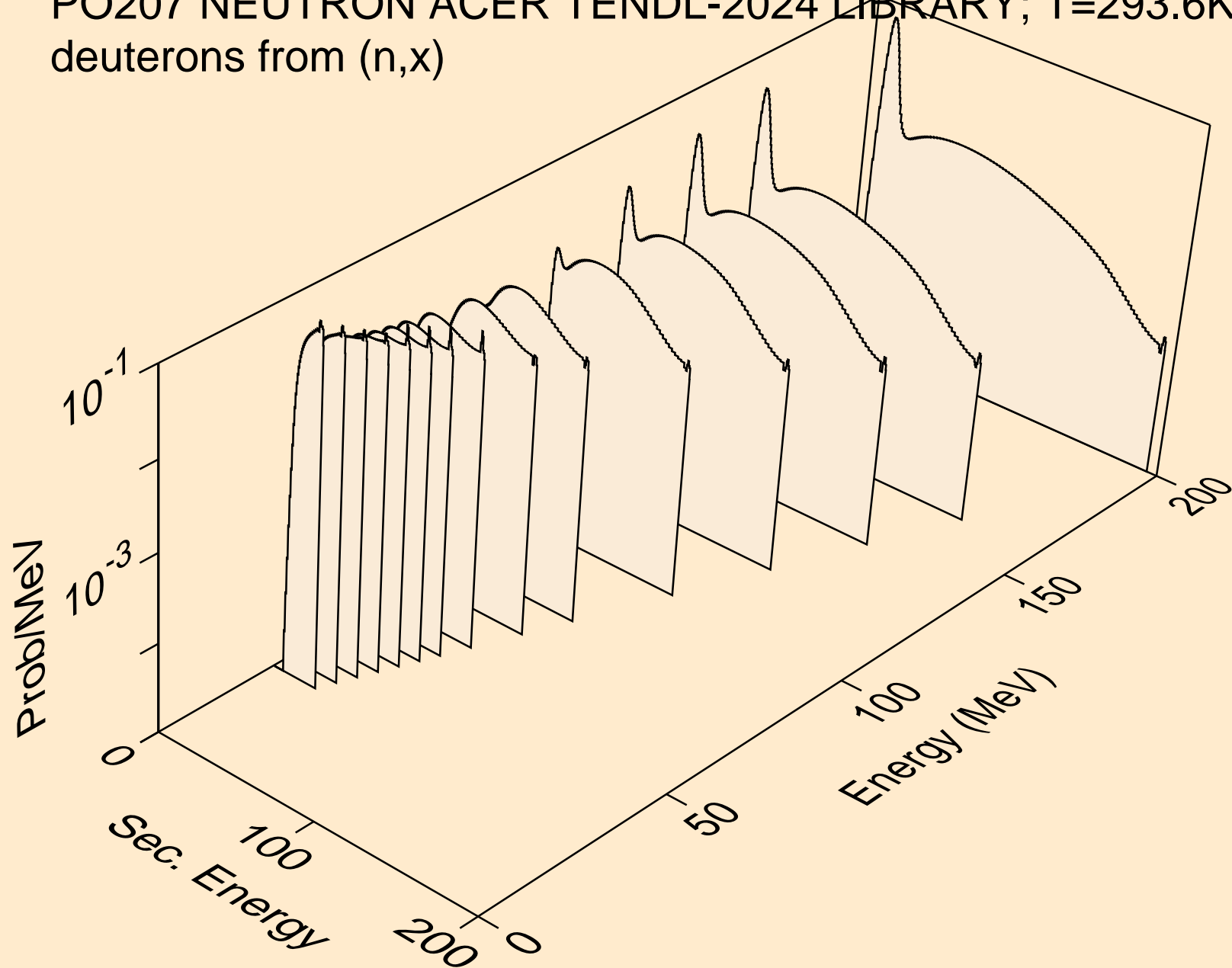

PO207 NEUTRON ACER TENDL-2024 LIBRARY; T=293.6K  
deuterons from (n,2nd)

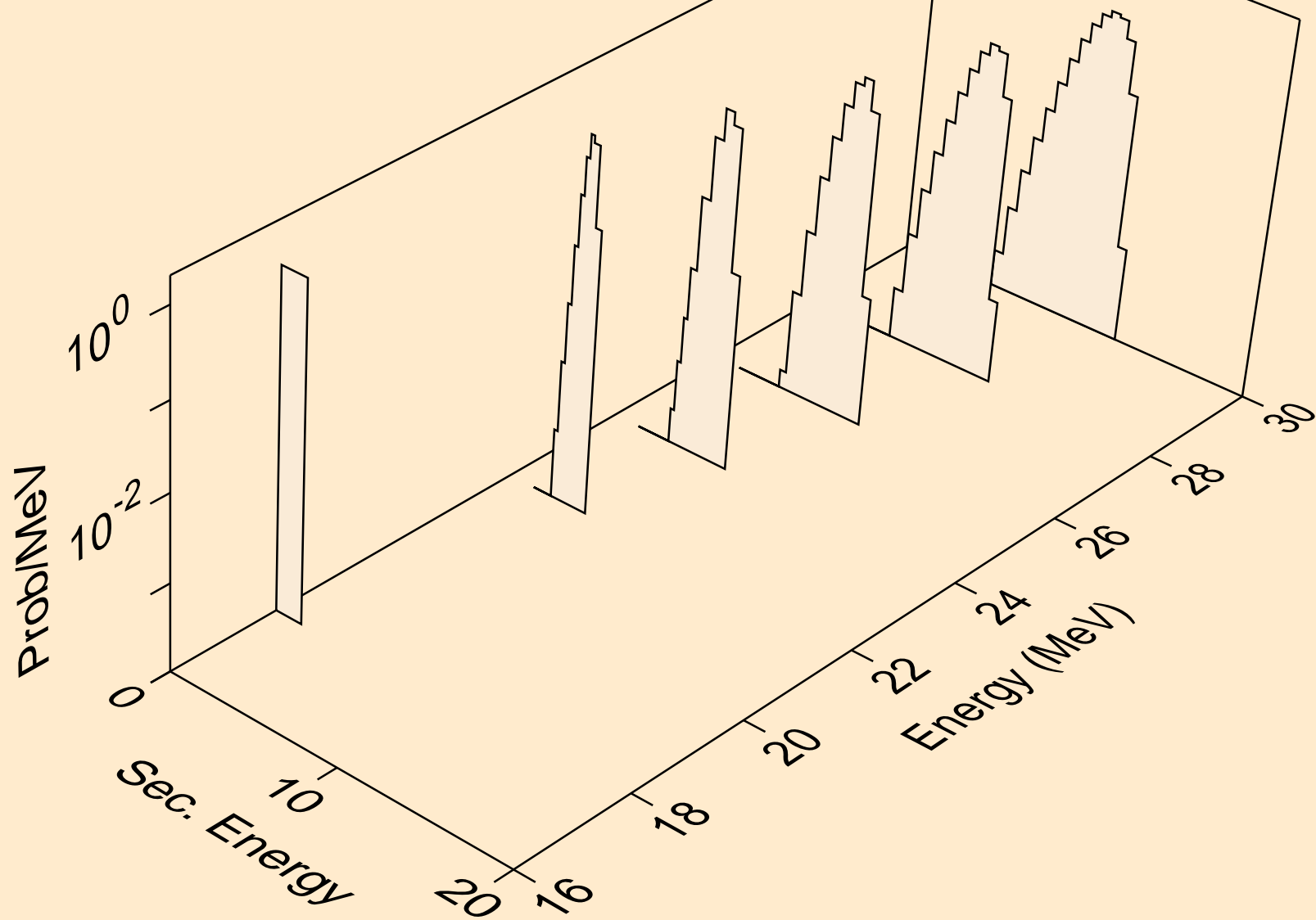

PO207 NEUTRON ACER TENDL-2024 LIBRARY; T=293.6K  
deuterons from (n,n\*)d

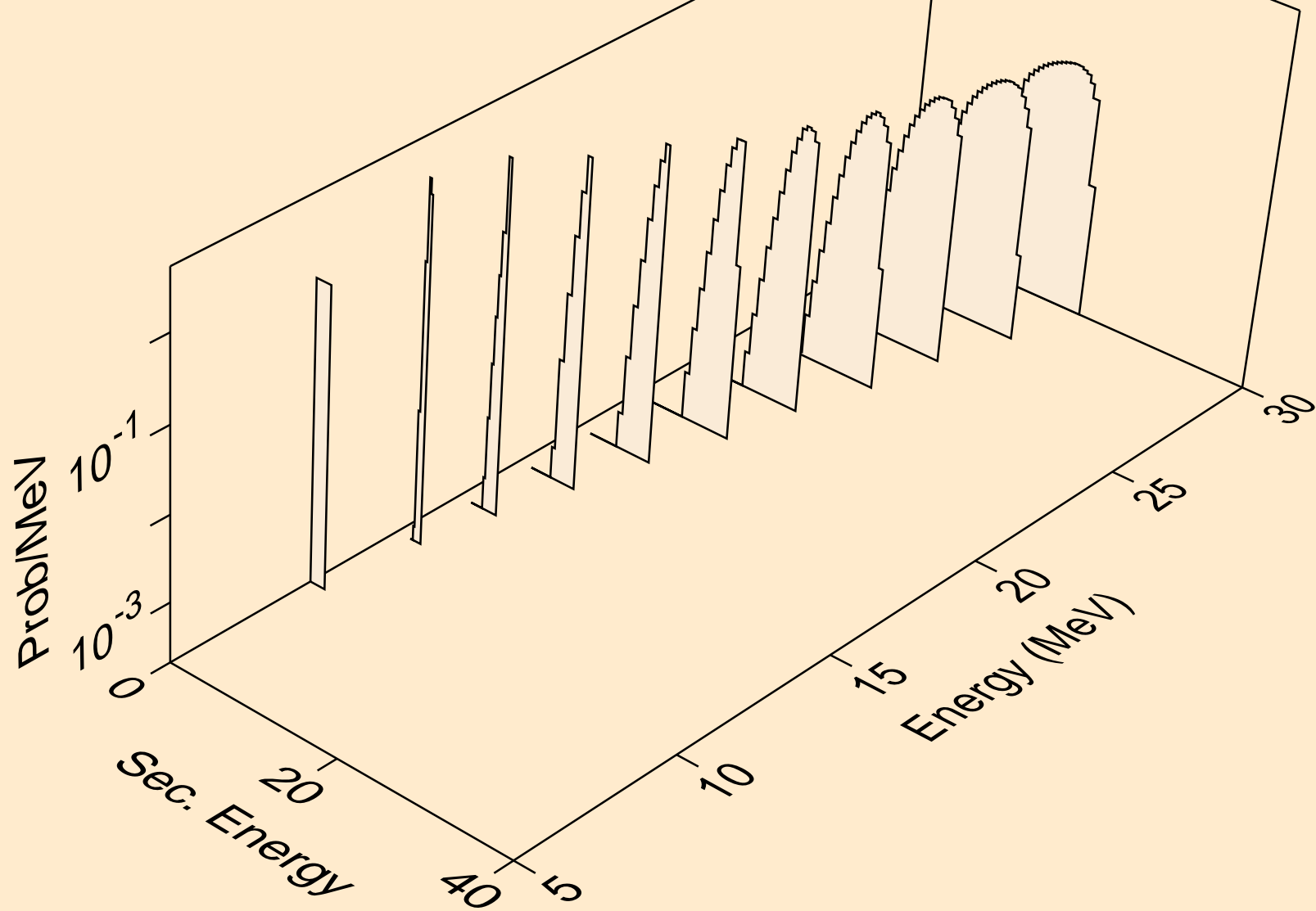

PO207 NEUTRON ACER TENDL-2024 LIBRARY; T=293.6K  
deuterons from (n,d)

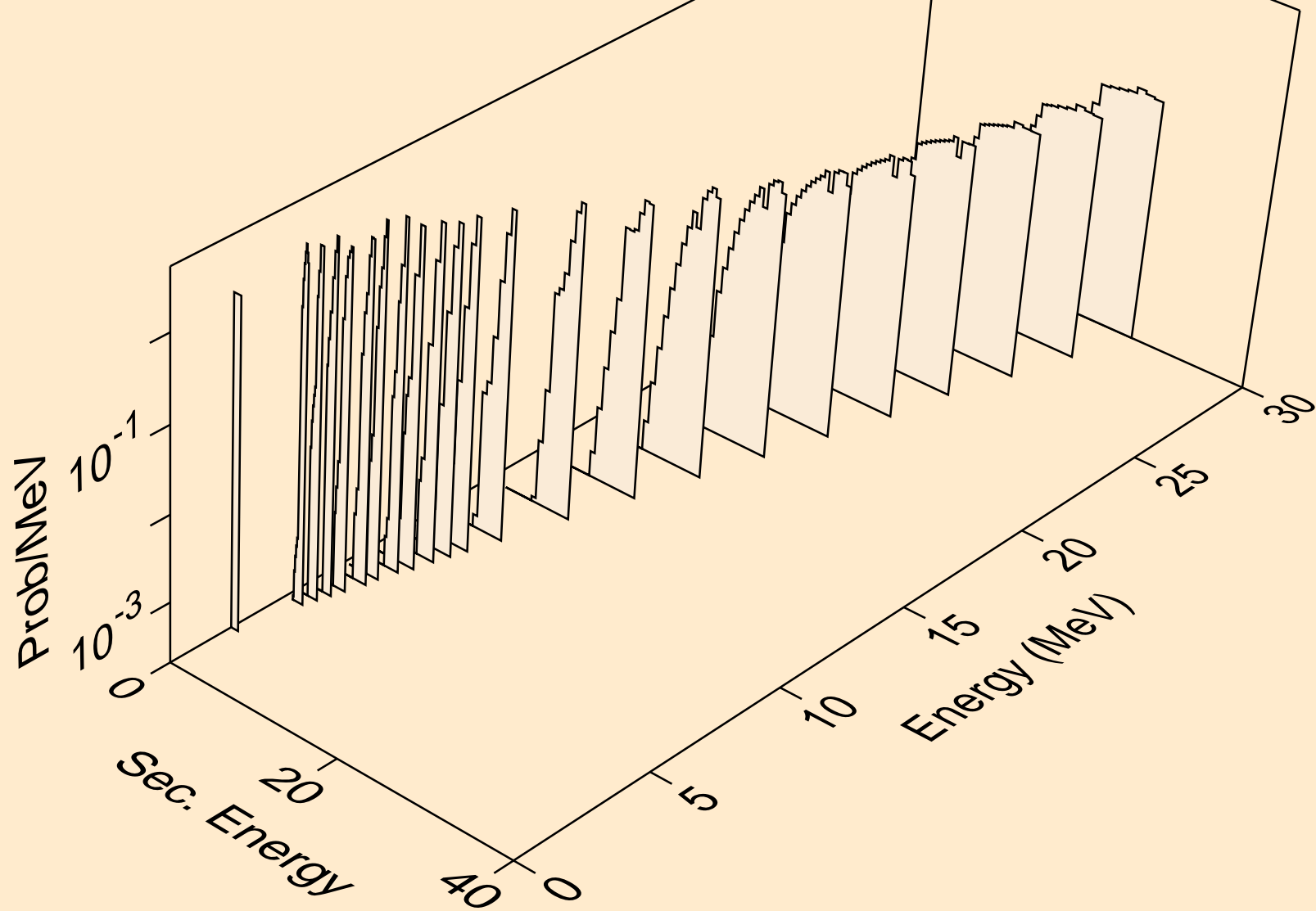

PO207 NEUTRON ACER TENDL-2024 LIBRARY; T=293.6K  
deuterons from (n,pd)

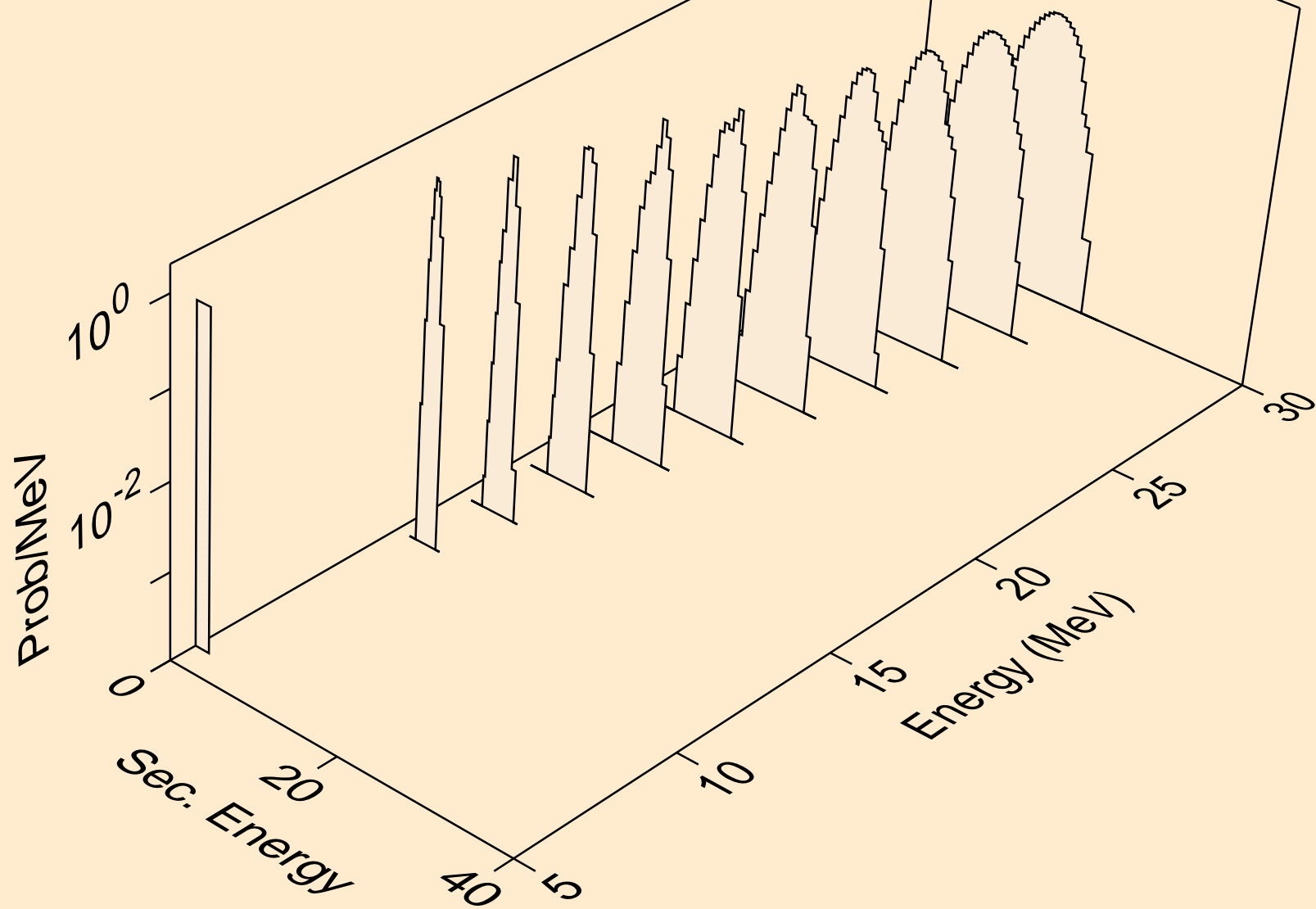

PO207 NEUTRON ACER TENDL-2024 LIBRARY; T=293.6K  
deuterons from (n,da)

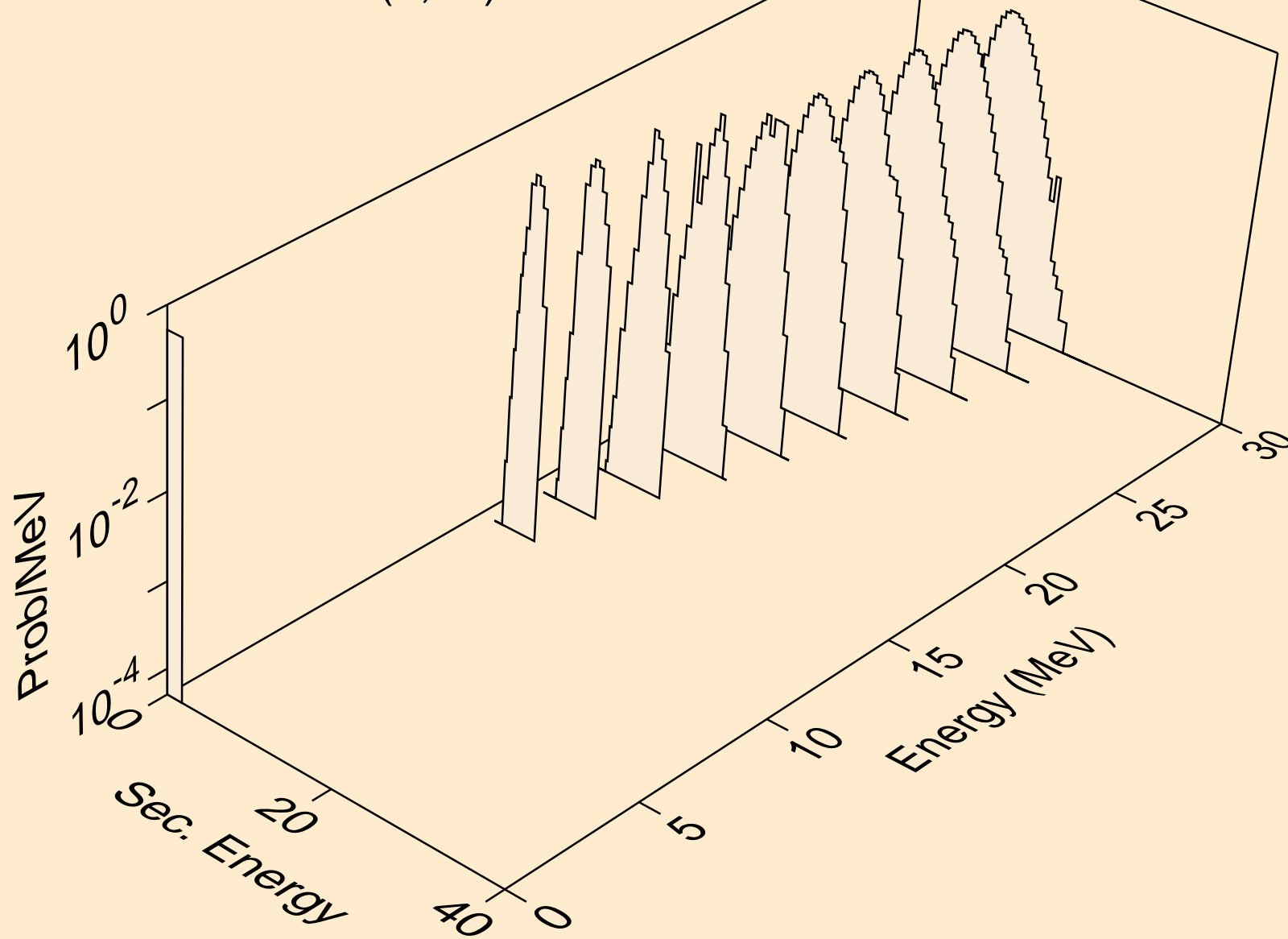

PO207 NEUTRON ACER TENDL-2024 LIBRARY; T=293.6K  
tritons from (n,x)

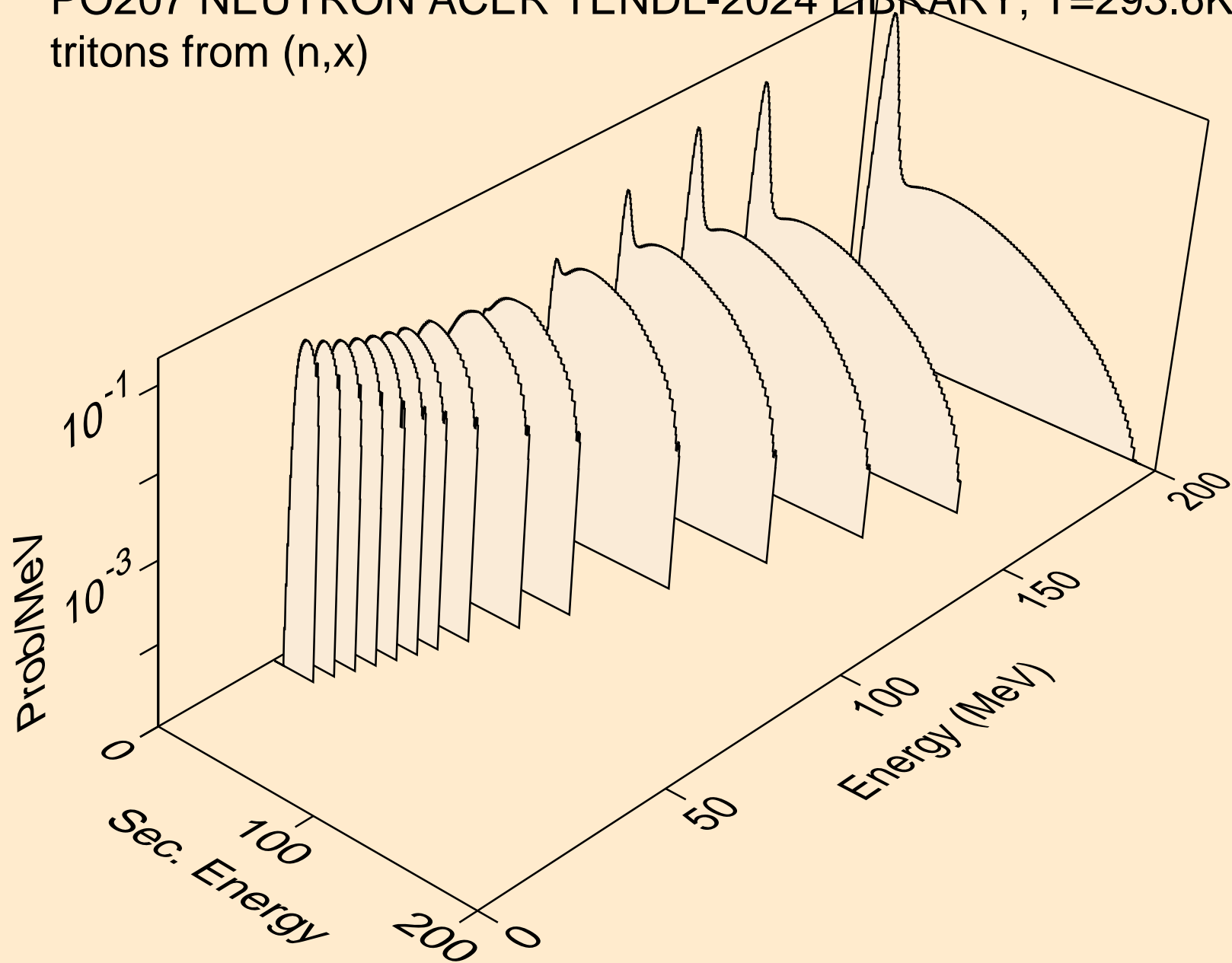

PO207 NEUTRON ACER TENDL-2024 LIBRARY; T=293.6K  
tritons from (n,n\*)t

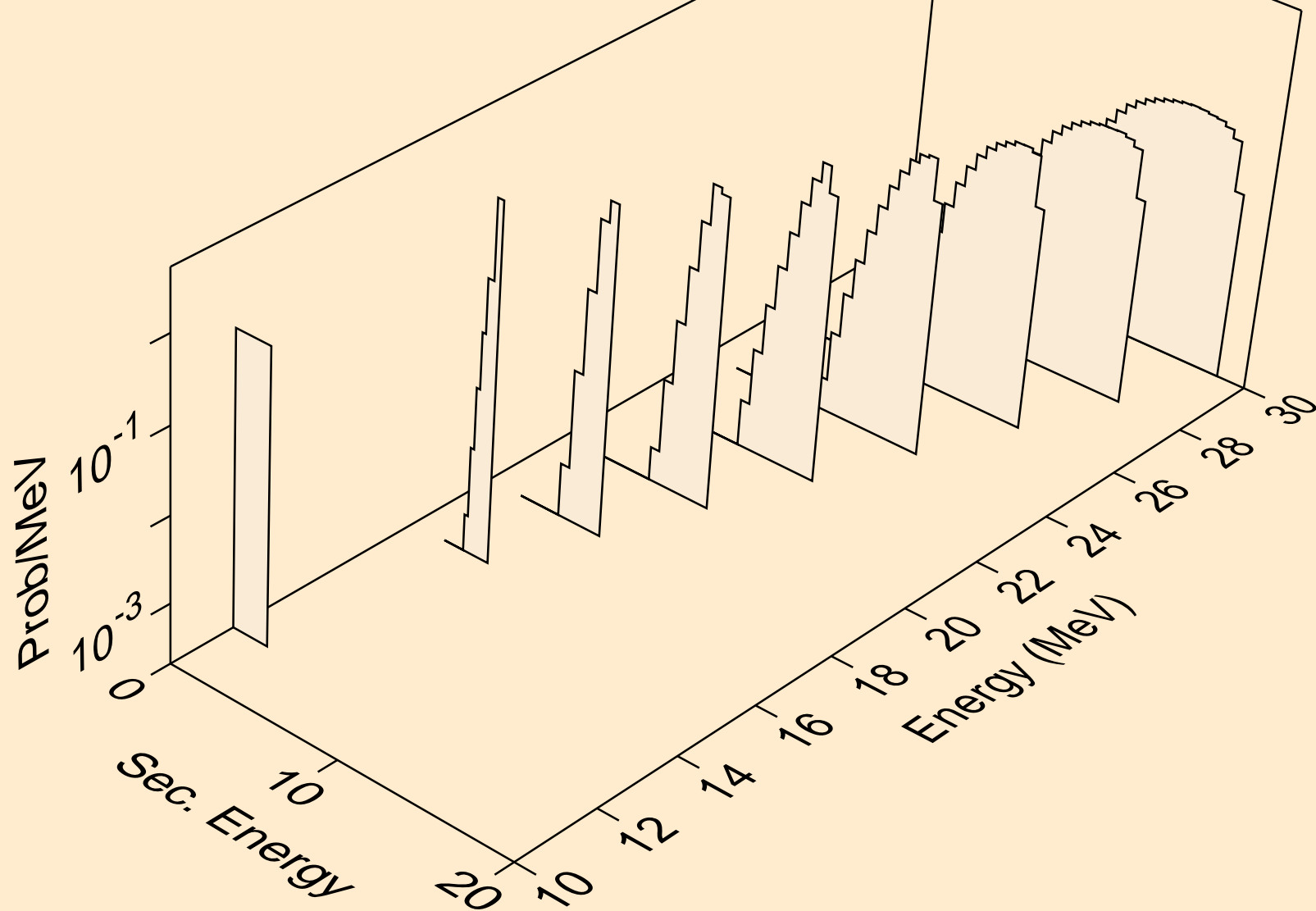

PO207 NEUTRON ACER TENDL-2024 LIBRARY; T=293.6K  
tritons from (n,t)

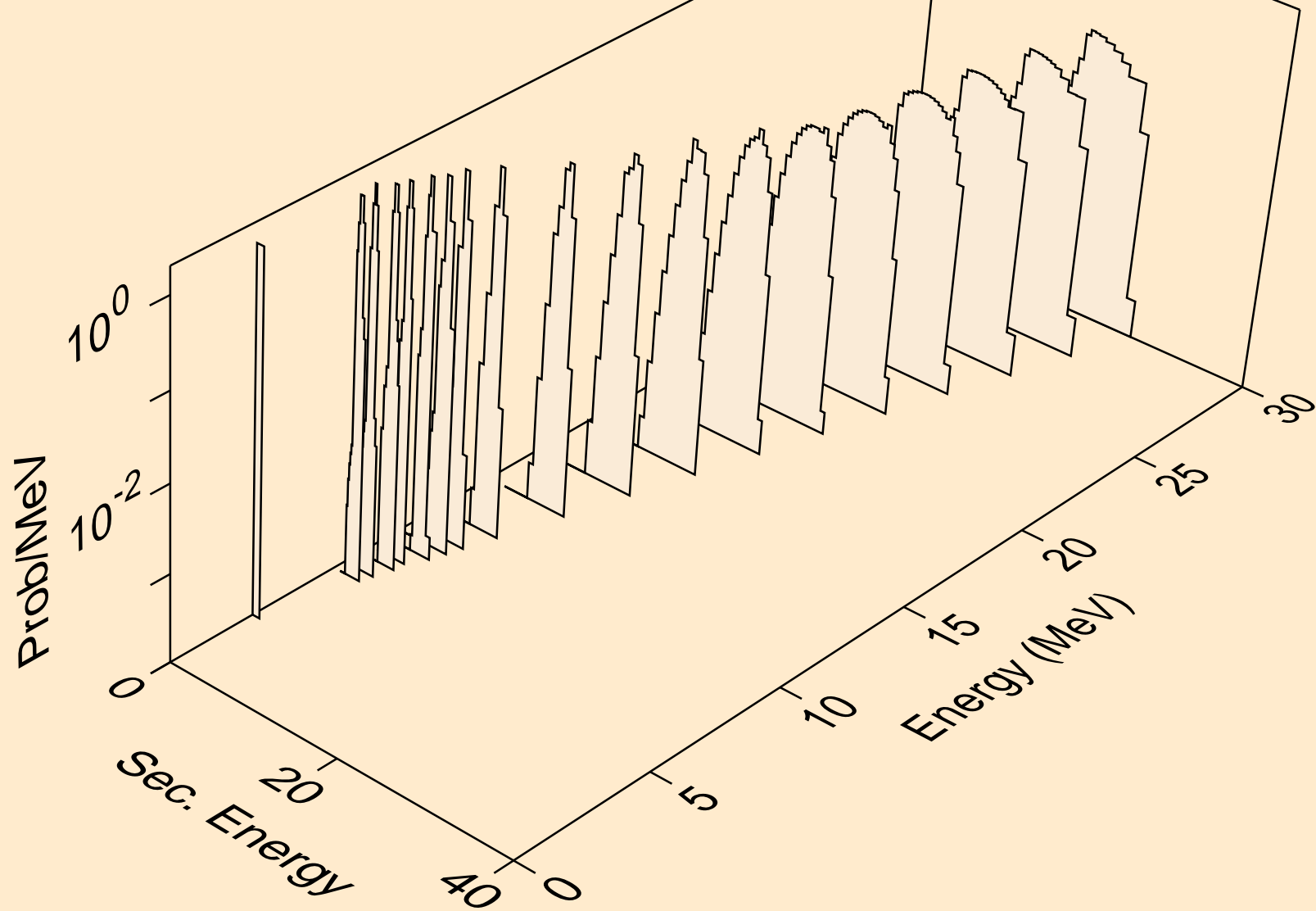

PO207 NEUTRON ACER TENDL-2024 LIBRARY; T=293.6K  
tritons from (n,pt)

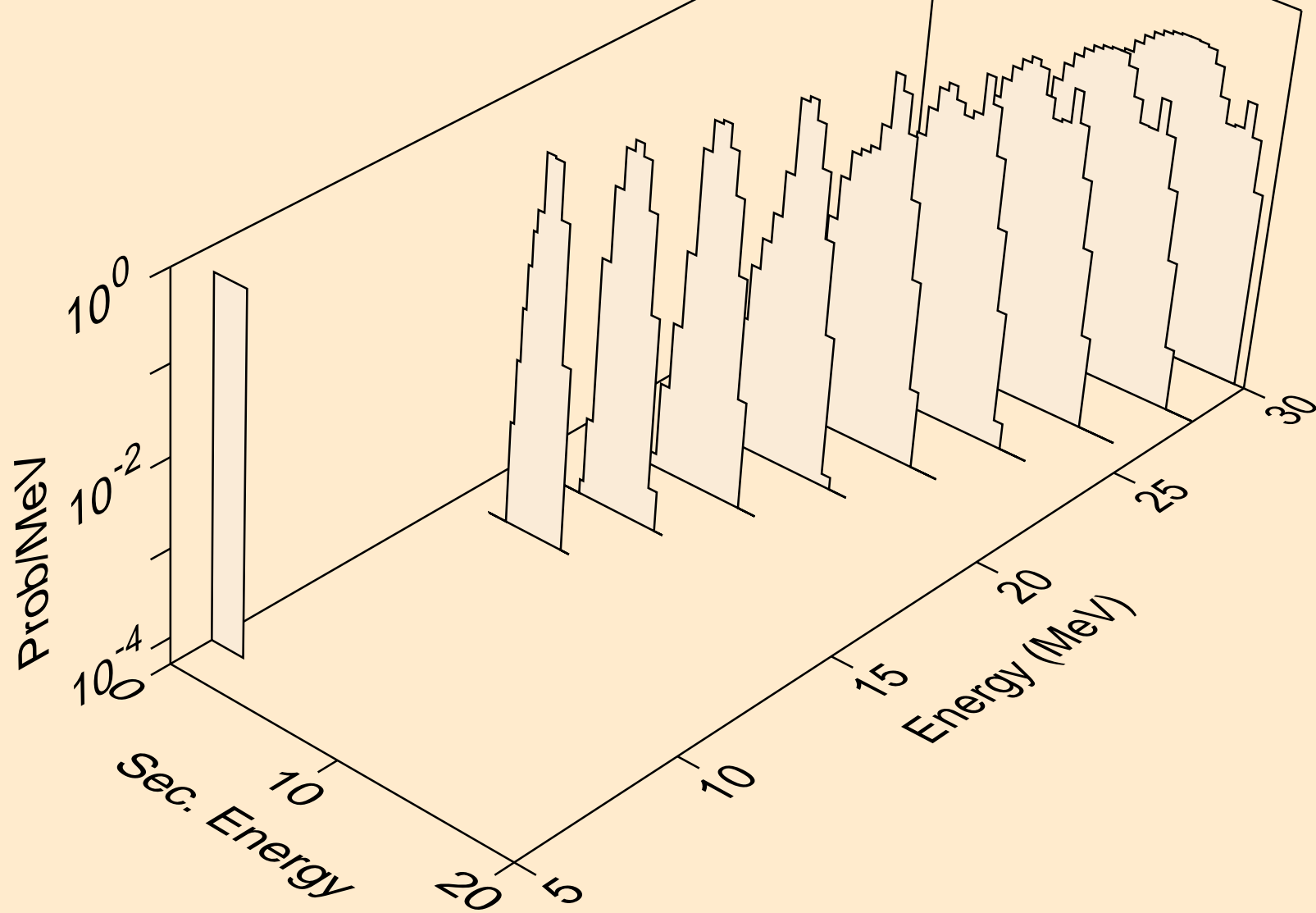

PO207 NEUTRON ACER TENDL-2024 LIBRARY; T=293.6K  
he3s from (n,x)

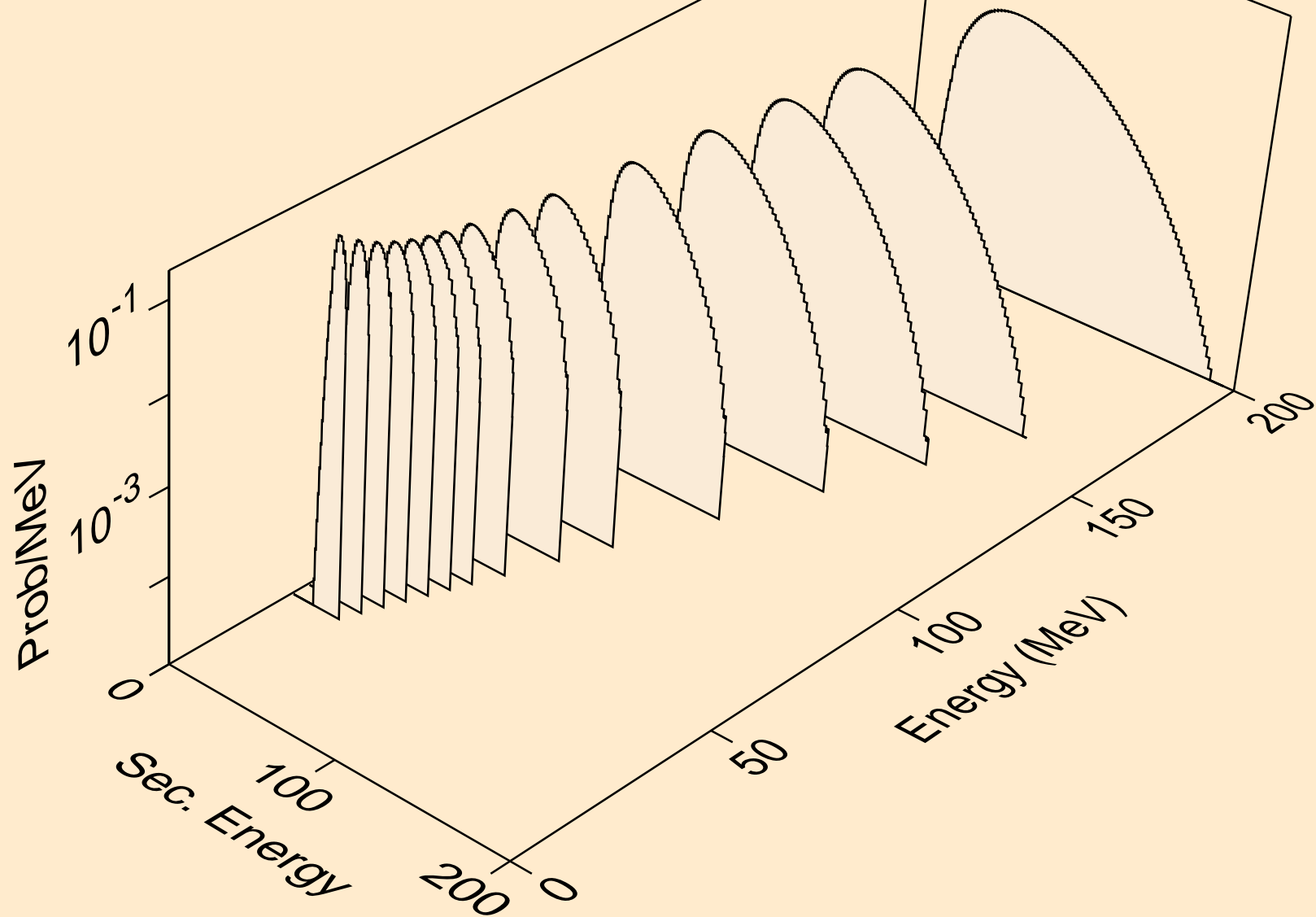

PO207 NEUTRON ACER TENDL-2024 LIBRARY; T=293.6K  
he3s from (n,n\*)he3

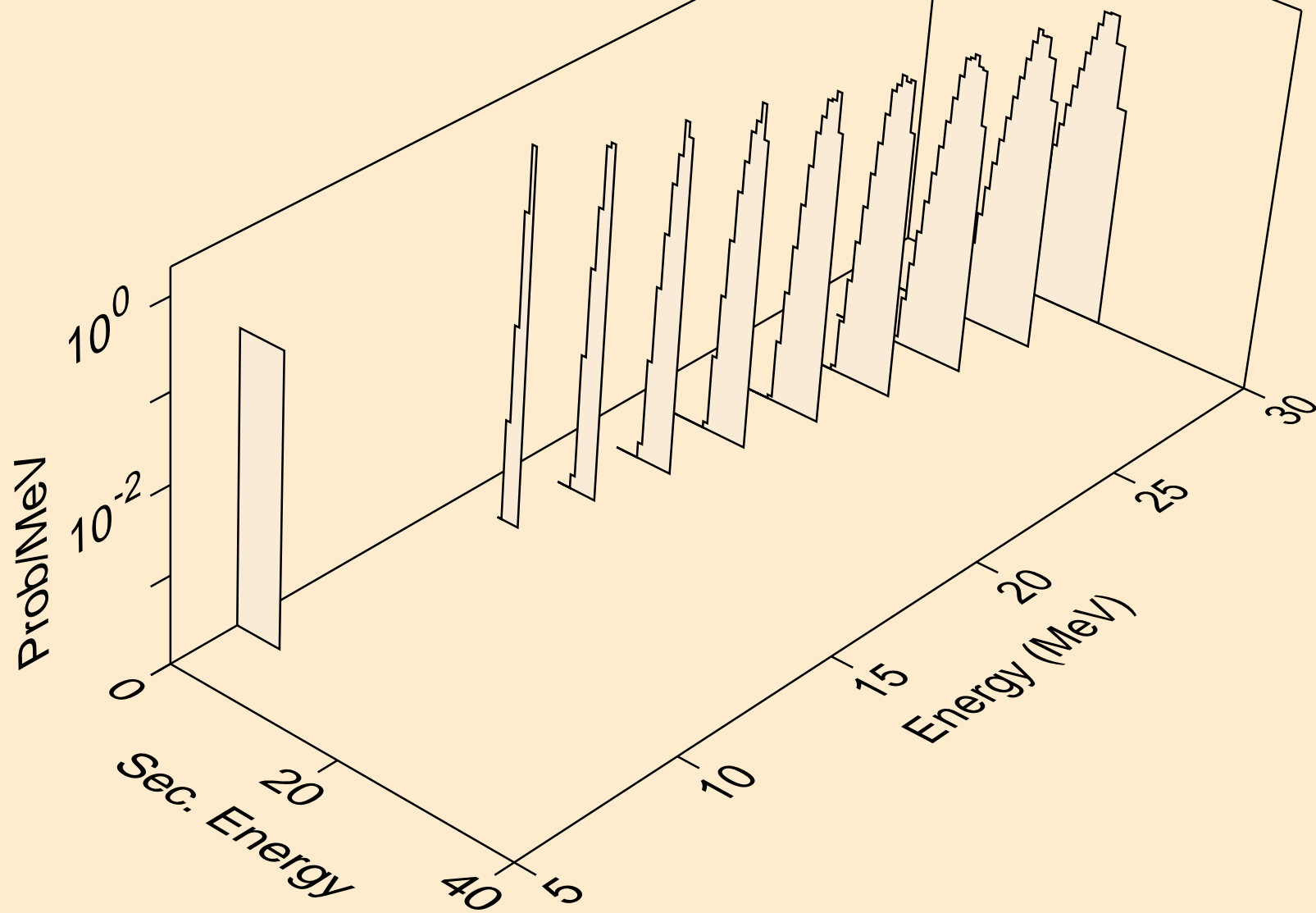

PO207 NEUTRON ACER TENDL-2024 LIBRARY; T=293.6K  
he3s from (n,he3)

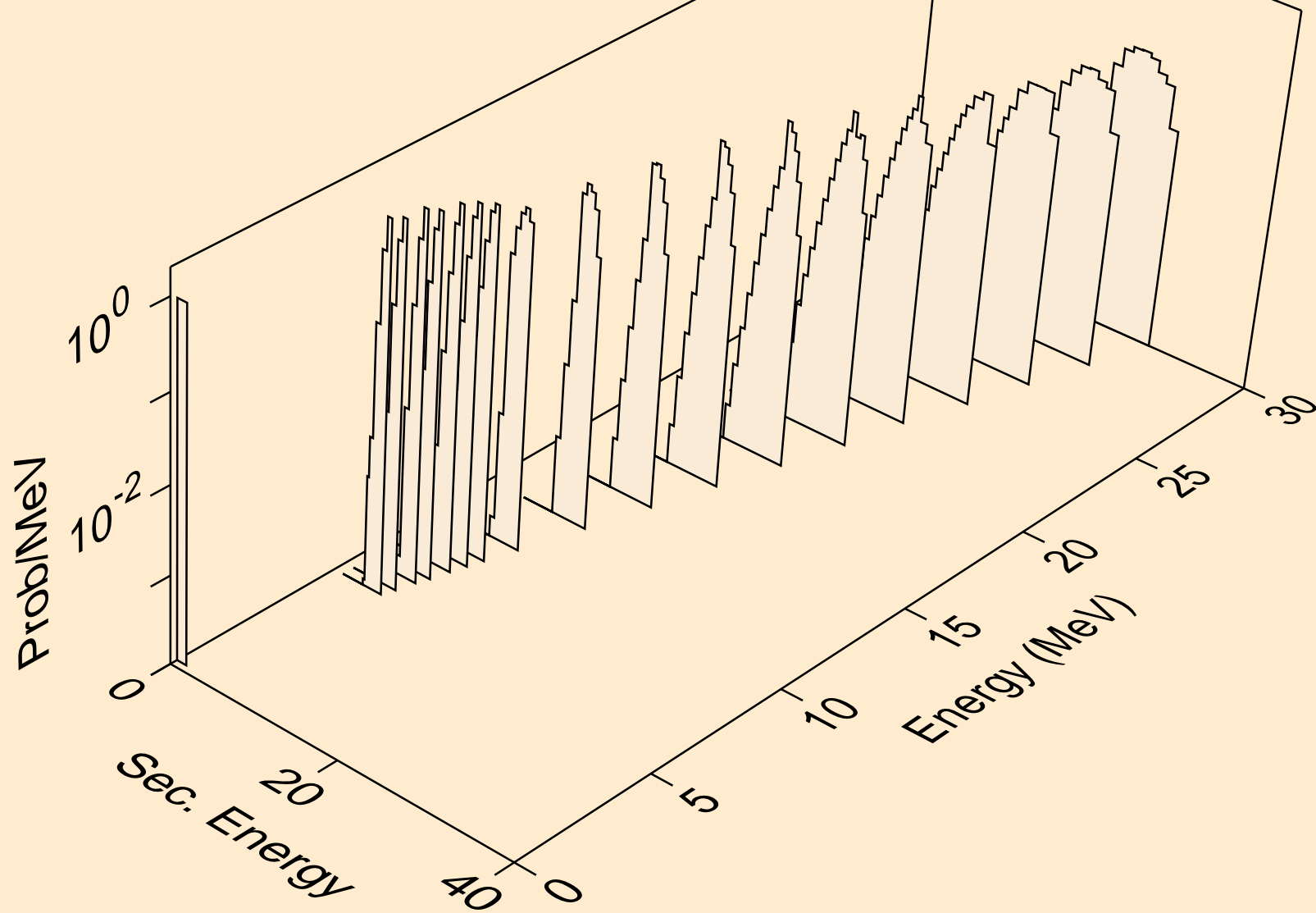

PO207 NEUTRON ACER TENDL-2024 LIBRARY; T=293.6K  
alphas from (n,x)

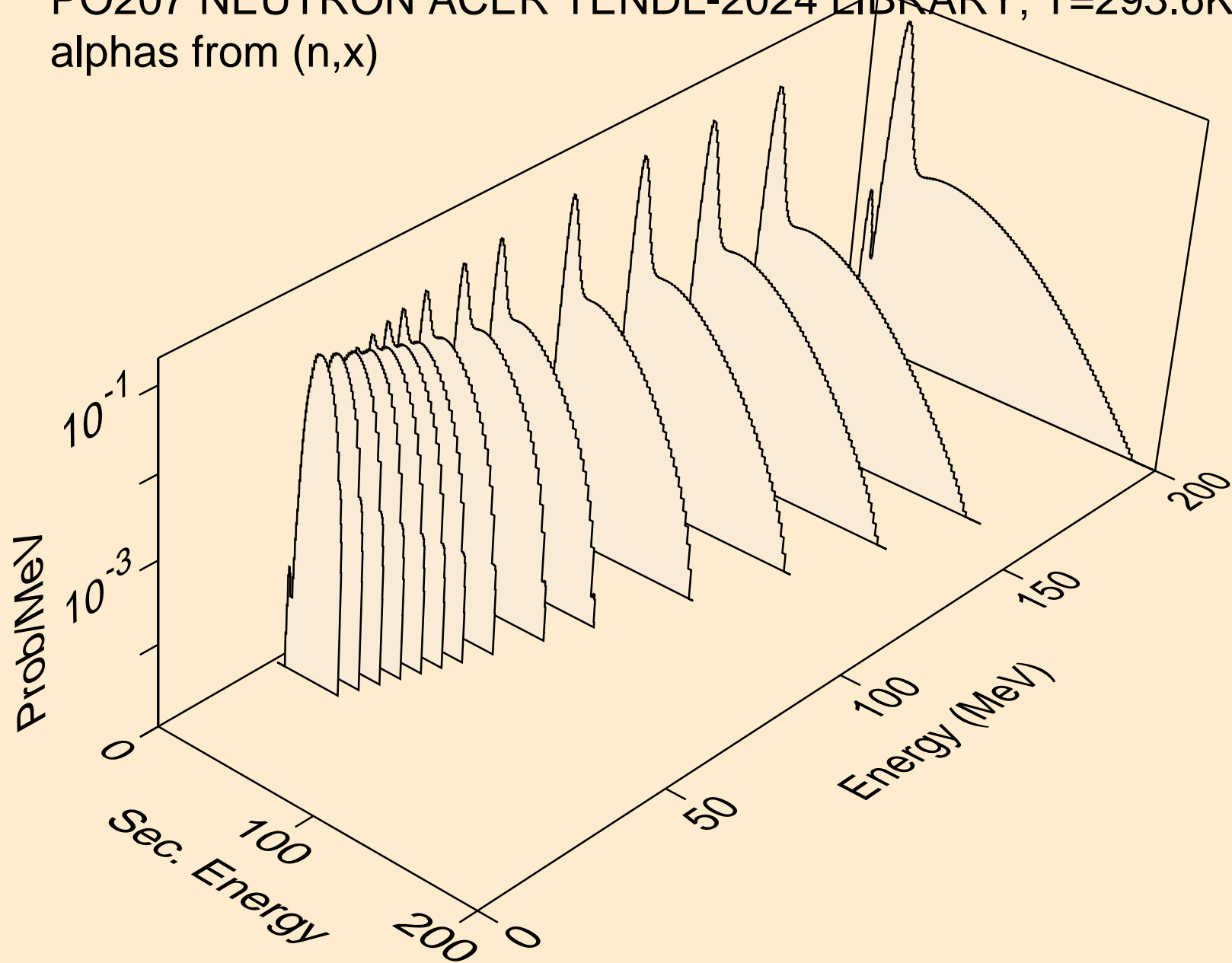

PO207 NEUTRON ACER TENDL-2024 LIBRARY; T=293.6K  
alphas from (n,n\*)a

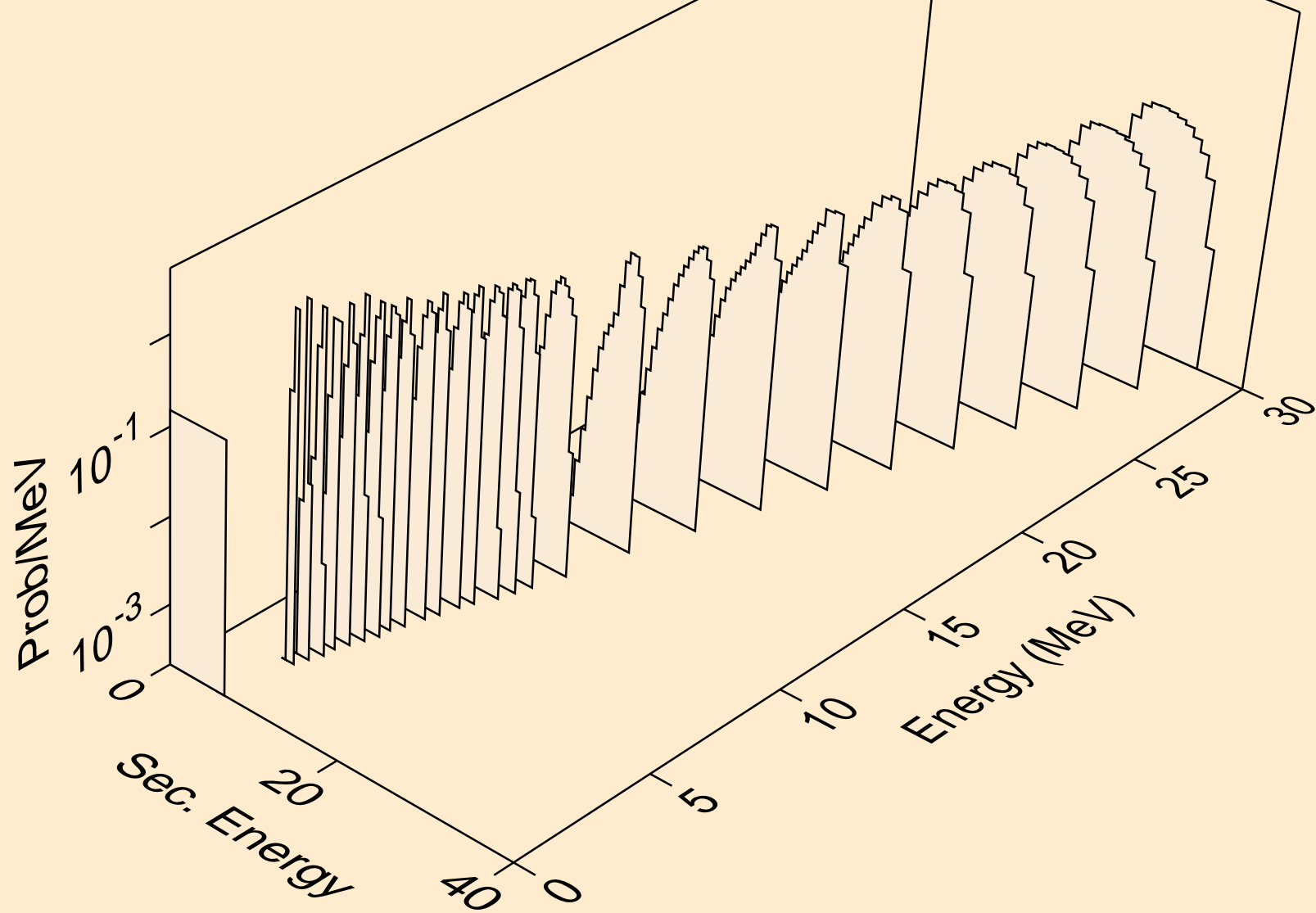

PO207 NEUTRON ACER TENDL-2024 LIBRARY; T=293.6K  
alphas from (n,2n)a

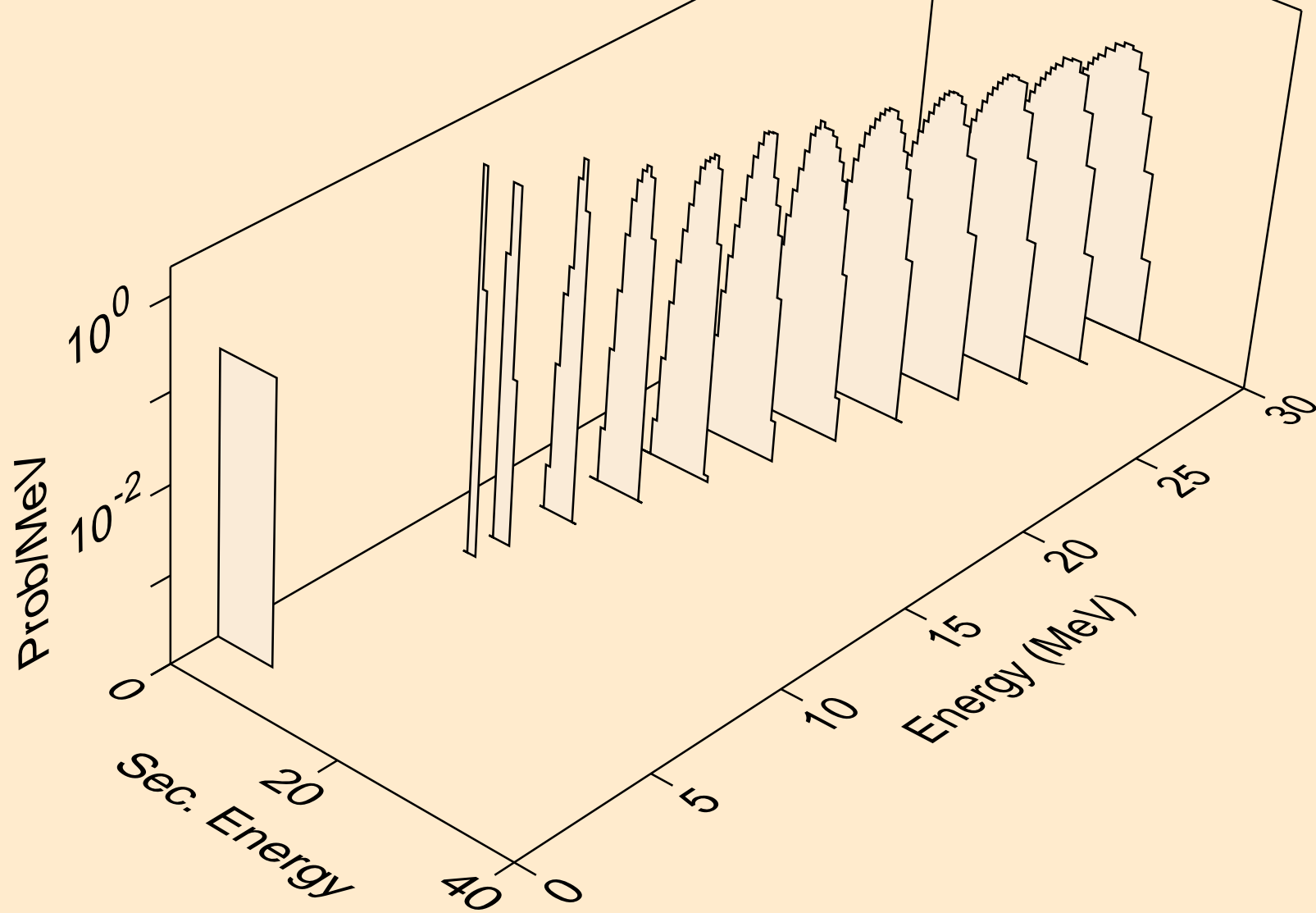

PO207 NEUTRON ACER TENDL-2024 LIBRARY; T=293.6K  
alphas from (n,3n)a

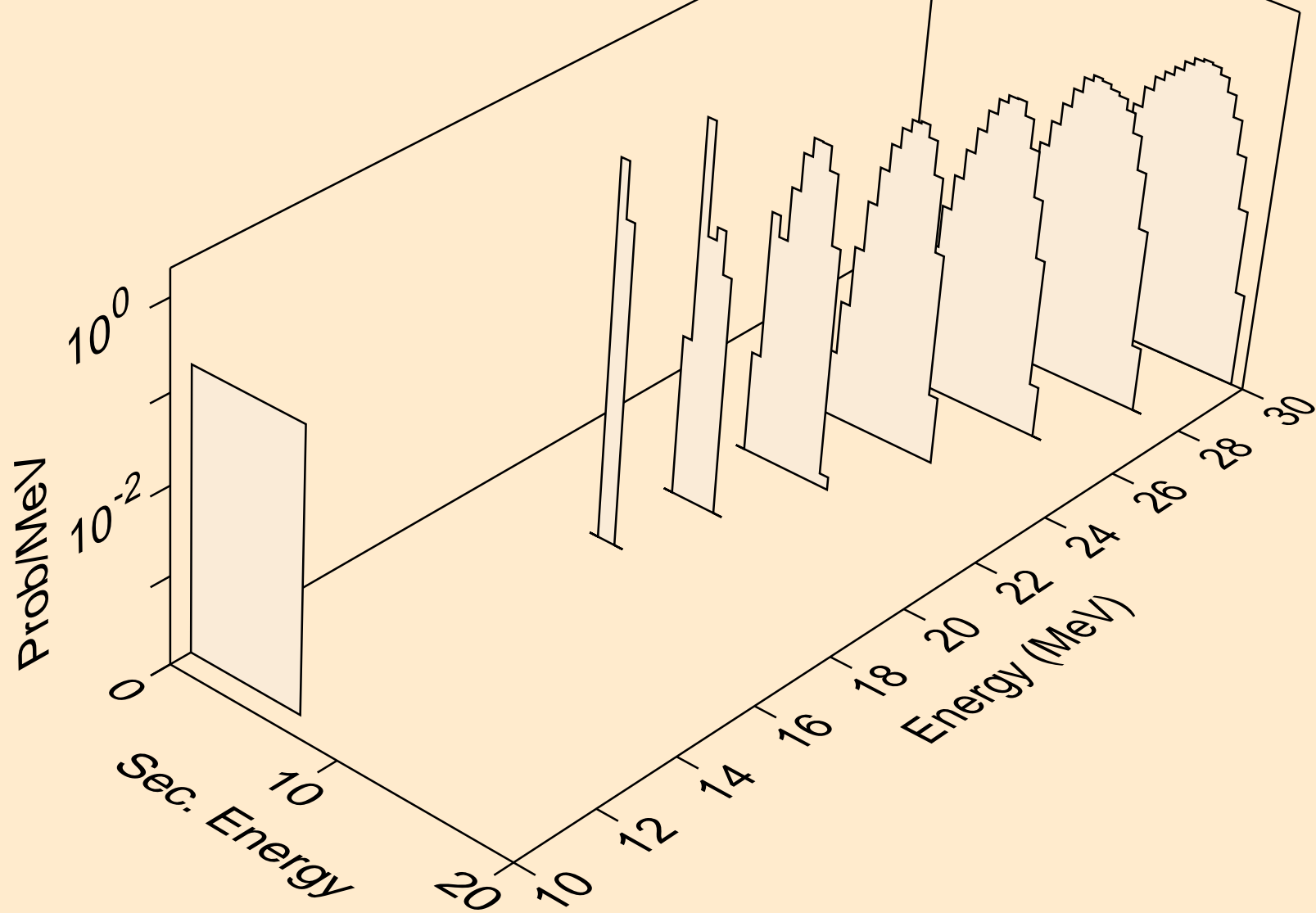

PO207 NEUTRON ACER TENDL-2024 LIBRARY; T=293.6K  
alphas from (n,n\*)2a

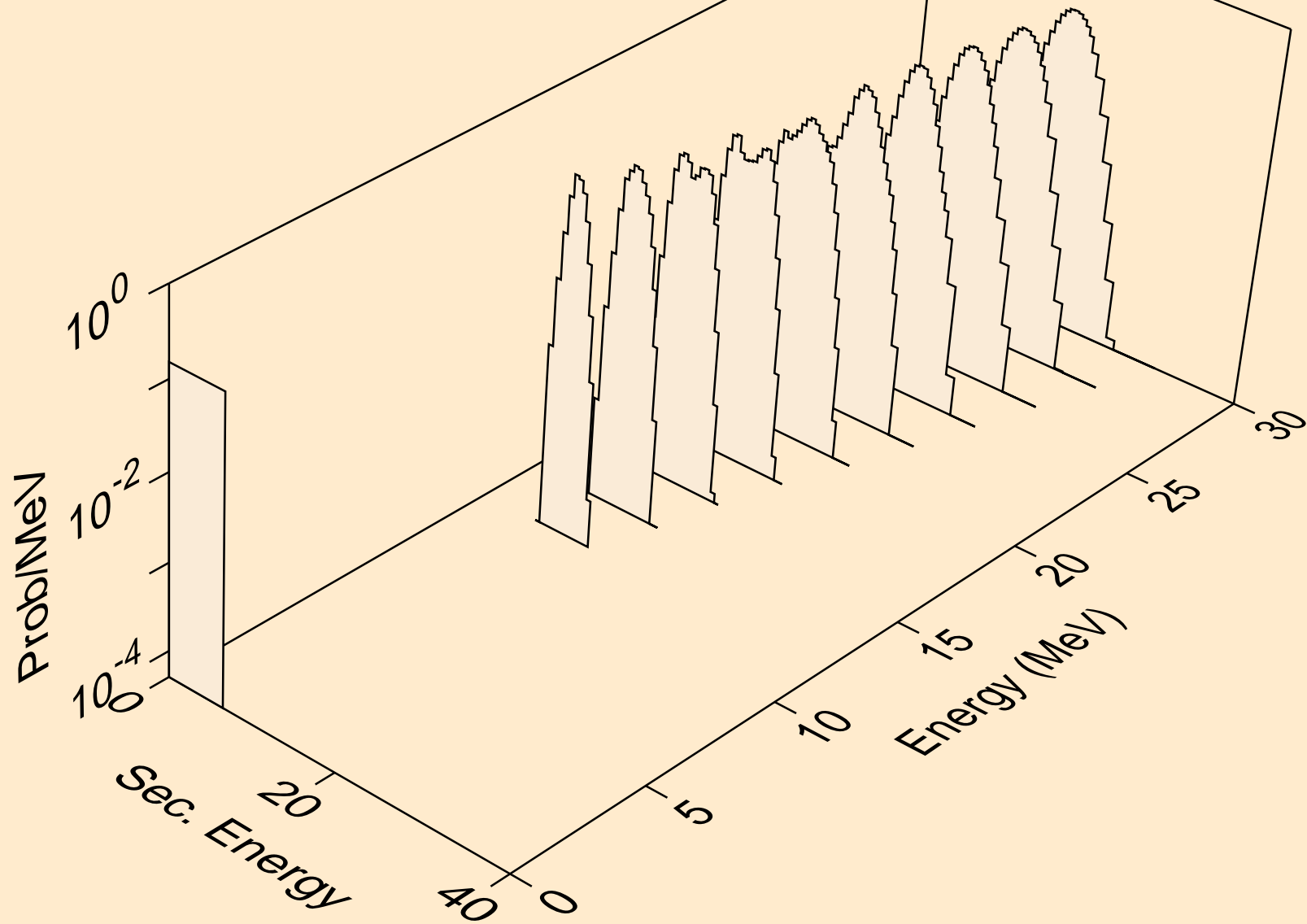

PO207 NEUTRON ACER TENDL-2024 LIBRARY; T=293.6K  
alphas from (n,npa)

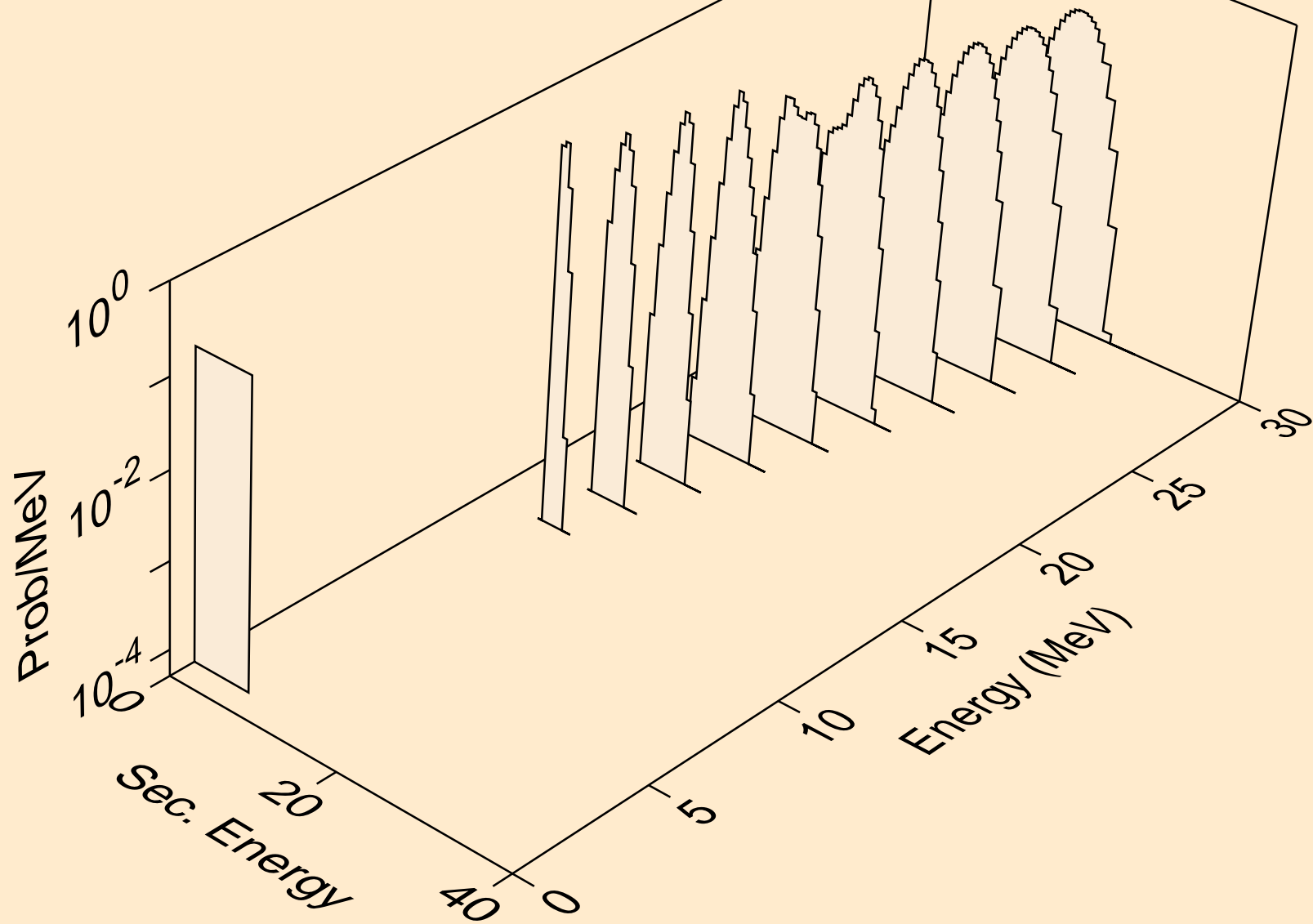

PO207 NEUTRON ACER TENDL-2024 LIBRARY; T=293.6K  
alphas from (n,a)

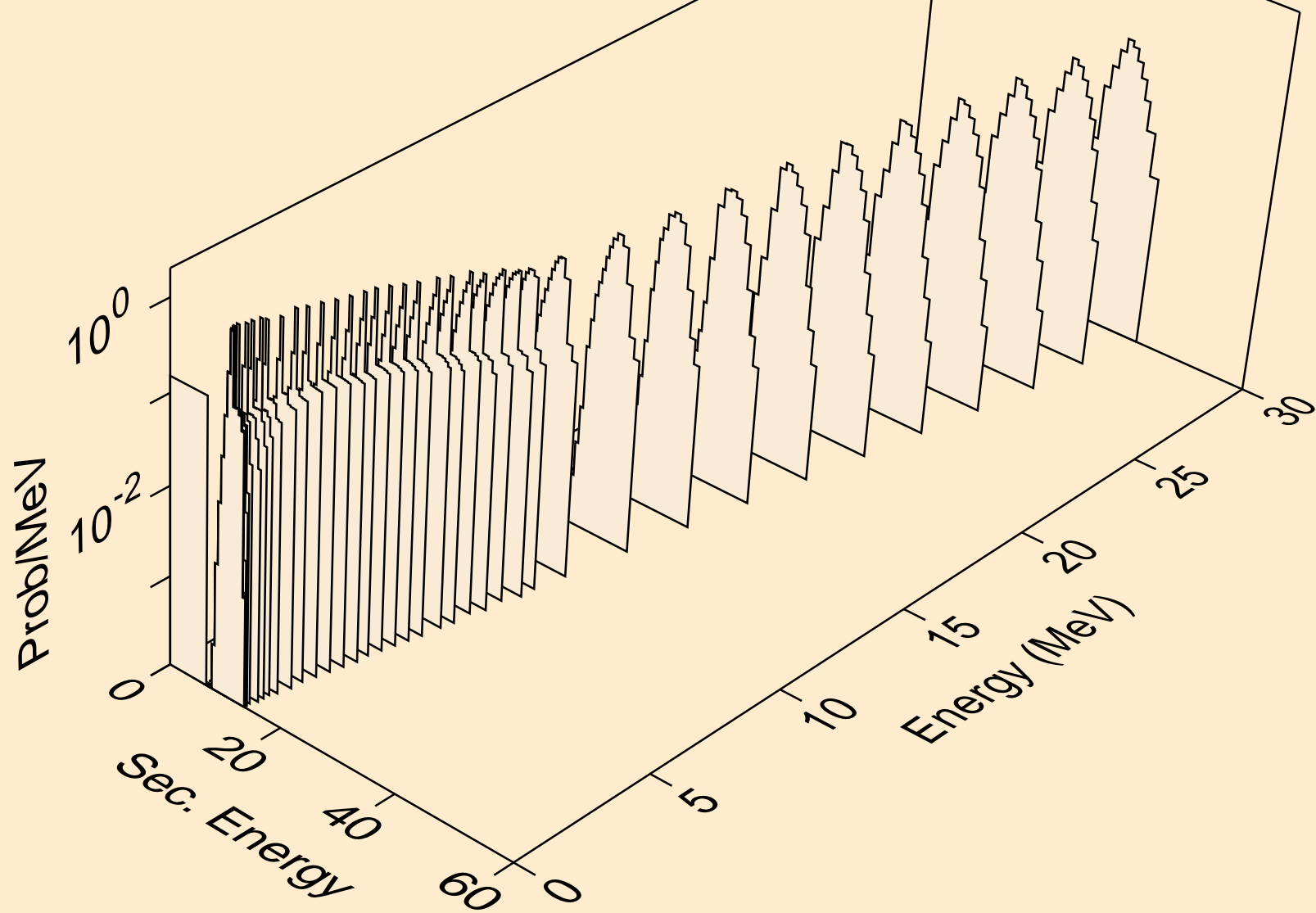

PO207 NEUTRON ACER TENDL-2024 LIBRARY; T=293.6K  
alphas from (n,2a)

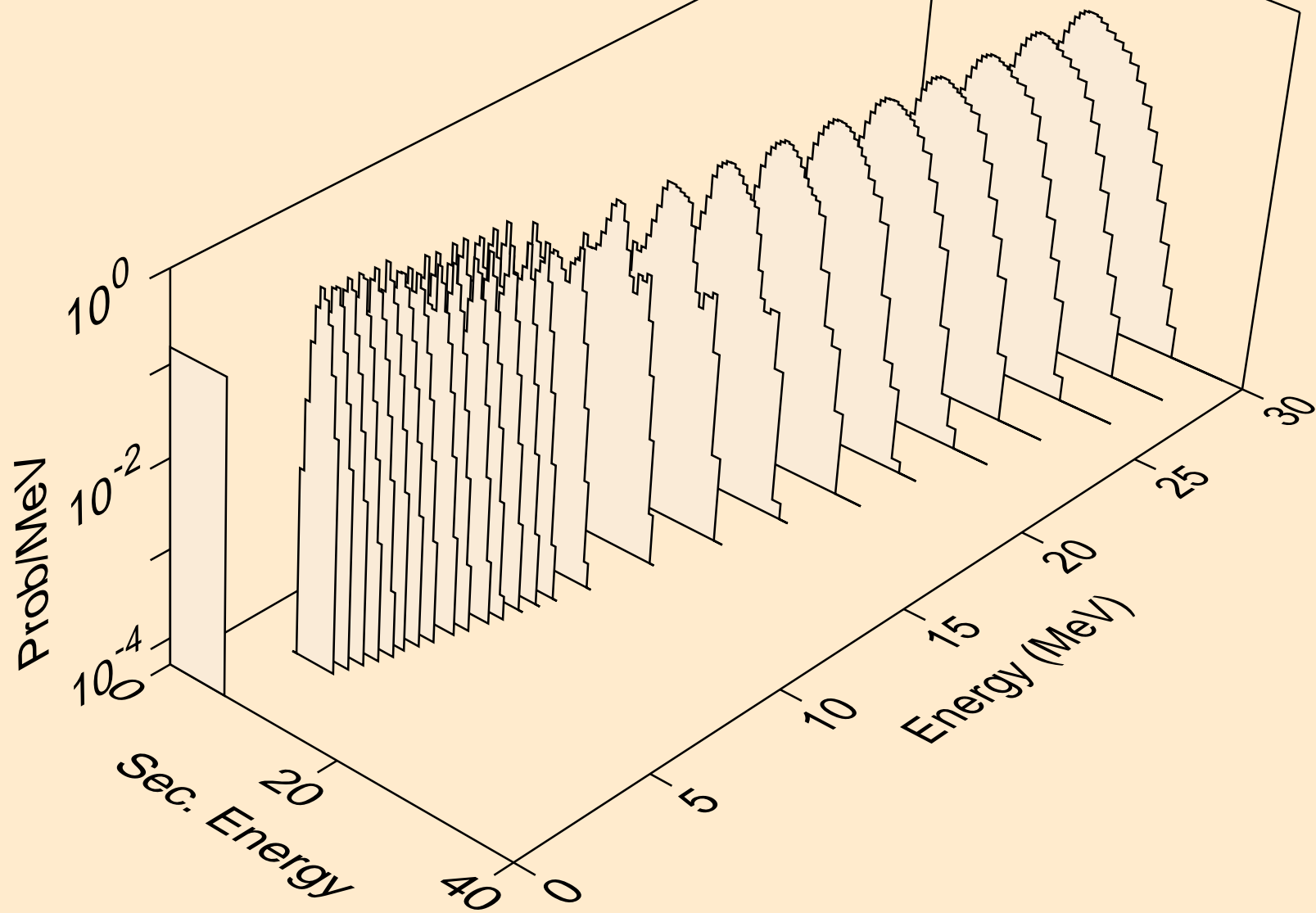

PO207 NEUTRON ACER TENDL-2024 LIBRARY; T=293.6K  
alphas from (n,pa)

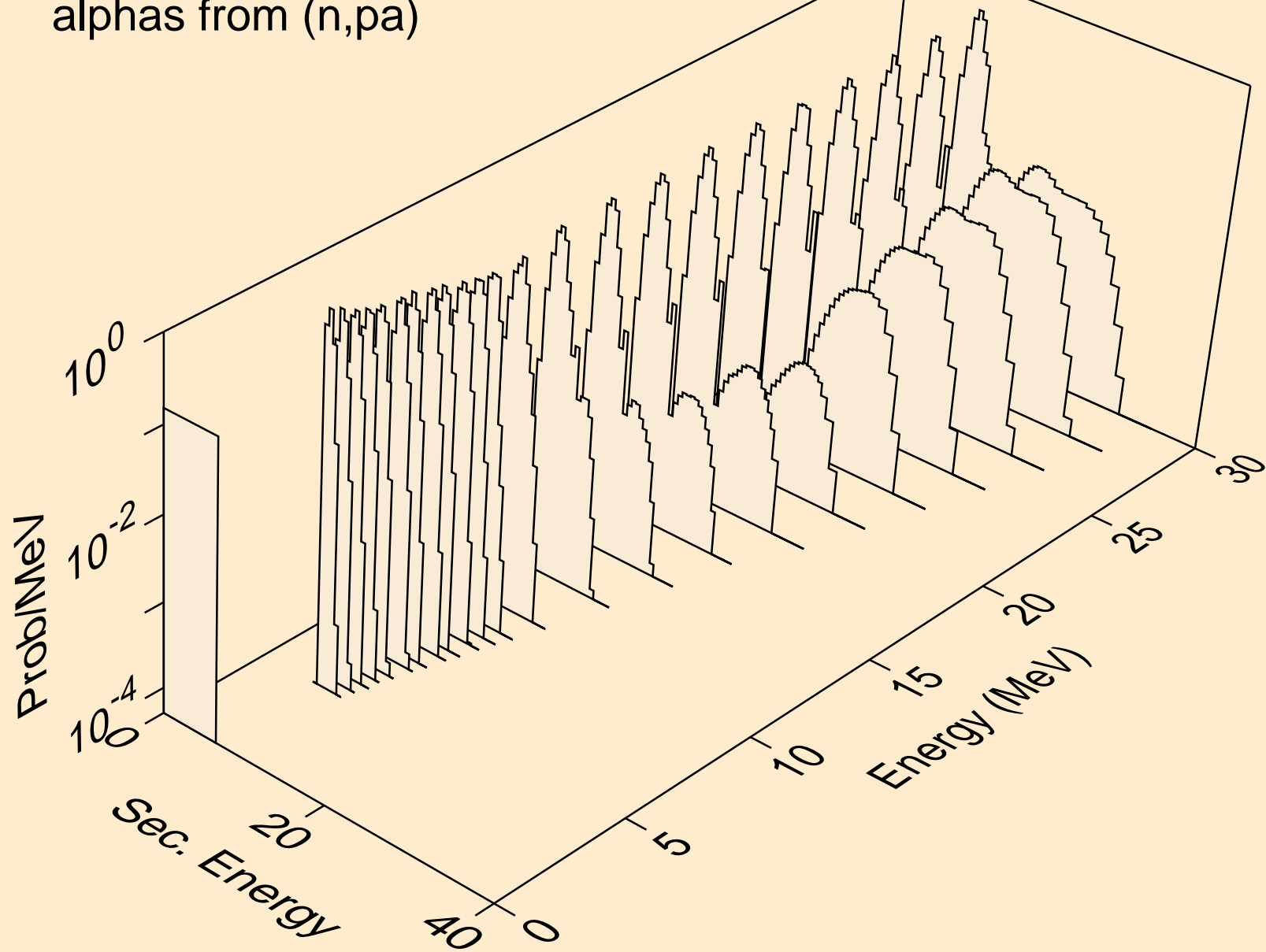

PO207 NEUTRON ACER TENDL-2024 LIBRARY; T=293.6K  
alphas from (n,da)

