

PT189 NEUTRON ACER TENDL-2024 LIBRARY; T=293.6K
Principal cross sections

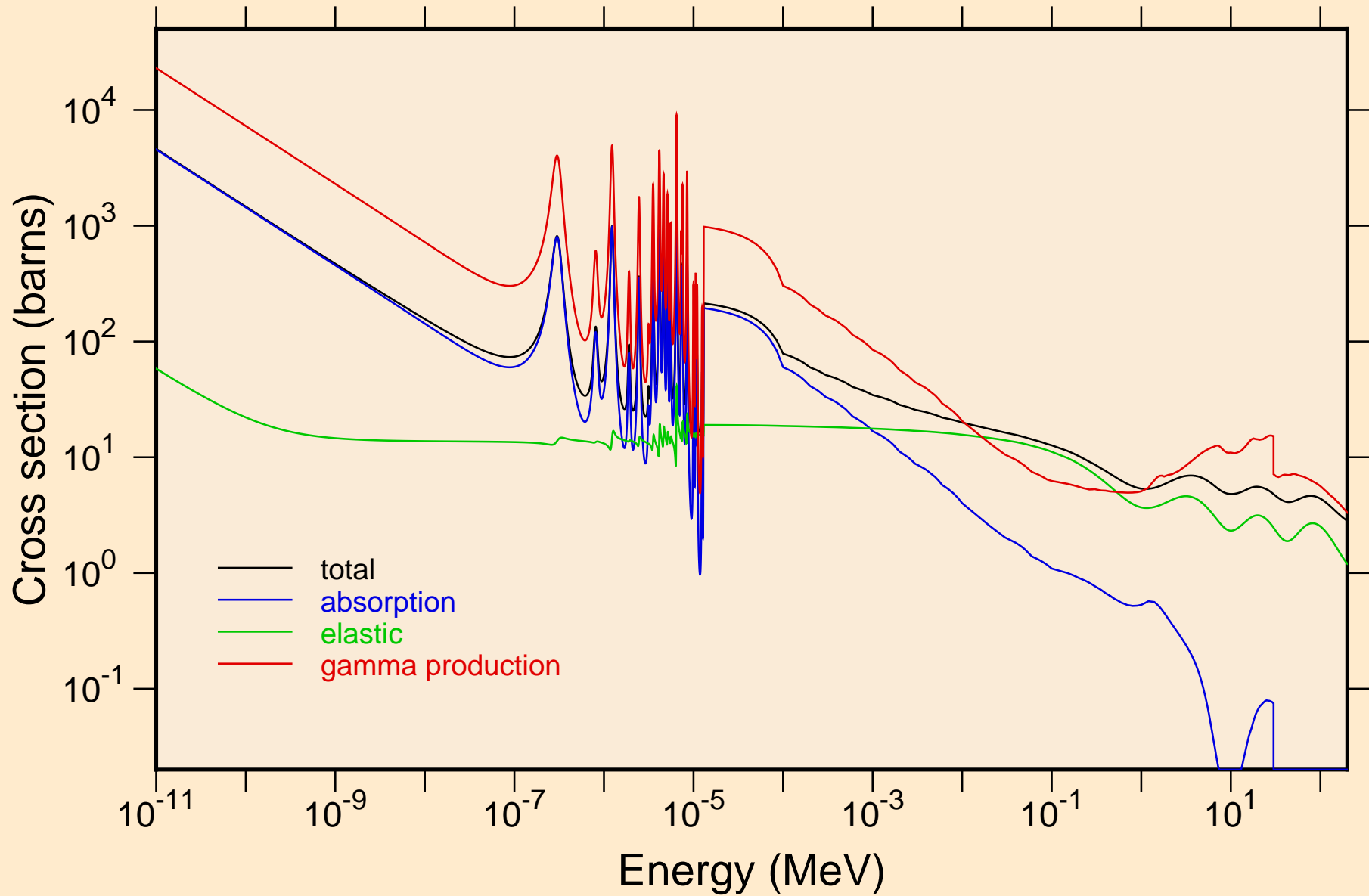

PT189 NEUTRON ACER TENDL-2024 LIBRARY; T=293.6K
resonance total cross section

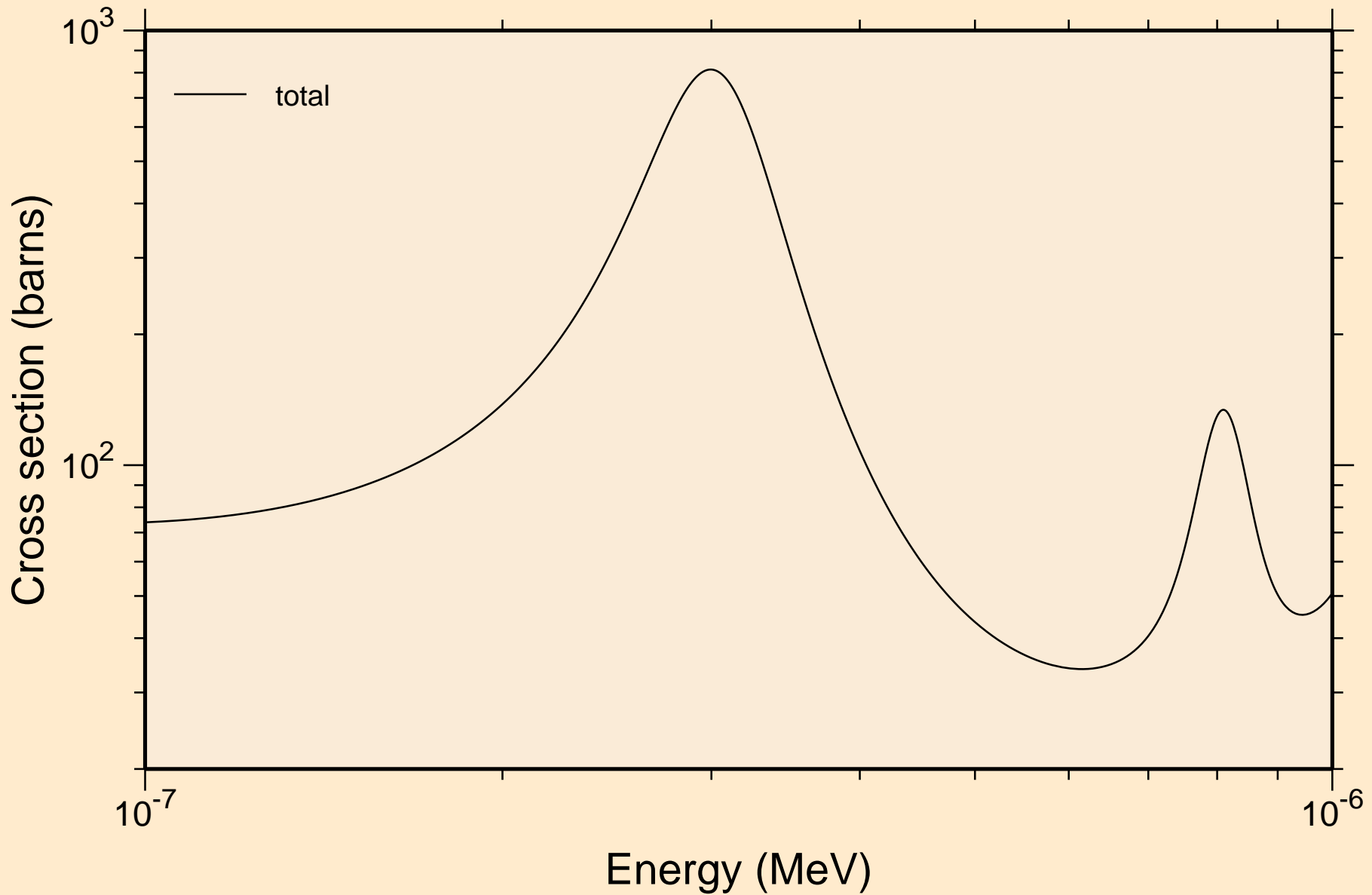

PT189 NEUTRON ACER TENDL-2024 LIBRARY; T=293.6K
resonance total cross section

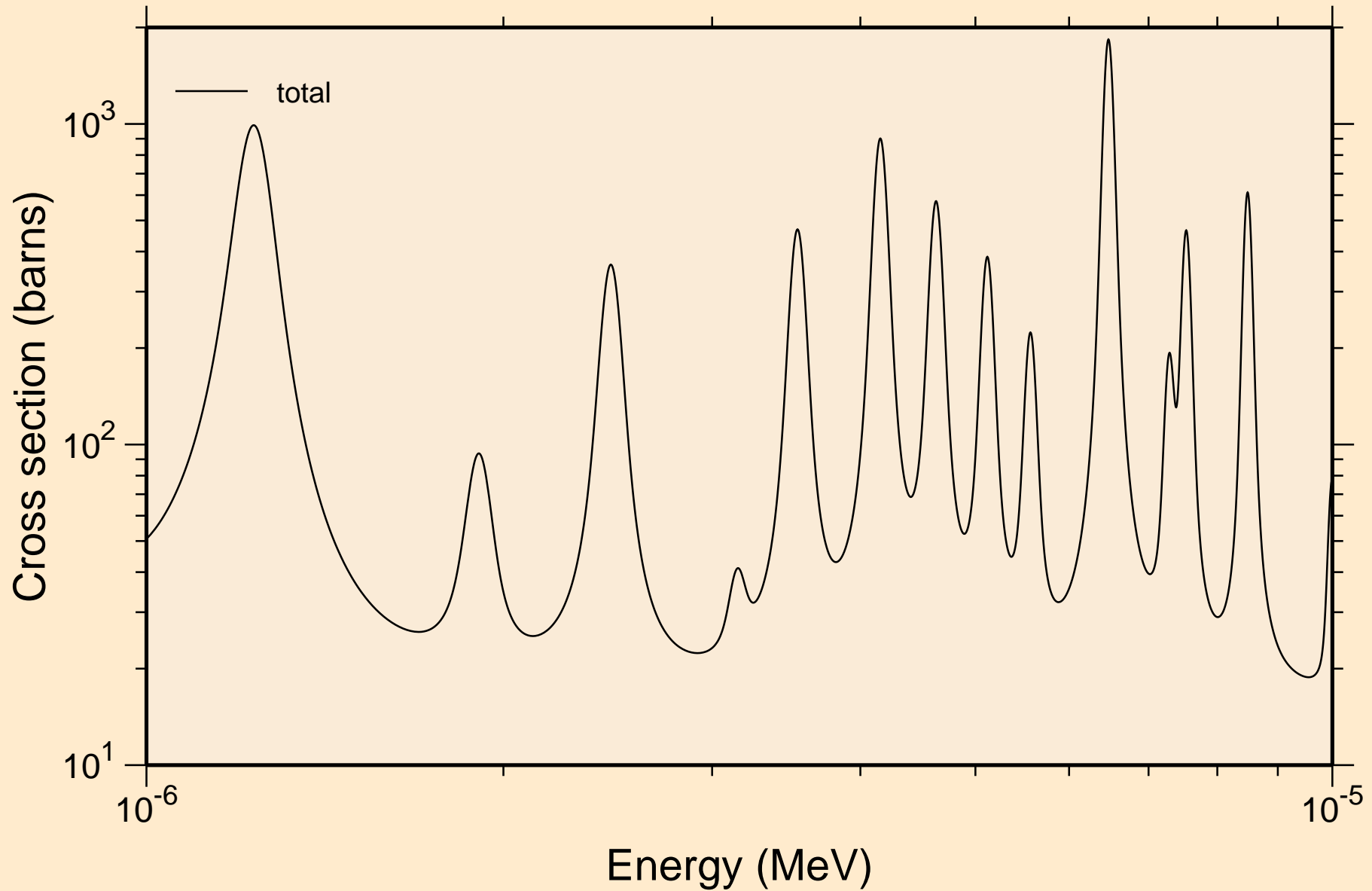

PT189 NEUTRON ACER TENDL-2024 LIBRARY; T=293.6K
resonance total cross section

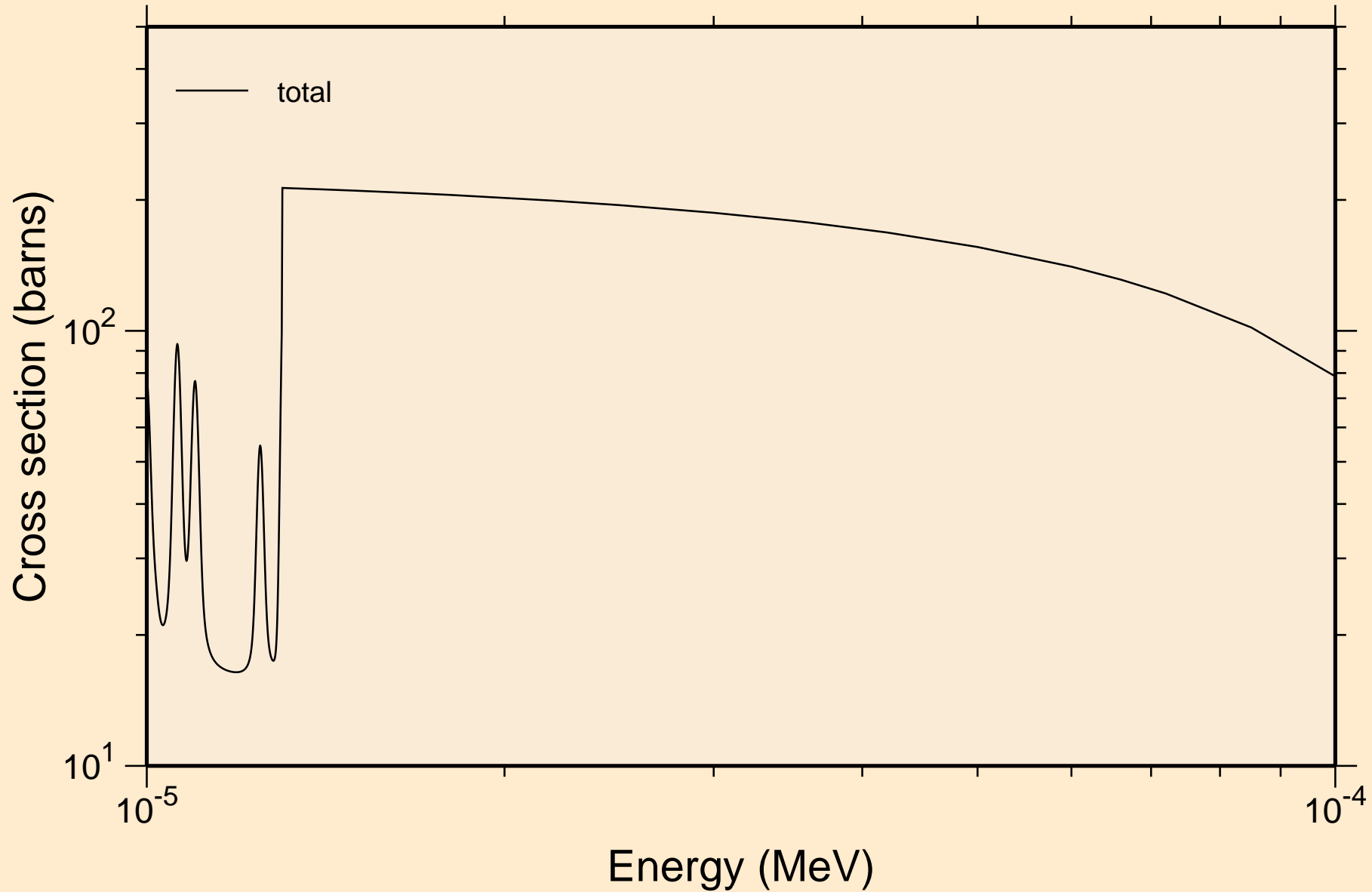

PT189 NEUTRON ACER TENDL-2024 LIBRARY; T=293.6K
resonance total cross section

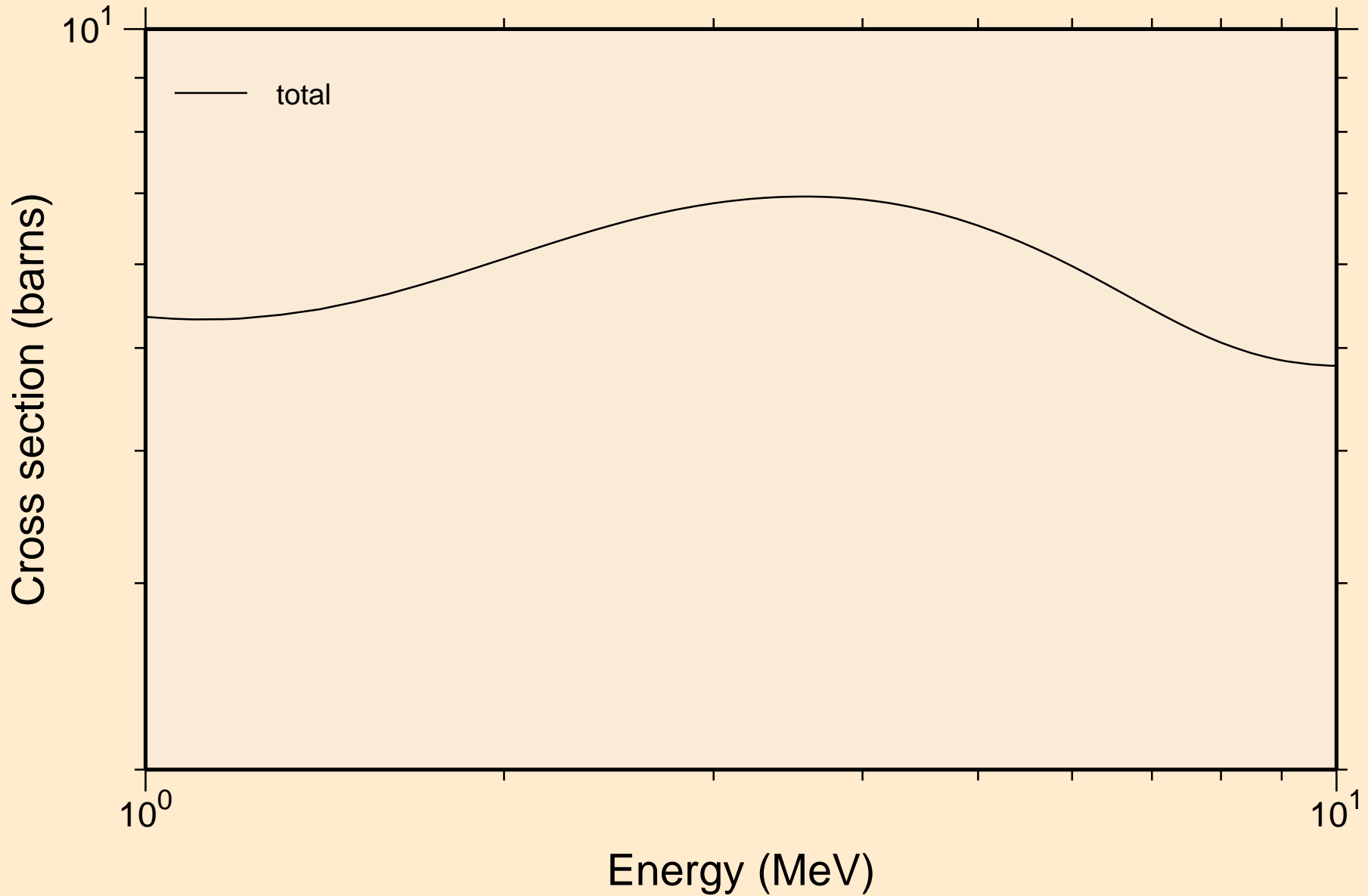

PT189 NEUTRON ACER TENDL-2024 LIBRARY; T=293.6K
resonance absorption cross sections

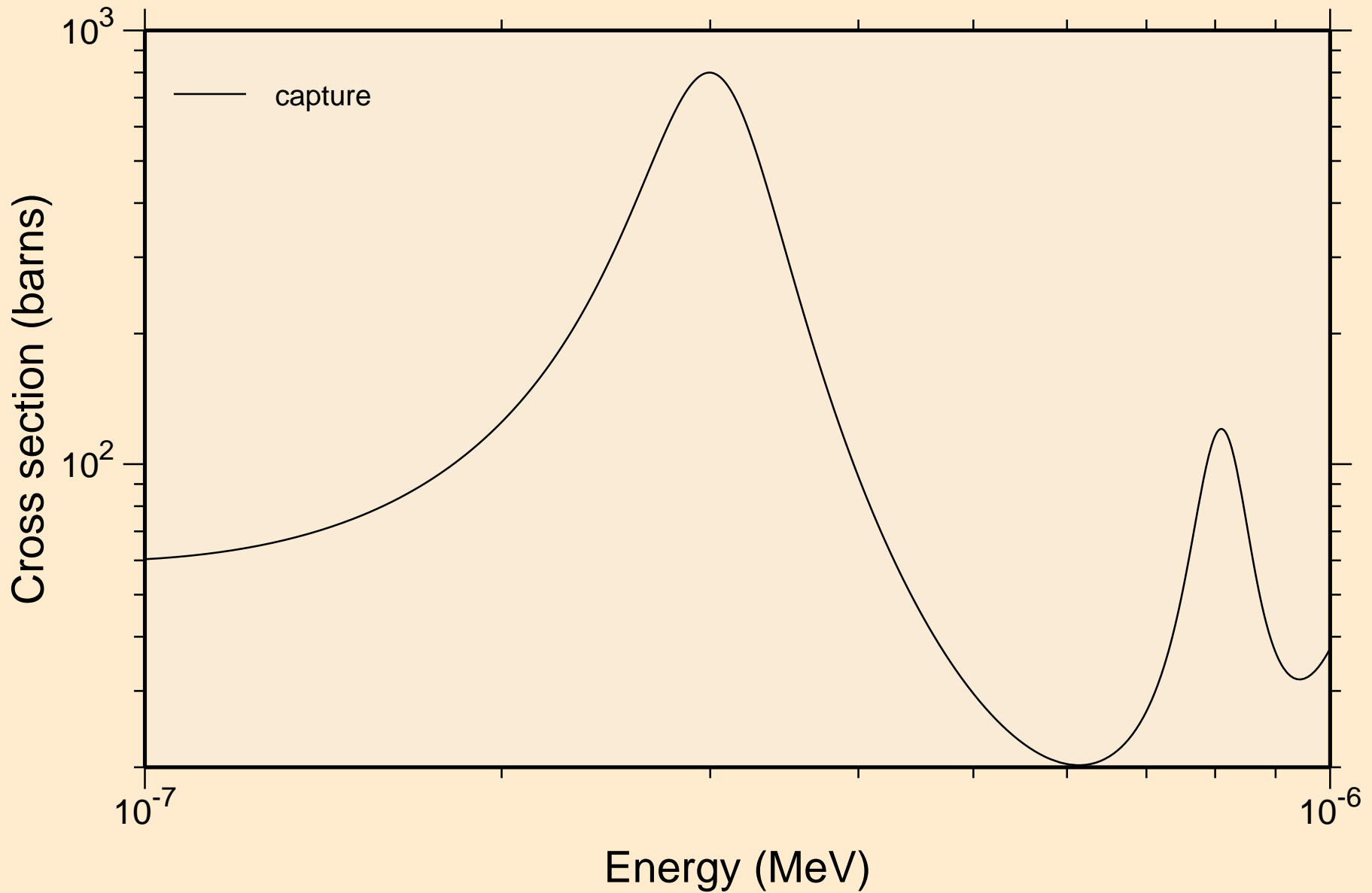

PT189 NEUTRON ACER TENDL-2024 LIBRARY; T=293.6K
resonance absorption cross sections

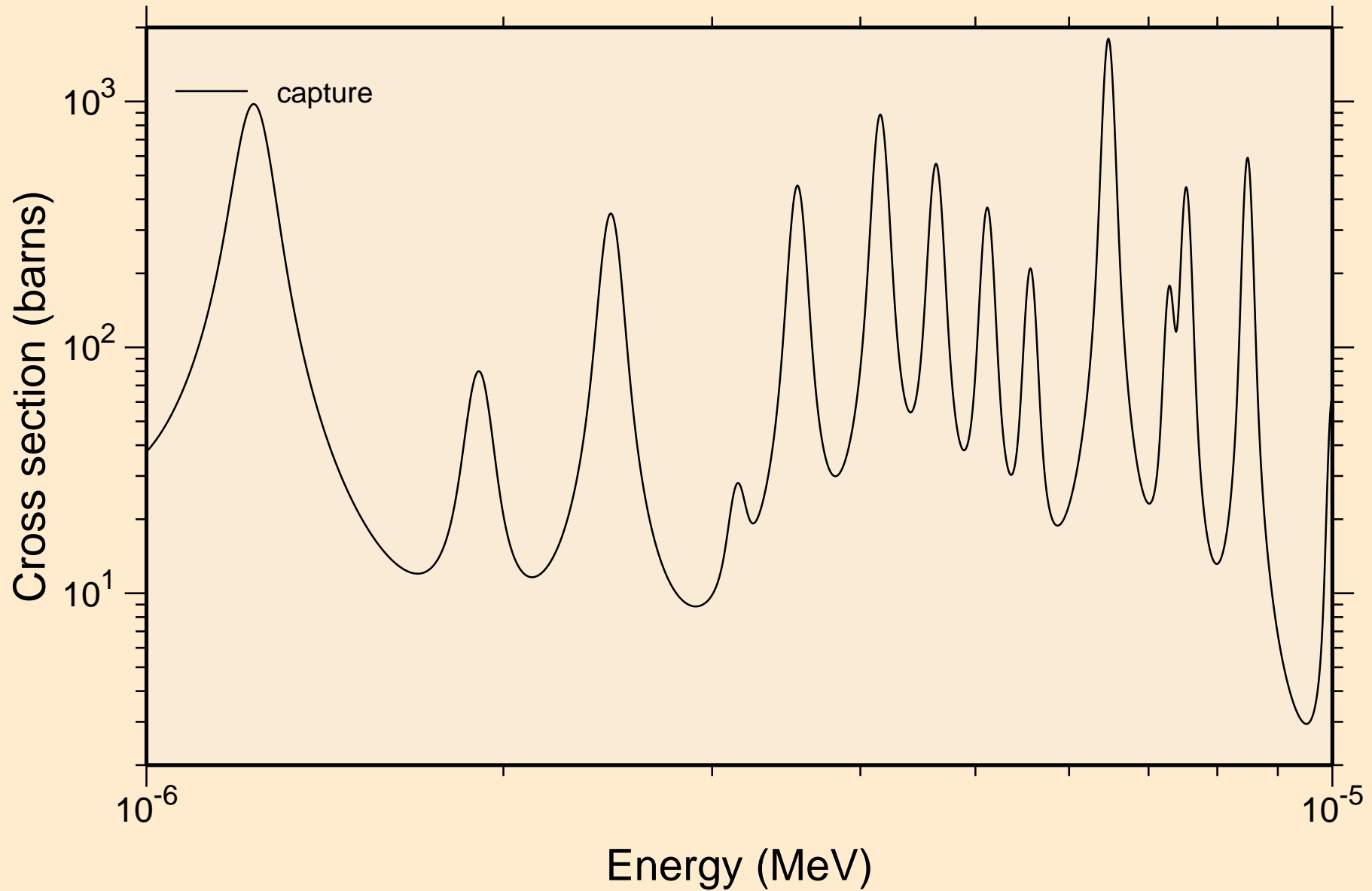

PT189 NEUTRON ACER TENDL-2024 LIBRARY; T=293.6K
resonance absorption cross sections

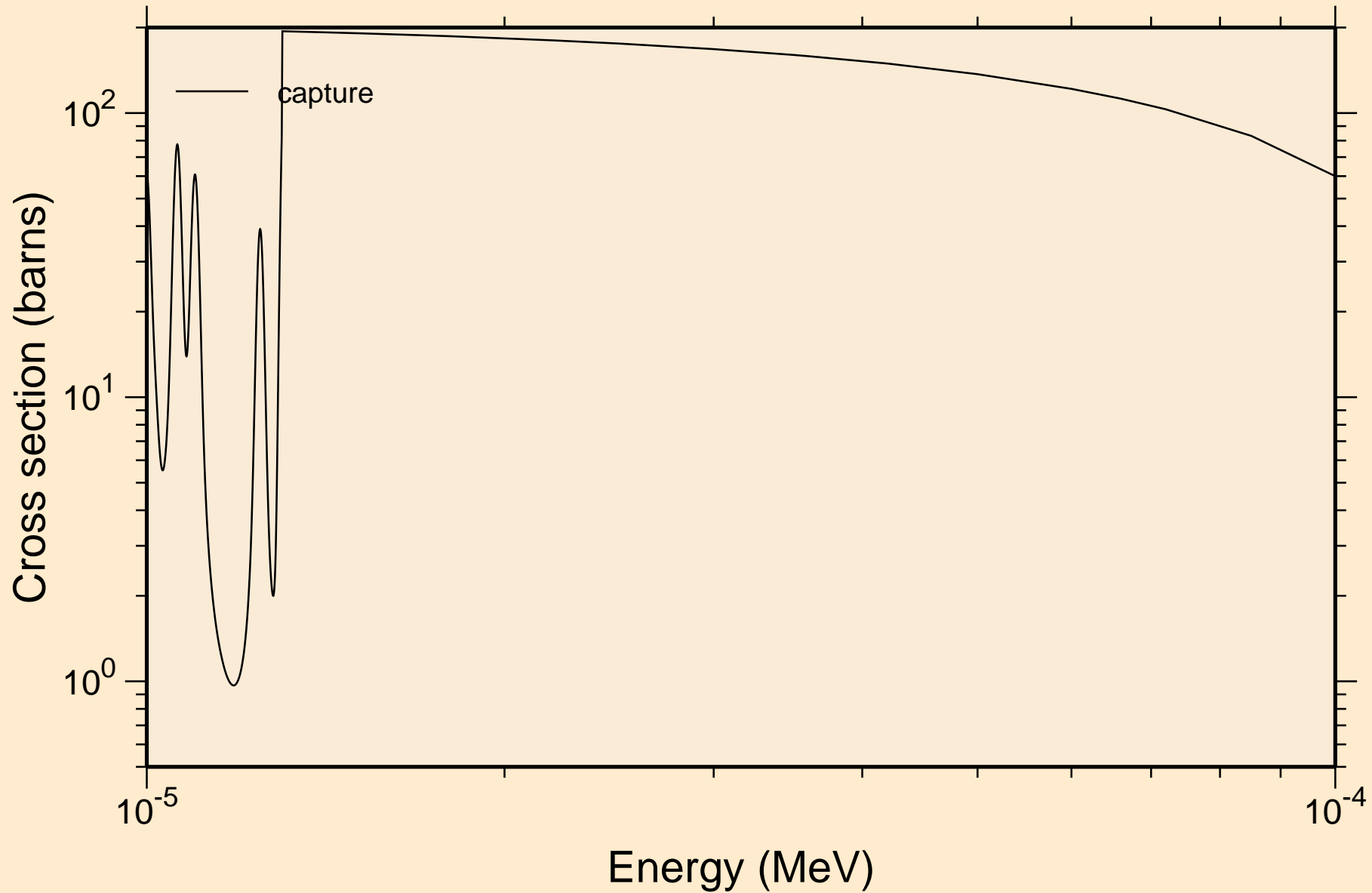

PT189 NEUTRON ACER TENDL-2024 LIBRARY; T=293.6K
resonance absorption cross sections

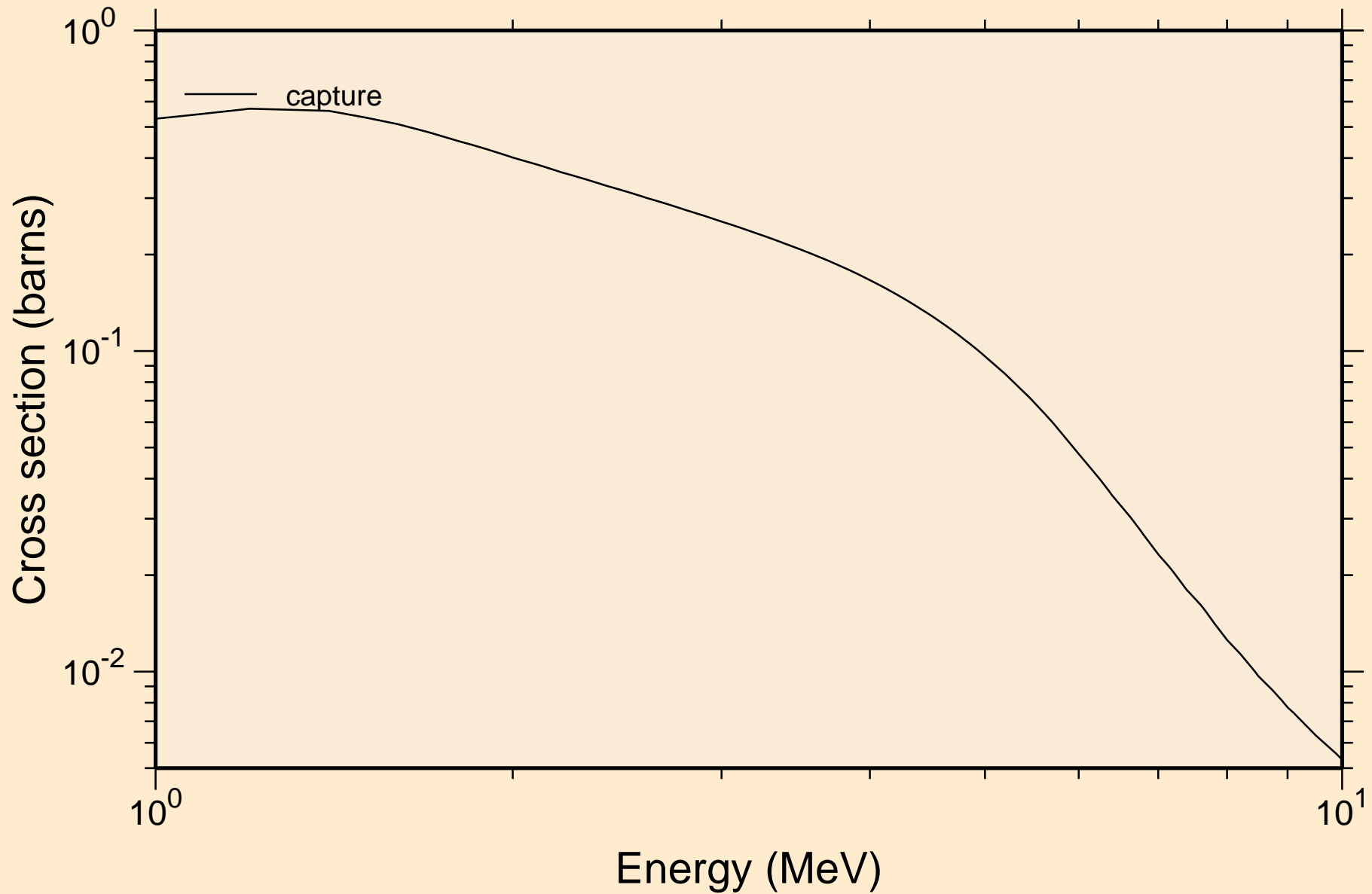

PT189 NEUTRON ACER TENDL-2024 LIBRARY; T=293.6K
Heating

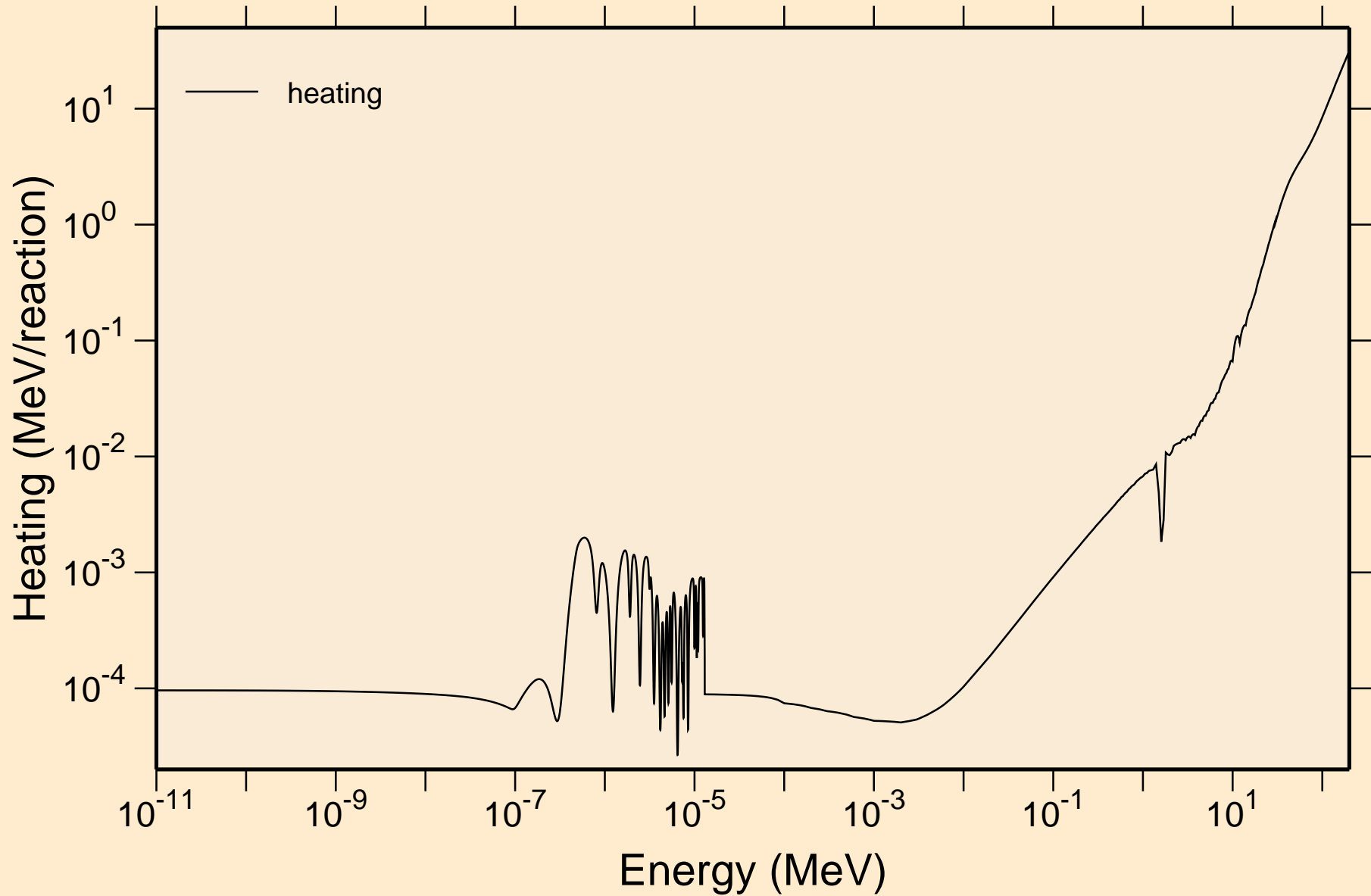

PT189 NEUTRON ACER TENDL-2024 LIBRARY; T=293.6K
Damage

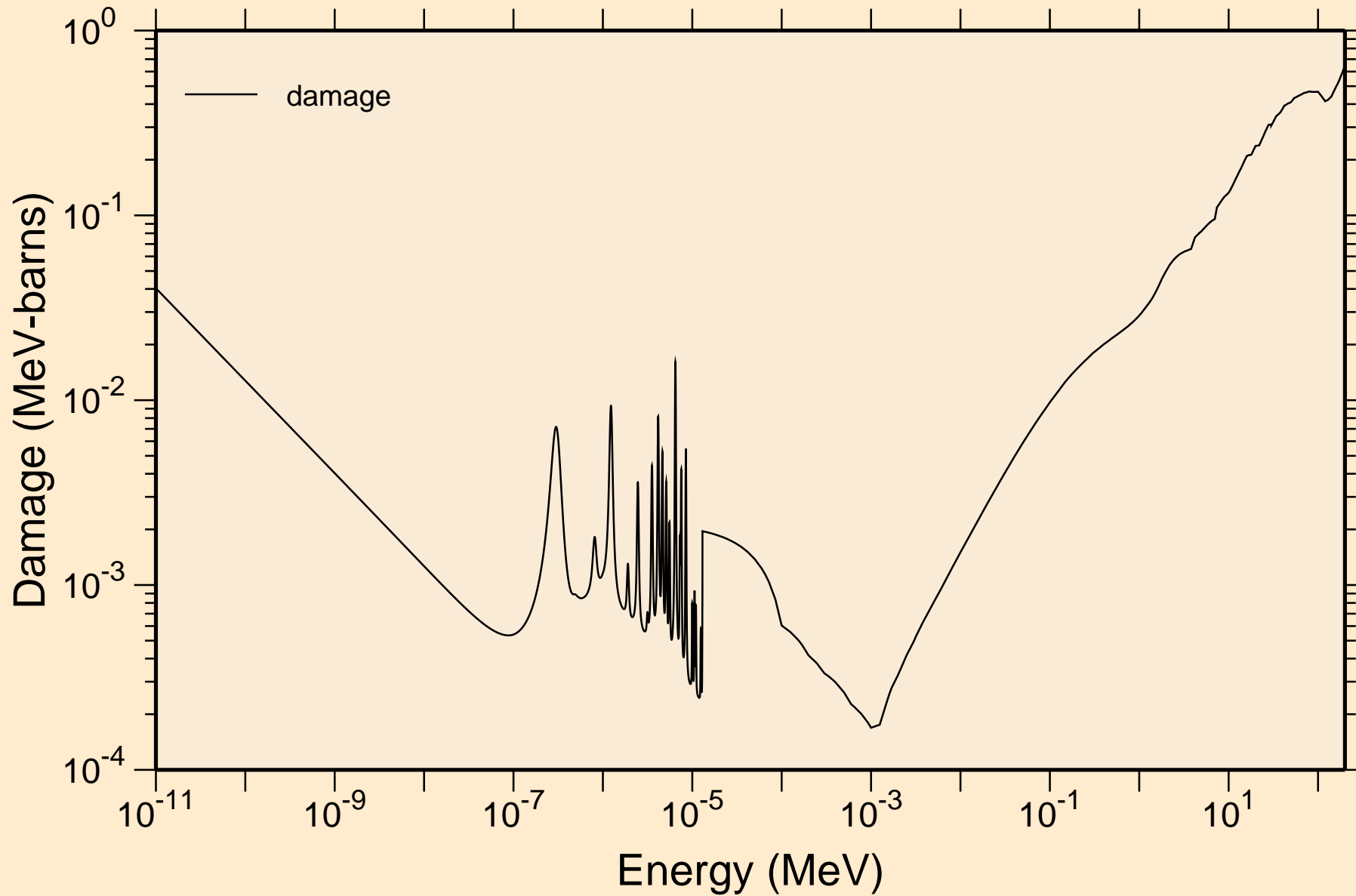

PT189 NEUTRON ACER TENDL-2024 LIBRARY; T=293.6K
Non-threshold reactions

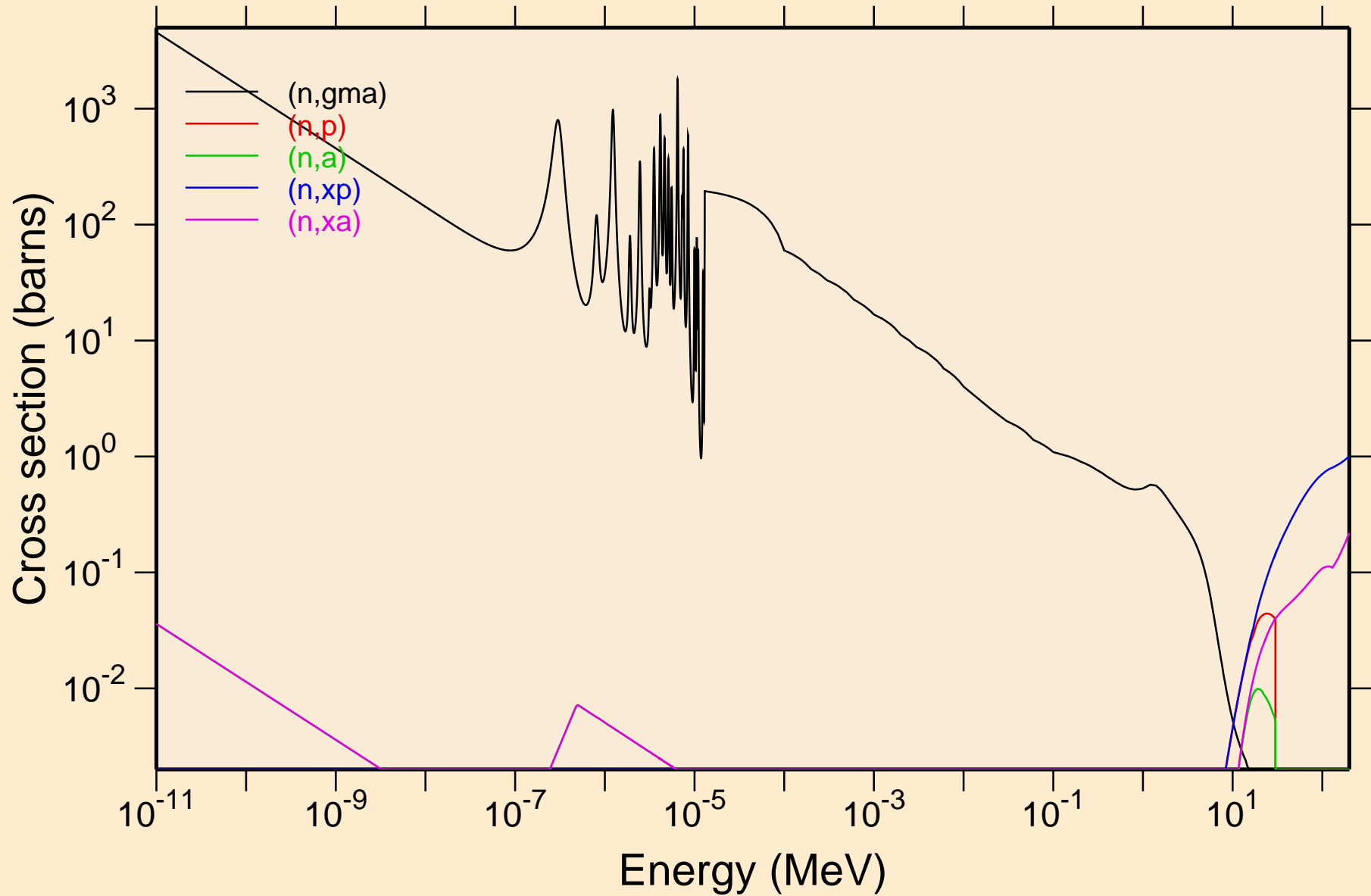

PT189 NEUTRON ACER TENDL-2024 LIBRARY; T=293.6K
Principal cross sections

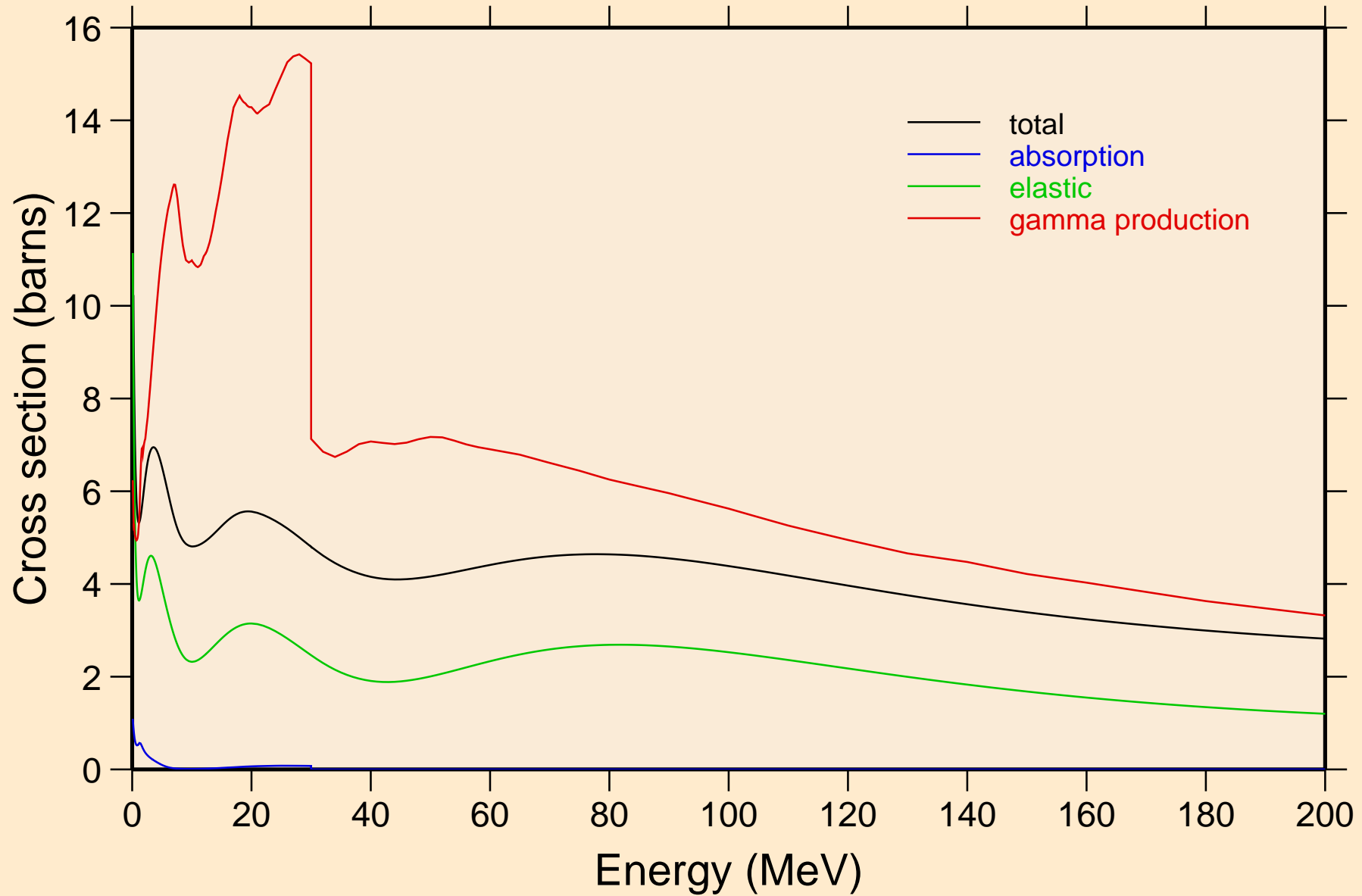

PT189 NEUTRON ACER TENDL-2024 LIBRARY; T=293.6K
Heating

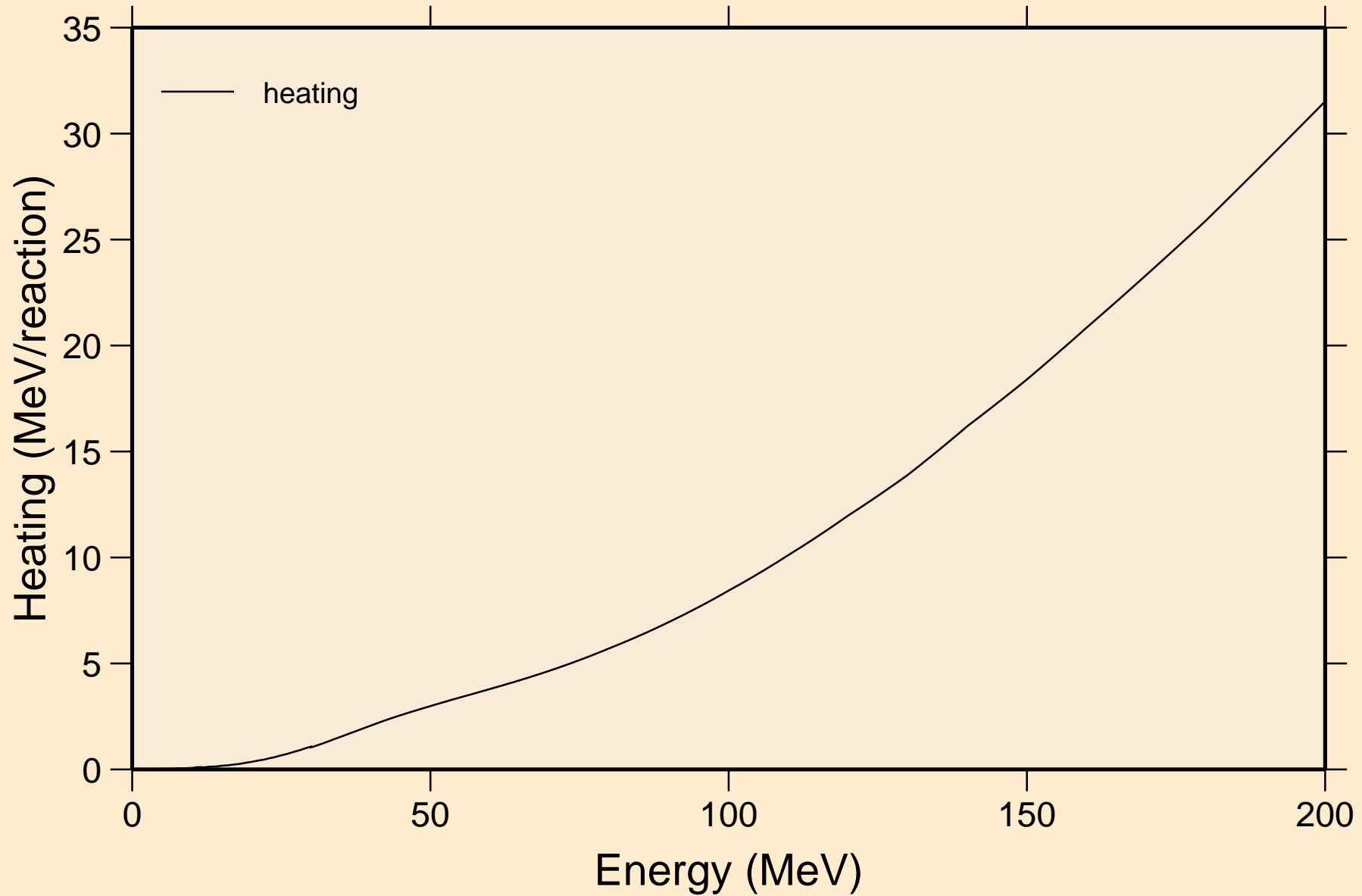

PT189 NEUTRON ACER TENDL-2024 LIBRARY; T=293.6K
Damage

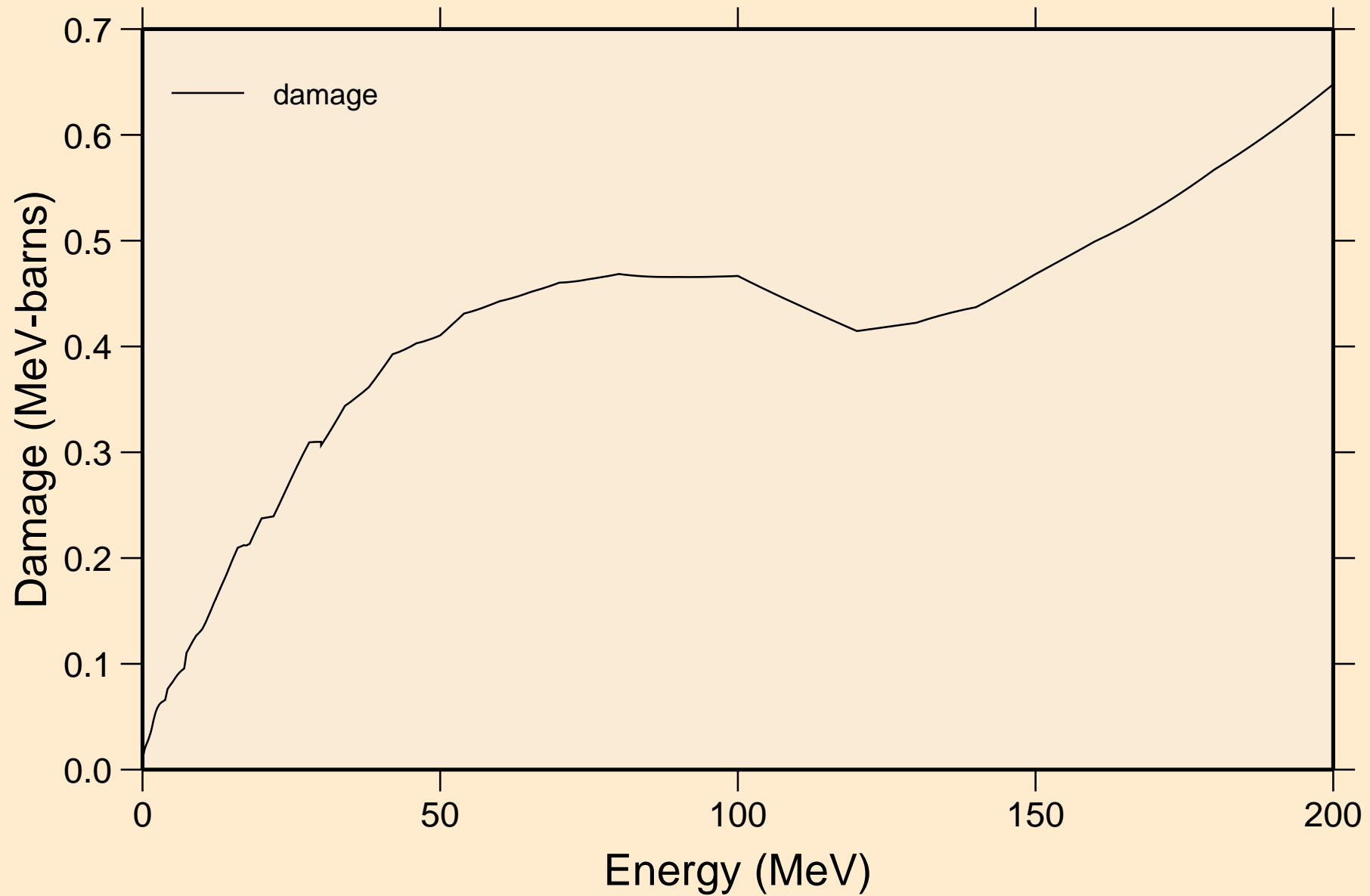

PT189 NEUTRON ACER TENDL-2024 LIBRARY; T=293.6K
Non-threshold reactions

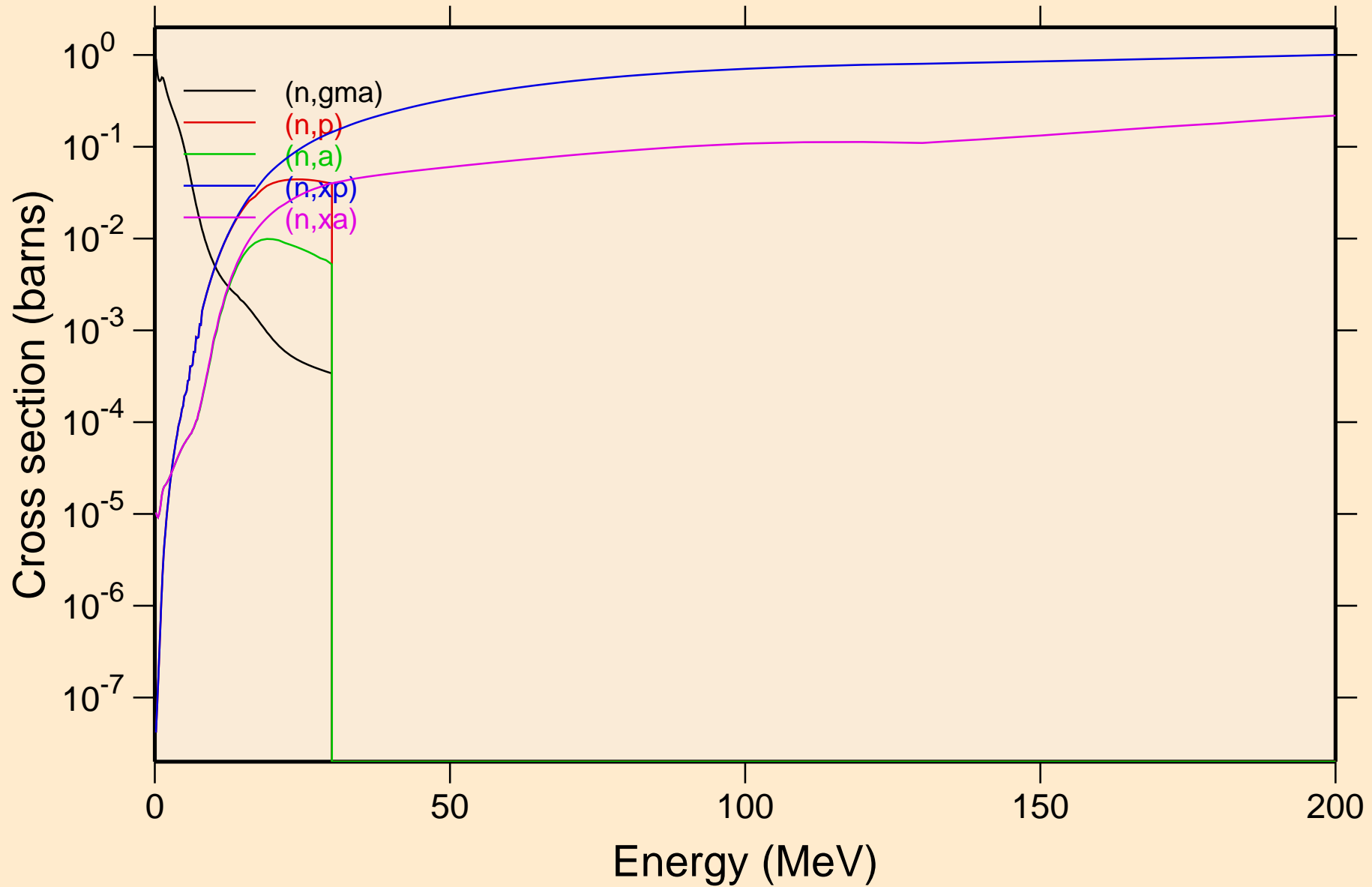

PT189 NEUTRON ACER TENDL-2024 LIBRARY; T=293.6K
Inelastic levels

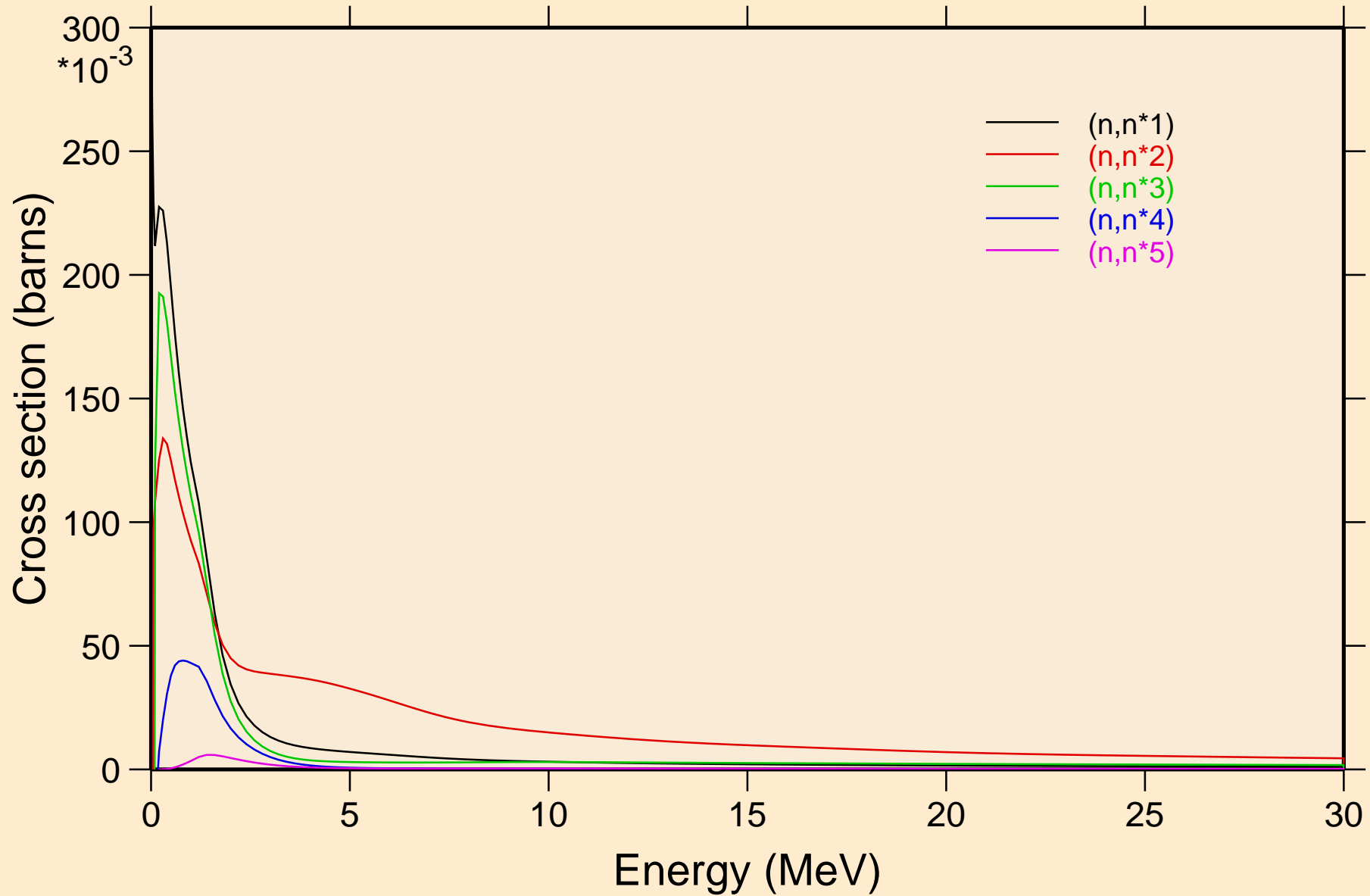

PT189 NEUTRON ACER TENDL-2024 LIBRARY; T=293.6K
Inelastic levels

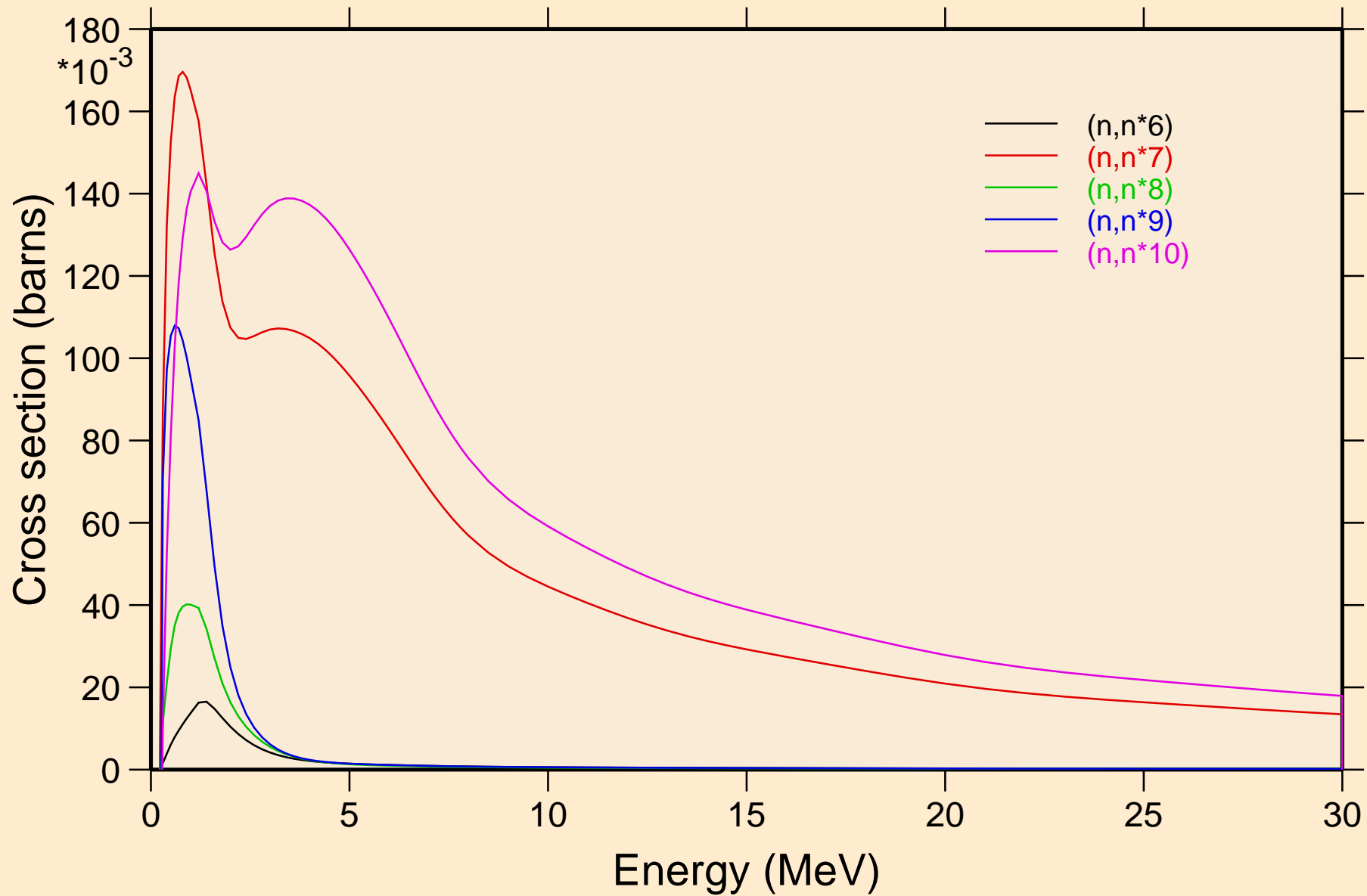

PT189 NEUTRON ACER TENDL-2024 LIBRARY; T=293.6K
Inelastic levels

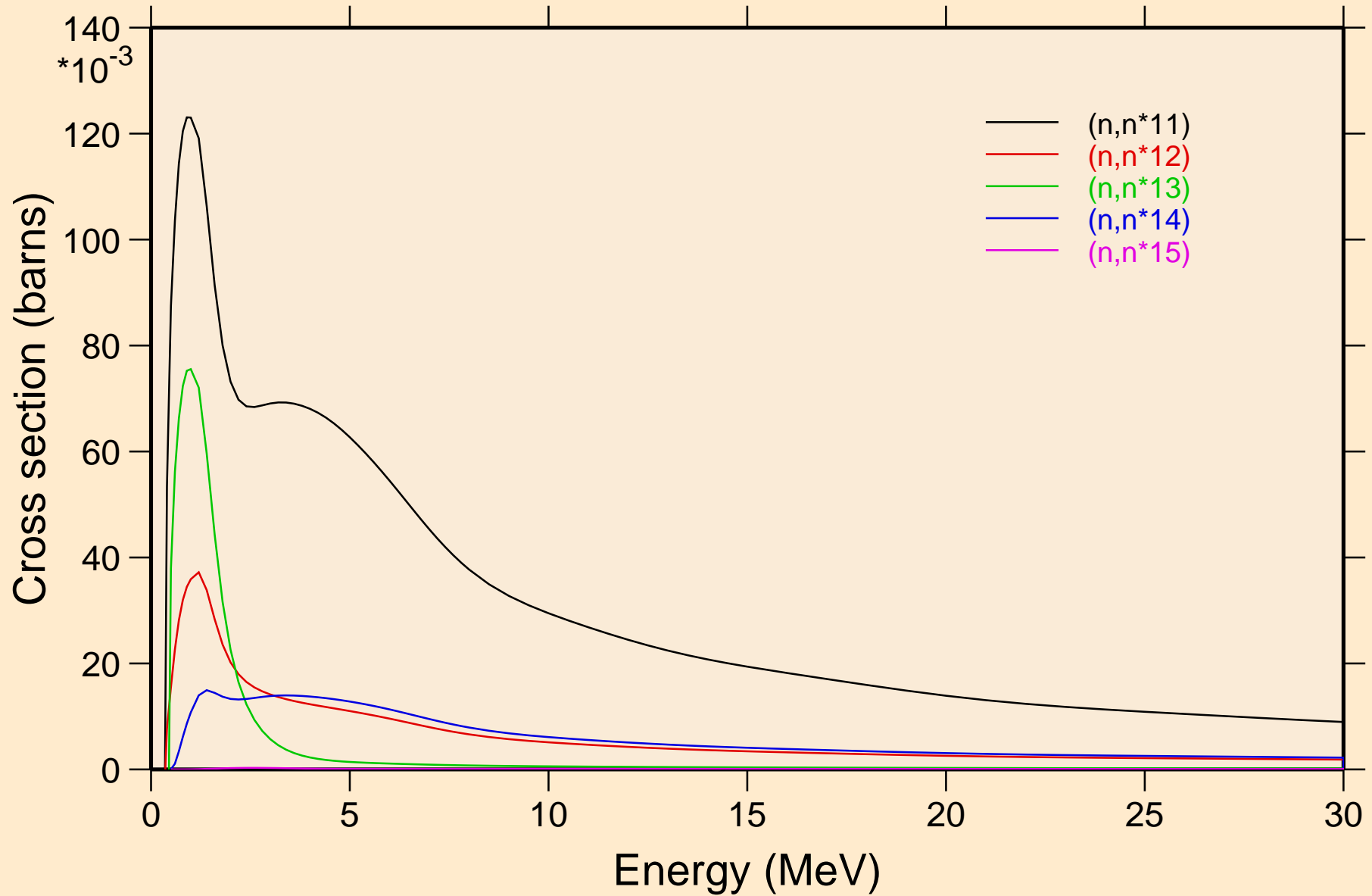

PT189 NEUTRON ACER TENDL-2024 LIBRARY; T=293.6K
Inelastic levels

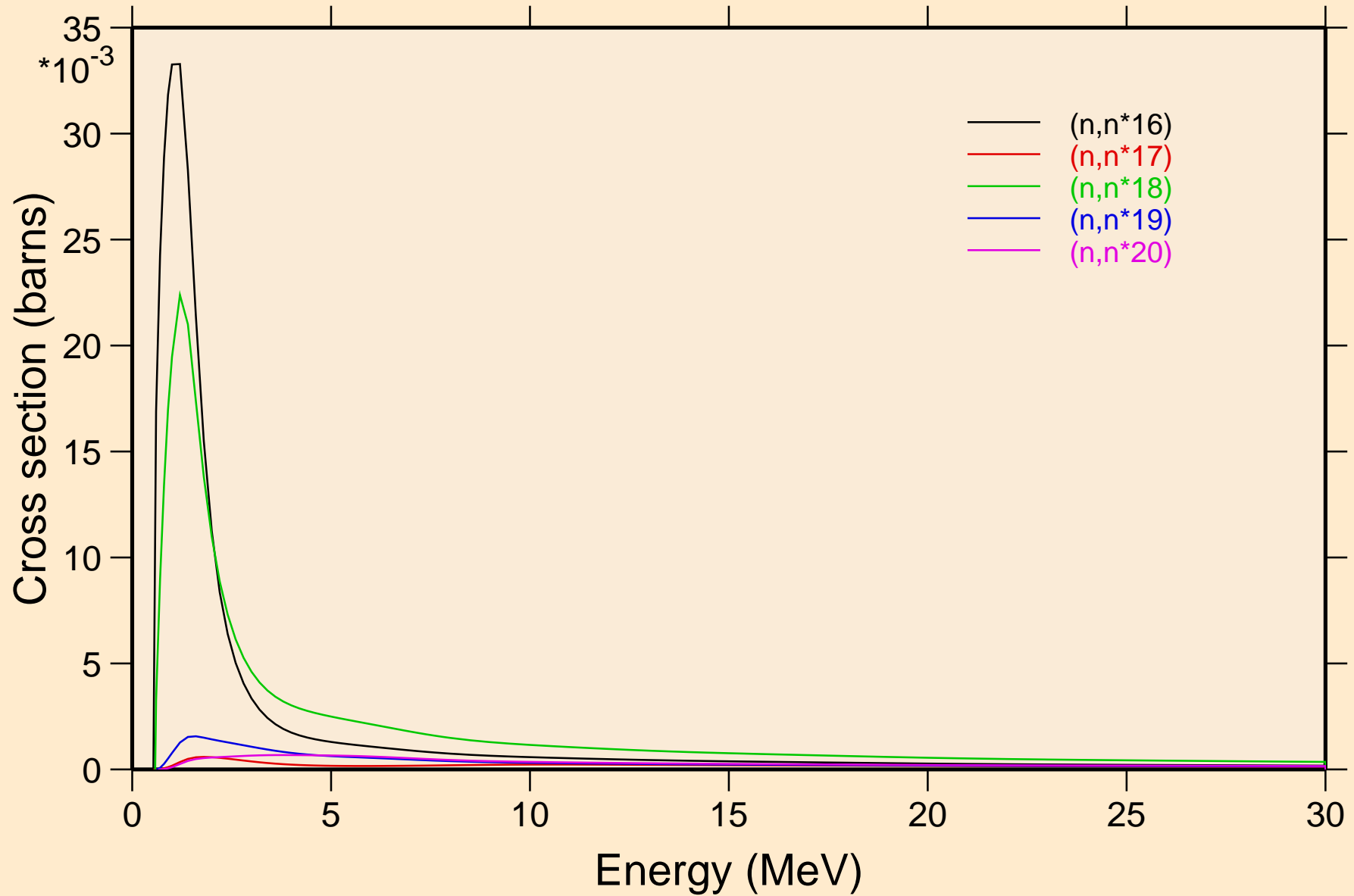

PT189 NEUTRON ACER TENDL-2024 LIBRARY; T=293.6K
Inelastic levels

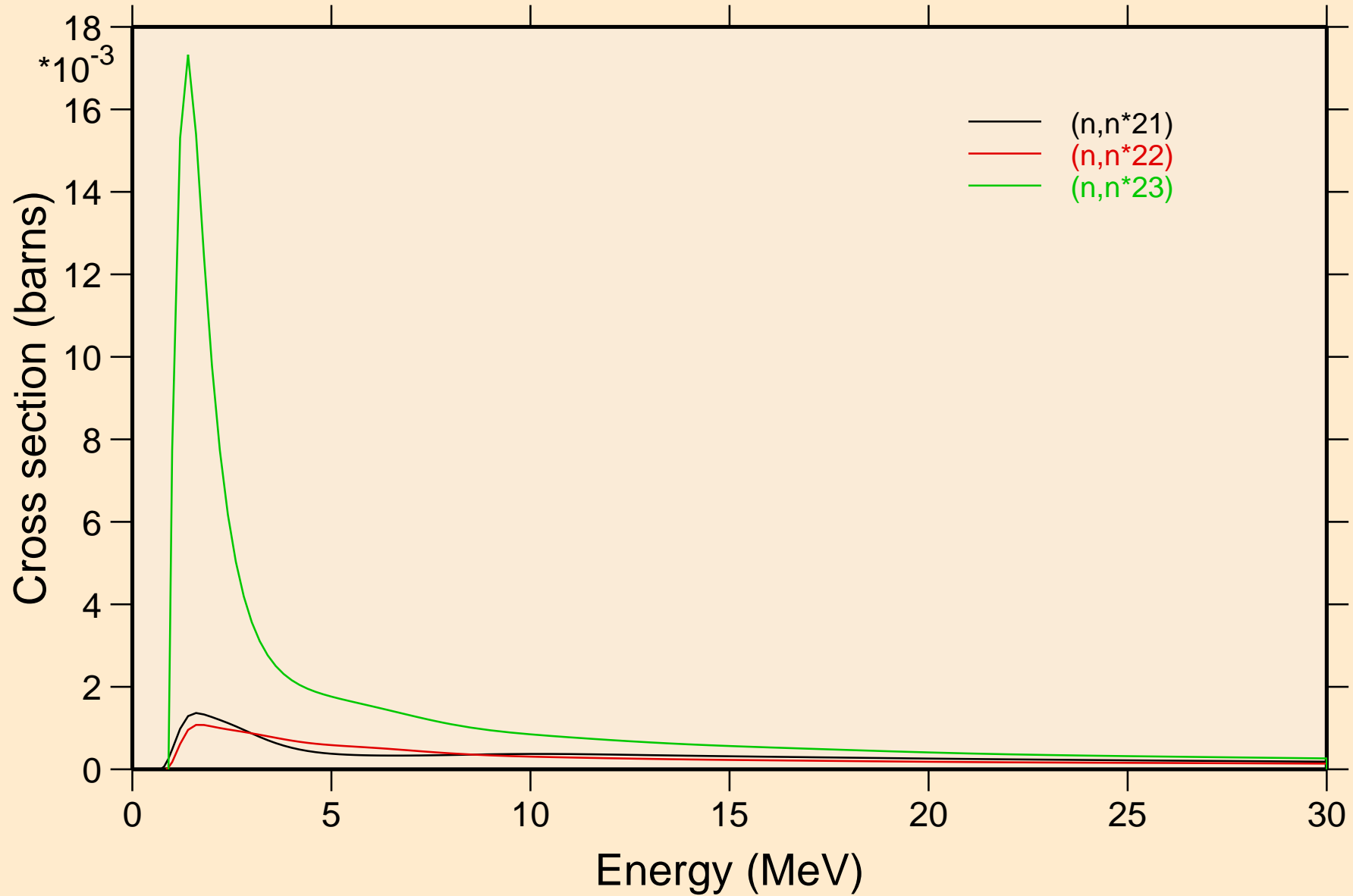

PT189 NEUTRON ACER TENDL-2024 LIBRARY; T=293.6K
Threshold reactions

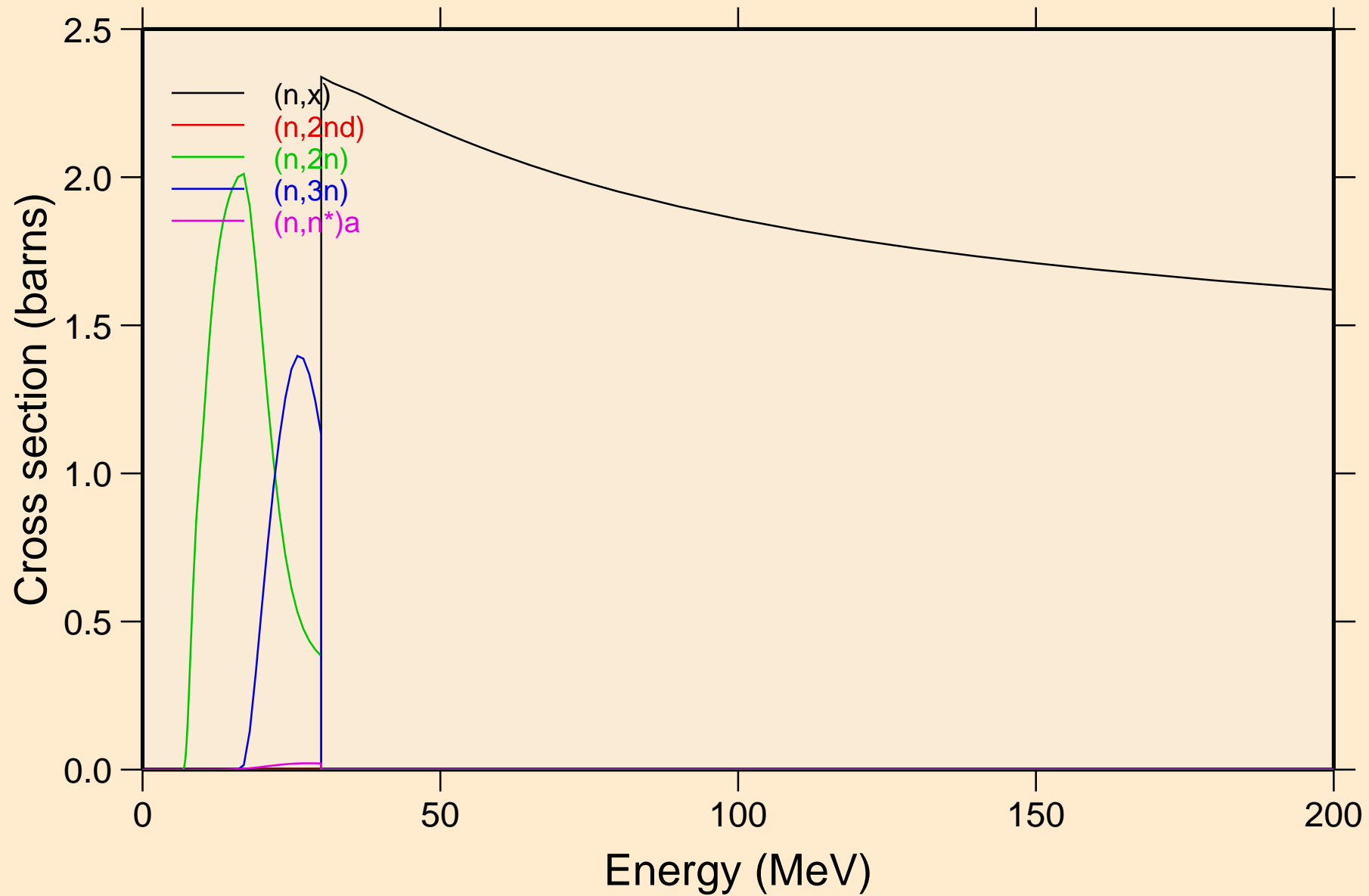

PT189 NEUTRON ACER TENDL-2024 LIBRARY; T=293.6K
Threshold reactions

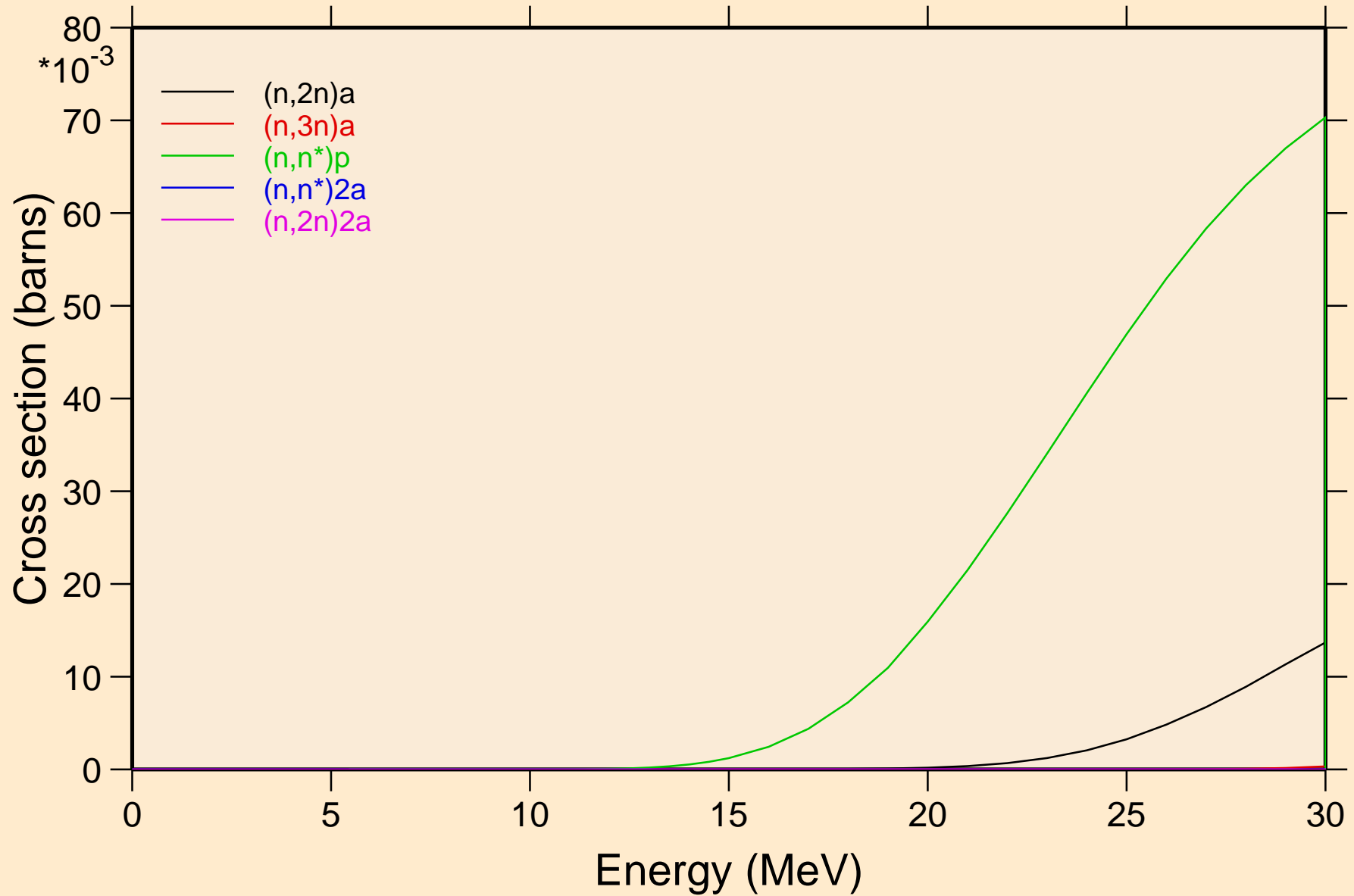

PT189 NEUTRON ACER TENDL-2024 LIBRARY; T=293.6K
Threshold reactions

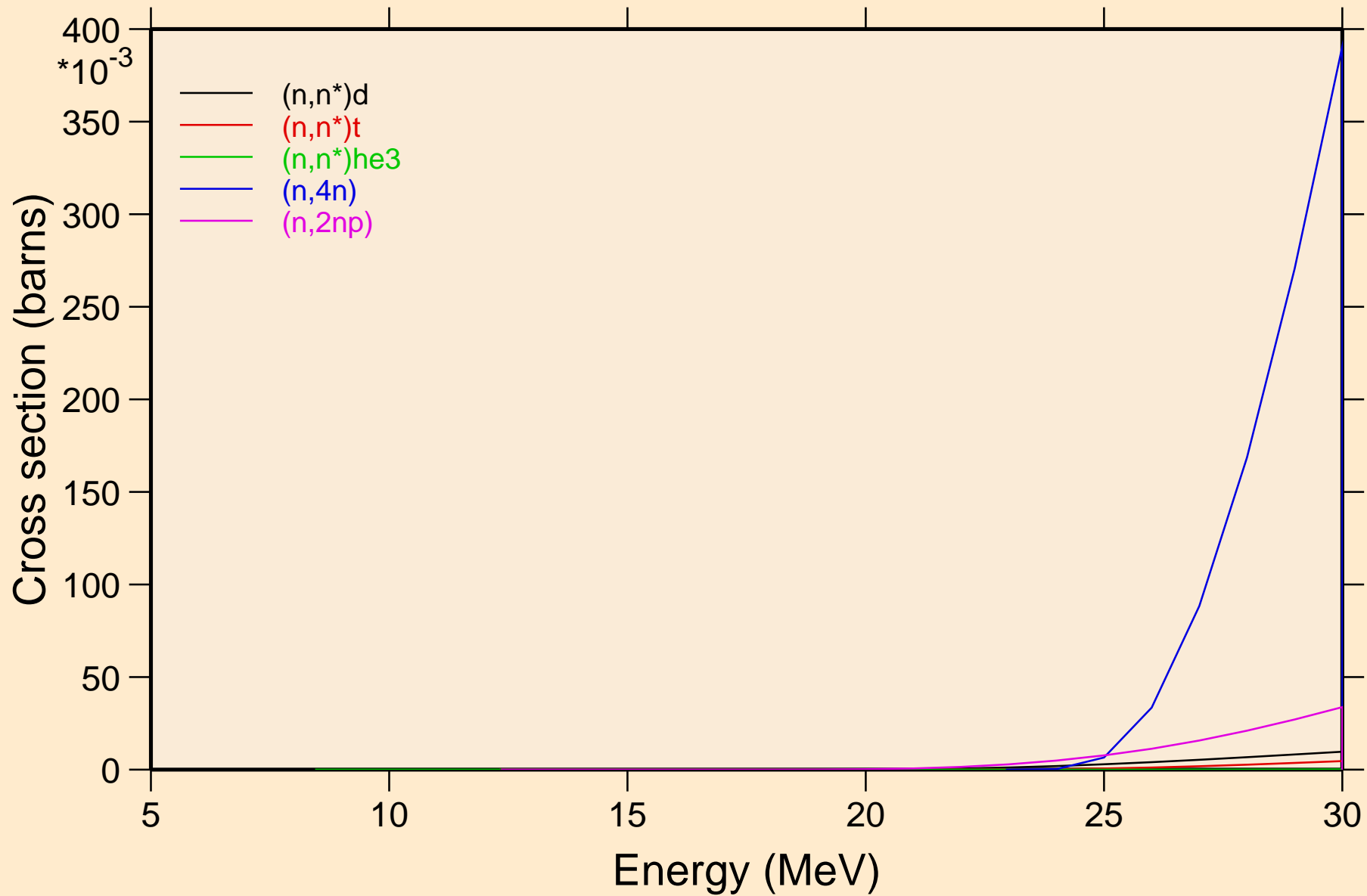

PT189 NEUTRON ACER TENDL-2024 LIBRARY; T=293.6K
Threshold reactions

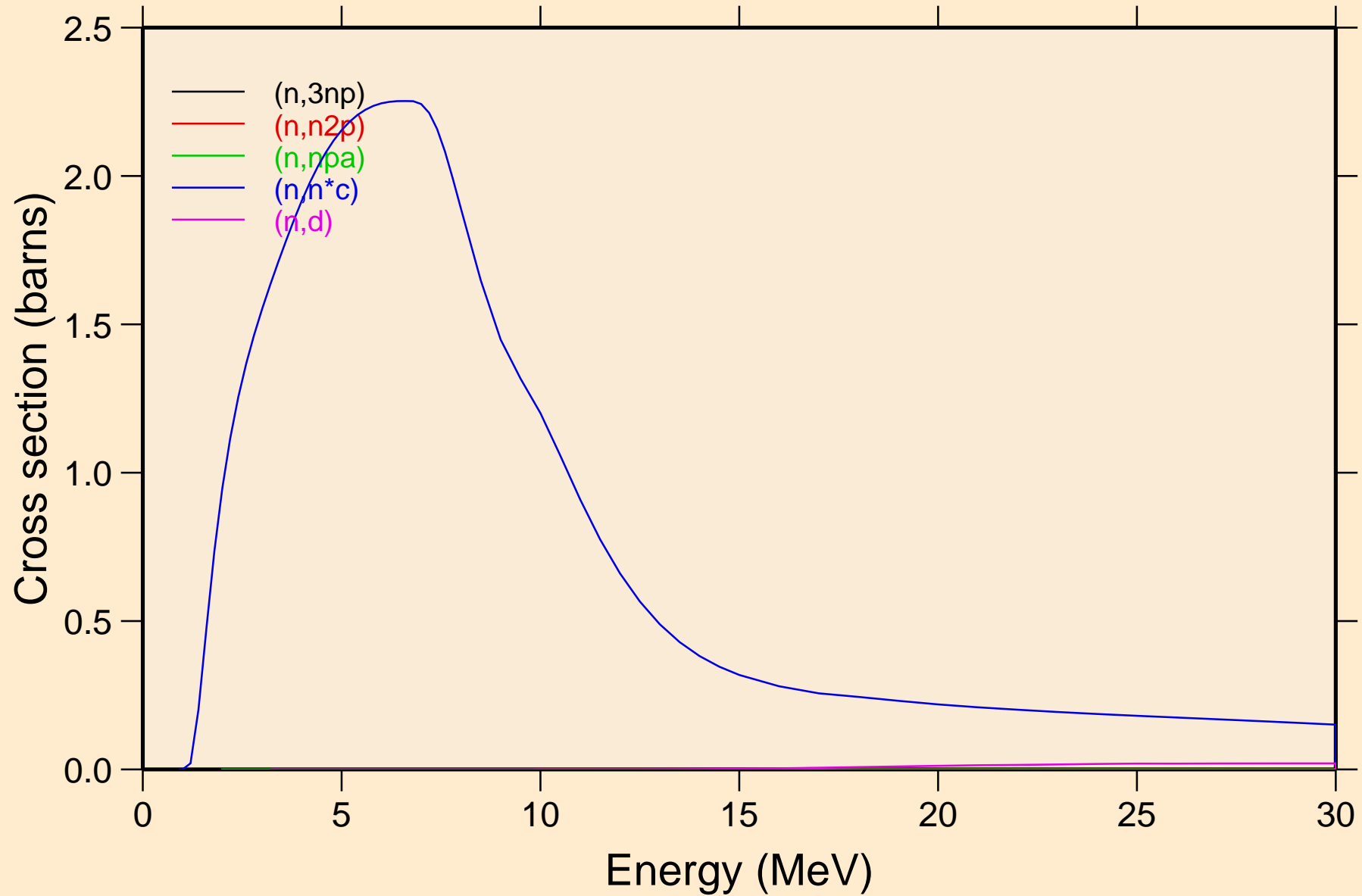

PT189 NEUTRON ACER TENDL-2024 LIBRARY; T=293.6K
Threshold reactions

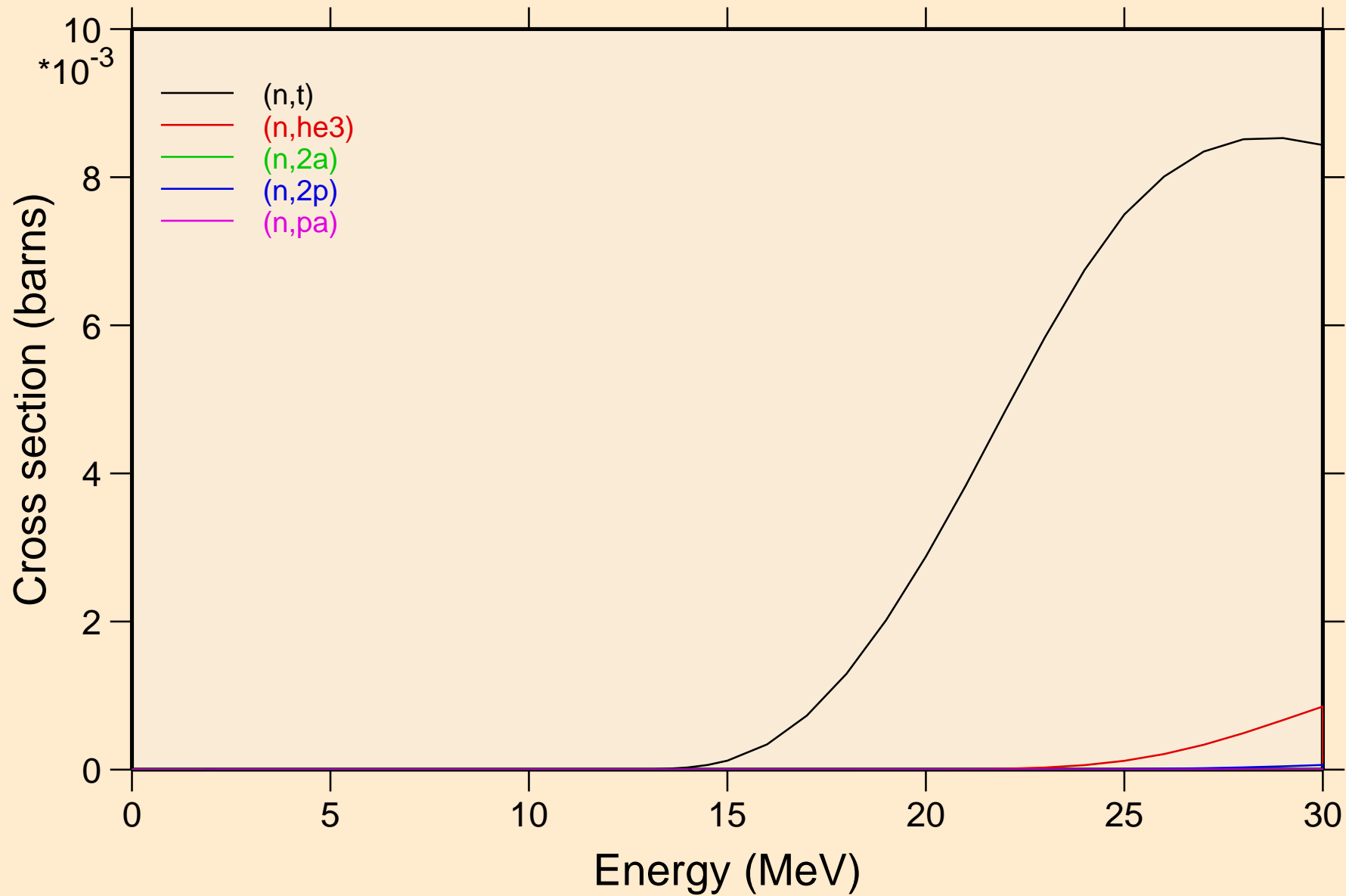

PT189 NEUTRON ACER TENDL-2024 LIBRARY; T=293.6K
Threshold reactions

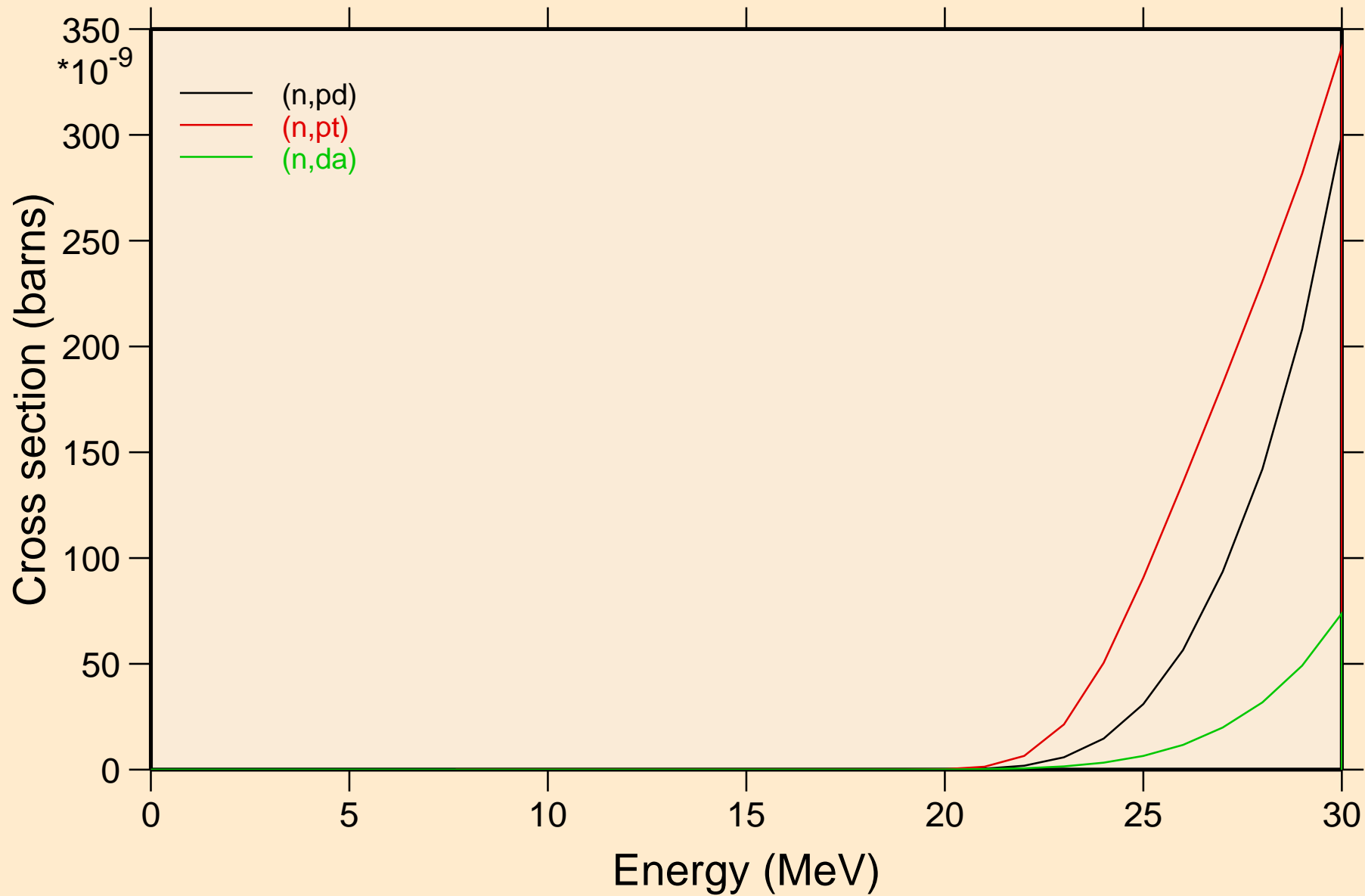

PT189 NEUTRON ACER TENDL-2024 LIBRARY; T=293.6K
Threshold reactions

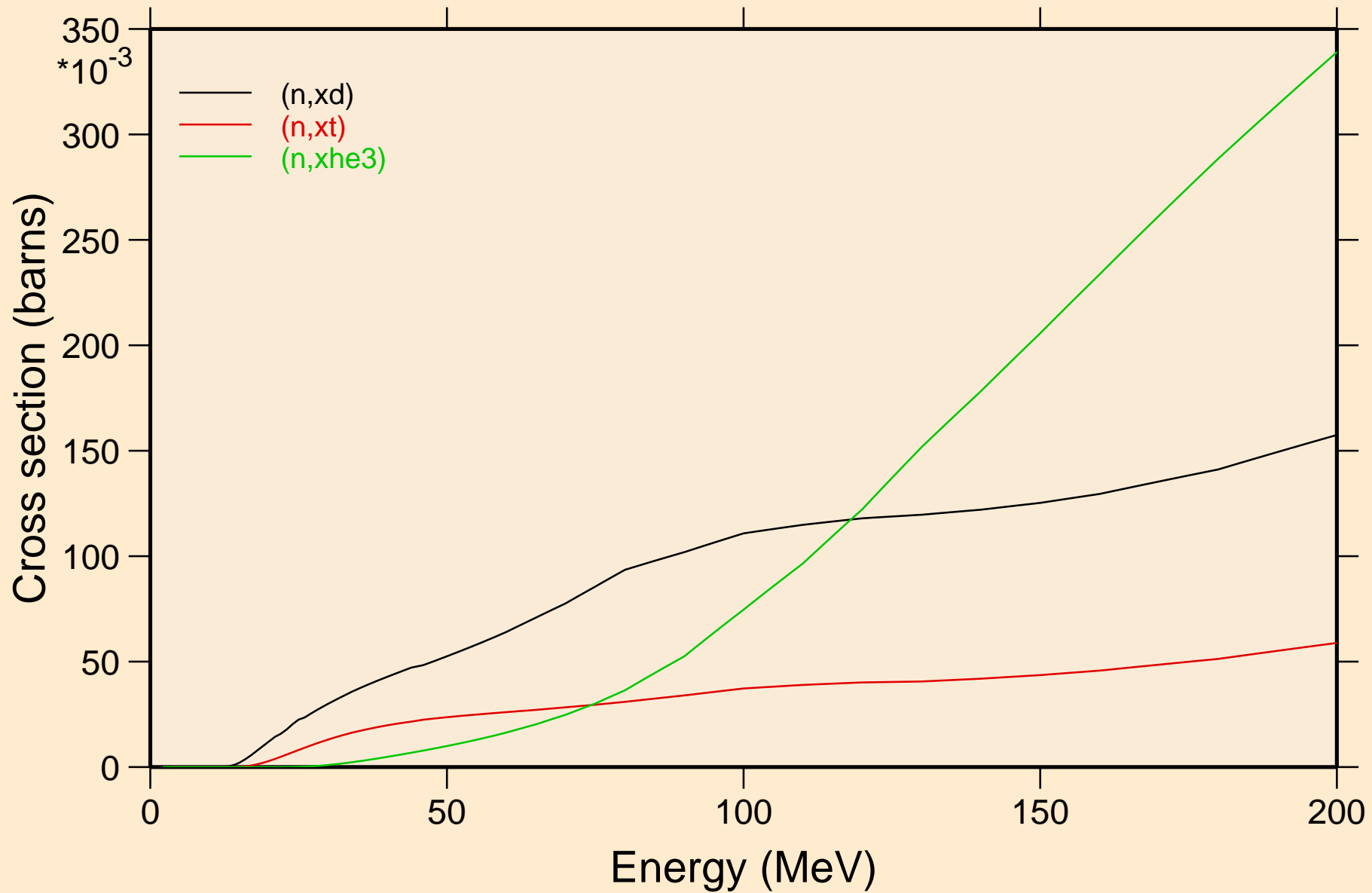

PT189 NEUTRON ACER TENDL-2024 LIBRARY; T=293.6K
angular distribution for elastic

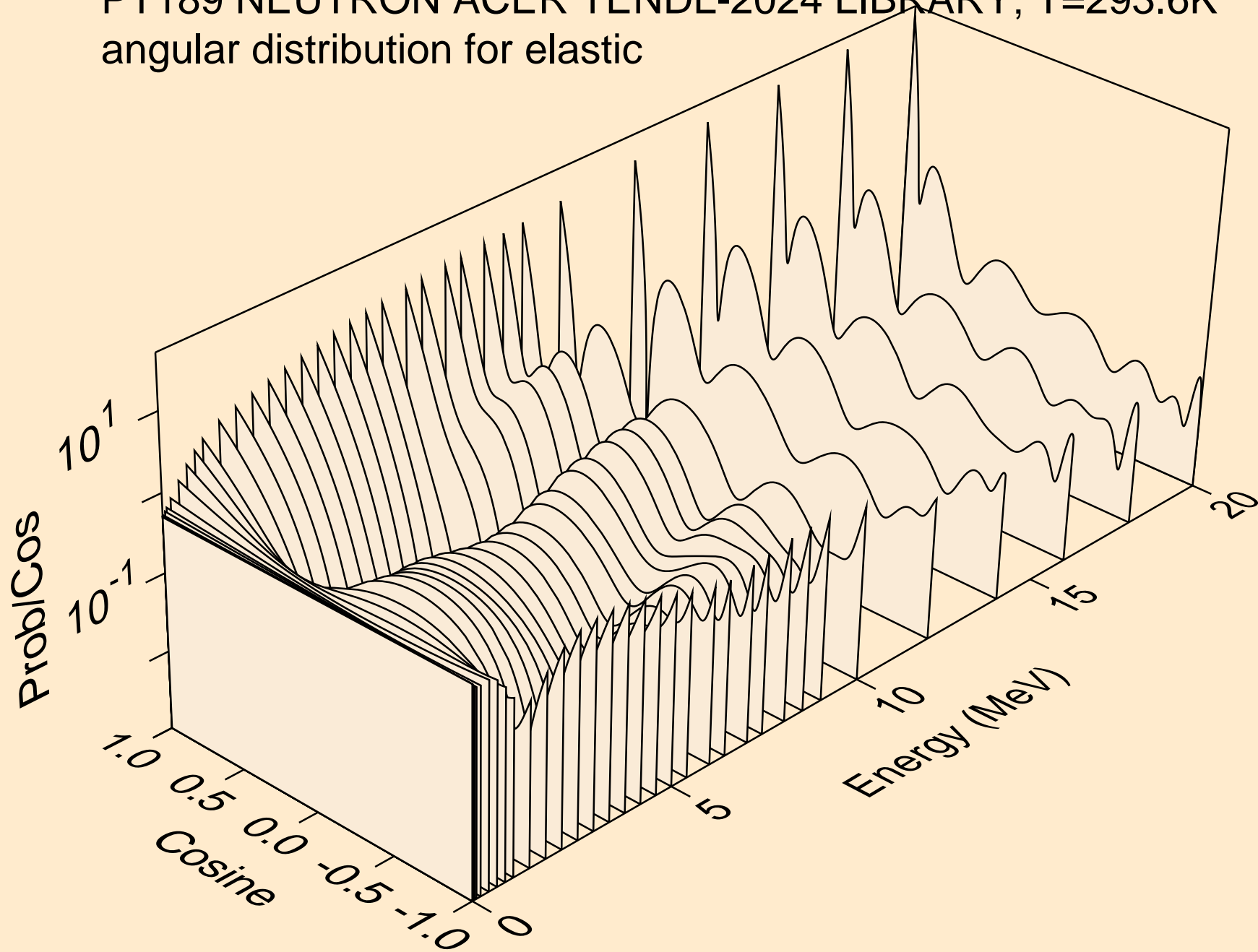

PT189 NEUTRON ACER TENDL-2024 LIBRARY; T=293.6K
angular distribution for elastic

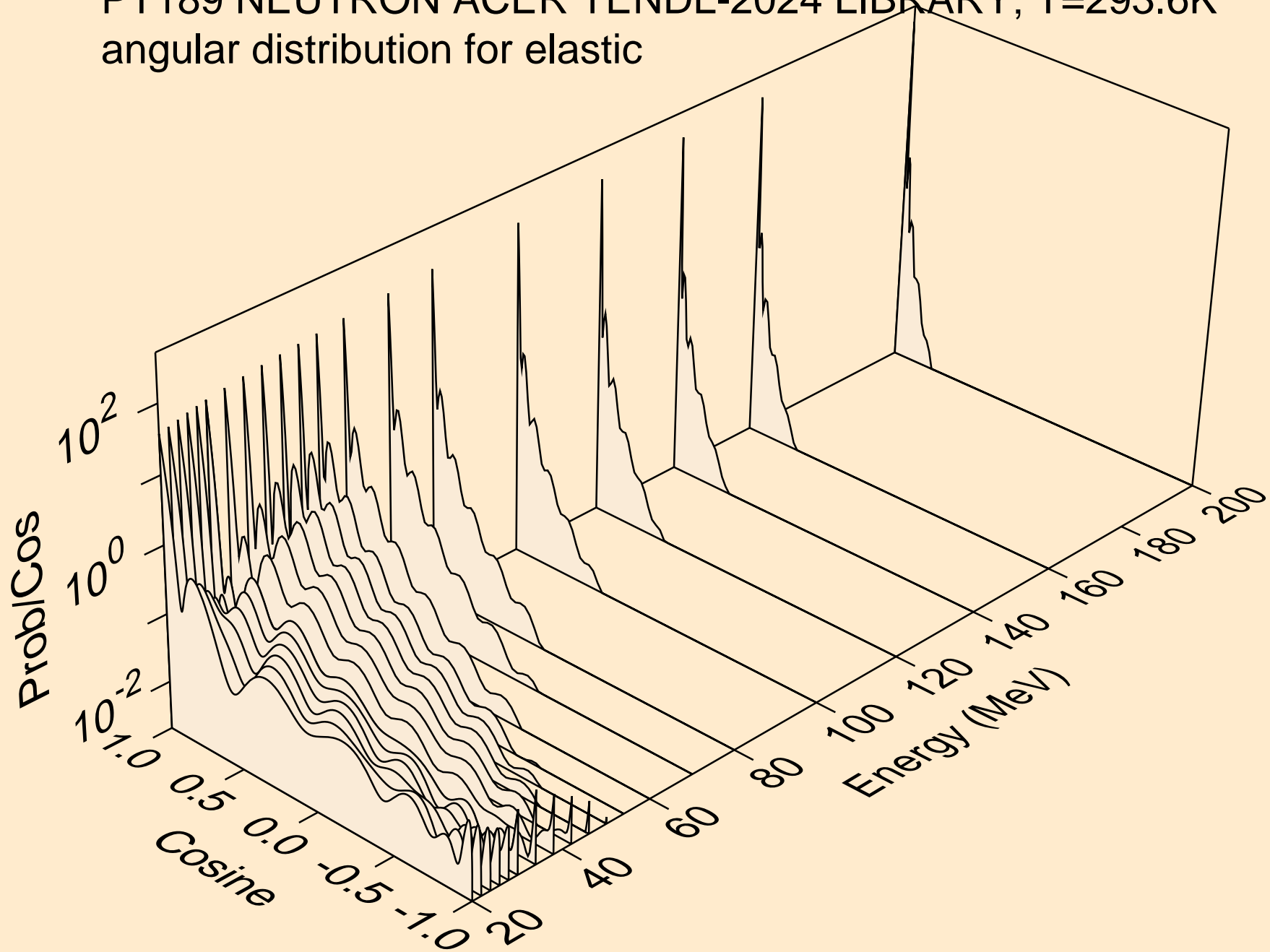

PT189 NEUTRON ACER TENDL-2024 LIBRARY; T=293.6K
angular distribution for (n,n*1)

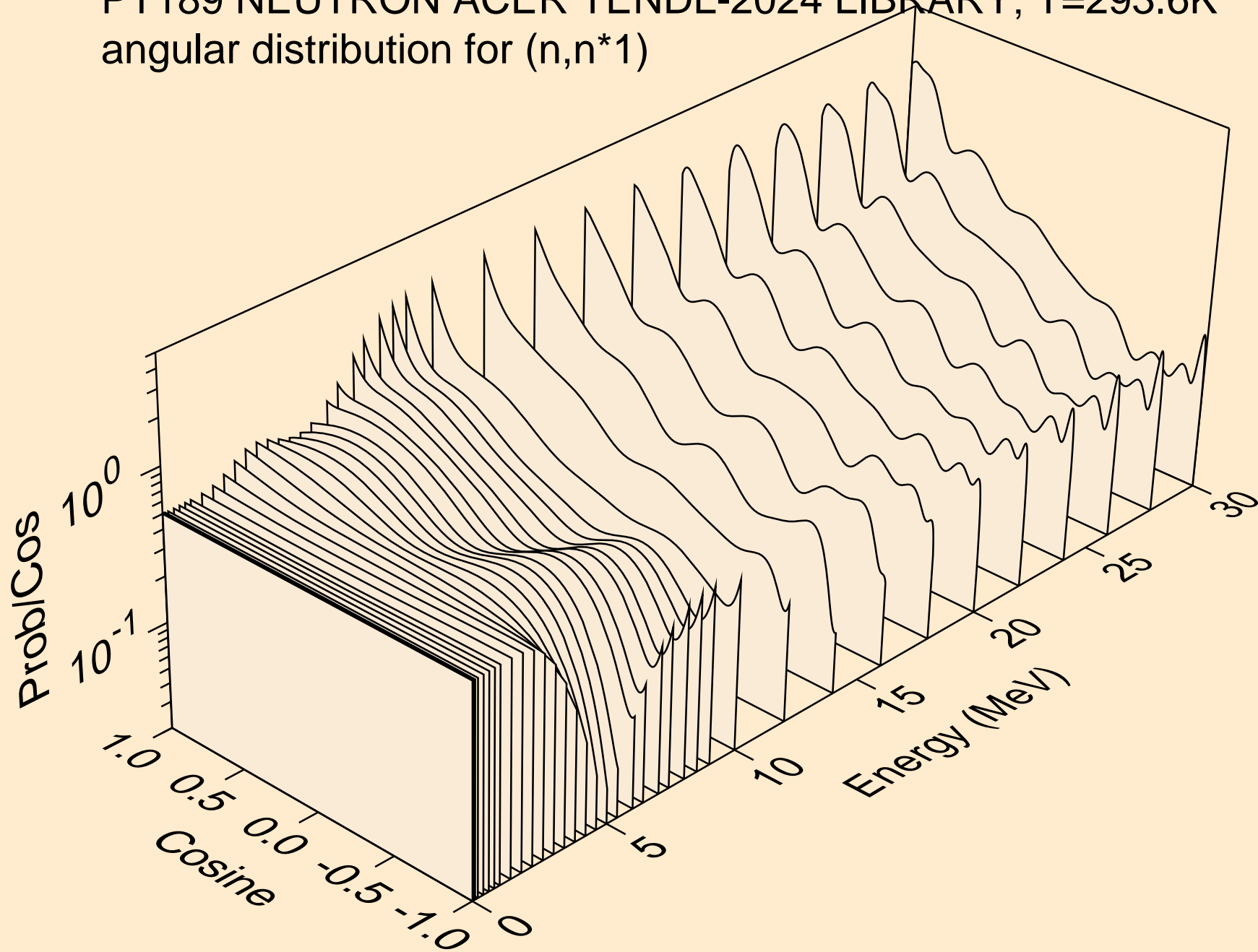

PT189 NEUTRON ACER TENDL-2024 LIBRARY; T=293.6K
angular distribution for (n,n*2)

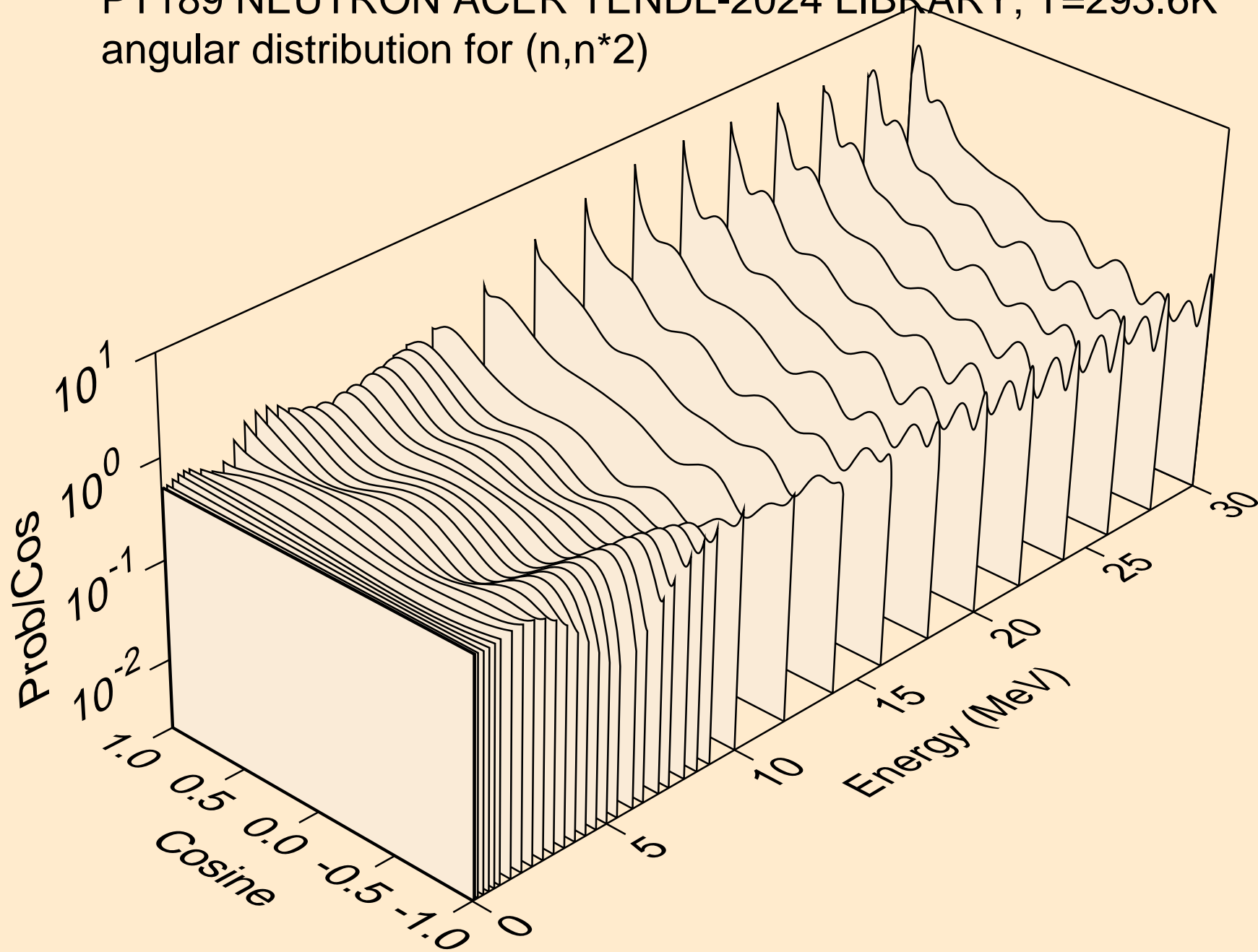

PT189 NEUTRON ACER TENDL-2024 LIBRARY; T=293.6K
angular distribution for (n,n*3)

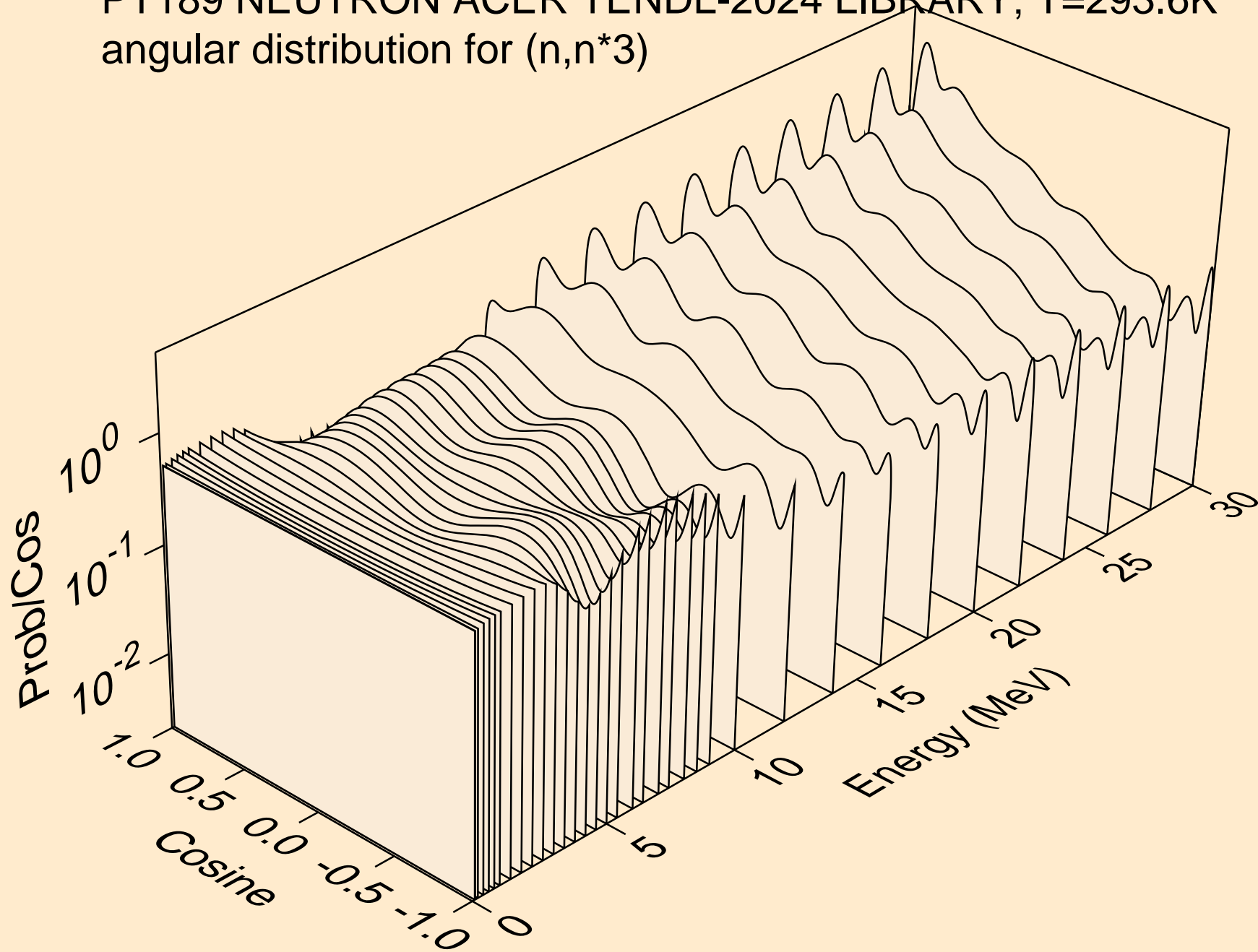

PT189 NEUTRON ACER TENDL-2024 LIBRARY; T=293.6K
angular distribution for (n,n*4)

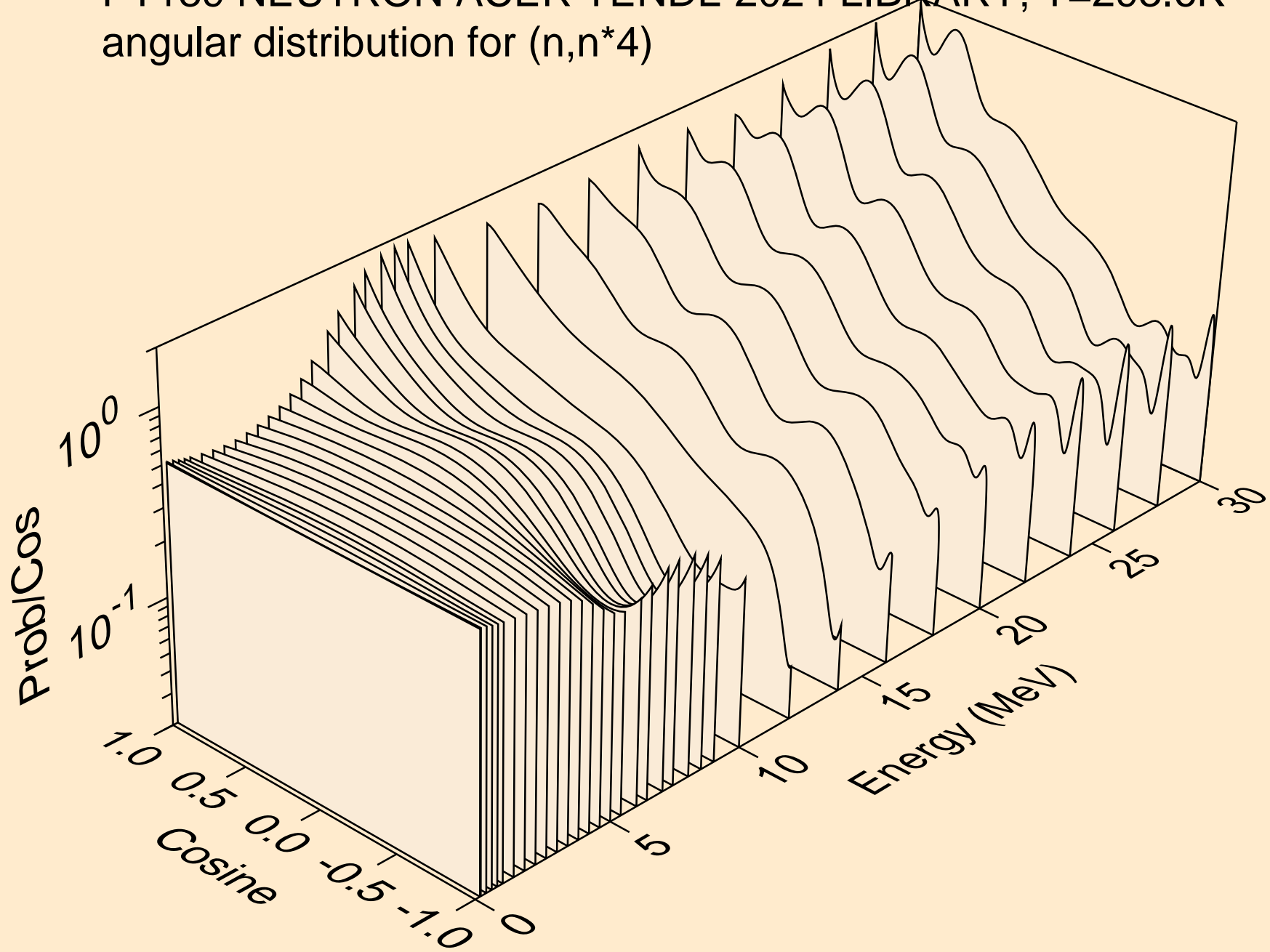

PT189 NEUTRON ACER TENDL-2024 LIBRARY; T=293.6K
angular distribution for (n,n*5)

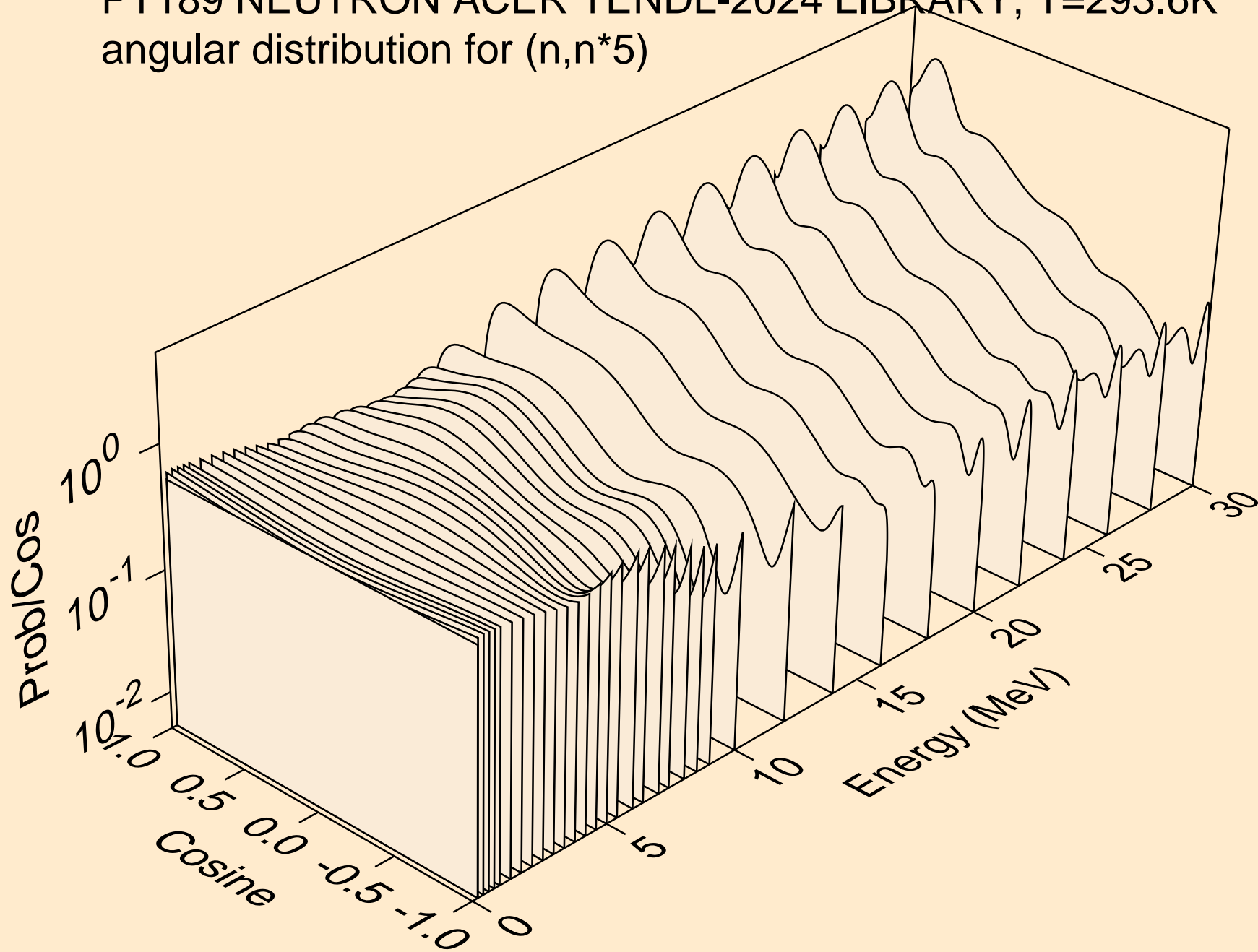

PT189 NEUTRON ACER TENDL-2024 LIBRARY; T=293.6K
angular distribution for (n,n*6)

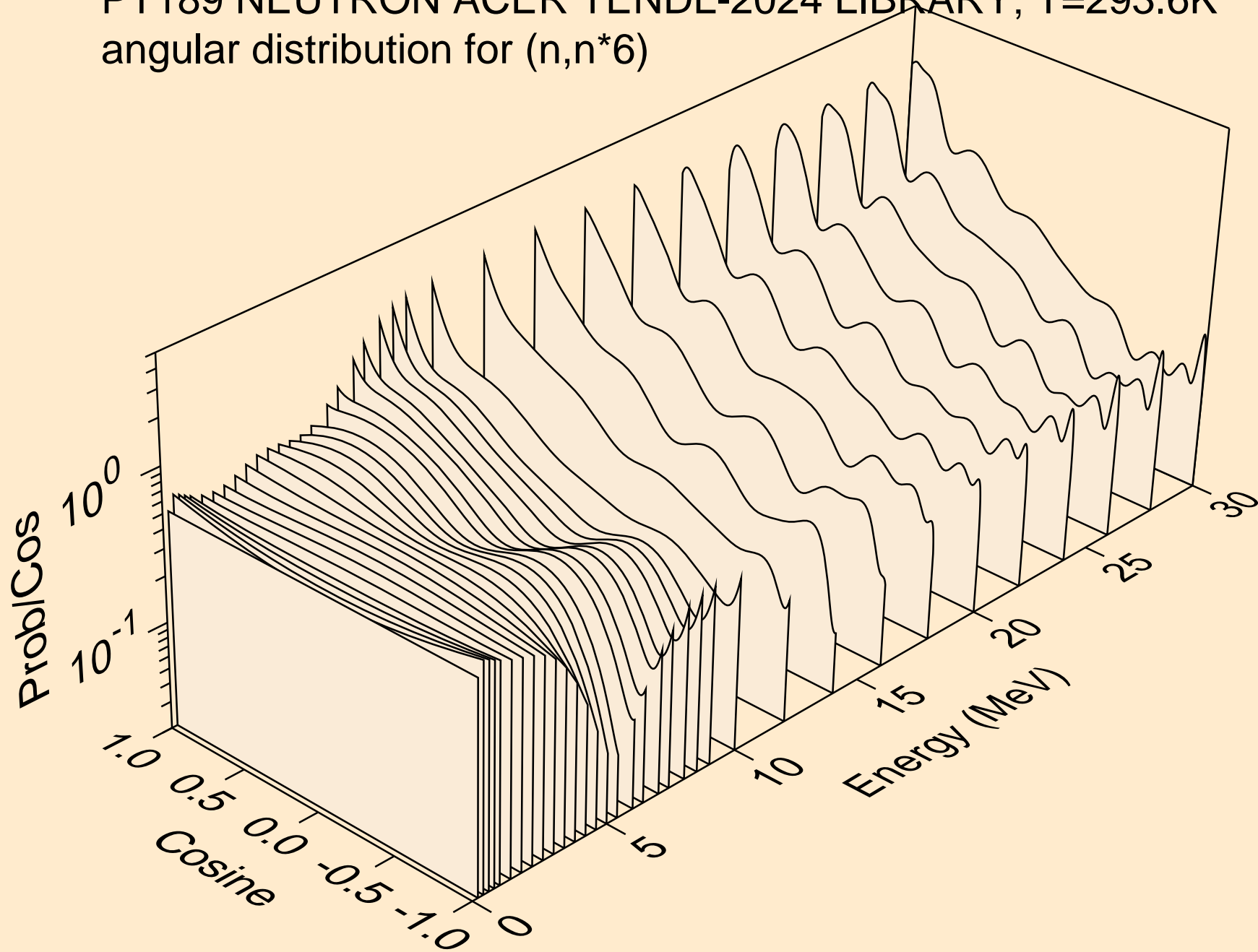

PT189 NEUTRON ACER TENDL-2024 LIBRARY; T=293.6K
angular distribution for (n,n*7)

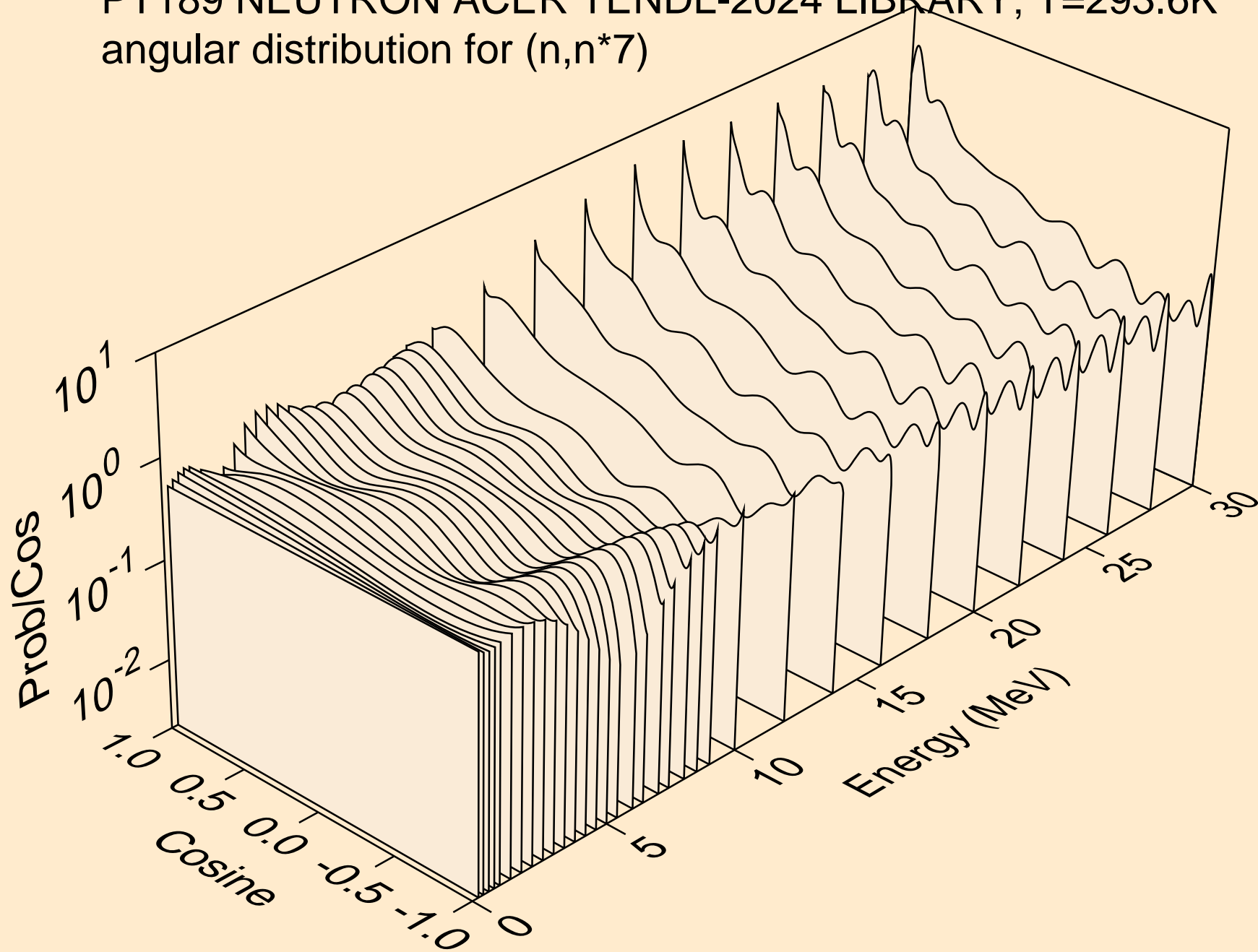

PT189 NEUTRON ACER TENDL-2024 LIBRARY; T=293.6K
angular distribution for (n,n*8)

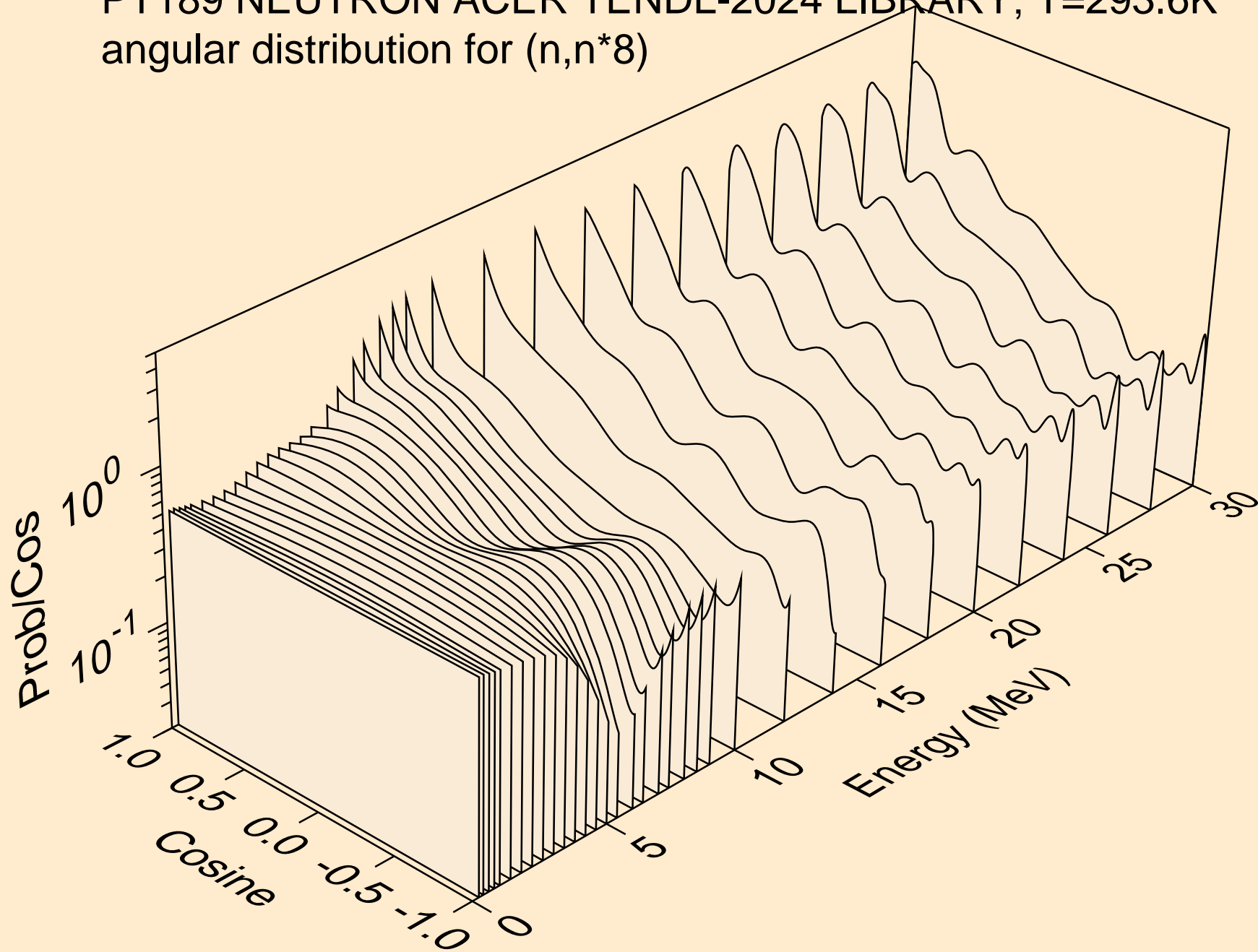

PT189 NEUTRON ACER TENDL-2024 LIBRARY; T=293.6K
angular distribution for (n,n*9)

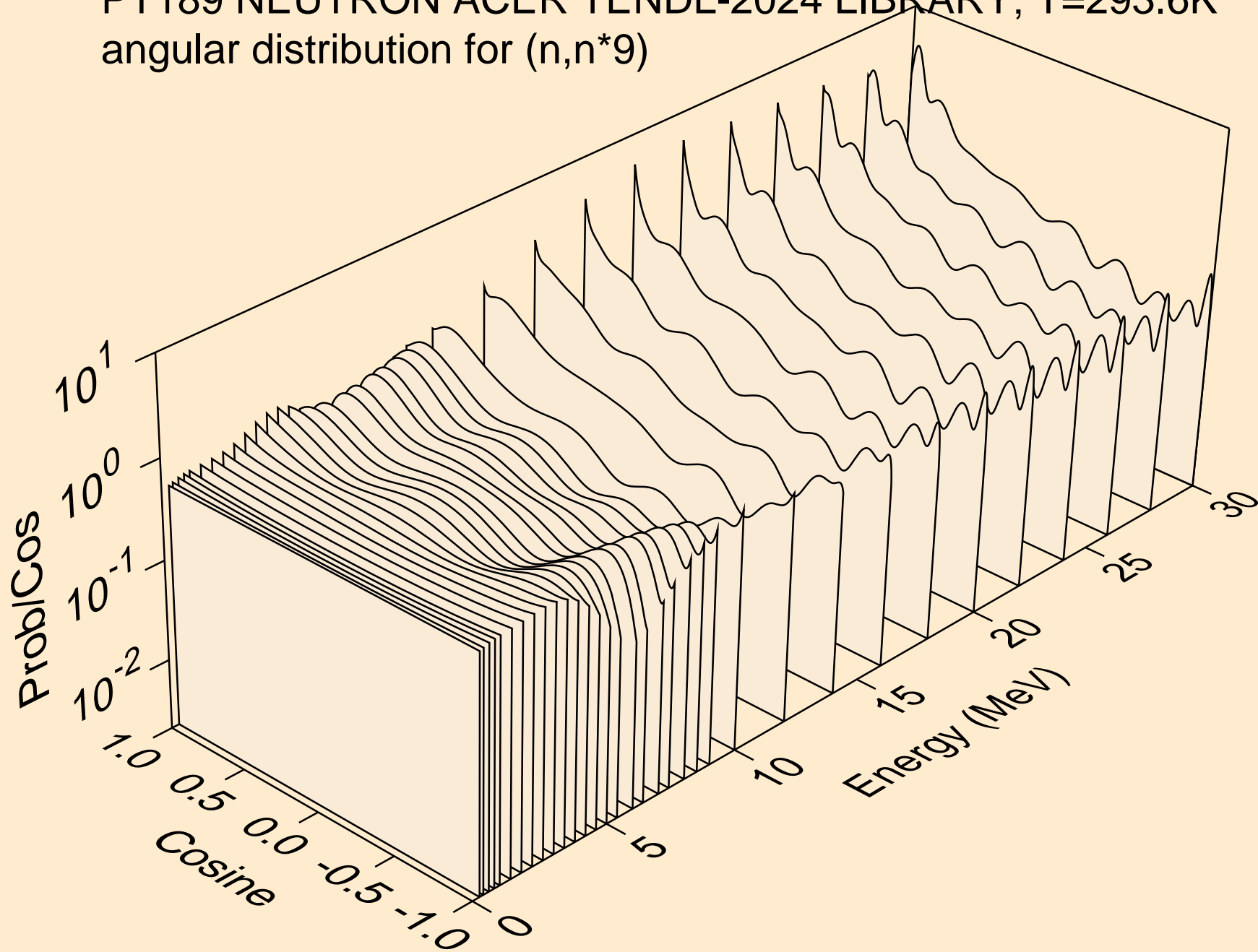

PT189 NEUTRON ACER TENDL-2024 LIBRARY; T=293.6K
angular distribution for (n,n*10)

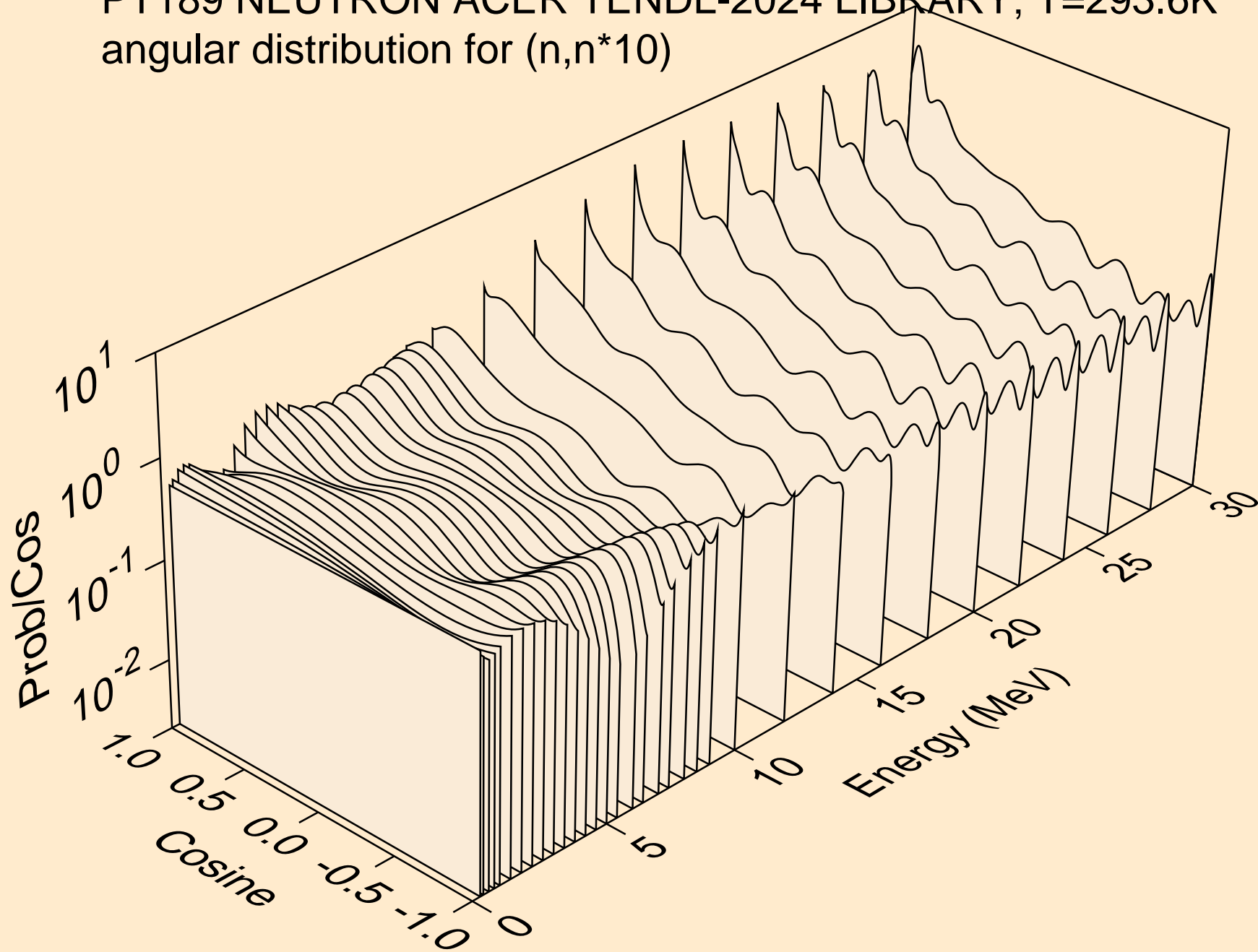

PT189 NEUTRON ACER TENDL-2024 LIBRARY; T=293.6K
angular distribution for (n,n*11)

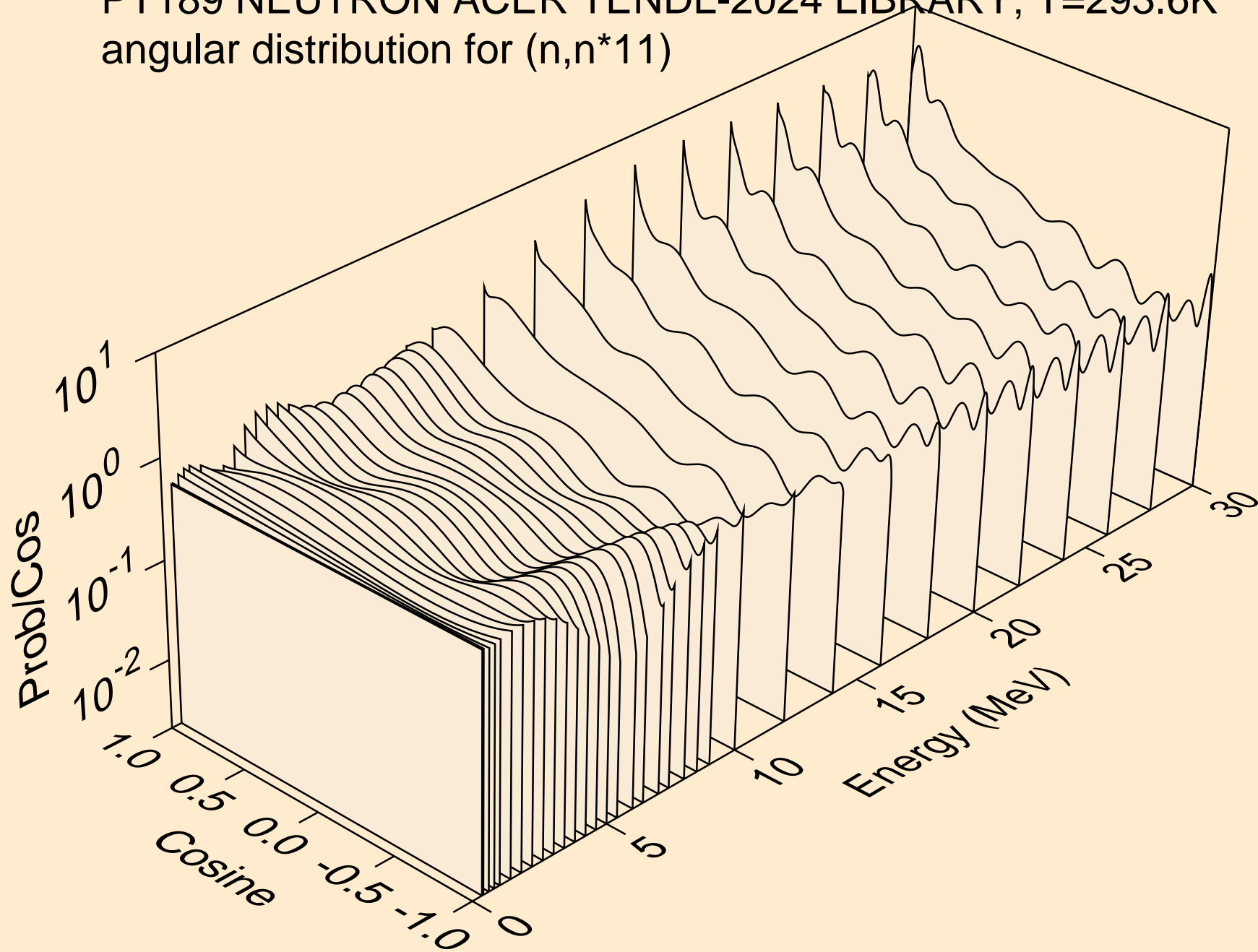

PT189 NEUTRON ACER TENDL-2024 LIBRARY; T=293.6K
angular distribution for (n,n*12)

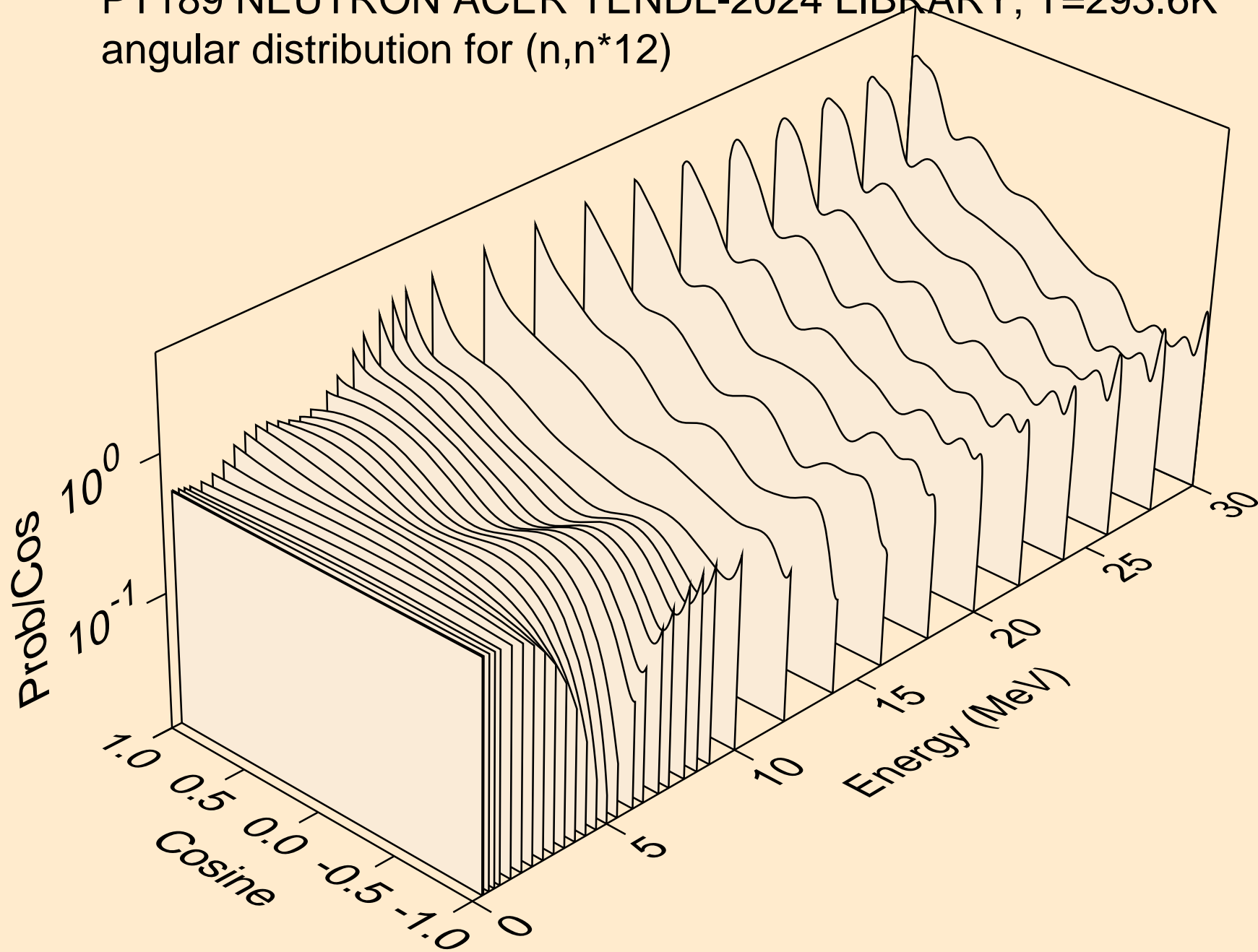

PT189 NEUTRON ACER TENDL-2024 LIBRARY; T=293.6K
angular distribution for (n,n*13)

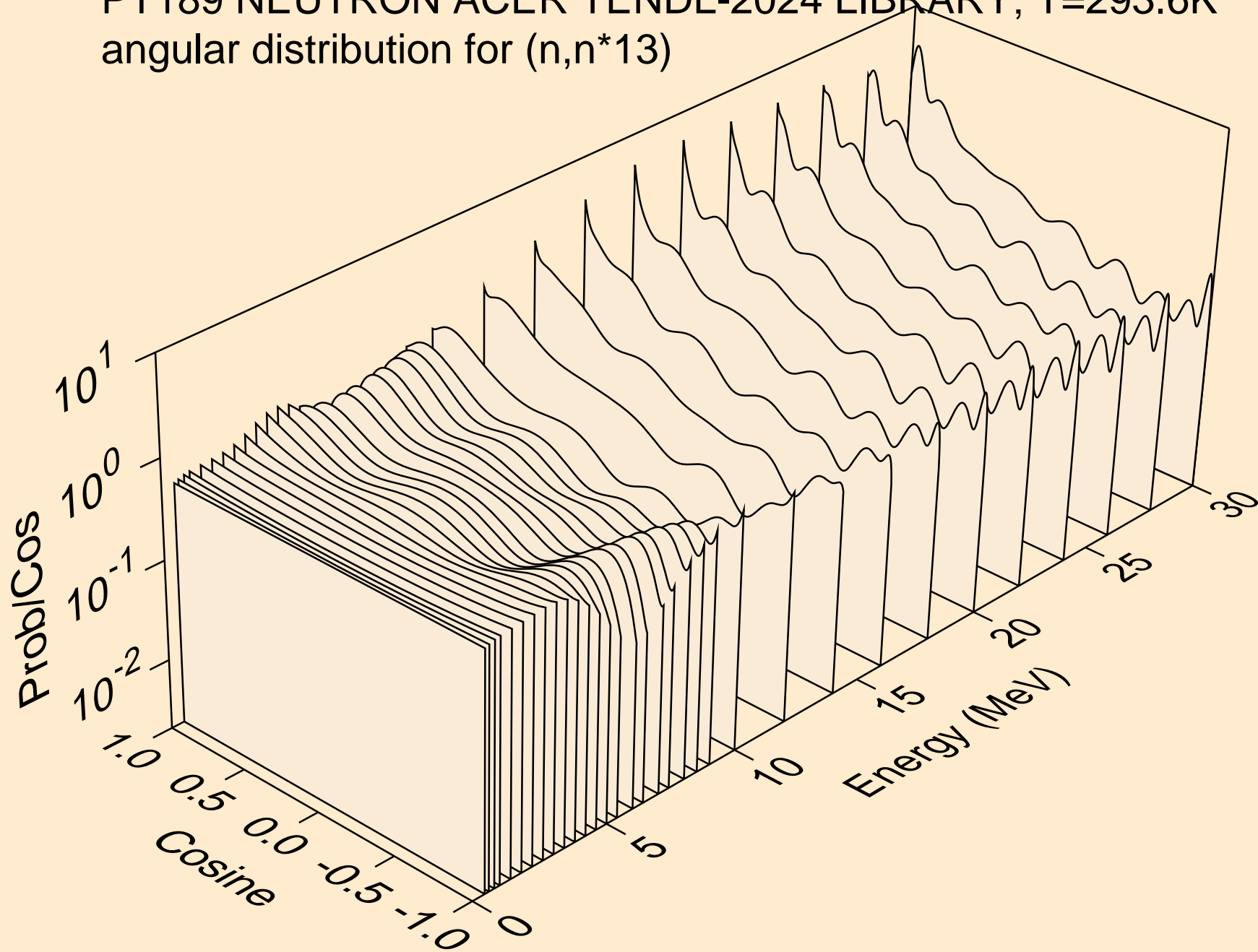

PT189 NEUTRON ACER TENDL-2024 LIBRARY; T=293.6K
angular distribution for (n,n*14)

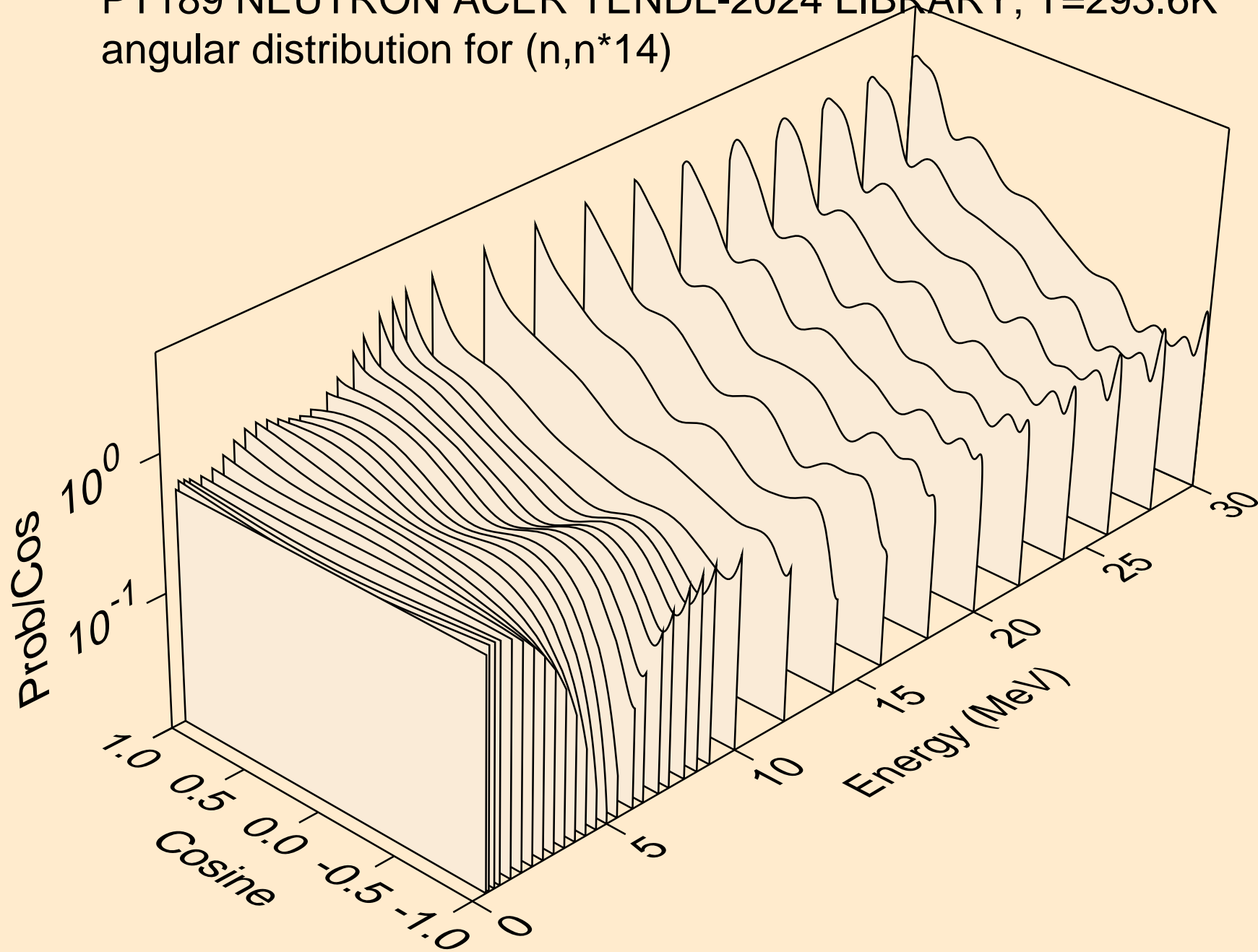

PT189 NEUTRON ACER TENDL-2024 LIBRARY; T=293.6K
angular distribution for (n,n*15)

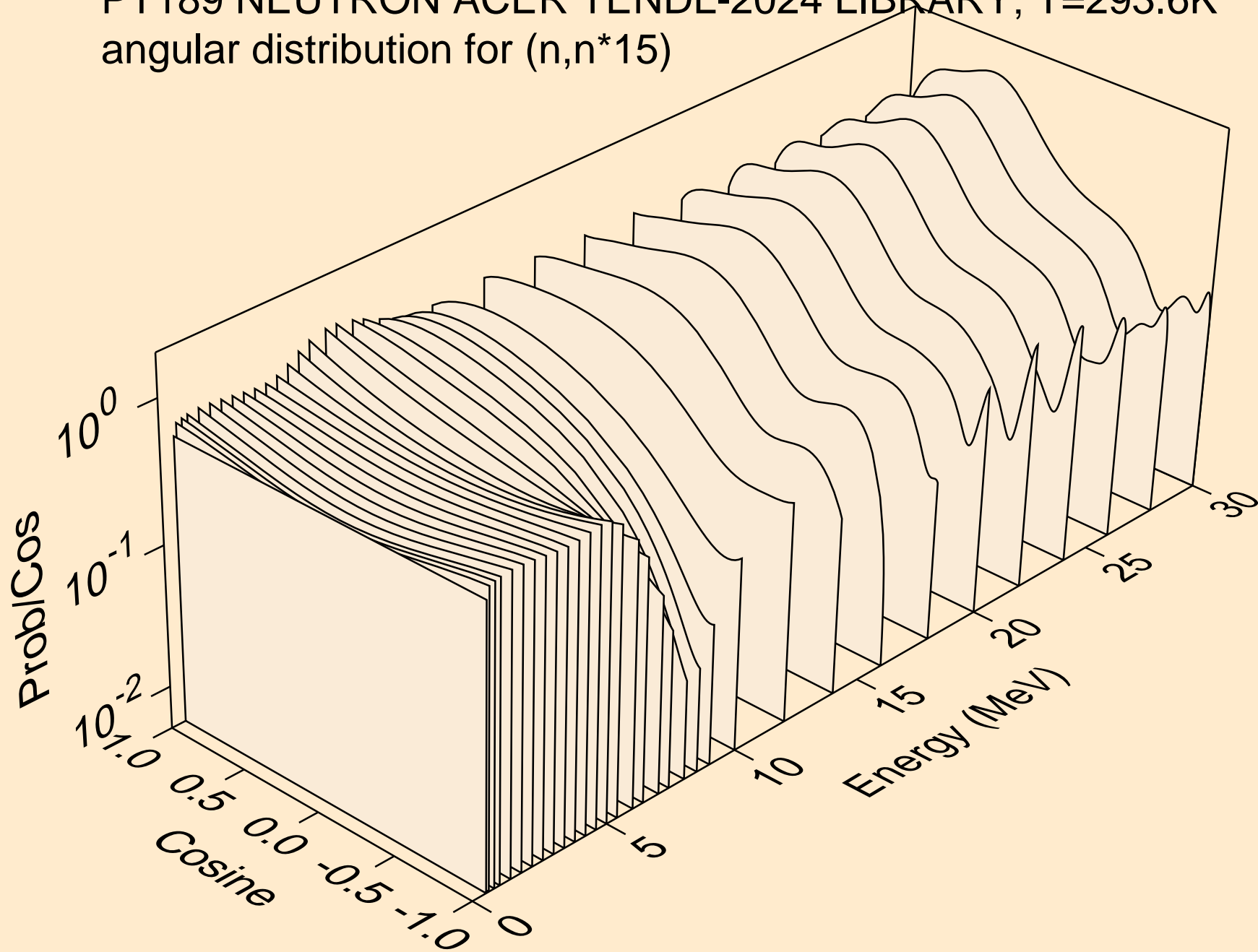

PT189 NEUTRON ACER TENDL-2024 LIBRARY; T=293.6K
angular distribution for (n,n*16)

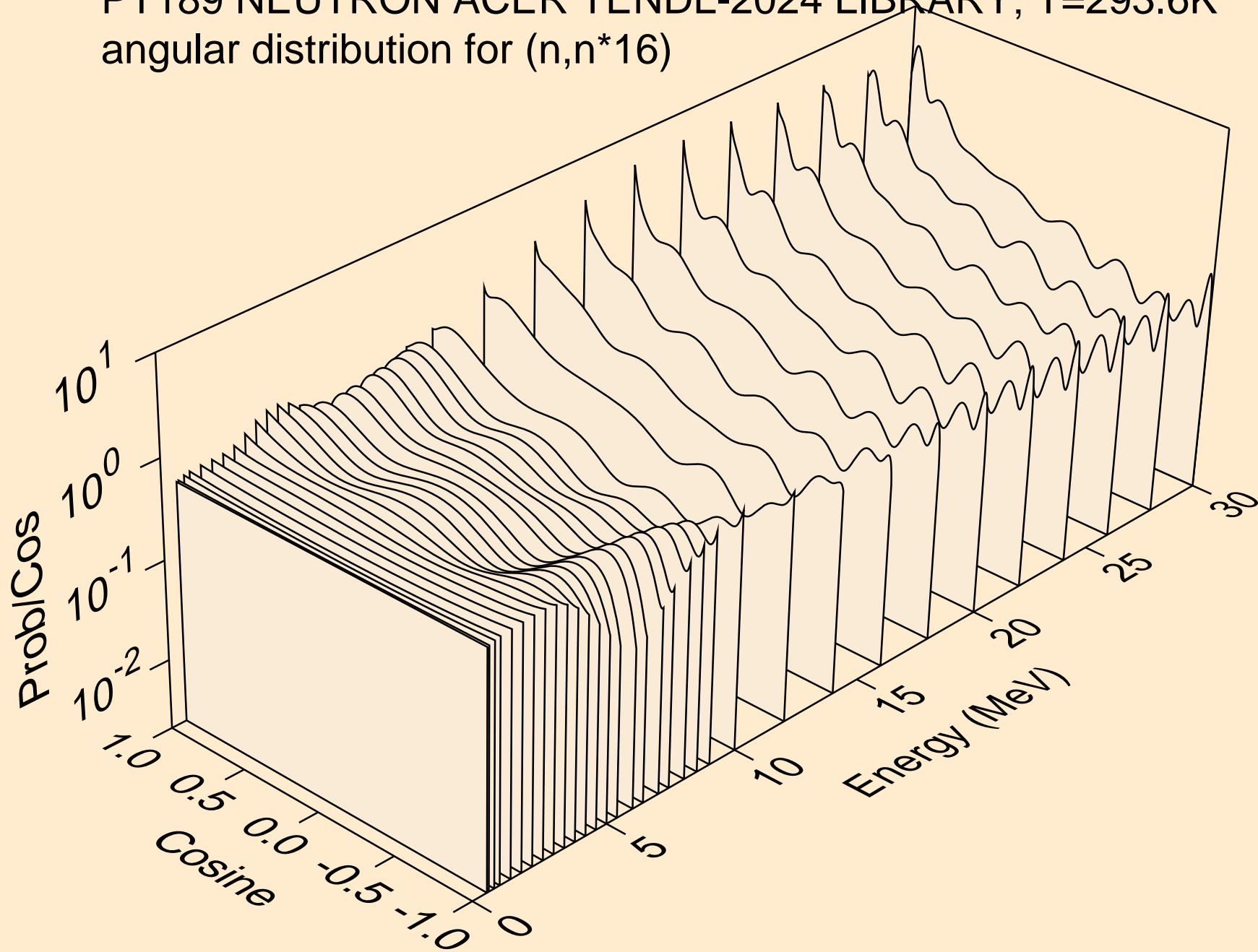

PT189 NEUTRON ACER TENDL-2024 LIBRARY; T=293.6K
angular distribution for (n,n*17)

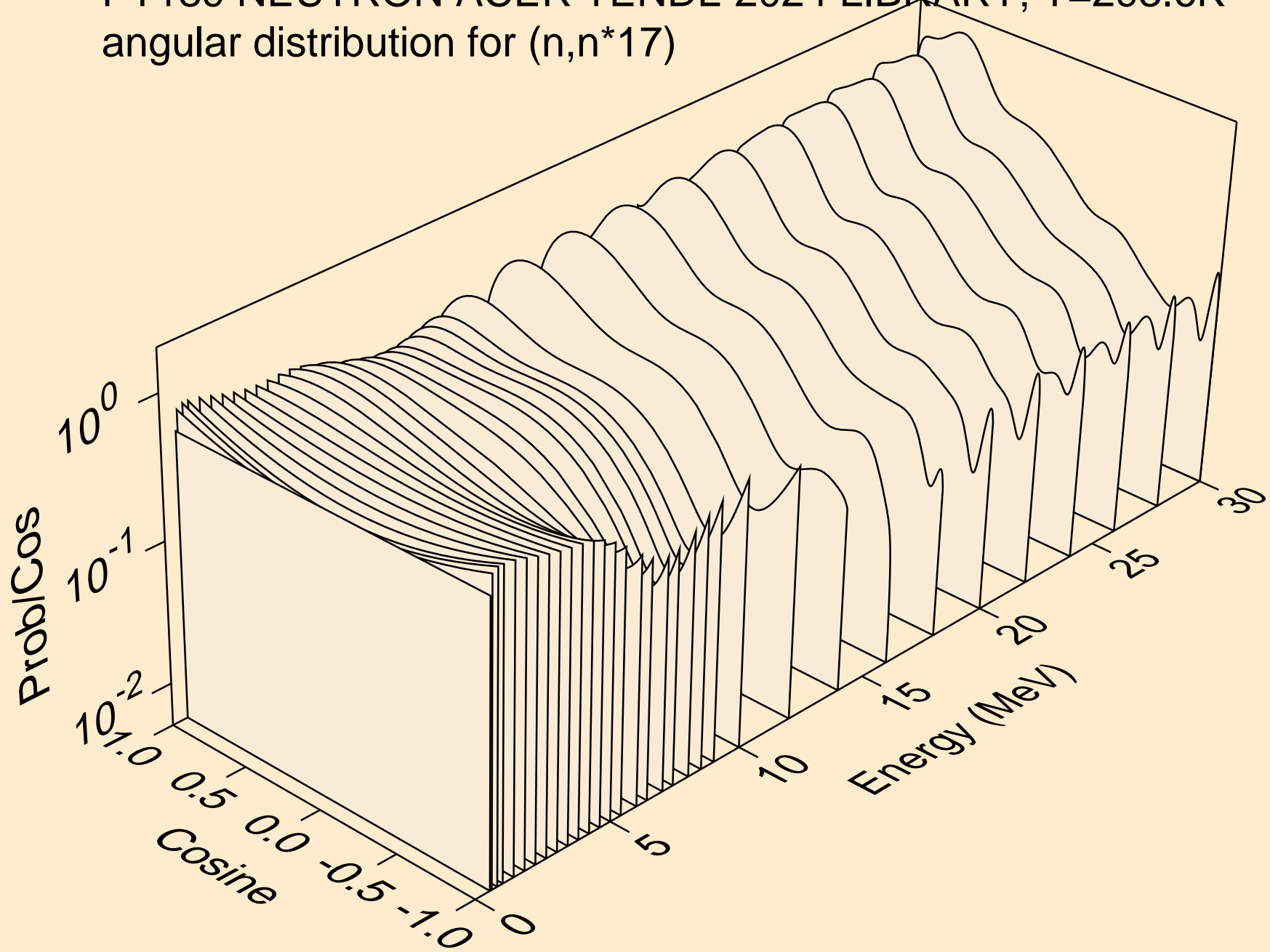

PT189 NEUTRON ACER TENDL-2024 LIBRARY; T=293.6K
angular distribution for (n,n*18)

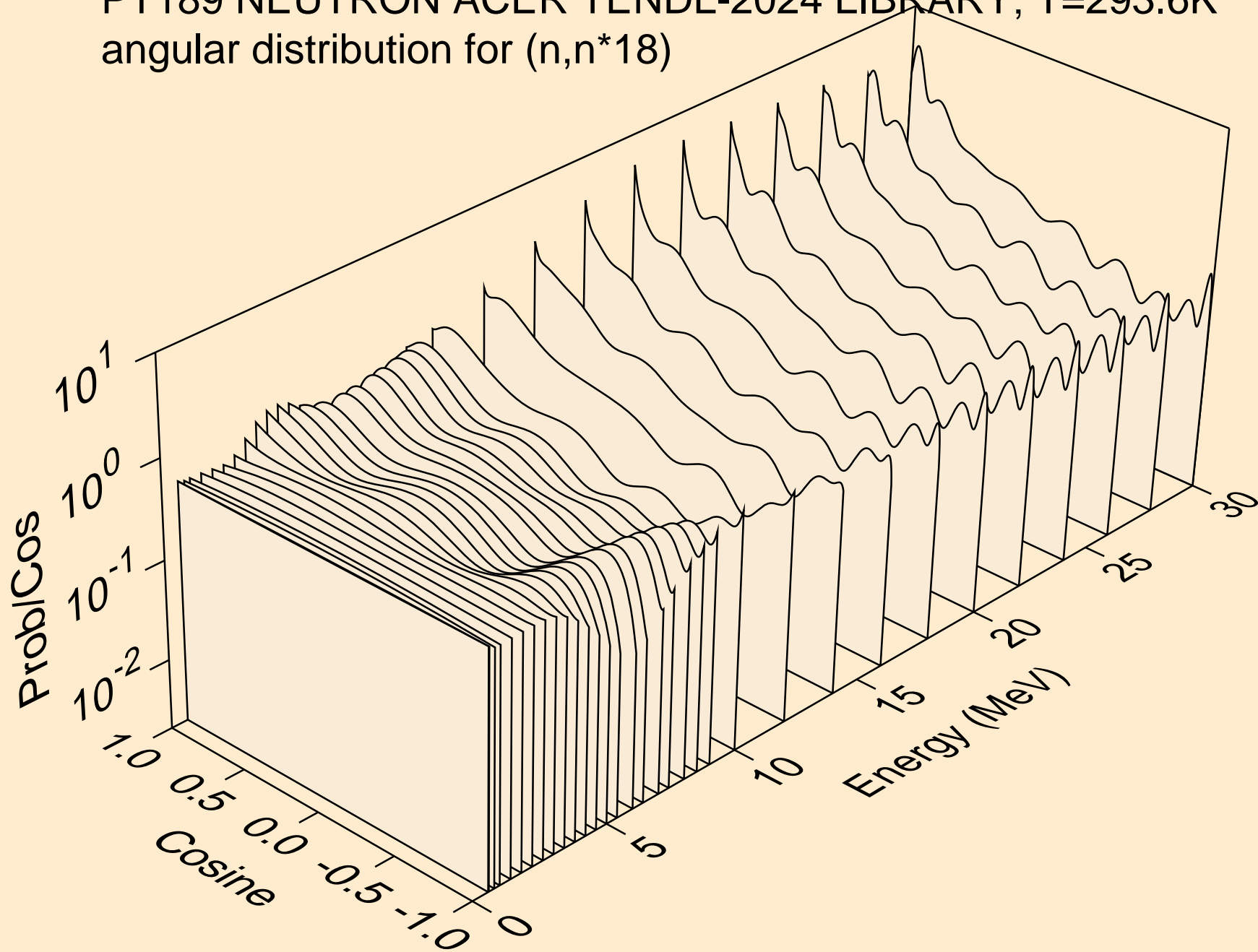

PT189 NEUTRON ACER TENDL-2024 LIBRARY; T=293.6K
angular distribution for (n,n*19)

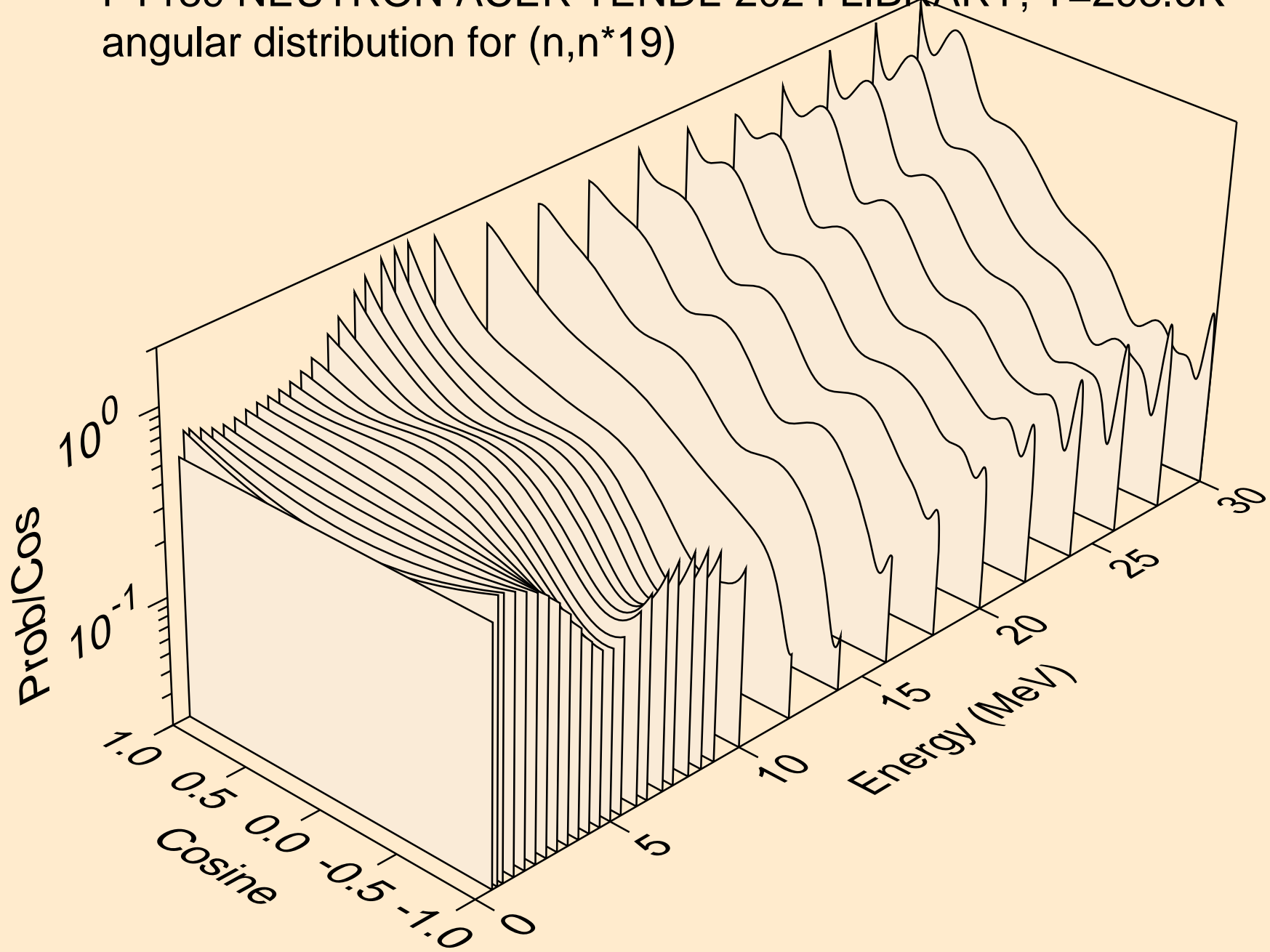

PT189 NEUTRON ACER TENDL-2024 LIBRARY; T=293.6K
angular distribution for (n,n*20)

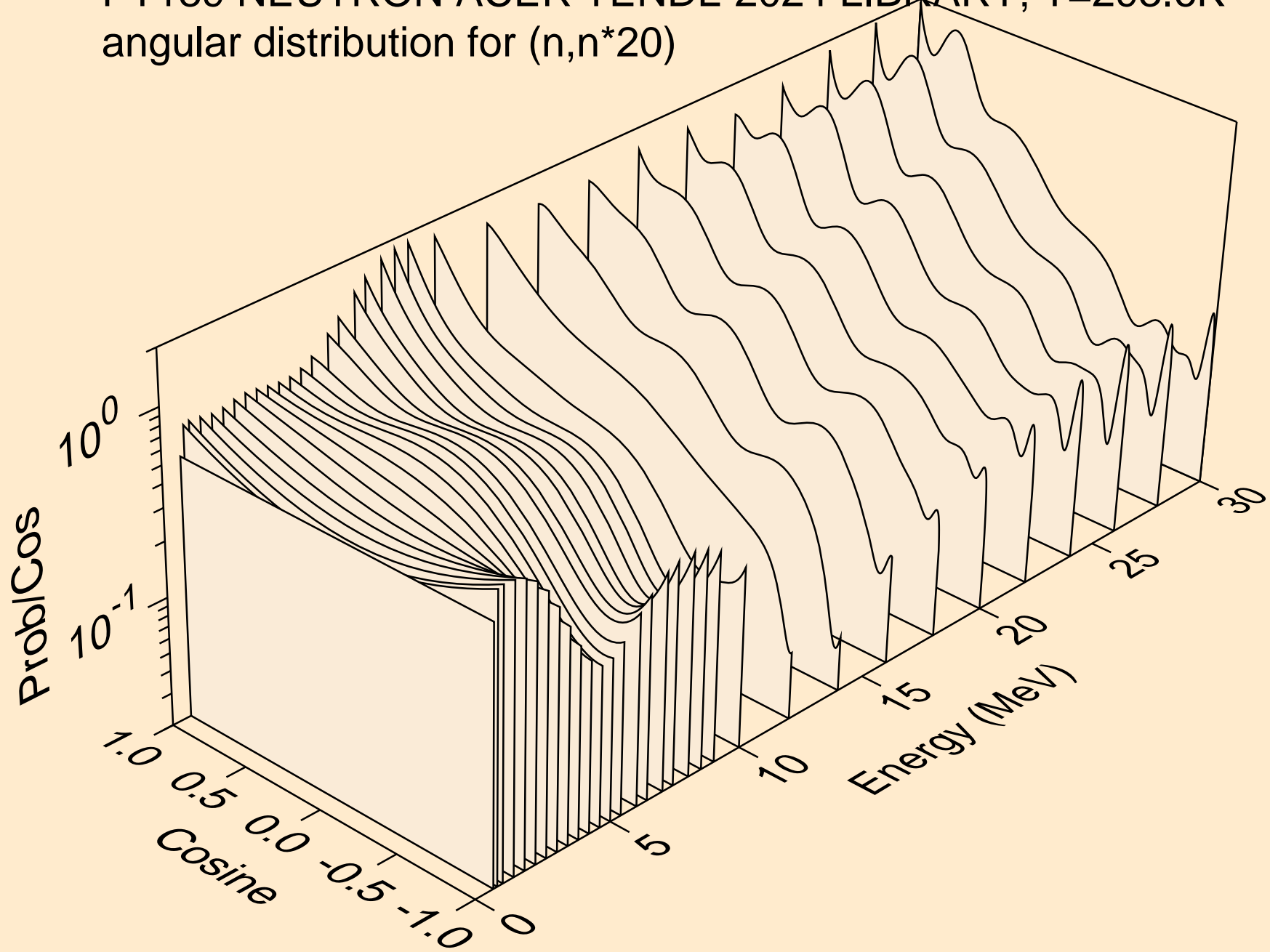

PT189 NEUTRON ACER TENDL-2024 LIBRARY; T=293.6K
angular distribution for (n,n*21)

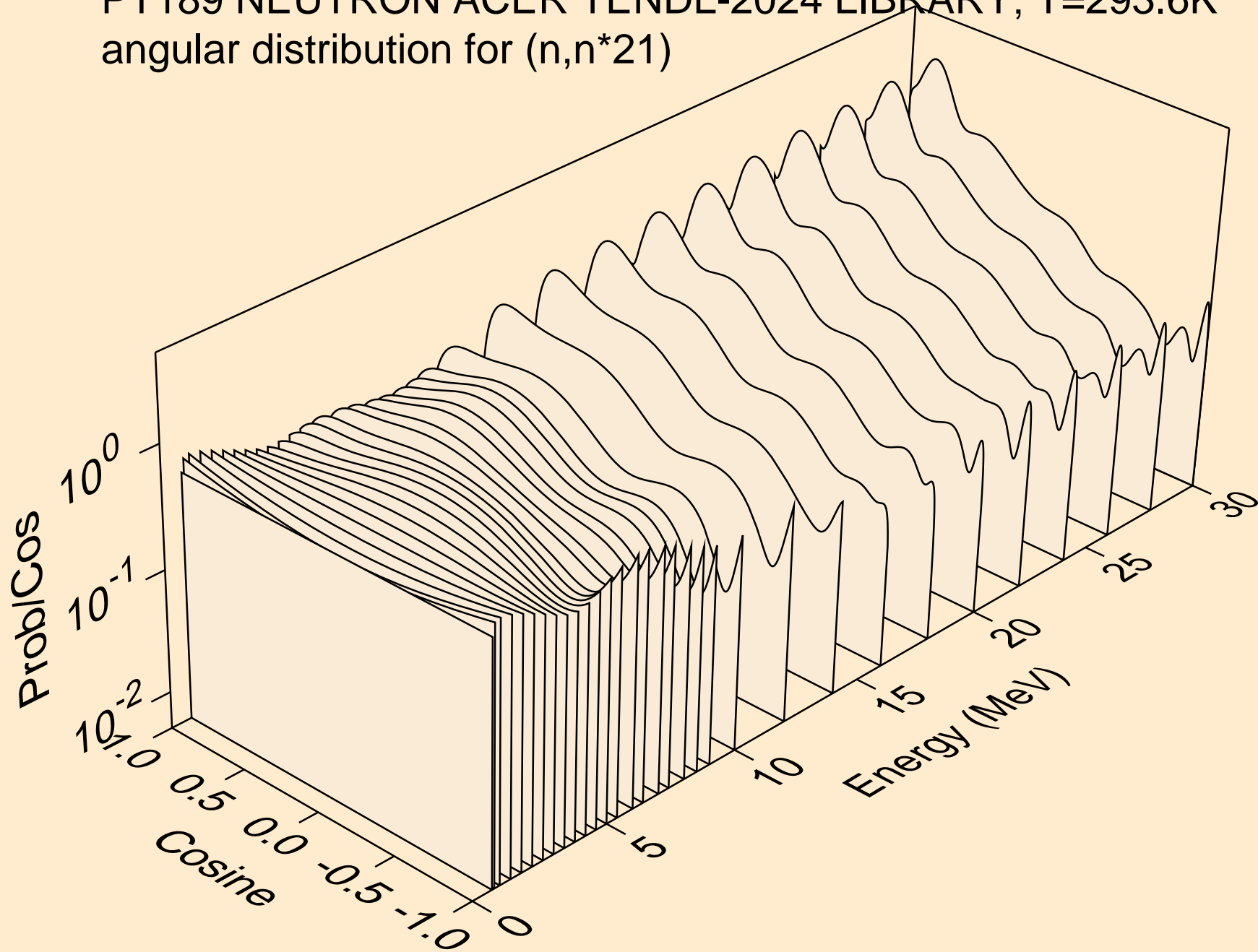

PT189 NEUTRON ACER TENDL-2024 LIBRARY; T=293.6K
angular distribution for (n,n*22)

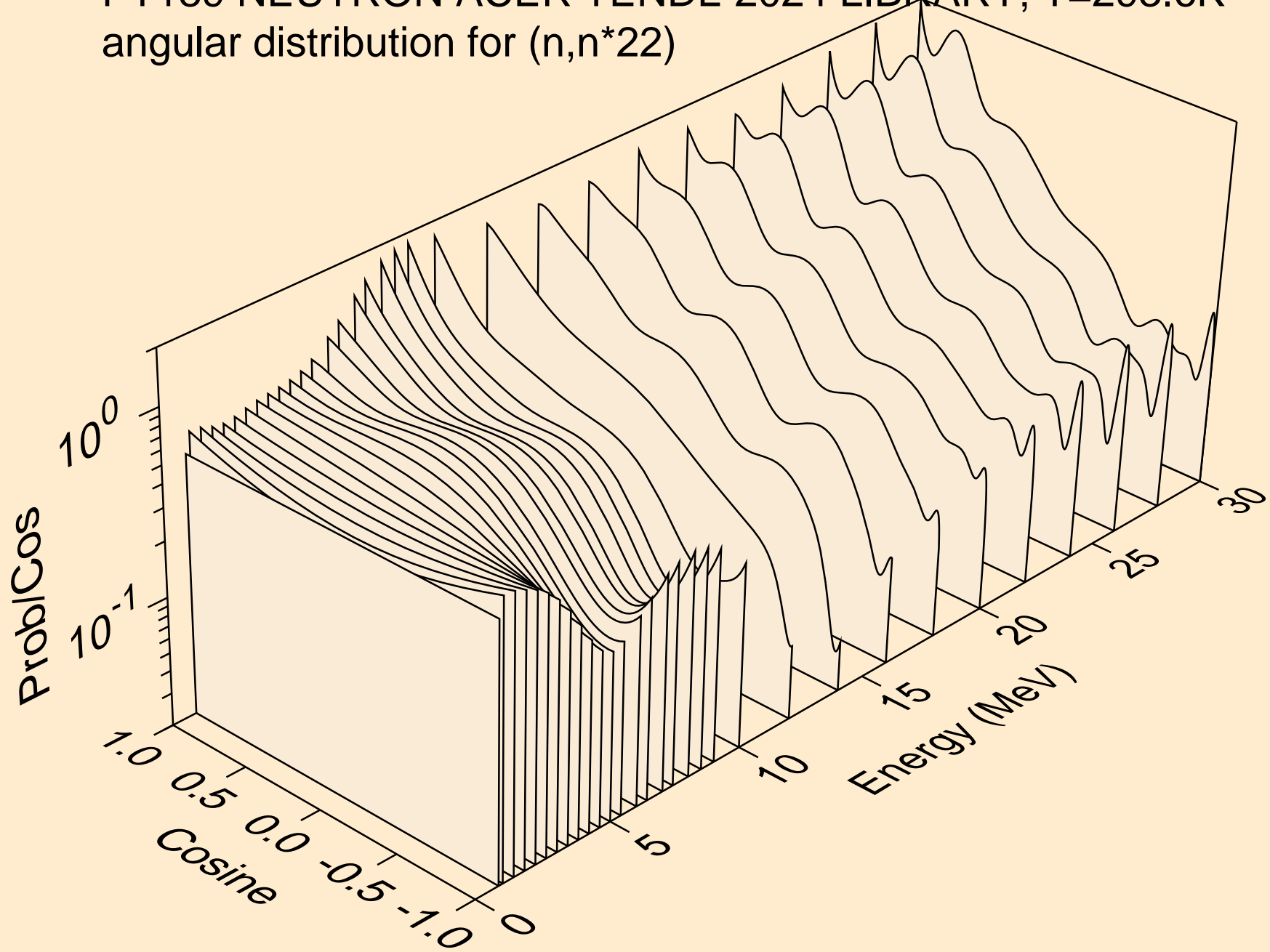

PT189 NEUTRON ACER TENDL-2024 LIBRARY; T=293.6K
angular distribution for (n,n*23)

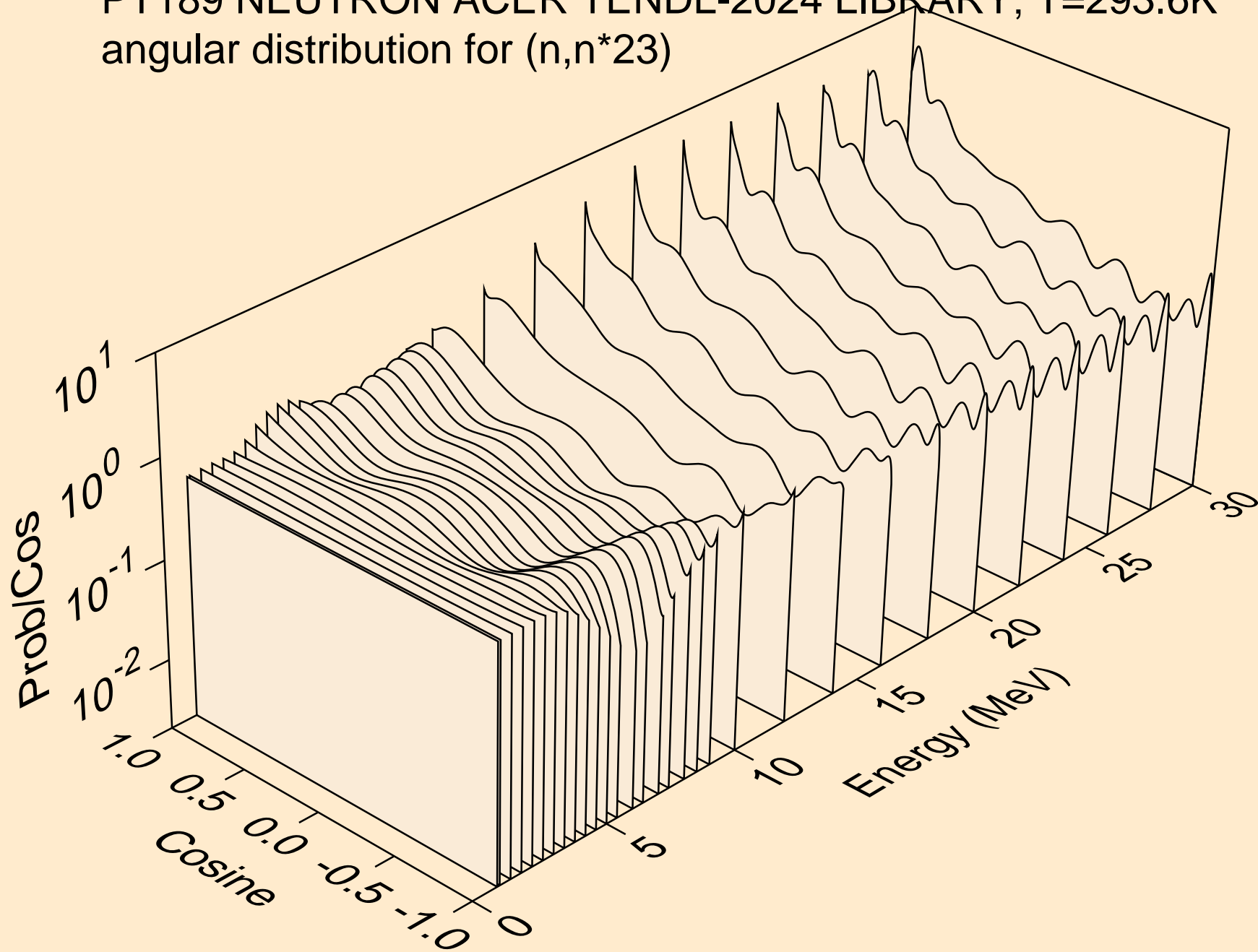

PT189 NEUTRON ACER TENDL-2024 LIBRARY; T=293.6K
Neutron emission for (n,x)

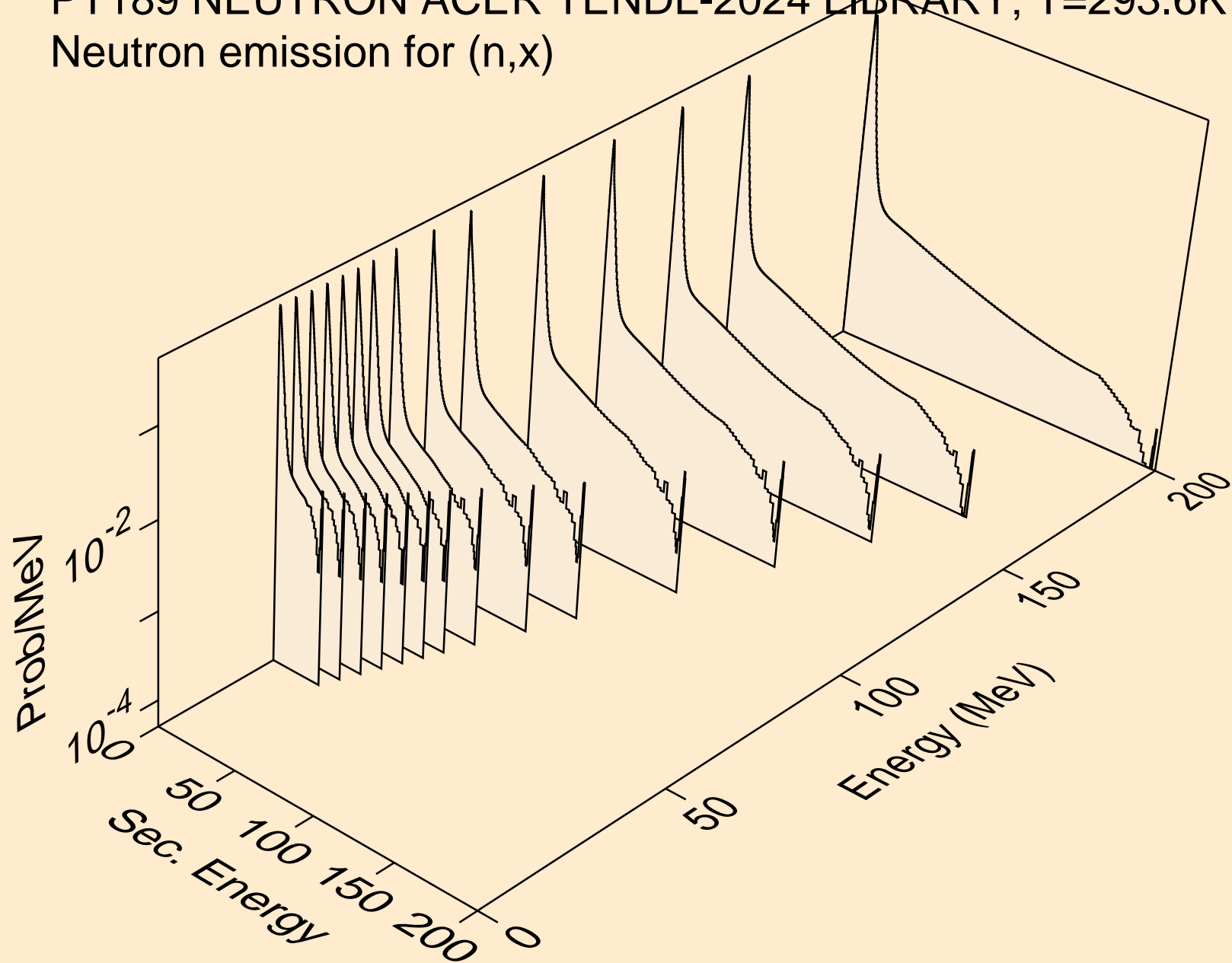

PT189 NEUTRON ACER TENDL-2024 LIBRARY; T=293.6K
Neutron emission for (n,2nd)

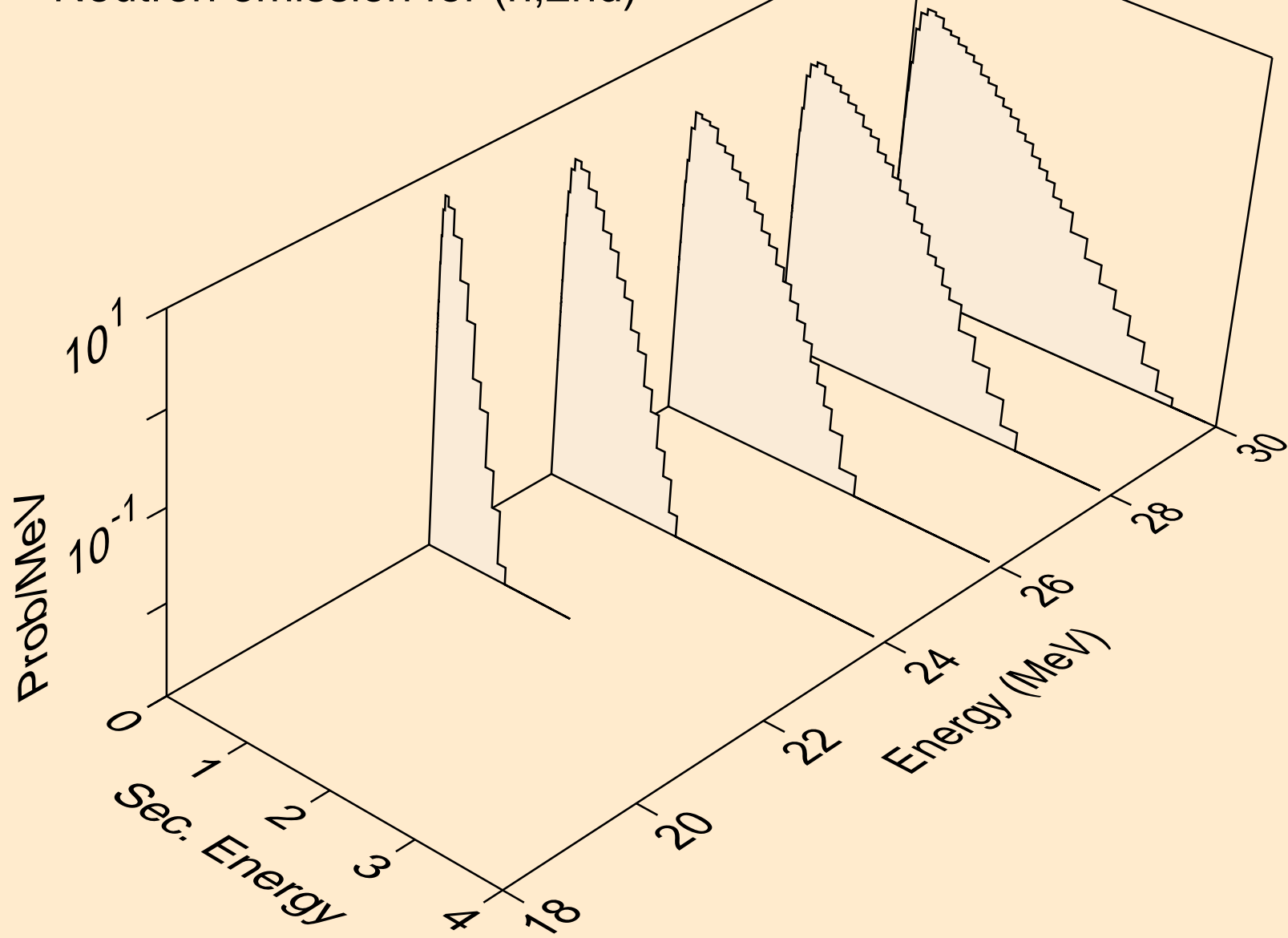

PT189 NEUTRON ACER TENDL-2024 LIBRARY; T=293.6K
Neutron emission for (n,2n)

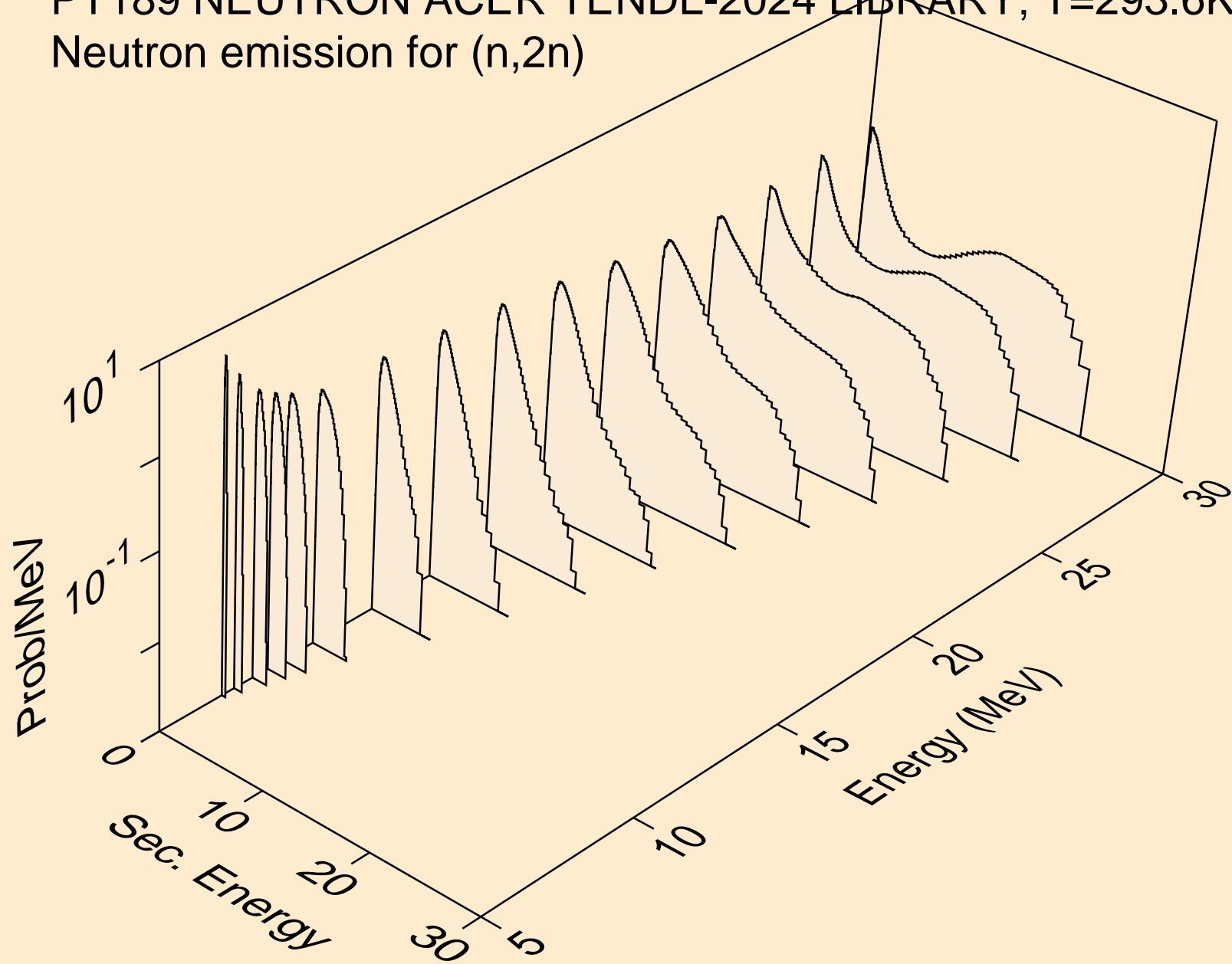

PT189 NEUTRON ACER TENDL-2024 LIBRARY; T=293.6K
Neutron emission for (n,3n)

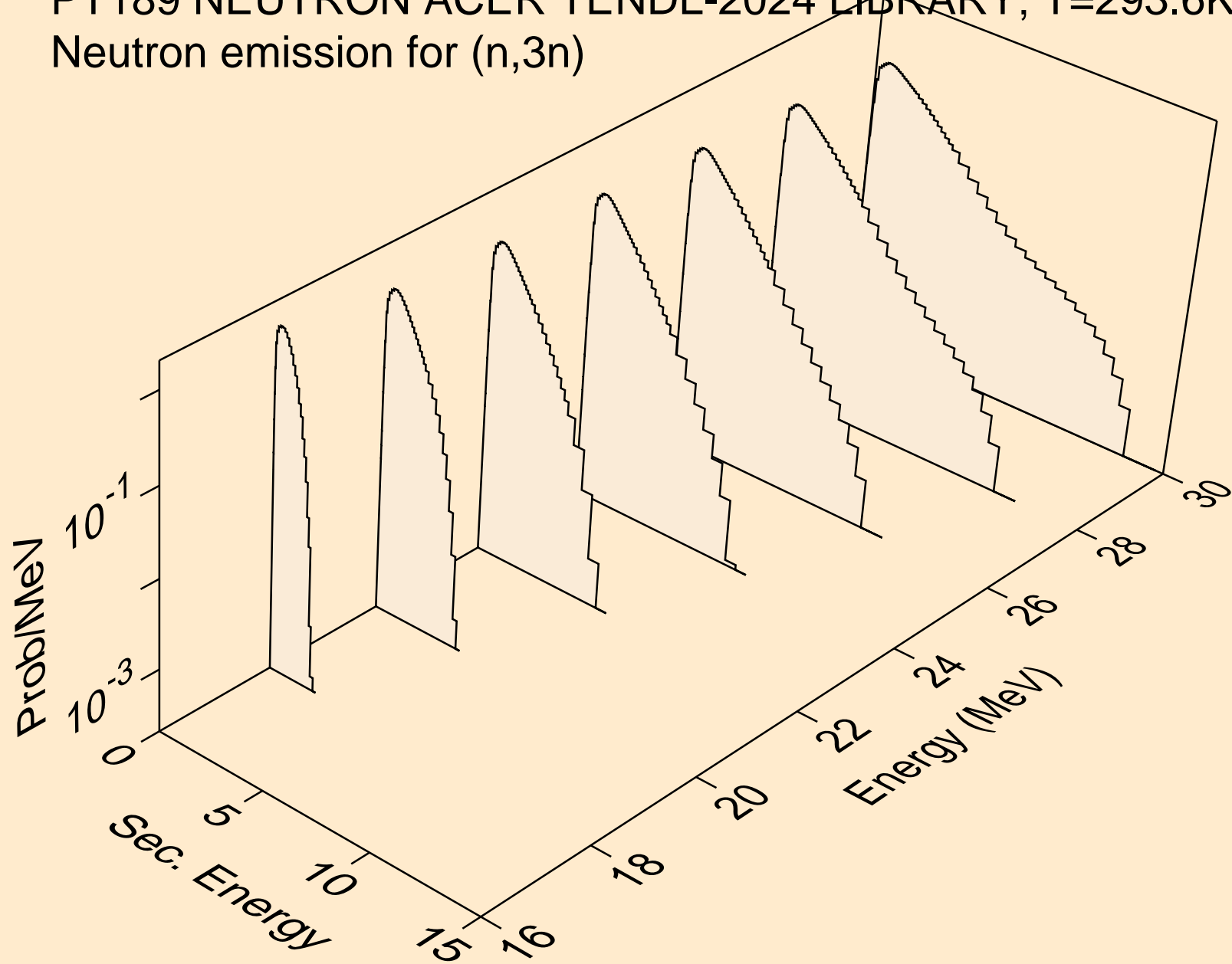

PT189 NEUTRON ACER TENDL-2024 LIBRARY; T=293.6K
Neutron emission for (n,n*)a

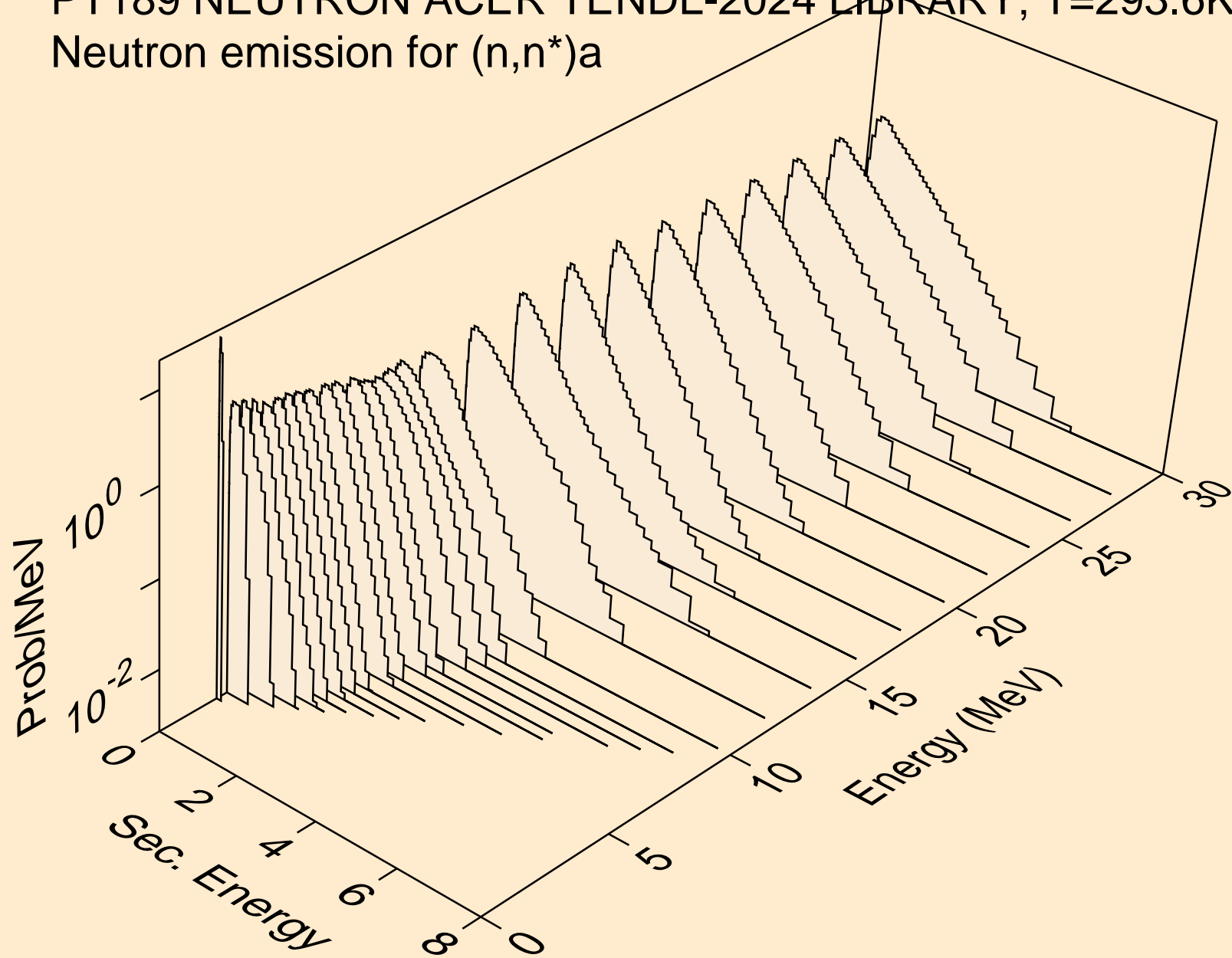

PT189 NEUTRON ACER TENDL-2024 LIBRARY; T=293.6K
Neutron emission for (n,2n)a

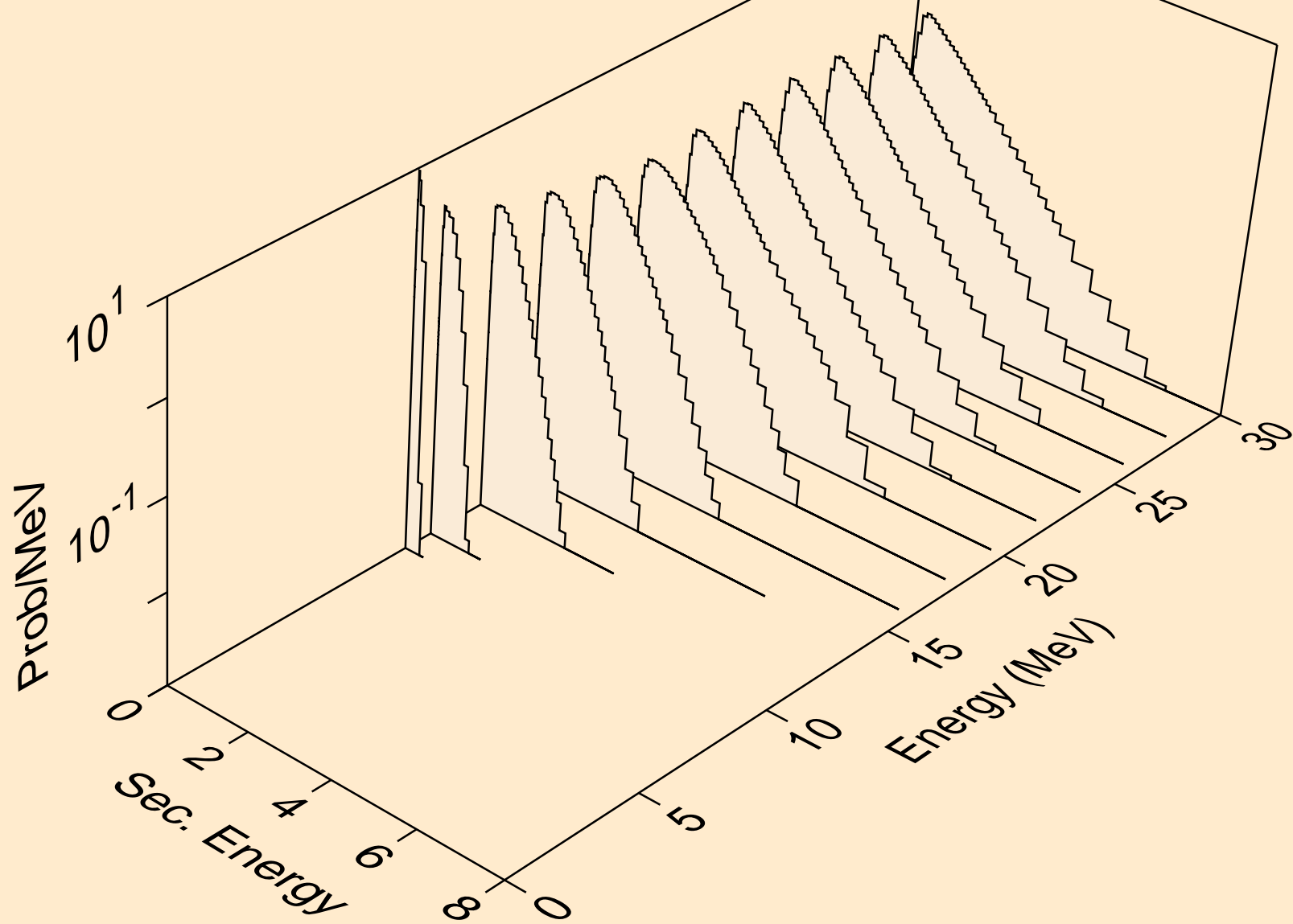

PT189 NEUTRON ACER TENDL-2024 LIBRARY; T=293.6K
Neutron emission for (n,3n)a

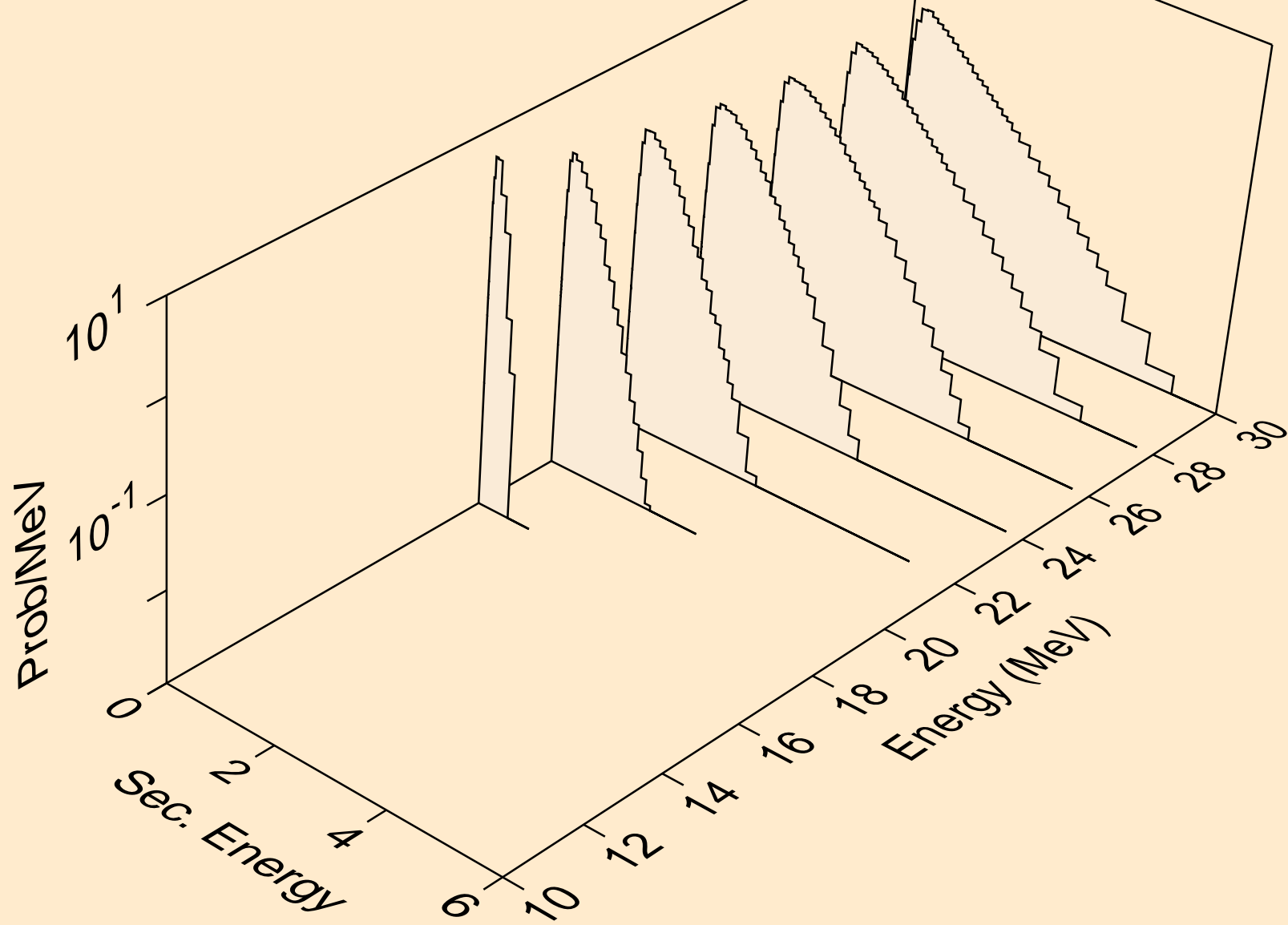

PT189 NEUTRON ACER TENDL-2024 LIBRARY; T=293.6K
Neutron emission for (n,n*)p

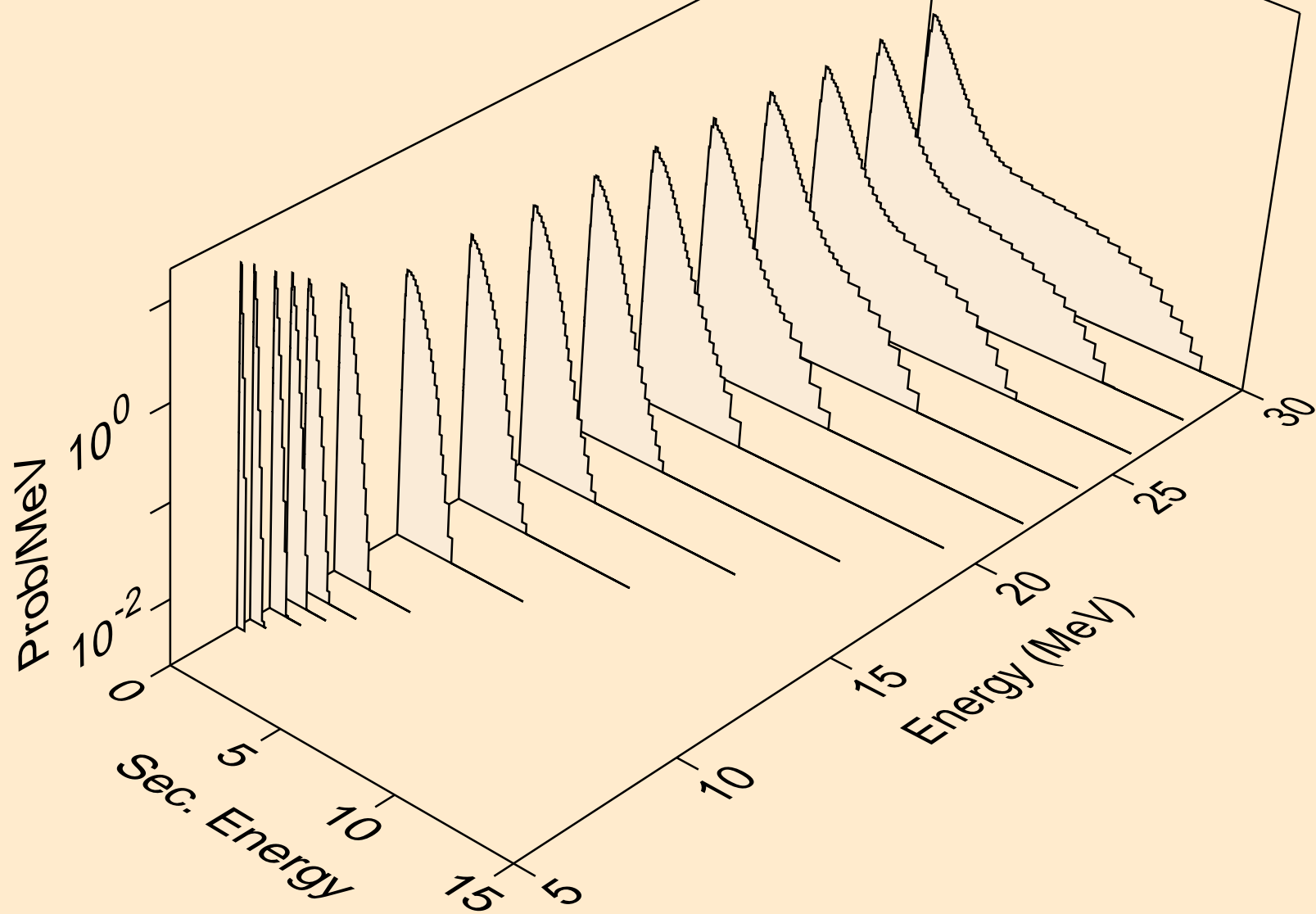

PT189 NEUTRON ACER TENDL-2024 LIBRARY; T=293.6K
Neutron emission for (n,n*)2a

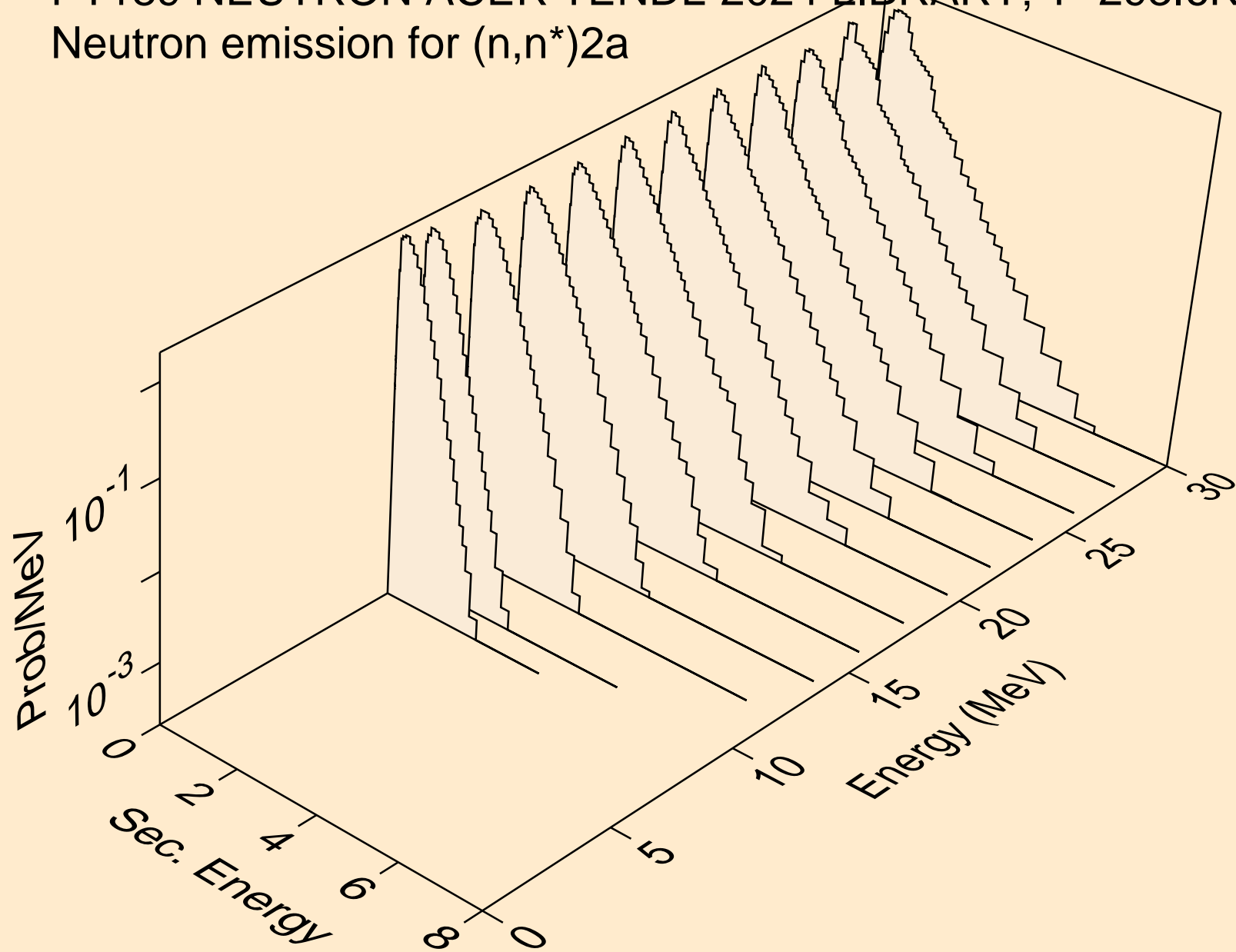

PT189 NEUTRON ACER TENDL-2024 LIBRARY; T=293.6K
Neutron emission for (n,2n)2a

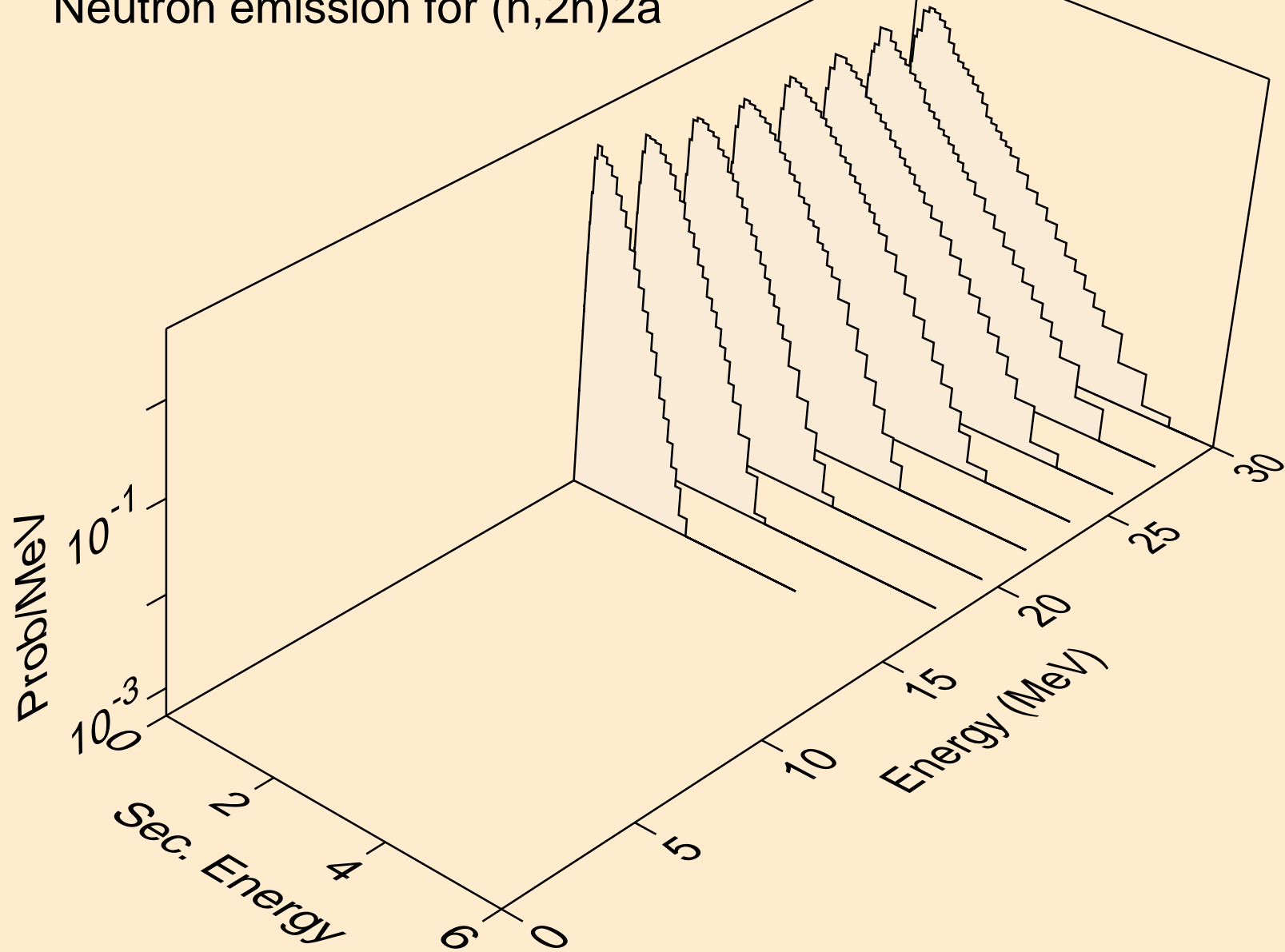

PT189 NEUTRON ACER TENDL-2024 LIBRARY; T=293.6K
Neutron emission for (n,n*)d

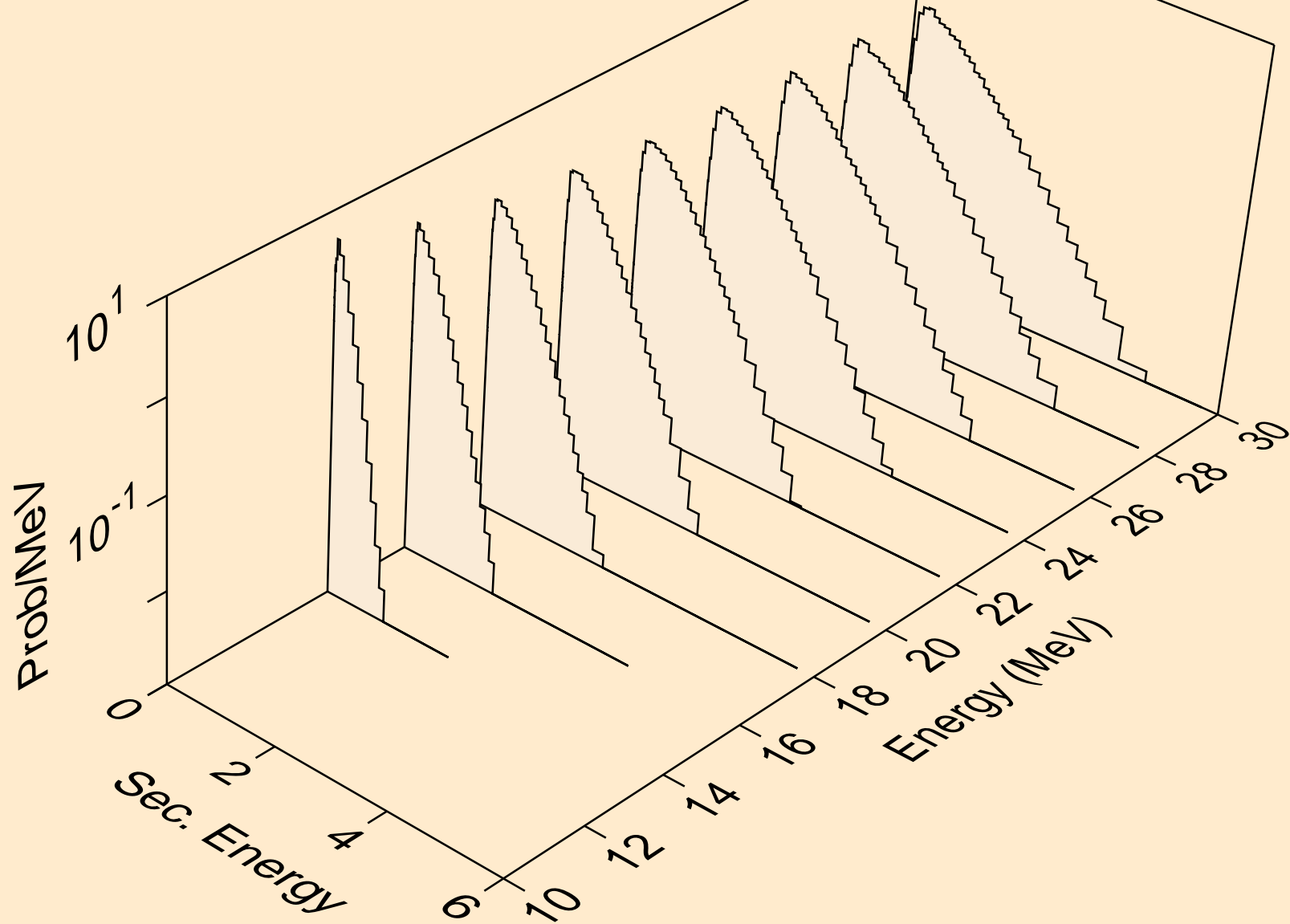

PT189 NEUTRON ACER TENDL-2024 LIBRARY; T=293.6K
Neutron emission for (n,n*)t

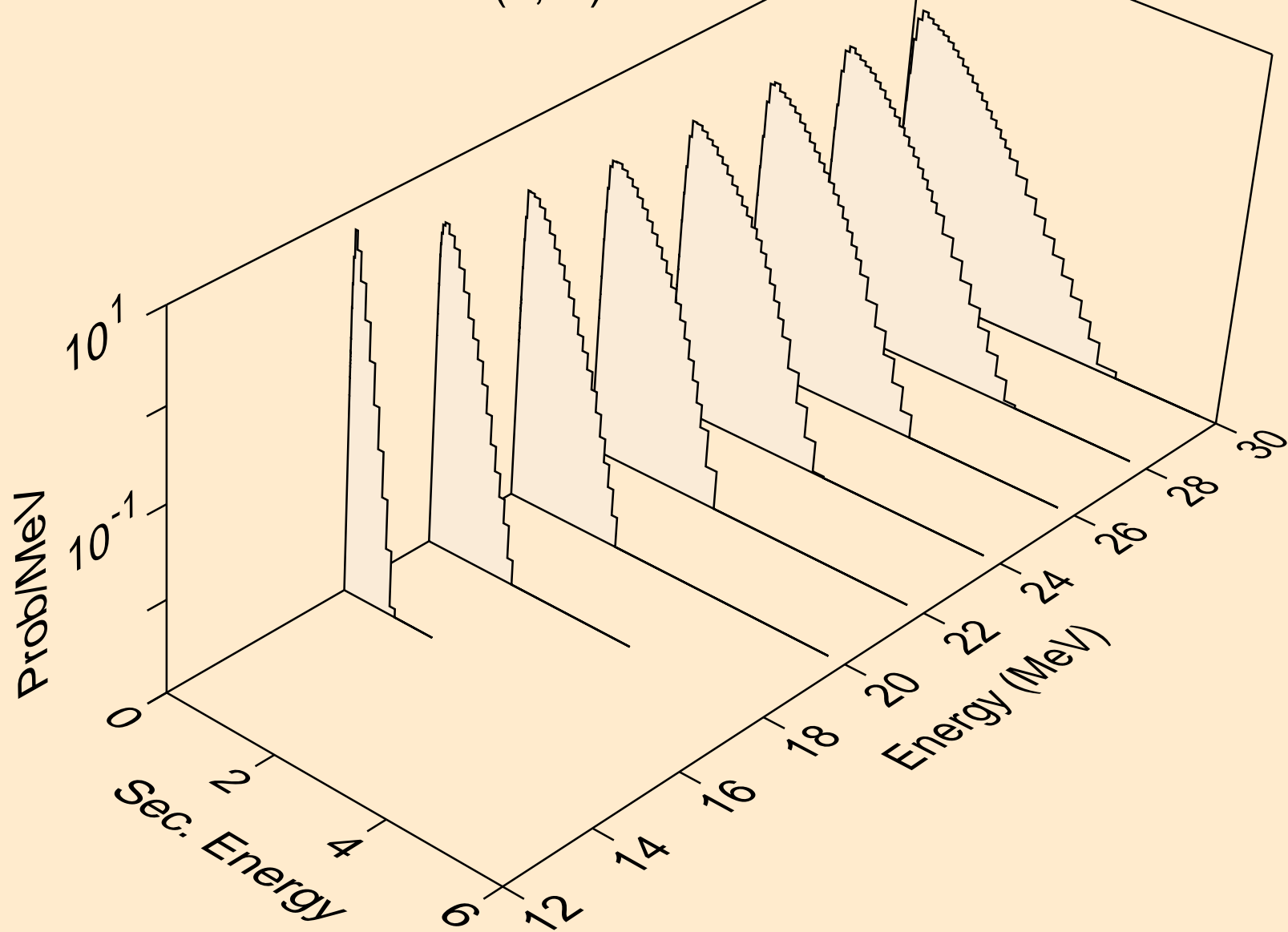

PT189 NEUTRON ACER TENDL-2024 LIBRARY; T=293.6K
Neutron emission for (n,n*)he3

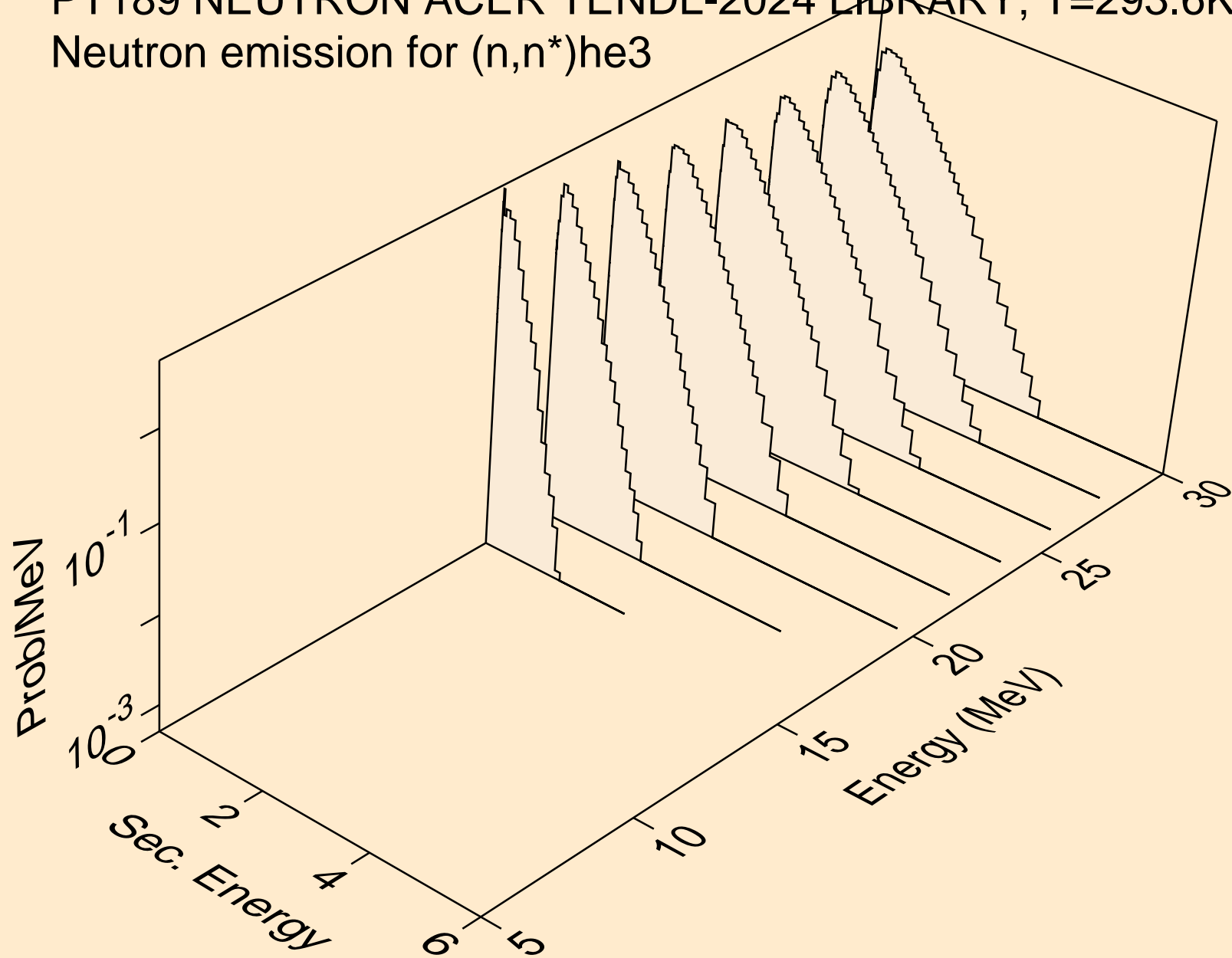

PT189 NEUTRON ACER TENDL-2024 LIBRARY; T=293.6K
Neutron emission for (n,4n)

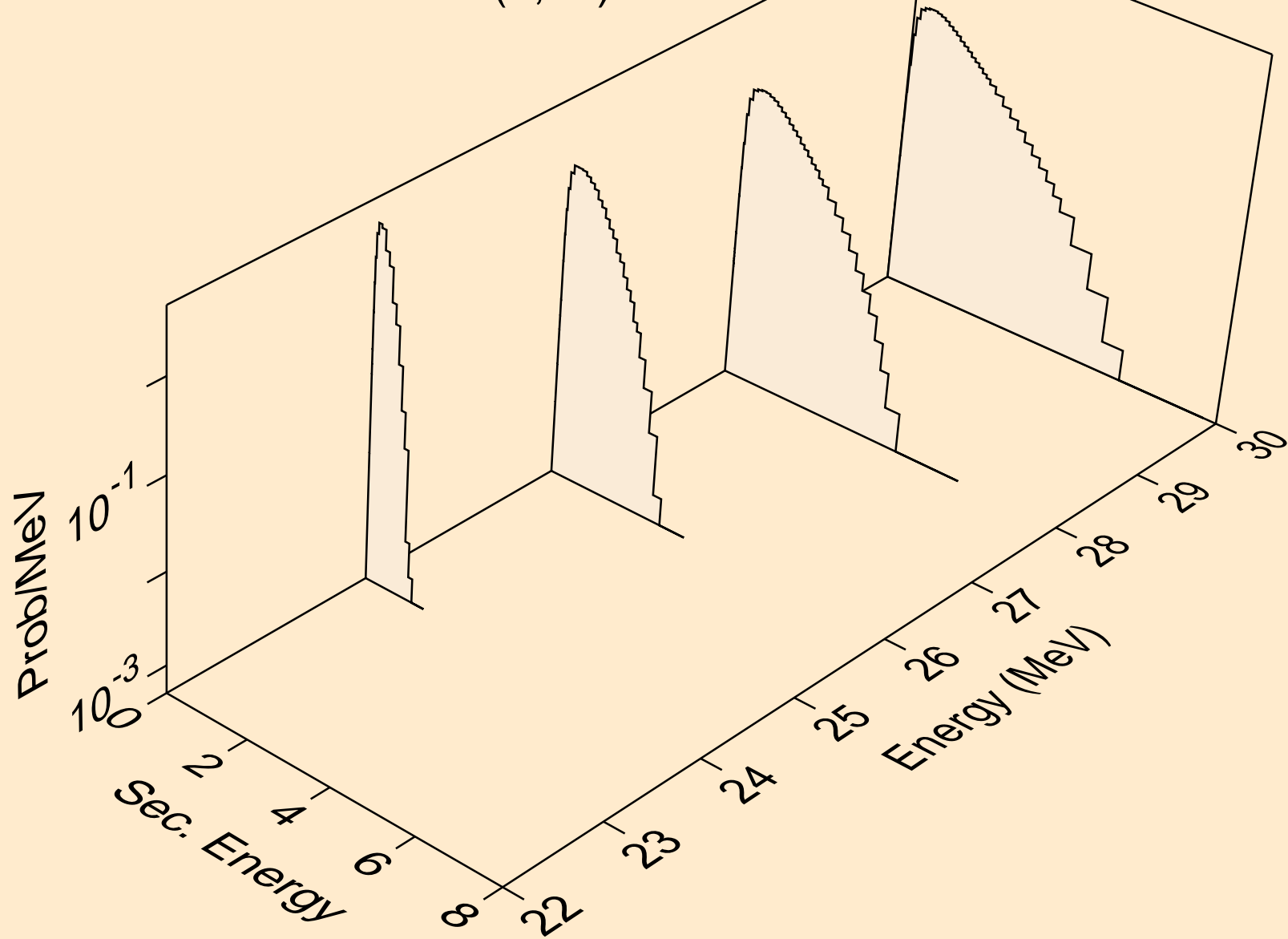

PT189 NEUTRON ACER TENDL-2024 LIBRARY; T=293.6K
Neutron emission for (n,2np)

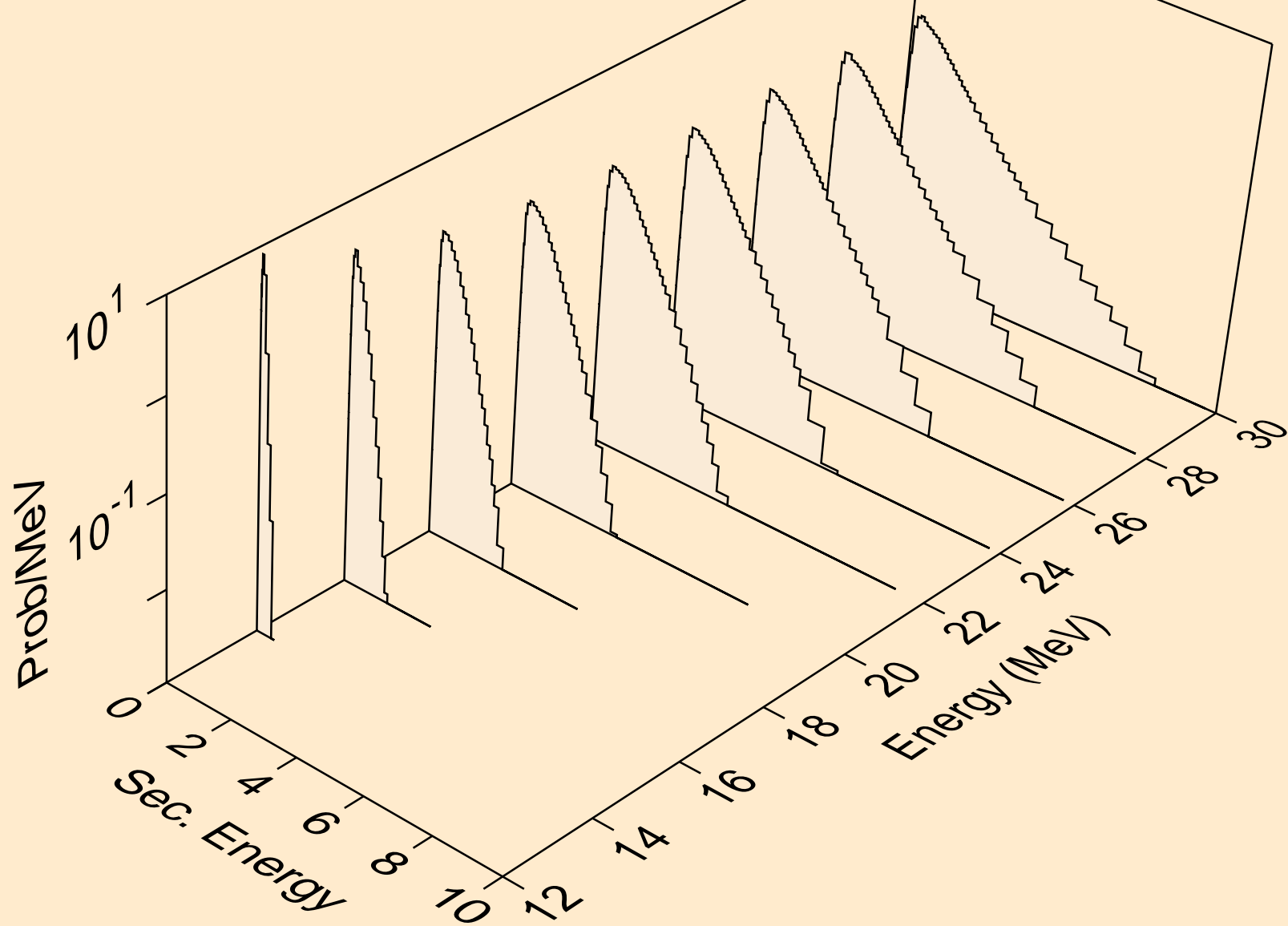

PT189 NEUTRON ACER TENDL-2024 LIBRARY; T=293.6K
Neutron emission for (n,3np)

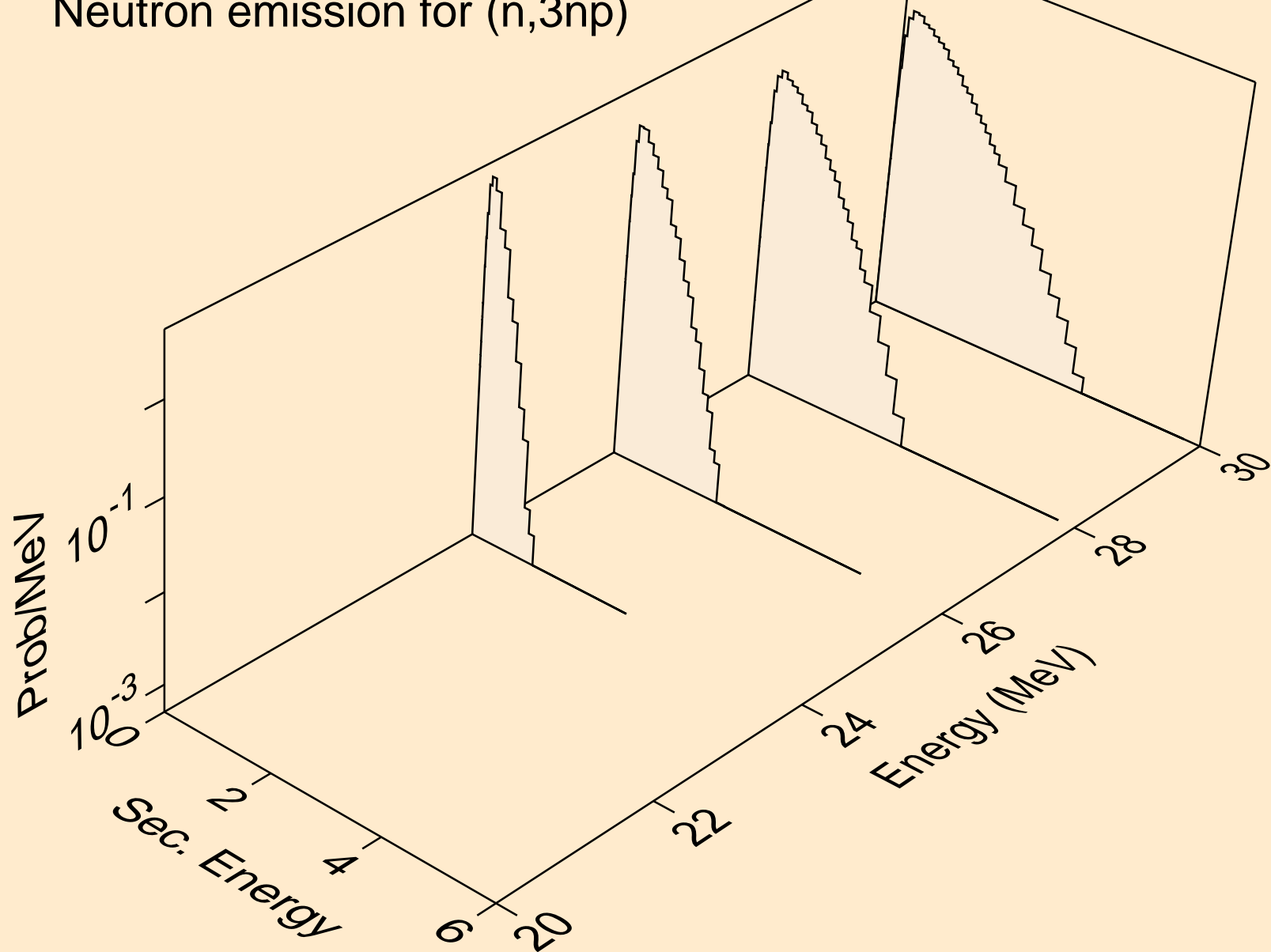

PT189 NEUTRON ACER TENDL-2024 LIBRARY; T=293.6K
Neutron emission for (n,n2p)

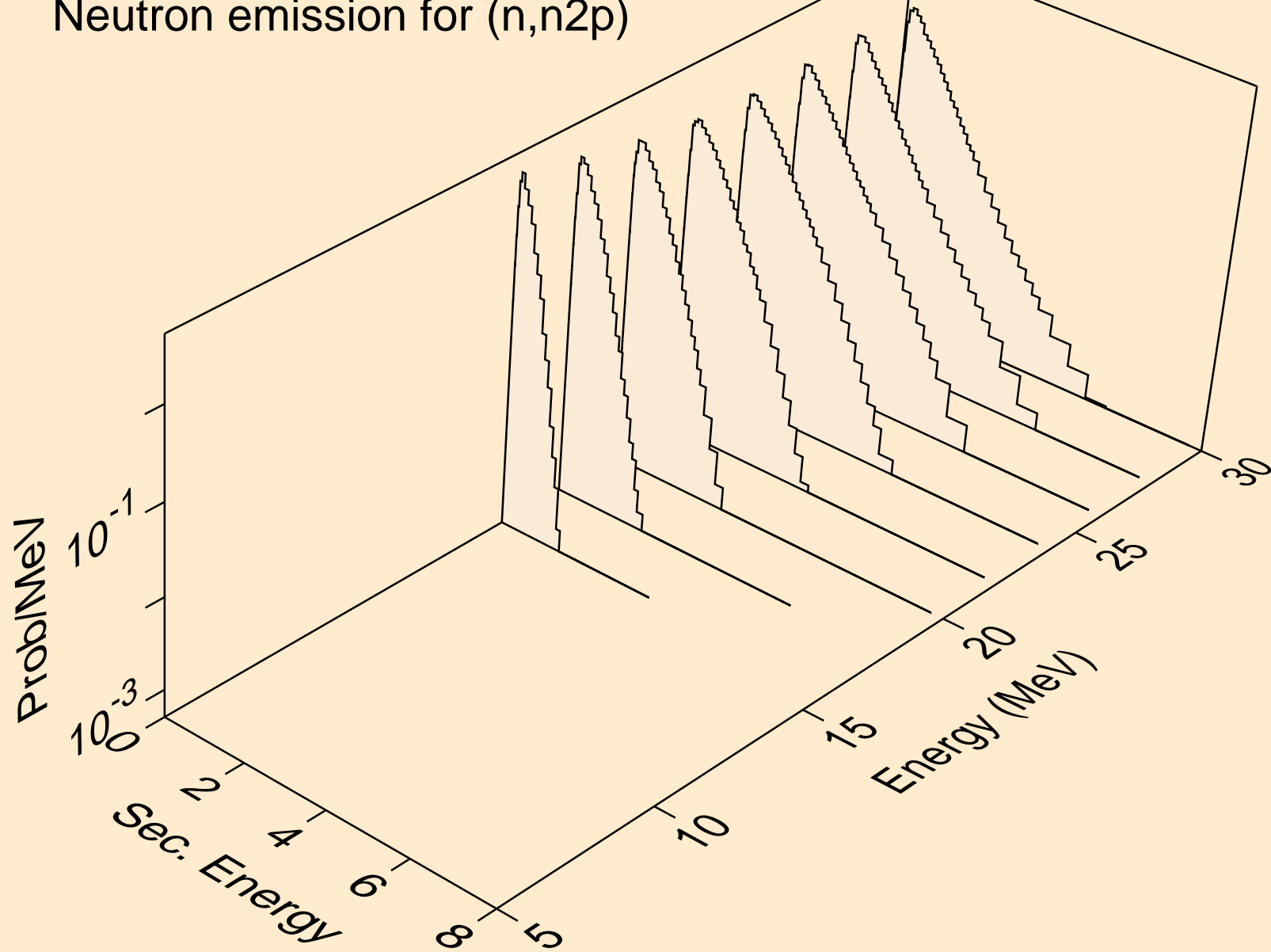

PT189 NEUTRON ACER TENDL-2024 LIBRARY; T=293.6K
Neutron emission for (n,npa)

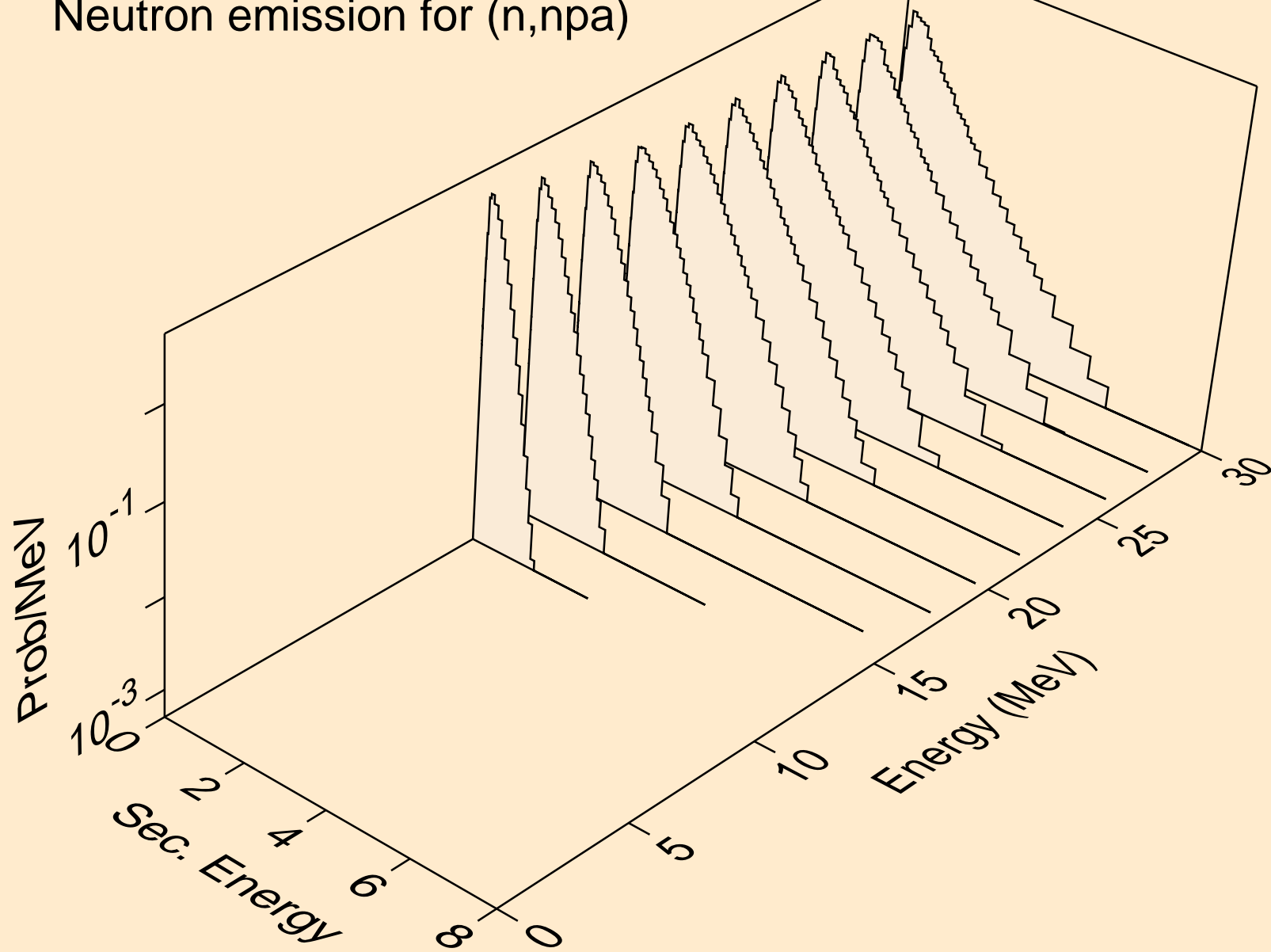

PT189 NEUTRON ACER TENDL-2024 LIBRARY; T=293.6K
Neutron emission for (n,n*c)

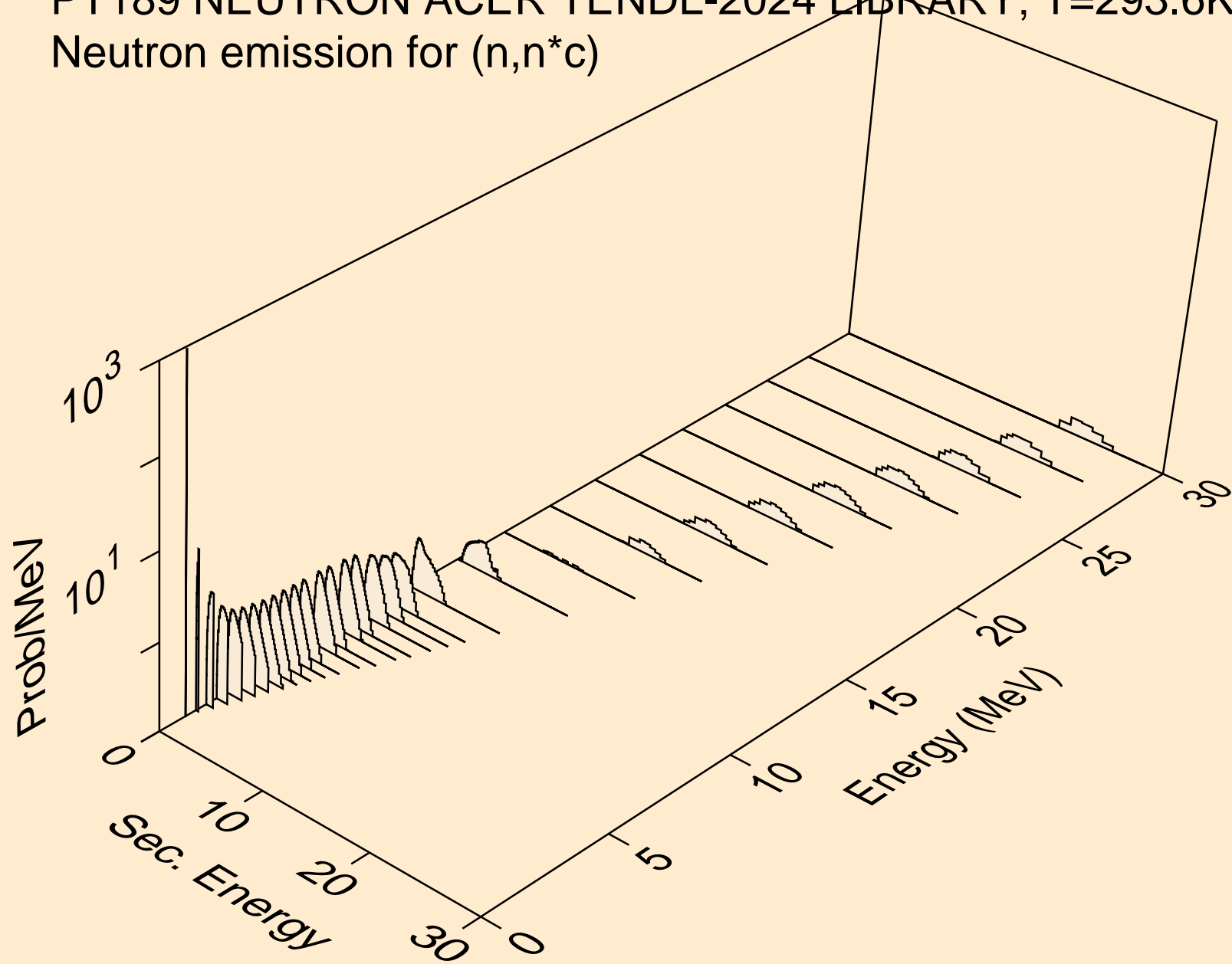

PT189 NEUTRON ACER TENDL-2024 LIBRARY; T=293.6K
Photon emission for (n,x)

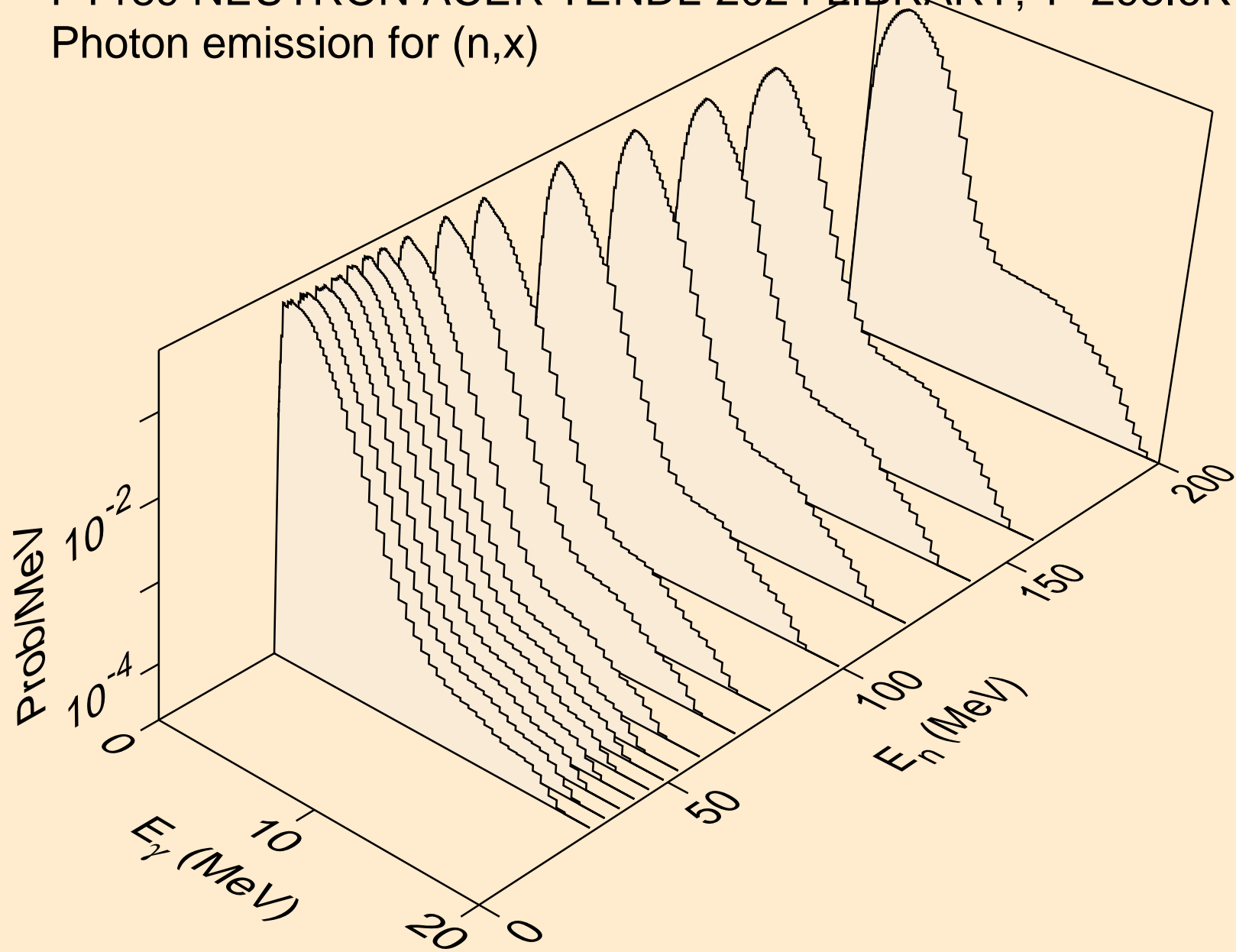

PT189 NEUTRON ACER TENDL-2024 LIBRARY; T=293.6K
Photon emission for (n,2nd)

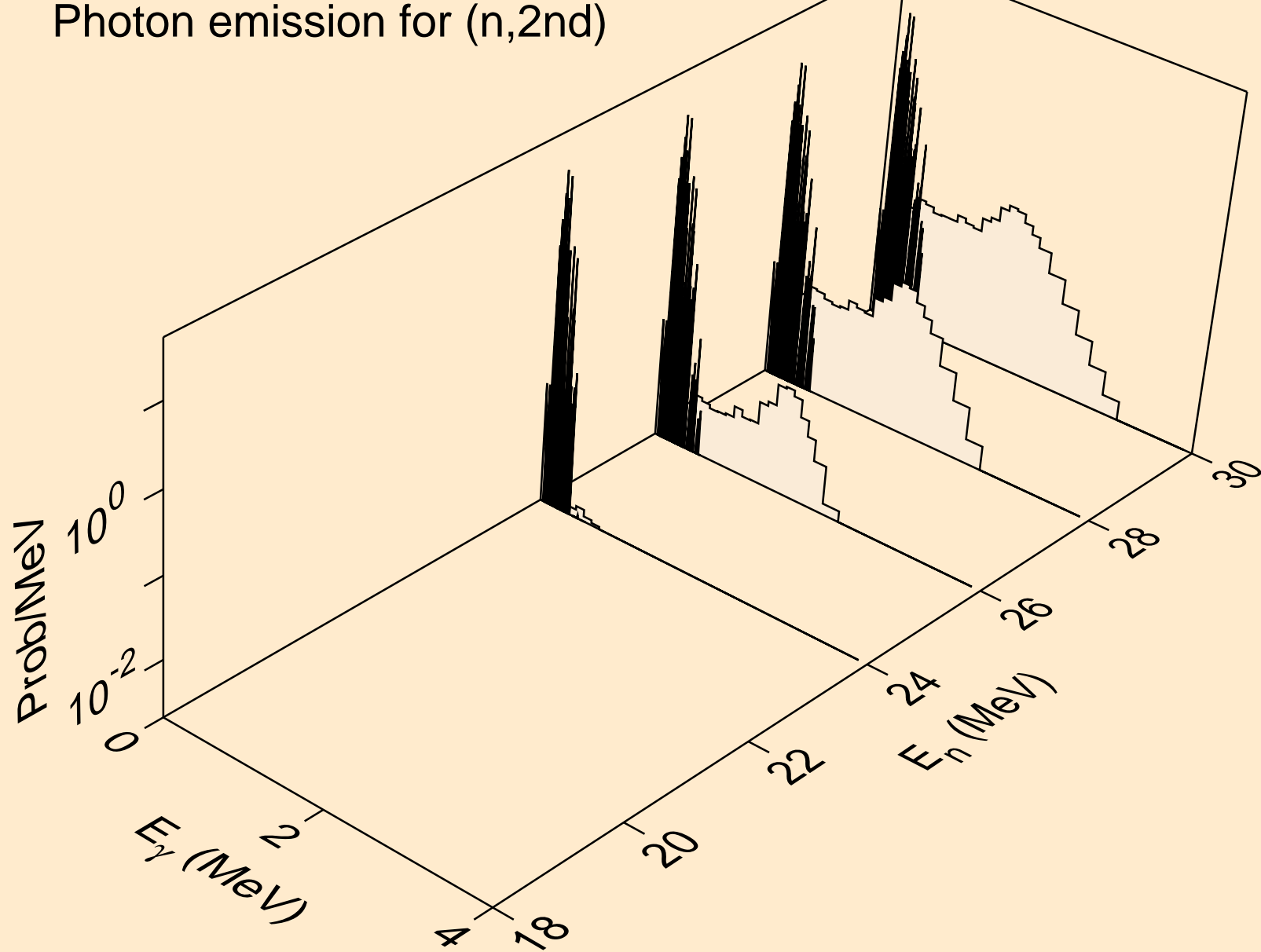

PT189 NEUTRON ACER TENDL-2024 LIBRARY; T=293.6K
Photon emission for (n,2n)

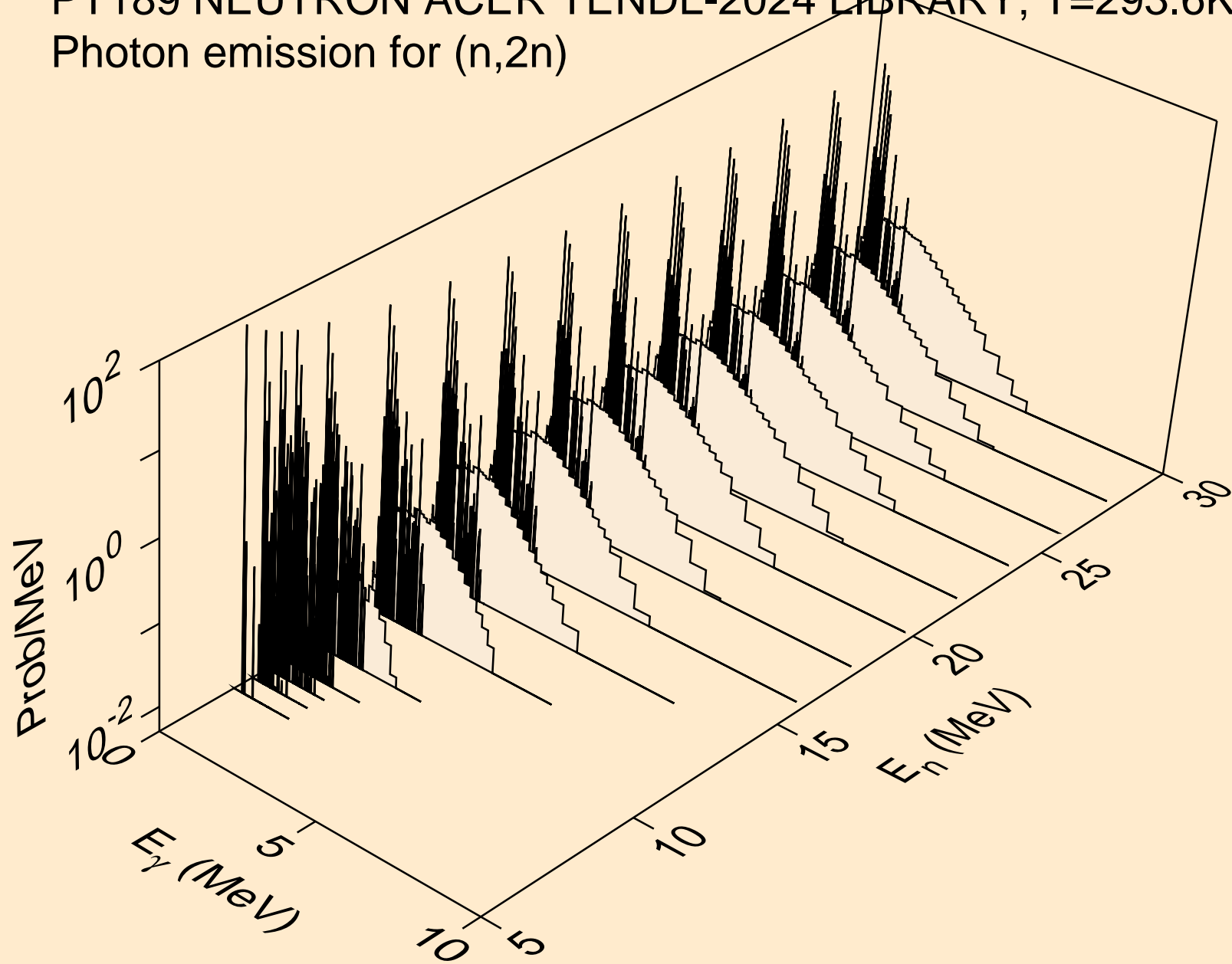

PT189 NEUTRON ACER TENDL-2024 LIBRARY; T=293.6K
Photon emission for (n,3n)

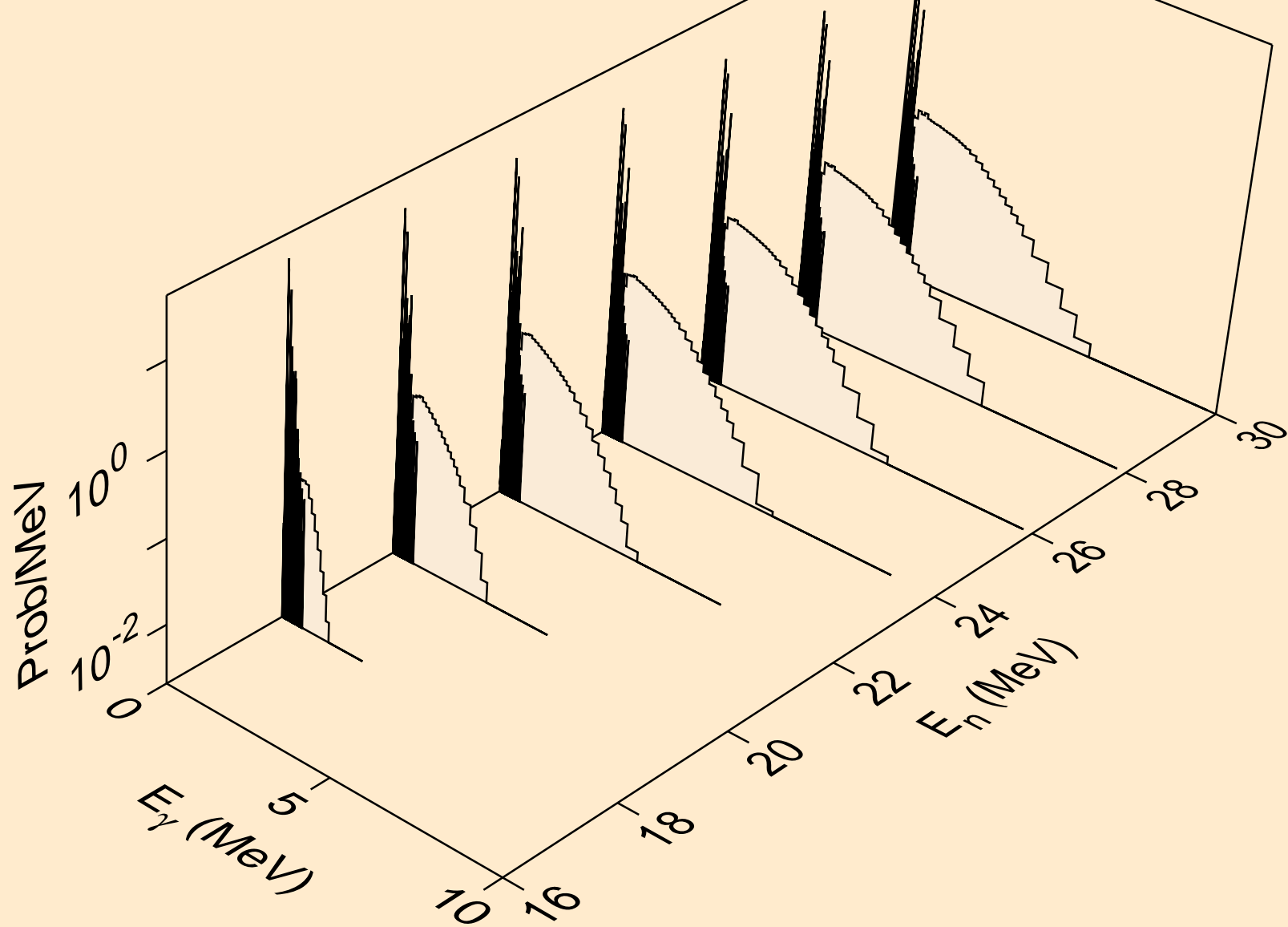

PT189 NEUTRON ACER TENDL-2024 LIBRARY; T=293.6K
Photon emission for (n,n*)a

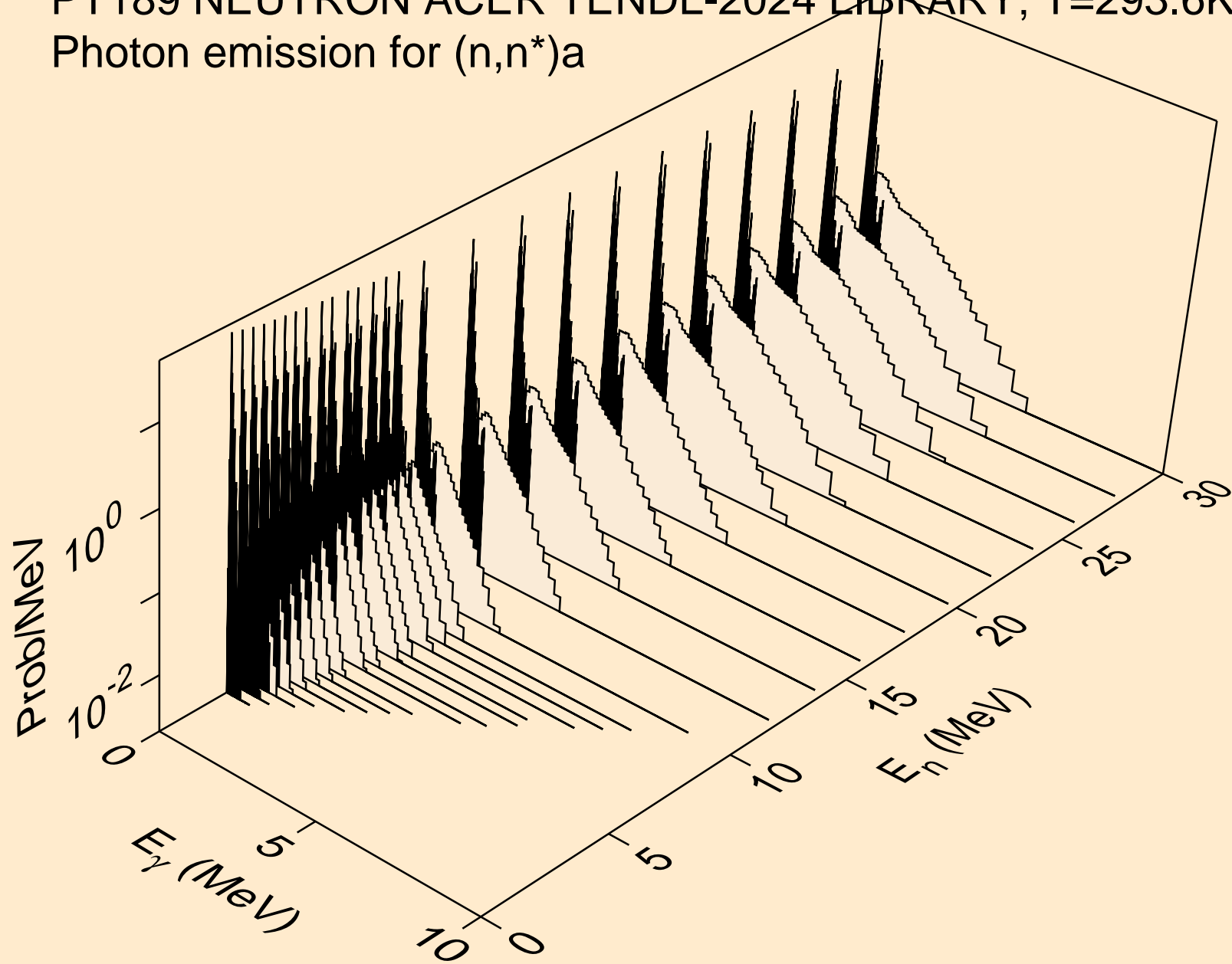

PT189 NEUTRON ACER TENDL-2024 LIBRARY; T=293.6K
Photon emission for (n,2n)a

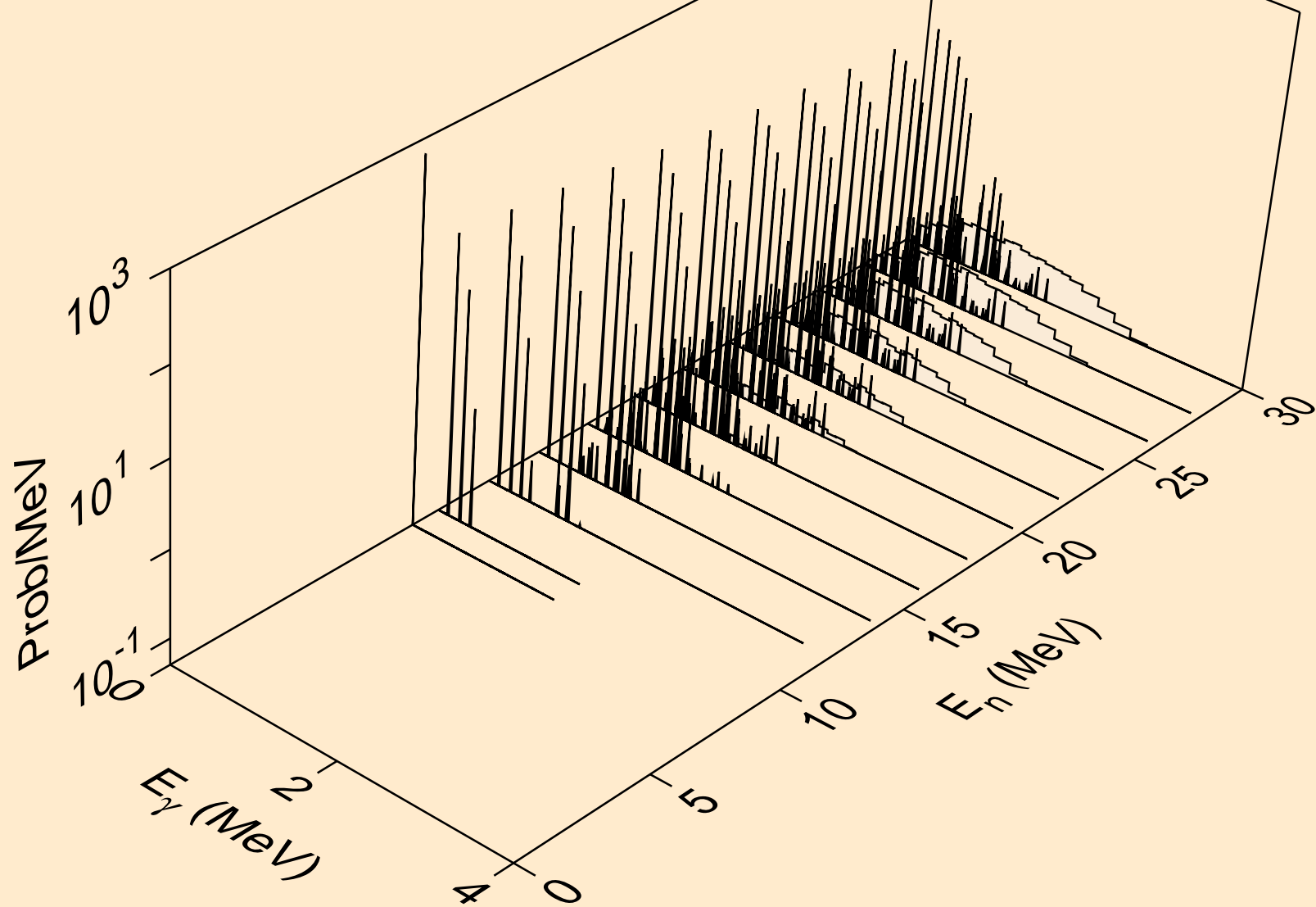

PT189 NEUTRON ACER TENDL-2024 LIBRARY; T=293.6K
Photon emission for (n,3n)a

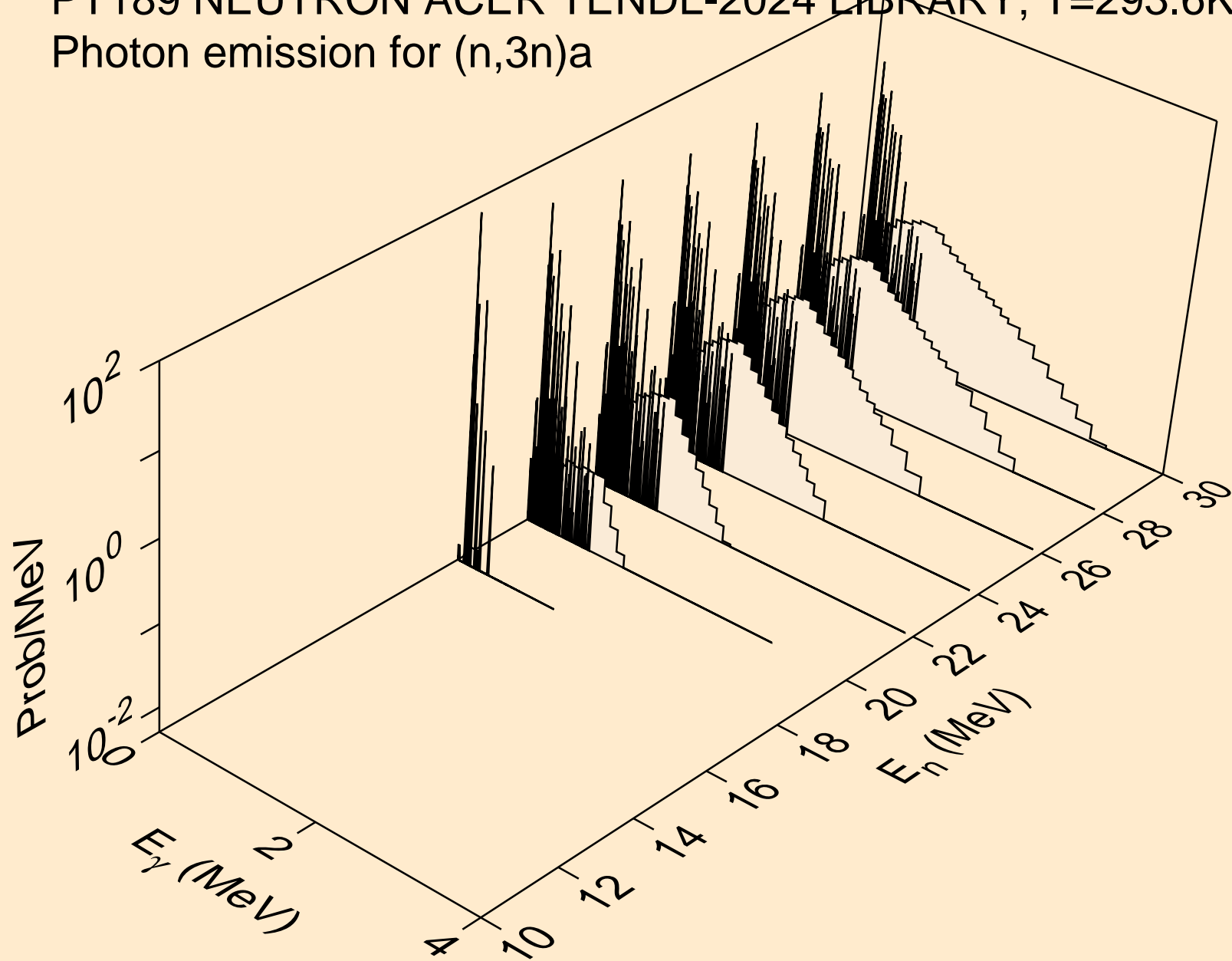

PT189 NEUTRON ACER TENDL-2024 LIBRARY; T=293.6K
Photon emission for (n,n*)p

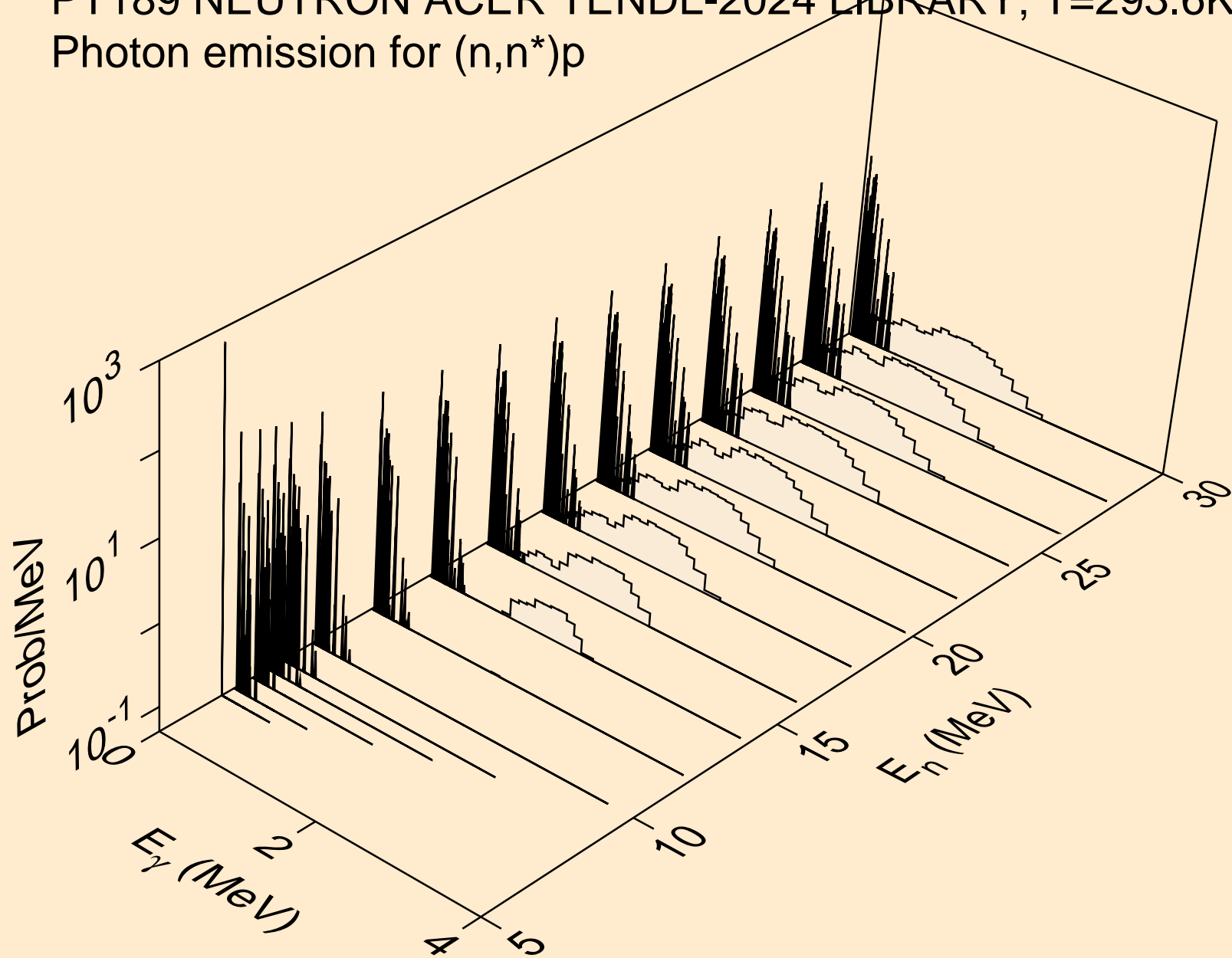

PT189 NEUTRON ACER TENDL-2024 LIBRARY; T=293.6K
Photon emission for (n,n*)2a

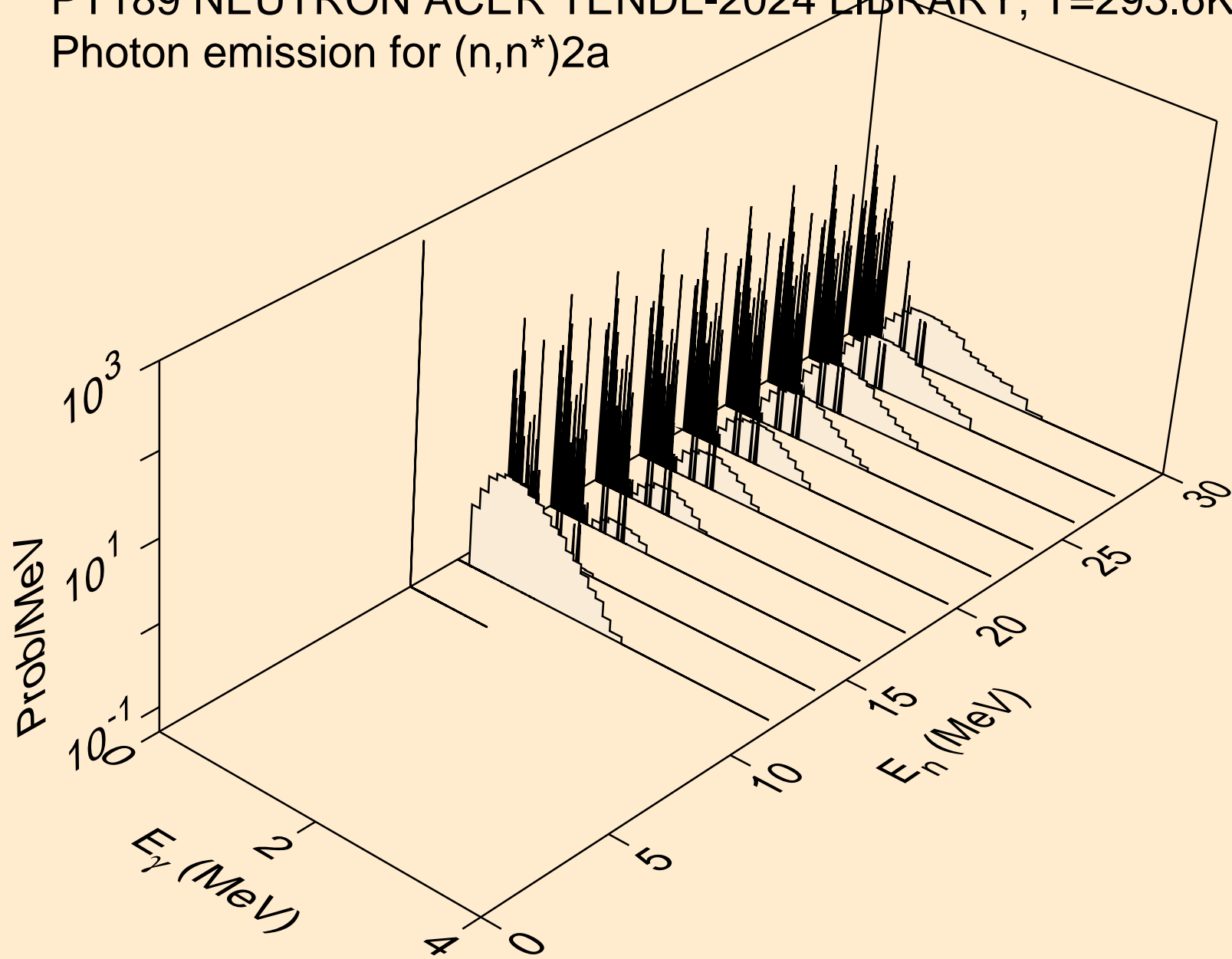

PT189 NEUTRON ACER TENDL-2024 LIBRARY; T=293.6K
Photon emission for (n,2n)2a

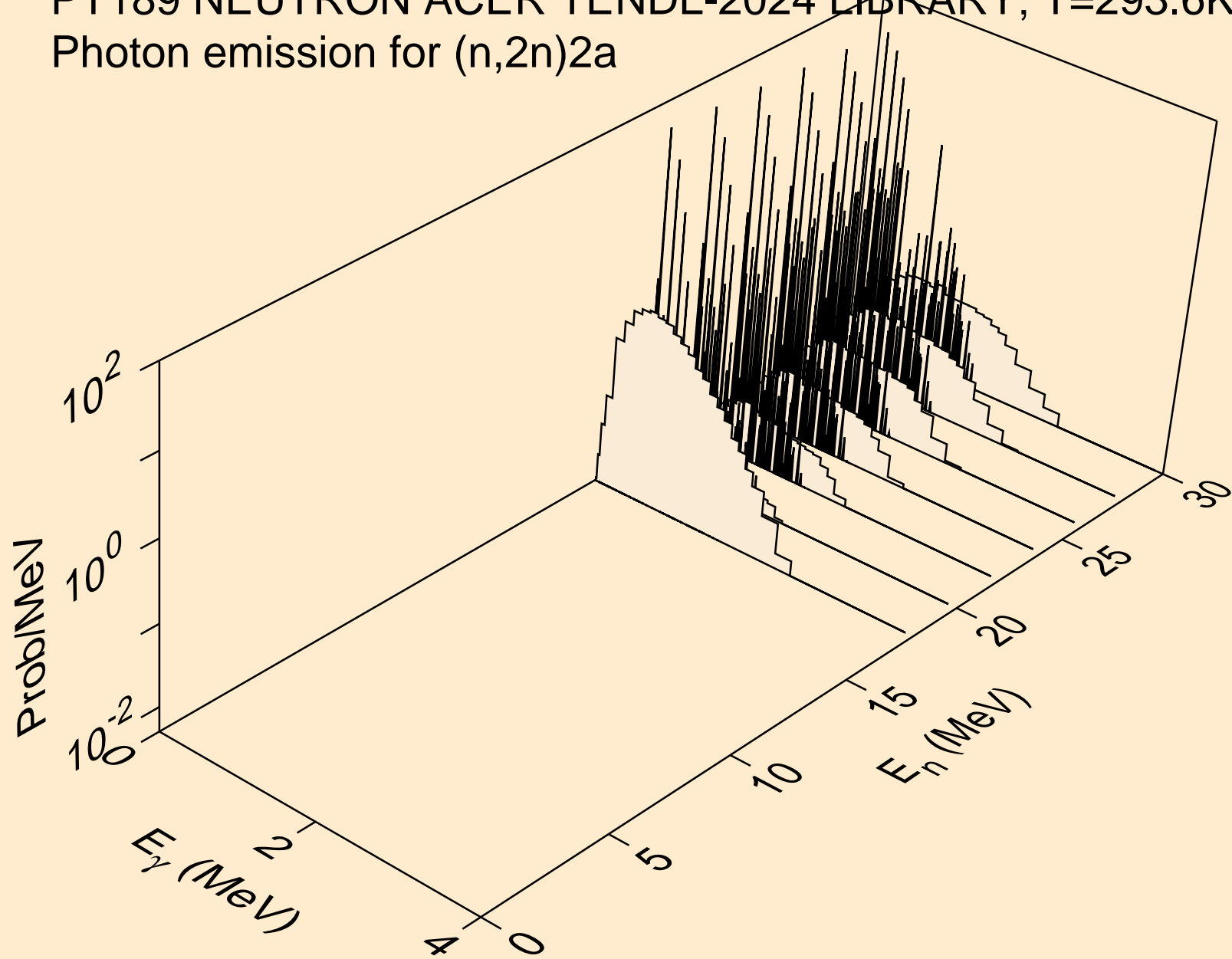

PT189 NEUTRON ACER TENDL-2024 LIBRARY; T=293.6K
Photon emission for (n,n*)d

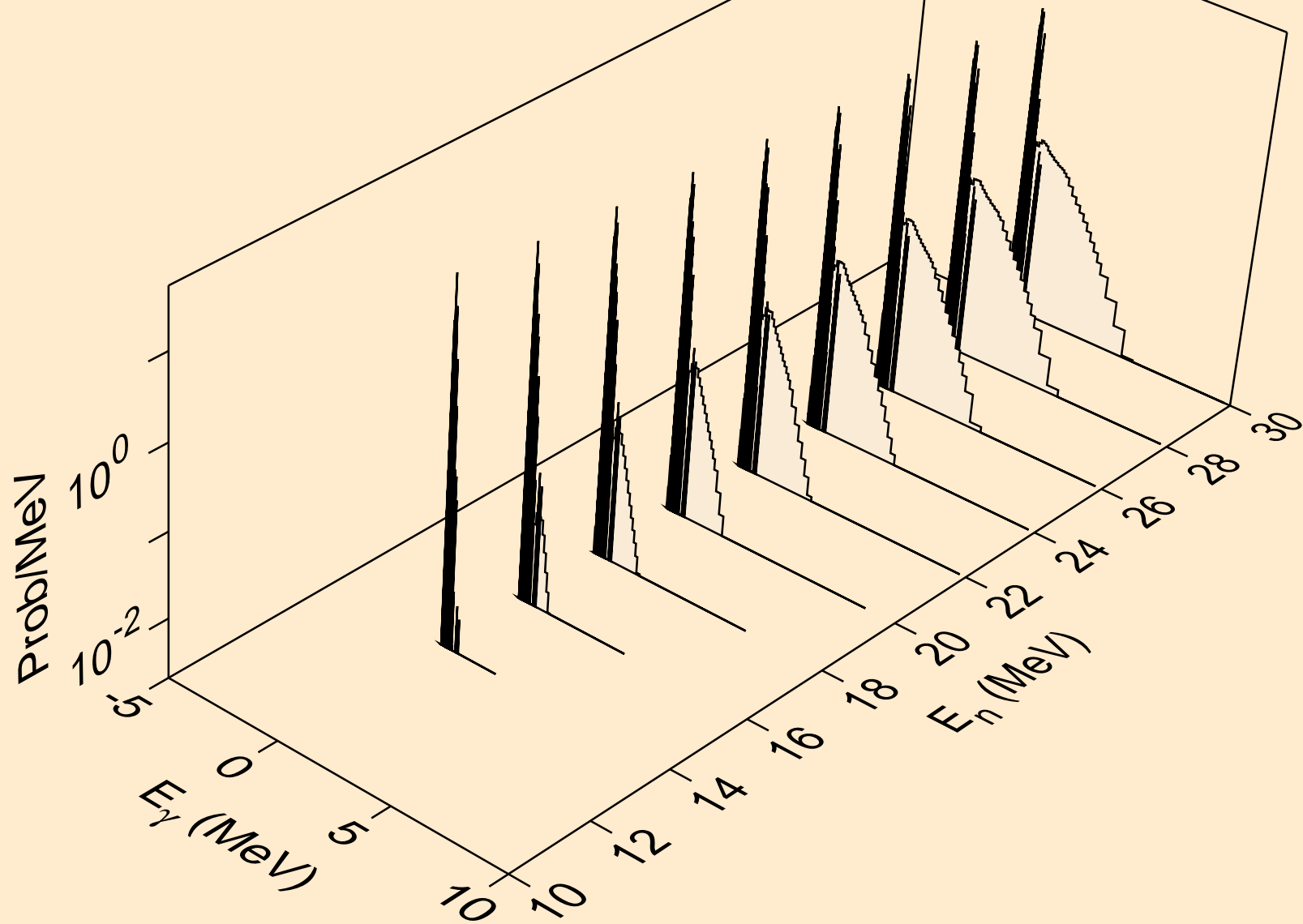

PT189 NEUTRON ACER TENDL-2024 LIBRARY; T=293.6K
Photon emission for (n,n*)t

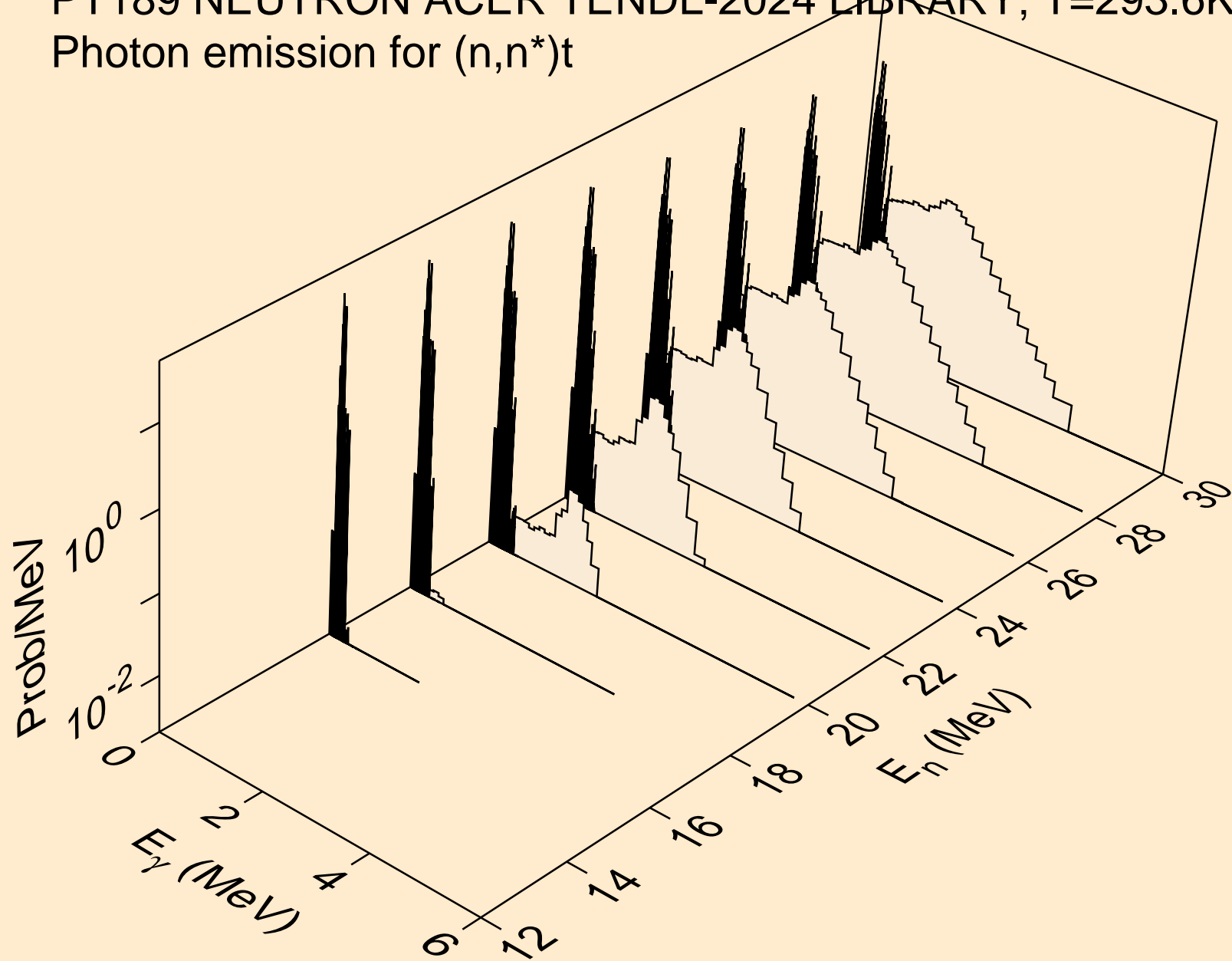

PT189 NEUTRON ACER TENDL-2024 LIBRARY; T=293.6K
Photon emission for (n,n*)he3

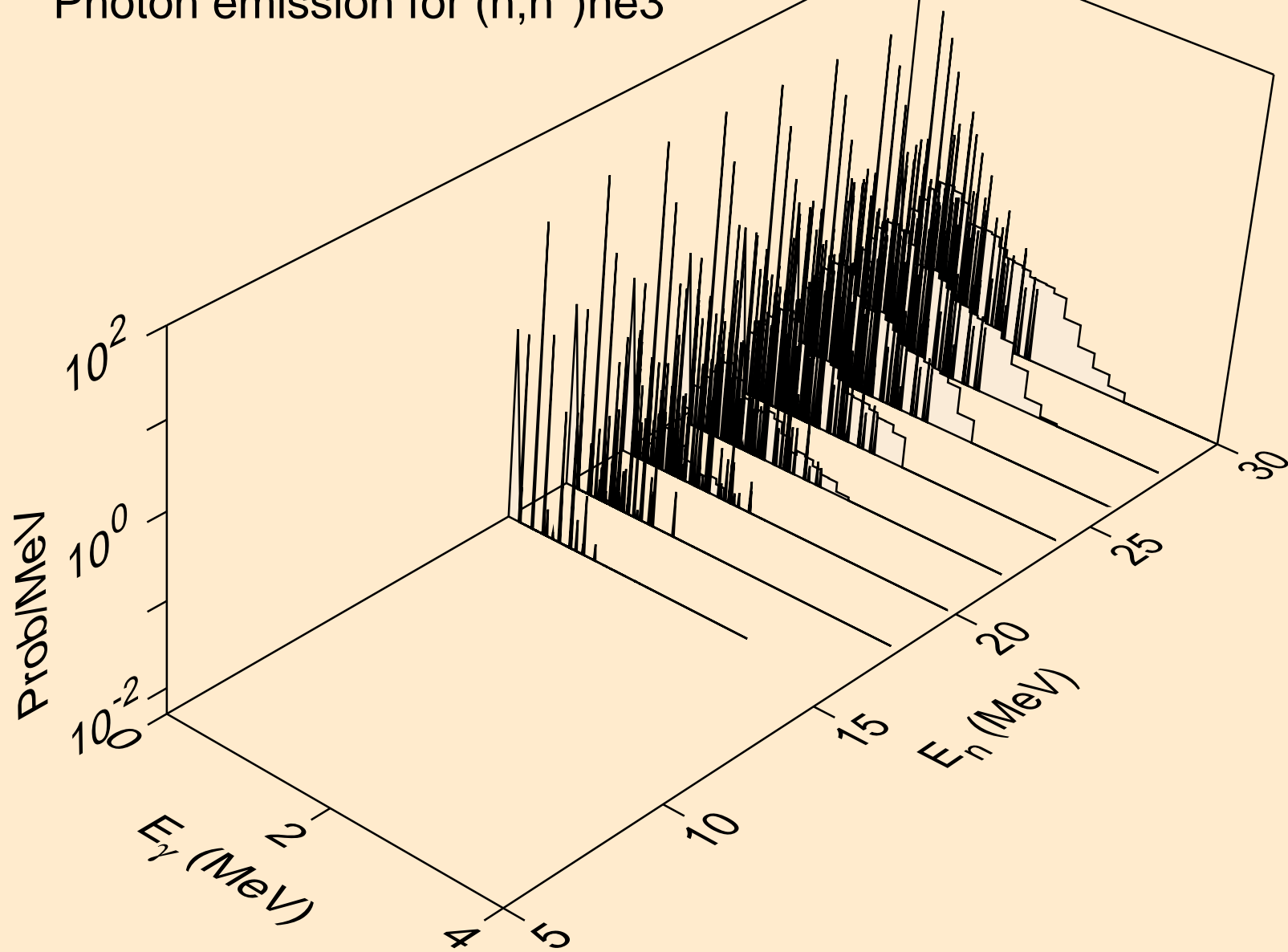

PT189 NEUTRON ACER TENDL-2024 LIBRARY; T=293.6K
Photon emission for (n,4n)

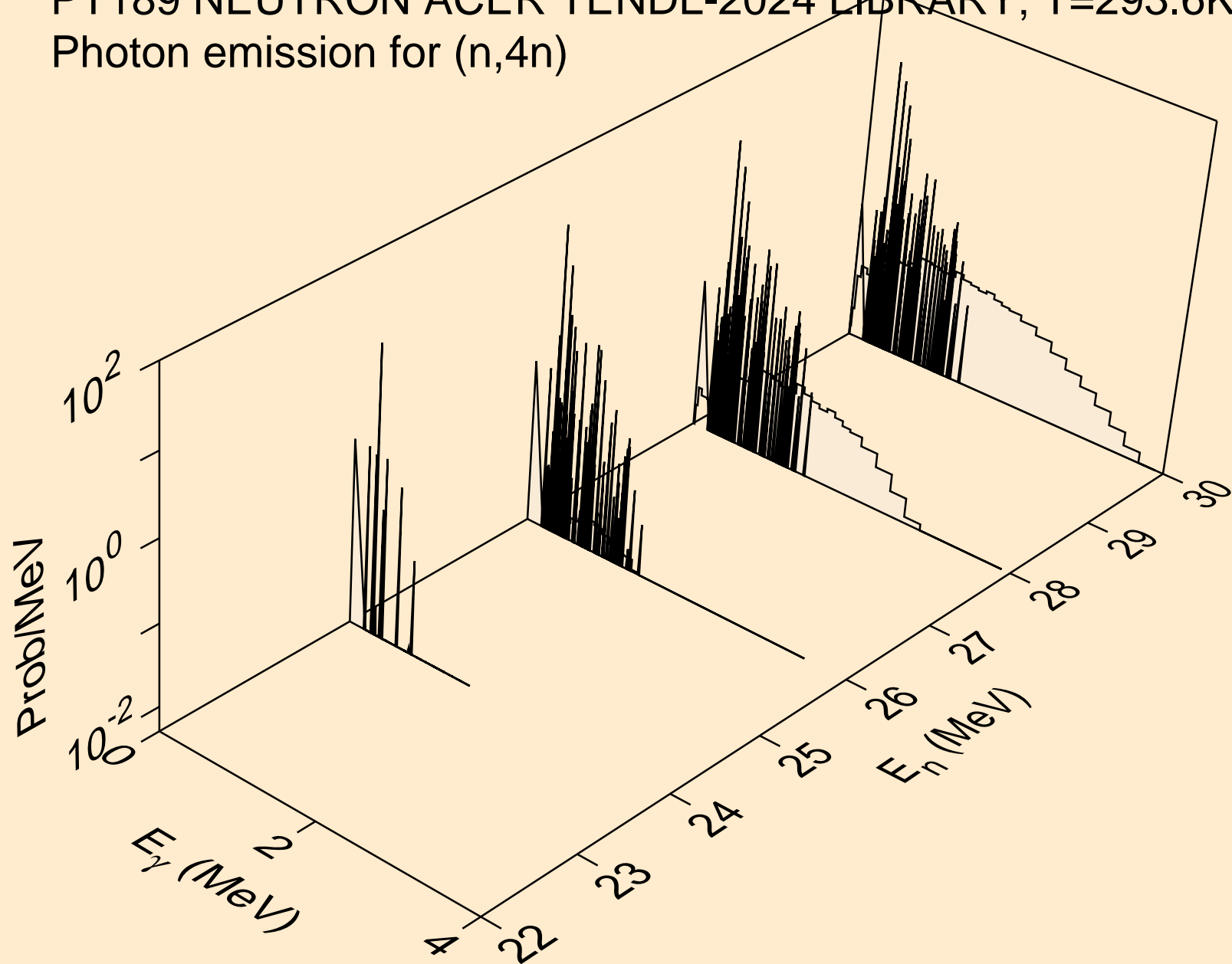

PT189 NEUTRON ACER TENDL-2024 LIBRARY; T=293.6K
Photon emission for (n,2np)

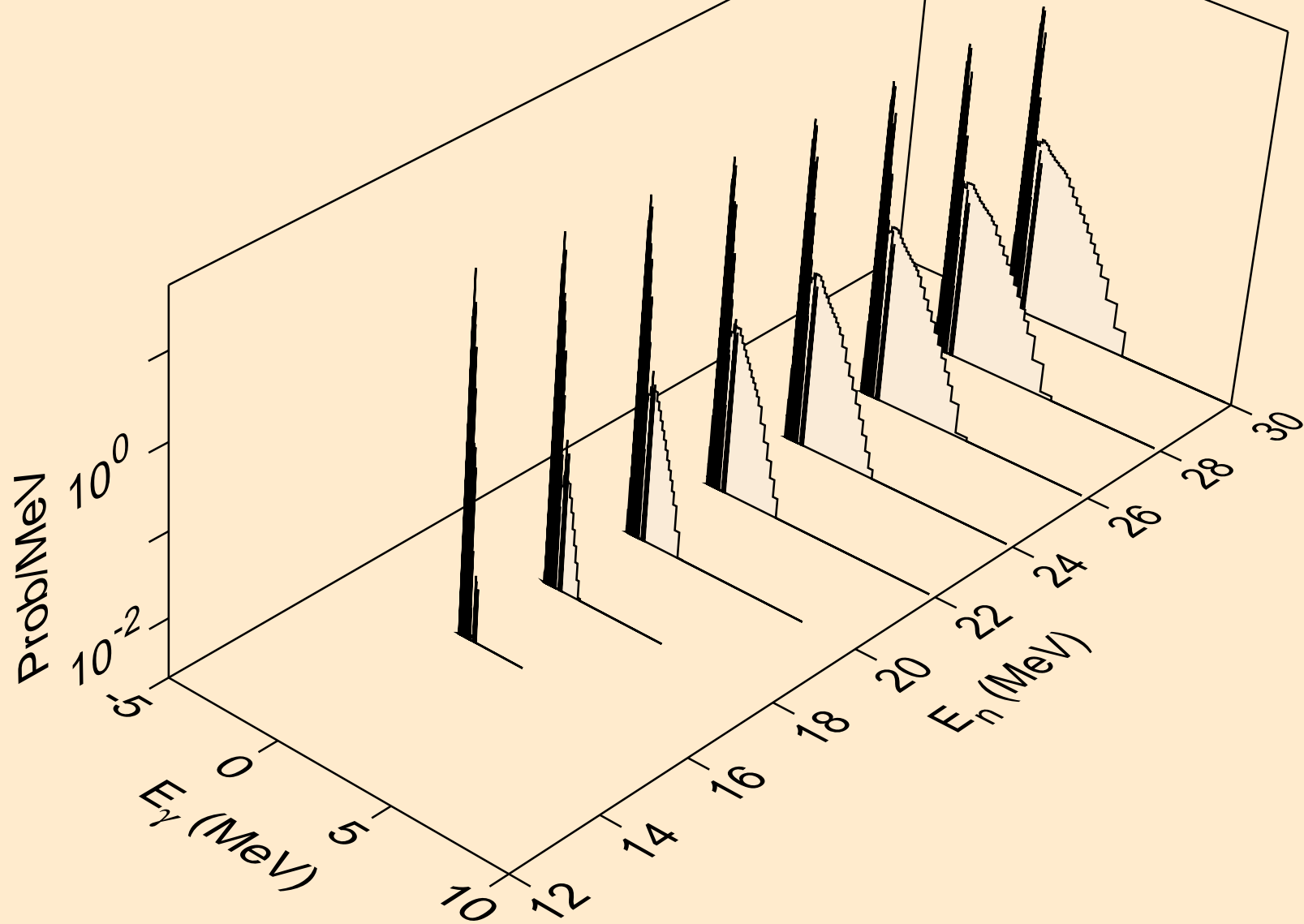

PT189 NEUTRON ACER TENDL-2024 LIBRARY; T=293.6K
Photon emission for (n,3np)

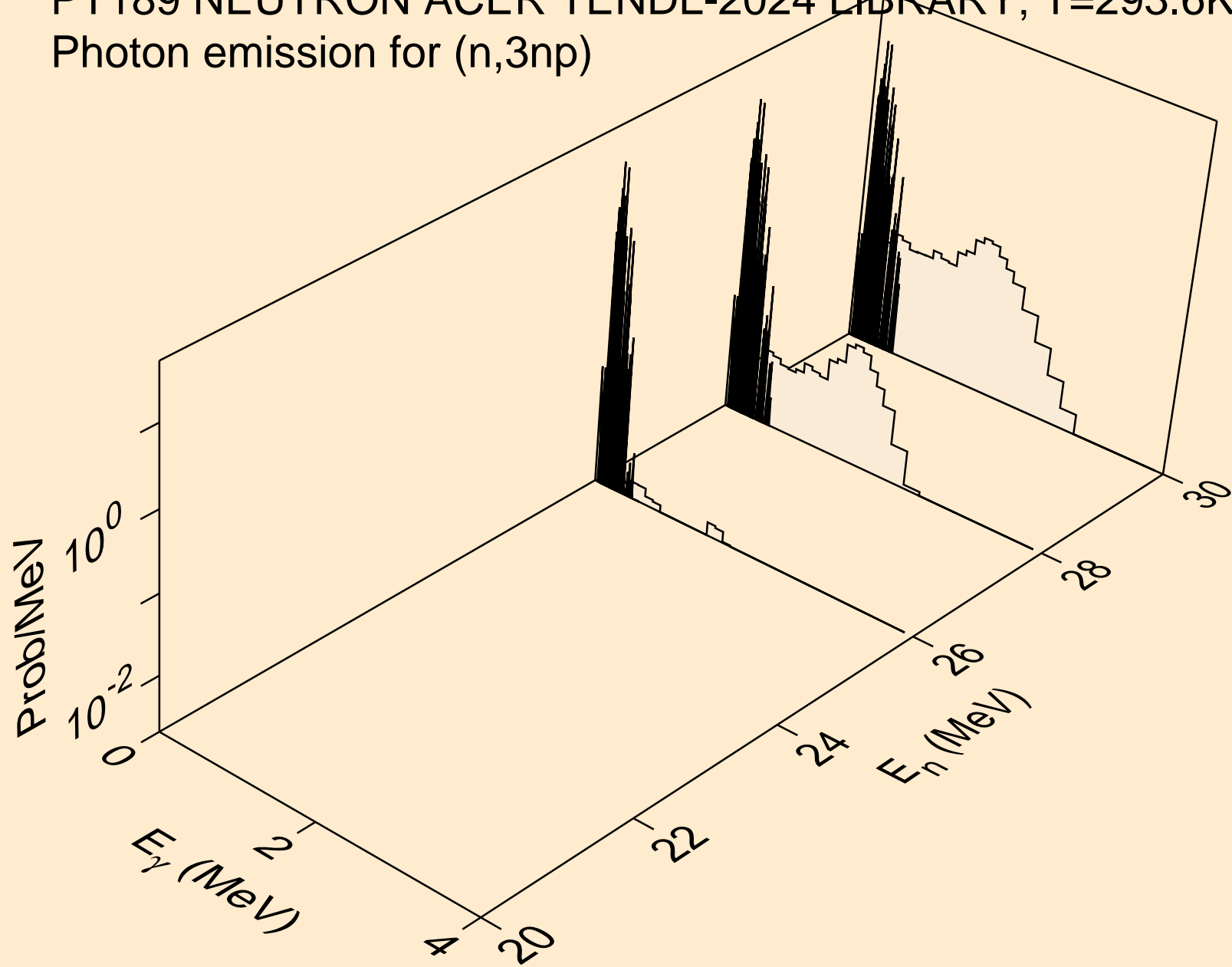

PT189 NEUTRON ACER TENDL-2024 LIBRARY; T=293.6K
Photon emission for (n,n2p)

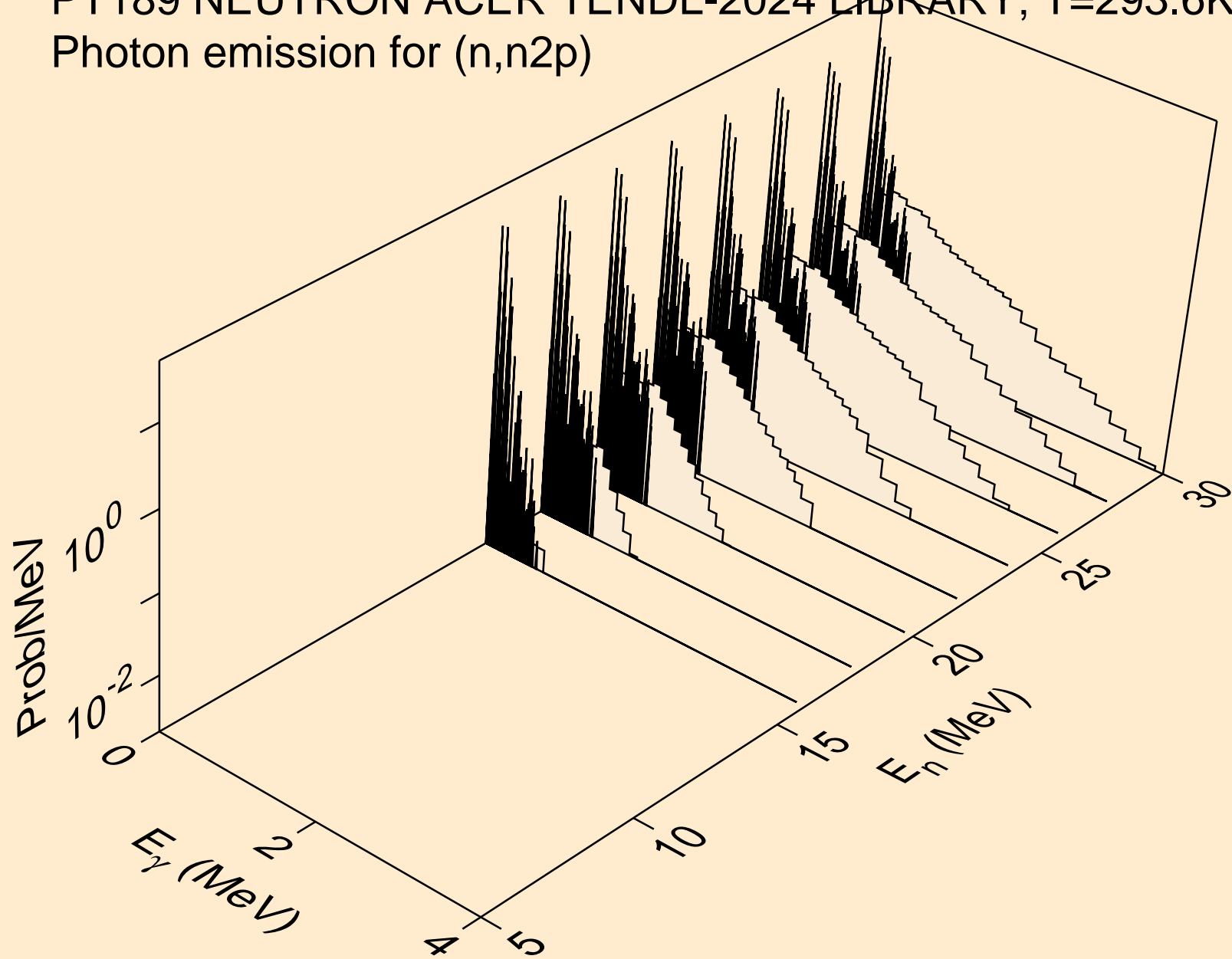

PT189 NEUTRON ACER TENDL-2024 LIBRARY; T=293.6K
Photon emission for (n,npa)

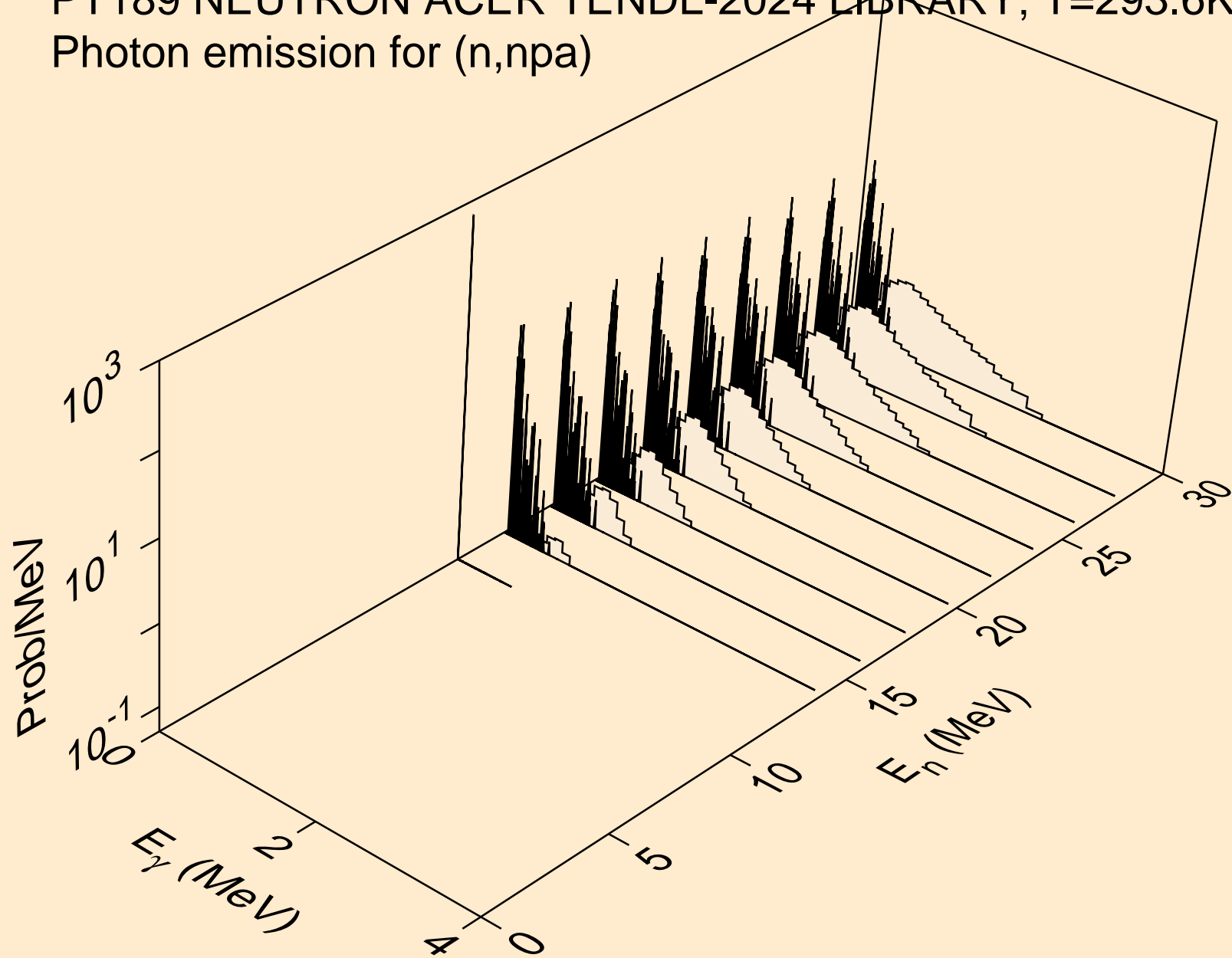

PT189 NEUTRON ACER TENDL-2024 LIBRARY; T=293.6K
Photon emission for (n,n*c)

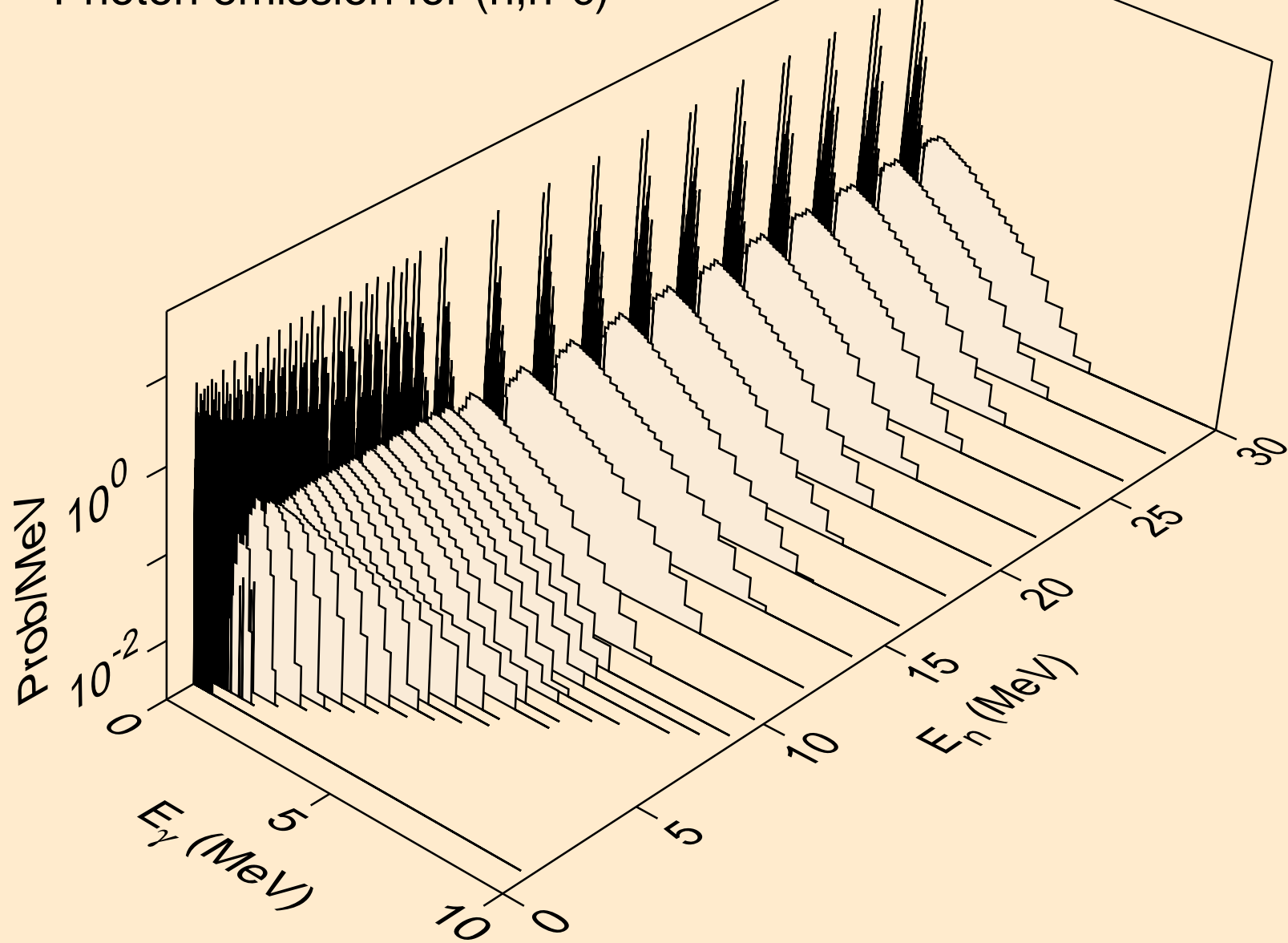

PT189 NEUTRON ACER TENDL-2024 LIBRARY; T=293.6K
Photon emission for (n,gma)

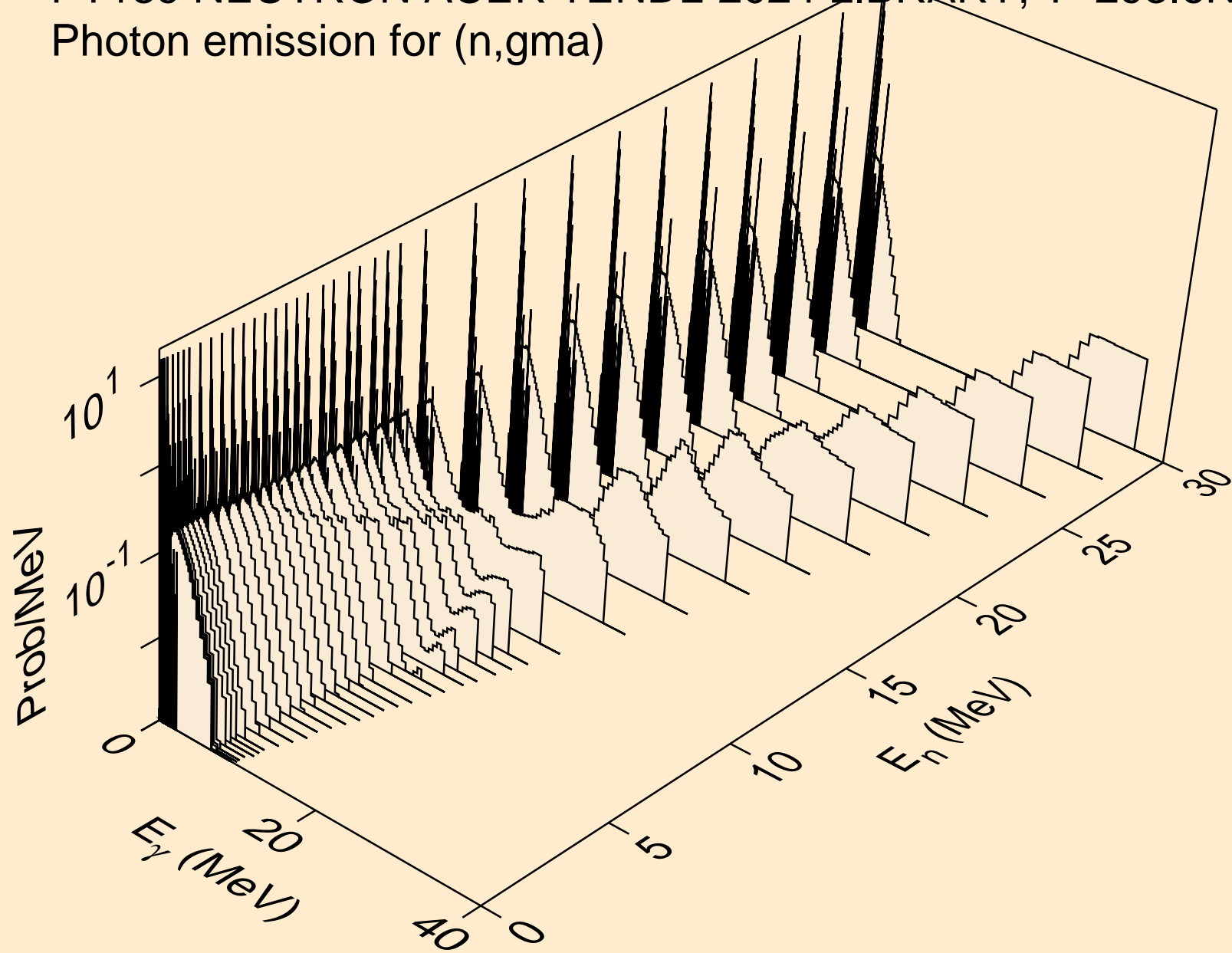

PT189 NEUTRON ACER TENDL-2024 LIBRARY; T=293.6K
Photon emission for (n,p)

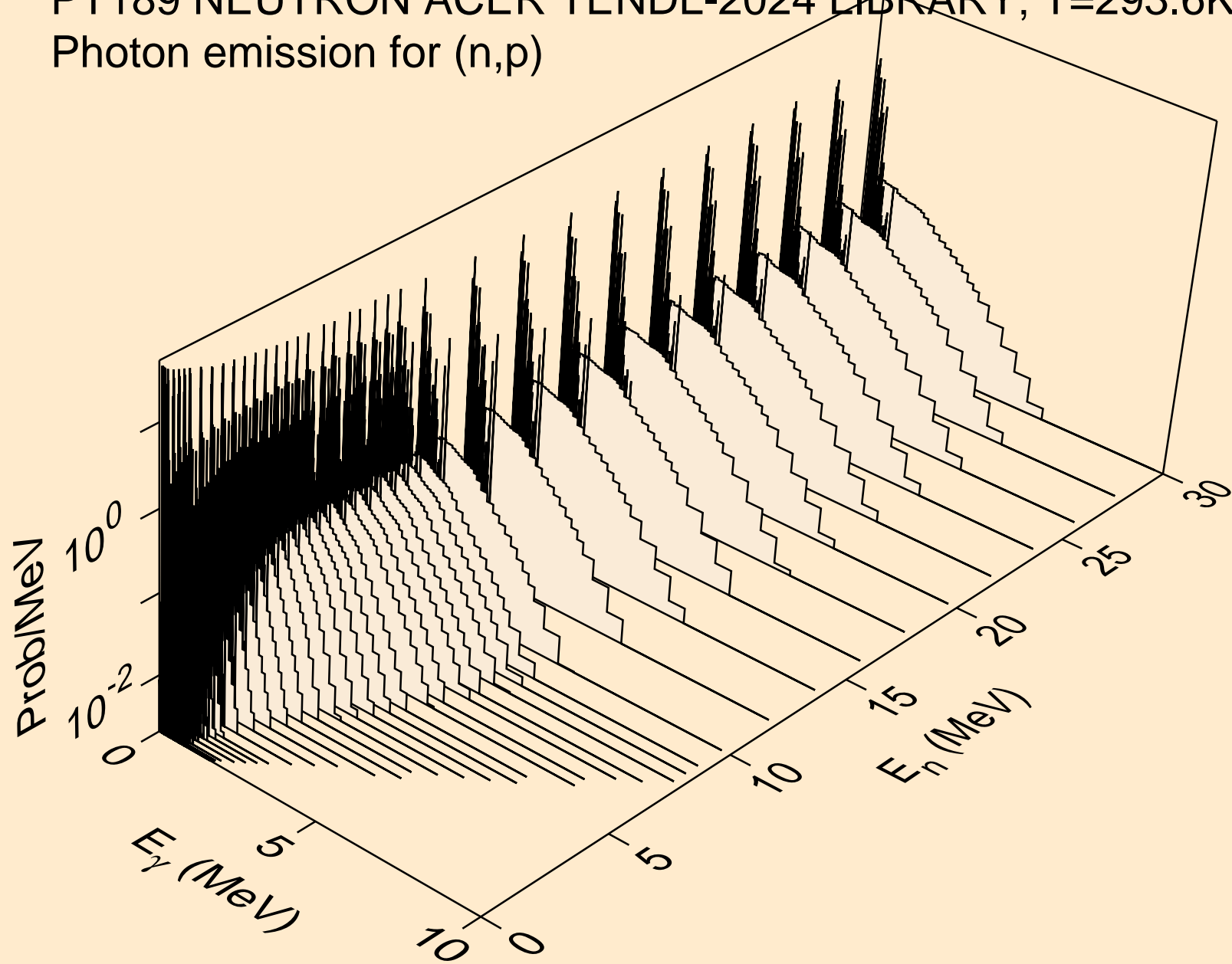

PT189 NEUTRON ACER TENDL-2024 LIBRARY; T=293.6K
Photon emission for (n,d)

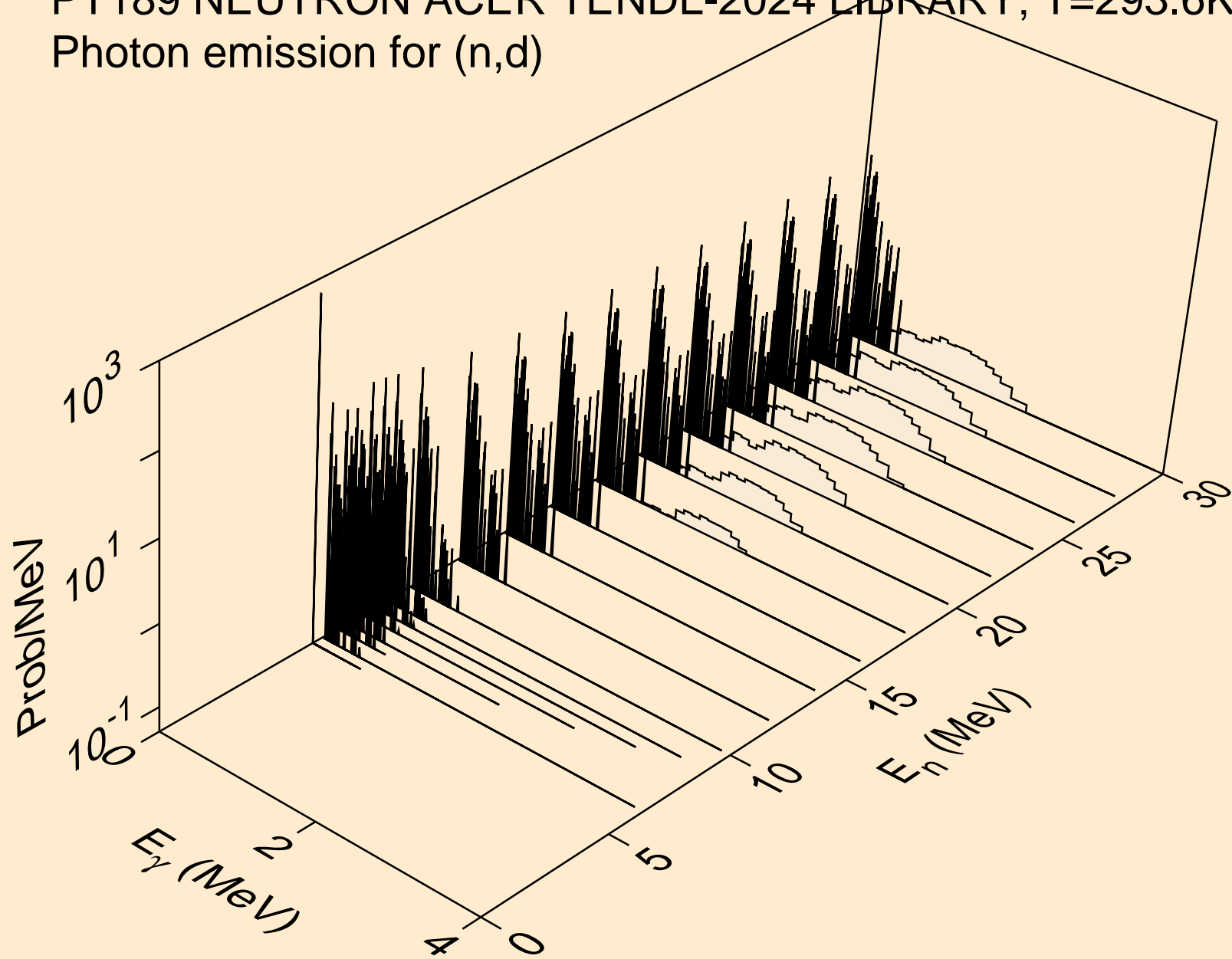

PT189 NEUTRON ACER TENDL-2024 LIBRARY; T=293.6K
Photon emission for (n,t)

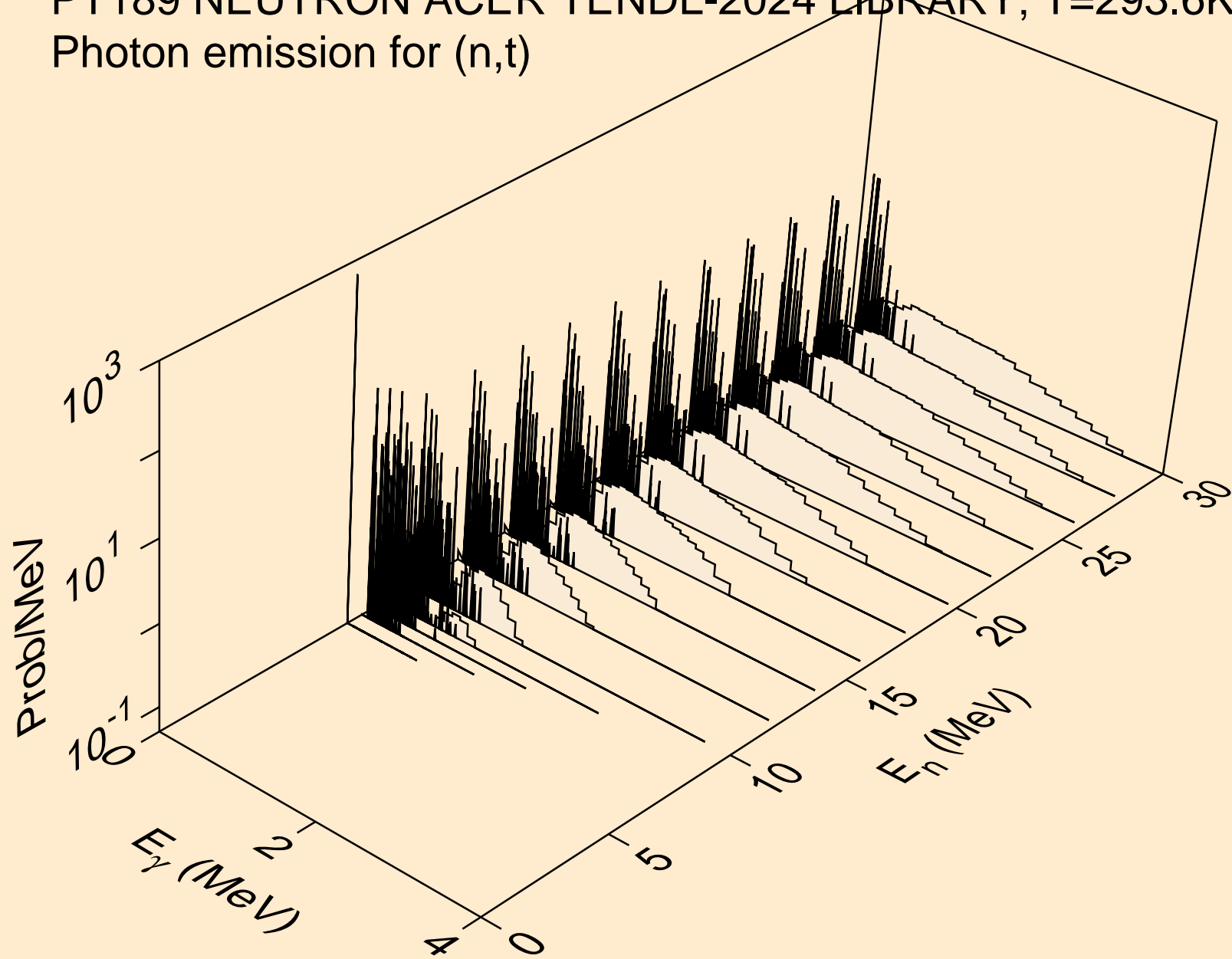

PT189 NEUTRON ACER TENDL-2024 LIBRARY; T=293.6K
Photon emission for (n,he3)

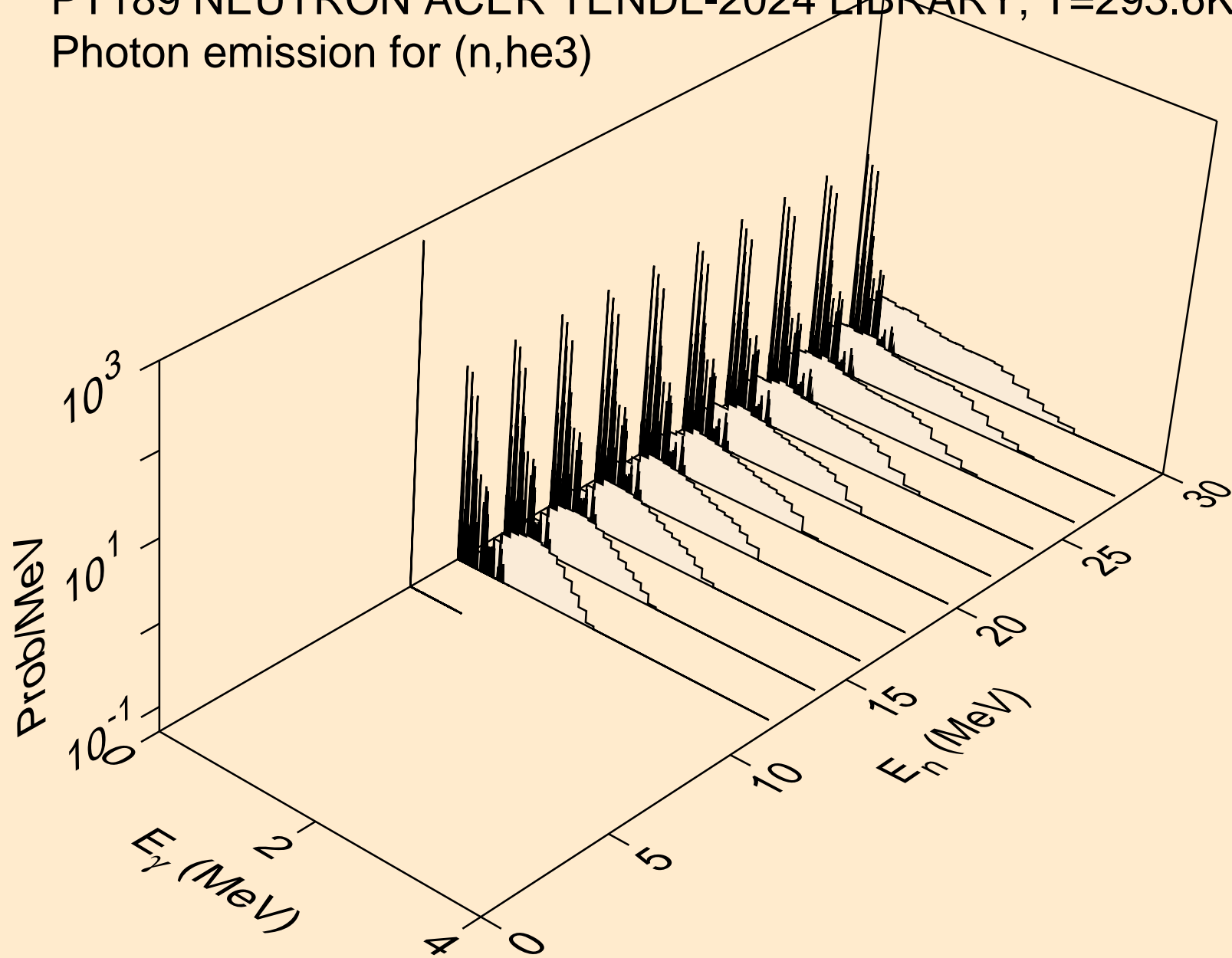

PT189 NEUTRON ACER TENDL-2024 LIBRARY; T=293.6K
Photon emission for (n,a)

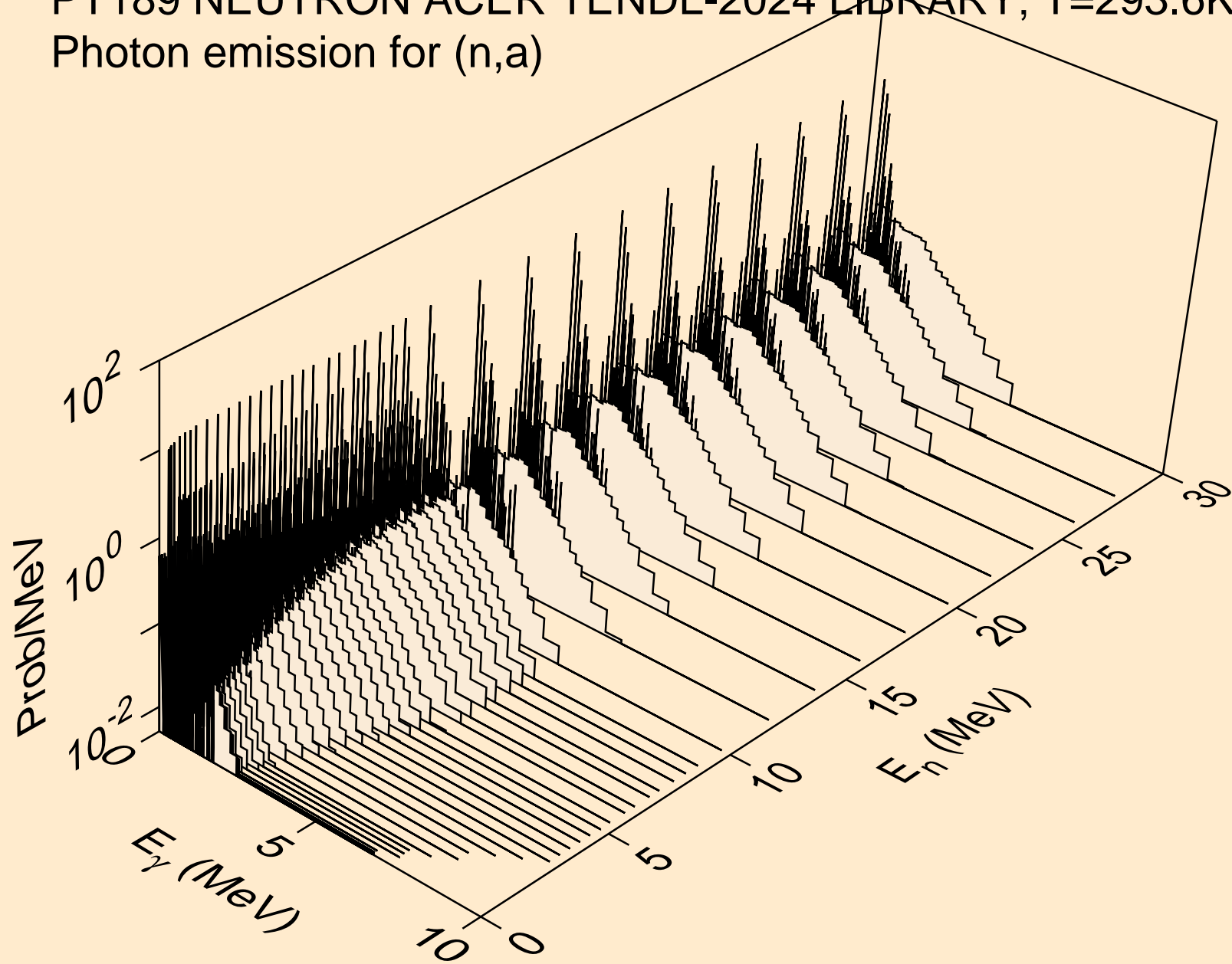

PT189 NEUTRON ACER TENDL-2024 LIBRARY; T=293.6K
Photon emission for (n,2a)

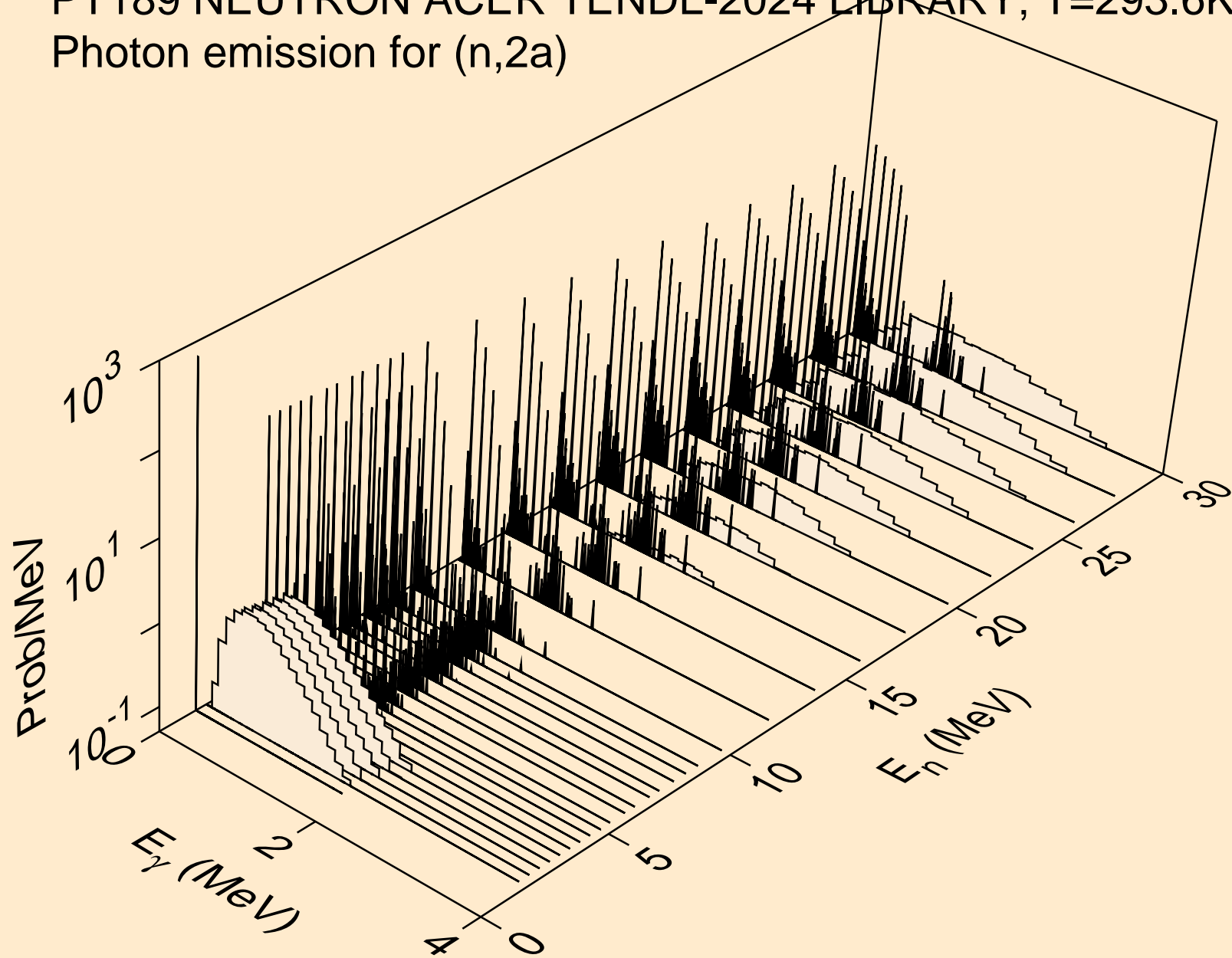

PT189 NEUTRON ACER TENDL-2024 LIBRARY; T=293.6K
Photon emission for (n,2p)

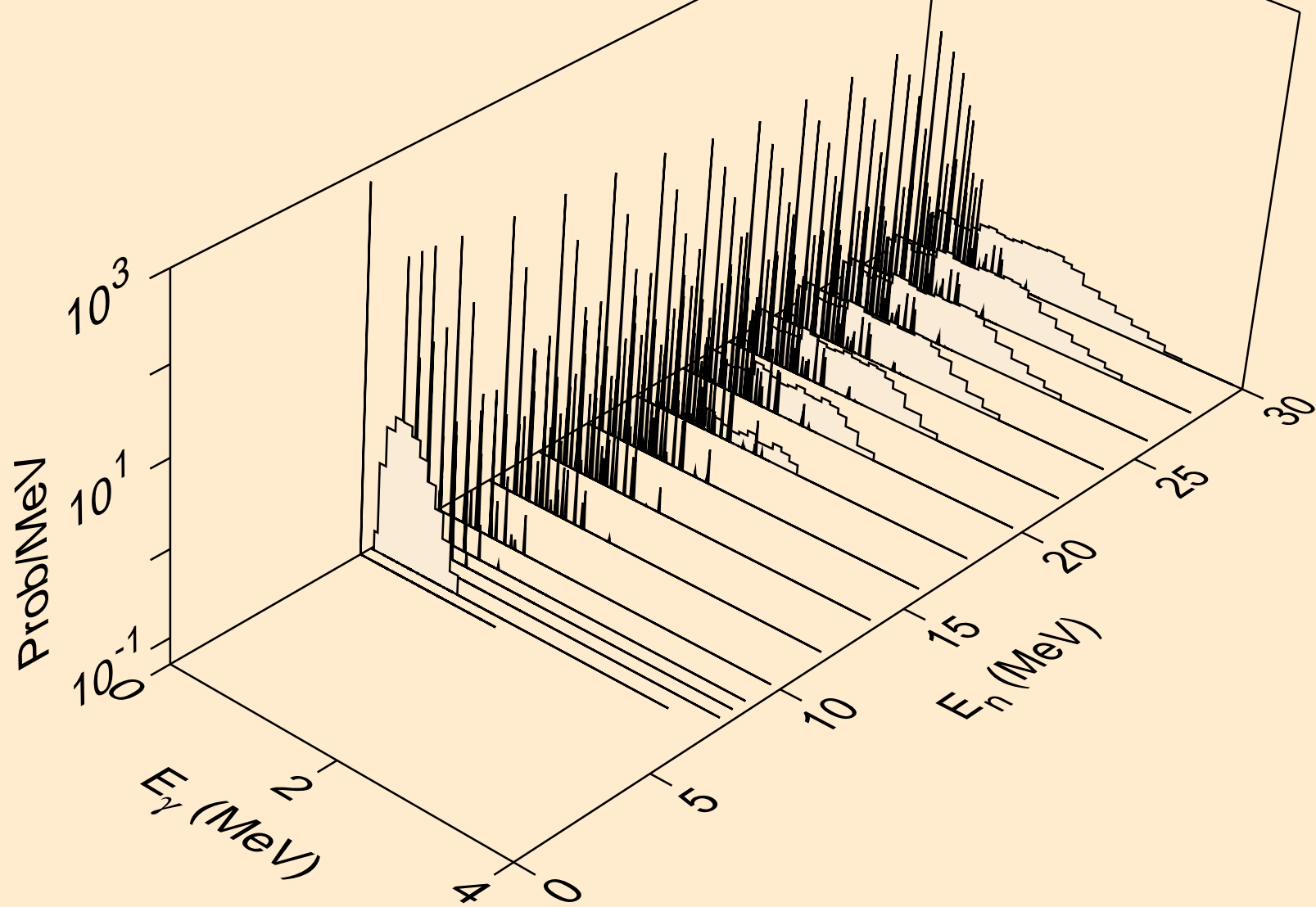

PT189 NEUTRON ACER TENDL-2024 LIBRARY; T=293.6K
Photon emission for (n,p α)

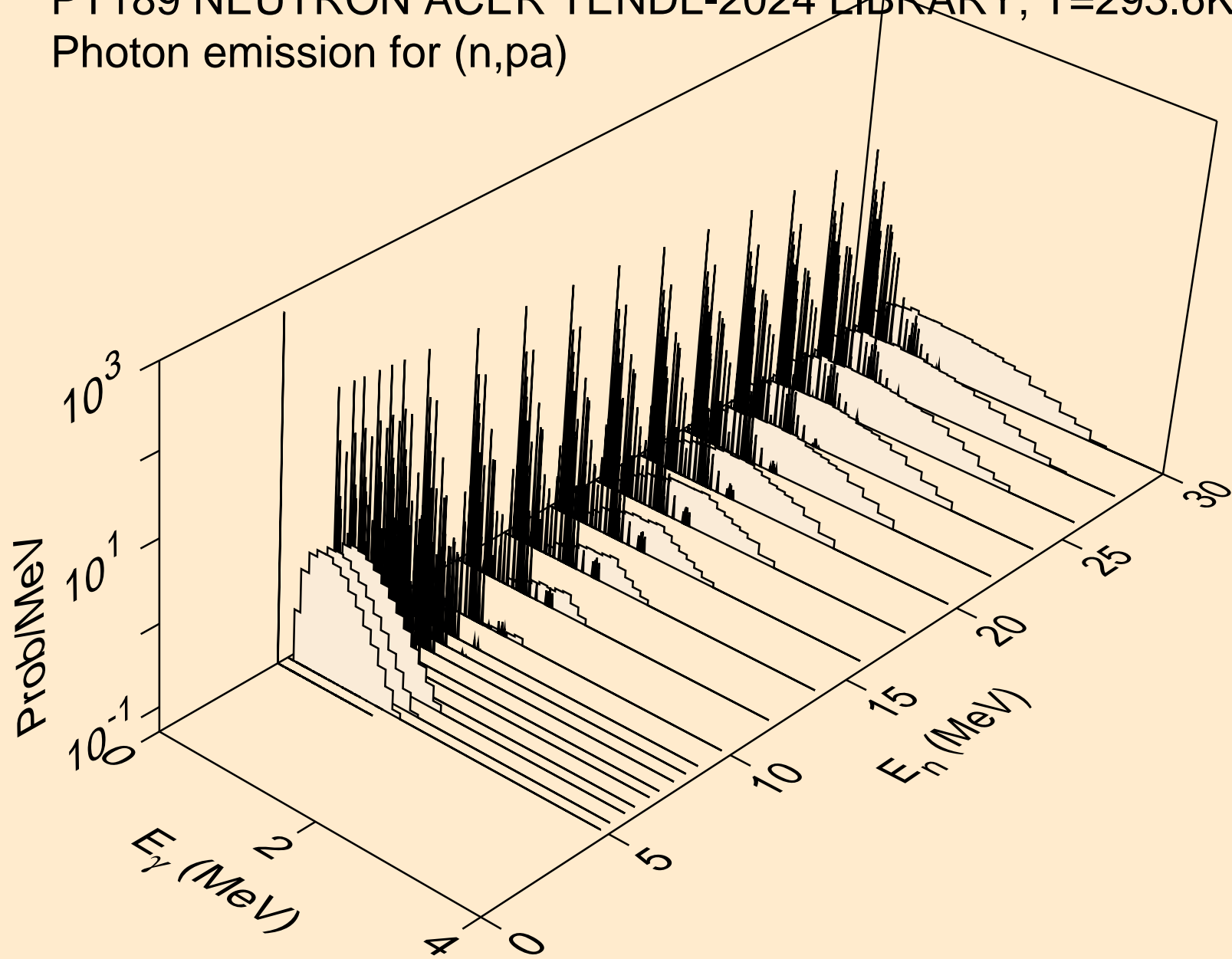

PT189 NEUTRON ACER TENDL-2024 LIBRARY; T=293.6K
Photon emission for (n,pd)

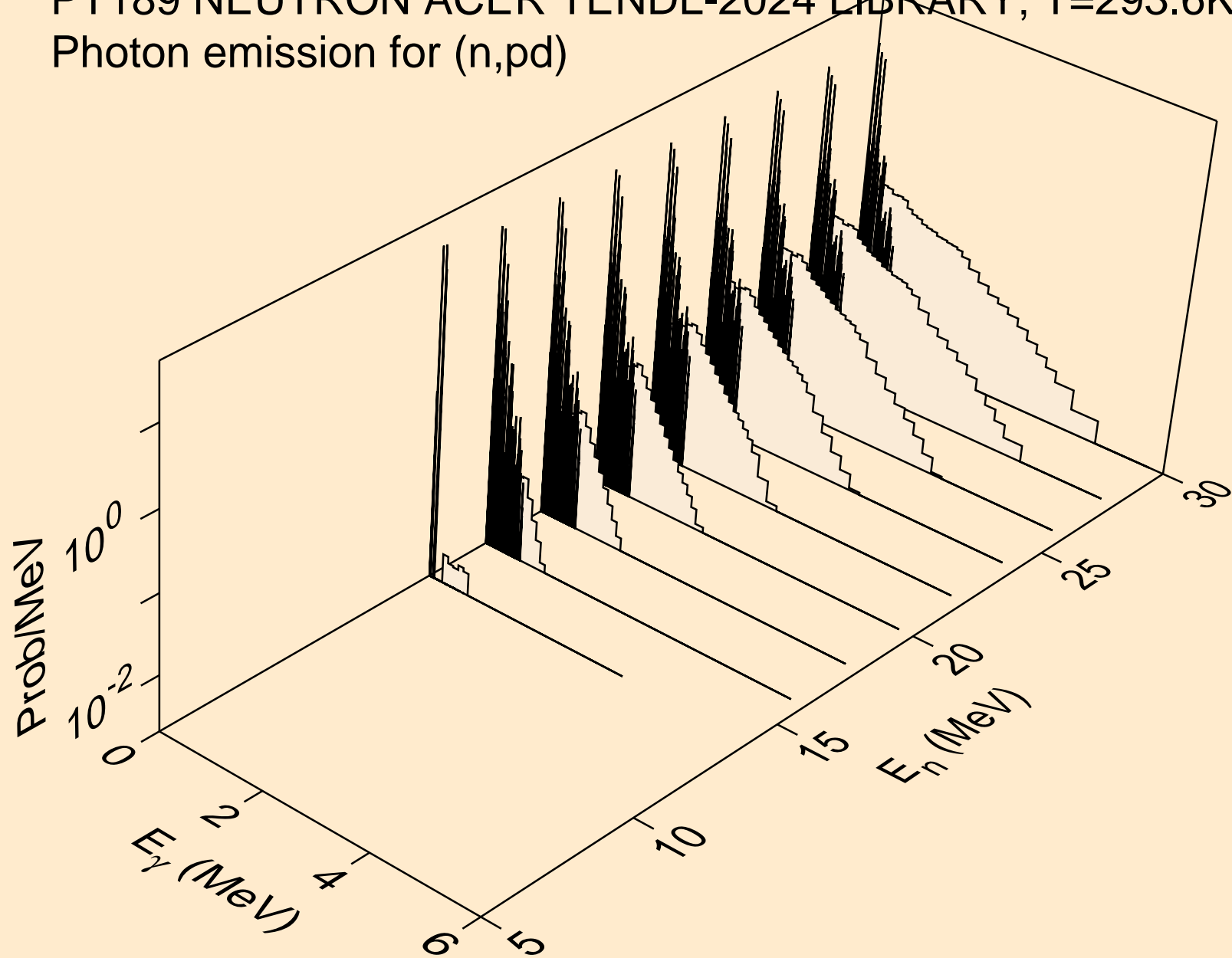

PT189 NEUTRON ACER TENDL-2024 LIBRARY; T=293.6K
Photon emission for (n,pt)

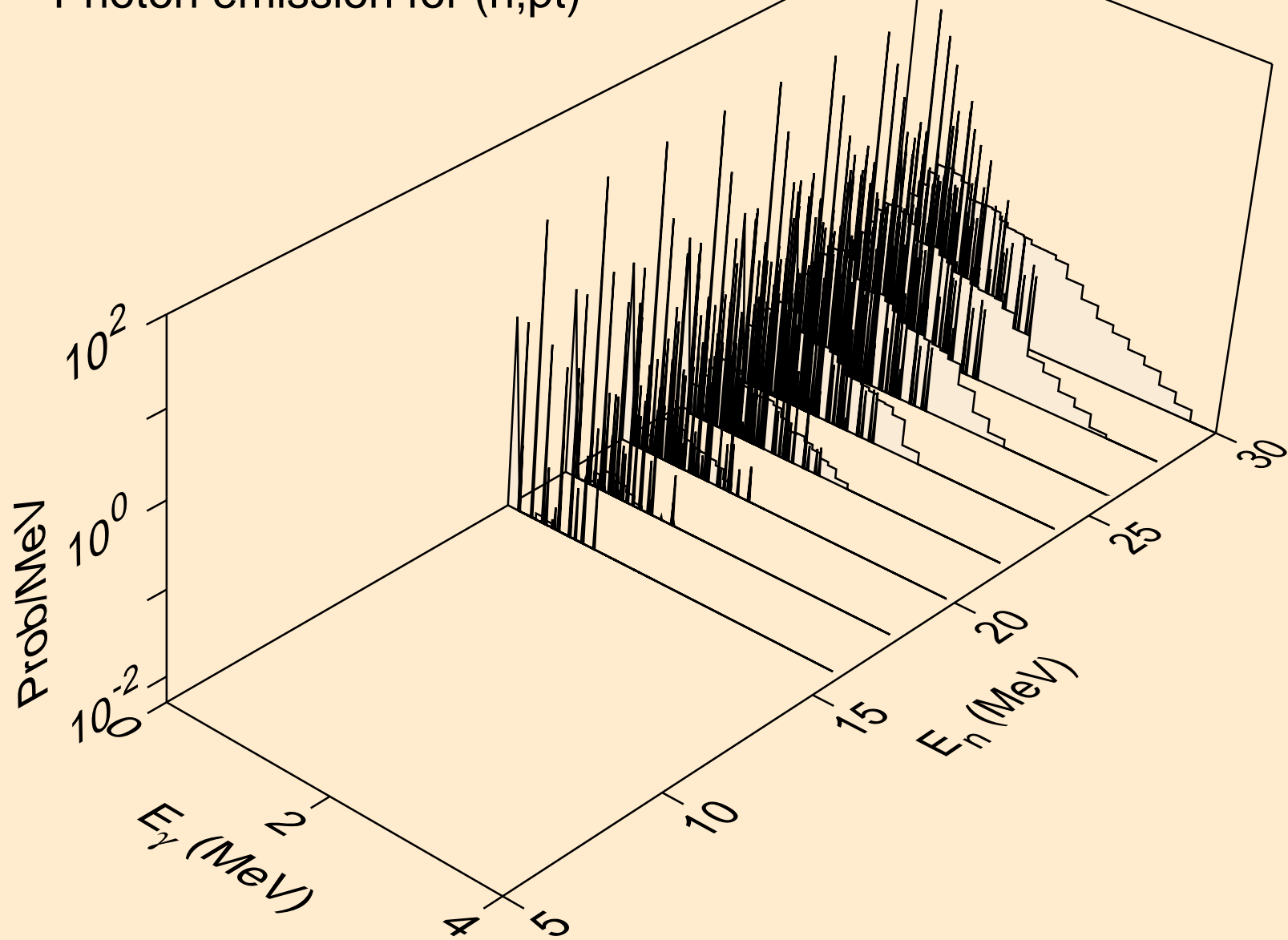

PT189 NEUTRON ACER TENDL-2024 LIBRARY; T=293.6K
Photon emission for (n,da)

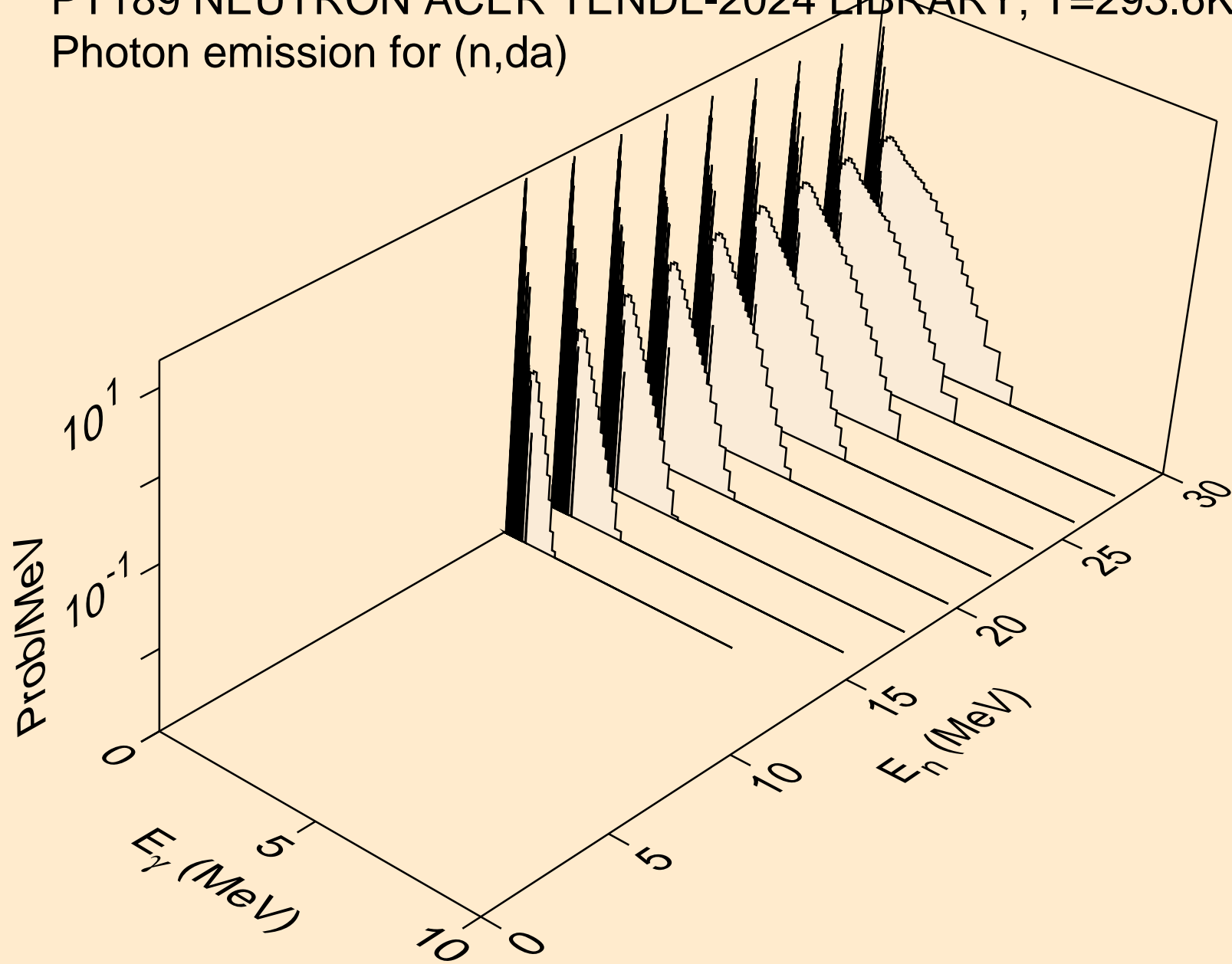

PT189 NEUTRON ACER TENDL-2024 LIBRARY; T=293.6K
thermal capture photon spectrum

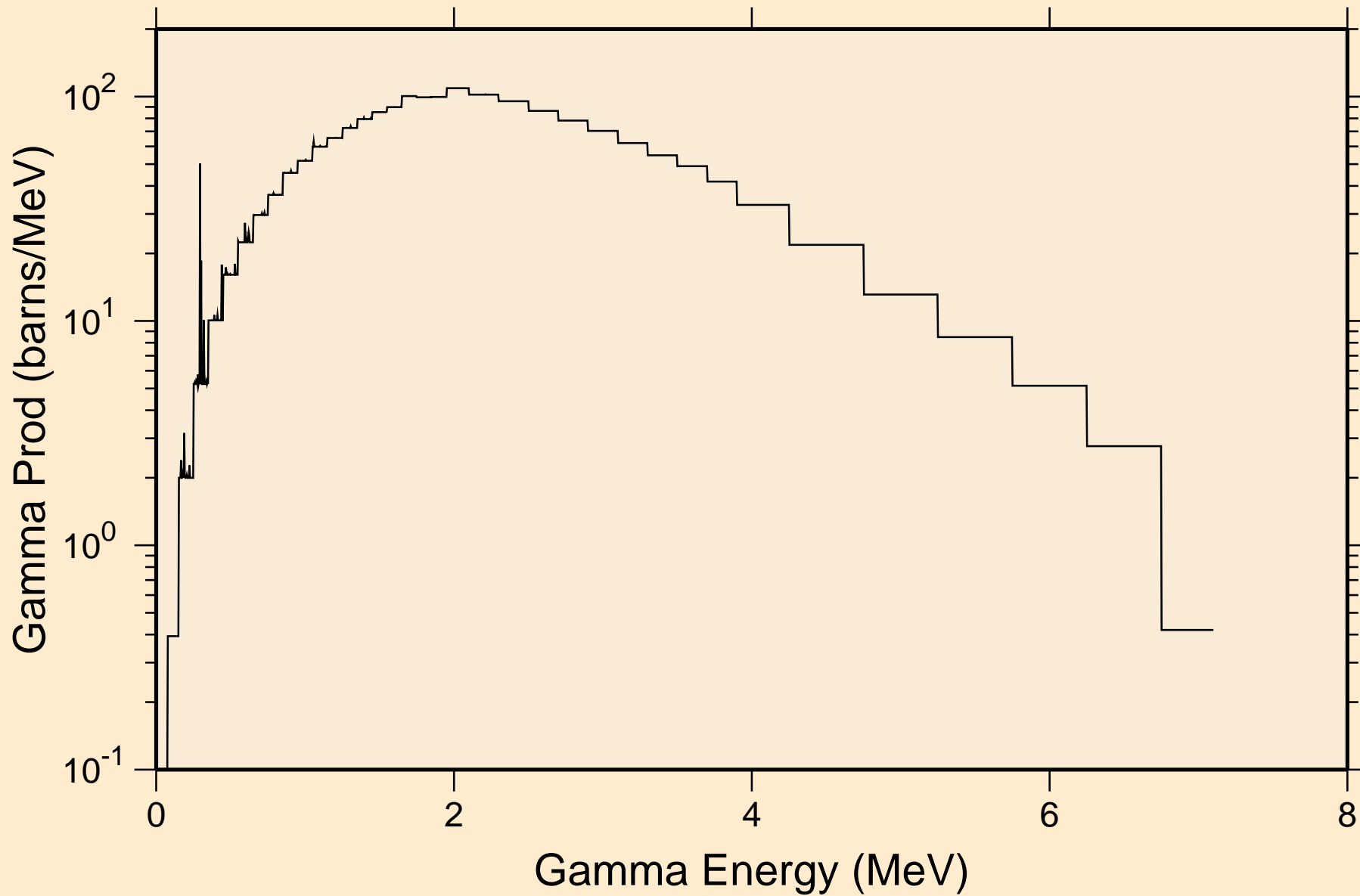

PT189 NEUTRON ACER TENDL-2024 LIBRARY; T=293.6K
14 MeV photon spectrum

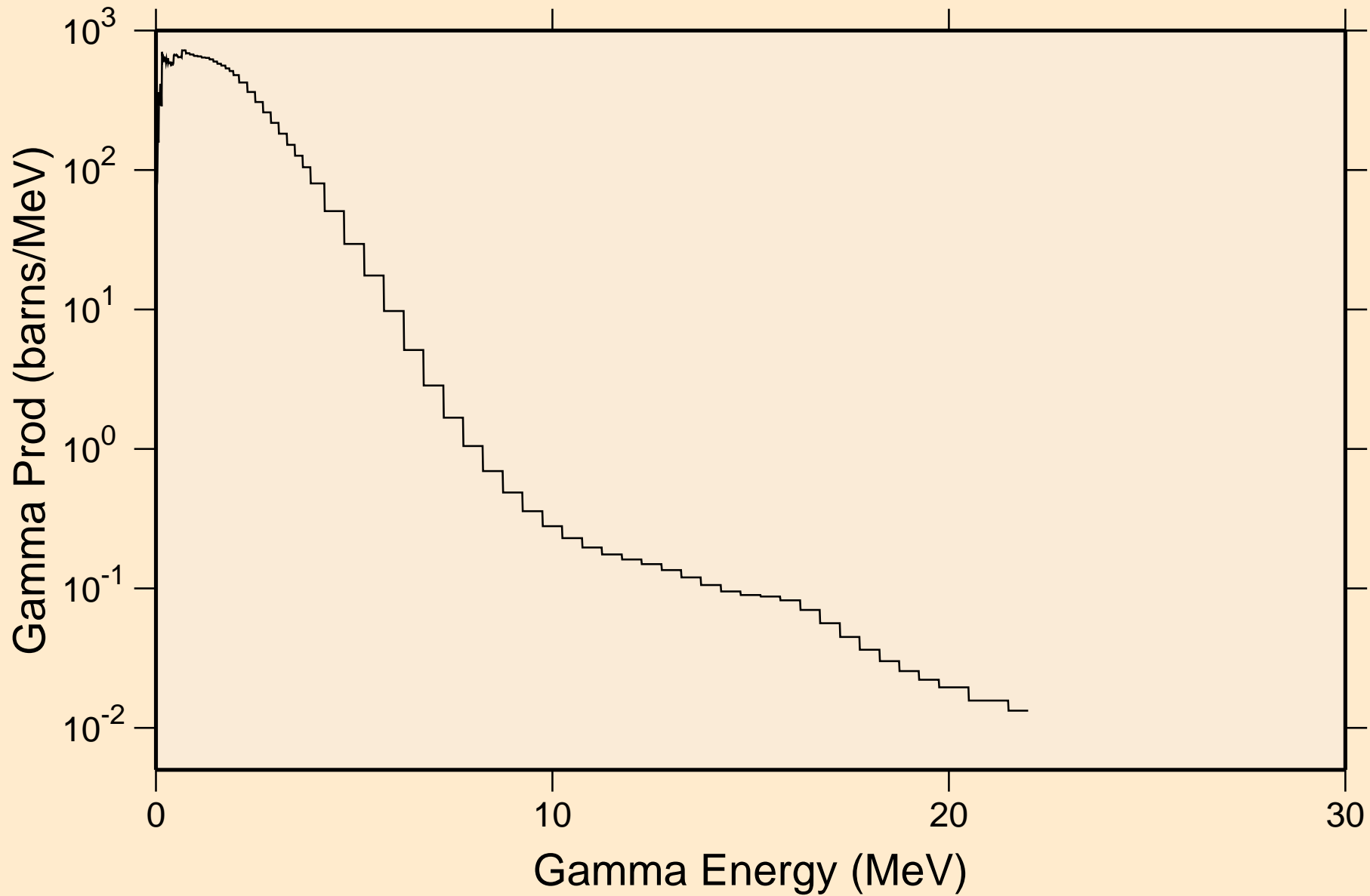

PT189 NEUTRON ACER TENDL-2024 LIBRARY; T=293.6K
Particle heating contributions

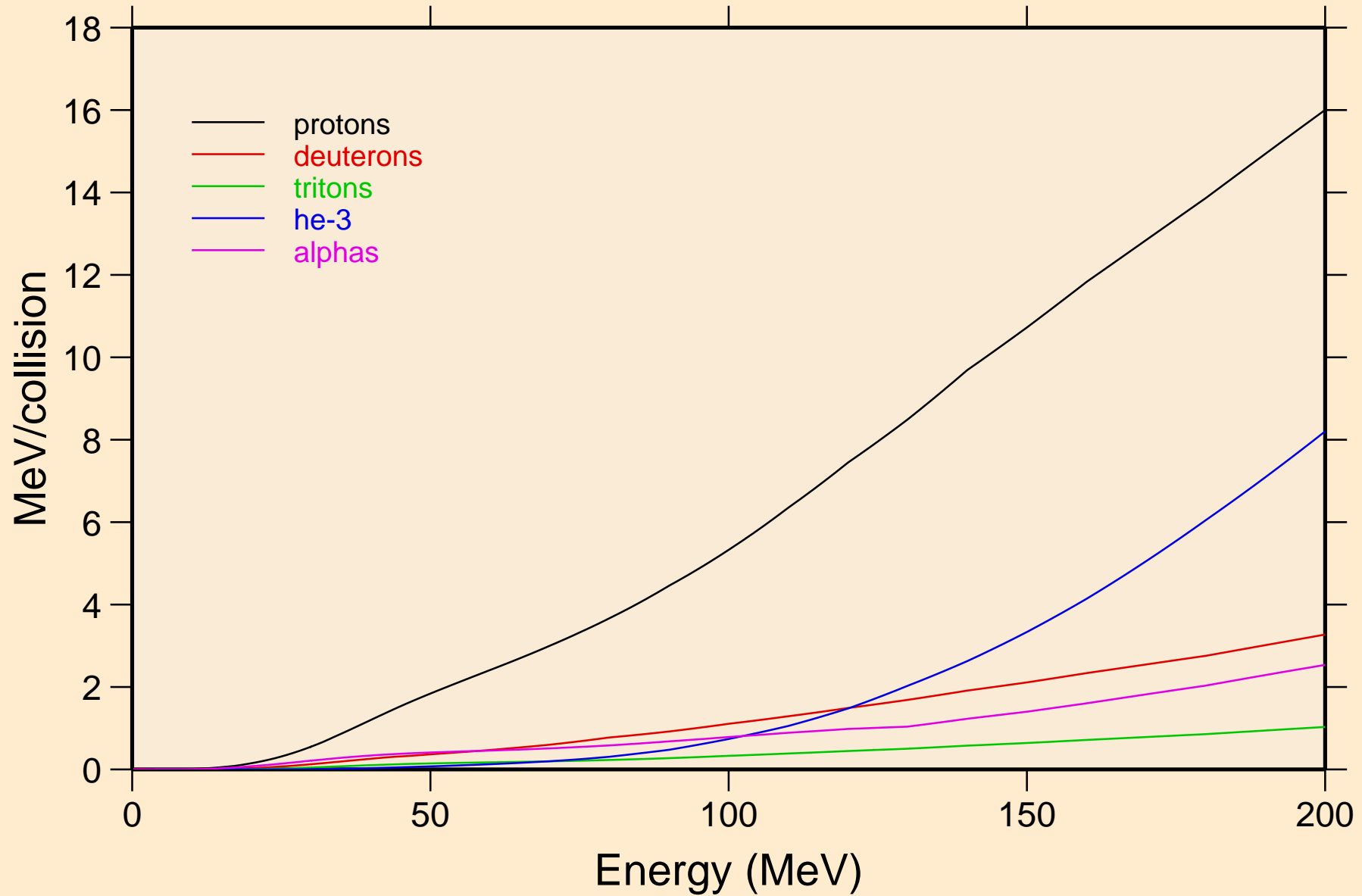

PT189 NEUTRON ACER TENDL-2024 LIBRARY; T=293.6K
Recoil Heating

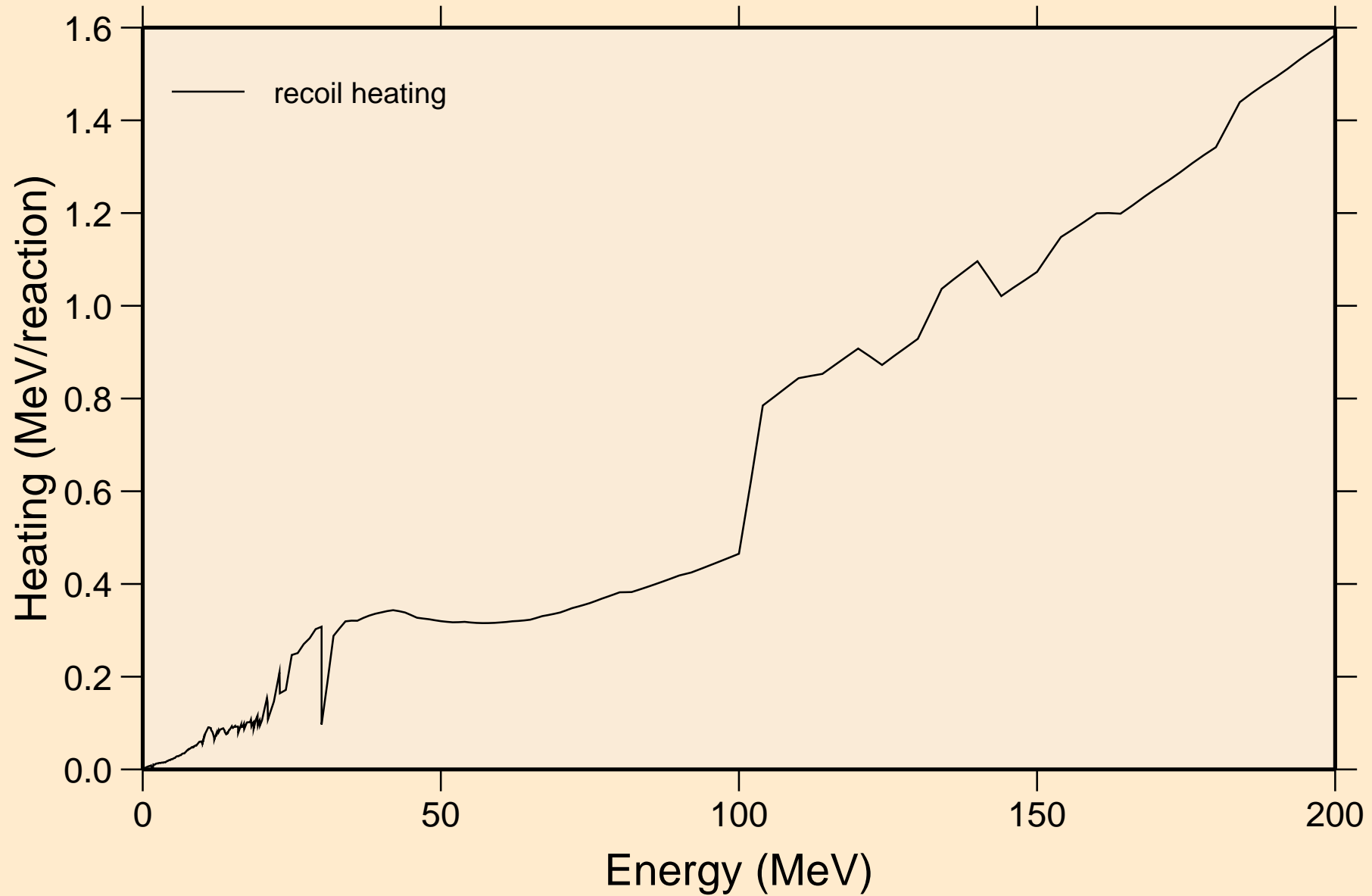

PT189 NEUTRON ACER TENDL-2024 LIBRARY; T=293.6K
Particle production cross sections

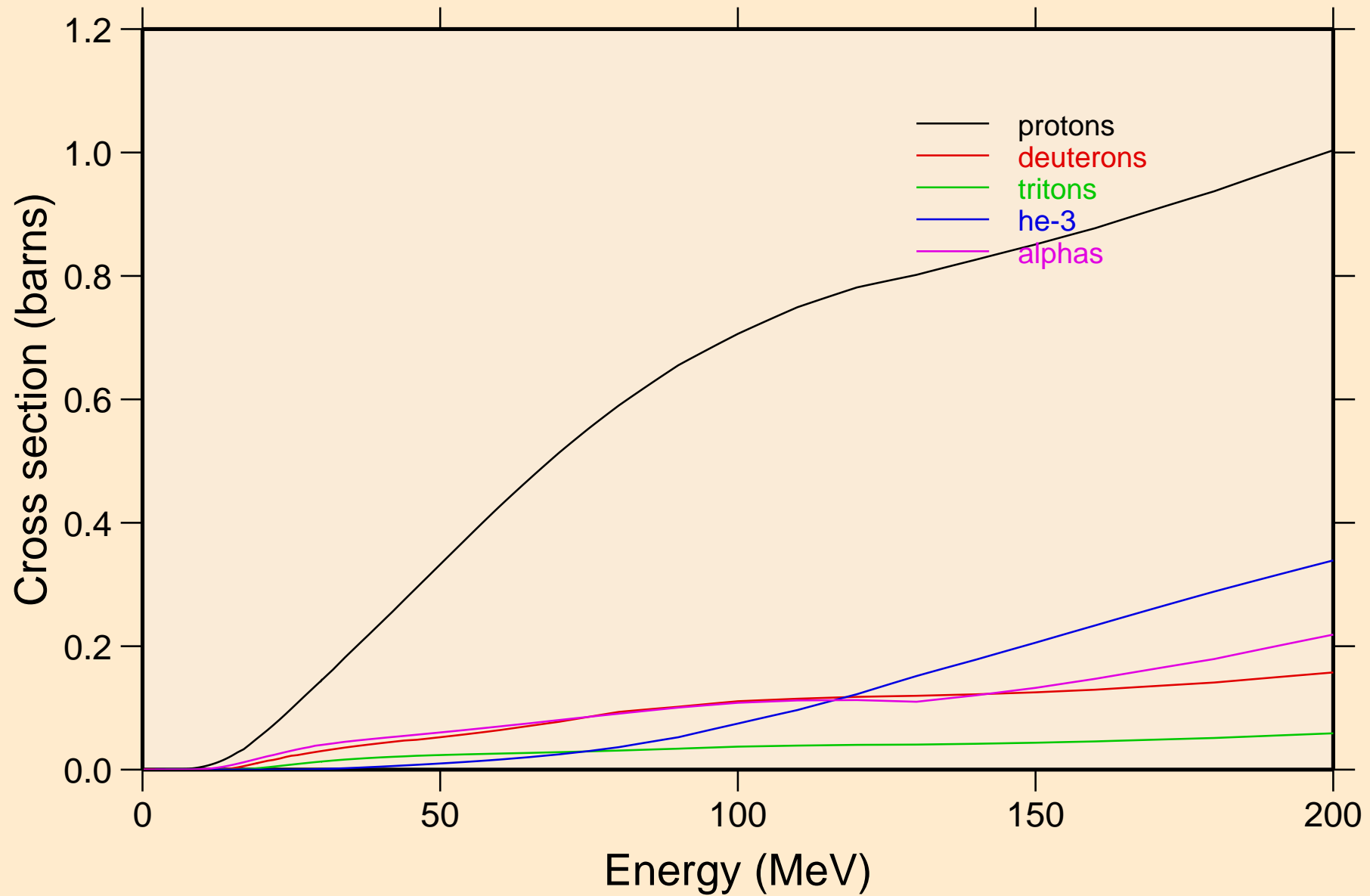

PT189 NEUTRON ACER TENDL-2024 LIBRARY; T=293.6K
protons from (n,x)

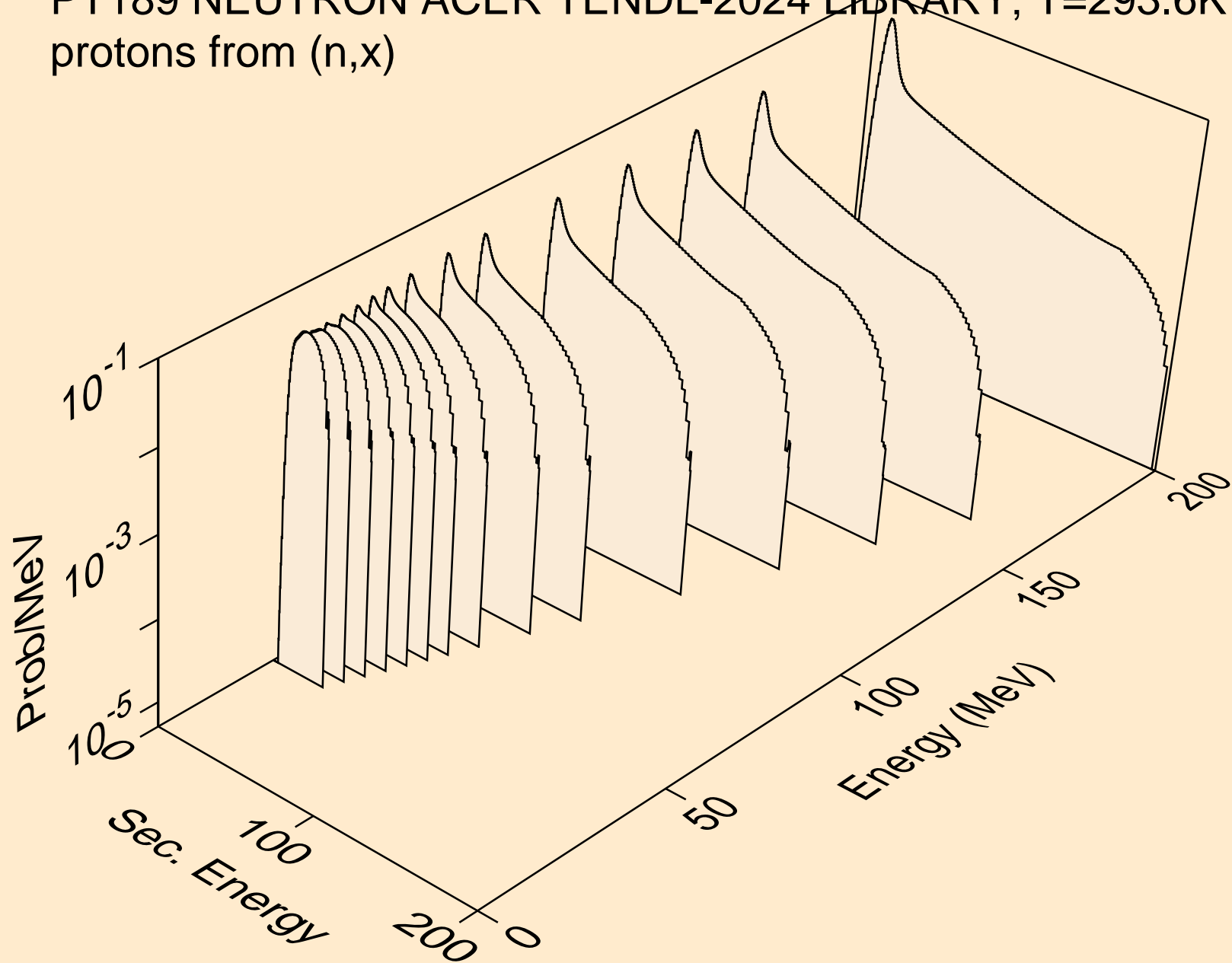

PT189 NEUTRON ACER TENDL-2024 LIBRARY; T=293.6K
protons from (n,n*)p

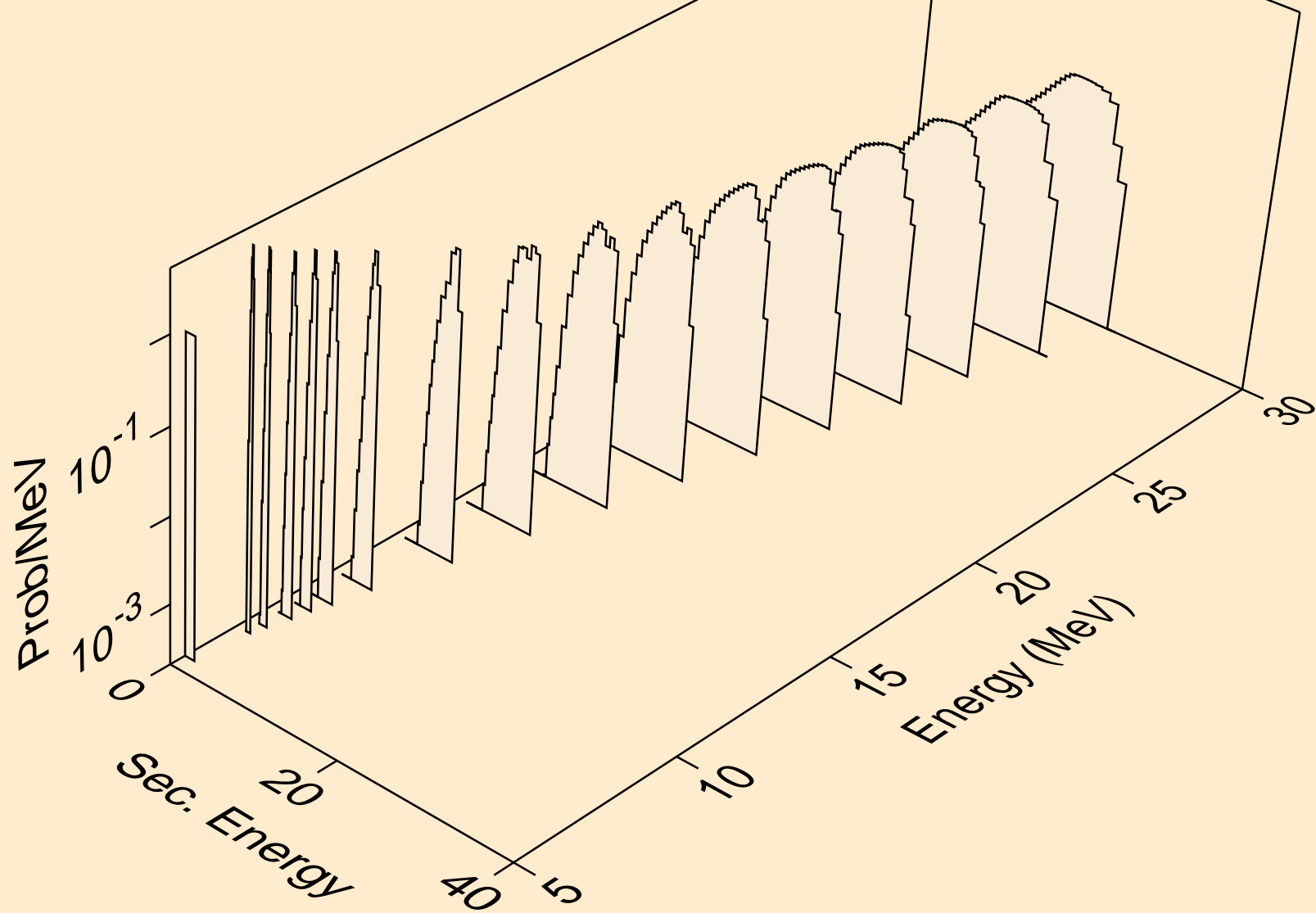

PT189 NEUTRON ACER TENDL-2024 LIBRARY; T=293.6K
protons from (n,2np)

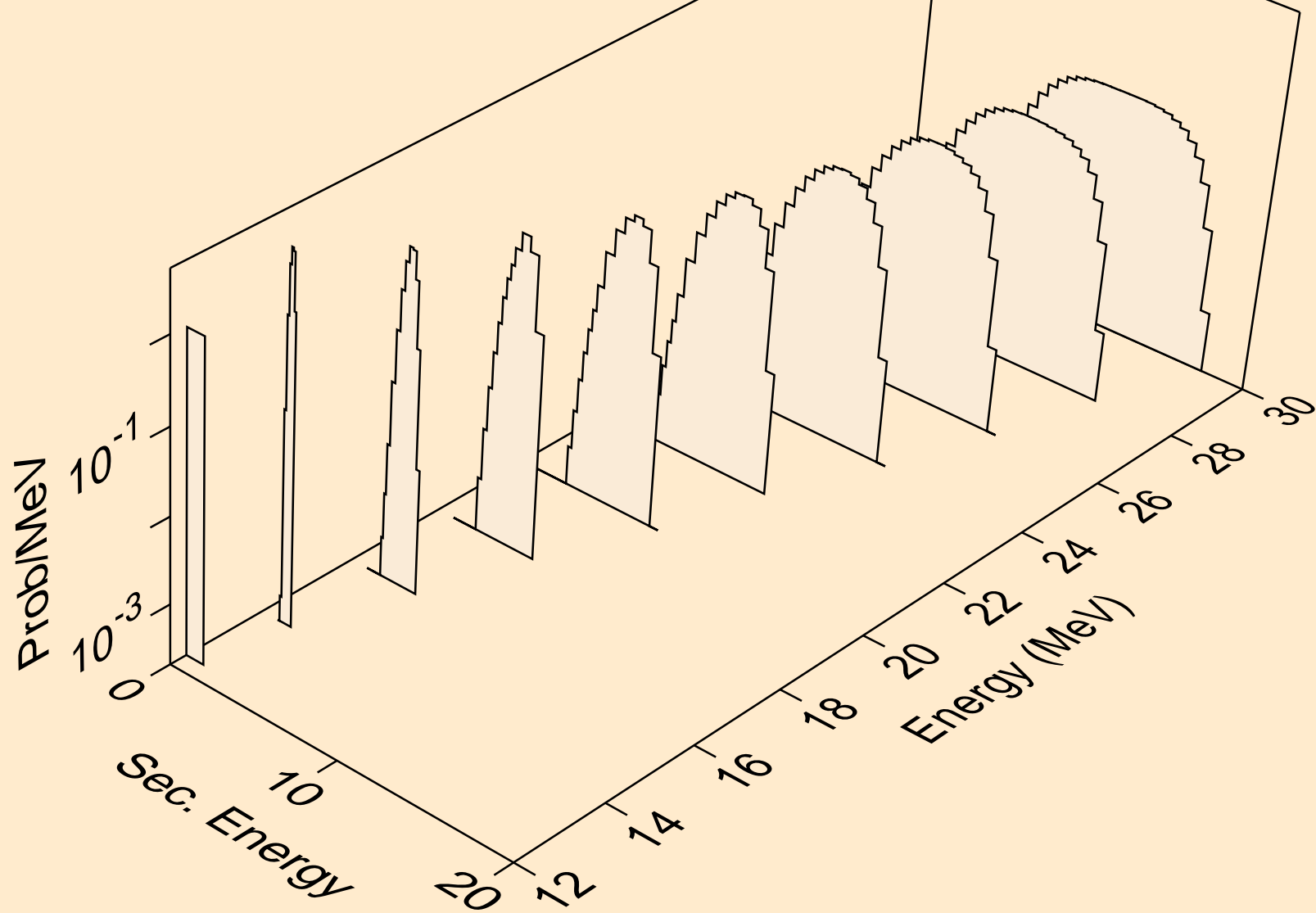

PT189 NEUTRON ACER TENDL-2024 LIBRARY; T=293.6K
protons from (n,3np)

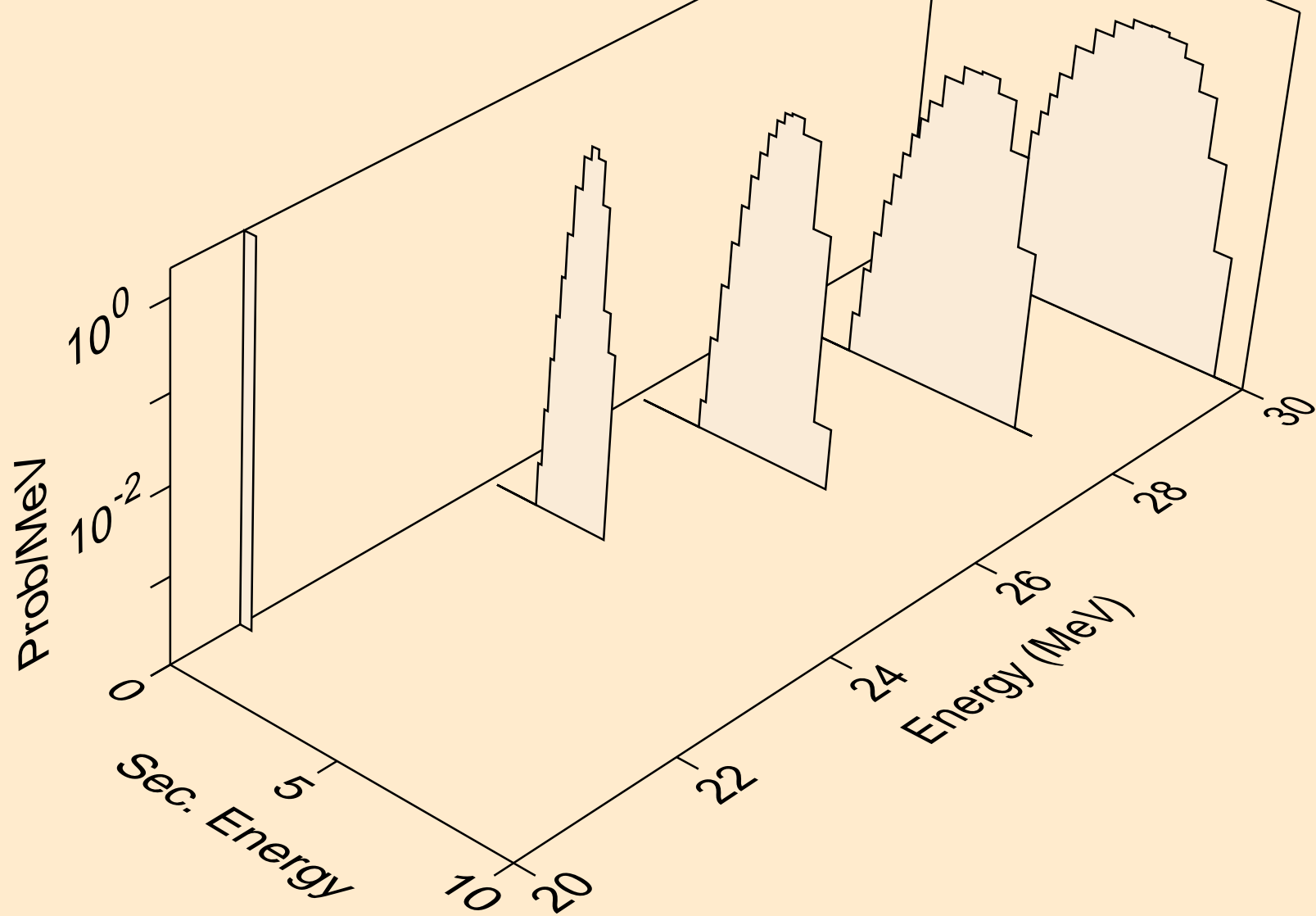

PT189 NEUTRON ACER TENDL-2024 LIBRARY; T=293.6K
protons from (n,n2p)

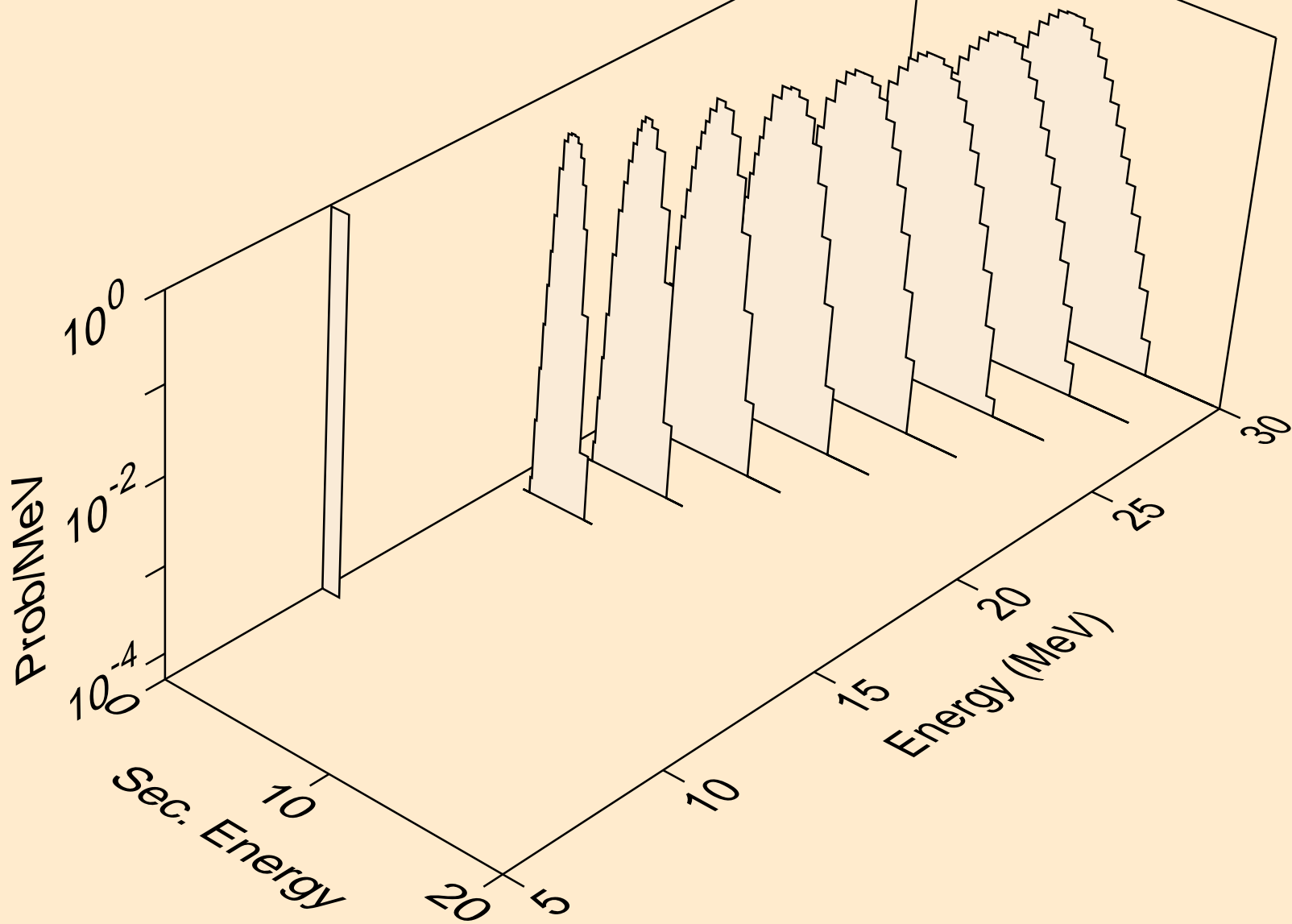

PT189 NEUTRON ACER TENDL-2024 LIBRARY; T=293.6K
protons from (n,npa)

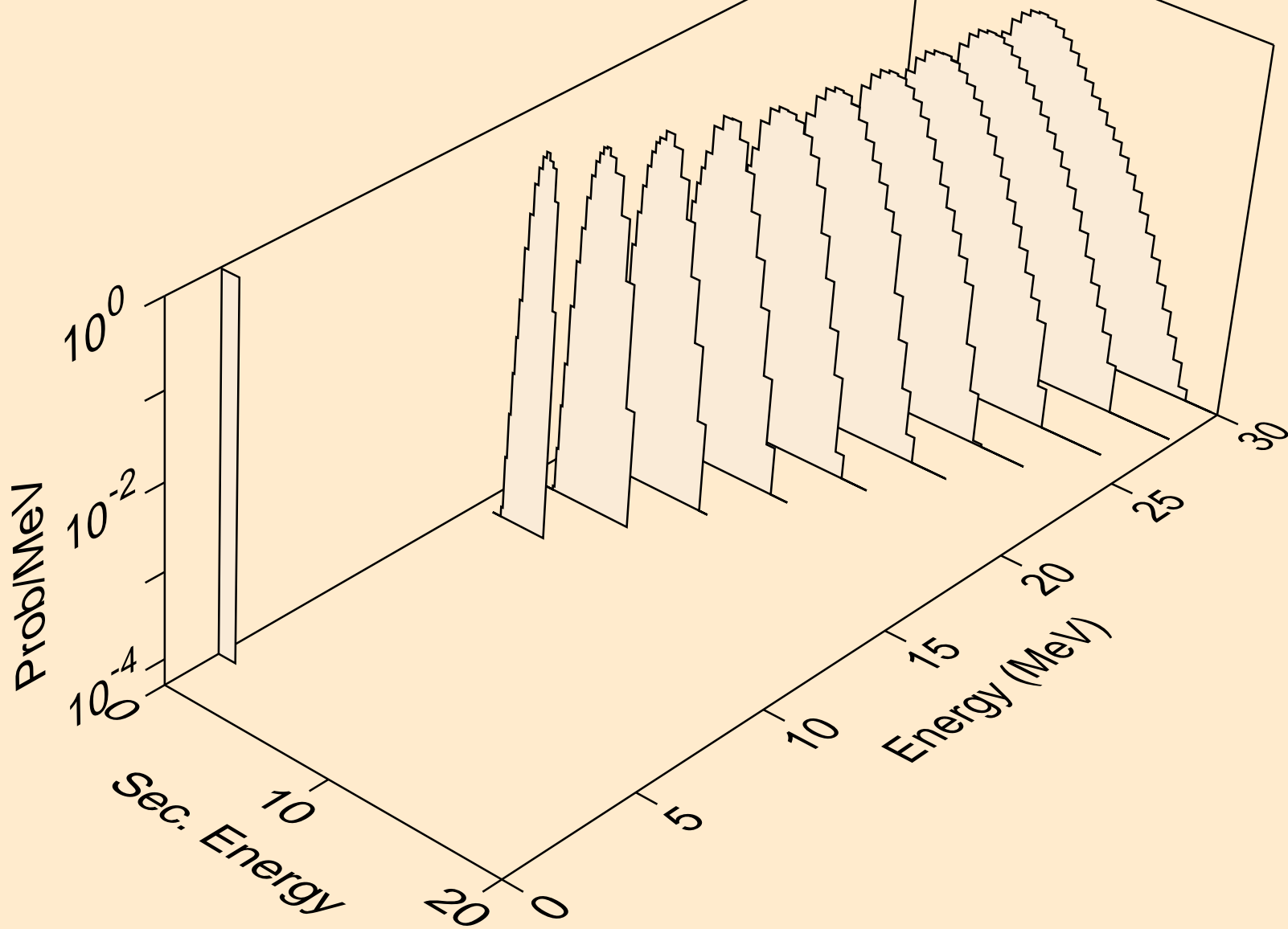

PT189 NEUTRON ACER TENDL-2024 LIBRARY; T=293.6K
protons from (n,p)

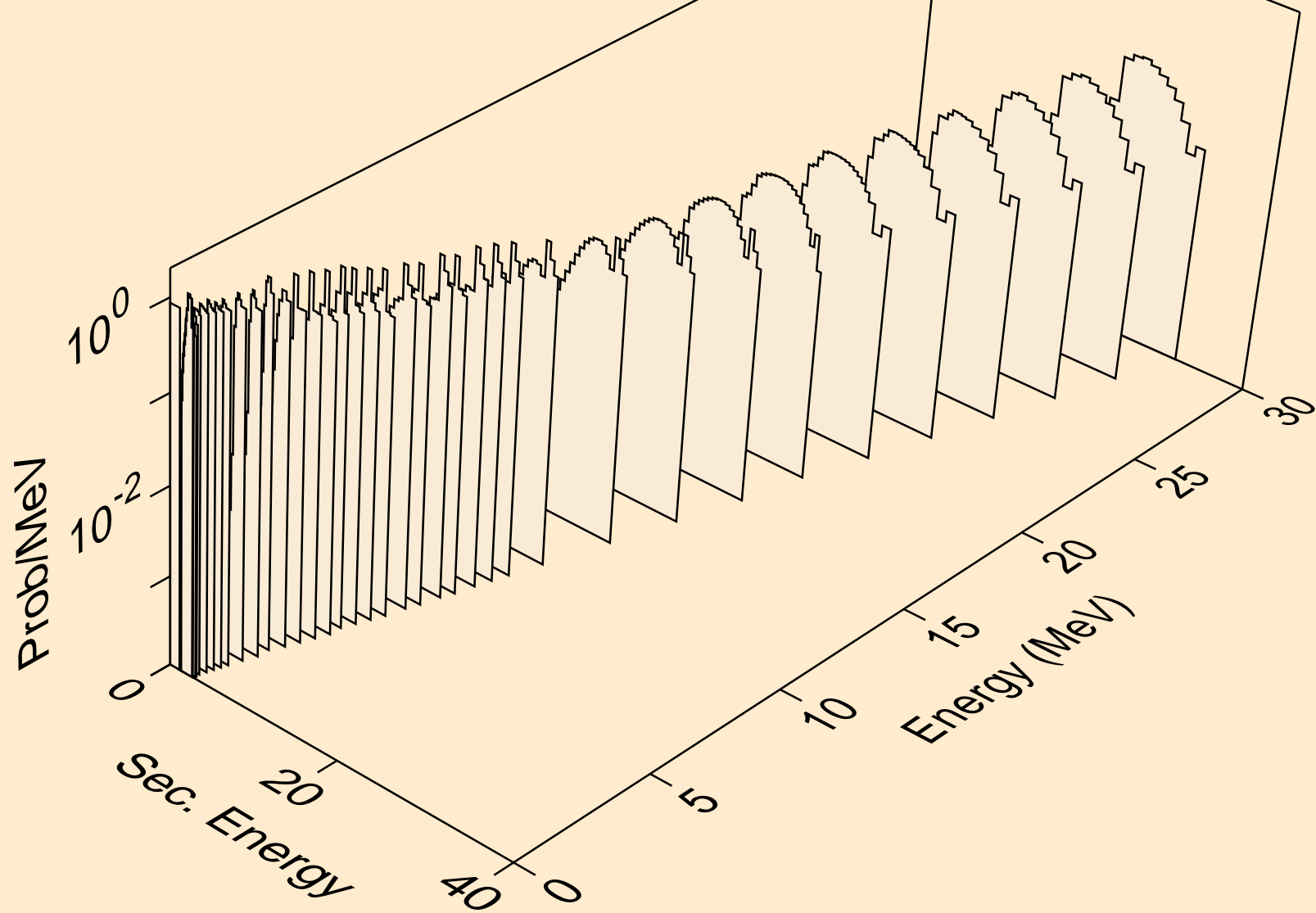

PT189 NEUTRON ACER TENDL-2024 LIBRARY; T=293.6K
protons from (n,2p)

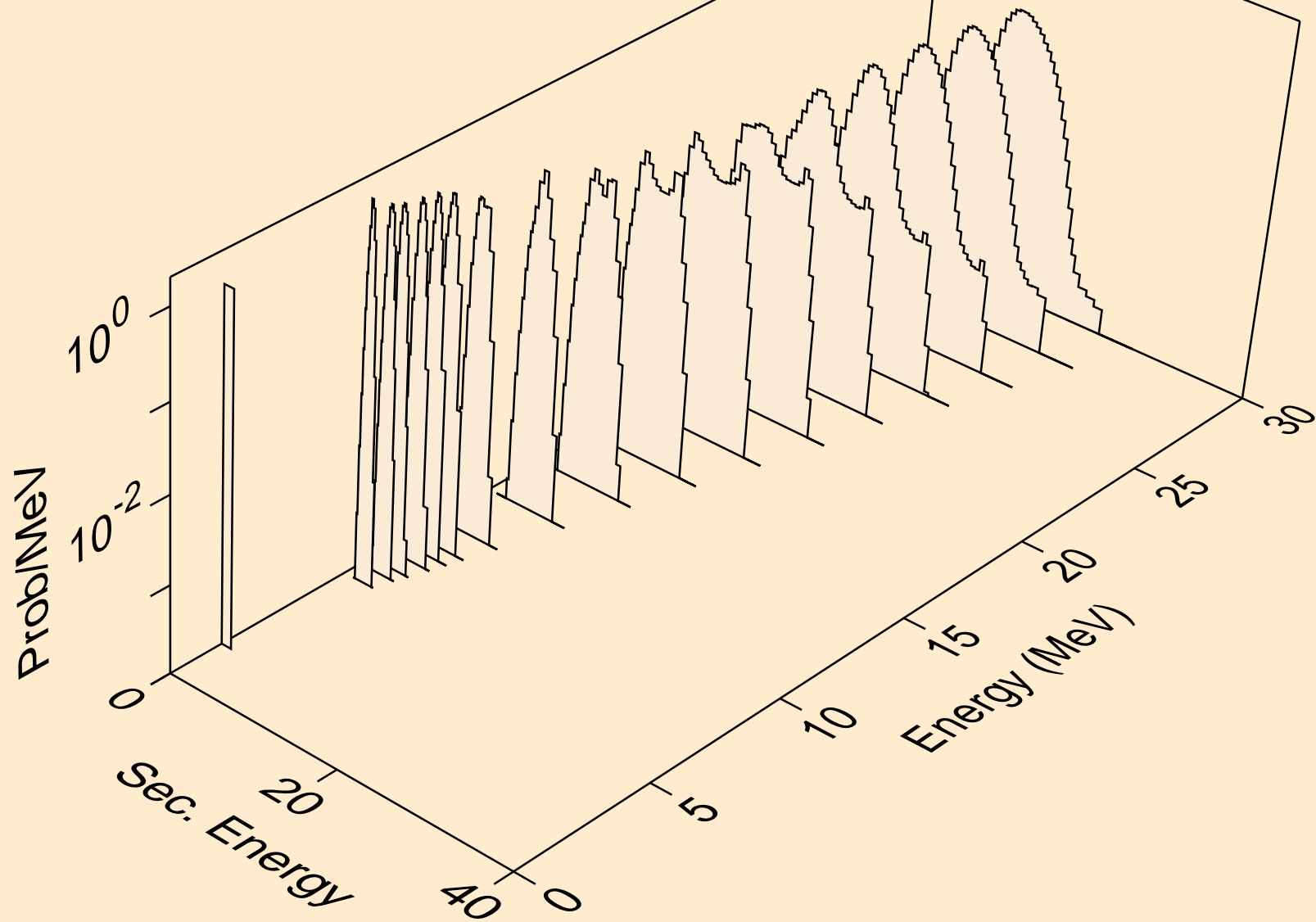

PT189 NEUTRON ACER TENDL-2024 LIBRARY; T=293.6K
protons from (n,p)

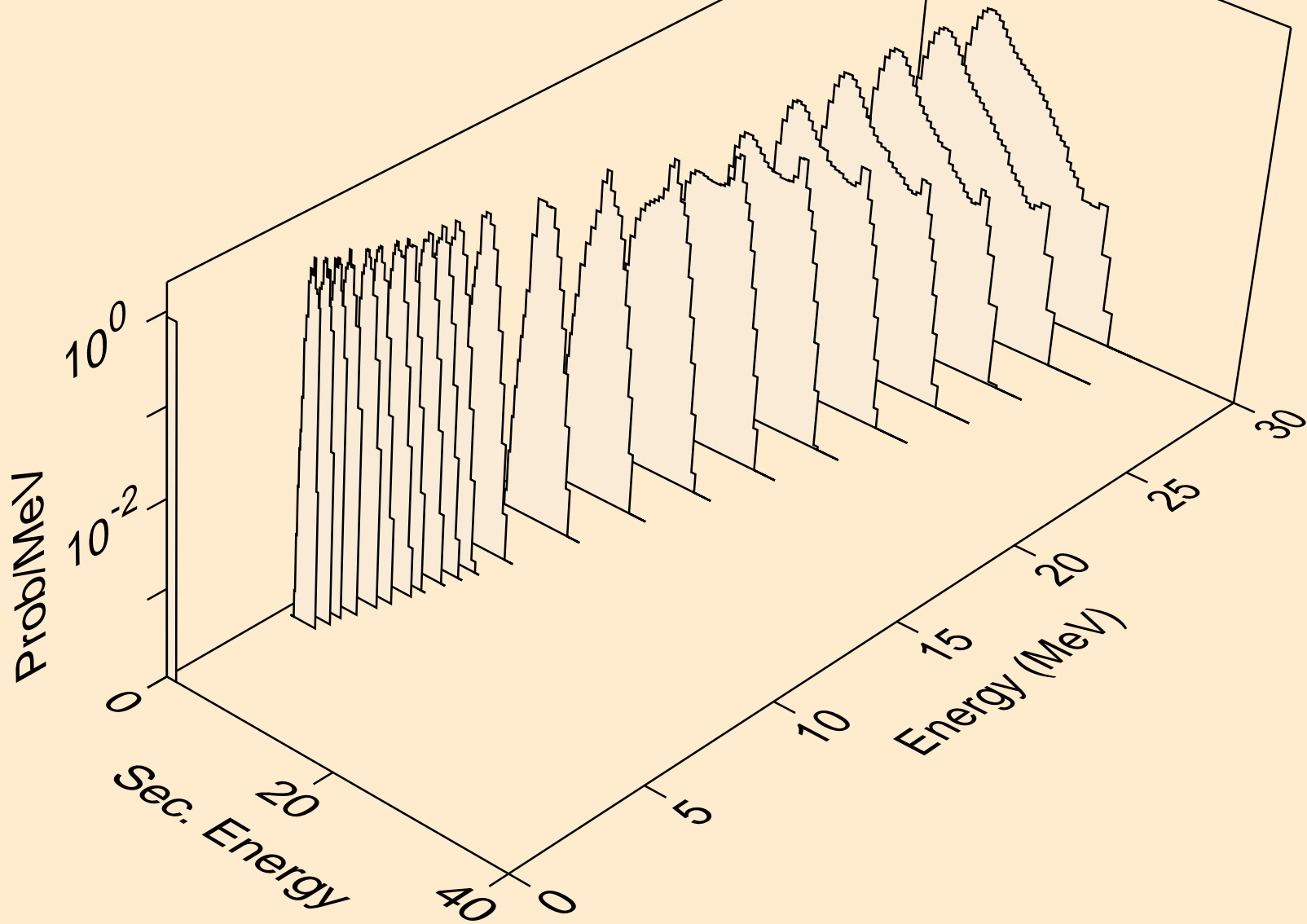

PT189 NEUTRON ACER TENDL-2024 LIBRARY; T=293.6K
protons from (n,pd)

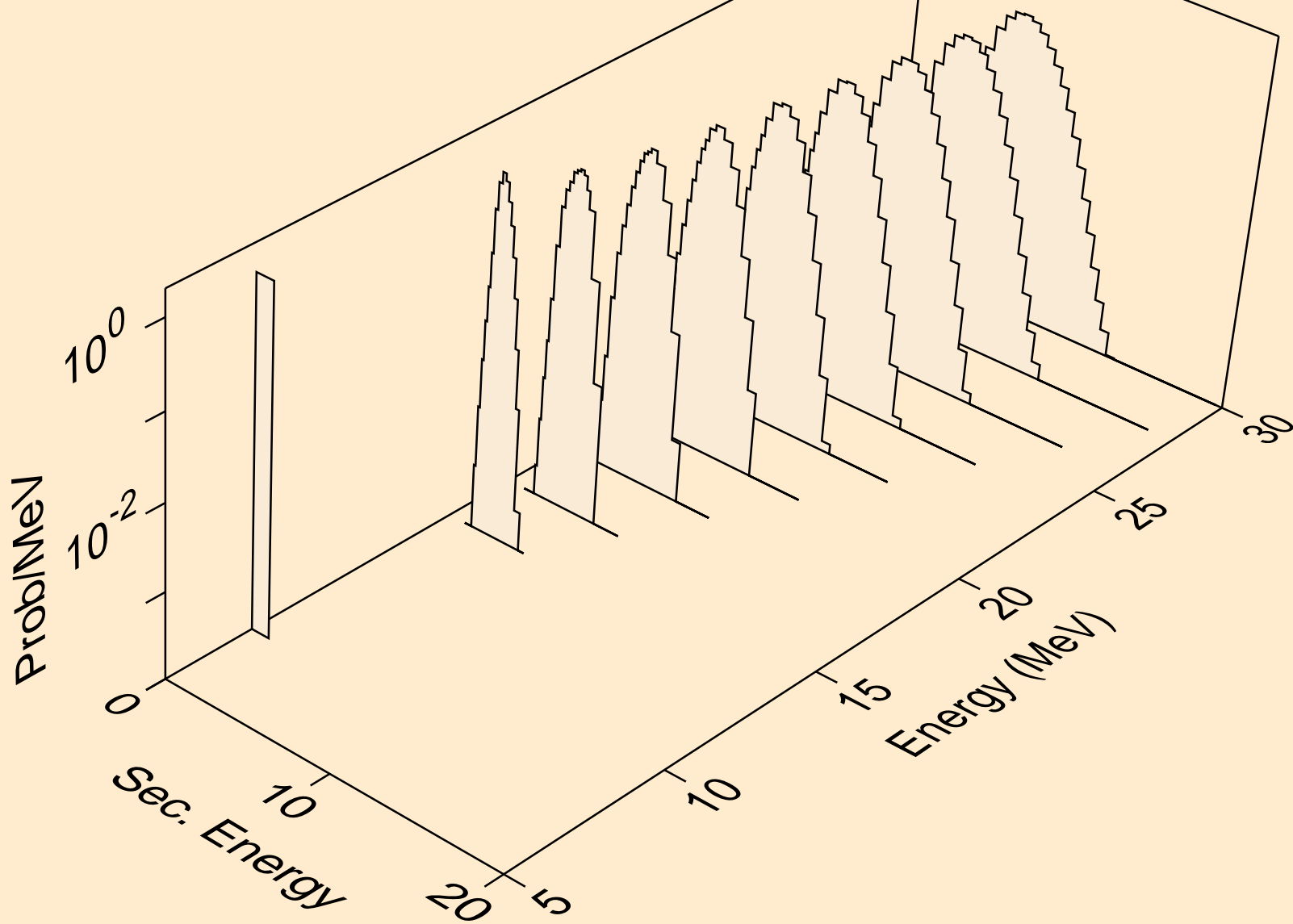

PT189 NEUTRON ACER TENDL-2024 LIBRARY; T=293.6K
protons from (n,pt)

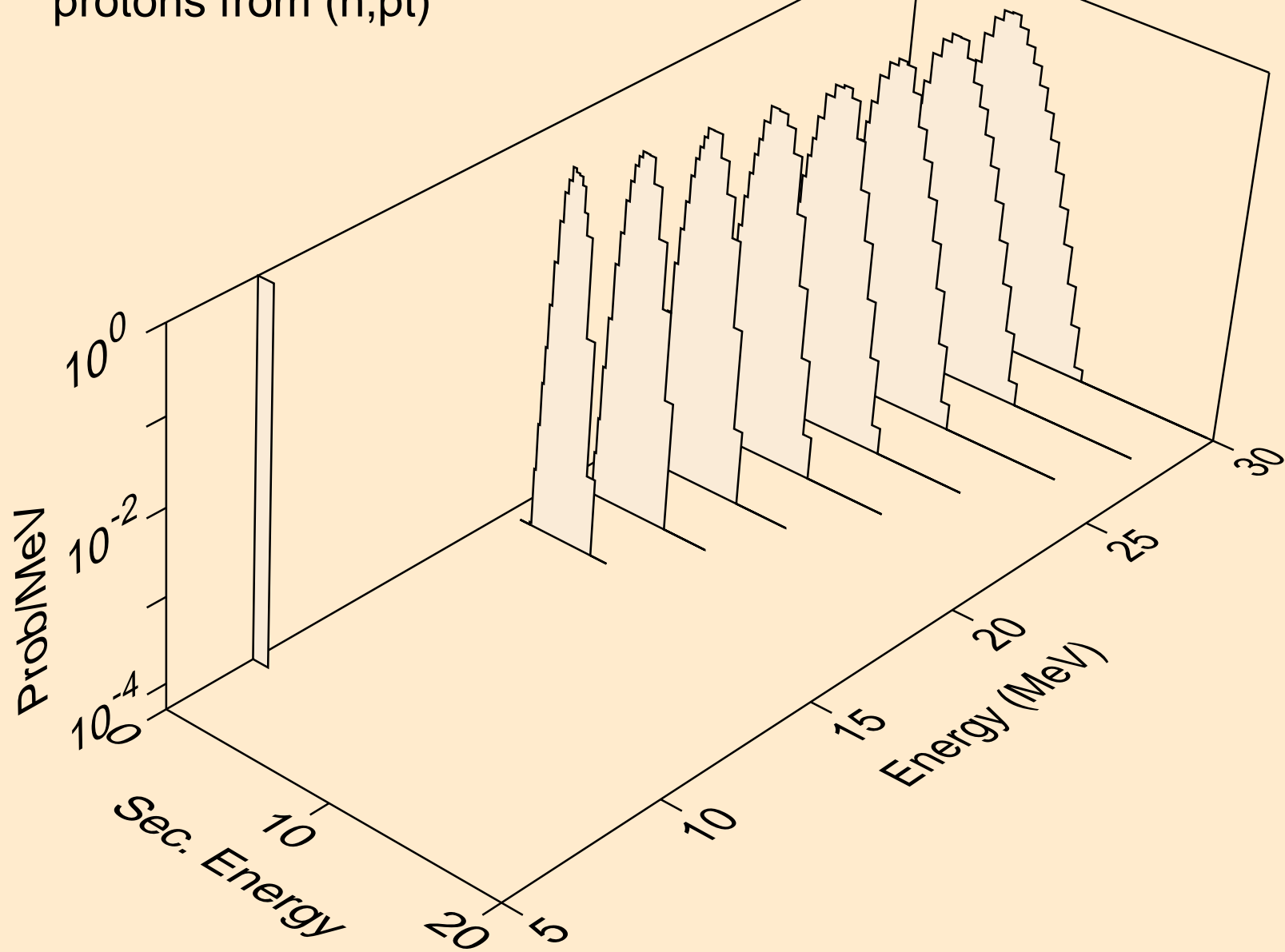

PT189 NEUTRON ACER TENDL-2024 LIBRARY; T=293.6K
deuterons from (n,x)

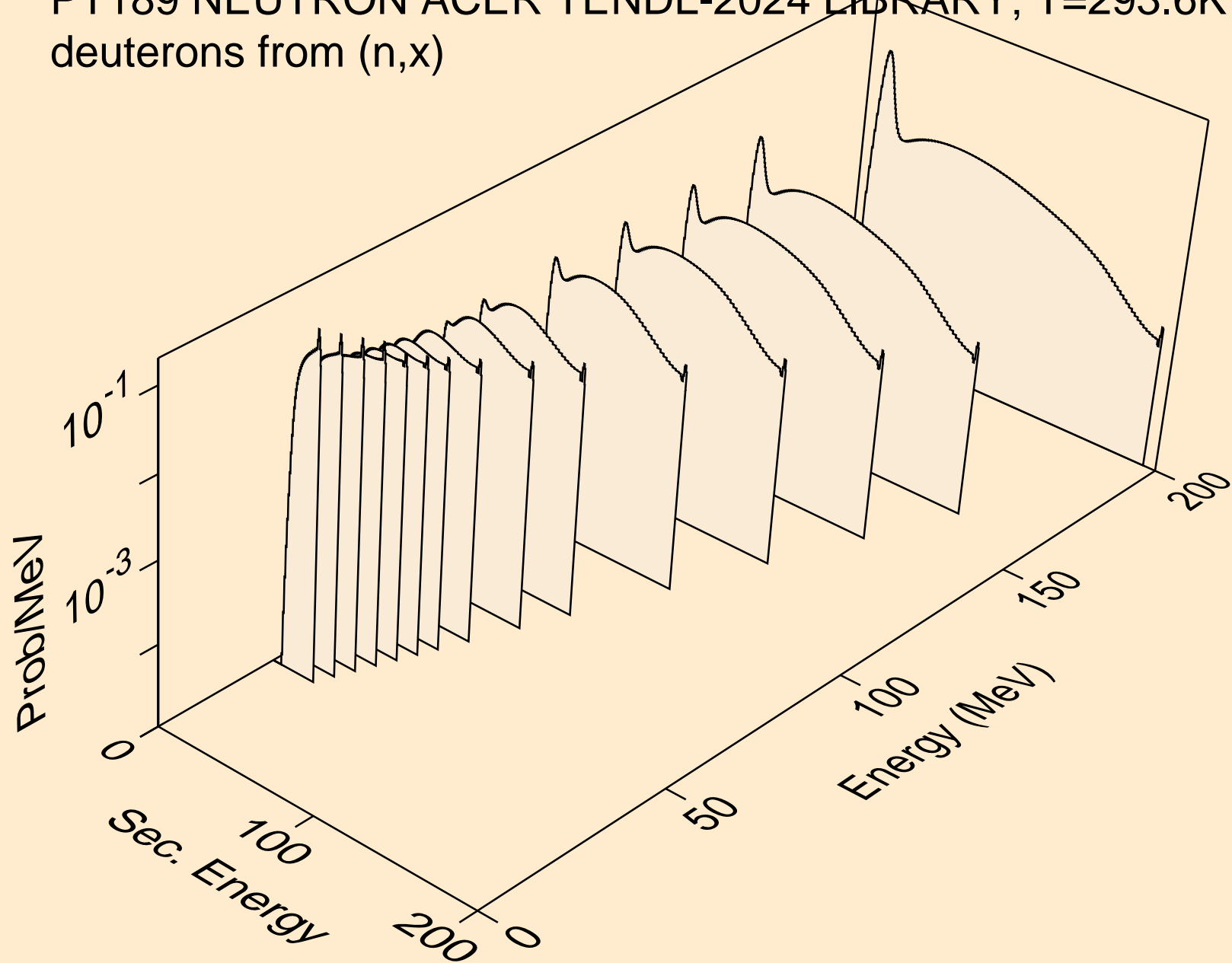

PT189 NEUTRON ACER TENDL-2024 LIBRARY; T=293.6K
deuterons from (n,2nd)

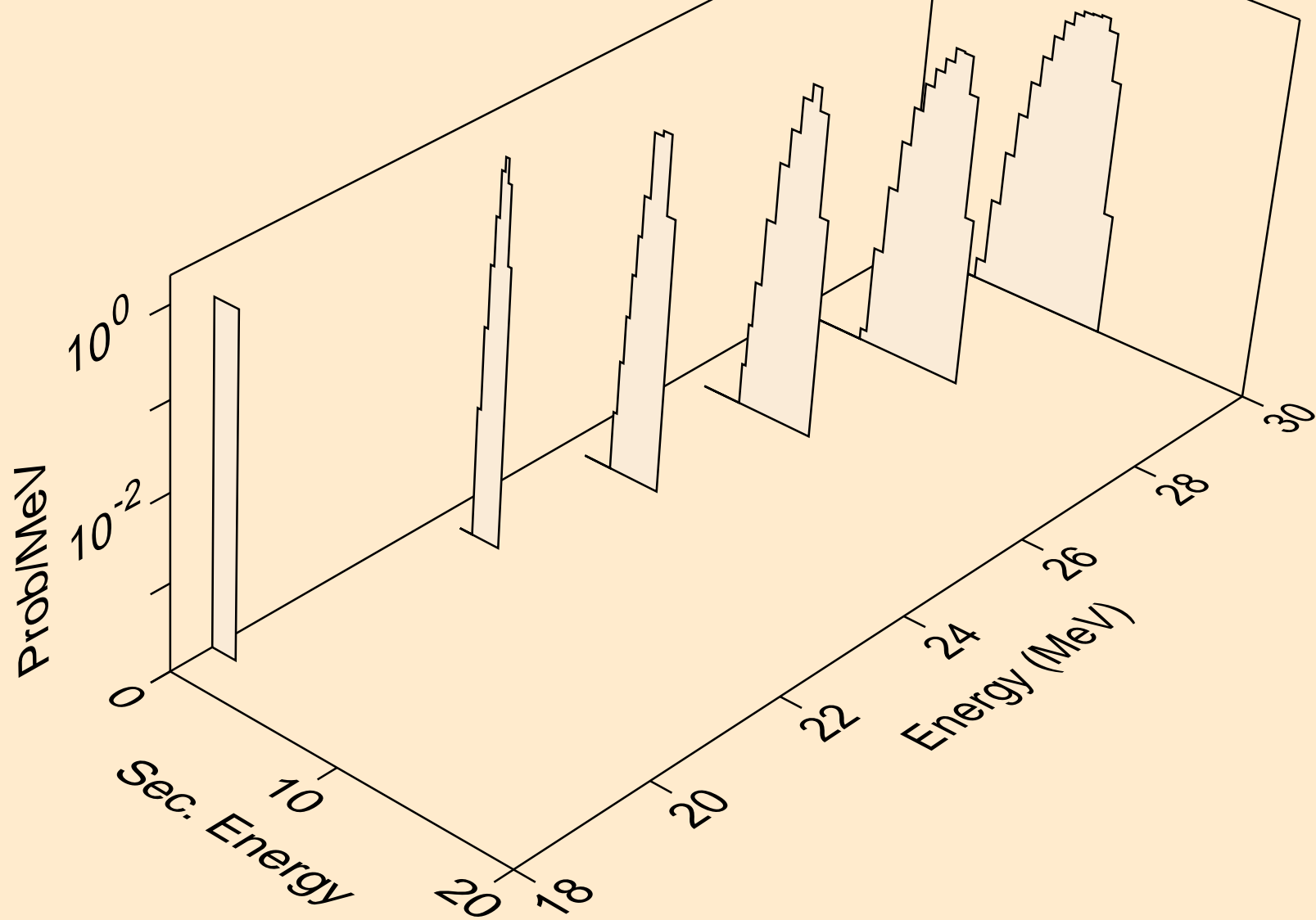

PT189 NEUTRON ACER TENDL-2024 LIBRARY; T=293.6K
deuterons from (n,n*)d

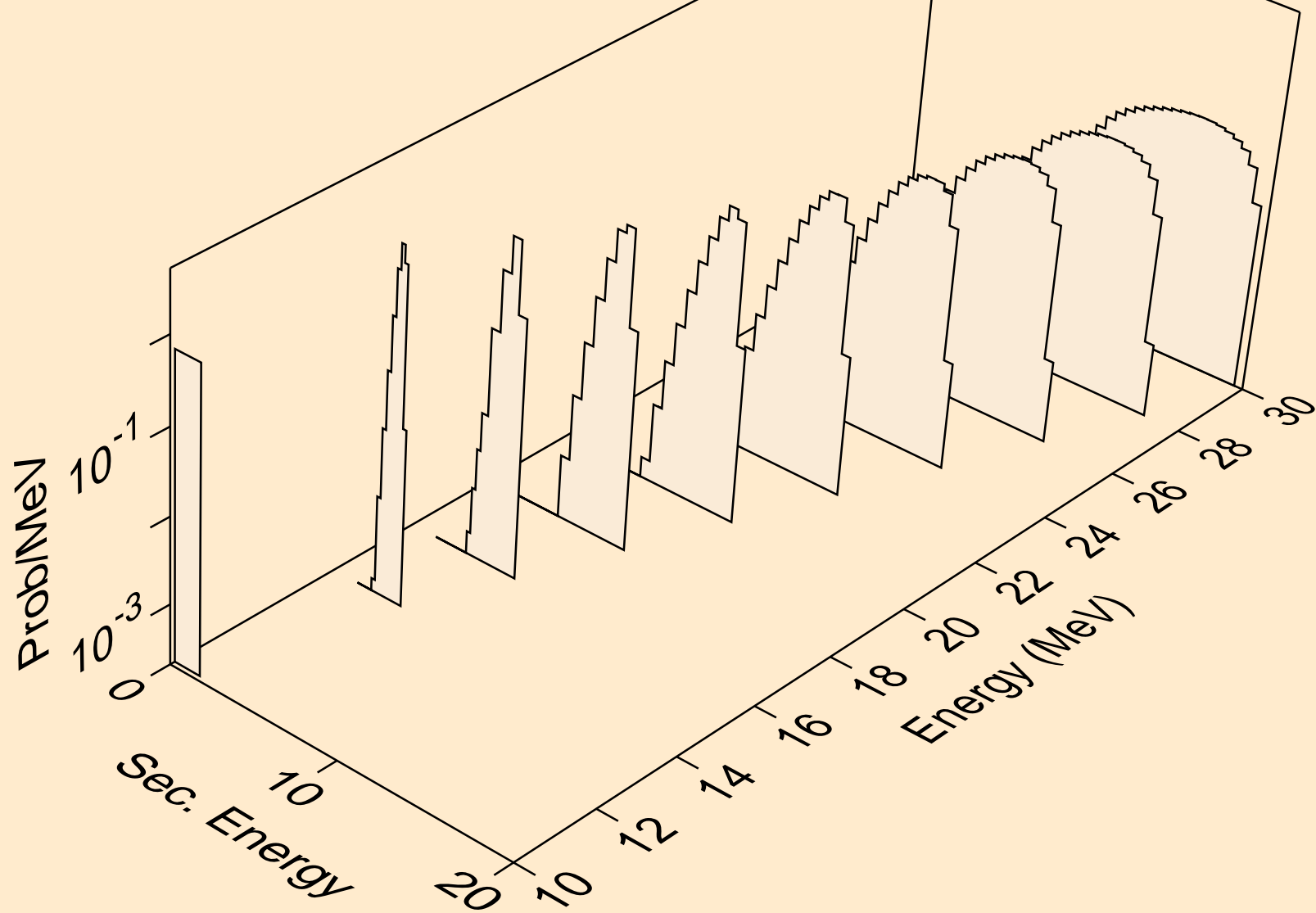

PT189 NEUTRON ACER TENDL-2024 LIBRARY; T=293.6K
deuterons from (n,d)

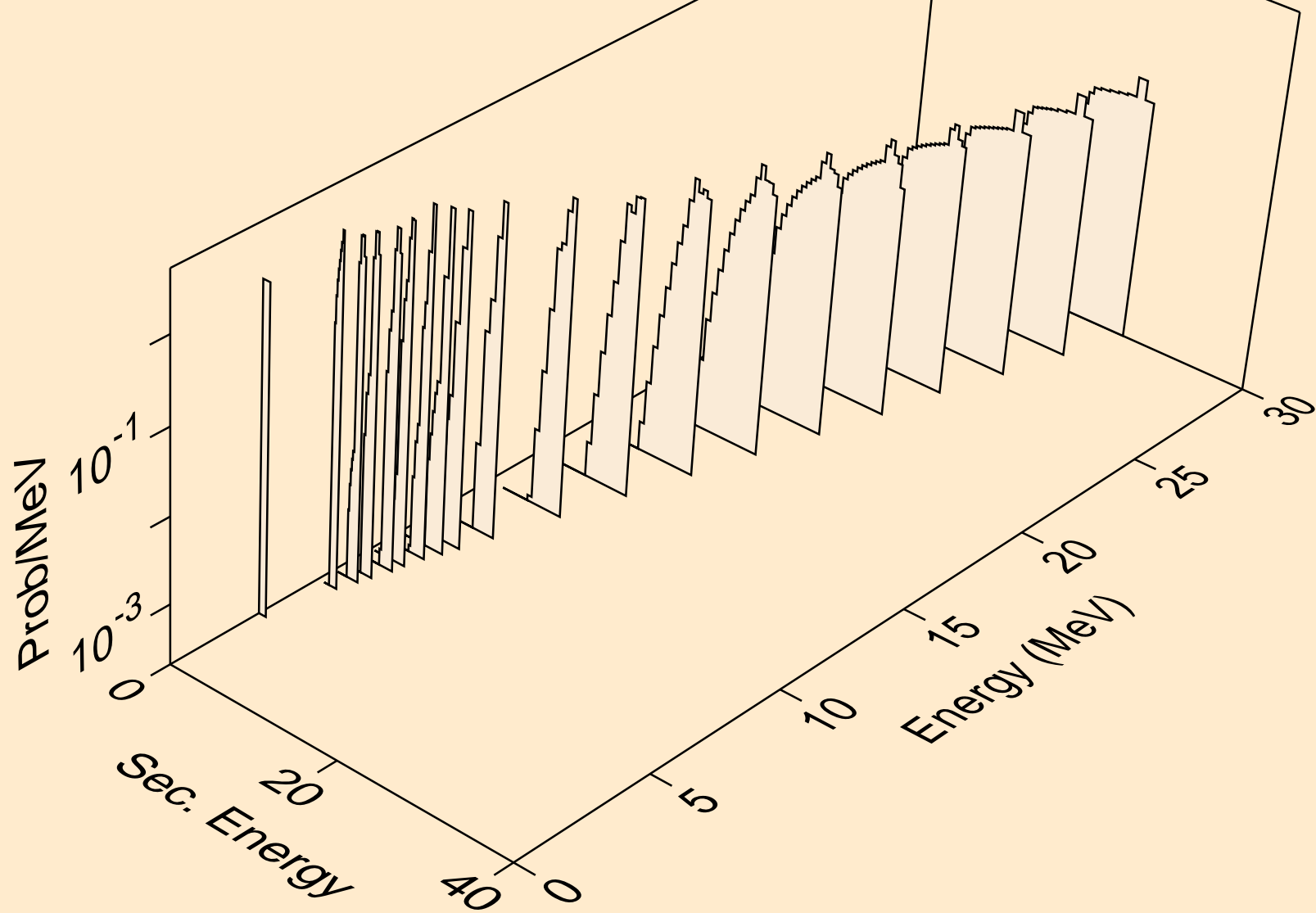

PT189 NEUTRON ACER TENDL-2024 LIBRARY; T=293.6K
deuterons from (n,pd)

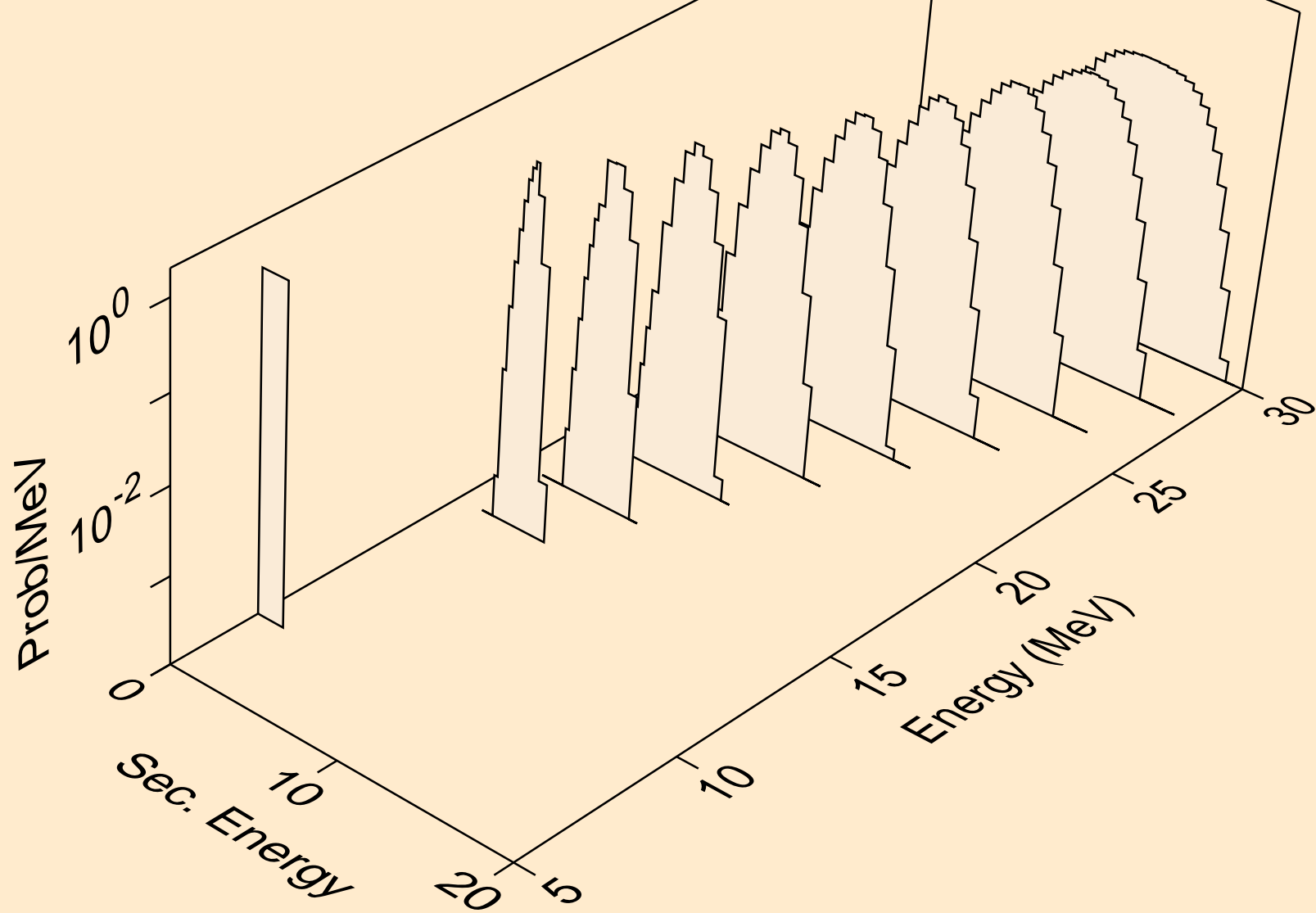

PT189 NEUTRON ACER TENDL-2024 LIBRARY; T=293.6K
deuterons from (n,da)

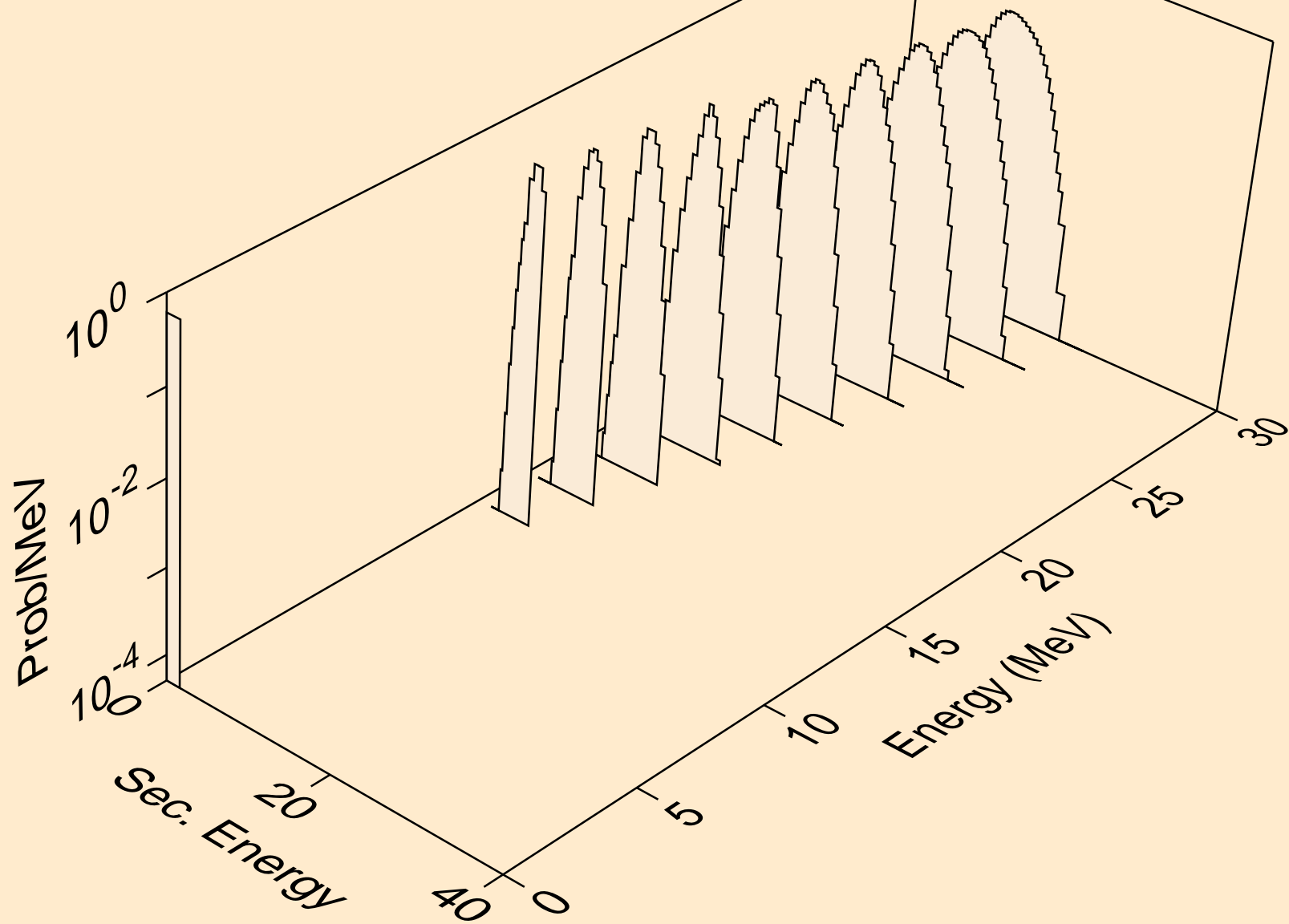

PT189 NEUTRON ACER TENDL-2024 LIBRARY; T=293.6K
tritons from (n,x)

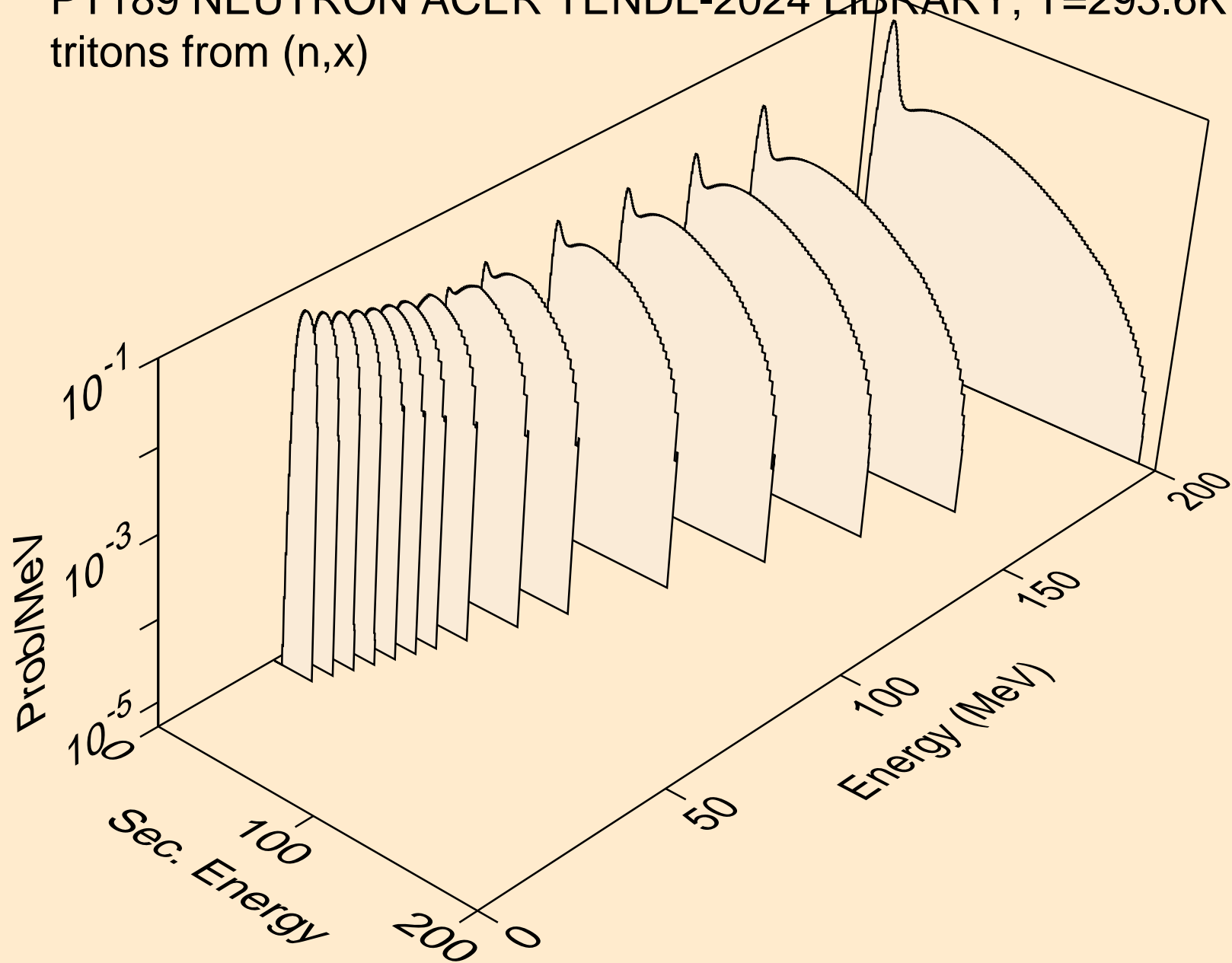

PT189 NEUTRON ACER TENDL-2024 LIBRARY; T=293.6K
tritons from (n,n*)t

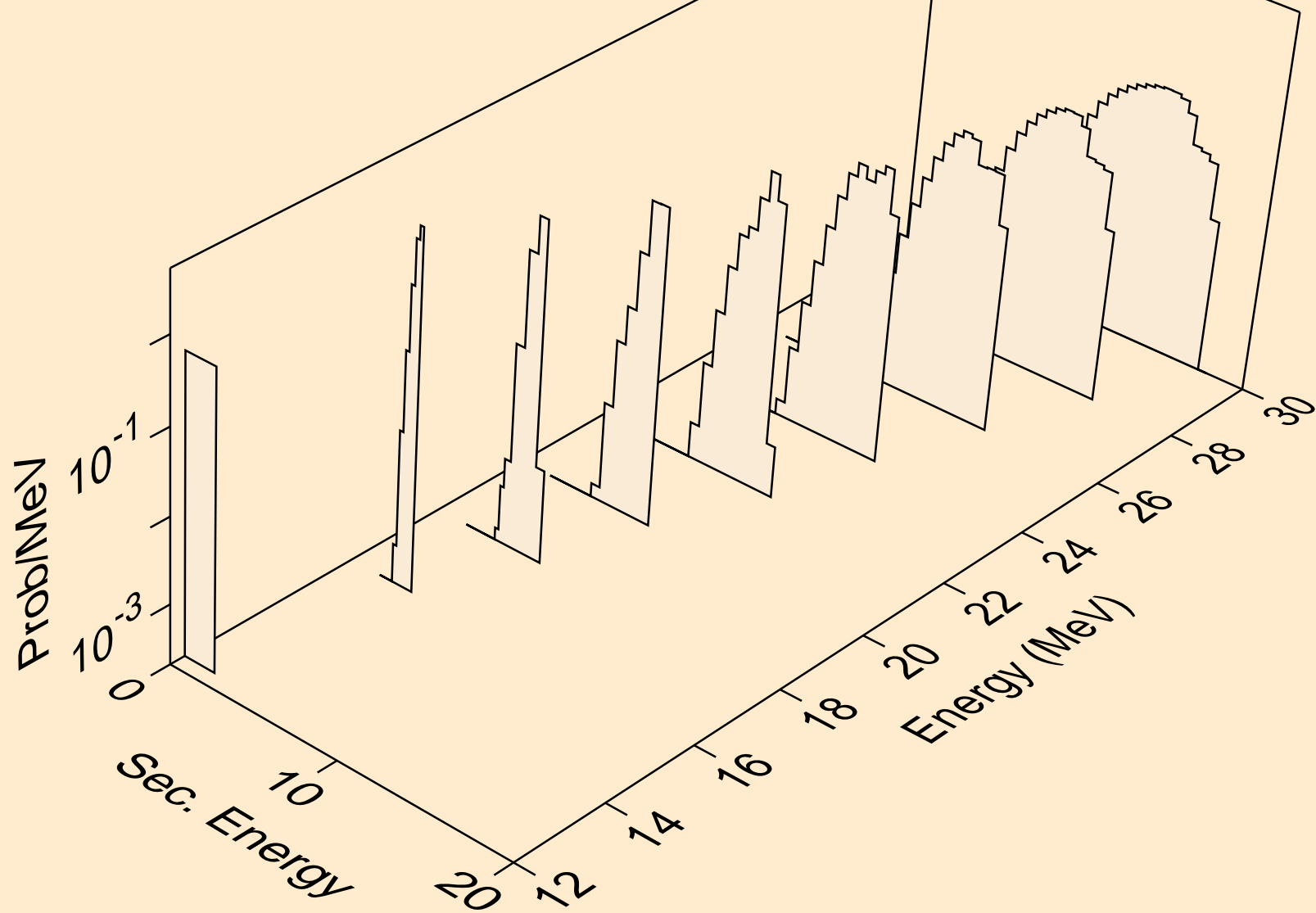

PT189 NEUTRON ACER TENDL-2024 LIBRARY; T=293.6K
tritons from (n,t)

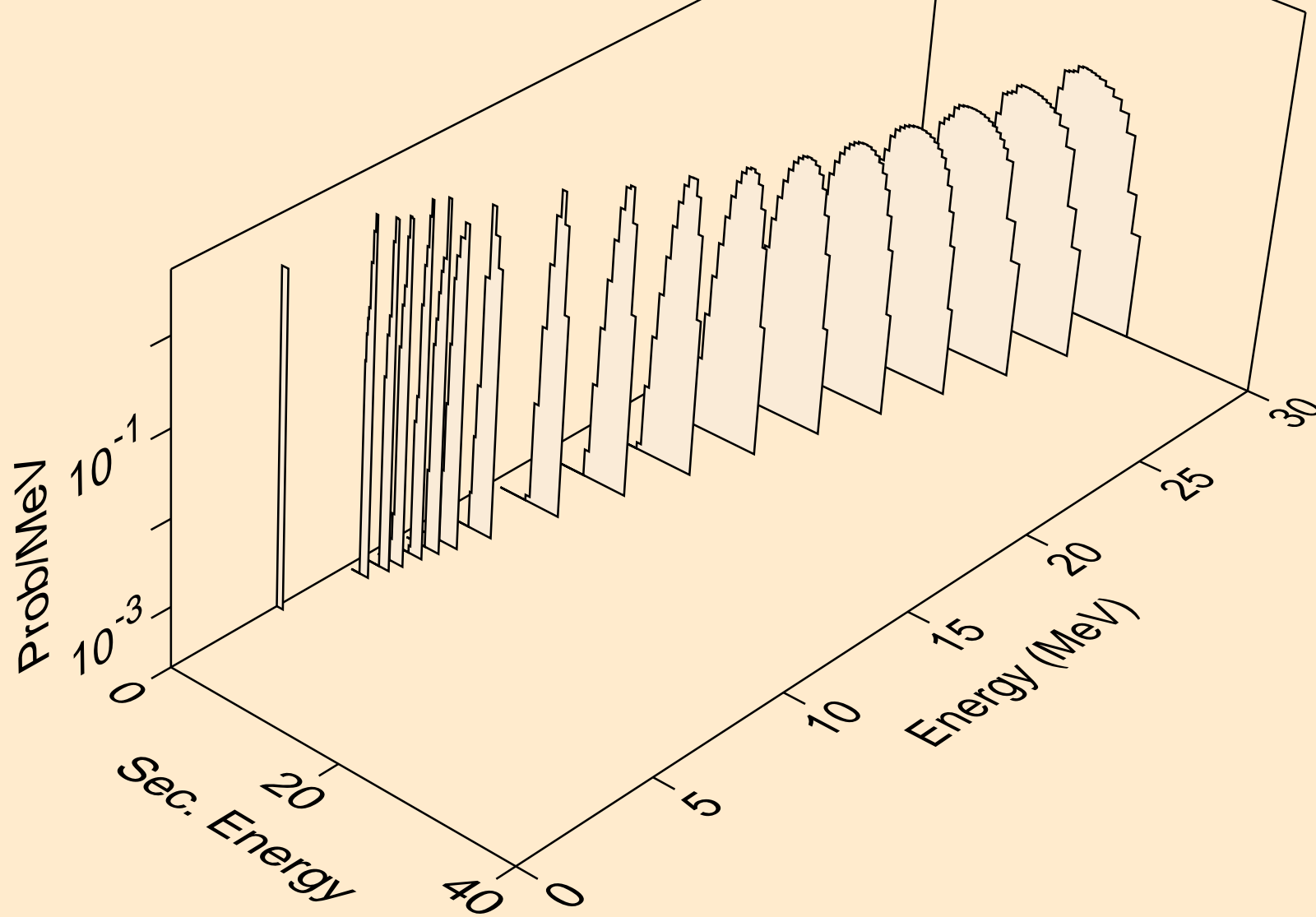

PT189 NEUTRON ACER TENDL-2024 LIBRARY; T=293.6K
tritons from (n,pt)

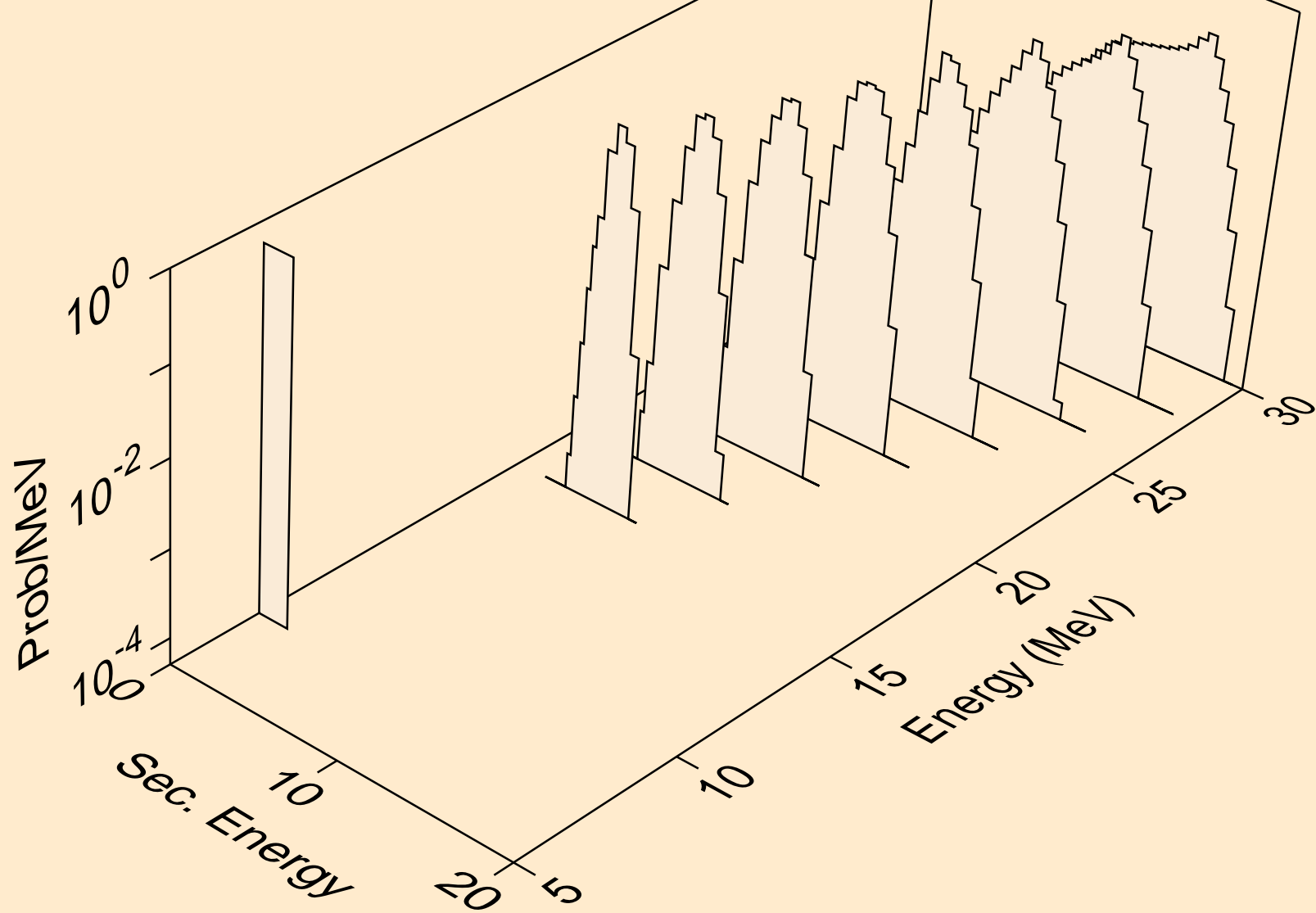

PT189 NEUTRON ACER TENDL-2024 LIBRARY; T=293.6K
he3s from (n,x)

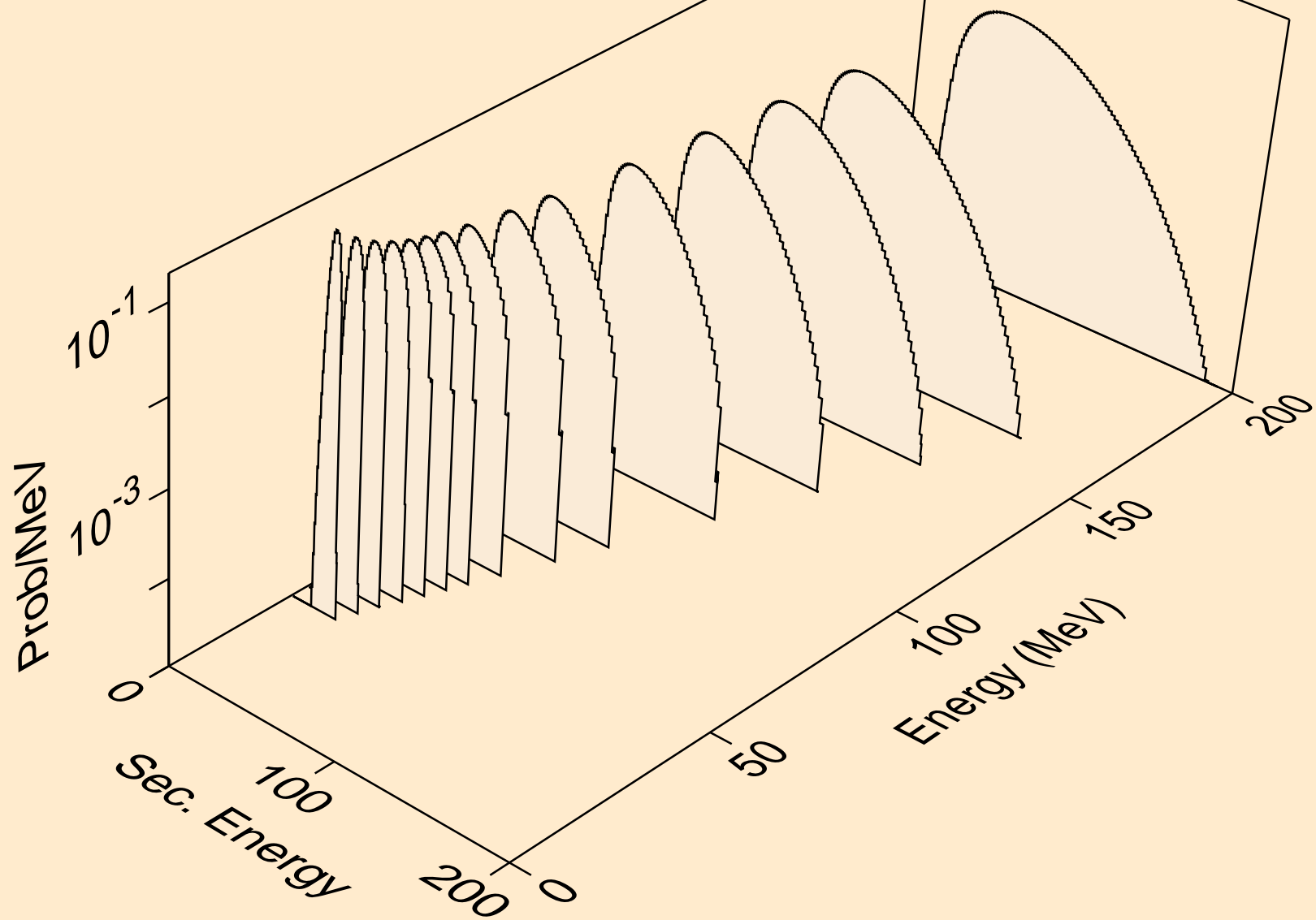

PT189 NEUTRON ACER TENDL-2024 LIBRARY; T=293.6K
he3s from (n,n*)he3

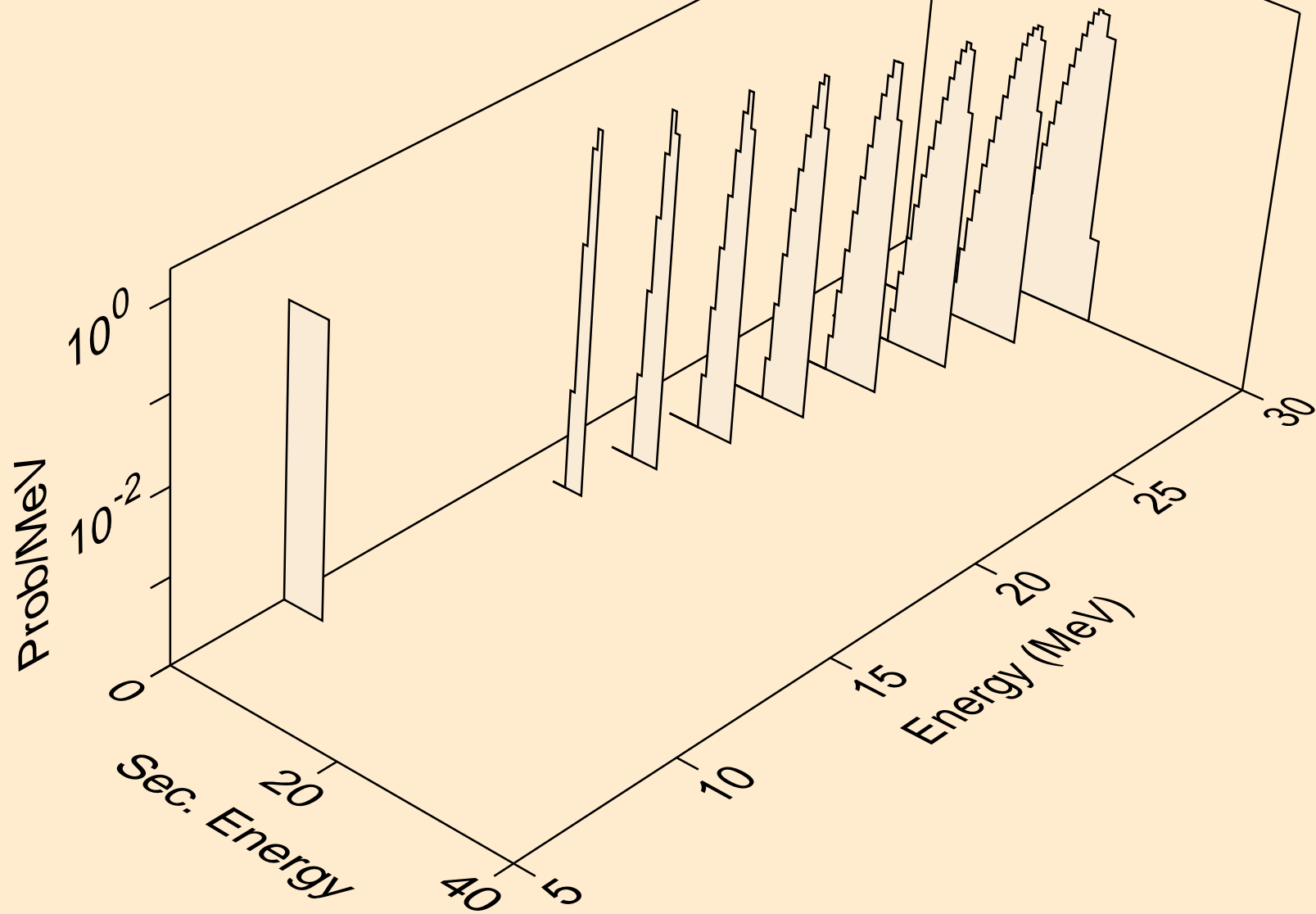

PT189 NEUTRON ACER TENDL-2024 LIBRARY; T=293.6K
he3s from (n,he3)

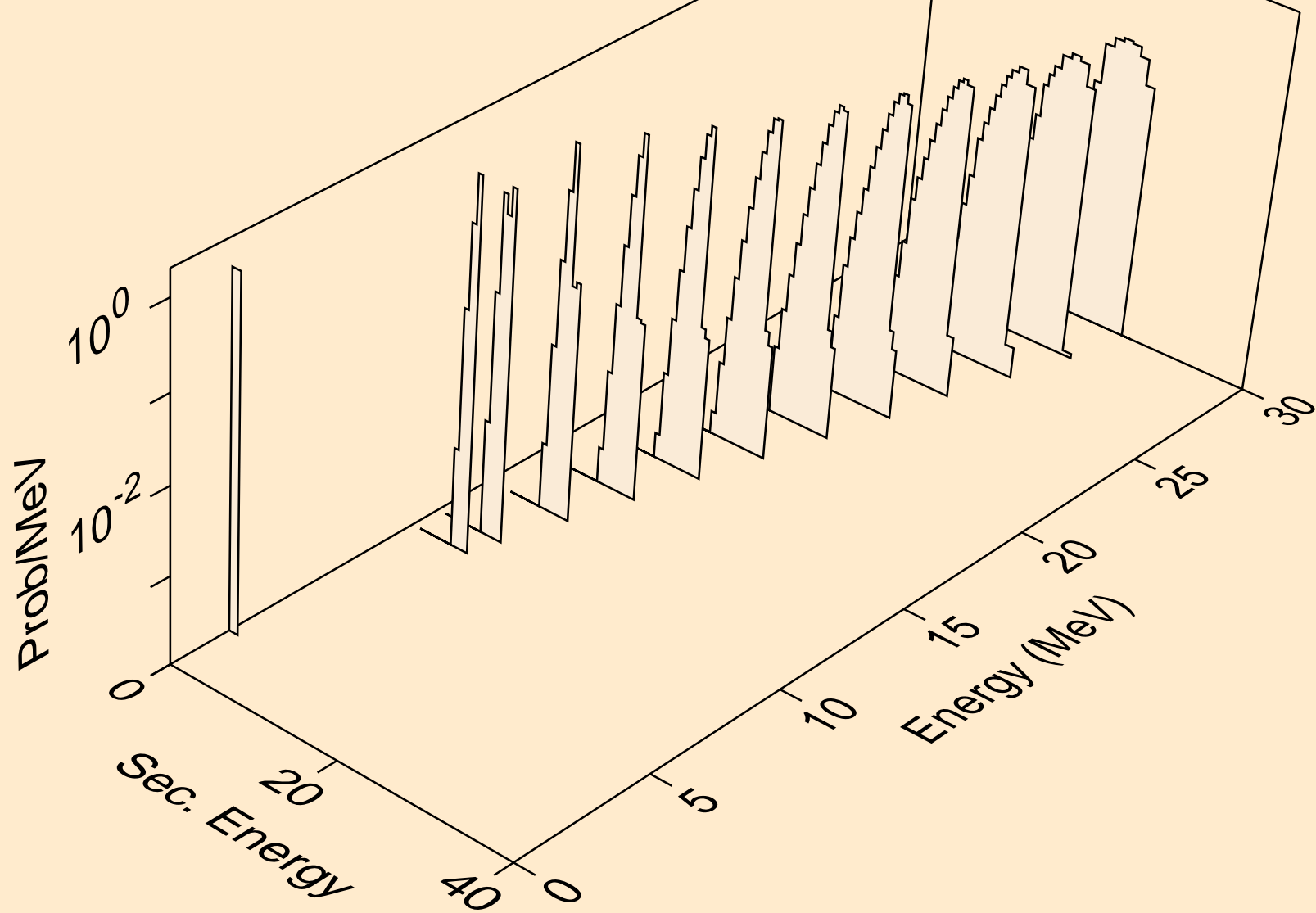

PT189 NEUTRON ACER TENDL-2024 LIBRARY; T=293.6K
alphas from (n,x)

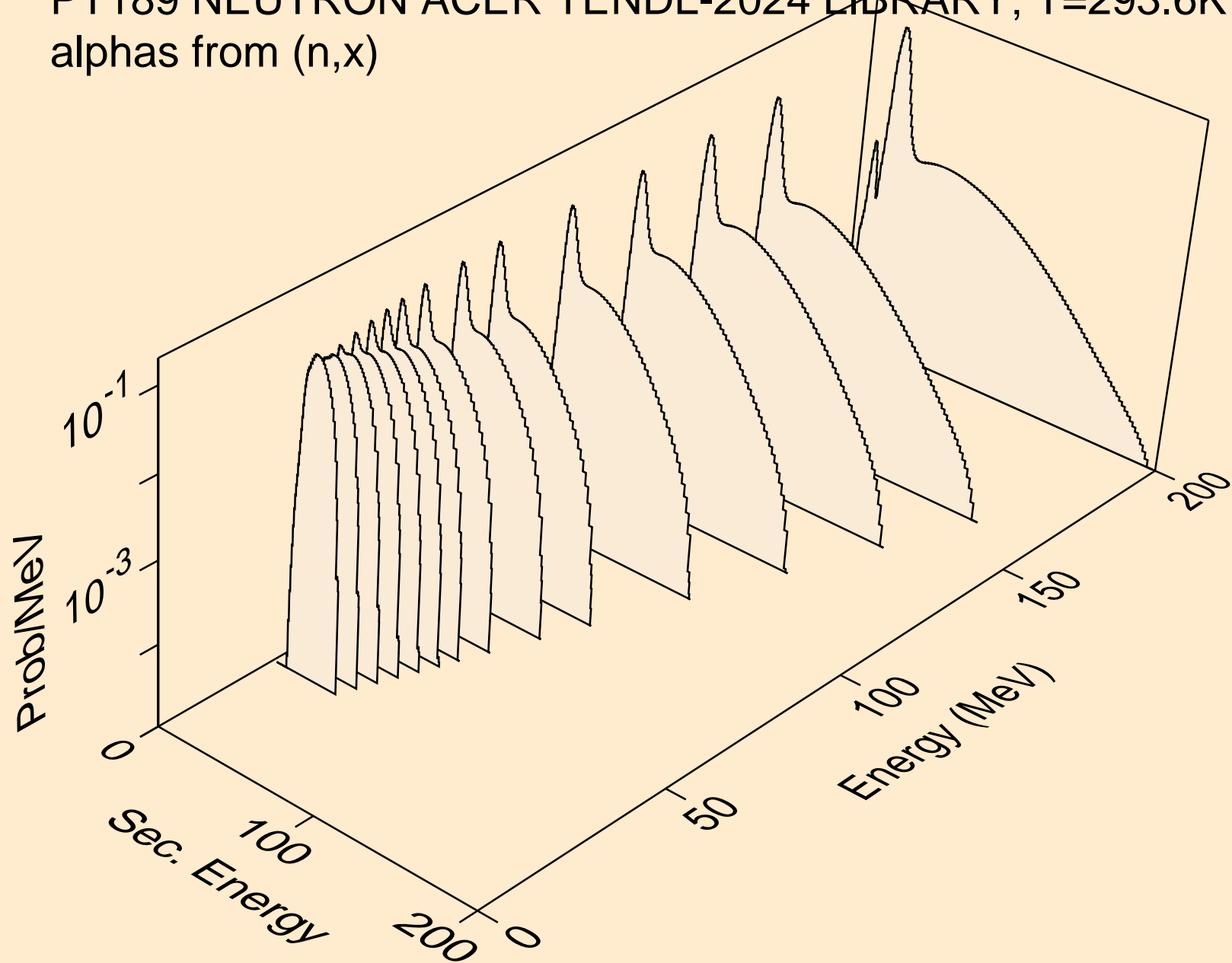

PT189 NEUTRON ACER TENDL-2024 LIBRARY; T=293.6K
alphas from (n,n*)a

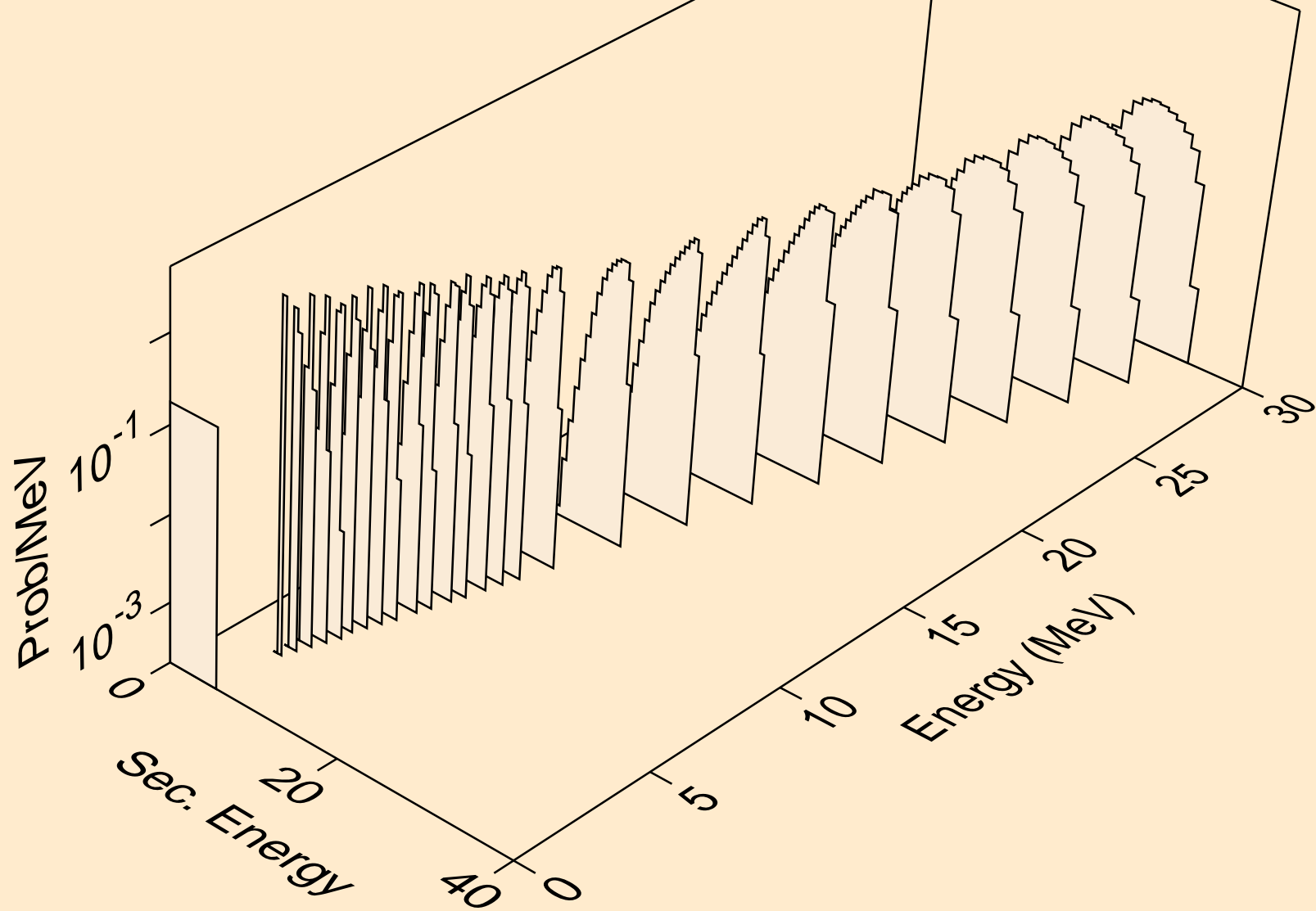

PT189 NEUTRON ACER TENDL-2024 LIBRARY; T=293.6K
alphas from (n,2n)a

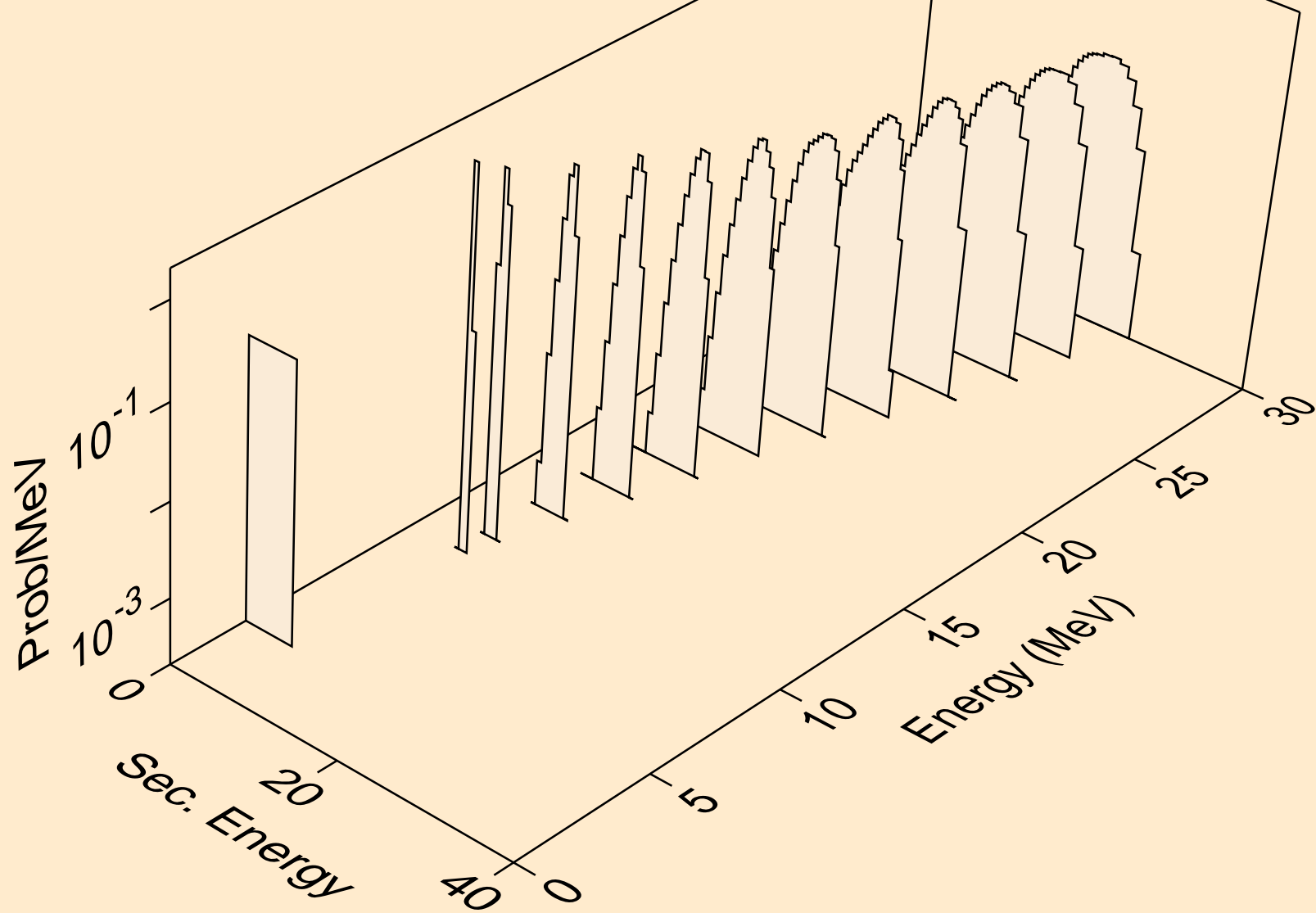

PT189 NEUTRON ACER TENDL-2024 LIBRARY; T=293.6K
alphas from (n,3n)a

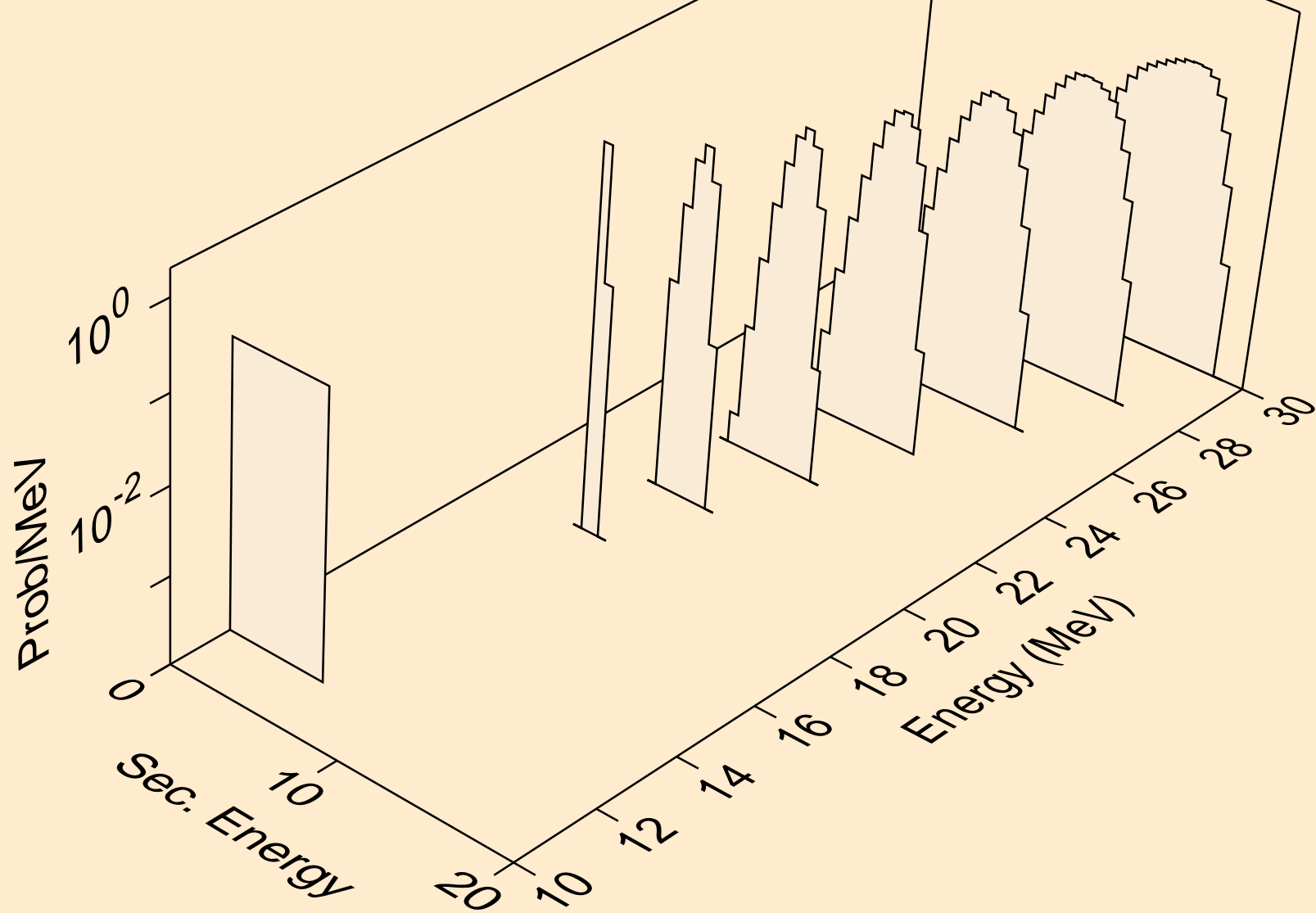

PT189 NEUTRON ACER TENDL-2024 LIBRARY; T=293.6K
alphas from (n,n*)2a

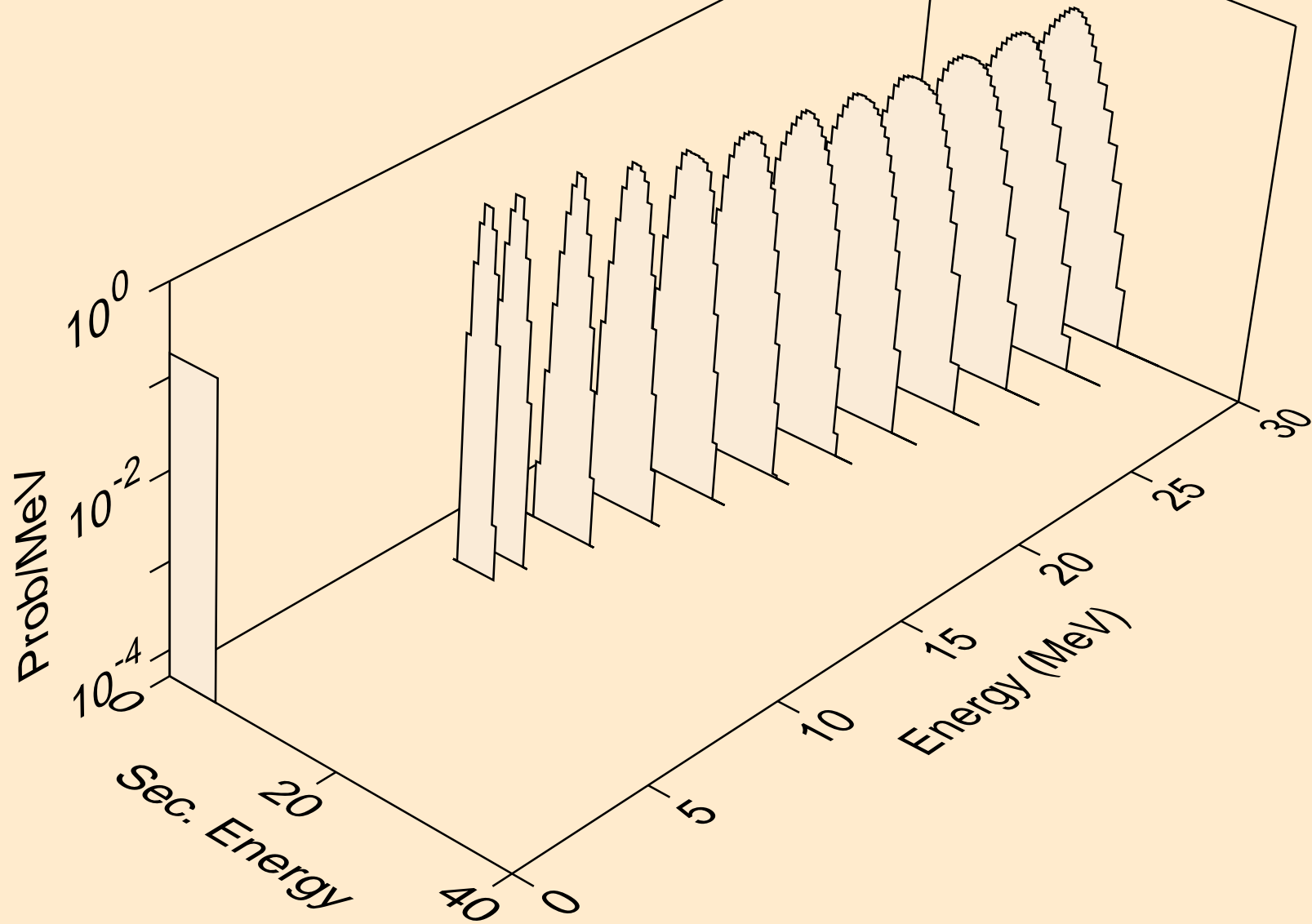

PT189 NEUTRON ACER TENDL-2024 LIBRARY; T=293.6K
alphas from (n,2n)2a

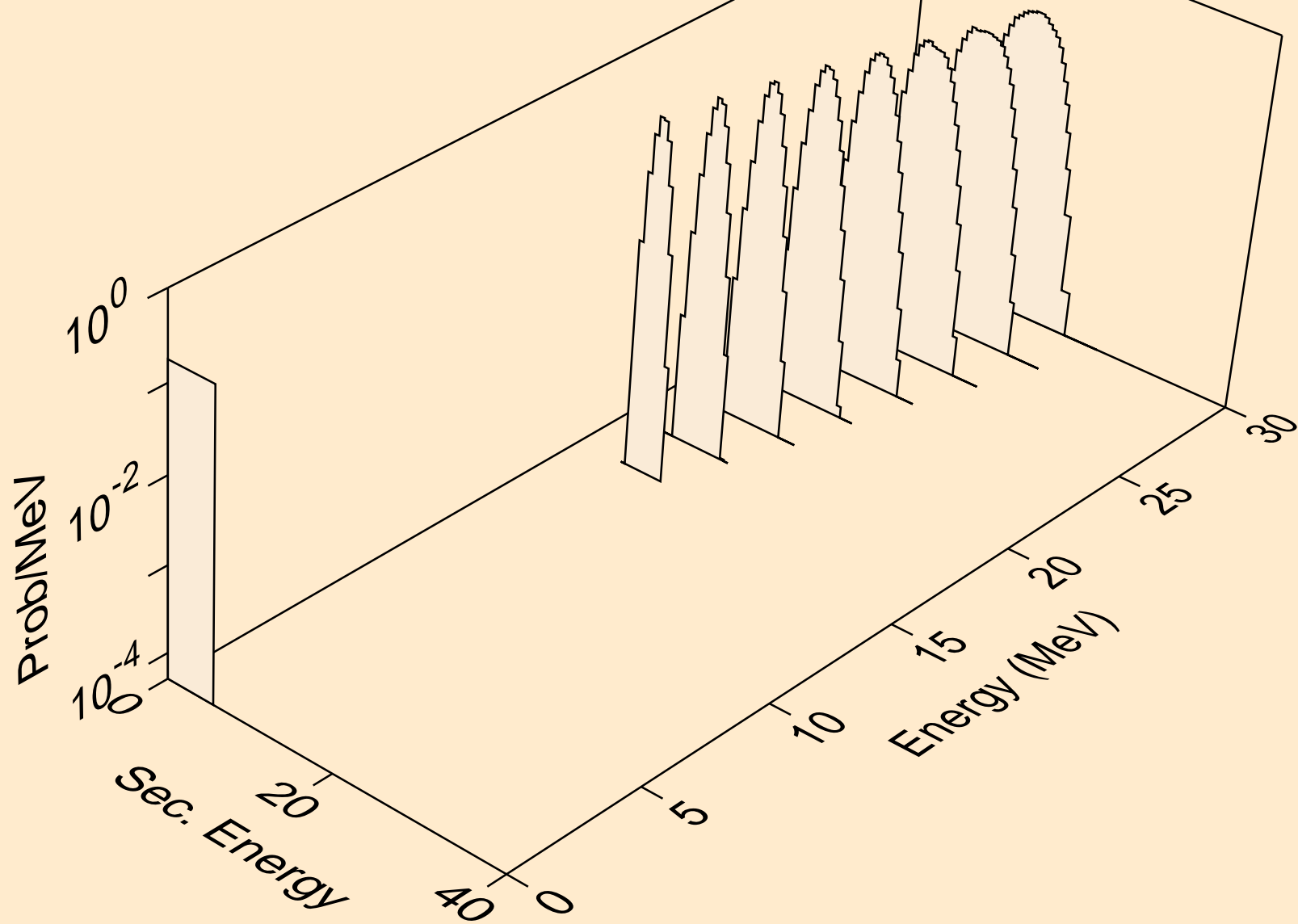

PT189 NEUTRON ACER TENDL-2024 LIBRARY; T=293.6K
alphas from (n,npa)

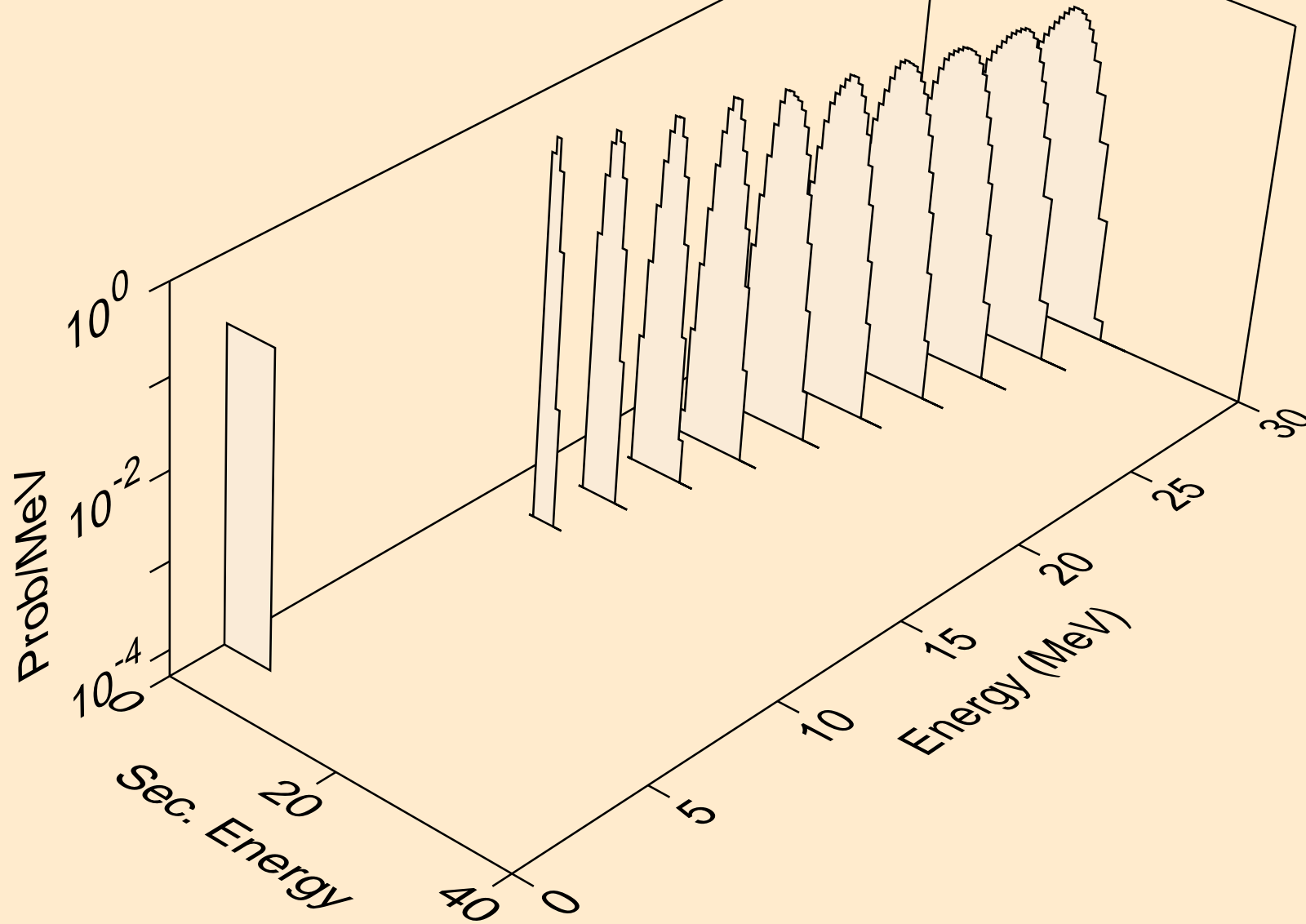

PT189 NEUTRON ACER TENDL-2024 LIBRARY; T=293.6K
alphas from (n,a)

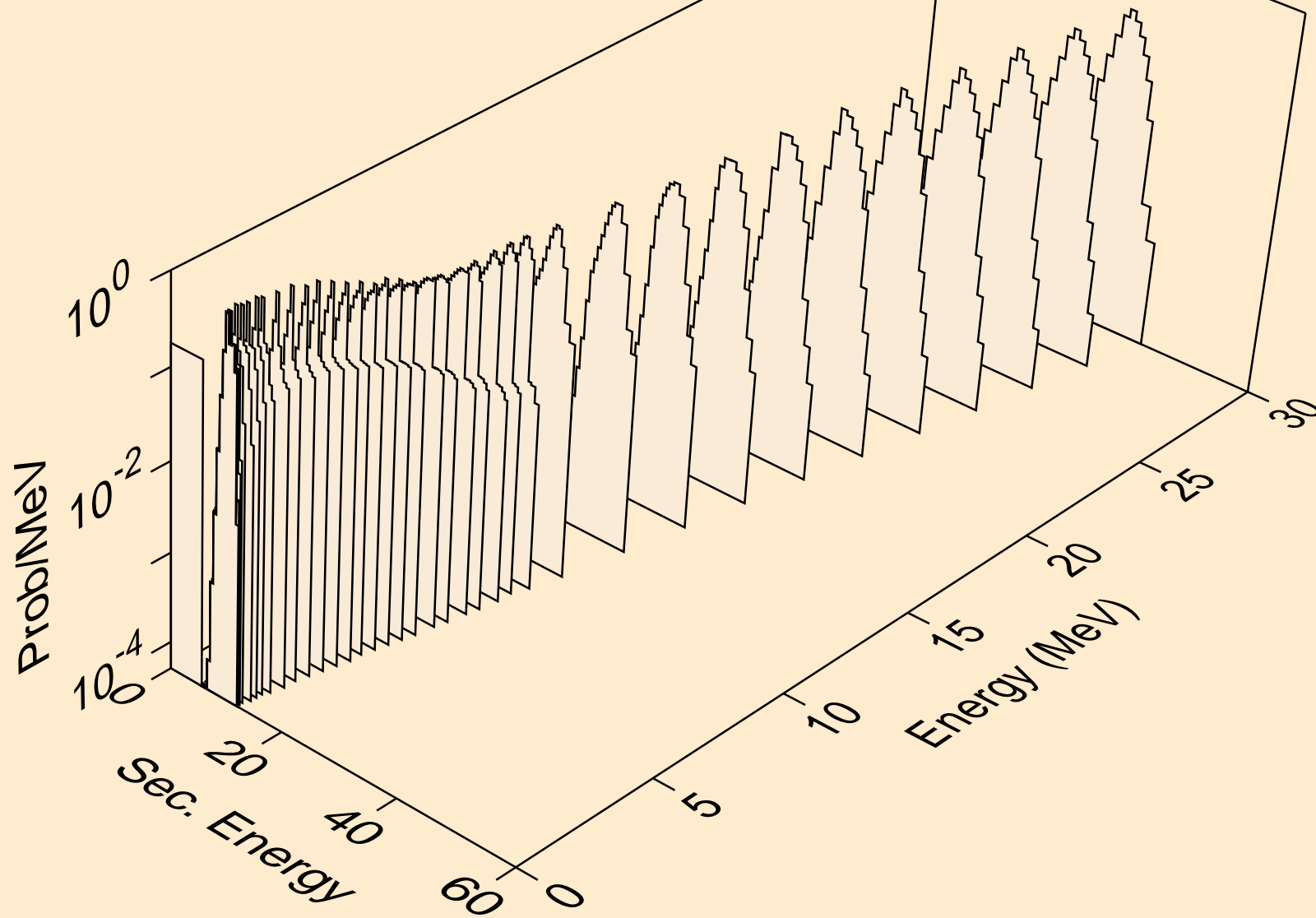

PT189 NEUTRON ACER TENDL-2024 LIBRARY; T=293.6K
alphas from (n,2a)

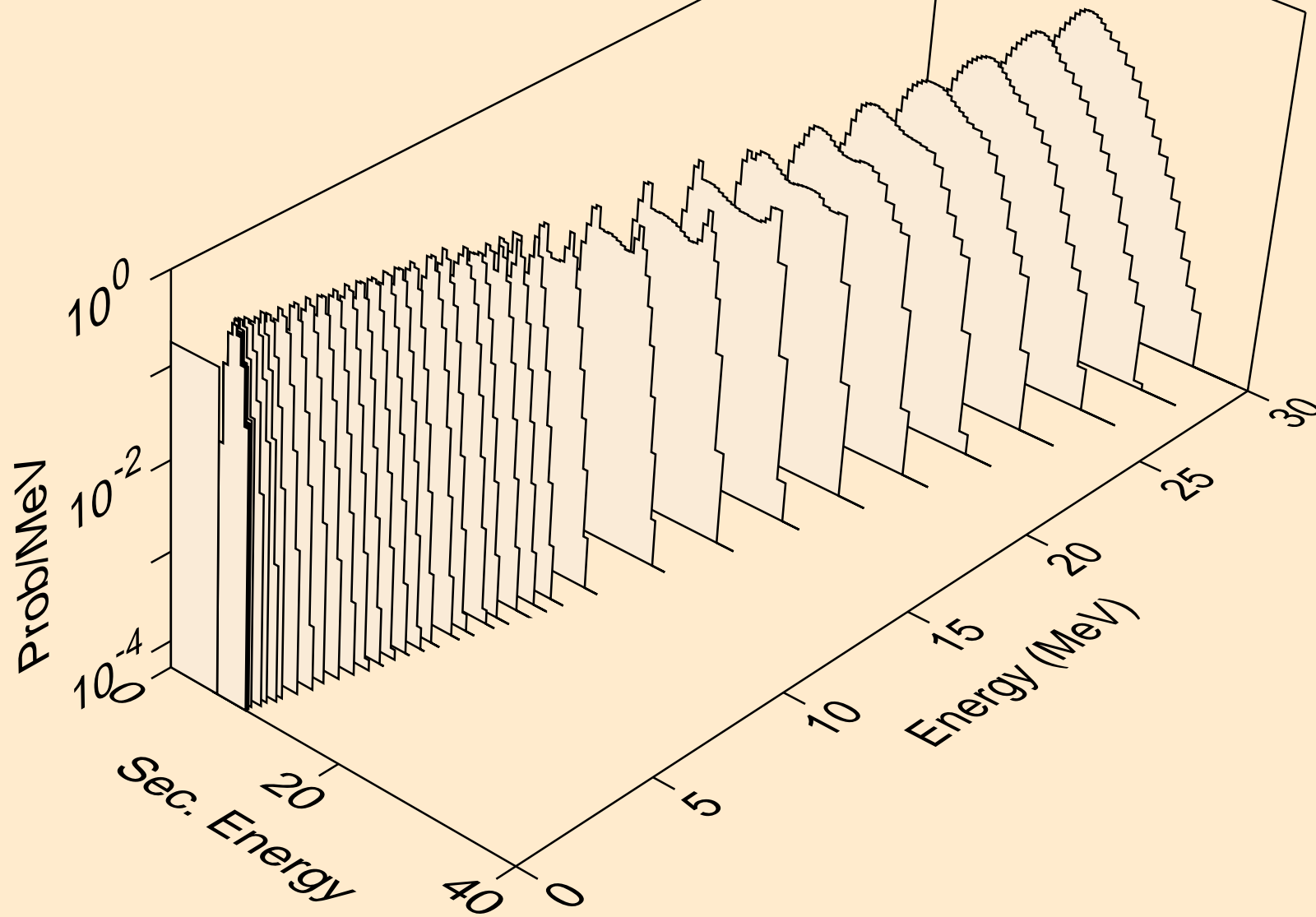

PT189 NEUTRON ACER TENDL-2024 LIBRARY; T=293.6K
alphas from (n,pa)

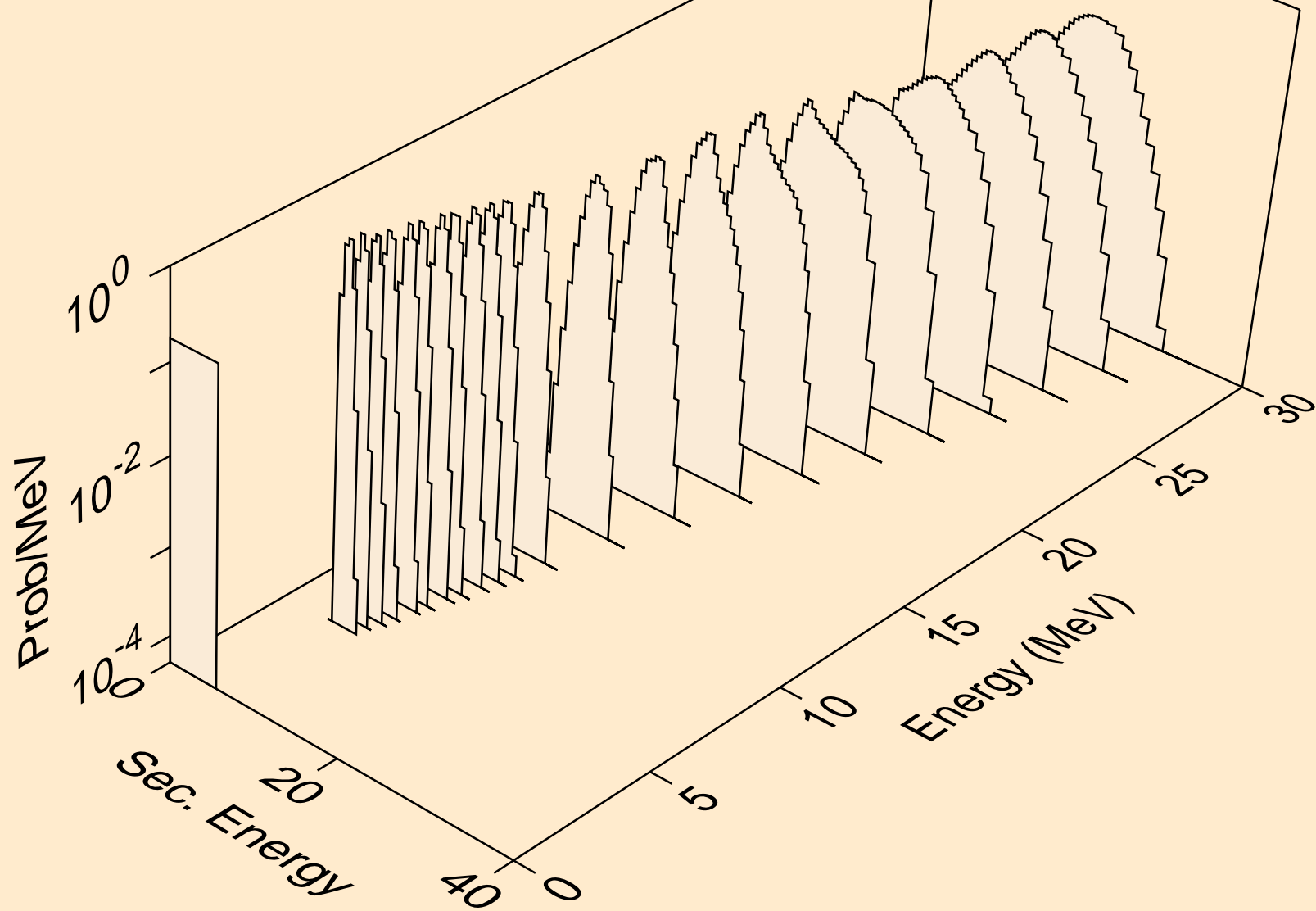

PT189 NEUTRON ACER TENDL-2024 LIBRARY; T=293.6K
alphas from (n,da)

